

# POPULAR MECHANICS MAGAZINE

WRITTEN SO YOU CAN UNDERSTAND IT

REG'D. TRADE MARK, GREAT BRITAIN, NO. 25

REG. U.S. PAT. OFF.

*See Page 97*

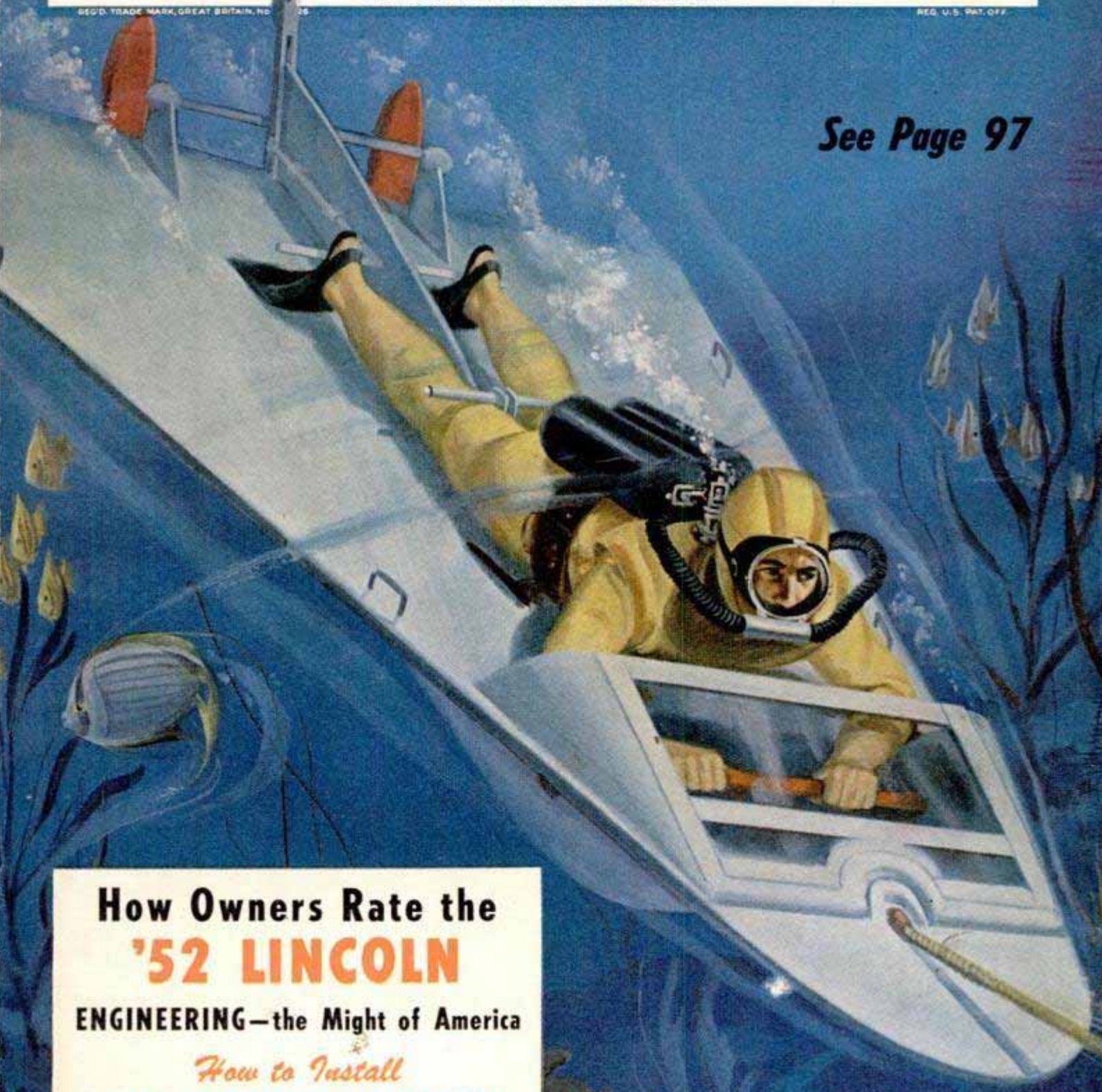

**How Owners Rate the  
'52 LINCOLN**

**ENGINEERING—the Might of America**

*How to Install*  
**WARM-AIR PERIMETER HEATING**

Spark Plugs that Perform **LIKE THIS** —

**178.497** **M.P.H. ON WATER**

will make **YOUR CAR** Perform *Better!*



"Flying on water" describes the new world's speed record set by Stanley S. Sayres in his Slo-mo-shun IV.

Mr. Sayres wired . . .

*"Slo-mo-shun IV continues to be the world's fastest boat . . . set new world's record of 178.497 miles per hour . . . 24 Champion Spark Plugs performed perfectly in her Allison engine . . . thanks for everything and congratulations."*

This sensational and extreme test of spark plug performance clearly points the way to the best spark plugs for your car. For it is from such an exceptional test as this that our engineers gain experience and knowledge that can be obtained in no other way. We constantly use such findings—to improve the quality and dependability of all Champion Spark Plugs. So, if you want a better performing engine in your car, **DEMAND CHAMPIONS!**

Owner and pilot, Stanley S. Sayres, set the above new world's speed record on Lake Washington, Seattle, on July 7th, hitting 185 m. p. h. on one run!



**FOLLOW THE EXPERTS**

*Demand*  
**CHAMPIONS**

**FOR YOUR CAR!**

# How your gas savings will pay for your oil

(YOU CAN CUT COSTS ON YOUR CAR)



1

"Want to save money on the up-keep of your car?"  
"Naturally, who doesn't?"



2

"Well, here's how. Change to Macmillan Motor Oil from any oil you have been using, and you'll save enough on gas to pay for a fill of Macmillan."



3

"How is that possible?"  
"Because hundreds and hundreds of road tests on cars like yours showed that motorists got an average of 8% more power from the same amount of gasoline after they changed to Macmillan Oil."



**8% SAVING IN GAS**

4

"That 8% more power means 8% savings in gas. With gas at 25¢ a gallon, that is a 2¢ saving or \$2.00 over a normal period between changes. That's enough to pay for a re-fill of Macmillan."



5

"Wait a second. How can a motor oil save that much gas?"  
"Because at 40 miles an hour on a level road, half of your gasoline is used up overcoming engine friction."



6

"So if you can find something which reduces that friction, it will make your car go farther or faster or climb a steeper hill. And, brother, that something is Macmillan Ring-Free Motor Oil!"

And, of course, this economy isn't the whole story, either. For while it's reducing friction, Macmillan Oil reduces deposits of carbon, gum, and sludge in the engine — giving you higher compression, better piston seal and less likelihood of ping — lower repair bills. It keeps your car newer longer.

Start using Macmillan Ring-Free Motor Oil in your car now—at any of the 25,000 independent service stations, garages or car dealers where you see the big, red "M" sign. Write me personally if you can't locate one quickly. I'll reply at once.

*Macmillan*  
President

MACMILLAN PETROLEUM CORPORATION  
530 W. 6TH STREET, LOS ANGELES  
50 W. 50TH. NEW YORK • 624 S. MICHIGAN, CHICAGO

Available at over 25,000 dealers wherever you see the sign of this big red "M."

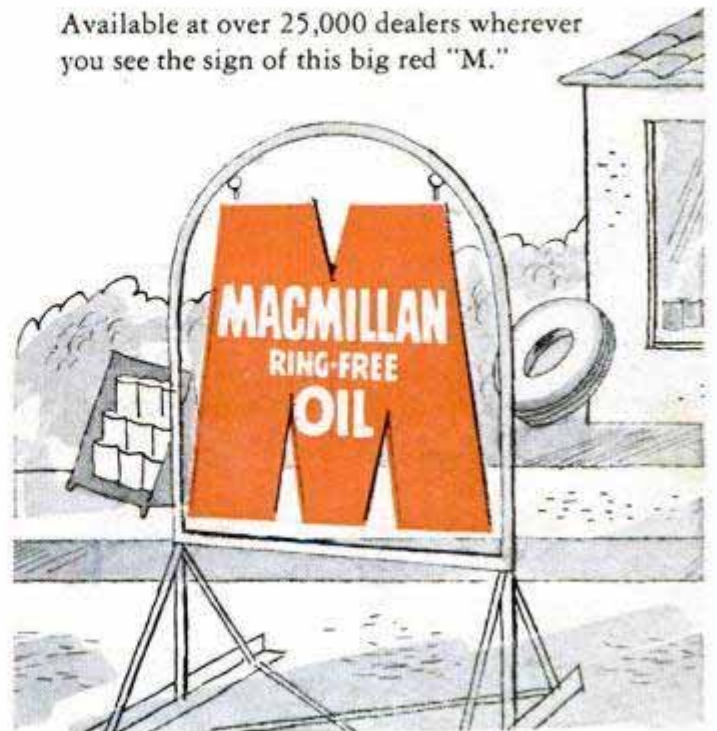

"Does  
5 <sup>KINDS</sup> OF JOBS  
Well!"

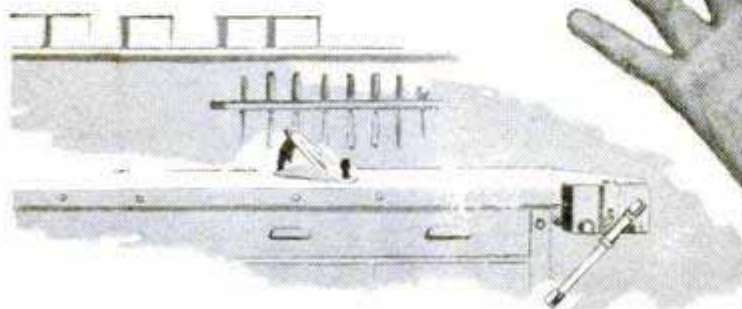

Buy a plier that's  
sure to be "the HIT of Your Kit"

## The SARGENT PARALLEL-ACTION PLIER!

(The Mechanical Hand)

What a plier! Actually *three* tools in one  
... plier, wrench, and wire cutter.

You'll quickly discover this Sargent to be  
the most useful tool you've ever had for  
jobs around the house.

Look what it does:

### 1. Grips like a vise

... compound leverage multi-  
plies power along entire length  
of the parallel jaws.



### 2. Cuts wire easily

... outside cutters cut wire  
even when it tightly hugs a  
flat surface.

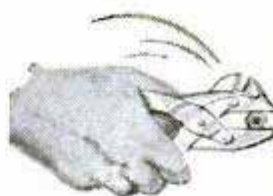

### 3. Holds nuts like a wrench

... powerful parallel jaws and  
extra leverage prevent round-  
ing corners.

### 4. Gets into tight spots

... and gets you out of them.  
Small nose permits probing  
in close quarters.

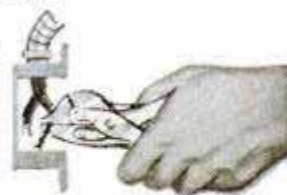

### 5. Unkinks wire

... open throat permits run-  
ning the wire between jaws,  
from either end, to straighten  
or pull it.



Go to your hardware dealer . . get  
your hands on one of these sturdy,  
all-purpose tools. You'll never let  
it go . . . especially when you hear

its price. You'll be delighted with  
your low-cost investment in a high-  
grade plier. Available in 4½",  
5½", 6½" and 8" lengths.

For further details, write Dept. 20 K!

Sargent and Company, New York • NEW HAVEN, CONN. • Chicago

Builders Hardware and Fine Tools since 1864

# Popular Mechanics Magazine

Registered in U. S. Patent Office and Canada

H. H. WINDSOR, *Founder*

H. H. WINDSOR, JR., *Editor and Publisher*



## this month's cover

LIKE A GIANT Manta ray, the strange craft glides swiftly, silently, down toward the floor of the ocean, a weirdly dressed man lashed to its back. This submarine version of a high-flying glider can bank and soar, dive and hedgehop to give its pilot all the thrills of a barnstorming aviator. The undersea wing is the brain child of Pierre Vanlaer, who enjoyed exploring the ocean bottom but wasn't satisfied with slow speeds. His graceful craft, towed by a powerful speedboat, now gives him the speed of a darting fish. Turn to page 97 for all the details of the Manta and the tale of how it once rebelled, soared up on a Riviera beach and deposited its master in the middle of a busy thoroughfare. The painting was done by 23-year-old Bill Johnson, one of the best in the business and no newcomer to our covers despite his age. Bill admits he's no deep-sea diver; his favorite sports are swimming and fishing

Published monthly by Popular Mechanics Company, 200 E. Ontario St., Chicago 11, Ill. H. H. Windsor, Jr., president; William Harrison Petridge, vice-president; D. F. Windsor, vice-president and secretary-treasurer; H. H. Windsor III, vice-president; Clover L. Perkins, advertising manager; Alan M. Deyoe, circulation manager. Single copy in the United States and Canada, 35 cents; subscription rates in United States and possessions, Canada, Philippines and countries of the Pan-American Postal Union, 1 year \$3.50; 2 years, \$6.00; 3 years \$8.00. To all other countries add \$1.00 a year over United States prices for overseas postage. If you plan to move, notify us at least 30 days in advance so you will not miss an issue. Give both your old and new addresses. Entered as Second Class Matter, September 15, 1903, at the Post Office at Chicago, Illinois, under Act of March 3, 1879. Entered as Second Class Matter at Post Office Dept., Canada. Registered as Second Class Matter at the Post Office at Mexico, D. F., Mexico, June 20, 1950. Copyright 1952 by Popular Mechanics Company. Copyright under International Copyright Union. Copyright in France. All rights reserved under Pan-American Copyright Union. Printed in the United States of America.

Volume 98

OCTOBER 1952

Number 4

Address all communications to:  
200 East Ontario Street, Chicago 11, Illinois

Managing Editor.....Roderick M. Grant  
Assistant Managing Editor.....Wayne Whittaker  
Shop Notes and Crafts Editor.....James R. Ward  
Radio-Television, Electronics Editor.....Frank L. Brittin  
Associate Editor, Aviation.....Aubrey O. Cookman, Jr.  
Associate Editor.....Clifford B. Hicks  
Associate Editor, Automotive.....Arthur R. Railton  
Assistant Shop Notes and Crafts Editor.....Wayne C. Leckey  
Assistant Editor, Makeup.....John C. Dalen  
Automotive Correspondent.....Siler Freeman  
Art Director.....Frank Beatty

### Assistant Editors

W. Clyde Lamme  
Theodore A. Daum  
Eastern Editor.....Richard F. Dempewolff  
Empire State Bldg., Room 2906, New York City 1  
Western Editor.....Thomas E. Stimson, Jr.  
302 23rd St., Santa Monica, Calif.  
London Manager.....Douglas W. Wedderspoon  
Eagle House, Jermyn St., London S. W. 1, England  
Director, Bureau of Information.....Allan Carpenter  
200 E. Ontario St., Chicago 11

## IN THIS ISSUE

I Ride the Sno-Cat	- - - - -	81
Undersea Television for British Navy	- - - - -	90
Ballet With Lights	- - - - -	94
Under the Sea on a Glider	- - - - -	97
The Owners Report on the '52 Lincoln	- - - - -	104
Parachutes by the Acre	- - - - -	112
Engineering—The Might of America	- - - - -	118
Hot Rods Burn Up the Desert	- - - - -	125
Operation Roll-Up	- - - - -	130
What's New for Your Home	- - - - -	142
Jungle Diamonds to Grind Our Tools	- - - - -	144

## For the Craftsman

What You Can Do With Decorative Laminates	165
Once a Tin Can (Part I)	174
U-Control Model Plane	189
Perimeter Heating	194
Know Your Car's Nervous System	202
Tip Your Tools With Carbide (Part II)	210
Shopping for Tools	216
Bending Sheet Metal With a Brake	220
Radio, TV and Electronics	227
Clinic for Homemakers	238

Other items, and manufacturers of available products described, are listed on pages 12, 14 and 16

**Your tune-up will last  
thousands of miles longer with**

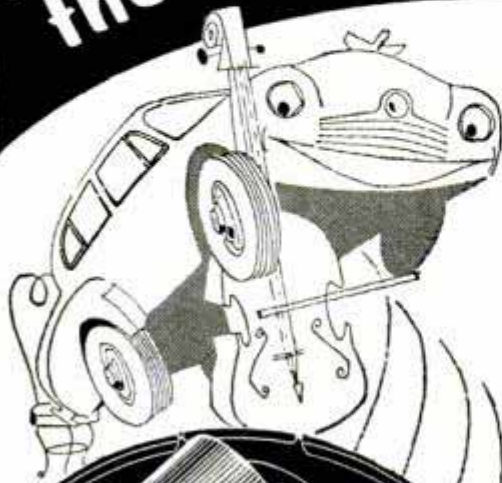

# Blue Streak

## heavy-duty ignition parts

**GET A TUNE-UP NOW** that will stay "in tune" for thousands of extra miles. Have your mechanic install **BLUE STREAK** heavy-duty points and condenser.

The **BLUE STREAK** point has a longer "life-span" because it carries more current, it dissipates heat faster. Its high amperage tungsten with a contact area that is 55.4% larger than regular points makes this possible. The **BLUE STREAK** condenser is hermetically sealed against its worst enemy: moisture.

The shop that carries **BLUE STREAK** heavy-duty ignition parts is a shop that really cares about your car.

**AUTO MECHANICS:** **BLUE STREAK** will better your business. Write on your billhead or sales slip for the name of your nearest **BLUE STREAK** jobber. Standard Motor Products, Inc., Dept. G, Long Island City 1, N. Y.

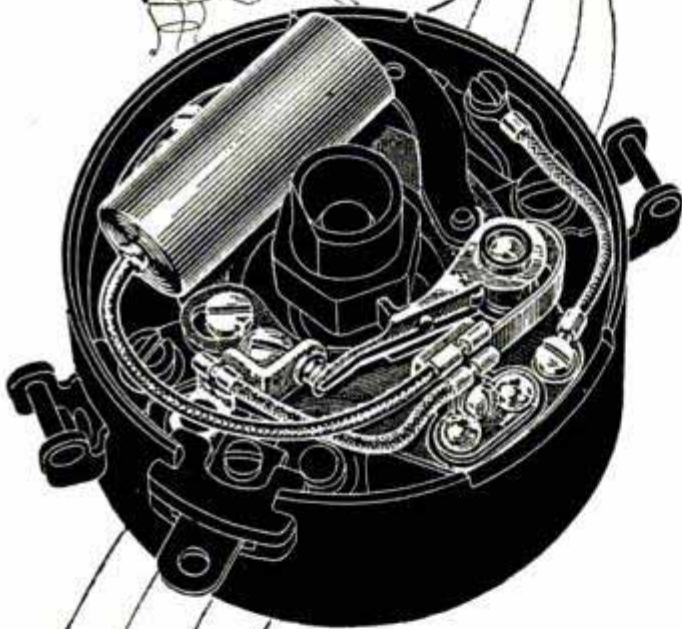

"FIRST" (1934)  
HERMETICALLY SEALED  
CONDENSER

"FIRST" (1937)  
HEADLIGHT RELAY

"FIRST" (1938)  
COMPLETELY SEALED  
DIMMER SWITCH

"FIRST" (1940)  
TRIPLE-PROTECTION  
TOP COIL

"FIRST" (1946)  
VINYLITE AUTO CABLE

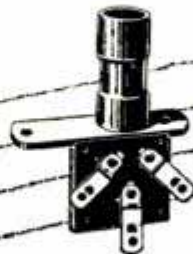
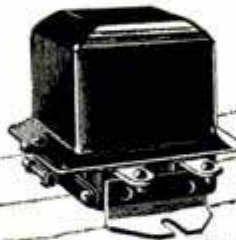
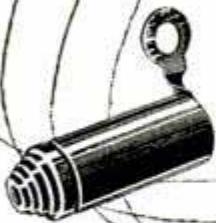

Tune up for those thousands of extra miles. Take your car to the Registered **BLUE STREAK** Shop in your neighborhood. Look for this sign.



# Blue Streak

**pioneer in heavy-duty ignition**



**“Company pays \$1200 for cost-cutting idea!”**  
**“Employee wins \$350 for suggestion!”** Ever wonder how *you* can cash in on *your* company’s suggestion system? Check these Bostitch case histories. There may be an idea here for *you* — and *your* company.

**BUSINESS:** Cabinetmaker  
**SUGGESTION:** Fasten bottoms and sides of small chests with Bostitch foot-powered stapling machine and  $\frac{3}{8}$ " staples.  
**RESULTS:** Five times faster than old method of nailing. Stapling more secure. Workers like it better.

**BUSINESS:** Gasoline Pump Manufacturer  
**SUGGESTION:** Instead of solder, use  $\frac{3}{8}$ " staples to fasten No. 8 mesh on foot valve bottom of pump.  
**RESULTS:** Production jumped from 20 an hour by soldering to 90 an hour with Bostitch.

**BUSINESS:** Tile Contractor  
**SUGGESTION:** Instead of nailing metal lath to wood studs and joists, use Bostitch hammers and tackers.  
**RESULTS:** One man can now lath 4 bathrooms in 2½ hours compared to 5 hours the old way.

**BUSINESS:** Garage Door Manufacturer  
**SUGGESTION:** Metal stitch aluminum panels together with Bostitch wire stitcher. Old method: drill and screw.  
**RESULTS:** Plant turns out 500 doors a day as against 50 before. Stitcher and special table jigs for positioning panels save space, material.

**BUSINESS:** Vacuum Cleaner Manufacturer  
**SUGGESTION:** To fasten metal discs inside fiber cylinders, use Bostitch metal stitcher instead of punching holes and riveting.  
**RESULTS:** Manufacturer saved \$6250 the first year.

**BUSINESS:** Frozen Food Locker  
**SUGGESTION:** Replace cellophane tape with Bostitch desk-type stapler for fastening ends of frozen food packages.  
**RESULTS:** Labor and material costs cut 50%. Bostitch method gives tight, permanent seal. Unlike tape, will not loosen at low temperatures.

**TO HELP YOU** find ways to apply Bostitch savings to *your* business, send for the 16-page illustrated booklet, “Time and Money-Saving Case Histories.” It’s *free*—and full of cost-cutting ideas!



**BOSTITCH** 550 Mechanic Street, Westerly, R. I.  
 Please send me a free copy of the Bostitch book of case histories.

Name \_\_\_\_\_  
 Address \_\_\_\_\_  
 City \_\_\_\_\_  
 Company \_\_\_\_\_

This One



962P-6BG-YP25

# FOR A BETTER "INSIDE JOB" — USE PYROIL

You may spend time and money in keeping your car polished, gleaming and color-bright on the outside. But what about the inside—the expensive "heart" of your car—the motor? Are you sure that's giving you the best performance at the lowest possible maintenance cost? One way to be absolutely sure is to use Pyroil. Pyroil won't take any of your time or effort—and costs just a few pennies. Pyroil improves lubrication. Pyroil prevents friction between cylinder surfaces and piston rings. Pyroil prevents clogging, caused by carbon deposits and rust. Pyroil cleans your motor, and keeps it clean.

For a better "inside job," add Pyroil—add miles to your car.

## Pyroil for Aircraft Engines

Use Aircraft Pyroil B for lubricating oil, Aircraft Pyroil A for gasoline.

**GIVEN!** An attractive Pyroil metal savings bank—takes coins up to 50¢ pieces. **MOTORISTS**, it's yours for the asking—sent postage paid.

Manufactured and Guaranteed by Pyroil Company, 164 Pyroil Bldg., La Crosse, Wisconsin.

Canadian Distributors: Central Purchasing Agencies, Ltd., Toronto, Ontario



**PYROIL COMPANY**  
164 Pyroil Bldg., La Crosse, Wisconsin

I want my car to last and run properly. Please tell me more about Pyroil and how it can accomplish this for me.

Name \_\_\_\_\_

Address \_\_\_\_\_

City or Town \_\_\_\_\_ State \_\_\_\_\_



in this corner.....

## THE EDITORS



### Letter to the Editor:

Ranch houses are very modern and convenient—for adults. For children, there is something lacking. No stairs to climb!

My friends, the Carl Moores of Elkins, W. Va., became concerned about this. When their youngsters, Luanna and Randy, visited grandmother's they were fascinated



by the staircase, but they were always being warned to stay away from the stairs for fear of accident. Since child-development experts say children need to climb, and ordinarily have learned the adult manner of step climbing by four years of age, the Moores decided to do something about it.

The result is a practice staircase built of scrap lumber by Mr. Moore for each of his children. Narrow enough that they can be carried indoors or out, the stairs are sturdy and safe, and can be placed back-to-back for an up-and-down staircase.

Sara Ann Brown,  
Associate Professor,  
Home Economics Education,  
West Virginia University,  
Morgantown, W. Va.

### Letter to the Editor:

You'll have an invasion of indignant Germans if you aren't careful. Just for the record, Mercedes cars are made by Daimler-Benz A. G. of Stuttgart, Deutschland. So please, in the interests of accuracy, don't

(Continued to page 8)





How these 18 Experts can help you

# Get into a High Pay ACCOUNTING CAREER

LaSalle's famous staff of Accounting authorities are helping thousands prepare for fast promotions and bigger pay. They can do the same for you!

If your heart is set on a larger income and all that it means . . . better home—fine car—larger bank account—more of the good things of life. . . .

If that's your ambition and you are really serious about it, then you owe it to yourself to get the REAL FACTS about Accountancy, and the many good-pay opportunities that can be YOURS through LaSalle's famous Problem Method plan.

It matters not whether you've had a single day of experience in this field—or whether you have already started but want to climb higher. LaSalle's expert training is designed to take you from where you are . . . to where you want to be . . . in higher positions and a lifetime career of security and good income.

### WHY YOU CAN'T FAIL TO GAIN

You see on this page a panel of experts who know Accounting from A to Z . . . all the way from simple bookkeeping, on up through advanced accounting, cost accounting, auditing, income tax, and coaching for the C.P.A. degree. These are only part of LaSalle's instruction staff. But what is most important to you . . .

... THESE C.P.A. EXPERTS KNOW HOW TO IMPART THEIR KNOWLEDGE TO OTHERS... HOW TO HELP YOU PREPARE QUICKLY YET THOROUGHLY FOR SUCCESS IN THIS VERY LUCRATIVE FIELD

The proof? What stronger proof could there be than



more than 3,500 Certified Public Accountants (approximately 10% of the U.S. total) who have trained with LaSalle? Or the hundreds of thousands of men and women whom LaSalle has helped qualify rapidly for more money, a brighter future, in a high-pay-lifetime career? These thousands came to us with different backgrounds of experience and varying degrees of ambition. Many have reported raises and promotions after only a few weeks of training. Thousands of them have written to say they are now earning 50% more—even double their former incomes—often in less than a year. These letters are published in book form for your inspection. They were written by real people, with real income, problems and ambitions—people who might be your next-door neighbor.

Yes, if you are really sincere in wanting to better your position—start your income climbing—enjoy a lifetime career of high standing and high reward—this friendly staff of experts can help you.

### SEND FOR FREE SAMPLE LESSON... ALSO BIG 48-PAGE BOOK OF LATEST INFORMATION ABOUT CAREER OPPORTUNITIES

You don't have to wonder what LaSalle's Accountancy plan is like. You will be sent a free sample lesson, which does not obligate you in any way. Study it—keep it—see for yourself how simple, clear, and easy it is to master. This is an actual lesson right out of the regular training—to show you exactly how LaSalle's Problem Method has trained more than 1,275,000 men and women from all walks of life.

Also . . . the 48-page book, "Accountancy, the Profession That Pays," gives all the latest facts about the new and growing opportunities in five different fields of profitable employment.

This can be an important day in your life. A coupon like the one below has started hundreds of thousands of men and women toward a bigger job, a larger income. It can do the same for you.

Mail the Coupon Today!

FREE 48-PAGE CATALOG

**LA SALLE**  
EXTENSION UNIVERSITY

A Correspondence Institution

417 S. Dearborn St., Dept. 1064 H, Chicago 5, Ill.

Send free Sample Lesson in Accounting—also, 48-page free book, "Accountancy, the Profession That Pays" . . . all without cost or obligation.

Name.....Age.....

Address.....

City & Zone.....State.....

FREE SAMPLE LESSON

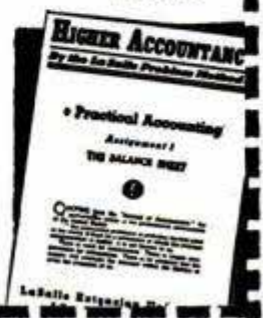

# THEY NEED YOU



*A typical interview...*

where Embry-Riddle students are pre-selected for essential, good-paying jobs in aviation even before their training is completed... they step right into their jobs as soon as they graduate!

...AND YOU CAN

**QUALIFY IN SIX MONTHS!**

**EMBRY-RIDDLE OFFERS YOU COMPLETE 6-MONTHS TO 2-YEAR COURSES...NOW!**

*Your Career is Waiting!*

The high regard of Embry-Riddle training by the leading airlines and the entire aviation industry is demonstrated time and again by the big demand for Embry-Riddle graduates.

There's an important high priority job in aviation waiting for you...however, if you do enter the services, Embry-Riddle training will definitely give you rating advantages. Thousands of Air Force men are Embry-Riddle trained.



#### AIRCRAFT & ENGINE MECHANICS

Vast numbers of properly trained A & E Mechanics are urgently needed. Our C. A. A. approved school with a quarter-century experience assures your quickest advancement. Embry-Riddle students learn fast with modern equipment, including jet...live aircraft, airline-size hangars.



#### AERONAUTICAL DESIGN AND TECHNOLOGY

Embry-Riddle's accelerated 26-mo. Aeronautical Design and Technology Course provides finest training available. Technicians with management responsibility enjoy highest salaries!



#### COMMERCIAL PILOT

Embry-Riddle trained pilots benefit from our years of experience with 30,000 students...the best instructors, up-to-date aircraft, superb year-round flying weather. Also Instrument and Instructor's ratings.



#### A & E COMBINED WITH COMMERCIAL PILOT

Airmen with dual pilot-engineering ability are needed by aviation companies and operators. Embry-Riddle combination training offers you the most in your aviation career.



**Embry Riddle**  
*International*  
**SCHOOL OF AVIATION**  
MIAMI 30, FLORIDA

**CLASSES ARE BEGINNING NOW...SEND THIS COUPON TODAY!**

Dean of Enrollments - Dept. 99  
Embry-Riddle School of Aviation  
Miami 30, Florida

Please Print

NAME \_\_\_\_\_

ADDRESS \_\_\_\_\_

CITY \_\_\_\_\_

STATE \_\_\_\_\_ AGE \_\_\_\_\_

I am interested in...

- A & E Mechanic  
 Commercial Pilot  
 Aeronautical Design and Technology  
 A & E Combined with Commercial Pilot  
 A & E Combined with Private Pilot
- Check One  Veteran  Non-Veteran

TRAIN IN MIAMI - AIR CAPITAL OF THE WORLD

(Continued from page 6)

put Mercedes under the heading of "Italian speedster" (page 101, August 1952). No doubt half the population of the U.S.A. has already pointed out your error.

You may like to know that we (the family) all appreciate *Popular Mechanics*... there is no magazine in this country of quite the same type. It is a pity your magazine can't penetrate the Iron Curtain.

Antony G. Bannister,  
Padston, Cornwall, England

*We blush. Not quite half the population detected the error. This German-made Mercedes was being groomed for an Italian race.*

The Editors

#### Letter to the Editor:

You might be interested in this picture of one of the tables in your *What to Make for Children*, built in Indonesia by the young fellow pictured here. His name is Machmoed and he is on the Toko Li Store staff,



Djakarta, Indonesia. He made the little table for the child of his boss, John Li [who] purchased the book from Indira, the Indonesian bookstore through which we are featuring and selling American books and magazines, including *Popular Mechanics Magazine* and your books, in Indonesia.

Alvin Grauer, vice-president,  
Pacific Book & Supply Corp.,  
New York City

#### Letter to the Editor:

In the July issue, Kenneth M. Hazen, Alliance, Ohio, in his letter to the editor stated: "The thermostat usually slows circulation. Have it removed for hot summer

(Continued to page 10)

# Tired of the same old job?

Sure, you are. Anybody gets tired of standing still in the same place. But don't get the idea that just quitting your present job and going somewhere else will take you out of the rut.

The trouble may be *inside yourself*. You're restless because you want to get ahead—make more money—do more interesting work. All right—why not?

Look around you. The men who are advancing are the trained men. They've learned special skills that bring them higher pay. It's the men without training who stick in the same old job.

What are you going to do about it? Just wait and hope for something better to come along? If you really *want to succeed*, you can get the necessary training by studying at home in your spare time.

International Correspondence Schools offer you a course in practically any field you choose, giving you the practical plus the bedrock facts and theory. You'll earn while you learn. Students report better jobs and more pay within a few months.

Read carefully the list of subjects in the coupon below.

Pick out the field of study that interests you most—the one with the greatest future for you. Then mark and mail the coupon, and *find out* what I. C. S. can do for you. All it costs is a stamp or postcard, yet it may be the most important step you've ever taken!



## wide choice of courses

I. C. S. offers a total of 391 different courses—391 roads to advancement. Among them is the one you want. You'll find the lessons modern, simple, easy to understand. Each one you study takes you farther along the road to knowledge and success.

## machine operator to shop foreman

"When I enrolled for my I. C. S. course in Carpentry and Millwork, I was a machine operator. Today, eleven months later, I am a shop foreman. As a consequence my salary has been increased 73.3%."



## Why Home Study?

When you learn the I. C. S. way, your time is your own. Arrange your schedule to suit yourself. No tiresome traveling to and from school. No classes missed because of other engagements. Home study through I. C. S. has proved out for millions of ambitious men and women. You, too, can use it to get ahead!

# INTERNATIONAL CORRESPONDENCE SCHOOLS



BOX 5539-L, SCRANTON 9, PENNA.

Without cost or obligation, please send me the booklet about the course BEFORE which I have marked X:

Please send information about I.C.S. employee training for companies.

- |   |   |   |   |  |
|---|---|---|---|--|
| <p><b>ART</b></p> <ul style="list-style-type: none"> <li><input type="checkbox"/> Commercial Art</li> <li><input type="checkbox"/> Magazine and Book Illustrating</li> <li><input type="checkbox"/> Cartooning</li> <li><input type="checkbox"/> Show Card and Sign Lettering</li> <li><input type="checkbox"/> Fashion Illustrating</li> <li><b>AUTOMOTIVE</b></li> <li><input type="checkbox"/> Automobile, Mechanic</li> <li><input type="checkbox"/> Auto-Elec. Technician</li> <li><input type="checkbox"/> Auto Body Rebuilding and Refinishing</li> <li><input type="checkbox"/> Diesel—Gas Engines</li> <li><b>AVIATION</b></li> <li><input type="checkbox"/> Aeronautical Engineering Jr.</li> <li><input type="checkbox"/> Aircraft Engine Mechanic</li> <li><input type="checkbox"/> Airplane Drafting</li> <li><b>BUILDING</b></li> <li><input type="checkbox"/> Architecture</li> <li><input type="checkbox"/> Arch. Drafting</li> <li><input type="checkbox"/> Building Contractor</li> <li><input type="checkbox"/> Estimating</li> <li><input type="checkbox"/> Carpenter and Mill Work</li> <li><input type="checkbox"/> Carpenter Foreman</li> <li><input type="checkbox"/> Reading Blueprints</li> <li><input type="checkbox"/> House Planning</li> <li><input type="checkbox"/> Plumbing</li> </ul> | <ul style="list-style-type: none"> <li><input type="checkbox"/> Heating</li> <li><input type="checkbox"/> Steam Fitting</li> <li><input type="checkbox"/> Air Conditioning</li> <li><input type="checkbox"/> Electrician</li> <li><b>BUSINESS</b></li> <li><input type="checkbox"/> Business Administration</li> <li><input type="checkbox"/> Certified Public Accountant</li> <li><input type="checkbox"/> Accounting</li> <li><input type="checkbox"/> Bookkeeping</li> <li><input type="checkbox"/> Stenography and Typing</li> <li><input type="checkbox"/> Secretarial</li> <li><input type="checkbox"/> Federal Tax</li> <li><input type="checkbox"/> Business Correspondence</li> <li><input type="checkbox"/> Personnel and Labor Relations</li> <li><input type="checkbox"/> Advertising</li> <li><input type="checkbox"/> Retail Business Management</li> <li><input type="checkbox"/> Managing Small Business</li> <li><input type="checkbox"/> Sales Management</li> <li><input type="checkbox"/> Salesmanship</li> <li><input type="checkbox"/> Traffic Management</li> <li><b>CHEMISTRY</b></li> <li><input type="checkbox"/> Chemical Engineering</li> <li><input type="checkbox"/> Chemistry</li> <li><input type="checkbox"/> Analytical Chemistry</li> <li><input type="checkbox"/> Petroleum—Nat'l Gas</li> <li><input type="checkbox"/> Pulp and Paper Making</li> <li><input type="checkbox"/> Plastics</li> </ul> | <p><b>CIVIL, STRUCTURAL ENGINEERING</b></p> <ul style="list-style-type: none"> <li><input type="checkbox"/> Civil Engineering</li> <li><input type="checkbox"/> Structural Engineering</li> <li><input type="checkbox"/> Surveying and Mapping</li> <li><input type="checkbox"/> Structural Drafting</li> <li><input type="checkbox"/> Highway Engineering</li> <li><input type="checkbox"/> Reading Blueprints</li> <li><input type="checkbox"/> Concrete Construction</li> <li><input type="checkbox"/> Sanitary Engineering</li> <li><b>DRAFTING</b></li> <li><input type="checkbox"/> Aircraft Drafting</li> <li><input type="checkbox"/> Architectural Drafting</li> <li><input type="checkbox"/> Electrical Drafting</li> <li><input type="checkbox"/> Mechanical Drafting</li> <li><input type="checkbox"/> Structural Drafting</li> <li><input type="checkbox"/> Sheet Metal Drafting</li> <li><input type="checkbox"/> Mine Surveying and Drafting</li> <li><b>ELECTRICAL</b></li> <li><input type="checkbox"/> Electrical Engineering</li> <li><input type="checkbox"/> Electrician</li> <li><input type="checkbox"/> Electrical Maintenance</li> <li><input type="checkbox"/> Electrical Drafting</li> <li><input type="checkbox"/> Electric Power and Light</li> <li><input type="checkbox"/> Lineman</li> <li><b>HIGH SCHOOL</b></li> <li><input type="checkbox"/> High School Subjects</li> </ul> | <ul style="list-style-type: none"> <li><input type="checkbox"/> College Preparatory</li> <li><input type="checkbox"/> Mathematics</li> <li><input type="checkbox"/> Commercial</li> <li><input type="checkbox"/> Good English</li> <li><b>MECHANICAL AND SHOP</b></li> <li><input type="checkbox"/> Mechanical Engineering</li> <li><input type="checkbox"/> Industrial Engineering</li> <li><input type="checkbox"/> Industrial Supervision</li> <li><input type="checkbox"/> Foremanship</li> <li><input type="checkbox"/> Mechanical Drafting</li> <li><input type="checkbox"/> Machine Design-Drafting</li> <li><input type="checkbox"/> Machine Shop Practice</li> <li><input type="checkbox"/> Tool Design</li> <li><input type="checkbox"/> Industrial Instrumentation</li> <li><input type="checkbox"/> Machine Shop Inspection</li> <li><input type="checkbox"/> Reading Blueprints</li> <li><input type="checkbox"/> Toolmaking</li> <li><input type="checkbox"/> Gas—Electric Welding</li> <li><input type="checkbox"/> Heat Treatment—Metallurgy</li> <li><input type="checkbox"/> Sheet Metal Work</li> <li><input type="checkbox"/> Sheet Metal Pattern Drafting</li> <li><input type="checkbox"/> Refrigeration</li> <li><b>POWER</b></li> <li><input type="checkbox"/> Combustion Engineering</li> <li><input type="checkbox"/> Diesel—Electric</li> <li><input type="checkbox"/> Electric Light and Power</li> </ul> | <ul style="list-style-type: none"> <li><input type="checkbox"/> Stationary Steam Engineering</li> <li><input type="checkbox"/> Stationary Fireman</li> <li><b>RADIO, TELEVISION, COMMUNICATIONS</b></li> <li><input type="checkbox"/> General Radio</li> <li><input type="checkbox"/> Radio Operation</li> <li><input type="checkbox"/> Radio Servicing—FM</li> <li><input type="checkbox"/> Television</li> <li><input type="checkbox"/> Electronics</li> <li><input type="checkbox"/> Telephone Work</li> <li><b>RAILROAD</b></li> <li><input type="checkbox"/> Locomotive Engineer</li> <li><input type="checkbox"/> Diesel Locomotive</li> <li><input type="checkbox"/> Air Brakes</li> <li><input type="checkbox"/> Car Inspector</li> <li><input type="checkbox"/> Railroad Administration</li> <li><b>TEXTILE</b></li> <li><input type="checkbox"/> Textile Engineering</li> <li><input type="checkbox"/> Cotton Manufacture</li> <li><input type="checkbox"/> Rayon Manufacture</li> <li><input type="checkbox"/> Woolen Manufacture</li> <li><input type="checkbox"/> Loom Fixing</li> <li><input type="checkbox"/> Finishing and Dyeing</li> <li><input type="checkbox"/> Textile Designing</li> <li><b>HOME ARTS</b></li> <li><input type="checkbox"/> Dressmaking and Designing</li> <li><input type="checkbox"/> Cookery</li> <li><input type="checkbox"/> Tea Room Management</li> </ul> |
|---|---|---|---|--|

Name \_\_\_\_\_ Age \_\_\_\_\_ Home Address \_\_\_\_\_

City \_\_\_\_\_ State \_\_\_\_\_ Working Hours \_\_\_\_\_ A.M. to \_\_\_\_\_ P.M.

Occupation \_\_\_\_\_

Special tuition rates to members of the Armed Forces. Canadian residents send coupon to International Correspondence Schools Canadian, Ltd., Montreal, Canada.

# Right Now! Handsome Hair! 3 Ways



**1**  
Fights  
Dandruff!



**2**  
Relieves Dryness  
and Itching!



**3**  
Grooms Hair  
Perfectly!

Lucky Tiger grooms your hair perfectly. But it does a lot more besides. Lucky Tiger kills on contact the dandruff germ, pityrosporum ovale, removes loose dandruff and gives your scalp a clean, wide-awake tingle. Treat your hair to all this, plus natural, greaseless grooming. Ask your barber, he knows.

## LUCKY TIGER 3-PURPOSE Hair Tonic

Sold at all toilet goods counters.



(Continued from page 8)

driving." There are several manufacturers using double-acting or two-way thermostats with bypass-type circulation in which the bypass is open for circulation during warm-up periods and then closed by one valve of the thermostat as the other valve opens for circulation through the radiator. Under these conditions, removal of the thermostat impairs circulation and may cause local hot spots to develop and valve seats to crack at the rear cylinders.

There are also engine designs where hood and side panels are a definite part of the air circulation for engine cooling. Opening the hood or removing the side panels [as Mr. Hazen suggested—Ed.] will tend to cause overheating rather than cooling of engine.

I do not question Mr. Hazen's results with his particular car, but believe the information may give other drivers trouble with their cars.

Austin M. Peters,  
Fayetteville, N. C.

### Letter to the Editor:

In the June issue [this] paragraph on page 83 is incorrect: "They are the first theaters aboard ship to have sloping floors for visibility." [The SS *United States*.]

Your source of information did not realize that the *Queen Elizabeth* has had a sloping theater since it was built . . . there is also a sloping theater on first-class on the *Queen Mary*, although it is not as fully perfected as the one on the *Queen Elizabeth*.

William P. Wreden,  
Menlo Park, Calif.

Mr. Wreden is correct. The SS *Caronia* also has a similar, sloping-floor theater for first-class passengers.

The Editors

### Letter to the Editor:

I have read with great interest of your plywood house (*Popular Mechanics*, May 1951). I have been advocating the use of plywood for houses right along, but due to the inertia of the public here in using other conventional materials such as brick, bamboo, stucco, wood sidings, etc., my efforts have not been too successful in convincing the public. The design, particularly with the build-it-yourself design, looks so unique and economical that it would fit very nicely into the poor economy of my country just now as many people are lacking of homes . . . [Could you] send me a set of the drawings of this ideal house with details?

K. P. Hu, president,  
Yangtze Wood Products Co.,  
Taipeh, Taiwan, China

# KEY TO A PRACTICAL UNDERSTANDING OF ELECTRICITY

\$1 PER MO.

● AUDELS HANDY BOOK OF PRACTICAL ELECTRICITY for Maintenance Engineers, Electricians and All Electrical Workers. A quick, simplified, ready reference book, giving complete instruction & practical

● INSIDE TRADE INFORMATION ON rules and laws of electricity—maintenance of electrical machinery—A.C. and D.C. motors—armature winding and repair—wiring diagrams—house wiring—power wiring—cable splicing—meters—batteries—transformers—elevators—electric cranes—railways—bells—sign flashers—telephone—ignition—radio principles—refrigeration—air conditioning—oil burners—air compressors—welding and many modern applications explained so you can understand.

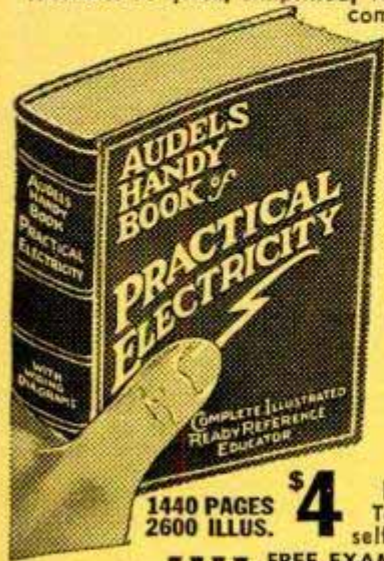

1440 PAGES  
2600 ILLUS.

\$4

Indexed for ready reference. To get this assistance for yourself, simply fill in and mail the

FREE EXAMINATION COUPON

AUDEL, Publishers, 49 W. 23 St., N.Y. 10, N.Y.

Please send me "Auodels Handy Book of Practical Electricity" for free examination. If satisfactory, I will send you \$1 in 7 days, then \$1 monthly until \$4 is paid. Otherwise I will return it.

Name \_\_\_\_\_

Address \_\_\_\_\_

Occupation \_\_\_\_\_

Employed by \_\_\_\_\_ P10



READ FOR PROFIT!

## AUDELS Carpenters and Builders Guides 4 vols. \$6

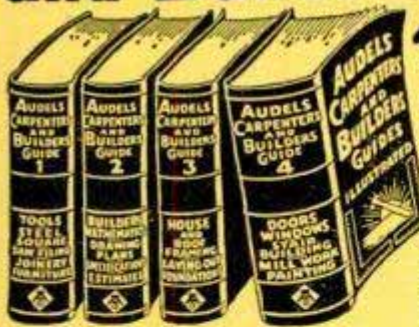

Inside Trade Information

for Carpenters, Builders, Joiners, Building Mechanics and all Woodworkers. These Guides give you the short-cut instructions that you want—including new methods, ideas, solutions, plans, systems and money saving suggestions. An easy progressive course for the apprentice and student. A practical daily helper and Quick Reference for the master worker. Carpenters everywhere are using these Guides as a Helping Hand to Easier Work, Better Work and Better Pay. To get this assistance for yourself, simply fill in and mail FREE COUPON below.

Inside Trade Information On:

How to use the steel square—How to file and set saws—How to build furniture—How to use a mitre box—How to use the chalk line—How to use rules and scales—How to make joints—Carpenters arithmetic—Solving mensuration problems—Estimating strength of timbers—How to set girders and sills—How to frame houses and roofs—How to estimate costs—How to build houses, barns, garages, bungalows, etc.—How to read and draw plans—Drawing up specifications—How to excavate—How to use settings 12, 13 and 17 on the steel square—How to build hoists and scaffolds—skylights—How to build stairs—How to put on interior trim—How to hang doors—How to lath—lay floors—How to paint.



AUDEL, Publishers, 49 W. 23rd St., New York 10, N. Y. Mail Auodels Carpenters and Builders Guides, 4 vols., on 7 days' free trial. If OK I will remit \$1 in 7 days and \$1 monthly until \$6 is paid. —Otherwise I will return them. No obligation unless I am satisfied.

Name \_\_\_\_\_

Address \_\_\_\_\_

Occupation \_\_\_\_\_

Employed by \_\_\_\_\_ P10

# WHAT ALL AUTO MECHANICS WANT TO KNOW

1800 PAGES



This Big Practical Book gives full information with working diagrams covering the principles, construction, ignition, service and repair of modern cars, trucks and buses.

Diesel Engines, Hydramatic & Fluid Drives Fully Explained.

A complete Guide of 1800 pages, with over 1500 illustrations showing inside views of working parts, with instructions for service jobs.

IT PAYS TO KNOW

How to fit pistons—How to locate engine knocks, How to fit connecting rod bearings—How to service main bearings—How to recondition valves—How to time valves—How to adjust fan belts—How to adjust carburetors and chokes, How to rebuild a clutch—How to service automatic transmissions—How to service brakes—How to adjust steering gear—How to cope with ignition troubles—How to service distributors—How to time ignition—How to "tune up" an engine.



\$4 COMPLETE • PAY \$1 A MO. TO GET THIS ASSISTANCE FOR YOURSELF SIMPLY FILL IN AND MAIL COUPON TODAY.

Step up your own skill with the facts and figures of your trade. Auodels Mechanics Guides contain Practical Inside Trade Information in a Handy Form. Fully illustrated and Easy to Understand. Highly Endorsed. Check the book you want for 7 DAYS FREE EXAMINATION. Send No Money. Nothing to pay postman.

## MAIL ORDER

AUDEL, Publishers, 49 W. 23 St., NEW YORK 10, N. Y.

Please send me postpaid for FREE EXAMINATION books marked X below. If I decide to keep them I agree to mail \$1 in 7 Days on each book or set ordered and further mail \$1 monthly on each book or set until I have paid price, otherwise I will return them.

- AUTOMOBILE MECHANICS GUIDE, 1800 Pages \$4
- TRUCK & TRACTOR GUIDE, 1299 Pages . . . 4
- DIESEL ENGINE MANUAL, 575 Pages . . . 2
- MACHINISTS HANDY BOOK, 1650 Pages . . . 4
- WELDERS GUIDE, 400 Pages . . . 1
- BLUE PRINT READING, 416 Pages . . . 2
- MATHEMATICS & CALCULATIONS, 700 Pages . . . 2
- SHEET METAL PATTERN LAYOUTS, 1100 Pages . . . 4
- SHEET METAL WORKERS HANDY BOOK, 388 Pgs. . . 1
- MECHANICAL DRAWING GUIDE, 160 Pages . . . 1
- MECHANICAL DRAWING & DESIGN, 480 Pages . . . 2
- AIRCRAFT WORKER, 240 Pages . . . 1
- TELEVISION SERVICE MANUAL, 384 Pages . . . 2
- RADIOMANS GUIDE, 914 Pages . . . 4
- ELECTRONIC DEVICES, 216 Pages . . . 2
- ELECTRIC MOTOR GUIDE, 1000 Pages . . . 4
- ELECTRIC WIRING DIAGRAMS, 272 Pages . . . 1
- ELECTRICIANS EXAMINATIONS, 250 Pages . . . 1
- ELECTRIC POWER CALCULATIONS, 425 Pages . . . 2
- HANDY BOOK OF ELECTRICITY, 1440 Pages . . . 4
- ELECTRIC DICTIONARY, 9000 Terms . . . 18
- ELECTRIC LIBRARY, 7000 Pages (12 Book Set) . . . 2
- MARINE ENGINEERS HANDY BOOK, 1258 Pgs. . . 4
- SHIPFITTERS HANDY BOOK, 250 Pages . . . 1
- REFRIGERATION & Air Conditioning, 1280 Pgs. . . 4
- MILLWRIGHTS & MECHANICS GUIDE, 1200 Pgs. . . 4
- POWER PLANT ENGINEERS GUIDE, 1500 Pages . . . 4
- ENGINEERS & FIREMANS EXAMS, 525 Pages . . . 1
- PUMPS, Hydraulics & Air Compressors, 1658 Pgs. . . 4
- ENGINEERS LIBRARY (3 Book Set) . . . 9
- MECHANICAL DICTIONARY, 950 Pages . . . 4
- GARDENERS & GROWERS GUIDES (4 Book Set) . . . 6
- CARPENTERS & BUILDERS GUIDES (4 Book Set) . . . 6
- PLUMBERS & Steamfitters Guides (4 Book Set) . . . 6
- MASONS AND BUILDERS GUIDES (4 Book Set) . . . 6
- PAINTERS & DECORATORS MANUAL, 450 Pgs. . . 2
- HOUSE HEATING GUIDE, 1000 Pages . . . 4
- OIL BURNER GUIDE, 384 Pages . . . 1



Check NOW!  
You Can Look Over Any Guide In Your Own Home — Start the Easy Payments If Satisfied

MAIL THIS TODAY

Name \_\_\_\_\_

Address \_\_\_\_\_

Occupation \_\_\_\_\_

Employed by \_\_\_\_\_ P10

# World's Most Complete! 1953 ALLIED TV & RADIO CATALOG

## FREE!

Everything in TV & Radio  
At Lowest Prices

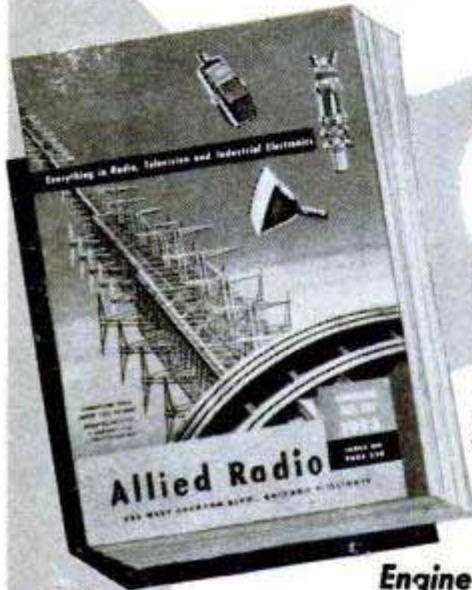

236 PAGES  
VALUE-  
PACKED

Everything for  
Experimenters,  
Builders,  
Amateurs,  
Servicemen,  
Engineers, Soundmen

Send for ALLIED's big 236-page 1953 Catalog, the value-packed guide to everything in TV and Radio! Latest home radios, TV equipment, Amateur supplies, High-Fidelity Sound, P.A. Systems, new recorders, test instruments, builders' kits—plus the world's largest stocks of electronic parts, tubes, tools and books.

Get more for your money—  
send today for your FREE  
1953 ALLIED Catalog!



SEND FOR  
FREE  
CATALOG

## ALLIED RADIO

ALLIED RADIO CORP., Dept. 5-K-2  
833 W. Jackson Blvd., Chicago 7, Illinois

Rush FREE 1953 ALLIED 236-Page Catalog.

Name \_\_\_\_\_

Address \_\_\_\_\_

City \_\_\_\_\_ Zone \_\_\_\_\_ State \_\_\_\_\_

## WHERE-TO-BUY-IT INDEX

Source of supply appears after items commercially available

### AUTOMOTIVE

Versatile armrest stores accessories (Car-Y-All Co., 89-70 220th St., Queens Village 12, N. Y.)	86
Plastic fender cover	96
Detroit Listening Post	103
Ticket vendor for parking lots	110
Motor-oil dispenser	116
Cunningham hardtop has Italian body	124
Replacement tail pipe bends to fit most cars	137
Ultrastreamlined German auto	141
Tester checks driving skill	141
Train brakes for trucks	163

### AVIATION

Feeder lines connect planes to central air-conditioning	86
British guided rocket flies over 2000 miles per hour in tests	111
Helicopter taxicab	116
Urgent single runways for airports	137
Build plastic wing	141
Ranch plane mounts loudspeakers, shotgun	153
French jet transport	157
"Dougmut" glider	260

### FARM AND GARDEN

Bean picker	109
Rotary tiller with rotary-mower attachment	124
Johnny Appleseed hires a mechanic	160

### HOUSE AND HOME

Window spray stops fading	91
Telephone night light	109
Versatile "refrigerette" keeps refreshments within easy reach	111
Electronic coffee pot hastens normal brewing process	111
Electric clothes drier plays tune at end of cycle	117
Baby pen (Walter Drake, Drake Bldg., Colorado Springs, Colo.)	142
Spreading butter (Guarantee Products Co., 950 S. Lincolnway East, South Bend, Ind.)	142
Keyhole light (Keholite Mfg. Co., Hudson, Ohio)	142
Sit-down showers (Sit-Down Shower Co., Box 1657, Chicago)	142
Clotheslines (General Tool & Machine Co., 1226 E. Michigan Ave., Kalamazoo, Mich.)	142
Sink facilities (American Standard, Box 1226, Pittsburgh 20, Pa.)	142
Alcohol coffeemaker (Caffe Espresso, 106 W. 52nd St., New York City)	143
Drapery pleating (John S. Vance Co., 2323 W. Giddings St., Chicago 25)	143
Dust catching (Byrd Tool & Mold Co., Plastics Div., 2953 W. 12th St., Erie, Pa.)	143
Washing wick (Haldane-Blake, Inc., 1426 W. 3rd St., Cleveland 13, Ohio)	143
Electric stick heats radiator (Gebhard Elektrowarme, Wald-brol near Cologne, Hammermuhle, Germany,—British Zone)	158
Cigarette watchman (Seymour-Sheridan Mfg. Co., Stratford, Conn.)	163
Wood-veneer wallpaper simulates paneling	272

### INDUSTRY

Metal floats in air during melting process	86
Proving-ground engineers solve difficult paving problem	87
Hydraulic hoist lifts subway train (Globe Hoist Co., Mermaid Lane and Queen St., Philadelphia 18, Pa.)	92
Cafeteria dining car	92
Giant-size slings ease bridge section into position	116
Float in deep well detects earth tremors	136
Nile station modernizes water-lifting technique	137
Push buttons set speed of freight cars rolling in automatic hump yard	138
Pack up your house and move (Transa-Housing, Inc., 1401 W. 17th St., Long Beach 13, Calif.)	154
Emergency shower tester	157
Crane cargo weigher	158
"Decarbonizing" factory	159
Log grapple	163
Out-of-place highway squeezed back into position	164
Stick-on thermometer	246
Oil wrapped in foil	262

### MILITARY AND NAVAL

Military tests coaxial helicopter	87
Navy announces its first atomic-powered submarine	117
Insulated rubber lifeboat keeps 15 survivors warm	129
Mechanics in a "refrigerator"	152
Psychological "gun"	157

### SPORTS AND RECREATION

Gas-filled golf ball	92
Indoor-outdoor electronic golf driver	129
Sportsman's kit (Marlee Co., Div. of New Video Lighter Mfg. Co., 3834 N. Sheffield Ave., Chicago 13)	158

### MISCELLANEOUS

Cigarlike pipe can't spill ashes	91
Dry shaver uses no electricity	91
"Television city" constructed in miniature	93
Artificial kidney purifies human blood	96
Tiny building and equipment illustrate fire-fighting lessons	102
French bicycle design gets greater pedal push	110
Police crash car prepared for all emergencies	110
Stop watch times split seconds	117
Float in deep well detects earth tremors	136
Baking decals on china	150
Multipurpose antennas	152

(Continued to page 14)



# INVENTORS

**L**earn how to protect your invention. The U. S. Patent Laws provide that any new and useful art, machine, article of manufacture, or composition of matter, or any new and useful improvement thereof, may be patented if the act of invention is involved. Therefore, every inventor with a valuable invention should take advantage of the Patent Laws and proceed for patent protection in order to safeguard his rights.

A patent gives the inventor the exclusive right to prevent others from making, using, or selling the invention claimed in the patent for a period of seventeen years.

The Patent Laws were enacted for the benefit of the inventor to give him protection for the features of his invention which are patentable. These features must be properly and concisely set forth and claimed in a formal application for patent, in order to comply with the requirements of the Patent Laws. For that reason, unless the inventor is familiar with patent matters, he should engage a competent registered patent attorney or agent to represent him. We are registered to practice before the U. S. Patent Office and are prepared to serve you in the handling of your patent matters.

A specially prepared booklet entitled "Patent Guide for the Inventor", containing detailed information with respect to patent protection and procedure, together with a "Record of Invention" form will be promptly forwarded to you without obligation upon request.

**CLARENCE A. O'BRIEN & HARVEY JACOBSON**

*Registered Patent Attorneys*

**21-K DISTRICT NATIONAL BUILDING**

**WASHINGTON 5, D. C.**

# AT LAST A REPAIR MANUAL 'made-to-order' FOR YOUR CAR!

NOW, IT'S A "CINCH" TO FIND & FIX ANY CAR TROUBLE—YOURSELF!

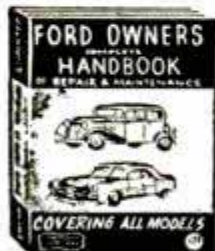

**1. FORD OWNERS HANDBOOK OF REPAIR AND MAINTENANCE**—How to fix any part of any Ford car from 1932 to date—shows beginner or expert how to locate trouble instantly and gives simple step by step repair instructions—everything the Ford owner wants to know about his car—the only complete Ford repair manual available whether you adjust windshield wipers or overhaul transmissions, this handy manual will show you how. **COLE'S PRICE \$1.50.**



**2. CHEVROLET OWNERS HANDBOOK OF REPAIR AND MAINTENANCE**—Now, beginner or expert can repair anything from carburetor to rear end, quickly, easily, right! This Chevrolet owners "bible" shows exactly what to do and how to do it—here's complete repair data for all Chevrolets from 1929 to date including Powerglide—covers all parts of your car, engine, transmission, rear end, electrical system, fuel system, brakes, steering, shocks. **COLE'S PRICE \$1.50.**

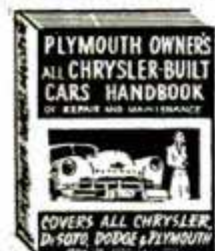

**3. DODGE, PLYMOUTH, CHRYSLER AND DE SOTO HANDBOOK OF REPAIR AND MAINTENANCE**—Shows how to locate and fix any kind of car trouble—save time, temper and money—do repairs yourself—make your car run better, last longer—the only service manual for Chrysler built cars on the market—every part of your car covered in detail—hundreds of "show how" pictures make repairs easier—includes all Chrysler built cars from 1935 to date. **COLE'S PRICE \$2.**

## SOUPING UP HOT RODS

**4. SOUPING THE STOCK ENGINE**—How to get top speed out of any stock or track engine—explains fully the five best ways to obtain peak performance—shows you exactly what to do and how to do it—hundreds of useful photos, charts, etc. **COLE'S PRICE \$2.**

**5. HOW TO HOP UP CHEVROLET AND G.M.C. ENGINES**—Complete manual of "souping" or speed tuning Chevrolet and G.M.C. 6 cylinder engines for high performance—all the facts about blocks, con rods, pistons, fuel, carburetion, ignition, supercharging and speed equipment including Wayne and Nicson. **COLE'S PRICE \$2.**

**6. HOW TO HOP UP FORD AND MERCURY V8 ENGINES**—Every method and short cut known for increasing power output discussed in detail—120 charts, tables—everything you need to know to get top efficiency in any Ford V8 engine. **COLE'S PRICE \$2.**

## TRY ANY BOOK FOR 30 DAYS

TO: COLE'S, 11 West 30th St. New York, N.Y.

### SEND NO MONEY

I'd like to examine for 30 days the books I have checked below! When the books arrive I'll pay postman plus a few cents delivery charges. If I'm not completely satisfied I'll return them for full refund.

CIRCLE NUMBERS REQUIRED 1 2 3 4 5 6

Name.....

Address.....

City..... State.....

Check here and SAVE POSTAL CHARGES! Enclose full payment with this coupon, we'll pay all shipping charges! Same 30 day return privileges of course! P.M.I.

(Continued from page 12)

Sundial clock for Oslo.....	153
Manmade mouse with a "memory".....	156
Aluminum foil dresses wounds.....	157
Dial air raid warning.....	158
Straight-line shotgun fires in two opposite directions.....	164

## Craftsman and Shop Notes Index

### AUTOMOTIVE

"Reverse polarity" plug for trickle charger.....	178
Roadside repair for fuel pump.....	219
Air-filter screen of car washed easily in container assembled from sheet tin.....	219

### FARMING

Discarded harrow teeth anchor fence posts.....	183
Comfortable milk stool made from scrap parts.....	186
Attaching temporary fence wire.....	209
Fence posts treated effectively with small supply of creosote.....	226
Nail kegs placed in racks form laying-nest units.....	226

### HOUSE AND HOME

Method for securing patches simplifies screen repairs.....	172
Solving home problems.....	180
Wall surrounding light switch shellacked for easy cleaning.....	183
Doorstop braces refrigerator to reduce vibration.....	186
Loose joint in furniture is glued with aid of medicine dropper.....	186
Attractive shelf fastened to bathroom wall for holding small radio and toilet articles.....	192
Whiting coated on storm windows simplifies cleaning after storage.....	192
Salvaging worn whisk broom.....	192
Protective coating on bristles extends useful life of broom.....	200
Repairing damaged chimney.....	208
Novel driveway gate made inexpensively by using large farm- implement wheels.....	209

### OFFICE, SHOP AND STORE

Preserving labels on sprayer tank.....	172
Loose-fitting night lock on door tightened with cardboard shims.....	178
Small parts stored in handy tray made by soldering tin cans together.....	182
Stamp pad located easily when tacked to paddle.....	183
C-clamp converts extension cord into temporary ceiling fixture.....	186
Steel tapeline oiled in device made from old spectacle case.....	191
Wood block "locks" light switch as reminder to employees.....	200
Shoe-polish bottle used for glue provides cap applicator.....	200
"Blackboard" sales card permits price change.....	209
Tapered arbor on motor shaft speeds changing buffers.....	209
Stool from disk-harrow blades.....	215
Screen wire used to point chalk.....	226

### PHOTOGRAPHY

Centrifugal film drier.....	187
Condenser flash unit.....	201
Tweezers used as spanner wrench for removing camera lens.....	206
Small mirror mounted at angle simplifies reading of lens settings.....	206

### TOOLS

Preventing damage to drills.....	178
Roller conveyor.....	207
Paint roller scraper (Brush-Save, Inc., 5049 W. Loomis Rd., Milwaukee, Wis.).....	217
Hand-operated mitering tool (Lander & Abbott, La Crescenta, Calif.).....	216
All-purpose oil (Mitchell Chemical Co., Inc., 2446 Main St., Stratford, Conn.).....	216
Spring tweezers (N. Sakata, 12 Fujimicho 2-Chome, Chiyodaku, Tokyo, Japan).....	216
Screw starter (Screw-Starter, Inc., 426 S. Bryant, Denver 9, Colo.).....	215
Nonclogging sanding cloth (Bay State Abrasive Products Co., 15 Union St., Westboro, Mass.).....	217
One-man chain saw (Von Ruden Mfg. Co., Claremont, Minn.).....	217
Portable shaper (Composite Die Supply Co., 14310 Birwood Ave., Detroit 4, Mich.).....	217
Punch lock clamp (Punch-Lok Co., 321 N. Justine St., Chicago 7).....	217

### WOODWORKING

Clothes rack from tree branch suits decor of rustic cabin.....	172
Rocket lamp.....	173
Modern cedar chest.....	178
Workbench encourages small-fry craftsman.....	183
Plan of the month—drawing bench.....	184

### WORKSHOP HINTS

Wax paper lubricates nails.....	173
Brass pad on lathe-dog screw prevents marring of work.....	182
Rack for wood-turning chisels permits easy removal.....	191
Small-parts tray swings under workbench.....	193

(Continued to page 16)

**IMPORTANT NOTICE**—It is the intention of this magazine to provide its readers with information regarding the latest developments in the mechanical arts. We take no responsibility as to whether the disclosures contained in our articles are covered by patents and advise readers to investigate this subject before making, using, or selling any of the products, machines, or processes described in order to avoid possible liability for patent infringements.



# INVENTORS

If you believe that you have an invention, you should find out how to protect it. The first step is to have a search made of the prior pertinent U. S. patents. If a report on this search indicates that the invention appears patentable you can apply for a patent, and the specifications and claims should be prepared.

The firm of McMorrow, Berman & Davidson, with offices in Washington, D. C., is qualified to take the necessary steps for you. We can make a preliminary search on your invention, advise you whether we think it can be patented, and prepare your application for patent.

Unless you are fully familiar with the U. S. Patent Laws, we recommend that you engage the services of a Registered Patent Attorney to protect your interests. The patent laws are *your* laws. A patent gives you the right to prevent others from making, using or selling the invention claimed in your patent for a period of 17 years.

Use these patent laws for your protection. Investigate whether your invention can be patented. If you have what you believe to be an invention, we suggest that you have this firm make a search for you.

*Send for a copy of our Patent Booklet entitled "How To Protect Your Invention," containing information about patent protection and patent procedure. Along with this we will also send you an "Invention Record" form, for your use in writing down and sketching details of your invention. We will mail them promptly. No obligation. They are yours for the asking.*

**McMORROW, BERMAN & DAVIDSON**

*Registered Patent Attorneys*

**PATENTS • COPYRIGHTS • PATENTS**

**135-C VICTOR BUILDING, WASHINGTON 1, D. C.**

# Are you flirting with fire?



Neglected wires cause automobile fires—burn up hundreds of cars, trucks, and buses every day!

Year after year, National Safety Council figures tell the same story: fire reports list “defective wiring” as the cause of as high as 92% of all vehicle fires.

**DON'T FLIRT WITH FIRE!** See that your wires and cables are checked *today*. Not only to prevent fire, but to prevent hard starting, poor engine performance, battery failure. When replacing wiring, insist on genuine Crescent Wiry Joe Wire and Battery Cables. There are none better!



Write now for this valuable free booklet!

**THE CRESCENT COMPANY, Inc.**  
Pawtucket, Rhode Island



Please send me my free copy of “The Effect of Defective Wiring on Car Performance.”

NAME \_\_\_\_\_

ADDRESS \_\_\_\_\_

CITY \_\_\_\_\_ ZONE \_\_\_\_\_ STATE \_\_\_\_\_

(Continued from page 14)

Wooden guide on grinding-wheel rest aids in knife sharpening	193
Rubber sheath for countersink made from rubber tubing	193
Soldering aid for work held in vise	205
Small-parts trays from cans	205
Improvised pipe nipple	215
Cream soap is handy for driving screws	215
Electric drill mounted on lathe cross slide drives milling cutter for cutting keyways	218
Scaffold supported by stepladders secured with hook-bolts	218
Jig clamped to round work provides guide when drilling holes	218
Can filled with steel wool used to clean soldering iron	219
Broken and worn twist drills converted into taper-shank end mills	219
End-drilling long work	226

### MISCELLANEOUS

Gourd made into jack-o-lantern	172
Buffer fitted with extra handle for easier manipulation	182
Pencil erasers polish small parts	182
Razor blades stored safely in slitted rubber tubing	183
Backrest used on plank seats carried easily when foiled	186
Rubber tape covering fishhooks prevents possible injury	192
Tube held over spray-gun nozzle directs thinner into container	192
Camp water supply toted in jugs suspended from dowel handles	200
Axhead fitted to pneumatic drill cuts through tree roots easily	215
Brackets on truck endgate serve as “sawhorse”	226

### Radio-Television, Electronics

Multiple TV receiving aid (Technical Appliance Corp., Sherburne, N. Y.)	227
Adjustable clip-on mirror (Allen B. DuMont Laboratories, 654 Madison Ave., New York City)	227
Beginner's two-tube a.c.-d.c. seven seas scout	228
Pipe-line shipments separated by radioactive tracers	230
Salvaging precious metals by means of ultrasonics (Raytheon Mfg. Co., Waltham 54, Mass.)	232
Amplifier for incoming phone calls (L. Linden, 1611 Polk Ave., Houston, Tex.)	232
Tool kit for radio-TV and electronic workers (Vaco Products Co., 317 E. Ontario St., Chicago 11)	232
Amplified megaphone employs transistors (General Electric Co., Syracuse, N. Y.)	232
“Flying finger” radiation detector (General Electric Co., Syracuse, N. Y.)	232

### Speedometer Cable Lubricated With Graphite Cartridge

Speedometer cables are lubricated to eliminate needle shimmy, chatter, grinding or cable breakage by means of a plastic cartridge containing graphite. The cable end is unscrewed

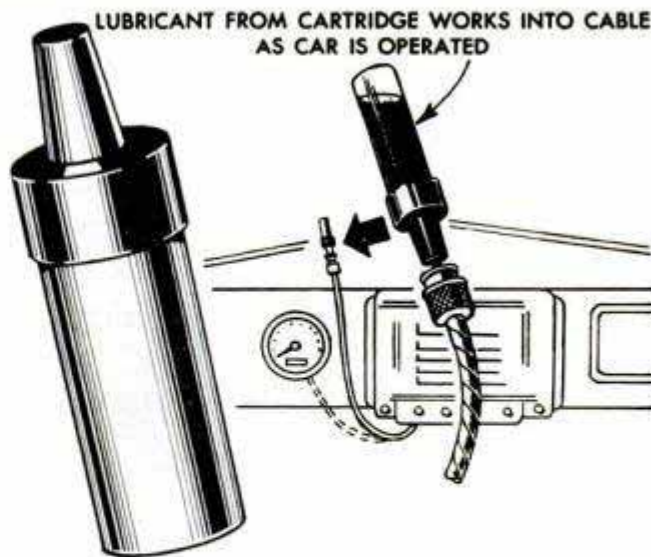

from the rear of the instrument panel. The lubricant cartridge is punctured with a key or pencil and held upside down against the cable locking nut as the car is driven. The rotation of the shaft draws the graphite down into the cable, providing a thorough lubrication to the length of the cable.

LEARN

# ELECTRICITY AND ELECTRONICS

ON REAL EQUIPMENT  
IN THE GREAT SHOPS  
OF **COYNE**



## RADIO-TELEVISION

Plays a Vital Roll in Nation's Defense

**HIGHER RANK—  
HIGHER PAY—  
IN ARMED FORCES**

Coyne Training will help you forge ahead in the Army, Navy, Air Force. And you'll be all set for a good future when you leave the service.

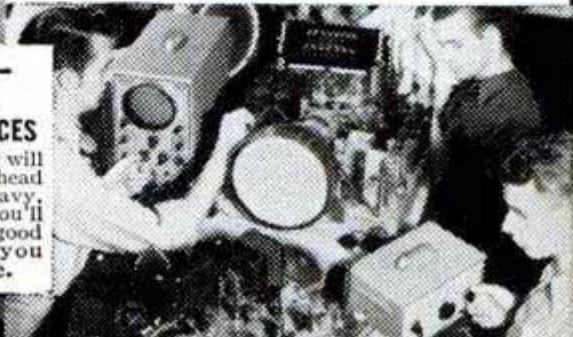

The tremendous growth of this new field is almost unbelievable. TV has been given the "go-ahead" in 1227 new communities, with 1845 new stations to be built. Unusual opportunity to get in on ground floor. RADIO-TELEVISION and ELECTRONICS are vital to our Defense Program. And they offer a world of opportunities for a real future when the emergency is over. Train quickly on actual equipment at Coyne by practical-technical methods. Get big Free Book today.

## ELECTRICITY—

**The Power Behind Our Defense Program**

A great opportunity field and vital to Defense. Thousands of trained Electrical and Electronics men needed in good jobs with a real future when the emergency is over. Why be satisfied with a "no future" job? Get Free Book that tells how thousands have prepared quickly for Electricity and Electronics at Coyne.

### TRAIN QUICKLY AT COYNE FOR VITAL FIELDS

ELECTRICITY-RADIO-TELEVISION-ELECTRONICS-VITAL in Industry and Armed Forces. TRAIN QUICKLY for better rating, if drafted—vital job in Industry, if not. Trained men whether 16 or up to 50 needed. Many men with physical handicaps can qualify. Prepare now for steady, well paid, essential jobs in A FIELD THAT ALSO OFFERS A REAL FUTURE WHEN THE EMERGENCY IS OVER.

#### WE TRAIN YOU IN CHICAGO

We do not teach by mail. All training is given in our Great Training Shops in Chicago, plus necessary theory. No advanced education or previous experience needed.

#### APPROVED FOR VETERANS— FINANCE PLAN FOR NON-VETS

Non-vets enroll now, pay most of tuition after graduation. If you need part-time work to help out with living expenses while at Coyne, we'll help you get it. Special plan for men of Draft Age.



**1** You are TOLD the how and why of each job.



**2** You're shown how to do typical jobs by trained instructors.



**3** You DO practical job YOURSELF on equipment.

### Mail Coupon for Big FREE BOOK

Whether you prefer Electricity or Television-Radio, train on actual equipment, at Coyne. Fill in and mail coupon TODAY. Paste it on a postcard if you wish. A big fully illustrated booklet and complete details will come by return mail. No salesman will call.



B. W. COOKE, President

## COYNE SCHOOL

ATECHNICALTRADE INSTITUTE  
CHARTERED NOT FOR PROFIT  
Established 1899  
500 S. Paulina Dept. 72-72H  
Chicago 12, Illinois

ELECTRICITY ★ TELEVISION ★ RADIO ★ REFRIGERATION ★ ELECTRONICS

B. W. COOKE, President  
COYNE SCHOOL

500 S. Paulina St., Chicago 12  
Dept. 72-72H

Send your BIG FREE BOOK and details of your training offer. This does not obligate me and no salesman will call. I am interested in

ELECTRICITY  TELEVISION-RADIO

NAME.....

ADDRESS.....

CITY.....STATE.....

# In Your Mind's Eye

## The Secret of MENTAL CREATING

IF you just like to dream, read no further. There comes a time when your fancies *must be* brought into light—and stand the test of every-day, hard realities. Are you one of the thousands—perhaps millions—whose thoughts never get beyond the stage of *wistful wishing*? Do you often come to from a daydream with the sigh, "If only I could bring it about—*make it real*?"

All things begin with thought—it is what follows that may take your life out of the class of those who hope and dream. Thought energy, like anything else, can be dissipated—or it can be made to produce actual effects. *If you know how to place your thoughts* you can stimulate the creative processes within your mind—through them you can assemble things and conditions of your world into a happy life of accomplishment. *Mental creating* does not depend upon a magical process. It consists of *knowing how* to marshal your thoughts into a power that draws, compels and organizes your experiences into a worth-while design of living.

### ACCEPT THIS *Free* BOOK

Let the Rosicrucians tell you how you may accomplish these things. The Rosicrucians (not a religious organization), a world-wide philosophical fraternity, have preserved for centuries the ancients' masterful knowledge of the functioning of the inner mind of man. They have taught men and women how to use this knowledge to *recreate their lives*. They offer you a free copy of the fascinating book, "The Mastery of Life." It tells how you may receive this information for study and use. Use coupon opposite.

*The* ROSICRUCIANS  
(AMORC)

SAN JOSE

CALIFORNIA

SCRIBE: I.R.C.  
The Rosicrucians (AMORC),  
San Jose, California.

Please send free copy of "The Mastery of Life,"  
and I shall read it as directed.

Name.....

Address.....

City.....

# GET SHOP-METHOD HOME TRAINING

for **SUCCESS** in Today's Top Industries!



SEND COUPON  
TODAY  
for **FREE**  
**BOOK** and  
**COMPLETE**  
**SAMPLE LESSON!**

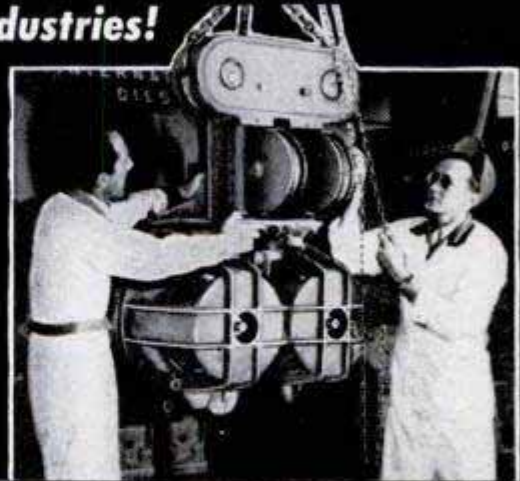

## RADIO-TELEVISION & ELECTRONICS OR AUTOMOTIVE-DIESEL & ALLIED MECHANICS

Like a business of your own or a good job with a big firm... and get paid for what you know? Shop-Method Home Training in Radio, Television, Electronics will bring you the job... money... you've always wanted. 105 million Radios, 3100 stations... 16 million TV sets, over 100 TV stations... many more, now Govt. restrictions are off. Defense industries want trained men for interesting, good pay jobs. Get into this opportunity-making industry... advance fast. Find out how... mail coupon. **TODAY!**

### I GIVE YOU STANDARD PARTS! INCLUDING TUBES!

—they are yours to keep. You actually learn by doing, build generators, receivers, a big Super-Het radio.

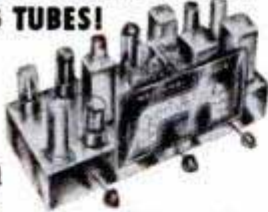

### THIS PROFESSIONAL FACTORY-MADE MULTI-TESTER IS YOURS!



Valuable equipment every Radio-TV man needs. Yours to keep!

### INVESTIGATE NOW!



LET NATIONAL SCHOOLS of Los Angeles, California, a Resident Trade School for almost 50 years, train you at home for today's unlimited opportunities. Pick your industry—mail coupon below now!

### EARN EXTRA MONEY WHILE YOU LEARN!

I show you how to earn extra money while learning! Many men have paid for their entire course in this way. You can, too. Remember: Shop-Method Home Training covers every phase of the industry—in an interesting step-by-step way. Why wait—take the first step to success—mail the coupon today!

**DRAFT AGE?** Training helps you get the service branch you want, advance fast.



That means higher pay and grade, more prestige—right away! Don't take a chance—mail coupon now!

Want to be your own boss... or get into booming industries? 8 million older cars need big, profitable services and repairs. Farm machinery is going Diesel. Defense industry begs for more and more trained mechanics for high-pay jobs. National Schools Shop-Method Home Training prepares you for all Automotive, Diesel, Allied Mechanics opportunities.

Helps you get the security, good pay you've always wanted. Send coupon for your Free Book and Sample Lesson now!

### I GIVE YOU THE TOOLS OF YOUR TRADE!

Big professional-quality kit of tools of your trade—and all-metal tool box. All yours to keep—part of your course; they help make your training more practical—start you off right!



## NATIONAL SCHOOLS

LOS ANGELES 37, CALIFORNIA

Established 1905

In Canada: 193 East Hastings Street  
Vancouver 4, B.C.



**DON'T PUT IT OFF GET THE BIG SALARY YOU'VE ALWAYS WANTED!**

### MAIL TODAY—YOU'RE "ON YOUR WAY"!

NATIONAL SCHOOLS, Dept. B-102  
4000 S. Figueroa Street  
Los Angeles 37, California

Mail in envelope or paste on postal card

I want to "get going"! Send me Free Book I checked and Free Sample Lesson. I understand no salesman will call.

- My Future in Radio-Television & Electronics
- My Future in Automotive-Diesel & Allied Mechanics

NAME \_\_\_\_\_ AGE \_\_\_\_\_

ADDRESS \_\_\_\_\_

CITY \_\_\_\_\_ ZONE \_\_\_\_\_ STATE \_\_\_\_\_

VETS! Check here if released from service less than 4 years ago.

Home study can help you



**Earn more money**



**Get a better job**



**Start your own business**

Opportunities are all around you. But to take advantage of any one of them you need special training. That's true whether you want to move ahead in your present job—start in a new field—or go into business for yourself. It's the *trained* man who succeeds.

I. C. S. has helped 5,918,632 men and women train themselves for advancement through home study. 391 different courses including high school. Direct, clear, understandable. Bedrock facts and theory plus practical application. Check the course you need on the coupon below. Mail it *today* for information plus free book "How to Succeed."

**INTERNATIONAL CORRESPONDENCE SCHOOLS**  
BOX H-5540-L SCRANTON 9, PA.

Without obligation, please send me the booklet about the course BEFORE which I have marked X:

- |   |   |   |
|---|---|---|
| <b>AUTOMOTIVE</b>   | <input type="checkbox"/> Carpenter Foreman          | <input type="checkbox"/> Plumbing         |
| <input type="checkbox"/> Automobile Mechanic                  | <input type="checkbox"/> Heating                    | <input type="checkbox"/> Steam Fitting    |
| <input type="checkbox"/> Auto-Elec. Technician                | <input type="checkbox"/> Air Conditioning           |   |
| <input type="checkbox"/> Auto Body Rebuilding and Refinishing | <input type="checkbox"/> Structural Engineering     |   |
| <input type="checkbox"/> Diesel—Gas Engines                   | <input type="checkbox"/> Surveying & Mapping        |   |
| <b>AVIATION</b>   | <b>DRAFTING</b>                                     |   |
| <input type="checkbox"/> Aeronautical Engineering Jr.         | <input type="checkbox"/> Aircraft Drafting          |   |
| <input type="checkbox"/> Aircraft Engine Mechanic             | <input type="checkbox"/> Architectural Drafting     |   |
| <b>BUSINESS</b>   | <input type="checkbox"/> Electrical Drafting        |   |
| <input type="checkbox"/> Business Administration              | <input type="checkbox"/> Mechanical Drafting        |   |
| <input type="checkbox"/> Certified Public Accountant          | <input type="checkbox"/> Structural Drafting        |   |
| <input type="checkbox"/> Commercial Art                       | <input type="checkbox"/> Sheet Metal Drafting       |   |
| <input type="checkbox"/> Accounting                           | <input type="checkbox"/> HIGH SCHOOL                |   |
| <input type="checkbox"/> Stenography & Typing                 | <b>MECHANICAL AND SHOP</b>                          |   |
| <input type="checkbox"/> Advertising                          | <input type="checkbox"/> Mechanical Engineering     |   |
| <input type="checkbox"/> Managing Small Business              | <input type="checkbox"/> Industrial Engineering     |   |
| <input type="checkbox"/> Show Card & Sign Lettering           | <input type="checkbox"/> Industrial Supervision     |   |
| <input type="checkbox"/> Salesmanship                         | <input type="checkbox"/> Foremanship                |   |
| <b>CHEMISTRY</b>  | <input type="checkbox"/> Machine Shop Practice      |   |
| <input type="checkbox"/> Chemical Engineering                 | <input type="checkbox"/> Tool Design                |   |
| <input type="checkbox"/> Chemistry                            | <input type="checkbox"/> Industrial Instrumentation |   |
| <input type="checkbox"/> Petroleum—Natural Gas                | <input type="checkbox"/> Reading Blueprints         |   |
| <input type="checkbox"/> Pulp and Paper Making                | <input type="checkbox"/> Toolmaking                 | <input type="checkbox"/> Sheet Metal Work |
| <input type="checkbox"/> Plastics                             | <input type="checkbox"/> Refrigeration              |   |
| <b>CIVIL ENGINEERING AND CONSTRUCTION</b>                     | <b>RADIO-TELEVISION</b>                             |   |
| <input type="checkbox"/> Architecture                         | <input type="checkbox"/> General Radio              |   |
| <input type="checkbox"/> Building Contractor                  | <input type="checkbox"/> Electronics                | <input type="checkbox"/> Television       |
| <input type="checkbox"/> Civil Engineering                    | <input type="checkbox"/> Telephone Work             |   |
| <input type="checkbox"/> Estimating                           | <input type="checkbox"/> RAILROAD                   |   |
|   | <input type="checkbox"/> TEXTILES                   |   |

Name \_\_\_\_\_ Age \_\_\_\_\_

Home address \_\_\_\_\_

City \_\_\_\_\_ State \_\_\_\_\_

Special tuition rates to members of the Armed Forces. Canadian residents send coupon to International Correspondence Schools Canadian, Ltd., Montreal, Canada.



**EASY TO PLAY** WILL NOT CRACK

Amazing new Pan-American wood clarinet in beautiful "violin finish," guaranteed *not to crack!* No other clarinet like it. Musically and mechanically superior. See it and other fine Pan-Americans at dealers everywhere, or write for free literature. Mention instrument. Address Dept. 1003.

Write FOR FREE FOLDER on instrument of your choice



**ACCOUNTANTS!** Earn \$5000 yearly part time. Sell and operate new C.P.A. Bookkeeping System.  
**BOOKKEEPERS!** Sell sensational plan to all small businesses. A "door opener" for income tax clients. Free sales and service manual with sample. Write — free details.  
**SALESMEN!** C. KERN, 4942 VINELAND, NO. HOLLYWOOD, CALIF.

Is Your Life Crowned With Success?



**LEXIPOWER**

**WE THINK IN WORDS. THOUGHT IS POWER.** Let this New Science show you how to WIN WITH WORDS — financially, socially, culturally. Develop a MASTERFUL VOCABULARY. Influence others, improve your personality, manifest your latent ability. You are judged and rated by every sentence you utter. Start using the POWER of LEXIPOWER after the first Lesson. Write NOW for FREE details about LEXIPOWER. Dime-a-Day LESSON CLUB.

LEXIPOWER LESSON CLUB  
517-M W. Deming Place Chicago 14, Illinois

**LEARN CARTOONING** Get in the BIG MONEY

Former Landon students are really cleaning up. Creators of "Steve Canyon", "Freckles", "Out Our Way", "Winnie Winkle", "Regular Fellers", "The Neighbors", "Strange as it Seems" are just a few of them. Simplified Landon Picture Chart method makes progress quick, exciting, easy. Earn while learning. Rush 10c for Picture Chart (to test your ability) and full details. Please state age.



Landon School of Cartooning, 5210 CTS Bldg., Cleveland, O.



**NEW!** Not just another glue—  
**BONDING AGENT R-313** is the successor to glue and solder. Permanently bonds metal to metal, glass to metal, plastic, leather, etc. Used by radiomen, hobbyists, etc. Also industries to cut prod costs. Prove it! GET KIT. Send \$1 today!

**CARL H. BIGGS CO.** 11616 W. Pico Blvd., Dept. 1  
W. Los Angeles 25, California



**HOT WATER**  
From ANY COLD WATER FAUCET!

**INSTANTLY—Yes, you can now have continuously running HOT water with the JET INSTANT HOT WATER HEATER, in kitchen, summer cottage, camp, office, factory or farm. Regulates from LUKEWARM to REAL HOT with a turn of the tap. A cinch to attach . . . No tools needed. 110 Volt AC DC. Durably constructed of gleaming chromed steel and porcelain. 8 foot U.L. Cord.**

**10 DAY MONEY BACK GUARANTEE!**  
Send only \$1.00 deposit, balance C.O.D. plus postage. Send \$4.98 and we pay postage. THE JET must give you satisfactory service!  
**IMPERIAL SALES CO.**  
480 Lexington Ave., Dept. H-1009, New York 17, N.Y.

Now IN YOUR OWN HOME Learn

# TELEVISION RADIO

*the Amazingly Effective*  
**D.T.I. WAY**

**—with the aid of BOTH  
HOME EQUIPMENT  
and HOME MOVIES**

**NO PREVIOUS EXPERIENCE NEEDED**  
**NOW...get  
EVERYTHING  
YOU NEED**  
for real Laboratory-  
Type training  
**AT HOME**

Above:  
Work over  
**300**  
fascinating  
experiments  
with this  
equipment

What will mailing the coupon below *do for YOU?* Just this! You'll find out about one of today's most remarkable... practical ways to prepare to get into America's amazing billion dollar opportunity field of TELEVISION-RADIO-ELECTRONICS. You'll see how to get into fascinating work that pays well... that offers one of America's most promising futures... that enables you to start your own business almost "on a shoe string," if you prefer this to a job opportunity.

And above all, you'll get some GOOD NEWS especially welcomed by men anxious to earn REAL MONEY in this thrilling field. For you'll see that NOW you can get the kind of practical, laboratory-type training so desirable for making real progress in Television-Radio-Electronics... and WITHOUT LEAVING HOME.

You'll see that DeForest's Training, Inc. sends everything needed to set up your own HOME LABORATORY. You get and keep the same type of basic electronic equipment used in our modern Chicago Training Laboratories. You get home training that includes the knowledge and experience gained from training thousands of students first hand in Chicago. And to top it all, you use DTI's amazingly effective and exclusive home training aid—INSTRUCTIVE MOVIES. But why not get the complete story? Mail coupon today for information-packed literature.

**MODERN LABORATORIES**

If you prefer, get all your preparation in our new Chicago Training Laboratories—one of the finest of its kind. Ample instructors, modern equipment. Write for details!

**MILITARY SERVICE!**

If you're subject to military service, the information we have for you should prove very helpful. Mail coupon today.

1. Build over 300 fascinating experiments from 16 BIG SHIPMENTS of Electronic-Radio parts which you KEEP.
2. Build valuable commercial-type test equipment—as shown to the left—which you KEEP. This includes a quality OSCILLOSCOPE—a must for Television work.
3. Use a 16 mm. movie projector and new series of Hollywood produced instructive movies—a wonderful aid to help you grasp important fundamentals faster...easier...better.
4. Enjoy well-illustrated, easy-to-read lessons with handy FOLD-OUT diagrams.
5. Get an honest-to-goodness EMPLOYMENT SERVICE to help you get a good job after graduating—or assistance in starting your OWN SALES AND SERVICE BUSINESS. Mail coupon today for the complete details.

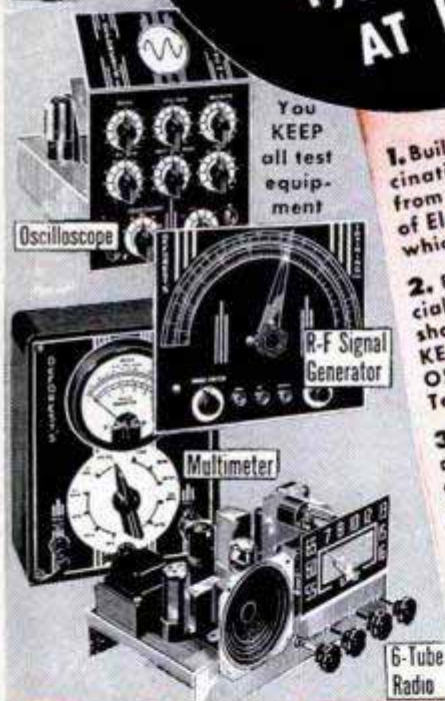
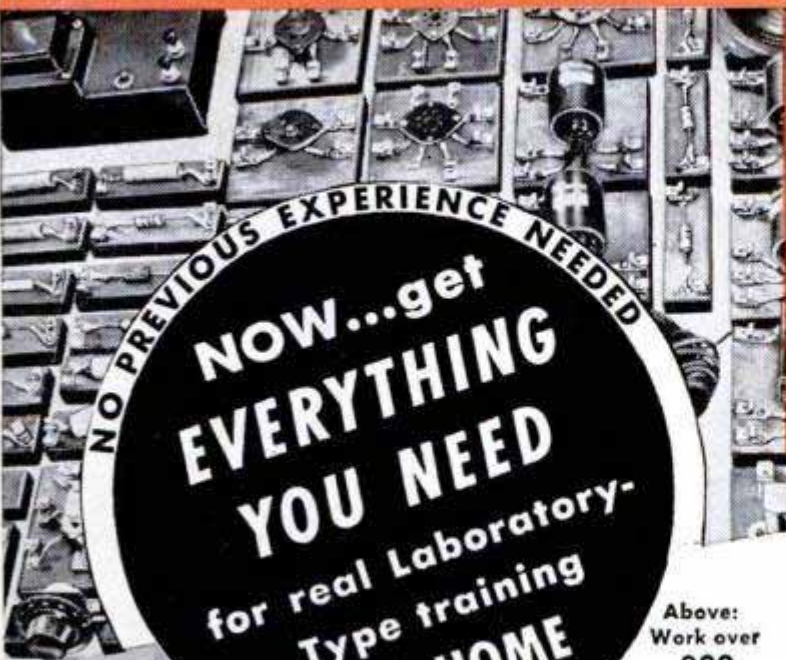

Get BOTH of these colorful,  
information-packed folders  
**FREE**



*Mail Coupon  
Today*

DeFOREST'S TRAINING, INC., Dept. PM-10-1  
2533 N. Ashland Avenue, Chicago 14, Ill.

I would like valuable, information-packed folders showing how I may get started toward a good job or my own business in Television-Radio-Electronics.

Name \_\_\_\_\_ Age \_\_\_\_\_  
Street \_\_\_\_\_ Apt. \_\_\_\_\_  
City \_\_\_\_\_ Zone \_\_\_\_\_ State \_\_\_\_\_

**DeFOREST'S TRAINING, INC.**  
AFFILIATED WITH  
**De Vry Technical Institute**  
CHICAGO 14, ILLINOIS



SEND  
NO MONEY  
•  
MORE THAN  
4000 PAGES  
•  
2750  
PICTURES

**9 BIG COMPLETE BOOKS  
BUILDING, ESTIMATING, CONTRACTING**

Examine this Up-to-Date Edition for 10 days. See how these nine books supply easily understood training that will help you to get a better job and make more money, or start a profitable business for yourself. Think what a BIG help it will be to have them handy for use in solving all sorts of building problems.

Learn to draw plans, estimate, do all-new construction and modern remodeling to meet fast growing demand. More than 4000 pages of practical, pay-raising information with 2750 helpful illustrations, on such subjects as blueprint reading, concrete forms, masonry, carpentry, steel square, electrical wiring, plumbing, heating, painting, and hundreds more.

In our more than 50 years we have never offered more complete building information. Send the coupon TODAY.

(A year's consulting privileges with our engineers now given with these books without extra cost.)

**AMERICAN TECHNICAL SOCIETY—Publishers Since 1898**  
Dept. G719, Drexel Ave., at 58th St., Chicago 37, Ill.

I would like to examine your 9-Volume Set of Building, Estimating, Contracting Books. I will pay the delivery charges only, but if I choose I may return them express collect. If after 10 days' use I prefer to keep them, I will send you \$3 plus postage and pay the balance at the rate of only \$4 a month until \$34.80 has been paid. Include consulting service as offered above.

Name \_\_\_\_\_

Address \_\_\_\_\_

City \_\_\_\_\_ State \_\_\_\_\_

Please attach letter giving employer's name and address (if self-employed give business man reference). Men in service please give home address.

**STOP THAT  
OIL EATER!**



GET NEW CAR PERFORMANCE WITH  
**PISTON SEAL**  
WITHOUT COSTLY OVERHAULING

Piston Seal—the amazing compound that forms a self expanding, pliable lubricating seal around pistons that compensates for wear. Eliminates oil burning, restores power and compression. Can be applied in a few minutes.

GOOD FOR 10,000 MILES



SIMPLY REMOVE  
SPARK PLUG AND SQUEEZE

FOR COMPLETE, FREE  
DETAILS WRITE TO

**RICHE DISTRIBUTING CO.** 11916 Madison Ave.,  
Dept. K, Cleveland 7, Ohio



**INSURED TIRE SERVICE  
POPULAR BRANDS**

**FREE** INSURANCE POLICY given with each used tire sold. We guarantee the amount of service you pay for.

Tube Given Free with Each Used Passenger Tire Upon Request

**SPECIAL!** Discount 10% on orders for two or more used tires

**YOU CAN'T LOSE!!**

Super Quality — Rugged Performance — 15 Months Insured Service			
600x16	\$4.55	670x15	\$5.25
650x15	4.95	670x16	5.35
650x16	5.95	700x15	5.40
		700x16	5.95
		760x15	6.45
		820x15	6.45
		850x17	4.75

Supreme Quality. Nothing Finer — 30 Months Insured Service			
450x20	5.95	450x21	6.25
600x16	5.65	650x15	5.75
650x16	5.85	670x15	5.95
700x16	7.75	700x15	5.75
750x16	12.50	710x15	6.50
550x17	5.75	760x15	6.95
525x18	8.45	820x15	7.50
640x15	5.75	475x19	5.75
		700x15(8)	10.45
		600x20	10.95
		650x20	11.75
		700x20	12.50
		32x6(8)	11.95
		32x6(10)	12.75
		750x20	14.50
		825x20	21.50
		750x16(8)	15.95
		900x20	19.95
		1000x20	20.45
		1100x20	26.75
		1000x22	19.50
		1100x22	24.75
		1200x20	23.50
		1100x24	22.75



GOODYEAR SUPER CUSHION			
600x16	9.95	670x15	10.95
640x15	10.45	670x16	10.75
650x15	10.95	700x15	12.95
650x16	10.95	700x16	13.95
		710x15	12.95
		760x15	13.95
		780x15	13.95
		820x15	14.95
		590x15	9.95

Factory Rebuilt. Guaranteed and Insured for 18 Months

**MIDLAND  
TIRE SALES**

1141 W. Randolph St., Dept. PM-2, Chicago 7, Ill.  
Speedy shipments on Mail Orders. Insurance Policy sent with each order. Deduct 10% on orders for 2 or more used tires. Send CHECK or MONEY ORDER with this ad.

**MANAGEMENT  
PRODUCTION**

Production experts earn big money. Thousands of firms need them. We train you thoroughly at home in spare time for management positions. Previous experience unnecessary. Personal training under supervision of production management authorities. Placement counsel and help. Write for FREE book "Industrial Management."

**LASALLE Extension University, 417 So. Dearborn St.**  
A Correspondence Institution, Dept. 1064 IM, Chicago 5, Ill.

**LEARN WATCH REPAIRING**



**AT HOME.** By our modern and original system of instruction you can learn every part of the **WATCH REPAIRING TRADE AT HOME.** Prepare yourself for a well-paying position or start in business after completing our course of instruction. Good watch repairers are in demand and generally earn very good salaries. For particulars apply to the

**WISCONSIN SCHOOL OF WATCH REPAIRING**  
759 N. Milwaukee, Dept. 10, Milwaukee 2, Wis.

**RADIO**

Engineering. All phases radio & electronics theory & practice; television; FM; broadcasting; servicing; aviation, marine & police radio. Prepare for high pay: 18-month course equal in radio content to 4 yrs. college. Enter Jan., March, June, Sept. Regular campus life. Write for catalog.  
**VALPARAISO TECHNICAL INSTITUTE, Dept. D, Valparaiso, Ind.**



**Bar Bells**

Buy Direct From Factory **\$895** up

Write for free booklet and price list

**INDEPENDENT IRON WORKS**  
2416 East 23rd Street, Dept. B  
Los Angeles 58, Calif.

**SAVE UP TO 50% AND MORE**

**OUT OF PAWN**

**GENUINE DIAMONDS**

VALUES FROM \$10 TO \$10,000

TIME PAYMENTS ARRANGED

SEND FOR **FREE CATALOG**

All diamonds reset in brand new modern mountings. Sold with a written iron-clad money back guarantee. Over 100,000 satisfied customers have bought diamonds from Berman's.  
Our reference—your own bank or any mercantile agency.

**Berman's Diamond Loan Bank**  
Dept. P —BERMAN BLDG., BALTIMORE 1, MD.

Diamonds from estates, banks, unredemmed pledges offered at substantial savings



# Now Any AUTO REPAIR JOB Can Be a "Push-Over" for You!

**Free**  
7-DAY OFFER!

**MOTOR'S  
AUTO  
REPAIR  
MANUAL**

**IN LESS TIME—WITH LESS  
WORK—AND MORE PROFITS!**

**N**OW, tackle anything from carburetor to rear end on ANY car built from 1935 thru 1952. And fix it quick, easy, right the **FIRST** time! Just look up make, model, and job in quick index of MOTOR's **brand-new** AUTO REPAIR MANUAL. Clear, illustrated instructions lead you step by step all the way. Covers all automatic and semi-automatic transmissions including the new Dual-Range Hydromatic, the new Power Steering.

**ONLY Manual of Its Kind!**

The engineer-editors of MOTOR Magazine condensed all the meat of over 170 official factory manuals for you. They dug out all the information you need—made sure every word and picture is crystal clear—and put the whole "works" into this one big 780-page book.

Contains 225,000 service, repair, tune-up facts. 38,000 essential dimensions! More than 2400 cut-away photographs, diagrams, charts show what the clear text tells.

Used by  
U. S. Army  
and Navy

**COVERS 851 MODELS—  
ALL THESE MAKES**

Buick	Henry J
Cadillac	Hudson
Chevrolet	Kaiser
Chrysler	Lafayette
Crosley	La Salle
De Soto	Lincoln
Dodge	Mercury
Ford	Nash
Frazer	Nash Rambler
	Oldsmobile
	Packard
	Plymouth
	Pontiac
	Studebaker
	Terraplane
	Willlys

**Win Prestige! Earn More Money!**

MOTOR's Manual makes every operation so easy that you'll find yourself tackling jobs you wouldn't think of doing before. And you'll win added prestige and more money in the bargain.

Beginners will find usable helpful guidance on every kind of repair and service job imaginable. Experts will be amazed by the time and labor-saving short cuts.

This GIANT Manual is used by Army, Navy, Technical Schools, and thousands of successful auto-repairmen. Now YOU can try it FREE for 7 days. Learn first-hand how it can pay for itself the first few times you use it!

**SEND NO MONEY**

Mail coupon below — *without money!* When your book arrives — *make it show you what it's got!* Unless you agree it's the greatest time and work saver you've ever seen—return book in 7 days and pay nothing. Mail coupon NOW! MOTOR Book Department, Desk 1M, 250 West 55th St., New York 19, N. Y.

**Same FREE Offer on  
MOTOR's New TRUCK  
& TRACTOR MANUAL**

A "must" for mechanics, truck specialists, service stations, fleet owners. Covers EVERY job on 3058 truck and 157 farm tractor models made from 1936 thru 1951! Over 2267 pictures, 925 pages, 300,000 facts. Used by Armed Forces.

All types of Gasoline Engines, Fuel Systems, Governors, Lubrication Systems, Starters, Generators, Clutches, Transmissions, Axles, Brakes, Steering, etc. For FREE 7-DAY TRIAL check box in coupon.



**Just 2 of the Many  
Letters of Praise**



"MOTOR's Manual paid for itself on the first 2 jobs, and saved me valuable time by eliminating guesswork." — W. SCHROP, Ohio



"Instructions so clear have no trouble learning anything about any car. Now working as mechanic in big plant." — SAM ORDONEZ, California

Published by MOTOR, The Leading Automotive Business Magazine.

**MAIL COUPON NOW FOR 7-DAY FREE TRIAL**

**MOTOR BOOK DEPT.  
Desk 1M, 250 West 55th St., N. Y. 19, N. Y.**

Rush to me at once (check box opposite book you want):  
 MOTOR's New AUTO REPAIR MANUAL. If O.K., I will remit \$1 in 7 days (plus 35c delivery charges), \$2 monthly for 2 months and a final payment of 95c one month after that. Otherwise I will return the book postpaid in 7 days. (Foreign price, \$8 cash with order.)  
 MOTOR's New TRUCK & TRACTOR REPAIR MANUAL. (Described at left.) If O.K., I will remit \$2 in 7 days, and \$2 monthly for 3 months, plus 35c delivery charges with final payment. Otherwise I will return book postpaid in 7 days. (Foreign price, remit \$10 cash with order.)

Print Name ..... Age .....  
Address .....  
City ..... State .....  
 Check box and save 35c delivery charge by enclosing WITH coupon entire payment of \$5.95 for Auto Repair Manual (or \$8 for Truck & Tractor Repair Manual). Same 7-day return-refund privilege applies.

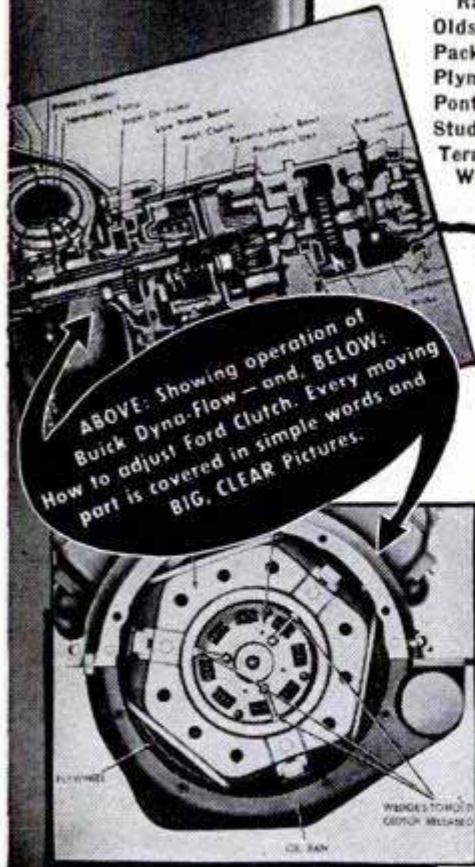

ABOVE: Showing operation of Buick Dyna-Flow — and, BELOW: How to adjust Ford Clutch. Every moving part is covered in simple words and BIG, CLEAR Pictures.



# Learn **ELECTRIC** APPLIANCE REPAIR IN YOUR Spare Time at Home



## START YOUR OWN BUSINESS

WITH A POTENTIAL MARKET OF 50,000,000 CUSTOMERS  
New shop-method, home training system gives you electrical know-how that used to take years to learn. Learn at home by building valuable testing kits, repairing your own and neighbor's appliances. It is not unusual for appliance repairmen to charge on the basis of \$5.00-\$8.00 an hour.

FREE ILLUSTRATED BOOK Shows you how you learn every phase of electrical appliance. How to make money while you learn. Write today for your FREE copy.

**CHRISTY TRADES SCHOOL, Dept. D-1103**  
4432 North Kedzie Ave. Chicago 25

## Learn this Profitable Profession



**IN 90 DAYS  
AT HOME**

## Money-Making Career Open to Men and Women, 18 to 60

Hundreds of men and women between 18 and 60 make \$10 to \$20 in a single day giving scientific Swedish Massage and Hydro-Therapy treatments. There is big demand from doctors, hospitals, sanatoriums and clubs. Graduates earn large full time income from these or in private practice in their own offices. Others make good money from home treatments given in spare time. Learn this interesting money-making profession in your own home, through our home study course. Same instructors as in our nationally known resident school. You can win independence and prepare for future security by qualifying for your Graduation Certificate. Course can be completed in 3 to 4 months. Many earn while they learn. Begin your training at once.



## NEW 32-PAGE BOOKLET FREE

Fill in the coupon below (please print name and address) and mail it for your FREE copy of 32-page Information Booklet. If you act at once we will include Anatomy Charts and Success Booklet which supply additional information you should have. All will be sent postage paid.

**THE COLLEGE OF SWEDISH MASSAGE**  
Dept. 264M, 41 E. Pearson St., Chicago 11, Illinois

Please send me FREE and postpaid New 32-Page Illustrated Booklet, Anatomy Charts and Success Booklet at once.

Name \_\_\_\_\_ Age \_\_\_\_\_

Address \_\_\_\_\_

City \_\_\_\_\_ State \_\_\_\_\_



## OWN a Business

**\$5 HOURLY Profit . . . .  
Even if NOW Employed**

Alert dealers can average \$5 hourly gross profit on services they render and \$3 on EACH of their servicemen at National Price Guide charges. You can profitably operate part time while building a full time business with servicemen.

### Clean & Mothproof, Rugs & Upholstery

**Duraclean** cleans by absorption! No scrubbing, soaking or shrinkage. Dirt and grease vanish as if by magic . . . matted pile rises . . . colors revive. Furnishings ready for use the same day.  
**Duraproof** protects against moths and carpet-beetles. Makes materials resistant to both. Backed by an International Money-Back 4-Year Warranty.

No experience needed. Easy to learn. Quickly established. Nationally Advertised Services rendered "in the home." No Shop Needed. We furnish enough materials to return your TOTAL investment. Territories limited. Write today for FREE booklet explaining details and Easy Terms. . . . Don't delay!

**DURACLEAN CO., 2-160 Duraclean Bldg., Deerfield, Ill.**

## Learn **ACCOUNTING** Business Administration

Bookkeeping, secretarial and allied subjects at home in your spare time or attend nationally approved resident school. Write for FREE Success Book giving complete information about courses, plans, rates and employment opportunities.

**Hills BUSINESS UNIVERSITY AND  
EXTENSION SCHOOL**  
619 W. MAIN ST. OKLAHOMA CITY 2, OKLAHOMA

## REAL ESTATE BE A BROKER

**PAYS BIG! SEND FOR FREE, BIG, ILLUSTRATED CATALOG NOW!** Graduates report making substantial incomes. Start and run your own business quickly. Men, women of all ages, learn easily. Course covers Sales, Property Management, Appraising, Loans, Mortgages, and related subjects. **STUDY AT HOME** or in classrooms in leading cities. Diploma awarded. Write TODAY for free book! No obligation.  
**WEAVER SCHOOL OF REAL ESTATE (Est. 1936)**  
Suite 300 Law Bldg. Dept. PM Kansas City, Mo.



## EASY TO LEARN CODE

Learn to increase speed with an Instructograph—the Radio-Telegraph Code Teacher that takes the place of an operator-instructor and enables anyone to master code without further assistance. Available tapes from beginners alphabet to typical messages on all subjects. Speed range 5 to 40 WPM. Always ready—no QRM. Thousands have "acquired the code" with the Instructograph System. Write today for convenient rental and purchase plans.

**INSTRUCTOGRAPH COMPANY**  
4701-V Sheridan Road, Chicago 40, Illinois



## AVOID SEPTIC TANK TROUBLES



Prevent Clogging, Back-ups, Offensive Odors in Septic Tanks, Cesspools, Outdoor Toilets. One Treatment lasts months. Guaranteed. \$1.69 at Hardware and Drug Stores.  
**d-CON CO., Inc., Chicago 11, Ill.**

## A "GOOD HAND" HELPS YOU SUCCEED!

### LEARN TO WRITE WELL

*Your Name*  
beautifully written, plus special pen-point for shaded writing.  
Only 10¢

Handwriting quickly improves with our easy-to-understand picture lessons! Put your spare time to good use; send today for  FREE BOOKLET, "How to Become a Good Penman," or check volumes wanted below at \$3. each:  Business Writing  Artistic Writing  Card Writing  Bird & Design Flourishing  Engraving Alphabets. COMPLETE SET \$4.50. Ask for price list of penman's supplies.

**TAMBLYN SCHOOL OF PENMANSHIP**  
S.A. Ziller, Pres., 442 Ridge Bldg., Kansas City, Mo., USA

## Learn **PHOTOGRAPHY** at Home

Splendid opportunities. Prepare in spare time. Practical basic training. Long-established school. Send for free book, "Opportunities in Photography." No obligation.  
**AMERICAN SCHOOL OF PHOTOGRAPHY, 835 Diversoy Pkwy., Dept. 1357, Chicago 14, Ill.**

# AMAZING, NEW LOW PRICED ELECTRIC JIG SAW

Make Hundreds of Useful, Practical and Artistic Things  
Like These at Home  
for FUN and PROFIT!

Anyone Can Use This New,  
Safe Powerful Tool!



Plug-In On  
Any 110-125  
Volt Circuit

EARN \$3 - \$4 - \$5 AN HOUR IN YOUR SPARE TIME!



Cuts Wood Up to 1/2 Inch; Metals, Plastics, Plywood,  
Veneers. So SIMPLE and SAFE a Child Can Use It!

HERE'S THE NEATEST, fastest, cleanest cutting Electric Jig Saw ever offered at anywhere near this new low price! A complete man-size power tool—NOT a vibrator. This fine Burgess model runs on a powerful, high-speed, built-in ROTARY motor! It's really a honey—the kind you've always wanted to own. And now it's yours for about HALF the price usually asked for a machine of similar quality and performance. Perfect for cutting curves or any odd shapes out of plywood, plain wood, plastics, Masonite, wallboard, fibreboard, etc. Makes it easy for anyone to cut even the most intricate patterns accurately.

You'll be amazed and delighted to see how quickly and easily you can make toys, household utility items, artistic gifts, signs, novelties, bird houses, etc. with this wonderful new power tool of a thousand uses. You get 22 full size patterns with your Rotary Motor Jig Saw. And there are countless other useful, decorative things you can make (and sell at a neat profit, if you wish). Magazines and books you can get at any library are loaded with good ideas. Bird houses that cost you about 30c should sell for at least \$2. Dozens of other popular, always-in-demand items bring you same big profits! You may readily earn enough with this one self-contained unit to equip a whole shop with other tools!

### Only Burgess Gives You These 14 BIG FEATURES!

- Rotary Motor with power to spare!
- Cuts hard or soft wood up to 1/2 inch thick
- Saws light metals
- Rugged built-in Rotary Motor (3400 r.p.m.)
- Tough, all-metal construction; built to last!
- Cuts Masonite, plastic, plywood, wallboard, etc.
- Portable. Use anywhere
- A man-size power tool, yet SAFE for youngsters
- Big throat clearance; saws to center of 16 1/2 inch circle
- Motor has self-lubricating bearings, cooling fan
- Roomy saw table measures 8 inches
- Saw base is rubber-cushioned, won't scratch bench
- Operates on any 110-125 volt outlet; comes with 6-foot UL approved cord and plug and handy toggle switch
- Makes straight cuts or any curves and shapes wanted
- Fully GUARANTEED by Burgess, world-famous manufacturer of fine precision power tools!

### SEND NO MONEY

You need send no money with handy coupon at right. Tear it out, fill it in and mail it today. When your Burgess Rotary Motor Jig Saw is delivered, deposit with postman only \$12.95, plus postage and handling charges.

Then use your Jig Saw for ten days, entirely ON APPROVAL. Try making some beautiful, useful things with it. See how neatly it cuts, how easy it is to use. Then, if you are not more than pleased in every way, simply send it back and your \$12.95 will be refunded in FULL, promptly! But our supply of these fine Burgess Jig Saws is limited—so act quickly to be sure of getting yours on this generous approval offer. Mail the coupon NOW.

IMPERIAL SALES Dept. S-740  
480 Lexington Ave.,  
New York 17, N.Y.

COMPLETE  
WITH A  
POWERFUL BUILT-IN  
ROTARY MOTOR  
EXTRA SAW BLADES  
AND

22 FULL SIZE  
PATTERNS  
\$12.95

LOOK!  
YOU CAN  
TRY IT FOR TEN DAYS  
ENTIRELY ON APPROVAL!

IMPERIAL SALES Dept. S-740  
480 LEXINGTON AVE., NEW YORK 17, N.Y.

YES! I want to try the new Burgess Rotary Motor Jig Saw for 10 days, entirely ON APPROVAL. On arrival, I will deposit \$12.95 plus postage and handling charges with postman. It is understood that if not delighted I may return Jig Saw within 10 days for prompt and full refund of my \$12.95.

Name .....

Address .....

City ..... Zone ..... State .....

SAVE APPROXIMATELY \$1.00 IN POSTAGE! Check here if you ENCLOSE \$12.95 plus 50c handling charge (\$13.45), in which case we pay shipping charges. Same refund GUARANTEE, of course!

**CORTINA**  
makes it FUN to



# SPEAK FRENCH-SPANISH

**RUSSIAN - GERMAN  
ITALIAN - BRAZILIAN - JAPANESE**

"Learn by Listening" to CORTINA RECORDS, at home, the NATURAL way — quickly, easily, cheaply.

**Only 15 Minutes a Day!**

The CORTINA method, famous for 70 years, teaches you to speak like a native. THOUSANDS have found it the most fascinating, most effective way to learn languages for Pleasure, Business, Travel, Culture. INVESTIGATE!

**Send For FREE BOOK!**

Illustrated 32-page book, "The Cortinaphone Short-Cut" sent FREE. No obligation. Tells just what you want to know. Interesting. Get It!

**ALL NEW RECORDINGS ON UNBREAKABLE RECORDS**

**WRITE TODAY**

**CORTINA ACADEMY (Est. 1882)**

Suite 6410, 105 W. 40 St., N. Y. 18, N. Y.

Please send me — without obligation — your free book. I am interested in (check)

French  Spanish  German  Italian  Brazilian  
 Russian  Japanese

Name.....

Address.....

City..... State.....

**VETS!** Check if NOW eligible under G. I. Bill.

SAY YOU SAW IT IN POPULAR MECHANICS

**Amazing New Auto "Trouble-Shooter"**

**Spots ANY Car Troubles—  
In a Jiffy!**

**MOTOR's Handy, Pocket-Size Manual Enables You To  
"Find What's Wrong" Quickly and Easily!**

NO more guessing or groping for causes of car ailments! Now you can put your finger on every possible cause of car trouble — by turning to indexed check-list in MOTOR's amazing new "TROUBLE-SHOOTER"!

For example if car has **Fan Belt Noise**, just turn to that section and you find SEVEN specific things that can cause it. In the same way, no matter what is wrong, this handy manual checks through 2000 possible causes in a jiffy! Covers engines, clutches, brakes, ignition, axles, battery, starting motor, springs, shock absorbers, steering wheels, tires, transmissions, etc. Section on automatic transmissions alone is worth the price of book. Saves time, work, headaches. A "must" for beginner or veteran mechanic. Handy spiral binding; stays open while you work.

**SEND NO MONEY — MAIL COUPON**

Pay postman \$1 on delivery, plus C.O.D. charges. If not satisfied, return book in 7 days for refund. Or SAVE C.O.D. charges by sending only \$1 NOW. Same return privilege.

**MOTOR Book Dept., Box EH,  
250 West 55th St., New York 19, N. Y.**

Rush me on approval, MOTOR's TROUBLE-SHOOTER. I will pay postman \$1 plus 43 cents postage and actual Gov't. C.O.D. charges. Unless satisfied, I may return book in 7 days for refund.

Name.....

Address.....

City..... Zone..... State.....

**SAVE MONEY!**—Check box and save 43c shipping charges by enclosing \$1 WITH coupon. Same refund privilege.



SEND FOR BIG **FREE CATALOG**



**GENUINE DIAMONDS**

**SAVE 50% and more!**

Genuine diamonds from N.Y.'s leading pawnbroker at fabulous savings Re-set in brand new, distinctive settings. Every diamond graded and bonded. 10 DAY MONEY BACK GUARANTEE. Our references:—your own bank or any Mercantile Agency. SEND FOR FREE CATALOG

**KASKEL'S**  
(Est. 1882)

Kaskel Bldg., 9 Columbus Ave.  
New York 23, N. Y. Dept. K7

**SHORTHAND in  
6 Weeks at Home**

Famous Speedwriting system. 120 wpm. No symbols; no machines; uses ABC's. Easy to learn; easy to write and transcribe. Low cost. 150,000 taught by mail. For business and Civil Service. Also typing. 30th year. Write for FREE booklet to:

**Speedwriting**  
Dept. 1510-2, 55 W. 42 St., New York 36 (R)



**MAKE BIG MONEY  
REPAIRING SEWING MACHINES**

**Earn \$300 in Spare Time**

Cash in on boom in home sewing. Make \$300 a month or more, in spare time, without experience, by repairing and modernizing old sewing machines. New 60-page book tells how to set up your own part time business. Includes repairing, selling, advertising, financing, rental set-up, etc. All the facts you need to know to get started. Send today for "Sewing Machines... a Profitable Business." Only \$1.00. Money-back guarantee.

**BREWER SEWING SUPPLIES COMPANY**  
Dept. 53, 305 West Adams Street Chicago

**STUDY TO BE A DOCTOR  
of Psychology or Metaphysics**

Obtain a Ps.D., Ms.D., D.D., or Ph.D. degree. Be a Teacher, Lecturer or Accredited Practitioner. Teach others how to achieve Health, Happiness and Contentment. Chartered by State. Write for FREE book telling how.

**THE NEOTARIAN COLLEGE OF PHILOSOPHY**  
Desk 8, Pickwick Building Kansas City 6, Missouri



**GROW MINIATURE TREES**

Grow authentic, LIVE dwarf trees!  
Fascinating hobby! Fabulous profit!

**SEND FOR FREE SEED & INSTRUCTIONS!**

**MINIATURE NURSERY CLUB**  
Dept. 7, P. O. Box 18696, Rimpau Sta.  
Los Angeles 19, California

**LOANS**  
by Mail  
**\$50 TO \$500**

Cash for any purpose — tools, workshop needs, consolidate bills. Wherever you live you can borrow by mail. No co-signers. No one will know of inquiry. Easy monthly payments to fit your income. Write for money-request application. Give name, address, age, occupation.

**AMERICAN LOAN PLAN**

(Under Nebraska State Banking Supervision)  
Dept. PM-10, City Nat'l. Bank Bldg., Omaha, Nebr.

**TURN RIGHT**

# Get on the Road to a Better Job-Brighter Future with RIGHT Training —then You Can Really GO!

**AMERICAN SCHOOL, Dept. G745, Drexel at 58th, Chicago 37, Ill.**

Without obligation, please send FREE and postpaid, full particulars about the subject checked below.

- |  |   |   |
|--|---|---|
| <input type="checkbox"/> Accounting              | <input type="checkbox"/> Drafting—Building Trades | <input type="checkbox"/> Plastics Engineering |
| <input type="checkbox"/> Air Conditioning        | <input type="checkbox"/> Drafting—Machine Trades  | <input type="checkbox"/> Plumbing—Practical   |
| <input type="checkbox"/> Architecture & Building | <input type="checkbox"/> Electrical Engineering   | <input type="checkbox"/> Private Secretary    |
| <input type="checkbox"/> Automotive Technician   | <input type="checkbox"/> Electricity—Practical    | <input type="checkbox"/> Refrigeration        |
| <input type="checkbox"/> Better Foremanship      | <input type="checkbox"/> Electronics—Industrial   | <input type="checkbox"/> Retail Merchandising |
| <input type="checkbox"/> Bookkeeping             | <input type="checkbox"/> High School Courses      | <input type="checkbox"/> Salesmanship—Outside |
| <input type="checkbox"/> Business Management     | <input type="checkbox"/> Machine Shop Operations  | <input type="checkbox"/> Sheet Metal Work     |
| <input type="checkbox"/> Contracting             | <input type="checkbox"/> Mathematics & Slide Rule | <input type="checkbox"/> Tool Making          |
| <input type="checkbox"/> Diesel Technician       | <input type="checkbox"/> Mechanical Engineering   |   |

NAME ..... OCCUPATION .....  
HOME ADDRESS ..... AGE .....  
CITY ..... STATE .....

**START NOW by checking, filling in and mailing this coupon.  
You'll get full information — No cost, No obligation!**

• *Today*, make the **BIG** decision of your life. Choose the career you want and take the first easy step toward your goal. Learn how you can get the training that can put you in the bigger pay class and give you security in the years ahead. Find out how, in spare time at home, you can qualify for work you prefer, and higher pay. Or if you are already in the work you like, find out how you can win quicker promotion and a larger income.

### **Backed by 55 Years of Training Know-How**

Since 1897 American School has helped many thousands of ambitious people toward success by providing specialized training for

commercial and technical advancement. Its study program for *you* has been prepared by experts in the subject you select and the school will give you guidance every step of the way. In time you might otherwise waste and at a cost you can afford you can prepare at home and really GO on the *right* road.

### **Don't Delay YOUR Start**

Give serious thought to the list of training courses listed above. Pick the opportunity that interests you, check it and add your name and address. (Check more than one if you are undecided which appeals most.) Then clip and mail the coupon. Full information will be supplied without cost or obligation.

**PRACTICAL, EFFECTIVE HOME STUDY TRAINING SINCE 1897**

**AMERICAN SCHOOL, Dept. G745, Drexel at 58th, Chicago 37, Ill.**

**THE SOONER YOU START, THE SOONER YOUR GOAL CAN BE REACHED**

REX FERRUS, Jowett Trophy Winner, who mailed me 10c and a coupon like the one below YOU mail now!



**HEY SKINNY—**  
How would YOU  
Like to GAIN  
**56 POUNDS OF**  
**MIGHTY MUSCLE**  
LIKE I DID!  
Through Jowett Training

I Added 7" TO MY CHEST  
WHY DON'T YOU  
I Put 4" of STEEL LIKE  
MUSCLE ON EACH ARM  
I've Broken All Records  
Beaten All Contenders for  
STRENGTH FEATS—WHY DON'T YOU?  
says REX FERRUS—  
Undefeated, Unchallenged Champion

**"ASHAMED OF BEING SKINNY?"**  
Here's How to Do Something About It  
"Like Rex Ferrus Did!" Says George F. Jowett,  
Known as World's Greatest Builder of HE-MEN  
Maybe you don't want to win cups, medals,  
championship belts like Rex Ferrus has. But  
just think of how wonderful it would be to  
KNOW YOU CAN BE SUCH A CHAMPION—to  
stop being skinny, puny, jeered at and bul-  
lied. Picture yourself with Rex Ferrus' phys-  
ique, muscles and HE-MAN power.

YES Sir — I can tell you from my OWN  
EXPERIENCE and the experience of thou-  
sands of my pupils that you CAN DO SOMETHING  
ABOUT IT, FAST AND EASY!  
NO! I don't care how skinny or flabby you  
are; if you're teen-ager, in your 20's or 30's  
or over; if you're short or tall, or what work  
you do. All I want is JUST 10 EXCITING MIN-  
UTES in your home to MAKE YOU OVER.

PROVE IT TO YOURSELF—It took me years  
to devise my BEST by TEST 5-Way Progress-  
ive Power Method.  
Send only 10c for my 5  
easy-to-follow, picture  
—packed courses now in  
1 complete volume "How  
to Become a Mighty  
He-Man." Try it for one  
night. Experi-  
ence the thrill-  
ing strength  
that surges  
through your  
muscles.

George F.  
Jowett  
'Champion  
of Champions'

**YOU CAN WIN**  
This 15" Silver Trophy  
as Rex Ferrus Did  
"I own EVERYTHING to the  
GREAT JOWETT METHOD," says  
Rex, "I advise every weakling  
who wants to become a success-  
ful He-Man or athlete to enroll  
with Jowett NOW!"



"You Sure Kept Your  
Promise to Power-  
Pack My Body" writes  
Ed L. Manfredi, Reno.



"I Gained 24 lbs. of  
Steel-Strong Muscle  
Thanks to Jowett's  
Wonder Course" says  
Rizalino Villanueva,  
Astoria, Oregon.

THIS MAY BE  
YOUR LAST  
CHANCE  
TO GET ALL 5  
PICTURE  
PACKED COURSES  
MILLIONS HAVE  
BEEN SOLD FOR  
\$1 AND MORE

FOR  
10¢

How to Build  
MIGHTY  
ARMS

How to Build  
A MIGHTY  
CHEST

How to Build  
A MIGHTY  
BACK

How to Build  
MIGHTY  
LEGS

How to Build  
A MIGHTY  
GRIP

**FREE**

PHOTO BOOK  
NOW  
to Achieve  
Nerves of Steel,  
Muscles of Iron

How to BECOME A  
MIGHTY HE-MAN

How to Build  
MIGHTY  
LEGS

How to Build  
A MIGHTY  
GRIP

**BOTH FREE FOR QUICK ACTION!**  
1. Photo Book of STRONG MEN 2. MUSCLE METER

**Jowett Courses**  
greatest in  
World for  
Building  
All-Around  
HE-MEN!  
—R. F. Kelley  
Physical  
Director

**JOWETT INSTITUTE OF PHYSICAL TRAINING Dept. PM-210**  
220 FIFTH AVENUE, NEW YORK 1, N. Y.

Dear George: Please mail to me FREE Jowett's Photo Book of  
Strong Men and a Muscle Meter, plus all 5 HE-MAN Building  
Courses: 1. How to Build a Mighty Chest, 2. How to Build a  
Mighty Arm, 3. How to Build a Mighty Grip, 4. How to Build  
a Mighty Back, 5. How to Build Mighty Legs—Now all in One  
Volume "How to become a Mighty HE-MAN." ENCLOSED FIND 10c  
FOR POSTAGE AND HANDLING (no C.O.D.'s).

NAME.....AGE.....  
ADDRESS.....  
CITY.....ZONE.....STATE.....

MAKE EXTRA MONEY **PLASTICS** LEARN AT HOME

LEARN HOW TO MAKE fast-selling PLASTIC NOVELTIES FURNITURE JEWELRY SIGNS TOYS LAMPS WRITE TODAY!

There are RICH OPPORTUNITIES for MEN and WOMEN with "know-how" in Plastics. Interstate's new Plastics course tells and shows how to make hundreds of fast selling items out of Plastics. Gives complete training in fabrication, casting, lamination, molding, internal carving, etc., in simple, easy, step-by-step language and pictures. Plastics and Fabricating Kits for 23 valuable Plastic items come with training at no extra cost. START A PLASTICS BUSINESS OF YOUR OWN. No other industry holds such promise for the future. You can make big money manufacturing novelties, toys, signs, etc., in your own home in spare or full time. Don't wait! Learn NOW how Interstate's Plastics Training qualifies you for success in the Plastics field.

PLASTICS AND SUPPLIES FURNISHED FOR 23 VALUABLE PROJECTS

**INTERSTATE TRAINING SERVICE**  
Dept. C3K Portland 13, Oregon

**"How to Make Money with Simple Cartoons"**

A book everyone who likes to draw should have. It is free; no obligation. Simply address **FREE BOOK**

**CARTOONISTS' EXCHANGE**  
Dept. 910A Pleasant Hill, Ohio

**FOAM RUBBER CUT SHAPES**

4 Chair Pads—16"x16"x1"—Only \$4.95 postpaid.  
Any shape or size for upholstered furniture, window seats, garden furniture. Mattresses and mattress pads, pillows, auto seat toppers, car cushions, etc. Lowest factory prices.

Send for FREE ILLUSTRATED CATALOG

**RIOR RUBBER CO., Dept. 201 50 E. Cermak Rd. Chicago 16, Ill.**

*Hand Guide!*

POSITIVELY controls movement of hand until one's Penmanship is quickly corrected. Inexpensive. Write, OZMENT (INVENTOR), 34-P, ST. LOUIS, MO. (BX665)

**ENGINEERING DEGREE IN 27 MONTHS**

**INDIANA TECHNICAL COLLEGE**

B. S. DEGREE, Aeronautical, Chemical, Civil, Electrical, Mechanical and Radio Engineering (inc. TV and Electronics). Drafting, 1-yr. G.I. Gov't approved. Low rate. Earn board. Large industrial center. Students from 48 states, 21 countries. Demand for graduates. Enter December, March, June, September. Write for catalog, 16102 E. Washington Boulevard, Fort Wayne 2, Indiana.

**Make BIG MONEY!**  
**RAISE CHINCHILLA RABBITS!**  
Cash Markets Supplied for Your Production  
**FREE - Illustrated Booklet - WRITE TODAY!**  
**ROCK HILL RANCH, SELLERSVILLE 36, PA.**  
World's Largest Breeder of Chinchilla Rabbits

**PLAY GUITAR IN 7 DAYS OR GET MONEY BACK**

Let Ed Sale, top Radio Guitarist, teach you to play a song the very first day, and any song by ear or note in 7 days! His famous book contains 52 photos, 87 chord charts, etc. Shows how to tune, keep time, build chords, bass runs, dance chords, swing, etc., plus 110 Popular Songs, words and music. Surprise friends, relatives. Popularity and fun galore. **SEND NO MONEY!** Just name and address to Ed Sale and pay postman \$1.98 plus C.O.D. postage (or send \$2 with order and I pay postage. Same guarantee). **ED SALE, Studio 1901, POINT PLEASANT, N. J.**



TRAIN **FASTER**—TRAIN **BETTER**—TRAIN **EASIER**  
 IN 10 MONTHS—OR LESS—FOR  
**RADIO-TELEVISION**

Our 21st Year Training Men for Greater Incomes and Security in Radio-Television

I SEND YOU  
**18 BIG KITS**

of Radio Television parts and equipment. Much of your training will be actual construction and experimentation . . . the kind of truly PRACTICAL instruction that prepares you for your Radio-Television career.



Frank L. Sprayberry  
 President  
 Sprayberry Academy  
 of Radio

**NEW! NO OBLIGATION PLAN**

You Have No Monthly Payment Contract to Sign  
 Pay For Your Training as You Earn and Learn

You can get into Radio-Television, today's fastest growing big money opportunity field, in *months* instead of years! My completely new "package unit" training plan prepares you in as little as 10 months or even less! *No monthly payment contract to sign—thus NO RISK to you!* This is America's finest, most complete, practical training—gets you ready to handle any practical job in the booming Radio-Television industry. Start your own profitable Radio-Television shop . . . or accept a good paying job. I have trained hundreds of successful Radio-Television technicians during the past 21 years—and stand ready to train you, even if you have no previous experience! Mail coupon and get all the facts—FREE!



**Valuable Equipment Included With Training**

The new Sprayberry "package" plan includes many big kits of genuine, professional Radio-Television equipment. You perform over 300 demonstrations, experiments and construction projects. You build a powerful 6-tube 2-band radio set, multi-range test meter, signal generator, signal tracer, many other projects. All equipment and lessons are yours to keep . . . you have practically everything you need to set up your own profitable Radio-Television service shop.

**Earn Extra Money While You Learn!**

All your 10 months of training is IN YOUR HOME in spare hours. Keep on with your present job and income while learning. With each training "package" unit, you receive extra plans and "Business Builder" ideas for spare time Radio-Television jobs. New television stations everywhere, open vast new opportunities for trained Radio-Television Technicians—and those in training. If you expect to be in the armed forces later, there is no better preparation than practical Sprayberry Radio-Television training.

**YOU BUILD** the Television set and the powerful superhet radio receiver shown above IN ADDITION to the other test units shown here. (Many are not illustrated.)

Approved for Veterans under the G. I. Bill

**SPRAYBERRY ACADEMY OF RADIO** 111 NORTH CANAL ST.  
 Dept. 10-0, Chicago 6, Ill.

**MAIL COUPON  
 TODAY!  
 NO OBLIGATION**

I invite you to get all the facts —  
**FREE TO YOU 3 BIG  
 RADIO-TELEVISION BOOKS**

Rush coupon for my three big Radio-Television books: "How to Make Money in Radio-Television," PLUS my new illustrated Television Bulletin PLUS an actual sample Sprayberry Lesson —ALL FREE. No obligation and no salesman will call. Mail coupon NOW!

**SPRAYBERRY ACADEMY OF RADIO, Dept. 100**

111 North Canal St., Chicago 6, Ill.

Please rush to me all information on your 10-MONTH Radio-Television Training Plan. I understand this does not obligate me and that no salesman will call upon me. Be sure to include 3 books FREE.

Name..... Age.....

Address.....

City..... Zone..... State.....



LET ME PROVE

# I Can Make YOU a New Man!



I'VE done it for thousands of other fellows, Let me prove I can add solid inches of handsome, ripping muscles to YOUR arms, legs, shoulders, back . . . make you an outstanding specimen of strength and self-confidence. My secret of "Dynamic Tension" does it in just 15 minutes a day. You'll be amazed at the results and so will your friends.

Charles Atlas—winner of title "World's Most Perfectly Developed Man"

FREE — My 32-Page Illustrated Book Is Yours — Not for \$1 or 10c — But FREE

32 pages packed with valuable advice, actual photographs of fellows who became new men almost overnight . . . with "Dynamic Tension." Book can mean turning point of your life. It's yours—ABSOLUTELY FREE! Send for it TODAY. Address me personally: CHARLES ATLAS, Dept. 8X, 115 East 23rd St., N. Y.



5 INCHES OF NEW MUSCLE

"My arms increased 1 1/2"; chest 2 1/2"; forearm 7/8"

C. S., W. Va. "Have put 3 1/2" on chest (normal) and 2 1/2" (expanded)." F. S., N. Y.

CHARLES ATLAS, Dept. 8X, 115 East 23rd St., New York 10, N. Y.

Send me—absolutely FREE—your famous book, "Everlasting Health and Strength"—32 pages, crammed with photos, answers to vital questions, valuable advice. I understand book is mine to keep, and sending for it does not obligate me in any way.

Name \_\_\_\_\_ Age \_\_\_\_\_  
 Address \_\_\_\_\_  
 City \_\_\_\_\_ State \_\_\_\_\_

## RIDE ELECTRICITY to SUCCESS!



The whole world moves electrically today. Electrical Engineers command important jobs and big pay. If you have an interest in electricity and a high school education you can go places in this great field.

Study at home. I. C. S. Electrical Courses have helped thousands of men to success. You study in your own spare time at home. No interference with your job. Lessons are clear, direct, understandable. Bedrock facts and theory plus practical application. Don't put it off. Send the coupon today and find out, without cost or obligation, what I. C. S. offers you! We'll also send free book "How to Succeed."

INTERNATIONAL CORRESPONDENCE SCHOOLS  
 Box H-5542-L, Scranton 9, Pa.

Please send me free book "How to Succeed" and information on the course I have checked below.

- Electrical Engineering       Electrical Maintenance  
 Electrician                       Electrical Drafting  
 Electric Power & Light

Name \_\_\_\_\_ Age \_\_\_\_\_  
 Home address \_\_\_\_\_  
 City \_\_\_\_\_ State \_\_\_\_\_

Special discount to members of the Armed Forces. Canadian residents send coupon to International Correspondence Schools Canadian, Ltd., Montreal, Canada.

## BUILD IT yourself!

... FOR AS LITTLE AS 42.50 — FULL PRICE!

• Enjoy building your own boat. It's EASY . . . it's FUN, you save half or more! Col-Kit "home-assembly" boat parts are factory pre-cut. Anyone can build a Col-Kit Boat, without special tools. Send for Brochures on complete line. LAMINATED FIBER GLASS . . . all weather boat protection . . . optional with all Col-Kit Boat units. Also available for any boat.



CALIFORNIA KIT BOAT CO.

742 So. Hill St. • Dept. 103 • Los Angeles 14, Calif.

## GET INTO BUSINESS for Yourself!

### METALIZING BABY SHOES

AT HOME IN SPARE TIME  
 Make your home your headquarters. Start now, full or part time. Famous Warner Success Plan backed by old established company tells everything — Facts cost nothing, now or ever. Time is precious. Big money waiting for serious minded men, women. SEND NAME ON A PENNY POSTCARD! I want you to read Complete WARNER Success Plan entirely at my risk. Read the facts—then decide. Rush name today. Write to Ray E. Brandell. WARNER ELECTRIC CO., 1512 Jarvis Ave. DEPT. M-3-5 Chicago 26, Illinois



FREE!  
 Offer of COMPLETE MONEY MAKING PLAN  
 Send No Money



### For Your Class or Club

Pins, rings and emblems. Over 300 designs. Finest quality. Reasonable prices. Pins, 35¢ up. Send 5¢ today for catalog. Dept. K, Metal Arts Co., Rochester, N.Y.

## BARGAINS IN BOOKS

Save money on latest best-sellers of all publishers. Also old-time favorites. New 57th annual catalog lists 25,000 books on Fiction, Reference, Juvenile, History, Religion, Science, Child Guidance, etc. Send post card today for FREE copy of 1952 catalog, "Bargains in Books."

FREE 128-page CATALOG

THE BOOK SUPPLY COMPANY, Dept. 22  
 564-566 West Monroe St., Chicago 6, Ill.

## EASY TO ASSEMBLE BOAT KITS 30 MODELS

### NEW 18 FT. OUTBOARD CABIN CRUISER

Other models 8 to 23 Ft. Rowboats, Outboards, Inboards



NEW CATALOG Only 35c, SEND COIN TODAY  
 U-MAK-IT PRODUCTS 703P-WHITTIER ST. Bronx 59, N. Y. City

## HOW TO FIX AUTO WIRING!



Let MOTOR'S Brand-New Guide Make It EASY to Do ANY Wiring Repair —on ANY Car Built from 1941 THROUGH 1952!

HERE'S the illustrated help you need to do ANY wiring repair or replacement on ANY car—quickly, easily, right! Just follow official factory wiring diagrams. Know WHERE to look. HOW to "breeze" through wiring repairs on Chassis; Convertible Tops; Direction Signals; Dome Lamp Circuits; Hydraulic Transmissions; Overdrives; Window Regulators; and much more. New guide saves time, work, headaches. 200 BIG 8 1/2" x 11" diagram-packed pages. Covers 525 models!

SEND NO MONEY. Try book at our risk. Just mail your name and address to: MOTOR Book Dept., Box W110, 250 West 55th St., New York 19, N.Y. Pay postman only \$3.75 plus C.O.D. charges. Use 7 days. Your money back if not delighted. (Or SAVE C.O.D. charges by sending \$3.75 now. Same Money Back Guarantee.)



# I Average \$20-\$25 Profit An Hour—Over \$100 a Day!



M. R. Stanley

## "For Easy and Profitable Selling PRESTO Can't Be Beat"

"Presto is the easiest selling and most profitable item I have ever sold or seen. My selling time actually shows me a profit of \$20.00 to \$25.00 per hour and I have yet to put in a 6-hour day without showing a profit of over \$100.00."

—M. R. Stanley, Montana

## Made \$175 in First 5 Days

"My first week my profit was \$175.00 for the 5 days. I have hit as high as \$44.00 profit in one day. Every sale is a thrill. I am certainly pleased and happy as it is the most and easiest money I ever made in my life."



C. S. Melious

—Cordian S. Melious, New York

## AVERAGES \$15.20 an Hour

"The 'natural' of this decade is the PRESTO FIRE EXTINGUISHER . . . because it is handy in size, simple to operate, and in the right price range. For every hour I have devoted to PRESTO I have earned an average of \$15.20 an hour."

—William F. Wydallis, Ohio



W. Wydallis



S. Hyman

## Made Over \$1000 a Month—Calls Sales "Automatic"

"PRESTO is the fastest money-maker ever produced. If a man demonstrates intelligently, sales follow automatically. I have made an excellent living with the PRESTO, having made over \$1000 a month."

—Stanley Hyman, New York

## Sells 18 PRESTOS in 15 Minutes

"You should have named your extinguisher 'Miracle.' Friday morning I brought one to the office where I work and in 15 minutes I had orders for 18 extinguishers. (Profit: \$37.78.) By Friday evening the balance of 2 dozen were sold and orders taken for a dozen more. I made a net profit of \$75.56 the first day."

—Richard E. Meade, Ohio



R. E. Meade

## "At Least \$20 a Day"

"I am selling a greater service at a lower cost than has ever been possible before. Every demonstration is a thrill and keeps me interested so that selling does not become monotonous. I really make \$20, at least, every day that I work."

—H. J. Kerr, Pennsylvania



H. J. Kerr

## Sells Average of 100 PRESTOS a Week—Part Time

"PRESTO is in a class by itself, small but mighty easy to handle, good on any kind of fire. My biggest week—two gross. My average sales on part-time basis—100 a week. Real salesmen putting in 8 hours a day can make a real week's pay selling PRESTO fire extinguishers."

—R. H. Taber, New Hampshire



R. H. Taber

## Over \$10 Profit an Hour—In Spare Time

"Unfortunately, I am unable to devote my full time to this remarkable line. To date I have put in 5 1/2 hours of work—at a profit to me of over \$10 an hour!"

—Hugh Sadler, New Jersey



H. Sadler

## No Sales Experience—Made Over \$1000 a Month!

Charles Kama of Texas had NO sales experience until he took up PRESTO. He did so well that he was featured as "Salesman of the Month" in a national sales magazine. In an interview he said: "I think I've succeeded pretty well. I'm making more than \$1000.00 a month—and I haven't touched bottom yet."



C. Kama

## WHO ELSE WANTS TO MAKE

# A WEEK'S PAY IN A SINGLE DAY!

## Men From Coast to Coast Are Making Money "Hand Over Fist" Showing Science's New "Midget Miracle" Presto Fire Extinguisher OVER A MILLION ALREADY SOLD!

WOULDN'T YOU like to be making the kind of money these men are making? Their stories (printed above) are examples of the brilliant success that Presto salesmen are enjoying. If so many men—some of them without previous sales experience—are doing so well, it proves that Presto is a "natural"—a red-hot product that ACTUALLY SELLS ON SIGHT!

### What Is the Secret?

Presto contains an amazing new chemical—"Chlorobromomethane" or "C.B." The Germans developed "C.B." as a secret defense against fire during the war. After the war, a famous American firm, The Dow Chemical Company, acquired the formula from the U. S. Government and began manufacturing it here. Then we (Merlite Industries) designed a handy—yet amazingly effective—fire extinguisher to contain and release this new wonder-chemical.

### So Easy to Handle!

In comparing the effectiveness of "C.B." in fighting various kinds of fires an authoritative testing laboratory's report states: "It has been proved that 'C.B.' is about 1.5 to 6 times as effective as other common extinguishing agents on an equal weight basis."



PRESTO contains "C. B." (Chlorobromomethane), the same chemical the U. S. Air Force specifies for fire-fighting in B-29s and other U. S. aircraft. No wonder Presto puts out fires in as little as 2 seconds and is called Science's "Midget Miracle."

This extra effectiveness of "C.B." means that Presto can be made light and handy enough for even a woman or child to use. Just a twist of the knob . . . and flames disappear! "Sells on sight" to Civil Defense workers, owners of homes, cars, stores, farms, service sta-

tions, boats, motorcycles, factories, offices . . . and to stores for re-sale.

### Why Large Presto Profits Are So Easy

Everyone is terrified at the very thought of FIRE! Every year fire kills more than 11,000 people—destroys over SEVEN HUNDRED MILLION DOLLARS in property. Millions of people have been waiting for this sure, simple, inexpensive safeguard.

Most people who see Presto in action want one or more—ESPECIALLY WHEN THE PRICE IS ONLY \$3.98 EACH! We give you dramatically powerful printed sales material to "talk from" . . . free certificates testifying that Presto is GUARANTEED FOR 20 YEARS!

Advertised in Life and Other National Magazines

YOU DON'T NEED TO INVEST A CENT! Just collect and keep \$1 or more every time you write an order—we collect balance and make delivery. (Or you can buy from us at extra-low wholesale prices and make up to \$2.18 per unit—we'll send you details.)

### Get Started Now . . . MAIL COUPON

Get started in this rich new field now. Don't put it off. Every day you hesitate may cost you \$10, \$15, or even \$50 you could otherwise be making. Mail coupon NOW for everything you need to get started right away!

MERLITE INDUSTRIES, Inc. Dept. 510, 201 E. 16th St. New York 3, N. Y.



Science's New "Midget Miracle" Over A Million Already Sold!

Folks Are Amazed When You Tell Them This New Kind of Protection Costs Only \$3.98

MERLITE INDUSTRIES, Inc., Dept. 510, 201 East 16th Street, New York 3, N. Y.

Please send me illustrated sales literature, liberal profit plan, order blanks—everything I need to get started making good money introducing the Presto Fire Extinguisher in my locality.

CHECK HERE IF YOU WISH TO ORDER A REGULAR PRESTO TO USE AS A DEMONSTRATOR (\$2.50). Pays for itself many times over in increased sales. Can be returned as often as you like for FREE re-fill. You needn't enclose any money now—we'll send Demonstrator C.O.D. (Or if you wish to save money, enclose \$2.50 and we'll pay postage.)

Name . . . . .

Address . . . . .

City . . . . . Zone No. . . . . State . . . . . (if any)

IN CANADA: Mopa Co., Ltd., 371 Dowd St. Montreal 1, P. Q.

# EARN MORE IN DRAFTING



More Opportunities for Employment and Promotion

"Here I am at work making good money as a draftsman. I'm glad I sent the coupon to Chicago Tech for that Free Trial Lesson and found out how easy it is to learn Drafting in spare time at home. Today I feel secure in my job because the draftsman's work comes first on any new project. And, in addition, drafts-men can't be replaced with machines. What's more, I feel I'm slated for promotion and more pay, because I see so many draftsmen advancing to high-pay jobs."

## LEARN IN SPARE TIME - AT HOME!

(or at the College in Chicago)

A few hours of pleasant home study every week—that's all. No interference with your present job. All the tools you need; drawing outfit included. With Chicago Tech's help, you train yourself step by step. This tested method—developed over 48 years of C.T.C. progress—prepares men quickly for good positions in industry.



### FREE INFORMATION—SEND COUPON

To prove to you how easy it is to learn Drafting at home by the Chicago Tech method, we will send you this FREE TRIAL LESSON. No charge for this lesson, now or later. Fill out and mail coupon, or send post card today.

## CHICAGO TECHNICAL COLLEGE

N-250 Tech Bldg., 2000 So. Michigan Ave., Chicago 16, Illinois

Mail me FREE Lesson with information about big opportunities in DRAFTING.

Name \_\_\_\_\_ Age \_\_\_\_\_

Address \_\_\_\_\_

City \_\_\_\_\_ Zone \_\_\_\_\_ State \_\_\_\_\_

## ENGINEERING DEGREE IN 27 MONTHS

### Big Demand for Graduates

Aeronautical, Chemical, Civil, Electrical, Mechanical and Radio Engineering (inc. TV and Electronics)

Hundreds of young men are earning B. S. ENGINEERING DEGREES annually in this recognized institution — year around operation. New terms start quarterly. Many students earn a major part of their college expenses in this large industrial center.

Low tuition. Competent instruction. Thorough, intense, practical program. Modern, well-equipped laboratories including new physics laboratory and modern wind tunnel. Individualized instruction emphasized.

Government approved for G.I.'s. Engineering preparatory courses. Students from 48 states and 21 foreign countries. Enter December, March, June, September. Send coupon for free catalog and full information. Enroll now.

SEND COUPON TODAY -

## INDIANA TECHNICAL COLLEGE

5102 E. Washington Boulevard  
Fort Wayne 2, Indiana

Please send me free information on B.S. Engineering Degree in 27 months as checked.

Aeronautical,  Chemical,  Civil,  Electrical,  
 Mechanical,  Radio-Television

Name \_\_\_\_\_

Address \_\_\_\_\_

## HOW HOMER DEVILLE of NEW YORK EARNED \$6,000.00 last year



### Demonstrating STARK BRO'S NEW PLAN FOR Beautifying Homes



Here's your Money-Making magic! Homer Deville of N. Y. made OVER \$6,000.00 LAST YEAR! B.J. Gilson earned over \$236.83 in just 5 days! Many other exceptional earnings records! These men followed the sensational Stark Bro's Money-Making Plan. Call on home owners and others with demonstration of new Home Beautifying, Value Boosting Plan. Every home in America your prospect for large, profitable Stark orders. Added income taking orders for World-Famous Stark Bro's Patented and Trade-Marked Fruit Trees. No experience needed to earn from very first day. Everything, including Giant new Demonstration Sales Outfit



**FREE Giant SALES KIT** send name ... given FREE. Rush name, address now!

**STARK BRO'S • Box 5503**  
Town of Louisiana, Missouri

## PUMP WATER FAST!

DRAIN WASH TUBS, CELLARS, CISTERNS  
IRRIGATE—FILL TANKS—DRAW WELL WATER

Pumps 2800 GPH. 420 GPH at 75' High or 1600 GPH from 25' well. Sturdy, Rustproof Alloy Metal. Six Blade Impeller. Uses any 1/8 to 1/2 H.P. Motor. Will not leak or clog. Fits any garden hose. Immediate Money Back Guarantee. Send Check, M.O., or C.O.D.

**895 IN U.S.**

**MOORE MANUFACTURING CO.**  
SWEDESBORO 1 NEW JERSEY

## "YOU ARE UNDER ARREST!"

Help Bring Crooks to Justice Through Scientific **CRIME DETECTION!**

We have taught thousands this exciting, profitable, pleasant profession. Let us teach you in your own home. Learn Finger Printing, Firearms Identification, Police Photography, Secret Service Methods thoroughly, quickly, at small cost. Over 800 of all American Bureaus of Identification employ I. A. S. students or graduates. We can prepare you for this fascinating work, during spare time. Write today, stating age, for "Blue Book of Crime."

INSTITUTE OF APPLIED SCIENCE, 1920 Sunnyside Ave., Dept. 1357, Chicago 40, Ill.

**FREE 16 PAGE BOOKLET**

**THE TRUTH ABOUT VITAMINS**

Vitamin Care Co., Dept. P,  
505-5 Av., N.Y.C. 17

**ELECTRIC APPLIANCE REPAIRMEN**

GET FREE SAMPLE COPY Write

Find all the sources of supply for parts on all ELECTRIC APPLIANCES... Washing Machines, Vacuum Cleaners, Ranges, Sewing Machines, Small Appliances, etc.

**The Only Publication Especially for the Appliance Repairman**

**ELECTRIC APPLIANCE SERVICE NEWS**  
Dept. M-25 176 W. Adams St. Chicago 3, Ill.

## RUPTURED?

Get Relief This Proven Way

Why try to worry along with trusses that gouge your flesh—press heavily on hips and spine—enlarge opening—fail to hold rupture? You need the Cluthe. No leg-straps or cutting belts. Automatic adjustable pad holds at real opening—follows every body movement with instant increased support in case of strain. Cannot slip whether at work or play. Light. Waterproof. Can be worn in bath. Send for amazing FREE book, "Advice To Ruptured" and details of liberal truthful 60-day trial offer. Also endorsements from grateful users in your neighborhood. Write:

**CLUTHE SONS, Dept. 31, Bloomfield, New Jersey.**

Date Changes  
AUTOMATICALLY  
EVERY DAY



One Year  
GUARANTEE  
with Service  
Certificate

## AMAZING *New* WATCH with MECHANICAL BRAIN

• It "Remembers" • It Tells Time • It Tells Date

MEASURES SPEED • MEASURES DIS-  
TANCE • RECORDS UP TO 12 HOURS  
• OVER 40 QUALITY FEATURES.

Precision Jeweled. Imported  
Swiss Movement. Accurate. De-  
pendable. Push-Button Stop and  
Start. Red Sweep-Second Hand.  
Unbreakable Crystal. Triple Chrome  
Plated Case. Shock Resistant. Nite-  
Vue Radium Glow Dial. Anti-Magnetic.  
Times Shop work. Times Photography.  
Times Sports. Times Races. Times Lab. work.  
Times Planes. Expansion Band Included.

Compare It at \$50.00

**\$8<sup>95</sup>**  
PLUS 90c  
FED. TAX

SEND NO  
MONEY

## New ELECTRONIC WALKIE-TALKIE Communication System

Perfect for room to room, house to  
garage, etc. No batteries, no tubes.  
Complete two way telephone sys-  
tem. Works at amazingly long dis-  
tances. Handy pocket size. Elec-  
tronic voice powered. No license  
or permit needed. Two units com-  
plete with wire, ready to use.

NO  
BATTERIES

NO  
PLUG-IN

**\$3<sup>95</sup>**  
LIMITED  
OFFER



## New HIGH- POWER FIELD GLASSES



ORDER AT OUR RISK.

WITH FAMOUS  
AMERICAN OPTICAL  
3-POWER LENSES

Not for \$10... But Only

**\$2<sup>98</sup>**  
SEND NO  
MONEY!

It's the bargain of a lifetime!  
They're light-weight, durably  
constructed and wonderfully  
clear. Perfect for sports events  
... traveling ... theater, na-  
ture study and dozens of other uses. Styled exactly like  
a famous imported binocular! Perfect clarity is assured  
with the 3-power lens manufactured by the world fa-  
mous AMERICAN OPTICAL COMPANY. Opens to big 7"x  
6" size. Complete with carrying strap at this low price.

## ALL METAL "JIFFY" CABINET

with 24 rustproof, solid  
ALUMINUM DRAWERS

Offers up to 72 compartments!

This handy cabinet has aluminum ham-  
mer finish in silver gray color. Each Jiffy  
cabinet is supplied with removable  
drawer dividers for use inside drawers  
and colored paper index labels for mark-  
ing contents of drawers. Individual metal  
drawer guides keep drawers in free slid-  
ing position. Jiffy cabinets are equipped  
with rubber feet to prevent surface  
marring.

### SPECIFICATIONS

Height ..... 12 inches  
Width .... 12½ inches  
Depth ..... 6 inches  
Max. inner compartments..72

**\$9<sup>95</sup>**

SEND NO MONEY

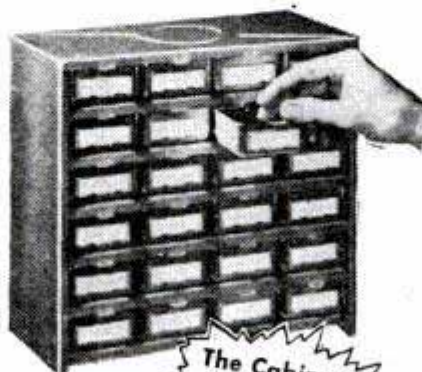

The Cabinet  
of 1001 Uses  
in Home or  
Shop

YOUNG PRODUCTS DEPT. 599 2605 Elmhurst, Detroit 6, Mich.

ORDER BY MAIL

Save UP TO 50%

WITH THESE

SENSATIONAL  
BARGAIN BUYS

Clip and Mail  
This Coupon

NOW For  
10 DAY TRIAL

**FREE**

EVERY ITEM SOLD ON 100% MONEY BACK GUARANTEE

CHECK ITEMS WANTED

- Mechanical Watch \$8.95  
plus 90c Fed. Tax
- Walkie-Talkie \$3.95
- Field Glass \$2.98
- Jiffy cabinet \$9.95

Young Products Dept. 599

2605 Elmhurst, Detroit 6, Mich.

Please rush items checked. If I'm not de-  
lighted, I may return my order within 10  
days for full refund of purchase price.

Send items listed. NAME \_\_\_\_\_  
I will pay postman plus postage.

I want to save post- ADDRESS \_\_\_\_\_  
age. I am enclosing full payment. Same CITY \_\_\_\_\_  
return policy applies. STATE \_\_\_\_\_

# GREER SHOP TRAINING

2230 So. Michigan Blvd.  
Chicago 16, Illinois

## Leader in Practical Training for 50 Years

Gain success by learning a trade offering security and high pay—go into business for yourself.

### Get the "Know-how" at Greer

You learn in our new, large, modern shops by working with latest tools and equipment of the trade — tear down, inspect, repair and rebuild... under supervision of experts. Greer founded 1902. Over 51,000 successful grads. Part time, full time, day and evening. E-Z terms. Mail coupon today.

**CLIP COUPON . . . MAIL TODAY**  
Greer Shop Training—2230 South Michigan  
Chicago 16, Illinois Desk 213

Please send information about trade checked:

- In our Chicago Shops:
- Auto Mechanics
  - Body, fender Repair
  - Diesel Mechanics
  - Welding—Arc, gas
  - Tool & Die
  - Refrigeration & Air-conditioning
  - Machine Shop
  - Piano tuning
  - G.I. appr. for Vets dischgd. after 7-25-47

Or learn at home—extension courses:

- Diesel
- Refrigeration
- Plastics

Name \_\_\_\_\_

Address \_\_\_\_\_

City \_\_\_\_\_

State \_\_\_\_\_ Age \_\_\_\_\_



## PUT YOUR IMAGINATION TO WORK and earn money while you save money

Build metal furniture, ornamental railings, power tool stands and other handy devices for the home... now all at little cost to you.

Unique Lincoln arc welder for the home.

Welds... Cuts... Solders... Brazes...

Torch Heats... Even Charges Batteries

Be a craftsman in metal along with your other hobbies. Now it's easy to do a craftsman-like job in metal as you build useful equipment for the house. The cost is low... only a few pennies for electrodes and current. And, at the same time, be the welder in your neighborhood. Repair fenders and tools. The money you earn... the money you save, helps buy other tools you want.



### "LINCWELDER 60"

Low in Price • Easy to Use

- Comes complete with instructions
- Operates on 115 volt grounded circuit (No. 12 wire fused for 20 amps)
- Approved by Underwriter's Laboratories
- Built by The Lincoln Electric Company, The World's Largest Manufacturer of Arc Welding Equipment.



Fill out and mail to Dept. 196, The Lincoln Electric Company, Cleveland 17, Ohio

- Ship me the "Linwelder 60" with accessories \$48.00. (Including headshield, electrodes, carbons, electrode holder, ground clamp and cable.)  Arc Torch \$6.25 extra.
- Battery Charging Attachment \$10.00 extra.
- Enclosed is  check  money order.
- Send me free bulletin on the new "Linwelder 60"

Name \_\_\_\_\_

Address \_\_\_\_\_

City \_\_\_\_\_ State \_\_\_\_\_ 196

## I need 500 Men To Wear and Show Made-to-Measure SUITS



### Pay No Money—Send No Money

My plan is amazing! Just take a few easy orders for my sensational values in made-to-measure suits—and get your own suits **without a penny cost** and make money too! Men can't resist the outstanding style, long wear and low price of my made-to-measure suits. You need no experience. Spare time pays big profits. Rush name and address today for complete details. **Big Free Sample Outfit** contains 150 actual woolen samples, style illustrations, etc. Write now!

**PIONEER TAILORING CO., Dept. M1116**  
Congress & Throop Sts., Chicago 7, Ill.

## TASOPE PHOTO-ENGRAVING PLANTS



Establish your own profitable **PHOTO-ENGRAVING** business. Make cuts for newspapers, printers, and advertisers. Make etched name plates, plaques etc. Instructions furnished, no experience necessary. Sold direct from factory since 1931. First five hundred cuts sold locally or by mail will pay for plant and pay you well for your time. Write for **FREE** catalog.

Material Cost  
Of This Cut 3/4c  
Selling Price  
\$1.00 And Up

**TASOPE DEPT. PM5, AURORA, MO.**

## STUDY INDUSTRIAL DESIGN

You can train at Art Center School in California with practicing professionals for upper-level jobs in **INDUSTRIAL DESIGN**. Recent graduates have been added to the staff at General Motors, Chrysler, Raymond Loewy, Henry Dreyfuss, etc. Majors in transportation, general product design, structures, community development, furniture design, packaging, display. 4-year degree courses. Learn to combine imaginative design with technical proficiency, coordinate utility and beauty. Stimulating environment. Field trips. Advantages of mild Southern California climate and nearby holiday spots. Coed. Placement service. Write for catalog.

**ART CENTER SCHOOL, Edward M. Adams, Director**  
5353 WEST THIRD STREET, LOS ANGELES 5, CALIFORNIA

## Permanize, Ceramize, Porcelainize METALIZE BABY SHOES WITHOUT AN OVEN

Amazing new Miracle Kit metalizes, permanizes, ceramizes or porcelainizes baby shoes, mittens, booties, cloth, lace, etc. without baking or firing. No equipment or experience needed. Big profits from your home. Send 25c for detailed complete instruction book.

**PROFESSIONAL COLOR-CRAFT, Inc., Dept. 22-PM**  
845 S. Wabash Ave., Chicago 5, Ill.

**PRINT YOUR OWN POSTCARDS** with the GEM Stencil Duplicator. Save Money. Hundreds of uses. **FREE TRIAL** — Write for Gem Outfit, complete with all supplies and Book of Ideas; sent postpaid. After 10 days pay only \$9.50 or return GEM. Unconditional guarantee. **BOND EQUIPMENT CO., Dept. 135, 6633 Enright, St. Louis 5, Mo.**



## OIL FILTER REFILLS... 10c



Here's News! Ordinary toilet paper makes an ideal oil filter. Laboratory tests prove it cleans oil faster and better than popular makes of filter elements. All you need is a simple set of **RETLIF ADAPTER PLATES**... and you can start using ordinary toilet paper rolls in your present oil filter. For proof and descriptive literature, send name and address to:

**RETLIF CORPORATION, Dept. 105**  
1239 No. Highland Ave., Los Angeles 38, Calif.

# SAVE \$\$\$ the Moto-Matic way!

## STOP Auto Thieves!

### Electric Burglar Alarm

Protects car, tires, gas, accessories!

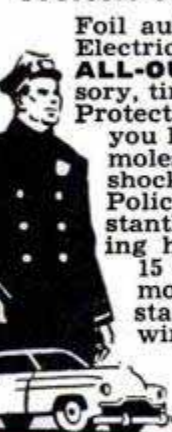

Foil auto thieves! The **NEW** Pend-Electric Burglar Alarm gives you **ALL-OUT** protection against accessory, tire, gasoline and auto thieves. Protects your **ENTIRE** car even if you leave the door open! Anyone molesting your car will get the shock of his life! The "Unseen Policeman" goes into action instantly, getting off loud, screeching horn blasts — continuing for 15 seconds after car is left alone. Even the most daring thief will run for it! Easily installed with a screwdriver. Complete with wiring, instructions, screws, on-off switch. Completely **AUTOMATIC** and ultra-sensitive. A real investment in peace of mind. **No. 34.** Bargain price.....**3.95**



**\$2.95**

### De Luxe Camera GADGET Bag

Have your photographic equipment at your fingertips wherever you go! The De-Luxe Camera Gadget Bag holds and protects camera, film, lenses, bulbs, filters, guides, flashgun, etc. Smart! Heavy duty, 16 gauge luggage tan "Granitol". 2 compartments and 2 zippers. Carrying straps. Size 8 1/2 x 7 x 4".

**No. 9** ..... **2.95**  
**No. 9-C** (Size 10 1/2 x 7 x 3 1/2") ..... **4.95**

Satisfaction Guaranteed or Money back!



Talk! Sing! Joke! over your own radio!

Amaze, mystify, entertain with this Super microphone. Broadcast news, special announcements, songs, jokes, plays right over your own radio. Easy to plug in. Can be used secretly and unseen! Loads of fun & educational too! **No. 89.** Special price, only **2.95**

### 5 Day Trial



Was \$10.00, Reduced to **6.88**

### PORTABLE GARAGE

Our **LOWEST** price ever for genuine **TRANS-KLEER**—the really **HEAVY DUTY** Portable Garage. Goes wherever your car goes... protects your car against the ravages of Winter or Summer; Snow, sleet, rain, insects, salt air, sand, etc. Whisks on or off **QUICK** and **EASY**. Takes little storage space. Folds away like a handkerchief! **SURE-GRIP** Bottom holds it on! Pays for itself. Do not confuse with cheap, re-used plastic models. **TRANS-KLEER** does not disintegrate, crack or melt! **FIRE RETARDANT!** Thousands sold for \$10.00. Now **DRASTICALLY REDUCED!** Mention car make, model, year, for best fit. **No. 140,** Now **6.88**



### Glorify your car!

### LEOPARD Plastic SEAT COVERS

Thousands Sold for **\$2.95**

**1.98**  
2 FOR **3.75**

Now **REDUCED—CHOOSE ANY DESIGN!**

### BARGAIN!

**ALSO: Zebra Scotch Plaid Stripes Colors**



**LEOPARD** Seat Covers... the design made famous by **CADILLAC!** Thousands sold for **2.95**. Now yours at a deep cut price! The

**RIGHTONE** material looks like **LEOPARD FUR**—gives beauty and distinction to your car. Adds new life to old worn interiors. Protects new car upholstery against wear, dust, grime, grease, soiling by rain, kids, pets. **Fire retardant!** Tough, durable, resists cracking. Handsome, tailored appearance. **NO pins! NO tacks! NO sewing.** Ingenious snap-tite feature. Just snap on or off! **LIFELIKE ZEBRA, SCOTCH PLAID, NEON STRIPES, any SOLID color**—All one low cut price—only **1.98** each or **3.75** for a set of **TWO!** Mention design desired, also car make, year, model, for best fit. Order by **No. 150.**



New! **ONLY \$3**  
Made in Germany

### HI-POWER BINOSCOPE WITH CARRYING CASE

Lifetime **BARGAIN!** Super Powerful Ground Lenses. Smooth, center-focusing mechanism. Enjoy for 5 days at **OUR** risk at sports events, hunting, fishing, trips, etc. See distant people without being seen. Compare with Jap or U. S. binoculars to \$7.50. **No. 134.** Our price with case ..... **3.00**  
**DE-LUXE MODEL** (Triple Power) with carrying case and special compass, also available. **No. 134-B.** Compare to \$10 binoculars. Our price.... **3.95**

### Don't Paint! SPRAY it The Easy Burgess Way!



Famous Burgess electric Sprayer paints, lubricates, disinfects, kills insects, reaches every nook and cranny! No more messy brushes and back-breaking toil! Fill jar with paint, lacquer, insecticide, etc. Push button, aim & the job is done quick & easy. Save time, work, paint. Professional looking results — uniform — no brush marks! Ideal for garden sprays, lubricating oils! Paint walls, furniture, ceiling — hard to get at places, also bikes, cars, etc. So clean, so easy! Has built-in **10V AC** motor, 8 ft. cord, adjustable spray. Up to 80 lb. pressure! **No. 187.** Below factory list price **7.89**



**SHAVE UP TO 1 YEAR WITH 1 BLADE!**  
 Even **NEW** blades shave BETTER with "Blademaster" action rotary "disk" included: tested "post."

### SEND NO MONEY—Try without obligation!

**MOTO-MATIC COMPANY, Dept. 6-L**  
 129 West 33rd Street • New York 1, N. Y.  
**RUSH** the following C.O.D. plus postage, on **5 DAY TRIAL**, with **GUARANTEE** of absolute satisfaction or full price back:

NUMBER	ITEM	PRICE

NAME \_\_\_\_\_  
 ADDRESS \_\_\_\_\_

# INVENTORS

Your first step—if you consider your invention to be something of importance—is to have a search made of pertinent, prior U. S. patents. If our search report indicates probable patentability of your invention, you may apply for a patent which gives you the right to exclude others from making, using or selling your invention as claimed for a term of 17 years.

This firm is registered to practice before the U. S. Patent Office and is available to assist in the preparation of the necessary drawings, specification and claims.

Ask for a copy of our instructive booklet "Patent Protection for Inventors" and our convenient "Evidence of Invention" form. No obligation.

**VICTOR J. EVANS & Co.** *Merlin M. Evans*  
REGISTERED PATENT ATTORNEY

730-L MERLIN BUILDING, WASHINGTON 6, D. C.

# INVENTORS

IF YOU WISH TO PROTECT YOUR INVENTION, You should take steps to protect it by a U. S. Patent. Write me for "INVENTION RECORD" form

**CARL MILLER**  
REGISTERED PATENT ATTORNEY

WOOLWORTH BLDG., 35th FLOOR, 102A  
NEW YORK CITY



# PATENTS

## C. A. SNOW & CO.

REGISTERED PATENT ATTORNEYS  
WRITE FOR INFORMATION TO  
428 SNOW BUILDING, WASHINGTON 1, D. C.



# INVENTORS

Before you make any effort to market your invention, you should take the first steps toward proceeding for patent protection.

I shall be pleased to furnish you with information relative to patent procedure, upon request from you, and this will be without any obligation on your part.

**PATRICK D. BEAVERS**  
Registered Patent Attorney

934 Columbian Building Washington 1, D. C.

# INVENTORS

If you have working models, blue prints, or patents, covering "special use" parts or assemblies for Chevrolet, Ford, or Plymouth Cars, it will be to your advantage to get in touch with us. Write us at the factory. Dept. PM



**NATIONAL MACHINE WORKS, INC.**  
P. O. BOX 4305 AUTOMOTIVE PARTS MANUFACTURERS OKLAHOMA CITY 9, OKLA.

# INVENTORS

Send for **REGISTERED PATENT ATTORNEY**  
**PATENT INFORMATION** Book and **PATENT ATTORNEY & ADVISOR**  
**INVENTOR'S RECORD** without obligation U. S. NAVY DEPT. 1930-1947  
**GUSTAVE MILLER** ASSOCIATE EXAMINER  
102-PM WARNER BUILDING U. S. PAT. OFF. 1922-1929  
WASHINGTON 4, D. C. **PATENT LAWYER**

# INVENTORS

Whether an invention is patentable can be substantially determined by a search of the U. S. Patent records. Without obligation, write for information explaining the steps you should take to secure a patent.

**JOHN N. RANDOLPH**  
Registered Patent Attorney

201 Columbian Building, Washington 1, D. C.

**DAN LURIE**  
"America's Most Muscular Man"  
—on television's "Big Top."



**FAMOUS DAN LURIE**

# BARBELLS

with 4 courses—low factory prices  
50 lb. set...\$ 8.48 | 150 lb. set...\$20.48  
100 lb. set... 13.98 | 200 lb. set... 25.98

Write for Free Catalog Order by Mail: 50% with order, bal. C.O.D. Extra wts. 13¢ per lb., F.O.B. plant  
**DAN LURIE BARBELL CO.**  
1701-M10 Pitkin Ave., Dept. 270-K, Brooklyn, N. Y.

# 'How to Make Money with Simple Cartoons'



A book everyone who likes to draw should have. It is free; no obligation. Simply address **FREE BOOK**

**CARTOONISTS' EXCHANGE**  
Dept. 910D Pleasant Hill, Ohio

**GREAT PROFITS**  
MAKE YOUR OWN RUBBER MOLDS

**X.L. RUBBER MOLDS**  
will realize you great profits quickly!  
WRITE FOR NEW FREE CATALOG

YOU can EASILY learn to cast thousands of perfect plaques, book ends, figurines, ash trays, etc. IT'S EASY, FUN, PROFITABLE!  
X.L. Rubber, Pts. \$2.50; Qts. \$4.00 (postage extra). Models and enough for 3 molds \$1.50 prepaid.



SEND FOR FREE FACTS

**PLASTIC ARTS STUDIO** Address Dept. 2  
3403 S. Madison St. Muncie, Ind.

# Learn Modern Appliance and Electrical Servicing

Revolutionary New Method **YOUR SPARE TIME!**  
shows you how—at home—in

We send you complete Home Training Kits and latest Engineered Test Equipment. You can actually earn BIG MONEY WHILE LEARNING! Many men are making \$2.50-\$3.00 and more PER HOUR! RUSH name and address for big FREE book and full details — WRITE TODAY!

**ADVANCE TRADES INSTITUTE** Dept. 201  
5944 NO. NEWARK AVE. CHICAGO 31, ILL.

# Learn BAKING At Home

Baking is one of America's high industries in wages. Nearly depression-proof. Thorough basic home course lays sound foundation. If you have aptitude, write for FREE BOOKLET, "Opportunities in Commercial Baking."  
**NATIONAL BAKING SCHOOL**  
835 Diversey Parkway Dept. 1357 Chicago 14, Ill.



# A GREAT OPPORTUNITY OPEN TO YOU IN THESE IMPORTANT INDUSTRIAL FIELDS

● TOOL ENGINEER

● TOOL & DIE DESIGNER

● MACHINE DESIGNER

● INDUSTRIAL ENGINEER

● INDUS. DRAFTSMAN

● TOOL & DIE MAKER

● MASTER MACHINIST

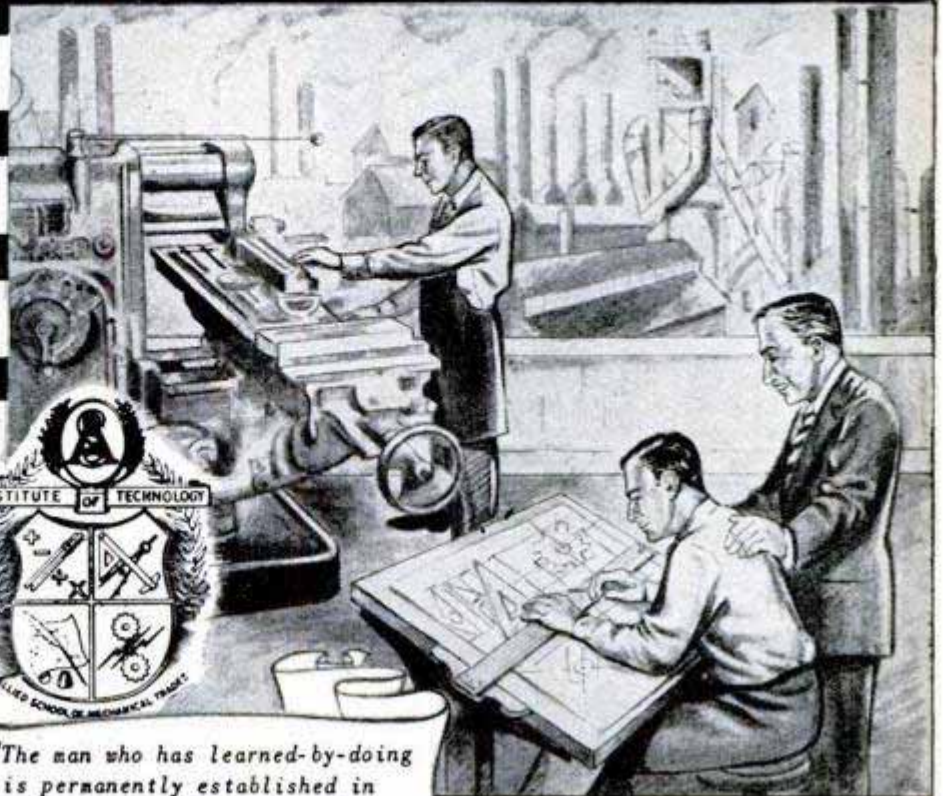

*"The man who has learned-by-doing is permanently established in Industry..."* HARRY LEBESON  
President of the Allied School

**"FROM THE BLUEPRINT TO THE FINISHED PRODUCT"**

**SELECT THE JOB YOU WANT!**

**LEARN TO EARN EASILY & QUICKLY THRU ALLIED'S TESTED TRAINING PLAN**

An unusual opportunity for industrially minded, ambitious men to get into these available key positions that carry with them high pay and security! The enormous expansion of American Industry, particularly of the Metal Trades, brought about an acute shortage of Draftsmen, Designers, Tool Engineers, Machinists, Tool and Die Makers and other allied skilled trades. With ALLIED training you can take your place in these important industrial fields.

Thousands of our successful graduates covering a period of a quarter of a century serve as a testimonial to ALLIED training.

ALLIED is approved by Industry, the American Society of Tool Engineers, Department of Education and Registration, the Department of Public Instruction -- State of Illinois and the Veterans Administration. Accredited by the Central Schools Association.

Free employment service and housing assistance all through your training period and after your graduation. Our industrial contacts cover the U. S. A.

**ALLIED SCHOOL of MECHANICAL TRADES**  
Allied Institute of Technology PM10  
1338-42 S. Michigan Ave. Chicago 5, Ill.

Gentlemen:

I want to get into important Industrial Trades and professions.

Send me without obligation your FREE BOOKS explaining Allied's course of instruction.

I am interested in  Resident Training.

I am interested in  Home Study Training.

I am eligible  I am not eligible  for training under the Revised G.I. Bill.

Name \_\_\_\_\_ Age \_\_\_\_\_

Address \_\_\_\_\_

City \_\_\_\_\_ State \_\_\_\_\_

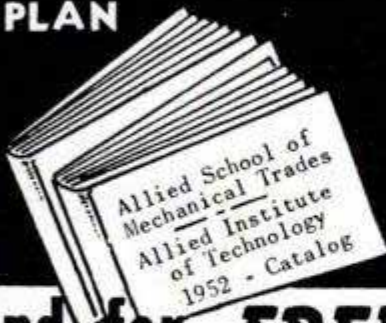

**send for FREE BOOKS**

**ALLIED SCHOOL of Mechanical Trades**  
1338-42 S. Michigan Ave.  
Chicago 5, Illinois



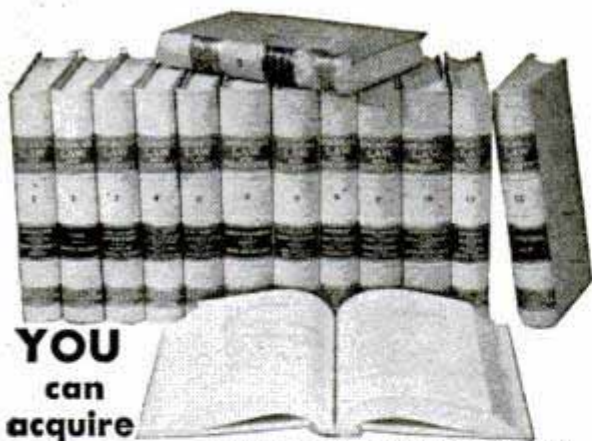

**YOU  
can  
acquire**

**LAW NIGHTS AT HOME!  
L. L. B. DEGREE**

LaSalle's famous Law Library—used as reference in many Law libraries and Law offices—has enabled thousands to master Law surprisingly fast, in spare hours at home, for business and professional advancement.

These 14 remarkable volumes, compiled by leading professors and lawyers, cover the whole basic field of Law in condensed, orderly, simplified manner.

You advance rapidly with this great library, plus special lectures furnished. We guide you step-by-step with personalized Problem Method of instruction . . . you learn by doing—handling legal problems—not by memorizing rules.

Send for two FREE 48-page booklets, "Law Training for Leadership," and "Evidence," answering questions about Law and its value to you, and telling how LaSalle Law graduates are winning rapid advancement in business and public life. Mail coupon below. No obligation.

**LA SALLE EXTENSION UNIVERSITY  
A Correspondence Institution**

417 S. Dearborn St. Dept. 1064L Chicago 5, Ill.

Send me your two FREE booklets described above, without obligation.

Name.....Age.....

Street.....

City, Zone & State.....

**UNLIMITED OPPORTUNITIES IN  
ENGINEERING  
DEGREE  
IN 27 MONTHS**

Study Engineering in this world-famed school, established 1884. Demand for our graduates exceeds supply. Growing shortage of engineers. No field offers greater opportunities for responsible, lucrative positions.

**Bachelor of Science Degree** in Mechanical, Civil, Electrical, Chemical, Aeronautical, Radio (Television) Engineering; Business Administration and Accounting. Also 36-weeks certificate course in Surveying and Drafting.

**Personalized Instruction.** Accelerated courses. Non-essentials eliminated. For ambitious, earnest students. Earn your degree in the shortest possible time. Preparatory courses. Placement service.

**Extensive Campus.** Well equipped, new and modernized buildings; up-to-date labs. Low cost. New terms start quarterly. Enter September, January, March, June.

Write today for free catalog and special information.



**TRI-STATE COLLEGE**

4102 College Ave., ANGOLA, INDIANA

**ELMER'S a Mr. Fix-it!**



It's amazing what this wonderful white glue can do on: furniture, wood, paper, fabric, pottery, leather, linoleum, etc. ELMER'S Glue-All is white magic for strong, invisible gluing. Dries in a jiffy! Wonderful for kids because it washes off hands and clothing instantly. Non-staining—and so easy and pleasant to work with. Get a trial-size bottle of ELMER'S Glue-All today—another Borden's product that belongs in your home.

If it's Borden's, it's GOT to be good



**ELMER'S  
GLUE-ALL**



*Borden's*

**When You LEARN By KCSW's Outstanding Method**

Don't let a lay-off catch you. **START NOW TO LEARN WATCHMAKING AT HOME IN YOUR SPARE TIME.** Earn extra money as you learn, repairing clocks and watches. You will be building your own business right at home.

Write for information on KCSW's HOME STUDY COURSE

**KANSAS CITY SCHOOL OF WATCHMAKING**  
1218 Admiral Blvd. Kansas City 6, Missouri

**COMPLETELY ASSEMBLED  
READY FOR IMMEDIATE USE  
60 POWER TELESCOPE \$3.95**

VARIABLE EYEPIECE 20 x 40 x 60 — BRASS BOUND

**NEW!** Three telescopes in one. 3 different magnifications. 20 power for ultra-bright images with 40 and 60 power for extra long range. Guaranteed to bring distant objects, people, sports events, ships, moon, stars, etc. 60 times as close.



Most powerful for anywhere near the money. 5 Sections. Closes to 1 ft. long. Contains 4 ground and polished lenses. Also used as a powerful compound microscope. Directions included. Mass production enables us to offer this instrument at amazing price of \$3.95. Nothing Else to Buy. We pay postage. Get yours now.

**CRITERION CO., Dept. PMB7, 331 Church St., Hartford 3, Conn.**

**Watch Repairing Pays  
Big Money Learn at home**



Watch repairers in great demand. Train step-by-step in 10 easy lessons. We furnish all tools and 15 jewel watch and practice movement. Turn spare time into cash. A licensed school. Low cost. Send for FREE book today.

**ILLINOIS SCHOOL OF WATCH REPAIRING**  
2870 Elston Ave., Dept. PM102 Chicago 18, Ill.

**PORTABLE GARAGE**

**\$675**



VINYL PLASTIC

USE IT ANYWHERE!

- Goes wherever your car goes • Folds compactly • Keeps rain, snow, dust, salt air, sun or sleet away • Protects your car's finish
- Durably constructed of vinyl plastic that is long wearing and tough
- Nylon threads for extra security • Spring-tite, elasticized bottom, holds securely in all kinds of weather • Fits all makes and models • Direct from manufacturer • Enclose check or money order for \$6.75, or sent C.O.D.

10-Day Money Back Guarantee

**MARDO SALES CORP.**

480 LEXINGTON AVE. DEPT. G-656 NEW YORK 17, N. Y.



# "How to Become a Mail Order Millionaire"



Read the inside facts about hundreds of "little fellows" who are running Mail Order businesses from their homes—many making \$20,000 and more every year! Learn how small investments (\$16.80 in one case!) have mushroomed into profits of thousands. This incredible reprint from *Mechanix Illustrated* will be sent absolutely free, along with details showing how you can quickly master the secrets of getting orders and money in your daily mail, in a business that's all yours. Rush name today. A postcard will do.

**SENT FREE!**

RUSH NAME ON POSTCARD TODAY

**The L. W. SURVEY** 7070 North Clark Street, Dept. 110, Chicago 26, Ill.

## Buy DIAMONDS at Wholesale Prices

Benefit from Loan foreclosures and Estate Liquidations. Values from \$50. to \$10,000.

Write Dept. A

**CITIZEN'S**  
Diamond Brokers

195 Mitchell St.  
Atlanta, Ga.



Save up to 50%

Write for FREE Catalog

Est. 1914

## NEW! CHEAP! OIL BURNER

AMAZING HEAT INVENTION



\$14.75 for Stoves  
\$29.50 for Furnaces

**BIG CASH DISCOUNT. SLIPS INTO ANY COAL STOVE, RANGE OR FURNACE.**

Quick, intense heat by finger-tip control. Cheaper than coal. No more shoveling coal or ashes. **SENT ON TRIAL.** Prove it pays for itself quickly by what it saves. \$1 bonus for testing.

We'll let you try one in your own home for one month. Send no money. Write for details today.

**NORTHWEST MFG. CO., 360-M Main, Mitchell, S. Dak.**

## 30 DAY FREE TRIAL



**High Power BINOCULARS**

Finest Precision Optics  
Featherlight  
Money Back Guarantee  
Easy Pay Plan  
Leather Case Incl'd.

33 MODELS  
\$14.95 up

**BUSHNELL Binoculars**

**Free! Catalog & Book "How to Select Binoculars"**  
Dealer Inquiries Invited  
Bushnell Bldg., Dept. M50  
Pasadena 1, Calif.

FREE GUIDE "How to Select Binoculars"

NAME \_\_\_\_\_ CITY \_\_\_\_\_  
ADDRESS \_\_\_\_\_ STATE \_\_\_\_\_

# PRINTING WITHOUT A PRINTING PRESS



I'LL SHOW YOU HOW YOU CAN EARN \$10 Per Hr. TIME!

AMAZING NEW HOME BUSINESS!

**SENSATIONAL NEW TRADE SECRETS CAN BE YOURS — WITHOUT RISKING ONE CENT.** Now, huge profits can be yours — you can start your own profitable printing business today — this week — or this month. You need no printing press; no other expensive equipment either. Every closely guarded secret of Screen-Printing (The New Miracle Way) can be yours. Don't delay.

**GET INTO BUSINESS FOR YOURSELF!** Be your own boss. Many people are finding Screen-Printing the opportunity to establish a spare time home business — without sacrificing job or pay check. The chance of a lifetime to "cash-in" on a new printing method not generally known. Orders come from stores, markets, gas stations, theaters — from every kind of business — A HUGE DEMAND! Help us fill it!

**EASY TO LEARN — NO EXPERIENCE NEEDED!** Anyone (young or old) can profit handsomely with this sensational new method. Earn while you learn! Materials cost you only 10% — you earn 90%. Few businesses make this high profit.

**EVERYTHING YOU NEED TO START NOW!** Complete easy step-by-step instructions — including all secrets illustrated plus large amount of materials — everything you need to make big money immediately — even a ready-made business plan which guides you every step of the way. This all can be yours — at our risk!

**SCREEN-PRINT IN DEFENSE!** Instrument faces, insignias, flags — hundreds of defense products are produced by Screen-Printing. Big opportunity for War Contracts — offers you big extra money if your wages are frozen too.

**SCREEN-PRINT Dept. 2A**  
1010 South Los Angeles Street,  
Los Angeles 15, California

PRINT POSTERS

FOR SALE

PRINT SIGNS

PRINT FABRICS

PRINT ON GLASS

PRINT INSTRUMENTS

PRINT LABELS

PRINT NOVELTIES

PRINT ANYTHING — PRINT EVERYTHING IN BEAUTIFUL COLORS TOO!

## LOOK! WHAT OTHERS ARE SAYING ABOUT THIS NEW PRINTING DISCOVERY

"It works like a charm. I'm so interested I almost forget to eat my meals."  
Mr. E. M. — Missouri

"Wonderful new method made \$80.00 first week — swamped with orders."  
Mr. R. T. — Florida

"Screen-Printing is nothing less than fascinating."  
Mr. S. M. D. — Massachusetts

"My first attempt at Screen-Printing netted me \$40.00."  
Mr. J. R. — Canada

"I would not take \$1,000 for it right now. Just what I have been searching the world over for."  
Mr. C. S. — Nevada

"I have been making 75% of my expenses doing it only spare time. No hired help."  
Mr. E. L. — Ontario



**FREE! SAMPLE PLAN & BROCHURE**

MAIL TODAY! DON'T PUT IT OFF!

**SCREEN PRINT CO., Dept. 2A**  
1010 South Los Angeles Street, Los Angeles 15, California  
Dear Mr. Nowak: Please rush FREE sample, brochure and plan — all details. Absolutely FREE.

# Mechanical Engineering



Everywhere in industry, trained engineers are in demand. If you have mechanical ability and a high school education you can put yourself in line for a bigger job — more money — a chance to go all the way to the top!

I. C. S. has trained thousands of men for advancement in the field of Mechanical Engineering. Many of them head their companies today. And they studied — as you can — in their own spare time at home.

I. C. S. Engineering Courses are clear, direct, understandable. They give you bedrock facts and theory plus practical application. You can progress at your own speed with no slower classmates to hold you back. With this personalized, individual instruction you really *know* your subject by the time you've earned your diploma. It costs nothing to find out what I. C. S. offers you. Mark and mail the coupon for information plus free book "How to Succeed."

## INTERNATIONAL CORRESPONDENCE SCHOOLS Box H-5541-L, Scranton 9, Pa.

Please send me free book "How to Succeed" and information on the course I have checked below.

- |   |  |
|---|--|
| <input type="checkbox"/> Mechanical Engineering | <input type="checkbox"/> Machine Shop Practice     |
| <input type="checkbox"/> Industrial Engineering | <input type="checkbox"/> Mechanical Drafting       |
| <input type="checkbox"/> Tool Design            | <input type="checkbox"/> Drafting & Machine Design |

Name \_\_\_\_\_ Age \_\_\_\_\_

Home address \_\_\_\_\_

City \_\_\_\_\_ State \_\_\_\_\_

Special discount to members of the Armed Forces. Canadian residents send coupon to International Correspondence Schools Canadian, Ltd., Montreal, Canada.

**I HELPED T.E.H. MAKE \$14 A DAY WHILE STILL LEARNING!**

T. E. H.—West Virginia. "By the time I finished half your course, I was making \$14.00 per day. I have made enough on the side to more than pay for the course."

**H. T. ARMSTRONG**

## Learn ELECTRIC APPLIANCE REPAIR & SERVICE

- WE TEACH:**
- How to Repair
  - Washing Machines
  - Vacuum Cleaners
  - Electric Ranges
  - Lamps, Motors, Irons, etc.,
  - REFRIGERATION and House Wiring At Home In Your Spare Time!

For a man handy with tools, and happiest when working with his hands, OPPORTUNITY is Wide Open Today in this great and growing field. Everyone is a customer for the man trained to service electric appliances.

### Open Your Own Shop

Our practical HOME COURSE teaches you this business from A to Z—preparing you to take a well paid job or open your own shop. You can actually start in your basement or garage with the tools we send you . . . before finishing.

We Include An **ELECTRICAL APPLIANCE TESTER**  
A Big Kit of Tools at NO EXTRA COST

## MAIL THIS COUPON for FREE BOOK

**H. T. ARMSTRONG**  
**PACIFIC TRAINING SCHOOLS**  
7217 S. Broadway, Dept. P-5210, Los Angeles 3, Calif.

Dear Sirs: Please send me, without obligation, your free booklet and complete details.

Name \_\_\_\_\_

Address \_\_\_\_\_

City \_\_\_\_\_ Zone \_\_\_\_\_ State \_\_\_\_\_

## New Low Cost Electric Water Heater Gives You HOT WATER AUTOMATICALLY From Your Present Tank!



- No dirt, grime, soot, flame!
- **SAFE!** Every part UL approved!
- Install in 10 Minutes, or less!
- No new tanks or plumbing required!
- Works automatically—saves on fuel bills!

Complete—Ready to Plug In — Only **\$19.95**

New, UL approved LECTROMATIC changes gas, coal or oil-burning water heater into modern ALL-ELECTRIC unit! Turns on automatically when needed, shuts off automatically when water is heated. To install, simply shut off water. Remove plug from water tank. Screw LECTROMATIC into opening (as shown), then PLUG IN! Plenty of hot water all day long. Uses only 1/4-1/2¢ electricity per gal. of hot water. Temp. adjustable from 100 to 180 degrees. Save postage. Send check or money order for \$19.95 now. Money back in ten days if not delighted. Full one year guarantee! ORDER NOW!

**COLLOID EQUIPMENT CO., INC.** Dept. PM10, 50 CHURCH STREET NEW YORK 7, N. Y.

## BE A LOCKSMITH

Learn Locksmithing and Keymaking from Experts in Your Spare Time at Home!

Locksmiths in big demand! No layoffs, no slow seasons! Age no disadvantage. Year-round, steady income in this permanent, respected field. Full or part time. Practical, illustrated lessons show how to make money even while learning! All materials, special tools supplied. FREE BOOKLET.

**INSTITUTE OF LOCKSMITHING, Dept. P-35**  
15 PARK AVE. RUTHERFORD, N. J.  
Lic. & Approved State of N.J. VA Approved

## Make Extra Money

Full or Spare Time—With Famous **HOOVER UNIFORMS**

No experience—no investment needed. Just show and take orders for best known line Uniforms for waitresses, beauticians, nurses, doctors, dentists, etc.—including DuPont Nylon Uniforms. It's easy work with Hoover—famous everywhere for smartest styles, top quality and value. FREE! Complete Style Display, details, money-making plans—write today. **HOOVER, Dept. HN39, New York 11, N.Y.**

## Become a Doctor of PSYCHOLOGY

Win the degree of Ps.D. Learn the secret of contentment, happiness. Solve mental worries. Experience the revelation of truth. Chartered college. Individual help. Write for FREE book. **COLLEGE OF UNIVERSAL TRUTH, 5153-B North Clark St., Chicago.**

## 250 POWER . . . .

Complete Telescope Lens Kit **only \$3.49** postpaid

Conquer Space, Explore the Universe, Planets, Moon Craters, New Stars, etc. Complete Lens Kit consists of 80 inch focal length ground and polished objective lens, eyepiece lenses for 50 POWER, 100 POWER, 150 POWER, 200 POWER, 250 POWER, and all necessary lens fittings. Easy to make from simple step by step instructions. (Tripod and mount not included.) Money back guarantee.

**BUSSE SALES CO., Hartford, Conn., Dept PM7**

## Tool and Die Design Training

**\$8,000 to \$15,000 YEARLY INCOME!**

ACME training has been fully proved in practice through its fine resident schools. Acme graduates report outstanding promotions, resulting in higher salaries. Progress is sure and easy through Acme's famous "COPE" System. Prepare yourself IN YOUR SPARE TIME for a secure position of responsibility and high earnings, and qualify at a time when you will have every opportunity to rise to a position in the \$8-15,000 per year salary bracket. Be successful — Go Farther Faster!

Detailed information upon request.

**ACME SCHOOL OF DIE DESIGN**  
(Correspondence Division, Dept. M)  
8 N. JEFFERSON STREET DAYTON 2, OHIO

# AMAZING NEW TRAINING PLAN



Leonard C. Lane,  
B.S., M.A.  
President of Radio-Television  
Training Association,  
Exec. Dir. of Pierce School  
of Radio and Television

## I PREPARE YOU AT HOME FOR BIG PAY JOBS IN **TELEVISION** RADIO ELECTRONICS WITHIN MONTHS!

**AT NO EXTRA COST!  
YOU GET A ROUND TRIP TO  
NEW YORK CITY**

FROM ANYWHERE IN THE U.S. OR CANADA—I pay your way to New York and return, PLUS 2 FREE weeks, 50 hours of advanced instruction and shop training at the **PIERCE SCHOOL OF RADIO & TELEVISION**. You use modern electronics equipment, including student-operated TV and Radio stations. You go behind the scenes of New York's big Radio-TV centers, to study first hand. And I give you all this **AT NO EXTRA COST!** (Applies to complete Radio-TV course only.)

Only RTTA makes this amazing offer.

### EXTRA FEATURES THAT MEAN MORE MONEY FOR YOU!

Thousands of new job opportunities will be available for you right in your own state, now that the government has lifted restrictions on new TV stations. My simple, successful methods can **PREPARE YOU NOW** to take your place in America's booming **TELEVISION and Electronics industries**... help you get the success and happiness that you always wanted out of life. You learn the practical, easy way by using actual parts and equipment in the 15 big Radio-TV kits I send you, including a **COMPLETE TV RECEIVER**... yours to build and keep.

### My Advanced Training Prepares You For Better Jobs

Then, after you finish your training for a position as a full-fledged TV Technician—where you can write your own ticket and choose from dozens of fascinating careers—I don't stop there! I continue to train you—**AT NO EXTRA COST**—to qualify for even better pay in the **BETTER JOBS** that demand FCC licenses, with my...

**FREE FCC COACHING COURSE**  
PREPARES YOU AT HOME FOR YOUR  
FCC LICENSE  
THE BEST JOBS IN TV AND RADIO  
REQUIRE AN FCC LICENSE  
Given to every student at **NO EXTRA COST** after  
TV Theory and Practice is completed.

### Earn Extra Money in Spare Time

Make as much as \$25.00 a week in your spare time while learning—repairing Radio-TV sets. Many of my students pay for their entire training from spare time earnings almost from the very beginning... start their own service business.

**FREE EMPLOYMENT ASSISTANCE.** My vocational adviser will show you how you can have a good-paying career in the locality of your choice.

### I GET MY GRADUATES GOOD PAYING JOBS

"As Merchant Ship Radio Officer, I receive \$887. for 40-day trip. Your training helped me get this fine position."  
—Stanley Nawrocki

I now hold a fine air-line position at La Guardia Field, New York City, thanks to your excellent training."  
—Joseph Rosenberg

"Your excellent instruction helped me get my present job as an airport radio mechanic for American Airlines."  
—Eugene E. Sanko

"Thanks to your training, I qualified for a good job as a Receiver Tester at Federal Telephone and Radio."  
—Paul Frank Seiler

Many others working at NBC, RCA, CBS, Dumont, Philco, Emerson, Admiral and other leading firms.

## RADIO-TELEVISION TRAINING ASSOCIATION

1629 Broadway, Radio City Station, New York City 19, N. Y.

Approved as a Correspondence School under the laws of the State of New York

**SET-UP YOUR OWN HOME LABORATORY WITH THE 15 BIG TELEVISION-RADIO KITS WE SEND YOU (At No Extra Cost)**

**YOU BUILD AND KEEP ALL THESE UNITS**

—INCLUDING BIG SCREEN TV RECEIVER, plus Super-Het Radio Receiver, R.F. Signal Generator, Combination Voltmeter-Ammeter-Ohmmeter, C-W Telephone Receiver, AC-DC Power Supply, Everything Furnished Including All Tubes.



**NOW!** Advanced FM-TV Training For Men Who Know Radio  
Prepares You For Higher Pay Jobs In A Few Months  
COMPLETE theory and practical training course... complete with kits including large screen TV receiver.  
FCC License Coaching Course Included FREE.

## VETERANS!

**MAIL COUPON TODAY**

MY SIMPLE METHODS MAKE SUCCESS EASY!

**IF ELIGIBLE UNDER NEW G. I. BILL (discharged after June 27, 1950)—CHECK COUPON BELOW!**



### NO SALESMAN WILL CALL!

Mr. Leonard C. Lane, President  
RADIO-TELEVISION TRAINING ASSN.  
1629 Broadway, Radio City Station  
New York 19, N. Y.

Dept. M-10

Dear Mr. Lane:

Mail me your **NEW FREE BOOK** and **SAMPLE LESSON** that will show me how I can make **BIG MONEY** in **TELEVISION**. I understand I am under no obligation and no salesman will call.

Name \_\_\_\_\_ Age \_\_\_\_\_

Address \_\_\_\_\_

City \_\_\_\_\_ Zone \_\_\_\_\_ State \_\_\_\_\_

I am interested in:  Radio-TV  Advanced FM-TV  
**VETERANS:** If qualified under new G.I. Bill, check here



**BOTH FREE**  
New Illustrated Book plus Sample Lesson



# A SIMPLE WAY TO BE AN ARTIST

**TRIAL PLAN makes it easy to start**

Let us PROVE we can teach you to draw at home in your spare time! You don't need previous art training. You don't have to risk a big sum of money. WSA now offers you its famous, complete, and modern home study course in *Commercial Art, Designing and Cartooning* — the same high calibre instruction that has started thousands to profitable careers in art.

**Only WSA Offers You This 38-Year Proven Method:**  
 Trial plan proves you can learn at home in spare time. We teach you from the beginning — step-by-step. Many students begin to earn extra money even before they finish the course. Qualify for well-paying positions in this interesting field. Two complete art outfits included. You get the first one when you enroll — with all the material you need to start. Don't delay. Take your first step now toward drawing for money and pleasure.

**MAIL COUPON FOR FREE BOOK**

**WASHINGTON SCHOOL OF ART**  
 Studio 1210F, Washington 5, D. C.

Send Free Book, "Art for Pleasure & Profit."  
 No salesmen. (Please print)

Name.....Age.....  
 Street.....  
 City.....Zone.....State.....

Course G.I. Appr. for Eligible Vets.



**FULLY GUARANTEED TIRES COST LESS!**

Nationally famous FIRESTONE, GOODRICH, U. S. ROYAL, GOODYEAR, and other makes. Every tire selected and inspected for your safety.

**FREE TUBE WITH EVERY PASSENGER TIRE**

New Tread Tires Guar. 24 Mos. (Mud & Snow Tires \$1. Extra)

550x15	7.98	600x16(6)	9.98	650x20(8)	19.95	700x16(6)	14.48
550x17	7.98	650x15	9.98	640x15	8.98	710x15	10.48
600x15	7.98	650x16	10.48	670x15	9.98	760x15	11.48
600x16	7.98	650x16(6)	12.48	700x15	11.48	820x15	12.98

**GOOD TIRES GUARANTEED 12 MONTHS**

600x16	4.14	700x16	5.14	32x6(8)	8.84	825x20	14.24
650x16	4.54	670x15	4.74	32x6(10)	10.84	900x20	13.34
650x15	4.34	650x20	7.84	750x20(8)	8.54	1000x20	14.14
700x15	4.64	700x20(8)	8.94	750x20(10)	9.94	1100x20	16.14

**AAA PREMIUM GRADE GUARANTEED 18 MONTHS**

550x15	5.48	700x15	5.98	760x15	5.58	750x20(10)	14.98
600x16	5.28	700x16	6.78	550x17	5.48	825x20	18.68
600x16(6)	5.58	700x16(6)	7.98	600x20	9.78	900x20	18.98
640x15	5.68	750x16(6)	8.98	650x20	10.88	1000x20	19.98
650x16	5.78	800x15	6.88	700x20	12.88	1000x22	21.98
650x16(6)	6.98	820x15	7.48	32x6(8)	10.48	1100x20	20.98
650x15	5.98	710x15	6.09	32x6(10)	12.48	1100x22	21.98
670x16	6.18	550x18	5.98	750x20(8)	12.98	1100x24	23.98

**MILITARY SPECIAL AA Guaranteed 12 Months**

900x16	10.69	1000x20	19.98
750x20	10.98	1100x20	21.98

**AAA GUARANTEED 18 MONTHS**

900x16	14.98	750x20	16.48
--------	-------	--------	-------

**NEW TREAD GUAR. 24 MOS.**

600x16	8.98
600x16(6)	9.98
700x15(6)	15.95
750x20(8)	24.98

**PYRAMID TIRE CO.**  
 1333-35 North 5th St.  
 Dept. M., Phila. 22, Pa.

**NO MORE COLD HANDS**  
 KEEP THEM WARM AS TOAST WITH THE NEW  
**WALTCO Sportsman POCKET HAND WARMER**

Controlled heat, no flame • Heat lasts up to 20 hours with one filling of lighter fluid • Absolutely safe • Easy to operate • Fits in pocket or mitten • Sparkling chrome plated brass • Complete with velveteen carrying bag, filler cup and instructions.

22 Kt. Gold Plated Model in Gift Box \$3.50

If your dealer can't supply, send check or money order  
 Dept. PM-10 **WALTCO PRODUCTS** 2300 W. 49th ST. CHICAGO 9, ILL.

Only \$2.29

**SEND FOR THIS FREE!**

**HOW TO BREAK and TRAIN HORSES**

Make money. Know how to break and train horses. Write today for this book FREE, together with special offer of a course in Animal Breeding. If you are interested in Galting and Riding the saddle horse, check here ( ) Do it today—now.

**BEERY SCHOOL OF HORSEMANSHIP**  
 Dept. 11010 Pleasant Hill, Ohio

**HOLLYWOOD BRONZE SUPPLY**  
**BRONZED BABY SHOE MOUNTINGS**

Are NOW AVAILABLE wholesale from our Eastern Distributor to give you FASTER Service at LOWER Costs! Send orders or requests for NEW Price Lists to:

**HOLLYWOOD BRONZE SUPPLY of OHIO**  
 15400 Miles Ave. Cleveland 28, Ohio

**Learn TATTOOING At Home**

Earn extra MONEY—Tattoo blood types and designs in your community. Splendid opportunity in every town. Prepare in spare time. Practical instructions. Send 25c for details and list of Tattoo Supplies. No obligations.

**ZEIS SCHOOL OF TATTOOING • 728 Leslie, Rockford, Ill.**

**FREE 226 STAMPS**

Including Famous Berlin Bear Stamp—used by Russians as propaganda to show "The Russian Bear" rebuilding Berlin. We'll also include 25 other stamps—all DIFFERENT—ALL FREE—to introduce our special bargain approvals. PLUS a FREE copy of our helpful, informative book, "How to Collect Stamps." Rush name, address, and 10c to help cover postage and handling to:

**LITTLETON STAMP CO., Dept. PM-10, Littleton, N. H.**

**Develop Hidden Earning Power**

**STUDY LAW**  
 at home! LL.B. Degree

Qualify yourself in spare time for advancement, greater earnings, business success. Now, more than ever, legal ability is in demand! Easy-to-understand step-by-step lessons and text material furnished — invaluable for permanent reference. Over 40 years expert instruction. 114,000 students enrolled. Easy payments. Find out now, at no cost, how study of law can help you. Write today for FREE Book "Law and Executive Guidance."

**AMERICAN EXTENSION SCHOOL OF LAW**  
 Dept. PM-55, 646 N. Michigan Ave., Chicago, Ill.

Now I've got a  
**HIGH PAYING CAREER in**  
**TELEVISION**  
**RADIO & ELECTRONICS**  
 —thanks to the famous  
**CRESCENT SCHOOL**  
*Home Study Course!*



Yes, a brilliant future  
 awaits you in **TELEVISION**.  
 My advice is to send for the  
 details now about the  
**CRESCENT** course!

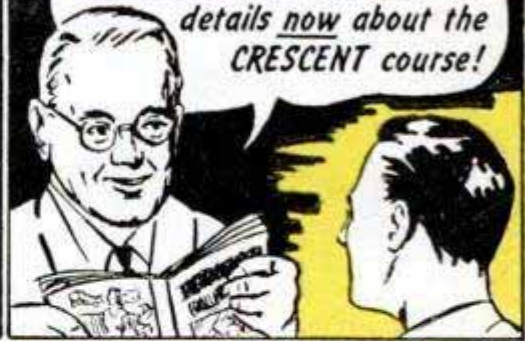

It's the **CRESCENT**  
**SCHOOL**  
**FREE** sample  
 lesson. Boy!  
 That was fast!



Gosh—I can actually earn while  
 I learn with the practical  
**CRESCENT SCHOOL** course!



Learning in my  
 spare time is so  
 easy with these  
 illustrated,  
 simplified  
 lessons!

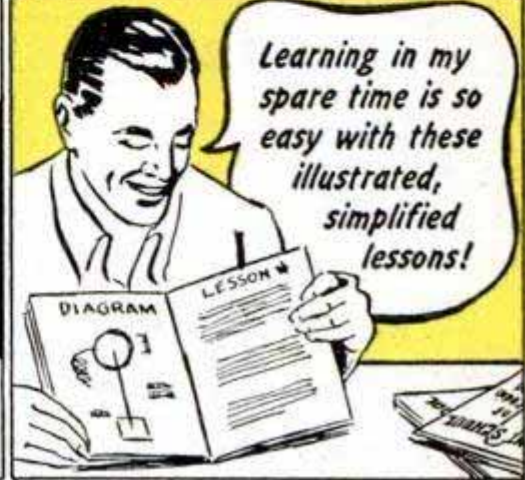

Wow! I built this swell TV  
 set myself with my complete  
**CRESCENT** kits!



I'm sure proud of my  
**CRESCENT SCHOOL** certificate  
 ... now I can really start  
 on a big career!



Imagine—my own business, a home,  
 a new car—and the **CRESCENT**  
**SCHOOL** course started it all!



Approved under the G.I. Bill,  
**CRESCENT SCHOOL** has trained  
 thousands for **BIG** careers in the  
 fast-growing **TELEVISION**  
 industry.



**CRESCENT SCHOOL**  
*"One of the largest  
 schools of its kind"*

**ACT TODAY** to start on a profitable  
 career in **TELEVISION!**  
 Get your  
 sample lesson **FREE!**

**SEND COUPON TODAY!**

**CRESCENT SCHOOL** Dept. B-10  
 500 Pacific St., B'klyn 17, N. Y.

Sirs: Rush your **FREE** sample lesson and full details about  
 the **CRESCENT SCHOOL** Home Study Course—at no obli-  
 gation to me!

NAME .....  
 ADDRESS .....  
 CITY..... ZONE..... STATE.....



New Amazing Invention—"Magic Art Reproducer"

# DRAW THE FIRST DAY!

NO LESSONS! NO TALENTS!

You Can Draw Your Family, Friends, Anything From REAL LIFE — Like An Artist Even If You CAN'T DRAW A Straight Line!



Complete for only

**\$1.98**

## FREE! "Simple Secrets of Art Tricks of the Trade"

This valuable illustrated guide is yours FREE with order of "Magic Art Reproducer." Easy ABC art tricks that anyone can follow on different techniques, effects, proportions, perspectives, shading, color, animated cartoons, human figures to use with "Magic Art Reproducer" for added touches to your drawings.

### SEND NO MONEY!

### Free 10-Day Trial!

Just send name and address. Pay postman on delivery \$1.98 plus postage. Or send only \$1.98 with order and we pay postage. You must be convinced that you can draw anything like an artist, or return merchandise after 10-day trial and your money will be refunded.

### Also Excellent for Every Other Type of Drawing!

- Human Figures • Outdoor Scenes, landscapes, buildings
- Still life, vases, bowls of fruit, lamps, furniture, all objects
- Copy photos, other pictures, portraits, etc.
- Copy blueprints, designs, decorations, etc., for woodwork, machine, for needlework, crocheting, knitting
- Copy all cartoons.

Yes, anyone from 5 to 80 can draw or sketch or paint anything now . . . the very first time you use the "Magic Art Reproducer" like a professional artist — no matter how "hopeless" you think you are! Anything you want to draw is automatically seen on any sheet of paper instantly! Then easily and quickly follow the lines of the "picture image" with your pencil . . . and you have an accurate original drawing that anyone would think an artist had done. Also makes drawing larger or smaller as you wish. Anyone can use it on any desk, table, board, etc.—indoors or outdoors! No other lessons or practice or talent needed!

Have fun! Be popular! Everyone will ask you to draw them. You'll be in demand! After a short time, you may find you can draw well without the "Magic Art Reproducer" because you have developed a "knack" and feeling artists have—which may lead to a good paying art career.

**Norton Products**

Dept. 5810-H, 296 Broadway New York 7, N. Y.

# Free! VITAMIN GUIDE BOOK

## Tells about "Red" Vitamin B-12

No longer need you pay \$4, \$5, \$6, up to \$15 per 100 capsules for the same vitamins your Doctor advises. After 20 minutes reading of this Guide Book you will understand vitamins as never before. You will not be fooled again by confusing, mysterious labels; you will be able to pick up any vitamin product and know if you get your money's worth. Stop buying blindly. This free book shows how to save up to 40% on vitamins, including the sensational wonder vitamins Folic Acid and "Red" Vitamin B-12, for blood building and many anemias. Send postcard today to VITAMIN-QUOTA, Department 873, 880 Broadway, New York 3, New York or Department 873, 1125 Crenshaw Boulevard, Los Angeles 19, California.

## FOR ALL TRUSS WEARERS FREE TRUSS PAD EASERS!

In order to introduce the new Active Man Truss Pad Easer—we will send every truss wearer who answers this advertisement a sample pad easer absolutely free. There are no strings to this offer, no obligation on your part—not a single penny to pay now or later. This remarkable pad easer provides a soft buoyant air cushion that fits under any truss pad—gives increased comfort, reduces irritation and greatly improves holding power of your truss. Write today for your FREE truss pad easer. Only one to a person.



**ACTIVE MAN TRUSS COMPANY**  
549 W. RANDOLPH STREET, CHICAGO 11, ILLINOIS

1/2" x 3 3/8" x 5 3/8"

## LOCKSMITHING & Key Making



### PRACTICAL UP-TO-DATE COURSE—ONLY \$4.95

Easy-to-learn modern information for self-instruction. How to work on locks, de-code, make master-keys, repair, install, service, etc. For every handyman, home owner, carpenter, mechanic, service station operator, fix-it shop, hardware dealer, gunsmith, 53 plain illustrated lessons. FULL PRICE ONLY \$4.95. SEND NO MONEY.

Just pay postman plus C.O.D. postage. Or send \$4.95 with order, we'll ship postpaid. Satisfaction guaranteed or refund. NELSON-HALL CO., 210 S. Clinton St., Dept. KY-2, Chicago 5, Ill.

## Do You Make These Mistakes in English?

MANY persons say "between you and I"—use "who" for "whom"—don't know whether to use one or two "e's" or "m's" or "r's." Every time you speak or write you show what you are. A command of effective English brings you added advantages, better opportunities.

You can improve your English through Sherwin Cody's 100% self-correcting invention. If you are ever embarrassed by mistakes in grammar, spelling, punctuation, or pronunciation, write for FREE book "How You Can Master Good English in 15 Minutes a Day." No obligation. SHERWIN CODY COURSE IN ENGLISH, 510 B & O Bldg., Rochester 14, N. Y.

## Learn This Craft—Earn Big Money

Look at the Help Wanted ads in your paper. The billion-dollar auto repair trade needs trained men NOW! The demand is big . . . pay is big . . . opportunities are great. You have a chance to grow with this growing trade, perhaps set up your own profitable shop.

### CASH IN ON YOUR SPARE TIME!

You can begin your Auto Body & Fender Training at home in spare time with the proven UEI plan. You learn about appearance reconditioning, metalwork, painting, welding, other practical phases without leaving your present job. Then get actual practice in our large, well-equipped shops, repairing wrecked cars under the guidance of skilled instructors. Get FREE book and all the facts by sending coupon NOW!

UTILITIES ENGINEERING INSTITUTE 2523 Sheffield Ave., Dept. XC-15, Auto-Crafts Div. Chicago 14, Ill.

### MAIL TODAY FOR FREE FACTS

**UEI**

has been training men for industry since 1927.

Auto-Crafts Div. UTILITIES ENGINEERING INSTITUTE 2523 Sheffield Ave., Dept. XC-15, Chicago 14, Ill. YES! Rush FREE Book and full facts on Auto Body & Fender Repair Training.

Name..... Age.....

Address.....

City..... Zone or County..... State.....

( ) Check for special information if under 17.

Fun! Thrills! With **MONOGRAM SUPERKIT**

**Corsair**

Finished Balsa and Plastic Parts

ONLY **89c**



America's Most Popular Models! 28 Airplanes, Ships, Race Cars

At Model Shops or by Mail

If no dealer near you send 89 cents for Corsair Kit, plus 25 cents for postage and packing to address below. Delivery guaranteed.

Enjoy the fun of masterpiece model making. Genuine SUPERKIT scale model airplanes including the famous carrier-based Corsair F4U-5 shown above. Easiest of all to build yet most detailed models ever produced. Kits contain completed wings with double airfoil, smooth carved bodies, precision-cut balsa parts, plastic 3 and 4 bladed props, pilots, canopies, cannon, rockets, bombs, display stand and other plastic parts. Complete catalog of 18 planes, including jets, 5 jet power race cars and 5 U. S. fighting ships FREE in every kit. Be sure you get Monogram Models.

MONOGRAM MODELS, Dept. 17, 3421 W. 48th Place, Chicago 32

# Become an ELECTRICAL or MECHANICAL ENGINEER IN 36 MONTHS

- ★ Bachelor of Science Degree
- ★ Engineering Associate Certificate, 12-18 Months
- ★ Service Preparatory Courses, 3-12 Months

The growing shortage of trained engineers and technicians offers greater opportunity for ambitious young men. By 1955 there will be at least two positions for every graduate. Enroll NOW and earn your B. S. Degree in 36 months. Each of three levels of study is complete in itself. Technician courses can also be applied as one-third of the degree program. Faculty of specialists. Military, practical or academic training evaluated for advanced credit. Terms open JANUARY, APRIL, JULY, OCTOBER.

## CHOOSE FROM THESE 15 PROGRAMS

- General Preparatory Course — 3 Months
- SERVICE LEVEL — 6 to 12 Months**
  - Electrical Service
  - Welding Operator
  - Radio-Television Servicing Course
- TECHNICIAN LEVEL — 12 to 18 Months**
  - Radio and Television
  - Electrotechnics
  - Welding
  - Refrigerator Service
  - Heating Service
  - Electronics
  - Air Conditioning
  - Mechanical
- ENGINEERING LEVEL — 36 Months — B. S. Degree**  
 Choice of functional electives: Production Sales or Research. • ELECTRICAL ENGINEERING — ELECTRONICS OR POWER MAJORS. • MECHANICAL ENGINEERING.

## MILWAUKEE SCHOOL OF ENGINEERING

NONPROFIT • FOUNDED IN 1903

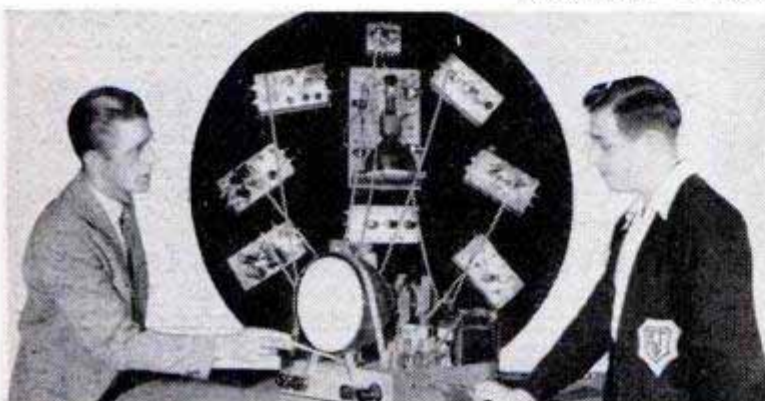

Milwaukee School of Engineering  
 Dept. PM 1052, 1025 N. Milwaukee  
 Milwaukee 1, Wisconsin

Without obligation, send catalog and information on.....  
 (Name of Course)

Name.....Age.....

Address.....

City.....Zone.....State.....

If veteran, indicate date of discharge

**Practical Carpentry**

**Get This Big Book**

New King Size encyclopedia on modern carpentry. 1100 illustrations reduce all jobs to simple, easy steps. EVERYTHING is covered... planning, foundations, framing, insulation, staircases, interior, exterior trim, garage construction, etc. Ideal for home owners who do own carpentry; apprentices. Valuable reference for experienced carpenters. Clip this ad and mail with \$5. bill or check today. MONEY-BACK GUARANTEE.

GOODHEART-WILLCOX CO., Dept. 187, 1321 S. Michigan, Chicago 5

**LAW FREE BOOK**

Your FREE copy of "The Law-Trained Man" shows how to gain prestige and greater earnings through Blackstone home law study. All instruction material furnished including 16-volume Law Library written by 65 well-known law authorities. Lawyers, judges among our graduates. LL.B. degree. Low cost; easy terms. Write today.

**BLACKSTONE COLLEGE OF LAW** 225 N. Michigan Ave.  
 Dept. 57, Chicago 1, Ill.

A Correspondence Institution Founded in 1890

# LEARN MEAT CUTTING AT NATIONAL

Pay After Graduation



The steady dependable trade of Meat Cutting taught easily in 8 short weeks. YOU LEARN BY DOING under actual meat market conditions in big modern school at Toledo.

For beginners or men with experience. Get a profitable store of your own. Remember, PEOPLE MUST EAT! Big pay jobs. Free employment help. Thousands of successful graduates.

Buying, cutting, percentage, pricing, advertising, selling, etc. A complete retail meat education. National School established over 25 years. Get National training NOW. Pay your tuition in easy weekly payments

after you graduate. Send coupon for FREE 52 page school catalog — TODAY. G.I. approved.

**National School of Meat Cutting, Inc., Dept. 50-K, Toledo 4, Ohio**

Send me your FREE school catalog on National Training at Toledo in Meat Cutting, Meat Merchandising and Self Service Meats. No obligation. No salesman will call.

Name.....Age.....

Address.....

City.....State.....

Approved Under G.I. Bill

# AIRCRAFT MANUFACTURING

**How To GET and HOLD  
a Good Job! \$2.00**

## Valuable NEW BOOK

- FOR THOSE WITH LITTLE EXPERIENCE WHO WANT TO BREAK INTO HIGH PAYING JOBS IN AIRCRAFT MANUFACTURING.
- FOR THOSE NOW IN AIRCRAFT WHO WANT TO ADVANCE TO HIGHER PAYING JOBS.

The only book of its kind—for the ambitious worker who wants to share high pay in America's expanding aircraft industry—all facts, in simple easily understood terms. Tells you exactly where YOU can fit in and how to go about securing your job. Helps you avoid unnecessary disappointments and wasted effort. Also includes the KEY TO RAPID ADVANCEMENT once you have your job. The soundest investment you ever made or your money back!

INDUSTRIAL RESEARCH  
BOX 398  
JOHNSTOWN, PENNSYLVANIA

I enclose \$2.00 for a copy of the book "Aviation Manufacturing: How To Get and Hold a Good Job."

NAME (PRINT) \_\_\_\_\_  
ADDRESS \_\_\_\_\_  
CITY \_\_\_\_\_ ZONE \_\_\_\_\_ STATE \_\_\_\_\_

# HOW TO MAKE YOUR OWN FURNITURE

**and save up to 80%!**



Why pay high prices for furniture? Make it yourself! Easy-to-follow, step-by-step directions in this BIG new book show you professional methods and tricks of the trade. Everything you need to know to make attractive, sturdy pieces for every room in the house. Have fun—and save up to 80% of cost of store-bought articles!

You get complete step-by-step directions on how to make: Chest of drawers. Lamp table. Cutlery tray. Drop leaf table. Wing chair. Chaise longue. Modern bedstead. Framed desk. Corner cupboard. Side chair. Arm chair. Standing bookshelf. And many other useful pieces. ALSO BUILT-INS SUCH AS: Recessed bookshelf cupboard. Closet and dressing table alcove. Corner seat. Divan with drawers. Bathroom, kitchen or bar counter. Closets. Bunks. Desks. AND MUCH MORE!  
Every job explained in careful detail. Large, clear illustrations show exact working procedure for each step. Professional methods given for cutting and joining operations; scraping, raising the grain, staining, varnishing, bleaching, toning, antiquing; designing furniture; etc.

**FREE 10-DAY TRIAL.** Send no money. Just mail coupon to get "HOW TO MAKE YOUR OWN FURNITURE" on free trial. After 10 days, return and owe nothing—or keep it and send low price of only \$3.95 plus few cents postage. Mail coupon NOW.

Simmons-Boardman Pub. Corp. PM-1052  
30 Church St., New York 7, N. Y.

Send me "HOW TO MAKE YOUR OWN FURNITURE" for FREE 10-DAY TRIAL. I will either return it in 10 days and owe nothing—or send you \$3.95 (plus postage) in full payment.

Name \_\_\_\_\_

Address \_\_\_\_\_

City \_\_\_\_\_ Zone \_\_\_\_\_ State \_\_\_\_\_

( ) SAVE! Send \$3.95 WITH THIS COUPON and we will pay postage. Money back if you return book.

# BOYS-IT'S FREE!

... NEW, EXCITING 16-PAGE BOOK  
on magic and marvels of chemistry

Shows you how to amaze friends with eye-opening tricks of chemical magic... like changing water to blood and blood to stone. Tells you how to do many fascinating home experiments and shows you the big, new Chemcraft outfits. Describes fun, thrills, adventure you can have with a Chemcraft chemistry outfit of your own. Send now for free copy



Chemcraft Senior Lab.

to Porter Chemical Co., 41 Prospect Ave., Hagerstown, Md.

HEY FELLAS/  
ask Dad for **CHEM-CRAFT**



**RUBBER STAMPS** Direct to You!

Handle mounted, made-to-order, rubber stamps. Low prices. Rapid service. Write FREE catalog type styles.

WALLACE STAMP CO. 644 Venice Blvd., Dept. P10  
Los Angeles 15, Calif.

**FREE  
CATALOG**

# FOAM RUBBER

The perfect cushioning for chairs, benches. Pillows and mattresses. Any size or shape at a saving. Send for free catalog and price list today.

**PYRAMID PRODUCTS, Inc.**

414 University Ave. Dept. A St. Paul, Minnesota

A **POSTCARD** CAN PUT YOU IN A FINE BUSINESS!

Rush Card TODAY for FREE SELLING OUTFIT!

Get in highly profitable, direct-from-factory, repeat-order shoe business! Sell amazing line of Air-Cushion Innersole comfort shoes to friends, neighbors, fellow workers. Dress, sport, work, safety shoes for men, women. Never sold in stores. Make \$10 to \$75, as much as \$200 monthly just in spare time. No investment. Send card TODAY for FREE SELLING OUTFIT!

CONSOLIDATED SHOE SYSTEM, Box CD-29  
Chippewa Falls, Wisconsin



LEARN TO THROW THE BOOMERANG

A Fascinating Sport  
and Unique Gift

SEND FOR  
YOURS  
TODAY

Flight Tested—Guaranteed to Return  
Golden Red, Jade Green or Natural  
with Story and Instructions \$2.00 ea.

**CARVED by Postpaid**  
**COL. JOHN M. GERRISH**

4409-M S.W. Parkview Lane, Portland 1, Ore.



# HURRICANE BI-PASS UNIT

Now! By popular demand—a complete muffler Bi-Pass Unit, to give your car the power and zip of straight pipe performance, in non-restricted areas.

Maintain your original exhaust system. Hurricane is equipped with dash control, enabling you to cut in or out at will. Fits all cars and trucks with 1 3/4" to 2 1/4" dia. engine pipes.

Unit complete as pictured, includes dash control, cut-out and cut-in; 48"-134" flexible tubing, clamps, and all necessary fastenings and packing. Price complete \$9.95 post paid. Satisfaction guaranteed. (Flexible tubing over 48" available at 46¢ per additional foot.) Send check or P. O. money order to

**ST. LOUIS PRODUCTS CO., Box 24-VK, Normandy 21, Mo.**

© 1952 St. L. P. Co.



**World's Greatest Hobby  
For Men and Boys!  
Get This Free Book. It  
Tells How You Can Learn to**

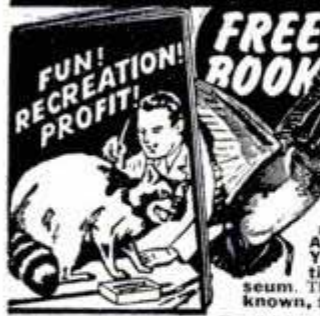

**FUN! RECREATION! PROFIT!**  
**FREE BOOK MOUNT BIRDS!**

**Learn At Home**

Men, Boys, Hunters, Fishermen, mount and save your lovely wild-game trophies. Be a Taxidermist. Mount Birds, Animals, Heads, Fish, Tan skins. YOU learn easily, quickly in spare time. Have a grand home-museum. The finest and the greatest hobby known, for sportsmen. Fun, real profits.

**FREE BOOK**

Yes, FREE. Beautiful strange, valuable Book, telling all about Taxidermy. Contains over 100 beautiful game-pictures. And it's yours FREE, if you rush your request. You can mount all kinds of wild-game, and common specimens too. We can positively TEACH YOU. So GRASP this opportunity. RUSH letter or postal for this amazing FREE BOOK. Don't delay. State your AGE. N. W. SCHOOL OF TAXIDERMY, 2510 Elwood Bldg., Omaha 2, Neb.

**GET THIS FREE BOOK**

**STOPS FOGGY WINDSHIELDS  
NEW Chemical Mitt**



**Amazing Discovery!** Autoists will over new FOG-STOP Windshield Cleaner. Simply glide over windshield chemically-treated Mitt—at once glass sparkles crystal clear. Blurry mist, frost, sleet, snow disappear like magic. Stops fogging. Sells like wild!

**SAMPLES FOR AGENTS** Sample offer sent immediately to all who send name at once. Hurry. Postcard will do. **SEND NO MONEY—just your name.** KRISTEE CO., Dept. 694, AKRON 8, OHIO

**CARBURETOR TOO RICH  
MAKES MOTORIST TOO POOR**



Car owners who are wasting money, getting poor mileage due to over-rich mixtures, will be pleased to learn how to save gasoline by **VACU-MATING OVER-RICH MIXTURES.** Vacu-Matic fits all cars, trucks and tractors. Automatic and operates on the supercharge principle. Easily installed in a few minutes. **SALESMEN WANTED! Big Profits**

For FREE particulars, how you can install one on your own car for introducing, just send your name and address on a postcard to **VACU-MATIC, 7617-1943 W. State St., WAUWATOSA, WIS.**

**McNess WANTS MEN  
TO RUN McNESS FARM HOME STORES**

**Wonderful Work  
for Man with Car**

Use your car as McNess Farm Home Store. Call on same homes month after month. Every farm family becomes your friend. Farmers depend on McNess Farm Home Stores for countless necessities—save orders for you—buy everything they can because McNess quality is tops, values are best, and every sale is guaranteed. Premiums, special offers, new products help you make good money from start.



**Use Your CAR to Raise Your PAY**

**WE SUPPLY CAPITAL**  
You supply car. We'll supply capital and sales know-how. You start making money first day. There's no finer, more enjoyable work anywhere. Pays well, permanent, no boss, no age limit. No sales experience necessary. This can easily be the biggest paying job you've ever had. Write today for free McNess Dealer Book. No obligation. (16)  
**THE McNESS CO., 25 Clark St., Freeport, Ill.**



**UNI-COATED\*!**

Brand New, top quality glasses. All have precision ground optics, durable lightweight bodies. Moisture and dust proofed. Achromatic!

**Featherweight!**

**16x50 \$69.50  
27 OUNCES!**

The ultimate in a fine binocular. Tremendous power. Featherweight (weighs only 27 ounces!). Precision made in every detail. UNI-COATED\*, providing sharper, brighter images. Individual focus. Objective lens is 50mm (2 inches) across!

ALL are UNI-COATED\*

Same Model CENTER FOCUS with individ. focus right eye.  
10x50.....\$49.50  
12x50.....\$59.50

**UNITED BINOCULAR BARGAINS!**



- 6x30 16 oz. Economy 4 1/2" x 6".....\$27.95
- 7x35 All round use, 5" x 6 1/2"..... 42.95
- 7x35 Center Focus 5" x 6 1/2"..... 46.95
- 7x35 German World's Lightest 14 oz! Center Focus..... 57.50
- 7x50 Brilliant—6 3/4" x 7 1/4" 3 1/2 lbs. 38.00
- 7x50 Center Focus 6 3/4" x 7 1/4"..... 39.50
- 8x30 Well Balanced 17 1/2 ozs..... 31.50
- 8x30 Center Focus—4 1/2" x 5 1/2"..... 37.50
- 8x30 German "Whisper Weight" 11 oz. Center Focus..... 39.50
- 8x40 More Power—5 1/2" x 6 3/4"..... 39.50
- 8x40 Streamlined 24 oz! 5 1/2" x 6 1/2"..... 49.50
- 10x30 18 1/2 oz.! Power combined with compactness..... 39.50
- 20x56 German 9 1/2" x 6"—27 oz.! Center Focus..... 99.50

**6X-10X POCKET ALL 3 ARE UNI-COATED\*, precision PRISM Binoculars. Superb Craftsmanship. Superior in every detail.**

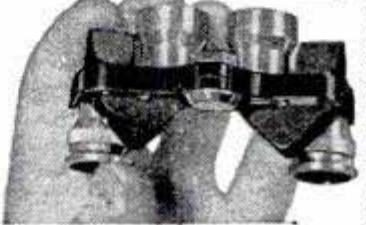

**10x They Are New! \$24.95**  
WEIGHS 7 1/2 OZ.! Palm sized. Full 10 Power. Color corrected. Achromatic lens. Perfect balance. Another UNITED first in revolutionary binocular developments.

**6x DUO-TONE \$16.95**  
Illustrated. Weighs only 4 1/2 oz.! Provide an excellent field of view. Satin black and chrome.

**7x ALL CHROME \$19.95**  
Sturdy. Precision made. Sharp, clear vision! Sale priced.

**SIX TELESCOPES IN ONE! \$30.75**

15 to 40 POWER  
American made Wollensak telescope. Instant focusing at tube to click—no guesswork. Telescope measures 9" closed, 27" when extended. Weighs only 18 oz.! Has rust proof chrome tubes, large 40mm objective lens. All 12 optical surfaces are COATED. See 22 bullet holes clearly at 300 feet. Use for astronomical observation. \$30.75 price includes fine leather case. Tax FREE!

**20 POWER WEIGHS ONLY 7 1/2 OUNCES! \$8.95**



2 1/2 Times Stronger than binocular used by the U. S. Armed Forces! UNI-COATED\*! Pocket size, 8 3/4" closed; 13 1/2" extended. Easy to hold. Easy to focus. NOT A CHEAPLY MADE TOY TELESCOPE but an all metal, precision machined (threaded fittings throughout) precision made Achromatic telescope. View distant objects (even miles away) brighter, clearer, sharper detail than ever before. Introductory price \$8.95 Tax FREE!

**UNI-COATED\*** Assuring users that applications of magnesium fluoride have been applied to the interior sides of the VITAL front and rear ACHROMATICS assuring users brighter, clearer, sharper images than ever before.

**FROM 3 CONTINENTS** come UNITED'S "BEST-BY-TEST" binoculars and telescopes. Above are from America, Germany and where not indicated from American influenced Japan where skilled German optical craftsmen tutored local optical workmen in advanced optical techniques. It explains why the quality is so high and the price so low.

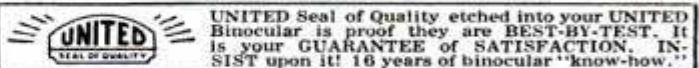

UNITED Seal of Quality etched into your UNITED Binocular is proof they are BEST-BY-TEST. It is your GUARANTEE of SATISFACTION. INSIST upon it! 16 years of binocular "know-how."

**30 DAY FREE TRIAL**

If not fully satisfied return for full refund! Cash orders rushed postpaid, on C.O.D.'s include \$2.00 deposit. Add Federal Tax. Prices of all of above binoculars include handsome genuine leather case and straps. SAVE by buying direct from UNITED "America's Outstanding Binocular Retailer." Serving satisfied sportsmen since 1936!

**FREE CATALOG** FREE! 36 page — 3 color binocular catalog listing over 60 different style binoculars, the Best By Test from 3 continents! UNITED has served over 100,000 Sportsmen. Buy UNITED and SAVE.

**UNITED BINOCULAR CO., United Bldg.,**

9043 S. Western Ave., Dept. ARF-5308, Chicago 20  
Display Sales Rooms open 9:00-3:30 Mon. thru Fri.  
**DEALERS WANTED**

# Get into ... PLASTIC LAMINATING AT HOME!

Sensational New  
**"ONE MAN  
BUSINESS"**  
... pays \$10 to \$20 profit  
for each dollar of cost.

Make \$20 to \$30 a day by our  
**MAGIC MAIL PLAN ... get  
orders and cash from your mailman!**

Here's the newest and most fascinating of all home-operated businesses. For the first time, a simplified machine brings the fabulous profits of Plastic Sealing and Plastic Laminating within the reach of the small operator. Can be

operated in a corner of the kitchen, basement, or garage. And any man or woman, regardless of age, education, or experience—can learn this interesting work in a few minutes of reading—can turn out professional jobs after one hour's practice.

## TWO EXCITING FIELDS FOR BIG PROFITS!

No house-to-house canvassing. No face-to-face selling. We not only supply the equipment you need for the work, but also show you exactly how to cash in big daily profits from two big demand fields.

### A FORTUNE IN PLASTIC SEALING

Millions of people want to protect valuable cards, photographs, documents and papers against wear, soil, and damage. By our MAGIC MAIL Plan you get this business through the mails. Open envelopes and take out money and orders. Details of this plan will amaze you. It will be sent free. Just mail coupon.

### ENORMOUS PROFITS IN LAMINATING

A creative, artistic business. Gift shops sell your entire output. Just a few of thousands of giftwares illustrated on this page. Beautiful colors. Endless designs. Exclusive "one of a kind" appeal brings sales at ten to twenty times the cost of materials. Beautiful illustrations and instructions for making these artistic novelties sent free.

The opportunities in Plastic Laminating are so big that space here does not permit even skimming the surface. To get any idea

**FREE** at all of the size of these markets and your place in this sensational business you must read the details. See for yourself how easy it is to do the work—how you can put plastic sheets into your machine and take out a fortune—how money and orders come to you in the mail—how gift shops clamor to get more and more of your creations—how you can start with one machine and build up a big production plant with others doing the work—how you can get money and business from every State in the Union—how you can achieve independence without study or experience.

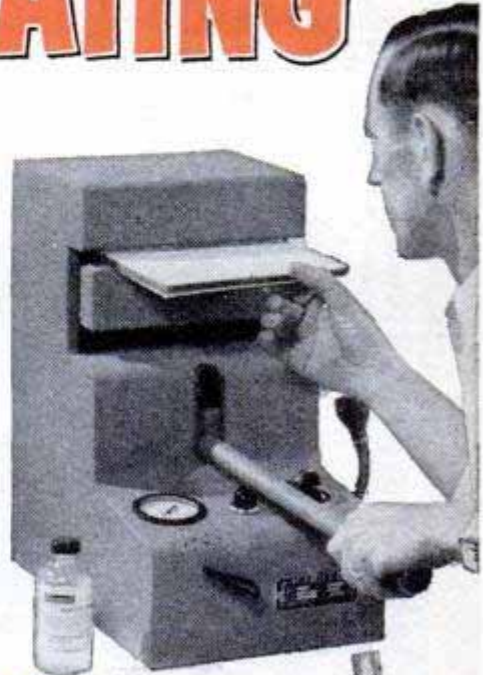

**RUSH COUPON**

Never before has such an opportunity been offered the small, home-operator—an opportunity to gain complete personal independence in a big money business of your own. Don't lose a minute. Get the facts at once. All information, fully illustrated with pictures, is free. Send the coupon—or send your name on a penny postcard. There is no charge now, or at any other time. We may be limited in the number of Warner Laminators that can be made up, so don't put this off. Send for the information on this exciting opportunity today.

### WARNER ELECTRIC CO.,

1512 Jarvis, Dept. L-10-S, Chicago 26, Illinois

■ **WARNER ELECTRIC CO., Dept. L-10-S**  
1512 Jarvis, Chicago 26, Illinois

Rush complete information with illustrations showing the things I can make and the money possibilities in Plastic Laminating. All this is free. I do not pay a penny now or at any other time. No salesman is to call. Send all facts by prepaid mail. Be sure to tell me how I get orders and money from my Postman by your MAGIC MAIL Plan.

■ **NAME** \_\_\_\_\_  
■ **ADDRESS** \_\_\_\_\_  
■ **CITY** \_\_\_\_\_ **ZONE** \_\_\_\_\_ **STATE** \_\_\_\_\_

### \$5-\$10-and \$20 BILLS COME TO YOU IN THE MAIL

By our MAGIC MAIL Plan you sit at home, send out mail, and get back money and orders. Additional profits in supplying local people with lifetime protection for

**SNAPSHOTS—IDENTIFICATION CARDS—DISCHARGE PAPERS—DRIVERS' LICENSES—SOCIAL SECURITY CARDS—VOTERS REG. CARDS—MENUS—BIRTH CERTIFICATES—CREDIT CARDS—BIRTH AND WEDDING ANNOUNCEMENTS—RAILROAD PASSES—IMPORTANT DOCUMENTS OF ALL KINDS.**

Lifetime protection. See how laminating protects against wear, soiling, and moisture damage with its smooth, flexible, plastic covering on each side. **LIFETIME PROTECTION** needed for valuable or sentimental objects of all kinds—even a priceless whisp of hair can be laminated. Think of the countless thousands of profit items for your Laminating Press.



### Thousands of Beautiful Art Creations

No one yet has been able to list the thousands of gorgeous articles that can be made by Laminating as explained in our Free Information. Just a few are

**COSTUME JEWELRY—CIGARETTE BOXES—JEWEL CASES—GLOVE AND HANDKERCHIEF BOXES—CUFF LINKS—NOVELTY BUTTONS—TRAY—CANDLESTICKS—COASTERS—CLOCK CASES—LAMP BASES—PICTURE FRAMES—BOOK ENDS—PAPER KNIVES—KEY CHAIN CHARMS—CHECKERS—CHESSMEN—ADVERTISING SIGNS—NAME PLATES—BOOKMARKS—BELT BUCKLES—TIE RACKS—KEEP-SAKES OF ALL KINDS.**

**WORLD'S  
BEST  
WANT AD  
MEDIUM**

# CLASSIFIED Advertisements



Advertisements in this section 85 cents per word, each insertion, minimum 10 words, payable in advance.

To be inserted under proper classification, copy must be in our office the 20th of the second month preceding date of issue

F. W. Johnson, Manager, Classified Advertising

Popular Mechanics Magazine, 200 East Ontario Street, Chicago 11, Illinois

## 1044 CLASSIFIED ADVERTISEMENTS 1044 OPPORTUNITIES FOR YOU

### AUTOMOBILES, MIDGET CARS

**FORD Speed Manual!** 128 pages latest Southern Calif. info on V-8, Mercury, Model A and B, Ford Six, Zephyr. How to install V-8 in Model A chassis. Data on cams, carbs, compression, ignition, exhaust supercharging, super fuels. Written by experts. Down to earth details that will save you money! Sent postpaid for \$2.00. California Bill, 6195 N. Figueroa, Los Angeles 42, California.

**"HOW To Buy a Used Car."** Over 100 easy-to-perform tests in one book. A complete guide. Only \$1.00. M. Kaminsky, Box 570-P, Mt. Vernon, New York. Satisfaction guaranteed.

NON-Profit organization supplies automobile literature—Old, new, foreign. Glossy photos, service manuals, data books, engineering papers; free motor magazines. Contact auto "nuts" everywhere. Get name on free mailing list. Auto Maniacs, Stockbridge, Mich.

**EYE-Catching personal license plate,** distinctive crest, your 3 initials. 8 1/2" x 5 3/4" steel, colorful baked finish. Send \$2.00 (2 for \$3.00.) Holden, 1516 Hillcrest Rd., Lancaster, Penna.

**POWERCAR Junior**—Real children's auto! See details under "Motorcycles, Bicycles."

**SPEED, Custom, racing equipment.** Wholesale, retail! Souping Manual—Catalog 25c. Circular free. Almqvist Manufacturing, Milford 44P, Pennsylvania.

**BUILD Midget auto.** Complete drawings, pictures and list of parts \$1.00. Lee's Midget Autos, 3301 Dupont Ave., So., Minneapolis, Minnesota.

**HELP Make and market new carburetor.** "Zip plus mileage." 17 parts. J. R. Fish, Daytona Beach M2, Fla.

**SEND For free life membership card.** Economy methods. Water Burners of America, LaVerne, California.

**STOP Thieves.** Burglar-proof your automobile. Send for free literature. Acme Alarms, 7033 Clyde Avenue, Dept. 3A, Chicago 49, Ill.

**LATEST 1952 Edition!** Just out—124 new pages! Get world's largest auto accessory and parts catalog and save money. Over 50,000 items, including Hollywood accessories, hi-speed equipment, rebuilt engines, all parts and accessories for all cars and trucks. We have that hard-to-get part! Jam packed with bargains. Completely illustrated. Send 50c (refundable). J. C. Whitney, 1919 Archer, Chicago 16.

**SAVE**—California custom accessories headquarters. Buy direct from original designers. Chrome dash panels, electric push button door-trunk conversions, fender skirts, dual mufflers, lowering kits, speed-dress up equipment. 40 page catalog, hundreds of photos—25c. Eastern Auto, 3319A South Grand, Los Angeles 7, Calif.

**SPEED Equipment** from the world's largest firm. 25c for huge catalogue. Newhouse Automotive Industries, Los Angeles 22.

**MAKE Your own Polyester-Fiberglass auto body.** Catalog 10c. Gem-O'-Lite, Box

### AUTO SUPPLIES AND EQUIPMENT

**BUICK, Cadillac, Oldsmobile, Pontiac 49-52; Kaiser 51-52; Studebaker Commander 51-52; Nash 52; owners attention.** Stop unstable ignition timing caused by a tilting distributor breaker plate. Get smoothness, power, economy with a "Breaker Plate Stabilizer Kit." Easy to install. No machine work necessary. Enjoy the performance of a smooth running efficient engine. Money back guarantee. Send \$1.75 to Jamco, 642 Eddy St., San Francisco 9, Calif. Postpaid.

**WORLD'S Handiest car accessory,** clips on sunvisor, holds coins, maps, sunglasses; no fumbling for necessities, can save your life. \$1.00. Murray Specialties, Box 904, Plainfield 1, New Jersey.

**INCREASE!** Gasoline mileage 3 to 5 more miles per gallon. Guaranteed gasoline vaporizer, also increases power. Easier starting. \$3.50. Turb-O-Vane, Stockton, California.

**FREE Information** on lighting Powerglide or Dynaflo dials. Gaiser, Box 25, Kokomo, Indiana.

**VALUABLE Knowledge book**—"120 Different Ways to Increase Gasoline Mileage." \$1.00. Holloway, Box 225, Bijou, California.

**CARBURETOR Too rich** makes motorist too poor. New invention saves gas "vacuumating." For free particulars, sample offer, write Vacuumatic, Dept. 1944, Wauwatosa, Wis.

**DRIVERS Right arm rest.** Convenient, comfortable; slips on-off. Occupies little space. No wires, pins, attachments. \$2.00 prepaid. JoBal Products, P.O. Box 93, Bridgeport 1, Conn.

**CHEVROLET Owners**—Save money; make your Chevy run better, last longer! Get Popular Mechanics big Manual for Chevrolet Owners today. 304 pages, hundreds of illustrations. Find out how to make your own repairs; keep your Chevy in tip-top shape. First minor adjustment saves you many times cost of book. Send \$3.50 today to Popular Mechanics Press, Dept. 108, 200 E. Ontario, Chicago 11, Ill.

**SOUPED-Up Mercury block assembly** \$295.00. Circular free. Auto Parts Service, West Salem 42, Ohio.

**IT Renews your old motor,** keeps that new motor young, saves gas and oil, increases power. Lachapelle's (patented) motor treatment. \$3.00 postpaid. Free circular. Write Joe Dillon, Authorized Warehouse and Agents Distributor, Box 323-A, Bridgeport, Ohio. Distributors and agents wanted. Exclusive territory.

**HYDRAULIC Jack repair kits.** Repair your own. Send for prices. Jack Parts Company, 2000 South Claiborne, New Orleans, La.

**NEW Automatic auto burglar alarms.** Guaranteed to stop thieves. Easily installed \$4.98. Novak Manufacturing Company, 3131 West 13th, Gary 1, Indiana.

**LACHAPELLE'S Treatment,** (patented). Puts babbit-type bearings on the pistons, for \$3.00. Free data. Ferns Products, 8120-B Walnut Dr., Los Angeles 1, Calif. Canada distribution, Master Auto Products, Box 3, Station C, Hamilton, Ontario. Cuban distribution, Luis Izaguirre, San Carlos 178, Cienfuegos.

**CAR Washer.** Finished job ten minutes. No drying. Mailed postpaid \$2.25. Delta

**VALVES.** We buy old worn valves. Mayco, 7120 Carnegie, Cleveland, Ohio.

**GM71 Discarded injector parts** wanted. Bares, 7120 Carnegie, Cleveland, Ohio.

**NEVER Change your oil!** Full details free. Thousands of users. New oil filter. Dept. PI, Henderize, Inc., 5667 Freeport Blvd., Sacramento, California.

**SPEED Equipment.** Edelbrock, Offenhauser, Navarro heads, manifolds, Winfield cams, dual ignition points. Chev. 37-51, Ford 49-51. Deeptone mufflers, headers, dual muffler sets, Mallory coils, distributors. Speed catalogue 25c. Urzi's Auto Supply, San Jose, California.

**BUY Racing heads, dual manifolds, hot coils, etc.,** without money. Information free. Newhouse Automotive Industries, Los Angeles 22.

**"HELL'S Bells"** in your automobile! For kids "16-60." Electrifying "clatter" commands attention, provokes amazement! It's new! Free literature. "Winco," Box 9525, Dallas, Texas.

**HOW To buy speed equipment** without money. No selling. Information free. Newhouse Automotive Industries, Los Angeles 22.

**NEW And used guaranteed parts** for civilian and army cars and trucks. Largest stock in America. Mail orders. Pioneer Auto Wrecking Co., 734 W. 13th Ave., Denver, Colorado.

**SIRENS.** Air horns! Bermuda bells. Free accessory catalog. McCanna Company, 200-PM East 21st, New York 10.

**CHEVROLET Owners:** Stop tappet noise with Kaye Tappet Silencers. Quality product. Easy to install. Money-back guarantee. Complete set \$5.95 postpaid. Kaye Products, 1321B So. Layton Blvd., Milwaukee, Wis.

**AUTO Radios** at wholesale. List free. Regent, 801 W. Erie, Philadelphia.

**BRUSH Plating outfits** connect to a battery. No tanks or shop required. Free particulars. Gunmetal Co., Ave. J., Decatur, Ill.

**AUTO Parts and accessories.** Briggs Automotive Engineering of Chicago, P.O.B. 3454 Merchandise Mart, Chicago 54, Ill.

### AUTO TRAILERS

**MODERN Utility, boat trailers.** Bumper hitches, axle assemblies. Box 141, Watertown, Conn.

**BUILD Streamlined house trailer.** Telescopes small for towing. Other models. Information, pictures 10c. Comstock Trailers, 585 Parsons, Kansas.

**BUILD Your own trailer!** Plans for all kinds. Illustrated catalog 10c. Jim Dandy, 125-M, Wausau, Wisconsin.

### MOTORCYCLES, BICYCLES, MOTORSCOOTERS AND SUPPLIES

**POWERCAR Junior**—Real children's electric auto. Plenty of power for hills, towing wagons, etc. Catalog free. Mystic River Sales, Dept. P-10, Mystic, Conn.

**BUZZZZ Magazine.** Describes, illustrates motorcycling completely. \$2.00 year. 20c copy. 5424-A Sawyer, Chicago 25.

FOUR Cylinder Henderson motor \$20. Harley \$10, others as low as \$3. Harley motorcycle \$20. Four airplane tires \$3, mafforder only. Send 25c for new catalogue Number Fifty just out listing the above and hundreds of other bargains in new and used midget cars, motorscooters, motors, parts, plans for homebuilders, etc. (35c by first class mail.) Midget Motors Directory, Athens, Ohio.

REBUILT Gasoline engines \$17.00 to \$37.00. Cauffiel Motor Industries, Temperance, Michigan.

HARLEY-Davidsons—All models and prices. Genuine late and old model supplies. Expert service. Send 25c for bulletin. Knuth's, 1753 Muskego, Milwaukee, Wis.

RECONDITIONED Motorcycles and motors. Chromium accessories. Complete stock Indian parts. Expert rebuilding. Fast service. Indian Motorcycle Sales, Kansas City 1, Mo.

U. S. Govt. surplus "45" Harley Davidson motors, complete with carburetor and generator, in running condition—\$69.50 f.o.b. Chicago. 25% deposit with order. Parts and accessory catalog 25c. Triangle, 2157 Harrison, Chicago.

WHIZZERS \$20; Midget car \$15; motor-scooter belt drive \$6; 3-wheel scooter car \$39.50. Send 25c (35c first class mail) for catalog #21 jammed with sensational bargains in wheels, motors, clutches, motor-scooters, midget cars, motorbikes, etc. Gall, 538 Erie, Toledo, Ohio.

#### AVIATION

PRIMARY Glider plans \$1.00. Literature 15c. McFarland Aircraft, Greenville, Ohio.

FLY 46" Captive glider. Learn first hand about wind currents. Sensational. Scientific. Educational. Easy to assemble and fly. \$1.00 each, pp. Blake Industries, Fairhope, Ala.

LIGHTPLANE Circular, illustrated, 20c. Craftsmann Books, Box 1153, Milwaukee 1, Wisconsin.

PROPELLERS. Plans, supplies for snow sleighs, air boats. Catalog 20c. Banks-Maxwell, Box 3301E, Ft. Worth, Texas.

PROPELLERS: For snowsleeds, boats. Literature. Standard Aircraft, Box 387, Ft. Worth, Texas.

#### BATTERIES, GENERATORS

EDISON Nickel odorless storage batteries. 12 to 600 ampere hour. Any voltage. Long guarantee. Literature. Hawley Smith Co., Croton Falls 1, N. Y.

#### ELECTRICAL SUPPLIES

FREE—War surplus catalog. Bargains galore. Welders, motors, generators, hydraulics, pumps, kits for assembling your own, other items. Save. LeJay Company, Minneapolis, Minnesota.

ELECTRIFY Your old treadle sewing machine. Save labor, sew faster, easier. Do it yourself easily, quickly. Very low cost. Write National Home Equipment Co., Fifty Church St., New York 7, N. Y.

TELEPHONES—Telephone wire. Solve communication problems with army field telephones. Anyone can install, operate. Free folder. Loris Sales, Box 1896-B, Sacramento, Calif.

LAMPS—25c Brings bargain parts catalog containing instructions for electrifying oil lamps, vases, etc. Gyro Lamps, 5402P Clark, Chicago 40.

ELECTRIC Pencil: Engraves all metals \$1.50. Beyer Mfg., 10511-H Springfield, Chicago 43.

LAMP Supplies—Wholesale. Any amounts. Prompt shipment on all parts for repairing and building lamps. Illustrated catalog 15c. Brown Lamp Co., Box 501, Wellston Sta., St. Louis 12, Missouri.

ELECTRIC Clock repairs simple, profitable. Most Telechron-G.E. rotors \$2.15. Sessions, Ingraham, \$2.45. Free parts list. Time Service Company, Dept. P-7, 710 Boush Street, Norfolk, Virginia.

#### WELDING, SOLDERING, PLATING

ELECTRO Plating equipment—New and used. Complete assemblies. All sizes for all types of plating. Baby shoe metallizing sets. Mounts, supplies, instructions. Free catalog. We buy used plating equipment. Send description. Hollywood Bronze Supply, Dept. 2, 1624 E. First Street, Los Angeles 33, Calif.

A.C. Welders. Four sizes. Lowest prices. Free literature. Holgerson's Service, Canton 1, Kans.

ACETYLENE Welding outfits, new \$49.00; used \$29.00. Arcwelders \$49.50. Eagle Welding, Dept. PM, 5085 Broadway, Chicago 40, Illinois.

WELDER Sale. 300 amp. d.c. aircraft type. Reg. \$99.50, special \$89.50. Harris Machinery Co., Minneapolis, Minn.

#### MACHINERY, TOOLS, SUPPLIES

CARBIDE Tipped circular saws available for first time direct from manufacturer! Outlasts steel saws 10 to 100 times. Immediate delivery on 6" diameter with 1/2", 3/8", 1 1/8" round, and 1/2" square and diamond arbors. Excellent for ripping and cross-cutting. Work equally well on woods, plastics, masonite, asbestos, formica, and non-ferrous metals. Withstands abrasion of plastics and urea glues. Special analysis steel bodies, designed for rigidity and support of carbide teeth. Same materials and workmanship as furnished industrial users. For longer life between sharpenings and smoother cuts, Meyco saws are unexcelled. Send check or money order for \$9.95. Specify arbor hole desired. Mailed postage paid, anywhere in United States. Sharpening service \$1.50, plus postage. W. F. Meyers Company, Bedford, Indiana—Manufacturers of precision tools since 1888.

"HYPO-Oiler"—Its hypodermic needle oils inaccessible spots. Pen size with pocket clip \$1. Literature free. Gaunt, A-827 Irving Park, Chicago, Ill.

FREE! Complete catalogs of precision tools for any job. Big stocks—famous brands: Lufkin, Starrett, Brown & Sharpe. Immediate delivery. Wide selection. Write for your copy today! Mid-City Hardware & Supply Company, 318 South Halsted Street, Chicago 6, Illinois.

HYDRAULIC Jacks, 3 ton capacity. For cars, trucks, mechanics, builders, farms, home owners. Direct from factory, \$8.75 each. Satisfaction guaranteed or money back. No c.o.d.'s please. Details free. Clark Mfg. Co., Beaver Park, Danvers, Mass.

ONLY \$3.95 P.P. 2" Universal lathe chuck. \$14.00 value. Har-Mur, 2349 Devon, Chicago 45, Ill.

McCULLOCH Chain saw parts. Complete stock. Parts list free. Specify model. Barnett Equipment, South Glen Falls, N. Y.

IMPORTED Precision measuring tools. Write, Marko, Box 1448, Oroville 1, Calif.

NEW Mail electric drills. Jacobs chuck 1/2", \$28.50; 1/4", \$14.75. Complete amp. terminal kits \$4.75. 2" Universal chuck \$4.75. Wilt Surplus, 7829 S. Racine, Chicago 20, Ill.

#### BOATS, OUTBOARD MOTORS

MARINE Conversions, manifolds, water pumps, transmissions converted, reverse gears, etc., most complete line on the market. Barr Marine Products Co., 2706 E. Castor Ave., Philadelphia 34, Penna.

SAVE 2/3 Cost. Assemble your own boat. We furnish parts. No experience necessary. Rowboats, cruisers. Illustrated catalog 25c. Midwest Boat Company, Menomonee Falls, Wisconsin.

P38 BELLY Tanks, steel, \$9.95. Free picture. Bucks Auto Wrecking, Box 89, Merced, Calif.

BUILD Beautiful fiberglass-plastic boats without using molds. New patented method. Write Speedcraft, 2450 Emerson, Off Square Lake Road, Pontiac, Michigan.

SAVE Money, have fun—Build your own boat. Popular Mechanics "23 Boats You Can Build" tells and shows you how. 192 pages, 500 illus., detailed diagrams and material lists. Everything from 10 ft. dinghy to 25 ft. cabin cruiser. Only \$2.00. Order today from Popular Mechanics Press, Dept. 107, 200 E. Ontario, Chicago 11, Illinois.

APPLY Polyester-Fiberglass coating to your boat. Permanent protection. Catalog 10c. Gem-O'-Lite, Box 686R, North Hollywood, California.

CONVERT Fords and Jeep to 100% marine engines with Osco's world famous Convo-Kits. Deluxe catalogue 25c (coin). Oscomotors, 3627B Lawrence, Philadelphia 40, Penna.

PLANS: Inboard-outboard runabouts, cruisers, sail. Wood, plywood, welded steel. Advise requirements. John B. Clark, N.A., 329 Kenmore, Bay Village, Ohio.

OUTBOARD Motor parts—New, used for all makes. Send stamp for price quotation, listing parts needed. Outboard Motor Mart,

TWENTY Plywood boat plans \$1.00. Catalog boat building plans 25c. The Rudder, 15 Murray Street, New York 7.

FULL Size, cut to shape boat patterns, blueprints, 7 1/2-38 feet. Illustrated "Build a Boat" catalog, 25c (coin). "How to Build Boats" book, \$1.00. PolyWog houseboat plans \$10. Marine catalog \$1.00. Cleveland Boat Blueprint Co., 3107 Detroit Ave., Cleveland 13, Ohio.

MARINE Conversions for Ford and Jeep engines. Catalog 10c. Lehman Manufacturing Company, 972D Broad Street, Newark 2, New Jersey.

NEW, Used, rebuilt marine motors. Marine conversions, fittings. Free catalog. Stokes Marine Supply, Dept. 24, Coldwater, Michigan.

#### ENGINES, MOTORS, DYNAMOS

REBUILT Gasoline engines \$17.00 to \$37.00 Cauffiel Motor Industries, Temperance, Michigan.

MOTORS—1/2 Horse \$15. 3/4, \$22. 1, \$35. A.C. generators, 750 watt, \$38.50. 3000 watt, \$125. Butler, 1885 Milwaukee, Chicago 47.

WINDING Data, listing 225 motors, single and three phase, \$1.00. Motor Data Co., Box 7631, Kansas City 3, Mo.

#### ATHLETIC EQUIPMENT, BODY BUILDING COURSES

GAIN Weight! 4 exercises will increase weight. Complete \$1.00. Body Builders, 36 Nevada Street, Winthrop, Mass.

"POLICE Jiu Jitsu," "Scientific Boxing," "Police Wrestling," 3 books complete \$1 postpaid. Books Publishing, 56 West 24th, New York 10.

REVOLUTIONARY New lift exerciser—Stretch-A-Wate. Fraction cost barbells. Free booklet. Stretch-A-Wate Co., Sappington (St. Louis), Mo.

BARBELLS. Exercise equipment. Courses. Free booklet. Good Barbell Co., Reading, Penna.

#### SPORTING GOODS, GUNS, FISHING TACKLE, ARCHERY, TRAPPING

AMMUNITION, American-foreign and obsolete. New guns. Dime for list. Central Sports, Deiphos 25, Ohio.

NINE Guns in one! New Poly-Choke converts any pump or autoloading shotgun from one choke to nine different chokes. Free booklet tells how. Write today to the Poly-Choke Co., 816 Tunxis St., Hartford, Conn.

SAFE-T-LURE; New, patented, exclusive. Every fisherman a purchaser. Fresh and salt water. Catches no clothing, weeds, logs—Only fish. Money-maker, sells on sight. Send 50c for sample. Your account credited, first order. Huntington Products, Dept. F, 140 E. 59th St., New York 22, New York.

HUNTING Guns from \$10.00. Kentuckies, Western guns, Colts. Antique-modern bargain list, 25c. Ed Agramonte, 201 Warburton, Yonkers 2G, N. Y.

MOLDS. (For fisherman's sinkers, squids, jigs and lures.) Handled and hinged. Quality fishing tackle. Free catalogue. E. L. Sweet & Son, Tonawanda, New York.

WITHOUT Weapons—100 trick knock-outs for self defense, \$1—1c each. Lincoln, 529 Main, Evanston 7, Ill.

FASCINATING. Practical book for hunter and trapper. Guide to Good Hunting and Trapping lists all popular game animals, tells how to hunt and trap them. Many articles by famous guides and sportsmen. Author Joe Godfrey is famous sportsman. 160 pages, \$3.00. Popular Mechanics Press, Dept. 90, 200 E. Ontario, Chicago 11, Ill.

CAST Iron molds—For casting fisherman's sinkers. Free illustrated booklet. Reading Instrument Co., Box 78, Reading, Penna.

FOREIGN Ammunition, knives, cross-bows, rifles. Catalog 10c. Ashton, 1511 Gardner, Hollywood 46, California.

120 PROFUSELY Illustrated pages antique pistols, swords, daggers, armor, etc. 50c. Robert Abels, M860 Lexington Ave., New York 21.

SHOTGUNS, Rifles, Revolvers, 500 modern, obsolete. Also cartridges. Each list 10c coin. Ed Howe, 52 Main, Coopers Mills, Maine.

5000 BARGAINS, Firearms, binoculars, war relics. Catalog 50c. Smith Firearms,

## TAXIDERM Y

TAXIDERM Y Supplies, books, instructions. Everything! Catalog 10c. Vandye's, Wessington Springs 12, S. Dak.

## BINOCULARS, TELESCOPES, MICROSCOPES, MAGNIFIERS

TERRIFIC Values, binoculars, telescopes, microscopes, \$3.95 up. Request free money saving catalog. Criterion, Hartford, Conn., Dept. P7.

SAVE! Save! New binoculars! Free catalog. Free book, "How to Select Binoculars." Write today! Bushnell's, 43-M40 Green, Pasadena 1, Calif.

BINOCULAR Specialists, all makes repaired. Authorized Zeiss, Hensoldt dealer. Tele-Optics, 5514 Lawrence, Chicago 30, Illinois.

POWERFUL Telescopes easily made. Lenses, erector, focusing tube, instructions for making 40X, 100X, 200X and 400X telescope \$5.00. Telescopic Camera Co., Manorville, N. Y.

WAR Surplus bargains, binoculars, telescopes, sextants, millions of lenses, prisms, reticles, eyepieces, objectives, etc. Mail 10c for big "Catalog CH." Send \$1.00 for Stock CH—10-piece lens kit and big instruction booklet. Edmund Scientific Corp., Barrington, N. J.

AMAZING Prices, new precision binoculars, telescopes and laboratory microscopes, French, German and Japanese. Free trial. Folder "Binocular Selecting," catalog free. Prentiss Importers, Mercury Bldg., West Los Angeles 25, Calif.

SAVE! Free 36 page, 3 color binocular catalog. 60 different models. United Binoculars, (A-4508), 9043 S. Western, Chicago 20.

ASTRONOMICAL Telescopes, binoculars, microscopes, bought, sold, repaired. Books. Rasmussen-Reece, Amsterdam, N.Y.

BUILD Your own microscope. 200 power. Complete castings, mounts, lenses, screws, instructions. Kit \$17.50. Free illustrations. Esco, 911 Willow Ave., Hoboken, N. J.

MAKE Your 6" telescope reflector. Glass, abrasives, instructions—\$8.50. F. Cameron, Box 65, Inwood 96, N. Y.

REFLECTING Telescopes, 60X, completely assembled \$29.75. Guaranteed observatory clearness. Free information. Skyscope, 475 Fifth Avenue, New York 17.

POWERFUL Astronomical telescopes easily made. Perfect lenses and instructions; 100X \$3.00; 100X and 200X \$4.00; 100X, 200X and 400X \$6.00. Full power, clear vision guaranteed. Instructions alone 10c. Suffolk Science Service, Riverhead, N. Y.

BINOCULARS, Telescopes, microscopes. Our 20th year of leadership in optical values. Bargain catalog free. Brownscope Co., 24 West 45th Street, New York.

REFLECTOR Telescope kits, refractors. Free illustrated bulletin. Esco Products, 911 Willow Ave., Hoboken, N. J.

GIANT Astronomical telescope with 6 ft. tripod \$15.00, f.o.b. factory. 100 power. (10,000 area magnification). Clear vision, full power guaranteed. Ready for use. Suffolk Science Service, Dept. BT, Riverhead, N. Y.

## PETS—DOGS, BIRDS, RABBITS, HAMSTERS, ETC.

BEAUTIFUL Pure white pedigreed police puppies. Ansonia Kennels, Mose, N. Dak.

RAISE Guinea pigs. Profitable occupation. Free booklet. Taylors, B426A, Hapeville, Georgia.

FAMOUS Angoras, Chinchillas, White Giants! World's most profitable rabbits. Finest heavy-producing prize-winners. Catalog free. P. M. Grinsteeds, Edwardsville, Illinois.

RAISE Rabbits. Markets plentiful. Request literature. Tayco Rabbitry, Hapeville, Georgia.

GOLDEN Hamsters, Bear strain. Pedigree stock. Breeders, laboratory or pet stock. Shipped express anywhere. Price list free. Charles E. Bowser, Smoke Run, Pennsylvania.

RABBIT Raising pays. Markets furnished. Free illustrated literature tells how. Old Mill Rabbit Farm, Elmhurst, Illinois.

CHOICE Rabbits and guinea pigs. Prices reasonable. Winfield Harrison, Fitzgerald, Georgia.

HAMSTERS. Official breeding information free. Exceptional profits. Golden Hamstery, Box 604 Edgewater, Cleveland, Ohio.

CHINCHILLAS Rented. We pay \$300.00 each for raising. Write: R. Rau, Rt. 2, Jeannette 3, Pennsylvania.

SPORTSMEN: 200 Pointers, Setters, Straight Cooners, combination hunters, rabbit and fox hounds. Reasonable. List free. Ramsey Creek Kennels, Ramsey, Ill.

ST. Bernards, Boxers, Hof Kennels, 5136 Cascade Rd. S.E., Grand Rapids 6, Mich.

STANDARD Rabbit Journal, B-241-M, Milton, Penna. Year \$1.00, sample dime, beginner's manual 25c.

YOUNG Parrots—Make fine talkers. Herb Miller, 1911-N, Lubbock, Texas.

MONKEYS, Baby Ringtail \$49, a musing white faced \$45. Shipped immediately. Shehyn's Pets, Silver Springs, Florida.

EARN Up to \$400 monthly raising Angora or New Zealand rabbits. Plenty markets. Particulars free. White's Rabbitry, Newark, Ohio.

HAMSTERS—Golden or spotted. Cages and equipment. Free illustrated details. Lakeview Hamster Colony, Newfield, New Jersey.

BOOKLET "Treatise on Breeding and Raising Canaries"—\$1.00. Audobon Publishing Co., 3449-PM N. Western, Chicago 18, Illinois.

MAKE Big money! Raise Chinchilla rabbits. Cash markets supplied. Write today! Rockhill Ranch, Sellersville 15, Penna.

MINK Raising information free. Complete. Lake Superior Mink Farm, Superior, EEl, Wisconsin.

A Practical beginning to successful rabbit raising. 48 page illustrated booklet. Dime. American Rabbit Breeders Association. 36 AR & CBA Bldg., Pittsburgh, Penna.

## PLANTS, SEEDS, NURSERY AND GARDEN SUPPLIES

FRUIT Trees! Stark Bro's sensational new "Dwarfs." Also standard size, exclusive patented, trade-marked varieties produce abundant, larger, better apples, peaches, pears. All fruit faster growing, quicker bearing. Also beautiful ornamental trees and shrubs. Get giant new colorphoto catalog free. Stark Bro's., Dept. 30003, Louisiana, Missouri.

HARDY Perennial gladiolus. Plant October. Other bulbs. Robinsons, Sebastopol, California.

GINSENG. Goldenseal. Hundred seeds \$1.50; thousand \$5. Dozen seed bearing plants \$1.50; hundred \$9. Complete instructions. M. Collins, Viola, Iowa.

## FARMS, FARM LANDS, REAL ESTATE

MISSOURI Land, 10 acres \$90. Other tracts, \$4.50 an acre. Payments. Free list, maps. John Calvert, Winter Haven, Fla.

UNITED Farm Agency's big free fall catalog of farm and country real estate bargains can help you plan soundly for your future security in the country. Good pictures, many states, easy terms, many equipped, unharvested crops included. For special service, state requirements, desired location. Write for your catalog today, it's free! United Farm Agency, 1408-PM Consumers Bldg., Chicago 4, Ill.

FLORIDA—New Lake County development adjoining Ocala National Forest. Best fishing, hunting. Safe from bombs. Nice homesites \$245 at \$10 monthly. Folder free. Howard Vernor, DeLand, Florida.

FARM And business catalog free! Big new edition. Hundreds of bargains from \$1000 up. Maine to Florida. West's, M-10, Pittsburgh 17, Penna.

OZARK Homes. Farms, timbered lands, \$10 acre. \$5 monthly. Write today. Armstrong's, Shook 34, Missouri.

CALIFORNIA Ranch lands. 50c to \$5 acre minimum bid. Farm-ranch-hunt-fish-retire. 10c brings illustrated land catalog, outline maps. Tax Land Sales, Box 2350 BW, Hollywood 28, Calif.

HOMES You can build for \$4500 to \$7046. Books that show every step. Popular Mechanics Famous Concrete Block House, \$2.00. Your Home and How to Build It Yourself, \$3.00. Ranch Type House You Can Build, \$3.50. Also full-sized builder's plans for each home at nominal price. Popular Mechanics Press, Dept. 102, 200 E. Ontario, Chicago 11, Ill.

NEW Strout catalog. Just out! Farms, homes, businesses, 31 states, coast-to-coast, bargains galore. Mailed free. Our 53rd year. World's largest. Strout Realty, 7 So. Dearborn St., Chicago 3, Ill.

\$5.00 MONTHLY Buys 40 acres near town; price \$200.00. Free list. Box 425-P, Carthage, Missouri.

FARM-Ranch opportunities. Favorable conditions. Washington, Minnesota, Montana, Idaho, Oregon, North Dakota. Literature, farm descriptions. Specify which state. J. W. Haw, 119 Northern Pacific Ry., St. Paul 1, Minn.

HOMESITES \$300—Convenient payments. California's finest garden section. On Morro Bay's scenic shores. Wonderful fishing, boating, bathing. Fertile soil, softest water, temperate climate, congenial community. Free literature. Richard Otto, Department M, San Luis Obispo, Calif.

## POULTRY, FARM SUPPLIES

KNOW How to raise poultry for profit. Read Poultry Industry. Every issue packed with helpful hints and practical suggestions. Latest articles on breeding, feeding and management. Subscribe now, 1 year 50c, 3 years \$1.00. U. S. funds or checks payable at a New York or Boston bank. Poultry Industry, Dept. PM, 376 Boylston St., Boston 16, Mass.

## PROFITABLE OCCUPATIONS

SEND For big, new 1952 illustrated catalog that will show you how to turn your spare time into cash—making quick-selling, highly profitable lamps. Every home a prospect. Hundreds doing it, you can, too. No experience or special tools required. Catalog No. 7 contains 56 pages filled with shades, shade frames, figurines and bases, oil lamp converters, boring compound, and dozens of similar items. Also all kinds of sockets, cords, pipes, harps, finials, bases, and hundreds of other parts—everything you need. Special 8-page section shows 6 beautiful lamps in kit form, ready to assemble. You buy wholesale, sell at retail. Make big profits. Send 25c today for new 1952 catalog and wholesale price list, you'll be glad you did. The 25c will be refunded on your first order. Gearon Co., Dept. 500-B10, 27 S. Desplains, Chicago 6, Ill.

WANT A diesel job? New opportunities to increase income. Higher pay. More money. We can help you qualify. Tools. Shop method home training. Write today! Diesel Tractor, Heavy Equipment Division, Interstate Training Service, Dept. 3K, Portland 13, Oregon.

"HOW To Make Money With Simple Cartoons"—A book everyone who likes to draw should have. It is free; no obligation. Simply address Cartoonists' Exchange, Dept. 910-CP, Pleasant Hill, Ohio.

PROFITABLE Occupation. Hand weaving loom plans and directions \$4. Bill Carter, 447 W. 60th Pl., Chicago 21.

MAKE. Sell artificial flowers, corsages, chenille dolls, jewelry. Starting kits, fibre, leaves, shellcraft, rhinestones, sequins, findings. Wholesale catalog, 10c. Profit-krafts, 4508T212 Lorain Ave., Cleveland 2, Ohio.

\$4 TO \$10 Hour spare-time in billion-dollar adjustment field. Qualify now! Write today. Universal Schools, M-61, Box 8202, Dallas 5, Texas.

BUY Wholesale thousands nationally advertised products at big discount. Sent free "The Wholesale Plan." American Buyers' Service, 628-R Linden, Buffalo, N. Y.

BE The Popular Mechanics representative in your neighborhood and earn big profits in your spare time. Write Popular Mechanics Magazine, Room 408M, 200 E. Ontario St., Chicago, Ill.

TYPISTS—Profitable home business. Complete copyrighted information, 50c. Gaunt, 827-A Irving Park, Chicago, Ill.

FOREIGN Employment construction men, building trades, helpers, office men, others interested in foreign projects. High wages, quarters, transportation. Send \$1 for foreign construction compendium and application forms. Foreign Service Bureau, Dept. PM-10, Metuchen, New Jersey. (Not an employment agency—no fees.)

SAIL Ho! Be a merchant seaman. Enjoy world travel. Big pay. Send now for free information. Seaways, Box 1231, Baltimore 3, Maryland.

**CONSTRUCTION** Job list. Published monthly. \$1.00. Dempster's Construction Scout News, Dept. 268-JN, Bridgeport, Ill.

**EARN \$1000.00** Monthly operating book-keeping or income tax service. Details free. Universal, Box 664-M, Springfield, Mo.

**JOBS Abroad.** How, when and where. Accurate information. \$1.00. Overseas Jobs, Dept. 335-A2, Baton Rouge, La.

**FOREIGN Jobs.** Contracts underway and soon starting in Africa, South America, Canada, England, Europe, South Pacific, Middle East, Mexico and Alaska. Send \$1.00 for foreign job news, information, application forms, etc. DCS Foreign Job News, Dept. 268-JO, Bridgeport, Ill.

**PROFITABLE** Easily made earrings. Kit for two different pair, sales plans, 50c coin. Pricopoulos, 761 Worthington, Springfield 5, Mass.

**BIGGEST** Job digest ever published. Your key to real opportunity! Make the big money now! Over 200 long-term foreign and domestic projects listed, plus copy of real foreign bonus check as added incentive. Act now! Rush \$1.00 immediately to Chilean-American Associates, P. O. Box 9061, Houston 11, Texas.

**"BRAZIL!"** New success land! Your chance? Find out now! Key business, farming, travel sources! Send 25c for "Brazil at Your Fingertips!" Brazil C9, P. O. Box 1799, Grand Central, New York 17.

**JOBS** Galore in greater L. A. area; big defense and peacetime openings for skilled and unskilled workers. We assist applicants. Send dollar for folio "Vital Facts You Should Know." Personnel Specialists, Room 515A, 610 South Broadway, Los Angeles 14, Calif.

**CASH** In on coming income tax boom. Become a tax expert. Earn \$50 and more daily, preparing income tax returns spare time. Experience unnecessary. Details free. Union Institute, Lakewood 2, New Jersey.

**FOREIGN** Contract applicants. Did you ever see a foreign contract? Or a copy of the typical medical examination given foreign contract workers? Or the rules governing foreign contract employees while on the job? Don't delay! Act now! Rush \$1.00 for faithfully reproduced copies of real foreign contracts, medical exam and rules actually used on the job recently by foreign contract employees. Entrepreneurs, Ltd., P. O. Box 379, Houston 1, Texas.

**\$10,800 PROFITS!** Your own mailorder business! No capital risk! "Success plan" (worth \$2) free! Write today! Treasury, 149 Storer, New Rochelle L-4, New York.

**WORK** For Uncle Sam! \$3000.00 to \$14,8000.00. Write. National Service Co., Box 1718, Washington 13, D. C.

**NOTARY Public;** How to become. \$5.00 Pierce, 927 Hickory St., St. Louis 4, Mo.

**ALASKAN Jobs!** Over 100 new construction contracts with names, addresses companies hiring. Thousands needed. Highest wages. Military, private construction, mining, fishing, lumbering, aviation, railroads, homesteading. Skilled, unskilled workers. Write today. Our information accurate. \$1.00 complete. Alaskan Opportunities (PM), Box 362, Kenmore, Washington.

**MEN—Women.** "Everybody likes candy." Learn to make professionally. Tools and supplies. (Our 42nd. year.) Ragsdale Candies, D6, East Orange, New Jersey.

**MUSHROOMS** Grown. Boxes, barrels. Manureless process 50c. Spawn \$1.00. Gordons, 553 William, Winnipeg, Manitoba.

**GROW** Mushrooms. Cellar, shed, and outdoors. Spare, full time, year round. We pay \$3.50 lb. We paid Babbitt \$4,165 in few weeks. Free book. Washington Mushroom Ind., Dept. 99, 2954 Admiral Way, Seattle, Wash.

**MAKE** Flexible molds! Cast plaques, bookends, figurines! Free sample! H. Tooker, 630-M Chestnut, Hamilton, Ohio.

**ALASKA—Last** American frontier. \$1.00 brings 1952 business directory, government map, construction projects military and civilian, homestead and highway facts, hunting-fishing-game rules, mining, aviation. List of firms hiring. How-when-where to apply. Alaska Opportunist, P. O. Box 883-P, Hollywood 28, California.

**RAISE** Pheasants on the \$100 week plan. Little capital and space can make you independent. Free details. Great Central Game Management System, Columbus 1, Kansas.

**FOREIGN** And Latin American employment. 1952 "Foreign Service Directory" gives up-to-minute facts on military and civilian construction, government jobs, major oil listings, aviation, transportation, steamship lines, mining, importers, exporters, how-when-where to apply, application forms, hot list firms hiring. \$1.00 postpaid. Global Reports, P. O. Box 883-P, Hollywood 28, Calif.

**\$40.00 WEEKLY** Made growing mushrooms, fresh, dried. Dominion patent 331583. Free spawn. North American, 169P Yonge, Toronto, Canada.

## BOOKS, PERIODICALS, PICTURES, POSTCARDS

**"THE Modern Clock."** All about clock repair. 502 pages. 173 illustrations. \$4.95, postpaid. 10-day return privilege. North American, Dept. 12K, 2018 North Ave., Chicago 47, Illinois.

**HELPFUL** Books for business, trade, hobby. Lists free. Helpful Book League, 15 East 40th St., New York, N. Y.

**ENGINEERING** And scientific books. Catalog available. Educational Aids, Dept. 3010, Box 248, Temple City, Calif.

**FIVE** Post card views of New York City and special offer 10c. Rupp, 418 East 163 St., New York City.

**"HOW** To Buy a Used Car." See Automobiles-Classified.

**SELF-Explaining** Bible: Illustrated circular free. Box 446-P, Minneapolis, Minn.

**FREE** Giant Popular Mechanics 40-page Golden Anniversary Book Catalog! Over 400 books on workshop planning, home building, household repairs, projects, motoring, sports, photography, money-making opportunities, machinery, inventions, crafts, hundreds more. Many not available in stores. Send postcard today to Popular Mechanics Press, Dept. 110, 200 E. Ontario, Chicago 11, Ill.

**SENSATIONAL** Book bargains! Free catalogue! Write: Old Prof's Book Shop, 9 W. Lawrence St., Pontiac 15, Mich.

**USED** Books supplied. Catalogue 10c. Balliol, Box 85, Station "K," Toronto, Can.

**FREE** Catalog, 400 popular books. Bargain prices. Books Publishing Co., 56 W. 24th, New York 10.

**BOOKHUNTERS!** All subjects. Send wants! Jaher Book Service, 620-P East 178 Street, New York 57.

**MAGAZINES** (Back dated)—Foreign, domestic — Arts, books, booklets, subscriptions, etc. Catalog 10c (refunded). Cicero's, 86-22 Northern Blvd., Jackson Heights, N. Y.

**BOOK** "Breeding of Parakeets" and cage-bird magazine—\$1.00. Audubon Publishing Co., 3449-PM N. Western, Chicago 18, Illinois.

**BOOKHUNTERS!** Scarce, unusual, miscellaneous books supplied. Atlantic Book Service, Lawrence Avenue, Charlestown 29, Massachusetts.

## GAMES, TOYS, NOVELTIES

**TOYS—Special** discount. Free catalog. Kiddieland, Box 115-A, Hollis 23, N. Y.

**YAHTZIE.** The new international game, successor to canasta. Complete 300-game set postpaid anywhere. \$1.00. P. O. Box 502, Crawfordsville, Indiana.

## MAGIC TRICKS, PUZZLES, JOKER NOVELTIES

**"VENTRILOQUISM** Selftaught"—Complete easy instructions book 20c. Loyal, 4014-P Amundson Avenue, New York 66.

**PROFESSIONAL** Catalog, 189 pages, 25c. Williams, 900 Plymouth, Ellwood City, Penna.

**"ITZAPIP"**—World's cleverest card trick. Everything supplied. 25c. Dewgray, General Delivery, Selma, Alabama.

**HYPNOTIZER!** The cutest trick you've seen, guaranteed! Invest \$1.00 in fun. Hypnotizer, 208 Iini Way, Aiea, Oahu, Hawaii.

**MAGIC** Catalog and lists 10c. Sterling Magic Co., Royal Oak, Mich.

**LATEST** Magic. Big illustrated catalog 10c. Top Hat, 529A Main, Evanston, Ill.

**WOODEN** Nickels, magic catalog, free trick. 35c. Fun 'N' Magic, 511 North St. Marys, San Antonio 5, Texas.

**BE** A magician. Large professional magic catalog of latest tricks, 35c. Ireland, C-109 North Dearborn, Chicago 2.

**"VENTRILOQUISM** Selftaught"—Complete book 25c. Greenview, Box 61-BH, Whitestone 57, New York.

**BIG** Fun kit! Unusual tricks, jokes, novelties, books. Howls galore. \$1.00. Johnson, 414 McRae, Wilmington, N. C.

**TRICKS.** Funmakers, puzzles, jumbo catalogue 15c. Andersen's, 6815P Ardmore, Chicago 31.

**PROFESSIONAL** Catalog and free trick 35c. Terry's Magic Studio, 6606 Duryea Court, Brooklyn 19, New York.

**MAGIC** Monthly, year 25c. New 1952 magic catalogue 10c. New joke lists 5c. Magic Factory, Minneapolis 2, Minn.

**512-PAGE** Catalogue of 2500 tricks, pocket, parlor, stage. World's finest magic. Send \$2.00 for catalogue (refunded first \$8.00 order). Kanter's, M-1311 Walnut, Philadelphia 7.

**FREE** Trick and large illustrated catalog 35c. Lerro Magic, 8111 Fifth Avenue, Brooklyn 9, N. Y.

**WORLD'S** Largest magic shop. Special: Big \$2 book of professional magic tricks, only \$1. Includes mailing lists. Holden's, M220 West 42nd St., New York.

**LATEST** Magic for pocket, parlor, stage. Catalog 500 tricks, only 10c. Unequaled magic service for 30 years. Douglas Magicland, Dept. 1, Dallas, Texas.

## COINS, TOKENS, CURRENCY

**KNOW** The value of your collection. Free booklet. Harry Smolin, Box P-288, Flushing, N. Y.

**BUILD** A coin album library. Details, sample 30c. Long Beach Stamp Company, Long Beach, New York.

**3c** PIECE And new lists 35c. Bolus, 1139 Eleventh N.W., Canton 3, Ohio.

**OLD** Money wanted. Will pay fifty dollars for nickel of 1913 with Liberty head (not buffalo). We pay cash premiums for all rare coins. Send 4c for large coin folder. May mean much profit to you. Numismatic Co., Dept. 20, Fort Worth, Texas.

**COIN** Collector's greatest magazine, wooden nickel and foreign money, 10c. Lawrence Brothers, Anamosa, Iowa.

**WHAT** Are your coins worth? Amazing Fell's new 1952 United States coin book. Everything on every single coin minted—Worth, value, how to sell, speculating, investment; other valuable facts. Cloth-bound. 150 illustrations. Send no money. Pay postman only \$1.50 (plus postage) or \$1.50 postpaid (refundable). Order now! Fell Publishers, 386-M6 4th Ave., New York City 16.

**FOREIGN** Coins 10 different 25c. Foreign bills 10 different 15c. Lists. Oliver Arnold, Macon, Missouri.

**66** COINS And bills, \$1.00. Oddehon, Box 482, St. Louis, Mo.

**COIN** Collector's Magazine. Largest independent, over 1000 pages per year. Sample copy 30c; \$3.00 per year. Hewitt, 7320-J Milwaukee Ave., Chicago 31.

**SET** Nine Japanese invasion notes for U. S. \$2.00. Catalogue thousands of coins, 25c. Shultz, Salt Lake 10, Utah.

**GET** Profit and pleasure in collecting old coins. Send 10c for 56 page illustrated coin catalog. You'll be delighted with it. Send for it now. B. Max Mehl, 370 Mehl Bldg., Fort Worth Texas. Largest rare coin establishment in U. S. Established 52 years.

**FREE!** Foreign coin, banknote and coin collectors illustrated catalog to approval service applicants. Send 3c postage. Tatham Coinco, Springfield 30, Mass.

**FIFTY** Assorted Indian cents, \$1.50. Rare 1931-S cents, \$1.00. Giant fifty-two page illustrated bargain catalog, 10c. Ben's PM Department, 31 North Clark, Chicago 2.

## STAMP COLLECTING

**PAY** Check gone? Are you paying too much for approvals? Try our books of 1,000. Priced at 1c and 2c each. Reference appreciated. Roseland Stamp Co., Dept. 10-A, Spring Lake, Michigan.

**RARE** Octagonal stamp. Giant triangle, gorgeous diamond, also mammoth and midget stamps given to foreign approval buyers. Gifts with purchases including Scott's International \$6.00 album, also latest Scott catalogues. Plymouth, Dept. A9, Bell, California.

**GIGANTIC** Collection free. Includes triangles, early United States, animals, commemoratives, British Colonies, high value pictorials, etc. Complete collection plus big illustrated magazine all free. Send 5c for postage. Gray Stamp Company, Dept. PM, Toronto, Canada.

**SAN Marino** collection free. 25 different, old and new issues, airmails, commemoratives, high values. Absolutely free with approvals. Viking, 130-ZZ Clinton St., Brooklyn, N. Y.

**FREE** Complete set of famous Americans, flags, parks and presidentials to approval buyers. Send 3c for 15 of the above stamps plus full particulars. Triboro Stamp Company, 145 Nassau Street, Dept. 110, New York 38, N. Y.

**POPULAR** Sets on approval. Write today. Samples and illustrated folder. W. Langford, 53 Durham Road, San Anselmo, California.

**U. S. Army and Navy** heroes on stamps: 10c with United States approvals. Locust, Box 205-T, Harmon-on-Hudson, New York.

**LOOKING** For bargains? Try out 1c & 2c approvals mounted in books of 1,000. We believe in both quantity and quality. First try will satisfy. Clark, Box 544-P2, Muskegon, Michigan.

**TWO** Mint pictorial sets: San Marino, Vatican, 5c. Request approvals. Silas Stamps, Box 55-X, Triborough Station, New York 35, N. Y.

**GIANT** Approvals. Thousands different, at 1 and 2c. Wahl's Stamp Exchange, 7008P Farragut, Chicago 31, Ill.

**MINT** U. S. 797 SPA sheet, 10c to applicants for U. S. approvals. M. Haycock, 235M 86th St., Brooklyn 9, N. Y.

**CLEANING** House—50,000 sets 5c to \$1.00. Selection sent on approval. Szima, 10 Silleck Street, Clifton, N. J.

**500 DIFFERENT** Stamps 30c with approvals. Ompach, 1818 Antoinette, Fort Wayne 5, Indiana.

**CANADA**—7 Commemoratives 10c. Attractive approvals. Rheume, 6591 11th Ave., Montreal 36, Canada.

**200 EXOTIC** Japan stamp—10c. Kenmore, Milford K57, N. H.

**COMMEMORATIVES**, 100 Mixed U. S., 25c. Ray Worth, 321 S. Cicero, Chicago 44.

**6 IONIAN** Island stamps free. Approvals. W-B-M, Box 758, Wilkes-Barre, Pennsylvania.

**LOWER** Priced stamps for general collectors. "Sunny," 1267 Tutwiler, Memphis 7, Tennessee.

**50 FOREIGN** 5c. Approvals. Brown, PM, 106 Center, Staten Island 6, New York.

**APPROVALS**, Penny up. Free gift. Kreisher, 710 Walnut, Reading, Penna.

**COSTA** Rica diamonds, 10c. Approvals. Herman Wolfel, 135 Glenwood, Manchester, New Hampshire.

**UNITED** States or foreign approvals. Jeffrey Stamps, Box 223, Forest Hills 75, New York.

**50 DIFF.** U.S.A. and 100 diff. foreign, 10c to approval applicants. Kem, 670 W. Florence, Los Angeles 44, Calif.

**312 MIXED** U. S. only 10c to "Gold Nugget" approval applicants! Nothing like them. Kessel's, Folsom, California.

**APPROVALS:** Fine Canadian and foreign. Claude Langlois, Victoriaville, Que., Canada.

**OLD** U. S. on approval. Low prices. MacG, 2905 Observatory, Cincinnati 8, Ohio.

**AFRICAN** Stamps free. Melrose Distributors, 6 Rockland St., Melrose 76, Massachusetts.

**ITALY**—100 Different 5c with approvals. De Respinis, G.P.O. Box 771P, New York 1.

**STAMP** Wallet containing small Ireland collection 5c with approvals. Amberg, 537P 35th, Union City, N. J.

**GIGANTIC** Approvals. Penny and up. Resch, 3739 N. Wilton, Chicago, Illinois.

**FREE!** Rare, colorful Spanish Morocco set complete, with temptingly-priced approvals. PG, 195 Park, Lewiston, Maine.

**FREE!** Powerful magnifying glass for 5c post. Bargain lists and approvals. Jamestown Stamp Co., Dept. 207, Jamestown, New York.

**EXCHANGE** Stamps universe. Particulars free. Exchangers, Bry 126, Seine, France.

**GOYA** Nude (2) 5c. Approvals. Han-nay's, 310 Quail, Albany 3, N. Y.

**NUDES** Set; colorful approvals—10c! Atlas, 2830-M Eisenhower, Racine, Wis.

**FLASH!** Worldwide stamp collection! 1005 different only \$1.00! Big illustrated money saving catalog free! "Stamps By Mail," 2133 Lunt, Chicago 45.

**SENSATIONAL!** Set each Honduras, Martinique, Guadeloupe, Guiana, also \$2-000,000 stamp. Brunel, over 100 different others. Everything 10c with approvals. Whitehead, 315P South 5th Ave., Canton, Illinois.

**FREE**, 30 Different U.S., to applicants for our unexcelled U.S. approval service. Sparta, Box 1082, Rochester 3, N. Y.

**UNITED** States! 58 different including commemoratives, airmails, 10c to approval applicants. Sunset, Dept. 343, Box 47, South Gate, Calif.

**FREE** Triangles with approvals. Variety collections—500, 60c; 1000, \$1.25; 2000, \$3.25; 3000, \$5.90; 5000, \$13.75. Philatelic House, Rockville Centre, N. Y.

**219 DIFFERENT** Including 19th century; diamond; jubilees; souvenir sheet—10c. Approvals. Brooks, 2352C East 23rd Street, Brooklyn 29, New York.

**GREAT** Free offer—Weird mosquito stamp, thrilling bicycle race, gorgeous orchid, colorful native drummer, gigantic diamond airmail, stamp albums, all to our approval buyers. Bell Stamp Service, Dept. S-4, Bell, California.

**10,000 PENNY** Approvals waiting for you. Many from exotic countries, pictorials, airmails, new issues. Tilbury, Box 862, Newark 1, N. J.

**FREE**, 25 British Colonies, illustrated lists, real stamp bargains, more free packets, sets. Stoll Stamp Service, 2632 Burnett, Louisville 10, Kentucky.

**BUY** From a reliable house, 500 different 60c, 1000 different \$1.20, 2000 different \$3.20, 300 different \$6.00. Super mission mix 30c. Worlds Largest Stamp Company, Box 1014, Oak Park 2, Illinois.

**WHOLESALE** Lists—Bargain collections, accumulations, singles. Mailed for 10c (refundable). Largentiere Stamps, 6462 83rd Place, Forest Hill 79, New York.

**FREE** Japan large flying geese stamp. Approvals included. Hathaway, P. O. Box 211 P, Hempstead, L. I.

**44 RECENT** Mint Japan and Korea \$1.00. Hauke, 4121 N. Mozart, Chicago, Illinois.

**100 DIFFERENT**, 100 Hinges, gauge, illustrated lists, all 10c. Roberts, Farmington 11, Missouri.

**ALBUM!** Capacity over 1000 stamps! Only 10c! Stampmart, Hartford 1, Conn.

**TRIANGLE**, Diamond, midget, giant Roosevelt, Hitler, others. Everything 3c with approvals. Thrifty Company, Silver Spring, Maryland.

**50 DIFFERENT** Free to approval applicants. Buckeye Stamps, Urbana, Ohio.

**100 DIFFERENT** U. S. 25c. 1000 different worldwide \$1.00. Approvals. Hegenbarth, 1545 Ardmore, Chicago 26.

**FREE** Monaco royalty, approvals. Elliott, Box 1686, Miami Beach, Florida.

**LOOK!** World packet, 250 different 25c. Allen, 211 Elmwood, Medina, Ohio.

**15 HUNGARIAN** Beauties 15c. Approvals. Spicka, 4032 Jaynes, Omaha 11, Nebr.

**BIG** U. S. illustrated catalogue free. Stone, 45 Bromfield, Boston 8, Mass.

**TRIANGLES!** 10 Different only 10c to new approval applicants. T. Moulblow, Box 278, East Northport, N. Y.

**SURPRISE** Grabbags. Big variety. 25c each. Monjar, Fairmount, Cincinnati 14, Ohio.

**FREE.** Price list. Beginner's packet. Stampinggrounds, Box 55, Glastonbury, Connecticut.

**103 DIFFERENT** Free! Approvals. 3c. Zampino, 2337 Bath Avenue, Brooklyn 14.

**100 DIFFERENT** U. S. commemoratives \$1.00. Luther Chick, 436 No. Main, Brewer, Maine.

**WONDERFUL** Offer—7 complete mint sets only 10c with approvals. Reich (M26), 4647 Kenmore, Chicago 40.

**"GOYA** Nude" set (catalogs 55c) 20c with approvals. Royal Stamp Company, Tamaqua, Penna.

**FREE!** 25 Different Switzerland with swell approvals. Kardell, 209 Bower, Santa Fe, New Mexico.

**ANGOLA!** Beautiful multicolor bird set plus 100 different stamps, 10c to approval applicants. Sunset, Dept. 486, Box 47, South Gate, Calif.

**1000 FOREIGN** Stamps off paper \$1.00. 5000, \$4.00. Anderson, Box 855, Mountain Home Tenn.

**90,000 STAMPS** Sale: Grabbag 30c. Special sellout lot \$1. Extra special with sets, stock cards, free gifts \$2. Literature free. Schollmeyer, Box 48, Brooklyn 25, N. Y.

**1000 MIXED** United States. Off paper. Guarantee 170 varieties. \$1.05 insured. Quaintance, Box 178F, Upper Sandusky, Ohio.

**STAMPS**—Variety, foreign and U. S. Mixed all different. Sent on approval. George Silverson, 608 E. 23rd St., Los Angeles, Calif.

**PACKETS;** 1000, \$1.25. 2000, \$2.75. 3000, \$6.00. 5000 mounted, \$15.00. 10,000, \$45.00. Russell, 20110 Natural Bridge, St. Louis 15, Mo.

**TERRIFIC** Bargains! Approvals 1/2c-5c. Gaines, 716-A South Sixteenth, Mattoon, Illinois.

**850 MIXED** U. S. Old-New, 25c. Lists. Weatherby, Medina, Ohio.

**COLLECTIONS** Being broken up for approvals, state needs. Lush, 9627A Martindale, Detroit 4, Michigan.

**OPPORTUNITY!** Gorgeous lot, triangles, diamonds, giants, midgets, flags, airmails, railroad stamps. Also Guiana, Djibouti, Mongolia, Angola, New Caledonia, etc. Everything only 10c to approval applicants. Evden, 58 North Montgomery Street, Valley Stream 2, N. Y.

**1c BARGAINS.** 75,000 Different stamps in books of 1000—Only 1c each sent on approval. References please. SIR, 228 Woodstock Street, Crystal Lake, Illinois.

**GENUINE** Bargain, 100 different stamps 25c. MacKellar, Box 4683, Los Angeles 24, California.

**300 DIFFERENT** United States—\$5.00. Approvals. Utechts, 1143D North Keeler, Chicago 51.

**SINGLES,** Sets, packets. Illustrated price lists 10c (refundable). D. Babineau, 7 Clifford St., Biddeford, Maine.

**AN** Extra bonus—Your choice latest Scotts Albums; catalogue and available philatelic accessories. Realize—you get these extra bonuses when you buy from our better foreign approvals. Write today for full particulars sent with trial approval selection. Americas' Stamp Service, Riverside 9, Calif.

**U. S.** Illustrated price list free. Lush, 9627 Martindale, Detroit 4, Mich.

**50 MINT** Stamps, including Monaco giant bicolours given approval applicants. Broadmoor Stamp Company, Pittsburgh 34, Penna.

**U. S. Catalog**—52 illustrated pages. 3c postage. Brock, 10516 Clifton, Cleveland 2, Ohio.

**500 MIXED** Stamps and surprise packet for 10c with approvals. Fahsing, Dept. PM, Atascadero, California.

**18 VALUE** Pictorial set. Free to approval buyers. Pleasure Stamps, 1865P—52nd, Brooklyn 4, N. Y.

**AMAZING** 333 Universal different, 25c. Economy approvals. Seifert, Box 1672, Reading, Penna.

**PENNY** Foreign approval stock. 1000 assorted, \$1.00. C. W. Ritchie, Watertown, S. Dak.

**TEN** Dandy sets, 10c to approval applicants. Faszold, 423c Cameron, St. Louis Co. 15, Mo.

**300 DIFFERENT** Given free with approvals. Postage 3c. Windsor Stamps, 1435 East 67th Place, Chicago 37.

**1,000 UNIQUE** Colorful attractive mounted stamps 1c-2c each. Rushed. Niagara Stamp Co., Niagara-on-the-Lake 71, Can.

**OLD** Scarce U.S. seconds on approval. Slight imperfections. Bargain prices. Hernefield, Clintonhill Station, Newark 8, N. J.

**"SNAKES,"** Rhinoceros, giant, pygmy, emu, kangaroos, koalabear, kookaburra and other fierce jungle beasts given if you request our exciting approvals. Niagara Stamp Co., Niagara-on-the-Lake 51, Can.

**APPROVALS,** Sets, singles with money saving price list free. Ward, 241 South Winchester, Campbell, Calif.

**100 DIFFERENT** Stamps free with approvals at 60% discount. Martinsen, Box 115, New York 33, N. Y.

**SEVEN** Triangles and assortment choicest beauties. Everything 10c with approval. Stan Bubenas, 27a James Ave., Clark Cranford, N. J.

**100 DIFFERENT** France 10c. Approvals. Aronson, 91 Marion, Brookline 46, Mass.

**100 DIFFERENT** France 10c. Approvals. Aronson, 91 Marion, Brookline 46, Mass.

**100 DIFFERENT** France 10c. Approvals. Aronson, 91 Marion, Brookline 46, Mass.

**100 DIFFERENT** France 10c. Approvals. Aronson, 91 Marion, Brookline 46, Mass.

**100 DIFFERENT** France 10c. Approvals. Aronson, 91 Marion, Brookline 46, Mass.

**100 DIFFERENT** France 10c. Approvals. Aronson, 91 Marion, Brookline 46, Mass.

**300 STAMPS** For only 10c.—This mammoth value includes airmails, pictorials; stamps from strange countries cataloguing up to 25c each! Also approvals. Mystic Stamp Company, Camden 80, New York.

**FREE "Stamp Finder."** Tells instantly country to which any stamp belongs. 32 pages profusely illustrated. Garcelon, Calais 17, Maine.

**200 DIFFERENT** Including Roosevelt triangle, 5c to approval applicants. M. Avalon Stamp Company, Springfield, Mass.

**FLAG Stamp**—Free with hydrate U. S. approvals. Wenigman, 1933 Patterson, Chicago 13.

**STAMPS Wanted.** Collections, duplicates, surplus stock, mint and used. Good grades only. Buy outright if bargain. What have you? Write us details. Vanroy Shirk, Lebanon, Penna.

**WORLDWIDE Variety packets** 100 10c; 500 60c; 1,000 \$1.25; 2,000 \$3.25; 5,000 \$13.75. Philatelic House, 189 Merrick Rd., Rockville Centre, N. Y.

**1/2-1-2c APPROVALS.** Bargains galore! Cole, 43A Rinewalt, Buffalo 21, N. Y.

**40 DIFFERENT U. S. commemoratives,** airmails 25c. Seidenberg, 944, Appleton, Wis.

**FREE Sample**—Interesting, informative, illustrated! National Stamp News, Anderson, South Carolina.

**AMAZING Offer!** 500 United States stamps—including commemoratives, air mails, high denominations to \$5.00. Only 15c to approval applicants! Illustrated bargain lists free. Mystic Stamp Co., Dept. 80, Camden, New York.

**POLAR Bear triangle, giant George Washington, six colored Ecuador, Arctic triangle, first American commemorative, Corsica, Devils Island, others.** Everything free with approvals. Capital Stamps, Little Rock 2, Ark.

**FREE**—Illustrated catalog! Kenmore, Milford, C-57, N. H.

**"HOW To Recognize Rare Stamps."** Free book illustrated! Kenmore, Milford, H-57, N. H.

**FREE.** Scott's International Album. Other big premiums. Full particulars with approvals. Raymax, 68-Z Nassau St., New York 38.

**DIFFERENT 500, 35c; 1000, \$1.00; 2000, \$2.00; 5000, \$10.00** with approvals at wholesale to clear. K. S. Holmes, London, Can.

**U. S. Price list free.** P. Wetterquist, 1635-13th Avenue, Rockford, Illinois.

**100 DIFFERENT Spain 25c.** Penny approvals included. Reed, Box 980, Chicago 90, Ill.

**50,000 STAMP Grabbags 25c each.** Anderson, 630B Bingham, Reading, Penna.

**307 ALL Different—Only 15c!** Beautiful collection: commemoratives, triangles, high values, bicolored stamps, etc. Garcelon, Calais 400, Maine.

**NICARAGUA Sports, Costa Rica agriculture sets 10c** with approvals. Seminole Stamps, Box 1138-P, Coral Gables 34, Fla.

**50%-75% DISCOUNTS!** Approvals from 33,000 collection—1/2c up! Schur, Box 235, Buffalo 12, N. Y.

**NOTHING Free.** Just good stamps reasonable. Send dime for seventy-four page catalog. Ben's Stamp Shop, 31 N. Clark, Chicago 2.

**WOW! 203 All different Germany 10c!** Zeppelins, semipostals, airmails, high values, etc. to new customers. Jamestown Stamp, Jamestown 512, New York.

**WORLD'S Largest stamp (7 1/2 x 14 inches).** A real curiosity! Retail for 50c, only 3c to approval applicants. Tatham Stamp Co., Springfield 30, Mass.

**ANTIQUES, RELICS, INDIAN GOODS, CURIOS**

**4 PERFECT Arrowheads \$1.00;** perfect pipe \$2.50, \$5.00; tomahawk \$3.00; knife 50c. Catalog 10c. H. Daniel, Lamar, Ark.

**PRECIOUS STONES, MINERALS**

**GEMOLOGY Books,** catalog 10c. Atlantic Books, Lawrence Avenue, Charlestown 29, Massachusetts.

**GEMCUTTING,** Silvercraft authority. Illustrated magazine tells how. Cut rocks, make jewelry. 150 ads illustrating equipment, offering gems for collectors, cutters. Postal brings literature. Lapidary Journal, Drawer B, Palm Desert, Calif.

**"GENUINE"**—Red Arizona rubies (garrets). Send quarter for packet. Bitner's, Box 1025, Scottsdale, Arizona.

**MINERALS** And rocks analyzed by former states geologist. Prospecting and Geophysical Office, 38-14 218th Street, Bayside, L.I., New York.

**JADE,** Agates, tiania, gems, hobbyists supplied, gem cutting machines. Free list. North West Gems, Box 305, Tacoma 1, Washington.

**GEMSTONES,** Mineral specimens. Every variety. Lowest prices. Postcard brings free booklet. Plummer's, 4720 Point Loma Ave., San Diego 7, Calif.

**FIND Tungsten, mercury, uranium** with Mineralight. Free brochure. Write Dept. PM8 Ultra-Violet Products, South Pasadena, California.

**GEMS,** Precious and semi-precious, genuine, from world-wide sources. Deal direct, no overhead, save money. Catalog 10c. Hill Co., 5450-G Portland Rd., Salem, Oregon.

## HOBBIES AND COLLECTIONS

**AMAZING Hobby**—Collect authentic armed forces insignia, ribbon bars, embroidered patches, naval rates; fascinating assortment of 57 for only \$1; special gift free with order. Pritt Co., Dept. M-10, 16 West 27th Street, New York City.

**TROPICAL Fish**—Information 25c. Clarke Enterprises, Box 413, Janesville, Wisconsin.

**50 DIFFERENT Army embroidered patches \$1.** Other bargains. Insignia Mart, 703A Broadway, New York 3, N. Y.

**JOIN Today's fastest growing hobby club.** Write for details. "Peoples Hobby Club-A," Box 171, Biloxi, Mississippi.

**MAKE Leathercraft your hobby.** Enjoy working with leather. Your leather belts, billfolds, purses, make ideal gifts or possessions. Free catalog. Tandy Leather, Box 397, C, Tulsa, Oklahoma.

**WHY You should join the National Association of Watch and Clock Collectors.** Write for free, eight-page descriptive folder. NAWCC, Box 299P, Bronxville, N. Y.

**WANTED:** Cigarette, tobacco cards. Write Charles Bray, East Bangor, Penna.

**UNUSED Matchbook covers—100 different \$1.00 36-page catalog 25c.** Charles Edelman, 1311C East 84, Cleveland 3, Ohio.

**INVENTING Can be an interesting and profitable hobby.** Write for complete particulars. Institute of American Inventors, Dept. 40-E 631-E St. N.W., Washington 4, D. C.

## CAMERAS, PHOTO SUPPLIES

**FREE Photographic bargain book** packed with hundreds of sensational values in still and movie cameras, lenses and latest accessories. Super savings for you in new and used equipment. No money down—Up to 15 months to pay. Liberal trade-in allowances, too, on your own equipment. Write now for your free copy to Central Camera Co., Dept. 9L, 230 S. Wabash Ave., Chicago 4, Ill. (Photographic Headquarters Since 1899.)

**500 CAMERA Repair parts \$4.95.** Catalog free. Leshko, 88-11 No. Munn, Newark, N. J.

**DOLLAR Brings candid camera.** Uses 328 film. Beewood Company, Box 615A, West Hyattsville, Maryland.

**WHOLESALE Photographic supplies.** Cameras, films, projectors, enlargers. Write for free catalog. Capitol Photo Supplies, 2428 Guadalupe, Austin, Texas.

**TERRIFIC Value!** Genuine pro camera, complete with film. Send \$2.00. Star Bureau, 234 Clinton Place, Newark, N. J.

**PHOTOMURALS.** Your negative or ours. Catalogue 25c. Photomammoth Murals, Dept. M, 12048 Vanowen Street, North Hollywood, California.

**BASS Says:** Trading since 1910. Used but good as new buys: 8mm. B.&H. Sportster \$52.50; 16mm. Keystone A-7, F:2.5 lens \$37.50; Voigt. 35mm. Vito II, flash shutter, Skopar F:3.5, like new \$38.50; Kodak Reflex F:3.5 lens, like new \$88.50; Contax I, F:2 Sonnar \$87.50; 3 1/4 x 4 1/4 Speed Graphic, Skopar F:4.5, Ibsor shutter, \$52.50. Satisfaction guaranteed. Bass Camera Co., Dept. AG, 179 W. Madison St., Chicago 2.

**ADD "Spice"** to home projection shows with colorful old-time Nickelodeon slides. 2x2. Write for free list. Nickelodeon Co., 25 E. Eldon, Bldg. Portland 5, Oregon.

## PHOTO FINISHING

**GIANT Size** deckle album prints. 8 exposure roll, 35c, 12 exposure 50c. Send money. Free mailers. Dowl Photo Co., P.O. Box 2077, Ft. Worth, Texas.

**ENLARGEMENTS!** Eight 5 x 7's or five 8 x 10's, \$1.00. Wilart Enlargers, Box 967, Little Rock, Ark.

**8 CONTACTS 30c, Jumbos 40c, 12, 45c; jumbos 55c. Reprints 4c; Jumbos 5c.** Western Photo, Dept. PM-102, Box 298, San Francisco 1, Calif.

**ENLARGING**—5 x 7—15c, 8 x 10—20c. Don's, 4307-12 Ave., Brooklyn 19, N. Y.

**CUSTOM Photo finishing.** Absolutely guaranteed jumbo album prints—8 exp., 35c; 12, 50; 35mm, \$1.00. Free mailer. Flash Foto, Box 36-M, Brooklyn 4, N. Y.

**SATISFACTION Guaranteed!** Eight jumbo size prints mounted in album, 35c—12 to 16 exposure rolls, 50c. Free mailers, quick service, finest developing, finishing. Photo Christmas cards, send negative. Crown Studios, Box 1223-PM, Dallas, Tex.

**CHRISTMAS Special**—15 photographic Christmas cards with envelopes and one 5x7 gift enlargement from your favorite negative only \$1.00. Photo Craft, Box 637 M, North Miami, Florida.

**KENT Studio**—8 jumbos 35c, 12-50c. 1140 N.W. 125th Street, Miami, Fla.

**16 PRINTS Or 8 jumbos** from roll or negatives, 25c with this ad. M. Skrudland, Box 486, Daytona Beach, Florida.

**CUSTOM Photo finishing guaranteed.** 8 exposures 35c; 12, 50c. Bound in beautiful plastic ringed album. Special! 35mm., 36 exposure \$1.00. Free mailer. Flash Foto, Box 36M, Brooklyn 4, N. Y.

**16 JUMBO Prints** from any size roll or negatives 35c, with this ad. S. Skrudland, Lake Geneva, Wis.

**PERSONALIZED Xmas cards.** 20-\$1.25. Send negative and 5c for sample card and list of styles. Graphic Photo Service, P.O. Box 72, Wilkes-Barre, Penna.

**GUARANTEED Quality.** Fast service. Eight jumbos in beautiful super pak plastic ring binder albums only 35c. Send for free mailers and particulars of our complete photo finishing service. Grand Fotos, G.P.O. Box 1410, New York 1, N. Y.

**FAST—Same day service!** 8 oversized prints in attractive plastic-bound book only 35c; 12-50c; 16-60c. Satisfaction guaranteed. Free exposure guide with first order. Pic-Sure, Box 899-B, Philadelphia 5, Penna.

**6 OR 8 Picture roll 35c, 12 or 16 picture roll 55c.** Each roll printed and developed. Handy album pack. If you fail to get pictures on your film a new roll will be sent you without extra cost. Send coin with roll. No c.o.d.'s. Mailing containers sent free. DeLuxe Film Service, Box 1268-A, Shreveport, Louisiana.

**BEAUTIFUL Enlargement** from each picture on 8 exposure roll 35c. Cut Rate Photos, Dept. B-4, Janesville, Wis.

**TWO Beautiful prints** from each picture on 8 exposure roll 35c. Thirty-one years of satisfied customers. Quick service. Lens Photos, Dept. J-4, Janesville, Wis.

## MOTION PICTURES AND SOUND EQUIPMENT

**FREE Movies.** Thousands of subjects, interesting, entertaining. Fascinating, new directory only 50c. National Cine, 50 Dayton Ave., Toms River, N. J.

**5000 NEW-Used 8-16mm. silent-sound films.** International-B, 2120 Strauss, Brooklyn 12.

**TAPE Recorders, tapes, accessories.** Unusual values. Dressner, 624-M East 20th Street, New York City 9.

**"ENTIRE Life Story of Christ"** 8 mm., 16mm., sound and silent, purchase or rent. Hemenway Film, 31 Church St., Boston 16, Mass.

**RENT 8MM. movies** 19c reel. Details dime. Cooper's Mart, Eaton, Ohio.

**WE Have it!** Send 10c for special listings and sample film strip. Reyelle, Box 12, Dept. PM, Hammels, N. Y.

**WILD Life films—Exciting.** Dramatic action in the natural habitat of fierce beasts of the jungle and forest. In 8mm. or 16mm. and 2"x2" slides. Gorgeous color or B. and W. Write for free illust. literature. Wild Life Films, 5-5-A Strohm Ave., North Hollywood, Calif.

**BARGAINS 16MM. sound films.** Also for exchange. Bedner, 5300 So. Talman, Chicago.



**PRICED Like wholesale and just released, these new 1-reel Blackhawk movies. 16mm. sound (300'), \$11.95 plus 25c postage. 8mm. silent (150'), \$2.98 plus 15c postage. Four railroad films: "Super Chief," "Western Pacific Fast Freight," "Golden Arrow" (London-Paris), "California Zephyr." Hundreds new-used 16mm. sound, silent, 8mm. bargains. Good used 16mm. sound projectors—Bell and Howells, Ampros, Victors—Often available \$129.95. Reels, cans, supplies like wholesale. Big new 24-page catalog free! Blackhawk Films Inc., 1215 Putnam Bldg., Davenport, Iowa.**

**LEARN Free lance, educational, Hollywood, and television film technique at home. State licensed. Write for free catalog. Motion Picture Institute, Birmingham 4, Michigan.**

**8-16MM. Silent-sound films. Complete rental library. All latest subjects. Free catalogue, sample film 10c. Garden Film, 317 West 50th, New York 19.**

**RENT 16MM. sound films, 50c reel. Large selection; free catalog. Film Service, 128 Chestnut St., Roselle Park, N. J.**

**GUARANTEED Fresh 8mm. roll, magazine; 16mm. roll, magazine movie films. Color. b&w. Free catalog. ESO-S, 47th Holly, Kansas City 2, Missouri.**

**MOVIE Camera film: 8mm. roll \$1.50, 16mm. 100' \$3.00. Free processing. Better Films, 742 New Lots, Brooklyn, N. Y.**

## MUSIC AND MUSICAL INSTRUMENTS

**1952 ACCORDIONS And used world's best makes. Save 50% and up. House of Accordions, 10 Conway Rd., Shelburne Falls, Mass.**

**LEARN Piano, singing, songwriting, professionally, with our amazingly easy self-taught courses. Also, music written to your poems. Music Teachers' Associates, 26 Potters Lane, Great Neck, N. Y.**

**1952 ACCORDIONS — Wholesale. Free catalog. American Accordion Center, 5329 Belmont, Chicago.**

**ELECTRIC Guitars, accordions, amplifiers, wholesale, free catalog. Carvin, Baldwin Park, Calif.**

**MUSIC Printing. For samples, rates, write Auto-Litho, Jensen Beach 3, Fla.**

**PLAY Piano by ear. Simplified. Particulars. Box 475-G, Lomita, California.**

**SONGWRITERS—Learn to write your own melodies. Simplified copyrighted course will teach you how in the shortest possible time at very small cost. Information on request, no obligation. Albert Koch, 2302 Milwaukee Ave., Chicago 47.**

**MUSIC Written to your words. Send poem and \$5.00. E-Z Publishers, 1133 Broadway, New York 10.**

**FREE Record of your song. Send your words. I'll write music. Johnny Mack, 1094 1/4-A West 39 Street, Los Angeles 37, Calif.**

**EXCITING News for songwriters! Kaye Music, 103B Saint Marks Place, New York City.**

**YOUR Words and our music. A winning combination! Send poems. Free examination. Song Promotion Guild, 350-M Broadway, New York 13.**

**POEMS Wanted for musical setting on percentage basis. Broadcast consideration. Sooner Song Co., 22-PM North West 8th, Oklahoma City 2.**

**POEMS Wanted! Opportunity knocks! Nationally known song writer composes music to your song poems. Send poems today for free examination and free copy of "Song Writing Secrets." Melody House, Dept. PM, Box 19007 La Tijera Station, Los Angeles 43, California.**

**SONGWRITERS—Competition demands modern harmony and singable melodies. Send poems for creative evaluation. Jimmy Seaver, Room 410, 203 N. Wabash, Chicago.**

**ACCORDIONS—Save 50% and up. Cash or terms. New and used. All brands. Wholesale to everyone. Free catalogue. Del Principe, 29 South Cicero, Chicago 44, Ill.**

**POPULAR Songs. How to write and sell them. Write for free booklet Successful Songwriting. Gateway Songs, Box 2470, Hollywood 28, Calif.**

**SONGWRITERS! Protect your ideas! Hold all songs; poems! Write for Safe Correct Procedure first! Song Service, Dept. P, 333 W. 56th St., New York 19, N. Y.**

**SONGWRITERS! Send poems, songs. Music Service, 243 West 72nd St., PM, New York 23.**

**WANTED! Poems for musical settings. Write Songwriters' Service, Clifton, N. J.**

**POEMS Wanted to be set to music. Free examination. Send poems. McNeil, Master of Music, 510-PM S. Alexandria, Los Angeles, California.**

**WRITE Songs. Big money and reputation. Write for information. J. Gordon Pub. Co., 4700 South California Avenue, Chicago.**

**SENSATIONAL Free booklet, "How To Write And Sell Songs." Get the facts first. Poems examined free. Reliable Music Service, Box 430-P, Hollywood 28, Calif.**

**1952 ACCORDIONS — Wholesale. Free catalog. American Accordion Center, 5329 Belmont, Chicago.**

**POEMS Wanted for musical setting. Send poems for free examination. Five Star Music Masters, 630 Beacon Bldg., Boston, Mass.**

**LYRICS Set to music and recorded. Free examination. Cherrier Recording, 732 So. Norton, Los Angeles, California.**

## RADIO AND TELEVISION

**BUILD 15 Radios—Only \$1.30 each. Experience unnecessary. Home radio and TV course includes trouble shooting and servicing lessons, radio principles, code instructions, practical radio building and repairs. You build and keep receivers, transmitters, amplifiers, test equipment and code oscillator. All parts, tools, instructions supplied, including radio tester and electric soldering iron. Send for big, new time and money saving catalog and radio TV repair guides. Enclose 25c. Progressive Electronics Co., 497 Union Ave., Dept. PM-23, Brooklyn 11, N. Y.**

**FREE 236 Page 1953 television-radio-electronic catalog! World's largest stocks, lowest prices. Complete supplies for builders, experimenters, amateurs, servicemen. Latest television, radios, phonos, recorders, sound equipment. Thousands of parts, tubes, test instruments, books, diagrams. Top quality money saving values. Get yours now! Allied Radio Corp., 833 W. Jackson Blvd., Dept. 34-K-2, Chicago 7, Ill.**

**RADIO-TV formulas, lucidly explained, make you professional over night! 16 pages, 20c. Serco, X261, Waltham, Mass.**

**HERE It is—A radio that works entirely on flashlight batteries, not a crystal set. Send 25c for description and schematic to A. Boscia, 39 Spencer Road, Rochester, N. Y.**

**24 PAGE Plans "18 long distance crystal sets" 25c, including "Radiobuilder," catalog. Laboratories, 1131-C Valota, Redwood City, California.**

**CLEARCO Crystal radio kit \$1.50; preassembled \$1.75. Free catalogue. Clearco Crystal Co., Box 1857, Milwaukee, Wis.**

**TELEVISION Self-service. Faster than local service. Savings. Protect yourself. Read Reader's Digest, June. Details: Cyward Television Service, West Point Pleasant, New Jersey.**

**DEALERS, Servicemen, agents wanted: We seek men in all parts of the country to sell radio and television tubes. All those selected will be given the best prices and warranty deal. We want active people on our side! The Rose Co., 98M Park Place, New York 7, N. Y.**

**ELECTRONIC Problems, devices, advice. Free information. Registered Engineer, 5208-E Onacrest, Los Angeles 43.**

**HOW To repair most radios in a few minutes without extensive study or expensive equipment. Only \$1.00. Details free. Slate's Radio Service, Corsicana, Texas.**

**ONE Tube loudspeaker radio diagrams 25c. Net-Loc, 44 Walker, Cambridge 38, Mass.**

**TELEVISION Interference filters. Price \$2.75. Stell's Co., Box 1104, Sioux City, Iowa.**

**MAKE Simple, tubeless, batteryless, distance-getting crystal radios. Crystal and illustrated instructions 25c postpaid. Allen, 427-P, Clinton, Mo.**

**TV And FM antennas. Yagi, conical, bow-tie, mounts, accessories. Lowest prices. Wholesale Supply Co., Lunenburg 1, Mass.**

**FASCINATING, Entertaining once-in-a-lifetime book! "Fifty Years of Popular Mechanics." Tremendously exciting story of most fabulous years in American history. Describes birth of auto, radio, airplane, television; hundreds of other inventions and world shaking events. Nostalgic old time ads and prediction of fabulous inventions to come next fifty years. Giant size—500 pages; 8 1/2"x11". Order now while stock still available. Send \$5.00 to Popular Mechanics Press, Dept. 109, 200 E. Ontario, Chicago 11, Ill.**

## BUSINESS OPPORTUNITIES

**START Your own mail order business with hundreds of repeat, sales proven, hobby-craft items. No stock to carry, no shipments to make. We pack and ship for you. For details send 25c. Mail Order Service, Dept. PM25, 845 S. Wabash, Chicago 5.**

**START A Venetian blind laundry. Profit opportunity for lifetime business. New machine method. Free booklet on request. F. C. Co., 442 N. Seneca, Wichita 12, Kansas.**

**DOLL Hospital instruction. Most profitable small business. Box 755, Southkent Branch, Grand Rapids 8, Michigan.**

**VENDING Machines—A post card may bring you the opportunity you are waiting for. No experience necessary. Stamps, nut, candy, gum and others. Small investment. Write Schoenbach Enterprise, Dept. 11, 1645 Bedford Ave., Brooklyn 25, N. Y.**

**MAKE Gifts, novelties, jewelry, from sea shells, fish scales, plastics! Wholesale, illustrated catalog 10c. Giftcrafts, Box 4550-PM, Coral Gables, Florida.**

**YOUR Own business without investment. Be an authorized agent for magazines and take care of new and renewal orders in your territory. Experience not necessary. We furnish all supplies free. Write for our catalog. Subscription Service Company, P. O. Box 2070, Birmingham, Alabama.**

**EXCLUSIVE Distributors. Amazing new DDT moth-resistant genuine crushed redwood cedar! Prevents moth damage to clothes, fabrics. Makes fragrant cedarized closets, drawers. Applied like paint; laboratory tested. Hardware, paint, building supply dealers, contractors buy quantities. Tremendous profit potential! Low priced; attractively packaged. Write for details. Millenco, 90-G Summit, Brookline, Mass.**

**PROFITABLE Home business. Make fast-seller chenille monkey trees, dolls, flowers. Terrific holiday demand. Information free. Velva, Bohemia 16, N. Y.**

**LEARN Sewing machine repair. Electrify, rent, sell spare time. Make "big money" like our other men-women do. New machines, motors, parts wholesale. Details free. Taylor Service, Hamilton PM-10, Ohio.**

**START Your own business on credit. Your own boss. 1586 of our dealers sold \$5,000 to \$27,500 in 1951. We supply stocks, equipment on credit. 200 home necessities. Sales experience unnecessary. Pleasant, profitable business backed by world-wide industry. Write Rawleigh's, Dept. J-U-PPM, Freeport, Ill.**

**IMPORT-Export! Opportunity, profitable, world-wide, mail-order business from home, without capital; or travel abroad. Established World Trader ships instructions for no-risk examination. Experience unnecessary. Free details. Mellinger 2A, Los Angeles 24.**

**\$5 AN Hour and more possible in your home. You can paint it with suede. Fabulous new business. Spare or full time. Spray on rainbow colors. Auto dashboards and trunks, signs, radios, toys, figurines, lamps, etc. Beautified with amazing new 3rd dimensional plush-like finish with touch-appeal as well as eye-appeal. I'll send you complete, step-by-step plans and equipment, including high-velocity spray gun for no-risk examination in your own home. Send no money, just name and address. Coast, 1004-AT S. Los Angeles St., Los Angeles 15.**

**ADVERTISING Book matches—Cash in on big demand; sell union label matches. Cuts for all businesses and political parties. Free powerhouse selling kit, low prices, protection guaranteed on repeat orders. Cash commissions. Superior Match Co., Dept. MX-1052, 7530 Greenwood, Chicago.**

**CHRISTMAS Cards—Religious; Sunday school teachers, individuals. New. Agents wanted. Samples. Art Printery, Pleasant Hill, Missouri.**

**FABULOUS Florida. Cool in summer—Warm in winter. Fast-growing Florida has business opportunities. If you are interested in going into business in fast-growing Florida, write State of Florida, indicating type of business you are interested in and stating your specific requirements. You will be put in touch with communities where opportunities exist. Get complete information, without cost or obligation. Write today. State of Florida, 4217C Commission Building, Tallahassee, Florida.**





**WRITE**—Jokes, poems, fillers, stories, etc. \$1.00 to \$750.00 paid each. Experience-investment unnecessary. Writing instructions and 204 markets \$1.00. Bob Rahlwes, 13870 Common, Roseville, Mich.

**OVER 200 Chicago job openings**, business opportunities, agents wanted. Guaranteed current list—\$2.00. Adams Associates, 30 West Washington, Chicago 2, Illinois.

**SELL** Printing by mail! We fill orders. Free plans, samples. Sutton Printing, Box 853-G, Waycross, Georgia.

**GET** Into mail order. It's fascinating. It's fun. It's highly profitable. Start at home in spare time. Details free. Lewis Bartlett, Richland, Georgia.

**WIN** Contest money. General Contest Bulletin gives hundreds of tips. Lists current contests and rules. Sample 25c. General Contests, 1609½ East 5th, Duluth, Minnesota.

**SCHOOL** Seniors—Sell classmates America's most beautiful graduation name cards. Largest selection. Highest commission. Outsell all others. Free sample kit. Printcraft, Dept. M, 1509 Maple St., Scranton 5, Penna.

**MONEY** In screen printing, selling, religious mottoes. Get info. Joseph Jones, Box 321, Meridian, Mississippi.

**TIE-Breaker** picture puzzles exposed, \$2.00. Wenograd, Box 1495, Philadelphia 5, Penna.

**SCHUHMACHER** Matmakers. Convert old tires into dollars. Devote full or spare time. S and S Patents, Inc., 1307 North Clark St., Chicago 10, Ill.

**EARN** Money evenings, copying and duplicating comic cartoons for advertisers. Adservice, Argyle 1, Wisconsin.

**MAKE** Money—Sewing and assembling at home. Liebig Industries, Beaver Dam 10, Wisconsin.

**50,000 ARTICLES** Wholesale. Source directory, dime. Nelko, Box 3462-DR, Chicago 54.

**BE** Appointed State Notary Public now! Details: Stationers, Helotes, Texas.

**PUBLISH** Your own magazine. Handsome 52 page format, well edited, illustrated. Cost low as \$1.00 month. Brings you prestige, profits. 25c brings sample, details. National, Ord, Nebr.

**READ** Progressive Mailtrade, the magazine that tells how to make money by mail. Dime brings sample and special offer. Progressive Mailtrade, Box 357, Sheboygan, Wisconsin.

### FORMULAS, PLANS, ETC.

**BRAND** New, spectacular chemical and fireworks experiments manual. Complete set-ups, formulas, instructions, \$1.00. Chemi-Technix Laboratories, 568C Riley St., Buffalo 8, New York.

**MODERN** Manufacturing formulas. Jack, Chemist, 5138 Gainor Road, Philadelphia 31, Penna.

**"HOW To Buy A Used Car."** See Automobiles—Classified.

**500 FORMULAS** And recipes. Riches in recipes. Tried and tested processes for home, factory and workshop. 25c postpaid. Allen, 427-FP, Clinton, Missouri.

**AMAZING** Values. Best, latest formulas. Catalog free. Nelko, 3462-P Merchandise Mart, Chicago 54.

**PRODUCT** Analysis, mfg'g formulas—processes developed. Plastics, Box 1574, Boston 4, Mass.

**BOOK**—10,000 Formulas, processes. \$3.98 postpaid. Free literature. K. Paullin, Loudonville, Ohio.

**LATEST** And best in modern manufacturing formulas since 1897. Lists free! Miller, 1517-A, Tampa, Florida.

**REAL** Manufacturing formulas. Lists free. Cummings, Chemist, Gordon Ave., Syracuse 4, N. Y.

**FORMULAS;** All kinds. Latest, best. Literature free. Kemixal, Park Ridge, Ill.

**TESTED** Formulas. Interesting descriptive booklet free. Pont, Box 635-PM, Terre Haute, Indiana.

### PLASTICS

**NEW** Liquid casting plastic. Clear, colors. Embed flowers, insects, coins. Saw, drill, carve. Send 25c for wholesale catalog and new sales manual showing how to make money at home. Castolite, Dept. L-101, Woodstock, Illinois.

**INTERNAL** Carvers increase profits, make television or night lights. Now available, plastic lamp base completely wired, with slot in top to illuminate your carved plaque. Available in opaque black, translucent ivory or pink. Send for sample and prices, \$1.25 postpaid. Arata, Roberts and Browne, Inc., Towaco, N. J.

**HI-Profits**—Gifts, jewelry. Free catalogue, details. Pilot Plastics, 67-B Fulton St., New York 38, N. Y.

**PLASTICS** In small lots. Lowest possible die cost. Dayton Rogers Manufacturing Co., Minneapolis 7, Minnesota.

**DON'T** Throw away that sawdust! Now amateurs can mold beautiful, durable, tools, gifts, etc. Cheap! Quick! At home. Instructions, designs \$2. Woodwaste Plastics, Seal Beach, California.

**WHOLESALE,** Retail material supplies. Internal carving, fabricating, jewelry, stock, findings, chains, atomizers, lighters. Many others. Free lists. Caraday, Box 71, Brooklyn 34, N. Y.

**WILDLIFE** Internally carved plastics. Wholesale literature 10c. Cosmopolitan Plasticrafters, Box 176, New York 8.

**PLASTICS,** Lucite, Plexiglas, acetates, complete supplies. Retail-wholesale prices. Catalog 10c. Gem-O-Lite, Box 686Q, North Hollywood, California.

**PLASTIC,** Sheets, rods, tubes, etc. Free list. Plastic Supply Co., 2901 N. Grand Blvd., St. Louis 7, Mo.

**LUCITE,** Plexiglas. Any size sheets, masked. Square foot (12 x 12) cost, 1/16", \$1.20; 1/8", \$1.40; 3/16", \$1.75; 1/4", \$2.08. Include 10% postage. Almac Plastics, 230 Fifth Ave., New York 1, N. Y.

### CHEMISTRY

**SAVE** Money! Supplies catalog, 20c refundable. Laboratory Sales, Box 161-E, Brighton, Mass.

**SPECTROSCOPE** For quick chemical analysis \$3.00. Kutting Sons, Los Altos, California.

**BRAND** New, spectacular chemical and fireworks experiments manual. Complete set-ups, formulas, instructions, \$1.00. Chemi-Technix Laboratories, 568C Riley St., Buffalo 8, New York.

**LABORATORY** Apparatus, chemicals, microscopes, complete chemistry sets, minerals, uranium ore. 10c brings catalog. Porter Chemical Company, Hagerstown 1, Maryland.

**AMAZING** New book of science. Experiments, formulas and catalogue of laboratory supplies. Only 25c. National Scientific Co., Dept. 16, 2204 W. North Ave., Chicago 47, Illinois.

**NEW** Idea chemical and apparatus outfits for home experimenting. Photo-scales, microscopes, chemicals, biological and laboratory supplies in small quantities. Catalog 25c. Established 1931. John H. Winn, 124A West 23rd Street, New York, N. Y.

**CHEMICALS** And apparatus for industrial, analytical, and private laboratories. Catalog 20c. Dept. M-50, Biological Supply Co., 1176 Mt. Hope Ave., Rochester 20, N. Y.

**ILLUSTRATED** Catalog: Chemistry, mineralogy, biology. 10c. Tracey Laboratories, Evanston, Illinois.

### HELP WANTED

**SHINE** Shoes without polish. New invention. Lightning seller. Shoes gleam like mirror. Samples sent on trial. Kristee 176, Akron, Ohio.

### AGENTS WANTED

**MEN!** Make extra money in your spare time. No house-to-house canvassing required. New car given as bonus. Amazing nylons guaranteed as long as 9 months depending on quantity, against runs, snags, holes, or replaced free. Rush name and hose size for simple money making plan. Lowell Wilkin, 17210 Wash., Greenfield, Ohio.

**THEY** Sell like hot cakes on a cold a.m. An easy \$25-\$50 day. More than 160 top selling, eye appealing Xmas and all occasion greeting card assortments. Every stop a push-over for sales and repeats. Line includes Xmas cards, gift-wrap sets, personalized stationery, notes, napkins, wide selection fine gifts and costume jewelry. We're sure and confident, that's why our sensational exclusive credit terms to outstanding producers. Write to-day for profit-making "on approval" kit. Modern, 71-A2 Fanshaw, Yonkers 5, N. Y.

**\$200 WEEKLY.** New invention. Amazing 4-second Presto emergency tire chains, fit all modern auto wheels. National advertising building big demand. 3 sales daily to oil stations, dealers, etc., make \$200 or more weekly. Territory going fast. Write Presto Chain Co., Dept. P-16, Des Moines 2, Iowa.

**ABSOLUTELY** Free! Big package actual sample fabrics and style presentation of dresses, lingerie, hosiery, etc. Take orders. Commissions big. Send no money. Melville Co., Dept. 7613, Cincinnati 25, Ohio.

**DO** You need money? \$35.00 is yours for selling only 50 boxes of our 300 Christmas card line. This can be done in a single day. Free samples. Other leading boxes on approval. Many surprise items. Experience unnecessary. Free samples personalized Christmas cards, stationery, napkins. Write today. It costs you nothing to try. Cheerful Card Co., 10 White Plains, N. Y.

**MAKE** Big money now with marvelous new Rolit knife sharpener. Big profits. Full or spare time, side line. Protected territory. Write today. Alden Speare's Sons Co., 136B Sixth St., Cambridge 42, Massachusetts.

**AMAZING** Big profits selling exclusive Sunshine Christmas cards. Nationally famous 21 for \$1.00 assortment is unequalled, sells on sight. Other tremendous Sunshine values: merry holly-day, nature prints. Park Avenue kromekotes, scripture text, gift wraps, stationery, etc. Send for samples on approval. Earn big money now! Sunshine Art Studios, Dept. PM-10, Springfield 1, Mass.

**MAKE** Wedding profits. Sell invitations, napkins, matches. Samples free. Dunbar's, Middlebush 3, N. J.

**MAKE** Extra money—For yourself, club or church. Up to 100% profit selling big value Christmas, all-occasion greeting card assortments to friends, others. 7 leading 21 card \$1.00 boxes, religious and novel cards. Gift wrappings, ribbons, stationery, napkins, animated books, sewing kits, unusual gifts. Over 150 items. Bonus plan. Experience unnecessary. Write for samples on approval. Special offers. Hedenkamp, 361 Broadway, Dept. PM-25, New York.

**AGENTS** Sell cosmetics. Write Jordan, 743 Dorrance Street, Philadelphia 46, Pennsylvania.

**SELL** Friends amazing value Christmas, all occasion greeting cards, new type gift wrappings, gifts that are different. Make up to \$1.00 a box. Bonus. Experience unnecessary. Request feature samples on approval and free samples name imprinted Christmas cards, stationery, napkins. New England Art Publishers, North Abington 720-B, Mass.

**"FOG-Stop"** windshield cloth. Instantly removes blurry mist, frost, sleet, snow. Stops windshield fogging. Samples sent on trial. Kristee 153, Akron, Ohio.

**SELL** Xmas cards customers own greeting on. Robinson, 269X Liberty, Paterson New York.

**MAKE** Money at home or in field sales, full or spare time. Sell subscriptions to leading magazines. Liberal commissions. Big Xmas season profits. Supplies furnished. Write Paramount Reading Club, 512 Palace Bldg., Minneapolis 1, Minn.

**BUY** Wholesale thousands nationally advertised products at big discount. Sent free "The Wholesale Plan." American Buyers' Service, 627-R Linden, Buffalo, New York.

**BIG** Profits on brand names! Appliances, giftwars, etc. like Weavever, Bulova, Eversharp, Hickok, Silax, Detecto, sell themselves. New! Illustrated catalog. Free! Over 220 items. Wunderman, 527-A Hendrix Street, Brooklyn 7, New York.

**MAKE** Money introducing world's cutest children's dresses. Big selection adorable styles. Low prices. Complete display free. Rush name. Harford, Dept. H-4341, Cincinnati 25, Ohio.

**YOUR** Own business—Used suits \$1.50, overcoats 65c, mackinaws 35c, shoes 12½c, ladies coats 30c, dresses 15c. Enormous profits. Catalog free. Moro, 558-AA Roosevelt, Chicago 7.

**MAKE** \$50 Daily selling to body shops and all mechanical trades: Drill saw or panel cutters, fits any ½-inch drill. E. Stackhouse, 219 N. 63rd, Philadelphia, Pennsylvania.

**SELL** New automatic floor waxer. Retail \$2.95. Profit 125%. Write for guaranteed sales plan. Smith Corp., Greenfield 14, Mass.



## EDUCATIONAL AND INSTRUCTION

**BECOME** An accountant. No previous bookkeeping experience required. We train you at home spare time, low cost. Ask for free booklet, "Accounting, the profession that pays." LaSalle Extension University, a correspondence institution, 417 South Dearborn Street, Dept. H-115, Chicago 5, Illinois.

**LISTEN**—Learn a language by Linguaphone. At home, quickly, easily, correctly master Spanish, French, German, Russian, Japanese—any of 29 languages through natural Linguaphone Conversational Method. Add to service, job, travel opportunities. Send for free book. Approved for Veterans' Training. Linguaphone Institute, 8310 Radio City, New York City.

**COMPLETE** Your high school at home in spare time with 55-year-old school. Texts furnished. No classes. Diploma. Information booklet free. American School, Dept. X745, Drexel at 58th, Chicago 37, Ill.

**HIGH School**—No classes. Study at home. Spare time. Diploma awarded. Write for free catalog HF-25, Wayne School, 2527 N. Sheffield, Chicago 14, Ill.

**PHOTOGRAPHY** For pleasure or profit. Learn at home. Practical basic training. Long established school. Write for booklet. American School of Photography, 835 Diversey Parkway, Dept. 3437, Chicago 14, Illinois.

**FOR** An extremely profitable lifetime business, operate a collection agency. Quickly learned. Write Cole Associates, Syracuse 2, N. Y.

**WANT** A diesel job? New opportunities to increase income. Higher pay. More money. We can help you qualify. Tools. Shop method home training. Write today! Diesel, Tractor, Heavy Equipment Division, Interstate Training Service, Dept. 3K, Portland 13, Oregon.

**BOOKKEEPERS!** Increase your earnings! Operate your own simplified "Dollar-A-Week" bookkeeping and tax service. Full or spare time. Details free. No obligation. Ellis, Box 200-K, Cedar Grove, North Carolina.

**WELDING** Training pays at Hobart Welding School, Box M-1022, Troy, Ohio. VA contract. Best equipment. Catalog free.

**GET** A gov't. job! Start high as \$73 week. Thousands of secure positions available now. Experience usually unnecessary. Get free 32-page civil service book showing jobs, salaries, requirements, sample tests. Write today: Franklin Institute, Dept. P-24, Rochester, N. Y.

**BOOKKEEPING**—Teach yourself at home. Complete self-check course only \$9.95. Consultation privileges with certified public accountant. If not delighted after ten day trial, money refunded. Or send 50c in coin for special bookkeeping aptitude test including grading service. P. D. Lipscomb, 6609 Avondale Drive, Oklahoma City, Okla.

**BECOME** Expert draftsman. Booklet free. Monroe Institute, PM-10, Alton, Ill.

**INCREDIBLE!** Unprecedented! Look under "Miscellaneous!" Bijou, Box 1727-MX, Hollywood 28, California.

**SMASH** That old worry habit with our amazing "Human Behavior Control" plan. Many helped. Write for unusual free lecture. No obligation. Personal Psychology, Inc., Box 1924-E, Louisville 1, Kentucky.

**STENOGRAPHERS**—Thousands needed now. Learn Triplespeed, NUABC Shorthand. Join selfstudy club. Earn course. Capital City College, PM Dept., Washington 5, D. C.

**MEDICAL** "Scrapbook!" Look under "Miscellaneous!" Bijou, Box M6-1727, Hollywood 28, Calif.

**NEW** Analytic, guaranteed method teaches algebra instantly. Write: Ziembeck, 6123 Orchard, Dearborn, Mich.

**LEARN** Handwriting and character analysis. Ideal profession. Free info. D. B. Lucas, 2419 Sunset Blvd., Los Angeles 26, California.

**LEARN** New language in ten minutes. Talk behind their back in front of their face. Send quarter to—W. B. Nichols, Bath Road, Bristol, Penna.

**PREPARE** For career in private investigation or public law enforcement work. Write for free Booklet "P." National Detective Academy, 257 South Spring St., Los Angeles 12, Calif.

**OWN** A collection agency. Big money. Franklin Credit, Roanoke 7, Virginia.

**USED** Correspondence courses and educational books, bought, sold, rented. Catalog free. Educational Exchange, Summer-ville, Ga.

**ANNOUNCING** Home study course in commercial baking. Practical basic training. Good field for those with aptitude. Nearly depression proof. Send for free booklet, "Opportunities in the Baking Industry." National Baking School, 835 Diversey Parkway, Dept. 3436, Chicago 14, Ill.

**GET** Government position! Complete home training for examination, \$9.95—Refunded if don't pass. Write Ozment Instructions, 34-CS, St. Louis, Mo.

**HOME** Study course, drugless therapy. Free literature. Institute of Drugless Therapy, Tama, Iowa.

**LEARN** Priceless secrets of technical metaphysics. Easy, simple. Write Canada School of Technical Metaphysics, 2532 McKenzie St., Vancouver, B.C., Canada, for amazing information.

**OIL** Coloring photographs can be a fascinating hobby or profitable sideline for those with artistic talent. Learn at home. Easy simplified method. Send for free booklet. National Photo Coloring School, 835 Diversey Parkway, Dept. 344C, Chicago 14, Illinois.

**MEDICAL** Laboratory technicians in great demand. We train you in your own home. Catalogue free. Imperial Technical Institute, Box 973-J, Austin, Texas.

**BE** A real estate broker. Study at home or in classrooms in leading cities. Write for big illustrated free book today. Weaver School of Real Estate, Suite 304 Law Bldg., Kansas City, Mo.

**MIDLAND** Linotype School, Charles City, Iowa. Civilian and Veteran Courses. Free placement. Established 1909.

**USED** Correspondence courses and books sold and rented. Money back guarantee. Catalog free. Courses bought. Lee Mountain, Pisgah, Alabama.

**SECRET** Investigation. Experience unnecessary. Investigators particulars free. George Wagner, M125 West 86th, New York 24.

**PIANO** Tuning pays. Learn this profitable profession at home. Our Tonometer and mechanical aids make learning easy. No knowledge music necessary. Diploma granted. Largest and oldest school—53rd year. G.I. approved. Write for booklet. Niles Bryant School, 78 Bryant Bldg., Washington 16, D. C.

**INVESTIGATOR** Training. Phillips Secret Service System, 1917-B North Ken-neth, Chicago 39.

## PLAYS, STORIES, MANUSCRIPTS

**MUSICAL** Comedy play (hilarious). Dorby Publishers, Box 131, Brier Hill, N. Y.

**BEGINNING** Writers: Let us show you how to get \$1 to \$20 checks in your daily mail doing simple spare time writing. Experience unnecessary. Details free. W. Herwell, 7016 Euclid, Cleveland 3, Ohio.

**I** want new writers to cash checks of \$1 to \$100 offered daily. The easiest way to write for pay. No previous experience necessary. Free details. Saunders M. Cummings, 468-11 Independence Bldg., Colorado Springs, Colo.

## SPECIAL SERVICES

**SOLVE** Your heating problems. Send \$2.00 with problem to S. M. Burkhard, 167 East Main St., Watertown, N.Y. Heating engineer with 30 years experience.

**SOURCE** Of supply information service. 25c for locating the source of supply for any article manufactured in United States. William Garber, Huntingdon, R.F.D. 1, Pennsylvania.

**ALASKAN** Remails: Fairbanks, Anchorage, Nome, Ft. Yukon. Your stamped letter remailed 50c. Use airmail. Arctic Re-mail Agency, Box 254, College, Alaska.

**BUSINESS**, Educational, curiosity. We'll take Chicago pictures for you. Free literature. Chicago True View, Studio B, 2251 N. Spaulding Ave., Chicago 47, Illinois.

**ST. Louis** remail letters, 25c, complete service. Box 105, St. Louis 5, Missouri.

**AROUND** The world remail service. Business and personal mailing address. Re-mailing from Chicago 25c, other states 30c. C. Mack's Mail Order, 5656 N. Hermitage, Chicago.

**LEGAL** Matters in Ecuador. Patents, trade marks, collections. Dr. Rene Moreno Andrade, P.O. Box 2273, Quito, Ecuador, S. A.

**INFORMATION** On any matter. Ferguson Research, 116-14 141st St., South Ozone Park 36, N. Y.

**LETTERS** Retailed 25c. Employment or classified columns airmailed \$1.00. Clarke, 5536 Pershing, St. Louis, Mo.

**WE** Can locate and purchase hard-to-get items. No item too difficult to procure. War surplus items at bargain prices. Write us for quick action. M. M. Maxwell Co., 422 N. Hart St., Chicago 22, Illinois. Dept. A102.

**DETROIT** Remails 25c, complete mailing service. Edwards, Box 1067, Allen Park, Michigan.

## CARTOONING, COMMERCIAL ART, SHOWCARD WRITING, SIGN PAINTING

**IF** You can do simple pen lettering you can make to \$4.50 per hour, spare time, operating our sensational, new service in your community. National Artists, 801-A North Marsalis, Dallas 3, Texas.

**LEARN** Brush lettering. Easy method anyone can learn includes alphabets. Professional brush free. Send \$3.00. Satisfaction guaranteed. Midwest Art School, Fort Wayne 2, Ind.

**"HOW To Make Money With Simple Cartoons"**—A book everyone who likes to draw should have. It is free; no obligation. Simply address Cartoonists' Exchange, Dept. 910-C, Pleasant Hill, Ohio.

**YOU** Can be a cartoonist! Learn at home, sparetime. Kirk's Simplified Method shows how. Complete course plus market guide, \$1.00 ppd. Kirk's Art Exchange, Dept. 9C, 2821 Idalia, El Paso, Texas.

**GAGWRITERS** And cartoonists needed. Beginners welcome. Cartoonists' Markets, La Habra, Calif.

**LEARN** Sign painting at home. Test lesson free. Ben Kerns, Box 812-P.M., Greenville, S. C.

**CHALK** Talks. Laugh producing program, \$1.00. Catalog 10c. Balda The Cartoonist, Oshkosh, Wisconsin.

## ADVERTISING AGENCIES, LETTER WRITERS, FOR ADVERTISERS

**ATTENTION** Swappers, traders. \$3.00 puts your 30 word ad in "The Texas Trader." Rio Hondo, Texas.

**YOUR** 50 Words advertisement, display printed on 16,000 sheets (ads on back) and mailed by reliable mailers—Only \$6.00. Louis Balogh, 1703G Roosevelt, Valparaiso, Indiana.

**NAMES:** Many categories; 1000, \$3.50 up. Bolaine Sales, Box 5004, St. Paul.

**WANT** Ads placed. Southern dailies list free. National Advertising Agency, 518 N. 21 St., Birmingham 3, Ala.

**FREE** Copy, layout service. Mailorder ad, 1,700,000 nationwide circulation, \$27.30 inch. 24-word classified, 20 big Sunday newspapers, \$30.00. Advertising ratebook free. Chicago Advertising Agency (established 1900), Chicago 4.

**FREE!** 1952 Advertisers Rate and Data Directory. 52 pages! E. H. Brown Advertising Agency, 20 N. Wacker, Chicago 6.

**ADVERTISE:** 24 Words, 100 Canadian newspapers \$5.50. Lists free. Advertising Bureau, 10511-C Springfield, Chicago 43.

**ADS** Placed in out of town newspapers and magazines. Low rates. Catalogue free. Ideas that pay. Baker Advertising Agency, Successors Ankrum Agency, 189 W. Madison, Chicago 2.

**ADVERTISERS!** Reach nearly 18,000,000 readers. 25 Sunday national key newspapers. 18 words, \$59.00. "Terrific pullers." 20 popular newspapers, \$11.50. Free booklet. Special—One inch display 2,-821,198 circulation, \$51.10. Newmark's Advertising Agency, (Established 1893), 217-7th Ave., New York 11.

**MAILING** Lists; \$5.00-1000 up. Write Dixie Service, King, N. C.

## RUBBER STAMPS AND OFFICE SUPPLIES

**RUBBER** Stamps—Any kind, size, or quantity. Send for catalog. We refund your postage. Esco 10 Print, 8 Holt, Dayton 7, Ohio.

**RUBBER** Stamps made. Free style list. Criterion, Box 2326, Denver 25, Colo.

**3 LINES**, Inked pad \$1.00. Laundry marking set, stamp, bottle ink, pad, \$1.35. Rubberpress, 1252 E. 75, Chicago 19, Ill.

**LINE** 25c; 2-45c; 3-65c. Stamp Works, Auburn, Nebraska.

## TYPEWRITERS, DUPLICATORS, OFFICE DEVICES

**TYPEWRITER Sale!** Adding machines. Saved up to \$20. New portables, reconditioned desk typewriters. Send 10c for catalogues. Apple, 993A Westchester Ave., New York 59, N. Y.

**VARITYPERS.** Reconditioned electric typewriters, \$100. Sachs, 121 West 23rd, New York 11.

**RECONDITIONED** Typewriters, printing devices, office machines, equipment. Dixie Graph, King, N. Car.

## PRINTING, MULTIGRAPHING, MIMEOGRAPHING GUMMED LABELS

**CARDS,** Envelopes, neatly printed. Samples. Morris, Box 331, Lake Charles, La.

**PHOTOENGRAVINGS** At about 1/2 price. Send for free price list. Billings, Box 4951, Los Angeles 1, Calif.

100 **MONARCH** Style envelopes and 100 bond letterheads \$1.50. Hanna, 1203 Waukazoo, Petoskey, Mich.

**PERSONALIZED Stationery**—100 sheets and 50 envelopes, imprinted with name and address in blue ink or 125 #6 3/4 envelopes, ideal for mailing checks, etc. Imprinted on flap for \$1.00 postpaid. Ashmont Stationery Co., Box 162, Highland Station, Springfield, Mass.

**BEAUTIFUL** Two color, raised print business cards. Dignified, appealing! Send for sample, prices. J. Hampton, 601 1/2 N. Main, Wichita, Kans.

125 8 1/2 x 11 **LETTERHEADS** And 125 envelopes \$2.00 postpaid. 24 hour service. Samples free. Catalpa Press, 5519 N. Clark, Chicago 40, Illinois.

100 **PRINTED** Business envelopes or letterheads \$1.00. Salesbooks \$3.00. Broadbrook, Botsford, Conn.

**FINE** Printing, reasonable. Free samples, prices. Gay Printing, Homer, N. Y.

**BETTER** Printing at lower prices. Try us first! Sutton Printing, Box 853-A, Waycross, Georgia.

**LETTERHEADS,** Etc., \$1.00 hundred delivered. Samples. Ritz, 1308 Haines, Philadelphia.

**TWO** Color designed printing. Estimates free. Osgoods, 1320-H Prospect, New York 59.

**XMAS** Cards \$1.00 hundred. Samples. Hurt & Fosse, Blue Ridge, Virginia.

100 8 1/2 x 11 **HAMMERMILL** Letterheads and 100 envelopes \$1.95. H. Hudson, Centredale, R. I.

**PRINTING** That pleases. Stationery, circulars, cards, etc. Samples. Mercury Press, Box 69M, Marengo, Iowa.

**EMBOSSED** Personal, appointment or business cards, \$3.95 per 1000 postpaid. Rudolph Guglielmi, 1556-A 74th St., Brooklyn 28, N. Y.

**FINE** Printing—Prompt service, prepaid. Wide selection of type styles, colors, etc. Cuts furnished. Samples—prices free. Wilcox, Nicholls, Georgia.

8 1/2 x 11 **LETTERHEADS,** 1000—\$4.00. Convincing samples. D'Yarmett Printing, Newark, Ohio.

100 8 1/2 x 11 **LETTERHEADS** \$1.00 Postpaid. Envelopes same. Race Printers, Hudson, New York.

**QUALITY** Printing! Free large catalog showing prices, types, cuts. Nationwide, 2337 Bath Avenue, Brooklyn 14.

1000 **BUSINESS** Cards \$2.50 prepaid. Samples free. Reliable Print Shop, 905 E. Jefferson, Louisville 6, Ky.

**MIMEOGRAPHING**—Letters, pricelists, formulas, instructions. Lowest prices. Lem's Letter Shop, 5710 Stanton, Detroit 8.

125 8 1/2 x 11 **LETTERHEADS** And 125 6 3/4 envelopes \$2.00, postpaid. 250 of each \$3.50. Going Print Shop, Box 1544A, Muskogee, Oklahoma.

500 3/4 x 2 1/4 **FOUR** Line gummed stickers 50c. Red border \$1.00. Moritz Printery, Saginaw, Mich.

## PRINTING OUTFITS AND SUPPLIES

**PRESSES,** Type, cabinets, supplies. List for stamp. Lincoln Press Company, 220-L Hartwell, Fall River, Mass.

**DO** Your own printing. Save money. Simple rules. We supply everything. Print for others; good profit. Raised printing like engraving too. Have home shop. Details free. Kelsey Presses, V-11, Meriden, Connecticut.

**PRESSES,** Supplies, paper. Catalog 10c. Custom, Box 211-P, Springfield, Missouri.

**MAKE** Your own self-molding rubber printing cuts. Plexirubber, Argyle 1, Wis.

**PRINTING** Presses, type, supplies. Lists 3c. Turnbaugh Service, Loysville, Penna.

## PATENT ATTORNEYS

**INVENTORS**—If you consider your invention to be something of importance, take steps to protect it with a United States Patent which gives you the right to exclude others from making, using and selling your invention as claimed. "Patent Protection for Inventors" outlines steps to take to secure patent protection. Mailed promptly without obligation. Victor J. Evans & Co., Merlin M. Evans, Registered Patent Attorney, 731-L Merlin Building, Washington 6, D. C.

**INVENTORS:** Learn how to protect your invention. Special booklet "Patent Guide for the Inventor" containing detailed information concerning patent protection and procedure together with "Record of Invention" form will be promptly forwarded to you upon request—without obligation. We are registered to practice before the U. S. Patent Office and prepared to serve you in the handling of your patent matters. Clarence A. O'Brien & Harvey Jacobson, Registered Patent Attorneys, 21B-K District National Building, Washington, D. C.

**INVENTORS**—If you believe that you have an invention, you should find out how to protect it. The firm of McMorro, Berman & Davidson is qualified to take the necessary steps for you. Send for copy of our patent booklet "How to Protect Your Invention" and "Invention Record" form. No obligation. McMorro, Berman & Davidson, Registered Patent Attorneys, 1342 Victor Building, Washington 1, D. C.

C. A. Snow & Co.—M427, Snow Building, Washington 1, D. C. Registered Patent Attorneys. Write for information.

**PATENTS.** "Proof of Invention" free. E. E. Vrooman, Registered Patent Attorney, 507 McKim Building, Washington 5, D. C.

"**INVENTOR'S** Guide" free. Frank P. Ledermann, Registered Patent Attorney, 154 Nassau Street, New York.

**REGISTERED** Patent attorney offers services. Sanders, 6430 Evans, Chicago 37, Ill.

**INVENTORS**—For "Invention Record" form, contact Carl Miller, Registered Patent Attorney, Woolworth Building, New York.

**INVENTORS:** When you are satisfied that you have invented something of value write me, without obligation, for information as to what steps you should take to secure a patent. Write Patrick D. Beavers, Registered Patent Atty., 935 Columbian Bldg., Washington 1, D. C.

**INVENTORS:** Without obligation, write for information explaining the steps you should take to secure a patent. John N. Randolph, Registered Patent Attorney, 203 Columbian Bldg., Washington 1, D. C.

**CANADA**—Ramsay Company Registered, 273 Bank Street, Ottawa, Canada.

## FOR INVENTORS

**INVENTORS**—If you believe that you have an invention, you should find out how to protect it. The firm of McMorro, Berman & Davidson is qualified to take the necessary steps for you. Send for copy of our patent booklet "How to Protect Your Invention" and "Invention Record" form. No obligation. McMorro, Berman & Davidson, 1341 Victor Building, Washington 1, D. C.

**INVENTORS:** Learn how to protect your invention. Special booklet "Patent Guide for the Inventor" containing detailed information concerning patent protection and procedure together with "Record of Invention" form will be promptly forwarded to you upon request—without obligation. We are registered to practice before the U. S. Patent Office and prepared to serve you in the handling of your patent matters. Clarence A. O'Brien & Harvey Jacobson, Registered Patent Attorneys, 21A-K District National Building, Washington, D. C.

**PATENT** Searches \$5.00, including patent copies. Same careful, reliable searches conducted for patent attorneys, 48 hour airmail service. "Record of Invention" free. Competent experienced investigators. Capitol Patent Service, Box 664-P, Washington 4, D. C.

**INVENTORS**—If you have a valuable invention, you are advised to authorize a preliminary search through appropriate classes of United States patents. This firm is registered to practice before the Patent Office and is available to make such search and report to you concerning the probable patentability of your invention. Instructive booklet with "Evidence of Invention" form sent upon request. Victor J. Evans & Co., 732-L Merlin Building, Washington 6, D. C.

"**INVENTOR'S** Guide" free. Frank P. Ledermann, Registered Patent Attorney, 154 Nassau Street, New York.

**INVENTORS!** For "Copyright, Design & Patent Guide" contact Mr. Metzler, 11 West 42nd, New York 18.

**INVENTORS** Sell your invention direct to manufacturers. Without obligation write National Patent Sales Co., Dept. M, Box 370, Richmond, Virginia.

**ATTENTION** Inventors: Do not reveal your idea to anyone until you have temporarily protected it. Get this protection (not a patent) for \$1.00. Stark Company, Grafton, Wisconsin.

**YOUR** Invention may have tremendous commercial possibilities. Search, marketing suggestions \$5.00. Sullivan-Johnson, 505 McKim Building, Washington 5, D. C.

**INVENTOR'S** Services available from patent research firm. Searches \$6.00, including patent copies, patentability analysis. Protection forms free. Industrial Patent Reports, Box 6296, Washington 15, D. C.

12 **RELIABLE** Concerns wanting patent or unpatented ideas, one dollar. J. Roudenbush, 3451 Taylor Blvd., Louisville, Ky.

**PATENT** Searches, \$5.00, including patent copies. Same reliable search as conducted for patent attorneys. Free protection forms, 48 hour service. Patent Service Institute, 945-A Pennsylvania Avenue, Washington 4, D. C.

**PATENT** Searches \$5.00, 48-hour service. Protection forms free. Write Raymond L. Smith, Patent Searcher, 622 Sheraton Building, Washington 5, D. C.

**PATENT** Searches \$5.00. Protection forms free. Patent drawings prepared. Write Patent Engineering Service, 711 14th Street, N.W., Washington 5, D. C.

**INVENTIONS** Sold—Hundreds of manufacturers need ideas, patented or unpatented, list free. Invention Bureau, 208-M Clinton, Oak Park, Illinois.

**PATENT** Searches \$5.00, 48-hour service. For free record of invention forms write Miss Ann Hastings, P. O. Box 176, Washington 4, D. C.

**INVENTORS**—Send for free patent information book and inventor's record. Registered Patent Attorney, Associate Examiner, Patent Office 1922-29; Patent Attorney & Advisor, Navy Department 1930-47. Gustave Miller, 82A Warner Building, Washington 4, D. C.

**INVENTORS:** Without obligation, write for information explaining the steps you should take to secure a patent on your invention. John N. Randolph, Registered Patent Attorney, 202 Columbian Bldg., Washington 1, D. C.

**SEARCHES**—Put your patent searches in the hands of a registered patent attorney or agent, as he qualifies to give a worthwhile patentability report. Record of invention form upon request and information on patent protection. Patrick D. Beavers, Registered Patent Attorney, 936 Columbian Bldg., Washington 1, D. C.

**INVENTORS**—For "Invention Record" form, contact Carl Miller, Registered Patent Attorney, Woolworth Building, New York.

**INVENTORS:** If you have an invention for sale, patented or unpatented, write Institute of American Inventors, Dept. 40A, 631-E St. N.W., Washington 4, D. C.

## INVENTIONS WANTED

**INVENTIONS** Wanted. Patented; unpatented. Tremendous manufacturers lists. Global Marketing Service, 1404 Mitchell, Oakland 1, Calif.

**INVENTORS**—If you have a patent application pending in the patent office or if your patent has already been granted, we can help you market your invention to our nationwide contacts. Write today for complete information, free. Patent Sales Promotion Company, Box 1225, Washington, D. C.

PRODUCTS, Mechanical, chemical; financed, marketed. No fees. Details free. Paisley, 2030 Chestnut, St. Louis, Mo.

PROTECT And sell your inventions. Details of our unique 4-point program and list of needed inventions free. Inventors Sales, 208-N Clinton, Oak Park, Illinois.

INVENTIONS Wanted. Patented, pending only. Inventors Patent Exchange, Hartford 1, Conn.

MARKETING Aid—Nation wide. Patented, patent pending. Booklet free. Market Contacts, 719-A2 Magnolia, Tupelo, Miss.

INVENTIONS Wanted. Patented or patent pending. 21 years experience promoting inventions. National Service Bureau, 3120 Meramec, St. Louis 18, Mo.

INVENTIONS Promoted. Patented or unpatented. Established 1911. Write Adam Fisher Company, 61 Enright, St. Louis, Mo.

INVENTORS: Hundreds of manufacturers have requested our assistance in locating marketable new products. Complete information free. Institute of American Inventors, Dept. 40-D, 631-E St. N.W., Washington 4, D. C.

### PATENTS FOR SALE

INVENTIVE Genius seeks your problem. Pens, electric switches, machinery. Your terms or employment. H. Hoehn, New Westminster 13, B. C. Phone 4423 R 1.

INVENTORS: Test the commercial value of your patented or unpatented inventions, quickly and inexpensively. Write for free information. Institute of American Inventors, Dept. 40-B, 631-E St. N.W., Washington 4, D. C.

### MANUFACTURING

STAMPINGS Die-cut in small lots. Lowest possible die cost. Dayton Rogers Manufacturing Co., Minneapolis 7, Minnesota.

MODELS—Small lot manufacturing. Metals, plastics, etc. Milburn, Burlington, Kentucky.

### MODELS, MODEL SUPPLIES

LIONEL, American Flyer, HO trains, and accessories at sensational discounts from nation's largest train stock. Send 25c for catalogue Northern Hardware Company, 4851 N. Broad Street, Philadelphia, Pennsylvania.

POWER Models. Unusual steam, gasoline and traction engines. Metals, tools, accessories. Catalog 50c. Chas. Cole, Ventura, Calif.

MINIATURE Locomotive, bi-monthly magazine about live steam model railroads—Tells "how-to" build, pictures of engines, cars, track set-ups, club news. Exciting, educational family hobby. Send \$3.00. Miniature Locomotive, Box 305F, Reseda, Calif.

BUILD Miniature homes with our accurately-scaled materials. Send 25c for booklet and samples. Architectural Model Materials, Inc., Dept. M102, 4208 Armitage Avenue, Chicago 39.

LIONEL Or American Flyer catalog 20c. Shannon's, 503 Franklin, Nutley 10, N. J.

1952-53 LIONEL, American Flyer catalog illustrated. Trains, accessories from America's largest stock. Building, operating, track layout ideas. New! Different! Send 50c today (money refunded with purchase). Hobby House Inc., Dept. BX, 800 Huron, Cleveland 15, Ohio.

MINIATURE Gasoline, steam and locomotive engines; finished or rough castings. Catalogue 25c (50c if airmail). Far East Patternmakers Guild, Shinjuku Post Office Box 36, Tokyo, Japan.

WORLD'S Finest illustrated catalog-handbooks. Railroads 84 pages 35c. Airplanes, boats, crafts, hobbies, tools 60 pages 25c. No stamps. Print name. E and H Model Hobbies, Room 70, 130 W. Cheltenham Avenue, Philadelphia 44.

SHIP Models—Most complete line in New England. Kits, fittings, plans, books, tools, engines, motors. Illustrated catalog 25c. James Bliss & Co., Inc., Dept. SM, 342 Atlantic Ave., Boston 10, Mass.

STEAM Engines, boilers, castings. Catalog 25c. Anton Bohaboy, 2297 Price, Rahway 7, N. J.

SHIP And yacht model fittings; blueprints. Send 25c for illustrated catalog No. 27—listing hundreds of items. A. J. Fisher, 1002-1 Etowah Ave., Royal Oak, Mich.

LIONEL, American Flyer, illustrated catalog free. Ben's PM Department, 134 North Dearborn, Chicago 2.

SHIP Models and yacht supplies complete. Large 64 page catalogue 30c. Bill Wild's, 510 East 11 St., New York City 9.

STEAM Locomotives, 1½", 1", ¾", ½", ¼" scales. Castings, rail, steam fittings! Thorough drawings with instructions. Catalog 50c. Little Engines, Wilmington, California.

### HOME CRAFTSMEN

BIG Savings leather—Now, for the first time, you can buy full sides of top grain cowhide at our special, amazingly low "tannery-to-you" prices. Write today for complete information. Address Department 2, W. D. Byron & Sons of Maryland, Inc., Williamsport, Md. Tanners of fine cowhide leathers since 1832.

90 ALL New, full size lawn ornament and novelty patterns, up to 20" high. Only \$1.00. Mastercraft 102M, 7041 Olcott, Chicago 31, Illinois.

GET Extra money. Make imported rhinestones into gorgeous jewelry. We furnish everything—Show you how! Complete crystal earring and bracelet kit plus "Success Book" only \$1.00. Money back guarantee. Book alone, 10c. Gemcraft, 18132 E. 13th, Cleveland 14, Ohio.

LEATHERCRAFT For pleasure or profit. Make easy-to-assemble purses, belts, gloves, woolskin toys, 100 other items for gifts or to sell. Send 10c today for big catalog. Largest leathercraft stock in U. S. J. C. Larson Co., 820 S. Tripp, Dept. 2550, Chicago 24.

OUR Biggest leather and craft catalog yet! 1000's of items. Send 25c (refunded with first order). Russo Handicraft Supplies, Dept. 10-C, 245 S. Spring, Los Angeles, California.

JIGSAW Owners attention! Start earning money at home cutting out wooden novelties and souvenirs. Write H. Cook, Dept. A, 4407 S. Normal Ave., Chicago 9, Illinois.

PARATOL Supreme "706-G" molder—Newly developed compound. The toughest rubber ever made for molding purposes. Supreme molds, precision reproductions, double strength. For the operator who wants the finest. Direct to consumer prices: \$2.75 per quart, one gallon cans, \$8.00; 5 gallon cans, \$7.75 per gallon; 4 ounce samples 50c to cover mail handling. U.S.A. only. Testworth Products Corp., Dept. B-2, P.O. Box 482, Itasca, Ill.

SCRAP Leather, assorted sizes up to 12" x 15", assorted colors. Ideal for purses, billfolds, keychains, etc. 6 lbs., guaranteed weight, \$3.50 ppd. (add 25c west of Mississippi. No c.o.d.'s please. Leather Crafters, Box 412-M, Evanston, Illinois.

FREE Small Cypress knee with each \$1.00 lamp size. Cy Products, Ella St., Lafayette, La.

89 FULL Size jig saw patterns of beautiful shelves, ornaments, toys, novelties. Plus "How, Where to Sell." Only \$1.00. Mastercraft 104M, 7041 Olcott, Chicago 31, Illinois.

WILD Animals! Ancient locomotives! Six-foot train! 34 quality jigsaw wall patterns, 50c! Pauls Plans, 2233A N. 35, Milwaukee 8, Wisconsin.

100 FULL Size jig saw patterns up to 20" high, only \$1.00. Pattern Service, Medway 9, Mass.

HAWAIIAN Full size patterns, Polynesian bowls, trays, perfume flacons, costume jewelry. Easily made by home craftsmen. Hawaiian recipes, party suggestions, all for \$1.00. Trader Hall's, Dept. M, Box 155, Honolulu 10, Hawaii.

ATOMIC Saw fits ¼" drill motor. 6" blade cuts 2 x 4 without turning. Information Willard's, Canoga Park 103, Calif.

LEATHER Secrets, complete encyclopedia of leather craftsmanship. More than 1,000 actual-size photos, drawings show how to cut, carve, emboss, tool, etc. Send for free information. Baird School of Leather Carving, Dept. 11A, Manitou Springs, Colo.

COLONIAL Reproductions—Easily built shelves, spice cupboards, wall boxes, etc. 32 full size patterns, plus "Fast Shellac-Wax Finishing" \$1.00. Vosbury Patterns, M. R. 95, Binghamton, N. Y.

LEATHERCRAFT. Free list. Francis Byrd, 3406 Montrose Ave., Richmond, Virginia.

NEW. Artistic free-form corner cabinet shelves. Dozens of arrangements. Full-size plans, 6 sizes \$1.00. Echo Acres Industries, Box 184, La Grange, Illinois.

LEATHERCRAFTERS: Illustrated catalog of materials, tools, kits, 10c. Art Leather, 411 Joseph Ave., Rochester 5, New York.

93 "ORIGINAL Idea" jig saw patterns \$1.00. Professional drawing, quality printing. Full size shelves, toys, lawn ornaments, novelties. Walker Studio PM10, 4343 Lindell, St. Louis 8, Mo.

\$46 PROM Square foot plywood; jigsaw necessary. Write: Woodarts, PM-252, Bridgewater, Mass.

100 SHADOWBOXES And novelty shelves from clever woodcraft kit. Full patterns, 25c. Millcrafters, 127M, Allegan, Michigan.

NEW "100 Best Woodworking Projects"—144 page Popular Mechanics book with 100 special projects for every member of the family. Furniture, toys, novelties, many more. Send \$2.00 to Popular Mechanics Press, Dept. 105, 200 E. Ontario, Chicago 11, Ill.

AMAZING New and sensational offer. Make costume jewelry at home from natural marine and botanical life: orange blossoms, pansies, starfish, etc. Free information. Write Jewelry by Julium, Box 460, Ft. Lauderdale, Fla.

SWISS Music movements, finest make, lowest price. Ask for leaflet. Jules Wolff, 74 Worth Street, New York.

WANTED Active plastic, wood workers. Avaco Master Crafts, Box 5903, Pittsburgh 10, Penna.

FREE Blueprint Catalog! Hundreds of projects—Motor scooter, furniture, toys, birdhouses, radios, garden furniture, power tools, boats, work benches, home freezer, many more! Send postcard to Popular Mechanics Press, Dept. 103, 200 E. Ontario, Chicago 11, Ill.

TRY Leathercraft. It's new. It's easy. It's educational. Make your own belts, billfolds, purses, hats, dresses, blouses, from durable low-priced leathers. Free catalog tells how. Tandy Leather, Box 397, C. Tulsa, Oklahoma.

TOOLING Copper, flock, finishes, free instructions. Bestcraft, Dept. M, 949 Kenwood Ave., Inglewood, Calif.

METAL Spinning. Everything in spinning lathes, tools and accessories. Send 20c in stamps for metal spinning instruction book and big catalog on woodworking tools. Boice-Crane Company, 943 Central Avenue, Toledo 6, Ohio.

REFINISH Your own furniture. \$1.00. Krafters, Box 86, Hubbard, Ohio.

FREE Seashell catalog. Shellcraft instruction book 35c. "Secors," Bradenton Beach, Fla.

VIOLIN Makers, amateurs, professionals. Fine tone European wood. Supplies. Tools. Patterns. Instructions. Illustrated catalogue 10c. Refunded. Premier Violin Supplies, Dept. VZ, 430 South Broadway, Los Angeles 13, California.

WHOLESALE Leather list free. Tinnin Leather Company, 213 East Walnut, Columbus 15, Ohio.

UPHOLSTER Own furniture. Catalog listing materials 10c. Original Supply Company, 5864 Hollywood Blvd., Hollywood 28, Calif.

LEATHERCRAFT, Copper tooling, textile painting, beadcraft, shellcraft. Many other crafts. Big free catalog shows everything you need. Kit Kraft, 7373 Melrose, Hollywood 46, California.

STENCILS, 15 Assorted for textiles, furniture, etc., \$1.00. Catalog 300 designs 25c, refundable first order. Marion Specialties, Box 141, Halesite, N. Y.

LEATHERCRAFT—New stylecraft folder free. New kits illustrated. Filigree belts, billfolds, purses, etc. Send 25c new catalog. Refunded first order. Apache Leather Co., 2804 East Washington St., Phoenix, Arizona.

MINIATURE Furniture kits. Colonial reproductions. Solid cherry. Catalog 20c. Culver Miniatures, 194 61st St., Dept. A, Niagara Falls, N. Y.

30 LAWN Ornament patterns. Ready cut. Full size. Color indicated. \$1.00 postpaid. Lincoln Craft Studio, Columbia, Conn.

LEATHERCRAFT. Tremendous stock of leather, tools, supplies, and kits. In leather business over forty years. Send 10c for big catalog. Sax Bros., 1111 No. 3rd, Dept. PM, Milwaukee 3, Wisconsin.

FREE Information. How to make money with jig saw. Write Jigsawers, 117-M Worth, New York 13.

KNOCKDOWN Cedar chests. Lumber and veneers. Free price list. Giles & Kendall Company, Huntsville, Ala.



"TOPS" In everything for leathercraft. Low priced kits, leathers, tools, lacing. Catalog 10c. Crown Leathers, 22 Spruce Street, New York 38.

WHOLESALE Shellcraft book 15c. Large shellcraft kit \$1.85 postpaid. Shell-Art Novelty, 5th and Moore, Philadelphia 48, Penna.

LEATHER. Tools, lacings, supplies. Free catalog. National Handicraft, 199 William St., New York 7.

### MAKE IT YOURSELF

NEED Extra money? Make wishing wells. See Business Opportunities column.

START Now. Assemble your own custom jewelry and sell to your friends for large profits. Free catalog. Great Lakes Plastic Company, 851 Sycamore St., Buffalo 12, New York.

CHRISTMAS Presents—Make your own. 60 patterns, toys, furniture, shelves, novelties, plus 88 page hobby book, \$1.00. Crafters of Pine Dunes, Oostburg 10, Wis.

BUILD Your home from your own design. Complete working plans prepared. H. C. Lightfoot, Civil Engineer, Richboro 1, Penna.

TOYS—Make your own! Ten plans \$1.00. Merihill Sales, Box 7029, Kansas City, Missouri.

MACHINERY Plans handbook 25c (refundable). Satisfaction guaranteed. Kimo, Box 307-P, New York 19.

IMISTONE-Veneer, house 35 x 28 \$55.00 only, all materials may be bought locally. Send \$2.00 for easy-to-follow Imistone instruction book to David Carlson, Gobles, Michigan.

POWERFUL Geiger counter easily built. Plans \$1.00. Technicraft, Box 1166, Boston 3.

300 PROJECTS You Can Make—In Popular Mechanics 32-page Blueprint Catalog. Send 3c stamp for copy. Popular Mechanics Press, Dept. 106, 200 E. Ontario St., Chicago 11, Ill.

GRANDFATHER Clock easily built. Big savings. See ad on page 274.

STREAMLINED. Built-in kitchen cabinets fit any kitchen. Illustrated manual describes designing and construction. All for \$1.00. Thombert Company, Newton, Iowa.

\$750 BUILDS Cozy 4 rooms and bath; concrete block, stuccoed. Instructions and blueprint \$1.00. Farrow, G83, Box 645, Columbus 16, Ohio.

BUILD With concrete, fieldstone, earth. Movable form system cuts costs. Construction simplified. Free literature. Smith, PM, Box 36, Eagle Creek, Oregon.

"CONCRETE Block Homes." 32-page booklet, on how to build. \$1.00. H. C. Lightfoot, Civil Engineer, Richboro 1, Penna.

BUILD Inexpensive concrete blockmaker. Motor, hand. Write. C. Lee, Mountain View, Oklahoma.

FREE Handbook. Build sawmills, block machines, freezers, tractors, scooters. Nichols Company, Purvis 2, Miss.

MAKE Your own "Stone-Veneer." Economical. Easily made, quickly applied. Looks like genuine stone. Transforms any home into one of excellent beauty. Formulas, illustrations, patterns. Alburg, Box 17, Carrollton, Mich.

SEND 25c Today for new large catalogue of supplies for 21 popular crafts. Dept. D-11. Dearborn Leather Company, 8625 Linwood Avenue, Detroit 6, Michigan.

BUILD Your own "tractor." Free information. Eltraco, D-1, Camptonville, California.

### WATCHES, OLD GOLD, JEWELRY

OLD Gold wanted. Highest prices paid on old or broken watches, diamonds, spectacle frames, dental gold and platinum. Cash by return mail. Information free on request. Alamo Watch Company, Second Floor, Melrose Building, Houston 2, Texas.

FREE Information. How to get watches repaired expertly at little cost. Watchmaker, 1209 E. Cotton, Longview, Texas.

WATCHMAKERS' Journal contains instructive articles for watchmakers and beginners. \$1.00 year. Sample copy 20c. Dean Co., Box 3218, Daytona Beach, Fla.

10 HIGH-Grade Swiss ladies' and gents' wristwatches needing minor repairs, \$18.00. Write for prices. B. Lowe, Holland Bldg., St. Louis 1, Mo.

WATCHES Overhauled \$4.50. Free watch catalog. Berkowitz, 1150 Castlehill, New York 61.

WATCHMAKERS! Beginners! Watches, movements. Descriptive list. Box 150, Chicago 90, Illinois.

RHINESTONES. Jewelry settings, camcos, sequins, beads. Send 10c for illustrated catalog. J & M Novelty, Dept. CL-3, Griffith, Ind.

5000 JEWELRY Styles, you can easily make yourself—Pins, earrings, bracelets, rings, matched ensembles. Instructions and catalog 10c. Barrys, 124 Ardsley Court, Newark, N. J.

HIGHEST Prices paid for old gold, silver, platinum, diamonds, watches, gold teeth, spectacles. Cash immediately. Goods returned if offer unsatisfactory. United Smelting Works (The Old Reliable), 39-B South State, Chicago 3.

JEWELRY Making can be a profitable hobby—Send 20c for our latest illustrated catalog. Milady-Fair Co., G.P.O. Box 1328, New York City.

WATCHMAKERS'—Jewelers' tools. Free instructions, catalog. Bengal Company, Culver City, California.

UNREDEEMED Diamond, 1-carat, \$295. 30-day refund. Free catalog. Broff's Diamond Loan Association, 411 Smithfield, Pittsburgh, Penna.

HIGHEST Cash paid for old, broken jewelry, gold teeth, watches, silverware, diamonds, spectacles, platinum. Free information. Satisfaction guaranteed. Rose Smelting Company, 29-A East Madison, Chicago.

### TOBACCO, SMOKERS' SUPPLIES

CIGARETTES—Roll 200 guaranteed to please for 75c. Particulars free. Pete Moberly, Box 864, Owensboro, Kentucky.

PERSONALIZED Algerian briar pipe handcarved with your initial \$5.50. Pipe Artist, 10427 Hayes Ave., Silver Spring, Maryland.

### OF INTEREST TO WOMEN

700 NEW Buttons \$1.25. All colors, designs, sizes. Dozens of "sets" for dresses, etc. Prepaid or c.o.d. plus postage. Guaranteed. Grandma Goodwin, Girard 12A, Illinois.

DRESSES 24c; Shoes 39c; men's suits \$4.95; trousers \$1.20. Better used clothing. Free cat. Transworld, 164-AD Christopher, Brooklyn 12, N. Y.

### FOR SALE—MISCELLANEOUS

NOISE. New ear filter stops loud noises, passes ordinary sounds. Protect your hearing, increase efficiency, comfort while working. Not hearing aid, ear-plug. Free details. Anza Co., 3560 A 20th St., San Francisco 10, Calif.

WHOLESALE. Ball pens, carded, \$2.00 dozen. Thomas Pens, Williamsburg, Brooklyn 11.

SPECIAL Offer. Hearing aid batteries. 6811 Stony Island Ave., Chicago 49, Ill.

SAVE Money on army, navy and factory surplus. Write today for new 60-page illustrated catalog. Tennusa Sales Co., Dept. C, 1451 Market, Chattanooga, Tenn.

CHROME Cabinet hardware. Bathroom accessories. Push button spraying enamel. Write Box 89, Troy 2, Ohio.

### WANTED—MISCELLANEOUS

ANTIQUES. Old relics, guns, coins, stamps, Indian flints, bottles, ox yokes, weapons, curios. New list prices paid. Instructions 25c coin. 125 guaranteed ways to make money included free. Daniel's Museum, Lamar, Ark.

WANTED Manufacturer for unusual child's car seat. Royalty basis. Patented. Kenneth Arnold, 1622-E Avenue Northeast, Cedar Rapids, Iowa.

WE Buy used plating equipment. Send description. Hollywood Bronze Supply, Dept. 22, 1624 East First Street, Los Angeles 33.

QUICKSILVER — Highest prices paid. Free containers. Wholesale Terminal, Norwood, Massachusetts.

SCRAP Mercury (quicksilver) tantalum, bismuth, tungsten. Metallurgical Products Company, Established 1909. 35th & Moore Sts., Philadelphia 45, Penna.

### PERSONAL

LETTERS Retailed and replies forwarded 25c. Private receiving address. Rates. McLaughlin, 369 Welch, Columbus 7, Ohio.

ENJOY A Puerto Rican vacation for a dollar? Browse through colorful twenty postcard gift packet! \$1.00 postpaid. Kenneth Burrell, Aguadilla, Puerto Rico.

MEXICAN Law practice. Reliably conducted. Box 1736, El Paso, Texas.

CONQUER Fear! Gain success, happiness. Positive results. \$1.00. Ward, 42-M Manchester, Springfield 8, Mass.

"HOW Can I find out?" You can! Information confidentially developed. Any matter, person, problem. Worldwide. Officially licensed. Established 1922. William Herman, 170 Broadway, New York City.

LETTERS Retailed 25c. Also private receiving address. Monthly rates. Shanks, Box 3110-D, San Francisco 19, California.

MEXICAN Law. General Practice Attorney, 1203 Arizona St., El Paso, Texas.

WANTED! Loving care and shelf space for sensational book bargains! Free catalogue! Write: Old Prof's Book Shop, Pontiac 15, Mich.

NEW York City remail 25c. Viewcards 10-\$1.00. Help wanted column New York City, Long Island, \$1.00. Box 276, Valley Stream, New York.

"HOW To Buy a Used Car." See Automobiles-Classified.

BORROW By mail. Loans \$50 to \$600 to employed men and women. Easy, quick. Completely confidential. No endorsers. Repay in convenient monthly payments. Details free in plain envelope. Give occupation. State Finance Co., 323 Securities Bldg., Dept. S-14, Omaha 2, Nebr.

BIBLE Reveals exact date of time of the end. Free. Write: Harvest, Jefferson City, Missouri.

"HOW Can I find out?" You can! Information discreetly developed. Any matter, person, problem, anywhere. Worldwide. Officially licensed, bonded service. Established 1922. Reasonable. Confidential. William Herman, 170 Broadway, New York.

HERE'S How and where to borrow \$50.00 to \$300.00 by mail. Confidential. Free particulars. Postal Finance Company, Dept. 45, Sioux City, Iowa.

### MISCELLANEOUS

"PIXIE Packets" for children 7-14. A different craft kit each month. Yearly subscription \$6.00. Entertaining, educational, excellent gift. Write for free literature. Pixie Packets, Dept. P-4, Ralston, Nebraska.

"PRECISION Barometers"—3 1/2" open enamel forecaster dial. Visible polished precision movement. Polished mahogany frame. Quality movement with altitude adjustment. Only \$5.95. Mail orders to C. and H. Company, 1514 Alaskan Way, Seattle, Washington.

LEATHERCRAFT. Everything needed by beginners, advanced hobbyists and professional leatherworkers. Largest stock of supplies in U. S. Moderate-priced tooling leathers, top quality calfskins, tools, supplies, kits. Send 10c for big catalog. J. C. Larson Co., 820 S. Tripp, Dept. 2551, Chicago 24.

HAVE You seen a copy of Mail Sale Advertiser? 20 pages. Copy 10c, year \$1.00. Ernest Martin, Preston, Va.

OUTDOOR Toilets, cesspools, septic tanks cleaned, deodorized with amazing Paw Paw Odorless. Tried and proved effective by over 150,000 worldwide customers. Easy, safe, economical to use. Saves digging, pumping. Satisfaction guaranteed or money back. Postcard brings free details. Burson Laboratories, Dept. B-27, Chicago 22, Illinois.

CESSPOOL Trouble? Start leaching process with Sursolvent, the miracle cesspool cleaner. Saves pumping. Reduces odors. Unclogs drains. Reclaims old systems to a condition approaching newness. Simple to use. Write for information. Electric Sewer Cleaning Co., Boston 34, Mass.

RECEIVE Magazines, samples, catalogues. Mails from everywhere. Offers, hundreds. Get listed 25c. Rorick, Box 86, Cincinnati 26, Ohio.

**HEARING** Aid amplifiers, complete, used. \$3.00. Hico, 615 W. 10th, Fort Worth, Tex.

300 **BIG** Mails guaranteed. Samples, plans, offers, propositions, 12 months listing, \$1.00 (refundable). Wright Publications, 2270 Hubbard, Memphis 8, Tenn.

**SAVE** Money. Cut hair at home. Illustrated booklet "The Home Barber" tells how. Only 25c. The Graham Co., 1238 W. Granger Ave., Lakewood 7, Ohio.

70 **BIBLE** Lessons, 25c. Bulletin, Box 87, Cathedral Station, New York 25.

**ROOTICATE** Destroys root growth in drains and sewers. Very inexpensive and effective. Write for details. Electric Sewer Cleaning Co., Allston 34, Mass.

100% **PURE** Maple syrup, \$2.25 qt., \$1.25 pt. Harold Bovee, Wautoma, Wis.

**CONFIDENTIAL** Wholesale plumbing and heating price lists will save you up to \$150.00 on future purchases. Send \$1.00. Town and Country, Box 15, Kimberton, Pennsylvania.

**PERSONALIZE** — Decorate glassware. Easily etch beautiful designs, monograms, initials in three minutes. Write for free folder. Etchall, Inc., Columbia 4, Missouri.

**INCREDIBLE!** Unprecedented! Become mental superman overnight! Floor everybody! No studying! "Memoprop" does your thinking! It's uncanny! Revolutionary! Free literature! Bijou, Box 1727-MX, Hollywood 28, California.

"**TRUE-TO**" 1952 election souvenir scroll of Eisenhower, MacArthur or Truman, also snappy Truman song, autographed sheet music, 50c. Write: "True-To" Souvenir, 1326 R. E. Lee St., Mobile, Alabama.

**HAVE** Fun, relaxation! Learn friendly, popular square dance! Easy instructions teaches you 30 dances, quickly! Only \$1.00 postpaid. Guthrie Shanks, Box 3110-G, San Francisco 19, Calif.

**SMASH** That old worry habit with our amazing "Human Behavior Control" plan. Many helped. Write for unusual free lecture. No obligation. Personal Psychology, Inc., Box 1924-M, Louisville 1, Kentucky.

**WINTER** Weatherstrip windows, doors. Circular free. E-Z-On, 1009 Harvard, Evanston 17, Ill.

**COWBOYS** - Cowgirls. Real western brand, certificate, booklet. Send 35c. Western Brand Registry, Colorado Springs, Colorado.

**STUDY** Wildlife, game warden, fish, park, forestry and patrol service. Details free. Write Delmar Institute, D11, Whittier, Calif.

**TEXAS** Passports, the original and unofficial, with amazing map, 50c. Passport, 1209 Calhoun, Houston, Texas.

**CARTOONS**. The kinds you'll like. Samples 25c. Verret, Raceland, Louisiana.

**RECEIVE** Mails, magazines, samples. Your name in numerous mailing lists 20c. Greenwood, Box 1116-O, New York 8.

**HAVE** Your photos, cards permanently sealed in plastic. Wallet size 25c. Urbanic, 620 St. Ann's Ave., Bronx 55, N. Y.

**ORGANIZERS** Wanted for debating clubs. Great opportunity. Thursday Evening Club, 324 Newbury St., Boston, Mass.

**YOUR** Leather jacket renovated expertly. Free circular. Berlew Mfg. Co., Dept. 8, Freeport, N. Y.

**MEDICAL** "Scrapbook" reprints 190 thrilling news items on latest wonder drugs, cures, lifesaving knowledge! Free literature! Bijou, Box M6-1727, Hollywood 28, Calif.

**LEATHER** Jackets repaired. New knit, zippers or relined. Work fully guaranteed. Jackets made to order. Free circular. Taubers, 689 Mission. San Francisco 5, Calif.

**FREE** Catalog! War surplus clothing. Amazing bargains. N. Y. Clothing Co., New York 29A.

**RECEIVE** Mammoth mails, magazines, catalogs! Three months 25c, year 50c. Waddell's Directory, 341B East 76th, New York 21.

**GOLD**. Silver, metal detectors. Geiger counters for uranium. Mineralights. Sensational new fully guaranteed models. None finer. Information free. Detectron Co., 5631 Cahuenga Blvd., North Hollywood, California.

**TREASURE**—M-Scope Geiger counters, mineral locators. Why buy something inferior when you can buy the best at a lower price? Backed by years of experience. Fully guaranteed by factory. Detects minerals, metals, gold, silver, coins. Payment plan available. Proven superior performance. Free 16 page illustrated booklet. Fisher Research Lab., Inc., Palo Alto, California.

**FREE** Blueprint Catalog! Hundreds of projects—motor scooter, furniture, toys, birdhouses, radios, garden furniture, power tools, boats, workbenches, home freezer, many more! Send postcard to Popular Mechanics Press, Dept. 103, 200 E. Ontario, Chicago 11, Ill.

**NEW LOW PRICES**  
on these powerful **NEW 1953**

# MIDWEST TELEVISION

Super Powered for "FRINGE" AREAS



Mammoth **20-Inch** Rectangular PICTURE

Easy to install in your own Cabinet.



**30 DAYS TRIAL EASY TERMS**

Midwest offers a sensational new 1953 line of beautiful consoles and complete chassis for easy installation in your own cabinet. Mammoth 20-Inch Television at low Factory Prices, and on 30 Days Trial.

Buy **DIRECT** from the **MIDWEST** Factory and **SAVE!**

SEND THIS COUPON For FREE MIDWEST 1953 Catalog

**MIDWEST RADIO & TELEVISION CORP.**  
Dept. 25B, 909 Broadway, Cincinnati 2, Ohio

NAME \_\_\_\_\_  
ADDRESS \_\_\_\_\_  
CITY \_\_\_\_\_ ZONE \_\_\_\_\_ STATE \_\_\_\_\_

# LEATHERCRAFT

THE "HE-MAN" HOBBY



**Make Leather Items for Gifts, to Sell, or for Your Own Use**

Get started now. **LARSON** Beginners' Kits of ready-cut projects require no tools or experience. Free instructions included. Make belts, gloves, moccasins, billfolds, woolskin animals and mittens, other attractive leather items. Also America's most complete stock for advanced hobbyists and professional craftsmen. **SEND 10c TODAY** for big illustrated catalog. **J. C. LARSON CO., 820 So. Tripp Ave. Dept. 2027, CHICAGO 24, ILLINOIS**

**EARN YOUR HIGH SCHOOL DIPLOMA**  
in 12-15 months

**STUDY AT HOME.** Success is yours when you have a high school education. You earn more, get better jobs, improve your social position. Prepare for college entrance if you wish. Start now. **WRITE FOR FREE LESSON AND BULLETIN** — no salesman will call.

**ACADEMY FOR ADULTS**  
Dept. PM-10 30 W. Washington Chicago, Illinois

5 Year Written Guarantee NEW **\$13.95**  
**17 JEWEL INCABLOC WATCH** WAS \$50 NOW ONLY

**DROP IT! WET IT! BANG IT!**  
Incabloc shock proof. Waterproof. Dust-proof. Tested best in Army and Navy Service. Anti-magnetic. Imported accurate Swiss lever movement. Sweep second hand. Radium dial.

**TO DAY FREE TRIAL** **SAVE \$36 IN BANKRUPT FACTORY STOCK SELLOUT**

Wear at our risk. Money back if not pleased. **SEND NO MONEY.** Pay postman plus tax and postage. Or enclose \$13.95 plus \$1.40 tax for men's watch, and we ship prepaid. (Ladies' model \$15.95 plus \$1.60 tax). Order now. Receive \$2 expansion band free with prepaid order.



**SAVE \$36**

**STANLEY SALES CO., Dept. P-10, Long Island City 4, New York**  
**POPULAR MECHANICS**



EVERY PASSENGER TIRE  
**UNCONDITIONALLY  
GUARANTEED**  
plus TIRE INSURANCE FREE

Here's DOUBLE proof that we bear the loss if your passenger tire wears out within the guarantee period or is damaged in any way (except willfully). Don't take risks: we send FREE insurance certificate PLUS written unconditional guarantee with your order.

**10% off ON TWO OR MORE USED TIRES**

**LOW COST QUALITY TIRES**

Unconditional Six Months' Guarantee plus Tire Insurance Free			
600-16	\$3.50	650-16	\$3.75
600-15	ea.	550-16	ea.
650-15		670-16	
550-15		750-17	\$3.95
		475-19	
		710-15	
		760-15	

**BETTER GRADE PASSENGER TIRES**

Unconditional One Year Guarantee plus Tire Insurance Free			
600-16	\$5.59	700-16	\$7.59
600-16 (6)	6.50	600-15	5.59
650-16	5.79	650-15	5.59
640-15	5.95	710-15	6.50
670-15	5.95	760-15	6.75
		700-15	\$5.59
		750-16	12.25
		820-15	7.55
		760-16	6.95
		550-17	5.75
		475-19	5.75
		760-16	7.75

**MUD AND SNOW TIRES**

TWO YEAR WRITTEN GUARANTEE			
600-16	\$6.95	900-16	\$12.95
650-16	7.50	650-16 (6)	9.50
		750-20 Reg.	\$12.50 Spec. \$15.95
		650-15	6.50

**EXTRA VALUE TRUCK TIRES**

ONE YEAR WRITTEN GUARANTEE			
600-20	\$10.75	750-20	\$14.50
650-20	11.75	825-20	\$21.50
700-20	12.50	900-20	19.50
		1000-20	20.00
		750-20 (10)	18.00

Complete line of High Mileage Tires in stock. Write for price list for sizes not listed. Take off 10% on orders for two or more tires. All prices F.O.B. Richmond, Va.

MAIL ORDERS PROMPTLY FILLED. Send check or money order with this ad. **THE SAFTYRE CO.** "FOR THAT SAFE TIRE" Dept. PM, 1801 E. Broad Street, P.O. BOX 2254, RICHMOND, VA.

**SAVE UP TO \$100.00** on your **STORM WINDOWS**

Assemble Combination Redwood or Aluminum Storm Windows Yourself!

These patented storm windows regularly sell for \$22.75 assembled. Now only \$6.50 knocked-down and shipped to you.

With only screen cloth and glass to buy locally, your total storm window cost is only about \$8.50 each. Upper and lower sash snap out from inside for easy washing. Screen replaces top or bottom sash during warm months—self storing in upper portion in winter. Frame stays in year 'round. No storage problem whatsoever. Only top-quality kiln-dried redwood. All standard window sizes.

**\$6.50\*** each Write for descriptive bulletin today, or send cash, check, or money order, for quick delivery. We pay freight on six or more windows. Satisfaction guaranteed or money back. \*Redwood 24/24 Glass—others, slightly higher.

DEALERS: A few choice areas are still available



**BUCKEYE SCREEN & WEATHERSTRIP CO.**  
1380 S. 22nd Street, Columbus, Ohio

SENSATIONAL NEW INVENTION  
**PRINT ANYTHING  
YOU WANT**

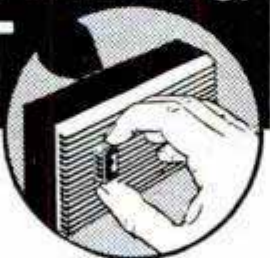

Now you can print anything you wish with this completely new printing outfit. "BASE LOCK" sets have complete alphabet of rubber letters and numerals which set FLAT AND TIGHT in rubber tongue and groove holder. Gives clean, sharp impressions every time. Used by leading firms everywhere. Now for the first time available to you, at this moderate price.

**\$4.95** postpaid  
No C.O.D.

INTRODUCTORY SET CONTAINS ALL OF THE FOLLOWING:  
More than 250 letters and numbers 1/8" high  
Type tweezers • 4-line holder 2 3/4" wide  
and FREE, one extra holder 1" wide  
**ORDER NOW!**

**U. S. RUBBER STAMP CO.** Dept. A  
227 Fulton St., New York 7, N. Y.

**MEN - WOMEN!**  
**Paint it  
with Suede**

**SPRAY ON  
RAINBOW COLORS**

for **PROFIT and Pleasure..**



**FLOK  
KRAFT**

**Flok-Kraft Covers:**  
Plaster, Fabric,  
Wood, Metal, Plastic,  
Rubber - any surface!

**A SENSATIONAL NEW  
HOME BUSINESS!**

**A NEW INDUSTRY...  
A NEW MIRACLE FINISH!!**

**MAKE \$500 to \$1000  
PER HOUR and more!**

**Read What  
Others Say  
About Flok-Kraft**

"... pleased with your course and I'm being swamped with work to do." W.F., Pa.

"Got \$52.50 for those 7 trunk interiors for about 4 hours work. \$7.50 per trunk." J.O., Mo.

"Received the flok-kraft outfit and everyone that saw it is very enthused. I only had it about thirty minutes and got an order for a hundred dollar job." Mr. C. H. Maryland

**PROFESSIONAL SECRETS CAN BE YOURS**

At last, secrets of this amazing miracle finish can be yours! Huge profits waiting to be tapped in tremendous new field. Flok-Kraft gives a velvety, luxurious surface to radios, lamps, toys, signs, store displays, figurines, auto dash boards—a thousand and one items to be seen on every hand easily and quickly beautified, enriched, increased in value with Flok-Kraft. Make old objects beautiful—saleable, make new things worth much more with this soft, rich covering that can be applied to any surface, even if old or worn.

**YOU CAN LEARN IN A FEW DAYS**

Make to \$5.00—yes! even \$10.00 and more per hour. Fully detailed Flok-Kraft instructions—complete and easy to understand—every point explained—shows you how to start on the road to big money, full or spare time.

**WE FURNISH EVERYTHING YOU NEED TO START**

You also get complete Flok-Kraft kit of materials and equipment that enables you to start at once. Add to your income from your regular job or begin to build a successful business of your own and do it all, right in a corner of your basement, garage, service porch, kitchen or living-room.

**GRASP THIS LIFETIME OPPORTUNITY TODAY**

I'll arrange to send you the complete outfit—everything you need to start—for leisurely, no-risk examination right in your own home. You owe it to yourself to investigate. Fill out and mail the coupon below for FREE details, Sample, Plan, etc. Do it today! Everything I send you now is FREE of charge and post-paid. Airmail is faster.

**YOURS TO EXAMINE  
WITHOUT RISK!!**

Complete instructions, starting kit of materials, equipment—complete, full details on how you can start your own business, spare or full time—EVERYTHING sent you to EXAMINE AT OUR RISK!

**FLOK-KRAFT and DEFENSE**  
Flok-Kraft offers a way to big, extra money, assisting defense manufacturers in many lines as well as filling a big demand on the home front.

NELS IRWIN  
Director of  
Instruction



COAST INDUSTRIES, Dept. 2A  
1004 S. Los Angeles St.  
Los Angeles 15, Calif.

SEND NO MONEY!  
JUST YOUR  
NAME AND  
ADDRESS

**FREE!**  
Booklet,  
Sample,  
Plan!



COAST INDUSTRIES, Dept. 2A  
1004 S. Los Angeles St.—Los Angeles 15, California  
Gentlemen: Please rush me FREE details, sample, etc. I understand that everything you send is free and that I'll be under no obligation now or ever.

NAME \_\_\_\_\_ STREET \_\_\_\_\_ CITY \_\_\_\_\_ STATE \_\_\_\_\_

# FOR YOUR TECHNICAL AND VOCATIONAL TRAINING

Come to the  
**UNIVERSITY OF HOUSTON**

One of America's large and most modern universities. Select from these fascinating fields:  aeronautics  air conditioning & refrigeration  auto body and paint  auto mechanics  auto upholstery & trim  diesel  drafting  electricity  electronics  machine shop  photography  radio  stationary engineering  television  welding  woodworking  furniture upholstery.

**PREPARE FOR YOUR FUTURE NOW . . .** with very latest methods and equipment, at modern U. of Houston College of Technology. Entrance: high school diploma, or over 18 and ability to profit from instruction. Beautiful campus—250 wooded acres in Houston, Texas—city of tomorrow. Full college activities, sports, social life. Day or night, short or longer courses. Co-op work-study programs . . . earn part of tuition and expenses with part-time job in your own career field, while you learn. Personal vocational counselling. Diploma on completion and all credits apply towards Bachelor of Applied Science Degree. Job placement assistance. Feb., June, Sept. semesters. Mail ad now for Free fully-illustrated brochure. No obligation. Mark X before choice of subject. **Do it today!**



ADMINISTRATION BUILDING

**University of Houston, College of Technology**  
Dept. 1A2 — HOUSTON 4, TEXAS

## FREE AVIATION BOOK . . .

You can cash in on America's fast-expanding industry—AVIATION. SPARTAN has trained thousands for well-paid jobs. You can qualify in a remarkably short time for employment with an airline, manufacturer of planes or aviation equipment. SPARTAN has calls for more graduates than are available. If you have ability, ambition and the necessary training, there is no limit to the success you can achieve.

Investigate the many opportunities and training required. Write for FREE BOOK

**SPARTAN**  
SCHOOL OF AERONAUTICS  
TULSA, OKLAHOMA

**MAIL COUPON TODAY**

Spartan School of Aeronautics  
Tulsa, Oklahoma Dept. PM-102  
Please send me complete information on: Course \_\_\_\_\_  
Name \_\_\_\_\_ Age \_\_\_\_\_  
Street \_\_\_\_\_  
City \_\_\_\_\_ State \_\_\_\_\_



## LEARN TO SERVICE AND REPAIR ELECTRIC APPLIANCES

Get a Good Job—Run Your  
Own Business

Be the man who knows how to service and make quick repairs on washing machines, vacuum cleaners, heaters, toasters, stokers and household motors and gadgets of all kinds. Get into this pleasant, easy and good pay work. Get the sensational new book—Electrical Appliance Repair and Servicing.

An investment of only \$3.00 will positively get you started in this vital field in a good-pay job or help you build up a profitable business of your own. Run it from your home. No starting capital needed. No experience in electricity required. The book explains how to diagnose and locate trouble and how to fix it. 246 pages. 188 how-to-do-it illustrations.



**MONEY  
BACK  
IF NOT  
SATISFIED**

Clip this ad and mail with only \$3.00, currency, check or M. O. or we will send C.O.D. Use book for 5 days. See how easily you can make it pay for itself hundreds of times over. Then if you are not fully satisfied—send it back and we will refund your money quick. Rush order today. Get started at once.

FREDERICK J. DRAKE & CO., Dept. 17, 117 Green Bay Road, Wilmette, Ill.

## How to Make Much More Money!

**FREE** Send name—learn how all types of business are boosting sales with Postcard Advertising. We'll also send **FREE** illustrated book of money-making ideas for your business—complete, unique advertising plans—and **30-day Trial Offer.**

**CARDMASTER CO., 1920 Sunnyside Ave.  
Dept. 1310 CHICAGO 40, ILLINOIS**



Low In  
Cost

5 year  
Guarantee

## WALKIE TALKIES! — \$4.99 COMPLETE SET OF 2

**POCKET SIZE — ELECTRONIC VOICE POWERED**  
No tubes, batteries, adjustments. Guaranteed to work anywhere up to ¼ mile with extra wire. Swell for room to room—garage to house, etc. Your own private, talk-listen phone. Not war surplus. Brand new. Guaranteed. Two complete units with interconnecting wire — **READY TO USE!**



**SEND \$1.00** deposit and pay postman \$3.99 plus postage charges or send \$4.99 for postpaid delivery. Available only by mail from **MIDWAY COMPANY, Dept. WPM-10, Kearney, Nebraska**

## BECOME AN EXPERT IN TRAFFIC

Traffic men earn \$4,000 to \$10,000 and up. Thousands of firms need experts on rates, tariffs, regulations. We train you thoroughly in spare time at home for executive traffic jobs. Personal training under traffic authorities. Placement counsel and help. Write for free 48-page book "Traffic Management—the Fast Growing Profession."

**LASALLE Extension University, 417 So. Dearborn St.  
A Correspondence Institution Dept. 1064T, Chicago 5, Ill.**

## Say You Saw It in Popular Mechanics

TUBE GIVEN WITH EVERY TIRE AT NO EXTRA COST



**Why Pay More!**

**FALL SPECIALS — AT LOW PRICES  
SAVE TIME — SAVE MONEY — SEND THIS AD**

GOOD USED TIRES "Not recapped."

19 YEARS AT THIS ADDRESS  
Be Wise—A TRIAL OF ONE TIRE WILL  
CONVINCE YOU.



EXTRA SPECIALS			30 MONTHS WRITTEN GUARANTEE				
600-16	\$4.72	550-15	\$4.92	700-15(6)	\$9.82	700-20	\$11.02
600-16(6)	5.72	640-15	4.92	750-16(8)	9.72	750x20(8)	12.72
650-16	5.72	670-15	5.12	700-17	10.72	750-20(10)	16.12
650-16(6)	6.42	710-15	6.62	750-17	11.62	825-20	18.32
700-16	6.42	760-15	5.82	750-15	14.02	900-20	17.32
750-16	6.92	808-15	6.52	825-15	16.02	1000-20	17.82
525-18	5.92	820-15	6.52	600-20	8.82	1100-20	20.52
550-17	4.92	670-16	6.62	650-20	10.22	1200-20	23.72
650-15	5.02	760-16	6.52	32x6(8)	10.62	1000-22	20.52
700-15	4.72			32x6(10)	10.92	1100-22	20.52

Whitewalls \$1.00 each Extra Military Treads 750x20(8) 14.02

Thousands of tires shipped all over U.S.A. All tires shipped F.O.B. Phila. Send Check or M.O. with this ad. Dept. 2.

**STANDARD 834 N. Broad St., Philadelphia 30, Pa.**

# FREE!

## COURSE of INSTRUCTIONS



SOME OF THE BOOKS AND LESSONS WAITING FOR YOU!

### IN BUSINESS OVERNIGHT! SUCCESS GUARANTEED!

Illustrated at the left are just a few of the THOUSANDS of useful and attractive things we teach you how to make without any tools or machinery . . . simply by CASTING!

You can start your own HOBBY AND NOVELTY SHOP in your own community. We will actually put you in business, supply you with ALL the merchandise you need and GUARANTEE YOUR SUCCESS!

Or you can start your own PLASTICS FACTORY and manufacture an ENDLESS VARIETY of beautiful and useful things for others to sell! Either way, we supply all the materials and instructions!

SEND 25c FOR FULL PARTICULARS AND BIG CATALOG!

We have THOUSANDS of unusual products and materials of immense interest and value to inventors, mold, die, tool and model makers, hobbyists, craftsmen and to every ambitious individual seeking to create wealth and security with his own two hands in a FASCINATING ENTERPRISE!



Yes, we'll teach you at home how to make the most beautiful things you have ever seen! Everything from novelties, gadgets, beautiful jewelry, gems, machine parts, lures, models . . . ALL without tools or machinery! The PLASTICAST PROCESS is as easy as pouring water out of a glass! Learn how to MANUFACTURE countless useful and attractive things with Liquid Plastics, Liquid Marble, Liquid Ivory, Liquid Glass, Liquid Clay, Plaster, Stone, Wood, Metal and Compositions . . . all taught to you FREE!

### SUCCESS GUARANTEED

The ONLY limitation is your imagination! No special talent, no previous experience, no special tools or machinery required! We not only TEACH you how to make these things but we show you how easy it is to dispose of your production, even selling part or all of your output to us! We will actually PUT YOU IN BUSINESS OVERNIGHT AND GUARANTEE YOUR SUCCESS! Yes, we'll set you up in the most fascinating business you ever dreamed of! In just a short time you'll be manufacturing sensational products of endless variety . . . it's all very fascinating and simple!

### HOW TO START

Just send 25c for our big 56 page catalog which elaborates on the PLASTICAST PROCESS; we will include your first book of instructions PLUS complete details of the most amazing offer that will ever come your way! Do it today . . . don't delay anything that can be so important to your future!



# PLASTICAST CO.

WRITE TO NEAREST OFFICE

Dept. C  
P. O. BOX 6737, CHICAGO 80, ILLINOIS  
P. O. BOX 987, PALO ALTO, CALIF.  
Canadian readers: Please send 35c to: Canadian Ind. Plastics, 1056 1/2 W. Pender St., Vancouver, B. C.

### Most Legal Troubles Can Be Avoided

### THIS BOOK SHOWS HOW

Avoid trouble, save high legal fees. This book by one of Nation's leading legal writers tells how to avoid all legal pitfalls apt to be met by average family . . . Wills, Civil Rights, Libel, Property Rights, Accidents, etc. Includes Dictionary of Legal Terms. Order yours today.

SEND NO MONEY! Pay Postman just \$2.98 plus C.O.D. and postage (or send \$2.98 with order and we pay postage.) Money back if not 100% satisfied.

AMERICANA CORPORATION

333 N. Michigan, Dept. 108, Chicago 1, Ill.



You can't afford to be without THIS BOOK!

## High School at Home

### Many Finish in 2 Years

No classes. No time wasted going to and from school. Progress as fast as your time and abilities permit. Standard H. S. texts supplied. Thousands enroll each year in this 55-year-old school. Send for FREE descriptive booklet.

AMERICAN SCHOOL, Dept. H745  
Drexel at 58th St., Chicago 37, Ill.

Without obligation, please send FREE descriptive booklet.

Name \_\_\_\_\_

Address \_\_\_\_\_

# BUILD A \$15,000 A YEAR FUTURE!



## IN THE EXCITING NEW BUSINESS OF LAUNDERING VENETIAN BLINDS

There is big money to be made cleaning Venetian Blinds and a permanent, fast growing, Lifetime Business, besides.

An amazing new kind of business of your own in a field that is growing like mad. Millions of Venetian Blinds need laundering at regular intervals.

With our new patented machine, you can start small—using your basement, garage or utility room to begin with. You can expand as your business increases by leaps and bounds. Income up to \$200.00 daily already being made by others. Small investment for equipment starts your own lifetime business—and monthly payment plan permits you to pay for it as you grow.

**FREE** Get all the facts about this sensational new kind of machine that launders blinds so fast that your charges are unbelievably low. People would rather send blinds to you than do the work themselves. Yet, you make 700% profit on every blind you clean. Get names of successful owners near you. Get details of the full amazing plan without obligation. Be first in your territory to start a business that has brought \$15,000 PROFITS the first year to others. Wire today or send name on postcard.

**VENETIAN BLIND LAUNDRY EQUIPMENT CO. INC.**  
442 N. SENECA ST. DEPT. 1010 WICHITA 12, KANSAS

# THIS 120 PAGE **GUIDE** FOR AMBITIOUS MEN **FREE!**

Have you had your copy?

120 pages of guidance to best-paid positions. Up-to-the-minute information for men who want to climb to the top. Tells how to get promotion, security and better pay through home study courses. This handbook "Engineering Opportunities" is free and entirely without obligation. Send the coupon. Make this your big year! Describes over ninety courses including:

Mechanical Eng.  
Aeronautical  
Television  
Building

Electrical  
Radio  
Automobile  
A.M.I.Mech.E.

A.F.R.Ae.S.  
A.M.I.C.E.  
B.S. (Pure  
Science)

--- SEND COUPON TODAY ---

Canadian Institute of Science & Technology Limited, 549 Century Building, 412, 5th Street, N.W., Washington, D.C.

Please forward free of cost or obligation your handbook, "ENGINEERING OPPORTUNITIES".

Name.....

Address.....

Course interested in..... Age.....

Canadian Address: Canadian Institute of Science 549 Garden Bldg., 263 Adelaide Street, W., Toronto, Ont.

# Famous 15 and 17 Jewel BULOVA WATCHES \$16.95 PLUS TAX

PRACTICALLY WHOLESALE TO YOU

UNLIMITED WRITTEN GUARANTEE

Were Up to  
**\$59.50**  
SAVE \$42.55

ALSO CHOICE OF  
• BENRUS • GRUEN  
• WALTHAM OR  
• ELGIN WATCHES



You get these unredeemed **UNLIMITED** guaranteed Bulova and other movements in latest style Yellow Gold Cases at this seasonally low price because we bought out SURPLUS STOCKS of leading New York and Md. Jewelers. Order now while they last. Specify make preferred and whether men's or ladies'! Only \$16.95, plus \$1.70 tax. Order right now.

**FREE TRIAL OFFER! WEAR AT OUR RISK!**  
Money back guarantee in 10 days if not delighted!

SEND ONLY \$1 with order. Pay balance C.O.D. plus postage. Or we pay postage if you enclose \$16.95 plus \$1.70 tax.

**UNLIMITED** Guaranteed—17 Jewel Swiss  
**WRIST WATCH**  
Worn by Army, Navy & Marines  
Originally \$59  
**\$14.95** Plus \$1.50 Tax  
New Incablock, Shock-Protected  
**WATER-DUST PROOF**

FREE! Handsome Expansion band with orders.

**MARYLAND DISTRIBUTORS, Dept. 416**

501 E. BALTIMORE ST., BALTIMORE 2, MD.

Write for Free Watch and Diamond Ring Catalog — Practically Wholesale Prices.

# MAKE MORE MONEY!

Army-Navy Inspectors on Defense contracts make high pay, enjoy prestige, travel. Prepare in spare time on easy payments. Write TODAY for facts. No obligation.

**PRECISION INSTRUMENTS SCHOOL**

161 N. 75th St.

Milwaukee 13, Wis.



# HE-MAN VOICE!

**STRENGTHEN** your voice this tested scientific way. Yes—you may now be able to improve the **POWER** of your speaking and singing voice... in the privacy of your own room! Self-training lessons, mostly silent. No music required.

**FREE BOOK** Write TODAY for Eugene Feuchtinger's great booklet "How to Develop a Successful Voice." It's absolutely FREE! You must state your age. Booklet mailed postpaid in plain wrapper. No salesman will call. Send your name and age **RIGHT NOW!** Perfect Voice Institute, 210 S. Clinton St., Studio KY-2, Chicago 6, Ill.

Our 533rd Advertisement

# REAL DIESEL ENGINE

**\$2.95**

- for planes, boats, midget cars
- 7500 RPM; 1/7 HP; ht. 3 1/2"; wt. 5 oz.
- precision machined for smooth operation

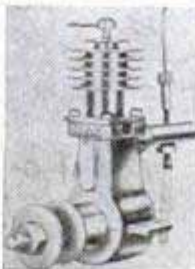

You just can't beat this price for a precision diesel engine! Streamlined, compact, easy to install. Thousands of satisfied users all over the world. Fast delivery if you **ORDER TODAY!** Send \$2.95 plus 25c postage.

**GOTHAM HOBBY CORP.** Dept. P, 107 E. 126th St. New York 35, N. Y.

# "MAKE MONEY IN YOUR OWN HOME"

—Making mirrors and renewing the old ones. You can learn this trade in less than seven days according to my **SCIENTIFIC-PRACTICAL COURSE**. Learn it as a hobby or as a profitable trade. This course is written in English and Spanish, and is so clear and well edited that it can be understood perfectly by anyone, no matter what his education may be. Send for free information. Write to: **PEDRO HALIBERTO CERVINO**, Calle R. Manduley 165, Hoiquin, Ote., CUBA.

SAY YOU SAW IT IN POPULAR MECHANICS

# French **DUELING SWORDS**

SET OF TWO **\$2.98**

Once used in deadly combat—now an exciting sport! Learn right at home. Fun—safe—educational. These swords are made of fine blue spring steel, polished metal



guards, turned handles, rubber safety tips. Fencing teaches quick thinking, develops coordination, posture. Since the Middle Ages, Europeans have enjoyed the sport of dueling. \*Now advocated by U.S. colleges. Set includes two swords and the booklet, "The Art of Fencing". Special mail order price. **YOUR MONEY REFUNDED IF NOT COMPLETELY SATISFIED** Send \$2.98 to

**TECHRITE CORP.**, Box 12 H, South Pasadena, Calif

# Men Who Can Play Music Are in Big Demand Today!



**TV Creates New Opportunities.** America is more "music conscious" than ever. Musicians needed by radio — TV — night clubs, etc.

Invited to Attend all kinds of gay social affairs. Meet interesting people — make valuable contacts.

Make Good Money Without Taking a Job. Teach music to others as you taught yourself—at \$2 to \$5 per lesson.

## NOW YOU CAN LEARN TO PLAY ...for Pleasure or Profit!

Start Playing Right Away — Even if You Don't Know A Single Note Now! Over 850,000 People Have Taken It Up!

What's YOUR secret musical ambition? To play in a band? Perform on radio or TV? Become a music teacher? Or just get more fun out of life?

You'll be amazed at how QUICKLY and EASILY we can help you make those dreams come true! We don't care how little you know about music today. If you can carry a tune . . . read plain English . . . look at big clear pictures . . . we can start you off playing simple melodies on your favorite musical instrument. Piano, accordion, guitar, ANY instrument. And you'll keep on developing your

musical skill so rapidly you'll find it hard to believe.

### Learn-by-Playing

No teacher needed. No boring scales or exercises to do. You learn-by-playing — just as you learned English when you were a child by speaking it. Step-by-step directions make it easy as A-B-C. Costs only a few cents each lesson.

No artificial methods or "gadgets" — you play real sheet music by notes. Soon amaze your family and friends with your beautiful renditions of popular songs . . . hymns . . . operettas . . . waltzes . . . all kinds of delightful music. No limit to how far you can go if you have serious professional ambitions—some of our former students (such as Lawrence Welk, for example) are now orchestra leaders.

### FREE BOOK and Lesson-Sample

Send for our valuable 36-page illustrated book showing exactly what we can do for you. Also included—free Lesson-Sample. No obligation; no salesman will call on you. Mail coupon to: **U. S. SCHOOL OF MUSIC, Studio B3010, Port Washington, N. Y.** (Special Reduced Prices in Instruments to our students). Now in our 54th Successful Year.



**U. S. School of Music, Studio B3010, Port Washington, N. Y.**

Send me Free Book and Free Lesson-Sample. No salesman is to call upon me. I'm interested in playing (name instrument)

I do  I do not—have instrument now

Name . . . . . (Please Print)

Address . . . . .

City . . . . . Zone . . . . . State . . . . .

### WHAM-O SPORTSMAN\*

\$1.50 POSTPAID 35-LB. PULL!

HITS LIKE A RIFLE—KILLS RABBITS, SQUIRRELS. Powerful, silent, accurate. For hunting, target, routing pests. Sportsman's choice sold world over!

### HUNTING SLINGSHOT

Heavy duty 7" ash stock. 40 steel balls, extra rubber, target.

GUARANTEED. At dealers, or send \$1.50 to Wham-O Mfg. Co., Box 87, South Pasadena, Calif.

\* Professional model of Nat'l Slingshot Assn.

SAY YOU SAW IT IN POPULAR MECHANICS

## IMPORT PAYS BIG

Opportunity to START AT ONCE IMPORTING big profit items for your own world-wide import-export business by mail order without capital, from home, anywhere; or work for others—profits unlimited, travel abroad if desired. No previous experience needed. Men, women . . . learn at home in spare time from established World Trader, easy step-by-step method. FREE details—write NOW! Airmail reaches us overnight. MELLINGER CO., Suite 25A 1717 Westwood, Los Angeles 24.



## AMAZING IMPROVED ELECTRIC SPRAYER MAKES HOME PAINTING EASY

Why wear yourself out using Expensive old-fashioned brushes. **Mistifier Sprayer** quickly, smoothly and evenly sprays glossy enamels, lacquers, insecticides, mothproofers and oils. All in one self contained unit that requires no compressor, motor or accessories. All metal non-corrosive parts makes this unit a LIFE-LONG useful tool. Sturdily constructed weighs only 2 lbs., uses standard replaceable Mason jar. Spray volume is adjustable, 80 POUNDS PRESSURE, fingertip control. AC-110 volts. **FOR PAINTING, SPRAYING, DISINFECTING, MOTH PROOFING.** Mistifier Sprayer works wonderful when painting wicker and all other furniture, cars, metal cans, partitions, concrete



SPRAY FURNITURE



PAINT AUTOS

brickwork, rough wood, boats, wagons, screens, cabinets, venetian blinds. Wonderful for Mothproofing clothes, rugs, drapes, storage closets, etc. Mistifier is Safe and Easy to use.



10 DAYS FREE TRIAL Unconditionally Guaranteed

ONLY 995 Complete—No Extras to Buy

We Guarantee that Mistifier Sprayer will apply paint smoothly, quickly, easily — or return it within 10 days for full purchase price refund. Only \$9.95 Postpaid or sent C.O.D. plus postage. Full instructions. Order Now.

IMPERIAL SALES, Dept. S-494 480 Lexington Ave., New York 17, N. Y.

**NOW READY!**

First Underslung  
Miniature Model—  
Ready to Build!



**Collectors' Model KIT—  
1914 REGAL Colonial Coupe \$3.95**

Recent magazine featured fascinating story of this celebrated antique auto—and now YOU CAN BUILD YOURS from our authentic scale model kits! When complete

—measures 8½" in length! It's the first underslung model kit ever made! All die-cut parts are of the finest materials—with die-cast plastic radiator, die-cut metal hood with louvre detail. History of car, also step-by-step instructions included. Order now for yourself or as a gift for every hobbyist on your Christmas list!



1904 OLDSMOBILE — \$1.95

**FREE! Write for a Copy  
of Our 4-Color Folder!**

IF YOU ORDER DIRECT — add 25c for postage and handling.

*hudson miniatures* **OLD TIMERS**

"Originators of Antique Autos in Miniature"

SCRANTON HOBBY CENTER, Dept. 14, Scranton 10, Pa.

**SEND ME**

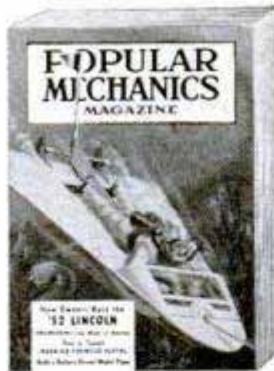

every month so I am sure to see each new issue. Here's

- \$3.50 for 1 year
- \$8.00 for 3 years

name \_\_\_\_\_

address \_\_\_\_\_

city \_\_\_\_\_ zone \_\_\_\_\_ state \_\_\_\_\_  
B-102

Hand this order to your newsdealer or send it to

**POPULAR MECHANICS**  
200 East Ontario St. Chicago 11, Ill.

**NEW!**  
**ALL ABOUT  
TELEVISION**

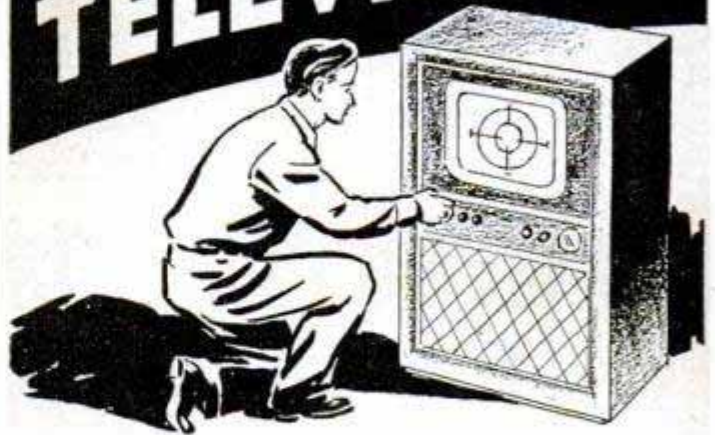

**Service Your TV Set Yourself and Save Hundreds  
of Dollars . . . Save on the Purchase of a New Set!**

Here's the brand new book that tells and shows you how 9 times out of 10 you can service your TV set yourself and save the \$5 to \$25 fee charged by professional repairmen for service calls.

Here are famous step-by-step instructions by John Derby, famous television engineer, which make it possible for you to locate trouble quickly and repair it in the matter of minutes. Hundreds of "show-how" photos, drawings and diagrams actually show you just how to go about making most TV repairs.

A special illustrated section contains actual photographs of imperfect TV pictures. By comparing the picture on your set with those in the book you immediately identify the trouble and then by following Derby's instructions you make the adjustment or repair which will give you perfect reception once again.

Find out how to install your own antenna at a savings of as much as \$20 . . . how to replace burnt-out picture tubes . . . how to get the best reception in outlying areas . . . how to save money when buying a new set . . . what to look for when you purchase a TV set.

Go with Derby into TV studios and see stars in action . . . see how television shows are produced and what goes on "behind the scenes."

No other TV book on the market is so comprehensive and so chock-full of valuable information. No other book can save you so much money.

Send just \$3.00 for your copy of "All About Television." Read it for seven full days and unless you agree that it can save you hundreds of dollars and enable you to service your TV set yourself just slip it back in its wrapper and return it to us for a full refund. Use the handy order blank today.

**Order on this Handy Coupon**

**POPULAR MECHANICS PRESS**  
200 E. Ontario Street, Chicago 11, Ill.

Remittance for \$3.00 enclosed. Rush postpaid my copy of "All About Television." Unless it is entirely satisfactory I may return it within seven days for a full refund.

NAME \_\_\_\_\_

ADDRESS \_\_\_\_\_

CITY \_\_\_\_\_ ZONE \_\_\_\_\_ STATE \_\_\_\_\_

Send C.O.D. (Postage extra)



# A BIG BUSINESS FOR YOU FREE!

## You Can Be The Maryland BOOK MATCH BROKER IN YOUR TERRITORY

If you are now selling anything at all to business men write us at once for plan to make every call pay **double** profits. One of greatest names in industry has openings for more Book Match Brokers. Write your own ticket on income—get in on this big money business. **Only Maryland offers Double Book Matches with Famous Glamour Girl Covers.** We give you the greatest line ever seen. Huge quantity buyers in every territory. Big Sales Kit puts you in a business of your own at once—full time, spare time or sideline. Write for Free Selling Outfit today.



**MARYLAND MATCH CO., Dept. 610**  
1100 S. EUTAW STREET, BALTIMORE 30, MARYLAND

EASY TO WORK WITH!

# FOAM RUBBER

DO IT YOURSELF AND SAVE 50%!



Your money back if you aren't satisfied with the perfect Foam Rubber! Re-cushion chairs, make your own pillows, mattresses, chair-pads, cushions! You'll save up to 50%—because you buy direct! **SEND FOR FREE PRICE LIST.** No C.O.D. Add 10% for postage and handling.



Shaped to fit  
**AUTO SEAT TOPPER PADS**  
**FOAM RUBBER**  
24x60x1 1/2" \$6.45  
Foam Rubber  
Child's Jr. Pillow  
12x16x5"—\$2.95

16 x 16 x 1 1/2"	\$1.30
16 x 20 x 1 1/2"	1.65
18 x 24 x 1 1/2"	2.00
24 x 24 x 1 1/2"	2.95
24 x 30 x 1"	2.95

All sizes approximate

## ADAMS FOAM RUBBER

5611 Broadway • Chicago 40, Ill.

DEPT. PM-10



## WHY SUFFER TONGUE BITE?

Cost 3 times as much to build as the best of old-fashioned pipes. But **KILL TONGUE BITE, STOP DRINK.** FREE circular tells WHY. Write:

**KLENSMOK PIPES**

P.O. No. M597, Johnson City, Tenn.  
R-Reg. U.S. Pat. Off. Pat's. and Pat's. Pend.

## BUTANE-PROPANE GAS ON YOUR CAR



Save up to 1/2 and get powerful Hi-Octane operation! Simple combination system (easily installed) can switch to gasoline instantly while running! Equipment for all cars—trucks.

**SEND \$2.00** for our complete "How to do it" booklet, instructions, photographs and special prices. (refunded on parts order) **ORDER NOW — TODAY.**

**LPG PRODUCTS CO., Dept. PM-10, KEARNEY, NEBR.**

Say You Saw It in Popular Mechanics



## I MAKE UP TO \$40 EVERY DAY

That's what you'll be saying when you line up with our company — full or spare time. We pay you every day for listing delinquent accounts for collection — secured from doctors, dentists, business firms, merchants, etc. No selling, demonstrating or collecting! Chance to become District Manager.

**WRITE TODAY** — if you are between 30 and 65. Both men and women wanted!

**UNITED FINANCIAL SERVICE OF AMERICA**  
253 Plymouth Bldg., Minneapolis 3, Minn.

## TOP-PAY JOBS Now Waiting!

## TELEVISION UPHOLSTERING AUTO MECHANICS

### Earn as you train at home Get a good job when you graduate

Earn up to \$50 a week in spare time as you train at home—and up to \$125 a week after you graduate. Easy illustrated lessons make every step easy. Twenty kits of parts and tubes to make 16-in. TV set included with television course; tools and materials to build ottoman sent with upholstery lessons. Thousands of trained men needed. Train in months. *Mail coupon for valuable free booklet!*

#### BODY & FENDER REBUILDING

#### DIESEL MECHANICS

#### MECHANICAL DRAFTING

#### BUILDING CONSTR'N

#### FOREMANSHIP

#### FACTORY MANAG'MT

#### REFRIGERATION

#### HIGH SCHOOL

### OTHER BIG OPPORTUNITIES

You don't have to give up your present job because you learn at home. So mail coupon today. State course. Begin your future now.

#### Commercial Trades Institute

1400 Greenleaf • Chicago 26  
Dept. 2-10

Name \_\_\_\_\_ Age \_\_\_\_\_

Address \_\_\_\_\_

City \_\_\_\_\_ State \_\_\_\_\_

Course \_\_\_\_\_

# LEARN 90 WAYS TO MAKE MONEY WITH YOUR CAMERA

## Earn While You Learn at Home in Spare Time

Here's your leisure-time short cut to immediate big earning power and a bright, exciting future. NYI's famous, low-cost HOME STUDY COURSE qualifies you quickly for spare-time earning or profitable, action-packed career. Top photo authorities give you down-to-earth professional know-how essential for success in more than 90 money-making opportunities in photography. No previous experience or expensive equipment necessary.

### Course Pays for Itself

Hundreds of students have earned enough while learning to pay entire tuition cost . . . and pocketed extra cash besides. NYI shows you how. You **LEARN BY DOING** through exciting, practical picture-taking assignments with experts giving **INDIVIDUAL** attention to YOU every step of the way. Find out about NYI's HOME STUDY COURSE now! Send for big FREE book. Write TODAY!

Our 43rd Year ● **RESIDENT TRAINING ALSO AVAILABLE**  
Approved for Vets

## FREE BOOK



### MAIL COUPON TODAY

**NEW YORK INSTITUTE OF PHOTOGRAPHY**  
Dept. 49, 10 W. 33 St., New York 1, N. Y.

Please send me complete information regarding

Home Study Course  Resident Training

Name \_\_\_\_\_

Address \_\_\_\_\_

City \_\_\_\_\_ Zone \_\_\_\_\_ State \_\_\_\_\_

Completed Popular Mechanics Ranch Type House and exact scale pictorial room and suggested furnishing layout. To right of dotted line is BASIC HOUSE. Expansion to the left. Designed for easy building in two convenient steps.

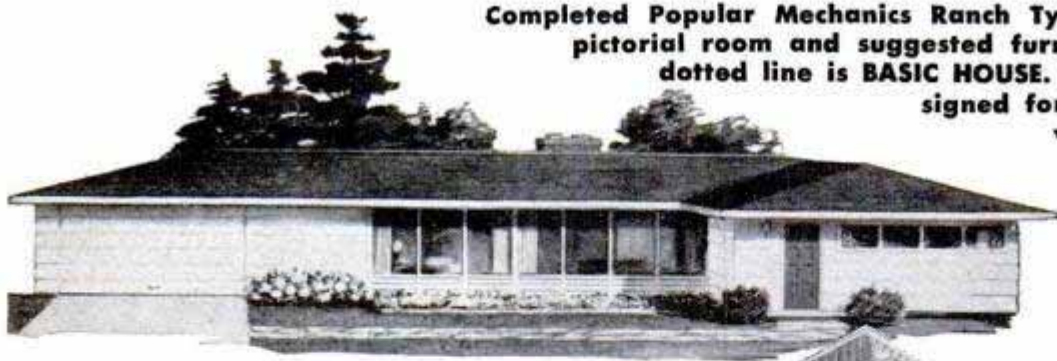

Basic house includes living room, dining area, two bedrooms, kitchen, bath, utility room and car port. Can be built for about \$5000.

More than 100,000 families have built their own homes in the past few years, doing all of the work, or most of it themselves. Right now, one of every five homes being built is at least partially owner-built. This proves that you too, if you can use hammer and saw, can build your own home and save more than one-half of the cost.



**Add  
When You  
Need More  
Room**

When expanding you add garage and breezeway, and car port becomes third bedroom. About \$2500.

**Build the Basic  
House First**

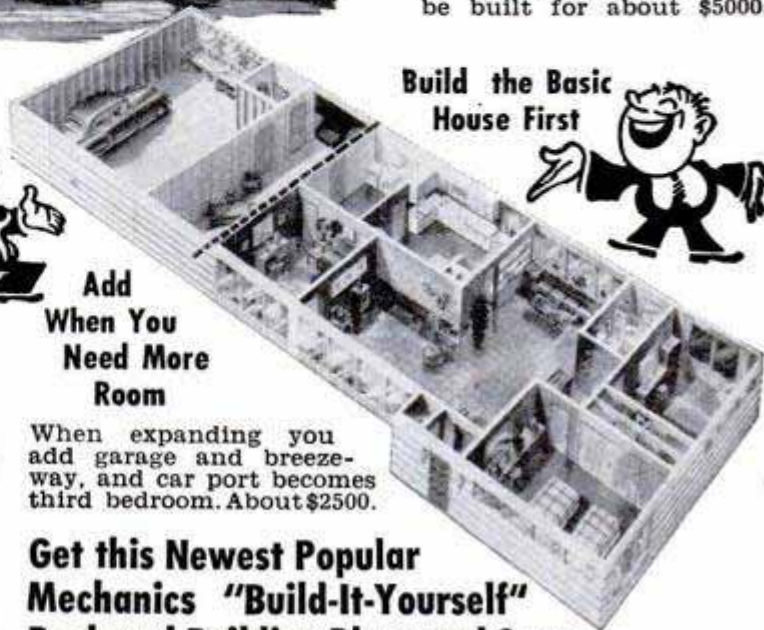

**Get this Newest Popular  
Mechanics "Build-It-Yourself"  
Book and Building Plans and Save  
Many Thousands of Dollars**

Book gives complete step by step instruction in simple language. Hundreds of pictures, actual photos and diagrams, showing every phase of construction, guide you from start to finish. Ten working size blueprints give floor plans, elevations, notes on construction, framing, lumber list, specifications, plumbing and wiring diagrams.

part of it. And at the same time, save in labor costs, more than he spends for material.

**Order Book and Plans Now**

Use the handy coupon below to order your copy of the RANCH-TYPE HOUSE BOOK AND PLANS. Read the book; study the plans and then you will be prepared to go right ahead when you are ready to build. Even if you have the house mainly built by others, you can still enjoy a tremendous savings by using the instructions and blueprints from Popular Mechanics.

**Read How and See How —  
Simplified Instruction**

You read "how-to-do-it" in the book. You see how it looks in actual pictures. You follow the plans for dimensions and details. You make use of labor-saving kinks and special methods developed especially for the project.

**No Previous Building  
Experience Required**

Any ordinary handy man, using only simple tools, can build this house with little or no assistance and enjoy every

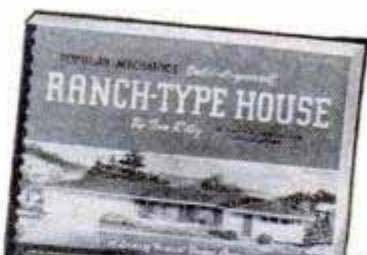

*Build this*  
**Popular Mechanics  
RANCH HOUSE  
Yourself!**  
*Save Over One-Half*

**Beat the High Cost of Home Owning  
It's Easier Than You Think**

Here is a dream home that can become a reality without too much worry about money. Build this beautiful Ranch Type Home yourself. Simply follow the Popular Mechanics RANCH TYPE HOUSE BOOK AND PLANS. You can save \$7,000 to \$10,000 and have one of the most desired homes of these times. You can build it all now—or part of it—and add garage, breezeway and another bedroom later on without affecting the basic house.

**Modern Design • Fully Finished • All-Season  
Build this Home Anywhere and Save**

Designed for Popular Mechanics by John F. Whelan, famous West Coast architect and designer of homes and entire villages. It's a year 'round house, 81 feet long and 29 feet wide. Fully insulated. Finished outside and inside with durable plywood and requires no plastering. Brick "island wall" and big fireplace in living room. Heating, unique ventilating system and latest development in electric wiring included. A dream home that can easily come true and a home that can grow with the family.

Reduced size illustrations from book. Building roof truss on floor for easy construction. Mrs. Tom Riley, Portland, Oregon, shingles the roof on her Popular Mechanics Ranch Type House



*Use This Handy Order Coupon*

**POPULAR MECHANICS PRESS, Dept. 70  
200 East Ontario St., Chicago 11, Ill.**

Send at once my copy of the Ranch-Type House Book and Plans as checked below:

- Remittance enclosed  Send C.O.D. (postage extra)
- Ranch Type House Book \$ 3.50
- Set of 10 Blueprints 13.50
- Book and Blueprints 15.00
- Duplicate Set of Blueprints 5.00

Name \_\_\_\_\_

Address \_\_\_\_\_

City \_\_\_\_\_ Zone \_\_\_\_\_ State \_\_\_\_\_

# new, easy way to.. STRIPE with PAINT



**\$1 ONLY**

**POSTPAID ATTENTION Home Craftsmen and Hobbyists**

**Do Perfect Paint Striping at Home with New Kind of PAINT STRIPING TOOL**

This Master Painters' Striping Tool makes it easy to do expert striping on furniture, bikes, model planes, autos, signs, toys, linoleum, wallboard, etc. Makes plain, painted walls look like tile. Paint straight lines... curved... circular or evenly spaced parallel lines the same way a professional painter does. Simply fill Tubular-Glass Paint Fountain with any color paint and wheel tip feeds paint evenly. Tips interchangeable—jaws split apart for easy cleaning.

**DEALERS Paint Striping Tool**

packed in attractive display cartons of 1 doz. Fast, profitable seller. Write for illus. circular, discounts.

Just the tool you've been waiting for! New PAINT STRIPING tool gives "professional" results every time, yet simple and easy to use as a fountain pen. Adjustable guide keeps lines straight as an arrow. Just as easy to make curves or free hand designs. Adds new beauty and finished look to everything you paint. Send dollar today.

**WENDELL MFG. CO., 4234 N. Lincoln Ave., Dept. 3-S, Chicago 18, Ill.**

# New ALL-IN-ONE DRAFTING KIT

Pat. Pend.



costs only \$14.86 to \$50.00 complete, including drawing set made in American Zone of Germany... in velvet-lined case.

**Combines ALL these drafting instruments and materials in one easy-to-carry case:**

**YOUR CHOICE OF 10 DIFFERENT TYPES DRAWING SETS — PLUS:**

- Protractor
- Architect's Scale
- Engineer's Scale
- 8" Triangle
- 10" Triangle
- French Curve
- Draftsman's Tape
- Pencil Pointer
- 2 Drawing Pencils
- 2 Erasers

Two large inner compartments for drawing paper, notes, blueprints. Scuffproof, water-proof 16" x 24" simulated leather case with slide-in carrying handles. This handy carry-all Drafting Kit is equally useful for architects, engineers, hobbyists, students and others who need a compact, convenient way to carry or store all drafting tools and supplies—in the field, at home or office. Once you use it, as so many are doing, you'll wonder how you did without it.

**Write Today for Descriptive Details**

**BERGER SCIENTIFIC SUPPLIES, INC.**  
342 Madison Avenue, New York 17, N. Y.

# NEW AUTOMATIC DEFROSTER

**ONLY \$7.95 YOU MAKE UP TO \$4 ON EVERY FAST SALE!**



Millions of defroster attachments sold at \$12.50 and \$9.95. Now — with new guaranteed HOLWIN at \$7.95 demand reaches new high peak. Men selling as many as 10 and 12 a day — right now. Your profits big — as high as \$4.00 cash on every sale. Converts any old style refrigerator into automatic defroster in 10 seconds. Just plug in. Terrific demonstrator. Women crazy for it at this price.

**FREE SEND NAME**  
Don't buy until you're satisfied. Rush name for free sales kit. Offer of demonstrator sample to all who answer this ad. Sales skyrocketing every day. Rush name for big money.

**NO CHARGE** for complete selling kit and offer of sample demonstrator. Rush name. If you've ever sold anything you'll clean up with HOLWIN. All mailed Free. Send name today for \$140-a-week opportunity.

**DEFROSTER SALES CO., 415 LaSalle St., Dept. H-8-S Chicago 10, Ill.**

# TOOL & INDUSTRIAL ENGINEERING DEGREE IN 26 MONTHS

Bach. Degree in Tool Engineering. Curriculum includes Mechanical Drafting, Tool & Die Designing. Facilities cover large and modern Machine Shops, Drafting and Engineering Laboratories. Approved by the American Society of Tool Engineers. G. I. Approved. Largest industrial center in the world. Free employment assistance and housing. 100% Placement of graduates. Year around classes. Write for catalog C-8.

**ALLIED INSTITUTE OF TECHNOLOGY**  
(Div. Allied School of Mechanical Trades)  
1338 SO. MICHIGAN AVE., Dept. PMA-10, CHICAGO, ILL.

**Say You Saw It in Popular Mechanics**

# SENSATIONAL OPTICAL BARGAINS AMAZING INSTRUMENT! ASTOUNDING VALUE!

## POCKET MICROSCOPE

Adjustable! 20, 40, 60 POWER!  
A compact, imported, handy precision instrument of many uses. Select power you want, then focus sharply by turning special micro-focus ring. Good quality optics. Full satisfaction guaranteed.

**SLIDE PROJECTOR SETS** Consists of all unmounted lenses you need to make the following size projectors:  
Stock #4029-H—35 mm. \$2.85 Postpaid  
Stock #4038-H—2 1/4" x 2 1/4" \$3.35 Postpaid  
Stock #4039-H—2 1/2" x 3 1/2" \$3.35 Postpaid

**SIMPLE LENS KITS** —Include plainly written, illustrated booklet showing how you can build lots of optical items. Use these lenses in photography and for dozens of other uses in experimental optics, building TELESCOPES, low power Microscopes, etc.  
Stock #2-H—10 lenses \$1.00 postpaid  
Stock #5-H—45 lenses 5.00 postpaid  
Stock #10-H—80 lenses 10.00 postpaid

Order by Stock No. Send Check or M. O. We Have Literally Millions of War Surplus Lenses and Prisms for Sale at Bargain Prices. Numerous Types of Instruments, Too! Write for FREE CATALOG-H.

**EDMUND SCIENTIFIC CORP., Barrington, N. J.**

# U.S. GOVERNMENT JOBS.

**START as high as \$3,795.00 a Year**

**VETERANS GET SPECIAL PREFERENCE**  
Railway Postal Clerks  
City Mail Carriers  
City Postoffice Clerks  
Stenographers-Typists  
Customs Inspectors  
Messengers, Etc.

**FRANKLIN INSTITUTE**  
(Not Government Controlled)  
Dept. N-83  
Rochester 4, N. Y.

**32-Page Book on Civil Service FREE.**  
Rush to me, entirely free of charge, 32-page book with: (1) A full description of U. S. Government jobs; (2) A list of U.S. Government jobs; (3) Tell me how to qualify for a job.

**Mail Coupon today—SURE**

Name \_\_\_\_\_  
Street \_\_\_\_\_  
City \_\_\_\_\_ Age \_\_\_\_\_

not everyone does as well, but E. O. Lockin, who started a business of his own, reports...

for 12 months I've averaged

**\$800 PER MONTH INCOME**

—most of it clear profit for me!

● Mr. Lockin expresses his grateful thanks for the opportunity to make a decent living on his own. Many men have discovered how to be independent, to be free of bosses and layoffs. L. A. Eagles grossed more than \$200 his first week. R. E. Traynor says, "I made \$62 gross in one day." Others report gross up to \$12,000 per year.

How much you make depends largely on you. You need no special skill, no large investment.

**No shop necessary.** Our **ELECTRIC RUG WASHER** cleans rugs, carpets right on floor... helps to show their natural color and beauty. So efficient and safe, used by largest hotels and railroads.

You take no risk. Machines fully guaranteed. Mail coupon today for complete information including how to start making big profits in YOUR OWN business.

**VON SCHRADER MFG. CO., RACINE, WIS.**

You, too, can start your own business. No special skill, no large investment required. Mail coupon today for interesting **FREE** book.

**VON SCHRADER MFG. CO.,**  
2030 "R" PL Racine, Wisconsin

Send at once (no obligation) your **FREE** booklet containing information about your **ELECTRIC RUG WASHER** and how I can start my own permanent, profitable business.

Name \_\_\_\_\_  
Address \_\_\_\_\_  
City \_\_\_\_\_ Zone \_\_\_\_\_ State \_\_\_\_\_

SAY YOU SAW IT IN  
POPULAR MECHANICS

## TRY HOME STUDY WATCHMAKING

Turn spare time hours to pleasure and profit. Master watch repairing the thrifty home study way. An exciting hobby or fascinating career. No experience needed. Send coupon today!

**FREE Sample Lesson**

**CHICAGO SCHOOL OF WATCHMAKING**

1608 N. MILWAUKEE AVE., DEPT. 1102, CHICAGO 47, ILL.

SEND FREE SAMPLE HOME STUDY LESSON

Name \_\_\_\_\_

Address \_\_\_\_\_

City \_\_\_\_\_ Zone \_\_\_\_\_ State \_\_\_\_\_

## SNAKE SKIN — ZEBRA

\$2.98

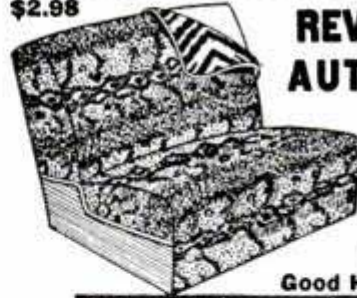

## REVERSIBLE AUTO SEAT COVERS

Made of  
**FLEXTON**

Approved by  
**Good Housekeeping**

Order direct from manufacturer and save!

● **SNAKE SKIN** on one side **ZEBRA** on the other. Made of Heavy Gauge plastic for long wear • **WATER-PROOF** and **STAIN-PROOF** • Simple to attach — with **REINFORCED OVERLAP** side grip elastic that holds securely • **PERFECT FIT COVERS** are made roomy and dress up your car's interior • **PATENTED SHRINKING** holds seat and back neatly. Sewn with **NYLON THREAD** for long wear. **LONG WEARING — DOUBLE DUTY.**

● **5 DAY MONEY-BACK GUARANTEE**

● **CHOICE OF SPLIT OR FULL FRONT SEAT STYLES** only \$2.98. Complete set for front and rear seats only \$5.00. When ordering specify make of car and style of seat. Order **NOW**. Enclose payment and save shipping charges. **C.O.D.** orders sent collect plus postage.

● **MARDO SALES CORP., Dept. SR-875**  
480 Lexington Avenue New York 17, N. Y.



## AMAZING NEW POCKET SIZE RADIO!

NO TUBES, BATTERIES OR ELECTRIC "PLUG-INS" NEEDED. "TUNES IN" MOST LOCAL RADIO STATIONS with STATIC-FREE CLEAR TONE. Has new perma-crystal diode and TINY SELF-CONTAINED SPEAKER PHONE—A marvelous real tiny pocket size radio to take with you anywhere you go — FOR REAL FUN AND ENJOYMENT. GUARANTEED TO WORK and should last for years!

SEND \$1.00 (Cash, M.O., Ck.) and pay postman \$3.99 C.O.D. postage or send \$4.99 for p.p. delivery. COMPLETE ready to play. By mail only from: Midway Company, Dept. PPM-10, Kearney, Nebr.



## MASTER MIND!

Learn Short-Cut Mathematics

Juggle figures, do baffling number tricks. Make people gasp at your marvelous lightning-quick mind. Multiply 4 figures by 4 figures without using old-fashioned multiplication! Big cloth-bound volume; fully illustrated course.

Sharpen up Your Brain Power

Includes worked-out problems, answers, etc. Sensational bargain, only \$1.95, postpaid or COD plus postage. Satisfaction guaranteed or refund. Order this amazing "Short-Cut Mathematics" today!

**NELSON-HALL CO., 210 S. Clinton St.**  
DEPT. 2-KY-2 CHICAGO 6, ILL.

**\$1.95**  
Complete

## THE ART OF DRAWING

Fascinating learn-by-doing lessons in drawing, painting, illustrating and commercial art. Prepared for YOUR instruction and enjoyment in spare time at home. Purpose: To turn amateur talent into PROFESSIONAL skill. Cost? Surprisingly low. Prepare now for a profitable career or a satisfying hobby! Send for **FREE** illustrated booklet, "Building a Future" in Art.

**GRANT SCHOOL of ART** Dept. A102, 225 N. Michigan Avenue, Chicago 1, Illinois

## HELPFUL BOOKS

Send post card asking for **FREE** catalog

Popular Mechanics Press, 200 E. Ontario, Dept. 601, Chicago 11



LEARN FASCINATING

## Leathercraft

Make your own bags, belts, wallets, etc. Learn fascinating, profitable leathercraft in spare time. Send 25c for valuable Catalog, has over 200 photographs. (refunded first purchase).

**BURTONS LEATHERCRAFT**

Dept. PM-10, 1755½ Glendale Boulevard, Los Angeles 26, Calif.



## Thrilling Work COLORING PHOTOS

Fascinating vocation learned at home by those with aptitude. Thrilling pastime. National method brings out life-like colors. Free booklet.

**NATIONAL PHOTO COLORING SCHOOL**  
835 Diversey Pkwy., Dept. 1357, Chicago 14

# AMAZING VALUES

**HAPPY the Cowboy**  
*in a terrific!*

- HE'S OVER 19" TALL!
- MOVES HIS MOUTH, ARMS AND LEGS!
- REAL COWBOY OUTFIT!

Hey kids—here's your chance to become a master ventriloquist—in a jiffy! Imagine—you can make **HAPPY the COWBOY** actually talk! (in your own voice, of course.) Pull the string in the back of his head—watch his lips move—hear your own words coming right out of **HAPPY'S** mouth! See how real he looks—rigged up in a cowboy hat, washable plaid shirt and western pants... Show off your skill at parties—at school! **SEND NO MONEY.** (C.O.D. you pay postage. We pay postage.)



**NEW! ELECTRIC REMOTE CONTROL**

**"Electra-JEEP"** the new 1952 sensation!

**\$3.98** complete

*A terrific buy at this price!*

**RUSH ORDER TODAY!**

- GOES FORWARD... REVERSE... LEFT... RIGHT.
- PUSH-BUTTON CONTROL... MOTOR TORQUE STEERING.
- INDOORS ON RUGS... OUT DOORS ON PAVEMENT.
- OVERALL SOLID METAL BASE

Here is the sensationally new scale model **ELECTRA JEEP** that captivates every child! Push the button and off she goes—forward, to the left, to the right, or reverse. Runs outdoors on pavement or indoors on rug. Over 1/2 foot long with overall solid metal base and solid rubber wheels, and motor torque steering. Loads of fun for children and grownups alike! Rush your order today! **SEND NO MONEY.** (C.O.D. you pay postage. We pay postage.)

**NEW! SENSATIONAL!**

**8 METAL CAR**

**"ACTION FLEET"**

*A Terrific Toy Set*



- Windows Go Up and Down
- Windshield wipers move.
- Gun moves and Bangs,
- Bell clangs...
- Taximeter registers...

Fascinate the youngsters with hours of fun and action. Imagine—every car **WORKS** in the line of duty! 1 car with working windshield wiper, 2 cars with windows that open and close, 1 police car with gun that bangs and recoils, 1 ambulance with ringing and swaying bell, 2 taxis with meters that register fare, 1 fire chief car with bell that rings and sways. All 8 cars made of durable steel... rubber wheels cannot come out... bottoms completely enclosed... all new Two-tone and metallic finish... all differently colored. **SEND NO MONEY.** (C.O.D. you pay postage. We pay postage.)

**NOVELTY MART Dept. PM 1**  
 59 East 8th Street, New York 3, N. Y.

- Please rush the items checked below:
- ELECTRA-JEEP ..... 3.98
  - HAPPY the COWBOY ..... 2.98
  - ACTION FLEET ..... 2.98
  - Send C.O.D. I'll pay postage.
  - I enclose \$....., you pay postage.

NAME \_\_\_\_\_

ADDRESS \_\_\_\_\_

CITY \_\_\_\_\_ ZONE \_\_\_\_\_ STATE \_\_\_\_\_

**RUSH YOUR ORDER TODAY! SATISFACTION GUARANTEED on all of the above items.**

Say You Saw It in Popular Mechanics

**GET MORE POWER**



## FISHER'S COMPRESSION SEAL

- Stop Burning Oil!
- Restore Compression!
- Save Gas!

**\$3.95**  
 postpaid

A small amount of Fisher's Compression SEAL in each cylinder bore will give you the economies of smooth, powerful (new car) performance and reduced oil consumption. \$25,000 indemnity insurance policy is your assurance it cannot harm the finest engine. Old cars may not need expensive overhauling.

**SATISFACTION GUARANTEED**

Only Fisher's Compression SEAL offers you their exclusive Satisfaction Guarantee. Return the used tube, if not completely satisfied. Only \$3.95 postpaid. Free illustrated folder. Send cash, check or money order today. Dealers, a postcard will send our representative to your door.

**ADVANCED ENGINEERING** Dept. PM-10, Box 7013  
 Los Angeles 37, Calif.



# Defense Plans Mean Bigger Pay for Good Machine Shop Men!

## Now You Can Be a MASTER MACHINIST!

GET bigger pay in this ESSENTIAL field! Learn shop work quickly—with big home study and reference course, the thoroughly revised American Machinists' Library, 6 Volumes, 2987 Pages, 2900 Pictures

How to operate lathes, drills, other machine tools; turning, boring, grinding, gear cutting, jigs and fixtures, drilling and surfacing, punches and dies, and MUCH MORE! Timely information on airplane assembly fixtures. Illustrations show every operation clearly. The facts are up to date. Brings you the extra "know-how" that means difference between "just another machinist" and



### FREE 10-Days' Examination

a Master Machinist. Invaluable help for anyone—from apprentice to shop executives. Packed with short-cuts. Will help to put you in big-pay class and to rate as an ESSENTIAL worker. Send no money. Mail coupon for 10-DAY FREE TRIAL. Note special price, easy terms.

McGraw-Hill Book Co., Dept. PM-10-52  
327 West 41st St., New York 18, N. Y.

Send for 10 days' FREE trial, the American Machinists' Library. If not satisfied I will return books. Otherwise I will send \$4.75, plus postage, then; and \$5 a month for 5 months. (Reg. price \$35.75; you save \$6.)

Name.....

Home Address.....

City & State..... PM-10-52

WE'LL PAY POSTAGE if you enclose \$4.75 first payment WITH coupon. Same return privilege for full refund.

## YES! SEND



directly to my door every month

I am enclosing

\$3.50 for 1 year

\$8.00 for 3 years

name.....

address.....

city..... zone..... state..... A-102

Hand this order to your newsdealer or send it to

**POPULAR MECHANICS**  
200 East Ontario St. Chicago 11, Ill.

## AIRPLANE WHEEL ASSEMBLIES



These wheel assemblies are all new, and of heavy duty construction. Depending on load desired to carry, they are ideal for House Movers, Farms, Trailers, Carts, Wheelbarrows, etc.

Complete with Wheel, Tire, Tube and Bearings

- 26:00 23:00 8:00x4 17:00 5:00x4 10 1/2 x 4
- Size 26:00, 10 ply tire, smooth tread, uses tapered axle size 3 in. x 2 1/2 in. 10 1/2 in. wide. Overall height 26 in. Static Load 6,300 lbs. Weight 54 lbs., Price \$47.50 ea.
- Size 23:00, 8 ply, smooth tread. This size complete with axle. Overall height 22 in. axle width 10 in. Static Load 4,700 lbs. Weight 70 lbs., Price \$37.50 ea.
- Size 8:00 x 4, 4 ply, smooth tread—uses straight 1 1/4 in. axle, 6 in. wide. Overall height 17 in. Static Load 900 lbs. Weight 13 lbs., Price \$27.50 ea.
- Size 17:00, 6 ply, smooth tread. Uses tapered axle, size 2 in. x 1 3/4 in. 8 in. wide. Overall height 17 in. Static Load 2,000 lbs. Weight 18 lbs., Price \$17.50 ea.
- Size 5:00 x 4, 6 ply, smooth tread. Uses straight 3/8 in. axle, 3 1/4 in. wide. Overall height 13 in. Static Load 1,800 lbs. Weight 8 lbs., Price \$12.50 ea.
- Size 10 1/2 x 4, 6 ply ribbed tire. Uses straight 3/8 in. axle, 3 1/4 in. wide. Overall height 10 1/2 in. Static Load 1,200 lbs. Weight 8 lbs., Price \$9.95 ea.

Prices F.O.B. Chicago. Include approx. postage on orders paid for in advance. C.O.D. orders enclose 25% balance sent C.O.D.

**U. A. S. Corp.** Dept. PM10 5637 W. 63rd Pl. Chicago 38, Illinois



## TALK-SING-PLAY OVER YOUR RADIO

with the real Radio Mike! Attaches in a jiffy—full instructions given! Swell for "parties"—"cut in" on or "kid" regular network programs or put on your own broadcasts! Amaze your friends—real fun. Beautiful Metallic Plastic 6 in. high! 12 RADIO BROADCAST LESSONS GIVEN with each mike SEND NO MONEY Just pay postman \$3.99 COD plus postage or send \$3.99 and we pay postage! Radio Mike is available only from us by mail—guaranteed. Midway Co., Dept. MPM-10, Kearney, Nebr.

## UPHOLSTER IT YOURSELF

With this brand new book you can upholster your own furniture at great savings. It contains the very latest information on new upholstering methods including the use of foam rubber. There are hundreds of illustrations so clear and to the point that you cannot go wrong. First you read how to do it and then you actually see how it is done. Order from your newsstand today, or if you prefer, send your order to address below.. **\$1.00**



**POPULAR MECHANICS PRESS**  
200 EAST ONTARIO ST., CHICAGO 11, ILLINOIS

## NEWLY INVENTED ADDING MACHINE DIALS like a PHONE

A MIDGET IN SIZE A GIANT IN PERFORMANCE

- Fast • Accurate • Dials the Answer • Adds and Subtracts Up to a Million • A Ruler • Flat • No Moving Parts • Fits into Pocket or Purse • Fully Guaranteed • Nothing to Learn • Start Using Right Away!



Mail Mart, PM-10, 27 E. 22 St., N. Y.

Easy to Carry

"It Measures As It Rolls"

## ROLLER RULE

HANDY MECHANICAL PENCIL

Measures Curves and Straight Lines. Any Shape. Any Distance. Any Surface.

**\$1.00** POST PAID

Roll head over surface. Inches and fractions record accurately on "Inch-O-Meter". Excellent pencil too! Order Now! 10 Day Money Back Guarantee! C.O.D. (postage extra). In Calif. add 3% Sales Tax.

**PENCIL SALES CO.**  
Dept. 1, 1213 E. Ocean Blvd., Long Beach, California

**\$ SAVE \$**

**ORDER BY MAIL**

From

**NEWHOUSE  
AUTOMOTIVE**

WORLD'S LARGEST DISTRIBUTOR  
OF SPEED AND POWER EQUIPMENT

**CUSTOMIZE YOUR CAR  
WITH A CONTINENTAL KIT!**

**SPECIAL! Ford-Chevy Kit only \$24.95**

New all-metal, 2 piece economy unit. (Tire stays in trunk.) Installs easily by drilling 1/4" holes, no alterations required. (Inc. chrome wheel disc at no extra cost). Fits all 1949-52 Ford and 1949-52 Styleline Chevy cars.

**ALSO DELUXE KIT MODELS**

Install it yourself and save! Kit is complete with gravel guard pan, metal tire cover, remote control lock release, chrome welts, special hub cap, license light, safety lock assembly, wheel mount bracket, bumper extension, and all necessary bolts and nuts for installation.

All 1950, 51, 52 Fords...ppd. **\$79.50**  
Chevrolet (Styleline body), tire size 670 x 15, 1949-52...ppd. **\$89.50**

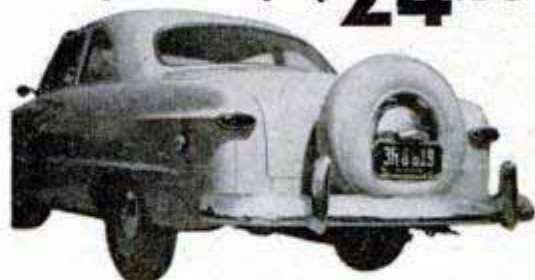

**OTHER KIT PRICES**

Kaiser (1947-52)... \$134.50 Packard (1951-52)... \$159.50  
Cadillac (1950-52)... \$159.50 Studebaker (1951-52)... \$139.00  
Mercury (1951-52)... \$149.00 Oldsmobile (1949-52)... \$149.50

Send only \$10.00 deposit, balance C.O.D.

**SAVE GAS**

**WITH A FUEL PRESSURE REGULATOR!**

STOP: ✓ Power Loss ✓ Fuel Waste  
✓ Carburetor Flooding

MANY USERS CLAIM UP TO 25% BETTER MILEAGE as this revolutionary new accessory stops gas waste caused by fuel pump pulsation. It eliminates carburetor overflowing and fuel "surge." Stops the annoyance and danger of "motor cut-out."

As this precision regulator s-m-o-o-t-h-s fuel flow, it also prevents vapor lock and percolating. It pays for itself ten-fold with gas savings, by eliminating frequent carburetor adjustment and by reducing engine and carburetor wear. Fits all cars and trucks.

30 day "money back" guarantee! Postpaid... **\$5.95**  
(Or send \$1.00, balance C.O.D.)



**STOP WASTING MONEY!**

**NEW OIL FILTER ELEMENT  
NEVER NEEDS REPLACING**

**Guaranteed for 10 Full Years**

Famous Filteral filters 100% of your oil through bronze cone which never needs replacing. This new porous oil filter will pay for itself by saving the cost of stock oil filter cartridge replacements. Gives maximum motor protection by removing all foreign matter the moment engine starts. No oil is lost or bypassed, regardless of temperature, and valuable protective additives are retained. To clean, just rinse the filter cone in gasoline. Complete filter unit.....



**\$12.95**

**\$6.95**

Cartridge only  
(to fit your filter).....

(List make and model of present filter and car)

**NEWHOUSE AUTOMOTIVE, Dept. BX-10, 5805 E. Beverly Blvd., Los Angeles 22, Calif.**

**THESE TWO Money Making BOOKS**

**Tell You HOW:**

- **How to Embed Real Flowers** in crystal-clear liquid Castolite—preserving their colorful beauty forever — and make real flower coasters, plaques and tiles.
- **How to Make Distinctive Jewelry**—Tie Clips and Cuff Links for men and women, Necklaces, Bracelets, Earrings, Pins and Pendants—to sell at big profit.
- **How to Set Pearls and Crystals** — embed golden minerals and native turquoise stones—make antique copper, gold and silver jewelry such as has never been seen before—anywhere.

- **How to Personalize** key tags, glove holders, scarf rings, purse pulls.
- **How to Make Extra Money** at home, by following simple methods that are fully explained and illustrated.
- **How to Have Your Own Business**, spare-time or full-time. Our practical 3 WAY-PLAN tells you how to get started.
- **How to Get Supplies**—at wholesale prices. And to do all these and many, many more projects to SAVE MONEY and MAKE MONEY.

Send 25c today for our "Success Plan for You" book and the Castolite Creations Manual.

The CASTOLITE CO., Dept. L-1, Woodstock, Ill.

**What Every Farmer Should Know About  
Taking Care of Farm Animals**

**The Most Popular Veterinary Guide Ever  
Printed**

This practical and helpful VETERINARY GUIDE FOR FARMERS prepares the farmer to perform many routine veterinary tasks—provides quick information that can often save the life of an animal—prevents disease in herds—saves money on the farm in a hundred different ways.

Written in plain understandable language. It covers symptoms, causes of disease and prevention, and treatment of cattle, swine, sheep, horses and poultry and warns when to call in the professional veterinarian. Names, terms and phrases made clear in a separate section. Over 100,000 copies of this book are in use on American farms. 275 pages. Fully illustrated. Only \$3.95. Order today under money-back guarantee.

POPULAR MECHANICS PRESS, Dept. PM13  
200 E. Ontario St. Chicago 11, Ill.

OCTOBER 1952

**When is wood glue  
really WATERPROOF?**

ANSWER: when it meets Military Specification tests for gluing wood for marine use.

Cascophen is a resorcin resin—the only cold-setting glue that passes these tests and is nationally available in small packages!

Use Cascophen for permanent wood bonds on boats, outdoor furniture, fishing tackle, archery and other wood sports equipment. Write for free descriptive folders. The Borden Co., Chemical Div., Dept. PM102, 350 Madison Avenue, New York 17, N. Y.



For boats,  
outdoor  
furniture, etc.

IF IT'S Borden's IT'S GOT TO BE GOOD!



**McMahan Cabinet Lifts** give hide-away storage for mixers, appliances, swing up for instant use. Easily installed in wood or steel, old or new cabinets, adjustable, all steel, instant "finger-tip" release, rigid, safe locking, balanced "always level" shelf. \$12.50 list complete. Larger models available for typewriters. McMahan Bros., Dept. P, 2220 S. Hoover St., Los Angeles 7, Calif.

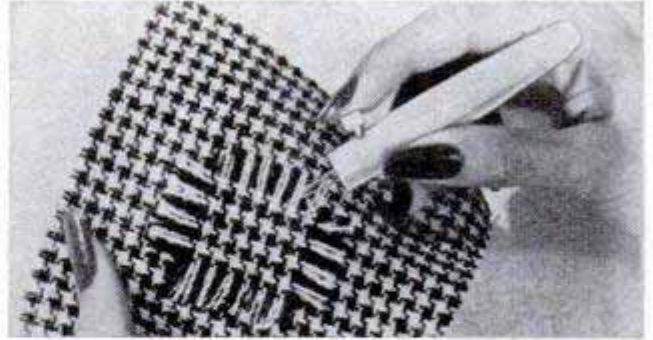

**Weaver Beaver**—Makes perfect invisible mending of damaged clothes easy, profitable. Save own clothes, make money from others. No skill required. Build own business. One finger works tweezer-like needles. No threading. \$1.00 ppd. No. c.o.d. Florida Direct Sales Co., Dept. C, Box 950, Sarasota, Florida.

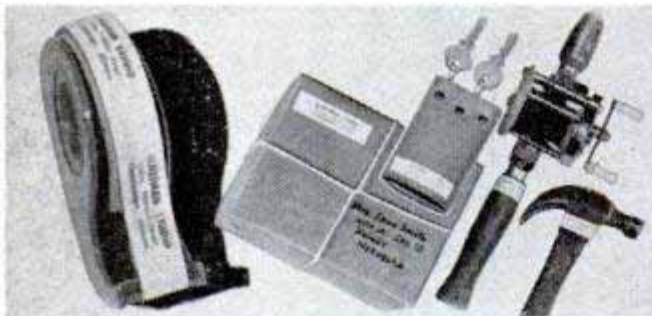

**Personalized "Scotch" Tape**—with name and address or other wording printed 300 times per roll. Use for return addresses on letters, packages; identify tools, books, etc. Ideal for gifts. Give wording desired and choice of white, green, yellow, orange, red, blue or silver tape. Only \$2 postpaid, dispenser included. Vickery Tape, Inc., Peru, Indiana.

**Nostalgic Model T Ford**—Remember the old tin lizzie that chugged down the street? It's now a lamp! Use as TV lamp, in den, living room, everywhere. Authentic replica of a 1917 Ford Coupe, black body, red wheels, gold trim; Fiberglas shade in gay-90's red; 18" high, base 6 x 9½". \$9.95 ppd. Or c.o.d. Home-crafts, 799 Broadway (PM), N. Y. 3.

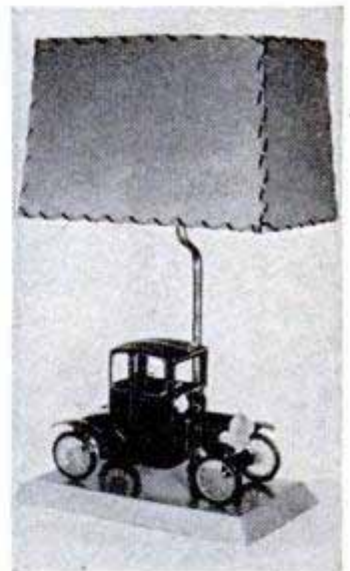

**Wow! Real Movies Without Screen or Projector.** Melton Pocket Movie Viewer shows live-action movies in color or black and white. Holds 50 ft. any 8 mm. film. Great for parties; swell for pals in service. \$4.95 ppd., money-back guarantee. Melton, Dept. PM3, P. O. Box 390, Reno, Nev. Film \$1.00 ea., ask for list.

**Young Craftsman**—Here is the perfect gift for any boy. It contains more than 450 fascinating projects for boys of all ages. It stimulates the imagination, trains the mind and hands. The projects can be made with only simple tools and inexpensive or waste materials. There are toys, bicycle trailers, all kinds of kites, bird houses, etc. The 224 pages contain detailed instructions and hundreds of illustrations. \$2.00 postpaid. Popular Mechanics Press, Dept. SG 2, 200 E. Ontario St., Chicago 11, Illinois.

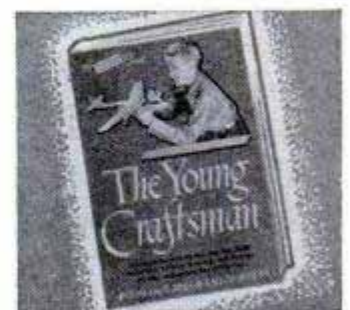





**Easy-to-Build Home Plans**—Find your dream home in this collection of plan books. Get more in comfort, design, construction. Owners, amateur builders and contractors have long used HBPS plans. Blueprints designed to meet FHA needs available for all homes at low-cost. Any one above books—\$1; all 3 just \$2. Home Building Plan Service, 2466 N.E. Sandy, Portland, Ore.

### Farmer's Handbook

—Over 100,000 farmers are using this book to save and make money. It has hundreds of articles and practical ideas for every farm. It covers farm operation and the farm home. It tells how to use short cuts and labor-saving ideas—gives methods that simplify the day's work and lighten chores. This book steps up farm efficiency, and saves time, labor and money. 284 fact-packed pages. Illustrated. \$3.00 postpaid. Popular Mechanics Press, Dept. SG 3, 200 E. Ontario Street, Chicago 11, Illinois.

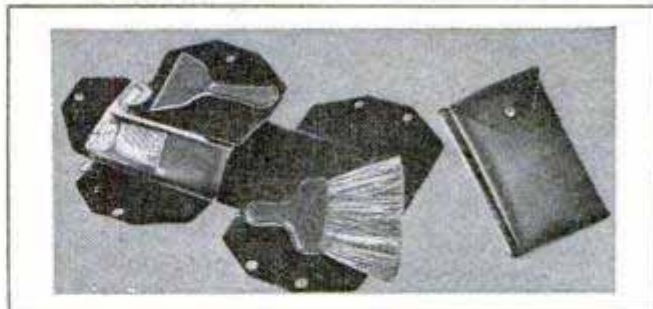

**Kit Full of Car Conveniences**—Keep in your glove compartment. Contains useful items you need on the road and often forget—brush for personal or car use, polishing cloth, comb, bottle opener, screw driver-key chain combination, windshield scraper to remove ice and snow. \$2.50 ppd. Hyde's, 135-37 Northern Blvd., Dept. P-10, Flushing 54, N. Y. C. Write for free gift catalog.

### Wind Velocity Dial

—For the amateur weatherman to hang on the wall beside his barometer. The handsome 4" polished brass dial shows every gust and lull in the wind, recording up to 100 m.p.h. Tells at a glance indoors how hard the wind's blowing outdoors. Complete with 3-cup anemometer; easily and quickly mounted on your roof, or television antenna; costs nothing to operate because it generates its own current. Fully guaranteed, with 50 feet connecting wire. \$49.95, ppd. Cape Cod Wind Indicators, Harwichport 1, Cape Cod, Mass.

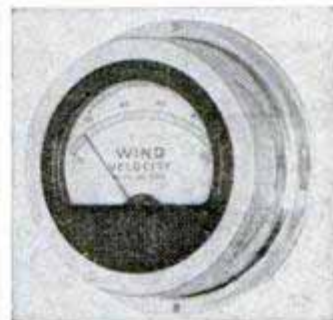

**Ingenuous Windshield Washer**—Press trigger (while in car); Misto-Matic releases powerful jet water spray to clear windshield of hazardous spatter, haze and insects. Start wipers and get clear, safe sight ahead. No installation. Fits in glove compartment. Large capacity—easily refilled. A valued gift to any motorist. \$2 postpaid. Hastings, 739 Boylston St., Boston 16, Mass.



**Double Linoleum Life**—Tape the seam between tub and wall or around sink with Clevco Linoleum Seal, a practical protection for your linowall or plaster. This flexible, adhesive-backed tape seals cracks against all moisture and dirt. 15 ft. roll in glossy black, white, blue or wine \$1.50 for 1 in. width, \$2 for 1½ in. ppd. State color. Clevco Products, Burien 1, Wash.

# a Bit about "Bite"



A "BITE" or snack after a dance, movie, or during a TV show is always fun!



"BITE" in tobacco is never any fun! Prince Albert is specially treated to insure against tongue bite!

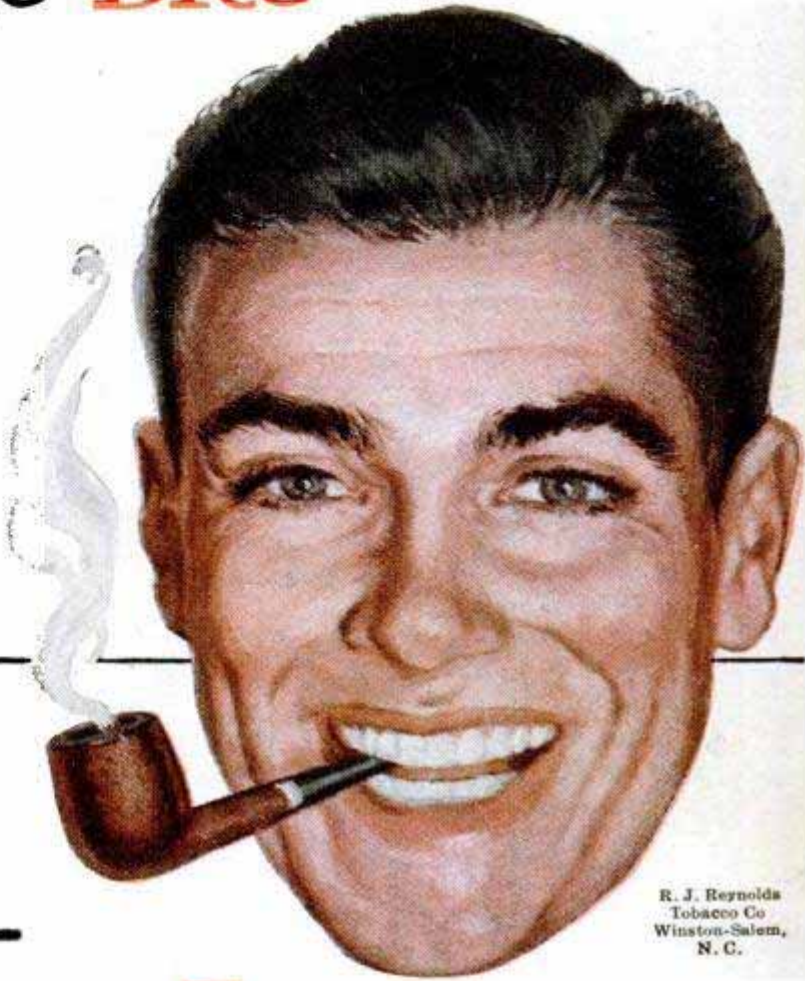

R. J. Reynolds  
Tobacco Co.  
Winston-Salem,  
N. C.

## Bite's Out Pleasure's In

*there's more tobacco in every tin*

THE NATIONAL  
JOY SMOKE

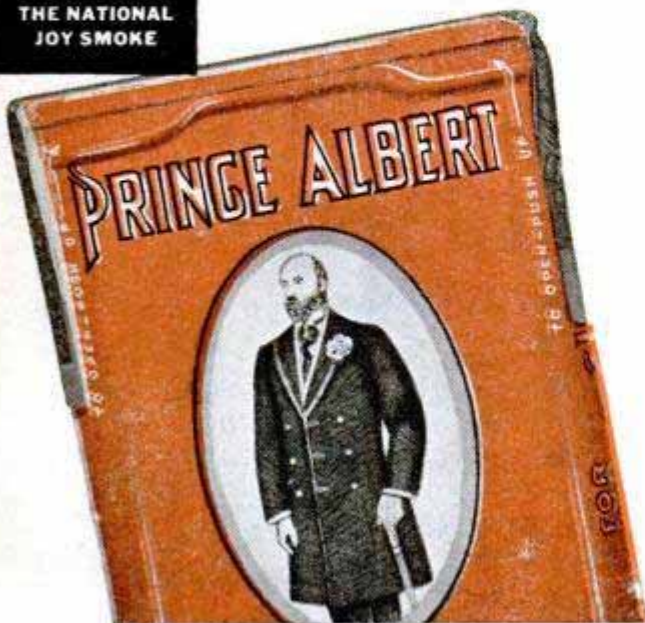

● Once you've tried P. A., you'll never want to smoke any other tobacco! Crimp cut and mild, Prince Albert is treated with the patented\* "No-Bite" process to assure you of greater smoking comfort! Whether you smoke a pipe or roll your own, you'll enjoy every puff of P. A.!

\*Process patented July 30, 1907

**MORE MEN SMOKE**

**PRINCE ALBERT**  
THAN ANY OTHER TOBACCO

Tom McHugh went along for the ride with two forest rangers on a rugged midwinter tour of duty in the Wyoming wilderness. Here is his story . . .

# POPULAR OCTOBER 1952 MECHANICS

WRITTEN SO YOU CAN UNDERSTAND IT  
VOL. 98 NO. 4

**H**OW'D YOU like to go on a Sno-Cat trip?" comes the invitation over the phone. "Just a short jaunt—three days to go 45 miles up Wyoming's Gros Ventre valley and back again."

The everyday tone of forest ranger A. K. Wogensen conceals the fact that our short jaunt will develop into a five-day battle against the worst blizzard of the season, a trek into a snowbound mountain valley with all the thrills of a roller-coaster ride.

Graying, winterwise Wogensen—"Wogy" for short—is anxious to make a winter check on his snowbound district. Forest ranger Val Simpson, five years out of college, will go along to survey the condition of the big game in the valley.

We shove off in the Sno-Cat on the twisting canyon road up the Gros Ventre valley.

It is cut cleanly into the canyon wall in summer, but snow has now drifted in to make the road almost indistinguishable from the hill.

Imagine yourself in the back seat as we edge our way over these treacherous side-hills. The cab in which you're riding is pivoted to the base of the tractor for greater flexibility. Right now, that magnifies your tilt. Val, who is driving, throws one hand over the door to keep from sliding onto Wogy in the seat alongside.

Val keeps asking you, "How much clearance do we have on the canyon side?"

You don't even have to lean out to see, for the "cat" is tilted; you can glance through the window and note how closely the tracks are creeping along the edge of the road.

## I RIDE THE SNO-CAT

by Tom McHugh



Angry at the trespassers, an elk defies the "cat" to advance. Seconds later, the elk bogged down in snowdrifts

You also can look a quarter mile beyond the tracks for an unexcelled—and unwanted—view of the canyon floor.

The Sno-Cat has a short turning radius because the front pontoons turn left when the rear ones turn right. Right now, that's a disadvantage. "I don't dare turn the steering wheel," Val says. "Before the cat swings away from the canyon edge the back end might swing out over the precipice."

Clattering over a steep hill, we surprise a herd of seven elk. Six flounder their way out of our path, now treading the snow crust, now plunging belly deep in the new powderlike snowfall.

One bull is fooled by a large drift of soft snow. Val yells, "There he goes!" as the bull's forelegs plummet into a quagmire of snow and the rest of his body follows in one grand lunge.

Too weak to rise, he lies there gasping for breath through a snow-powdered nose. Finally, he gathers enough energy to stand, and stand defiantly he does. Even the approach of the Sno-Cat fails to budge him.

A moment later, the bull's knees start to waver a little, then give way completely as he collapses into the snow. As we chug on up the valley, the bull is still lying on the ridge. Ravens circle overhead.

Val knows that omen only too well. At frequent intervals on this trip he stops to examine the available forage. He finds little grass and very few fresh, palatable twigs.

"There are so many elk in this country they've mined out their lode of food," he remarks. "If we can't reduce the size of the herd we'll have nothing left but a ghost town."

As we roll into Goosewing Ranger Station, Val starts supper while Wogy and I head off on skis toward the snow-measurement course. Wogy screws together three hollow aluminum cylinders. He then plunges this tube into the snow at intervals on the course. The average weight of these cores of snow is a measure of the water content. Water is liquid gold to the Jackson Hole and Snake River ranchers in the valleys below. Snow-survey predictions will tell them whether to expect a drought or an abundance of water during the summer.

Next morning the Salt Lake City radio forecasts snow. The dry crackle of snow static over the ranger-station phone also tips us off on the approaching storm.

Grinding on up the valley the Sno-Cat, at 10 miles an hour, roars mightily across the quiet snow. Two moose turn around and gawk at us as if we are an expedition from another planet. Wogy takes note of them for his game census.

The cat furrows its way toward a series of treeless, rolling hills. We barely push into this open area before the blizzard roars in at its worst.

Visibility drops to zero. The hills become a mass of blank white. "There's no difference to the eye between a level spot and a vertical bank," Wogy complains, "but to the cat there's a great difference: One's easy going, the other'll roll us over if we hit it sideways."

"No landmarks to guide us here," Val says. "I think we're lost. Glad I'm in a Sno-Cat and not flying an airplane right now."

We stop until visibility clears a bit. Then Wogy steers off in a different direction. "I'm not lost," he reassures us, "but I have

**Snow—above, below and all around—has to be shoveled from in front of the cat's treads so it won't tip over on drifted slopes**

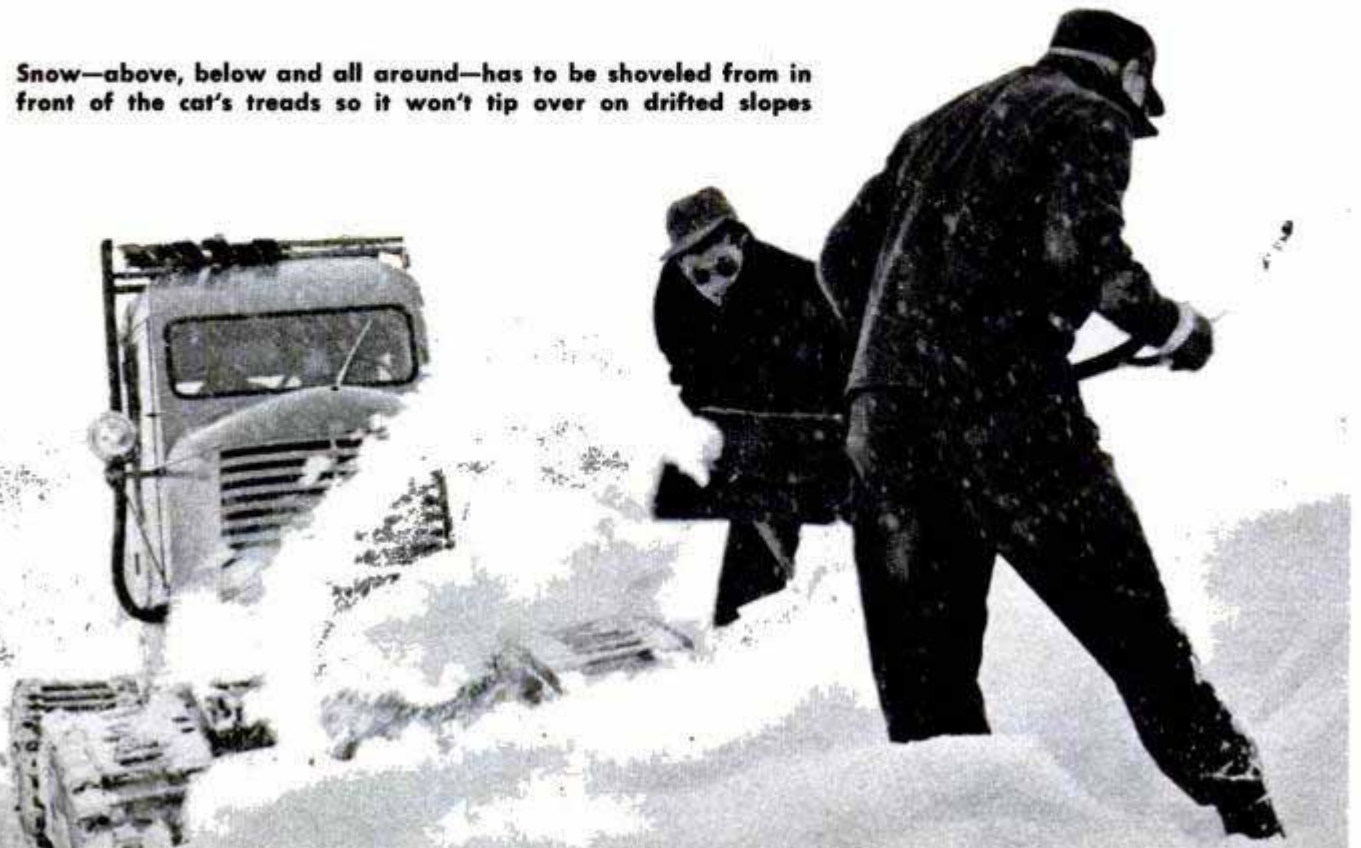



These are the three who made the trip. Left to right: ranger Wogensen, author McHugh and ranger Simpson

a heck of a time going where I want to go."

All windows except the driver's are now plugged with snow.

As the pontoons seek firm footing in the powder snow, I get a bottomless feeling. My stomach keeps playing Ping-pong with my tonsils.

"Let's take no chances with visibility," Wogy says to Val. "Tom and I'll ski ahead to blaze a safe route for you to follow in the cat." At times the blizzard thickens so much that Val cannot see us through the pelting snow, even though we are but 30

feet in front of him. Worse yet, if we ski out of sight of that cat, we're "gone turkeys."

As we inch our way down a steep-walled valley, Wogy suddenly waves us to a stop.

"No soap," he shouts. "Too much new snow piling up on these steep slopes. Avalanche danger! We'd better head for the open country."

No sooner has he said this than we're startled by a quick crunching noise. Whoomf! We look up just in time to see the snow on the valley wall opposite us disintegrate in a tangle of cracks and roll toward

An incidental duty during the 90-mile trip was to deliver mail to snowbound ranchers like Otto Miller



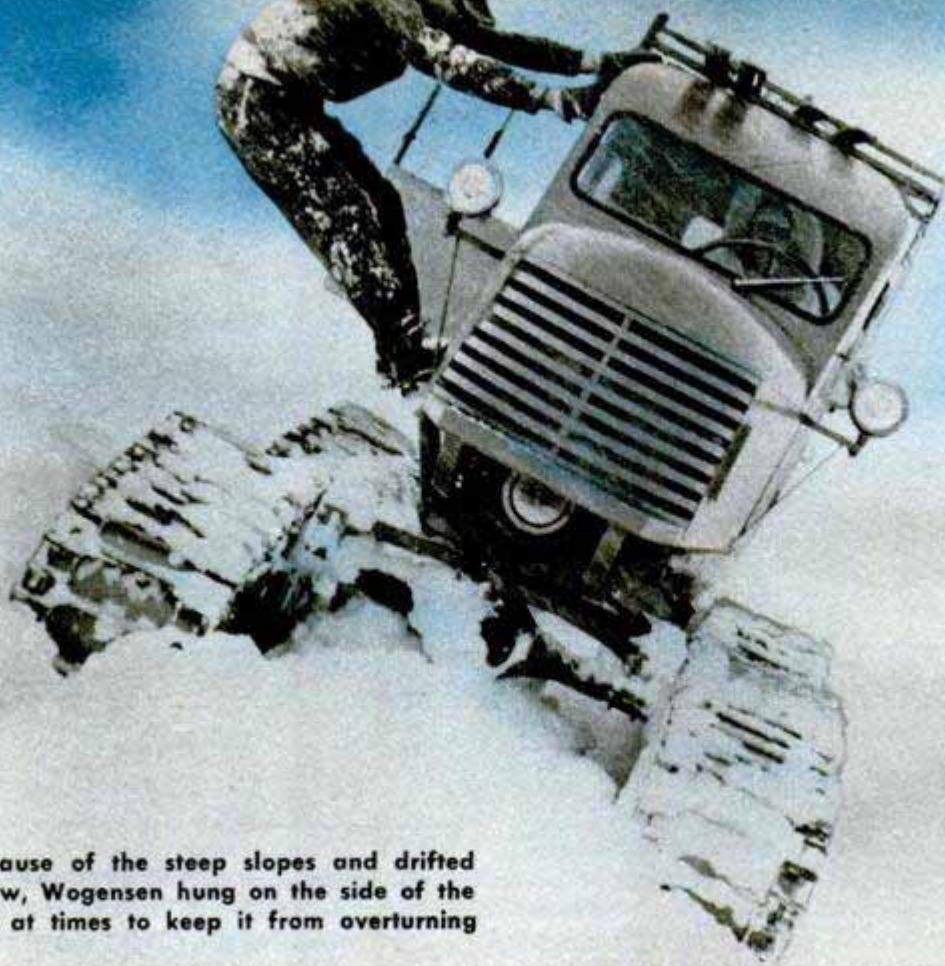

Because of the steep slopes and drifted snow, Wogensen hung on the side of the cat at times to keep it from overturning

the place where our party might have been. The snow slide loses momentum on the valley floor.

The route now leads over some treacherous willow bottoms—treacherous because the ice on the stream might have air pockets. "We'll cross only on the still waters," says Wogy. The ice is two feet thick there.

Finally, the cabins of the Robinson ranch loom out of the winter dusk. We weave through the gate just before darkness, the cat's engine roaring.

The Robinsons never expected to see beast or Sno-Cat in this dense blizzard that heaped drifts as high as a man. It took us nine hours to go nine miles. That's even slower than snowshoeing, but a man on snowshoes would not last long in that storm.

After supper, Bob Robinson talks with Wogy about some timber he'd like to cut on the forest land.

The final lap of our journey leads up through towering pines. The trail was built for horses, yet Jeeps might possibly make it

In a state feeding area, the travelers watched a workman throwing out hay for elk visible on horizon





Weighing a core of snow, a ranger predicts how much water will be available in spring



Snow and ice freeze around sprocket wheels of the cat and have to be melted away by heat from an extension of the exhaust pipe

in summer; we are out of the size class of either but we'll try it anyway. To negotiate some sharp curves we have to back up and go forward several times.

The steep hills give us even more trouble. Because of the loose powder snow, hills only 40 feet long may take a dozen tries. The cat pushes ahead, packs the snow for another three feet, and then slips in the loose powder.

By this time my stomach is rebelling at the bouncing of the cab as we move up and down hills, the tense moments as we skirt canyons and the bounces as we rock over fallen logs.

By now the Sno-Cat has carried us safely over 44 miles of rough country. It seems ungrateful of us to abandon it, but with only a mile to go to the final stop we are halted by fallen trees and snow slides.

"Five hours of sawing and shoveling to go one mile—it just isn't worth it," Val says. "We'll ski the rest of the way."

As we break over the top of the next hill, we come into sight of Phil Norton's ranch. His 15 malamutes spot us and bark and yowl a welcome—or at least we hope it's a welcome. We are the first outsiders they have seen in four months.

(Continued to page 262)

Guests for dinner! The Robinsons welcome their first visitors in three months as the cat arrives at ranch



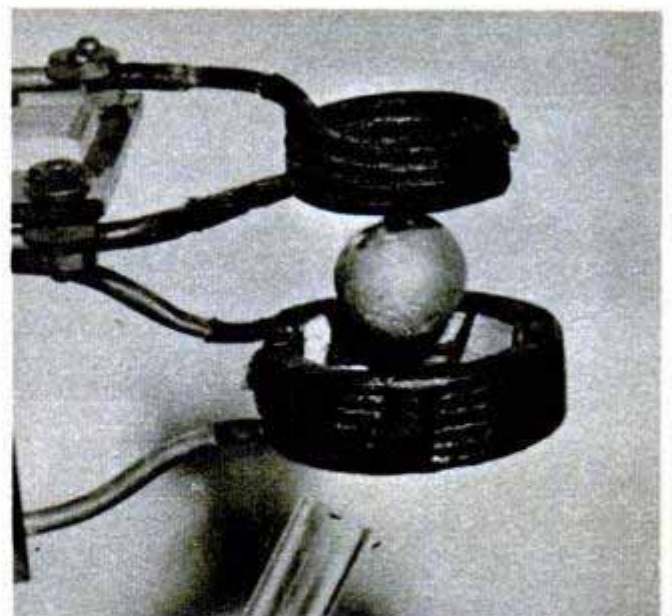
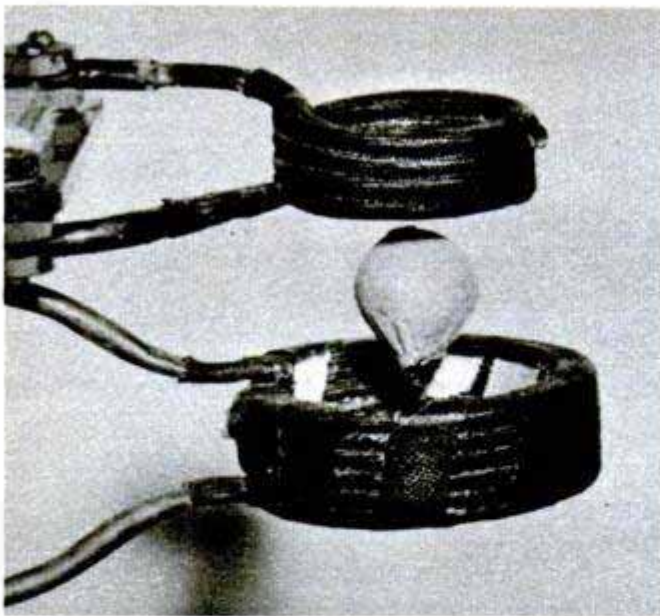

## Metal Floats in Air During Melting Process

Lumps of metal are melted electrically while suspended in air by a magnetic field in a process developed by Westinghouse. Because it eliminates the use of a crucible, the process prevents contamination by impurities in the crucible itself. Two conical coils generate electromagnetic fields to support the metal in space. Chunks up to 4 inches by 2½ inches and weighing up to 19 ounces have been melted successfully by

the process. The actual melting is done by induction heating. Currents used go up to 1200 amperes at 9600 cycles. The molten metal is held together by an oxide film or, where such a film does not form (as in a vacuum), by surface tension. By adjustment of the current, the molten metal can be drained into a receptacle or in some cases the whole melt can be dropped out of the magnetic field at will.

## Feeder Lines Connect Planes to Central Air-Conditioning

Passenger planes waiting to take off from the Greater Pittsburgh Airport will plug into a central air-conditioning and heating system. Trap doors on the apron where the

aircraft park will cover hoses for fresh air as well as for gasoline and oil. Reconditioned air will be pumped from the lines and through the ventilation ducts of the planes.



## Versatile Armrest Stores Accessories

Lessening driving fatigue, a triple-purpose armrest provides a handy compartment for driving and personal accessories. At the end of a trip, the unit and its contents can be carried like luggage into the hotel or home. It is held in place by a U-shaped wire that fits between the seat and the seat back.

Sources of available products described in this issue are indexed on pages 12, 14 and 16. Sources of further information on other articles are listed in the WHERE-TO-FIND-IT LIST, available from the Bureau of Information, 200 E. Ontario St., Chicago 11



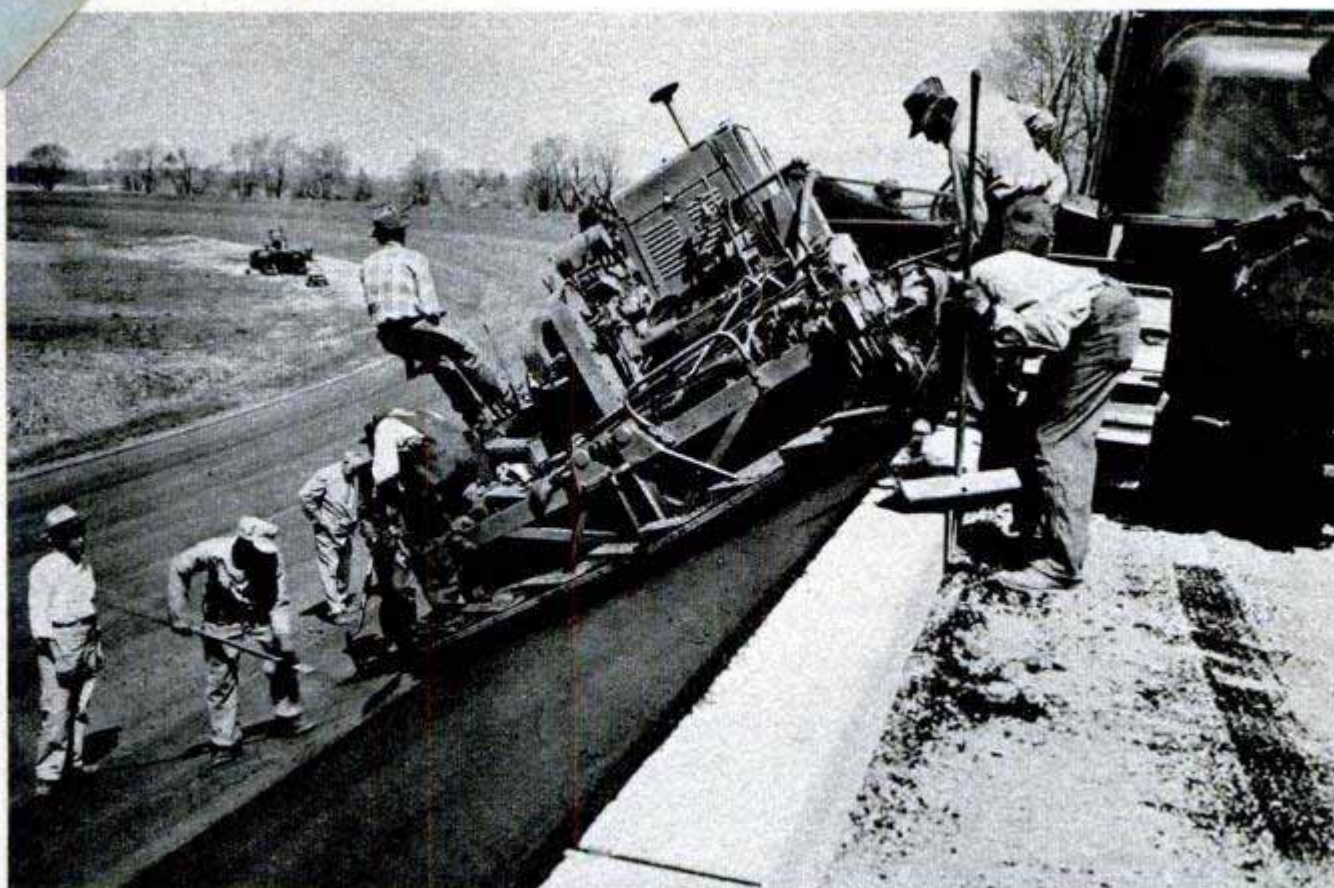

## Proving-Ground Engineers Solve Difficult Paving Problem

Confronted by the problem of paving steeply banked test-track turns, engineers at General Motors' proving ground were forced to devise a new system of road building for on-the-slant operations. Conventional paving equipment could not operate on the saucer-shaped turns, which at some places achieved angles of 37 degrees. Roads were built adjoining the outside of the three turns and a foot-high concrete curb installed. A tractor on this roadway held

the finishing machine in place on the slope by means of a cable attached to its built-in winch. The massive 11-ton roller, shaped to fit the average contour, was fastened by a cable to a specially equipped truck on the roadway. The truck had four extra wheels, two of which rested vertically upon the top of the curb and two others, mounted horizontally under the truck, which bore against the side of the curb. Carburetion and lubrication systems were altered.

## Military Tests Coaxial Helicopter

Able to carry seven persons in commercial use or three litter patients and a medical attendant during rescue work, a new coaxial helicopter is being tested for military use. More compact than other helicopters, it features fewer parts, simpler control and a higher payload in proportion to gross weight. It will cost less than similar craft, according to the manufacturer. The two rotors spinning in opposite directions eliminate the necessity for a tail propeller to counteract torque pull, thus simplifying design. The resulting auto-like shape of the craft explains the fact that



only minor changes would be necessary to transform it into a "convertiplane" suitable for ground and air travel.

# You Name It!

Things are not what they seem. Take a look through the camera's eye and sometimes even the commonest objects appear strange and weird. See how many you can identify, then check your list with the answers on page 242

1.	_____
2.	_____
3.	_____
4.	_____
5.	_____
6.	_____
7.	_____
8.	_____



1



2

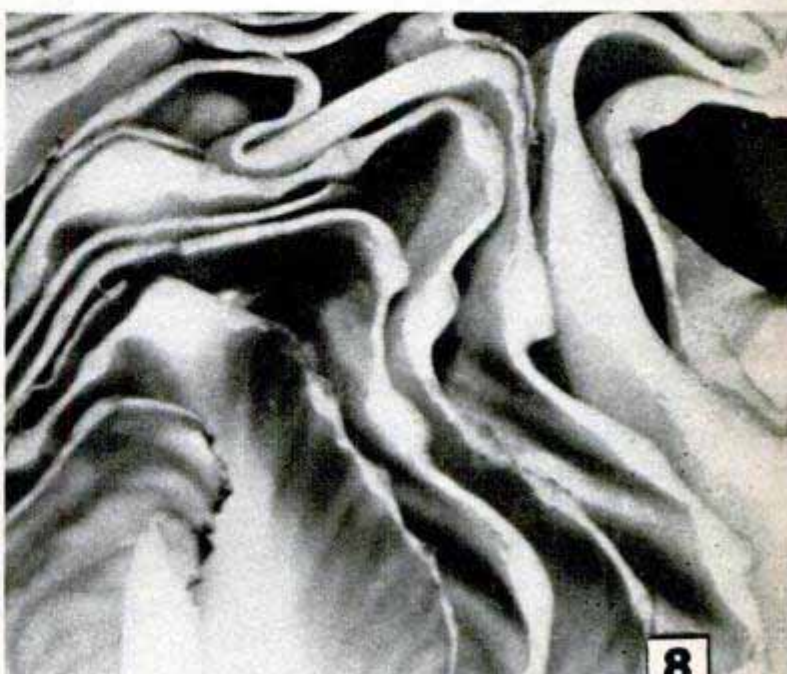
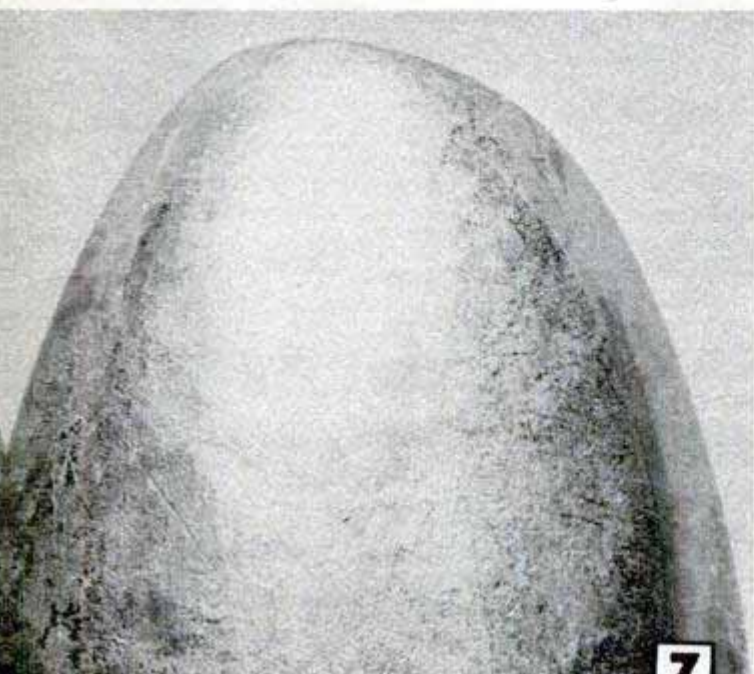
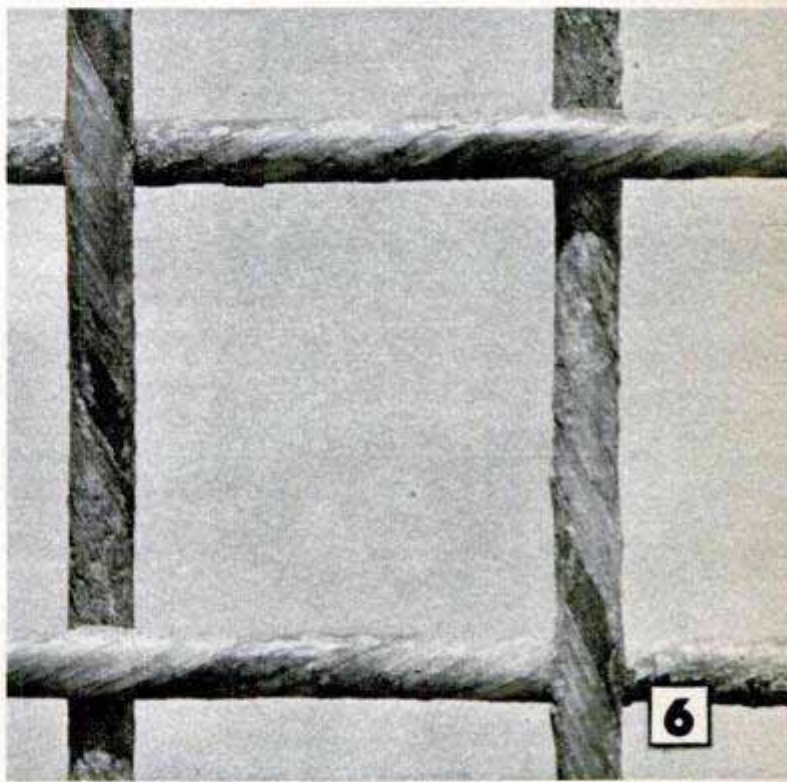
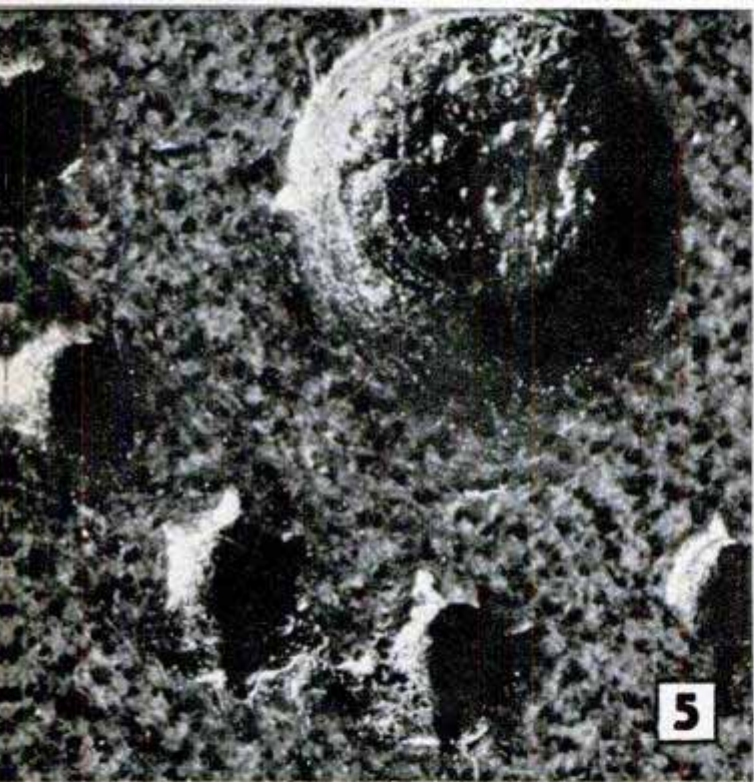
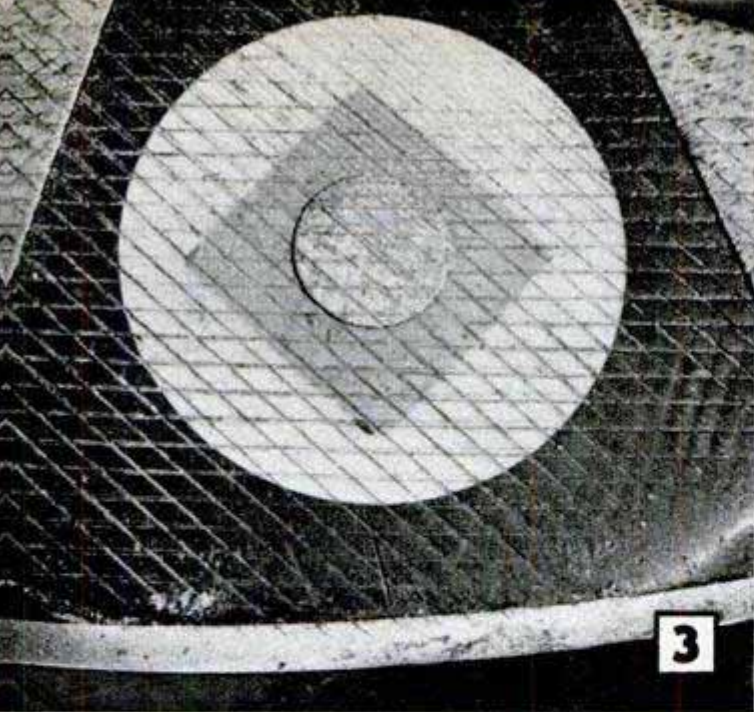

# UNDERSEA TELEVISION for

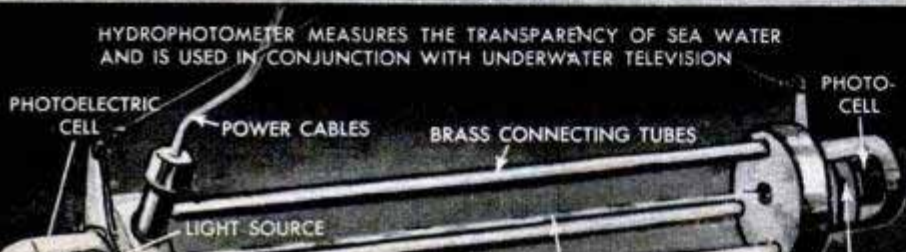
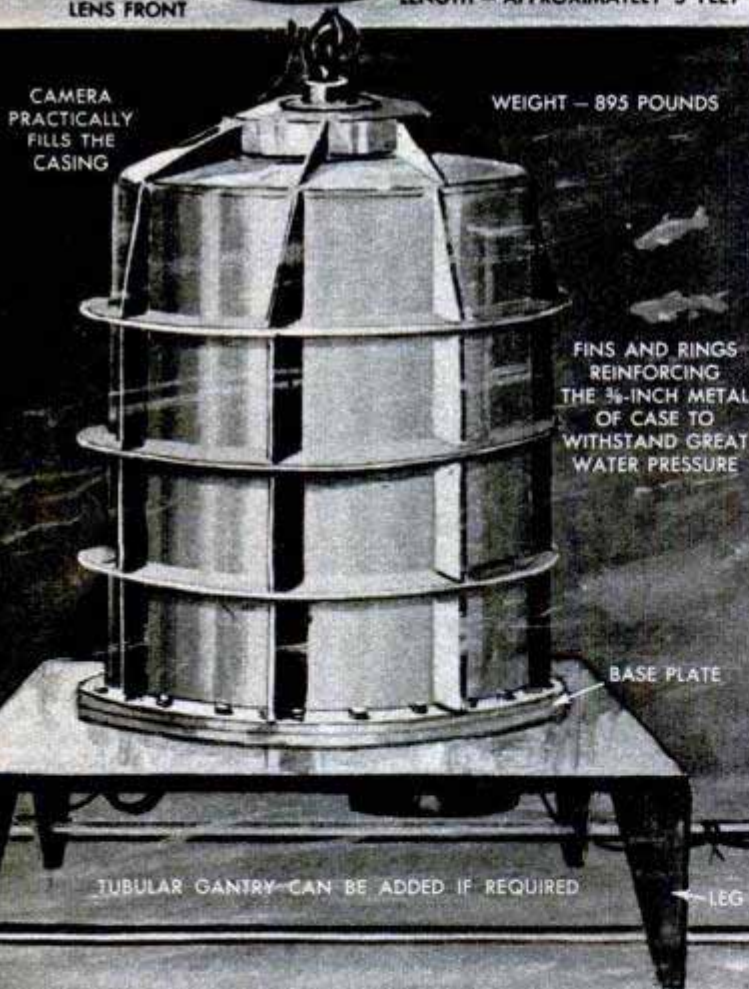
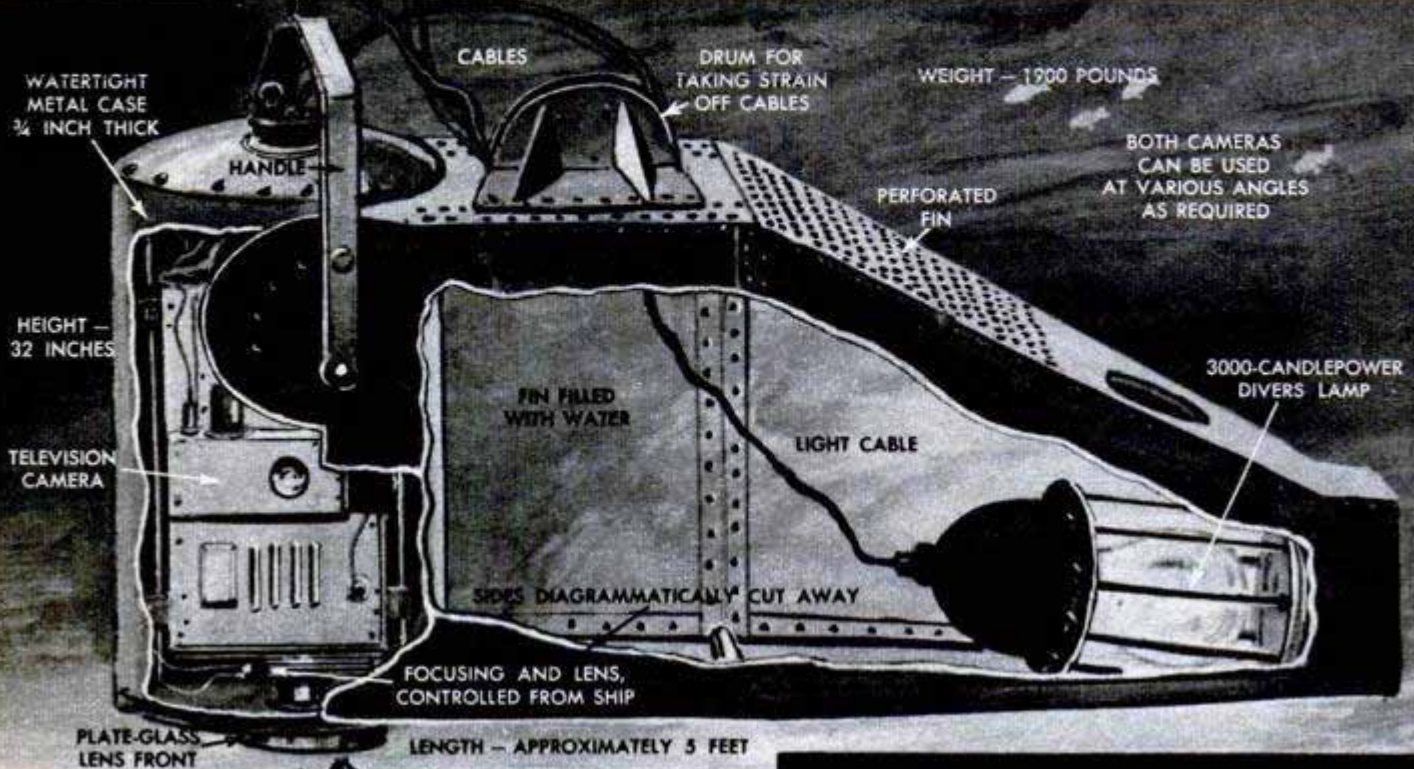

TELESCOPIC LEGS  
USED WHEN  
EXAMINING SEA BED

# BRITISH NAVY

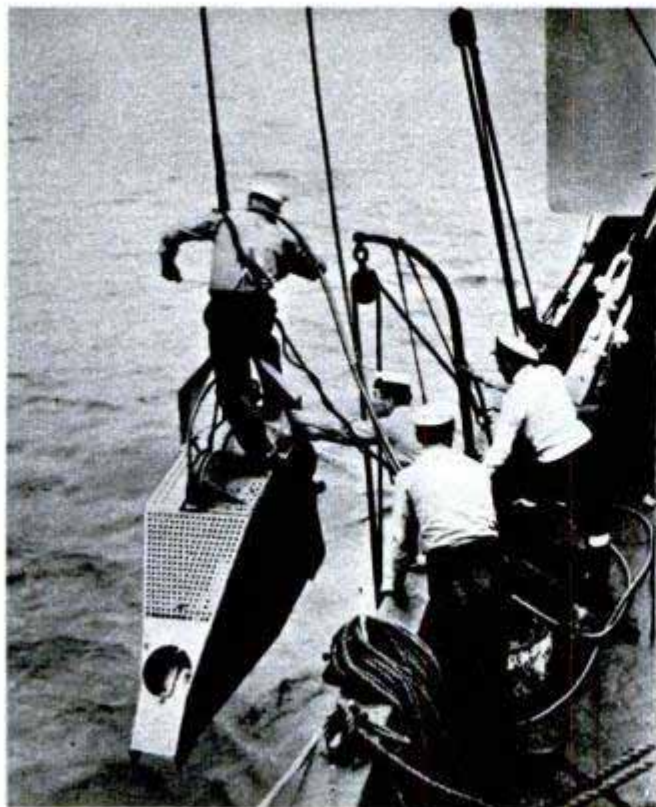

British seamen prepare to lower underwater-television camera over a sunken ship in Falmouth Bay

**TELEVISION** cameras in watertight steel cases are now probing ocean depths of 1000 feet for the British Admiralty. The cameras can be controlled and focused from the surface and the picture is observed on a screen on board ship. Light for the camera is supplied by a 3000-candlepower lamp that penetrates murky waters in which a diver could not operate. The British Admiralty Research Laboratory, which developed the camera, first used underwater television in the search for the sunken submarine *Affray* last year. An ordinary television camera was enclosed in a metal drum. Later, the big model at the top of the opposite page was built. It proved bulky to handle and is being replaced by the lightweight model. The lenses on both cameras are remotely controlled for close-up and wide-angle views. Scores of uses for underwater television include salvage operations, the inspection of the hulls of ships (saving time and money now spent in dry dock), harbor surveys and in any capacity where the eye of man must go underwater.

Eventually a TV broadcast from a ship may be hooked up with a relay system to bring to home screens a fascinating picture of the underwater deep-sea regions. A great advantage of the underwater camera is that it is operated without risk of life from the safety of a ship's deck.

OCTOBER 1952

## Window Spray Stops Fading

Sprayed from a pressurized container, an invisible coating for windows reduces fading of fabrics by bright sunshine. The coating keeps the inside of the windows sparkling clear, too. A fingertip valve on the container controls the fine spray.



## Cigarlike Pipe Can't Spill Ashes

Shaped like an oversize cigar, a new pipe burns the tobacco in an enclosed chamber that prevents spilled ashes and permits smoking in the wind and rain. The tobacco bowl holds the usual amount of tobacco and screws to the end of the pipe. A small air inlet keeps the pipe burning. A metal pagoda-shaped filter is easily cleaned and provides a clean, dry smoke.

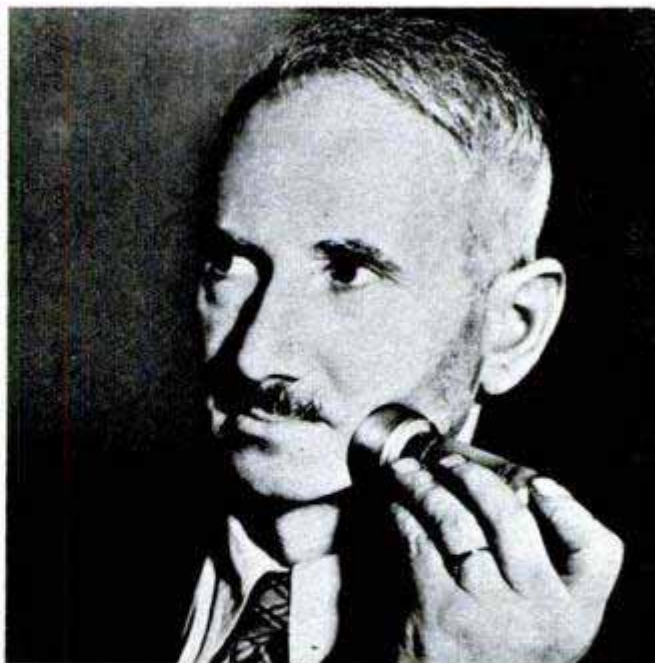

## Dry Shaver Uses No Electricity

It takes only three minutes to give yourself a shave with a rotating razor that uses no electricity, water or soap. Invented by an Englishman, the razor was introduced at the British Industries Fair in London. The razor blades are self-sharpening.

91

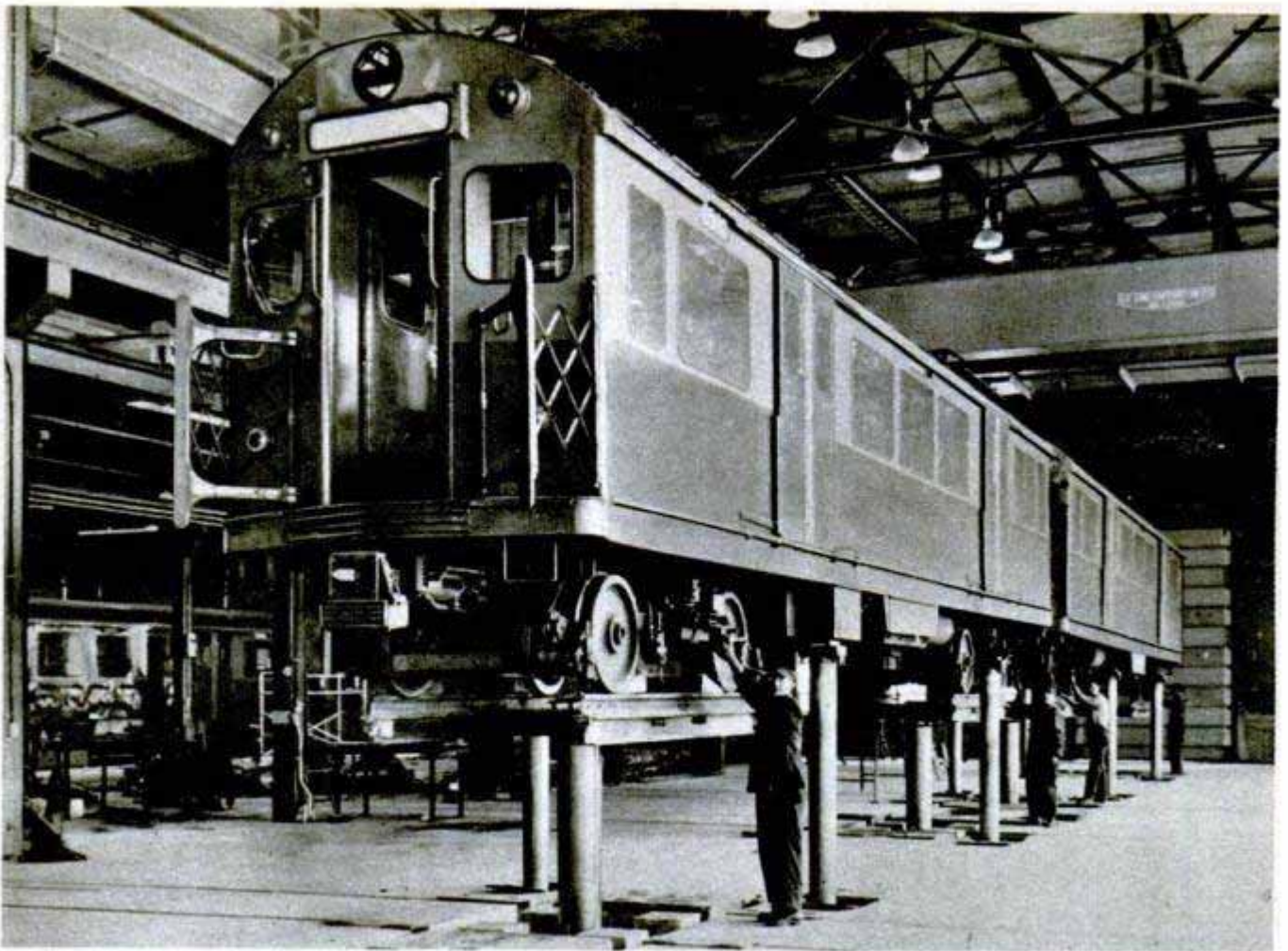

## Hydraulic Hoist Lifts Subway Train

Massive subway cars in an East Boston, Mass., repair shop are hoisted like automobiles by a set of hydraulic rams. Four rams are employed to lift a 45-ton two-car train off the tracks. Another set of eight rams supports the train while the first set is used

to lower the disengaged truck assemblies and swivel them around in line with tracks leading to another section of the shop. Horizontal leveling is near-perfect. The method is much faster than the former system which used overhead cranes.

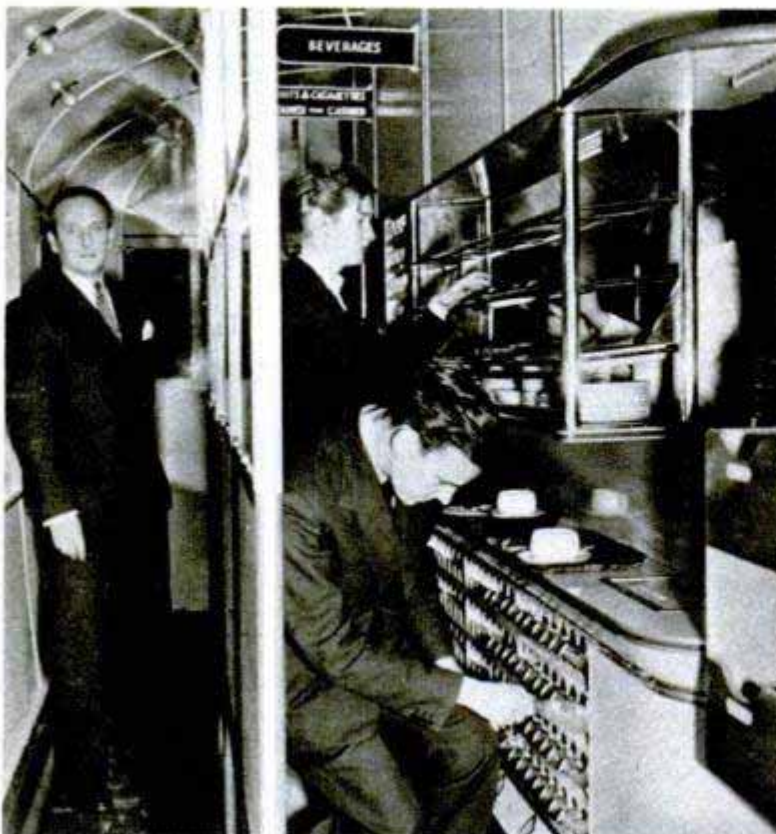

## Cafeteria Dining Car Displayed in England

Recently displayed in Victoria Station, London, an experimental self-service dining car is being tested by British Railways. Although the only one built to date, it may serve as the model for an entire fleet of cafeteria cars. The car contains, besides food and equipment, tables with tip-up seats for 48 passengers.

## Gas-Filled Golf Ball

Extra-sensitive, a practice golf ball containing thousands of non-connecting gas cells helps the golf enthusiast to improve his game. Made of an expanded cellular plastic, it is like a real golf ball in size, color and appearance. Because it is only  $\frac{1}{13}$  as heavy as its model, however, it can be used safely indoors and outdoors.

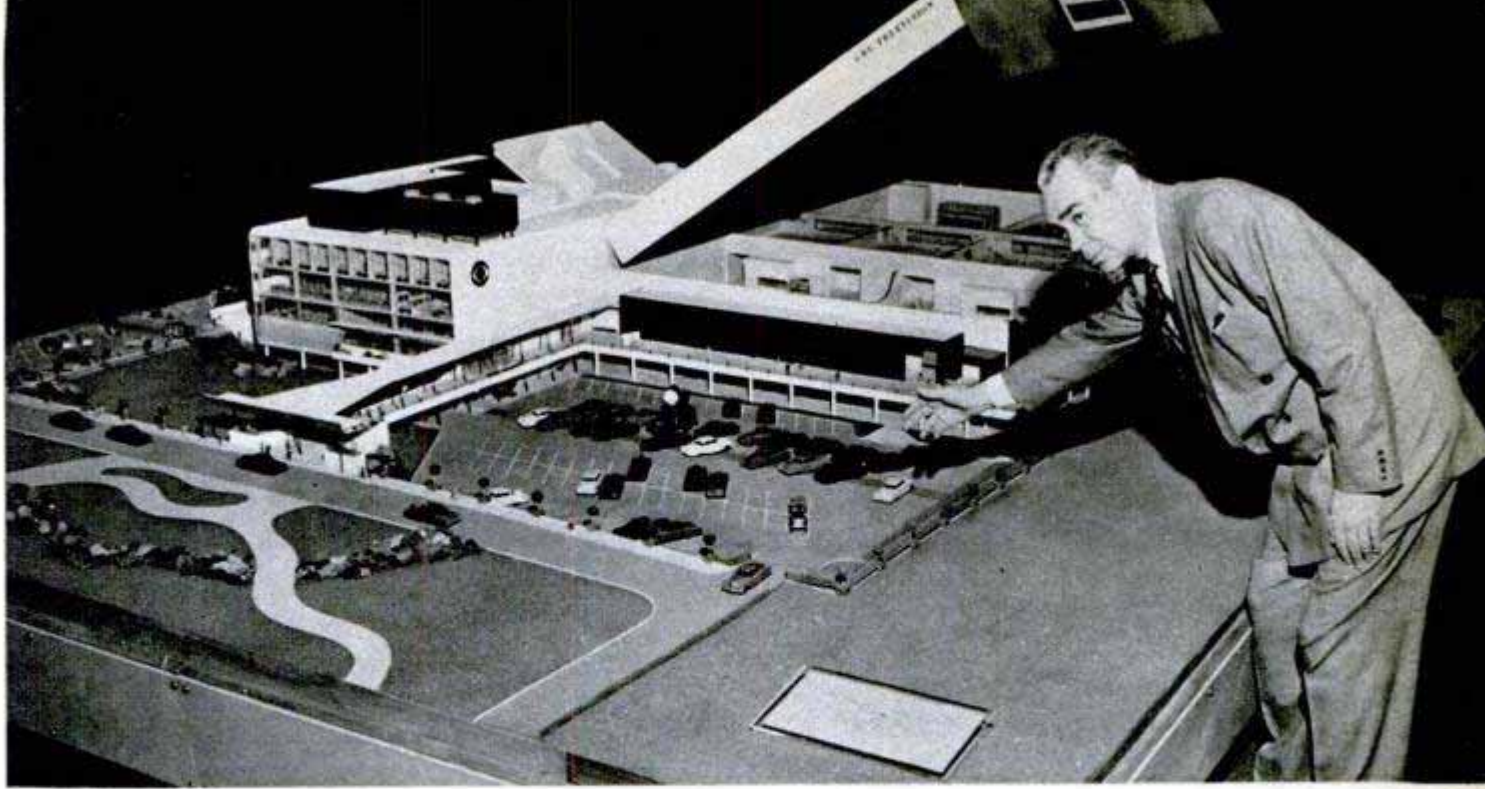

## "Television City" Constructed in Miniature

All the facilities of a huge television center are built into an elaborate scale model for public exhibit. The Columbia Broadcasting System now is constructing the real "Television City" in Hollywood. The precision-built model measures 15 feet long and 14 feet wide, and is complete with landscaping, parking lots with automobiles, miniature equipment, furniture and 200 lead figurines, each 1½ inches tall. Electric controls lift the roofs, move the walls and operate lights to give viewers a detailed inspection of the big building. A revolving stage in the model contains pirouetting dancers. There's even a spinning record turntable, with a record about the diameter of a cigarette. The initial unit of the real building will have four giant studios, each with 12,100 square feet of floor space. Eventually the company hopes to build a total of 20 studios in Hollywood's Television City.

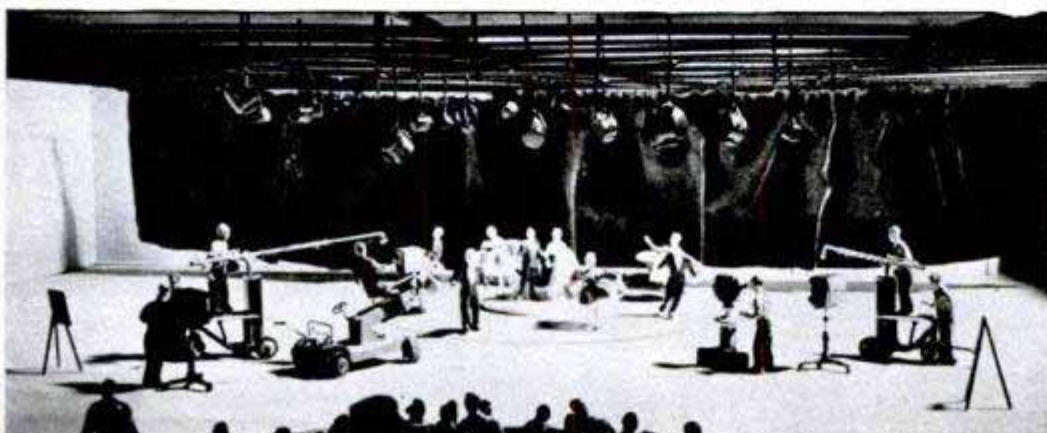
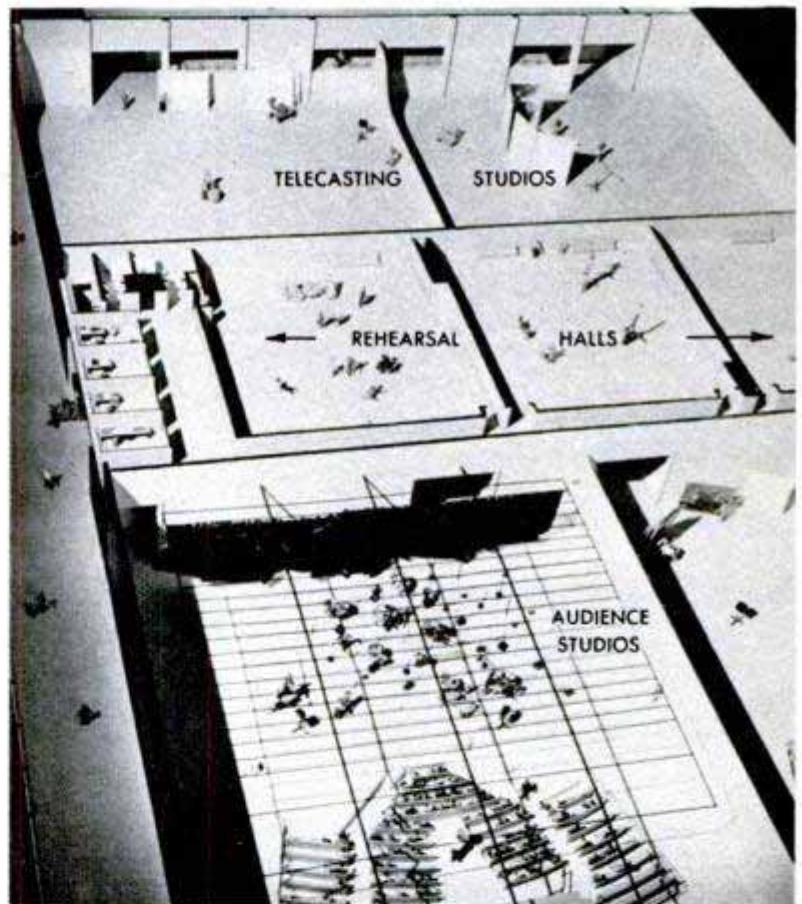

With roof lifted, the model shows rehearsal halls and studios. Audience studio in foreground even has overhead grid for hanging the draperies for the scenery. Left, people are 1½ inches high, equipment cast to scale



**P**HOTOGRAPHERS recently have been "painting pictures" in the air with lights, using batteries and film to produce startling photos. To make the pictures on these pages, photographer George Pickow attached four electric lights to two young ballet stars. The lights were powered by batteries strapped to the dancers. Then, with the camera shutter open, Pickow photographed the light patterns made by the dancers as they went through the classic movements of the ballet. As soon as a dancer completed her performance, Pickow touched off a flash from strobe lights to catch her in the final position. The resulting photos show the ballerina in every movement of her dance—how high she leaped, how many times she leaped, how regular her movements were. Thus the pictures provided interesting studies of value to the dancers. ★ ★ ★

## *Ballet with Lights*









Blood from patient passes into cabinet of the artificial kidney, where impurities are drained off. It then passes back into patient through opening in a vein. Above right, key element is plastic tubing which filters out impurities. Below, top view of kidney shows tubing coiled around three wire-mesh cylinders

## Artificial Kidney Purifies Human Blood

Completely tested and now in successful operation, an artificial kidney takes over when normal kidney functioning fails or is inadequate. The instrument, developed by Westinghouse engineers in cooperation with medical authorities, is about the size of a console radio and can be easily moved from one hospital to another. The principal element is a 50-foot length of plastic tubing similar to the material used for sausage casings, which is wound around three cylinders made of fine mesh wire. Blood is drawn from the patient's arm and passed through the tubing. The plastic contains microscopic holes which filter out the impurities. The impurities are drained off, while the purified blood returns to the patient through a venous opening in the other arm.

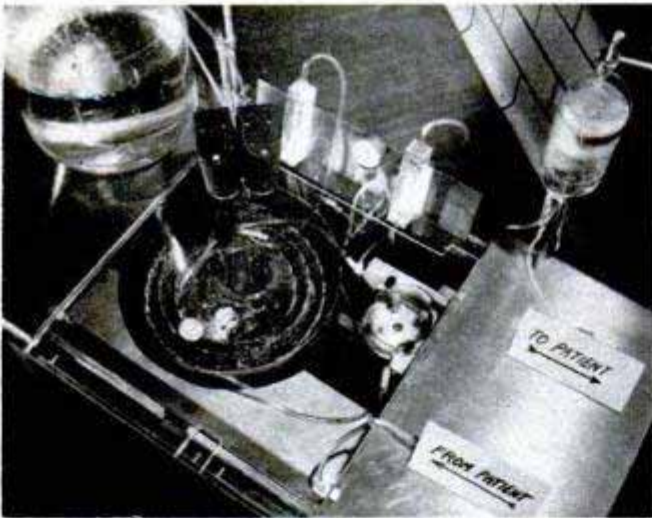

## Plastic Fender Cover

Fenders are protected from accidental damage during repair work by a cushioned plastic cover that is impervious to acid, oil and anti-freeze. Cemented to the back of the cover is a sponge-rubber sheet that allows the mechanic to place tools, instruments or heavy parts on the fender without damage to the finish. The sponge rubber also prevents the cover from slipping. A quick wipe with a moist cloth cleans the cover.



Used during preflight tests, a new instrument checks 200 airplane electrical circuits in less than 10 seconds.

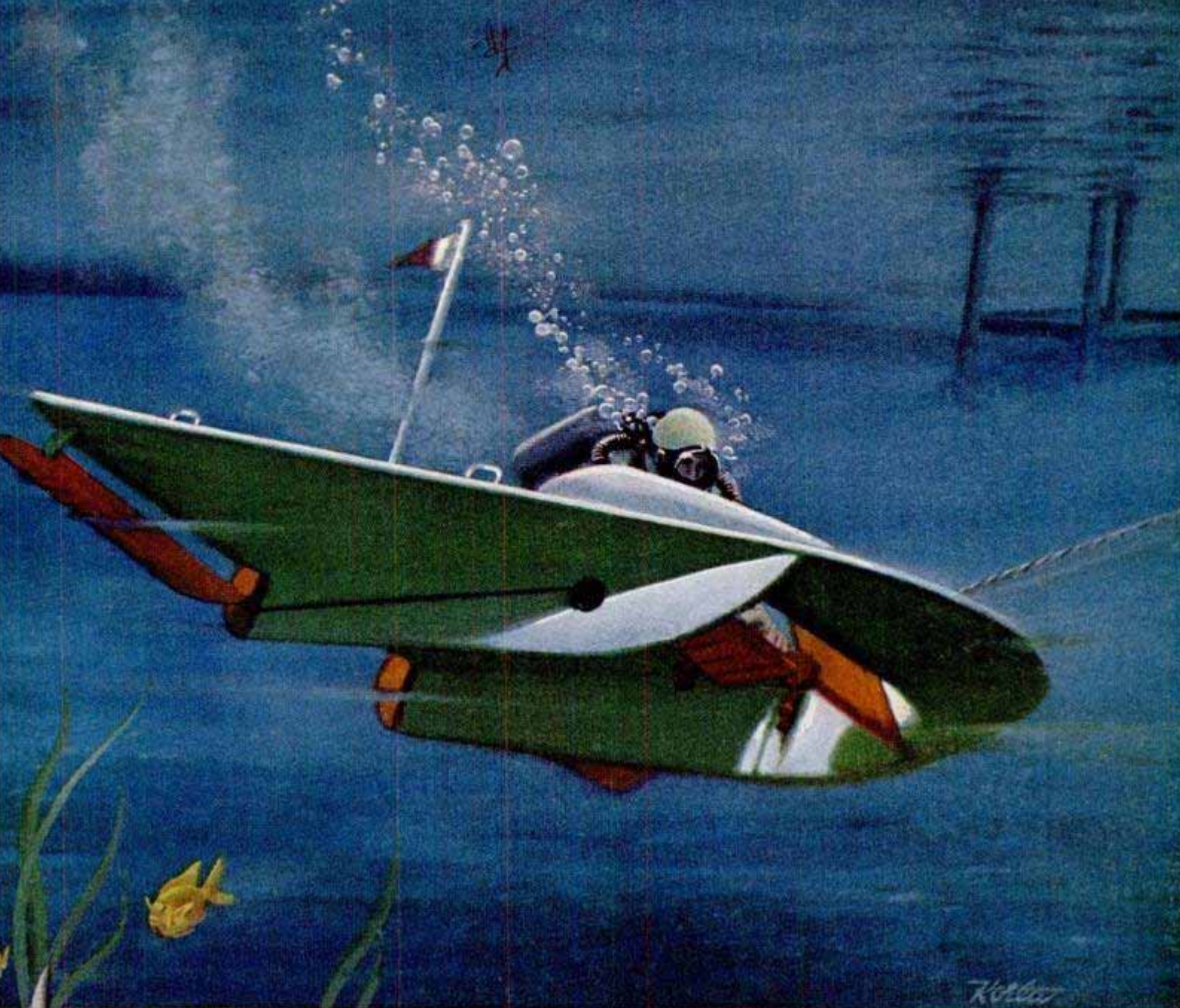

# UNDER the SEA on a GLIDER

By Richard F. Dempewolff

LIKE A MONSTROUS white Manta ray skimming along beneath the swell of the southern seas, one of the strangest-looking craft ever devised has been going through its paces off the French Riviera this year. Out of the depths it comes, towed by a powerful speedboat. The delta-shaped wing, stretching some 14 feet from the tip of its rakish, pointed prow to its flared, seven-foot-wide tail, is a submarine version of a glider. A pair of rudders juts from its stern, like tail surfaces of a "Flying Wing" in miniature.

Sprawled on the back of this strange

wing, the pilot rides, held in place by rubber loops at his elbows and by steel braces over his thighs. Rubber flippers encase his feet. A sleek, skintight rubber suit covers him from neck to ankles and keeps him snug against seas as cold as 40 degrees. Goggles, a tight rubber cap and air mask cover his head.

Observers have to look fast to see him, because in a moment he'll be gone again. With a tug of his hands, he pulls at aileron controls and the skimming craft dips beneath the waves without a splash or a bubble. A few seconds later he may be 100

*P. Van Horn  
Class alpin  
81 Rue P. Antilles  
Cannes, France  
Horn*

*See Man 53 92*



Goggled and helmeted, the prone pilot grips the controls that operate ailerons to make the wing dive or bank. One red aileron is seen at left

Compressed-air bottle is strapped to pilot's back. Each bottle provides 30 minutes' air supply and the pilot can wear three of them if he wishes



feet below the surface, gliding over the ocean bottom at 10 miles an hour. He banks and turns like an airplane as he skirts the reefs and rocks on a thrilling ride. According to enthusiasts, it surpasses anything the barnstorming pilots ever tried in the way of "buzzing" or hedgehopping with an airplane.

The wing, called "Manta" after the deep-sea monster it resembles, is the brainchild of a French aviator-sportsman named Pierre Vanlaer. As a member of the Under Sea Alpinist Club at Cannes, the inventor was dedicated to exploring and spear fishing among the reefs that stud the ocean floor along the Riviera.

Despite the fact that with air mask, goggles, webbed feet and rubber suit he could browse at a depth of about 200 feet for 20 minutes, Vanlaer wasn't quite satisfied. He wanted to get around the bottom faster, cover lots more territory, waste fewer precious minutes getting down there, and to be at Davey Jones' door without having used up all the energy it takes to swim down that far.

There's nothing really new about diving boards. For untold centuries natives on the Niger River in Africa have been tying themselves to flat boards with downward-sloping prows. When tugged against the current by men on the shore, the board would submerge, fisherman and all, and the man on deck could leisurely spear any fish that happened by, without exerting himself.

Based on the same hydrographic principles as those primitive boards, Vanlaer's great submarine wing, weighing 550 pounds under ballast, is one big hydrofoil, scientifically



Ready for an underwater "flight," the wing weighs 550 pounds. Over 100 pounds of that weight is ballast

contoured in wood and cork. The outer surface is sheathed in a plastic skin, coated with several layers of paint. Beneath the wing, two keels project to prevent the craft from whipping and rolling while cruising beneath the sea. At the end of each keel is the vertical vane of a rudder. Along the Manta's trailing edge are the ailerons, providing an up-and-down or "bank" control, and a collapsible signal mast rises from her stern. It swings down when the wing is deep underwater, can be pulled vertical to signal the towboat when the wing is ready to surface.

The pilot lies prone on top of the wing. In front of him is a shield of heavy transparent plastic that acts in the water as a windshield would on dry land. Without the protection of this shield, the tremendous force of the water pushing against him would tear the diver's helmet from his head.

The pilot guides his craft under the sea

in much the same way an airplane pilot maneuvers an aircraft. His feet are hard against the rudder bars which activate both rudders simultaneously. His hands rest on a pair of bars that move back and forth independently, and tilt either aileron to any desired degree. To execute a left turn underwater, the pilot pulls his left aileron up, his right one down and kicks the right rudder bar. The undersea wing banks over like an airplane and around she goes in a long, swooping turn. She climbs when the ailerons are tilted up and noses over in a dive when they're tipped downward.

"On a towrope 300 feet long," says Vanlaer, "and hauled at a speed of one to eight knots by a speedboat, she'll dive 125 feet in a 22-degree descent. The longer the rope, of course, the deeper she'll go. She'll dive as deeply as any man's physical condition will stand. Instead of one air bottle—good for a full 30 minutes since the diver doesn't



Sliding into the blue Mediterranean at the end of a 300-foot line, the wing and pilot prepare for a dive

need to exert himself—the Manta carries three, giving her passengers a one-and-a-half-hour ride. What if the rope breaks? As soon as she loses speed, she bobs to the surface like a cork.”

Because of its buoyancy and sensitive

controls, an undersea-wing pilot has to watch himself on the turns or he's liable to slew into a barrel roll, catch the force of the water under the wing and flip up out of the ocean.

Vanlaer tells how embarrassed he was

Below left, red objects are rudders controlled by foot pedals. Right, pilot displays a souvenir of a flight



when on the wing's first sea trial, the Manta flipped from the water, broke her towline and headed for shore at a lively clip, landing high and dry.

A second run that afternoon was more successful, and the Manta has been going strong ever since. Vanlaer is rigging an electric signal system to connect the Manta with the towboat by a two-way circuit that will be entwined in the towrope. A battery on the boat will provide power to ring a bell activated by a button control on the wing. Thus a Manta pilot, by a system of code signals, will be able to order course and speed changes while soaring beneath the sea. Vanlaer is also designing an engine which he hopes will provide the Manta with its own propulsion system and make it completely free to wander around the ocean floor unhampered by the limitations of a towrope. "A good pilot," he points out, "can easily perform all kinds of maneuvers as it is—barrel rolls, ups and downs, climbing and diving turns."

As it stands, Vanlaer considers the Manta a perfect vehicle for scientific study of undersea flora and fauna over wide areas. A Manta rider uses half the air a regular diver consumes in his underwater excursions. ★ ★ ★

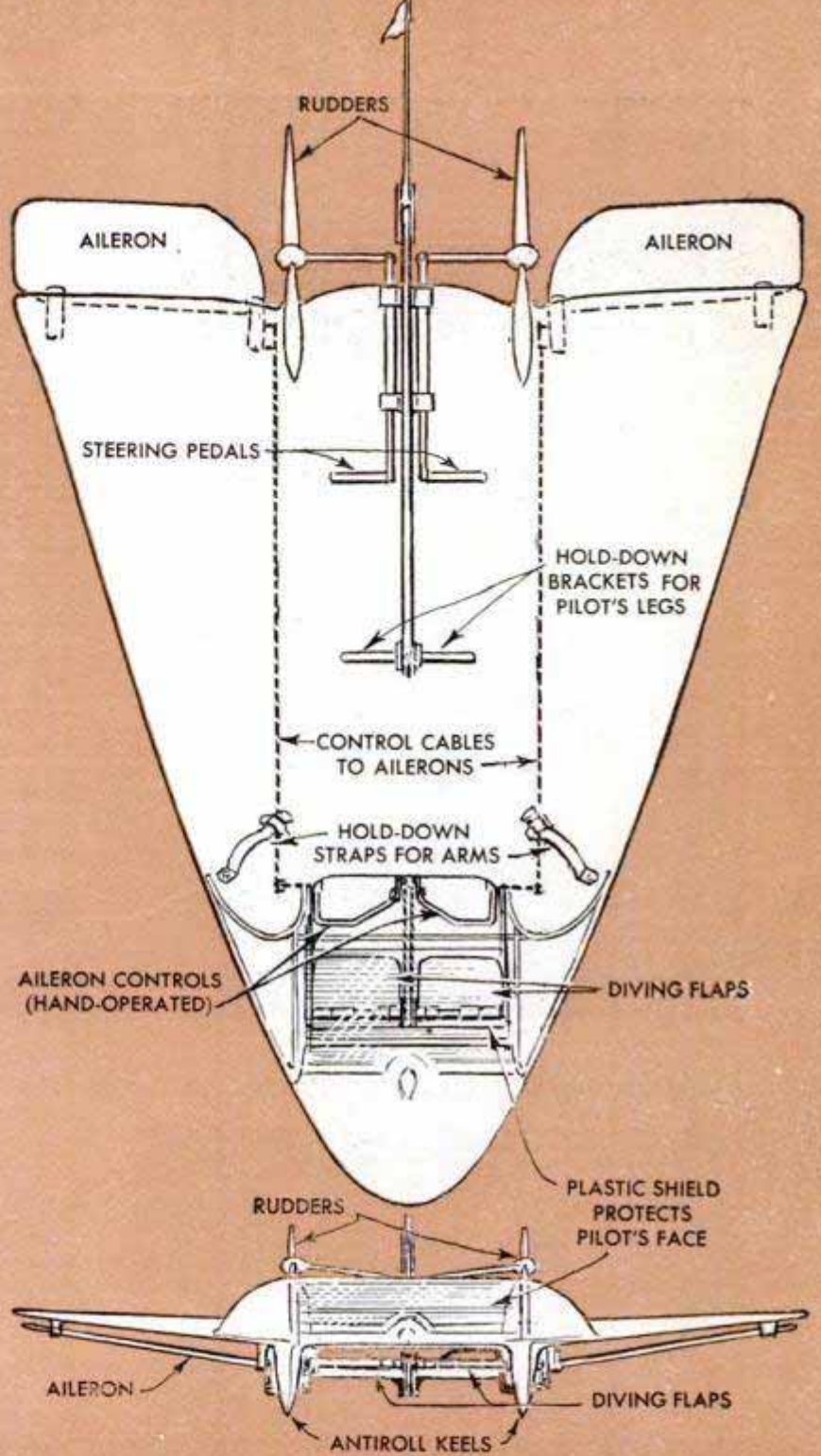

Two drawings, above, show the details of the underwater wing. Flag is used as a signal. When the pilot nears the surface, he raises flag as it is at left so the crew of towboat can see it

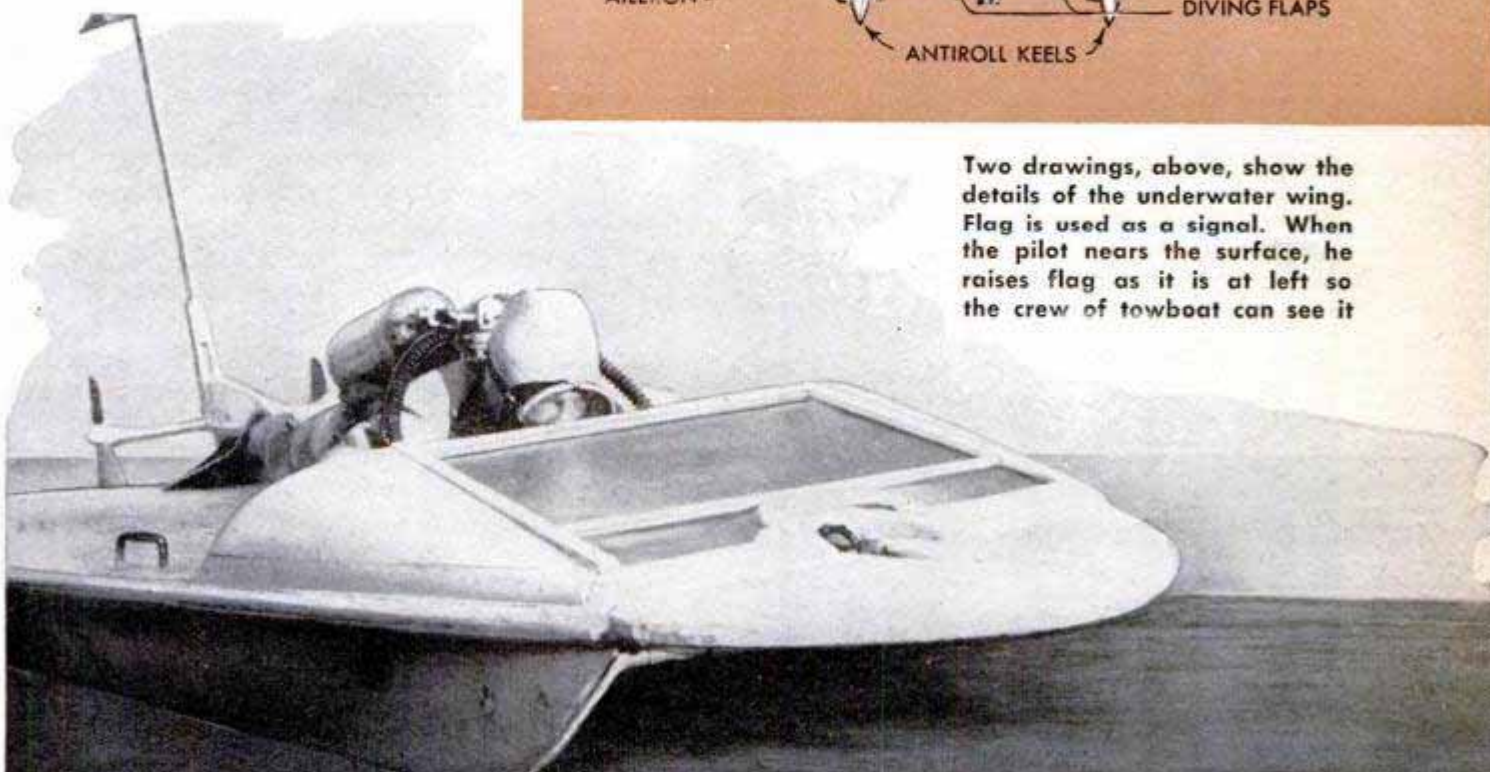

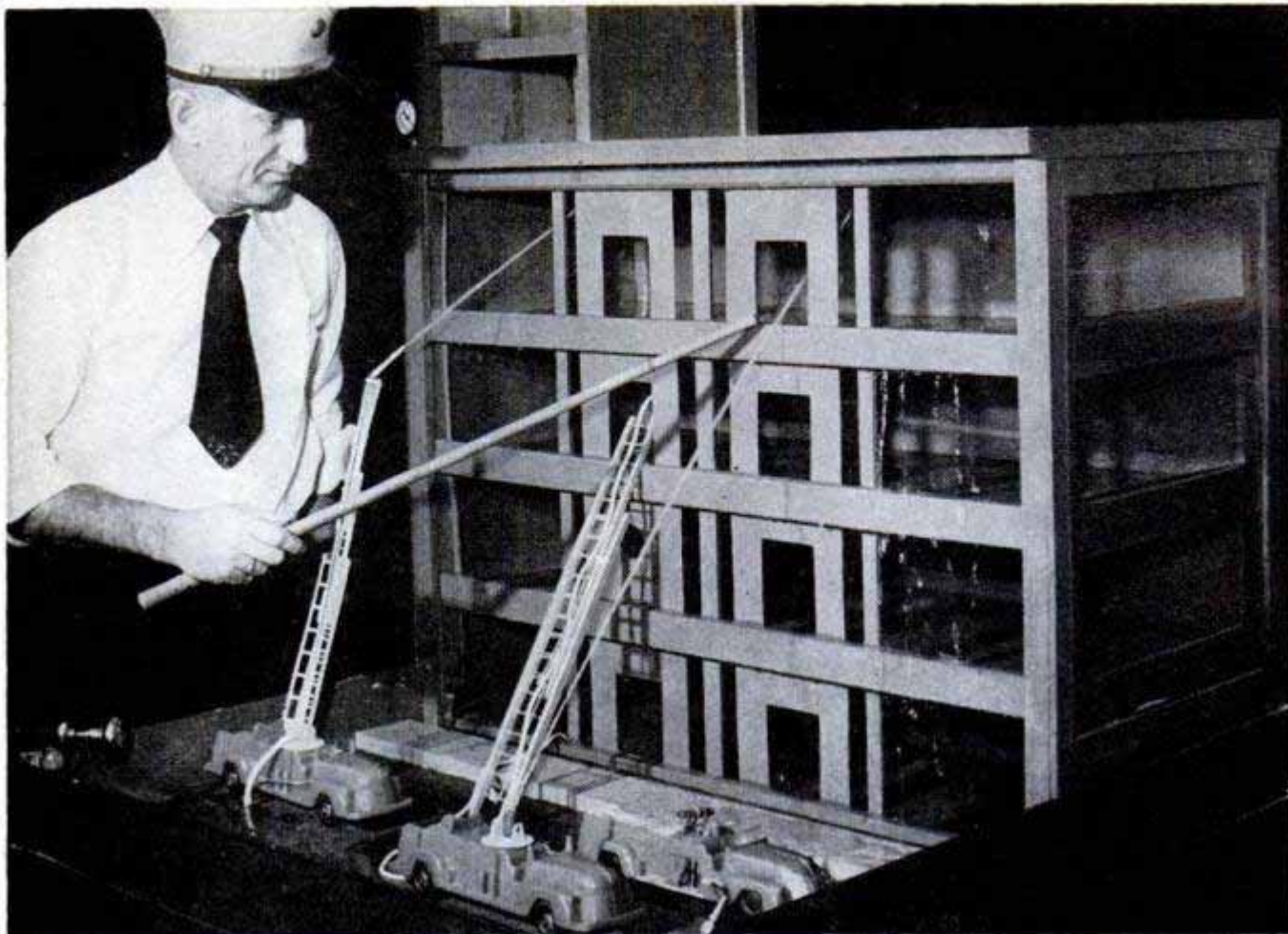

## Tiny Building and Equipment Illustrate Fire-Fighting Lessons

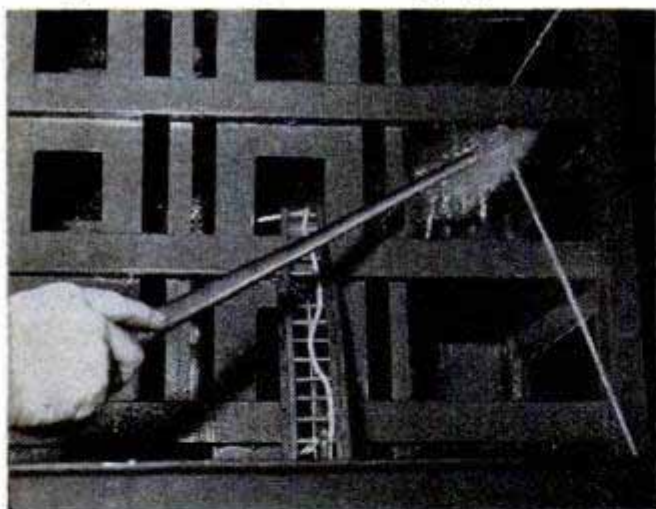

AN EIGHT-STORY miniature building and plastic toy fire trucks, revamped into actual working models, are helping in the training of West Hartford, Conn., firemen. The realistic set was designed and built by deputy chief John O'Laughlin to aid in demonstrating the latest methods of fire control. Though only four feet high, the building has a simulated height of 98 feet and a pressure-fed sprinkler system which draws its supply from a water tank on the roof of the structure. Odds and ends found around the fire department's repair shop went into the conversion of the toy trucks and pieces of brass were lathe-turned into scale-sized nozzles.

During classroom sessions, the deputy chief builds small fires on the various floors and then, by means of the sprinkler system, extinguishes the blaze or brings the trucks and hose equipment into action. The tiny trucks have hose equipment consisting of a ground gun, a deck gun and an aerial gun which throw streams of water into the stories at the proper angles. Individual pet-cock valves control the water supply to each truck and a drain carries off excess water flowing from the building.

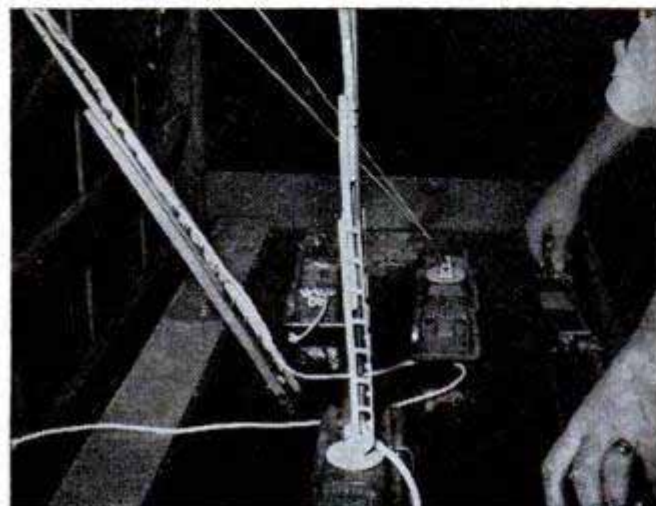

Water deflected off the ceiling, top left, can be used as sprinkler to quench flames. Left, pet cocks control force of water directed into the miniature building





# Detroit Listening Post

*By Siler Freeman*

**T**HE AUTO PLANTS will turn on the steam this month to make up for production losses during the 53-day steel strike. This will be the last big month for output of 1952 models. The new models will follow closely the last of the 1952s, but inevitably there has been a delay in introductions.

Not that the plants will not be making this year's models in November and some in December. Schedules are being run out but there is a much better chance of getting a 1952 model quickly than a 1953 model. Steel shipments in this quarter, while better, are still fluctuating enough to make uncertain how fast the dealers will be stocked with 1953 models so that they can count on deliveries to customers. There will be a push, however, by the manufacturers to get the new models into production and iron out the inevitable "bugs" in the assembly lines.

Hopes for an early start on the new Chevrolet appear dim right now. Chevrolet dealers had hoped to get the jump on their arch rivals with an early showing of the new, restyled models. Now it appears they will not have them in their showrooms until the first week in January, perhaps the second.

Buyers will be intrigued next year by air-conditioning units offered by General Motors and Chrysler. The GM unit will be available on the Cadillac and Oldsmobile and is a product of GM's Frigidaire division. It marks the successful result of many years' striving for a small, compact unit that will permit installation in the back of a car and work efficiently. The Chrysler unit is the product of a research program dating back to 1939 and has been on test cars for years.

Another attention-getter this coming year will be a rash of American sports cars, which have been discussed in this column before. Chrysler's C-200 will be built in limited numbers, probably about 300 being scheduled for the initial test. Buick's Skylark will be put into production and both Cadillac and Oldsmobile will test reaction by showing their versions of the American sports car in the GM show, due for the Waldorf-Astoria the middle of January. Packard has made no move as yet.

Naturally, both of these attention-getting moves will affect only a small segment of the car-buying public because of price. The tag on the air-conditioning units is still being debated but it will be in the neighborhood of \$500. The sports cars will be priced at least \$1000 over what the regular convertible is now tagged.

But both are long-range possibilities as yet. Air conditioning for all cars is an engineer's dream. Only high-volume output could put it, like power steering, within the reach of the lower-priced car buyers. After all, automatic transmissions at first were believed too luxurious an item to be offered the general public.

Larger volume would gradually bring the cost of sports cars into a more attractive price class. Most of the manufacturers who are planning this type of offering are using as much of their regular tooling as possible.

Buick, for instance, adapts the Roadmaster chassis to the Skylark. It may even go in for Kirksite dies for the body changes to hold the cost figures down. Chrysler will use the New Yorker chassis for its C-200. Cadillac and Olds, too, will utilize much of their basic designs.

All the sports cars will have one thing in common, wire wheels. It is the spin of the style turntable that brings these back into the American field. Wire wheels once were common, now there isn't a single wire-wheel manufacturer on this side of the ocean. But there will be soon, if the trend continues.

A former high-priced item promises to reach down into the mass market in the coming year. This is the tubeless tire. B. F. Goodrich Co., which pioneered the tubeless tire, finally bringing it on the market after years of testing, has announced a new low-priced tire of this variety in volume production. At least one passenger-car manufacturer may use it as original equipment.

The tubeless tires now in use have proved themselves. They are lighter, build up less heat and are almost blowoutproof. They use quite a large amount of natural rubber but this is now plentiful and the price is getting much nearer synthetic.

THE POPULAR MECHANICS MOTOR SURVEY  
AS CONDUCTED BY FLOYD CLYMER

# The OWNERS

- 1- I am the owner of a 1952 Lincoln:  
2- I have owned it approximately \_\_\_\_\_  
Speedometer, now 9,471  
3- Having tried both kinds, I find the  
regular gasoline  premium (high test) gasoline   
4- My average gasoline mileage is 14 m.p.g. for city driving, and  
16 m.p.g. for country driving.  
5- I CHANGE OIL  every \_\_\_\_\_ miles (never add oil between changes).  
I change oil every 5,000 miles, but also ADD  one quart every 2,000 miles.  
6- Roadability and handling qualities are: Excellent  Good  Unsatisfactory   
7- Maneuverability in traffic seems to be: Excellent  Good  Unsatisfactory   
8- Acceleration is: Exceptional  Very Good  Average  Poor   
9- Curb and road clearance is: Satisfactory  Too High  Too Low   
10- Here are my main reasons for purchasing a Lincoln: Modernistic in appearance, good trade in, Wonderful riding and handling features.  
11- Particular features I like are:  New ball-joint type front wheel suspension  
 New body styling in general  "Overhead mounted" brake & clutch pedals  
 Combination front bumper & grille  Center location of gas-filler pipe at rear  
 Compact, unit-type instrument panel  Shorter, 123-inch wheelbase  
12- Specifically, what do you dislike about your Lincoln? The Chrome is terrible. Windows rattle too much, car that expensive should have backup lights standard.  
13- Have you ever owned a Lincoln before? Yes  No  How many? \_\_\_\_\_  
14- Would you buy another Lincoln? Yes  Possibly  No   
15- How do you rate your dealer service? Excellent  Good  Average  Poor   
16- How do you rate your Lincoln, generally? Excellent  Good  Average  Poor

### GENERAL INFORMATION

- 17- What type of engine would you prefer in your next new car? In-line  V-type   
Number of cylinders: 6  8  Valves: Side  Overhead   
18- Are you satisfied with the horsepower rating of your Lincoln (160 h.p.)? Yes  No   
Approximately what H.P. rating would you like in your next new car? 190  
19- What specific improvements would you like to see in your next car? Better and more chrome, more acceleration after it slows to 15 or 20 M.P.H.  
20- Based on your present experience, which transmission would you prefer: Conventional   
Conventional with Overdrive  Hydra-Matic Drive  Other type automatic trans

This questionnaire will be tabulated fairly, and your name will be held in strict confidence; we request that you attend to each question listed. Thank you.

Please mail promptly to:

FLOYD CLYMER,  
1268 SO. ALVARADO ST.  
LOS ANGELES 6 CALIF.

My name: \_\_\_\_\_  
Address: \_\_\_\_\_  
City & State: Charlotte, N.C.  
Occupation: Salesman

Write your personal comments here:

*Car rides, and handles exceptionally well especially at high speeds. Hugs the road and sticks to curves better than any.*

Clymer tests the Lincoln on the washboard roads that trail off from the Western highways. His personal test yielded the same results as a poll of the owners: The Lincoln is a rugged, easy-to-handle car



The true test of an automobile begins when the owner takes the wheel. This is another report from owners of 1952 cars who answered questionnaires sent by *Popular Mechanics* to 1000 Lincoln owners from coast to coast

# REPORT on the '52 LINCOLN

By Floyd Clymer

**M**OST LINCOLN OWNERS consider themselves among the elite in American motordom. They expect, according to our survey, a high degree of perfection in their cars. Some minor defects which owners of other makes haven't bothered to mention in previous surveys were brought up gravely by Lincoln owners, who seemed to think their cars should be above reproach. They expressed a demand for high-quality materials and workmanship.

Seventy-seven percent of those reporting use premium gasoline, and many of these never have bothered to try less expensive fuel. Although a number reported low gasoline mileage, the over-all average (16.2 miles per gallon for country driving and 13.3 miles per gallon for city driving) showed that the new Lincoln engine is somewhat more economical to operate than its predecessors. The average Lincoln owner seems more interested in performance.

Several owners registered complaints of excessive oil consumption and oil leakage. The new overhead-valve V-8 engine has found general favor but may still have a few "bugs." Although some owners complained of noisiness of the overhead-valve mechanism, 88 percent want this type in future cars. The present horsepower output of the engine appears satisfactory; 80 per-

cent indicated no desire for a horsepower increase in future models.

It is obvious that the owners now take automatic transmissions for granted; 94 percent want such a unit on their next car, while all have it on their present '52 Lincolns. Hydra-Matic drive was favored, although many suggested that Lincoln use Fordomatic or Merc-O-Matic next time. The conventional three-speed transmission seems to have lost all appeal—not a single owner wanted it on his next car and only six percent wanted it with overdrive.

## ACCELERATION TESTS

1952 LINCOLN CAPRI  
WITH DUAL-RANGE HYDRA-MATIC

¼ mile from zero	Drive range only .....	22.2 sec.
	Low and Drive .....	21.3 sec.
½ mile from zero	Drive range only .....	33.6 sec.
	Low and Drive .....	32.4 sec.
0 to 30 m.p.h.	Low range only .....	4.9 sec.
0 to 60 m.p.h.	Drive range only .....	15.9 sec.
	Low and Drive .....	14.8 sec.

(In tests using both Low and Drive, shift from Low to Drive was made at 30 m.p.h.)  
Top speed (by speedometer) showed over 110 m.p.h.  
Actual top speed, about 7% less (speedometer variation)

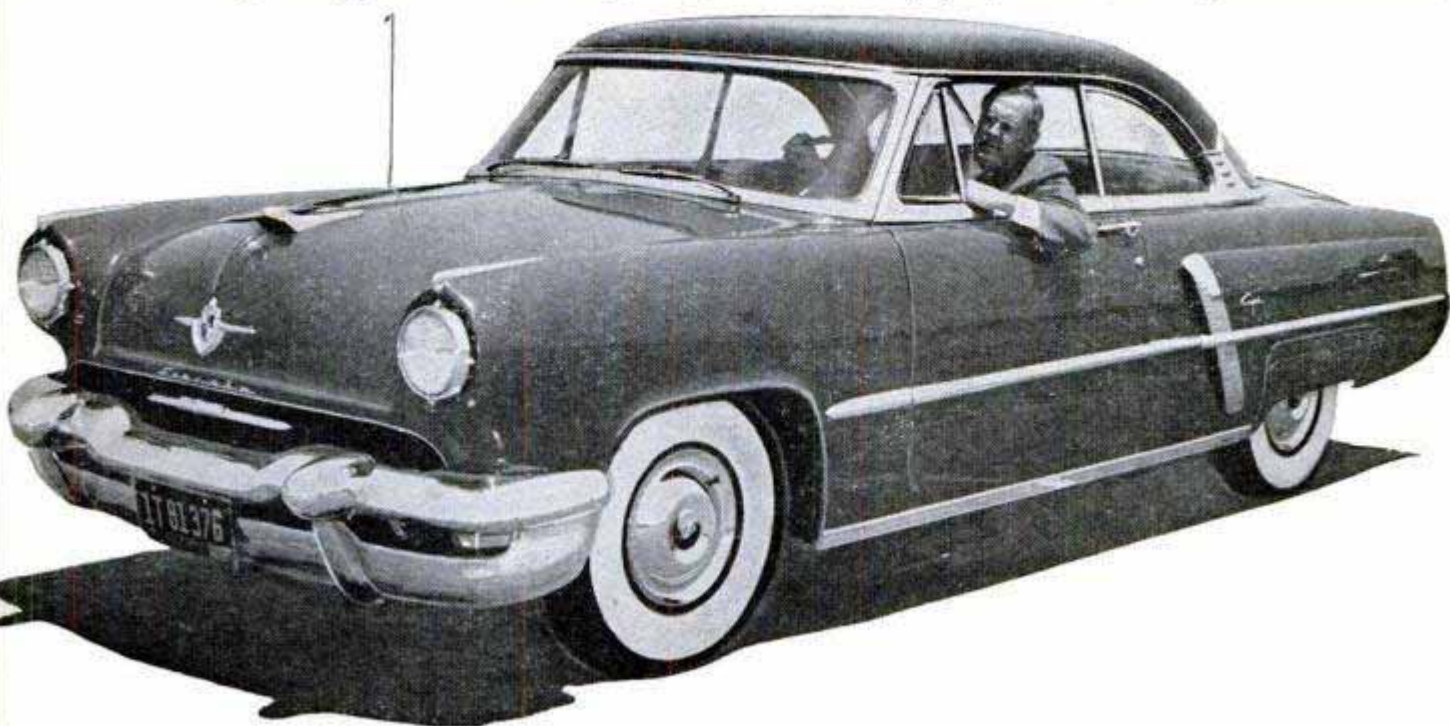

# Percentages From PM Poll

Owners of Capri models.....	53%
Owners of Cosmopolitan models.....	47%
Use premium gasoline.....	77%
Use regular gasoline.....	23%
Average gasoline mileage in country.....	16.2 m.p.g.
in city.....	13.3 m.p.g.

(All Hydra-Matic-equipped cars)

Average mileage for oil change.....	1391
Owners who add oil (also change periodically).....	24%
Average mileage for adding one quart.....	863
Roadability excellent.....	88%
good.....	11%
unsatisfactory.....	1%
Maneuverability excellent.....	82%
good.....	17%
unsatisfactory.....	1%
Acceleration exceptional.....	46%
very good.....	37%
average.....	14%
poor.....	3%

## BEST-LIKED FEATURES

New body styling.....	90%
Ball-joint front suspension.....	71%
"Overhead mounted" foot pedals.....	70%
Center location of gas-filler pipe.....	65%
Unit-type instrument panel.....	60%
123-inch wheelbase.....	58%
Combination bumper and grille.....	45%

(These percentages are based on answers to direct questions asked in questionnaire.)

## OWNERS' RATING OF CAR

Excellent.....	63%
Good.....	23%
Average.....	9%
Poor.....	5%

## GENERAL INFORMATION

Owners preferring the following on next car:	
V-type engine.....	98%
In-line engine.....	2%
Eight cylinders.....	99%
Six cylinders.....	1%
Overhead valves.....	88%
Side valves.....	12%
No increase in horsepower output.....	80%
Average horsepower output desired.....	161*
*(Lincoln horsepower figure—160—was tabulated for those owners who expressed satisfaction with present ratings.)	
Automatic transmission.....	94%

Conventional transmission with overdrive.....	6%
Conventional transmission only.....	0%
Hydra-Matic drive exclusively.....	89%*
Other type of automatic transmission.....	11%*

\*(Percentage of the 94% preferring automatic-transmission units.)

Previous Lincoln owners.....	63%
Will buy another Lincoln.....	65%
Might buy another Lincoln.....	27%
Will not buy another Lincoln.....	8%
Dealer service rated:	
excellent.....	42%
good.....	30%
average.....	15%
poor.....	13%

Chief purchase reasons (in order of popularity):

1. Styling features—interior or exterior
2. Lincoln-prestige factor
3. Previous Lincoln ownership
4. Driving ease—roadability and handling
5. Riding qualities
6. Mechanical features—engine, transmission
7. New V-type, overhead-valve engine
8. Performance impressions from demonstration

Improvements desired in next car (in order of preference):

1. Increased acceleration and power
2. Distinctive body styling (unlike other Ford products)
3. Better body fit, assembly
4. Quieter and smoother-running engine
5. Smooth-shifting automatic transmission
6. Higher quality hardware, interior fittings
7. Improved mechanical accessibility (battery and spark plugs more convenient)
8. Increased legroom
9. Easier steering at low speeds—power-assisted or otherwise
10. Higher quality chrome and paint finish.

Most frequent objections:

1. Body-styling features—similarity to other Ford-built cars, short wheelbase
2. Rough engine performance at lower speeds and idling
3. Lack of acceleration and power—particularly at cruising speeds
4. Noisy engine—particularly in the overhead-valve mechanism
5. Jerky shifting or noisy automatic transmission
6. Thin chromium trim and paint finish
7. Body fitting, poor assembly, etc.
8. Excessive oil consumption
9. Inadequate legroom in rear and front
10. Thin metal in window cranks and door handles

A great majority of owners approved Lincoln's new body styling, the unit-type instrument panel, the new ball-joint type front suspension, the pendulum (overhead-mounted) brake and clutch pedals and the shorter, 123-inch wheelbase. Of seven new Lincoln features we listed on the questionnaire, the combination bumper and grille was the least liked and was noted as a complaint in several cases. The centrally located gas-tank filler is liked by 65 percent of the owners, and more would like it if the license plate did not have to be held down while the tank is being filled.

More than 60 percent of the owners polled had owned Lincolns previously and 65 percent indicated

**New ball-joint front suspension system gives easy ride, stability at high speeds**

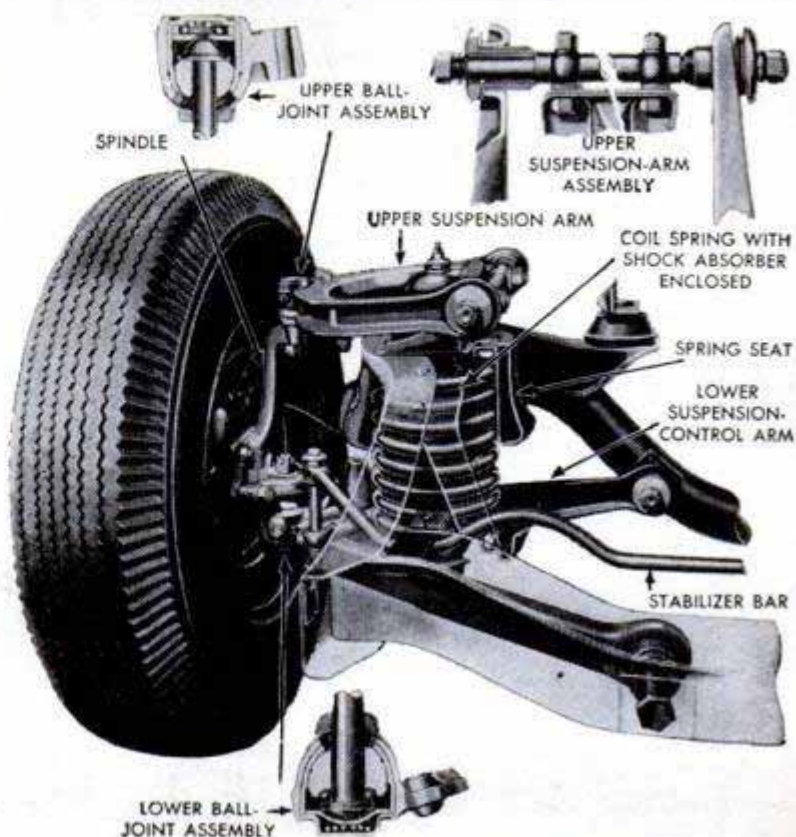

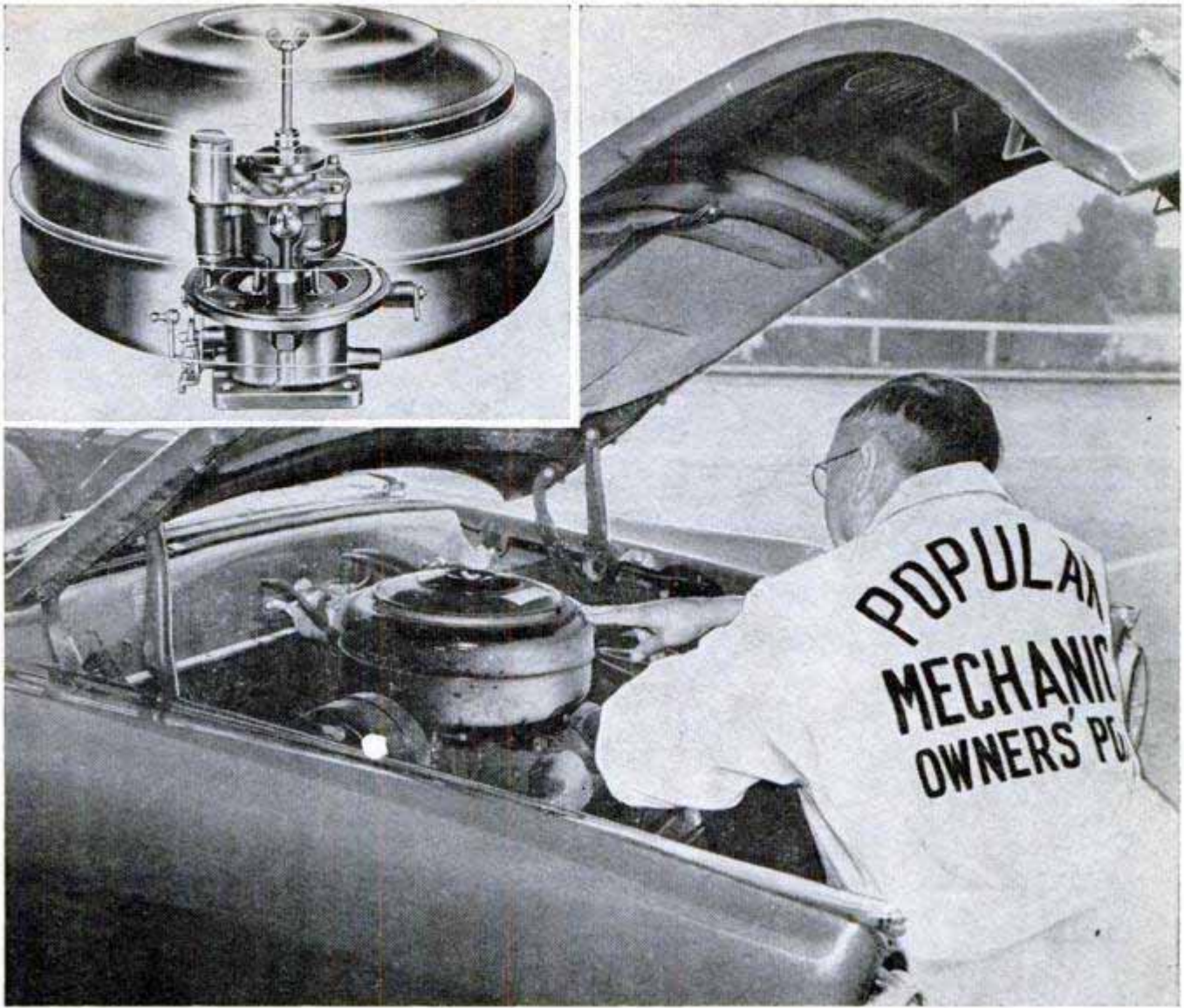

Big air cleaner surrounds carburetor instead of being mounted on top. Padding under hood deadens sounds

they intend to buy another one. Dissatisfaction with various features was expressed by eight percent, who said they definitely would not buy another Lincoln. Seventy-two percent said dealer service was excellent or good, while 28 percent said it was average or poor. As our surveys of other makes have shown, an improvement in dealer service seems to be needed.

Some typical comments on the 1952 Lincoln Cosmopolitan and Capri models:

"Modernistic in appearance, good trade in, car rides and handles exceptionally well at high speeds. Three cheap features mar the finest car on the road: Thin, flimsy chrome on the front grille, cheap material in back of back seat, and cheap siding for doors."—Charlotte, N. C., salesman.

"Outside of being a little underpowered for its weight, my Lincoln Capri is a great car. Fastest I've ever owned—110 miles per hour is easy by speedometer. Roadability beats them all. My next car will again be a Lincoln and my dealer is also tops."—Chicago attorney.

"Interior trim and appointments equal to the finest custom coachwork of today.

Battery of the Lincoln is in a controversial new position—beneath the feet of the front-seat passenger

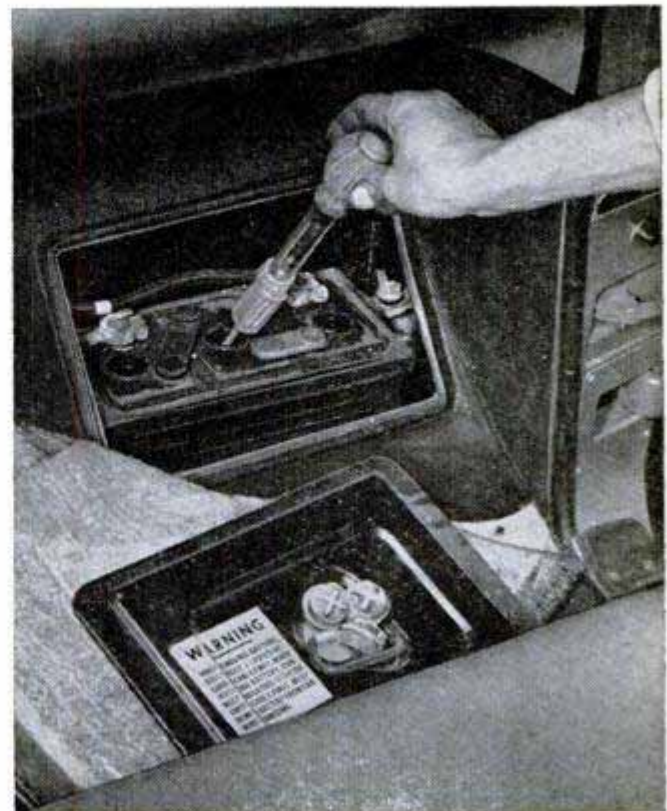



Special fastener holds visor in position. Graph below shows results of the economy test of the Lincoln

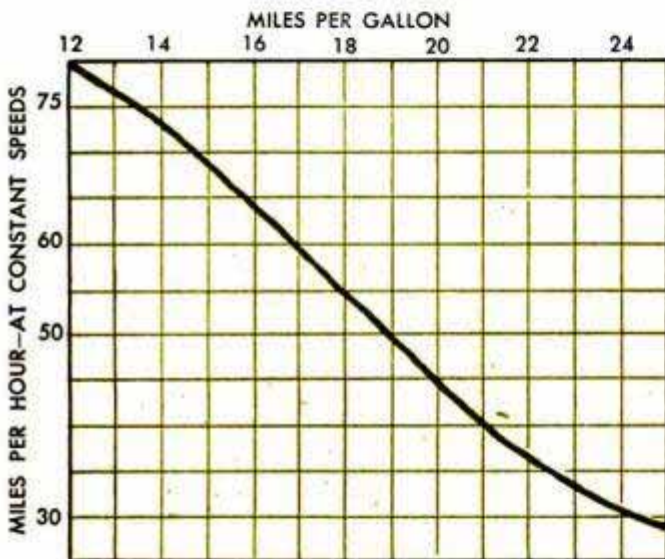

Lincoln engine is a V-8 with overhead valves and a 7.5 to 1 compression ratio. Clymer says it's flexible and fast but the horsepower could be a little higher

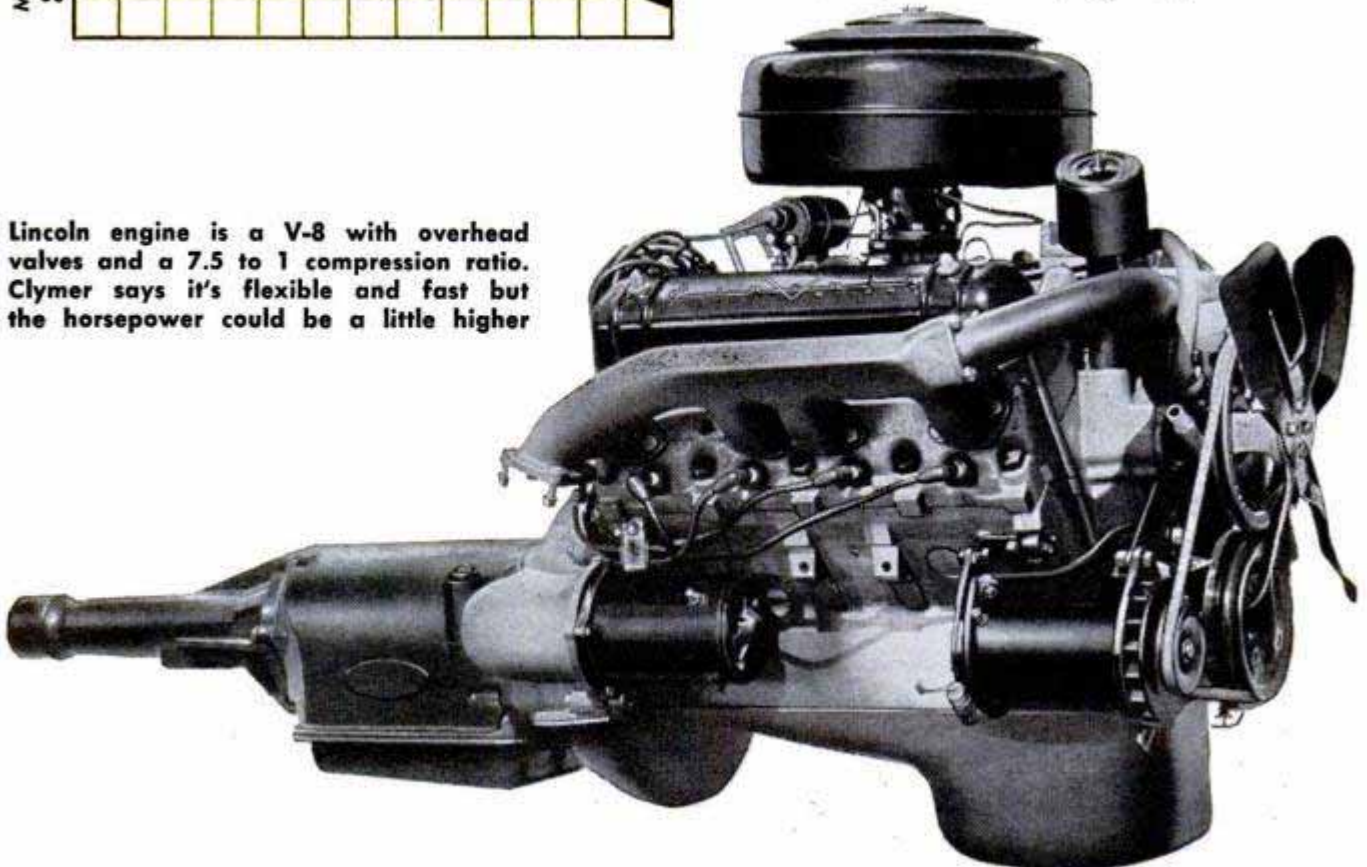

Mechanically, a finely engineered product. Three inches more wheelbase would allow added legroom."—Detroit plant manager.

"This is my fifth Lincoln and I have been satisfied with them all. I believe they should increase the horsepower rating. A car of this price and beauty should have more horsepower to drive it."—Morgantown, W. Va., electrician.

"I am extremely satisfied with my '52 Capri. I bought it because of good service and the faith that after '47 to '51 they were bound to come up with a good car for once. . . . This car can take corners better than any I ever have driven."—Caterville, Mass., physician.

"Roadability and maneuverability of this car is amazing. . . . It already has saved my life when I had to brake and steer to the shoulder to avoid a sight-seer in the New Mexico mountains. No other production car could have recovered its stability after this!"—Lubbock, Tex., farmer.

"My Lincoln is used only for business, on trips averaging 300 miles a day. It has never tired me. It has good high-speed characteristics but is sluggish at speeds below 50 miles per hour."—North Hollywood, Calif., highway contractor.

"Engine quiet at all speeds, the least road noise of any car I ever have driven."—San Rafael, Calif., executive.

"Finest car I've ever driven. If only I could get four miles more per gallon, I'd be satisfied for life."—Eau Claire, Wis., cafe owner.

"I am very impressed with the ease of

(Continued to page 252)

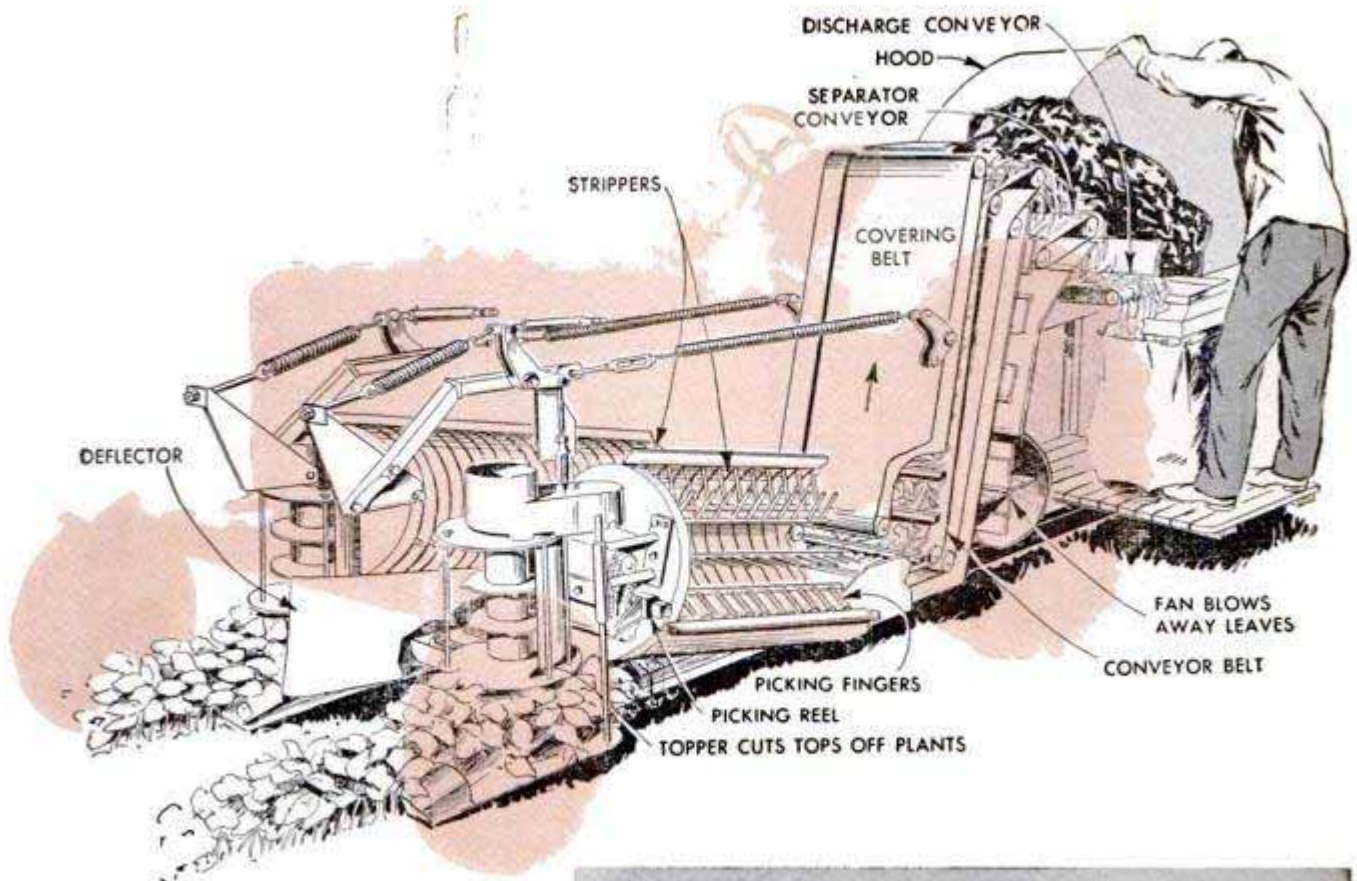

## Bean Picker

Snap beans are combed right off their plants by a new harvester which strips two rows at a time. The picker is mounted on a four-wheel tractor and operates from the power take-off. A cylindrical picking reel is mounted on each side of the tractor. As the tractor moves down the rows, a topper cuts off the excess top growth of the plants. When a plant moves into the reel, stainless-steel fingers comb off beans and leaves and deposit them on a conveyor. The reels are sloped down toward the rear so the picking begins at the top of the plant and works down as the tractor moves forward. The conveyor elevates the beans through air ducts which remove the leaves and soil, and the beans then move into two



discharge hoppers. The harvester can be used on certain types of beans which produce virtually the entire crop at one time, so only one picking is required. Three men, including the tractor operator, are required to run the picker.



## Telephone Night Light

Attached to any standard telephone, a lighting device serves as either a permanent night light or as a convenience light that goes on automatically to illuminate the dial when you pick up the handset. A switch controls the device. With the switch in the forward position, the light burns continuously; with the switch pushed back, the light goes on only when the handset is lifted. In addition, each time you pick up the handset, three emergency telephone numbers, written on the face of the unit, are illuminated.



## Police Crash Car Prepared for All Emergencies

Long experienced in first-aid work, John J. Manning of Detroit, a retired police sergeant, has designed a crash car for police patrols. His invention can be adapted to any standard two-door automobile. A four-way roof light and a hood pull-over light with the word "Police" on two sides iden-

tify the car at night. Emergency equipment carried under the rear seat includes a collapsible tubular steel stretcher, fire extinguisher, shovel, sledge hammer, rope, bolt cutters, rubber gloves, dog snare, blankets and a riot gun. The right half of the front seat removes to make room for stretcher.

## French Bicycle Design Gets Greater Pedal Push

By moving the pedals forward and up so the legs pump diagonally toward the front rather than up and down, a French bicycle designer claims to have increased leg power by 30 percent. The design is based on the principle that two forces represented by the sides of a parallelogram are equal to the force represented by the diagonal. The small front wheel used in the design permits sharp turns with greater stability, the inventor claims.

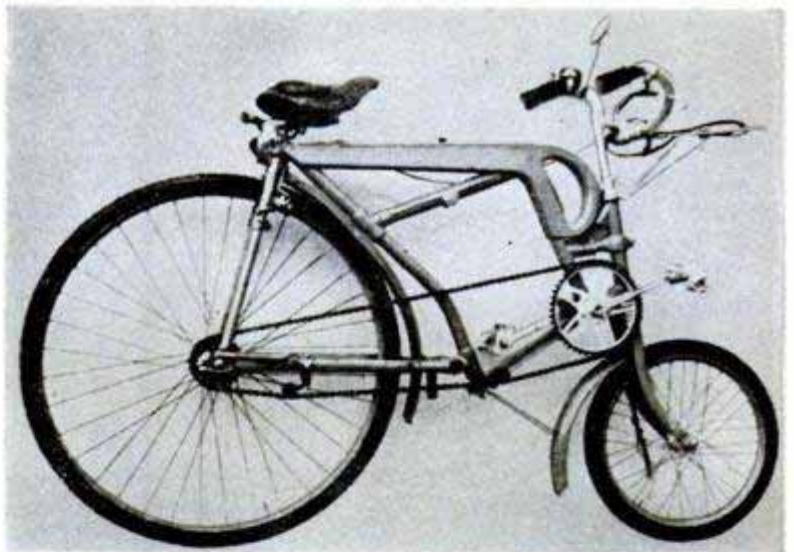

## Ticket Vendor For Parking Lots

Parking lots without attendants are the result of a coin-operated ticket vendor which enables one operator to supervise several lots. Similar in operation to municipal parking meters, except that there is only one meter at each entrance, the device vends a ticket which the customer places on the seat of his locked car. Periodic checks are made throughout the day. The vendor can be set from five to fifty cents.



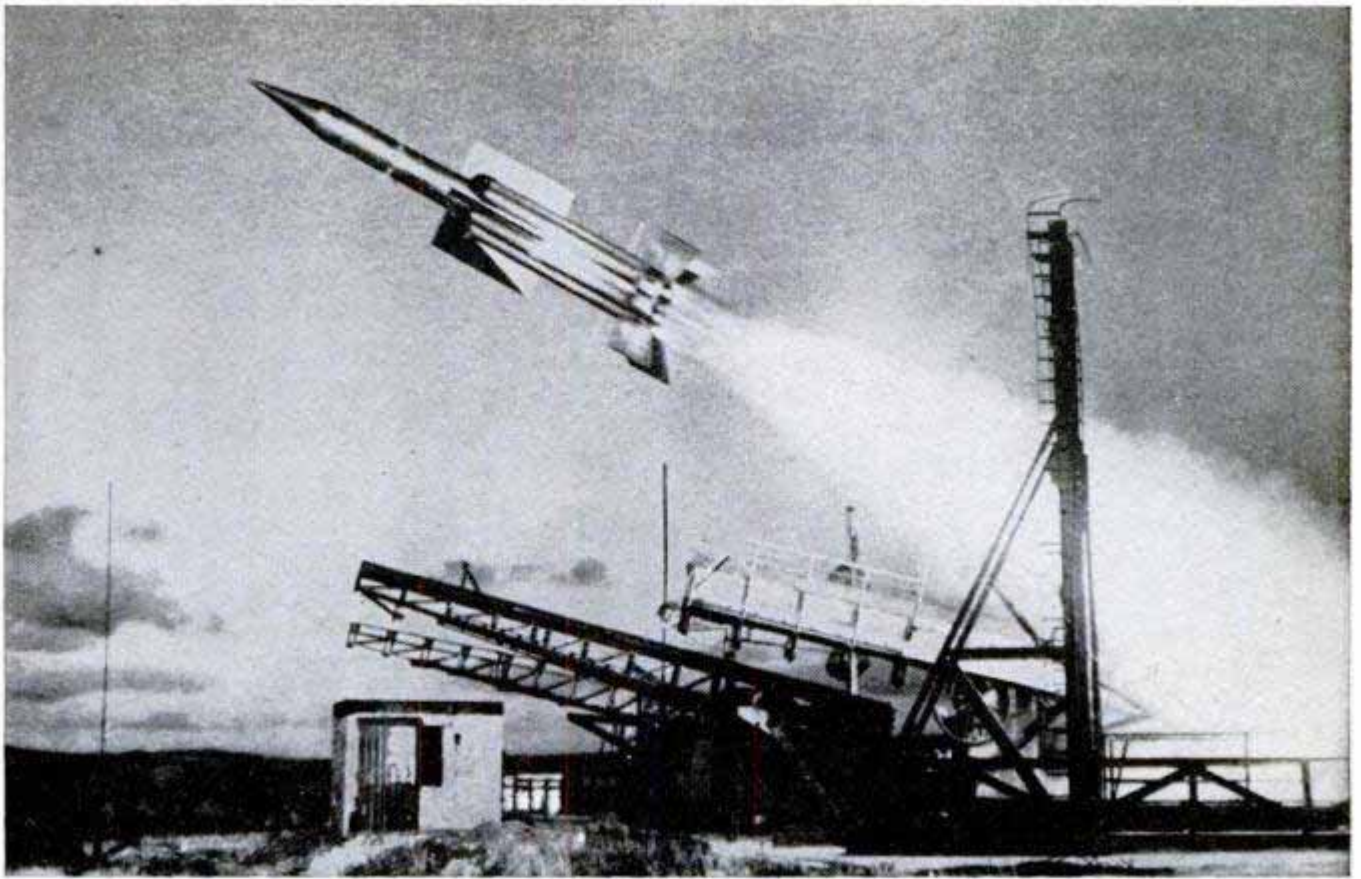

## British Guided Rocket Flies Over 2000 Miles Per Hour in Tests

Guided by a radar beam, an anti-aircraft rocket being tested in England travels over 2000 miles per hour and higher than any modern bomber can fly. It carries booster motors along its sides which are dropped

shortly after take-off. The missile is launched from an inclined platform. It reportedly can twist and turn with four to five times the degree of maneuverability of a pilot-manned fighter plane.

## Electronic Coffee Pot Hastens Normal Brewing Process

You'll be able to prepare coffee in a fraction of the usual time with a recently patented electronic coffee pot. Designed for use in the new short-wave-induction heat ranges, the vacuum coffeemaker is much like conventional models. The bottom sec-

tion is of glass which allows high-frequency waves from the oven to pass through and boil the water in less than a minute. But the upper part is made of a metal which shields the ground coffee from becoming scorched during the rapid heating process.

## Versatile "Refrigerette" Keeps Refreshments Within Easy Reach

Styled like a piece of modern furniture, a miniature refrigerator stores snacks and beverages right in the room where they are to be served. Handy in recreation rooms and living rooms, the two-cubic-foot cabinet keeps refreshments within arm's reach of TV viewers and partygoers. Placed in the bedroom or nursery, the refrigerator makes midnight trips to the kitchen unnecessary. As a drug cabinet in doctors' offices or beverage cooler in businessmen's offices, the refrigerator may find extensive use. It is available in several colors.



Ⓜ Turbine and gear assembly for the aircraft carrier USS *Forrestal* will be the most powerful ever designed for ship propulsion, Westinghouse engineers report.

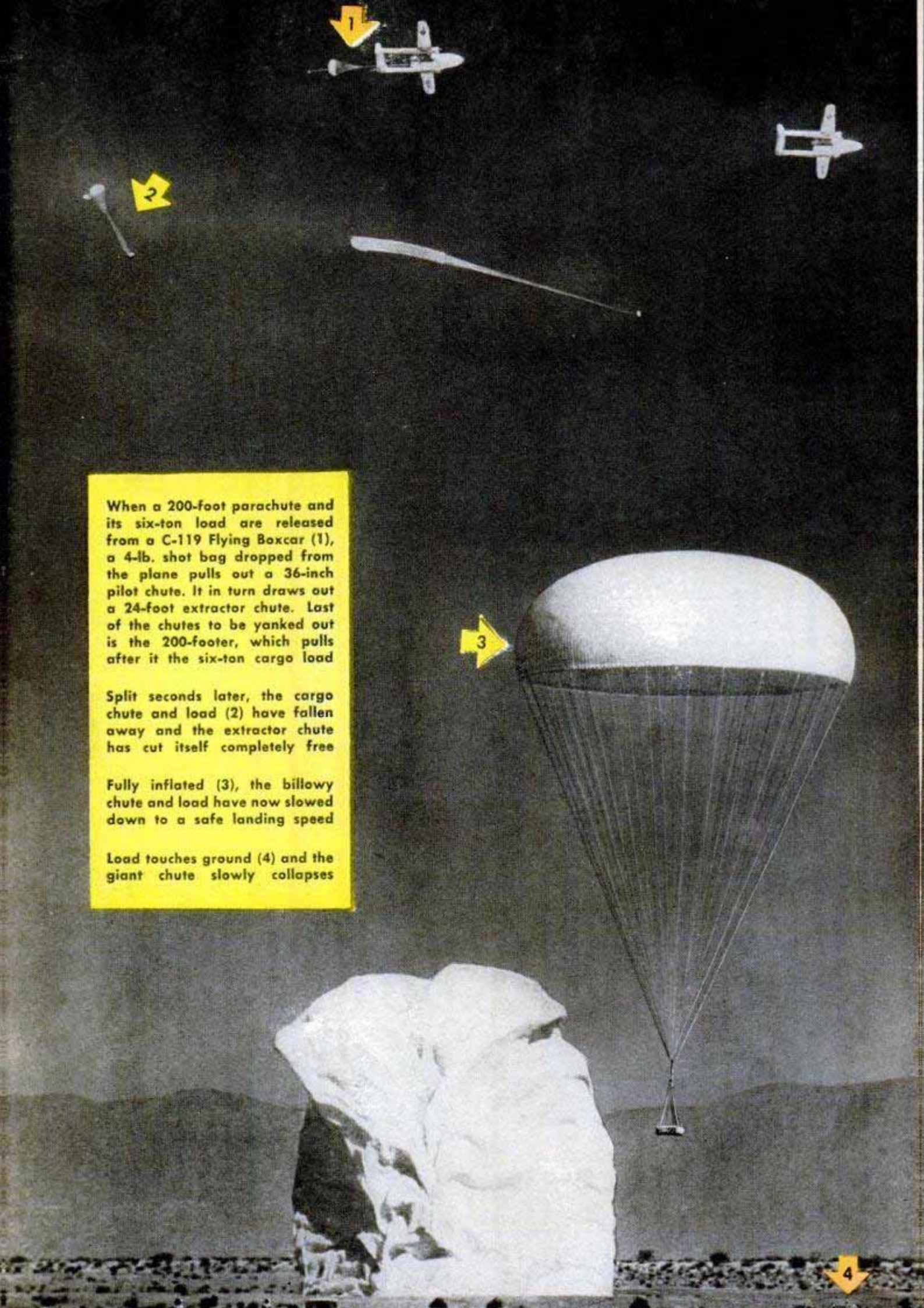

When a 200-foot parachute and its six-ton load are released from a C-119 Flying Boxcar (1), a 4-lb. shot bag dropped from the plane pulls out a 36-inch pilot chute. It in turn draws out a 24-foot extractor chute. Last of the chutes to be yanked out is the 200-footer, which pulls after it the six-ton cargo load

Split seconds later, the cargo chute and load (2) have fallen away and the extractor chute has cut itself completely free

Fully inflated (3), the billowy chute and load have now slowed down to a safe landing speed

Load touches ground (4) and the giant chute slowly collapses

# Parachutes by the Acre

**N**OW THAT WE can drop armies of paratroopers behind enemy lines, why not equip them with big trucks, heavy artillery, and fully armored tanks, also delivered by air? Why not drop an entire convoy of armored vehicles in enemy territory, with ammunition in place and fuel tanks full, ready for immediate use?

That's the reasoning behind huge new parachutes that the Department of Defense is trying out at its Joint Parachute Facility at El Centro, Calif.

Biggest of all the chutes is a giant, 200 feet in diameter, that contains about three-quarters of an acre of rip-proof nylon. This enormous white bag has lowered six-ton loads safely to the ground from 2300 feet and is

Cluster of three 100-foot chutes, above, lowering a two-ton weight. Shock of the opening ripped one

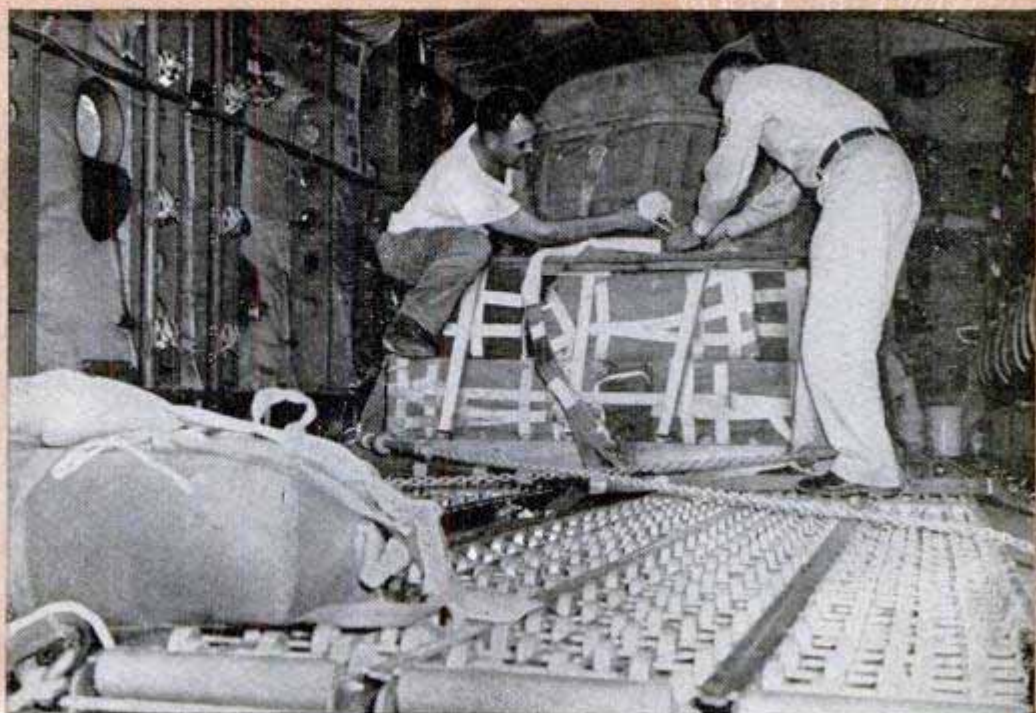

Two-ton load, with three 100-foot chutes in bags tied down on top of it, inside a Flying Boxcar

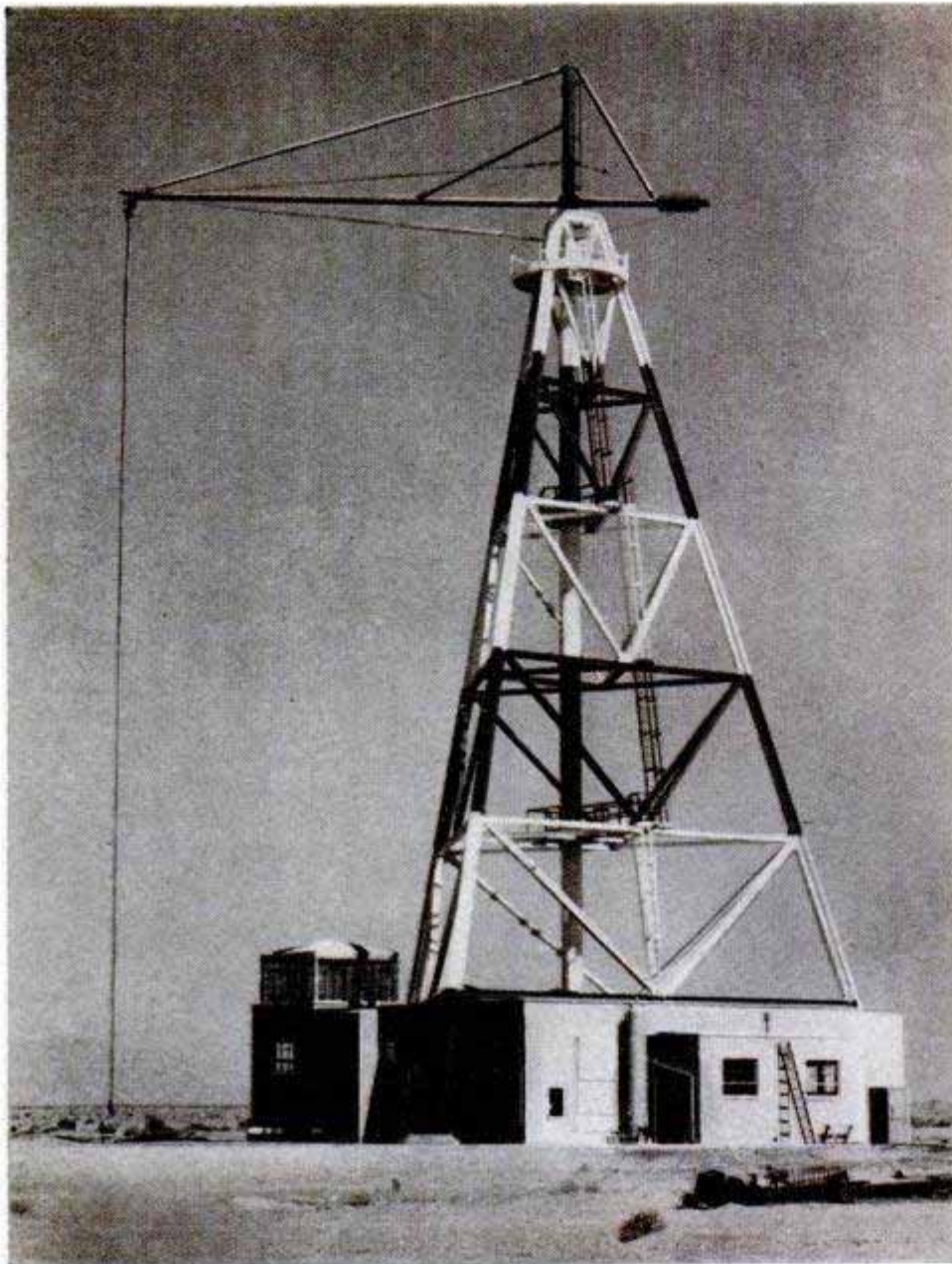

Chutes are whirled at speeds up to 500 m.p.h. on a lofty 130-foot test tower

Parachutes used in whirl-tower tests are housed in cab at the end of a long cable until release time. The cable is suspended from a rotating boom

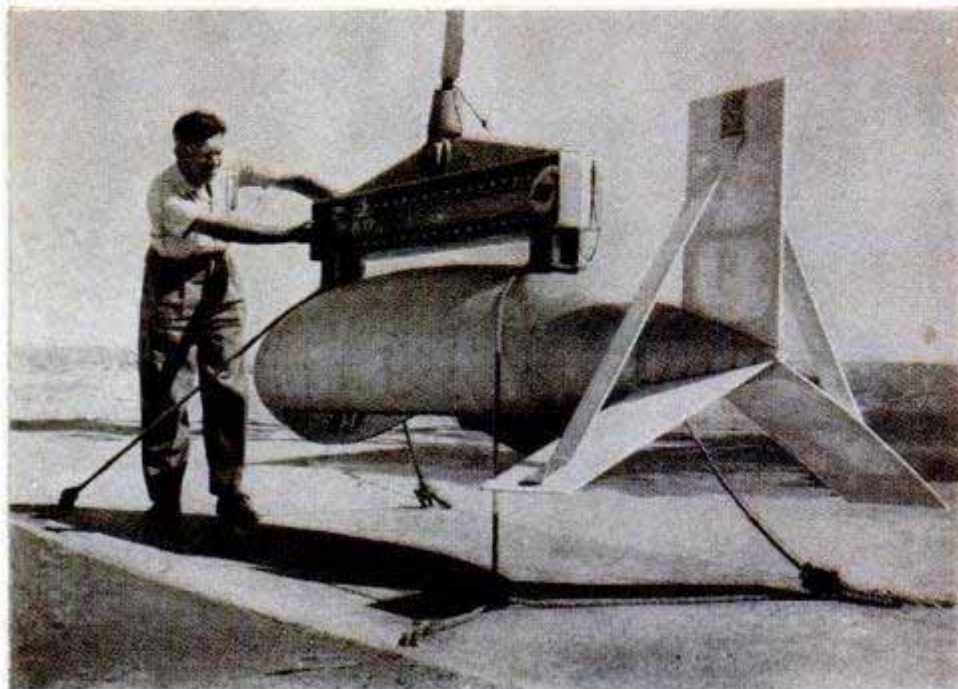

In emergencies, test jumpers can rely on a spare chute

being further tested with loads up to eight tons. For comparative purposes, some four-ton loads are now being dropped with clusters of three or more 100-foot parachutes.

Also being tested at the parachute facility, operated jointly by Air Force and Navy personnel, are better parachutes for pilots flying at high speeds and high altitudes. Chute harnesses that are built integrally with G-suits are being tried out, and one new technique for a pilot who has to bail out at extreme altitudes is to use a three-foot parachute to steady himself while he plummets down to a comfortable altitude at

Installing data recorder in the torso of a dummy jumper



which he opens his main chute and checks his once-rapid descent to a safe speed.

New containers that are lowered by parachute and may be packed with anything from ammunition to arctic survival kits are being tested. They are used for spot delivery from the air. With practice, a pilot can land one within a 50-foot circle from an altitude as low as 50 feet, at a speed of several hundred miles per hour.

A 130-foot-tall whirl tower that will whirl experimental parachutes at speeds up to 500 miles per hour at the end of its 118-foot arm is to go into operation at El Centro, as is a new paragon that fires missiles at speeds up to Mach 2.3 (about 1750 miles per hour). Parachutes attached to the missiles will thus be tested at those speeds. ★ ★ ★

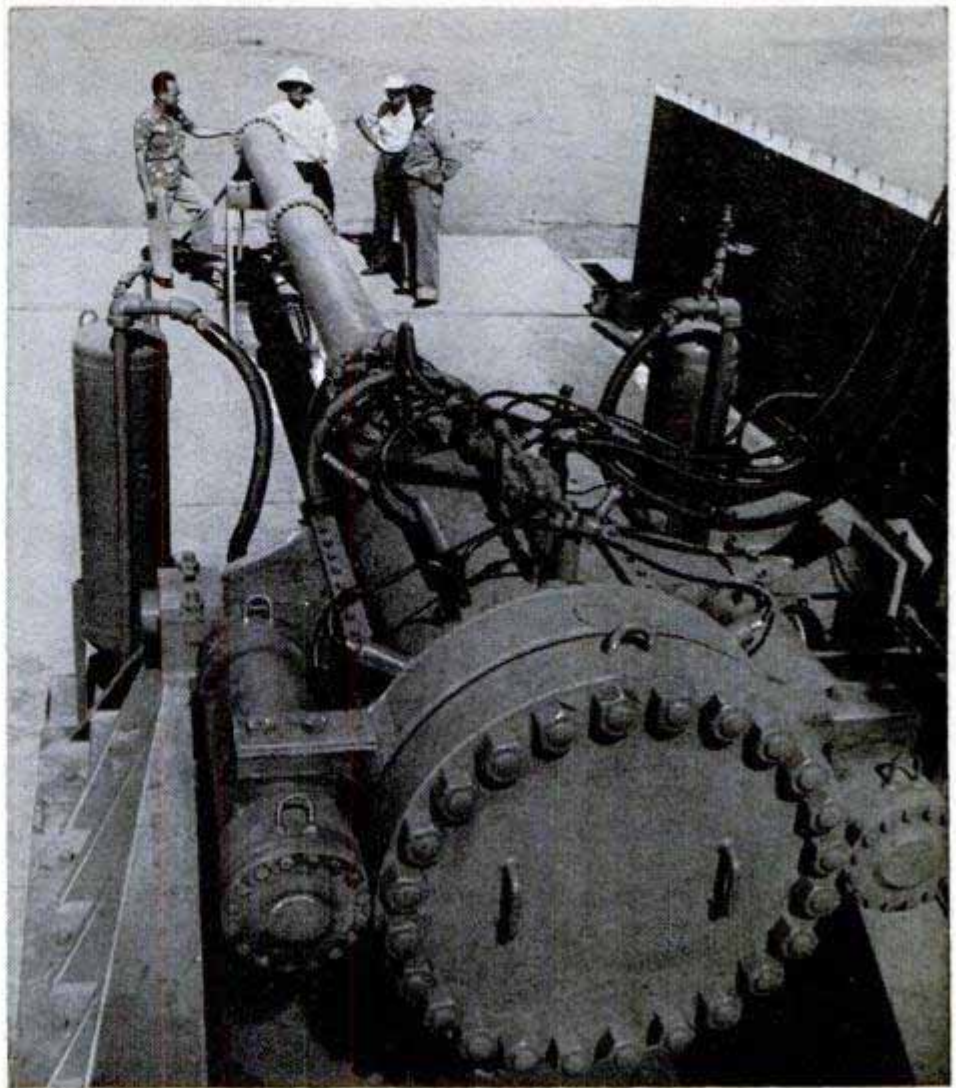

Chutes are attached to cannon-fired missiles for tests at 1750 miles per hour

Models being tested for arctic use have alternate panels of white and bright red to attract attention

Can under airplane wing, containing a complete arctic survival kit, is automatically dropped by parachute



## Giant-Size Slings Ease Bridge Section Into Position

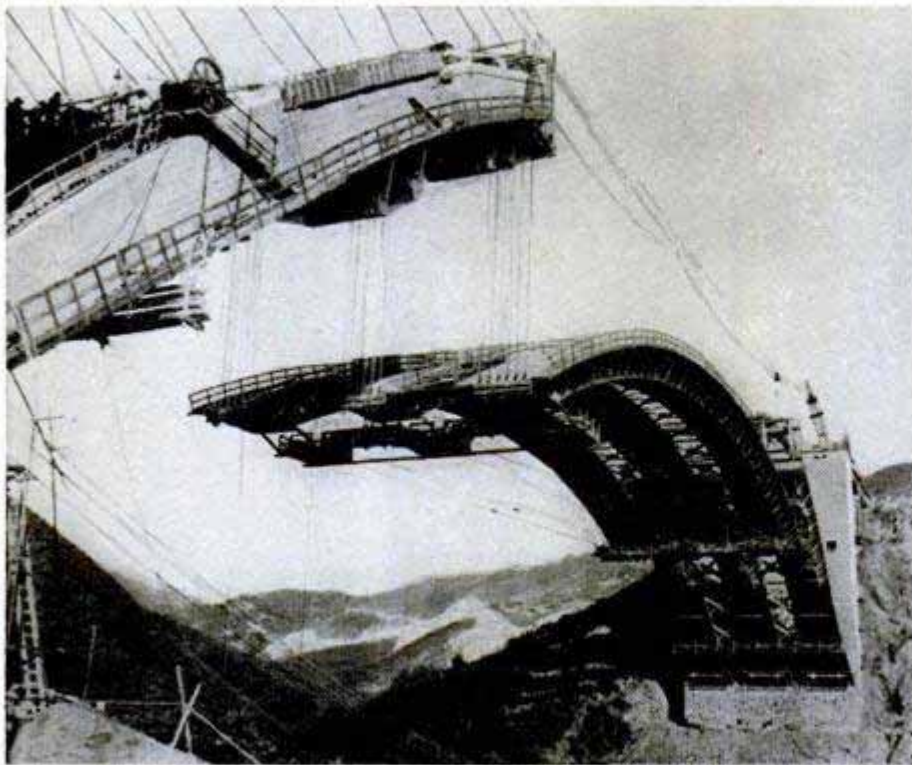

In a spectacular road-building operation in Venezuela, a complicated system of huge slings and pulleys eased a pre-stressed concrete bridge into position across a narrow but deep valley. The unique bridge is one of three along the route of the new Autopista, a 10½-mile superhighway between Caracas and La Guaira and is said to be the world's largest pre-stressed concrete span. The highway will cut the driving time between the two South American cities from one hour to 15 minutes. Costing \$6,000,000 a mile, the road is one of the most expensive ever built.

## Helicopter Taxicab

Designed as an aerial taxicab between cities and airports, prototypes of a new five-place helicopter are expected to be completed this year. Its 155-mile-per-hour cruising speed compares with about 100 miles per hour for conventional helicopters. The tubular-steel fuselage, covered with molded plastic glass fiber, will have about five times the crash strength of present designs. Stub wings will supply lift and help reduce the vibration of the rotor-blade tips.

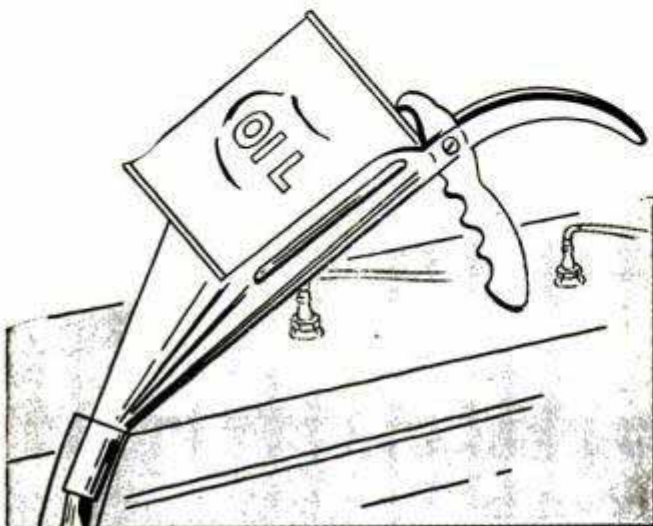
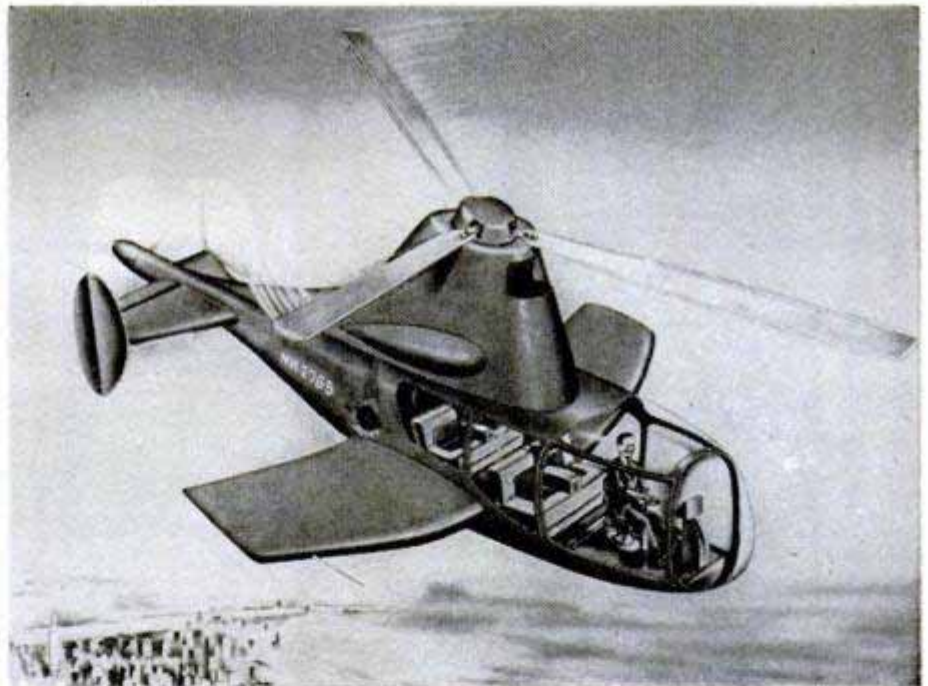

## Motor-Oil Dispenser

Cans of motor oil are quickly pierced and their contents emptied into auto filler pipes with the aid of a cast-aluminum handle. The can simply is cradled in a trough in the handle. When the handle is squeezed, the bottom of the can is cut open by carbon-steel blades and a vent hole is cut in the top. The oil flows through a funnel built into the front of the dispenser.

☐ Air and sea rescue craft of light, bright scarlet may result from Navy researchers' findings that that color is more visible than the bright chrome yellow now in use.

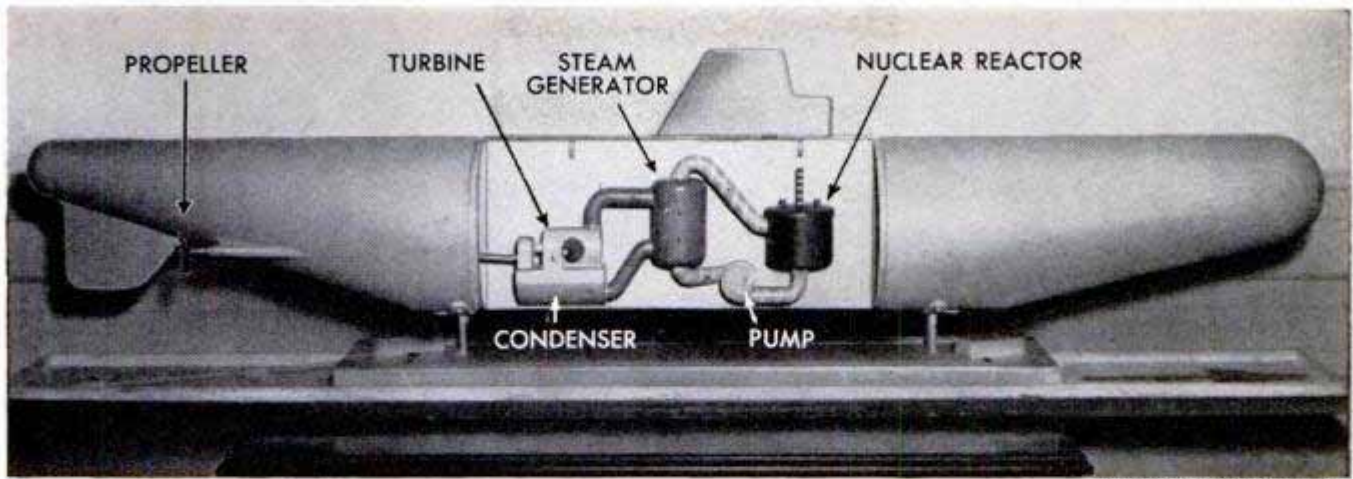

Official U.S. Navy photo

## Navy Announces Its First Atomic-Powered Submarine

In the first nuclear-powered submarine, the USS *Nautilus*, one pound of uranium will develop the power of 6,200,000 pounds of coal or 360,000 gallons of gasoline. The atomic undersea ship is now under construction at Groton, Conn. Uranium fuel

generates heat at a rate controlled by three control rods at the top of a nuclear reactor. The heat is removed from the reactor by water flowing through pipes to a steam generator, or boiler, which produces steam to drive a turbine that turns the propeller.

## Electric Clothes Drier Plays Tune at End of Cycle

As a gentle reminder for the housewife, a new electric clothes drier plays *How Dry I Am* when its cycle is completed. Operated by a small electric motor, five tone chambers sound the notes and then shut off. The musical signal was especially designed by a Westinghouse engineer after makers of music boxes and door chimes were unable to meet the requirements.

## Stop Watch Times Split Seconds

Reliable accuracy to within  $\frac{1}{25}$  second is claimed for a stop watch devised by two Canadian college students. Commercial stop watches, started and stopped by pressing a button, usually time to the nearest  $\frac{1}{5}$  second. The whole seconds on the watch are recorded by an electromagnetic counter resembling the mileage indicator on an automobile. Each second is further divided into 25 equal parts by a rotary switch, which successively illuminates 25 lights in a circle on the front panel of the instrument. Each fifth light is red and the remainder are green. When used in racing, the timer is connected to the starting gun and starts when the trigger is pressed. The first contestant to interrupt a light beam at the finish line actuates a photoelectric cell which halts the timer. The instrument also has been found useful for taking direct measurements of the speed of sound.



## TV Bug Eradicator

There's a man in Hollywood with a job that would give any ordinary mortal galloping nightmares. He's Lew Winkler, and it's his responsibility to eliminate the bugs in all the TV cameras, circuits and monitors in the city's biggest video studio. In a feature next month you'll find out how he kept a show on the air literally with his two bare hands. There'll also be another exclusive "Owners Report" and Floyd Clymer test on a new car.

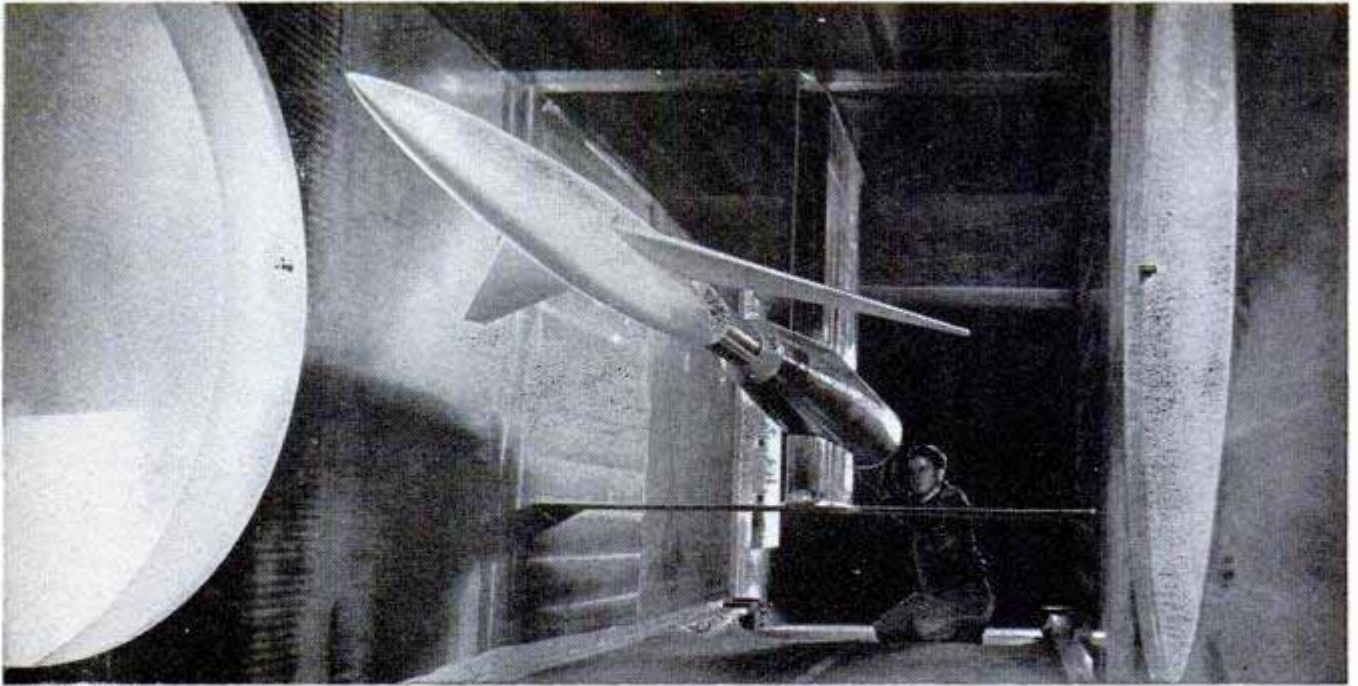

Westinghouse photo

In aviation, it's engineers such as the man above working in a supersonic wind tunnel who lead the way

# ENGINEERING---the Might

By Harland Manchester

**T**HE AMERICAN IDEA" means many things to many people, and re-evaluation of the concept will continue as long as man lives. Meanwhile most will agree that one of America's greatest contributions to welfare is its unique ability to take inventions and discoveries, test, develop and apply them, and design and produce in great quantities new and better machines and goods at prices within the reach of millions. The people who do all this are engineers.

Most engineers are unobtrusive people. They seldom advertise, pose for Man of Distinction or figure as heroes in movies. They are few. Count people on the street and every 387th will be an engineer. He looks like everyone else. Yet everything around us would collapse without him.

When you rise in the morning and turn up the thermostat, confident that warmth will follow, you are voting your faith in the American engineer. You turn the tap, sure that the water won't poison you, because the engineer has taken steps to protect you. When you snap the light switch, step on your car starter, board the 8:15, take an elevator or pick up the phone, you are reaping the fruits of uncountable engineering man-hours. Maybe you've heard of

The record-breaking queen of the seas, luxury liner *United States*, is a masterpiece of engineering. Her towering sleek hull is designed for speedy travel

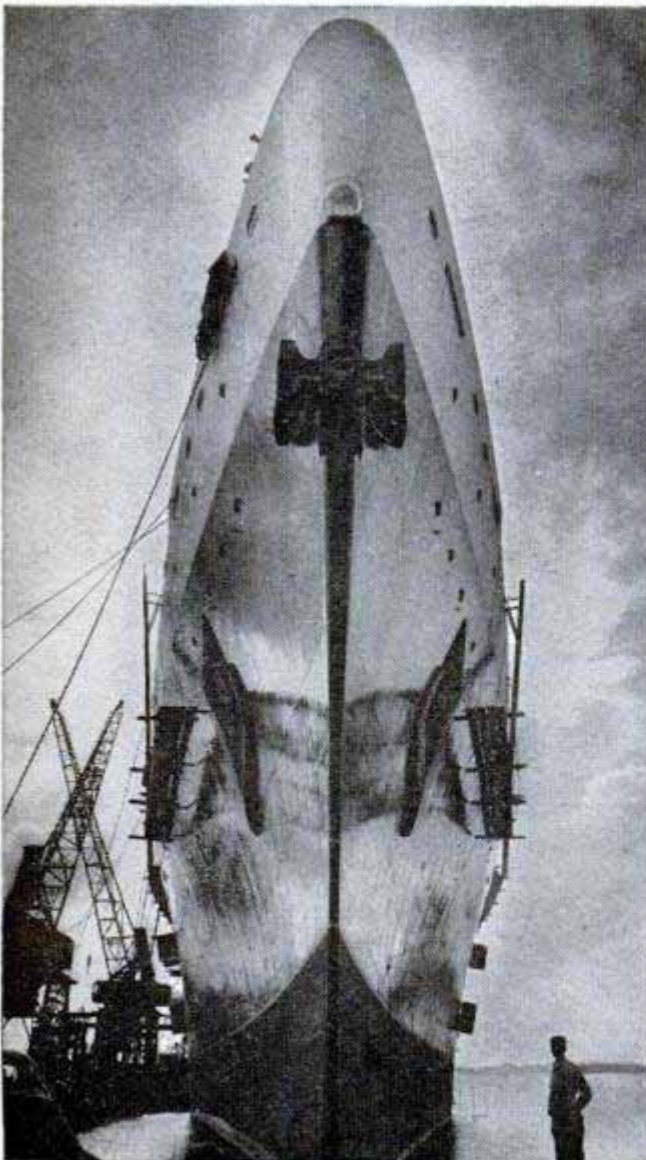



only the bright luminaries—the Edisons and the Fords—but your machines serve you well because the 400,000 engineers of American industry, most of them as obscure as the coral that builds the atoll, are constantly measuring, checking, testing, designing, each playing a vital role in the great American game of doing things never done before.

If the merit system is ever used in erecting statues, some day there will rise a monument to a shirt-sleeved young man with eyeshade and sliderule—or perhaps he'll squint through a transit or wear dungarees stained with lube oil. They could carve on the plinth: The Man Who Makes Things Work—The American Engineer.

This year is the centennial of American engineering. There have been engineers since man made crude weapons, harnessed

fire and contrived the wheel, for an engineer, as Dr. Vannevar Bush puts it, "is a man who applies science in an effective manner to supply human needs and desires." But for centuries, engineering was considered a military science, and its practitioners had no formal standing in the crafts of peace. Then in 1852 the American Society of Civil Engineers was formed in New York, "civil" meaning "nonmilitary." Later the title became limited to builders of bridges, highways, harbors, dams and the like, while those who worked in chemistry, mechanics, metallurgy, agriculture, automobile design, aviation, radio, motion pictures and a score of other specialized fields branched off to form their own groups.

In a single century, American engineers have transformed a horse-and-oxen outland into a dynamic industrial complex,

Engineers below are at work on hydrogenation plant where other engineers will make products from coal

# of America

Behind the scenes of America's growth during the last 50 years are the engineers who have made possible the building of giant dams and power plants, ships and planes that have broken records on the ocean and in the sky, bridges and highways and railroads, houses and skyscrapers, factories where modern mass production was born

Union Carbide photo



A  
50<sup>th</sup> ANNIVERSARY  
FEATURE



B-47 soaring here into the skies with jet take-off was created by Boeing engineers shown at bottom of page

in which seven percent of the world's people, living on six percent of the world's land, do forty percent of the world's work. High on the long roster are the names of Edison, engineer of the light bulb; Bell, of the telephone; Tesla, father of alternating current; Steinmetz, creator of the mathematical language of electricity; John Ericsson, builder of the first ironclad naval vessel; Simon Lake, builder of the first successful submarine; Haynes, Ford, Duryea, Winton, the Stanley brothers et al., of the horseless carriage, the immortal Wright brothers, and Sikorsky, of the helicopter. Their names stand out, but behind each stood an indispensable supporting cast.

The skyscraper owes much to many men. Peter Cooper introduced structural iron beams when he built Cooper Union in 1857. Other men followed, in 1885 William LeBaron Jenney, designing the Home Insurance Building in Chicago, created the load-bearing steel skeleton and demoted outer walls to "skin," thus siring the lofty symbol of the American metropolis.

Pioneers in bridgebuilding were James Buchanan Eads, who completed the first great steel-arch bridge across the Mississippi at St. Louis in 1874, and John August Roebling, wire manufacturer and civil engineer, who in 1855 refuted skeptics by introducing the wire suspension bridge at Niagara Falls, and who later used the same technique in designing the great Brooklyn

Bridge. In subway design, the great name is William Barclay Parsons, creator of the New York system; in city water-supply systems, John R. Freeman, and in irrigation dams, John Savage, designer of the Hoover, the Grand Coulee, and of other dams in China and India.

In the last 50 years, the pace of engineering has accelerated. The science of electronics has spawned a new breed of engineers and, by creating new instruments and tools, has incredibly widened the horizon of their nonelectronic brethren. It was on New Year's Eve, 1906, that Lee de Forest, Yale Sheffield graduate who studied under the great Willard Gibbs, ran through the rain to his laboratory on New York's 14th Street with a shoe box containing two fragile tubes packed in cotton wool—the world's first triodes, in which the revolutionary third element was a platinum wire bent roughly in the shape of a kitchen grid-iron. This first amplifying tube—the result of years of pioneer engineering—lasted only 30 minutes, but it ushered in modern radio and television, long-distance telephony, facsimile, electronic welding, talking pictures, radar and giant computing machines, changing forever the life of man and making jobs for hundreds of thousands.

Other epochal advances in electronics were conceived by Edwin H. Armstrong when he was a student of electrical engineering at Columbia under the great Prof.



Michael Pupin. Working with the early feeble amplifying tube. Armstrong thought its output could be increased by feeding back some of its outgoing energy into the grid. The result was regeneration, one of a series of advances which made it possible to replace the "model T" radio's one-man earphone with a loudspeaker which could be heard by crowds. But when Armstrong boosted the signal, he also helped to create static, and he and Pupin went back to the laboratory in an attempt to slay the raucous monster. Years later, Armstrong brought forth frequency modulation, now enjoyed by millions of exacting listeners who like their fidelity high, and by other millions to whom mobile two-way FM systems bring prompter taxicab service.

There are many other cornice-worthy names in electronics, none of whom could have done his work without the guidance of his seniors and the help of little-known assistants. Hundreds of engineers today can point to improvements in the giant electronic structure and say "I did it."

Today's transportation system, with its intricate complex of automotive production, oil refineries, highways, railroads and airlines, was made possible by engineering developments in motors and fuels during the last three decades. The long campaign to squeeze more power out of gasoline began when Dr. Thomas Midgley, Jr., a young mechanical engineer from Cornell, set out to find an additive for fuel that would silence an engine's knock, and came up with tetraethyl lead. Then it was found that the new fuel made possible engines of high compression

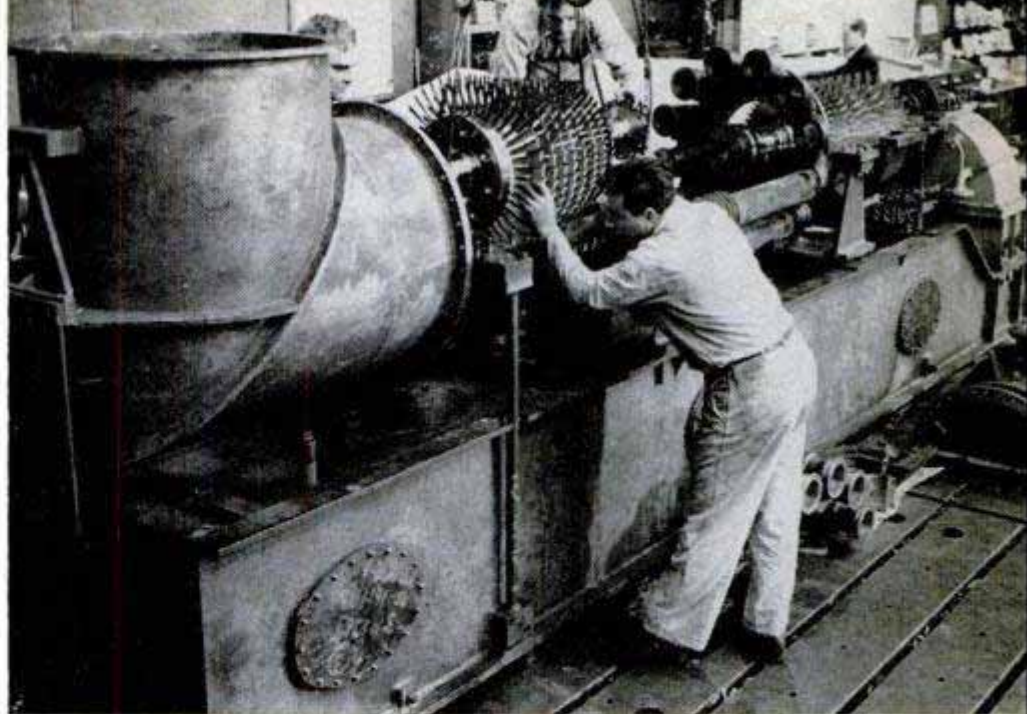

Westinghouse photo

Engineers at work on 2000-horsepower gas turbine for locomotive expect it to compete economically with diesels and steam. It burns heavy oil



Los Alamos Photo Laboratory

It took engineering skill to solve the problem of handling radioactive materials in atomic laboratories. Unit above is used for weak radiation. Below, Chesapeake Bay bridge, longest span, is an engineering triumph



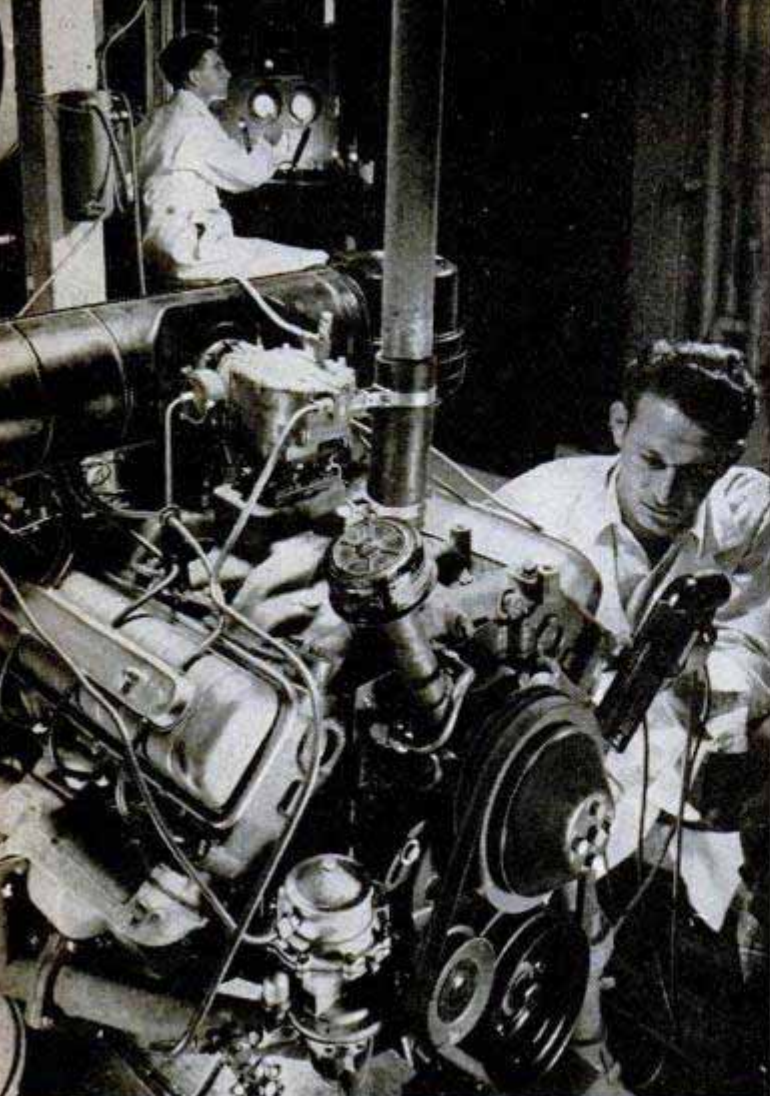

General Motors photo

Automotive engineers work constantly to improve engines; above, three high-compression jobs in test



Westinghouse photo

An engineer uses anechoic (no echo) chamber in big acoustics laboratory to check hum of a transformer

that would perform more work per gallon; the Chrysler engineering trio of the '20s, Zeder, Breer and Skelton, brought out the Red Head engine, and the race for still better fuels and engines was on. Engineer Eugene Houdry came over from France with his catalytic cracking plan for building high octanes without the use of lead; other "cat" cracking systems followed, and soon 100-plus-octane fuel was ready to increase airplane speeds and cut flying time to all parts of the planet.

Other engineers, notably self-taught Clesie Cummins of Columbus, Ind., and a staff under the direction of Charles F. Kettering of General Motors, took the cumbersome diesel, sweated it down to drive trucks, busses and streamlined trains, and paved the way for its possible widespread use in passenger cars. The gas turbine owes much to Sanford Moss who, as an engineering student at the University of California in 1896, "invented" it without knowing that others had proposed it. Many years later he built it in the form of the turbosupercharger of World War II, which used power from hot exhaust gases to pack in air to push bombers to high altitudes, and contributed greatly to jet-plane engineering. In 1919 Robert H. Goddard of Clark University,

popularly regarded as a fanatic who wanted to fly to the moon, wrote a paper about his rocket experiments which was avidly read in Germany by men who later built the V-2. Because of his pioneer work, experimental rocket ships will soon fly at 100,000 feet; later they may penetrate outer space.

All these developments are mere beginnings. We are on the threshold of a technological boom that will make the work of recent decades look like the primitive gropings of a caveman, for the overlapping nature of various advances has drastically slashed the time lag between discovery and utilization. For instance, engineers are working on a possible relation between the atomic bomb and food spoilage. The AEC is now burying radioactive waste fission products in the ground. Foods can be sterilized by radiation. Can we put two and two together and get a four that means indefinite open-shelf storage of foods now highly perishable? Or consider the economic effect of de-salting sea water on southern California, and the coastal areas of Peru, Chile and Australia.

Dr. James B. Conant, gazing into his "plastic ball," has hinted that economic utilization of solar energy may come in before we get cheap power from atomic

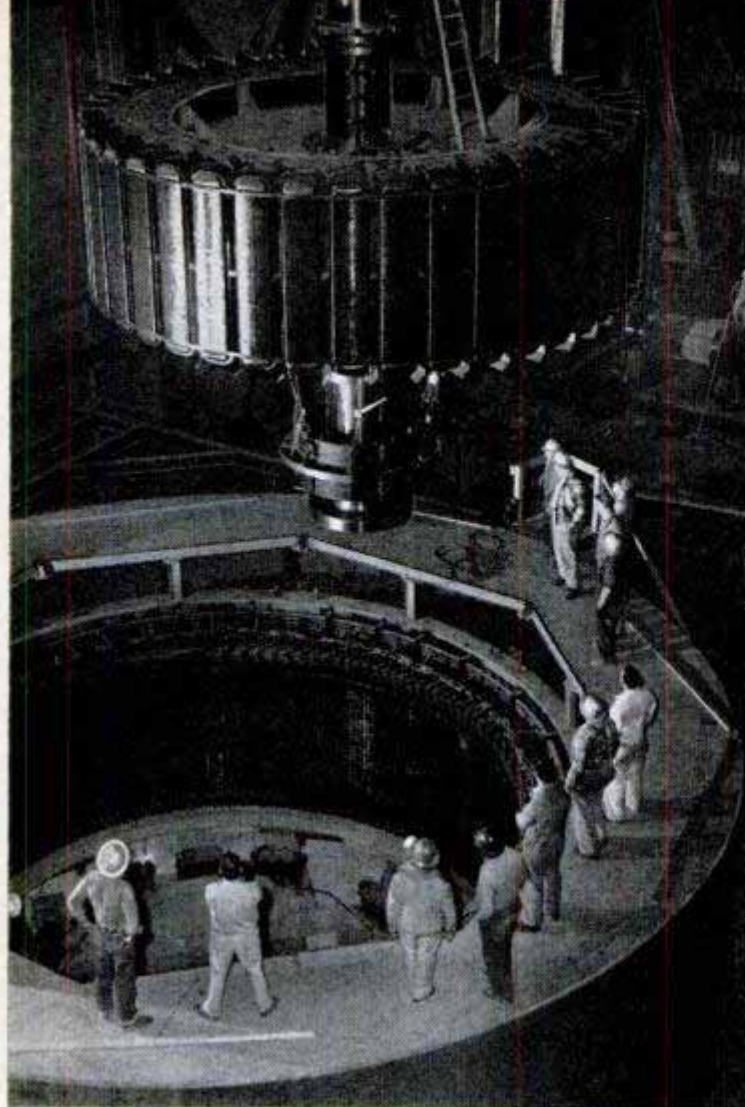

Engineers look on while a million-pound generator rotor is moved slowly into position for lowering into the generator stator at Hungry Horse Dam, Mont.

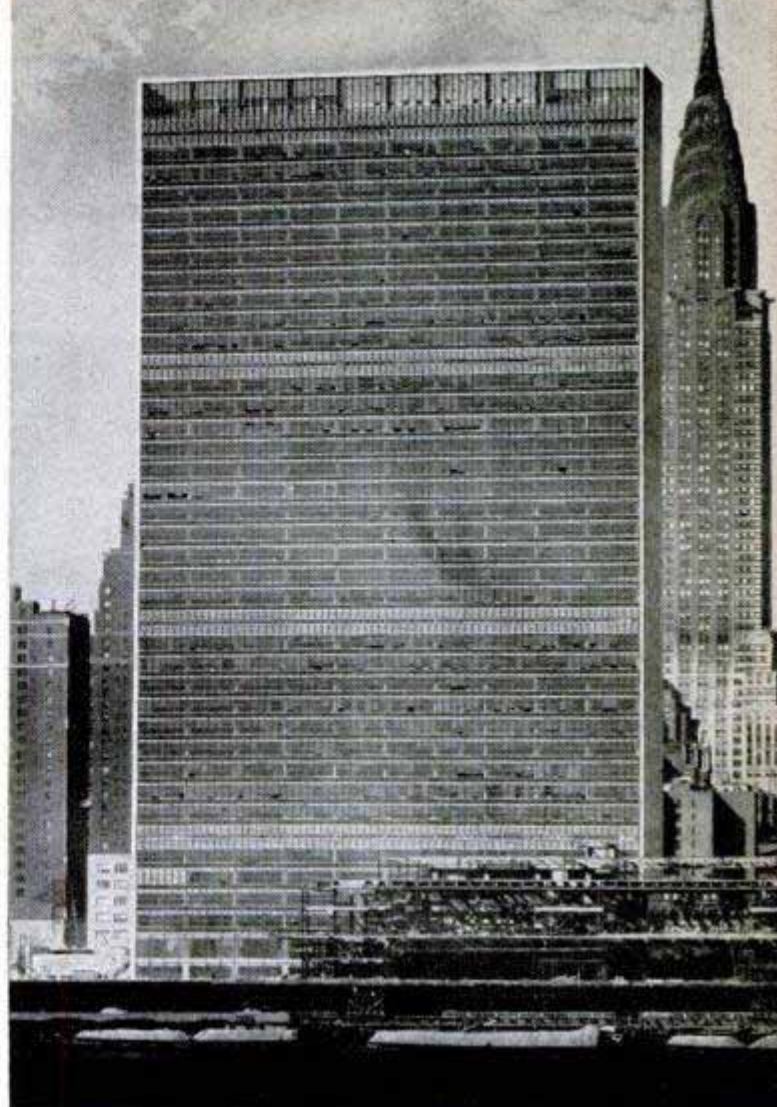

Every big city in the U.S. contains skyscraper monuments to engineering skill, such as the United Nations building. Below, cosmotron in atom laboratory

Brookhaven National Laboratory photo

plants. Engineers are working on it. And hundreds of other engineers are working on the more efficient utilization of oil, coal and gas. Some, like E. M. Barber of the Texas Company, are building "mechanical octanes" into automotive engines to enable high-compression motors to run on kerosene; others are pushing the use of high-octane "bottled gas" as a motor fuel, and still others are exploring the cheap underground gasification of coal to save labor and add to the world's fuel supply. Many a boy now in high school may help to achieve these goals.

There is a challenge to chemical engineers in the new fluorocarbon resins, which promise harder and more durable plastics and new lubricants and coolants. Thousands of possible synthetic-rubber polymers await combination; some of them may bring us synthetic truck tires that won't overheat, further reducing our dependence on the rubber tree, and others may reach that millennial goal—the tire that lasts as long as the car. Future engineers may find a bonanza in the now-wasted lignin released from wood in pulp plants, and others will undoubtedly discover newer and better

(Continued to page 258)

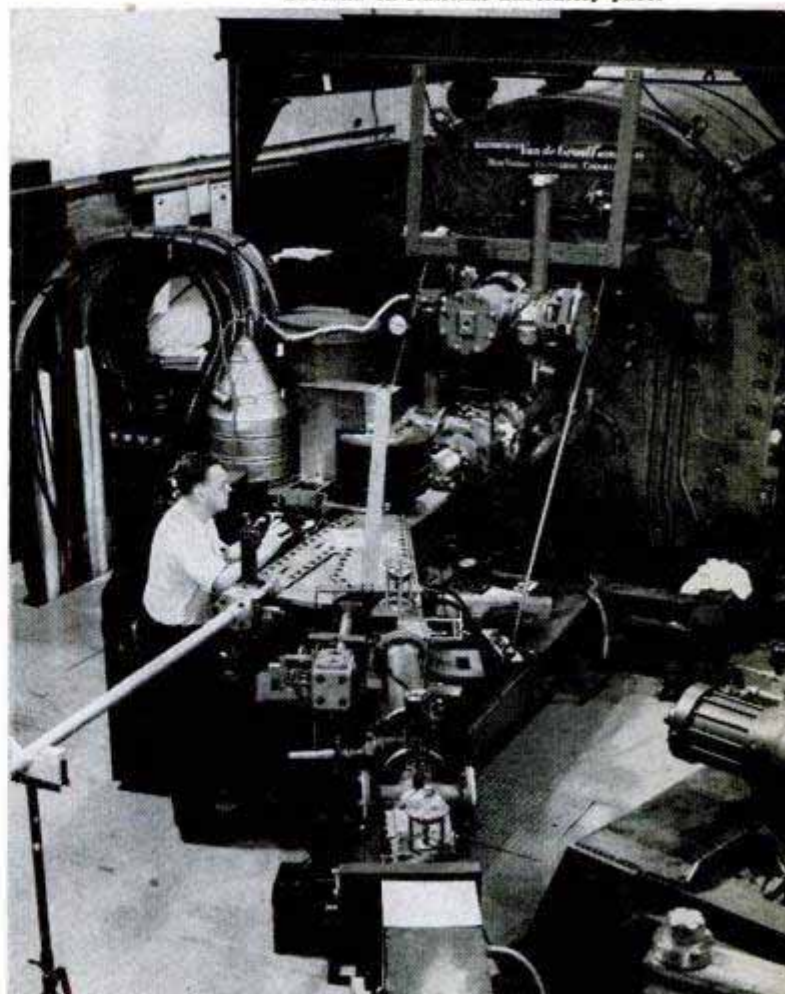

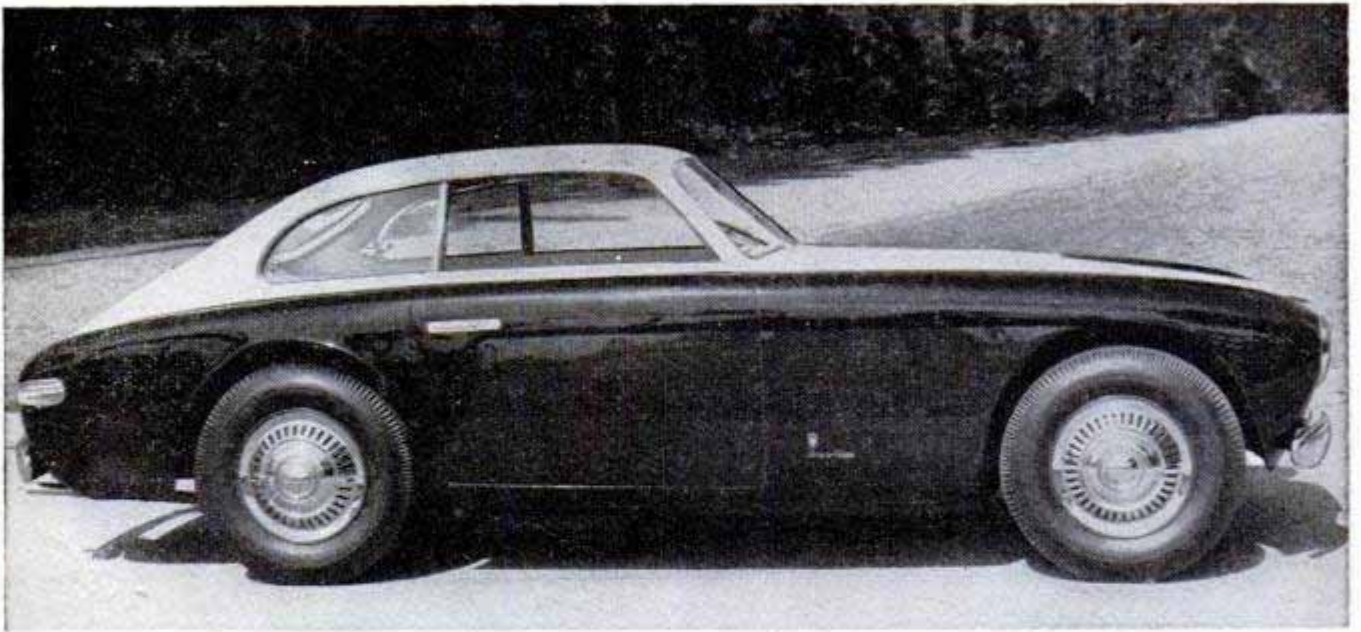

## Cunningham Hardtop Has Italian Body

Combining the race-bred American C-3 chassis with the Continental styling of Vignale in Italy, the new Cunningham hardtop model gives performance plus beauty. Functional streamlining has almost completely eliminated wind noise at high speeds, according to the manufacturer. The lightweight but strong chassis is powered

by a Chrysler V-8 engine equipped with four carburetors. It combines race-car performance with limousine comfort. Powerful brakes, which stop the car in a fraction of normal braking distance, and careful weight distribution make the fast car extremely safe to operate. Delivered at the factory, it will sell for \$9000 plus taxes.



## Rotary Tiller With Rotary-Mower Attachment

With a new rotary tiller, the homeowner can mow his lawn as well as cultivate his garden. The machine prepares a level, aerated seedbed and fills depressions in the ground. It cultivates within an inch of growing plants and tills a 12-inch swath up to 7 inches deep. The rotary mower is

attached to the machine with four bolts. It cuts a 16-inch strip.

☐ Cherrapunji, India, holds the world's record for the greatest amount of rainfall over a period of two years—1605.05 inches, about the height of a 12-story building.



Lined up on the Bonneville Salt Flats ready for their trials, are super hot rods with "push" cars in between

# Hot Rods Burn Up the Desert

By Thomas E. Stimson, Jr.

**A**MATEUR SPEED enthusiasts who set more than a score of new automotive records at Bonneville late in August are laying plans to capture for the United States the world's unlimited speed record for the flying mile.

They won't do it this year and probably not in 1953, for John Cobb's two-way average of 394 miles per hour (403 one way) is far beyond the capability of any amateur

car built to date. Yet, year by year, the hot-rod drivers are getting closer to Cobb's record.

Four years ago at the Bonneville national speed trials the fastest car was timed at 189 miles per hour; in 1950 the best speed was 210, and last year a twin-engined streamliner was clocked at an average of 221 miles per hour. This year the same Bill Kenz streamliner, powered by two Ford V-8s that

Body of "lakester" class car consists of an aircraft drop tank (top removed here showing driver in seat)

Engine of this lakester entry is a reworked Chrysler FirePower. Fuel injectors replace usual carburetor

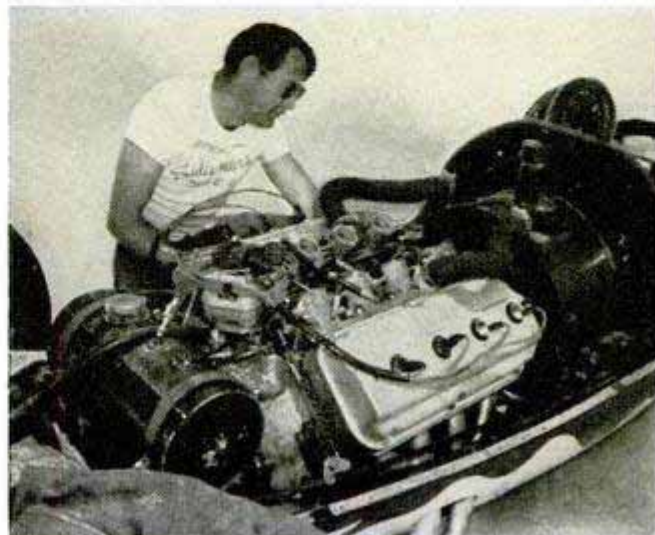
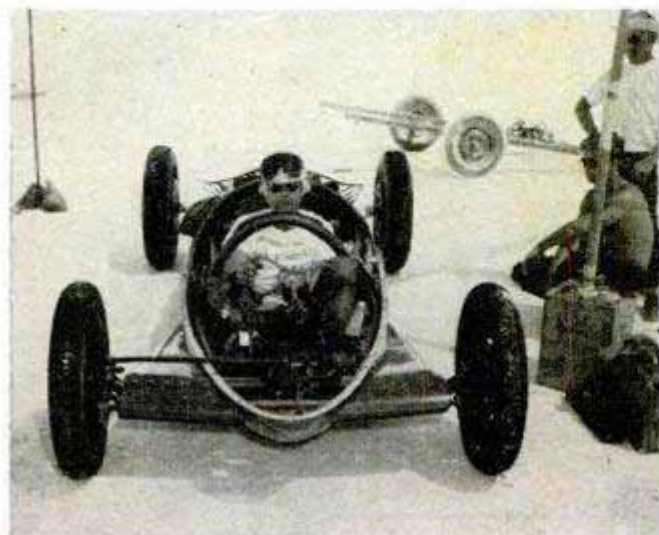

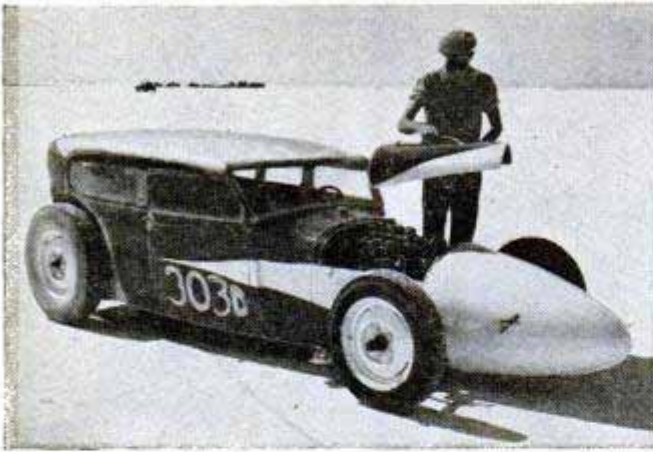

With fenders removed, a new streamlined nose and the top lowered, this entry was in the nonfender class

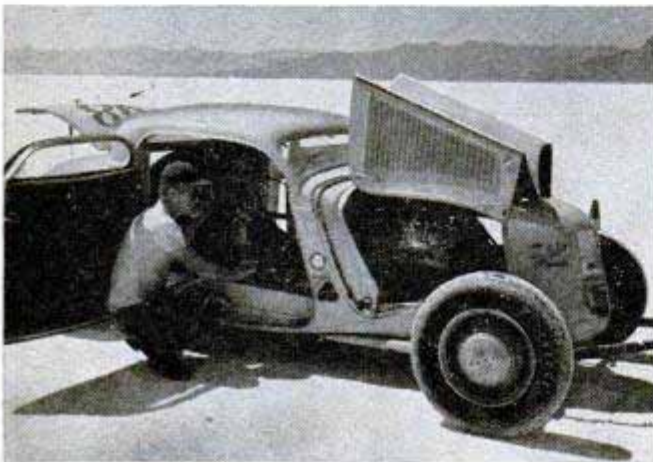

The top of this competition coupe was chopped down to an extreme degree to afford better streamlining

In the unlimited streamliner class, Bill Kenz of Denver set a record of 244 miles per hour with car below

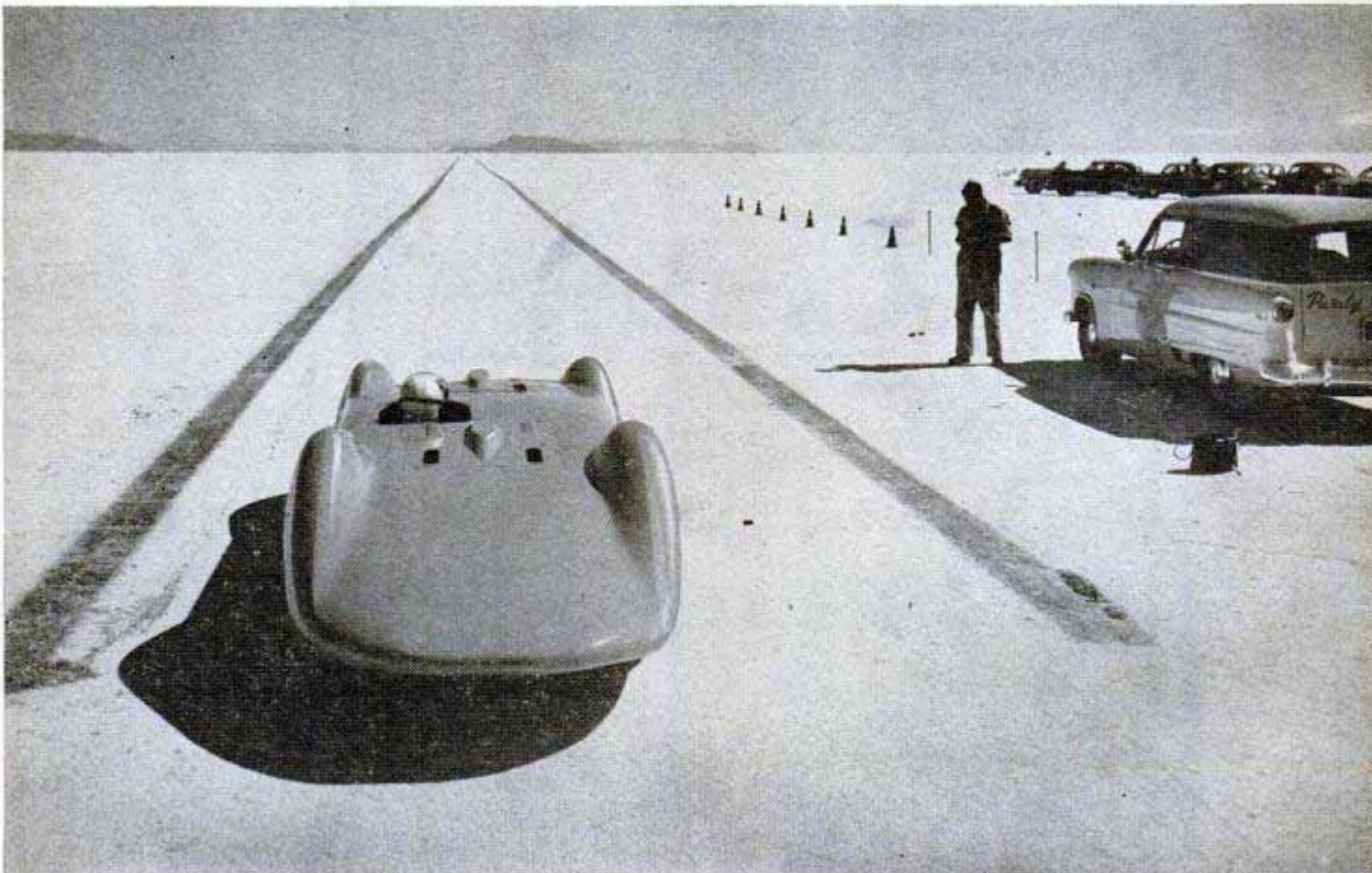

develop 225 horsepower each, jumped its speed to 244 miles per hour, two ways along a measured mile. On one part of the course the car was clocked at 252 miles per hour.

With the know-how that they are acquiring at Bonneville, several different groups of amateur builder-drivers are about ready to design and build cars capable of 400 miles per hour or better. One group would use a pair of souped-up Chrysler FirePower engines in a very light chassis, another group plans to rework a pair of Allison aircraft engines to develop more than enough power. All of them are designed to hug the ground at high speed to avoid literally flying into the air.

The chief obstacle at present is the problem of tires. Cobb had special tires that were built to secret specifications and that aren't available in this country. The best tires that we have, the Indianapolis race-car type, are not good enough even for the speeds being made today by amateurs on the salt flats. The streamlined hot rods use Indianapolis tires from which most of the rubber has been deliberately buffed away to prevent the treads flying off from sheer centrifugal pull at high speeds.

Even so, portions of the tread of both front tires of the Kenz car were thrown off during his record run. Another driver blew a rear tire at 180 miles per hour, felt a slight bump, and managed to hold the car





Roadster (center) approaches one of the electric-eye timing devices at Bonneville; timer's stand at left

under control when it had decelerated down to 100 miles per hour. A third car blew both rear tires while traveling at 240 miles per hour.

The Bonneville national speed trials are the nation's premier amateur automobile classic, held the last week of August on the glistening white surface of an enormous salt flat in the desert 125 miles west of Salt Lake City. It's a week of speed on a wholesale basis, with an average of a car a minute howling along a six-mile-long course. Two-way runs for records are held in the mornings; one-way tune-up trial runs are held in the afternoons.

The event is sponsored by the Southern California Timing Association and is open to anyone with a fast car that can pass the stringent safety requirements. All drivers pay a \$15 fee that permits them to go through the time traps as often as they desire during the week.

This year some 225 different cars raced against time at Bonneville, with many of them changing engines after setting a record so that they could qualify to compete in a different class. Half a dozen of the cars were clocked at better than 200 miles per hour. Time is taken on a quarter-mile time trap for trial runs and over a pair of mile-long traps for official records. A Crocker electric-eye timer-printer that immediately shows the speed of a car in any of the traps is used. The cars don't race against each other, they are flagged away from the starting line one at a time.

Competition is divided into 14 different classes, including sedans with and without fenders, roadsters and modified roadsters,

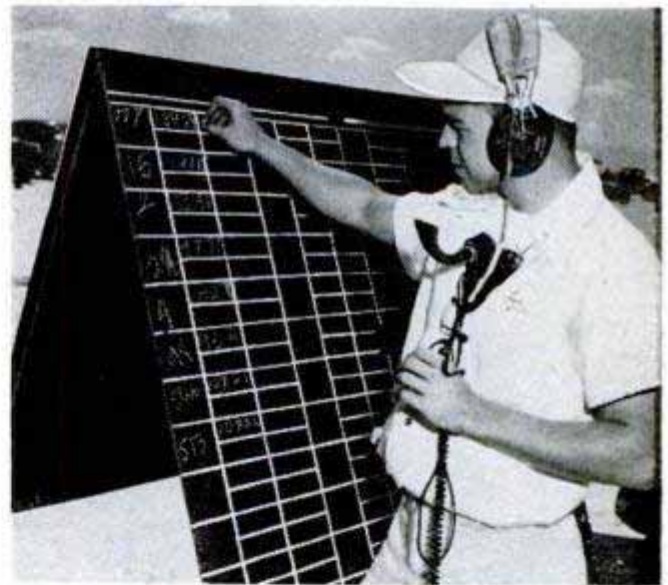

Recorder's phone is connected to timer's stand and he enters car numbers and speeds made on each run

competition coupes, "lakesters" with aircraft wing-tank bodies, and true streamliners. These classes are subdivided into five groups according to engine displacement, making a total of 70 different competition classes. The event is also open to stock cars, modified stock cars, and motorcycles.

This year new records were made in practically every class. A modified roadster powered by a V-8 60 made a two-way average of 137 miles per hour, a phenomenal speed considering its small engine. Another roadster with a reworked Mercury engine was clocked at 166 miles per hour, another record, and a similar engine in a lakester wing-tank body was timed at 198 miles per hour.



Fuel lines (above) feed three carburetors of sedan (below) which burned up desert at 135 miles an hour

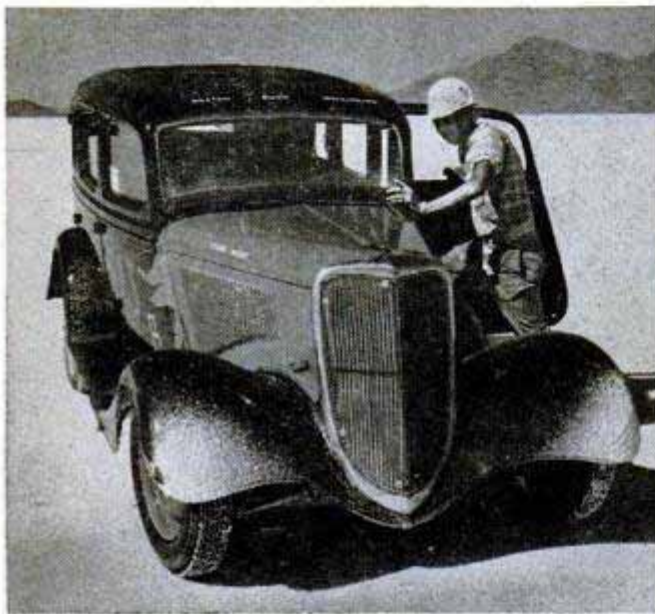

Below, at start of six-mile straightaway, a drop-tank lakester gets started with aid of a push car

Competition coupes and roadsters in particular are weird-looking vehicles after they have been modified as much as the rules permit. Many of the cars have long snouts in front for better streamlining, all of them are lowered toward the ground as much as the rules will allow, and the interiors are "gutted" of all upholstery.

An example is a sedan built by Willie Waddill of Flint, Mich. The frame of this car consists of a thin-wall inner-drive-shaft tubing and the whole chassis weighs less than that of a Model A. The power plant is a reworked Cadillac engine equipped with two four-throat carburetors and delivers close to 300 horsepower. Over this race car is mounted the reshaped body of a Crosley sedan.

In their efforts to achieve greater speeds, most of the hot-rod designers dispense with radiators. Engines get sufficient cooling from water circulated from reservoirs. One owner fueled his roadster with racing fuel plus pure oxygen that was pumped to the carburetors from a special tank. Molded glass-fiber bodies were used by half a dozen builders.

Representative of the most advanced cars in this year's trials was the City of Burbank, a 17-foot-long streamliner that weighs 1750 pounds and whose molded glass-fiber body stands only 33 inches high. It was built as a hobby by George Hill, a heat-treater, and Bill Davis, a carpenter, both of Burbank, Calif. The car represents a cash outlay of something less than \$3000 and yet on its first try it set a new world record of 230 miles per hour for its class, breaking the German-made record.

The car is powered with a Class B type

(Continued to page 298)

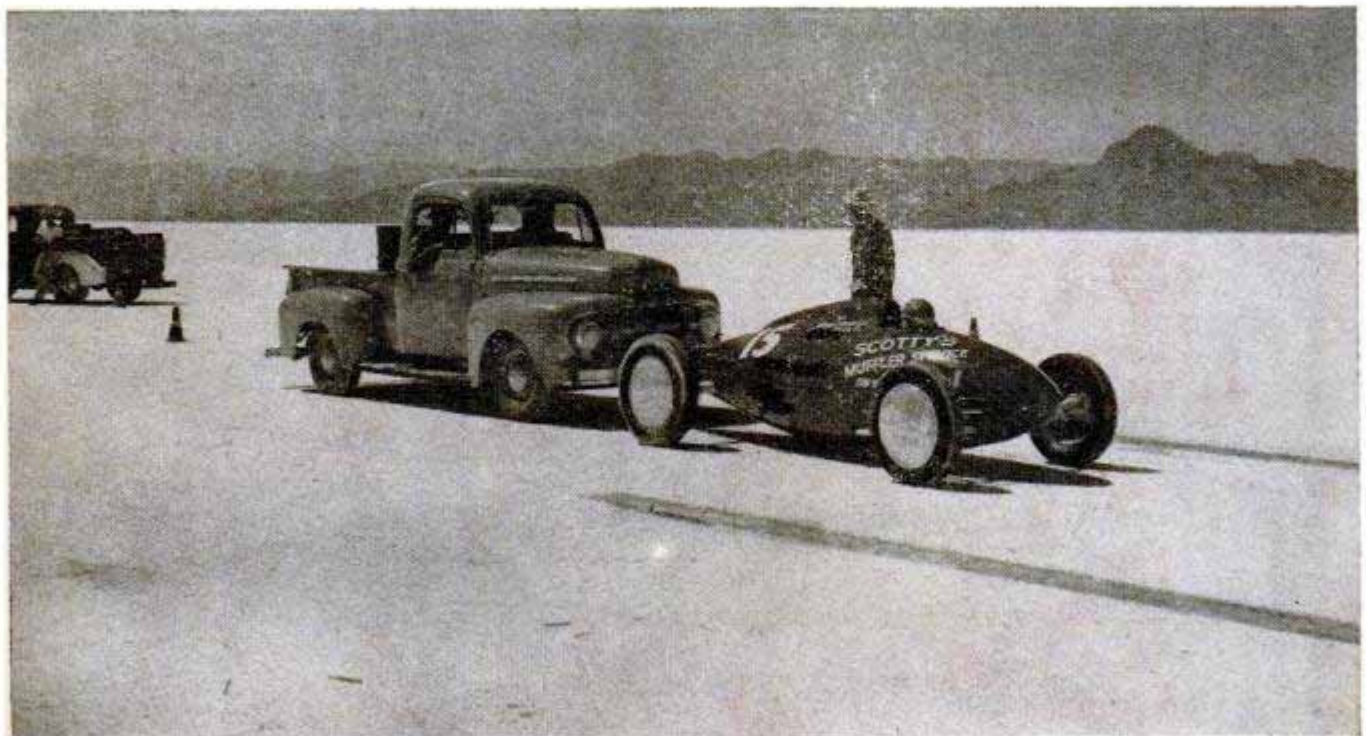



## Insulated Rubber Lifeboat Keeps 15 Survivors Warm

Inflated in only 30 seconds, a 15½-foot rubber lifeboat will provide protection for 15 men in either subzero or blistering tropical weather. A temperature of about 70 degrees is maintained inside the cabin of the lifeboat by dead-air-space insulation in both the canopy and floor liner. In cold

weather, the insulation holds in body heat of the survivors to boost air temperature. In extremely hot weather, the insulated floor liner can be removed to take advantage of the cooling effect of the water against the boat bottom. The liner can be towed as an additional life raft if necessary.



After the deflated package is thrown into the water, a release cable is pulled and carbon-dioxide gas snaps the 230-pound boat out of its carrying case. The insulated canopy takes shape as gas fills the arched rubber columns that support it. An automatically released sea anchor holds the boat steady during boarding. The boat also contains 50 pounds of canned drinking water, desalting kits for sea water, 30 pounds of rations, paddles, as well as other items of survival equipment.

## Indoor-Outdoor Electronic Golf Driver

Bad weather conditions do not interfere with practice on an electronic golf driver that can be used indoors or outdoors. It registers both the distance and the direction of each drive on a light panel. The ball is natural rubber molded onto a spring steel stem and it is never driven off the "tee." The distance of each drive is determined by counting the number of revolutions of the shaft to which the ball is attached. The shaft is mounted within two sets of gimbals which provide information as to whether the ball was hit properly, grounded, hooked or sliced. Designed for coin operation, the machine may be easily converted to continuous operation simply by pulling a plug.

Lining up a tee shot on the electronic driving machine is Babe Zaharias, one-time women's professional champion



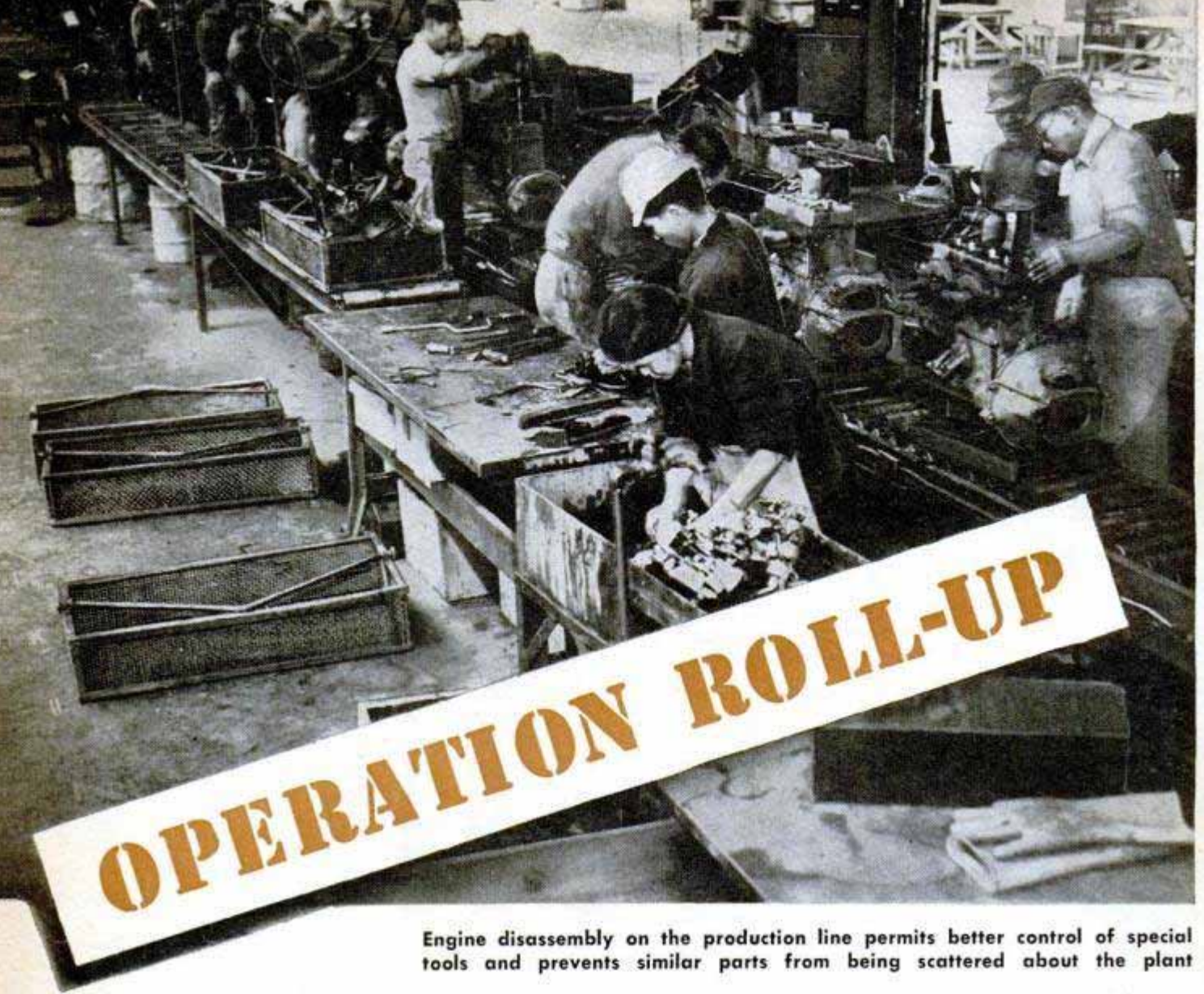

Engine disassembly on the production line permits better control of special tools and prevents similar parts from being scattered about the plant

From beginning to end, the engine-rebuilding "production line" is traced on this and the following two pages

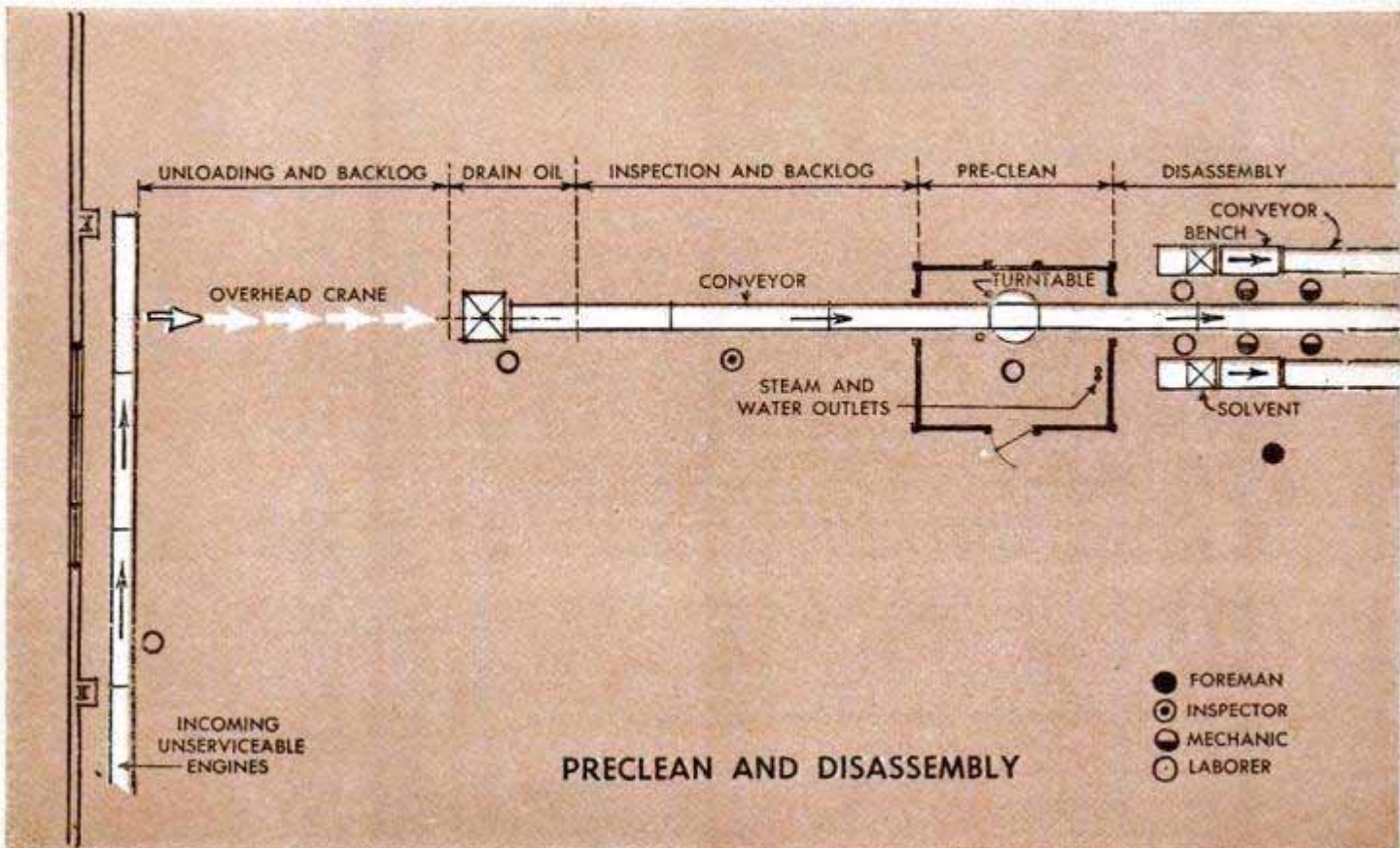

Precleaning of all unserviceable engines is done on a special turntable made from a truck rear axle

By E. L. Klein

PRIOR TO 1948 the repair of vehicles of the U. S. Army occupying Japan was accomplished by field maintenance units and Depot Ordnance shops using the "Stall Operation" method. This method is especially adaptable to vehicles requiring lesser repairs such as the grinding of valves, replacement of piston rings or adjustment of the carburetor.

In 1948 the problem demanded a more thorough and complete method of repairing the vehicle and its major components, a method which extended to actual remanufacture. The engines had to be disassembled for their component parts, and those parts subsequently repaired and effectively reassembled as new engines. Years of open storage on the Pacific islands and the battle damage to which the vehicles were subjected necessitated this extensive procedure. The quantities of vehicles and associated equipment to be handled by ordnance in Japan after World War II, in the operation known as Roll-Up, made a production-line method more economical and practical than the Stall Operation method for reclaiming the millions of dollars' worth of precious transportation assets gathered from far-flung Pacific islands.

The Army Ordnance Corps established a Base Industrial Group known as the BIG-5 to accomplish this task. A group of engineers

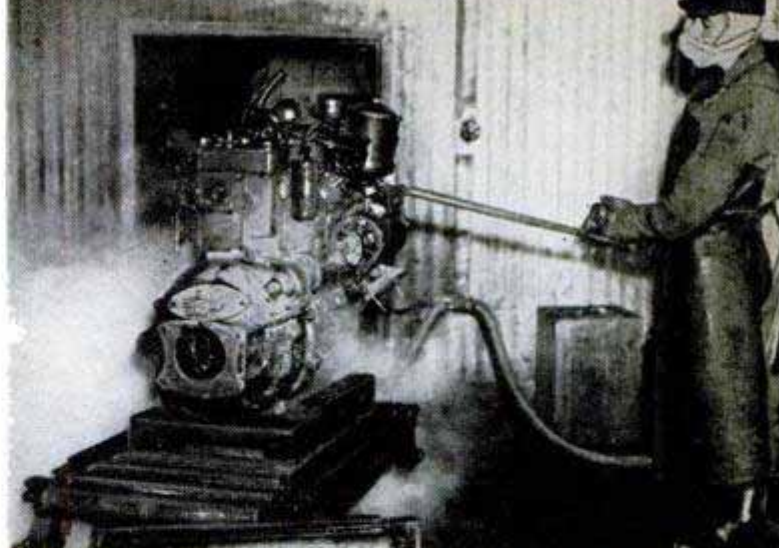

### Editor's Note:

The end of World War II found the islands of the Pacific littered with tanks and trucks and weapons, abandoned to jungle rot and rust. Fortunately Army Ordnance began in 1948 a tremendous rebuilding program in Japan, eventually putting to work 30,000 Japanese and 850 Americans to restore over 60,000 trucks, Jeeps and other vehicles, 700,000 weapons and 700,000 tires and tubes. Maj. Gen. E. L. Ford, Chief of Army Ordnance, said of the project: "If it had not been for the ROLL-UP program, we would not have been able to give support to the action in Korea in the early days." This report on the vital program was written for *Popular Mechanics* by the American who was its chief engineer for four years and is now back in the U. S.

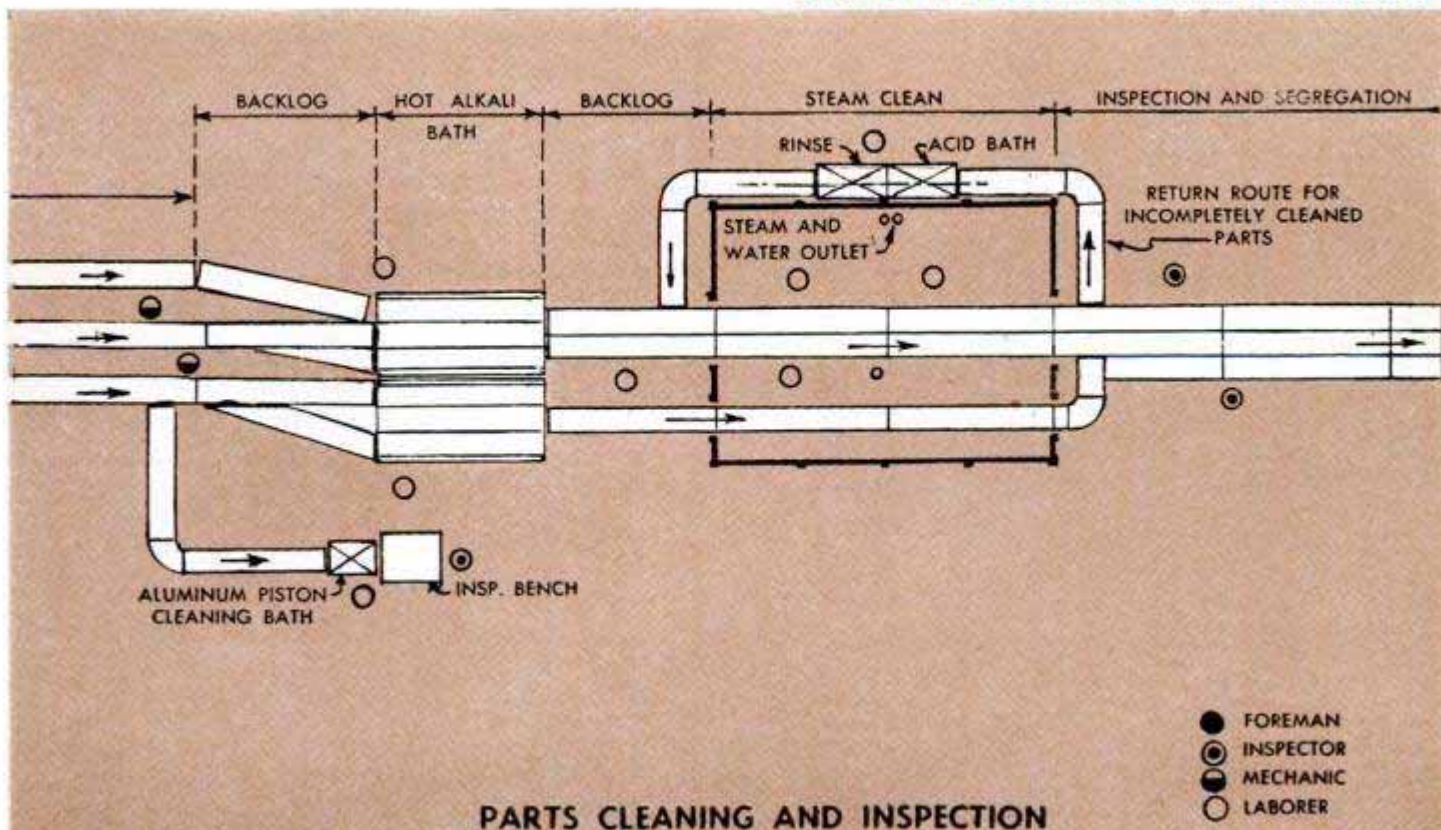

PARTS CLEANING AND INSPECTION

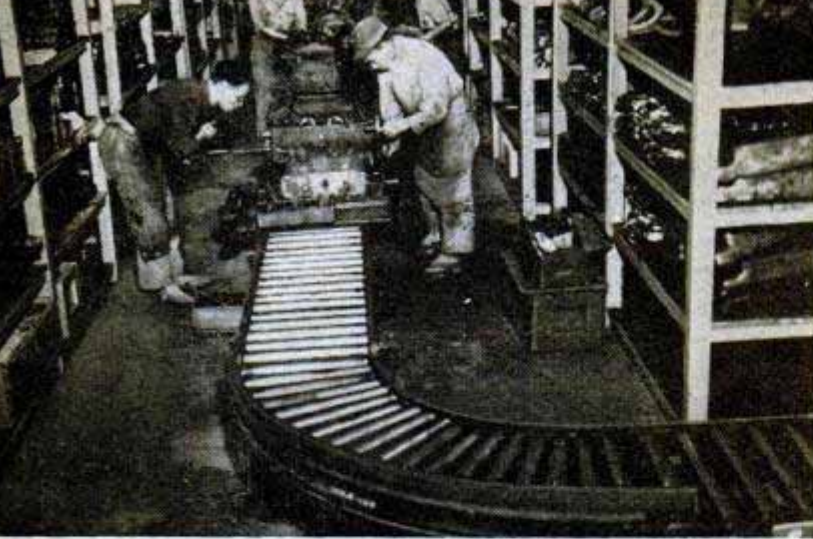

Parts bins alongside the line are easily accessible. Below, dynamometer testing of the completed engines

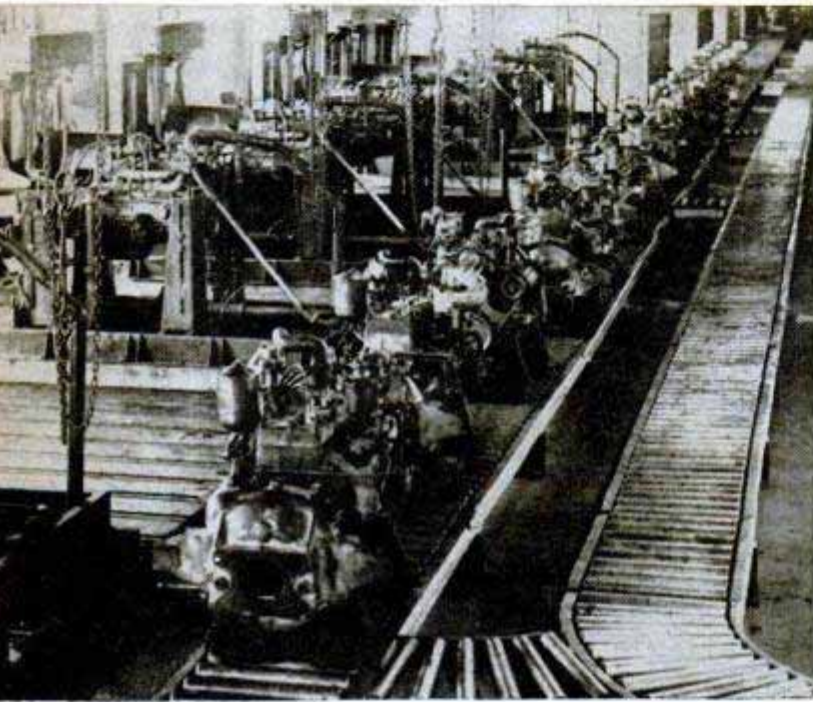

and inspectors was recruited in the U. S. to operate with the ordnance officers in the Pacific area. A nucleus of civilian industrial experts, proceeding as a team, traveled to Japan. Within five months they had designed, installed and put into operation the first mass-production line for engines.

Factories were surveyed and selected. Time studies were made. Thorough tool-engineering studies were completed to determine the best placement of machinery in the production lines. U.S.-made machine tools from the Roll-Up program, along with Japanese reparations machinery, were gathered, repaired and utilized to their fullest extent. Many specialized tools and fixtures were designed and fabricated to do specific jobs.

The training program for the Japanese mechanics and inspectors was one of the most significant phases in the development of this industrial project. Although the production lines were carefully designed so that each worker had a limited and specialized job to perform repeatedly, an extensive training program was conducted for the workers. They were instructed in the American standards of fits and tolerances of precision machine parts. They were taught scheduling and supply procedures.

Japanese supervisors and inspectors were put to work on the first production line as mechanics so that they might thoroughly understand the procedures and production-line problems. Thus they were better equipped to carry out their

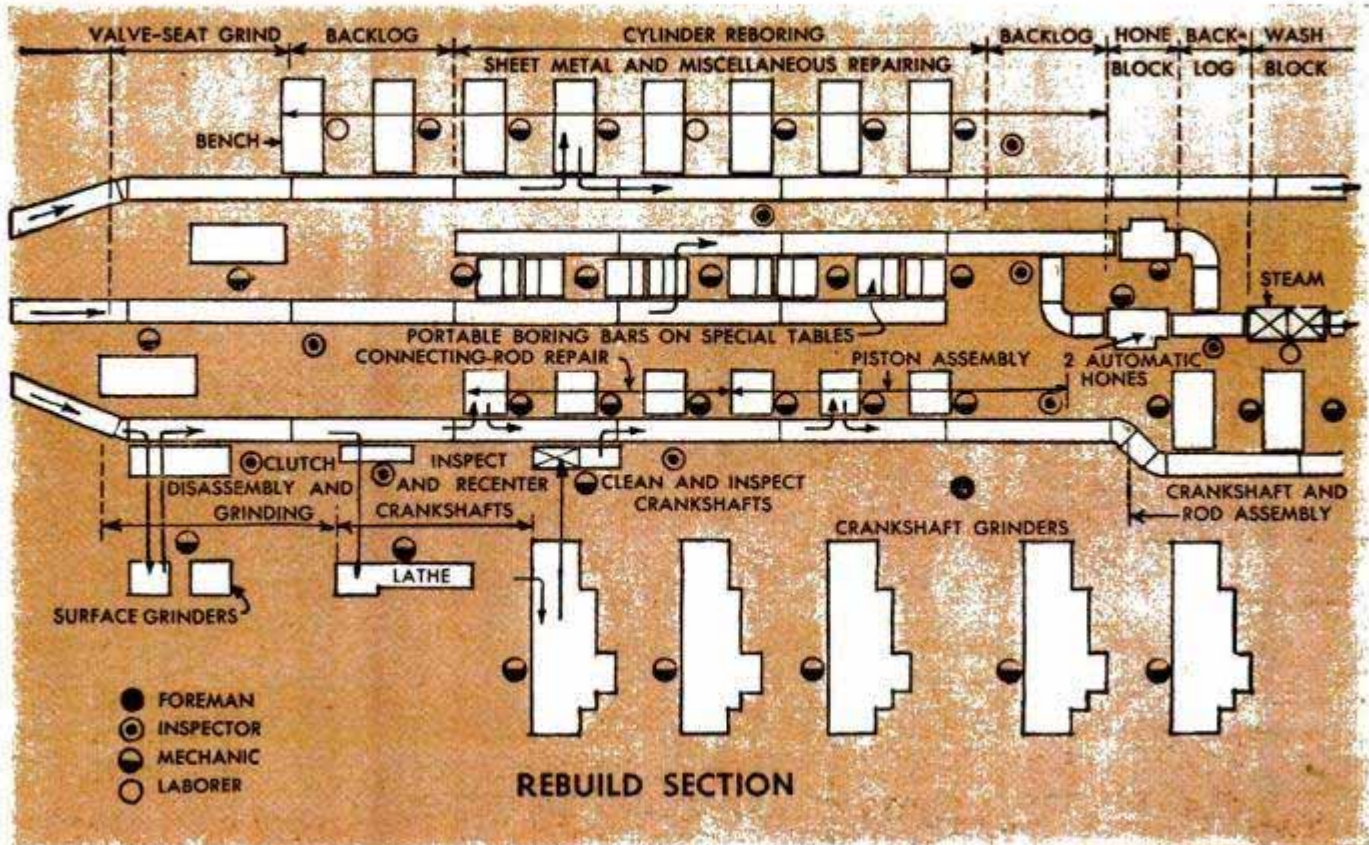

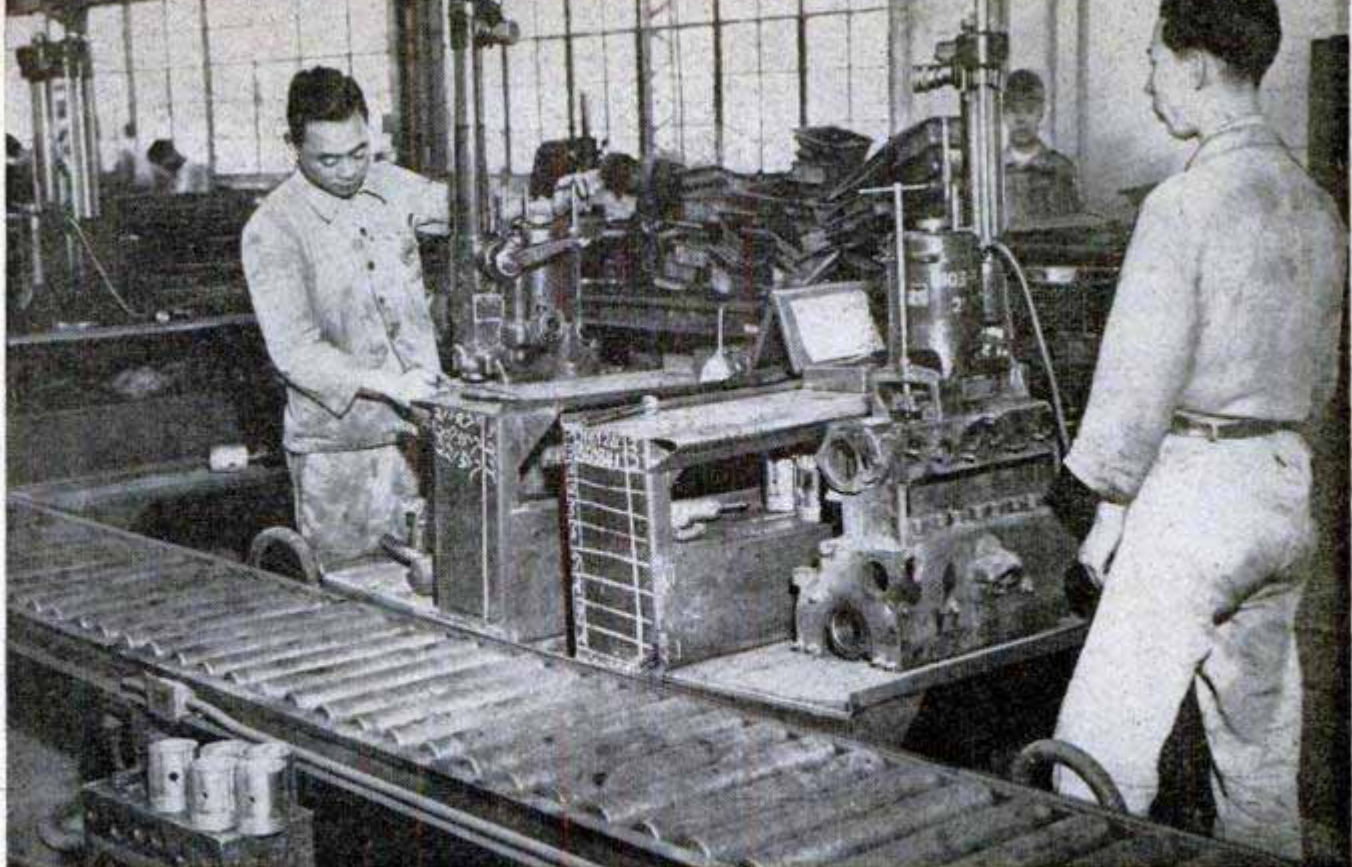

Japanese workmen reboring cylinder blocks on special tables made to utilize available portable boring bars

supervisory functions later. Farmers from the rice paddies and demilitarized soldiers were taught gainful occupations in the automotive field with stress being placed upon quality control. To teach the allowable wear limits and clearances of fit in the internal working parts of the engine, classes in precision-measuring instruments were conducted. Sample parts from unserviceable engines and other bilingual visual aids were employed.

Through the training program, production began before the plants had been fully converted and tooled. All engines and assemblies were put through a two-hour run-in and dynamometer test. Those failing were disassembled so that the faults and steps to correct them could be made known to the workers and inspectors in the responsible departments.

Spare replacement parts for the production lines were obtained from requisitions on U. S. depots. Other parts came from the mountains of boxes of unidentified supplies reclaimed through the Roll-Up program and from Japanese production. The manufacture of spare automotive parts was largely responsible for the general recovery of the Japanese automotive-parts industry, greatly aiding the rise of technical standards in an extensive use of detailed manufacturing plans and specifications. Unserviceable parts and scrap, accumulated due to their uneconomical repair, were disposed of through Army channels or reissued as raw material to the Japanese contractors who furnished replacement parts requiring critical materials.

After removing the parts from their shipping containers, the first step in the remanufacture of the unserviceable engine was to drain the crankcase oil and clean all external surfaces. Supply personnel performed an important role in collecting and "staging" the engines so that a continuous backlog would be available.

The external cleaning of the engine surfaces was accomplished in a clean, well-lighted compartment by the use of a mixture of steam and soap solution. Increased efficiency was gained by the removal of grease residue and road dirt. Disassembly operations could then be performed with a minimum of disruption.

Engines were disassembled on a production line—each man performing the same operation repeatedly with a minimum of selected hand power tools. Two automatic elevators dipped baskets of engine parts in a near-boiling alkali solution for 20 minutes to remove greases. After this, they were steam-cleaned and treated with phosphoric acid to remove rust. Nonferrous parts, such as aluminum pistons, were cleaned separately to prevent deterioration by the alkali.

Valve seats in the engine block were re-faced before the cylinder walls were rebored. Cylinder-wall cracks were readily detected in this operation and those blocks having cracks set aside for specialized handling. A battery of crankshaft grinders was installed between two engine production lines to allow shifting of the work load

(Text continued to page 256)

TURN PAGE FOR MORE PHOTOGRAPHS



## TRUCKS FROM JUNK

1

Department of Defense photos

Tens of thousands of trucks and Jeeps are awaiting rebuilding in Japan. Some were "knocked out" in Korea

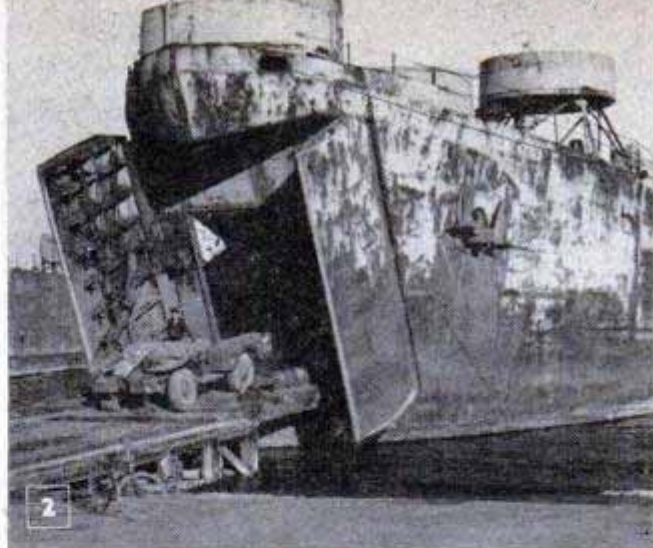

2

Reversing its job of bringing new trucks to the Pacific, this LST now carries wrecks back to Japan



4

Four to six years' storage in tropical climates took a toll of acres of boxes filled with parts and supplies

Nimble fingers sort bolts, nuts, screws and washers as they pass along on a fabric conveyor belt

Reassembly of trucks gets under way when frame is placed on the main line. Specially designed jigs handle the heavier parts for greater efficiency and safety. Compressed-air outlets speed the operations



7

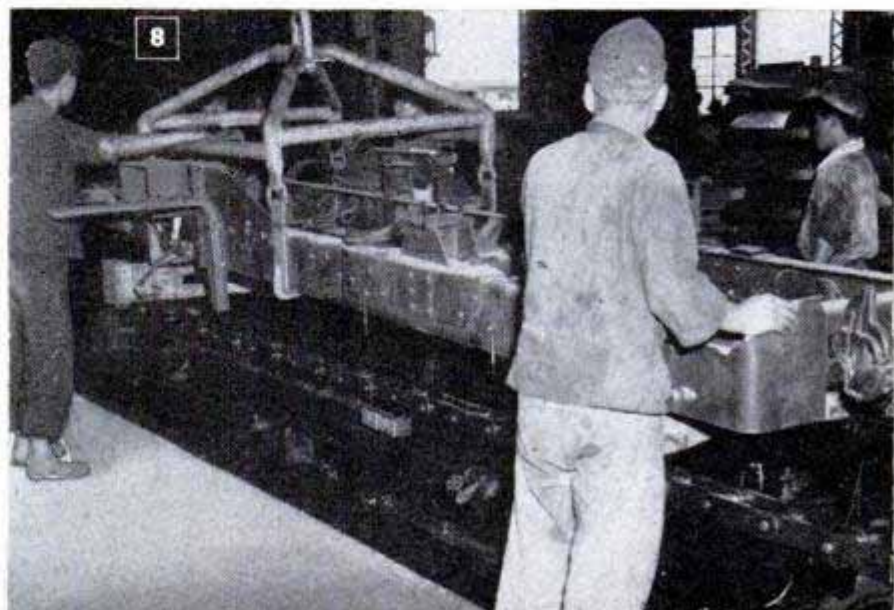

8





To handle the simultaneous unloading of several ships, a former Japanese seaplane ramp provided an ideal docking apron. Subsequent in-storage maintenance was an important factor in preventing further deterioration



Typical of many vehicles requiring remanufacture is "junkie" above. Excessive damage ruled out the possibility of repair

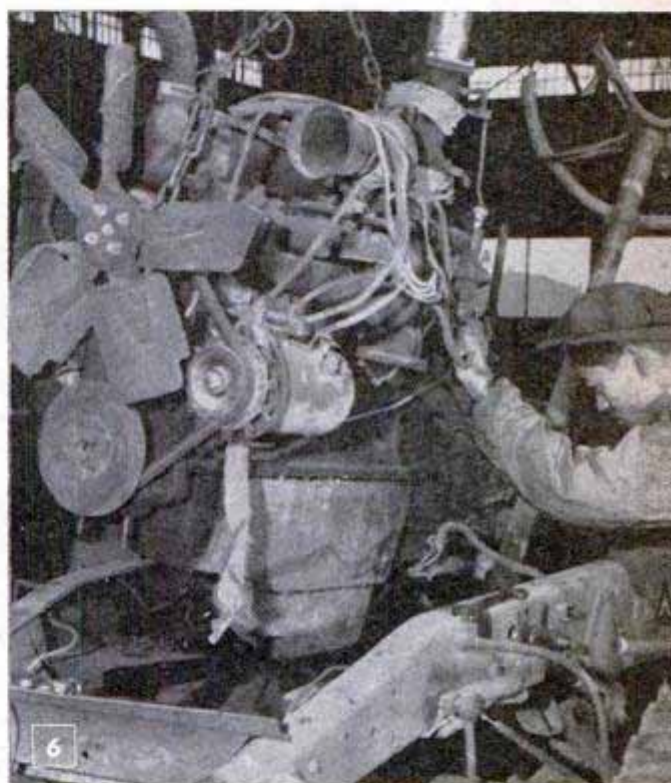

Steam and high-pressure water washing begins after all canvas and wood are removed

Condition of the frame determines the salvage frequency for trucks, and the body is the most important factor for Jeeps

Following their repair, all vehicles get a primer and a coat of olive-drab enamel

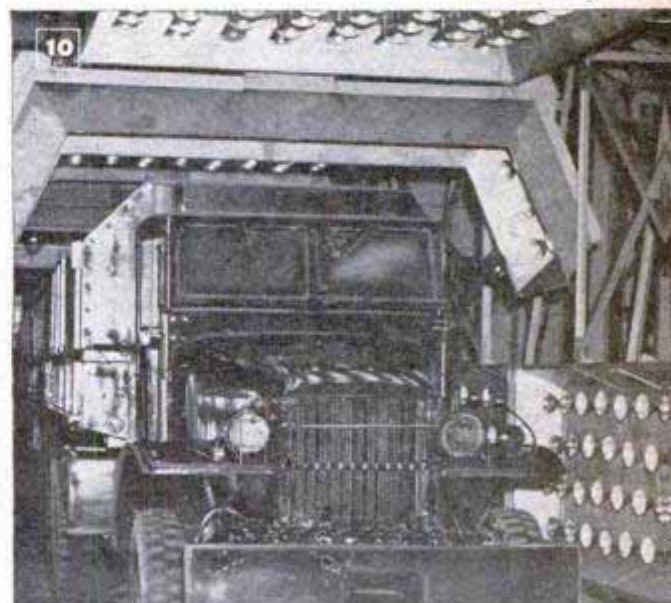
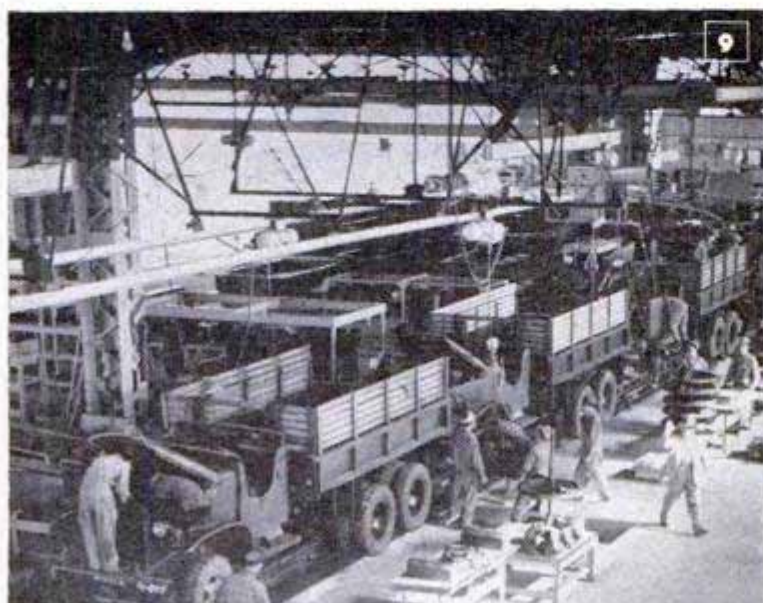

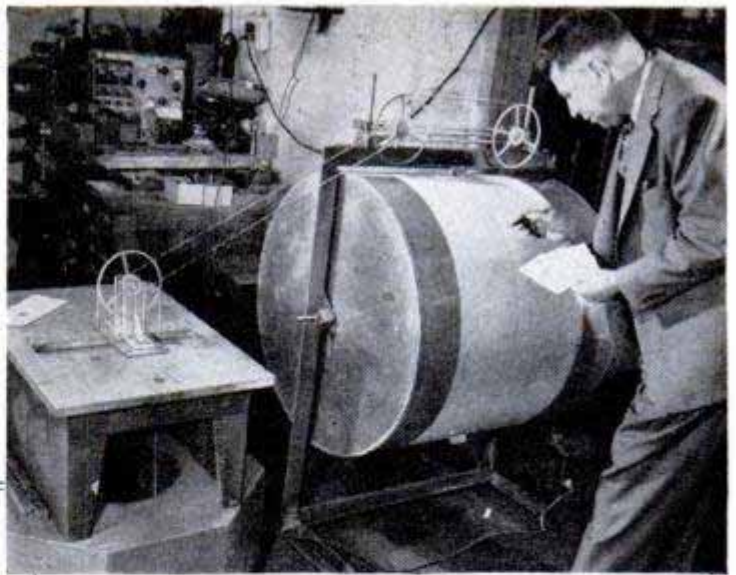
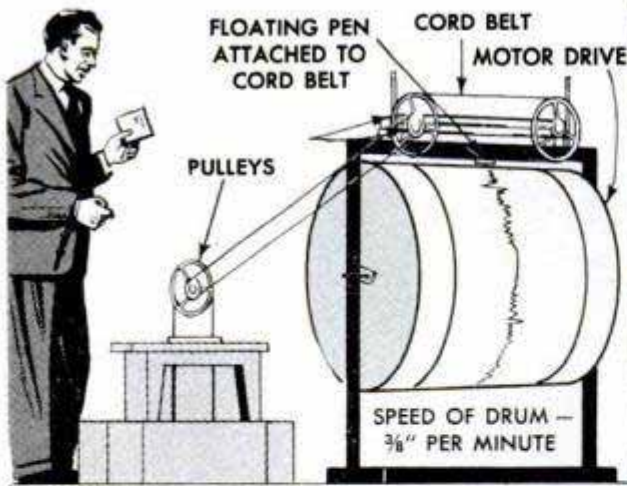

Left, cutaway shows details of the well seismograph. Actually, it is three miles from Lake Michigan. The vertical crack at well base is the fault believed to detect tremors. Above, Rexin reads seismograph drum

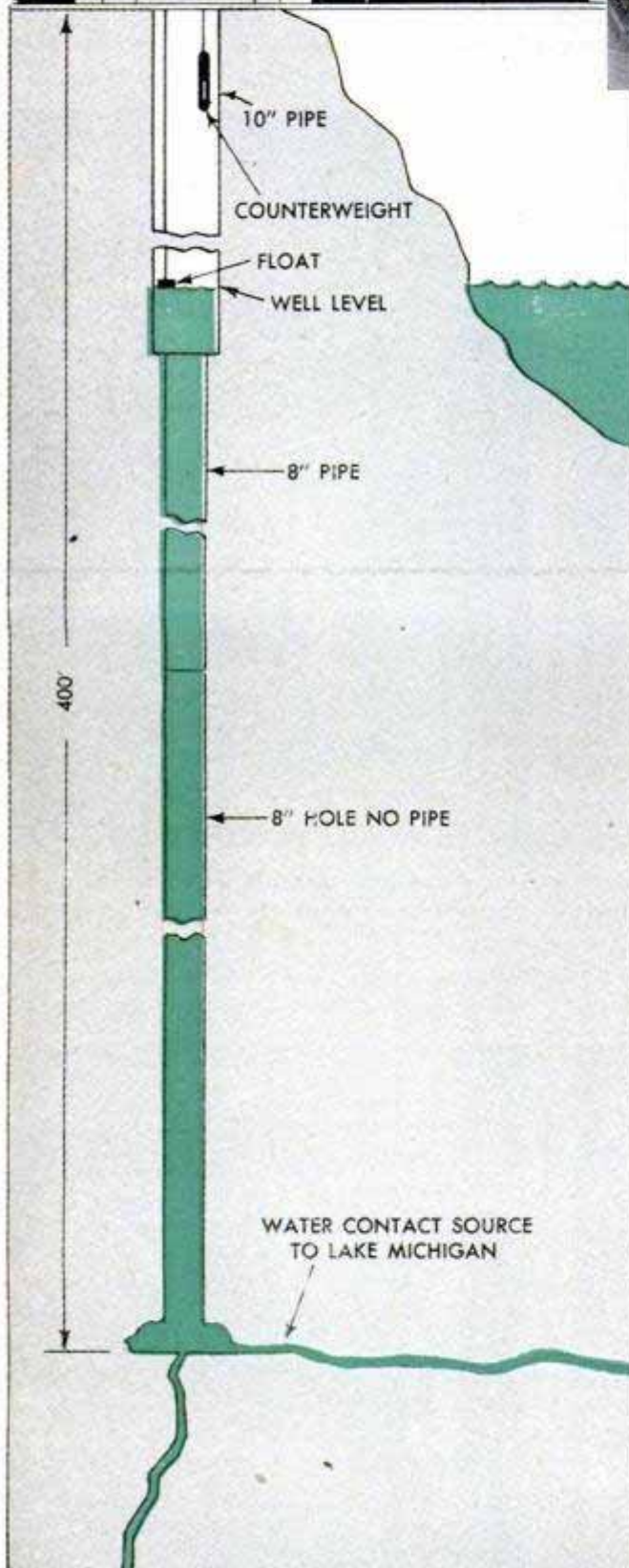

## Float in Deep Well Detects Earth Tremors

TODAY Elmer Rexin, Milwaukee plant engineer, is one of the best-informed amateur seismologists in the world because there happened to be an old artesian well under his boiler room.

The well, 400 feet deep, detects and measures the world's earthquakes faster and more accurately than the seismographs scientists rely on, amateur Rexin claims.

An ordinary aluminum piepan floats in the well (the water was contaminated years ago by subterranean gas and is no longer fit to drink) and is connected by cables and pulleys to a stylus on a drum graph. As the water reacts to underground earth movements, the float moves and its motion scrawls a wiggly line on the graph. The theory is that directly beneath the well is a fault that extends deep into the earth. Being water-filled, the fault acts as a sensitive subterranean probe. Rexin discovered the well's capabilities by accident in 1946 when it was being used to study the declining Wisconsin water table. Biggest quake it has recorded was in August 1950, when for 12 hours the stylus bounced around describing a tremendous earth movement in Tibet. During this period, the water level in the well varied as much as 120 inches!

It is also believed that the well is connected to Lake Michigan, although this has no bearing on its function as a seismograph. Rexin's well is three miles from the lake, yet he can plot the rise and fall of the lake's level, detect tides, and measure barometric pressures over the lake by watching the water level in the well.



From hand-cranked spirals, above, that for centuries have raised water on the Nile came the idea for 445-hp. pump at right

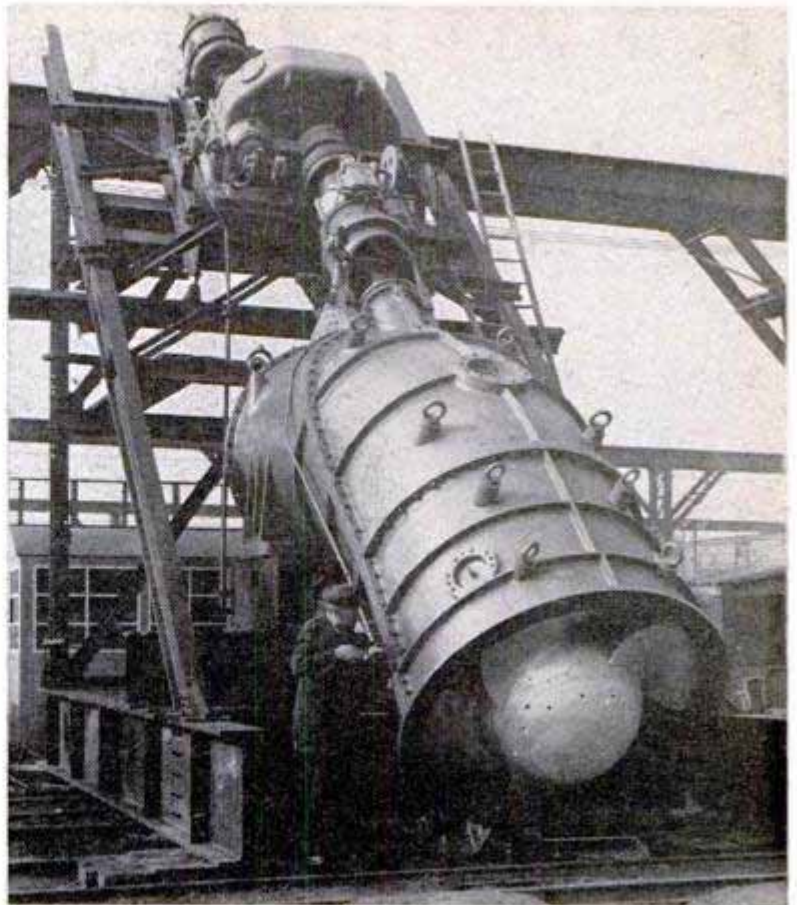

## Nile Station Modernizes Water-Lifting Technique

Adapting an ancient method to a modern problem, a German engineer has built giant electric screw shovels to lift large volumes of water at a new pumping station on the Nile near Alexandria. Driven by 445-horsepower motors instead of the hand cranks used by ancient Egyptians, screw-shaped spirals in a set of four pipes raise the water. The pipes are set at a 45-degree angle with the sucking end always completely below

the water's surface. Sieves prevent stones from entering the intake and damaging the screw blades.



## Replacement Tail Pipe Bends to Fit Most Cars

Flexible enough to permit bending over the knee, a replacement tail or exhaust pipe for automobiles can be formed quickly to fit most cars. The bendable pipe eliminates the need for small shops to carry a wide variety of tail pipes. Six sizes of the new pipe permit duplication of 600 standard tail pipes. After the pipe is bent, it retains its new shape rigidly.

## Urge Single Runways for Airports

Future U. S. airports will have single runways or several parallel runways, if the recommendations of the President's Airport Commission are followed. Its members pointed out that cross winds have little effect on modern heavy planes during landings and that light planes can be equipped with castered cross-wind landing gears. It would mean that relatively long, narrow strips of land would be required for airports instead of the broad areas now needed. Building restrictions would be necessary only in two directions. Since heavier aircraft require longer runways, the commission urged that transcontinental and international airports have 8400-foot runways, with room to expand to 10,000 feet.

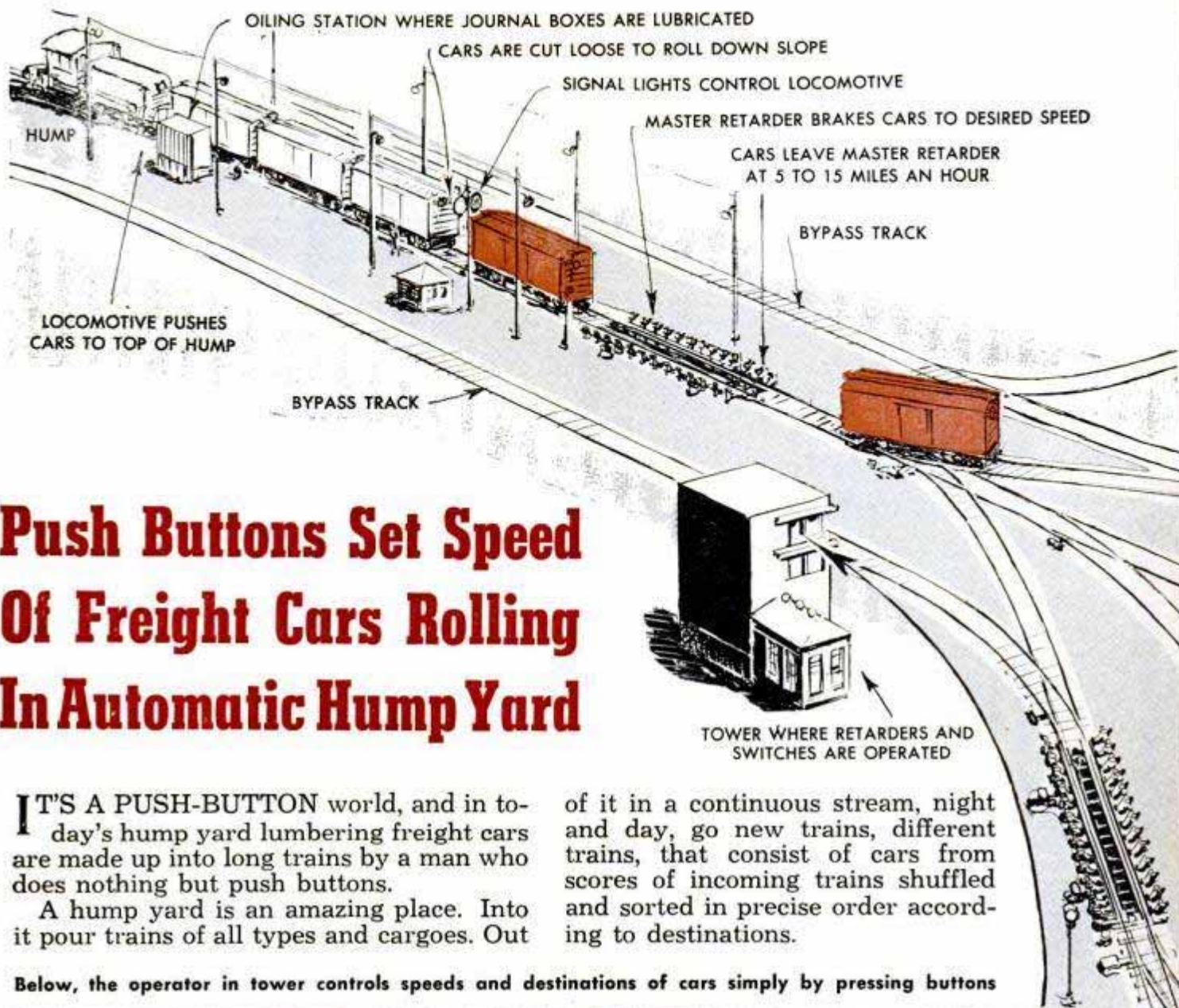

## Push Buttons Set Speed Of Freight Cars Rolling In Automatic Hump Yard

**I**T'S A PUSH-BUTTON world, and in today's hump yard lumbering freight cars are made up into long trains by a man who does nothing but push buttons.

A hump yard is an amazing place. Into it pour trains of all types and cargoes. Out

of it in a continuous stream, night and day, go new trains, different trains, that consist of cars from scores of incoming trains shuffled and sorted in precise order according to destinations.

Below, the operator in tower controls speeds and destinations of cars simply by pressing buttons



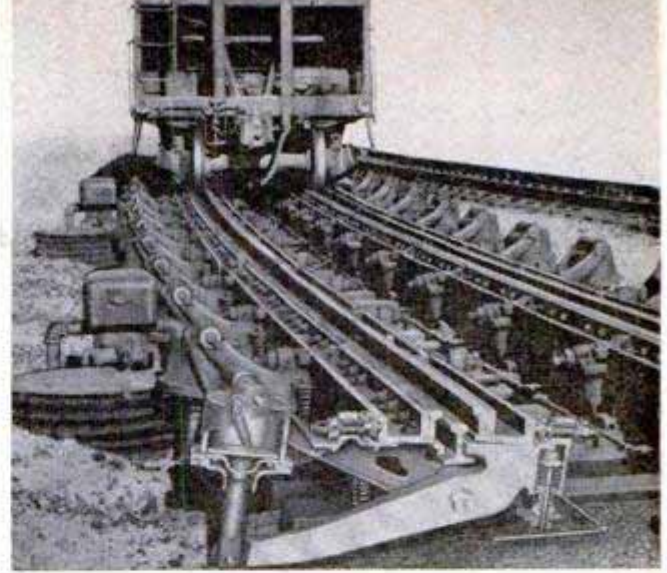
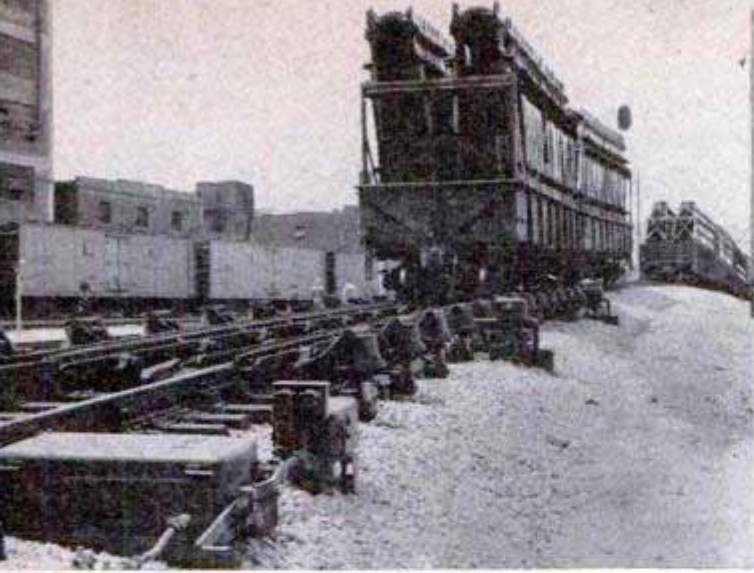

"Cut" of two cars rolls down the hump into retarder

Cutaway (foreground) shows design of the retarders which grip wheels of a car to slow it down to the correct speed. Drawing on these pages shows hump yard in operation. The red cars are being classified

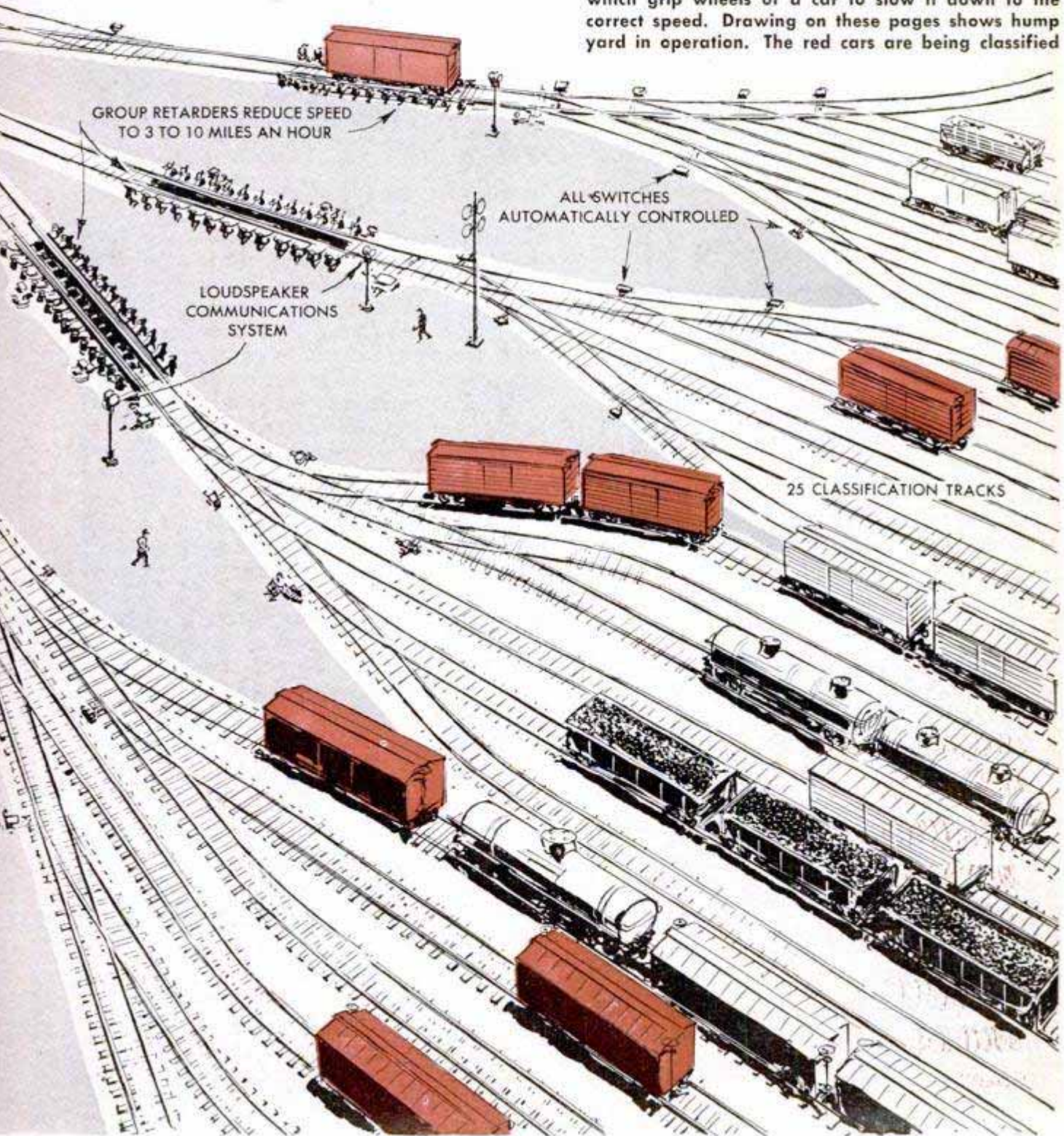

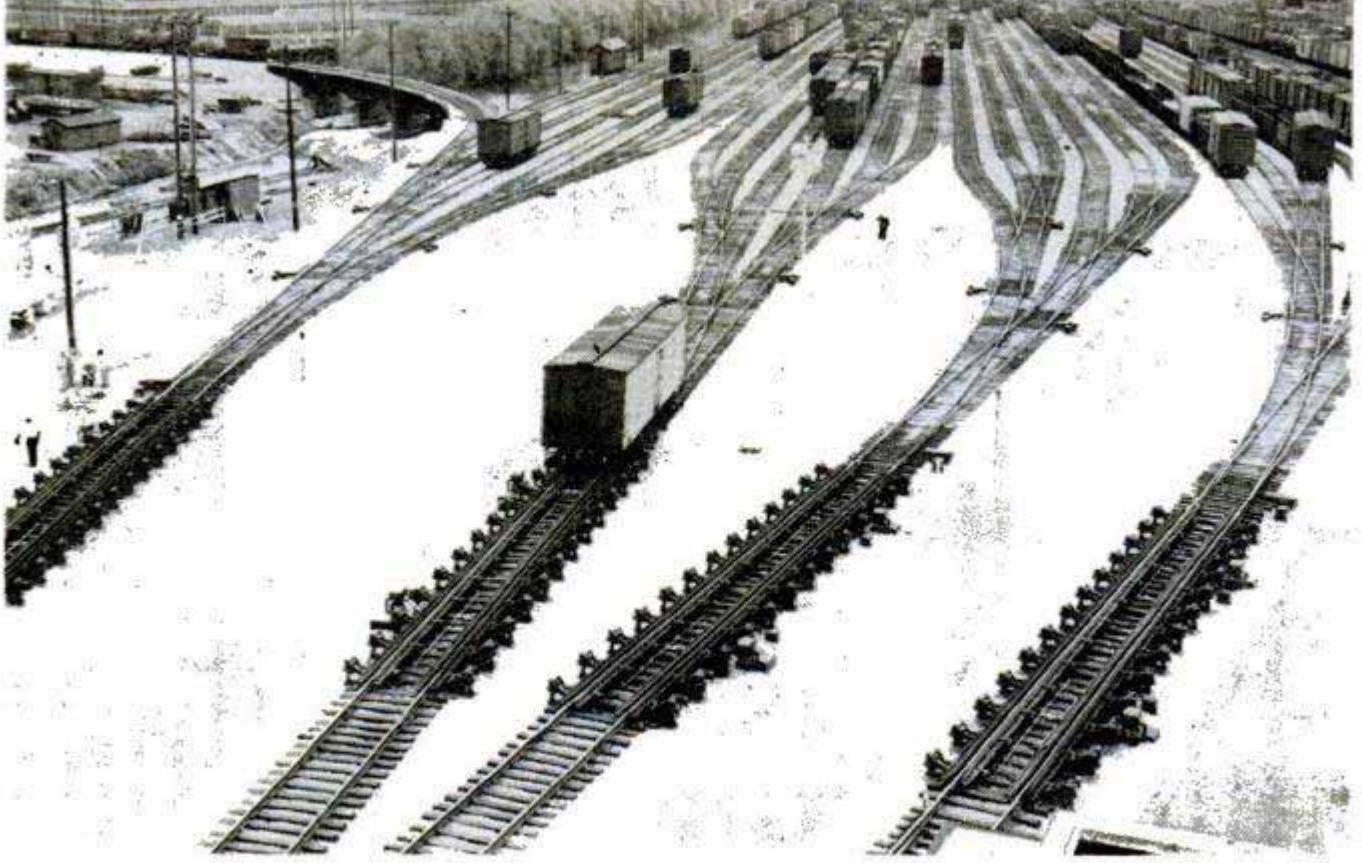

Car shown leaving a group retarder will be switched automatically into any of six tracks in front of it

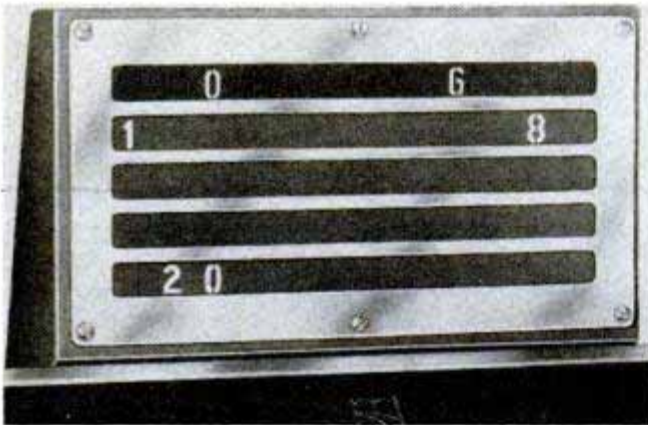

Above, indicator lights show tracks that cuts now being made will occupy. Below, this button "tells" retarders to slow car down to five miles an hour

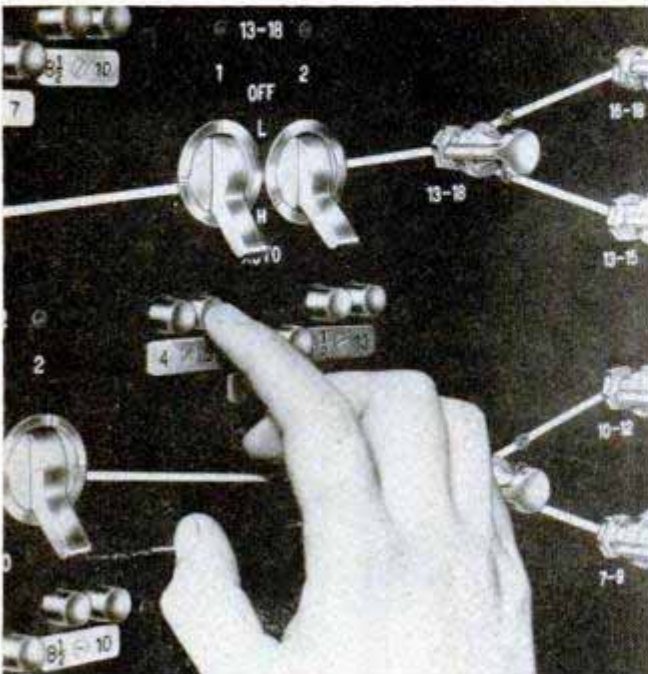

The automatic hump yard makes freight-car classification faster, gentler and more efficient. Most automatic is the Air Line Yard of the Chicago, Milwaukee, St. Paul and Pacific Railroad in Milwaukee, Wis. There the control-tower operator breaks up and makes up trains at the touch of a finger. His window-walled tower would be a paradise to a model railroader.

By pressing one button as the freight car rolls down the slope, he routes it to any of 25 tracks spread out before him. That single action guides the car through a half dozen switches to its train-in-the-making. By pressing a second button, the operator regulates the speed of the car. It's as simple as that. Free-rolling down the hump, the cars are slowed down by retarders that grip the wheels as they roll along.

He can set up in advance as many as five "cuts" (as railroaders call any car or group of cars being classified as a unit). As each cut rolls down the hump, switches in front of it are thrown automatically, taking the unit to its proper track.

Speed is controlled by retarder action. Some cars are heavy and fast-rolling, others lighter and slow-rolling. The operator estimates the speed needed to take the car to its spot on the classification track, pushes a button marked for that speed and the automatic retarders slow it down quickly and precisely. The grade of the tracks is such that after the cars leave the retarders they gradually slow down to a stop.

The new yard will handle 2400 cars in a 24-hour operating day. This is twice as fast as the system it replaced. ★ ★ ★

## Ultrastreamlined German Auto

Its rear fenders providing the ultimate in the current fin styling, an ultrastreamlined German car is said to be capable of more than 125 miles an hour. Four exhaust pipes provide a rocket-ship effect in the rear. It is powered by a supercharged 40-horsepower engine and was designed by Rudolph Haller, former airplane and speedboat manufacturer in Munich.

## Build Plastic Wing

Latest of the plastic products is a delta-shaped aircraft wing now being tested in England. The makers claim it is the first step toward an all-plastic plane that could be built for half or less the cost of metal aircraft. The material consists of asbestos fiber bonded together to form large, soft, feltlike sheets. During the heat-curing process, 198 wires leading to thermocouples attached throughout the mold are connected to an automatic telephone exchange. The temperature of any area being cured can be found by dialing the number of the thermocouple on an ordinary telephone dial. After "cooking," the completed wing



is sanded and, by a technique similar to French polishing, given the hard, glossy surface needed for high-speed aircraft.

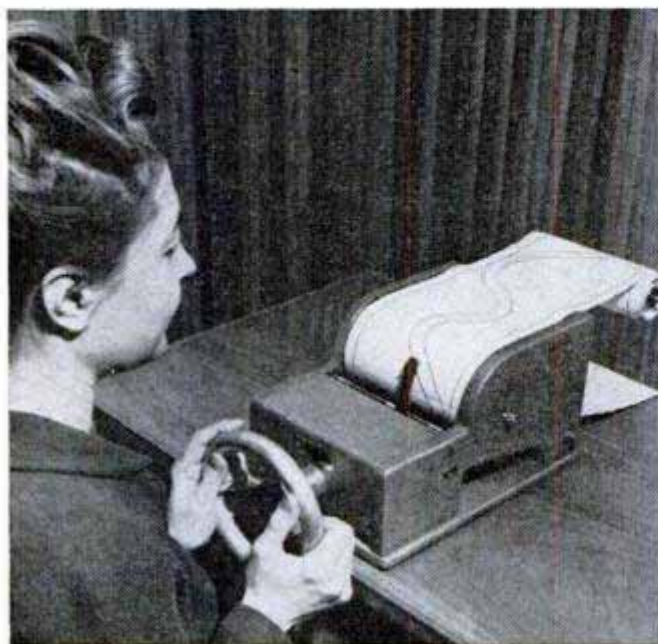

## Tester Checks Driving Skill

In Rome, Italy, drivers are tested for their reaction speed and aptitude by a miniature steering assembly. The machine has a paper roll which unwinds in front of the driver. Two parallel lines curve back and forth across the paper to simulate a winding road. The driver operates a miniature steering wheel, which in turn moves a pencil pointer to trace a line on the paper. A good driver keeps the pencil line between the two lines already traced.

If you do not find the information you need in the WHERE-TO-BUY-IT INDEX, starting on page 12, sources of further information are available without charge from Bureau of Information, *Popular Mechanics Magazine*, 200 E. Ontario St., Chicago 11

# WHAT'S NEW FOR Your Home



**1** SINK facilities in the center of the kitchen floor save steps for housewives. A new cabinet design is easy to get at from any of its four exposed sides. It is cubical and approximately twice the width of conventional wall-type sinks. The top has twin sink bowls and a combination tabletop and drainboard

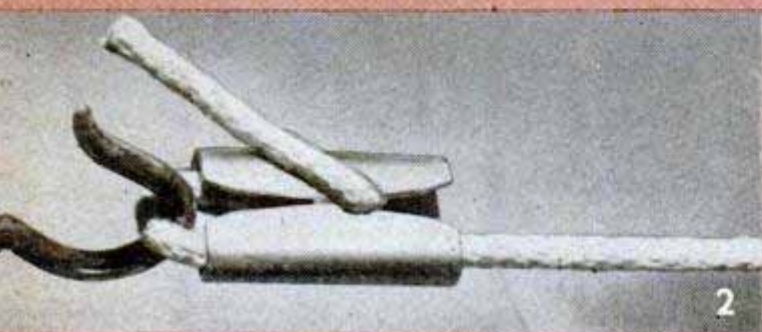

**2** CLOTHESLINES are held taut by a metal tie that can be applied in five seconds. No knots are needed. The line is passed through the holder, pulled taut and secured in a lock slot. It is also useful to truckers or anyone using rope or cord. It is made from heavy-gauge steel, plated to prevent rusting

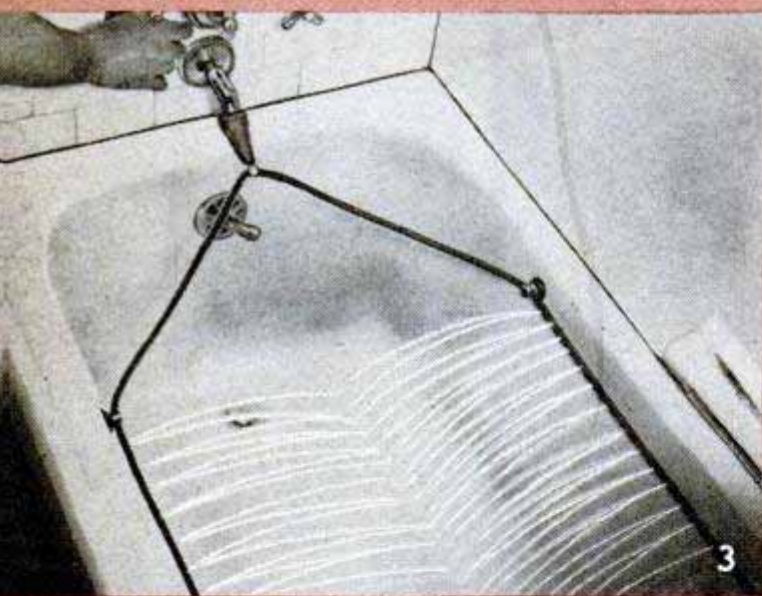

**3** SIT-DOWN SHOWERS are made possible by a novel rubber-tube device which may be attached easily by means of rubber suction cups to the sides of any bathtub. There is a faucet attachment at the center of 10 feet of perforated hose, with a metal T-tube dividing the flow of water between the two sides

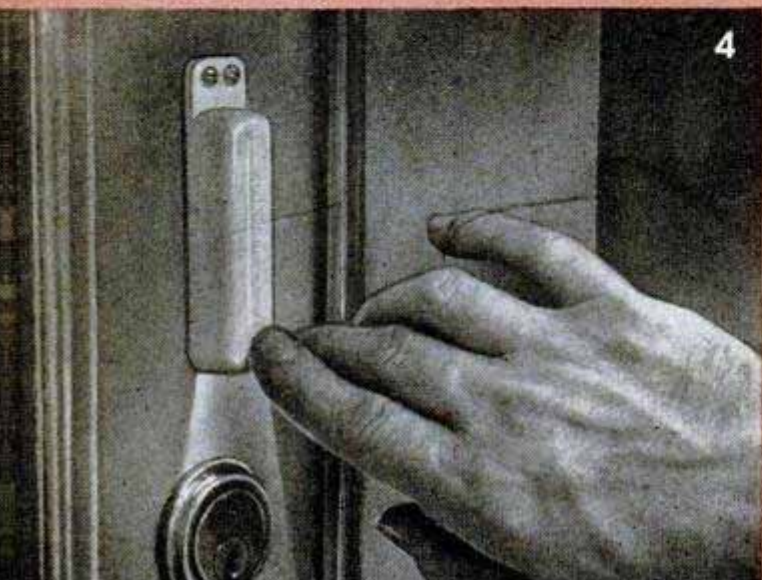

**4** KEYHOLE LIGHT is provided by a small unit that is attached to a door or an adjacent casing. It contains a battery cell and lamp, with a lens-type bulb, and lights when touched. It is also useful in illuminating meter dials in dark locations and as an emergency panel light for boats and autos

**5** SPREADING BUTTER on ears of corn and hot rolls is done more quickly and with less waste with a new butter cylinder. On picnics it also prevents exposing the butter to insects. After the cylinder is three-quarters filled, a plunger is inserted and finger pressure forces the butter out as needed

**6** BABY-PEN transportation is simplified by a new lightweight model that can be folded and carried in one hand. It consists only of wood latticework that surrounds the child. The pen weighs six and a half pounds and packs into a small space for traveling. It is made of hardwood, with metal joints and corners





**7** DRAPERY PLEATING is done quickly and easily when a new pleating kit is used. It contains a strip of tape, cut to size for making one pair of draperies, using 48 inches of material, and a set of 10 metal pleaters that snap onto fasteners attached to the tape. The pleating areas are indicated by printed crease lines and a small clip is used to make each pinch

**8** ALCOHOL is used to generate steam for a new coffeemaker. It provides a brew that is served piping hot in four minutes. The steam generated by the alcohol flame passes through the finely ground coffee, extracting the full flavor, and then passes in a condensed form through the spout into the cup. Chrome-finished, the brewer comes in two and four-cup sizes

**9** DUST-CATCHING corners on stairways and in cupboards and drawers are eliminated by plastic triangles that round out the space. A small dab of special plastic glue holds them firmly in place. They come in packages of 40 in amber, ivory, mahogany, red, green and crystal clear. Once installed, they will remain in place indefinitely without additional attention

**10** WASHING WICK, water supply and wipe-dry squeegee are combined in a new aluminum window washer. A touch-type valve starts and stops the flow of water through the unit's hollow handle to the wick. The wool-felt wick's rough texture permits easy removal of even stubborn, dried bug stains. The specially cured rubber squeegee dries and polishes quickly

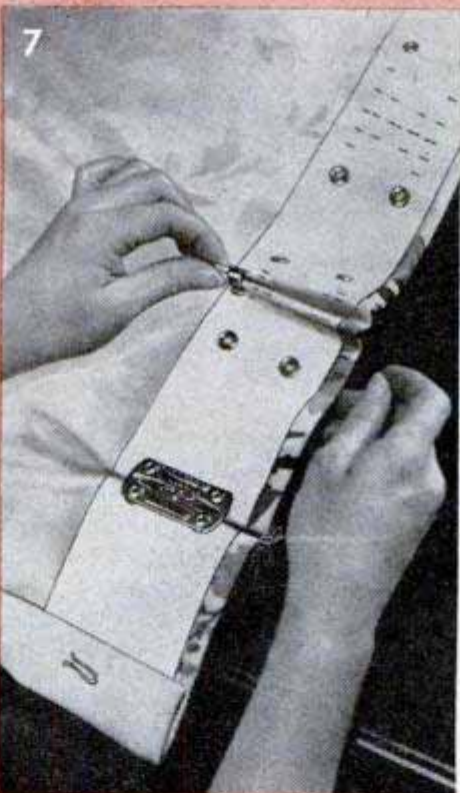
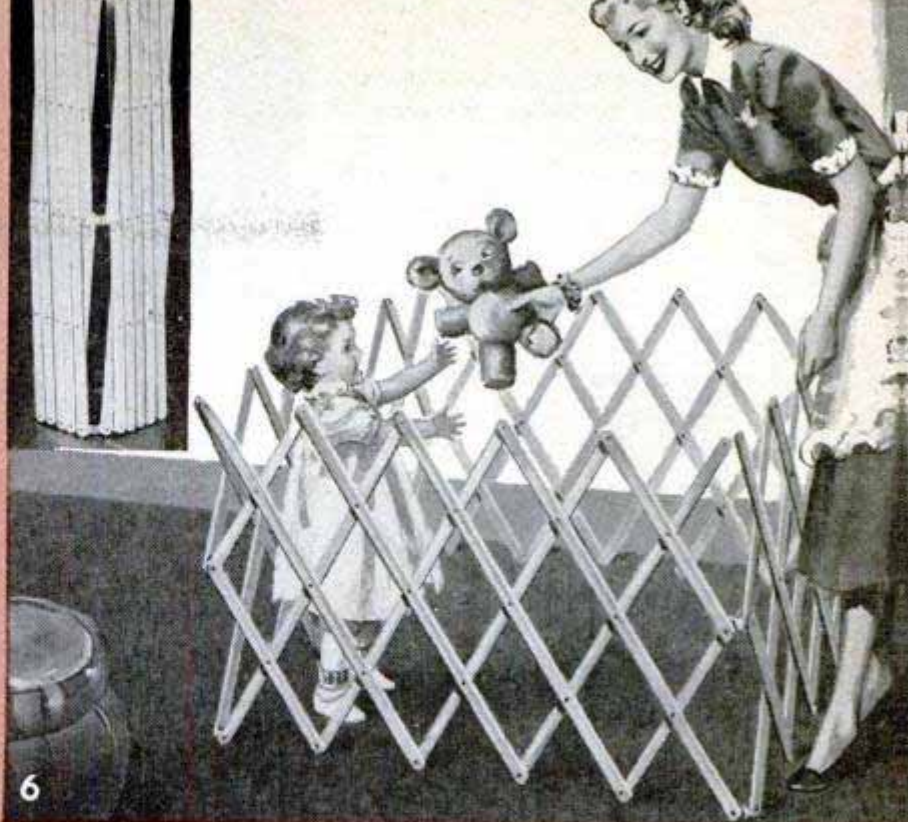

WATER-FLOW VALVE

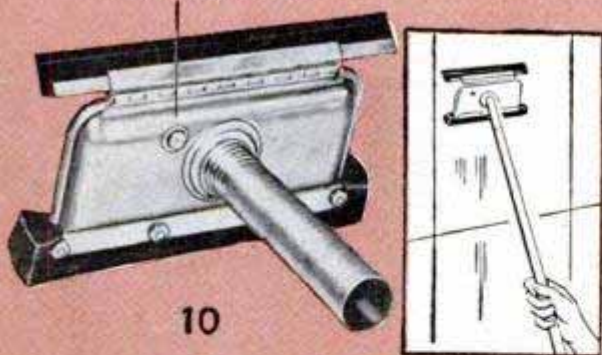

10

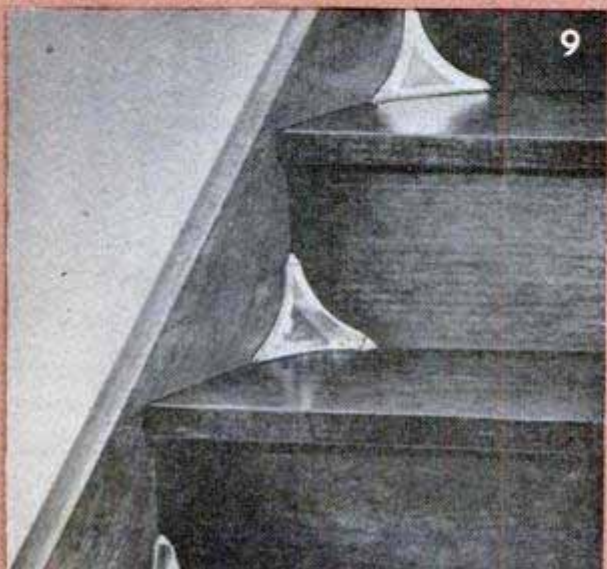

9

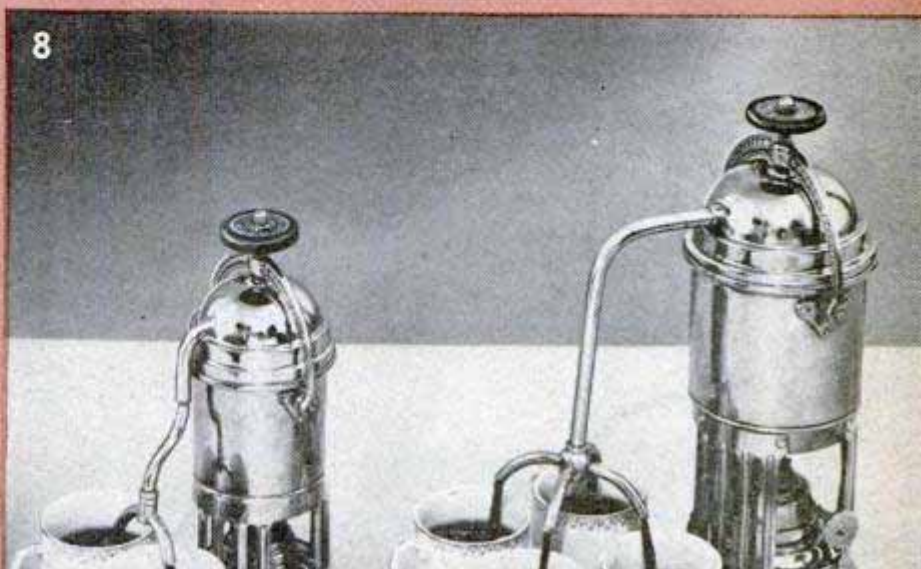

8

Native laborers patiently build diversion dams to change the course of rivers. Diamond deposits in this area are found in subsoil of river beds

**By L. Witherspoon**

*Mutual Security Agency photos  
by George Rodger*

**Native tribesmen  
are sifting  
the river beds  
of Africa  
for hidden  
treasure**

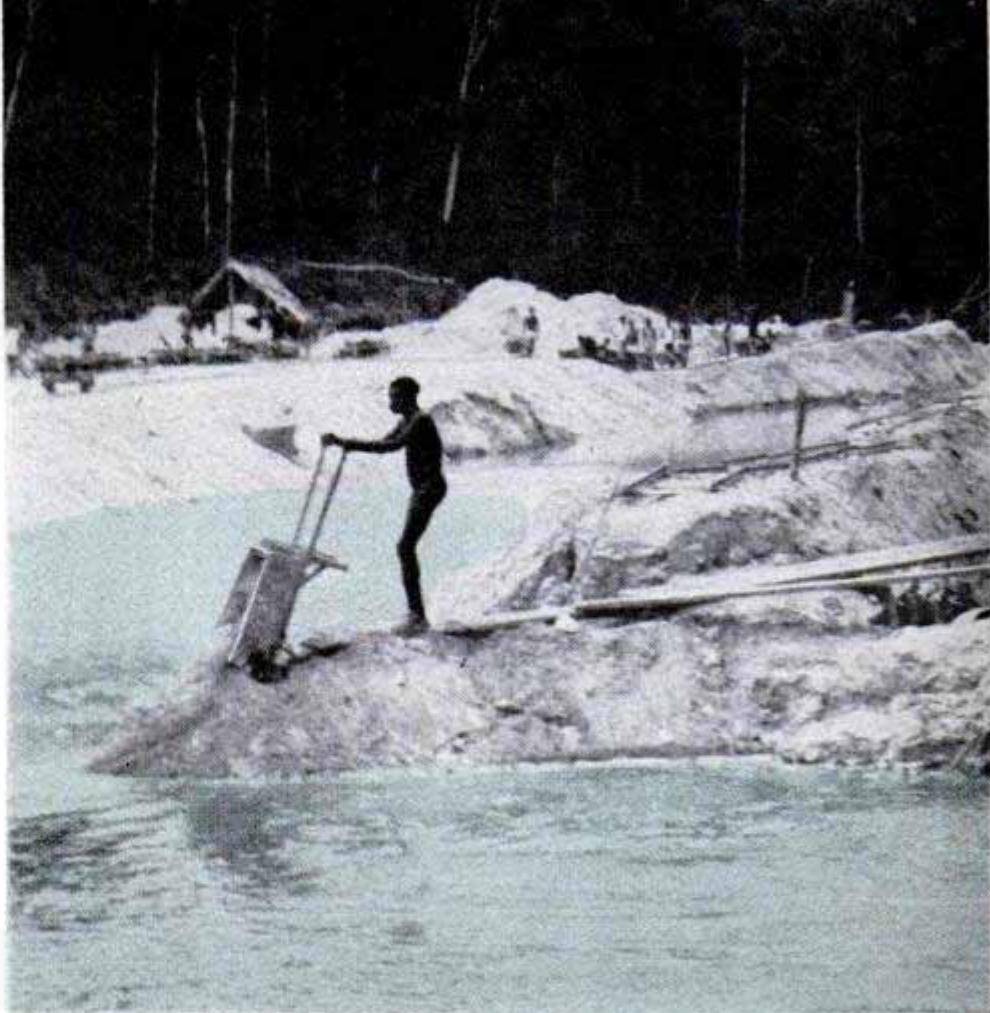

## JUNGLE

Mechanization comes to the jungle. Gravel extracted by pick and shovel moves to the washing mill on a conveyor belt. Workers scoop up any that falls off

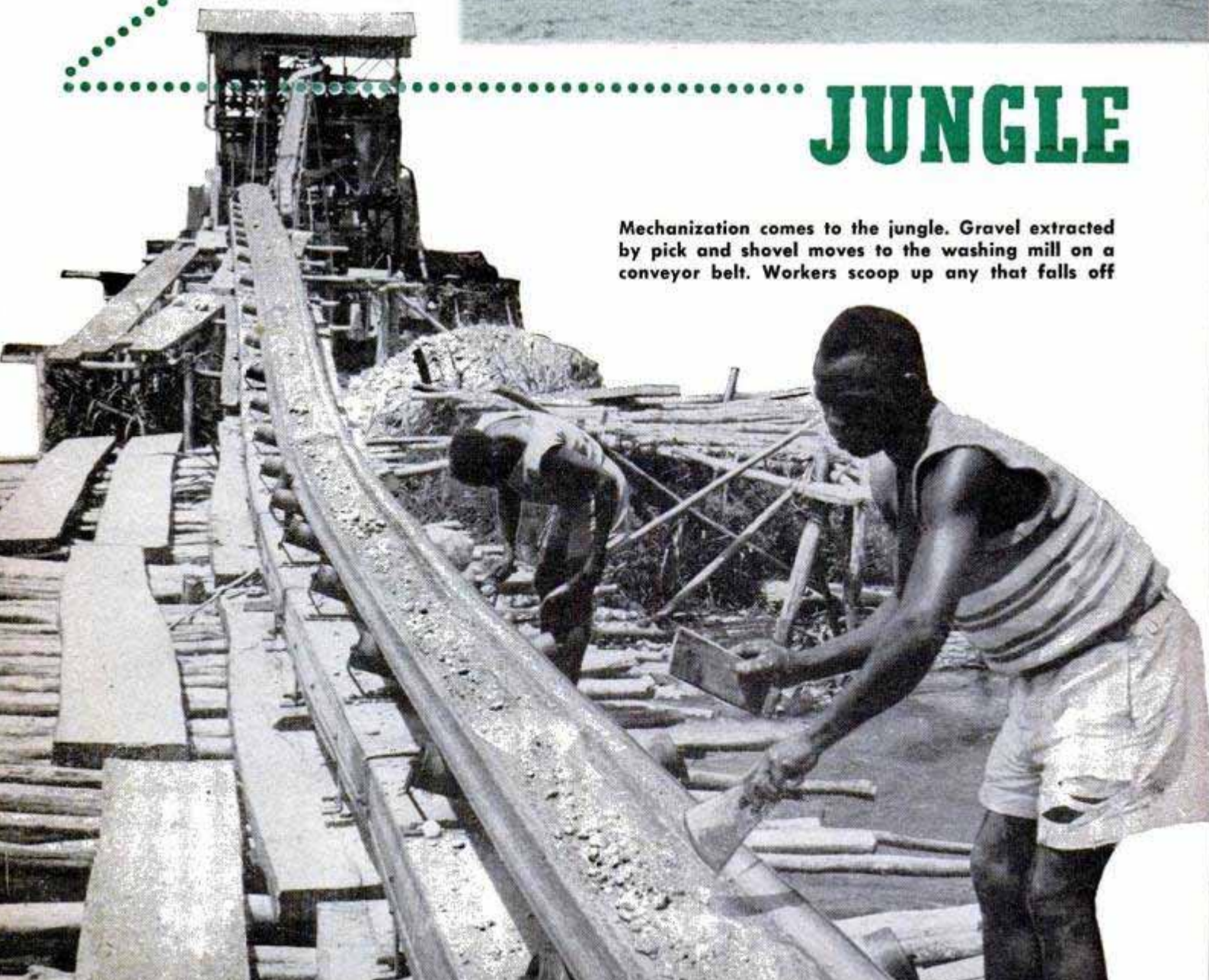



## DIAMONDS to Grind Our Tools

**O**NE MORNING last fall a pigmy hunter spearing game along the Lopo River in French Equatorial Africa suddenly halted in terror. Just ahead some fantastic, roaring creature was crushing trees as thick as a man's neck. A blood brother of this strange giant was biting out chunks of soil as big as a pigmy hut to make a new channel for the river. Several smaller specimens were chugging up and disgorging clanking beams of structural steel.

The pigmy looked on for a moment, then dropped his sack of game and ran as fast as his legs would travel. Maybe the witch doctor could explain it all.

The tree dozer, the diesel-powered shovel and the fleet of trucks which frightened the native would have seemed familiar enough to an American or European. But the purpose of all this activity might have been a trifle hard to grasp. The principal object was to find diamonds—not primarily diamonds for women to wear but in-

dustrial diamonds to use in American cutting and tooling machines.

If jewel diamonds were found—and the jewel and industrial types usually are found together—they would be welcome as a means of bringing down the over-all cost. But the real goal was industrial diamonds for the United States.

Until World War I, diamonds of all colors except yellow, white and blue-white were

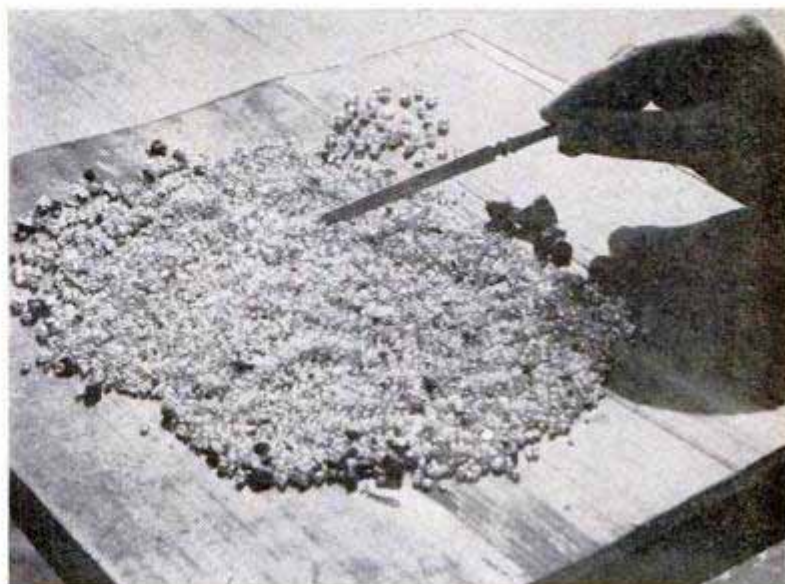

Ten-day yield of diamonds from one camp, equal to 1600 carats, is worth \$20,000

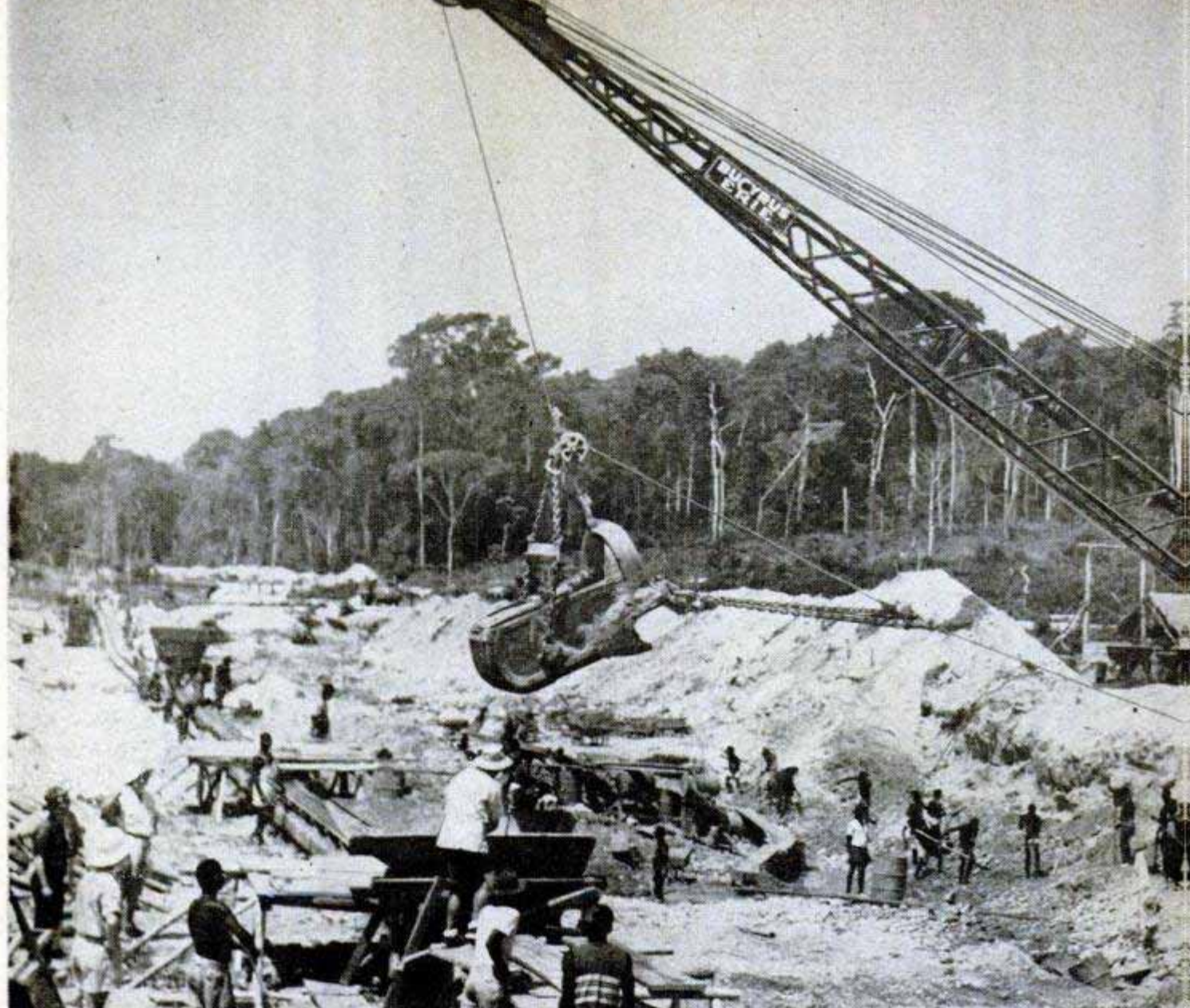

During the working days a big dragline excavator made in America towers over the pigmy workers. Below, when there is an occasion for a celebration, the natives perform their traditional dances to the rhythmic beat of the tom-toms

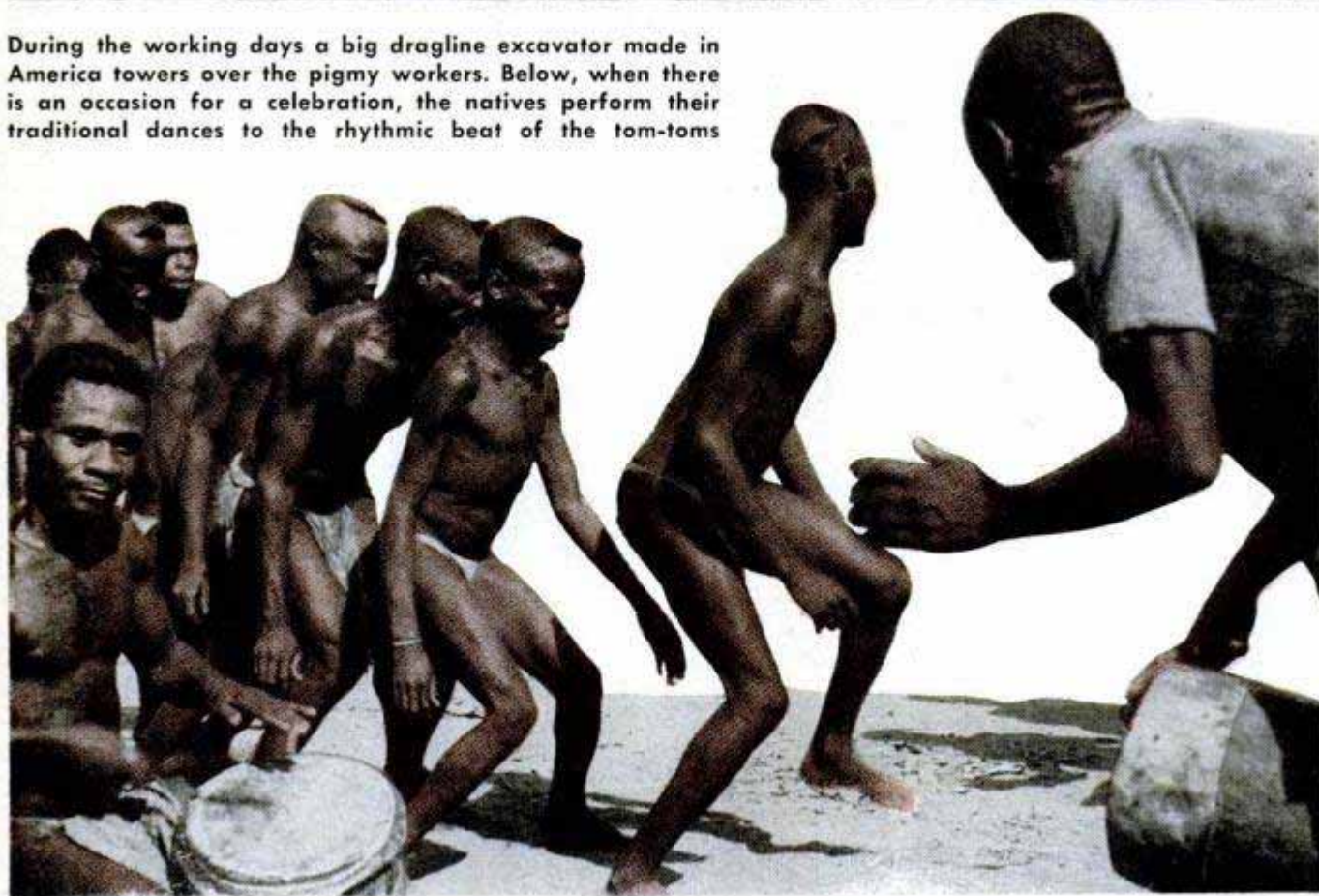



Cans containing the diamond-bearing concentrate, sealed to prevent theft, are loaded at each camp and sent to a central plant for the final washing



After final wash, diamonds adhere to a tray covered with a special substance known as diamond grease. They'll be cleaned by boiling them in acid baths

a drug on the market. Black, brown, gray or other off-tints of diamonds were not sold at all or went at bargain-basement rates.

During the war these ugly ducklings of the diamond trade began to come into their own. A diamond is the hardest substance known and therefore provides the best cutting or grinding edge. Diamonds and diamond abrasives were required to cut and dress the bullet-resisting steels of war. For this, the off-color diamonds were every bit as good as gem diamonds.

By the outbreak of World War II, there was a whole range of metals made of tungsten, vanadium, silicon, tantalum, boron and other minerals hard to manage. Moreover, airplane and tank engines, submarine torpedo heads and a score of other armaments had to be built with components tooled to an accuracy of perhaps .0001 inch.

There were not, of course, enough industrial diamonds to do all the cutting and grinding, but enormous quantities were required simply to smooth and true the surfaces of the tools doing the grinding.

After 1945 the fine tolerances being built into peacetime machines like truck and

automobile engines kept the market for industrial diamonds from sagging too badly. The present drive for rearmament has made the demand much greater.

The world's diamond mines are now producing at the rate of 14 or 15 million carats a year, or about twice the average production before World War II. Of this total approximately 80 percent are for industrial use.

The United States regularly absorbs three fourths of the world's diamond production, jewel and industrial. As a matter of policy it is encouraging new and independent sources which will be capable of maintaining a steady supply.

Between 80 and 90 percent of all diamonds are produced or marketed under the control of De Beers Consolidated Mines Ltd., of South Africa, one of the world's tightest monopolies. The United States government has favored the development of independently controlled mines like those in French Equatorial Africa.



Though power machines have changed the jungle, some workers still load diamond-bearing gravel with shovels

Through the Mutual Security Agency, formerly the Economic Cooperation Administration, the United States has aided two related French companies to prospect and open mines in French territories lying on each side of the equator. To search the Gabon, principally south of the equator, the Societe de Recherches et Exploitations Diamantiferes (Soredia) has received a loan of 228 million francs, equivalent to about \$650,000.

This loan came from the French "counterpart fund," a sum each MSA nation accumulates in local currency when it sells to its own citizens goods purchased abroad with MSA dollars. By law, five percent of the counterpart funds must be set aside to pay the administration expenses of MSA and to acquire materials needed for the United States' strategic stock pile. The loan to Soredia was made from the five-percent fund. Repayment is contingent upon the

Here's the amiable chief of the Bingay tribe, a family of 60 interrelated persons



When prospectors found diamonds here, natives cleared the area. Three of them worked five days to hack down giant kapok tree

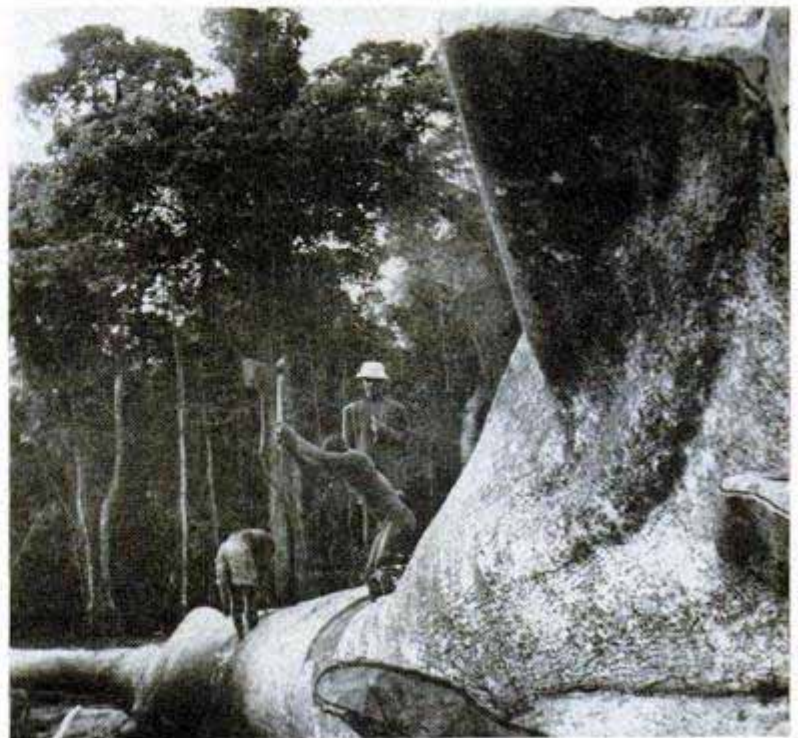

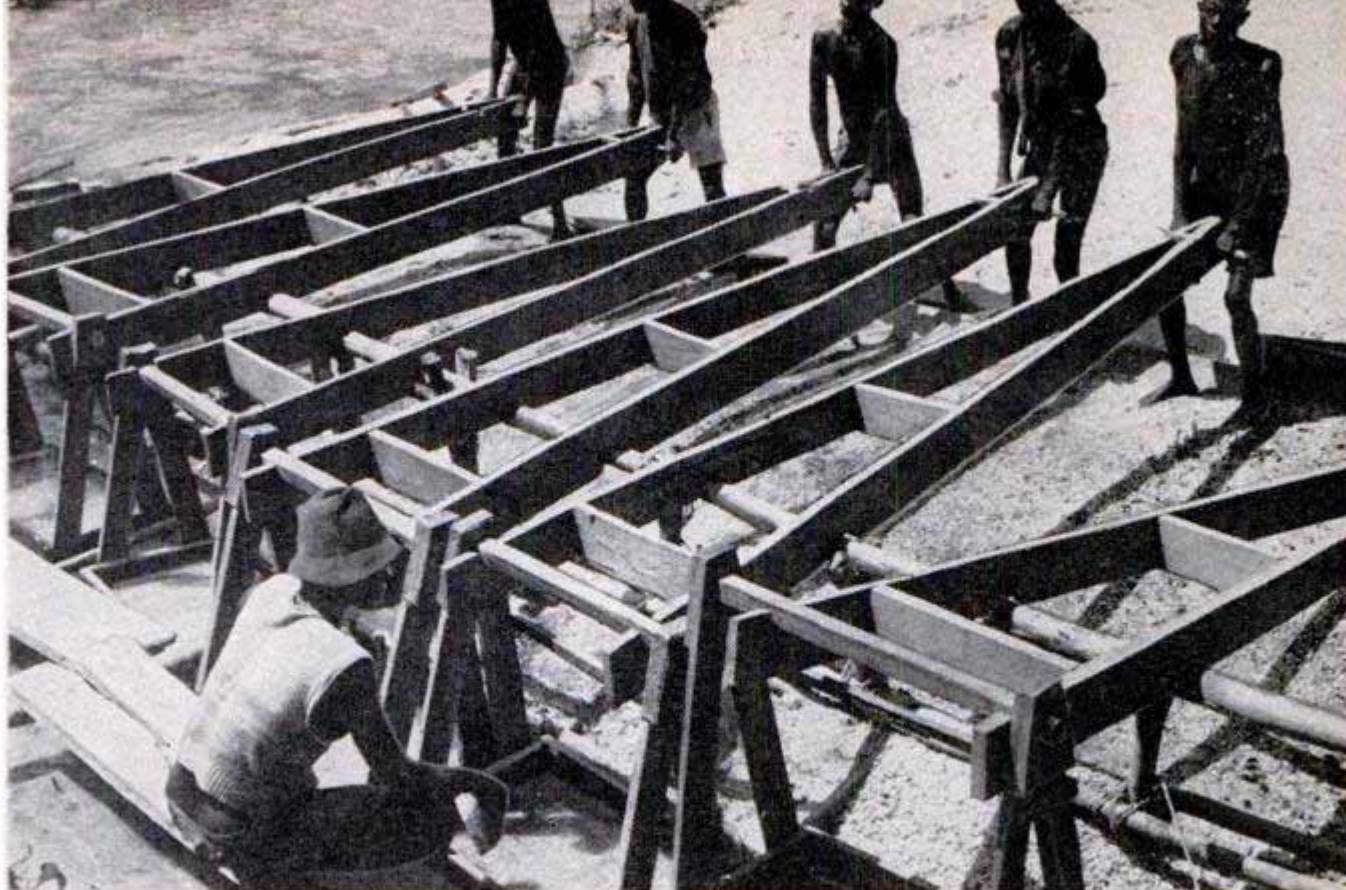

discovery of diamonds in commercial quantities.

Soredia's concession covers 34,000 square miles of tropical rain forest, an area about three fourths the size of the state of New York. The engineers have marked this off into a grid of large and small squares. The large squares represent several square kilometers; the smaller ones represent only one square kilometer.

First, flying squads of prospectors and their native helpers make test drillings on the large grid. In areas where the findings are encouraging, other prospecting parties dig test holes at likely looking points in each square of the smaller grid. The gravel is concentrated and panned on portable rigs and a record is made of the results.

Prospecting squads in the Gabon — totaling 35 Europeans and 2800 natives — already have turned up several diamond deposits which will, according to company reports, repay mining.

Across the equator,  
(Continued to page 242)

In older method of separating diamond gravel, a laborer holds one end of joppling jig and shakes it rhythmically. The concentrate settles and useless material can be scraped away. Below, here's the modern method of obtaining same result. Washing mill concentrates gravel automatically

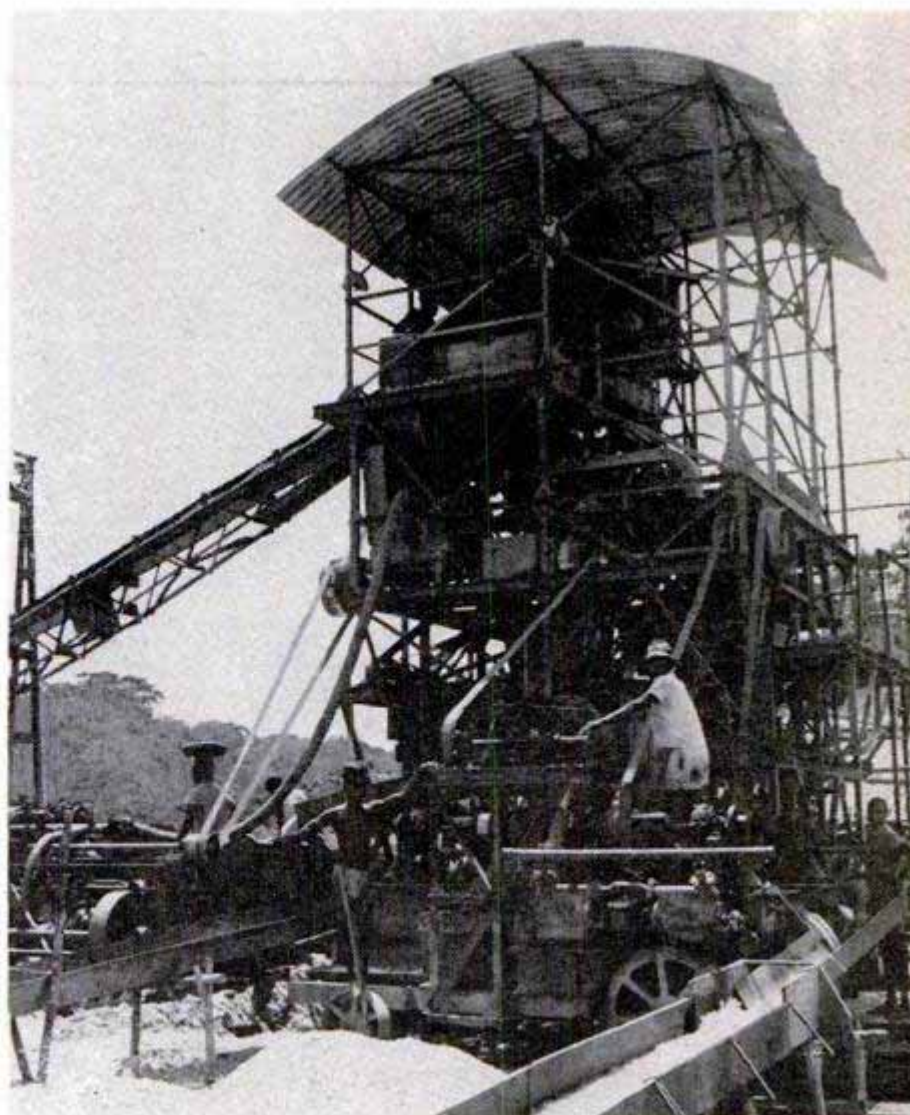



Skilled girl gives the plate a final touch-up before it is slipped into the kiln for a six-hour treatment

## BAKING "DECALS" ON CHINA

Photographer prepares camera to copy a painting. He'll print his photo on gummed paper to make the "decal"





**By Joseph Adams**

**I**N A STUDIO barn at Setucket, Long Island, skilled workers are transferring famous Audubon and Currier & Ives paintings to china and tile through a unique "decal" method. They even embed cartoons deep in the chinaware.

The method was developed by Richard Delano, formerly an architect of New York, who began decorating china as a hobby several years ago. The pieces he turned out for relatives were received so well that he decided to give more serious attention to his hobby. He bought some property at Setucket and soon converted an old red barn on the premises into a workable laboratory. Here he set about reproducing original paintings permanently on fine china.

The system he worked out combines decals with hand painting. An original painting or a fine print is copied on film with a camera. The resulting negative is used to print the piece of art work on gummed paper. This print is made in one color, magenta, on the gummed side of the paper. Lacquer is then applied to the print, producing a "sandwich" with a layer of paper on one side, a layer of lacquer on the other and the print between. When the paper is dampened, the design can be slipped off in its binding of lacquer and applied to the plate, just as conventional decals are applied.

Skilled girls — there are about two dozen of them in the studio — now go to work with fine brushes and pigments, applying colors to the decal to duplicate every tint.

Delano worked for years to perfect a system for baking the china or tile so the colors actually become a part of the plate or ash tray without bubbling or sizzling out. In his system the plates with their decals are placed in a kiln and baked for about six hours at a temperature of 1400 to 1500 degrees F. During this long period of intense heat, the china becomes soft enough so the colors seep down into it, while the lacquer goes up the flue. This leaves the design embedded in the china without a trace of the lacquer on the finished plate.

In the past year about a million pieces of dinnerware and tile have been decorated. ★ ★ ★



Inventor of the unique system started decorating china years ago as a hobby. Here he mixes pigments in further experiments



When gummed paper is dampened, design can be slipped off in its protecting film of lacquer and applied to the plate. Below, when plates are baked, colors seep down into the china



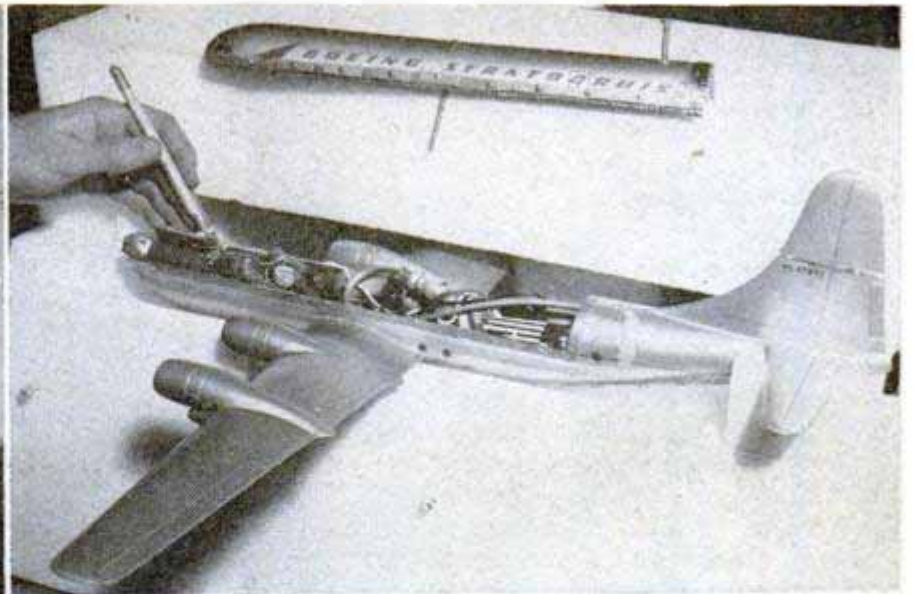
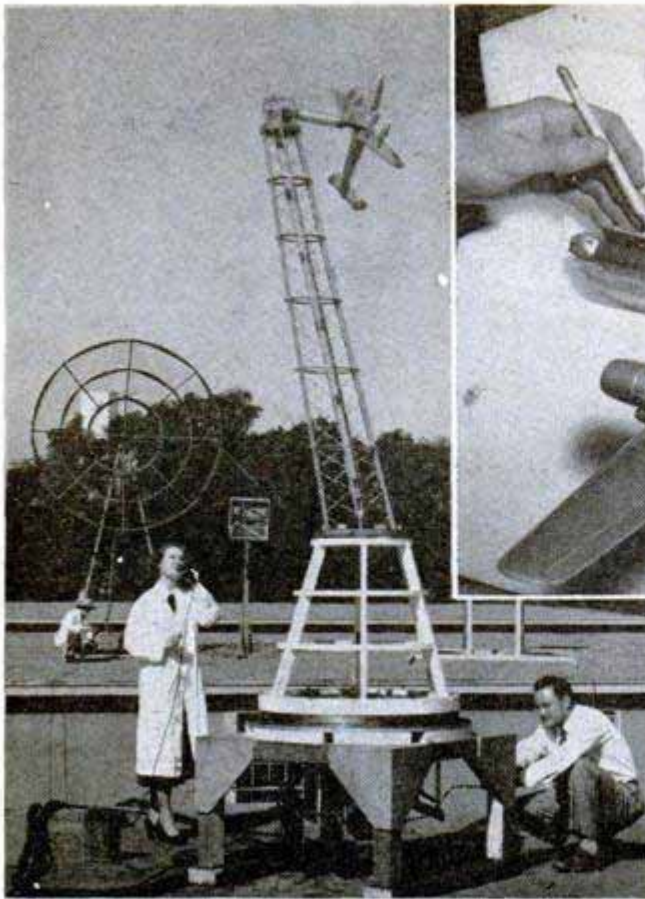

Airplane models are rotated on stand, left, to test antenna radiation patterns. Miniature transmitter, above, in a 1/70-scale model of a Stratocruiser

## MULTIPURPOSE ANTENNAS

Automatic tuning to a single antenna for the many items of electronic gear needed in today's airplanes is accomplished by a matching unit developed at the Stanford Research Institute. It adjusts the antenna to the operating frequency of the transmitter or receiver being used and compensates for changes caused by factors such as ice formation. Stanford's engineers, at Air Force request, are experimenting with an-

tennas built flush with the skin of the aircraft. Tests reveal that the external antennas needed for the nine or ten radio units normally carried in transports cause drag equivalent to 90 horsepower at 300 miles an hour. At expected future speeds of about 600 miles an hour, over 700 horsepower would be needed to overcome present antennas' air resistance. Miniatures ranging from  $\frac{1}{565}$ -scale models to 10-foot skeleton mockups are used in the research.



### Mechanics in a "Refrigerator"

Air Force mechanics are volunteer guinea pigs in experiments aimed at discovering how to maintain aircraft at bases where temperatures drop to 50 below zero. These tests, conducted at the aeromedical school, Randolph Field, Tex., may lead to improved clothing and also to a method of selecting personnel best suited for work in extreme cold. By running large numbers of mechanics through a standardized test, researchers hope to learn what personal characteristics, temperament and background make the best mechanic in frigid climates. The standardized test procedure involves removing a propeller part from a sealed box, disassembling it, putting it back together in the shortest possible time and then sealing it in the box again.

☛ An electric "tongue" which "tastes" the saltiness of foods by means of electrodes inserted in solids or liquids has been developed by Norwegian scientists.



Loudspeakers located at wing struts enable rancher to relay instructions to cowboys during roundup operations. Automatically fired shotgun mounted on landing-gear V, right, is aimed by pointing plane

## Ranch Plane Mounts Loudspeakers, Shotgun

Techniques borrowed from modern warfare are being used on a Texas ranch to speed operations and hunt down coyotes and birds of prey. Strafing and observation operations are combined by Bob Masterson of Paducah in a Piper Super Cub which mounts a public-address system to direct cowboys on the ground and an automatic, 12-round shotgun which fires below the propeller disk. With the sound system, Masterson can call down instructions to his men, greatly facilitating roundup operations and the location of strays. The shotgun, located on the landing-gear V, is especially effective in shooting eagles, which

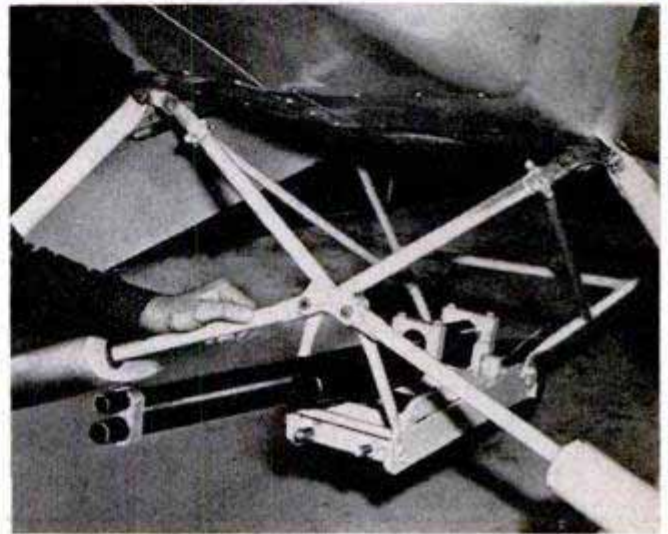

prey on small animals, and is much more accurate under this arrangement than when fired from the wide window of the plane. Installation of speakers at wing struts provides the most broadcast quality in all directions.

## Sundial Clock for Oslo

Designed to top the town hall of Oslo, a giant sundial clock has been completed by the House of Ungerer, famed French clockmakers. Circled by the 12 signs of the zodiac, it shows Oslo local time, astronomical time, time of sunrise and sunset, sun and moon positions in relation with the constellations of the zodiac, moon phases, and sun and moon eclipses. The adjustments of the astrolabe are made by electrically driven clockwork.

Information not listed on articles in the index frequently is listed in the WHERE-TO-FIND-IT LIST, which is available to readers without charge from the Bureau of Information, *Popular Mechanics*, 200 E. Ontario Street, Chicago 11

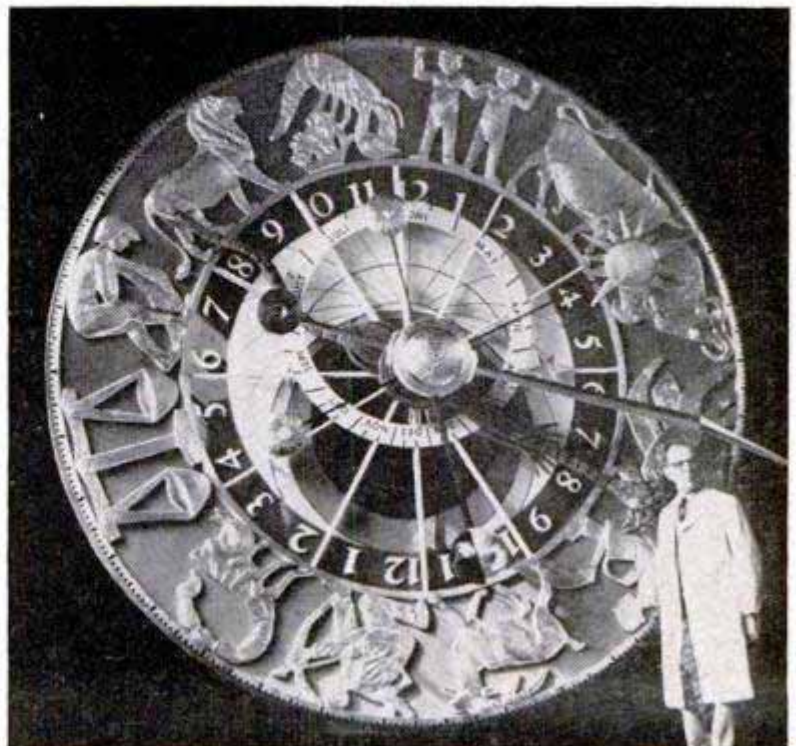



Fold-up home is comfortable emergency housing which can be dismantled, moved and rebuilt in half a day

# PACK UP YOUR HOUSE



Home has a 20-foot living room, two bedrooms separated by a modern bath, a kitchen with stove and refrigerator, three closets and a shaded patio. Below, down comes lattice over patio to start moving job

**YOU CAN HAVE** lunch in a new two-bedroom house, then pack it up and move it at 50 miles an hour through traffic to a new homesite, where you can unpack and rebuild your house in time for dinner. The house, in addition to the two bedrooms, has a 20-foot living-dining room, a cabinet kitchen furnished with a refrigerator and stove, three closets, and a shaded patio. An inexperienced crew of four men can dismantle the house and fold it into a shipping package measuring 8 by 10 by 30 feet in about 1½ hours. The home can be rebuilt in even less time.

Since 1949 the Federal Housing Administration has been seeking a full-size, com-

With a socket wrench a workman removes the fasteners which are used to join the attractive walls

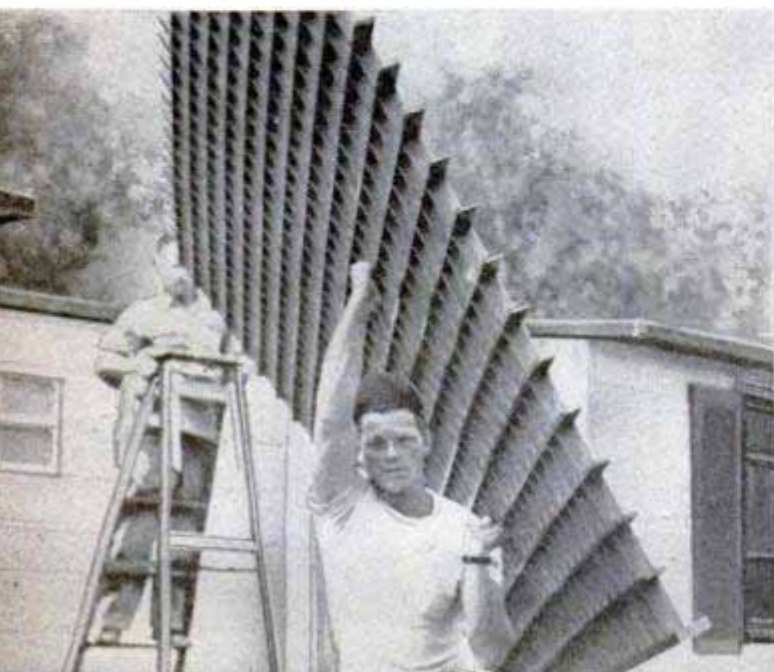

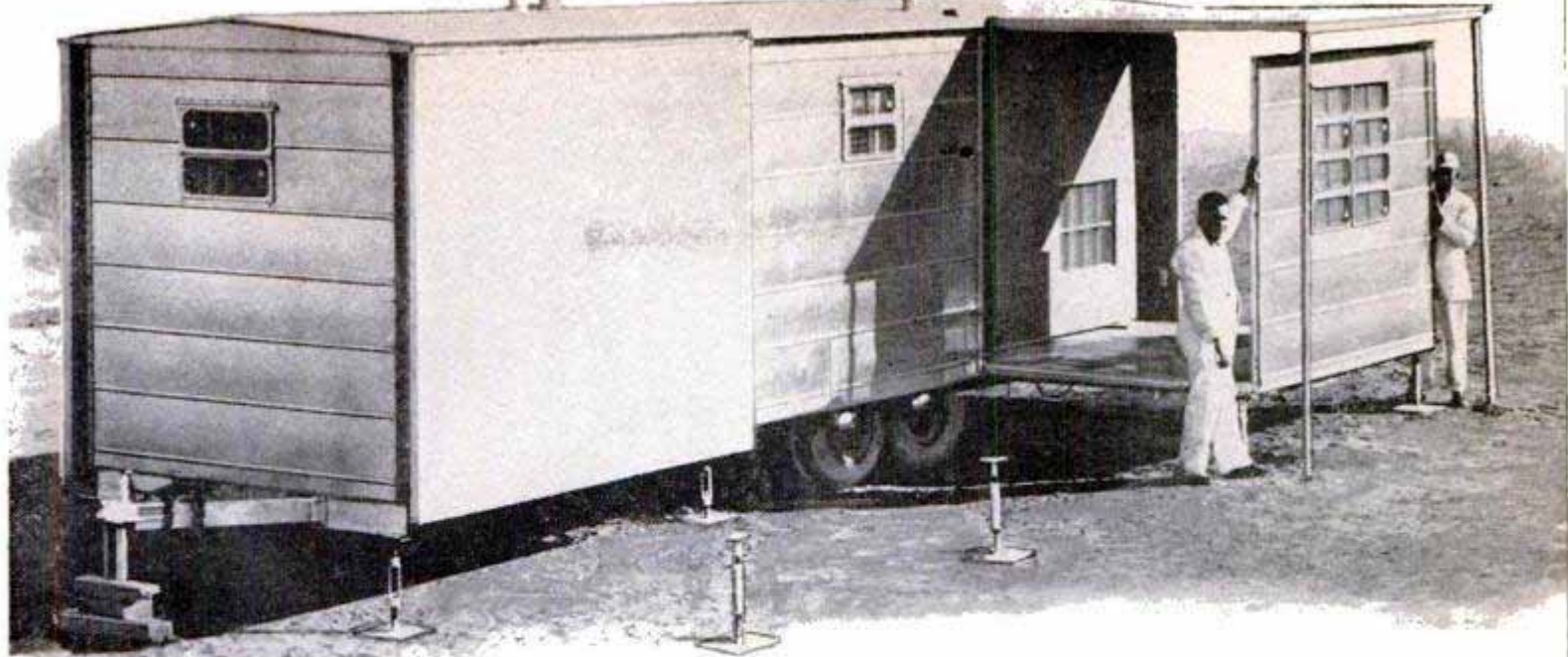

Home has been moved like a house trailer on a special chassis and now is ready to be "unfolded" on new site

# and MOVE!

By Paul W. Travis

portable house that could be moved after a housing emergency was over. The fold-up home was designed as an answer to that problem. H-shaped, it has 800 square feet of floor area, weighs 10,000 pounds and sells for about \$8000. Two oil burners heat the building. It is moved on a special dolly and chassis, which are removed after the house has been installed on a wooden foundation at the new site. Thus an entire settlement could be moved with only dolly and chassis. On moving day the house is collapsed by removing the lateral walls and setting them upright in cradles built into the living room. Outer walls fold and the roof drops to form the exterior sides of the package. ★ ★ ★

Midway in the packing, one of the lateral walls can be seen installed in special cradle in living room



Panel wall with its doorway is tipped sideways and slipped into place. This is secret of home's mobility. Below, propped-up ceiling will become side of package

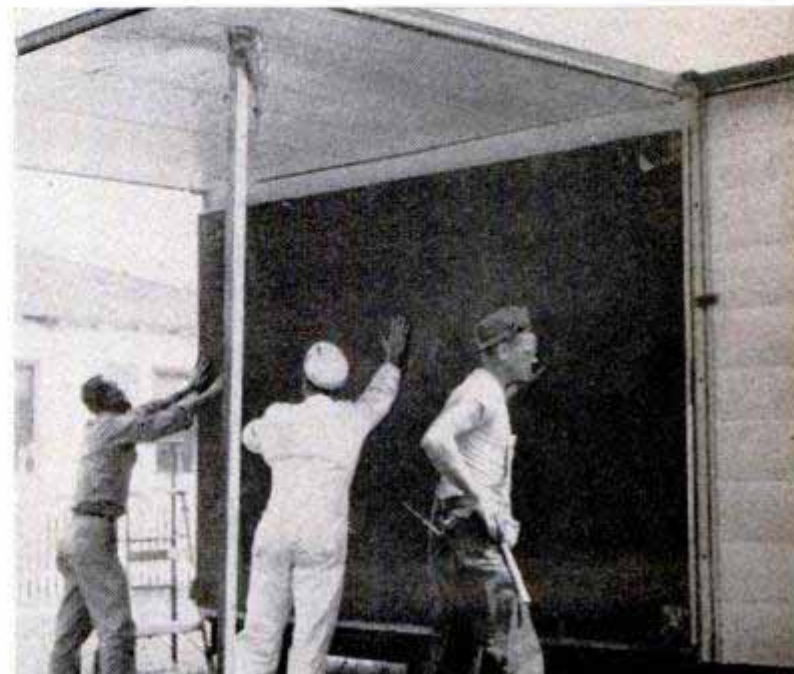
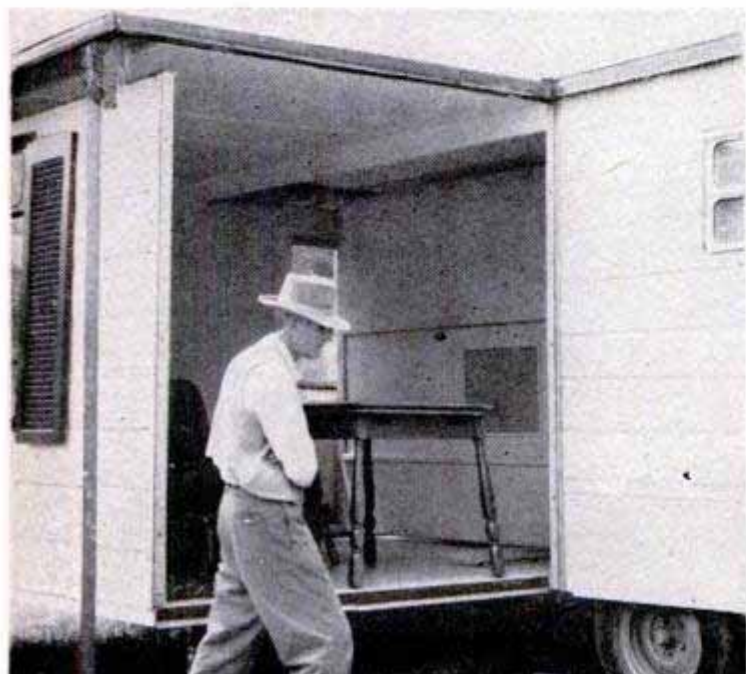

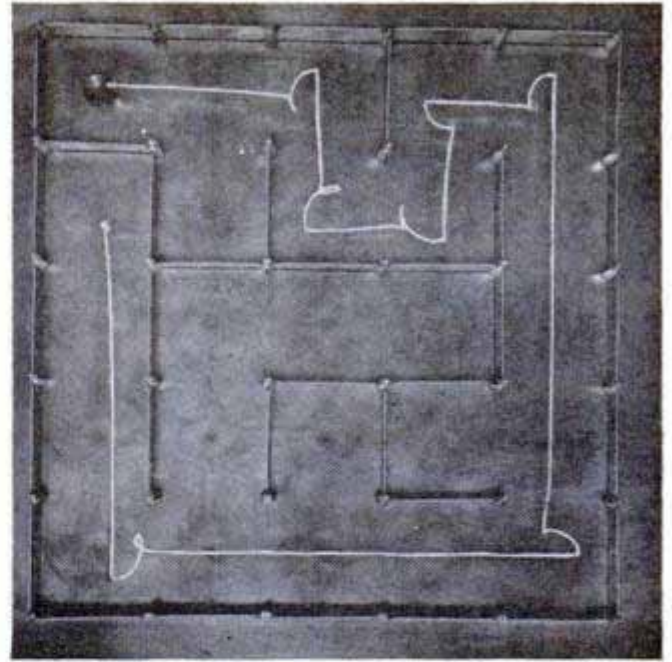
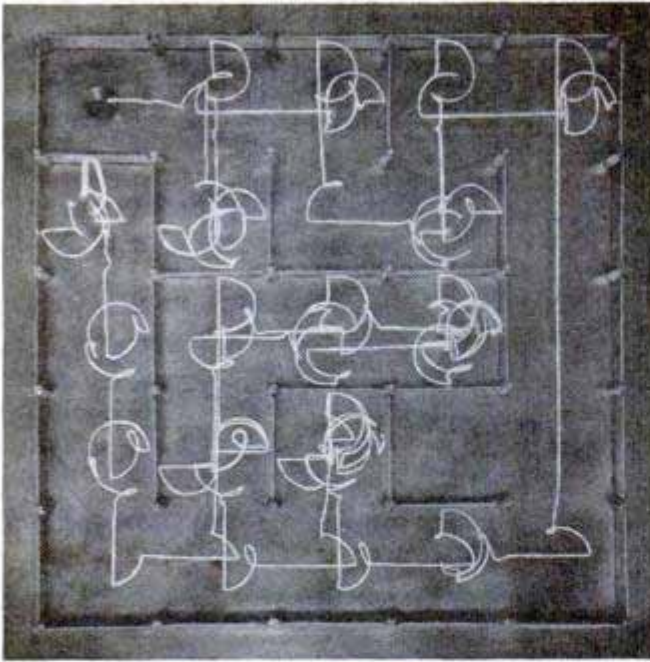

Time exposures show mouse's route through maze first time, and direct route once it had solved the problem

## *Manmade Mouse With a "Memory"*

There's a manmade mouse in New York City that goes scuttling down corridors, bumping into walls, backing up and exploring until finally it finds its "piece of cheese"—an electric terminal. The mouse is the work of Dr. Claude E. Shannon, a Bell Telephone Laboratories mathematician. Strangely enough, it is supplying basic knowledge of the type of switching relays used in telephone systems. The mouse is a bar magnet. On a metal plate Doctor Shannon builds a maze with sections of aluminum fence. There are a million possible variations to the maze. The scientist places the mouse at an arbitrary point in

the maze and the "cheese" at another point. Then the mouse goes scampering off to find the cheese. When it bumps into a wall, it turns around until it finds its way out. Minutes may pass before it finds the cheese, but once it has solved the problem, it can be placed anywhere on its previous route and go directly to the bait. The mechanism for the mouse is under the table; a motor-driven electromagnet seizes the mouse in a magnetic grasp and feels its way around the barriers. A circuit containing 59 relays serves as the mouse's "memory" to guide the mechanical creature back to the bait.

**Mouse actually is a bar magnet operated by magnetic force of an electromagnet installed under the table**

**Inventor builds random maze, then places mouse anywhere in it. The mouse scurries off to find its "cheese"**

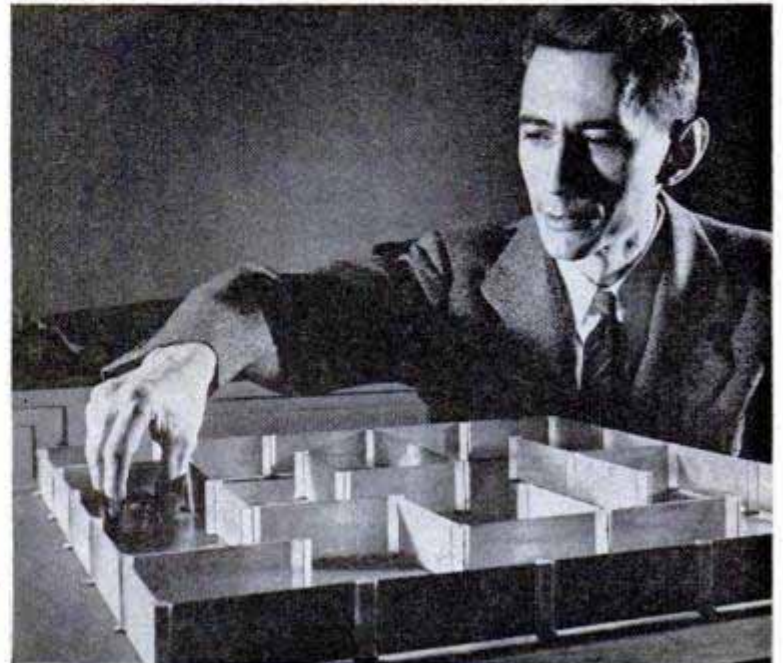
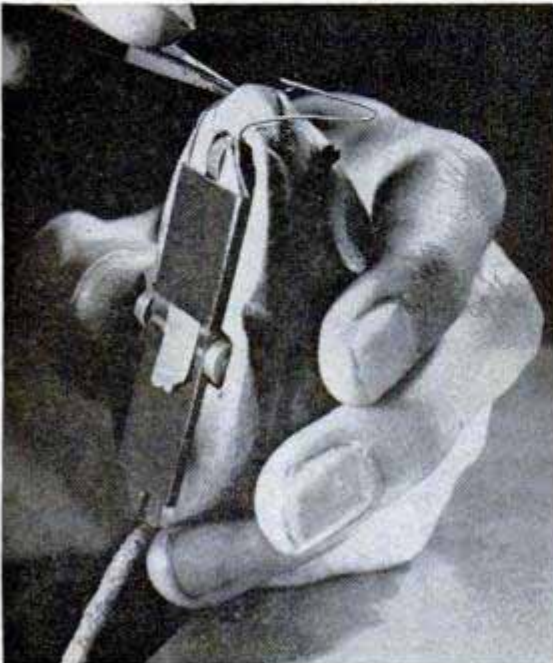

## Jet Transport

Under construction in France is a twin-jet transport for feeder service in Europe and North Africa. Carrying 60 passengers, it is designed for 300 to 1200-mile distances, less than the British Comet's best range. The principal turbojets will be supplemented by small auxiliary jet engines. Flexibility and stability are chief features.



## Funnel-Type Tester for Emergency Showers

Safety engineers at General Electric can test emergency showers installed at strategic points in the workrooms without getting so much as a drop on them. A large funnel directs the flow from the shower into a can from which the water is piped to a near-by sink. These showers release large volumes of water and are designed for dousing a scientist or laboratory worker in case his clothes catch fire or are sprayed by acid.

## British Army Doctors Test Aluminum Foil Dressings

British Army doctors report that aluminum foil has been used successfully as a covering or dressing for operation wounds. More than 100 cases, ranging from large abdominal incisions to small cuts on the arms, have responded favorably to aluminum dressings. The doctors state that the foil doesn't adhere to the wound, is easily removed and is more comfortable.

## Psychological "Gun"

Mounted atop an Army tank, a high-powered loudspeaker conveys information and announcements to enemy forces. The 300-watt amplifier is designed to broadcast surrender invitations and accurate news counteracting enemy propaganda. It may also be used for emergency battle communications within friendly lines.

☐ To help them glide through 600-mile-per-hour air, a special compound is used to coat the rivetless exterior of Boeing-Stratojet fuel tanks.



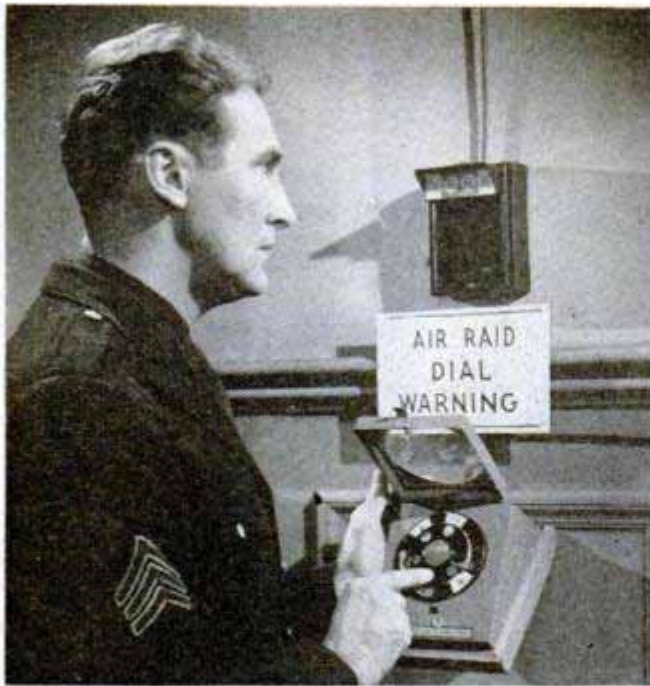

### Dial Air-Raid Warning

Dialed like a telephone at a central point, a signaling system uses a private one-way circuit to warn of air raids. The warning signal can be received at many points simultaneously. The system is designed for use in factories, schools, public buildings and other places where many persons may be at work in different rooms. In the central office, the operator simply dials the code color corresponding to the degree of alert. At the receiving end, a bell rings in code and a colored light flashes continually. Four alert signals—yellow, red, white and blue—can be transmitted. If desired, the receiving system can be wired so the confidential yellow alert is received only at authorized points. The operator ends the warning by dialing "stop," or dials another color signal.

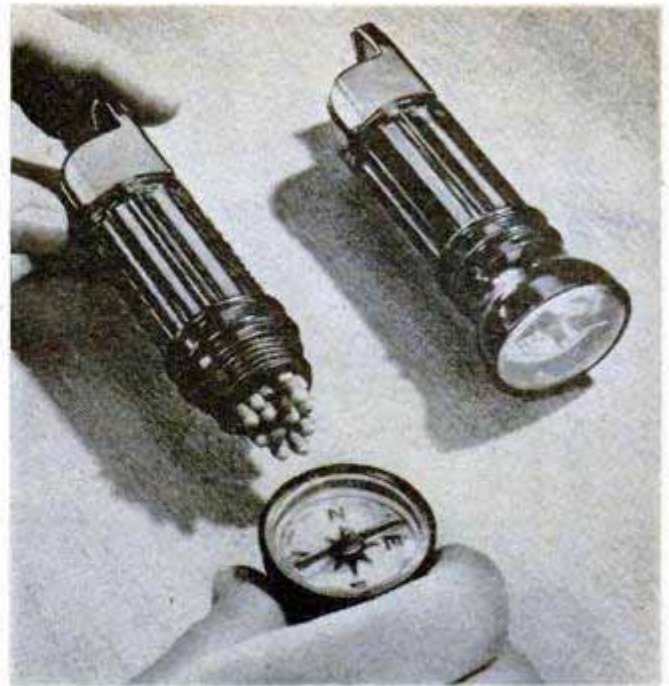

### Sportsman's Kit

Designed for use in field, woods and mountains, a three-in-one kit holds a luminous compass, waterproof match case and signaling whistle. Room for a small candle or map is also provided. Light enough to be carried in a pocket or from a sling around the neck, the closed kit will float in water.

### Crane Cargo Weigher

Suspended from the end of a loading crane, a gargantuan scale weighs cargo as it is being transferred from or to ships' holds. Built in England, the scale shows accurate weight on its clock-dial face in half-ton units up to a maximum of 120 British tons (134 U. S. tons). Of cast iron, it is eight feet long, two and a half feet wide, and has a weight of 3000 pounds.

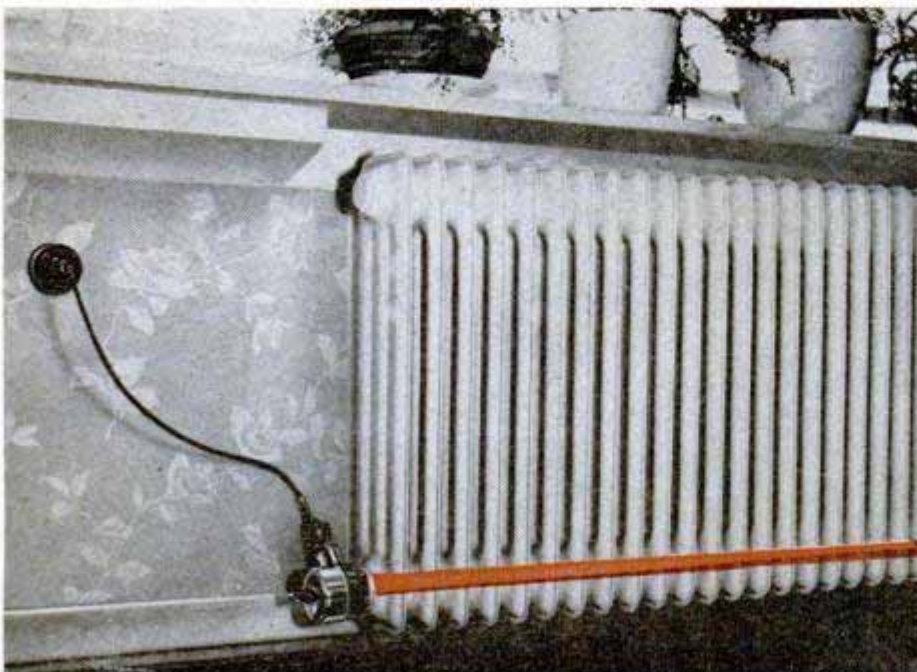

### Electric Stick Heats Radiator

Steam radiators can be made hot enough to take the chill off a room on a cool day with an electric heating stick developed in Germany. The stick is screwed into the bottom of the radiator in place of the standard plug. Connected to an electric outlet, the stick gets hot and warms the entire radiator.

⌚ Lightning struck the Empire State Building in New York City 226 times during the last 10 years.



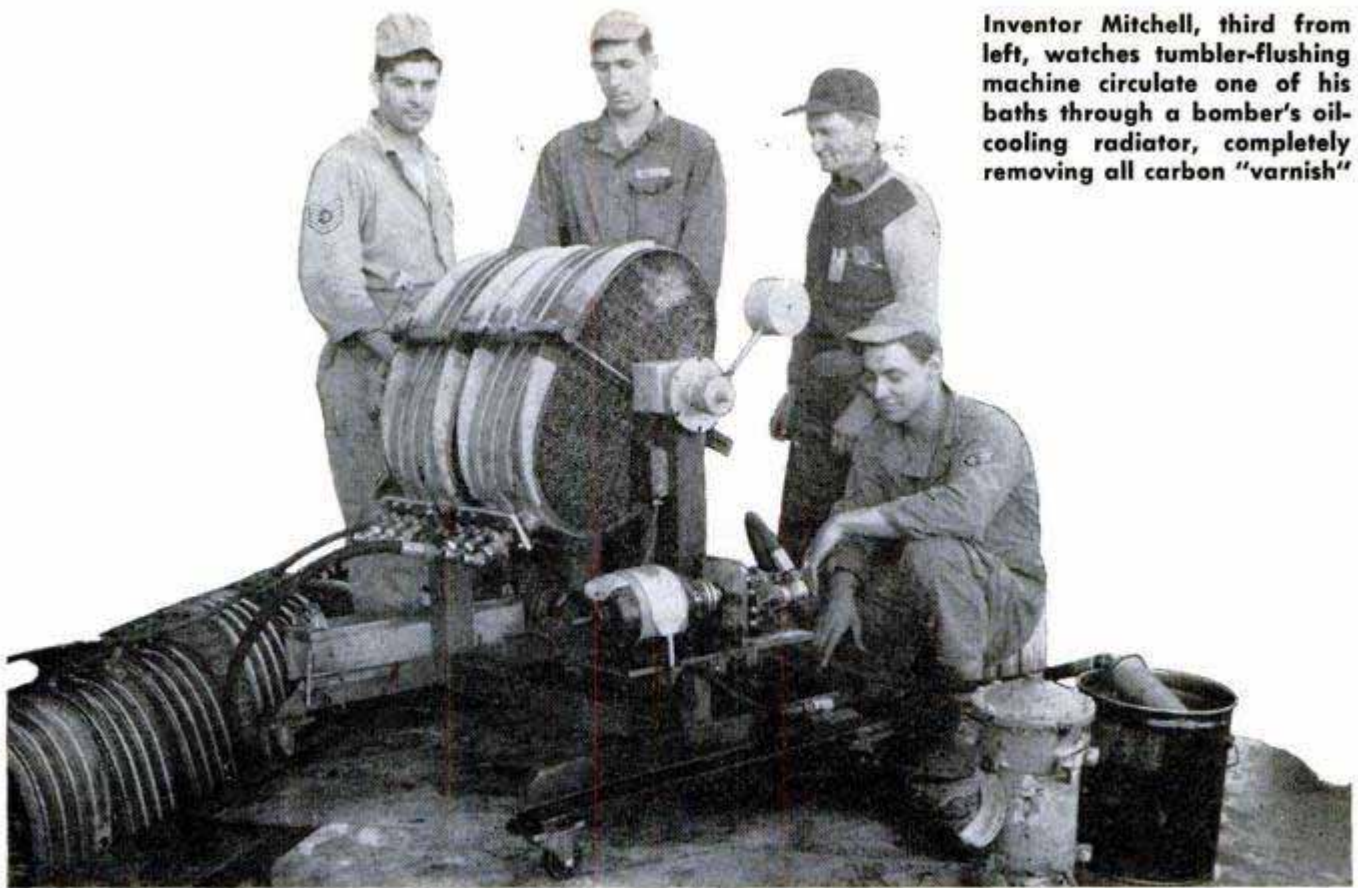

Inventor Mitchell, third from left, watches tumbler-flushing machine circulate one of his baths through a bomber's oil-cooling radiator, completely removing all carbon "varnish"

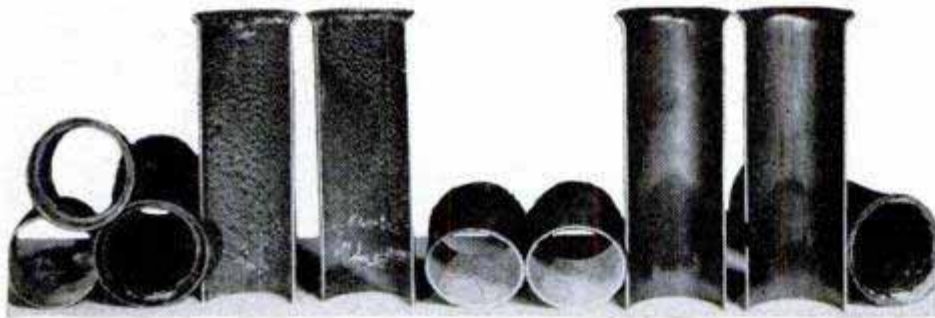

In less than eight minutes, a chemical bath changes carbon-coated B-24 exhaust stacks at left to the bright, sparkling surfaces displayed at right

Water and steam being used on a B-29's engine cowling remove dirt and grease prior to paint-removal process that restores brightness to metal

## "DECARBONIZING" FACTORY

AN IDEA Robert Mitchell first tried out in his wife's bread pans became a "decarbonizing" factory that has saved the government almost \$500,000. Mitchell, a foreman in the welding shop at March Air Force Base in California, used the pans to test some chemical baths he hoped would remove carbon from the exhaust stacks of aircraft engines. Sandblasting it away, an expensive process, also cuts through the hard surface of the stacks. Mitchell's formulas worked. They now do a half dozen different kinds of cleaning and restoration jobs at the base. They remove carbon from collector rings and the stacks of reciprocating engines and from some portions of jet engines, carbon "varnish" and other deposits from oil-cooling radiators of bombers, and old paint from miscellaneous aircraft parts. His cost-cutting ideas have brought him four awards from the suggestion committee at the base, three of which were top \$250 awards.



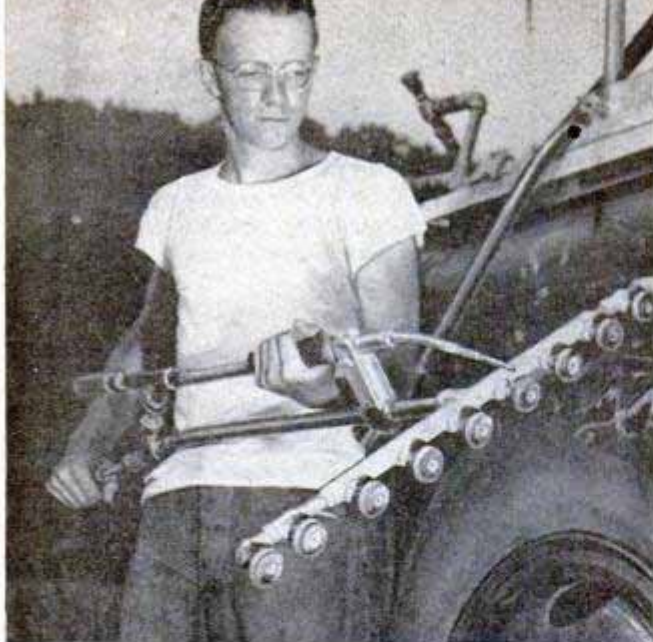

Lower line of this double-barreled spray gun has 10 nozzles for "shotgun" work and an upper, single line for "sharpshooting." Below, homemade unit that carries 100 boxes, each on tracks with roller-skate wheels

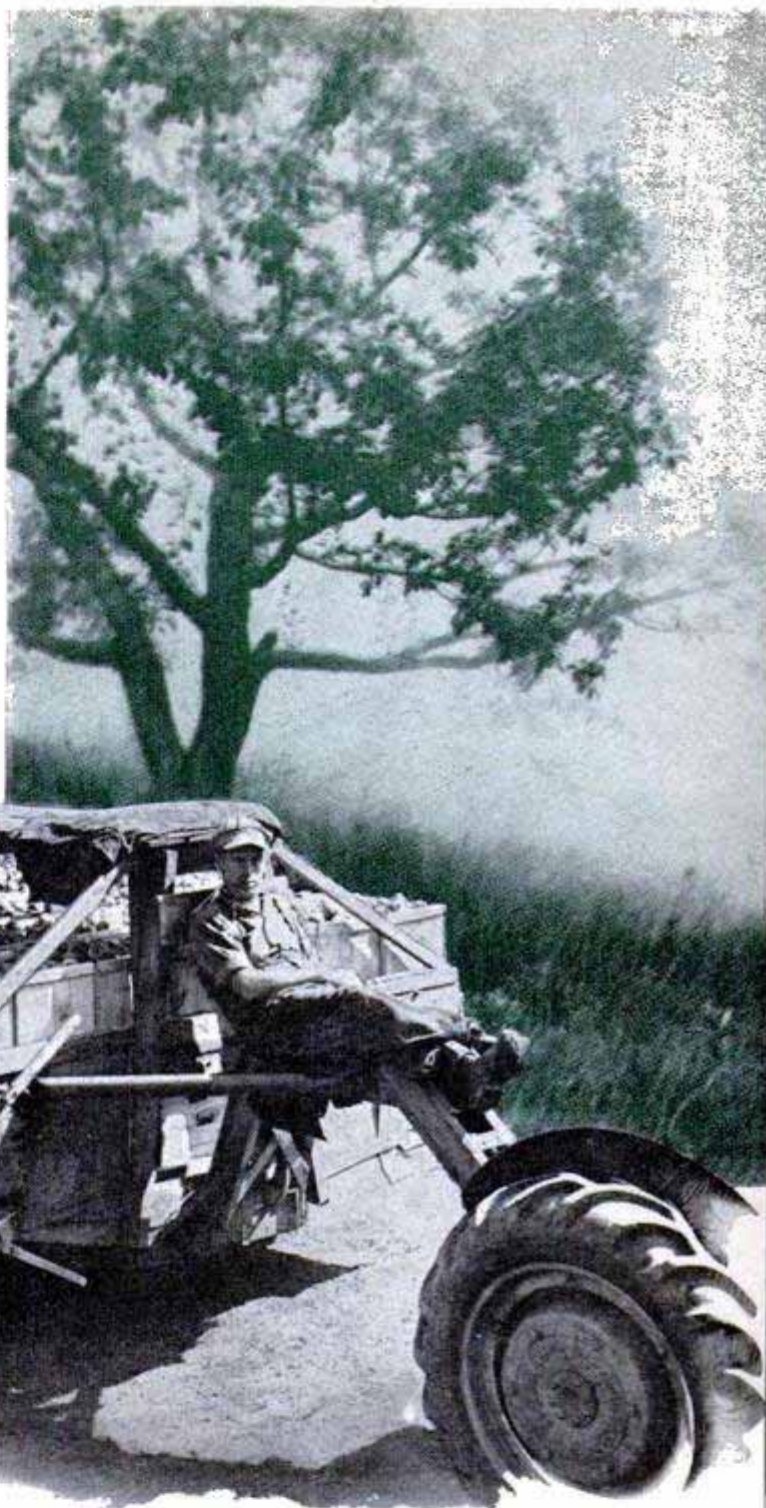

### By William Gilman

**R**EMEMBER that apple tree you used to raid when you were a boy? It's been mechanized into big business by the gadgets of modern science and gimmicks of native ingenuity.

Today's apple crop is grown mainly by specialists. They're allergic to doing by hand what machinery will do faster and better. Just one big riddle still baffles them—the automatic apple picker. A fortune awaits the inventor who dreams up such a harvester—every apple in the 200 million bushels that America picks and packs annually is still snapped off twigs by hand.

The rest has been transformed by plant

breeding, engineering and chemistry. For example, today's spraying isn't aimed at orchard pests alone. There are also the hormone sprays dropped by plane or helicopter that chemically thin out the growing apples so those remaining will ripen bigger and better, and the "sticker" sprays that make finished fruit hang on till the pickers can come.

Applegrowers can't meet expenses from windfalls and inferior apples sold for cider and applesauce. Facing mounting competition from citrus fruits, they'll try anything that produces apples with "eye appeal" and keeps them that way.

Handling apples from orchard to packing shed can easily bruise them. One solution



With automatic nozzles at the sides and "sharpshooter's" tower, this sprayer does complete job on one pass

# **Johnny Appleseed Hires a Mechanic**

has been hauling them in small trailers lined with foam rubber. Newest is the car-ferry system used by F. Cabot Holbrook, an M.I.T.-trained engineer who turned applegrower.

He built a double-decker trailer, so no apple box would sit on top of other fruit. Instead, each box rests on tracks equipped with roller-skate wheels.

At the packing shed, the receiving dock has similar tracks to match. The tractor-hauled trailer pulls up alongside. The dock is adjusted by chain hoist so that its tracks line up with those of the trailer, then boxes are rolled off without banging and bruising. When the trailer leaves, tilting the dock with the chain hoist sends boxes gently

Sound fruit riding rubber belt is automatically graded into six sizes, with packer at each station filling boxes provided on overhead track. Revolving rubber wheels trap all the apples large enough to make contact and whirl the fruit into packing trays





**Cross-braced to the tractor, an old hayrake is put to work gathering brush after orchard pruning. The rake's 10-foot reach gathers brush under tree limbs as the driver circles and a second tractor scoops it up and carries it to bonfire**

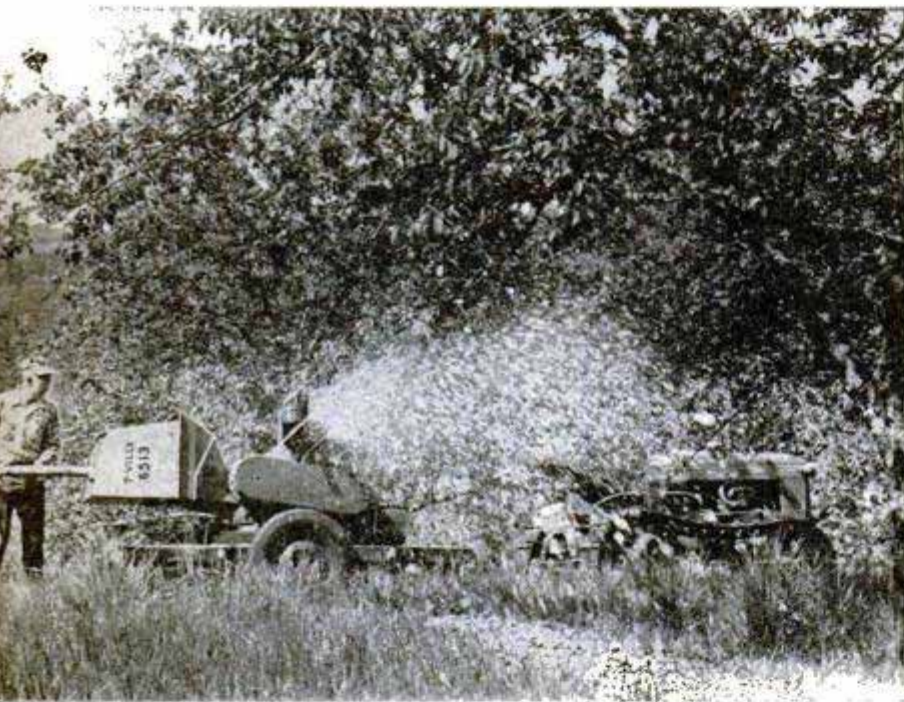

**Branches up to six inches in diameter are fed into a chipping machine and then blown back under trees as mulching material. Below, there's no bumping or hand labor that might bruise the apples as they move on track rollers into the packing shed**

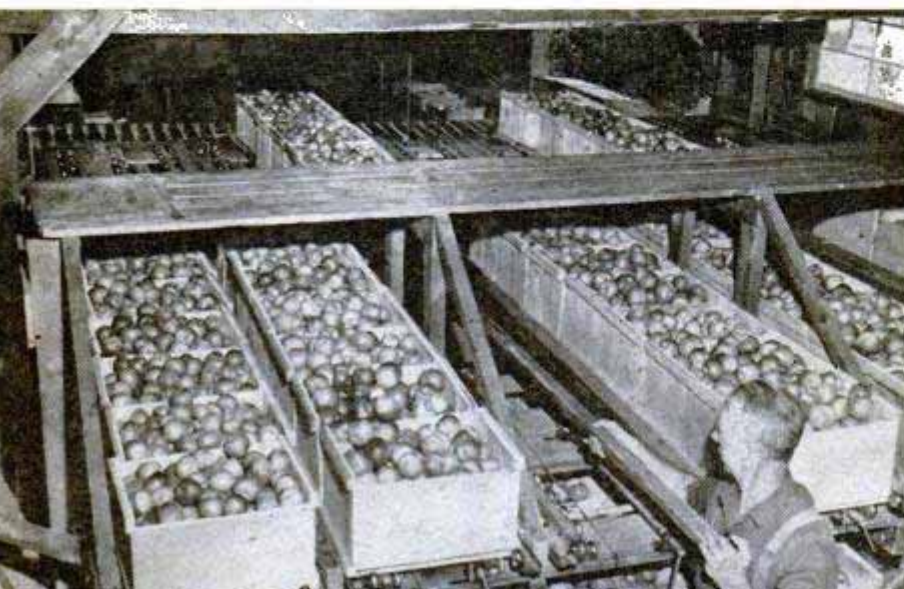

sliding down to the track that feeds them to the automatic grader.

There's a wide choice of such machines that sort the fruit by sizes. In the latest type, as apples ride a rubber belt they are given a rotating motion every few feet when they pass under a sponge-rubber paddle. At each of six stations, a revolving, rubber-tired wheel overhead catches those apples large enough to make contact and rolls them off into a free-wheeling tray attended by a woman who packs them in boxes for storage or shipment. The sorting wheels are set at different heights. Largest apples come off first, smallest ones run the gauntlet to the last station.

A temperature just above freezing helps keep apples fresh over winter. But newest methods go beyond mere cold storage. They also seal the apples inside a "gas chamber" where the air steadily receives chemical scrubbing. Blowing it through canisters of activated carbon removes ethylene, a ripening gas that hastens spoilage. And circulating air through tanks of caustic soda keeps oxygen low without allowing carbon dioxide to build up.

This is equivalent to suffocating the apples—slowing down their "breathing" makes them last twice as long and they leave storage in May practically as juicy and firm as they were when hanging on trees in October.

Winter months, when his trees are dormant, find the orchardist busy as ever. In bad weather he sticks to his workshop, overhauling spray equipment, building wood boxes for next season's fruit, converting old jalopies into orchard trailers.

During mild spells trees receive the "manicuring" that produces healthier and finer fruit. The orchard worker now uses a pneumatic pruner that's faster and easier than the old-fashioned saw—up to a half dozen such "guns" can be run by compressed-air lines from a tractor's power take-off.

But the power pruner can't touch hard-to-reach limbs so orchardists carry the mechanized method a step further with homemade elevator platforms erected on trailers or mounted over the tractor itself.

(Continued to page 248)



## Log Grapple

Mounted on a standard truck, a log loader picks up  $\frac{1}{4}$  cord of logs at a time and pivots 180 degrees to lower them onto a

truck's bed. Designed for use in off-road areas of pulp forests, the loader is hydraulically operated. It can lift 3000 pounds of logs to a height of 14 feet. The loading cycle takes only 20 seconds.

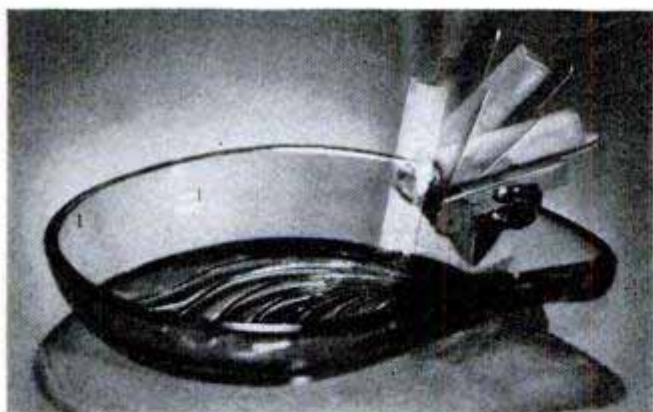

## Cigarette Watchman

If you leave a burning cigarette on the shelf of an automatic ash tray, you don't have to worry. The shelf will dump the cigarette into the tray when it has burned down to the danger point. A thermostatic spring does the trick. When the butt has burned down and the end is opposite the spring, the metal expands and flips the shelf up and over, dropping the burning cigarette into the commodious ash tray where it can do no harm.

## Train Brakes For Trucks

Brakes similar to those used on railroad cars have been developed for trucks by a German inventor. A brake shoe is installed behind and in front of each rear wheel. The shoes will stop a heavy truck traveling about 25 miles per hour in less than 17 feet, according to the inventor. They also stop backward skidding on icy slopes.



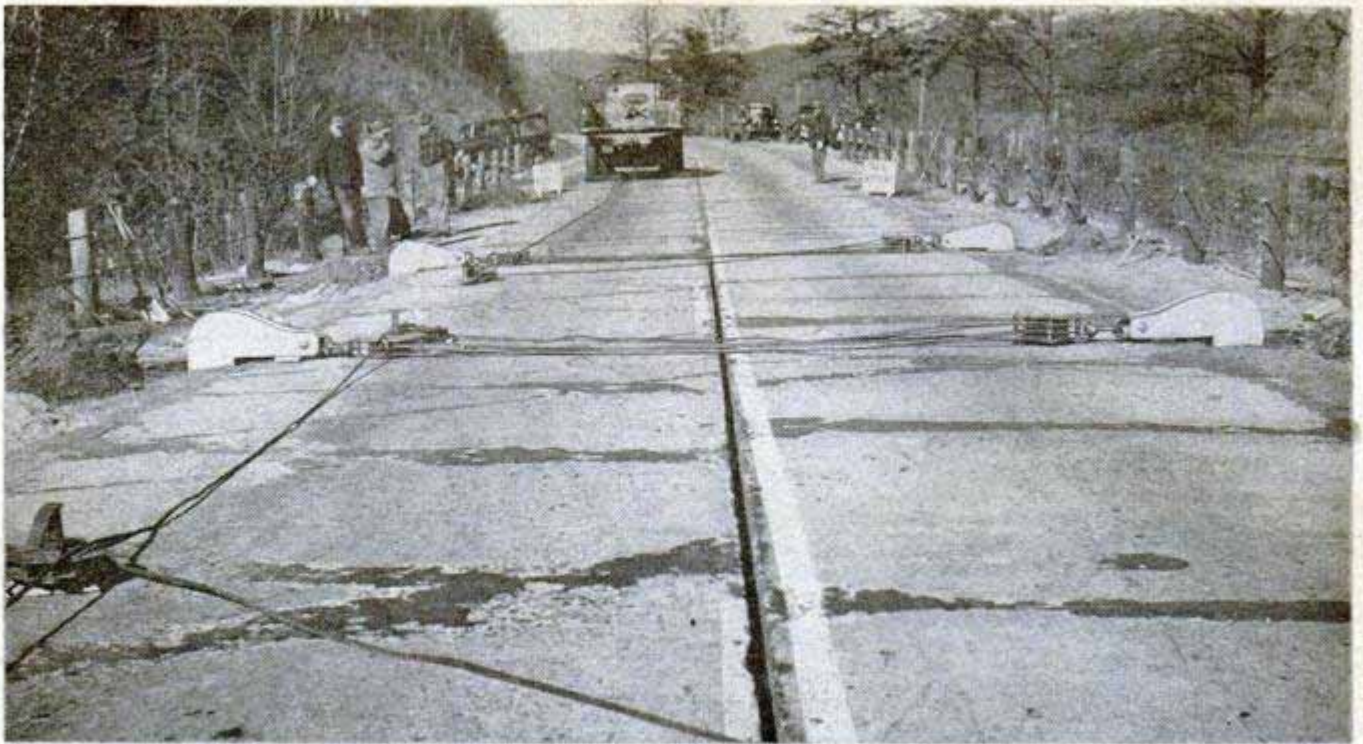

## Out-of-Place Highway Squeezed Back Into Position

Huge slabs of highway concrete which have slipped out of position can be moved back into place through a unique system devised by the Connecticut State Highway Department. The eight-inch slabs, measuring 60 feet long and 11 feet wide, weigh an average of 60 tons. In the town of Haddam, Conn., the slabs had slipped apart as much as 2½ inches. Using mud jacks, the crew propped up the pavement. Then the men installed heavy hooks on opposite sides of the pavement and connected the hooks with block and tackle. When a winch truck pulled on the cable, the blocks moved slowly back into position.

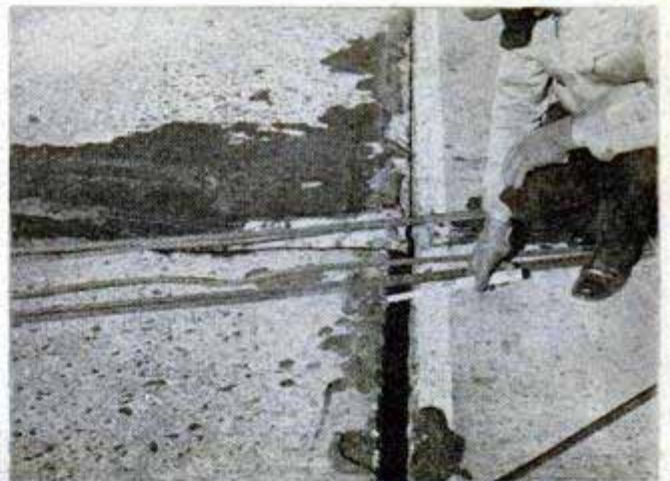

## Straight-Line Shotgun Fires in Two Opposite Directions



Police and Army ordnance officers in Chicago have been puzzled by a strange little weapon — a double-barreled shotgun which fires in opposite directions. The barrels, which thread together, are each about four inches long. When they are unscrewed, 20-gauge shotgun shells can be slipped into the chambers. One lever fires both barrels. The owner told members of the Chicago Police Department that he picked up the unique firepiece while serving with American occupational forces in Germany.

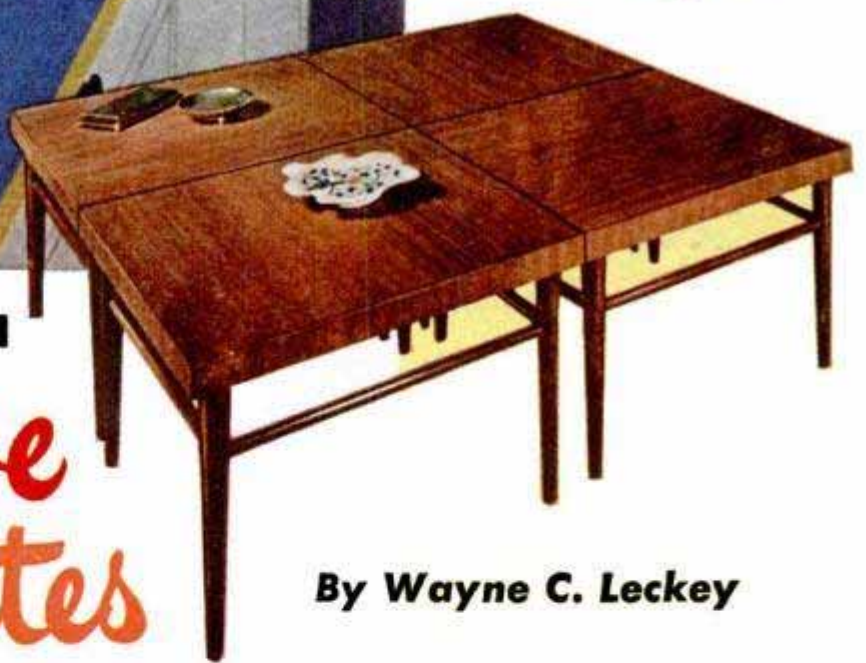
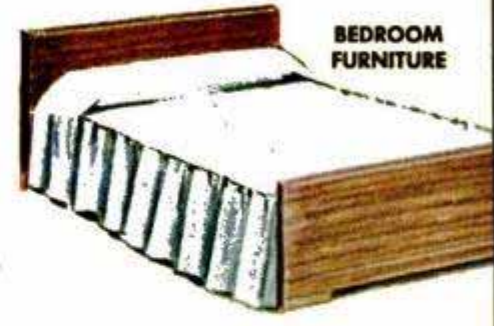

Photos courtesy United States Plywood Corp.

**WHAT YOU CAN DO WITH**  
**Decorative Laminates**

**By Wayne C. Leckey**

**M**OST EVERYONE knows what usually happens when a frosty drink is placed on a highly polished table or a burning cigarette accidentally falls from an ash tray—the table top is ruined and a costly refinishing job is in order. Homeowners who have experienced this will be eager to learn of a comparatively new plastic material that literally defies marring. Called decorative laminate, this amazing plastic material will withstand most acids, will resist heat and cold and endure chemical action. It is virtually unstainable. It won't chip, scratch, craze when wet, or corrode when soft drinks, food or liquor is spilled on it. It requires no refinishing or polishing — just a quick wipe with a damp



**WINDOW SILL**

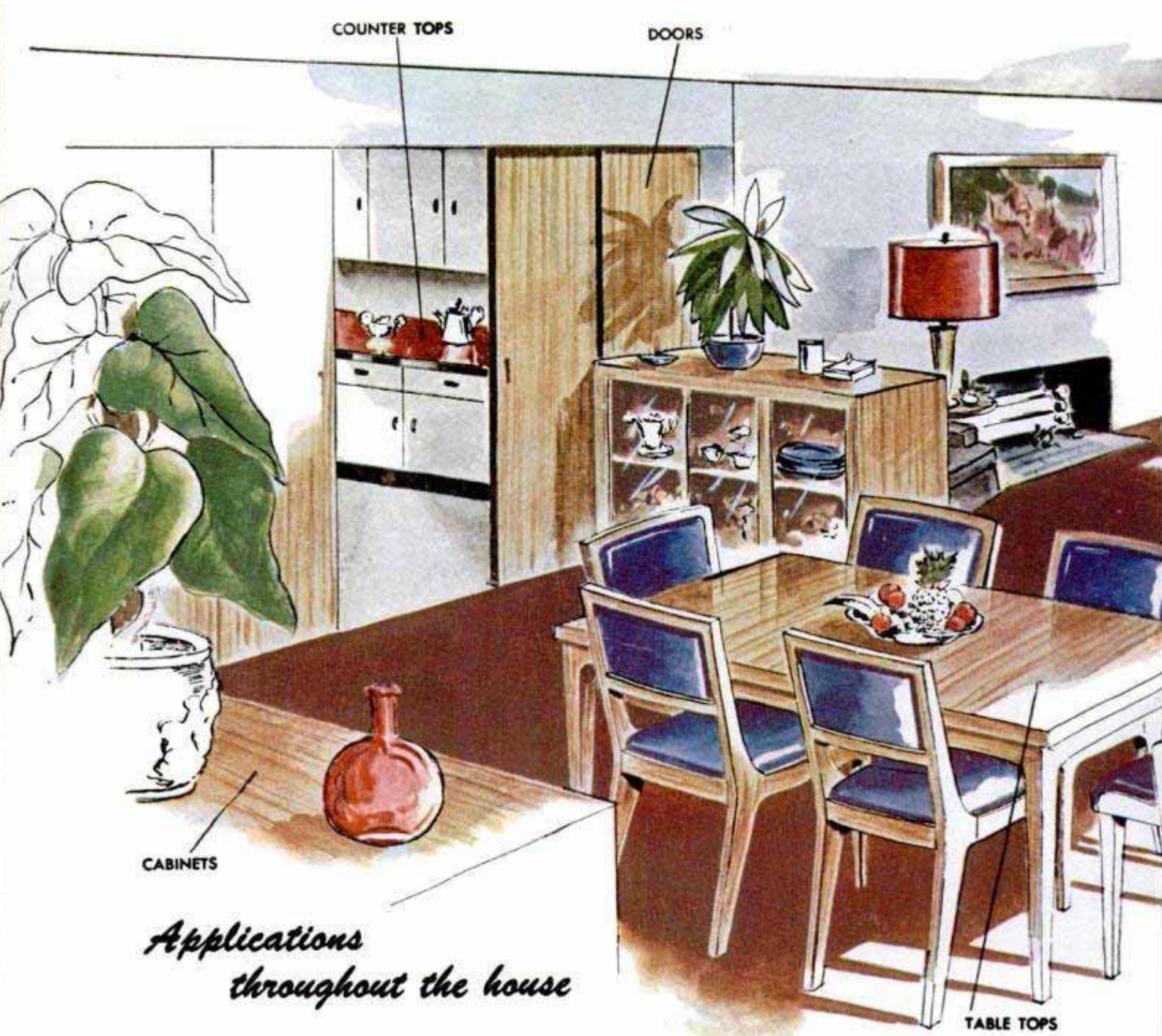

*Applications  
throughout the house*

cloth will bring back its original bright luster, year after year.

Familiar to many who first remember seeing it on restaurant tables and counter tops, decorative laminate, as its name implies, is a durable high-pressure plastic laminate with a decorative surface. It is made up of many layers of resin-soaked kraft paper and veneer which are fused together under intense heat and pressure. The laminations actually merge to form a new substance which is coated with a super-tough skin of clear plastic that locks in the color and pattern for life. Marketed under several different trade names, decorative laminate can be had in roll or sheet form and in a score of patterns and colors, including beautiful reproductions of rich mahogany, oak, prima vera and walnut wood grains. Available in various lengths and widths, decorative laminate also may be

purchased at lumberyards, ready bonded to  $\frac{3}{4}$ -in. plywood. Most linoleum stores carry laminates and the cement that's needed to apply them.

Decorative laminates are at home in every room of the house. On kitchen counters, cabinets and other work surfaces where cleanliness is a must, this miracle material provides a most practical covering. Liquids, grease and food particles leave no residue on its impervious glass-smooth surface. On furniture in the living room and bedroom, laminate fills the double function of fashion and lasting utility. A more practical top for a cocktail table could not be found. In the bathroom it does triple duty in repelling water, medicines and cosmetics. On a refreshment bar in the recreation room it comes through without a scratch or stain. Dated panel doors can be converted to beautiful flush doors by



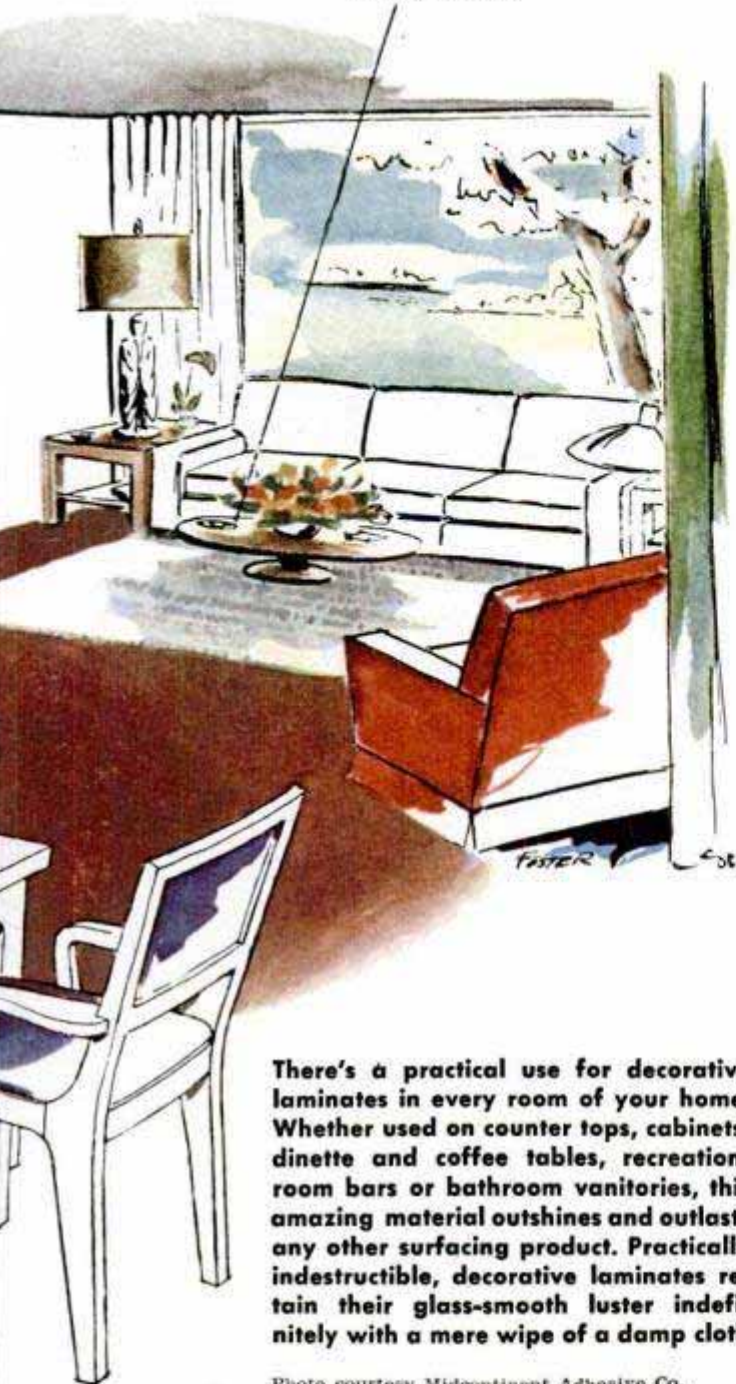

There's a practical use for decorative laminates in every room of your home. Whether used on counter tops, cabinets, dinette and coffee tables, recreation-room bars or bathroom vanities, this amazing material outshines and outlasts any other surfacing product. Practically indestructible, decorative laminates retain their glass-smooth luster indefinitely with a mere wipe of a damp cloth

Photo courtesy Midcontinent Adhesive Co.

covering them with any of the true wood-grain reproductions to be had. Window sills will stay permanently protected from the hot sun when surfaced with laminate. A section of a wall can be paneled in wood grain to give contrast to a papered or painted wall.

While decorative laminates have an exceptionally durable surface, it is not so hard that it cannot be damaged under certain conditions, and while it can stand constant abuse, one should avoid giving it unnecessary punishment. It is neither recommended nor necessary to clean the surface with gritty scouring powders—only a damp cloth is needed to clean it. Also, avoid placing a hot pressing iron directly on the laminate, or using it as a cutting surface. Always place a pad under a toaster, waffle iron, percolator or other hot appliance.

Heretofore, the application of decorative laminate has been limited to the furniture manufacturer having facilities for gluing and clamping the material securely to the surface. Now, thanks to the development of special "no clamp" adhesives, the application of decorative laminate can be done right at home with a few common hand tools. Of the several adhesives available, Roltite and Tapon were successfully tried by the author in bonding several different decorative laminates.

While laminates can be had in both roll and sheet form, the roll type is  $\frac{1}{32}$  in. thick and the sheet type is  $\frac{1}{16}$  in. thick. The thinner material is cut by merely scoring the top surface with an awl and then bending it upward to snap it off, whereas the heavier  $\frac{1}{16}$ -in. material must be cut with a fine-tooth (metal-cutting) keyhole saw, using downward strokes to avoid chipping. It is always best to cut the material about 1 in.

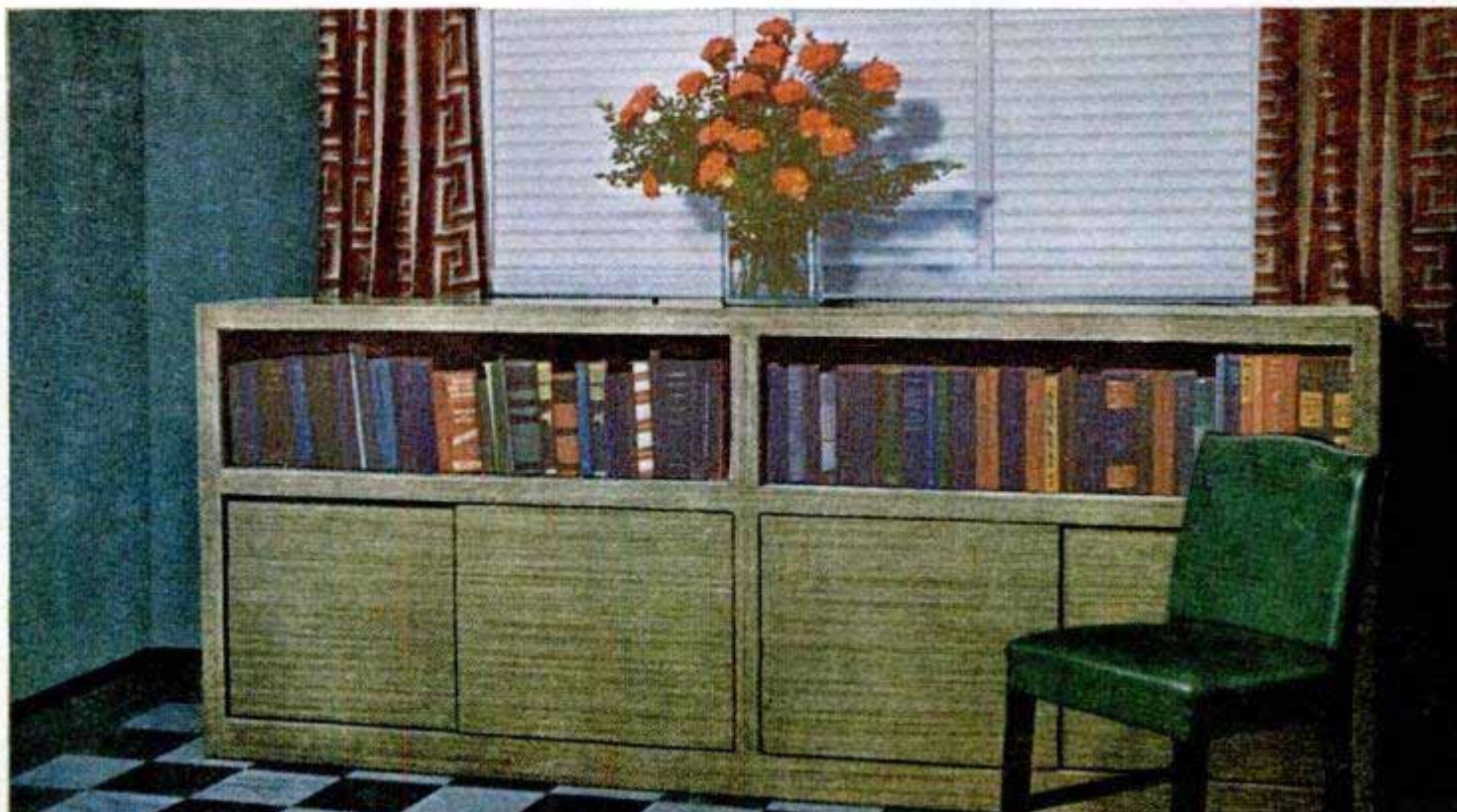



Photo courtesy General Electric Co.

While not a sheet laminate but of the same durable quality, molded counter is available in 6-ft. lengths



Photo courtesy Midcontinent Adhesive Co.

Above, laminate makes excellent durable covering for traveling case, and a most practical surface material for a vanity in a powder room as pictured below

Photo courtesy The Formica Co.



oversize to be on the safe side if chipping should occur and also to have enough waste to later trim carefully to line. When it comes to actual application, the work should be done in a room temperature of at least 70 deg. F., and it is important, too, that the laminate be of room temperature. The cement must be applied warm, heating it beforehand in a pan of hot water until it is warm to the touch. All wood surfaces to be covered must be flat, clean and dry. If the surface has been painted or varnished, better results are had if the finish is removed. If the edges as well as the top surface are to be covered, the laminate is always applied to the edges first, using a cement of thicker consistency which is made specifically for edge work. Assuming that only the top and not the edge of a work counter is to be covered, first brush a coat of cement on the wood with a clean paintbrush and allow to dry at least 30 min. Then apply a second coat. While this is drying, brush a coat on the back of the laminate and allow all coats to dry not less than 30 min. There's no need to hurry, the cement can be left to dry up to two hours and still be workable. To determine when the cement is dry enough to bond the laminate, test it with a piece of wrapping paper. If, after pressing it on the cement, it has a tendency to pull the cement away from the surface, the cement is not dry enough. If for any reason it is necessary to allow the cement to dry for a longer period than specified, it can be reactivated by applying another coat on top of the first one. Strive to brush an even coating over the entire area; dull spots upon drying indicate that the application was too thin.

These decorative laminate samples show four popular patterns which are available in variety of pastel shades and wood grains to suit any interior treatment



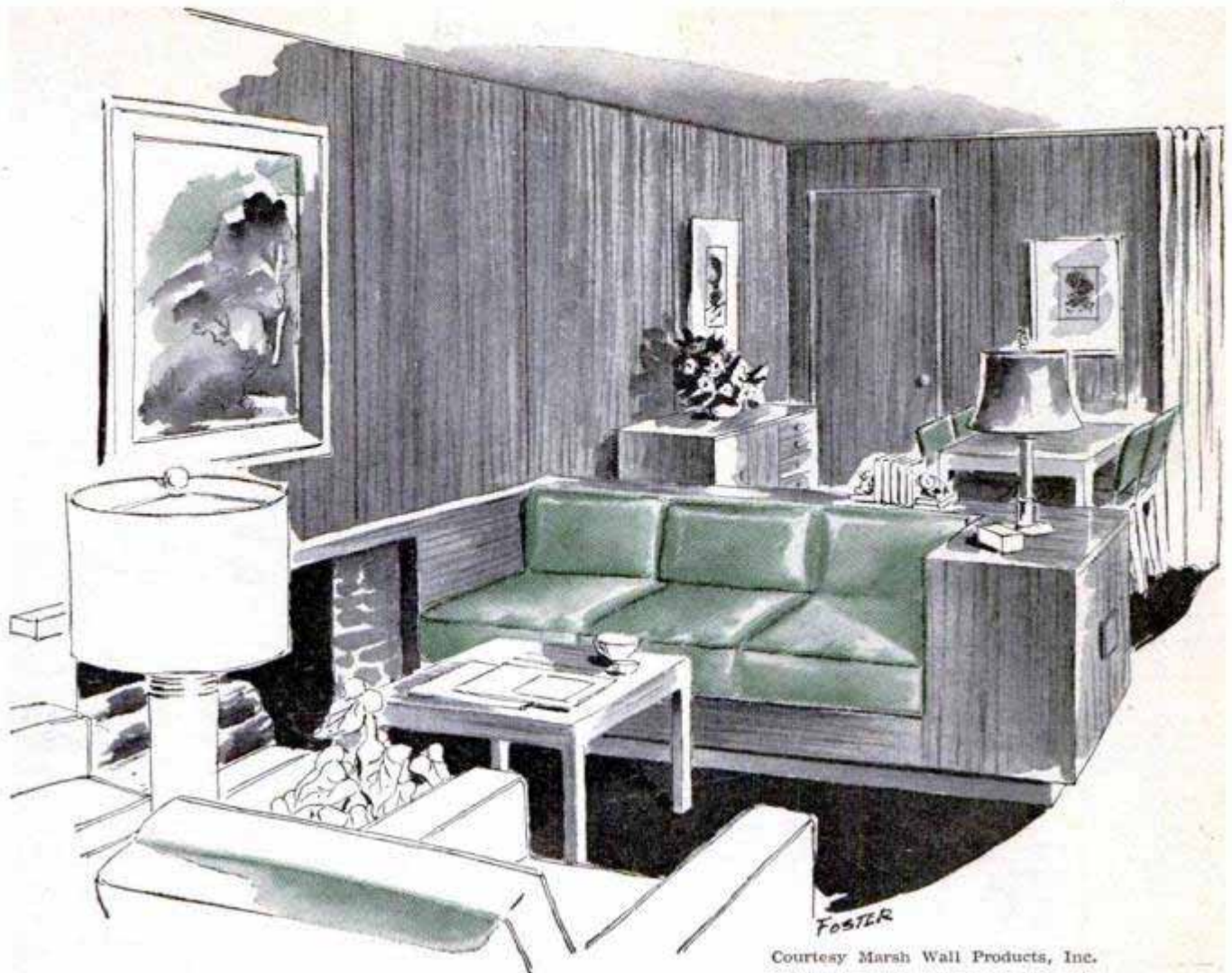

Courtesy Marsh Wall Products, Inc.

Because bonding is immediate and permanent when both cemented surfaces come in contact, wrapping paper is used as a separator to permit the laminate to be positioned and aligned properly. The paper is placed lightly over the cemented surface and the laminate placed on top of it. When in proper position, the laminate is raised slightly and the paper is withdrawn two or three inches. This allows a portion of the laminate to make contact with the coated surface, after which the paper is pulled out all the way. All that remains to be done is to roll the laminate firmly to assure over-all contact, and the bonding is completed. Trimming the edges back to line is done

Beautiful walls which require only a wipe of a cloth to clean are had by paneling a living room or den with rich wood grains of mahogany, walnut or oak

with the square edge of a single-cut file, working carefully and slowly to avoid chipping. If the laminate is to be covered with a metal or wooden edging, carefulness is not too important. If the edge of the laminate is not to be covered, the laminate is finally filed at a slight bevel, just enough to break the sharp corner. This is done with the flat side of the file as pictured. Don't worry about any excess cement on the surface, it is easily rubbed off with the fingers.

Remember that if the edge of the work is

Here are pictured the two methods recommended for cutting roll and sheet-type laminate. Roll type is scored with pointed tool like an awl or ice pick and bent upward to snap off. Sheet laminate is cut with a fine-tooth saw

CUTTING ROLL-TYPE LAMINATES  
( $\frac{1}{32}$ " THICK)

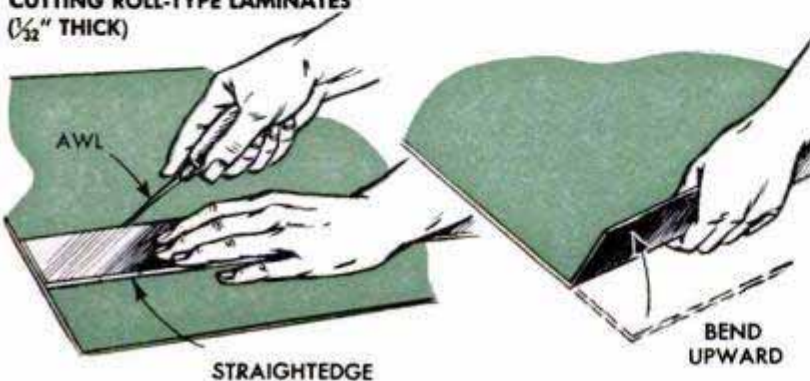

CUTTING SHEET-TYPE LAMINATES  
( $\frac{1}{16}$ " THICK)





The cement is applied warm with a clean paintbrush and left to dry at least 30 min. Two coats are applied to the wooden surface and one to the laminate

#### POSITIONING THE LAMINATE

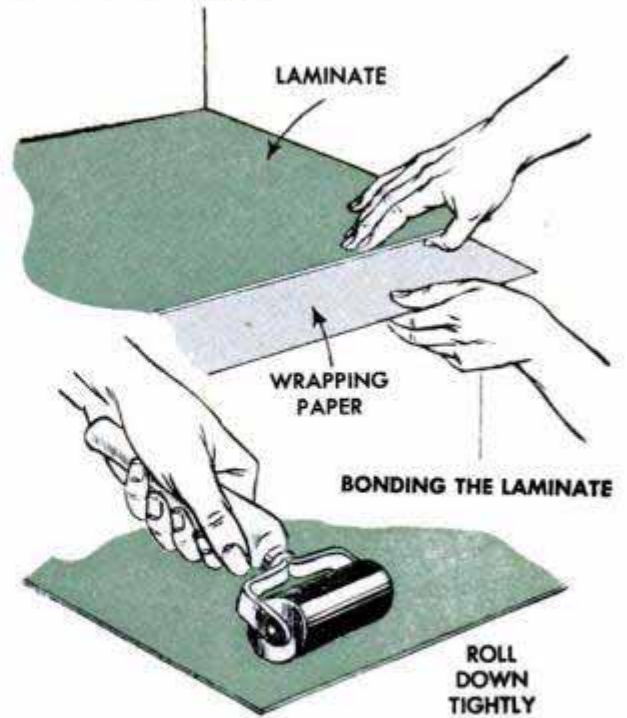

Wrapping-paper separator permits laminate to be positioned on cemented surface prior to final bonding. Rolling with firm pressure assures positive contact

#### FINISHING



CUTTING LAMINATE FLUSH

DRESSING EDGE

#### APPLYING EDGE FACING

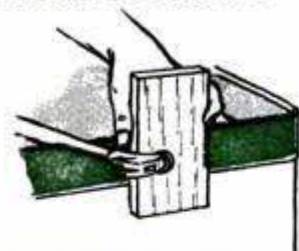

PROJECTS 1/4"

#### MAKING SINK OPENINGS

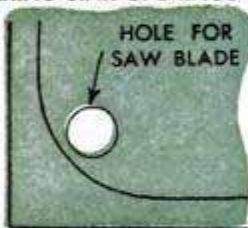

PRICK MARKS  
FILE TO LINE WITH  
FINE RASP

#### REPAIRING POOR BOND



HEAT LAMP

to be covered, the edge is done first and then the top surface. Cut the laminate so that it will be flush with the bottom of the edge and wide enough to extend about 1/4 in. above the top surface. Apply the cement as before, using a special and thicker cement (Tapon), and let dry. Then apply by aligning the laminate in position and tapping it in place with a hammer and a block of wood. Finally, the waste is filed off as before, flush with the top surface. Laminate covering the surface should always be laid to extend over the edge of the facing strip. If it is necessary to bend the facing strip around a corner, heat it at the bend with a heat lamp (never an open flame) to prevent surface cracking. Do not attempt to bend it around a sharp corner.

Where a seam must be used, abutting edges of the laminate are first placed face to face and both cut at one time. This is done by clamping the material between two hardwood boards having perfectly straight edges, allowing the laminate to extend about 1/4 in. Saw as close to the hardwood as you can without cutting into it and then dress down both edges of the laminate with a file before removing the clamps. Where the abutting ends of the laminate have a tendency to curl, place a piece of wrapping paper over the seam and press the laminate with an electric pressing iron set at 200 deg. F., or "silk" on indicator dial. Move the iron back and forth with pressure until the laminate becomes hot and has relaxed into positive contact at the seam.

If for any reason you obtain a poor bond

## CUTTING A SEAM

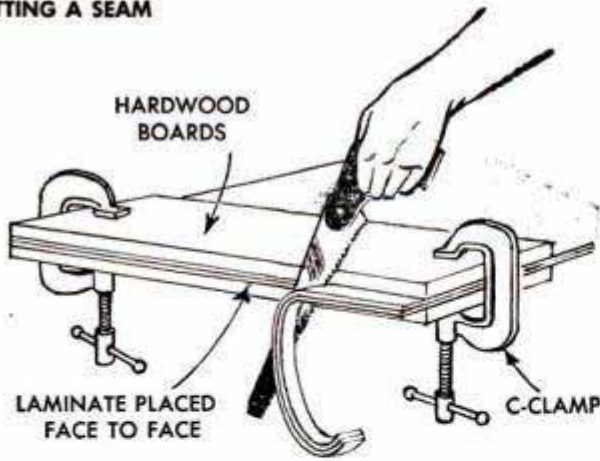

or if a blister should develop under the laminate, the defective area generally can be repaired by heating it until hot (130 deg. F.). This relaxes the laminate and reactivates the cement film, after which mere pressure usually will rebond the spot. If not, a C-clamp and block of wood will do the trick where it is possible to clamp the work. In the case of a blister, heat and press the surface as described and then quickly chill the surface with ice. If it is necessary to remove the laminate completely, cement solvent applied with an oil can to the cement will soften it to the point where the laminate can be peeled carefully from the surface. In the case of some cements, it is recommended that repairs must be made within a few days of the original application, as the cement tends to vulcanize with age and prevents any repairs being made.

Where walls are perfectly straight and flat, the laminate can be applied directly. Otherwise, it is best to provide a smooth base of hardboard. If desired, hardboard panels can be purchased prebonded with laminate and ready for direct application. The left-hand photo below shows a wall covered with prebonded laminate. ★ ★ ★

Photo courtesy Woodall Industries, Inc.

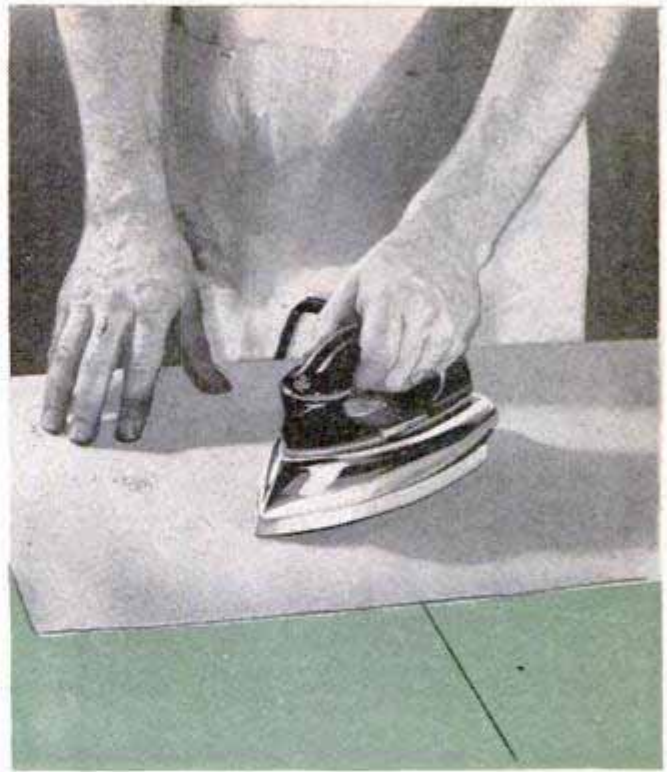
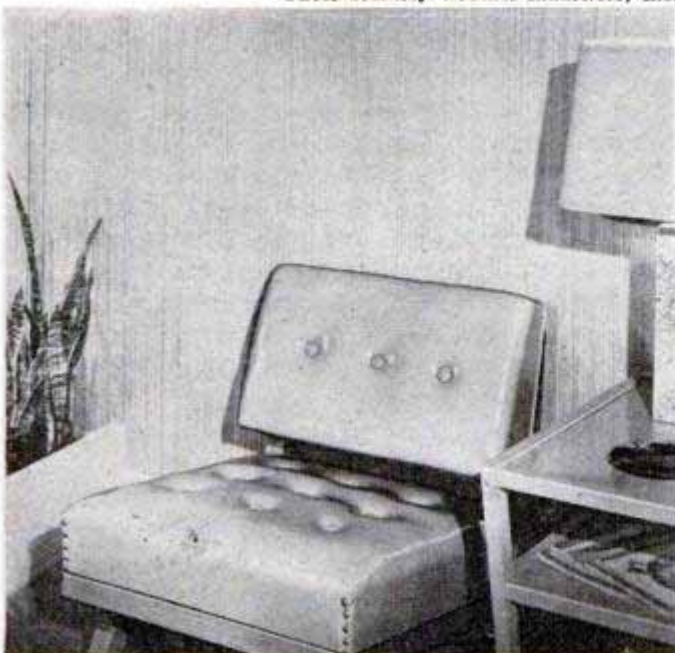

Abutting edges of a seam which have a tendency to curl, are heated with an iron to make pliable and pressed in contact with the cement-coated surface

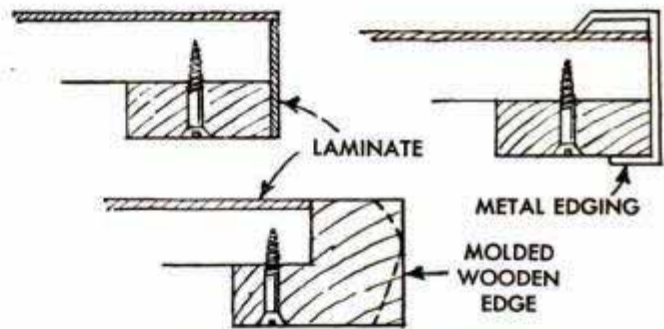

BUILT-UP EDGES AND EDGE TREATMENT

If you do not wish to face the edge of the work with laminate, the edge can be attractively concealed with either a metal or wooden molding. Note that laminate applied to the surface extends over facing strip

Photo courtesy The Formica Co.



## Gourd Made Into Jack-O-Lantern



Traditional jack-o-lanterns made from hollowed pumpkins lack the durability and portability so much desired by Halloween pranksters. A good substitute that fills all the practical requirements can be made from a large gourd of the necked variety. The gourd selected should be properly dried and coated with shellac or orange-colored enamel. Cut eyes, nose and mouth in the appropriate design, then cut off the neck of the gourd at a point just below the bulbous end. Fit the lens of a large flashlight into the opening, trimming or padding the opening as required to obtain a snug fit. The flashlight is held securely in place with several turns of cellulose tape.

G. E. Hendrickson, Argyle, Wis.

## Method for Securing Patches Simplifies Screen Repair

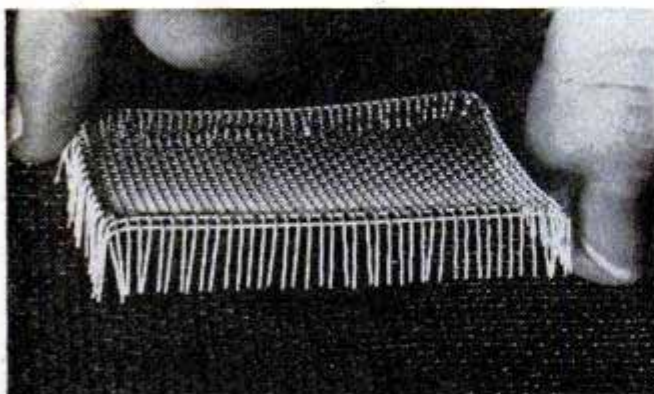

No thread or string is needed to put a neat patch on a screen door or window. The job can be done by using only a piece of screen. Cut the patch about 1 in. larger all around than the hole to be patched. Un-

ravel four or five of the wires running parallel with the edges of the patch and bend the remaining ends at right angles to the patch, as shown in the photograph. Then, place the patch over the hole in the screen, pushing the wire "teeth" of the patch through the openings in the screen and clinching them toward the center of the patch on the other side of the screen.

R. F. Donovan, Guttenberg, N. J.

## Clothes Rack From Tree Branch Suits Decor of Rustic Cabin

Fastened to a wall of a cabin or summer home, this rustic clothes rack will furnish additional "hooks" upon which jackets, raincoats and other outer garments may be hung. A rack of this kind may also be used to support a number of fishing poles if desired, making it unnecessary to store them in corners in an unsightly manner. After obtaining a straight branch having a suitable number of smaller branches to serve as hooks, strip the bark from it and allow it to dry for several days. This done, stain or varnish the branch to match or complement the color of the wall.

R. F. Bertrand, Dearborn, Mich.



## Preserving Labels on Sprayer Tank

If not protected, the paper labels on a garden-sprayer tank, which contain important instructions as well as the model number, soon become illegible. To preserve the labels, cover them with one or two coats of spar varnish or clear lacquer. Be sure that the protective coating extends beyond the edges on all sides of the labels in order to prevent water and chemicals from working under the edges of the paper.

N. R. Bangert, Sacramento, Calif.

☛ To fill cracks between floor boards shrunk by too close proximity to the heating plant of a home, use a paste mixture of fine sawdust and shellac with whiting and color added.

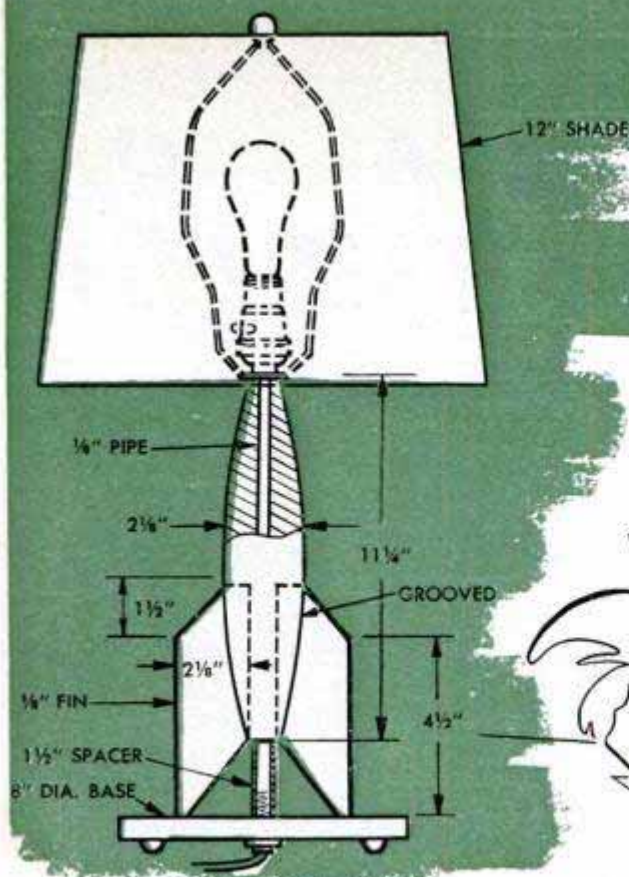

# ROCKET LAMP

By Marvin Reid Hartley

ALUMINUM FOIL

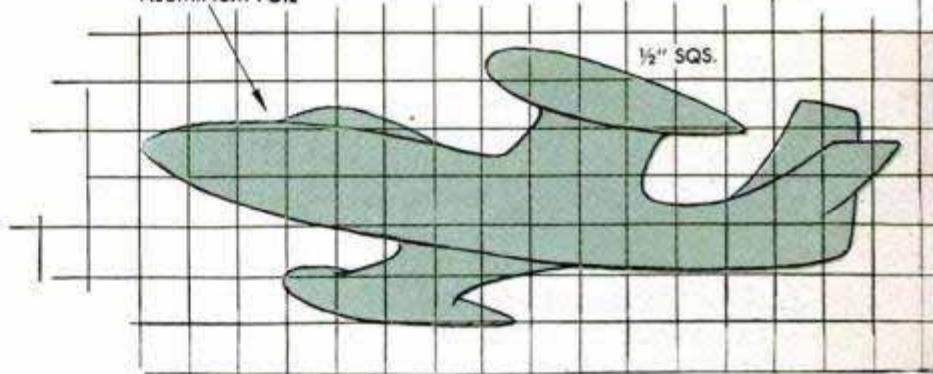

THIS ROCKET desk lamp will have the space-minded youngster beaming with enthusiasm. The rocket-shaped standard is a split hardwood turning, each of the two parts first being grooved lengthwise to take a 1/8-in. fixture pipe. After grooving, the parts are glued together, the ends plugged temporarily and turned to the contours of a rocket hull, following the dimensions given. After turning, the lower end of the rocket is slotted to receive four tail fins of

1/8-in. stock. The fixture pipe inserted through the hull anchors the rocket to a wooden base 8 in. in diameter. Note that a spacer of red plastic or fiber is slipped over the exposed end of the pipe before fastening it to the base. The top end of the pipe is fitted with a standard lamp socket and harp, and a suitable lamp shade is decorated with a jet-plane silhouette cut from aluminum foil. Dark blue is suggested for the base, with light blue for the rocket.

## Wax Paper Lubricates Nails

One craftsman finds that nails are easier to drive if they are wrapped with a wad of wax paper and held for starting as shown in the photo. The paper automatically coats the shank of the nail with a thin film of paraffin as the nail is being driven, lubricating the nail without affecting its holding power. This will prove especially helpful when driving thin coated nails in certain hardwoods where there is a strong tendency for the nails to bend under the hammer blows.—Ken Murray, Colon, Mich.

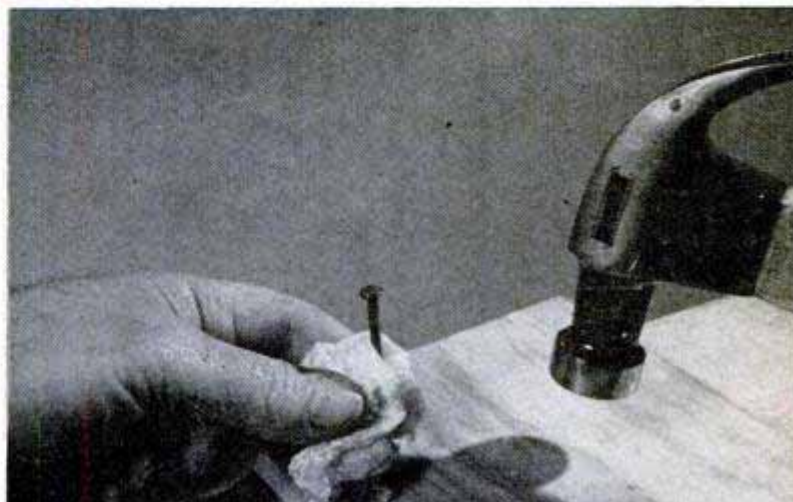



# Once a Tin Can

By Bertram Brownold

## PART I

**C**RAFTSMEN who like to work with metals but find that copper, aluminum and other favorite materials not only are expensive but difficult to get, can discover an unlimited source of metal by using the common tin can. The cost is nothing and the material, which actually is tin-plated steel, works into an unexpectedly handsome project. When the tin plate has been hammered and burnished with steel wool it takes on an attractive silvery gleam that remains bright indoors without lacquer or other protective coatings.

To store the tin plate for further use, remove the ends of the cans with a rotary-type opener. Then cut one side of the can parallel to the seam and as close to it as possible. Flatten the cylinder to form a rectangular sheet of metal which, from the largest household-size can in general use, will be about  $7\frac{1}{2} \times 19$  in. However, should you decide on a project which requires a larger sheet of metal, you usually will be

able to obtain cans of sufficient size from local restaurants or soda fountains.

When marking the metal for cutting, use a scribe or awl, but if it is difficult to see the scribed lines coat the work with India ink before scribing. The ink dries rapidly and is easy to wash off when finished.

Cut straight lines and large-radius curves with tin snips, using a pair of old scissors to cut curves having a small radius. Use a jigsaw with a fine-toothed blade for inside cuts, and sandwich the work between two pieces of thin, soft wood for cutting. Lay out the pattern on the upper piece of wood.

You probably will want a hammered surface for most of the projects, and this is attained quickly by indenting the metal with a ball-peen hammer. The work is placed on a block of wood for hammering, the effect being varied by the softness or hardness of the block, the size of the hammer, force of the blows and thickness of the metal. With a little experimenting, just the right effect can be attained. You will notice that hammering the metal causes the sheet to buckle, or become dished. This can be corrected by placing the metal between two boards after hammering and

**Decorative wall sconce features reflector made from coffee-can top. Tabs anchor socket to slotted drip pan which is riveted to tenon on front end of arm. Rear arm section is filed flat for riveting reflector**

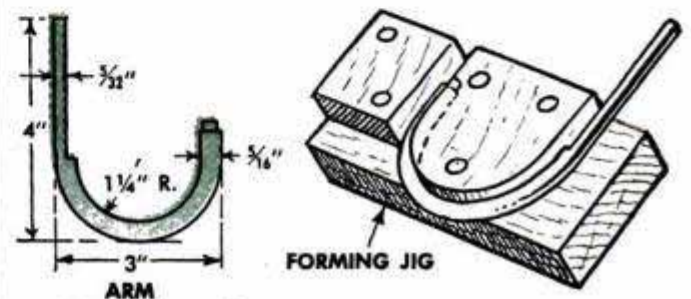
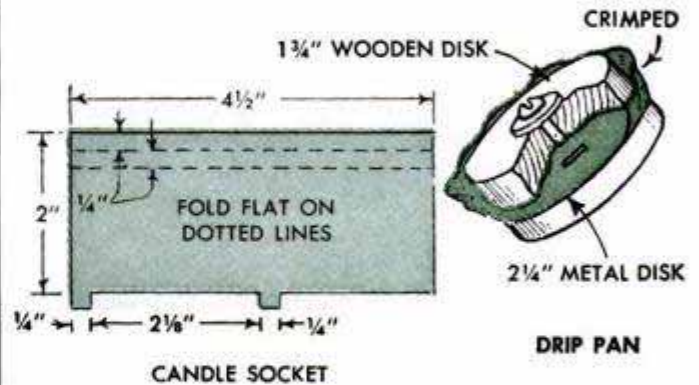
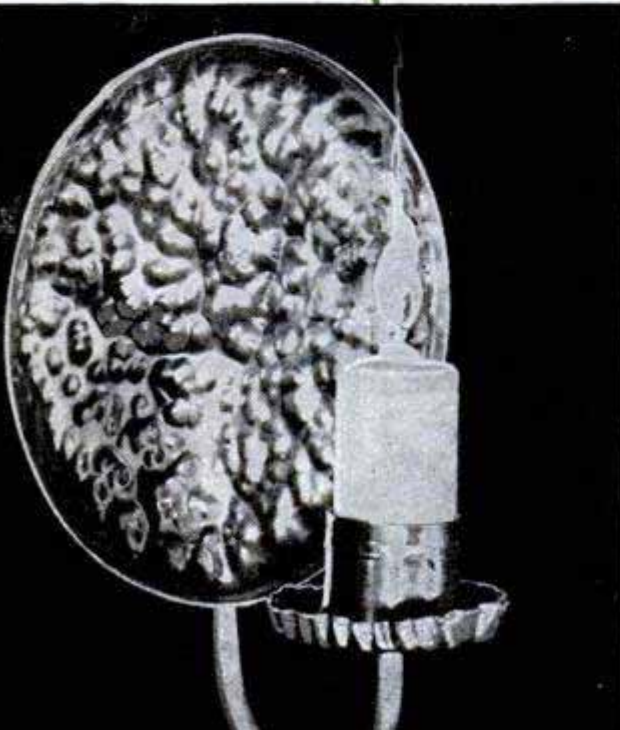



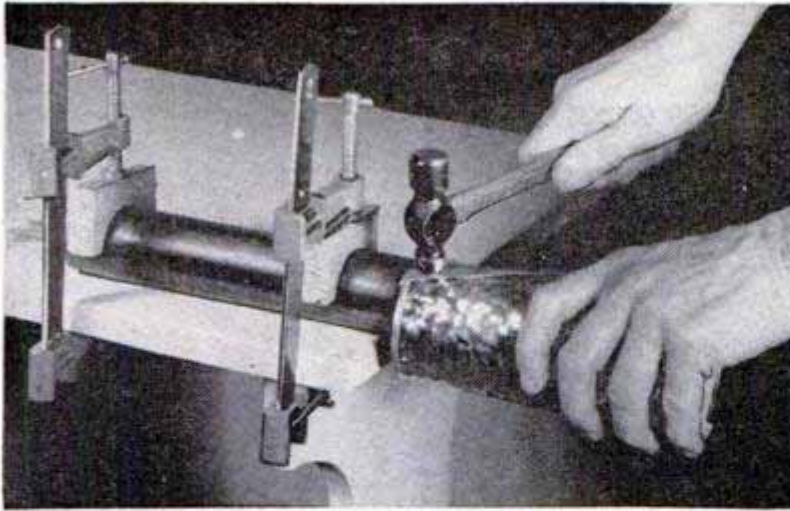

Attractive flower vase is made by bending hammered metal around pipe and riveting spiral overlays to cylinder. Angle irons riveted to sides of vase permit fastening to the base



*Flower Vase*

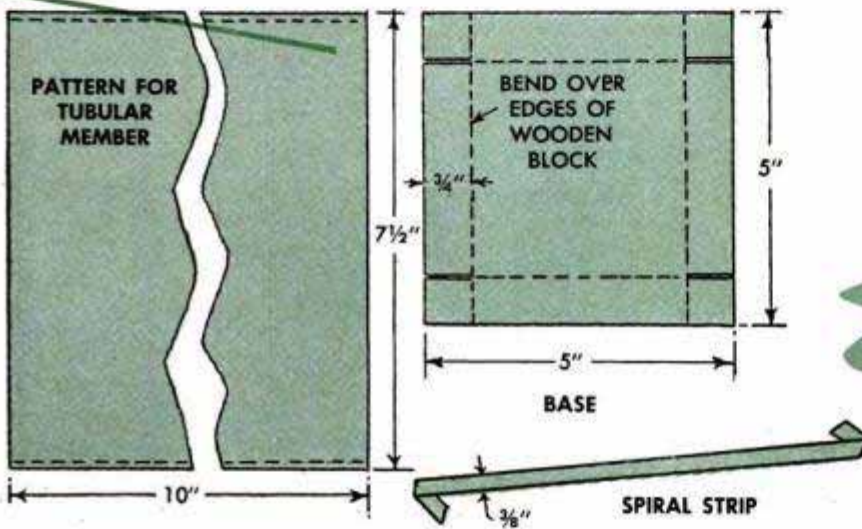

To make hammered cigarette trough, below, can is flattened, peened and then bent to form the trough at right angles to its original bend. In this way, the ends of the can sides provide ready-made beaded edges for the trough. Tabbed endpieces and center divider are riveted to the trough, while the wooden feet and lid handle are fastened with small round-headed screws. The trough is lined by cementing clear cellophane to the tin plate. An unusual coffee warmer and two neat napkin rings are detailed on the following page. Sides of the coffee warmer consist of eight separate pieces riveted together, four each of patterns shown in upper detail

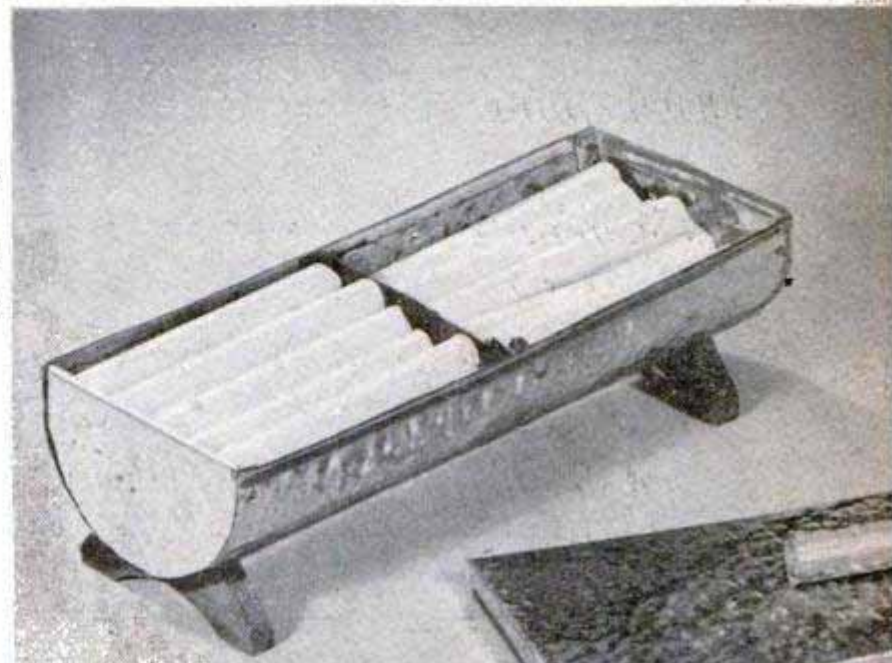
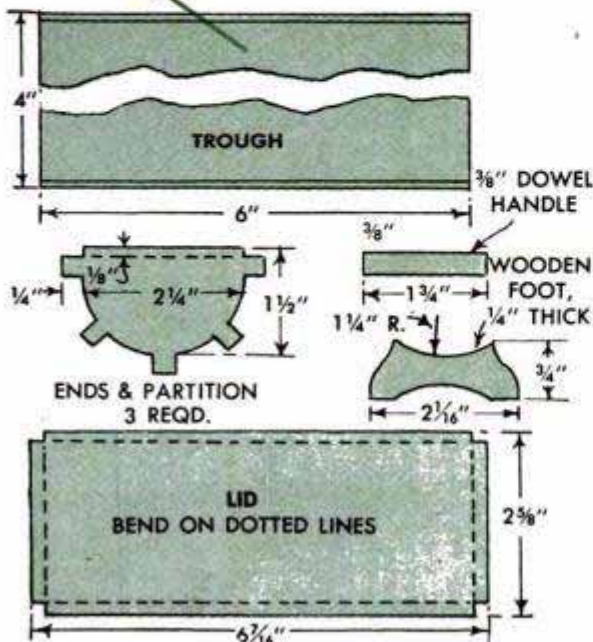

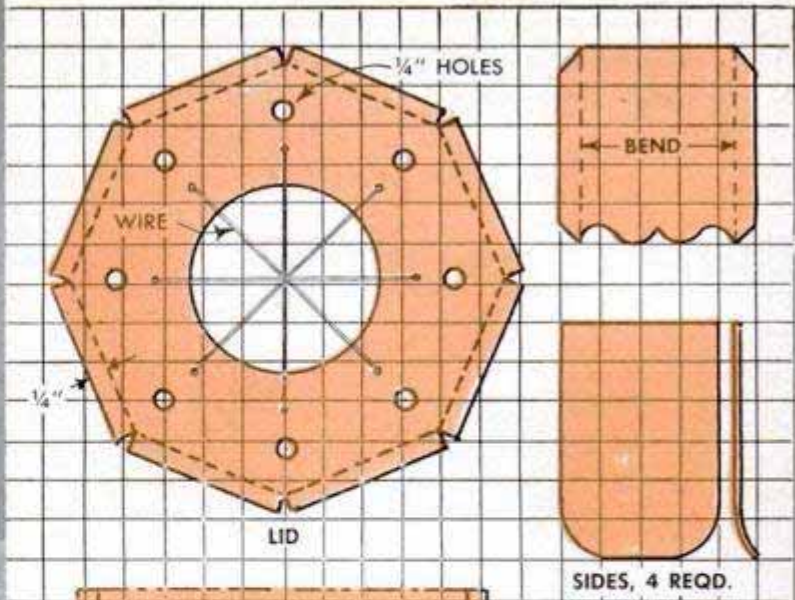

*Coffee Warmer*

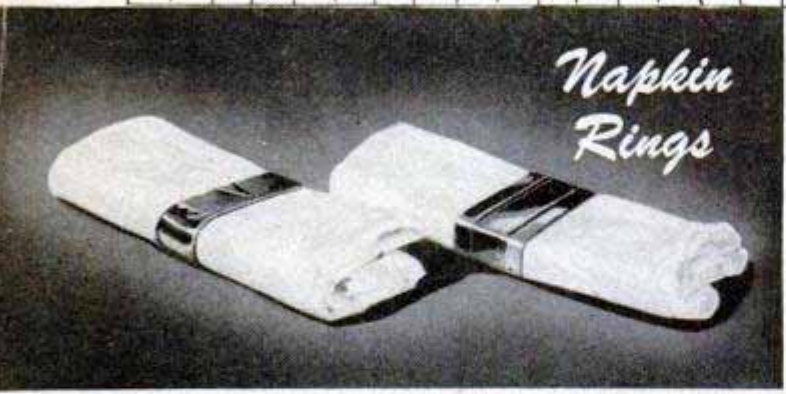
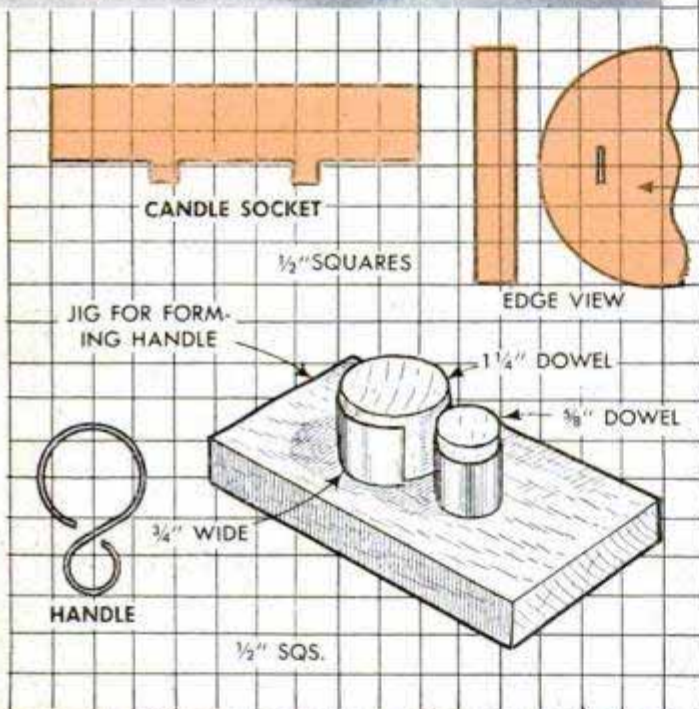

*Napkin Rings*

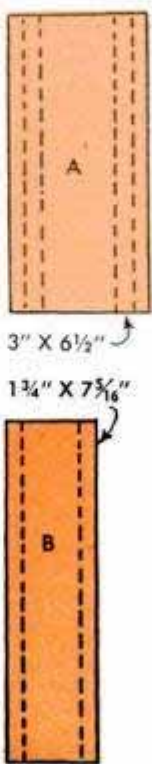

then striking the wooden surface with several sharp blows of a hammer.

Small nails (about the size used in cigar boxes) provide excellent rivets for sheet-metal work. Clip the nails so only a short length of shank remains, and back up the nailhead with an iron surface for riveting. As punching holes for the rivets upsets the metal around the holes, making a tight riveting job difficult, drill all the rivet holes. If the chuck of your drill press or hand drill will not take the small-diameter drills necessary, chuck the bit in a pin vise and then chuck the vise in the drill. A nail set also can be used for punching the holes in sheet metal. ★ ★ ★

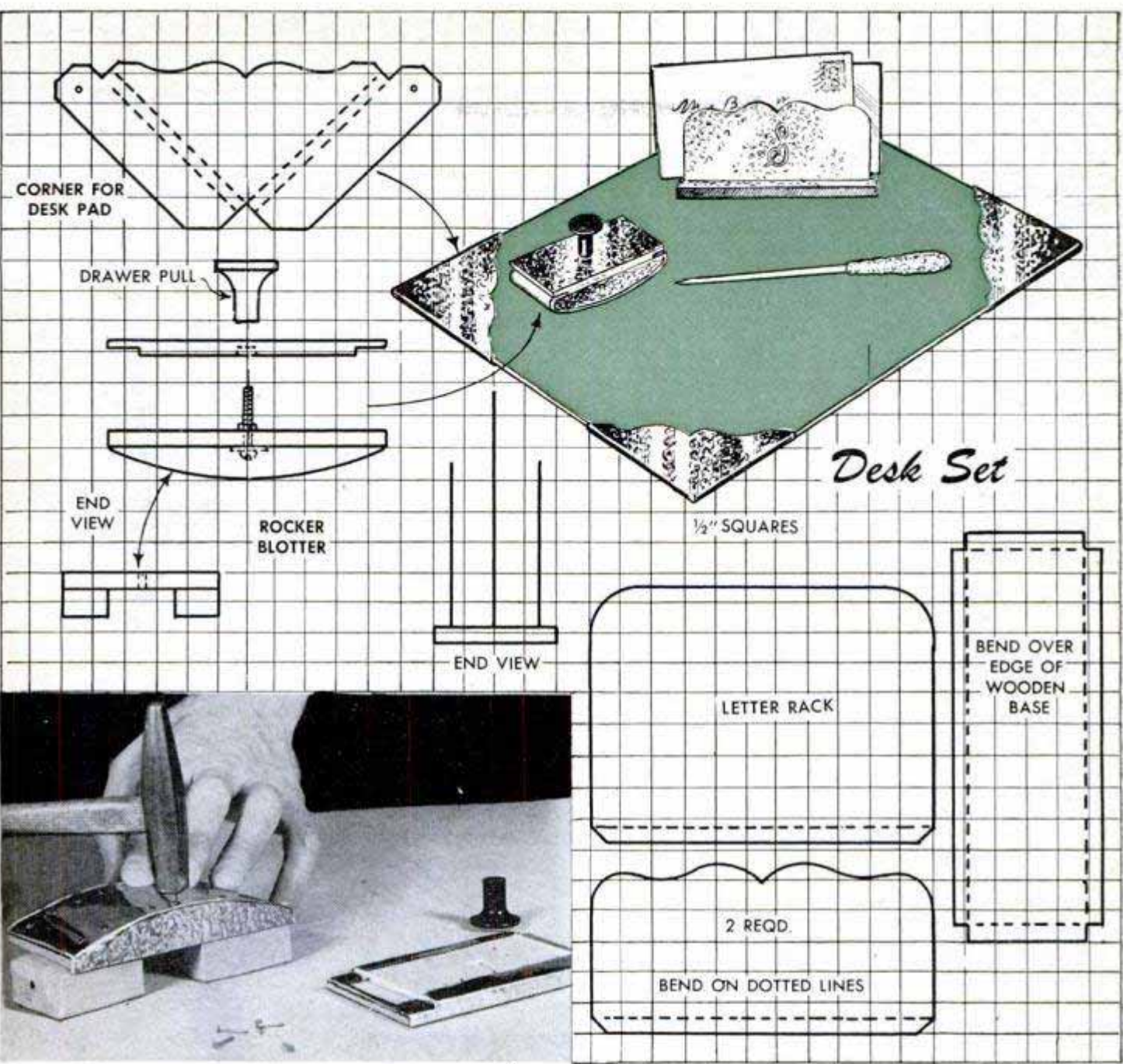

In matching desk set, above, tin plate corners are riveted to linoleum base to make desk pad. Rocker blotter is metal-covered wooden form. Uprights of letter rack are tacked to wooden base, and tin plate is riveted to the handle of purchased letter opener

The old-fashioned sugar trough, below, can be assembled with either metal or wooden ends. Note in the photo how a cardboard template is used when scribing the ink-coated metal. As ordinary ball-peen hammer makes too large an indentation for this work, peen by hammering with ball head of small hinge pin

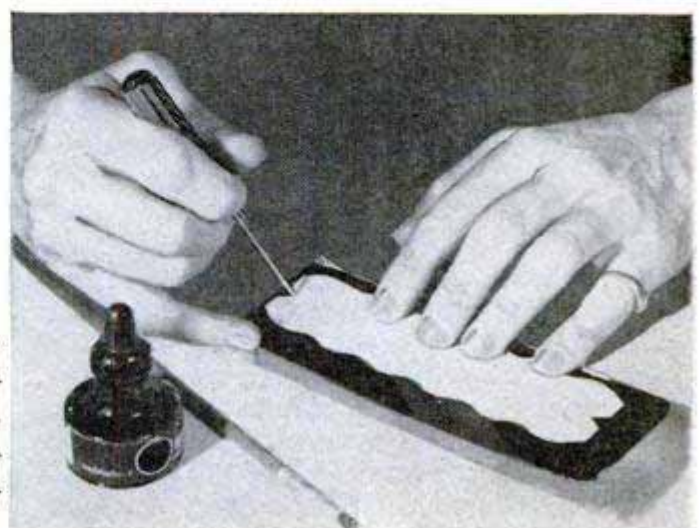
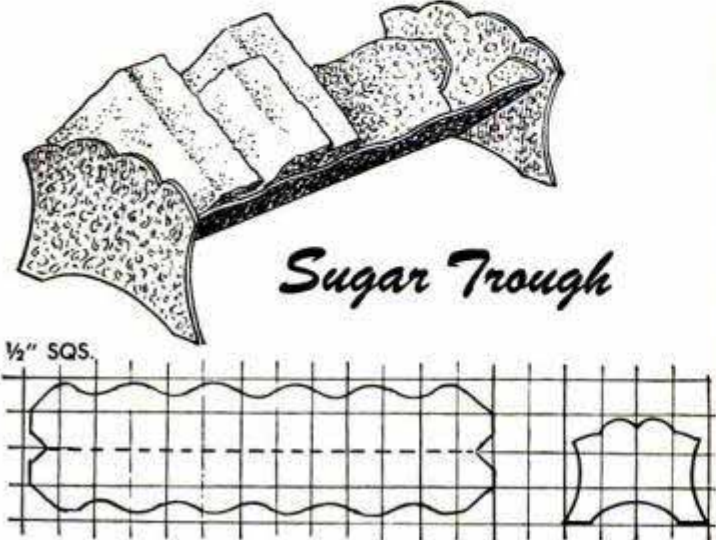

# MODERN CEDAR CHEST

## Loose-Fitting Night Lock on Door Tightened With Cardboard Shims

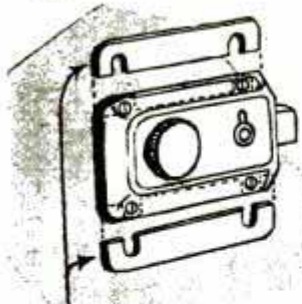

CARDBOARD STRIPS

Doors having night locks that have worked loose frequently produce rattling noises when exposed to strong winds. One way to make the lock fit snugly again, without having to recut the woodwork in order to move the latch plate, is by using cardboard shims between the lock and the door. Simply loosen the screws that hold the lock in place and slip the shims, which are notched for the screws, under the lock.

## Preventing Damage to Drills

SPONGE RUBBER

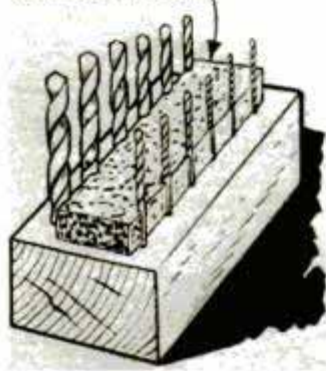

Whether carried in a toolbox or kept on a workbench, a set of drills stored in a drill holder has less chance of falling out and being damaged if wedged in place by a piece of sponge rubber as shown. Cut the rubber wide enough so that the edges are forced against the drills and can "grip" them securely.

Frank M. Butrick, Alma, Mich.

## "Reverse Polarity" Plug For Trickle Charger



Reversing the polarity of a trickle charger for use on cars having a positive or negative ground is easily done by installing a special two-piece plug, or connector, in the line connecting the charger to the cigar-lighter outlet. The line from the charger to the outlet is cut at the halfway point and male and female plugs are attached to the ends, care being taken to preserve the identity of the wires through the plugs. Then letter the word "negative" across the two plugs as indicated. To use the charger on a car having a negative ground, connect the plugs as above. To use on a positive ground, simply turn one plug over to reverse the polarity.

Ed Packer, Chicago.

CLEAN, UP-TO-DATE lines and an extra storage drawer distinguish this roomy cedar chest. The unit is built primarily of cedar-faced plywood or solid cedar plus your choice of cabinet wood, the end grain of the plywood at the front corners of the chest being hidden by two beveled posts. The top, which is of 1<sup>3</sup>/<sub>16</sub>-in. plywood, is given a heavier appearance by a 1<sup>1</sup>/<sub>4</sub>-in. molding applied to the front and both ends. The molding is laid in a mitered rabbet for an invisible joint and is also mitered at the corners. A 1/4 x 1/2-in. sponge-rubber gasket is cemented along the top edges of the side panels to form an airtight seal when the top is closed. When fitting the tray, be sure that sufficient clearance is allowed between the tray ends and the end panels of the chest to permit mounting combination hinges and lid supports on the inside of the panels. Note in section A-A that the front edges of the end panels are tenoned to fit the corner posts and that the panels are grooved to take tenons on the ends of the front panel. The rear edge of each end panel is mitered and joined to the rear panel with a spline as in the lower right-hand detail. Both back and end panels are grooved 4<sup>1</sup>/<sub>4</sub> in. from the lower edge to support the bottom panel.

### MATERIAL YOU WILL NEED

- Cedar-faced plywood**
  - 1 pc.—13/16" x 19" x 48"—Top
  - 2 pcs.—13/16" x 18 1/8" x 19-15/16"—Ends
  - 1 pc.—13/16" x 19-15/16" x 48"—Back
  - 1 pc.—13/16" x 15-5/16" x 46 3/8"—Front
  - 1 pc.—3/4" x 16 5/8" x 46 3/8"—Bottom
- Solid cedar**
  - 2 pcs.—3/4" x 5" x 15 1/4"—Tray ends
  - 2 pcs.—3/4" x 5" x 44 3/8"—Tray sides
  - 1 pc.—1/2" x 4 3/4" x 43 3/8"—Tray partition
  - 2 pcs.—1" x 1 1/4" x 16 1/4"—Tray supports
- Plywood**
  - 1 pc.—1/4" x 15" x 43 3/8"—Tray bottom
  - 1 pc.—1/4" x 3" x 47 1/4"—Front-base overlay
  - 1 pc.—1/4" x 16 1/8" x 42 3/8"—Drawer bottom
- Cabinet wood**
  - 2 pcs.—5/16" x 1 1/4" x 19"—Top end molding
  - 1 pc.—5/16" x 1 1/4" x 48"—Top front molding
  - 1 pc.—7/16" x 3/4" x 47 3/8"—Top front filler
  - 2 pcs.—3/4" x 1 3/4" x 19"—Posts
  - 1 pc.—3/4" x 1 3/4" x 46 1/2"—Top drawer rail
  - 1 pc.—3/4" x 1 3/4" x 47 1/4"—Front drawer rail
  - 2 pcs.—3/4" x 3 1/4" x 18"—End base
  - 1 pc.—3/4" x 3" x 46 1/2"—Front base
  - 1 pc.—3/4" x 3 1/2" x 43 3/4"—Drawer front
- Lumber**
  - 2 pcs.—1/2" x 3 1/2" x 16 3/4"—Drawer sides
  - 1 pc.—1/2" x 3 1/4" x 42 3/8"—Drawer back
  - 1 pc.—3/4" x 1 3/4" x 46 1/2"—Back drawer rail
  - 2 pcs.—3/4" x 3" x 16 3/8"—Side drawer rail
  - 1 pc.—3/4" x 3" x 46 1/2"—Back base
  - 1 pc.—3/4" x 1 1/2" x 16 1/2"—Drawer guide
  - 1 pc.—9/16" x 3" x 16 1/8"—Drawer slide
- Miscellaneous**
  - 2—combination hinges and lid supports
  - 2—2" dia. brass drawer knobs
  - 1—chest-lid lock
  - 1—drawer lock
  - 4—3/8" dia. furniture glides
  - 7'—1/4" x 1/2" sponge-rubber gasket

By John Bergen

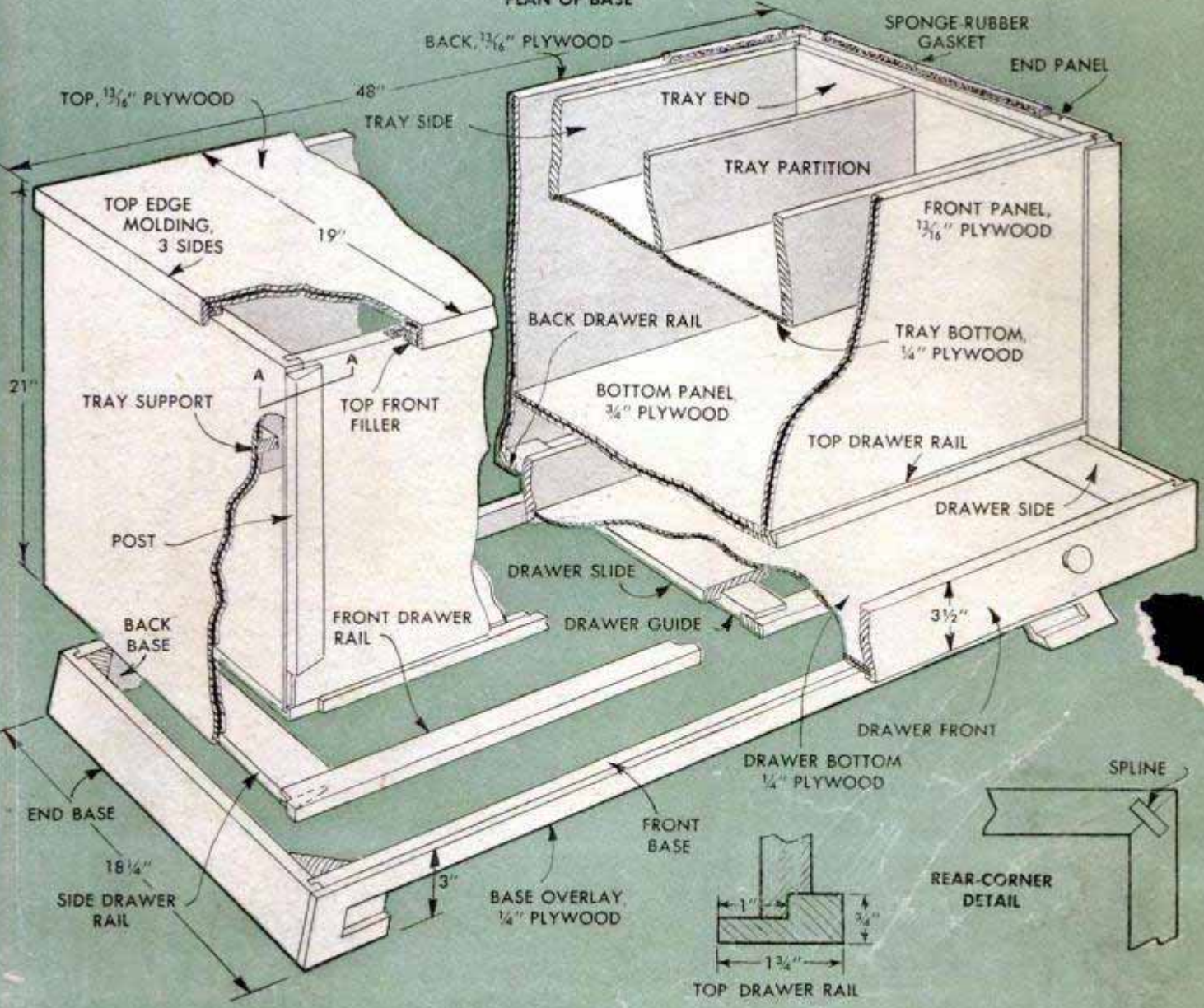
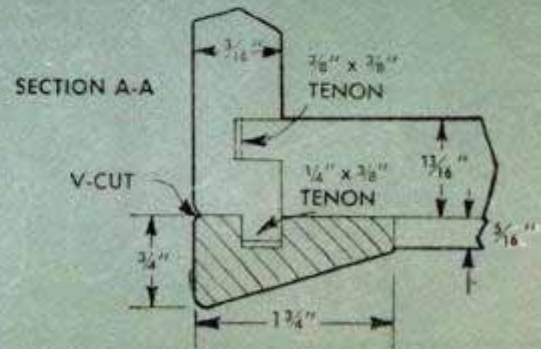
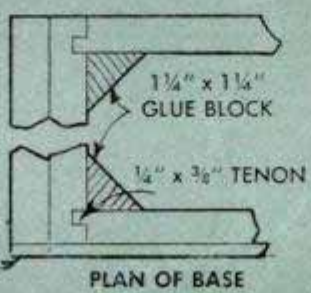
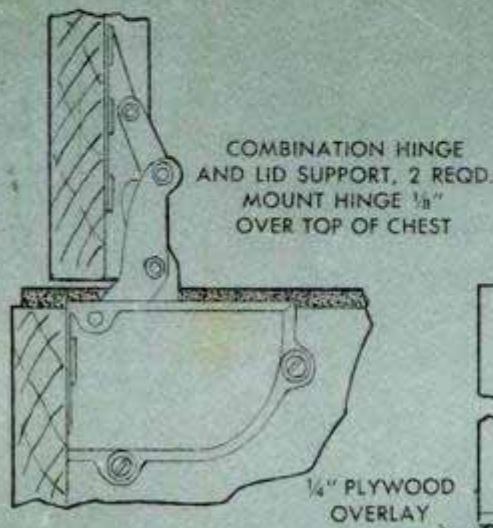
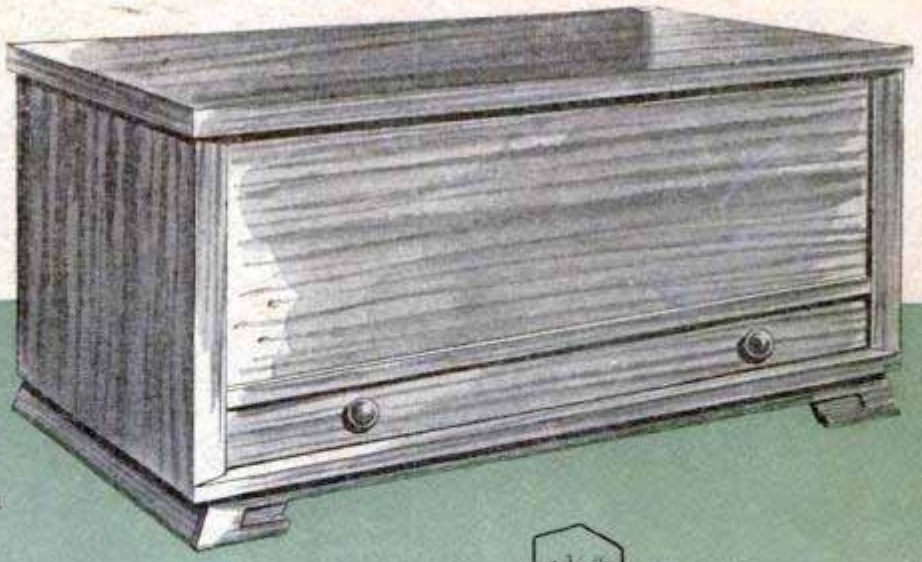

# Solving HOME PROBLEMS

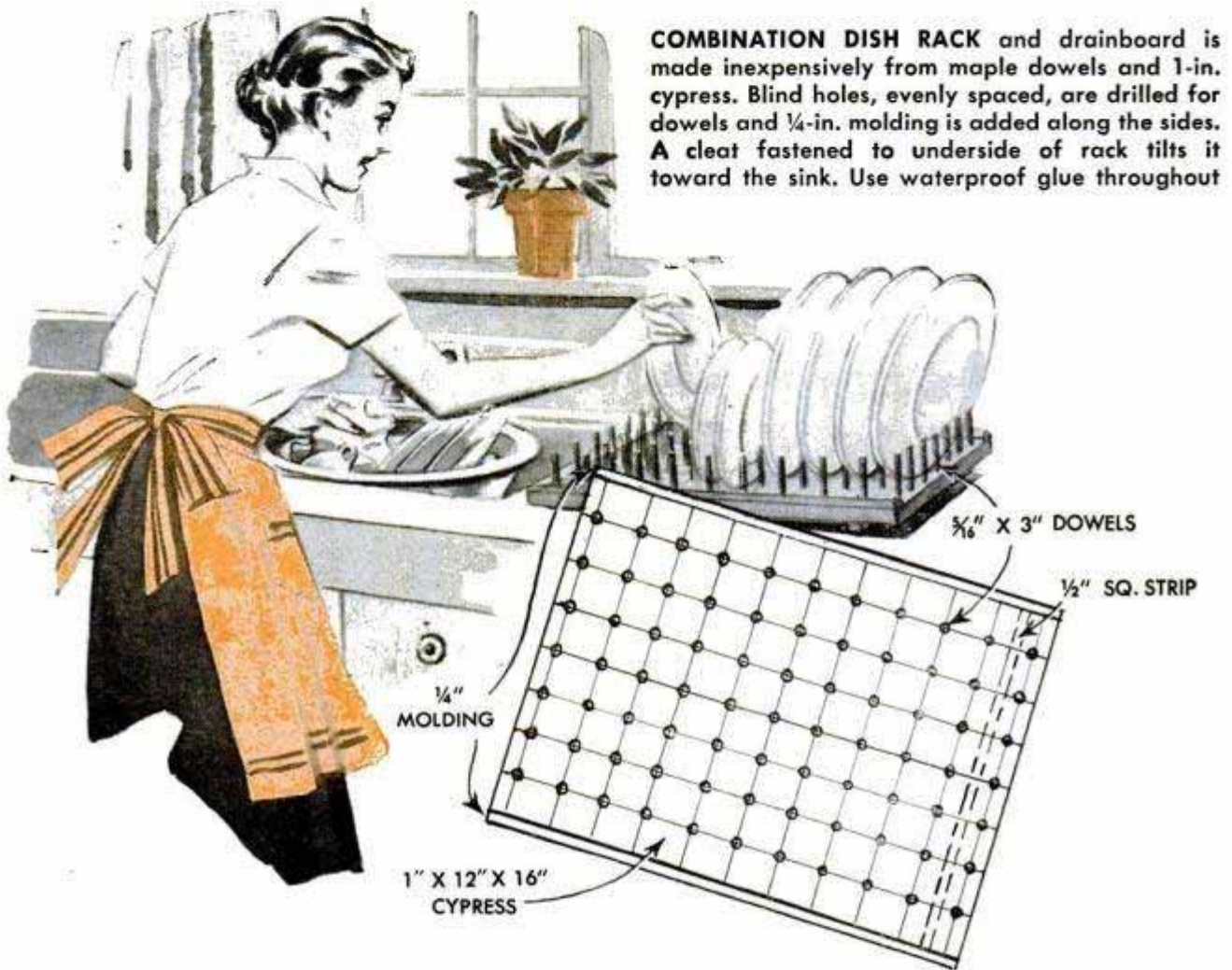

**WHEN REMOVING DECALS** from walls or wood-work prior to painting, first soften them with denatured alcohol. The alcohol will loosen the decals to the point where they can be scraped off easily. Then sand the surface smooth before painting

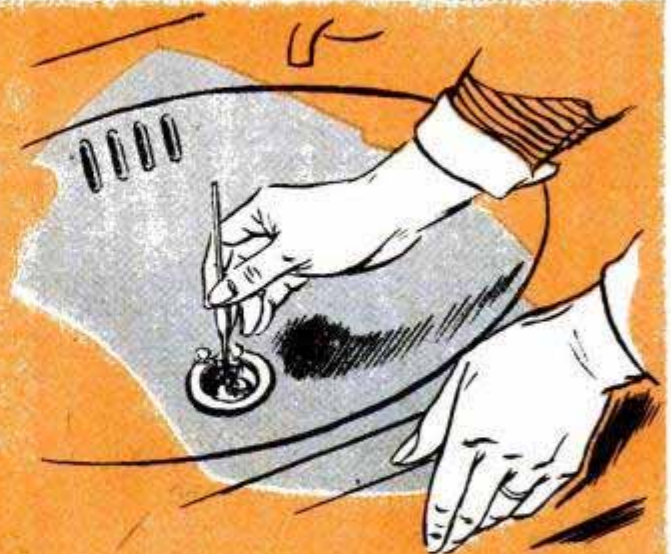

**IF HAIR HAS CLOGGED** the drain in the bathroom lavatory or bathtub, you will find that an ordinary crochet hook can be used to clean out the drain. Hair that has wrapped around the parts of the drain may be removed with a small tweezers

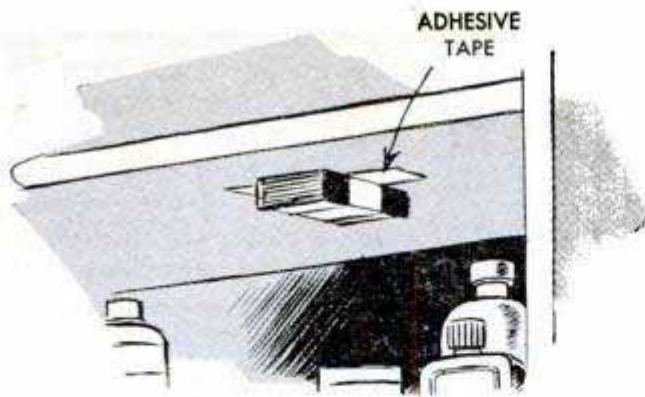

**TO KEEP RAZOR BLADES** out of reach of children, open the package at one end and tape the package to the underside of upper medicine-cabinet shelf

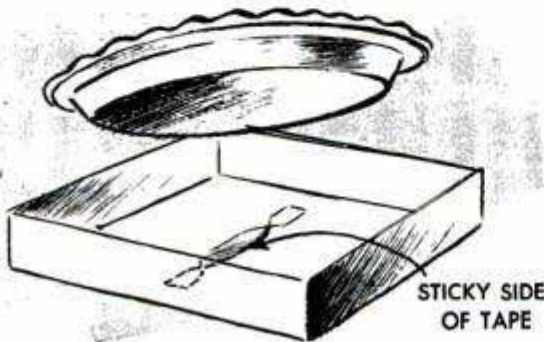

**PIE OR CAKE** carried on picnic is not likely to shift inside box and be crushed if strip of cellulose tape is twisted and stuck to bottom of the box as above

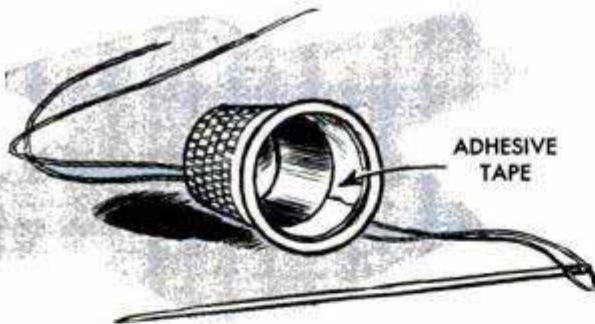

**A THIMBLE THAT** is too large for your finger can be made to fit snugly in a few seconds by placing a narrow strip of adhesive tape inside thimble rim

**DEFROSTING REFRIGERATOR** is less trouble if folded bath towel is placed under coils to catch ice and drops of water that otherwise would fall to the floor

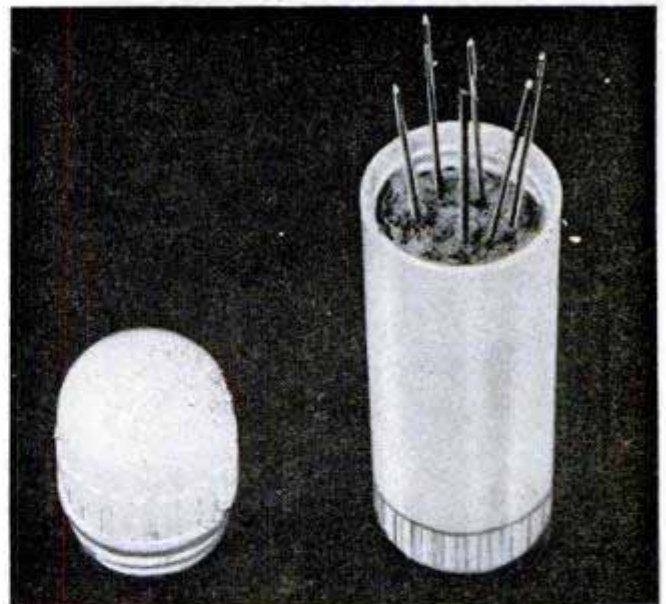
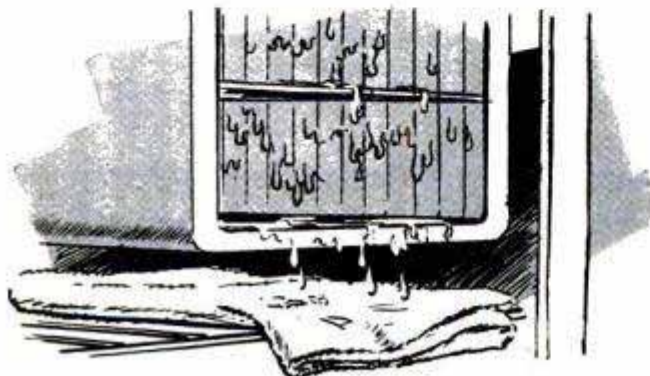

**HANDY NEEDLE CASE** is improvised from plastic container used to hold inhaler-type medication. Insert is removed and piece of cellulose sponge pressed in base. Screw-on cap covers tops of the needles

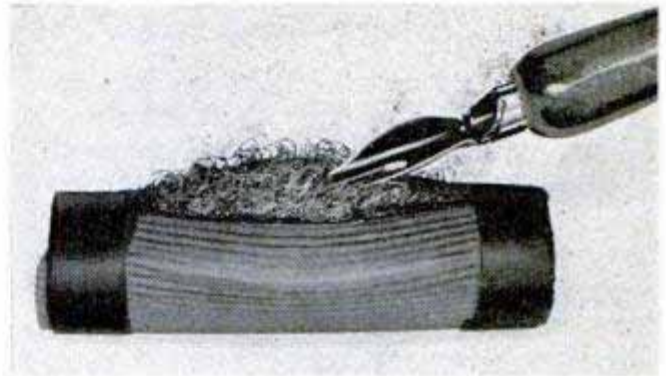

**STEEL WOOL** quickly cleans dried ink from pen points. The wool is inserted in section of rubber tubing which is split lengthwise and taped at ends. Pen point is brightened by pressing into steel wool

**HANDLING OF RECIPE** clippings while cooking or baking is avoided by inserting recipe between tines of a fork. This not only saves time but also protects favorite recipes from becoming worn and stained

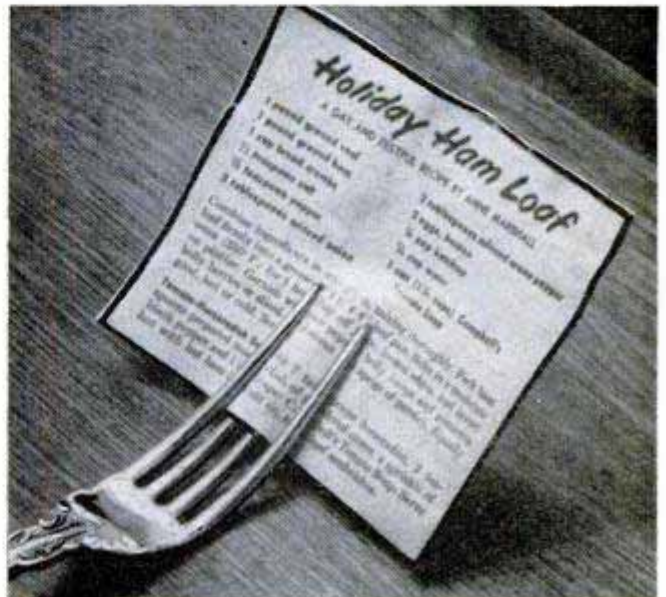

## Small Parts Stored in Handy Tray Made by Soldering Tin Cans Together

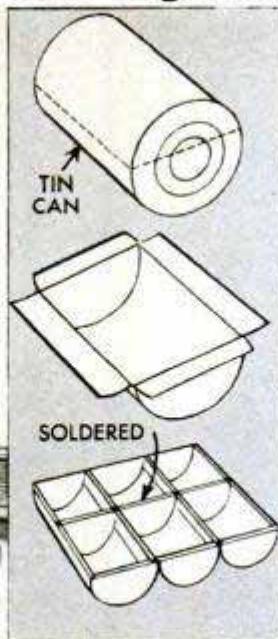

A number of discarded tin cans of uniform size, preferably of the type in which condensed milk is sold, can be made into a useful sectional tray for storing various small parts. First, cut the cans in the manner indicated in the detail, allowing tabs to remain on the ends and sides so that the cans may be crimped together. After arranging the cans in the particular order desired, crimp and solder them together. The outside tabs then should be bent over and flattened in order to eliminate any sharp edges.—Huge Lineback, Stillwater, Okla.

## Brass Pad on Lathe-Dog Screw Prevents Marring of Work

The clamping screw of a lathe dog often mars the work, especially if the turning is of soft metal. Makeshift pads generally used to prevent marring usually fall out of place or are difficult to find when needed. However, cups turned from brass and bored to press-fit over the tip of the clamping screw provide excellent nonmarring pads which are always at hand. Pads are made by chucking a piece of brass rod in the lathe and boring with the drill held in the tailstock chuck. A slight chamfer is turned on the face of each pad to relieve a sharp edge. A set of different-size dogs can be "padded" in this manner.

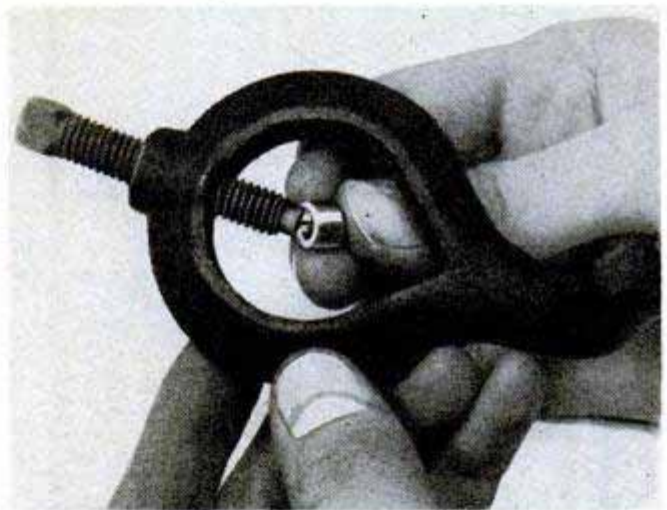

## Buffer Fitted With Extra Handle For Easier Manipulation

When waxing a car, it often is difficult to hold a small motor-driven buffer steady, especially when the cleaning disk is caked with wax. To overcome this, one car owner removed the handle and bracket from an old coffeemaker and attached them to the buffer as shown, thus enabling him to steady the tool with both hands. If a percolator handle is used, a bracket can be made from a strip of sheet metal.

Grover Brinkman, Okawville, Ill.

## Pencil Erasers Polish Small Parts

Pencil stubs having the erasers still intact serve as handy polishing heads for brightening small metal parts when making jewelry or models. Simply chuck the stub in the drill press and lock the spindle.



# Workbench Encourages Small-Fry Craftsman

Designed especially for a young "carpenter," aged two, this tiny workbench proved just the thing for encouraging craftsmanship in one small fry. It also helped curtail further practicing of his handiwork on walls and woodwork of his home. Constructed with simple tools, the bench top consists of 2 x 6s cleated together with 2 x 4s. Back and side panels, as well as doors and front trim, are of plywood. The bench is assembled with glue, screws and nails, then sanded. The top is stained and the cabinet enameled. — Jerome Parker, Sonoma, Calif.

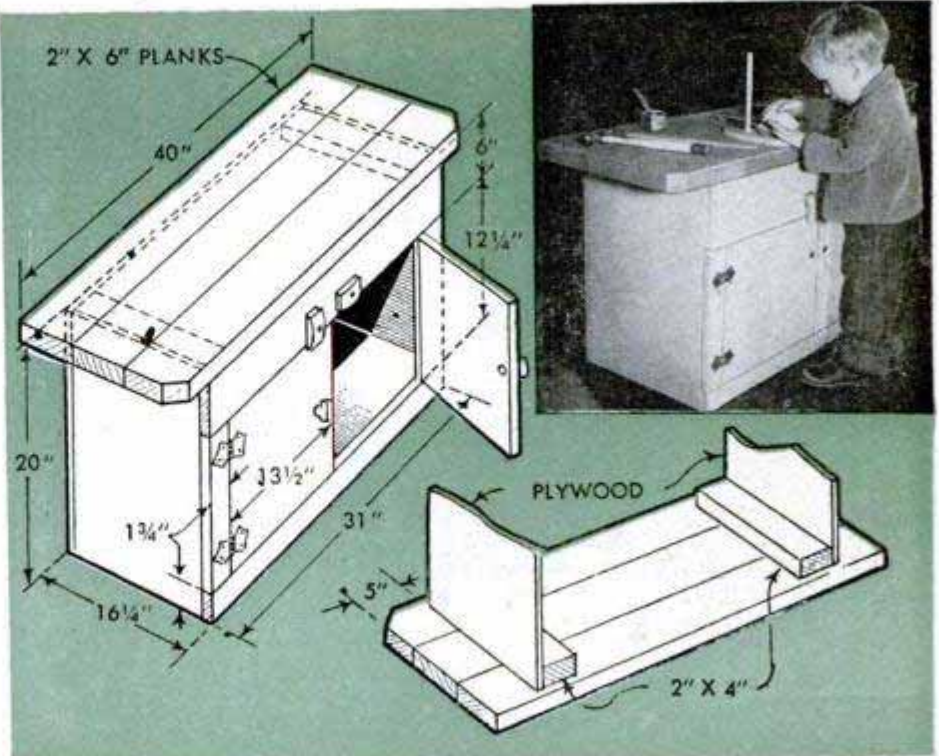

## Stamp Pad Located Easily When Tacked to Paddle

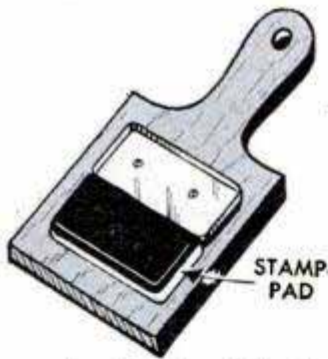

Finding that his small rubber-stamp pad always seemed to be hidden under papers on his desk whenever he needed it, one shipping clerk adapted it for hanging on the wall within easy reach. To do this, he tacked the cover of the pad to a wooden paddle which in itself makes the pad easier to locate on occasions when it becomes misplaced.

## Discarded Harrow Teeth Anchor Fence Posts

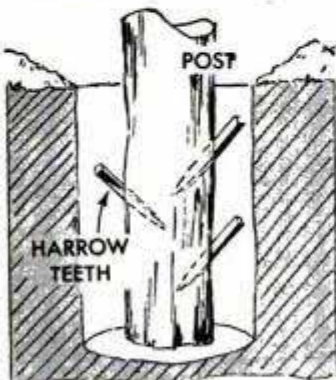

Fence posts set in wide ditches or other low spots in fields often are loosened by frost action and contraction of the wires causing the fence line to go slack when the ground thaws. After making several unsuccessful attempts to solve this problem, one farmer salvaged the worn teeth from an old drag harrow and drove several of these into each post

before setting. Note in the detail that the harrow teeth are driven into the post at an angle. The projecting ends of the teeth engage tamped soil around the post and prevent it from being lifted.

## Razor Blades Stored Safely In Slitted Rubber Tubing

Used safety razor blades can be stored quite safely in a workbench drawer or a tool box, provided the blades are first pressed into a short length of rubber tubing as shown in the illustration. Several blades may be stored in each slit if desired.



## Wall Surrounding Light Switch Shellacked for Easy Cleaning

To simplify the removal of finger marks giving a soiled appearance to the wall around a light switch, first clean the wall and then apply one or two coats of fresh, white shellac. This will enable you to clean the wall quickly and as often as necessary with a damp cloth.

☛To prevent a new penpoint from scratching as it writes, hold the point over the flame of a lighted match for a few seconds to eliminate any irregularities in the metal.

# PLAN of the MONTH...

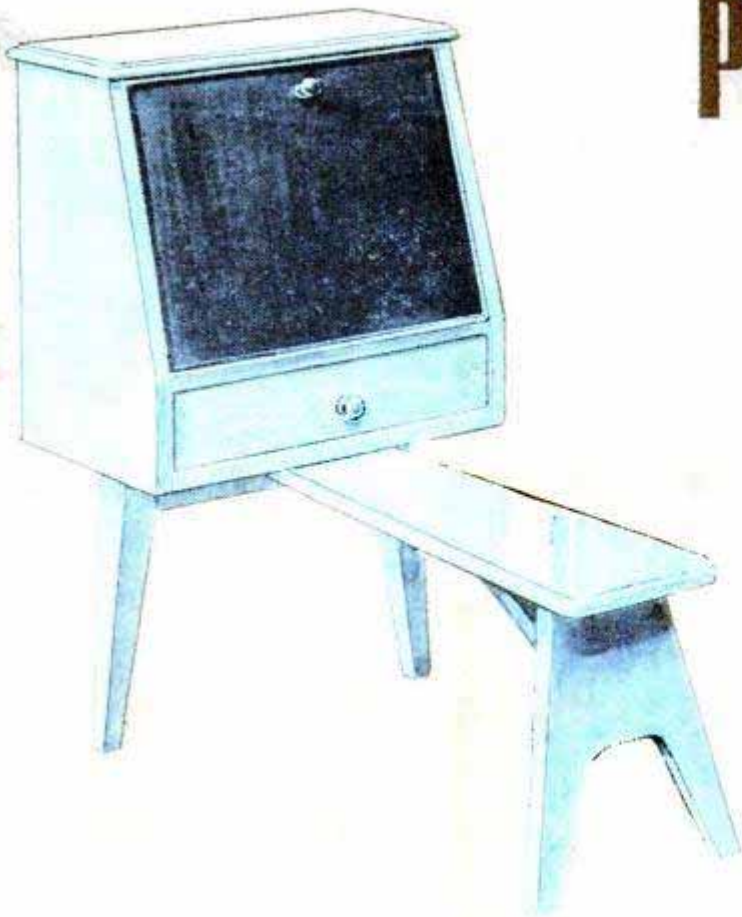

## MATERIAL LIST

Clear Lumber			
1 pc.	$\frac{3}{4}$ "	x 6 $\frac{3}{4}$ "	x 18 $\frac{1}{2}$ " — Top
2 pcs.	$\frac{3}{4}$ "	x 10"	x 18" — Sides
1 pc.	$\frac{3}{4}$ "	x 8 $\frac{1}{2}$ "	x 25" — Bench seat
1 pc.	$\frac{3}{4}$ "	x 11"	x 12" — Bench end
1 pc.	$\frac{3}{4}$ "	x 2 $\frac{1}{2}$ "	x 10 $\frac{7}{8}$ " — Brace
2 pcs.	1 $\frac{3}{4}$ "	x 1 $\frac{3}{4}$ "	x 12 $\frac{7}{8}$ " — Legs
1 pc.	$\frac{3}{4}$ "	x 2 $\frac{1}{2}$ "	x 11 $\frac{7}{8}$ " — Leg cross brace
1 pc.	$\frac{3}{4}$ "	x 7 $\frac{3}{8}$ "	x 16 $\frac{7}{8}$ " — Shelf
2 pcs.	$\frac{3}{4}$ "	x 9 $\frac{3}{4}$ "	x 16 $\frac{7}{8}$ " — Shelves
1 pc.	1 $\frac{1}{2}$ "	x 2 $\frac{1}{2}$ "	x 16 $\frac{7}{8}$ " — Shelf
1 pc.	1 $\frac{1}{2}$ "	x 1 $\frac{1}{2}$ "	x 16 $\frac{1}{4}$ " — Rail
2 pcs.	$\frac{1}{2}$ "	x 3 $\frac{1}{4}$ "	x 10" — Side stops
1 pc.	$\frac{3}{4}$ "	x 2 $\frac{7}{8}$ "	x 16 $\frac{1}{8}$ " — Drawer front
2 pcs.	$\frac{1}{2}$ "	x 2 $\frac{7}{8}$ "	x 9 $\frac{3}{8}$ " — Drawer sides
1 pc.	$\frac{1}{2}$ "	x 2 $\frac{1}{8}$ "	x 15 $\frac{5}{8}$ " — Drawer back
1 pc.	$\frac{3}{4}$ "	x 3 $\frac{1}{4}$ "	x 16 $\frac{1}{4}$ " — Cleat
Hardboard			
1 pc.	$\frac{1}{4}$ "	x 9 $\frac{1}{8}$ "	x 15 $\frac{5}{8}$ " — Drawer bottom
1 pc.	$\frac{1}{4}$ "	x 17"	x 15 $\frac{5}{8}$ " — Back
Birch Plywood			
2 pcs.	$\frac{1}{4}$ "	x 2 $\frac{1}{2}$ "	x 6 $\frac{1}{2}$ " — Dividers
1 pc.	$\frac{3}{4}$ "	x 16"	x 13 $\frac{3}{4}$ " — Blackboard

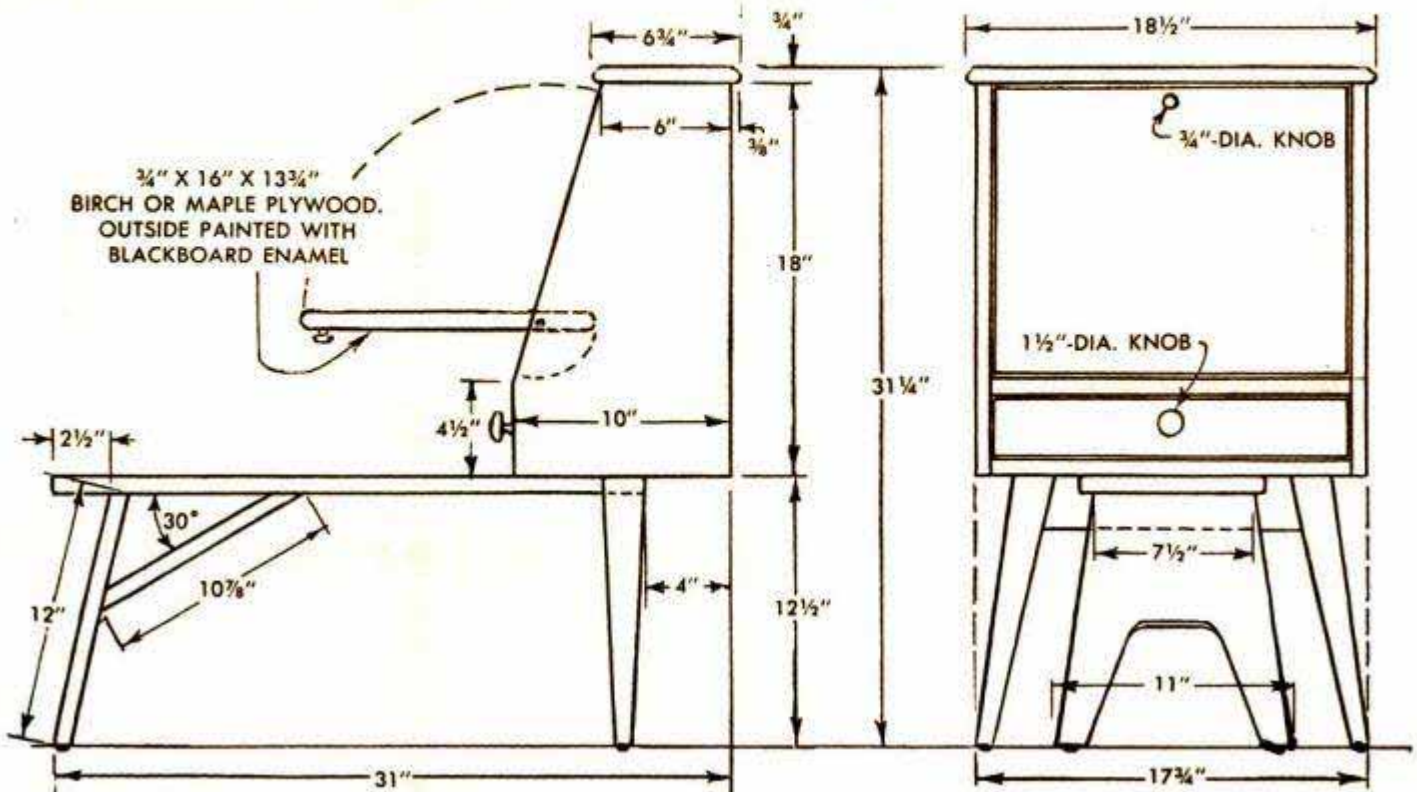
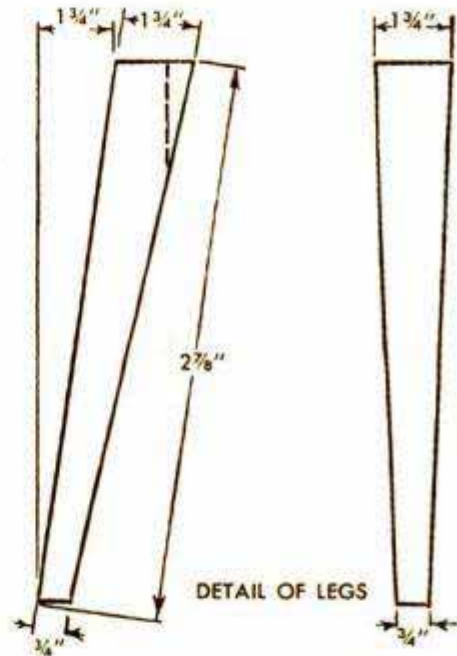
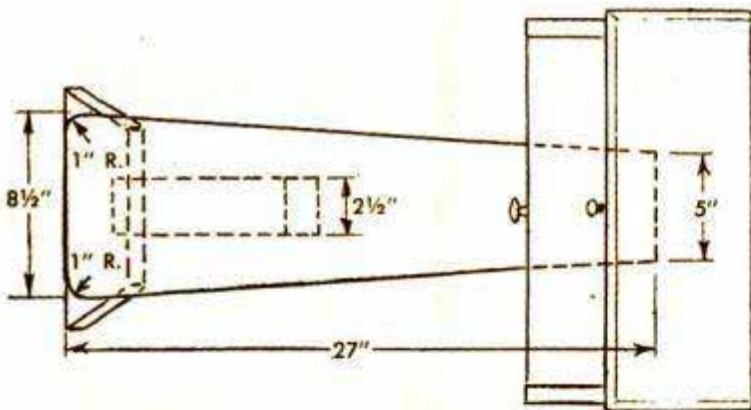

# ... Drawing Bench

The child who likes to play with chalk, crayons and water colors will spend many happy hours at this "sawhorse" drawing bench. The hinged desk front is coated with blackboard enamel to provide a large drawing surface when closed. When opened, the front forms a desk top and discloses a handy storage rack for paper and coloring books as well as three compartments for drawing materials. A drawer for odds and ends is installed directly beneath the desk top. Note that the cross brace which is fitted between the splayed legs of the desk unit is notched to take the end of the bench seat. The latter is inserted in the notch and fastened with glue and screws to the underside of the desk after the bench endpiece and brace have been assembled

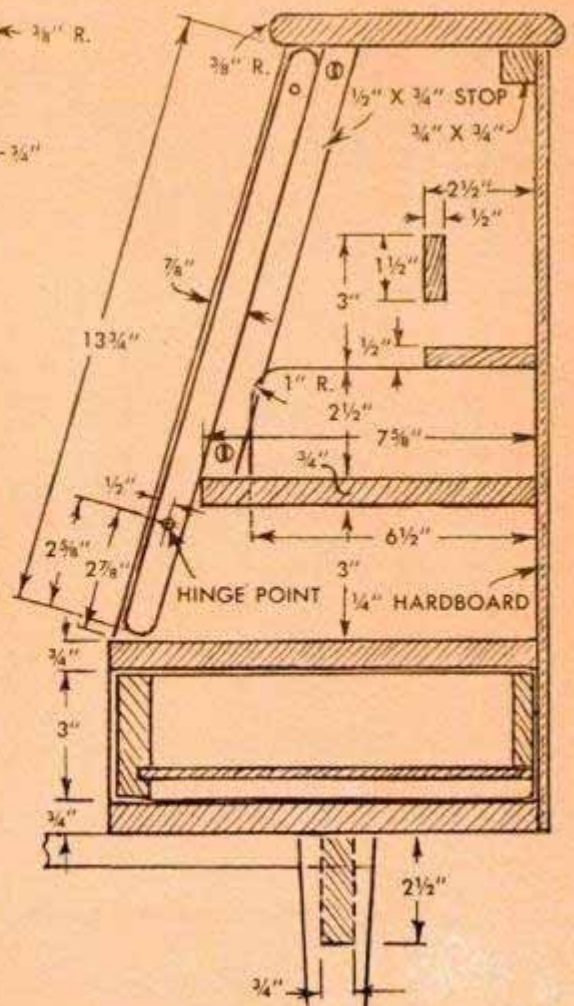
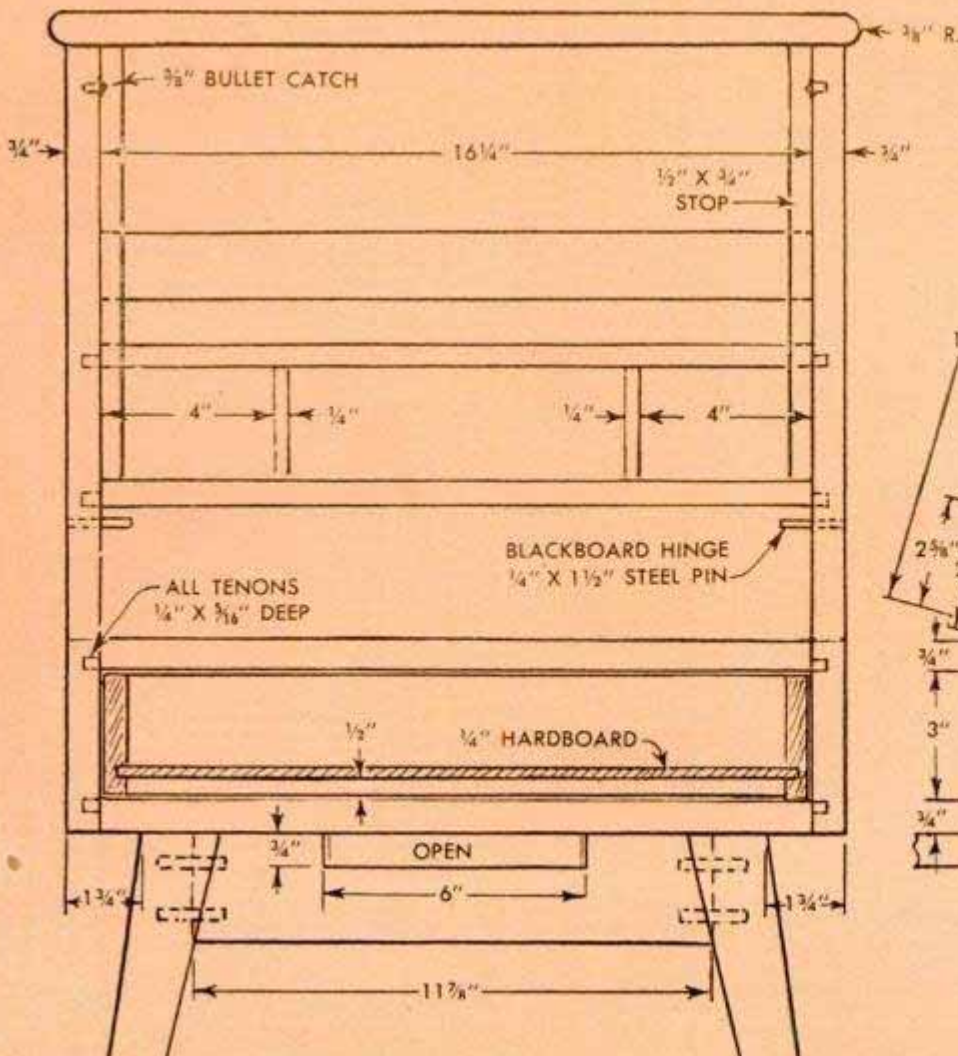
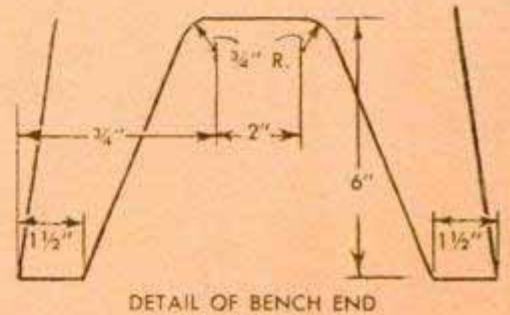
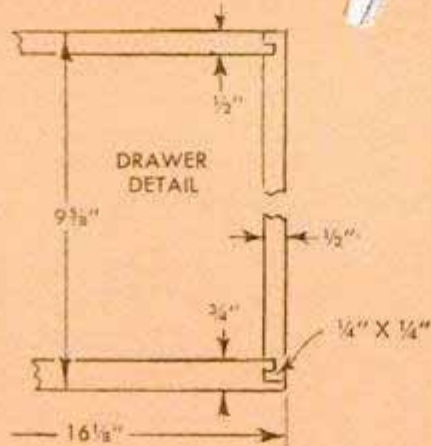
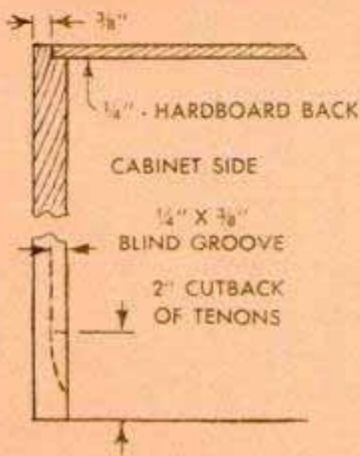
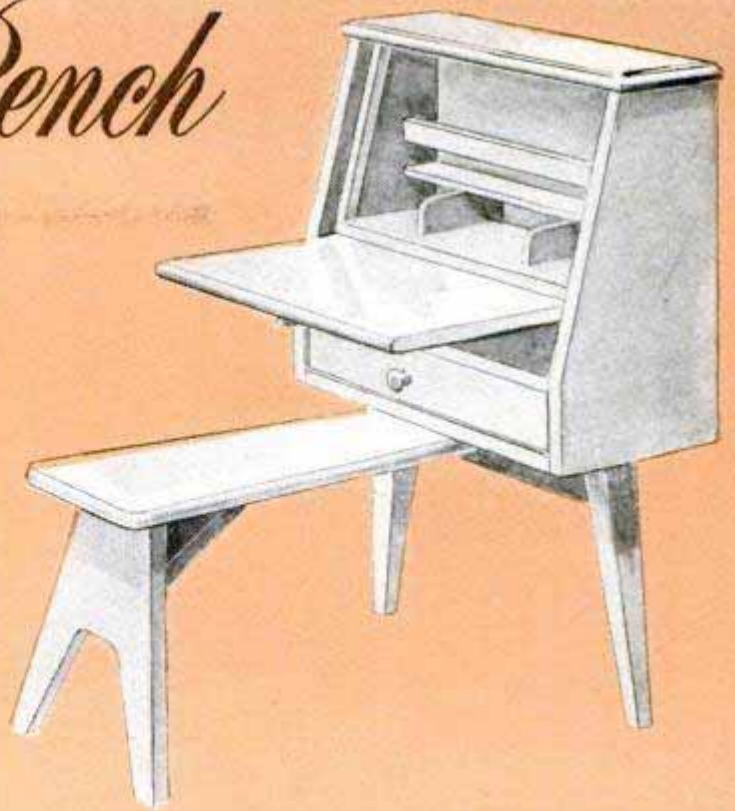

## Backrest Used on Plank Seats Carried Easily When Folded

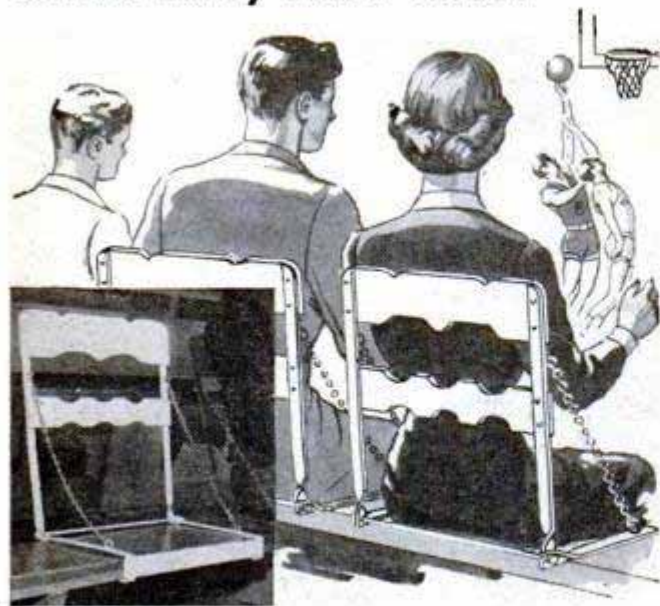

The discomforts of sitting on plank seats at sporting events led one enthusiast to design and construct a lightweight, folding backrest. Consisting of seat and back sections having flat-steel frames joined together by a plywood seat brace and two back panels, the backrest is folded where the two sections pivot on a steel rod which also serves as an additional brace. The seat frame is bent over the seat brace and turned back at the ends sufficiently to hook over the front edge of a plank. The back is supported by lengths of chain attached to the seat section which, in use, is anchored under the legs of the occupant.

Fulton H. Travis, Yakima, Wash.

## Comfortable Milk Stool Made From Scrap Parts



Needing another milk stool, one farmer hit upon the idea of constructing one from an old bucket and a discarded implement seat to provide additional comfort. After the bail was removed, the seat was bolted to the bottom of the bucket in the manner shown.

## Doorstop Braces Refrigerator To Reduce Vibration

In instances where a refrigerator tends to vibrate excessively whenever the door is closed sharply, the annoying vibration

may be reduced to a great extent by fastening a rubber-tipped doorstop to the wall in back of the refrigerator. The doorstop screw is driven into a stud at a height just below the top of the refrigerator cabinet. Then the refrigerator is pushed back until there is just a slight pressure against the stop.—W. H. McCloy, Pasadena, Calif.

## C-Clamp Converts Extension Cord Into Temporary Ceiling Fixture

When it is necessary to use a lamp and an extension cord as a temporary ceiling fixture in a building where there are exposed joists or rafters, a C-clamp will enable you to support the lamp in almost any location desired. Simply fasten the clamp to a joist or any other convenient projection, loop the cord over it as shown, and tie or tape it in place.

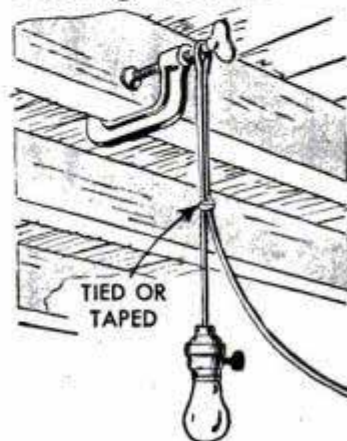

## Loose Joint in Furniture Is Glued With Aid of Medicine Dropper

To avoid taking a piece of furniture apart in order to glue a loose joint, drill a small hole at an angle in the tenon through which glue may be injected with a medicine dropper. The dropper will supply sufficient pressure to cause the glue to reach all parts of the joint. After wiping off any glue that has seeped out, press the parts together and use clamps or rope to hold them until the glue has dried.



# Centrifugal FILM DRIER

By Hugh Smiley, Jr.

THIS CENTRIFUGAL cut-film drier whirls away surface water in a few seconds, leaving your negatives free of dust, stains and abrasion marks to assure sparkling prints. The drier, which handles film up to 4 x 5 in., consists of a brass disk fastened to the shaft of a small, 1750-r.p.m. motor. The latter is mounted vertically on a base made of  $\frac{1}{8}$ -in. sheet aluminum, one end of the base being drilled for the motor cord and fitted with a rubber grommet. The 7-in. drying disk is cut from 18-ga. brass and center drilled for fitting to a faceplate fastened to the motor shaft. The faceplate can be made from a small brass gear blank or by cutting the rim from a die-cast pulley. After the disk and faceplate are aligned on a dummy shaft, three equally spaced holes are drilled around the center hole as shown below. These are countersunk and tapped for 8-32 screws which join the two parts. The negative is held on the disk by engaging opposite ends of the film under the heads of two brass machine screws. These are turned into tapped holes in the disk and held with locknuts so that a  $\frac{1}{32}$ -in. gap is left between the screwheads and the top of the disk. The screws are located so the center of the film bows about  $\frac{3}{4}$  in. when placed between them, and two or three pair may be used to take different sizes of film. The negative, of course, must be centered over the motor shaft, and to speed centering, index marks are punched where the corners of the film contact the disk. If necessary, balance the disk by applying solder to the underside. Film-pack negatives can be semidried by centering them flat on the disk and turning them over after drying one side.

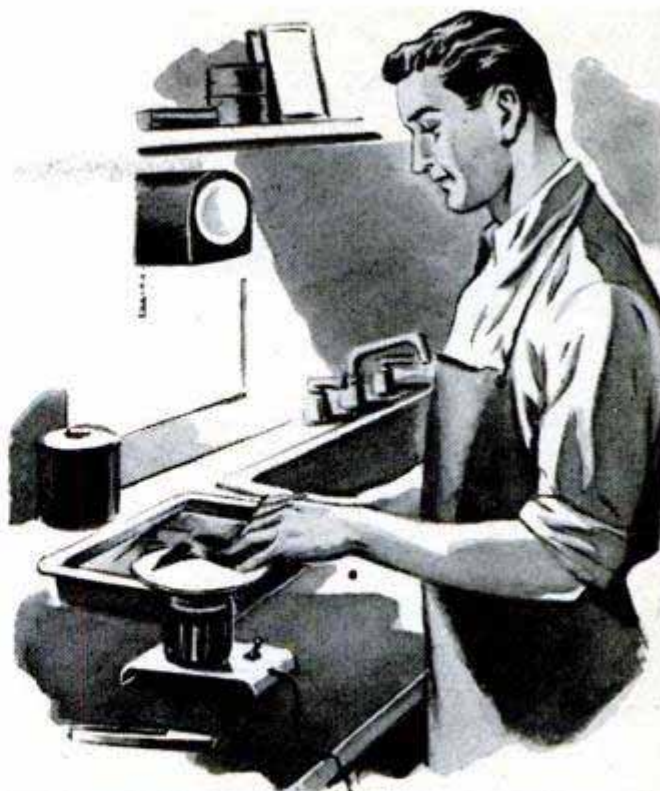

Negative is mounted on drying disk by inserting edges under heads of small machine screws. When drier is spinning, centrifugal force holds film against both screwheads in addition to throwing off water

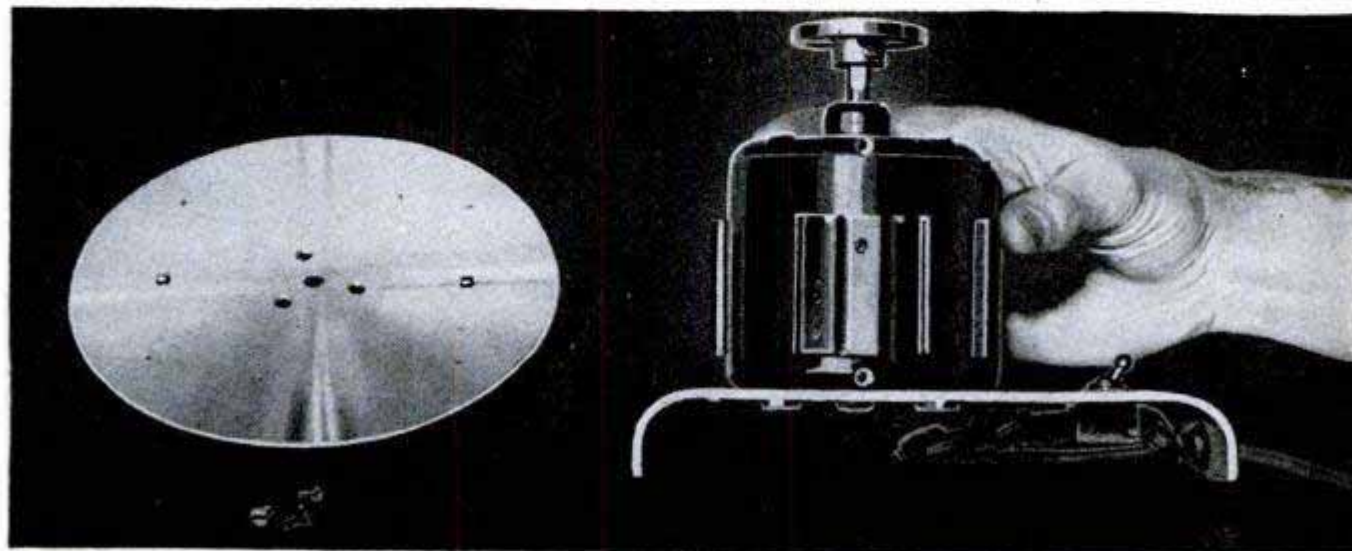

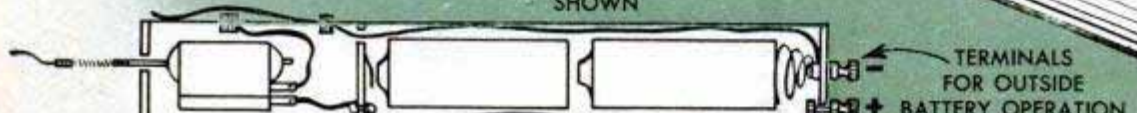
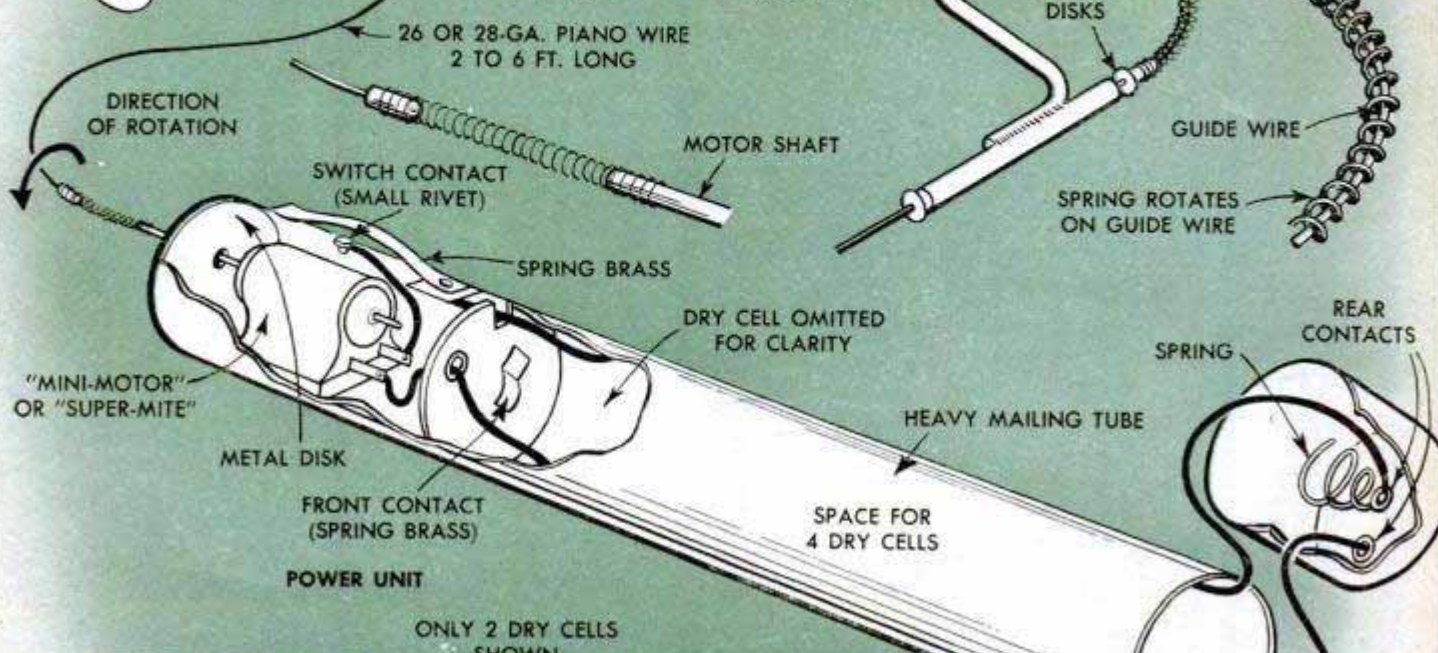
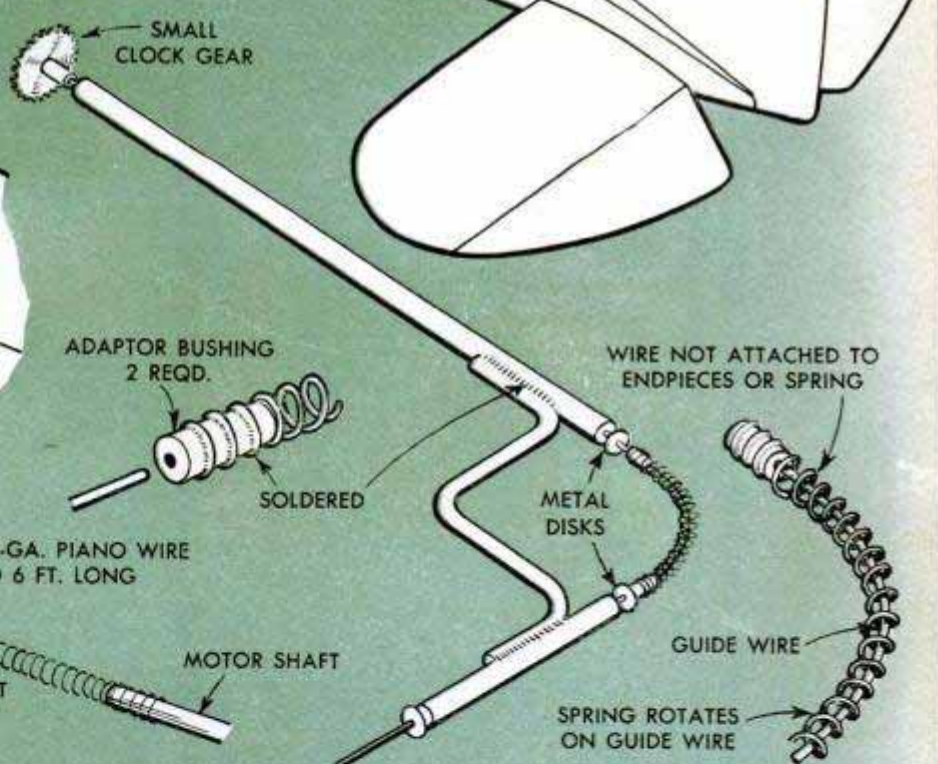
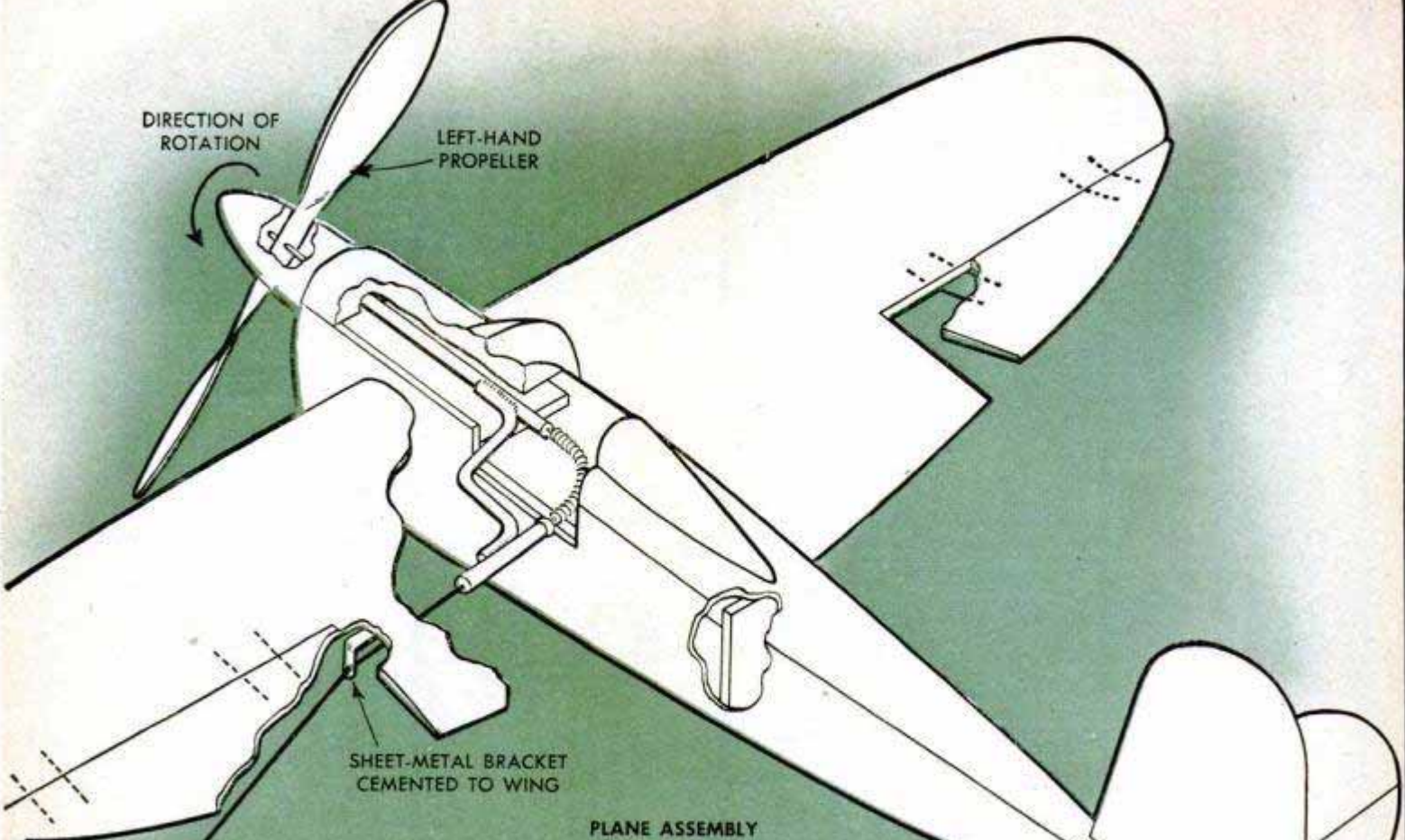

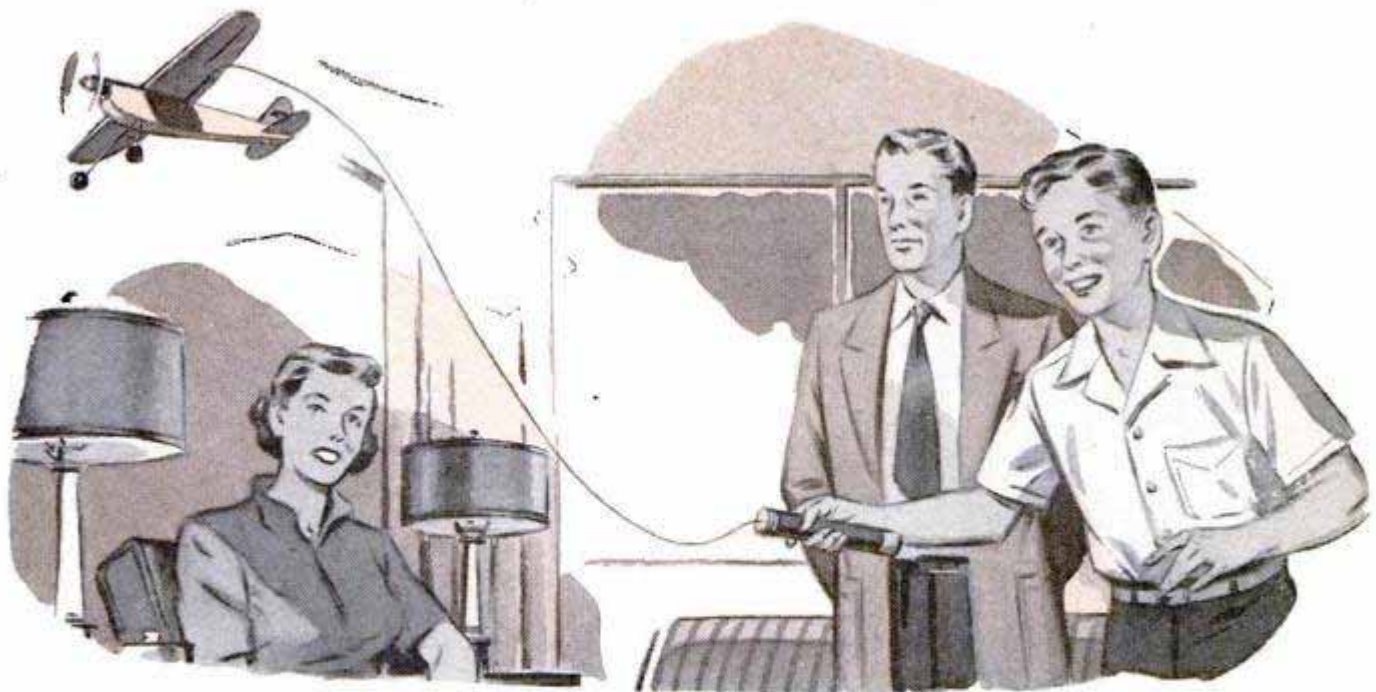

# U-CONTROL MODEL PLANE

By Kai M. Klemm

**P**OWERED by a novel electrically driven remote-control unit, this tiny plane will fly level, zoom and loop on a circular course in a small living room. The control unit, which also supplies power, is housed in a mailing tube about the size of an ordinary flashlight, except that it is slightly longer to accommodate four flashlight dry cells and a tiny electric motor. The motor drives the propeller through a "flexible shaft" of fine piano wire, the length of the wire depending on the radius of the flight space available. Because of the constant speed of the left-hand prop and the connection of the flexible shaft to the fuselage at its center of gravity, the plane maintains level flight without any tendency to nose down due to torque.

All parts of the plane are made of balsa-wood, except, of course, the angle drive and the landing gear. Sheet balsa,  $\frac{1}{16}$  in. thick, is used for all parts except D, E and F in the details on the following page. The sides of the fuselage are made first, then the bulkhead, A, is glued in place. Next, both the sides are glued together at the tail and cowl block, C, is glued in place. The landing-gear frame is bent to fit inside the fuselage and must be cemented in place before the bottom is put on. The inclination of the frame is shown by dotted lines on the details. After gluing on the bottom, the fuselage is sanded to contour and sides are slotted for the stabilizer. Now make the wing, stabilizer and fin, but do not attach the wing until the angle drive is in place.

The details on the opposite page show the

assembly of the angle drive and how it is placed in the plane. The drive housing consists of two pieces of  $\frac{1}{16}$ -in. o.d. brass tubing held at right angles by a brace of brass wire to which the housings, or sleeves, are soldered. The piano-wire shaft from the motor is passed through the short sleeve so that the end projects. A thin metal disk about  $\frac{3}{16}$  in. in dia. is soldered to the end of the wire. Then a length of the piano wire is inserted in the long sleeve, cut to required length, and a  $\frac{3}{16}$ -in. metal disk is soldered to the end. The flexible connector between the two shafts is made as in the right-hand center detail on the opposite page. The drive is made through a fine coil spring of the type and weight found in camera-shutter releases. The ends of the spring are soldered to short bushings cut from  $\frac{1}{16}$ -in. o.d. brass tubing and the outer ends of the bushings are soldered to the metal disks at the ends of the flexible shafting. Before soldering the bushings to the metal disks, pass a length of spring-brass wire through the bushings and the coil spring and bend to a uniform curve, cutting to length as required. When the assembly is made and all parts have been soldered in place, the spring and bushings turn on the curved-wire guide. In this manner power from the flexible shaft is transmitted at right angles without buckling the spring. Care must be taken in assembling to assure that the curved wire is free at the ends and that the metal disks do not bind against the ends of the short and long sleeves. Adjust the unit by bending the wire brace until it turns freely.

The angle-drive unit is assembled in the

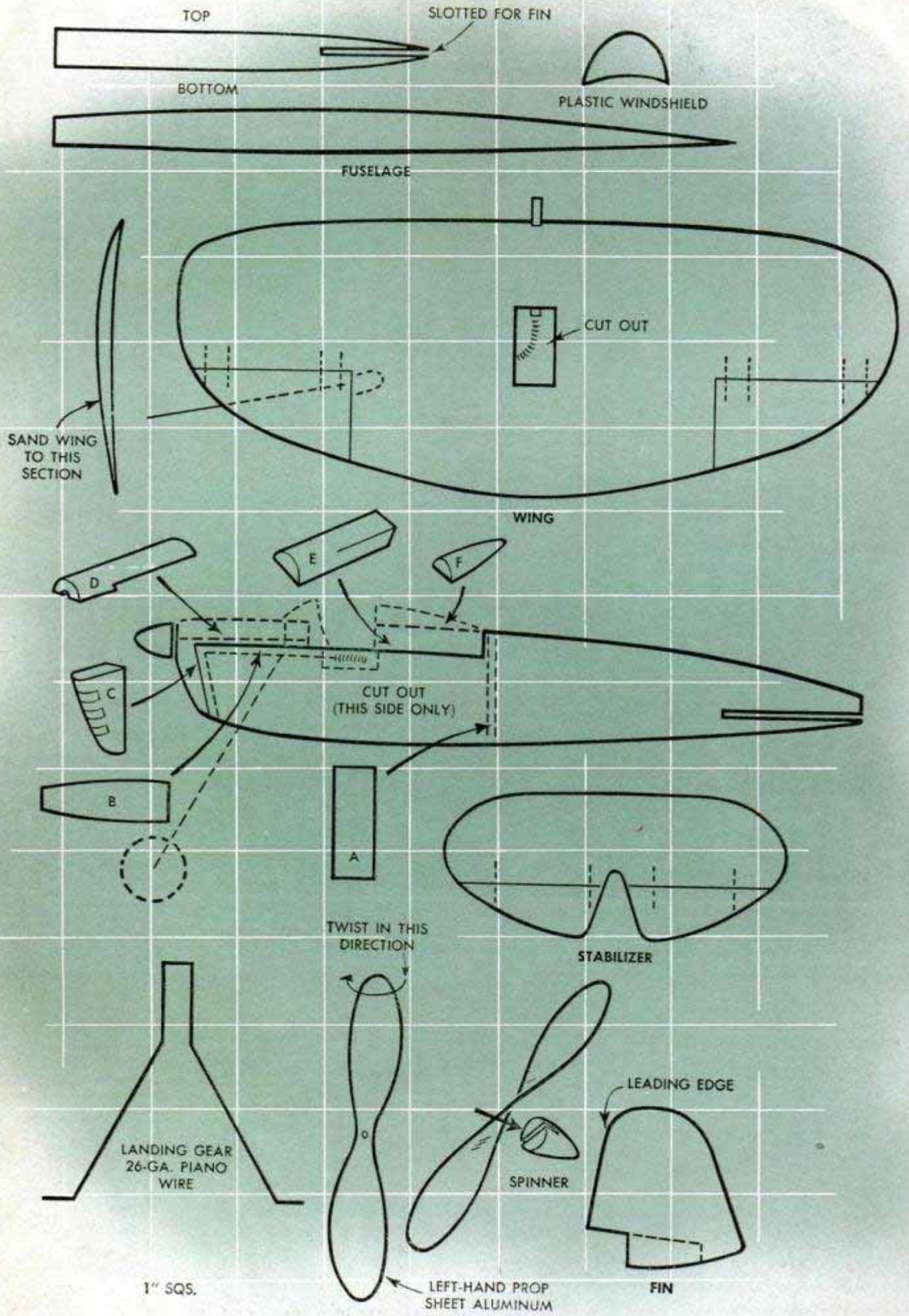



fuselage as in the upper detail on the opposite page. First glue part B in place, then cement the long sleeve, or propeller shaft bearing, to it. Note that a part of the brace and the short sleeve project from the opening in the side of the fuselage. Next, sand the wing to the airfoil indicated in the detail and cut out and hinge the ailerons with lengths of fine copper wire. Cement the wing in place on the fuselage with a 3-deg. angle of incidence. Then add the rear cowling, E, the windshield and headrest fairing. As the final step in this assembly, bend a bracket bearing from sheet brass and drill a hole for the piano-wire shaft near the end of one arm. Then slip the bracket over the wire and cement it to the underside of the wing as shown.

The power unit, shown in the lower details on page 188 consists of a mailing tube divided into two compartments, the smaller housing the motor, with its shaft projecting through an oversize hole in the cardboard disk which is cemented or taped to the end of the tube. A coil spring about 1 in. long and of the same general characteristics as that used in the angle drive is used to form a flexible connection, or universal joint, between the motor shaft and the piano-wire shaft. In order to make the connection it will be necessary to solder a suitable bushing to the end of the piano-wire shaft as shown in the detail. Then the spring is slipped over the bushing and soldered. It is not soldered to the motor shaft, as a tight fit is sufficient to transmit the full power of the motor.

The battery compartment of the tube is closed at the lower end with a friction cap made of sheet brass. Two terminals and a compression spring are fitted in the cap and the positive terminal is insulated from the metal. After wiring and installing a switch and dry cells, test the assembly for smooth operation without the prop. If there is any tendency toward vibration, the cause must be found and corrected before the assembly will operate satisfactorily. Cut the prop to the size indicated from thin sheet aluminum, give it a left-hand twist and mount on the prop shaft with a small disk of sheet metal to which a short length of  $\frac{1}{16}$ -in. brass tubing has been soldered to form a hub. If available, a small gear wheel from a clock is just the thing. Fit the prop with a balsawood spinner as in the details.

Flying the plane is quite simple. Once in the air it is controlled by arm movements. Successful maneuvers depend on the application of power at the proper time and also in the guidance of the hand and arm. Experimentation with elevator and aileron settings will be necessary. ★ ★ ★

## Steel Tapeline Oiled in Device Made From Old Spectacle Case

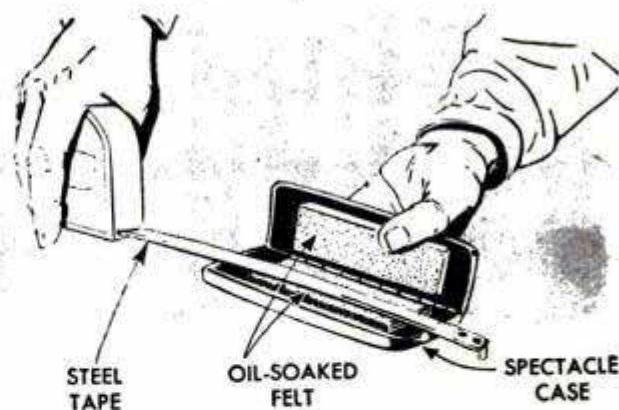

An old spectacle case containing two pieces of felt will provide a handy oiler for a tapeline. The pads are cemented or otherwise attached inside to the bottom and the top of the case, after which they are soaked with oil. In use, the tapeline is pulled between the pads to apply a light film of oil. Clean the pads and replenish the oil supply from time to time.

## Rack for Wood-Turning Chisels Permits Easy Removal

I find this open rack for wood-turning chisels much more satisfactory than clip hangers, slotted boards or other devices. A tool can be removed or replaced in an instant without getting caught on anything. The base is a  $\frac{3}{4}$  x 5 x 17-in. board supported on shelf brackets. The tool handles rest in large holes bored part way through the wood, these holes being continued through the wood with a smaller drill to permit easy removal of the shavings. The tool blades fit in open cuts in a  $1\frac{1}{2}$ -in. strip nailed to a backboard. The tools are tilted back sufficiently to prevent them from falling out.

Robert Hertzberg, Jackson Heights, N. Y.

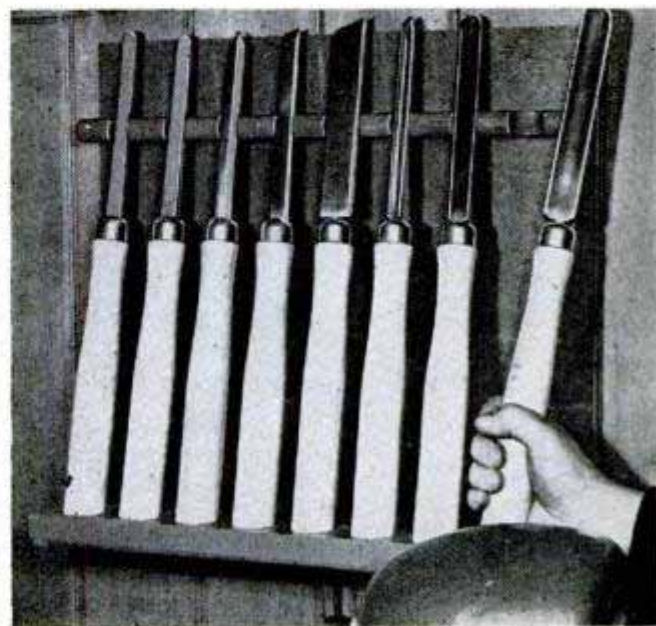

## Attractive Shelf Fastened to Bathroom Wall For Holding Small Radio and Toilet Articles

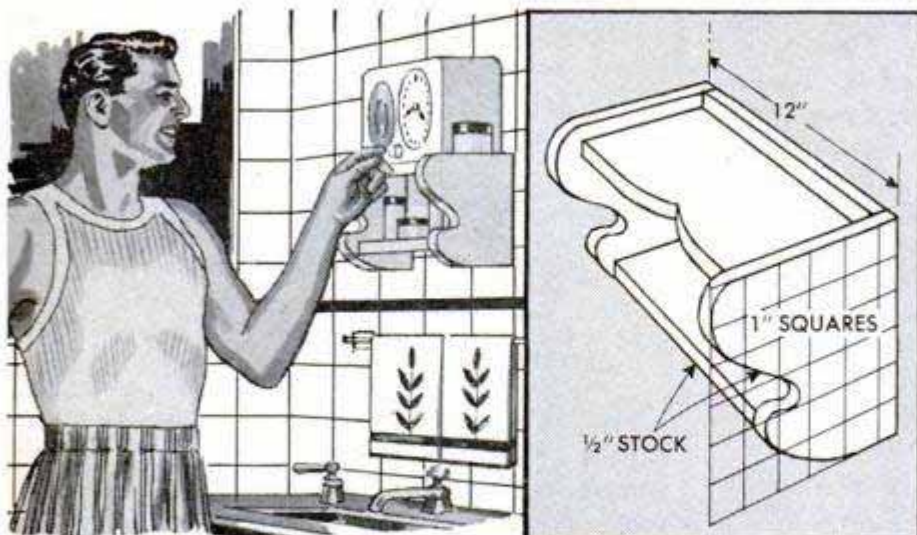

Designed primarily to provide extra storage space for toilet articles in a bathroom, this easy-to-make shelf also will accommodate a small radio. Using a template, outline the sides on  $\frac{1}{2}$ -in. stock or plywood. After cutting the pieces, assemble them with glue and screws and sand smooth before finishing. Fasten the shelf to the wall with screws. **Caution:** To prevent possible electric shock, the radio should be located out of reach of any person using the tub or shower. A. E. Fenn, Chicago.

## Whiting Coated on Storm Windows Simplifies Cleaning After Storage

If you want to avoid having to wash storm windows on a cool fall day, wash them after removing them in the spring and coat the panes with whiting or a cleaning compound such as Bon Ami before storing them. Mix the whiting and water to a creamlike consistency and apply with a

sponge. Once dry, the whiting seals the glass from dust and when wiped off, after the windows are taken out of storage, will provide sufficient abrasive action to clean and polish the glass. Under ordinary circumstances the windows will be found clean enough to forego washing them again.

## Rubber Tape Covering Fishhooks Prevents Possible Injury

To prevent fishhooks from snagging on clothing and equipment as well as possibly injuring the fingers, cut small pieces of rubber tape and fold them over the point and barb of each hook. The tape not only can be removed easily but also may be used several times if necessary.

Martin D. Koehler, River Grove, Ill.

## Salvaging Worn Whisk Broom

Instead of discarding a whisk broom that has become worn badly, try trimming and shaping the edges to a point at the center. The broom is ideal for cleaning corners in cupboards, closets and drawers.—Marguerite McLees, Moose Jaw, Sask., Can.



## Tube Held Over Spray-Gun Nozzle Directs Thinner Into Container

When spraying thinner to clean a paint-sprayer gun, you can reduce the danger of fire, as well as the loss of thinner, by slipping a piece of tubing over the nozzle to direct the spray into an empty container. The tubing will cause most of the mist to condense. Although impure after one spraying, the thinner still can be used to reduce paint and lacquer, or used as a thinner in a priming coat.

Clyde Allison, Cadillac, Mich.

# Small-Parts Tray Swings Under Workbench

One advantage of this tray for small parts is that it can be mounted within easy reach on a leg of a workbench and simply swung out of the way when not in use. Constructed almost entirely of scrap parts, the tray itself is cut from one end of an oil or gasoline drum, while the conical-shaped center section of the tray is formed from a round piece of metal cut from the other end. The cone is made by cutting a narrow segment from the metal, overlapping the newly cut edges and riveting them together. The cone is then soldered to the bottom inside surface of the tray. Partitions may be made from either  $\frac{3}{8}$  or  $\frac{1}{2}$ -in. stock, and are beveled on one end so that they fit snugly where they converge at the center of the tray. Two lengths of flat steel are welded together as shown to provide a supporting bracket, while hinges welded to the ends of the steel are screwed to a work-

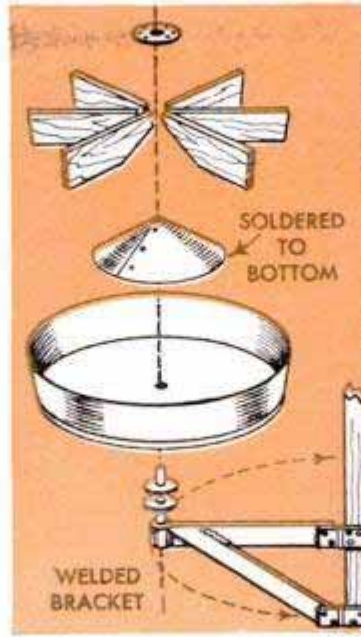

bench leg to anchor the bracket to the bench. The tray itself rotates on a steel rod fitted vertically in an eye formed on the outer end of the bracket and welded in place. Two or three washers are used to assure sufficient clearance between the bracket and the bottom of the tray.

T. O. Honiball, Detroit, Mich.

## Wooden Guide on Grinding-Wheel Rest Aids in Knife Sharpening

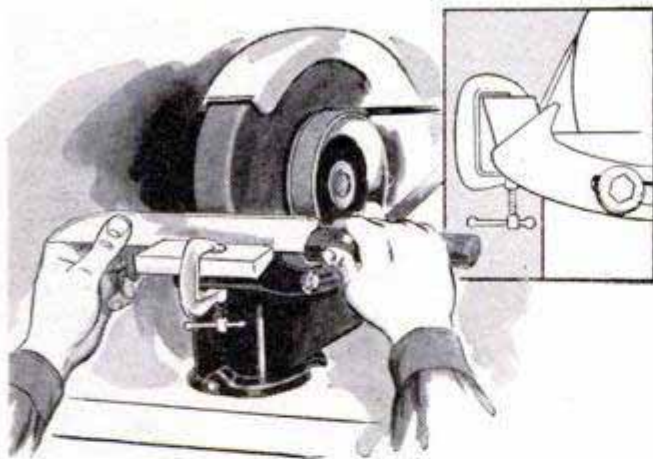

With a wood-block guide similar to the one illustrated clamped to the rest on a grinder, it's easy to obtain a perfect hollow-ground edge on a knife blade no matter how many times it is lifted from the grinding wheel during the operation. The guide should be at least two or three times greater in length than the thickness of the wheel, so that the entire blade may be fed across the wheel at the same angle. Because of the difference in grinder rests, the guide will have to be beveled to fit the crosspiece and also to provide a flat surface for the clamp to grip.—J. B. King, Orange, Tex.

## Rubber Sheath for Countersink Made From Rubber Tubing

To protect the cutting edges of a countersink to be stored in a toolbox or a drawer, slip a piece of rubber tubing over it as indicated. If the latter is not available, try one of the fingers from an old rubber glove, or a plastic tube corked at both ends.

John J. Rea, Urbana, Ill.

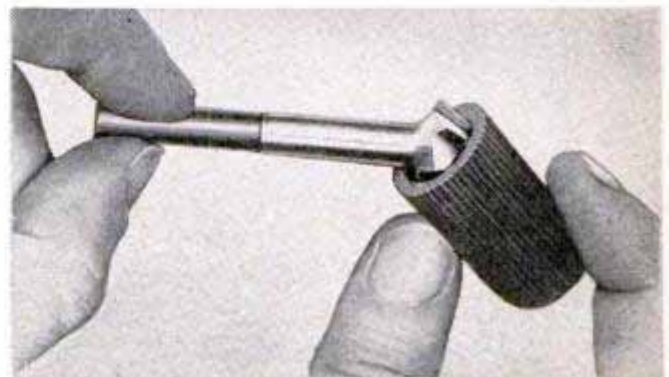

When gluing a small piece that cannot be clamped, such as a chip from a piece of furniture, use a short strip of cellulose tape to hold it.

# It's New and Better! "PERIMETER"

These forced-air systems mean warm floors and more comfort for one-story basementless homes built over concrete slabs or crawl spaces

By E. R. Haan

**W**ARM-AIR perimeter heating not only improves living comfort in basementless homes but also has the advantages of simplicity and comparably low cost. Perimeter heating differs from ordinary forced warm-air heating in three ways: (1) Warm-air ducts are installed in or under the floor, keeping it warm and providing radiant heat for the rooms above. (2) Warm-air outlets with diffusing-type registers are located along outside walls at floor level and preferably under windows. This placement of the registers provides a curtain, or blanket, of warm air where it is needed most, thus eliminating the usual temperature differential in rooms. (3) Return air is taken back to the furnace through high grilles in partitions instead of through grilles located at floor level.

**Four common arrangements:** Perimeter-heating systems are applied in different ways. The loop system, Fig. 1, is used in basementless homes having slab-type floors of concrete. The warm-air ducts, which are embedded in the concrete, extend from the furnace to, and entirely along, the perimeter of the slab. The radial system, Fig. 2, can be used in homes built over either slabs or crawl spaces. This system does not assure an entirely warm border in slab floors, and usually is not used where the floor area exceeds 1000 sq. ft. The radial system is better suited to homes built over crawl

Certain photos and data courtesy of National Warm Air Heating and Air Conditioning Association

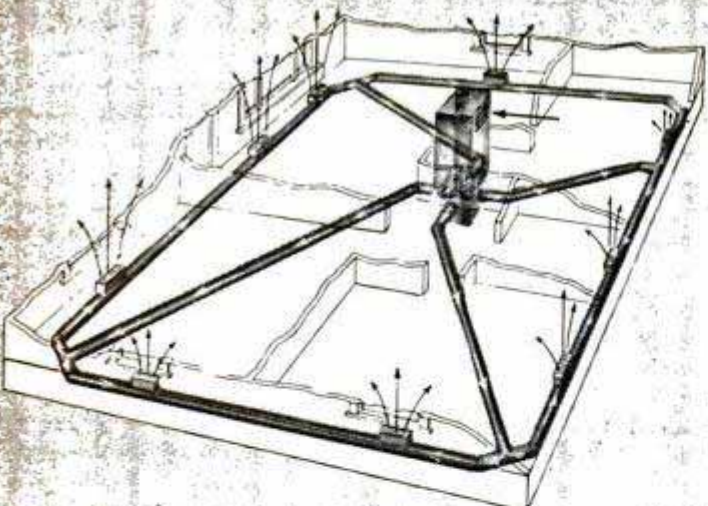

LOOP SYSTEM

1

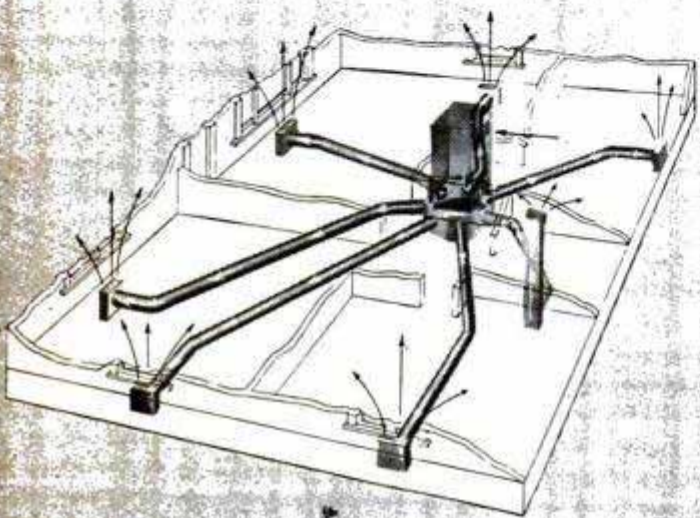

RADIAL SYSTEM

2

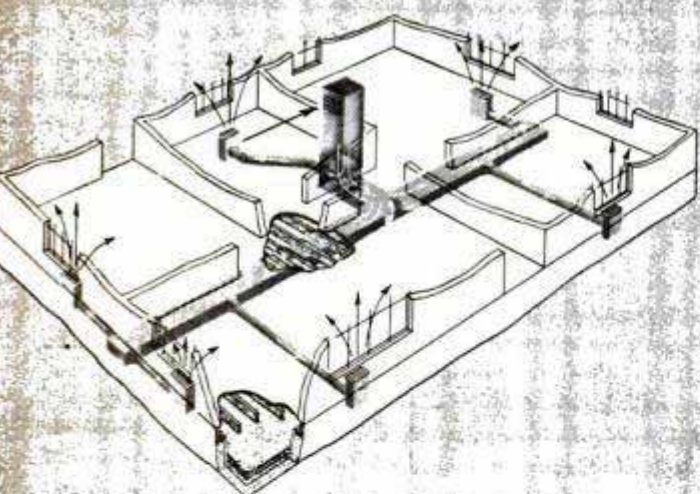

EXTENDED-PLENUM SYSTEM

3

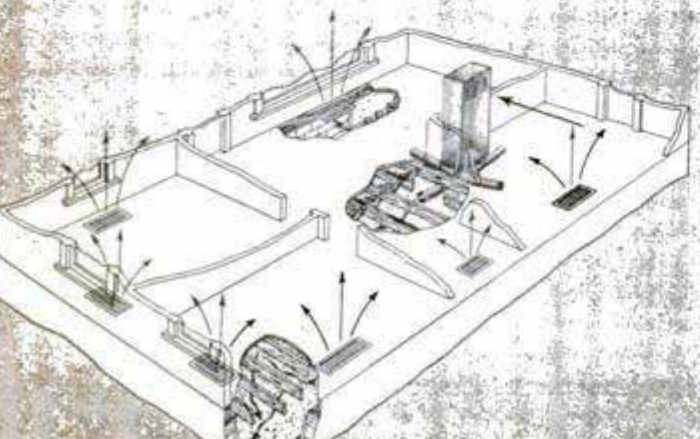

LATERAL SYSTEM

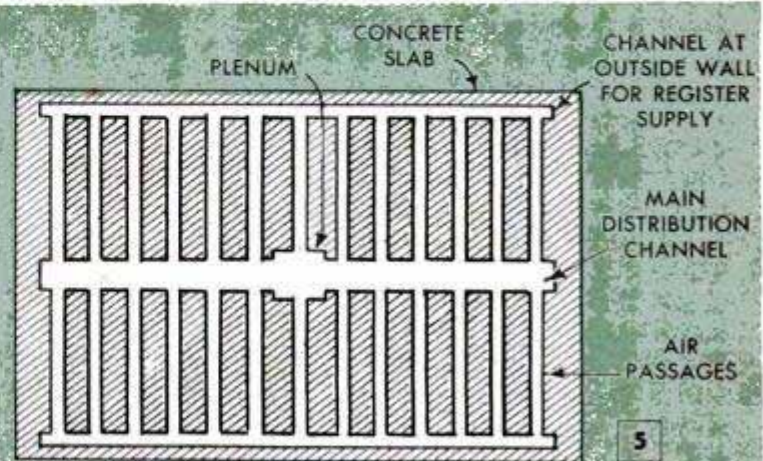

5

# HEATING

*with forced warm air*

spaces, and in such installations the floor area may be over 1000 sq. ft. In long, narrow homes or where the furnace cannot be located centrally, the extended-plenum system, adaptable for crawl spaces, Fig. 3, has definite advantages in obtaining better heat distribution. The plenum is the chamber in or adjacent to a furnace from which warm air enters the distribution ducts. Fig. 4 shows a crawl-space-plenum system which is adaptable to small homes. It has stub ducts about 6 ft. long extending from the plenum. A fifth system, called the lateral system, Fig. 5, is used for large slab-floored buildings. It must be designed especially for the building to provide uniform space heating and to avoid excessively warm floors.

**Dry location essential:** Standing water and damp earth under a heated crawl space or a concrete slab are the cause of more unsatisfactory heating installations in basementless homes than any other single factor except possibly inadequate insulation. *Where such conditions cannot be corrected a heating system that introduces heat under or into the floor should not be used.*

You can minimize the collection of surface water under a slab or crawl space simply by installing drainage tile around the footings as in Fig. 7, A. The tile lines should have a slope of  $\frac{1}{4}$  in. per ft. They should connect to a combination sewer or a storm sewer, or to some other point of disposal such as a dry well, Fig. 7, B. The outside of the foundation walls also should be covered with a  $\frac{1}{2}$ -in. layer of portland-cement plaster. After this has cured, apply a coat of damp-proofing compound or hot tar. Diversion of surface water is particularly necessary on the side of a house facing a rise of ground. In locations where the water table is apt to rise during spring months or after prolonged rainfall, it may be advisable to provide drainage lines under the house as in Fig. 7, C. The tile is covered with a substantial layer of coarse gravel or crushed stone. A moisture barrier over the gravel, Fig. 8, also is required.

**Under-slab fill:** Never use cinders as fill under a slab floor. Only coarse gravel with the fines removed is suitable. The layer should be at least 4 in. thick and must be

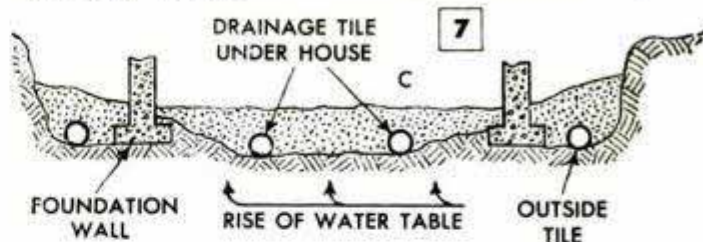
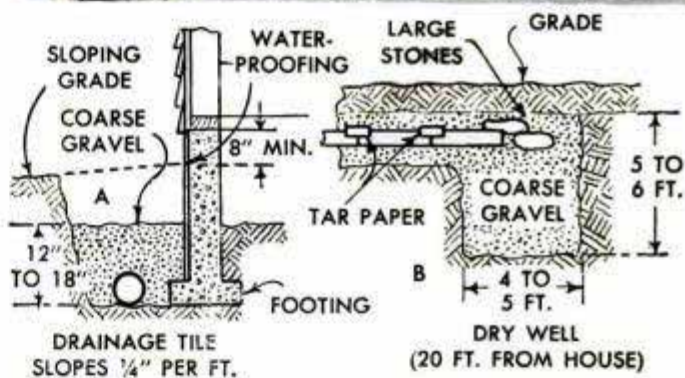

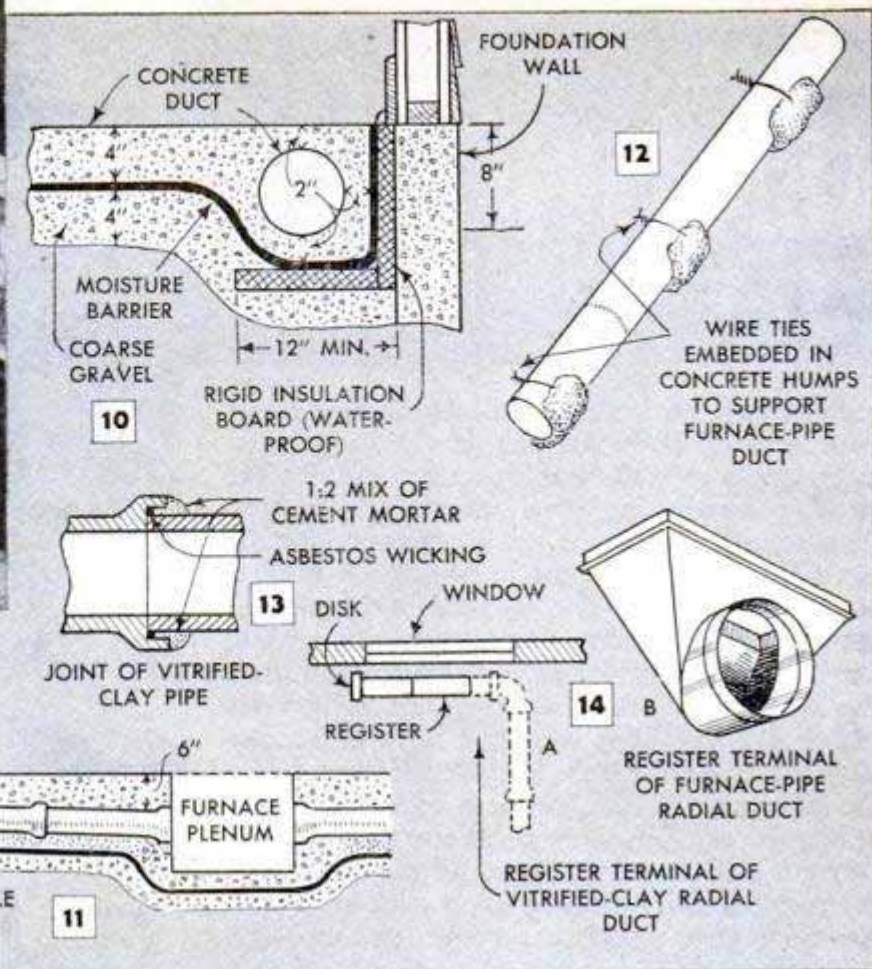

thoroughly tamped. Before placing the fill, trenches are dug at the locations of the ducts so that the gravel layer under them will be of equal thickness, Fig. 10. Trenches near the furnace plenum should be 6 in. deeper than those for perimeter ducts. Connecting ducts are sloped between the two levels as in Fig. 10. Edge insulation is installed as in Fig. 9 after leveling and tamping the gravel. This extends along the entire length of the foundation wall, between it and the slab, Fig. 10. It should be of the rigid, waterproof type, preferably 2 in. thick. The horizontal pieces should extend inward not less than 12 in.

**Moisture barrier under slab:** Before the slab floor is poured, the gravel fill is covered with a layer of 55-lb. asphalt roll roofing, Figs. 8, 10 and 11, which forms a moisture barrier. The edges are overlapped from 4 to 6 in. and sealed with roofing cement. The barrier should extend up along the foundation walls to the floor surface. Wherever it must be cut to fit around pipes, it should be sealed as in Fig. 19.

**Placing ducts in trenches:** Trenches should be deep enough to permit a 2-in. layer of concrete to be poured entirely around all the ducts as in Figs. 10 and 11. The concrete covering over ducts at the plenum should be about 6 in. thick, Fig. 11. The reason for this is to obtain uniform heat penetration through the floor—the air entering the ducts at the plenum being

so much hotter than it is at the perimeter.

**Installing sheet-metal ducts in slab:** Furnace pipe of 28 ga. may be used for ducts. For small homes the 6, 7 or 8-in. sizes are sufficient. The size selected should be used throughout the system. Round ducts are recommended. Perimeter ducts are located so that the center of the registers will be from 7 to 9 in. inside the finished wall line to clear drapes and curtains, Figs. 16, B, and 25, B. Sheet-metal ducts must be held in place securely when the slab is being poured. This can be done by embedding wire in humps of concrete placed under the ducts to hold them at the correct height. Tie the wires around the ducts after the concrete humps have hardened, Fig. 12. Sheet-metal brackets, Fig. 6, often are used to support the pipe. Register fittings of sheet metal can be used at the ends of radial ducts as in Fig. 14, B, or rectangular forms as shown in Fig. 6 can be used.

**Vitrified-clay ducts:** Vitrified-clay pipe also may be used for ducts, Fig. 15. It is supported by gravel or sand, preferably fine gravel. The joints are calked with asbestos wicking, about one third their depth, then filled with a 1:2 mix of portland-cement mortar, Fig. 13. Both short and long-radius fittings are used for changes of direction. The open ends of pipe at register locations of a radial system are closed with vitrified-clay disks, Fig. 14, A, which are held in place while pouring the slab.

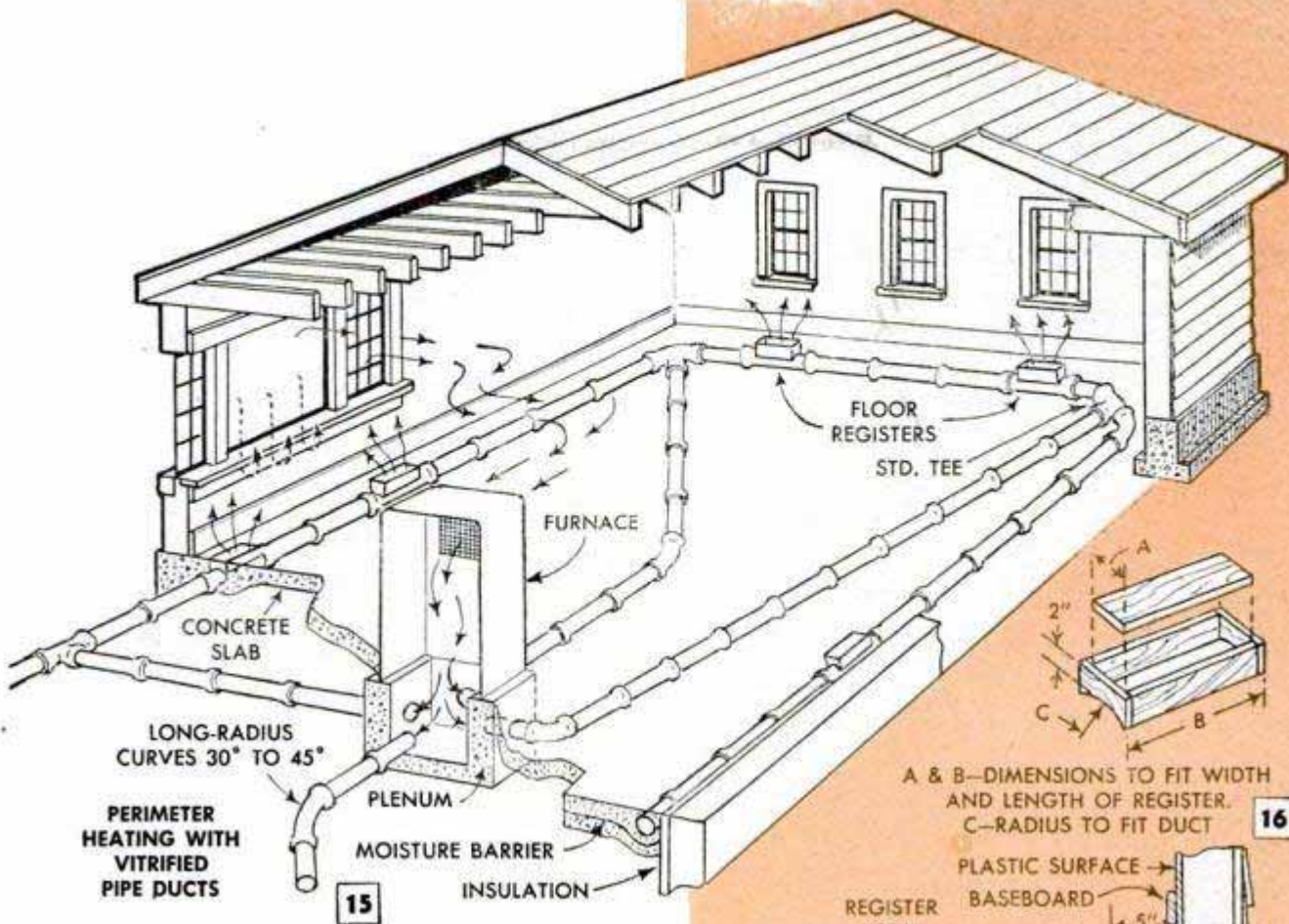

15

**Register openings in slab floors:** To form register openings in concrete over ducts, removable wooden forms fitted with covers as in Fig. 16, can be wired to the pipe or sheet-metal forms used, Fig. 6. However, the pipe is not cut until the registers are to be installed. If desired, the wooden forms can be left in place to provide a base to which registers may be fastened. Sometimes wall registers are installed just above floor level. In this case only the type designed for perimeter heating is used. Slotted baseboards may be used instead of registers, an installation particularly adaptable for crawl-space-plenum systems. Fig. 17 shows how a duct and register are placed under a kitchen cabinet that occupies the entire wall space. A wall-type register is used in bathrooms.

**Concrete plenum cast with slab:** In slab floors the plenum can be cast integral with the slab, using an inside form which is suitably braced. See Figs. 11 and 18, A. Sheet-metal ducts are allowed to extend through the wall of the plenum and are cut off flush with the wall of the plenum after the forms are removed. Vitrified-clay pipe is butted against the forms as shown in Fig. 18, B. The floor, laid after the forms are removed, should be not less than 2 in. thick, and should come from 1½ to 2 in. below the bottom of the ducts. If a metal plenum is used, it should be entirely enclosed in concrete. The plenum may be provided with

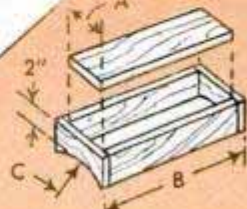

A & B—DIMENSIONS TO FIT WIDTH AND LENGTH OF REGISTER. C—RADIUS TO FIT DUCT

16

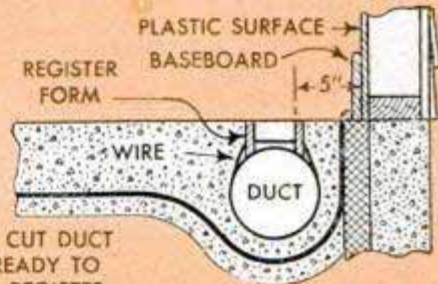

DO NOT CUT DUCT UNTIL READY TO INSTALL REGISTER

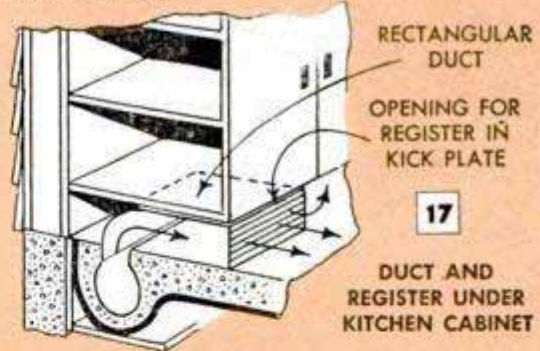

17

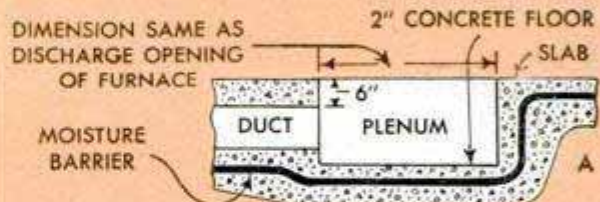

CONCRETE PLENUM CAST INTEGRAL WITH SLAB

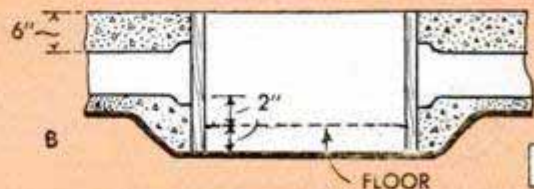

18

HUB END OF VITRIFIED-CLAY DUCTS BUTT AGAINST FORM

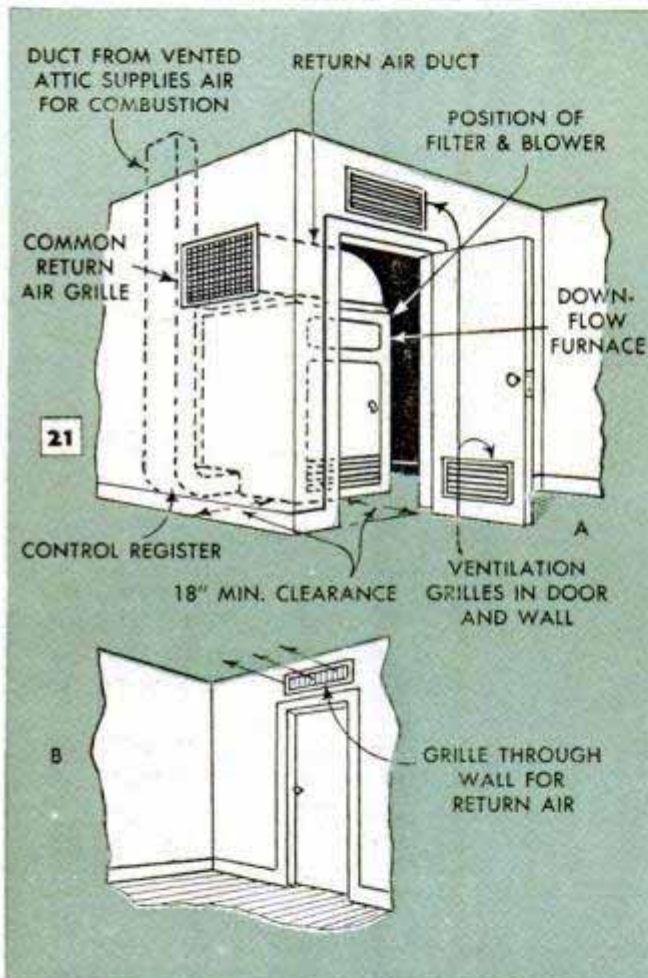
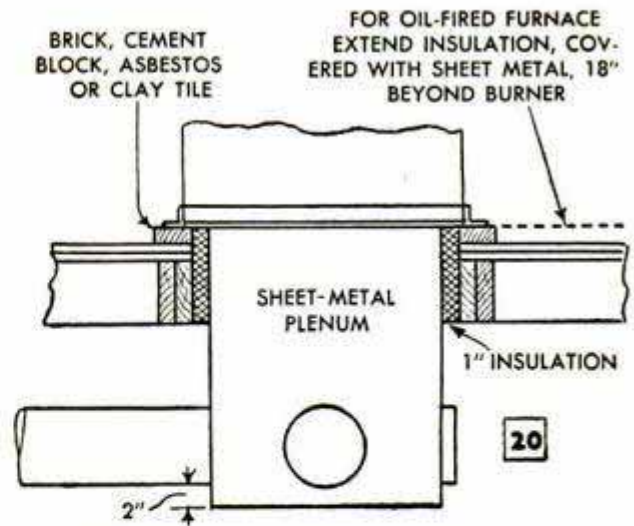
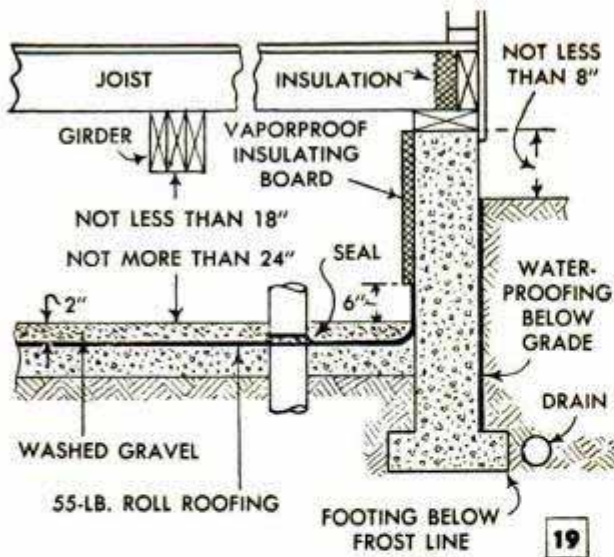

a floor drain over a small dry well as a precaution against the possibility of water collecting in the plenum due to an overflowing bathtub or water closet.

**Crawl-space requirements:** As shown in Fig. 19, a crawl space used for perimeter heating must be completely sealed against the entrance of moisture, and it also must be insulated and sealed at the walls to prevent infiltration of cold air. High humidity in a crawl space should be prevented as it causes rapid deterioration of the wooden structural parts of a house and also causes rusting of ducts. The earth floor of a crawl space is covered first with a layer of coarse gravel at least 4 in. thick. Over this is laid

a continuous moisture barrier, the same as in slab floors. The moisture barrier is covered with a 2-in. protective layer of concrete or washed gravel. The space between the floor and the house girders should not be less than 18 in. nor more than 24 in. Foundation walls should extend below frost level and should be waterproofed on the outside. Drainage tile are provided where necessary. Cracks in the wall and those between it and the sill are caulked. Rigid waterproof insulating board, 2 in. thick, is cemented to the inside of the walls with roofing cement. It should overlap the upturned moisture barrier of the floor.

Escape of air from a crawl space to an attic should be prevented by sealing all stud spaces in outside walls and partitions with insulating batts having vapor-barrier coverings. Vent openings as well as the entrance to a crawl space should be tightly sealed during the heating season. The floor of the house is not insulated, as heat transmission through it is one of the requirements of perimeter heating. Neither are the warm-air ducts insulated. The ducts may be either round or rectangular in shape and are suspended from joists, observing regulations as to clearance from combustible materials. Besides the warm-air outlets to the house, there should be one or more warm-air ducts opening into the crawl space; also a return-air duct, Fig. 22. The crawl space should never be used for storage.

**Plenum for crawl spaces:** The plenum for a crawl space is a square or rectangular sheet-metal chamber having the same size opening as the discharge opening of the furnace. A round plenum should not be used unless approved by the furnace manufacturer. The framed opening in the floor should be about 1 in. larger than the plenum, Fig. 20, and the space between the two should be packed with fireproof insulation. When connected to a down-flow furnace, both plenum and furnace should be supported on a base of noncombustible



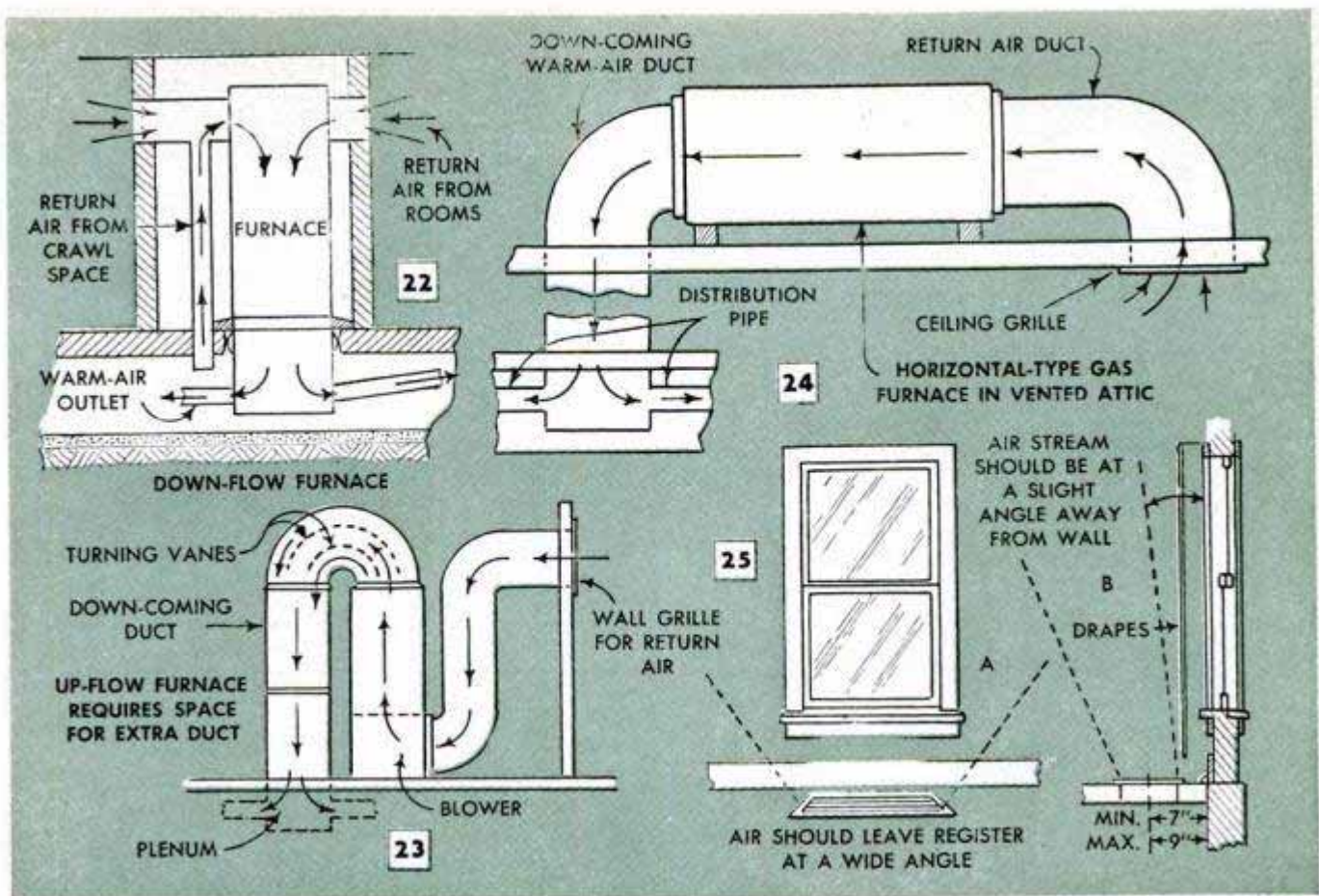

material such as brick, cement block, asbestos or clay tile. The joint between plenum and furnace must be tightly sealed with furnace cement or a suitable calking compound. The bottom of the plenum should be at least 1½ to 2 in. below the distribution pipes.

**Return-air grilles:** One or two return-air grilles in partitions next to the furnace, Fig. 21, A, generally are adequate for small homes. The grille, or grilles, should be of proper size and centrally located where air can flow to them unobstructed. A common return-air grille to the furnace should never be located in a kitchen, bathroom or bedroom. Fig. 21, B, shows how grilles are located over doors that are left closed most of the time. Those placed over bedroom doors should be the type that can be closed manually. When a furnace is installed in a confined space, the return-air grille in the wall of the enclosure should connect to a duct that is sealed to the furnace.

**Furnace selection:** Practically any automatic oil or gas-burning furnace designed for forced-air heating can be used. Although a down-flow furnace usually is the most adaptable type for perimeter heating, Fig. 22, the conventional up-flow furnace may be used if it is provided with two ducts as in Fig. 23. A horizontal gas-burning furnace can be placed in a vented attic as in Fig. 24.

If the building is so tightly constructed that a sufficient amount of air for combustion is not supplied by natural infiltration,

a duct to provide combustion air can be run up to a vented attic as shown in Fig. 21, A. Clearance between the furnace and the closed door of the enclosure should not be less than 18 in. Similar clearance all around the furnace gives easy access for keeping the space clean and for servicing the furnace. A door providing access should have a grille at its bottom and another grille should be fitted in the partition above the door to provide for normal ventilation of the enclosure.

**Automatic temperature controls:** Automatic controls are furnished with the furnace. The room thermostat, which operates the burner, should be located at the recommended height on a partition well away from warm air coming from the registers, and also where temperatures are least likely to fluctuate from opening doors or using a fireplace. For perimeter heating, slow, continuous forced-air circulation is preferred, with the burner operating at frequent intervals, the room thermostat being adjusted to a differential of 1½ deg. In down-flow furnaces, failure of the blower to function will cause the filter motor and blower to become overheated. To prevent damage an additional limit-control switch is installed to turn off the burner when such trouble occurs. Registers should be of the type designed to discharge warm air in a fan-shaped spread and away from the walls as in Fig. 25, A and B. Registers should be fitted with adjustable dampers, or valves.

★ ★ ★

## Camp Water Supply Toted in Jugs Suspended From Dowel Handles



Instead of carrying water in one large, cumbersome container to our campsite, I used four 1-gal. jugs, carrying two in each hand to better balance the load. Carrying handles were made from dowels and slipped through the jug handles, using cotter pins as shown to keep them in place. Hardwood sticks cut to the proper size could be used in place of the dowels, while wooden pins or wrappings of wire could be substituted for the cotter pins.

Edmund D. Sherman, Johnston, R. I.

## Protective Coating on Bristles Extends Useful Life of Broom



To get maximum service from an ordinary corn broom, coat the ends of the bristles with thinned shellac. In some cases, this treatment will double the life of the broom. Pour shellac, 1 part, and alcohol, 1 part, in a shallow pan and dip the end of the

## Heating Comfort

is assured without fluctuating room temperatures if your forced-air furnace is converted to continuous air circulation. This prevents air stratification, and intervals of hot and cold temperatures will no longer cause discomfort. A story next month tells how any homeowner can make this change in his furnace at practically no cost.

broom in the solution. The coating, which should be applied whenever the broom begins to show signs of wear, hardens the bristles to a certain extent but does not reduce the efficiency of the broom.

Don Nielsen, Aurora, Neb.

## Wood Block "Locks" Light Switch As Reminder to Employees

As a reminder to hired help that the lamp serving as a night light in a building is to be left on after work each day, a farmer installed a small block of wood below the switch. The block, mounted in the manner illustrated, pre-

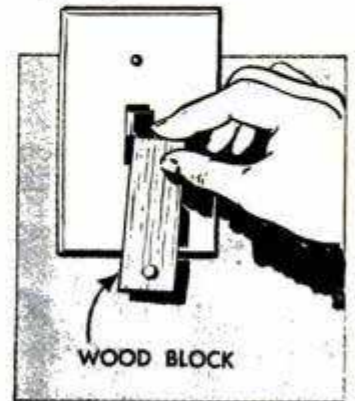

vents the lamp from being turned off so long as it remains in an upright position. Pivoted to the wall on a nail, the block must be moved to one side before the switch can be snapped to the "off" position. The requirements of the operation, however, serve sufficiently to remind the user that the light is to be left on.

Charles Stratton, Hollis, N. H.

## Shoe-Polish Bottle Used for Glue Provides Cap Applicator

A discarded liquid-shoe-polish bottle, once it has been washed thoroughly in strong soapsuds, makes an ideal container for glue. The dauber, which also should be washed, makes an excellent glue applicator. It's a good idea, too, to dip the wooden stopper that forms the handle of the applicator in hot paraffin, which will make it less difficult to remove whenever the glue is to be used.



# CONDENSER FLASH UNIT

WHILE THREE to six volts usually are required to fire photoflash bulbs, it has been found that they can be fired with far less current if a condenser is used to provide a higher voltage. This makes for a more compact flash unit, as a small hearing-aid battery is adequate to fire No. 5 flash bulbs. Current from the battery builds up in the condenser after each bulb is fired, and a resistor allows the condenser to charge but impedes the flow of current so as not to fire the bulb prematurely. When the shutter contacts close, the battery and resistor are shorted out, which causes the condenser to discharge and fire the bulb. The resistor serves to protect the battery during this period of a dead short, so the battery does not burn out. As the strength of the battery weakens, a slightly longer interval is required each time to charge the condenser, but as the current that flows from the battery is used only to fire the bulb, the current consumed each time is very little. Hence, extra-long life can be had from the battery. In addition, a more positive synchronization results from minimized resistance due to the low current and high voltage. While the unit will not operate a solenoid-type synchronizer, it is



made to order for the many cameras having mechanical-type synchronizers or built-in synchro-shutters.

Housed in a sheet-metal case formed as shown and provided with a cover, the unit is attached to the camera with a bolt which engages the tripod-screw hole. Only five parts are needed: a 22½-volt hearing-aid battery, a 100-mfd. condenser, a 2700-ohm resistor, a bayonet-base flash-bulb adapter and a receptacle for plugging in the shutter cord. Wooden blocks fitted with brass contacts provide a compartment for the battery.—John M. Avery, Dexter, N. Y.

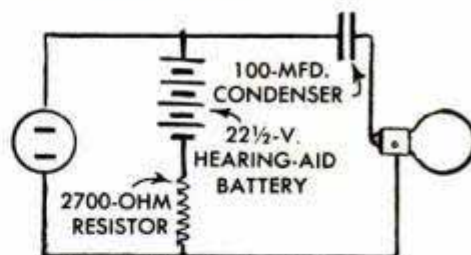
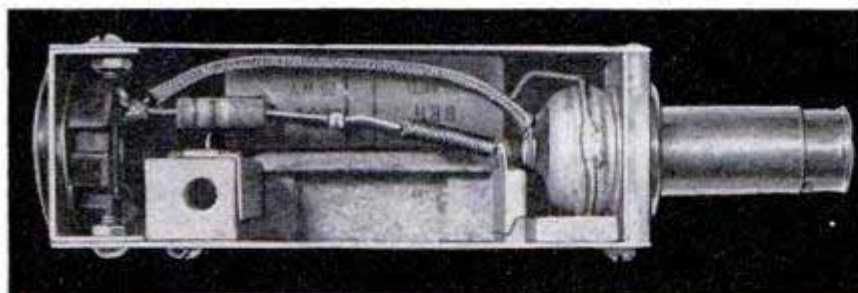

WIRING DIAGRAM

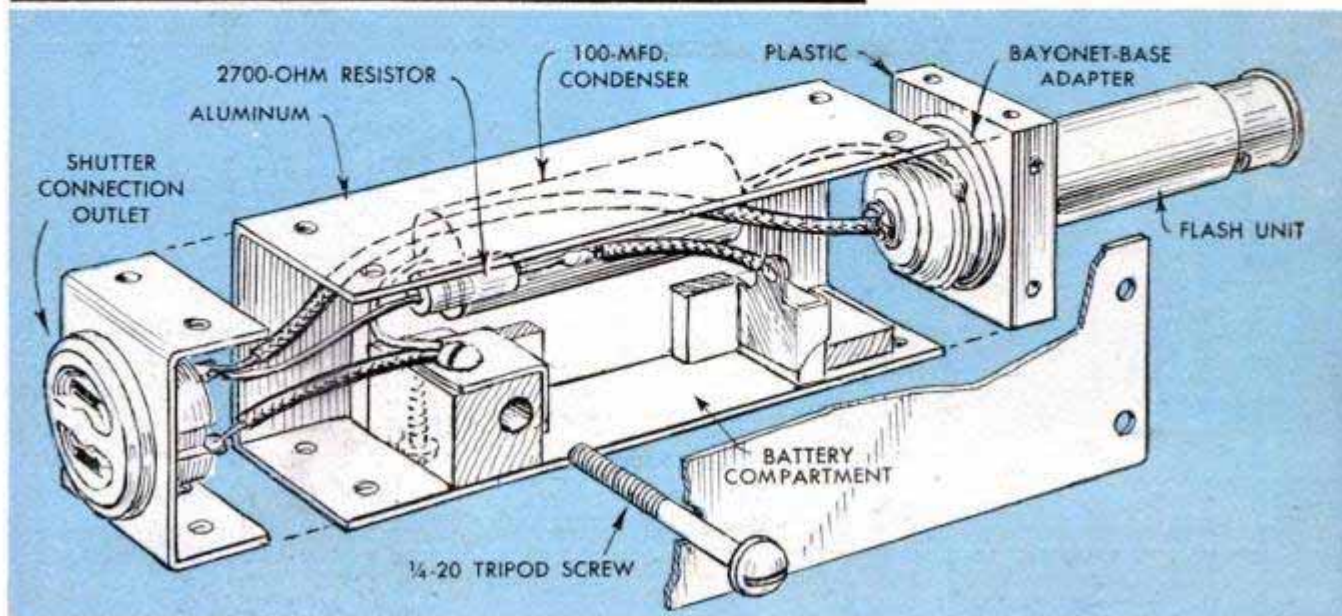

# Know Your Car's NERVOUS SYSTEM

By W. K. Mitchell and  
Howard B. Birt



## EMERGENCY MEASURES

### *Important Maintenance Steps*



Frequently check water level in battery and add distilled water to maintain correct acid level



Keep battery and cable terminals tight, clean and free from corrosion. Inspect the parts periodically



Always make sure that the generator, starter and distributor are properly lubricated at all times



Keep distributor contact points and spark-plug electrodes clean and properly set to correct gap

THROUGH THE YEARS one of the most marked advances in the automotive industry has occurred in the dependability of the car's electrical system. Today, a motorist driving a modern passenger car and giving it reasonable attention, can expect to encounter only a bare minimum of electrical-system trouble. In addition, there are more repair garages, tow-in services and mechanics available than ever before. Nevertheless, even with these advantages, it is still possible for a modern car to develop electrical trouble when in an isolated spot where immediate assistance is not available.

For this reason, it is a wise policy for every driver to know how to use a few simple emergency measures that are calculated to help him "limp in" to a mechanic if the necessity should arise. A number of these measures, pertaining to the electrical system of the car, can be employed almost anywhere without special tools, equipment, or skills.

**Defective battery:** There is a great difference between an internally defective battery and a run-down, or discharged, battery. The latter, which is experienced by most motorists at one time or another, simply requires that the car be pushed while in gear and with the ignition turned on. This will start the engine and the generator will supply current to operate the car as long as the engine is running.

A battery with an internal defect, such as a short circuit between cells, is a more serious matter. In cases of this type, the defective battery usually will drop the generator voltage so low that the engine

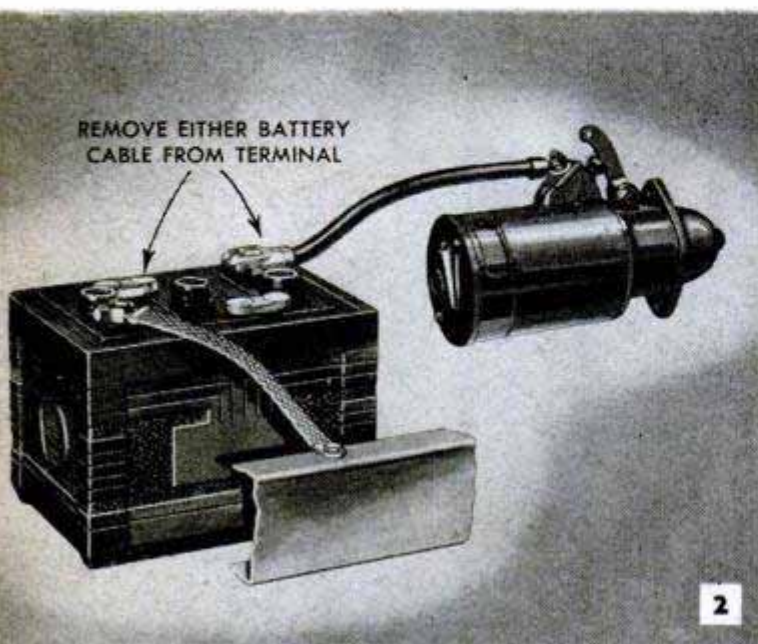

REMOVE EITHER BATTERY  
CABLE FROM TERMINAL

cannot be started even though the car is pushed. In this type of emergency, either of the battery cables can be removed, Fig. 2, to take the battery completely out of the charging circuit, and the engine then can be started by pushing the car, in gear, with the ignition turned on. When driving with the battery disconnected, the parking lights or some other electrical load should be kept on to prevent development of a damaging high voltage.

Should the car battery run dry, exposing the tops of the plates above the water line in one or more cells, and distilled water cannot be obtained, it is safer to add any water rather than drive the car with a dry battery.

**Solenoid trouble:** If the solenoid or the magnetic switch on the starter fails to close, the starter will not be actuated. Then the first thing to do is to check the battery charge by switching on the lights or blowing the horns. If the battery seems to be in good condition, run a wire from the battery terminal on the switch, Fig. 1, A, to the coil terminal, B. This will close the circuit and, if the trouble is somewhere in the starter-solenoid control circuit, cause the starter to crank. If the starter does not crank, the trouble is inside the solenoid and the latter should be checked thoroughly.

It also is possible for the solenoid switch to stick in the closed position after the starter has cranked the engine. Should this happen, the solenoid will not release, the shift lever cannot return properly and the engine will spin the starter. In such an emergency, quickly remove the small wire from the solenoid terminal. This ordinarily will cause the solenoid to release, thus indicating that the trouble is somewhere other than in the solenoid switch and that it will have to be systematically found and corrected. If removing the wire does not release the solenoid, chances are that a coil is shorted inside the solenoid. In this case, remove the battery lead from the solenoid to cause it to release. If this step must be taken it will be necessary to hold or wire together the various leads which terminate on the battery terminal

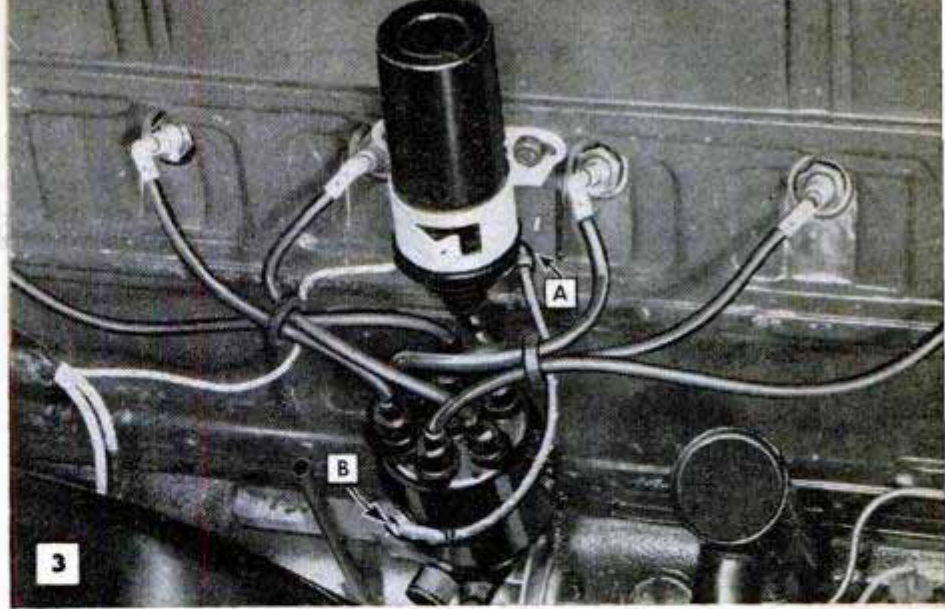

When ignition switch cannot be used to stop engine, remove the primary-coil lead either from the coil, A, or the distributor, B

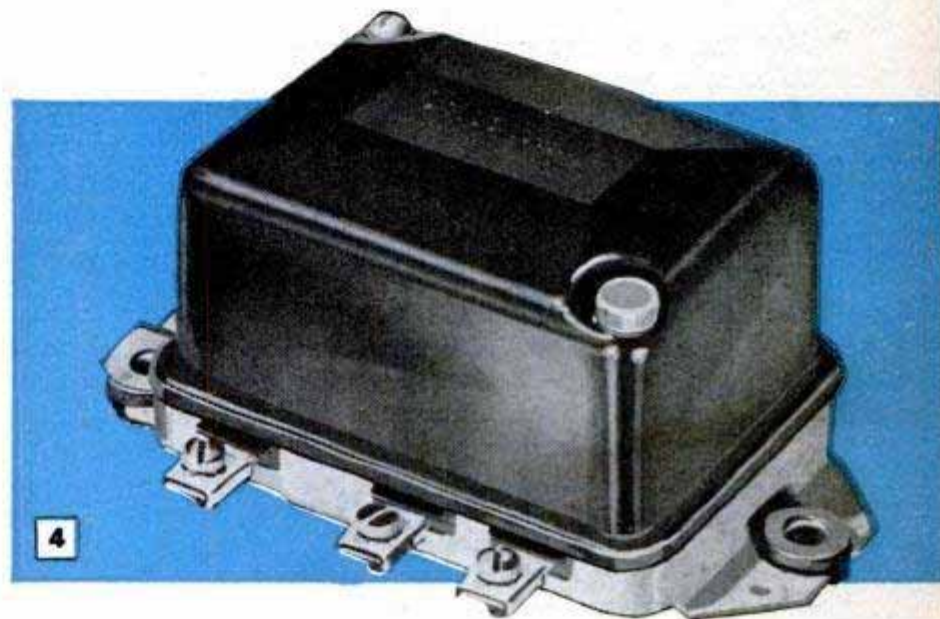

To drive with defective regulator, disconnect it from circuit by removing lead from field terminal and grounding it to base of regulator, above. Below, when generator won't charge, ground field terminal, A, to generator frame, B, with a length of wire

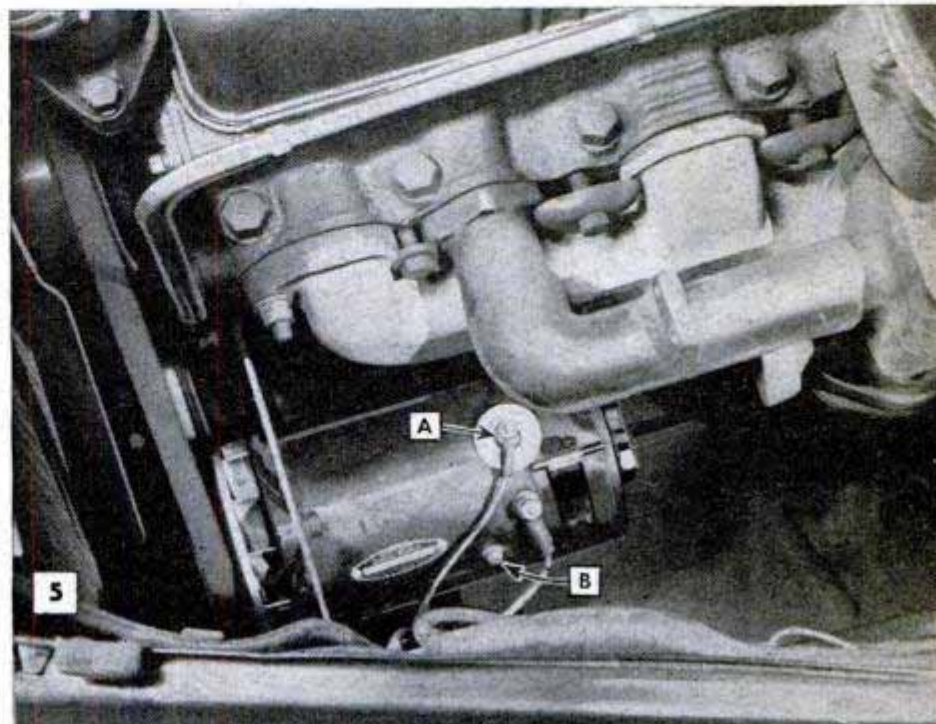

## Condition of Battery

## Ammeter Reading

## Indication

FULLY CHARGED

+



=

NORMAL

FULLY CHARGED

+



=

OVERCHARGING

DISCHARGED

+

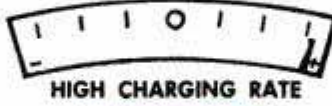

=

NORMAL

DISCHARGED

+

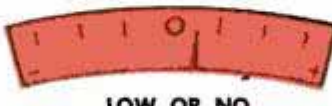

=

UNDERCHARGING

6

of the solenoid in order to keep the engine running.

**Defective ignition switch:** Should the ignition switch become inoperative due to a key being broken in the switch lock, or for any other reason while the engine is running, the engine will continue to run. To stop the engine and also prevent discharging of the battery through the ignition circuit, remove the primary lead either from the distributor or the coil, Fig. 3, point A or B.

**Generator trouble:** Should the generator commutator become coated with oil or gum to a point where the generator cannot charge, and sandpaper or a brush-seating stone is not available, the commutator can be cleaned temporarily with an ordinary pencil eraser. To do this, remove the generator-cover band, idle the engine, and move the eraser back and forth across the rotating commutator. After the oily film

has been removed, move a dry rag back and forth across the revolving commutator to complete the cleaning. This procedure often will enable the generator to resume charging until a more thorough cleaning job can be performed.

A break anywhere in the field lead connecting the regulator and the generator will prevent the generator from charging. If this happens, ground the generator field terminal to the generator frame with a short piece of wire, Fig. 5. This will permit the generator to charge and the car can be driven. However, the car must be driven less than 25 m.p.h. in high gear, and at slow engine speeds in lower gear, while the generator field terminal is grounded. Otherwise the generator will charge uncontrolled and could damage itself or other parts of the car's electrical equipment.

**Defective regulator:** An internal defect in the regulator can shut off the supply of field current to the generator and stop it from charging. If this should happen, the car can be driven a short distance on battery current alone. However, if it is necessary to drive for a length of time that might run down the battery, especially at night when the lights must be used, the regulator can be disconnected from the circuit so that the generator will charge. To do this, remove the lead from the field terminal of the regulator, pictured in Fig. 4, and ground it to the regulator base. Again, it is necessary to drive at low speeds to pre-

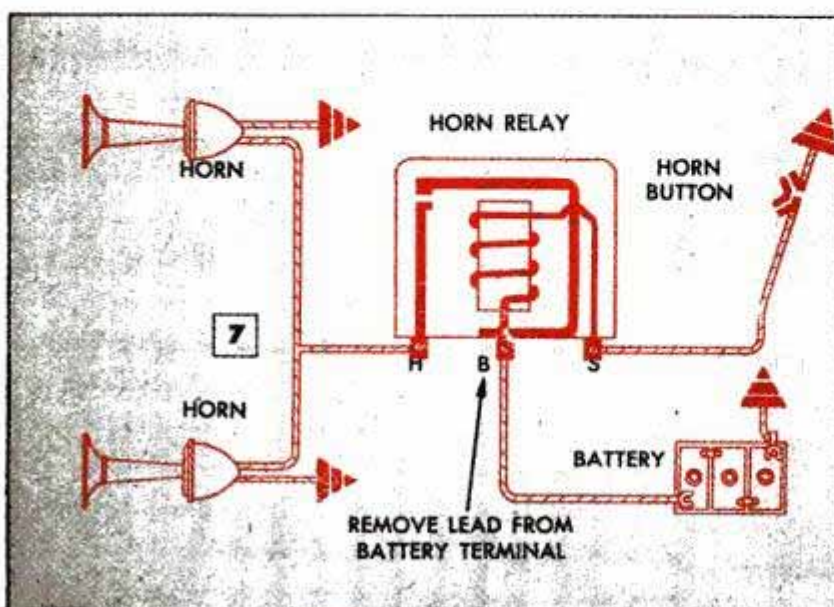

Photos and information courtesy Delco-Remy Division, General Motors Corp.

vent the uncontrolled generator from damaging the system.

**Stuck horn:** Occasionally a short circuit develops somewhere in the horn wiring which causes the horn to blow continuously. This can happen even when the car is unoccupied, causing considerable disturbance, particularly in a busy area, and quickly discharging the car's battery.

The fastest and easiest way to stop a "stuck" horn is to remove the battery lead from the center terminal on the horn relay, Fig. 7, B. This disconnects the horn from the battery and silences it until the trouble can be located and repaired. The bare end of the battery lead should be fastened back so that it cannot short-circuit against any metal part.

Probably the most simple and effective manner in which a motorist can know when to expect possible trouble in the electrical system is to maintain a regular watch over the ammeter on the instrument panel. Note in Fig. 6 how the ammeter reading indicates either a normal condition or the possibility of something wrong. Also note the condition of the battery that is indicated in the chart, as slight variations will change the interpretation.

If the ammeter shows a high charging rate over an abnormally long period, the battery could be low or running too hot, there may be a defective unit in the regulator, a ground could exist in the generator field circuit (in either the generator, the regulator or the wiring) or the regulator could be set too high.

If the ammeter shows a very low, or "no" charging rate over a like period of time, look for loose connections, frayed or damaged wiring, internal defects in the battery, high resistance in the charging circuit, too low a regulator setting, oxidized regulator contact points, or a defective generator.

Regular maintenance is, of course, the best possible way of avoiding trouble, prolonging the life of the car's electrical system and insuring better engine performance. Thorough maintenance procedures covering each of the electrical units have been discussed in previous installments of "Know Your Car's Nervous System."

\*\*\*

### Editor's Note

This is the concluding installment in the series of articles in which we have attempted to explain the function, maintenance and repair of the electrical system of a car so that the owner could better understand it. If you have enjoyed reading the articles, or have benefited by them, and would like to see other parts of the car described in a similar manner, drop a line to James R. Ward, the Craftsman Editor.

## Soldering Aid for Work Held in Vise

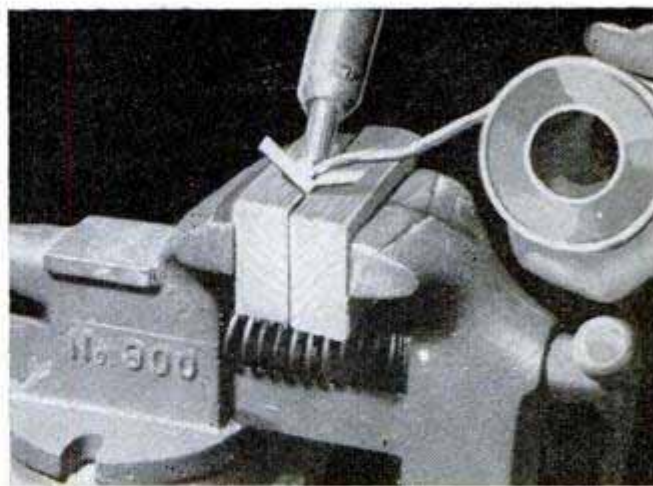

When small work must be held in a vise for soldering, the job can be speeded up considerably if the work is gripped between two pieces of wood as shown in the illustration. Soldering is done more quickly inasmuch as the wooden blocks prevent heat loss to the jaws of the vise.

J. W. Rocke, Atkinson, Neb.

## Small-Parts Trays From Cans

Supported along the underside of a shelf above a workbench, trays cut from small tin cans will provide containers in which screws, nails and other small parts can be stored close at hand. First, obtain cans of uniform size, preferably beverage or juice cans in which only one hole has been punched for removal of the contents. Now, using tin snips or sheet-metal shears, cut one side of the can as indicated in the detail, leaving the center section to serve as a handle. Quick identification of the contents can be made possible simply by soldering one item to each tray end. The trays may be hung on hooks or other suitable supports attached to shelves.

George Kapitan, New York City.

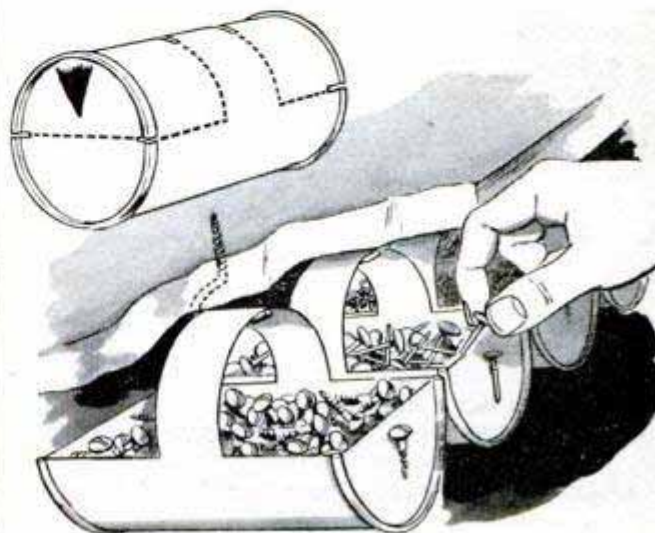

## Tweezers Used as Spanner Wrench for Removing Camera Lens

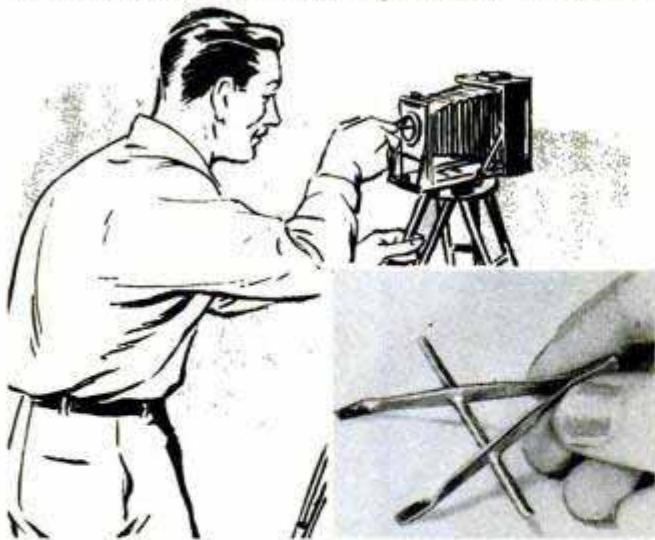

Owners of cameras having removable lenses will find that a lens can be removed or replaced safely with the aid of a spanner wrench made from a pair of tweezers and a short length of stiff wire. First, the points are cut off the tweezers and the ends filed square. Then aligning holes are drilled through the legs of the tweezers to take the short length of wire. Next, the legs are spread to correspond with the size of the lens retaining ring and held with a wooden block while the wire is soldered in place. Finally, each leg of the tweezers is placed in a vise and twisted 90 deg. with pliers to form blades to engage the slots in the retaining ring.

## Small Mirror Mounted at Angle Simplifies Reading of Lens Settings

When using a lens other than the original one on a Graflex camera, you will find that the "f"-stops, located on the side of the lens, are rather difficult to read. However, by mounting a small mirror just below the lens in the manner shown, the settings may be read with little difficulty. Cut the small mirror from a larger one and attach it with rubber cement to a wedge-shaped piece of wood, which has been shaped so that, when screwed to the camera, it will hold the mirror at an angle of about 40 deg. to the lens.

Roy J. Wexler, Stamford, Conn.

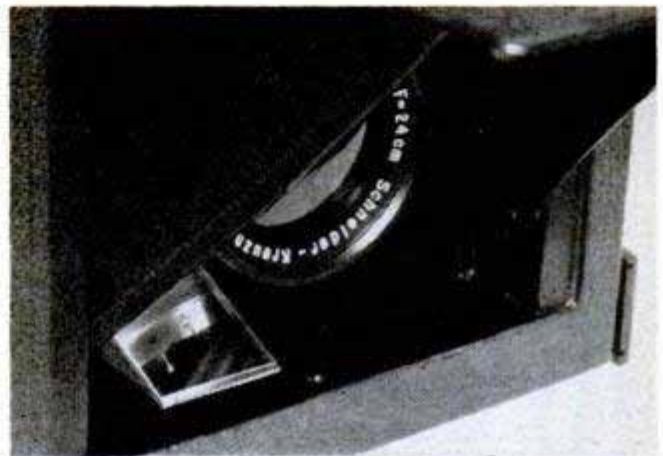

## Popular Mechanics Bookshop

### Collected Your Bonus?

We used to give you *Forty Power Tools You Can Make* in one volume, and was it a best seller! Nearly 200,000 copies have been sold. Now you can get a fifty percent bonus, for the new book just published to replace the famous "Forty" brings you not forty, but sixty . . . the new title, naturally, is *Sixty Power Tools and How to Build Them*. Its 144 pages are packed with valuable instructions on how to turn scrap and discarded materials into up-to-date power tools at low cost. Among these tools are a double-duty sander, jigsaw, four-wheel bandsaw, wood shaper, circular saw and lathe, motor mount, hydraulic press, grinding jig, boring-tool support and many more. Order the book from Popular Mechanics Press, 208 E. Ontario St., Chicago 11, for \$2.50.

### Don't Scream for Help . . .

Called the plumber lately? Or the electrician or roofer? Too often the SOS for emergency repairs brings a slow response

and a fancy bill. Actually, the cost of any home-repair job should be \$2.50. That's the price of *Popular Mechanics' Guide to Home Repairs*. The book will pay for itself many times over the first time you need help in fixing a leaky faucet, installing some needed insulation, doing a bit of carpentry or fixing an electrical outlet. It offers ideas for remodeling, door and window repairs, hints on laying tile and building stairs. Send for the 192-page book today from Popular Mechanics Press, 208 E. Ontario St., Chicago 11.

### Those Portable Electric Tools . . .

Are you making them work for you? They are a versatile family, capable of a thousand odd jobs—carving and sanding, inlay work and auto repair, sawing trees and lumber—in fact there are probably scores of uses you haven't discovered for your own tools around the house. Make the most of them by reading Robert L. McShane's *Portable Electric Tools*, a \$2.00 *Popular Mechanics* book. Order it from our Book Department, 208 E. Ontario St., Chicago 11.

All books available from Popular Mechanics Book Department, 208 E. Ontario St., Chicago 11





# SHOP NOTES

## ROLLER CONVEYOR

*for tilting-arbor saw*

By Dick Hutchinson

**H**ANDLING long stock safely on a small saw table single-handed requires use of a roller-type conveyor. This unit supports the unwieldy overhang of the stock either at the back or side of the table when ripping or cross-cutting. Unless the overhanging portion of the stock is supported in a level position it is difficult to do accurate work when ripping or molding on the long edge of the material and equally difficult to cut, groove or mold across the grain. The conveyor detailed below has been designed especially for use with a small floor-type circular saw having a tilting arbor and a motor mounted at the rear of the floor stand. It will serve equally well when used with a bench-type saw. A shelf, or table leaf, is placed in the overhanging section of the top

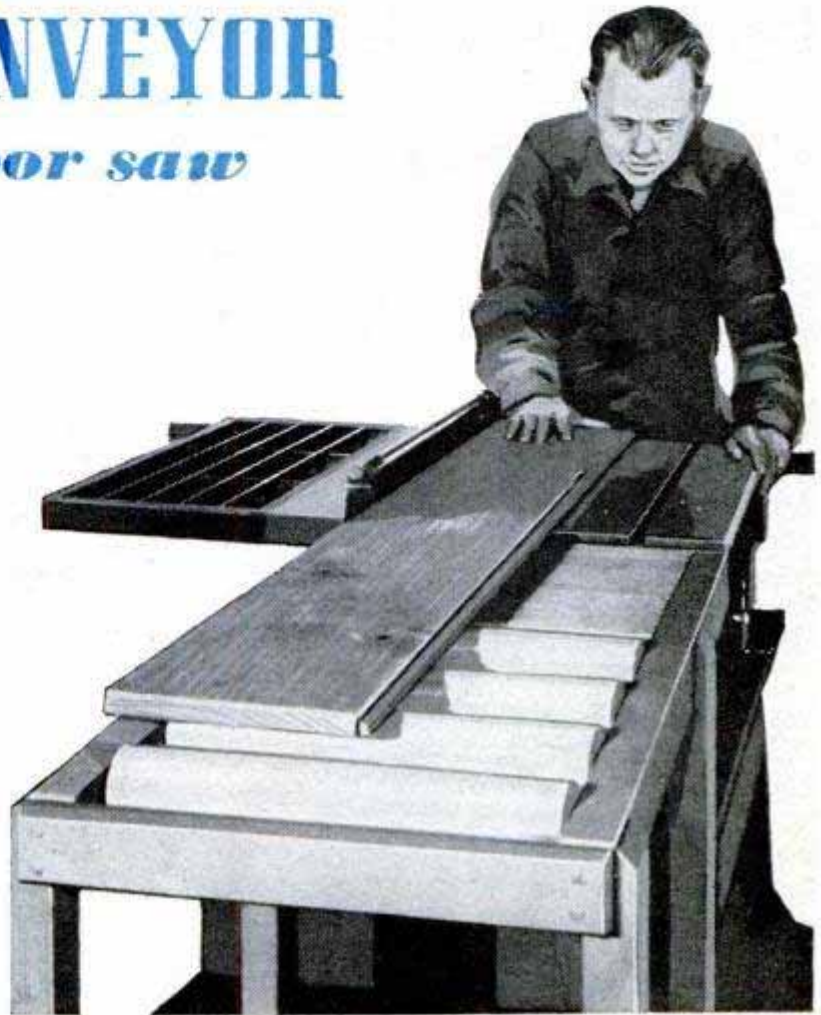

Conveyor can be used at the side or rear of the saw table to support long stock when ripping or crosscutting. A plywood-covered extension at the forward end of conveyor protects motor

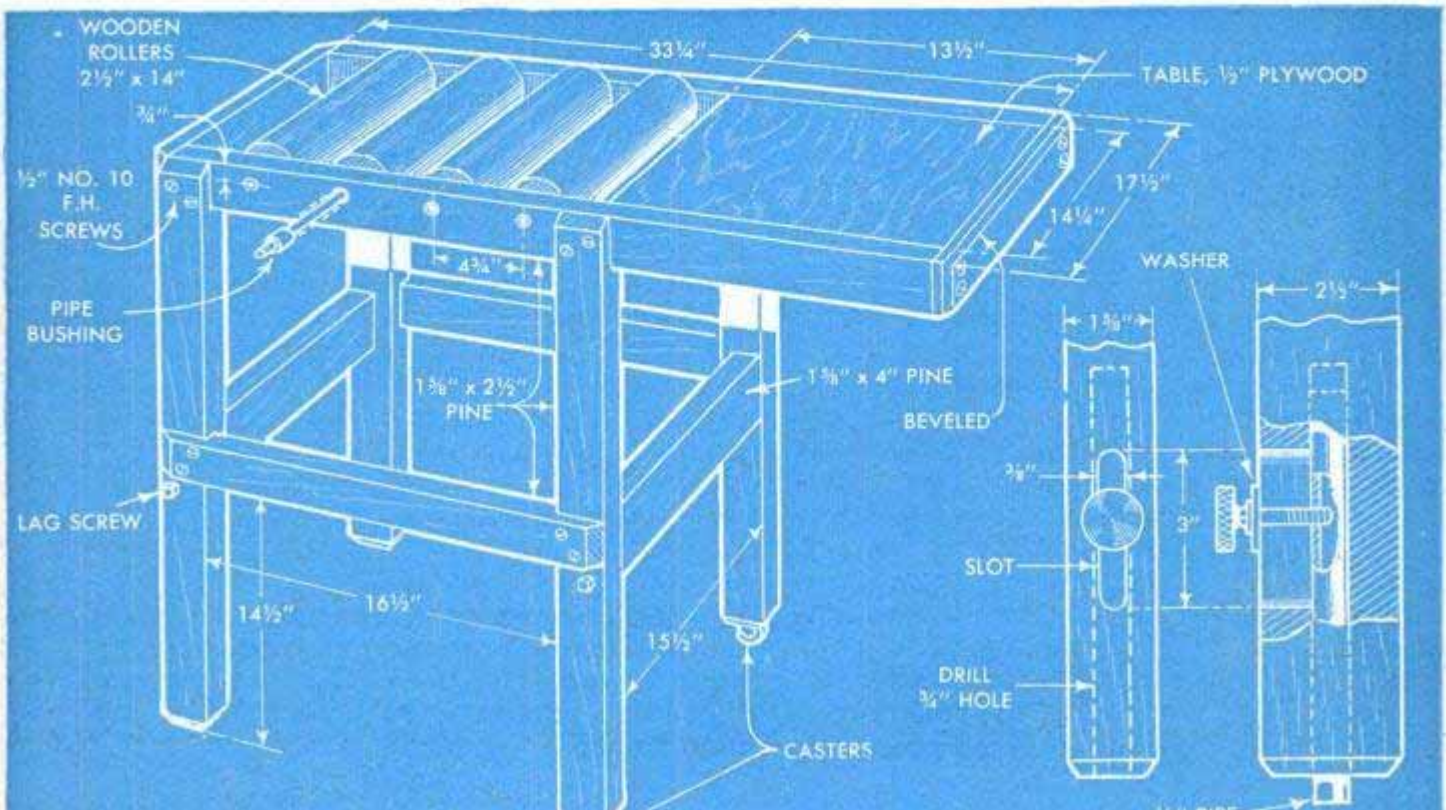

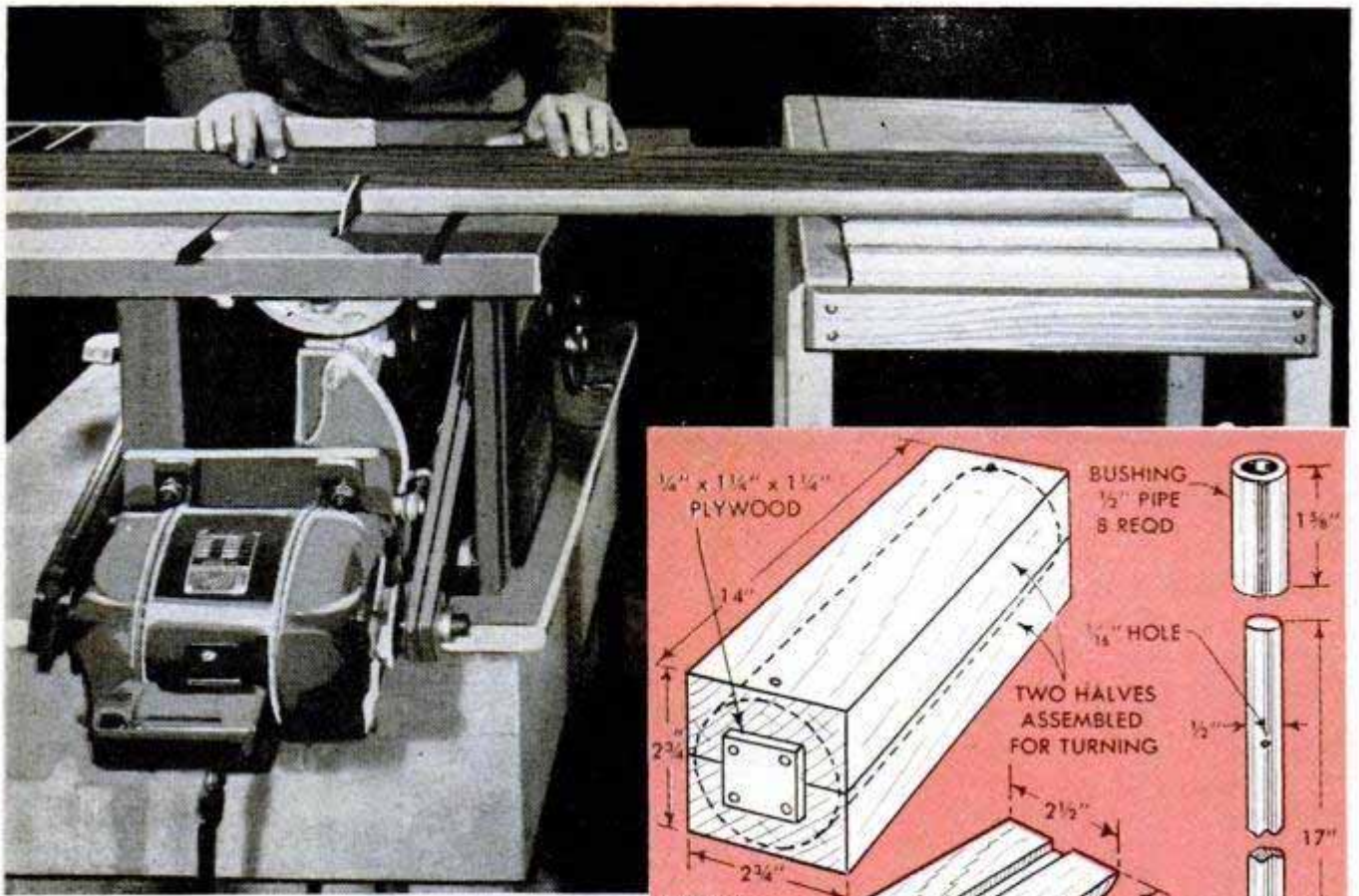

frame to shield the motor from sawdust and small pieces trimmed from the stock. Four hardwood rollers are mounted in the top frame at the rear of the table extension. Details on the preceding page show how these can be made by first grooving two pieces of hardwood, then nailing them together for turning in the wood lathe. After turning, the halves are separated, the shaft inserted and the parts glued together permanently.

Another method that saves considerable time is to make the rollers from ordinary household rolling pins which are readily available and are turned from selected hardwoods. Simply cut off the handles on each roller, center a hole in each end and drive in a stub shaft.

Check the dimensions of your saw table before cutting stock for the frame of the conveyor. Probably some dimensions will have to be altered from those given in the detail. Before assembling, check the length of the legs to make sure that correct allowance has been made for the casters, and that the leg extension works freely. The extension built into one leg provides a handy means of leveling the conveyor on an uneven floor. Construction of the top frame and the legs is quite simple, the upper ends of the legs being notched over the horizontal frame members and attached with flat-headed screws. In assembling, it's a good idea to use glue in all joints. After assembly, make sure that all the rollers turn freely. Photos above and on the preceding

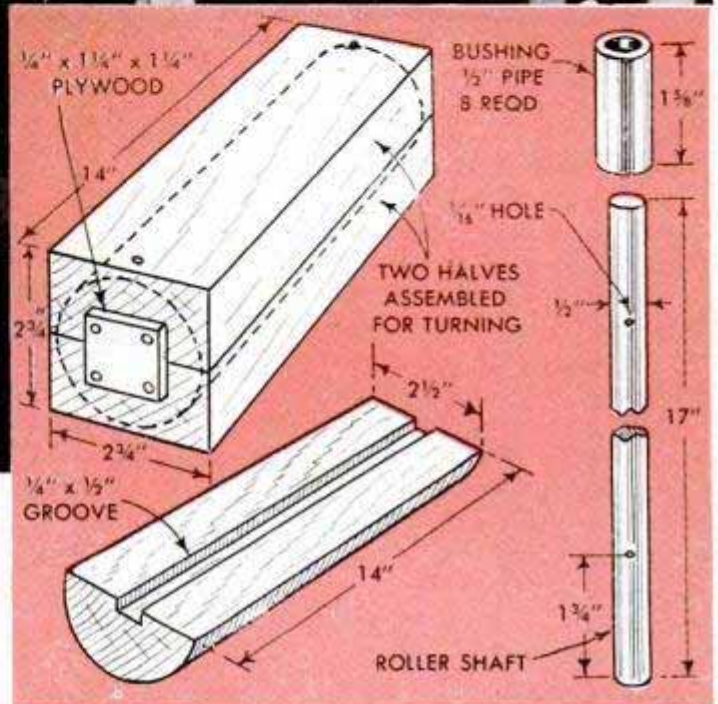

page show the conveyor in use at the side and rear of the saw table for crosscutting and ripping operations. The casters on two of the legs make it easy to move the unit to either position. ★ ★ ★

## Repairing Damaged Chimney

When the bricks near the base of a chimney have begun to crumble due to an accumulation of moisture, repairs can be made easily by replacing two or three bricks at a time. Use a hammer and cold chisel to chip away the defective bricks and mortar and, after replacing the bricks, allow the mortar to set for a day or two before removing more bricks. Repeat this operation until all the damaged bricks have been replaced. Use a mortar of quick-setting cement and sand, adding very little lime. If the chimney does not have a cleanout door, leave out a couple of bricks and fit the opening with a metal cover.

Arthur N. Nelson, Kansas City, Mo.

☛ When using an electric mangle during the winter, leave it in a warm room at least one hour before it is used. This will assure that lubricants have been softened so the mangle will be easier to operate.

Working in his spare time only, one homeowner utilized the wheels from an old horse-drawn hay-rake to provide a unique but inexpensive driveway gate. Pieces of 1-in. flat iron were drilled with holes in order to fit over and pivot on large, screw-type hinge pins fastened to the gateposts, after which they were welded to the rims. Iron rods, which work up and down in brackets that are attached to vertical spokes below the hubs as shown, serve as stops for the gates when lowered into short lengths of pipe set in the ground.—A. M. Morgan, Lafayette, Calif.

## Novel Driveway Gate Made Inexpensively By Using Large Farm Implement Wheels

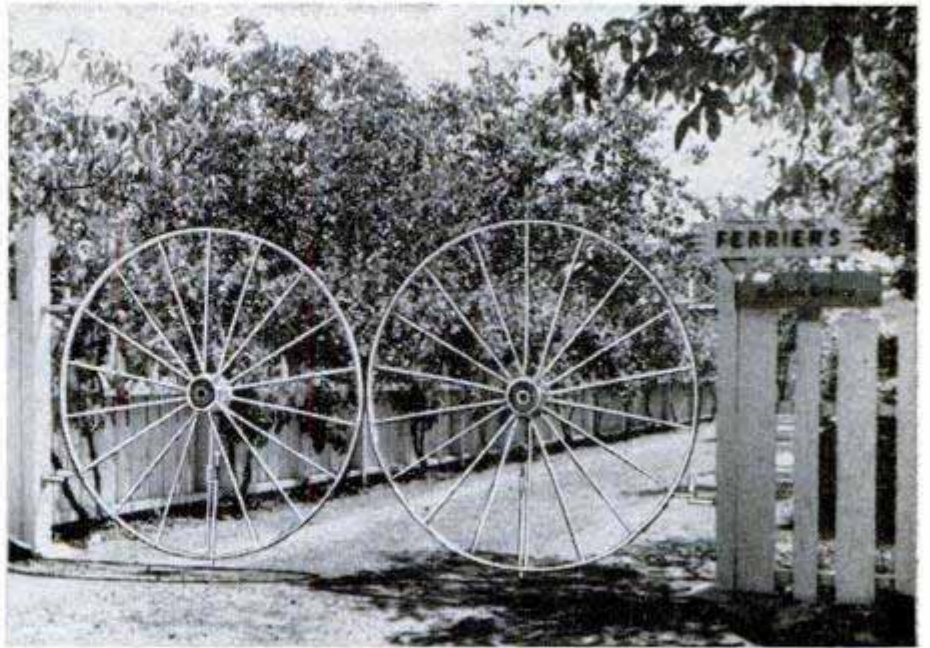

## "Blackboard" Sales Card Permits Price Change



To avoid making new sales cards each time a price change is required, one merchant paints a black square on each card where the price of the item normally is lettered in crayon.

He uses a regular blackboard paint which dries with a dull finish having a slight "tooth" that makes prices lettered in white or colored chalk clearly legible, yet easy to erase.

## Attaching Temporary Fence Wire

Whenever it is necessary to set up a short temporary fence, one farmer uses hog rings to fasten the wire to staples driven in the fence posts. The easily opened rings permit the fence wire to be removed from the posts quickly without prying loose the staples, and the latter may be left in the posts ready for use when they are again needed. Note in the accompanying detail that the rings are clamped around the wire as the staple is engaged.

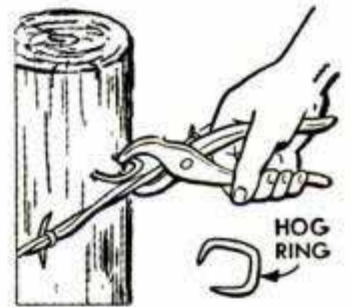

## Tapered Arbor on Motor Shaft Speeds Changing Buffers

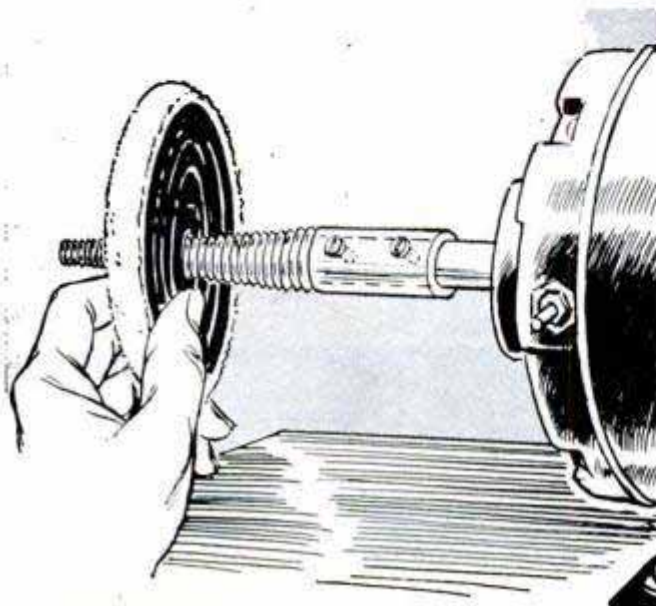

Where several buffing wheels were being used repeatedly during a particular polishing operation, one small-shop owner found that his workmen were spending much of their time in changing buffing wheels. This led to the use of tapered arbors instead of the regular straight type so that the wheels could be quickly threaded on or off without having to tighten or loosen a nut. Buffing wheels used on an arbor of this type usually have lead or wooden bushings. Due to the tapered spindle and the fact that the thread is either a right or left-handed one, the wheels actually tighten themselves on the arbor when in use. Arbors are available in several diameters from dealers in jewelers' supplies.

William Lane, St. John's, Newf., Can.

# TIP YOUR TOOLS WITH

## Part II

**A**FTER READING in Part I of the phenomenal production performance that can be expected from tools tipped with carbide, the small-shop machinist, as well as the home craftsman, will be eager to learn how comparatively simple it is to tip his own cutting tools with this hardest of metals made by man.

Of the two wonder metals, cast alloy and cemented carbide, that so outperform the cutting ability of even super-high-speed steel, cemented carbide is the harder. Like the diamond, it will scratch glass, cut the hardest file and stand up in taking the "skin" cut from cast iron. But like all very hard materials, the tool grades of cemented carbide tend to be brittle and consequently cannot stand excessive shock loads. However, being extremely hard, carbide turns all materials at speeds higher than are possible with other cutting tools. As previously described in Part I, tools tipped with cast alloy (Tantung) are used for turning all materials except hardened steel, ceramics or other very hard substances.

Carbide blanks for tipping your tools are available in a variety of shapes and sizes and at very little cost. They can be purchased separately or in kit form which includes the flux, silver solder and even a torch for brazing the tips in place, as well as a suitable silicon-carbide grinding wheel.

In addition to such standard shapes as those used to tip common lathe tool bits, there are special blanks to be had for tipping your present set of wood-turning chisels, Fig. 1, conical blanks to tip your lathe centers, etc. All come in blank form which means that they must be ground and sharpened after being brazed to the tool. Once properly ground and sharpened, the tips will stay sharp longer than any other cutting tool. Only an occasional light grinding and honing are required to maintain their diamond-hard, razor-sharp cutting edges.

Whether tipping a lathe tool bit, chisel, plane iron, masonry drill or saw blade, the steps are essentially the same. The steps in tipping a lathe tool bit, for example, consist of (1) shaping the tool shank; (2) cutting the recess to receive the carbide blank; (3) brazing the blank to the shank, and (4) grinding the carbide tip. Fig. 4 pictures four types of rabbeted recesses generally used in forming a seat for the carbide blank. Type A is recommended primarily where the tool is to be used for grooving and cutting-off operations. Type B is used when support for the blank against side thrust is necessary. The most widely used recess is type C, which provides support for the carbide blank against both side and end thrust. Recess type D is used for both

Converting your present set of wood-turning chisels is done easily by grinding the ends to a point and tipping them with a standard set of Tantung blanks. Note that blanks have V-notches to give maximum brazing union

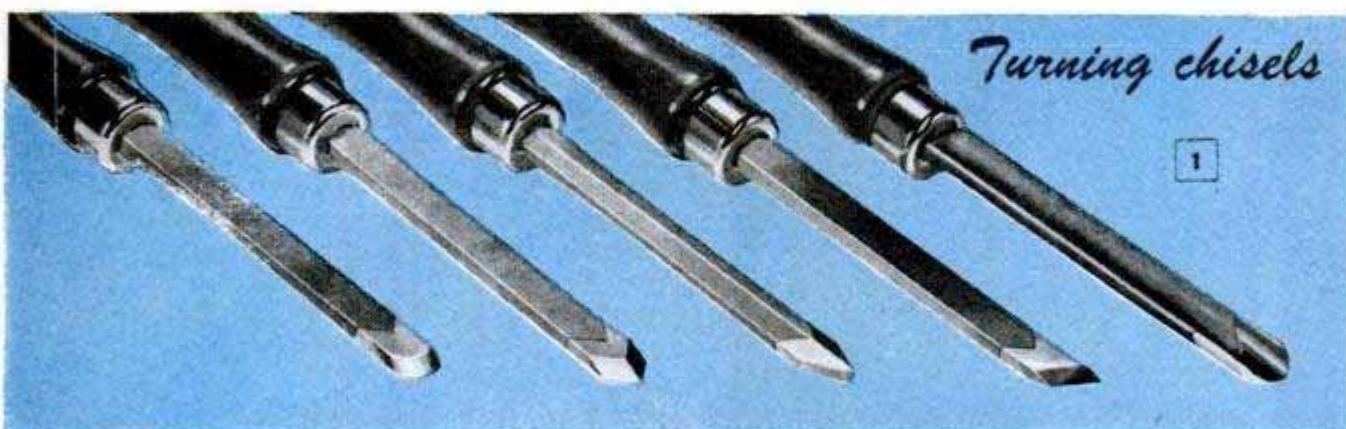

ROUND-NOSE TIP

SPEAR-POINT TIP

PARTING-TOOL TIP

SKEW-TOOL TIP

GOUGE-TOOL TIP

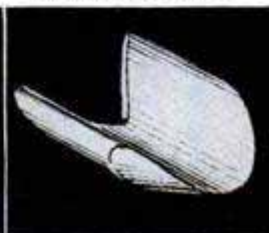
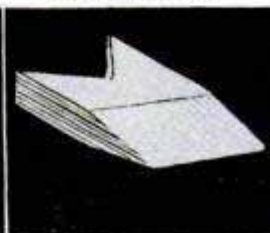
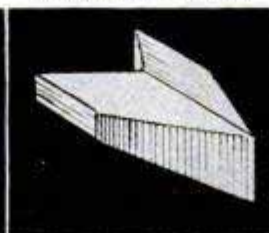
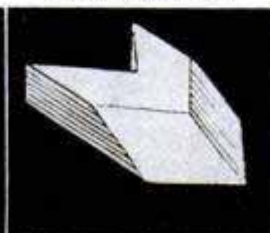
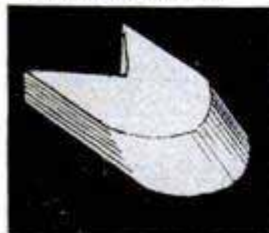

# CARBIDE

1st— CUT BRAZING-ALLOY STRIPS

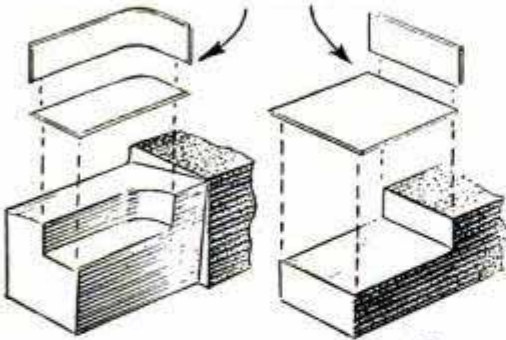

2

2nd— CLEAN RECESS WITH CARBON TETRACHLORIDE



3rd— COAT WITH FLUX

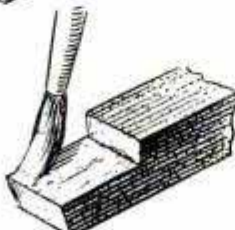

4th— APPLY HEAT WITH TORCH

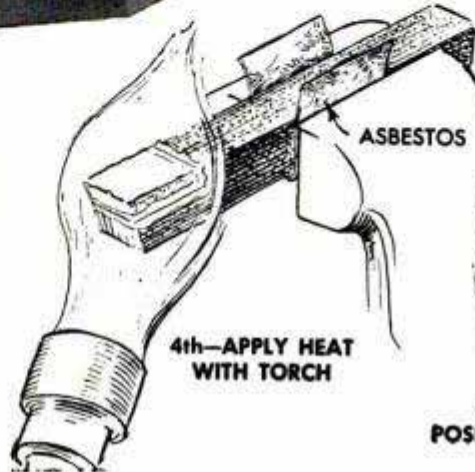

5th— HOLD TIP IN POSITION AND LET COOL

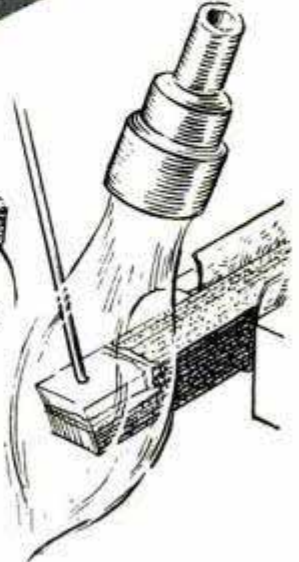

*Steps in tipping a lathe tool bit*

TYPES OF TIP RECESSES

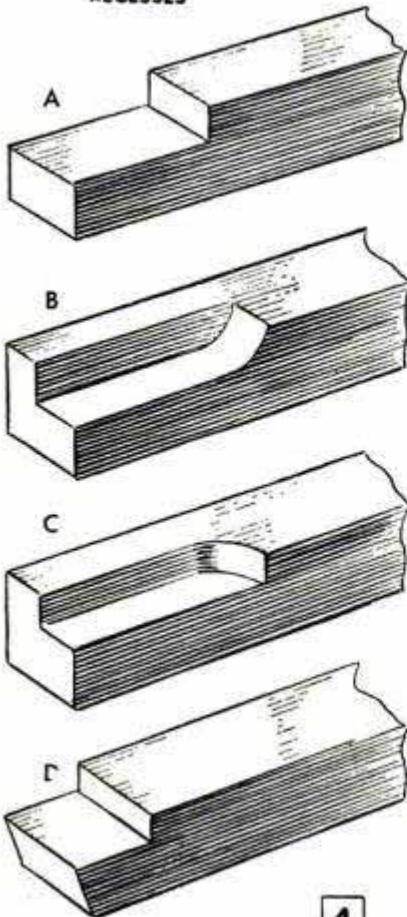

4

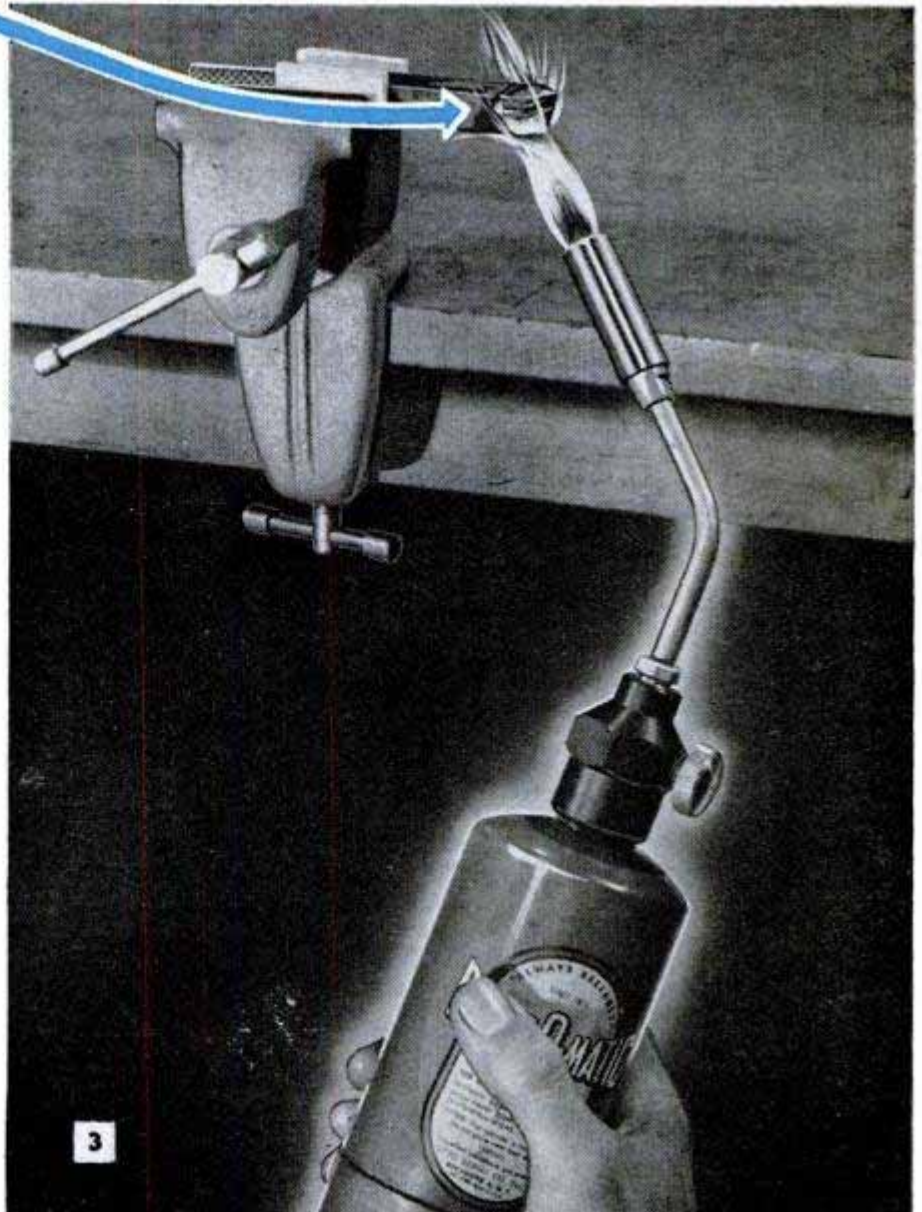

3

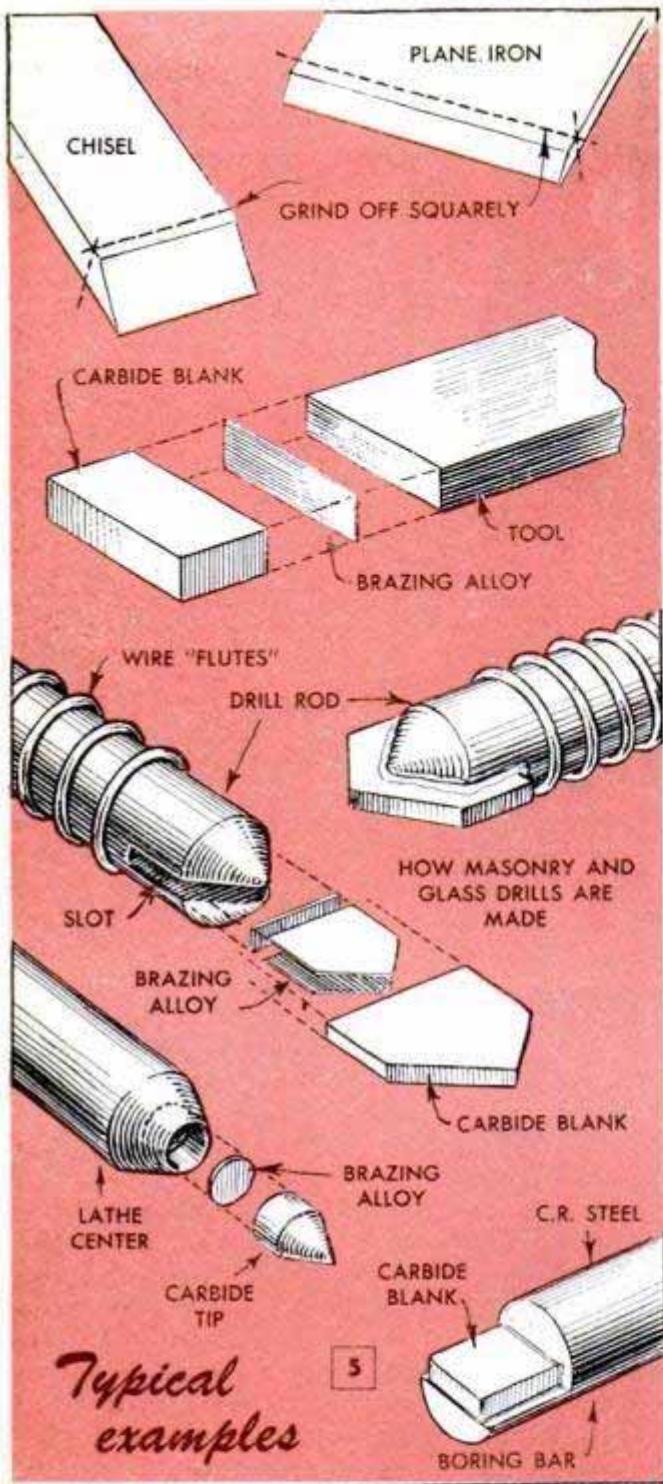

right and left-hand turning tools. In some cases, depending upon the particular machining operation, the carbide blank can be brazed directly to the top surface of the shank, thus eliminating the recess. Front and side relief angles are machined usually before the recess is cut. These, as a rule, are milled from two to four deg. greater than the specified primary relief on the tool so that after brazing it is only the carbide tip that needs to be ground. In forming the recess of the particular type required, it is important that it be perfectly flat. Any unevenness in the recess may cause the carbide tip to crack in use.

Originally, most tipped tools were brazed in a furnace. In recent years tool manufacturers have adopted high-frequency induction heating which is quicker and gives the operator complete supervision over the tool during brazing. Induction brazing causes less softening of the tool shank since only that part of the steel in the vicinity of the carbide tip is heated. However, a very satisfactory brazing job can be done with an oxyacetylene welding torch, and if such a torch is not available, both the small-machine-shop worker and the home craftsman can do an excellent job of brazing with one of the inexpensive compressed-gas torches now on the market, Fig. 3. The five steps in brazing a tip to a lathe tool bit are pictured in Fig. 2. First, pieces of brazing alloy (sheet silver solder) are cut slightly larger than the recess. Next, all surfaces to be joined are cleaned with carbon tetrachloride. This is important to assure a good bond. Now, with the tool shank clamped in a vise and insulated from it with small pieces of asbestos, thin paste flux is applied to the recess and the silver solder placed in position. Finally, a second application of flux is applied and the carbide tip is set in place in the recess.

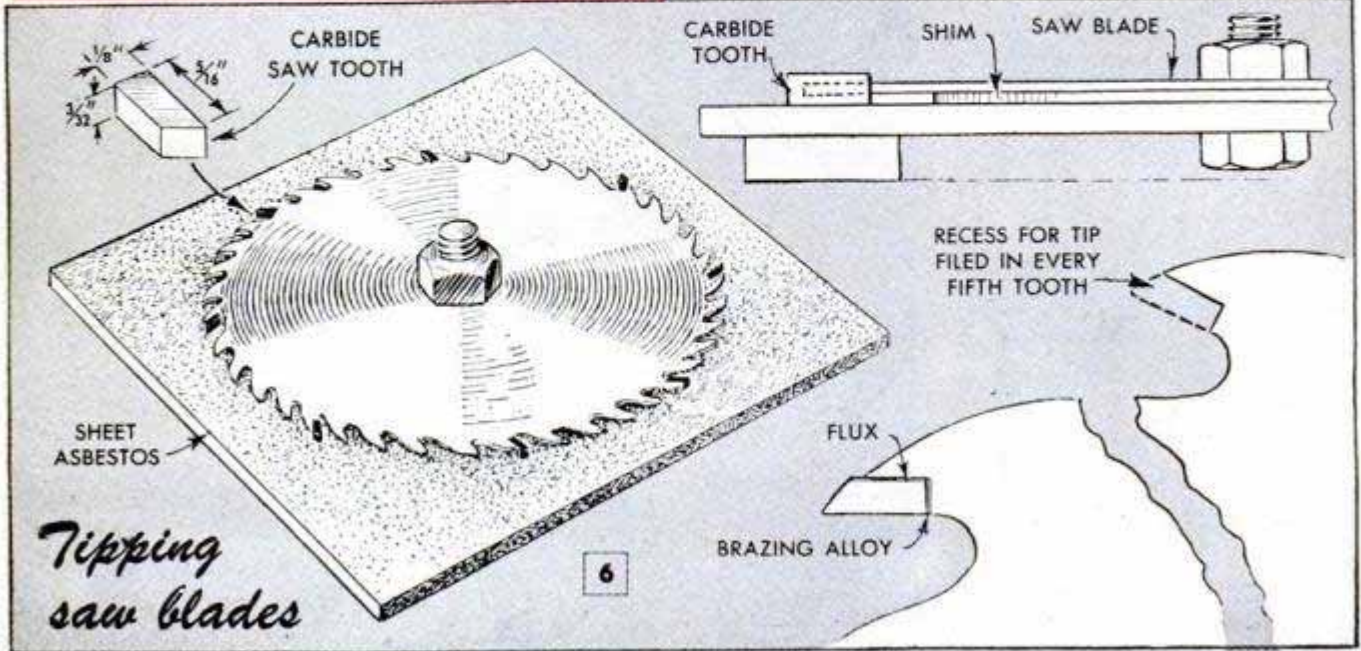

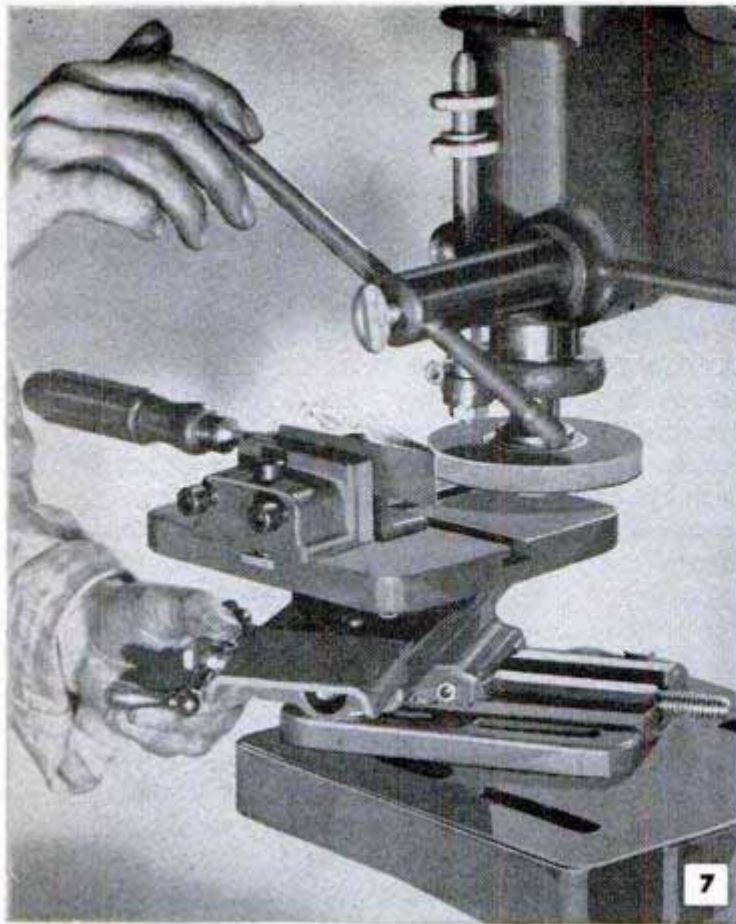

Either straight or cup-type wheels can be used. Typical grinding setup in photo above shows how universal milling table can be used in conjunction with drill press. Lathe tool-post grinder provides another setup

**TOOL ANGLES RECOMMENDED FOR MACHINING VARIOUS MATERIALS**

Material to be cut	Back rake (Degs.)	Side rake (Degs.)	Front relief (Degs.)	Side relief (Degs.)
Aluminum alloys	10-20	10-20	8-12	6-10
Aluminum castings	10-20	10-20	6	6
Brass, yellow	0-5	2-6	4-8	4-8
Bronze and its alloys	0-5	0-10	4-6	4-6
Cast iron:				
soft	0-4	4-6	4-6	3-6
hard	0	3-6	3-5	3-4
chilled	0	3-6	3-5	3-5
malleable	0-4	4-8	3-5	3-5
Copper	0-10	8-15	6-8	6-8
Fiber	0-10	6-12	5-10	6-10
Plastics	0-10	6-12	5-10	6-10
Rubber:				
hard	5-15	8-15	6-10	6-10
soft	10-20	8-20	8-15	8-15
Steel:				
up to 200 Brinell	0-10	4-15	6-8	6-8
200-275 Brinell	0-8	4-10	5-8	5-8
275-350 Brinell	0-5	4-8	5-8	5-8
350-425 Brinell	0-3	0-6	4-6	4-6
425-up Brinell	0	0	4-6	4-6
Zinc-base die castings	0-10	8-12	6-10	6-10

In brazing the tip, the tool shank should be heated first, playing the flame of the torch to the underside of the shank and holding it a short distance from the tip. Heating should be done gradually. If heated too rapidly, the carbide tip may crack. Move the flame around to both sides of the tool so that no part becomes overheated. When the proper brazing temperature has been reached, which is when the silver solder melts and the end of the shank and carbide tip become a dull cherry red, the carbide blank is held in position with a pointed rod or the tang of a file. When the silver solder has melted completely, the flame is removed and the blank is pressed firmly into the recess and held until the brazing solder solidifies. Pressing down on the blank will force out excess solder and assure a tight brazing union. Only a thin film of solder is needed to make a sound weld. Scale, flux and excess brazing material are cleaned off with a wire brush and the tool is ready for sharpening.

Brazing the tip of a wood chisel or plane iron with cast alloy is done in a very similar manner. In both cases, a recess for the tip is not required, the present beveled edge of the tool being merely ground off square and the blank butted and brazed to the square end. Excellent masonry drills of various sizes can be made inexpensively by slotting the end of drill rod to take regular carbide masonry tips. The slot is made wide enough to allow room for the pieces of brazing solder. Converting your present circular saw blade to a carbide-tipped blade is not too difficult. Pockets for the tiny carbide teeth are filed in every fifth tooth or so and then the tips are brazed in the pockets, bolting the saw blade to a piece of thick asbestos and shimming it to center

**WHEELS RECOMMENDED FOR GRINDING CARBIDES**

Type of operation	Abrasive used	Grain size	Grade	Porosity	Bond
Offhand					
Roughing	SiC	60	H, I, J	6	Vitrified Resinoid
Finishing	Diamond	100	J		
	SiC	100	H, I, J	5	Vitrified Resinoid
	Diamond	100	J		
Machine Grinding					
Roughing	SiC	60	G, H, I	5-6	Vitrified
Finishing	SiC	80-100	H, I, J	5-6	Vitrified
SURFACE GRINDING					
Roughing, dry	SiC	60	G, H, I	6	Vitrified
Finishing, dry	SiC	100	G, H	5	Vitrified
Roughing, wet	Diamond	100	J		Resinoid
Finishing, wet	Diamond	220	J		Resinoid
Form grinding, wet	SiC	100-120	J, K	5	Vitrified
Lapping					
Average lap	Diamond	220-320	H, I		Resinoid
Fine lap	Diamond	400-500	H, I		Resinoid
Extra-fine					
	Nickel-chromium cast-iron disk charged with #4 diamond dust				

**R.P.M. AND PERIPHERAL SPEED IN F.P.M. FOR GRINDING WHEELS OF VARIOUS DIAMETERS**

WHEEL Diameter (inches)	Peripheral speed in F. P. M.							
	4,000	4,500	5,000	5,500	6,000	6,500	7,000	7,500
1	15,279	17,189	19,098	21,008	22,118	24,828	26,737	28,647
2	7,639	8,594	9,549	10,504	11,459	12,414	13,368	14,322
3	5,093	5,729	6,366	7,003	7,639	8,276	8,913	9,549
4	3,820	4,297	4,775	5,252	5,729	6,207	6,685	7,162
5	3,056	3,438	3,820	4,202	4,584	4,966	5,348	5,730
6	2,546	2,865	3,183	3,501	3,820	4,138	4,456	4,775
7	2,183	2,455	2,728	3,001	3,274	3,547	3,820	4,092
8	1,910	2,148	2,387	2,626	2,865	3,103	3,342	3,580
10	1,528	1,719	1,910	2,101	2,292	2,483	2,674	2,865

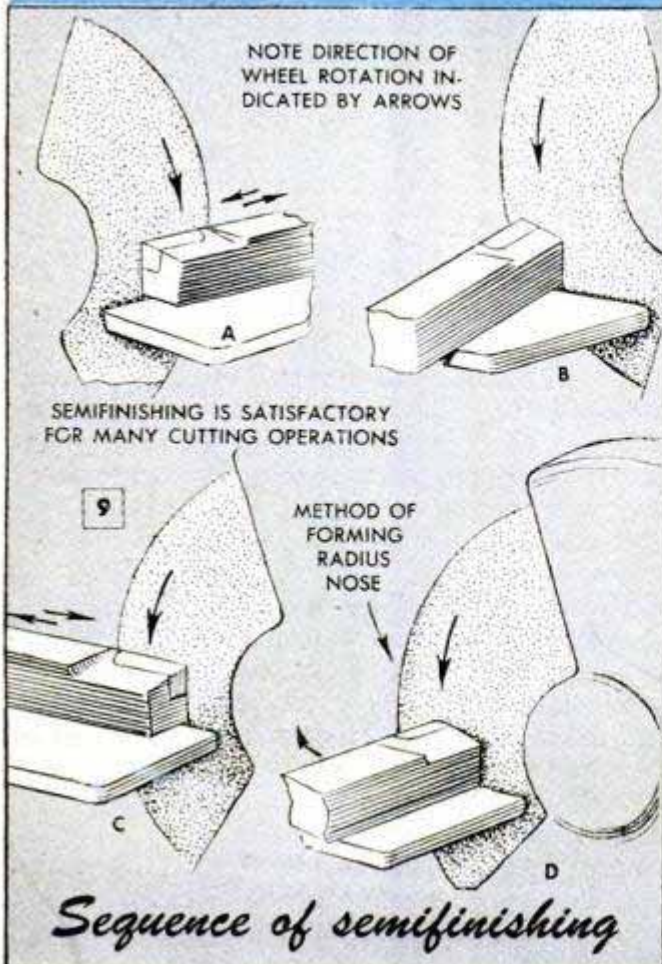
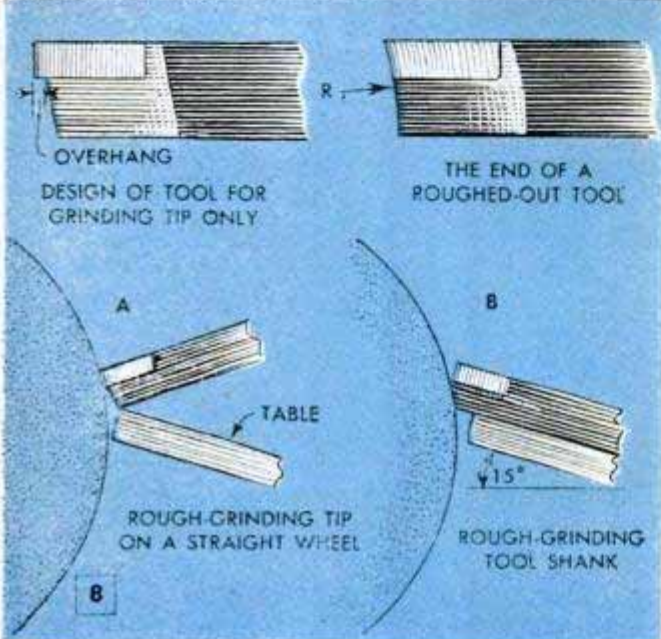
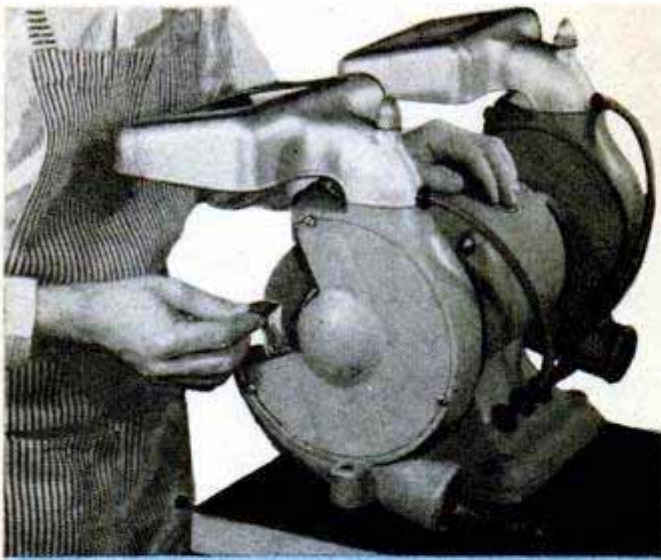

the carbide tips on the edge of the blade, Fig. 6. Tipping your lathe tailstock center is easily done by center-drilling the end to receive a disk of solder and a standard carbide tip. Boring bars, scribes and other tools may be tipped.

Now to grind the tips: Silicon-carbide wheels (Si C) are commonly used for rough as well as finish grinding of sintered carbide tools. For ordinary offhand (free-hand) and machine grinding, a wheel of open porous structure is needed. A wheel which is too hard may result in localized heating and cause the tool tip to check and crack. While a soft-type wheel will prevent heating, avoid using a wheel which is so soft it will wear rapidly. Because of their lower cost, silicon-carbide wheels of the proper grit are frequently preferred to the diamond wheel. Wheels most commonly used for grinding single-edge tools are the straight and cup types. The straight wheel has an advantage over the cup wheel in that it provides a somewhat cooler cutting action due to minimum surface contact. Carbide-tipped tools are usually designed so that grinding of the shank is not necessary. The carbide tip overhangs the end of the shank approximately  $\frac{1}{64}$  in. as shown in the upper left-hand detail, Fig. 8. In cases where a tool becomes badly chipped, the grinding sequence pictured in details A and B, Fig. 8, is used. The ends of the tip and the tool shank are rough-ground with a straight wheel. The concavity produced is later removed in the semigrinding operation. In all carbide sharpening, the grinding wheel should rotate so that the cutting is done from the cutting edge toward the body of the carbide. This important rule is indicated by the direction-of-rotation arrows in Fig. 9. If this rule is not followed, the edge of the carbide is apt to chip.

Here is the grinding procedure to follow in rough-grinding a lathe tool bit using a 60-grit silicon-carbide wheel: First, the face of the tool is ground. Next, the front relief is ground about 4 deg. more than the finished relief angle, leaving a land approximately  $\frac{1}{32}$  in. for finishing. The side relief angle is next rough-ground to about 10 deg., a  $\frac{1}{32}$ -in. land being left on the side for final grinding. After rough-grinding comes semifinishing in which the tool edge is further ground, this time using a 100 to 200-grit silicon-carbide wheel. First, the table is set to the desired rake angle and the top of the tool is finished. Following this, the front relief is ground. The table is then set for the side relief angle and the tool ground accordingly, making certain that the wheel rotation is against the cutting edge. If the tool is to be used in the semifinished condition, the nose radius is ground by swing-



ing the tool shank in an arc on the table as in step D, Fig. 9. When it is necessary to have the cutting edge ground to a high degree of finish, the edge is finish-ground, or lapped, with a 220-grit diamond wheel or 180-grit silicon-carbide wheel. Under no circumstance should the ground tools be dipped or quenched in water during or after grinding. This drastic cooling is very apt to crack the carbide tip.

In a concluding article next month, actual and unusual tool setups will be pictured and described, citing instances where small shops have licked stubborn production problems by tooling-up with carbide. ★ ★ ★

Information courtesy Vascoloy-Ramet Corp. and American Technical Society of Chicago

### Cream Soap Is Handy For Driving Screws

Instead of using a piece of hard soap for coating wood screws to make them drive easier, I keep a tube of cream shampoo in my toolbox. I find that this is much handier than hard soap and works just as well. Before starting a screw just squeeze a drop on it and spread with your finger. Liquid shampoo that comes in plastic containers will work just as well, in most cases.

Norm Jacky, Fond Du Lac, Wis.

### Improved Pipe Nipple

When a short pipe nipple is not available, one can be made by cutting off the threaded end of a longer pipe to the desired length and then threading the severed end. To grip the short piece of pipe in a vise without damaging the end already threaded, screw it into a coupling which has been placed on a longer piece and then mount the assembly in the vise.

Michael Ligocki, Gary, Ind.

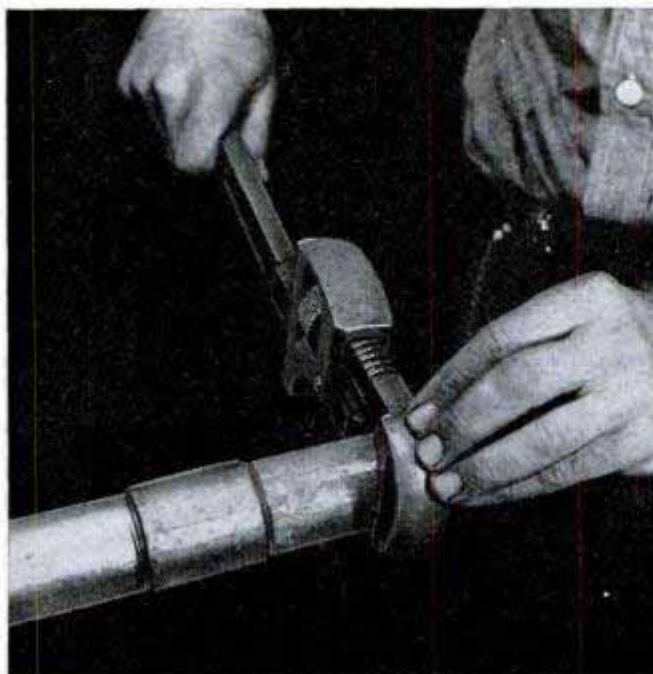

### Axhead Fitted to Pneumatic Drill Cuts Through Tree Roots Easily



To provide a quick means for cutting through such obstructions as thick tree roots or timbers buried in the ground and, in some cases, submerged in water, one contractor welded an axhead to the shaft of a pneumatic drill. Before welding, the axhead was cut off just below the eye, or handle opening, and slotted in the manner indicated. Before the new arrangement is put to use, however, the rotating pawl in the drill must be disconnected in order to keep the axhead from rotating.

John Krill, North Lima, Ohio.

### Stool From Disk-Harrow Blades

When the nature of the work necessitates stooping or kneeling for long periods of time, this light shop stool makes the job less tiresome. It's made from two discarded disk-harrow blades assembled with a long threaded rod and a pipe spacer. The



upper blade should be 16 in. in dia., but the lower one forming the base can be 18 or 20 in. in dia. For added comfort, use a farm-implement seat cushion.

A. M. Wettach, Mt. Pleasant, Iowa.

# SHOPPING FOR TOOLS



1

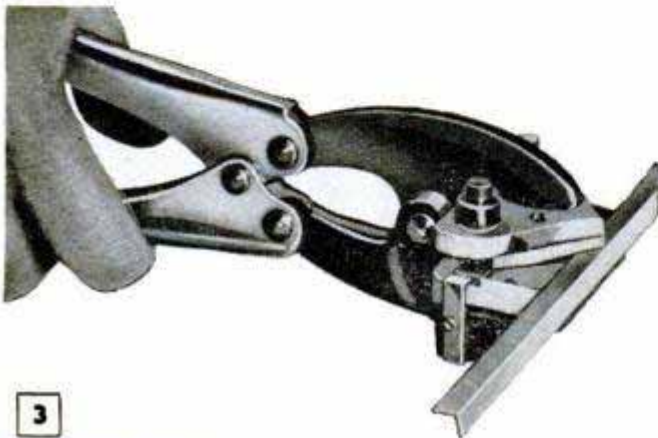

3



4



5



2

1. **SPRING TWEEZERS** equipped with an adjustable magnifying glass are designed to aid in sorting and assembly of small parts. Glass is mounted on a two-piece arm pivoted at three points to give a universal adjustment of magnifying lens. Latter can be locked securely at any desired position after adjustment

2. **ALL-PURPOSE OIL** for household use is now available in a pressurized container especially adapted for application of the oil in a thin film to all bright and polished metal surfaces subject to corrosion. Affords positive protection for hand and power tools in damp basements. Protects chrome-plated car parts

3. **HAND-OPERATED MITERING TOOL** works like a pair of pliers and cuts miters, notches and slots in mild steel up to 1/32-in. thickness and nonferrous metals up to 1/16 in. Interchangeable dies make it easy to change from one operation to another. Unit is especially effective for mitering cuts in light-metal angles



6



**4. PAINT-ROLLER SCRAPER** makes short work of difficult and tedious job of cleaning paint rollers. Scraper has a curved edge which removes paint without damaging wool covering. After roller has been rinsed in solvent, scraper is used to remove solvent from fabric. Handle has blade for opening paint cans

**5. SCREW STARTER** holds small screws for starting in the most difficult-to-reach places. Dual bits placed side by side rotate in screw slot when a slight pressure is applied to the handle. When the screw has been gripped tightly mechanism locks automatically. After screw has been started, the tool is easily disengaged

**6. NONCLOGGING SANDING CLOTH** is new development in abrasives consisting of individual abrasive grains embedded in a tough, open-mesh fabric. Works on either wood or metal and may be used wet or dry, flat or folded, just like ordinary sandpaper. Both sides of open-mesh cloth may be used before discarding

**7. ONE-MAN CHAIN SAW** is driven by hydraulic mechanism from tractor power take-off. Hydraulic pump is attached to power-take-off mounting pad on tractor, and is connected to saw motor by hose lines. By-pass in pump protects operator and saw unit should saw clog or pinch in cut. Saw unit weighs only 30 lb.

**8. PUNCH-LOCK CLAMP** gives a uniform clamping action on circular, square or rectangular work such as hose, ducts, rope and thin-walled tubing. Applied with a ratchet-type tool, the clamp is locked under tension by indenting the clamp bands with a special punch built into the tool. A single hammer blow locks clamp

**9. PORTABLE SHAPER** works on wood, hardboards and nonferrous metals. Unit is hand-held and can be operated in any position on concave and convex surfaces in either vertical or horizontal positions. Useful in pattern work, aircraft fabrication, furniture construction and boatbuilding. Motor 1 hp., 18,000 r.p.m.

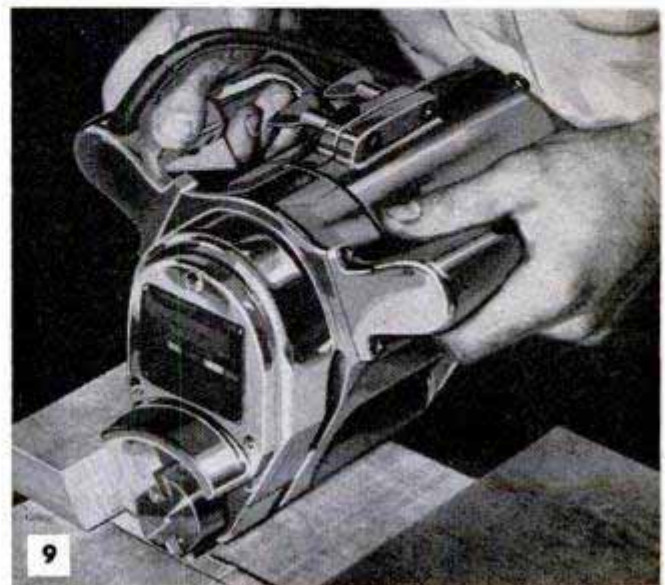
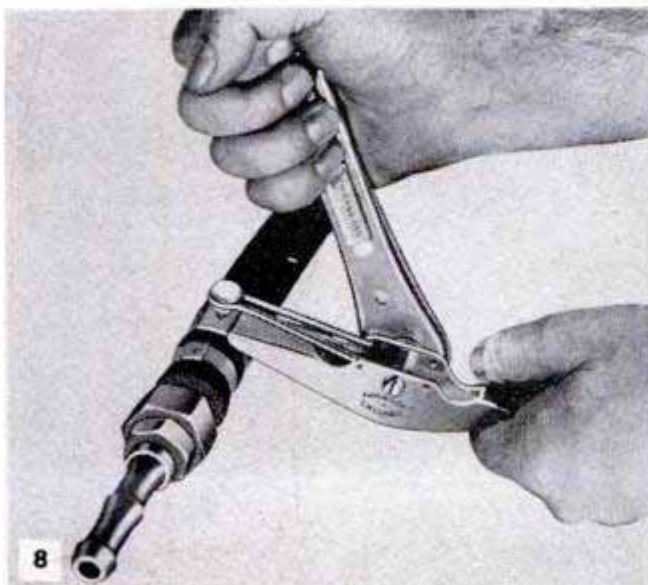

## Electric Drill Mounted on Lathe Cross Slide Drives Milling Cutter for Cutting Keyways

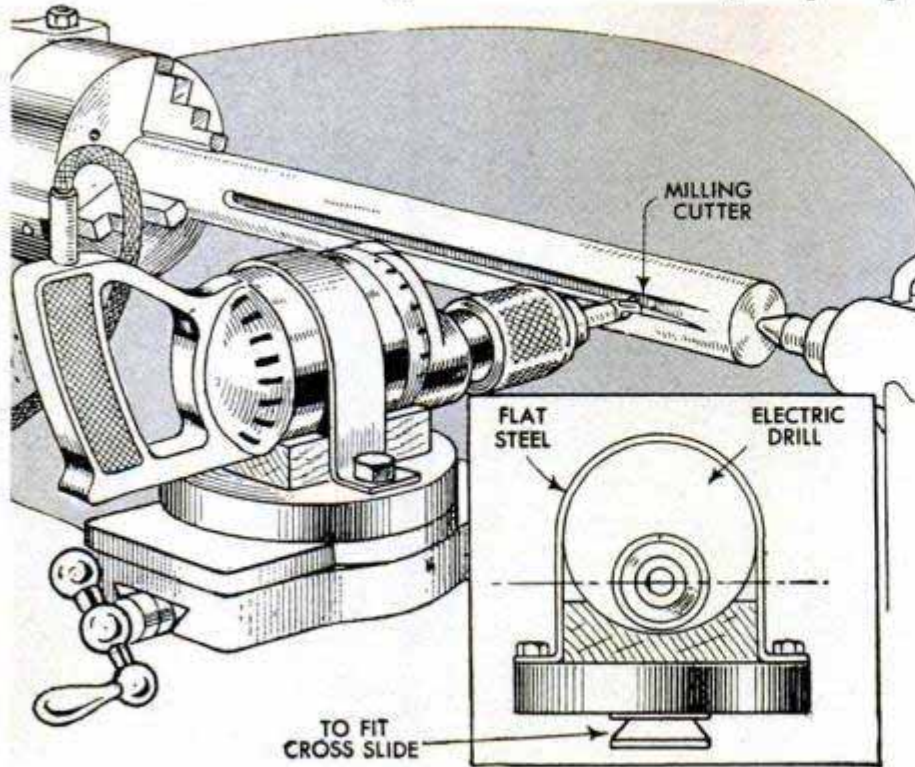

Keyways can be cut in a lathe by chucking a milling cutter in an electric hand drill and mounting the drill on the cross slide. First, a steel disk is made up with a tapered lug on the bottom to engage the dovetail slot in the cross slide. The drill then is placed upside down on a wooden block after which both drill and bed are clamped to the disk with a piece of flat steel. Shape the bed so the center line of the drill chuck aligns with the lathe center. With the work held between centers, tighten the tailstock center, lock the headstock and turn on the power. Now feed the milling cutter along the side of the work.

## Scaffold Supported by Stepladders Secured With Hook-Bolts

When using a plank scaffold supported by stepladders, many painters and decorators find that the plank frequently will tip dangerously when they tread near the edges. To overcome this, one painter cut slots, centered on the plank and located a short distance from each end, to take a hook-bolt. The slots are cut long enough to permit easy adjustment of the bolts to

the steps without the need for moving the ladders. The bolts are inserted in the slots so that they hook under the steps and thus, when tightened, hold the plank firmly in place. A washer is placed under each nut to support the bolt in the slot. In many cases, this arrangement will permit the ladders and plank to be moved about as a single unit.

## Jig Clamped to Round Work Provides Guide When Drilling Holes

The usually difficult job of drilling holes in round work is greatly simplified by the use of this jig and a center drill. The center drill is used to start the hole, after which a regular twist drill of the correct size is used to complete the hole. As you can see in the detail, the jig consists of two metal blocks, one of which serves as a base and the other a cap. Both pieces are drilled centrally for the guide hole which takes the drill. The base is drilled and tapped on each side of this hole to take two stud bolts, which project to hold the cap in place. The latter is drilled to slide over the two studs and has a V-groove cut in the underside to aid in gripping round stock. After the work has been put in place, two nuts are turned down on the studs to hold the cap against it. The jig can be made any size desired, and if you have a variety of work to do it's a good idea to make up more than one of them. Each one can be made to hold work of different sizes within a given range.

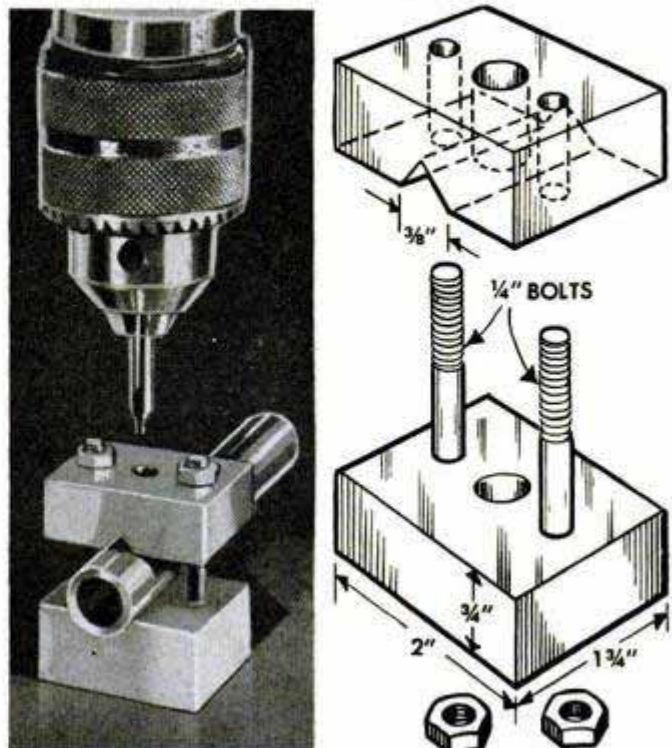

Since neglect of the air-filter screen on an automobile will eventually affect the engine's performance, care should be taken to assure periodic cleaning of the unit. According to most car manuals, this should take place about every 1000 miles. The job of cleaning the screen may be simplified to a great extent by washing it in a container, similar to the one shown, which has been partly filled with kerosene. Sides of the container are semi-circular in shape and, together with a center strip, are cut from large tin cans to form the container itself. Another strip is bent to form a base and is soldered in place. One end of the container is flared slightly and fitted with a 1/4-in.

## Air-Filter Screen of Car Washed Easily In Container Assembled From Sheet Tin

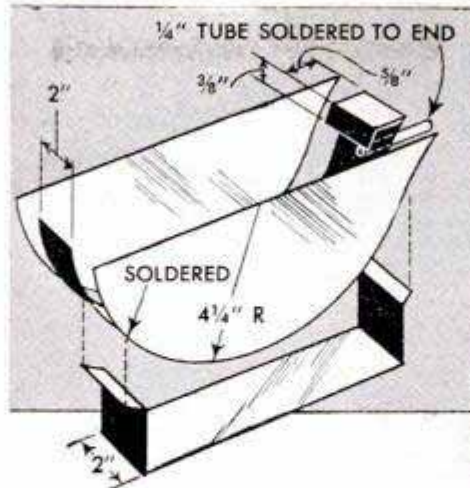

tube to facilitate emptying when finished. After the screen has been washed thoroughly, it should be drained and oiled before installing it again.

R. Hanscom, Elmhurst, Ill.

## Can Filled With Steel Wool Used to Clean Soldering Iron

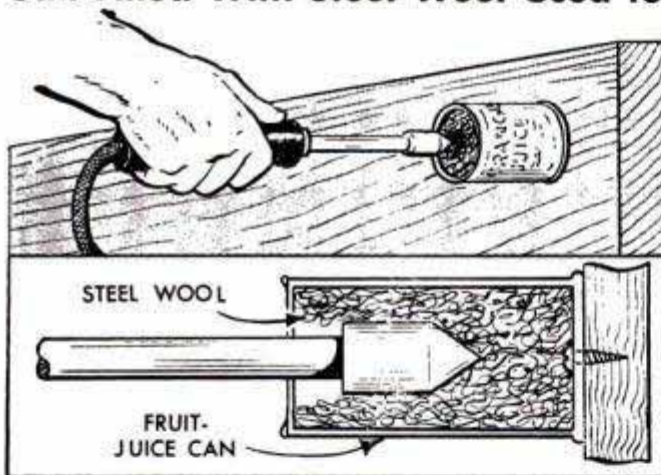

To keep the tip of a soldering iron clean and bright, insert it from time to time in a can containing steel wool, working it back and forth and twisting it around. Use a can of the type in which baby foods or frozen fruit juices are sold and screw it to a wall or part of a workbench. After filling the can with steel wool, bend part of the edge over to keep the wool from being pulled out whenever the iron is withdrawn. It's also a good idea to drive several metal screws into the side of the can to prevent the wool from turning with the iron as it is twisted around inside the can.

## Broken and Worn Twist Drills Converted Into Taper-Shank End Mills

Broken or worn drills can be salvaged by converting them into end mills for cutting keyways, grooves and recesses. To do this, first square the ends of the drills and then grind each cutting lip to a 3-deg. bevel. To avoid spring or possible breakage, drills of small diameters should be kept quite short or well supported by chucking them close to the cutting end.

## Roadside Repair for Fuel Pump

Stranded by a pin-point leak in a fuel pump, I wet a soft cloth and wrapped it tightly around the body of the pump, holding it in place with a short length of cord. This simple repair enabled me to drive several miles to a service station where the defective pump could be replaced.

Wilbert W. Thomas, Thayer, Mo.

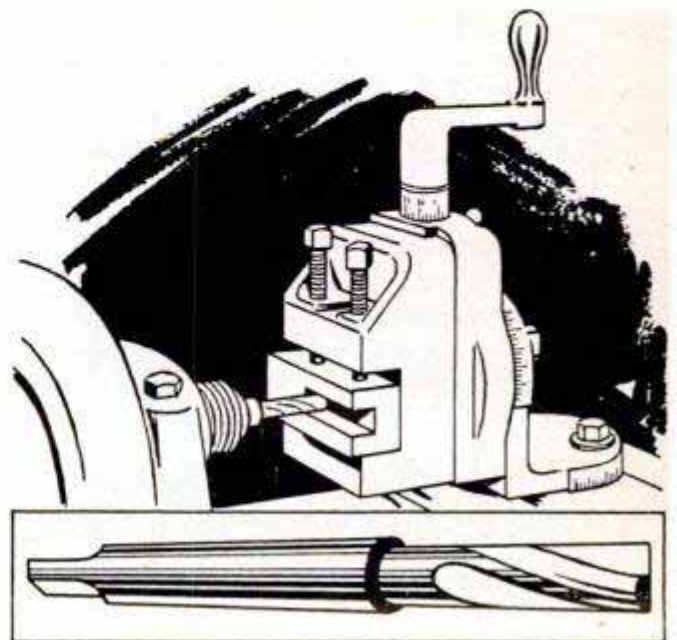

# Bending

# SHEET METAL with a BRAKE



1 POLISHED STAINLESS STEEL bent in a zigzag pattern makes this attractive modern lamp base. Top cap and base are of hardwood

ONE OF THE main characteristics of sheet metal and the one that appeals most to the craftsman is that it can be bent to a wide variety of shapes. In small shops the tool that does this job is a simple hand-operated device, commonly called a brake, or bar former. Fig. 3 shows a typical bench-type brake suitable for craftwork and light professional jobs in metals up to 20-ga. steel. A brake of this type has three main parts — anvil, folding leaf and clamp bar. The work is supported on the anvil, held by the clamp bar and bent by rotating the folding leaf, Fig. 2. Although brake work requires no skill so far as any individual bend is concerned, it takes a considerable amount of actual experience to make the operator familiar with various sheet-metal shapes.

**Reverse bends:** This is one of the few multiple bends which the brake can make without complications. The work is alternately turned face up and face down to make as many bends as desired, Fig. 5. As each bend hooks over the folding leaf, the minimum step which can be made with the

By  
Sam  
Brown

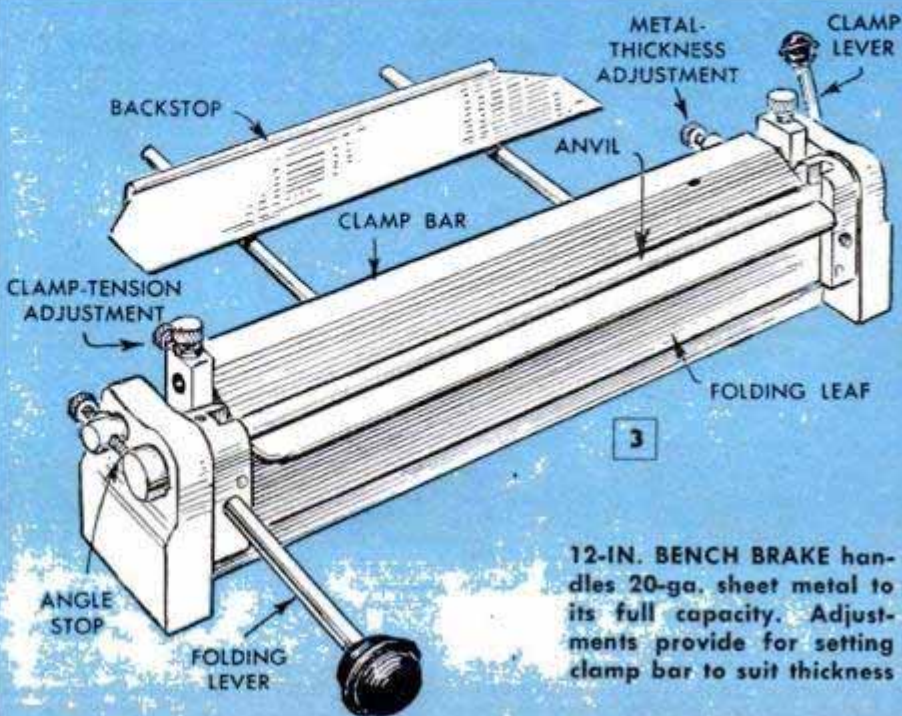
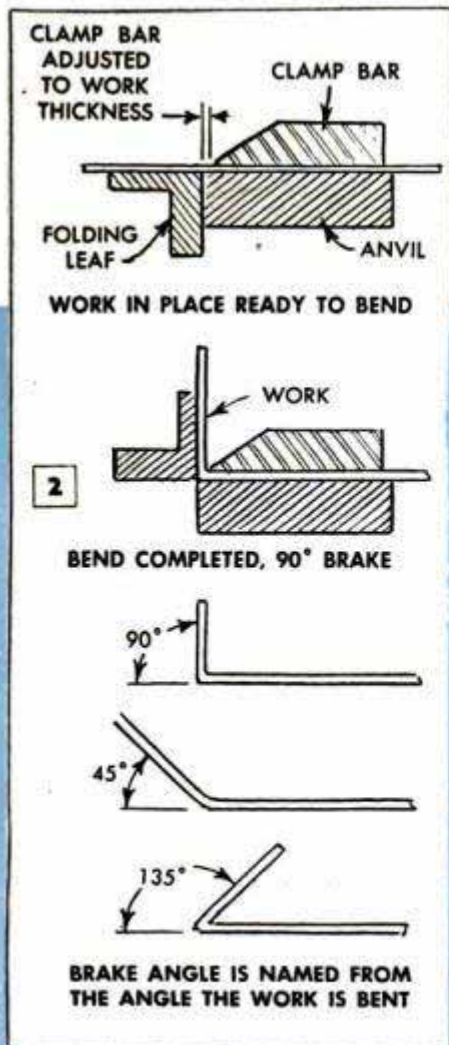

12-IN. BENCH BRAKE handles 20-ga. sheet metal to its full capacity. Adjustments provide for setting clamp bar to suit thickness

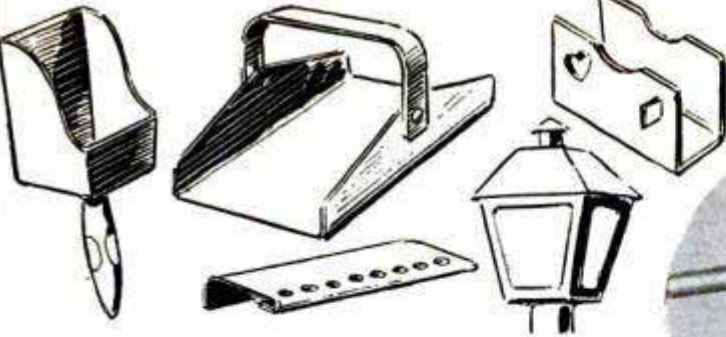

brake shown in Fig. 3 is 1 in., the width of the folding leaf. If the front portion of the folding leaf is removed, reverse bends with  $\frac{3}{8}$ -in. steps can be made, Fig. 4. Steps over 1 in. may be made as desired. In this case, alternate bending lines must be marked on opposite sides of the work so that they are visible when the work is turned over. Many interesting projects can be made with reverse bends, such as the lamp pictured in Fig. 1 and detailed on page 223. Bends also may be made on a diagonal, and pleated flower pots or fan shapes can be worked by making the bends wider at one end than the other. Reverse bends usually are made with a 90-deg. brake. When many bends are to be made it is worth-while to set the angle stop, Fig. 3, to assure the same angle of bend throughout.

**Closed forms:** A closed form is usually a tube shape, Fig. 6, and it can have any number of sides. A hem  $\frac{1}{4}$  in. wide, or wider, ordinarily is provided to fasten the ends of the form together. A closed form offers no complications provided it can be fitted over the clamp bar, Fig. 6. The sequence of operations in making a typical closed form is shown in Figs. 7, 8 and 9. The hem usually is made first. Also, when the tube approximates the shape and size of the clamp bar, the hem should be made on the short side, as in Fig. 6. Starting with the short side, you naturally finish with a long side, Fig. 8, which matches the shape of the clamp bar. Any good bench brake has an instantly detachable clamp bar to permit ready removal of closed work, Fig. 9.

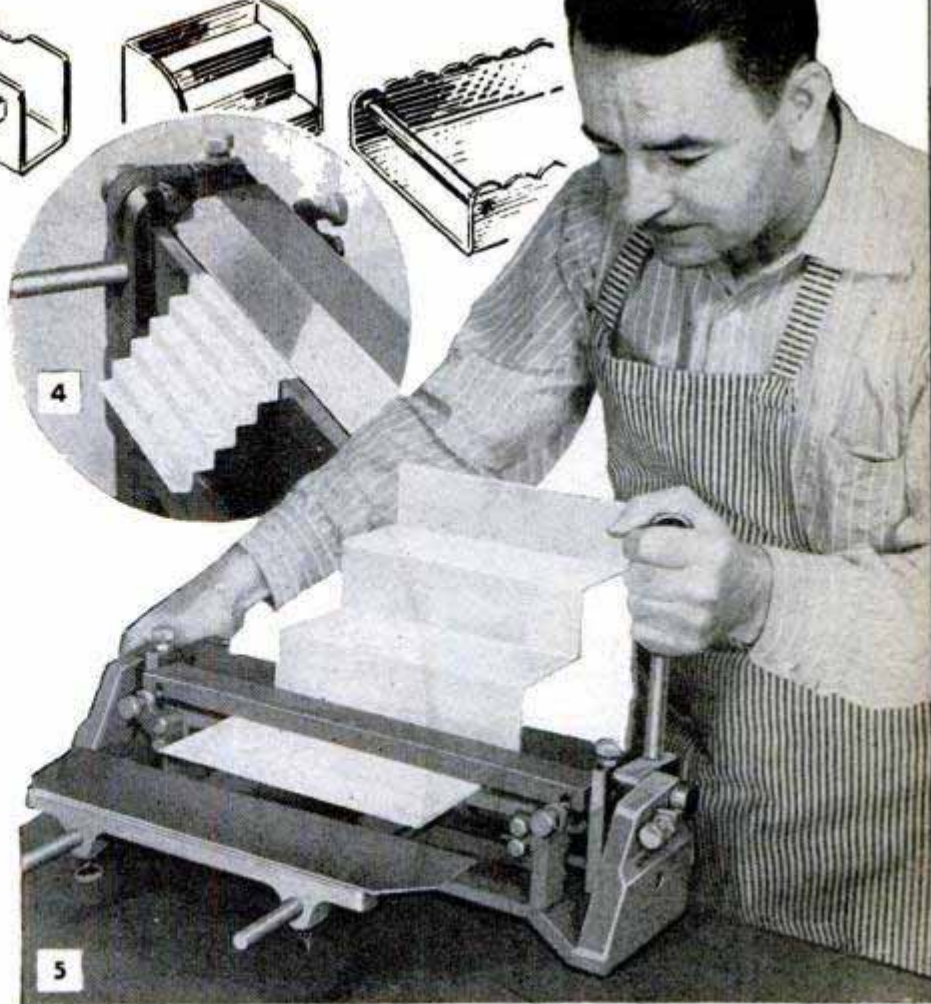

**REVERSE BENDS** can be continued indefinitely by turning the work over to make the successive bends. Steps as small as  $\frac{3}{8}$  in. in width can be made simply by removing the front portion of the folding leaf in the manner pictured in the inset above, Fig. 4

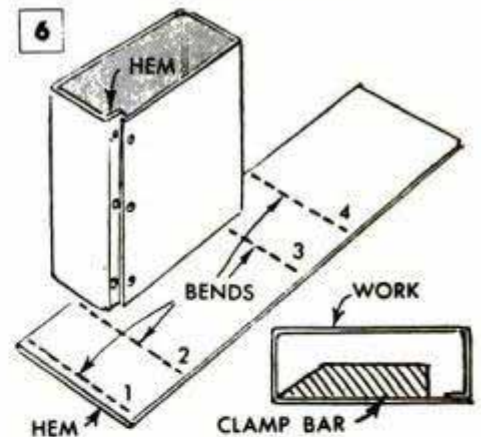

**CLOSED FORMS** are readily made when shape is slightly larger than clamp bar. Photos show how it's done

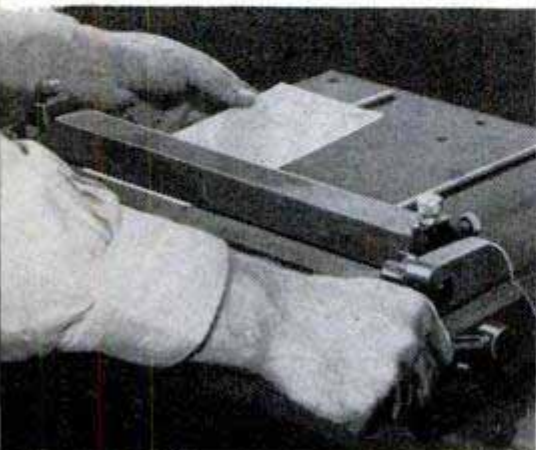

**7** SETTING WORK FOR FIRST BEND

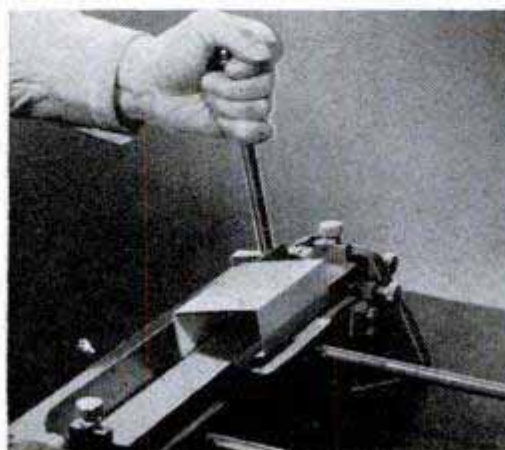

**8** MAKING THE LAST BEND

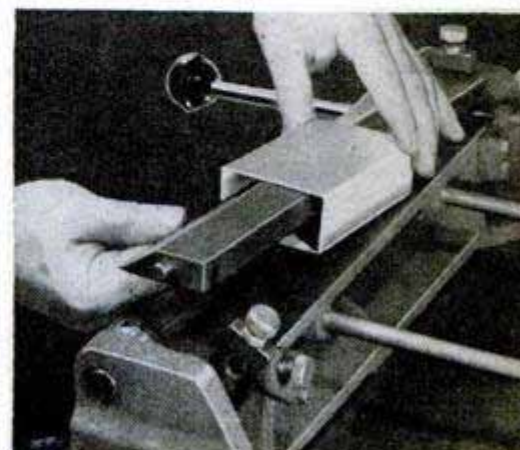

**9** BAR RELEASED TO REMOVE WORK

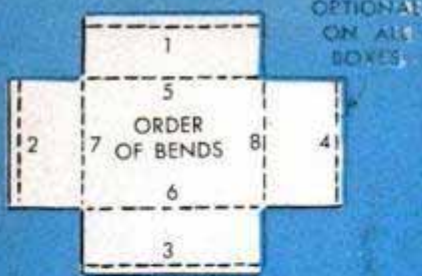

STYLE 1  
ONE-PIECE  
BUTT JOINT

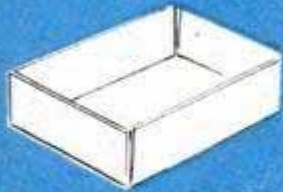

STYLE 2  
ONE-PIECE  
TAB JOINT

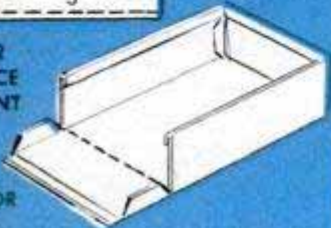

CENTER, OR  
CORNER,  
SEAM

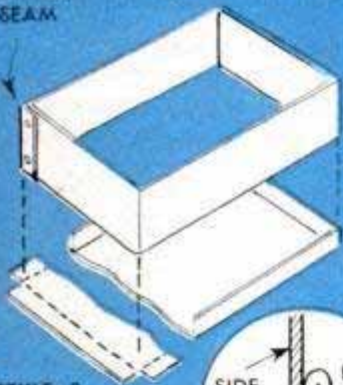

STYLE 3  
TWO-PIECE,  
FLANGE  
BOTTOM

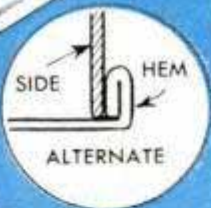

STYLE 4  
TWO-PIECE,  
MITERED ENDS

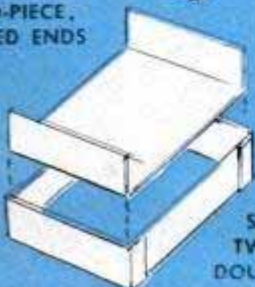
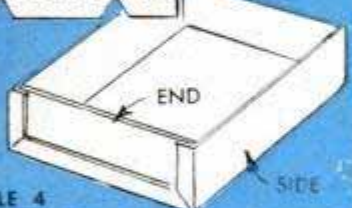

STYLE 5  
TWO-PIECE,  
DOUBLE ENDS

13

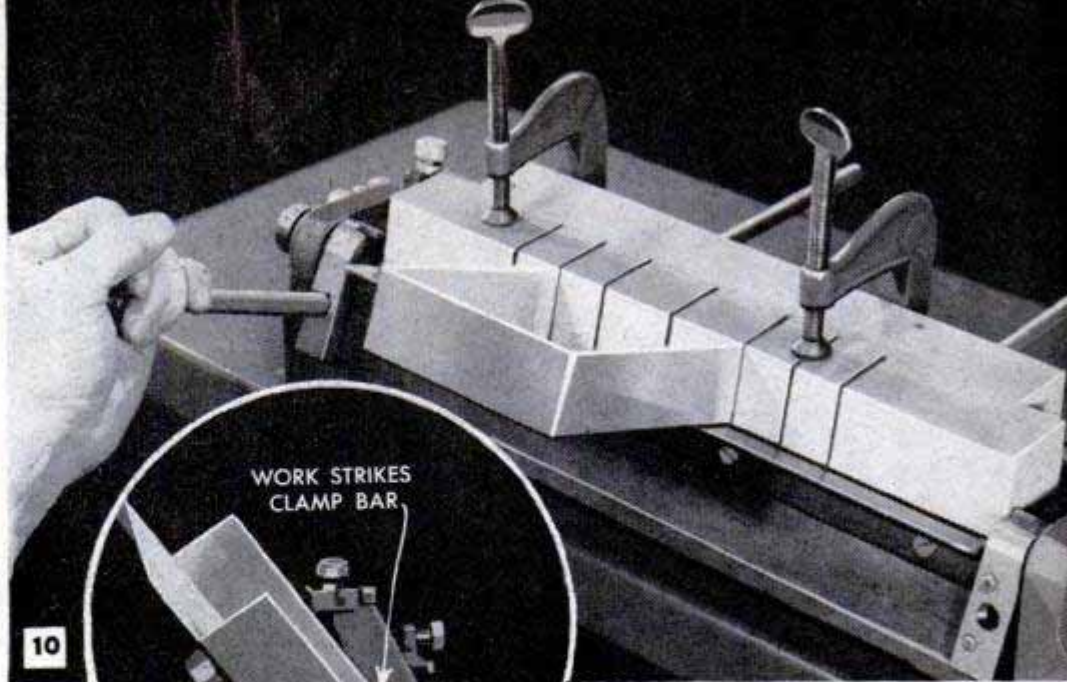

10

11

WORK STRIKES  
CLAMP BAR

BOX BENDS require a special clamp bar which can be made of hardwood. Note how the slots in bar take sides of box when making closing bend

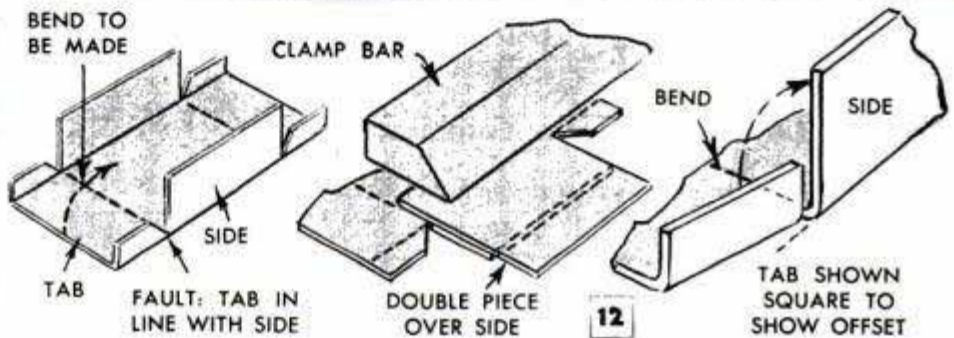

12

OFFSETTING TABS with the use of a doubling piece of metal permits easier and neater bending of those bends that close the box form in final assembly

When a closed form is smaller than the clamp bar, the work will run into the bar on the final bend. Most work of this kind is simply forced on the last bend, permitting the work to distort and then reshaping by hand hammering or hand pressure alone. It is sometimes worth-while to make up special thin clamping bars, Figs. 23 and 24, to suit small openings.

**Box bends:** There are many different ways to make sheet-metal boxes, five of the more popular styles being shown in Fig. 13. The simplest is one-piece construction with butted joints, style 1. Although the joints usually are soldered, open joints are practical for certain jobs. The standard clamp bar of the brake cannot be used for most box bends. What happens is shown in Fig. 11. When a style-1 box is made, it is no trick at all to bend two opposite sides of the box, but when you try bending the two remaining sides you find the first bends striking the clamp bar, Fig. 11. Special clamp bars can be purchased or made to solve this problem. One style is the slotted bar, Fig. 10, which is satisfactory if made of hardwood. It should have a front-edge bevel of about 15 deg. and the back edge should be notched to take advantage of the screw adjustment to set it square with the folding leaf. A wooden bar is not strong enough to take pivot pins to work with the regular folding lever. This makes it necessary to clamp the bar for each end as in Fig. 10.

Perhaps the most common box construction is style 2 with



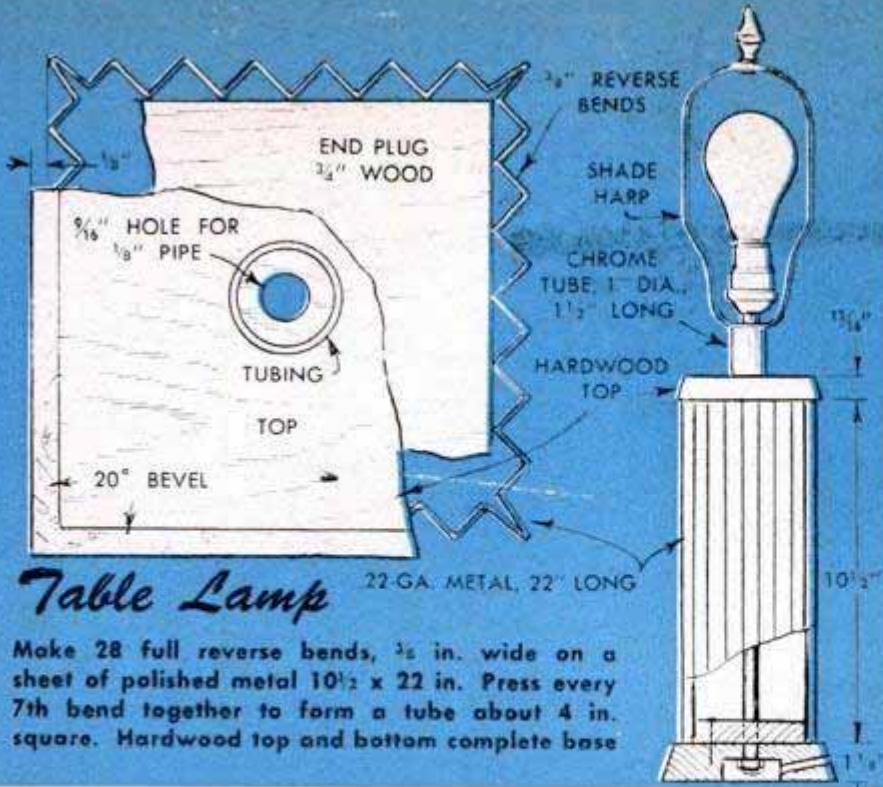

## Table Lamp

22-GA. METAL, 22" LONG

Make 28 full reverse bends,  $\frac{1}{2}$  in. wide on a sheet of polished metal  $10\frac{1}{2} \times 22$  in. Press every 7th bend together to form a tube about 4 in. square. Hardwood top and bottom complete base

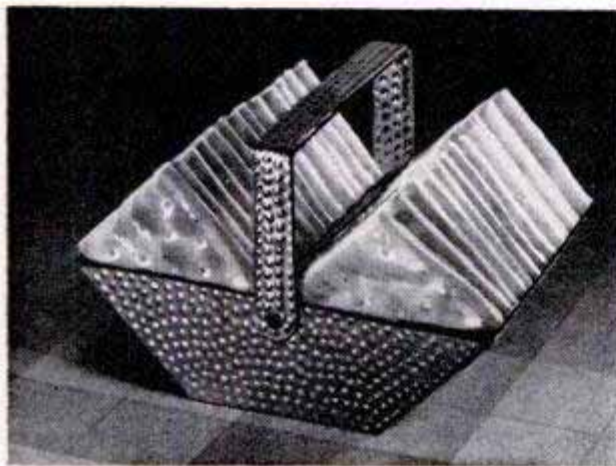

## Cracker Server

Form the outer part first, then bend the inner part to fit. The handle is bent from a  $\frac{3}{8} \times 9$ -in. strip. Using plain metal, the outer part can be 20-ga., the inner part 22-ga. and the handle 18-ga. metal. Server in the photo is made from 24-ga. chrome-plated stock with a hob-nail finish which was made by tapping with a rounded punch. Note the unusual surface texture

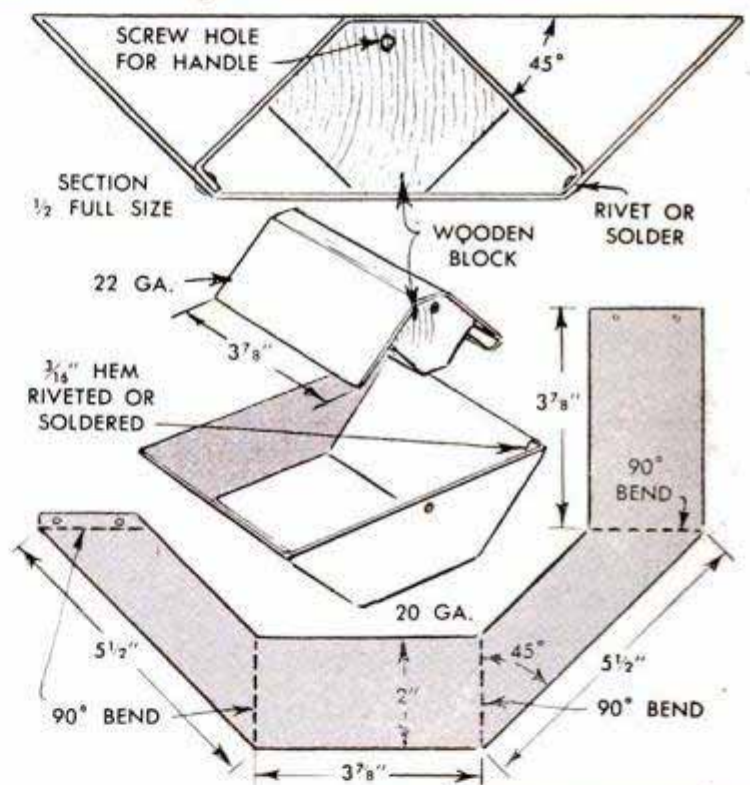

## Crumb Tray

This is a simple brake job. Handle sections are hammer-finished before bending. Tray is made from stainless steel, red brass or cold-rolled copper

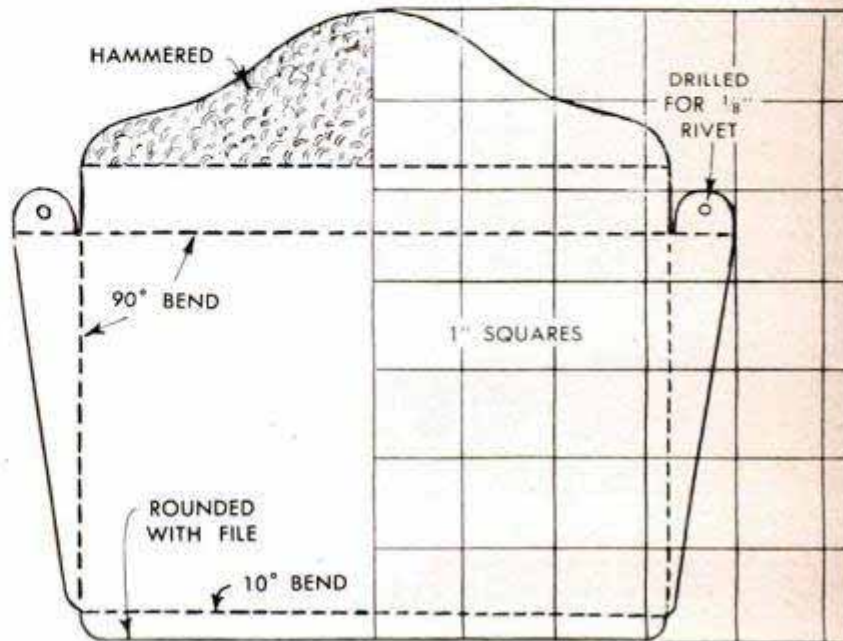

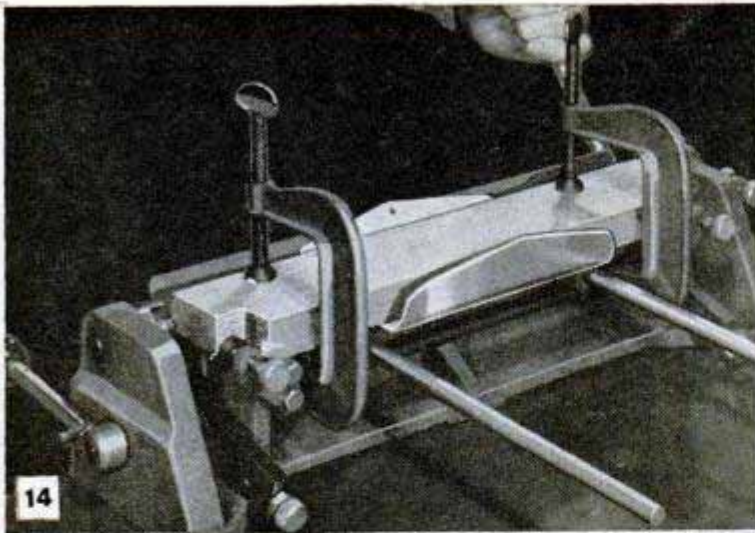

**ROUND CORNERS** are bent with aid of a clamp having radius worked on one edge. An angle of 105 deg. corrects springback

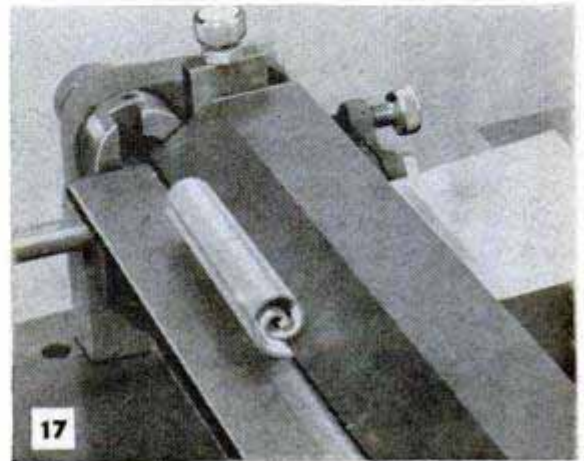
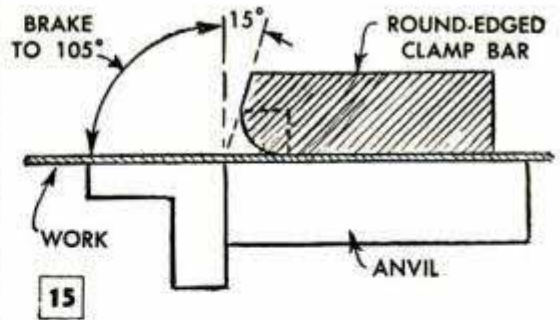

**SPIRALS** are easily worked out with short successive bends. The angular type, which is commonly used as decoration, is formed as detailed in the sketches at the left. Note the clamp bar

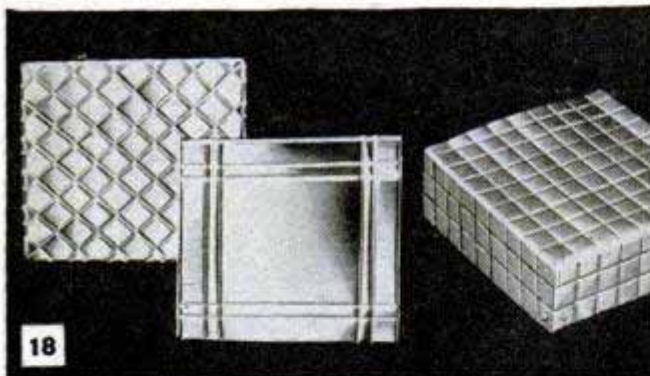
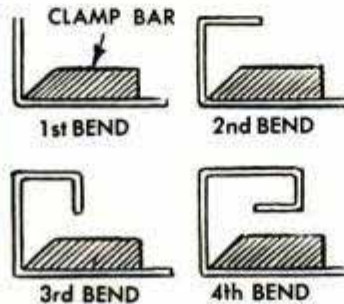
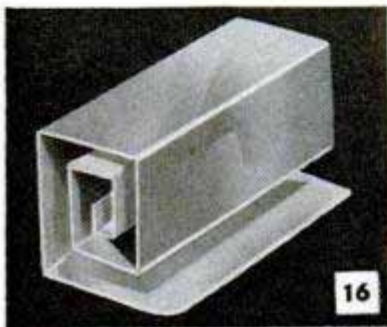

**CREASING** is useful for special forms of ornamentation. Lines are deepened by using pad under metal

tab joints. One trick in making a box of this kind is the offsetting of the tabs, which allows a much neater fit than when the tabs are simply formed in line with the side bend. Fig. 12 shows how to offset. When ordinarily bent, the tabs are directly in line with the sides and do not bend in or out readily when the final bend is made. Now, if you use a doubling piece of metal over the side of the box when the bend is made, Fig. 12, the tabs will be offset slightly to the inside, as shown in the right-hand detail, permitting a neat corner closure. Where the tabs are to form on the outside of the box, the tabs would take the doubling pieces instead of the side.

Style-3 box is a useful pattern. The sides are bent easily, being simply a closed form. The bottom is like the style-1 box with the

flanges inside or outside as desired. Style 4 is a neat form of construction requiring no offsetting. Style 5 often is useful since it can be made without difficulty by using the standard clamp bar.

**Pyramids:** This figure can have any number of sides, four being the most common. When you have a big center opening—big enough to fit over the clamp bar—the bending of the pyramid is easy, being essentially the same as a simple closed form, Figs. 19 and 22. A pyramid with a small center opening will always strike the clamp bar but usually can be forced, or, it can be worked over a special clamp bar made small enough to pass through the work, as shown in Figs. 23 and 24. Pyramids which run to a peak, Fig. 20, form readily if the stretchout of the figure is contained in a half circle or less. When this is the case, you usually can bend all but the last fold without interference. Peaked pyramids having a stretchout greater than a half circle should be designed with diametrical bends as in the right-hand detail, Fig. 20. A peak figure like this cannot be formed fully on the brake since the work eventually fouls at the bends. Hand reforming is necessary.

Fig. 21 is the one type of pyramid which cannot be formed on the average brake. You can make the center bend, but that's all. If you try to make the other bends, you will get a crease across the work where it is not wanted. One common solution to a

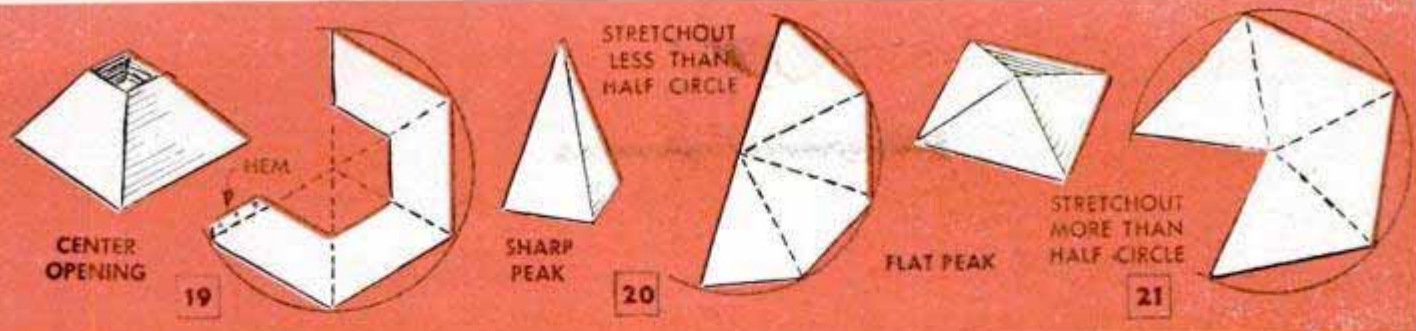

**PYRAMIDS** can have any number of sides but figures with center openings are the easiest to bend to shape

job of this kind is to make the work in two parts and solder together. Otherwise, the center bend can be made on the brake and the other two bends made by hand hammering over a steel bar.

**Round corners:** With round-corner wooden clamp bars which you can make easily, a brake will form round corners of any radius, Fig. 14. After the round is formed on the wooden bar with a suitable shaper cutter, the remainder of the edge should be sawed at a 15-deg. bevel, as in Fig. 15. When the bar is fitted in place, it should be set back slightly to allow a brake angle of about 105 deg., which is necessary to overcome springback. Since the standard clamp bar opens to about  $\frac{1}{4}$  in. above the anvil, rounds of  $\frac{1}{4}$ -in. radius or less also can be worked by slipping a piece of hardwood with a rounded edge under the regular clamp bar. Half-round bends are formed by first making a single quarter-round bend and then shifting the work slightly for a second bend.

**Spirals:** Both angular and round spirals may be made with the brake. The round spiral can be worked with the regular clamp bar, making successive short bends about  $\frac{1}{16}$  in. apart to curve the work, Fig. 17. The same technique with a  $\frac{1}{8}$ -in. round-nose bar is faster and somewhat smoother. The angular spiral is a plain job of bending, as shown in Fig. 16, starting with the short bend and continuing with as many additional bends as required.

**Creasing:** Creasing is a handy brake operation having utility value in the formation of complicated figures, that is, you can crease and flatten almost any figure and then reform it by hand. Opening of the crease by hand causes more or less rounding of the standing part of the metal and this can be used to advantage in making flutes or beads. Creasing also is used for ornamentation, Fig. 18, and is especially effective on thin metals backed with rubber or other soft material to make the crease more pronounced. The top side of the work shows crease the best and if a soft backing is used it should be placed under the work.

★ ★ ★

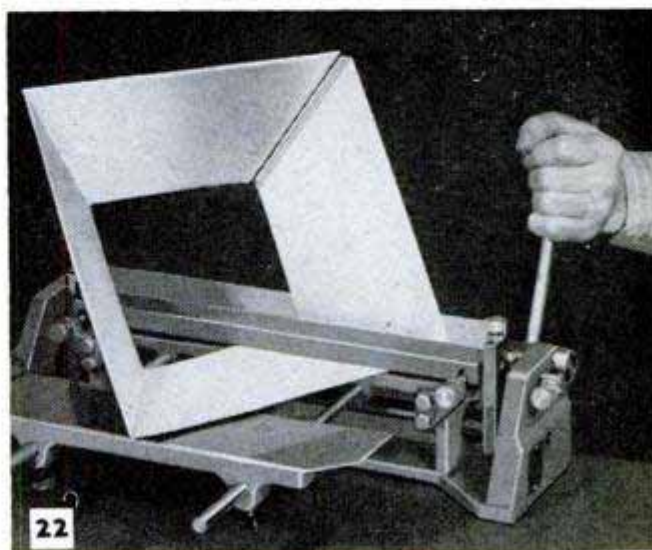

**BIG CENTER OPENING** assures simple bending because clamp bar is always clear. Hem is braked first

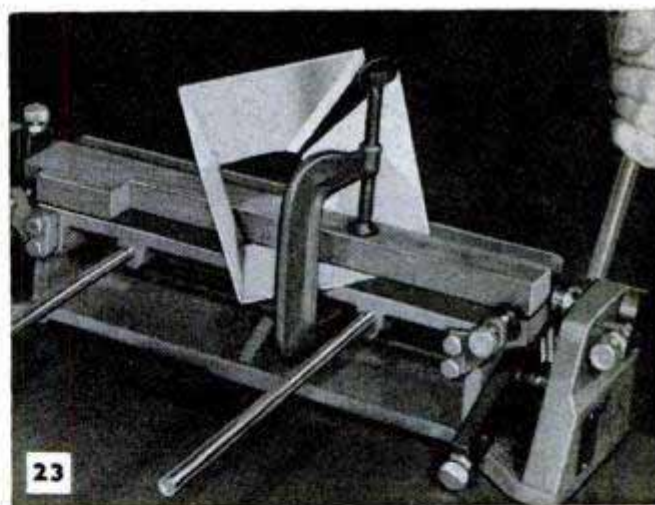

**SPECIAL CLAMP BAR**, above, is made of hardwood to form pyramid with small opening. Below, wood screw in bar is used to set position of adjusting screw

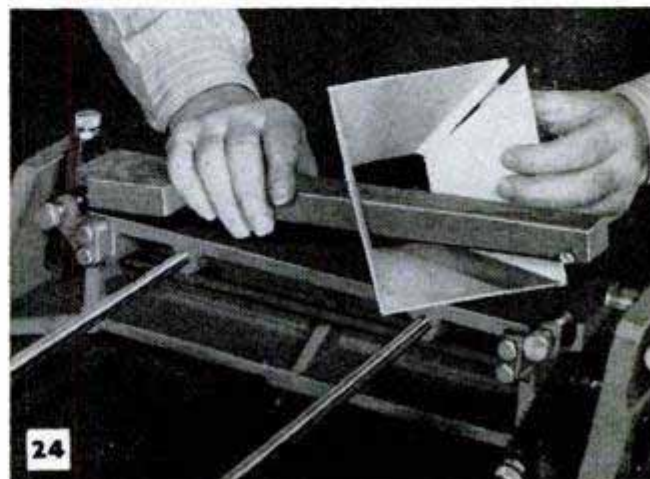

## Brackets on Truck Endgate Serve as "Sawhorse"

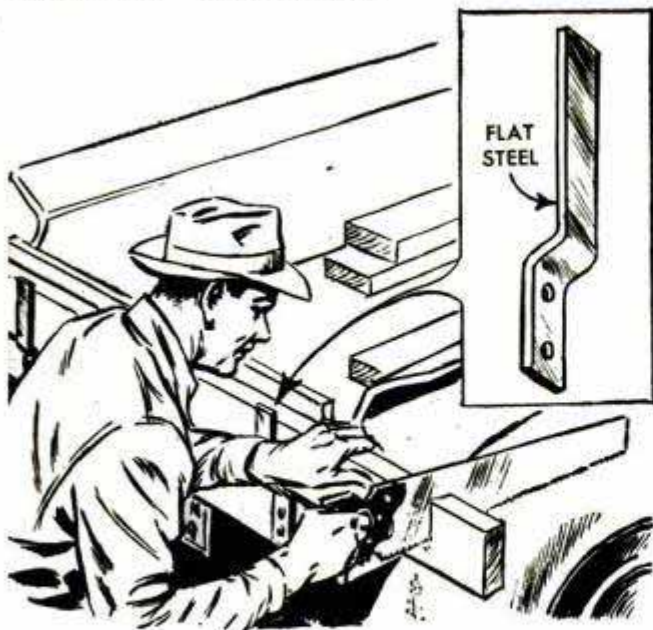

Contractors and others whose work requires occasional rough sawing of boards, will find that a couple of steel brackets bolted to the endgate of a truck serve ideally as a substitute for a sawhorse. The brackets are shaped from  $\frac{1}{4}$ -in. steel. Their length and the amount they are offset will be determined by the width and the thickness of the work usually handled.

## Screen Wire Used to Point Chalk

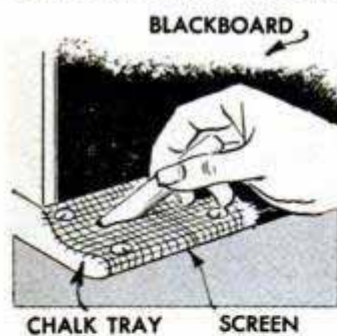

Attached to one end of the chalk rail of a blackboard, a small piece of screen wire will provide an ideal surface on which to point pieces of chalk. The screen, which is tacked in place, permits the chalk shavings to sift through onto the rail where they may be collected and disposed of easily.

## Fence Posts Treated Effectively With Small Supply of Creosote

If pressurized-creosoted fence posts are not available, you can give posts the protective coating necessary for added life by soaking the ends to be placed in the ground in an oil drum containing creosote. However, if a sufficient amount of creosote for covering the posts to the depth desired is lacking, soak them for several days, or a week, in all of the creosote on hand. This done, lower a garden hose to the bottom of the drum and run in water to raise the creosote, which will float, higher on the

posts. Again let them soak for a few days, repeating the operation until the posts are creosoted to the desired height.

Otto E. Kirchner, New York City.

## End-Drilling Long Work

The ends of shafting or other long work can be drilled with little difficulty in a drill press by allowing the work to project through the center hole of the drill-press table and holding it in place with a clamp-type lathe dog. A tool-maker's parallel clamp also may be used if available. By swinging the work table to the right, or to the left, holes can be drilled either in the center, off-center or around the edges of the work.

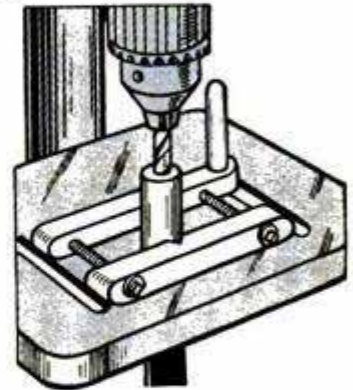

By swinging the work table to the right, or to the left, holes can be drilled either in the center, off-center or around the edges of the work.

## Nail Kegs Placed in Racks Form Laying-Nest Units

To reduce the number of broken eggs in multiple-nest units, one poultryman replaced his regular equipment with units made by racking ordinary nail kegs in rows one above the other as pictured. Note that the wooden racks are constructed so that the kegs are inclined uniformly at an angle of about 30 deg. The individual kegs are easily removed for cleaning.

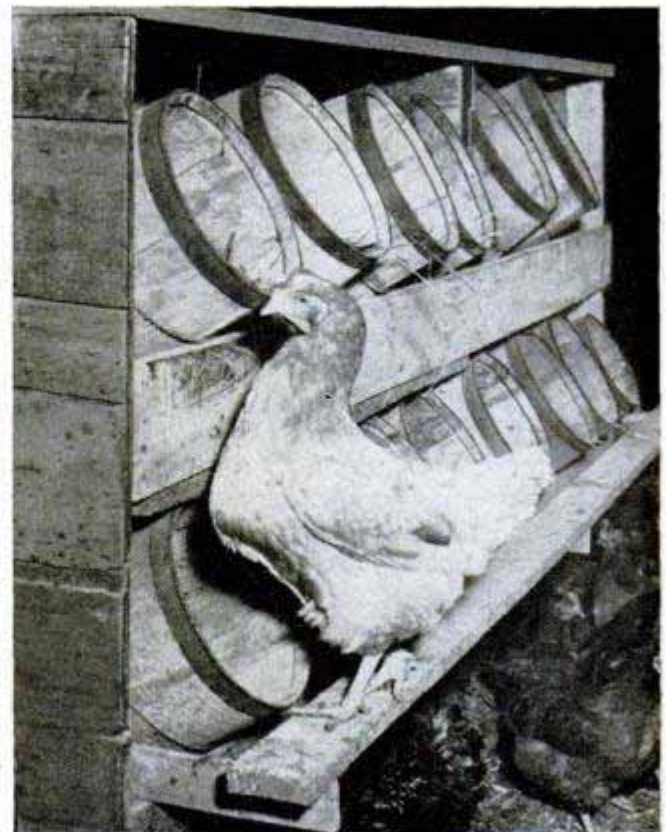

## HINTS FOR TV-SET OWNERS

**A**—Using a reading glass for ultrafine focusing on a camera ground glass is an old photographer's trick that can be employed for fine tuning on the television screen. When the scanning lines are magnified it is easy to adjust the control for ultrasharp focus which provides an improved picture for viewing

**B**—Nonpowered isolation box for use with a TV-antenna-distribution system in apartment houses, hotels and stores. It contains a matching network of resistors providing an isolation factor between receivers of at least 30 db, with a minimum signal drop across the outlet. Terminals are for 300-ohm twin-lead

**C**—Three-way cube tap spliced to the TV interlock line cord, commonly used for testing in place of the regular cord, increases its usefulness. It may be employed to connect a soldering iron, test lamp or other equipment without hunting for a wall outlet. Many TV servicemen find this a useful timesaver

**D**—TV-picture aligning is simplified by the use of a target sight printed on the surface of a mirror. Designed by Du Mont engineers as an aid to servicemen, this unit attaches to a chair in front of the television receiver with a spring clamp. The mirror is adjustable to give the proper viewing angle

**E**—One TV-set owner had a simple solution for his problem of intermittent noise caused by antenna vibrations being transmitted down the mast, through the roof and along partitions. He placed toy sponge-rubber balls on the ends of each antenna element which corrected the troublesome vibration period

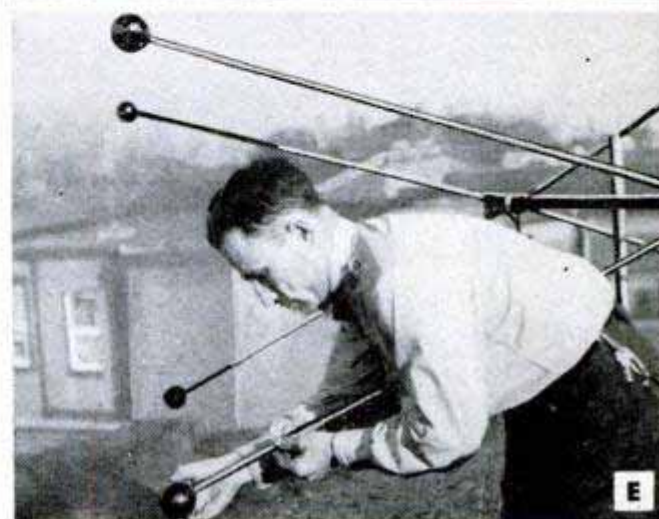
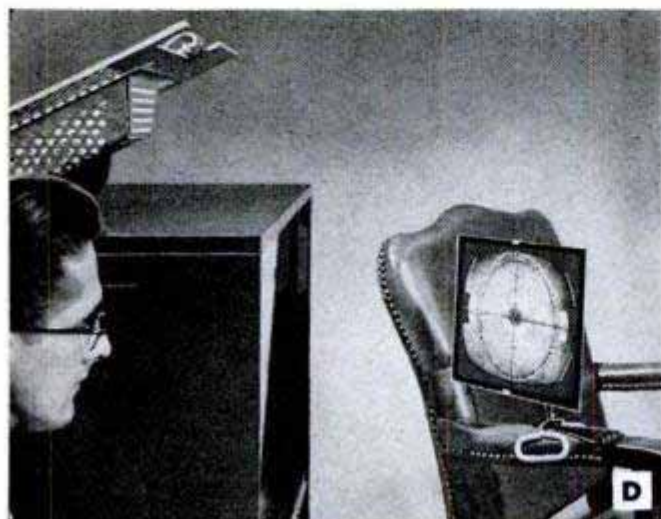
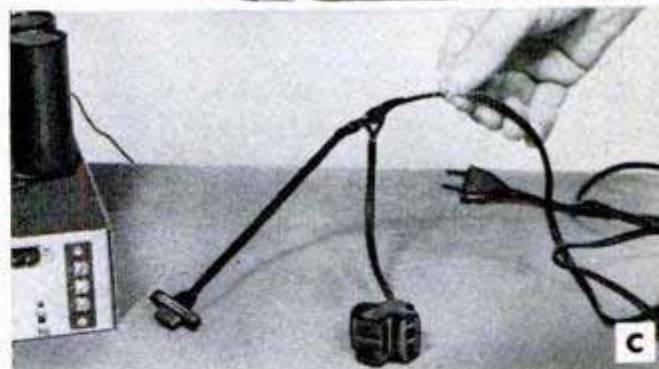

# BEGINNER'S TWO-TUBE A.C.-D.C.

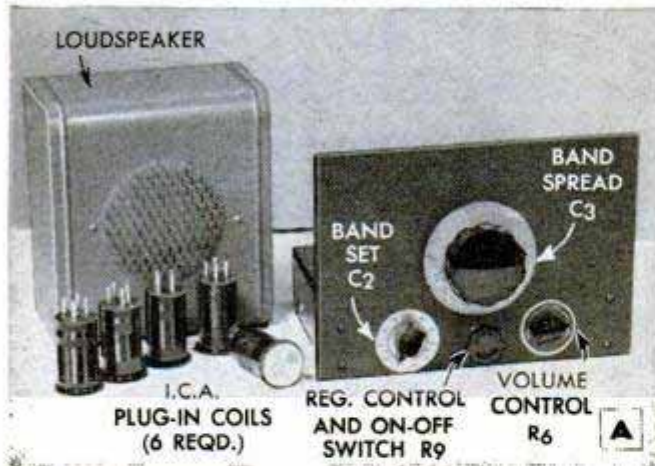

ALTHOUGH simple in appearance, this little student-type radio receiver can literally hop the oceans and bring in stations from many foreign countries. This, of course, means if a suitable antenna is used, and if local receiving conditions are normal.

If you intend to become an amateur radio operator, or if you are interested in listening in on amateur or short-wave stations as well as standard broadcast programs, this simple 2-tube receiver represents a worth-while project. It has been especially designed for the beginner and, though you have had no previous experience with radio, you should have little difficulty in building the receiver and obtaining satisfactory results. Although only two vacuum tubes are used, the performance is similar to that of a 4-tube radio because one of the tubes actually consists of two separate tubes in one envelope, and a selenium rectifier eliminates the need for a separate rectifier tube. There are no coils to wind as the six I.C.A. coils are available from any of the large radio-parts houses.

The circuit is that of a regenerative receiver followed by an audio voltage amplifier and a power-output tube. To change from one band to another it is necessary merely to plug in the coil designated.

A complete schematic circuit diagram is

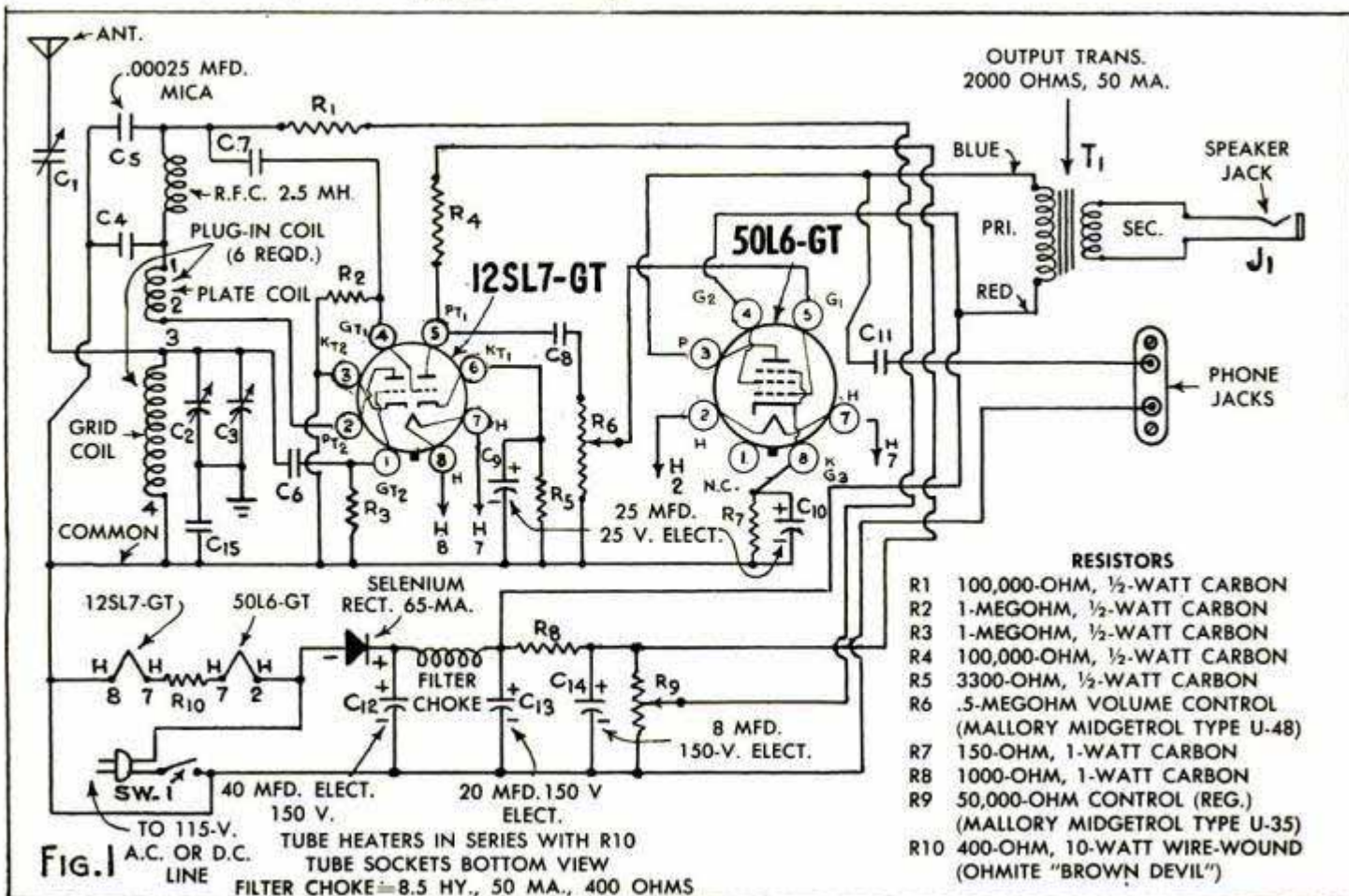

# SEVEN SEAS SCOUT

given in Fig. 1 and a pictorial wiring diagram appears in Fig. 2. The chassis-base construction in Fig. 2 does away with socket mounting holes. The selenium rectifier is mounted with a 2-in. machine screw. Check photos A, B, D and E for locations.

To mount C1, the 3-30-mmfd. antenna trimmer condenser, two fiber spacers are used so that there will be sufficient space between the condenser and the side of the chassis to permit opening and closing of this variable capacitor by means of a wooden "screwdriver." The common-negative bus bar (a piece of No. 12 bare copper wire) is supported by a soldering lug on the 12SL7-GT tube-socket mounting screw. Do not substitute metal for the hardboard chassis-top strips and rear panel; the front panel must be metal. All small resistors and capacitors are mounted by their leads and these leads are covered with spaghetti tubing. Keep all leads short and use rosin-core

(Continued to page 236)



C

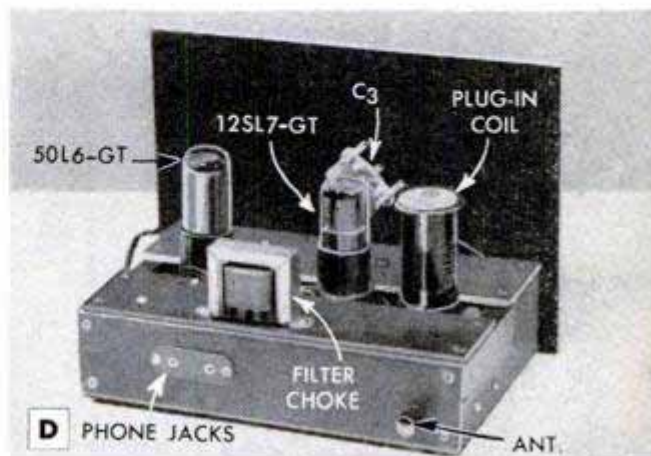

D

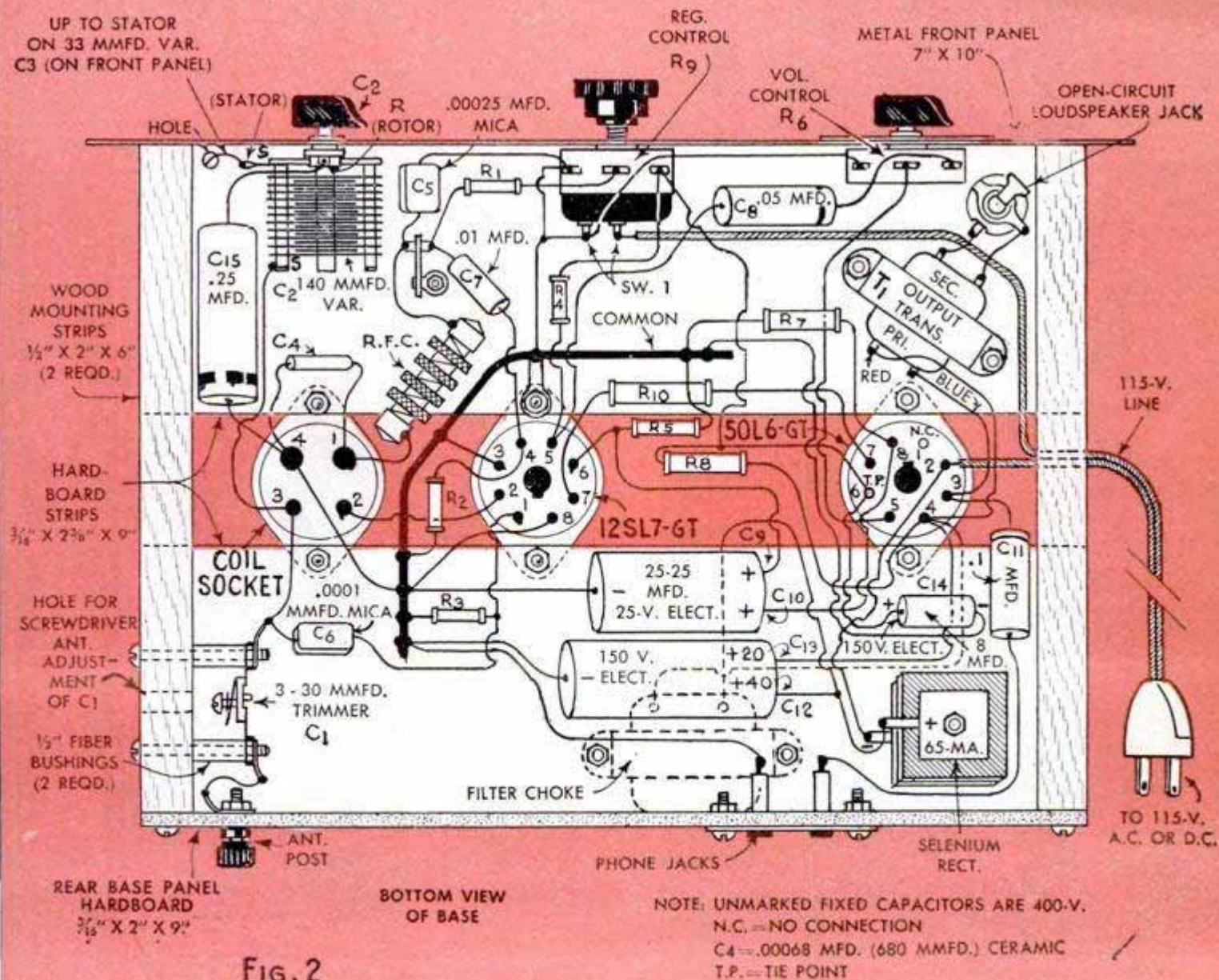
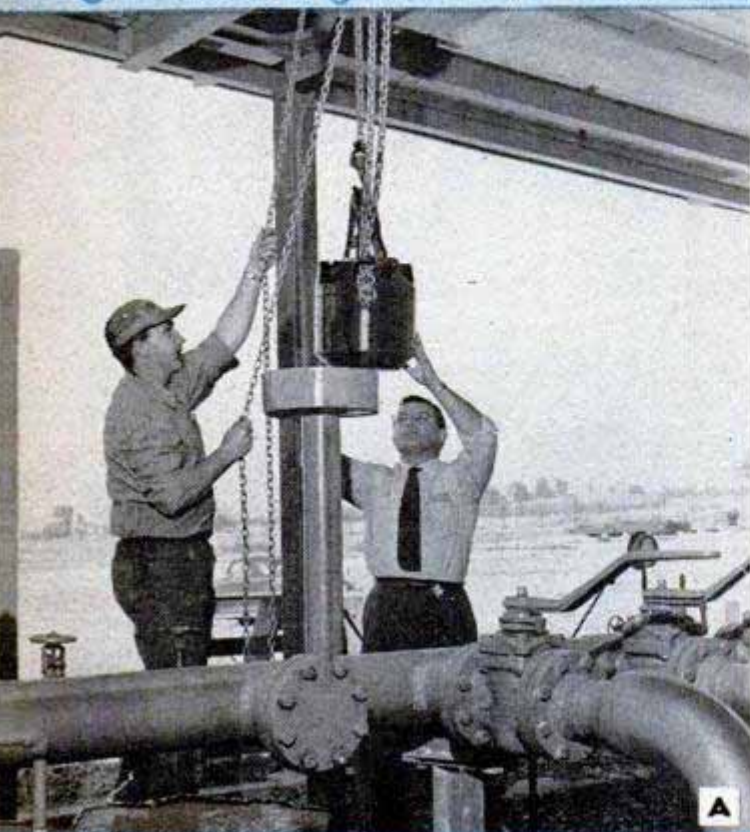

FIG. 2

# PIPE-LINE SHIPMENTS



**C**OMMON-CARRIER pipe lines transporting successively such varied items as gasoline, diesel oil and heating oils, must indicate at the terminals when one fluid ends and the other begins. The Salt Lake Pipeline Company, a subsidiary of the Standard Oil Company of California, has developed a new method for doing this which does away with the wasteful process of constant sampling. It also saves valve attendants many hours of watchful waiting.

The new method consists of introduction at the starting point of a minute amount of radioactive antimony at the boundary between two products. Geiger tubes attached to the pipe at destination indicate immediately to the operator the arrival of a new product so that he can change valves and direct the arriving product into a different storage tank. A short pipe line with one starting point and one destination could measure the number of gallons pumped and thus approximate the division point between the two products. But this pipe-line company was faced with the problem of seven intermediate take-off points where a portion of a product might be delivered, involving many small individual shipments over 566 miles of pipe line extending from Salt Lake City, Utah, to Pasco, Wash.; see map, Fig. 1.

The Atomic Energy Commission, aware of the possible value to American industry of the "know how" developed within the atomic-energy program, is cooperating. In this case the radioactive antimony used is ordinary antimony prepared in the Rich-

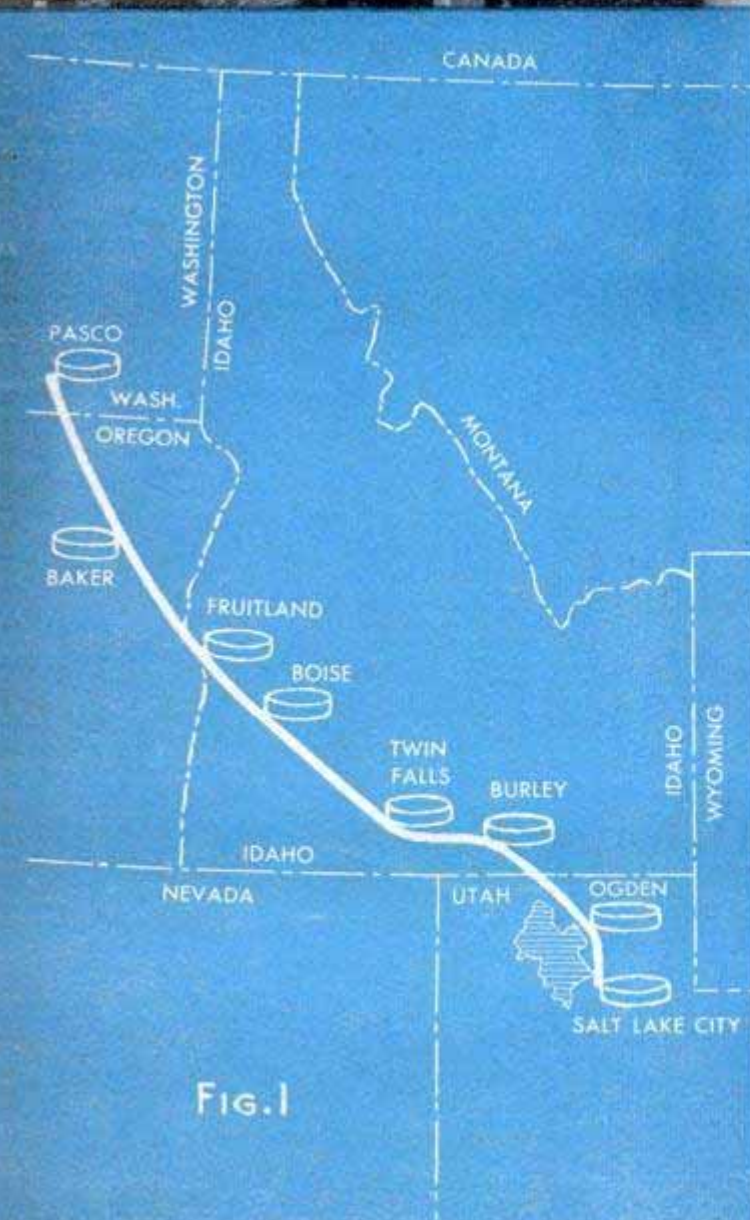



# SEPARATED BY RADIOACTIVE TRACERS

mond Laboratories of the California Research Corporation. It is shipped to the U. S. Atomic Energy Commission at Oak Ridge, Tenn., and placed in an atomic pile where it is subjected to a neutron bombardment which converts a portion of the antimony to the radioactive form. This "hot" material is returned in a lead container to the oil-company laboratories where it is further processed and diluted with a light oil to become this tracer fluid.

Only at the point where the tracer solution is introduced into the pipe line is the quantity of radiation sufficient that special precautions must be taken by lead shielding, remote-control valves and mirror observations. At the introduction point, photo A, the shielded shipping container is shown being hoisted onto a safety stand at the Salt Lake pumping station. This radioactive tracer fluid is then removed from the container and placed in the injection apparatus connected with the pipe line, photo B. The operator in photo B is measuring the tracer fluid being injected into the pipe line by means of a remote-control handle.

The Geiger tubes, connected to a preamplifier, are mounted in position on the pipe line at the destination point, photo C. As the boundary between the two shipments moves along the pipe line, the radioactive tracer moves with it as indicated in Fig. 2. At each take-off point the signal from the Geiger tubes is fed through the amplifier into a counting-rate meter connected with the Radioactivity Recorder, photo D. As the boundary arrives, a sharp break in the line being traced signals the arrival of a new product. ★ ★ ★

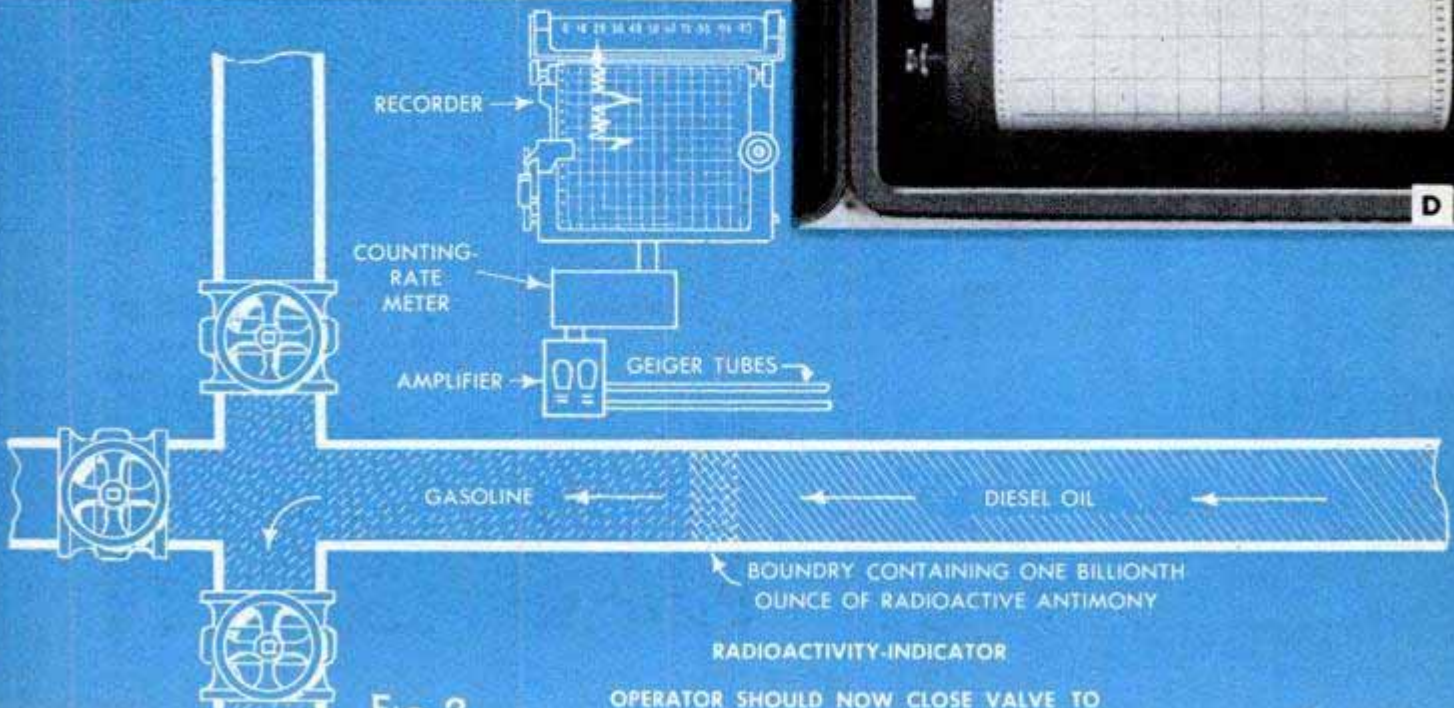
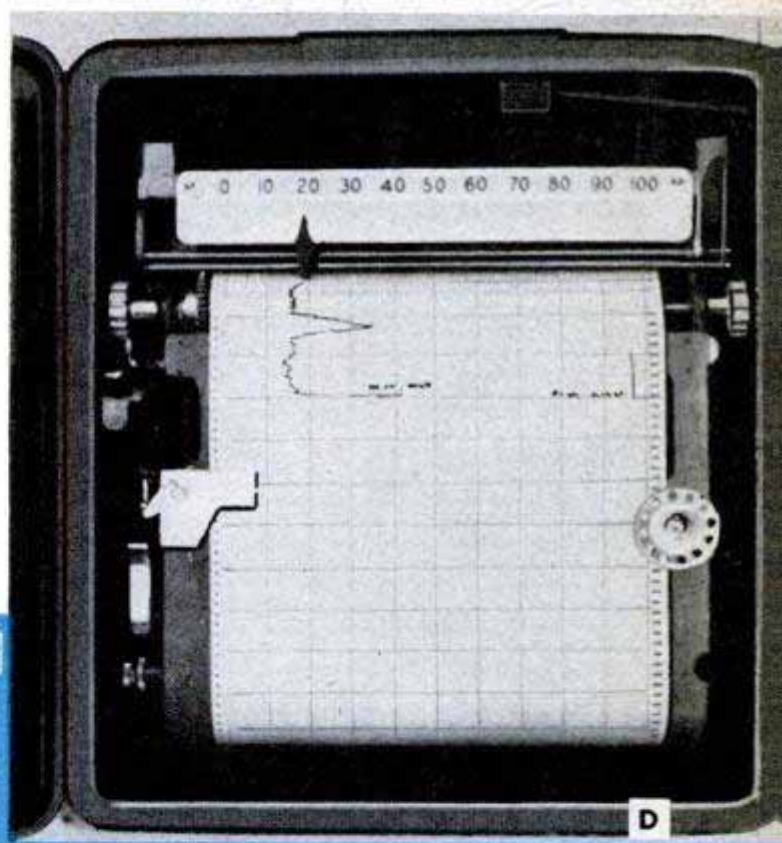
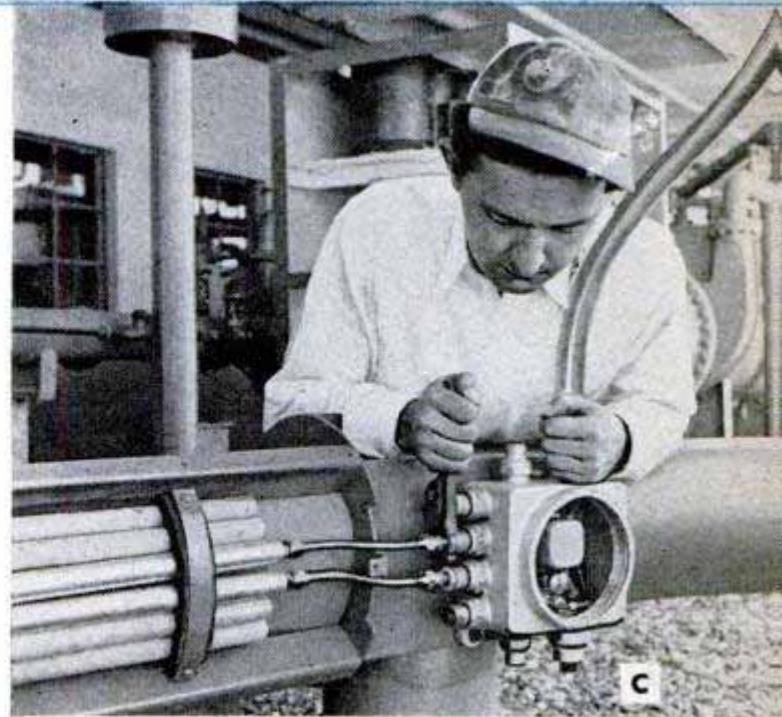

## Ultrasonics and Electronics Today

ULTRASONICS — the sound frequencies which human ears cannot hear—are now being used by one of the large radio-tube manufacturers to conserve materials vital to the nation's defense program. The device illustrated in photo A vibrates at a frequency more than three times that of the highest audible pitch. It is employed to shake off glass beads from valuable tungsten-alloy rods salvaged from faulty discarded vacuum tubes.

The telephone-amplifier unit, shown in photo B, is a useful electronic device that leaves the hands free for writing or other work while the person listens and replies to incoming calls. It operates from any electrical outlet; no connections to the phone line. A special 27-piece tool kit designed for radio, TV and electronic servicemen appears in photo C. It contains practically every hand tool necessary for this work, plus extra pockets for other favorite tools. Putting the finger on deadly atomic rays in planes flying over A-bomb blast sites is the grim job of the electronic instrument shown in photo D. It is known as an ion chamber and is claimed to be much smaller than other gamma-ray detectors of the same sensitivity. It looks like, and is called, "the Finger." The amplified megaphone demonstrated in photo E employs tiny germanium crystals called transistors. It amplifies the normal speaking voice to a volume comprable to a cheerleader's yell. Small batteries are enclosed within the amplifier unit near the mouthpiece.

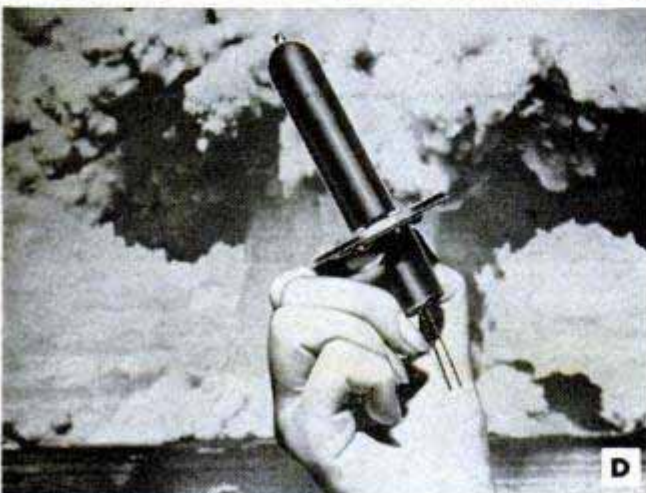
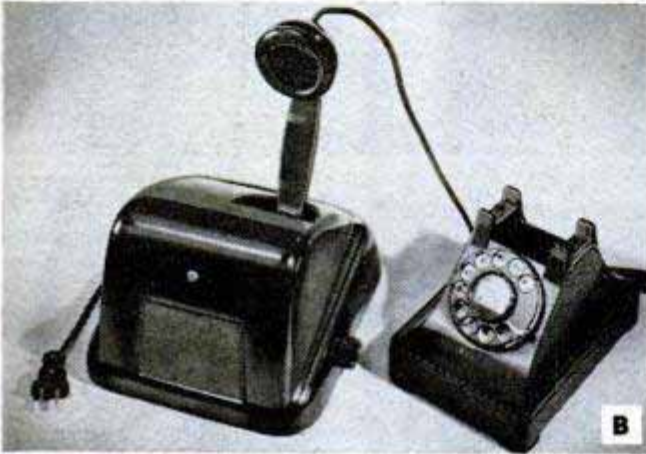

# Which battery do you want in your car?

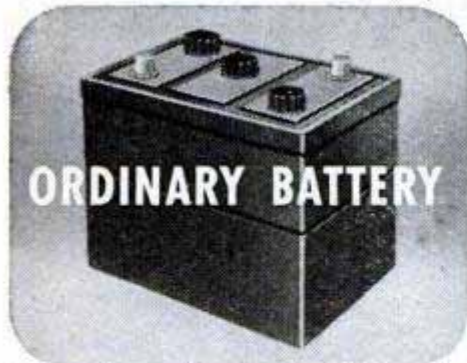

**ORDINARY BATTERY**

1. In ordinary batteries, small particles keep flaking off positive plates . . .

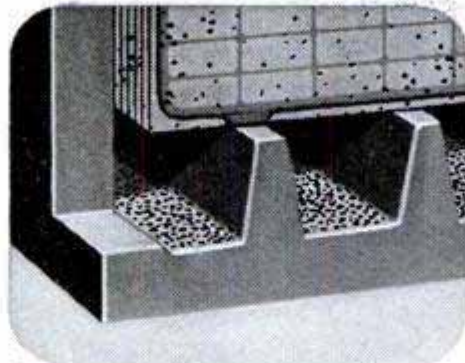

2. so ordinary design batteries must have large sediment wells at bottom of case to hold these particles.

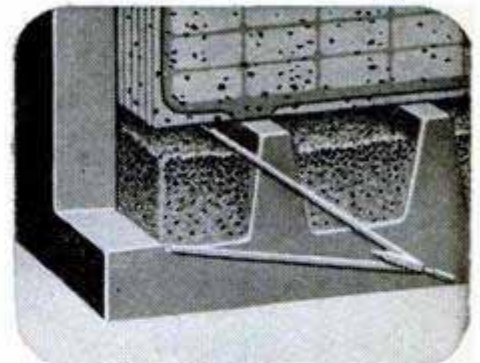

3. Even these sediment wells in ordinary batteries aren't big enough to hold flaking particles from positive plates . . .

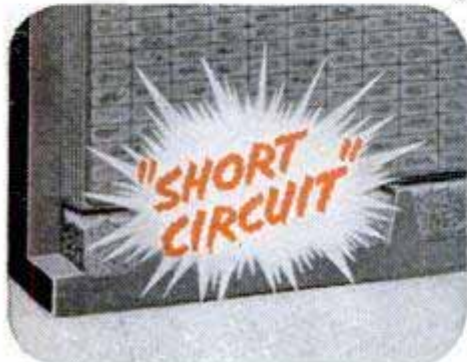

4. so particles pile up and short circuit plates, causing failure.

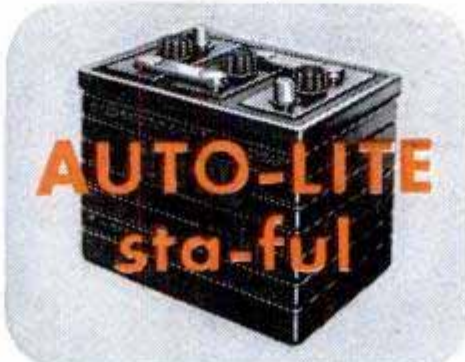

5. But in the Auto-Lite "Sta-ful" Battery, every positive plate has a Fibre-glass retaining mat protecting it . . .



6. to hold the active materials in place to reduce shedding and flaking.

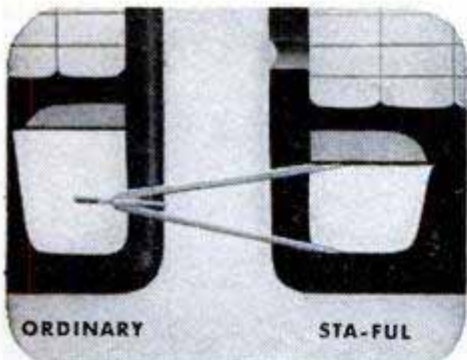

7. Side-by-side view shows that the Auto-Lite "Sta-ful" Battery doesn't need the extra space at bottom that ordinary design batteries do. So extra space . . .

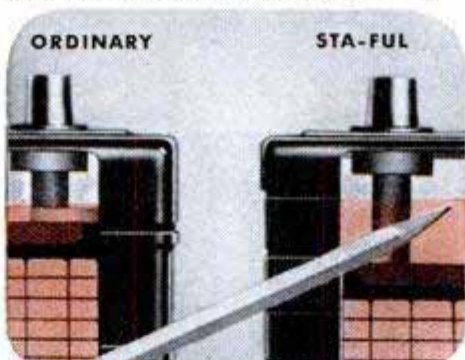

8. in "Sta-ful" Battery is moved to top where it holds more electrolyte, giving room for over 3 times the liquid reserve in the "Sta-ful" as in ordinary batteries.

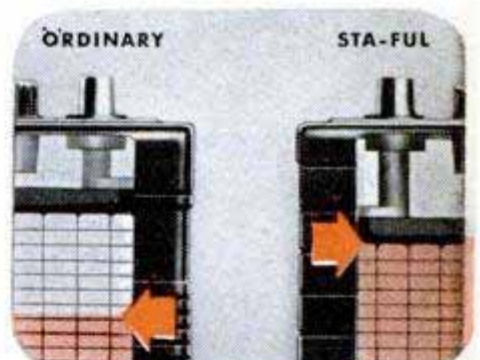

9. Here's proof of performance! Equal water evaporation shows how the Auto-Lite "Sta-ful" extra reserve keeps plates covered and active.

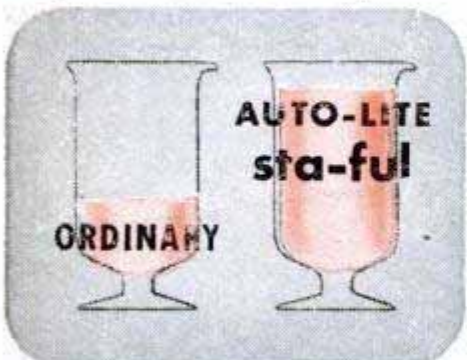

10. That's why "Sta-ful" needs water only 3 times a year in normal car use. Auto-Lite "Sta-ful" Batteries give longer life, too, in tests conducted according to minimum life cycle standards.

**AUTO-LITE BATTERY CORPORATION**  
Toledo 1 Ohio

**AUTO-LITE**  
**sta-ful**  
*...needs water*  
*only 3 times a year*  
IN NORMAL CAR USE

# Developing, Printing, Enlarging ... a fascinating hobby

**So easy to begin, too—and inexpensive**

**D**ID YOU KNOW that Kodak offers a complete printing kit for only \$4.95 (see opposite page)—that for this small amount you can have the thrill of making prints from your own negatives? Taking the picture is really only half the fun. Developing and printing can double your enjoyment from photography. And for less than \$50 you can acquire a fine enlarger that will let you select the ideal portion of your picture ... eliminate unwanted areas ... make the final print even more than what you hoped for when you clicked your camera shutter.

On these pages you see just a few examples of a wide choice of equipment now on display at your Kodak dealer's. He will be glad to start you off right and help to keep you within your budget.



Easy to set up—Simple design gets the "Hobbyist" into action fast.



Rotary negative carrier—Open-frame, open-hinge type. Loads quickly.

**Complete enlarger — less than \$50.** The Kodak Hobbyist Enlarger uses cold-light illumination—perfect protection for negatives. Only reflected light reaches negatives. Integrating-sphere lamphouse, together with specially created interior reflective coating, results in even light distribution. Newly designed negative carrier loads easily. Knobs are provided for locking both elevation and focus. Enlarges up to 7 times. Kodak Enlarging Ektanon Lens, 89mm.,  $f/6.3$ , helps produce crisp, sharp enlargements. For negatives through  $2\frac{1}{4}'' \times 3\frac{1}{4}''$ . \$44.

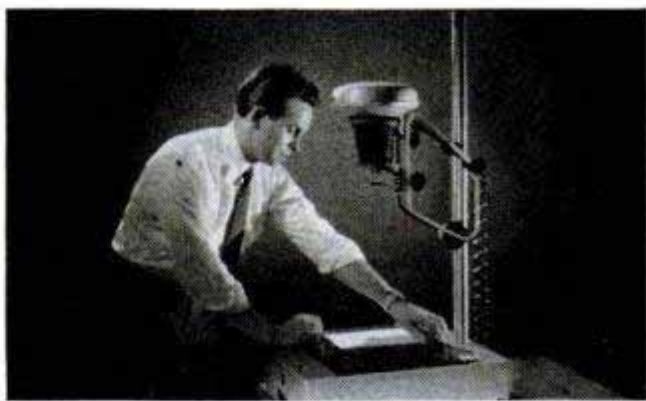

**Fine, versatile enlarger—the Kodak "Flurolite"**—\$99.50 (without lens). Advanced design ... integrating-sphere light source for even illumination ... easy-loading rotary negative carrier. Focusing and elevating knobs may be used at the same time. With accessories, the  $2\frac{1}{4}'' \times 3\frac{1}{4}''$  "Flurolite" quickly converts for copying and many other uses.

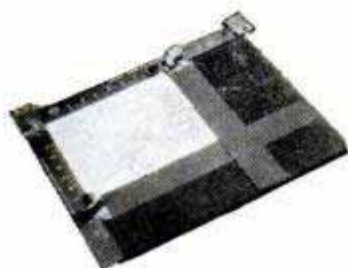

**Eliminate unwanted areas in enlargements—**Select ideal portions with the help of Kodak Masking Easel,  $11 \times 14$ . For use with any vertical enlarger. Can be adjusted for  $\frac{1}{4}''$ - to  $\frac{3}{4}''$ -inch margins. \$9.60.



**Everything you need for printing—Kodacraft Printing Kit** contains rocker-type trays, printing frame, paper, graduate, Kodak Tri-Chem Pack, thermometer, stirring rod. \$4.95.



**For developing and printing—Kodacraft Photo-Lab Outfit** includes printing frame with masks for popular negative sizes, Kodacraft Roll-Film Tank, other essentials. \$8.75.



**Includes metal printer—Kodacraft Advanced Photo-Lab** offers complete developing and printing equipment. Everything can be packed in printer for handy storage. \$14.10.



**Converts ordinary tray into effective washer—Kodak Automatic Tray Siphon.** Washes prints and films automatically. Hypo-laden water is siphoned out as fresh water enters. \$4.50.



**Kodacraft Roll-Film Tank (left)** is easy to load, pour; holds 16 oz. of solution. After loading, it can be used in lighted room. Includes aprons for 620-120, 616-116, and 127 films. \$2.53. **Kodacraft Miniature Roll-Film Tank (right)** permits simultaneous development of two rolls of 35 mm. film or Bantam-size film (828). \$2.53.



**A Safelight that adjusts quickly—Kodak Adjustable Safelight Lamp (left)** has double-swiveled shank and bracket. \$7.40. **The new Kodak 2-Way Safelight (right)** provides either direct or indirect illumination—or both. For light in two directions, simply take out removable metal panel in back and replace with a safelight filter. \$4.50.

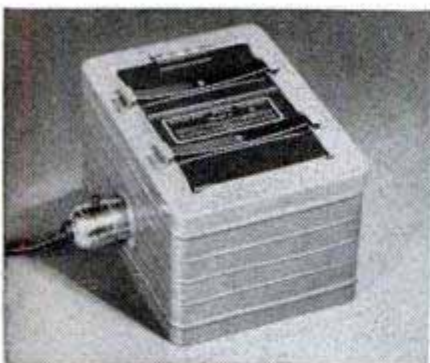

**Kodacraft Metal Printer, Model A—** accepts negatives from 35mm. up to 4 x 6 inches. Metal construction with hinged platen. An easy-to-follow folder of instructions is supplied. \$6.95.



**For timing contact and projection printing—Kodak Electric Time Control.** The printer or enlarger plugs into the control. Automatic timing 1 to 57 seconds. Repeat timing possible. \$13.50.



**Spring-wound Kodak Timer—** covers all intervals up to 60 minutes, has both minute and split-second hands. Tilting base permits adjustment to any angle. \$7.20.

Your Kodak dealer will be glad to demonstrate this equipment for you. Make his store your headquarters for all your photo needs.

*Prices subject to change without notice*



# Care and Feeding of Engines

BY S. P. CORP

## THE CASE OF THE SLOW WINDSHIELD WIPER

Most cars have a windshield wiper booster pump mounted on the fuel pump. Any time your wiper operates at less than 80 strokes per minute, check this booster pump for trouble—because such trouble can affect engine operation.

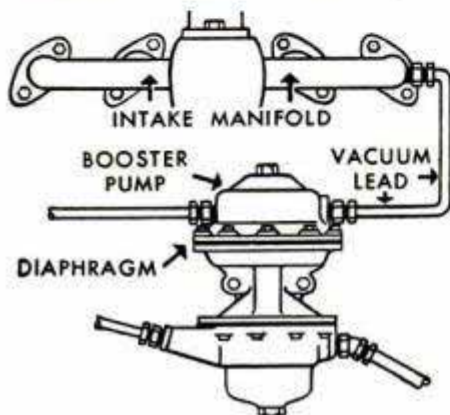

ness in the valves of the end cylinder, eventually burning the valve seats.

Remove vacuum line at intake manifold. Plug the hole in the manifold and run the engine. If engine idles smoothly (when it missed before) the trouble is in booster pump or vacuum line. If there is any trace of oil in the line, your booster pump needs a new diaphragm—because a cracked or damaged diaphragm has been causing oil waste. The oil you see has been sucked up from the crankcase and delivered to the intake manifold, to be burned with fuel.

If your windshield wiper seems slow, at any engine speed, check the booster pump!

## TEST SHOCK ABSORBERS

Shock absorber trouble can cause hard steering, pitching on turns, and hard riding. Check each corner by trying to bounce the car, holding the end of a bumper. If it bounces several times before coming to rest, the shock absorbers need attention. To remove, take off upper and lower holding nuts from rubber bushing on studs. Lock lower end of absorber in a vise, and pump up and down full length of travel. If it sticks at any point, or is hard to pull, it should be replaced. If there is no resistance, valves are leaky and it should be replaced. Normally, there should be more resistance in extending than in compressing.

## NEW FREE BOOK ON CAR CARE

Send for your free copy of the new illustrated booklet, "MORE POWER, Less Oil, Less Gas" which tells you how to keep your car running better. It also tells you all about Sealed Power KromeX Ring Sets, engineered especially to fight heat, friction, abrasion, and corrosion in late-model cars and trucks. Sealed Power Corporation, Dept. G-10, Muskegon, Michigan.

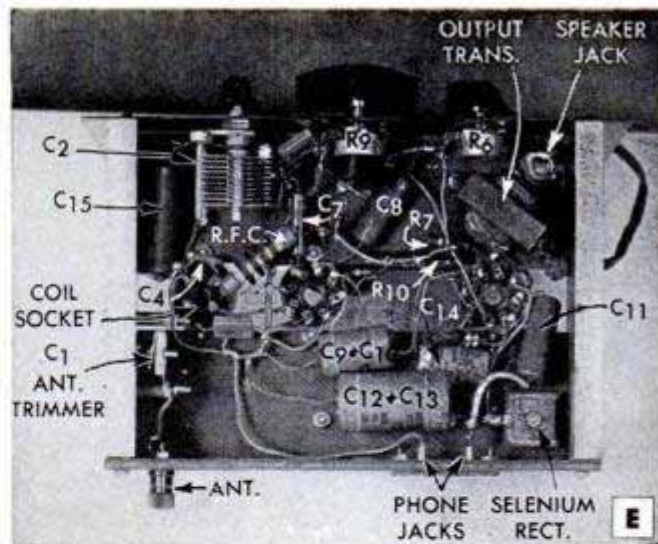

## Beginner's Two-Tube A.C.-D.C. Seven Seas Scout

(Continued from page 229)

wire solder to assure good connections.

Two sets of plug-in coils are employed: one short-wave set of I.C.A. type 1471 consists of four 4-prong coils which cover 9.5 to 217 meters; and two broadcast-band coils, I.C.A. set type 1473, cover from 190 to 550 meters. The six coils cost less than \$5.00.

For best results on both short-wave and broadcast bands use an outdoor antenna approximately 75 to 100 ft. long, especially for distant stations. However, a 20 to 40-ft. wire stretched around the room is sufficient for bringing in locals. Tuning the short-wave bands is somewhat critical and it takes patience and practice. The initial test should be made with one of the broadcast-band coils and a pair of headphones. The volume control should be set about  $\frac{1}{2}$  on, then advance the regeneration control, R9, until a thud or hiss is heard as the band-set condenser, C2, is rotated. This is the critical point of oscillation. Adjust the antenna trimmer condenser, C1, for maximum capacity (widest opening) possible while maintaining the critical oscillating point over the entire band. After this adjustment, turn R9 down to the point where the whistles and oscillations stop. This is the point of maximum sensitivity and clarity for music and speech. Short-wave and amateur stations occupy a small space on the band-set dial. After the band is located, use the band-spread condenser, C3, as it spreads these short-wave stations out for easier tuning. Turn C3 very slowly; a vernier tuning knob can be added to this dial if desired. Any small PM speaker can be plugged into the open-circuit speaker jack. Detailed student material list R-413 is available from Popular Mechanics Radio and Electronics department upon receipt of ordinary letter postage. ★ ★ ★

# Don't put in a drop of Anti-freeze

... until you've cleaned out rust with



## DU PONT Cooling System CLEANSER

**It's a safe, easy way to prevent  
clogged radiators that waste anti-freeze,  
cause trouble and expense**

Now, before freezing weather sets in . . . before you put in anti-freeze . . . it's time to clean out your cooling system. **Du Pont Cleanser** makes the job safe, simple and thorough. You can even let the cleanser work while you're driving. And neutralizer is included in the can for a complete job. Du Pont Cleanser removes all rust—*without reverse flushing*, without fuss. Get an economical can at your service station or auto supply store today.



Insure against leaks that waste anti-freeze with  
**DU PONT COOLING SYSTEM SEALER**

Don't let radiator leaks rob you of anti-freeze. Seal it in with **Du Pont Cooling System Sealer**. Even when the cooling system is apparently watertight, many permanent anti-freezes will "creep" and be lost by seepage through tiny pinholes. Such leaks are stopped immediately by Du Pont Sealer. It's simple to use, flows with the water and can't clog, or harm hose or metal parts.



**BETTER THINGS FOR BETTER LIVING  
... THROUGH CHEMISTRY**

# Here's how for home painters



**Wire handles cut your hands?** Slit a piece of garden hose, slip it on the handle. Result: a comfortable hand grip. Another neat trick when repainting your house: use Devoe's new Wonder-1-Coat House Paint and get 2-coat protection and beauty in just one coat.

**Protect "almost-dry" surfaces.** Use wax paper on newly painted floors or stairs that may be tacky after initial drying. The wax film is harmless to the paint. When painting your floors, use Devoe's Floor and Deck Enamel. It dries quickly to a tough finish.



**Stored for quick identification.** If the paint in a can isn't all used, make a paint mark on the outside of the can to show level of what's left, and what the dry color looks like. With the Devoe Library of Color system you can always find the exact color you want.

**Avoid spattering and dribbling.** When pouring from a gallon container of turpentine, hold the can with the spout at the top! Then the air enters freely above the liquid and the stream is steady and easy to control. Not many people know this trick.



You can get all the painting accessories that you need—and many more helpful tips at the sign of the Devoe Diamond. Why not stop in and see your Devoe Dealer very soon? You'll find his name listed in the Classified section of your Phone Book.



## Clinic for Homemakers



As a service to our readers in solving the hundreds of problems pertaining to a home—inside or out—the editors of *Popular Mechanics* invite you to present your problems to The Clinic Editor for help and advice. Address your questions to The Clinic Editor, *Popular Mechanics Magazine*, 200 East Ontario Street, Chicago 11, Ill.



### Installing Outlet Box

**Q**—I wish to install an electrical outlet in a wall just above the baseboard. I believe the plaster has been applied over wooden lath as the house is quite old. How does one locate studs and determine beforehand if there are obstructions in the wall? How is the box fastened in place after the opening is cut?

G. M., Calif.

**A**—The studs are located easily by tapping the wall lightly with a hammer. Spaces between studs will give forth a hollow sound when the plaster is tapped, but when a light blow is struck directly over a stud the sound will be more sharp and metallic. After locating the studs, determine the desired location of the outlet box and mark its position on the wall. Cut through the plaster with a cold chisel on the pencil lines outlining the box. Then remove the plaster and expose the lath. Cut through the lath with a keyhole saw, being careful to keep the cuts within the outline. In some cases it is possible to cut the lath so that the box can be attached directly to them but a better way is to use special metal box supports made for the purpose. Insert these through the opening and bend the tabs down so that the supports do not drop inside the wall. Connect armored cable to the box and position it in the opening, adjusting the mounting brackets to bring the box flush with wall surface. Then pull the supports tightly against the inside wall surface and bend the tabs of both supports tightly over the edges of the box. Homeowners who make installations of this type should be sure that they are thoroughly familiar with the requirements of local electrical codes.

### Concrete Drain Keeps Garage Dry

**Q**—My garage is built into a slope, the rear of the floor being about 6 in. below grade. Frequently water seeps through the wall and spreads over the floor. What should I do to prevent this?—P. T., Ill.

**A**—It would seem that the simplest thing to do would be to dig a shallow channel or trench at the rear wall along its entire length, sloping the trench in each direction from the center. Pour about 3 in. of concrete into the trench and trowel smooth to a concave surface to form a drain channel. This will carry away any surface water that drains from the slope. In some cases it is possible to form a grassed waterway by first removing the sod in squares. Then dig a trench to a depth of 3 to

(Continued to page 240)



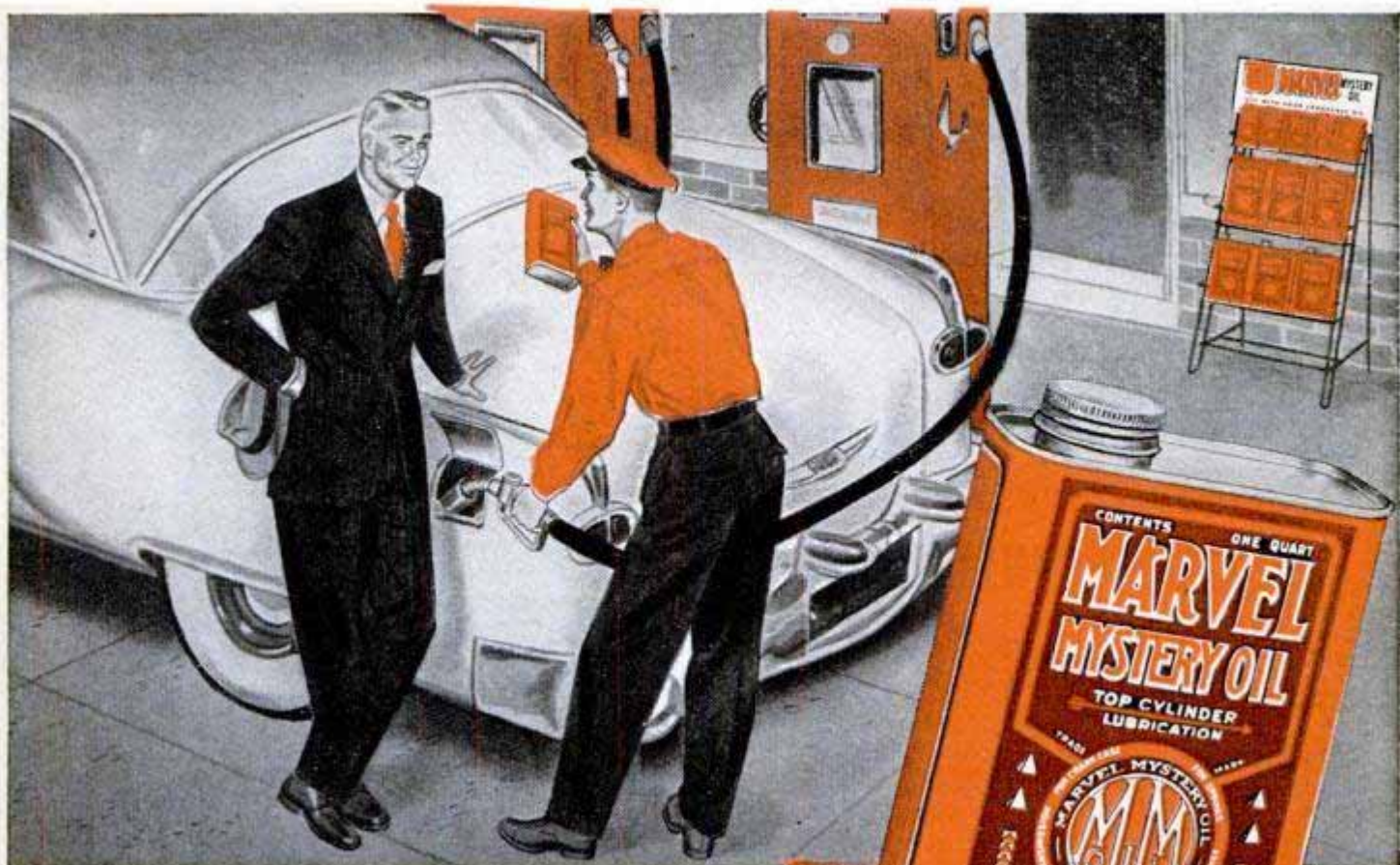

## Make Friends with Marvel!

**Y**OU PULL UP to a gas pump, face glum. Gas again! This bus sure isn't delivering miles per gallon. You ask the station attendant what's wrong, thinking, "Here it comes. The big service repair bite . . ." The man surprises you. He takes a can of Marvel from the rack. "Chances are", he says, "there's *nothing* wrong with your car Marvel won't clean up in a jiffy."

This you've got to see! You let him pour a can of Marvel into the crankcase and gas tank. You slip behind the wheel, turn the ignition, step on the gas . . .

**ZOOM!** New power . . . new pleasure . . . new smoothness . . .

Marvel is a specially developed lubricant for today's high compression engines. It goes to work immediately, sending a strong, tough, heat-resistant film of oil to all moving parts. Eliminates hydraulic valve clatter . . . provides ring seal . . . cleans, cools, and protects bearings and vital upper cylinder areas. Marvel puts "guts" in your engine. You get a faster pick-up . . . more engine hours per dollar . . . many more miles of smoother, more efficient driving.

Try a can of Marvel in your engine today See if your car doesn't run better, longer . . . right from the start.



Install a Marvel Inverse Oiler for direct lubrication to the heart of your engine. Feeds in direct proportion to horsepower curve through inverse ratio to manifold vacuum. No other oiler works on this principle! Fully adjustable. Easy to install. Fully guaranteed.



MARVEL MYSTERY OIL...THE MECHANIC'S CHOICE FOR THIRTY YEARS

**EMEROL Mfg. Co., Inc.**

Dept. 122, 242 W. 69th Street, New York 23, N.Y.

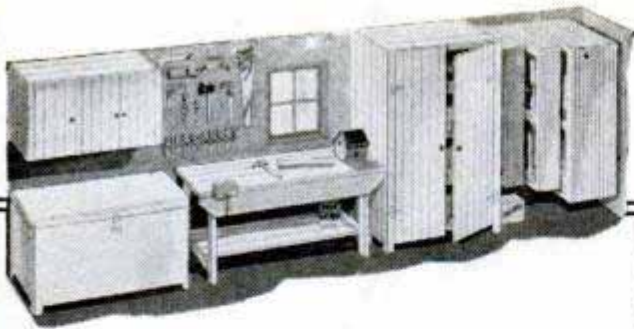

## One of 6 New Garage Designs with Extra Storage Space

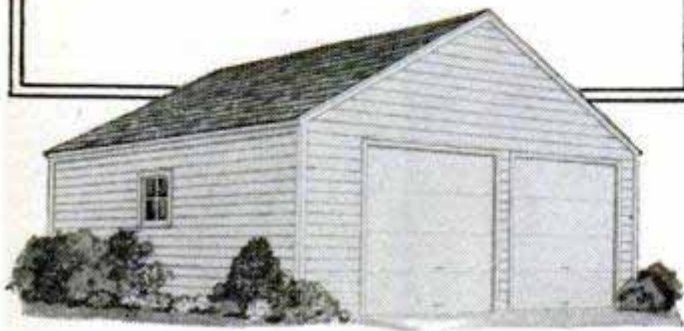

"Garage-plus-storage" is the new trend in garage design. Now it's easy to erect the garage you need to include extra space for extra storage room.

Weyerhaeuser offers 6 basic plans for single and double garages which can be expanded to include a variety of arrangements for extra storage space and cabinets.

With complete blueprints and material lists covering the structural and storage features, these garages can be erected quickly with Weyerhaeuser 4-Square Lumber. Write for folder illustrating and describing all 6 garages and storage features, or see your local lumber dealer.

### Weyerhaeuser Sales Company

2001 First National Bank Bldg., St. Paul 1, Minnesota

● Please send details on your "garage-plus-storage" plans.

Name \_\_\_\_\_

Address \_\_\_\_\_

Town \_\_\_\_\_ Zone \_\_\_\_\_ State \_\_\_\_\_

5 in., sloping it each way from the center as before. Then replace the sod, pressing the squares into close contact with the soil underneath. Water the resodded area periodically at intervals of several days.

### Moving Shade Tree

Q—We have an elm tree growing at one corner of the lot on which we recently built our new home. The tree is between 7 and 8 in. in dia. through the trunk. Apparently it has grown out of the center of a mound of earth about 3 ft. high and we are fearful that as the tree grows older it will die. Should we cut it down or move it to another location? — W.E., Mo.

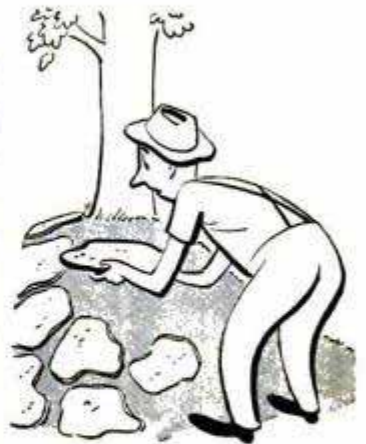

A—Leave the tree where it is, at least for a time. Any shade tree, especially the hardy elm, adds to the value of the homesite. The tree in question is not likely to be affected by a lack of moisture in the mound or the surrounding topsoil, as its roots will seek moisture deep in the subsoil. In this case they will likely go even deeper than normal because of its location. We suggest that you slope the sides of the mound more or less uniformly and cover the soil with flat stones laid in a hit-and-miss pattern with 2 to 3-in. spacings between the stones. There are a number of perennial rock plants which will thrive in such a location. These can be planted in the spaces. Try to arrange the stones so that they will act as terraces to prevent the soil from washing away before the plants strike root. Small pieces of burlap also can be used to prevent soil from washing.



### "Transparent" Painting

Q—I have an old-style dresser, which is made of oak and, although it now is fairly dark-colored, I believe it was originally finished in the natural color of the wood. I'd like to refinish it in blond color, but I don't know how to apply finishes of the type I see on new furniture built of oak and other woods. How is it done?—T.D., N.Y.

A—The degree of success you have in applying the so-called blond finish will depend to some extent on the type of finishing materials used on the piece originally. If you are sure that the wood is oak (some old pieces of this type were made of chestnut or ash) and it has been finished in the natural color, then it should be comparatively easy to remove the old finish with a varnish remover and sand the wood preparatory to applying the new finish. Be sure that you remove all the old finish, also the remover, unless the latter is the type which does not affect new finishing materials. One simple method of attaining an attractive blond finish is to apply a thin coat of ordinary oil-base paint or a semigloss enamel in a rich cream color. Before the paint sets rub off the excess with a soft cloth until the grain of the wood shows through the coating. Allow the remaining paint to dry thoroughly, then sand lightly, dust and apply a coat of flat varnish. As a rule it is not necessary to fill wood that has been previously finished as most of the filler will remain in the wood grain. When refinishing by the method described above, the paint pigment also acts as a filler. It should be understood, of course, that this is only one method of producing the finish you desire, but we recommend it as being one of the simplest.

# Wow! What a bite!



1 The quick-starting, fast-penetrating point of the new Standard Metal Drill.

## FOR DRILLING METAL Set No. H45—High Speed Steel

A New Metal Drill with quick-starting point. 5 Drills to set, one each  $\frac{1}{4}$ " ,  $\frac{5}{16}$ " ,  $\frac{3}{8}$ " ,  $\frac{7}{16}$ " and  $\frac{1}{2}$ ". All have  $\frac{1}{4}$ " shank to fit electric hand drill or drill press. Plastic box with clear lid.

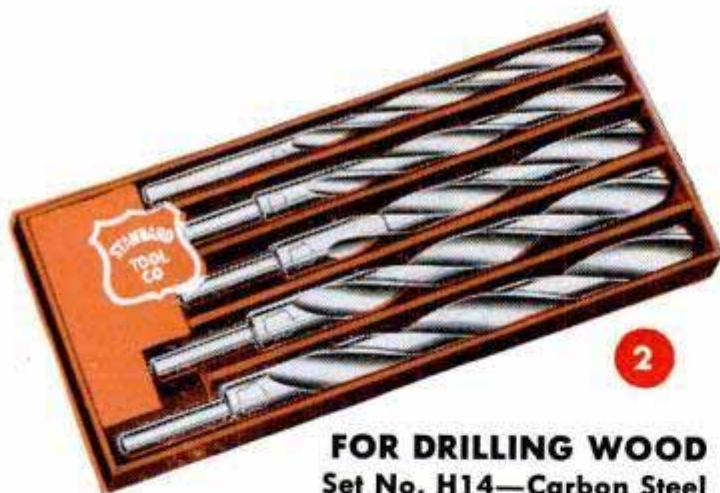

## FOR DRILLING WOOD Set No. H14—Carbon Steel

Five Drills in set, one each  $\frac{1}{4}$ " ,  $\frac{5}{16}$ " ,  $\frac{3}{8}$ " ,  $\frac{7}{16}$ " and  $\frac{1}{2}$ ". All Drills have  $\frac{1}{4}$ " shank to fit electric hand drill and drill press. Strong tray with divider protects drills. Clear plastic cover.

Quick-penetrating action from new type points makes "Standard" the best Drill to use.

Standard Drills for Metal and Wood Boring do better, faster work because of special construction.

1 The point of this drill is new in design. It starts quicker than any drill you've ever used and penetrates rapidly. A great time-saver in drilling sheet metal; equally effective in heavy stock. Drills are made of finest grade High Speed Steel—heat treated for greatest durability.

2 These new drills are designed with wide, smooth flutes to remove the chips and drill a clean hole. Tempered to avoid damage if metal is encountered in drilling.

**Buy Them at Your Hardware Store**  
Standard Shield Brand Drill Sets are now sold by Hardware Stores. Identify them by the Shield Brand—it is a guarantee of quality and satisfaction. If your dealer does not have them, send us his name. We will supply you direct on receipt of money order or check. Use the coupon below.

The best drilling equipment is no better than the drills you use in it. For best results, use Standard Shield Brand Drills.

### USE THIS COUPON

Standard Tool Co., 3950 Chester Ave., Cleveland 14, Ohio

Please send me postpaid Standard Drill Sets:

No. H45 Standard High Speed Sheet Metal Drill Set @ \$8.00 ( ) ; No. H14 Standard Carbon Steel Wood Boring Drill Set @ \$3.98 ( )

Literature on other Standard Drill Sets ( )

I enclose check or money order for \$.....

Name \_\_\_\_\_ (Please Print)

Street Address \_\_\_\_\_

City and State \_\_\_\_\_

I usually buy tools at (Name of Store) \_\_\_\_\_

Address \_\_\_\_\_

This offer good in U. S. only

# STANDARD TOOL CO.

3950 Chester Avenue • Cleveland 14, Ohio



Since 1881, makers of production cutting tools for industry. Special Drill Sets for the home craftsman and shop owner.



*Handy Hank says:*

"Try these slick tricks with **PLASTIC WOOD**"

**HANDLES LIKE PUTTY  
HARDENS INTO WOOD!**

**Fill Holes Around Pipes!**

Handy Plastic Wood seals cavities to prevent dust, drafts, bugs, mice from coming through. Has dozens of uses all through the house.

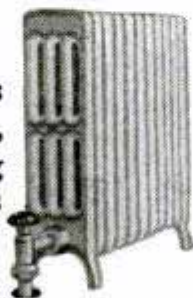

**RESET LOOSE SCREWS**

Clean and fill old screw holes with Plastic Wood. Let dry and drive screws back into place. Plastic Wood holds firmly, lastingly. Won't crack or pull away. And it's so easy! *Handles like putty... hardens into wood!*

**MEND BROKEN TOYS**

Plastic Wood sticks firmly to most common surfaces... wood, metal, plastic, fabric, plaster and composition. Plastic Wood is a real toy saver!

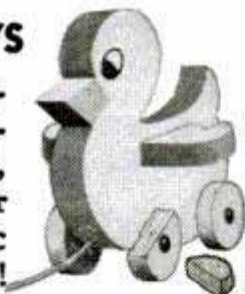

Plastic Wood makes dozens of home repairs *easy!* Can be sawed, sanded, carved or drilled. Will not chip, crack or peel. You'll want Plastic Wood Solvent, too, for controlling the consistency of the Plastic Wood, and for cleaning hands and tools.



**Jungle Diamonds to Grind Our Tools**

(Continued from page 149)

northeast of the Gabon lies the Ubangi-Shari, where Soredia's mother corporation, Compagnie Miniere de l'Oubanghi Oriental (CMOO), has been mining diamonds since 1932. This is the area from which American circuses used to import strange native women with spadelike lips, and necks elongated by wearing a succession of brass rings.

The diamonds in the Ubangi and the Gabon are found not in the craters of extinct volcanoes, where most South African diamonds are found, but in the alluvial subsoil of river beds where they were deposited in some long-past geological age. They are recovered by removing an overburden of 5 to 15 feet of mud, sand and fine rock that hides the diamond-bearing gravel.

This gravel is passed through a separator which washes it and shakes off the lighter material. The "diamond concentrate" which remains is then shipped in large metal containers to a central plant.

There the diamonds are extracted by a washing process based on the affinity of diamonds for grease. The diamonds are held by the grease while the water floats away everything else. Finally the diamonds are cleaned in a bath of sulphuric and hydrochloric acid and are ready to be classed and graded.

Camp Lopo, on a tributary of the Mambere River, is one of the Ubangi mines which is being mechanized under the MSA assistance project. The diamond-bearing gravel, found 15 feet under the bottom of the Lopo River, gives a good yield of diamonds, a relatively large share of which is of gem quality. Practically all, gem and industrial, are of good size.

Camp Lopo is fortunate also in having a large supply of modern mining machinery. The other camps are less fortunate. MSA aid to CMOO, as the Ubangi enterprise is called, began about the same time as the war in Korea. With no priorities, deliveries of machinery have been slow.

The population of Camp Lopo consists of three white men, 200 native laborers and about 350 native women and children. The

(Continued to page 244)

**You Name It!**

Here are the correct answers to the "You Name It!" photo quiz on pages 88 and 89:

1. Burned match; 2. Condensation on windowpane; 3. Face of golf club; 4. Base of pine cone; 5. Design on man's shoe; 6. Tennis-racquet gut; 7. Bottom of tablespoon; 8. Slice of cabbage.

# Fashioned for the Future...

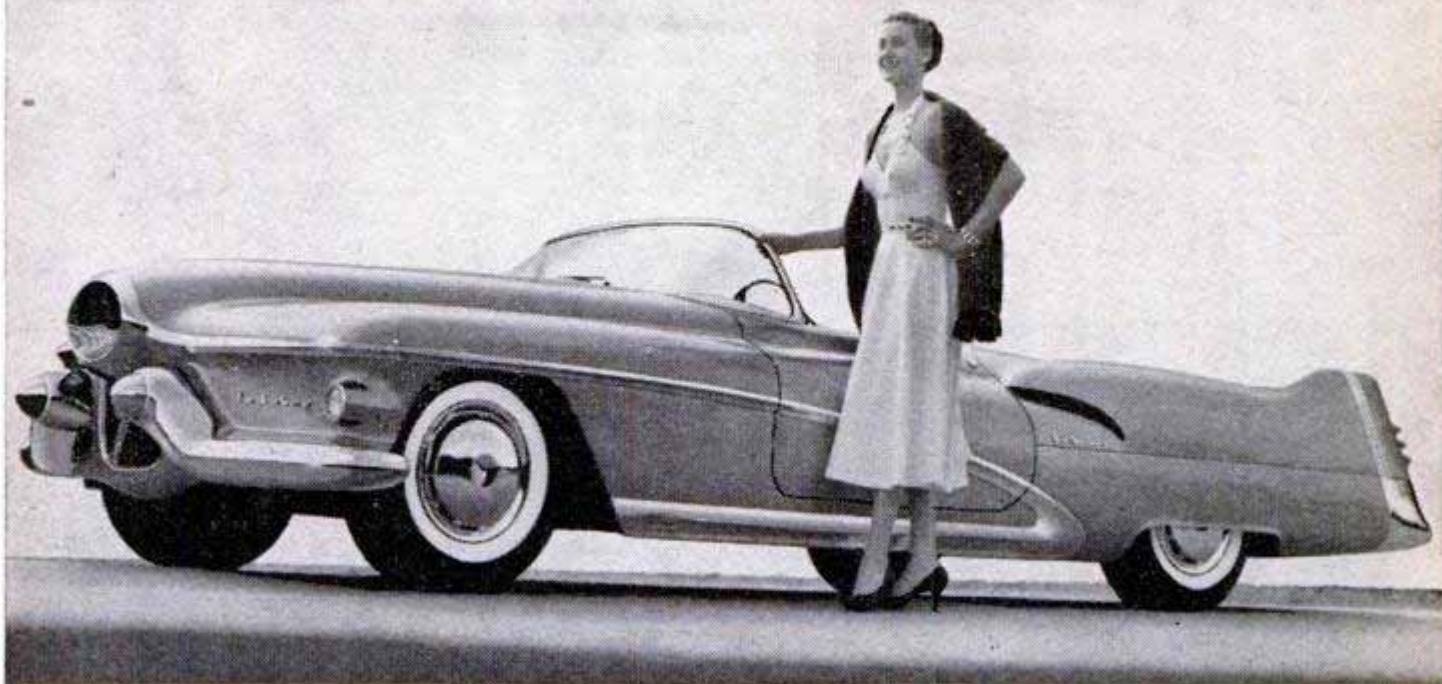

STYLED FOR THE FUTURE



FEATURES OF THE FUTURE



POWERED FOR THE FUTURE

What will tomorrow's motor car be like?

Motorists can find many indications of a very wonderful tomorrow in the spectacular General Motors experimental car—*Le Sabre*.

To spark the Le Sabre 335 horsepower engine, its designers selected AC Spark Plugs. Exhaustive tests proved that AC's patented *CORALOX* Insulator best withstood the extreme temperature and high compression developed in this high-powered engine.

What all this adds up to—for today's motoring and tomorrow's—is better spark plug performance. Insist upon ACs for your car.

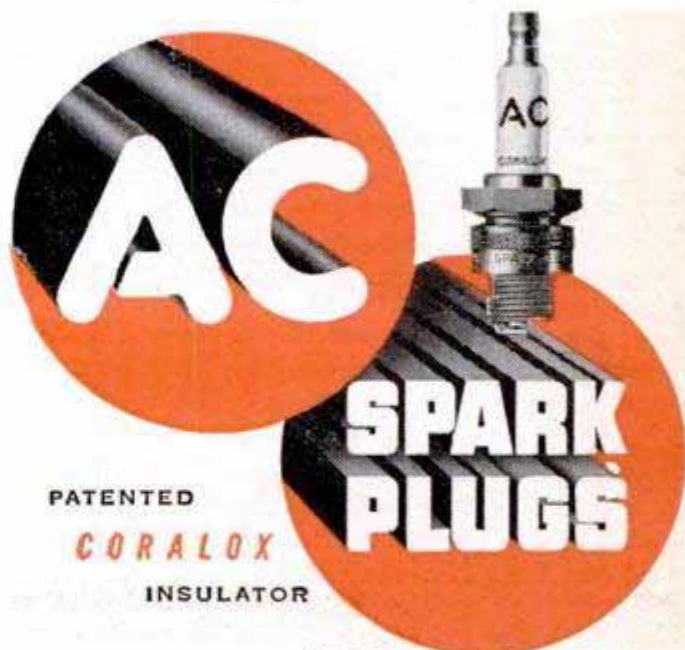

AC SPARK PLUG DIVISION  GENERAL MOTORS CORPORATION

panel a dining room...

do over a kitchen

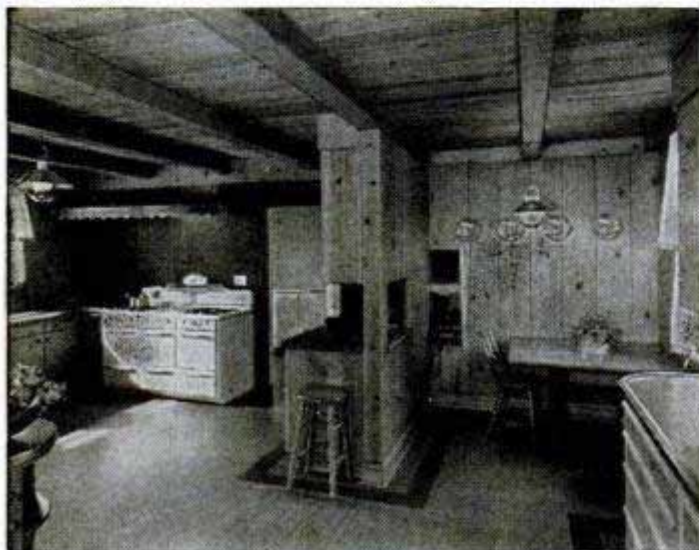

## with easy-to-work **WESTERN PINES\***

LET these lovely-to-look-at, easy-to-work and handle woods of the Western Pines\* add their own lasting beauty to your remodeling jobs or workshop projects!

Doorways, halls, walls, playrooms, kitchens, built-ins, bunk bedrooms—whatever you build or remodel, these fine-grained, soft-textured woods make your work easier, give lasting satisfaction. They can be painted, enameled, stained—or left natural; they adapt themselves to any architectural design or decoration theme.

Send today for your **FREE** copy of **NEW** colorful, idea-packed booklet, "Enchanting Homes of Western Pines." 68 pictures, many in gorgeous color, with details and suggestions for "doing it yourself" with the woods of the Western Pines\*. Write to **WESTERN PINE ASSOCIATION**, Dept. 538-N, Yeon Bldg., Portland 4, Oregon.

These are the Western Pines

- IDAHO WHITE PINE
- PONDEROSA PINE
- SUGAR PINE

natives live in traditional thatched huts. The European men live in clay-brick cottages but cannot have their wives and children with them. This is permitted in only a few central towns.

Europeans have to learn to live with the jungle itself as well as with its natives. They must become accustomed to the sweltering equatorial heat; two months of relentless rain and floods in July and August; the threat of mite-borne diseases; the war against the malarial mosquito and the tsetse fly, the bearer of sleeping sickness. The seasoned jungle hand is careful to sleep under a mosquito net. He learns that most jungle animals are harmless if left alone, but that he must be on the alert against dangerous exceptions such as the panther and the crocodile.

In the Gabon and the Ubangi, the python, which kills by constriction, is the most dangerous snake. Python skins, however, bring a good price from fancy-shoe manufacturers. It is not unusual to see python skins drying on the wall of a French engineer's cottage. The python has other uses, according to one French commissioner.

"You see," he said, explaining a slithering noise, "I have a python living between the ceiling and the roof. He's been up there two months. I used to think I'd go up and clean him out. But now we're on cozy terms. I sleep better because he keeps away the chirping bats and the singing lizards."

Some ticklish problems arise with the natives who make up the mine-labor force. In the first place, labor is scarce. Until less than a hundred years ago, the population was cut frequently and drastically by slave hunters. Native diseases, abetted by new scourges brought by the white men, now take their toll. Forty is regarded as a ripe old age.

France is sponsoring a road-building program in the area and plantations of cotton, coffee and palms increase competition for the insufficient labor supply.

CMOO has found that the best labor-recruiting officers are the native women. In the native economy, the women do the work. They plant, cultivate and harvest the crops. The men confine themselves to occasional hunting. In the mining camps this order is reversed. The men work regularly, food better than the native diet is supplied as part of the wages and it is the woman's turn to take life easily.

Each measure to improve the health or living conditions of the natives has to be introduced with care. One morning the chief foreman of one camp woke up to find every hut in the native quarters deserted. A new health measure had offended a

(Continued to page 246)



# See All That's NEW in LIONEL TRAINS And ACCESSORIES

See your Lionel Dealer for some of the biggest thrills in your model railroading life. He'll put these new Lionel masterpieces through their paces. See them in action—the newest locomotives, super speedliners and streamliners. In Pullmans, the new astra-domes and observation cars. In accessories, the new operating signal bridge, the new operating switch tower, the new operating barrel loader. See your Lionel dealer soon and see the greatest model railroad show in years.

SEE HOW YOU CAN GET THIS REAL ENGINEERS CAP EVERY YOUNG RAILROADER WANTS  
See Extra-Special Coupon Offer Below



NEW... BARREL LOADER

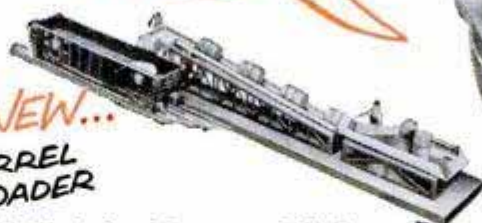

Special offer below. Extra special in box at right. Enclose correct amount and be sure to write your name and address clearly.

## SPECIAL COUPON OFFER!

LIONEL TRAINS, P.O. Box 9, Dept. U, N.Y. 46, N.Y.

- I enclose 25¢ for catalog offer below —
1. The new 36-page full color Lionel Catalog
  2. Rule Book (including signals) for Model Railroaders
  3. Model R. R. Town Building Kit—Stores, etc.

OR

- I enclose 50¢ for catalog offer above plus engineer's cap →

Name \_\_\_\_\_

Address \_\_\_\_\_

City \_\_\_\_\_ Zone \_\_\_\_\_ State \_\_\_\_\_

TWO OFFERS CHECK ONE

## EXTRA-SPECIAL COUPON OFFER!



ALL For 50¢

Official Engineer's Cap in striped denim, plus 5 R.R. insignia emblems to wear on it, together with Catalog, Rule Book, and Building Kit, all for only 50¢!

✓ Check cap size here.

Small Medium Large





## Protecting the Performance of the BUICK XP-300

As you might imagine, there's far more to this experimental car than its striking styling. For, under its graceful hood, there's a giant of an engine that is destined to change many present-day concepts of motoring performance.

*To protect the performance of its 335-horsepower engine, Buick engineers specified the exclusive use of AC Oil Filters with Aluvac Elements!*

Aluvac is the AC-developed filtering material that removes dirt particles as small as 1/100,000 of an inch from engine oil. It's unaffected by moisture, hot oil and harmful crankcase acids.

Aluvac Elements are available for almost every car. Ask for one next time your oil is changed.

AC SPARK PLUG DIVISION  GENERAL MOTORS CORPORATION

native taboo and the workers had decided to revert to the old life in the jungle. They never came back.

In the Ubangi-Shari, labor conciliation is based on a local institution called the "palabre," or "palaver." If the workers feel they are not getting their due, their spokesman goes to the chief foreman and demands a palabre. The palabre may last one or two days or more, depending on the time that is needed to agree on the issue and restore good feeling.

The palabre serves not only as a labor-relations instrument but also as a court of domestic relations. If a wife runs away with another man, the husband may demand that the company executives bring her back.

Women cause more friction than anything else. The natives do not win their wives by love, looks or prowess, but buy them from the fathers. The price, which the husband pays annually for life, booms in the mining camps. The single men resent this and show their dissatisfaction now and then with a sit-down strike. The CMOO naturally tries to persuade the men to return to work as soon as possible.

The MSA thinks its program to obtain strategic materials in Africa makes good sense—and at the same time it gives thousands of natives their first practical contact with Western civilization. ★ ★ ★

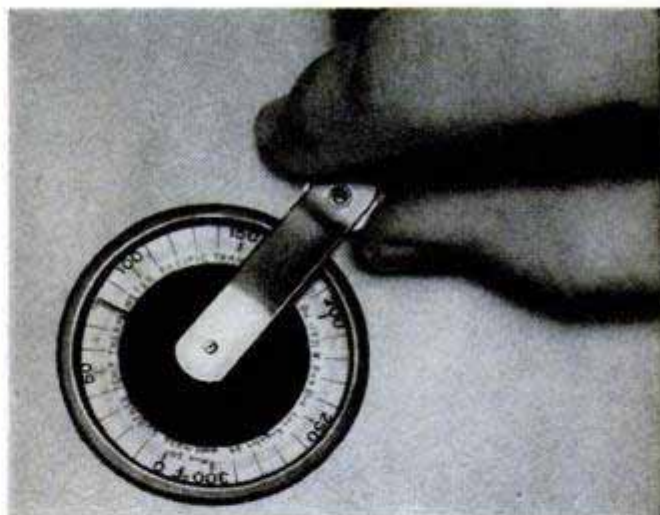

### Stick-On Thermometer

Held in place by nonmelting silicone grease, a small industrial thermometer measures surface temperatures up to 300 degrees F. It can be used on a variety of surfaces, including those of ducts, pipes, refrigerators, freezers, ovens, electric motors, floors and radiators. Graduated in two-degree units, it is accurate within two degrees, plus or minus, and weighs only an ounce. A magnetic clamp furnished with the instrument may be used to hold it in place on steel and other ferrous surfaces.



# YOU CAN HAVE

all the  
precision  
of industrial  
machine tools  
in your own  
home shop

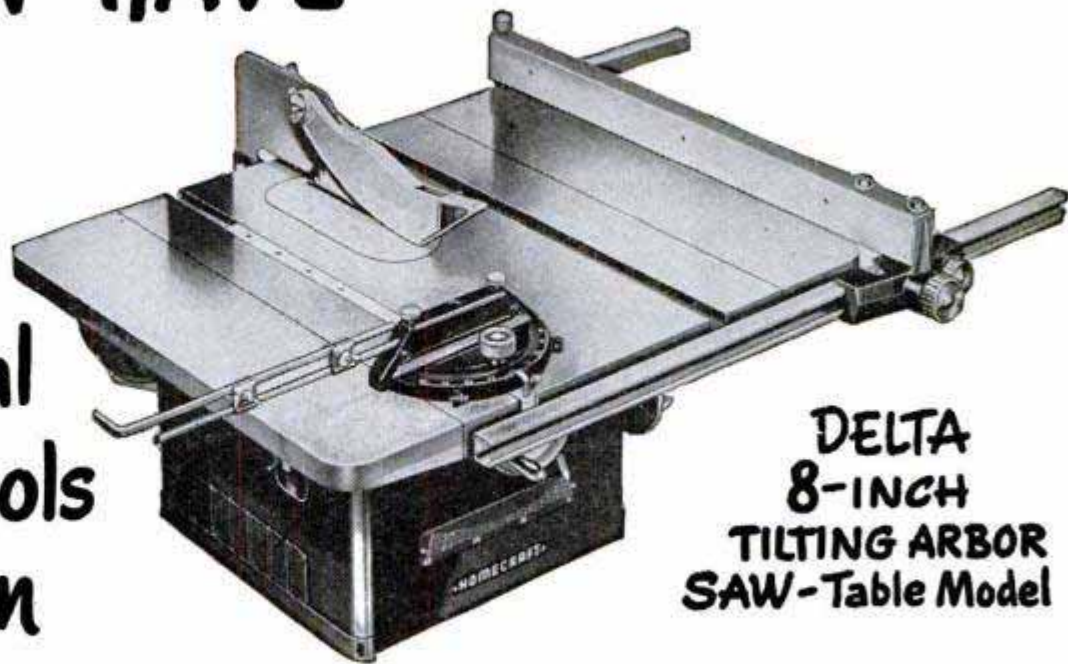

**DELTA  
8-INCH  
TILTING ARBOR  
SAW-Table Model**

Home shop work is a real joy when things come out according to plan . . . when cuts are true . . . joints fit snugly into place . . . drawers slide smoothly . . . all without the exasperating nuisance of refitting.

Of course, it takes precision machines to turn out accurate work. That's why smart folks buy Delta Homecraft Tools. For remember, Delta has spent years building the finest precision machine tools for industrial use. And the same accuracy and hair-line precision that is required for these Delta-Milwaukee Tools is built into the Homecraft Tools *you* buy. We just don't know how to build them any other way.

So . . . buy the best . . . buy Delta . . . have machine tool precision and lifetime service in your own home workshop.

*There's a Delta Power Tool for Your Job-*

WOOD OR METAL WORKING

53 MACHINES—246 MODELS—MORE THAN 1300 ACCESSORIES

For Delta Dealers, see your Classified Phone Directory under "Tools".

### *These Delta 8" Tilting-Arbor Saw Features INSURE ACCURACY AND PRECISION*

1. Lubricated-for-life ball bearings—keep dirt out, lubricant in
2. Precision-bored bearing seats—fit close, cannot become loose
3. Pre-loaded bearings—eliminate arbor end-play
4. Precision-ground arbor—assures even contact between arbor and bearings, means greater accuracy
5. Dynamically balanced pulleys—prevent wear-producing vibration

These excellent features, typical of Delta precision quality, are fully described in the new Delta Homecraft Catalog—packed full of valuable information and suggestions on how to get the utmost of fun and satisfaction out of your home workshop and your Delta Homecraft Tools. Send for your copy—it's free. Use the coupon.

<b>DELTA MILWAUKEE</b>	<b>DELTA POWER TOOL DIVISION</b>
	<b>Rockwell</b>
	<b>MANUFACTURING COMPANY</b>
502L N. LEXINGTON AVENUE • PITTSBURGH 8, PA.	
Please send me the new Delta Homecraft Catalog.	
Name _____	
Address _____	
City _____ Zone _____ State _____	

**WOODLIFE**  
The Original  
WATER REPELLENT  
PRESERVATIVE

contains

**penta**  
CHLOROPHENOL

## WOODLIFE PROTECTS WOOD

The doors, windows, flooring, shingles, siding and all other WOOD in your New Home or Remodeling Job can be protected for life against decay, termites, troublesome warping, swelling, splitting and other moisture damage! And...it can be painted! Specify WOODLIFE water repellent preservation—used by leading millwork manufacturers, applied by many lumber dealers.

**OR... buy WOODLIFE in handy containers from your lumber dealer.**

Write for FREE literature on WOODLIFE

**PROTECTION PRODUCTS  
MANUFACTURING COMPANY**

KALAMAZOO 100, MICHIGAN

send for **FREE CATALOG**

America's Foremost  
*money-making*  
**MECHANICS'  
TOOLS**

It's easy to own the same "pay-off" tools used and endorsed by America's top-earning mechanics throughout the automotive, aviation and industrial fields! Snap-on tools help you handle every repair job faster, easier, better. And they LAST... pay for themselves over and over again! Start building your own tool set now with basic Snap-on units—add others any time. Genuine Snap-on tools are never sold in stores—direct to users only. Mail coupon for free catalog.



**Snap-on Tools**  
THE CHOICE OF BETTER MECHANICS

**SNAP-ON TOOLS CORPORATION**  
8062-J 28th Ave., Kenosha, Wisconsin  
Send me free catalog of Snap-on tools.

Name \_\_\_\_\_  
Address \_\_\_\_\_  
City \_\_\_\_\_ Zone \_\_\_\_\_ State \_\_\_\_\_

## Johnny Applesseed Hires a Mechanic

(Continued from page 162)

Here's where the sky is the limit on ideas. One grower made his pneumatic lift out of war-surplus retractable-landing-gear cylinders. Another sends his men and their pruning guns up and down on a platform built over the hydraulic hoist from a filling station's outdoor greasing rack.

After pruning comes cleanup, formerly a tedious hand job. Here, too, hydraulic methods have stepped in. An old-fashioned dump hayrake is attached with braces to the side of a tractor which circles the rake around under each tree. Its hydraulic lift deposits the branches in a windrow between the tree rows. It's followed by a second tractor with a hydraulic-run buckrake mounted in front. The long, flat teeth sweep up the windrows and bring the brush to a safe spot chosen for a jumbo bonfire.

Apples can't stand big winds, which can kill trees in winter, uproot them or throw an apple crop to the ground. Latest solution is the "installment plan" windbreak used at Arthur B. Burrell's orchard in Peru, N. Y. He set out double rows of protectors—Lombardy poplars and red pines side by side. The speedy poplar grew 60 feet tall in 15 years. They aren't a long-lived species but when they're gone, the slower, more permanent pines will be ready for sentinel duty against wind.

With spring starts the spraying and the dusting; 12 to 15 times each fruit tree is fully covered against leaf-eating insects, fruit-ruining worms and fungus diseases.

Another of Holbrook's workshop products is the double-barreled spray gun he adapted from standard equipment. Its lower line has 10 nozzles for "shotgun" spraying. Turning a handle switches to the upper, single-jet line for spotting work.

When Holbrook's spray machine moves through the orchard, there aren't any missed branches. The rig itself carries four automatic nozzles on each side. For limbs higher and farther away, an aluminum tower was welded on and it carries two "sharpshooting" men, each with a double-barreled gun. For good measure, the tractor driver himself mans a swivelling spray gun used low on trees and around corners.

Even the apple itself has changed in recent years, and plant breeders already list over 7000 varieties. Old favorites have been pushed out by newer varieties like Baldwin. But its trees weren't hardy enough in winter, and McIntosh came down out of Canada to become the most common apple of today—with new rivals popping up every year to promise something even better.

★ ★ ★

# HOW TO PROTECT YOUR HOME

## for years to come!

It's *wood* that gives warmth and livability to your home. And wood windows, doors, porches and flooring—all last longer and stay better looking treated with protective PENTA solutions.

PENTA safeguards against rot, decay and termites. Available in water repellent solutions, it helps your woodwork resist swelling and warping, providing an excellent surface for painting.

When you build or make repairs **BE SURE**—buy PENTA protected lumber. You can buy and apply PENTA solutions yourself . . . also available in handy one and five gallon cans from your lumber dealer. Protect the value, protect the appearance of your home—protect with PENTA!

THE DOW CHEMICAL COMPANY  
MIDLAND, MICHIGAN

penta\*  
protected  
against termites  
and decay



This picnic table will provide pleasure for years to come because it is protected by a PENTA solution—safe from decay and rot. Fences, porches, garages, trellises will last years longer. Wherever you use wood—you need PENTA!



PENTA protects framing lumber against termites and decay, protects the very foundations of your house—rafters and roofing, joists and plates, sills and subflooring. Water-repellent PENTA solutions also minimize warping and swelling—prime causes of plaster cracks and sticking windows and doors. Exterior use for windows, doors, trim and porches helps them resist decay for better appearance and easier upkeep.



see your lumber dealer

for PROTECTIVE

# penta\*

**SOLUTIONS**

THE DOW CHEMICAL COMPANY, DEPT. PE 55, MIDLAND, MICHIGAN  
Please send FREE information on PENTA, the clean wood preservative.

NAME \_\_\_\_\_

ADDRESS \_\_\_\_\_

CITY \_\_\_\_\_ STATE \_\_\_\_\_

**DOW**  
\* penta  
CHLOROPHENOL

**NOW AVAILABLE  
TO YOU...**

# THE FABULOUS REVOLUTIONIZED

Easy to convert old or even worn out tools into costly carbide tipped tools for modern hi-speed, close tolerance production at a fraction of the cost of new tools with these sensational conversion kits.

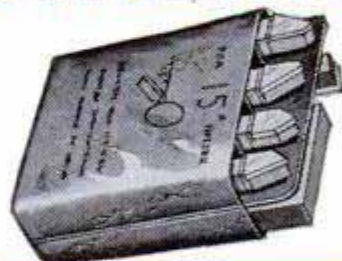

**KIT  
#1**

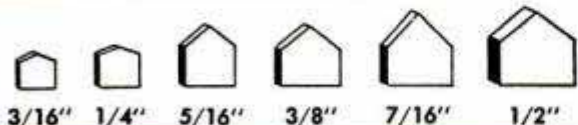

**TUNGSTEN CARBIDE MASONRY DRILL KIT.** Make your own fine Masonry Drill set from old carbon twist drills, broken masonry drill or any round or hexagon rod with this complete kit of six genuine tungsten carbide tips. Comes complete with instructions, Brazing alloys and Flux. **YOU CAN MAKE TOOLS VALUED AT OVER \$12.00 FOR ONLY \$2.50**

**KIT  
#2**



**TUNGSTEN CARBIDE METAL FORM TOOL BIT SET.** Five tips, complete with instructions for tipping your present tools or making new tools from easily obtainable bar stock. You couldn't begin to buy such tools for the low cost at which you can now make your own. Includes Brazing alloys and Flux. **COMPLETE KITS ONLY \$1.95**

**KIT  
#3**



**TANTUNG WOOD AND PLASTIC TURNING TOOL KIT.** You can make the world's finest wood and plastic turning set from your present set—or from easy-to-obtain bar or pipe stock—with this 5 piece set. Comes complete with instructions. Brazing alloy and Flux. Tools of this quality would cost you over \$25.00. **MAKE THEM YOURSELF FOR ONLY \$3.75**

**KIT  
#4**



**MAKE-YOUR-OWN SMALL TOOL KIT.** One Tungsten Carbide rod approximately 1"x1/8" and one 2" by 1/8" diameter with which to make a host of wonder-working small tools. Easy-to-obtain rod makes unexcelled tools for marking, engraving, or Etching on hardest steels, porcelain, enamels or glass. Tip old prick punches. Make small turning and boring tools, guides, rollers, etc. Complete with instructions, Brazing alloy and Flux. **ONLY \$1.95**

**KIT  
#5**



**TANTUNG.** Consists of a bar of genuine VASCOLOY-RAMET Tantung 5/16" square by approximately 3" long plus a bar of Tantung 1/4" square and approximately 3" long to fashion priceless tools by making tips for your own old tools, solid form tools, chisels, etc. A platinum colored, jewel-like metal. Non-corrosive. You'll find unlimited uses for it in tool-making. **ONLY \$3.95**

**KIT  
#6**

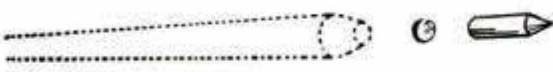

**TUNGSTEN CARBIDE LATHE AND GRINDER CENTER TIPS.** Easily brazed onto your old centers—or you can make your own! This genuine Tungsten Carbide Lathe and Grinder Center Tip insures longest trouble-free accurate work. 1/4" by 7/16" Complete with instructions, Brazing alloy and Flux. **TIPS ONLY \$1.70 each**

**KIT  
#7**



**COMPLETE TOOLS FOR THE FIRST TIME.** The finest metal forming tools the world has ever seen. Five tools plus handy silicon carbide hone in beautiful plastic case, 1/4" Shanks consisting of Threading, Round nose, rt. and lf. facing or turning and general purpose tools. Precision ground, diamond lapped. Designed to operate in regular tool holders without adjustment. **ONLY \$4.95**

**KIT  
#8**



**STANDARD PRODUCTION TOOLS — TUNGSTEN CARBIDE**  
Choice of five different styles—four different sizes. When ordering give sizes and style wanted—state whether for steel or other materials.

STYLES	SIZES	PRICE
THREADING #8A	5/16"	\$1.95
ROUND NOSE #8B	3/8"	\$2.50
RIGHT FACING #8C	7/16"	\$3.00
LEFT FACING #8D	1/2"	\$3.50
GENERAL PURPOSE #8E		

**KIT  
#9**



**WORLD'S FASTEST BORING MASONRY DRILLS**  
Ejects all dust from even the deepest hole. Never before such speeds for drilling concrete, brick, marble, tile, stone.

WHEN ORDERING	No. 9A 3/16"	\$1.80	No. 9D 3/8"	\$2.15
GIVE BOTH NO.	No. 9B 1/4"	\$1.80	No. 9E 7/16"	\$2.40
AND SIZE	No. 9C 5/16"	\$1.95	No. 9F 1/2"	\$2.70

**KIT  
#10**

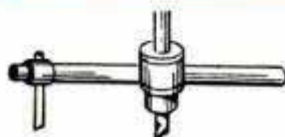

**A TIME SAVER TOOL SPECIAL!** Genuine Carbide tipped Circle Cutter. Cuts the toughest metals, fibres and plastics with unbelievable speed and ease. Circles from 1" to 5" and 3/4" deep. Has 1/4" shank—a fine precision tool. **SOLID CARBIDE CUTTING TIP ONLY \$6.50**

# CARBIDE TOOLS THAT HAVE PRODUCTION!



## XL BOND GRINDING WHEELS

Due to the extreme hardness of Tungsten Carbide, regular grinding wheels will not adequately grind or sharpen your new Carbide tools. Until only recently, most Carbide grinding had to be done with fantastically costly Diamond wheels. Now a recent achievement of the Chicago Wheel and Mfg. Co. makes available to you a Silicon Carbide Grinding Wheel that closely approaches the performance of a Diamond Wheel—at a fraction of the cost. These Grinding wheels may be purchased with your Kit and Tools.



Specify whether for Carbide or Tantung.

**XL-CARBIDE RECOMMENDED FOR CARBIDE**  
**XL-TANTUNG RECOMMENDED FOR TANTUNG**

4" x 1/2" WHEEL ONLY .....	\$1.75
5" x 1/2" WHEEL ONLY .....	\$2.50
6" x 1/2" WHEEL ONLY .....	\$3.00
7" x 1" WHEEL ONLY .....	\$4.90

**Deluxe Tapered Cone Wheel for Precision Finishing**  
 4" CONE WHEEL .....



## BERNZ-O-MATIC BLOW TORCH

The handiest torch on the market. Ideal for brazing your tool tips. Instant heating propane gas torch — no priming or pumping. Pencil-flame type for concentrated heat in medium and light soldering, metal working, brazing, etc. Burns in any position at 2300°F. Throw-away cylinder lasts up to 15 hours burning time. Fits in any tool box; 10" long, 2 3/4" dia. Complete with loaded cylinder ready to operate. Be sure to order extra cylinders of Propane Gas fuel.

Torch \$6.95 — Replacement Cylinders \$1.95 ea.

All Carbides and Tantungs Used on Time Saver Tools are of the World's Finest Vascoloy-Ramet All-Purpose Grade

## TIME SAVER TOOLS, INC.

DEPT. 210, MUNDELEIN, ILL.

By special arrangement with the world famous American Technical Society of Chicago, TIME SAVER TOOLS is able to offer the first authoritative text book on carbides designed to supply the man at the machine, the vocational student, the designer, and the engineer with a wealth of practical knowledge on carbide tools. Presented in understandable form for ready reference.

416 pages.

283 illus.

Washable

Cloth Binding

Price \$5.50

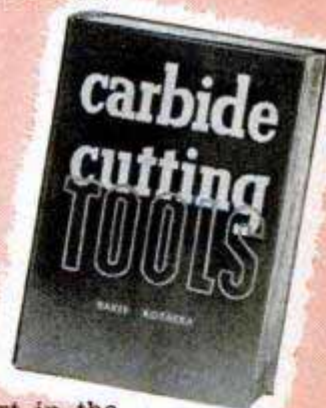

Become an expert in the use of carbide cutting tools. Text Book covers Converting to Carbides, Tipping a Carbide Tool, Grinding Single Point Tools, Carbide Tool Design, Cutting Speeds, Cutting Power, Coolants and Carbide Tools, Multiple-Edge Tool Design, Grinding and Use of Tools, etc. Book will be shipped directly by American Technical Society of Chicago.

### TIME SAVER TOOLS, INC., Dept. 210, Mundelein, Illinois

Send me at once the material checked below.  I enclose payment in full.  Ship C.O.D. plus charges.

- |   |   |
|---|---|
| <input type="checkbox"/> KIT #1 @ \$2.50 ea.                  | <input type="checkbox"/> Masonry Drills—No. _____ |
| <input type="checkbox"/> KIT #2 @ \$1.95 ea.                  | Size _____ PRICE \$ _____                         |
| <input type="checkbox"/> KIT #3 @ \$3.75 ea.                  | <input type="checkbox"/> KIT #10 @ \$6.50 ea.     |
| <input type="checkbox"/> KIT #4 @ \$1.95 ea.                  | <input type="checkbox"/> XL Bond Grinding Wheels  |
| <input type="checkbox"/> KIT #5 @ \$3.95 ea.                  | XL Carbide <input type="checkbox"/> XL TAN-       |
| <input type="checkbox"/> KIT #6 @ \$1.70 ea.                  | TUNG <input type="checkbox"/> SIZE _____          |
| <input type="checkbox"/> KIT #7 @ \$4.95 ea.                  | 4" TAPERED CONE <input type="checkbox"/>          |
| <input type="checkbox"/> STANDARD PRODUCTION                  | PRICE \$ _____                                    |
| TOOLS   | <input type="checkbox"/> BERNZ-O-MATIC BLOW       |
| Style _____ Size _____  | TORCH @ \$6.95                                    |
| Steel <input type="checkbox"/> Other <input type="checkbox"/> | <input type="checkbox"/> EXTRA CYLINDERS          |
| Price \$ _____  | FUEL @ \$1.95 ea.                                 |
|   | TOTAL \$ _____                                    |

Text Book "CARBIDE CUTTING TOOLS" @ \$5.50

NAME \_\_\_\_\_

ADDRESS \_\_\_\_\_

CITY \_\_\_\_\_ ZONE \_\_\_\_\_ STATE \_\_\_\_\_

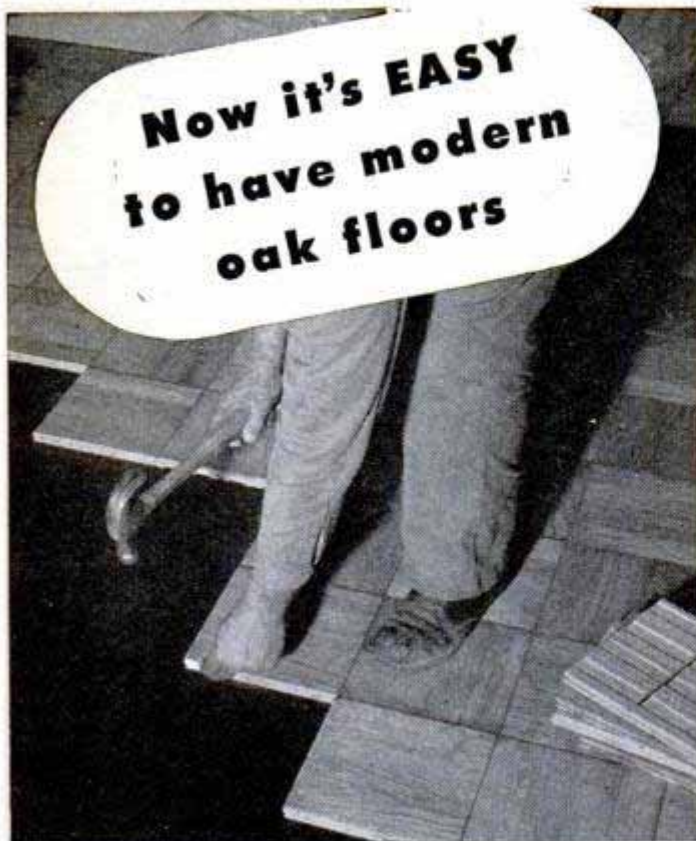

**Now it's EASY  
to have modern  
oak floors**

*Your choice of block or strip design*

## Just lay prefinished Bruce oak flooring right over your old floors... no sanding or finishing

You can give your home new beauty at low cost with a prefinished Bruce Hardwood Floor. Completely finished—even waxed—at the factory, this highest quality oak flooring can be nailed right over old floors. No sanding or finishing... no mess or smell. Ready for use as soon as laid. Made in strip or block (parquet) design.

**"Scratch Test" Finish** — The Bruce factory-applied finish is baked into the pores of the wood. The "Scratch Test" (left) will prove to you that this durable finish does not scratch or chip or mar like an ordinary floor finish.



**Moderate in cost** — A new Bruce Hardwood Floor will cost you less than a good rug or carpet. Easy to keep clean and beautiful, too. It's just the thing to use in fixing up or adding a room. Let your lumber dealer give you an estimate. Mail coupon below for colorful literature.

### MAIL FOR FREE LITERATURE

E. L. Bruce Co., Box 397-D, Memphis 1, Tenn.  
Send complete information on prefinished Bruce Hardwood Floors.

Name .....

Address .....

City ..... State .....



**Bruce Hardwood Floors**

*Product world's largest hardwood flooring maker*

## The Owners Report on the '52 Lincoln

*(Continued from page 108)*

handling in the Lincoln compared to other big cars."—Wortendyke, N. J., realtor.

"The Lincoln has what the others say they have."—Milwaukee, Wis., sheet-metal worker.

"No road 'wander' or wind noise in car at high speeds. Very fast, yet I get 20 to 22 miles per gallon in the country. Comfortable driving position. Needs about 20 horsepower more for mountain driving."—Denver, Colo., cattleman.

### 1952 LINCOLN SPECIFICATIONS

**Cosmopolitan and Capri Models**

#### ENGINE

Type ..... 90° V, 8 cyl., OHV  
Bore and stroke ..... 3.8 in. x 3.5 in.  
Piston displacement ..... 317.5 cu. in.  
Brake horsepower ..... 160  
Compression ratio ..... 7.5:1  
Transmission ..... Dual-Range Hydra-Matic drive (4-speed) standard equipment on all models

#### GENERAL

Steering ratio ..... 20.4:1  
Steering wheel, lock to lock... 5¼ turns  
Turning radius ..... 22 ft. 8 in.  
Brakes ..... Conventional with riveted linings  
Tire size ..... 8.00 x 15  
Recommended tire pressure... 26 lb. front; 22 lb. rear  
Weight (4-dr. sedan, unladen)... 4170 lb.  
Wheelbase ..... 123 in.  
Tread, front ..... 58.5 in.  
Tread, rear ..... 58.5 in.  
Height over-all (unladen)... 62.7 in.  
Width over-all ..... 77.5 in.  
Length over-all ..... 214.1 in.  
Road clearance ..... 8.2 in.

#### CAPACITIES

Oil ..... 5 qt.  
Water ..... 24.5 qt. (with heater)  
Gasoline ..... 20 gal.

#### INTERIOR DIMENSIONS

Front-seat width ... 62.6 in. Headroom, rear ... 34.7 in.  
Rear-seat width ... 62.1 in. Legroom, front ... 43.1 in.  
Headroom, front ... 36.1 in. Legroom, rear ... 41.6 in.

The questionnaires always ask what the owners dislike about their cars, and here is a cross-section of the answers:

Quite a few agreed with a San Francisco physician that the Lincoln needs more legroom in the back seat.

An East Haven, Conn., salesman expressed the sentiments of several owners: "When you buy a car in the \$4000 class, it is annoying to have people ask you how you like your new Mercury—or Ford. Lincoln should make a car to look like a Lincoln." Concurring in this complaint were others including an Indianapolis grocer, who remarked, "General Motors certainly did not make a Cadillac to look like a Chevrolet."

Some agreed with a Birmingham, Ala., manufacturer who didn't like the position of the battery beneath the floor board,

*(Continued to page 254)*

For preparing  
new  
surfaces



smoothing seams  
and  
joints



removing old paint



refinishing furniture

4 EXCLUSIVE  
FEATURES



**KING-SIZE BOTTOM PLATE**  
extends beyond body of tool  
for sanding in very close  
quarters.



**MODERN SWITCH HANDLE**  
is located close to housing for  
better control, less operator  
fatigue.



**AUXILIARY KNOB HANDLE**  
gives choice of three positions  
for ease in sanding close to  
obstructions.



**UNIQUE PAPER HOLDER**  
stays open when attaching or  
detaching paper, frees both  
hands for job.



**NEW**  
**Black & Decker**  
**Utility**  
**No. 44 SANDER**  
**only \$46.95**

- "Satin-Smooth" Finish, every time, in any direction, because tool produces small  $\frac{3}{16}$ " orbit 4250 times per minute!
- Ten Times Faster than hand sanding on wood, metal, plastics, compositions!
- Light Weight, only 5½ lbs., easy to use . . . helps even beginner do professional jobs!

**Black & Decker**  
**ELECTRIC UTILITY TOOLS**  
**PORTABLE ELECTRIC TOOLS**



**Bob Davis says:**

"Take it from a guy who cut his eyeteeth on tools, this new B&D Utility No. 44 Sander is a top buy! It's smooth-running, gives a finish like satin and it's priced below tools of comparable quality! Just attach a 3½" x 9" sheet of abrasive paper; plug it in any electric outlet (A.C. or D.C.); and you're ready for the finest finish sanding — no final hand sanding needed! When you want a real tool, not a mere toy, pick the brand the experts choose . . . BLACK & DECKER!"



**WRITE FOR FREE BOOK!**  
Packed with helpful, money-saving hints on home jobs!  
Send to: Home Service Dept.  
H10M, THE BLACK & DECKER  
MFG. Co., Towson 4, Md.

Name.....

Address.....

City & State.....

# Pointers for Home Painters Floors:

Remove wax and polish by washing floor with turpentine. Wipe dry. Unless this is done, finish coats may not dry or stick properly.



Paint in areas about four feet square. Start in far corner and work toward door. For best results use wide nylon-bristled brush—one designed for the job.



On open-grained floors, brush wood filler into pores. Rub across grain with burlap to remove excess. Let dry. Sand lightly with grain. Clean with cloth moistened with turpentine.



To store brushes for long periods, clean thoroughly and wrap securely in manner shown here. Brushes stay in better condition when they're kept in good shape.

**JOB AFTER JOB**, you'll get best results with a well-tipped nylon paint brush. Durable Du Pont nylon bristles paint smoother . . . are clean and sanitary . . . never get brittle . . . don't break off even under the roughest treatment. And nylon bristles last from 3 to 5 times longer than ordinary bristles. Leading manufacturers make nylon paint brushes in all types and sizes. Look for the name **NYLON** on the handle. Be sure to pick the size brush designed for the job . . . and demand Du Pont nylon bristles.

*150th Anniversary*



Better Things for Better Living  
... through Chemistry

The best brushes have  
**DU PONT NYLON  
BRISTLES**



There's lots of luggage space in the rear compartment, which has a counterbalanced, self-locking lid

while others went along with a Beloit, Wis., banker who complained that the ash tray is too far from the driver.

Other miscellaneous grievances:

"Noisy valve lifters and smoke coming out of the exhaust for a couple of minutes after starting. They can't fix it."—West Newton, Mass., textile sales manager.

"Two oil leaks within 5800 miles."—Teaneck, N. J., publisher.

"Find parts hard to locate. . . Dealers state they are slow in coming from factory. Very inconvenient at present. Maybe better later."—Birmingham, Ala., salesman.

"Plugs foul up at low speeds."—Bloomfield, N. J., sales manager.

"Workmanship is not comparable with that of former models. A lot of little things could be remedied. It's too good a car to be built carelessly."—Jacksonville, Fla., restaurant owner.

Several owners, such as a Perth Amboy, N. J., salesman, indicated they were satisfied with the car but suggested Lincoln change its body lines for more distinction.

A frequent observation was that Lincoln provides an unusually easy ride at high speed. "I travel an awful lot," wrote a Corpus Christi, Tex., sailor, "and this is the only car I have found that doesn't beat me and my wife at high speeds."

"The feeling that we have something solid and dependable under us at all times makes motoring a pleasure," said a Columbia City, Ind., machine-repair man.

"The 1952 Lincoln is a big improvement in the line."—Catonsville, Md., attorney.

"We have six Lincolns in my office and they all have proved satisfactory."—Indianapolis insurance agent.

A few gratuitous suggestions were received from some owners:

(Continued to page 264)



Tungsten carbide tips on all 8 teeth

# SEARS CUT PRICES Up to \$5.00 on Carbide-Tipped Saws!



8-inch blade  
Only  
**\$7.95**  
Each

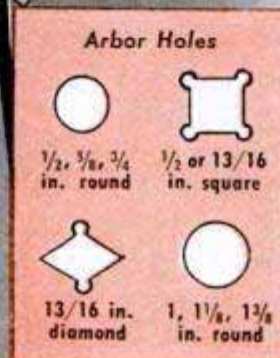

## CRAFTSMAN Carbide-tipped 8-tooth Saw Blades . . . Buy now! Regular low prices cut even lower until October 31st!

Already priced lower than other carbide-tipped blades . . . now **SALE** priced until **October 31st!** Out-performs similar blades selling for much higher prices! One of these saws—a 10-inch blade in actual service—sawed more than 27 miles of  $\frac{3}{8}$ -inch laminated Masonite without resharpening, until damaged by a steel object.

Safer 8-tooth design . . . teeth project only .020 inch above non-cutting edge. Saw can't grab—protects you from kick-back injuries! Special steel saw blade is heat treated: **tungsten carbide tipped.** Cuts faster . . . easier . . . uses less power than ordinary circular saw blades . . . generates less heat . . . needs less resharpening.

Rips, cross-cuts, miters. Cuts woods, plastics, Formica, Masonite, Transite, laminates, roofing, aluminum, etc. (Not for masonry, steel, iron, or other ferrous metals.) All sizes reduced until Oct. 31, 1952, at your nearest Sears Retail Store!

Diam.	Arbor Hole	Fits These Saws	Price
5 $\frac{7}{8}$ in.	13/16 in. diamond	6-in. Skil-saw elec. hand saw.	\$ 6.95
6 in.	$\frac{1}{2}$ in. square . . .	Mall; DUNLAP elec. hand saw	6.95
6 in.	$\frac{9}{8}$ to $\frac{1}{2}$ in. round bushed arbor . . .	Porter-Cable electric hand saw; bench saws . . . . .	6.95
6 $\frac{1}{8}$ in.	1 $\frac{1}{8}$ in. round . . .	6-in. Black and Decker . . . . .	6.95
6 $\frac{1}{2}$ in.	$\frac{1}{2}$ in. round . . . . .	CRAFTSMAN 6 $\frac{1}{2}$ -in. electric hand saw; bench saws . . . . .	6.95
7 in.	$\frac{5}{8}$ to $\frac{1}{2}$ in. round bushed arbor . . .	Bench saws . . . . .	7.95
7 in.	13/16 in. diamond	Skil-saw, and Sears former 02186 electric hand saw . . .	7.95
7 in.	$\frac{1}{2}$ in. square . . . . .	Mall electric hand saw . . . . .	7.95
8 in.	$\frac{5}{8}$ to $\frac{1}{2}$ in. round bushed arbor . . .	CRAFTSMAN 8-in. electric hand saw; bench saws . . . . .	7.95
8 in.	13/16 in. square . . .	Mall electric hand saw . . . . .	7.95
8 in.	13/16 in. diamond	Skil-saw electric hand saw . . .	7.95
8 in.	1 $\frac{3}{8}$ in. round . . . . .	Black & Decker elec. hand saw	7.95
10 in.	1 to $\frac{3}{4}$ - $\frac{5}{8}$ in. round bushed . . . . .	Bench, builders', radial, and swing saws . . . . .	10.50
12 in.	1 to $\frac{3}{4}$ in. round bushed arbor . . . . .	Radial saws, swing saws, and bench saws . . . . .	16.50

**CRAFTSMAN** and **DUNLAP** Tools by **SEARS, ROEBUCK and CO.**  
Famous for fine quality . . . precision performance . . . low price!



with 40 most  
useful accessories  
in see-thru case

**\$2995**



**GRINDS • DRILLS • POLISHES • CARVES • CUTS • SANDS  
SAWS • ENGRAVES • ROUTS on WOOD • METAL • PLAS-  
TIC • GLASS • LEATHER • BONE AND OTHER MATERIALS**

**Only Loyd Scruggs Gives You All These Features**

- 110 V., A.C.-D.C.; U. L. approved.
- 25,000 r.p.m.—all the power you'll need.
- Compact (6" long, 1 5/8" diam.), balanced for easy handling.
- Efficient fan, aluminum housing for cool operation.
- Positive switch tested for 100,000 operations.
- 7-bar commutator (not 3) increases performance.
- Ball bearing construction, sealed-in lubrication.

**TRY IT** at your Hardware Store, Department  
Store or Hobby Shop

Not until you use this palm-size powerhouse — and see for yourself the sweet way it performs countless jobs — will you know why the new **LOYD SCRUGGS PRECISION POWER TOOL IS YOUR MOST PRACTICAL BUY!** For the name of your nearest dealer and interesting free folder, write The Loyd Scruggs Co., 1022 N. Sixth St., Dept. PM-1052, St. Louis 1, Mo.

*Loyd Scruggs*  
**PRECISION POWER TOOL**

## Operation Roll-Up

(Continued from page 133)

between them with a minimum of handling and a saving in operational time.

Three grinders were integrally mounted on a three-foot-thick concrete foundation. This was insulated from the floor of the building so as to prevent vibrations from being transmitted to the machines. The honing of the cylinder walls was accomplished by single-spindle automatic honing machines. The cylinder diameter was made to fit the piston, and working clearance was established by the use of a shim-and-pull gauge.

The first step in the reassembling of the engine was to fit the connecting-rod bearings to the crankshaft. The connecting rods were straightened and rebored where necessary. In the meantime, the cylinder block was washed thoroughly to remove any possible grinding residue. The final assembly of engines was likewise accomplished in the sequential manner on a production line. The open-backed stock bins were filled from the outside so that the workers might have free access in their working position. A ready supply of bolts, nuts and washers was carried in the trays attached to the sides of a roller conveyor line.

Electrical subassemblies and accessories were gathered in the carburetion and electrical section. Here carburetors, fuel pumps, generators, starters and distributors were disassembled, repaired, reassembled and tested on individual production lines. Spark plugs also were cleaned, adjusted, tested and sorted for reuse.

After being dynamometer tested, the engines were given two coats of paint and dried between banks of infrared lights. These were installed on either side of the conveyor line and were adjustable to accommodate different-sized engines. Two painting booths with waterfall backing kept the air free of stray paint and fumes. The volatile gases were removed from the paint-drying line by ducts and fans. In the processing section the engines were sprayed internally with a rust-inhibiting oil. The electrical accessories were sealed and sprayed with an ignition-sealing compound. Following this operation, the engines were boxed in reusable containers and delivered to the supply channels.

Unique in Japan, and outstanding by comparison with engine-remanufacturing facilities in the U. S., these production lines have performed a most important function in extending the taxpayers' dollars. At the same time they provide the indispensable replacement assemblies which support the United Nations in Korea today. ★ ★ ★

# YOU CAN'T DO A BAD PAINT JOB

## with New Gold Bond Velvet!



**GOLD BOND VELVET** is the easiest-going wall paint you ever used! Ready-to-use. No primer needed. Dries in minutes to a velvet smooth surface that won't crack, chip or peel.

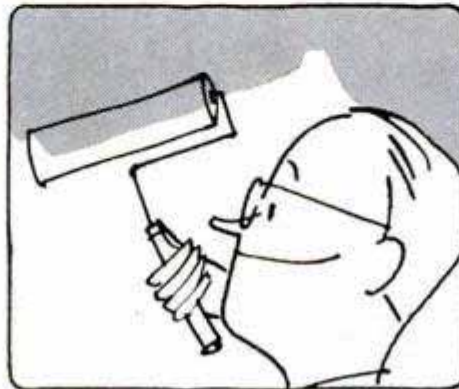

**FLOWS ON!** Just dip your roller or brush in odor-free Gold Bond Velvet and see how it goes on almost by itself! It eliminates what professional painters call "drag," which is so tiring.



**WITH ORDINARY PAINT** you have to guard against lap or brush marks, touch-up spots. No worry with Gold Bond Velvet! This latex-base paint blends perfectly... you can't do a bad job!

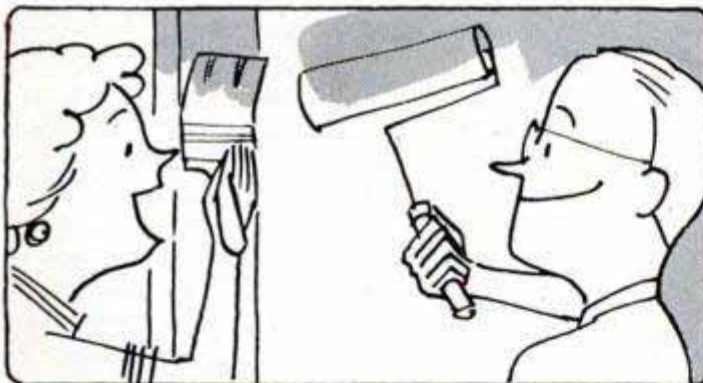

**COVERS WALLS AND WOODWORK, TOO!** Use Gold Bond Velvet over paint, plaster, wallboard and even over most wallpaper... without an undercoater.

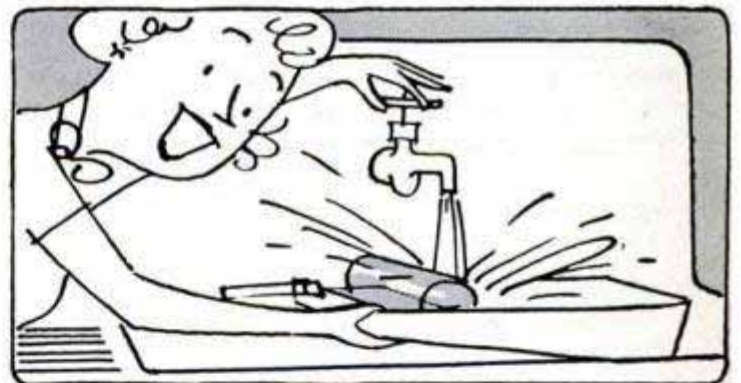

**EASY TO CLEAN UP!** Brush or roller cleans off with plain water. Spatter or splash marks clean up with a damp cloth. No turpentine needed.

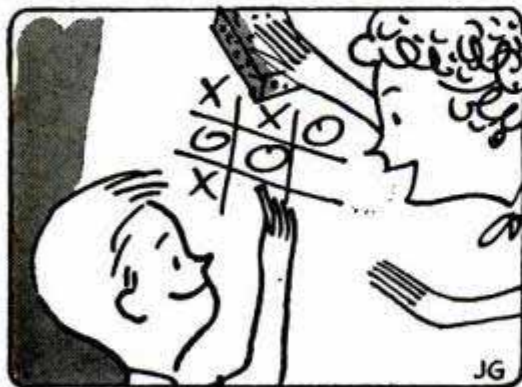

**SCRUBABLE!** Durable Velvet can be scrubbed year after year without harm. Pencil, crayon, finger marks and food smears wipe right off!

Ask your local Gold Bond paint dealer or lumber and building material dealer to show you the 12 new Velvet colors. The orange and tan label is your assurance of another top quality National Gypsum Company product.

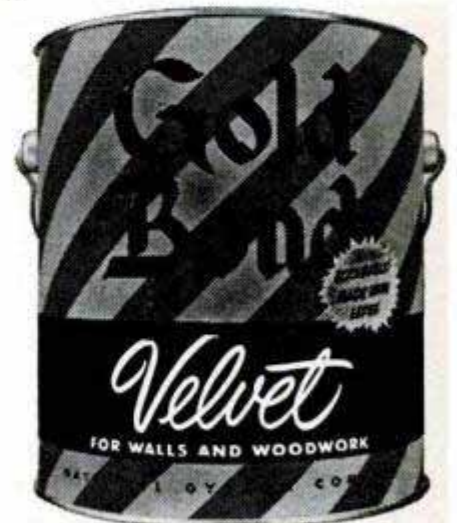

NATIONAL GYPSUM COMPANY • BUFFALO 2, NEW YORK



\* What Termites are to a house, Wearmites are to your engine! These minute bits of grit, dirt and tarry sludge that contaminate motor oil, cause engine wear and destruction. Car, truck and tractor engines that grow old before their time can usually point to these unseen mechanical vermin as the cause!



**Exterminate Grit, Dirt, and Sludge WEARMITES with-**

**wix**  
TRADE MARK REG.

**ENGINEERED FILTRATION**

A WIX HEVI-DUTY Oil Filter Cartridge rids motor oil of more destructive contamination and continues its job of cleaning oil for far longer periods of time! By using WIX Cartridges you save three ways! You get better service from your motor oil . . . you save on less frequent filter changes . . . you save unnecessary engine wear! Ask your Serviceman about WIX today.



**wix**  
TRADE MARK REG.



**OIL FILTERS CARTRIDGES**  
**WIX ACCESSORIES CORP., GASTONIA, N. C.**  
**IN CANADA: WIX ACCESSORIES CORP. LTD., TORONTO**

## Engineering—the Might of America

(Continued from page 123)

formulas for weed killers and insecticides.

We are notorious for neglecting our rivers. Sanitary engineers must clean them up, and hydraulic engineers must catch up with Europe in learning from the operation of hydraulic models how to prevent disastrous floods. Air safety, solution of today's intolerable traffic problems, modern city planning and cheap, durable houses are other challenges. We are just beginning to use prestressed concrete to build light, graceful bridges and buildings and save scarce steel. We need more engineers who understand it.

One would think that in a nation of mechanically minded, adventurous youth there would be a stampede into a profession that offers such opportunities and satisfaction. Unfortunately, such is not the case. Industry is wailing about the shortage of engineers, and has been signing up whole graduating classes, sight unseen. T. A. Marshall, Jr., head of the Engineering Manpower Commission of the Engineers Joint Council, reports that civilian industry alone needs 30,000 engineering graduates a year. Last June the colleges turned out about 28,000. Enrollments show that only 19,000 will be available in 1953, and less than 17,000 the following year.

The blame for this appalling situation is variously distributed. The U. S. was the only big belligerent engaged in World War II which had a policy of drafting engineers and engineering students for general military service—a great waste of skilled manpower. The decline in fledglings is partly due to the delayed effect of the low birth rate during the mid '30's, partly to a false report or a glut of engineers widely published two years ago.

Today the engineering student is getting more attention than a triple-threat back. Executives tour the campuses armed with attractive contracts. Albert Meyer, head of the Engineering Societies' Personnel Service, reports that the average graduate with a B.S. or an M.E. degree can command starting pay of \$325 to \$350 a month, that the boy with the Master's degree can get \$375, while the Ph.D. can start life at \$450 to \$500. This scale applies to *average* graduates; the exceptional man can get more, and can often choose among half a dozen firm offers. This means, among other things, that the engineering graduate can marry at once if he wishes—a privilege few professional men enjoy.

Reports indicate that the tightest pinch is in electrical engineers, with mechanical

(Continued to page 260)

# REMODEL IT YOURSELF... USE THE BEST



**save**  
**1/3**  
**or even more!**

PUT YOUR FOOT DOWN...  
INSIST ON **GOLD SEAL®**  
**LINOLEUM TILE!**



Put down **Gold Seal Linoleum Tile** and know that you've got the *right* tile over your wood floor. For this is *genuine* inlaid linoleum... *flexible*... designed to take the up-and-down movement of the average wood floor without a strain. It *can't* snap, chip, or shatter!

**And Gold Seal Linoleum Tile practically installs itself!** These tiles are precision-cut into *true, right-angled 9" x 9" squares*. They slice into odd shapes with just a knife... without heating, scoring, or hacksawing.

**It's greaseproof to household fats and oils.** Even splatters from a hot frying pan won't pit, soften, discolor, or disintegrate it.

**What a floor you get!** A smooth, warmly colorful floor, with all the quiet, restful resilience of the very finest custom installations... *at just a fraction of the cost!* Satisfaction guaranteed or your money back!

ABOVE ALL, USE **GOLD SEAL**  
**CONGOWALL®** IT'S UP FOR  
GOOD IN OVER 5,000,000 HOMES!



**There's only one Gold Seal Congowall**... the baked-enamel wall covering that looks, feels, and cleans like expensive ceramic tile... *never* needs refinishing, repairing or repainting.

**Only one genuine Congowall** that's so tough and sturdy... yet so flexible and *downright simple* to put up. Just paste it to the wall... that's all! Congowall's special, patented backing *locks* it to your wall... *keeps it there*, smooth and tight for good!

**Only Gold Seal Congowall** gives you a choice of 16 true tile colors, plus the new Ivy and Vine patterns. Cost? Only about 15¢ a square foot... including the Gold Seal *guarantee* of complete satisfaction or your money back!

**FREE!** Special do-it-yourself decorating booklet... 16 pages of full-color pictures, ideas, suggestions... easy-does-it hints for all rooms. Instruction booklet, too!

-----MAIL COUPON TODAY-----

Congoleum-Nairn Inc.  
Kearny 15, N. J.

Please send me **FREE** Decorating  
Booklet and Instructions.

Name \_\_\_\_\_

Address \_\_\_\_\_

City \_\_\_\_\_ Zone \_\_\_\_\_ State \_\_\_\_\_



**CONGOLEUM-NAIRN INC.**

© KEARNY, N. J.

MAKERS OF GOLD SEAL GUARANTEED FLOOR AND WALL COVERINGS

*Money-Making Jobs...*

**ALL AROUND YOU!**

APARTMENTS

CHURCHES

NEW HOMES

STORES

SCHOOLS

OLD HOMES

SHOPS

**BE YOUR OWN BOSS!** *Big Money* waiting for you today in floor surfacing! Hundreds of prospects near you! The floor next door may be your first job—and business mushrooms as folks tell others. Earn as high as \$50 and more a day sanding floors with an easy-to-run American Machine. Pleasant indoor work—steady the year round. A sound opportunity to get in something for yourself and be *your own boss!* No schooling—no experience needed. Only small investment in sander gets you started to success! Send coupon for “money-making booklet” entitled “Opportunities in Floor Surfacing”—enclose 25c in coin or stamps to cover handling.



## AMERICAN FLOOR MACHINES

**SEND!**

The American Floor Surfacing Machine Co.  
535 So. St. Clair St.  
Toledo 3, Ohio

Enclosed find 25c in stamps or coin for booklet “Opportunities in Floor Surfacing”, telling me how I can start my own floor sanding business.

Name.....

Street.....

City..... State.....

and chemical engineers next in scarcity, but any kind of an engineer is snapped up. West Coast aircraft firms say, “If he’s an engineer, we take him and retrain him if necessary.”

Once, the boy who aspired to corporation leadership went to law school; now engineering is the royal road to management. Leading engineering societies report that more than 30 percent of their members are in administrative or management posts.

All these prospects should appeal, not only to the boy choosing a vocation, but to the relatives who pay the bills. Yet it would be a serious mistake to suggest engineering to “fast buck” careerists. Most engineers are able to live comfortably by any reasonable standard, but few become rich. Only those who are fascinated, even excited, by the opportunities of the work itself, who wish to become a part of the highly skilled corps which is shaping tomorrow’s world in the service of mankind, should enter a calling which demands honesty and objectivity as first essentials. For such men, the engineering profession offers rewards found in few other occupations.

### “Doughnut” Glider



Sporting a round hole in the center, a new type of glider has been designed by members of the Aachen University Aero-club in Germany. A full-size glider is being constructed from the model, shown in above illustration, which is six feet in diameter. In actual flight, the pilot will sit in the forward section of the craft.

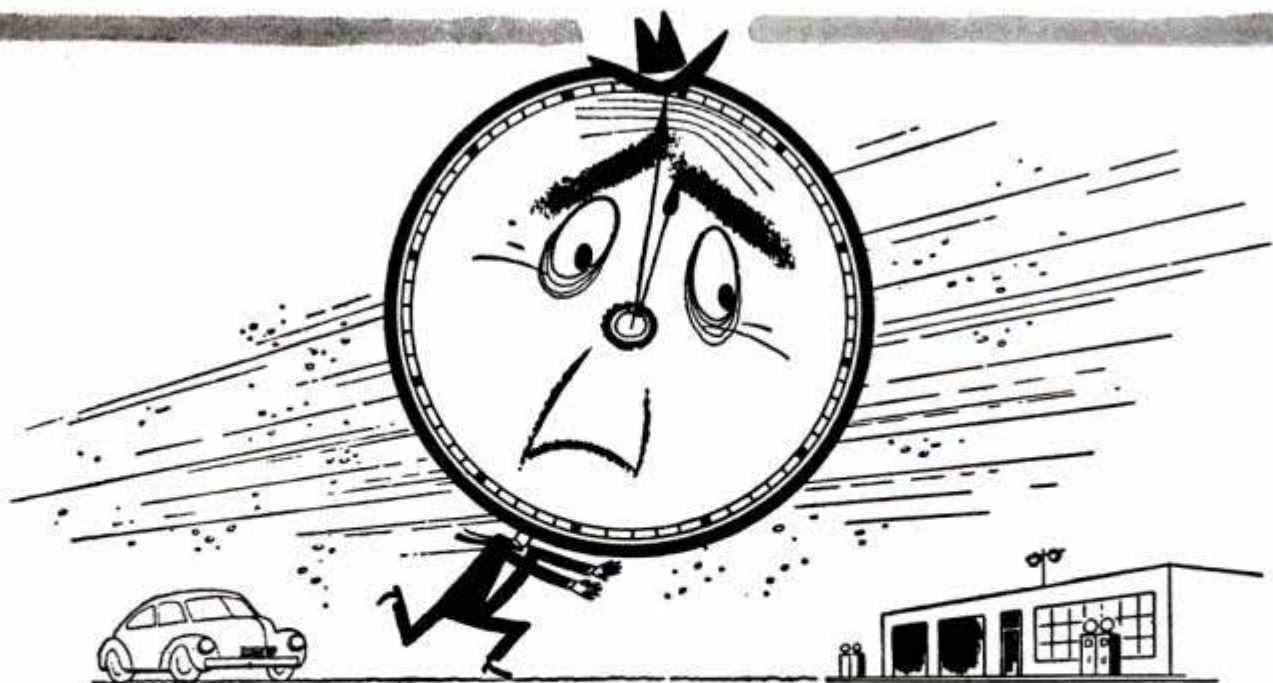

# Don't be a last minute man!

## PROTECT YOUR CAR NOW WITH PEAK® ANTI-FREEZE

Why run the risk of an unexpected cold wave that may freeze up your car's radiator or engine? Drive in early and let your serviceman clean the cooling system and put it in tip-top shape. Then, get Peak... the all-winter, all-weather anti-freeze. One filling is all you need for complete winter protection. Peak saves you the fuss and bother of check-ups after

every warm spell...it won't evaporate or boil away even on the warmest day. What's more, Peak's *exclusive* anti-rust combination keeps the cooling system clean all winter...prevents corrosion and rust clogged radiators. Beat the last minute rush - drive in and ask for Peak today. PEAK ANTI-FREEZE is a product of Commercial Solvents Corporation.

LOOK FOR THE BLUE AND SILVER CAN...

...\$3<sup>75</sup>  
GALLON



Freeze? FORGET IT!



Boil-away? NOT A CHANCE!



Rust? NEVER! NEVER!



ONE FILLING  
IS ALL  
YOU NEED

PEAK...THE ALL-WINTER...ALL-WEATHER ANTI-FREEZE

# HOW TO...

## SET UP or KNOCK DOWN

# SAWHORSES FAST!

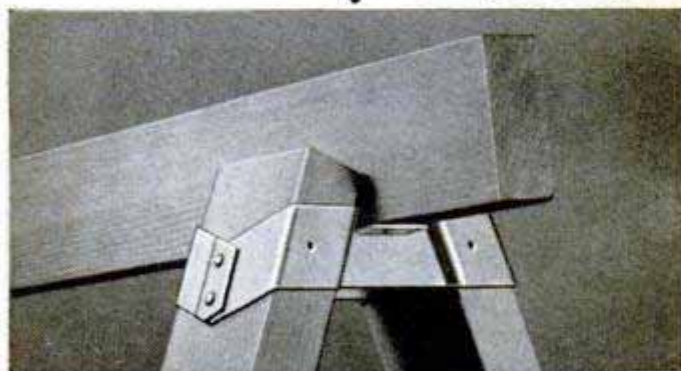

Use Strong, Lightweight

## NU-WAY SAWHORSE BRACKETS

Set up or knock down sawhorses in jig time! Carry them in your car . . . or store them easily . . . the modern way—the NU-WAY!

Practical, simple, time-saving NU-WAY Brackets are inexpensive . . .

**ONLY \$1.50** (one pair makes up one Sawhorse).  
**PAIR**

See your Hardware, Paint or Lumber Dealer NOW! If he does not carry Nu-Way Brackets, send check or money order for \$1.50 per pair (postpaid) to:



Work Benches



Scaffolding

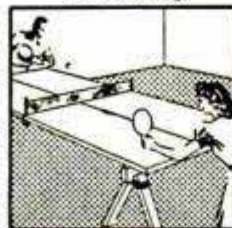

Hobby Tables



Temporary Tables

THOMAS PRODUCTS CO., 8490 Lyndon, Detroit 21, Mich.

SEND me \_\_\_\_\_ pairs NU-WAY Sawhorse Brackets.

I enclose \$\_\_\_\_\_ in check or money order.

My name \_\_\_\_\_

Address \_\_\_\_\_

City and State \_\_\_\_\_

My favorite Dealer is:

Store Name \_\_\_\_\_

Address \_\_\_\_\_

City, State \_\_\_\_\_

## I Ride the Sno-Cat

(Continued from page 85)

That evening Phil Norton gives Wogy some valuable information on wildlife conditions in the upper valley.

On our trip back down the valley the next day, we stop at the Wyoming Game and Fish Commission's elk trap. On Wogy's next trip up here he'll be trapping elk. Each one will be labeled with a numbered metal eartag so its movements can be traced if later bagged by a hunter or captured.

Now, however, we will have to ready the elk trap. "An elk'll fall out of sight in those giant snow drifts!" Wogy exclaims. "Val, see if you can pack 'em down with the cat. Later, we'll scatter some hay around to lure in the elk."

As we race on down the valley at the alarming speed of 12 miles an hour, the deep powder sinks unevenly under our pontoons. And as the pontoons rock, the cab pendulums back and forth considerably. We gallop onward and the feeling of being seasick also races onward. At any moment I expect to look out the window and see porpoises playing in the white waves. Wow! Open the window for air, Mc-Hugh, you've been riding in this land-locked ship too long!

A night at the Goosewing Ranger Station and we're ready to shove off on the final jaunt of our 90-mile trip. The same trip by ski or snowshoe would have taken many more days of tedious travel. The Sno-Cat is the only vehicle that could take us and our equipment over this mountain terrain.

As we chug back into town, some natives gather to look over our odd vehicle. While Val steers the cat onto its trailer, one of the local men speaks to Wogy, "Sure musta been easy goin' in that contraption!"

Wogy looks at the man and smiles. He doesn't say a word. ★ ★ ★

## Oil Wrapped in Foil

Oil and grease drums are now being made of layers of aluminum foil laminated to linerboard. They were tested for a year under the same rugged handling given conventional steel drums, including ship and truck movement, and rough usage by logging, construction and mining crews. Made in 5 and 15-gallon sizes, sheet-steel tops and bottoms are attached to the shells by a special process. The new containers are eventually expected to replace the 30 and 35-gallon steel drums, which because of their original cost have to be reused many times and thus add bookkeeping and re-conditioning costs during the transfers.



# FOR EASIER SCRATCH-FREE SANDING . . . . . USE DREMEL STRAIGHT-LINE ACTION SANDERS

**FOR ALL HOUSEHOLD AND WORKSHOP SANDING**  
 You'll find Dremel Electric Sanders indispensable around the house and workshop. Thousands of satisfied users have proved only Dremel straight-line action sanding can produce professional-like, scratch-free surfaces. Both models sand with-the-grain, are durably built to give years of service. Avoid slow, tiresome hand sanding. See "where to buy" instructions at the bottom of this page.

## MODEL 2000

A high speed, fast-cutting production sander for home and shop use. Its straight-line with-the-grain action is ideal for redecorating jobs, furniture and cabinet making, boat building or refinishing, etc. Recommended by painters and carpenters for sanding woodwork, doors, stairways, dry wall joints, etc. Weighing less than 5 lbs., it is perfect for difficult vertical and overhead sanding jobs. Has 21 sq. in. (3 1/2" x 7") sanding pad. **\$24.50**

Price includes this sturdy steel storage case (shown below) with handy carrying handle; 25 assorted abrasives; 1 sheepskin pad.



### FREE SANDING GUIDE

A handy "How-To-Do-It" booklet containing helpful hints on sanding and refinishing procedures is packed free with each Dremel Sander. Extra copies available for 8.25.

## A DREMEL SANDER IS SO EASY TO USE

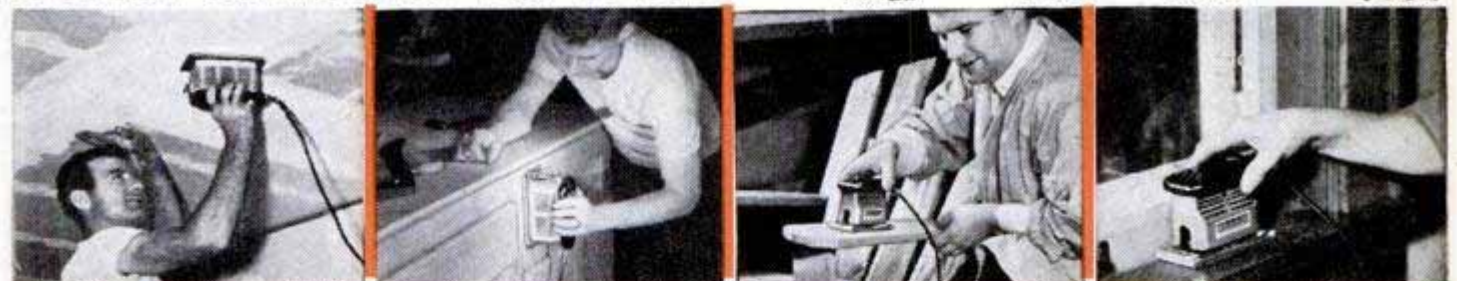

A "must" for sanding dry-wall joints. Fast—cuts refinishing time in half. Prepares furniture for repainting. Sands right into tight corners.

## GRINDS • CARVES • DRILLS • ROUTS • ENGRAVES • SHARPENS DREMEL Electric MOTO-TOOL



**KIT NO. 2** Includes Model 2 Moto-Tool and 23 Accessories (High-Speed Steel Cutters, Grinding Wheels, Polishers). Packed in sturdy hard-wood case. **\$23.50**

### FASTEST, MOST POWERFUL TOOL IN ITS CLASS —APPROX. 27,000 R.P.M.

Most practical tool a man can own—more powerful than any similar tool you can buy. Works well in wood, plastics, and metal. For home maintenance jobs you'll wonder how you got along without it. For model making it's a must. And for general shop operations it saves time and money. Compare it, try it, buy it. You be the judge.

**Check These Important Features:** Oilless sealed bearing • Dynamically balanced armature • Shockproof, Bakelite housing • Dust-filtered air cooling system • Sturdy 110-120 V., A.C.-D.C. motor • Wt. only 13 oz. • A precision tool widely used in industry for many years.

**KIT NO. 1** Includes Model 1 Moto-Tool and 34 Accessories (Steel Cutters, Grinding Wheels, Polishers, etc.). Packed in attractive lacquer-finished wood case. **\$17.50**

**MOTO-TOOL NO. 2** Offers more convenience and long life features for the money than any other hand grinder. Thousands of satisfied users. Moto-Tool No. 2 (With 1 emery wheel point) **\$16.50**



## MODEL "A"

The lighter capacity Model "A" Sander is an excellent all-purpose household sander for home maintenance, furniture polishing, hobby projects, etc. Wonderful wax polisher. Perfect for massage use. Weighs only 2 1/2 lbs.; has 12 sq. in. (2 3/4" x 5 3/8") sanding pad. **\$14.85**

Price includes: 6 sandpapers, 1 sheepskin, 1 felt pad.

**BOTH MODELS FEATURE:** Only 2 moving parts; easy one-hand operation; 10-second paper change; 14,400 strokes per minute; 110-120 V., 60 cycle, A.C.

To produce flawless work of professional quality, all sanding must be done with the grain of the wood. Therefore, when selecting a Sander, it is important to remember that only Straight-Line, with-the-grain action is suitable for finish sanding operations. For the finest finishes, insist on a Dremel.

Note How Dremel With-The-Grain Action Eliminates Cross-Grain Scratches

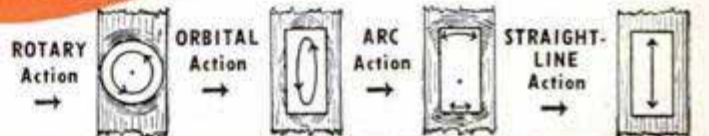

SEE YOUR LOCAL DEALER Dremel Tools are sold at better dealers everywhere. If your dealer can't supply, order direct on a five-day trial, money-back guarantee. Remit in full, and we will ship post-paid. Or, send only \$2.00 now, pay postman balance plus postage and C.O.D. fee.

DREMEL MANUFACTURING CO.

Dept. 112-K

RACINE, WISCONSIN

"Would like to see leather upholstery available in sedans as standard equipment."  
—Glen Ellyn, Ill., printer.

"Women with high-heeled shoes need a comfortable footrest."—Winchester, Mass., manufacturer.

"Power brakes and power steering, plus a little more horsepower, would do wonders on this car."—Los Angeles, Calif., sales manager.

"New cars should be serviced and checked free of charge through 5000 miles, thus catching everything which may not be right."—Porterville, Calif., grower.

Lincoln apparently gives a strong feeling of security. "I have had occasion to drive several other cars of top quality," wrote a Park Ridge, Ill., lawyer, "and I can truthfully say the Lincoln is a magnificent road car. It holds the road under the most adverse conditions and conveys a feeling of complete safety to driver and occupants."

As could be expected, the average gas mileage reported by Lincoln owners was somewhat lower than that recorded for smaller, lighter cars. The survey showed that Lincoln owners average 13.3 miles per gallon in city driving, 16.2 miles per gallon in the country. In this connection, a St. Louis, Mo., manufacturer's agent could well be the envy of many drivers today. He wrote: "I don't worry too much about gas-

oline mileage and haven't kept any real check on what I am getting. I feel that the difference between 15 miles to the gallon and 19 miles amounts to only a few dollars by the end of the year, so I don't worry about it!" (This is exactly the feeling of many owners of high-priced cars, according to our surveys.)

No conclusion can be reached in this survey on the matter of chrome trim. As many owners said they wanted more chrome and some said they wanted less, the argument remains unresolved. (Many owners of nearly every make think the chrome is not good enough.)

A few owners complained that many garage mechanics seem at a loss in going about repairs. A Charlotte, N. C., owner wrote: "My Capri spends at least one full day a week in the shop, and the mechanics don't even like to work on the motor because of its poor response to their efforts." This was echoed by a Toledo, Ohio, engineering executive who said: "On a trip, I drove into a Lincoln-Mercury service shop in a town of more than 100,000. I waited 2½ hours, but they didn't know what to do with the car. They said they hadn't received instructions as to what service should be rendered. I had trouble and put in all new plugs after 3000 miles. That's good?"

(Continued to page 266)

Only the new Millers Falls

No. 966 Sander-Polisher

*Does Them  
All*



**\$37<sup>50</sup>** with 6" rubber pad, 6" lamb's wool bonnet, and three 6" sanding discs.

Additional accessories and attachments are available to save you time and money on hundreds of jobs.

- Buffing ✓
- Disc Sanding ✓
- Orbital Sanding ✓
- Drilling ✓
- Grinding ✓
- Polishing ✓
- Waxing ✓
- Mixing Paint ✓
- Wire Brushing ✓

Compare its uses . . . compare its price . . . compare its quality. You'll find no other power tool offers so much for so little. See it at your hardware dealer's or write for full details.  
Millers Falls Co., • Greenfield, Mass.



*The Mark of Superiority*



It's a 6" Disc Sander and Polisher



It's a Fine Finish Sander with the No. 980 Orbital Attachment

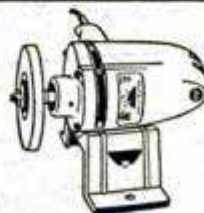

It's a Bench Unit with the No. 9668 Stand



It's a ¼" Drill with No. 9665 Jacobs Key Chuck

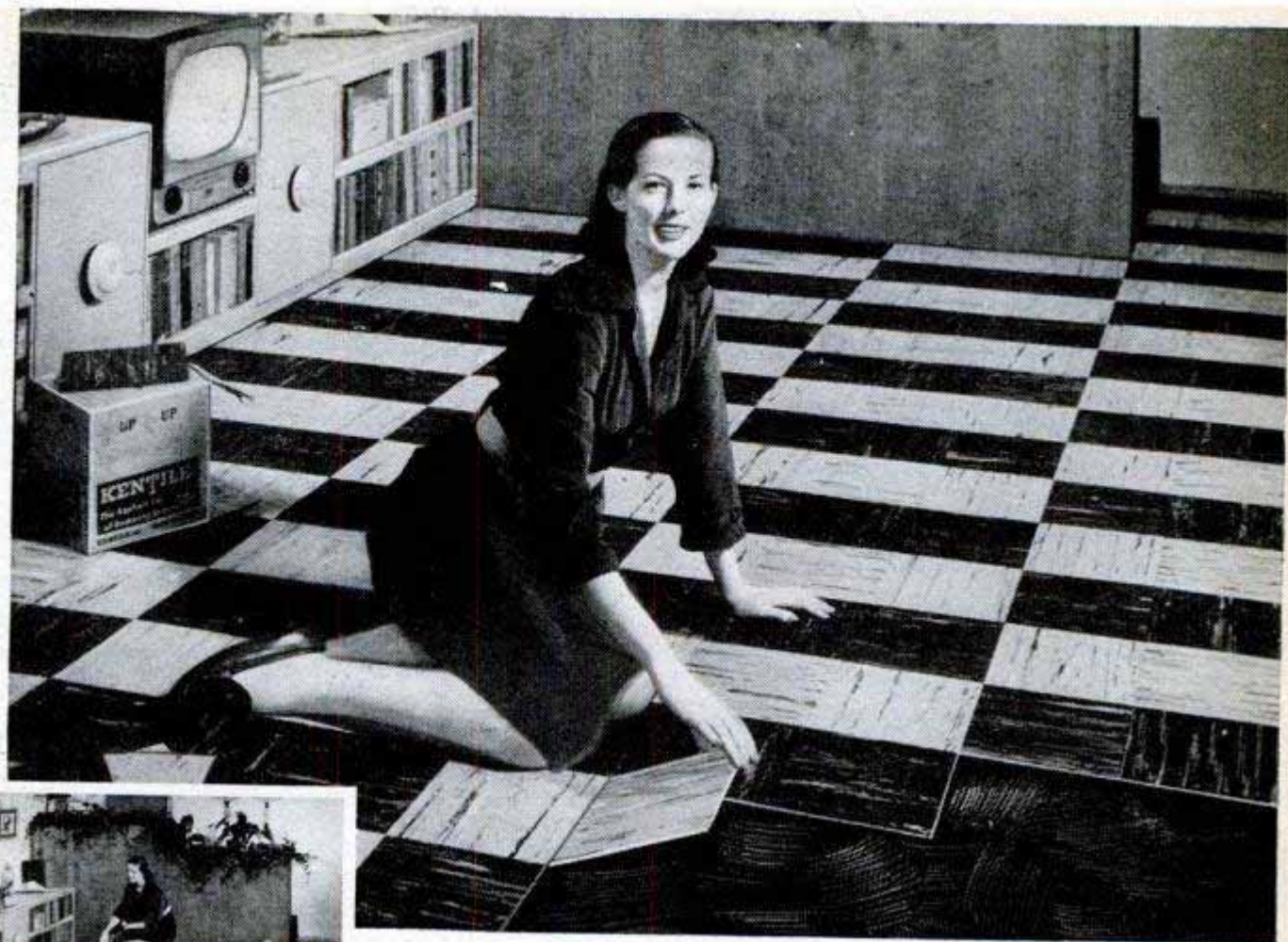

**STEP 1...** Mrs. Lansing follows the simple instructions. Here she's beginning to spread adhesive over half the play room.



**STEP 2...** She puts tiles down in place, one at a time. When half the floor is covered, the adhesive is spread over the remaining half.



**STEP 3...** After adhesive is ready, Mrs. Lansing continues installing tiles... and the other half of the room is finished... and all ready to walk on.

## Mrs. Richard Lansing shows how to install a **KENTILE FLOOR** like this for only **\$22<sup>25</sup>\*** FOR 9'x16'6" FLOOR

Think of the money you'll save! 26 glorious colors to choose from give you colorful beauty for kitchen, bedroom, living room...anywhere in your house. Cleaning is easy with Kentile...it sheds dirt and stains...gleams like new with occasional no-rub waxings...stays bright and fresh even with the hardest kind of service.

So why buy floor-coverings with just a colored surface that wears off with use? For so little more you can now get wear-resistant Kentile with colors extending right through each tile—and with quality assured by this guarantee.

KENTILE, INC., 58 2nd Ave., Dept. G-9, B'klyn 15, N. Y.

Only Kentile dealers  
offer you these  
low-priced Guaranteed  
Kentile Floors

\*Price quoted is for a 9'x16'6" Kentile floor (less stair area) installed by you. Your Kentile Floor may cost less or slightly more, depending on size of room, colors and freight rates. See your local Kentile dealer. He's listed in the classified phone directory under FLOORS. In Canada, T. Eaton Co., Ltd.



# KENTILE®

The Asphalt Tile of  
Enduring Beauty



### KENTILE

### GUARANTEE

#### FOR SELF-INSTALLED KENTILE

Kentile, Inc. will provide new tile without charge for any Kentile that wears out... and on which colors wear off... during your own occupancy of your home when you have installed Kentile. This guarantee does not apply to damage caused by improper handling, or failure to follow the instructions for installation and maintenance available at your Kentile dealer's.



## make your **HANDS** **MORE CREATIVE** with **X-acto Knives and Tools**

Creative hands can be your greatest asset... X-acto knives and tools help the intelligent coordination of active minds and agile fingers... they can develop skill and dexterity in any art or handicraft you select.



Whether it's boat whittling, model airplanes, wood-carving, leathercraft, model railroads or any other handicraft, you can make your hands more creative with "designed-for-the-job" precision-engineered X-acto knives, tools and handicraft kits.



X-acto offers the complete line of handicraft knives, interchangeable blades, tools and attractive kits



From 25¢ to \$30.—at dealers everywhere.



No. 82  
X-ACTO KNIFE CHEST  
\$4.20



Send 15c to cover postage  
for our new illustrated  
28-page Catalog.



**X-acto Crescent Products Co., Inc.**  
440 Fourth Avenue, New York 16, New York

A wide variety of responses was received to the question, "How do you rate your dealer service?" Of the owners replying, 42 percent said excellent; 30 percent good, 15 percent average and 13 percent poor. In all our surveys to date, this item has been one of the most important factors in the owner's decision as to whether he would buy the same make of car again.

A Mansfield, Ohio, housewife, voiced what must be the unanimous sentiment of automobile owners everywhere in her response to our question, "What specific improvement would you like to see in your next car?"

She replied: "Same car at a lower price."

**And now for my own test** of the Lincoln Capri. We drove the test car from the factory in Detroit to Los Angeles via Indianapolis, Denver, Grand Junction and Las Vegas—a distance of 2750 miles—which included considerable off-road testing in the mountains and deserts. We made several detours over rough and muddy roads.

Lincoln has gone overboard in its styling, and engineering improvements have made the new Lincoln a really worth-while automobile in appearance, performance, roadability and economy. Over all kinds of highways, including tests in the Rocky Mountains of Colorado and the Nevada and California deserts, I found the Lincoln to be responsive and superior to most cars in its class in roadability and cornering.

The new 160-horsepower engine of overhead-valve design has 317.5 cubic-inch displacement and a 7.5 to 1 compression ratio. It is fast, flexible and has little vibration. The engine weighs 100 pounds less than the engine used in the 1951 Lincoln. The 1952 four-door sedan is 242 pounds lighter than the 1951 four-door model.

The new ball-joint front suspension system enables one to corner at high speeds with a feeling of safety and with little steering effort. The car steers almost as easily while in motion as if it were equipped with power steering, and easier at all speeds than most cars of comparable weight. The controlled-action shock absorbers give a very comfortable ride. Only twice at high speeds did the front or rear end "bottom" when we hit sharp bumps.

Another feature I like is the dual mufflers (one for each bank of four cylinders). This eliminates some back pressure and should help some in cooling. The dual system also should increase top speed and power a trifle.

The car has excellent top speed. On long open stretches the speedometer needle well above 110 miles per hour, the last figure on the dial. (Like most speedometers

(Continued to page 268)

# How Creative Designing Gives You This Easier Working, Precision Bench Saw:

## WIZARD 8 INCH TILT-ARBOR SAW

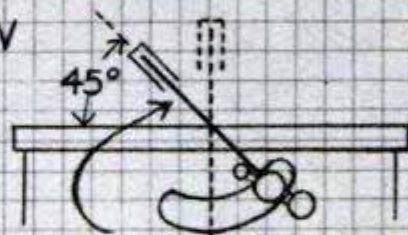
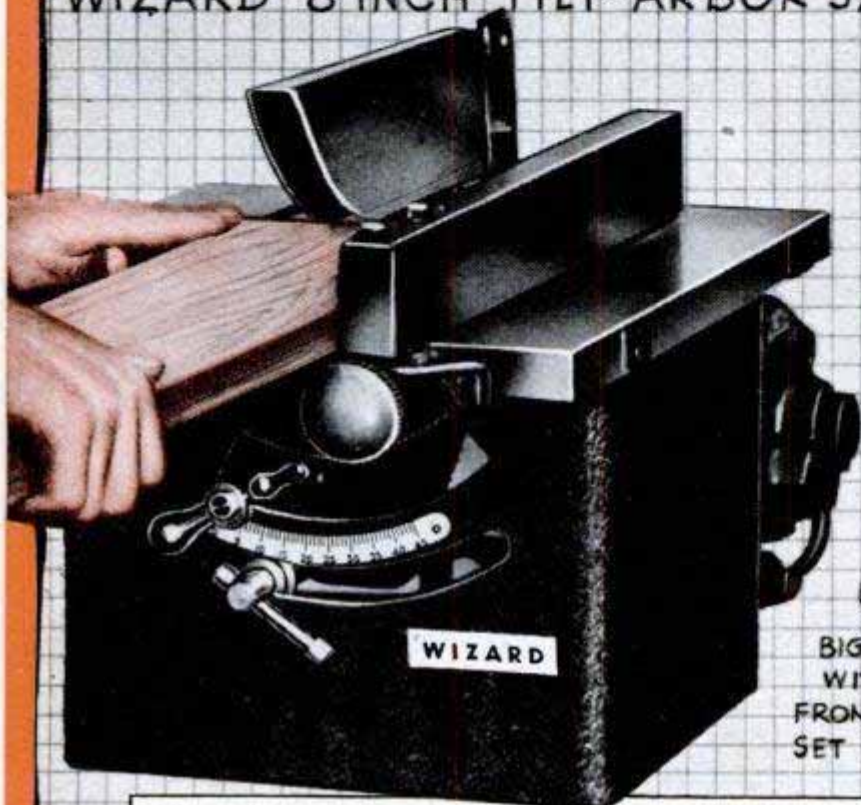
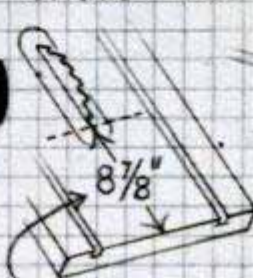
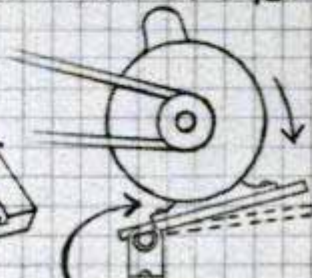

TABLE AND WORK STAY LEVEL WHILE BLADE TILTS TO 45°... BEVEL CUTS A 2"X4" MAXIMUM STRAIGHT CUT DEPTH OF 2<sup>5</sup>/<sub>8</sub>".



BIG 17"X14" TABLE WITH FULL 8<sup>7</sup>/<sub>8</sub>" FRONT WHEN BLADE SET FOR 1" CUT.



FLOATING MOTOR RAIL CONTROLS BELT TENSION FOR EFFICIENT OPERATION.

Fix-up jobs and woodworking are fun with this rugged saw. Save hours of tiresome hand sawing . . . your work's done with greater accuracy *in minutes!* 8" combination blade zips through piece after piece . . . rips, crosscuts, rabbets, bevels! Dado capacity: 1<sup>5</sup>/<sub>8</sub>" deep, 11/16" wide. 1/2" ball-bearing arbor never needs oiling. Complete with blade, guard, splitter, V-belt, pulley, motor rail, miter gauge, fence. (2H1006) **\$53.95**

## WESTCRAFT 1/2" SOCKET SET

12-PIECE SQUARE DRIVE

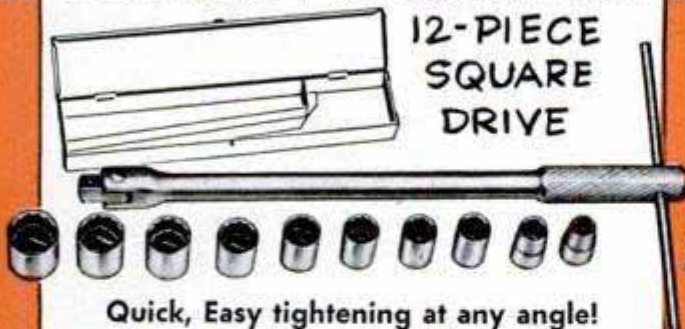

Quick, Easy tightening at any angle! 10 most-used alloy steel 12-pt. sockets with hot broached, uniform tapered walls. Chrome plated. Tee Flex handle & crossbar: Metal box. (HR2950) **\$9.45**



## WIZARD ELECTRIC 1/4" DRILL

Whirls through wood, metal, plastic in a flash! Motor gives perfect speed-power balance. Alloy steel-cut gears. Trigger switch. Precision "hand-tite" chuck. (2H1379) **\$12.48**

CHOOSE FROM OVER 1,100

**Wizard-Westcraft Tools** SOLD ONLY BY **Western Auto**

STORES AND ASSOCIATE STORES

NOTE: WESTERN AUTO ASSOCIATE DEALERS OWN THEIR OWN STORES AND SET THEIR OWN PRICES. TERMS AND CONDITIONS. PRICES MAY VARY DUE TO DIFFERENCES IN LOCAL CONDITIONS. IF YOU DO NOT KNOW THE LOCATION OF YOUR NEAREST WESTERN AUTO STORE, WRITE: WESTERN AUTO SUPPLY CO., 2107 GRAND, KANSAS CITY, MISSOURI. (PM102)

# LOOK what you can MAKE

with  
**DURON\***  
THE HARDBOARD  
OF 1,001 USES!



CABINETS



TABLES



ROOM DECORATIONS



TOYS



GAMES



NOVELTIES

Make an end-table, make a chair—and make it out of DURON Hardboard! Versatile DURON is wonderful material for craftsmen: hand-bend it easily for curved-front effects, saw it without later sanding, nail it without splintering. Yes, work it just like wood—but get neater results for less cost. Marble-smooth on both sides, you don't even paint DURON unless you want a different color. For your next project, try this strong, wood-fiber base plastic material. DURON... the hardboard with 1,001 uses in your shop!

\*T. M. Reg. U. S. Pat. Off.

See your lumber dealer. Or send for these two folders—free. Packed with useful shop information. Write: United States Gypsum Co., Dept. 143-O, 300 W. Adams St., Chicago 6, Ill.



**UNITED STATES GYPSUM**

The Greatest Name in Building

I found it approximately 7 percent fast at top speed.) The acceleration is not quite as fast as I had expected up to about 60 miles per hour, but the flow of power is smooth and there is little vibration at any speed. Above 60 miles per hour, acceleration is excellent. The car could stand a few more "horses." Regular gasoline was used during the entire test run with practically no evidence of pinging or heating. Even in the mountains, over muddy roads, and in the desert I was unable to make the engine heat.

On a short cut through Zion National Park, Utah, we encountered several hours of heavy rain. Much of the road was unpaved and we drove in mud for many miles. The body was tight and there were no water leaks. Two squeaks developed but later disappeared. There were no rattles and I noticed that even at high speed there was little body rumble or wind noise.

The hood lifts easily and locks from the outside. I'd prefer an inside hood lock, which affords some protection for underhood units.

Visibility in the new Lincoln is outstanding, although the front end is about as wide as that of any car I ever have driven. The windshield is curved and one-piece. It has a slight uniform tint throughout—just enough to break or filter the rays of the sun, but not enough to give a noticeable effect at twilight. The wrap-around rear window on the Capri model gives excellent rear vision. As in most other cars, there is considerable reflection day and night on the curved windshield from the top of the instrument panel.

The brakes are exceptionally good, and the foot brake is operated by a wide pedal with slight pressure. The pedal is of the pendulum type hanging from above, and thus eliminates any hole in the floor board where dirt, water or air can enter. The suspended pedal and linkage to the master cylinder allows quite a bit of travel and leverage before pedal pressure actuates the brakes, so the application may be severe. After I learned the "feel" it was easy to apply the brakes gradually. The hand brake is at the right side and requires quite a lot of pressure to apply. As soon as the ignition is turned on, a red warning indicator starts flashing and continues until the hand brake is released.

The instrument panel is beautiful and the instruments are grouped directly in front of the driver. The speedometer face deserves mention, as it has a separate trip-mileage indicator. The odometer, or mileage, figures are under the needle and thus are not hidden at any time. The speedometer needle is thin and gives a fairly accurate indication

(Continued to page 270)

# SURPLUS MACHINE SHOP TOOLS AT PRICES YOU CAN AFFORD



## NEW HIGH SPEED SMALL DRILLS

Sizes available—letter size C, fraction size 3/16", number sizes 2, 5, 10, 12, 13, 18, 40 & 50. 12 of any one size, doz. \$2.15  
12, any mixture of your selection of above sizes . . . . . \$2.35  
NOTE: Min. order, 1 doz. Large quan. available at further discounts.

**SET 12** different size H. S. straight shank Drills, 1/4" to 1/2", lengths up to 7". Only . . . . . **\$3.98**

## HIGH SPEED DRILLS

1/4" to 17/32" WITH 1/4" SHANKS!  
**SET 6** different size H. S. Drills, 1/4" to 17/32" all with 1/4" shanks. PPD. . . . . **\$2.98**

**SET 10** of above, **36F** PPD. . . . . **\$4.95**  
Sets 35F and 36F will fit any 1/4" drill.

## HIGH SPEED DRILLS

1/2" to 1-3/16" WITH 1/2" SHANKS!  
5 Drills for less than the price of one new Drill!

**SET 5** different size H. S. Drills **32F** 1/2" to 1-3/16" . . . . . **\$7.95**

**SET 10** different size H. S. **33F** Drills 1/2" to 1-3/16" . . . . . **\$14.50**  
These new and used H. S. precision Drills with 1/2" shanks can be used in a 1/2" elec. drill or a 1/2" capacity lathe or drill press.

## HIGH SPEED MORSE TAPER SHANK DRILLS

**SET 15** Different Size High Speed Morse Taper Shank Drills up to 9/16" with No. 1 and 2 tapers. New and used. \$50 value. Priced at only . . . . . **\$6.49**

**SET 20** Different Size High Speed Morse Taper Shank Drills from 1/4" to 1" New and used. \$70 value. Priced at only . . . . . **\$12.95**

**SET 10** Different Size High Speed Morse Taper Shank Drills from 1/2" to 1 1/4". **15F** New and used. \$50 value. Priced at only . . . . . **\$9.95**

**SET 8** Different Size High Speed Morse Taper Shank Drills from 1" to 2" with No. 3, 4, and 5 tapers. New and used. \$125 value. Priced **\$29.95** only.

## 6 SLITTING SAWS WITH MANDREL

**SET 6** different size high speed Slitting Saws, 5 pcs. 2 1/2" dia. x 1" arbor, plus 1 pc. 5" dia. x 1 1/2" arbor. Thickness from .040 to .071. Cuts wood, aluminum, brass, steel, etc. PLUS SPECIAL MANDREL which enables use of saws in 1/4" or 1/2" electric drill. \$25 value. PPD. Only . . . **\$4.95**

7 selected, sharp H. S. Slitting Saws as above to use on your own mandrel or milling machine. New and used. Ppd. **\$4.95** A bargain at . . . . .

## HIGH SPEED WOODRUFF KEY SEAT CUTTER

**SET 5** different size cutters. Can be used as mounted milling **4F** cutter or circular saw. All with 3/8" and 1/2" shanks, widths up to 3/4", dia. up to 1". New and used. Ppd. . . . . **\$3.95**

## NEW MOUNTED STONES

**SET Mixture of 12** Mounted Stones with 1/4" shanks. PPD. . . . . **\$2.49**

**New Buffing Wheels**  
Approx. 5/16" thickness.  
5 pcs. 7" dia. . . . . \$1.70  
5 pcs. 8" dia. . . . . \$1.70  
5 pcs. 9" dia. . . . . \$2.00  
5 pcs. 10" dia. . . . . \$2.50  
5 pcs. 12" dia. . . . . \$2.50  
Large quantity available at an enormous saving!

## New Rotary FILE MIX

7 different pcs., High Speed 1/4" shank. PPD. . . . . **\$4.49**  
**SET 14** different pcs., as above. PPD. . . . . **\$8.79**

## DOUBLE-END END MILLS

**SET 4** right hand H. S., 3/8" straight shank End Mills up to 3/8" dia. . . . . **\$3.98**

## LARGE SAW BLADES

These large steel, flat high speed steel, flat ground, circular blades are in excellent, usable condition. Excellent for cutting brass, copper, aluminum and other soft metals, bone, plastics, rubber, paper, etc.  
8 x 1/16 x 5/8 arbor . . . . . ea. \$2.50  
10 x 3/32 x 1 arbor . . . . . ea. 2.50  
12 x 3/32 x 1 arbor . . . . . ea. 2.50  
14 x 3/32 x 1 arbor . . . . . ea. 2.50

## H. S. TAPER SHANK CHUCKING REAMERS

**SET 15** Different Size High Speed Morse Taper Shank **25F** Chucking Reamers up to 1 1/2" with No. 1 and 2 tapers. New and used. Priced at only . . . . . **\$7.95**

**SET 8** Different Size High Speed Morse Taper Shank **13F** Chucking Reamers from 1/4" to 1". New and used. Priced at only . . . . . **\$6.95**

## HIGH SPEED HAND TAPS

**SET 8** different size H. S. Std. Thread Hand Taps up to 5/8". **1F** including 2 Std. H. S. Pipe Taps. . . . . \$2.95  
**SET 40F** 16 same as above . . . . . \$4.80

**NEW NORTON CUT-OFF WHEELS: 80-grit MSL.** Will cut stone, steels, plastics, etc.  
3 x 1/16 x 1/4 arbor 3 pcs. . . . . 25c  
3 x 1/16 x 1/4 arbor 3 pcs. . . . . 27c  
4 x 1/16 x 1/4 arbor 3 pcs. . . . . 30c  
4 x 1/16 x 1/4 arbor 3 pcs. . . . . 30c  
4 x 1/8 x 1/4 arbor . . . . . ea. 25c  
8 x 1/8 x 3/8 arbor . . . . . ea. 70c

**TAP HANDLE** . . . . . \$2.75  
No. 6 (5/32" to 3/4" Cap.)  
Only . . . . . Discounts on quantity

## BARGAIN TOOL & SHOP MIXES—PPD.

- 30 GRINDING WHEELS 1/4" arbor, 4" diameter max. . . . . **\$3.29**
- 12 FILES up to 12" length, a buy at . . . . . **\$3.49**
- 2—8" WIRE WHEELS coarse and fine, 1" thick, 3/8" bore. Pair only . . . . . **\$2.29**
- 300 SPRINGS all types and sizes . . . . . **\$1.79**
- 100 MOUNTED POINTS 1/8" and 3/32" shanks. Various shapes . . . . . **\$8.98**
- SURPRISE MIX: Over 50 pcs. for your 1/4" elec. drill including rotary files, drills, bits, reamers, grinding wheels and arbors for our customers who like pleasant surprises. Your money back if you aren't satisfied. . . . . **\$2.98**
- BEARING MIX: About 40 needle, ball and roller bearings, new and used. Up to 2 1/2" dia. approx. 5 lbs. Outstanding buy at . . . . . **\$2.95**
- RIVET MIX: 5 lbs. assorted rivets; cherry, explosive, etc. Hundreds of rivets. . . . . **\$2.29**

## GENERATORS!

**P1 GENERATOR** 200-amp. 24-volt, continuous duty. Wt. 48 lbs. Special closeout price. F.O.B. Tulsa. . . . . **\$14.98**  
**ESA GENERATOR** 50-amp, 12 volt continuous duty. Wt. 21 lbs. F.O.B. Tulsa. Only . . . . . **\$9.98**  
These used, guaranteed serviceable aircraft quality generators are easily convertible for welders, power plants, boats, platers, etc.  
**2 H. P. MOTOR** 24-volt, 90-amp. double end ball-bearing shaft. Wt. 18 lbs. F.O.B. Tulsa, only . . . . . **\$7.00**

Money-Back Guarantee On RECEIPT of Merchandise. All mdse. mixture of new and reconditioned unless specified new. All orders (Except those specified F.O.B. Tulsa) are shipped Post Paid, saving you up to 25% on total delivered cost!

Write For Free Catalog Describing Thousands of Bargain Cutting Tools.

## HYDRAULIC BARGAIN DEPT.



**New Hydraulic Hose!!**  
2000-lb. Test  
• Any length • Std. Pipe Connections  
3/8" and 1/2" ID Available

Length in feet	Price 3/8" ID	Price 1/2" ID	Length in feet	Price 3/8" ID	Price 1/2" ID
1	\$1.50	\$1.65	6	\$3.60	\$3.75
2	2.25	2.40	7	3.75	3.95
3	2.75	2.95	8	3.95	4.10
4	2.95	3.10	9	4.25	4.40
5	3.40	3.60	10	4.50	4.65

11 to 50 ft. lengths available at 40c per ft. for 3/8" ID hose and 45c per ft. for 1/2" ID hose. All lengths priced complete with connections! Finest construction. Double wire internal braid.  
Note: Large quantities available at additional discounts.

## NEW VICKERS MF9, 6 H.P. HYDRAULIC MOTOR

Unit is compact, powerful. Displaces .507 cu. in. per revolution, 6 gal. per min. at 3000 RPM, 1500 PSI. Positive displacement. Angle type. Rated at 6 H. P. Rotates either direction. Unit can also be used as a pump. Here is the finest hydraulic motor available at a fraction of its new cost of over \$200. . . . . **\$29.50**  
Our price only . . . . .

**NEW VICKERS HYDRAULIC MOTOR:** Serial No. MF 1071130 B.C. F. 2. cu. in. displacement per rev. .378, 3600 R.P.M., 1000 P.S.I. Unit similar to above only with smaller displacement and H.P. Only . . . . . **\$24.50**

## NEW VICKERS HYDRAULIC VARIABLE DISPLACEMENT PUMP

Unit is used where a varying volume under continuous pressure is desired from a motor pressure generator in a hydraulic circuit, with non-pulsating flow. Pump will deliver maximum volume at any pressure setting between 600 and 900 PSI. When the volume of oil required is reduced from maximum to 0, a pressure rise up to 100 PSI above setting will occur. Any pressure setting is made by adjusting regulating screw. Unit has 1100 PSI internal relief valve. Pump housing serves as a reservoir for system and has built-in compressed air supercharger making the system independent of outside atmosphere pressure. Rotation is to the left only, continuous duty RPM 3750. .484 cu. in. per revolution displacement. PPD. . . . . **\$29.50**

## NEW MASTER HYDRAULIC CONTROL VALVE for controlling two single or double action cylinders separately or simultaneously. Valve is close center type. 1500 PSI rating, only . . . . . \$9.98

## PESCO HYDRAULIC GEAR TYPE PUMP

Rated at 3 GPM, 3750 RPM, 1500 PSI, 1/2" drive spline. Gov't cost over \$90. Yours for only . . . . . **\$9.49**

## NEW GEAR BOX TRAIN

6 to 1 gear ratio to two flex shaft outlets; one 1 1/2" flex shaft included. Unit includes 8 gears and 7 precision bearings. Many other gear ratios possible. Wt. 10 lbs. PPD! **\$6.95**

## 1/20 H. P., 110-VOLT MOTOR

60 cycle A. C. 1550 RPM. bronze bush bearing. 5/16" shaft. Wt. 4 lbs. Used, guaranteed serviceable. Only . . . . . **\$2.49**

## 24-VOLT TRANSFORMER: 110-volt A. C. to 24-volt, 3 amps. Just the thing for your small 24-volt motors. . . . . \$1.95

**T & T TOOL** 221 W. SECOND TULSA, OKLA.

of the speed. It is much more effective than needles on many other cars, in which the styling department has gone overboard by using a wide, thick needle so the driver cannot accurately determine his speed.

All instruments are included in the one panel. The starter operated by push button. Radio antenna is raised or lowered by push button which operates only when the engine is running. The radio reception is excellent and the Capri has front and rear speakers. Either can be controlled by the turn of a selector. One cigarette lighter and an ash tray are located near the center. An ash tray and lighter are located in each armrest for rear-seat passengers. There are four levers for controlling the air and temperature, the vents, the defroster and the blowers. The heating system is excellent—adequate and well-engineered to circulate heat or cool air on either side of the car. The control levers are conveniently located but are somewhat complicated and require some study for manipulation. The operation of the entire system could be simplified. The dome-light switch is in an unhandy position, low on the left-side panel behind the driver's seat.

The full-circle horn ring is the first I have noticed that does not partially obstruct the view of the speedometer or other instruments on the dashboard.

There is a neat map light under the dash, operated by a toggle switch. The clock is small but easy to read and it kept excellent time. The glove compartment is about average size.

At times, as in many other modern cars, there is a disturbing reflection of the sun off the top of the instrument panel.

Six and a half turns of the window crank are required to lower or raise the window; in my opinion, far too many. (Engineers should try the Plymouth or new Willys window-cranking ratio.) The doors open easily by a push button on the outside and a convenient lever on the inside. It takes about average pressure to close the doors.

The bumpers are massive and afford ample protection.

One of the new features this year (which also appears on Ford and Mercury cars) is the new center-fill gas tank, which permits the driver to enter a station on either side of a gasoline pump. Most service station attendants I talked with liked this feature, but several complained that the license plate which hides the center cap had to be held down while the cap is removed and the tank filled.

The test car was equipped with the new Dual-Range Hydra-Matic transmission, which is an improvement over the former

(Continued to page 272)

# POWER like this you've never

*ride Harley-Davidson's NEW '53 Twin for the thrill of*

**ADVANCED  
ENGINE  
DESIGN**



- 45 degree V-type Overhead Valve Engine — 55 horsepower
- The only motorcycle engine in the world with Hydraulic Valve Lifters
- Hemispherical Combustion Chambers for maximum performance
- Valve Rotators prevent carbon on valve seats and hot spots on valves
- Aluminum-bronze cast-in valve seat inserts reduce valve wear and assure proper valve seating

Sensationally new! Another reason why Harley-Davidson continues to lead the field with the newest, smoothest riding, best performing motorcycles in the world. The new '53 Twin sets the pace for thrills with an improved 74 OHV motor . . . a twin that's packed with features that lead the way for the entire automotive industry.

Here's flashing power for swift, fun-packed miles. Tops, too, in comfort, reliability and sleek, streamlined styling. See and ride the sensational Hydra-Glide at your dealer's today. Bring a buddy along. Or send 25 cents for illustrated literature and a copy of the Enthusiast magazine, filled with exciting action pictures and stories.

Harley-Davidson Motor Co., Dept. P, Milwaukee 1, Wis.



**HARLEY-  
DAVIDSON**  
**HYDRA-GLIDE®**

POPULAR MECHANICS





## Build This Handy SHELF-DOOR WARDROBE With Easy-To-Use Plywood

HERE's a brand new idea in built-ins—a single storage unit that combines a big, roomy wardrobe for coats and dresses . . . ample drawer space for shirts and sweaters . . . plus *extra* storage space for socks, odds and ends and jewelry inside the generously shelved doors. Easy to build. All you need are a few sheets of plywood, some framing lumber, hardware, ordinary tools and common sense. Ideal "handy man" project.

*Douglas Fir* Plywood

AMERICA'S BUSIEST BUILDING MATERIAL

**PLANS ONLY 10¢**

This ingenious shelf-door wardrobe, designed by E. W. Hanson, Stillwater, Minn., was awarded first prize in national architectural competition for plywood built-ins. Complete plans, bill of materials and finishing instructions are available for only 10c. Also available: Portfolio of over 50 top contest designs. 10c. Mail coupon today!

DOUGLAS FIR PLYWOOD ASSOCIATION (Good USA Only)  
Department 910, Tacoma 2, Washington  
Please send material checked. I enclose 10c for each.

- Wardrobe Plans  
 Design Portfolio

Name .....

Address .....

City.....Zone...State.....

**seen before**  
*a lifetime*

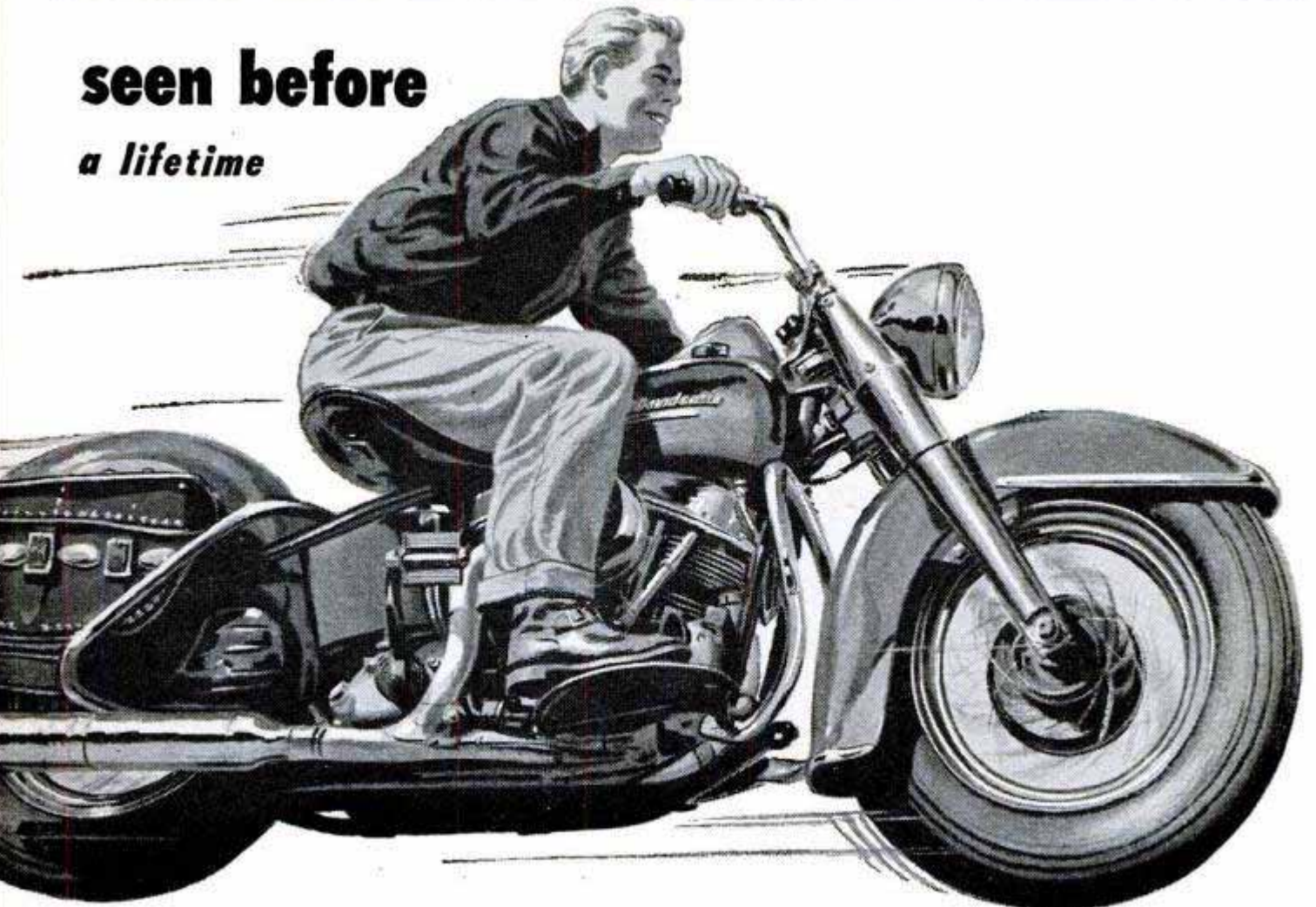

*Magic Clips*  
**Attach Chains**  
**To Auto Wheels**  
*Instantly*



## Get Out of Trouble After Your Car is Stuck

### On Ice, In Snow, Mud or Sand

An amazing new invention . . . *PRESTO Emergency Tire Chains* are snapped on to wheels *instantly after your car is stuck* . . . not before. This assures a savings in fuel, tire wear and time . . . you drive smoothly along with complete confidence of having efficient traction to *get out of trouble* from wheels spinning next to the curb, on ice at intersections, up that sloping driveway, off wet and muddy highway shoulders, in mud or snow. Chains are used only when needed and therefore give years of service. There are no straps to tighten . . . no jacking up the car . . . no loss of time, fuel and tires because you can get your car out of trouble instantly, this easy *PRESTO* way:—

**MAGIC CLIPS** are inserted between the tire and rim (like wheel balancers) and chains are attached instantly when needed. Wheels stay in balance and the clips are unnoticed. One box of four chains (enough for one car) assure trouble-free driving.

ORDER DIRECT for two weeks trial on our money-back guarantee of your entire satisfaction. Postage prepaid if payment in full is sent with order, or write for free circular.

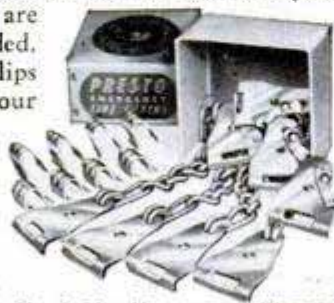

No. 1 Size (for one car) fit 5.25 to 7.20 tires, \$5.95. No. 2 Size (for one car) fit 7.60 to 8.20 tires, \$6.45.

Dealers, Agents Wanted

**PRESTO CHAIN CO.** 213 W. 7th St.  
 Des Moines 2, Ia.

single-range unit. The gearshift indicator is well located high on the steering column and easily read. It is conveniently marked for positions 3 or 4 in the drive range. Under normal conditions No. 4 position is used, which permits the four speeds to change automatically. If the throttle is held to the floor board, the transmission will shift into fourth speed at 70 miles per hour. No. 3 of the drive range actually gives three forward speeds that shift exactly the same as No. 4, but fourth speed is inoperative. No. 3 is convenient for quick acceleration in city driving or in descending hills. In No. 4 position, the top gear actually is similar to an overdrive unit. At speeds between 30 and 60 miles per hour, when the throttle is depressed to the floor board, the unit automatically drops into third speed.

There is, of course, the conventional low gear for use when extreme pulling power is needed; it also can be used as an extra brake in descending steep hills. Low and reverse positions are next to each other on the indicator, which is desirable for rocking the car in mud or snow.

The car is very economical for its size and weight (see my gas mileage chart). The 1952 A.A.A. Mobilgas Economy Run (Class G) was won by a Lincoln Capri with an average mileage of 22.36 miles per gallon at 40.84 miles per hour average speed from Los Angeles to Sun Valley, Idaho—a distance of 1415 miles; Lincoln also placed second in the sweepstakes, which was won by Mercury. Average mileage of all 25 competing cars was 22.057 miles per gallon; thus Lincoln mileage actually beat the average of all cars, including the light ones. (Average drivers do not drive as carefully or at speeds as slow as the contestants in this annual Economy Run, hence their mileage is lower.)

After exhaustive tests I would rate Lincoln as one of the three finest mass-produced cars built in the United States.

The new Lincoln styling and the many new features, several of which are exclusive, attracted much attention wherever we stopped. Lincoln is making new enthusiasts and converts in 1952. ★ ★ ★

## Wood-Veneer Wallpaper Simulates Paneling

Extremely thin wood veneer, bonded to a paper base, serves as a wallpaper which gives the appearance of real paneled walls. The veneer is available in birch and beech, stained in 12 colors. A roll measures 27½ inches wide by 47 feet long and is hung in the same manner as ordinary wallpaper. The veneered wall is easily cleaned with ordinary furniture polish.

# 4 big reasons why Genuine Ford Parts are best for your Ford!



Careful laboratory tests prove that Genuine Ford Parts live up to Ford specifications.



## They're **MADE RIGHT**

Each Genuine Ford Replacement Part reflects the designing and manufacturing skill of the men who designed and built your Ford.

## They **FIT RIGHT**

Because every Genuine Ford Part is designed right, it will last longer. Every Genuine Ford Part is exhaustively tested by Ford engineers.



Genuine Ford Parts are easy to work with in repair jobs.



Genuine Ford Parts are track tested in scorching desert heat on Ford's Arizona test track.



## They **LAST LONGER**

Save time and money . . . specify Genuine Ford Parts. They're perfect counterparts of the parts built into your Ford when it was new.

...and they're

**TRACK TESTED**

Grueling track tests on Ford test tracks prove that there are no better parts available for your Ford.

Come in...  
**"LET'S GET ACQUAINTED"**

When your Ford needs service attention take it where you see the Genuine Ford Parts Sign



Tough tests on Ford's Dearborn test track prove that Genuine Ford Parts can take it.

Save by Specifying →

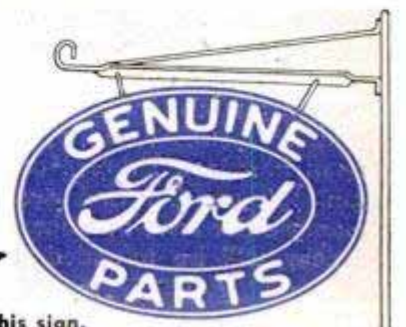

Available at all Ford Dealers' and selected independent garages which display this sign.

# Never be without power!

## FAIRBANKS-MORSE GENERATING SETS

Fairbanks-Morse  
1800 Watt  
A.C. Generator

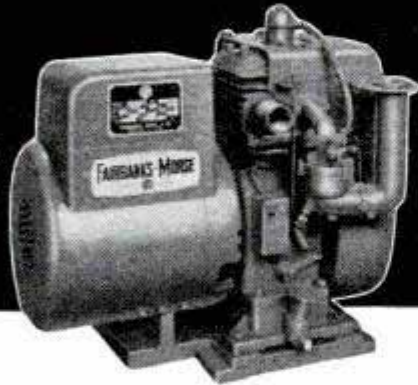

Even though storms, accidents or calamities cut off your power supply, you can still have plenty of power to operate lights, utilities, tools etc., if you install a Fairbanks-Morse stand-by generating set—*now!*

Fairbanks-Morse Generating Sets are available in capacities from 600 to 35,000 watts, A.C. or D.C., with manual, remote or automatic starting. There are sizes for all shops, filling stations, garages, farms, homes, stores, and other businesses. For complete details, see your local Fairbanks-Morse dealer, or write Fairbanks, Morse & Co., Chicago 5, Ill.



## FAIRBANKS-MORSE,

a name worth remembering

# 4 TOOLS IN 1

The Complete  
METAL WORK SHOP  
FOR HOME AND PLANT

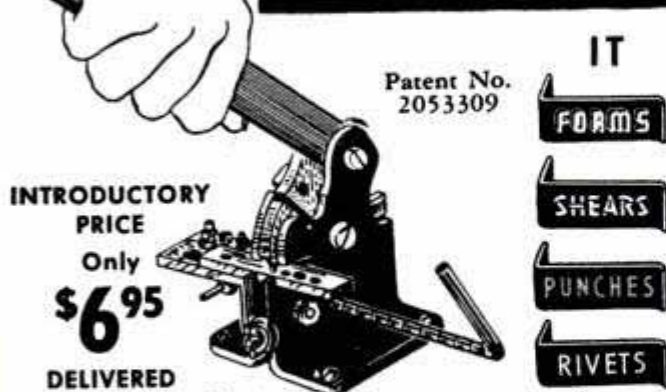

INTRODUCTORY  
PRICE

Only  
**\$6.95**

DELIVERED

Ideal for hobbyists, craftsmen, repair shops, garages, model mfgs., experimental labs, etc. Handles metals up to  $\frac{1}{4}$ " thickness depending upon hardness. Shipped complete with  $\frac{1}{8}$ ",  $\frac{3}{16}$ " and  $\frac{1}{4}$ " punches and riveting dies. Check or money order must accompany order. No C.O.D.'s. Money will be refunded if not fully satisfied.

**ALBERT J. TATU CO.**

85 Columbia Dr. Dept. F-2 Williamsville 21, N.Y.

# MAKE Big MONEY WITH THE

# Universal LAWN MOWER GRINDER!

Enjoy a profitable lawn mower sharpening business of your own. No previous experience needed. Place a hand or power mower on the UNIVERSAL GRINDER. With only ONE SET-UP you quickly grind the stationary blade and all the reel blades to proper clearance WITHOUT REMOVING A SINGLE BLADE from the mower.



**PROOF**

G. Spurlock, of Arkansas, writes: "I have my Universal Grinder two months and made a net profit of \$227.00".

C. E. Hardy of Miss. writes: "I am doing a fine business with the Universal Grinder. I spent 40¢ for a newspaper ad and have done nearly \$500.00 of business." Write today for FREE FACTS about Big Profits in Lawn Mower Sharpening.

**ROGERS MFG. CO., DEPT. M-102  
LINDSEY, OHIO**



## BRONZE FOUNDRY

Schools and Home Workshops

Make your own castings of aluminum, copper, bronze, silver. Foundry sets are available in three sizes including 2400 Deg. F. blast Furnaces. \$22.50; \$29.50; and \$42.00. f.o.b. Kansas City. Free Circular.

**KANSAS CITY SPECIALTIES CO.** P. O. Box 6022, Dept. P-10  
KANSAS CITY, MO.

SEND  
**30¢**

stamps or coin for  
3 oz. sample can

**TASGON**

**KEEP TASGON IN  
YOUR TOOL KIT!**

A few drops of Cabot's TASGON—the fast-working, penetrating rust solvent—will do wonders for you in freeing frozen nuts, bolts, joints. Cuts through gummed-up oil and paint quickly and effectively.

**SAMUEL CABOT INC., 1067 Oliver Bldg.,  
Boston 9, Mass.**



## BUILD FINE GRANDFATHER CLOCK NOW

The simple sensible Red-i-Kut way as thousands have—**SAVE HALF. SHOP TESTED PLANS "SPIRIT OF THE CENTURY"** Narrow waist 35" tall or stately straight side "SPIRIT OF AMERICA." **EASY-TO-FOLLOW** photographs PLANS tell all—plus **BROCHURE** of heavy brass weight Westminster, tube chime, movements, gorgeous dials,  $\frac{3}{4}$ " solid mahogany case kits. Send \$1.00 today — Both plans \$1.50 NOW.

**KUEMPEL CHIME CLOCK CO., #4 Kuempel Bldg., Minneapolis 16, Minn.**

## DEPENDABLE CRAFT SUPPLIES

WRITE FOR CATALOG  
SINCE 1926

LEATHER CRAFT • PLASTICS • POTTERY  
CRAFT • BLOCK PRINTING • BELT CRAFT •  
TEXTILE COLORS • POWER TOOLS • WOOD  
BURNING • INSTRUCTION BOOKS • ETC.

**DWINNELL CRAFT SHOP**  
Dept. PM-1052, Wheeling, W. Va.



SAY YOU SAW IT IN POPULAR MECHANICS

## NEW TOOL for Your DRILL PRESS

### CUSHION CENTER HOLE CUTTER

Cuts Holes or Discs— $1\frac{1}{4}$ " to 8" Diameters

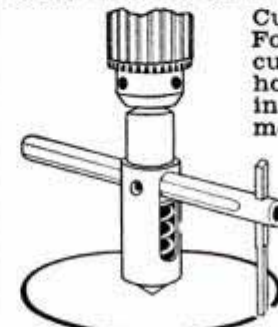

Cuts wood, plastic or light metals. For drill press or lathe. Clean, even cuts up to 1" depth. Cushion center holds work in place. No center holes in work. Fast work. Quick adjustment. The  $\frac{1}{2}$ " straight shank fits all  $\frac{1}{2}$ " chucks or adapters. Hardened tool steel cutter, ground for wood and plastics. Special direct-from-factory price, \$4.50 postpaid. No COD. Order today!

**Satisfaction Guaranteed**

If you are not satisfied, return tool for prompt refund. Complete instructions with tool.

**IVAN TOOL CO.**

1236 W. FORT ST.  
DETROIT 26, MICH.

LOWEST PRICES ON

# WAR SURPLUS and OTHER SPECIALS



## AIRCRAFT QUALITY HYDRAULIC EQUIPMENT

Large supply of new labor-saving, economical hydraulic equipment in many types and sizes. Use these positive, highly efficient smooth pressure hydraulics on presses, arbors, lifts, loaders, power control, positioning, brakes, plastic dies, auto frame alignment, etc., etc.



**ITEM #42**—Double acting hydraulic cylinder, 4" bore, 18" stroke. Rated lift capacity with 1000 PSI line pressure is 12,500 lbs. Ship. wt. 30 lbs. F.O.B. Chicago. An Excellent Buy for... **32.50**

**ITEM #16C**—Double acting hydraulic cylinder, 1 1/2" bore, 26" stroke. Will lift 1760 lbs. with 1000 PSI line pressure. Weight 8 lbs. A \$55.00 value. Now only. Postpaid **16.95**

**ITEM #6**—Double action hydraulic cylinder, 3" bore, 24" stroke, will lift 7070 lbs. with 1000 PSI line pressure. Steel barrel. 1 1/8" stainless steel shaft. Ship. wt. 26 lbs. F.O.B. Chicago. **28.00**

**ITEM #126**—Four-way, open center control valve with built-in adjustable relief valve. Factory set at 1000 P.S.I., spring loaded neutral position, for use with one double acting cylinder. In neutral position cylinder is locked and pump unloaded. Fully balanced plunger type, smooth, positive, easy operation, can be used as single unit or mounted in series of any combinations desired. Has 3/4" pipe thread inlet and outlet, 1/2" pipe thread cylinder ports. Newly manufactured to our specifications. Shipping weight 8 1/4 lbs. An outstanding Buy! F.O.B. Chicago **21.50**

### HYDRAULIC SPEED REDUCER

**(ITEM #115) WITH FINGERTIP CONTROL** Delivers variable output speed from 0 to input speed. Uses input power from 1/4 to 1 1/2 HP. Standard 3/8" input and output keyed shafts. Input speed—not to exceed 750 RPM, rotation—counter-clockwise facing shaft. Adjustable relief valve set at 100 inch pounds may be reset to 180 inch pounds. Made by Westinghouse-Oil Gear. Overall dimen. 7 1/2" x 7 1/2" x 1 1/2". Gov't. acq. cost \$428. Complete with full instructions and 2 qts. of oil. Shipping Wt. 31 lbs. F.O.B. Chicago. **54.50**

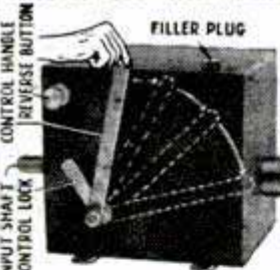

**ITEM #160**—PESCO GEAR TYPE HYDRAULIC PUMP—Compact—Powerful—Reliable. Especially designed for belt drive from fan belt, power take-off, drive pulley, electric motor or small gas engine. Equally suitable for direct coupling. Pedestal type mounting with two bolt holes for 3/8" hold-down bolts. Standard 1/2" pipe thread inlet and outlet ports. Delivers 4.5 GPM at 1000 PSI at 2800 RPM with 3 HP. Will actuate one Item #6, 3" bore, 24" stroke cylinder in 10 seconds. Hardened steel gears turn in dense oilite bronze bearings. Rotation—clockwise facing shaft. Guaranteed trouble-free service. Ship. wt. 6 lbs. F.O.B. Chicago. **22.50**

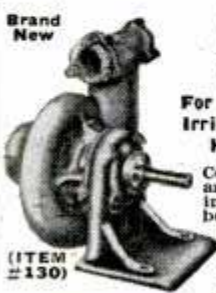

## General Motors — Allison CENTRIFUGAL PUMP 200 GALLONS PER MINUTE

For Draining Basements • Fire Fighting  
Irrigation • Fuel Transfer • Swimming Pools  
Home Water Systems • Dewatering

Converted for high volume commercial, home, and industrial use. Standard 2 1/2" pipe thread inlet, twin 1 1/4" pipe thread outlets. Ball bearing supported 3/4" shaft. Easy priming. Rotation, counter-clockwise facing shaft. Gov't. acq. cost \$145.00. Complete with full instructions. Ship. wt. 35 lbs. F.O.B. Chicago. **39.50**

## ALL UNCONDITIONALLY GUARANTEED — PREPARE NOW FOR POWER FAILURE! IMMEDIATE DELIVERY GENERATING PLANTS



**LARGE STOCK MANY SIZES FROM 350 WATTS TO 25 KVA**  
**ITEM #183**—3000 to 4000 WATT GENERATOR SET—FEATURES—Power for your home or business. Simply connect to power panel or house circuit. Constant voltage regardless of load. Push button start or stop. Easily made full automatic start or stop. **SPECIFICATIONS**—Size 19"x30"x48". Steel skids, weatherproof housing, requires no building. Wt. 725 lbs. Hercules 4-cyl. 10 HP gasoline engine. Load governor. Oil filter. Quiet muffler. 6-volt starter, generator Hobart 115 volt, 60 cycle, 3000 to 4000-watt generator. Furnishes either single or three phase power, 2 or 3 wire. Panel contains oil gauge, voltmeter, ammeter, circuit breaker, voltage regulator, start button. Today's cost over \$1200.00. **SALE PRICE, 465.00**

**ITEM #178**—350 watt—110 volt—60 cycle A.C. direct coupled to 1 cylinder Midco engine. Shpg. Wt. 116 lbs. F.O.B. Chicago. **125.00**

**ITEM #178**—3 KW—110 Volts D.C. This mighty unit develops 3 KW—28.5 amps. D.C. Standard Deico generator direct coupled to a Model ZZF Briggs and Stratton 1 cylinder, 5-7 HP, air cooled, rope starting gas engine. Instruments include voltage control rheostat and voltmeter. Wt. 275 lbs. F.O.B. Chicago. **295.00**



### UTILITY CENTRIFUGAL PUMP

**ITEM #30**—For draining cellars, laundry tubs, irrigating gardens, etc. Die-cast construction, inlet and outlet fits standard garden hose. Has standard 1/2" shaft with flat for pulley attachment. Maximum capacity 2400 gallons per hour. Use 1/8 to 1/2 HP. Overall dimensions 5 3/4" x 6 3/4" x 5 1/2". Postpaid **6.95**



### G-1 TANK

Slightly Used—Like New tanks for tire inflators, on compressors, pulsation chambers, floats, buoys, fluid and milk containers, etc. Tough, light, shatterproof, 450 PSI, 2100 cu. in. (approx. 9 gals.) int. vol. 24"x12", 1/4" threaded openings at both ends. Wt. 19 lbs. F.O.B. Chicago. **5.95**

**ITEM #63**—Use these tanks for tire inflators, on compressors, pulsation chambers, floats, buoys, fluid and milk containers, etc. Tough, light, shatterproof, 450 PSI, 2100 cu. in. (approx. 9 gals.) int. vol. 24"x12", 1/4" threaded openings at both ends. Wt. 19 lbs. F.O.B. Chicago. **5.95**

### 1/4" ELECTRIC DRILL KIT STANDARD DUTY • MODEL 77-5

**ITEM #348**—contains 1/4" Electric Drill with 3-jaw knurled chuck, double pole automatic electric switch, 10' rubber covered—oil and gasoline resistant cord and pistol grip handle. Drill has universal 115 volt AC-DC motor, precision heat-treated alloy steel gears enclosed in grease tight housing. Accessories include drill bits in graduated sizes, sanding discs, lamb's wool buffer, wire buffer wheel, mounted grinders, etc. All enclosed in sturdy, metal box. Shipping weight 8 lbs. A terrific buy! F.O.B. Chicago. Only. **20.95**



### NEW, Model 353 DUAL RANGE D. C. ARC WELDER

for Stationary or Portable Use. **HEAVY DUTY RANGE TO 250 AMPS. NEW 'MAGIC TERMINAL' FOR LOW CURRENT 30 TO 100 AMPS. IDEAL FOR • FARM • FACTORY • GARAGE • WORKSHOP** These precision engineered D.C. Arc Welders contain the highest quality War Surplus aircraft components built to exacting government specifications. They are light in weight, have over-sized lifetime grease-sealed ball bearings, air cooled commutator, dial type rheostat for easy pin-point control, a high-low rheostat switch, reactor coil for even arc and the new 'MAGIC TERMINAL' low current welding range for welding lighter materials. Designed for many years of trouble-free service. Run welder from drive pulley or power take off of a tractor or Jeep. 7 1/2 HP electric motor or 10 HP gas engine at 2500 R.P.M. Uses two V-belts or flat belt. Continuous output rating 200 amps. Intermittent welding rating 250 amps., 30 volts. This sensational price includes double V or flat belt pulley and complete operating instructions. Ship. wt. 107 lbs. \$350.00 value. **119.50**



### FREE: NEW 48-PAGE BARGAIN CATALOG

Chuck-full of unsurpassed War Surplus Equipment Bargains for farm, home, factory and workshop. You save on everything at Groban's. Write Today!

ORDER DIRECT FROM AD — SEND PAYMENT OR PURCHASE ORDER TODAY — SATISFACTION GUARANTEED

**GROBAN SUPPLY CO. 1139 SO. WABASH AVE., CHICAGO 5, ILL. DEPT. P.M.10**

**EVERY ELECTRIC DRILL  
A POWERFUL PORTABLE SAW**

**JOIN THE THOUSANDS who  
SAVE WORK — SAVE TIME**  
and do the job **BETTER** with



**CAN BE USED WITH ONE HAND**

**SAFETY-  
YOKE**

At  
Better  
Hardware  
Stores  
Everywhere

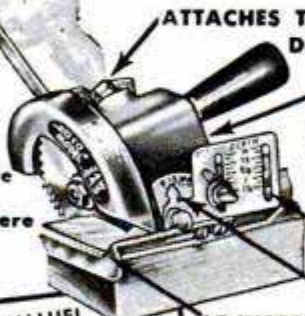

**ATTACHES TO ANY 1/4" ELECTRIC  
DRILL IN ONE MINUTE!**

**ANGLE DRIVE  
(with STEEL GEARS)  
ELIMINATES  
DANGEROUS  
DIRECT DRIVE.**

**DEPTH GAGE,  
0 to 1 1/4".**

**ADJUSTABLE BEVEL GAGE,  
RIP GAGE. 0 to 45° ANGLE.**

**Also has VISUAL GUIDE  
(not shown).**

**CUTS 1 1/4",  
or 2x4 by  
turning over**

**90-DAY  
FACTORY  
GUARANTEE**

**WHAT A VALUE!**  
No. 445 "ARCO-SAW"  
(shown)  
**1.50**  
with ALL GAGES  
& 4" "HYCARBON" Cross-  
cut Blade.  
No. 444 "ARCO-SAW" —  
same as above, less gages.  
Has accurate  
visual guide **99¢**

**READ WHAT ENTHUSIASTIC "ARCO-SAW" USERS SAY:**

Best of all my tools. H.D., Wauwatosa, Wisc.  
...a wonderful time saver...very simple to operate. M.H., L.I., N.Y.  
...haven't used a handsaw since I purchased the "ARCO-SAW".  
D.S., West Roxbury, Mass.

*If Not Available at Your Dealer, Try "ARCO-SAW"  
on Our Unconditional 10-Day Money Back Guarantee.*

**NOW AVAILABLE!  
"ARCO SAFECUT"**

**THE SAFEST CIRCULAR  
SAWBLADE EVER MADE!**

COMPARE THESE QUALITY FEAT-  
URES WITH BLADES COSTING  
CONSIDERABLY MORE: Made of  
finest tempered tool steel, precision  
ground; "Kick-back" accidents elim-  
inated, cannot drag hand into saw-  
blade; Blades quickly and easily re-  
sharpened with ordinary handfile;  
30% less power needed, smaller mo-  
tor can be used.



**TOP  
QUALITY! LOW  
COST!**

6-inch Blade..... **\$1.75** 7-inch Blade..... **\$1.95** 8-inch Blade..... **\$2.15**  
Special Bores for Skil, Mall, B & D Saws — Add 30¢

**CONVENTIONAL TYPE BLADES ALSO AVAILABLE IN  
RIP, CROSSCUT and COMBINATION STYLES at  
same prices as above.**

Made of FINEST TEMPERED TOOL STEEL, HANDFILED.

BE SURE TO ASK FOR "ARCO" TOOLS AT YOUR DEALER TO-  
DAY! If not available, send us check or  
M.O. (Postpaid). C.O.D.'s—postage ex-  
tra. Write for literature of other tools.

**DEALERS: Write for  
nearest jobber.**

**ARROW METAL PRODUCTS CO.**

Dept. PM-10, 140 WEST BROADWAY, NEW YORK 13, N. Y.

SAY YOU SAW IT IN POPULAR MECHANICS

**PRECISION T.C. PARALLEL CLAMPS**

Made of the finest quality for the craftsman. Hardened  
throughout. Metal clips to hold  
screw in place on return.

Opening Price C.W.O. PREPAID  
Each DELIVERY

5/8" \$1.10  
1" 1.35 IMMEDIATE SHIPMENT  
1 1/2" 1.55 ON ALL ORDERS  
2" 1.90  
2 1/2" 2.15  
3 1/2" 3.85



Dealers and distributors  
write for details.

**PRECISION T. C. COMPANY**  
1305 S. Laramie Ave., Cicero 50, Ill.

**SPECIAL LIMITED TIME OFFER!**

**FREE** BUFFING COMPOUND  
of extra cost with **Dico Buffs**



Take this ad to your Hardware Dealer  
... buy one or more Dico Buffs (4" or  
larger) ... and he will give you a tube  
of Dico TC6 Buffing Compound—*absol-  
utely free.* "How-to-buff" Manual free  
with each packaged Buff, too. Take ad-  
vantage of this offer today, because ...

**IT'S FUN TO BUFF AT HOME WITH  
DICO BUFFS and COMPOSITIONS**

This authorizes you to supply Dico Com-  
pound from your stock, as offered above.  
Send this ad, with your name and ad-  
dress, and we will mail replacement  
stock, postpaid.

To Dico Dealers

**DIVINE BROTHERS CO., Dept. B-1052, Utica, N. Y.**

**HOBBYISTS! SHOPMEN! Special** ONLY **\$54.50**

**PALMGREN "HOBB-E" Rotary, Index, Milling Table**  
Ideal for Model Parts or Shop Work

Mill-Grind-Drill-Index-Rout curved or straight-  
Rabbit and Mortise on drill press or lathe.  
8" Table, 4" Cross Feed, 360° Rotation, Accu-  
rately Graduated. Bolts to table. Order NOW!  
SAVE \$100. Only \$54.50. Less Rotary Feed  
\$43.75. Write for "HOBB-E" Tool Circular.



**CHICAGO TOOL and ENGINEERING CO.**  
8365 South Chicago Ave. Chicago 17, Ill.

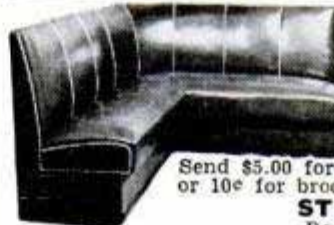

Anybody Handy With Tools Can Build

**LEATHER LOUNGES  
FOR KITCHENS AND  
RESTAURANTS**

Frames, springs, filling, con-  
struction simplified.

Send \$5.00 for complete plans and instructions,  
or 10¢ for brochure.

**STEFAN GALENSKI**  
Designer & Manufacturer

2221 BROADWAY

BUFFALO 12, NEW YORK

**Reduce  
RADIO NOISES**



**SIMPLY PLUG** Radio or Appliance cord

into Noise Eliminator and plug into wall socket. Enjoy recep-  
tion FREE from many distracting noises. Send No Money, pay  
postman \$1.25 each (2 for \$2.00) plus postage or send cash  
and we'll mail postpaid. Try 5 days, money back if not de-  
lighted. Many hundreds of satisfied users. Send for yours today. 2 for  
MERIT SALES, Dept. K-30, 4225 Eldone Dr., Baltimore 29, Md. \$2.00



**TELEPHONE SHOULDER REST...**

SNAPS INTO PLACE — NO SCREWS, STRAPS, HOOPS, OR BOLTS

**"RECEIVE-EASE"**

EXPERTLY DESIGNED IN THE  
STYLE OF YOUR TELEPHONE

Leaves both hands free

A CONVENIENCE IN THE HOME OR OFFICE

SEND \$1.00 (All mailing & costs included in

this price) plus your name, address, & tele-  
phone model No. E-1 or F-1 indicated on underside—

to CAPPS DISTRIBUTING CO., Box 328

South Pasadena, California

(As advertised or your money refunded)



**RICHARDSON**

priced for you in '52

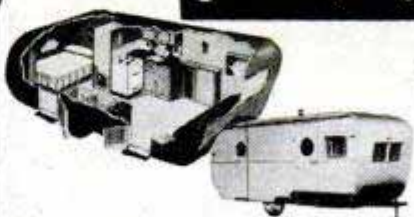

This new low priced  
21-foot Sportsman  
model has been de-  
signed with the out-  
door man in mind.  
Write to Dept. P for  
free literature.

**RICHARDSON TRAILER MFG.**

Elkhart CO., Inc. Indiana

# Sensational New Development

Install Your Own  
Beautiful Wood-Paneled Walls  
at a New Low Price!

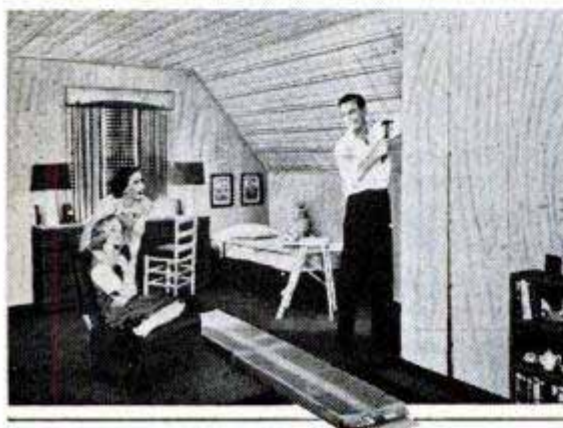

## Pre-finished Hazelwood Plankweld →

You can panel a 13½ foot wall  
with one package costing only \$47.50!

**A Real Wood! Not An Imitation!** Here's a name you'll remember... a wood you can't forget! Newest member of the famous Weldwood Plywood family... new *pre-finished* blonde hardwood *Plankweld* panel.

**Beauty At A Bargain!** Never before such beauty in a panel... for so little cost! What a pleasing, light *honey-color!* What *uniformity* of color! What beautiful *graining!*

**Decorative, Permanent, Crackless.** You can put Hazelwood Plankweld right over old or new walls... right over shabby or cracked plaster. Without furring or framing.

**Easy to Install!** Hazelwood Plankweld is so easy and quick to install! If you can handle a hammer, you can do it yourself! Do it over a week-end! And once these panels are up, there is absolutely nothing more to do except thrill to their beauty. For *life!*

Panels are ¾" thick, 16¼" wide... 6', 7', or 8' long. They are edge-grooved to provide a neat lap joint... designed with a simple, concealed metal clip that holds Hazelwood Plankweld firmly to the wall.

**What SAVINGS!** Hazelwood Plankweld is so low in price that a package of 10 panels—costing only \$47.50—permits you to panel a 13½ foot wall, 8 feet high. (Or an even

longer wall if there are doors or windows.)

**Durable Finish is Factory-Applied.** Hazelwood Plankweld comes to you already finished—which means that once you erect it, your job is done! You don't have to finish it—the tedious finishing job has been done for you at the factory. And the finish is so durable, you can rub a coin across it without leaving a mark!

**Ends Redecorating Problems!** No paint, no stain, no redecorating will ever be needed. The factory-applied finish of Hazelwood Plankweld will retain all of its rich, original lustre... with only occasional waxing.

**You've Got To SEE  
Hazelwood Plankweld!®**

See this truly wonderful new Plankweld panel and other Weldwood products at any of our 60 distributing units from coast to coast. Or visit your Weldwood Dealer today! You'll recognize at once that *everything* about Hazelwood Plankweld is just what you've been waiting for! Its beauty! Its *permanence!* Its ease of *installation!* Its *low, low cost!*

Pre-finished Hazelwood is also available in 4'x8' panels.

See and feel Hazelwood Plankweld. Remember, like all interior Weldwood Plywood, Hazelwood Plankweld is guaranteed for the life of your home. Plankweld is also available in pre-finished oak, birch and Philippine Mahogany at slightly higher cost.



Send for  
**FREE**  
sample

UNITED STATES  
PLYWOOD CORPORATION  
Box 61, New York 46, N. Y.

Gentlemen:

Please send me free sample of Hazelwood Plankweld with descriptive literature.

Name \_\_\_\_\_

Street \_\_\_\_\_

City \_\_\_\_\_ Zone \_\_\_\_\_ State \_\_\_\_\_

PM-10-52

## Weldwood® Plywood

a product of

UNITED STATES PLYWOOD CORPORATION

World's Largest Plywood Organization

Dealers Everywhere

Branches in Principal Cities • Warehouses in Chief Trading Areas



**Throw Away  
Nicotine\***

**ENJOY CARE-FREE  
FILTERED SMOKING**

in

**MEDICO**

**Crest \$3** *Finest Medico ever made.  
Exquisite Burgundy Finish*

**MEDICO V. F. Q. — \$2** With NEW NYLON BIT.  
Exclusive! Guaranteed Bite-Proof!  
Odorless! Tasteless! Cushion Bite!  
**MEDICO MEDALIST — \$1.50**

\*When filter turns brown—in Medico Pipes or Cigarette Holders—throw it away, with nicotine, juices, flakes, tars it has trapped. Insert a fresh filter for cooler, cleaner and dryer smoking. Imported Briar.



Box of  
10 filters—10¢

Wide variety of styles and sizes.  
Write Medico Pipes, Inc., N.Y. 22, for Booklet M

**MEDICO CIGARETTE & CIGAR HOLDERS — \$1**

Get the handy  
**TORIT ACETYLENE BLOWPIPE OUTFIT**  
for soldering and all small jobs requiring heat

Consists of torch, 4 tips, soldering copper, hose, connections for acetylene tank, and instructions for use.

Ideal for garages, repair shops, home workshops, etc. Ask for free literature on Torit Outfit No. 23 or order now. Sent postpaid for only . . . . .

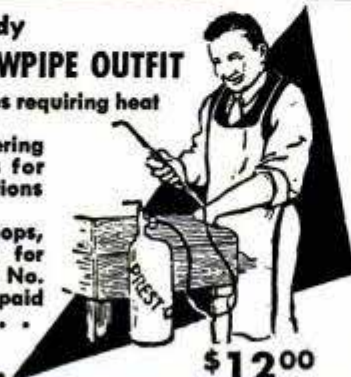

**\$12.00**

**TORIT** MANUFACTURING CO.

273 Walnut St. • St. Paul 2, Minn.

**Super Powerful All Channel TV RECEPTION IN ALL DIRECTIONS**

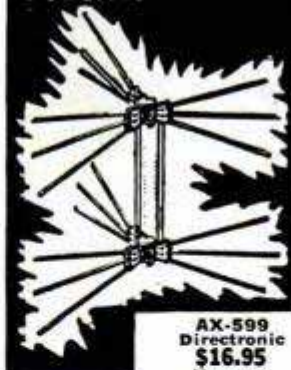

**AX-599  
Directronic  
\$16.95  
You pay  
postage**

Do not remit more than complete purchase price. 25% deposit on C.O.D. orders, please. Money-back guarantee.

**Rocket DIRECTRONIC  
MOTORLESS TV ANTENNA**

**360° Electronically Switched Beam**

- No Motors
- No Roof Orientation
- No Electric Power
- No Ghosts
- Flick of Switch Clears Picture Instantly

In the city or in an ultra-fringe area, the Directronic will out-perform ordinary antennas. Only the Motorless 360° Directronic TV Antenna offers "around the compass" reception WITHOUT Rotors. Clarity of picture will amaze, it's so bright, so sharply defined. AX-599 "Serviceman's Array" contains Hi-Pac molded insulator of extremely high tensile strength, 18 hi-tensile aluminum alloy elements, 1 set of connecting stubs (3), Universal U-Clamps for masts to 1 1/2", Directronic Beam Selector, 75 feet of Tri-X Cable.

**NATIONAL ELECTRONICS OF CLEVELAND**  
310 DELCO BLDG. CLEVELAND 3, OHIO



**WHEN VISIBILITY IS POOR DRIVE CONFIDENTLY WITH A HULL AUTO COMPASS**

• Fog, rain, snow, dark of night hide road signs—make driving a headache unless you have a Hull Auto Compass. Hull continually proves the handiest instrument in your car. Write for local dealer's name, literature.

**MORE HULLS IN  
USE THAN ALL  
OTHERS COMBINED**

**Beaconlite** \$6.95  
ILLUMINATED  
**STREAMLINE** \$4.95  
STANDARD (not illus.)

**HULL MFG. CO.** P.O. Box 246-D10, Warren, O.

**WAR BARGAINS**  
*Over 200 terrific*  
**SURPLUS** *ALSO FACTORY*  
**VALUES!**  
*SURPLUS*  
**SEND FOR FREE**  
*catalog*  
**SIoux FALLS SURPLUS STORE**  
**SIoux FALLS, S. DAK.**

**LAWN ORNAMENT-NOVELTY PATTERNS**

28 Lawn Ornament Patterns, 25c. Other Patterns: 15-20" high; Dutch Girl, Dutch Boy, Pirate, Bull Terrier, Mexican Girl, Mexican Boy, Dwarf, Penguin, Flower Girl. 10¢ each. 25 Novelty Patterns, 30¢. All 62 Full Size Patterns, \$1.00. Strother Pattern Service, Dept. DB-8, Box 128, Belington, W. Va.

**Clark EXPANSIVE BIT**

**CUTS BETTER • COSTS LESS!**

Accurate, fast; cuts smooth holes in hard or soft wood. Chrome vanadium steel blades, all chrome body. No. 250, 1/2"-1 1/2", \$1.89; No. 251, 3/4"-3", \$2.19. **GUARANTEED.** At your dealer or write Dept. PM10

**ROBERT H. CLARK COMPANY • Beverly Hills, California**

**Say You Saw It in Popular Mechanics**

**ACE TOOLS**



Be permanently  
tooled-up for every operation  
on your Metal Cutting Lathe.

No. 8-A Ace Tool Set for 9" and 10" Swing Lathes—fits shank size 3/8" x 3/4". Includes Turning, Knurling and Threading Tools with high speed cutters, blades and wrenches. 8 complete tools in fitted steel case—nothing else to buy. See your local dealer or order direct.

**ARMSTRONG BROS. TOOL CO.**  
5268 W. Armstrong Ave., Chicago 30, Ill.

**\$26.95**



# Build A MODERN READY-CUT HOME! *Costs You Less!*

Shipped  
Direct  
from Our  
Mill



\$4736

*Liberty Homes*

\$3184



*Save 30% to 40%  
on Your New Home.*

Don't pay several hundred dollars more than necessary when you build a home! Buy direct from our mill at our low factory price. We ship you the lumber cut-to-fit, ready to erect. Paint, glass, hardware, nails, etc., all included in the price—no extra charges. Plans furnished—also complete building instructions. No wonder our customers write us that we saved them 30% to 40%. Architecturally approved construction. (Not pre-fabricated.)

### Visit a Liberty Home!

Many thousands of Liberty Homes have been built in all parts of the country. There is one near you that you can visit and inspect. Write us and we will give you its location.

31 Designs to Choose From  
AS LOW  
AS . . . \$2180

Recommended by Banks and  
Building and Loan Associations

### Handsome Big CATALOGUE

Pictures wonderful homes in colors at money-saving prices. Designs to suit everyone. Send 25c for catalogue today.



**LEWIS MANUFACTURING CO.** 1220 LAFAYETTE AVE., BAY CITY, MICH.

### New MOTOR BARGAINS for Home, Farm & Industry



- |            |  |
|------------|--|
| 1/2 H.P.   | Dayton, 3450 RPM IND type . . . . . \$18.50                            |
|            | Westinghouse, DBL shafts, 1725 RPM . \$22.50                           |
| 3/4 H.P.   | Westinghouse, dbl. shafts, 3450 RPM . \$23.50                          |
|            | Eicor, capacitor type ball brg., 1725 RPM . . . \$32.50                |
| 1 H.P.     | General Electric, cap. ball brg. dbl. shafts, 1725 RPM . . . . \$34.50 |
|            | General Electric, cap. type, 3450 RPM . . \$34.50                      |
| 1 1/2 H.P. | Eicor, 1750 RPM, cap. type . . . . . \$52.00                           |
|            | Dayton, 3450 RPM, cap. type . . . . . \$57.00                          |
| 2 H.P.     | Dayton, 3450 RPM, cap. type, dbl. shaft . \$62.50                      |
|            | Westinghouse, ball brg. cap. type, 1725 RPM . . . \$67.50              |
| 2 H.P.     | Dayton, 3450 RPM, rep. ind. . . . . \$67.50                            |
|            | Dayton, 3450 RPM, rep. ind. . . . . \$75.00                            |
| 2 H.P.     | Leland, 1725 RPM, rep. ind., ball brg. . . \$79.00                     |
|            | Above Special Prices are F.O.B.  |

ALL NEW MOTORS WITH ONE YEAR FACTORY GUARANTEE  
All are 110 V. or 110/220 V. 60 cy. 1 ph. A.C. Motors.  
Write for FAN CIRCULAR: Listing Blades, Guards, Motors, ALL SIZES: Attic, Window or Room Cooler

C. MARSHALL SALES  
3546 W. Fullerton Ave., Dept. P-10, Chicago 47



### 16 TO 1 SPEED REDUCERS

For Display Table — Barbeque Spits — Toy Auto Gear Box — Experimental Uses, Etc. Gears Enclosed in Aluminum Housing. Bronze Gear, Hardened Worm, Input Shaft 1/4 in. Output Shaft 3/4 in. Speed Reducer #R 161. . . \$3.95 Post Paid

### New Explosion Proof Motors

Underwriters approved, Class I, Group D, explosion proof motors, Westinghouse and Leland makes, heavy duty repulsion induction and capacitor types. For pumping gasoline, lacquer or use on jobs where motor is exposed to hazardous fumes or material, abrasives, dirt and dust. All 3/4" shaft, 1750 RPM.

No. EP-25, 1/4 HP, 110/220V, 60 cy., 1 ph.	\$23.50
No. EP-33, 1/2 HP, 110/220V, 60 cy., 1 ph.	\$28.50
No. EP-333, 1/2 HP, 220 volt, 60 cy., 3 ph.	\$32.50
No. EP-32, 1/2 HP, 32V, direct current . . .	\$33.50
No. EP-115, 1/2 HP, 115V, direct current . . .	\$37.50
No. EP-230, 1/2 HP, 230V, direct current . . .	\$24.50
No. EP-233, 1/2 HP, 230V, direct current . . .	\$27.50

All prices F.O.B. Chicago

### Volume Blowers for Heating, Ventilating, Exhausting

Blowers for forced drafts, heating boosters, exhausters, coolers, dryers and dust collectors. 110 volt A.C., 50/60 cycle motors.

- \*Midget Blower: 5 CFM 2 in. Wheel . . . \$ 6.95
  - \*50 CFM Blower: 3 inch Wheel . . . \$ 9.75
  - \*75 CFM Blower: 4 inch Wheel . . . \$11.25
  - \*250 CFM Blower: 5 inch Wheel . . . \$22.50
  - \*600 CFM Blower: 6 inch Wheel . . . \$38.50
  - \*1000 CFM Blwr: 8 inch Wheel . . . \$52.00
  - \*1500 CFM Blwr: 9 inch Wheel . . . \$72.00
- \*These Blowers with Motors shipped Post Paid. Larger sizes are F.O.B.



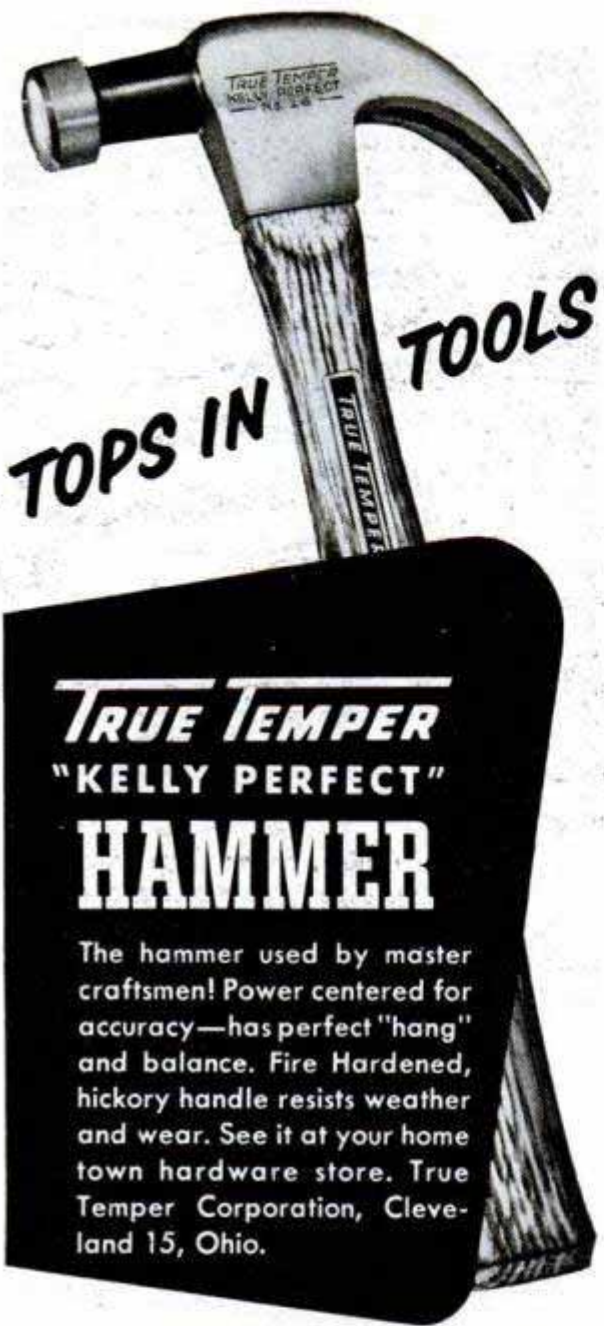

**TOPS IN TOOLS**

**TRUE TEMPER  
"KELLY PERFECT"  
HAMMER**

The hammer used by master craftsmen! Power centered for accuracy—has perfect "hang" and balance. Fire Hardened, hickory handle resists weather and wear. See it at your home town hardware store. True Temper Corporation, Cleveland 15, Ohio.

**TRUE TEMPER Corporation**

FOR OVER 100 YEARS MAKERS OF FINE TOOLS, FISHING RODS, GOLF SHAFTS

**PRECISION CALIPER**  This Trade Mark guarantees highest quality



MODEL #30-78 With set screw accurately fixing position of the slide

M-Z-B PRECISION CALIPERS made by the leading European precision tool craftsmen. Guaranteed highest accuracy for any kind of precision work. Chrome steel, spring-tempered, glass hard on all measuring surfaces. For measuring inside, outside, thread and depth. To read .001" and 1/128", 8" overall, 6" graduation.

The following models have the famous M-Z-B cam lock which guarantees fixed and never shifting setting when pressure lock is released.

#30-61	Chrome Steel	.001" & 1/128"	\$14.00
#30-64	Chrome Steel	.001" & 1/20mm	\$14.00
#30-62	Stainless Steel	.001" & 1/128"	\$16.50
#30-65	Stainless Steel	.001" & 1/20mm	\$16.50

Leather cases supplied free of charge with each Caliper. You pay postage on C.O.D. Money back guaranteed. Other models up to 12" available. Send for our catalog of fine imported pliers.

**\$9.75**  
POST PAID

**INTER-CONTINENTAL TRADING CORP.**  
90 WEST 57 STREET • NEW YORK 6, N. Y.



**INSIDE-OUTSIDE PAINT PEELER**

"Paint-Dozer"

**\$9.95**  
complete

Strip paint to bare wood at rate of 6-10 feet per minute! Big 16 sq. in. heating area blisters paint... attached rear blade strips it off in one continuous motion! Ideal for house exteriors, boats, cabinets, all woodwork. Excellent painter's tool! Faster, neater than blow-torch! Operates on household electric current. Even beginners do fast, clean work with "Paint-Dozer". Has long-lasting ceramic 1,000° Hi-Temp heating element; heavy stamped-steel construction; Marinite insulation; pistol-grip hardwood handle. Complete with front and rear detachable blades and skids; groove and ridge cleaners; 8 ft. neoprene cord; safety stand; attachable front guide handle for horizontal work. Fully guaranteed! Order from your dealer, or write today for this professional tool. Fast shipment.

**OTTO KONIGSLOW MFG. CO., DEPT. T2**  
3610 PERKINS AVENUE • • • CLEVELAND 14 • OHIO



**NOW! FILE YOUR OWN SAWS**

Do expert saw filing at home. Precision filing easy without experience. Two simple adjustments. Keeps any hand saw extra sharp and true-cutting. Complete with file. Money back guarantee. Cash with order, prepaid. (COD postage extra.) Order today. \$2.95.

**\$2.95**  
EACH

ANOTHER SPEEDCOR TOOL  
**THE SPEED CORP. PM-10**  
512 N.E. 73 Ave., Portland 16, Oregon



**GEARS**

**In Stock - Immediate Delivery**  
Gears, speed reducers, sprockets, thrust bearings, flexible couplings, pulleys, etc. A complete line is carried in our Chicago stock. Can also quote on special gears of any kind. Send us your blueprints and inquiries.

Send for Complete Catalog No. 10  
**CHICAGO GEAR WORKS**  
440-50 N. Oakley Blvd., CHICAGO 12, ILL.



**STARRETT "Tools and Rules" BOOK**

Describes and illustrates the precision methods skilled mechanics use. Only one dime. Write Dept. AP.

THE L. S. STARRETT CO., Athol, Mass., U. S. A.

**NEW! SUCTION CELLAR DRAINER**

Capacity 300 GALLONS per Hour!  
No more hand-pumping or balling of flooded basements when you have DRAINMASTER. Just connect to a handy faucet with garden hose, submerge in flood water, run another length of hose to open drain or out a window. DRAINMASTER does the rest. Solid brass, no moving parts to wear. Drains fish ponds, boats, swimming pools, trenches, tanks, etc. ORDER TODAY! **\$3.95**  
Be prepared for flood emergency. postpaid  
Money-Back Guarantee  
M. F. WHITE Co., Dept. 2-PM, 55 Stuart St., Boston 16, Mass.

SAY YOU SAW IT IN POPULAR MECHANICS

**ELECTRICITY Anywhere**

FOR PORTABLE, EMERGENCY OR HOME USE

ONAN Electric Plants generate 110-volt, 60-cycle current for homes, farms, cabins and resorts beyond the highline. Lightweight, portable plants cut costs, speed work for contractors. Standby plants protect units against power failure. 400 to 55,000 watts. Gasoline or Diesel-powered. Priced from \$219.00.

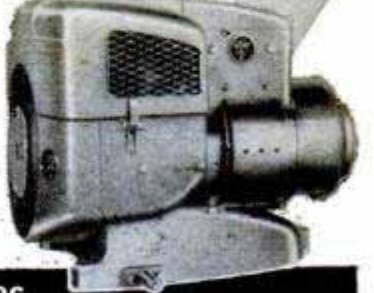

WRITE FOR CATALOG  
**D. W. ONAN & SONS INC.**  
5862 UNIVERSITY AVE., MINNEAPOLIS 14, MINN.

# How to cut down the high cost of upkeep

With SHOPSMITH, you can have a made-to-order power tool for every household job!

In each position, SHOPSMITH equals or exceeds single-purpose tools in capacity, accuracy, ease of operation!

SHOPSMITH's "changeability" saves you space, equips you to handle over 100 different operations. Changeover time is less than a minute!

SHOPSMITH costs \$189.50 complete except for motor (\$34.50) and bench ends (\$9.95). See it demonstrated at leading hardware and department stores or any Montgomery Ward store.

**SAVE UP TO 70% ON BUILT-INS!** You can turn out professional-quality cabinetwork with SHOPSMITH. As 8-inch circular saw, SHOPSMITH features extra-large capacity, hairline accuracy, simple adjustments.

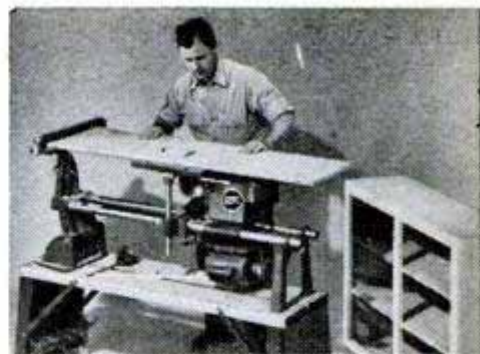

**FURNITURE REPAIRING MADE EASY!** You can replace a broken table leg or rebuild priceless antiques — SHOPSMITH's simple, functional design makes either an easy job. Lathe has 15-inch swing, 33 inches between centers.

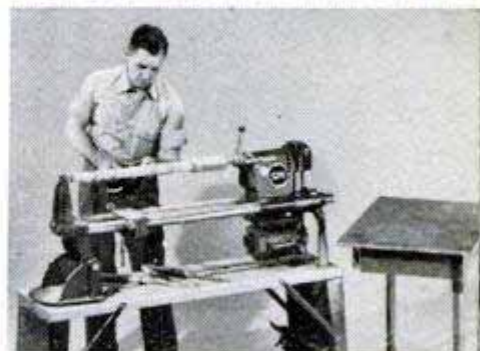

**MAKE YOUR OWN STORM WINDOWS!** Save up to \$12 each! SHOPSMITH's unique flexibility speeds the job by making special jigs unnecessary. In vertical drill press position, SHOPSMITH is a multi-purpose tool in itself!



**MIGHTY HANDY FINISHING TOOL!** If you've ever tried to point fence pickets (after they've been sawed), you know how useful the SHOPSMITH 12-inch disc sander can be. Also used for extremely accurate jointing.

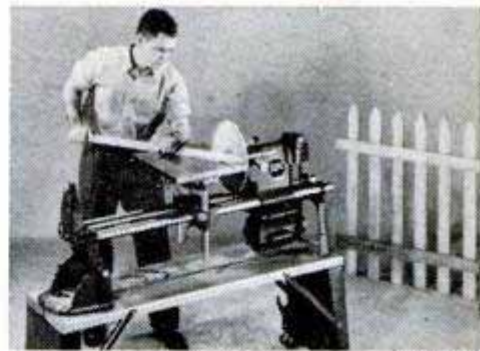

**DO 1001 JOBS FASTER, EASIER!** Any sawing, sanding, turning or drilling job is quickly mastered when you have SHOPSMITH. Horizontal drill, for example, easily handles work too big or too awkward for most drill presses.

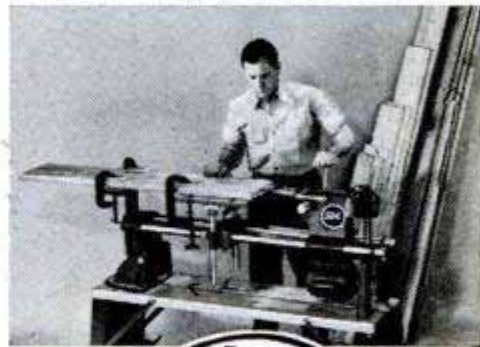

**MAGNA ENGINEERING CORPORATION**  
Dept. 222-B  
at factory nearest you  
12819 Coit Road,  
Cleveland 8, Ohio, OR  
Menlo Park, Calif.

Please send me a free copy of the SHOPSMITH catalog and the name of my nearest SHOPSMITH dealer.

Name \_\_\_\_\_

Address \_\_\_\_\_

City \_\_\_\_\_ State \_\_\_\_\_



Autumn's Color  
everywhere

Don't risk poor pictures...especially off-color pictures...by guessing at exposure. It's too often costly and disappointing. Just use a WESTON Exposure Meter to quickly determine correct camera settings. Then all your still or movie pictures will be correctly exposed...all color-true. See the WESTON at your local camera store today. WESTON Electrical Instrument Corporation, 617 Frelinghuysen Avenue, Newark 5, N. J.

## WESTON EXPOSURE METERS



The Meters Most Photographers Use



Send for this  
**BIG NEW**  
*Hunt's*  
**WOODWORKERS**  
**CATALOG NO. 19**

NEW LOW PRICES

ONLY  
**15c**

Offers greatest selection of fine domestic and imported woods--and hundreds of woodworkers items at bargain prices!

You'll save time and money with this big, new catalog. Contains everything wood craftsman needs. Shows 32 rare and fancy woods in color...43 veneer designs...275 scroll patterns...multicolor inlays, overlays, bandings...all kinds of tools, machinery, cabinet hardware, ornaments, mouldings...and pages of valuable tips, ideas, information, instruction. Send for your copy NOW. Only 15c--refundable on your first order.



- 144 PAGES
- QUICK DELIVERY
- on maple, poplar, oak, mahogany, red cedar, cherry, walnut, and many others--all properly seasoned and kiln dried.

MAIL THIS COUPON--TODAY!

CRAFTSMAN WOOD SERVICE CO.  
2729 S. Mary St., Dept. A10  
Chicago 8, Illinois

Send me the big, new, money-saving Catalog No. 19. Enclosed is 15c--refundable on my first order.

Name \_\_\_\_\_  
Address \_\_\_\_\_  
City \_\_\_\_\_ Zone \_\_\_\_\_ State \_\_\_\_\_

FINE TOOLS  
*NEED*  
FINE OIL!



• Lubricates



• Prevents Rust

• Cleans • Polishes

SOLD EVERYWHERE

## 3-IN-ONE Oil

## SHEET METAL BRAKES

Angles, flanges, Pittsburgh locks, 24 G. steel, heavier aluminum. Cam locking, mount on bench, truck or floor stand. Truss braced-steel. Express collect. 30", 65 lbs., \$28.50. 36", 75 lbs., \$33.00. 48", 100 lbs., \$48.00.



Iron benders, 32" hi. 35 lbs., \$8.00. 12" BRAKE fits in vise, forms compound bends in 20 gauge steel. Not illustrated. Express collect. \$12.00. IRON BENDER forms hooks, angles, eyelets, etc. Capacity 1 1/2 x 2", 5/16 x 1 1/2". 10 parts, all steel, express collect. \$9.50. 24" CURVE FORMER. Forms straight and tapering pipes 2" to 2 ft. in diameter. 16 gauge, express collect. \$9.50. (Immediate delivery. Order cash or C.O.D., or send for folder)

VYKE BRAKE CO., P-1116 So. 27th ST., Omaha 5, Nebr.

## SAW SERVICE MEN



Put your business on a better paying basis by installing nationally famous

ACME SAW SHOP  
EQUIPMENT

- Acme Circular Saw Sharpeners
- Acme Hand Saw Filers, etc.

Send For Free Literature

MAX MFG. CO. 138 Stockton Ave. San Jose, Calif.



## FIX LOOSE CHAIRS

Amazing "Chair-Loc" S-W-E-L-L-S Wood!

NOT  
A  
GLUE

Penetrates wood fibres--makes them e-x-p-a-n-d, locking chair rungs, dowels, legs, handles, knobs, ladders, joints, drawers TIGHTLY in place. Use no metal devices or cements. NOTHING LIKE IT! Quick, clean, easy. Not necessary to take parts apart. Lasts years. Over 300,000 sold! CRAFTSMEN'S SPECIAL--1 pt. \$1.50 postpaid. Money back guarantee. Or small size 35c at Hardware and 5 & 10's. Order NOW from Chair-Loc Co., Lakehurst 7B, N. J.

FREE Instruction Booklet



SAY YOU SAW IT IN POPULAR MECHANICS

## TREASURE! URANIUM!

GEIGER COUNTERS--METAL DETECTORS  
GEIGER COUNTERS for Uranium, METAL DETECTORS for gold, silver and buried treasure. 5 models from which to choose. We have one in your price range. No finer instruments available anywhere. FREE ILLUSTRATED FOLDERS.



THE *Detectron* CO. Model DG-7  
5631 CAHUENGA, NO. HOLLYWOOD, CALIF.

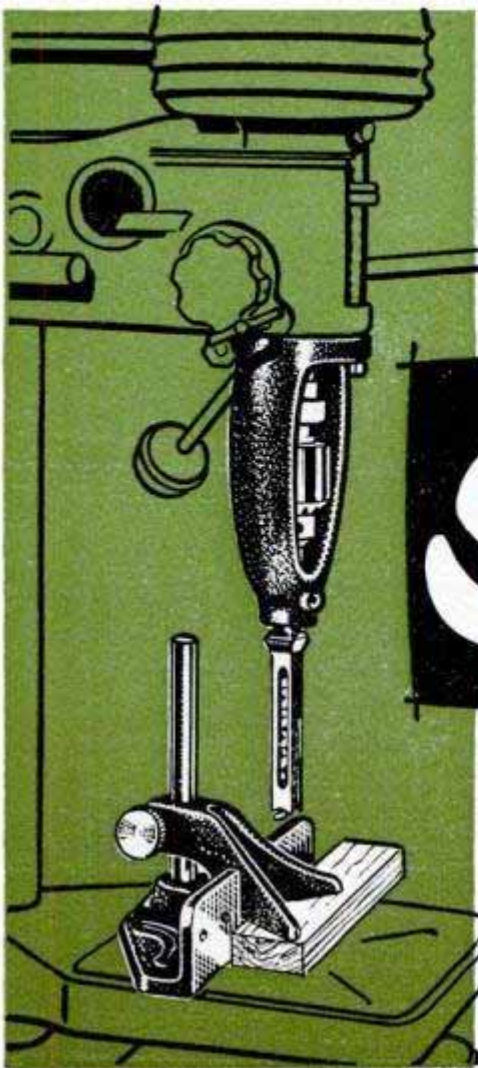

## OTHER FAMOUS SHOPMASTER ACCESSORIES



Rip fence assembly.



Dado sets.



Sanding drum, 2" diameter.



8" Circle saw blades

Lathe turning tools.



Jig saw blades. Six to an envelope.



Chucks for lathe.



# SAVE HOURS OF HARD LABOR CUT SQUARE OR RECTANGULAR HOLES WITH A **SHOPMASTER** MORTISING KIT

Save hours of unnecessary work of hand chiseling with a handy Shopmaster Mortising Kit. Cut square or rectangular holes with your present drill press . . . easily attachable . . . easy to remove too. Just one of the many famous accessories available by Shopmaster.

**\$14<sup>50</sup>**



**FREE** Complete catalog of the famous quality Shopmaster tools and accessories . . . Write Department PM10.

1214 Third St. South, Minneapolis, Minnesota

## KING MIDGET

WORLD'S LOWEST PRICED  
2 PASSENGER AUTO



Drive it for 75c per week. Amazing performance. Surprising comfort. All steel construction. Ready to run or assemble it yourself with our bolt together parts. Rider agents wanted. Earn your car Free. Send 25c for detailed literature or \$1 (refunded first order) for actual assembly book and service manual filled with photos, drawings, specifications, etc.

MIDGET MOTORS MFG. CO. ATHENS, OHIO

SAY YOU SAW IT IN  
POPULAR MECHANICS

## LAWNMOWER SHARPENER OPERATORS

Increase your output...  
Year 'round business!

**NEW**  
**BED KNIFE GRINDER**  
sharpens all  
STRAIGHT EDGE TOOLS

**New Ideal Bench Grinder**  
doubles your output of sharpening jobs, speedily grinds straight blade knives. Sharpens all kinds of straight edge tools and ice skates. Write for FREE, fact-filled folder.

**THE FATE-ROOT-HEATH COMPANY**  
Dept. PM-10, Plymouth, Ohio



## Make Your Own!

The Only Tool  
You Need  
Is A Screwdriver!

- BEAUTIFY YOUR HOME
- PROTECT IT FROM THE ELEMENTS

## ASSEMBLE AMERICA'S Most Beautiful CANOPIES AND WINDOWS

IT'S EASY! Just do the top - the sides are ready. They're pre-treated, too, ready for paint.

WRITE FOR FREE MEASURING  
CHART AND LITERATURE

**Save 50%**

8974 St. Charles Rd. *Herbert's* St. Louis 14, Mo.

NAME \_\_\_\_\_

ADDRESS \_\_\_\_\_

CITY \_\_\_\_\_ ZONE \_\_\_\_\_ STATE \_\_\_\_\_



# Congress Pulleys

Standard equipment on Bendix, Frigidaire, Hamilton, General Electric and many other appliances

LOOK FOR THIS DISPLAY



Congress quality costs no more! Insist on the drive preferred by most original equipment manufacturers. There is a difference! Congress Drives are electrolytically plated, diamond-bored and tested for trueness.

Buy Congress V-Belts and Pulleys from your local supplier.

Q-D Sheaves — Heavy Duty and Steel Cable V-Belts—FHP Drives



## CONGRESS DRIVES DIVISION

TANN CORPORATION  
World's Largest Manufacturer of FHP Pulleys  
DETROIT 34, MICHIGAN



# CAR HARD TO START?

Get **EASY STARTING**  
... Smoother Engine  
Performance... Save Gas!  
with **SENSATIONAL NEW**

**SISSON**  
*Electrimatic*  
**CHOKE**



Positive, dependable electric choking gives quick, easy starts every time in any weather. Smoother warm-up... no stalling... no flooding... no seasonal adjustment! Fits any car equipped for automatic choking. \$5 complete.

**INSTALL IT YOURSELF**  
**Get FREE Illustrated Folder**

Sisson Choke, 1652 Ohio Avenue  
Anderson, Indiana

Please send me **FREE** illustrated Electrimatic folder  
 I enclose \$5 (check or money order) for one Sisson Electrimatic Choke with complete instructions

Car Make \_\_\_\_\_ Year \_\_\_\_\_ Cyl. \_\_\_\_\_

Carburetor Make \_\_\_\_\_

Name \_\_\_\_\_

Address \_\_\_\_\_

City \_\_\_\_\_ Zone \_\_\_\_\_ State \_\_\_\_\_

NATIONALLY KNOWN

**PET** 1/4" #77

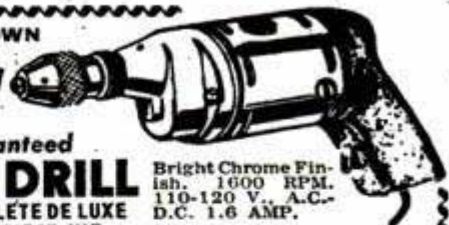

Factory Guaranteed  
**ELECTRIC DRILL**

Bright Chrome Finish—1600 RPM.  
110-120 V., A.C.—  
D.C. 1.6 AMP.



COMPLÈTE DE LUXE  
38 PIECE KIT  
only  
**\$17.95**  
\$27.95 Value

Includes above Drill, plus 37 accessories. Drills, buffs, cleans, grinds, mixes paint, polishes, sands, sharpens, waxes, wire brushes, etc. Sturdy steel case. Instructions included.



Postage 50c additional. 3% sales tax in N.Y.C. Send check or M.O. COD's, \$5 deposit.

**GOLDEN ELK PRODUCTS CO.**  
12 East 41st St., N.Y.C. (17), HA 9-7810

**DRILL ALONE**  
only  
**\$12.95**

\$17.95 Value  
**LABOR-SAVING FOR HANDYMAN AND HOUSEWIFE**

10 day money back guarantee

## TOOLS AT WHOLESALE

PROFESSIONAL MECHANICS HAND TOOLS

Farm, Household and Special Tools

TOP QUALITY, FACTORY GUARANTEED

Write Today for  
**FREE CATALOG**

**MECHANICS CO-OP**

Dept. X Oakland 8, Calif.



## CASH IN YOUR SPARE TIME!

**BIG MONEY IN OWN BUSINESS**

YOU CAN MAKE UP TO \$40 a DAY sharpening and setting circular saws for factories, builders, lumber yards—with

**NEW BELSAW COMPLETE CIRCULAR SAW SHOP. Low Cost, only \$15 down, sharpens 4 to 5 saws an hour. No experience needed! Instructions furnished. Send Postcard Today for FREE BOOK.**



**BELSAW MACHINERY CO 3704 Field Bldg. Kansas City 2, Mo.**

## FREE CRAFT CATALOG



**120 PAGES...** Craft Supplies, Tools, Designs, Instruction Books from America's Largest, Most Complete Handcraft Stock.

Send for your free copy NOW!

**GRIFFIN CRAFT SUPPLIES**

5626-A Telegraph Ave • Oakland 9, Calif.

## BULL DOG HITCHES



Heavy Drop Forge Steel Construction. Strong — Safety-Engineered Reliable

Model No. 1-B  
NOW ONLY  
\$4.95

Post Paid (when paid in advance)

Made for trailers with up to 2,500 pounds capacity.

1 3/4" dia. shank Fits 1 1/4" pipe tongue

**HAMMER BLOW TOOL COMPANY**

Wausau 13J, Wisconsin



## FORCED AIR

INSTALL IT YOURSELF AND SAVE UP TO \$200  
CONVERT YOUR GRAVITY FURNACE TO MODERN QUICK FORCED AIR HEAT. INSTALL McLARTY FANS IN YOUR COLD AIR PIPES. NO SHEET METAL WORK REQUIRED. SIMPLE ELECTRIC CONNECTIONS. LOWEST COST SYSTEM TODAY.

McLARTY SYSTEMS 2607 DICKMAN RD. BATTLE CREEK, MICHIGAN

In Canada Write  
WINNIPEG SUPPLY & FUEL  
WINNIPEG, MANITOBA

**FREE CIRCULAR**

● NOW YOU CAN SPRAY  
OUTDOORS OR IN...  
WITH **BECKER**  
PRESSURE-TYPE  
SPRAY GUN



Completely portable, ruggedly built—no electric cords or hoses to bother with. Powered by inexpensive CO2 cartridges, which spray up to one container full (21 oz.) — *Not a toy* — used widely in industry — sprays paint, insecticides, varnishes, enamels, moth-proofing. Dozens of uses around home, cottage or business — anywhere you want to take it! Complete instructions packed with each unit.

If your dealer can't supply, send \$15.95, we ship postpaid — or \$2. now and pay postman balance plus postage and COD. Money back if not delighted after 5 days' trial.

**SULLIVAN-BECKER CO.**  
Dept. 112-K Kenosha, Wis.



ONLY  
**\$15.95**  
with 3  
cartridges

For **ADJUSTABLE  
WRENCHES**

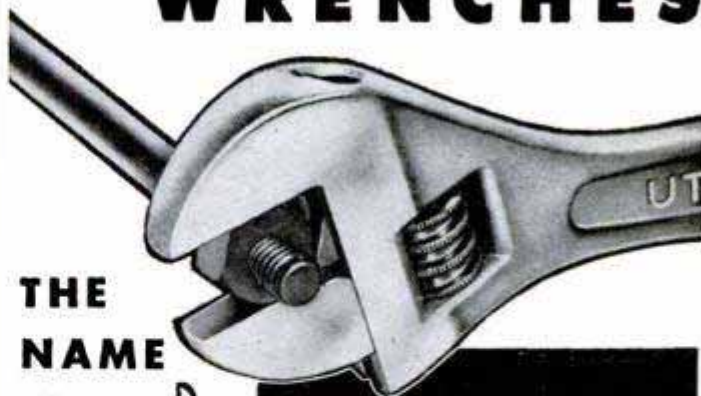

THE  
NAME  
IS



**UTICA**

... the adjustable wrenches with induction hardened jaw surfaces — that last up to 10 times longer.

THE NAME IS  
**UTICA**



THE NAME IS  
**UTICA**



THE NAME IS  
**UTICA**



ASK FOR THEM BY NAME...

**UTICA** ADJUSTABLE WRENCHES

4", 6", 8", 10" and 12" sizes. Also in handsome 3-wrench package (W-4) with 6", 8" and 10" sizes at attractive price.



IT PAYS TO BUY QUALITY TOOLS  
and the world's best tools are made in U.S.A.

Cut glass easily  
ask your dealer for  
**Red Devil**  
glass cutters



RED DEVIL TOOLS, IRVINGTON 11, N. J., U. S. A.

**FRONTIER CHUCK WAGON**

Complete model kit of wood. Plastic wheels. 1/2" scale, 13" long. Easily assembled for pleasure or to sell. Dandy for home or business display. \$1.65 Prepaid.

Other 1/2" scale kits are: Stage coach \$1.60; top buggy \$1.35; covered wagon \$1.60; buckboard \$1.10; ranch wagon \$1.25; beer wagon \$1.60; surrey \$1.85; Mansom cab \$1.60. Attractive horse and harness kit to go with above models \$1.60 each. Order today. Illustrated folders 10c.



**TONTZ COUNTRY STORE** DEPT. M-1, ELSINORE, CALIF.

**NEW FAST LIGHT WEIGHT TRENCHER**

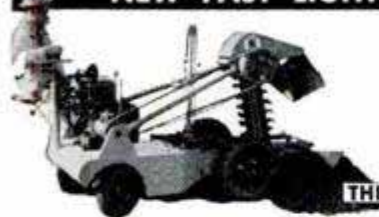

Portable DITCH-WITCH digs 4" to 6" clean, even ditches to 42" depth in every type soil. Complete unit — self propelled — outdigs 8 men. 3 economical, rugged models. Write for illustrated literature.

**THE CHARLES MACHINE WORKS**  
Perry, Oklahoma

**NOW—40 different CUTS with  
AMAZING, NEW**



**Warren**  
DADO SAWING WASHERS  
On Your Saw Blade  
Just dial widths to cut parallel grooves perfectly smooth. No warp, vibration

or trick screws. Strengthens blade, perfect balance. GUARANTEED! At your dealer's or order direct. Give arbor size—1/2", 3/8", 3/4", 1".

Send for free booklet  
**WARREN WASHERS COMPANY**  
Dept. 30, Box 98 North End Station, Detroit, Mich. ONLY  
**\$4.95** PER SET



## BETTER LIVING

... at new low cost!

Join thousands of happy, worry-free and rent-free New Moon owners. Move to top paying jobs, enjoy travel and vacation fun — a home completely furnished and ready to live-in, including kitchen, bath and automatic heating system. Own a New Moon on our rent-like payment plan and enjoy all the comfort and advantages of genuine home ownership at once. **Free!** Write today for literature describing the complete line of New Moon apartment homes.



**REDMAN TRAILER CO.**  
40 BRIDGE ST., ALMA, MICH.

## Greatest tool values CATALOG FREE



**AUTO  
SERVICE  
MEN**

**FARM  
MECHANICS**

**PROFESSIONAL  
MECHANICS**

**WORKSHOP  
HOBBYISTS**

This brand-new book gives you full information on High-Quality, Low-Price Indestro Tools your dealer can supply. The very newest designs in regular or special hand tools, tool sets and complete tool chests; every tool finely made, properly heat-treated, ground and polished for years of satisfying service. Insist on Indestro, the choice of professional shop men.

**send coupon for INDESTRO catalog**

**FILL OUT AND MAIL NOW FOR FREE COPY**

Send to INDESTRO MANUFACTURING CORP.  
N. Kildare at Schubert, Chicago 39, Ill.

*Write your name and  
address in margin space*

## 2 DRILLS in 1

**\$11.95**  
post paid

Send check or Money Order  
Satisfaction guaranteed  
Order yours now

This attachment gives you two drills in one. It converts any 1/4 inch electric drill to 1/2 inch capacity. Reduction gears reduce the drill speed 5 to 1, the average speed of a 1/2 inch drill, and thereby increases the power. Absolutely indispensable for all shop work and home craftsmen.

**G. M. CO. MANUFACTURING, INC.**  
1308 43rd AVE.  
LONG ISLAND CITY 1, NEW YORK

## NEW SAW SHARPENER

Improved #64 Hand Gummer sharpens all types circular saws 4" to 20" diam. Ideal for saw shops. Self-Centering adjustment for quick, easy set-ups. Complete with 1/4 HP motor, 1 grinding wheel & cord. \$79.50 FOB Portland, Wt. 70#. SEND FOR FREE LITERATURE.

**P. T. HOBBS MACHINERY**  
8375 N. INTERSTATE AVE.  
Dept. P.M.-61, PORTLAND 17, OREGON

## NEW INVISIBLE WOOD FASTENERS

**HARD STEEL**

Especially Designed for Countersinking

New type "CHEVRONS," 3/8" depth for hard and soft woods of thicknesses up to 2 1/2". Draws wood together. Just hammer in and countersink instantly with Chevrons Countersink. Illustration shows slots filled with putty. Prevents rust. At your dealer or send only \$1.00 for 100 "Chevrons," postpaid. Add 35c for countersinking tool. Money back if not delighted.

**E. B. PACKARD CO., Inc., Dept. PM-10,**  
139 CEDAR ST., NEW YORK 6, N. Y.

## CRESCENT TOOLS

*Give Wings to Work*

ASK YOUR  
HARDWARE  
DEALER

## ELECTRIC MOTOR BARGAINS!

1/2 HP	1750 or 3450 RPM	19.75	1 1/2 HP	3450 RPM	47.50
2 HP	3450 RPM	65.00	3 HP	3450 RPM	77.50

All prices F.O.B. Immediate Delivery

Every Motor Fully Guaranteed

Heavy Duty, Repulsion Induction and Capacitor Types, 110-220 Volts, 60-cycle, Single-phase. Standard Makes (G.E., Wagner, Leland, Westinghouse, etc.). Rush your order TODAY—large stock of motors—1 & 3 phase. 32-v. direct current bargains. Prices f.o.b. **ROBERTS ELECTRIC CO., 849 W. Grand, Dept. 34, Chicago, Ill.**

## BE A FROGMAN!

Join the new national FROGMAN CLUB today. All you have to do is send \$1.00—be sure to include your name and address—and here's what you get:

- 1) A miniature pair of Frog Feet. Can be worn on key chain, lapel or hung on windshield as lucky charm.
- 2) An attractive membership card.
- 3) A Frogman decal to be used on your windshield, bicycle or notebook.
- 4) A booklet on "How To Swim Underwater" and "The Supreme Sport of Spearfishing".
- 5) Periodic bulletins on the latest developments in Frogman equipment and news.
- 6) Complete catalog of Frogman equipment available for purchase.
- 7) A free coupon for \$1.00, which can be used toward the purchase of a pair of regular size Frog Feet, \$6.95 or equivalent in value. This is redeemable at your local sporting goods dealer, drug store, auto supply store or toy departments. If no such dealer available in your area, we will handle direct.

**BE A FROGMAN — Send your dollar today!**

**National Frogman Club**  
1428 Maple Avenue, Dept. PM-7, Los Angeles, 15, Calif.



SAVE 50% - THOUSANDS HAVE ASSEMBLED

**\$42<sup>UP</sup>**

# PACKAGED BOAT KITS

## 27 MODELS

Dinghies, skiffs, racers, inboards, outboards and cruisers. Assemble your own boat, it's easy, it's fun!

All parts pre-cut or pre-fabricated from finest materials. Get all the facts from our big 24 page catalog. See how Packaged Boats are built, how they perform, how exclusive construction features make assembly easy. Includes specifications, performance data plus hardware and paints.

SEND 25¢ for NEW 24 PAGE CATALOG

CUSTOM-CRAFT - DEPT. 7 - BUFFALO 7, N. Y.

## BOAT PLANS PATTERNS

Over 50 modern plans and full size patterns. Racing classes, cruisers, inboards, outboards, sail boats. By famous designers. 6' to 30'. DESIGN CATALOG 35¢. Design Catalog and boat building handbook, \$1.00

MARINE MART - DEPT 7 - BUFFALO 7, N. Y.

## DRAINS Cellars, Laundry Tubs; CIRCULATES Oil; IRRIGATES Gardens

Original "Type P" Pump has 2400 GPH capacity. 360 GPH 75' high, or 1500 GPH from 25' well. Use any 1/4 to 1/2 HP motor. DOES NOT CLOG. 1" intake; 3/4" outlet.

Postpaid if cash with order. (West of Miss. add 50¢.) Motor coupling included.

MONEY BACK GUARANTEE. Also Gear Pumps in all sizes.

LABAWCO PUMPS, BELLE MEAD 7, N. J.



**\$6.95**

### MONEY for MEN ALL DATA FREE

THE PLASTEX Industry needs manufacturers on small scale and for big production of Lamp and Clock Stands, Art Goods and Novelties in Plastex and Marble imitation. Experience unnecessary. 1/2 material makes regular 10¢ store sellers. Rubber moulds furnished for speed production. Small investment brings good returns. We are now placing big Chain-Store Orders with manufacturers. Ambitious men have chance for real prosperity. Our Free booklet will interest and benefit you.

**PLASTEX INDUSTRIES, Dept. A**  
3400 Third Ave. New York 56, N. Y.

## NOW-FIXIN' IS FUN

... WITH THE GRIPPING STRENGTH OF MORE THAN **10 MEN** IN YOUR HAND!

**Model 10-W \$2.60**

**WISE-GRIP WRENCH**

Imagine the tough jobs you can tackle with TONG-GRIP in your hand! Only VISE-GRIP locks with such tremendous power. Won't slip. Holds, turns, twists, pulls, cuts . . . easily adjusts to ratchet action. A locking wrench, super-pliers, vise, pipe wrench, end wrench—in a SINGLE TOOL! 7" and 10", with or without cutter. Only \$1.85 to \$2.60 at your hardware dealer.

Manufactured Only By  
**PETERSEN MFG. CO., Dept. P-10, DeWitt, Nebr.**

# Arc Welding

pays big with the new  
**Hobart**



Hundreds of dollars extra profit monthly can be yours with this

← **LOW COST**  
250 amp. (full size)  
**ARC WELDER**

## HOBART ARC WELDERS ARE SIMPLIFIED

Be independent! Set up your own welding shop and start earning big money. With a Hobart "Simplified" Welder, that is easy to use—a welder that will let you go out after the big pay jobs for farmers, contractors, factories, builders, etc.

Hobart Welders are rugged, dependable, economical — let you handle all types of work — assure low cost, high quality welds. That's why they're used in America's leading production plants. Hobart Welders give you 1000 combinations of welding heat—let you make fine welding adjustments right at your work, without returning to machine. Auxiliary power outlet lets you operate lights, tools, etc. Available in gas and electric models, portable and stationary. Check coupon for complete details.



Electric Drive DC Welder



**Complete Text and Lessons Book.** Covers all welding work. 544 pages, over 600 illus. . . . . \$3.00

**Lessons Book.** Complete operator's training course. 200 pages, fully illus. \$1.00

**Practical Design.** Hundreds of welding ideas in design form. 3 vols. 100 designs each. Single vol. . . . \$3.50 Set of 3 . . . . \$10

### Learn QUICKLY at the Hobart school



Earn big money doing all kinds of welding work. Learn quickly, easily, at low cost in modern non-profit Hobart Trade School. Complete or partial courses. Best equipment, thorough training, experienced instructors.

Check coupon and MAIL TODAY!

**HOBART BROTHERS CO., Box M-102, Troy, Ohio**  
"One of the world's largest builders of arc welders"

**HOBART BROTHERS CO., Box M-102, TROY, OHIO**

Send complete details on items checked.

<input type="checkbox"/> Electric Drive Welders	<input type="checkbox"/> Gas Drive Welders
<input type="checkbox"/> Hobart Trade School	<input type="checkbox"/> Complete Text
<input type="checkbox"/> Practical Design: Vol. 1	<input type="checkbox"/> Vol. 2
<input type="checkbox"/> Vol. 3	<input type="checkbox"/> Set of 3 Vols.
<input type="checkbox"/> Lessons Book	<input type="checkbox"/> Cash encl. <input type="checkbox"/> C.O.D.

NAME \_\_\_\_\_

ADDRESS \_\_\_\_\_

CITY \_\_\_\_\_ STATE \_\_\_\_\_

**FREE** new booklet "Guide to Better Welding"

## For Discriminating Users



Scientists, explorers and engineers choose Burgess Batteries where lives depend on battery power, because they are recognized as best by the experts. Insist on using Burgess Batteries in your flashlight. Burgess Battery Company, Freeport, Ill.; Niagara Falls, Can.

## A Quality Dry Battery For Every Purpose

## AUTUMN LEAVES VANISH LIKE MAGIC

with Easy Rolling  
**MOW-MASTER**  
*Grind-a-Leaf*



- Pulverizes leaves instantly.
- Cleans lawns in a jiffy.
- Adds desirable mulch and humus to the lawn.

**NO RAKING  
NO HAULING  
NO BURNING**

In Spring remove Grind-a-Leaf attachment and Mow-Master is ready for mowing lawns or cutting weeds. ONE MACHINE DOES IT ALL — Two H.P. engine — Light weight and easy to handle.

Write for colorful brochure and name of your nearest MOW-MASTER dealer.

**Featuring  
HANDY  
RECOIL  
STARTER**



**Propulsion Engine Corp.**

Subsidiary Food Machinery & Chemical Corp.

Dept. PM-10, 7th St. & Sunshine Rd., Kansas City, Kas.



## MAKE EXTRA MONEY with Larson Leathercraft

### Easy-To-Assemble Kits No Experience Needed

Get started now. LARSON Beginners' Kits of ready-cut projects require no tools or experience. Free instructions included. Make belts, gloves, moccasins, billfolds, woolskin animals and mittens, other attractive leather items. Also America's most complete stock for advanced hobbyists and professional craftsmen. SEND 10c TODAY for big illustrated catalog. **J. C. LARSON CO., 820 So. Tripp Ave. Dept. 2127, CHICAGO 24, ILLINOIS**

## Super Kem-Tone THE DELUXE WALL PAINT

Buy it! Try it! See how easy it is for you to transform a room in a day. Super Kem-Tone is guaranteed washable, comes in 16 ready-mixed colors, requires no thinning because it comes ready-to-use, you just stir and apply. After it is thoroughly dried, Super Kem-Tone will withstand repeated washings with usual household cleaners without losing its beauty. Sold at leading Paint, Hardware, Lumber and Department Stores Everywhere.

## SUPER DRILL GRINDER



Sharpens round shank drills from 3/32" to 1/2" in diameter, up to 6" long. Grinds old drills like new in 4 different point angles, using hand or power grinding wheels. Money-back guarantee. Only \$2.95

At Dealers or Postpaid  
**A. D. McBURNEY 317 E. 4th St., Dept. A-22 Los Angeles 13, Calif.**

## VARIABLE SPEED HYDRAULIC POWER TRANSMISSION



It has Infinite Speeds 0 to 550, Reverse, Automatic Overload Protection; Adjustable Torque up to 180 inch pounds. 5/8" Input and Output Shafts. It will handle 1/4 to 1 1/2 H.P. Motor. Case measures 7 1/2" long, 7" high 6 1/2" wide. **VALUE OVER \$300. Shipping Wt. \$54.50**  
25 On C.O.D. Orders we require a 10% Only Fob. Chicago Deposit.

**DIRZIUS MACHINE SHOP "G" 1423-25 So. 52nd Ave., Cicero 50, Ill.**

## DO MORE PLANING JOBS WITH LOW-COST BELSAW \$215.00



**AMAZING 12 1/4-IN. PLANER Does All Ordinary Planing Mill Jobs.** Provides attachments for Jointing, Rabbeting, Tongue, Groove, Matching. 12 1/4 x 6-in. capacity, 3-knife solid round all-steel cutterhead. Power feeds at 24 feet per minute, 42 cuts per inch. Provides for full line of accessory attachments — Grind and Joint knives IN THE CUTTERHEAD WITHOUT REMOVING.

**BELSAW MACHINERY CO.**

1019 Field Bldg., 315 Westport Rd., Kansas City 2, Mo.

**FREE BOOK**

## PERFECT CORNERS EVERYTIME!

The sturdy Belrus Corner Clamp enables even an amateur to make PERFECT right-angle corners for screens or frames of any kind. YOU CAN'T FAIL! Ideal for artists too . . . it's a MUST in the tool-chest of EVERY home craftsman . . . SAVES time, SAVES dollars! Get yours by RETURN MAIL, Postpaid, only \$2.45.



**Eagle Products**

84A Meriden, Connecticut

For Brilliant  
Light  
Anywhere  
Any Time

IT'S THE NEW  
**Big Beam**  
HERMETICALLY  
**SEALED BEAM**

only  
**\$7.50**

less standard  
6-volt  
lantern battery



HAS UNLIMITED  
SPORTS, UTILITY,  
EMERGENCY USES

See your dealer or write for folder

U-C LITE MFG. CO., 1066 W. Hubbard St., Chicago 22, Ill.

SPECIAL FOR HOBBYISTS,  
JEWELERS & WATCHMAKERS,  
TOOL & DIE MAKERS



**SWISS  
NEEDLE FILES**

Genuine Swiss files in all  
shapes for fine precision  
work. Full dozen 5 1/2 inch  
needle files to a set.

ORDER BY MAIL TODAY!

**STURDY TOOL & HARDWARE CO.**  
Sole Distributors for U.S.A.  
156 Chambers St., New York 7

ONLY  
**\$3.60** POSTPAID  
set of 12

**You Can Make  
DRAIN TILE**

and Build a Profitable  
Community Enterprise

Farm drainage, home building,  
reclamation projects, highway con-  
struction. From these and other  
sources come the biggest demand  
for drain tile in history. More local  
plants are urgently needed.

Millions of dollars' worth of drain  
tile are used annually. Much of it, ordinarily, is shipped  
from far distant points. Local manufacturing is economical,  
logical, profitable. The Champion Drain Tile Machine makes  
manufacturing easy. Pares production costs. Requires no  
skilled labor. Makes all sizes from 3" to 12". Yet requires only  
a moderate investment.

**Outstanding Manufacturing Opportunity**

Champion-made cement tile are dense,  
strong, and truly round. No distortion, no  
shaling. Worth more than clay tile, but can  
be sold for less — and still leave a handsome  
profit margin.

Write for the Drain Tile Book. Tells about cement  
tile as a local manufacturing enterprise. Tells about easy-payment terms. Write today.

**Concrete Equipment Company**  
522 Ottawa Ave., Holland, Michigan



E2

SAVE  
MONEY



AND TROUBLE WITH—  
**BOWES**



**STOP-LEAK**

Come winter you will have to buy some sort  
of anti-freeze for your car, or else you won't  
"run." Anti-freeze is expensive. If your radi-  
ator or any part of your cooling system is  
leaking, you will quickly lose your expensive  
anti-freeze. Put a can of BOWES STOP LEAK  
in your radiator today and make sure that  
you will have "smoother motoring" this winter.

BOWES Stop Leak will not clog your radi-  
ator. It's SURE . . . SAFE . . . PERMANENT.

YOUR CAR DESERVES  
THE WINTER SAFETY OF  
**BOWES RADIATOR CHEMICALS**

**RADIATOR KLEN-ZUR**

Removes rust, scale, lime, oil and  
grease . . . contains no harmful acid  
. . . gets cooling system clean as new.



**RADIATOR  
RUST-ROUT**

Prevents trouble-making rust ac-  
cumulation in cooling system . . .  
also lubricates water pump.

DRIVE IN  
Where You  
See This Emblem...



BOWES "SEAL FAST" CORP., INDIANAPOLIS 7, IND.

# Save MONEY! DRIVE BY "MILE-O-METER"

REG. U.S. PAT. OFF.



SAVE GAS  
TUNE-UP ENGINE  
MONEY-BACK  
GUARANTEE

CHECK  
PERFORMANCE



Huge 24-page  
Motorist's Manual  
PLUS  
"Mile-O-Meter"  
Mileage Calculator  
included FREE!

Install Mile-O-Meter on the dashboard of your car and start to save money right away. Mile-O-Meter shows how many miles-per-gallon you're getting as you drive, when your engine needs tuning up, and what adjustments to make for maximum power and economy. Fits all cars . . . easy to install . . . no holes to drill. Pays for itself over and over! Ideal for gifts!

DELUXE Model, illuminated, chrome trim, 3 3/4" dia. **\$1495**

STANDARD Model, 2 5/8" dia. **\$ 975**

Fed. Tax included — Shipped postage prepaid.

## GALE HALL ENGINEERING

DEPT. 249 BOSTON 18, MASS.

# WELD IT YOURSELF! IN A JIFFY!

**Weld, Cut, Braze, Solder  
IRON, STEEL, BRONZE, BRASS,  
ALUMINUM & OTHER METALS**

Tool and Equipment breakdowns are always annoying and costly. Don't let them bother you. Get a Dynamic Arc Welder. You can do expert work on your very first job. Welders operate from any properly wired 110 V. AC line. The handiest "tool" in your workshop. A Dynamic Welder will save its low cost over and over again in time and money.

**DYNAMIC INDUSTRIAL type  
transformer Arc Welder  
75 amp. output for industrial or  
Workshop use.**

**DYNAMIC  
WELDER CO.**

Dept. D2-KC, 15 E. 23rd St.  
Chicago 16, Ill.



### Everything YOU NEED

One low price gives you a complete welding outfit ready to use. Save Money! Buy direct! Sold on 10 day money back guarantee. Send today for FREE details.

**Free Details and "How to Weld"**



## PAINT ROLLERS cleaned in seconds

Just put the roller cover into a can of Imperial Roller Cleaner and shake. In 30 seconds it is completely cleaned! Remove, wipe dry and you can re-use immediately. Same fluid may be used for as many as 6 cleanings. Safe for roller cover and your hands. At better paint and hardware stores.

## IMPERIAL Roller Cleaner

Write for leaflet

Wilson-Imperial Company, 119 Chestnut St., Newark 5, N. J.



## NEW SMALL PARTS CABINET

Metal bound. Baked green enamel. Green plastic drawers. Removable dividers. At hardware stores. Write for free catalog—complete Waterloo line of metal boxes and cabinets.

Waterloo Valve Spring Co., Waterloo, Ia.



## Treasure and Minerals

Easily located with new Lightweight M-Scope Detector. Superior performance, lowest price, monthly payment plan.

FREE LITERATURE

FISHER RESEARCH LAB., INC.  
PALO ALTO CALIF.

Over 800 items listed! Over 200 illustrations! Accurate, detailed, scale models of warships, tanks & planes. PLUS model railroad equipment

ALL IN AUTHENTICAST CATALOG VOL III ONLY 35c  
COMET METAL PRODUCTS CO., INC.

91-04 132nd St. Richmond Hill, N. Y.

## With Our ARMATURE TESTER



you get instructions how to use it to test for ground, open circuits, and for shorts. How to set voltage regulator, to locate generator trouble, to make quick check-up on generator, regulator, starter, and fix them. Tester guaranteed to work and give long years of service. Order today. Shipping paid. Send \$15.00

**TEX TESTER CO.**

#1 Box 133A

Spring, Texas

## Foley Filer Users—Attention!!

Save on File Expense! Improve Your Workmanship!  
Sharpen More Saws With Each File!

"FLOATING ROLLERS" will solve these problems for you! "FLOATING ROLLERS" replace saw carrier clips and have a tension spring which holds the carrier snug to the lower rollers, eliminating irregular size teeth, carrier play, etc., which must be remedied before precision work can be accomplished. Many other features make the "FLOATING ROLLERS" a MUST investment for you. Easily attached in five minutes.

For Model F-16, F-24 or F-61 Foley Filer, equipped with carrier rollers, \$7.50 per set.

For Model F-5, F-16 or F-24 not equipped with carrier rollers, \$10.25 per set.

Order a set today for 30-days trial. If not satisfied in any way, return them and your money will be refunded. Save COD and postage charges by sending check or money order with order, or write for further information.

**STADICK MANUFACTURING CO.**  
Box 73, New Ulm, Minnesota

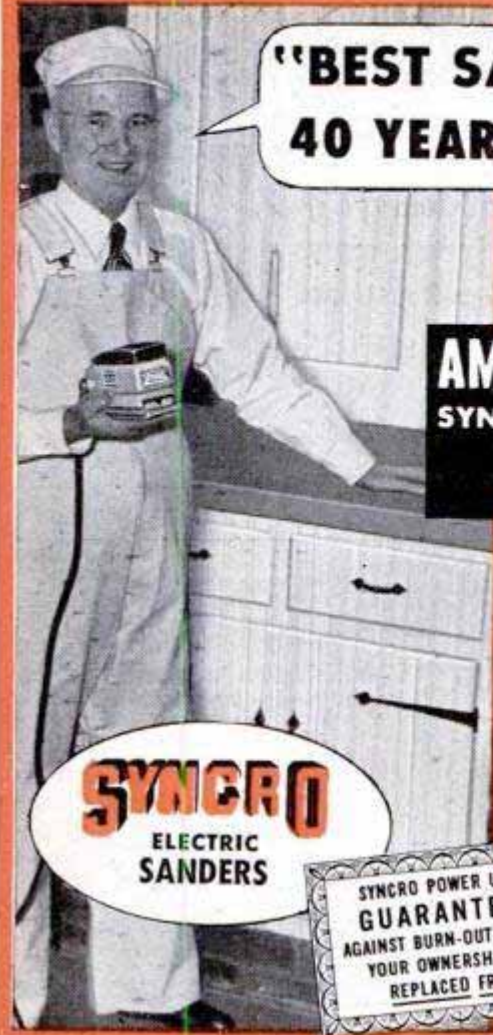

**"BEST SANDER I'VE USED IN 40 YEARS OF DECORATING!"**

Mr. Henry S. Jokela, nationally-known decorator, continues: "I've never found a finish sander to equal Syncro 504—so powerful, durable, dependable and easy to handle. Its low cost just doesn't seem possible."

only \$19.95



UL No. 504

**AMAZING TESTS PROVE SYNCRO SANDERS DO MORE WORK PER SQUARE INCH OF SANDING PAD SURFACE THAN SANDERS COSTING TWICE AS MUCH.**

In material removal tests for portable electric sanders conducted in the SYNCRO lab—on most of the leading medium priced sanders on the market today—it was proven conclusively that sanders manufactured by SYNCRO Corporation remove more material per square inch of sanding pad surface than sanders costing more than twice as much . . . This is your proof that SYNCRO Sanders are your best buy.

Need we say more about this superlative Syncro Sander when you read what Henry S. Jokela, famed decorator, says about it—when you read the Laboratory Test Results regarding durability? Of course, Syncro Power Units are ALSO the ONLY such type GUARANTEED during ownership or replaced free! And—Syncro's platen is designed to do ALL finish sanding . . . not just large flat surfaces. Syncro is BEST for dry wall constructions. It is NOT an orbital type sander. Buy this durable, GUARANTEED, powerful, yet amazingly light sander at dealers or postpaid from factory, \$19.95.



No. 504-D in Metal Carry Case

Holds "504" sandpapers, polish pads, cord, 9" x 5" x 5". At dealers or postpaid, \$22.95

**SYNCRO ELECTRIC SANDERS**

**SYNCRO POWER UNITS GUARANTEED AGAINST BURN-OUT DURING YOUR OWNERSHIP OR REPLACED FREE!**

SYNCRO CORPORATION — DEPT. D-102, OXFORD, MICHIGAN, U.S.A.

**A REVOLUTIONARY CATCH FOR CUPBOARD DOORS!**

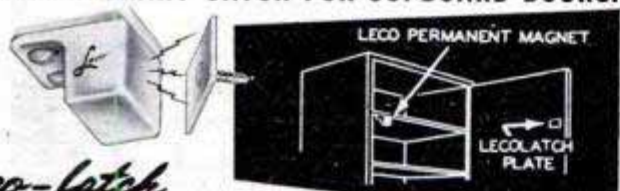

**Leco-latch with the PERMANENT MAGNET**  
No Moving Parts • No Springs • Absolutely Trouble Free

Utilize the continuous energy of the Permanent Magnet. It will work for you silently and efficiently for the rest of your life! Lasts forever—nothing to get out of order. . . Works perfectly—even if doors sag or warp. . . Doors open easily—without snap, noise or jerk. . . Holds doors in place firmly, yet gently. . . Easily installed. . . Improves appearance. See your local lumbar or hardware dealer, or write to

LABORATORY EQUIPMENT CORPORATION ST. JOSEPH 12, MICHIGAN

**GREATEST SAVING EVER OFFERED! U. S. GOV'T SURPLUS**



**"BARGAIN BOOK"**

**SAVE ON WINTER NEEDS!**

It's loaded with bargains in genuine Gov't Surplus for farm-home-industry. Save up to 85% on clothing, hardware, sporting goods, etc. The "Book of the Year". Send 10c for yours today.

MAIL TODAY Only 10c

500 BARGAINS • FARMS • SPORTS • HOME • SHOP  
**FISLER SALES CO.**  
723 WALNUT ST., DESK M-10, KANSAS CITY, MO.

**RADIO EXPERIMENTERS:**

**\$1.79**

**MIDGET ELECTRONIC POWER SUPPLY KIT**

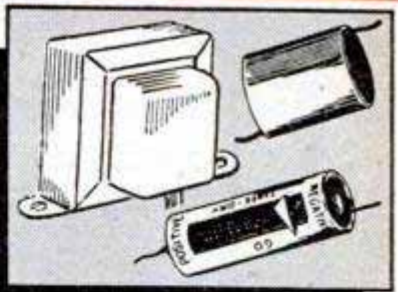

**110 VOLT FILTERED DC at 40MA**

Here at a Big Saving you get Top Quality basic components for a Power Supply with many applications . . . for Mike or Phono Pre-Amp, Midget Radios or Audio Amplifiers, Photo Cell equip., Garage Door Openers, Code Practice Oscillators, TV Boosters, Test Equipment, etc. Kit consists of a compact, fully enclosed Power Transformer, pri: 117 V. 60 cycle AC 110 V @ 40 MA. H.V. Sec., and 6.3 V @ 1 amp. for filament. A 35 MA-130 V. Selenium Rectifier and a 16 Mfd-150 V. DC wkg-225 V. peak electrolytic Filter Condenser . . . both very compact and easy to mount with the tinned wire leads. Wt. 1½ lbs. You Get All Above No. 14B993. PER KIT.....\$1.79

Include allowance for postage if shipment by parcel post is desired.

**BURSTEIN-APPLEBEE CO.**  
Dept. P, 1012-14 McGee St.  
Kansas City 6, Mo.

I enclose \$.....for.....Power Kits.  
 Send me FREE your 1953 Catalog No. 531.  
Name.....  
Address.....  
City.....State.....



**FREE! BIG 1953 RADIO CATALOG**

# IT'S A FACT!

No other work shoes of any make are made of triple-tanned, inner-shell horsehide like...

## WOLVERINE SHELL HORSEHIDES

That's why Wolverines are buckskin-soft, dry soft, STAY soft... yet give you many more miles of wear on any work shoe job.



See your Dealer and Try on Wolverine Shell Horsehides

### FREE Wolverine Vu-Riter

It's the very newest in ball point pens and it's yours 100% FREE of cost just for asking us "Who is my nearby Wolverine dealer?" Write today to Wolverine—Box UG-10—Rockford, Mich.



# DAMP BASEMENT?

CHANGE IT INTO A DRY, BEAUTIFUL

- WORKSHOP
- PLAY ROOM
- BEDROOM
- LAUNDRY

MEDUSA BASEMENT BOOK TELLS HOW

Contains easy-to-follow basement plans. Has beautiful 4-color, inexpensive decorating ideas. Tells how to make damp basements dry. Methods approved by architects, contractors and builders. Save yourself needless trouble and expense. Read this book on the right way to decorate and damp-proof your basement. Mail coupon today.

SEND ONLY 50¢

MEDUSA PORTLAND CEMENT COMPANY  
P. O. Box 5151 • Cleveland 15, Ohio  
Please mail me the 36-page, four color Medusa Basement Book. Enclosed is 50¢.



Name .....  
Address .....  
City ..... Zone ..... State .....

## Small-Tough-

Just right for carrying or storing — it's palm size! Made of heavy gauge metal. Switch glows in the dark. Uses 2 standard 1 1/4" batteries. See your dealer . . . . \$1.89 less 5¢.

# Bright!



DELTA ELECTRIC CO., Marion, Ind.

## Delta BUDDY LITTLE ELECTRIC LANTERN

## STEEL TOOL BOXES

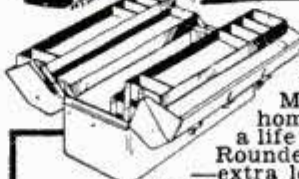

With the Famous "Grip-Loc" Handle!

When "Grip-Loc" handle is up, box is locked—tools can't spill. Made for Mechanics—for shop or home. Sturdy, heavy duty—will last a life time. Built to carry up to 700 lbs. Rounded corners. Trays for small tools—extra length for long handled tools. 24 gauge steel. Built-in continuous hinges—sturdy suit case bolts. Wrinkle enamel two-tone finish. Smooth enamel trays. Hip roof cantilever design. 17" length, \$9.50. 21" length, \$10.50. Shipped postpaid. Order today. If your dealer can't supply you, order direct. MASTER MECHANICS SALES, Box 31, WOODSTOCK, ILLINOIS



## HAVE MORE FUN TRAVELING

DINSMORE AUTO COMPASSES are a constant source of information, interest and education. Passengers love it! Saves time, worry. No back-track, no wrong turns. Quickly installed. You'll enjoy every minute of driving with America's first and finest illuminated auto compass. Fully jeweled with micromatic compensator. If your dealer cannot supply, order direct. Only \$5.49 postpaid.

**FREE** Folder on compasses for the hunter, camper, fisherman, sailor, plus a history of the compass, "Pants, knives and Compasses." Send for your copy today.



DINSMORE INSTRUMENT COMPANY 1802-39 Keiso St. Flint 1, Michigan

## Build your own JET ENGINE!



SEND NO MONEY

Order these plans today

1. JET PROPELLED BICYCLE. Assemble your own. Photo and instructions, \$1.00.
2. HOW TO MAKE EXPERIMENTAL JET ENGINES. Seven sheets drawings with information and instructions \$2.95.
3. BOTH OF ABOVE in one order \$3.75. SEND NO MONEY. Order both at once \$3.75 C.O.D. in USA plus c.o.d. postage. Send check or Money Order and we pay postage. Get other information too. Rush Order.

J. HOUSTON MAUPIN, Dept. 55, Tipp City, Ohio

BeMaCo Dependable

## AUTOMATIC SAW SET

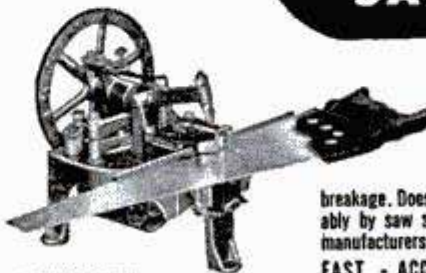

Sets 400 teeth per minute on hand or band saws 4 to 16 point. Hammer and anvil action sets teeth accurately and uniformly... No tooth breakage. Does a perfect job. Used profitably by saw shops everywhere and saw manufacturers. Every machine guaranteed!

FAST - ACCURATE - DEPENDABLE

★ INCREASES PROFITS **BEAVER MFG. CO.**

Saw Machine Div. #14-M  
800 SO. ISIS AVE. • INGLEWOOD, CALIF.

What?

POWER TOOLS

only \$16 EACH!

EASY TIME PAY PLAN

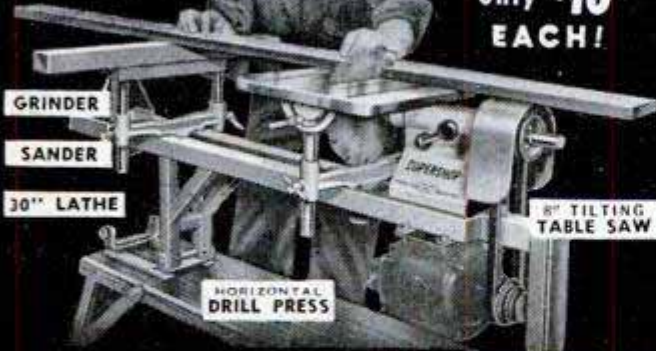

GRINDER

SANDER

30" LATHE

HORIZONTAL DRILL PRESS

8" TILTING TABLE SAW

5 POWER TOOLS IN ONE

FACTORY TO YOU \$79.95

SUPERSHOP offers you a precision-built complete power tool workshop. 100% ball bearing, RUGGED. Accurate. Big capacity. 15 day FREE trial. Money back guarantee. Mail postcard for FREE catalog. Buy on easy pay plan.

POWER TOOLS, INC. 140 YATES AVENUE BELOIT, WISCONSIN

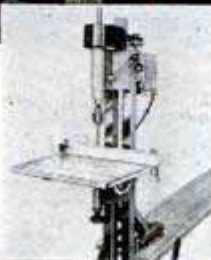

VERTICAL DRILL PRESS

WELD BRAZE, SOLDER, and CUT

ONLY \$1475 F.O.B. complete!



No experience needed. Follow simple instructions, weld on iron, steel, bronze, brass, aluminum, and other metals. Plugs into any properly wired 110 volt A.C. or D.C. line. Make or save time and money doing repair work for yourself and others. Repair men, farmers, tinsmiths, home and auto owners, hobbyists, etc., say FOUR-WAY pays for itself over and over. Order today or send for free details.

Larger Equipment Available on Request FOUR-WAY WELDER COMPANY, Dept. F2-KC 2326 S. Michigan Ave. • Chicago 16, Illinois

ORDER NOW 10 DAY TRIAL

AMAZING TOOL for FARM and HOME!

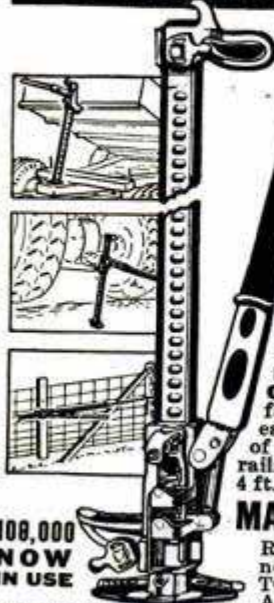

LIFTS 3 TONS! PULLS POSTS! STRETCHES WIRE! WAGON BED HOIST! Hundreds Of Other Uses!

Amazing HANDYMAN jacks up trucks, tractors, wagons, or buildings; unexcelled as auto bumper jack; pulls posts, pipes, roots, small stumps; stretches woven or barbed wire fence; splices wire; makes hoist, clamp, spreader, etc. LIFTS, PULLS, PUSHES with 3 TON CAPACITY. Hundreds of uses around farm, home, garage. Simple and easy to use. One man can do work of ten. Sturdily constructed of railroad steel and malleable iron. 4 ft. long—27 lbs. Will last years.

MAIL Your Order NOW!

Rush ceiling price of only \$1575 now for your HANDYMAN TOOL. (West of Denver, \$16.75). Actually a \$20.00 value. We pay

transportation. SATISFACTION GUARANTEED or your money back. MAIL YOUR ORDER TODAY. HARRAH MFG. CO., Dept. N-8, Bloomfield, Indiana

How to get more mileage out of your motoring dollar



WATCH FOR LOOSE OR FRAYED WIRES Check your car's wiring—and you may avoid road breakdowns, battery failure or a destructive car fire. Watch for bad insulation, loose connections, spots where wires may be rubbing against sharp metal edges. Keep several spare fuses in glove compartment, too.

Clutch facings will not take a "riding"

... your pocketbook will suffer an unnecessary drain if you "ride" the clutch. "Holding" on hills with the clutch is wasteful, too. Use your clutch only for starting and shifting...it will last longer...save you money.



CLUTCH PEDAL IS NOT A FOOT REST



REPLACE CLOGGED OIL FILTER

Keep a fresh oil filter on the job. Your oil filter can trap more than 2 pounds of sludge and abrasives in 5,000 miles of normal driving—may get so choked up it can't filter out harmful abrasives any more. Before that happens, install a fresh Purolator\* Refill. Purolator's matchless, accordion-pleated, plastic-impregnated element gives up to 10 times more filtering area... traps gritty particles as tiny as .000039" in diameter... saves you expensive engine repairs. Yet a Purolator Micronic\* Refill costs as little as \$1.60.

\*Reg. U.S. Pat. Off.

Check your oil filter every time you change your oil

PurOlator (ENGINEERED FOR EVERY MAKE OF CAR) Micronic OIL FILTER



Built for economy-minded hobbyists who demand . . .  
**QUALITY PLUS!**

# SHOPMASTER

## 8" TILTING ARBOR SAW

# \$49.95

A new Shopmaster tool at a new low price. Durably constructed of rugged cast aluminum alloy with large table working surface. Has visible and convenient operating mechanism. It's an excellent all-around tool for the new hobbyists' workshop.

Slightly lower Zone 1

**FREE** Complete catalog of the famous quality Shopmaster tools.



NEW MITRE GAUGE STOP ROD INCLUDED

MASSIVE CAST CONSTRUCTION

SIMPLIFIED TILTING CONTROLS

SEALED FOR LIFE BALL BEARINGS

Other famous

SHOPMASTER TOOLS

20" TILTING TABLE JIG SAW



TABLE SIZE SPINDLE SHAPER



20" TABLE SIZE SABER SAW



12" DRILL PRESS



BELT AND DISC SANDER



10" SWING WOOD TURNING LATHE



12" TILTING TABLE BAND SAW



10" TILTING ARBOR SAW



1214 THIRD ST. SOUTH • MINNEAPOLIS, MINNESOTA

## STOP FURNACE LEAKS

Save Fuel Costs

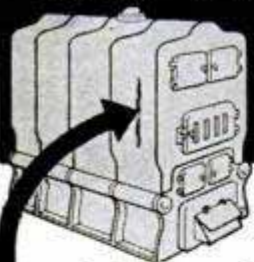

Seal up every heat-wasting crack, opened seam and other leak in your furnace, boiler, tank, radiators and piping tight — as professional repair men do — with Smooth-On No. 1 Iron Cement. Do it yourself — now — and cut this winter's fuel bills. You apply Smooth-On like putty, it hardens like metal, and stays tight, because it expands slightly as it sets. Buy Smooth-On No. 1 in 1 3/4-oz., 7-oz., 1-lb., or larger sizes at your hardware store. If they haven't it, write us.

### FREE Repair Handbook

40 pages of ingenious, tested, short-cut repairs. Simple directions. 170 illustrations. Write today for YOUR free copy of the Smooth-On Handbook.

SMOOTH-ON MFG. CO., DEPT. 37K  
570 Communipaw Ave., Jersey City 4, N. J.

Do it with  
**SMOOTH-ON**

THE IRON REPAIR CEMENT OF MANY USES



### SPORTONE MUFFLERS

- Ford & Chevrolet.....\$ 4.45
  - All other popular cars..... 5.45
  - V-8 Dual Sets..... 15.95
  - Chromed Silentips..... 2.95
- (Please state make & year of car on all orders.)

**SANDEE MUFFLER CO.**  
5643 Corryne Place • Culver City, California

### KEEP YOUR SAWS SHARP WITH



### Forbes' Saw Filing Guide

Simple. Practical. Easy to use. No complicated adjustments. Always ready for quick "touch-up". Hard and Soft Wood positions. Save sweat and aching arms. Your saw cuts faster, straighter, cleaner, easier. Take pride in better work. Guide Complete with Full Instructions. **POST PAID \$1.00**

JO'THAN FORBES  
BOX 811, SYRACUSE, N. Y.

## HASTINGS

STEEL-VENT PISTON RINGS  
The best money you can spend on your car!

SAY YOU SAW IT IN POPULAR MECHANICS

## ELECTRIC WELDER

AC or DC 110 Volts



"The Little Marvel" All-Metal welder. 5-year written guarantee. Welds 1/8" thick metal or money back. Repairs tanks, tools, fenders, machine parts, etc. Comes complete with everything — rods, unit, eye shield, and directions. We also make a welder for 16 to 22 gauge metal . . . \$3.95 complete. Transformer welder \$18.95. On C.O.D., postage extra.

**\$6.45** Complete

ESSAY MFG. CO., Inc., Dept. 51, Quincy 69, Mass.





Better Sights  
FOR  
**BETTER "SHOTS"**

Sheard "Gold"  
Front Sight  
**\$1.75**

Standard  
Front Sight  
**\$1.25**



Marble's  
Flexible  
Rear Sight,  
with automatic  
spring joint.  
Can be locked  
down. With 2  
discs. Price **\$6.00.**

At your dealer, or  
write for Catalog

Marble Arms & Mfg. Co.

578 Delta Ave. Gladstone, Mich.

For faster, more accurate sighting  
equip with a combination of

**MARBLE'S SIGHTS**



Flat Top Rear. Price **\$2.00**



Semi-Buckhorn Rear  
Price **\$2.00**

No. 69  
Flat Top  
Sporting  
Leaf.  
**\$2.00**



(232)



**MAGNETS LIFT 225 lb.**  
GENUINE ALNICO - NEVER WEAKENS

AMAZING, PERMANENT MAGNETS—WILL NOT WEAKEN! NON-ELECTRIC

Retrieve guns, tackle, tools and other steel items from lake, river, plating tanks, drains or other hard-to-reach spots. Recover drills, taps, etc. from sweeping. Clear alley of harmful tacks, nails. Many other uses. Pays for itself quickly. GUARANTEED. Try any magnet one week. Money refunded if you are not well pleased.

No. M-725 (Weights 54 oz.) Has pull of 225 lbs. on steel block. **\$15.00**  
No. M-675 (Weights 49 oz.) Has pull of 175 lbs. on steel block. **\$10.50**  
No. M-650 (Weights 41 oz.) Has pull of 150 lbs. on steel block. **\$ 8.50**  
No. M-30 Hobbyist assortment of six small magnets. **\$ 1.50**

Send Money Order or Check. We pay postage. No C.O.D.'s.

MIAMI MAGNET COMPANY, 3240 N. W. 27th Ave., Miami 42, Fla.

**NO FINER GIFT for the MECHANICALLY-MINDED BOY**

(From 6 to 60)



Now offered by your local dealer or direct from manufacturer — dependable small motors for dry-cell operation. Practical, educational, suitable for hobby and experiment. Thousands used on toys, turntables, models of all kinds. Safe as a flashlight. Fully Guaranteed.

Model 5002 — a metal cased reversible motor with built-in speed reducer. Powerful Alnico magnet. Pulleys for 4000 and 1000 RPM. Mounting bracket and belt supplied. For 3-4 1/2-6 volts. Price **\$3.00**

Model 3100A — "Tiny Atom" Motor — speeds up to 6000 RPM. Double extended shaft. Permanent Alnico magnet field, wound rotor. Heavy duty transparent plastic case. For 1 1/2-3 volts. Price **\$2.00** (with pulley \$2.25).

Model 3000 — "Tiny Atom" Motor with variable speed gear train. Provides 10 useful powerful working speeds from 30 RPM. to 400 RPM. Complete kit with educational handbook — **\$4.00**

Remit with order and we pay postage in U. S. A. C. O. D. — plus postage.



**WILSON'S OF CLEVELAND**

425 Lakeside Ave., N.W. • Cleveland 13, Ohio

For quick delivery see your local dealer — or order direct

**Most versatile folding rule—**

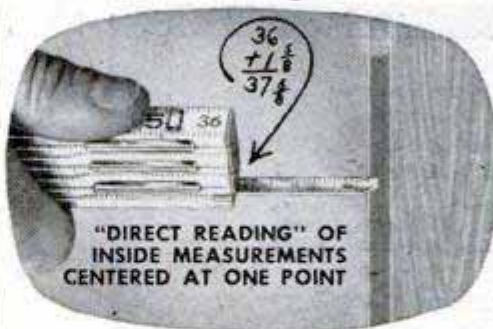

"DIRECT READING" OF INSIDE MEASUREMENTS CENTERED AT ONE POINT

**NEW STANLEY "100 PLUS" EXTENSION RULE No. X226**

Make no mistake, the new Stanley "100 Plus" Extension Rule is the handiest, most versatile folding rule you can buy.

Read it four ways — on inside measurements using slide, entire reading is centered at one point — no chance for errors; may also be used as an ordinary extension rule for inside measurements, and as a regular folding rule reading from either end.

Use it as a marking gauge for measurements in 2" and 4" multiples.

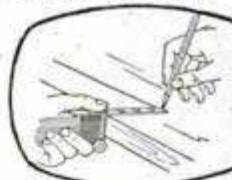

**CHECK THESE "100 PLUS" RULE FEATURES:**

- Easy to read Big Black Numbers on White Sticks.
- Square ends — butt flush with work.
- Opens to even inches at end of each stick.
- Handy for end-to-end measurements — opens in 6" multiples to full length, 72".
- 8-inch Brass slide removable for use as depth gauge.
- New plastic finish wears four times longer.
- Extra Thick Rock Maple Sticks graduated all edges.

For real rule value ask for the X226 at your hardware dealer's. **\$2.65 each.**

**STANLEY TOOLS, New Britain, Connecticut**

THE TOOL BOX OF THE WORLD



Reg. U.S. Pat. Off.

Hardware • Tools • Electric Tools • Steel Strapping • Steel



P1

**TOY PATTERNS—6 for 25c**

Ideal gifts for the youngsters.

Two sets — 6 full-size patterns in each.



P2

**SEND TOY PATTERNS NOW!**

Stanley Tools, 3102 Elm St., New Britain, Conn.  
(In Canada: Stanley Tool Co. of Canada, Ltd.,  
3102 Stanley St., Roxton Pond, Quebec)

Enclosed is.....Send Patterns checked  
.....Patterns P1 (25c) .....Patterns P2 (25c)

Name.....

Address.....

City and State.....

# WYTEFACE

TRADE MARK

## STEEL TAPES

No squinting, no guessing when you use WYTEFACE Steel Tapes. Jet black markings (foot numbers in red) on a white background. Easier to read in any light. Faster, more accurate measurements. Rust-resisting, hard to kink, simple to clean.

Protected by U. S. Patent 2,089,209

*"I'll take the WHITE one every time!"*

**KEUFFEL & ESSER CO.**

## PARTS FOR MILITARY TRUCKS

FOR JEEP, DODGE, CHEV., GMC, STUDEBAKER, 4 WHEEL DRIVE AND 6 WHEEL DRIVE. ALSO PARTS CATALOG. WRITE

### AXLES FOR TRAILERS

(Surplus) Heavy Duty axles suitable for building of many types of trailers, farm wagons, etc. Standard width straight axle, 2 inch square and is complete with Hubs, Tinkens bearings, 6 Hole

750x20 or 825x20 wheels, without brakes, only \$69.50

Dual Wheels..... add \$15.00 extra

### NEW JEEP TOPS and CURTAINS

Military type, easily adapted to civilian type Jeep. Complete top & back curtain, side curtains, snap-on doors, 5 windows. Waterproof, OD color. 25 lbs. FOB, K.C. \$59.50

All prices quoted good 30 days FOB, Kansas City  
25% DEPOSIT REQUIRED ON ALL ORDERS

## American AUTO PARTS CO.

1830 LOCUST - DEPT. PM  
KANSAS CITY, MISSOURI.

### CAPE COD CHAIRS TRELLISES • ARBORS DUTCH WINDMILLS

Chairs style B-C-A PLANS 50c Ea., all 3 only \$1.00. 12 different trellis designs PLAN of all 12 only 50c. Authentic 40" high Dutch Windmill Detailed PLAN only 75c. Unique 40" high Lighthouse having copper lantern, ideal for garden or on lake shore of summer home. Large detailed PLAN 75c. SPECIAL all plans above \$3.00 val. Only \$2.50. Send 10c for catalog

Craftsman's Model Co. Dept. P45 DELAFIELD, WIS.

### Life Time WALL TILE Plastic

**34c Per Square Foot Buy Direct & Save 34c**

Modernize your kitchen or bathroom. We teach you, instructions free. Earn big money modernizing your neighbors' homes with Plastic Wall Tile. Send \$2.00 for kit of samples—20 smart colors—complete with instructions. Cost of kit credited against first order.

**MONEY BACK GUARANTEE**

O'NEIL TILING CO., Dept. T, 1521 W. 87th St., Chicago 20, Ill.

## 6 GREAT SHAW DU-ALL

Plow  
Plant  
Cultivate  
Mow  
Rake  
Cut  
Trees  
Saw Wood

Walking or Riding Tractors  
1 1/2, 3, 5 H.P. walking models. 5, 8, 12 H.P. riding tractors. Get just the power you need in Shaw extra strength superior traction machines. All wanted tools, attachments. Dependable for nearly 50 years. See a Shaw dealer. Write for FREE literature, low prices—today.

**SHAW Mfg. Co.** 4510 Front St., Galesburg, Ks.  
668-G N. 4th St., Columbus, O.

### MADE RITE CORPORATION

Trailer Running Gear

58" 2 TON AXLE \$8.00 RETAIL SPECIAL PRICE TO DEALERS PAT PENDING.

F. O. B. 6454 EPWORTH BLVD.  
DETROIT 10, MICHIGAN

## AS MUCH FUN AS A CIRCUS

# 52 BALLOONS \$1

THAT MAKE GIANT

# CIRCUS ANIMALS

Some blow up 3 ft. to 4 ft. Easy to make GIANT CIRCUS ANIMALS—Instructions included. 4 ft. Ostrich, 3 1/2 ft. Giraffe, a yard full of 12" kittens. Make a big SANTA CLAUS and a set of REINDEER. FREE with each \$2.00 order, a genuine baNoon squawker. FREE with each \$5.00 order, 50 plastic toys (A Complete Western Rodeo). Send for FREE Catalog of tricks—magic.

CIRCUS BALLOONS, Dept. PM-10  
62 Garth Rd., Scarsdale, N. Y.

## Amazing!

# 3in1 JIG SAW SANDER FILER

with built-in electric motor

**CUTS SCROLLS LIKE MAGIC!**

U. S. Patent No. D-161025

**EXTRA if you order TODAY!**

Reg. \$1.00 Set of 10 PROJECT PATTERNS that make it simple to make toys, household items . . . most anything, given as your FREE BONUS GIFT when amount in full accompanies order. (We pay postage.)

**A terrific value For "Boys" 6 to 60 \$16.95**

Complete with

- 3 PROJECT PATTERNS
- 3 SAW BLADES
- ALLEN WRENCH
- 1 (4" x 9") VENEER

**10 DAY TRIAL • MONEY BACK GUARANTEE**

KENLEE Industries, Dept. PM10, 2817 No. Clark St., Chicago 14, Ill.

Enclosed is \$16.95 (check or M.O. in full)  
Send 3 in 1 Saw and \$1.00 FREE GIFT both POST PAID.

Enclosed is \$2.00 part payment. I will pay postman balance plus postage on C.O.D. delivery.

Name \_\_\_\_\_  
Address \_\_\_\_\_ Zone \_\_\_\_\_  
City \_\_\_\_\_ State \_\_\_\_\_

# Every Time You Use It...

**YOU'LL VALUE ITS  
CAPACITY AND  
VERSATILITY!**

**Atlas**  
8" TILT/ARBOR SAW

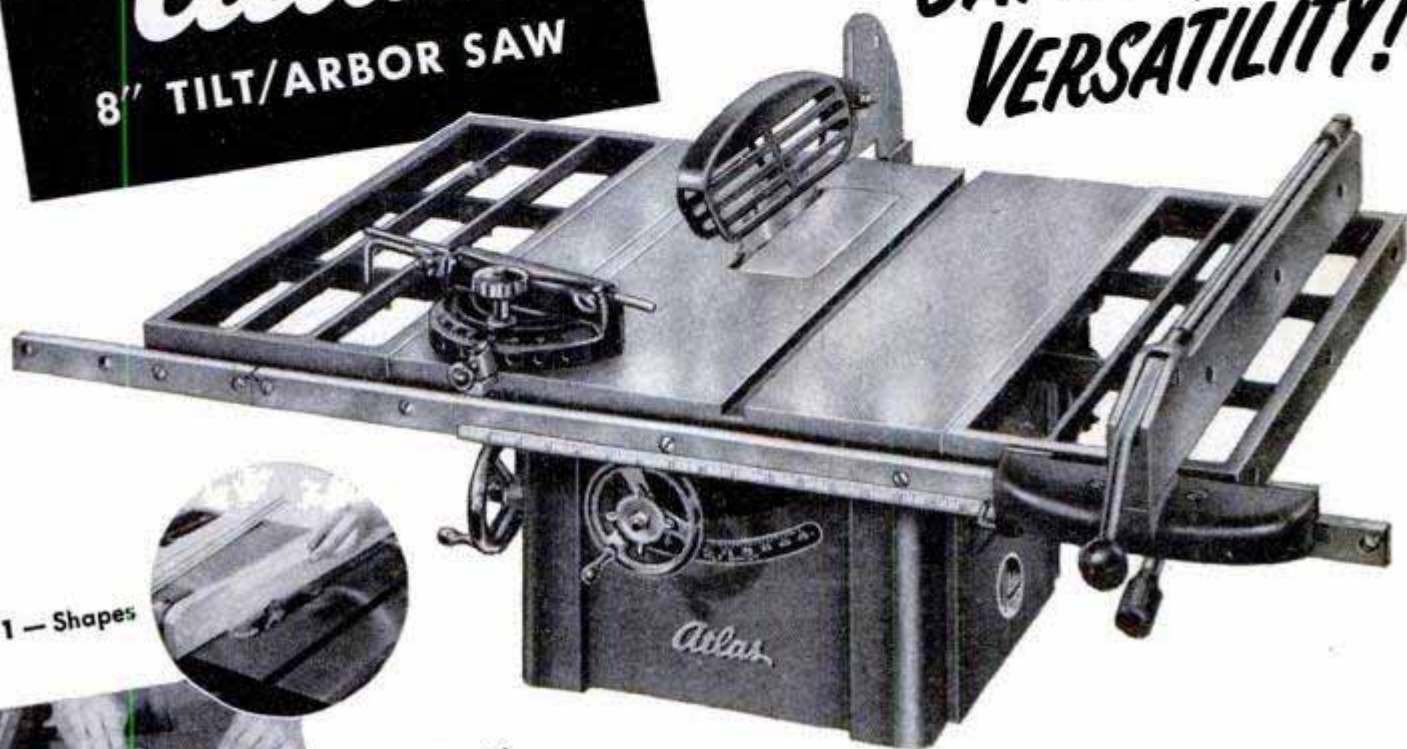

1 — Shapes



2 — Cuts tapers



3 — Dadoes



4 — Bevels, chamfers (Table always flat)



5 — Cuts tenons



## SPECIFICATIONS

Max. Depth of Cut.....	2 3/8" *
Table Ahead of Blade.....	10 3/4" *
Rip to Center of.....	19" panel
With one extension.....	36 1/2" panel

Saving you time, money and improving work accuracy *every* time you rip or crosscut a board to size is *just the beginning* of this saw's usefulness.

It handles easily and accurately such sawing operations as cutting angles, double angles, chamfers, bevels, tenons. And with low cost Atlas accessories it cuts all dadoes... handles a host of straight shaping and moulding operations.

Atlas is *the* saw for your shop. Its double-locking patented fence is the best you'll find on any saw. Blade tilts — your work stays flat — for safe accurate angle sawing. Has sealed-for-life ball bearings. Precision-ground grey-iron table. Grill extensions, original with Atlas, for handling big stock. See these and many other features at your Atlas dealers, or send for catalog today.

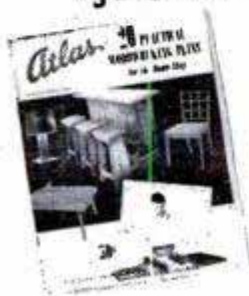

### NEW 20-PLAN BOOK ONLY 50¢

20 original, practical projects for your home and family... drawings photos, step-by-step instructions. Send check or cash (no stamps), \$1.65 outside U.S.A.

### USE THIS COUPON FOR FREE CATALOG

ATLAS PRESS CO., 1024 N. Pitcher St., Kalamazoo, Mich.

Please send FREE woodworking tool catalog

Inclosed is \_\_\_\_\_ for \_\_\_\_\_ 20-Plan Books

Name \_\_\_\_\_

Address \_\_\_\_\_

City, State \_\_\_\_\_



Model 413D

Your

# "OUTING PALS"

for Good Food  
Good Light  
Wherever You Go!

You always have good food with a Coleman Camp Stove along. You're sure of plenty of light in camp at night with a Coleman Lantern. Unsurpassed for emergency uses in floods, disasters, power failures.



Model 200



## CAMP STOVE • LANTERN

**Easy Meals**—The Coleman Camp Stove cooks like a city gas range. Instant lighting. Two and three-burner models. Make and burn their own gas from gasoline. Safe—help prevent forest fires. Fold up and carry like a suitcase.

**More Fun** with the powerful Coleman All-Purpose Lantern. Floodlights 100-ft. area. Compact; light weight; sturdier built. 8 to 10 hours lighting service from one filling. Safe; can't spill fuel. Stormproof. Coleman REFLECTOR makes it a high-power spotlight. See it lighted—ask your dealer.



THE COLEMAN COMPANY, INC., WICHITA, KANS.

**MAIL COUPON TO** The Coleman Co., Inc.  
Dept. 207-PM2, Wichita 1, Kansas

Please send me free literature about Coleman Camp Stoves, Lanterns and other Coleman Appliances.

NAME \_\_\_\_\_

ADDRESS \_\_\_\_\_

CITY \_\_\_\_\_ STATE \_\_\_\_\_

## Hot Rods Burn Up the Desert

(Continued from page 128)

reworked Mercury engine that uses a new kind of fuel-injection system instead of carburetors, developed by Clem TeBow and Don Clark. Running on alcohol, the engine develops 250 horsepower on the dynamometer, 320 horsepower when running on a 50-50 mixture of alcohol and nitromethane.

For the engineering that went into it, for its performance, and its safety features, the car was awarded the Maremont trophy that carries with it a \$1000 university scholarship and other prizes. An editor of *Popular Mechanics* served as one of the judges who made the decision.

The City of Burbank's safety was graphically demonstrated during the second of its two runs. At an estimated 240 miles per hour the right rear tire blew apart and the left rear tire lost much of its tread. Hill kept the car under control until it came to a stop, unharmed. The full mile had been traveled at a speed of 233 miles per hour which, averaged with a previous slower run, gave a two-way speed of 230.16 miles per hour.

When amateur hot-rod enthusiasts can build a car that goes as fast as this and that proves to be as safe as this one, it won't be long before they are shooting at the "big time" record—the world's unlimited record for the mile. ★★★

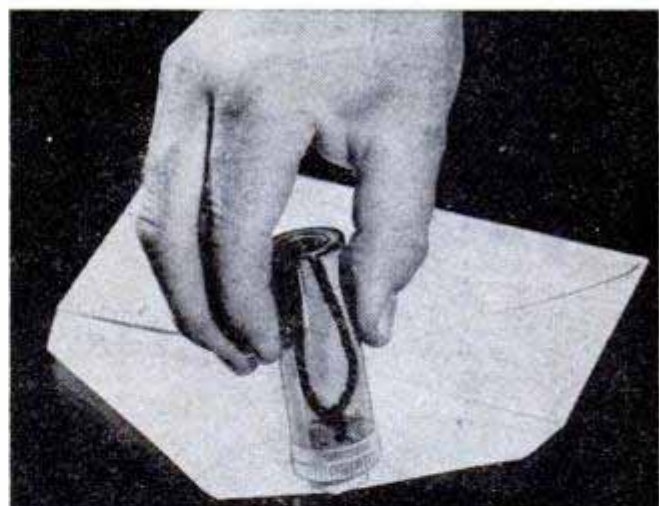

## Miniature Moistener

Designed to save wear and tear on the tongue, a thumb-sized moistener eliminates the nuisance of licking stamps, labels and envelope flaps. Filled with water, the three-inch moistener will remain wet on top until its contents are exhausted. A cellulose sponge plugging a hole in the removable cap connects to a double wick that reaches the bottom of the container which is one inch wide and three inches long.

# Careful, Son!

*those are mighty  
important people  
you're shooting!*



Don't be nervous when we tell you, sonny, but you're about to take a picture of the most important twosome in the world!

Sure it's your mom and dad... and that means they're pretty big people to you.

But thousands of folks you don't know look up to them with respect, too, and try in every way to win their friendship.

These other folks are the people who manufacture brand name products... who want every mom and dad to buy the things they make, again and again.

These brand-makers carry on continuous programs of research and product improvement,

employ scientists and testing engineers... all in an effort to make better products that will please more people.

That is what brand names mean... signs of the pride and responsibility of the firms that make the products. They tell you at a glance: these are made by manufacturers who care.

Read the advertisements in this magazine carefully and remember the brand names of the products you like. You save time shopping that way, get exactly what you want. Most important, you keep yourself the "boss" of the most productive industrial system in the world.

*Yes, in the factories of the brand-makers, yours is the final word. Your free choice of branded products makes you the boss. You can keep it that way by demanding the brands you want.*

*Brand Names Foundation*  
INCORPORATED

A NON-PROFIT EDUCATIONAL FOUNDATION • 37 WEST 57TH STREET, NEW YORK 19, N. Y.

Make \$20 to  
\$30 a Week

**EXTRA  
MONEY**



## MACHINE SAW FILING PAYS UP to \$3 or \$4 an HOUR

• Turn your spare time into CASH—sharpening saws with a Foley Automatic Saw Filer pays up to \$3 or \$4 an hour. You will find you can make \$20 to \$30 a week in your spare time as a starter.

You can work in your basement or garage—no experience necessary. "The first saw I sharpened with my Foley Filer came out 100%"—writes Clarence E. Parsons. No canvassing—"I advertised in our local paper and got in 93 saws"—says M. L. Thompson. The Foley is the only machine with which you can file all hand saws, also band saws and cross-cut circular saws.

## SEND FOR FREE BOOK "MONEY MAKING FACTS"

Shows how you can get business from home owners, farmers, carpenters, schools, factories, etc. With a small investment, no overhead, no stock of goods to carry, you can get right into a cash business,—and possibly later on develop into a full-time repair shop. Send coupon today for Free Book. No salesman will call.

"Each saw I filed got me six more and business has been picking up that way since a year ago. If it keeps up I will have to buy another Foley Saw Filer."  
William C. Baldwin

"I have done 4 or 5 thousand saws in my spare time in the 4 1/2 years since I got the outfit, and they are all coming back." Len Crego

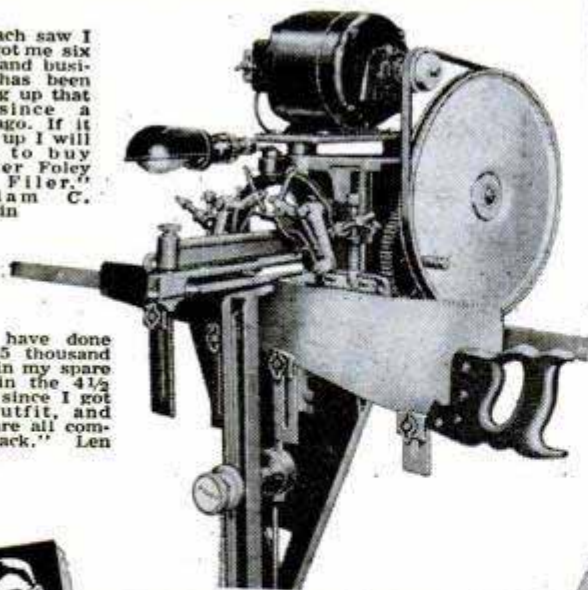

Send Coupon for **FREE BOOK**

**FOLEY MFG. CO., 1016-2 Foley Bldg.  
Minneapolis 18, Minnesota**

Send **FREE BOOK**—  
"Money Making Facts"

Name.....  
Address.....



## Magnet Holds Micrometer For Checking Wheel Alignment

Portable and easy to use, a micrometer to determine wheel alignment on cars, trucks and busses fastens to the hub flange by means of a powerful magnet. The unit has a built-in level and a calibrated dial to measure the various angles. The angles are indicated in positive and negative gradations on the dial.

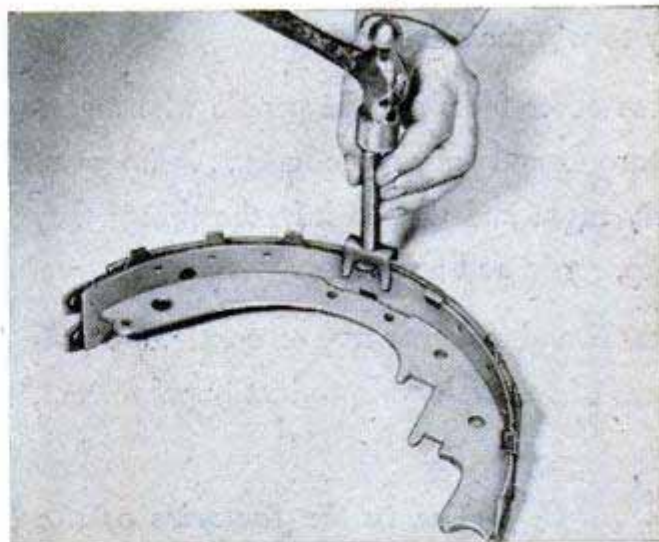

## Bonded Brake Linings Applied With Machinist's Hammer

Rivetless brake linings, bonded to a metal backing plate, are installed on any brake shoe in 10 minutes with ordinary hand tools. Tabs on the backing plate are bent over the brake shoe with a crimping tool or machinist's hammer. Available in 13 sizes, they fit almost all American cars.



# BUY from C&H - you'll save and be sure!

ALL ITEMS GUARANTEED AS REPRESENTED Order with confidence from C&H

## 80-1 ratio GEAR REDUCER

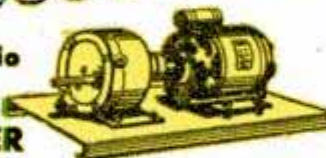

Double reduction. Operates on any 1/8 to 1/2 HP electric motor. 23 RPM. Can be used as winch, barbecue, dummy elevator, operate turntable, electric garage door opener, television antenna. REGULARLY \$45.00. NOW ONLY.....\$28.50

## 54 to 1 BOSTON Speed Reducer



Reduces speed of ordinary 1750 rpm electric motor to 33 rpm. Lists at \$55.00. Our price.....\$29.50

## ELECTRIC HAND SAWS

Compare these sensational prices! All NEW Brand Name SURPLUS Electric Saws. 110v. AC-DC fan cooled motors, lightweight design, balanced for easy handling in any position. Can be adjusted for depth and angle of cut. Ripping guide included.

6 3/4".....	\$32.50
7 1/2".....	\$42.50
8 1/4".....	\$59.50



## SEALED BEAM HEADLAMP

6" G.E. sealed beam headlamp in streamlined black enamel steel housing. An ideal light for tractors, trucks, boats, workshops, drive-ways, etc. 5/8" mounting bolt. 6 or 12v. Only \$3.00 ea. or 2 for \$5.00

## ALARM HORNS • SIRENS

Motor driven (not a vibrator). Heavy duty with great power and long life. Adjustable for high, medium or low tone. 110v. AC current. Weather proof. For alarm on boats, school yards, factories, air raid siren, etc. List price \$47.00. Our price NEW.....\$15.45



## HOT ROD SUPERCHARGER

Extra soup and go at a price you can't afford to miss. SEE HOW SIMILAR SUPERCHARGER is used in PICTURE and article on p. 67 AUG. '50 issue of POPULAR MECHANICS. Mfr'd by Borg-Warner. Specifications: 7 1/2" deep, 7" high. Wgt. 17 lbs. Compact and sturdy. 4 base mounting holes. 3/4" outlet. 5/8" shaft with female Lovejoy coupling. Priced today at \$85. OUR SPECIAL SALE PRICE.....\$31.00

## POWER and HAND WINCHES

For—BOATS, TRUCKS, FARMERS, LOGGERS, CONTRACTORS, ETC.

Hand winch, 3-1 ratio, 600 lb. pull, drum has 1 1/2" spool. 6" flange, takes 7/8" cable, stop locking pawl, wgt. 26 lbs. \$18.95

Ball bearing Hand winch, low ratio 1-1, high ratio 3-1, 600 lb. pull.....\$29.50

Same as above with bronze worm gear, 2 speeds, 1-1 & 12-1, and hand brake—\$39.50

1/2 HP electric ball bearing model; releasing brake starts motor, brake on-motor off; compact gear box, 12 rpm drum speed. \$135.00

3/4 HP, same as above, 3" drum.....\$165.00

Heavy duty, 10-1 ratio, double drum model with jaw-type clutch, wgt. 280 lbs. \$49.95

CABLE, 1/4" preformed stainless steel aircraft, 100 ft. or less.....17c/ft.

Over 100 ft.....15c/ft.

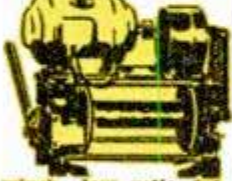

## BOOSTER FANS

Fits any 8", 9", 10" furnace pipe. 1500 RPM motor with 6" cord, mounting frame, 7" blade. Motor 110 volt 60 cycle 1550 RPM. Easy to install. Silent operation. Warm those rooms with long runs. Stock #583. Regular \$11.95. Your price \$6.95

Steel framed, easily mounted SIGNAL exhaust fans. Operate in vertical or horizontal position. Quiet, long life ball bearings.

FANS	FAN SHUTTERS
10".....	\$12.95 \$4.50
12".....	\$16.95 \$4.95
16".....	\$23.95 \$5.95
20".....	\$39.95 \$6.95

## High Volume BLOWERS

Top performance for forced draft, ventilating, exhausting, cooling and drying, 110v. AC.

75 cu. ft. per min.....	\$10.95
150 cu. ft. per min.....	13.95
300 cu. ft. per min.....	17.95
500 cu. ft. per min.....	36.00



## BUILD YOUR OWN INCLINE or DUMB WAITER ELEVATOR

Get all the convenience of a dumb waiter elevator for store, shop, restaurant and home—or the convenience of an incline elevator on steep lake shores, hills, ravines, etc. at lowest cost. We furnish complete parts. Steel Car—Guide Rails—Worm Gear—Limit Switches—Electrical Control—Steel Cable. SEND 25c for completely diagrammed instructions with list of parts, kits and prices.



## ELECTRIC HOT WATER HEATER

Heat water faster, easier with this immersion unit. 115 v. AC—1250 watt Westinghouse or Chromolox element. Manual unit, \$42 value, \$6.95; thermostatic Fenwall control \$8.95. Element with Fenwall thermostat \$8.95. 10 gal. steel tanks 12x21" — \$9.95; 8x42" — \$11.95; 18" cord #12/2 or 3 conductor with plug \$2.25.



## "JANITROL" AIRCRAFT HEATERS

Warms up fast—just the thing for heating trucks, buses, garages, etc. Has an output of 50,000 BTU's per hour. 24 volts DC. Length 33" diameter 13". weight 14 lbs. Original cost \$130. Our special sale price NEW, only.....\$19.95



## AUTOMATIC AIR COMPRESSOR UNIT

Compressor with 2x1 3/4" piston controlled for intermittent duty by regulator and check valve. Heavy duty capacitor motors 110/220 v. AC. 12x24" tank mounted on rubber tired wheels. 1 1/2 hp. \$99. 1 1/2 hp. \$109. Tank only \$149.50.



## Flexible Shaft Grinder

"MALL" PORTABLE 1 1/2 HP. 3450 RPM, 110-220 volt dustproof motor mounted on universal trunnion. Heavy base has a convenient tool tray and large easy rolling casters. Flexible shaft is equipped with both full speed and angle spindle and straight spindle. List price \$172.00. Your price with all attachments, NEW.....\$99.00



## NEW TOOL POST GRINDER

1/4 hp. AC-DC 7000 rpm motor with 3 1/2x3 1/2" external grinding wheel, smaller internal wheel, 7 ft. rubber cord, switch and attachments. Lists at \$90. Only \$49.50

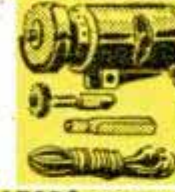

# SAVE OVER 50%

ON THESE BRAND NEW WAR SURPLUS POWER UNITS

BE PREPARED for any emergency!

300 WATT 110-220 volt AC, 60 cycle light plant powered by 1 HP gas engine, direct drive, mounted base, wgt. 40 lbs. Ideal for campers, P.A. systems, house trailers, etc. Equipped with handle for easy carrying.....\$99.00

750-1000 WATT 110 volt AC, powered by Briggs & Stratton gas engine.....\$169.00

1000-1200 WATT 110 volt AC.....\$194.00

2000-2500 WATT 110 volt AC, 60 cycle, slow speed generator, 5.10 HP Briggs & Stratton gas engine. NEW.....\$294.50 To make plant 110-220 add \$40.00 for transformer.

2500-3000 WATT 110 volt AC, 60 cycle, Leland generator—runs at slow speed (1800 r.p.m.) for longer life, 8.25 HP Briggs & Stratton gas engine. You can rely on this plant for all average home needs—freezer, stoker, pump, hot plate, radio, etc.—and overloads from starting motors. Reconditioned and fully guaranteed. \$295.00, NEW \$345.00 Plants, same as above, built in 1951, with tools and spare parts. Lists at \$790.00, Our price.....\$426.00 To make plant 110-220 add \$48.00 for transformer.

3000 WATT, 110-220 volt with push button starter. Starter battery is automatically charged by plant. Gas engine same as in plant above.....\$465.00

5000 WATT, 120 volt, 60 cycle AC, Hercules 4 cyl. gas engine, Hobart generator, completely automatic, radio & TV filtered, power cable plus, exhaust pipe and manual. Lists at \$1800. Our price \$795. Extra parts and tools \$25. 150' reel 2-wire #8 rubber cable with connectors \$90. 150' 3-wire remote control cable & switch \$25. Plant complete with parts and 2 reels of cable \$895. To make plant 110-220-v., add \$75 for transformer.

Write for FREE circular on the following plants.

7500 WATT 110 volt AC, 4 cyl. gas engine, NEW \$995.00

10,000 WATT 110-220 AC, Recond'nd \$1195, NEW \$1494

25,000 WATT 220 v AC, 3 phase, or 110-220 v AC, single phase. Reconditioned.....\$1995.00 NEW.....\$2495.00

35,000 WATT 110-220 volt, Diesel, Rebuilt.....\$2995.00

50,000 WATT 240 v. AC, 3 phase. Diesel, NEW.....\$5900.00



## HEAVY DUTY RUBBER ELECTRIC CABLE

(Nothing less than 50 ft.)

4 Wire #18 Neoprene standard, per ft.....	7c
18 ft. with plus.....	\$3.00
Wire 14 50 to 225 ft., per ft.....	16c
Wire 12 12 ft. with plus.....	\$3.50
Wire 10 75 ft., per ft.....	28c
Wire 10 80 to 225 ft., per ft.....	30c
Wire 10 75 ft. length, per ft.....	35c
Wire 8 75' reel and connectors.....	\$ 70.
2 Wire #4 Concentric 50 to 250 ft. underground, per ft.....	60c
1 Wire #10 Rubber, 50-500', per ft.....	94c
15 Cond. #18 GE Stranded 50-300' O.D. 1 3/16", per ft.....	50c
10 Cond. #18 Solid, per ft.....	10c
Telephone wire, 250', per ft. 2c; 1000' 1 1/2c	



## GENERATORS

300 Watt, R.P.M. 3400, 110 and 220 volt, 3 1/2" shaft, \$40.00, 2500-3000 Watt, R.P.M. 1800, 115 volt, AC. \$235.00, 3000 Watt, R.P.M. 2800, 110 volt, DC. Deleo ball bearing, 1" shaft. List \$343.00. To you at only \$99.00, 5000 Watt, 115 volt, R.P.M. 1800, single phase \$259.00, 10,000 Watt, 110-220 volt, 60 cycle, 1200 R.P.M.....\$550.00

TRACTOR DRIVEN GENERATOR 2500 W. 110-220 volts with floating mount to keep belts tight \$287.00. Generator only.....\$235.00

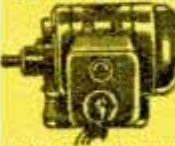

## and other bargain items

GOODRICH RUBBER HOSE 2" I.D. 2 ply, 25 lengths, worth \$25, at \$3.95; 3 lengths \$10.00

AIR COMPRESSORS from 1/2 HP, 12 gal. tank at \$39.00, to 10 HP, 80 gal. tank at \$777.00

WELDING ROD—Manufactured by Murex. All purpose type 8, AC-DC 5/32", 50 lb. box \$3.00

OHMMETERS, Read 25 to 0, in leather carrying case, Reg. \$29.95, Only.....\$7.95

FYR FTYERS, Fire extinguisher approved by Underwriter's, Reg. \$14.05, Only.....\$6.95

1/2 TON SHOP Utility WAGONS, steel frame, rubber tires, ball bearings.....\$48.50

## COASTER WAGON POWER UNIT

You'll thrill the kids with this simplified power attachment. Made of heavy gauge steel with lever controlled power engagement. Easily attached to ordinary coaster wagon or midget auto. Special \$15. Unit & 1 1/4 HP gas engine, \$54 value, ONLY.....\$49.50



## SEE THE ADVANCE DESIGN

### THE NEW DART RULE

"CLEAR VISION" DESIGN



**\$1.25**

6' length

- "Clear-Vision" for easier reading of inside measurements.
- "Anti-Pop-Out" blade design
- Blade stays put at any length
- Available in all lengths — 6', 8', and 10'
- Easy-to-Read white blade

**DART**  
Mason, Mich.

AT YOUR HARDWARE STORE

## DOES DOZENS OF HOUSEHOLD JOBS



Your All-Purpose  
**WELLER Gun**

Homecraftsmen —  
Hobbyists—Here's your  
most useful tool! Instant-heating

WELLER Guns cut rubber and composition floor tile—remove old putty from windows—repair rain spouting, radio and TV sets, furniture finishes, electrical wiring—heat-seal home-freezer packages—build model railroads—solder costume jewelry—re-groove guto tires. Dozens of other money-saving jobs, too. See dual-heat (high or low) WELLER Guns with low-cost replaceable tips at your Hardware Dealer.

- Send for Literature. New bulletin tells all about sharp-shooting WELLER Guns. Send for your copy today.

**Weller** **SOLDERING GUNS**

816 Packer Street, Easton, Pa.

## New GRAVELY CHAIN SAW

Notches, fells, trims toughest trees . . . No stooping, lifting, or carrying! One of 21 tools for every lawn, garden, field or farm job . . . powered by the 5-HP Gravelly tractor!

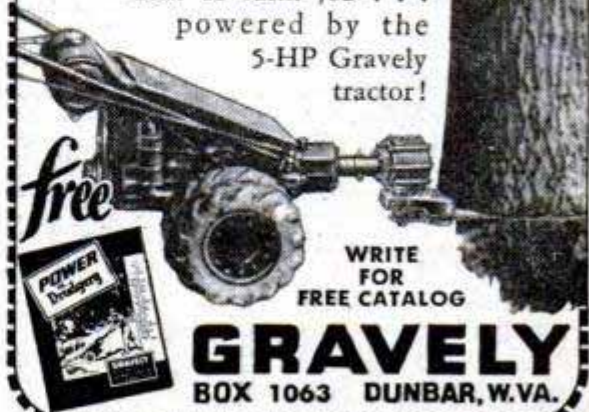

WRITE FOR FREE CATALOG

**GRAVELY**  
BOX 1063 DUNBAR, W.VA.

## ELECTROSCOPE

This electroscope detects and measures relative strength of radioactive substances. Easily assembled kit includes all electroscope parts, complete instructions . . . postpaid **\$375**

**PLOYHAR ELECTRONICS**

Box 441, Main Post Office Los Angeles 88, Calif.

## Government Surplus B-29 Gun Sights



Have 1000 in original cartons. Cost U. S. Government \$140.00 each. While they last \$3.50 each. Can be made into projector lens, magnifying glasses, telescopes or many other things. The lens are 3 1/2", F1/9 and have 2 single lens and one achromatic. Get yours before they are all sold.

**WICHMAN**

1423 BERKSHIRE  
GROSSE POINTE 30, MICHIGAN

## ONE-MAN SAWMILL LOW \$50.00 AS... DOWN



Take BELSAW Portable Sawmill right to the trees—turn out valuable lumber for local yards—do "custom sawing" for neighbors. BELSAW lasts a lifetime. No crew needed. Power with old auto engine. Beginners get excellent results. Send postcard for FREE BOOK, "How To Make Lumber."

**BELSAW MACHINERY CO.**

8117 Field Bldg. 315 Westport Rd, Kansas City 2, Mo.

## ANY 35mm FAN CAN NOW OWN ONE! SLIDE PROJECTOR \$9.95

What a buy! A streamlined 100 watt projector, sturdily constructed of stamped metal, with a special concentrating condenser and a 4" f:3.5 color corrected lens, dual slide carrier ready to use. Projects your 2x2" (35mm, 828, taken with Argus, Bolsey, Pony, Bantam etc.) color slides giant LIFESIZE with clarity, brilliance, sharpness you'd never expect possible at so moderate a cost! Shipping Cost 60c.



## 30x40 Projection Screen \$6.89

Customers examining the screen in our store ask unbelievably: "Is it really beaded? Does the low price include tripod and screen?" But after learning what they get, they admit that they expected to pay 100% to 150% more! Yes, you pay far below wholesale price for a first rate screen, equally suited for movie (8mm or 16mm) and slide projection. Crystal-beaded pyroxilin surface actually adds brilliance to your films and slides, makes them come to life! Screen raises and lowers on elevating rod, metal can has beautiful scratchproof finish, carrying handle sets for balanced carrying, sturdy, plated tripod has protective rubber tips. Thousands of our screens are in use by churches, clubs, colleges and amateurs.

OTHER SIZE BEADED	40x40" . . . \$8.19	37x50" . . . \$9.84
TRIPOD SCREENS	50x50" . . . \$11.89	52x70" . . . \$24.95

Prepay in full or send \$1.00 deposit with C.O.D. orders. Shipment is made Railway Express, shipping costs collect (or you prepay for 11 lbs. pp. and ins. for 20x10, 40x10 screens).

**SPIRATONE**, Dept. PM, 49 W. 27th St., New York, N. Y.



**RELIEVES PAIN OF  
HEADACHE • NEURALGIA  
NEURITIS**

**FAST**

The way  
thousands of  
physicians  
and dentists  
recommend



Anacin® relieves headache, neuralgia, neuritis pain fast because Anacin is like a doctor's prescription—that is, Anacin contains not just one, but a combination of medically proven, active ingredients in easy-to-take tablet form. Thousands have been introduced to Anacin through their own dentist or physicians. If you have never used Anacin, try these tablets yourself for incredibly fast, long-lasting relief from pain. Don't wait. Buy Anacin today.

**AIR COMPRESSOR  
BARGAIN**

Ideal air supply for farm and home workshop or small garage. Use own motor or engine, 1/4-1/2 or 1/2 H.P. Mount as desired.

Will inflate 600 x 16 tire from zero in 50 sec. Will furnish air for 2 C.F.M. paint gun for refinishing automobiles, implements and small buildings. Also for insecticide spraying and power greasing.

**PISTON TYPE**—up to 150 lbs. pressure, 2" bore, 1 3/4" stroke, up to 2.8 C.F.M. Compact — rugged — dependable. Heavy counter balanced crankshaft with two bronze main bearings, splash lubrication, dust tight crankcase. Disc valves. Built-in air filter. 3 ring piston. 8" V-pulley. Thousands in use. Will last for years.

We pay transportation east of Rockies. 30 day money back guarantee. Send check or money order today. Prompt Shipment.

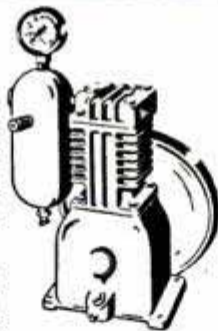

As shown with pulsation tank, gauge, safety valve and drain cock. Shipping weight 24 lbs. . . . . **\$32.50**

Compressor only (2x13 1/4) with 8" V-pulley. Shipping Wgt. 18 lbs. . . . . **\$20.50**

Hose—15 ft. with tire chuck. . . . . **\$3.25**

**NELSON COMPRESSOR SALES**

831 SPRING ST.

QUINCY, ILLINOIS

**GOOD NEWS FOR WEEK-END CARPENTERS!**



**Plywood now made  
in new small-size  
handy panels**

**Now At Your Lumber Dealers  
In New, Self-Service Racks**

Buy your plywood the easy new Handy Panel way. Easy to use because they're top-quality Douglas fir plywood . . . real wood, strong and light. Easy to carry because they come in stock sizes 2x4 feet and smaller. Popular thicknesses. Easy to select from new self-service racks at lumber dealers everywhere. Every panel clearly labeled with type, grade and price. Pick up your plywood today—the economical Handy Panel way.

**DOUGLAS FIR PLYWOOD  
handy panels**

**MAIL COUPON FOR VALUABLE FREE FOLDERS**

Douglas Fir Plywood Association, Dept. 9A, Tacoma, Wash.

Please send free plywood finishing and wood-working folders. (Good USA Only)



(Name).....

(Address).....

(City).....(Zone)...(State).....

**WAR SURPLUS BARGAINS**

**\$500,000.00 INVENTORY for QUICK LIQUIDATION**

Surplus items—hundreds of them for home, shop, factory, farm and outdoor use. New items, used items, reconditioned items—all at tremendous savings—all priced for quick sale.

Page After Page of Values

This big catalog shows page after page of amazing money saving values. Write for your copy today. Send 10c to cover postage, mailing, etc. Write today!

**SEND TODAY FOR YOUR COPY 10c**

**STARK'S** Dept. 509 So. STATE STREET CHICAGO 5, ILLINOIS

**AT LAST... a genuine  
PLASTIC LAMINATE  
you can apply  
YOURSELF!**

**LAMIDALL®**

**for walls, top surfaces  
and 101 other uses!**

You've seen Lamidall on restaurant counters, on table tops and on walls of stores, offices and homes... wherever attractive, durable surfaces are needed. You can get Lamidall in beautiful wood grains and colorful patterns in easy-to-handle, easy-to-work panels up to 4' x 12'. You can cut it, drill it, and easily bond it to other surfaces. See Lamidall display at your lumber—floor and wall covering dealer.

**TOUGH 1/8" THICK  
STRUCTURAL PANELS**  
with a hard, durable, glass-smooth plastic surface that resists abuse, stains and heat...easy to cut and apply!

Here are a few ways you can use Lamidall:

- WALLS
- COUNTER TOPS
- TRAYS
- SHELVES
- WINDOW SILLS
- SHADOW BOXES
- TOYS
- SEWING BOXES
- DOOR KICK PLATES
- HOT DISH PADS
- FURNITURE
- CUT-OUT LETTERS

**SPECIAL  
OFFER**

Send only **\$1.00**  
for large trial panel!

Send \$1.00 TODAY for a 11 7/8" x 47 7/8" panel. Specify wood grain or pattern, either light or dark shade. Shipped express collect.

**WOODALL INDUSTRIES INC.**

3518 OAKTON STREET • SKOKIE, ILL.

**SAVE FUEL—  
MAKE YOUR HOME COZIER**

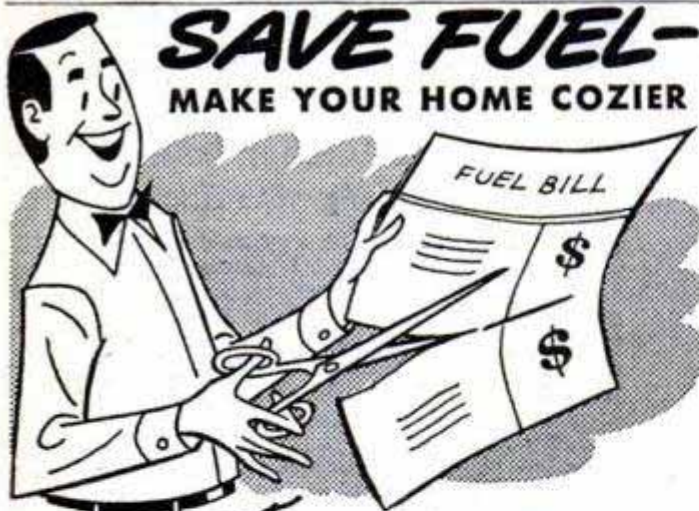

with *Bridgport*

**INNER-SEAL  
WEATHER STRIPPING**

Those air leaks around doors and windows are costing you money—seal them up *permanently* with Inner-Seal. Made of live sponge rubber bead with woven spring-wire tacking strip. Tough, flexible, resilient, waterproof.

Ask your hardware or building supply dealer for a copy of "Why & How to Weather-strip"... it's loaded with useful information. Or write today to Dept. PM10.

**BRIDGEPORT FABRICS, INC., BRIDGEPORT 1, CONN.**

**THE EASY WAY  
TO DRILL & SAW**

**Powerful  
Cummins #190 Electric  
DRILL & SAW KIT**

**Factory Guaranteed**

Includes 1/4" Drill (1700 RPM, 115 V. AC-DC); 4" Saw Attachment (Adjustable); 1/4" Capacity Jacobs Chuck; 3 Steel Twist Drills; Horizontal steel drill stand, which converts drill into bench grinder, buffer, polisher, sander, etc. Attractively packaged. Instructions included.

Postage 50c additional. 3% sales tax in N.Y.C.

Send check or M.O. COD's, \$5 deposit.

**GOLDEN ELK PRODUCTS CO.**

12 East 41st St., N.Y.C. (17), HA 9-7810



Only **\$19.95**  
**\$27.95 Value**  
**DANDY FOR HOME & SHOP USE**  
10 day money back guarantee

**ADJUSTABLE HOLLOW AUGER**



USUAL **\$7 VALUE**  
**\$2.00**

YES, We said \$7 VALUE! CUTS TENONS or WHEEL SPOKES. Adjusts 1/4 to 1 1/4" Diam. Send cash, check or money order, plus 35c for mailing to E. G. HOWARD, 2240 S.W. 19th Terr., Miami, Fla.

**BATTERIES!—START**

—a factory at home and re-cast junk batteries into new; latest achievement. We supply complete instructions and everything needed. Large daily profits!

BATTERY LABORATORIES, Dept. PM, Minneapolis 4, Minn.



**LEATHERCRAFT** and many other crafts

**SHELLCRAFT**

• easy to do

**TEXTILE PAINTING**

• profitable too

Send for **FREE**

**BIG CATALOG TODAY**

• complete supplies

• everything you need

**KIT KRAFT** • 7373 Melrose Ave. Dept. 29, Hollywood 46, Calif.

**NEW, IMPROVED CALCULATOR  
FOR WOODWORKERS only 25c**



Instantly gives information on lumber, nails, concrete mixes, painting materials, etc. Convenient, simple to read. Just set dial for nail specifications, to convert linear to board feet, find bit sizes for screws, compare characteristics of woods. 6" diameter heavily varnished cardboard. Send 25c, no stamps, please to Greenlee Tool Co., 2110 Columbia Avenue, Rockford, Illinois.

SAY YOU SAW IT IN POPULAR MECHANICS



**STOP WASTING OIL!**

Tune up your car engine with **COMPOUND SEAL** to cut oil waste, boost power and quiet piston slap. Easy to install—just squeeze tube contents into spark plug openings. **COMPOUND SEAL** expands; fills worn space between pistons and cylinder walls while you drive. This *proven* treatment will add 10,000 miles or more of quieter, smoother performance.

Only **\$3.00** Postpaid

**Economy Products**  
BOX 1133B NEW BRUNSWICK, N. J.

MONTH AFTER MONTH, YEAR AFTER YEAR, YOU SEE OUR AD. REMEMBER IT'S DANGEROUS to pay less if you want A-1 used (NOT ABUSED) TIRES. IF IT'S YOUR FAMILY'S SAFETY, LOOK BEYOND THE 'PRICE TAG' VETS AND SERVICEMEN TAKE 10% ON 1 TIRE OR MORE

**GOOD YEAR Firestone**

GOODRICH, UNITED STATES, GENERAL & OTHERS, NOT RECAPS DOUBLE WARRANTY & UNCONDITIONAL GUAR. ON PASS. TIRES

BEFORE YOU ORDER READ THOSE TOP LINES AGAIN Our policy is to select your tires so carefully, as if our very future depended on the service given by that particular tire.

**FREE TUBE WITH EVERY GOOD GRADE & FINEST GRADE TRUCK & PASSENGER TIRE**

GOOD GRADE—GUAR. 20 MONTHS (NOT JUST 6 OR 12 MOS.)		FINEST GRADE. 30 MONTHS GOLDEN RULE GUARANTEE BOND (NOT JUST 24 MONTHS) THIS GRADE MADE US WORLD FAMOUS	
600-16 \$4.14	820-15 \$5.44	600-20 \$7.14	32x6(8) \$8.64
650-16 5.42	700-15 4.54	650-20 7.94	32x6(10) 9.94
700-16 5.04	670-15 4.48	700-20 8.54	900-20 13.18
650-16 4.44	710-15 4.68	750-20 8.64	1000-20 13.78
760-15 5.04	550-17 4.64	825-20 14.78	1100-20 13.94

600-16(6) 7.38	475-19 5.08	700-15(6) \$12.48	700-20 \$11.08
650-16 5.98	640-15 5.08	700-17 13.48	750-20(8) 15.48
650-16(6) 8.28	670-15 5.68	750-16 10.78	750-20(10) 12.78
700-16 6.48	710-15 5.88	750-17 16.68	825-20 18.48
750-16 9.78	760-15 6.08	750-15 19.08	900-20 17.28
525-18 5.08	800-15 6.58	825-15 22.18	1000-20 17.88
550-17 4.98	820-15 6.68	600-20 8.78	1100-20 19.58
650-15 5.38	670-16 6.38	650-20 10.28	1200-20 23.28
700-15 5.58	760-16 7.58	32x6(8) 11.48	1000-22 19.58
WHITEWALLS \$1 ea.	EXTRA 32x6(10) 11.88	1100-22 20.48	

Buy the 'Right' Truck Tires for 'Your' Job. Thousands of the Best Fleetowners Depend on us.

Std. Guar. 20 Mos. Rugged Guar. 32 Mos. **MILITARY MUD-SNO TREAD**

750-20Std \$10.78	750-20Rugg \$16.24
600-16 " 6.48	600-16Rugg 9.95
900-16 " 10.58	900-16Rugg 15.68

FACTORY RESULT SNOW-TRED TIRES 30 MOS. GUAR. "New Tire Traction" Tread Not Worn. Perfect Casings.

670-15	760-15	650-15	700-16
710-15	820-15	700-15	800-15

**\$11**

**BLATT** BLATT BLDG., GIRARD & LANCASTER AVES. DEPT. PM, PHILADELPHIA 31, PA. Send check or money order & this ad. We won't ship a tire we wouldn't use. Blatt: Name famous in tires since 1915. Shipments RUSHED Down South, Up North and FAR WEST

**Print Your Own**

Cards, stationery, advertising, etc. Save money. Print for others, good profit; easy rules sent. Raised printing like engraving, too. Sold direct only. Write for free details. Kelsey Presses, F-37 Meriden, Conn.

**Build Your Own Trailer!**

SAVE MONEY WITH A **Mastercraft** UTILITY TRAILER KIT

You can build your own trailer and save with Mastercraft's new line of trailer kits, parts, and accessories because this quality line is offered direct from the factory at really low prices . . . so write TODAY.

1/2 TON KIT Only \$54.75 FED. TAX INCL.

**Mastercraft TRAILERS, INC**

155 FACTORY STREET • MIDDLETOWN • CONN

**MODERN LAWN MOWER SHARPENER**

Service departments of leading Lawn Mower manufacturers use the Modern Lawn Mower Sharpener. One lever moves lawn mower into grinding position. Gasoline and oil remain in engine while sharpening, no dismantling of wheels, roller or handle. The Modern is a precision bed knife grinder—no extra grinder to buy. Imitated but never equaled—Compare before you buy.

If it isn't a Modern it can't be Modern (Prices subject to change without notice)

**MODERN MFG. CO.**  
160 N. Fair Oaks - Pasadena 1, Calif.

WRITE FOR FREE BOOKLET 100 **\$263.00** with motor F.O.B. PASADENA

**WAR SURPLUS AND OTHER BARGAINS SAVE UP TO 90%**

**METALMITRE** makes mitering of metals easy

Unique hand tool mitres metals with ease and precision. Takes place of heavy, stationary machines. Can be carried on job, saves 1000's of unnecessary steps. Makes job easier, neater, faster. Gives clean and accurate cuts with simple squeeze of handle. Snap-in dies go on tool to permit burr-free mitering, notching and slotting of non-hardened steel up to .1/32", as well as metals like copper and aluminum up to 1/16". 2 lb. tool has built-in 15 to 1 pressure ratio, high leverage. Nothing like it for working with moulding, sheet metal, fiberboard, plastics and masonite. Unconditionally guaranteed with proper use. This sturdy-made tool will last a life-time. New wonder tool of the metal industry, a \$50 value—INTRODUCTORY OFFER, complete with heavy gauge steel carrying case and 4 snap-in dies, postpaid, only **\$33.50**.



**LOW VOLTAGE CIRCUIT TESTER**

Made for U. S. Ordnance Dept. to rigid specification. Portable steel hand-carrying unit is a self-contained trouble shooting device for making a complete and rapid check of the generator battery circuit, incl. any circuit & voltage regulators. Battery voltage, regulators, cut-out settings & generator performance easily determined. It's great for garages, mechanics, truck fleet owners, boat and marine mechanics. Can be used on any 6 or 12 volt system. Approx. Govt. cost \$175. NEW. Complete with instruction book, only **\$32.50**. Shpg. Wt. 20 lbs.



**HIGH SPEED DRILLS** All new. Fractional & numbered. Orig. value \$18. Nationally known brand. Assorted sizes. Set of 30, **\$3.50**

**MICROSWITCH** Type Z-2" x 1". Used open or closed. For automatic contacting . . . light, sound, model train systems, chimes, etc. NEW! 5 for \$2. Alum. Spring Actuator to fit above Microswitch. . . . 5 for \$2.



**MAGNETIC BASE INDICATOR HOLDER**

For all types of dial indicators with guaranteed lifetime ALNICO magnets. V-slotted base has a 45 to 50 lbs. pull, permits immediate application without clamps or special attachments and mountings can be made on cylindrical surfaces. For machinists, tool-makers and inspectors. Base 3 1/2" long by 1 1/8" wide. NEW. . . . **\$3.50 ea.**



**DRILL GRINDER** Sharpens round, square or tapered drills up to 6" long. Even an amateur mechanic can get a new, factory finish on a drill in 25 seconds. New protractor feature gives every drill sharpening angle, with 5 convenient angles already marked off. Usable with hand or power stone. A brand new development. All new **\$2.80 ea.** Postpaid in U.S.A.



**MICROMETERS** Chrome plated, precision engineered, carefully tooled to give long life. All new 0-1" capacity—**\$2.25 ea** 1-2" capacity—**\$3.50**.



Send 25c for 1952 catalog. Bargains for everyone. Check, Money Order or Cash. 25% deposit on C.O.D. orders. Prices F.O.B. Culver City, Calif., unless otherwise stated.

**AIRBORNE SALES CO., INC.** Dept. PM 1052 8501 Stellar Dr. Culver City, Calif.

**When is wood glue really WATERPROOF?**

ANSWER: when it meets Military Specification tests for gluing wood for marine use.

Cascophen is a resorcin resin—the only cold-setting glue that passes these tests and is nationally available in small packages!

Use Cascophen for permanent wood bonds on boats, outdoor furniture, fishing tackle, archery and other wood sports equipment. Write for free descriptive folders. The Borden Co., Chemical Div., Dept. PM102, 350 Madison Avenue, New York 17, N. Y.

For boats, outdoor furniture, etc.

**CASCOPHEN WATERPROOF RESIN GLUE**

If it's **Borden's** IT'S GOT TO BE GOOD!





**A MUST FOR EVERY FARM FAMILY!  
SAVES MONEY FOR HOME OWNERS!  
A PRICELESS GIFT TO SEND TO  
A FAMILY ON THE FARM!**

**Farm Help That Works  
Every Day in the  
Year For  
Only \$3**

*A Thousand and  
One Ideas You Can  
Use on the Farm!*

Popular Mechanics Farm Manual is packed with practical ideas and usable information that can easily be worth hundreds of dollars to every farm family and to home owners everywhere. Here are a few of the things it covers:

**Farm Machinery and Implements**

How to make tractors, scoops, scrapers, cordwood saws, buckrake, power driven elevator, "Farm-ette"—odd job tractor, hoists, dump trucks, spreaders, seed-grain duster, posthole auger, etc.

**Farm Workshop Equipment and Repairs**

Welding on the farm, soldering, workshop power saws, home built air compressor, small shop forge, workbenches, curing gas engine troubles, hydraulic rams, drive your own wells, etc.

**Poultry and Livestock**

How to build poultry houses, incubators, brooders, at low cost, feeding, stock care hints, hog care gadgets, etc.

**Vegetable Storage — Processing**

All-winter vegetable storage, preparing food for home-freezer storage, how to make your own home freezer, charts, guides.

**Farm Home Improvement**

Fencing, repairing electrical appliances, plumbing, electrical wiring, saving coal, painting, curing leaky basements, hanging wall paper, making garden tools, garages, working with concrete, painting, etc.

**Farm Hints and Kinks**

Forty pages of illustrated practical ideas, short cuts, etc., that will save time, labor and money around every farm and city home.



**POPULAR MECHANICS  
FARM  
MANUAL**

**Use This Book to Step up Farm Efficiency—  
Increase Farm Production—Improve Farm  
Appearance—Save Time, Labor, Money!**

This is the book that thousands of farmers and home owners have waited for. It is the experience of hundreds of successful operators brought together in one handy, easy-to-read, easy-to-use, working handbook by the editors of Popular Mechanics. It is brimful of short cuts, labor-saving ideas, ingenious apparatus and methods that will simplify the day's work and lighten some of the more tedious chores, make money and save money for you.

**284 FACT  
PACKED PAGES  
•  
HUNDREDS OF  
ILLUSTRATIONS  
•  
FULL SIZE  
Library Binding**

**HELPS IN THE FIELD — IN THE BARN — IN THE HOME**

Every department of the farm is covered in the Farm Manual. Every member of the family will find in it something that he or she can use to tremendous advantage in farm operation, maintenance and improvement, from the building and care of equipment to painting the farm home and fast freezing fruits and vegetables. It covers all farm buildings, the farmhouse and other homes and is of interest equally to the woman looking for home improvement, beauty and convenience and the man striving for easier and more profitable operation.

**ORDER TODAY — FOR YOURSELF — FOR A GIFT**

Use the coupon below. Mail it today. Book will be sent at once, post-paid if you include payment with your order. If you don't think the Farm Manual is worth even more than you paid for it after five days' use, send it back by mail and your money will be refunded. This may be the best investment you ever made. Rush coupon today.

**MAIL COUPON • Money Back if Not Satisfied**

**Popular Mechanics Press, Dept. 49C  
200 East Ontario St., Chicago 11, Ill.**

Send \_\_\_\_\_ copies of the Farm Manual at once.  
 Remittance (\$3.00 each) enclosed. Send postpaid. Add 15% if outside U.S.A.  
 Send C.O.D. (\$3.00 each) plus delivery charges. U.S.A. only.  
(If sent as a gift to another, send name and address on separate sheet.)

Name \_\_\_\_\_  
Address \_\_\_\_\_  
City \_\_\_\_\_ Zone or Route \_\_\_\_\_ State \_\_\_\_\_

**POULTRY HOUSES You Can Build**



**Keep Your Tractor Rolling**



**MECHANICAL "Hired Man"**

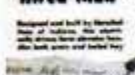

**INCUBATORS you can make**



**Farm Dump Truck Saves Shoveling Off Load**



**Storing Vegetables for Winter**



**NO BLIND SPOTS . . .**



FULLY GUARANTEED

USERS ARE BOOSTERS

WHEN YOU DRIVE WITH

## Wyd-Vue

### Pano-scopio REAR VIEW MIRROR

Gives complete panoramic vision around your car, BOTH SIDES as well as rear • Reduces danger of side and rear collisions • Makes driving many times . . .



Full 160° rear and side vision with Wyd-Vue Mirrors. Dangerous limited vision with standard mirror.

### EASIER—SAFER—PLEASANTER!

Scientifically designed • A series of five integrated, optically true mirrors, rubber mounted in attractive 22 gauge steel frame finished in soft black vinyl.

### EASY TO INSTALL • FITS ANY CAR

No holes to bore, no special tools • Simple brackets easy to apply and adjust.

ONLY **\$795**

Transp. prepaid  
Save C.O.D. charges  
Send check or money order.

SALES AGENTS WANTED

ARGYLE FAIR, INC., 1029 W. Argyle, Chicago 40, Ill.

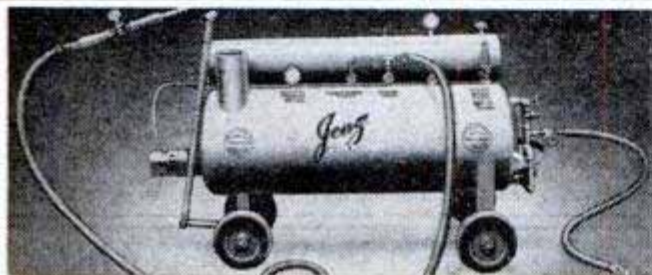

## EARN \$6.00 PER HOUR

At a cost of 20c with the NEW JENZ SUPER CHIEF STEAM CLEANER. Portable—No moving parts—Cleans anything—Any place—Motors—Chassis—Machinery—Floors—Buildings—Oil Rigs, etc.—Oil fired—Economic—Fully tested and warranted. 75 lbs. steam in ten min.—Model 90, Complete as illustrated. **\$388.50**

F.O.B. shipping point

HI-PURE LABORATORIES, Evansville, Ind.

## ACCURATE, low cost shooting



**Crosman**  
.22 CAL. PNEUMATIC RIFLE

**\$13.50**

CROSMAN ARMS CO., Dept. 45, Rochester 20, N.Y.

## NEW—Sensational! GEIGER COUNTER



### "The SNOOPER"

LOW PRICE ONLY **\$24.95**

COMPLETE

Get one for atom bomb defense. So small it fits in the palm of the hand or in the hip pocket, and yet more sensitive than many large, expensive instruments. Weighs only 1 1/4 lbs. Uses flash-light battery. Low price includes earphone, radio active sample, instructions. Sold with ironclad moneyback guarantee.

**ORDER YOURS TODAY**—Send \$5.00 with order or payment in full to save C.O.D. Write for free catalog on larger, more elaborate Geiger Counters, metal locators and our Scintillator Counter.

Dealer Inquiries Invited **PRECISION RADIATION INSTRUMENTS**  
2235 PM So. La Brea, L.A. 16, Calif.

## GET THE WORLD'S LEADING TV & RADIO CATALOG

**FREE**

236  
VALUE-  
PACKED  
PAGES

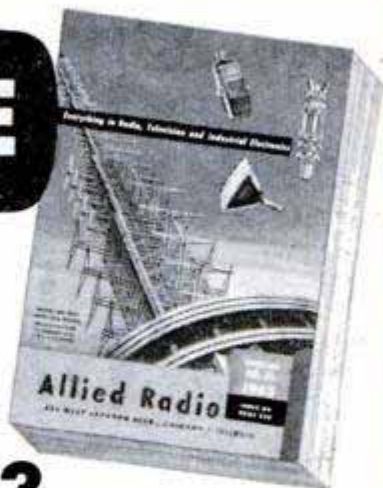

## 1953 ALLIED BUYING GUIDE

Save on Everything  
in TV & Radio!

Everything for Experimenters, Builders, Amateurs, Servicemen, Engineers and Soundmen

Get the big 236-page 1953 ALLIED Catalog featuring the world's largest selections of latest top-quality electronic equipment at lowest, money-saving prices. See the newest in TV, home radios, Amateur Equipment, Hi-Fidelity sound, P.A. systems, recorders, test instruments, builders' kits—plus thousands of parts, tubes, tools and books. Get more for your money from the World's Largest Radio Supply House. Send today for your FREE 1953 ALLIED Catalog!



FREE CATALOG

SEND FOR IT TODAY

## ALLIED RADIO

ALLIED RADIO CORP., Dept. 5-KK-2

833 W. Jackson Blvd., Chicago 7, Illinois

Rush FREE 1953 ALLIED 236-Page Catalog

Name \_\_\_\_\_

Address \_\_\_\_\_

City \_\_\_\_\_ Zone \_\_\_\_\_ State \_\_\_\_\_

**BUILD IT** **FIX IT**  
with **AMBROID**

● Ready-to-use  
● Fast drying  
● High tensile strength  
● Transparent  
● Waterproof

**IT STAYS STUCK**

**AMBROID**

THE UNIVERSAL Liquid CEMENT



Dries entirely by evaporation of the solvent. Quick setting—no distortion. Ideal for assembling, repairing, home crafts, electrical work, factory, workshop or household use. Send postcard for free literature.

**EIE** Try Ambroid in your business, too. For over 40 years recognized as the leading industrial adhesive of its type.

Art galleries, museums, and leading industrial concerns, rely on AMBROID

**TRY A TUBE TODAY**—At most hardware stores and hobby shops. If your dealer cannot supply you, send 25c for big 2 oz. tube, postpaid. Money back guarantee.

**AMBROID** 303 FRANKLIN ST. BOSTON 10, MASS.

# Handy Oil

## for Handy People!

**SAVE** with Archer Pol-mer-ik 100% pure linseed oil. Refinishes furniture. Antiques. Brings out beauty of wood grain.

**USE IT FOR PAINTING.** Levels better. Brushes smoother. Lasts longer.

**101 WAYS TO USE.** Free booklet shows "Handy Uses Around Home".... "How to Paint", and "How to Save".

SEND POSTCARD FOR FREE BOOKLET

**Archer Pol-mer-ik**  
100% PURE SUPER-TREATED  
**LINSEED OIL**



Archer-Daniels-Midland Co., 603 Roanoke Bldg., Mpls. 2, Minn

BE YOUR OWN WEATHER FORECASTER WITH THIS FINE, IMPORTED **Barometer**



Precision-made by German craftsmen, this scientific ANEROID BAROMETER is something every man has always wanted. Useful, decorative, accurate. In cherry-finished hardwood case, its intriguing mechanism in gleaming brass and clear glass reflects its excellence. A gift to OWN or give. 5 1/4" diam. Forecasting chart with each Barometer.

**\$7.95 POSTPAID**  
(No C.O.D.'s please)

Campus Camera Shop, 1083-A Broxton Ave. Westwood Village, Dept. PM-2, Los Angeles 24, Calif.

MAKE ANY SIZE FOLDAWAY TABLE, WORK BENCH ETC.

with **FOLDAWAY** TUBULAR STEEL **FOLDING LEGS!**

COMPLETE 30" LEGS \$7.98 PLUS POSTAGE FOR 12" WEIGHT OR SHIPPED EXPRESS COLLECT ORDER TODAY!

SHIPPED COMPLETE, READY TO FASTEN TO YOUR TOP IN A MINUTE—FOLDS FLAT, EASY TO CARRY AND STORE—RUBBER TIPPED—MAKE A SMART PING-PONG TABLE DISPLAY, MODEL TRAIN, PICNIC OR BANQUET TABLE. Satisfaction Guaranteed.

Dept. P.M. 1100 ALTAMONT AVE. SCHEENECTADY 7, N. Y.

**THE DIAMOND MFG. CO.**

**SILVER SOLDER TORCH & KIT \$7.95**

JOINS ALL METALS PERMANENTLY

Do your own repairing. KIT includes one tube silver solder paste and 10 5-in. lengths silver solder alloy. Hot-test ALCOHOL TORCH known. 2700° F. flame. Operates in any position, indoors or out. Pint of special fuel included. Complete outfit ready for use \$7.95 postpaid. TORCH alone with pint of special fuel \$6.85. KIT alone \$1.65. Instructions included.

AMERICAN PRODUCTS CORP., 422 S. Dearborn, Dept. 3-1, Chicago

**REAL LEATHER NAVY HELMET**

NO HOOKS, TUBES OR HOLES

Brand new NAVY helmet of rich Cordovan Brown leather lined with soft warm fleece. Detachable chin strap. Ideal for flyers, cyclists, farmers, hunters. Children love them! Cost Gov't. \$10.00. Small, medium, large sizes. Send cash, chk.; 25% dep. plus postage on COD. Money back guarantee. **\$2.00 pp**

**GRAND-HAWTHORNE SURPLUS**  
1439 S. E. Grand, Dept. PM10-52  
Portland, Oregon

**POWER HACKSAW \$52.75**

LESS MOTOR  
F. O. B. Benton Harbor

● Rugged cast iron construction. Wt. 56 lbs. bronze bearings. Draw cut. Auto. return lift. Auto. shut-off. Vise swivels 45°. Cap. 4"x4".

Send for full details and name of nearest dealer.

Dept. PM-102  
**EXCEL MACHINE TOOLS** BENTON HARBOR, MICHIGAN

WANT TO **SAVE GAS?** 1/2 MILLION NOW USE GANES

AMAZING GANE NEEDLE TRY ONE FREE IN YOUR CAR!

TRY BEFORE YOU BUY!

MANY GANE NEEDLE USERS REPORT UP TO 25% more mileage, faster pickup, easier starting and smoother idling.

NOW TEST A GANE NEEDLE IN YOUR CAR for ten days, then compare your mileage and performance. If satisfied, send \$1.50 per needle (8 cyl. cars take 2). If not satisfied, just return it—fair enough? Since authorities differ on its merits and some users report no improvement, TRY BEFORE YOU BUY! (Gane Needle replaces idling adjustment screw in carburetors—easily installed in a few minutes.)

WRITE TODAY. ENCLOSE NO MONEY. PAY POSTMAN NOTHING. Just send us your name, address, and make and year of car.

**NATIONAL AUTOMOTIVE RETAIL CORP., Dept. J-10**  
350 W. Washington Blvd. Venice, California

**FREE Auto Economy Manual**  
Tells how to save gas, tires, brakes, etc. Also introduces many new economy products. (Sent absolutely free to all who try Gane Needles.)

# CONTINENTAL KIT

**NEW DRESS UP KIT** that is **FLASHY & RACY**

FOR FORD, CHEVROLET, MERCURY, OLDSMOBILE & PONTIAC. Does Not Hold a Tire. Simple Installation.

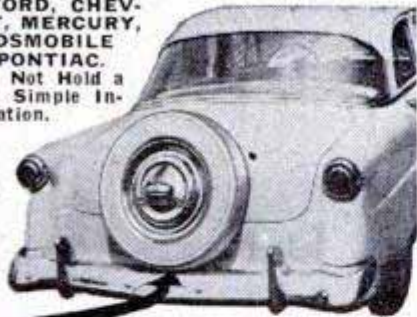

Gives that exclusive CONTINENTAL look at an inexpensive price. Creates a smart, swanky appearance.

This kit creates that "Continental" look at a price you can afford. Gives the impression of being built into the trunk and that long sweeping appearance. As it does Not hold a tire, it eliminates expensive installation. Easy to install, just remove name plate off trunk lid. Access to trunk handles, and on 1952 Ford & Mercury to gas cap by lifting Chrome cap. For all 1949-52 Fords and Chevrolets (except streamline), 1952 Mercury with No Holes to Drill. Also fits 49-52 Pontiac all models, 52 Olds 88 all models—convertible & hard top, 52 Olds 98 all models. In addition to tire and wheel cover, kit includes: Chrome Cap, Chrome License Light, License Holder & all fittings. Send 25% cash with order. Complete Kit only. **\$29.50**

SEND FOR OUR NEW CATALOG

The World's Largest Auto Accessory & Parts Catalog. Save Money on "Everything Automotive". Over 50,000 items, including Hollywood Accessories, Hi-Speed Equipment, Rebuilt Engines, all parts & accessories for all cars & trucks. We have that hard-to-get part. Over 124 pages, Completely Illustrated. Send 50c (refundable).

**J. C. WHITNEY & CO.**  
1917SP ARCHER AVE. CHICAGO 16, ILL.

# DRILL PRESS OWNERS!

HERE'S 1 TOOL WITH 5 DISTINCT USES



**THE BARRON MULTI-PURPOSE ROTARY WOOD PLANER**

PLANES & SURFACES • PANELS & BEADS  
ROUTS & GROOVES • RABBETS • TENONS **\$7.50** COMPLETE

Finest precision performance—certainty of skilled workmanship—time-saving, money saving short cuts—yours with world famous Barron Drill Press Tools. Fifteen important operations—all available on any standard drill press—with Barron Accessories. Equip your shop with these versatile exclusively designed tools—and save up to \$500. 200,000 Barron owners have bought on our liberal 10 day full money back guarantee. Order, or write for catalog. **BARRON TOOL CO. INC.**

355 Architects Bldg., Detroit 1, Mich.

FREE Workshop Guide & Catalog

MADE \$ 900 IN SPARE TIME



That's what L. H. Mix did in a year! You can make up to \$3 or \$4 an hour sharpening saws with the Foley Saw Filer. Steady cash business, no canvassing. Start spare time—Free Book shows how. Write Foley Mfg. Co., Dept. P.M., Minneapolis 18, Minn.

SPRAY "PAINT" FROM A CAN

DON'T PAINT IT...

**SPRAINT it!**

COMPLETE • NOTHING ELSE NEEDED



"PAINTS EVERYTHING" 22 COLORS in HIGH LUSTRE ENAMEL

- |                 |               |               |        |
|-----------------|---------------|---------------|--------|
| Sea Foam Green  | Emerald Green | Gloss Black   | Orchid |
| Dynamic Maroon  | Cayuga Blue   | Gloss White   | Yellow |
| Chrome Aluminum | Ridge Green   | Plastic Clear | Ivory  |
| Machinery Gray  | Topedo Gray   | Coppertone    | Coral  |
| Zinc Chromate   | Royal Blue    | Pastel Blue   | Gold   |
| Primer          | Chartreuse    | Chinese Red   |        |

69 PER 12 oz. CAN

DEALER Inquiries INVITED

**WESTERN SUPPLY CO. Inc.**

5650 GRAND RIVER (Dept. M) DETROIT 8, MICH.

# BESSEN

America's Best Dishwasher Buy



Now you can own a modern dishwasher! Buy a BESSEN. It's Portable. It's Safe—Non-electrical—Economical. Its price complete and delivered to you is an amazingly low of \$69.50. No installation cost as it sets on your sink-top and its powerful, efficient Water-Motor connects to faucet. Laboratory approved. Washes, rinses and air dries dishes and silverware for average family in 10 minutes. On sale at leading department stores in many cities. 2 Year Guarantee. C.O.D. orders require \$10 deposit, balance on delivery plus charges.

**BESSEN COMPANY**

Mail Order Dept. 10, P. O. Box 3561, Chicago 54, Ill.  
Dealer Inquiries Invited

SAVE MONEY • SAVE FUEL • BE WARMER

# STORM WINDOWS

OF GENUINE **DUPONT** CELLULOSE ACETATE

• CLEAR AS GLASS  
No cloudy vinyl plastic effect—but as transparent as the windows it covers.

• INSTALL IN MINUTES . . . FROM INSIDE  
Scissors and Scotch tape are all you need. No climbing ladders for outside installation! No marring of window sills with tacks. Simply tape on . . . as easy as mending a page!

• PERMITS AIRING OF ROOMS

Just lift off tape when open window is desired . . . Replace when window is closed.

**100% AIRTIGHT** — Used by the U.S. Gov't. Fit any window. Roll size 36" x 288". Sheets easily taped together to cover wider windows. Completely waterproof . . . Instructions furnished. They'll pay for themselves many times over in fuel savings alone. Fill in and mail the coupon TODAY.

5 WINDOWS for \$6 POSTPAID



T. C. TOR, 2113 Bellevue St. Phila. 40, Pa., Dept. PM 1

GENTLEMEN: Please ship immediately ( ) rolls (ea. roll 36" x 288") — at \$6. per roll of TOR Plastic Storm Windows . . . ea. roll enough for five average size storm windows — with instructions.

( ) I will pay postman \$ . . . plus few cents postal collection fee. ( ) Am enclosing payment herewith (saving collection cost)

Name . . . . .  
Address . . . . .  
City . . . . .

**SEND NO MONEY!**

Pay Postman  
YOUR MONEY BACK  
IN FULL IF RETURNED  
IN 10 DAYS

## AIRMEN, MARINES and AF and MC WAR VETERANS

Show your colors on your personal car, with just pride. You will make new friends wherever you drive. Upgrade your car with these authentically and beautifully designed, red, gold and blue metal auto insignias. The respect and courtesy they'll engender may well save you many a parking ticket, etc.

**Sold with a 30 DAY UNCONDITIONAL  
MONEY BACK GUARANTEE**

Price \$3.00 each and \$5.00 a pair, front and rear, complete with car attachments. Please state AF or MC, Active Service—or AF or MC, War Veteran. Send check or money order to

**PROFESSIONAL ASSOCIATION**

NORTHPORT, N. Y. Dept. E

SELL TO YOUR FRIENDS

Wholesale prices on request.

## AT LAST!



Chisels and bits  
in one handy kit!

Only  
**\$13.50**

Money  
back  
guarantee

Brand new. Nothing like it on the market. A rich Cherry Wood fitted case containing six Acrobore Auger Bits and three Witherby Woodchuck Chisels—and in the most popular sizes. This kit keeps the tools in one place—always handy. Protects cutting edges too.

Woodchuck Chisels made of special crucible steel. They take and hold an extremely sharp edge. Handles are tough, red Tenite.

Acrobore Auger Bits are precision machined. Boring is fast and clean.

Fine tools, made by Witherby and Acrobore, two of New England's most reputable manufacturers. Try your hardware store. If not available, send \$13.50 to us. We pay postage. No C.O.D.'s.

**WITHERBY - Acrobore**

105 DUANE STREET • NEW YORK 8, N. Y.



Covers All Models 1940 to 1952

— All Features — Including  
Powerglide  
Transmission

### Get the NEW Popular Mechanics Owner's Manual

If you drive a Chevrolet—any model—1940 to 1952—get this new owner's manual today. It will save you money on repairs and service; give you safe, economical and trouble-free motoring and protect your investment in your Chevrolet by keeping it constantly at top value. Can easily be worth hundreds of dollars to you in a single year.

# Chevrolet Owners

Spend Less to Own  
and Drive Your Car

### Official, Authoritative Bumper to Bumper Information

Prepared by a noted automotive authority and Popular Mechanics editors with the full cooperation of Chevrolet engineers and service specialists. Covers all phases of Chevrolet operation, service and maintenance. 304 pages of practical information and hundreds of photos, diagrams, charts, and sectional views, make every part, every operation, easy to understand. Complete index enables you to put your finger on the information you want instantly.

### Prevents Costly Repairs

Explains everything about your car; what can go wrong; how proper adjustment and servicing should be done; how to prevent major troubles and costly repairs later on. Even if you don't service your car at home the manual will save you important money on every day operation.

### Mail Coupon Today

Mail coupon now. Send only \$3.50 for prepaid delivery or you can pay postman, plus charges. See money back guarantee in coupon.

Learn All About Chevrolet's Powerglide Automatic Transmission

Know Your Chevrolet Valve-in-Head Engine and How It Operates

Understand Chevrolet's Center Point Steering and Unitized Knee-Action.

Protect Your Investment. Know Your Chevrolet.

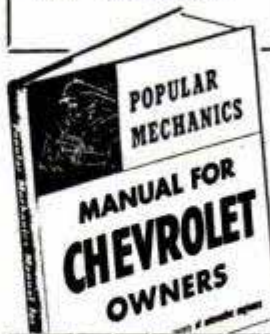

**POPULAR MECHANICS PRESS**  
200 East Ontario St., Chicago

Send Manual for Chevrolet Owners at once. If not satisfactory I will return it within 5 days and you will refund full purchase price.

Remittance for \$3.50 enclosed.

Send C.O.D.

Name \_\_\_\_\_

Address \_\_\_\_\_

City \_\_\_\_\_ State \_\_\_\_\_



# GIGANTIC MAIL SALE

WAR SURPLUS  
EXCESS INVENTORY  
BANKRUPT STOCK

## POWER PLANTS & GENERATORS

- Master Plants, 5KW, 115-230 v, 60-c, 4-cyl. engine, manual start. Cost over \$1100. \$531.70
- Onan Plants, 5KW, 115-v, 60-c, 4-cyl. engine, push button start. Cost over \$1400.00 **\$689.50**
- Burdex Plants, 2KW, 115-v, 60-c, Special **\$297.50**
- Homelite Plants, 1.5KW, 115-v, 60-c, Special **\$199.50**
- Kato Generators, 5KW, 115-v, 60-c, with control panel, drive pulley, etc. 1800 RPM. 1 phase. Cost \$550. **\$259.50**
- Burdex Generators, 115-v, 60-c, Ball bearing, 500-w, \$94.50; 1000-w, \$134.90; 2000-w, \$159.50.

• Many other plant bargains in catalog.

## Winches - Clutches - Blocks

- Boat, dock, business hand winch, 1-4 gear ratio. Special **\$19.95**
- Farm-Truck-Contractor heavy duty hand winch. Dual ratio 1-3, 1-9. Finest cast steel construction. Special **\$29.98**
- Chain Hoist. Lever type 3000 lb. capacity **\$19.48**
- Winch Cable, 1/4" super-flexible (4000 lbs. cap.) 50' with load hook **\$9.90**
- Army Snatch Block, 13,000 lb. List \$19.40. **\$12.95**
- Clutch, 6 H.P. Many uses **\$14.95**

## WELDING GENERATOR KITS

- \$275 Aircraft 200-250 amp, 28-v, generators. Complete with cooling fan, field rheostats and "How To Build" welder instructions **\$24.65**

## PHONES — CITY and RURAL

- Rural Magneto. Compact oak case, Wall, (a) 3 bar, 1000-ohm, \$9.95; (b) 4-5 bar 1600-ohm, \$13.90. CITY up-right desk, with bells \$4.99. Phone only, \$2.69.

## AIR POWER GREASE GUNS

- Super special genuine Lincoln automatic air power grease guns. Ideal for farmers, contractors, etc. Operates off any compressor. List \$60.80. SALE **\$23.95**



Order From Ad, or Write for 4 FREE Catalogs!

OUR 30-YEAR POLICY: • Everything Guaranteed Satisfactory • We Pay Shipping Charges in U. S.

## BURDEN PAYS ALL SHIPPING CHARGES

## AIR COMPRESSOR UNITS

- Paint, blow up tires, control termites, clean greasy engines, blow dust, etc. Build your own or buy ready-built units.
- DeLuxe Air Kit. Consists stainless tank 12"x24", finest 1-cyl. 3 cfm piston compressor, valves, gauge, fittings, hose, excellent paint gun, blow gun, pressure regulator, chuck and "How To Build Portable Outfit." Special **\$45.49**
- Economy Air Kit. Same as above except 6"x24" tank and no regulator or paint gun. Each **\$31.90**

- Air Components. Top quality. 1-cyl. piston comp. \$20.50; 2-cyl. pis. comp. \$49.50; Adj. Auto pressure switch, \$4.95; pressure regulator, \$2.65; Adj. safety valve, \$1.95; Pressure gauges, 0-160 lbs. \$1.89.

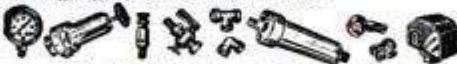

Write for interesting Air Data-Catalog.

## TRACTOR WEED SPRAY OUTFITS

- Leading make. All stainless steel. 7-row outfit. Guaranteed finest unit made. List \$225.50. Buy now to save this year's taxes. Special Fall Closeout **\$129.50**
- 5-row all-brass outfit **79.50**



## SUPER BARGAINS

- Duro 110-v Hand Hi-Speed Ball Bearing Grinder and Kit. List \$24.50. Sale **\$13.40**
- Hydraulic Tractor Contour Level. Mounts on tractor. Plow on perfect contour. No surveying. List \$46. Sale **\$16.90**
- Polished Laminated Plane Propellers (New) Many uses—snow sleds, boats, etc. Cost over \$150.00. Sale **\$12.95**
- Electric and Gas Chain Saws. Write for prices.

FREE CAT-ALOG

## SPECIAL FOR THE MONTH BATTERY CHARGER (6 Amp.)

Leading make 110-v, 60c, 6 amp. chargers. Install in garage, keep car battery fully charged for easy winter starting. List \$18.95. SALE **\$12.15**



## WATER PUMPS and SYSTEMS

- Save up to 60%. Ask us for expert advice on your problem. Pumps for wells, basements, weed spraying, septic tanks, garden irrigation, etc.
- Centrifugal Pumps. Cast iron, stainless steel shaft, bronze impeller, ball bearings. No. 75, 3/4", \$18.90; No. 100, 1" \$28.90; No. 150, 1 1/2", \$35.60.
- Bronze Rotary Pumps. Low pressure. (25 lbs. max.) Self priming. No. 12, 1/2", \$12.75; No. 34, 3/4", \$16.95; No. 101, 1", \$22.95; Hi-Pressure type (150 lbs. max.) No. 812, 1/2", \$14.50; No. 634, 3/4", \$20.95; No. 610, 1", \$27.95.
- Irrigation War Surplus Pump, 10,000 g.p.h., 2 1/2" intake. Two 1 3/4" outlets. Spe. \$39.50
- Burdex Shallow Well System. 110-volt, 60-c, 300 g.p.h., 40 lbs. pressure, fully automatic. Easy to install **\$69.50**
- Adj. Auto. Pressure Switch, \$4.95; 3/4" foot valve, \$2.49; pressure gauge 0-60 lbs. \$1.89; also hose, strainers, etc., at real savings.
- Hand Pump. Lever type, high capacity, Pump basements, tanks on farms, etc. Cost \$35. \$27.80

## ARMY HOT AIR HEATERS

Forced air type. Burns gasoline, kerosene or fuel oil. Thermostatic control. 110-v. blower. Tremendous heat output (40,000 BTU). Compact portable size 17 1/2" high, 21" long. Wt. 44 lbs. Cost over \$190.00. Sale **\$59.50**

## Miscellaneous Surplus Bargains

- Tachometer, 0-4000 r.p.m. Direct rd. \$6.79
- Drawing Sets. Finest quality. 13-pc. 9.89
- Clock Timer Switch, 110-v, 60-c. 4.72
- Heater Elements, 110-v, 200-w. 3.99
- Immersion Heater, 110-v, 800W. 3.95
- Guy-Turnbuckles, Army 12". Useful. 10 for. 3.89
- Motors, 110-v, 80 r.p.m. 6.95
- Hydraulic 19" Cylinders (Cost \$90) 18.49
- D.C. Welding Generators (250 amp.) 99.90
- Magneto Farm Telephones, 1600 ohm. 13.90
- Engineers Hand Level 5.84
- Surveyors Precision Level 37.95
- Air-Operated Power Grease Gun. 29.85
- Hundreds other bargains in tools.

## BURDEN SALES COMPANY

814 "O" ST.,

LINCOLN, NEBRASKA

Take it easy with this... **2 H.P. SNOW BLOWER**

one of 15 attachments available with

**GEORGE**

LAWN & GARDEN TRACTOR

Powerful! Adjusts to dry or wet snow!

TRACTOR ONLY WITH 2 H.P. ENGINE **\$11950**

SNOW BLOWER **\$2950**

14 OTHER TOOLS \$4.50 to \$42.50

F.O.B. SULLIVAN

Health Saver, Money Saver, 12 months a year! Fully guaranteed! Compare with others at \$50 to \$75 more. Write for folder 30.

GEORGE GARDEN TOOL DIV. Community Industries Assn. Sullivan • Illinois

Make 100% to 150% Profit!

**MANUFACTURE BUILDING BLOCKS**

In Your Own Back Yard

**AMAZING GENERAL BLOCK MACHINE**

CAPACITY 1000 BLOCKS PER DAY

Only \$218 LESS MOTOR F.O.B. PLANT

SHIPPING WEIGHT 400 Lb.

Here is an outstanding opportunity for men of vision and small capital. Cinder and concrete blocks are in great demand. Millions used for homes, factories, public buildings. Sell all you produce at 100% to 150% mark-up.

**PEAK BUILDING DEMAND!**

The General Block Machine is amazingly practical, foolproof. Simple to operate indoors or outdoors. Rugged all steel construction. Vibrator mounted in sealed ball bearings. Produces up to 1,000 blocks per day. Superior 3 Core Type that meets all building code requirements. Can produce 4 x 8 x 16, 8 x 8 x 16, 12 x 8 x 16 blocks. All materials obtainable anywhere. All operating instructions and mixing formulas supplied. Full details FREE without obligation.

**GENERAL ENGINES CO.**

DEPT. M-102 • 307 HUNTER ST. • GLOUCESTER, N. J.

Includes floor plans for 6 beautiful, easy to build concrete block bungalows. Shows ways to save money. How to lay blocks, lay out building lines, mix concrete, build steps, porches and concrete floors. Mail coupon at once with \$1.

Wonderful Book Written & Illustrated by Experts

HOW TO BUILD YOUR OWN CONCRETE BLOCK HOME Only \$1 Prepaid

Name .....

Address .....

City .....

**ELECTRIFY your SEWING MACHINE**

NEW LOW PRICE!

**\$10.50** 1 YR. GUARANTEE

Buy direct from manufacturer and save! Kit comes fully wired, installed in a jiffy. Fits all machines! You get these all-new parts:

- Motor & Bracket
- AC-DC 115v 60c
- Multi-speed foot control
- Cord set & block
- Easy instructions
- Steel pulley & belt

FREE... reg. \$2.95 chrome SEW-LITE given with every kit. 10 DAY FREE TRIAL — ORDER NOW!

Send no money, pay COD or send money order and we'll pay postage. Please state whether wheel on your machine turns toward you or away from you. Shipping wt. 6 lbs.

**SENIOR SEWING MACHINE CO.**

197 CLIFTON PLACE Dept. PM-40 BKLYN, N. Y.

## STOP WASTING MONEY ON NEEDLESS OIL CHANGES!

### YOU CAN EVEN USE CRANKCASE DRAININGS! "RECLAIMO"

#### Amazing Invention Refines Oil As You Drive — Fits Any Car!

U. S. Bureau of Standards says, "Oil never wears out mechanically." Why change it? Just purify it! RECLAIMO uses engine heat to refine oil continuously. Removes not only impure solids, but also water and dangerous dilution, that causes formation of sludge and corrosive engine acid. Be safe and sure . . . all year 'round . . . with RECLAIMO . . . Yet never again spend dollars on oil changes! Write today for details of our 90 DAY MONEY-BACK GUARANTEE OFFER.

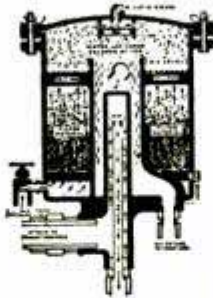

### GET THIS VITAL BOOK



32 page "OIL FACTS" opens your eyes to lubricating facts you never dreamed of! Why and how big users like Greyhound use oil for 200,000 miles, etc., etc. Send 25c for book, refunded if you order RECLAIMO. Write to M-9, RECLAIMO MFG. CO., 5083-85 Elston Avenue, Chicago 30, Illinois.

Wm. Schwaige, U. S. Pats. 1757223, 1834654, 2068473.

### P & C Hot Forged Tools

Do the job **FASTER!**

You get down to business fast with P & C Tools. They're master craftsman designed to fit openings quickly... turn nuts and screws smoothly... get into tight places easily. And tough, too, with special analysis alloy steels scientifically heat treated. Look for the P & C rotary tool display unit at your favorite tool dealer's. He'll show you—"the best tools money can buy."

Write for handy pocket catalog. Complete data on some 300 P & C Tools.



P & C Hand Forged Tool Co.  
Box 5926H  
Portland 22, Ore.



## 6 COLOR PENCIL COMPLETELY AUTOMATIC

NEW! SENSATIONAL VALUE!

**GUARANTEED!** \$1.00

JUST DIAL TO SELECT COLOR ONLY

Red, Green, Yellow, Blue, Black, Orange

The world's only 6-color pencil. Precision built — jewelry crafted. Visible lead indicator — you're never caught short. New Roto-Dial selector — no clumsy outside fringes. Built-in shock absorber eliminates lead breakage. Rich 2-tone black onyx and silver. Attractively packaged in beautiful gift box. **SEND NOW \$1.00 OR LIMITED OFFER OF THREE FOR \$2.50.** Immediate delivery.

FULL PRICE

... covers everything: pencil containing colored leads, postage and handling.

IDEAL QUALITY GIFT BEAUTIFUL!

Dealers and Imprinted Advertising Inquiries Invited

MICHAEL PRODUCTS, Dept. M1, 565 Tenth Ave., N. Y. 36  
SOLE MAIL ORDER DISTRIBUTOR!

### NEW IMPORTED HACKSAW HANDLE

Adjustable. — Takes any standard new or broken blade. "No frame to get in your way or broken blade to throw away."



ORDER TODAY Only \$1.00 No C.O.D.

Satisfaction guaranteed.

A MUST FOR EVERY TOOL CHEST.

THE MAILMAN, 4025 N. Kostner Avenue, Chicago 41, Illinois

## SAY YOU SAW IT IN POPULAR MECHANICS

### Guide to HOME REPAIRS



### Pays for Itself 100 Times Over

Beat the high cost of home upkeep. Save hundreds of dollars every year on carpentry, electrical, painting, plumbing and other jobs around the house with Popular Mechanics GUIDE TO HOME REPAIRS. Simplified how-to-do-it instruction and 646 pictures make all jobs, inside and out, easy. Covers construction, remodeling, modernizing, repairing that you can do yourself at small cost. 192 page cloth bound book only \$2.50 postpaid. Order today under our money back guarantee.

POPULAR MECHANICS PRESS, Dept. PM16  
200 EAST ONTARIO STREET CHICAGO 11, ILLINOIS

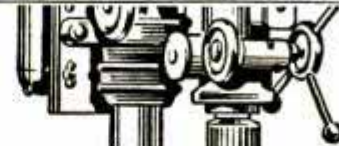

## Handy Flexible SHAFT

With 1/8 Inch Adjustable Chuck

ONLY \$3.95

OLD FAN MOTOR



VACUUM CLEANER MOTOR



Converts any motor, drill press, electric drill, electric fan (10 inch or larger) into a handy rotary tool.

Attach ROTA-SHAFT in a jiffy. Use for grinding, polishing, sharpening, cleaning, engraving, making tools, carving on metal, plastic, wood, leather, glass. Handles tools from zero to 1/8 inch diameter. 40-inch overall length. Complete with buff and sanding disc ready to use in a drill press chuck. ORDER TODAY!

**SEND NO MONEY!** Mail your order. Pay Postman only \$3.95 plus postage on delivery. Try 10 days — if not delighted return for money back. For use on motor—35c extra for Special Coupling. Give exact size of motor shaft diameter.

STRADER PRODUCTS CO., Dept. G-101  
259 Strader Ave. Cincinnati 26, Ohio



## FILE SAWS THE RIGHT WAY

SUPER FILER No. 9



SO EASY with this new filing jig and jointer anyone can now sharpen any handsaw like new! When file hits hardened steel rollers teeth are finished and EXACTLY THE SAME HEIGHT. All teeth cut and saw runs true and smooth! Jig and instructions \$2.95 postpaid. FREE FOLDER.

### SHARPEN YOUR CIRCULAR SAWS

The RIGHT WAY on your own saw table. Sharpens rip, cutoff, hollow ground and combination blades—6" to 10". Saws stay round with correct bevel. Precision made, easy to use. GUARANTEED. Only \$6.95. Includes \$3.00 Grinding wheel.

"TRU-CIRCLE" saw set automatically sets teeth at 10° or more. \$2.95

AT DEALERS OR POSTPAID

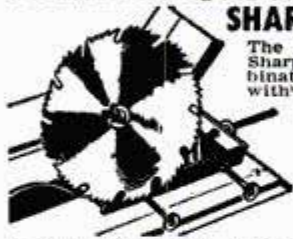

A. D. MCBURNEY, 317 E. 4th St., Los Angeles 13, Calif., Dept. A-22

## REMOVE TREE STUMPS

Beautiful your yard with amazing STUMP-RID. Easy to use without digging, grubbing or chopping. Send only \$1.00 for enough STUMP-RID to remove 1 large stump. Guaranteed.

JOHN'S CO. Dept. E1 GIRARD, ILLINOIS

## SAVE MONEY-ON PAINTING

FREE BOOK TELLS how to get better paint results at no extra cost. Given free by America's leading aluminum producer so you can get full value and satisfaction from aluminum paint. Written by experts . . . packed with facts . . . write for "Paint it Bright."

Aluminum Company of America, 1716K Gulf Bldg., Pittsburgh 19, Pa.



## BIG LEATHER & CRAFT CATALOG!

1000's of items for Leathercraft, Textile Painting, Copper Tooling, Kits, Projects, Tools, Supplies, Etc. Send 25c (refunded with 1st order) to:

RUSSO HANDICRAFT SUPPLIES Dept. 4-CD, 245 S. SPRING LOS ANGELES 12, CALIF.

## WARN HUB CAP MAKES 2 JEEPS OUT OF 1

Ends front wheel drag on 4-wheel drive Willys vehicles; Army 3/4 Ton Dodge, Chev.

Saves gas up to 3 miles per gallon, tire wear, front axles, increases speed and power. Stops shimmy—front wheels coast out of gear! 4-wheel drive handles, performs, climbs like 2-wheel. Install or remove WARN HUB CAPS in 10 minutes. Polished aluminum, guaranteed. Rush check, M.O., or C.O.D. Write for circular.

WARN MFG. CO., P. O. Box 6064A, Seattle 88, Wash.

## MAKE YOUR OWN TRAILER

or shop wagon with this sturdy aero. tire, tube and wheel with bearings for \$8.50 complete. Tires OD 10 1/2" high, 3 1/2" wide. Bore for axle 5/8".

### WRITE FOR FREE CATALOG

on other sizes with stub axles and other farm tires. Wheel barrow and Trailer manufacturer inquiries invited.

Part #21

804 HAMMOND BLDG., Dept. PM DETROIT 26, MICH.

## HARMO TIRE & RUBBER CO.

## HELPFUL BOOKS

Send post card asking for FREE catalog Popular Mechanics Press, 200 E. Ontario, Dept. 601, Chicago 11

WORLD'S SMALLEST, LIGHTEST PORTABLE BATTERY-POWERED TAPE RECORDER

The Magnemite

For All Field Recording Without AC Power! Letterhead size. Weighs 10 lbs., including batteries. Spring motor runs 15 minutes per winding. Write for literature and prices.



AMPLIFIER CORP. of AMERICA 398-P BROADWAY NEW YORK 13, N.Y.

**NOW!**  
**YOU SAVE UP TO 50%**  
**ON**  
**AUTO PARTS, ACCESSORIES**

**EVERYTHING** you need for your car — 50,000 items including thousands of **HARD-TO-GET PARTS** plus many **unusual accessories** offered for the **FIRST TIME**—all at **wholesale prices!**

Now you can get *everything* you need for your car—even many hard-to-find parts and accessories you can't buy in stores! Get them at wholesale prices—save up to 50%. You'll find these 50,000 thrilling bargains described and illustrated in a giant new wholesale catalogue.

**Biggest, Most Complete Line in All America for Cars, Trucks, Taxis . . . from the oldest to latest models**

This amazing catalogue offers big choice of automotive accessories and parts. Also custom-styling accessories—high-speed parts, accessories to soup up stock engines for top speed, acceleration, economy. Catalogue includes new style Hollywood accessories different from anything you've seen in stores. Other exciting buys at wholesale prices include:

- Auto radios
- Mufflers and pipes
- Engines and parts
- Transmissions and parts
- Tires and tubes
- Tools
- Body parts
- Radiators
- Springs and shocks
- Ignition parts

New, used, rebuilt parts and accessories for all makes, years, models of all autos, trucks and taxis.

### GIANT CATALOGUE

Just off the Press—124 illustrated pages, jammed with 50,000 automotive items at wholesale prices. Value \$1.00. For limited time only, yours for just 25c—which will be credited on your first \$5.00 order. Send today for YOURS.



### Exciting get-acquainted FREE GIFT OFFER

Amazing, valuable new scientific check chart that shows you exactly how to know if your car is safe—sent as a FREE GIFT with every catalogue. It explains how you can easily make your car safe. Offer limited, so rush coupon today.

### MAIL THIS COUPON TODAY

Limited Time Offer! Rush Coupon Today!

J. C. Whitney & Co.  
1917-PC Archer Ave., Chicago 16, Ill.  
Please rush me your giant catalogue, \$1.00 value, that describes 50,000 automotive items that I can get at wholesale prices. I enclose 25c—which will be credited to me on my first \$5.00 order. Also send me FREE GIFT.

Name.....  
Address.....  
City.....Zone.....State.....

J. C. WHITNEY & COMPANY  
1917-PC Archer Ave.  
Chicago 16 Illinois

## REMODEL... Kitchens-Bathrooms

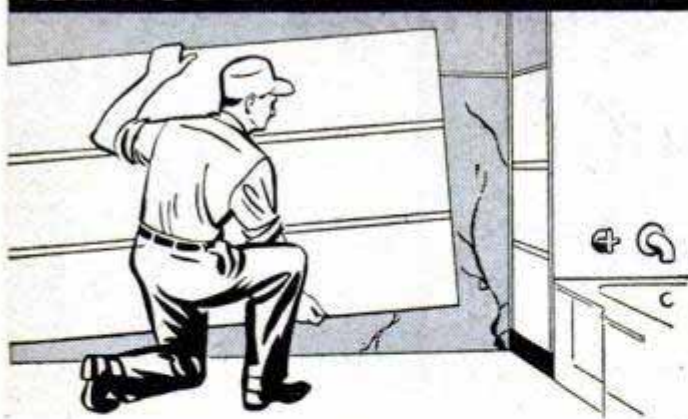

### Do it yourself with easy-to-install MARLITE Wall Panels

It's easy to modernize old walls and ceilings with plastic-finished Marlite panels. Beautiful Marlite never needs redecorating, cleans with a damp cloth. Big panels 5/32" thick and 4' wide, lengths to 12', go up fast over any wall. Cut and fit with ordinary carpenter tools. 63 color and pattern combinations at your lumber store now!

MARSH WALL PRODUCTS, INC., Dept 1042, DOVER, OHIO  
Subsidiary of Masonite Corporation



Write for FREE  
"How-to-do-it"  
instructions and  
Color Folder

**Marlitz**  
PLASTIC-FINISHED  
WALL and CEILING PANELS



## A Man's GIFT!

For that man among men who works with his hands. He's always wanted power tools, but he's been too unselfish to buy them for himself. Give him a PET Power Tool for Christmas!



Mirror finished 1/4" drill.  
In gift box, \$19.95



Gold-tone finished  
1/4" drill. In gift  
box, \$20.95



Chromium and satin finished  
1/4" drill. In gift box, \$14.95



35-pc. attachment set  
Fits any 1/4" drill.  
Sands, grinds, polishes.  
In gift box, \$7.95

Zip-Sawer Jr. converts  
any 1/4" drill into a  
portable saw. In  
gift box, \$7.95

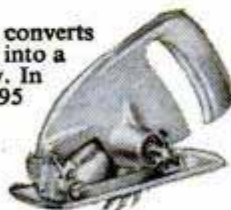

Favorite of  
"DO-IT-YOUR-SELFERS"



**PORTABLE ELECTRIC TOOLS, INC.**

320 W. 83rd St., Chicago 20, Ill.

In Canada: Portable Electric Tools, Ltd., Toronto, Ontario



# STOP!

✓ BURNING OIL  
✓ PISTON SLAP  
✓ POWER LOSS

OVERHAUL YOUR

MOTOR IN 10 MINUTES with a **MOTOR**

CLEANSE with "MOTOR PURGE"

**RENEW KIT**

In the **FIRST** step of the famous Motor Renew Treatment, the "Purge" formula cleans, quiets and frees rings, valves and pistons from efficiency and power robbing carbon, gums and varnish. Pour this miracle solvent into the cylinders, run your motor and watch the combustion residue billow out your exhaust pipe.

RENEW with "COMPRESSION SEAL"

RESTORE COMPRESSION . . . GET NEW POWER, SPEED AND ECONOMY with "Compression Seal!" As the **SECOND** step of the Renew Treatment, squeeze this self expanding mineral compound into your cylinders where it can fill worn spots (which cause compression leaks) between cylinder walls and pistons. Thus it restores compression . . . cuts oil-gas waste and eliminates costly engine overhaul and ring jobs.

**100% MONEY BACK GUARANTEE!**

A \$100,000 insurance policy guarantees that this "Renew" treatment will not harm the finest engine.

Dealer Inquiries Invited!

FREE Auto Manual  
With Each Order!

Kit treats all cars and trucks

**\$6.95** Postpaid  
(Or send \$1 deposit,  
balance C.O.D.)



Before

After

CONSOLIDATED ENGINEERING, Dept. PMK-10  
10407 W. Washington Blvd., Culver City, Calif.

## HELPFUL BOOKS

Send post card asking for FREE catalog

Popular Mechanics Press, 200 E. Ontario, Dept. 601, Chicago 11

Say You Saw It in Popular Mechanics

## 500 TO 2000 POWER!

### Microscopes... Optics

UNHEARD-OF VALUES IN  
PROFESSIONAL-QUALITY  
OPTICAL INSTRUMENTS

These fine instruments are used throughout the United States in laboratories, schools, colleges and physicians' offices.



Model 635  
(illustrated)  
40X to 600X  
\$29.95 Postpaid!  
\$125 value

Model 300  
(triple turret)  
Student Microscope  
100-200-300X  
\$14.95 Postpaid!  
\$75 value

SEND FOR FREE 32-PAGE CATALOG

World's greatest values in hobbyists, students, and professional research microscopes, complete accessories, mechanical stages, eyepieces, prepared slides, dissecting microscopes, ore, mineral, metal and gem microscopes, binoculars, telescopes, magnifying glasses of all types. Every item a bargain — with money-back guarantee!



AKRON 4400 SUNSET BLVD  
LOS ANGELES 27, CALIF.

Dept. 10P

# IT'S LEJAY FOR WAR SURPLUS — BARGAINS GALORE

## HYDRAULIC EQUIPMENT

**No. 8—Double Action Cylinder** 1½" bore, 5" stroke, ½" shaft. Lifting capacity 1760 lbs. with 1000 P.S.I. input. Overall length 15¾". Ball bearing mounts on both ends... **\$7.95**

**No. 6—Double Action Cylinder** 1½" bore, 26" stroke, 1" shaft. Lifting capacity 1760 lbs. with 1000 P.S.I. input. Overall length 35". Bolt mount at bottom, clevis at top. \$55.00 Value—now only... **\$15.95**

**No. 2—(As Illustrated) Double Action cylinder** 4" bore, 18" stroke, 1½" shaft, lifting capacity 12,500 lbs. with 1000 P.S.I. input. Overall length 30¾". Clevis mounting at bottom, threaded shaft at top. Cost Gov't. over \$300.00—Special... **\$29.75**

**No. HP4—Hand Pump** with handle. Built in check valve—Capacity 2000 lbs. Pressure. \$55.00 Value... **\$11.25**

**No. 211 — Pesco Type** pump for oil, water, air, 1" pipe thread ports. Splined self-aligning shaft... **\$15.25**

## WELDER SPECIAL \$39.95

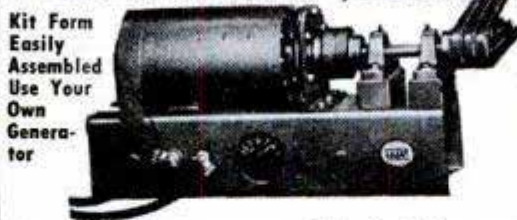

Kit Form Easily Assembled Use Your Own Generator  
Powerful 200 ampere machine includes special mounting base and all equipment necessary for welder.  
**AW5 Kit — Complete \$39.95**  
as above  
Same Kit including Gen-erator and Arc Stabilizer **\$77.90**

### ACCESSORY KIT BARGAIN



**EXTRA! A \$17.20** Accessory Kit Complete for only **\$15.95!** Includes Welding Helmet, Electrode Holder, 5 lbs. Ass't. Rods, Two 10 ft. Welding Leads with terminals and ground clip, plus Audel's Welding Guide. Sold with any Welder Kit... **\$15.95**  
Special Price...

**MONEY BACK GUARANTEE—**Send Check or Money Order—or small deposit and we will ship C.O.D. Catalog of additional Surplus Bargains, Sent FREE.

## LEJAY MANUFACTURING CO., INC.

747 LeJay Bldg., Minneapolis 8, Minn.

## TEACH YOURSELF! BOOK BARGAINS (Postpaid)



Used by Armed Forces Institute in World War II.

- 1. Electricity for Beginners.** Learn the electrical trade with this simple, well illustrated book. Over 400 pages of concise, clearly written information. Electricians earn big money. Complete... **99c**
- 2. Machine Tool Operation.** Learn a high pay trade. Complete data on machine work of all kinds. Learn to be an expert machinist. Detailed and simple to understand. Over 500 illustrations and examples **99c**
- 3. Basic Mathematics.** Essentials of mathematics and arithmetic in simple form. This basic course essential as foundation for all trades. Simple review of arithmetic and mathematics in 1 concise book. Easily understood... **99c**
- 4. Mathematics Essential to Electricity and Radio.** This course applies mathematics directly to electricity, radio. Practical and detailed with over 1,000 workable examples and illustrations... **99c**
- 5. The Small Business.** Detailed and valuable information on how to set up your own business. Full of illustrations and general information on all types of small businesses. Easily understood and applied... **only 99c**

**SPECIAL—Order all 5 above books ppd., \$3.99**

**ORDER FROM THIS AD**

## HELPFUL BOOKS

Send post card asking for FREE catalog  
Popular Mechanics Press, 200 E. Ontario, Dept. 601, Chicago 11

## MAGNETS OF ALL TYPES — 10c UP

AMAZINGLY POWERFUL!  
8 ounce horseshoe magnet—\$1.50.  
Our Leader, 1 lb. magnet lifts 40 lbs. \$2.95. New alloy—will not weaken! Useful for lifting valuables from tanks, lakes, or rivers easily! 7 small magnets \$1.25 with list of many shop and home uses. Satisfaction guaranteed.  
R. EYRICH, 1219 W. MEINECKE AVE., MILWAUKEE, WIS.



**EASIER  
QUICKER  
BETTER**

## ROOF FRAMING

### Rafter Length and Cuts Without Use of Square!

Lay out any type of roof more accurately and in only one-fifth of the time required by other methods. Get the **POULSEN METHOD OF ROOF FRAMING**. It will save your time and make money for you. Valuable tables—54 of them—starting with one-quarter inch rise per foot of run—simplify all roof framing problems. Tables give common, hip, valley and jack rafter length and necessary cuts in a jiffy without calculation. Learn also how to measure rafters from top and edge—definitely and accurately. No need to bother with centers and making adjustments for cuts.

#### For Amateur and Professional

Every handyman, repairman, amateur carpenter and professional builder needs this **POULSEN METHOD** book. It saves four-fifths of all roof layout time and labor. Everything is already worked out for you in simple, easy-to-use tables. Cloth bound. Book has 90 pages and many illustrations. Besides the tables it contains every other bit of roof information a carpenter, whether amateur or journeyman, should have.

#### Money Back Guarantee

Clip this ad and send with your name and address and \$3.00 for your copy postpaid today. Money back if not fully satisfied.

**POPULAR MECHANICS PRESS**

DEPT. RF 200 E. ONTARIO ST. CHICAGO

## HAVE A BIGGER — MORE EFFICIENT HOME WORKSHOP

Popular Mechanics **PLANNING YOUR HOME WORKSHOP** shows you how to make use of every inch of space in your workshop; detailed floor plans, wiring layouts and power tool hookups plus actual photographs of famous home workshops you can use as models. Save money by building your own shop furniture. Special Where-to-Buy-It Guide, 450 Illustrations. Cloth Bound. Working Diagrams. Order your copy today from **\$2.50**  
**POPULAR MECHANICS PRESS**  
200 E. Ontario Street Chicago 11

## HI-SPEED COPE-SAW DRILL-BIT

**INTERNATIONAL TWIST DRILL CORP.**

DRILLS SAWS REAMS  
NANDY CUTTER

DRILL, SAW, REAM... metal, pipe, wood, plastic, Transite, etc. Use with any electric drill, slow drill press, lathe or milling machine. Drills own starting hole—upper part of bit is used to cut, saw or ream circles, ovals, squares or scrolls. Easy to operate. Ideal for carpenters, mechanics, electricians, plumbers, hobbyists, many others. Abrasive resistant, high speed steel. Flutes ground from solid. Will withstand severe continuous use without breaking. Resharpened at no charge. Takes place of up to \$50 in tools. ¼" diameter, 2" cutting sections, total length 3½". Also available specially designed for wood or metal and in 2½" and 1½" lengths. Write for details. Specify all-purpose bit. Shipped same day. Money-back guarantee. Dealer inquiries invited. **SEND CASH, CHECK OR MONEY ORDER** Manufactured and distributed by: **INTERNATIONAL TWIST DRILL CORP.**  
618 Wyandotte, Rm. 636, Kansas City 6, Mo.

**only \$3.95 POST PAID**

# Big Deal!



Yessir!...Your Hardware Dealer Has It for You NOW...

## SIMONDS SI-CLONE SAWS

That's right — Simonds quality at pop prices! First time you've seen a line like this . . . 13 saw-types up to 12" diam. (including dado heads and carbide-tipped saws). Round or special-shape center holes. Best saws made at these prices (look below) for home workshops, schools, contractors, and light industrial work. See your hardware dealer now.

RIP • CUT-OFF • EASY-CUT & COMBINATION

6" - \$1.75	8" - \$2.15	10" - \$3.15
7" - 2.00	9" - 2.65	12" - 4.35

**GUARANTEE**  
Made of SIMONDS STEEL  
fully guaranteed  
against any defect in  
material or workmanship.

### SIMONDS SAW AND STEEL CO.

FITCHBURG, MASS.

Factory Branches in Boston, Chicago, San Francisco, and Portland, Ore. Canadian Factory in Montreal, Que.



### Pesco Positive Displ. Hydraulic Pump

Gear type. No. 1P-349. Rated 1500 PSI, .227 cu. in. per rev. 1 GPM at 1500 RPM. Operating speed, 3750 RPM. Splined shaft. Rotation either direction with slight adj. 3/4" pipe ports. Mtg. flange. Size, 5-9/16" x 3 1/4". Used, guaranteed serviceable. Wt. 4 lbs. **ONLY \$9.95**

Heating Unit. 110V 1000W AC-DC. Size, 7 1/2" dia. x 2 1/4". Wt. 3 1/2 lbs. New. **\$2.49**



### AVIATOR'S OXYGEN OUTFITS

Brand New! Ball out type. Consists of all-metal tank, brass release valve, 0-3000 lbs. gauge and breather hose, canvas bag. Capacity, 1800 lbs. Tanks not filled. Ideal for emergency oxygen supply for airmen, mountaineers, firemen, paint shop workers, ambulances, etc. Shpg. Wt. 4 lbs. **ONLY \$5.95**

Refill Fitting for Aviator's Oxygen Mask—Demand type. Oxygen Type A-14. 24" rubber Bottle. **\$1.95**

Order From This Ad! Prices F.O.B. St. Louis, Mo. Include postage with check or M.O. **FREE MONEY BACK GUARANTEE!** **Catalog**

Ed. Aguado Trdg. Co., Dept. N, Box 4525 Plaza Sta. St. Louis, Mo.

### Visual Inspection Shield



Powerful 5" dia. lens. Adj. stand. Two 6 W fluorescent tubes & ballasts. Off-on switch. Cord. Ideal for jewelers, engravers, hobbyists, parts inspectors, etc. Used, excellent shape. Wt. 15 lbs. **\$14.95**

### HANDY-DAPTER \$3.00

PREPARED IN U.S.A.  
CONVERTS ANY 1/4" CHUCK TO 1/2"  
IN A JIFFY. PROVIDES MORE USES FOR YOUR HAND OR ELECTRIC DRILL.  
DRILL PRESS, LATHE, FLEX SHAFT, ETC. ORBITS DIRECT FROM  
**CRAFTSMAN'S SUPPLY CO.** 506 ARIZONA ST. ALBUQUERQUE, NEW MEXICO



### BETTER MILEAGE—INCREASED POWER with Miracle Action Tur-B-Lizer reported by hundreds!

Carburetor specialists say Tur-B-Lizer is best patented improvement they have seen. Tested in over million miles of driving. Write for full facts or send \$3 for 6 cyl. type, \$4.50 for 8 cyl. Money back guarantee.

SALESMEN WANTED  
**Universal Tur-B-Lizer Co.**  
623 E. STATE ST. MILWAUKEE, WISC.



### You'll Never Have to Clean Another MESSY PAINT BRUSH!

Get a BRUSHKEEPER—and you'll always have a soft, clean brush! After painting, fill can with any paint thinner . . . suspend brush on minute wires . . . put lid on. Paint flows from bristles to bottom of can, leaves brush clean, straight, free-flowing. Perfect safekeeping for finest brushes—can't harm bristles. No holes to drill. No evaporation, fumes, or odors. Holds 6 brushes, all sizes. Never sold in stores; send cash, check or M.O. for prepaid shipment with money-back guarantee. . . . each **\$1.50**

3 for \$3.95  
**DE-SIGN CO.** 8016 Holmes St., Kansas City, Mo.

### make your own Gems 29.50 F.O.B.

All necessary lapidary equipment is furnished, including a super-charged diamond blade for sawing, and all wheels for grinding, shaping and polishing; also complete instructions. The complete equipment as shown, less motor and belt, for only \$29.50. f.o.b. Burlington, Wisconsin. Write today for information and literature.

**B&I MANUFACTURING CO.**  
Dept. S Burlington, Wis.

### THE NEW WATERBORG

#### MILLING ATTACHMENT FOR YOUR DRILL PRESS

#### MAKES AN IDEAL MILLING MACHINE FOR HOME AND SHOP

Do model work, tool making or experimental work in your spare time and earn extra money. Sturdy and accurate. Hardened and ground spindle, bronze spindle-bearing, bracket swings out of the way when not in use. 5"x12" table top, 10" longitudinal travel, 7" cross slide. Only \$77.75 complete with bracket for 13", 14", or 15" drill press, 17" bracket \$2.00 higher. Brackets or tables also sold separately. A few jobs will pay for the attachment. Illustrated Circular on request.

**WATERBORG MACHINE CO.** 2830 Rapids Drive Dept. PM-1, Racine, Wis.

# DO IT YOURSELF!

## CALK WITH *Nu-Calk* SPEED LOAD

It's easy to calk those cracks around window and door frames. Just slip a Speed Load into the gun and you're ready! It's the fastest, most economical way to apply Nu-Calk — the world's finest calking compound.

## REPAIR ROOFS WITH *Nu-Phalt* PLASTIC ASPHALTIC CEMENT

Don't put up with leaky roofs or flapping shingles. Use Nu-Phalt—the ready-to-use asphalt base cement—on chimney flashing, gutters and general roof repairs. Has outstanding adhesive qualities on wet or dry surfaces. Can be applied with a calking gun, or with a putty knife.

On Sale at all Leading Hardware, Lumber and Building Supply Dealers

AVAILABLE WITH  
OR WITHOUT  
PLASTIC  
NOZZLE



### MACKLANBURG DUNCAN CO. OKLAHOMA CITY, OKLA.

AVAILABLE WITH  
OR WITHOUT  
PLASTIC  
NOZZLE

*We guarantee this will amaze you\**

UP TO 50 FEET OR MORE

# LEVELALL

Packed in husky wooden carrying case 12 x 11 3/4 x 3 1/4". Only 6 pounds, easily carried.

DEALERS SOLICITED

## PERFECTLY ACCURATE LEVEL

*With One-Man Operation*

### FASTER THAN \$100 ENGINEER INSTRUMENTS!

SIMPLE... any ONE man can work it. ● GOOD INVESTMENT... saves expense of a surveyor and his assistant. ● ACCURATE, FOOL-PROOF... based on a simple fundamental of physics. ● FAST... finds level points as quick as you make a pencil mark. Requires no sighting, no signaling. ● WORKS AROUND CORNERS! Does not require seeing distant measuring point. ● IS WEATHER-HARDY. Can be used in rainy or snowy weather. ● STURDILY built. Nothing to get out of adjustment. Always a correct level.

A FEW OF LEVELALL'S MANY USES: For footings, foundation forms, batter boards, sills, lintels, floors, ceilings, road gradings, driveways, lawns, walks, piping, drainage, farm contouring, all general construction normally needing an expensive leveling instrument.

WHAT LEVELALL GIVES YOU: Complete instructions on all uses and types of work. A sturdy leveling instrument consisting of 50 feet of superior quality vinyl polychloride tubing, filled with red Level-Flo liquid. Two Levelall mounting brackets of cadmium-plated steel with universal tube attachment. Sturdy wooden carrying case.

THE DELUXE LEVELALL is also offered with 75' of tubing — an extra supply of Levelflo fluid — and a Handsome DeLuxe Carrying Case.

\$ **7<sup>45</sup>**

Who can PROFIT  
with a LEVELALL:

Contractors, builders, engineers, carpenters, masons, plumbers, road builders, landscape gardeners, farmers, home owners.

### \* UNCONDITIONAL MONEY - BACK GUARANTEE LEVELALL

87 WEBSTER ST., ROCKLAND, MASS.

Mail me ..... Levelall instruments at \$7.45 each. It is understood that whether I order C.O.D. or enclose remittance, you guarantee satisfaction or money back upon return of Levelall within ten days.

Mail me DeLuxe Levelall at \$12.45.

NAME

ADDRESS

CITY  ZONE  STATE

Send C.O.D. I will pay postman full purchase price plus delivery charge on arrival.

Full purchase price is enclosed. Send postpaid.

The Chief

# WORK BENCH

A CHRISTMAS PRESENT HE'D APPRECIATE

*Built to Last a Lifetime!*

With Bottom Shelf and 18" Sq. Grooved and Dovetailed Top and to a Smooth, Satiny Finish.

Drawer. 2"x6", Solid Plank, 1"x8" Back Rail, Shellacked 6 Ft. Long • 34" High • 26" Deep. Shipped Knock-down, with Bolts, Nuts and Screws and ABC Chart for Quick, Simple Assembly.



**\$19.95**  
F.O.B. DETROIT

Send Check or Money Order, or Will Ship C.O.D. (\$5 Deposit)

**MOHAWK LUMBER CO.** Dept. 33  
14525 W. Chicago Blvd., Detroit 27, Mich.  
Enclosed  Check  Money Order for \$.....  
Ship..... **CHIEF WORK BENCHES**  
Quantity.....  
at \$19.95 each, F.O.B. Detroit, Mich.  
 Send C.O.D., \$5 Deposit Enclosed.

NAME.....  
ADDRESS.....  
CITY..... STATE.....

*Prompt Delivery*

**MOHAWK LUMBER CO.**  
14525 W. Chicago Boulevard  
DETROIT 27, MICHIGAN

## HELPFUL BOOKS

Send post card asking for FREE catalog

Popular Mechanics Press, 200 E. Ontario, Dept. 601, Chicago 11

# FIX YOUR OWN... PLYMOUTH or CHEVROLET

**IT'S EASY!**

Popular Mechanics Magazine has just published two new Owners Manuals covering all 1941 to 1952 models of Plymouth and Chevrolet cars. So accurate mechanics use them...so simple a woman can understand them.

Save money on your repairs. Prevent trouble. Enjoy care-free driving. Increase trade-in value. Avoid major repairs by fixing minor troubles before they get serious. Get sparkling performance at all times. Each manual has 272 pages, more than 350 photos, diagrams, tables, charts, breakdown drawings, plus clear, non-technical directions that make all repairs simple as ABC. Each Manual written by Ed Packer, one with assistance of Chrysler Corporation, the other with assistance from General Motors Corp. Shows you how to diagnose troubles by feel, sound, sight, smell and performance. Simple trouble shooting. Permanent repairs. Emergency repairs. Plus "How to get value from garages."



**MONEY BACK IF IT DOESN'T SAVE MORE THAN THE COST!**

One minor repair will save the cost ten times over. Read it. Then you decide. If you don't see that you'll save more than the cost, send it back for refund. **SEND NO MONEY.** Just send postcard. Be sure to specify whether you want **PLYMOUTH or CHEVROLET Manual.** Postman will deliver c. o. d. for \$3.50 plus postage. Or, to save postage cost, send \$3.50 with your order. Send today. Save its cost on your next repair.

**POPULAR MECHANICS PRESS**

200 E. Ontario, Dept. 1810, Chicago 11, Illinois

## PROCESS 33 INSTANT PAINT BRUSH CLEANER

Spend Less and Save More With

**HOME KINKS**



POPULAR MECHANICS IDEAS, HINTS AND KINKS FOR HOME OWNERS

Get the new 1953 edition of HOME KINKS. Popular Mechanics famous money-saving book for home owners. It's packed with ideas, hints, kinks, to make your home more livable, more valuable and to save you hundreds of dollars every year. Inside the house and out—basement, attic, garage, yard, garden—it gives you ideas and help you can use. Hundreds of pictures. Pictorial cover, only 50 cents, by mail or at news dealers.

POPULAR MECHANICS PRESS, Dept. PM10, 200 E. Ontario St., Chicago 11

Say You Saw It in Popular Mechanics



## NEW POPULAR MECHANICS MAGAZINE LIBRARY FILE

Brand New, Grand New Way to Preserve Each and Every Issue of Popular Mechanics

Now you can preserve every treasured issue of Popular Mechanics in these ingenious, custom-built storage files. Constructed to look like an attractively bound book, Popular Mechanics Magazine Library Files afford neat, orderly, flick-of-the-finger convenience. Handy reference index printed on back records the exact location of selected articles, diagrams, etc. A "must" for every reader of Popular Mechanics Magazine. A sensational Popular Mechanics value scoop. Order yours today. Use the handy coupon.

**Only 70c**  
PER SET OF 2  
(set holds 12 issues)  
POSTAGE PAID  
5 sets only \$3.10  
10 sets only \$6.00  
POSTPAID

**USE THIS COUPON...MAIL TODAY**

Popular Mechanics Magazine, Dept. PL P10-52  
200 East Ontario Street, Chicago 11, Illinois

Please rush PREPAID \_\_\_\_\_ set Popular Mechanics Magazine Library Files. (QUANTITY)

Remittance for \$ \_\_\_\_\_ is enclosed. (AMOUNT)

Name \_\_\_\_\_

Address \_\_\_\_\_

City \_\_\_\_\_ Zone \_\_\_\_\_ State \_\_\_\_\_



An outstanding  
circular saw value!

**\$59<sup>95</sup>**  
LESS SWITCH  
AND MOTOR

Model CG-3013  
Prices subject to change  
without notice.

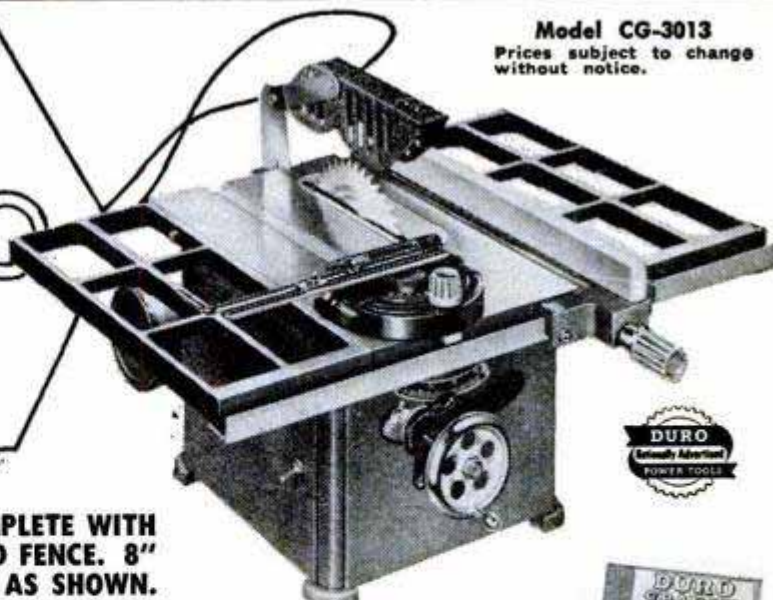

**DURO 8" TILTING ARBOR CIRCULAR SAW—COMPLETE WITH EXTENSIONS, MITRE GAUGE, BLADE GUARD AND FENCE. 8" BLADE, MOTOR PULLEY AND V-BELT—EXACTLY AS SHOWN.**

This completely new DURO 8" Ball Bearing Tilt Arbor Saw is like 8 tools in one—and it's the biggest saw value on the market today. You will find it the workhorse of your workshop—your major power tool handling an amazing variety of jobs. There is a full 7 7/8" ahead of the blade. It makes cuts up to 2 3/8" in depth. With gridded extensions the work table measures 26x7 1/8". The new Duro arbor lock, tilts and locks the blade . . . instantly, safely, with one control. Only Duro offers the exclusive new motor pulley which insures a positive drive, less belt twist and longer belt life. Send coupon today for full details and specifications.

**A NEW KIND OF PROJECT MAGAZINE**

Refreshingly new material—presented with photographs, plan drawings, step by step instructions, that even a beginner can follow easily. Send 25c for sample copy, or you can save 1/3 and get 6 issues for \$1. Either way we'll refund your money if not delighted.



**DURO METAL PRODUCTS CO.**  
2699 North Kildare Ave., Chicago 39, Ill.

Please send me full details about the new Duro 8" Tilt Arbor Saw.

- I enclose 25c for sample copy of DURO CRAFTER Project Magazine.
- I enclose \$1 for 6 full issues of the DURO CRAFTER.

Name .....

Address .....

City ..... Zone ..... State .....

Dealer's Name .....

**DURO METAL PRODUCTS CO.**  
2699 NORTH KILDARE AVE. CHICAGO 39, ILL.

Makers of Nationally Advertised Duro-Chrome Hand Tools

**SURPLUS CLOSEOUT  
ELECTRIC MOTOR**



1/2 HP safety switch SP type, Delco model A8364, 115 volts, 60 cycle, 1 phase regular current, 1725 rpm. Unused but shell worn, tested, gross wt., 22 lbs. Runs on side and on end. . . . . **CLOSEOUT \$10.95**

**RADIO RECEIVER & TRANSMITTER**

as taken from twin engine aircraft. As mounted on plywood base with receiver, transmitter, 24 volt dynamotor, control boxes & switches, noise filter, plugs, cables, etc. (as pictured). Receiver range 200 to 400KC, 2500 to 7850KC, transmitter range 2500 to 7700KC with extra coils. Tubes included. For hams, experimenters, mobile use, etc. with conversion. Model BC429 & BC430. 43" long, 19" wide, 10" high, gross wt., 80 lbs. Original cost hundreds of dollars, now



as is. . . . . **CLOSEOUT \$24.95**  
Send check, cash or money order. All shipped fob Houston best way.  
**AERO PARTS SUPPLY, Municipal Airport, Houston 17, Texas**

Say You Saw It in Popular Mechanics

**MAKE IT 'N BAKE IT!  
All Plastic Modeling Compound**

"The Plastic that's Fantastic"

Bakes into permanent colorful plastic products in 7 min. at 350°F in kitchen oven.

**Make It 'n Bake It** — A scientific plastic material which will challenge and serve your creative ability. Its clean, amazingly easy-working properties make it ideal for hand modeling—jigs, dies, tools, fixtures, pattern work, reproductions, negative and positive molds.

Make professional plastic products for your own pleasure or profit.

Send One Dollar — for generous working quantities of six vivid colors—red, blue, yellow, green, white, black.



**BASIC PLASTICS, INC., LEOMINSTER, MASS.**

NAME .....

ADDRESS .....

CITY ..... ZONE ..... STATE .....

**FREE!**

Booklet by world's largest manufacturer of motors on HOW TO SELECT THE RIGHT MOTOR FOR YOUR JOB

**SEND ME FREE BOOKLET!**

Section 674-120, General Electric Co., Schenectady 5, N. Y.

NAME \_\_\_\_\_

STREET \_\_\_\_\_ PLEASE PRINT

CITY \_\_\_\_\_ ZONE \_\_\_\_\_ STATE \_\_\_\_\_

**GENERAL GE ELECTRIC**

# DRIVE FOREVER AND NEVER CHANGE YOUR OIL!



WITH AMAZING,  
FULLY GUARANTEED  
**TISSU-PAK**  
OIL FILTER

**Keeps engine oil sparkling clean.** Eliminates expensive oil changes and costly element replacements. Inexpensive to buy. Easy to install on all gasoline engines up to 14 quarts crankcase capacity—automobiles, trucks, tractors, stationary and marine engines.

**Enthusiastic testimonial from thousands of individual and fleet users.** Write today for FREE "Tissu-Pak Facts." Mailed immediately.

**HENDERIZE, INC.** ● 5667-B2 Freeport Boulevard  
Sacramento, California

## FAMOUS FARM EASY CENTRIFUGAL CLUTCH

for YOUR GAS ENGINE . . . **9.95** and UP.

A better, entirely mechanical clutch with pulley, for easy installation on all 1/2 to 12 H.P. engines. 100% efficient. Trouble free, guaranteed construction. Proved for years.

**Amazing Performance \* Low Cost**  
Automatic pick-up of load—loadless idling—no stalling—easy starting—prolongs engine life. Hundreds of uses on farm equipment, in industry and construction fields.

At Farm Implement Stores or write for Free Folder, State H.P., shaft and pulley size. Dealers Wanted.

**FARM EASY PRODUCTS, INC.**  
1208 E. Centennial • Muncie, Indiana



**BUILD  
YOUR OWN  
MACHINE TOOLS  
CASTINGS - DRAWINGS**

Catalog with complete construction drawings of this 8 inch Modelmaker screw cutting lathe with milling, grinding and hand shaper attachments, 25 cents postpaid, or send \$1 for drawings of three lathes, three milling machines and six inch crank shaper. Refund on castings order.  
**FOOTATUCK CORPORATION, 100 Sammis Pl., Stratford, Conn.**

## LUTHY AERO TYPE SPARK PLUGS

<b>ALUMINUM OXIDE INSULATORS</b>	<b>ENGINEERED SETS</b>
3 point electrode . . . packed in engineered sets . . . longer life . . . high speed performance . . . more economy . . . more R.P.M. . . . more miles to the gallon.	8 cyl. sets <b>\$7.12</b> 6 cyl. sets <b>\$5.34</b>

**LUTHY AERONAUTICAL SALES CO., Jackson, Mich.**



Send me a set of \_\_\_\_\_ plugs. Enclosed is \$\_\_\_\_\_

NAME \_\_\_\_\_

ADDRESS \_\_\_\_\_

YEAR OF CAR \_\_\_\_\_ MAKE AND MODEL \_\_\_\_\_

# BUILD THIS HOUSE Yourself

## The Famous Popular Mechanics House

The picture below is from an actual photograph of the Build-It-Yourself House with breezeway and garage, as built by Jack Brownson, 23-year-old veteran, in Aurora, Illinois.



Designed by Popular Mechanics and Famous Architects. Every Detail Simplified and Explained. No Previous Experience Needed!

Can you use everyday tools as well as the average Popular Mechanics reader? Then you, too, can easily build this modern house in any of its five designs, doing every part of the job yourself. The new Popular Mechanics Book, "Your Home—How to Build It Yourself" will show you how.

### Space for Living and Family Growth

This beautiful, modern house is 1 1/2 stories, with basement, living room, kitchen, dining nook, two bedrooms, bath, plenty of closets and space for two additional bedrooms on second floor. The house itself is 35' 9"x28' 11"; breezeway 20' 10"x8'; garage 20' 10"x12'.

### The House That Has Everything

Designed for easy construction and the most living space for the least cost, the Build-It-Yourself House is also most attractive and suitable for any community and most income groups. The basic plan is adaptable to four other exterior designs.

### Get Book and Plans Now—Build When You Can

You may never have thought about actually building a house yourself, but now that building restrictions have been lifted, it is easier than you think. So order book and plans today. Even if you engage a contractor to build for you, you will need the plans. And you certainly will want the book which can easily save you hundreds of dollars, whether you build this or any other house.

## Mail Coupon for New Book and Plans!

*Build It Yourself  
or Have It Built  
—Save Hundreds  
of Dollars!*

### PLANS YOU CAN READ AND FOLLOW

Plans consist of ten working-size blueprints—floor plans, elevations, construction notes, framing, joints, lumber and mill list, specifications, plumbing and wiring diagrams. Every measurement is marked—every detail made clear as ABC. Book has 100 pages—three-fifths are photographs and drawings. Some sections in colors, showing just how your house will look when finished.

**BIG BOOK**  
8 1/2 x 11 inches



## MAIL COUPON FOR BOOK AND PLANS

**POPULAR MECHANICS PRESS, Dept. 16**  
200 E. Ontario St., Chicago 11

I enclose \$\_\_\_\_\_ Send me the items checked at once.

Your Home and How to Build It Yourself . . . . . \$ 3.00  
 Complete set of plans for Popular Mechanics Home . . . 12.50  
 Book and plans at reduced price . . . . . 14.00  
 Duplicate sets of plans . . . . . 5.00

NAME \_\_\_\_\_

ADDRESS \_\_\_\_\_

CITY \_\_\_\_\_ Zone \_\_\_\_\_ State \_\_\_\_\_

# BUILD YOUR OWN POWER TOOLS—TILT/ARBOR SAW

## Exclusive GIL-BILT Build-It-Yourself Features

- No machining—build easily with hand tools only
- No blueprint reading—step-by-step pictorial plans, full scale patterns, actual photographs
- Sturdy wood, aluminum, and steel construction
- Capacity and performance of commercial saws selling for \$80 and up

**BANDSAW**  
**BELT SANDER**  
**SAVE \$50**  
**OR MORE**

## GIL-BILT 10-INCH TILTING ARBOR SAW



- 27x28 in. table, 13 1/2 in. capacity in front of blade
- 10 in. blade cuts 3 1/4 in. deep, tilts full 45 degrees
- Floor model 34" high, table always stays level

- New Departure ball bearing arbor, 3/4" precision shaft turned down for 5/8" bore blades, alum. housing, shipped ready to run
- Jackscrew and 4 1/2 in. dia. handwheel lowers and raises blade
- Cast aluminum miter gauge and self-aligning rip fence guide

GIL-BILT Metal Parts Kit includes Plans, ball bearing arbor, miter gauge and bar, rip fence guide, dado insert, lock knobs, jackscrew mechanism and handwheel, and all other metal parts (less blade)..... **\$20.95**  
Same Kit with 10" Combination Blade **\$24.90**  
Same Kit with 8" Combination Blade **\$23.90**

## GIL-BILT 12-INCH BAND SAW

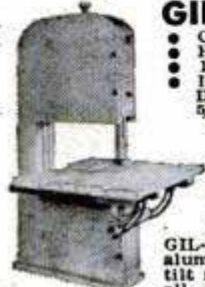

- Cuts to center of 24 inch circle
- Handles stock up to 6 inches thick
- 18x18 inch table tilts 45 degrees
- Lower wheel and drive pulley runs on sealed New Departure Ball Bearings; Upper wheel runs on two 5/8" bore Oilite Bronze bearings.

- Upper wheel tension and tilt mechanism of cast aluminum, completely assembled.
- Upper and lower blade guides. Each has ball thrust bearing, self-lub bronze jaws.
- Rigid cast aluminum wheels fully machined ready-to-install. Heavy rubber tires.
- Uses standard 78 inch blades up to 3/8 in. wide.
- Fully enclosed mechanism for utmost safety.

GIL-BILT Metal Parts Kit includes Plans, rubber tires, aluminum wheels, 1/4 in. blade, ball bearing spindle, tilt mechanism, blade guides, table tilt segments, and all other metal parts..... **\$21.95**

Return Kits in 10 days for refund if not satisfied.

(Prices include postage within 300 miles. Over 300 add 5%)

Also available—Plans and Parts Kit for Belt Sander and 8" Tilt Table Saw. Order Plans at \$1.00 each—Send postpaid anywhere in the world or write for FREE descriptive catalog.

**GILLIOM POWER TOOLS** P. O. Box 1-PK, Lambert Field St. Louis 21, Missouri

## MACHINISTS This is it!

45-50 lb. Magnetic Pull. Precision Adjustment. Similar to Surface Gauge. 2 Split Adapter Bushings with each Holder.  
**10 DAY TRIAL MONEY BACK GUARANTEE**

Model 200B Erick Magno Holder for Dial Indicators with Unconditionally Guaranteed Alnico Magnets

**\$545** Plus 25c Postage  
Less Indicator Catalog on Request 10c



MARTIN-315 BOND BLDG. WASH. 5, D.C.

# The NEW Model 50 UTILITY TESTER FOR REPAIRING ALL ELECTRICAL APPLIANCES-MOTORS

*an all-around electrical trouble shooter*



- Measures A.C. and D.C. Voltages, A.C. and D.C. Current, Resistances, etc.
- Will measure the current consumption while the appliance under test is in operation. The appliance or utility may be plugged directly into the front panel receptacle. A special pair of insulated clip-end leads is included for motors, etc.
- Incorporates a sensitive direct-reading resistance range which will accurately measure all resistances commonly used in electrical appliances, motors, etc. This range will enable continuity checks and tests for shorts and opens.
- Will test thermostats, radio tube filaments, bulbs, fuses, fluorescent, condensers, switches, field coils, circuit breakers, lighting systems, etc.

Handsome round cornered molded bakelite case 3 1/4" x 5 7/8" x 2 1/4". Complete with all test leads and instructions.

**\$13.90**

## SHIPPED ON APPROVAL No Money With Order - No C.O.D.

Try it for 10 days before you buy. If completely satisfied send \$3.90 and pay balance at rate of \$2.00 per month for 5 months. —No Interest or Carrying Charges Added. If not completely satisfied, return to us, no explanation necessary.

**SUPERIOR ELECTRONIC CO., INC.**  
Dept. D-35, 227 Fulton Street, New York 7, N. Y.

Please rush 1 Model 50. I agree to pay \$3.90 within 10 days after receipt and \$2.00 per month thereafter.

Name \_\_\_\_\_  
Address \_\_\_\_\_  
City \_\_\_\_\_ Zone \_\_\_\_\_ State \_\_\_\_\_

Say You Saw It in Popular Mechanics



It's ready!  
JUST ADD  
WATER

# SAKRETE

(P. O. Box 11, St. Bernard 17, O.)

PRE-MIXED  
**CONCRETE & MORTAR IN A BAG!**

At Lumber, Building Material and Hardware Dealers . . .

# A Real POWER MICROSCOPE



(IMPORTED)

TEST IT IN YOUR HOME AT NO RISK

AMAZINGLY POWERFUL      PRECISELY ACCURATE  
COMPLETE—NO EXTRAS TO BUY      10-DAY MONEY BACK GUARANTEE

See Tiny Insects . . . Plant Life . . .

A Human Hair . . . Magnified 100 times

3 WAY ADJUSTMENT      Focus—Tilt—Light

Parents!

Don't let the price fool you. This AUTHENTIC MICROSCOPE is patterned from a model costing over \$100. No mere toy, but scientifically designed for STUDENTS, TEACHERS and HOBBYISTS. Entertainment and education for all. Sold on 10-DAY MONEY-BACK GUARANTEE. Just \$4.95 complete, postpaid. Or pay postman only \$4.95 and postal charges. Please act promptly.

Only  
**\$4.95**  
POSTPAID

Has many of the features of precision instruments costing hundreds of dollars

PRECISION SCIENTIFIC INSTRUMENT CO.      1607 Farwell, Dept. PM      Chicago 26, Illinois

**POPULAR MECHANICS**

**FAMOUS LITTLE LIBRARY  
OF USEFUL INFORMATION**

*Complete Set  
of 126 BOOKS  
only \$17.95*

**25 BOOKS \$3.75  
12 BOOKS \$2.00  
5 BOOKS \$1.00**

**SINGLE BOOK 25c**

Here at amazingly low cost is the practical help and information you have always wanted. Articles in previous issues of Popular Mechanics have been classified according to subject and are now available in these handy reprint booklets.

*Check titles wanted, clip ad, mail today.*

**HOME WORKSHOP**

Power-Driven Saws—74: How to build.  
Drill Presses, Plane, Grinders—79.  
Sanders—80: Details on 8 machines.  
Wood & Metal-Turning Lathes—81.  
Filing Machine, Hacksaw, Cutoff Wheel, Shaper—82: Full details on these.  
Metal Lathe Tools—101: How to build.  
Workbenches and Tool Cabinets—47.  
Spray Painting—84: Proper methods.  
From Pattern to Casting—91: How castings are made in sand molds.  
How to Use a Circular Saw—135.  
Jigsaw Technique—136: How to use.  
Bandsaw Know-How—137: Techniques.

**HOME IMPROVEMENTS**

Painting Your House Inside and Out—117.  
Simple Home Improvements—104: Save money.  
Building Extra Rooms in Your Attic—23: Add to the value of your home.  
Basement Playrooms—24: Build an attractive playroom in your basement.  
House Wiring—89: How-to-do-it.  
Curing Leaky Basements—45.  
Fitting Home Game Room—55.  
Built-In Fixtures—78: Several.  
Lower Your Fuel Cost—31: Practical kinks that will save you hundreds of dollars.  
Hanging Wallpaper—38: Hints and tricks.  
Ridding the Home of Insect Pests—107.  
Constructing Indoor & Outdoor Fireplaces—88: Details on stone fireplaces.

**CRAFTWORK • HOBBIES**

Games and Puzzles—131: Have fun at home.  
Model Planes You Can Build—129: Several.  
Fun With Your Model Railroad—127.  
How to Make Novelty Jewelry—126.  
Working with Plastics—61: Novelties, etc.  
25 Shelves You Can Make—64: Wall shelves, etc.  
Novelties Turned on Lathe—62: Dishes, etc.  
Projects in Plastics—112: How to use.  
Inlay Pictures—Veneering—63.  
Whittling and Wood Carving—65: Methods.  
Action Toys—66: 21 easy-to-make toys.  
Marionettes—113: How to make and use.  
High Flying Kites—67: How to build.  
Windmills & Weathervanes—68.  
Lamps in Wood, Metal, Plastic—69: Several.  
Bows and Crossbows—115: How to make.  
Playground Equipment—73: 8 projects.  
Metal Craft—28: Simple instructions.  
Weaving and Recaning—37: Full details.  
Gem Cutting—42: How to cut and polish.

**USING TOOLS**

How to Use Your Drill Press—125.  
Correct Measurements—106: How to obtain.

Tool and Saw Sharpening—92: Tricks and hints.  
Technique of Using Drills and Wood Bits—90.  
Successful Wood Turning—32.  
How to Read Blueprints—71: Tells you how.  
Metal Turning Lathe Kinks—99.  
Operating a Metal Turning Lathe—100.  
Heat Treating and Case Hardening—102.  
Working with Glass—103: Cutting, etc.  
Using Basic Tools—120: Tips and hints.

**WELDING • SOLDERING**

Rewinding & Servicing Electrical Motors—75: Repairing and rewinding motors.  
Electrical Appliances, How to Fix—111.  
Electromagnets & Solenoids—44.  
Transformer Construction—41: Directions.  
The Boy Electrician—43: Five projects.  
Soldering & Brazing—17: Tells how to.  
Arc & Spot Welders—5: How to use & build.  
Build Your Own Relays—123: Instructions.  
Home Burglar Alarms, Secret Locks and Time-Setting Systems—128.  
Welding with Arc and Gas—134: Tips.

**AUTOMOBILE BOOKS**

House Trailers—121: Build it yourself.  
Automobile Kinks and Shortcuts—10.  
Building Trailers—Small Teardrop and Utility—27: Can be built in your spare time.  
Motor-Driven Midget Car & Scooter—34.  
Curing Auto Electrical Troubles—95.

**BUILD A BOAT**

14 Ft. Outboard Runabout—2: How to build.  
Rowboats, Bicycle Boat, Small Dinghy—83.  
Small Sail Boats—84: For young sailors.  
Two Outboard Runabouts—85: 14 ft. & 12 ft.  
Build Your Own Canoe, Kayak, Surfboard—30: Complete building details.  
Fast Class-E Ice Yacht—22: Build your own.

**GARDENING HELPS**

Lawn and Garden Equipment—124.  
Handy Farm Implements—114: How to build.  
Tractor Attachments—116.  
Backyard Gardening—39: Helpful hints.  
Lawn & Garden Novelties—72: Easy to build.  
Trellises, Pergolas, Fences—76.  
Lawn & Garden Furniture—77.  
Colored Concrete Garden Furniture—6.  
Farm & Garden Tractors—8: How to build.

**PHOTOGRAPHY**

Home Movie Equipment—118: How to use.  
Photo Lighting—119: Helpful information.  
Photo Enlargers—1: Complete plans.  
Photo Printers & Dryer—25: Describes three.  
Photo Darkroom Equipment—96.  
Picture Projector, Trick & Table Top Photography—97: Tips on how to make.  
Photo Kinks—98: Money-saving ideas.

**FURNITURE MAKING**

Furniture Upholstery and Repair—122.  
Rustic Furniture—18: How to build.  
Children's Room Furniture—51.  
Book Ends—52: Good selection from 10 designs.  
Small Tables—54: Interesting styles.  
Desks—53: Many varied designs.  
Smoking Stands—56: Seven designs given.  
Plain & Novelty Wood Finishing—40.  
Book Cases—59: Eight designs.  
Magazine Racks—49: Ten attractive racks.  
Clock Cases—50: Several types.  
Serving Trays for Every Occasion—53.

**MISCELLANEOUS**

Cleaning Formulas—11: Make your own.  
Re-Silvering Mirrors—70: How to do it.  
How to Build a Concrete Block Machine—110: Make your own block machine.  
It's Easy to Tie Knots—105.  
Chemical Experiments—93: Several.  
Taxidermy—9: How to mount small animals.  
Log Cabins and Tourist Cottages—14.  
Magic for Everybody—29: Simple tricks.  
Trapping Small Animals—33: How to trap.  
Training Your Dog—35: Tricks and obedience.  
Small Furnaces—36: For melting copper, etc.  
Electroplating with Copper, Nickel, Chromium, Lead, Zinc, Cadmium—86.  
Plating Non-Metallic Objects—Plating with Gold, Silver, Alloys—87.  
Telescopes—20: Design and construction.  
Poultry Houses—108: How to build.  
Guns & Decoys—109: Clean guns, make decoys.  
For Better Business—130: Timely tips.  
For Better Business—132: Saves time.  
For Better Business—133: For smooth operation.

**USE THIS HANDY ORDER COUPON NOW!**

**POPULAR MECHANICS PRESS**  
200 E. Ontario St., Chicago 11, Ill.  
I enclose \$\_\_\_\_\_ (U.S. currency may be mailed if carefully wrapped) for "Little Library" booklets numbers:

**24 Books \$3.75    12 Books \$2.00    5 Books \$1.00    1 Book 25c**

NAME \_\_\_\_\_

ADDRESS \_\_\_\_\_

CITY \_\_\_\_\_ ZONE \_\_\_\_\_ STATE \_\_\_\_\_

# BUY WHOLESALE FROM FACTORY SAVE 50-85%



## PORTABLE LIGHT PLANTS

350 watts—115 v. D.C. powered by a sturdy, easy-starting 1 1/2 hp. Briggs engine, perfect for lights, radios, razors, etc. in cabins or trailers. Use standard light bulbs. Built-in control box with receptacle—just plug in. Weighs only 65 lbs. Item 273. Reg. price \$199.50. **\$99.75**

(Item 24) A terrific value at

**PUSH BUTTON START A.C. PLANT**  
500-700 watts—115 v.—60 cyc. A.C. Powered by a rugged 2 hp. easy-starting Briggs gas engine. No wiring necessary, just plug in and operate. Plenty of current for any oil burner, freezer, brooder, pump, emergency lights, etc. which require up to 700 watts. Ideal for Civil Defense, Fire Depts., trailers and camps. Complete with voltmeter and built-in winding to charge 6 v. auto batteries. Item 24. Wt. 85 lbs. Fully guaranteed. Be prepared if war or storm knocks out power lines. Reg. \$275 value. **\$143.50**  
700-800 Watt Plant (Item 44) same as above but larger engine. **\$169.95**  
1000-1200 Watt Plant (Item 45) same as Item 24 but larger generator and engine. **\$199.50**

## GIANT 2000-2500 WATT PLANT

110-120 V. 60 cyc., A.C. Absolutely the best made—exclusive dynamically balanced armature; heavy windings developed up to 5000 watt overload for motor starting. Skio-mounted—portable. Powered by easy starting Briggs or 6 hp. Wisconsin engine—complete with all accessories; engine easily disconnected for other uses. Big outlet box, voltmeter, no wiring necessary. Ample current for all purposes. Factory warranty and instructions included. Wt. 220 lbs. Reg. \$585.00. Special at. **\$299.50**  
With Electric Self Starter (Item 179) **\$359.50**  
**GENERATOR ONLY** and control box. **\$169.50**  
Drive it with your engine or tractor.



(Item 31)

**3000-3500 WATT PLANT**  
(Item 198) 110-220 v.—60 cyc. A.C. with Wis. Engine, push button start. **\$399.50**  
Wt. 370 lbs. Heavy duty. **\$239.50**  
Generator only for belt drive. **\$239.50**  
Wt. 115 lbs. (Item 198A)

## HI-LINE 6000 WATT PLANT

(Item 182) Push Button Start, 115-230 v. 60 cycle A.C. A brute of a power plant with a rugged 13 hp. Wisconsin engine. Plenty of electricity for ranges, water heaters, freezers, pumps, machinery, etc. Affords both 110 and 220 volts. Ideal where heavy current is needed. Wt. 590 lbs. Easily worth \$995.00. With self starter. **\$645.00**  
Factory Spec. **\$645.00**  
Generator and control box only, belt driven. Use your engine or tractor. **\$345.00**  
Wt. 240 lbs.

Write for information on any sizes not listed. Buy Wholesale—Direct From Factory—World's Largest Direct Selling Light Plant Factory. You can pay more—but you can't buy better.

## MASTER AIR COMPRESSOR

(Item 209) High pressure type for large volume of air for heavy duty service. For paint spraying, inflating truck and auto tires, greasing, and the hundreds of other jobs done by compressed air. Piston type. 2" bore compressor with built-in air filter, Master built with hi-strength alloys and precision bearings. Stainless steel tank, 12" x 24", 2100 cu. in. cap. Safe up to 500 lbs. Equipped with automatic switch that starts and stops motor to maintain desired pressure (up to 150 lbs.) and check valve, safety valve, gauge, shut-off valve, 20 ft. air hose and tire chuck. Beautifully balanced on ball bearing wheels and rubber tires. Note low factory prices. With 1 1/2 hp 110 v. A.C. motor (Reg. \$175.00) (Item 209) **\$98.50**  
With 1/2 hp motor (Reg. \$199.50) (Item 209A) **\$119.50**  
With 2 hp Briggs Gas Engine (Reg. \$199.50) (Item 209B) **\$109.50**  
Compressor only (2" x 3 1/2") (top quality) (Item 209C) **\$20.50**  
Larger Compressor (2" x 2") (none better) (Item 209D) **\$24.50**  
Giant Compressor (twin 2 1/2" x 2") (Item 209E) **\$54.50**

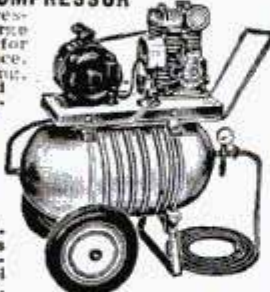

A complete line of spray guns and air tanks available at factory prices.

## IMMEDIATE DELIVERY—ALL ITEMS

### HEAVY DUTY D-C ARC WELDER



(Item 38)

Use as portable or shop welder. Up to 300 amps. Senior model. Made for years of trouble-free, continuous service. Will handle light or heavy jobs. Easily welds up to 3/4" plate using 1/4" rods. Built-in air cooling system. Arc is easy to strike and hold, because of specially designed arc stabilizer. Hi-lo switch and dial control gives wide range of welding heats. Run welder at 2600 rpm. with tractor, jeep or 15 hp. gas engine, or 7 hp. elec. motor. Complete with instructions, guar. and double V belt or flat pulley. You can pay more, but you can't buy a better **\$99.75**

**DUAL CONTROL MODEL** same as above but with built-in dual rheostat for low heat **\$119.50**  
**WELDING KIT.** Two 10 ft. leads, welding helmet, electrode holder, ground clamp. Sold only with welder at. **\$10.50**

### EXTENSION CORD



(Item 16) 40 ft. heavy duty, made of specially insulated No. 14 2-conductor wire. So tough that you can drive over it and yet flexible and easy to handle. Resists oil, grease or water. Extends electricity up to 400 ft. without voltage drop. Use indoors or out. Complete with heavy rubber plug and outlet. Wt. 2 1/2 lbs. Usually \$4.50—Special 40 ft. **\$1.99**  
Comb: 2-40 ft. and 1-20 ft. (total 100 ft.) **\$4.95**  
100 foot length (one piece) **\$4.85**  
**WIRE ONLY (Item 50):** No fittings, 100 ft. **\$4.00**

### HEAVY DUTY POWER CABLE

#12-2 Cond.—stranded, very flexible, rubber covered, special outside conductor for grounding power tools, etc. Finest heavy duty power cable made. U.S. Surplus.  
50 ft. (Wt. 8 lbs.) Item 199 **\$6.95**  
100 ft. (Wt. 16 lbs.) Item 200 **\$12.95**

### 79 Pc. CARPENTER'S TOOL SET



Professional quality. A complete set of Master Mechanic tools featuring the famous Stanley brand. All neatly arranged in a beautiful sturdy 32" hvy. steel tool box. Set includes: Powerful 1/2" Electric Drill (optional), 3 Stanley Wood Chisels, 29" Spring Steel Saw, Steel Bench Vise, Tin Shears, 9 Drill Bits, Sharpening Stone, 8" Plane, 24" Stanley Level, Hack-saw, Stanley Rule, 5 Double End Wrenches, 13 Ass'd. Hacksaw Blades, Stanley Hand Drill, 10" Vise Wrench, Comb. Square, Stanley Hammer, Stanley Ratchet Brace Coping Saw, 7 Coping Saw Blades, Steel Wrecking Bar, 4 Screw Drivers, Offset Screw Driver, Nail Set, 4 Ass'd. Files, 8 Pc. Allen Wrench Set, Auger Bit Set and many other tools. Worth at least \$150.00 if purchased separately. Save cost of tools on one or two jobs. A terrific value.  
Item 242, Wt. 41 lbs. **\$39.50** (without Electric Drill)  
Item 242A, Wt. 45 lbs. **\$49.50** (incl. Electric Drill)  
Tool box only **\$8.95**  
Item 243, Wt. 15 lbs.

### POTTER'S WHEEL



Power Driven—Foot pedal speed control. New compact modern design. Precision built to meet exacting requirements of professional artists—the finest wheel ever built. Mechanism fully enclosed for safety and to exclude moisture and clay. Foot-controlled variable speed drive provides instant, smooth speed range of 30 to 150 rpm. Equipped with adjustable arm rests. Easy to operate—even for handicapped persons. Reversible 10" throwing head—back side recessed for casting plaster bats. Larger 18x18" throwing table; wedging wire attached; removable water cup inside. Heavy bronze bearings pre-lubricated, sturdily built for long, dependable service. Use 1/4 hp motor (not incl.). Shipped fully assembled—just mount wheel and motor on table or sheet of 3/4" plywood. Self storing—tip up on edge. Wt. 45 lbs. List price \$125. Factory special. **\$64.50**

### Factory Prices on Catalog Items

Send 10¢ for BIG 1953 catalog. Hundreds of bargains.

All items brand new. Prices f.o.b. Chicago area. 10 day Money back guarantee. Send check or M.O.

## MASTER SNOW BLOW SELF-PROPELLED

It's a lawn mower It's a plow  
It's a power sickle It's a bulldozer  
It's a cultivator It's a rotary tiller



Tractor shown with Snow Blow Attachment

Here at last is a power unit that does everything at a price that can't be matched. Built-in power takeoff to drive pumps, saws, generators, etc. Safety clutch—can't burn out. More versatile and efficient than tractors costing twice as much. Basic self propelled 2 hp tractor with Briggs

Item 208 or Clinton famous engine. Only **\$119.50**  
Snow Blow **\$29.50** Bulldozer **\$11.25**  
Rotary Tiller **\$42.50** Lawn Mower **\$ 4.50**  
Sickle Bar Mower **\$42.50** Cultivator **\$ 8.75**

Freight prepaid to most areas. Easy payment plan available.

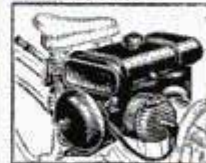

### COMMANDO MOTOR BIKE

"The Winged Wheel with the Magic Feel"

New, super-modern 1953 Model. This job is the Cadillac of all motor bikes. Sensational automatic drive permits idling or infinite speed range, merely through use of throttle. Engine drives on rear wheel through Dynarotor—no belts or chains. Free wheeling control permits pedaling if desired. Perfect balance and comfort. Mounted on famous Schwinn bike, America's finest. Sturdy, dependable, easy starting, light weight engine provides surging power, up to 150 miles per gal. Plenty fast, too. Fully guaranteed. Wonderful for vacation trips... Use pedals for exercise and motor for speed and distance. Ride one to work and save. Men's or Women's models.

Commando Captain, 1 Cyl.—1 1/2 hp., with elec. headlight, item 90B **\$199.50**  
Commando General, 2 Cyl.—3 hp., with elec. headlight, item 91B **\$249.50**  
Commando Motor only, with complete mounting kit and instructions (can easily be installed on any bike in an hour).  
1 cyl., item 90 **\$125.00**  
2 cyl., item 91 **\$149.50**  
All Commandos shipped prepaid in U.S.

### 32 pc. SOCKET SET

32-pc. Socket Set (Item 59) Highest quality guar. non-breakable sockets made by Husky. Beautifully matched chrome alloy, absolutely the best. Complete range of 21 sockets from 1/4" thru 7/16" in 1/4" drive and 7/16" thru 1-1/16" in 1/2" drive; 2 extensions, reversible 1/2" ratchet, adaptor bit, slide head, all angle coupling, 2 end wrenches, 1/4" speeder handle and sturdy metal tool box. For prof. mechanics who want the best. Wt. 14 lbs. Easily worth \$41.50. While they last. **\$16.95**



### 45 pc. SOCKET SET

(Item 205) Contains a complete set of sockets in 1/2" drive, 3/8" drive and 1/4" drive, plus all necessary extensions, handles, speeders, reversible ratchets, etc.; all unbreakable, guaranteed against breakage. Beautifully matched chromed thin wall alloy sockets in a sturdy handsome steel tool box. Wt. 17 lbs. List Price \$62.90. Factory Special. **\$26.95**

### 3/8" DRIVE 15 Pc. SOCKET SET

(Item 201) Same top qual. as above—includes 7 sockets 3/8" thru 3/4", reversible ratchet, extension flex. handle, cross bar, 3 punches, metal tool box. Wt. 5 lbs. **\$9.95**  
List Price \$18.96. Our Spec. **\$9.95**

### HYDRAULIC JACKS

(Item 208) Heavy duty, precision built, smooth, positive acting with built-in relief valve. Hi-Lift with screw extensions. Govt. surplus at a fraction of orig. cost. (Handle included).  
1 1/2 ton (Item 208) **\$6.45**  
Wt. 11 lbs.  
3 ton (Item 208A) **\$9.45**  
Wt. 15 lbs.  
5 ton (Item 208B) **\$11.45**  
Wt. 17 lbs.

### HEATING & VENTILATING FAN

(Item 10) Easily installed in furnace pipes. Forces even heat to all rooms. Over range, removes kitchen smoke and odors. Powerful continuous duty motor, 110-120 v. A.C. Quiet, super efficient fan moves huge volume of air (400 to 600 c.f.m.)  
8" Fan, wt. 5 lb. **\$6.35**  
9" Fan, wt. 6 lbs. **\$7.45**  
10" Fan, wt. 7 lb. **\$8.45**  
12" Fan, wt. 8 lb. **\$9.45**

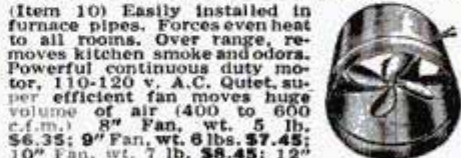

Heavy-duty 12" fan, enclosed motor, suitable for spray booths, restaurant exhausts, poultry houses, and other difficult applications. Wt. 12 lbs. Item 10D **\$12.95**

MASTER MECHANIC MFG. CO., DEPT. 7B, Burlington, Wis.



Here's **INSIDE PROOF**  
that your best buy is an A. O. Smith

**Permaglas**<sup>®</sup>  
Automatic Water Heater

See how just one year's use proves the superiority of the A. O. Smith *Permaglas* water heater. The glass-surfaced steel tank can't rust because *glass can't rust!* That's why you don't have to replace a *Permaglas* water heater every few years.

*Permaglas* gives you all the sparkling clean hot water you want. So, be thrifty. Be safe. Buy an A. O. Smith *Permaglas* gas or electric water heater for all your hot water needs in the years ahead.

**COSTS NO MORE** than ordinary water heaters  
the **ONLY** water heater with **Four B.I. protection**,  
**Four Basic Improvements by A. O. Smith:**

1. Glass-surfaced steel tank can't rust because *glass can't rust!*
2. Absence of dissimilar metals inside tank!
3. Interior tank fittings shielded from electrolytic action... the cause of all corrosion!
4. "Neutrolizer"... the anti-corrosion stand-by protector!

For complete information on *Permaglas* automatic water heaters, write: A. O. Smith Corp., Dept. PM-1052, Kankakee, Illinois.



**A.O. Smith**  
PERMAGLAS-HEATING PRODUCTS

Manufacturers also of A. O. Smith  
Conversion Burners, Home-Heating  
Boilers, Winter-Air Conditioning and  
Commercial Water Heaters



## NEW MIDGET OILER!

Ideal for lubricating hard to reach parts of model machinery, delicate instruments, and small working parts of all types in home, office, or shop. "HYPO-OILER", pen size, has a fine hypodermic needle. To use, simply squeeze the transparent oil chamber for the desired amount. Attractive cap with pocket clip protects needle when not in use. Get your "HYPO-OILER" today at your hobby store or order direct. Ask for circular on other unusual items.



\$1

Postpaid

GAUNT INDUSTRIES Dept. A, 827 Irving Park, Chicago



## Gerstner TOOL CHESTS

FIRST in the minds of good Toolmakers and Machinists for their good tools. Free Catalog.

**GERSTNER TOOL CHESTS**

452 Columbia St.

Dayton 7, Ohio

## New Jet Engine Burns Gasoline



### Powers Your Models

**FASTER IT MOVES, THE MORE POWERFUL THE THRUST!** New fun & thrills for model makers & experimenters. Ram jet M.E.W. 601 rocket engine has no moving parts. Runs on regular gasoline. (Not a CO2 unit). Gives powerful, continuous thrust lasting 3 minutes. Maximum thrust lasts 1 1/2 min. Easy to start & re-fuel. Lasts indefinitely. Aluminum tail pipe, brass fuel metering nozzle, steel compression tank. With booster tank. 5 3/4-in. long; 1 1/2 oz. Complete, ready to run. **\$2.98**

Use alone or in pairs (2 for \$5.45) Each Postpaid...  
**JOHNSON SMITH CO., Dept. 595, Detroit 7, Michigan**  
Send 10c for Big Catalog of 3000 Novelties, Funmakers, Gadgets, etc.

Say You Saw It in  
**POPULAR MECHANICS**

**PLEASE  
SEND ME**



for the  
time checked.  
I am enclosing . . .

1 year \$3.50  
2 years \$6.00

name \_\_\_\_\_

address \_\_\_\_\_

city \_\_\_\_\_

zone \_\_\_\_\_

state \_\_\_\_\_

C-102

Hand this order to your newsdealer or send it to

**POPULAR MECHANICS**  
200 East Ontario St. Chicago 11, Ill.

**Why Pay List Prices? BUY WELLWORTH PRODUCTS . . . SAVINGS UP TO 50%**

**Now! PORTABLE AUTOMATIC COMPRESSOR UNIT**

**22 GALLON TANK**

**at a saving of more than \$75**

1/3 H.P., 110 volt A.C. 2" bore, 125 lbs. pressure, 2.8 cu. ft. Wt. 150 lbs.

**WELLWORTH FEATURES**

- |                                       |                                  |
|---------------------------------------|----------------------------------|
| <b>STAINLESS STEEL VALVES</b>         | <b>AIR INTAKE FILTER</b>         |
| <b>3 PISTON RINGS</b>                 | <b>DUST-PROOF CRANKCASE</b>      |
| <b>ALUMINUM PISTON</b>                | <b>POSITIVE LUBRICATION</b>      |
| <b>SOLID BRASS VALVE RETAINERS</b>    | <b>BALANCED CRANKSHAFT</b>       |
| <b>2" x 8" RUBBER-TIRED WHEELS</b>    | <b>EASY-GRIP HANDLE BAR</b>      |
| <b>10 FT. CORD AND PLUG</b>           | <b>FAN-COOLED PULLEY</b>         |
| <b>20 FT. AIR HOSE AND TIRE CHUCK</b> | <b>AUTOMATIC PRESSURE SWITCH</b> |
|                                       | <b>SAFETY VALVE</b>              |
|                                       | <b>SILENT CHECK VALVE</b>        |

Larger size compressor units furnished with same tank and accessories described above:

- with 2 1/2 x 2 Compressor, 1/2 h.p. motor, **\$136.50**  
 3.24 c.f.m., wt. 175 lbs.  
 with 2 1/2 x 2 Duplex compressor, 1 h.p. motor, 7.35 c.f.m., wt. 200 lb. **\$189.50**



**"Wellworth" BLOWER BARGAIN**

Quiet operating. Double wheel inlet, double width blower. For heating, ventilating, cooling, air washing, exhausting and forced draft. DIMENSIONS: 10" wheel; outlet 13 1/8" x 11 3/8"; inlet 8 3/4". Height 19". Width 18". Depth 16 1/2". C.F.M. 1/4" S.P. 1600; outlet vel. 1575. Wt. 45 lbs. **BLOWER LESS MOTOR AND DRIVE. \$27.50**

With belt and variable speed pulleys, \$2.50 extra. Same Blower, complete, with 1/4 H. P. Motor. **\$45.00**

**CONTINENTAL GAS ENGINE**

Red Seal. 2 HP with 6 to 1 reduction gear. Operates at 450 R.P.M. For lawn mowers, scooters, garden tractors, pumps, compressors, generators. etc. List Price \$70.50. Shipping wt. 54 lbs. **\$47.50**  
 SPECIAL PRICE. . . . .  
 Same engine, 3600 r.p.m., \$47.50

**MERCURY CLUTCH**

3" A-belt pulley. Centrifugal action for heavy loads. 5/8" bore. \$22.50 list. Special. . . . **\$9.95**  
 3/4" bore. . \$10.95

**WISCONSIN GAS ENGINE**

Big Saving. 1952 model. A.K.N. 4 to 6 H. P. Wt. 75 lbs. List \$112.00 **\$89.50**

**PRICES F.O.B. CHICAGO. MONEY BACK GUARANTEE. SEND CHECK OR MONEY ORDER TODAY. PROMPT SHIPMENT. WRITE FOR FREE CATALOG.**

Model 3 X

**\$98.50**

Regulator, gauge and filter. . . . . **\$8.95 extra.**  
 With 1 1/2 h.p. gas engine. . . . . **\$124.50**

**PRICES OF COMPRESSORS ONLY**

- |   |                |
|---|----------------|
| 2 x 1 3/4—requires 1/4 or 1/2 h.p. motor, wt. 16 lbs. . . . . | <b>\$20.50</b> |
| 2 1/2 x 2—requires 1/2 or 3/4 h.p. motor, wt. 24 lbs. . . . . | <b>\$27.95</b> |
| 2 1/2 x 2 duplex—requires 1 h.p. motor, wt. 45 lbs. . . . .   | <b>\$54.50</b> |

Any compressor unit above furnished with stationary tank for \$5.00 less.

**LIGHT PLANTS**

Brand New, War surplus. Signal Corps Power unit PE197. 115 volt 60 cycle A.C. single phase 5 K.W. Hobart water cooled, 14 h.p. 4 cyl. Hercules engine. Remote control. Complete panel board with instruments. Housed in metal case. Regular price of unit, \$1900. Shipping Wt. 1250 lbs. Price complete . . . . . **\$795**

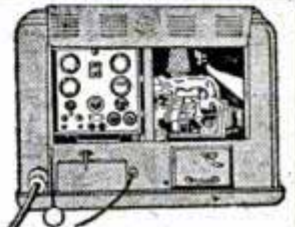

**LELAND GENERATORS**

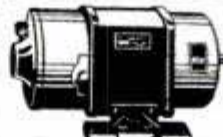

2500 to 3000 watts, 110 v. 60 cy. single phase 1800 r.p.m., self excited. Fungus treated for long life. 1951 model. Brand new, in original factory crate. Ship. wt. 135 lbs. **\$195**  
 List \$325. SPECIAL PRICE. . . . .

**GEAR HEAD MOTORS**

- |   |                |
|---|----------------|
| Right angle gear head 6 RPM 1/4" shaft, 3 1/2 lbs. . . . .          | <b>\$11.95</b> |
| Right angle gear head 135 RPM 3/16" shaft, 2 lbs. . . . .           | <b>9.50</b>    |
| Bottom type gear head 1250 RPM 3/8" shaft, 2 lbs. . . . .           | <b>10.25</b>   |
| Same motor without gear head 12,000 RPM 3/16" shaft, 2 lbs. . . . . | <b>6.95</b>    |

**WELLWORTH TRADING CO.**

1832 S. WABASH AVE., Dept. D-1052, CHICAGO 16, ILL.

**YOU CAN BUILD A VIOLIN FOR PLEASURE OR PROFIT**



Now you can build a rich toned mellow violin modeled after a famous "Strad." YOU CAN MAKE A STRADIVARIUS VIOLIN contains 8 full scale plans plus complete instructions. You work directly from the plans with no confusing scale of dimensions to translate. Detailed instructions for each step including varnishing and stringing—even shows how to build your own tools. Cloth bound. Order today from

**POPULAR MECHANICS PRESS . . . \$3.50**  
 200 EAST ONTARIO STREET, CHICAGO 11, ILLINOIS

**HELPFUL BOOKS**

Send post card asking for FREE catalog  
 Popular Mechanics Press, 200 E. Ontario, Dept. 601, Chicago 11

Say You Saw It in Popular Mechanics

**AUTO ENGINE SPEED CONTROL GOVERNORS**

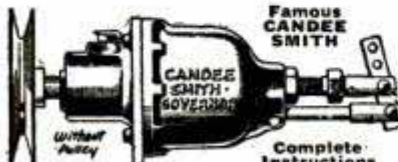

NOW use your auto or truck engine for stationary power. SAVES GASOLINE—LOW COST — LONGER LIFE. No overload. Gives constant speed. Guaranteed. 31 Successful Years.

Oil Ring Bearing (not shown) **29.95**  
 Ball Bearing 31.50 and 34.75 PREPAID

Complete Instructions  
 Wanted: Mfr's. Reps.—Jobbers—Auto Parts Dealers

Dept. PM-10, ROYAL EQUIPMENT CORP., 906 Main, Burbank, Calif.

**POWER SAW and MOWER IN ONE**

SAVE UP TO \$100.00 CUTS TREES and SCRUBS—QUICKLY CHANGES TO A LAWNMOWER.



Mow grass, weeds—or clear a field of scrub trees quickly, easily. FREE BUILDING instructions show how . . . Send name on postcard today.

T & H MFG. CO. Dept. P  
 811 East 31 St., Kansas City, Mo.

# Schupack's AMAZING TOOL BARGAINS! ALL BRAND NEW MERCHANDISE



**SURPRISE VALUE**  
**100 Pieces**  
**FOR ELECTRIC GRINDERS**  
 Grinding Wheels, Cut-off Wheels, Sanding Discs, Mounted Stones, Sharpening and Honing Stones, Rotary Cutting Burs, Abrasive Cart-ridges, Mandrels, and many other items.  
**\$1.00** Post-paid

**FLEXIBLE SHAFT — ONLY \$4.95** Post-paid  
 Fits all electric drills & hand power tools. 35 3/4" long. Oilite bearings. Core of specially wound, high carbon steel wire in flexible steel casing. Will accommodate tool shafts up to 1/4" dia. For lathes, electric drills, etc.

**112 PIECE ASSORTMENT \$3.95** Post-paid  
**FOR ELECTRIC GRINDER**  
 \$10.00 VALUE — ONLY  
 Here's what you get! Mounted Stones on 1/2" shank, Drum Sander, Sanding Sleeves for sander, Rotary Cutters, Wire Scratch Brush, Bristle Brushes, Circular Saw, Buffing Wheel, Grinding Wheel, Rubber Polishing Wheel, Cut-off Wheels, Rubber Cylinder, Mandrels to fit above tool, asst'd. Sanding Discs, Sharpening Stone, etc.

**2 DRUM SANDERS \$1.50** Post-paid  
 With 12 Bands in Assorted Grits. 1 1/2" dia. x 1" long on 1/4" arbor with 12 bands  
**ONE DRUM, 1" DIA. x 1" LONG ON 1/4" ARBOR WITH 6 EXTRA SLEEVES \$1.00** Post-paid

**18 ROTARY CUTTERS \$5.85** Post-paid  
 \$13.50 Value  
 Illustrated 1/2 actual size  
 Assorted sizes cutter on 1/4" or 3/32" shank. Will fit all hand grinders. Ideal for cutting wood, metal, or plastic. Brand new.

**12 MOUNTED WHEELS** and points on 1/8" Shank. **\$2.95** Post-paid  
 For grinding on plastic, wood, soft and hard metals. Regular \$8.40 List Val.  
**12 WHEELS ON 1/4" SHANK \$3.60**  
**18 MOUNTED POINTS ON 3/32" SHANK \$2.50**

**12 MINIATURE CUTTERS \$1.00** Post-paid  
**FOR CUTTING WOOD, PLASTIC, or METAL**  
 Actual size. Ass't. shapes on 3/32" shank. For die makers, home workshop, etc.  
**24 SHORT SHANK MINIATURE CUTTERS 7/8" LONG, \$1.00**

**ADAPTER CHUCK \$1.50** Post-paid  
 With 2 interchangeable collets, opening from 3/32" to 1/2".  
 Price each only.

**2 CIRCULAR SAWS \$1.50** Post-paid  
 ON 2 MANDRELS — ALL AT ONE LOW PRICE  
 1" diameter saws on 1/4" Mandrels. For cutting wood, plastic, or soft metals. Order at once!

**20 ABRASIVE ROLLS, \$1.00** Post-paid  
 cloth, and 1/8" mandrel for grinding, sanding, deburring metal, plastic, wood or rubber, ONLY.....

**7 HIGH SPEED TWIST DRILLS \$1.00** Post-paid  
 15 DRILLS FOR ONLY \$2.00! Order Today!  
 7 Popular Sizes — up to 1/4". Brand new, ideal for home or shop use. Fits all standard chucks.  
**5 DRILLS FROM 1/4" TO 1/2" DIAMETER — \$1.95**  
 NEW ILLUSTRATED CATALOG 10c.

**SCHUPACK SUPPLY CO., 7331 COTTAGE GROVE AVE., DEPT. M-35 CHICAGO 19, ILL. SEND CHECKS OR M. O. NO COD'S PLEASE**

**Ideal for Color and Black & White!**  
**TELEPHOTO for Argus C-3 \$9.95**  
 A \$20.00 value! Screws right into front of Argus C3 lens. Is instantly removable, requires no installation, no dismantling. Doubles picture area on negative or transparency, eliminates unwanted background, brings distant objects close with greater clarity. Auxiliary lens is coated, color-corrected, requires no change in exposure or lens opening, comes with simple instructions.  
**WIDEANGLE** aux. lens covers 50% more of subject than normal lens, coated, color-corrected, a must for indoor, landscape, architectural photography. **\$9.95**  
 Filterholder, fits both lenses \$1.25  
 Leather Case, for each lens 75c  
 Telephoto Mask, shows correct field of telelens. . . . .50c  
 Wideangle Finder Attachment, shows wideangle view. . . . . \$1.95

Similar Telephoto and Wideangle lenses, at the same prices, are available for most other 35mm cameras—Boisey, Kodak 35, Signet, Pony, Argus A2, C4, Mercury, etc. Shipping Cost 25c.  
**DEVELOPIX, Dept. PM, 35 Maiden Lane, N. Y. 38, N. Y.**

**\$ Free Course! Big Profits! \$**  
**Flocks & Sandblasts**  
 Dual Purpose Spray Gun! Uses only 25 lbs. Air Pressure  
 • Thousands of uses in Home, Shop, Industry. Makes Auto Interiors Clean & New. Lines drawers, Marproofs lamp bases, Refinishes any object. All in colorful Flock. Etch & Frost windows, glassware, etc. Removes Paint & Rust from Autos, Tools. Guaranteed! Send \$24.75 or write for free information. Flocking supplies!  
**BLASTO SPRAY GUN MFG.**  
 Dept. PM-10, 7007 Haas Avenue, Los Angeles 47, Calif.

**Steil's Amazing ELECTRONIC TUNER**  
 Reduces Interference in All Television Sets  
 Check Type Interference  
 P.M. IMAGE  DIATHERMY  
 AMATEUR or HAM  OTHER TYPES  
 Any Set Owner can attach it easily  
 Save Money **\$2.75** Paid Post H.C.O.D. You Pay Postage  
 Blue Screen Filter 17-inch or 20-inch Reduces Eye Strain \$2.50  
**STEIL'S COMPANY DEPT. W BOX 1114 SIOUX CITY, IOWA**

**GIANT BALLOONS**  
 Genuine govt. surplus weather & target balloons. Have fun or make money with 'em. Great sport in back yard or for parties, picnics, dances, fairs, etc. Great attention getters, it'll bring the crowds to business events, conventions, exhibitions, trade shows; for lodges, civic occasions or school functions. Thousands of satisfied customers from coast to coast! Order now at these low prices.  
**3 Ft. Dia. 39c — 6 Ft. Dia. 79c — 13 Ft. Dia. \$1.39**

**SPRINGFIELD RIFLE STOCKS**  
 Genuine Army surplus. They're NEW, untreated, straight-grained, solid walnut Rifle Stocks. Free of cosmoline, too. These are perfects, there's no warpage. In fact, they're worth every bit of \$40. Now look at these prices . . .  
**With Modified Pistol Grip . . . . . \$3.95**  
**Springfield Straight-Away . . . . . 1.95**  
 • Add 10% for handling & delivery. Calif. residents please add sales tax.  
**WAR ASSETS DIV. VOLUME SALES CO.**  
 Dept. M-10-52, 3930 Sunset Blvd., Los Angeles 29, Calif.

**SEND FOR GIANT 1952 BOOK ON ELECTRIC TRAINS—**  
 Huge, 48 page catalog filled with full color pictures of American Flyer Trains and accessories. Send 10c to Gilbert Hall of Science, 342 Erector Square, New Haven, Conn.

**BRAND NEW NYLON STORAGE COVERS** Lightweight only 5 1/2 lbs.  
 for outdoor storage of cars, boats, machinery, equipment, etc.  
 Strongest, lightest covers ever made. New DuPont Nylon 2-ply with fused waterproof coating on nylon cloth. Folds away easily. Secured with heavy elastic. Protection against wind, rain, sun, salt-air, mildew, etc. 15-day money-back guarantee. Not to be confused with plastic covers selling for less!  
 Give Standard Size Car Model **\$16.95**  
 Extra Large Size for Cad- dy, Linc., etc. \$2.50 extra plus 70c postage  
**DEFENDER TEXTILE CORP., 317 Canal St., Dept. PM, N.Y. 13, N.Y.**



# RADIO BARGAINS

## RADIO MIX

Ideal for 'ham' operators, experimenting, etc. Mix contains: Headset, mike, button, trans. wire, insulators, switches, condensers, rheostats, terminals, jump cable, etc. 249  
8 packed lbs.

## RADIO HEADSET

HS-30U - Two magnetic type receivers in waterproof brass case. Soft rubber inserts in each receiver to fit into wearers' ear. Pliable steel head band. Ideal for communications, divers, workers in noisy compartments, etc. . . . NEW. 329

## NAVY SOUND-POWER PHONE SET

Used by the Navy for flight deck and gunnery control. An ideal emergency communication system because they require no power supply. Perfect for office-to-shop house-to-garage or barn, or any point-to-point within 1/2 mile radius. These sets are fully sound-powered. A set includes 2 phones on chest plate, two headsets, button switches, 35' of cable. . . . 995

## RADIO ANTENNA REEL

For tuning beam antenna, opening and closing doors, etc. Powered by 1/8 HP, 24V, GE motor, engaged to a gear reduction only when electrical contact is made. Operates in either direction. Ideal for an auxiliary power take-off. Has 150 RPM at take-off. NEW 875 USED 675

## MAKE YOUR OWN HYDRAULIC REMOTE CONTROL

The ideal remote control for hundreds of uses such as throttle controls, engine & motor controls, switches, machinery, on large & small boats, in shop or factory, etc. Eliminates messy cables, pulleys, wire & rope connections. Gives positive, full range, instant action. Kit has two No. 3 Hydraulic Cylinders, shut-off valves, bleed valves and all fittings. The two cylinders are connected by tubing (any length) and filled with oil. When Master is moved the Slave responds equally in movement and pressure. Master may be used with many slaves by simple adaption. Hydraulic Copper tubing for use with above unit. . . 18¢ run ft. Complete assembly instructions furnished with each kit. KIT ONLY 1795

## BENDIX HYDRAULIC PUMP AND MOTOR

Has 3 1/2 GPM capacity at 600 PSI. Motor is 1 1/2 HP, 24V, DC. Operates on either 1/2 or 3/2V, DC current. Has built-in relief valve adj. to 1500 PSI. This unit ideal for boat tanks, hyd. lifts, portable loaders etc. Cost gov. approximately \$350.00. 1950

# SAVE UP TO 85% ON WAR SURPLUS

## COMPLETE UNIT



## MAKE YOUR OWN POWER UNIT

AS SEEN IN AUGUST ISSUE OF POPULAR SCIENCE Here's a unit PACKED WITH BRUTE FORCE! Does all those hard, heavy jobs that ordinary Power Tools cannot handle. Easily made from a vacuum cleaner type motor, a gear reduction drive and a few homemade parts. Can be used for turning large nuts & bolts, digging post holes, drilling large holes in wood or metal, driving power tools, & machinery, lifting, pulling, pushing, or any job where a slow speed with high take-off is required. YOU CAN'T STALL IT! Lightweight, easy to handle. Has 1000's of uses in the home, garage, shop, factory. We supply complete instructions as compiled by Popular Science Mag.

MOTOR 325

GEAR BOX NEW 295 USED 675

## 3 SPEED TRANSMISSION

Converts a high speed, low power input into low speed, high power take-off. Has 2 take-off shafts at 4 to 1 and 16 to 1 ratios. Gear box has a worm drive, bronze gears and a throw-out clutch. Will operate in either forward or reverse directions. Adaptable to many uses on power machinery. . . . 1995

## 90° TRANSMISSION

Has 1 1/2 to 1 gear reduction through bevel gears. Pre-lubricated bearings in dust proof housing. - A Positive lever control clutch. Size: 7" x 6" - 3/4" take-off shaft. . . . 395

## PRESSURE TANKS

G-1 Type - Stainless Steel, shatterproof & rustless. Has reinforcing ribs and is pressure tested up to 400 PSI. Has high safety factor. Both ends have 1/4" pipe ports. Ideal for use as a buoy, drinking water supply, underwater fishing, diving, painting, cooking, or spraying. G-1 - 12 1/2" x 24" ONLY 1095 G-2 Tank- 500 cu. in. cap. . . 395 A-4 Tank- 104 cu. in. cap. . . 195

## LEATHER BELT KITS

Made of bark tanned, top grain cowhide. Designed to wear on your belt. So convenient and handy to carry your small tools. Sturdy and durable - reinforced with rivets. For use by mechanics, technicians, etc. "A" - ELECTRICIAN'S KIT - 7 Pocket. Equipped for tools, tape pencil, etc. 349 "B" - RADIO & TV REPAIRMAN'S KIT Has one large and two small pockets. 279

## PIANO HINGE

1 1/2" x 5 1/2" Cat. Plated Steel . . . \$ .89 1 1/4" x 7 1/2" Aluminum . . . . . 1.29 3 1/2" x 5 1/2" Stainless Steel . . . . 1.98

## AIRCRAFT CABLE

Rust resistant, alloyed steel. Extra flexible. Pre-formed, 7 x 19 strand. On reels. 1/16" - 4 1/2 ft. (7x7) 7/32" - 11 1/2 ft. 5/64" - 5 ft. (6x7) 1/4" - 12 1/2 ft. 3/32" - 5 1/2 ft. (7x19) 9/32" - 15 ft. 1/8" - 7 ft. " 5/16" - 16 1/2 ft. 5/32" - 7 1/2 ft. " 3/8" - 18 ft. 3/16" - 10 1/2 ft. " 1/2" - 20 ft. Stainless Steel Cable - Pre-Formed 1/16" . . . . . 7 ft. | 5/32" . . . . . 20 ft. 1/8" . . . . . 18 ft. | 3/16" . . . . . 23 ft. Bronze Cable - Not Pre-Formed 1/16" - 5 ft. | 5/16" - 23 ft. 1/4" - 17 ft. | 1/2" - 38 ft.

## ELECT. GYRO

50,000 RPM Motor is an integral part of balance wheel. Has double-end shaft to drive precision tools or machinery at precise, controlled speeds. Ball bearing mounted. High or low voltage. Ideal for experimental work, labs, hobbyists, technicians, etc. 495

# ORDER BY MAIL!

## GADGET MIXES

GADGET MIX - Rivets, Spacers, Bolts, Screws, Gears, Wheel Bearings, Springs and Clamps 119 No. 106, 5 lbs.

BEARING MIX No. 178A - Approx. 20 needle, Ball & Roller Bearings, New and Used. Sizes: 1/2" to 4" Some of these cost Gov't \$10 apiece. 5 pounds ONLY . . . 159

FILE MIX - 10 assorted Files - 4" to 12". Includes vixens, half rounds, mills, bastard, etc. - in seconds & used but good condition. One vixen alone is worth our price 99¢ for entire mix. . . . 99¢

## RIGHT ANGLE SPINDLE DRIVE or GEAR BOX

Has 18-3/4" stroke at 1 to 1 ratio. 7/8" input and take-off shafts may be shortened if desired. Input shaft has universal joint. Has a threaded mount stud with tapered roller bearing adaptable to swivel mount. . . . 795

## ELECTRIC ACTUATOR

Has hundreds of uses for any mechanical device needing controlled two way action. Will open, close, raise or lower doors, windows, gates, . . . . . 1295

CTU-2 Foote Linear Actuator. 24 Volt, DC, 8500 RPM, 1/6 HP series wound motor. Gives 4-1/2" stroke in 13-1/2 sec. Compression & tension loads up to 750 lb. Has adjustable micro switch for limits of travel. Overall length retracted is 11 inches. . . . . 795

EASTMAN ACTUATOR Has a 1/8 HP, 24V, DC, 10,000 RPM motor & push-pull actuator. Actuator has a 4" travel through a reduction gear box. Has adjustable limit switches and forward and reversing relays. Overall length extended, 20"; retracted 15 1/2". 1295

## GEAR HEAD MOTORS

Heavy duty, G.E. MOTOR. 2 HP, 24V, DC, 125 amp., reversible motor to drive a reduction gear unit giving 36 to 1 ratio at take-off. Unit will operate on 6 or 12 volts 36 to 1 G.E. (306 shaft RPM) 1095 28 to 1 Eclipse (130 shaft RPM) 20 to 1 Eclipse (110 shaft RPM) EACH

## GHM-528 Lear GEAR HEAD MOTOR

Lear 24 volt DC, 7.6 amp, series wound reversible motor with over-load clutch. Motor turns 11,000 RPM driving thru a 11 to 1 gear reduction box which turns the final take-off shaft 1000 RPM. Adjustable limit switches control limit of travel. Take-off shaft adapts to flex or rigid drive. Size: 10" x 4". . . . . 995

## FIRE EXTINGUISHER

Kiddle Lux - CO2 Type - Built to Gov't specifications. Has heavy, shatter-proof case. Recent hydrostatic test. Reconditioned and fully charged. LIKE NEW! All are READY FOR INSTANT USE! 3 1/2 lb. size with Swing Nozzle . . . 17.95 7 1/2 lb. size with Horn . . . . . 23.75 10 lb. size with new Squeeze Grip Handle & 3/4" flex hose with Horn 29.75 15 lb. size with Wheel Control . . . 37.95 15 lb. size with Squeeze Grip Handle, 4 ft. flex hose, Plastic Horn . . 42.50

## 32 POSITION SWITCH

Was used as a bomb selector switch. Has 32 separate contact points through 1 common lead. Ideal for use in radio, experimental work, electronics, shops, factories, etc. - Has 32 post, Amphenol connector plug. Uses 12-24 volts, current, in all metal case. 395

## AGASTAY-TIME DELAY RELAY

A 24 volt solenoid is held from a fraction of a sec. to 15 seconds by a Time Delay mechanism. When coil is energized it operates a double pole, single throw relay switch. Can be used on electric locks, animated signs, labs, etc. Fully adjustable by set screw. 225

## 230 PAGE CATALOG

1000's of ITEMS! Fully illustrated! For the MECHANIC, SPORTSMAN, HOBBYIST, HOME OWNER, etc. War Surplus - Factory Closeouts and General Merchandise Values! Save on Hardware, Hand & Power Tools, Gadgets, Sports Equipment, Hydraulics, etc. SEND 50¢ for HANDLING & MAILING.

## WESTINGHOUSE AIR COMPRESSOR

1000's now in use for spraying, inflating, air tools, in garages, laboratories, shops & on trucks, tractors, jeeps, etc. Light weight but powerful. Operates on 1/2 HP, gas or electric motor. Runs in either direction. Delivers approx. 3.27 CFM at 600 RPM or 6.54 CFM at 1200 RPM. Has 2" bore, 1-1/2" stroke. We also have available motors, tanks & fittings to adapt this unit. 2395

# PALLEY SUPPLY CO.

2263 EAST VERNON AVENUE DEPT. PM-10 LOS ANGELES 58, CALIF.

Order From This Ad. Pay by M.O. or check. P.O.'s. acceptd. from D&S firms. 1/2 deposit with C.O.D.'s. All Prices FOB Los Angeles.

# SOUTH BEND 14½" LATHES

*Make Tough Jobs*  
**EASY**

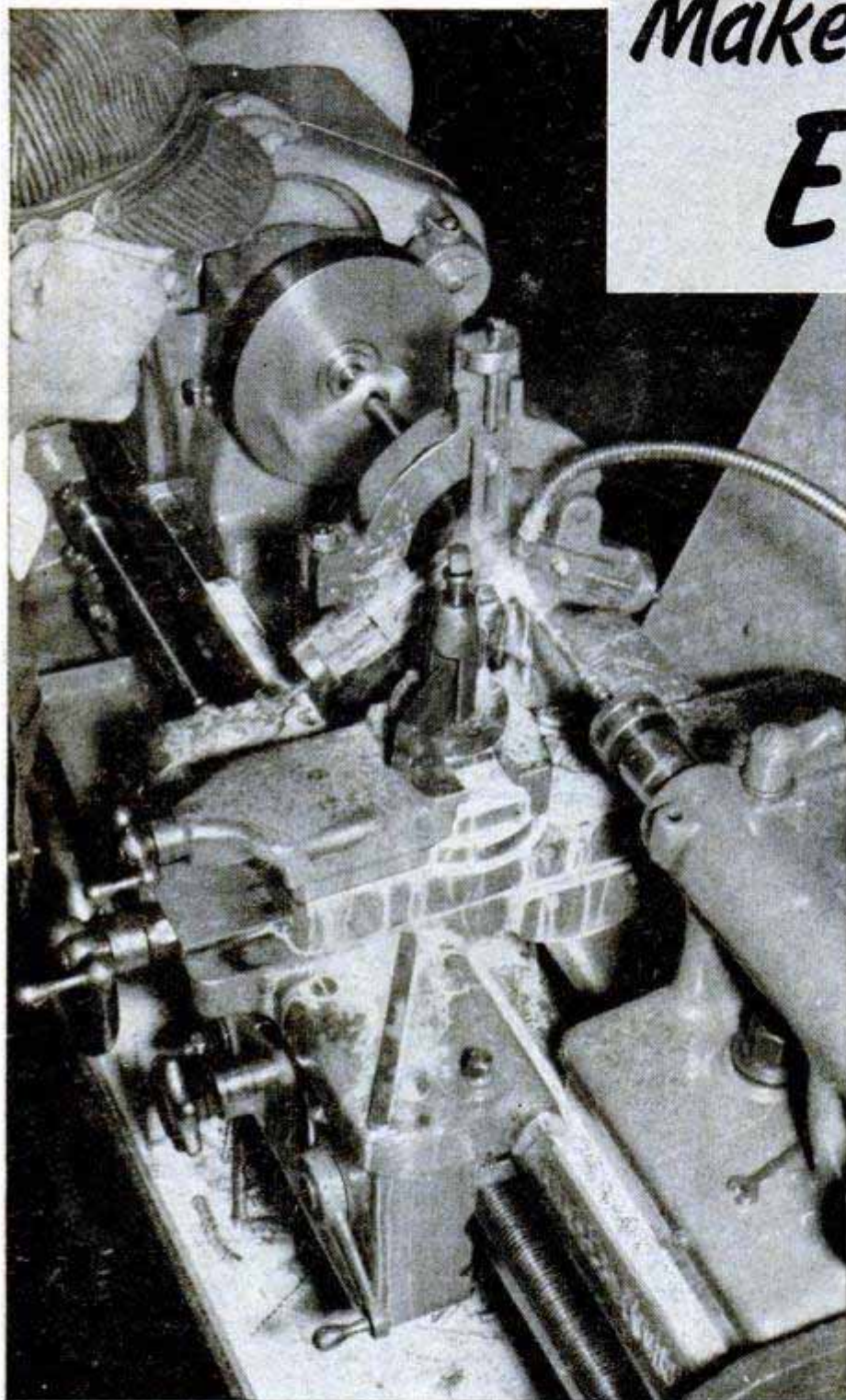

When tolerances start slowing up output, then is the time you need South Bend 14½" Lathes. Many plants have found they can save manhours and material by running the tough operations on these precision lathes — this is the type of work they do best. Their versatility enables you to keep them busy on a wide variety of work with a minimum of set-up time. Many attachments are available for special classes of work. Find out now how these lathes can give you efficient machining — *mail the coupon below today.*

## SPECIFICATIONS

**SWING:** 14½" over bed and saddle wings; 10¼" over saddle with chip guard removed.

**BED LENGTHS:** 5, 6, 7 and 8 feet.

**DISTANCE BETWEEN CENTERS:** 24½ to 60½ inches.

**COLLET CAPACITY:** 1 inch.

**SPINDLE BORE:** 1¾ inches.

**SPINDLE SPEEDS:** Eight . . . 30 to 875 r.p.m.

**POWER LONGITUDINAL FEEDS:** 48 R.H. or L.H., .0015" to .0841".

**POWER CROSS FEEDS:** 48, .0006" to .0315".

**THREAD CUTTING:** 48 R.H. or L.H. pitches, 4 to 224 per inch.

**CROSS SLIDE TRAVEL:** 10 inches.

SEND INFORMATION  
CHECKED:

\_\_\_\_\_

TOOLS & ATTACHMENTS



9" and 10"  
BENCH LATHES



10" to 16-24"  
FLOOR LATHES



½" and 1" Collet  
TURRET LATHES



14"  
DRILL PRESSES



7"  
BENCH SHAPERS

Name \_\_\_\_\_ Company \_\_\_\_\_

Street \_\_\_\_\_ City & State \_\_\_\_\_

Building Better Tools Since 1906 • SOUTH BEND LATHE • South Bend 22, Indiana



# AMERICA'S NEWEST \$\$\$ HOME BUSINESS!



Real live **ORANGE TREE** Full grown, but only inches high. Notice the tiny oranges you can actually pick and eat—blossoms, too. Easy to grow in any climate.

## Earn Big Money — SPARE TIME! **GROW LIVING "MING" TREES**

- NEW Amazing HOME-BUSINESS!
- NEW Fascinating HOBBY!



### CASH IN ON ANCIENT ORIENTAL SECRETS

Never before has such a PROFITABLE OPPORTUNITY come to light. Centuries ago, Oriental royalty astounded the world by growing actual LIVING miniature "dwarf trees". These fabulously beautiful trees were desired by all other countries, but the Oriental Emperors jealously guarded their growing secrets. The death penalty was demanded if anyone grew dwarf trees, or gave away the growing secrets. However, Americans in World War II succeeded in purchasing some specimens and brought them to America—NOW THE SECRET IS OUT—and promises to be one of the most profitable spare-time home-businesses ever. Get all the facts! Mail coupon below today.

### IT'S EASY! TO GROW ALL KINDS OF TREES

Even a child can successfully grow valuable perfect miniature specimen trees, once they know the secrets. Lovely PIR, PINE, CYPRESS, fragrant JUNIPER, sturdy OAK, LEMON, CHERRY, ORANGE, nearly every kind. It's easy.



**JUNIPER TREE**—Only 12" high with a 2 foot spread — an enviable prize in any home, office, school, etc.



**CYPRESS TREE** — Perfect replica — only 15" high. Green the year around.

### GROW THEM AT HOME! IN YOUR SPARE TIME! NO EXPERIENCE NEEDED!

Start your own Business! If you've ever planted a garden—you know the wonderful sense of accomplishment you feel. Growing actual living miniature trees is A HUNDRED TIMES MORE FASCINATING—yet, can be extremely profitable because these miniature specimens are new and rare. and anything new and rare means big prices and big profits for those offering it first.

#### NO LARGE INVESTMENT—NO OVERHEAD

You can start on a shoestring because you start with seeds costing "pennies", but sell trees for "tens of dollars". Mother Nature makes money for you. You don't need a lot of equipment or space either. Raise hundreds of trees in your house, yard, garage or window sill—you don't need much room.

#### TAKES ONLY A FEW MINUTES A DAY

NO LONG HOURS of tedious work—NO STUDYING of detailed instruction courses are necessary. Take care of dozens of trees in 5 minutes daily. Keep your present job—have TWO INCOMES instead of one. Of course, you can grow thousands full time—it's up to you.

#### GROW IN ANY KIND OF CLIMATE

Even if the temperature gets as cold as -10°F or as hot as 150°F you can successfully grow your trees year around. They are easy to protect.

#### SOME SOLD FOR \$1,000—EVEN \$2,000 EACH!

But \$25, \$50, \$100 and more per tree is common. You pocket all the profit. YOU CAN HAVE LIVING TREES TO SELL ALMOST AT ONCE. Amazing new secret process permits you to see results immediately. No waiting months or years. Mail Free Seed Coupon Today.

#### Living Midget "Ming" Trees Are Becoming The SENSATION OF ALL AMERICA.

Orders are coming from all over! Living Ming Trees are fashionable, smart decorations everywhere.

#### HELP US FILL THE HUGE DEMAND!



• FROM HOMES—They're a "must" in all homes, as well as all new modern architecture building.



• FROM INTERIOR DECORATORS—They can't seem to get enough of them for their customers.



• FROM CLUBS, HOTELS, SCHOOLS, FLOWER SHOPS, ETC.—These rare and exotic trees are extremely popular and in great demand.

**FREE!**  
GENUINE SEEDS & ILLUSTRATED DETAILS



#### NATIONAL NURSERY GARDENS

8463 So. Van Ness Ave., Dept. M-10  
Inglewood 4, California

Please RUSH ME FREE SEED AND ILLUSTRATED DETAILS. I understand I am under no obligation. This is a Free offer from you.

Name \_\_\_\_\_  
Address \_\_\_\_\_  
City \_\_\_\_\_ Zone \_\_\_\_\_ State \_\_\_\_\_

★  
**NATIONAL NURSERY GARDENS**  
Inglewood 4, California





No wonder so many drivers, mechanics, and dispatchers are "campaigning" for REO these days! *Drivers* vote for *Gold Comet Power* that mows down mountains—as much as 20% faster than other tractors of the same class with identical payloads. Drivers vote for Reo's new comfort-conditioned cab, too! *Mechanics* vote for Reo engine accessibility and ease-of-maintenance. *Dispatchers* cast their ballots for Reo dependability. No idle promises—the Reo performance "platform" is being proved again and again, on every highway in the nation, every single day!

**the Senator says:**

You can't beat the machine — if it's a Reo. Drive a Reo\* and you'll see why veterans of the road are flocking to Reo's Band Wagon.

\*Gold Comet gasoline or LPG-powered

**REO MOTORS, INC., Lansing 20, Michigan**

**REO** Builds The Amazing **EAGER BEAVER** Truck For The U.S. Army.

