

POPULAR MECHANICS

MAGAZINE

WRITTEN SO YOU CAN UNDERSTAND IT

No. 410428

REG. U.S. PAT. OFF.

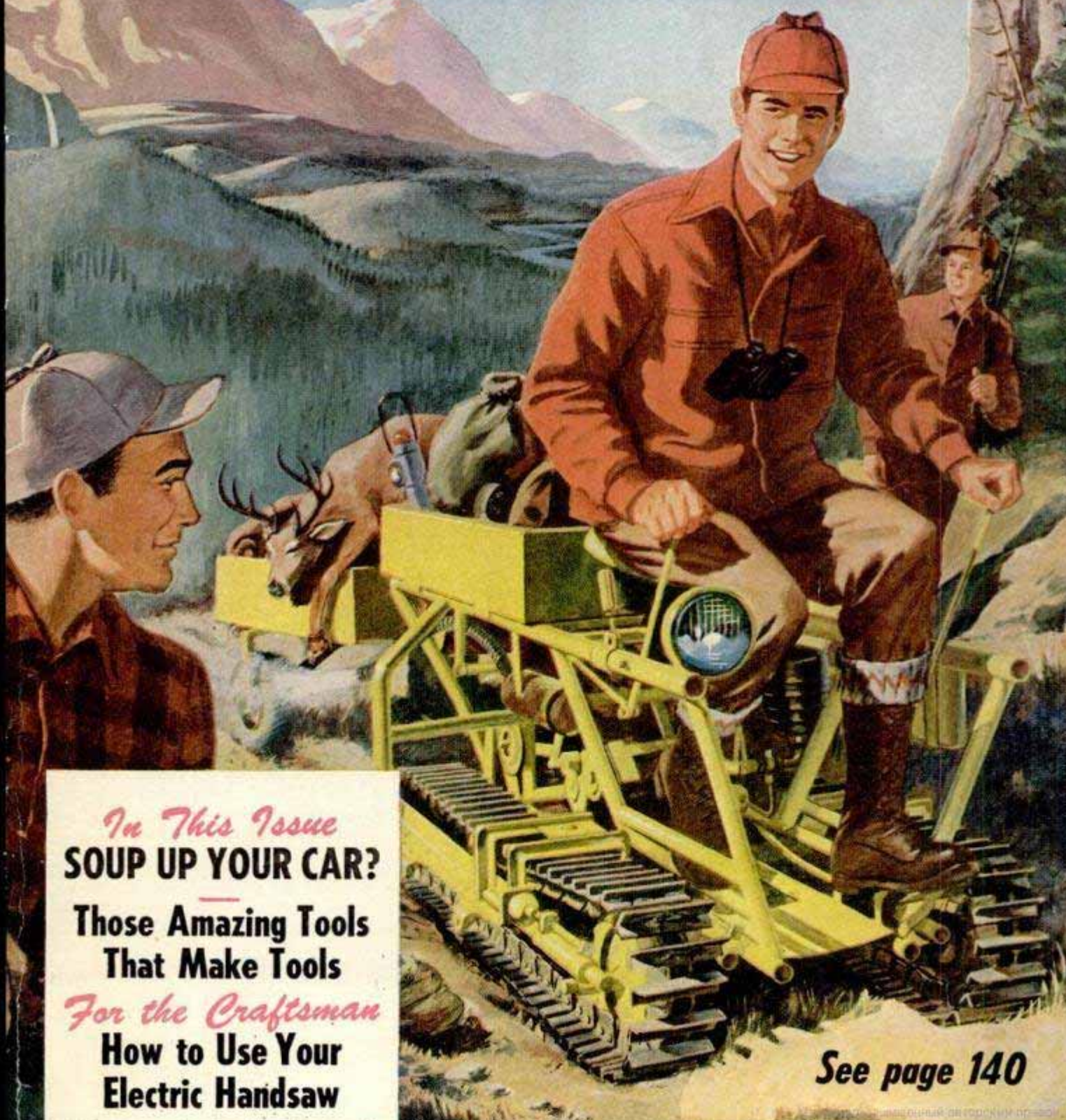

In This Issue
SOUP UP YOUR CAR?

Those Amazing Tools
That Make Tools
For the Craftsman
How to Use Your
Electric Handsaw

See page 140

**BUILDS THE FIRE IN BUICK'S
FIREBALL ENGINE**

AC

PATENTED
CORALOX
INSULATOR

**SPARK
PLUGS**



... AND USED ON EVERY NEW BUICK SINCE 1908

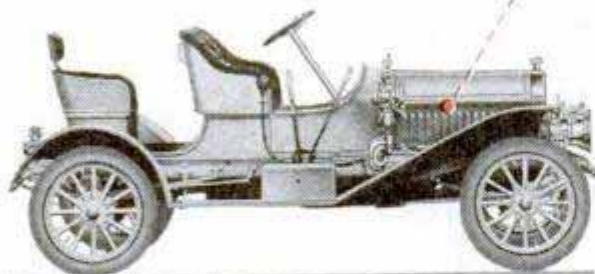

The latest thing in 1908, this model "S" Buick had a 4-cylinder, 29-horsepower engine -- wood spoke wheels with 32" x 4" tires -- three oil lamps, gas headlights, horn and repair outfit as standard equipment. The top and double rumble seat were extra.

Buick engineers specified AC Spark Plugs as factory equipment way back in 1908 -- have continued to do so for 44 years.

ACs with patented *CORALOX* Insulator are a "natural" for Buick's famous high-compression, high-powered Fireball engine. *CORALOX* provides better electrical insulation -- greater resistance to fouling -- surer firing at every engine speed and temperature.

You can get these *CORALOX* advantages for your car, too, no matter what the make or model -- for there's an AC type specially engineered for every type of engine.

AC SPARK PLUG DIVISION



GENERAL MOTORS CORPORATION

YOU CAN INSTALL IT YOURSELF

"World's Most Beautiful Flooring"



Beautiful in den or living room. Never slippery, cleans with a damp mop—and it never needs waxing.



Perfect for the kitchen. Not affected by water, will not rot or mildew, ideal for counter tops and wainscoting — and it never needs waxing.



Practical for children's rooms or play rooms. Resists scuffing —recovers quickly from denting—and it never needs waxing.

Send for free—"How To Install" booklet — Goodyear Flooring Dept., Akron 16, Ohio

**PRE-POLISHED
VINYL-TILE
NEVER NEEDS WAXING**

Amateurs can install Vinyl-Tile and get a neat, professional-looking job. Handy kit is available, along with full illustrative instructions.

Pre-polished Vinyl-Tile is the All-Vinyl flooring decorators have proclaimed "The World's Most Beautiful Flooring." You can depend on it for years and years of long wear and lasting beauty.

Vinyl-Tile comes to you in 12 marbled colors and 12 solid colors — colors that add warmth and beauty to any room. Economical, too. Available at better flooring dealers and department stores everywhere.

Vinyl-Tile BY
GOOD YEAR

This One



RTE3-KU3-HNT1

Telephone Science Shares Its Knowledge

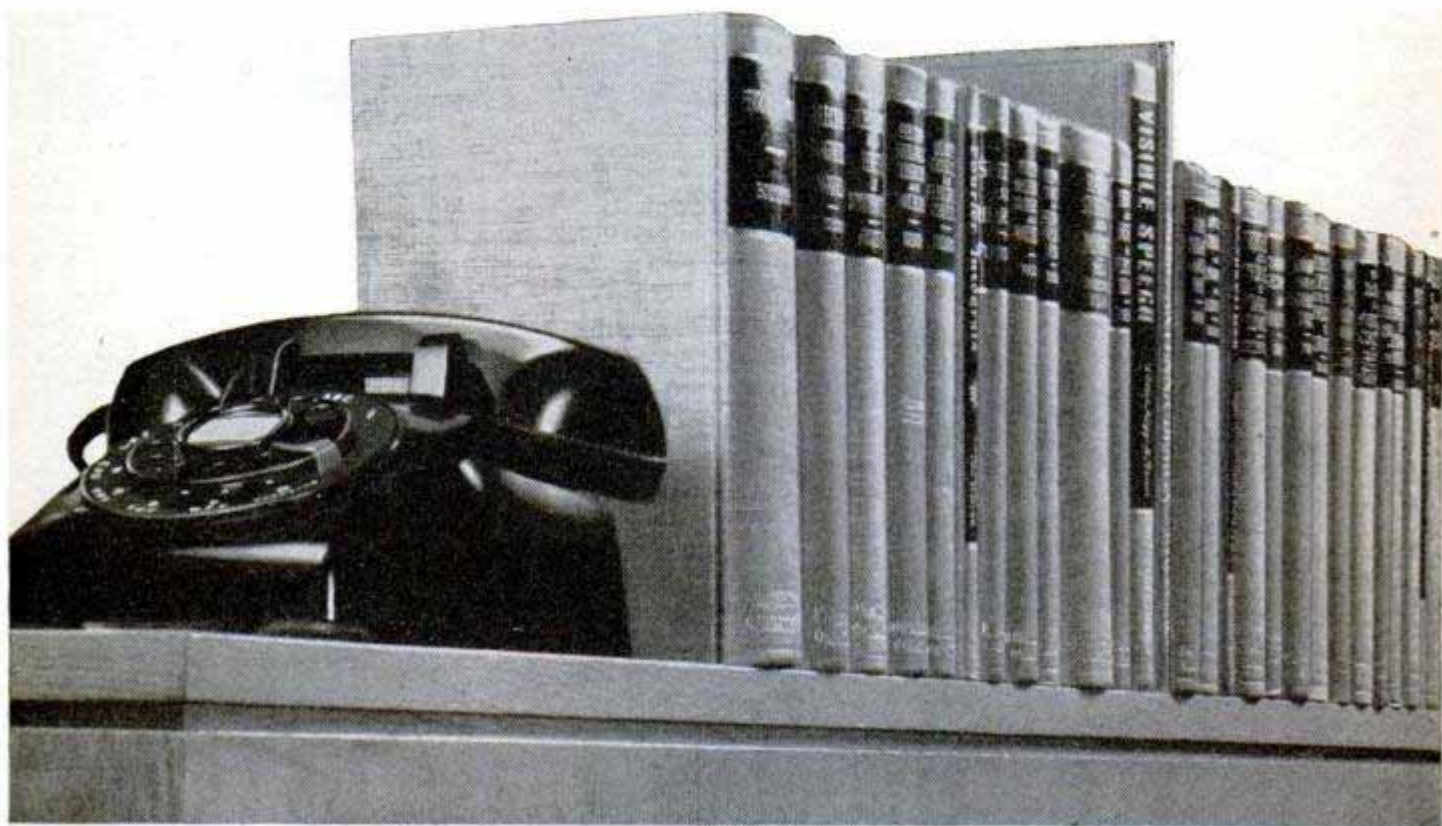

The Bell Telephone Laboratories Series of books is published by D. Van Nostrand Company. Other technical books by Laboratories authors have been published by John Wiley & Sons. Complete list of titles, authors and publishers may be obtained from Publication Department, Bell Telephone Laboratories, New York 14, N. Y.

In their work to improve your telephone service, Bell Laboratories make discoveries in many sciences. Much of this new knowledge is so basic that it contributes naturally to other fields. So Bell scientists and engineers publish their findings in professional magazines, and frequently they write books.

Most of these books are in the *Bell Telephone Laboratories Series*. Since the first volume was brought out in 1926, many of the

List of Subjects: Speech and hearing, mathematics, transmission and switching circuits, networks and wave filters, quality control, transducers, servomechanisms, quartz crystals, capacitors, visible speech, earth conduction, radar, electron beams, microwaves, waveguides, traveling wave tubes, semiconductors, ferromagnetism.

books have become standards . . . classics in their fields. Twenty-eight have been published and several more are in the making. They embody the discoveries and experience of one of the world's great research institutions.

Bell scientists and engineers benefit greatly from the published findings of workers elsewhere; in return they make their own knowledge available to scientists and engineers all over the world.



BELL TELEPHONE LABORATORIES

Improving telephone service for America provides challenging opportunities for individual achievement and recognition in scientific and technical fields.

Popular Mechanics Magazine

Registered in U. S. Patent Office and Canada

H. H. WINDSOR, *Founder*

H. H. WINDSOR, JR., *Editor and Publisher*



this month's cover

CLAWING ITS WAY up a mountain trail is the "Go-Devil," as strange yet useful a vehicle as you'll find anywhere in the Rockies. For years, Alco Timmons rode horses in hunting elk, antelope and deer, then toted his kill out of the rough Rocky wilderness on his mounts. But Timmons discovered that there were hunting spots too rough even for a horse. The result—and Timmons' handiwork—is the Go-Devil, a power-packed little vehicle that won't give up anywhere this side of mountain-goat country. Only 54 inches long, the tiny tractor will fight its way up a steep mountain grade hauling three hunters and the carcasses of two or three animals. Under full load there's not much of the tractor to be seen, for three men—including one perched 'way out front for balance—just about cover up the mighty crawler. For more details on the Go-Devil, its motor and its unique trailer turn to [page 140](#)

Published monthly by Popular Mechanics Company, 200 E. Ontario St., Chicago 11, Ill. H. H. Windsor, Jr., president; William Harrison Fetridge, vice-president; D. F. Windsor, vice-president and secretary-treasurer; H. H. Windsor III, vice-president; Clover L. Perkins, advertising manager; Alan M. Deyoe, circulation manager. Single copy in the United States and Canada, 35 cents; subscription rates in United States and possessions, Canada, Philippines and countries of the Pan-American Postal Union, 1 year \$3.50; 2 years, \$6.00; 3 years \$8.00. To all other countries add \$1.00 a year over United States prices for overseas postage. If you plan to move, notify us at least 30 days in advance so you will not miss an issue. Give both your old and new addresses. Entered as Second Class Matter, September 15, 1903, at the Post Office at Chicago, Illinois, under Act of March 3, 1879. Entered as Second Class Matter at Post Office Dept., Canada. Registered as Second Class Matter at the Post Office at Mexico, D. F., Mexico, June 20, 1950. Copyright 1952 by Popular Mechanics Company. Copyright under International Copyright Union. Copyright in France. All rights reserved under Pan-American Copyright Union. Printed in the United States of America.

Volume 98

SEPTEMBER 1952

Number 3

Address all communications to:
200 East Ontario Street, Chicago 11, Illinois

Managing Editor.....Roderick M. Grant
Assistant Managing Editor.....Wayne Whittaker
Shop Notes and Crafts Editor.....James R. Ward
Radio-Television, Electronics Editor.....Frank L. Brittin
Associate Editor, Aviation.....Aubrey O. Cookman, Jr.
Associate Editor.....Clifford B. Hicks
Associate Editor.....Arthur R. Railton
Assistant Shop Notes and Crafts Editor.....Wayne C. Lecky
Automotive Editor.....Siler Freeman
Art Director.....Frank Beatty

Assistant Editors

W. Clyde Lamme
Theodore A. Daum
Eastern Editor.....Richard F. Dempewolf
Empire State Bldg., Room 2906, New York City 1
Western Editor.....Thomas E. Stimson, Jr.
302 23rd St., Santa Monica, Calif.
London Manager.....Douglas W. Wedderspoon
Eagle House, Jermyn St., London S. W. 1, England
Director, Bureau of Information.....Allan Carpenter
200 E. Ontario St., Chicago 11

IN THIS ISSUE

It's News: Plant Bites Bug! - - - - -	65
The \$500,000 Puppet Show - - - - -	81
TV Brings Color to Movie Theaters - - - - -	86
The Owners Report on the '52 Nash - - - - -	90
The Tools That Make Tools - - - - -	96
Stereophotography Sweeps the Country - - - - -	106
"Soup Up" Your Car? - - - - -	120
What's New for Your Home - - - - -	126
What's It Like to Crash . . . ? - - - - -	128
Ice-Cube Airport - - - - -	134
Cafeteria for Boat Builders - - - - -	144

For the Craftsman

Make Your Lighting Count - - - - -	149
One-Evening Projects - - - - -	165
Stop Those Heat Losses - - - - -	172
Know Your Car's Nervous System - - - - -	186
Camera Attachment Copies Color Slides - - - - -	190
Collet Attachment for the Metal Lathe - - - - -	193
How to Use Your Electric Handsaw - - - - -	196
Tip Your Tools With Carbide (Part I) - - - - -	204
Radio, TV and Electronics - - - - -	211
Clinic for Homemakers - - - - -	222

Other items, and manufacturers of available products described, are listed on pages 12, 14 and 16



There's a CRESCENT TOOL in the PROPER SIZE for every job

CRESCENT not only makes a wide variety of daily-used Hand Tools . . . but makes them in a complete range of sizes. Good tools, like CRESCENT and CRESTOLOY, are designed to handle work loads within their generously-rated capacities. If Buster would read "How to Use Hand Tools," he would get a lot more mileage out of that fine Crescent Cabinet Screwdriver . . . and require less attention from the First Aid Department. CRESCENT and CRESTOLOY TOOLS are sold by Hardware Dealers and Industrial Distributors everywhere.

FREE BOOK

Has all the answers. It tells what tools to use and how to use them. Fully illustrated. A postcard will bring it to you. Send today.

CRESCENT TOOLS

Give Wings to Work

*Sign of the Artisan
Symbol of Excellence*

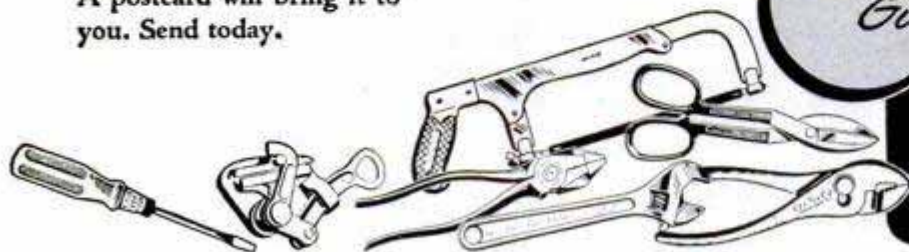

Crescent is our trade-mark, registered in the United States and abroad, for wrenches and other tools. Sold by leading distributors and retailers everywhere and made only by CRESCENT TOOL COMPANY, JAMESTOWN, NEW YORK

Does 8% sound like much to You?



1 "Do you know that, at 40 miles an hour on a level road, half of your gasoline is used up overcoming engine friction?"



2 "I never realized that. Then only half of my gas makes my car go?"



3 "Right! Now, anything that reduces that friction will make your car go faster or farther or climb a steeper hill."
"Sounds reasonable."



8% SAVING IN GAS

4 "That something is Macmillan Ring-Free Motor Oil. Hundreds and hundreds of tests made on cars like yours showed that motorists got an average of 8% more power after they changed to Macmillan Oil from whatever brand they had been using. This means an 8% saving in gas."



5 "So what? Eight percent doesn't sound like much."
"If gas is 25¢ a gallon, that 8% means a saving of 2¢."

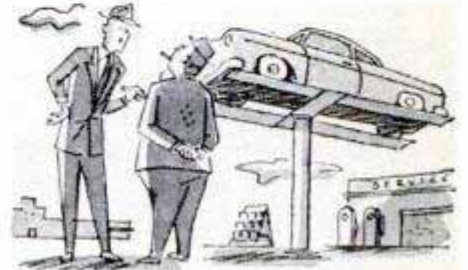

6 "Can that amount to much?"
"That saving of 2¢ a gallon on gas means a saving of \$2.00 over a normal period between oil changes — enough to pay for your change of Macmillan Oil."

And, of course, this economy isn't the whole story, either. For while it's reducing friction, Macmillan Oil reduces deposits of carbon, gum, and sludge in the engine — giving you higher compression, better piston seal and less likelihood of ping — lower repair bills. It keeps your car newer longer.

Start using Macmillan Ring-Free Motor Oil in your car now — at any of the 25,000 independent service stations, garages or car dealers where you see the big, red "M" sign. Write me personally if you can't locate one quickly. I'll reply at once.

MACMILLAN PETROLEUM CORPORATION
530 W 6TH STREET, LOS ANGELES
50 W 50TH, NEW YORK
624 S. MICHIGAN, CHICAGO

Macmillan
President

Available at over 25,000 dealers wherever you see the sign of this big red "M."



PYROIL

keeps your car

"Oil Right"

● You can be sure your motor is getting the RIGHT amount of lubrication on the RIGHT parts at the RIGHT time, when you use Pyroil. Because Pyroil contains the special property of making ordinary oil adhere to exposed motor surfaces. This protective film of oil clings to vital piston rings and cylinder walls, preventing condensation and rust. Pyroil makes your car "start easy". It cleans your motor and keeps it clean. You're so right to add Pyroil—it will keep your car "oil right"—it will add miles to your car.

● Pyroil for Aircraft Engines

Use Aircraft Pyroil B for lubricating oil, Aircraft Pyroil A for gasoline.

GIVEN! An attractive Pyroil metal savings bank—takes coins up to 50¢ pieces. **MOTORISTS**, it's yours for the asking—sent postage paid.

Manufactured and Guaranteed by Pyroil Company, 157 Pyroil Bldg., La Crosse, Wisconsin.

Canadian Distributors: Central Purchasing Agencies, Ltd., Toronto, Ontario



PYROIL COMPANY
157 Pyroil Bldg., La Crosse, Wisconsin
I want my car to last and run properly. Please tell me more about Pyroil and how it can accomplish this for me.

Name _____

Address _____

City or Town _____ State _____



in this corner.....
THE EDITORS



Letter to the Editor:

Through a friend I learned about that article in *Popular Mechanics* (March 1952) on extrasensory perception. Some years ago [at a] summer resort near the St. Lawrence River . . . I met two animals which interested me. True, there was nothing of extrasensory powers in them . . . The duck



was a constant companion of the dog. But what was remarkable was this: every time a stick was thrown out into the river, the dog would swim after it; then the duck would swim out furiously after the dog, and it would hop on the back of the dog's head and hold on with its beak, riding all the way back.

John Mathusz,
New York City.

Letter From a Modern "Stradivarius"

The letter that follows comes to us from Dr. Ben Sweetland of San Francisco. Some years ago Doctor Sweetland reviewed on his radio program the *Popular Mechanics* book, "You Can Make a Stradivarius Violin." The result of that broadcast is revealed in this letter, a rare human document that gives us a warm feeling for a hobbyist who devoted a new-found skill to enriching the lives of others:

"Dear Doctor Sweetland:

"A few years ago I heard a hobby program, where you described the making of a violin. It seemed to me to be the most

(Continued to page 8)

5 reasons why ACCOUNTANCY

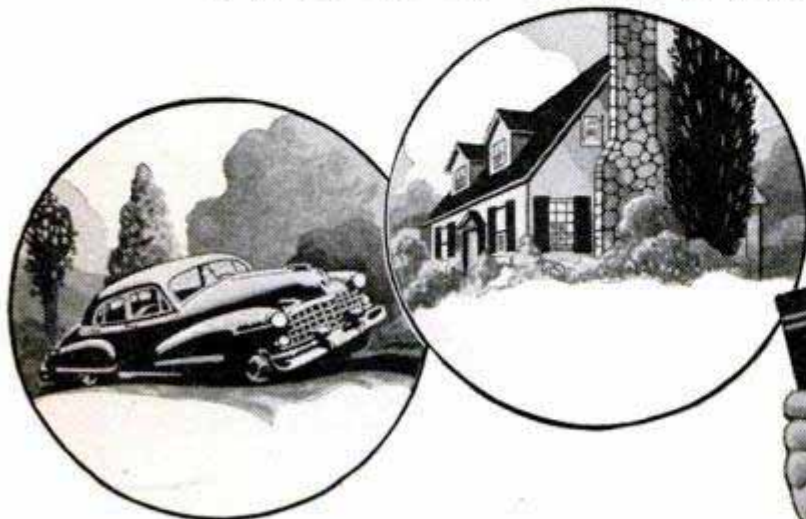

offers you MORE MONEY . . . and SUCCESS!

REASON #1. If you were an expert accountant right now, chances are you would find yourself among the highest-paid of all professional men and women. Even back in "depression years," surveys showed that accountants earned more on the average than men in other major professions.

REASON #2. The demand for accountants is great—everywhere. All businesses must have trained accountants to cope with ever-growing requirements. It's a profession offering wide opportunity—always—to the man who knows.

REASON #3. You can fit into any business, anywhere in the country—because accounting principles are universal. Think what this means in terms of security and independence!

REASON #4. Accountancy is open to all. Any man or woman of good intelligence, who enjoys figure work and is willing to follow LaSalle's systematic "problem method" plan, can rapidly qualify for a highly profitable, enjoyable lifetime career . . . and he doesn't have to finish his training before beginning to "cash in."

REASON #5. Without losing a day from your present work, you can prepare in spare hours at home, at low cost, under LaSalle's step-by-step "Problem Method" of "learning by doing." This famous plan accounts for LaSalle's remarkable record of having trained nearly 10 per cent of all Certified Public Accountants in the U. S. . . . and of having put many thousands of others into high-paying careers.

Send today for LaSalle's interesting booklets, "Accountancy, the Profession That Pays," and "Success Reports." Learn about the five great fields of opportunity . . . and LaSalle's time-tested plan for helping men and women to rapid advancement, higher income, greater prestige and professional standing. The coupon below will bring these fact-filled booklets to you—without cost or obligation—also, a free sample lesson showing LaSalle's famous "Problem Method" plan of instruction.

→ **GET FREE SAMPLE LESSON** ←

**WHICH . . . ?
can help you most ?**

- Accounting—Elements to C.P.A. Coaching
- Bookkeeping
- Cost Accounting
- Auditing
- Income Tax
- C.P.A. Coaching

LaSalle Extension University
— A Correspondence Institution —

Dept. 964 HR 41 S. Dearborn St. Chicago 5, Ill.

Please send me, free of all cost or obligation, a sample lesson in Accounting . . . also, your 48-page illustrated books, "Accountancy, the Profession that Pays," and "Success Reports."

Name Age
Address
City, Zone, State

LASALLE
417 S. Dearborn St.,
CHICAGO 5, ILL.

THEY NEED YOU



A typical interview...

where Embry-Riddle students are pre-selected for essential, good-paying jobs in aviation even before their training is completed... they step right into their jobs as soon as they graduate!

...AND YOU CAN

QUALIFY IN SIX MONTHS!

EMBRY-RIDDLE OFFERS YOU COMPLETE 6-MONTHS TO 2-YEAR COURSES...NOW!

Your Career is Waiting!

The high regard of Embry-Riddle training by the leading airlines and the entire aviation industry is demonstrated time and again by the big demand for Embry-Riddle graduates.

There's an important high priority job in aviation waiting for you...however, if you do enter the services, Embry-Riddle training will definitely give you rating advantages. Thousands of Air Force men are Embry-Riddle trained.



AIRCRAFT & ENGINE MECHANICS

Vast numbers of properly trained A & E Mechanics are urgently needed. Our C. A. A. approved school with a quarter-century experience assures your quickest advancement. Embry-Riddle students learn fast with modern equipment, including jet...live aircraft, airline-size hangars.



AERONAUTICAL DESIGN AND TECHNOLOGY

Embry-Riddle's accelerated 26-mo. Aeronautical Design and Technology Course provides finest training available. Technicians with management responsibility enjoy highest salaries!



COMMERCIAL PILOT

Embry-Riddle trained pilots benefit from our years of experience with 30,000 students...the best instructors, up-to-date aircraft, superb year-round flying weather. Also Instrument and Instructor's ratings.



A & E COMBINED WITH COMMERCIAL PILOT

Airmen with dual pilot-engineering ability are needed by aviation companies and operators. Embry-Riddle combination training offers you the most in your aviation career.



CLASSES ARE BEGINNING NOW...SEND THIS COUPON TODAY!

Dean of Enrollments - Dept. 99
Embry-Riddle School of Aviation
Miami 30, Florida

Please Print

NAME _____

ADDRESS _____

CITY _____

STATE _____ AGE _____

I am interested in...

- A & E Mechanic
 Commercial Pilot
 Aeronautical Design and Technology
 A & E Combined with Commercial Pilot
 A & E Combined with Private Pilot

Check One Veteran Non-Veteran

TRAIN IN MIAMI - AIR CAPITAL OF THE WORLD

(Continued from page 6)

wonderful thing; even if I never played an instrument myself, I had always an adoration for the violin. Still I lived a drab sort of life . . . dissatisfied . . . disgruntled.

"And when you spoke about the possibility to build a violin, it seemed like a revelation of beauty—like a rainbow in glowing colors at the other end of the street. I secured the plans and began at once to build my first violin. It took me exactly three months, so lovingly and caressingly did I do the work.

"As I said before, I do not play any musical instrument, but I seem to have an appreciation of music and especially of the magic tunes of a fiddle. So there I was, with a violin I hoped would be good, and no one to play it. Just as carefully as I built this first treasure, I began searching for the very person who should have it to play.

"I did find the boy, whose parents could not afford to buy one, but whose hungry heart longed to possess a violin of his own. He has had lessons in school and practiced on a borrowed instrument.

"I know you appreciate the great joy and satisfaction which came to me from then on. The boy makes big strides and comes frequently to play for me, because, strangely enough, this first violin of mine does sound beautiful. Maybe it is not my work at all. Maybe it is the art of the boy, who produces these magical tones, but it could be the combination. I like to think so, because both of us, the boy and I, are in a kind of ecstasy when he plays.

"I have made already three violins and each time one is finished, I go on a search for the person who should have it. The second violin went to a nine-year-old girl in the orphanage. She, too, is very talented and promises to become a very good musician. And the last one went to an elderly gentleman, a refugee from Europe, who had lost everything.

"He is a very outstanding violinist, and was so grateful for the instrument that he immediately gave his services free to the two children who received my first two violins. He gives them lessons in my house and these hours are hours of gold to me.

"He has already opened a studio to teach and made a success of it. There is such a blessing in giving and it all started with that hobby broadcast of yours, years ago. . . . Thank you."

Letter to the Editor:

Recently I recalled an experience signifying the versatility of your magazine. For some it may seem ludicrous but for others it might save some of the long

(Continued to page 10)

CRACK DOWN ON MONEY WORRIES!

You can have more money for things you need—a better job—bigger responsibility—congratulations and praise—by letting I. C. S. train you to succeed instead of standing still



Higher prices! Higher costs! Bigger taxes! You feel them too—because they leave LESS for necessities, LITTLE for luxuries! But YOU can have money for shoes, food, clothing, pleasure. Business and industry are still looking for men and women who can qualify for higher jobs. Not tomorrow, not the next day, but TODAY. With the right training you can name your own price. Why stay where you are?

TRAIN—TO GET THERE I. C. S. will show you how to develop the skills and hidden talents within you, how to bring out your personality and self-force, all a part of you. Let these assets go to work for you—right away!

Study at home, what a relief!



No need to go out and sit and listen. Study WHEN you want and WHERE you want. Any time—no set hours. Do it when you feel like it—and get MORE out of I. C. S. training!

THERE'S NO TRAINING LIKE I.C.S. TRAINING!



LOOK WHAT OTHERS SAY



Typical of thousands of letters from students

"Thanks to I. C. S. training, my salary has been increased 204%!" N. E., Bellingham, Wash.

"Mention of my I. C. S. course alone opened a new position for me!" A. R. P., South Gate, Calif.

"I got a break over more experienced fellows because of my I. C. S. training." M. D., Suncoak, N. H.

"The I. C. S. course marked a milestone in my career." J. R., Philadelphia, Pa.

I. C. S. offers you 391 courses to choose from—in any and every field. Every course trains you for a bigger job and higher pay.

BIGGER JOB, HIGHER PAY, HAPPIER FAMILY

All this comes from qualifying yourself for the job above. It takes training and skill. And the only place you can get them is out of yourself. Do something to make training and skill your allies.



WOMEN—here's your chance

I. C. S. offers women many courses to qualify for better jobs, bigger responsibility, more pay, a brighter future.



GOING INTO ARMY-NAVY?



Don't get in a rut. Qualify for bigger rating, higher pay. Start training today—be ready when the time comes.

Get started on the road to success. That means—send this coupon—it brings important information. Also free book "How to Succeed."



INTERNATIONAL CORRESPONDENCE SCHOOLS

ICS

Box 5536-L, SCRANTON 9, PA.

Please send me free 36-page book, "How to Succeed."
Please rush me free booklet on career subject checked:

Accounting & Mgmt.
 Automobiles
 Chemical Engineering

Commercial Art
 Drafting
 Electrical Engineering

High School
 Mechanical Engineering
 Television & Radio

Name _____ Age _____
Address _____
City _____ State _____
Employed by _____ Position _____

Special tuition rates to members of the Armed Forces. Canadian residents send coupon to International Correspondence Schools Canadian, Ltd., Montreal, Canada

Men, can your hair pass the caress test?



**Grooms hair,
never
greases it**



The proof is in
the palm of your hand!

20% more
for your money!

Using a hair tonic now? Then try this simple test. Rub your hand across your hair—just as she might do tonight! Does your palm pick up a sticky film of oil or grease? If it does—switch to Mennen Cream Hair Tonic—it's lightly-blended—grooms the hair but leaves no trace! Contains Lanolin. Helps remove dandruff scales and relieves dry scalp. Get your first bottle today—pass the caress test tonight!

MENNEN
Cream Hair Oil **FOR MEN**

(Continued from page 8)

hours usually incurred while waiting for a repairman.

During my last years at Berlin high school I did an abnormal amount of riding in an antique automobile. On one trip I had the misfortune of experiencing my second blowout for the 33-mile trip from home. I dismantled the tire with the customary animosity only to find I had no tire-repair patches. The other mishap destroyed the tire beyond all methods of emergency repair, so there I was, stuck with no blowout patches for a tire, a hole two inches long, insufficient funds for a taxi and a pending engagement.

I repaired the tube with the light-duty patches and from my collection of your magazines I selected a well-read copy. Inserting it within the casing over the injury, I then assembled the unit.

The following day . . . I again tore the tire apart to find the injured surface had increased, but after being subjected to over 70 miles, your magazine still had many more to go.

Who could ask for better emergency service from an already-read magazine?

Bob Reeve,
Ulm, Germany.

Letter to the Editor:

This is a coal-burning seven-horsepower Case model steam engine that I built. It carries 120 pounds of steam, is eight feet



long and weighs 1500 pounds. It required two years' spare time and \$300 for material to build it. It is $\frac{2}{3}$ scale of a 65-horsepower Case steam engine.

H. L. Bolton,
Reece, Kan.

☐ Fifty-nine million adults use motorcars daily in the United States.

WHAT Every AUTO MECHANIC Wants to Know

A motor vehicle is a machine of many parts, each part designed and constructed for its own special function. All good mechanics, like good doctors, should know the working theory and operation of each part and understand what causes trouble and how to remedy it.



LET AUDELS AUTO GUIDE SOLVE YOUR PROBLEMS

Every auto mechanic, helper, serviceman and operator can use a copy of AUDELS AUTOMOBILE GUIDE. The information it gives saves time, money and worry. Highly indorsed by all users. It presents the whole subject of auto mechanics from A to Z in plain language and simple terms.

This Big Practical Book gives full information with working diagrams covering the principles, construction, ignition, service and repair of modern cars, trucks and buses.

A complete Guide of 1800 pages, with over 1500 illustrations showing inside views of the working parts, with instructions for service jobs. Diesel engines, Fluid and Hydra-matic drives fully explained.

IT PAYS TO KNOW HOW TO

How to fit pistons—How to locate engine knocks—How to fit connecting rod bearings—How to service main bearings—How to recondition valves—How to time valves—How to adjust fan belts—How to adjust carburetors & chokes—How to rebuild a clutch—How to service automatic transmissions—How to service brakes—How to adjust steering gear—How to cope with ignition troubles—How to service distributors—How to time ignition—How to "tune up" an engine.

INFORMATION IN A HANDY FORM

73 INTERESTING CHAPTERS—Read this partial list of subjects on which practical information is fully given for quick reference under the headings as shown below. Ready Reference Index.

All Parts of an Automobile—Automotive Physics—The Gas Engine—Gas Engine Principles—Multi-Cylinder Engines—Horse Power—Automobile Engines—Stationary Parts—Moving Parts—Pistons—Piston Rings—Connecting Rods—Crank Shafts—Valves—Valve Gear—Cams and Cam Action—Valve Timing—Cooling Systems—Fuel Feed Systems—Dual Fuel Feed—Mixture—Carburetors—Carburetor Service—Automatic Choke—Super-Chargers—Transmissions—Special Transmissions—Fluid and Hydra-matic Drives—Clutches—Universals and Propeller Shafts—

A Ready Reference

—The Differential—Rear Axles—Rear and Front Suspension—Running Gear—Brakes—Wheel Alignment—Knee Action—Steering Gear—Tires—Lubricants and Lubrication—Automotive Electricity—Ignition Systems—Magneto Ignition—Spark Plugs—Ignition Coils—Distributors—Automatic Spark Control—Ignition Timing—Generators—Starters—Generator and Starter Testing—Lighting Systems—Storage Batteries—Charging and Testing—Diesel Engines and Trouble Shooting.

7 DAYS' FREE TRIAL

TO GET THIS ASSISTANCE FOR YOURSELF SIMPLY FILL IN AND MAIL COUPON TODAY.

\$ 4 COMPLETE PAY \$ 1 A ONLY 1 MO.

Ask to See It!

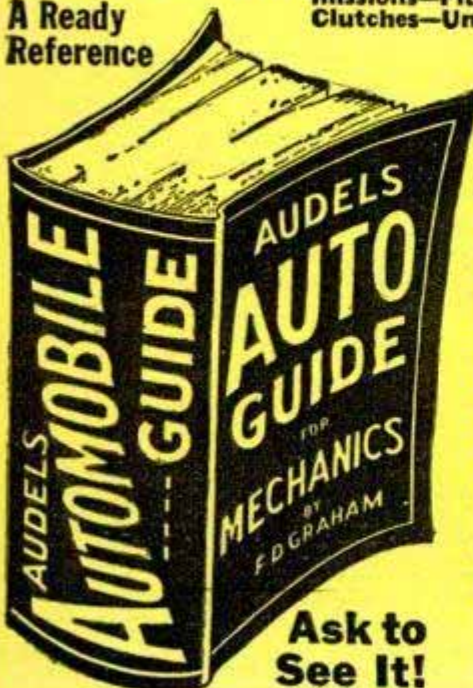

O. K. SAY READERS.....

"Well Worth the Price" "SAVED ME \$50"
 "Most Useful and Complete"
 "It has my Highest Recommendation"
 "The Best Money can Buy"
 "Easy for the Mechanic to Understand"

Sent on 7 Days Approval

Step up your own skill with the facts and figures of your trade. Auodels Mechanics Guides contain Practical Inside Trade Information in a handy form. Fully Illustrated and Easy to Understand. Highly Endorsed. Check the book you want for 7 DAYS FREE EXAMINATION. Send No Money. Nothing to pay postman.

CUT HERE MAIL ORDER

AUDEL, Publishers, 49 W. 23 St., NEW YORK 10, N. Y.

Please send me postpaid for FREE EXAMINATION books marked (X) below. If I decide to keep them I agree to mail \$1 in 7 Days on each book or set ordered and further mail \$1 monthly on each book or set until I have paid price, otherwise I will return them.

- | | |
|---|------|
| <input type="checkbox"/> TRUCK & TRACTOR GUIDE, 1299 Pages . . . | \$ 4 |
| <input type="checkbox"/> AUTOMOBILE MECHANICS GUIDE, 1800 Pages | 4 |
| <input type="checkbox"/> DIESEL ENGINE MANUAL, 575 Pages | 2 |
| <input type="checkbox"/> MACHINISTS HANDY BOOK, 1650 Pages | 4 |
| <input type="checkbox"/> WELDERS GUIDE, 400 Pages | 1 |
| <input type="checkbox"/> BLUE PRINT READING, 416 Pages | 2 |
| <input type="checkbox"/> MATHEMATICS & CALCULATIONS, 700 Pages . | 2 |
| <input type="checkbox"/> SHEET METAL PATTERN LAYOUTS, 1100 Pages | 4 |
| <input type="checkbox"/> SHEET METAL WORKERS HANDY BOOK, 388 Pgs. | 1 |
| <input type="checkbox"/> MECHANICAL DRAWING GUIDE, 160 Pages . . . | 1 |
| <input type="checkbox"/> MECHANICAL DRAWING & DESIGN, 480 Pages | 2 |
| <input type="checkbox"/> AIRCRAFT WORKER, 240 Pages | 1 |
| <input type="checkbox"/> TELEVISION SERVICE MANUAL, 384 Pages . . . | 2 |
| <input type="checkbox"/> RADIOMANS GUIDE, 914 Pages | 4 |
| <input type="checkbox"/> ELECTRONIC DEVICES, 216 Pages | 2 |
| <input type="checkbox"/> ELECTRIC MOTOR GUIDE, 1000 Pages | 4 |
| <input type="checkbox"/> ELECTRIC WIRING DIAGRAMS, 272 Pages | 1 |
| <input type="checkbox"/> ELECTRICIANS EXAMINATIONS, 250 Pages . . . | 1 |
| <input type="checkbox"/> ELECTRIC POWER CALCULATIONS, 425 Pages . | 2 |
| <input type="checkbox"/> HANDY BOOK OF ELECTRICITY, 1440 Pages . . . | 4 |
| <input type="checkbox"/> ELECTRIC DICTIONARY, 9000 Terms | 2 |
| <input type="checkbox"/> ELECTRIC LIBRARY, 7000 Pages (12 Book Set) | 18 |
| <input type="checkbox"/> MARINE ENGINEERS HANDY BOOK, 1258 Pgs. | 4 |
| <input type="checkbox"/> SHIPFITTERS HANDY BOOK, 250 Pages | 1 |
| <input type="checkbox"/> REFRIGERATION & Air Conditioning, 1280 Pgs. | 4 |
| <input type="checkbox"/> MILLWRIGHTS & MECHANICS GUIDE, 1200 Pgs. | 4 |
| <input type="checkbox"/> POWER PLANT ENGINEERS GUIDE, 1500 Pages | 4 |
| <input type="checkbox"/> ENGINEERS & FIREMANS EXAMS, 525 Pages . | 1 |
| <input type="checkbox"/> PUMPS, Hydraulics & Air Compressors, 1658 Pgs. | 4 |
| <input type="checkbox"/> ENGINEERS LIBRARY (3 Book Set) | 9 |
| <input type="checkbox"/> MECHANICAL DICTIONARY, 950 Pages | 4 |
| <input type="checkbox"/> GARDENERS & GROWERS GUIDES (4 Book Set) | 6 |
| <input type="checkbox"/> CARPENTERS & BUILDERS GUIDES (4 Book Set) | 6 |
| <input type="checkbox"/> PLUMBERS & Steamfitters Guides (4 Book Set) | 6 |
| <input type="checkbox"/> MASONS AND BUILDERS GUIDES (4 Book Set) | 6 |
| <input type="checkbox"/> PAINTERS & DECORATORS MANUAL, 450 Pgs. | 2 |
| <input type="checkbox"/> HOUSE HEATING GUIDE, 1000 Pages | 4 |
| <input type="checkbox"/> OIL BURNER GUIDE, 384 Pages | 1 |

Name _____

Address _____

Occupation _____

Employed by _____ P9

AUDEL, Publishers, 49 W. 23 St., New York 10, N. Y.

WHERE-TO-BUY-IT INDEX

Source of supply appears after items commercially available

AUTOMOTIVE

See-saw auto lift (Kurt Goerg, 55 Wolfhagen Strasse, Kassel, Germany)	71
Wet battery shipped without liquid in cells has added useful life (Firestone Tire & Rubber Co., 1200 Firestone Parkway, Akron 17, Ohio)	74
Battery acid kept at constant level by catalytic caps (Industrial Research, Inc., 4016 N.W. 29th St., Miami 42, Fla.)	76
Key-case tire gauge (The Crow's Nest, 475 Fifth Ave., New York City 17)	85
Detroit Listening Post	89
Spacious sports car—the Cyclonic (Harold A. Clark, 7902 West Drive, North Bay Village, Miami 41, Fla.)	104
Built in 1887—and still running	114
Wheel balancer (Morgan Wheel & Equipment Co., 2007 St. Mary's, Omaha, Neb.)	118
Emergency fuel unit (Viking Tool & Machine Corp., 2 Main St., Belleville 9, N. J.)	118
Electric detector spots metal particles (Hines Freund, 126 Tempelhofer Damm, Berlin-Templehof, Germany (American Zone))	119
Reflective sheeting	124
Sportster is a \$6200 hybrid	125
Three-wheel automobile	142
Ventilated backrest keeps driver cool, comfortable. (Earl S. Nolting, Frank Veale Mfg. Co., Inc., 1709 Central Ave., Columbus, Ind.)	142
Record-breaking motorcycle carefully streamlined	147
Streak eliminator (H. & M. Products, 8530 S. Vincennes Ave., Chicago 20)	147
All states approve tinted glass	230

AVIATION

Tip tanks for turboprops increase planes' range	70
24 rockets ring nose of Lockheed's jet Starfire	113
Superspark starts jets (Bendix Aviation Corp., Scintilla Magneto Div., Scintilla, N.Y.)	116
Seven-foot airplane flies 150 miles per hour	117
Navy airship longer than football field	117
Airplane parker speeds operations at Colombian airport	119
Test-stand truck for airplane engines	148
Piper light transport designed for business use (Piper Aircraft Corp., Lockhaven, Pa.)	148

HOUSE AND HOME

Furnace-blower regulator eliminates blast of cold air (Perfection Stove Co., 7609 Platt Ave., Cleveland 4, Ohio)	71
Cardboard easy chair is strong enough to support 2000 pounds (H. Linden, 44-1611 Polk Ave., Houston 2, Tex.)	74
All-weather awnings made from kits (Herbert's Aluminum Awnings, 8974 St. Charles Road, St. Louis 14, Mo.)	116
Electronic amplifier brightens TV	118
Fry bag (Ett-Barr Co., Box 401, Pasadena 18, Calif.)	126
Mending tape (John Dritz & Sons, 1115 Broadway, New York City 10)	126
Door grab (Hobby Hill, Inc., 14 N. Michigan Ave., Chicago 11) 126	126
Range table (Cribben & Sexton Co., 700 N. Sacramento Blvd., Chicago 12)	126
Folding door (Rolscreen Co., Pella, Iowa)	127
Safety incinerator (Alsto Co., 4007 Detroit Ave., Cleveland 13, Ohio)	127
Portable shower (Madca Treasure Chest, 532 Pine Ave., Long Beach 12, Calif.)	127
One-leg table (Bathalde, Knox Products, Inc., Deland, Fla.)	127
Two-in-one brush (Kangaroo Brush Co., 3856 Spring Garden St., Philadelphia 4, Pa.)	143
Door delivered in frame (Haskelite Mfg. Corp., Grand Rapids 2, Mich.)	143
Wallpapering device (Mir-A-Kl. Wallpaper Hanger Co., 116 Danforth Ave., Jersey City 5, N.J.)	143

INDUSTRY

Pour painting	70
"Method X" (Method X Co., 3113 Forbes St., Pittsburgh, Pa.)	75
Steel clips save labor	85
Self-warming power lines	116
Shelf-size water filter (E. Machlett and Son, 220 E. 23rd St., New York City 10)	234

MILITARY

Rugged Patton tank has one-piece cast hull	113
Snow melter	124
"Woodpecker" field phone	147
Flying Jeep	148

OFFICE, SHOP AND STORE

Simplified computing drum figures pay-roll deductions (Kirk Plastic Co., 170 E. Jefferson Blvd., Los Angeles 11, Calif.)	75
Meals cooked and served by coin-operated vending machine (General Electric Co., Syracuse, N.Y.)	75
No-dip fountain pen prevents inky fingers (Sheaffer Pen Co., Fort Madison, Ia.)	116
Winch-run conveyor (Belsaw Machinery Co., 315 Westport Road, Kansas City 2, Mo.)	139
Ink dispenser (Goodenow Co., 4933 Wyandotte, Kansas City 2, Mo.)	236
Mechanical mail clerk	236

(Continued to page 14)

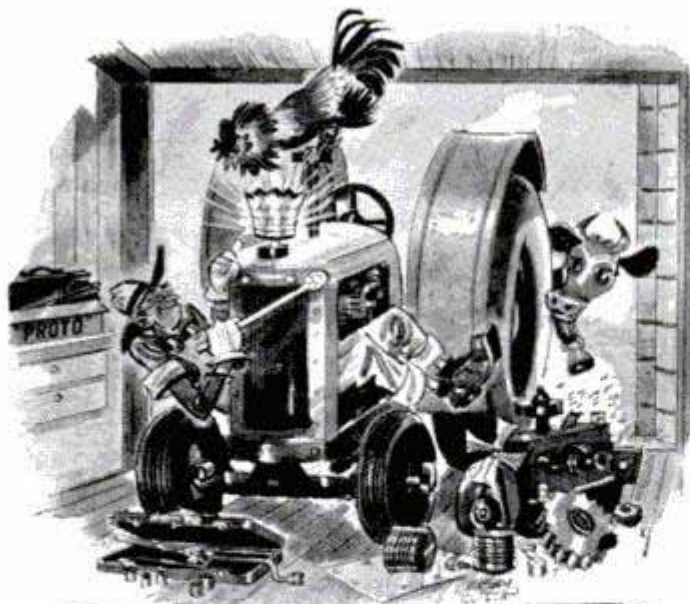

They Know Where e'er
King Tractor Rules... that
PROTO means
PROfessional
TOols!

There are several reasons why *all* tool experts prefer **PROTO** professional tools. User-tested designs provide strength, lightness and ease of handling. **PROTO**-specified alloy steels, properly forged and heat treated, insure extra life. Modern manufacturing produces accurate tools for fast, safe use. And the guarantee protects buyers. Choose the *professional* tools you need from the complete line at your **PROTO** dealer's store. Send 10¢ for 68-page catalog to

PLUMB TOOL COMPANY
2255S Santa Fe Ave., Los Angeles 54, Calif.

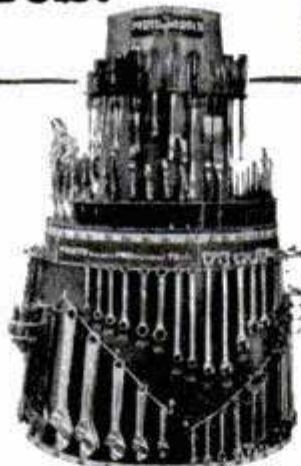

Wrenches • Pliers • Screwdrivers
Punches • Chisels • Sockets
Handles and Many Others.



Eastern Factory—Jamestown, N.Y.

INVENTORS

Learn how to protect your invention. The U. S. Patent Laws provide that any new and useful art, machine, article of manufacture, or composition of matter, or any new and useful improvement thereof, may be patented if the act of invention is involved. Therefore, every inventor with a valuable invention should take advantage of the Patent Laws and proceed for patent protection in order to safeguard his rights.

A patent gives the inventor the exclusive right to prevent others from making, using, or selling the invention claimed in the patent for a period of seventeen years.

The Patent Laws were enacted for the benefit of the inventor to give him protection for the features of his invention which are patentable. These features must be properly and concisely set forth and claimed in a formal application for patent, in order to comply with the requirements of the Patent Laws. For that reason, unless the inventor is familiar with patent matters, he should engage a competent registered patent attorney or agent to represent him. We are registered to practice before the U. S. Patent Office and are prepared to serve you in the handling of your patent matters.

A specially prepared booklet entitled "Patent Guide for the Inventor", containing detailed information with respect to patent protection and procedure, together with a "Record of Invention" form will be promptly forwarded to you without obligation upon request.

CLARENCE A. O'BRIEN & HARVEY JACOBSON

Registered Patent Attorneys

21-J DISTRICT NATIONAL BUILDING

WASHINGTON 5, D. C.

WHAT SECRET POWER DID THIS MAN POSSESS?

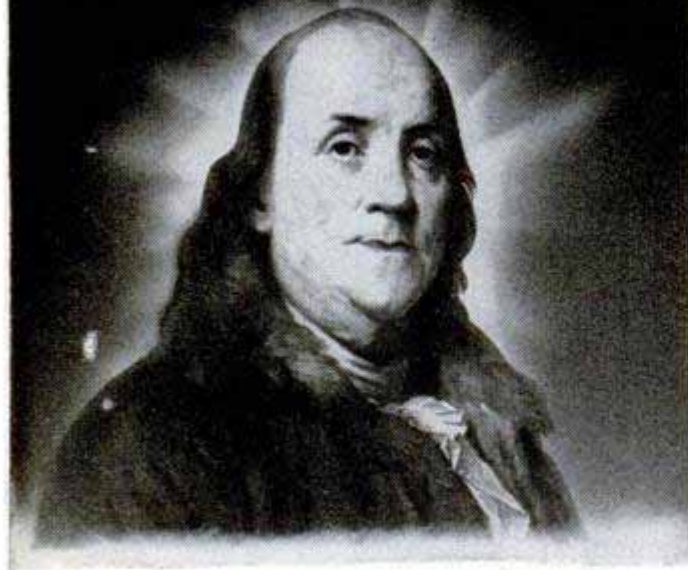

BENJAMIN FRANKLIN
(A Rosicrucian)

WHY was this man great? How does anyone—man or woman—achieve greatness? Is it not by mastery of the powers within ourselves? Know the mysterious world within you! Attune yourself to the wisdom of the ages! Grasp the inner power of your mind! Learn the secrets of a full and peaceful life!

Benjamin Franklin—like many other learned and great men and women—was a Rosicrucian. The Rosicrucians (NOT a religious organization) first came to America in 1694. Today, headquarters of the Rosicrucians send over seven million pieces of mail annually to all parts of the world. Write for YOUR FREE COPY of "The Mastery of Life"—TODAY. No obligation. No salesmen. A non-profit organization. Address: Scribe I.A.R.

THIS BOOK FREE!

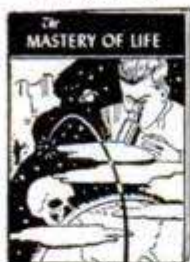

The ROSICRUCIANS

SAN JOSE • (AMORC) • CALIFORNIA

—SEND THIS COUPON—

Scribe I.A.R.
The ROSICRUCIANS (AMORC)
San Jose, California
Please send me the free book, *The Mastery of Life*, which explains how I may learn to use my faculties and powers of mind.

Name _____
Address _____
City _____

(Continued from page 12)

PHOTOGRAPHY

Interchangeable lenses for slide projector (Davidson Mfg. Co., 5146 Alhambra Ave., Los Angeles 32, Calif.)	70
Child's stereoscope (Craftsman Guild, 1001 N. Orange Drive, Hollywood, Calif.)	80
Microfilm file card (Remington Rand Inc., 315-4th Ave., New York City 10)	80
Twin-socket light bar (Eastman Kodak Co., Rochester 4, N. Y.)	123
Exposure guide (Kal & Kal Photo Labs., 707 Blvd. St., Syracuse 11, N. Y.)	123
Photoflash test bulb (Westinghouse Electric Corp., Lamp Div., Watessing Center, Bloomfield, N. J.)	123
Film-trimming aid (E. Leitz, Inc., 304 Hudson St., New York City 18)	123
Wide-angle camera takes "instant" panoramas without tripod (Chiyo-Yoko Co., Ltd., 7-6 Chome, Ginzahigashi, Chuo-ku, Tokyo, Japan)	139

MISCELLANEOUS

"Killer" frigates of Britain and Canada hunt fast new submarines	72
Brookhaven cosmotron has 60-foot 2200-ton magnet	76
Lawn-mower lapper (Fate-Root-Heath Co., Lawnmower Sharpener Div., Plymouth, Ohio)	76
"Manicurist" for steel roadways	77
You name it!	78
Deaf-blind "talker" taps fingertips	80
A scientist diagnoses the flying saucer	95
Can jet boat blast record?	112
Zippered-back wheel chair (American Wheel Chair Co., Inc., 3451 West 5th Ave., Chicago 24)	119
Book restorer	124
"Hit me" sign	124
Huge French hangars have concrete roofs	133
British locomotive has jet engines	139
Go hunting on a "Go-Devil"	140
Sighting device helps golfers achieve straighter strokes (Tru-Stroke Co., 9 E. Broadway, Alton, Ill.)	142
Wakeless torpedo	143
Revolver grip holds ammunition (George Wylie, 5320 Miller Ave., Gary, Ind.)	234
Full-color wirephotos sent by fast method	282

Craftsman and Shop Notes Index

AUTOMOTIVE

Leaky gas line on stranded truck sealed with clay in emergency	171
"Rodding" clogged auto radiator	184
Emergency flare protects driver while making tire repairs	189

FARM AND GARDEN

Sack duster for home garden	180
Car frame provides useful skid for hauling of heavy objects	195
Giant self-feeder containing hay saves work on dairy farm	195
Toy balloon discourages hens from eating eggs	195
Trailer fitted with tractor tires has greater load capacity	203
Roof over area between hog houses provides shady "breeze-way"	203
Water piped from windmill pump cools milk and waters stock	209
Hay bales protect celery in ground during early winter months	209
Garden tools stored overhead in racks suspended from ceiling	210
Loading winch on machinery trailer driven by tractor power take-off	210

HOBBIES AND NOVELTIES

Storage bags for children's toys	158
Kazoo provided by combining clothespin and strip of paper	160
Don't throw out the clock	161
Colored stripe on golf ball simplifies identification	164
Two-tone target	171
Drying wet negatives	192

HOUSE AND HOME

Glass held by window hangers for storage on wall	159
Solving home problems	162
Absorbent-cotton dispenser	164
Tool made from dowel and wire speeds job of pitting cherries	167
Cactus having artificial blossoms appears to bloom perennially	167
Cut-flower arrangement in vase held firmly by Vermiculite	170
Sandpaper mask around keyhole helps guide key at night	180
Bobbins stored on nail	180
Shield under coffee-pot handle prevents burned fingers	182
Shutters used inside windows in place of Venetian blinds	182
Citrus fruit attracts birds	184
Indoor window garden	185

JIGS, GAUGES AND FIXTURES

Medicine-dropper bulb makes emergency grommet	167
"Collet" improvised from copper tubing for salvaging broken drills	203
Sandpaper facing on miter gauge prevents "creeping" of work	209
Gauge for plane-iron holder indicates grinding angle	210

(Continued to page 16)

IMPORTANT NOTICE—It is the intention of this magazine to provide its readers with information regarding the latest developments in the mechanical arts. We take no responsibility as to whether the disclosures contained in our articles are covered by patents and advise readers to investigate this subject before making, using, or selling any of the products, machines, or processes described in order to avoid possible liability for patent infringements.

INVENTORS

If you believe that you have an invention, you should find out how to protect it. The first step is to have a search made of the prior pertinent U. S. patents. If a report on this search indicates that the invention appears patentable you can apply for a patent, and the specifications and claims should be prepared.

The firm of McMorrow, Berman & Davidson, with offices in Washington, D. C., is qualified to take the necessary steps for you. We can make a preliminary search on your invention, advise you whether we think it can be patented, and prepare your application for patent.

Unless you are fully familiar with the U. S. Patent Laws, we recommend that you engage the services of a Registered Patent Attorney to protect your interests. The patent laws are *your* laws. A patent gives you the right to prevent others from making, using or selling the invention claimed in your patent for a period of 17 years.

Use these patent laws for your protection. Investigate whether your invention can be patented. If you have what you believe to be an invention, we suggest that you have this firm make a search for you.

Send for a copy of our Patent Booklet entitled "How To Protect Your Invention," containing information about patent protection and patent procedure. Along with this we will also send you an "Invention Record" form, for your use in writing down and sketching details of your invention. We will mail them promptly. No obligation. They are yours for the asking.

McMORROW, BERMAN & DAVIDSON

Registered Patent Attorneys

PATENTS • COPYRIGHTS • PATENTS

135-B VICTOR BUILDING, WASHINGTON 1, D. C.

NOW YOU CAN BUILD IT WITH CONCRETE BLOCKS



This practical guide shows every step from how-to-plan to how-to-build with one of the most abundant and economical building materials known to man. Over a hundred pictures and cut-away diagrams show exactly what to do and what not to do. Tells how to plan, place corner block, make foundations easily, how to paint for special purposes. A picture story of everything in building any type of structure with concrete blocks, easily and inexpensively.

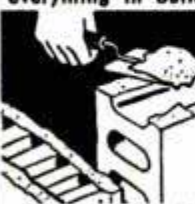

Here's how to apply Mortar

Here's how little this book costs you . . . or if you don't keep it after 10 days trial, return it and you owe nothing. **\$2.75**

CARPENTRY FOR EVERYONE



A clear explanation of modern carpentry construction including framing, roof constructions, general carpentry work, exterior and interior finish of buildings, building forms and working drawings, and farm buildings. Covers everything you need to know about lumber, tools, joints and splices, floors, stairs, partitions, rafters, etc. Gives short cuts and tricks used by the master carpenter. Easy to understand. 504 pages, 580 illustrations. **\$2.50.** Use 10 day no-cost trial coupon below.

INSTALL & REPAIR YOUR OWN PLUMBING

How to Design and Install Plumbing by A. J. Matthias, Jr. A completely up-to-date guide that fits the needs of the beginner yet so complete that even the master plumber can pick up some new tricks of the trade. Contains hundreds of illustrations, full size blueprints, specifications and instructive details for septic tanks, storm drainage, soil pipe, water supply, fixtures, traps, drains, pumps, etc. An outstanding feature is complete design and installation of plumbing in a modern six-room, two bath residence. 349 illustrations, 442 pages. **\$3.95.** Use coupon.

Mail this coupon today—10 days trial at no cost to you

American Technical Society, Dept. C-619
848 East 58th Street, Chicago 37, Illinois

Please rush me the following books I'm checking below to examine at home. If I'm not convinced these books will help me save thousands of dollars by doing my own building and planning, I may return the books and owe nothing.

- | | | | |
|--------------------------|--|--|--------|
| <input type="checkbox"/> | CONCRETE BLOCK CONSTRUCTION FOR HOME AND FARM..... | \$2.75 | |
| Examine | <input type="checkbox"/> | CARPENTRY | \$2.50 |
| at home | <input type="checkbox"/> | HOW TO DESIGN AND INSTALL PLUMBING | \$3.95 |
| at no | Other How-to-do-it books, profusely illust. | | \$1.75 |
| cost. | <input type="checkbox"/> | Painting and Decorating | \$3.95 |
| | <input type="checkbox"/> | Electric Wiring—Residential and Farm Bldgs. | \$3.00 |
| | <input type="checkbox"/> | How to Insulate Home & Farm Bldgs. | \$3.00 |
| | <input type="checkbox"/> | Bricklaying—Skill and Practice | \$2.25 |
| | <input type="checkbox"/> | Steel Squares | \$2.25 |

Name _____

Address _____

City _____ State _____

- Ten day no-cost-trial. If I keep books, will remit by check or money order.
- Send C.O.D. Same return privilege—money refunded.
- I'm enclosing \$ _____ now to save postage—same return privilege—money refunded.

(Continued from page 14)
OFFICE, SHOP AND STORE

- Inexpensive fire extinguisher utilizes plastic container.....158
- Pocket-type pencil sharpener attached to inside of drawer...170
- War-surplus vibration dampeners provide typewriter feet....180
- Substitute stencil ink.....195

TOOLS

- Concrete forms removed quickly with special wrecking bar...164
- One-piece outdoor tool kit.....164
- Improvised screwdriver bit.....170
- Tamp improvised from scrap parts.....182
- Separate mandrel in slip roll forms sheet-metal tubing.....203

WOODWORKING

- Linoleum paste used as filler.....158
- Modern bookcase.....159
- Plan of the month—plant stands.....168
- Foldaway crib.....181
- Jigsawed boot scrapers.....183

WORKSHOP HINTS

- Lock washer quickly improvised.....158
- Nail with shoulder filed on end makes improvised brad driver...160
- Fired .22 caliber cartridges used as substitutes for rivets.....161
- Beeswax coating binds nail in hole.....167
- Cork removed from bottle with jigsaw blade.....170
- Reshaping hand-plane cap iron.....182
- Section of old bicycle frame provides workbench stool.....184
- Oilstoning saw teeth after filing improves performance of blade.....202

MISCELLANEOUS

- Clothespin keeps electric cord in wall outlet.....158
- Care of small boat in autumn simplifies spring painting.....159
- Index marks permit binoculars to be focused rapidly.....160
- Container for live bait made from milk carton.....160
- Spray gun altered to take small cans of paint.....164
- Wood-chopping safeguard.....167
- Guard for tractor-tire valve stem.....167
- Motorcycle stored in basement with aid of portable stand.....180
- Substitute brush for electric razor.....182
- Extra mantles carried on lantern.....184
- "Frock" worn over wrist watch keeps out dirt.....189

Radio-Television, Electronics

- Twin antenna for VHF and UHF (La Pointe-Plascomold Corp., Windsor Lock, Conn.).....211
- Three-station UHF-TV translator (General Electric Co., Electronics Park, Syracuse, N. Y.).....211
- Indoor reflector corner-type UHF TV antenna (RCA Victor Corp., Camden, N. J.).....211
- Miniature TV receiver (E.M.T. Sales and Service Ltd., Hayes, Middlesex, England).....211
- Battery eliminator for portables and farm radios.....212
- Lightweight radar set steps up plane safety.....214
- Binaural tape recorder and amplifier (Allied Radio Corp., 833 W. Jackson Blvd., Chicago 7).....216
- Folded corner enclosure for 8" speakers (Electro-Voice Inc., Buchanan, Mich.).....216
- Williamson 10-watt amplifier kit (Standard Transformer Corp., 3580 Elston Ave., Chicago).....216
- Portable battery-operated tape recorder (E.M.I. Factories, Ltd., Hayes, Middlesex, England).....216

Discover Tiniest Star

Said to be the smallest star known to man, a recently discovered astral body is about the size of our moon. But, although it would take 40 million of such stars to equal the sun in volume, it weighs 40 percent more, according to astronomers at the universities of Minnesota and Arizona. Only 2500 miles in diameter, it is one of the "white dwarf stars," all of which have fantastically high densities. Average material of the new star is about 55 million times as dense as water, the discovering scientists estimate. Known only by its catalogue number, L 886-6, the tiny star is located in the winter evening Milky Way about midway between the Big and Little Dog Stars at a distance of 25 light years from the earth, and is 10,000 times too faint to be seen by the unaided eye.



Picture yourself going places



You've done it often. Call it day-dreaming if you like, but you've seen yourself in a bigger job — giving orders and making decisions — driving off in a smart new car — buying your family a fine home.

There's nothing wrong with dreams. But how about making them come true? *You can do it, if you're willing to try!*

Look around you. The men who are going places are the *trained* men. They've learned

special skills that bring them better jobs and higher pay. It's the men *without* training whose dreams never come true.

What are you going to do about it? Just wait and wish? If you really *want to succeed*, you can get the training you need by studying at home in your spare time. International Correspondence Schools offer you a course in just about any field you choose, giving you the practical plus the bedrock facts and theory. No skimming or skimping! And you'll be earning while you learn. Students report better jobs and more pay within a few months.

Look over the list of subjects in the coupon below. Pick out the one that interests you most — the one that holds the greatest future for you. Then mark the coupon, and mail it today. *Find out* what I. C. S. can do for you. It costs only a stamp or postcard, but it's the first step if you want to go places!

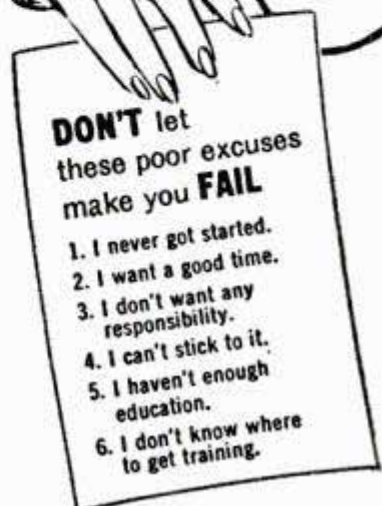

DON'T let these poor excuses make you **FAIL**

1. I never got started.
2. I want a good time.
3. I don't want any responsibility.
4. I can't stick to it.
5. I haven't enough education.
6. I don't know where to get training.

GOING INTO THE ARMY OR NAVY?

Earn more pay, win a higher rating, quicker promotion by having this specialized knowledge and credit. I. C. S. courses have helped thousands advance in the services.



SMARTEST THING HE EVER DID

"I noticed that the trained men held the better jobs. That's when I decided to take an I. C. S. course. Enrolling with I. C. S. was one of the smartest things I ever did. The position as Plant Engineer I hold today is largely due to the 'know-how' derived from my I. C. S. texts. I. C. S. can help any man who will study."

L. P. S., Elkhart, Ind.

INTERNATIONAL CORRESPONDENCE SCHOOLS



BOX 5537-L, SCRANTON 9, PENNA.

Please send information about I.C.S. employee training for companies.

Without cost or obligation, please send me the booklet about the course BEFORE which I have marked X:

- | | | | | |
|---|---|---|---|---|
| <p>ART</p> <ul style="list-style-type: none"> <input type="checkbox"/> Commercial Art <input type="checkbox"/> Magazine and Book Illustrating <input type="checkbox"/> Cartooning <input type="checkbox"/> Show Card and Sign Lettering <input type="checkbox"/> Fashion Illustrating AUTOMOTIVE <input type="checkbox"/> Automobile, Mechanic <input type="checkbox"/> Auto-Elec. Technician <input type="checkbox"/> Auto Body Rebuilding and Refinishing <input type="checkbox"/> Diesel—Gas Engines AVIATION <input type="checkbox"/> Aeronautical Engineering Jr. <input type="checkbox"/> Aircraft Engine Mechanic <input type="checkbox"/> Airplane Drafting BUILDING <input type="checkbox"/> Architecture <input type="checkbox"/> Arch. Drafting <input type="checkbox"/> Building Contractor <input type="checkbox"/> Estimating <input type="checkbox"/> Carpenter and Mill Work <input type="checkbox"/> Carpenter Foreman <input type="checkbox"/> Reading Blueprints <input type="checkbox"/> House Planning <input type="checkbox"/> Plumbing | <ul style="list-style-type: none"> <input type="checkbox"/> Heating <input type="checkbox"/> Steam Fitting <input type="checkbox"/> Air Conditioning <input type="checkbox"/> Electrician BUSINESS <input type="checkbox"/> Business Administration <input type="checkbox"/> Certified Public Accountant <input type="checkbox"/> Accounting <input type="checkbox"/> Bookkeeping <input type="checkbox"/> Stenography and Typing <input type="checkbox"/> Secretarial <input type="checkbox"/> Federal Tax <input type="checkbox"/> Business Correspondence <input type="checkbox"/> Personnel and Labor Relations <input type="checkbox"/> Advertising <input type="checkbox"/> Retail Business Management <input type="checkbox"/> Managing Small Business <input type="checkbox"/> Sales Management <input type="checkbox"/> Salesmanship <input type="checkbox"/> Traffic Management CHEMISTRY <input type="checkbox"/> Chemical Engineering <input type="checkbox"/> Chemistry <input type="checkbox"/> Analytical Chemistry <input type="checkbox"/> Petroleum—Nat'l Gas <input type="checkbox"/> Pulp and Paper Making <input type="checkbox"/> Plastics | <p>CIVIL, STRUCTURAL ENGINEERING</p> <ul style="list-style-type: none"> <input type="checkbox"/> Civil Engineering <input type="checkbox"/> Structural Engineering <input type="checkbox"/> Surveying and Mapping <input type="checkbox"/> Structural Drafting <input type="checkbox"/> Highway Engineering <input type="checkbox"/> Reading Blueprints <input type="checkbox"/> Concrete Construction <input type="checkbox"/> Sanitary Engineering DRAFTING <input type="checkbox"/> Aircraft Drafting <input type="checkbox"/> Architectural Drafting <input type="checkbox"/> Electrical Drafting <input type="checkbox"/> Mechanical Drafting <input type="checkbox"/> Structural Drafting <input type="checkbox"/> Sheet Metal Drafting <input type="checkbox"/> Mine Surveying and Drafting ELECTRICAL <input type="checkbox"/> Electrical Engineering <input type="checkbox"/> Electrician <input type="checkbox"/> Electrical Maintenance <input type="checkbox"/> Electrical Drafting <input type="checkbox"/> Electric Power and Light <input type="checkbox"/> Lineman HIGH SCHOOL <input type="checkbox"/> High School Subjects | <ul style="list-style-type: none"> <input type="checkbox"/> College Preparatory <input type="checkbox"/> Mathematics <input type="checkbox"/> Commercial <input type="checkbox"/> Good English MECHANICAL AND SHOP <input type="checkbox"/> Mechanical Engineering <input type="checkbox"/> Industrial Engineering <input type="checkbox"/> Industrial Supervision <input type="checkbox"/> Foremanship <input type="checkbox"/> Mechanical Drafting <input type="checkbox"/> Machine Design-Drafting <input type="checkbox"/> Machine Shop Practice <input type="checkbox"/> Tool Design <input type="checkbox"/> Industrial Instrumentation <input type="checkbox"/> Machine Shop Inspection <input type="checkbox"/> Reading Blueprints <input type="checkbox"/> Toolmaking <input type="checkbox"/> Gas—Electric Welding <input type="checkbox"/> Heat Treatment—Metallurgy <input type="checkbox"/> Sheet Metal Work <input type="checkbox"/> Sheet Metal Pattern Drafting <input type="checkbox"/> Refrigeration POWER <input type="checkbox"/> Combustion Engineering <input type="checkbox"/> Diesel—Electric <input type="checkbox"/> Electric Light and Power | <ul style="list-style-type: none"> <input type="checkbox"/> Stationary Steam Engineering <input type="checkbox"/> Stationary Fireman RADIO, TELEVISION, COMMUNICATIONS <input type="checkbox"/> General Radio <input type="checkbox"/> Radio Operation <input type="checkbox"/> Radio Servicing—FM <input type="checkbox"/> Television <input type="checkbox"/> Electronics <input type="checkbox"/> Telephone Work RAILROAD <input type="checkbox"/> Locomotive Engineer <input type="checkbox"/> Diesel Locomotive <input type="checkbox"/> Air Brakes <input type="checkbox"/> Car Inspector <input type="checkbox"/> Railroad Administration TEXTILE <input type="checkbox"/> Textile Engineering <input type="checkbox"/> Cotton Manufacture <input type="checkbox"/> Rayon Manufacture <input type="checkbox"/> Woolen Manufacture <input type="checkbox"/> Loom Fixing <input type="checkbox"/> Finishing and Dyeing <input type="checkbox"/> Textile Designing HOME ARTS <input type="checkbox"/> Dressmaking and Designing <input type="checkbox"/> Cookery <input type="checkbox"/> Tea Room Management |
|---|---|---|---|---|

Name _____ Age _____ Home Address _____

City _____ State _____ Working Hours _____ A.M. to _____ P.M.

Occupation _____

Special tuition rates to members of the Armed Forces. Canadian residents send coupon to International Correspondence Schools Canadian, Ltd., Montreal, Canada.

The 97 Pound Weakling

who became "The World's Most Perfectly Developed Man"

"I'll Prove that YOU, too, can be a NEW MAN!"

Charles Atlas

I KNOW, myself, what it means to have the kind of body that people pity! Of course, you wouldn't know it to look at me now, but I was once a skinny weakling who weighed only 97 lbs. I was ashamed to strip for sports or undress for a swim. I was such a poor specimen of physical development that I was constantly self-conscious and embarrassed. And I felt only HALF-ALIVE.

Then I discovered "Dynamic Tension." It gave me a body that won for me the title "World's Most Perfectly Developed Man."

When I say I can make you over into a man of giant power and energy, I know what I'm talking about. I've seen my new system "Dynamic Tension" transform hundreds of weak, puny men into Atlas Champions.

Only 15 Minutes a Day

Do you want big, broad shoulders—a fine, powerful chest—biceps like steel—arms and legs rippling with muscular strength—a stomach ridged with bands of sinewy muscle—and a build you can be proud of? Then just give me the opportunity to prove that "Dynamic Tension" is what you need.

No "if's," "and's," or "may-bes." Just tell me where you want handsome, powerful muscles. Are you fat and flabby? Or skinny and gawky? Are you short-winded, peppy? Do you hold back and let others walk off with the prettiest girls, best jobs, etc.? Then write for details about "Dynamic Tension" and learn how I can make you a healthy, confident, powerful HE-MAN.

"Dynamic Tension" is an entirely NATURAL method. Only 15 minutes of your spare time daily is enough to show amazing results—and it's actually fun! "Dynamic Tension" does the work.

FREE — My 32-Page Illustrated Book Yours — Not \$1 or 10c — But FREE



Send NOW for my famous book, "Everlasting Health and Strength." 32 pages, packed from cover to cover with actual photographs and valuable advice. Shows what "Dynamic Tension" can do, answers many vital questions. Page by page it shows what I can do for YOU.

This book is a real prize for any fellow who wants a better build. Yet I'll send you a copy absolutely FREE. Just glancing through it may mean the turning point in your whole life! Rush the coupon to me personally: Charles Atlas, Dept. 8W, 115 East 23rd St., New York 10, N. Y.

CHARLES ATLAS, Dept. 8W, 115 East 23rd St., New York 10, N. Y.

Send me — absolutely FREE — a copy of your famous book, "Everlasting Health and Strength" — 32 pages, crammed with actual photographs, answers to vital health questions, and valuable advice to every man who wants a better build. I understand this book is mine to keep, and sending for it does not obligate me in any way.

Name _____ Age _____
 Address _____
 City _____ State _____

(Please print or write plainly)



CHARLES ATLAS

Holder of Title "The World's Most Perfectly Developed Man"

No Experience Needed To PRINT YOUR OWN POST CARDS

The GEM STENCIL DUPLICATOR saves money... gets results quickly! Hundreds of uses for every type of business and organization. We ship the GEM complete with all supplies. Guide Board for accurate printing and 60-page Book of Ideas at the special low price of only \$9.50 (a \$15 value).

FREE TRIAL OFFER

Our 21st Year

Use the GEM FREE at our expense! SEND NO MONEY. Write and complete GEM outfit will be sent you postpaid. After ten days, send us only \$9.50 or return the GEM. You must be satisfied!

BOND EQUIPMENT CO. Dept. 135
 6633 Enright • St. Louis 5, Mo.



FALSE TEETH

KLUTCH holds them tighter

KLUTCH forms a comfort cushion; holds dental plates so much firmer and snugger that one can eat and talk with greater comfort and security; in many cases almost as well as with natural teeth. Klutch lessens the constant fear of a dropping, rocking, chafing plate. 25c and 50c at druggists... If your druggist hasn't it, don't waste money on substitutes, but send us 10c and we will mail you a generous trial box.

KLUTCH CO. Box 5293-I ELMIRA, N. Y.



SEND FOR THIS FREE!

Make money. Know how to break and train horses. Write today for this book FREE, together with special offer of a course in Animal Breeding. If you are interested in Galting and Riding the saddle horse, check here () Do it today—now.

BEERY SCHOOL OF HORSEMANSHIP
 Dept. 1109 Pleasant Hill, Ohio

LAW FREE BOOK



Your FREE copy of "The Law-Trained Man" shows how to gain prestige and greater earnings through Blackstone home law study. All instruction material furnished including 16-volume Law Library written by 65 well-known law authorities. Lawyers, judges among our graduates. LL.B. degree. Low cost; easy terms. Write today.

BLACKSTONE COLLEGE OF LAW Dept. 56, Chicago 1, Ill.
 A Correspondence Institution Founded in 1890

I Built My Modern New Home with EXTRA MONEY

Selling Stark Fruit Trees, Roses, Flowering Shrubs, Vines!
Exceptional Week's Earnings \$1,122.15!



If you really want to turn full time or spare hours into big money... follow the lead of Merle Winlers who earned exceptional profits as high as \$1,122.15 in a single week with Stark Bro's. This exceptional opportunity is wide open to any ambitious man or woman. Stark Bro's world famous exclusive U. S. Patented and Trade Marked Fruit tree varieties are Super-Quality. Stark Bro's now help you cash in vast new-home market with Super-Quality flowering shrubs, roses, shade trees...

everything to make the home beautiful. NO EXPERIENCE NEEDED. We show you how and supply Giant new SALES KIT FREE.
STARK BRO'S Nurseries & Orchards Co.
 Desk 5593 Town of Louisiana, Missouri

**Train QUICK
in Big Coyne
shops**

GREAT OPPORTUNITY FIELDS!

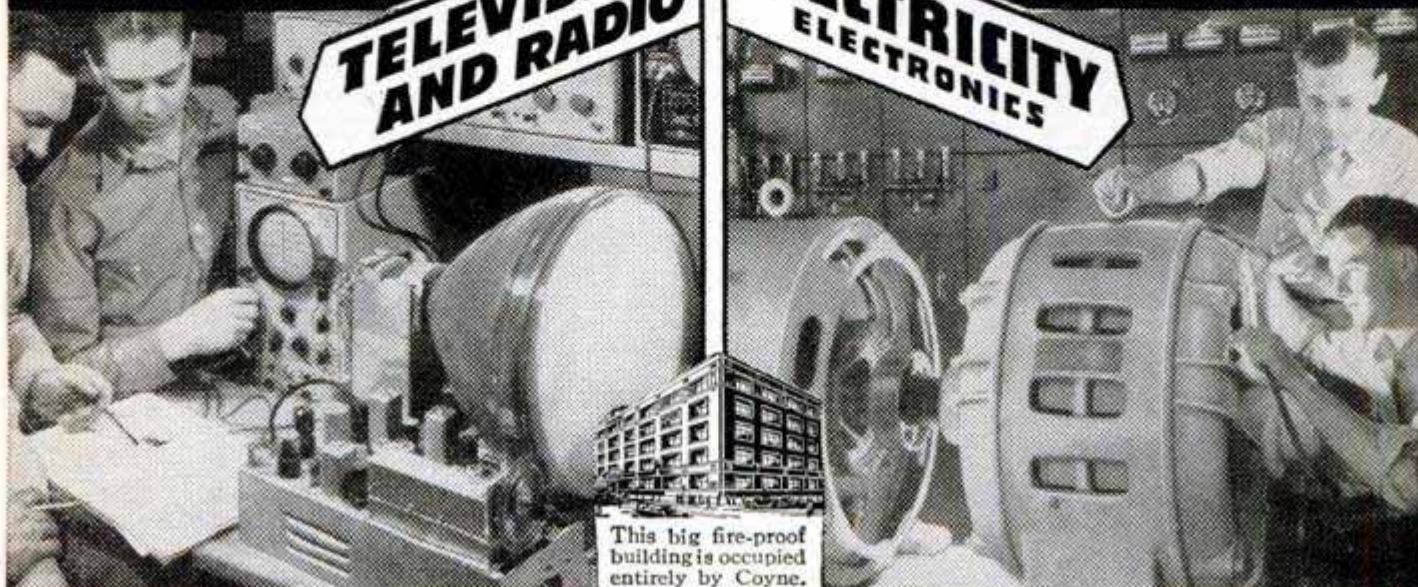

TRAINED YOUNG AND OLDER MEN — VITALLY NEEDED IN NATION'S DEFENSE AND MILITARY PROGRAMS

Where do you fit in today's gigantic Defense Program and Industrial expansion? Trained young and older men will play an important part in vital fields. Electricity and Television-Radio are essential to our Defense Program in both Industry and Armed Forces. Don't wait to be assigned to a dull, low pay, no future job. Get training Quick at Coyne and be ready to pick one of many job opportunities or get a better rating if drafted. Today it's not how young or how old you are that counts, but how prepared you are for jobs that demand skilled men. So, qualify now for:

1. BETTER RATING, HIGHER PAY IF DRAFTED.
2. A VITAL JOB IN INDUSTRY, IF NOT IN DRAFT.

NOT "HOME-STUDY" LESSONS

Our famous Television-Radio Practical-Technical method gives you practical experience on a massive outlay of equipment. Not by correspondence lessons, but actual shop work plus necessary technical training. You are trained right here in the great Coyne shops that have been training men and young men for over 50 years.

TELEVISION-RADIO ELECTRICITY

A great opportunity field and vital to Defense. Here at COYNE you're trained for Construction, Testing, Trouble-Shooting on Radio, Public Address, Sound Units. Training includes FM, Television Installations, Servicing, etc. Many Coyne trained men in good jobs or own well paying Television-Radio businesses of their own.

INCLUDING INDUSTRIAL ELECTRONICS

The Power behind the entire Defense Program. Big future in Power Plant Work, Motors, Armature Winding, Home and Factory Wiring, Appliances, Refrigeration, Maintenance, Illumination, etc. Lifetime job service to Coyne graduates. Send for BIG FREE BOOK.

LARGEST, OLDEST, BEST EQUIPPED SCHOOL OF ITS KIND IN THE U.S.

**Mail Coupon for
Big FREE Book!**



Whether you prefer Television-Radio or Electricity, train on actual equipment at Coyne. We will send you a Big, fully illustrated Book, indicate below, which course interests you most. No salesman will call. Mail coupon TODAY.



START NOW—PAY LATER

Don't let lack of money hold you back. You can finance most of your tuition and pay for it later, in easy monthly payments. Special plan for men of draft age. We'll help you get part time work, if you need it, to help pay living costs while at Coyne.

G. I. APPROVED

B. W. COOKE, President

COYNE

SCHOOL

A TECHNICAL TRADE INSTITUTE
CHARTERED NOT FOR PROFIT
Established 1899
500 S. Paulina Dept. 62-72H
Chicago 12, Illinois

ELECTRICITY ★ TELEVISION ★ RADIO ★ REFRIGERATION ★ ELECTRONICS

B. W. Cooke, President
COYNE SCHOOL, 500 S. Paulina St.
Dept. 62-72H, Chicago 12, Ill.

Send me your Big Free book, and details of your special plan for men of draft age. I am interested in field checked below. This does not obligate me.

TELEVISION-RADIO ELECTRICITY

NAME.....

ADDRESS.....

CITY..... STATE.....

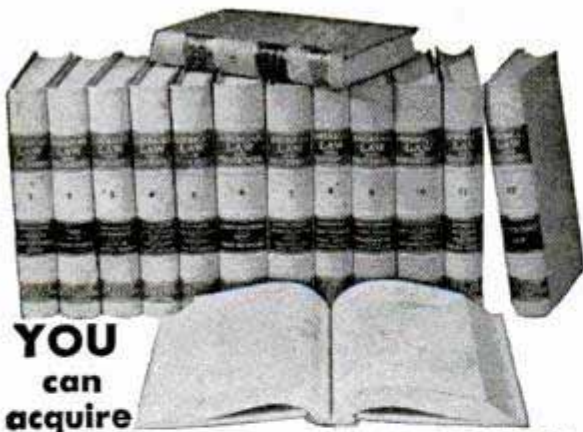

**YOU
can
acquire**

LAW NIGHTS AT HOME! L. L. B. DEGREE

LaSalle's famous Law Library—used as reference in many Law libraries and Law offices—has enabled thousands to master Law surprisingly fast, in spare hours at home, for business and professional advancement.

These 14 remarkable volumes, compiled by leading professors and lawyers, cover the whole basic field of Law in condensed, orderly, simplified manner.

You advance rapidly with this great library, plus special lectures furnished. We guide you step-by-step with personalized Problem Method of instruction . . . you learn by doing—handling legal problems—not by memorizing rules.

Send for two FREE 48-page booklets, "Law Training for Leadership," and "Evidence," answering questions about Law and its value to you, and telling how LaSalle Law graduates are winning rapid advancement in business and public life. Mail coupon below. No obligation.

LA SALLE EXTENSION UNIVERSITY A Correspondence Institution

417 S. Dearborn St. Dept. 964L Chicago 5, Ill.

Send me your two FREE booklets described above, without obligation.

Name Age

Street

City, Zone & State

ENGINEERING DEGREE IN 27 MONTHS

Big Demand for Graduates

Aeronautical, Chemical, Civil, Electrical, Mechanical and Radio Engineering (inc. TV and Electronics)

Hundreds of young men are earning B. S. ENGINEERING DEGREES annually in this recognized institution — year around operation. New terms start quarterly. Many students earn a major part of their college expenses in this large industrial center.

Low tuition. Competent instruction. Thorough, intense, practical program. Modern, well-equipped laboratories including new physics laboratory and modern wind tunnel. Individualized instruction emphasized.

Government approved for G.I.'s. Engineering preparatory courses. Students from 48 states and 21 foreign countries. Enter September, December, March, June. Send coupon for free catalog and full information. Enroll now.

SEND COUPON TODAY

INDIANA TECHNICAL COLLEGE

592 E. Washington Boulevard
Fort Wayne 2, Indiana

Please send me free information on B.S. Engineering Degree in 27 months as checked.

Aeronautical, Chemical, Civil, Electrical,
 Mechanical, Radio-Television

Name

Address

LEOPARD
COWHIDE

\$298

**REVERSIBLE
AUTO SEAT
COVERS**

Made of
FLEXTON
Approved by
Good Housekeeping

Order direct from manufacturer and save!

LEOPARD SKIN on one side

- COWHIDE on the other. Made of Heavy Gauge plastic for long wear
- WATERPROOF and STAINPROOF
- Simple to attach—with REINFORCED OVERLAP side grip elastics that hold securely
- PERFECT FIT COVERS are made roomy and dress up your car's interior
- PATENTED SHIRRING holds seat and back neatly. Sewn with NYLON THREAD for long wear. LONG WEARING-DOUBLE DUTY

5 DAY MONEY-BACK GUARANTEE!

- CHOICE OF SPLIT OR FULL FRONT SEAT STYLES only \$2.98.
- Complete set for front and rear seats only \$5.00. When ordering specify make of car and style of seat. Order NOW Enclose payment and save shipping charges. C.O.D. orders sent collect plus postage.
- MARDO SALES CORP., Dept. R-381
- 480 Lexington Avenue New York 17, N. Y.

LEARN WATCH REPAIRING

AT HOME. By our modern and original system of instruction you can learn every part of the **WATCH REPAIRING TRADE AT HOME.** Prepare yourself for a well-paying position or start in business after completing our course of instruction. Good watch repairers are in demand and generally earn very good salaries. For particulars apply to the

WISCONSIN SCHOOL OF WATCH REPAIRING
759 N. Milwaukee, Dept. 9, Milwaukee 2, Wis.

SHINE WITHOUT 'POLISH'

New Invention! • Sells Like Wild

Replaces messy pastes, liquids. Simply glide over shoes—and PRESTO!—you have a lustrous, long-lasting shine. No mess. No muss. No soiled hands. Clean, Handy. **WORKS LIKE MAGIC!** For Men's, Women's and Children's Shoes. Low priced. Lightning seller!

SAMPLES FOR AGENTS Sample offer sent immediately to all who send name at once. Hurry. Postcard will do. **SEND NO MONEY—just your name.** KRISTEE CO., Dept. 693, AKRON 8, OHIO

\$5000.00 IN PRIZES DRAW MY HEAD

1st & 2nd PRIZES
**COMPLETE \$130 ART COURSE
80 OTHER VALUABLE PRIZES**
Your Drawing Judged and Answered

Take this test and try for a thrilling prize. Discover if you have profitable Art talent. You may gain a lifetime of happiness and high earnings. If you mail your drawing today. Amateurs only. Our present students not eligible. Copy this girl 4" to 6" high in pen or pencil, and mail to us. None returned. Winners notified. New \$5,000 Contest each month. Your drawing will be entered in Contest for month in which we receive it. Send your drawing now with your name, address, age, occupation. Enter today.

WALLER ART EXCHANGE Studio 141, 1000 N. Charles St. Baltimore-1, Maryland

MAKE EXTRA MONEY PLASTICS LEARN AT HOME

LEARN HOW TO MAKE fast-selling PLASTIC NOVELTIES FURNITURE JEWELRY SIGNS TOYS LAMPS

There are RICH OPPORTUNITIES for MEN and WOMEN with "know-how" in Plastics. Interstate's new Plastics course tells and shows how to make hundreds of fast selling items out of Plastics. Gives complete training in fabrication, casting, lamination, molding, internal carving, etc., in simple, easy, step-by-step language and pictures. Plastics and Fabricating Kits for 23 valuable Plastic items come with training at no extra cost. **START A PLASTICS BUSINESS OF YOUR OWN.** No other industry holds such promise for the future. You can make big money manufacturing novelties, toys, signs, etc., in your own home in spare or full time. Don't wait! Learn NOW how Interstate's Plastics Training qualifies you for success in the Plastics field.

PLASTICS AND SUPPLIES FURNISHED FOR 23 VALUABLE PROJECTS

INTERSTATE TRAINING SERVICE
Dept. 3CJ Portland 13, Oregon

NOW AT HOME IN SPARE TIME!
Start Towards Security, Big Pay!



LEARN RADIO
plus
TELEVISION
AND ELECTRONICS

LEARN IT THOROUGHLY! FROM AMERICA'S MOST COMPLETE HOME TRAINING SCHOOL!

You Get All The Parts - Even Tubes - for this modern Superheterodyne Receiver - and lots of other equipment. And you get to keep it!

Let **NATIONAL SCHOOLS**—the famous resident-training school founded in 1905—train you as you want to be trained. One of the largest schools of its kind, National is located in Los Angeles—center of Radio-Television world! You learn from lessons prepared by men who are successful Radio and Television technicians.



BIG FREE BOOK TELLS YOU HOW

Page after page—in **COLOR**—tells you everything you want to know! Mail the coupon. Get yours—today! **PLUS A FREE SAMPLE LESSON!**

You Train at Home—In Your Spare Time! National Schools Shop-Method Home Training gives you basic and advanced instruction in all the phases of Radio-Television-Electronics.

You learn fast from hundreds of diagrams and pictures. All instructions are written by experienced technicians who work in Radio and TV every day. All instructions have been developed and tested in National Schools' own big labs and studios, which are equipped with the latest RCA equipment. No wonder this National Schools course is so up-to-date, practical, easy!

We Teach You How To Make Welcome Extra Money—While You Learn!

Many National Schools students—men like you—make plenty of extra dollars in spare time! Fixing neighbors' radios and appliances—and other ways we teach you. You can earn while you learn!

LOOK! WE SEND YOU ALL THESE PARTS!



With famous National Schools Shop-Method Home Training, you learn *by doing*—the easy, practical, interesting way. The way you want to learn. We send you many parts—all of modern professional quality. You do lots of practical experiments. You advance day by day, step by step. The free book tells you all about it. Answers all your questions. Use the coupon. And do it now—while you're thinking of it.



ONLY NATIONAL SCHOOLS GIVES YOU THIS PROFESSIONAL MULTI-TESTER!

You get this amazing new testing instrument! Ready to use! Simple to operate. Accurate and dependable. And—it's light enough to carry around—so you can use it at home or on service calls.

HERE ARE ONLY A FEW OF THE GOOD-PAYING JOBS YOU CAN CHOOSE!

- Radio Station Engineer
- Inspector Technician
- District Service Manager
- Service Specialist
- Aircraft Radio Inspector
- Special Gov't Positions
- Own Your Own Repair Shop
- Sound Truck Operator

Attention! Men Going into the Service Soon!

With this training you can get into special service classifications—with higher pay and grade—fast!

FREE SERVICE FOR GRADUATES!

National Schools helps you find your place in the field of your choice. We help you start toward the good pay you've dreamed of. Get the training you should have. Mail the coupon for the facts—today.

NATIONAL SCHOOLS

LOS ANGELES 37, CALIFORNIA • ESTABLISHED 1905
 In Canada: 193 E. Hastings St., Vancouver, B.C.

Today's Shortage of Trained Technicians Creates Chance of a Lifetime For You!

Think of it! With guided missiles, radar, and other electronic devices so important to defense! And with over 90,000,000 radios, over 12,000,000 TV sets. With more than 3100 radio stations...over 100 TV stations—and more building every day. Men are wanted in Radio-Television-Electronics—America's fastest-growing field—act quickly!

Job Security! Big Money! For YOU! in Today's Expanding Industries!

National Schools graduates—men just like you—are earning good money all over the country. Why not you? Enjoy your work—rather than having to drag along in just any old job. Mail coupon today—find out how easy it is.

National Schools Has Trained 1000's of Successful Men! Why Not YOU?

In almost every state—and many foreign countries—National Schools graduates are filling big jobs with national companies. Or running their own successful businesses. National Schools Shop-Method Home Training is complete training. You can take advantage of today's great opportunities in Radio-Television-Electronics—fast.

DON'T PUT IT OFF! GET THE BIG SALARY YOU HAVE ALWAYS WANTED!

MAIL THIS COUPON TODAY—WITHOUT FAIL!

NATIONAL SCHOOLS, Dept. RB-92
 4000 South Figueroa Street
 Los Angeles 37, California

Mail in envelope or paste on postal card

Mail me FREE the book mentioned in this ad. Also a free sample lesson. I understand no salesmen will call on me and that there is no obligation.

NAME _____ AGE _____

ADDRESS _____

CITY _____ ZONE _____ STATE _____

Vets! Check here if released from service less than 4 years ago.

150 DIAGRAMS and HOW TO READ THEM

150 DIAGRAM BOOK FREE

For Examining Coyne's Great 5-Volume Set On

ELECTRICITY

HERE'S a valuable book of 150 Electrical and Radio wiring diagrams with charts and instructions. Practical information you need to win security and promotion. It's yours FREE merely for examining Coyne's 5-Volume Set on Applied Practical Electricity on 7-day's free trial. This 5-Volume Set COVERS EVERYTHING ELECTRICAL from home appliance repairs to advanced AC-DC motors and equipment. Thousands of diagrams and photos . . . written so both "beginners" and "old-timers" can easily understand.

7-DAY'S FREE TRIAL Send for 5-Volume Electrical Set on 7 day's FREE TRIAL. We'll include Shop Prints Book FREE. If you keep the set, send just \$3 after 7 days and \$3 a month until \$15.95 plus postage is paid (cash price: \$14.95). Or return the set in 7 days and owe nothing. Either way, Shop Prints Book is yours to keep, FREE! Mail coupon AT ONCE!

Send No Money



FREE COUPON NOT AN ORDER - JUST A REQUEST TO SEE BOOKS

Educational Book Publishing Division
COYNE ELECTRICAL & TV-RADIO SCHOOL
 500 S. Paulina St., Dept. 92-R6, Chicago 12, Ill.

Rush 5-Volume Electrical Set for 7 day's FREE Trial per your offer. Include Shop Prints Book FREE.

Name _____ Age _____

Address _____

City _____ Zone _____ State _____

Check here if you are enclosing \$14.95. We pay postage. 7-day Money Back Guarantee.

Learn this Profitable Profession



IN 90 DAYS AT HOME

Money-Making Career Open to Men and Women, 18 to 60

Hundreds of men and women between 18 and 60 make \$10 to \$20 in a single day giving scientific Swedish Massage and Hydro-Therapy treatments. There is big demand from doctors, hospitals, sanatoriums and clubs. Graduates earn large full time income from these or in private practice in their own offices. Others make good money from home treatments given in spare time. Learn this interesting money-making profession in your own home, through our home study course. Same instructors as in our nationally known resident school. You can win independence and prepare for future security by qualifying for your Graduation Certificate. Course can be completed in 3 to 4 months. Many earn while they learn. Begin your training at once.

NEW 32-PAGE BOOKLET FREE

Fill in the coupon below (please print name and address) and mail it for your FREE copy of 32-page Information Booklet. If you act at once we will include Anatomy Charts and Success Booklet which supply additional information you should have. All will be sent postage paid.

THE COLLEGE OF SWEDISH MASSAGE
 Dept. 264L, 41 E. Pearson St., Chicago 11, Illinois

Please send me FREE and postpaid New 32-Page Illustrated Booklet, Anatomy Charts and Success Booklet at once.

Name _____ Age _____

Address _____

City _____ State _____

OWN Your Own Business

\$5 per hour

Clean and Mothproof rugs and upholstery "in the home" or public buildings. If now employed, you can operate in spare time and build up a permanent profitable full-time business. Alert dealers can average \$5 hourly gross profit on service they render and \$3 on EACH of their servicemen at National Price Guide charges. Easy to learn . . . quickly established.

DURACLEAN cleans by absorption! No scrubbing, soaking or shrinkage. Dirt and grease vanish . . . matted pile rises . . . colors revive. Furnishings used again same day.

DURAPROOF resists moths and carpet beetles. Your service backed by a National Money Back 4 Year Warranty.

We furnish enough material to return your total investment in War-proof Business. **EASY TERMS.** Send for **FREE** booklet TODAY.

DURACLEAN CO., 2-169 DURACLEAN BLDG., DEERFIELD, ILL.



PATENTED PORTABLE EQUIPMENT

GREAT PROFITS

MAKE YOUR OWN RUBBER MOLDS

X.L. RUBBER MOLDS
 will realize your great profits quickly!
 WRITE FOR NEW FREE CATALOG

YOU can EASILY learn to cast thousands of perfect plaques, book ends, figurines, ash trays, etc. IT'S EASY FUN, PROFITABLE!

X.L. Rubber, Pts. \$2.50; Qts. \$4.00 (postage extra). Models and enough for 3 molds \$1.50 prepaid.

Address Dept. 2
 3403 S. Madison St.
 Muncie, Ind.

SEND FOR FREE FACTS

REAL ESTATE BE A BROKER

PAYS BIG! SEND FOR FREE, BIG, ILLUSTRATED CATALOG NOW! Graduates report making substantial incomes. Start and run your own business quickly. Men, women of all ages, learn easily. Course covers Sales, Property Management, Appraising, Loans, Mortgages, and related subjects. **STUDY AT HOME** or in classrooms in leading cities. Diploma awarded. Write TODAY for free book! No obligation.

WEAVER SCHOOL OF REAL ESTATE (Est. 1936)
 Suite 300 Law Bldg. Dept. PM Kansas City, Mo.



Bar Bells

Buy Direct From Factory **\$8.95 up**

Write for free booklet and price list

INDEPENDENT IRON WORKS
 2416 East 23rd Street, Dept. B
 Los Angeles 58, Calif.

Learn ACCOUNTING

Business Administration

Bookkeeping, secretarial and allied subjects at home in your spare time or attend nationally approved resident school. Write for FREE Success Book giving complete information about courses, plans, rates and employment opportunities.

Hills BUSINESS UNIVERSITY AND EXTENSION SCHOOL
 619 W. MAIN ST. OKLAHOMA CITY 2, OKLAHOMA

Say You Saw It in Popular Mechanics

RUPTURED?

Get Relief This Proven Way

Why try to worry along with trusses that gouge your flesh—press heavily on hips and spine—enlarge opening—fail to hold rupture? You need the Cluthe. No leg-straps or cutting belts. Automatic adjustable pad holds at real opening—follows every body movement with instant increased support in case of strain. Cannot slip whether at work or play. Light. Waterproof. Can be worn in bath. Send for amazing **FREE** book, "Advice To Ruptured" and details of liberal truthful 60-day trial offer. Also endorsements from grateful users in your neighborhood. Write:

CLUTHE SONS, Dept. 31, Bloomfield, New Jersey.

NOW...from D.T.I.'s MILLION DOLLAR TRAINING CENTER

Learn to master

TELEVISION

RADIO - ELECTRONICS

by getting **EVERYTHING YOU NEED!**



NOW—
get training
to suit your **NEEDS**

TAKE YOUR CHOICE

Come to
D.T.I.'s great
CHICAGO LABORATORIES

... one of the
Nation's FINEST!

Now, in the heart of the nation's TV Center, you can get all of your preparation in D.T.I.'s big, modern, wonderfully equipped training laboratories. Loads of commercial equipment and ample, well qualified instructors help you get a thorough, practical preparation in the **SHORTEST POSSIBLE TIME**. Part time student Employment Service can help you pay your way while in training.

Employment Service

As soon as you complete either the Chicago Laboratory or Home Training, you'll find D.T.I.'s grand Employment Service ready to help you start earning real money. Get full facts. Mail coupon today.

MILITARY SERVICE!

If you're subject to military service, the information we have for you should prove very helpful. Mail coupon today.

89 WAYS TO EARN MONEY
IN TELEVISION
RADIO ELECTRONICS

ACT NOW! MAIL COUPON TODAY
Get this publication **FREE!**

DeFOREST'S TRAINING, INC. DEPT. PM-9-I
2533 N. ASHLAND AVE., CHICAGO 14, ILLINOIS

I would like your Opportunity News Bulletin showing "89 Ways to Earn Money in Television-Radio-Electronics"; also, complete facts about the training opportunity made possible by your organization.

Name _____ Age _____
Address _____ Apt. _____
City _____ Zone _____ State _____



America's amazing multi-billion dollar Television field now offers you a chance of a lifetime to get started toward a grand job or your own business. With TV station limit now raised from 108 to 2053, Television is headed for almost every community. Mail coupon today. See how you may prepare to cash in on the coming TV BOOM.

Get **ALL** of your training **AT HOME!**
... including setting up your own **HOME LABORATORY**

If unable to come to D.T.I.'s big Chicago laboratories, we'll provide you with one of today's most complete and effective combinations of major home training aids. Not only will you get (1) well illustrated lessons and (2) the unique and wonderful aid of instructive **HOME MOVIES**, but you'll also (3) set up your own **HOME LABORATORY**.

You'll get and keep 16 big shipments of electronic parts—the same type of basic equipment used by students in our wonderfully equipped Chicago laboratories. You'll work over 300 interest-gripping experiments for the practical experience you need. This even includes building and keeping the valuable commercial test equipment and Super Radio Set shown at left. Mail coupon today for the whole exciting story.

Use 16mm.
MOVIES

Only D.T.I. provides you with the loan of visual training movies at home to help you master important basic points faster ... easier ... better!



Build a 17 inch TV set

After completing foregoing training, and for a moderate added cost, you may build and keep this top quality, 17 inch TV Receiver—an optional feature for valuable added experience.

"ONE OF AMERICA'S FOREMOST TELEVISION TRAINING CENTERS"

Established 1931

De FOREST'S TRAINING, INC.
AFFILIATED WITH
De VRY Technical INSTITUTE
CHICAGO 14, ILLINOIS

Learn ELECTRIC APPLIANCE REPAIR IN YOUR SPARE TIME AT HOME



START YOUR

ONE BUSINESS THAT IS NOT EFFECTED BY STRIKES, DEPRESSIONS OR POLITICS

OWN BUSINESS WITH A POTENTIAL MARKET OF 50,000,000 CUSTOMERS

New shop-method, home-training system gives you electrical know-how that used to take years to learn. Learn at home by building valuable testing kits, repairing your own and neighbors' appliances. It is not unusual for appliance repairmen to charge on the basis of \$5.00-\$6.00 an hour.

FREE ILLUSTRATED BOOK

Shows you how you learn every phase of electrical appliance. How to make money while you learn. Write today for your FREE copy.

CHRISTY TRADES SCHOOL
Dept. D-1003
4432 North Kedzie Ave., Chicago 25

Can A Man My Age Become A Hotel Executive Even Though He Has No Previous Hotel Experience?

Would you like to step into a well-paid position in a Hotel, Club, Restaurant, essential Defense Housing Project? Would you like to look forward happily to the future? The success of Lewis graduates from 18 to 50 PROVES you can!



Clyde B. Corley, Veteran, Without Previous Hotel Experience, Wins Ass't. Manager's Position

"After my release from the Air Force, I enrolled for Lewis Training. Now Assistant Manager of this Club, my position is fascinating as well as lucrative. The people with whom I am associated are of the finest calibre. My salary is more than \$400. a month, and I've been in this work less than a year! All thanks to Lewis Training."

Step Into a Well-Paid Hotel Position FREE Book Gives Fascinating Facts

Our FREE Book, "Your Big Opportunity," explains how you can qualify for a well-paid position at home, in leisure time; tells how you are registered FREE of extra cost in the Lewis National Placement Service. Most important, it shows how you can be a Lewis Certified Employee—certified to "make good" when placed in a position. Mail the coupon NOW!

Course Approved for Veterans' Training

LEWIS HOTEL TRAINING SCHOOL
Room VO-324, Washington 7, D. C.

36th ANNUAL SUCCESSFUL YEAR

Send me the Free Book, "Your Big Opportunity," without obligation. I wish to know how to qualify for a well-paid position at home, in my leisure time.

Name _____
(Please Print Name & Address)

Address _____

City _____ Zone _____ State _____

SHORTHAND IN 6 WEEKS

LEARN AT HOME — LOW COST

Write 120 words per minute. Age no obstacle. Famous Speedwriting Shorthand system. No symbols; no machines; uses ABC's. Easiest to learn and use. Fast preparation for a better position. Nationally used in leading offices and Civil Service; also by executives, writers, speakers, lawyers, scientists, students at college. Over 150,000 taught by mail. The very low cost will surprise you. Also typing. 29th year. Schools in over 300 cities.

WRITE FOR FREE BOOKLET TO

Speedwriting

Dept. 1509-2, 55 W. 42 St., N. Y. 36 (R)

BECOME AN EXPERT IN TRAFFIC

Traffic men earn \$4,000 to \$10,000 and up. Thousands of firms need experts on rates, tariffs, regulations. We train you thoroughly in spare time at home for executive traffic jobs. Personal training under traffic authorities. Placement counsel and help. Write for free 48-page book "Traffic Management—the Fast Growing Profession."

LASALLE Extension University, 417 So. Dearborn St.
A Correspondence Institution Dept. 964T, Chicago 5, Ill.

NEW! SUCTION CELLAR DRAINER



Capacity 300 GALLONS per Hour!

No more hand-pumping or bailing of flooded basements when you have DRAINMASTER. Just connect to a handy faucet with garden hose, submerge in flood water, run another length of hose to open drain or out a window. DRAINMASTER does the rest. Solid brass, no moving parts to wear. Drains fish ponds, boats, swimming pools, trenches, tanks, etc. ORDER TODAY! **\$3.95**

Be prepared for flood emergency. **postpaid**

Money-Back Guarantee

M. P. WHITE Co., Dept. 1PM, 55 Stuart St., Boston 16, Mass.

GET THIS SUIT AS A BONUS!



Sell popular Smith tailored-to-measure suits. Make up to \$10.00-\$15.00 daily taking orders from friends. You get paid 3 times—(1) when you take the order and pocket the cash profit.—(2) when we pay you an EXTRA cash bonus.—(3) when you get your own suit as an added bonus, without cost. No experience needed. Send for FREE selling kit and sample line. Write fully, give age, sales exp., etc.

W. D. SMITH & CO., Dept. D
833 W. Jackson Blvd., Chicago 7, Ill.

Watch Repairing Pays Big Money Learn at home



Watch repairers in great demand. Train step-by-step in 10 easy lessons. We furnish all tools and 15 jewel watch and practice movement. Turn spare time into cash. A licensed school. Low cost. Send for FREE book today.

ILLINOIS SCHOOL OF WATCH REPAIRING
2870 Eiston Ave., Dept. PM92, Chicago 18, Ill.

BOYS! MAKE YOUR OWN RADIO



Make your own simple, tubeless, batteryless Crystal Radio. SEND 25c for a GENUINE MELOMITE CRYSTAL with complete illustrated instructions for making your own set. Crystal sent postpaid with instructions and our own publication, "THE MAGIC CRYSTAL" which is full of news, diagrams, questions and answers of interest.

SEND 25c FOR YOUR CRYSTAL TODAY!

ALVA ALLEN RADIO Dept. PM-9 Clinton, Mo.

Learn BAKING At Home



Baking is one of America's high industries in wages. Nearly depression-proof. Thorough basic home course lays sound foundation. If you have aptitude, write for FREE BOOKLET. "Opportunities in Commercial Baking."

NATIONAL BAKING SCHOOL
835 Diversey Parkway Dept. 1356 Chicago 14



7 DAY FREE TRIAL
Return and Pay Nothing if Not Completely Satisfied



NOW! You can easily
Fix ANY Car
in less time-- and do a better job too!

Used by U. S. Army and Navy



MOTOR's Manual paid for itself on the first 2 jobs, and saved me valuable time by eliminating guesswork." — **W. SCHROP, Ohio**



"Instructions so clear have no trouble learning anything about any car. Now working as mechanic in big plant." — **SAM ORDENEZ, Cal.**



"I have become foreman of my garage—thanks to help of your Manual." — **ELMER HENSLER, Wisc.**

Here's the Quick, Easy Way to Repair ANY CAR BUILT SINCE 1935. Step-by-Step Instructions by Factory Experts, Over 2400 "How-to-do-it" Pictures, Over 200 "Quick Check" Tables Make it "Easy as Pie" For Even a Beginner To Do A First-Rate Job.

NO auto repair job is tough when you've got MOTOR's brand-new 1952 AUTO REPAIR MANUAL. Shows how to save work on "ornery" jobs. Helps you make MORE MONEY by doing more jobs in less time. Try this amazing book FREE for 7 days.

Want to fix anything from carburetor to rear end, Jeep to Cadillac, shaky '35 to shiny '52? Here's the quick, easy, right way—the way factory experts advise. Just look up make, model, and job in quick index—and go to it. Clear, ILLUSTRATED instructions lead you step by step through whole job.

NO OTHER MANUAL LIKE IT!

The engineer-editors of MOTOR Magazine collected and "broke down" over 170 official

factory shop manuals for you—spotted all the vital repair information you need—dove-tailed it all together into ONE handy, easy-to-understand book.

EVERYTHING YOU'LL NEED TO KNOW

MOTOR's Manual takes nothing for granted. Starts at the very beginning; tells how to identify all 851 car models. More than 2400 easy-to-follow Photos, Drawings, Diagrams guide you step-by-step right thru each operation. Over 800 big pages crammed with Factory Specifications and Adjustment Tables, Tune-up Charts, Tables of Measurement and Clearances, Overhauling and Replacement facts. Automatic Transmissions (including New Dual-Range Hydramatic), Engines (including New De Soto, Lincoln, Ford Engines), Ignition, Generators, Carburetors, Brakes, Overdrives, and much MORE!

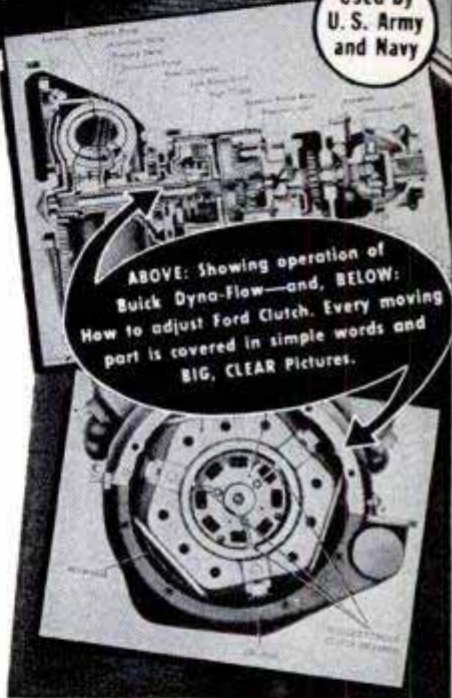

ABOVE: Showing operation of Buick Dyna-Flow—and, BELOW: How to adjust Ford Clutch. Every moving part is covered in simple words and BIG, CLEAR Pictures.

COVERS 851 MODELS — ALL THESE MAKES

- | | | |
|-----------|-----------|------------|
| Buick | Ford | Nash |
| Cadillac | Frazer | Rambler |
| Chevrolet | Henry J | Oldsmobile |
| Chrysler | Hudson | Packard |
| Cord | Kaiser | Plymouth |
| Crosley | Lafayette | Pontiac |
| De Soto | La Salle | Studebaker |
| Dodge | Lincoln | Terraplane |
| | Mercury | Willis |

Same FREE Offer on NEW MOTOR'S TRUCK & TRACTOR REPAIR MANUAL

New Edition covers EVERY job on EVERY popular make gasoline truck and farm tractor made from 1936 thru 1952! Over 2267 pictures, 930 pages, 300,000 facts. All types of Gasoline Engines, Fuel Systems, Governors, Lubrication, Ignition, Starters, Generators, Clutches, Axles, Brakes and more!

For FREE 7-DAY TRIAL, check box in coupon.



Try Book FREE 7 Days

SEND NO MONEY! Just mail coupon! When the postman brings book, pay him nothing. First, make it show you what it's got! Unless you agree this is the greatest time-saver and work-saver you've ever seen—return book in 7 days and pay nothing, owe nothing. Mail free trial coupon today! Address **MOTOR Book Dept., Desk 1K, 250 West 55th St., New York 19, N. Y.**

MOTOR Published by MOTOR, The Leading Automotive Business Magazine.

MAIL COUPON NOW FOR 7-DAY FREE TRIAL

MOTOR BOOK DEPARTMENT
Desk 1K, 250 West 55th Street, New York 19, N. Y.

Rush to me at once: (Check box opposite book you want)

MOTOR's New AUTO REPAIR MANUAL. If O. K. I will remit \$1 in 7 days, (plus 35c delivery charge), then \$2 monthly for 2 months, and a final payment of 95c a month later. Otherwise I will return book postpaid in 7 days. (Foreign price, remit \$8 cash with order.)

MOTOR's New TRUCK AND TRACTOR REPAIR MANUAL. (Described at left.) If O.K. I will remit \$2 in 7 days, and \$2 monthly for 3 months, plus 35c delivery charge with final payment. Otherwise I will return book promptly. (Foreign price, remit \$10 cash with order.)

Print Name.....Age.....

Address.....

City & Zone No.....State.....

SAVE 35c delivery charge by enclosing WITH COUPON check or money order for full payment of \$5.95 for Auto Manual (or \$8.00 for Truck Manual). Same return-refund privilege applies.

MR. TV OWNER!

Stop TV Interference At Once And Stop It—For Good!

An amazing no-risk challenge to every set owner who is tired of paying \$5-\$10-\$15 for THE SAME TV REPAIRS . . . OVER AND OVER AGAIN!

Do you know that 95% of the wavy lines, streaks, zags, distortions, picture roll, flutters, and snow that ruins your TV viewing are not caused by your set at all? That they cannot be eliminated by your repairman, no matter how good he is! That they cannot be prevented by your antenna, no matter how powerful it is!

Yes, 95% of your costly television troubles are caused by electronic TV interference from the outside. And the only way to permanently remove that interference is to BLOCK IT OUT, before it even reaches your set—in exactly the same way sunlight glare is blocked out by sun glasses, before it reaches your eyes.

This is exactly what a revolutionary new TV invention—the TELERON TV WAVE TRAP (Pat. Pend.)—does for your set. This amazing "Interference Eliminator" actually eliminates the 6 most aggravating forms of interference, before they can reach your set. It actually strengthens your reception on all channels—even in poor reception areas.

WHICH OF THESE 6 TV HEADACHES DO YOU WANT TO REMOVE FOR GOOD?



WAVY LINES — Caused by airplane flying as much as 15 miles away from your home. Mr. OSCAR HOLDEN of New York City writes: "My TELERON WAVE TRAP eliminates 95% of all wavy lines within 15 minutes after I clipped it on my set."



DISTORTION—Caused by outside telephone lines up to 11 miles away from your home . . . or by other neighborhood TV sets and antennas that compete with your set for the same channel.

TELERON WAVE TRAP eliminates 93% of all this interference BEFORE IT REACHES YOUR SET.



S N O W — Caused by constantly running electrical appliances in your home—such as refrigerators and oil burners.

Mr. M. CAINE of Chicago, Ill. reports: "I live in a big apartment house where there's plenty of electrical interference. But since I clipped a TELERON WAVE TRAP on my set I haven't been bothered once by snow."



BORER EFFECT — Caused by doctor's diathermy machine—or amateur radio operator as much as 3 miles away from your home.

Mr. WILLIAM BENTLEY of Los Angeles writes: "My family couldn't go through a night of TV viewing without getting terrific TV interference from a hospital about 2 miles away. Then I heard about the TELERON WAVE TRAP. I tried it. And now, 6 months later I have only been bothered once by those diathermy machines in that hospital."



STREAKS — Caused by car ignitions, trucks or busses up to 2½ miles away from your home . . . or by neon signs, doorbells, electric toasters, broilers, radios and phonographs within 1 mile of your home.

TELERON WAVE TRAP eliminates 98% of all this in-

terference BEFORE IT REACHES YOUR SET.



TV STATIC—Caused by atmospheric conditions up to 5 full miles away from your home.

TELERON WAVE TRAP eliminates 95% of all this irritating interference BEFORE IT REACHES YOUR SET.

MOVIE-CLEAR RECEPTION 365 DAYS A YEAR!

Send for your TELERON WAVE TRAP today. Send no money. When your TELERON WAVE TRAP arrives simply clip it on the back of your set. It takes only 30 seconds—you need no special tools, no training. And it fits every set made since 1947—no matter what the brand, style or year. See for yourself how this amazing invention gives you sharp, clear pictures. How it adds new life to your picture even in fringe areas—even in weak reception zones—even on channels you could hardly pick up before.

HERE'S PROOF—TEST IT IN YOUR OWN HOME! AT OUR RISK!

If you order your TELERON TV WAVE TRAP today, you do not pay the \$5 that 50,000 other TV owners paid—you deposit only \$2.98 with the postman. If after you clip this amazing TELERON WAVE TRAP on your set, you are not getting perfect movie-clear reception—please return for full money back! You try it at our risk—you do not buy it until you are 100% satisfied. ORDER TODAY AND SAVE \$2!

ORDER TODAY AND SAVE \$2! MAIL COUPON NOW!

TELERON TV WAVE TRAP, Dept. 9, 699 Madison Ave., N. Y. Please send me the TV WAVE TRAP immediately, at \$2.98, plus C.O.D. postage. I understand that satisfaction is guaranteed 100%.

Name.....
(Please Print)

Address.....

City..... Zone..... State.....

Cash Check Money Order. SAVE MORE! Send \$3.00 with coupon. We pay all postage charges. Same Money-Back Guarantee.

POOR MILEAGE
ENGINE MISSES
OVERHEATS
CLUTCH SLIPS



REAR END NOISE
SHORT CIRCUIT
WEAK BRAKES
BURNS OIL

Know What's Causing ANY Car Trouble IN A JIFFY!

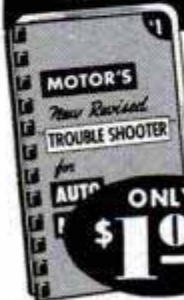

TRACK down knocks, misses, breakdowns, noises—in a jiffy! MOTOR'S "TROUBLE-SHOOTER" covers over 2,000 specific causes of troubles—engines, clutches, brakes, ignition—all other parts. Valuable cross-section diagrams. For beginner or expert mechanic. Section on automatic transmissions alone worth the low \$1 price. SEND NO MONEY. Try book for 7 days. Mail coupon NOW!

SEND NO MONEY

MOTOR Book Dept., Box EC,
250 West 55th St., New York 19, N. Y.

Rush me MOTOR'S new work-saving TROUBLE-SHOOTER. I will pay postman \$1 on delivery, plus 43¢ actual Gov't. postage and C.O.D. charges. Unless completely satisfied, I may return book in 7 days for refund.

Name.....

Address.....

City..... Zone..... State.....

SAVE 43¢ POSTAGE, C.O.D. CHARGES. Check here and send \$1 WITH coupon, then WE pay shipping costs. Same refund guarantee.



MEN! TRAIN NOW FOR A BIG PAY FUTURE IN DIESEL & SCIENTIFIC MOTOR TUNE-UP

- Diesel Construction
- Diesel Engine Repairman
- Diesel Operator
- Industrial Maintenance
- Auto Engine Rebuilding
- Bus & Truck Maintenance

Be a Trained Diesel Man

Go places with DIESEL! Farms, factories and power plants, trains, ships, trucks, buses all use DIESEL POWER... all need DIESEL-trained men! You can start your DIESEL training at home, in spare time, with tested, proved U E I training. Course includes practical work on Diesel engines under skilled instructors. You learn the operation, maintenance, servicing of all types of Diesel engines, PLUS Scientific Motor Tune-up.

ACT NOW! If you have mechanical ability, you'll like Diesel! High School diploma not necessary. Write now for FREE book, "EARNING POWER IN DIESEL." Act Today!

MAIL NOW FOR FREE BOOK!

UTILITIES ENGINEERING INSTITUTE, Dept. DC-22,
2521 Sheffield Ave., Chicago 14, Ill. (Founded 1927)

O.K.! Rush, without obligation, FREE Book on DIESEL.

NAME.....

ADDRESS.....

CITY..... ZONE..... STATE.....

Check here for information if under 17.

PORTABLE GARAGE

\$6.95

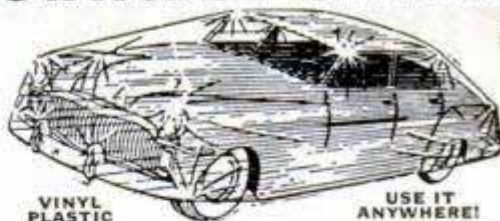

VINYL PLASTIC

USE IT ANYWHERE!

- Goes wherever your car goes
- Folds compactly
- Keeps rain, snow, dust, salt air, sun or sleet away
- Protects your car's finish
- Durably constructed of vinyl plastic that is long wearing and tough
- Nylon thread grommets for extra security
- Spring-tite, elasticized bottom, holds securely in all kinds of weather
- Fits all makes and models
- Direct from manufacturer
- Enclose check or money order for \$6.95, or sent C.O.D.

10-Day Money Back Guarantee

MARDO SALES CORP., PL 5-1161

480 LEXINGTON AVE.

DEPT. 357

NEW YORK 17, N.Y.

TASOPE PHOTO-ENGRAVING PLANTS



Material Cost
Of This Cut 3/4¢
Selling Price
\$1.00 And Up

Establish your own profitable PHOTO-ENGRAVING business. Make cuts for newspapers, printers, and advertisers. Make etched name plates, plaques etc. Instructions furnished, no experience necessary. Sold direct from factory since 1931. First five hundred cuts sold locally or by mail will pay for plant and pay you well for your time. Write for FREE catalog.

TASOPE DEPT. PM5, AURORA, MO.

RUPTURE



RELIEF...OR YOUR MONEY BACK
Original, patented Web,
copied but never matched.
Users say it's best ever. Relief
or no cost to you. Write:

WEB TRUSS CO., Dept. M-9, Hagerstown, Md.



GROW MINIATURE TREES

Grow authentic, LIVE dwarf trees!
Fascinating hobby! Fabulous profit!

SEND FOR FREE SEED & INSTRUCTIONS!

MINIATURE NURSERY CLUB

Dept. M, P. O. Box 18696, Rimpau Sta.,
Los Angeles 19, California

BE A LOCKSMITH



Learn Locksmithing and Keymaking from Experts in Your Spare Time at Home!
Locksmiths in big demand! No layoffs, no slow seasonal
Age no disadvantage. Year-round, steady income in this
permanent, respected field. Full or part time. Practical,
illustrated lessons show how to make money even while
learning! All materials, special tools supplied.
Send for FREE BOOKLET

INSTITUTE OF LOCKSMITHING, Dept. P-34
15 PARK AVE. RUTHERFORD, N. J.
Lic. & Approved State of N.J. VA Approved

'How to MAKE MONEY with Simple CARTOONS'



A book everyone who likes to draw should have. It is free; no obligation. Simply address

FREE BOOK

CARTOONISTS' EXCHANGE
Dept. 99D Pleasant Hill, Ohio

Thrilling Work COLORING PHOTOS
Fascinating vocation learned at home by those with aptitude. Thrilling pastime. National method brings out life-like colors. Free booklet.
EASY TO LEARN NATIONAL PHOTO COLORING SCHOOL
835 Diversey Pkwy., Dept. 1356, Chicago 14

VOTE TODAY

FOR THE FUTURE YOU WANT!

AMERICAN SCHOOL, Dept. G645, Drexel at 58th, Chicago 37, Ill.
Without obligation, please send FREE and postpaid, full particulars about the subject checked below.

- Accounting
- Air Conditioning
- Architecture & Building
- Automotive Technician
- Better Foremanship
- Bookkeeping
- Business Management
- Contracting
- Diesel Technician

- Drafting—Building Trades
- Drafting—Machine Trades
- Electrical Engineering
- Electricity—Practical
- Electronics—Industrial
- High School Courses
- Machine Shop Operations
- Mathematics & Slide Rule
- Mechanical Engineering

- Plastics Engineering
- Plumbing—Practical
- Private Secretary
- Refrigeration
- Retail Merchandising
- Salesmanship—Outside
- Sheet Metal Work
- Tool Making

NAME.....

HOME ADDRESS.....

CITY.....

OCCUPATION.....

AGE.....

STATE.....

THIS IS YOUR BALLOT

Check the career that interests you most, Fill in spaces and mail at once—no obligation

● Today, choose the job you want — and prepare for it in spare time at home. Or if you are already engaged in the work you like best, start training now for quicker promotion. In hours you might otherwise waste, gain the knowledge and skill that can help you to get ahead faster, make more money, and have greater security.

Thousands before you have followed this plan and were able to step out ahead of others who didn't fit themselves for advancement or who seemed willing to trust to luck.

Training Backed by 55 Years of Experience

For over half a century American School has helped ambitious men and women

toward success by providing specialized training for commercial and technical advancement. At a cost you can afford you can prepare at home to climb in the kind of work you prefer. American School's study program for you has been planned by experts with years of experience in the subject you select and they will give you needed guidance every step of the way.

Don't Delay Your Start

Give serious thought to the list of training courses listed above. Pick the opportunity that interests you, check it and add your name and address. (Check more than one if you are undecided as to which appeals most.) Finally clip out and mail the "ballot" and full information will be supplied, without cost or obligation.

PRACTICAL, EFFECTIVE HOME STUDY TRAINING SINCE 1897

AMERICAN SCHOOL, Dept. G645, Drexel at 58th, Chicago 37, Ill.

THE SOONER YOU START, THE SOONER YOUR GOAL CAN BE REACHED.

You are in demand if you can draw!



Make Money with your brush and pen! If you like to draw, sketch, or paint, take the Free Talent Test. No fee. No obligation. Mail this coupon TODAY!



ART INSTRUCTION, INC., Dept. 9132

500 S. 4th Street, Minneapolis 15, Minnesota

Please send me your FREE Talent Test.

Name _____ Age _____

Address _____ Phone _____

City _____ Zone _____ County _____

State _____ Occupation _____

STUDY TO BE A DOCTOR of Psychology or Metaphysics

Obtain a Ps.D., Ms.D., D.D., or Ph.D. degree. Be a Teacher, Lecturer or Accredited Practitioner. Teach others how to achieve Health, Happiness and Contentment. Chartered by State. Write for FREE book telling how.

THE NEOTARIAN COLLEGE OF PHILOSOPHY

Desk B, Pickwick Building Kansas City 6, Missouri



**I GAINED
53 LBS. OF SHAPELY
POWER-PACKED
MUSCLES**

← says Roger Hirsch, N. Y. →

NOW **2** Which of these?
BEFORE **ME'S** is YOU?

"That 112 lb.—6 ft. spindly-armed Sissy at right was ME a few short weeks ago", says Roger Hirsch. Look at him NOW! I gave him 53 lbs. of MIGHTY MUSCLES, added 6½ inches to his CHEST, 3 inches to each ARM! They don't call him SKINNY any more!

NO! I don't care how skinny or flabby you are. All I want is 10 minutes a day in your home to make you over by the same method I turned myself from a wreck into a Champion of Champions. You'll become an ALL-ROUND, ALL-AMERICAN, HE-MAN, A WINNER in everything you tackle—or my training won't cost you one cent.

ROGER HIRSCH was a 112 lb., 4 ft. WEAKLING. Look at him NOW!

SEND ME ONLY **10¢** for **5** PICTURE-PACKED HE-MAN BUILDING Courses and also get **Both FREE** 1. PHOTO BOOK OF STRONG MEN 2. A MUSCLE METER

JOWETT INSTITUTE, Dept. 220 Fifth Ave., New York 1, N.Y. PM-29

Dear George: I enclose 10¢ for which please send me on trial all 5 picture-packed HE-MAN Building Courses, FREE Photo Book, and Muscle Meter.

NAME _____ AGE _____
(Please print plainly. Include Zone Number)

ADDRESS _____ No C.O.D.'s

CITY _____ ZONE _____ STATE _____



"Win This 15" Silver Trophy as I did."



Own Your Own Home

1-2 BEDROOMS as low as **\$69000**

NOW you can build YOUR OWN HOME at a price you can afford... Sturdy, fireproof, termite proof, concrete block and wood construction. Ideal for average family. Working plans include Living Room, Kitchen, Bath, and 1 or 2 Bedrooms.

• Complete designs, easy working plans, material lists, and illustrated step-by-step instructions to build ALL Sunny-Cal Homes **Only \$100 PPD.** MONEY BACK GUARANTEE

SUNNY-CAL Homes 1621 N. Cahuenga Blvd., Dept. 1 Hollywood 28, California

TOOTHACHE?

Ask your Druggist for **DENT'S** TOOTH GUM TOOTH DROPS POULTICE

SANDEE

SPORTONE MUFFLERS

Ford & Chevrolet.....	\$ 4.45
All other popular cars.....	5.45
V-8 Dual Sets.....	15.95
Chromed Silenttips.....	2.95

(Please state make & year of car on all orders.)

SANDEE MUFFLER CO.
5643 Corryne Place • Culver City, California

Learn PHOTOGRAPHY at Home

Splendid opportunities. Prepare in spare time. Practical basic training. Long-established school. Send for free book, "Opportunities in Photography." No obligation.

AMERICAN SCHOOL OF PHOTOGRAPHY, 835 Diversey Pkwy., Dept. 1356, Chicago 14, Ill.

EVEN IF YOU DON'T KNOW A NOTE OF MUSIC NOW...

You Can Learn Your Favorite Instrument This Easy A-B-C Way

No special talent, no previous musical training needed. This remarkable U. S. School home-study method is so successful because you learn to play by playing real tunes by note, right from the very start.

Once you start a U. S. School Course you look forward to the time you spend on your lessons. No tiresome exercises. No long-winded explanations. Instead of hard work, learning to play becomes a happy pastime. You begin with simple



EASY AS A-B-C



melodies. As you improve, you take up more advanced tunes. Sooner than you ever dared hope you're thrilled to find yourself playing many popular numbers by note. And no matter which instrument you take up, the cost is only a few pennies a day.

FREE BOOK AND FREE LESSON-SAMPLE

If you honestly want to learn music, to be invited everywhere, and get lots more fun out of life, send in the coupon below for our FREE 36-page Book and Free Lesson-Sample. They give full details. (Special prices on instruments to our students.) **U. S. SCHOOL OF MUSIC, Studio B309, Port Washington, N.Y.** (Now in Our 34th Successful Year)



**U. S. School of Music, Studio B309,
Port Washington, N. Y.**

Send me FREE BOOK and FREE Lesson-Sample. No obligation—and no salesman is to call upon me. I'm interested in playing (name instrument) _____

I do I do not—have instrument now.

Name _____ (please print)

Address _____

City _____ State _____
(Please state Zone No. (if any))

AMAZING 2-FOR-1 OFFER

BE A LICENSED* TV TECHNICIAN

LICENSED TV MEN MAKE MORE MONEY

L. C. Lane, B.S., M.A.
Pres. RTTA & Pierce Schools

COMPARE RTTA'S EXTRA FEATURES

1. I furnish you ALL parts and equipment to build your own COMPLETE TV RECEIVER, plus training to qualify YOU as a TV TECHNICIAN in America's booming TELEVISION industry . . . within months. Many of my students pay for their entire training from spare time earnings, while studying . . . start their own business.

2. Then—to qualify you for better pay . . . BETTER JOBS, I give you my . . .

*FREE FCC LICENSE COACHING COURSE

- Prepares you for your FCC License
 - Included at NO EXTRA COST
- The best jobs in TV & RADIO require an FCC LICENSE.

NEW YORK ROUND TRIP—FARE FREE!

Yes, wherever you live in the U.S. or Canada, I pay your way to New York and return, after you finish your home study course. I give you two free weeks of advanced instruction, 50 hours of shop training at famous Pierce School of Radio & TV. (Applied to complete Radio-TV course only.)

MY SIMPLE METHODS MAKE SUCCESS EASY!

I have helped hundreds of men—most of them with NO PREVIOUS TRAINING—get ahead in TV. Even with a grammar school education, you can master my practical methods where you use actual parts and equipment and learn by doing." PREPARE NOW for thousands of new job opportunities coming right in your own state, with lifting of TV freeze. Don't delay. Mail the coupon and let my FREE BOOKS show you how easy it is.

YOU BUILD AND KEEP 15 BIG RADIO-TV KITS

INCLUDING BIG SCREEN TV . . .

Everything At No Extra Cost



Train for Success Like These Men



"Thanks to your training, I qualified for a good job as a Receiver Tester at Federal Telephone and Radio."
—Paul Frank Seier



"Your excellent instruction helped me get my present job as an airport radio mechanic for American Airlines."
—Eugene E. Basko



"I'm making good money in my own business repairing and installing radio & TV sets—thanks to your training."
—Irwin Polansky

NOW!

For Men
Who Know Radio

ADVANCED FM-TV TRAINING COURSE PREPARES YOU FOR HIGHER PAY JOBS IN A FEW MONTHS

COMPLETE theory and practical training course . . . complete with 6 kits including large screen TV receiver. FCC License Coaching Course included FREE.

NO SALESMAN WILL CALL!

BOTH FREE! SEND NO MONEY! MAIL NOW FOR FREE FACTS!



Mr. Leonard C. Lane, President
RADIO-TELEVISION TRAINING ASSOCIATION Dept. M-9
1629 Broadway, New York 19, N. Y.

Dear Mr. Lane: Mail me the facts on your amazing 2 for 1 offer with no obligation to me. I UNDERSTAND NO SALESMAN WILL CALL.

NAME _____ Age _____

ADDRESS _____

CITY _____ ZONE _____ STATE _____

I am interested in: Radio-TV Advanced TV-FM
VETERANS! If qualified under G.I. Bill, check here

RADIO-TELEVISION TRAINING ASSOCIATION

Approved as a Correspondence School under the Laws of the State of N. Y.

1629 Broadway, Radio City Station, New York City 19, N. Y.

GET THE WORLD'S LEADING TV & RADIO CATALOG

FREE

236
VALUE-
PACKED
PAGES

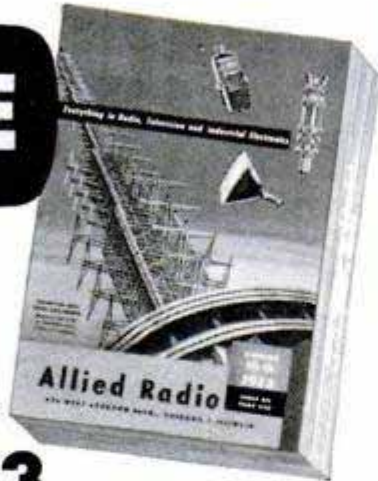

1953 ALLIED BUYING GUIDE

Save on Everything
in TV & Radio!

Everything for Experimenters, Builders, Amateurs, Servicemen, Engineers and Soundmen

Get the big 236-page 1953 ALLIED Catalog featuring the world's largest selections of latest top-quality electronic equipment at lowest, money-saving prices. See the newest in TV, home radios, Amateur Equipment, Hi-Fidelity sound, P.A. systems, recorders, test instruments, builders' kits—plus thousands of parts, tubes, tools and books. Get more for your money from the World's Largest Radio Supply House. Send today for your FREE 1953 ALLIED Catalog!



FREE
CATALOG

SEND FOR IT TODAY

ALLIED RADIO

ALLIED RADIO CORP., Dept. 5-J-2
833 W. Jackson Blvd., Chicago 7, Illinois
 Rush FREE 1953 ALLIED 236-Page Catalog

Name _____

Address _____

City _____ Zone _____ State _____

VALUES FROM \$10 TO \$10,000

OUT OF PAWN

GENUINE DIAMONDS

TIME PAYMENTS ARRANGED

FREE CATALOG

SAVE UP TO 50% AND MORE

All diamonds reset in brand new modern mountings. Sold with a written iron-clad money back guarantee. Over 100,000 satisfied customers have bought diamonds from Berman's.

Berman's Diamond Loan Bank
Dept. P —BERMAN BLDG., BALTIMORE 1, MD.

Diamonds from estates, banks, unredeemed pledges offered at substantial savings

Is Your Life Crowned With Success?



LEXIPOWER

WE THINK IN WORDS. THOUGHT IS POWER. Let this New Science show you how to WIN WITH WORDS — financially, socially, culturally. Develop a MASTERFUL VOCABULARY. Influence others, improve your personality, manifest your latent ability. You are judged and rated by every sentence you utter. Start using the POWER of LEXIPOWER after the first Lesson. Write NOW for FREE details about LEXIPOWER. Dime-a-Day LESSON CLUB.

LEXIPOWER LESSON CLUB

517-L W. Deming Place

Chicago 14, Illinois

New PRINTMASTER!

PRINT YOUR OWN POSTCARDS

Advertise ECONOMICALLY. Use Postcard MESSAGES for EFFECTIVE Advertising! Ideal for Notices, Sales, Announcements, Forms, Labels, Etc., in every type of Business and Organization. Time and Money Saver! Send today for FREE Illustrated Information.



PRINTMASTER DUPLICATOR CO. 655 S. WELLS ST., DEPT. PM-4 CHICAGO 7, ILL.

AVIATION

The aircraft industry urgently needs trained personnel. Here is YOUR opportunity for a rewarding and interesting future. Study Aeronautical Engineering, Engineering Drafting, Airplane and Engine Mechanics (approved by C.A.A.). Outstanding faculty, modern equipment. Part-time employment. Free placement service. Big demand for graduates. 23rd year. Founded by Curtiss-Wright. Write for free bulletin and "Opportunities in Aviation".

AERONAUTICAL UNIVERSITY

Dept. 75, 1905 Prairie Avenue, Chicago 16, Illinois

ENGINEERING DEGREE IN 27 MONTHS

INDIANA TECHNICAL COLLEGE

B. S. DEGREE, Aeronautical, Chemical, Civil, Electrical, Mechanical and Radio Engineering (inc. TV and Electronics). Drafting, 1-yr. G.I. Gov't approved. Low rate. Earn board. Large industrial center. Students from 48 states, 21 countries. Demand for graduates. Enter September, December, March, June. Write for catalog, 1692 E. Washington Boulevard, Fort Wayne 2, Indiana.

There's BIG MONEY in UNIFORMS and Work Clothes that ADVERTISE!

Every business and businessman is swinging over to employee uniforms and work clothes, embroidered with company name, trademark, sales message, etc. The field is new. Prospects

... ORLON ... Available Soon! TOPPS will be first with uniforms made of Dupont's miracle ORLON! They promise fantastic profits! Get details now!

are everywhere; garages, service stations, factories, coal dealers, dairies—and hundreds more. Profits are huge. You take orders by the dozen and gross! One man made over \$800.00 on a single sale! You get the business everytime because you offer latest, finest fabrics. Big selling kit Free!



TOPPS, Dept. 619, Rochester, Indiana

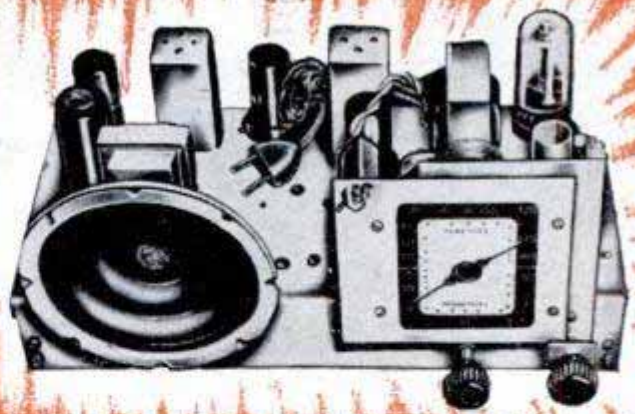

TRAIN **FASTER**—TRAIN **BETTER**—TRAIN **EASIER**
 IN 10 MONTHS—OR LESS—FOR
RADIO-TELEVISION

Our 21st Year Training Men for Greater Incomes and Security in Radio-Television

I SEND YOU
18 BIG KITS

of Radio-Television parts and equipment. Much of your training will be actual construction and experimentation . . . the kind of truly PRACTICAL instruction that prepares you for your Radio-Television career.



Frank L. Sprayberry
 President
 Sprayberry Academy
 of Radio

NEW! NO OBLIGATION PLAN

You Have No Monthly Payment Contract to Sign
 Pay For Your Training as You Earn and Learn

You can get into Radio-Television, today's fastest growing big money opportunity field, in *months* instead of years! My completely new "package unit" training plan prepares you in as little as 10 months or even less! *No monthly payment contract to sign—thus NO RISK to you!* This is America's finest, most complete, practical training—gets you ready to handle any practical job in the booming Radio-Television industry. Start your own profitable Radio-Television shop . . . or accept a good paying job. I have trained hundreds of successful Radio-Television technicians during the past 21 years—and stand ready to train you, even if you have no previous experience! Mail coupon and get all the facts—FREE!

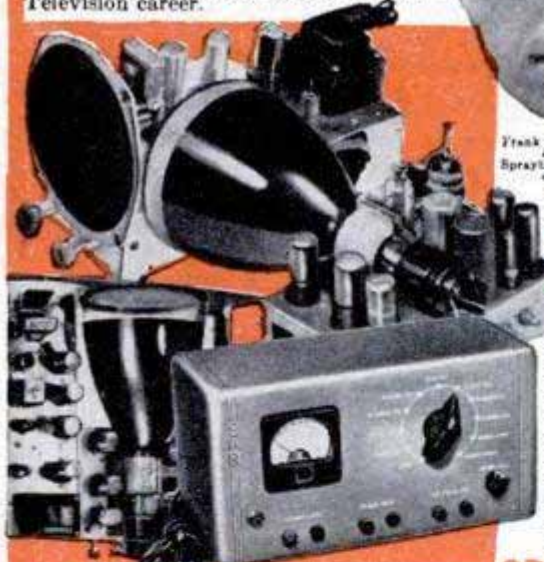

**Valuable Equipment Included
 With Training**

The new Sprayberry "package" plan includes many big kits of genuine, professional Radio-Television equipment. You perform over 300 demonstrations, experiments and construction projects. You build a powerful 6-tube 2-band radio set, multi-range test meter, signal generator, signal tracer, many other projects. All equipment and lessons are *yours to keep* . . . you have practically everything you need to set up your own profitable Radio-Television service shop.

Earn Extra Money While You Learn!

All your 10 months of training is IN YOUR HOME in spare hours. Keep on with your present job and income while learning. With each training "package" unit, you receive extra plans and "Business Builder" ideas for spare time Radio-Television jobs. New television stations everywhere, open vast new opportunities for trained Radio-Television Technicians—and those in training. If you expect to be in the armed forces later, there is no better preparation than practical Sprayberry Radio-Television training.

YOU BUILD the Television set and the powerful superhet radio receiver shown above IN ADDITION to the other test units shown here. (Many are not illustrated.)

Approved for Veterans under the G.I. Bill

SPRAYBERRY ACADEMY OF RADIO 111 NORTH CANAL ST.
 Dept. 10-N, Chicago 6, Ill.

**MAIL COUPON
 TODAY!
 NO OBLIGATION**

I invite you to get all the facts —
**FREE TO YOU 3 BIG
 RADIO-TELEVISION BOOKS**

Rush coupon for my three big Radio-Television books: "How to Make Money in Radio-Television," PLUS my new illustrated Television Bulletin PLUS an actual sample Sprayberry Lesson —ALL FREE. No obligation and no salesman will call. Mail coupon NOW!

**SPRAYBERRY ACADEMY OF RADIO, Dept. 10-N
 111 North Canal St., Chicago 6, Ill.**

Please rush to me all information on your 10-MONTH Radio-Television Training Plan. I understand this does not obligate me and that no salesman will call upon me. Be sure to include 3 books FREE.

Name..... Age.....

Address.....

City..... Zone..... State.....

C. T. C. TRAINING IN DRAFTING

PREPARES FOR
PROMOTION
•
MORE MONEY
•
SUCCESS



"Here I am at work making good money as a draftsman. I'm glad I sent the coupon to Chicago Tech for that Free Trial Lesson and found out how easy it is to learn Drafting in spare time at home. Today, I feel secure in my job. What's more, I feel I'm slated for promotion and more pay."

LEARN IN SPARE TIME—AT HOME!

(or at the College in Chicago)

A few hours of pleasant home study every week—that's all. All the tools you need; drawing outfit included. This tested method—developed over 48 years of C.T.C. progress—prepares men quickly for good positions in industry.



FREE INFORMATION—SEND COUPON

To prove to you how easy it is to learn Drafting at home, we will send you this FREE TRIAL LESSON. Mail coupon or send post card today.

CHICAGO TECHNICAL COLLEGE

M-250 Tech Bldg., 2000 So. Michigan Ave.
Chicago 16, Illinois

Mail me FREE Lesson with information about big opportunities in DRAFTING.

Name _____ Age _____
Address _____
City _____ Zone _____ State _____

WHY SUFFER TONGUE BITE?

Cost 3 times as much to build as the best of old-fashioned pipes. But KILL TONGUE BITE, STOP DRINK. FREE circular tells WHY. Write:

KLENSMOK PIPES

P.O. No. M597, Tenn.
Johnson City, Tenn.
R-Reg. U.S. Pat. Off. Pat's and Pat's. Pend.

Only WSA Offers this Simple way to

BE AN ARTIST

TRIAL PLAN makes it easy to start! Prove to Yourself You Can Learn to Draw at Home in Your Spare Time For 38 years we have trained thousands of satisfied WSA Artists. Why not you? Qualify for a well-paid position in this exciting field. Commercial Art, Designing, Cartooning all in one complete home study course. TWO ART OUT-FITS included. No experience necessary. Get the facts—trial plan makes it easy—write now.



MAIL COUPON FOR FREE BOOK

WASHINGTON SCHOOL OF ART
Studio 129F, Washington 5, D.C.

Send Free Book, "Art for Pleasure & Profit."
No salesmen. (Please print)

Name _____
Street _____ Age _____
City _____ Zone _____ State _____

I am interested in your new Trial Plan



New Low Cost Electric Water Heater Gives You HOT WATER AUTOMATICALLY From Your Present Tank!

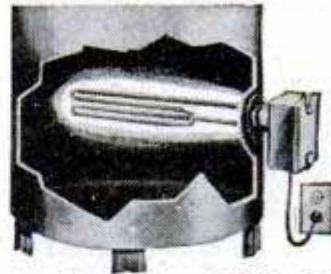

Complete—Ready to Plug In—Only **\$19.95**

New, UL approved LECTROMATIC changes gas, coal or oil-burning water heater into modern ALL-ELECTRIC unit! Turns on automatically when needed, shuts off automatically when water is heated. Remove plug from water tank. Screw LECTROMATIC into opening (as shown), then PLUG IN! Plenty of hot water all day long. Uses only 1/4-lge electricity per gal. of hot water. Temp. adjustable from 100 to 180 degrees. Save postage. Send check or money order for \$19.95 now. Money back in ten days if not delighted. Full one year guarantee! ORDER NOW!

COLLOID EQUIPMENT CO., INC. Dept. PM9, 50 CHURCH STREET NEW YORK 7, N. Y.

WHAM-O SPORTSMAN*

\$1.50 POSTPAID

35-LB. PULL!

HITS LIKE A RIFLE—KILLS RABBITS, SQUIRRELS.

Powerful, silent, accurate.

For hunting, target, routing pests.

Sportsman's choice sold world over!

HUNTING SLINGSHOT

Heavy duty 7" ash stock.

40 steel balls, extra rubber, target.

GUARANTEED. At dealers, or send \$1.50 to

Wham-O Mfg. Co. Box 8T, South Pasadena, Calif.

* Professional model of Nat'l Slingshot Assn.

NEVER FAIL FLASHLIGHT NEEDS NO BATTERIES

A wonderful device that is always ready for service. Never needs batteries. Self generating power that gives a strong beam. Carry with you always. Keep in Car, Boat, Home, Office or Factory. Just the thing for those Summer Walks and camping trips. WILL NEVER FAIL YOU. Rush your name and address right now. Pay postman \$4.98 plus postal charges, or save approximately 50¢ by enclosing your check with order. Telephone order to MU-8-4971.



IMPERIAL SALES, 480 Lexington Avenue, Dept. F-479, New York 17, N.Y.

HIGH SCHOOL Taken at Home

EARN A DIPLOMA

High school graduates get better jobs, earn more. Earn your diploma at home in spare time in 18 to 24 months. Equals resident school. College prep. Credit for attendance elsewhere. Books supplied. Write for free booklet!

COMMERCIAL TRADES INSTITUTE, Dept. H2-9
1400 Greenleaf Avenue • Chicago 26, Illinois

Catalog of 3000 Novelties 10c

Send 10c for amazing catalog of novelties, live animals, scientific supplies, hobbies, funmakers, planes & boats, looms, magic tricks, joke articles, unusual seeds, gadget timesavers, cameras, optical goods, projectors, movies, lucky jewelry, religious novelties, disguises, musical instruments, stamps, coins, puzzles, fortune tellers, radios, auto & bike accessories, telescopes, magnifiers, compasses, banks, smokers' gadgets, artists' supplies, printing sets, engines, motors, shockers, knives, billfolds, fireworks, guns, rifles, sports, books, games, plants, etc. Send name, address & 10c to: **JOHNSON SMITH & CO., Dept. 546, Detroit 7, Michigan**

When You Can Earn More in WATCHMAKING LEARN By KCSW's Outstanding Method

Don't let a lay-off catch you. **START NOW TO LEARN WATCHMAKING AT HOME IN YOUR SPARE TIME.** Earn extra money as you learn, repairing clocks and watches. You will be building your own business right at home.

Write for information on KCSW's HOME STUDY COURSE

KANSAS CITY SCHOOL OF WATCHMAKING
1218 Admiral Blvd. Kansas City 6, Missouri

GET INTO

AUTO-DIESEL

& ALLIED MECHANICS

Master All Phases

JOBS LIKE THESE ARE AVAILABLE TO TRAINED MECHANICS. CHOOSE THE FIELD YOU LIKE BEST

GET COMPLETE TRAINING FOR:

Automotive Motor Tune-Up • General Garage Mechanic • Agricultural Implements Mechanic • Diesel Engine Rebuilding • Diesel Fuel Injection • Auto Engine Rebuilding • Auto Electrical Service • Parts Dealers • Bus & Truck Lines • Industrial Maintenance • Contracting and Excavating • Business of Your Own • AND MANY OTHERS!

SHOP-METHOD HOME TRAINING BY AN ESTABLISHED RESIDENT SCHOOL TRAINS YOU FOR ALL OPPORTUNITIES IN AUTO & DIESEL INDUSTRIES!

Opportunity is everywhere for the trained Auto-Diesel Mechanic. Highways throng with cars, buses, trucks, tractors. Garages and service stations are busy. Farm machinery is "going Diesel." Factories, ships, farms, railroads, general industry, are dependent on engine power. Here's a dynamic, fast-growing field that needs trained men who know all phases: installation, operation, maintenance and repair. Now-National Schools offers you a practical, all embracing Auto-Diesel Mechanic's Course, including all these advantages:

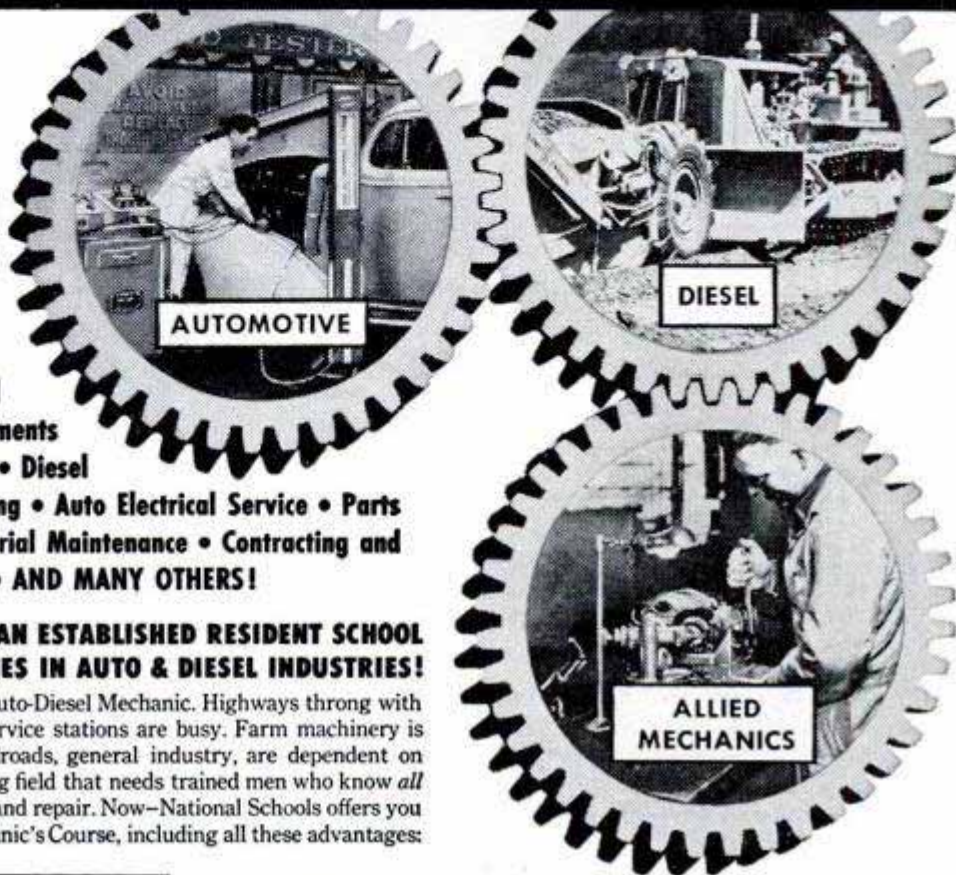

COMPLETE SHOP-METHOD HOME TRAINING COVERS

DIESELS—High Speed and Heavy Duty SEMI-DIESELS—Gasoline and Special Fuel Engines AND ALLIED MECHANICS!

- | | |
|-----------------------|------------------------|
| Basic Lesson Texts | Engine Service Manuals |
| Diesel Installations | Engine Repair |
| Operation-Maintenance | Drive Systems |
| Diesel Chart Manual | Diesel Electric Power |
| Spare Time Lessons | Thermodynamics |

AND YOU CAN EARN WHILE YOU LEARN!

With our practical Master Shop-Method Home Training, you study at home in your spare time. You get Spare Time Work Lessons showing you how to earn while you learn, for extra money and experience. You learn by DOING.

DRAFT AGE? Services offer better ratings, more pay to men with training. Start now—if called while training, we'll make satisfactory adjustment for you.



FREE BOOK and SAMPLE LESSON show how we train you! SEND FOR THEM TODAY!

WE GIVE YOU TOOLS OF YOUR TRADE

TO MAKE YOUR TRAINING COMPLETE, WE GIVE YOU PROFESSIONAL QUALITY TOOLS AND EQUIPMENT, INCLUDING ALL-METAL TOOL BOX! THEY ARE PART OF YOUR INSTRUCTION, YOURS TO KEEP! DON'T MISS THIS OPPORTUNITY OF A LIFETIME! GET THE FACTS—MAIL THE COUPON NOW!

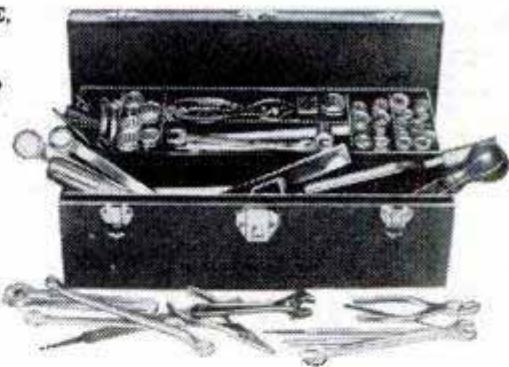

NATIONAL SCHOOLS

LOS ANGELES 37, CALIFORNIA • ESTABLISHED 1905
In Canada: 193 E. Hastings St., Vancouver, B.C.



FIND OUT NOW...MAIL COUPON TODAY

**NATIONAL SCHOOLS, Dept DB-92
4000 South Figueroa Street
Los Angeles 37, California**

Mail in envelope or paste on postal card

Mail me FREE the book "My Future in Automotive-Diesel & Allied Mechanics" and the Sample Lesson. I understand no salesman will call on me.

NAME _____ AGE _____

ADDRESS _____

CITY _____ ZONE _____ STATE _____

INVENTORS

Your first step—if you consider your invention to be something of importance—is to have a search made of pertinent, prior U. S. patents. If our search report indicates probable patentability of your invention, you may apply for a patent which gives you the right to exclude others from making, using or selling your invention as claimed for a term of 17 years.

This firm is registered to practice before the U. S. Patent Office and is available to assist in the preparation of the necessary drawings, specification and claims.

Ask for a copy of our instructive booklet "Patent Protection for Inventors" and our convenient "Evidence of Invention" form. No obligation.

VICTOR J. EVANS & Co. *Merlin M. Evans*
REGISTERED PATENT ATTORNEY
730-K MERLIN BUILDING, WASHINGTON 6, D. C.

INVENTORS

IF YOU WISH TO PROTECT YOUR INVENTION, You should take steps to protect it by a U. S. Patent. Write me for "INVENTION RECORD" form

CARL MILLER
REGISTERED PATENT ATTORNEY
WOOLWORTH BLDG., 35th FLOOR, 92A
NEW YORK CITY

INVENTORS

Whether an invention is patentable can be substantially determined by a search of the U. S. Patent records. Without obligation, write for information explaining the steps you should take to secure a patent.

JOHN N. RANDOLPH
Registered Patent Attorney
201 Columbian Building, Washington 1, D. C.

INVENTORS

Before you make any effort to market your invention, you should take the first steps toward proceeding for patent protection.

I shall be pleased to furnish you with information relative to patent procedure, upon request from you, and this will be without any obligation on your part.

PATRICK D. BEAVERS
Registered Patent Attorney
934 Columbian Building Washington 1, D. C.

INVENTORS

Send for **REGISTERED PATENT**
PATENT INFORMATION **ATTORNEY**
Book and
INVENTOR'S RECORD Patent Attorney & Advisor
without obligation U. S. NAVY DEPT. 1930-1947
GUSTAVE MILLER ASSOCIATE EXAMINER
92-PM WARNER BUILDING U.S. PAT. OFF. 1922-1929
WASHINGTON 4, D. C. **PATENT LAWYER**



PATENTS
C. A. SNOW & CO.
REGISTERED PATENT ATTORNEYS
WRITE FOR INFORMATION TO
428 SNOW BUILDING, WASHINGTON 1, D. C.

INVENTIONS Wanted At Once

If you want to market, or sell, your invention for cash or royalties, Write for our Free Booklet. Send no drawings. We also welcome hearing from firms, or private capital, wishing to review inventions in any field. We will be glad to send notice of clients inventions.

GLOBAL MARKETING SERVICE
1404 Mitchell Street Dept. PD Oakland 1, Calif.

MAKE MONEY with Bostonian SHIRTS

Take orders for famous line finest quality dress and sport shirts. Also women's tailored blouses. All styles, fabrics, colors, sizes. Low Prices. No experience needed. FREE Big, beautiful Sales Kit with actual fabric samples. Send no money, but rush name now! **Bostonian Mfg. Co.**, 89 Bickford St., Dept. S-40, Boston 30, Mass.



60 POWER TELESCOPE \$3.95

VARIABLE EYEPIECE 20 x 40 x 60 — BRASS BOUND
NEW! Three telescopes in one. 3 different magnifications. 20 power for ultra-bright images with 40 and 60 power for extra long range. Guaranteed to bring distant objects, people, sports events, ships, moon, stars, etc. 60 times as close. Most powerful for any where near the money. 5 Sections. Closes to 1 ft. long. Contains 4 ground and polished lenses. Also used as a powerful compound microscope. Directions included. Mass production enables us to offer this instrument at amazing price of \$3.95 complete. Ready for immediate use. We pay postage. Get yours now.

CRITERION CO., Dept. PMB6, 331 Church St., Hartford 3, Conn.

Run the Best "Shoe Store Business" in Town!

I'll put a "Shoe Store Business" right in your hands. You don't invest a cent—make profits from \$10 to \$75, as much as \$200 monthly in spare time. No store overhead. Exclusive comfort features build quick profits and repeat business. Sell amazing line of Air-Cushion comfort shoes to friends, neighbors, fellow workers. Dress, sport, work, safety shoes for men, women. Send postcard today for FREE SALES OUTFIT!
CONSOLIDATED SHOE SYSTEM, Box GD-27, Chippewa Falls, Wisc.

IMPORT PAYS BIG

Opportunity to **START AT ONCE** **IMPORTING** big profit items for your own world-wide import-export business by mail order without capital, from home, anywhere; or work for others—profits unlimited, travel abroad if desired. No previous experience needed. Men, women... learn at home in spare time from established World Trader, easy step-by-step method. **FREE details—write NOW!** Airmail reaches us overnight. **MELLINGER CO., Suite 259, 1717 Westwood, Los Angeles 24.**



A GREAT OPPORTUNITY OPEN TO YOU IN THESE IMPORTANT INDUSTRIAL FIELDS

TOOL ENGINEER

TOOL & DIE DESIGNER

MACHINE DESIGNER

INDUSTRIAL ENGINEER

INDUS. DRAFTSMAN

TOOL & DIE MAKER

MASTER MACHINIST

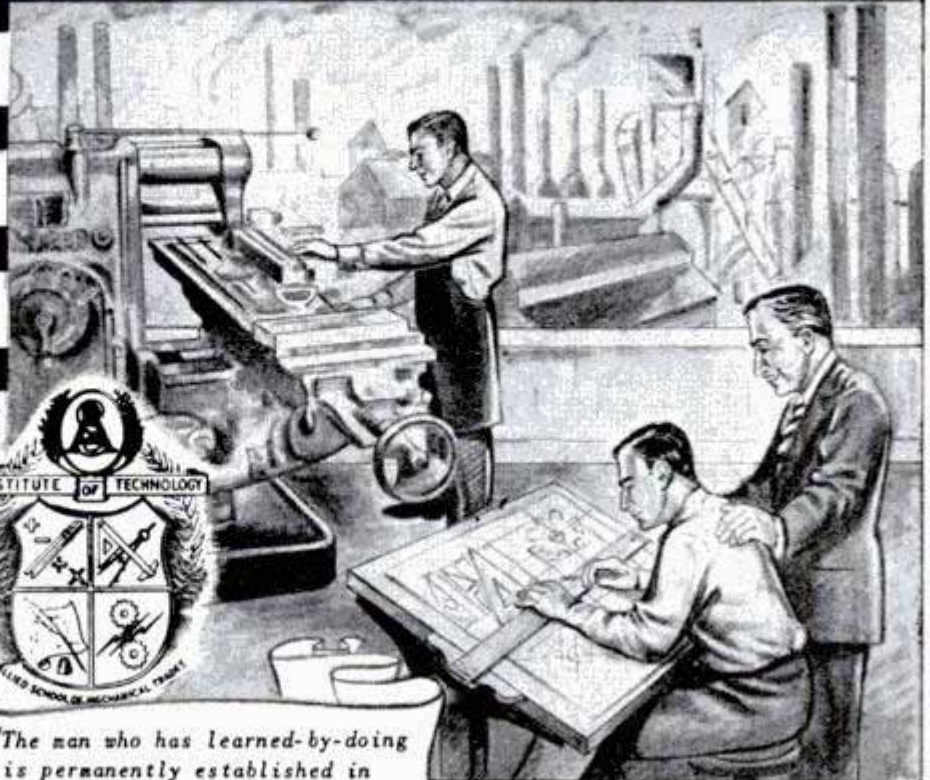

"The man who has learned-by-doing is permanently established in Industry.." HARRY LEBESON
President of the Allied School

"FROM THE BLUEPRINT TO THE FINISHED PRODUCT"

**SELECT
THE JOB
YOU WANT!**

**LEARN TO EARN
EASILY & QUICKLY
THRU ALLIED'S
TESTED TRAINING
PLAN**



An unusual opportunity for industrially minded, ambitious men to get into these available key positions that carry with them high pay and security! The enormous expansion of American Industry, particularly of the Metal Trades, brought about an acute shortage of Draftsmen, Designers, Tool Engineers, Machinists, Tool and Die Makers and other allied skilled trades. With ALLIED training you can take your place in these important industrial fields.

Thousands of our successful graduates covering a period of a quarter of a century serve as a testimonial to ALLIED training.

ALLIED is approved by Industry, the American Society of Tool Engineers, Department of Education and Registration, the Department of Public Instruction -- State of Illinois and the Veterans Administration. Accredited by the Central Schools Association.

Free employment service and housing assistance all through your training period and after your graduation. Our industrial contacts cover the U. S. A.

ALLIED SCHOOL of MECHANICAL TRADES
Allied Institute of Technology PM-9
1338-42 S. Michigan Ave. Chicago 5, Ill.

Gentlemen:

I want to get into important Industrial Trades and professions.

Send me without obligation your FREE BOOKS explaining Allied's course of instruction.

I am interested in Resident Training.

I am interested in Home Study Training.

I am eligible I am not eligible for training under the Revised G.I. Bill.

Name _____ Age _____

Address _____

City _____ State _____

send for **FREE BOOKS**

**ALLIED SCHOOL
of Mechanical Trades**

1338-42 S. Michigan Ave.
Chicago 5, Illinois



CORTINA
makes it FUN to



SPEAK FRENCH-SPANISH

RUSSIAN - GERMAN
ITALIAN - BRAZILIAN - JAPANESE

"Learn by Listening" to CORTINA RECORDS, at home, the NATURAL way — quickly, easily, cheaply.

Only 15 Minutes a Day!

The CORTINA method, famous for 70 years, teaches you to speak like a native. THOUSANDS have found it the most fascinating, most effective way to learn languages for Pleasure, Business, Travel, Culture. INVESTIGATE!

Send For FREE BOOK!

Illustrated 32-page book, "The Cortinaphone Short-Cut" sent FREE. No obligation. Tells just what you want to know. Interesting. Get it!

ALL NEW RECORDINGS ON UNBREAKABLE RECORDS WRITE TODAY

CORTINA ACADEMY (Est. 1882)

Suite 649, 105 W. 40 St., N. Y. 18, N. Y.

Please send me — without obligation — your free book. I am interested in (check)

French Spanish German Italian Brazilian
 Russian Japanese

Name.....

Address.....

City.....State.....

VETS! Check if NOW eligible under G. I. Bill.

SAY YOU SAW IT IN POPULAR MECHANICS

BUILD A \$15,000 A YEAR FUTURE!



IN THE EXCITING NEW BUSINESS OF LAUNDERING VENETIAN BLINDS

There is big money to be made cleaning Venetian Blinds and a permanent, fast growing, Lifetime Business, besides.

An amazing new kind of business of your own in a field that is growing like mad. Millions of Venetian Blinds need laundering at regular intervals.

With our new patented machine, you can start small—using your basement, garage or utility room to begin with. You can expand as your business increases by leaps and bounds. Income up to \$200.00 daily already being made by others. Small investment for equipment starts your own lifetime business—and monthly payment plan permits you to pay for it as you grow.

FREE

Get all the facts about this sensational new kind of machine that launders blinds so fast that your charges are unbelievably low. People would rather send blinds to you than do the work themselves.

Yet, you make 700% profit on every blind you clean. Get names of successful owners near you. Get details of the full amazing plan without obligation. Be first in your territory to start a business that has brought \$15,000 PROFITS the first year to others. Wire today or send name on postcard.

VENETIAN BLIND LAUNDRY EQUIPMENT CO. INC.
442 N. SENECA ST. DEPT. 109 WICHITA 12, KANSAS

MEN WANTED!



Make \$15-\$20 in Few Hours Spare Time—up to \$210⁰⁰ a Week FULL TIME—with Amazing **D-FROST-O-MATIC!**

Millions of housewives want this sensational new Automatic Refrigerator Defroster! No more messy hand defrosting! Just plug in D-FROST-O-MATIC and refrigerator is defrosted automatically every night! Sales easy, sure when you leave D-FROST-O-MATIC on FREE TRIAL—housewives won't let you take it out! Saves money, food, time, work! **Big profits for you**—up to \$210.00 a week full time—\$15 to \$20 in just a few spare hours! Start spare time and build big, prosperous business... quickly, easily!

SELLY of California started in his spare time and now sells 1600 D-Frost-O-Matics a month!

Rush Name Today for Profit Details and FREE TRIAL PLAN!

More than 29,000,000 prospects waiting! Rush your name and address today. We'll airmail exciting facts, proof and sure-profit Free Trial plan. No obligation. Write today.

D-FROST-O-MATIC, Dept. M-6
173 W. Madison Street, Chicago 2, Ill.

RADIO

Engineering. All phases radio & electronics theory & practice; television; FM; broadcasting; servicing; aviation, marine & police radio. Prepare for high pay: 18-month course equal in radio content to 4 yrs. college. Enter Jan., March, June, Sept. Regular campus life. Write for catalog.
VALPARAISO TECHNICAL INSTITUTE, Dept. D, Valparaiso, Ind.

MANAGEMENT PRODUCTION

Production experts earn big money. Thousands of firms need them. We train you thoroughly at home in spare time for management positions. Previous experience unnecessary. Personal training under supervision of production management authorities. Placement counsel and help. Write for FREE book "Industrial Management."

LASALLE Extension University, 417 So. Dearborn St.
A Correspondence Institution, Dept. 9641M, Chicago 5, Ill.

Hand Guide!
POSITIVELY controls movement of hand until one's Penmanship is quickly corrected. Inexpensive. Write, OZMENT (INVENTOR), 34-P, ST. LOUIS, MO. (BX665)

STUDY AT HOME WITH AN EDUCATIONAL INSTITUTION

Courses in **ARTS AND SCIENCES:** Philosophy; Education; Letters; Public Health; Medical Jurisprudence; Psychology; Sociology; Physics; Chemistry; Geology; Pol. Science; Theology; Law; Business and Commerce; Accounting; Mathematics; Statistics; Agriculture. Courses in **ENGINEERING:** Electrical, Civil, Mechanical, Drafting, Architectural, Automotive, Steam, Diesel, Aeronautical, Radio, Structural, Mining, Industrial, Petroleum, Marine, Refrigeration, Air Conditioning, Chemical. Send for free catalog.

McKinley-Roosevelt Incorporated, 4610-K32, Sheridan Rd., Chicago 40, Illinois



Before You Buy Your Trailer—READ...

TRAILER TOPICS MAGAZINE

It brings you the latest in Trailer Coaches—Equipment—Accessories—Trailer Trips—Trailer Parks and many other interesting monthly features at only—\$3.00 for 2 years.

(6 MONTH TRIAL SUBSCRIPTION \$1.00)

TRAILER TOPICS MAGAZINE (Room 1579)
28 East Jackson Blvd., Chicago 4, Ill.

MASTER WATCHMAKING

At Home - NOW!



Learn *professional methods* of watch repairing without leaving home or job . . . enjoy a profitable hobby . . . or prepare for a new career. The easy-to-follow Sweazey System shows you step by step how to fix watches from start to finish. It's fascinating! Can easily lead to a business of your own.

Tools, Supplies and Equipment all Furnished

CSW's Master Course brings you everything you need to learn watch repairing at home. Included are: practice watches . . . professional equipment—such as watchmaker's lathe and staking tool . . . 200 more tool and supply items . . . 51 special texts . . . and other aids to assure complete, practical, professional instruction.

CSW HAS BEEN TRAINING MASTER WATCHMAKERS SINCE 1908

Why not be one of our successful graduates? Learn how Chicago School's streamlined training can speed *your* success. Previous experience unnecessary. Get the facts now!

SEND COUPON TODAY!

CHICAGO SCHOOL OF WATCHMAKING

Founded 1908

1608 MILWAUKEE AVE., CHICAGO 47, ILL.



FREE SAMPLE LESSON!

CHICAGO SCHOOL OF WATCHMAKING

1608 N. MILWAUKEE AVENUE, DEPT. 192 CHICAGO 47, ILLINOIS

Please send free sample lesson and full information on home study course in Master Watchmaking.

(This offer limited to USA and members of Armed Forces overseas. Other plans available for foreign students.)

Name _____

Address _____

City _____ Zone _____ State _____

BOYS-IT'S FREE!

... NEW, EXCITING 16-PAGE BOOK on magic and marvels of chemistry

Shows you how to amaze friends with eye-opening tricks of chemical magic . . . like changing water to blood and blood to stone. Tells you how to do many fascinating home experiments and shows you the big, new Chemcraft outfits. Describes fun, thrills, adventure you can have with a Chemcraft chemistry outfit of your own. Send now for free copy to Porter Chemical Co., 40 Prospect Ave., Hagerstown, Md.

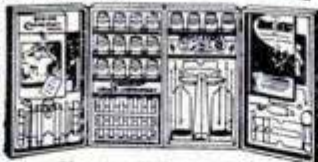

Chemcraft Senior Lab.

HEY FELLAS! ask Dad for **CHEMCRAFT**

Tells How You Can Learn to

FREE BOOK MOUNT BIRDS!



Learn At Home

Men, Boys, Hunters, Fishermen, mount and save your lovely wild-game trophies. Be a Taxidermist. Mount Birds, Animals, Heads, Fish, Tan skins. YOU learn easily, quickly in spare time. Have a grand home-museum. The finest and the greatest hobby known, for sportsmen. Fun, real profits.

FREE BOOK

Yes, FREE. Beautiful strange, valuable Book, telling all about Taxidermy. Contains over 100 beautiful game-pictures. And it's yours FREE, if you rush your request. You can mount all kinds of wild-game, and common specimens too. We can positively TEACH YOU. So GRASP this opportunity. RUSH letter or postal for this amazing FREE BOOK. Don't delay. State your AGE. N. W. SCHOOL OF TAXIDERMY, 2509 Elwood Bldg., Omaha 2, Neb.

SEND FOR FREE BOOK ↓

EXAMINE THESE EIGHT ELECTRICAL BOOKS

AT OUR RISK!



3769 PAGES

2784 PICTURES

134 TABLES

MAIL COUPON

SEND NO MONEY

LEARN FAST—MAKE MORE \$

Here's electrical know-how in eight sturdy volumes — our 19th edition of practical, easy-to-understand information for both beginners and experienced workers. For more than 45 years our editions have helped ambitious men to get better jobs, win promotions, make more money. The set we now offer you covers more than 1000 indexed subjects. By a gradual step-by-step process it takes you into all branches of electricity and supplies "how-to-do-it" knowledge in a clear and thorough manner. The electrical field is tremendous and always expanding. There are golden opportunities for beginners who want to climb to the top—bigger-pay opportunities for those now in the field who want to progress faster. These great books can give you the boost you need. **SEND THE COUPON NOW.** If you keep the books we'll include a year's consulting privileges with our engineers, no extra cost!

AMERICAN TECHNICAL SOCIETY—Publishers Since 1898
Dept. E619, Drexel Ave., at 58th St., Chicago 37, Ill.

I would like to examine your 8-Volume Set of Electrical Books, I will pay the delivery charges only, but if I choose I may return them express collect. If after 10 days' use I prefer to keep them, I will send you \$3 and pay the balance at the rate of only \$4 a month until \$34.80 has been paid. Include consulting service as offered above.

Name _____

Address _____

City _____ State _____

Please attach letter giving employer's name and address (if self-employed give business man reference). Men in service please give home address.



WORK IN COOL SAN DIEGO

Illustrated
book sent
FREE

San Diego offers you California living at its best — and Convaair gives you the top working conditions. Employee Retirement Plan. Group Insurance. Two weeks vacation. Eight holidays annually. Free Housing Office and much more — plus that wonderful San Diego climate. These classifications now open for you:

- | | |
|-----------------------------|-------------------------------|
| 1. TOOL DESIGNERS | 8. FIELD & SERVICE MECHANICS |
| 2. TOOL PLANNERS | 9. AIRCRAFT MECHANICS |
| 3. PATTERN MAKERS | 10. AIRCRAFT ELECTRICIANS |
| 4. TOOL & DIE MAKERS | 11. IBM TAB MACHINE OPERATORS |
| 5. JIG AND FIXTURE BUILDERS | 12. INSPECTORS |
| 6. MACHINISTS | |
| 7. LOFTSMEN | |

CONVAIR

Send this coupon for FREE book and details:

Employment Office 700
Consolidated Vultee Aircraft Corporation
3302 Pacific Hiway
San Diego, California

NAME _____
OCCUPATION _____
ADDRESS _____
CITY _____ STATE _____

New Way to Improve YOUR ENGLISH



A command of effective English gives you added advantages and better opportunities. Poor English handicaps you more than you will ever realize. You can improve your English through Sherwin Cody's 100% self-correcting invention. If you are embarrassed by mistakes in grammar, spelling, punctuation, or pronunciation, this free book "How You Can Master Good English in 15 Minutes a Day" will prove a revelation to you. Send for it now. It is free. No obligation. No agent will call. Address SHERWIN CODY COURSE IN ENGLISH, 59 B&O Building, Rochester 14, N. Y.

BRAND NEW

30 DAY FREE TRIAL

High Power
BINOCULARS

Finest Precision Optics
Featherlight
Money Back Guarantee
Easy Pay Plan
Leather Case Incl.

33 MODELS
\$14.95
up

BUSHNELL Binoculars

Free! Catalog & Book
"How to Select Binoculars"
Dealer Inquiries Invited
Bushnell Bldg., Dept. M49
Pasadena 1, Calif.

FREE GUIDE "How to Select Binoculars"

NAME _____ CITY _____
ADDRESS _____ STATE _____

TUBE GIVEN WITH EVERY TIRE AT NO EXTRA COST



Why Pay More!

FALL SPECIALS — AT LOW PRICES
SAVE TIME — SAVE MONEY — SEND THIS AD

GOOD USED TIRES "Not recapped."

19 YEARS AT THIS ADDRESS

Be Wise—A TRIAL OF ONE TIRE WILL CONVINCE YOU.



19 MONTHS WRITTEN GUARANTEE			
600-16 \$4.02	820-15 \$5.32	600-20 \$7.02	32x6(10) \$8.52
650-16 4.42	700-15 4.32	650-20 7.42	32x6(10) 9.82
700-16 5.02	670-15 4.52	700-20 8.42	900-20 13.22
650-15 4.02	710-15 4.72	750-20 8.42	1000-20 13.82
760-15 5.02	550-17 5.52	825-20 14.02	1100-20 14.82

EXTRA SPECIALS				29 MONTHS WRITTEN GUARANTEE			
600-16 \$4.72	550-15 \$4.92	700-15(6) \$9.82	700-20 \$11.02	600-16(6) 5.72	640-15 4.92	750-16(8) 9.72	750-20(8) 12.72
650-16 5.72	670-15 5.12	700-17 10.72	750-20(10) 16.12	650-16(6) 6.42	710-15 6.62	750-17 11.62	825-20 18.32
700-16 6.42	760-15 5.82	750-15 14.02	900-20 17.32	750-16 6.92	800-15 6.52	825-15 16.02	1000-20 17.82
525-18 5.92	820-15 6.52	600-20 8.82	1100-20 20.52	550-17 4.92	870-16 6.62	650-20 10.22	1200-20 23.72
650-15 5.02	760-16 6.52	32x6(8) 10.62	150-22 20.52	700-15 4.72	760-16 6.52	32x6(10) 10.92	1100-22 20.52
Whitewalls \$1.00 each Extra				Military Treads 750x20(8) 14.02			

Thousands of tires shipped all over U.S.A. All tires shipped F.O.B. Phila. Send Check or M.O. with this ad. Dept. 2.

STANDARD 834 N. Broad St., Philadelphia 30, Pa.

FOR BIG MEN ONLY!

SIZES 10 to 16 WIDTHS AAA to EEE

We specialize in large sizes only. Shoes in wide style variety; sox, rubbers, overshoes, shoe trees. Send for FREE Catalog TODAY!

SEND FOR FREE CATALOG

KING-SIZE, Inc., 942, Brockton, Mass.

SAY YOU SAW IT IN
POPULAR MECHANICS

FREE 12 Hitler Stamps

ALL DIFFERENT! Sent FREE to secure names for our mailing list. We'll include other interesting offers for your inspection—PLUS a FREE book, "How to Collect Stamps." Just write to: Littleton Stamp Co., Dept. PM-9, Littleton, N.H.

MAKE MONEY! Sell Warm **LEATHER** Jackets

Rush Card TODAY for FREE SELLING OUTFIT! Sell warm leather jackets to truckers, milkmen, gas stations, etc. Men really go for these fast-selling garments of Horsehide, Capeskin, Suede, Nylon, and 100% Wool. Warm quilted linings, fur collars! As our man in your community, you make BIG MONEY on every sale, yet you don't invest one cent. Rush card NOW... start building your own big profit-making business right away. CONSOLIDATED SHOE SYSTEM, Box CD-28, Chippewa Falls, Wis.

SILVER SOLDER TORCH & KIT \$7.95

JOINS ALL METALS PERMANENTLY

Do your own repairing. KIT includes one tube silver solder paste and 10 5-in. lengths silver solder alloy. Hottest ALCOHOL TORCH known. 2700° F. flame. Operates in any position, indoors or out. Pint of special fuel included. Complete outfit ready for use \$7.95 postpaid. TORCH alone with pint of special fuel \$6.85. KIT alone \$1.65. Instructions included. AMERICAN PRODUCTS CORP., 422 S. Dearborn, Dept. 3-H, Chicago

REAL PANSY COASTERS
Make Them at Home

EASY — FUN
PROFITABLE

Now create new and truly different gift articles like the beautiful pansy coaster shown —made by embedding real pansies in Castolite—the "magic" liquid casting plastic. With our simple step-by-step method you can make hundreds of valuable articles, including smart costume jewelry, chic Hi-Style buttons, colorful key tags, tie-clasps, cuff links, plaques, tiles, many other things. Send 25¢ for Big Castolite Creations Manual. FREE with Manual, inspiring New Home-Success Plan. Write:



CASTOLITE CO., Dept. K-1, Woodstock, Ill.



Now I've got a
HIGH PAYING CAREER in
TELEVISION
 RADIO & ELECTRONICS
 —thanks to the famous
CRESCENT SCHOOL
 Home Study Course!



Yes, a brilliant future
 awaits you in **TELEVISION**.
 My advice is to send for the
 details now about the
CRESCENT course!



It's the **CRESCENT**
SCHOOL
FREE sample
 lesson. Boy!
 That was fast!

Gosh—I can actually earn while
 I learn with the practical
CRESCENT SCHOOL course!



Learning in my
 spare time is so
 easy with these
 illustrated,
 simplified
 lessons!



Wow! I built this swell TV
 set myself with my complete
CRESCENT kits!

I'm sure proud of my
CRESCENT SCHOOL certificate
 ... now I can really start
 on a big career!



Imagine—my own business, a home,
 a new car—and the **CRESCENT**
SCHOOL course started it all!

Approved under the G.I. Bill,
CRESCENT SCHOOL has trained
 thousands for **BIG** careers in the
 fast-growing **TELEVISION**
 industry.



CRESCENT SCHOOL
 "One of the largest
 schools of its kind"

ACT TODAY to start on a profitable
 career in **TELEVISION!**
 Get your
 sample lesson **FREE!**

SEND COUPON TODAY!

CRESCENT SCHOOL Dept. B-9
 500 Pacific St., B'klyn 17, N. Y.

Sirs: Rush your **FREE** sample lesson and full details about
 the **CRESCENT SCHOOL** Home Study Course—at no obli-
 gation to me!

NAME

ADDRESS

CITY.....ZONE.....STATE.....



INSTALL A "MILE-O-METER"

LEARN HOW TO SAVE GAS AND TUNE YOUR OWN MOTOR . . .

"Mile-O-Meter" on the dashboard registers miles per gallon faithfully at all speeds, under every driving condition . . . Will show what speed your engine delivers its maximum power. Can save you many gallons of gas . . . Provides constant check on engine condition — Warns you of operating imperfections for 31 different motor adjustments . . . Nationally advertised in leading magazines and newspapers . . . Can be installed in a few minutes . . . transferred from old to new car. Fine watch precision . . . Order yours today!



STD. Model
\$9.75
2 3/4" Dia. Ppd.
Fed. Tax Incl.

HUGE 24 PAGE INSTRUCTION MANUAL AND MILEAGE CALCULATOR INCLUDED FREE!



Installation requires no experience . . . becomes a constant companion on every trip. Saves cost in a short time. This professional gauge is a must!

\$14.95 DELUXE MODEL with Chrome Ring
3 3/4" Dia. Ppd. Fed. Tax. Incl.

GALE HALL ENGINEERING Dept. 239

BOSTON 18, MASS.

DELUXE MODEL NOW ILLUMINATED

Some make more, some less;

GEO. HELD reports—

\$350 gross in single
WEEK
IN MY OWN BUSINESS

Here's wonderful opportunity to start money-making business of your own—with electric upholstery cleaner.

● Here's YOUR chance to start a money-making, year-'round business of your own and make the success you've dreamed about. R. O. Donnley took in \$40 in seven hours. O. W. Ware landed a \$750 hotel job. J. S. Corbit grossed \$279.50 his first month. And so it goes. Homes, hotels, offices, clubs, all places where furniture is used, offer you big profit possibilities. Auto upholstery also.

NO SHOP OR OFFICE NECESSARY

● You clean furniture on customers' premises. No hauling. No high rents. Supplies are inexpensive, you operate at low cost from your home. What you take in is mostly profit.

DON'T DREAM—DO SOMETHING NOW

● It costs nothing to investigate an opportunity like this. If you want to be your own boss—free from layoffs, strikes and bosses, we will help you to start and succeed. Don't delay . . . read the facts, then decide for yourself.

MAIL COUPON TODAY FOR FREE BOOK

● **VON SCHRADER MFG. CO.**

● 1930 "D" Pl., Racine, Wisconsin

● Send at once (no obligation) your **FREE** booklet containing information about your Electric Upholstery Cleaner and how I can own my own permanent, profitable business.

● Name _____

● Address _____

● City _____

Zone _____ State _____

Powerful Motor

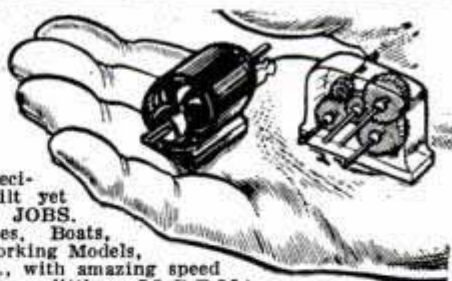

One of the smallest precision motors ever built yet does **GIANT-SIZED JOBS**. Drives Model Planes, Boats, Construction Sets, Working Models, Trains and Cars, etc., with amazing speed up to 6800 R.P.M. (or as little as 50 R.P.M.), using the reduction gears that come with this exciting set. The **MIGHTY MIDGET** does hundreds of jobs. It's a Honey. Looks exactly like a Big Motor, yet measures 1"x1 1/4" and weighs one ounce. For only \$2.98, YOU GET LOTS MORE with this Mighty Midget. You get a complete set of gears and pulleys and a transparent multi-ratio gear box as well as a battery clip with two batteries and instructions. **NO SHOCKS, SPARKS, NO SHORTS, NO TRANSFORMER NEEDED.** Reverses immediately, too! Endless hours of fun. Enclose check or money order for \$2.98 for this entire set and we will pay postage. C.O.D. orders plus postage.

IMPERIAL SALES CO.

480 LEXINGTON AVE. DEPT. M-464 NEW YORK 17, N.Y.

TO LOCATE THE WOOD STUDS IN YOUR WALL



USE A DOWSER*

When hanging mirrors, pictures, shelves. Also when repairing or altering.

\$2.00 Ppd. Money-back guarantee.

The Roll of the Ball Finds the Stud in the Wall

You May Need One Tomorrow!

FORD PRODUCTS, Dept. P-2, Tuckahoe, N. Y.



OWN WORLD'S FINEST CRYSTAL RADIO
\$8.95 COMPLETE KIT Money Back Guarantee

Plays anywhere. Needs no tubes, batteries or electric current. Gets distant stations clearly. Special selector switch for best reception. Head phones, aerial kit included. Nothing else to buy. Assembled in minutes. Big 5"x4 1/2"x6 3/8" table model size. Send \$1.00 deposit now, we'll mail C.O.D. for balance.

JAEGER & CO.

P. O. BOX 246A SKOKIE, ILL.

LOCKSMITHING & Key Making



PRACTICAL UP-TO-DATE COURSE—ONLY \$4.95

Easy-to-learn modern information for self-instruction. How to work on locks, de-code, make master-keys, repair, install, service, etc. For every handyman, home owner, carpenter, mechanic, service station operator, fix-it shop, hardware dealer, gunsmith. 53 plain illustrated lessons. **FULL PRICE ONLY \$4.95. SEND \$4.95 WITH ORDER.** We'll ship postpaid. Satisfaction guaranteed or refund.

NELSON-HALL CO., 210 S. Clinton St., Dept. JY-2, Chicago 5, Ill.

SAY YOU SAW IT IN
POPULAR MECHANICS

Tool and Die Design Training

\$8,000 to \$15,000 YEARLY INCOME!

Acme training has been fully proved in practice through its fine resident schools. Acme graduates report outstanding promotions, resulting in higher salaries. Progress is sure and easy through Acme's famous "Cope" System.

Prepare yourself in your spare time for a secure position of responsibility and high earnings, and qualify at a time when you will have every opportunity to rise to a position in the \$8-15,000 per year salary bracket. Be successful — go farther faster!

Detailed information upon request.

ACME SCHOOL OF DIE DESIGN

(Correspondence Division, Dept. M)

8 N. JEFFERSON STREET

DAYTON 2, OHIO

BECOME AN Electrical Engineer

20 POWER! WHISPER WEIGHT 7½ OUNCES

2½ TIMES STRONGER THAN BINOCULARS USED
OFFICIALLY BY THE U. S. ARMED FORCES

Whisper Weight—7½ ounces. Easy to hold—Easy to focus. Ideal for indoor, outdoor sports, vacationing, trips, long distance spotting. Pocket size measures only 6½" closed 13½" open.

NOT A CHEAPLY MADE TOY TELESCOPE. But an all metal, precision machined threaded fittings throughout. Precision ground, achromatic telescope that invites comparison. Bears the famous UNITED "Seal of Quality" because they are UNI-COATED, assuring buyers that an application of magnesium fluoride has been applied to the interior sides of the VITAL front Achromatic and rear Ocular lens so users can view distant objects (even those miles away) clearer, brighter and in sharper detail than ever before. Made in American occupied Japan where skilled German optical craftsmen tutored local optical workmen in advanced techniques. It explains why the quality is so high and the price so low. UNCONDITIONALLY GUARANTEED. Try for 30 days. If not absolutely satisfied return for an immediate unquestioned refund of your money. Introductory price.....



\$8.95

Tax Free

Cash orders postpaid. C.O.D.'s include \$2.00 deposit.



UNITED BINOCULAR CO., United Bldg.
9043 S. Western Ave., Dept. ARF-5108,
Chicago 20 Dealers Wanted



- Major in Electronics or Power
B. S. Degree in 36 months
- Television Technician
Certificate in 18 months

FOLLOW THIS PLAN
By 1954 there will be at least two positions for every engineering and technician graduate. Enter these opportunities early... earn your B. S. Degree in 36 months through optional year 'round study.

TELEVISION TECHNICIANS are needed throughout America's fastest growing industry.
You become a *Radio Technician* in 12 months. In 6 additional months become a *Radio-Television Technician*. These Technician Courses are complete in themselves and can be applied as *one-third* of the B. S. Degree program. Recent developments forecast unlimited opportunities for TV technicians and engineers.

Choose from these courses:
General preparatory course—
3 months

SERVICE 6 months

- Electricity
- Welding
- Refrigeration
- Heating

TECHNICIAN 12 to 18 months

- Radio and Television
- Electronics
- Electrotechnics (Power)
- Mechanical Technician
- Welding
- Air Conditioning

ENGINEERING 36 months
B.S. Degree

- Electrical Engineering
Major in Electronics or Power
- Mechanical Engineering

TERMS OPEN OCTOBER, JANUARY, APRIL, JULY
Military, Practical, or Academic training evaluated for advanced credit. Faculty of specialists. Over 48,000 former students from all states and 23 overseas countries. Nonprofit. Founded in 1903.

MILWAUKEE SCHOOL OF ENGINEERING

MILWAUKEE SCHOOL OF ENGINEERING
Dept. PM-952, 1025 N. Milwaukee
Milwaukee 1, Wisconsin

Without obligation send Catalog for Electrical Engineering, B. S. Degree, major in Electronics; Power; "Your Career"; Occupational Guidance Bulletin on: Radio-TV Electrical Power Mechanical Engineering Welding Heating, Refrigeration, Air Conditioning Preparatory.

Name.....Age.....

Address.....

City.....Zone.....State.....

If veteran, indicate date of discharge.....



LEARN MEAT CUTTING

through actual practice. Profitable Meat Cutting and Self Service Meats taught easily, quickly. LEARN BY DOING at Toledo in just eight short weeks under actual market conditions. For beginners or men with experience. All subjects taught thoroughly and completely. Diploma. Job help. Get store of own. People must eat. School in operation over 25 years. Approved for GI training. Send today for FREE illustrated catalog. No obligation. NATIONAL SCHOOL OF MEAT CUTTING, Dept. 50-J, Toledo 4, Ohio

Learn TATTOOING At Home

Earn extra MONEY—Tattoo blood types and designs in your community. Splendid opportunity in every town. Prepare in spare time. Practical instructions. Send 25c for details and list of Tattoo Supplies. No obligations. 2815 SCHOOL OF TATTOOING • 728 Leslie, Rockford, Ill.

STUDY INDUSTRIAL DESIGN

You can train at Art Center School in California with practicing-professionals for upper-level jobs in INDUSTRIAL DESIGN. Recent graduates have been added to the staff at General Motors, Chrysler, Raymond Loewy, Henry Dreyfuss, etc. Majors in transportation, general product design, structures, community development, furniture design, packaging, display, 4-year degree courses. Learn to combine imaginative design with technical proficiency, coordinate utility and beauty. Stimulating environment. Field trips. Advantages of mild Southern California climate and nearby holiday spots. Coed. Placement service. Write for catalog.

ART CENTER SCHOOL, Edward M. Adams, Director
5353 WEST THIRD STREET, LOS ANGELES 5, CALIFORNIA

CARTOONING

HAVE FUN! MAKE MONEY! Cash in on your sense of humor AT HOME—BY MAIL! No experience needed to start. Write today FOR FREE TRIAL LESSON and full particulars. Moon Gag Cartoon School, Dept. D, Fall Creek, Wis.

Develop Hidden Earning Power

STUDY LAW

at home! LL.B. Degree

Qualify yourself in spare time for advancement, greater earnings, business success. Now, more than ever, legal ability is in demand! Easy-to-understand step-by-step lessons and text material furnished — invaluable for permanent reference. Over 40 years expert instruction. 114,000 students enrolled. Easy payments. Find out now, at no cost, how study of law can help you. Write today for FREE Book "Law and Executive Guidance."

AMERICAN EXTENSION SCHOOL OF LAW
Dept. PM-54, 646 N. Michigan Ave., Chicago, Ill.

Get into...

PLASTIC LAMINATING AT HOME!

Sensational New
**"ONE MAN
BUSINESS"**
..pays \$10 to \$20 profit
for each dollar of cost.

Make \$20 to \$30 a day by our
MAGIC MAIL PLAN... get
orders and cash from your mailman!

Here's the newest and most fascinating of all home-operated businesses. For the first time, a simplified machine brings the fabulous profits of Plastic Sealing and Plastic Laminating within the reach of the small operator. Can be

operated in a corner of the kitchen, basement, or garage. And any man or woman, regardless of age, education, or experience—can learn this interesting work in a few minutes of reading—can turn out professional jobs after one hour's practice.

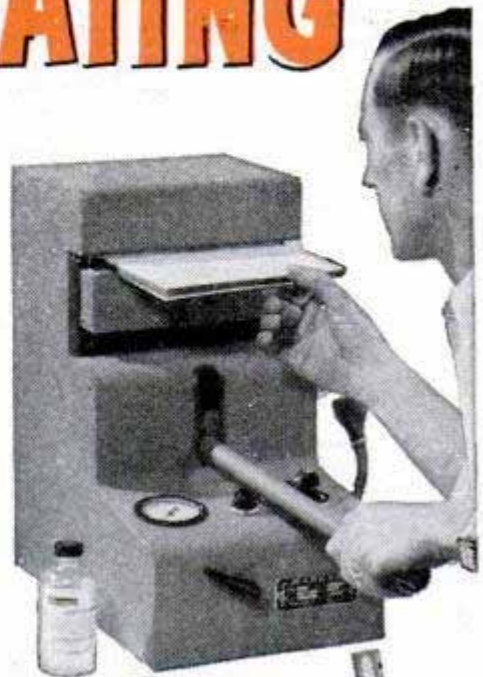

TWO EXCITING FIELDS FOR BIG PROFITS!

No house-to-house canvassing. No face-to-face selling. We not only supply the equipment you need for the work, but also show you exactly how to cash in big daily profits from two big demand fields.

A FORTUNE IN PLASTIC SEALING

Millions of people want to protect valuable cards, photographs, documents and papers against wear, soil, and damage. By our MAGIC MAIL Plan you get this business through the mails. Open envelopes and take out money and orders. Details of this plan will amaze you. It will be sent free. Just mail coupon.

ENORMOUS PROFITS IN LAMINATING

A creative, artistic business. Gift shops sell your entire output. Just a few of thousands of giftwares illustrated on this page. Beautiful colors. Endless designs. Exclusive "one of a kind" appeal brings sales at ten to twenty times the cost of materials. Beautiful illustrations and instructions for making these artistic novelties sent free.

The opportunities in Plastic Laminating are so big that space here does not permit even skimming the surface. To get any idea

FREE at all of the size of these markets and your place in this sensational business you must read the details. See for yourself how easy it is to do the work—how you can put plastic sheets into your machine and take out a fortune—how money and orders come to you in the mail—how gift shops clamor to get more and more of your creations—how you can start with one machine and build up a big production plant with others doing the work—how you can get money and business from every State in the Union—how you can achieve independence without study or experience.



RUSH COUPON

Never before has such an opportunity been offered the small, home-operator—an opportunity to gain complete personal independence in a big money business of your own. Don't lose a minute. Get the facts at once. All information, fully illustrated with pictures, is free. Send the coupon—or send your name on a penny postcard. There is no charge now, or at any other time. We may be limited in the number of Warner Laminators that can be made up, so don't put this off. Send for the information on this exciting opportunity today.

WARNER ELECTRIC CO.,

1512 Jarvis, Dept. L-10-P, Chicago 26, Illinois

WARNER ELECTRIC CO. Dept. L-10-P
1512 Jarvis, Chicago 26, Illinois

Rush complete information with illustrations showing the things I can make and the money possibilities in Plastic Laminating. All this is free. I do not pay a penny now or at any other time. No salesman is to call. Send all facts by prepaid mail. Be sure to tell me how I get orders and money from my Postman by your MAGIC MAIL Plan.

NAME _____
ADDRESS _____
CITY _____ ZONE _____ STATE _____

\$5-\$10-and \$20 BILLS COME TO YOU IN THE MAIL

By our MAGIC MAIL Plan you sit at home, send out mail, and get back money and orders. Additional profits in supplying local people with lifetime protection for
SNAPSHOTS—IDENTIFICATION CARDS—DISCHARGE PAPERS—DRIVERS' LICENSES—SOCIAL SECURITY CARDS—VOTERS REG. CARDS—MENUS—BIRTH CERTIFICATES—CREDIT CARDS—BIRTH AND WEDDING ANNOUNCEMENTS—RAILROAD PASSES—IMPORTANT DOCUMENTS OF ALL KINDS.

Lifetime protection. See how laminating protects against wear, soiling, and moisture damage with its smooth, flexible, plastic covering on each side. **LIFETIME PROTECTION** needed for valuable or sentimental objects of all kinds—even a priceless whisp of hair can be laminated. Think of the countless thousands of profit items for your Laminating Press.



Thousands of Beautiful Art Creations

No one yet has been able to list the thousands of gorgeous articles that can be made by Laminating as explained in our Free Information. Just a few are
COSTUME JEWELRY—CIGARETTE BOXES—JEWEL CASES—GLOVE AND HANDKERCHIEF BOXES—CUFF LINKS—NOVELTY BUTTONS—TRAY—CANDLESTICKS—COASTERS—CLOCK CASES—LAMP BASES—PICTURE FRAMES—BOOK ENDS—PAPER KNIVES—KEY CHAIN CHARMS—CHECKERS—CHESSMEN—ADVERTISING SIGNS—NAME PLATES—BOOKMARKS—BELT BUCKLES—TIE RACKS—KEEP-SAKES OF ALL KINDS.

**WORLD'S
BEST
WANT AD
MEDIUM**

CLASSIFIED Advertisements



Advertisements in this section 85 cents per word, each insertion, minimum 10 words, payable in advance.

To be inserted under proper classification, copy must be in our office the 20th of the second month preceding date of issue

F. W. Johnson, Manager, Classified Advertising
Popular Mechanics Magazine, 200 East Ontario Street, Chicago 11, Illinois

YOU'LL PROFIT

By reading and answering the classified ads in this section. Hundreds of opportunities for you to make and save money

AUTOMOBILES. MIDGET CARS

HELP Make and market new carburetor. "Zip plus mileage." 17 parts. J. R. Fish, Daytona Beach 11, Fla.

MAKE Your own Polyester-Fiberglass auto body. Catalog 10c. Gem-O-Lite, Box 686S, North Hollywood, California.

SPEED Equipment—Save 50%. Hollywood mufflers \$4.95. Dual muffler kits \$9.95, header kits \$9.95, dual intake manifolds \$12.95, racing cams \$25.00, hi-compression heads \$18.95, water injectors \$5.95. Thousands of accessories! Almquist Engineering, Milford 34P, Pennsylvania. Dealers wanted.

MIDGET Racers—Revolutionary engine. See details under Motors, Engines, Dynamos.

NEW Tires for Crosleys and British cars. Walraven Motors, Marion, Ohio.

WANTED To buy custom or antique car any location. Send full particulars. Robert Meader, 1041 Territorial, Benton Harbor, Mich.

EARLY Auto ads for framing. Stutz, Mercer, Pope, etc. 8x10 lithographs. Ten for \$3.00 postpaid. Motorprints, Box 14433, Los Angeles 4, California.

HOW To buy a used car! Complete information and instructions in one book! Send only \$1.00 to: M. Kaminsky, Box 570, Mt. Vernon, N. Y.

COLLECTORS, Mechanics: Non-profit organization now offering old, new and foreign automobile literature, repair manuals, glossy photos, data books; free motor magazines. Write today; get name on free mailing list. Auto Maniacs, Stockbridge, Mich.

STOP Thieves. Burglar-proof your automobile. Send for free literature. Acme Alarms, 7033 Clyde Avenue, Chicago 49, Ill.

SPEED Equipment from the world's largest firm. 25c for huge catalogue. Newhouse Automotive Industries, Los Angeles 22.

HOP Up, the monthly magazine that leads the field for hot rods, custom cars, speed secrets and racing information. Send 20c for sample copy or subscribe now, \$2.00 year. Write Dept. PM, 530 Colorado Blvd., Glendale 4, Calif.

LATEST 1952 Edition! Just out — 100 new pages! Get world's largest auto accessory and parts catalog and save money. Over 50,000 items, including Hollywood accessories, hi-speed equipment, rebuilt engines, all parts and accessories for all cars and trucks. We have that hard-to-get part! Jam packed with bargains. Completely illustrated. Send 25c (refundable). J. C. Whitney, 1919 Archer, Chicago 16.

SERVICICLE \$15. Midget car \$10. Dart motorscooter \$17, less engines; two cylinder opposed 5 horsepower engine \$20, others \$7.50 up (mailorder only). Send 25c for catalogue number 47, listing these and hundreds of other bargains in midget cars, motorscooters, outboard motors, homebuilders parts, plans, etc. (35c by first class mail). Midget Motors Directory, Athens, Ohio.

SAVE — California custom accessories headquarters. Buy direct from original designers. Chrome dash panels, electric push button door-trunk conversions, fender skirts, dual mufflers, lowering kits, speed-dress up equipment. 40 page catalog, hundreds of photos—25c. Eastern Auto, 3319A South Grand, Los Angeles 7, Calif.

AUTO SUPPLIES AND EQUIPMENT

AUTOMATIC Starter switch for cars having solenoid switch only. Works from gear shift and so handy you will be thrilled with it. Special get-acquainted price \$7.50. Write for information. Louis F. Jezek, Route 3, Box 192, Temple, Texas.

VALVES. We buy old worn valves. Mayco, 7120 Carnegie, Cleveland, Ohio.

BE Independent, save money. Grind crankshafts without disassembling engine. New hand operated tool \$3.75. Literature. D. McGee, 719 Cascade, Wenatchee, Wash.

HURRICANE Exhaust cut-out. Prepaid \$4.95. Kapelle, 3015 California, Topeka, Kansas.

INCREASE! Gasoline mileage 3 to 5 more miles per gallon. Guaranteed gasoline vaporizer, also increases power. Easier starting. \$3.30. Turb-O-Vane, Stockton, Calif.

HI-Compression heads. Chevrolet and Power-Glide \$49.50, others. Write Auto Parts Service, West Salem, Ohio.

OVERHAUL Worn rings, valves, and cylinder walls by metalplating with Motaloy while you drive. Restores worn parts on old engines. Reduces wear on new. No tools needed. Safe, economical, guaranteed! Details free! Garden State Sales, Inc., Garwood 4, N. J.

PATENTED. A better motor for \$3.00. Free data. Ferns Products, 8120-B Walnut Dr., Los Angeles 1, Calif.

GM71 Discarded injector parts wanted. Bares, 7120 Carnegie, Cleveland, Ohio.

ALITE Top-oiler-vapor system used. Most effective, economical. Lowest cost. \$5.95 c.o.d. Oil formula free. Give car name and year. H. Schneider, 651 Southern Blvd., New York City 55, N. Y.

DUAL Manifolds, Fords, Chevrolets, Plymouth, others. \$12.75 c.o.d. Auto Parts Service, West Salem, Ohio.

RENEW Your old motor, keep that new motor young for only \$3.00. Lachapelle's (patented) 100,000 mile treatment puts babbitt bearings on pistons, rings. Increases power, saves gas, oil. \$3.00 postpaid. Circular free. Joe Dillon, Authorized Warehouse Distributor, Box 323, Bridgeport, Ohio. Distributors and agents wanted. Exclusive territory.

NEW Electroplating outfit, \$2.98 complete. Solarscope, Box 263, Detroit 2, Mich.

RACE Drivers — Hot rods, motorists. Stop friction. Use Formula #1 Special Compound helps win that race. Send \$1.50 one oil treatment! S. Persek Distributing Co., 7306 Ditmars, Jackson Heights, N. Y.

THERMO Plastic seal! Guaranteed cracked-leaking battery repair! Needed every shop. Northlaker, Peoria 4, Ill.

MOTORIST Save gasoline by vacuumating overrich mixtures. Fits all cars. For free particulars write Vacuumatic, Dept. 1935, Wauwatosa, Wis.

NEVER Change your oil! Full details free. Thousands of users. New oil filter. Dept. PI, Henderize, Inc., 5667 Freepoint Blvd., Sacramento, California.

FIBERGLAS-Plastics for bodies and hard tops. Professional instructions free with order. Write leading suppliers. Industrial Plastics, 4425 Linden Street, Oakland 8, California.

WOLF Whistle auto horn. Precision constructed. No holes to drill. Fits any gasoline engine. \$3.00 prepaid. Charter Oak, 256A 145 Ave., St. Petersburg 6, Fla.

REMANUFACTURED Engines. New car guarantee. Marvin, Box 5046, Cleveland 1, Ohio.

SPEED Equipment. Edelbrock, Offenhauser, Navarro heads, manifolds, Winfield cams, dual ignition points. Chev. 37-51, Ford 49-51. Deeptone mufflers, headers, dual muffler sets, Mallory coils, distributors. Speed catalogue 25c. Urzi's Auto Supply, San Jose, California.

"WATER Injection." Airflow needles. Economy methods. Free illustrated information. Neher Industries, La Verne, Calif.

BUY Racing heads, dual manifolds, hot coils, etc., without money. Information free. Newhouse Automotive Industries, Los Angeles 22.

LIGHT Your Powerglide and Dynaflo dials. Information free. Gaiser, Box 25, Kokomo, Ind.

HOW To buy speed equipment without money. No selling. Information free. Newhouse Automotive Industries, Los Angeles 22.

NEW And used guaranteed parts for civilian and army cars and trucks. Largest stock in America. Mail orders. Pioneer Auto Wrecking Co., 734 W. 13th Ave., Denver, Colorado.

SIRENS. Air horns! Bermuda bells. Free accessory catalog. McCanna Company, 200-PM East 21st, New York 10.

TIRES: Wholesale. Major brands. Free list. Field Tire, Downingtown 3, Penna.

CHEVROLET Owners: Stop tappet noise with Kaye Tappet Silencers. Quality product. Easy to install. Money-back guarantee. Complete set \$5.95 postpaid. Kaye Products, 1321B So. Layton Blvd., Milwaukee, Wis.

AUTO Radios at wholesale. List free. Regent, 801 W. Erie, Philadelphia.

BRUSH Plating outfits connect to a battery. No tanks or shop required. Free particulars. Gunmetal Co., Ave. J., Decatur, Ill.

AUTO Parts and accessories. Briggs Automotive Engineering of Chicago, P.O.B. 3454 Merchandise Mart, Chicago 54, Ill.

AUTO TRAILERS

BUILD Streamlined house trailer. Telescopes small for towing. Other models. Information, pictures 10c. Comstock, 585, Parsons, Kansas.

BUILD Your own trailer! Plans for all kinds. Illustrated catalog 10c. Jim Dandy, 125-M, Wausau, Wisconsin.

MOTORCYCLES, BICYCLES, MOTORSCOOTERS AND SUPPLIES

HOT Rod tail pipe makes bikes sound like real motor! Send \$3.00 cash or money order. Money-back guarantee. Hot Rod, 210 West 7th, Los Angeles 14.

HARLEY-Davidsons—All models and prices. Genuine late and old model supplies. Expert service. Send 25c for bulletin. Knuth's, 1753 Muskego, Milwaukee, Wis.

WHIZZER \$20; Servicycle (good tires) \$20; motorbike conversion kit \$25; Cushman motorscooter \$25; Harley twin \$25. Rush 25c (35c first class mail) for catalog #952 listing many other amazing bargains in motors, midget cars, motorscooters, motorbikes, etc. Associated, Box 1764-CS, Toledo, Ohio.

RECONDITIONED Motorcycles and motors. Chromium accessories. Complete stock Indian parts. Expert rebuilding. Fast service. Indian Motorcycle Sales, Kansas City 1, Mo.

PARTS, Pistons, new, used, cheap. Harley, Indian, Henderson. List 10c. Ballak, 811 N. 9th, St. Louis 1, Missouri.

U. S. Govt. surplus "45" Harley Davidson motors, complete with carburetor and generator, in running condition—\$69.50 f.o.b. Chicago. 25% deposit with order. Paris and accessory catalog 25c. Triangle, 2157 Harrison, Chicago.

WHIZZERS \$20; Midget car \$15; motor-scooter belt drive \$6; 3-wheel scooter car \$39.50. Send 25c (35c first class mail) for catalog #21 jammed with sensational bargains in wheels, motors, clutches, motor-scooters, midget cars, motorbikes, etc. Gall, 538 Erie, Toledo, Ohio.

AVIATION

MODEL Plane builders: Get your copy of "Modelers Design Data" \$1.00. Box 3128, Fort Worth, Texas.

PROPELLERS, Plans, supplies for snow sleighs, air boats. Catalog 20c. Banks-Maxwell, Box 3301E, Ft. Worth, Texas.

PROPELLERS: For snowsleeds, boats. Literature. Standard Aircraft, Box 387, Ft. Worth, Texas.

BATTERIES, GENERATORS

EDISON Nickel odorless storage batteries. 12 to 600 ampere hour. Any voltage. Long guarantee. Literature. Hawley Smith Co., Croton Falls 1, N. Y.

ELECTRICAL SUPPLIES

FOR Sale: Quantity, new, 6 ampere vane type d.c. ammeters, \$1 each; 3 for \$2, pre-paid. Strickland Electric Co., 1427M E. 18th Ave., Columbus, Ohio.

FREE—War surplus catalog. Bargains galore. Welders, motors, generators, hydraulics, pumps, kits for assembling your own, other items. Save. LeJay Company, Minneapolis, Minnesota.

LAMPS—25c Brings bargain parts catalog containing instructions for electrifying oil lamps, vases, etc. Gyro Lamps, 5402P Clark, Chicago 40.

ELECTRIC Pencil—Writes, engraves all metals. \$2.95. Reb Industries, 265-DAG, Elmhurst, Illinois.

TEN Conductor leaded armored cable. Schwarz, 3907 Twenty-fifth, St. Louis 7, Mo.

LAMP Supplies—Wholesale. Any amounts. Prompt shipment on all parts for repairing and building lamps. Illustrated catalog 15c. Brown Lamp Co., Box 501, Wellston Sta., St. Louis 12, Missouri.

ELECTRIC Clock repairs simple, profitable. Most Telechron-G.E. rotors \$2.15. Sessions, Ingraham, \$2.45. Free parts list. Time Service Company, Dept. P-7, 710 Boush Street, Norfolk, Virginia.

ELECTRIC Pencil: Engraves all metals \$1.50. Beyer Mfg., 10511-H Springfield, Chicago 43.

WELDING, SOLDERING, PLATING

A.C. Welders, Four sizes. Lowest prices. Free literature. Holgeron's Service, Canton 1, Kans.

WELDER Sale. 300 amp. d.c. aircraft type. Reg. \$99.50, special \$89.50. Harris Machinery Co., Minneapolis, Minn.

ACETYLENE Welding outfits, new \$49.00; used \$29.00. Arcwelders \$49.50. Eagle Welding, Dept. PM, 5085 Broadway, Chicago 40, Illinois.

ELECTRO Plating equipment—New and used. Complete assemblies. All sizes for all types of plating. Baby shoe metallizing sets. Mounts, supplies, instructions. Free catalog. We buy used plating equipment. Send description. Hollywood Bronze Supply, Dept. 2, 1624 E. First Street, Los Angeles 33, Calif.

MACHINERY, TOOLS, SUPPLIES

CHUCKS: Independent; Universal—threaded 1½"-8, 1"-8, 1"-10, 1"-12 or with adapter recess; also 6" Universal threaded 2¼"-8. The only complete line of bench lathe chucks built to heavy duty standards. Other chucks to 16" diameter. Write for free literature or quotation. No obligation. Westcott Chuck Co., 3600 Walnut, Oneida, N. Y.

BARGAINS in socket sets. Postcard brings catalog. William A. Hinds, 625 No. Broadway, New Philadelphia, Ohio.

NEW Mail electric drills. Jacobs chuck ½", \$28.50; ¼", \$14.75. Complete amp. terminal kits \$4.75. 2" Universal chuck \$4.75. Wilt Surplus, 7829 S. Racine, Chicago 20, Ill.

BOATS, OUTBOARD MOTORS

BOAT Patterns, kits. Thirty designs. Descriptive literature and illustrated boat construction book 50c. Marine fittings catalog 20c postpaid. Germain Boat Company, West Saginaw 3, Michigan.

APPLY Polyester-Fiberglass coating to your boat. Permanent protection. Catalog 10c. Gem-O'-Lite, Box 686R, North Hollywood, California.

CONVERT Fords and Jeep to 100% marine engines with Osco's world famous Convo-Kits. Deluxe catalogue 25c (coin). Oscomotors, 3627B Lawrence, Philadelphia 40, Penna.

PLANS: Inboard-outboard runabouts, cruisers, sail, Wood, plywood, welded steel. Advise requirements. John B. Clark, N.A., 329 Kenmore, Bay Village, Ohio.

CURE That leaking boat with Fiberglass-plastic covering. Ends caulking and painting. Nationally approved process. Easily applied, complete instructions. Industrial Plastics, 3807 Harrison Street, Oakland 11, Calif.

TWENTY Plywood boat plans \$1.00. Catalog boat building plans 25c. The Rudder, 15 Murray Street, New York 7.

OUTBOARD Motor parts—New, used for all makes. Send stamp for price quotation, listing parts needed. Outboard Motor Mart, Inc., 229A State Street, Boston, Mass.

FULL Size, cut to shape boat patterns, blueprints, 7½"-38 feet. Illustrated "Build a Boat" catalog, 25c (coin). "How to Build Boats" book, \$1.00. PolyWog houseboat plans \$10. Marine catalog \$1.00. Cleveland Boat Blueprint Co., 3107 Detroit Ave., Cleveland 13, Ohio.

MARINE Conversions for Ford and Jeep engines. Catalog 10c. Lehman Manufacturing Company, 972D Broad Street, Newark 2, New Jersey.

NEW, Used, rebuilt marine motors. Marine conversions, fittings. Free catalog. Stokes Marine Supply, Dept. 24, Coldwater, Michigan.

ENGINES, MOTORS, DYNAMOS

MOTORS—½ Horse \$15. ¾, \$22. 1, \$35. A.C. generators, 750 watt, \$38.50. 3000 watt, \$125. Butler, 1885 Milwaukee, Chicago 47.

REVOLUTIONARY Engine—Ideal for race cars, boats, or any other application where light weight power is desired. Develops approximately 125 h.p., yet weighs only 80 pounds. Contains only one primary moving part. 12 definite power impulses per revolution. Idles at 400 r.p.m. Normal speed 8,000 r.p.m. Burns gasoline, kerosene or fuel oil. Simple welded construction, utilizes standard auto engine parts such as carburetors, spark plugs, etc. Eliminates the need for water cooling system, pistons, rods, crankshaft, etc. For engineer drawings and complete working plans send \$5.95. Revolutionary Engine, P.O. Box #202, Dayton, Ohio.

WINDING Data, listing 225 motors, single and three phase, \$1.00. Motor Data Co., Box 7631, Kansas City 3, Mo.

ATHLETIC EQUIPMENT, BODY BUILDING COURSES

TWO Sensational books "Police Jiu Jitsu," "Scientific Boxing." Everything \$1.00. Turner Company, 1170-B1 Broadway, New York 1.

100 TRICK Knockouts for self defense. \$1. 1c each. Lincoln, 529 Main, Evanston 1, Illinois.

BARBELLS. Exercise equipment. Courses. Free booklet. Good Barbell Co., Reading, Penna.

SPORTING GOODS, GUNS, FISHING TACKLE, ARCHERY, TRAPPING

CAST Iron molds—For casting fishermen's sinkers. Free illustrated booklet. Reading Instrument Co., Box 78, Reading, Penna.

WESTERN Guns, Colts, Winchester 73's, Kentuckys, hunting guns. Antique-modern gun list 25c. Ed Agramonte, 201 Warburton Ave., Yonkers 2G, N. Y.

FOREIGN Ammunition, knives, crossbows, rifles. Catalog 10c. Ashton, 1511 Gardner, Hollywood 46, California.

TENTS, Canvas; direct from manufacturer. Also war surplus. Camping equipment, sleeping bags. Tremendous selections. Free catalogue. Low prices. Morosan Sales, Dept. PM-7, 10-15R 50th Avenue, Long Island City 1, New York.

ILLUSTRATED Sales catalogue, historical firearms, swords, war relics; 50c coin. Brick House Antique Shop, New Paltz 9, N. Y.

PUT More game on your table! Free "Wing-Shooters Handbook" tells pump or autoloading shotgun shooters how. Write the Poly-Choke Co., 815 Tunxis St., Hartford, Conn., for your copy.

FLY Tying vise. Quality product. Circular. Blixt Custom Built Vises, Box #772, Appleton, Wis.

120 PROFUSELY Illustrated pages antique pistols, swords, daggers, armor, etc. 50c. Robert Abels, M860 Lexington Ave., New York 21.

SHOTGUNS, Rifles, Revolvers, 500 modern, obsolete. Also cartridges. Each list 10c coin. Ed Howe, 52 Main, Coopers Mills, Maine.

5000 BARGAINS. Firearms, binoculars, war relics. Catalog 50c. Smith Firearms, Runnemeade, N. J.

BINOCULARS, TELESCOPES, MICROSCOPES, MAGNIFIERS

TERRIFIC Values, binoculars, telescopes, microscopes, \$3.95 up. Request free money saving catalog. Criterion, Hartford, Conn., Dept. P6.

SAVE! Save! New binoculars! Free catalog. Free book, "How to Select Binoculars." Write today! Bushnell's, 43-M39 Green, Pasadena 1, Calif.

SAVE! Free 36 page, 3 color binocular catalog. 60 different models. United Binoculars, (A-4508), 9043 S. Western, Chicago 20.

SAVE, Buy direct—Wholesale prices. Get free illustrated binocular buyers guide. F-E Binoculars, Dept. 1, 2251 W. Pico Blvd., Los Angeles 6, Calif.

POWERFUL Telescopes easily made. Lenses, erector, focusing tube, instructions for making 400X telescope \$5.00. Complete telescope with tripod brings objects 13 times closer, 150 times larger. \$7.00. Telescopic Cameras, Manorville, N. Y.

ASTRONOMICAL Telescopes, binoculars, microscopes, bought, sold, repaired. Books. Rasmussen-Reece, Amsterdam, N. Y.

BUILD Your own microscope. 200 power. Complete castings, mounts, lenses, screws, instructions. Kit \$17.50. Free illustrations. Esco, 911 Willow Ave., Hoboken, N. J.

WAR Surplus bargains, binoculars, telescopes, sextants, millions of lenses, prisms, reticles, eyepieces, objectives, etc. Mail 10c for big "Catalog CH." Send \$1.00 for Stock CH—10-piece lens kit and big instruction booklet. Edmund Scientific Corp., Barrington, N. J.

MAKE Your 6" telescope reflector. Glass, abrasives, instructions—\$8.50. F. Cameron, Box 65, Inwood 96, N. Y.

REFLECTING Telescopes, 60X, completely assembled \$29.75. Guaranteed observatory clearness. Free information. Skyscope, 475 Fifth Avenue, New York 17.

AMAZING Prices, imported precision binoculars. Free trial. Pricelist, folder "Selecting Binoculars" free. Prentiss Importers, Mercury Bldg., Los Angeles 25, Calif.

POWERFUL Astronomical telescopes easily made. Perfect lenses and instructions: 100X \$3.00; 100X and 200X \$4.00; 100X, 200X and 400X \$6.00. Full power, clear vision guaranteed. Instructions alone 10c. Suffolk Science Service, Riverhead, N. Y.

BINOCULARS, Telescopes, microscopes. Our 20th year of leadership in optical values. Bargain catalog free. Brownscope Co., 24 West 45th Street, New York.

REFLECTOR Telescope kits, refractors. Free illustrated bulletin. Esco Products, 911 Willow Ave., Hoboken, N. J.

GIANT Astronomical telescope with 6 ft. tripod \$15.00, f.o.b. factory. 100 power. (10,000 area magnification). Clear vision, full power guaranteed. Ready for use. Suffolk Science Service, Dept. BT, Riverhead, N. Y.

GUNS, Binoculars, telescopes, watches. Buy, sell, trade. Schmeer's, Donnellson, Iowa.

PETS—DOGS, BIRDS, RABBITS, HAMSTERS, ETC.

RAISE Chinchillas. Let your spare time insure your future. Visit or write The West Virginia Chinchilla Ranch, Moorefield, W. Va.

ENCYCLOPEDIA Of canaries and other cage birds (including budgies) with questions and answers—\$2.75 plus 25c postage. Audubon Publishing, 3449-P.M. N. Western, Chicago, Ill.

RAISE Rabbits. Markets plentiful. Free booklet. Tayco Rabbrtry, Hapeville, Ga.

GOLDEN Hamster. Pedigree stock. Breeders, laboratory or pet stock. Shipped express anywhere. Price list free. Charles E. Bower, Box 34, Smoke Run, Penna.

SPORTSMEN: 200 Pointers, Setters, Straight Cooners, combination hunters, rabbit and fox hounds. Reasonable. List free. Ramsey Creek Kennels, Ramsey, Ill.

RABBIT Raising pays. Markets furnished. Free illustrated literature tells how. Old Mill Rabbit Farm, Elmhurst 2, Illinois.

ST. Bernards, Boxers, Hof Kennels, 5136 Cascade Rd. S.E., Grand Rapids 6, Mich.

AMERICA'S Largest breed of rabbits. Tops for meat and highest fur prices. Information free. Texas State Rabbrtry, Friendswood, Texas.

RAISE Guinea pigs. Amazing profits. Free booklet. Taylors, B426A, Hapeville, Georgia.

CHOICE. Selected rabbits. Prices reasonable. Write, Winfield Harrison, Fitzgerald, Ga.

RAISE Mink: Free booklet, pen plans, inside "secrets," feed, care. Mink are money makers. Investigate today. Lawrence Molgard, Brigham City 12, Utah.

STANDARD Rabbit Journal, B-241-M, Milton, Penna. Year \$1.00, sample dime, beginner's manual 25c.

MONKEYS Are the best pets—Intelligent, easily trained, inexpensive. Send 10c for catalog. Tropical Hobbyland, 1525R N.W. 27th Avenue, Miami, Florida.

YOUNG Parrots — Make fine talkers. Herb Miller, 1911-N, Lubbock, Texas.

MONKEYS, Baby Ringtail \$49, a musing white faced \$45. Shipped immediately. Shehyn's Pets, Silver Springs, Florida.

EARN Up to \$400 monthly raising Angora or New Zealand rabbits. Plenty markets. Particulars free. White's Rabbrtry, Newark, Ohio.

HAMSTERS—Golden or spotted. Cages and equipment. Free illustrated details. Lakeview Hamster Colony, Newfield, New Jersey.

BOOKLET "Treatise on Breeding and Raising Canaries"—\$1.00. Audubon Publishing Co., 3449-P.M. N. Western, Chicago 18, Illinois.

MAKE Big money! Raise Chinchilla rabbits. Cash markets supplied. Write today! Rockhill Ranch, Sellersville 15, Penna.

MINK Raising information free. Complete. Lake Superior Mink Farm, Superior, Eel, Wisconsin.

A Practical beginning to successful rabbit raising. 48 page illustrated booklet. Dime. American Rabbit Breeders Association, 36 AR & CBA Bldg., Pittsburgh, Penna.

PLANTS, SEEDS, NURSERY AND GARDEN SUPPLIES

GINSENG, Goldenseal. Hundred seeds \$1.50; thousand \$5. Dozen seed bearing plants \$1.50; hundred \$9. Complete instructions. M. Collins, Viola, Iowa.

GINSENG Growing instructions 10c. Seeds reasonable. Specialty Farm, Rockford, Minn.

CORSAGE Materials. Flower arrangers' supplies. Artificial flower parts. House plant helps. Free catalog. Floral Art, Dept. PMJ, Teaneck, New Jersey.

FRUIT Trees! Stark Bro's sensational new "Dwarfs." Also standard size, exclusive patented, trade-marked varieties produce abundant, larger, better apples, peaches, pears. All fruit faster growing, quicker bearing. Also beautiful ornamental trees and shrubs. Get giant new colorphoto catalog free. Stark Bro's., Dept. 30093, Louisiana, Missouri.

FARMS, FARM LANDS, REAL ESTATE

NEW Strout catalog. Just out! Farms, homes, businesses, 31 states, coast-to-coast, bargains galore. Mailed free. Our 53rd year, World's largest, Strout Realty, 7 So. Dearborn St., Chicago 3, Ill.

SEE Houston grow. Now is the time for you to buy a fine, big tract near Houston, Texas, the fastest growing city in U. S. for only \$195, payable \$10 cash and \$10 monthly. Insured title, taxes one dollar yearly. Great oil producing, refining and chemical center. Fine profits being made by many. These tracts located near two paved highways, electricity, schools, bus service, etc. Write today for maps, pictures and full information. Free. Bailey Wood, Owner, Box 6223, Houston 6, Texas.

UNITED Farm Agency's big free fall catalog of farm and country real estate bargains can help you plan soundly for your future security in the country. Good pictures, many states, easy terms, many equipped, unharvested crops included. For special service, state requirements, desired location. Write for your catalog today. It's free! United Farm Agency, 1408-PM Consumers Bldg., Chicago 4, Ill.

FARM And business catalog free! Big new edition. Hundreds of bargains from \$1000 up. Maine to Florida. West's, M-9, Pittsburgh 17, Penna.

GOOD Homes in the Ozarks. Free lists. Owensby, Buffalo, Missouri.

CALIFORNIA Ranch lands. Seized and sold for taxes. 50c to \$5 acre minimum bid. 10c brings illustrated land catalog, outline maps. Tax Land Sales, Box 2350-BW, Hollywood 28, California.

BUILDING Or buying a new home? Having trouble over financing, plans, construction, etc.? Let us solve your problems. Send \$1.00 per question. Lawrence-Prince Associates, Mount Kisco, N. Y.

\$5 ACRE. \$5 Monthly buys 40 acres good Missouri land. Lists mailed free. Write Mr. Armstrong, Shook 34, Mo.

\$5.00 MONTHLY Buys 40 acres near town; price \$200.00. Free list. Box 425-P, Carthage, Missouri.

FARM-Ranch opportunities. Favorable conditions. Washington, Minnesota, Montana, Idaho, Oregon, North Dakota. Literature, farm descriptions. Specify which state. J. W. Haw, 119 Northern Pacific Ry., St. Paul 1, Minn.

HOMESITES \$300 — Convenient payments. California's finest garden section. On Morro Bay's scenic shores. Wonderful fishing, boating, bathing. Fertile soil, softest water, temperate climate, congenial community. Free literature. Richard Otto, Department M, San Luis Obispo, Calif.

FARM MACHINERY AND SUPPLIES

PREVENT Rust—Apply on metal that is exposed to the weather, in grey color. Price \$2.50 per quart. Prevent Rust, P.O. Box 307, Downers Grove, Ill.

POULTRY, FARM SUPPLIES

KNOW How to raise poultry for profit. Read Poultry Industry. Every issue packed with helpful hints and practical suggestions. Latest articles on breeding, feeding and management. Subscribe now, 1 year 50c, 3 years \$1.00. U. S. funds or checks payable at a New York or Boston bank. Poultry Industry, Dept. PM, 376 Boylston St., Boston 16, Mass.

PROFITABLE OCCUPATIONS

FOREIGN Jobs. Contracts underway and soon starting in Africa, South America, Canada, England, Europe, South Pacific, Middle East, Mexico and Alaska. Send \$1.00 for foreign job news, information, application forms, etc. DCS Foreign Job News, Dept. 268-JM, Bridgeport, Ill.

WANT A diesel job? New opportunities to increase income. Higher pay. More money. We can help you qualify. Tools. Shop method home training. Write today! Diesel, Tractor, Heavy Equipment Division, Interstate Training Service, Dept. 3J, Portland 13, Oregon.

SEND For big, new 1952 illustrated catalog that will show you how to turn your spare time into cash—making quick-selling, highly profitable lamps. Every home a prospect. Hundreds doing it, you can, too. No experience or special tools required. Catalog No. 7 contains 56 pages filled with shades, shade frames, figurines and bases, oil lamp converters, boring compound, and dozens of similar items. Also all kinds of sockets, cords, pipes, harps, finials, bases, and hundreds of other parts—everything you need. Special 8-page section shows 6 beautiful lamps in kit form, ready to assemble. You buy wholesale, sell at retail. Make big profits. Send 25c today for new 1952 catalog and wholesale price list, you'll be glad you did. The 25c will be refunded on your first order. Gearon Co., Dept. 500-B9, 27 S. Desplaines, Chicago 6, Ill.

HAND-PAINTED neckties, blouses, scarves, handkerchiefs, etc. It's so easy, so much fun—and there's lots of money in it, too. The book Everyone Can Paint Fabrics by Pearl F. Ashton shows you exactly what to do. Your copy; illustrated, only \$3.95 from T. Y. Crowell Co., Dept. PM9, 432 Fourth Ave., New York 16.

\$4 TO \$10 Hour spare-time in billion-dollar adjustment field. Qualify now! Write today. Universal Schools, M-60, Box 8202, Dallas 5, Texas.

CONSTRUCTION Job list. Published monthly. \$1.00. Dempster's Construction Scout News, Dept. 268-JL, Bridgeport, Ill.

MEN, Women visit foreign countries on modern ships. Big pay, adventure, excitement. Experience unnecessary. Details free. Davenport, 1170-A3 Broadway, New York 1, N. Y.

FOREIGN Employment construction men, building trades, helpers, office men, others, interested in foreign projects. High wages, quarters, transportation. Send \$1 for foreign construction compendium and application forms. Foreign Service Bureau, Dept. PM-9, Metuchen, New Jersey. (Not an employment agency—No fees.)

FOREIGN Contract applicants. Did you ever see a foreign contract? Or a copy of the typical medical examination given foreign contract workers? Or the rules governing foreign contract employees while on the job? Don't delay! Act now! Rush \$1.00 for faithfully reproduced copies of real foreign contracts, medical exam and rules actually used on the job recently by foreign contract employees. Entrepreneurs, Ltd., P. O. Box 379, Houston 1, Texas.

OVERSEAS Jobs. Big pay, transportation, expenses. Clerical, professional, mechanical workers, most all trades. Latest listings airline, construction, export-import, manufacturing, oil, steamship companies, many other opportunities, up to date information on securing employment, contracts, income tax, application forms. \$1.00. Overseas Jobs, Dept. 335-A1, Baton Rouge, La.

INVESTIGATING! Skip tracing! Locating missing persons, hidden assets. Quickly learned. Free details. Pacific Institute, 2328 Santa Clara Avenue, Alameda, Calif.

"DUPLICATOR"—Scales anything. Engraving, carving attachment. Sample engraving 25c. Desco, 6334-K Sepulveda, Van Nuys, Calif.

BUY Wholesale thousands nationally advertised products at big discount. Sent free "The Wholesale Plan." American Buyers' Service, 628-PM Linden, Buffalo, N. Y.

NOTARY Public; How to become, \$5.00. Pierce, 927 Hickory St., St. Louis 4, Mo.

TERRIFIC Demand! Big earnings! Sell figurines! Teach figurine painting! Full instructions for organizing home classes; professional lesson "How to Paint Figurines;" catalog illustrating approximately 400 art figures; price list including wholesale discounts; all only 15c coin. Figurines, Minneapolis 15, Minnesota.

BOOKKEEPERS Earn \$100.00 week operating bookkeeping-tax service. Details free. Universal, Box 664-M, Springfield, Missouri.

CRIMINAL Law! Prepare for coming jobs as policeman, deputy sheriff, guard, border patrol. Free details. Pacific Institute, 2328 Santa Clara Avenue, Alameda, California.

\$10,800 PROFITS! Your own mailorder business! No capital risk! "Success plan" (worth \$2) free! Write today! Treasury, 149 Storer, New Rochelle L-3, New York.

ALASKAN Jobs! Over 100 new construction contracts with names, addresses companies hiring. Thousands needed. Highest wages. Military, private construction, mining, fishing, lumbering, aviation, railroads, homesteading. Skilled, unskilled workers. Write today. Our information accurate. \$1.00 complete. Alaskan Opportunities (PM), Box 362, Kenmore, Washington.

MEN—Women. "Everybody likes candy." Learn to make professionally. Tools and supplies. (Our 42nd. year.) Ragsdale Candles, D6, East Orange, New Jersey.

MUSHROOMS Grown. Boxes, barrels. Manureless process 50c. Spawn \$1.00. Gordons, 553 William, Winnipeg, Manitoba.

GROW Mushrooms. Cellar, shed, and outdoors. Spare, full time, year round. We pay \$3.50 lb. We paid Babbitt \$4,165 in few weeks. Free book. Washington Mushroom Ind., Dept. 99, 2954 Admiral Way, Seattle, Wash.

MAKE Flexible molds! Cast plaques, bookends, figurines! Free sample! H. Tooker, 630-M Chestnut, Hamilton, Ohio.

ALASKA—Last American frontier. \$1.00 brings 1952 business directory, government map, construction projects military and civilian, homestead and highway facts, hunting-fishing-game rules, mining, aviation. List of firms hiring. How-when-where to apply. Alaska Opportunist, P.O. Box 883-P, Hollywood 28, California.

FOREIGN And Latin American employment. 1952 "Foreign Service Directory" gives up-to-minute facts on military and civilian construction, government jobs, major oil listings, aviation, transportation, steamship lines, mining, importers, exporters, how-when-where to apply, application forms, hot list firms hiring. \$1.00 postpaid. Global Reports, P.O. Box 883-P, Hollywood 28, Calif.

FREE Book "505 Odd, Successful Businesses." Work home. Expect something odd! Pacific, Oceanside, Calif.

RAISE Pheasants on the \$100 week plan. Little capital and space can make you independent. Free details. Great Central Game Management System, Columbus 1, Kansas.

\$40.00 WEEKLY Made growing mushrooms, fresh, dried. Dominion patent 331583. Free spawn. North American, 169P Yonge, Toronto, Canada.

BOOKS, PERIODICALS, PICTURES, POSTCARDS

SENSATIONAL Book bargains! Free catalogue! Write: Old Prof's Book Shop, 9 W. Lawrence St., Pontiac 15, Mich.

ENGINEERING And scientific books. Educational Aids, Dept. 309, Box 248, Temple City, Calif.

LANDSCAPE Etching, full color, 11x17, ready for framing, \$1.00. Superior, 105 Court Street, Brooklyn 2, New York.

COMICS Wanted. Large quantities only. New or used. Also pocket novels. C. W. Merchandising Co., 38 Myrtle Ave., Brooklyn 1, N. Y.

FREE Catalogue. Special interesting books. Melvin Powers, 1324 Wilshire, Hollywood 17, California.

USED Books supplied. Catalogue 10c. Bailiol, Box 85, Station "K," Toronto, Can.

FREE Catalog, 400 popular books. Bargain prices. Books Publishing Co., 56 W. 24th, New York 10.

BOOKHUNTERS! All subjects. Send wants! Jaher Book Service, 620-P East 178 Street, New York 57.

MAGAZINES (Back dated)—Foreign, domestic — Arts, books, booklets, subscriptions, etc. Catalog 10c (refunded). Cicerone's, 86-22 Northern Blvd., Jackson Heights, N. Y.

BOOK "Breeding of Parakeets" and cage-bird magazine—\$1.00. Audubon Publishing Co., 3449-PM N. Western, Chicago 18, Illinois.

BOOKHUNTERS! Scarce, unusual, miscellaneous books supplied. Atlantic Book Service, Lawrence Avenue, Charlestown 29, Massachusetts.

GAMES AND ENTERTAINMENT

FORTUNE Telling game for young girls. Loads of laughs, hours of fun. \$1.00 postpaid. Midwest Enterprises, 3344 So. May St., Chicago 8, Illinois.

MAGIC TRICKS, PUZZLES, JOKER NOVELTIES

VENTRILOQUISM Taught. 3c stamp brings particulars. Smith, 801 Bigelow, reoria 5, Ill.

PROFESSIONAL Catalog and free trick 35c. Terry's Magic Studio, 6606 Duryea Court, Brooklyn 19, New York.

"**VENTRILOQUISM** Selftaught." Complete easy instructions book 10c. Loyal, #014-L Amundson Avenue, New York 66.

ATTENTION Magicians! Magic tricks, books, jokers novelties, etc. Big illustrated catalog only 25c. Top Hat Magic, 529M Main, Evanston, Illinois.

TRICKS, Funmakers, puzzles, novelties. Catalog 10c. Andersen's, 6815P Ardmore, Chicago 31.

"**VENTRILOQUISM** Selftaught"—Complete book 25c. Greenview, Box 61-BC, Whitestone 57, New York.

"**FUN** With Newspaper," completely illustrated, 35c. Rocky Nelson, Box 766, Cedar Rapids, Iowa.

MAGIC Monthly, year 25c. New 1952 magic catalogue 10c. New joke lists 5c. Magic Factory, Minneapolis 2, Minn.

3 CARD Monte trick and catalog 25c. Sterling Magic, Royal Oak, Mich.

512-PAGE Catalogue of 2500 tricks, pocket, parlor, stage. World's finest magic. Send \$2.00 for catalogue (refunded first \$8.00 order). Kanter's, M-1311 Walnut, Philadelphia 7.

VENTRILOQUISM Self taught. Quick, easy instructions. 25c. "Ventriologist," Cal Allen, Texas.

FREE Trick and large illustrated catalog 35c. Lerro Magic, 8111 Fifth Avenue, Brooklyn 9, N. Y.

WORLD'S Largest magic shop. Special: Big \$2 book of professional magic tricks, only \$1. Includes mailing lists. Holden's, M220 West 42nd St., New York.

BIG Fun kit! Tricks, jokes, novelties, books. Real clever stuff. Howls galore. \$1.00. Johnson, 414 McRae, Wilmington, N. C.

LATEST Magic for pocket, parlor, stage. Catalog 500 tricks, only 10c. Unequaled magic service for 30 years. Douglas Magician, Dept. 1, Dallas, Texas.

PROFESSIONAL Catalog, 124 pages, 25c. Williams, 900 Plymouth, Ellwood City, Penna.

COINS, TOKENS, CURRENCY

OLD Money wanted. Will pay \$100 for 1894 dime, S. mint. \$50 for liberty head nickel (not buffalo). Big premiums paid for all rare coins. Send 4c for large coin folder. May mean much profit to you. Numismatic Co., Dept. 20, Fort Worth, Texas.

LIBERTY Nickels, 10 different \$1.00. Numismatist, 105 Windsor, Reading, Penna.

WORLD'S Greatest magazine for coin collectors, wooden nickel, and foreign money. 10c. Lawrence Brothers, Anamosa, Iowa.

66 COINS And bills, \$1.00. Oddehon, Box 482, St. Louis, Mo.

AMERICAN Illustrated coin catalog with buying and selling prices \$1. Canadian catalog \$1.50. List 10c. Coin Exchange, (Canada), Box 35, Toronto A, Canada.

FIFTEEN Different uncirculated silver dollars, \$25.00. Complete U.S. list on request. Wm. Johnson, 644 E. Valerio, Santa Barbara 3, Calif.

COIN Collector's Magazine. Largest independent, over 1000 pages per year. Sample copy 30c; \$3.00 per year. Hewitt, 7320-J Milwaukee Ave., Chicago 31.

SET Nine Japanese invasion notes for U. S. \$2.00. Catalogue thousands of coins, 25c. Shultz, Salt Lake 10, Utah.

GET Profit and pleasure in collecting old coins. Send 10c for 56 page illustrated coin catalog. You'll be delighted with it. Send for it now. B. Max Mehl, 370 Mehl Bldg., Fort Worth Texas. Largest rare coin establishment in U. S. Established 52 years.

FREE! Foreign coin, banknote and coin collectors illustrated catalog to approval service applicants. Send 3c postage. Taham Coinco, Springfield 30, Mass.

FIFTY Assorted Indian cents, \$1.50. Rare 1931-S cents, \$1.00. Giant fifty-two page illustrated bargain catalog. 10c. Ben's PM Department, 31 North Clark, Chicago 2.

STAMP COLLECTING

50 MINUTE Stamps, including Monaco giant bicolours given approval applicants. Broadmore Stamp Company, Pittsburgh 34, Penna.

300 DIFFERENT British Colonies \$1.00. Scott, 2653 Midwood, Toledo 6, Ohio.

U. S. Catalog—52 illustrated pages. 3c postage. Brock, 10516 Cuiton, Cleveland 2, Ohio.

500 MIXED Stamps and surprise packet for 10c with approvals. Fanning, Dept. PM, Atascadero, California.

PENNY Approvals. Free gift. S. Kreisher, 710 Walnut, Reading, Penna.

FREE: Mint British Colonies from Tonga, Seychelles, Brunel, Transjordan, Saawak, Solomon Islands, Caymans, Gilbert Ellice—Free with approvals. Viking, 130-Z Clinton Street, Brooklyn, N. Y.

PAYING High prices for approvals? If your collection numbers under 15,000 try our 1c and 2c approvals. In books of 1,000 different. Lots to choose from at lowest prices. Also special offer to customers. Clark, Box 544-P1, Muskegon, Michigan.

18 VALUE Pictorial set. Free to approval buyers. Pleasure Stamps, 1865P—52nd, Brooklyn 4, N. Y.

1/10 CATALOGUE While our supply lasts on many over stocked foreign stamps. Try them on approval. Premiums on purchases. Roseland Stamp Co., Dept. 10-E, Spring Lake, Michigan.

FINE Approvals. Fast, personal service. What countries do you prefer? I'll send their stamps. Skinner, 438 Locust, Long Beach 12, California.

14,000 STAMPS, 50c Weekly. Details free. Sjoquist, 985 Fenwood, Valley Stream 17, New York.

LOWER Priced stamps for general collectors. "Sunny," 1267 Tutwiler, Memphis 7, Tennessee.

FREE Stamps from every selection of attractive foreign sets. Return postage pre-paid. Leonard Krier, Quinter, Kansas.

AMAZING 333 Universal different, 25c. Economy approvals. Seifert, Box 1672, Reading, Penna.

FOREIGN Stamps: All kinds. Mint, used, singles, sets 19th, 20th century. Free price lists, with Scott numbers or without. Please state preference. Write today. Laze Co., Hackensack, N. J.

PENNY Foreign approval stock. 1000 assorted, \$1.00. C. W. Ritchie, Watertown, S. Dak.

UNITED States mint specials! Tixep, Cipex souvenir sheets, 778-81, 948—50c; flags complete—\$1.00. Want lists filled. Brooks, 2352F East 23rd Street, Brooklyn 29, New York.

SURPRISE Set plus "Fun and Profit in Stamp Collecting" 10c. Approvals. John Arnott, 710 14th St. N.W., Washington 5, D. C.

FREE! Rare colorful San Marino's Columbus pictorial set. With temptingly priced approvals. "PG," 195 Park, Lewiston, Maine.

FREE: Famous American set (21) or ten different U. S. airmails with request for U. S. or British approvals with order for 100 different U. S. commemoratives for dollar bill. Gables Stamp Studio, Box 985, Coral Gables, Florida.

TEN Dandy sets, 10c to approval applicants. Faszold, 423c Cameron, St. Louis Co. 15, Mo.

SONGWRITERS—It's new, it's different, it's honest. Send lyrics for outstanding offer. Dick Reynolds, Leonard 6, Tex.

300 DIFFERENT Given free with approvals. Postage 3c. Windsor Stamps, 1435 East 67th Place, Chicago 37.

90,000 STAMPS Sale: Grabbag 30 cts. Special sellout lot \$1. Extra special with sets, stock cards, free gifts \$2. Literature free. Schollmeyer, Box 48, Brooklyn 25, N. Y.

HAVE Quit saving stamps. Bargains galore. Write Anthony Sterle, Jr., 1130 E. 67 St., Cleveland 3, Ohio.

MINT (Unused) United States approvals. Patrick Agencies, 3650A Central, Indianapolis 5, Indiana.

UNBEATABLE! Over 100 different with triangles. Liberia, Tangier, Morocco, etc. Everything 10c with approvals. Reeve, 576-C Crawford, Windsor, Ont., Canada.

URUGUAY: Great assortment. Write for price list and free stamps. Holt Stamp Co., Colon 1586, Montevideo, Uruguay.

CANADIAN Collection free — Includes early Victorian issues, jubilees, high values, commemoratives, special issues, Newfoundland, pictorials, etc., etc., together with Philatelic Magazine all free. Send 5c postage. Empire Stamp Company, Dept. PM, Toronto, Canada.

DEALERS—Wholesale list. Postage 3c. Frank, 5031 Queensberry, Baltimore 15, Maryland.

1000 **MIXED** U. S. and foreign 25c. Monjar, Fairmount, Cincinnati 14, Ohio.

FREE Complete set of famous Americans, flags, parks and presidentials to approval buyers. Send 3c for 15 of the above stamps plus full particulars. Triboro Stamp Company, 145 Nassau Street, Dept. 109, New York 38, N. Y.

BIG Bag mixed stamps. Enormous quantity, \$1.00. Longacre Shop, 583y Sixth Avenue, New York City 11.

FREE—“German War Issues,” cataloging \$10.82, to approval buyers. Royal Stamp Company, Tamaqua, Penna.

1,000 **UNIQUE** Colorful attractive mounted stamps 1c-2c each. Rushed. Niagara Stamp Co., Niagara-on-the-Lake 71, Can.

UNITED States, all different, 8 airmails plus 50 others including commemoratives for 10c to approval applicants. Sunset, Dept. 311, Box 47, South Gate, Calif.

60% DISCOUNT Approvals—Many bargains. Gaines, 716-S Sixteenth, Mattoon, Illinois.

OLD Scarce U.S. seconds on approval. Slight imperfections. Bargain prices. Hernefield, Clintonhill Station, Newark 8, N. J.

FREE Rare set, Povilauskas, 212 E. 3rd St., New York 9, N. Y.

110 **DIFFERENT** Hitlers, Roosevelt, Liberia, Haiti, etc. with approvals 10c. Buckley, 208 Ludlow Bldg., Dayton 2, Ohio.

BIG U.S. illustrated catalogue free. Stone, 45 Bromfield, Boston 8, Mass.

60c **WORTH** Of exciting sets of stamps for only 6c! Foreign approvals. Campress, Manchester 1, Connecticut.

KOREA #104 Block, value \$1.60, free. Request approvals. Raydon Stamps, 2860 Maplewood, Grand Rapids 6, Michigan.

15 **HUNGARY** Beauties 15c, approvals. Spicka, 4032 Jaynes, Omaha 12, Neb.

FREE 10 Different Siam to approval applicants. Lucas, Box 387M, Lombard, Ill.

BETTER Grade British Colonials at popular prices. Borgen, Box 343, Berkeley, Calif.

“**SNAKES**,” Rhinoceros, giant, pygmy, emu, kangaroos, koalabear, kookaburra and other fierce jungle beasts given if you request our exciting approvals. Niagara Stamp Co., Niagara-on-the-Lake 51, Can.

SCANDINAVIA, 200 Selected, guaranteed different, \$1.00. Westamp, 1822 Comox St., Vancouver, B.C., Canada.

STAMPS Bought—Price list 25c. Reimer, 1119E Chestnut, Saginaw, Michigan.

APPROVALS, Sets, singles with money saving price list free. Ward, 241 South Winchester, Campbell, Calif.

AMAZING Offer! Shoebox full of stamps \$2.50. Nelson, Box 346-M, Rye, N. Y.

GENUINE Bargain, 100 different stamps 25c. Mackellar, Box 4683, Los Angeles 24, California.

100 **DIFFERENT** Stamps free with approvals at 60% discount. Martinsen, Box 115, New York 33, N. Y.

VATICAN'S Colorful Cardinals complete, plus three 1947 ahrs, only 20c with approvals. Fred Pittsley, South Montgomery, Napa, Calif.

SHEPARD Stamp News, One year 20c. Sample free. Box 1147, Chicago.

SEVEN Triangles and assortment choicest beauties. Everything 10c with approval. Stan Bubenas, 27a James Ave., Clark Cranford, N. J.

100 **DIFFERENT** France 10c. Approvals. Aronson, 91 Marion, Brookline 46, Mass.

300 **STAMPS** For only 10c.—This mammoth value includes airmails, pictorials; stamps from strange countries cataloguing up to 25c each! Also approvals. Mystic Stamp Company, Camden 80, New York.

FREE “Stamp Finder.” Tells instantly country to which any stamp belongs. 32 pages profusely illustrated. Garcelon, Calais 17, Maine.

200 **DIFFERENT** Including Roosevelt triangle, 5c to approval applicants. M. Avalon Stamp Company, Springfield, Mass.

ALBUM! Holds over 1000 stamps! Only 10c! Stampart, Hartford 1, Conn.

77 **DIFFERENT** United States—25c. Approvals. Utechts, 1143-D North Keeler, Chicago 51.

FLAG Stamp—Free with hygrade U. S. approvals. Wenigman, 1933 Patterson, Chicago 13.

STAMPS Wanted. Collections, duplicates, surplus stock, mint and used. Good grades only. Buy outright if bargain. What have you? Write us details. Vanroy Shirk, Lebanon, Penna.

WORLDWIDE Variety packets 100 10c; 500 60c; 1,000 \$1.25; 2,000 \$3.25; 5,000 \$13.75. Philatelic House, 189 Merrick Rd., Rockville Centre, N. Y.

1/2—1—2c **APPROVALS**. Bargains galore! Cole, 43A Rinewalt, Buffalo 21, N. Y.

40 **DIFFERENT** U. S. commemoratives, airmails 25c. Seidenberg, 944, Appleton, Wis.

FREE Sample—Interesting, informative. Illustrated! National Stamp News, Anderson, South Carolina.

AMAZING Offer! 500 United States stamps—including commemoratives, air mails, high denominations to \$5.00. Only 15c to approval applicants! Illustrated bargain lists free. Mystic Stamp Co., Dept. 80, Camden, New York.

POLAR Bear triangle, giant George Washington, six colored Ecuador, Arctic triangle, first American commemorative, Corsica, Devils Island, others. Everything free with approvals. Capital Stamps, Little Rock 2, Ark.

FREE—Illustrated catalog! Kenmore, Milford, C-57, N. H.

“**HOW** To Recognize Rare Stamps.” Free book illustrated! Kenmore, Milford, H-57, N. H.

FREE. Scott's International Album. Other big premiums. Full particulars with approvals. Raymax, 68-Z Nassau St., New York 38.

500 **EXOTIC** Japan stamps—10c. Kenmore, Milford, J-57, N. H.

DIFFERENT 500, 35c; 1000, \$1.00; 2000, \$2.00; 5000, \$10.00 with approvals at wholesale to clear. K. S. Holmes, London, Can.

U. S. Army and Navy heroes on stamps; 10c with United States approvals. Lucust, Box 305-T, Harmon-on-Hudson, New York.

U. S. Price list free. P. Wetterquist, 1635—13th Avenue, Rockford, Illinois.

100 **DIFFERENT** Spain 25c. Penny approvals included. Reed, Box 980, Chicago 90, Ill.

50,000 **STAMP** Grabbags 25c each. Anderson, 630B Bingaman, Reading, Penna.

FREE Collection — Over 100 different stamps of world; commemoratives, animals, natives, ships, famous men, others all to approval buyers; also Scott albums, catalogs. Bell Stamp Service, Dept. S-2, Bell, Calif.

START Your own stamp business. Send for free circular. Donald Shepard, Box 1147, Chicago.

FREE! Powerful magnifying glass. Jamestown Stamp, Jamestown 202, New York.

307 **ALL** Different—Only 15c! Beautiful collection: commemoratives, triangles, high values, bicolored stamps, etc. Garcelon, Calais 400, Maine.

NICARAGUA Sports, Costa Rica agriculture sets 10c with approvals. Seminole Stamps, Box: 1138-P, Coral Gables 34, Fla.

UNITED States approvals—Select, used, mint. Kingsbury, South Woodbury 2, Vt.

50%-75% DISCOUNTS! Approvals from 33,000 collection—¹/₂c up! Schur, Box 235, Buffalo 12, N. Y.

NOTHING Free. Just good stamps reasonable. Send dime for seventy-four page catalog. Ben's Stamp Shop, 31 N. Clark, Chicago 2.

WOW! 203 All different German 10c! Zeppelins, semipostals, airmails, high values, etc. to new customers. Jamestown Stamp, Jamestown 512, New York.

WORLD'S Largest stamp (7 1/2 x 14 inches). A real curiosity! Retail for 50c, only 3c to approval applicants. Tatham Stamp Co., Springfield 30, Mass.

PRECIOUS STONES, MINERALS

COLLECTORS: Free mineral; sample labels. Foster, 664 Rose, Venice, Calif.

JADE, Agates, titanias, gems, hobbyists supplied, gem cutting machines. Free list. North West Gems, Box 305, Tacoma 1, Washington.

GEMOLOGY Book! Catalog 10c. Atlantic Books, Lawrence Avenue, Charlestown 29, Massachusetts.

GEMSTONES, Mineral specimens. Every variety. Lowest prices. Postcard brings free booklet. Plummer's, 4720 Point Loma Ave., San Diego 7, Calif.

FIND Tungsten, mercury, uranium with Mineralight. Free brochure. Write Dept. PM8 Ultra-Violet Products, South Pasadena, California.

GEMS, Precious and semi-precious, genuine, from world-wide sources. Deal direct, no overhead, save money. Catalog 10c. Hill Co., 5450-G Portland Rd., Salem, Oregon.

GEMCUTTING, Silvercraft authority. Illustrated magazine tells how. Cut rocks, make jewelry. 150 ads illustrating equipment, offering gems for collectors, cutters. Postal brings literature. Lapidary Journal, Drawer B, Palm Desert, Calif.

ANTIQUES, RELICS, INDIAN GOODS, CURIOS

ANTIQUE Guns, pistols, flintlocks, muskets, rifles, swords, edged weapons. Westbrook, 5537 Lafaye Street, New Orleans, La.

TEN Good arrowheads \$1.00. Lynn Crandall, Box 697, Idaho Falls, Idaho.

4 **PERFECT** Arrowheads \$1.00; perfect pipe \$2.50, \$5.00; tomahawk \$3.00; knife 50c. Catalog 10c. H. Daniel, Lamar, Ark.

HOBBIES AND COLLECTIONS

FREE Catalog, Miniature bars and cabinets. Small glass animals filled with fruit cordials. Write Bottled Curios, Calumet Bldg., Miami 32, Florida.

NEVER Before sold by the pound at such low prices. Jewelry parts, findings, beads, pearls and stones. Findings and parts assorted \$2.50 lb.; 5 lbs. \$8.50; imported beads assorted \$1.50 lb.; 5 lbs. \$6.00; high luster pearls assorted \$2.00 lb.; 5 lbs. \$8.50; 100 imported stones assorted \$1.50, 1000 assorted \$5.00. Merchandise Distributing Co., Dept. B, 19 East 16th St., New York 3, N. Y.

WANTED: Cigarette, tobacco cards. Write Charles Bray, East Bangor, Penna.

SALT And pepper shaker collectors. Illustrated catalogue over 80. Handmade personalized by disabled veteran. 25c. Satisfaction guaranteed. Utley, 411 Galveston, Brokenarrow, Okla.

AMAZING Hobby — Collect authentic armed forces insignia, ribbon bars, embroidered patches, naval rates; fascinating assortment of 57 for only \$1; special gift free with order. Pritt Co., Dept. M9, 16 West 27th Street, New York City.

UNUSED Matchbook covers—100 different \$1.00 36-page catalog 25c. Charles Edelman, 1311C East 84, Cleveland 3, Ohio.

INVENTING Can be an interesting and profitable hobby. Write for complete particulars. Institute of American Inventors, Dept. 40-E 631-E St. N.W., Washington 4, D. C.

CAMERAS, PHOTO SUPPLIES

PHOTOMURALS. Your negative or ours. Catalogue 25c. Photomammoth Murals, Dept. M, 12048 Vanowen Street, North Hollywood, California.

PHOTOGRAPHY For pleasure or profit. Learn at home. Practical basic training. Long established school. Write for free booklet. American School of Photography, 835 Diversey Pkwy., Dept 343C, Chicago 14.

BUY Photographic supplies wholesale. Films, cameras, projectors, binoculars. Expert camera repairing. Free catalog. Capitol Photo Supplies, 2428 Guadalupe, Austin, Texas.

ADD “Spice” to home projection shows with colorful old-time Nickelodeon slides. 2x2. Write for free list. Nickelodeon Co., New Fleidner Bldg., Portland 5, Oregon.

BASS Says: Trading since 1910. Used but good as new buys: 8mm. B.&H. Sportster \$52.50; 16mm. Keystone A-7. F:2.5 lens \$37.50; Voigt. 35mm. Vito II, flash shutter. Skopar F:3.5, like new \$38.50; Kodak Reflex F:3.5 lens, like new \$88.50; Contax I, F:2 Sonnar \$87.50; 3 1/2 x 4 1/4 Speed Graphic, Skopar F:4.5, Ibsor shutter, \$52.50. Satisfaction guaranteed. Bass Camera Co., Dept. AG, 179 W. Madison St., Chicago 2.

FREE Photographic bargain book packed with hundreds of sensational values in still and movie cameras, lenses and latest accessories. Super savings for you in new and used equipment. Liberal trade-in allowances, too, on your equipment. Write now for your free copy to Central Camera Company, Dept. 9L, 230 S. Wabash Ave., Chicago 4. (Photographic headquarters since 1899.)

PHOTO FINISHING

16 PRINTS Or 8 jumbos from roll or negatives, 25c with this ad. M. Skrudland, Box 486, Daytona Beach, Florida.

8 CONTACTS 30c, Jumbos 40c, 12, 45c; jumbos 55c. Reprints 4c; jumbos 5c. Western Photo, Dept. PM-92, Box 298, San Francisco 1, Calif.

EIGHT 5x7 Or five 8x10 enlargements, \$1.00. Wilart Enlargers, Box 967, Little Rock, Ark.

CUSTOM Photo finishing guaranteed. 8 exposures 35c; 12, 50c. Bound in beautiful plastic ringed album. Special! 35mm., 36 exposure \$1.00. Free mailer. Flash Foto, Box 36M, Brooklyn 4, N. Y.

16 JUMBO Prints from any size roll or negatives 35c, with this ad. S. Skrudland, Lake Geneva, Wis.

PERSONALIZED Xmas cards, 20-\$1.25. Send negative and 5c for sample card and list of styles. Graphic Photo Service, P.O. Box 72, Wilkes-Barre, Penna.

GUARANTEED Quality. Fast service. Eight jumbos in beautiful super pak plastic ring binder albums only 35c. Send for free mailers and particulars of our complete photo finishing service. Grand Fotos, G.P.O. Box 1410, New York 1, N. Y.

SPECIAL Offer, 8 exposure roll 25c; 12 exposure 40c. Super pak albums. Post-L-Pix, Box 1D, Worcester 4, Mass.

8 OVERSIZE Snapshots from roll, 25c with this ad. Foto's, Box 8, Aurora 1, Ill.

SATISFACTION guaranteed! Eight jumbo size prints mounted in album, 35c—12 to 16 exposure rolls, 50c. Free mailers, quick service, finest developing, finishing. Crown Studios, Box 1223-PM, Dallas, Texas.

FAST—Same day service! 8 oversized prints in attractive plastic-bound book only 35c; 12-50c; 16-60c. Satisfaction guaranteed. Free exposure guide with first order. Pic-Sure, Box 899-B, Philadelphia 5, Penna.

6 OR 8 Picture roll 35c, 12 or 16 picture roll 55c. Each roll printed and developed. Handy album pack. If you fail to get pictures on your film a new roll will be sent you without extra cost. Send coin with roll. No c.o.d.'s. Mailing containers sent free. DeLuxe Film Service, Box 1268-A, Shreveport, Louisiana.

BEAUTIFUL Enlargement from each picture on 8 exposure roll 35c. Cut Rate Photos, Dept. B-4, Janesville, Wis.

TWO Beautiful prints from each picture on 8 exposure roll 35c. Thirty-one years of satisfied customers. Quick service. Lens Photos, Dept. J-4, Janesville, Wis.

MOTION PICTURES AND SOUND EQUIPMENT

TAPE Recorders, tapes, accessories. Unusual values. Dressner, 624-M East 20th Street, New York City 9.

FREE Giant catalog of 8mm and 16mm films for home movie enthusiasts. Films for every occasion. Lee Stann, Dept. PM9, 11 Willard Ave., Mt. Vernon, N. Y.

FREE Movies. Thousands of subjects. Interesting. Entertaining. Fascinating. New directory, only 50c. National Cine, Box 247, Toms River, N. J.

TAPE Recorders at bargain prices! Eighteen makes. 1200 feet plastic tape \$2.10. Write Magnetic Recorders Co., 7120-A Melrose Avenue, Los Angeles 46, Calif.

WE Have it! Send 10c for special listings, and sample film strip. Reyelle, Box 12, Hammels, N. Y.

BARGAINS 16MM. sound films. Also for exchange. Bedner, 5300 So. Talman, Chicago.

LEARN Free lance, educational, Hollywood, and television film technique at home. State licensed. Write for free catalog, Motion Picture Institute, Birmingham 4, Michigan.

5000 NEW-Used 8-16mm. silent-sound films. International, 2120 Strauss, Brooklyn 12.

8-16MM. Silent-sound films. Complete rental library. All latest subjects. Free catalogue, sample film 10c. Garden Film, 317 West 50th, New York 19.

RENT 16MM. sound films, 50c reel. Large selection; free catalog. Film Service, 128 Chestnut St., Roselle Park, N. J.

GUARANTEED Fresh 8mm. roll, magazine; 16mm. roll, magazine movie films. Color, b&w. Free catalog. ESO-S, 47th Holly, Kansas City 2, Missouri.

MOVIE Camera film: 8mm. roll \$1.50, 16mm. 100' \$3.00. Free processing. Better Films, 742 New Lots, Brooklyn, N. Y.

MUSIC AND MUSICAL INSTRUMENTS

SONGWRITERS—800 Names and addresses of America's best song publishers. Plus copyright information. \$1.00 Info., 338 S. Audubon, San Antonio 12x, Texas.

YOUR Words and our music. A winning combination! Send poems. Free examination. Song Promotion Guild, 350-M Broadway, New York 13.

POEMS Wanted for musical setting on percentage basis. Broadcast consideration. Sooner Song Co., 22-PM North West 8th, Oklahoma City 2.

PLAY Guitar in 7 days! Famous beginners photographic charted course positively teaches how to play over 200 hillbilly, popular and western songs by ear or note, plus latest hit songs. Free details, Ed Sale, Studio 300, Point Pleasant, N. J.

MUSICAL Instruments, accordions, guitars, 10-day trial, free catalog. Meyers, 454-A Michigan, Detroit 26, Michigan.

ELECTRIC Guitars, accordions, amplifiers, wholesale. Free catalog. Carvin, Baldwin Park, Calif.

POEMS Wanted! Opportunity knocks! Nationally known song writer composes music to your song poems. Send poems today for free examination and free copy of "Song Writing Secrets." Melody House, Dept. PM, Box 19007 La Tijera Station, Los Angeles 43, California.

SONGWRITERS—Competition demands modern harmony and singable melodies. Send poems for creative evaluation. Jimmy Seaver, Room 410, 203 N. Wabash, Chicago.

ACCORDIONS—Save 50% and up. Cash or terms. New and used. All brands. Wholesale to everyone. Free catalogue. Del Principe, 29 South Cicero, Chicago 44, Ill.

YOUR Voice made loud, clear and powerful with my diaphragm exerciser. Inexpensive. Write, Inventor "Oz," 34V, Box 665, St. Louis, Mo.

SENSATIONAL Free booklet, "How To Write And Sell Songs." Get the facts first. Poems examined free. Reliable Music Service, Box 430-P, Hollywood 28, Calif.

1952 ACCORDIONS—Wholesale. Free catalog. American Accordion Center, 5329 Belmont, Chicago.

POEMS Wanted for musical setting. Send poems for free examination. Five Star Music Masters, 630 Beacon Bldg., Boston, Mass.

LYRICS Set to music and recorded. Free examination. Cherrier Recording, 732 So. Norton, Los Angeles, California.

MUSIC Arranged. Songs printed. Frank Wildt, Music Publisher, Lancaster, Penna.

POPULAR Songs. How to write and sell them. Write for free booklet Successful Songwriting. Gateway Songs, Box 2470, Hollywood 28, Calif.

SONGWRITERS! Protect your ideas! Hold all songs; poems! Write for Safe Correct Procedure first! Song Service, Dept. P, 333 W. 56th St., New York 19, N. Y.

SONGWRITERS! Send poems, songs. Music Service, 243 West 72nd St., PM, New York 23.

POEMS Wanted to be set to music. Free examination. Send poems. McNeil, Master of Music, 510-PM S. Alexandria, Los Angeles, California.

WRITE Songs. Big money and reputation. Write for information. J. Gordon Pub. Co., 4700 South California Avenue, Chicago.

WANTED! Poems for musical settings. Write Songwriters' Service, Clifton, N. J.

RADIO AND TELEVISION

ELECTRONIC Problems, devices, advice. Free information. Registered Engineer, 5208-E Onacrest, Los Angeles 43.

EIGHT Radio building plans \$1.00. Master Kit Company, Box 206, Belleville, Ontario.

FREE 236 Page 1953 television-radio-electronic catalog! World's largest stocks, lowest prices. Complete supplies for builders, experimenters, amateurs, servicemen. Latest television, radios, phonos, recorders, sound equipment. Thousands of parts, tubes, test instruments, books, diagrams. Top quality money saving values. Get yours now! Allied Radio Corp., 833 W. Jackson Blvd., Dept. 34-J-2, Chicago 7, Ill.

BUILD 15 Radios—Only \$1.30 each. Experience unnecessary. Home radio and TV course includes trouble shooting and servicing lessons, radio principles, code instructions, practical radio building and repairs. You build and keep receivers, transmitters, amplifiers, test equipment and code oscillator. All parts, tools, instructions supplied, including radio tester and electric soldering iron. Send for big, new time and money saving catalog and radio TV repair guides. Enclose 25c. Progressive Electronics Co., 497 Union Ave., Dept. PM-22, Brooklyn 11, N. Y.

SIMPLE Radio and television trouble analyzer. Service your own sets and save. \$1.00 prepaid. Stegotronics, Colchester, Conn.

HOW To repair most radios in a few minutes without extensive study or expensive equipment. Only \$1.00. Details free. Slate's Radio Service, Corsicana, Texas.

ONE Tube loudspeaker radio diagrams 25c. Net-Loc, 44 Walker, Cambridge 38, Mass.

TELEVISION Interference filters. Price \$2.75. Stell's Co., Box 1104, Sioux City, Iowa.

MAKE Simple, tubeless, batteryless, distance-getting crystal radios. Crystal and illustrated instructions 25c postpaid. Allen, 427-P, Clinton, Mo.

TV And FM antennas. Yagi, conical, bow-tie, mounts, accessories. Lowest prices. Wholesale Supply Co., Lunenburg 1, Mass.

BUSINESS OPPORTUNITIES

START Your own mail order business with hundreds of repeat, sales proven, hobby-craft items. No stock to carry, no shipments to make. We pack and ship for you. For details and instructions send 25c. Mail Order Service, Dept. PM25, 845 S. Wabash, Chicago 5.

BIG Profits weaving rugs—Send 10c for our catalog, sample card, and low prices on carpet warps, rug fillers, looms, parts, inexpensive beam counter. If you have a loom, give make and width please. OR Rug Company, Dept. 9216, Lima, Ohio.

TRADE Magazines will help you to success. Get latest copies through our easy-to-get-acquainted service. Hundreds of business, trade, educational, professional, hobby, sport, advertising, construction, laundry, legal, lumber, machinery, mail order, marine, metal, military, milk, milling, motion picture and others covering all interests. Send for list today. It's free. Commercial Engraving Publishing Company, 34C North Ritter, Indianapolis 19, Indiana.

FISHWORM Breeding. Literature free. Manual \$1.00. Postpaid. Dixdok, Kent, Ohio.

RESILVERING Mirrors, formula 50c; two-way lookout mirrors, (No one sees you), 50c; coppered mirrors, 50c. All \$1.00. Nelko-Mir, Box 3462-J, Chicago 54.

FIGURINE Molds and many others, liquid rubber, statuary plasters, flock finishes, Glo-candle wax, etc. Illustrated catalog and "Plastercraft" manual free. Blue Rapids Supply, Blue Rapids, Kansas.

MIRACLE Seller. Cross-chain. Lord's Prayer viewer with 12 imported rhinestones, fabulously boxed. Sample and wholesale prices \$1.00 postpaid. New York Article Company, G.P.O. Box 405, New York 1, N. Y.

ADVERTISING Book matches—Cash in on big demand; sell union label matches. Cuts for all businesses and political parties. Free powerhouse selling kit, low prices, protection guaranteed on repeat orders. Cash commissions. Superior Match Co., Dpt. MX-952, 7530 Greenwood, Chicago.

START Home perfume business. No equipment. Everything furnished. Emly Enterprises, Box 319-P9, North Hollywood, Calif.

ALL Profit: Get manufacturer's, distributor's, dealer's profits yourself by making, selling, installing important heating specialties. Details free. Harrington, Box 103ME, St. Matthews, Kentucky.

START Home manufacturing business. Make cleaners, soaps, polishes, cosmetics. Free literature. Kemix, Park Ridge, Ill.

REPEAT Sales guaranteed, cheapest, best glass dishwashing liquid for taverns, restaurants. Samples, details 50c. Riesen, 419 Vliet Street, Milwaukee 12, Wis.

I Made a great success in the collection agency business. I can teach you too—quickly. Write me. George H. Cole, Syracuse 2, N. Y.

LEARN Sewing machine repair. Electrify, rent, sell spare time. Make "big money" like our other men-women do. New machines, motors, parts wholesale. Details free. Taylor Service, Hamilton PM-9, Ohio.

START Your own business on credit. Your own boss. 1586 of our dealers sold \$5,000 to \$27,500 in 1951. We supply stocks, equipment on credit. 200 home necessities. Sales experience unnecessary. Pleasant, profitable business backed by world-wide industry. Write Rawleigh's, Dept. I-U-PPM, Freeport, Ill.

\$5 AN Hour and more possible in your home. You can paint it with suede. Fabulous new business. Spare or full time. Spray on rainbow colors. Auto dashboards and trunks, signs, radios, toys, figurines, lamps, etc. Beautified with amazing new 3rd dimensional plush-like finish with touch-appeal as well as eye-appeal. I'll send you complete, step-by-step plans and equipment, including high-velocity spray gun for no-risk examination in your own home. Send no money, just name and address. Coast, 1004-AS S. Los Angeles St., Los Angeles 15.

MAKE Money at home as renewal headquarters for all magazines. Big Christmas sales profits now. Liberal commissions. Supplies furnished. Write for free catalog. McGregor Magazine Agency, Dept. 500B, Mount Morris, Ill.

YOUR Own business without investment. Be an authorized agent for all magazines and take care of new and renewal orders in your territory. Experience not necessary. We furnish all supplies free. Write for our catalog. Subscription Service Company, P.O. Box 2070, Birmingham, Ala.

OPERATE Profitable mailorder business. Particulars free. George Lenhoff, Lincoln 8, Nebraska.

IMPORT-Export! Opportunity, profitable, world-wide, mail-order business from home, without capital; or travel abroad. Established World Trader ships instructions for no-risk examination. Experience unnecessary. Free details. Mellinger 29, Los Angeles 24.

LIQUID Rubber. Make flexible molds. Quart \$2.95, 1/2 gallon \$4.75, gallon \$8.50 (prepaid). Chaney, 1130 E. 16th St., Jacksonville 6, Fla.

SELL Cheap balloons. Ten gross assorted \$5.00. Samples airmail \$1.00. Dwarkadas, Third Bholwada 38PM, Bombay 2.

SUPPLY Lists and ideas for home workers free. Lincoln Supply, Box 449, Irwin, Penna.

SEND For free booklet, "There's Money in Plastics." Bing Products, PM-952, Watertown 72, Mass.

SELL By mail, big profits, free details. Write Keystone, Box 332A, Hazelton, Penna.

EARN Income at home. Spare time. Start small, grow big. Lifetime security. Particulars free. Reho, Box 21A, Whitsett, Penna.

NATURAL Molding rubber. Free sample. Tribby Supply, Post Office Box 3091, Station F, Jacksonville, Florida.

FREE Fascinating business plan! Details. C-O-C, Box 204, New York 21.

\$4.25 DOZEN Men's ties, sample, others. Berlin, 166 Keap Street, Brooklyn 11, New York.

TO \$35.00 Weekly. Spare time, home operated mail order business. Successful small "beginner's" plan. Everything supplied. Lynn, 10420-M National, Los Angeles 34, California.

SEVERAL Mailorder money making homework offers. W. W. Jenkins, Lucasville, Ohio.

INVISIBLE Reweaving—Big profit, big demand, easy-to-learn with low-cost complete course—nothing else to buy, ever. Details free, write today: Fabricon, Dept. N-6, 8342 S. Prairie Ave., Chicago 19, Ill.

START A nutmeat business in spare time. Experience unnecessary. Literature free. Jack Kershaw, Carterville, Missouri.

CASH Income from your backyard! Unlimited businesses! Pickett's, Florence, Ky.

RE-REFINE Used oil. Scot re-refiner converts old oil into new. Literature free. Scot Mfg. Company, 9009 Osage Lane, St. Louis, Mo.

PRINT Without a printing press. Posters, banners, greeting cards, toys, glassware, neckties, anything! New easy revolutionary method. No special equipment or experience needed. Work full or spare time at home. No selling. We set up your own local business. Wonderful money-making opportunity. Free sample. Profitable ideas, beautifully illustrated plan free. Write: Screen-Print, 1010-M South Los Angeles Street, Los Angeles 15.

HAVE Home mail business—Success assured beginners with \$100 or more. Ideal-mailbox service. Booklet 25c. Details free. NMD Agency, Box 88-J, Dorchester 22, Mass.

MAKE Big money at home. Inexpensive. Box 475, Lomita, Calif.

FIGURINE Moulds 50c up. Write: Oman, 101 Wilken Street, St. Paul, Minnesota.

BE Own boss. Operate profitable mail order business. Sensational new monthly magazine tells how to start; where to find items; how, where to advertise. Hundreds fascinating money-making facts from experts every month. 50c copy. 12 big issues only \$5. Mail Order Business, Dept. C, 19 West 44, New York City.

WANTED! Home producers, by manufacturers in our contact service. Become a sub-contractor casting plastic products for these companies. Thousands of easy-to-make items required. Cash in at home, without previous experience. Write for free list of 100 most wanted items. Plastic Service Assoc., Dept. PM9, East Boston 28, Mass.

ESCAPE Wage slavery. Easily. Operate your own profitable lifetime business. Free literature. Corley, H186 Ackerman, Clifton, New Jersey.

GET Dollar orders by mail—Keep 90c. \$10 starts you. Details free. Genmerco, Box 142-J, Dorchester 24, Mass.

"PROFITABLE Decorating business." Fascinating! Instructive. Only \$1.00. Fran Council, Box 150-M, Wildwood, New Jersey.

OWN A mail-order paper products business. Sell envelopes, tags, bags, boxes by mail, wholesale. Tremendous demand. Steady profits. No capital necessary. Write Omaha Envelope Service, Dept. 94, 4721 California, Omaha 3, Neb.

VENDING Machines earn big money! An investment as low as \$10.50 will start you in this fascinating, profitable business that can lead you to the road of success and independence. Routes can be established and operated in either full or spare time with no experience needed. Write for full details and our free catalog illustrating our nut, candy, gum and stamp vendors; also pin ball machines, music boxes, etc. Write immediately to Parkway Machine Corporation, Dept. 7, 715 Ensor Street, Baltimore 2, Maryland.

BUY Wholesale thousands nationally advertised products at big discount. Sent free "The Wholesale Plan." American Buyers' Service, 629-PM Linden, Buffalo, N. Y.

BABY Shoe mountings. Book ends, frames, etc. Emjay Metal Co., 135-17 135 Ave., So. Ozone 20, N. Y.

TIN-Cans. Turn them into cash. Nine methods. Instructions 50c. Charles Company, 12-DAH, Norwood, Ohio.

MAKE 10 Items for 10c each—Sell at \$1.00. Complete plans \$1.00. Details free. Associated, Box 767-P, Worcester 1, Mass.

MAKE Big money making and selling your own soil conditioner, septic tank cleaner, cedar coating plaster, silicone polishes, waterless hand cleaner, nylon bleach and many other new 1952 money-makers. Investment small! Profits immense! Literature free! Liscomb Miller, Dept. 1517, Tampa, Florida.

SENSIBLE, Profitable, delightful business. Trifling capital. Carl Jamer, Manorville, N. Y.

PROFITABLE Home business. Electroplate novelties, autoparts, mirrors, baby shoes, etc. Portable Tyco Electro-Plater \$5.95. Free booklet. Tyco Metals, Box 13231-MC, Houston 19, Texas.

"MAKE Perfume." Profitable mailorder business. Catalogue free. "International," 6347 Parnell-PM-9, Chicago 21, Illinois.

MAIL Order business—Your opportunity. "How to Build Your Own Mail Order Business." Beginner's idea-book tells "how." 25c postpaid. Promptly refunded if not satisfied. Albert Zimmer, 206 Central Ave., Lockland 15, Ohio.

MAKE \$6.73. You sell one—and they're amazingly easy to sell! We have new adding machines in original factory cartons you can sell for only \$14.95 and you make 45%. They're executive model portables, precision built with automatic clearance, direct subtraction, fully guaranteed. Send for life size color photo with full details. Write today to Lightning Adding Machine Co., Inc., Dept. P-21, 1260 West Second Street, Los Angeles 26, Calif.

OPERATE "Escalator" mailorder system, selling our products or any products. Fastest, most revolutionary mailorder system known. Write: Selbyco, Decatur 160, Ill.

FREE Formulas and instructions for making newest big profit perfume specialties from tap water. DeCasto of Hollywood, P.O. Box 447, Hollywood 28, Calif.

HOME Business opportunity mailing literature to new mothers. Everything furnished. Big earnings. Orders filled. Delray, Box 3852M, Columbus 13, Ohio.

OPERATE Profitable mail order business. \$1.00 for sample and instructions. Ellison, 409 Hazel Street, Warren, Penna.

SMALL Bowling alleys earn big money. Easy. Square, Excelsior, Minn.

THROWN Away! Tons of ground rubber by recappers. Make it into plastic rubber of 1000 uses. Easy. Inexpensive. Start profitable business. Instructions, samples \$1.00. Ceeten Products, Cornelia, Ga.

START Your own mail-order business; on small capital. Proven plans. Write for interesting literature. Metro, Box MP-1794, Houston, Texas.

NEW Kind mail order home work! Carry no merchandise. No selling, manufacturing, experience, advertising investment, capital necessary. Eye-opening proof 3c stamp. S. Torrey, Melrose 76, Mass.

MAKE Perfumes at home. Write, "Carey Laboratories," 1914 Chouteau PM-9, St. Louis 3, Missouri.

FROM Basement to big time—In four years I went from basement lathe models to \$120,000 gross sales per year. I could have done it in two years if this booklet I am offering you on how to do it had been available. It covers development, manufacture, sales, finance and business records. Send \$2.00 today for what cost me \$20,000 to learn. Send now to Clay Manufacturing Co., Box 199, Northfield, Minn.

MAIL Selling opportunities galore! Free! Wehner, Box 142-A, Roxbury 19, Mass.

HOW And where to obtain capital? Free details. Star Service, Wapakoneta, Ohio.

OPERATE Profitable mailorder business. Write Jasco, 2623-M Columbus, New Orleans 19, Louisiana.

MAKE Money from newspaper clippings. Siegel, Box 183 PM, New York 2.

START Home mailing business. Little capital required. Instructions telling how, 25c (refundable.) Siwaslian, 4317C Gleaner, Elmhurst 73, N. Y.

POPCORN Poppers, peanut roasters, candy floss. Sno-Konette, Northside Co., Indianola, Iowa.

EARN 400% Selling attractive low priced watches. Free salesman's sample. Result Sales, 580 Fifth Ave., New York 36A.

WATERLESS Hand cleaners. Highly profitable home mailorder and mfg. business. Simply add water to concentrates or ready-packed under your own label. Everything furnished. Western B Aircraft, Los Angeles 19.

START Business without capital! Reliable. 15-A Park Row, New York 38, N. Y.

SMALL Investment in Artkote molds puts you in \$5.00 hour stone facing business. Sample mold \$2.00. Dividend Company, Liverpool, N. Y.

FIX Typewriters. Free booklet describes our modern, inexpensive home-study course. Factory methods taught. Write: Typewriter, 8915 Corbet, Tarentum, Penna.

LEARN Metalizing baby shoes, jewelry, gifts. Bronze, gold, silver. Complete success plan free. Kiktavi Building, 7217-PM South Broadway, Los Angeles 3.

300% PROFIT Or more. Send for pattern to make wallet from 1 pc. of leather. No sewing. Scissors and pattern needed only. \$1.00 check or money-order. S.E.B., Box 33, Westville, N. J.

SELL By mail to automobile owners. Millions of prospects. Fast selling items. Everything furnished. Write: Eastern, Box 142-P, Dorchester 24, Mass.

MUSHROOMS Grown. Boxes, barrels. Manureless process 50c. Spawn \$1.00. Gordons, 553 William, Winnipeg, Manitoba.

MAKE Money at home mailing cards, circulars. Everything furnished. Start at once with almost no investment. Paton, Box 55-P, New York 23, N. Y.

BIG Profits making new greaseless doughnuts. Start in kitchen. Wholesale to grocers and cafes. Free plans. M. Ray Company, 3605 South 15th Ave., Minneapolis 7, Minnesota.

REPRESENT US in your area. Write for descriptive folder. International Trading Center, 1900 Euclid, Cleveland 15, Ohio.

AMAZING. Refinish auto dash. Grain appears like magic. Details free. Modern Aids, 248 So. Main, Jamestown, N. Y.

BIG Money and fun growing live miniature Ming trees on your window sill. Write for free rare tree seed and plan. National Nursery Gardens, 8463 South Van Ness, Inglewood 4, California.

SEA-Shells for making gifts, novelties, jewelry. Catalog 10c. Instruction book of 155 photographed designs \$1.10. Giftrcrafts, Box 4550-PX, Coral Gables, Florida.

MAKE Your home workshop pay up to \$6.00 hourly for your spare time. Even more with wife's help, and she'll love it! Details free. The Old House, Box 8, Spring, Texas.

FLEXIBLE Rubber moulds for plaster and Marble figurines. Sample and large illustrated catalog 25c, refunded on first order. K-C Novelties, Dept. 23, Easthampton, Mass.

MAKE Money spare or full time, casting metal toys and novelties. Big wholesale and chain store demand for autos, soldiers, ashtrays, banks, etc., keeps manufacturers busy. Production moulds furnished for up to 100 and more castings per hour. No experience or special place necessary. Write for information and illustrations of patterns needed. Metal Cast Products Co., Dept. A, 1696 Boston Road, New York 60, N. Y.

EARN Money at home with your typewriter! Spare time! Details free. Edwards, Publisher, 3915-PM 12th, Des Moines 13, Iowa.

WHY Not make extra dollars repairing zippers? Excellent profits uncrowded field. Details free. Texas Specialty Company, 204-B Texas, Texarkana, Texas.

FREE Folder—100 ways to make money in silk screen printing. National, Box 88-PM, Dorchester 22, Mass.

SELL By mail to women—Real merchandise. Everything furnished, orders filled. Big profits. Charles, Box 32-S, New York 63, N. Y.

START Mailorder bookshop—Build your future. 25c brings booklet, samples, exciting ideas. General Publications, Ossining, New York.

START A Venetian blind laundry. Profit opportunity for lifetime business. New machine method. Free booklet on request. F. C. Co., 442 N. Seneca, Wichita 12, Kans.

MAKE Tough, durable plastic—1c pound. Makes attractive floors, walls, built-ins, roofs. Build good home, \$150.00 room. Bays Laboratory, Oklahoma City 9.

LIQUID Molding rubber, \$2.95 quart, \$9.95 gallon prepaid! Plastercraft Supply Company, 3051 St. Clair Ave., Cleveland 14, Ohio.

NEW Exceptionally profitable plans, ideas for home operated mail business. Rush name. Miller, 1772-P Carlyon Road, East Cleveland 12, Ohio.

MAKE Flexible molds! Cast plaques, bookends, figurines! Free sample! H. Tooker, 630-R Chestnut, Hamilton, Ohio.

21 POPCORN, Candy apple formulas, proven money-makers. Send \$1 today for formulas, catalog of money-making ideas. Concession Supply, 3916 Secor, Toledo, Ohio.

RECAST Old batteries into new. Latest achievements. Battery Laboratories, Minneapolis.

READ "Advance"—The voice of mail order. Offers money-making opportunities, sources of supply, personal guidance, etc. Issued monthly. Sample copy 35c. Yearly subscription \$2.00. Advance Publishing Company, 313 East 21st Street, Suite 450, New York 10, N. Y.

BOOKKEEPERS—Earn \$5000 yearly part time. Sell, operate new sensational CPA bookkeeping service. Kern, 4942 Vineland, North Hollywood, Calif.

GOOD Paying business silvering mirrors, plating autoparts, reflectors, bicycles, bathroom fixtures, etc., by late method. No tanks or shop required. Outfit furnished. Free booklet. Gunmetal Co., Ave. H, Decatur, Illinois.

POPCORN And potato chip equipment. Long Eakins Company, 5260 High, Springfield 99, Ohio.

BUY Wholesale. Thousands articles. Supply directory, 10c. Idealco, Park Ridge, Illinois.

EARN Extra money! "Homeworker Magazine" tells how. Sample 25c. Sizemore, Box 7, 4917 Kostner, Chicago 30.

BOOKKEEPERS, Keep books, small firms spare time. Manual latest technique by C.P.A.. \$3.00. Modern Business, Box 406, Youngstown 1, Ohio.

FREE Book "505 Odd, Successful Businesses." Work home! Expect something odd! Pacific, Oceanside, Calif.

46 FROM Square foot plywood; jigsaw necessary. Write: Woodarts, Bridgewater, Mass.

EXTRA Money—No selling, operate vendors. Amazing profits, details free. Silver King, Suite 220, 622 Diversey, Chicago 14.

BUY It wholesale! Manufacturers, distributors offer 850,000 items. Literature free. Olsen, 1231-A East Third St., Duluth 5, Minn.

EARTH WORM Breeding? First, get unusual story. "An Earthworm Turned His Life." Free. Earthmaster, Dept. 14, El Monte, Calif.

INCOME From local information. No selling. Write Neherco, La Verne, Calif.

UNPAINTED Bookends, plaques, statues, figurines. List. Haverty Products, 822-17th St., Altoona, Penna.

OPERATE Profitable mail order business. Write Walter Service, 4159-A East 112th, Cleveland 5, Ohio.

DOLLARS in personalized baby record books. Sell by mail. Use same literature we do. No-Co-Ro, Oakland 6, Calif.

MADE \$24,500 Using money making plans from Schemer Magazine, world's oldest mailorder publication. Box 275M, Canfield, Ohio. Year \$2.00. Sample 20c.

MINK Raising information free. Complete. Lake Superior Mink Farm, Superior, EE1, Wisconsin.

COPUBLISH Leading m.o. paper. Latest copy Mail Sale Advertiser, details, dime. Vanroy Shirk, Lebanon, Penna.

COLORGLAZED Concrete pottery made without molds. Patented method. Cemetery products, novelties, tiles. Basement leak-sealing. Money-making projects. Booklet, details free. Men only. National Potteries Company, Grand Rapids, Minnesota.

MONEYMAKING OPPORTUNITIES

BE Independent, be secure, have your own profitable business—Earn \$20.00 and more a day making beautiful, fast-selling lamps at home. No equipment needed. Illustrated course teaches you quickly. Course, parts catalog, wholesale price list—only \$2. Gearon Co., Dept. 200-B9, 27 S. Desplaines, Chicago 6, Ill.

START Home candy kitchen. Interesting information free. Schenck, 717-P W. Penn. Butler, Penna.

SELL Titania gems. \$9.75 carat wholesale. More brilliant than diamonds. Free catalogue. Diamonite, 1404-M Mitchell, Oakland 1, Calif.

WHOLESALE. Hundreds nationally advertised utilities, Bulova, Remington, Dornier, etc. Save 30% up. Illustrated catalog \$1.00 (redeemable). Modern Wholesale, Columbus, Kansas.

MAKE Money with a typewriter. Complete information 50c. Claude Wiese, 1516 Franklin, Waterloo, Iowa.

PROFITS—Free radio advertising. Pay commission only on orders received. Over 400 radio stations active. Free information. Mishek, 2, Wasaca, Minn.

\$200 WEEKLY Reported! No selling. Free booklet. T. J. Surface, Roanoke 4, Virginia.

START A buying service. Buy wholesale thousands nationally advertised products. Make big profits selling at sizeable discounts. Send postcard for details. American Buyers Service, 631-PM Linden, Buffalo, N. Y.

SELL Printing by mail! We fill orders. Free plans, samples. Sutton Printing, Box 853-G, Waycross, Georgia.

DIME Brings latest money-making opportunities. Satisfaction guaranteed. Floyd Huff, Box 291, Russellville, Arkansas.

GET Into mail order. It's fascinating. It's fun. It's highly profitable. Start at home in spare time. Details free. Lewis Bartlett, Richland, Georgia.

START A profitable subscription business in spare time! We need men and women (young or old) as representatives for all leading national magazines. Liberal commissions paid for new and renewal subscriptions. Start earning money in this pleasant work at once! Clip this ad and send with your name and address to: International Circulation Division, Dept. PM, Hearst Magazines, 250 W. 55th St., New York 19, N. Y.

HOW To get your mail order advertising free revealed by famous expert. Also other "inside" secrets. Free details. Benson Barrett, 1751-A2 Morse, Chicago 26.

WIN Contest money. General Contest Bulletin gives hundreds of tips. Lists current contests and rules. Sample 25c. General Contests, 1609½ East 5th, Duluth, Minnesota.

CREW Managers—Big profits handling \$3.95 photo enlargement deal. Allen Studio, Riegler Bldg., Little Rock, Ark.

SCHOOL Seniors—Sell classmates America's most beautiful graduation name cards. Largest selection. Highest commission. Outsell all others. Free sample kit. Printcraft, Dept. M, 1509 Maple St., Scranton 5, Penna.

BOYS Earn \$3.00 an hour on the streets in your town. Send 50c for complete detailed instructions to Brown, 4840 Washington Street, Downers Grove, Illinois.

\$10,800 PROFITS! Your own mailorder business! No capital risk! "Success plan" (worth \$2) free! Write today! Treasury, 149 Storer, New Rochelle 3, New York.

GET Into wonderful mail-order business. Orders filled free. Send 10c (refundable) for sample literature, details. Paragon, Box MP-2194, Houston, Texas.

MONEY in screen printing, selling, religious mottoes. Get info. Joseph Jones, Box 321, Meridian, Mississippi.

MAKE Money using your telephone! Book tells how. Profitable spare or full time work. For housewives, disabled persons, salesmen, etc. Send \$2.00 for "How to Telephone and Make Money" to How-To Publishing Company, 544 Market, San Francisco 4, California.

595 MONEY Making secrets. Send stamp. Book Service, P.O. Box 453, Port Chester, N. Y.

TIE-Breaker picture puzzles exposed, \$2.00. Wenograd, Box 1495, Philadelphia 5, Penna.

CHURCHES, Clubs, organizations, receive \$130.00 plus 12 card tables free. Unique Gift Plan, Pine Hill, New Jersey.

SCHUHMACHER Matmakers. Convert old tires into dollars. Devote full or spare time. S and S Patents, Inc., 1307 North Clark St., Chicago 10, Ill.

GET Money making offers. All parts United States. Trial listing 10c. 3 months 25c. year \$1. Powell, 5713-A Euclid, Cleveland 3, Ohio.

EARN Money evenings, copying and duplicating comic cartoons for advertisers. Adservice, Argyle 1, Wisconsin.

MAKE Money—Sewing and assembling at home. Liebig Industries, Beaver Dam 10, Wisconsin.

BRAND New sure fire money maker. Write Post-Rite, Box 802, Sioux Falls, S. Dak.

\$100-\$200 WEEKENDS No selling or manufacturing. Brennan, 4025-Z Lanker-shim, North Hollywood, California.

50,000 ARTICLES Wholesale. Source directory, dime. Nelko, Box 3462-DR, Chicago 54.

FREE Book "505 Odd, Successful Businesses." Work home. Expect something odd! Pacific, Oceanside, Calif.

BE Appointed State Notary Public now! Details: Stationers, Helotes, Texas.

PUBLISH Your own magazine. Hand-some 52 page format, well edited, illustrated. Cost low as \$1.00 month. Brings you prestige, profits. 25c brings sample details. National, Ord, Nebr.

READ Progressive Mailtrade, the magazine that tells how to make money by mail. Dime brings sample and special offer. Progressive Mailtrade, Box 357, Sheboygan, Wisconsin.

BE The Popular Mechanics representative in your neighborhood and earn big profits in your spare time. Write Popular Mechanics Magazine, Room 408M, 200 E. Ontario St., Chicago, Ill.

FORMULAS, PLANS, ETC.

BRAND New, spectacular chemical and fireworks experiments manual. Complete set-ups, instructions \$1.00. Chemi-Technix Laboratories, 568N Riley Street, Buffalo 8, New York.

500 FORMULAS And recipes. Riches in recipes. Tried and tested processes for home, factory and workshop. 25c postpaid. Allen, 427-FP, Clinton, Missouri.

AMAZING Values. Best, latest formulas. Catalog free. Nelko, 3462-P Merchandise Mart, Chicago 54.

PRODUCT Analysis, mfr'g formulas—processes developed. Plastics, Box 1574, Boston 4, Mass.

BOOK—19,000 Formulas, processes. \$3.98 postpaid. Free literature. K. Paullin, Loudonville, Ohio.

LATEST And best in modern manufacturing formulas since 1897. Lists free! Miller, 1517-A, Tampa, Florida.

MODERN Manufacturing formulas. Jack, Chemist, 5138 Gainor Road, Philadelphia 31, Penna.

REAL Manufacturing formulas. Lists free. Cummings, Chemist, Gordon Ave., Syracuse 4, N. Y.

FORMULAS; All kinds. Latest, best. Literature free. Kemixal, Park Ridge, Ill.

TESTED Formulas. Interesting descriptive booklet free. Pont, Box 635-PM, Terre Haute, Indiana.

PLASTICS

INTERNAL Carvers increase profits, make television or night lights. Now available, plastic lamp base completely wired, with slot in top to illuminate your carved plaque. Available in opaque black, translucent ivory or pink. Send for sample and prices, \$1.25 postpaid. Arata, Roberts and Browse, Inc., Box 576, Fair Lawn, N. J.

NEW Liquid casting plastic. Clear, colors. Embed flowers, insects, coins. Saw, drill, carve. Send 25c for wholesale catalog and new sales manual showing how to make money at home. Castolite, Dept. K-101, Woodstock, Illinois.

10 LBS. Plexiglas for \$5. Assorted sizes and thicknesses of clear and colored Plexiglas shipped express collect. Send \$5 with order to world's largest plastic sign manufacturer. Neon Products, Inc., Lima, Ohio.

PLASTICS, Lucite, Plexiglas, acetates, complete supplies. Retail-wholesale prices. Catalog 10c. Gem-O-Lite, Box 686Q, North Hollywood, California.

PLASTIC, Sheets, rods, tubes, etc. Free list. Plastic Supply Co., 2901 N. Grand Blvd., St. Louis 7, Mo.

LUCITE, Plexiglas. Any size sheets, masked. Square foot (12 x 12) cost, 1/16". \$1.20; 1/8", \$1.40; 3/16", \$1.75; 1/4", \$2.08. Include 10% postage. Almac Plastics, 230 Fifth Ave., New York 1, N. Y.

CHEMISTRY

SAVE Money! Supply catalog 20c. refundable. Laboratory Sales, Box 161-E, Brighton, Mass.

LABORATORY Apparatus, chemicals, microscopes, complete chemistry sets, minerals, uranium ore. 10c brings catalog. Porter Chemical Company, Hagerstown 1, Maryland.

BRAND New, spectacular chemical and fireworks experiments manual. Complete set-ups and instructions \$1.00. Chemi-Technix Laboratories, 568N Riley Street, Buffalo 8, New York.

AMAZING New book of science. Experiments, formulas and catalogue of laboratory supplies. Only 25c. National Scientific Co., Dept. 16, 2204 W. North Ave., Chicago 47, Illinois.

NEW Idea chemical and apparatus outfits for home experimenting. Photo-scales, microscopes, chemicals, biological and laboratory supplies in small quantities. Catalog 25c. Established 1931. John H. Winn, 124A West 23rd Street, New York, N. Y.

CHEMICALS And apparatus for industrial, analytical, and private laboratories. Catalog 20c. Dept. M-50, Biological Supply Co., 1176 Mt. Hope Ave., Rochester 20, N. Y.

ILLUSTRATED Catalog: Chemistry, mineralogy, biology. 10c. Tracey Laboratories, Evanston, Illinois.

HELP WANTED

TIRED Of no money, second rate jobs? Like to start a real career with a lifetime of high salaries? Write me about two growing fields that need men. Ed Howes, Dept. 292, 456 W. Santa Barbara Ave., Los Angeles 37, Calif.

NEW Bathroom deodorizer. Hangs on wall. Banishes odors bathroom, kitchen. Lightning seller. Samples sent on trial. Kristee 175, Akron, Ohio.

AGENTS WANTED

WOMEN! Men! Make extra money in your spare time. No house-to-house canvassing required. New car given as bonus. Amazing nylons guaranteed as long as 9 months depending on quantity, against runs, snags, holes, or replaced free. Rush name and hose size for simple money making plan. Lowell Wilkin, 1729 Wash., Greenfield, Ohio.

PHOTO-Salesmen, agents. Sell beautiful hand colored plastic enlargements and sensational new photo compacts, rings, bracelets, lockets, etc. Collect deposit, we deliver. Profitable sideline. Send card for free sample kit. Novel Portrait Co., 3343 North Ave., Chicago, Ill.

NEW Plastic mending tape. Just press on! Repairs clothing instantly. Lightning seller. Samples sent on trial. Kristee 152, Akron, Ohio.

CASH In on your spare time! Sell beautiful new Regal Christmas greeting cards and gift assortments. No experience necessary. Costs nothing to get started. Show wonderful samples to friends, relatives, neighbors. Merely take orders and pocket up to 100% profit. Write today for samples on approval. Regal Greetings, Dept. 103, Ferndale, Michigan.

JOBBERs And agents wanted. Metaiglas—The marvelous multiple purpose cleanser and polish that has revolutionized cleaning problems. Samples and attractive prices sent on request. Belvidere Laboratories, Belvidere, Illinois.

EXTRA Money! Make up to \$1.00 a box selling amazing value Christmas, all occasion greeting cards, gift wrappings, gifts. Bonus. Surprise offer. Experience unnecessary. Request feature samples on approval, free samples name imprinted Christmas cards, stationery, napkins and free catalog. New England Art Publishers, North Abington 719-A, Mass.

\$1 STARTS You in business. Sell fine \$1 ties. \$1.50 and up values only \$7.20 dozen, you make \$4.80. Send only \$1 for 2 sample ties. Catalog free. Philip's Neckwear, Dept. 949, 20 West 22nd Street, New York 10.

DOUBLE Your income. Sell both guaranteed nylons and Christmas cards. Even beginners make big money with this unbeatable line Fanmour greetings, imprint stationery, napkins, children books, gifts and hosiery. Free samples of imprint greetings and catalog. Complete selling outfit on approval. Fanmour, 200 Fifth Avenue, Dept. PM-9, New York 10.

MAKE Extra money—For yourself, club or church. Up to 100% profit selling big value Christmas, all-occasion greeting card assortments to friends, others. 7 leading 21 card \$1.00 boxes, religious and novel cards. Gift wrappings, ribbons, stationery, napkins, animated books, sewing kits, unusual gifts. Over 150 items. Bonus plan. Experience unnecessary. Write for samples on approval. Special offers. Hedenkamp, 361 Broadway, Dept. PM-24, New York.

WHOLESALE Catalogue! Nationally advertised appliances, radios, watches, etc. Cam Company, 1717—58th St., Brooklyn 4, N. Y.

AMAZING Big profits selling exclusive Sunshine Christmas cards. Nationally famous 21 for \$1.00 assortment is unequalled, sells on sight. Other tremendous Sunshine values: merry holly-day, nature prints. Park Avenue kromekotes, scripture text, gift wraps, stationery, etc. Send for samples on approval. Earn big money now! Sunshine Art Studios, Dept. PM-9, Springfield 1, Mass.

BIG Profits selling ties. \$2.00 values, \$6.50 dozen. Free catalog. Empire Cravats, 648 Broadway, New York 12.

TAKE Large unit orders for wool uniforms, caps, shirts, ties, wallets, personal initialed buckles with belts, cap badges, 3000 emblems. Send for free outfit now! Hook-Fast Co., Dept. PM, Roanoke, Va.

WANTED—Salesman sell nationally advertised mdse. Televisions, radios, appliances, housewares, watches, jewelry, silverware, other gift items. Arco Sales Company, P.O. Box 6187, Sta. B, Albuquerque, N. M.

CALL On friends with sensational Christmas cards in handy assortments. Price, \$1.00. Profit up to 50c. Also popular-priced personal Christmas cards, everyday assortments, etc. Samples on approval. Wallace Brown, Dept. R-4, New York 10, N. Y.

APPROXIMATELY 100% Profit. Success depends on your ability, energy. Experience preferable. Pas-Cal Vitamin-Mineral Products, Box 203-F, Altadena, Calif.

AT Last! Something new and sensational in Christmas cards. Make extra money fast! Show satins, velours, metallics. Gets easy orders. Pays up to 100% cash profit. 30 free samples. With name 50 for \$1.25. Big line. Amazing new glo-in-the-dark ornaments, personalized matches, stationery. Several \$1.00 boxes on approval. Puro Greetings, 2801 Locust, Dept. 240-L, St. Louis, Mo.

EASY Profits selling printing! Large catalog free. Nationwide Printing Company, 2337 Bath Avenue, Brooklyn 14, N. Y.

MAKE \$1000 With reproductions of famous perfumes. Write Perfumers 49, Box 5334, Chicago 80, Illinois.

NEED Money? \$50.00 yours, sell only 100 boxes new Xmas cards. Other amazing offers. Free samples imprinted cards. Feature box assortments on approval; over 100 profitable items. Work with a national leader. Pen-'N-Brush, Dept. PM-9, 139 Duane St., New York City 13.

HIGH School and junior high school students earn big profits taking subscriptions to Hop Up magazine. Hot rods, customs, galore! Free details or send 20c for details and sample copy. Hop Up Magazine, Room 116, 530 West Colorado, Glendale, California.

CHRISTMAS Card money-makers! Everybody wants new 25 for \$1.50 gold-name cards. Cash in big. 161 fast-sellers. Profits to 100% on \$1 boxes; gift bonuses. 4 assortments on approval; imprints free. Creative Cards, 2505 Cermak, Dept. 115-C, Chicago.

BIG Profits selling magic glass cleaner. It's better. \$3.00 per case. R. E. Stiely, Millersburg, Penna.

WANTED—Purchasing agents. No money or experience required. Write Dept. C, Purchasing Manager, 2719 Lawrence, Chicago, Ill.

JUST Out! New thrilling sensation in Christmas cards. Make big money! Show lustre foils, satins, brilliants. Amazing values bring easy orders! Magic glo-in-the-dark ornaments, personalized stationery, matches. 30 free samples. With name 50 for \$1.25. Several \$1.00 boxes on approval. Joy Greetings, 507 N. Cardinal, Dept. 60-C, St. Louis, Mo.

VALUES Galore—100 blades 45c. Gross needlebooks \$4.80. Automatic cigarette lighters \$7.20 dozen. Fullsize 25c ballpens \$8.40 gross. Bargain catalog 5001 items free. Cutrate wholesalers since 1916. Mills Sales Co., 26 West 23rd St., New York.

BE A money maker. Represent magazines year around. Wonderful home work. Big Christmas profits now. Liberal commissions. Everything furnished. Write for free catalog. McGregor Magazine Agency, Dept. 500A, Mount Morris, Ill.

FAST Selling household gift items. Big profits. Tydor, Whitesboro, New York.

MAKE Money introducing world's cutest children's dresses. Big selection adorable styles. Low prices. Complete display free. Rush name. Harford, Dept. H-3341, Cincinnati 25, Ohio.

GLOW-In-the-dark Santa Claus, safe, plastic toy or tree ornament. Deluxe engraved note paper. Other novelties. Sample assortments 50c or \$1.00. Matsonian Co., Northboro, Mass.

BIG Profits selling genuine wooden nickels. Samples, wholesale prices—35c. Berkie, 1125 Fulton, San Antonio, Texas.

SELL Finest nylon hosiery. Guaranteed against everything, snags, runs, holes. Demonstration kit free to you with actual sample stocking. American Mills, Dept. 401, Indianapolis.

SELL Big money maker to men and women. Easy handwork makes fast-selling useful articles. Sample free. Sunmade Company, Brockton 64, Massachusetts.

BIG Profits in spare time! Ambitious men-women who need money. Get assortment full-size samples fine foods, household necessities. Friends, neighbors buy eagerly. Send for free details. Just write Blair, Dept. 31HS, Lynchburg, Va.

ABSOLUTELY Free! Big package actual sample fabrics and style presentation of dresses, lingerie, hosiery, etc. Take orders. Commissions big. Send no money. Melville Co., Dept. 7552, Cincinnati 25, Ohio.

HUGE Profits. Assemble rhinestone jewelry. Sample kit \$1.98. You sell for \$6.50. Wholesale catalog 20c. House of Hobbies, Box 790R, Evanston, Ill.

HOTTEST Seller ever! Get in on the ground floor! Huge profits await you as our agent selling full or part time new nationally advertised top quality Pennsylvania saw sets. Tempered steel saws for every use—all on one handle. Hacksaw, crosscut, frozen meat and bone saw, pruning saw, keyhole saw, dovetail saw, all on one handle. Tremendous value everyone can use, everyone wants! Sells on sight! Send for free illustrated catalogue. James R. Barnet Co., Dept. M, Box 188, Wellesley Hills, Mass.

CARDED Mdse. headquarters—Also agents' supplies; aspirins, combs, handkerchiefs, pocket knives, pipes, shoe laces, razor blades, nylons, novelties. Over 1000 items. Write for price lists, Maloney & Sons, 1063 W. Broad St., Columbus 8, Ohio.

\$21.60 IS Yours for selling 144 educational toys. Plastic. Sample 10c. Radio Code Whistle Co., 1259 Westlake Ave., Cleveland 7, Ohio.

BUY Wholesale thousands nationally advertised products at big discount. Sent free "The Wholesale Plan." American Buyers' Service, 627-PM Linden, Buffalo, N. Y.

SCHOOL Seniors—Earn sensational profits selling classmates America's most beautiful graduation name cards. Largest selection. Out sells all others. Free sample kit. Printcraft, Dept. M, 1509 Maple St., Scranton 5, Penna.

THEY Sell like hot cakes on a cold a.m. An easy \$25-\$50 day. More than "160" top selling, eye appealing "Xmas and all occasion" greeting card assortments. Every stop a push-over for sales and repeats. Line includes Xmas cards, gift-wrap sets, personalized stationery, notes, napkins, wide selection fine gifts and costume jewelry. We're sure and confident, that's why our sensational exclusive credit terms to outstanding producers. Write to-day for profit-making "on approval" kit. Modern, 71-A1 Fanshaw, Yonkers 5, N. Y.

SELL Nationally advertised merchandise. Catalog 25c. (Refunded first order.) Ellison, 409 Hazel St., Warren, Pennsylvania.

AMAZING Quick easy cash is yours. No selling necessary, just show Rainbow's beautiful Christmas card assortments. Children's books, gifts, novelties, personalized stationery, napkins, etc. Save friends, relatives, etc., time and money. No investment. Deal with one of New York's largest imprint companies for guaranteed satisfaction. Costs nothing to try. Write today. Samples on approval. Rainbow, 34 E. 1st St., New York 3.

BIG Profits hand made ties \$6.25 dozen. Information free. General Products, 11 North Pearl, PM2, Albany 7, N. Y.

MEXICAN Feather pictures. Christmas novelty. \$1.00 (stamps) brings \$2.00 worth samples. Refunded if unsatisfied. Aztec Art, Apartado 762, Mexico City.

GET Into toys! Big money! Show free toy-gift line full or spare time. Take orders, pocket juicy profits. Styleco, Dept. E283, Cincinnati 10, Ohio.

NATIONALLY Advertisd vinylite plastic raincoats. Men's, women's. Samples \$2.50. Yale Clothing, Meriden, Conn.

MAKE Wedding profits. Sell invitations, napkins, matches. Samples free. Dunbar's, Middlebush 3, N. J.

DO You need money? \$35 is yours for selling only 50 boxes of our 300 Christmas card line. This can be done in a single day. Free samples: Other leading boxes on approval. Many surprise items. Experience unnecessary. Free samples personalized Christmas cards, stationery, napkins. Write today. It costs you nothing to try. Cheerful Card Co., 10 White Plains, New York.

PRINTING—Salesbooks, envelopes. Free illustrated catalog. Ersco, Dept. PM, Bronx 72, N. Y.

QUICK Extra cash! Sell America's outstanding line of Christmas box assortments and personalized lines. Plus hundreds of extra profit items. Monogram playing cards, wedding invitations, gift items, deluxe album of exclusive cards, nylon hosiery. Write today for 60 free samples in six beautiful portfolios. Gift catalog included. Elmcraft Chicago, Dept. 3, 5930 S. Western Ave., Chicago 36, Ill.

BIG Bargains! Terrific profits! Selling new-used clothing. Suits \$1.75, pants 35c, topcoats \$1.00, dresses 20c, shoes 20c. As little as \$25 starts you. No experience necessary. Free wholesale catalog. Superior, 1250-A Jefferson, Chicago 7.

NEED Extra cash? Free sales kit. Sell personal initialed buckles with belts, cap badges, tie clasps, etc. Choose from 3000 emblems. Hook-Fast, Box 1425PM, Providence, R. I.

SHINE Shoes without "polish." New invention. Lightning seller. Shoes gleam like mirror. Samples sent on trial. Kristee 150, Akron, Ohio.

MEXICAN Feather pictures. Sell on sight; 200% profit! Free details. Sample 20c stamps. (No coins). Sylviap, Apartado 9036, Mexico City.

AGENTS — 300% Profit selling genuine gold window letters; stores and offices. Free samples. Metallic Sign Letter Co., 431-D North Clark, Chicago.

MEXICAN Feather pictures. High profit! Fast sellers! Adelphi, Box 57-B, Bellerose 6, N. Y.

GOLD Lacquered and silver sign letters. Windows, doors, trucks. Standard sizes. Penny and up samples. Atlas-P, 544 West 79th, Chicago 20.

YOUR Own business—Used suits \$1.50; topcoats 50c; shoes 12 $\frac{1}{2}$ c; ladies' coats 30c; dresses 10c. Enormous profits. Catalog free. Moro, 558-AA Roosevelt, Chicago 7.

CALIFORNIA Sweet smelling beads. Sensational sellers. Free particulars. Mission, 2328PM West Pico, Los Angeles 6, Calif.

\$50 WEEKLY Selling finest razor blades, other items. Free details. Edisans, Box 274, Far Rockaway, N. Y.

MAKE Tremendous profits with fast-selling costume jewelry! Buy direct! Sell your friends, neighbors and customers at big savings to them! Write for our free catalog! Penn Jewelry, Dept. P, 826 W. Lacka., Scranton, Penna.

EXCELLENT Sideline for printing and advertising salesmen. Decalcomania name plates in small quantities. Great demand. Also, make money with our line of automobile initials and sign letters. Free samples. "Ralco" XL-Roxbury, Boston 19, Mass.

AGENTS: Stamping names on key protectors. Sample 25c. Stamping outfits, checks, social security and name plates. Hart Mfg. Co., 303 Degraw St., Brooklyn, N. Y.

SALESMEN, Distributors, fast selling costume jewelry direct from factory. Big picture catalog, free. Pickcraft, M19 Bank, Attleboro, Massachusetts.

HIGH-GRADE SALESMEN

EASY-To-sell, nationally advertised wheel balancer. A huge market. Every service station and garage wants it. You make \$19.75 to \$24.00 per sale. You can earn up to \$86 a day easily. No experience necessary. Write Precision Engineers Company, Department 10, 701 Heinz Avenue, Berkeley, California.

WANT To make real money? You can positively make \$50.00 a day and up selling a brand new item going to every type of food and beverage store, factories, laboratories, hospitals, etc. First time advertised. Samples furnished. Utility Dura-wear, 53 West Jackson Blvd., Dept. PM-9, Chicago, Illinois.

ANYONE Can sell Hoover DuPont nylon uniforms for beauty shops, waitresses, doctors, nurses, others. In white and colors. Exclusive styles. Top quality. Low priced. Exceptional income. Real future. Equipment free. Write fully. Hoover, Dept. E-100, New York 11, N. Y.

GET Into million dollar work clothes business. Earn big money now, unlimited future! Sell finest-quality embroidered uniforms and work clothes to factories, garages, everybody! Huge profits possible. No experience needed. Gorgeous selling kit, actual fabric samples, including miracle Orlon! Everything free! Write Topps, Dept. 539, Rochester, Indiana.

A Postcard can put you in business! Complete line. Leather jackets, 151 shoe styles. Big commissions. No experience, no investment. Send postcard for free outfit. Mason Shoe Mfg. Co., Dept. MA-9, Chippewa Falls, Wisconsin.

ADVERTISING Book matches—Cash in on big demand; sell union label matches. Cuts for all businesses and political parties. Free powerhouse selling kit, low prices, protection guaranteed on repeat orders. Cash commissions. Superior Match Co., Dept. M-952, 7530 Greenwood, Chicago.

CALENDARS, Advertising novelties, matches. All styles, including religious, varnished, 12 sheet, girls. Hundreds of advertising novelties, book matches, etc. Fleming Calendar Co., Sales Division, 6539 Cottage Grove, Chicago 37, Ill.

MAKE Big money—Season starting. Sell 1953 calendars, advertising specialties and executive gift line. Experience unnecessary. Commissions advanced. Outfit free. North American Calendar, 605-AA Washington, Chicago 6.

MONEY Making opportunity! Take big profit orders for world famous patented varieties fruit trees. Also flowering shrubs, roses, vines. Big sales outfit free. Stark Bro's., Desk 30193, Louisiana, Missouri.

SALESMEN—Get happy! Hundreds different things to sell; all details free! Write what you sell now; what you'd like to sell. Your mail box will run over! Salesmen's Service, Drawer 8711, Fort Worth 12, Tex.

IS \$210 A week worth a postcard to you? Then rush card with name and address for special free trial plan that sells amazing new automatic refrigerator defroster "like hot cakes!" Write to Mr. Lewis, D-Frost-O-Matic Corp., Dept. M-102, 173 W. Madison, Chicago 2, Ill.

AD Matches! Sell amazing designs—20, 30, 40 and 240-light book matches. Bigger spot cash commissions; every business a prospect. Low prices for high quality. Repeats. Start without experience; men, women; full, part time. Buy nothing! Sales kit furnished. Match Corp., Dept. PM-33, Chicago 22, Illinois.

HOT Special. Power mower—\$36.00. County agency. Rotacut-RP, Excelsior Springs, Mo.

WRITE 3 Words—Collect \$7.65 on 10-second demonstration to merchants. Write on glass with amazing magic crayon—Presto! 5 color advertising message takes fire, glows like brilliant neon. Three sales daily bring \$22.95 profit. Rush postcard for details. Complete sales kit, free! Maxilume Co., 125 W. Hubbard, Dept. CL-8-F, Chicago 10, Illinois.

MAKE Money with fast-selling Bostonian shirts. Blouses too. Spare time, full time. Sales kit free. Bostonian, 89 Bickford, Dept. R-10, Boston 30, Mass.

BEST Source for nylons. Rich Co., 215 W. 98, New York 25.

NEW Jobs open in selling! Send name, address for five free issues of Opportunity Magazine's money-making guide, listing hundreds of companies who'll pay you well, full or part-time. No experience needed. Opportunity, 28 E. Jackson, Dept. 17, Chicago 4, Ill.

EDUCATIONAL AND INSTRUCTION

COURSES: Computing machinery, mathematics, small robots, logic, writing, statistics, etc. Individuals or study groups. Scholarships. We have students in 37 states, 10 countries. Free announcement. Berkeley, 19 Milk Street, R42, Boston 9, Massachusetts.

BECOME An accountant. No previous bookkeeping experience required. We train you at home spare time, low cost. Ask for free booklet, "Accounting, the profession that pays." LaSalle Extension University, a correspondence institution, 417 South Dearborn Street, Dept. H974, Chicago 5, Ill.

ANNOUNCING Home study course in commercial baking. Practical basic training. Good field for those with aptitude. Nearly depression proof. Send for free booklet, "Opportunities in the Baking Industry." National Baking School, 835 Diversey Parkway, Dept. 3436, Chicago 14, Ill.

BOOKKEEPERS! Increase your earnings! Operate your own simplified "Dollar-A-Week" bookkeeping and tax service. Full or spare time. Details free. No obligation. Ellis, Box 200-J, Cedar Grove, North Carolina.

GERMAN Slide rules, scales, drafting instruments. Barttro, 11J East Peoria, Pasadena, Calif.

TIRED Of no money, second rate jobs? Like to start a real career with a lifetime of high salaries? Write me about two growing fields that need men. Ed Howes, National Schools, Dept. 492, 4000 S. Figueroa St., Los Angeles 37.

WANT A diesel job? New opportunities to increase income. Higher pay. More money. We can help you qualify. Tools. Shop method home training. Write today! Diesel, Tractor, Heavy Equipment Division, Interstate Training Service, Dept. 3J, Portland 13, Oregon.

MAKE Up to \$45-\$55 week as a trained practical nurse! Learn quickly at home. Booklet free. Chicago School of Nursing, Dept. M-9, Chicago.

GET Government position! Complete home training for examination, \$9.95—Refunded if don't pass. Write Ozment Instructions, 34-CS, St. Louis, Mo.

HIGH School—No classes. Study at home. Spare time. Diploma awarded. Write for free catalog HF-24, Wayne School, 2527 N. Sheffield, Chicago 14, Ill.

WORK For U. S. gov't! Men—women. Start high as \$73.00 week. 95,000 jobs open! Qualify now! Experience usually unnecessary. Get free 32-page book showing jobs, salaries, requirements, sample tests. Write today: Franklin Institute, Dept. N-24, Rochester, N. Y.

PRACTICAL Nursing—Learn easily at home, spare time. Big demand, good earnings. High school not necessary. Write for free facts, Wayne School, Dept. FG-11, 2525 Sheffield, Chicago 14, Ill.

WELDING Training pays at Hobart Welding School, Box M-922, Troy, Ohio. VA contract. Best equipment. Catalog free.

BECOME A doctor of psychology or metaphysics. Learn secret of contentment, happiness. Win degree of PsD. or MsD. Solve mental worries. Free book. College of Universal Truth, 5153-C N. Clark, Chicago.

WAKE Up your personality with new "Human Behavior Control" plan. Users praise it. Request amazing free lecture today. No obligation. Personal Psychology, Inc., Box 1924-E, Louisville 1, Kentucky.

USED Correspondence courses and educational books, bought, sold, rented. Catalog free. Educational Exchange, Summer-ville, Ga.

WITHOUT Weapons. 100 trick knockouts for self defense. \$1. 1c each. Lincoln, 529 Main, Evanston 18, Illinois.

"SCREWDRIVER Techniques," authoritative, for new ease and efficiency. 25c. Brush Mechanical Products, 377 N. McMullen St., Portland 12, Oregon.

WRITE Slanted short stories for extra pay in spare time. Your name and address brings full details and free trial training offer. Croydon Schools, 1541 North Larrabee, Chicago 10.

INCREDIBLE! Unprecedented! Look under "Miscellaneous!" Bijou, Box 1727-MW, Hollywood 28, California.

DRAFTING—Learn quickly. Booklet free. Monroe Institute, PM-9, Alton, Illinois.

EARN Extra pay writing short stories in spare time. "101 Technical Pointers for Fiction Writers" shows you how to write and where to sell. Send \$1.00 today for 28 big pages of proved instruction. Money-back guarantee. Gavin Gray, 1541 North Larrabee, Chicago 10.

MEDICAL "Scrabook!" Look under "Miscellaneous!" Bijou, Box M5-1727, Hollywood 28, Calif.

HOME Study course, drugless therapy. Free literature. Institute of Drugless Therapy, Tama, Iowa.

OWN A collection agency. Big money. Franklin Credit, Roanoke 7, Virginia.

LEARN Priceless secrets of technical metaphysics. Easy, simple. Write Canada School of Technical Metaphysics, 2532 McKenzie St., Vancouver, B.C., Canada, for amazing information.

OIL Coloring photographs can be a fascinating hobby or profitable sideline for those with artistic talent. Learn at home. Easy simplified method. Send for free booklet. National Photo Coloring School, 835 Diversey Parkway, Dept. 344C, Chicago 14, Illinois.

LEARN Auctioneering in classes or by mail. Earn big commissions. Sample 1-sesson free. Nelson Auction School, Renville P. Minnesota.

MEDICAL Laboratory technicians in great demand. We train you in your own home. Catalogue free. Imperial Technical Institute, Box 973-J, Austin, Texas.

BE A real estate broker. Study at home or in classrooms in leading cities. Write for big illustrated free book today. Weaver School of Real Estate, Suite 304 Law Bldg., Kansas City, Mo.

MIDLAND Linotype School, Charles City, Iowa. Civilian and Veteran Courses. Free placement. Established 1909.

USED Correspondence courses and books sold and rented. Money back guarantee. Catalog free. Courses bought. Lee Mountain, Pisgah, Alabama.

SECRET Investigation. Experience unnecessary. Investigators particulars free. George Wagner, M125 West 86th, New York 24.

PIANO Tuning pays. Learn this profitable profession at home. Our Tonometer and mechanical aids make learning easy. No knowledge music necessary. Diploma granted. Largest and oldest school—53rd year. G.I. approved. Write for booklet. Niles Bryant School, 78 Bryant Bldg., Washington 16, D. C.

INVESTIGATOR Training. Phillips Secret Service System, 1917-B North Kenneth, Chicago 39.

PLAYS, STORIES, MANUSCRIPTS

LOOKING For a book publisher? Write for free booklet PM3. Vantage Press, 120 West 31 St., New York 1.

MUSICAL Comedy plays. Dorby Publications, P.O. Box 131, Brier Hill, New York.

BEGINNING Writers: Let us show you how to get \$1 to \$20 checks in your daily mail doing simple spare time writing. Experience unnecessary. Details free. W. Herwell, 7016 Euclid, Cleveland 3, Ohio.

I want new writers to cash checks of \$1 to \$100 offered daily. The easiest way to write for pay. No previous experience necessary. Free details. Saunders M. Cummings, 468-11 Independence, Bldg., Colorado Springs, Colo.

SPECIAL SERVICES

INFORMATION On any matter, Ferguson Research Specialists, 116-14 141 St., South Ozone Park 36, N. Y.

REMAIL Your letters 25c. Two scenic postcards 25c. Newspaper 25c. Pierce, 927 Hickory St., St. Louis 4, Mo.

FLORIDA: Remail letters, 20c each. Kinsella, 2626 22 St. South, St. Petersburg, Florida.

DETROIT Remails 25c, complete mailing service. Edwards, Box 1067, Allen Park, Michigan.

WIS. Postmarked. The Land of Lakes. Pretend you are traveling. Letters, cards, remailed 25c each; 5 for \$1.00. 8 scenic cards \$1.00 remailed free. Mail received and forwarded \$3.00 month. H. U. Bishop, 405-A 2nd St., Neenah, Wis.

NEW YORK! Remails 25c. Dozen scenic postcards \$1.00. Help wanted section \$1.00. Groveman, 1900 Newkirk, Brooklyn, N. Y.

CHICAGO'S Goldcoast to skidrow. You name it, we'll photograph it. Business, educational, curiosity. Literature free. Chicago True View, 2251 N. Spaulding Ave., Studio A, Chicago 47, Illinois.

ST. LOUIS remail letters 25c. Box 105, St. Louis 5, Missouri.

LETTERS Remailed 25c each. Los Angeles help wanted or other classified columns airmailed \$1.00. Russ DeJohn, 8408 Arrington Ave., Rivera, California.

CARTOONING, COMMERCIAL ART, SHOWCARD WRITING, SIGN PAINTING

YOU Can be a cartoonist! Learn at home, sparetime. Kirk's Simplified Method shows how. Complete course plus market guide, \$1.00 ppd. Kirk's Art Exchange, Dept. 9C, 2821 Idalia, El Paso, Texas.

"HOW To Make Money With Simple Cartoons"—A book everyone who likes to draw should have. It is free; no obligation. Simply address Cartoonists' Exchange, Dept. 99-C, Pleasant Hill, Ohio.

AMATEUR Artists. Earn good money, spare time, doing small, simple pen lettering for advertisers. Materials furnished. National Artists, 801-A North Marsalis, Dallas 3, Texas.

GAGWRITERS And cartoonists needed. Beginners welcome. Cartoonists' Markets, La Habra, Calif.

LEARN Sign painting at home. Test lesson free. Ben Kerns, Box 812-P.M., Greenville, S. C.

CHALK Talks. Laugh producing program, \$1.00. Catalog 10c. Balda The Cartoonist, Oshkosh, Wisconsin.

ADVERTISING AGENCIES, LETTER WRITERS, FOR ADVERTISERS

FREE Copy, layout service. Mailorder ad, 1,700,000 nationwide circulation, \$27.30 inch. 24-word classified, 20 big Sunday newspapers, \$30.00. Advertising ratebook free. Chicago Advertising Agency (established 1900), Chicago 4.

FREE! 1952 Advertisers Rate and Data Directory. 52 pages! E. H. Brown Advertising Agency, 20 N. Wacker, Chicago 6.

NAMES Of opportunity seekers, 1000-\$1.00. James A. Shrum, Penalosa, Kansas.

ADVERTISE: 24 Words. 100 Canadian newspapers \$5.50. Lists free. Advertising Bureau, 10511-C Springfield, Chicago 43.

ADS Placed in out of town newspapers and magazines. Low rates. Catalogue free. Ideas that pay. Baker Advertising Agency, Successors Ankrum Agency, 189 W. Madison, Chicago 2.

ADVERTISERS! Reach nearly 18,000,000 readers. 25 Sunday national key newspapers. 18 words, \$59.00. "Terrific pullers." 20 popular newspapers, \$11.50. Free booklet. Special—One inch display 2,-821,198 circulation, \$51.10. Newmark's Advertising Agency, (Established 1893), 217-7th Ave., New York 11.

MAILING Lists; \$5.00-1000 up. Write Dixie Service, King, N. C.

RUBBER STAMPS AND OFFICE SUPPLIES

SET Of 9 collection and reminder stamps \$1.95. Free catalog. Postage refunded. Escoc's 8 Print, 8 Holt, Dayton 7, Ohio.

LINE 25c; 2-45c; 3-65c. Stamp Works, Auburn, Nebraska.

TYPEWRITERS, DUPLICATORS, OFFICE DEVICES

RECONDITIONED Typewriters, printing devices, office machines, equipment. DixieGraph, King, N. Car.

PRINTING, MULTIGRAPHING, MIMEOGRAPHING, GUMMED LABELS

FINE Printing—Prompt service, prepaid. Wide selection of type styles, colors, etc. Cuts furnished. Samples—prices free. Wilcox, Nicholls, Georgia.

8 1/2 x 11 LETTERHEADS, 1000—\$4.00. Convincing samples. D'Yarmett Printing, Newark, Ohio.

100 8 1/2 x 11 LETTERHEADS \$1.00 Postpaid. Envelopes same. Race Printers, Hudson, New York.

CARDS, Bond, Kraft envelopes, 100 \$1.00, up. Samples, Morris, Box 331, Lake Charles, Louisiana.

NEED Printing? Request samples, prices. Gooch, 202PM, Hernando, Miss.

100 LETTERHEADS, 100 Envelopes \$1.95. Hurt and Fosse, Blue Ridge, Virginia.

1000 BUSINESS Cards \$2.35. Other printing. Dornfeld, Iron Ridge 14, Wis.

QUALITY Printing! Free large catalog showing prices, types, cuts. Nationwide, 2377 Bath Avenue, Brooklyn 14.

MIMEOGRAPHING. Letters, circulars, forms, folios. Simple illustrations, samples free. Pennway, 439 1/2 Adams Avenue, Scranton, Penna.

100 PRINTED Envelopes or paper, business, personal \$1.00. Broadbrook, Botsford, Conn.

BUSINESS And personal stationery. Free samples, prices. Sutton Printing, Box 85?-M, Waycross, Georgia.

TWO Color designed printing quotations, gladly. Osgood, 1320-G Prospect, New York 59.

CIRCULARS—5000 5 1/2 x 8 1/2, \$18; 3 3/4 x 5 1/2, \$8.25; folders, books. Garrison Press, Harrisonburg, Va.

1000 BUSINESS Cards \$2.50 prepaid. Samples free. Reliable Print Shop, 905 E. Jefferson, Louisville 6, Ky.

MIMEOGRAPHING—Letters, pricelists, formulas, instructions. Lowest prices. Lem's Letter Shop, 5710 Stanton, Detroit 8.

125 8½x11 LETTERHEADS And 125 6¾ envelopes \$2.00, postpaid. 250 of each \$3.50. Going Print Shop, Box 1544A, Muskogee, Oklahoma.

500 ¾x2¼ FOUR Line gummed stickers 50c. Red border \$1.00. Moritz Printery, Saginaw, Mich.

PRINTING OUTFITS AND SUPPLIES

PRESSES, Supplies, paper. Catalog 10c. Custom, Box 211-P, Springfield, Missouri.

PRINT Your own cards, stationery, circulars, advertising. Save money. Simple rules. Print for others, nice profit. Raised printing like engraving too. Have home shop. Details free. Kelsey Presses, L-11, Meriden, Conn.

PRESSES, Type, cabinets, supplies. List for stamp. Lincoln Press Company, 220-K Hartwell, Fall River, Mass.

"1250 MULTILITH—How to Operate." 35 pages. Sent to any address in the world for \$1.00. Continental Co., Box 4951, Los Angeles 1, California.

MAKE Your own self-molding rubber printing cuts. Plexirubber, Argyle 1, Wis.

PRINTING Presses, type, supplies. Lists 3c. Turnbaugh Service, Loysville, Penna.

PATENT ATTORNEYS

INVENTORS—If you consider your invention to be something of importance, take steps to protect it with a United States Patent which gives you the right to exclude others from making, using, and selling your invention as claimed. "Patent Protection for Inventors" outlines steps to take to secure patent protection. Mailed promptly without obligation. Victor J. Evans & Co., Merlin M. Evans, Registered Patent Attorney, 731-K Merlin Building, Washington 6, D. C.

C. A. Snow & Co.—M427, Snow Building, Washington 1, D. C. Registered Patent Attorneys. Write for information.

PATENTS. "Proof of Invention" free. E. E. Vrooman, Registered Patent Attorney, 507 McKim Building, Washington 5, D. C.

INVENTORS—If you believe you have an invention, we can make a preliminary search on your invention and advise you whether we think it can be patented. Send for copy of our patent booklet "How to Protect Your Invention" and "Invention Record" form. No obligation. McMorrow, Berman & Davidson, Registered Patent Attorneys, 134-Z Victor Building, Washington 1, D. C.

INVENTORS: Learn how to protect your invention. Special booklet "Patent Guide for the Inventor" containing detailed information concerning patent protection and procedure together with "Record of Invention" form will be promptly forwarded to you upon request—without obligation. We are registered to practice before the U. S. Patent Office and prepared to serve you in the handling of your patent matters. Clarence A. O'Brien & Harvey Jacobson, Registered Patent Attorneys, 21B-G District National Building, Washington, D. C.

"INVENTOR'S Guide" free. Frank P. Ledermann, Registered Patent Attorney, 154 Nassau Street, New York.

REGISTERED Patent attorney offers services. Sanders, 6430 Evans, Chicago 37, Ill.

INVENTORS—For "Invention Record" form, contact Carl Miller, Registered Patent Attorney, Woolworth Building, New York.

INVENTORS: When you are satisfied that you have invented something of value write me, without obligation, for information as to what steps you should take to secure a patent. Write Patrick D. Beavers, Registered Patent Atty., 935 Columbian Bldg., Washington 1, D. C.

INVENTORS: Without obligation, write for information explaining the steps you should take to secure a patent. John N. Randolph, Registered Patent Attorney, 203 Columbian Bldg., Washington 1, D. C.

CANADA—Ramsay Company Registered, 273 Bank Street, Ottawa, Canada.

FOR INVENTORS

INVENTORS—If you believe you have an invention, we can make a preliminary search on your invention and advise you whether we think it can be patented. Send for copy of our patent booklet "How to Protect Your Invention" and "Invention Record" form. No obligation. McMorrow, Berman & Davidson, Registered Patent Attorneys, 134-Y Victor Building, Washington 1, D. C.

INVENTORS—If you have a valuable invention, you are advised to authorize a preliminary search through appropriate classes of United States patents. This firm is registered to practice before the Patent Office and is available to make such search and report to you concerning the probable patentability of your invention. Instructive booklet with "Evidence of Invention" form sent upon request. Victor J. Evans & Co., 732-K Meriin Building, Washington 6, D. C.

INVENTORS Problems solved. 8 two hour evening sessions. \$10.00. Write Brooklyn College, Adult Education, Brooklyn 10, N. Y.

PATENT Searches \$5.00, including patent copies. Same careful, reliable searches conducted for patent attorneys. 48 hour airmail service. "Record of Invention" free. Competent experienced investigators. Capitol Patent Service, Box 664-P, Washington 4, D. C.

CASH From ideas. Information free. Write Grayland, 5312PM Grace, Chicago 41.

INVENTORS! For "Copyright, Design and Patent Guide" contact Mr. Metzler, 11 West 42nd, New York 18.

PATENT Searches, \$5.00, including patent copies. Same reliable search as conducted for patent attorneys. Free protection forms, 48 hour service. Patent Service Institute, 945-A Pennsylvania Avenue, Washington 4, D. C.

PATENT Searches \$5.00. 48-hour service. Protection forms free. Write Raymond L. Smith, Patent Searcher, 622 Sheraton Building, Washington 5, D. C.

INVENTORS—If you have a worth while invention, sell it direct to manufacturer. Keep all profits. Without obligation write National Patent Sales Co., Dept. 1, Box 370, Richmond, Va.

PATENT Searches \$5.00. Protection forms free. Patent drawings prepared. Write Patent Engineering Service, 711 14th Street, N.W., Washington 5, D. C.

INVENTIONS Sold—Hundreds of manufacturers need ideas, patented or unpatented, list free. Invention Bureau, 208-M Clinton, Oak Park, Illinois.

PATENT Searches \$5.00. 48-hour service. For free record of invention forms write Miss Ann Hastings, P. O. Box 176, Washington 4, D. C.

INVENTORS—Send for free patent information book and inventor's record. Registered Patent Attorney, Associate Examiner, Patent Office 1923-29; Patent Attorney & Advisor, Navy Department 1930-47. Gustave Miller, 82A Warner Building, Washington 4, D. C.

PATENT Owner representative. Years of experience. Can I help you? Charles A. Scott, 773PM Garson Avenue, Rochester 9, N. Y.

BE Safe. Get temporary protection (not a patent) on your idea. Cost \$2.75. Free information. Box 113, Cedarburg, Wis.

INVENTORS: Learn how to protect your invention. Special booklet "Patent Guide for the Inventor" containing detailed information concerning patent protection and procedure together with "Record of Invention" form will be promptly forwarded to you upon request—without obligation. We are registered to practice before the U. S. Patent Office and prepared to serve you in the handling of your patent matters. Clarence A. O'Brien & Harvey Jacobson, Registered Patent Attorneys, 21A-G District National Building, Washington, D. C.

INVENTORS: Without obligation, write for information explaining the steps you should take to secure a patent on your invention. John N. Randolph, Registered Patent Attorney, 203 Columbian Bldg., Washington 1, D. C.

SEARCHES—Put your patent searches in the hands of a registered patent attorney or agent, as he qualifies to give a worthwhile patentability report. Record of invention form upon request and information on patent protection. Patrick D. Beavers, Registered Patent Attorney, 935 Columbian Bldg., Washington 1, D. C.

INVENTORS—For "Invention Record" form, contact Carl Miller, Registered Patent Attorney, Woolworth Building, New York.

INVENTORS: If you have an invention for sale, patented or unpatented, write Institute of American Inventors, Dept. 40A, 631-E St. N.W., Washington 4, D. C.

INVENTIONS WANTED

PRODUCTS, Mechanical, chemical; financed, marketed. No fees. Details free. Paisley, 2030 Chestnut, St. Louis, Mo.

INVENTORS: We have ready buyers. Get "Inventors Guide" before spending money for patents. Tells how to develop, protect, make success, list of needed products, proof of invention forms. Send only \$1.00. Inventors Creative Service, 354 South Spring Street, Los Angeles 13, Calif.

INVENTIONS Wanted. Patented or unpatented. Free details. Tremendous manufacturer's lists. Global Marketing Service, 1404 Mitchell Street, Oakland 1, Calif.

PROTECT And sell your inventions. Details of our unique 4-point program and list of needed inventions free. Inventors Sales, 208-N Clinton, Oak Park, Illinois.

INVENTIONS Wanted. Patented, pending only. Inventors Patent Exchange, Hartford 1, Conn.

MARKETING Aid—Nation wide. Patented, patent pending. Booklet free. Market Contacts, 719-A2 Magnolia, Tupelo, Miss.

INVENTIONS Wanted. Patented or patent pending. 21 years experience promoting inventions. National Service Bureau, 3120 Meramec, St. Louis 18, Mo.

INVENTIONS Promoted. Patented or unpatented. Established 1911. Write Adam Fisher Company, 61 Enright, St. Louis, Mo.

INVENTORS: Hundreds of manufacturers have requested our assistance in locating marketable new products. Complete information free. Institute of American Inventors, Dept. 40-D, 631-E St. N.W., Washington 4, D. C.

PATENTS FOR SALE

PATENT 2,543,465 For sale. Royalty basis. Many uses. H. Morey, 418 S. Spencer, Aurora, Illinois.

BUTTONHOLE Cutter patent for sale. Nora Gilliam, La Porte, Texas.

INVENTORS: Test the commercial value of your patented or unpatented inventions, quickly and inexpensively. Write for free information. Institute of American Inventors, Dept. 40-B, 631-E St. N.W., Washington 4, D. C.

MANUFACTURING

MODELS—Small lot manufacturing. Metals, plastics, etc. Milburn, Burlington, Kentucky.

MODELS, MODEL SUPPLIES

MODEL Plane builders: Get your copy of "Modelers Design Data" \$1.00. Box 3128, Fort Worth, Texas.

WORLD'S Finest illustrated catalog-handbooks. Railroads 84 pages 35c. Airplanes, boats, crafts, hobbies, tools 60 pages 25c. No stamps. Print name. E and H Model Hobbies, Room 70, 130 W. Cheltenham Avenue, Philadelphia 44.

BUILD Miniature homes with our accurately-scaled materials. Send 25c for booklet and samples. Architectural Model Materials, Inc., Dept. M92, 4208 Armitage Avenue, Chicago 39.

SHIP Models—Most complete line in New England. Kits, fittings, plans, books, tools, engines, motors. Illustrated catalog 25c. James Bliss & Co., Inc., Dept. SM, 342 Atlantic Ave., Boston 10, Mass.

STEAM Engines, boilers, castings. Catalog 25c. Anton Bohaboy, 2297 Price, Rahway 7, N. J.

SHIP And yacht model fittings; blueprints. Send 25c for illustrated catalog No. 27—listing hundreds of items. A. J. Fisher, 1002-1 Etowah Ave., Royal Oak, Mich.

LIONEL. American Flyer, illustrated catalog free. Ben's PM Department, 134 North Dearborn, Chicago 2.

SHIP Models and yacht supplies complete. Large 64 page catalogue 30c. Bill Wild's, 510 East 11 St., New York City 9.

STEAM Locomotives, 1½", 1", ¾", ½" ¼" scales. Castings, rail, steam fittings! Thorough drawings with instructions. Catalog 50c. Little Engines, Wilmington, California.

HOME CRAFTSMEN

METAL Spinning. Everything in spinning lathes, tools and accessories. Send 20c in stamps for metal spinning instruction book and big catalog on woodworking tools. Boice-Crane Company, 943 Central Avenue, Toledo 6, Ohio.

PARATOL Supreme "706-G" molder—Newly developed compound. The toughest rubber ever made for molding purposes. Supreme molds, precision reproductions, double strength. For the operator who wants the finest. Direct to consumer prices: \$2.75 per quart, one-gallon cans, \$8.00; 5 gallon cans, \$7.75 per gallon; 4 ounce samples 50c to cover mail handling. U.S.A. only. Testworth Products Corp., Dept. B-1, P.O. Box 482, Itasca, Ill.

FULL Size patterns. Toys, furniture, novelties. Illustrated folder 10c. Willard's, Canoga Park 93, California.

REFINISH Your own furniture. \$1.00. Krafters, Box 86, Hubbard, Ohio.

COLONIAL Reproductions—Easily built shelves, spice cupboards, wall boxes, etc. 32 full size patterns \$1.00. Vosbury Patterns, MR95, Binghamton, N. Y.

FREE Small cypress knee with each \$1.00 lamp size. Postage paid on \$5.00 order. Cy Products, Ella St., Lafayette, La.

LEATHERCRAFT For pleasure or profit. Make easy-to-assemble purses, belts, gloves, woollens toys, 100 other items for gifts or to sell. Send 10c today for big catalog. Largest leathercraft stock in U.S. J. C. Larson Co., 820 S. Tripp, Dept. 2450, Chicago 24.

SWISS Music movements, finest make, lowest price. Ask for leaflet. Jules Wolff, 74 Worth Street, New York.

OUR Biggest leather and craft catalog yet! 1000's of items. Send 25c (refunded with first order). Russo Handicraft Supplies, Dept. 9-C, 245 S. Spring, Los Angeles, California.

16 NEW Lawn chairs, 22 picnic tables, benches, trellises, etc. All 38 plans with necessary full size patterns, \$1.00. Mastercraft 93M, 7041 Olcott, Chicago 31, Ill.

BIG Profits in birdhouses. Accurate scale plans for six different houses 50c. Lokenor, 211 Ship Avenue, Beachwood, New Jersey.

FREE Seashell catalog. Shellcraft instruction book 35c. "Secors," Bradenton Beach, Fla.

90 ALL New, full size lawn ornament and novelty patterns, up to 20" high. Only \$1.00. Mastercraft 92M, 7041 Olcott, Chicago 31, Illinois.

VIOLIN Makers, amateurs, professionals. Fine tone European wood. Supplies. Tools. Patterns. Instructions. Illustrated catalogue 10c. Refunded. Premier Violin Supplies, Dept. VZ, 430 South Broadway, Los Angeles 13, California.

SHELLCRAFT, Jewelry, plastics catalog, (wholesale) 20c. Giftcrafts, Box 4550-K, Coral Gables, Florida.

89 FULL Size jig saw patterns of beautiful shelves, ornaments, toys, novelties. Plus "How, Where to Sell." Only \$1.00. Mastercraft 94M, 7041 Olcott, Chicago 31, Illinois.

WHOLESALE Leather list free. Tinnin Leather Company, 213 East Walnut, Columbus 15, Ohio.

FULL-Size patterns to make dozens of modern curved shape cabinet shelf arrangements. \$1.00. Echo Acres Industries, Box 184, La Grange, Illinois.

LEATHERCRAFT Kits. Catalog 25c. Wholesale Leathercraft Company, District 763, PM2, Box 165, Milwaukee 14, Wis.

PROFESSIONAL Furniture finishing supplies. Beautiful illustrated catalog and simplified instruction manual \$1.00. Col-orall, 515 Cedar Lane, Teaneck, N. J.

JIG Saw owners—Tired of old ideas? See our unique patterns. Sample and illustrated folder 10c. Walker Studio, PM9, 4343 Lindell, St. Louis 8, Mo.

MAKE Your own furniture with our modern wrought iron legs. Write for prices. Artiron, Inc., 1727 Glendale Blvd., Los Angeles 26, Calif.

UPHOLSTER Own furniture. Catalog listing materials 10c. Original Supply Company, 5864 Hollywood Blvd., Hollywood 28, Calif.

VIOLIN Making—The most rewarding hobby. Fascinating pamphlet 30c. Luthier, GPO Box 1500, New York 1, N. Y.

LEATHERCRAFT—A lifetime hobby. Work with leather. Earn money. Tools, designs, supplies available. Your job is easy. Free catalog. Tandy Leather, Box 397, Dept. 4, Tulsa, Oklahoma.

BEAUTIFUL Large illustrated catalog of leathercraft supplies for the craftsman. Send 25c coin or stamps (refunded with first order). Nicewarner Leather Co., Craft Division, Dept. M1, 14-16 E. Chestnut St., Columbus 15, Ohio.

CLEANEST Fine white wiping waste, big five pound box \$3.00, postpaid. Satisfaction guaranteed. Abbeon Supply, 179-27 Jamaica Avenue, Jamaica 32, New York.

LEATHERCRAFT, Copper tooling, textile painting, beadcraft, shellcraft. Many other crafts. Big free catalog shows everything you need. Kit Kraft, 7373 Melrose, Hollywood 46, California.

STENCILS, 15 Assorted for textiles, furniture, etc., \$1.00. Catalog 300 designs 25c, refundable first order. Marion Specialties, Box 141, Halesite, N. Y.

70 WOODWORKING Patterns \$1.00. Mosbro Patterns, 44-M Victor, Mimico, Ontario.

LEATHERCRAFT—New stylecraft folder free. New kits illustrated. Filigree belts, billfolds, purses, etc. Send 25c new catalog. Refunded first order. Apache Leather Co., 2804 East Washington St., Phoenix, Arizona.

MINIATURE Furniture kits. Colonial reproductions. Solid cherry. Catalog 20c. Culver Miniatures, 194 61st St., Dept. A, Niagara Falls, N. Y.

SHELLCRAFT Catalogue and eighteen late designs 25c, refunded first order. Rice's Shellcraft, Dept. B, 1711 N. Mills St., Orlando, Florida.

30 LAWN Ornament patterns. Ready cut. Full size. Color indicated. \$1.00 postpaid. Lincoln Craft Studio, Columbia, Conn.

LEATHERCRAFTERS: Beautiful tanned snake skins, kits, finished products. Tex Harris Snake Farm, Box 424, Warsaw, Indiana.

LEATHERCRAFT. Tremendous stock of leather, tools, supplies, and kits. In leather business over forty years. Send 10c for big catalog. Sax Bros., 1111 No. 3rd, Dept. PM, Milwaukee 3, Wisconsin.

"TOPS" In everything for leathercraft. Low priced kits, leathers, tools, lacing. Catalog 10c. Crown Leathers, 22 Spruce Street, New York 38.

FREE Information. How to make money with jig saw. Write Jigsaws, 117-M Worth, New York 13.

WHOLESALE Shellcraft book 15c. Large shellcraft kit \$1.85 postpaid. Shell-Art Novelty, 5th and Moore, Philadelphia 48, Penna.

KNOCKDOWN Cedar chests. Lumber and veneers. Free price list. Giles & Kendall Company, Huntsville, Ala.

LEATHER, Tools, lacings, supplies. Free catalog. National Handicraft, 199 William St., New York 7.

MAKE IT YOURSELF

HURRICANE—Wire fabric window guards and shutters for top protection. Durable, lightweight, admit daylight and air. Easily made, low costs. Instructions \$1.00. Pohler's Saw Shop, P.O.B. 383, Hollywood, Florida.

STREAMLINED, Built-in kitchen cabinets fit any kitchen. Illustrated manual describes designing and construction. All for \$1.00. Thombert Company, Newton, Iowa.

\$750 BUILDS Cozy 4 rooms and bath; concrete block, stuccoed. Instructions and blueprint \$1.00. Farrow, G83, Box 645, Columbus 16, Ohio.

BUILD With concrete, fieldstone, earth. Movable form system cuts costs. Construction simplified. Free literature. Smith, PM, Box 36, Eagle Creek, Oregon.

MACHINERY Plans handbook 25c (refundable). Satisfaction guaranteed. Kimo, Box 307-P, New York 19.

"CONCRETE Block Homes." 32-page booklet, on how to build. \$1.00. H. C. Lightfoot, Civil Engineer, Richboro 1, Penna.

BUILD Simple weather forecaster. Plans \$1.00. McFerran, P.O. Box 96, Fort Wayne, Indiana.

GRANDFATHER Clock easily built. Big savings. See ad on page 269.

BUILD Inexpensive concrete blockmaker. Motor, hand. Write. C. Lee, Mountain View, Oklahoma.

SMALL Apartment size circular home. Includes living room, bedroom, kitchen, bath, fireplace. Can be built for \$1000. Plans \$1.00. Portercraft, Box 87A Mt. Washington, Cincinnati 30, Ohio.

FREE Handbook. Build sawmills, block machines, freezers, tractors, scooters. Nichols Company, Purvis 2, Miss.

MAKE Your own "Stone-Veneer." Economical. Easily made, quickly applied. Looks like genuine stone. Transforms any home into one of excellent beauty. Formulas, illustrations, patterns. Alburg, Box 17, Carrollton, Mich.

SEND 25c Today for new large catalogue of supplies for 21 popular crafts. Dept. D-11, Dearborn Leather Company, 8625 Linwood Avenue, Detroit 6, Michigan.

BUILD Your own "tractor." Free information. Eltraco, D-I, Camptonville, California.

HOMES You can build for \$4500 to \$7046. Books that take you through every step. Popular Mechanics Famous Concrete Block House, \$2.00. Your Home and How to Build It Yourself, \$3.00. Also full-sized builder's plans for each home at nominal price. Popular Mechanics Press, Dept. 102, 200 E. Ontario St., Chicago 11, Ill.

WATCHES, OLD GOLD, JEWELRY

WATCHMAKERS' Tools, materials, supplies, repairs, catalog. Gales, Box 1000, Chicago 90, Ill.

RHINESTONES. Jewelry settings, cameos, sequins, beads. Send 10c for illustrated catalog. J & M Novelties, Dept. CK-3, Griffith, Ind.

5 ELGIN, Waltham, Illinois, Hampden gents' wristwatches needing minor repairs, \$18.00. Write for prices. B. Lowe, Holland Bldg., St. Louis 1, Mo.

5000 JEWELRY Styles, you can easily make yourself—Pins, earrings, bracelets, rings, matched ensembles. Instructions and catalog 10c. Barrys, 124 Ardsley Court, Newark, N. J.

WATCHES Overhauled \$4.50. Guaranteed. Free watch catalog. Berkowitz, 1150 Castlehill, New York 61.

HIGHEST Prices paid for old gold, silver, platinum, diamonds, watches, gold teeth, spectacles. Cash immediately. Goods returned if offer unsatisfactory. United Smelting Works (The Old Reliable), 39-B South State, Chicago 3.

JEWELRY Making can be a profitable hobby—Send 20c for our latest illustrated catalog. Milady-Fair Co., G.P.O. Box 1328, New York City.

WATCHMAKERS'—Jewelers' tools. Free instructions, catalog. Bengal Company, Culver City, California.

UNREDEEMED Diamond, 1-carat, \$295. 30-day refund. Free catalog. Broff's Diamond Loan Association, 411 Smithfield, Pittsburgh, Penna.

HIGHEST Cash paid for old, broken jewelry, gold teeth, watches, silverware, diamonds, spectacles, platinum. Free information. Satisfaction guaranteed. Rose Smelting Company, 29-A East Madison, Chicago.

TOBACCO, SMOKERS' SUPPLIES

CIGARETTES—Roll 200 mild-satisfying for 75c. Particulars free. Pete Moberly, Box 850, Owensboro, Kentucky.

RAZORS, BLADES, SHARPENING

1000 CLEAN, Smooth shaves from one blade! Sensational new stropper automatically turns blade on genuine pigskin strop having honing and stropping sides. Keenly sharpens any make single or double-edge blade quickly, easily, safely. Guaranteed! \$2.95 postpaid, or send for free details. Rowan's, 2351 Linden Avenue, South Plainfield 3, New Jersey.

OF INTEREST TO WOMEN

DRESSES 24c; Shoes 39c; men's suits \$4.95; trousers \$1.20. Better used clothing. Free cat. Transworld, 164-AD Christopher, Brooklyn 12, N. Y.

FOR SALE—MISCELLANEOUS

SAVE Money on army, navy and factory surplus. Write today for new 60-page illustrated catalog. Tennusa Sales Co., Dept. C, 1451 Market, Chattanooga, Tenn.

TEA—One pound \$2.50. Free delivery. Greenland Tea Co., Darjeeling, (India).

CHROME Cabinet hardware. Bathroom accessories. Push button spraying enamel. Write Box 89, Troy 2, Ohio.

MAGAZINE Readers! Send card today. You'll see your savings Windsor's way. Subscription specials, any publication. Free folder shows you the situation. Write Windsor's "Magazine Headquarters," Dept. B-1, McRae, Georgia.

WANTED—MISCELLANEOUS

QUICKSILVER — Highest prices paid. Free containers. Wholesale Terminal, Norwood, Massachusetts.

SCRAP Mercury (quicksilver) tantalum, bismuth, tungsten. Metallurgical Products Company. Established 1909. 35th & Moore Sts., Philadelphia 45, Penna.

PERSONAL

BORROW By mail. Loans \$50 to \$600 to employed men and women. Easy, quick. Completely confidential. No endorsers. Repay in convenient monthly payments. Details free in plain envelope. Give occupation. State Finance Co., 323 Securities Bldg., Dept. R-14, Omaha 2, Nebr.

ADDRESS Engraved metal tag. Returns lost articles. 50c, five \$2. Box 676, Springfield 1, Massachusetts.

LETTERS Remailed or replies forwarded 25c each. Monthly rates \$2.00. McLaughlin, 369 Welch, Columbus 7, Ohio.

ENJOY A Puerto Rican vacation for a dollar? Browse through colorful twenty postcard gift packet! \$1.00 postpaid. Kenneth Burrell, Aguachilla, Puerto Rico.

NATION'S Capitol. Letters remailed 25c. Clark, Box 5107, Washington 19, D. C.

"HAPPINESS" Magazine gives you 12 vital secrets for happier, more successful living. Sample copy 25c. Complete details free. Wayne Publishers, Box 4216-M, Jacksonville, Florida.

LETTERS Remailed 25c. Also private receiving address. Monthly rates. Shanks, Box 3110-D, San Francisco 19, California.

MEXICAN Law. General Practice Attorney. 1203 Arizona St., El Paso, Texas.

"HOW Can I find out?" You can! Information discreetly developed. Any matter, person, problem, anywhere. Worldwide. Officially licensed, bonded service. Established 1922. Reasonable. Confidential. William Herman, 170 Broadway, New York.

HERE'S How and where to borrow \$50.00 to \$300.00 by mail. Confidential. Free particulars. Postal Finance Company, Dept. 45, Sioux City, Iowa.

MISCELLANEOUS

HYDROPONICS—Here is complete instruction for your fascinating, profitable backyard soilless garden. 50 page booklet with diagrams and illustrations. Written by America's foremost authority on soilless culture. Only \$2.00 postpaid. Order today while the supply lasts. Gilbert Co., Box 22, San Diego 6, Calif.

ATOMIC Tags. Name, address and blood type or social security number impressed in metal disc. Also used as key protector. 35c, 3 for \$1.00. R. Roth, Laurel Springs, N. J.

LEATHERCRAFT For pleasure or profit. Make easy-to-assemble purses, belts, gloves, woolskin toys, 100 other items for gifts or to sell. Send 10c today for big catalog. Largest leathercraft stock in U.S. J. C. Larson Co., 820 S. Tripp, Dept. 2451, Chicago 24.

CHILEAN Copper souvenir. Remit \$1.00 to Chilean Novelties, P.O. Box 9354, Santiago, Chile, and you will receive by registered parcel post a beautiful copper hand-hammered Mexican hat which can be used either as a desk ornament or as an ash tray.

SEND Your name, address and \$1.00 to C. V. Tidswell, Route 4, Adrian, Michigan. We will send you post paid four solid brass identification indented plates. Ideal for brief-cases, traveling-bags, all leather goods, trunks, boats, tool-boxes, etc. Lasts a life time.

"PIXIE Packets" for children 7-14. A different craft kit each month. Yearly subscription \$5.00. Entertaining, educational, excellent gift. Write for free literature. Pixie Packets, Dept. P-3, Raiston, Nebr.

CESSPOOL Trouble? Use Peps-It. Saves pumping costs, deodorizes, reduces masses. Rejuvenates fermentation action. Safe. Sanitary. Free descriptive literature. Costs only \$2.50. Chemical Cesspool Cleaning Co., Boston 34, Mass.

SQUARE Dance instructions, calls, 25 sets. \$1.00. Rayburn, Eureka Springs, Ark.

STUDY For game warden, park, forestry, and patrol service. Write Delmar Institute, D-11, Whittier, Calif.

RECEIVE Magazines, samples, catalogues. Mails from everywhere. Offers hundreds. Get listed 25c. Rorick, Box 86, Cincinnati 26, Ohio.

PLASTIC Sealing photos, cards, wallet size 25c. Urbanick, 620 St. Ann's Ave., Bronx 55, N. Y.

RECEIVE Mails, magazines, samples. Your name in numerous mailing lists 25c. Greenwood, Box 1116-K, New York 8.

CESSPOOL Trouble? Start leaching process with Sursolvent, the miracle cesspool cleaner. Saves pumping. Reduces odors. Unclogs drains. Reclaims old systems to a condition approaching newness. Simple to use. Write for information. Electric Sewer Cleaning Co., Boston 34, Mass.

EXPERIENCED Roof repairs. Franchise protection. Luster-Kote, 19417 Derby, Detroit, Michigan.

300 BIG Malls guaranteed. Samples, plans, offers, propositions, 12 months listing, \$1.00 (refundable). Wright Publications, 2270 Hubbard, Memphis 8, Tenn.

SAVE Money. Cut hair at home. Illustrated booklet "The Home Barber" tells how. Only 25c. The Graham Co., 1238 W. Granger Ave., Lakewood 7, Ohio.

70 BIBLE Lessons, 25c. Bulletin, Box 87, Cathedral Station, New York 25.

ROOTICATE Destroys root growth in drains and sewers. Very inexpensive and effective. Write for details. Electric Sewer Cleaning Co., Allston 34, Mass.

SMASH That worry habit with new "Human Behavior Control" plan. Users praise it. Request amazing free lecture today. No obligation. Personal Psychology, Inc., Box 1924-M, Louisville 1, Kentucky.

ROACH Killer. One treatment lasts years. \$2.00 postpaid. Kosoglad Laboratories, 17209 Ardmore, Detroit 35, Michigan.

INCREDIBLE! Unprecedented! Become mental superman overnight! Floor everybody! No studying! "Memoprop" does your thinking! It's uncanny! Revolutionary! Free literature! Bijou, Box 1727-MW, Hollywood 28, California.

WORLD'S Smallest! Precision thimble-size cigarette lighter. Chrome and reptile-skin finished. Actually works. \$1.00. Gene M. Love, 103 E. 11th St., Charlotte, N. C.

HAVE Fun, relaxation! Learn friendly, popular square dance! Easy instructions teaches you 30 dances, quickly! Only \$1.00 postpaid. Guthrie Shanks, Box 3110-G, San Francisco 19, Calif.

MEDICAL "Scrapbook" reprints 190 thrilling news items on latest wonder drugs, cures, lifesaving knowledge! Free literature! Bijou, Box M5-1727, Hollywood 28, Calif.

ORGANIZERS Wanted for debating clubs. Great opportunity. Thursday Evening Club, 324 Newbury St., Boston, Mass.

LEATHER Jackets repaired. New knit, zippers or relined. Work fully guaranteed. Jackets made to order. Free circular. Taubers, 689 Mission, San Francisco 5, Calif.

YOUR Leather jacket renovated expertly. Free circular. Berlew Mfg. Co., Dept. 8, Freeport, N. Y.

FREE Catalog! War surplus clothing. Amazing bargains. N. Y. Clothing Co., New York 29A.

NOISE. New ear sound filter stops loud noises, passes ordinary sounds. Protect your hearing, increase efficiency, comfort. No wires, batteries, lasts indefinitely. Not hearing-aid. Free details. Anza Co., 3560A 20th St., San Francisco 10, California.

RECEIVE Mammoth mails, magazines, catalogs! Three months 25c, year 50c. Waddell's Directory, 341B East 76th, New York 21.

GOLD, Silver, metal detectors, Geiger counters for uranium. Mineralights. Sensational new fully guaranteed models. None finer. Information free. Detectron Co., 5631 Cahuenga Blvd., North Hollywood, California.

OUTDOOR Toilets, cesspools, septic tanks cleaned, deodorized with amazing new product. Just mix dry powder with water; pour into toilet. Safe, no poisons. Save digging, pumping costs. Postcard brings free details. Burson Laboratories, Dept. C-36, Chicago 22, Illinois.

TREASURE Finders for gold, silver and minerals. Money back guarantee. Best available. Also Geiger counters for uranium prospectors, free information. Write Goldak Company, 1541 West Glenoaks, Glendale 1, Calif.

PANNING Gold lesson and catalogue. Beginners supplies, books, "maps where to go" free. Old Prospector, Box 729D1, Lodi, Calif.

TREASURE—M-Scope Geiger counters, mineral locators. Why buy something inferior when you can buy the best at a lower price? Backed by years of experience. Fully guaranteed by factory. Detects minerals, metals, gold, silver, coins. Payment plan available. Proven superior performance. Free 16 page illustrated booklet. Fisher Research Lab., Inc., Palo Alto, California.

High School at Home

Many Finish in 2 Years

No classes. No time wasted going to and from school. Progress as fast as your time and abilities permit. Standard H. S. texts supplied. Thousands enroll each year in this 55-year-old school. Send for FREE descriptive booklet.

AMERICAN SCHOOL, Dept. H645
Drexel at 58th St., Chicago 37, Ill.

Without obligation, please send FREE descriptive booklet.

Name _____

Address _____



MASTER MIND!

Learn Short-Cut Mathematics

Juggle figures, do baffling number tricks. Make people gasp at your marvelous lightning-quick mind. Multiply 4 figures by 4 figures without using old-fashioned multiplication! Big cloth-bound volume; fully illustrated course.

Sharpen up Your Brain Power

Includes worked-out problems, answers, etc. Sensational bargain, only \$1.95, postpaid or COD plus postage. Satisfaction guaranteed or refund. Order this amazing "Short-Cut Mathematics" today!

NELSON-HALL CO., 210 S. Clinton St.
DEPT. 2JY-2 CHICAGO 6, ILL.

\$1.95 Complete

LOANS

by Mail

\$50 TO \$500

Cash for any purpose — tools, workshop needs, consolidate bills. Wherever you live you can borrow by mail. No co-signers. No one will know of inquiry. Easy monthly payments to fit your income. Write for money-request application. Give name, address, age, occupation.

AMERICAN LOAN PLAN

(Under Nebraska State Banking Supervision)
Dept. PM-10, City Nat'l. Bank Bldg., Omaha, Nebr.

**Yours for the asking—
No charge—no obligation**

"How to Become a Mail Order Millionaire"

Read how Gilbert on a "peanut" investment built up to \$350.00 A DAY. Learn how Zimmerman started a mail order business on a buck private's pay and spiraled \$16.80 into a big yearly income. See how a Chicago clerk quit a \$75.00 job and now makes \$22,000 a year in his own Mail Order business. Read how a southern boy made a fortune selling war-surplus parachutes which he bought as he went along. All Free! Send name on coupon for a copy of this fascinating reprint of "How to Become a Mail Order Millionaire" from Mechanix Illustrated plus details on the L.W. Mail Order Survey.



Start on a SHOESTRING!

The real-life stories of success in Mail Order read like fairy tales. If I had not personally known these people their stories would be hard to believe. Yet they are not only true, but they represent just a few of the hundreds of "little operators" who have been swept into big money by Mail Order.

GAINES. I personally guided his start when he invented an automatic pants presser. He started with one little ad in one magazine. Four years later he retired — with enough real estate to keep him in cash income the rest of his life.

VAN MARK. I worked with him for six years. I met him when he was a wagon man for a tea and coffee house, knocking on doors. He went into Mail Order on nothing—made money from the start—ended up six years later with savings of \$50,000 and an income of \$5000.00 a year for life without further work.

DUGGAN. A few years ago he was a truck driver. Started fooling with Mail Order in a spare room in his spare time. Last year he said, "I don't know how much I'm worth—after you get the first million you quit keeping track."

MRS. NIXON. Started a small Mail Order business at home—just to keep occupied. It looked good and she came to me for advice. I showed her how to expand. In two years the business got so big her husband resigned his job to help manage it.

FOXMAN. Foxman worked as a hack writer at \$70 a week. He had idle time in the evenings—ran an ad offering something he didn't have—got so many orders he had to find a source of supply. He made \$18,000 the first year. He gives me credit for "showing the way."

JORGENSEN. Consulted me about a specialty product. On my advice he ran one ad to "test" its saleability. That ad brought sales of \$50,000. In his first year he did a business of nearly a half million dollars. His original investment was less than a thousand.

These things I have seen. These people I have helped to the realization of their dreams — these and hundreds of others. My own fortune was made in Mail Order. And now my secrets can be yours.

L. W.

Have you ever thought of running a profitable little sideline right from your home? Has it occurred to you that you are just as capable as anyone else of making money on a product or service that can be sold by mail? Have you ever looked into the Mail Order business as it's run (on tiny investments) by innumerable small operators?

Forget about Sears and Ward's! Read about the "little fellows" . . . clerks, teachers, vets, mechanics, salesmen and others . . . who are packing Mail Order items in bedrooms, spare rooms, attics, garages, cellars . . . dumping them in the Post Office . . . and quietly banking the fistful of Money Orders, cash and checks delivered to them daily by the mailman.

An annual business of almost a billion dollars is done by "little fellows" who advertise and sell just one item! The Department of Commerce of the United States says, "A number of the most successful obtain incomes as high as \$40,000 to \$50,000.00."

It's an incredible story . . . a story of a business that's wide-open for newcomers . . . with opportunities for income far-and-away greater than you can ordinarily hope to attain by holding down a job. And in Mail Order you can stay as small as you wish—run your deal as a \$50 or \$75 weekly sideline—or consider jacking it up into really big figures as a full time operation.

Glance at the examples at left. These true stories are far from unusual. Multiply them by the hundreds and you begin to get an idea of what can be done . . . what is being done . . . in the phenomenal Mail Order field.

Yet, if you were to jump blindly into Mail Order your chances would be slim. A peculiar brand of "know-how" is vital in this little-known, little-understood business. This is fortunate for you. If any Tom, Dick, or Harry would "click" in Mail Order, the field would have been overloaded years ago.

But now you have the opportunity to learn the authentic secrets of successful Mail Order operation. They are revealed for the first time, step by step, in an extraordinary new Survey . . . the L.W. Confidential Mail Order Letters.

This Survey is not a course—not a book—not a group of lessons. It is a simple guide that anyone can follow. It shows you how to pick the right product for Mail Order. It shows you exactly how to start a profitable business fast, with cash or Money Orders in the envelopes you receive. It shows how to buy your product out of the very money you get in the mail, so you don't have to tie up cash in large supplies of your product. It gives you actual examples of ads and letters, analyzed to show how and why they make money. It demonstrates the months to start, the time to expand, the best way to get prospects' names. It reveals from A to Z the confidential facts that have made fortunes for Mail Order operators who use them.

Mail the coupon today, or simply send your name and address on a postcard. No salesman will call. We will mail, postage prepaid, a Free copy of "How to Become a Mail Order Millionaire" and along with it will give you complete facts about the L.W. Mail Order Survey. Read the facts. Then decide whether you would like to spend spare time or full time in a profitable, fascinating Mail Order enterprise. If you think you would like to follow the footsteps of hundreds of others who are now making good money in this way, you can get your L.W. Survey and begin at once.

Please don't decide to write us "a little later." Send your name now, before you forget. This one little act might be the first step to a future of independence and wealth.

**The L. W. MAIL ORDER SURVEY, Dept. 19
7070 N. CLARK ST., CHICAGO 26, ILL.**

The L. W. MAIL ORDER SURVEY, Dept. 19
7070 N. CLARK ST., CHICAGO 26, ILL.

Mail me a free copy of "How to Become a Mail Order Millionaire" and details about the L. W. SURVEY. It is understood there is no charge at any time, and that I am not under the slightest obligation. After reading, I will decide whether I want to use the L. W. Confidential Letters to help me start a Mail Order business at home.

NAME.....

ADDRESS.....

CITY.....ZONE.....STATE.....

NEW LOW PRICES
on these powerful **NEW 1953**

MIDWEST TELEVISION

Super Powered for "FRINGE" AREAS

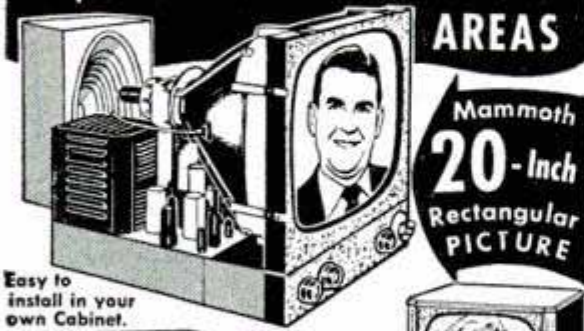

Easy to install in your own Cabinet.

Mammoth
20-Inch
Rectangular
PICTURE



30 DAYS TRIAL EASY TERMS

Midwest offers a sensational new 1953 line of beautiful consoles and complete chassis for easy installation in your own cabinet. Mammoth 20-Inch Television at low Factory Prices, and on 30 Days Trial.

Buy **DIRECT** from the **MIDWEST** Factory and **SAVE!**

SEND THIS COUPON	MIDWEST RADIO & TELEVISION CORP.
For FREE	Dept. 25A 909 Broadway, Cincinnati 2, Ohio
MIDWEST 1953 Catalog	NAME _____
	ADDRESS _____
	CITY _____ ZONE _____ STATE _____

Say You Saw It in **POPULAR MECHANICS**

NEW "PAINT PEN"

PAINT STRIPING TOOL
Works like a Fountain Pen
Stripes with Paint instead of Ink!

This amazing new "PAINT PEN" is a Paint Stripping Tool that makes it easy to do expert striping on furniture, bikes, model planes, autos, signs, toys, linoleum, wall board, etc. Surfaces paint-stripped look like tile. Paint straight, curved, circular or evenly spaced parallel lines the same way a professional painter does. Simply fill Tubular Glass Paint Fountain with any color paint and wheel tip feeds paint evenly. Tips interchangeable — jaws split apart for easy cleaning. Tool complete with tip for 1-16 inch stripe only \$1.00 postpaid. Other complete tools with 1-64, 1-32, 3-64, 1-16, 3-64, 3-32, 1-8 inch tips, \$1.50 ea. Extra tips, 75c each. Complete KIT with 7 tips, \$5.00. C.O.D.'s postage collect. Here's the handiest tool in your whole painter's kit. Get yours today!



Paint
STRAIGHT, CURVED OR PARALLEL LINES

Home Craftsmen

Just the tool you've been waiting for! New Paint Stripping Tool gives "professional" results every time, yet simple and easy to use as a fountain pen. Adjustable guide keeps lines straight as an arrow. Just as easy to make curves or free hand designs. Adds new beauty and finished look to everything you paint. Send \$1 now!

Only \$1.00

WENDELL MFG. CO., Dept. 3-P
4234 LINCOLN AVENUE, CHICAGO 18, ILL.

DEALERS
PAINT STRIPING TOOL packed in display cartons of 1 doz. Fast, profitable seller. Write for illustrated circular, discounts

Famous 15 and 17 Jewel **BULOVA WATCHES** \$16.95 PLUS TAX

PRACTICALLY WHOLESALE TO YOU



UNLIMITED WRITTEN GUARANTEE

Were Up to **\$59.50**
SAVE \$42.55

ALSO CHOICE OF
• BENRUS • GRUEN
• WALTHAM OR
• ELGIN WATCHES

You get these unredeemed **UNLIMITED** guaranteed Bulova and other movements in latest style Yellow Gold Cases at this sensationally low price because we bought out **SURPLUS STOCKS** of leading New York and Md. Jewelers. Order now while they last. Specify make preferred and whether men's or ladies! Only \$16.95, plus \$1.70 tax. Order right now.

FREE TRIAL OFFER! WEAR AT OUR RISK!
Money back guarantee in 10 days if not delighted!

SEND ONLY \$1 with order. Pay balance C.O.D. plus postage. Or we pay postage if you enclose \$16.95 plus \$1.70 tax.

UNLIMITED Guarantee—17 Jewel Swiss

WRIST WATCH

Worn by Army, Navy & Marines

Originally \$59

\$14.95 Plus \$1.50 Tax

New Incablock, Shock-Protected **WATER-DUST PROOF**

FREE! Handsome Expansion band with orders.

MARYLAND DISTRIBUTORS, Dept. 399

501 E. BALTIMORE ST., BALTIMORE 2, MD.

Write for Free Watch and Diamond Ring Catalog — Practically Wholesale Prices.

Success-Winning VOICE!

Sound like the **HE-MAN** you are

STRENGTHEN your voice this tested scientific way. Yes—you may now be able to improve the **POWER** of your speaking and singing voice... in the privacy of your own room! Self-training lessons, mostly silent. No music required.

FREE BOOK Write TODAY for Eugene Feuchtinger's great booklet "How to Develop a Successful Voice." It's absolutely FREE! You must state your age. Booklet mailed postpaid in plain wrapper. No salesman will call. Send your name and age **RIGHT NOW!** Perfect Voice Institute, 210 S. Clinton St., Studio JY-2, Chicago 6, Ill.



JUST OUT! 1952 EDITION

It's New! It's Different! Get world's largest Auto Accessory & Parts Catalog and save money. Over 50,000 items, including Hollywood Accessories, Hi-Speed Equipment, Rebuilt Engines, all parts & accessories for all cars & trucks. We have that **Hard-To-Get** part! Jam packed with bargains. Completely illustrated. (100 pages) Send 25c (refundable).

J. C. WHITNEY & CO., 1917-XP Archer Ave., Chicago 16, Ill.

How to Make Money in PHOTOGRAPHY

EARN WHILE YOU LEARN AT HOME! Unique, low-cost **LEARN-BY-DOING** method and **INDIVIDUAL** attention trains you quickly at home in spare time. Start making money in photography at once! We show you how. Our 43rd year. Big **FREE** colorful book gives full facts. Write TODAY! Resident Training also available. **NEW YORK INSTITUTE OF PHOTOGRAPHY** Dept. 49, 10 W. 33 St., New York 1 N.Y.



French STYLE DUELING SWORDS \$2.98 SET OF TWO

Once used in deadly combat—now an exciting sport! Learn right at home. Fun—safe—educational. These swords are made of fine blue spring steel, polished metal guards, turned handles, rubber safety tips. Fencing teaches quick thinking, develops coordination, posture. Since the Middle Ages, Europeans have enjoyed the sport of dueling. *Now advocated by U.S. colleges. Set includes two swords and the booklet, "The Art of Fencing". Special mail order price. **YOUR MONEY REFUNDED IF NOT COMPLETELY SATISFIED** Send \$2.98 to **TECHRITE CORP.** Box 12H, South Pasadena, Calif

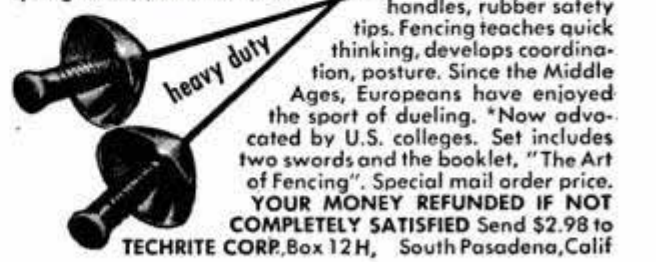

FREE!

COURSE of INSTRUCTIONS

Yes, we'll teach you at home how to make the most beautiful things you have ever seen! Everything from novelties, gadgets, beautiful jewelry, gems, machine parts, lures, models . . . ALL without tools or machinery! The **PLASTICAST PROCESS** is as easy as pouring water out of a glass! Learn how to MANUFACTURE countless useful and attractive things with Liquid Plastics, Liquid Marble, Liquid Ivory, Liquid Glass, Liquid Clay, Plaster, Stone, Wood, Metal and Compositions . . . all taught to you FREE!

SUCCESS GUARANTEED

The ONLY limitation is your imagination! No special talent, no previous experience, no special tools or machinery required! We not only TEACH you how to make these things but we show you how easy it is to dispose of your production, even selling part or all of your output to us! We will actually PUT YOU IN BUSINESS OVERNIGHT AND GUARANTEE YOUR SUCCESS! Yes, we'll set you up in the most fascinating business you ever dreamed of! In just a short time you'll be manufacturing sensational products of endless variety . . . it's all very fascinating and simple!

HOW TO START

Just send 25c for our big 56 page catalog which elaborates on the PLASTICAST PROCESS; we will include your first book of instructions PLUS complete details of the most amazing offer that will ever come your way! Do it today . . . don't delay anything that can be so important to your future!

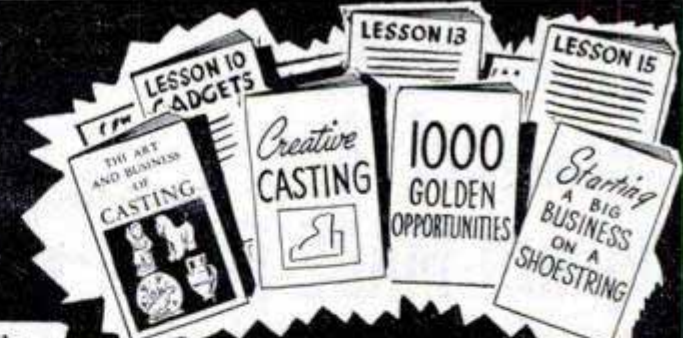

SOME OF THE BOOKS AND LESSONS WAITING FOR YOU!

IN BUSINESS OVERNIGHT! SUCCESS GUARANTEED!

Illustrated at the left are just a few of the THOUSANDS of useful and attractive things we teach you how to make without any tools or machinery . . . simply by CASTING!

You can start your own HOBBY AND NOVELTY SHOP in your own community. We will actually put you in business, supply you with ALL the merchandise you need and GUARANTEE YOUR SUCCESS!

Or you can start your own PLASTICS FACTORY and manufacture an ENDLESS VARIETY of beautiful and useful things for others to sell! Either way, we supply all the materials and instructions! SEND 25c FOR FULL PARTICULARS AND BIG CATALOG!

We have THOUSANDS of unusual products and materials of immense interest and value to inventors, mold, die, tool and model makers, hobbyists, craftsmen and to every ambitious individual seeking to create wealth and security with his own two hands in a FASCINATING ENTERPRISE!



PLASTICAST CO.

WRITE TO NEAREST OFFICE

Dept. C
P. O. BOX 6737, CHICAGO 80, ILLINOIS
P. O. BOX 987, PALO ALTO, CALIF.
Canadian readers: Please send 35c to: Canadian Ind. Plastics, 1056 1/2 W. Pender St., Vancouver, B. C.

Learn Modern Appliance and Electrical Servicing

Revolutionary New Method shows you how—at home—in **YOUR SPARE TIME!**

We send you complete Home Training Kits and latest Engineered Test Equipment. You can actually earn BIG MONEY WHILE LEARNING! Many men are making \$2.50-\$3.00 and more PER HOUR! RUSH name and address for big FREE book and full details — WRITE TODAY!

ADVANCE TRADES INSTITUTE Dept. 102
5944 NO. NEWARK AVE. CHICAGO 31, ILL.

250 POWER



Complete Telescope Lens Kit only \$3.49 postpaid

Conquer Space, Explore the Universe, Planets, Moon Craters, New Stars, etc. Complete Lens Kit consists of 80 inch focal length ground and polished objective lens, eyepiece lenses for 50 POWER, 100 POWER, 150 POWER, 200 POWER, 250 POWER, and all necessary lens fittings. Easy to make from simple step by step instructions. (Tripod and mount not included.) Money back guarantee.

BUSSE SALES CO., Hartford, Conn., Dept. PM6
SEPTEMBER 1952

WORK FOR THE



GOVERNMENT

START AS HIGH AS \$3,795.00 YEAR
Many Appointments To Be Made Experience Usually Not Required **MEN—WOMEN** Mail Coupon Today—Sure

FRANKLIN INSTITUTE, Dept. M-83, Rochester 4, N.Y. (Not Govt. Controlled)
Sirs: Rush with charge, (1) 32-page book with list of U.S. Government Jobs. (2) Tell me how to get one of these jobs.

COUPON
Name _____
Address _____ Age? _____



Electrical Appliance Repairs MADE EASY

New Repair Manual Covers EVERY Repair on ALL Home Appliances

NO repair job is too tough with the help of this big new Guide. TELLS and SHOWS how to service ALL home appliances. SAVE MONEY keeping your own appliances like new—or MAKE MONEY with a home repair shop of your own... full or spare time.

OVER 850 "how-to-do-it" pages, packed with pictures, drawings, diagrams. Sectional charts locate "trouble spots" in a jiffy... make it easy to dismantle and reassemble appliances correctly. A-B-C directions tell "why" as well as "how" Book covers fundamentals of electricity for beginners. Over 150 manufacturers supplied the servicing and repair data.

FREE 10-DAY EXAMINATION—Coupon will bring you "Electrical Appliance Servicing" to examine FREE—without obligation. Mail it NOW!



Covers ANY Service or Repair on:
 Irons • Toasters • Heaters • Vacuum Cleaners • Sewing Machines • Refrigerators • Air-Conditioners • Fans • and much more.

McGRAW-HILL BOOK CO., Inc., Dept. PM-9-52
 327 West 41st St., New York 18, N. Y.

Send Crouse's Electrical Appliance Servicing for 10-DAY FREE EXAMINATION. If not satisfied I will return it—pay nothing. Otherwise, I will keep it—send only \$2.50 (plus small delivery charge) then—and \$3.00 a month for 2 months to complete payment.

Name.....
 Address.....
 Employed by.....
 City.....
 State.....
 Zone No. (if any).....
 WE'LL PAY DELIVERY if you enclose \$8.50 (check or M.O.) WITH coupon. Same 10-day Return Privilege, for full refund.

MONTH AFTER MONTH, YEAR AFTER YEAR, YOU SEE OUR AD. REMEMBER IT'S DANGEROUS to pay less if you want the finest (nonskid) USED tires.

GOOD YEAR Firestone

GOODRICH, UNITED STATES, GENERAL & OTHERS, NOT RECAPS
 DOUBLE WARRANTY & UNCONDITIONAL GUAR. ON PASS. TIRES

Our policy is to select your tires so carefully, as if our very future depended on the service given by that particular tire.

FREE TUBE		WITH EVERY GOOD GRADE & FINEST GRADE, TRUCK & PASSENGER TIRE	
GOOD GRADE TIRES—GUAR. 20 MONTHS (Not Just 6 or 12 Mos.)			
600-16	\$4.14	820-15	\$5.44
650-16	5.42	700-15	4.54
700-16	5.04	670-15	4.48
650-15	4.44	710-15	4.68
760-15	5.04	550-17	4.64
600-20	\$7.14	32x6(8)	\$8.64
650-20	7.94	32x6(10)	9.94
700-20	8.54	900-20	13.18
850-20	8.64	1000-20	13.78
1100-20	14.78	1100-20	13.94

FINEST GRADE 30 MONTHS GOLDEN RULE GUARANTEE BOND (NOT JUST 24 MONTHS) THIS GRADE MADE US WORLD FAMOUS		30 MONTHS GUAR. TRUCK TIRES	
600-16	\$5.38	700-16(6)	\$8.78
600-16(6)	7.38	475-19	5.08
650-16	5.98	640-15	5.08
650-16(6)	8.28	670-15	5.68
700-16	6.48	710-15	5.88
750-16	9.78	760-15	6.08
525-18	5.08	800-15	6.58
550-17	4.98	820-15	6.68
650-15	5.38	670-16	6.38
700-15	5.58	760-16	7.58
WHITEWALLS \$1 ea.	EXTRA	32x6(8)	11.48
		32x6(10)	11.88

Buy the "Right" Truck Tires for "Your" Job.
 Thousands of the Best Fleetowners depend on us.

Std. Guar. 16 Mos. Rugged Guar. 30 Mos.
MILITARY MUD-SNO TREAD
 750-20 \$10.08 750-20Rg. \$16.68
 600-16Std. 6.18 600-16Rg. 9.98
 900-16Std. 10.08 900-16Rg. 16.68

BLATT BLATT BLDG. GIRARD & LANCASTER AVES. DEPT. PM, PHILADELPHIA 31, PA.
 Send check or money order. Send this ad with order. We won't ship a tire we wouldn't use. "3 GENERATIONS OF 'TIRE BLATTS'"
 Shipments RUSHED Down South, Up North and Far West

Secrets of VENTRILOQUISM Now Revealed!



Easy to learn in 60 to 90 days with our Home Study Course. RESULTS GUARANTEED. Make Money! Be Popular! Have Fun! Big Opportunity! Radio, Television, Stage, Appearances! For FREE information regarding price and terms, WRITE. You must state your age. Dummy Catalog 25c.
FRED MAHER SCHOOL OF VENTRILOQUISM
 Box 36, Studio 1 Kensington Station Detroit 24, Michigan

THE ART OF DRAWING

Fascinating learn-by-doing lessons in drawing, painting, illustrating and commercial art. Prepared for YOUR instruction and enjoyment in spare time at home. Purpose: To turn amateur talent into PROFESSIONAL skill. Cost? Surprisingly low. Send for FREE illustrated booklet, "Building a Future" in Art.

GRANT SCHOOL of ART Dept. A92, 225 N. Michigan Avenue, Chicago 1, Illinois



FIX YOUR FORD and SAVE

Brand new handbook for owners and mechanics by Bill Toboldt, Editor, Motor Service Magazine. Covers all Ford V-8's and 6's, 1932 to 1952. Gives you the know-how of hundreds of Nation's top Ford service men. Includes repair and service short-cuts and kinks, tune-up specifications, how to increase gas and tire mileage, make car run better, last longer, worth more, Hot rods and speed-ups too. Simplified. Packed with pictures. If you drive a Ford you need this book. Clip this ad and mail with name, address and \$2.50. Money back in 5 days if you want it.
 Goodheart-Willcox Co., Dept. 185, 1321 S. Michigan Ave., Chicago 5



Build it Yourself!

TRAILER COACHES

Complete Trailer Book and Construction Data for 10, 16 and 22 Foot Trailers — Only \$1.50

Partial Contents
 Trailer Parks—Living in a Trailer—Towing a Trailer—Floor Plans—Service—Classifications—Balance—Dollies—Jacks—Weight Distribution—Construction—Working Drawings for a Two-Place, Standard Travel and Standard Dwelling Trailers. Size 8 1/2 x 11 1/4 inches.

POPULAR MECHANICS PRESS • Dept. 350, 200 E. Ontario St., Chicago

GREER SHOP TRAINING

2230 So. Michigan Blvd. Chicago 16, Illinois

Leader in Practical Training for 50 Years

Gain success by learning a trade offering security and high pay—go into business for yourself.

Get the "Know-how" at Greer

You learn in our new, large, modern shops by working with latest tools and equipment of the trade — tear down, inspect, repair and rebuild... under supervision of experts. Greer founded 1902. Over 51,000 successful grads. Part time, full time, day and evening. E-Z terms. Mail coupon today.

MACHINIST

WELDING GAS ARC

BODY, FENDER

DIESEL MECHANICS

AUTO MECHANICS

REFRIGERATION

PIANO TUNING



CLIP COUPON . . . MAIL TODAY
 Greer Shop Training—2230 South Michigan Chicago 16, Illinois Desk 213

Please send information about trade checked:
 In our Chicago Shops: Auto Mechanics Diesel Mechanics
 Body, fender Repair Tool & Die
 Welding—Arc, gas Refrigeration & Air-conditioning
 Refrigeration & Air-conditioning
 Machine Shop Piano tuning
 G.I. appr. for Vets dischgd. after 7-25-47

Or learn at home—extension courses:
 Diesel Refrigeration Plastics

Name.....
 Address.....
 City.....
 State..... Age.....



\$ SAVE \$

ORDER BY MAIL

From

**NEWHOUSE
AUTOMOTIVE**

WORLD'S LARGEST DISTRIBUTOR
OF SPEED AND POWER EQUIPMENT



RODGER WARD, FAMOUS RACE DRIVER, SAYS: "Auto-Moly's the greatest oil miracle I've ever used!"

"AUTO-MOLY" CAN DOUBLE ENGINE LIFE!

By plating (through molecular attraction) the vital moving parts of your engine with millions of microscopic molybdenum "roller bearings", "Auto-Moly" reduces engine friction up to 66%. This amazing oil treatment protects newly fitted metal engine parts and prevents seizure and bearing failure even if car oil and water systems fail. One treatment assures old or new cars 5,000 miles of silent, smooth, economical operation. TRY IT TODAY... FULL "MONEY BACK" GUARANTEE IF NOT AMAZED!

"GEAR CONCENTRATE"
(4 times the strength)
For differential & transmission..... \$3 ppd.

**3 TIMES THE PUNCH!
3 TIMES THE LIFE!**

with **TRIPLE FIRE "Airplane Type" Spark Plugs**
(The Only Plug With A 20,000 Mile Unconditional Guarantee)

The 3 POINTS of this great new plug assure QUICKER STARTING, SMOOTHER PERFORMANCE, BETTER MILEAGE AND LONGER PLUG LIFE. Each point fires alternately and is pointed to give a hotter spark flash. Designed to meet the needs of modern high compression engines, these plugs feature "Lifetime Cerdo Material" insulation... first proven in fighter plane plugs. This insulation material resists heat, tetra-lead shorting and etching and prevents porcelain jacket breakage. Grueling laboratory and actual road and track tests prove greater durability, efficiency and power.

Sold in perfectly matched sets... List car make, model & year.
Only 89c each (Complete satisfaction or your money back!)



1 can (Full treatment)..... \$1.15 post-paid
4 cans (A year's supply)..... \$4.00 post-paid

SAVE GAS
WITH A **FUEL PRESSURE REGULATOR!**

STOP: ✓ Power Loss ✓ Fuel Waste
✓ Carburetor Flooding

MANY USERS CLAIM UP TO 25% BETTER MILEAGE as this revolutionary new accessory stops gas waste caused by fuel pump pulsation. It eliminates carburetor overflowing and fuel "surge." Stops the annoyance and danger of "motor cut-out."

As this precision regulator s-m-o-o-t-h-s fuel flow, it also prevents vapor lock and percolating. It pays for itself ten-fold with gas savings, by eliminating frequent carburetor adjustment and by reducing engine and carburetor wear. Fits all cars and trucks. **\$5.95**
30 day "money back" guarantee! Postpaid...
(Or send \$1.00, balance C.O.D.)

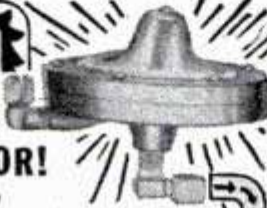

**CUSTOMIZE YOUR CAR
WITH A
CONTINENTAL KIT!**

Install It Yourself and Save

Give your car that longer, lower 1960 look. Make tire changing quick and easy. Instructions show how to easily install it yourself.

Kit is complete with gravel guard pan, 3 section tire cover, fender trim cover (Ford), remote control lock release (Chevy), chrome welts, special hub cap, license light, safety lock assembly (Ford), wheel mount bracket, bumper extension (Ford), and all necessary bolts and nuts for installation. Metal tire cover and gravel guard in primer-coat paint.

Chevrolet kit (fits all Styleline body styles, tire size 670x15) 1949 thru 1952..... **\$89.50**
Ford Kit (fits all body styles) 1950 thru 1952..... **\$79.50**

OTHER KIT PRICES

Kaiser (1947-52).....\$134.50 Packard (1951-52).....\$149.50
Cadillac (1950-52)..... 149.50 Studebaker (1951-52)..... 139.00
Mercury (1951-52)..... 139.00 Oldsmobile (1951-52)..... 149.50

NEWHOUSE AUTOMOTIVE, Dept. BX-9, 5805 E. Beverly Blvd., Los Angeles 22, Calif.

Easy-to-Build Old-Time Autos!

FREE!
Write for
Your Copy of
Our 4-Color
FOLDER

Authentic models—5" to 10 1/2" in length—to assemble in your leisure hours! All our kits include shaped parts, wheels, lights, horn, radiator, etc. and instructions. Choice of 16 antique autos—\$1.95 to \$3.95 each.



1904 OLDSMOBILE \$1.95

IF YOU ORDER DIRECT, add 25c for postage and handling.

Hudson Miniatures' "OLD TIMERS" Antique Auto Sets
SCRANTON HOBBY CENTER, Dept. 14, Scranton 10, Pa.

5 Year Written Guarantee NEW
17 JEWEL INCABLOC WATCH **\$13.95**
WAS \$50 NOW ONLY

DROP IT! WET IT! BANG IT!

Incabloc shock proof. Waterproof. Dust-proof. Tested best in Army and Navy Service. Anti-magnetic. Imported accurate Swiss lever movement. Sweep second hand. Radium dial.

TO DAY FREE TRIAL **SAVE \$36 IN BANKRUPT FACTORY STOCK SELLOUT**

Wear at our risk. Money back if not pleased. SEND NO MONEY. Pay postman plus tax and postage. Or enclose \$13.95 plus \$1.40 tax for men's watch, and we ship prepaid. (Ladies' model \$15.95 plus \$1.60 tax). Order now. Receive \$2 expansion band free with prepaid order.

STANLEY SALES CO., Dept. A, Long Island City 4, New York



SAVE \$36



TALK-SING-PLAY OVER YOUR RADIO

with the real Radio Mike! Attaches in a jiffy—full instructions given! Swell for "parties"—"cut in" on or "kid" regular network programs or put on your own broadcasts! Amaze your friends—real fun. Beautiful Metallic Plastic 6 in. high!

12 RADIO BROADCAST LESSONS GIVEN with each mike
SEND NO MONEY Just pay postman \$5.99 COD plus postage or send \$3.99 and we pay postage! Radio Mike is available only from us by mail—guaranteed.
Midway Co., Dept. MPM-9, Kearney, Nebr.

SENSATIONAL OPTICAL BARGAINS
MAKE YOUR OWN ASTRONOMICAL TELESCOPE



Build instruments worth up to \$600.00. Kits include Mirror Blank, Polishing Pitch, Abrasives, Flat Sur. Mirror, Eye Lens, Mag. Lenses, etc. Order dia. desired.

Stock #	Size	Postpd. Price
70,003-H	4 1/4"	\$ 7.00
70,004-H	6"	11.00
70,005-H	8"	18.00
70,006-H	10"	25.00
70,007-H	12 1/2"	45.00

SLIDE PROJECTOR SETS Consists of all unmounted lenses you need to make the following size projectors:
Stock #4029-H—35 mm. \$2.85 Postpaid
Stock #4038-H—2 1/4" x 2 1/4" \$3.35 Postpaid
Stock #4039-H—2 1/2" x 3 1/2" \$3.35 Postpaid

SIMPLE LENS KITS—Include plainly written, illustrated booklet showing how you can build lots of optical items. Use these lenses in photography and for dozens of other uses in experimental optics, building TELESCOPES, low power Microscopes, etc.
Stock #2-H—10 lenses..... \$ 1.00 postpaid
Stock #5-H—45 lenses..... 5.00 postpaid
Stock #10-H—80 lenses..... 10.00 postpaid

We Have Literally Millions of War Surplus Lenses and Prisms for Sale at Bargain Prices. Numerous Types of Instruments, Too! Write for FREE CATALOG-H

EDMUND SCIENTIFIC CORP., Barrington, N. J.

Date Changes
AUTOMATICALLY
EVERY DAY

Included
**FULL YEAR
GUARANTEE**
And Unconditional
Service Certificate



AMAZING *New* WATCH

with **MECHANICAL BRAIN**

Remembers • Tells Time • Tells Date

MEASURES SPEED • MEASURES DISTANCE • RECORDS UP TO 12 HOURS
• OVER 40 QUALITY FEATURES.

Precision Jeweled. Imported Swiss Movement. Accurate. Dependable. Push-Button Stop and Start. Red Sweep-Second Hand. Unbreakable Crystal. Triple Chrome Plated Case. Shock Resistant. Nite-Vue Radium Glow Dial. Anti-Magnetic. Times Shop work. Times Photography. Times Sports. Times Races. Times Lab. work. Times Planes. Expansion Band included.

Compare It at \$50.00

\$8⁹⁵
Plus 90c
Fed. Tax

SEND NO MONEY
Pay postman plus
postage or pre-
paid if remit-
tance ac-
companies
order.

YOUNG PRODUCTS, DEPT. 598

2605 ELMHURST, DETROIT 6, MICH.

Bargain of the Year!

524 DIFFERENT GENUINE
STAMPS 50c

This Sensational Collection
of Unusual Postage Stamps

Includes:

Hungarian Triangle Bird Set; Spain's Goya Nude Duchess; Albania Roosevelt-Churchill Issue complete; Da Vinci's Mona Lisa in Original Colors; South Molucca's (a new nation) 3 gorgeous sets; MacArthur Issue, U.P.U. issue, United Nations Set; Indonesia U.P.U., and hundreds more! To introduce our bargain approvals 524 ALL DIFFERENT stamps cataloging over \$11.00 for only 50c!



STAMPEX CO., 116-HM Nassau St., NYC

HELPFUL BOOKS

Send post card asking for FREE catalog

Popular Mechanics Press, 200 E. Ontario, Dept. 601, Chicago 11



HAVE A BIGGER — MORE EFFICIENT HOME WORKSHOP

Popular Mechanics **PLANNING YOUR HOME WORKSHOP** shows you how to make use of every inch of space in your workshop; detailed floor plans, wiring layouts and power tool hookups plus actual photographs of famous home workshops you can use as models. Save money by building your own shop furniture. Special Where-to-Buy-It Guide, 450 Illustrations, Cloth Bound, Working Diagrams. Order your copy today from

\$2.50
POPULAR MECHANICS PRESS
200 E. Ontario Street Chicago 11

DYNA-MITE POCKET RADIO

POWERFUL! PERSONAL! PORTABLE!

- Covers Full Broadcast Band 550-1600 K.C.
- Selective Dyna-Coil Tuning
- Batteries and All Parts Fit Within Case
- Hearing-Aid Battery-Powered, Long Life
- Tiny Acorn Low Drain Tube
- Loud Clear Tone
- Over 1,000 Mile Range
- No Antenna Used for Local Reception
- No Ground Connections Ever Needed
- Picture Diagram for Radio Beginners



\$5.99
Postpaid

This neatly engineered little **KIT** was designed to give you a real personal, portable radio that you can enjoy anywhere without disturbing others. Use it on camping trips, in bed, in your office or just anywhere. Remember this is not a weak crystal set but a powerful "VACUUM TUBE" receiver that will give you good local and long distance reception. Set, with tube less batteries **ONLY \$5.99 postpaid**. A deposit of \$1.00 is acceptable in U.S. and possessions on COD orders. If batteries are desired we will supply at only \$1.50 per set includes TWO "A" and ONE "B". These are obtainable at local hearing aid concerns.

Alnico magnet receiver \$1.25 only, when purchased with KIT. All parts guaranteed.

Order Today at This Unbelievable Low Price!

PRECISION ELECTRONICS LABORATORY

DEPT. A

PLACERVILLE, CALIF.



**EASIER
QUICKER
BETTER**

ROOF FRAMING

Rafter Length and Cuts
Without Use of Square!

Lay out any type of roof more accurately and in only one-fifth of the time required by other methods. Get the **POULSEN METHOD OF ROOF FRAMING**. It will save your time and make money for you. Valuable tables — 54 of them — starting with one-quarter inch rise per foot of run — simplify all roof framing problems. Tables give common, hip, valley and jack rafter length and necessary cuts in a jiffy without calculation. Learn also how to measure rafters from top and edge — definitely and accurately. No need to bother with centers and making adjustments for cuts.

Money Back Guarantee

Clip this ad and send with your name and address and \$3.00 for your copy postpaid today. Money back if not fully satisfied.

For Amateur and Professional

Every handyman, repairman, amateur carpenter and professional builder needs this **POULSEN METHOD** book. It saves four-fifths of all roof layout time and labor. Everything is already worked out for you in simple, easy-to-use tables. Cloth bound. Book has 90 pages and many illustrations. Besides the tables it contains every other bit of roof information a carpenter, whether amateur or journeyman, should have.

POPULAR MECHANICS PRESS

DEPT. RF

200 E. ONTARIO ST.

CHICAGO

IF YOU CAN SELL— LOOK AT THIS



Millions sold at \$12.50 and \$9.95. Now hitting new sales peaks at \$7.95 with up to \$4.00 profit for you.

How the women love a "bargain". They all want this amazing attachment because in five seconds it transforms their old style refrigerators into modern, automatic defrosters. Flash demonstrator. Instant sale in four out of five calls at this new low price. Yet you make as high as \$4.00 on each fast sale. Our men say they've never had anything like it before. Reynolds making \$140.00 a week practically "giving them away". Rush name for FREE SELLING KIT and offer of sample demonstrator to all who answer this ad. The HOLWIN is guaranteed for 2 years—and we guarantee your sale. Don't wait. Rush name at once.

Defrosler Sales Co.
415 N. La Salle St., Dept. H-8-P, Chicago 10, Ill.

FREE Send Name
Don't buy until you're satisfied. Rush name for free sales kit. Offer of demonstrator sample to all who answer this ad. Sales skyrocketing every day. Rush name for big money.



... LIFE OF THE PARTY!

There's nothing like a set of drums in your house to bring the gang together!

Whether artist or amateurs, you and your friends will have great times and loads of fun.

BUY SLINGERLAND—the make that KRUPA uses.

Send for
FREE catalog!

SLINGERLAND DRUM COMPANY

1329 Belden Ave.

Chicago, Illinois

GET MORE POWER!

Fisher's Compression SEAL **\$3.95** postpaid



- Stop Burning Oil!
- Restore Compression!

A small amount of Fisher's Compression SEAL in each cylinder bore will give you the economies of smooth, powerful (new car) performance and reduced oil consumption. Only takes minutes to apply... yet adds 10,000 more miles of economical driving pleasure to your car. A \$100,000 insurance policy is your assurance it cannot harm the finest engine.

SATISFACTION GUARANTEED

Full purchase refunded, if not completely satisfied. Why pay more when you can get Fisher's Compression SEAL... for less. No oil solvent baths necessary!

Send cash, check or M.O. today. Only \$3.95 postpaid. Free Folder. Dealers Inquire!

ADVANCED ENGINEERING Dept. PM-9, Box 7013 Los Angeles 37, Calif.

START A SIDELINE

AT HOME—Pleasant, Spare Time Work
No House-To-House Selling

Pays \$500 Profit in One Hour

EASY TO LEARN—It costs little to start. Tested plan brings orders to you for metalized Baby Shoes. You do work on equipment we furnish. Plenty of work in every neighborhood to keep a couple making good money.

FREE Send name for details on Warner Success Plan. No charge. Learn about this interesting, profitable homework. Business booming. Write now.

WARNER ELECTRIC CO., 1512 Jarvis Ave., Dept. M-3-P, Chicago 26, Ill.

SAY YOU SAW IT IN POPULAR MECHANICS

When is wood glue really WATERPROOF?

ANSWER: when it meets Military Specification tests for gluing wood for marine use.

Cascophen is a resorcin resin—the only cold-setting glue that passes these tests and is nationally available in small packages!

Use Cascophen for permanent wood bonds on boats, outdoor furniture, fishing tackle, archery and other wood sports equipment. Write for free descriptive folders. The Borden Co., Chemical Div., Dept. P.M., 350 Madison Avenue, New York 17, N. Y.



For boats, outdoor furniture, etc.

IF IT'S *Borden's* IT'S GOT TO BE GOOD!

COULD YOU USE FIRST TIME OFFER! \$1,000,000? \$3.95

We'd like to Hand You the Million—But You Realize That's Impossible. BUT WE CAN MAKE YOU HEALTHY!

weighs only 1 1/2 lbs.!



HIP POCKET GYM

THERE'S NO MAGIC, NO MIRACLE

HIP POCKET GYM helps both stout and skinny people. Using scientific and medical principles, it helps the body help itself by automatically adjusting to your strength and ability. You do not have to be Mr. America—even children can use it!

SO SIMPLE! SO EASY! No nailing on walls—no crawling on floors—no swinging from ceilings—no lengthy correspondence courses! A few minutes a day in a lazy man's way rids you of that run-down, tired feeling!

- Recommended By Over a Half Million People during the past 25 years without one word of advertising!
- Builds Health in Veterans' Hospitals!
- Scientifically Constructed of pure natural rubber that actually improves with age! So light and compact—take it wherever you go!

5 DAY MONEY BACK GUARANTEE

FREE With every HIP POCKET GYM you get FREE a Complete Set of Health and Strength Exercises!

MAIL COUPON TODAY

MAJOR LEAGUE SUPPLIERS.
Dept. PM-1, 160 Green St., New York 12, N. Y.
Please send... HIP POCKET GYMS @ \$3.95 each. PLUS FREE set of Health and Strength Exercises. Total amount Enclosed \$..... Check Money Order \$1 DEPOSIT with C.O.D. Save Handling and Postal Charges by Sending Check or Money Order.
Name.....
Address.....
City..... Zone..... State.....

If I am not satisfied for any reason whatsoever, I may return the Hip Pocket Gym within 5 days for full refund!

New Amazing Invention—"Magic Art Reproducer"

DRAW THE FIRST DAY!

NO LESSONS! NO TALENTS!

You Can Draw Your Family, Friends, Anything from REAL LIFE — Like An Artist Even If You CAN'T DRAW A Straight Line!



Also Excellent for Every Other Type of Drawing!

- Human Figures • Outdoor Scenes, landscapes, buildings
- Still life, vases, bowls of fruit, lamps, furniture, all objects
- Copy photos, other pictures, portraits, etc.
- Copy blueprints, designs, decorations, etc., for woodwork, machine, for needlework, crocheting, knitting
- Copy all cartoons.

Complete for only

\$1.98

FREE! "Simple Secrets of Art Tricks of the Trade"

This valuable illustrated guide is yours FREE with order of "Magic Art Reproducer." Easy ABC-art tricks that anyone can follow on different techniques, effects, proportions, perspectives, shading, color, animated cartoons, human figures to use with "Magic Art Reproducer" for added touches to your drawings.

SEND NO MONEY! Free 10-Day Trial!

Just send name and address. Pay postman on delivery \$1.98 plus postage. Or send only \$1.98 with order and we pay postage. You must be convinced that you can draw anything like an artist, or return merchandise after 10-day trial and your money will be refunded.

Norton Products

Dept. 5809, 296 Broadway
New York 7, N. Y.

LINGUAPHONE for LANGUAGES



**FRENCH SPANISH JAPANESE
GERMAN RUSSIAN ITALIAN
PORTUGUESE**

— any of 29 languages

NO TEXTBOOK CAN TEACH YOU TO SPEAK

With LINGUAPHONE World's-Standard Conversational Method, you bring a foreign land right into your own home—you LISTEN and LEARN another language the same easy, natural way you learned English long before you went to school. AT HOME you hear native men and women speak about everyday matters, you listen—you Understand—you SPEAK correctly, easily, quickly. You read and write. You can learn in 20 minutes a day.

WORLD-WIDE ENDORSEMENT

Internationally used by schools, colleges, governments, Armed Services and over a million home-study students of all ages.

STOP Wishing — START Talking

MAIL COUPON TODAY for fascinating FREE Book.

LINGUAPHONE INSTITUTE, 143-09 Radio City, N. Y. 20

Approved for Veterans' Training

LINGUAPHONE INSTITUTE
143-09 Radio City, N.Y. 20, N.Y.

Send me your FREE Book.

LANGUAGE INTERESTED _____

NAME _____

ADDRESS _____

CITY _____ ZONE _____ STATE _____

New
**Advertising
Machine**



Prints & Illustrates Gov't Post Cards

FREE Learn how thousands of business men, in every line, are boosting sales in spite of conditions—with ad messages—printed and illustrated in a few minutes on gov't post cards—with amazing new patented **CARDMASTER**. Your "today's" ideas, read by your prospects next morning. Not a toy, but a sturdy advertising machine, built to last for years. Low price, sold direct. Guaranteed for five years. Send name today.

SEND NAME We'll send **FREE** illustrated book of money-making **IDEAS** for your business and complete, unique advertising plans. **RUSH YOUR NAME TODAY.**

CARDMASTER COMPANY
1920 SUNNYSIDE, Dept. 139, CHICAGO 40, ILL.

EARN YOUR HIGH SCHOOL DIPLOMA

in 12-15 months

STUDY AT HOME. Success is yours when you have a high school education. You earn more, get better jobs, improve your social position. Prepare for college entrance if you wish. Start now. **WRITE FOR FREE LESSON AND BULLETIN**—no salesman will call.

ACADEMY FOR ADULTS

Dept. PM-9 30 W. Washington Chicago, Illinois

WE CAN HELP YOU

With your leathercraft hobby, send 10c today for our illustrated catalog.

FIRESIDE HOBBY SUPPLIES

8109 MACARTHUR BLVD. OAKLAND, CALIF.

how to **RESTYLE YOUR CAR!**



1001 sensational new ideas plus how to use the latest techniques; all-new 160 page book, photo-packed with startling new restyled cars to show how your car can be a dazzling custom beauty! Send only 85¢ (75¢ plus 10¢ postage) to **RE-STYLE YOUR CAR**, 5959-P Hollywood Blvd., Los Angeles 28, Calif. **BIG SPEED & SPORT, CUSTOM CARS, HOT RODS, HOW TO BUY A CAR** books, 85¢ each—ORDER TODAY!

Say You Saw It in Popular Mechanics

WAR SURPLUS BARGAINS

\$500,000.00 INVENTORY for QUICK LIQUIDATION

Surplus items—hundreds of them for home, shop, factory, farm and outdoor use. New items, used items, reconditioned items—all at tremendous savings—all priced for quick sale.

Page After Page of Values

This big catalog shows page after page of amazing money saving values. Write for your copy today. Send 10c to cover postage, mailing, etc. Write today!

SEND TODAY FOR YOUR COPY

10c

STARK'S Dept. PM-9 509 So. STATE STREET CHICAGO 5, ILLINOIS



TIRES · TIRES · TIRES

GUARANTEED WHOLESALE VALUES

UNCONDITIONALLY GUARANTEED

plus TIRE INSURANCE FREE!



10% OFF ON TWO OR MORE USED TIRES

or is damaged in any way (except willfully). Don't take risks: we send FREE insurance certificate PLUS written unconditional guarantee with your order.

Here's DOUBLE proof that we bear the loss if your passenger tire wears out within the guarantee period (except willfully). Don't take risks: we send FREE insurance with your order.

LOW COST QUALITY TIRES

Unconditional Six Months' Guarantee plus Tire Insurance Free

600-16	\$3.50	650-16	\$3.75	550-17	\$3.95
600-15	ea.	640-15	ea.	475-19	ea.
650-15		550-16		710-15	
550-15		670-16		760-15	

QUALITY TRUCK TIRES

ONE YEAR WRITTEN GUARANTEE

600-20	\$10.75	750-20	\$14.50	825-20	\$21.50	1100-20	\$26.95
650-20	11.75	32x6 (8)	11.75	900-20	19.50	1100-22	24.50
700-20	12.50	32x6 (10)	12.50	1000-20	20.00	750-20 (10)	18.00

BETTER GRADE PASSENGER TIRES

UNCONDITIONAL ONE-YEAR GUARANTEE plus TIRE INSURANCE FREE

600-16	\$5.59	700-16	\$7.59	700-15	\$5.59	550-16	\$5.97
600-16 (6)	6.50	600-15	5.89	750-16	12.25	550-17	5.75
650-16	5.79	650-15	5.59	550-15	5.59	475-19	5.75
640-15	5.95	710-15	6.50	820-15	7.50	760-16	7.75
670-15	5.95	760-15	6.75	670-16	6.95		

EXTRA MILEAGE TRUCK TIRES

Two Year Written Guarantee

750-16-8	\$16.50	650-20	\$16.75	750-20 (10)	\$23.50	1100-20	\$32.50
700-17	16.50	700-20	17.50	825-20	25.75	1000-22	29.75
750-17	19.75	32x6 (8)	16.75	36x8	27.50	1100-22	32.50
700-18	19.50	32x6 (10)	17.50	900-20	26.50		
600-20	15.50	750-20 (8)	18.50	1000-20	29.75		

MUD AND SNOW TIRES

2 YEAR WRITTEN GUARANTEE

600-16	\$6.95	900-16	\$12.95	750-20 Reg.	\$12.50	Spec.	\$15.95
650-16	7.50	650-16 (6)	9.50	650-15	6.50		

SPECIAL - CUSTOM RECAPS - SPECIAL

Two Year Unconditional Guarantee plus Tire Insurance Free

600-16	\$8.95	650-15	\$10.95	700-15	\$11.95	760-15	\$11.95
650-16	10.95	670-15	10.95	710-15	11.45	820-15	13.50

All prices F.O.B. Richmond, Va.

SAFTYRE CO., INC. "FOR THAT SAFE TIRE" MAIL ORDERS PROMPTLY FILLED.
 Dept. P-M-1 1801 E. BROAD ST., P. O. BOX 2254, RICHMOND, VA. Send check or money order with this ad.

GET FASCINATING NEW FREE PROFIT PLAN



MR. NELS IRWIN

SEND NO MONEY. I WANT YOU TO EXAMINE EVERYTHING WITHOUT RISKING A CENT.

BIG DEMAND FOR NEW MIRACLE FINISH.
 We show you every step. Fitting huge year-round demand... easy to understand instructions tell you how. Earn up to \$5 an hour spare-full time. A few cents' worth of materials brings you dollars!

GRASP THIS OPPORTUNITY TODAY.
 It's too good to miss... Fill out coupon, mail today. Get FREE sample, FREE plan, big IDEA booklet. No salesman will call! Do it NOW... be first in your community to cash in on this huge new market!

COAST INDUSTRIES - Dept. 29 1004 S. Los Angeles Street Los Angeles 15, California.

Items shown: AUTO DASHBOARD, SHOES, PHONOGRAPH TURNTABLES, AUTOTRUNK INTERIORS, RADIOS, TOYS, LAMPS, JEWELRY BOXES, COVERS ANY SURFACE.

Tired of monotonous, low-pay jobs - of working for the other fellow? Tap rich profits in huge NEW field. Have your own lifetime business - earn REAL money -

say goodbye forever to time clocks bosses! Become part of tremendous expanding industry - yet work right at home!

LEARN IN A FEW DAYS THROUGH PROVED, TESTED METHODS

to start earning more money with this amazing MIRACLE finish - gives a velvety, luxurious surface to radios, lamps, toys, signs, store displays,

figurines, auto dashboards - hundreds of items. FREE PROFIT PLAN offers everything you need to start at once. Fill out coupon, mail today.

PROFIT UP TO \$500 PER HOUR

INVESTIGATE TODAY!

USE COUPON FOR FREE SAMPLE

COAST INDUSTRIES Dept. 29
 1004 S. Los Angeles St., Los Angeles 15, Calif.
 Gentlemen: Please rush me all details FREE

FLOK KRAF

NAME _____

STREET _____

CITY _____ STATE _____

Bass WEEJUNS

... for leisurely comfort

Bass QUAIL HUNTERS

... for field and stream

Bass SKI BOOTS

... for extra control

Bass SPORTOCASINS

... for better golf

G. H. BASS & CO.
 60 Main Street
 Wilton, Maine

EARN BIG MONEY!

MR. NELS IRWIN

GROW "LIVING" MIDGET TREES!

AT HOME - SPARE TIME - NO EXPERIENCE NEEDED!

It's new! Amazing! At last, the secret of growing miniature (MING) trees can be yours. FULL GROWN, dwarf trees - only a few inches high. Beautiful miniature fir, orange, oak, Chinese elm, peach, pine, cypress - any kind! All BLOOM - and even BEAR FRUIT. All perfect healthy specimens - but miniature in size! Make costly home decorations and expensive centerpieces. (SOLD FOR OVER \$1,500 EACH.) Big demand. Costs only pennies - takes only minutes per week. IT'S EASY! Fun! A new fascinating hobby - a new fabulous \$\$\$\$ business. Send for free secret plan details and real seed.

HELP US FILL HUGE DEMAND

These trees are being demanded by STORES · CLUBS · HOTELS · FLORISTS · HOUSEWIVES · INTERIOR DECORATORS · COLLECTORS · HOBBYISTS - Big Money Opportunity for you.

Types shown: FIR TREE, CYPRESS TREE, JUNIPER TREE.

HOW TO LEARN GROWING SECRETS

SEED FREE

MAIL TODAY FOR FREE SEED AND PLAN!

NATIONAL NURSERY GARDENS, Dept. M9
 8463 South Van Ness, Inglewood 4, California
 Rush me FREE PLAN and SEED IMMEDIATELY!

Name _____

Address _____ Zone _____

City _____ State _____



STOP!

- ✓ BURNING OIL
- ✓ PISTON SLAP
- ✓ POWER LOSS

OVERHAUL YOUR

MOTOR IN 10 MINUTES with a **MOTOR**

CLEANSE "MOTOR PURGE" with



RENEW KIT

In the **FIRST** step of the famous Motor Renew Treatment, the "Purge" formula cleans, quiets and frees rings, valves and pistons from efficiency and power robbing carbon, gums and varnish. Pour this miracle solvent into the cylinders, run your motor and watch the combustion residue billow out your exhaust pipe.

RENEW "COMPRESSION SEAL" with



RESTORE COMPRESSION . . . GET NEW POWER, SPEED AND ECONOMY with "Compression Seal". As the **SECOND** step of the Renew Treatment, squeeze this self expanding mineral compound into your cylinders where it can fill worn spots (which cause compression leaks) between cylinder walls and pistons. Thus it restores compression . . . cuts oil-gas waste and eliminates costly engine overhaul and ring jobs.

100% MONEY BACK GUARANTEE!

A \$100,000 insurance policy guarantees that this "Renew" treatment will not harm the finest engine.

Dealer Inquiries Invited!

FREE Auto Manual With Each Order!

Kit treats all cars and trucks

\$6.95 Postpaid (Or send \$1 deposit, balance C.O.D.)



Before



After

CONSOLIDATED ENGINEERING, Dept. PMN-9, 10407 W. Washington Blvd., Culver City, Calif.

PLEASE SEND ME

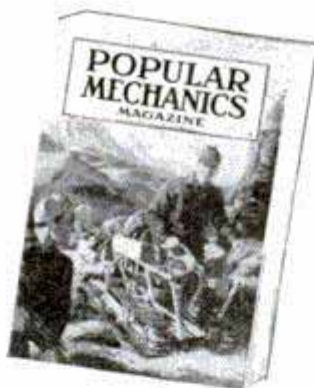

for the time checked.

I am enclosing . . .

1 year \$3.50
2 years \$6.00

name _____

address _____

city _____ zone _____ state _____ C-92

Hand this order to your newsdealer or send it to

POPULAR MECHANICS
200 East Ontario St. Chicago 11, Ill.



INSURED TIRE SERVICE POPULAR BRANDS

FREE INSURANCE POLICY given with each used tire sold. We guarantee the amount of service you pay for.
Tube Given Free with Each Used Passenger Tire Upon Request

SPECIAL!
Deduct 10% on orders for two or more used tires

YOU CAN'T LOSE!!

Super Quality	Rugged Performance	15 Months Insured Service
600x16 \$4.55	670x15 \$5.25	700x16 \$5.55
650x16 4.95	670x16 5.35	710x15 5.45
650x16 5.95	700x15 5.40	760x15 5.95
		820x15 6.45
		550x17 4.75

Supreme Quality	Nothing Finer	30 Months Insured Service
450x20 5.95	450x21 6.25	700x15 (6) 10.45
600x16 5.65	650x15 5.75	800x20 10.95
650x16 5.85	670x15 5.95	650x20 11.75
700x16 7.75	700x15 5.75	700x20 12.50
750x16 12.50	710x15 6.50	32x6(8) 11.95
550x17 5.75	760x15 6.95	32x6(10) 12.75
525x18 5.45	820x15 7.50	750x20 14.50
650x19 8.75	475x19 5.75	825x20 21.50
		1100x24 22.75



GOODYEAR SUPER CUSHION

600x16 9.95	670x16 10.75	760x15 13.95
650x15 10.95	700x15 12.95	760x16 13.95
650x16 10.95	700x16 13.95	820x15 14.95
670x15 10.95	710x15 12.95	590x15 9.95

Factory Rebuilt. Guaranteed and Insured for 18 Months

MIDLAND TIRE SALES

1141 W. Randolph St., Dept. PM-1, Chicago 7, Ill. Speedy shipments on Mail Orders. Insurance Policy sent with each order. Deduct 10% on orders for 2 or more used tires. Send CHECK or MONEY ORDER with this ad.



AMAZING NEW POCKET SIZE RADIO!

NO TUBES, BATTERIES OR ELECTRIC "PLUG-INS" NEEDED. "TUNES IN" MOST LOCAL RADIO STATIONS WITH CRYSTAL-FREE CLEAR TONE. Has new perma-crystal diode and TINY SELF-CONTAINED SPEAKER PHONE—A marvelous real tiny pocket size radio to take with you anywhere you go — FOR REAL FUN AND ENJOYMENT. GUARANTEED TO WORK and should last for years! (Cash, M.O., Ck.) and pay **SEND \$1.00** postman \$3.99 C. O. D. postage or send \$4.99 for p.p. delivery. COMPLETE ready to play. By mail only from: Midway Company, Dept. PPM-9, Kearney, Nebr.

HELPFUL BOOKS

Send post card asking for FREE catalog

Popular Mechanics Press, 200 E. Ontario, Dept. 601, Chicago 11

OWN A... PLYMOUTH?

FIX IT YOURSELF!

Popular Mechanics Magazine has just published a new Owners Manual covering all 1941 to 1952 models of Plymouth cars. So accurate mechanics use it . . . so simple a woman can understand it.

Save money on your Plymouth repairs. Prevent trouble. Enjoy care-free driving. Increase trade-in value. Avoid major repairs by fixing minor troubles before they get serious. Get sparkling performance at all times. Has 272 pages, more than 350 photos, diagrams, tables, charts, breakdown drawings, plus clear, non-technical directions that make all repairs simple as ABC. Written by Ed Packer with assistance of Chrysler Corporation. Shows you how to diagnose Plymouth troubles by feel, sound, sight, smell and performance. Simple trouble shooting. Permanent repairs. Emergency repairs. Plus, "How to get value from garages."



MONEY BACK IF IT DOESN'T SAVE MORE THAN IT COSTS!

One minor repair will save the cost ten times over. Read it. Then you decide. If you don't see that you'll save more than the cost, send it back for refund. SEND NO MONEY. Send postcard. Ask for PLYMOUTH Manual. Postman will deliver C.O.D. for \$3.50 plus postage. Or, save postage by sending \$3.50 with order. Send today. Save its cost on your next repair.

POPULAR MECHANICS PRESS

200 E. ONTARIO DEPT. 18 CHICAGO 11, ILLINOIS

Free!



YOUR INITIAL RING

This simile of a \$500.00 ring with your INITIAL set into a ruby color stone and 2 sparkling brilliants on the sides is yours to KEEP even if you should return merchandise for refund! It's Thoresen's way of saying, "We appreciate your patronage!" Thoresen makes lifetime friends!

SAVE 70%

THORESEN'S SACRIFICE SALE!

SAVE 70%

FORCED TO RAISE CASH

This is positively your **LAST** opportunity to save up to 70% in our nationwide Sacrifice Sale to raise cash. Prices subject to rise steeply very soon! Buy now for immediate needs... lay away for Christmas Gifts. Remember! All Thoresen merchandise is brand new and sold on 7 Day money back Guarantee. All watches subject to Thoresen's famous Unlimited Guarantee exclusive of parts for lifetime of business. Send money order, check or cash and save postage. C.O.D.'s cheerfully filled, plus postage. **RUSH COUPON NOW!** Address: reliable, nationally known:

THORESEN DIRECT SALES, Dept. 6-K
131 WEST 33rd STREET NEW YORK 1, N. Y.



7.95 PLUS TAX

"MECHANICAL BRAIN" CHRONOGRAPH & Calendar Watch

LOWEST price ever for this little marvel! Measures speed & distance. Precision made Swiss movement. Quality features of \$50.00 watches, PLUS chronograph & tachymeter dials, 2 push buttons to start & stop, rugged case in heavy chrome plate, radium dial glows at night, anti-magnetic, unbreakable crystal. Flexible Expansion band, Times planes, photos, lab & shop work, sports, etc. **UNLIMITED** guarantee exclusive of parts! Checked by us in America! No. 250. LOOK AT OUR price, why pay more? 7.95 plus 80c tax. Total 8.75

TRIPLE POWER GERMAN

CARRYING CASE GIVEN \$3

Why pay \$10 for crudely made binoculars, claiming 1.5 mile ranges? Look thru **KLAR-OVIS** once—you'll be amazed! Made by German artisans. Big size 3x40 millimeter lenses. Smooth center focusing for quick adjustments. Excellent for sports events, hunting, theater. **FREE** of extra cost: Flex-O-Matic carrying case with shoulder strap. No. 134. A great value, complete. 3.00

Heavy Duty — Full Size — Guaranteed QUALITY SEAT COVERS
Look over these low, low prices

No. 149—Blue, red or green 2 for 2.88 (Price 1.95)
No. 186—Clear Plastic 2 for 1.88 (Price 1.00)
No. 150—Leopard Design 2 for 4.79 (Price 2.92)
No. 188—Snake skin Design 2 for 5.44 (Price 3.65)

Choose your favorite design! Gives beauty, distinction, prestige to your car. Compare with skimpy, inferior seat covers! What a difference! Thoresen seat covers are thick, durable. Never crack or peel! Generously tailored. Up to 50% more material than others! For ALL cars, makes, models, from Ford to Cadillac. Ingenious **LASTIK-LOCK** feature. No pins, NO tacks! Triple gauge binding plus Criss-Cross corner stitching for extra strength. Mention car make, model & year, also if for front or back seat. Indicate design number.

RADIO MIKE 2.95

Broadcast over your radio!

Entertaining, educational! QUICK-EASY to plug into your own radio, SECRETLY from another room to nearby friends! Cut into national programs with a no-voice em.c.s. singing, speeches. Aid to voice development & for loudspeakers in stores, factories, houses to workshop. No. 89. With base & instructions. Only 2.95

Famous BURGESS PAINT SPRAYER 639

Powerful electric motor. Sprays enamel paint, varnish, DDT varnishes, insecticides. No brush of sprayers. world's largest mfr. of sprayers. Deep slashed, wear below regular manufacturer's list price. Includes mfr. Service Certificate. No. 187. Cut price, while they last... 6.39

PORTABLE GARAGE 688

Heavy Duty—Was \$10

The ideal garage—goes wherever your car goes—resists the ravages of summer sun or winter snows, rain, insects, etc. Whisks on or off quick and easy. Folds away like a handkerchief. Takes little storage space. Sure-Grip elasticized bottom. Complete with security. Pays for itself many times over. Do not confuse with inferior, cheap, Thoresen's resists cracking or peeling, withstands long wear. NOW at a drastically reduced price during our Sacrifice Sale! No. 140. Only 6.88

THE POWER TOOL OF 1000 USES

Famous Speedway Hi Power Drill

Complete with 37 accessories! Powerful elec. motor; 1 1/2" chuck easily converts to 1/2" attachment. Genuine torque system. 37 accessories NOT counted. hi-speed drills to \$32.95. No. 151, usually to \$39.95. Sacrifice, 14.95, postpaid.



Sweep-Second BARGAIN
Lowest price ever for this dependable sweep-second watch! Rugged case. FREE metal stretch band! No. 216. Usually \$6.95 plus tax. Now at 4.69 plus 47c tax, total 5.16.

Water Protected "SUBMARINE"
You'd expect to pay \$40! Jewelled, shock protected! Sweep-second; unbreakable crystal; Thin case; luminous! Expansion band. No. 252. 8.95 plus 90c tax... total 9.85.

Intra-Block Jewelled SHOCK-RESIST
Hit it, drop it! Swiss shock absorbers, protects! Sweep-second; unbreakable crystal; rad.-glo dial; stretch band. No. 260. Yours for only 5.44, plus 56c tax. Total 5.99.

Genuine Focus-Balanced Binoculars OUR LOWEST PRICES EVER!

We stake our reputation on these imported Prismatic-Achromatic binoculars! All Filtro-Lite coated, color corrected and Focus-Balanced, free from undesirable aberrations! Thoresen's Focus-Balancing guarantees you years of thrilling enjoyment. Compare Thoresen's Sacrifice prices — 'nuf said! All with leather case & straps.

NOTE — All prices FULLY TAX PAID!

6x30mm (No. 157) A real bargain,	27.85
tax paid	
7x50mm (No. 153) I. F. Naval type, tax paid	33.95
7x50mm (No. 153-C) Center Focus, Extra sharp	39.85
8x30mm (No. 146) Center Focus, Ultra-precise	38.50
10x50mm (No. 155) Terrific Quality! Special at	59.95
16x30mm (No. 156) The powerhouse! Tax paid	66.50

16x50mm Powerhouse No. 156—Terrific 10 power lenses & correlated prisms equal to \$250 models. Brilliant even in moonlight! Pigskin case, straps. Tax paid, only 66.50

Send now for FREE INITIAL RING & HOME TRIAL!

THORESEN DIRECT SALES, Dept. 6-K
131 West 33rd Street, New York, N.Y.

RUSH the following on 7 day home trial & Initial Ring, with Guarantee Certificate. If not delighted you are to return price paid but I will keep the ring in any case. Ring size: _____

Remittance enclosed. Send prepaid. Send COD plus post.

NO.	ITEM	PRICE

NAME: _____
ADDRESS: _____
TOWN: _____

NOTE: If you do not know ring size, send string or paper strip.

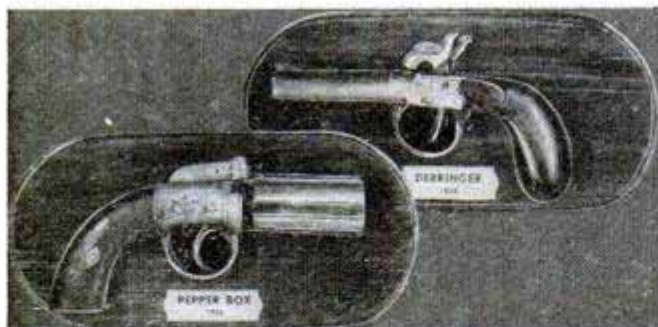

Antique Guns for Your Wall — Reproductions of famous old-time pistols, perfect in every detail! Handsomely mounted on 5" x 10" simulated mahogany plaques with gold metal name plates. Exciting history of each gun included. "Derringer" (right) or "Pepper Box" (left) models. Only \$4.95 each, BOTH for \$9.50 ppd. Dreer's, Dept. 248, 1934 Arch St., Philadelphia 3, Pa.



Wipe Away Rust —

Amazing new product wipes away rust, corrosion and grime from metal "Like Magic." It loosens and removes even the most stubborn, encrusted, pitted rust in a jiffy — from

Tools, Machinery, Automobiles, Bicycles, Boat Trim, Lawn Mowers, Garden Equipment, Sink Pipes, Radiators, etc. Watch the gleaming appearance restored in seconds to all your metal surfaces. A minute application — see rust disappear. Large 6 oz. bottle, \$1.00 ppd. Results guaranteed or money back! Bedford Co., 80 E. 11th St., Dept. R15, New York 3.

Lucite Treasure Dome — Grandfather's heirloom watch becomes modern easy-to-wind useful timepiece in beautiful crystal-clear DuPont Lucite dome. Blond, ebony, mahogany base. Showcase for medals too. Specify use, medal or watch. \$3.95 ppd. No c.o.d.'s. Carol Beatty, Dept. 63, 635 S. Kenmore Ave., Los Angeles 5, Cal.



Nostalgic Model T Ford —

Remember the old tin lizzie that chugged down the street? It's now a lamp! Use as TV lamp, in den, living room, everywhere. Authentic replica of a 1917 Ford Coupe, black body, red wheels, gold trim; Fiberglass shade in gay-90's red; 18" high, base 6 x 9½". \$9.95 ppd. Or c.o.d. Homecrafts, 799 Broadway (PM), N. Y. 3.



Ouch! Feet Hurt?—Here's quick relief for painful calluses, blisters, spur or bruised heels, or foot fatigue. Perx Air Cush'n Innersoles give immediate comfort—just slip in your shoes and walk! Air movement gently massages feet. Odorless, non-absorbent, light plastic. Order by shoe size. Only \$2 a pr. Cash, m.o., chk. Lillywhite Dist. Co., 1136 6th St., Manhattan Beach, Calif.

Young Craftsman

—Here is the perfect gift for any boy. It contains more than 450 fascinating projects for boys of all ages. It stimulates the imagination, trains the mind and hands. The projects can be made with only simple tools and inexpensive or waste materials. There are toys, bicycle trailers, all kinds of kites, bird houses, etc. The 224 pages contain detailed instructions and hundreds of illustrations. \$2.00 postpaid. Popular Mechanics Press, Dept. SG 2, 200 E. Ontario St., Chicago 11, Illinois.

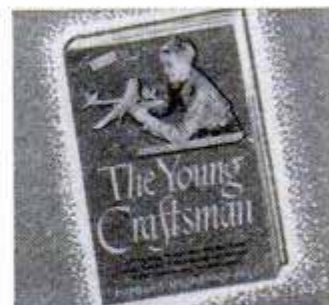



Parakeets — Rare little talking birds — blue, green, yellow or blue-white. Ideal pet, companion, gift. So much fun — talk better than parrots, learn dozens of cute tricks! Small (about 7" long),

clean, hardy, long-lived. Easy, inexpensive to feed. Young birds, ready to train, only \$7.95 each. Training book ("The Talking Budgie"), \$1.00. Feed, \$1.00. Cage, \$5.95. Bird, book, feed, cage, \$14.90. Check, m.o. or c.o.d. Prompt express delivery, charges collect. Satisfaction guaranteed. Parakeets, Dept. B-89, 304 Kansas Ave., Topeka, Kans.



Planning to Build or Remodel?—You'll find the exact book you need in the New Home Library List. Includes books on plans for building your own home, remodeling, redecorating, landscaping, fireplace and barbecue construction, etc. You'll get hundreds of new ideas. Send 10c for Home Library List to: Complete Home Plan Service, 17261-69 Osborne St., Northridge 9, Calif.



Rain and Snow Deflectors—Clip on door. Set up air currents that permit driving with windows partly open in rain. Add smart touch. No interference with vision. Fit all cars and trucks except wood station wagons, hard and soft top convertibles. Transparent red, blue, green, or clear plastic. \$2.95 pair, ppd. except on c.o.d. Add 9c tax in Ohio. Jeba Plastic, Newark, Ohio.

Wind Velocity Dial

—For the amateur weatherman to hang on the wall beside his barometer. The handsome 4" polished brass dial shows every gust and lull in the wind, recording up to 100 m.p.h. Tells



at a glance indoors how hard the wind's blowing outdoors. Complete with 3-cup anemometer; easily and quickly mounted on your roof, or television antenna; costs nothing to operate because it generates its own current. Fully guaranteed, with 50 feet connecting wire. \$49.95, ppd. Cape Cod Wind Indicators, Harwichport 1, Cape Cod, Mass.

Pocket Movie Viewer—See your film without projector, anyplace, anytime. Melton movie viewer holds 50-ft. standard 8-m.m. film, gives clear, live-action picture. Ideal for private viewing, for mailing film to friends, servicemen. Money back guaranty. \$4.95 ppd. Melton, Dept. PM-2, 1619 E. 2nd, Reno, Nevada. Ask for film list.

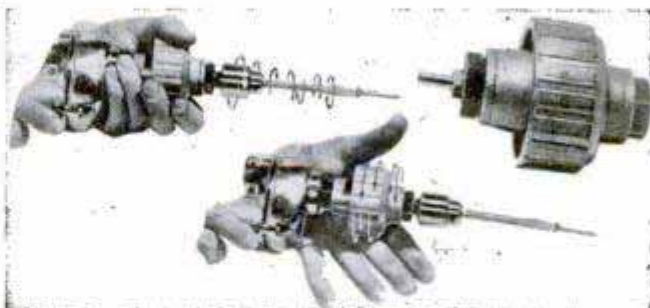

5-to-1 Speed Reducer Fits Any 1/4" Drill — Convert your 1/4" electric drill to electric screw-driver—drill holes to 1 1/4" in wood, to 1/2" in masonry. Planetary gear system provides tremendous torque increase. Instant starting, stopping with hand clutch control. To operate tool, simply grip reducer; release to stop. \$9.95 ppd. Babcock & Co., 6251 Claremont Ave., Oakland 18, Calif.

There is a difference in sealed-beam headlamps

...and this
is it →

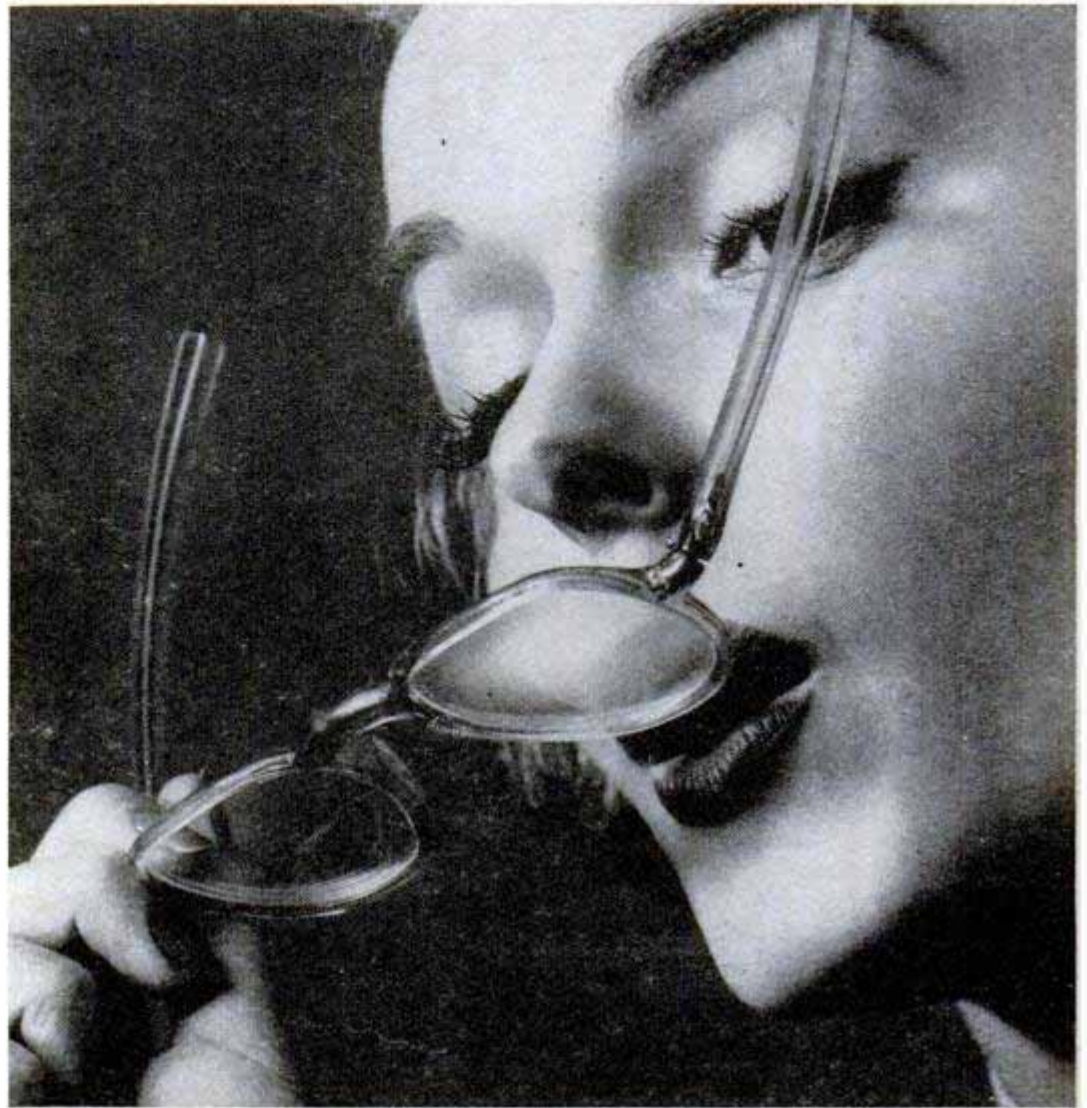

All-Glass sealed-beam headlamps do not grow dim



One-piece All-Glass construction. Dirt and moisture can't get in.

Filaments held in vise-like grip. Can't shake loose.

Mirror-like, built-in reflector. Stays bright.

Rugged, hard-glass precision lens to put light where you want it.

WHEN YOU BLOW ON YOUR GLASSES, moisture condenses on the lens. When moist air gets inside some types of sealed-beam headlamps, the same thing happens. It condenses on lens and reflector. And as the water deteriorates the reflector, the lamp grows dimmer.

Moisture *can't* get into General Electric sealed-beam headlamps because they're All-Glass and all one big bulb. Tests show they average 99% as much light after years of use as when new. To drive and enjoy it—knowing you can see safely—get General Electric All-Glass headlamps.

You can put your confidence in—

GENERAL  **ELECTRIC**



POPULAR MECHANICS

SEPTEMBER 1952

WRITTEN SO YOU CAN UNDERSTAND IT
VOL. 98 NO. 3

It's News:



By Thomas E. Stimson, Jr.

PLANTS THAT bite back at the bugs are the big news in agriculture this year. In Wisconsin, pea vines grown from treated seed are green and healthy even though other vines right alongside them are heavily infested with pea aphids. Insects that migrate to the treated plants curl up and die within 48 hours.

At the U. S. Department of Agriculture experiment station at Beltsville, Md., researchers have reversed the tables on the red-spider mite that loves to feed on young

beans. Now the mites themselves die when they attack the plants.

At the Riverside citrus-experiment station of the University of California, lemon seedlings and mature orange trees are killing all the mites and aphids that formerly were a serious problem. And at the university's ornamental test plots in Los Angeles you can inspect flowers and shrubs that remain unharmed by insects even though they are almost touching control plants teeming with various pests.

One of the many ways the new insecticides can be utilized effectively is with a fog-spray applicator





Measuring out solution that will be used to water soil around gladiolus bulbs to ward off the mites

These plants are lethal to many insect enemies because they've been vaccinated, so to speak, with one of the new systemic insecticides. The insecticide is absorbed by the plant and circulates through its sap stream. The entire structure, from bark to fresh young leaves, becomes highly toxic to insects that exist by sucking their nutrient from the plant.

Most of the new bug killers have little or no effect on the large leaf-chewing insects such as grasshoppers, codling moths,



Proportioning dispenser mixes liquid fertilizer and insecticide with water flowing through garden hose

beetles, weevils and various worms. These still must be controlled by the usual methods. And the systemic insecticides are not equally effective against all sucking insects on all plants. Each combination of insect and host is receiving separate study.

In a general sense, however, agriculture now has a new and effective way of controlling the multitudes of sucking insects that cause more than half the several billion dollars of insect crop damage in the United States alone every year. To a large

Upward and outward route of systematic insecticides is traced in leaves by a radioactive-phosphorus compound

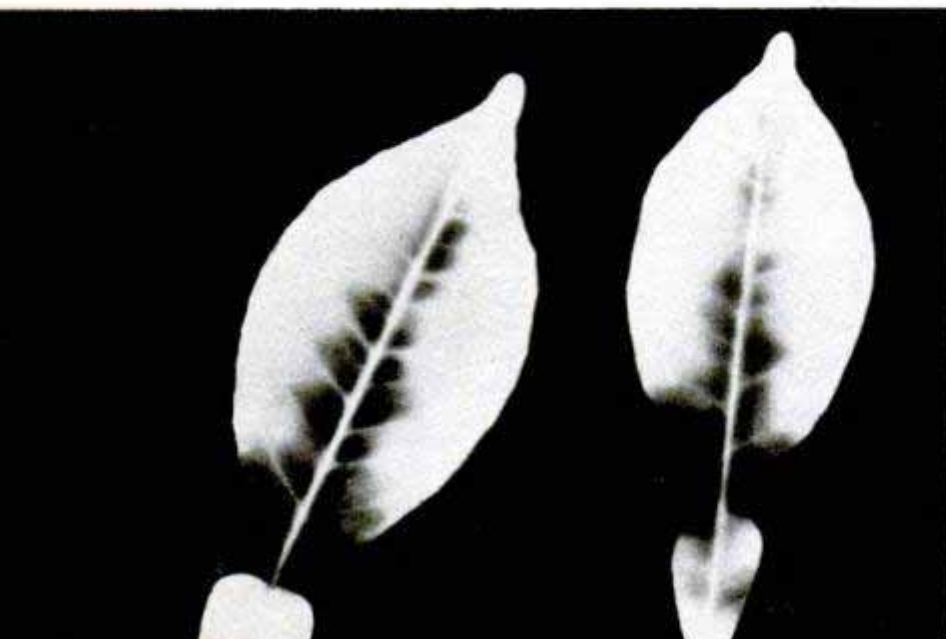

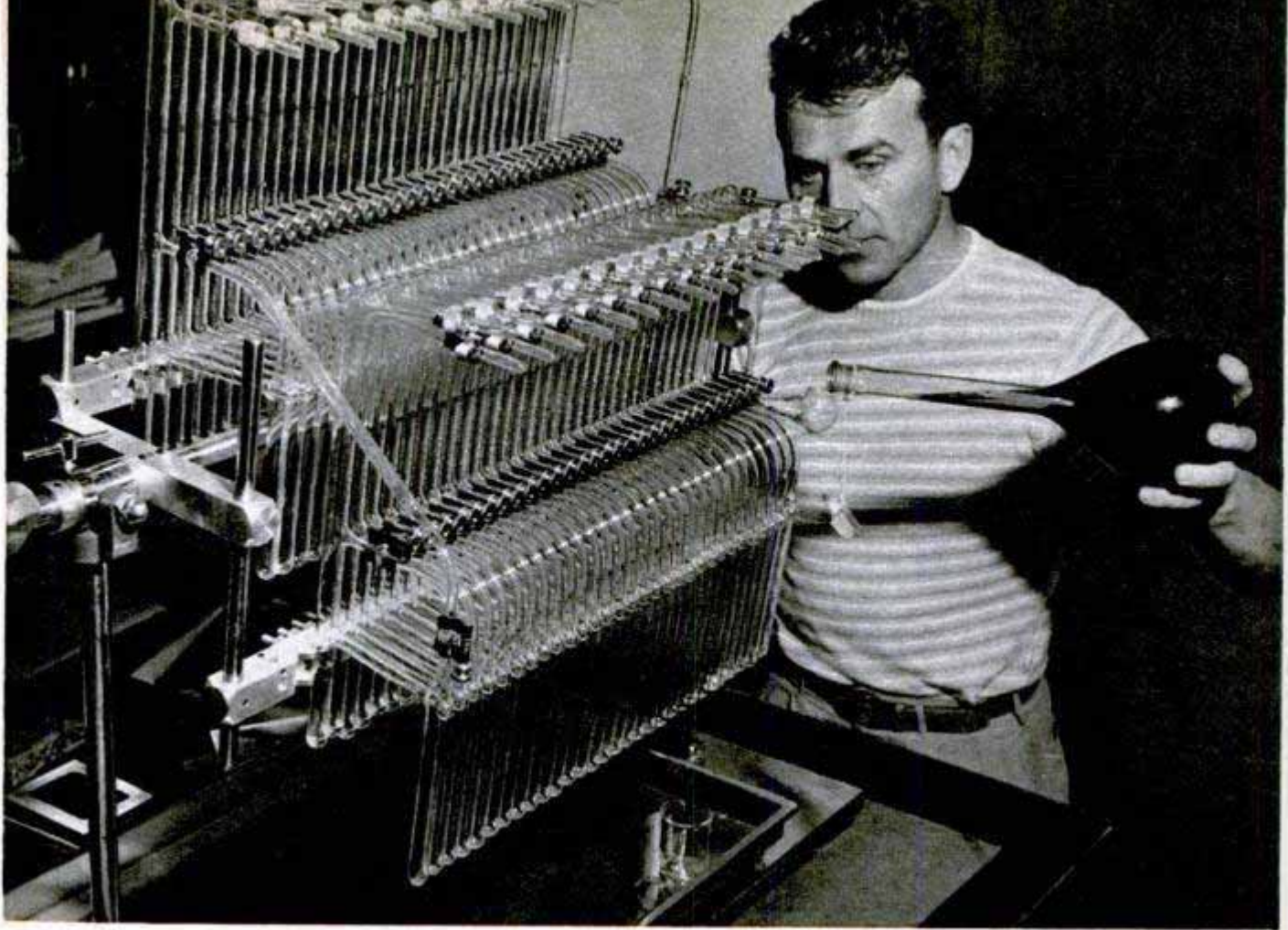

Solvents that separate all the substances in a liquid help in determining amount of phosphorus in a plant

Mite growth is stimulated by placing infested leaves below oranges, on which mites crawl and lay eggs

extent, too, plant diseases transmitted by these insects are automatically curtailed.

One of the most dramatic tests to which the systemics have been put occurred last year in Africa when thousands of acres of valuable cacao plants apparently were doomed by a virus transmitted by the mealy bug. A systemic insecticide wiped out the bugs and, in turn, conquered the virus epidemic.

With an ordinary insecticide sprayed or dusted on a plant, more insecticide must be applied the next week, and the week after. Only insects touched by the substance are killed.

A systemic, on the other hand, begins a 100-percent kill at once. It reaches everywhere. It poisons insects concealed under the folds of leaves or hidden in blossoms as well as those in plain sight. It is still lethal a month later. New shoots and leaves that appear long after the insecticide was applied are automatically protected. One dose often protects a plant during its entire growing season.

It seems to make little difference how the material is applied. The solution may be sprayed on the plant, added to the irrigation water or sprinkled on the ground so that it filters down to the roots. The Wisconsin pea seeds were simply moistened with insecticide before they were planted.

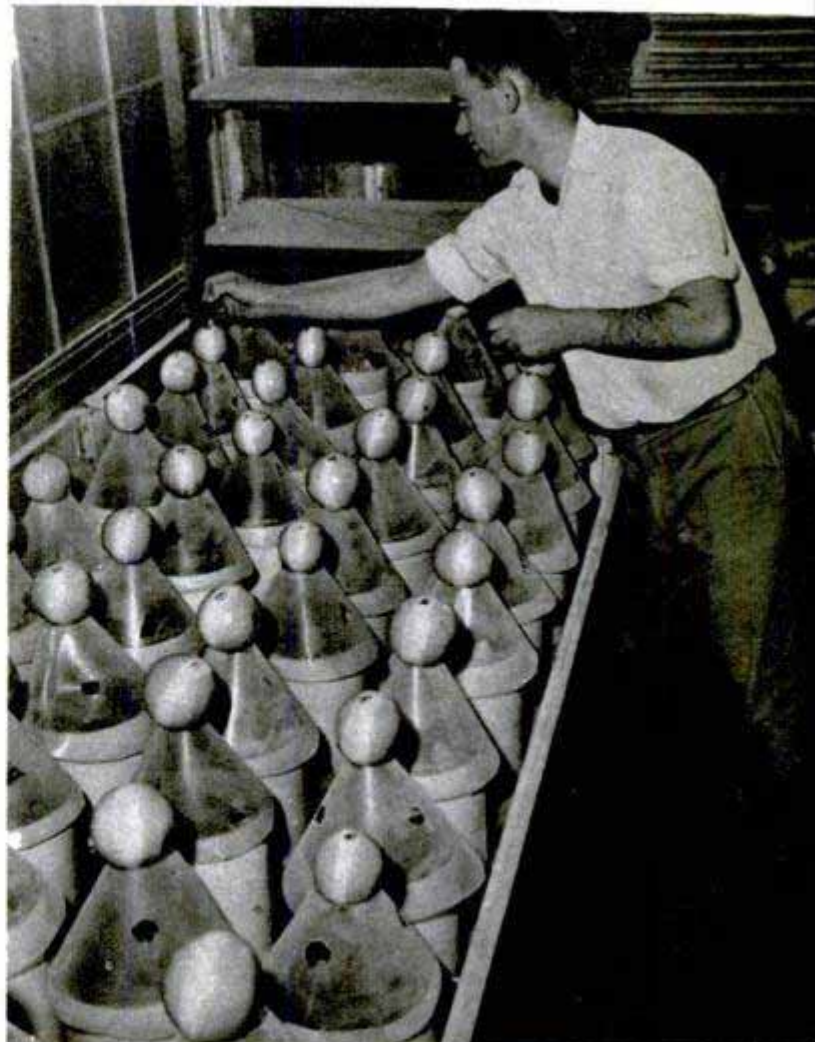



Entomologist at the University of California injects a systemic insecticide into the trunk of an orange tree, using bottled gas to force the fluid in under pressure

When added to a solution of chemical fertilizer and water, the material becomes part of a treatment in which plants are irrigated, fertilized and protected from pests in a single operation.

At Riverside, the material has been injected into tree trunks with good results, then the same killing effect was obtained merely by painting or spraying the solution on a section of bark. This is quick and cheap and probably will be the standard method of application for various types of fruit trees.

The new insecticides are organic phosphates. One is called OMPA, a handier title than its full name: octamethylpyrophosphoramidate. One of its commercial names is Pestox. A related compound, produced under the trade name of Systox, has an even more cumbersome chemical designation: 0, 0-diethyl-0-2 (etnylmercapto)-ethyl thiophosphate.

OMPA is solely a systemic, while Systox seems to be lethal both as a systemic and as a contact material. To date, OMPA has

been approved by the Department of Agriculture in aerosol form for control of aphids and mites on carnations, chrysanthemums and roses in greenhouses. Systox so far has been registered only as a soil drench for outdoor use on roses and chrysanthemums. Later this year systemics may be available to commercial growers of numerous other ornamental trees, shrubs and flowers. They may also become available for use on cotton against aphids and mites.

Possibly within a year or so, the systemics may be approved for use by commercial growers of edible field and truck crops and fruit. Right now the research people are double-checking to learn if the insecticides could have any ill effects on the consumers of those products.

This precaution is necessary because the phosphorus compounds are deadly poisons; in fact, the systemics are a direct outcome of German efforts during World War II to find a devastating nerve gas. The specific insecticides now being tested were compounded by Dr. Gerhard Schrader of West



Germany. All of them work by short-circuiting an insect's nervous system. Operators who apply the insecticides must take the same extreme care against breathing the fumes or coming in contact with the substances as are vitally necessary with other highly toxic insecticides.

For this reason the organic phosphates now in use probably never will become available to home gardeners. They are simply too dangerous. There's a good chance, however, that additional research will uncover other systemic insecticides less toxic to warm-blooded animals.

When properly used by trained operators, there are several reasons why the systemics appear to have a large future. They are generally applied in such dilute solutions that they are immediately toxic only to very small organisms. The plants slowly convert the insecticide into nontoxic phosphorus compounds. Crops that are sprayed or irrigated with a systemic early in the growing season apparently become completely nontoxic again by the time they are ready to be eaten.

To learn more about how a systemic insecticide circulates through a plant and how

long it remains effective, radioactive phosphorus-32 is being used as a tracer element by the entomological-research staff of the Riverside citrus-experiment station in studies under the direction of Dr. R. L. Metcalf. The work at Riverside is related to other studies on systemics being conducted at scores of other laboratories both here and abroad.

In a typical experiment the radioactive-insecticide solution is added to the water that irrigates the roots of a plant, then a Geiger tube traces its spread up the trunk, out the branches and into the leaves. The speed with which the sap stream picks up the radioactive phosphorus and circulates it through the plant structure can be determined exactly. The movement is principally upward. That is, a systemic placed in contact with the roots rapidly circulates up and out to the leaf tips, while very little goes down to the roots if it is applied only to the leaves.

Other tracer techniques that can measure one part in one billion are used to determine the amounts of active phosphorus that may remain in the edible portions of a plant at the time it would be used as food. Lengthy investigations in England have not revealed bad effects on experimental animals that were fed large quantities of apples, strawberries, shelled peas and infusions of hops from crops that had been treated with systemic insecticides. Similarly, feedings of Brussels sprouts and sugar beets that had been protected with systemics produced no pathological symptoms in experimental animals. The systemics already are in moderately wide commercial use in England.

There is a suggestion that the systemics produce larger, faster-growing plants in addition to killing insect enemies. Rose

(Continued to page 238)

Detector, left, measures radioactive phosphorus remaining in plants weeks after insecticide was applied. Hand-infesting a leaf protected by systemic insecticide, right, with mites to test toxicity of leaf on mites





Lockheed Aircraft Corp. photo

Tip Tanks for Turboprops Increase Planes' Range

Wing-tip tanks may stretch the range of fuel-hungry turboprop airliners. The jet and propeller combinations use about 50 percent more fuel than conventional engines. The big metallic teardrops, devised

by Lockheed for early jet fighters, are already in experimental use on two U. S. Navy Super Constellations. The 600-gallon tanks develop enough lift to offset their loaded weight.

Interchangeable Lenses For Slide Projector

Color photographers can show 35-millimeter and 2¼ by 2¼-inch transparencies on the same projector thanks to its interchangeable lens system. Two sets of condenser lenses are available and both are mounted in metal cages for easy handling. Also, there are two sizes of slide changers for the projector. The condensing-lens systems prevent hot spots and increase the brilliancy of the slides. Coated five and eight-inch projection lenses are available in addition to the standard six-inch size.

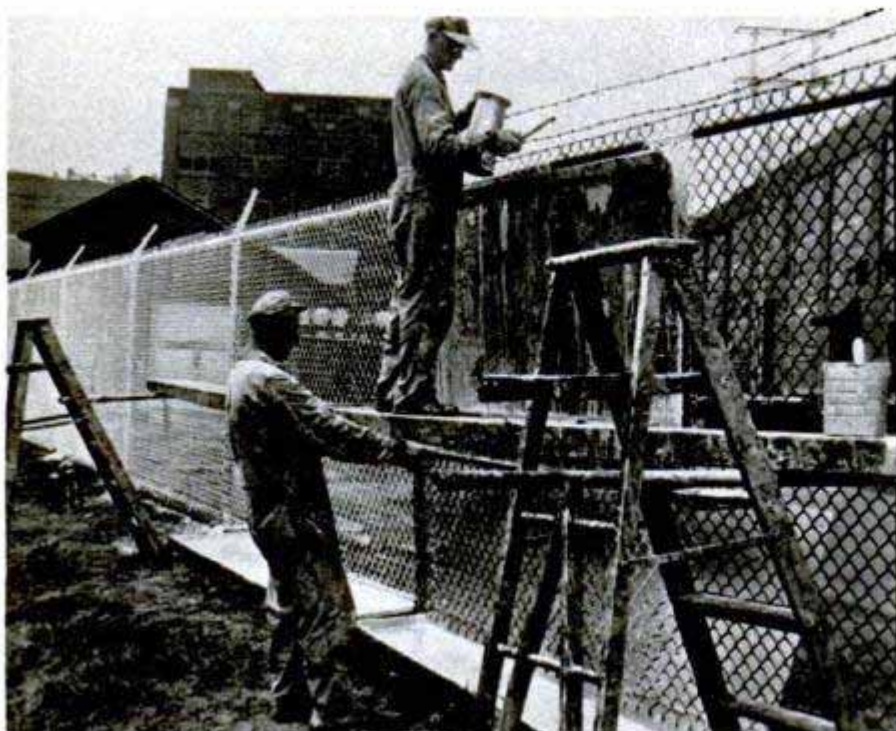

Pour Painting

Painters at the Aluminum Company of America's New Kensington Works pour, rather than brush or spray, aluminum paint on the company's wire fence. Five by five-foot panels fitted closely on each side of the fence guide the paint over the wire and troughs catch the excess. After pouring, one painter goes over the fence with a brush, touching up small portions of the posts that were not covered. The method is said to reduce the cost of maintaining such fences by 50 percent.

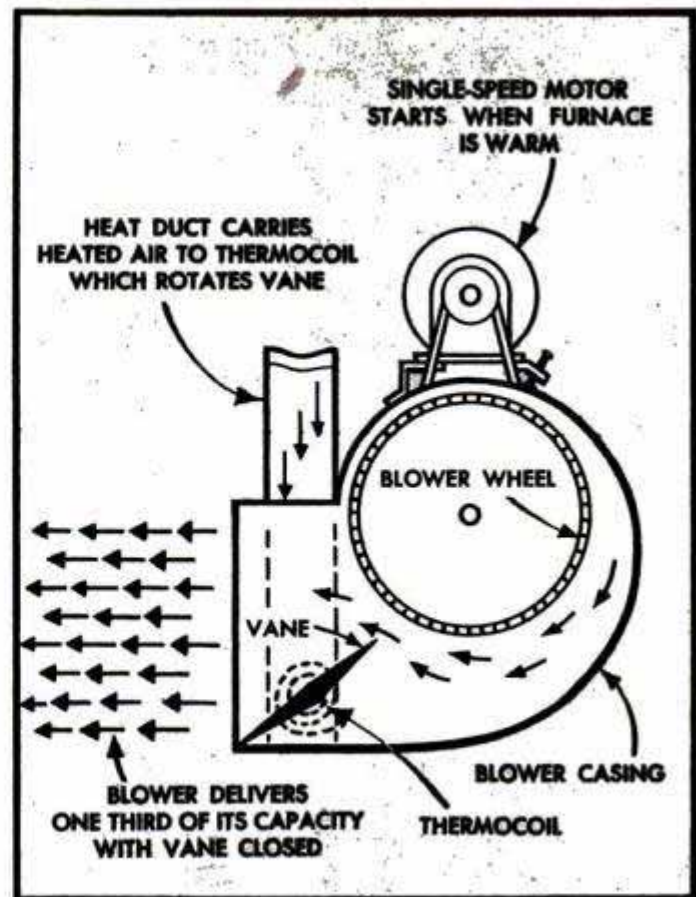
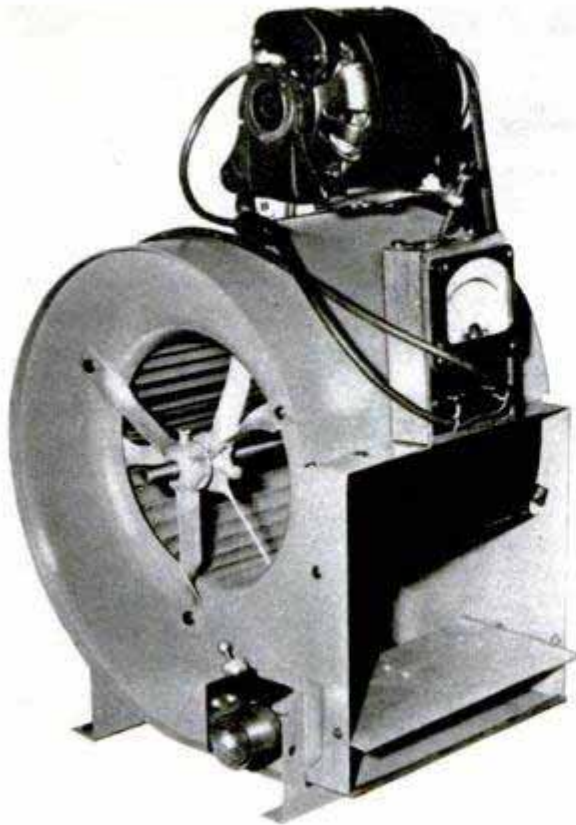

Furnace-Blower Regulator Eliminates Blast of Cold Air

With a furnace blower that has a single-speed motor and an adjustable vane, it is possible to obtain a gradual flow of warm air without the usual cold blast at the start of the heating cycle. The control mechanism, regulated by a thermocoil arrangement, opens gradually, delivering just the

right amount of air in coordination with the amount of heat in the furnace bonnet. Wide open for full flow at peak output, the vane reduces air volume as bonnet heat is reduced but only shuts off the blower when all warm air has been drawn from the bonnet.

Solvent Degums Automobile Carburetor in 20 Minutes

Gum and varnish which accumulate inside the carburetor are removed in a 20-minute operation that involves no disassembly except removing of the air cleaner and disconnecting the fuel line. The solvent used is mixed with gasoline and fed directly into the carburetor as fuel. The engine is operated for five or ten minutes at all

speeds from idle to full throttle with frequent pumping of the accelerator. This works the solvent into all critical areas of the carburetor, dissolving and flushing away gums, lacquer and varnish. After the treatment, the engine will idle more smoothly, start easier and respond more quickly, reports the solvent's manufacturer.

See-Saw Auto Lift

Raising either end of a car to a height of four feet, a German see-saw lift is simple and inexpensive. The car is driven onto two tracks, which can be adjusted to various widths, and locked in place at or near the balancing point. One man can then easily raise either end. The automobile lift has a maximum capacity of 1½ tons.



"KILLER" FRIGATES **of BRITAIN and CANADA** **HUNT FAST NEW SUBMARINES**



FAST BRITISH ANTISUBMARINE
FRIGATE DISCHARGING HER
"SQUID" BATTERY

STARBOARD TRIPLE-BARRELED "SQUIDS"

DUAL-PURPOSE GUNS

LIGHT ANTI-AIRCRAFT GUNS

TRIPLE-BARRELED "SQUIDS"

DEPTH-CHARGE DISCHARGER

WHIP ANTENNAS

DEPTH-CHARGE THROWER

21-INCH TORPEDO TUBES

BRITISH FAST ANTISUBMARINE FRIGATE
DISPLACEMENT: 1405 TONS
(FULL-LOAD DISPLACEMENT: 2500 TONS)
LENGTH: 358 FEET BEAM: 36 FEET
STEAM TURBINES SPEED: 34 KNOTS

BRTAIN AND CANADA are building a new fleet of "killer" frigates to meet the menace of fast submarines and deadly torpedoes that follow their quarry by means of "homing" devices. Production has been stimulated both in these countries and the United States by the existence of approximately 300 Soviet U-boats.

Designed for speed, seaworthiness and quantity production, the frigates have aluminum or light-alloy superstructures and upper works and possess extremely high sides and light armament.

British naval engineers originated the new design after converting several destroyers for the purpose. World War II frigates and corvettes, effective against

Axis U-boats, proved too slow for present use. Ordinary destroyers ride too low in the water to make them effective in all weather.

Among the latest antisubmarine equipment included in the new ships are "squids," triple-barreled mortars similar in action to the World War II "hedgehogs." Fired ahead of the ship, they can be trained accurately on targets spotted by listening devices and their projectiles will burst at any predetermined depth. They represent a marked advance over depth-charge throwers which fire "blind" into the area around the ship's stern and over hedgehogs which scatter the area of the target with missiles that explode only upon direct contact. ★ ★ ★

Below, three of the "killers" on patrol; ship in upper left has just located an enemy submarine and is discharging mortar-thrown "squid" projectiles upon the target. Many features of craft are secret

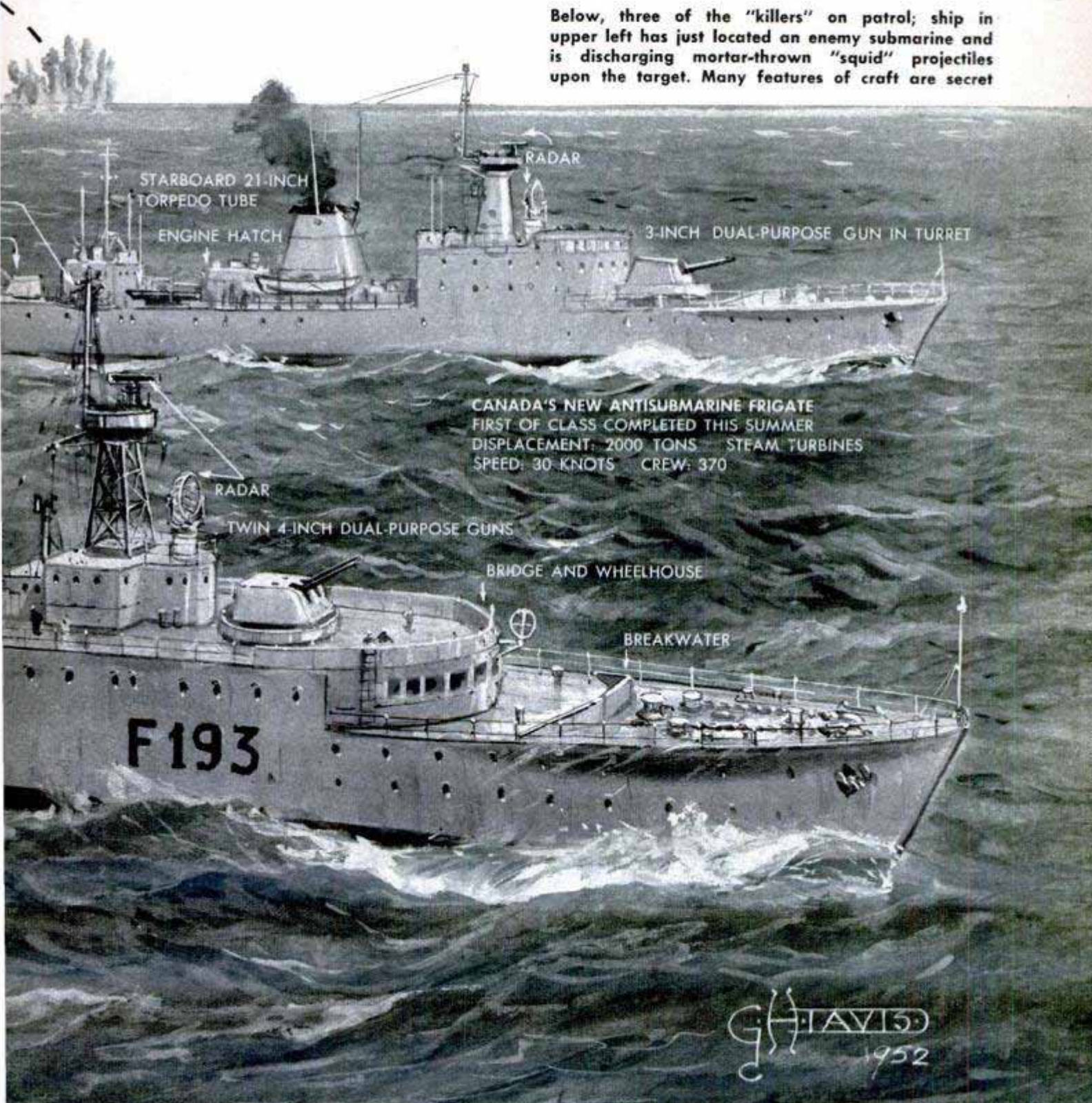

CANADA'S NEW ANTISUBMARINE FRIGATE
FIRST OF CLASS COMPLETED THIS SUMMER
DISPLACEMENT: 2000 TONS STEAM TURBINES
SPEED: 30 KNOTS CREW: 370



With spring cushions and colorful slip covers in place, the cardboard chairs are comfortable and handsome

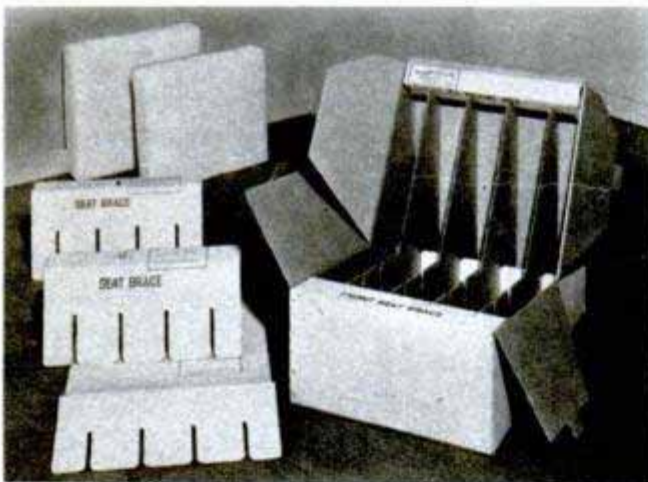

Here are the chair components. Assembly requires no tools. It comes apart easily for storing or moving

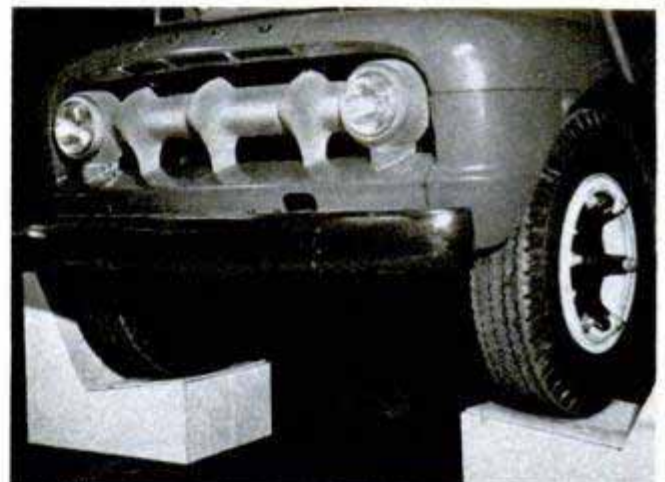

Each chair is supporting 2200 pounds without damage. Drops from a fourth-story window did no harm either

Cardboard Easy Chair Is Strong Enough to Support 2000 Pounds

Strong enough to support a ton, a corrugated-fiberboard easy chair can be assembled without tools and knocked down for storage or moving. The framework is simply a box like those in which much of the nation's freight is moved. Strength and rigidity are provided by four vertical dividers which run up to form the support for the backrest. Cross braces nest into

these dividers like the sections of an egg crate. Flaps fold over to form a completely enclosed unit with flat surfaces to which the spring cushion pads of the chair are fastened. Slip covers in a wide range of patterns are provided with the chairs. The chair comes in two models, one with arms and one without. The armless chairs can be placed side by side to form a sofa.

Wet Battery Shipped Without Liquid in Cells Has Added Useful Life

Added useful life is claimed for a storage battery that is manufactured, shipped and delivered to the consumer in a dry state. The battery is built with fully charged plates and will retain its full strength for years in the dry state. At the point of sale,

battery acid is poured into the cells and the useful life of the battery begins. None of its energy is wasted during transportation and storage on dealer's shelves. The battery is made possible by a new glass separator and a polyethylene acid container.

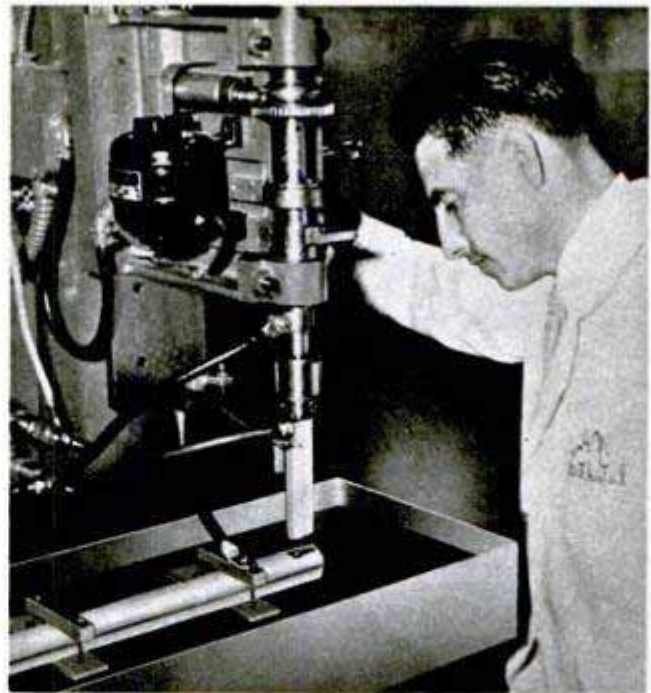
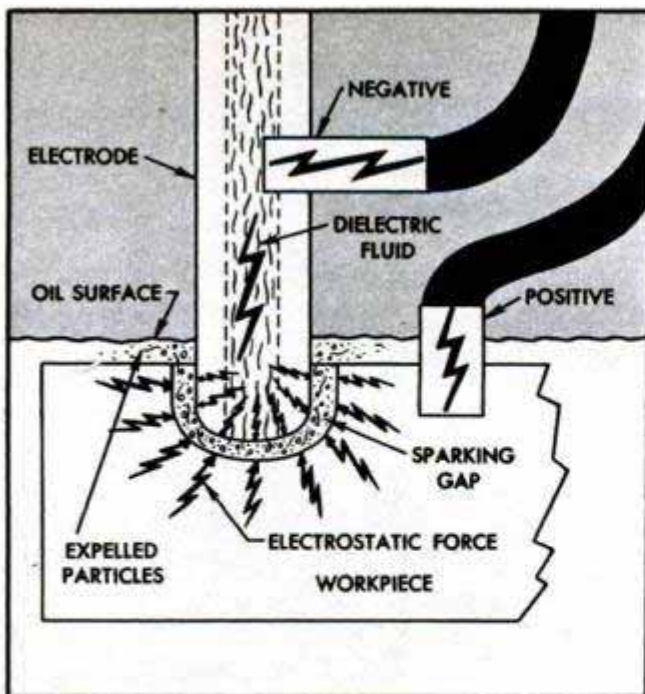

Diagram shows how the electrode, shaped to do the desired machine work, is moved down through the workpiece. The current causes metal particles to detach themselves. Right, tool is operated much like a drill press

"Method X"

Extremely hard metals such as sintered carbides can be machined accurately and easily through a system known as "Method X," which utilizes sparks as cutting tools. The cutting instrument is similar in appearance to a drill press. It can perform all metalwork operations including boring, drilling, tapping, external and internal shaping and engraving. The workpiece is clamped to a table which is submerged in a dielectric fluid such as fuel oil or kerosene. The shape of the desired machine work, such as a gear, determines the shape of the electrode, which is fastened in the

machine and brought down toward the workpiece. Electrodes are made of any highly conductive, easily machined material such as brass, and are shaped to a negative of the work to be produced. As the electrode is brought close to the workpiece, high-current densities cause metal particles to detach themselves from the work material and they are carried away by the fluid. Removal of the metal is a mechanical, not thermal, effect of the current. Particles are detached without melting, so intense heat does not change the exposed surfaces physically or chemically. Complicated shapes can be cut in the hardest metals by properly shaping the electrodes.

Meals Cooked and Served by Coin-Operated Vending Machine

Precooked and frozen in advance, complete meals will be heated and ready to serve in little more than a minute in the near future, forecasts a General Electric engineer. The heater, says T. P. Curtis, would be placed in drugstores, railroad sta-

tions and other places where it would dispense hot meals when the customer drops in coins. Inside the machine is an electronic tube known as a magnetron. It generates high-frequency waves which defrost and heat precooked meals in 70 seconds.

Simplified Computing Drum Figures Pay-Roll Deductions

Seconds are all the time it takes to figure old-age and withholding-tax deductions on any amount of pay with a simplified computer. The machine contains a drum on which various scales are printed. The operator rotates the drum to the proper pay scale and the deductions are read off in a quarter of the normal computing time, says the maker. Interchangeable drums are available for figuring weekly, biweekly, semimonthly or monthly pay periods.



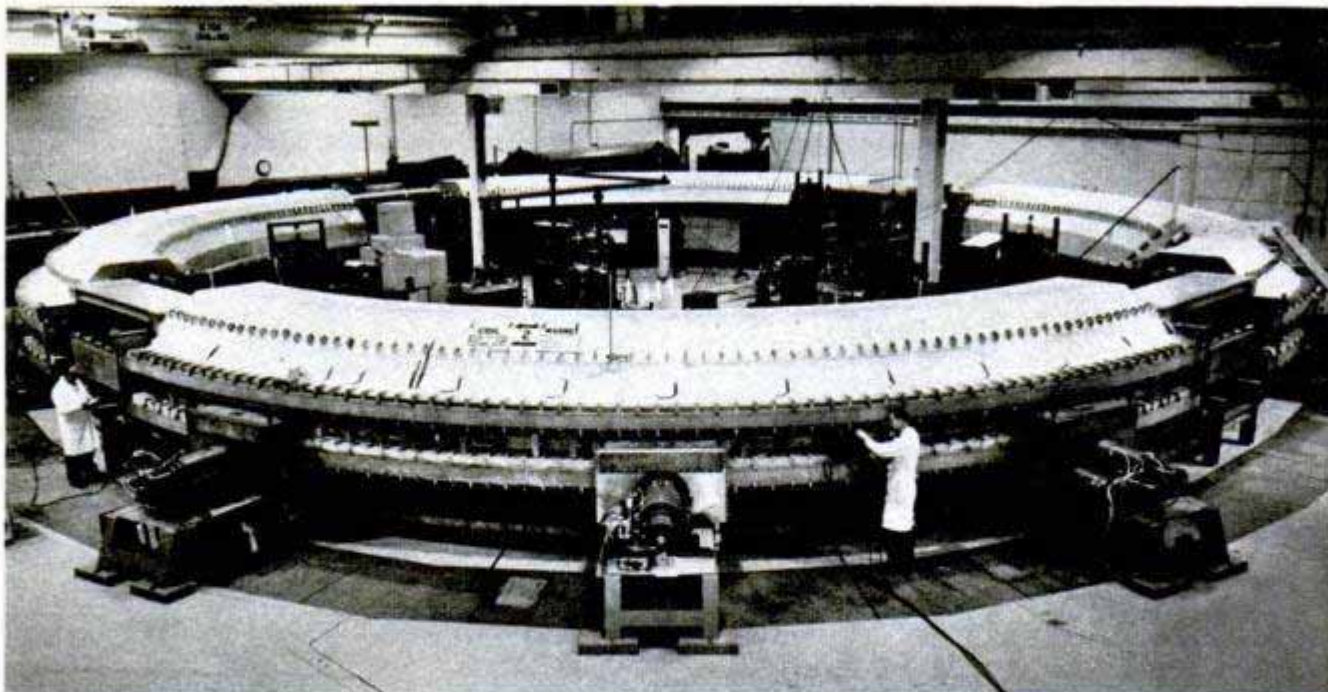

Brookhaven Cosmotron Has 60-Foot, 2200-Ton Magnet

Protons will speed around the 60-foot magnet of the Brookhaven cosmotron to an energy exceeding two billion electron volts before striking targets of copper or liquid hydrogen. Collisions at such energies are expected to produce mesons, the short-lived particles which appear in cos-

mic rays and seem to hold the key to nuclear forces. The ring-shaped magnet weighs 2200 tons and is powered by a generator which delivers a maximum of 40 million watts. During the acceleration, the atomic particles will make three million trips around the magnet.

Battery Acid Kept at Constant Level by Catalytic Caps

Containing a catalyst which converts escaping gases into water, a new set of automobile battery caps keeps acid at a safe level eight times longer than the conventional caps and also prevents corrosion. There is no installation problem. You merely screw on the oversize caps and throw away the originals. The catalyst also gives warning of overcharge. In normal operation, the caps are warm to the touch.

When they become hot (around 200 degrees) they indicate that the voltage indicator is not functioning properly. By capturing the corrosive sulphuric-acid fumes and washing them back into the battery, the caps prevent corrosion and also maintain a constant level of acidity in the battery. About 95 percent of the escaping water (in the form of hydrogen and oxygen) is retained by the palladium catalyst.

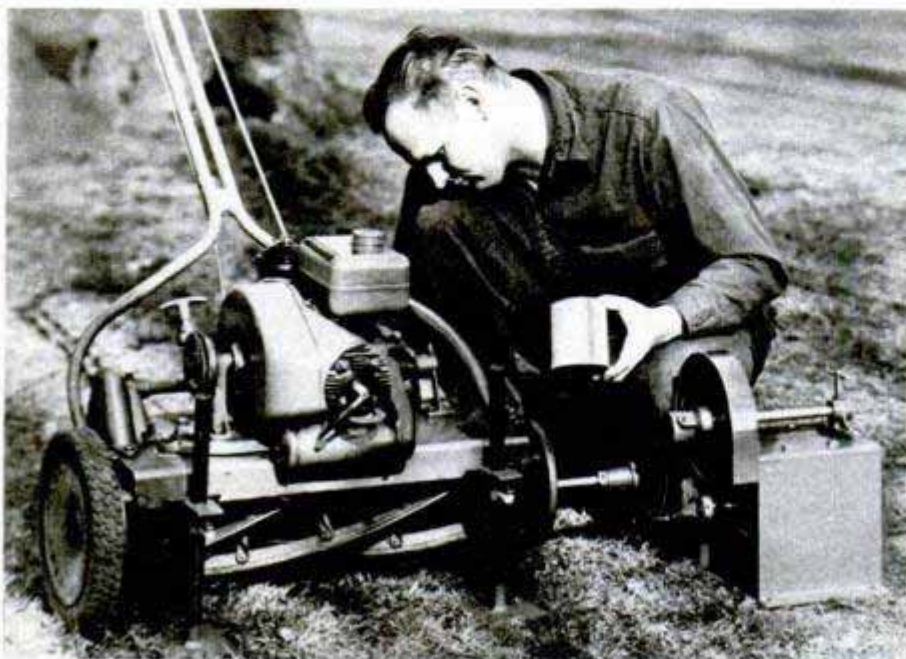

Lawn-Mower Lapper

Lawn mowers are quickly sharpened by a portable lapping machine which can be used anywhere within reach of an electrical outlet. The mower is supported on two jacks, its shaft connected to the machine through a coupler. The $\frac{1}{3}$ -horsepower motor turns the mower reel to sharpen the blades when a lapping compound is applied. A grinding wheel or wire brush may also be mounted on the motor shaft if desired.

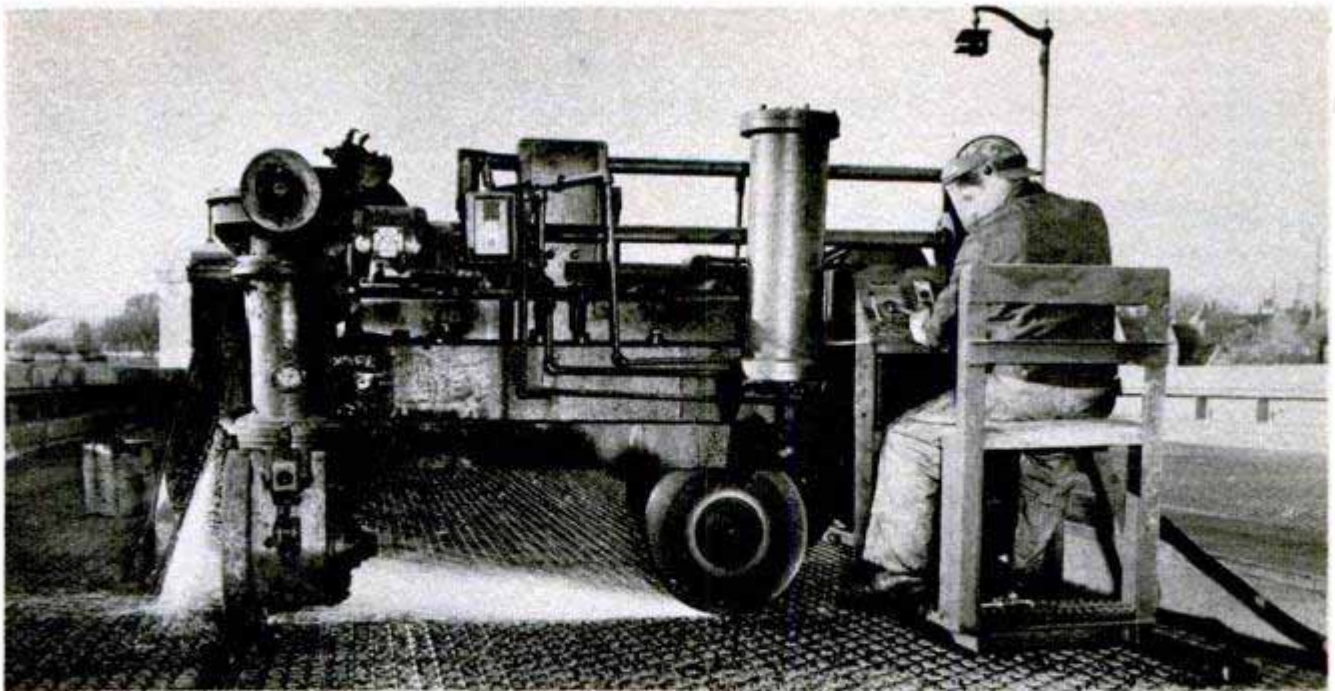

Sparks shoot out from beneath grinding wheels as the rail-mounted machine goes to work on a steel roadway

“MANICURIST” FOR STEEL ROADWAYS

STEEL-SURFACE roads, similar to portable landing strips used by the Air Force, are given a nonskid “manicure” job by a mobile grinding machine. Though “waffle iron” roads of steel have been in use for years, they have proved hazardous in wet and freezing weather because the surface is so smooth. In the past the metal grids were disassembled and shipped to the factory in sections, where they were milled to provide greater traction. The new machine does the job on the site, thereby saving the cost of disassembly and preventing the closing of important highways. The “mani-

curist” uses six 24-inch carbon-steel blades to grind nonskid grooves $\frac{1}{8}$ to $\frac{1}{4}$ inch deep in the steel surface. The machine travels along a pair of portable steel tracks, grinding grooves at the rate of 360 square feet of roadway per hour. About 14,000 square feet can be grooved before the blades have to be sharpened. The grooved surface provides a great deal more friction drag than the smooth steel. The grinding machine, believed to be the only one of its kind, cost \$30,000. Its three motors—one for the hydraulic pumps, one for the saws and another for the drive—operate on 440 volts.

Rough surface on machined grid at left offers much greater traction than smooth steel surface at right

Six carbon-steel blades can grind nonskid surface on roadway at a rate of 360 square feet per hour



You Name It!



Things are not what they seem. Take a look through the camera's eye and sometimes even the commonest objects appear strange and weird. . . . See how many you can identify, then check your list with the answers on page 226.

1

1. _____
2. _____
3. _____
4. _____
5. _____
6. _____
7. _____
8. _____
9. _____



2

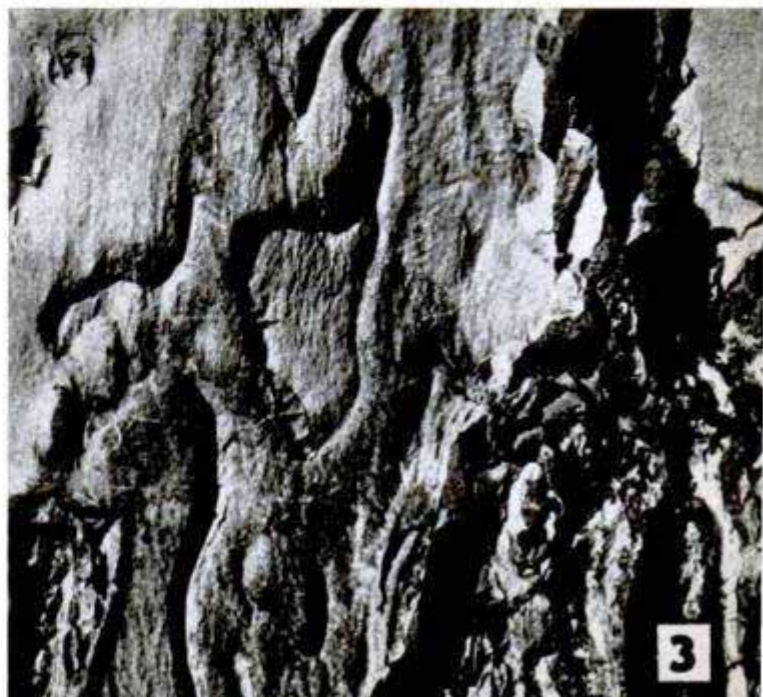

3

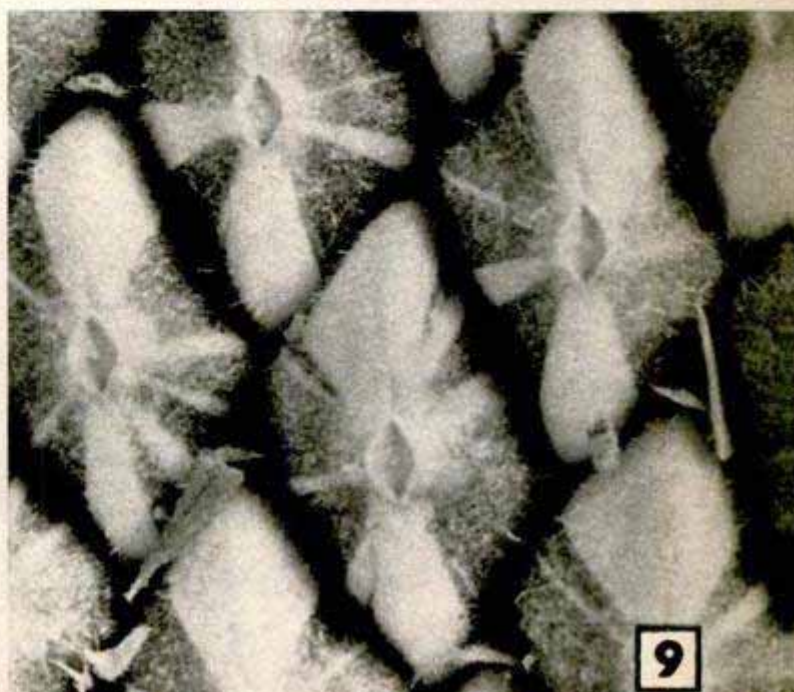
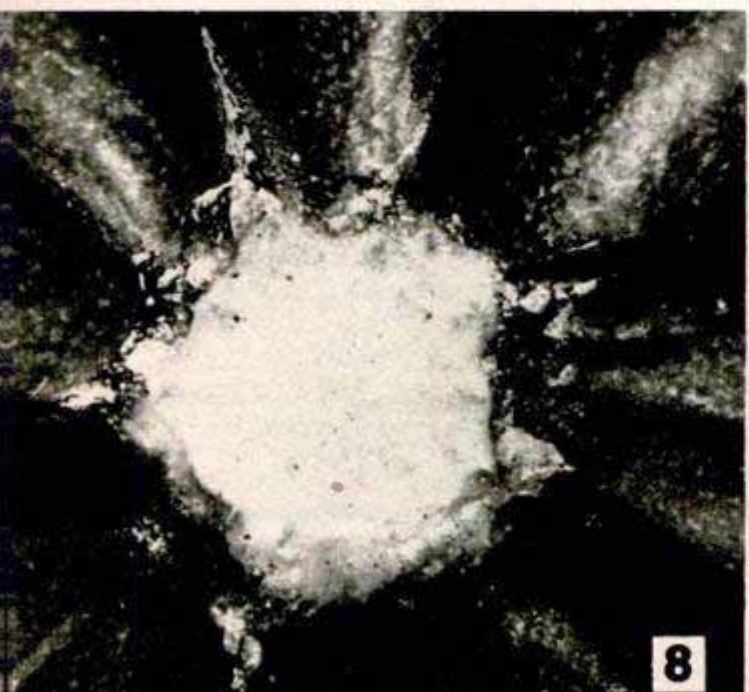
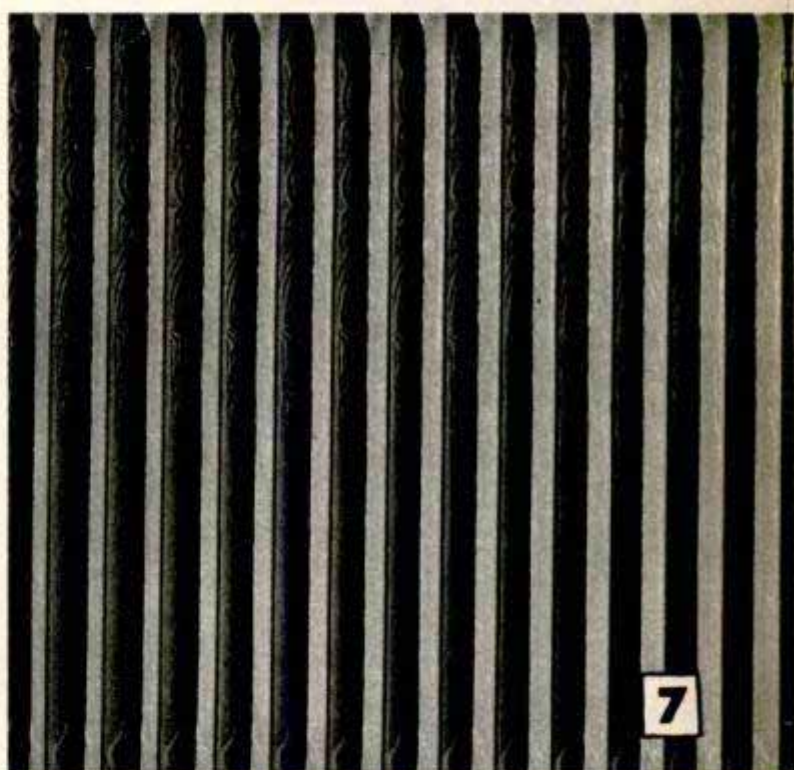
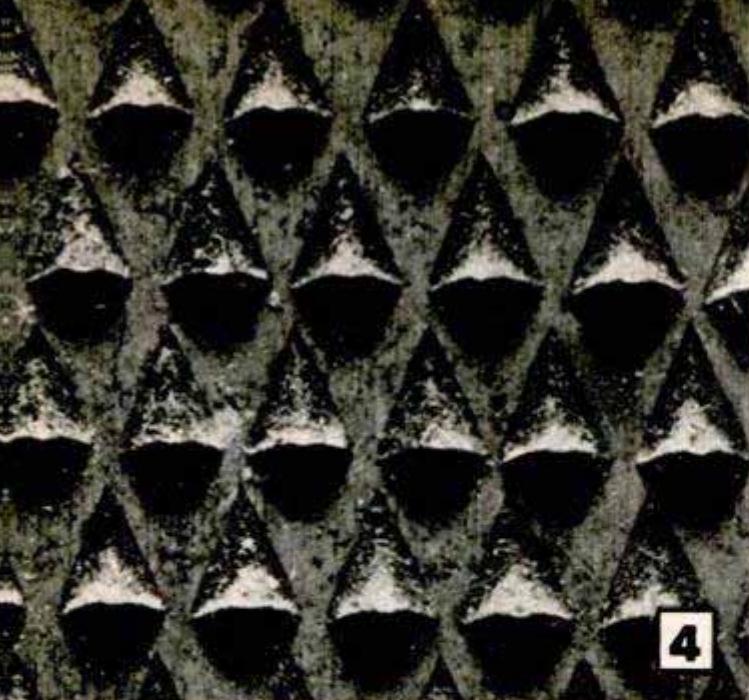



Child's Stereoscope

Children see their favorite nursery rhymes in three dimensions with a simple plastic stereoscope designed to withstand rough usage. Such stories as "Jack and the Beanstalk," "Cinderella" and others are told in a series of color prints drawn for stereoscopic vision. Ten different illustrated stories are provided with the viewer.

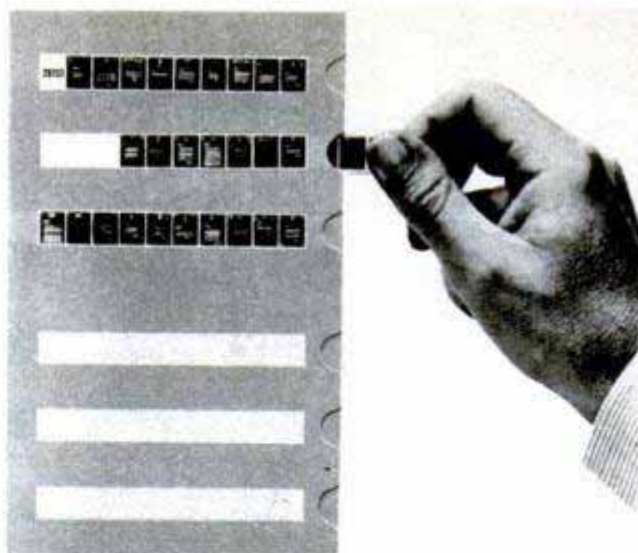

Microfilm File Card

Microfilm strips are filed safely in a slotted card that protects them during storage without interfering with their accessibility. The strips do not have to be removed from the card for viewing or copying. Indexing is done on the card. Inactive films are easily replaced. A 5 by 8-inch card will hold 65 microfilmed letters.

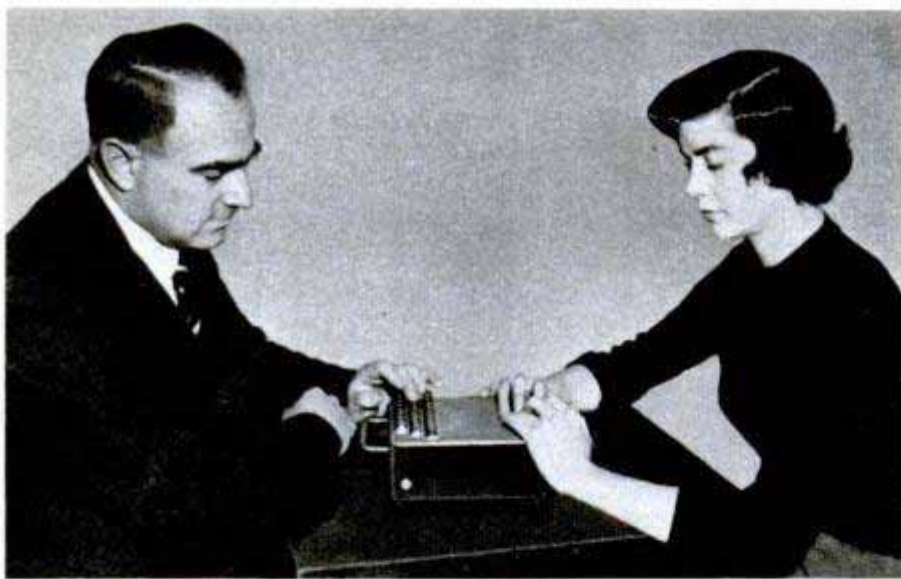

Deaf-Blind "Talker" Taps Fingertips

Through a new "conversation" instrument developed in England, those who are both deaf and blind can converse with each other or receive messages from anyone. There are two versions of the machine, each equipped with a typewriter keyboard which the speaker operates. The listener places fingers in six apertures and "receives" through Braille studs which tap the message on his fingertips. Any number of listeners can take part through repeater machines. A one-finger portable version small enough to fit into a handbag enables the carrier to converse with anyone who can operate the typewriter keyboard.



☞ Built to cool cockpits in high-speed aircraft, a new American device can change a searing blast of 600-degree air into snow within $\frac{1}{8}$ second.



Pretty puppeteer poses on stage of the world's most elaborate puppet theater to show comparative size of tiny "actors" and the 52-piece "orchestra" in pit

The \$500,000 Puppet Show

By Wayne Whittaker

MARVELS OF ELECTRONICS are combined with the ancient art of puppetry to give Chicago a truly unique puppet theater. The new miniature theater, which seats only 208 persons, is a medieval jewel box in red plush and gold with exquisite hand-painted murals and crystal chandeliers. Although the theater building is a separate unit, it adjoins and is operated in conjunction with a Swedish restaurant on Chicago's near north side.

Here full operas are given with recorded music and a retinue of more than 1700 specially built puppets—all on the grand scale of the New York Metropolitan or Paris opera houses. The puppets include a full 52-piece "orchestra" which occupies a pit in front of the 20-by-30-foot stage. When the lights dim, the orchestra pit is raised to stage level. A diminutive conductor,

Fredrik A. Chramer, owner of the puppet theater, directs operas from the complicated control booth

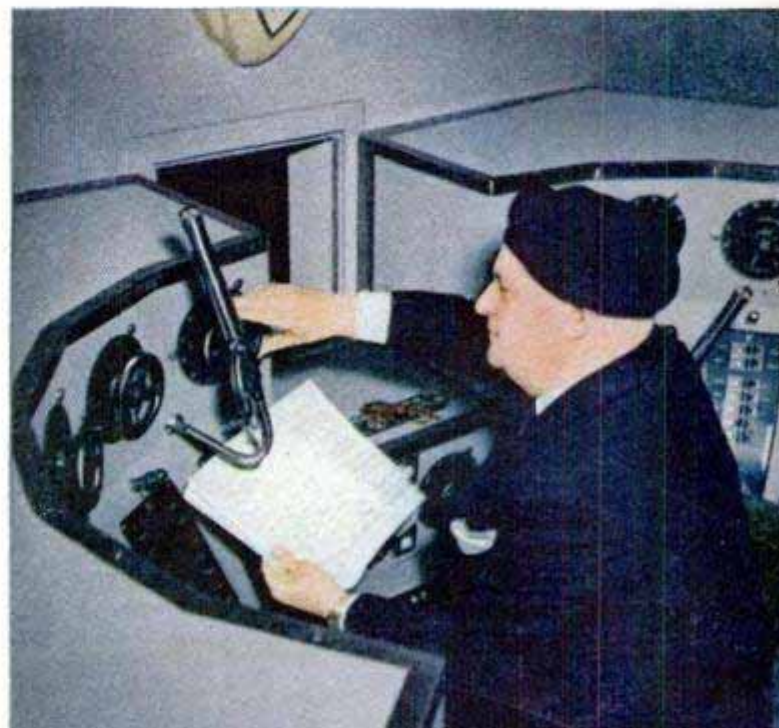



Nadine Kangas, a puppeteer, displays the full cast of puppets which will be used in the opera *Rigoletto*

fondly nicknamed "Tosci" by the puppeteers, walks out, takes a bow, turns to his orchestra and lifts his baton. He leads the group in perfect tempo, and natural movements give an almost perfect illusion. The orchestra's movements are controlled backstage by a single lever, but Tosci is operated from below the stage by one of the eight puppeteers. It takes 15 persons behind the scenes to put on an opera, including stage directors, scenery and wardrobe personnel, and one or two persons in the control booth located above the miniature balcony.

This control booth with its semicircular instrument panel, sound equipment, microphones, switches, dials and flashing lights resembles nothing more than the cockpit of a B-29 bomber. The "pilot" occupies a seat before a window that gives him a perfect view of the stage. He is almost encircled by the control board. From here he controls all sound reproduction and the elaborate lighting equipment, which consists of footlights with 620 small bulbs, proscenium border lights with 1240 bulbs, flood border lights with 112 bulbs, 20 miniature spotlights with 100-watt bulbs and two 20-foot-long cyclorama blue lights with 75-watt bulbs.

The director is in constant touch by wireless intercom with the puppeteers, who

Cutaway painting of the theater shows puppeteers at work beneath slotted stage during *Madame Butterfly* performance. Below are workrooms and storage space

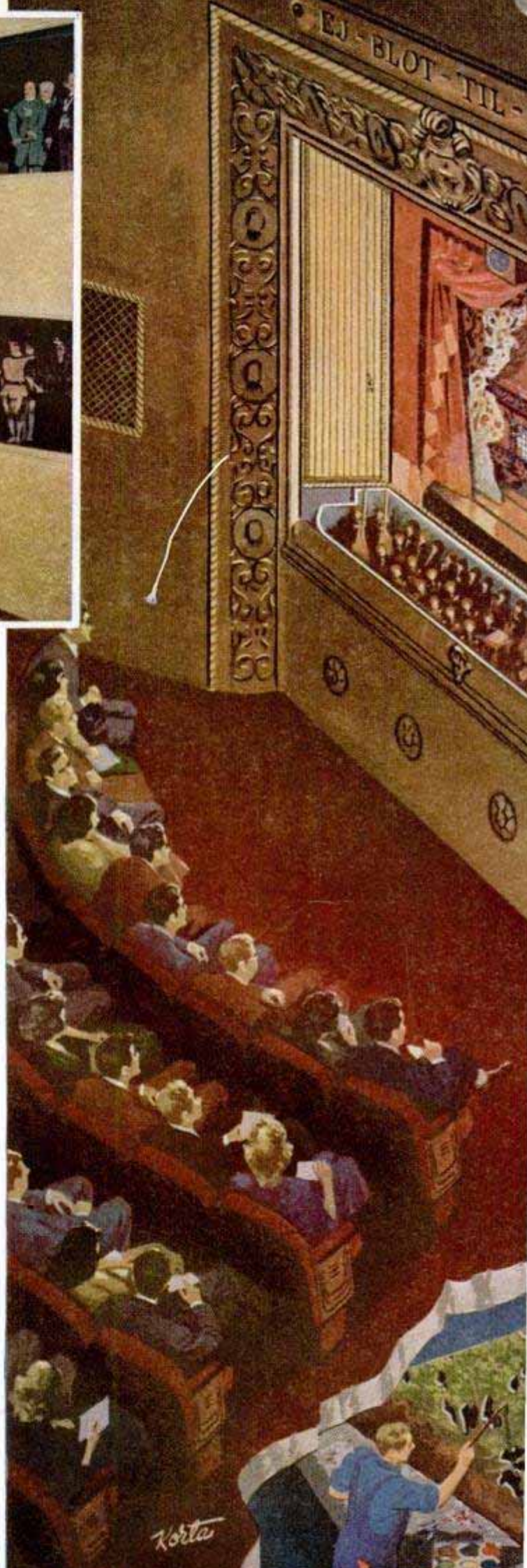



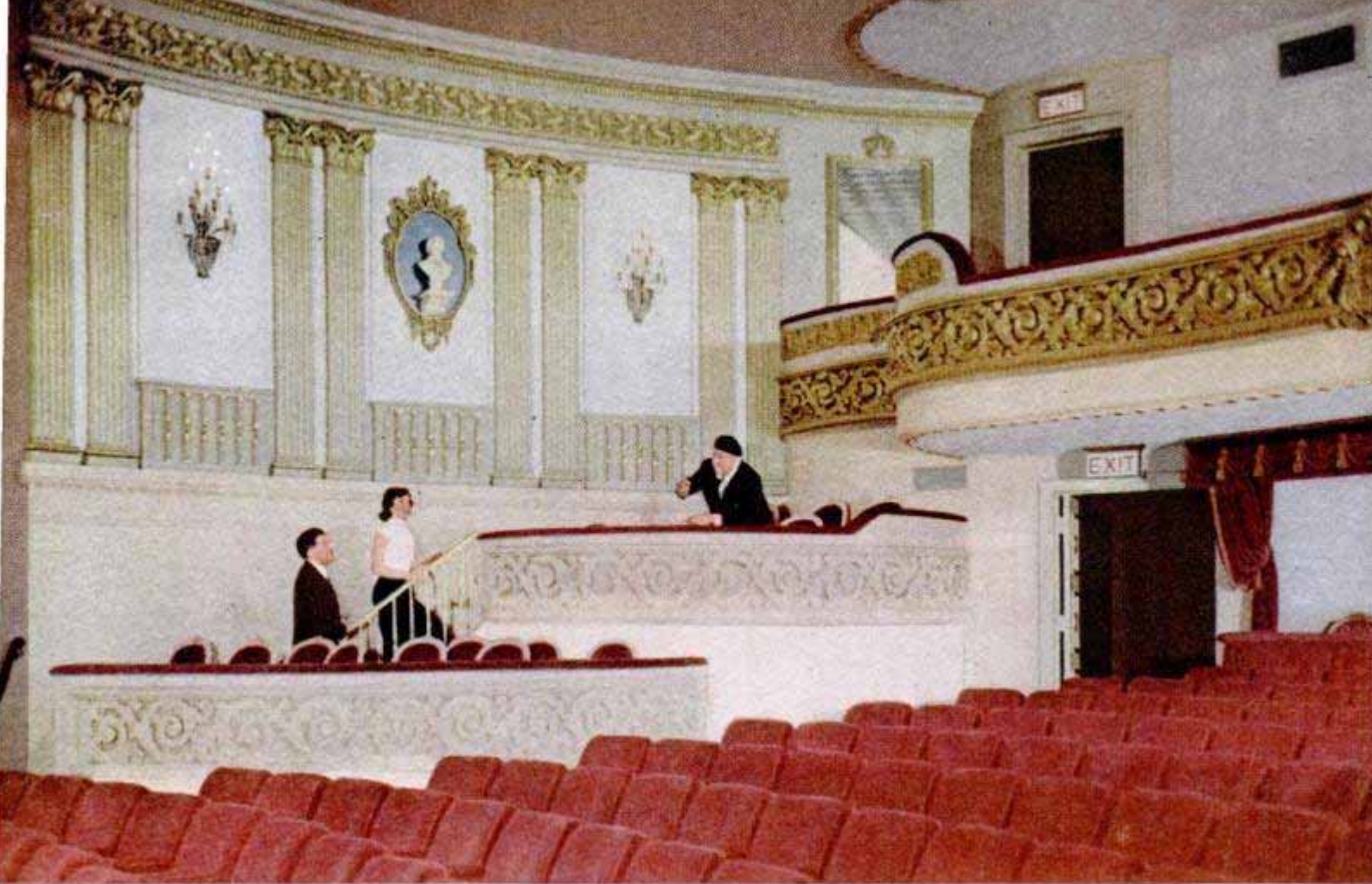

Jewel-box interior of the puppet theater, which seats 208 persons, is like a miniature grand-opera house

must work in cramped space under the stage. The opera puppets are not like marionettes, which are operated by strings from above. They are rigid puppets supported from below by rods and controlled by wires with rings on the ends which fit the puppeteers' fingers. The stage floor has

Johannes Foerster studies each puppet after performance and dabs make-up paint where it's needed

row after row of horizontal slots along which the puppets move and a bisecting center slot enabling them to move from one row to another and to the front or rear of the stage.

The puppeteers sit on low stools equipped with rollers which enable them to scoot

To pick up their cues, puppeteers working below the stage wear headphones which are plugged into stools



silently about beneath the slotted floor. Occasionally there may be a collision at the height of some complicated operatic scene, but usually all runs smoothly after weeks of rehearsal. The stools are specially equipped to pick up impulses from wires built into the floor. All operators wear headphones plugged into the stools and the transmission of their cues from the control booth is similar to the operation of a walkie-talkie radio. Microphones are located under the stage so the puppeteers can talk back to the booth. Their voices come into the booth through a loudspeaker.

During a recent evening performance, a puppeteer's headphones snagged a wire connected to a bouquet which was being carried carefully by a puppet on the stage. The bouquet whisked through a slot in the floor in a jiffy. After a moment of subdued hilarity among the puppeteers, the bouquet obligingly rose through the floor and back into the hands of Suzuki, the maid of Madame Butterfly.

The headphones of the puppeteers pick up the opera music and singing along with the director's cues. Eventually all 17 operas will be recorded on a four-track tape so they can be fed simultaneously into the electronic control board, which will transmit only the music and singing to the theater auditorium; the music and singing plus cues into the headphones of the puppeteers; and the music and lighting directions for all scenes to the director in the booth.

One of the greatest tributes guests pay to the little opera occurs after a performance when they ask if the puppets are three or four feet high. Actually they are only 13 inches high but everything in the stage settings is in such perfect proportion that the puppets seem much larger. A great deal of the scenery, which is all built in the theater's own workshop backstage, is patterned after that of the Metropolitan Opera. The theater now owns 340 pieces of scenery for settings, which include street scenes, gardens, palaces, Japanese pagodas, bridges, forests, mountains and churches. Elaborate backdrops and other stage effects are lowered from a fly loft three stories high. The rigging ropes and weights could support the heavy settings of a normal-size theater, according to Fredrik A. Chrumer, the owner.

In many scenes where the action is simple and the lighting subdued, this miniature opera creates a complete illusion of reality—a triumph of electronics and hard work.

★ ★ ★

¶ Emphasizing the growing complexity of aircraft, more than three million hours of engineering time were required to design the latest U. S. Air Force bomber.

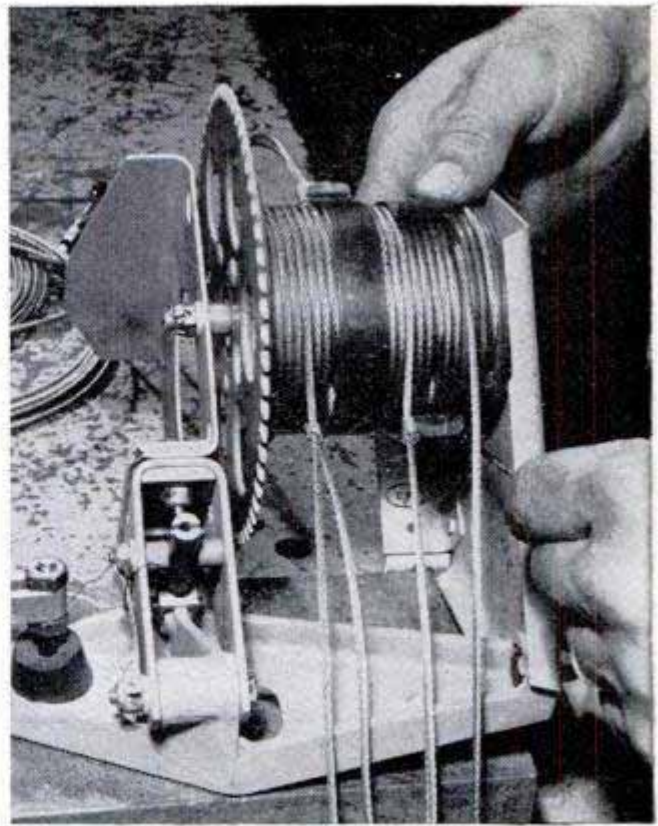

Steel Clips Save Labor

Spring-steel clips and a holding fixture are being used in a Texas aircraft plant to halve labor costs in wrapping cables on drum assemblies. Formerly, one man held the cables in place on the drum while the other performed the actual wrapping operation. The new process uses one worker, who pushes the steel clips over the drums after each cable is wound in place. He is then free to wrap additional cables on the assembly.

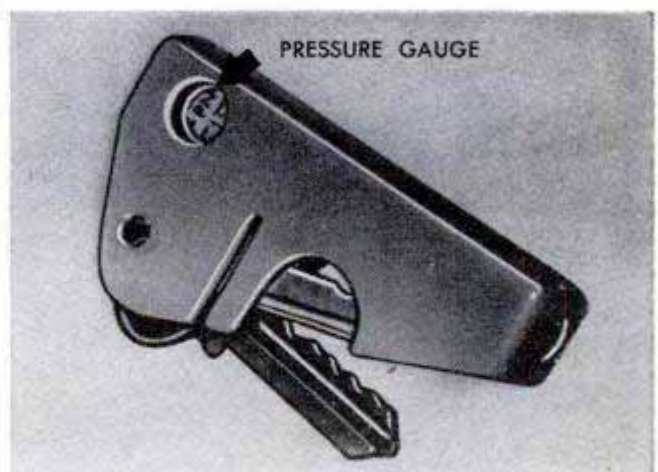

Key-Case Tire Gauge

With car keys in a neat plastic case that also includes an accurate tire gauge, motorists are constantly reminded to keep a close check on the pressure of their tires. Three keys fold into the smooth-surfaced case, which will not snag pocket or handbag linings.



While the action goes on, theatergoers blocks away watch this scene in brilliant color on a giant TV screen

TV BRINGS **COLOR** TO MOVIE THEATERS

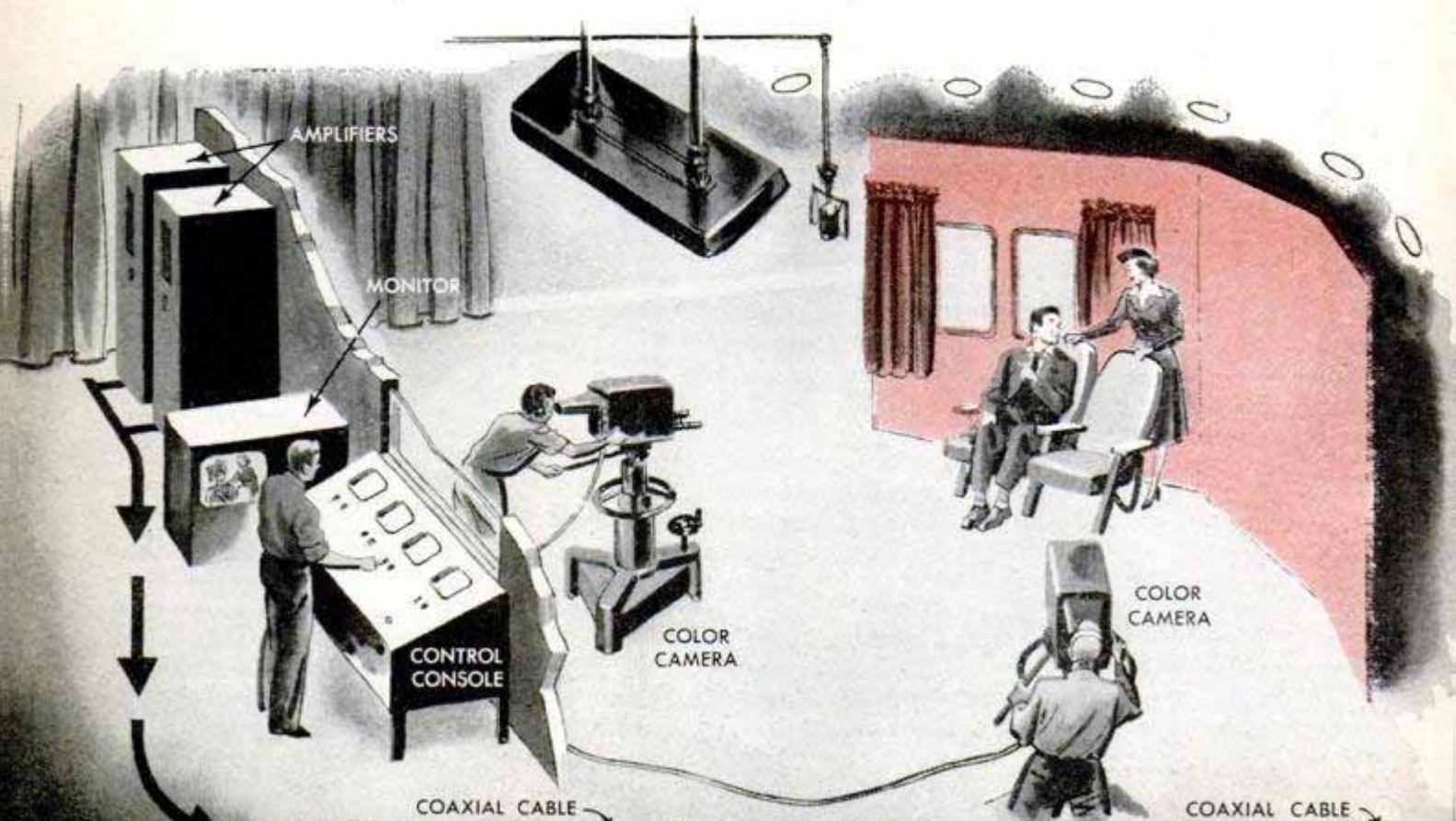

COLORFUL DANCERS drifted across the big movie screen in the plush New York preview theater of Twentieth Century-Fox a few weeks ago. It looked like standard Technicolor, only brighter. Gaily costumed girls whirled through a grand spectacle of flashing color. Then came the surprise from an announcer in the theater:

"What you are witnessing is not a film, but a live show being performed, as you watch it, in our studios six blocks from this building!"

The trick is Eidophor — a revolutionary big-screen system of color television which soon may bring to your neighborhood theater Broadway shows in actual progress, singers and comedians as they perform 1000 miles away in a night club, scenes from concerts, operas, circuses, water carnivals, and sports events while they're happening.

Until now, the stumbling block in large-screen TV has been light. On your home receiver, you get a picture as the electron beam zips over the phosphor coating inside the face of the tube, making it glow. But projected to the size of a movie screen, that

picture would be only about as brilliant as midnight.

Secret of Eidophor (coined from Greek words meaning "image bearer") lies in the big projector, which looks like a standard commercial movie projector, with a carbon arc lamp to supply a dazzling light source. It is also a big color-TV receiving set. Its cathode gun, triggered by the telecast impulses, shoots an electron beam on a revolving, bowl-shaped mirror. The mirror is coated with a thick Eidophor fluid about the consistency of honey. The electron-picture impulses hit this surface and make tiny dents in it as the beam flashes along, scanning a little rectangular patch of 525 lines every 150th of a second. Though you could never see it with your eye, the beam has "carved" a relief image of the TV picture on that fluid. If you could see a cross section of the fluid under a microscope, it would look like a mountain range.

Light from the carbon arc above the bowl passes through a slotted mirror set at a 45-degree angle in front of it. Half the light hits the mirrored bars and bounces down



Drawing on these two pages illustrates the color system of theater television. At present, telecasts are transmitted only a few blocks via a coaxial cable, but later the signals will be relayed all over the nation. The heart of the system is the projector shown in the foreground, below. Left, this black-and-white picture was taken during a showing of color television. The scene was in full color and filled a movie screen 14 feet high and 20 feet wide

COLOR TV
THEATER PROJECTOR

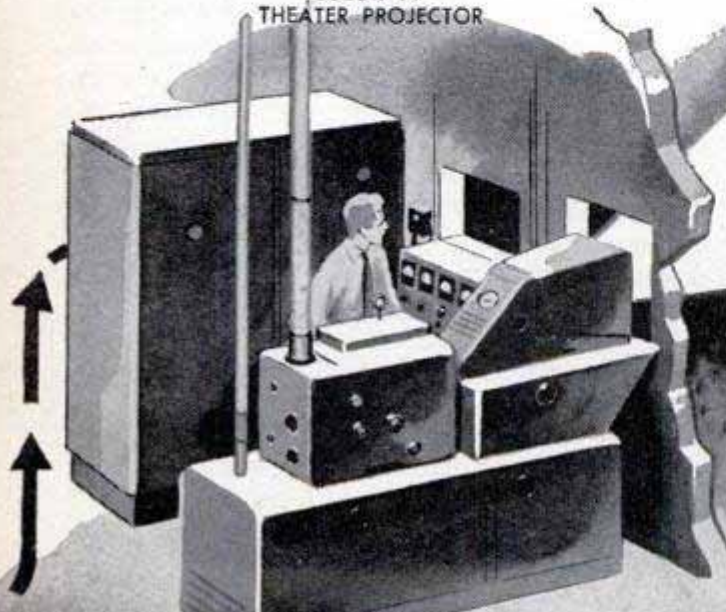

Picture signal comes in at right (see arrow) and "carves" image on concave mirror. Light from carbon arc bounces off this image and up through slotted mirror, projection lens and out to the screen. Color is added to picture by a spinning wheel. When blue portion of picture is received from camera, light from arc light passes through the blue segment of wheel, adding blue to image

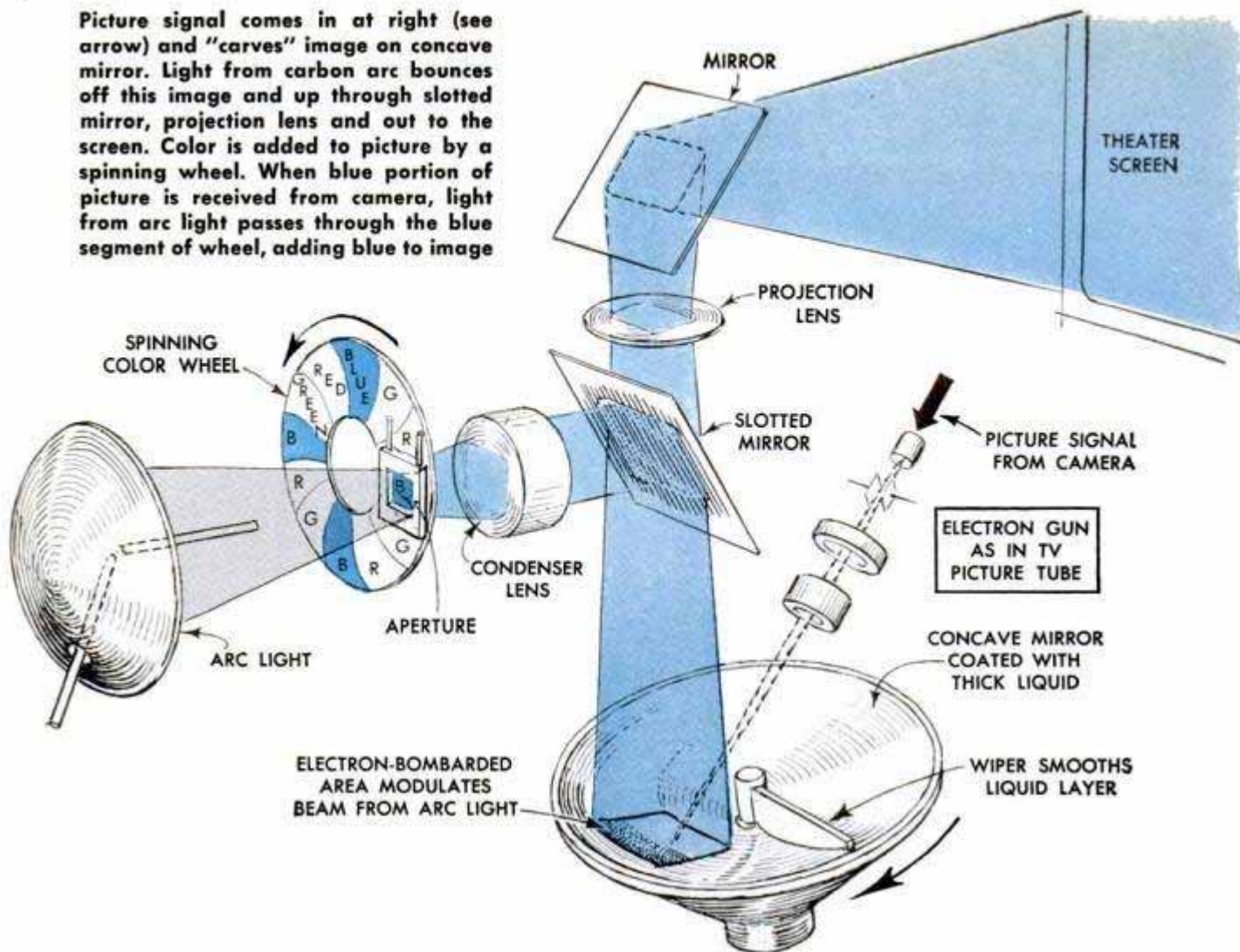

onto the image on the bowl. If there is no picture on the fluid, those light rays bounce right back up to the mirrored bars and back to the lamp housing. But when a picture is on the fluid, the microscopic dents deflect the light rays in varying degrees, so that they bounce up through the slots in the mirror, pass through a series of mirrors and lenses and out onto the big screen.

The tiny irregularities in the fluid will reflect more light or less, depending on how deep and steep they have been carved by the electron beam. Thus, the light and shadow of the picture are reproduced by the strong light beam bouncing off the bumps.

Concave mirror is polished before being installed in projector. In use, it is coated with a thick fluid

As the mirrored bowl containing the image revolves, its surface passes under a stationary blade that wipes the Eidophor fluid and evens its thickness.

To get color, engineers adapted the CBS sequential system of color TV.

Whirling color wheels in the TV camera and in front of the projector's carbon arc lamp are synchronized. When the camera picks up a red impulse through the red segment of its wheel, the cathode gun shoots a "red" impulse to etch a depression on the Eidophor fluid. Meantime, the carbon-arc lamp is shining through the red panel in its wheel. Hence red light will be reflected to the screen from that tiny bump in the Eidophor fluid. So, in microsecond sequence, each color speck flashes on to the screen just the way the camera records it in the studio. So fast do the flecks of color flash onto the big screen, and so fast does the electron beam scan the picture field (one complete picture each 150th of a second) that the human eye sees only a smooth flowing picture in full color.

Current plans call for launching Eidophor this year or next with a show something like the live shows at Radio City Music Hall and the "Roxy" today. It will go out to theater chains on the microwave or coaxial circuit three or four times a day. ★ ★ ★





Detroit Listening Post

By Siler Freeman

THE AMAZING sales appeal of the automatic transmission has not blinded the auto industry to its inherent imperfections. There is no company with an automatic transmission on the market which is not seeking better performance from it through design changes and improvements. Those who have not yet come out with such a transmission are still weighing the merits of the two principal types, the planetary and the torque converter.

Of all the larger companies, Chrysler perhaps has been the most reluctant to go into fully automatic transmission. It has various types which can be called only semi-automatic and has made a thorough study of one real automatic type which is not yet in production.

Which way it will go is indicated by a recent announcement that it has a new high-performance torque converter for the six-cylinder Windsor. The feature of this transmission—and it may be an important one—is that the new device combines the torque-converter oil system with the engine oil system.

The transmission carries the same name—Fluid Torque Drive—as the one used on the larger Chrysler models in conjunction with the V-8 180-horsepower engine. Chrysler officials claim that it has “high breakaway torque multiplication characteristics”; that is, it starts off fast.

Integrating the two oil systems is said to provide longer life to the engine oil. The company says that only two oil changes a year are needed in average operation.

Combining the two oil systems also eliminates the torque-converter oil pump and sump. The converter’s oil is air-cooled by blades in the outside of the converter shell and by drawing large quantities of air over the shell, the blades eliminate the need for separate oil coolers.

General Motors, which actually pioneered automatic transmissions, is not yet entirely satisfied with its three candidates. Particularly Buick’s Dynaflo and Chevrolet’s Powerglide have been neither as economical nor efficient as the company would like. Hydra-Matic is still the leader,

is being used in the other three General Motors cars and has greater acceptance.

Neither Buick nor Chevrolet will admit any shortcomings of their particular transmissions. Although Buick is attempting to keep it secret, it is known that the company will make an important change in Dynaflo in the next models. It is reported the Buick version will come much closer to Hydra-Matic and may combine the torque converter with a three-speed gearbox.

Chevrolet has been experimenting with something closer to the Ford automatic transmission which was engineered by Borg-Warner. In fact, the latter’s engineers worked out a new design for Chevrolet which was later rejected. But some of those features will be adapted to Powerglide.

There has been another persistent report that the Detroit Transmission Division of G.M. has been working on a smaller unit of Hydra-Matic, presumably for use in the new Chevrolet.

Cadillac also has been experimenting with an automatic transmission of its own. (G.M. is planning an optional air-conditioning unit on the 1953 Cadillac and Oldsmobile models.)

Just as development continues on transmissions, so does it progress on engines. Higher-octane fuels are predicted, so work is going ahead on higher compressions. Right now, the question is how many more car makers will have high-compression V-8s in their 1953 models. Mercury, which was believed a certainty in this field, isn’t so sure now.

Chevrolet is the enigma. It has a high-compression V-8 in the works and may have a pilot model out soon. But no tooling has been ordered. It appears impossible even for versatile Ed Cole, new chief engineer, to work around this obstacle in time for ’53.

Only Buick and Dodge appear on schedule with the new engines. Pontiac is holding off another year and so is Packard.

One thing is certain about the 1953 models—they will be easily distinguishable from their predecessors outside, if not under the hoods. ★ ★ ★

The OWNERS

Clymer points to the horizontal carburetor on the left side of the Nash Ambassador engine



MECHANICS MOTOR SURVEY BY FLOYD CLYMER

Ambassador
 Transmission Overdrive Hydra-Matic Drive
 15. Speedometer mileage is now 5428.
 operates satisfactorily using:
 gasoline
 m. p. g. for city driving, 17 miles per gal.
 m. p. g. for country driving, 21 miles per gal.

5. I CHANGE OIL every _____ miles (and never add oil between changes).
 I change oil every 3000 miles, but also ADD one quart every 1800 miles.

6. Roadability and handling qualities are: Excellent Good Unsatisfactory
 7. Maneuverability in traffic seems to be: Excellent Good Unsatisfactory
 8. Acceleration is: Exceptional Very Good Average Poor up to 50 mph.
 9. Curb and road clearance is: Satisfactory Too High Too Low

10. Here are my main reasons for purchasing a Nash: Style, ride, twin beds, and weather-eye system. Also visibility.

11. Particular features I like are:
 New "Golden Airflyte" body styling by Pinin Farina
 Airflyte unitized body and frame construction
 Airflex independent wheel suspension - by long, vertical coil springs.
 Nash "twin-bed" and reclining seat
 New safety-type instrument panel
 Weather-Eye heating and air-conditioning system
 New, "squeeze-type" door handles

12. Specifically, what do you dislike about your Nash? Large turning radius for small car. Wipers stop with speed-up with conventional transmission

13. Have you ever owned a Nash before? Yes No How many? Two ^{drive}

14. Would you buy another Nash? Yes Possibly No (has different fuel pump than overdrive model)

15. How do you rate your dealer service? Excellent Good Average Poor

16. How do you rate your Nash, generally? Excellent Good Average Poor

GENERAL INFORMATION

17. What type of engine would you prefer in your next new car? In-line V-type
 Number of cylinders: 6 8 Valves: Side Overhead Except with full load.

18. Are you satisfied with the horsepower rating of your Nash (88 or 120)? Yes No
 Approximately what H.P. rating would you prefer in your next new car? 120

19. What improvements would you like to see in your next car? Shorter turning radius and improvement for windshield wipers.

20. Based on your present experience, which transmission would you prefer? Conventional
 Conventional with Overdrive Hydra-Matic Drive Other type automatic trans.

This questionnaire will be tabulated fairly, and your name will be held in strict confidence. We request that you attend to each question listed. Thank you

Please mail promptly to:

FLOYD CLYMER
 1268 SO. ALVARADO ST.
 LOS ANGELES 6, CALIF.

My name: _____
 Address: _____
 City & State: Dracont, Mass
 Occupation: Mechanic

(Please write your personal comments on reverse side.)

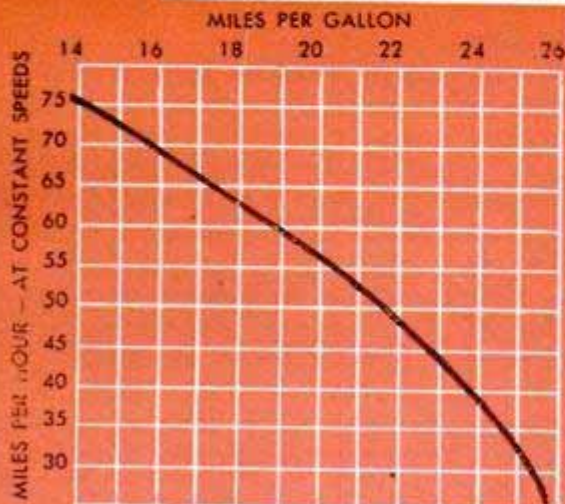

— Results of the economy test of the 1952 Nash Ambassador four-door sedan with Dual-Range Hydra-Matic

The true test of an automobile begins when the owner takes the wheel. This is another report from owners of 1952 cars who answered questionnaires sent by Popular Mechanics to 1000 Nash owners from coast to coast

REPORT on the 1952 NASH

By Floyd Clymer

NASH IS ONE of the few American car manufacturers to make important design changes for 1952. Eighty-eight percent of the owners who filled out our Nash questionnaires made favorable comments on the Golden Airflyte body styling. However, there were some loud howls from owners about the long turning radius of the Nash with its skirted front wheels.

This report covers the Statesman and Ambassador models, as the Rambler models were covered in a previous *P.M.* survey. While the V-8 engine trend increases, 65 percent of Nash owners prefer in-line engines. Nash owners also like six-cylinder cars as 65 percent prefer sixes while 35 percent want an eight. The fact that 32

percent of the owners rated dealer service "average" or "poor" would indicate a need for improvement there.

Despite the high-compression ratios of both Statesman and Ambassador engines—7:1 and 7.3:1 respectively—61 percent of Nash owners reporting said they use regular gasoline satisfactorily.

Nash scored unusually high in average miles per gallon, compared with other cars of similar size. Gas-mileage figures of 28 and 30 miles per gallon in country driving were reported frequently by owners of Statesman models. The lowest average figure tabulated—17.6 miles per gallon for the Ambassador in city driving—is near the highest average figure of several other cars

Wide and squat, the Nash has above-average roadability, Clymer reports. Long slot at base of the windshield is air intake of the ventilating system



ACCELERATION TEST

1952 Nash Ambassador Custom 4-Door Sedan
with Dual-Range Hydra-Matic Drive

¼ mile from zero	(Drive range 3 only)	22.10 seconds
	(Drive and Low ranges)	21.70 seconds
½ mile from zero	(Drive range 3 only)	34.40 seconds
	(Drive and Low ranges)	33.60 seconds
0 to 30 m.p.h.	(Low range only)	5.70 seconds
0 to 60 m.p.h.	(Drive range 3 only)	17.10 seconds
	(Drive and Low ranges)	16.60 seconds

Where both Drive and Low ranges were used, the change from Low to Drive was made at about 30 m.p.h.

Top speed by speedometer—102-104 m.p.h.

Actual top speed, about 7% less (speedometer variation)



There is room plus accessibility in the sliding-drawer glove compartment mounted below the center of the new Nash dashboard

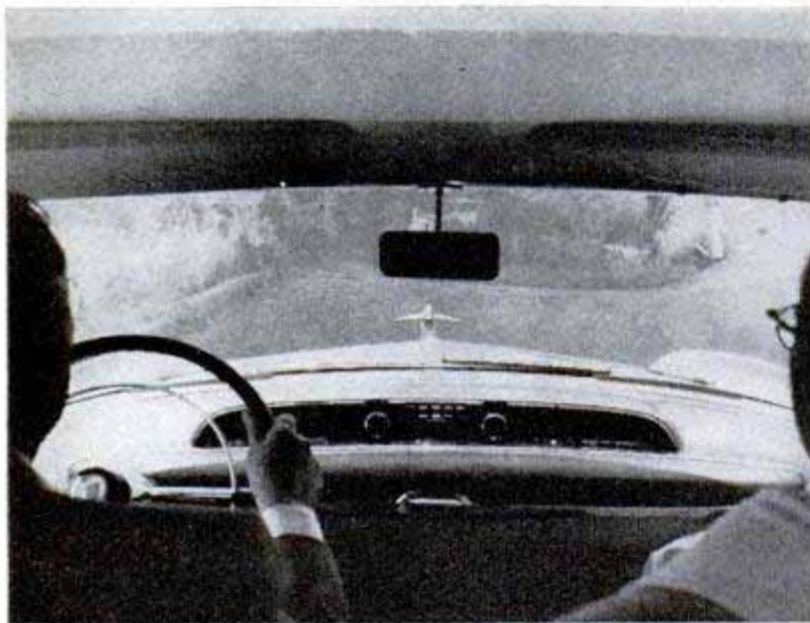

Above, sloping hood gives excellent vision ahead of car and permits driver to see both front fenders. Crash pad across the dashboard is too narrow for real protection, the report shows. Below, recessed spare tire is inconvenient when trunk is full



in the Nash price range. (The survey showed that economy of operation was one of the major reasons why owners bought Nash cars.)

Nash owners are not so automatic-transmission conscious as those of several other makes we have polled. The overdrive unit is very popular with owners. The poll showed that 60 percent of Nash owners reporting use either conventional transmission or conventional with overdrive; 58 percent said they intend to have the same on their next cars.

The new Pinin Farina Golden Airflyte body styling for 1952 was a big factor listed in "reasons for purchase." A recurring objection was the poor fitting of body, panels and doors with a few owners mentioning squeaks and rattles (as we find they do with all makes). Still remaining a resoundingly popular Nash feature is the twin-bed and reclining-seat arrangement; 81 percent of the owners said they liked this exclusive Nash offering. Sixty percent of those reporting mentioned that they liked the new squeeze-type door handles.

There were complaints about the new instrument panel. Some said that the shelf, or ledge, reflected sunlight into the windshield, while others thought the crash pad was not wide or thick enough to be any more than an ornament.

Nash's Weather-Eye heating and air-conditioning system, a pioneer in its field more than a decade ago, had general approval; 88 percent of the owners checked it as desirable. Most owners approved the Nash Airflyte unitized body and frame construction, and Airflex wheel suspension with its long coil springs.

To the question, "How do you rate your Nash generally?" the responses were: Excellent, 63 percent; good, 32 percent; average 4 percent; poor, 1 percent.

Here are some random comments from owners:

"The Statesman is excellent but underpowered." — Chicago doctor.

"We are pleased with the

Percentages From PM Poll

Owners of Statesman models.....	51%
Owners of Ambassador models.....	49%
Owners having Hydra-Matic Drive.....	40%
Owners having conventional transmission with overdrive.....	36%
Owners having conventional transmission only.....	24%
Owners using regular gasoline.....	61%
Owners using premium gasoline.....	39%
Average gasoline mileage in country:	
Statesman.....	22.5 m.p.g.
Ambassador.....	20.2 m.p.g.
Average gasoline mileage in city:	
Statesman.....	19.8 m.p.g.
Ambassador.....	17.6 m.p.g.
<i>(Owners reporting on cars with overdrive unit averaged about 2 m.p.g. more and Hydra-Matic owners about 2 m.p.g. less than above)</i>	
Average mileage for change of oil.....	1480
Add oil (also change periodically).....	5%
Average mileage for adding one quart.....	906
Roadability excellent.....	78%
good.....	21%
unsatisfactory.....	1%
Maneuverability excellent.....	57%
good.....	40%
unsatisfactory.....	3%
Acceleration exceptional.....	16%
very good.....	58%
average.....	23%
poor.....	3%
<i>(Includes both Statesman and Ambassador models)</i>	
Road clearance satisfactory.....	97%
too high.....	2%
too low.....	1%

BEST-LIKED FEATURES

Golden Airflyte body styling.....	88%
Airflyte body-frame construction.....	66%
Airflex independent wheel suspension.....	69%
Nash twin-bed and reclining seat.....	81%
Safety-type instrument panel.....	49%
Weather-Eye air-conditioning.....	88%
Squeeze-type door handles.....	60%
<i>(These percentages are based on answers to direct questions asked in questionnaires)</i>	

OWNERS' RATING OF CAR

Excellent.....	63%
Good.....	32%
Average.....	4%
Poor.....	1%

GENERAL INFORMATION

Owners preferring the following on next new car:	
In-line engine.....	65%
V-type engine.....	35%
Six cylinders.....	65%
Eight cylinders.....	35%
Overhead-valve arrangement.....	77%
Side valve location.....	23%
No increase in horsepower output.....	72%

Average horsepower output desired.....	116*
<i>(Respective Nash horsepower figures—88 and 120—were tabulated for those owners who expressed satisfaction with present ratings)</i>	
Conventional transmission with overdrive.....	48%
An automatic-transmission unit.....	42%
Conventional transmission only.....	10%
Hydra-Matic Drive exclusively.....	93%*
Other type of automatic transmission.....	7%*

**(Percentage of the 42% preferring automatic-transmission units)*

Previous Nash owners.....	73%
Will buy another Nash.....	67%
Might buy another Nash.....	30%
Will not buy another Nash.....	3%
Dealer service rated:	
Excellent.....	40%
Good.....	28%
Average.....	23%
Poor.....	9%

Chief purchase reasons (In numerical order):

1. Economy of operation.
2. Styling features—interior or exterior.
3. Riding qualities and comfort.
4. Previous satisfactory ownership
5. Mechanical features.
6. Roadability, driving ease, handling qualities
7. Interior space—for passengers and luggage.
8. Good trade-in allowance on old car, dealer good will.

Improvements desired in next new car (in order of preference):

1. Increased acceleration and power.
2. Better body assembly and tighter construction.
3. Body-styling changes—longer hood, less width.
4. Various mechanical improvements—smoother-shifting automatic transmission, less brake-pedal pressure required.
5. Better-quality paint and chrome trim.
6. Easier steering—power-assisted or otherwise.
7. Increased gasoline economy.
8. Electric windshield wipers.
9. More comfortable riding position.
10. Shorter turning radius for parking.

Most frequent objections (both models):

1. Body fitting or assembly.
2. Low acceleration or power.
3. Unusually wide turning circle.
4. Width of body or other styling items.
5. Thin chrome trim or paint finish.
6. Seats too soft or too short under legs.
(Particularly front seats noted)
7. Sun glare caused by bright trim through curved-glass areas, front and rear.
8. Low resale value.
9. Excess brake-pedal pressure required for quick stop.
10. Low gasoline economy.
11. Weak armrests on front doors.
12. Horizontal location of spare tire in trunk
13. Hydra-Matic shifting becomes jerky.
14. Horn ring obstructs vision of instruments—particularly Hydra-Matic quadrant.

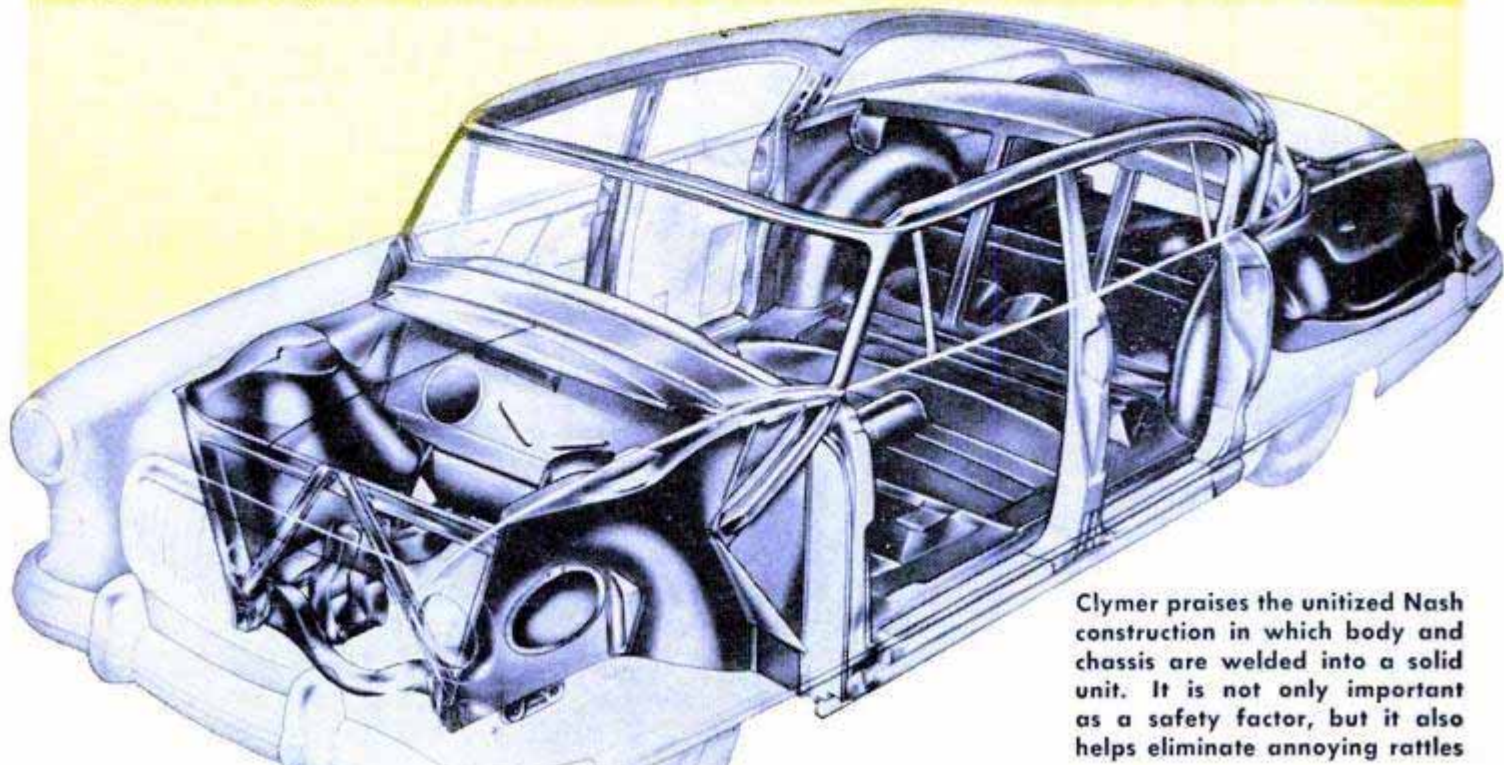

Clymer praises the unitized Nash construction in which body and chassis are welded into a solid unit. It is not only important as a safety factor, but it also helps eliminate annoying rattles



On Hydra-Matic-equipped Nash models, you start the engine by pulling up on the knob of the shift lever

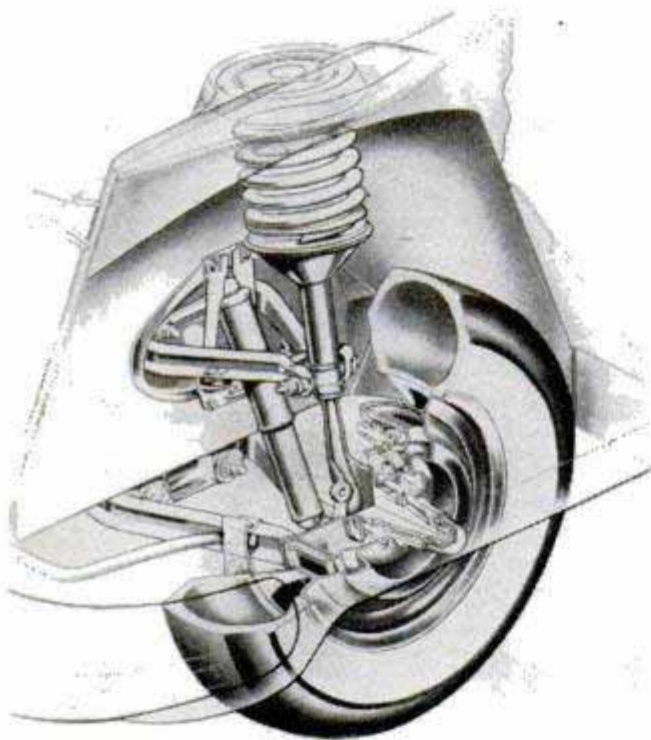

Above, high-mounted front coil springs reduce side-sway on corners. Below, exclusive with Nash is the reclining front seat that adds comfort to long trips



looks, comfort and roominess of the new Nash. More power would be desirable in the Statesman if it didn't cut down the mileage too much. The car could hold the road better and make a U-turn easier."—Chicago school secretary.

"The Ambassador is the best-handling car a woman can buy — and economical, too."—Springfield, Ill., housewife.

"The Statesman has all the room we need, gas mileage is very good and upkeep is low. Could use about 5 or 10 more horsepower for climbing."—Chicago barber.

"The seats are the way I like them. I can drive all day without feeling it's a hard day's work."—Fond du Lac, Wis., maintenance machinist.

"Bed arrangement for vacations is great."—Indianapolis lawyer.

Some owners agreed with a Dracut, Mass., machinist that the turning radius is too large and that this made the car hard to park. Others, including a Bristol, Tenn., textile supervisor, said that the doors leak.

"If you sit back on the front cushion it feels thin and inadequate."—Elizabeth City, N. C., retired naval officer.

"Doors don't close tightly. They have to be slammed."—West Allis, Wis., barber.

"Chromework and light reflect in left-front window. . . . Noisy with windows closed in wind or rapid driving."—Topeka, Kans., social worker.

"No power for this kind of country—too many hills. OK on flat stretches."—Putnam, Conn., drop-hammer operator.

"My Statesman jerks a good deal on deceleration."—Tempe, Ariz., assembler.

"Front tires are hard to change with tools supplied."—Midway Park, N. C., marine.

"Give the front end of the Nash as much style as the back end and you will have a

(Continued to page 262)

Below, easily accessible yet concealed from view is the gasoline-filler cap on the new Nash. It is beneath a hinged cover that is part of the right taillight



A Scientist Diagnoses the

FLYING SAUCER

By Dr. I. M. Levitt

Director, The Fels Planetarium, Franklin Institute, Philadelphia

ONCE UPON A TIME the only place where flying saucers were seen was in the far West. In the desert areas of western United States the lone prospector looked up, saw the momentary appearance of strange lights, and went about his work.

Today there are hundreds of thousands of persons in the desert regions working for the Atomic Energy Commission and the armed services. Today, the tremendous population in that part of the country has brought to the attention of scientists the fact that there are strange illuminated features in the sky. Make no mistake about it. Something is seen—but that something is not a flying saucer from another world nor is it an airplane from any other country on earth.

The features are mirages pure and simple. They are generally associated with hot, dry countries and are most commonly seen over desert regions. As one goes higher and higher in the atmosphere the air gets cooler and cooler, but occasionally there is found a warm layer riding on top of a cold layer of air. This is usually brought about by the ground cooling more rapidly than the air after the sun goes down. As a result, there is found a temperature inversion and the light normally going up and being lost in the sky is bent. Thus light sources from distant cities will be seen against a black sky. If there is any motion of the air layers, the lights will move across the sky at incredible speeds.

In newspaper reports which appeared in past weeks there seem to have been a great many of these observations in the East—particularly around Washington, D.C. Why should we see them over Washington when that city is far removed from the desert regions which father mirages? The answer to this question is very likely found in the unbearably hot weather to which we have been subject this summer.

The advent of the prolonged hot weather simulated desert conditions which gave rise to the mirages appearing over Washington and the eastern seaboard, and the flying-saucer scare was on again.

It is this writer's opinion that the flying saucers will continue to be seen until the

weather moderates. When the temperature inversions cease to exist, the flying saucers will disappear.

Jet planes pursued these saucers, but as yet have not succeeded in catching them and they obviously cannot catch them because they are mirages. It is true that they have been picked up on radarscopes and clocked at about 100 miles an hour, but this does not substantiate their existence.

The problem of their appearance on radar screens has set many people wondering. Radar, because of its magnificent use in the past war and its high level of attainment, has been looked upon as infallible. The truth of the matter is that radar is as unstable as any other electronic device in use today.

During the last war it was not uncommon for the radar screens to pick up "twilight ghosts." Almost every evening, when the sun set, there would appear sharp "pips," or "blips," which would last for perhaps 10 minutes. This effect was most pronounced in the tropics, again where there was the maximum possibility for a temperature inversion. There are many effects in radar scanning which cannot be explained.

In a way, the effects are similar to the television anomalies which we experience today. Some of you have turned the dial and suddenly picked up a station which is several hundred miles away. This is normally an impossibility because we receive television signals purely as a line-of-sight wave. When the station is farther than 90 miles away, in most cases the signal is too attenuated for reception. However, television anomalies appear at certain times which are probably governed by atmospheric conditions and these conditions include ionized portions of the atmosphere.

Similarly, there appear radar anomalies that can give rise to the "indistinct" blips which are reported in the daily papers. Just why or how these originate is not understood except that electronic engineers know they exist. Even the wavelengths of the two systems are not too dissimilar. Normal television is transmitted at a frequency of about 200 megacycles. The normal radar

(Continued to page 298)

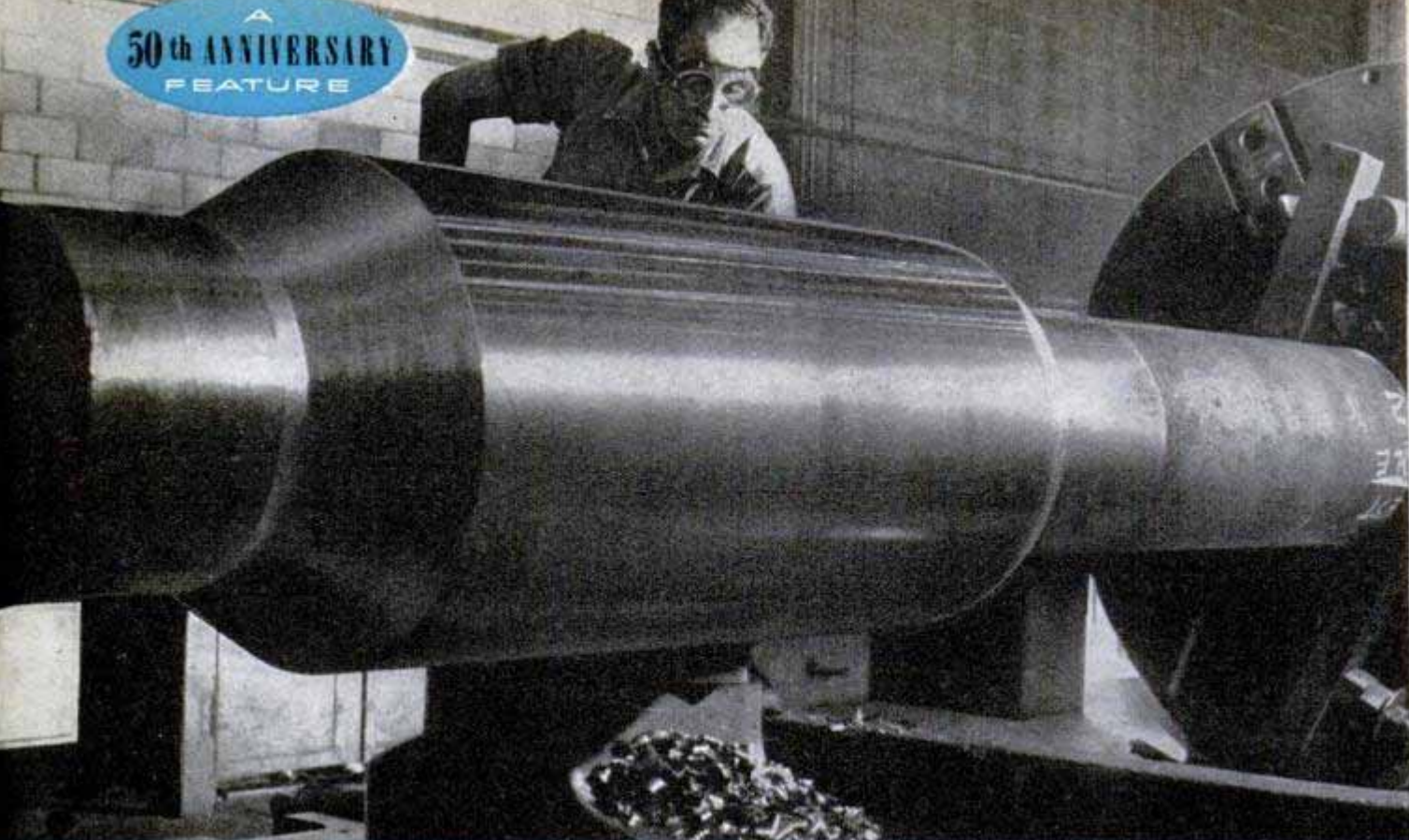

U. S. Steel Corp. photo

By George Scullin

Giant steel roll soon to take its place in a U. S. Steel rolling mill is machined on a 60-inch lathe in the forging shop at the firm's Homestead District works

**The jet engine and the wrist watch,
the power saw and the 1952 automobile—
all are products of those modern wonders—**

THE

AROUND early March this year, a few newspapers announced casually that the Air Force had been given the green light on the purchase of 20 machine tools. It was just a small story and the editors couldn't get too excited about it. Not even at the size of the machines, four stories high; or their cost, \$389,000,000! Stories like that are routine in this year of 1952.

But what if that story, through some slip in the time machine, had appeared before the young editors preparing the first issues of *Popular Mechanics* in 1902? What about it would be strange?

Not the words "Air Force," though man had yet to fly a power-driven aircraft. These farseeing young men were already convinced that man *would* fly, and soon, and that there would be an Air Force. Not the size of the machines. These editors were dedicating their magazine to the conviction that the years to come would produce mechanical wonders beyond anything even dreamed of at the turn of the century. To anticipate these marvels and explain them in words and pictures their readers could understand was the job they had already

created for themselves. But we do think they would have been stunned by the \$389,000,000.

In 1902 that sum would have bought the year's output of the entire machine-tool industry, would have bought the industry as well, and there would have been enough left over to put a little white fence around the whole thing. In fact, the industry was so small that few people had ever heard of it, and fewer still knew what it was.

Yet this is the tiny industry that has made possible our entire way of life. Without it, we would be living on the products of our bare hands, with a standard of living approaching that of Colonial days.

What are these machines that produce all this magic? Well, they are a weird family. They are the tools that make the tools that make everything else. But, being a family, they also make each other. This makes them the only self-procreating race in the machine world.

To understand the huge, fantastic, almost-human machine tools of today, let's take a look at their ancestors as the first editors of *Popular Mechanics* knew them.

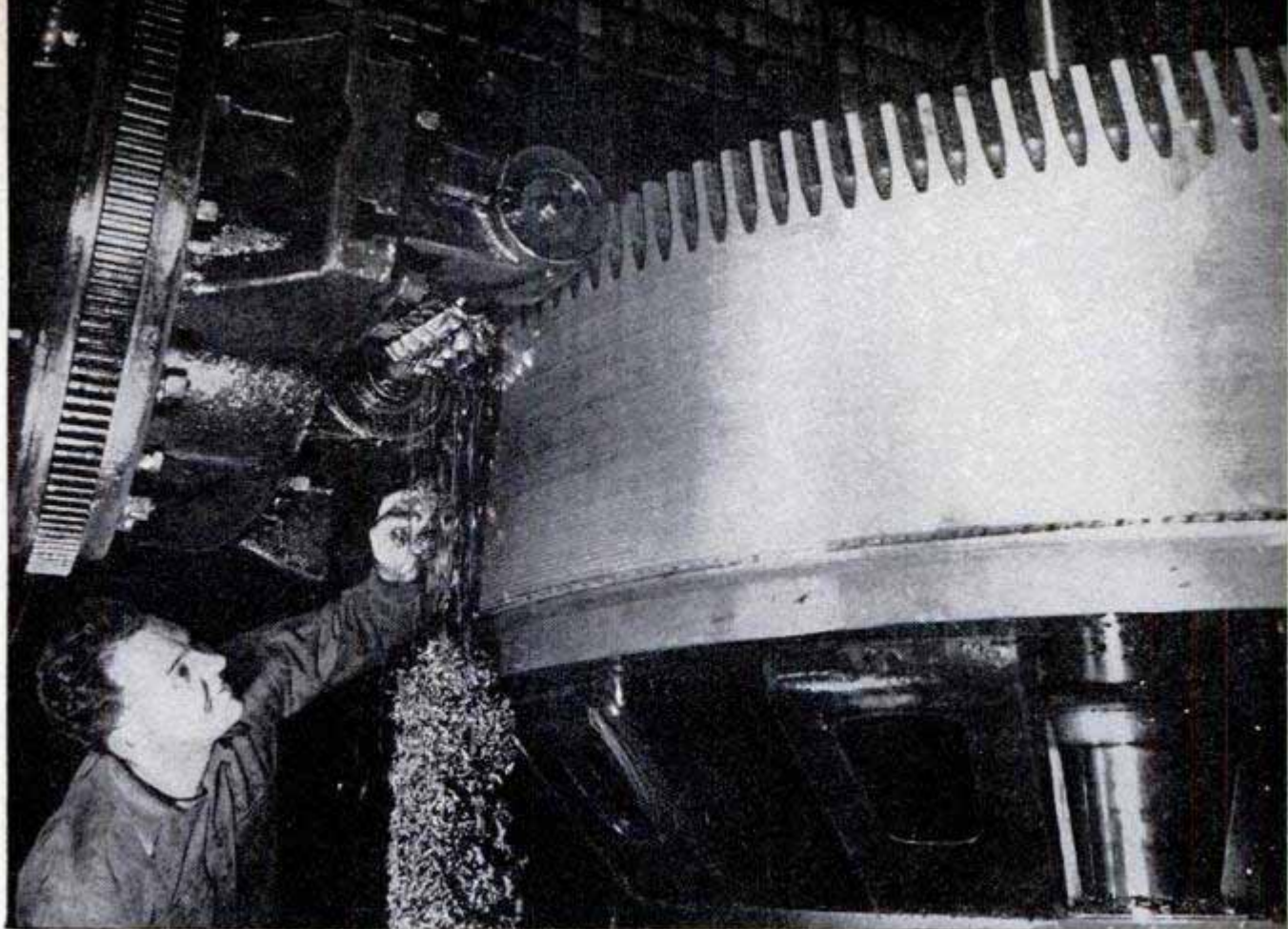

Westinghouse photo

Hobbing machine cuts teeth in a gear over eight feet in diameter; chips pile up beneath the cutting tool

TOOLS THAT MAKE TOOLS

A lot of selective breeding has gone into them since, but basically they remain unchanged. In 1902 a machine tool was described as a non-portable, power-driven tool that shaped metal by removing surplus material in the form of chips.

The first and oldest of these tools was the lathe. By 1902 a more flexible version called the turret lathe was coming into popularity. The next was the drill, which was fine for drilling holes in metal but not always accurate enough for some of the close-tolerance work required in 1902. For tolerances of .001 inch, a boring machine was used. Today drilling and boring are words often used interchangeably, but to the

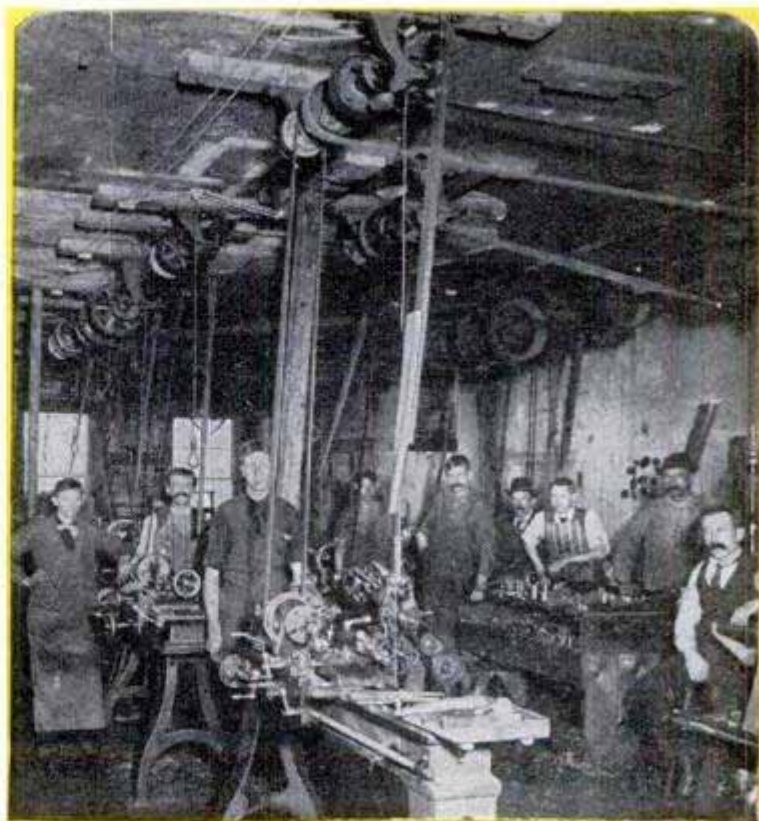

Machine-tool shop of 50 years ago presented maze of overhead pulleys. This was National Acme Company

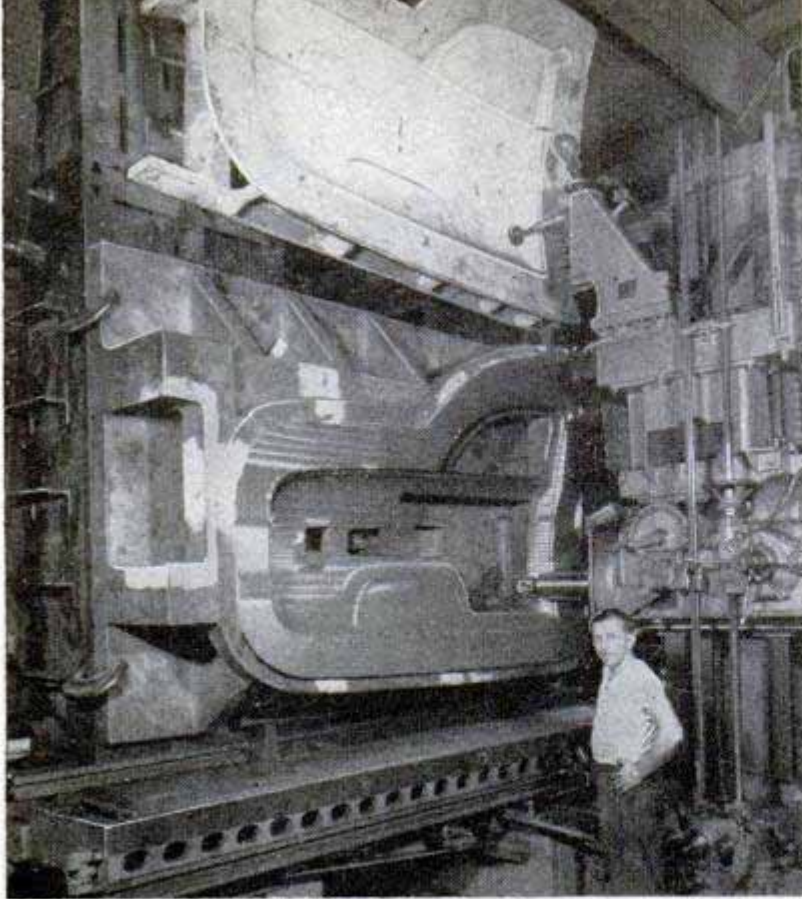

Giddings & Lewis Machine Tool Co. photo

Horizontal boring, drilling and milling machine is equipped with hydraulic duplicating device for making automobile-body die. Below, special machine does precision work for U. S. Steel Corp.

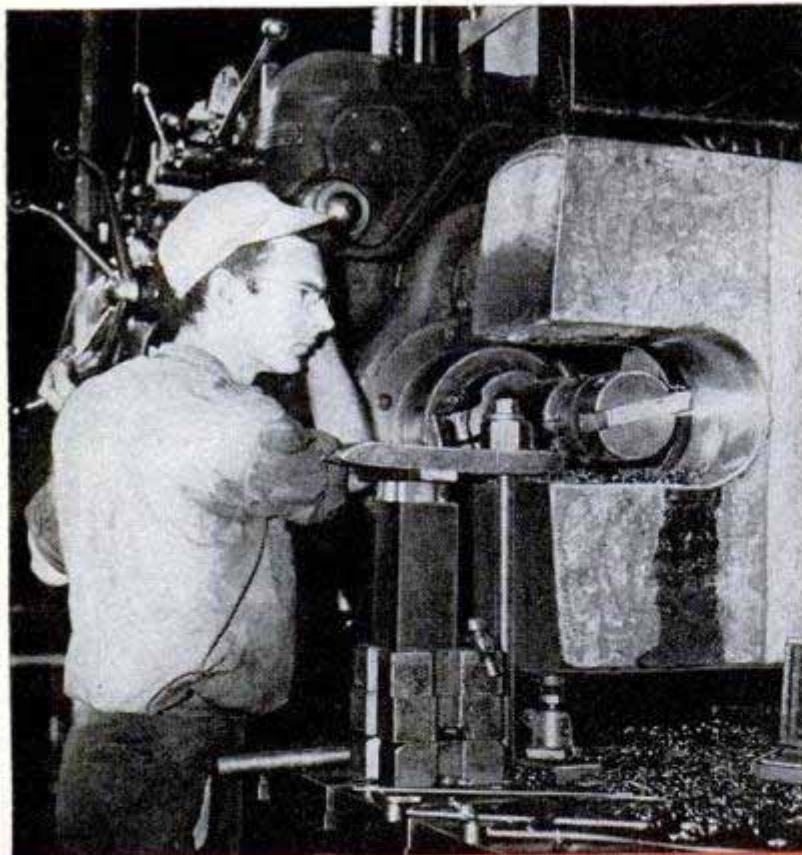

artisan of 1902 there was a big difference. A drill was a high-speed revolving tool that cut a hole in stationary stock, often whipping around as it did so to produce a hole larger than its own diameter. A boring machine revolved the stock around a stationary, absolutely rigid cutting tool, producing an unwaveringly true hole. An axle housing or a cylinder for a steam engine would be examples of boring-machine work; bolt holes and tap holes would be examples of drill-press work.

The big machines of the day were the planing machines. Since no casting is perfectly true when it comes from the foundry, the planing machine would grab a huge casting, such as the bed for a huge printing press or steamship engine, and plane it down to size much as a wood plane is used to true up a block of wood. If the single, rigidly held cutting tool remained stationary, and the work in progress was passed back and forth beneath it, the process was called planing. If the work in progress was fixed in a stationary bed, and the cutting tool passed back and forth over it, the process was called shaping, or slotting.

The milling machine was a late arrival in the machine-tool family. It was produced by crossbreeding a circular saw with a planer. Wide teeth in a rotating cutting wheel chew out the metal being fed to it. Its advantage over the straight-stroking planer was that it could smooth curved surfaces as well as flat and is handier for the production of smaller jobs. It was also ideal for cutting grooves or slots into flat or round surfaces, and for cutting the teeth in gear blanks.

And then, of course, there were the grinding machines, highly refined descendants of

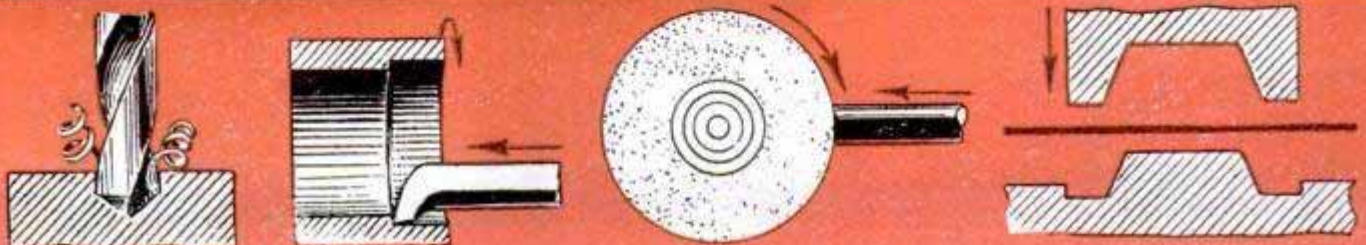

DRILLING AND BORING

GRINDING

SHEARING AND PRESSING

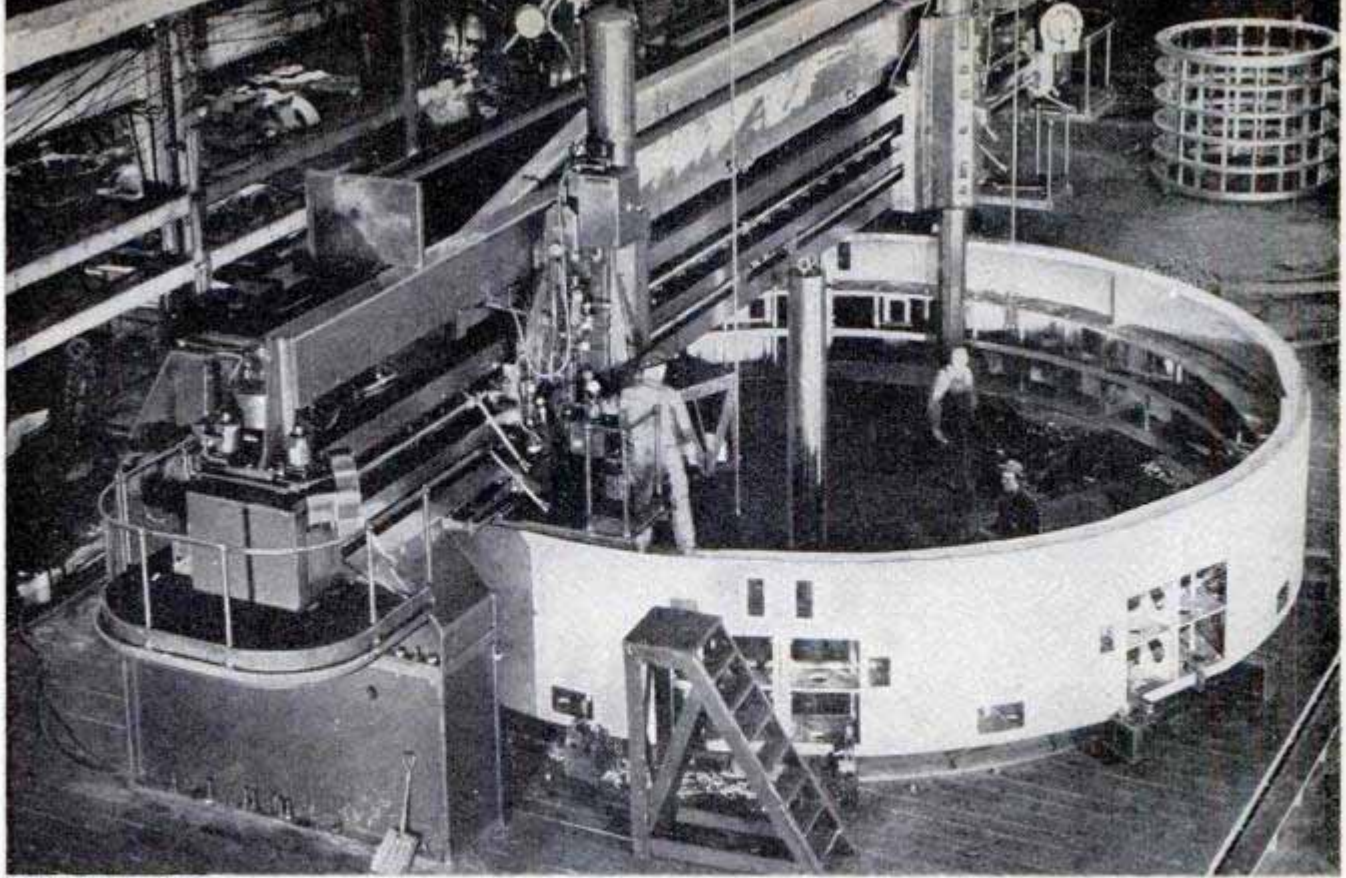

Westinghouse photo

Huge boring mill machines giant turbines and generators; it has 34 electric motors and weighs over 400 tons

the old grindstone. With these high-powered abrasive wheels, tools could be sharpened, burrs ground from rough stock and a mirrorlike finish applied to surfaces requiring a bright polish.

Humble, simple machines. But in their way they were the masters of what machine-tool people call "the basic arts of shaping metal." In 1902 the basic arts were turning, drilling and boring, planing and shaping, milling, and grinding. To these in recent years have been added, though they do not shape metal by removing chips, the arts of metal cutting with power shears, forging, pressing and stamping.

In action, the machine-tool shop of 50 years ago was a nightmare of overhead pulleys, slapping belts, squealing metal being tortured by overtaxed cutting tools, clouds of greasy spray from the coolant and grease thrown out by the exposed gears. The floor was covered with chips and spirals of metal, hard on the feet but providing a nonskid surface among the pools of oil. Along with the obvious dangers from breaking belts, snapping tools and flying chips were the dangers of mashed hands and feet in handling the heavy work. All

pieces except the heaviest of casting and rolled stock had to be muscled into the machines by hand, as many as six men being necessary to center a casting in the chucks, vises, clamps or other fixtures being used to lock it in place for machining.

But if the shop was a nightmare compared to today's standards, the pride of the men in their work couldn't be greater in any day and age. These men were true artists, imbued with a powerful, vital creative force that could whip any task, no matter how big. It seems incredible now that there were only about 10,000 of them. The entire industry consisted of less than 200 small, family owned shops, some employing less than 20 men. Most of them had come into being with the Civil War when, for the first time, there developed an acute need for weapons and machines so accurately made that their various parts were interchangeable. It was no coincidence, then, that most of the firms got their start in New England, for that was the home of the weaponmakers since Revolutionary days. By 1902, however, many had moved farther west to start businesses in Cleveland, Cincinnati, Chicago, Rockford and Milwaukee,



PLANING

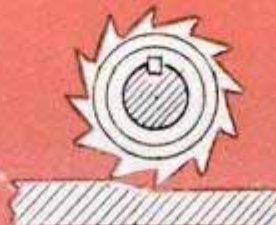

MILLING



TURNING

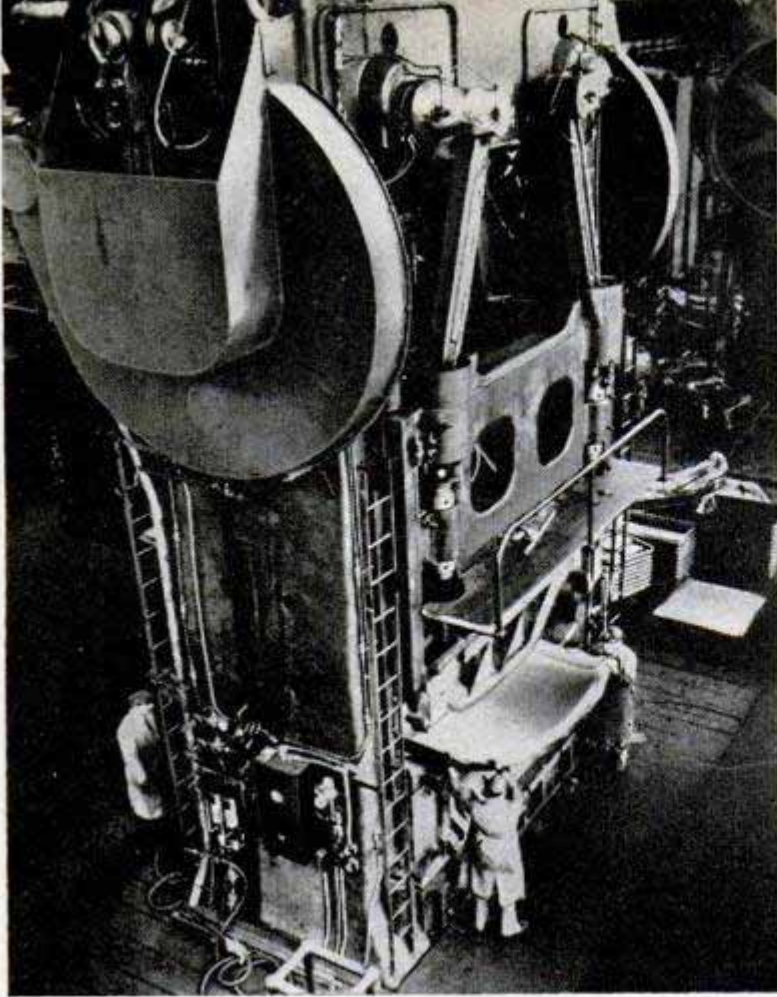

Towering 700-ton mechanical press stamps tops for automobiles. Below, die-sinking machine which can duplicate in hard steel the precise and intricate shapes of a plaster or wooden master

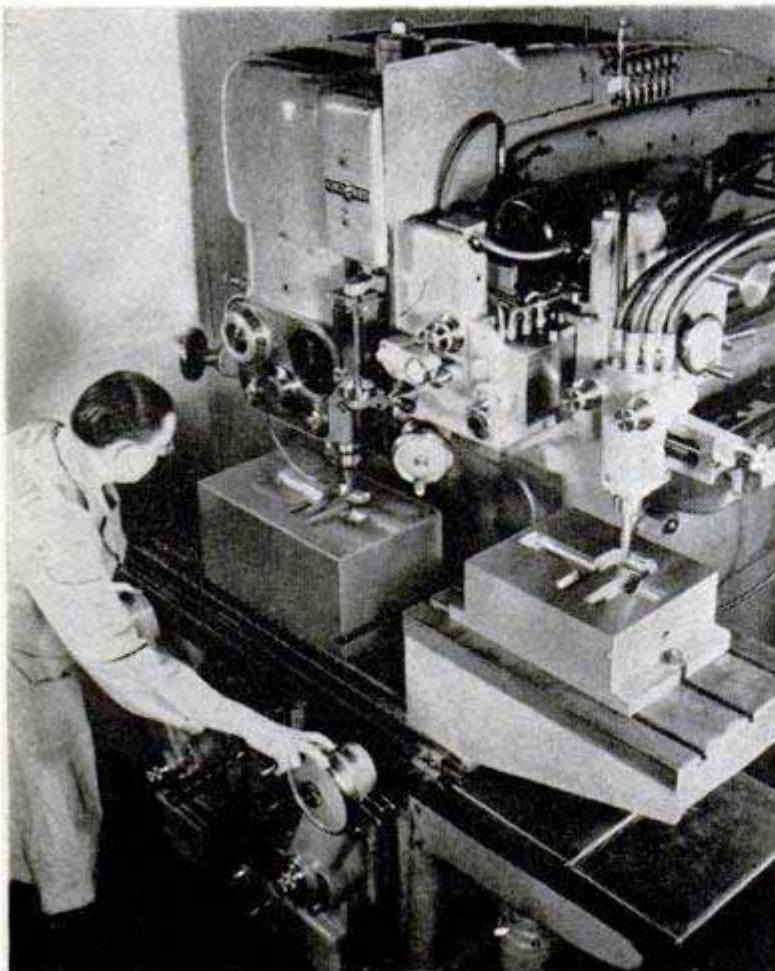

spreading their art as they went.

The making of a skilled machine-tool worker was a matter of years. Not only did he have to master every machine in the shop, he had to have the imagination to make his machines stand up and do things they had never done before. Nothing could be too big, too complex, or too technical for the machine-tool maker.

To illustrate this, machine-tool makers like to tell the story of Worcester Warner, cofounder in 1880 of the Warner & Swasey Co., makers of turret lathes. Not satisfied with the challenges within his own field, he set out to improve the accuracy of astronomical observations by building the telescope for the Lick Observatory on Mount Hamilton, Calif. By the time he finished the job he had spent so much money mastering new techniques that the turret-lathe company was all but broke. So he lost another fortune by contracting to build the Yerkes telescope, a masterpiece of incredible precision. In fact, losing money on great telescopes became such a habit with him that the casual observer might have laughed at him. But so valuable were the new techniques he mastered that each time he lost a fortune, his firm gained a bigger one. Not only were its own turret lathes drastically improved, the rest of the machine-tool industry benefited from the lessons he learned in milling, planing and grinding huge castings to tolerances of one ten-thousandth inch. Without his pioneer work in the machining of tremendous castings, there would be no 200-inch telescope on Mount Palomar, and it is certain that some of the lessons he learned advanced considerably the day of the cyclotron and all the other vast, unbelievably accurate machines that made possible atomic energy.

For a moment go back to 1902—the year that started the great race into the Machine Age. The call to get set came the year before when Oldsmobile began the mass production of automobiles. The gun went off when Packard, in that magic year of 1902, introduced the H-slot gear shift. Suddenly industry needed machine tools to cut millions of gears, turn out thousands of internal-combustion en-

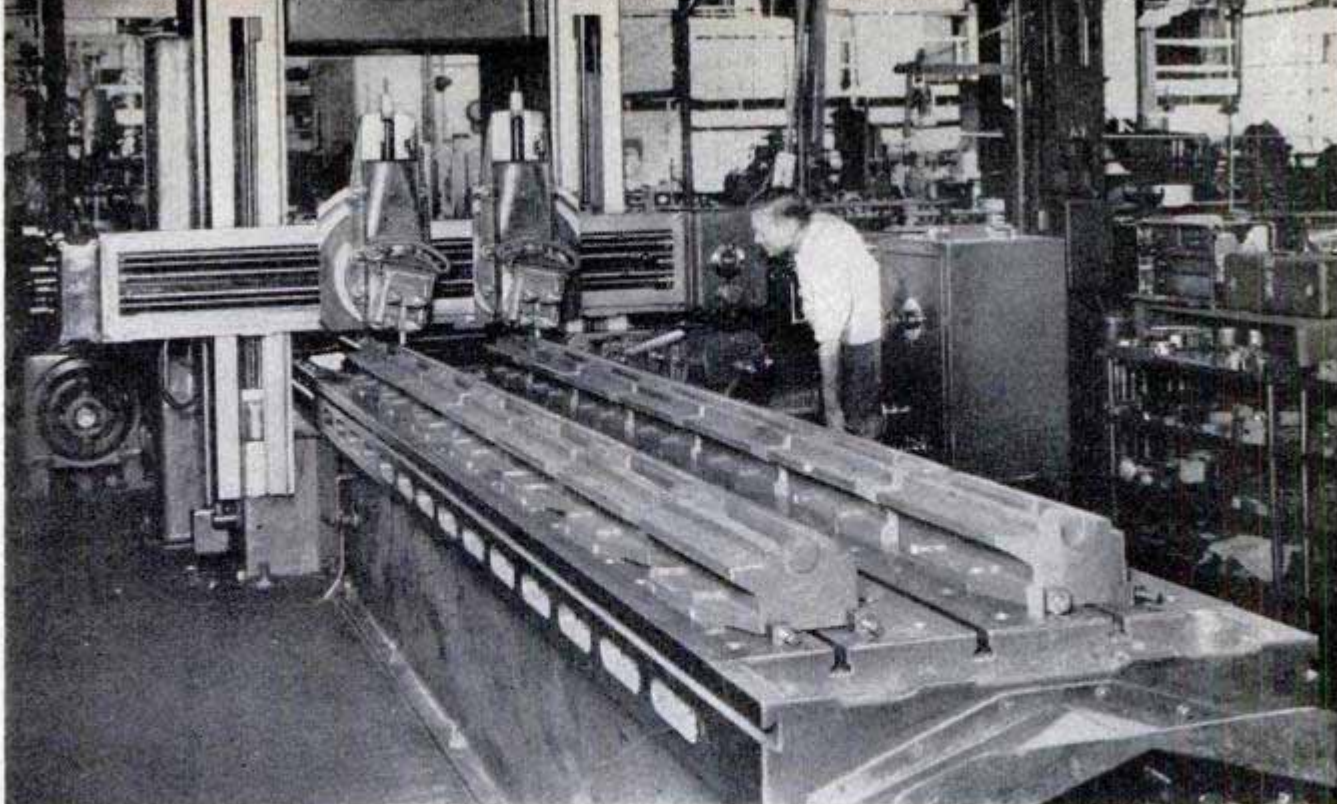

A planer — the cutting tool is held stationary and parts to be planed are moved back and forth beneath it

gines, stamp out car bodies, turn out wheels and axles.

The world exploded into a frenzy of mechanical action. The flying machine, the skyscraper, the Panama Canal, great locomotives and steamships, vast dams and hydroelectric plants, a telephone for the home and a thing called wireless. And World War I.

Up to World War I the tiny machine-tool industry had done its job of making millions of jobs for others without basically changing the design of its tools. The industry had built bigger tools, and faster tools, but as was pointed out firmly, there are only so many things you can do to improve hammers, saws and chisels, and similar rules applied to basic things like machine

Steel parts for an atom smasher come big. This one being machined for a cyclotron weighs 260,000 pounds

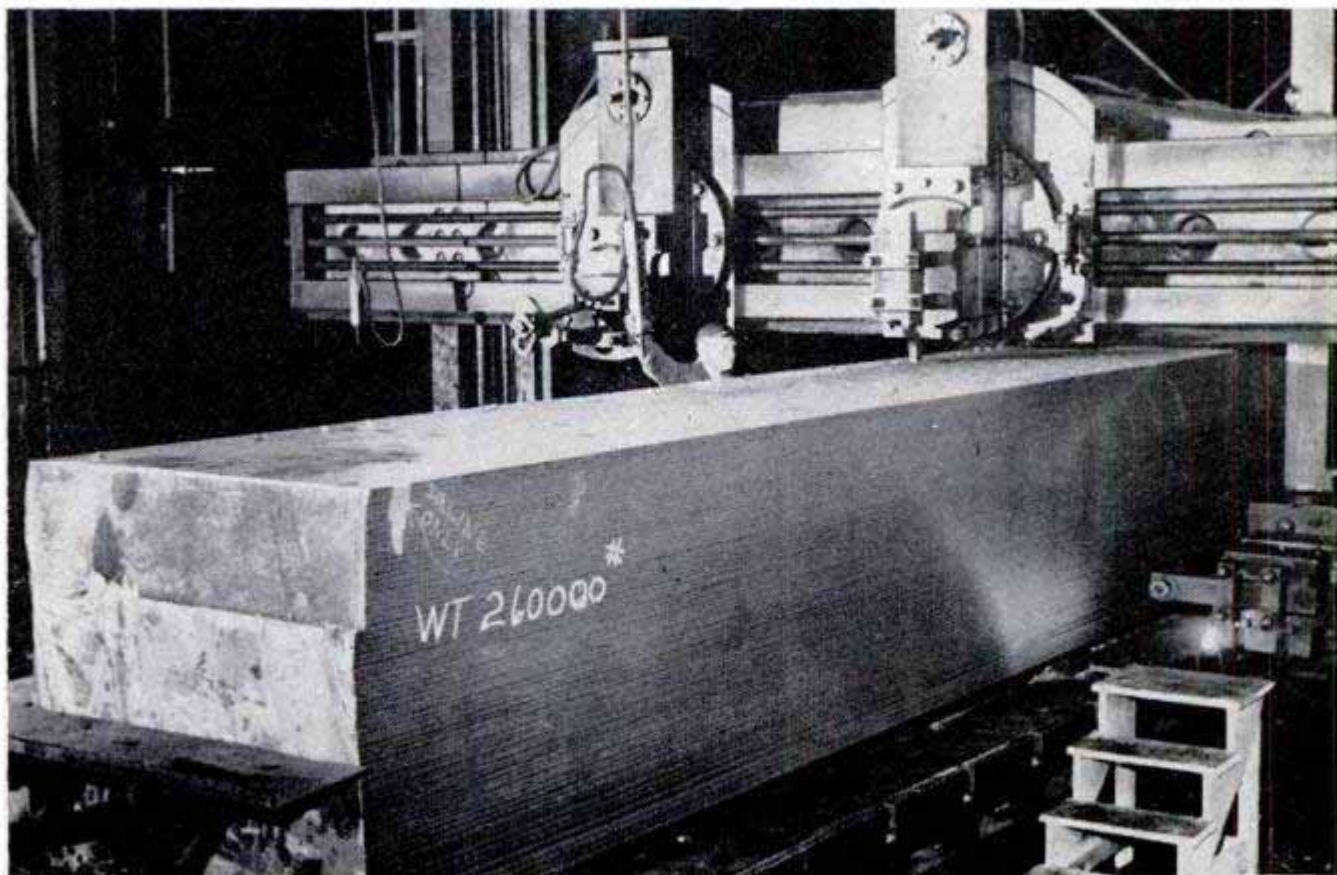

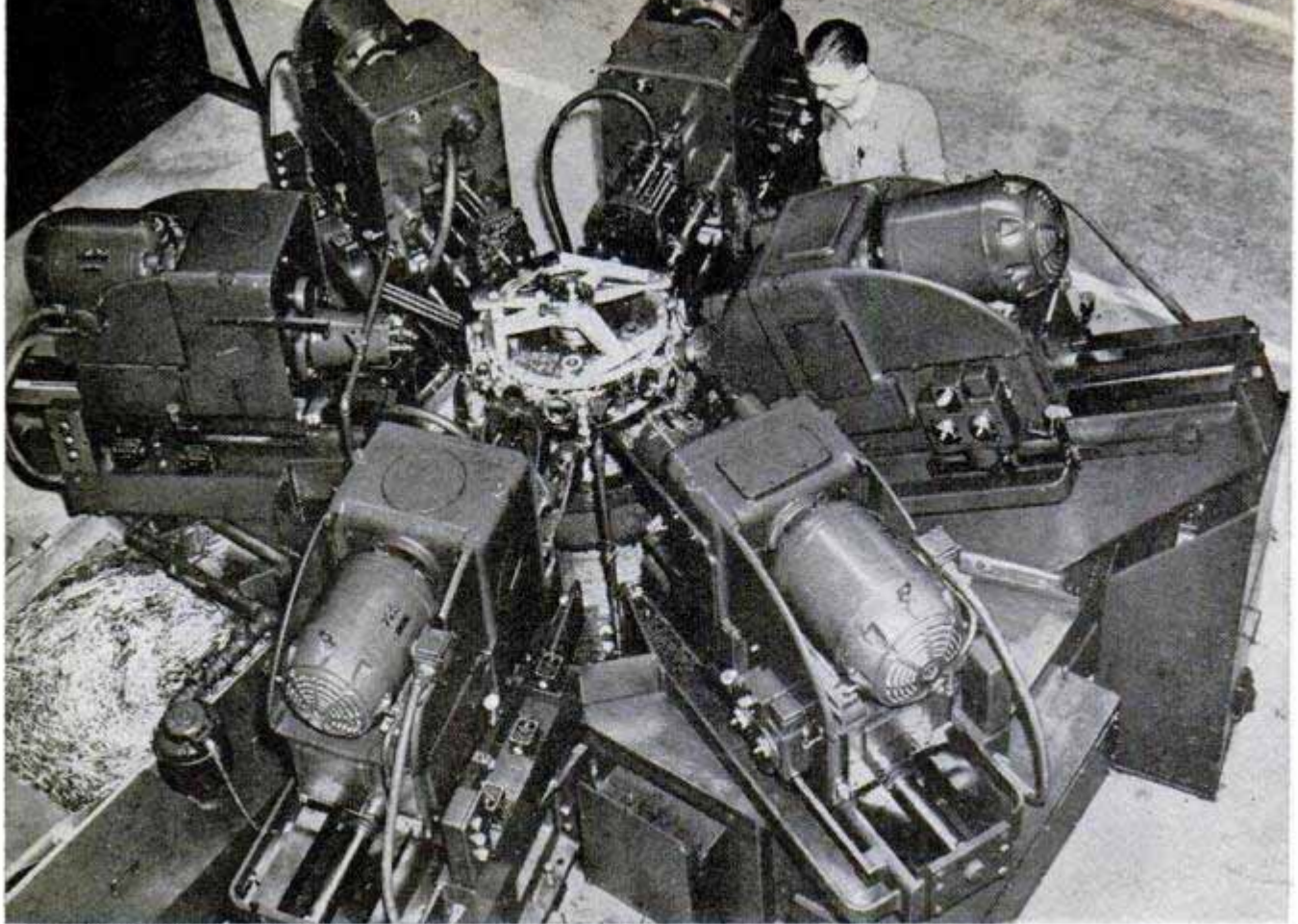

Wright Aeronautical Corp. photo

Ingenious machine performs 45 boring and facing operations in 24 minutes — used to require eight machines

tools. The staggering needs of the war changed all that hidebound thinking.

Let us take a look at what the toolmakers did to the planer. This machine had been content to pass a single casting beneath a single cutting tool and return for the next stroke. Planers were 24, 30 and 36 inches wide with tables 6, 8 or, at the most, 10 feet long. Now they extended the bed of the planer so they could put a dozen castings in a row and pass the whole works under the cutting tool in one long, mighty sweep. Then they made it wider so that they could put two rows of castings on at a time and they had two heads on the rail and two side heads, which meant that four cutting tools were at work on two parallel rows of several castings. Planers got to be 6, 8 and 10 feet wide with tables 30 and 40 feet long. Production went up 1200 percent.

Then the electrical industry came to the assistance of the planer by designing a reversing motor drive which permitted a selection of cutting speeds adapted to the material that was being handled, to say nothing of very much faster speeds, both for cutting and for return. The return speeds went up and the development of better cutting tools made higher cutting speeds practicable. In some cases the work would be set up on a second table while the planer was at work. The finished work with the table to which it had been fastened was lifted off, the next series of castings already fastened to a plate would be lowered to the planer table and the setup in that way made very quickly.

With the reversing motor drive, in planing a row of castings the table can move at slow cutting speed, speed up in the gap

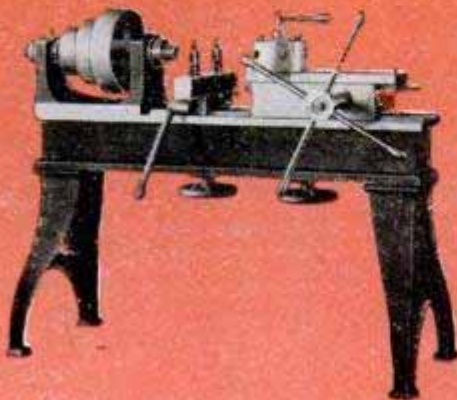

1881

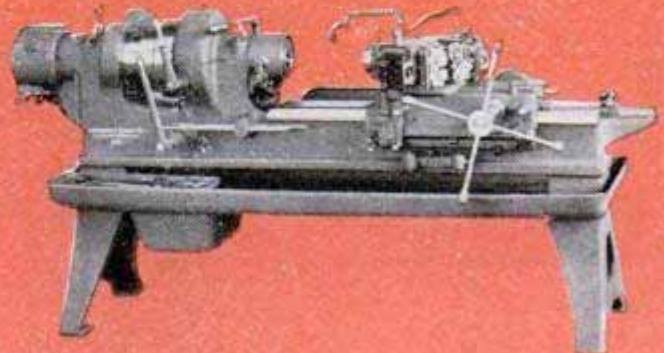

1900

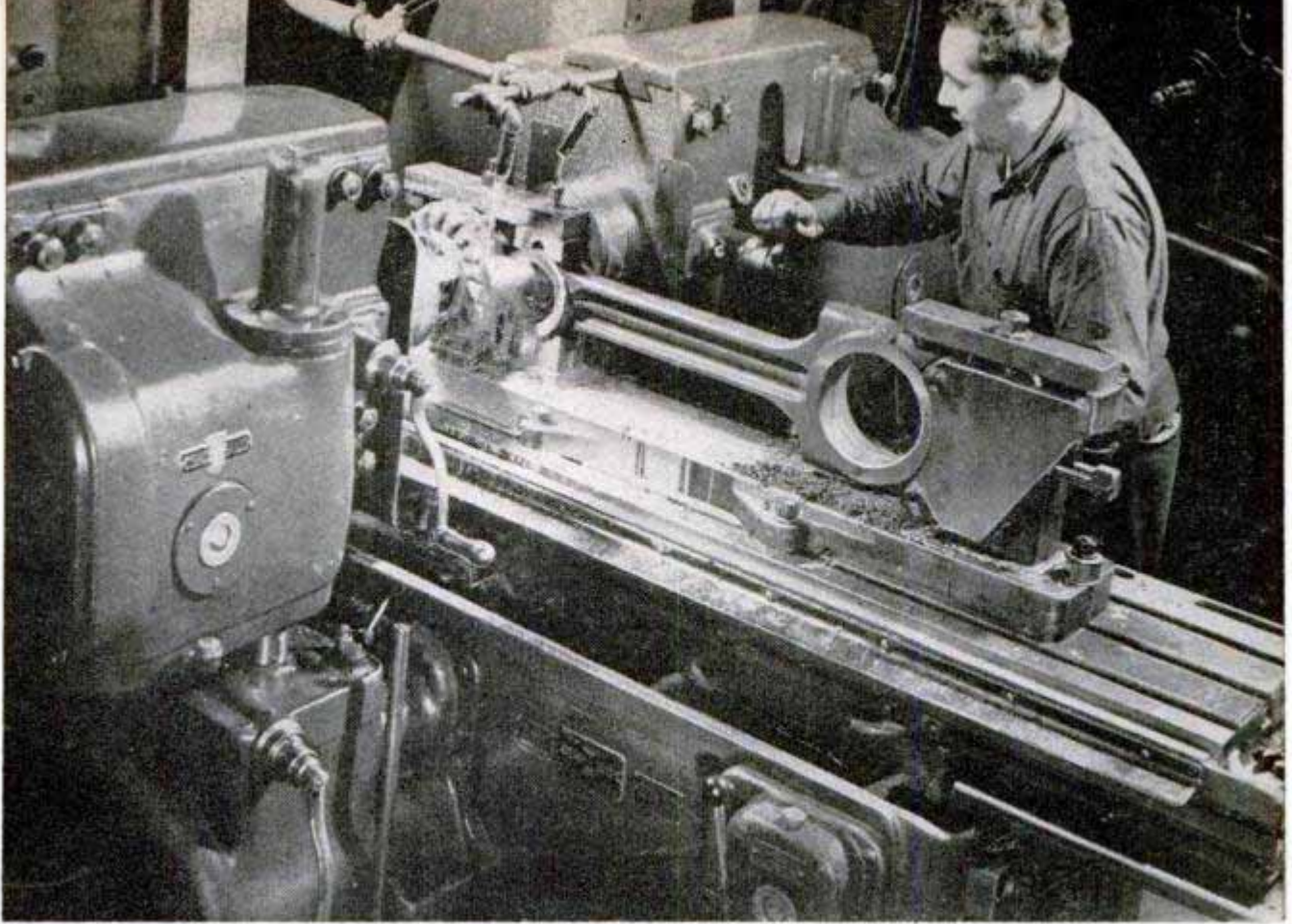

This milling machine is finishing both sides of a diesel-engine connecting rod

between the pieces and slow down again as the tool enters the next piece.

When the castings are planed they are lifted off to a conveyor. In fact, with overhead hoists lowering the casting into place and conveyors or hoists taking them away, the operator was free to concentrate on the accuracy of his work so the result was not only an overwhelming increase in production but a very substantial improvement in accuracy.

What was happening to the planer was happening to all the rest of the machine-tool family.

(Continued to page 242)



Courtesy National Machine Tool Builders Association

Skilled toolmaker takes many hours to finish-grind steel teeth of broaching cutter with high precision in 10,000ths of an inch

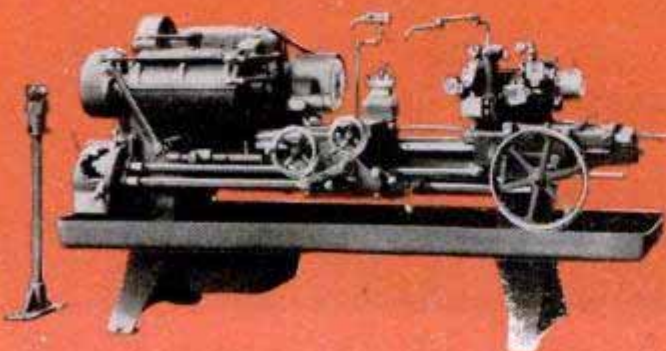

1915

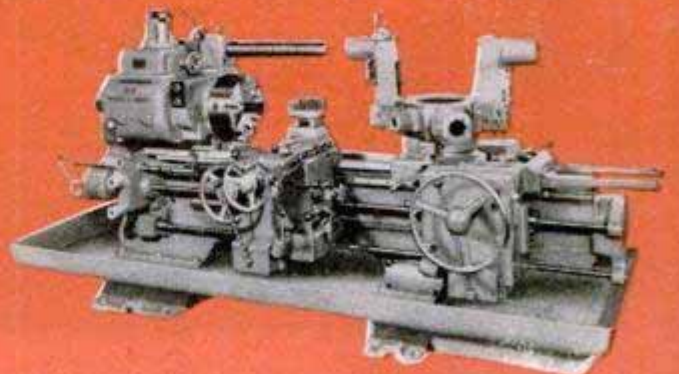

1952

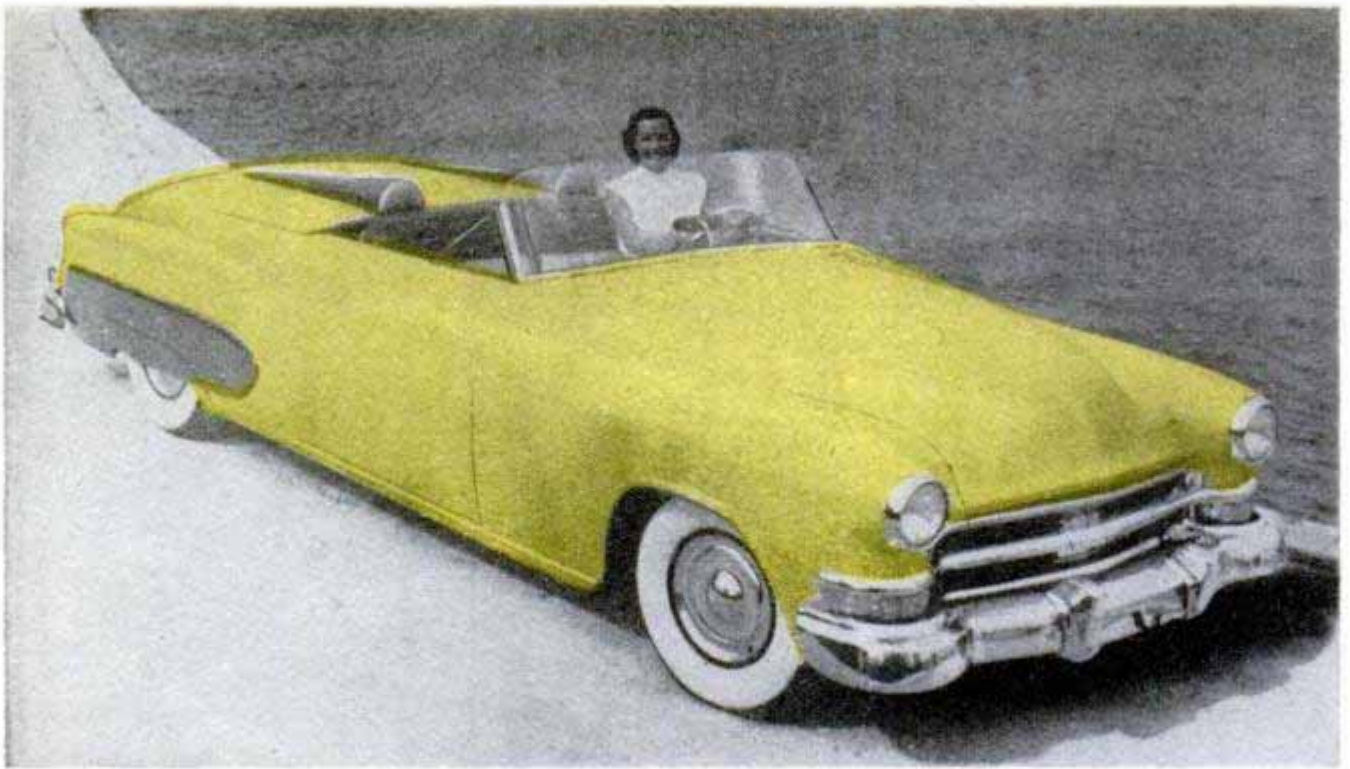

There's nothing cramped about the Cyclonic. Rear seat is blocked off here by a removable streamlined cover

SPACIOUS SPORTS CAR—THE CYCLONIC

BECAUSE he demanded speed plus comfort in a sports car, Harold A. Clark of Miami Beach, Fla., had to have it custom made—and as a result set a new standard among the low-slung, high-strung speedsters of the motorcar family.

The car, called the Clark Cyclonic, is built around a Chrysler New Yorker chassis and seats six in comfort—a welcome change in sports cars which usually specialize in cramped two or three-passenger cockpits. It's a big car, weighing over 4500 pounds and boasting an over-all length of almost 18 feet. The New Yorker chassis

Door handles are absent. Door swings open when you press a small button (arrow) in front of windshield

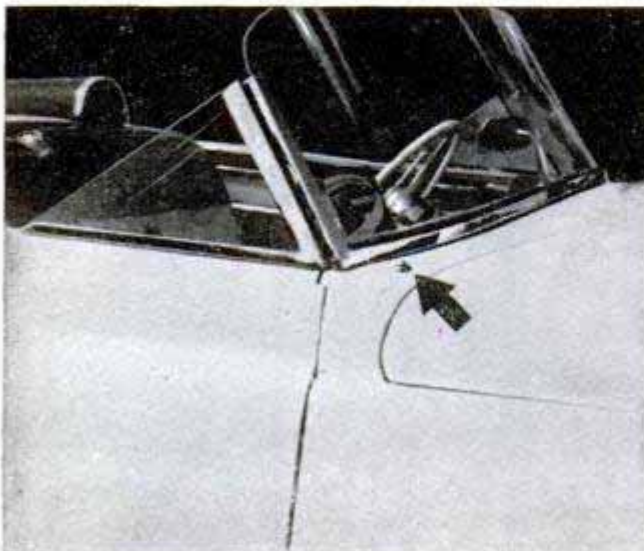

was dropped two inches to lower the center of gravity for better control on turns.

So exciting did his new car prove to be that Clark decided to manufacture models for sale. The price—\$15,000 each.

Clark's present plans call for producing about 48 cars a year in four models—a five-passenger open phaeton with no top, a six-passenger hardtop and two convertibles. Biggest prospective market is Argentina and other South American countries, according to Clark.

Powering the Cyclonic is a FirePower engine souped up to 225 horsepower by the

With its rear-seat cover off, the Cyclonic has ample room for six. The upholstery is leather, of course

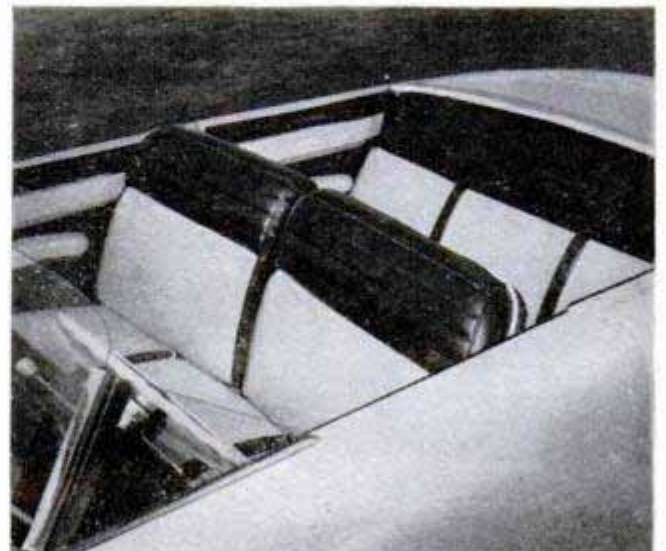

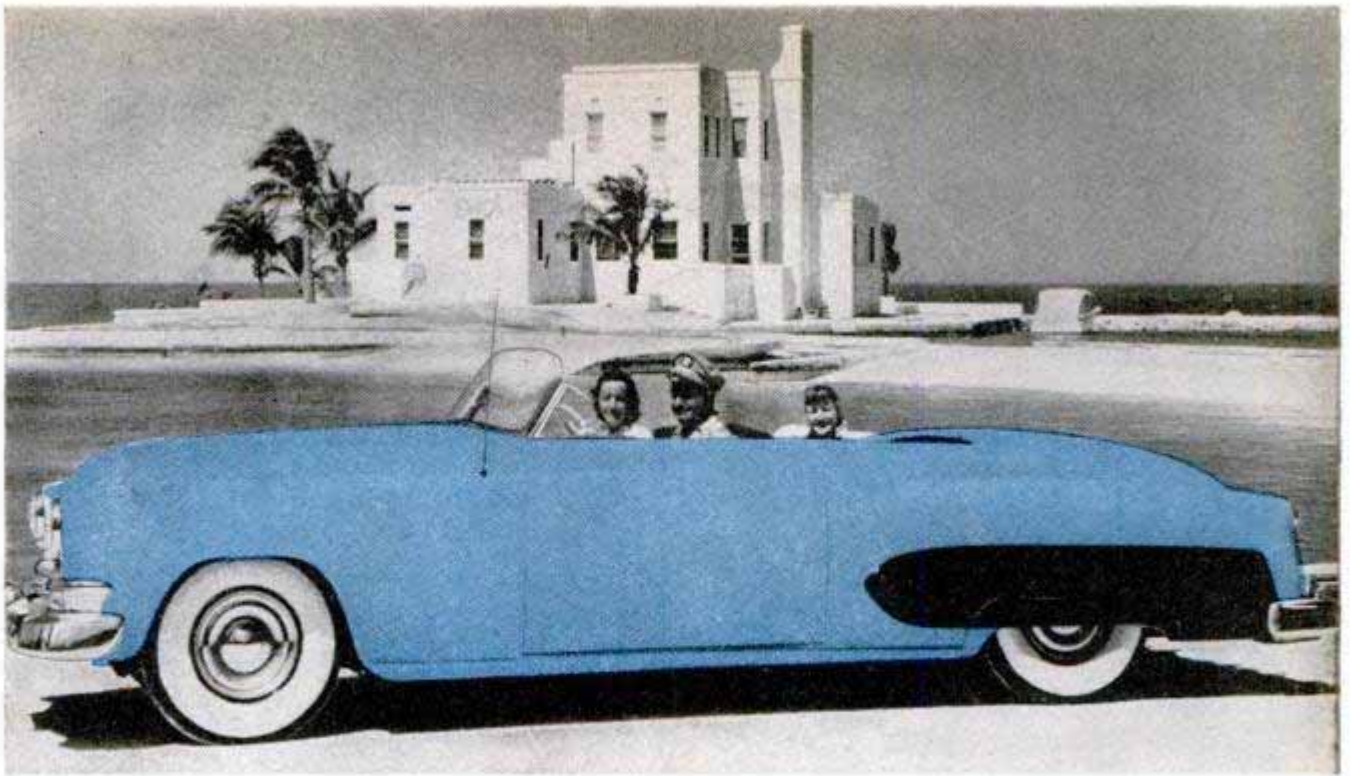

Some body parts were "borrowed" from other cars—Chrysler hood, Buick windshield and Packard rear fenders

Cunningham conversion that includes a high-compression manifold and four carburetors. New pistons and connecting rods can push that up to 250 horsepower. Another 10 horsepower is obtained with an exhaust cutout for country driving. By removing the chrome-plated air filters from atop the carburetors, Clark says he can boost output eight more horsepower. Together, these modifications add up to enough

extra power to boost the Cyclonic's top speed to 150 miles an hour.

Doors and trunk are opened by solenoid magnetic switches. On each cowl, just in front of the windshield, is a small button that operates the solenoids, eliminating the need for door handles that would mar the car's smooth lines. You press a button and a door swings open. Buttons on the dashboard open the doors from inside.

Power plant is a Chrysler FirePower V-8 souped up to 225 horsepower by a new manifold and four carburetors

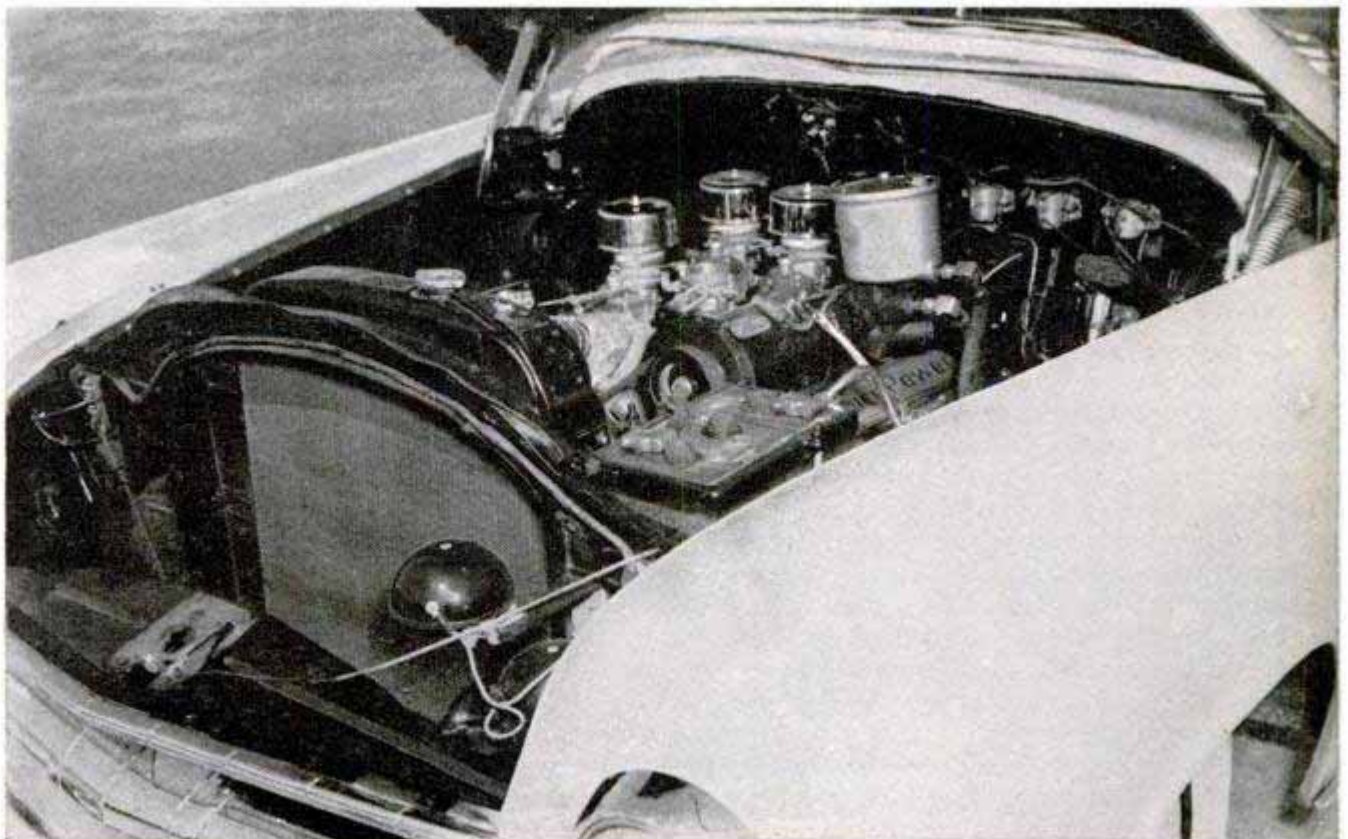



David White Co.
315 W. Court St.
Milwaukee, Wis.

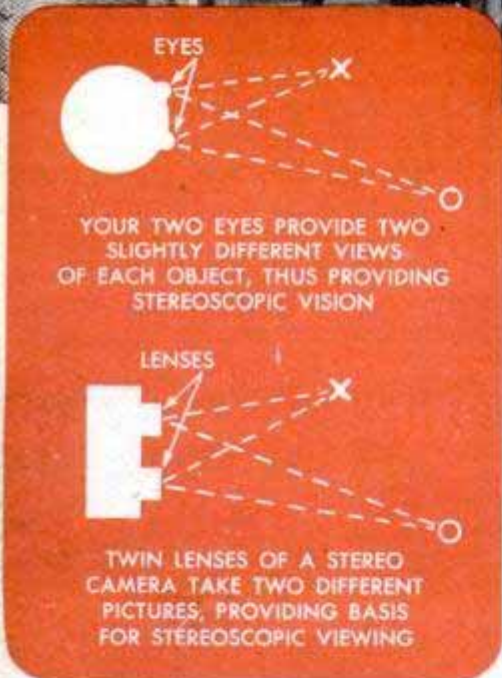

Today, the whole family enjoys three-dimensional slides with a twin-lens projector like the Stereo-Realist model. The Polaroid glasses separate two images so brain can create depth illusion

STEREOPHOTOGRAPHY

Sweeps the Country

By Ewart Thomas

ONCE YOU'VE TAKEN pictures in three dimensions you'll never be satisfied with flat photography again."

That's what thousands of photo fans are saying and their numbers are increasing every day. Color pictures in three dimensions are almost as realistic as life.

In three dimensions, a color picture of mountain scenery gives you the illusion of actually looking out a cabin door. A close-up of a flower becomes so lifelike that you can almost smell its fragrance.

The tall building that was so disappointing when photographed with a single-frame camera now seems to stretch up toward the clouds. The view of the lake that was a flop as a conventional print suddenly be-

comes a realistic picture of sparkling water.

These three-dimensional effects are produced by the same principle that governs your own two-eyed stereoscopic vision. Stereophotography uses pairs of pictures taken with lenses spaced to match the distance between the pupils of your eyes. You get the same impression of depth, distance and roundness of objects as you do when looking at the scene itself.

Hollywood has spent millions getting stereo ready for the screen, but you can just about equal the best results of the professionals at costs ranging from a few dollars to several hundred dollars. You don't have to be an expert or a millionaire to get dramatic results.

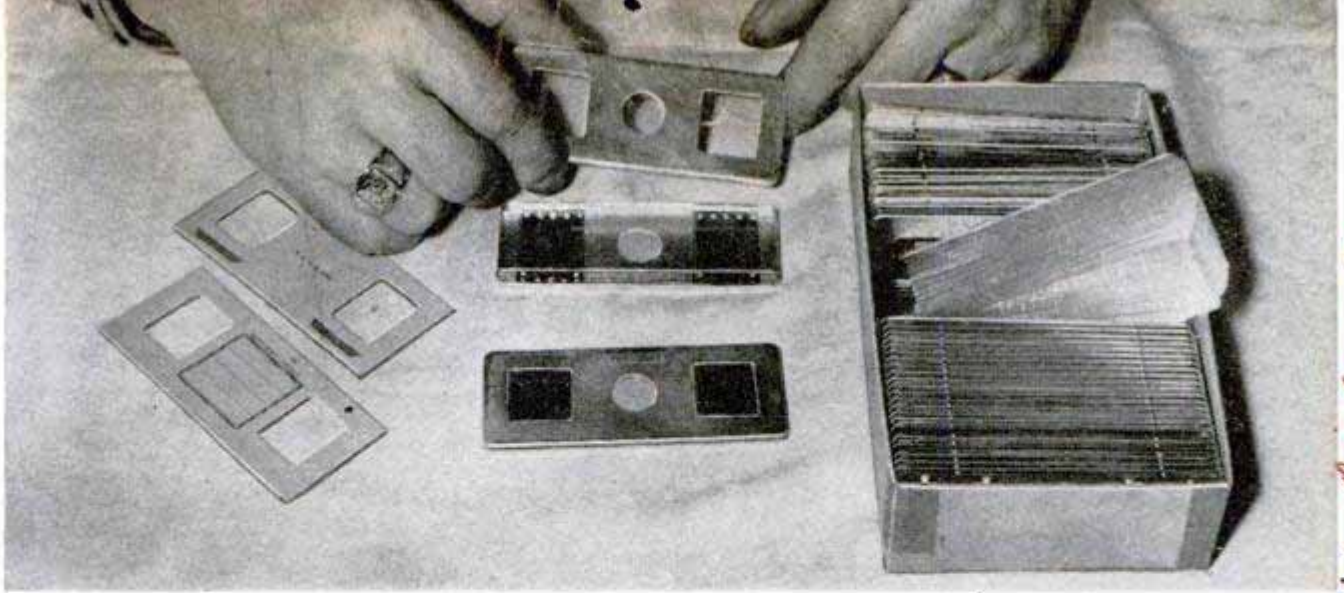

*Advertising Displays, Inc.
Covington, Ky.*

Precise mounting of the two views in slide is necessary if you are to get the stereo effect without eyestrain

You can convert your camera to stereoscopy with a "flop over" tripod head that costs \$5. You take one picture, wind the film for the next exposure, move the tripod head and camera to the other position, and shoot the second picture of the pair. Or, at virtually no cost, you can build a flat wooden tray 2½ inches wider than your camera and attach it to your tripod. Take one picture with the camera pushed snugly into one corner of the tray, the other picture with the camera in the other corner. Correctly mounted and viewed, the paired pictures provide a stereo effect.

A stereo attachment for taking both pictures at the same time has a set of diagonal mirrors and fits over the lens of your present camera. It retails at about \$15.

Best results, however, are obtained with cameras designed especially for stereo. These are mostly in the 35-millimeter film size and have twin corrected lenses that shoot simultaneous side-by-side pictures. Precision instruments, they usually contain built-in range finders and provision for synchronized flash. Prices begin at \$88.50 and go up past \$400.

The paired transparencies made by these

R. F. McGraw, stereo expert, uses the top camera for square pictures, the lower one for horizontal shots

One of these stereo projectors mounts its two lenses side by side, the other has them one above the other

*R. F. MCGRAW
607 N. HERMOSA
SIERRA MADRE, CALIF.*

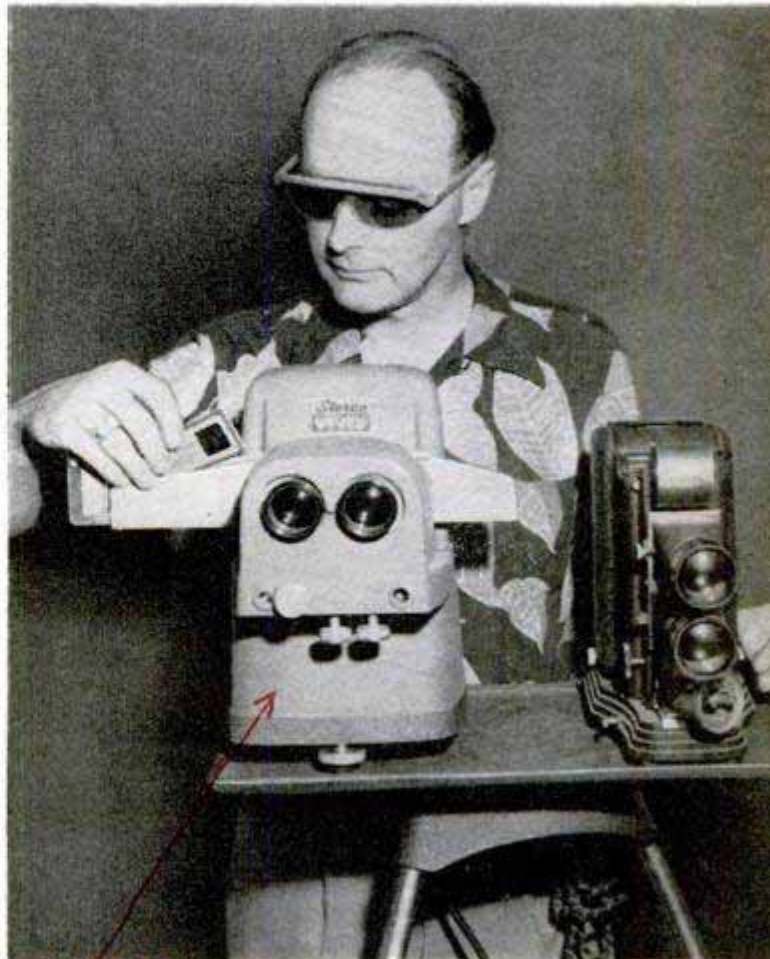

*Three Dimension Co., Inc.
1255 Addison*

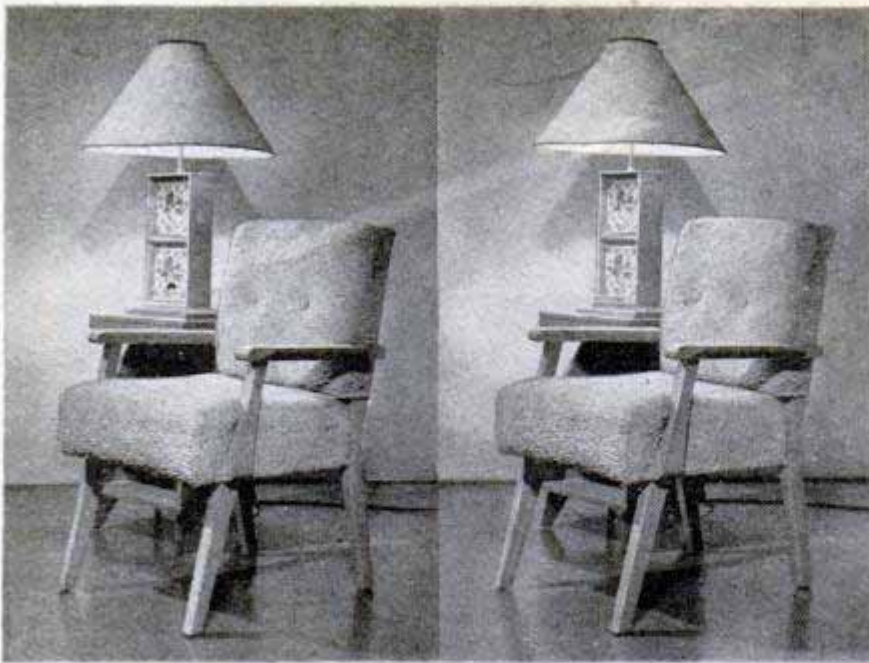

With practice you can see in depth without a viewer. Two shots at left are a stereo pair. Place a cardboard between them, as in the top sketch.



Stare down, being careful that each eye sees only one view. The two will blend into a single stereo scene. Another way is more difficult. Hold them at normal viewing distance and look over them at a distant object. Raise the pair into your line of vision as in sketch at left.



Don't refocus the eyes. You'll see three images. Concentrate on center one. It has depth

cameras are mounted in slides and are viewed in a special viewer. A cheap viewer costs a dollar. For \$15 and up, you can get one with self-contained battery illumination and adjustments for focus and parallax. The viewers will take black-and-white reversal transparencies as well as color.

You may make ordinary black-and-white prints and view them by reflected light in a stereoscope similar to those that were popular years ago. Few persons, however, are satisfied with anything less than color transparencies.

If you aren't content with a hand viewer you can project your three-dimensional color transparencies onto a screen, enlarging them to life size if the screen is big enough. You will need a two-lens stereo projector, a metallic-coated flat screen, or at least one that doesn't have a beaded surface, and Polaroid spectacles for yourself and each member of the audience.

The most dramatic effects of all are provided by motion pictures in three-dimensional color. An attachment that converts almost any 16-millimeter movie camera to stereo sells for \$45. A complete outfit consisting of camera converter, bracket, converter for the projector and a special screen lists at \$83.50. With these attachments for your equipment, you can produce films guaranteed to enthrall any audience. You can scare your guests with a scene in which an automobile charges straight at the camera. The effect is so realistic that the audience instinctively ducks out of the way. Polaroid spectacles must be worn, of course.

Here are some tips for good stereo pictures, no matter what type or size of camera you use:

Right, "flop over" tripod head keeps camera in proper position for paired stereo shots of still subjects

Hold the camera level, preferably on a tripod. It's a good idea to cement a tiny spirit level to the top of the camera. Pictures taken with the camera tipped to one side can't be straightened in the viewing mask and they create eyestrain.

Use a small aperture to focus the entire scene. A fuzzy background gets by in flat

You Can Take Stereo



*The Ward Co.
see pg. 111*



View-Master photos

Costs are cut by a new stereo camera that puts 69 pairs on a roll. Film cutter, above, automatically

punches out the pairs which are then inserted in a reel, above, and viewed with inexpensive stereoscope

photography but it spoils the illusion in stereo. Misty landscapes are not good subjects for the same reason.

Avoid empty shadows in a picture. They look like holes or tunnels and will spoil the effect.

Use a person or object in the near foreground to heighten the stereo effect if you wish, but avoid placing the figure too close to the camera. Four feet is a safe distance for pictures to be used in a hand

viewer, eight feet is safer for pictures that are to be projected. Closer objects will produce eyestrain.

Tilting the camera upward produces an unfortunate distortion in flat photography but in stereo the effect is realistic. (Vertical tilting is not the same as tipping the camera to one side.) In stereo, too, you can shoot through a row of tree trunks or other objects that would produce only a cluttered foreground in ordinary pictures. In a flat

Pictures With Your Single-Lens Camera

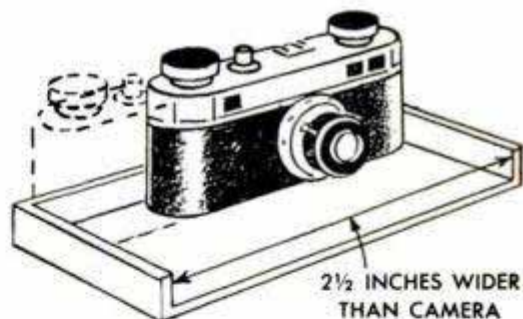

Tray holds camera for stereo. On second exposure, slide camera to other corner. Left, wide tripod head permits greater camera movement for exaggerated stereo

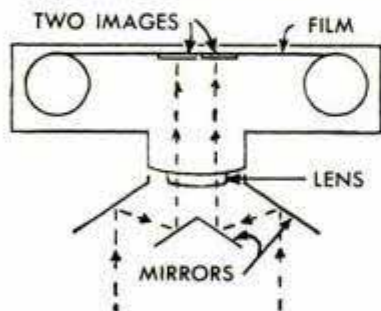

Right, beam splitter slips on lens of any camera to shoot stereo pair simultaneously. Each one of photos is half normal size. With it, you can take action shots. Other devices shown here take still scenes only. Above, light paths in beam splitter

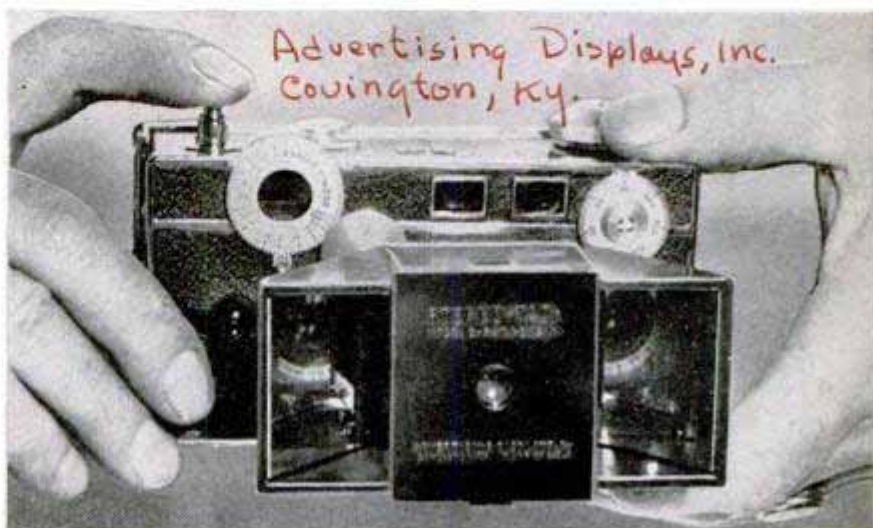

Commercial Picture
Equip, Inc.
1567 W. Homer
Chicago.

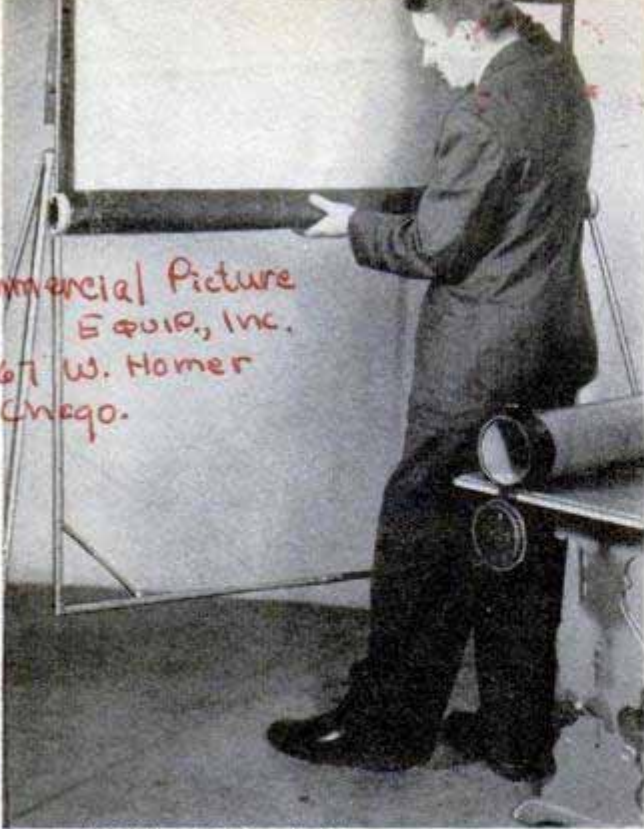

Commercial Picture Equipment photo

Rubber screen, held under tension inside metal frame, provides flat surface required for stereo projection

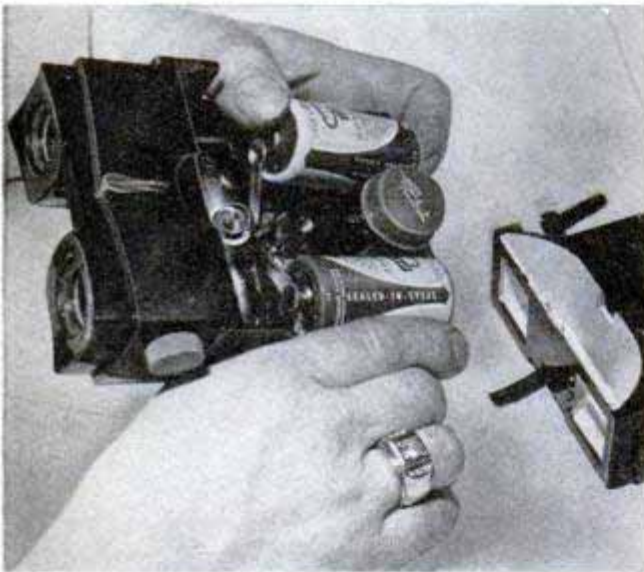

Most fans show stereo slides with viewers. Above, flashlight batteries power the light source of this viewer. Below, three more hand viewers. The one at right has own light, others rely on outside sources

photo the trees would block the view—in stereo you can look right past their trunks.

For a novel effect, aim the camera to pick up the reflections of a street scene on a store window. That's a shot to be avoided in ordinary photography, but in stereo you'll find that you can look through the window into the store itself, or you can focus your eyes on the reflections on the window and see, in three dimensions, the details of the scene on the street.

R. F. McGraw, photographic artist whose three-dimensional pictures have been exhibited, suggests that the best stereo pictures are those made of subjects from three to ten feet from the camera because the effect is most pronounced at short distances. The usual stereo landscapes are not effective, pretty though they may be, because any subject that is several hundred feet or more away tends to look like a painted backdrop.

A distant scene, however, can be effectively photographed by hyperstereo; that is, by taking the two pictures at a greater than normal interocular distance apart. McGraw uses a wide arm on a tripod for making stereo pairs at distances up to 14 times the normal separation. One frame of film is exposed at one end of the arm, the other frame is exposed at the other end. Aerial stereo pairs may be made as much as $\frac{1}{2}$ mile apart to give a true picture.

There are many pseudostereoscopic effects, but true stereo must conform to three basic rules: 1. There must be two pictures from two points of view; 2. Each eye must see only the picture intended for it; 3. Superimposition of the two images must take place in the brain.

This explains why special viewers or polarizing spectacles must be used when looking at stereo pictures.

There is another method, the lenticular system, that depends on a surface consisting of parallel raised ridges or rods to impart a stereo effect. It is effective only when viewed from certain angles.

The so-called anaglyph system also con-

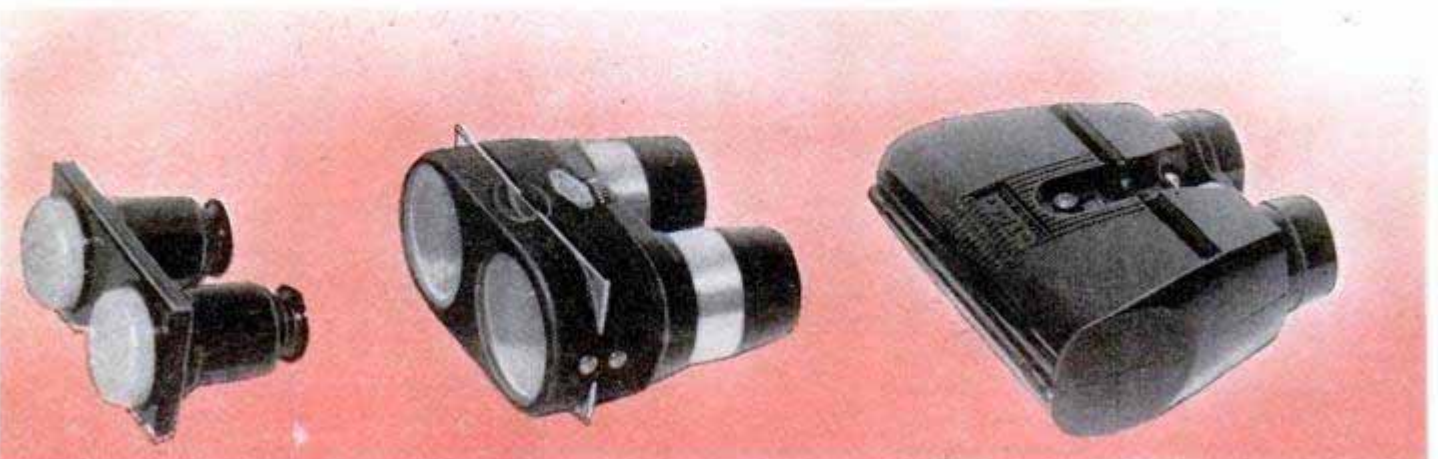

forms to the basic rules of stereo and was used in a few experimental motion pictures 20 years ago. Two tinted images are thrown on the screen and the audience wears spectacles with a green filter for one eye, a red filter for the other. The system works but is extremely tiring to watch.

More satisfactory and much less tiring is the modern projection system in which the two images are each polarized at a different angle. The audience wears polarizing spectacles consisting of Polaroid filters that sort out the two images, one for each eye. Motion pictures in stereo, based on this method, are being demonstrated now by the Natural Vision Corporation of Hollywood. The system was designed by Friend Baker, nationally known stereo expert, and uses two cameras and two projectors.

Somewhat different is an alternate-frame technique developed by Maj. R. V. Bernier of the Air Development Center, Wright-Patterson Air Force Base. A single motion-picture camera is used instead of twin cameras. A beam splitter which uses diagonal mirrors is placed before the camera lens and a special rotating shutter exposes one frame of film via the left mirror, the next frame via the right mirror. Thus, in succession, views as would be seen by the left and then the right eye are exposed.

For projection, a polarizer is rotated in front of the lens. One frame of film is polarized in one direction, the next frame in the opposite direction. Members of the audience wear Polaroid spectacles and each eye sees only the images intended for it.

Optical-research people say that in the future we'll have movies and television in three dimensions that can be viewed without visual aids. William G. Straube, researcher at the Pacific Optical Corp., has

To show stereo movies, a mirror device is placed in front of projector to direct both images on screen. Polarized glasses have to be worn by the audience



Nord Company photo

Stereo movies are made by adding a beam splitter to lens. By proper masking, regular viewfinder is used

worked out the theory of one such system.

Straube proposed a large "spatial" nuclear vacuum tube in which particles in space would be ionized or excited to visibility by impulses from a radar-type viewing camera. Any scene picked up by the radar camera would be duplicated in miniature and in three dimensions inside the tube, near objects appearing in precise detail near the front of the tube and distant objects being made visible by local excitations toward the rear of the tube. Some experts think that within a decade we'll be able to build a tube like that, something that seems fantastic today. ★ ★ ★

Another stereo-movie beam splitter, designed for the Bolex camera, has bracket for offsetting viewfinder. With this outfit you can make sound movies in stereo

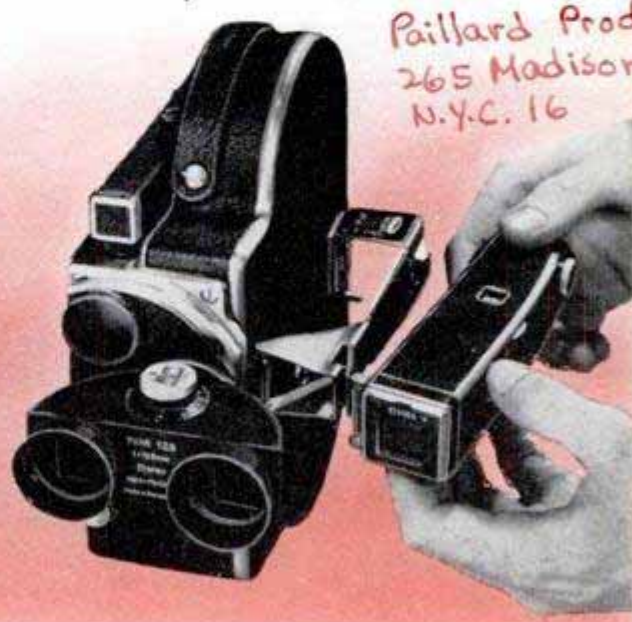

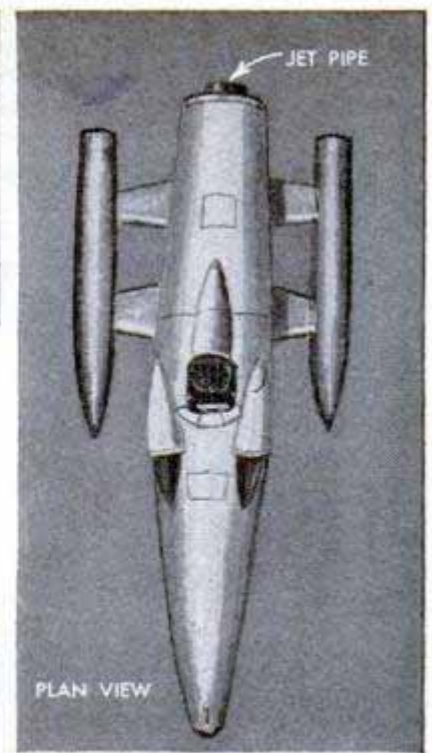
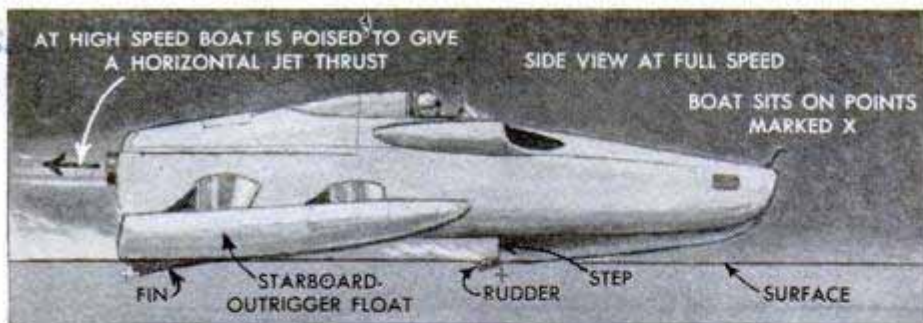

Can Jet Boat Blast Record?

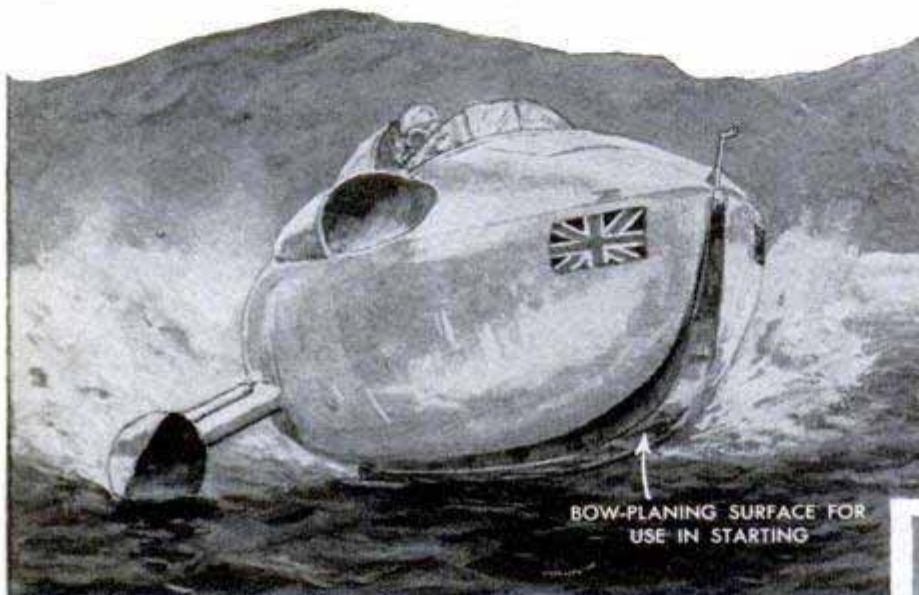

IT IS BELIEVED THAT CRUSADER WILL REACH A SPEED OF OVER 200 M.P.H. ON LAKE WINDERMERE

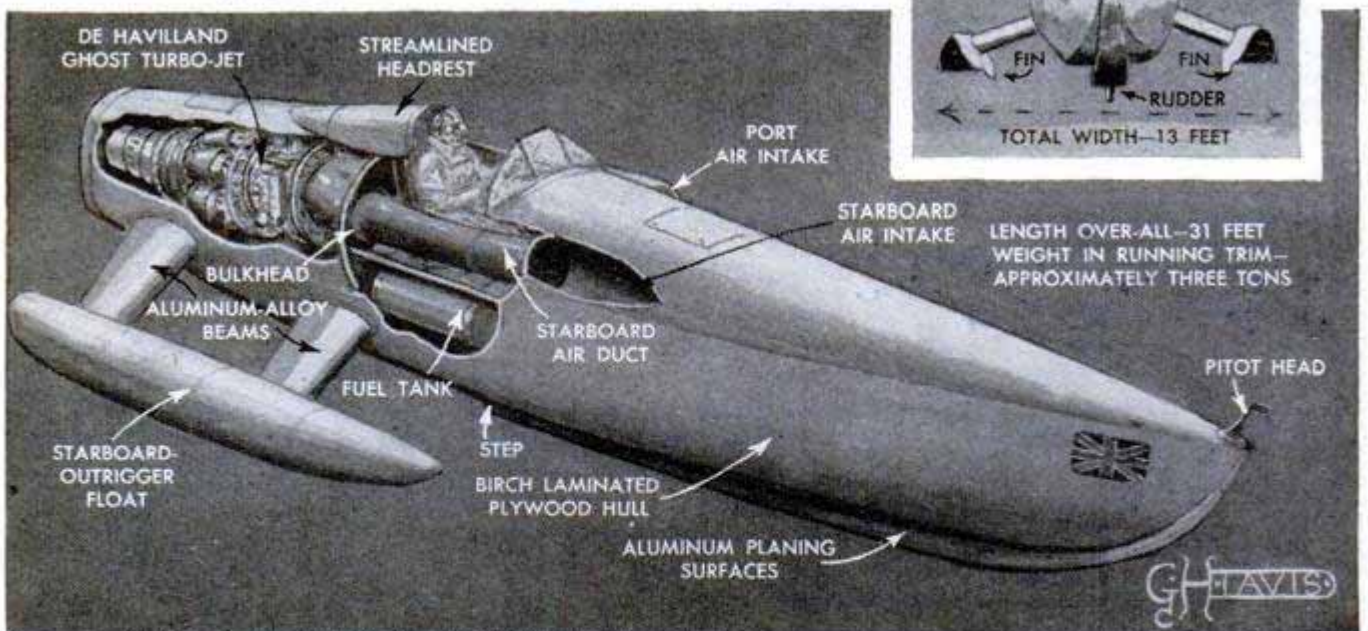
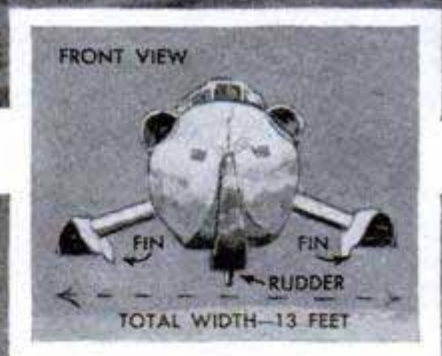

Drawn especially for Popular Mechanics by G. H. Davis, English artist

Can a strange new boat powered by a jet aircraft engine set a world's speed record? The answer will come soon when John Cobb, of land speed fame, tries his odd craft on Lake Windermere in England. The present speed mark, set a few weeks ago

by Stanley Sayres of Seattle, Wash., is 178.497 miles per hour. Cobb expects his boat to skim the surface at better than 200 miles per hour. The 31-foot racer, made of aluminum alloy and birch plywood, has two outriggers to give it high-speed stability.

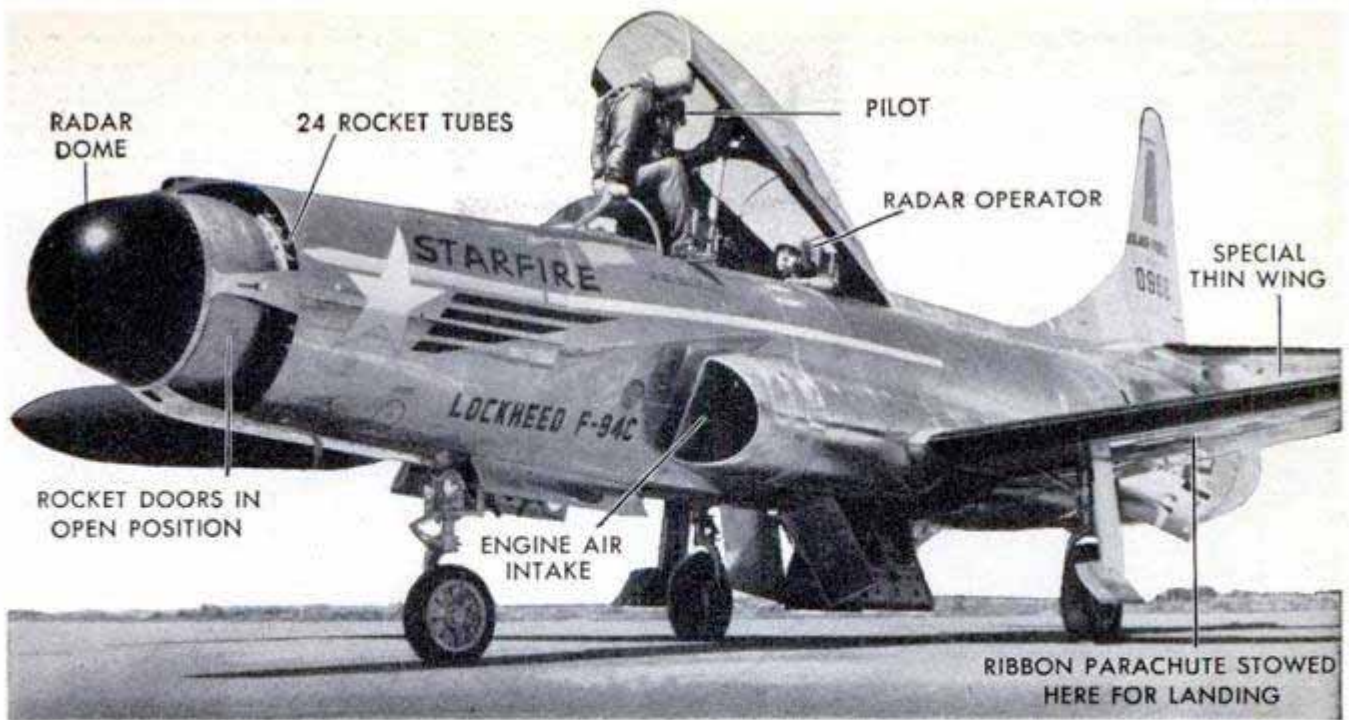

24 Rockets Ring Nose Of Lockheed's Jet Starfire

Bristling with 24 air-to-air rockets housed in a ring around its nose, the Lockheed C-94C Starfire is an almost-automatic jet airplane. Radar and specialized, brain-like instruments enable it to spot the enemy

miles away, lock onto the target, track, close and open fire—all by itself. The Starfire carries two dozen 2.75-inch rockets. It has a top speed of over 600 miles an hour and exceeds 20,000 pounds fully loaded.

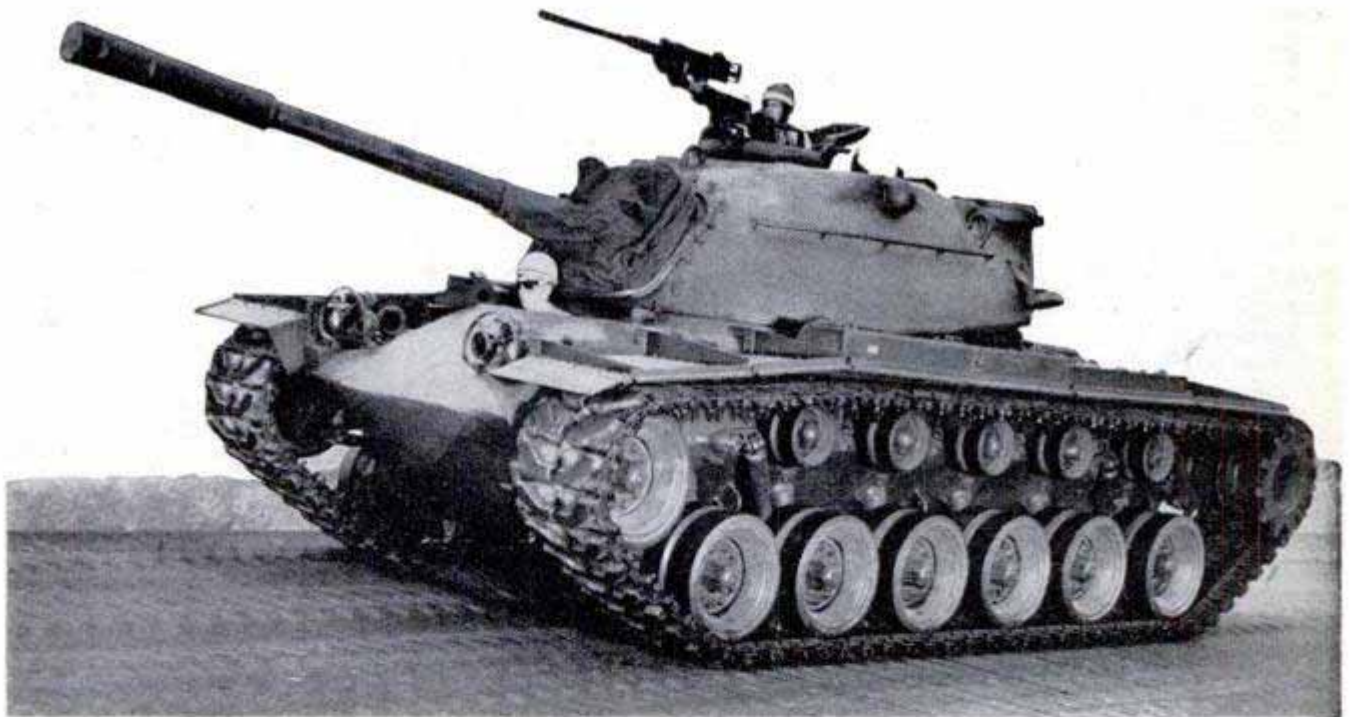

Rugged Patton Tank Has One-Piece Cast Hull

With the first one-piece hull ever cast, the new Patton 48 tanks are going into service as the U. S. Army's most rugged medium armor. Their sloping, elliptical sides afford greater protection and better vision to the crew. In the 45-50-ton class, the Patton carries a four-man crew. A high-velocity 90-mm. gun is augmented by one 30-

caliber and two .50-caliber machine guns. Unique is the placement of one .50-caliber gun atop the turret; it can be aimed, fired and reloaded from inside the tank without exposing any crew member. The Patton has power steering and a cross-drive transmission that eliminates driver fatigue. Its Chrysler engine develops 810 horsepower.

Looking for a good used car?
Here's the 1887 Johansen. It will
be displayed in the U. S. this
month at the American Automob-
ile Association's old-car show

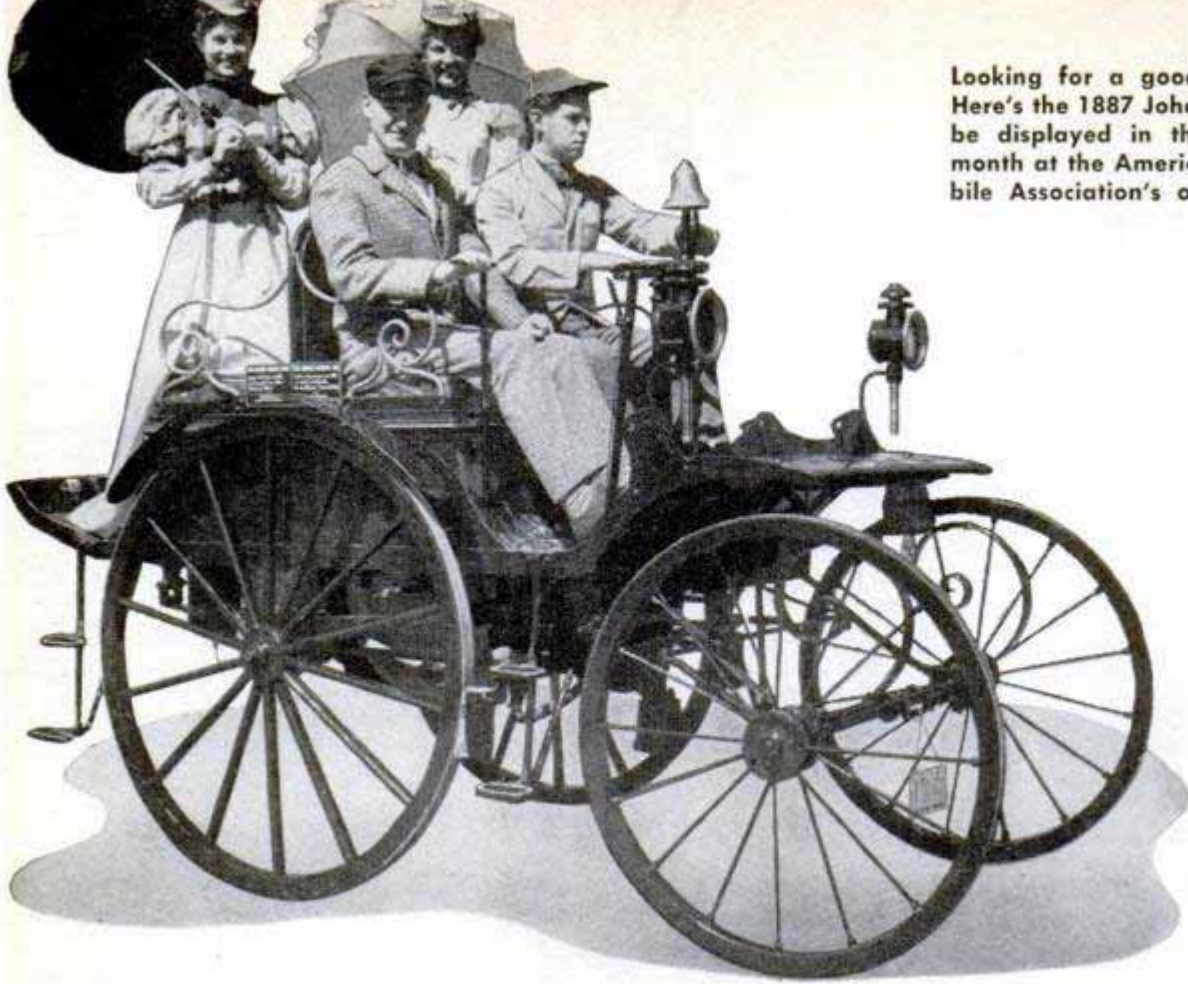

BUILT IN 1887— AND STILL RUNNING

Fuel is vaporized for the two cylinders
by evaporation from sponges inside the
carburetor. Pistons are made of cast
iron and are equipped with five rings

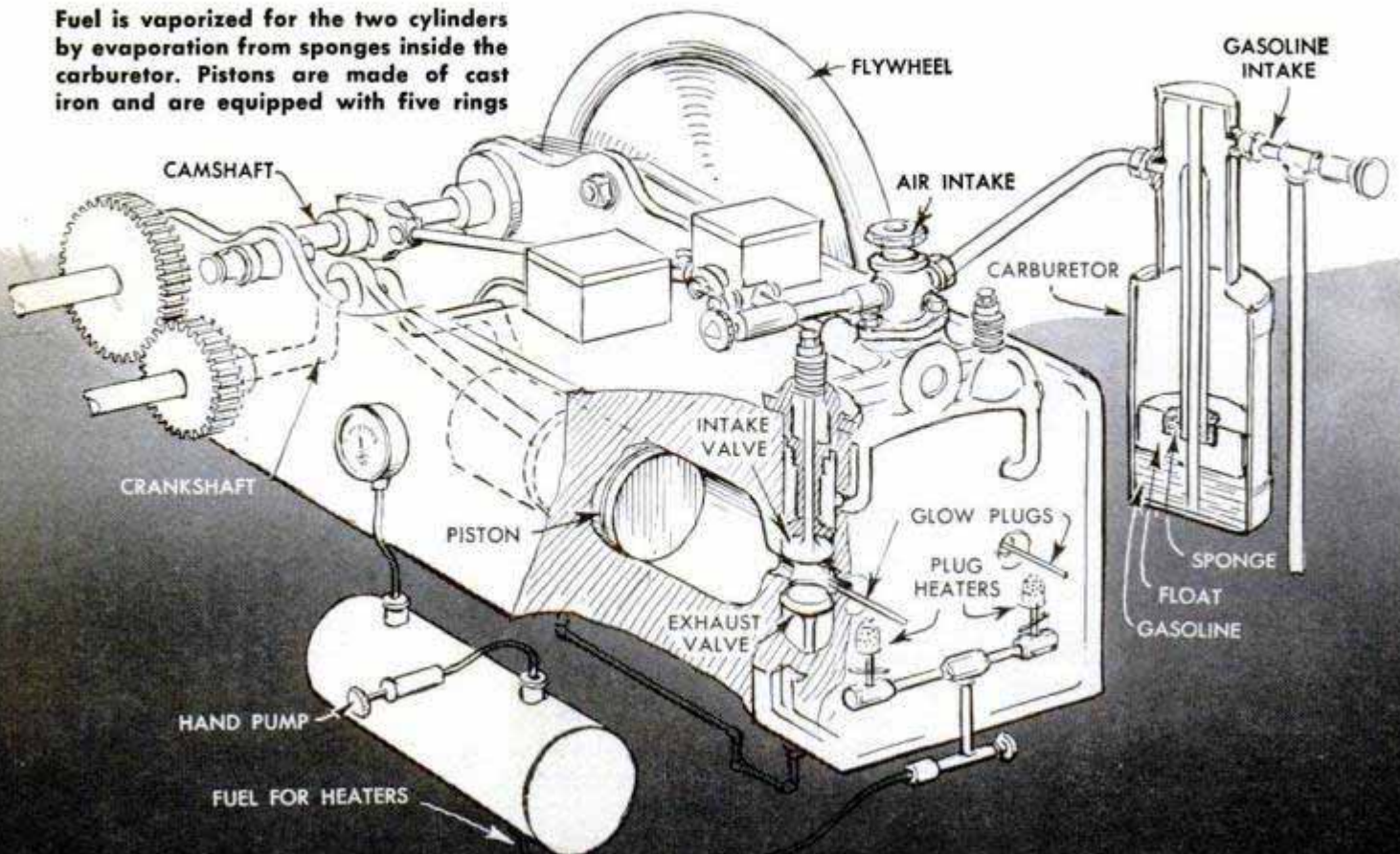

Below, steering the Johansen car is confusing to the modern driver. When you want to turn right, you spin the steering wheel to the left! Like all early cars, it was simply a carriage in which an engine replaced the horse

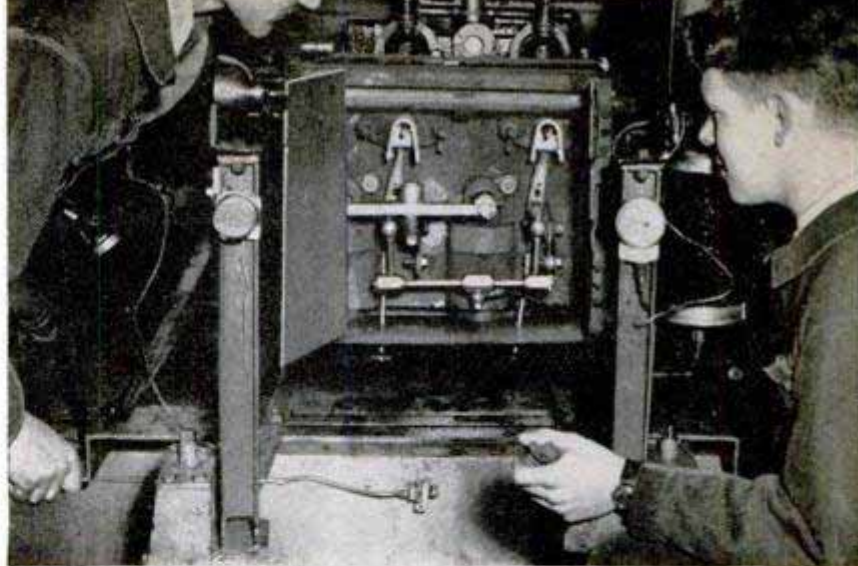
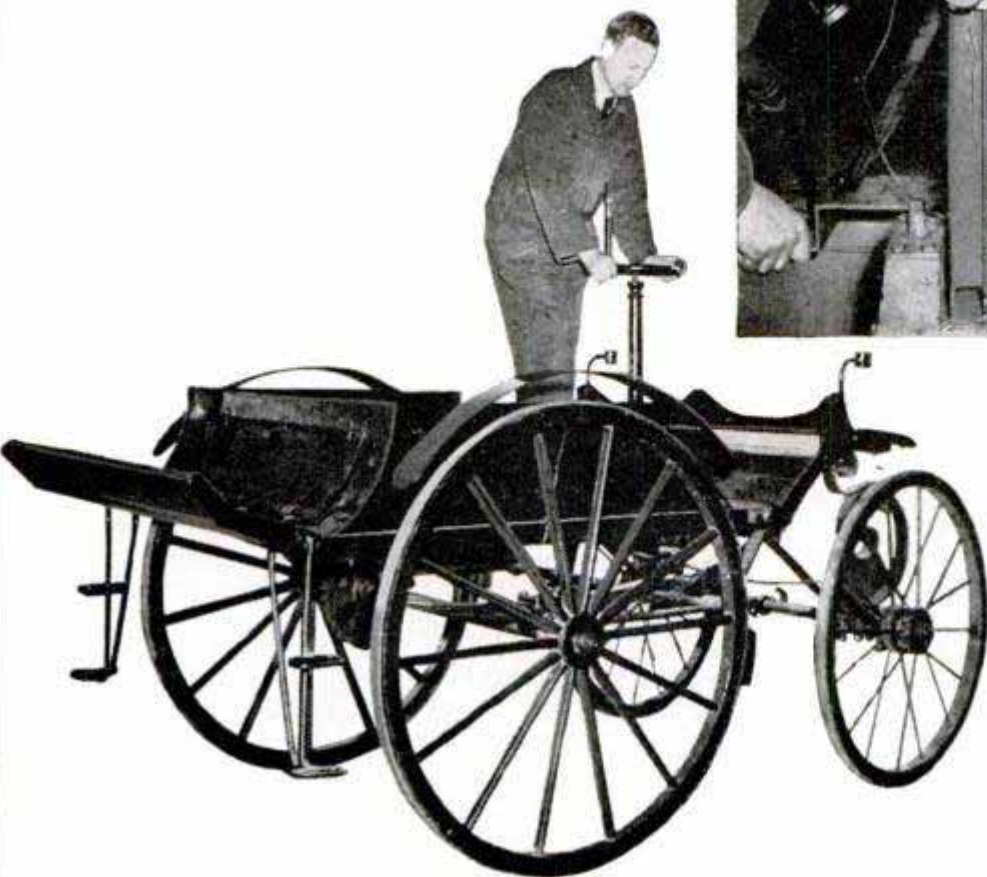

Above, the Danish mechanics who restored the 65-year-old power plant look over its ignition system. No electricity is used. Tiny blowtorches keep two steel rods hot enough to ignite the fuel. To advance the spark, both torches are moved closer to the block; to retard it, they are moved away. Below, lubrication was a problem. Two small boxes atop engine hold oil that is carried to the main bearing by pipes and wicks. Other friction surfaces have to be oiled with an oil can before starting a trip

IT WAS 65 years ago that a Copenhagen blacksmith named Urban Johansen donned a bowler hat, combed his beard and drove Denmark's first gasoline automobile. Its two-cylinder engine developed a feeble $3\frac{1}{2}$ horsepower. For several years, the car chugged around the city, until in 1890 it was stored away and forgotten—one of the world's first "junked" automobiles.

When the Royal Danish Automobile Club had its 50th birthday last year, it located the Johansen car. Parts were missing and dirt and corrosion covered the engine. Skilled Danish mechanics worked over it to put it in operating condition. The tanks were filled, the ignition heaters lighted and after two turns of the crank, the engine, for the first time in 62 years, coughed into action—a tribute to the genius of a Danish blacksmith.

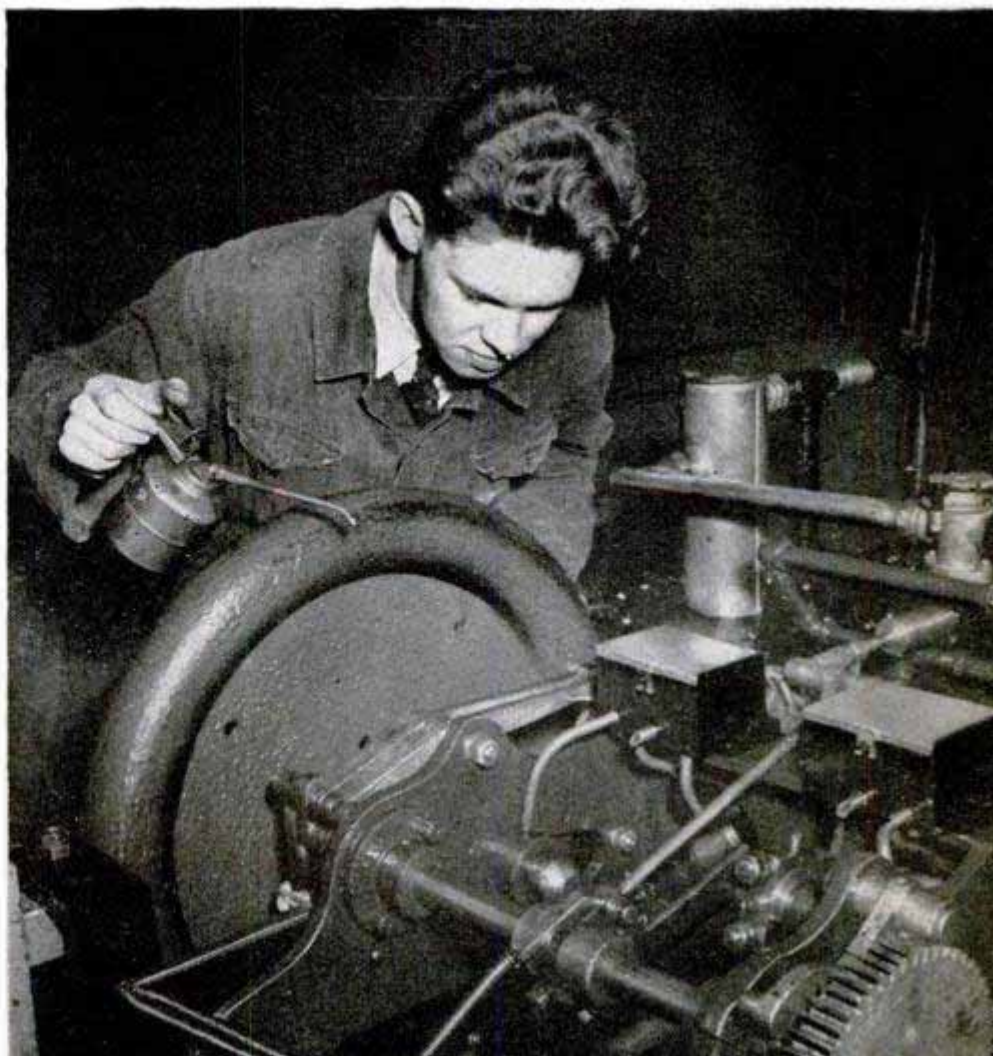

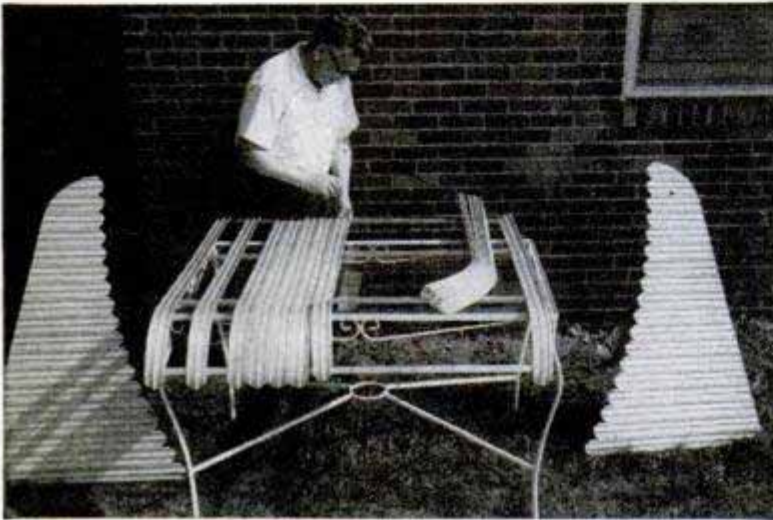

All-Weather Awnings Made From Kits

Homeowners now can assemble and install their own permanent awnings and door canopies. The protective coverings are available in kit form in a variety of shapes and sizes. Each kit includes pre-drilled framing members, pre-assembled sides, curved aluminum strips, and bolts to fasten the strips to the frame. The strips interlock to form a rigid, weatherproof awning or canopy. All the parts are pretreated to give them a surface suitable for painting. The awnings, which project 43 inches from the building, have either convex or concave tops and curved or straight sides. The same awnings and canopies are available completely assembled with baked-enamel finish.

Superspark Starts Jets

Jet-fighter planes are started by a new seven-pound electronics system that produces a 10,000-watt spark that produces a 10,000-watt spark from a mere 24-volt current supply. Developed by Bendix Aviation, the unit is now in volume production at Scintilla, N. Y.

Self-Warming Power Lines

Planned short circuits and deliberate overloading of power lines sounds like sabotage, but it's only a method of ice removal now practiced by many power companies. During sleet storms and freezing rains heavy electrical loads are applied, and so much current flows through the wires that they become heated. The ice then melts and drops to the ground. If no preventive measures are taken, lines burdened with ice may snap or swing violently in the wind, seriously damaging transmission facilities.

Another Anniversary Feature!

"Count people on the street, and every 387th will be an engineer. He looks like everyone else, often more so. Yet everything around us would collapse without him." So writes Harland Manchester, famous author, in an anniversary feature on engineering and the great American engineers. The story tells the adventures and ceaseless toil of the 400,000 engineers of American industry, "obscure as the coral that builds the atoll," who measure, check, test and design everything from bathtub faucets to atomic power plants. It's the story of a challenge that grows greater with every accomplishment. Don't miss "Engineering—the Might of America" in the October issue.

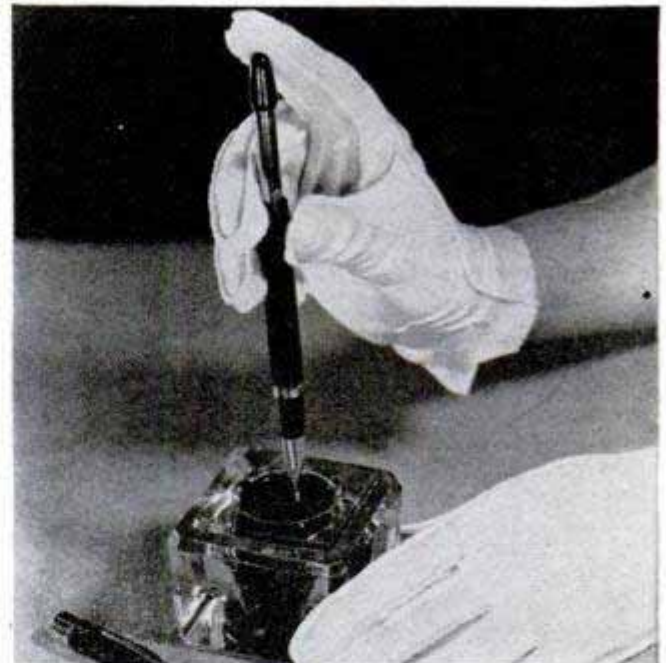

No-Dip Fountain Pen Prevents Inky Fingers

Ink blotters and pen wipers aren't necessary if you use a "messless" fountain pen which fills without dipping. A concealed tube extends from the nib when the pen is to be filled, and sucks up the ink. A slight push of the finger depressing the plunger retracts the feeder line.



There is no space wasted in the 452-pound Sky Baby, so compactly built that there isn't room enough for a chute for the pilot. It flies 150 miles an hour



Seven-Foot Airplane Flies 150 Miles Per Hour

With a wingspan of slightly more than seven feet, an airplane believed to be the smallest in the world flew 150 miles an hour over the California desert. The 452-pound Sky Baby is 9 feet 10 inches long. It was built at a cost of \$2200 for air shows and exhibitions. For visibility and balance the lower wing is set ahead of the upper wing, with a gap of only 39 inches separating the two.

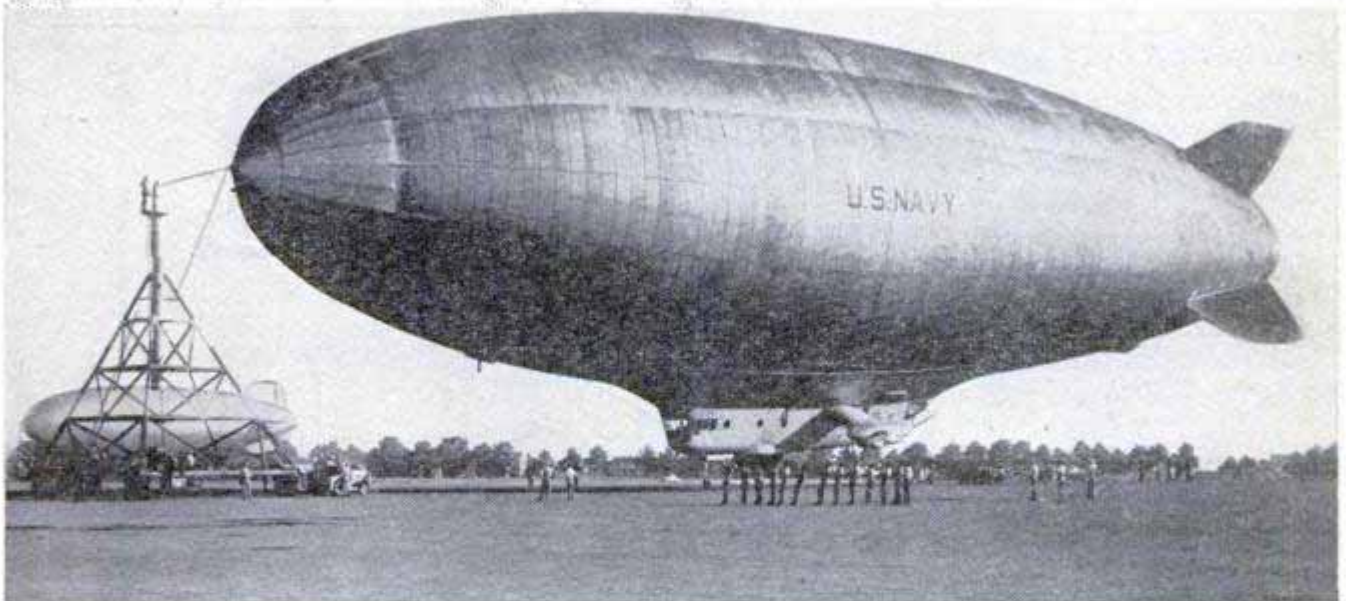

Navy Airship Longer Than Football Field

Described by the U. S. Navy as the largest ever built, a new nonrigid airship has been added to the lighter-than-air fleet at Lakehurst, N. J. It is 324 feet long, 95 feet high and has a helium capacity of 875,000

cubic feet. The giant ship's 800-horsepower engines can be repaired in flight and special refueling equipment will enable it to remain aloft indefinitely. It was built by Goodyear at Akron, Ohio.

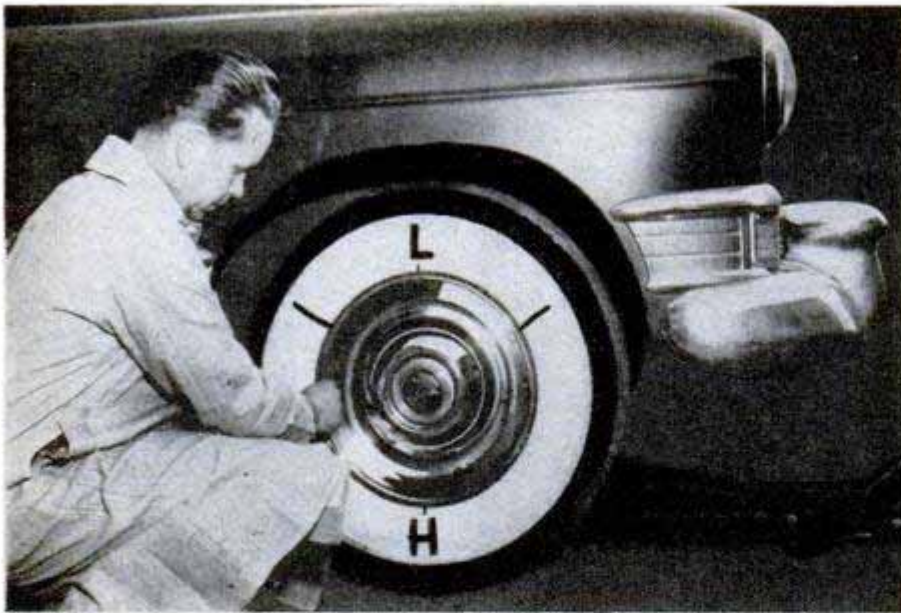

After heavy portion of wheel settles to the bottom, magnetic weights, below, are added equally at ten and two o'clock positions to balance it



Wheel Balancer

Wheel balancing is simplified and speeded with the use of a new system employing one-ounce magnetic weights and an indicator blade. It is based on the principle used in balancing armatures and generators, and the equipment can be carried in a pocket. Two wheels can be balanced in five minutes. After the heavy part of the wheel settles to the bottom, or six o'clock, position, both it and the light, or twelve o'clock, position are marked. After the wheel is turned until the light and heavy marks are horizontal, magnetic weights are added until the heavy portion is counterbalanced. The wheel is returned to its original position and conventional lead weights equal to twice the weight required to balance the wheel are attached to the rim, half at the ten o'clock position and half at two o'clock. The indicator blade is used to measure the positions accurately.

Emergency Fuel Unit

Installed in one minute on the carburetor air intake, a compact emergency fuel system starts any vehicle stalled by gasoline troubles. By-passing the gas tank, fuel pump and all lines, the unit injects the proper fuel-air mixture directly into the engine, giving normal acceleration at all speeds. It is leakproof, holds one gallon of gasoline, and is nine inches in diameter and six inches high.

Electronic Amplifier Brightens TV

Clearer, brighter TV images reportedly will result from use of a new electronic light amplifier for television sets. The amplifier receives a beam of light forming an image, transforms it into a beam of electrons, increases the intensity of the electron beam and then transforms it back into a light beam duplicating the original image with increased intensity. Lee deForest, "father of radio," and William A. Rhodes are co-inventors of the device, which they patented last spring.

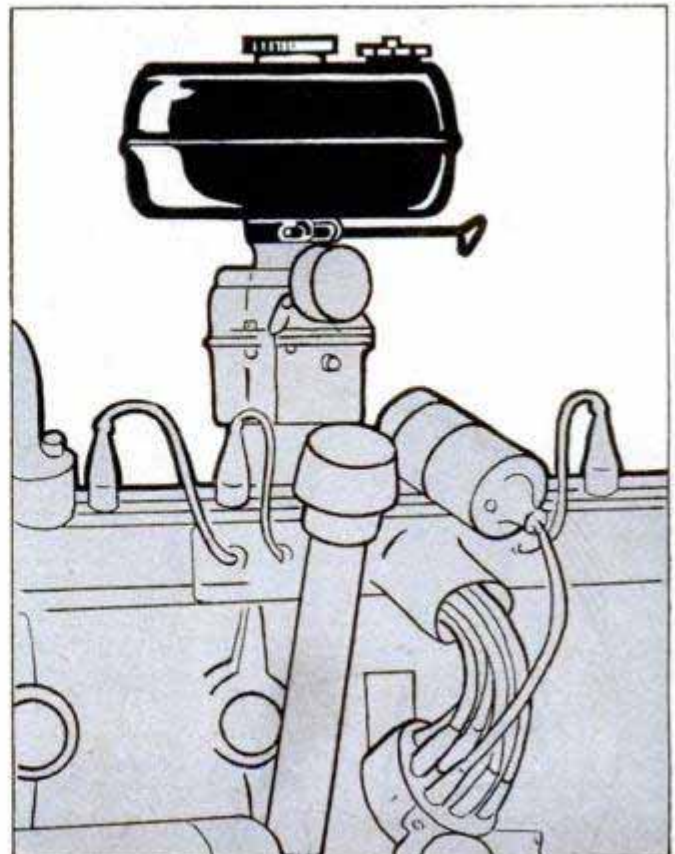

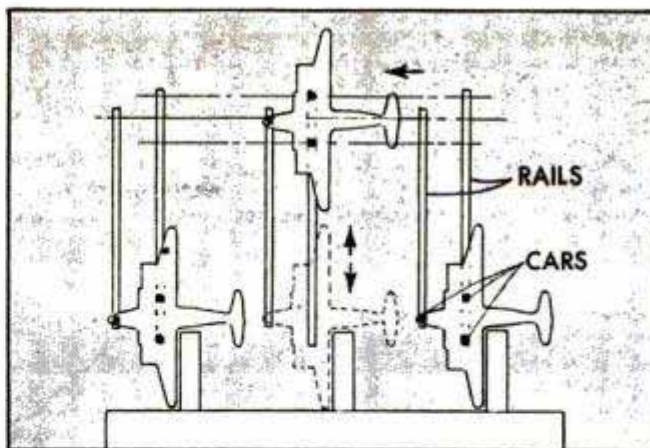

Airplane Parker Speeds Operations at Colombian Airport

At Barranquilla, Colombia, airplanes' time on the ground has been halved by equipment which moves transports sideways to the terminal over two sets of tracks that are almost flush with the ramp's surface. After the airplane is taxied into position with the nose wheel on a dolly on one

set of tracks and the main landing wheels on two dollies on the other track, an electric winch pulls it flush against the terminal. Passengers and cargo are loaded and unloaded directly to and from the building. Plane servicing can be handled by fixed units, eliminating many portable units.

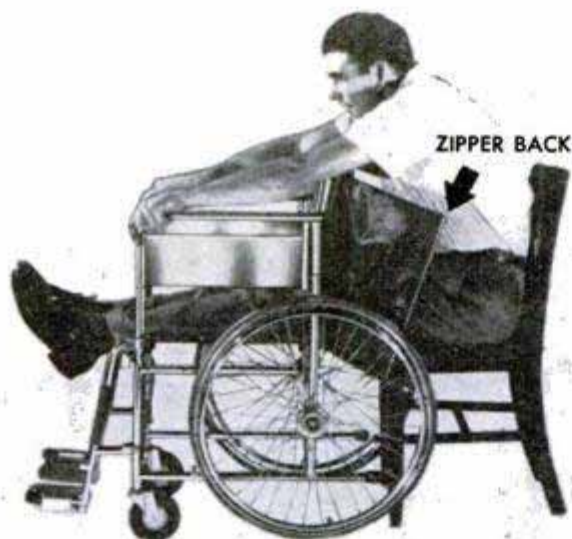

Zippered-Back Wheel Chair

Wheel-chair users have more freedom of movement when their chairs have zippered backs. Quickly opened, the zipper back enables the invalid to transfer himself from the wheel chair to a regular chair or bed by sliding backward. The return to the wheel chair is equally simple.

☞ "Raining cats and dogs" is too weak a term to describe the day at Baguio in the Philippines when 45.99 inches of rain fell in 24 hours.

Sources of available products described in this issue are listed on pages 12, 14 and 16. Sources of further information on other articles are listed in our free WHERE-TO-FIND-IT LIST. For your copy just write to the Bureau of Information, *Popular Mechanics*, 200 East Ontario Street, Chicago 11

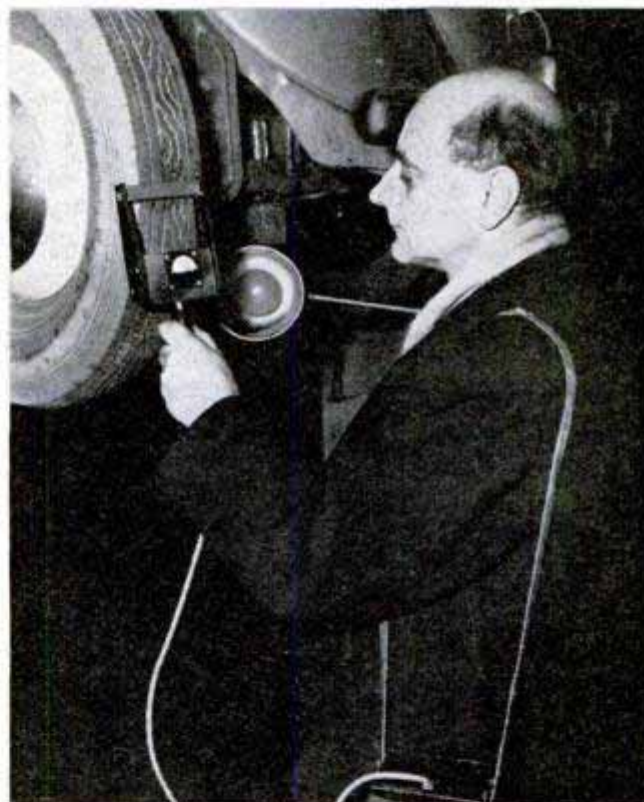

Electric Detector Spots Metal Particles

Nails or metal particles hidden beneath the surface of automobile tires are quickly spotted with a high-frequency detector developed by a German engineer. The detector consists of two coils, one to create oscillations that are picked up by the second coil. An amplifier, suspended from the operator's shoulder, transmits the data to a meter on the back of the detector unit. When the detector passes over a metal particle, the needle notifies the operator.

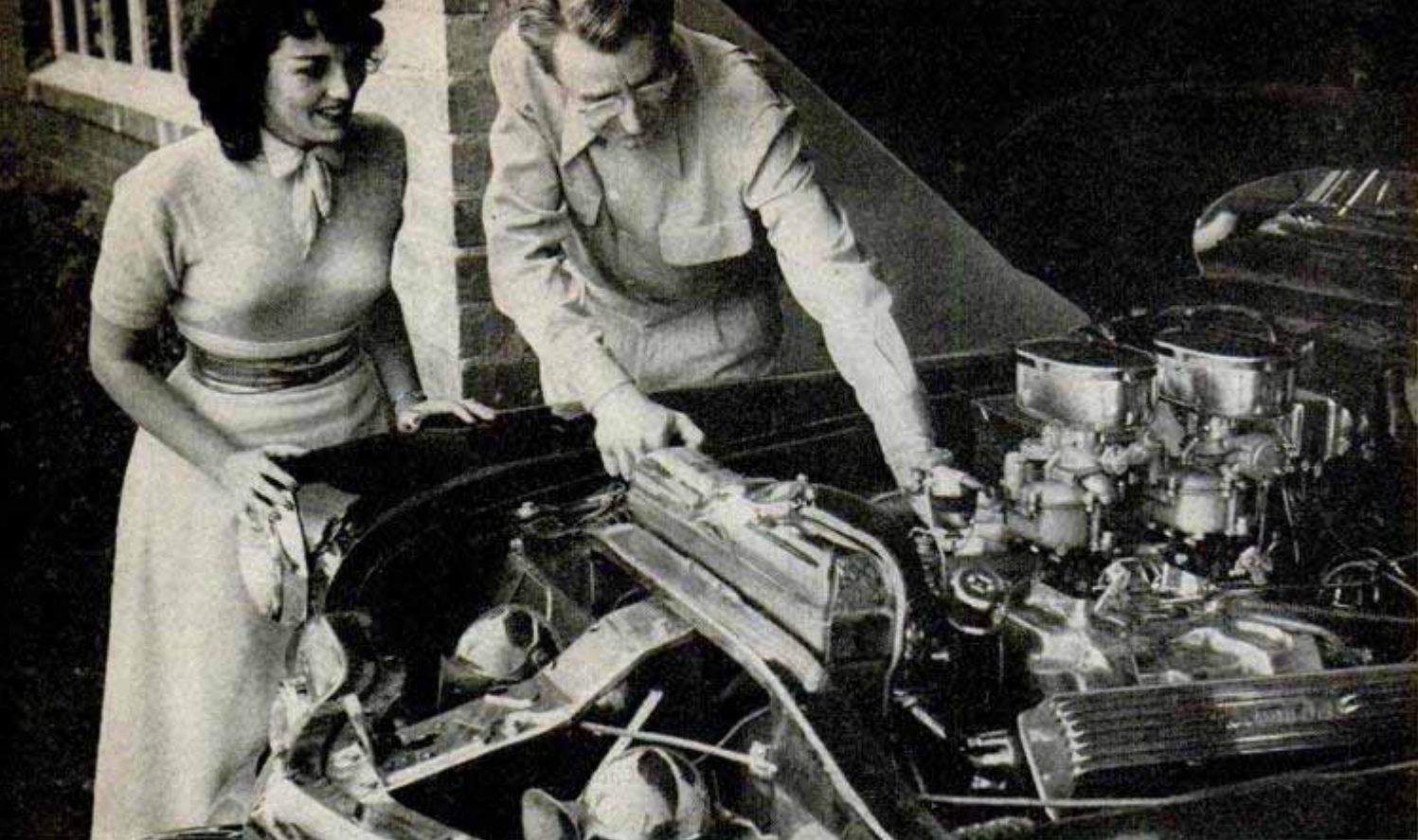

Cadillac owner listens as Edmunds explains engine modifications made in his shop to boost car's performance

"Soup Up" YOUR CAR?

Labeled parts in the exploded drawing of a Cadillac V-8 are those Edmunds installs in modifying engine

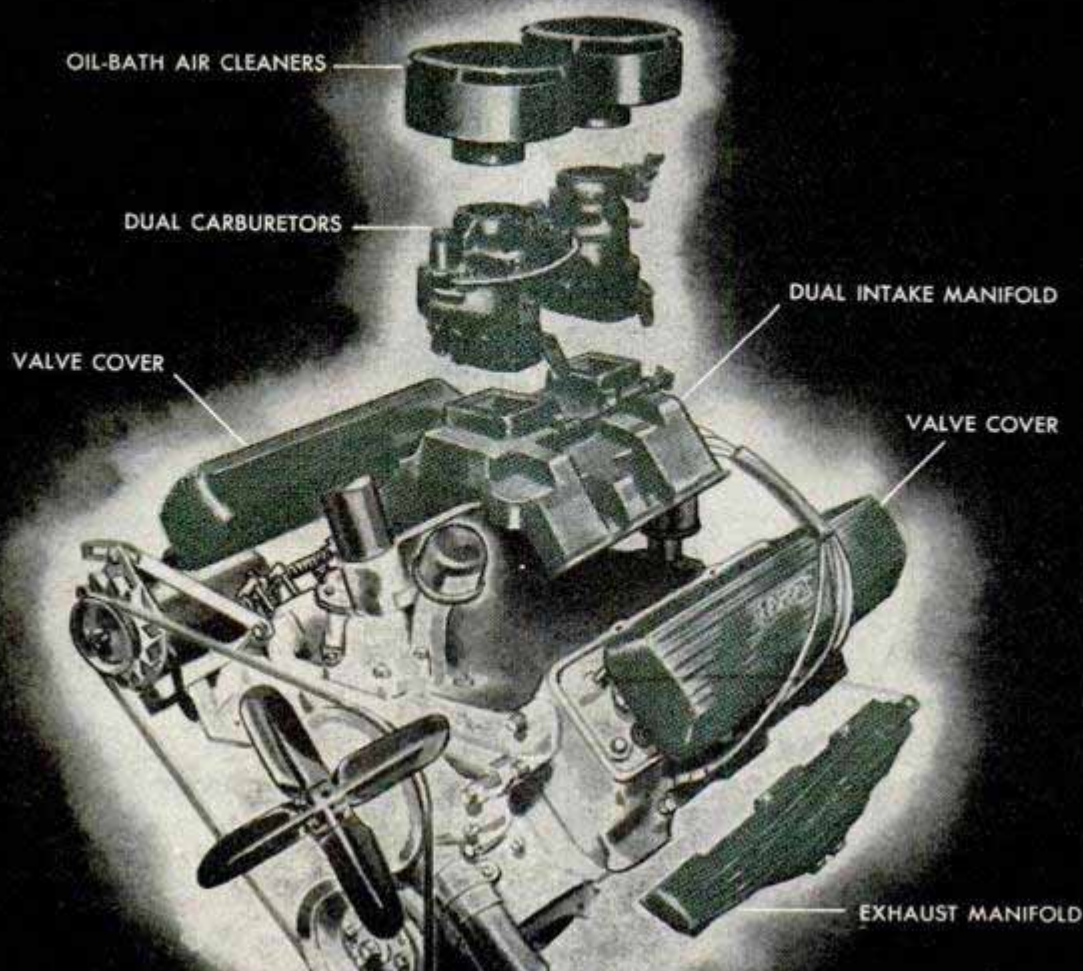

By Lou Jacobs, Jr.

TO MANY MOTORISTS, an automobile engine is merely something under the hood that makes the wheels go around. But not to the motorcar enthusiast! To him, an engine is a fine instrument to be tuned, adjusted and adapted until it's a slim whisker shy of the impossible perfection.

It is this enthusiast who keeps Eddie Edmunds busy. Edmunds builds engine parts that boost performance by an average of 25 percent—parts like cylinder heads, manifolds and air cleaners. Designed for stock engines, these modifiers convert any run-of-the-assembly-line car into a "souped up" custom job with more power, speed and efficiency.

You've heard a lot about hot rods and souped-up stock cars. At times, the horsepower-happy enthusiasts seem to have come from another world. In garages and back-yard workshops, amateur engineers argue over terms like volumetric efficiency and torque. But don't feel bad because you can't juggle technical nomenclature. From the Edmunds factory at West Los Angeles, Calif., you can get the same results and you don't have to know a wrist pin from a needle valve.

Suppose you're driving a late-model Plymouth with the 97-horsepower engine. Eddie Edmunds says his redesigned head and

dual-intake manifold will raise this to about 120 horsepower. Similar jumps are possible with most other cars at a cost of \$75 to \$150, depending upon the engine. For the valve-in-head Chevrolet, Edmunds claims a 26-percent boost in horsepower with the replacement of the manifold.

Students of the revamped cylinder head will understand easily that such claims are not exorbitant. Not every driver, however, knows that extra power can be obtained with mass-produced modifiers that can be bought and installed by any mechanic.

In the Mexican road race, the Chrysler Saratoga that set a new speed record with amazing sprints of 112 miles an hour was altered with an Edmunds dual-intake manifold. The Kiekhaefer Aeromarine Motors Company owned the entry. They ordered Edmunds' specially designed Chrysler manifold for the stock car and then redesigned it further. Nearly a third of the cars in that race carried Edmunds equipment that came right off his assembly line, though only one of them was actually remodeled in Edmunds' shop. The road racers installed the new parts as they came from the factory or modified them according to their requirements.

His reputation growing annually, Edmunds recently moved into a new factory where about 50 men and women work to make good engines better. In half the plant

Mechanic tightens down an Edmunds cylinder head on a 1951 Packard engine. Fluting carries off more heat



Dual-intake manifold is said to boost output of the Chrysler Fire Power engine from 180 to 214 hp.

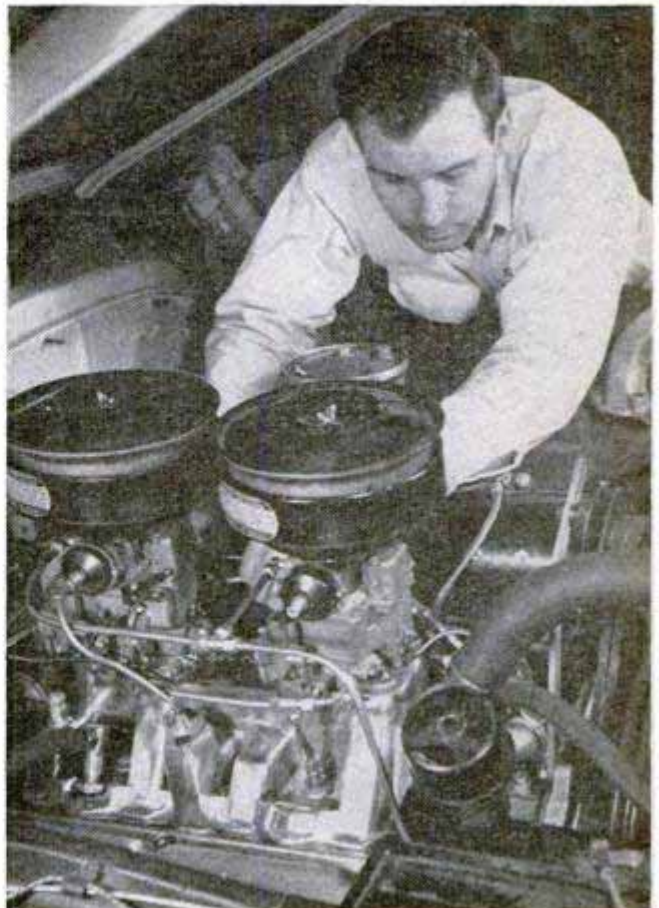



Patternmaker works on a new model for the Edmunds Nash cylinder head. Fluted head in background is the current modification



Above, aluminum-alloy manifold is carefully fitted into a jig to be drilled. Below, all Edmunds parts are thoroughly buffed and polished to improve appearance and increase heat transmission



Edmunds manufactures his own designs for dual-intake manifolds, cylinder heads and air cleaners, all of which are said to bring out the best in any American car and in some foreign cars.

About 150 different parts cast in an aluminum alloy are drilled, buffed, polished and finished on a production-line basis. A couple of patternmakers are kept busy constantly revising designs as new-model cars are introduced. Edmunds uses his influence in Detroit to get drawings or complete engines of most American cars before they are sold to the public so he can be ready with new modifications. Not long ago he had a call from a Los Angeles dealer who announced that he had a brand-new Lincoln engine for Edmunds to work on if he was interested. The dealer explained that if he could tell customers that 200 horsepower was available for their cars he would have an extra selling point.

The other half of Edmunds' plant is the installation department where local motorists get service, where mechanics from all over come for training and where slick custom jobs are devised for affluent drivers. Edmunds' brochures boast openly about the 325 horsepower obtainable from a 160-horsepower Cadillac engine. This kind of job—which includes reboring, new cams, new ignition and the works—costs \$1475, if anyone is interested. It means virtually a new motor. Edmunds, however, will tackle any kind of a modification from the simple addition of one or more of his standard parts through revamping a whole engine, depending on the customer's desires—and his pocketbook.

At this point someone might ask, "If Edmunds can improve the ordinary motor so drastically, why don't the big manufacturers grab his stuff or devise their own for the same purpose?" The answer to that is twofold. First, although well-known, the theories of engine design and revision are complicated and controversial. More power is obtainable from delicate adjustments and major improvements involving terms like volumetric efficiency and

(Continued to page 240)

PHOTO FOURSOME



Twin-Socket Light Bar

Lightweight and compactly designed, a metal support that attaches to the tripod socket of a movie or still camera holds two photoflood lights for even lighting. The lights are attached to two sloping uprights which pivot on the ends of the horizontal member. For storage, the uprights can be swung inward.

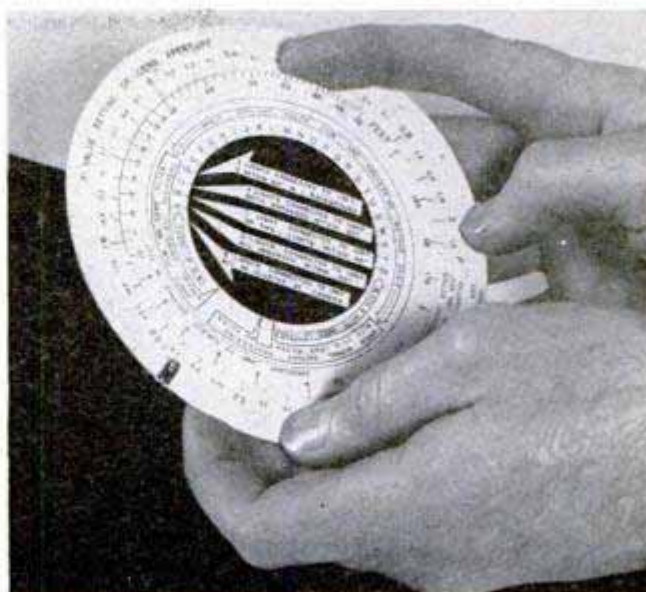

Exposure Guide

Based on 3600 controlled exposures, an exposure computer provides the speed-light photographer with a means of getting consistently good results on color work. The computer is locked in adjustment for any type of light unit from 10 to 5000-watt-seconds output. A manual is provided to explain the computer's use.



Photoflash Test Bulb

Photographers can quickly check both batteries and circuits before shooting flash pictures by means of test bulbs developed by Westinghouse. The bulbs use the proper voltage to test the circuits under normal conditions. In addition, the relative brightness of the bulb provides an indication of the battery condition.

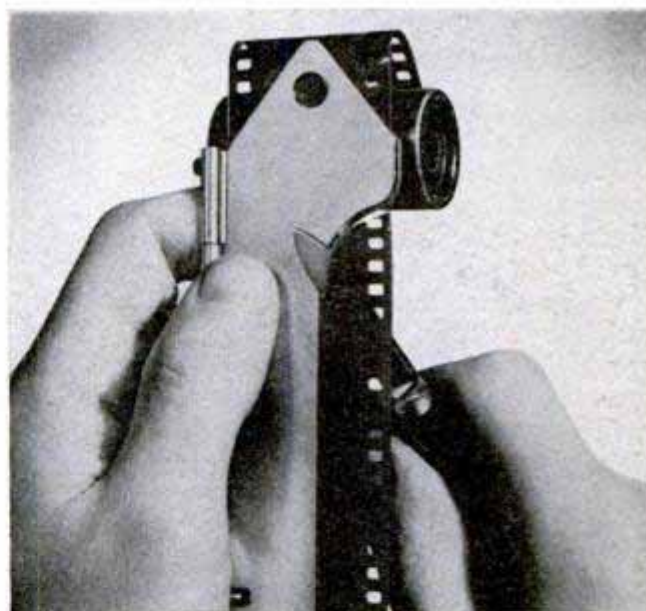

Film-Trimming Aid

Now available is a template for photographers who buy 35-millimeter film in bulk and load their own cartridges. The user can trim the leader with a pocketknife while the template is held tightly against the film. The precisely cut leader fits into the takeup spool accurately and prevents film from binding while being wound.



Snow Melter

Live steam is being used by the Army to melt ice and snow. The snow melter, designed for use in the Arctic, consists of a steam generator mounted on a Weasel. In earlier models the snow had to be shoveled into the machine. With the new melter the snow or ice can be converted into liquid anywhere and the water is pumped off as needed. Holes can be melted through the ice of lakes by using a metal cone on the end of the steam hose. The cone minimizes the loss of heat. Fresh water can be pumped through the resulting holes.



Book Restorer

Books with broken bindings and crumbling covers can be restored to good condition with a new plastic adhesive. If the binding has been broken, the adhesive merely is brushed along the "spine" of the book while the covers are clamped together.

"Hit Me" Sign

When overzealous marksmen banged away at highway signs in Nevada, the highway department decided to do something to save the markers. The solution? Small bull's-eye signs bearing the message "Hit Me" were fastened below the highway signs. If dented bull's-eye markers are any indication, the project is a big success.

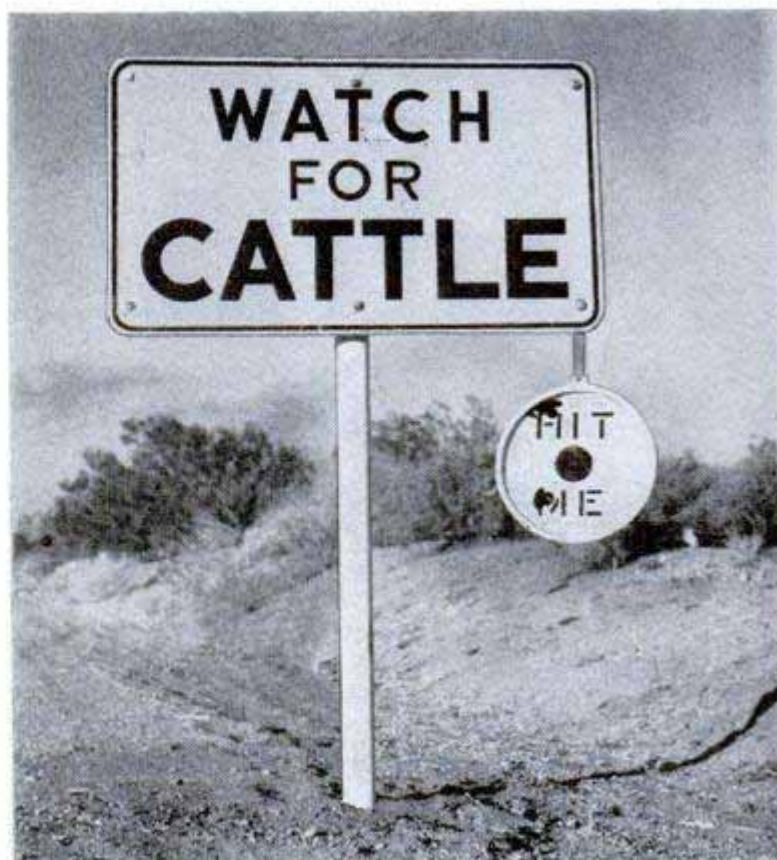

Reflective Sheeting

At night, motorists can see a truck outlined with reflective sheeting 70 percent faster than one without the material, according to Dr. A. R. Lauer of the Iowa State College Driving Research Laboratory. His information has guided the National Research Council in its recommendation that reflective sheeting be used to outline the rear of a motor vehicle to lessen danger of rear-end collisions.

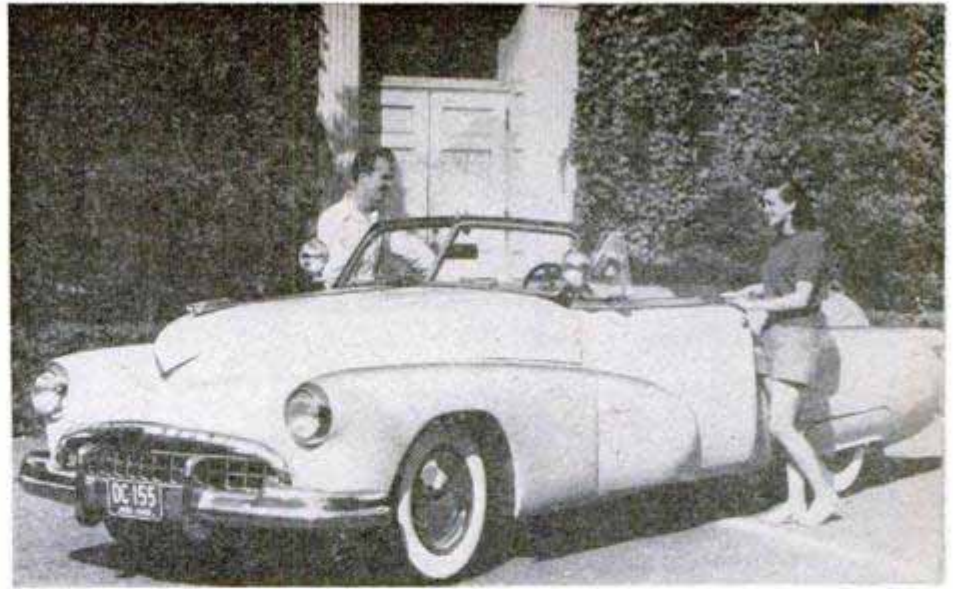

Motor Trend photos

Sportster Is a \$6200 Hybrid

BASICALLY, it is a 1947 Buick convertible. But the dealer who sold it would never recognize it now! It's the Monte Carlo, a custom sports car that combines parts of 11 cars plus some novel features of its own. Included in the list of "contributors" are Ford, Mercury, Cadillac, Oldsmobile, Nash and Packard. Built for Dale Collister of East Cleveland, Ohio, the hybrid sportster cost more than \$6200. Twenty buttons on the cleanly designed dashboard control a wealth of accessories, including a record player in the glove compartment. The automatic-opening trunk lid moves straight up for about a foot before pivoting open to clear the Continental-style spare-wheel mounting. Actual construction took five men almost a year.

Above, any auto expert will spot parts of a Buick, Cadillac, Packard and Mercury in the front end. Left, tail pipes emerge from rear-fender bulge. Below, a record player is built into glove compartment. Bottom, dash control panel is neat and functional



Motor Trend drawing

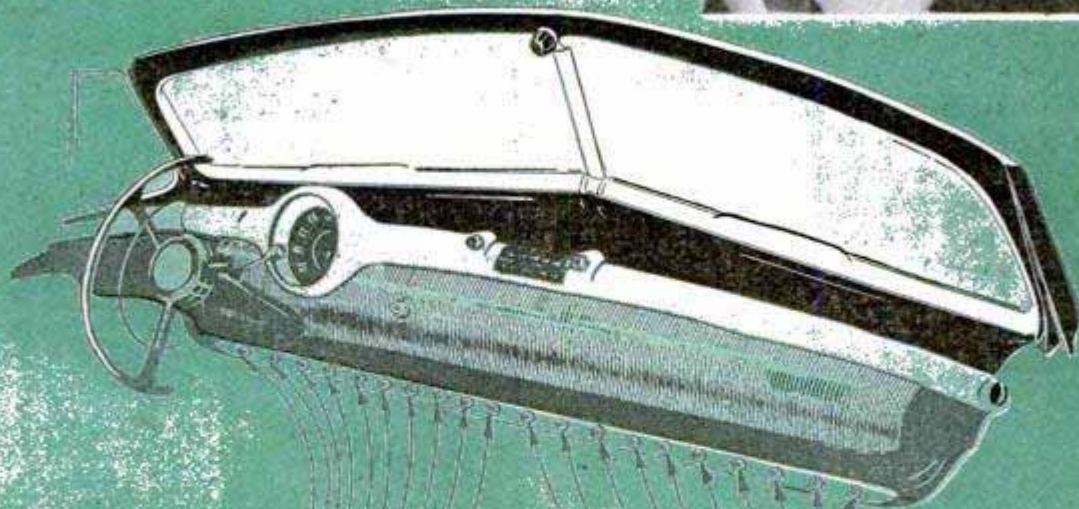

- EMERGENCY BRAKE RELEASE
- SPARE BATTERY & EMERG. STARTER
- TOP CONTROL
- HOOD
- DECK LID
- LIGHTS
- THROTTLE
- MIXTURE
- INJECTOR
- COOL-AIR VENT

- COMPARTMENT
- SPOTLIGHTS
- PHONOGRAPH & REJECT
- SPEAKERS
- THERMOSTAT
- BLOWER
- SIDE DEFOG
- FRONT DEFOG
- WINDSHIELD WIPER & WASHER
- WARM-AIR DUCT

WHAT'S NEW FOR

Your Home

1. "FRY BAG" made of heavy-gauge vinyl is a strong and sturdy container for use when breading meats and covering chicken sections with flour preparatory to frying. The top folds over and snaps so that the chance of losing any flour is held to a minimum. With proper care, the bag will last for many years

2. MENDING TAPE for plastic-goods repairs slashed shower curtains, raincoats and tablecloths. Strip of clear plastic tape is applied to the wrong side of torn article. A thin press cloth is laid over tape and tear, and ironed lightly. Process is also used to seal seams when making plastic articles

3. DOOR GRAB features a rubber hook which catches and holds a door that might otherwise swing shut. As the door is pushed back, it hits the inner heel of the hook which is deflected and then springs back to maintain a firm grip. The hook may also be folded back and used as a sturdy door bumper

4. RANGE TABLE on wheels masquerades as a double-oven unit until it's time to prepare a meal. Then the section is easily pulled out and used as a time-and-step saver. You can load it with food and utensils for a whole meal, then roll everything over to the side of the range for convenient cooking

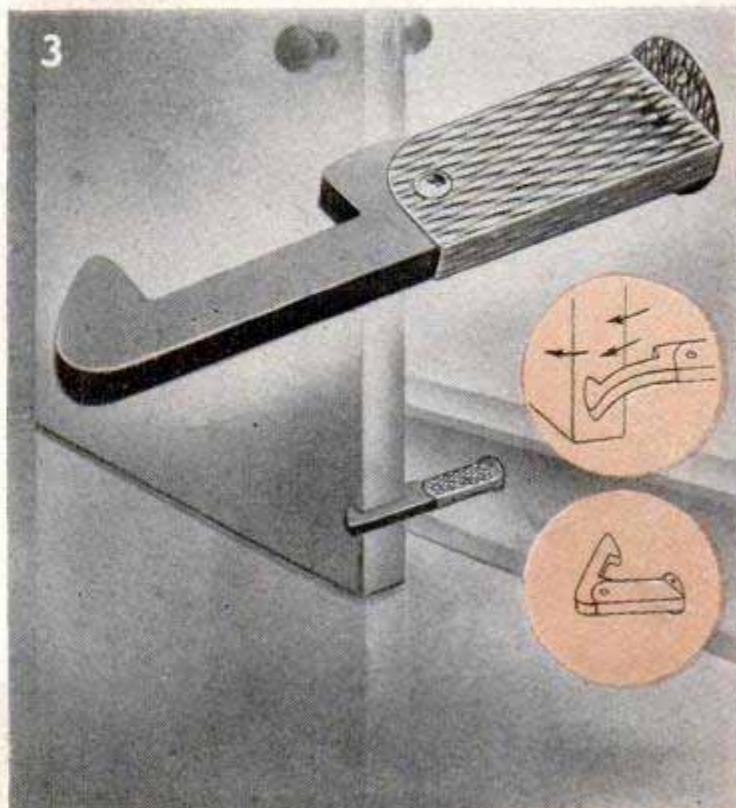

5. FOLDING DOOR of wood saves space in areas where swing-out door would be inconvenient. The door is particularly suited for use on closets, between dining room and kitchen, and in small bedrooms. Fully assembled at the factory, the door and fixtures come as a fully packaged unit which is easy to install. The door hangs from a metal track, is held together by hidden springs

6. SAFETY INCINERATOR prevents trash flying during waste disposal by a closed construction and a small-mesh screen on top of the "chimney." Designed to maintain an effective draft, the disposal unit reduces refuse to fine ashes. Sturdily built of fire-resistant alloy steel, it won't blow over and can burn unattended within 10 feet of any building. Three models in two sizes are manufactured

7. PORTABLE SHOWER turns any tub into a shower stall after only a few minutes' installation time. No tools are required to fit the sturdy unit into place. Adjustable to any height or position, it is anchored by suction fasteners. The no-splash spray head makes shower curtains unnecessary. It is easily folded and packed away for trips, and is especially well-suited for motels and resorts

8. ONE-LEG TABLE for dressing the baby can be used even in a small bathroom. With a wash basin or a chair forming its other leg, the table stands 30 inches high and provides sufficient space for dressing, changing or sponge-bathing an infant. The table top measures 37 by 17 inches. When not in use, the table folds up and can be stored in a closet or on the back of the bathroom door

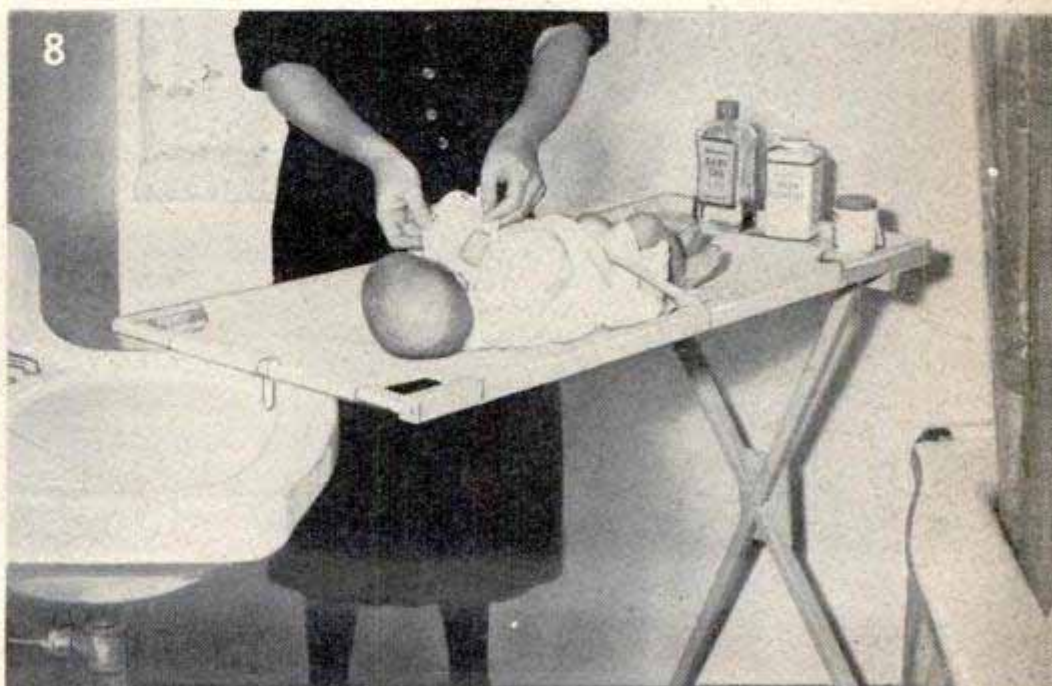
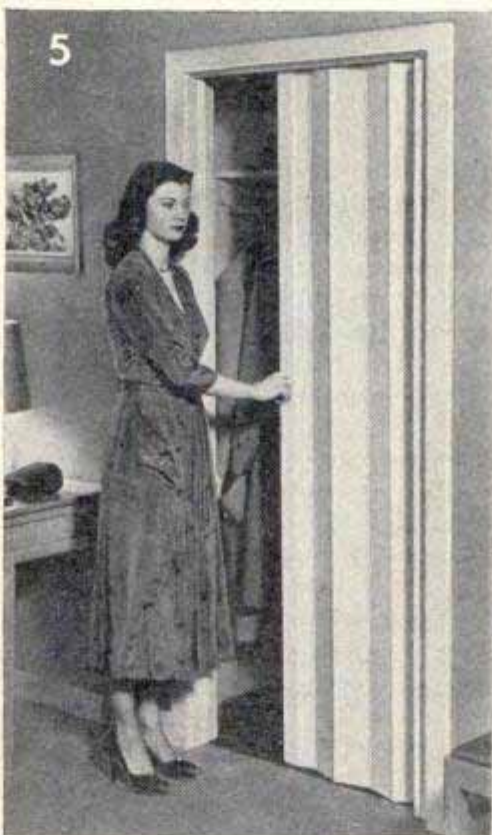

What's It Like to

... A group of engineers is sampling danger on the road to make driving safer for you

By Richard F. Dempewolff

THE BIG, high-powered sedan roared around a curve in a black-top road winding through the hills outside Epping, N. H. Its tires yowled as we gunned into a long straightaway. The driver, wearing a white crash helmet, hunched low over the wheel.

"We'll take her only to 50," he yelled back at me. "Hug the floor and press yourself hard against the back of the front seat. Be sure your head is below the seat level because when that junk on the back ledge takes off, it'll need more than you to stop it." I did as I was told and waited for the jolt. From my position on the floor in back I could twist my head and watch the junk we'd piled on the ledge behind the back seat—old shoes, boxes and coat hangers. "Shrapnel" is what these men call it.

We really were moving. I saw treetops and telephone poles flash by like sticks in a picket fence. Then it came—the panic stop; an ear-piercing screech as all four tires bit the pavement, a mighty force that pressed me hard against the back of the front seat. The thud-thud of flying objects hitting something solid. Then everything was still.

Though I'd been watching that pile of stuff on the ledge, I never saw it go. With

a take-off speed of about 50 miles per hour it had zinged to the windshield in a split second. Every bit of it was in the front seat. A shoe had knocked the driver's crash helmet askew. Without the helmet, he'd have been knocked silly. The boxes were broken at the corners. Since this was only a demonstration for my benefit, we'd used featherweight objects; the boxes were empty and the shoes light. If we'd used the kind of things most people keep on the back-seat ledge, cans of car polish, flashlights, steel tools and the like, they'd have gone where such objects always do in a head-on collision or panic stop—right through the windshield. Anyone in their path might have been killed instantly.

Admittedly, that ledge behind the back seat is a handy place to stow things. But the men in white crash helmets at Epping are proving with facts and figures that it—like many other features demanded by the customer in today's automobile—is a thing tomorrow's car should be without.

Every day the countryside around Epping reverberates to the roar of speeding engines. Tires squeal as violently rocking sedans driven by padded, helmeted men lashed to the seats are flipped into spins on dry roads. Spine-tingling sounds of cars

Engineer throws a sedan into a spin at 60 miles an hour. It didn't roll over but spun around several times

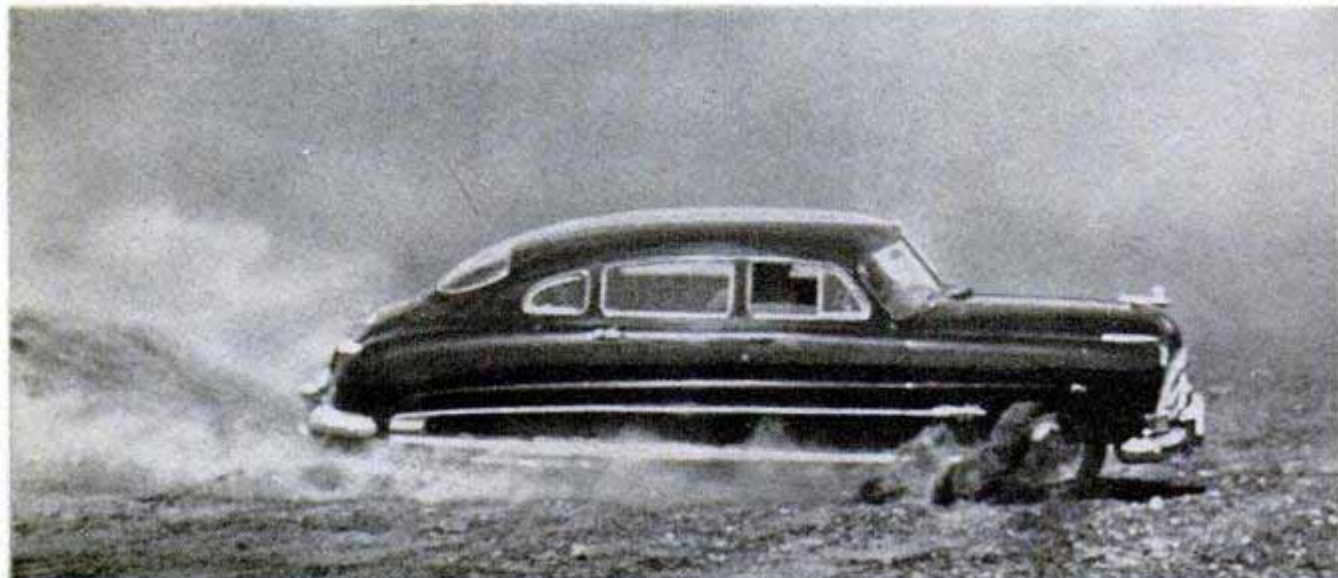

CRASH . . .



catapulting head-on into stone walls echo through the hills. Farmers listen with puzzled expressions to the shuddering drum of stock autos racing along railroad ties. It's all for the purpose of measuring what happens to the cars and the objects in them under accident situations. Radar beams track the path and speed of the loose gear that explodes in all directions when one of these cars squeals to a panic stop. Movie cameras lashed to a car's steel frame record the direction and point of impact of accurately weighted human dummies (the most battered of these is affectionately known as "Mr. Willsoffen" among the Epping drivers) as they bash their canvas heads into hazardous dashboard knobs, burst through the windshield, pop out sprung doors and wham into steering posts when the test cars screech to a violent stop.

The car-wrecking outfit that does this demolition work is Motor Vehicle Research, an organization devoted to the development of better and safer automobiles. Sparked by Dean Fales of Massachusetts Institute of Technology and A. J. White, a man with a high-compression personality, M.V.R. hopes that out of the piles of mangled steel

"Mr. Willsoffen," test dummy of life size and weight crashes skull through windshield in a panic stop

Speed Age photo
Here's what happens when safety precautions aren't observed. Four girls were killed in this 90-m.p.h. crash





Special antifatigue car has solid armrests, chrome painted flat black, steering rim as big as ax handle

in its back yard will come automobile-design features that will cut the highway death toll that last December claimed its millionth victim—the same number of American lives lost in all wars since the Battle of Lexington.

Statistics prove that in spite of the head shaking that goes on every time an airplane crashes, it is almost twice as safe to ride an airplane as a car on the basis of passenger miles covered.

As long as cars go where they're steered and as long as people do the steering, there will be accidents. The men at M.V.R. want to find and eliminate the things that kill people when they crack up. "Unless he's been in a collision," White points out, "a person can't conceive of the explosive forces unleashed in a car at the instant of impact. A car smacking a wall at 60 miles an hour gets about the same jolt it would



M.V.R. reports that simple precaution of safety belt on passengers would cut the death toll remarkably

if it were dropped nose first from a ten-story building."

What about those loose objects in the back of the car under such a wallop, for instance? Police accident records provide one source of vivid clues.

In one recent crack-up, a car traveling at 40 miles an hour rammed another head-on. A pair of shoes on the rear-seat ledge went right through the windshield. Suitcases, chains and tools in the trunk burst through the back of the rear seat and wound up piled against the driver's back.

In another disaster caused by a blowout, a speeding car hit a tree. A picnic basket in back burst wide open, sending knives, forks and plates in all directions. One of the forks was moving so fast it severed the driver's spinal column. Similarly, a bicycle lashed to the back of a convertible broke its retaining rope when the car hit an abutment

HOW NOT TO DRIVE A CAR: In crash or panic stop, children in back seat would be thrown over the windshield. Those in front would be pinned against dash. Objects on back seat and ledge become "shrapnel"

DANGEROUS





If you see a crash coming, say M.V.R. engineers, cradle head in your arms on dash

In a test at M.V.R. proving grounds, French Renault leaps across a ditch. On this particular car the front wheels didn't buckle

at 70 miles an hour and killed everyone in the car.

To learn just what happens to loose objects in panic or collision stops, White and his men loaded a standard station wagon with a 30-pound case of soft-drink bottles, cartons of canned goods and other assorted objects. Then they rigged a man on the tail gate. He was double-strapped with safety belts lashed over the back bumper, his outstretched feet were pressed hard against a four by four of solid oak that ran across the car and was secured to the frame. In his lap he held a special radar set.

The driver climbed aboard, fastened himself to the seat with a safety belt that was anchored to the steel frame of the car and off they went at 60 miles an hour. Suddenly the brake pedal shot to the floor and the interior exploded. Within a split second, the interior of the car was alive with broken

bottles. The tiny microwave beam of the radar gun, traveling at 186,280 miles per second, bounced back and forth between the set and the rocketing case of pop as it took off and clocked it at 42 miles per hour. Traveling at that speed, 30 pounds of bottles are as effective a killer as a load of grape-shot with a heavy powder charge behind it.

"If we hadn't had a heavy wood baffle across the wagon, it would have gone right through the front of the car taking the front seat and everything with it," said White. "Anyone in that front seat would have been killed—and that was just a panic stop, not a collision."

What happens to people in these panic stops? One driver at Epping recently took Mr. Willsoffen for a high-speed ride in a brand-new sedan and whammed the brakes at 70 miles an hour while movie cameras recorded the result in slow motion. Mr.

FOR SAFE DRIVING: These features have been tested by M.V.R. and could be built into tomorrow's car. They include baby seat welded to frame, passengers seated backward and webbed safety belts fastened to chassis

RECOMMENDED FOR SAFETY

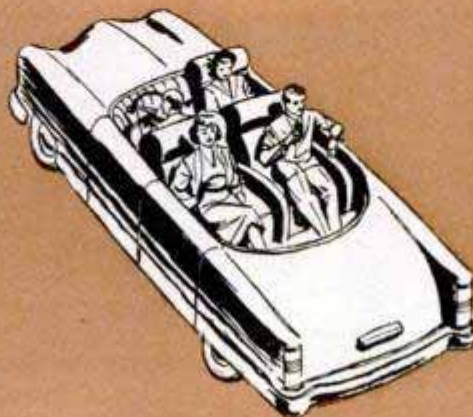

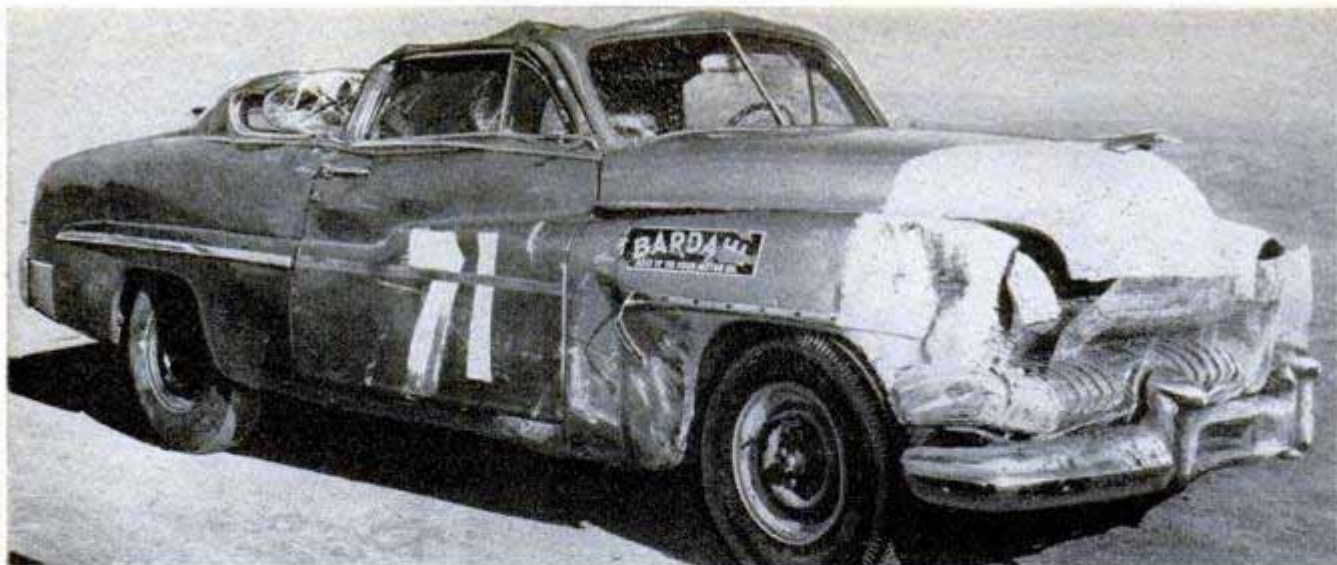

Speed Age photo

Stock car with steel bracing supporting roof was rolled at high speed. Belted-in driver emerged unhurt

Willsoffen, sitting beside the belted-in driver, cracked his artificial skull against the dash and kept right on going through the windshield.

"Passengers just don't stand a chance," says White, "and the one beside the driver stands the least of all."

As a result of the work done so far at M.V.R., these men know that speeds as low as 40 or 45 miles an hour can be extremely dangerous. And the maddest people, they point out, are parents who ride with youngsters on their laps or permit children to stand on the front seat. "It's like putting them in the breach of a cannon," they report. "The added weight of an adult body shoving the child into the dashboard in a crash or panic stop gives the kiddie that much less chance of coming through alive."

The human skull can stand impacts up to 600 pounds per square inch. In instantaneous

deceleration tests at Epping, radar has tracked Mr. Willsoffen's carefully weighted 180-pound body at a force equal to 500 pounds per square inch—or one G—in a car that stopped short from only 30 miles per hour. At 60 Mr. Willsoffen would leave his seat with a two-G wallop and hit the dash with an impact of nearly twice as many pounds per square inch as his simulated human skull could take.

How can Mr. Willsoffen and—more to the point—you and I survive such crash situations in a speeding car of modern design? M.V.R. has several answers, many of them already tested successfully in their roaring stock vehicles.

"As it stands," explains White, "you hardly could bounce your car end over end at 60 miles an hour and live to tell your friends about it. But professional racers

(Continued to page 220)

Braced engineer operates a radar set which will check flight of a case of soft-drink bottles in a panic stop

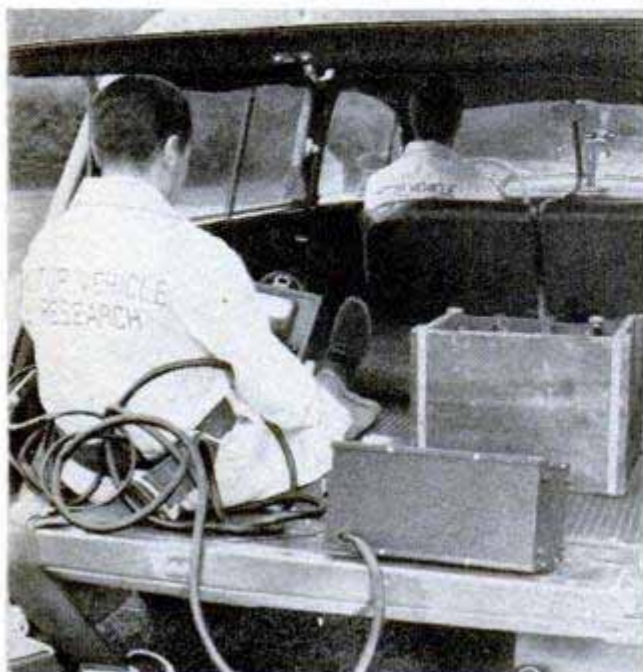

Here's what happened. Box would have crushed passenger against dash. Child in photo climbed in later



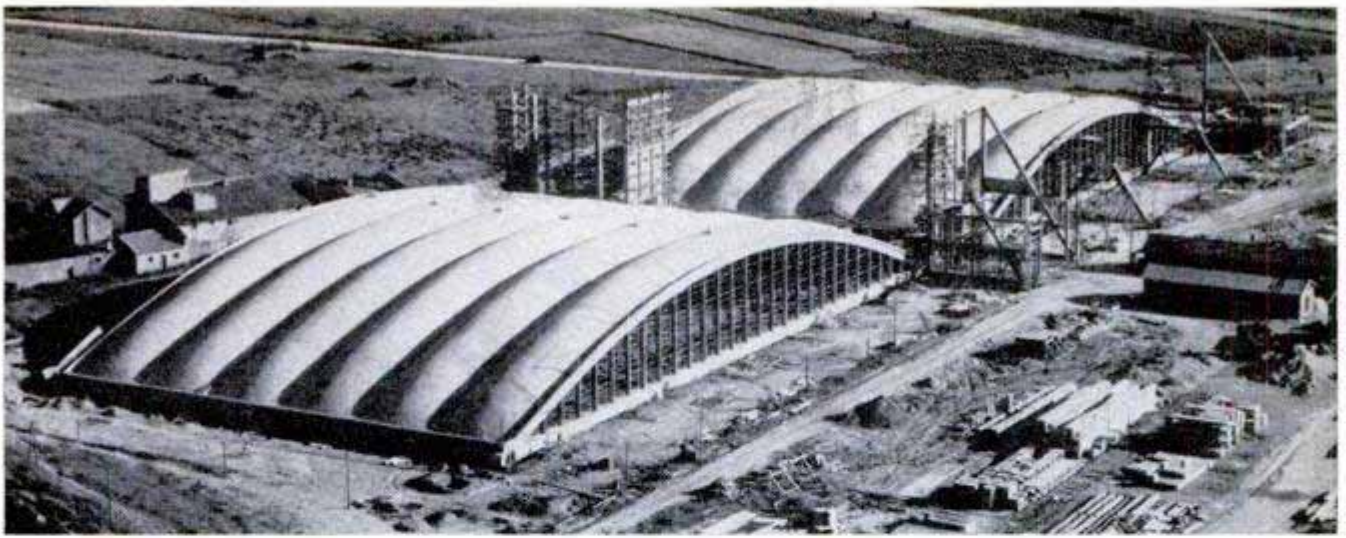

Each one large enough to cover a football field, these arched concrete roofs were poured at ground level

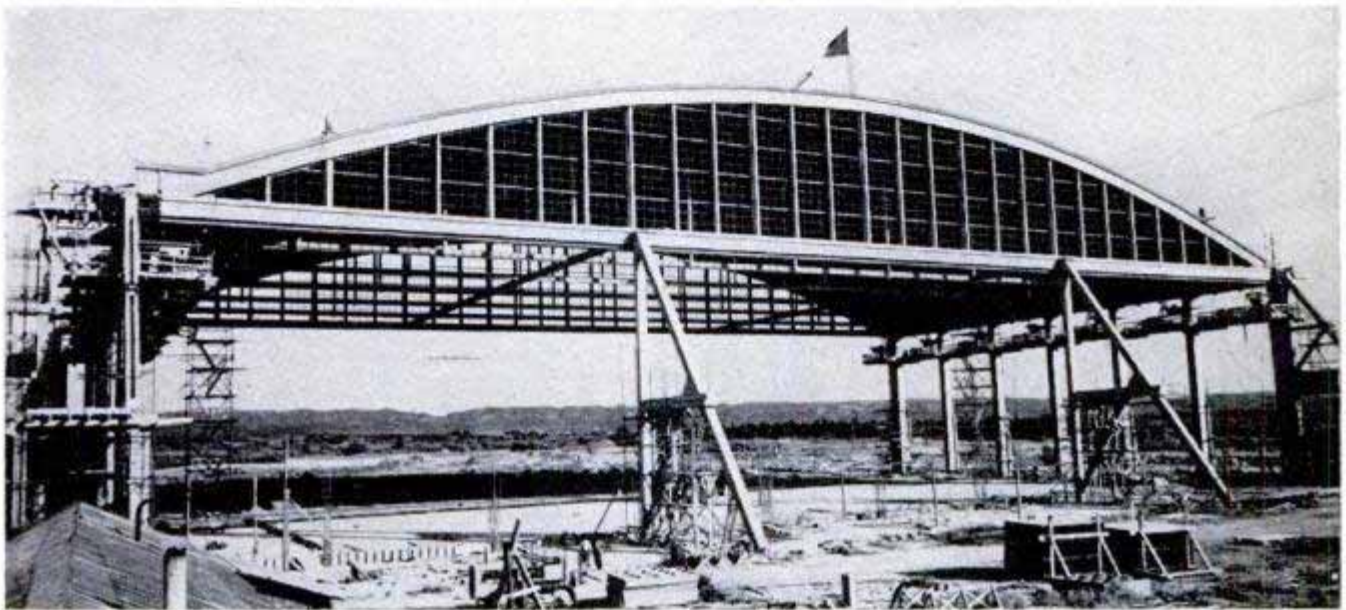

Lifting a roof to its 62-foot height required 184 working hours. The 328-foot front opening is unobstructed

HUGE FRENCH HANGARS HAVE CONCRETE ROOFS

POURED at ground level, a reinforced-concrete roof for a French airplane hangar was elevated to its final height of 62 feet by a hydraulic-jacking operation that required 23 eight-hour shifts. Four such roofs were built to cover two double hangars at the Marseilles Airport. Each roof is 200 feet long and 328 feet wide, providing an uninterrupted entrance clearance of that width. Even the largest airplanes can roll in and out with ample clearance. The hangars are said to be the world's largest reinforced-concrete structures of this type. No roofing material is needed. The concrete is sufficiently weatherproof. Each roof weighs 4200 metric tons, or more than nine million pounds. Seven columns on each side support this tremendous weight, the monolithic self-supporting arches making addi-

tional support unnecessary. The roof is attached solidly at one end, the other end resting on huge concrete rollers which allow for movement caused by expansion and contraction of the material. The doors open by winding up on a vertical roller in the partition between the hangars.

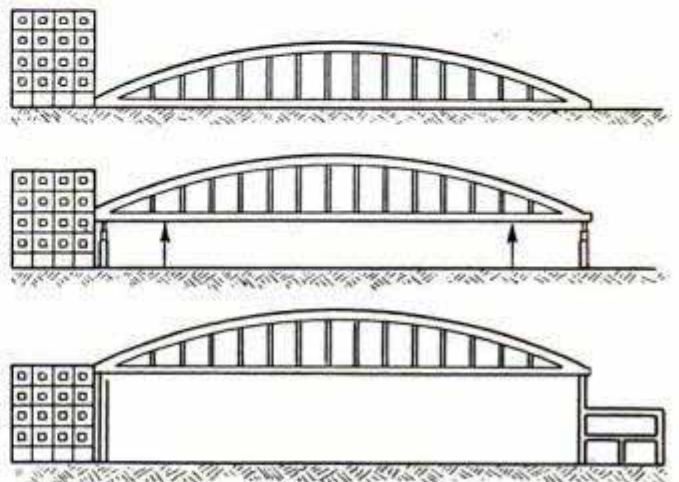

Three stages in the roof lifting. The 18 hydraulic jacks were controlled from a central board. Hangar door will roll up like a window shade on its side

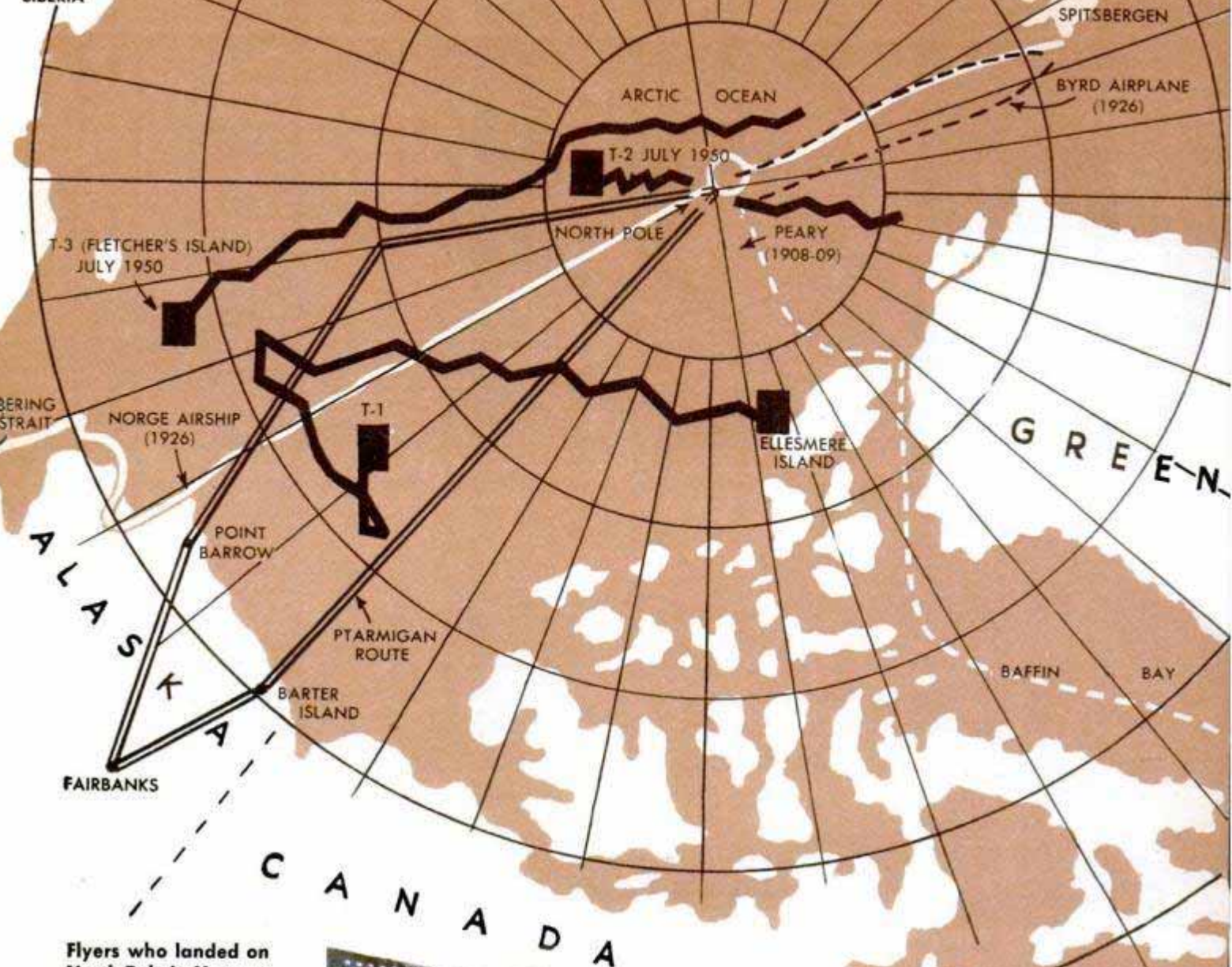

Flyers who landed on North Pole in May put American and Air Force flags at "top" of the world. Glass jars inside oil drums contain dated notes



In the suburbs of the North Pole, our scientists and Air Force men are "at home" on gigantic floating islands of ice. Here's the story of their . . .

ICE-CUBE

ICE IS A RED-HOT topic now in military circles.

Massive floating islands of it in the Arctic Ocean are currently inspiring both alarm and speculation. One such body is 20 miles wide and equally long. Their possession—and manner of use—could prove the balance factor for war or peace.

The three now known could conceivably become steppingstones for faster air operations over the "top" of the world—between Russia and North America. Several hundred miles closer to Russia than our nearest land bases, they could serve as emergency-field and weather-station sites for the international airlines.

Legally, since they have no fixed loca-





Map indicates paths of drifting ice islands since discovery, and routes of "firsts" at North Pole by land, airship and plane. U. S. airmen now fly Ptarmigan round-trip route from Fairbanks over pole every other day

By Aubrey O. Cookman, Jr.

AIRPORT

tion, they belong to no one. Probably the old axiom of possession being nine tenths of the law will be the sole determinant.

The ice islands are spacious and strong enough to handle the largest aircraft now flying, or even seriously contemplated. Their thickness is estimated at 200 or more feet, probably stout enough to withstand bombs and torpedoes as well as 300,000-pound airplanes. They are the closest we've come to an unsinkable aircraft carrier.

Some light was shed on their possibilities and importance this spring when an Air Force general and seven companions landed a twin-engine transport on the smallest of them. Among them was Lt. Col. Joseph Fletcher, the island's discoverer. It was then about 100 miles from the North Pole and the surface temperature was 50 degrees below zero. Three men were left on the island with shelter and provisions to establish an observation base. Five men were added later.

Shortly afterwards a Navy plane headed for a landing on the ice adjacent to the pole itself was forced down and disabled on the island. Its crew was evacuated by an Air Force plane on a regular supply mission. For a while the island's population was swelled to 20.

These mammoth ice cubes also have a great scientific potential as stable platforms from which one of the world's least-known regions can be studied. Its heart, the North Pole, was discovered only 42 years ago and big voids still exist in our knowledge of the Arctic. Information on currents, weather, magnetic fields and the ocean floor's topography is woefully inadequate.

Although false, the old notion that the

About seven miles in diameter, T-3 ice island is now drifting close to the pole. It slopes from 10 to 50 feet above the surrounding ice pack. It has been renamed Fletcher's Island in honor of Lt. Col. Joseph Fletcher who this year, when temperature was 50 below, led first party to land on it

U. S. Air Force photo



1. Airmen checking ice strength for landing attempt first parachute geophones down, then drop explosive charge timed to go off just above ice. Resulting sound wave, relayed to plane, reveals ice's thickness

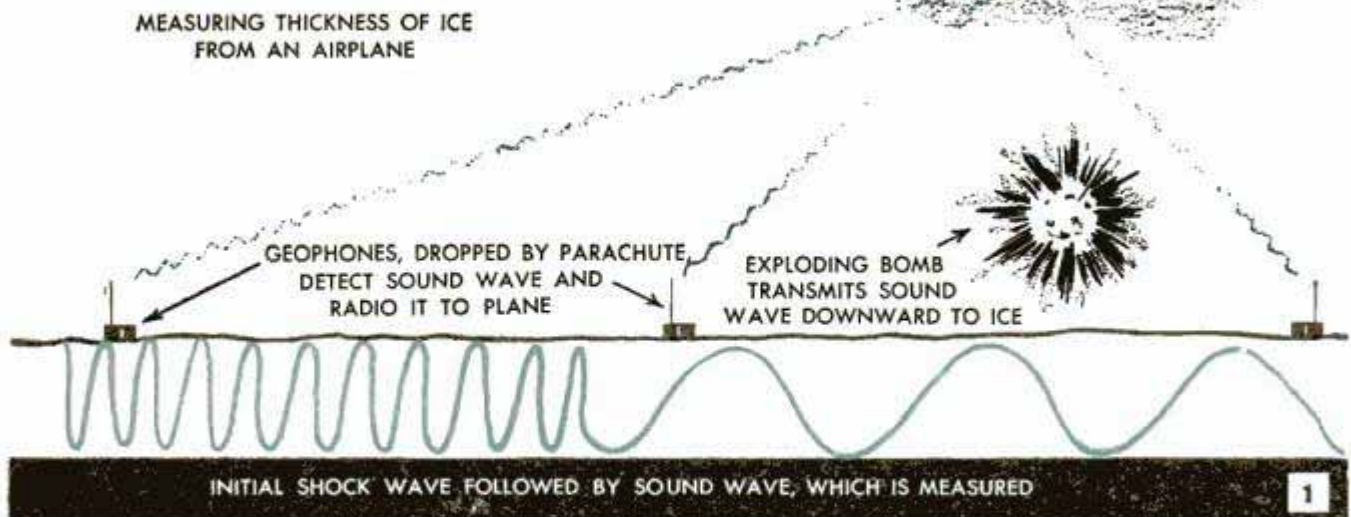

2. Differences in arrival times of bomb's shock waves at geophones, below, indicates floe's rate of movement

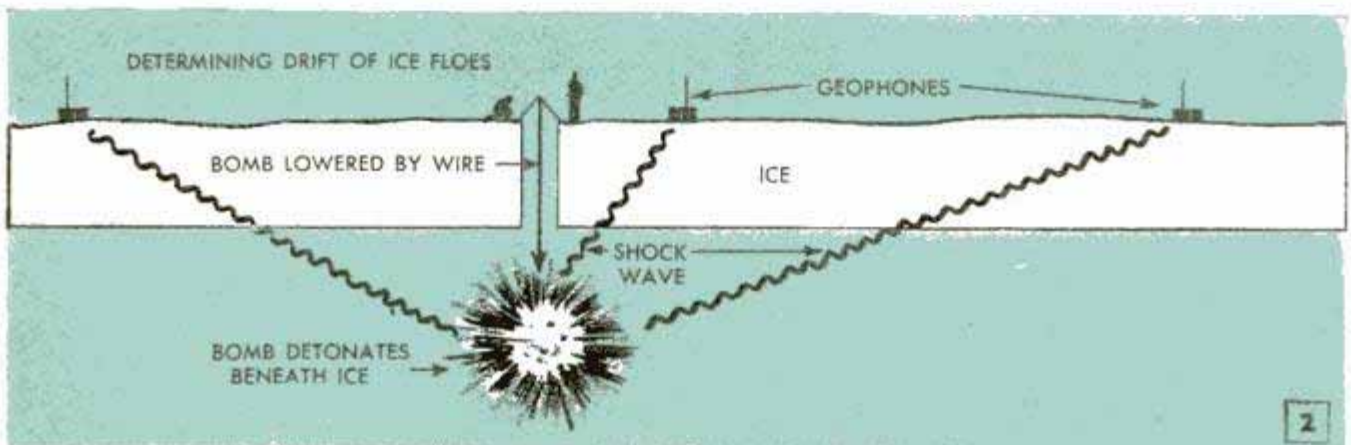

immediate pole area was an ice and snow-sheathed land mass is still widely held. It gained momentum from accounts of Adm. Robert E. Peary's dramatic dog-sled dash to the site in 1909, when the ice was frozen solid for the winter. Aerial observations by Amundsen in 1926 and countless others since have established the polar region as all water, but the erroneous, popular impression persists.

It wasn't until six years ago that the first of the islands, large as they are, was first seen. It was drifting about 300 miles north of Point Barrow, Alaska, when first detected on the radar screen of an Air Force B-29 flying a routine weather-reconnaissance mission. Fog shrouded the area but the mysterious object's position was radioed back. It wasn't until days later that other airmen finally tracked down and for the first time saw the discovery.

Their find was a solid sheet of snow-covered ice, wedge-shaped and about 20 miles across at its widest point. Dropping down closer, they saw that its sides were 30 to 50 feet above the sea. It was christened

Target X, then later renamed T-1 Island.

It differed unmistakably from pack ice in color and appearance. The latter is frozen sea water and has a pale-blue hue, darker where the ice is thinnest. Ten feet is about an average thickness for the floes. From October to June, when the pack is jammed most solidly, it presents a criss-cross pattern of old pressure ridges formed by wind and currents grinding the separate floes together. The edges crumple and pile up in hummocks as high as 30 feet.

The islands are apparently of freshwater glacial origin, perhaps formed on the bays and coasts of the Canadian Arctic Archipelago. Experts have pin-pointed the northern coast of Ellesmere Island as the probable birthplace of T-2, discovered in 1950. T-3, where the Air Force expedition landed and encamped, was also found in '50. If all three originated at Ellesmere, and broke off in successive chunks, the largest has been floating for thousands of years.

In contrast to the ice pack's wintertime pressure ridges and its summertime cracks and separations, the islands resemble gent-

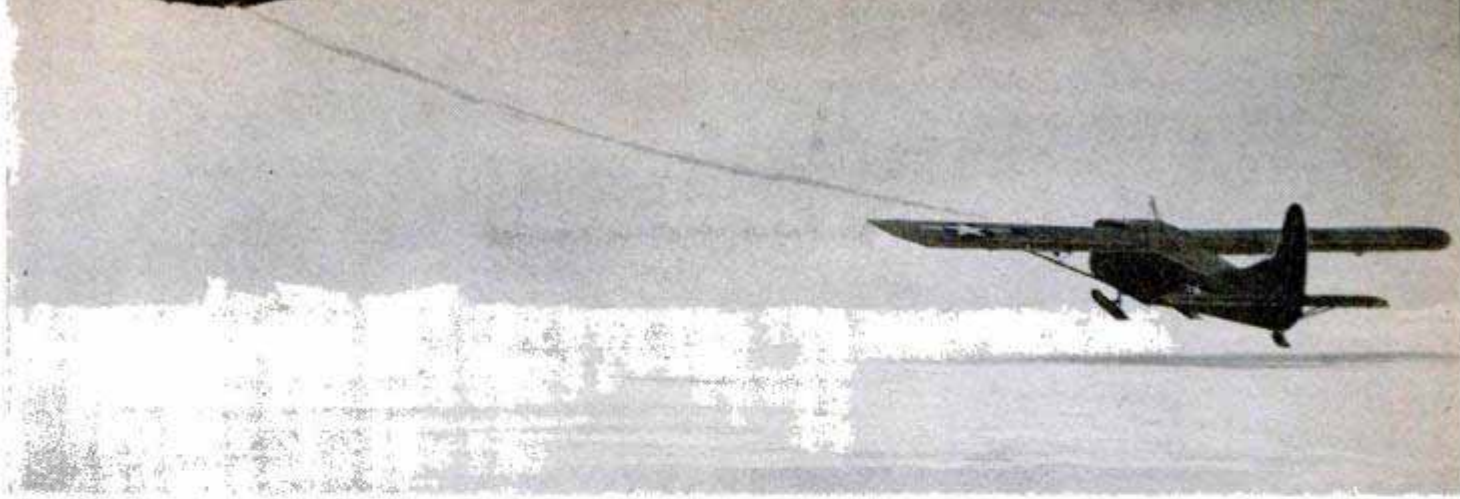

Above, gliders have solved the problem of getting men and supplies on and off the smaller floes. Pickups by transports are now a routine Arctic operation

Camps like the one below, set up by U. S. scientific parties, now break the flat whiteness of floating ice. Note ski gear on the C-47 in the background



ly rolling plains. They have low, parallel ridges, between which shallow pools of water form during the summer. The islands tilt very slightly, generally at right angles to the ridges.

The islands drift at a slow, variable speed. Patrol planes tracking T-1 found that it moved approximately 1500 miles in three years. The path of all three is believed to follow a clockwise motion around the world's top. If any failed to continue the turn they make north of Greenland, near the Arctic Ocean's only wide and relatively deep outlet, they would probably float out through Baffin Bay into the Atlantic and melt. In the cold Arctic their size remains relatively unchanged.

This isn't the first time explorers, military strategists and others have considered ice air bases. Early in 1937 a Russian party headed by Arctic scientist Dr. Otto Schmidt put a bomber down on the frozen ice and set up a camp 11 miles from the pole. It was announced as an advance weather station to aid Russian airmen who later that same year flew nonstop over the Arctic

from Moscow to southern California.

Four of Schmidt's group stayed behind, spending nine months on an ice floe making observations. By then their fast-moving floe had drifted almost 1500 miles, nearly two thirds of the way down the east coast of Greenland. Their soundings fixed the ocean's depth at the pole at greater than 14,000 feet. Only about a half dozen other reliable depth checks are on record for that area. One early visitor followed the figure he entered in his records with this notation—"The string wouldn't reach any farther."

More recently the United States has moved vigorously into the polar picture. Since 1946, crews of the Alaskan Air Command have been flying weather missions over the pole, from Fairbanks, every other day. Units of the 10th Rescue Squadron, headed for several years by veteran Arctic explorer Col. Bernt Balchen, have combed Alaska, northern Canada and the ocean ice in reconnaissance and mercy missions.

Balchen and his men proved many times that twin-engine airplanes could be landed safely on small ice masses. Once they flew



Scaling frozen glacier walls is part of the training for flyers of Alaska's famed 10th Air Rescue Squadron

a JATO-equipped C-47 with a special retractable ski-wheel landing gear on and off Taku Glacier to aid a stranded party of 16 scientists. They've demonstrated repeatedly that helicopters are perfectly adapted for ice-floe rescues.

Air navigation in the Arctic is improving. To replace magnetic compasses, practically useless near the pole because of their tendency to point straight down, a system of gyroscopic compasses has been devised. Coupled with celestial bearings and radar information, it gives the navigator reliable checks on his course and speed. Another helpful new device enables him to take a bearing on the polarized rays of the sun after it has sunk below the horizon.

The U. S. Navy also has been active in Arctic research, with particular emphasis on oceanographic studies. This year they are repeating Operation Ski Jump, which last year accomplished 12 ice landings, one 820 miles south of the pole. Among other things, they found ice 18 inches thick will support a C-47 a short time in emergencies.

One of the most important recent contributions to Arctic operational know-how came from a team of scientists with Air Force assistance. Geophysicists, they included Albert P. Crary and Robert Cotrell of the Massachusetts Institute of Technology, and Maurice Ewing, Frank Press and Jack Oliver, of Columbia's Lamont Geological Laboratories.

Military men had been trying for years to find a way to measure the thickness of ice without having to bore holes every 1000

feet or so. An idea for measuring the ice by remote control from the air stemmed, oddly enough, from studies once made by Ewing and Press that had nothing whatever to do with ice. In fact, it had to do with a volcano—Krakatoa, the crater on an island near Java which blew up with such a bang in 1883 that the whole island disappeared into the sea and the blast's shock wave raced around the earth seven times.

Studying reports on the explosion, Ewing and Press ran into some odd inconsistencies. Documented evidence clocked the arrival of the aerial shock wave at various places where it shattered windows and buildings. Other reports, describing the sea wave that roared across the Indian Ocean, told exactly when it reached such places as the English Channel, Panama and San Francisco. Despite the fact that vibration waves in air and in water do not travel at the same speed, a comparison of reports showed that when Krakatoa exploded, the air and tidal wave arrived every place at the same time.

Ewing and Press decided that the air wave was the only important shock wave thrown out by the volcano. They reasoned that the tidal wave wasn't a ripple caused by the big boom but instead was created directly by the disturbance in the air. From this they concluded that any disturbance in the air affects the earth beneath it.

They checked their theory on Lake Superior's ice, setting up several geophones (baby seismographs) and then exploding

(Continued to page 260)

British Locomotive Has Jet Engines

British Railways is not counting out the iron horse in this jet age—it is giving it a more powerful punch by putting a jet-powered locomotive on the rails. The new locomotive operates on the same principle as a turbojet airplane engine except that the actual driving power is electric. The gas turbine, which drives three generators to produce the electricity, consists of three components. These are a rotary compressor which delivers air at 60 pounds per square inch, a combustion chamber in which regular diesel fuel oil is burned and a turbine where the heated air expands to develop the power for turning the generators. Each of six driving axles is geared to

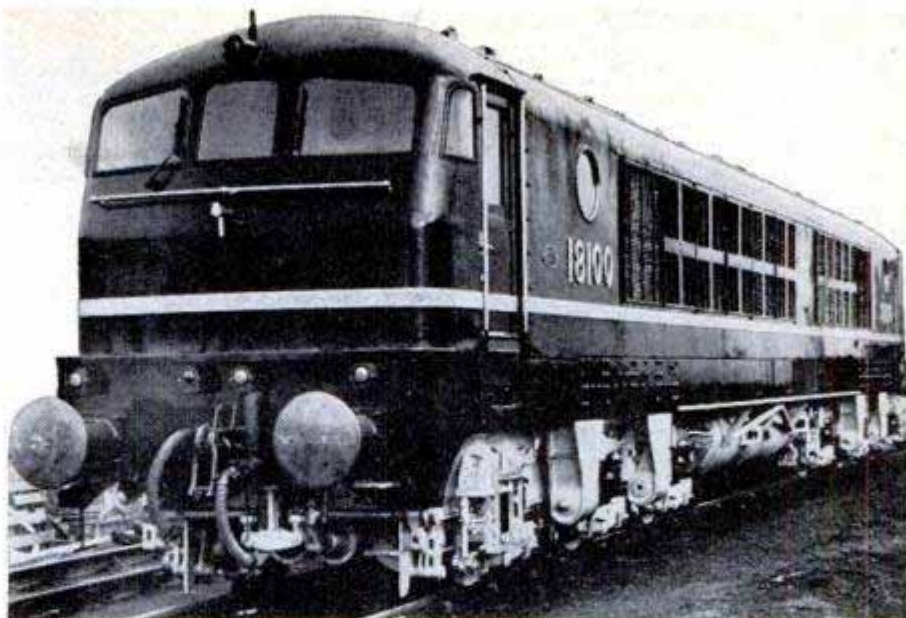

British Railways photo

two electric motors. Actual rated output of the jet locomotive is 2540 horsepower at the rails, about twice that of a conventional diesel locomotive of the same weight and length. The 90-mile-per-hour engine is 66 feet long and weighs 129 long tons.



Wide-Angle Camera Takes "Instant" Panoramas Without Tripod

Panoramic shots without a tripod are made possible by a Japanese camera that uses a swinging lens to produce photographs of extremely wide angles. The camera has three shutter speeds— $\frac{1}{500}$, $\frac{1}{200}$ and

$\frac{1}{8}$ second. A tripod is used only with the slowest of these. Unlike most wide-angle photos, those taken with the swinging-lens camera have a minimum of distortion. It is expected to sell for about \$200.

Winch-Run Conveyor

One man can load or unload material weighing up to 1000 pounds with a new winch-operated conveyor. The conveyor is designed to handle heavy equipment in buildings which have no loading dock. One end of the 10-foot channel rests on a truck bed while the load is cranked up the channel. The two-speed winch can be locked to stop the load at any point.

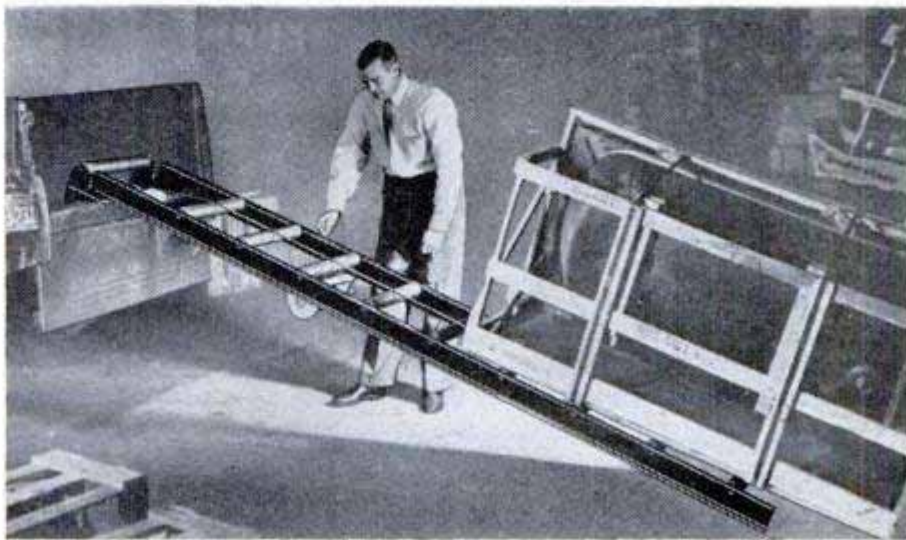

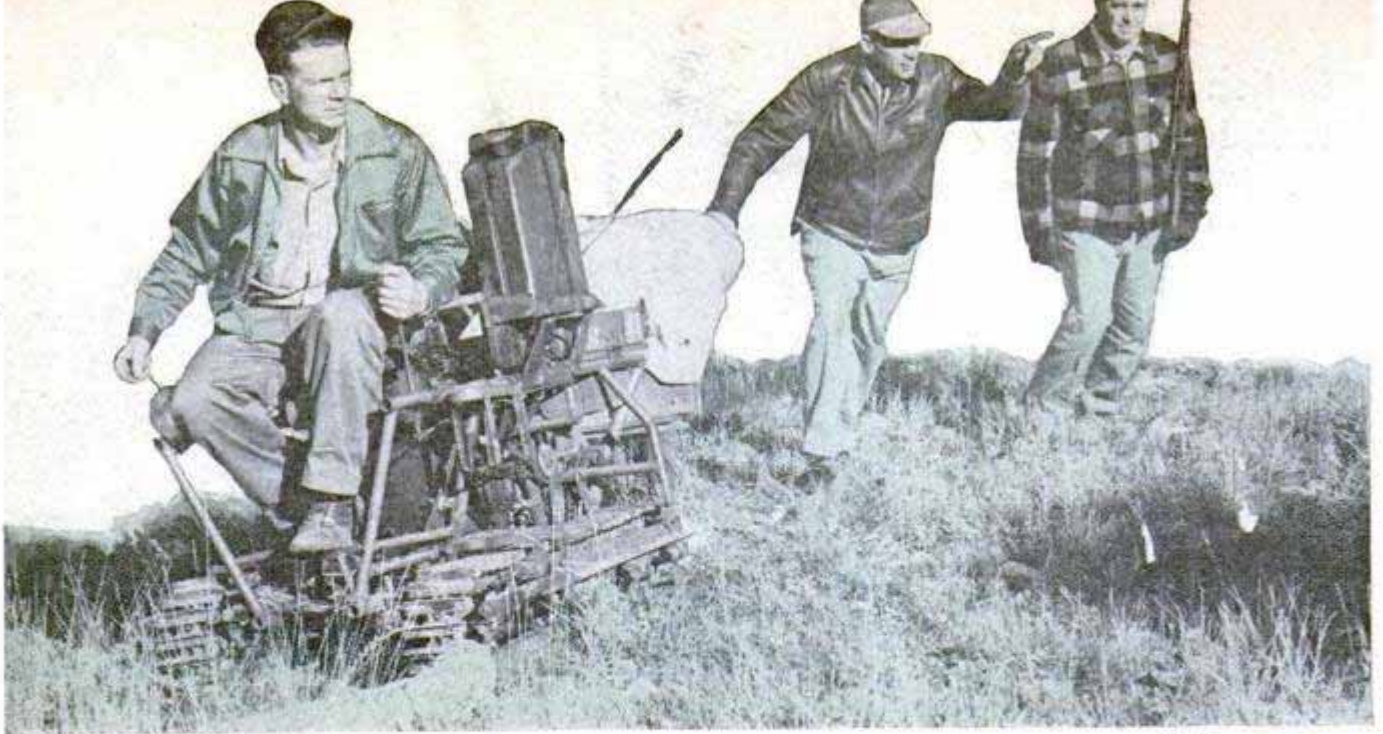

Seeking big game, these men use a mountain-climbing machine which outperforms horses

GO HUNTING ON A "Go-

By Wilton S. Allen

LIKE most other hunters in the Rocky Mountains, Alco Timmons of Casper, Wyo., for many years used horses in the hunting of elk, antelope and deer and for packing the kill back to camp. Timmons kept two horses solely for this purpose but he found many spots where game was killed that were too rough for even a horse.

Timmons, whose principal business is the reconditioning of wrecked vehicles, wanted

a machine that was small and compact and could be loaded onto the back of a pickup truck, yet powerful enough to travel in the steepest and roughest of places.

After much experimentation, he developed a vehicle which he calls the "Go-Devil" because it will go almost anywhere and climb almost anything. Designed more for power than for speed, it will haul three hunters and the carcasses of two or three elk, antelope or deer up a rough grade of more than 65 degrees.

The machine measures 54 inches long, 27 inches high and 34 inches wide. It weighs less than 500 pounds, including a trailer of similar size which serves as a cover when the machine is not in use.

Timmons made most of the parts himself. The framework is of welded iron pipe, the tracks are of chain and angle steel and the one-cylinder four-horsepower scooter motor is geared down through a series of chains and belts for power.

The Go-Devil has two forward speeds and will pull more than a thousand pounds at either six or ten miles per hour. There is a control lever for each track, making 180-degree pivot turns possible, and an extra passenger seat mounted in front of the driver to permit added weight for better traction on steep climbs. ★ ★ ★

"Go-Devil" has two forward speeds. Tank-type treads permit travel in roughest terrain, 180-degree turns



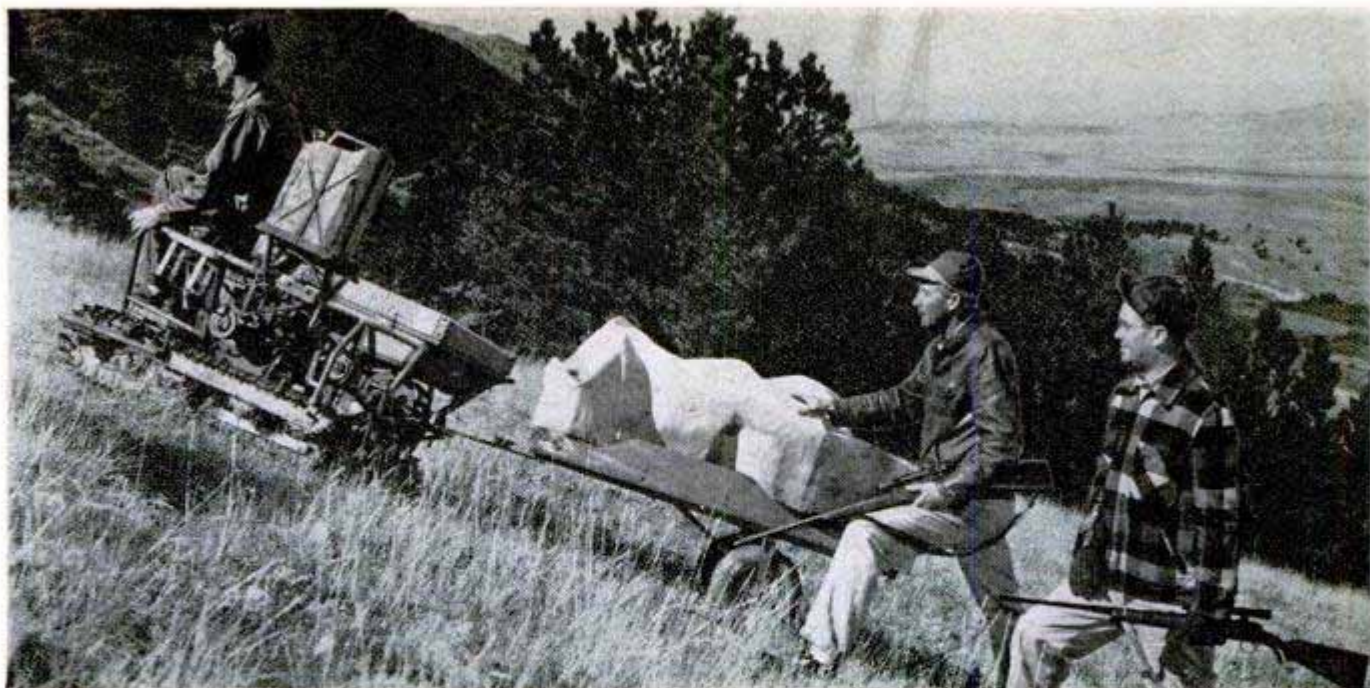

-Devil"

Above, machine draws trailer loaded with game back to camp. The Go-Devil can pull more than a thousand pounds up steep hills. Below, the machine will negotiate 65-degree grades with extra passenger in front for added traction. Lower left, trailer fits over Go-Devil, serves as cover. Total weight of both is less than 500 pounds

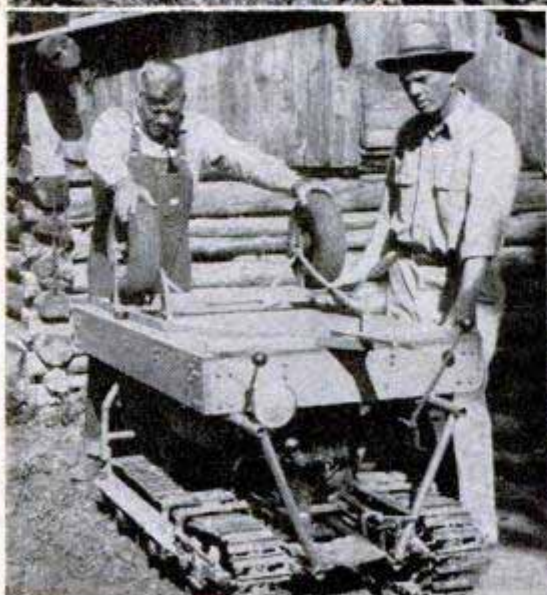



Ventilated Backrest Keeps Driver Cool, Comfortable

One of the discomforts of hot-weather driving, the perspiration-soaked shirt, is eliminated by a backrest of wood and woven, laminated fiber. The open design

provides ample ventilation and is resilient enough to be a comfortable support. It stands up against the back cushion and won't fall over when you get out of the car.

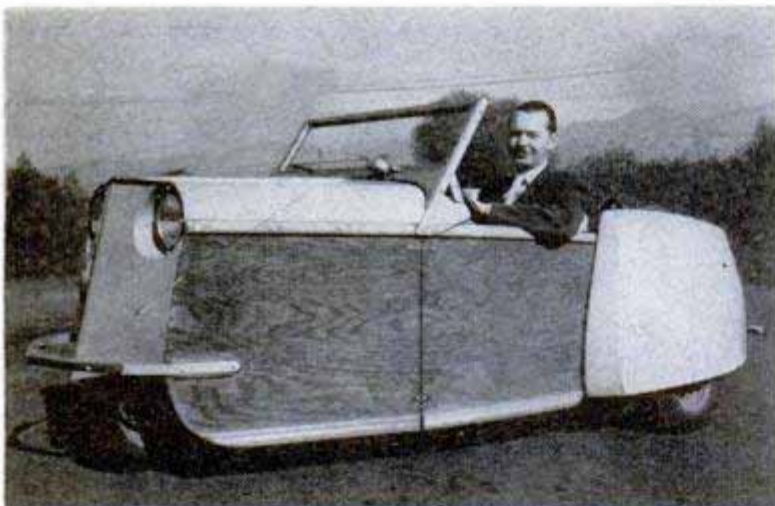

Three-Wheel Automobile

With a sheet of plywood, some auto spare parts, an 8 $\frac{1}{4}$ -horsepower engine and much ingenuity, Walter Korff of Burbank, Calif., built a three-wheel car with a top speed of 50 miles an hour. Korff's car stands 49 inches high, is 9 $\frac{1}{2}$ feet long and weighs 684 pounds. The little vehicle has an automatic clutch and transmission, sealed-beam headlights, mechanical brakes, a Chevrolet generator and a Ford starter. The total cost of the car was \$250.

Sighting Device Helps Golfers Achieve Straighter Strokes

Clamped to the shafts of putters and irons, a plastic sighting device allows the golfer to see whether his stroke follows a straight line as it goes through the hitting zone. Intended for use in practicing putting and short approach shots, the sight can be changed quickly from one club to another. A black line that runs the length of the sight shows the angle of the club face as it passes through the hitting zone.

If you do not find the information you need in the WHERE-TO-BUY-IT INDEX, starting on page 12, sources of further information are available without charge from Bureau of Information, *Popular Mechanics Magazine*, 200 E. Ontario St., Chicago

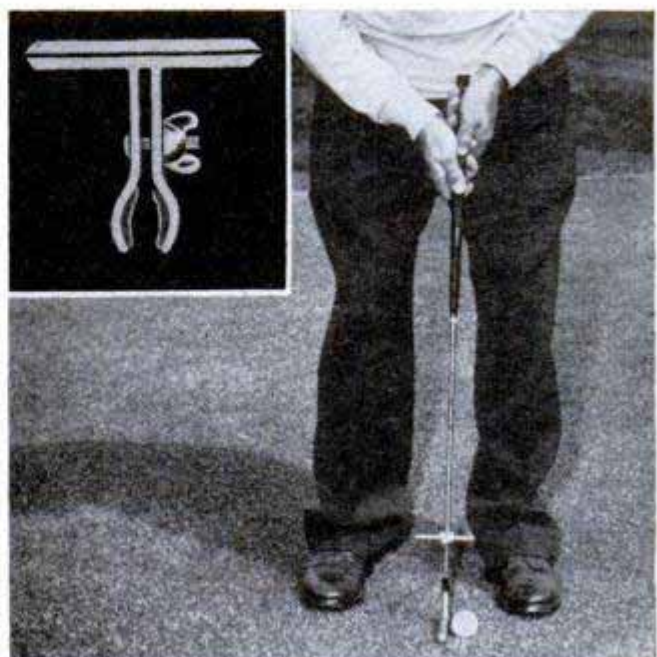

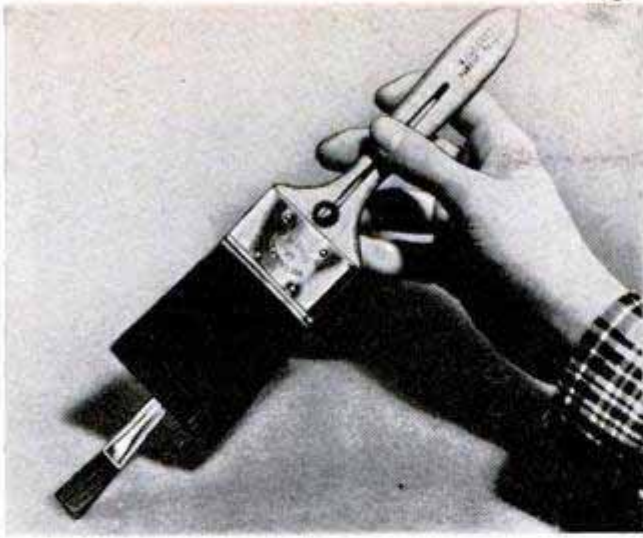

Two-in-One Brush

You always have a small brush handy when you are painting with a two-inch brush that is actually two brushes in one. A sliding button on the handle moves the small brush out for painting corners, sash and moldings. There's no need to stop to change brushes. The combination brush saves cleanup time, too—only one brush to clean instead of two.

Wakeless Torpedo

Bubbles that betray a torpedo's path are eliminated with use of a fuel whose exhaust gases are absorbed by the water. A newly patented torpedo invented by the late Dr. Robert H. Canfield of Washington, D. C., burns compounds of hydrogen and carbon, or of hydrogen, carbon and oxygen. According to the inventor, torpedoes formerly were driven by the product of combustion of fuel with air. The discharged nitrogen caused the bubbles and resulting telltale wake. When the compounds are burned in the presence of nearly pure oxygen, water completely absorbs the products of combustion. The patent was delayed 16 year for security reasons.



Door Delivered in Frame

Installation of a new door already hung in its frame is simple—the two sections of the frame merely are nailed to the wall. The assembled door and frame are adjustable to fit any wall thickness from $4\frac{1}{4}$ to $5\frac{1}{2}$ inches. A carpenter can uncrate and hang the unit in about 20 minutes. All the hardware is installed except the knobs, which are slipped into place after the frame has been nailed to the wall. The units are available in all standard door sizes.

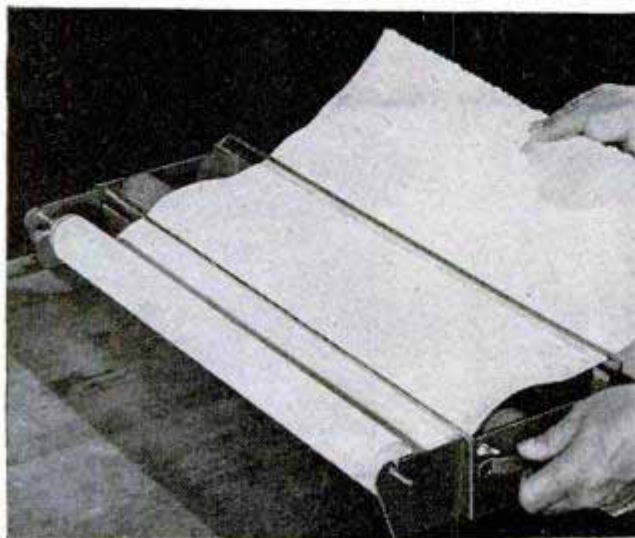

Wallpapering Device

Wallpapering is simplified by a new unit consisting of paste drum, paper roller, paste roller and a series of guides. After mixed paste is poured into the drum and a paper roll strung through the rollers, the unit is placed on the floor about one foot from the wall. The pasted paper is then pulled out, applied to the top of the wall and smoothed down with a brush.

CAFETERIA

For Boat Builders

By Jack B. Kemmerer

WHEN FRED CARNAHAN of Santa Monica, Calif., was a youngster, he was bitten by the boat bug. He has been building boats ever since. At first he had to do it the hard way—without proper tools or materials. It was then he developed a sympathy for the “poor” yachtsman who has more time and enthusiasm than money. And that is why so many enthusiasts today flock to his build-it-yourself boat yard to turn dreams into reality.

The boat yard, a few blocks from the ocean, was built for the small customer. Facilities include a machine shop, a free plans-and-design service, power tools, marine hardware and fittings department, ways for new construction, repairs and storage.

The machine shop has a lathe, circular saw, bandsaw, jointer and table sander. Once a customer proves he can handle the equipment, he is permitted to use it for any job. If the builder can't operate it, Carnahan will do the job for him at a very low cost and sometimes for nothing.

The average man who stops in for information has never owned a boat. He may have been looking for a cheap boat but has given up because even the small craft costs too much when new.

Carnahan explains that most of the cost of a boat is in the labor and not the materials. If the prospective owner is willing to build his own, he can save, in most cases, more than 50 percent.

The hull is the hardest part to build. If the customer prefers, the yard will build the hull and he can take over from there. Precut kits, made by many manufacturers, are also available and merely require assembly to put a small but first-class cruiser in the water.

The boat yard maintains a complete selection of portable power tools available on a rental basis. For \$2.50 a day, the builder can use electric sanders, power saws, drills and spray guns. When his boat is completed, he can rent a trailer to haul it to the ocean for the launching ceremony.

Marine hardware and fittings are expensive, so the boat yard has a supply of used



BOATS

CARNAHAN MARINE PROD. CO.

Walking around the build-it-yourself boat yard, you see a variety of activity, as proved by this montage. Boats range from the small cruiser at left to the 36-footer at right below. By doing the work himself, a boatowner can cut costs in half. Boat at right is in for repairs after its trip from New York through the Panama Canal. Bottom left, a salesman most of the time, this enthusiast works on the hull of his 26-foot cabin cruiser on week ends. At left is a novice building a 16-foot cabin cruiser, his first boat. Below, tiny cruiser, called "poor man's yacht," sleeps two persons and is powered by an outboard

Carnahan not only provides expert advice, but he also helps out customers who are unable to operate any of the power tools in the machine shop of his novel boat yard



equipment and the buyer can make trade-ins on the things he needs.

The yard handles 25 boats, ranging in size from 8 to 46 feet, and, in addition, ways are available for repair and storage. Space rental rates are based on the boat size and are 30 cents per foot per month.

Most amateurs work on week ends and the average boat takes about six months to complete. One young couple built a 16-foot cabin cruiser—their first boat—and always brought their baby with them. They would put her in a high chair where she could oversee the work and when the boat was finished it was named after her.

Another customer, a salesman, has built several boats and is now working on a 26-foot cabin cruiser that will sleep four. A retired newspaperman is building a 16-foot cabin cruiser himself while the yard builds the hull of a 36-footer for him. He intends to practice on the smaller cruiser and take over the larger one when the hull is ready. This boat has a glass-fiber bottom and will be one of the largest such boats built on the Pacific coast.

Twin-hull catamaran, knifing through the surf here, was built at the yard



The most unusual boat built in the yard is a catamaran with twin hulls 20 feet long. The "cat" is one of the oldest sailing designs in the world and also one of the fastest. The young man who built it has formed a club and plans are underway to construct several more at the yard.

One customer even rents space for manufacture. He makes balsa-wood surfboards and sells them all along the coast.

Carnahan never forgets that his yard was started for the customer with limited capital. "If I can give a young fellow a broken can of paint or an end of something, I let him have it," he explains. "Most places charge for every little thing, but that's against our policy. We don't give merchandise away, by any means, but it doesn't cost much to be a good guy and when they have more money to spend they remember us."

Once an enthusiast has built a boat, he is generally a confirmed sailor. Invariably, in a short time the craft is too small and he's back with ideas for a larger one. About half of the yard's customers are already on their second or third boat and bid soon to get out of the "little guy" category, at least as far as their boats are concerned. ★ ★ ★



↑ Streamlining of the partially completed shell was tested in a pond. Above right, Bohm squatted in racing position so shell could be tailored to his body. Below left, shell is checked. Right, Bohm sets new record

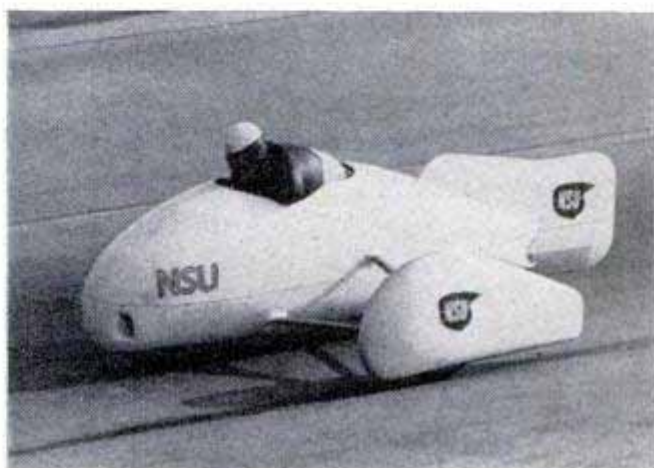

Record-Breaking Motorcycle Carefully Streamlined

When Hermann Bohm set a new world's record for the racing motorcycle, he did it in a vehicle so streamlined it actually was tested in a pond. Bohm squatted for hours on the motorcycle while his assistants made the shell-like covering to his own measurements. When the shell was completed it

was taken to a small pond where the streamlining was given a thorough test. The sleek design finally was adopted and installed on the motorcycle. In the resulting vehicle, Bohm set a new record of 154 miles per hour for a racing motorcycle with attached sidecar.

Streak Eliminator

Despite heavy downpours, windshields can be kept crystal clear with a concentric attachment for wipers. It shifts the blade to a different wiping position at the end of each stroke. The blade moves $\frac{1}{8}$ inch to eliminate streaks and smears caused by overlapping strokes.

"Woodpecker" Field Phone

Making a sound that imitates the tap of a woodpecker, a new Army field telephone doesn't give away the position of front-line troops when it rings. The tapping noise, which replaces the bell, can be adjusted in volume. The telephone is completely waterproof.

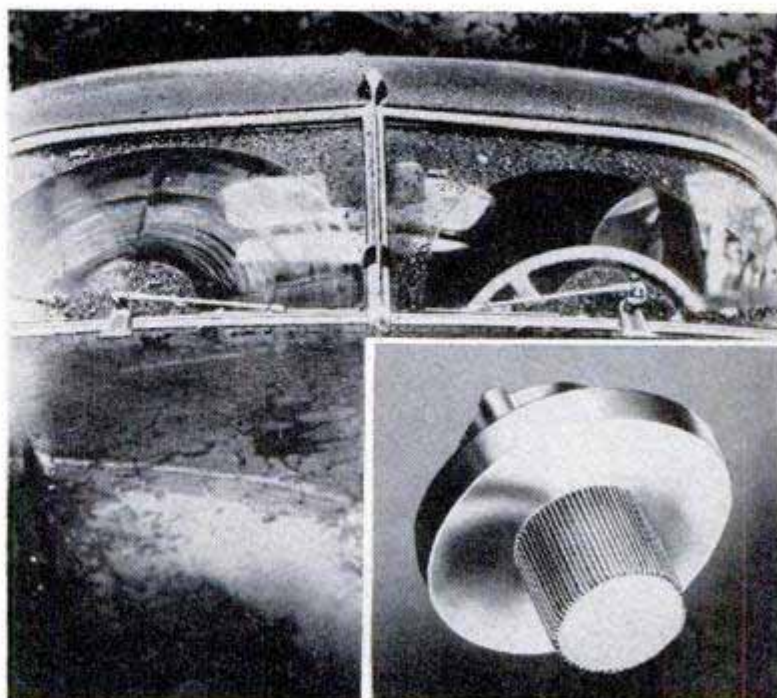



Piper Light Transport Designed for Business Use

Intended for executive travel and charter trips, a new light transport is being tested by Piper Aircraft. The roomy four-placer is designed to fill the need for a relatively low-cost airplane for round-the-clock fly-

ing. Two 135-horsepower Lycoming engines give it a cruising speed of more than 150 miles an hour at sea level. The price for the initial production models, scheduled for next year, will be less than \$25,000.

Test-Stand Truck For Airplane Engines

Prolonged engine check-ups no longer need to keep airliners out of service. Panair, in South America, now removes an ailing engine and installs it on a mobile test-stand truck. Another engine replaces it on the airplane during the trouble-shooting and repair. The eight-ton truck is fitted with a truss and an adapter plate to take a complete propeller-and-engine power package.



Flying Jeep

Actually smaller than its earth-bound predecessor, a Jeep helicopter is capable of traveling 80 miles an hour and has a cruising range of about 120 miles. The midget can be dropped from a large plane, unpacked by two men and put into the air in 20 minutes. It will be used for observation, air evacuation of wounded or hauling small supplies and messages.

Army doctors in Korea are using an artificial kidney in the hope that it may save the lives of battle casualties subject to prolonged shock and repeated transfusions.

the

POPULAR
MECHANICS

CRAFTSMAN



MAKE YOUR LIGHTING COUNT

By Frank N. Stephany

DOES NIGHTFALL make your home seem cheerless even though you have tried any number of decorating schemes and rearranged the lamps in every conceivable combination? Or, do you return from work or shopping and wonder why you can't see as well in your own home as in the office or store? If so, yours is one of the majority of American homes that suffer from inadequate lighting.

According to a recent survey by General Electric home-lighting experts, 95 percent of all homes in the average community lack

lighting in quantity and quality sufficient for the day-to-day needs and comfort of the family. In addition to the somewhat gloomy and unpleasant atmosphere which usually accompanies inadequate lighting, ordinary household tasks become more difficult and, in some cases, even unsafe.

Adequate home lighting falls into two categories which must be combined for best results. These are general room illumination, and lighting for specific tasks. The former can be achieved with concealed fluorescent lamps and indirect diffuser

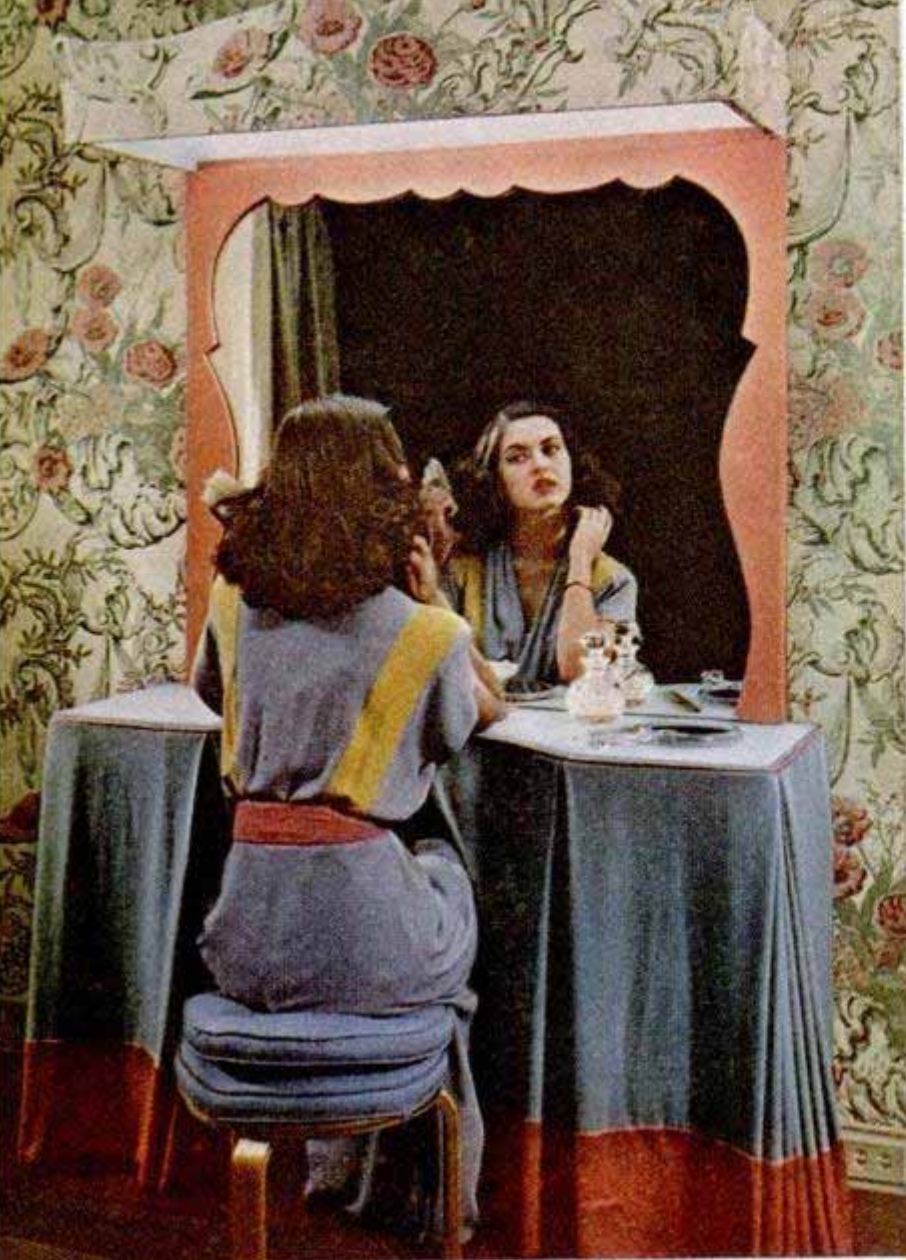

Photos and information courtesy of General Electric Co.

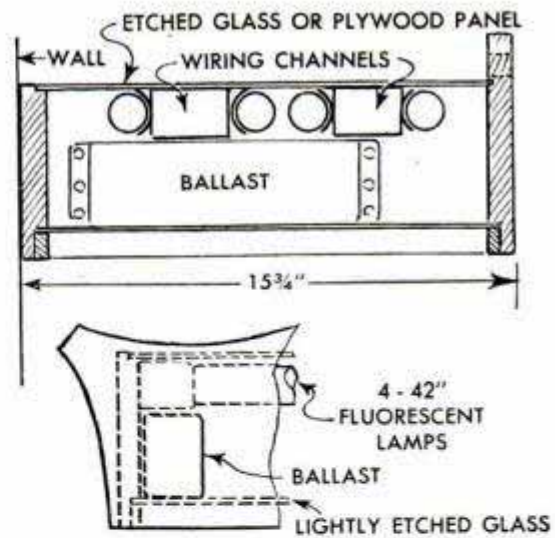

Papered to match bedroom walls, this attractive mirror canopy gives plenty of light over the dressing table as well as general room illumination. Top of canopy is etched glass for indirect light or plywood painted white to reflect downward

bowls on portable floor and table lamps, while the latter is gained by correct placement of portables and utilizing of direct fluorescent light from various types of fixtures. Good lighting need not and should not be harsh. For comfort, the light must be sufficiently diffused and yet be present in a quantity that permits quick, easy accomplishment of any particular task, such as reading, shaving, painting, sewing or cooking. Besides this, modern home light-

Diagram below indicates recommended locations of wall or ceiling fixtures, fluorescent lamps and convenience outlets for light-conditioning a modern home

- CONVENIENCE OUTLET
- FLUORESCENT LAMP
- WALL OR CEILING FIXTURE

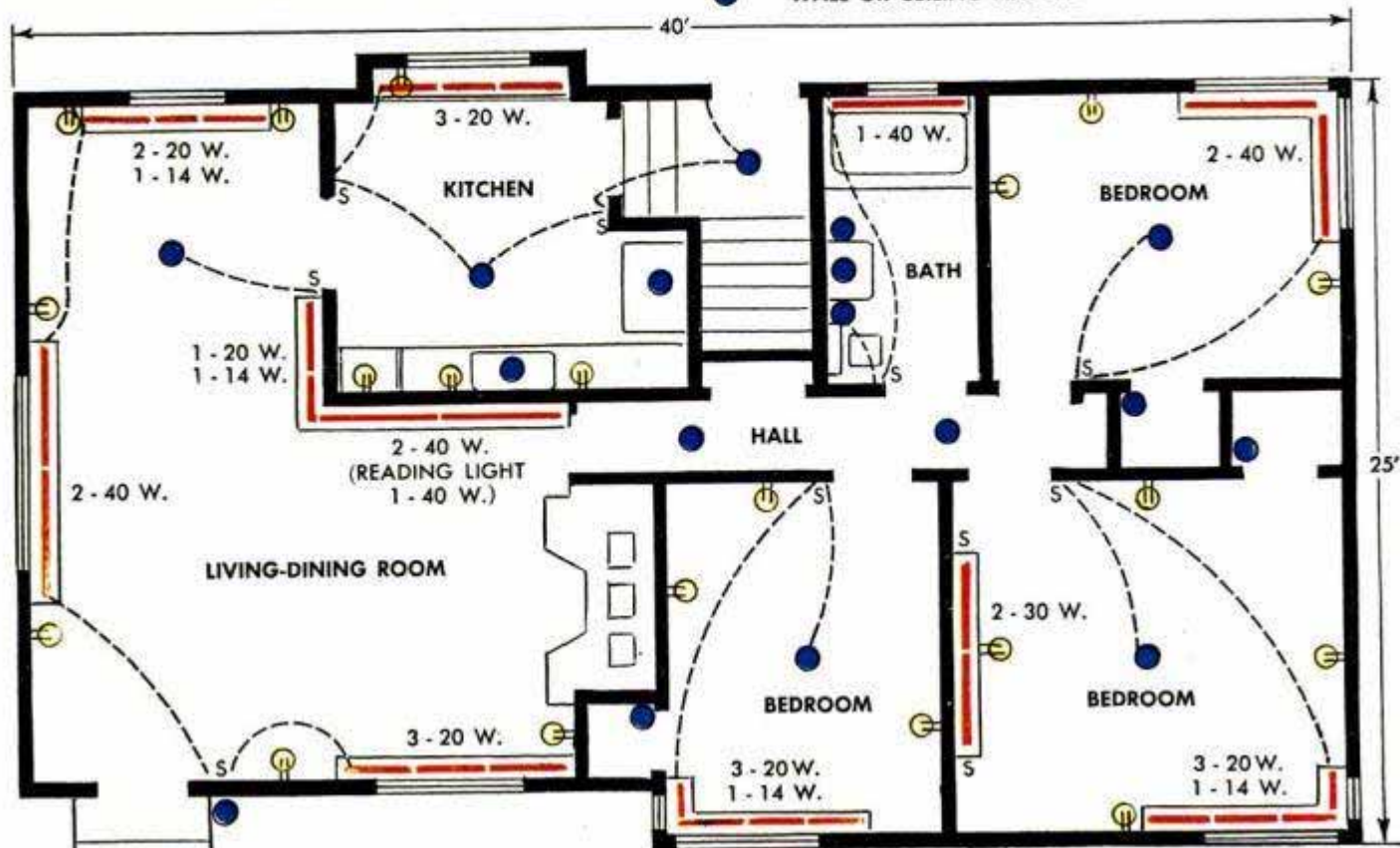

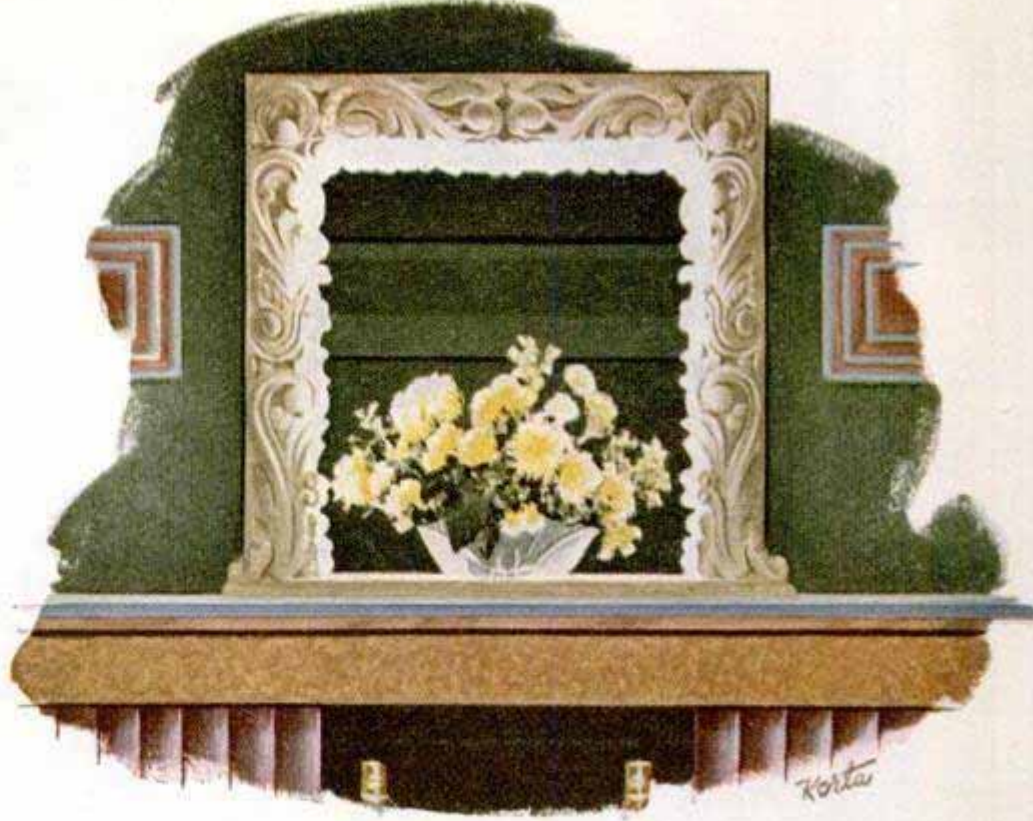
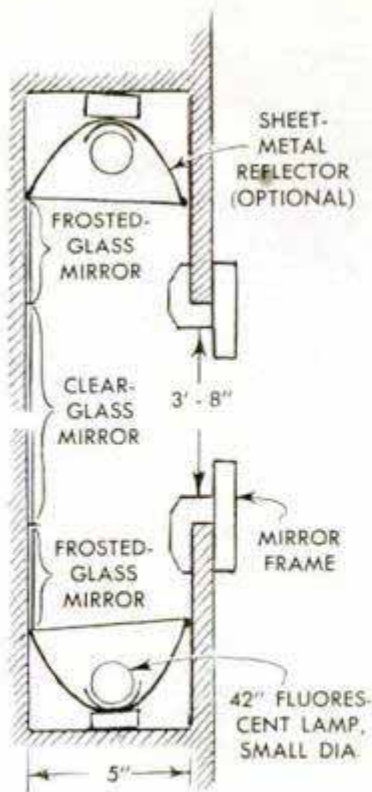

ing should improve the beauty and livability of the home. In other words, you can literally decorate with light.

The most efficient way to attain a properly lighted home would be to build the lighting into the plans. However, as this was not done in the past and, in most cases, is not done at the present time, it is up to the homeowner to improvise with the cir-

Recessed mirror and hidden fluorescent sidelights combine to achieve this beautiful mantel treatment

cuits and outlets available to him. This can be done with surprising effectiveness and without expensive construction chiefly with the use of valance and wall-bracket lighting and the proper positioning of portable floor and table lamps.

General Electric's Horizon House, which portrays the ultimate in home lighting, is partially shown below. Soffit unit over the sofa contains two rows of fluorescent lamps to illuminate the painting, the sofa, or both





Compare photo above with same view at top of page. New ceiling fixture plus the lighting installations, Fig. 1, details A and B, accomplished the change

Valance along opposite living-room wall conceals two 40-w. fluorescent lamps, spotlight for piano and reflector-flood reading light, as in Fig. 1, C



Note in photos on this page and in Fig. 1 how light played prominent role in transforming drab, gloomy living room into the most cheerful spot in the house

The floor plan on page 150 shows a typical room arrangement with suggested fluorescent-lighting installations, convenience outlets and locations of ceiling and wall fixtures. This, of course, is an ideal layout from the lighting standpoint and the homeowner who must work on a limited budget cannot expect to follow it in its entirety. However, many of the innovations can be worked out with a reasonable amount of expense and may be used to improve the quality of the lighting where it is needed most. Note, for instance, the fluorescent-light installation on the wall between the living-dining room and kitchen. One version of this setup is illustrated on page 149. Here you will notice that the reading light is concealed under a bookshelf, and fluorescent cove lighting is installed along the top of a row of wall cabinets which round the corner of the room. This is a typical example of the way lighting and utility can be combined.

The drawings on pages 154 and 155 give recommended lighting recipes for various specific purposes. To get the most benefit from this type of pin-point lighting in your home, follow the dimensions as closely as possible and ask your lamp dealer for his recommendations as to the type of lamp and wattage of bulb most suitable for the intended purpose. Space does not permit

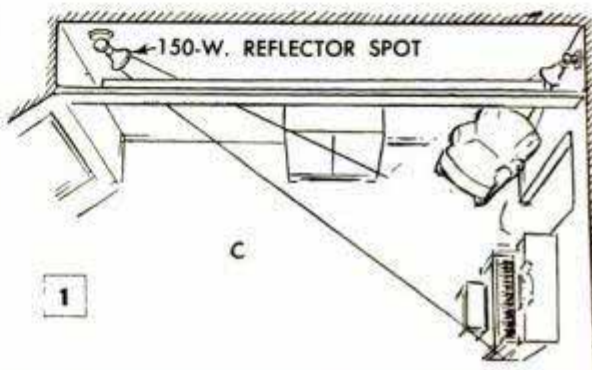
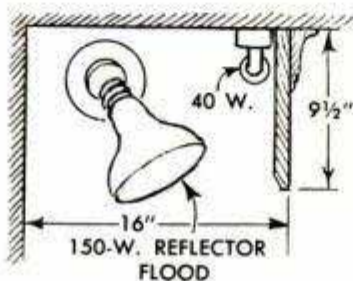
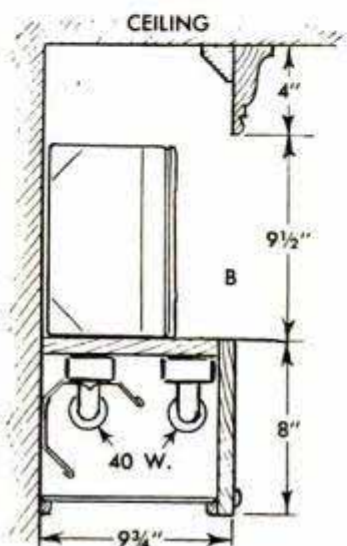
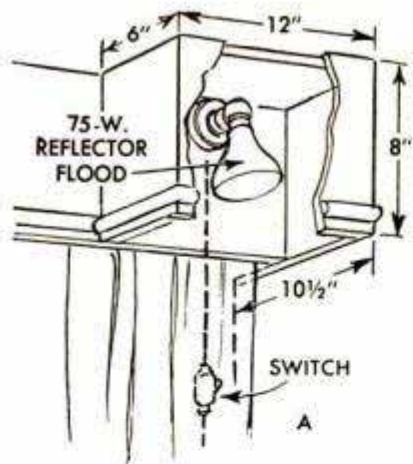

Indirect valance lighting, more efficient portables and a concealed mantel light brighten cozy living room

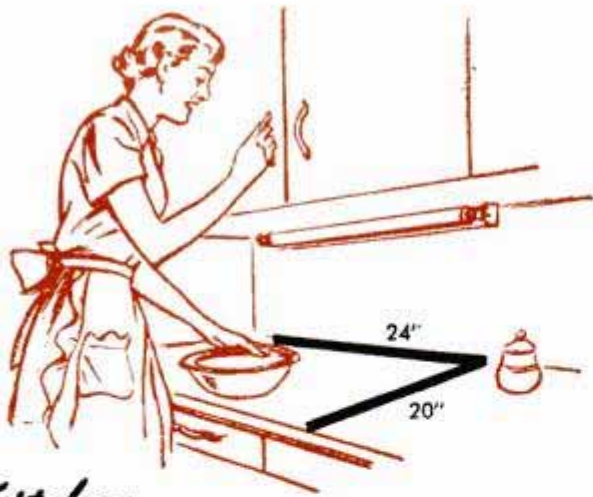

Kitchen

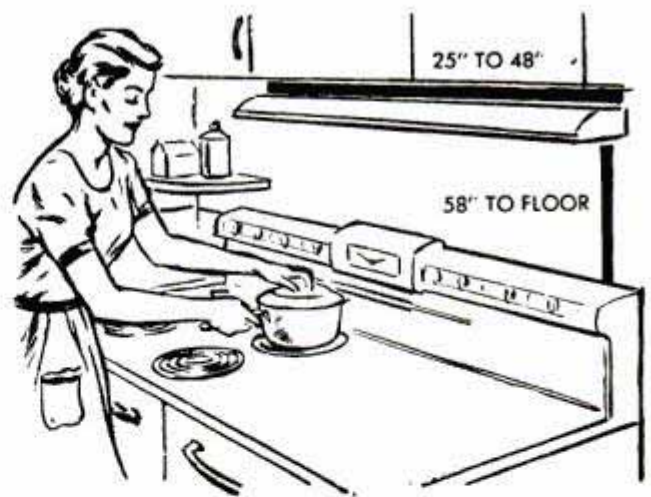

Reading



Bedroom



Writing Desk





giving all the information on lighting recipes in this story. The subject is covered more thoroughly in a booklet called "See Your Home in a New Light" which probably can be obtained from the dealer where you purchase your lamps and fixtures.

As built-in cove lighting along the walls of a room is quite costly in most cases, the valance has become a popular and effective substitute for obtaining diffused over-all illumination. Fig. 3 gives the basic dimensions for different types of window valances; one type for direct lighting only, another for indirect only, and a third type which supplies direct and indirect light.

The valance intended for indirect or combination lighting should be mounted 12 in. or more down from the ceiling, and the lamp channel is located flush with the top edge of the valance. These two factors are important in order to attain maximum spread of light across the ceiling. The 4-in. distance from the wall or woodwork surface to the center of the lamp is needed for distribution of light over the full length of drapery. The latter should be hung as close to the wall as possible. However, if you



Drawings on these pages show locations of lamps for specific purposes throughout the house. When buying portable lamps, check with your dealer to be sure that size and design are suitable for intended use

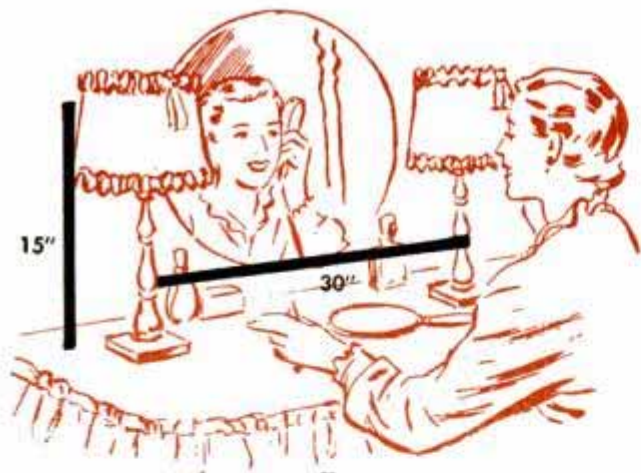

Bathroom

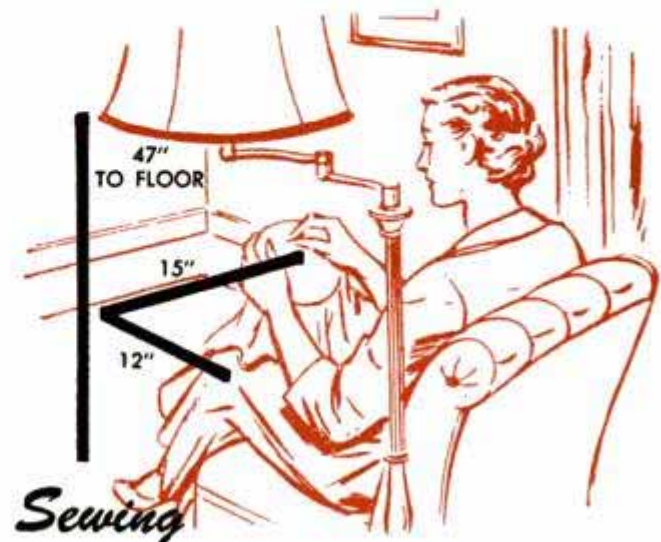

Sewing

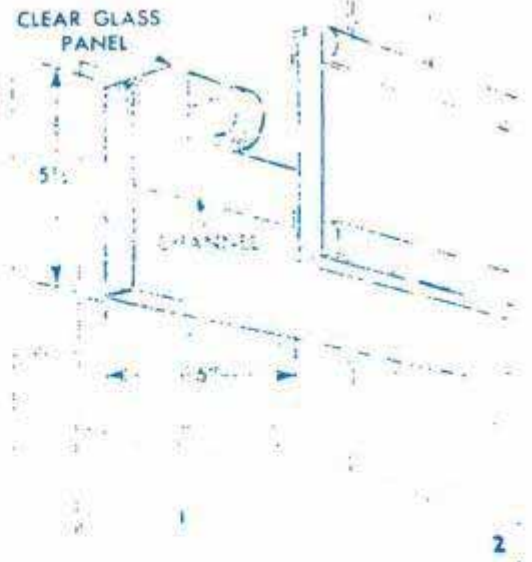

2

find that with your present traverse rods, the 4-in. dimension does not bring the fluorescent tube beyond the drapery, increase the thickness of the wooden backing strip to bring the channel farther out from the wall. Then increase the distance from the valance to the wall proportionately. Paint all inside surfaces of the valance white to reflect the maximum amount of light.

The length and location of valances as well as the type selected is determined by the arrangement of the room and the effect you have in mind. In one instance a valance may be used to provide lighting along the entire length of a single wall to balance the light from portable lamps. In another, full-length valances may be in-

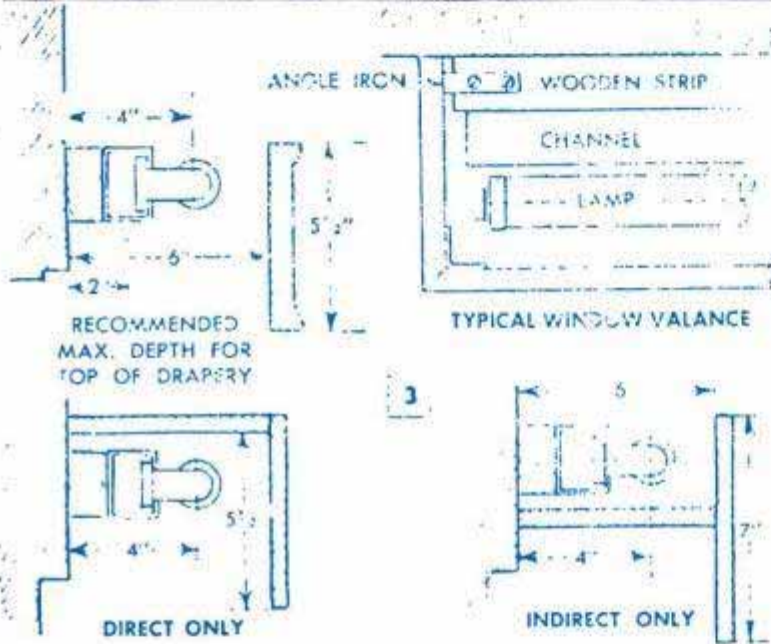

3

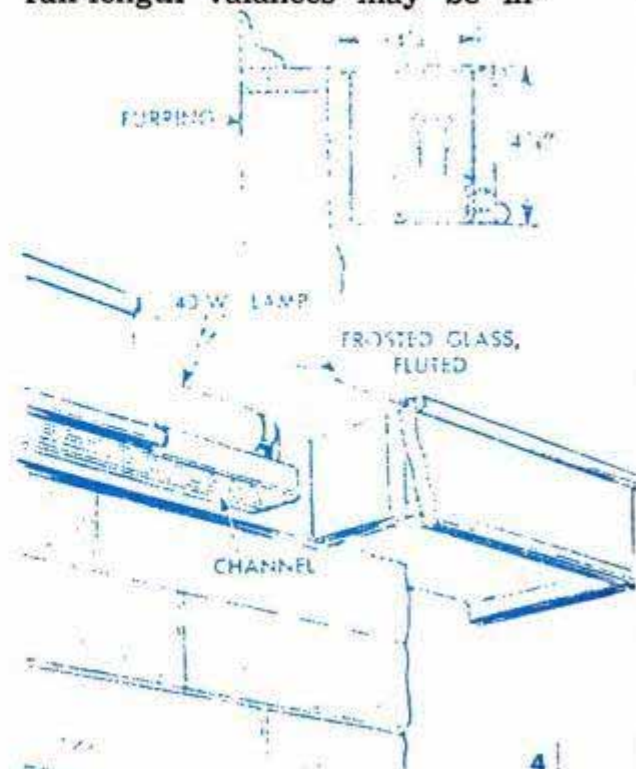

4

Panel of white-painted fiberboard above student's desk provides reflecting surface to attain maximum light from pin-up lamps

stalled along opposite or adjoining walls, or window-length valances can be used over the windows all around the room so each wall contributes to the over-all lighting effect. Bays, alcoves, picture windows, offsets and wall sections or windows flanking a fireplace all lend themselves extremely well to the valance-lighting treatment. You will find, too, that the installation of valance lighting will permit moving the furniture to new arrangements which were never before practical due to the lack of sufficient light. Fig. 5 offers an example of how furniture and portable lamps can be arranged when the general lighting level has been increased with valance lighting.

A few of many possible lighting installations are pictured and detailed on these pages. Fig. 1 details the drapery brackets, soffit lighting and the wall-length valance with its concealed spot and flood lights which combine to light-condition the redecorated living room shown in the photos. The wall bracket detailed in Fig. 2 not only provides plenty of light for working at the kitchen range, but doubles as a handy and attractive spice shelf. Utilizing a clear-glass panel for the shelf permits a certain amount of indirect illumination to produce an interesting treatment. The indirect fireplace-mantel light, Fig. 4, is an important feature of the living room pictured below Fig. 1. By means of light, the painting over the fireplace is given the prominence which it rightfully deserves. For a bookcase similar to the one pictured at the right, just install one or more fluorescent-lamp channels.

As you look through your home, keep in mind these examples of the thoughtful and successful use of light. Without a doubt you will notice for the first time any number of ways in which light can be applied in your own home to make the decorating more effective, and more important, to make your everyday living more enjoyable.

★ ★ ★

Lighted bookcase with glass top plus ceiling spotlight trained on painting form bright, dramatic corner in small apartment

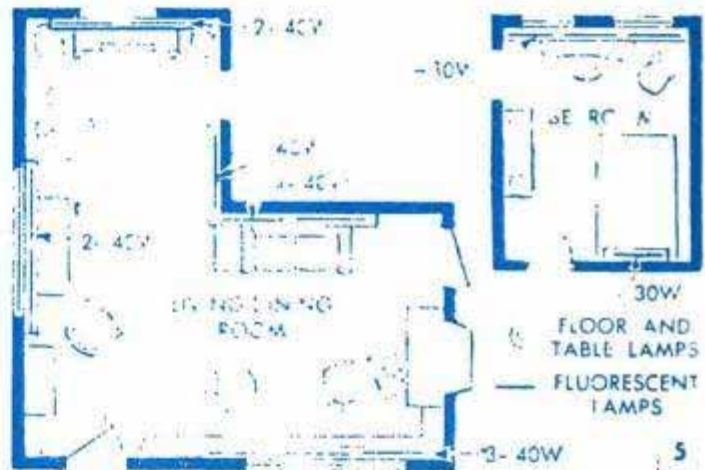
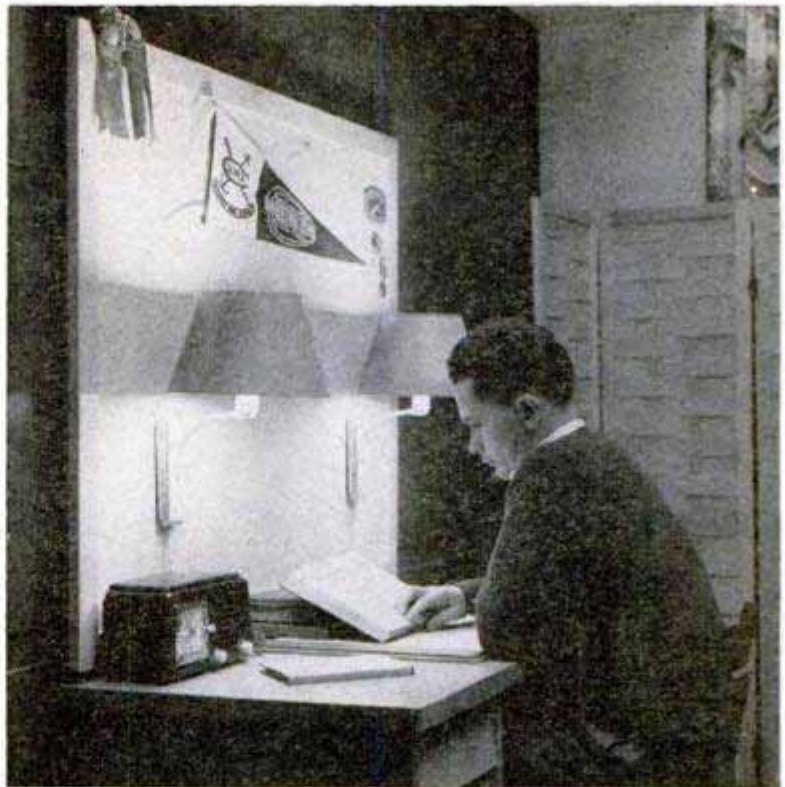

Storage Bags for Children's Toys

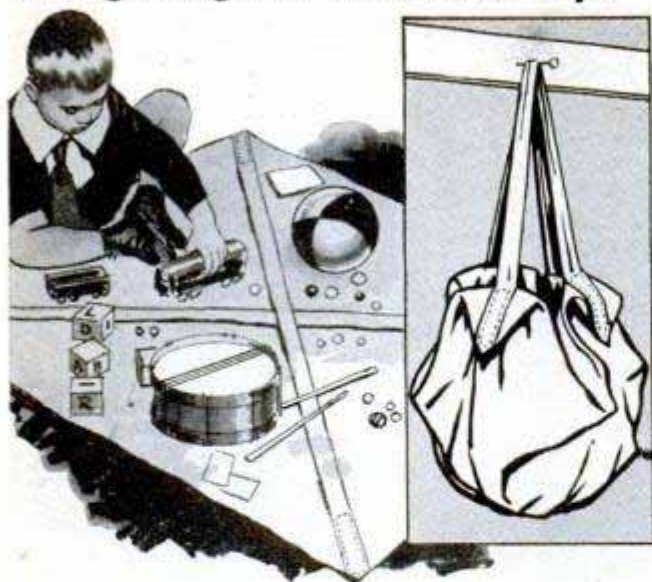

Mothers of small children should welcome this solution to the ever-present problem of picking up toys after playtime is over for the day. By placing strips of canvas or webbing diagonally across the blanket and sewing them at the corners of the blanket, blocks, rattles, dolls and other playthings can be gathered up quickly and stored out of the way on a hook in the closet. Lifting of the straps where they cross forms a spacious bag for the purpose.

Lock Washer Quickly Improvised



The next time you have to lock a nut and there is no lock washer available, try using a common friction washer that has been slotted as indicated. To prepare the washer, cut four short, equally spaced slots in it. Then, twist each segment formed by the slots slightly to produce a propeller-like shape. Also, cut a single notch on the underside of the nut as indicated. In this way, when the nut is tightened against the washer, the notch will engage one of the four segments formed in the washer. The other three will bite into the surface under the washer and thus prevent the nut from working loose.

Herbert E. Fey, New Braunfels, Tex.

Inexpensive Fire Extinguisher Utilizes Plastic Container

Small, inexpensive fire extinguishers that will shoot a stream of carbon tetrachloride up to 10 feet are improvised quickly from plastic squeeze-type containers. Remove the nozzle head from the container and enlarge the opening with a needle so the extinguisher will throw a steady stream. Then

fill the container with carbon tetrachloride and replace the cap. It is best to use a 3 or 4-oz. container which can be sealed tightly to avoid evaporation of the chemical. Carbon tetrachloride is especially suitable for putting out small fires caused by electrical defects. *Caution:* However, be sure to provide adequate ventilation when using this chemical, as the fumes are likely to be dangerous.—Jack H. Lewis, Willow Run, Mich.

Clothespin Keeps Electric Cord In Wall Outlet

The annoyance of having an electric cord pull out or work loose in a wall outlet while operating a tool such as a soldering iron or an electric drill can be prevented with a spring-type clothespin. Mounted on the wall several inches below the outlet, the clothespin will hold the cord securely and resist (up to a certain point) any tension placed upon it. A little slack in the cord between the socket and the clothespin will facilitate the removal of the cord when necessary.

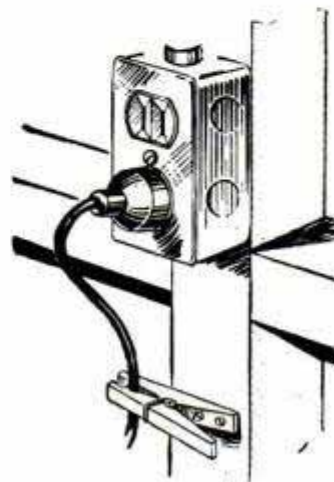

Linoleum Paste Used as Filler

Especially suitable for filling the edges of plywood, linoleum paste also will serve in many other cases as an emergency wood putty. Most brands of such paste shrink very little in drying and can be sanded to a smooth, hard finish. However, if the plywood is to be finished in a natural color, apply the cement carefully since it possibly might stain the wood.

Ken Murray, Colon, Mich.

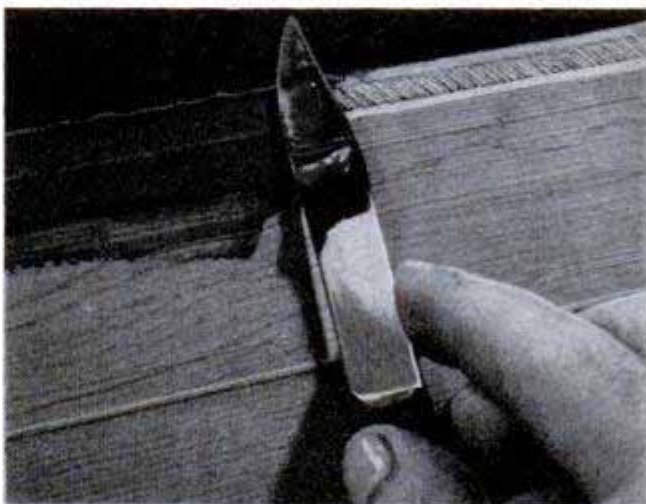

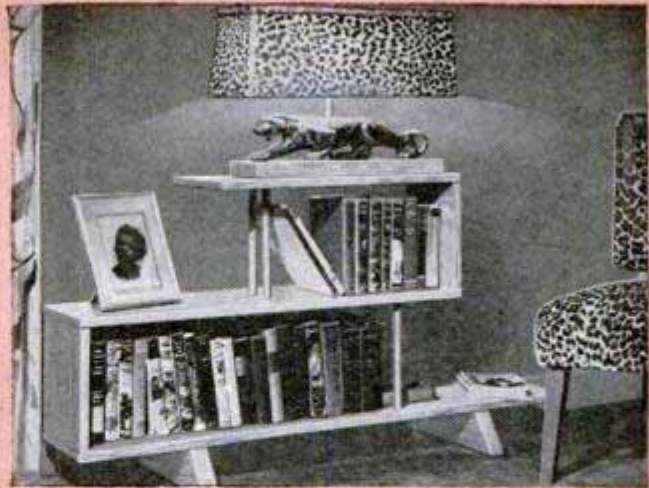
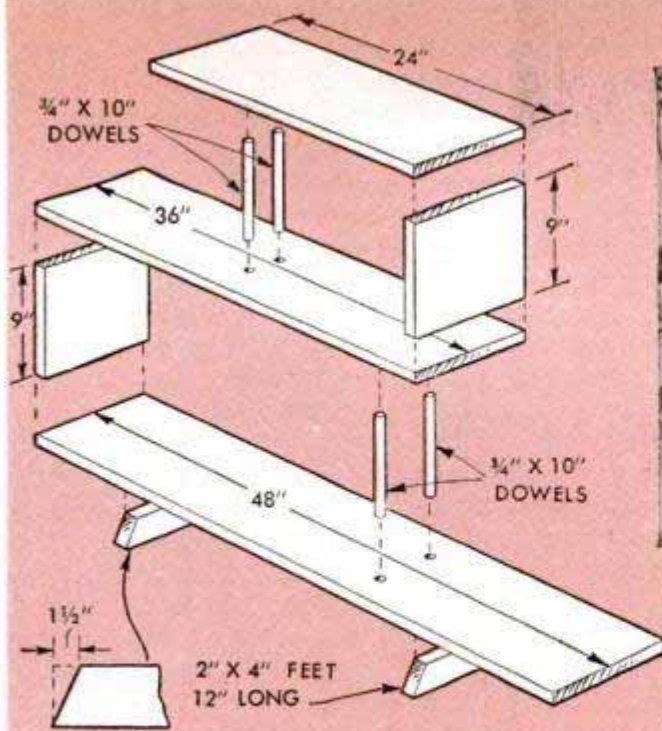

MODERN BOOKCASE

By Ray Burchette

Truly modern, this attractive bookcase can be cut and assembled in one evening and finished the next. The shelves and end panels are of 1 x 10 while the feet are sections of 2 x 4. Open ends of the shelves are supported by pairs of 3/4 x 10-in. dowels which are located about 18 in. from the ends and set in 1/2-in.-deep holes drilled in the shelf stock. Sand carefully before assembly, glue and clamp. When the glue has dried, finish sand and apply shellac or enamel

Care of Small Boat in Autumn Simplifies Spring Painting

While most boatowners prefer to paint their craft in the spring, a little care before the boat is stored in the autumn will minimize considerably the amount of work that will be necessary before painting is begun the following season. Winter is an excellent time during which a boat may be dried for painting. Before a boat is placed in storage, however, it should be cleaned thoroughly. All oil and grease should be removed before it can further penetrate the wood, as should any scum or dirt before it has dried. After applying paint cleaner with a cloth, the boat should be scoured with a stiff brush, using water containing a water softener. Small boats of the outboard and row-boat types are stored best by standing them

on their transoms indoors when space permits. Otherwise, they must be stored outdoors where precautions must be taken to protect them effectively from ice and drifting snow. These are accomplished by resting the boat upside down several feet off the ground upon supports placed not only at the bow and stern but also amidships. This will help forestall the possibility of any undue strain being placed upon the keel and the planking. A tarpaulin, weighted at the edges to hold it in place, should be used to cover the boat. In the spring, after the boat has been brushed and wiped clean, it will be ready for caulking and painting provided there are no minor repairs to be made.

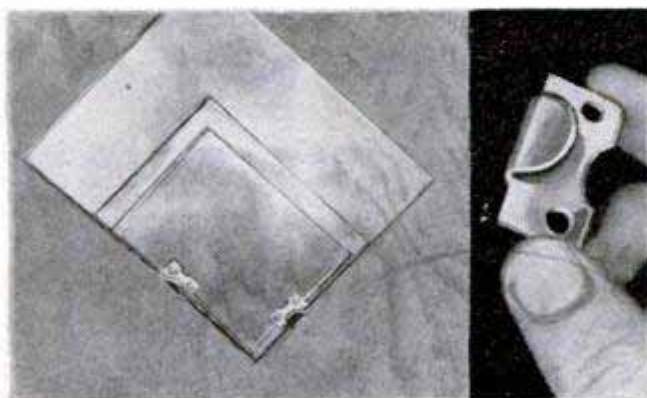

Glass Held by Window Hangers For Storage on Wall

When placed at right angles and mounted on a wall as shown, two metal hangers of the type used for hanging screens and storm windows will safely support a pane of glass on a wall. The hangers, which are placed at a distance from one another which varies according to the size of glass to be accommodated, should be attached to the wall with flat-headed wood screws.

Kazoo Provided by Combining Clothespin and Strip of Paper

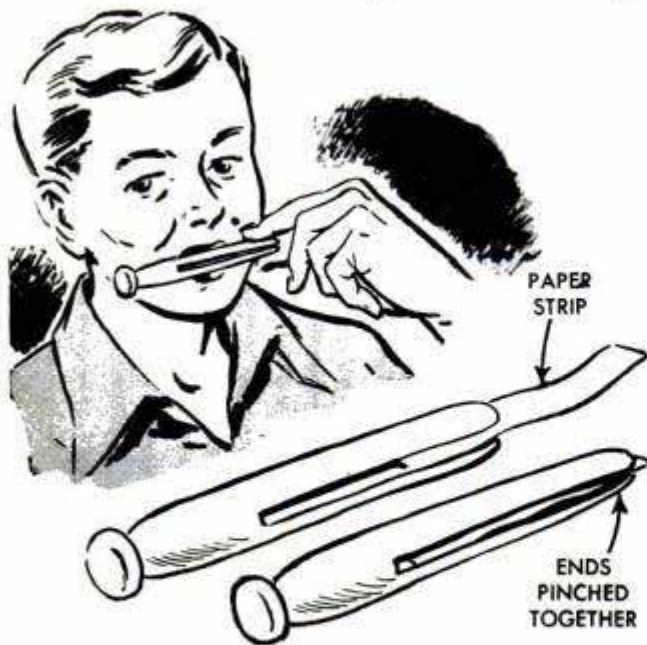

Children will enjoy "playing" a kazoo, one of the simplest of all musical instruments. This version of it can be improvised in a matter of seconds by placing a strip of stiff paper between the prongs of a clothespin. When held to the lips as shown, two different basic sounds can be produced by expelling the breath against the edge of the paper. A pleasant though slightly distorted musical tone can be produced by humming or singing into the instrument, whereas a raucous, high-pitched tone may be produced by forceful blowing. The pitch is controlled vocally when humming, while adjusting the depth to which the paper is inserted in the clothespin regulates the pitch when employing the latter technique. The paper is held in the position desired simply by pinching the ends of the clothespin together.

Index Marks Permit Binoculars to Be Focused Rapidly

Binoculars having individually focused eyepieces can be adjusted quickly without a need for looking at the graduated scale by adding an index mark to each eyepiece. To do this, first focus the binoculars for average distances and then apply a narrow strip of adhesive tape to the barrel of each eyepiece. Strips of tape approximately $\frac{1}{8}$ in. wide have been found most effective. Place the tape directly at the top of the eyepiece, carrying it slightly over the inside surface of the rim so that it can be seen while using the instrument. As a result of these markings, you will be able to see when both strips are at the top position, thus indicating that the binoculars are in proper focus.



Nail With Shoulder Filed on End Makes Improvised Brad Driver

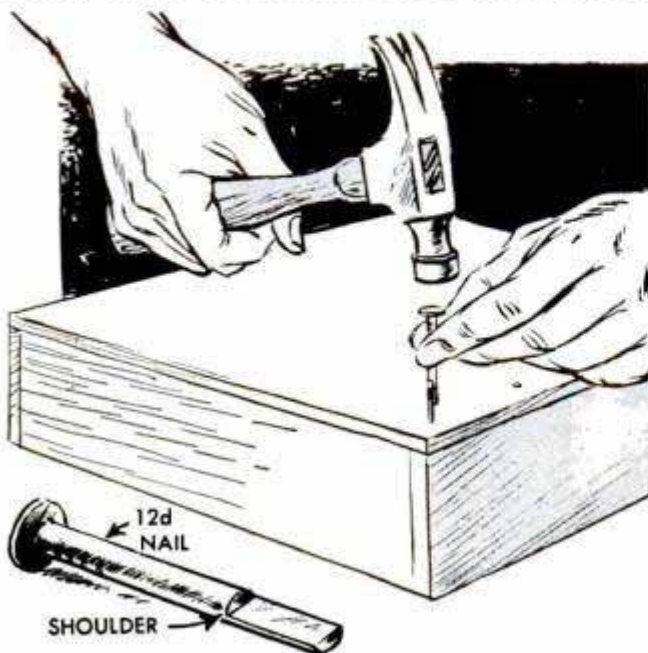

The use of an ordinary 12d nail will provide an effective driver when starting brads. Simply remove the point and file the end of the nail as shown to form a shoulder. If desired, a shallow groove in which to fit the brad can be made by drilling a hole in the end of the nail before filing.

Mrs. T. F. Watts, Charlotte, N. C.

Container for Live Bait Made From Milk Carton

With numerous small air holes punched in it, a discarded cardboard milk carton will provide an excellent container for carrying live grasshoppers and other insect baits on a fishing trip. After rinsing and drying the carton, put in the bait and press down the pouring flap.

Henry Barthel, Roland, Okla.

Don't throw out the **CLOCK**

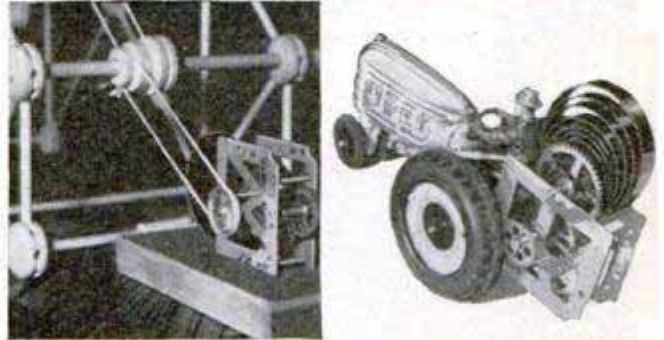

When that old faithful—the spring-driven alarm clock—finally breaks down, think twice before tossing it out. Stripped of its balance wheel, hairspring and pallet, the works will provide an excellent “motor” for operating several different toys. For example, it will be found ideal for driving a slow-moving ferris wheel built from a toy construction set. It can be used to power a model stern wheeler or to drive a toy tractor. In the latter case, the clock is tied to the rear axle in a position to bear against the tractor tire when under tension of a rubber band. A suitable drive pulley for the motor is fitted to the central hand shaft. This can be made from a spool or taken from a construction set. The unwanted parts are removed from the clockworks by loosening the small nuts that hold the frame together. As a precaution, be sure that the main spring is fully unwound before removing the parts, and in reassembling the works, solder the frame nuts in place to prevent loosening.—Richard F. Trump, Ames, Iowa.

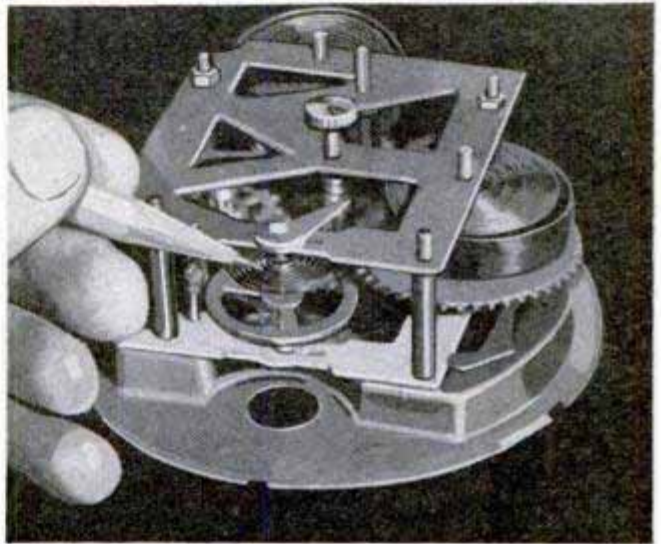

Here are the parts which must be removed—the hairspring, balance wheel and pallet, or ratchet pawl

Fired 22-Caliber Cartridges Used as Substitutes for Rivets

In a pinch where only a few rivets are needed, empty 22-cal. cartridges make neat substitutes for tubular rivets in fastening together leather, metal or other material. In the case of soft material like

leather, a washer is required under the head of the “rivet” to prevent it from pulling through. A rosehead countersink makes an ideal tool for slitting and flaring the rivets, after which the split ends are hammered flat. In addition to serving as rivets, the cartridges also can be used to punch their own holes in thin leather by striking sharply with a hammer. They also may be used to decorate a belt, holster or other leather article. *Caution:* If unfired cartridges are used, do not merely remove the bullets. Be doubly sure that the charge is removed completely, as a hammer blow will explode the unfired primer in the bottom of the cartridge.

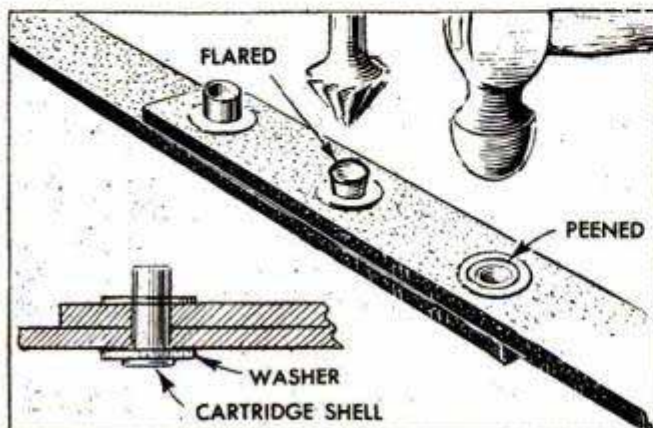

Given a coat of fresh, white shellac, a cracked pane of glass in a window can be weatherproofed temporarily until replaced.

Solving HOME PROBLEMS



1—VACUUMING A RUG PAD is easier if a mesh vegetable bag is slipped over the nozzle of the vacuum cleaner. Bag keeps the nozzle from "sticking" to rug, enabling it to be moved back and forth readily



2—DON'T DISCARD WAX CANDLES just because they no longer can be washed clean with soap and water. You will find that wiping them with a cloth moistened with alcohol will restore the original finish quickly



VACUUM-BOTTLE CORK wrapped with aluminum foil will not absorb odors from soup or beverage in the bottle or transmit taste from one food to another

SAVE TIME when removing silk from ears of corn by brushing the corn with a whisk broom. Start at the top of the ear and brush briskly toward stem end

SERRATING ONE EDGE of short hose section and tacking over end of force-cup handle forms a handy tool for loosening lint from a clogged sink drain

CHEWING GUM can be removed from clothing by first softening the gum with egg white and then washing the soiled fabric with soap and water

KNIFE CUTS in plastic tablecloths are repaired neatly with small pieces of cellulose tape. Stick tape to underside of cloth to seal cut portion

TO FACILITATE CLEANING your fingernails after a particularly grimy or greasy job, dig them into a bar of soap several times before starting the work

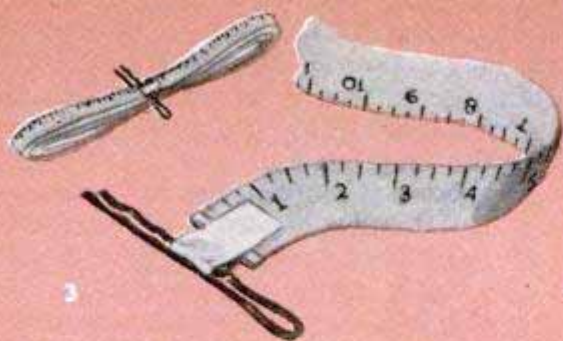

3—CLOTH MEASURING TAPE won't become tangled in sewing drawer if folded and clipped with bobby pin. Tape pin to one end of measuring tape

4—IF LID OF CEREAL BOX is difficult to remove, place strip of wax paper under it before replacing. Pull end of paper upward to lift lid

5—RUBBER TAPE on bottom of furniture legs prevents skidding. Tape is not noticeable if cut flush with front of leg and run slightly up back

6—TO KEEP CURTAINS from slipping off corner nails of stretcher, press small vacuum-bottle corks over corner nails after attaching curtains

7—MAGNETIC LATCH for cabinet door is made by taping bar magnet to underside of shelf opposite two large-headed nails or tacks driven in door

8—SCREENS ARE RUSTPROOFED before storing for winter by coating lightly with linseed oil. Apply oil with scrap of carpet nailed to wooden block

9—FOR PERMANENT shelf scallop, cut strips of plywood or tempered hardboard, tack to shelf edge and paint to suit. Decals may be added

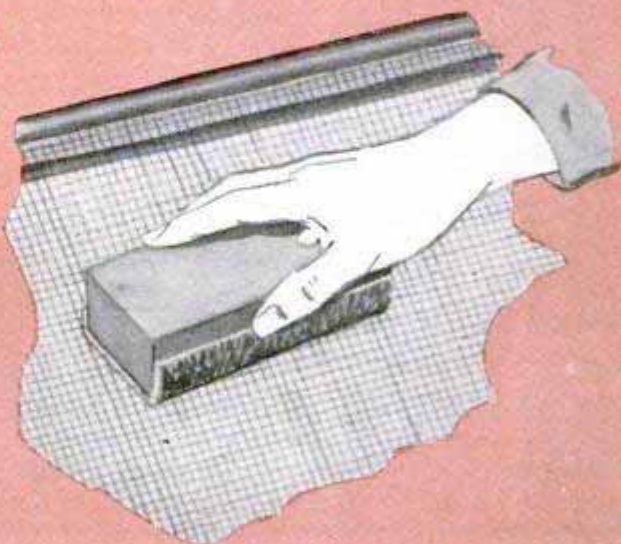
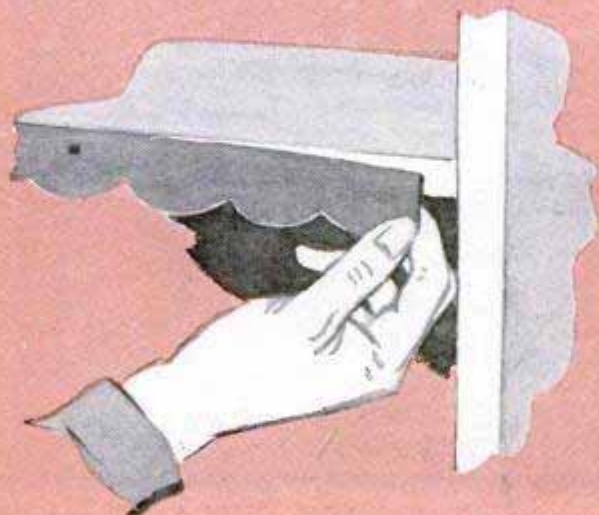
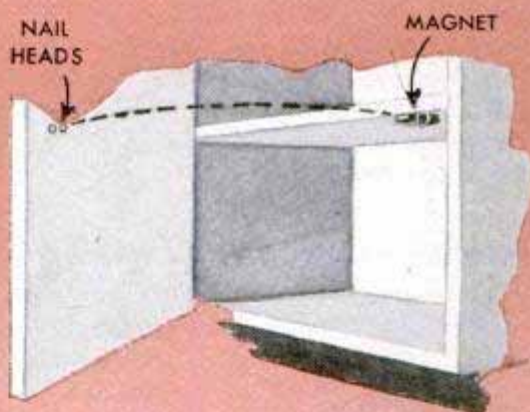
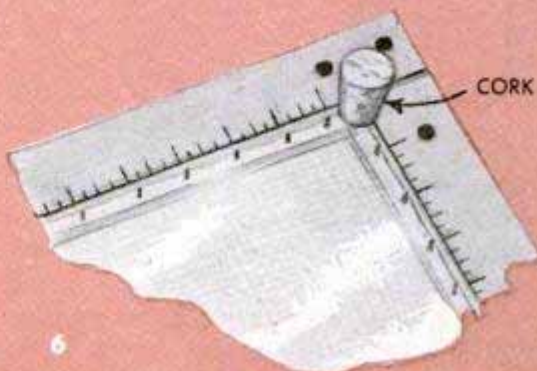

Concrete Forms Removed Quickly With Special Wrecking Bar

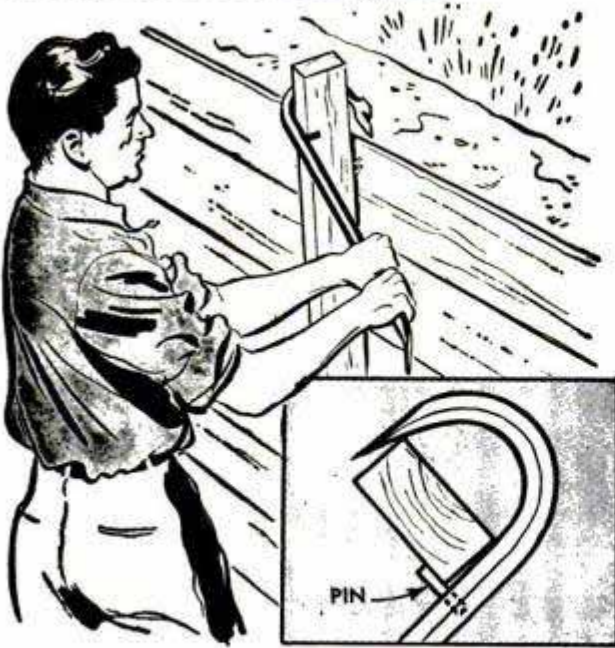

Fitted with a steel pin, a wrecking bar is just the thing for quickly tearing down concrete forms. The pin is located near the hooked end of the bar, as in the detail, so that a twisting pressure can be applied to the wooden uprights to pry them from the form boards. Drive the pin in a blind hole drilled in the bar, using a pin having a diameter less than $\frac{1}{4}$ in., so that the bar will not be weakened excessively by a comparatively large hole. Be sure that the hole is deep enough so that the pin may be anchored securely.

One-Piece Outboard Tool Kit

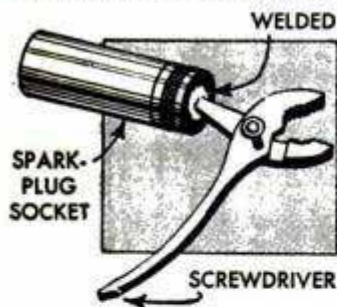

A one-piece emergency tool for the repair of an outboard motor is made easily by welding a spark-plug socket to one handle of slip-joint pliers and grinding the end of the other

handle to form a screwdriver blade. For greater usefulness, use the pliers of the type having a wire cutter incorporated in the jaws.

Colored Stripe on Golf Ball Simplifies Identification



Stamping one's name or otherwise marking a golf ball for purposes of identification still doesn't eliminate the necessity, in

most cases, of having to pick up the ball to positively identify it. However, I have found that a brightly colored stripe encircling the ball makes it easy to identify it at a glance, regardless of how the ball lies. To do a neat job of adding the stripe to each ball, a regular striping tool was used. This required a means of holding the ball in contact with the striping wheel, so I devised a simple holder from a short length of coat-hanger wire. Simulating the jaws of a caliper, the ends of the wire were pointed and spread sufficiently to grip the ball. By holding both the wire holder and the striping tool in one hand in such a way that the ball touches the wheel, a neat stripe can be painted on the ball simply by rotating it in the holder with the other hand.

Ed Packer, Chicago.

Absorbent-Cotton Dispenser

One way a dispenser for absorbent-cotton rolls can be made is by slotting the cover of a small cardboard box and then leading the cotton roll through the slot. The cover is held in place with cellulose tape.

Spray Gun Altered to Take Small Cans of Paint

In my work as a modelmaker I use many colors of paint which are purchased in 3 or 4-oz. glass jars. To save time and prevent the waste of paint, I altered my spray gun so that the paint jars could be substituted for the regular jar on the gun. To do this, I made an auxiliary suction tube, as shown in the detail, to take the smaller jars. One of the small jar covers was clamped between nuts on the tube so that the paint jars could be screwed to it. This permitted the various colors of paint to be used right out of the original jars.

Herbert R. Pfister, New York City.

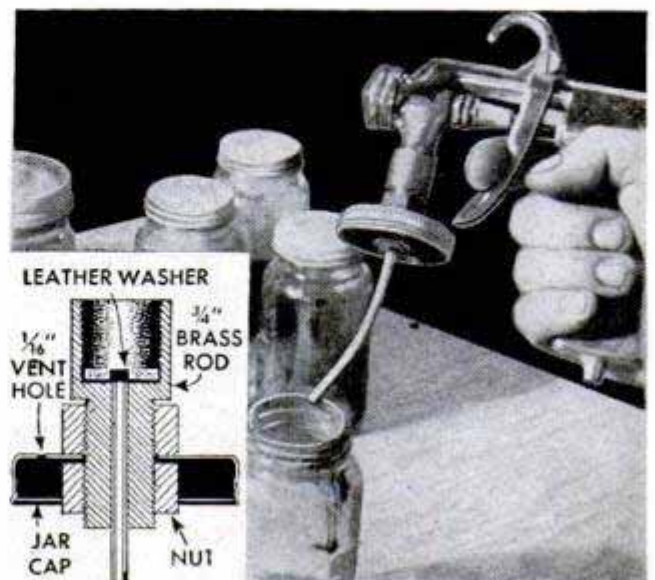

1 EVENING PROJECTS



Both the refreshment server pictured above and the Lazy Susan on following page utilize plastic cheese boxes as food containers. The server is fitted with a wire bail for carrying and the cheese boxes are supported on swinging trays pivoted at the center

By Bertram Brownold

REFRESHMENT SERVER

HOSTESSES WILL like the compact and ready convenience of this little server which provides for an attractive arrangement of both food and beverages. Three square pieces cut from $\frac{1}{4}$ -in. plywood and having the corners cut diagonally, are assembled with grooved corner pieces to form a three-tiered tray. Holes cut through the top piece provide a holder for six beverage glasses. A handle, or bail, is made by twisting wire strands as in the center photo at the left. Swinging trays support semicircular plastic boxes of the type in which certain kinds of cheese are sold. Note that the bottom of each tray consists of a semicircular piece of plywood

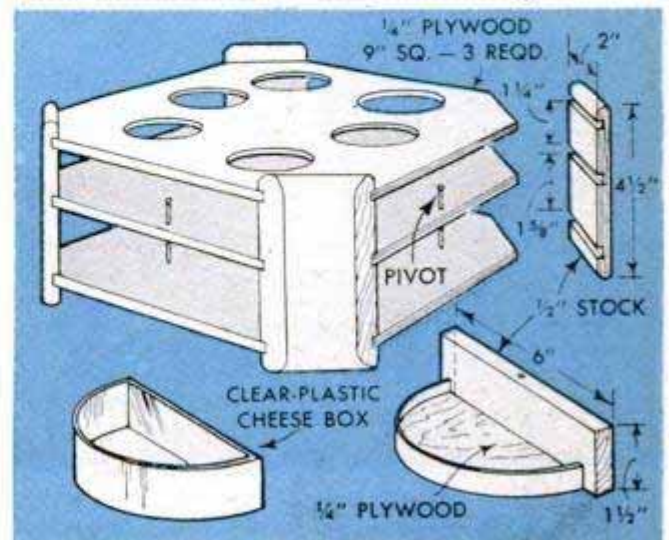
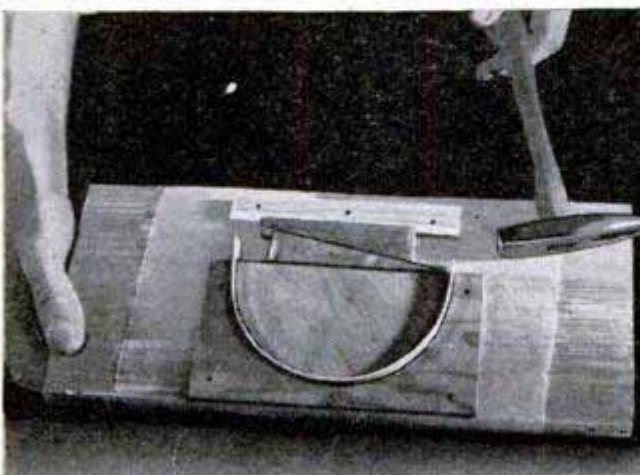
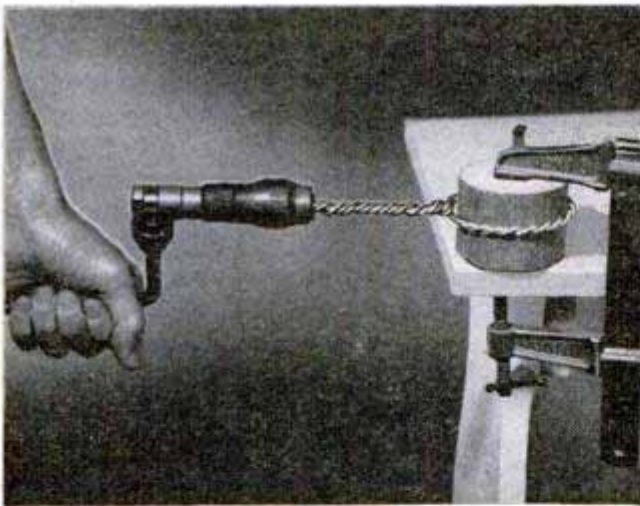

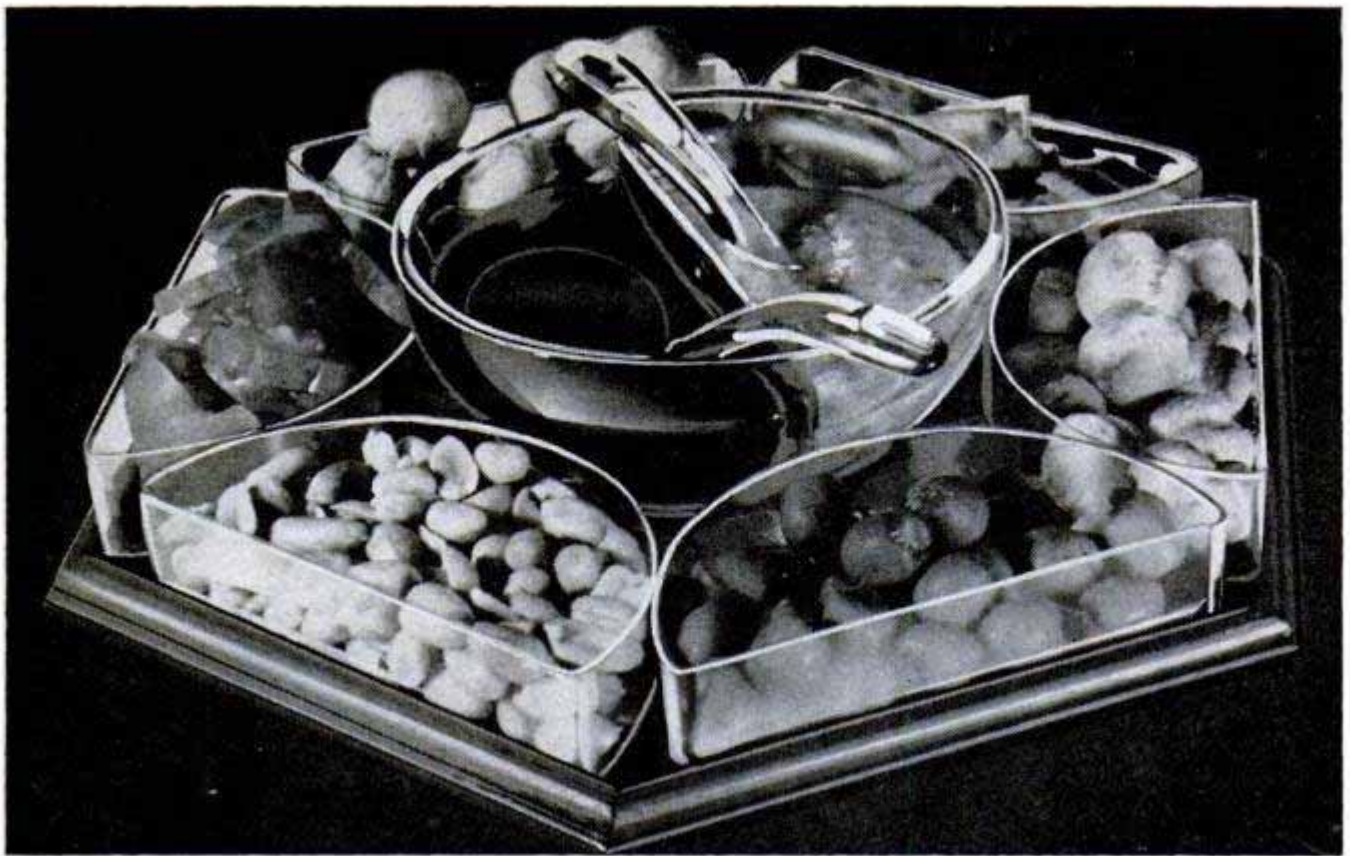

edged with a strip of $\frac{1}{16}$ -in. plywood, the edging strip being glued to the bottom piece as in the lower left-hand photo.

LAZY SUSAN

Six marbles of uniform size, which are

held in place with a plywood retainer, provide the ball thrust bearing for this Lazy Susan. The individual food trays are the same as those used on the server. The rotating tray, which also provides the upper raceway for the ball bearing, is cut to a hexagonal shape from $\frac{1}{4}$ -in. plywood and is fitted with an edging, or gallery, of $\frac{1}{4}$ -in. quarter round. The two-part base consists of shouldered turnings which telescope as in the detail at the left. Note that the bottom of the larger turning is counterbored to take the $\frac{1}{8}$ -in. flange on the smaller one. The length of the smaller turning and also the thickness of the larger one are determined by the diameter of the marbles used as bearings. In assembling, the smaller member of the base is inserted in the hole in the larger member and the balls and retainer are placed on top. Then three small screws are driven through the tray into the smaller member of the base. ★ ★ ★

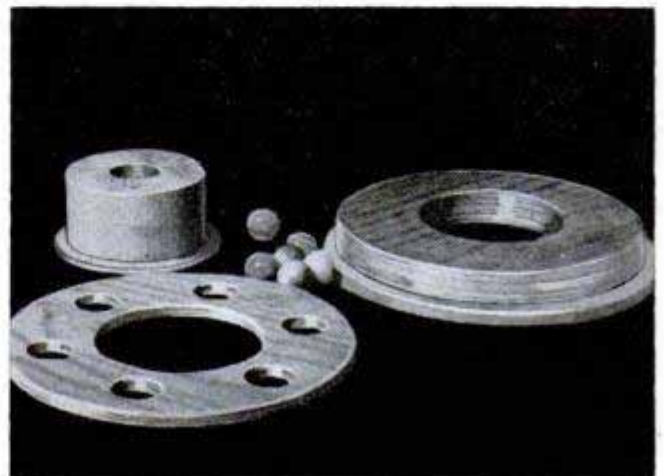
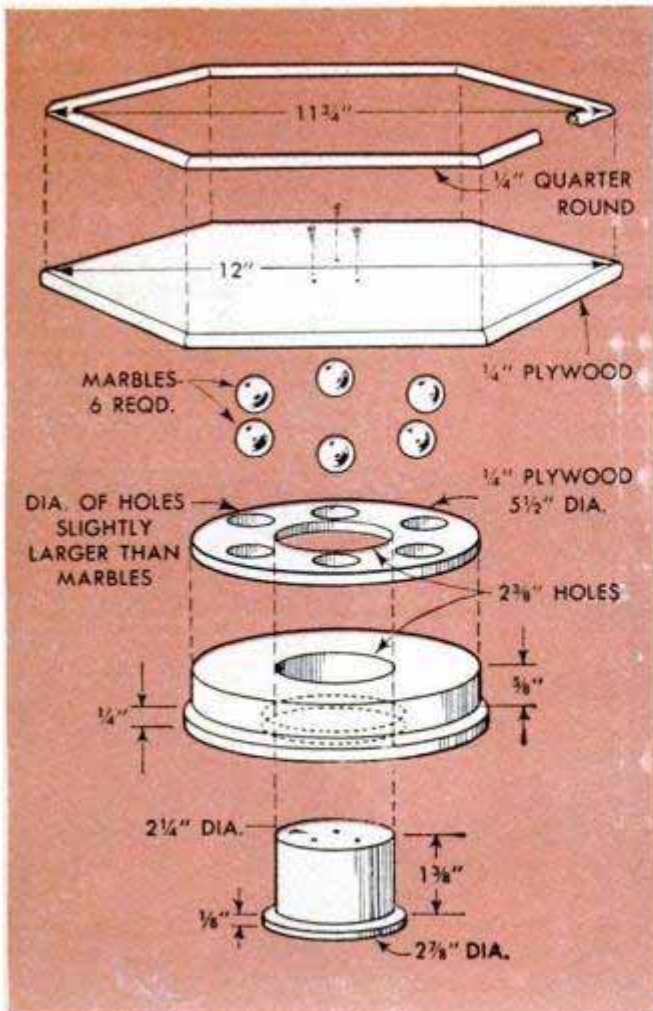

Guard for Tractor-Tire Valve Stem

One farmer devised a metal guard for the valve stems of his tractor tires to keep the hogs from chewing on them and to prevent mud frozen to the undersides of the fenders from breaking them off. The guard



consists of a 1 1/4-in. nipple placed over the valve stem and screwed into a plumbers tap that is welded to the tractor rim. The guard can be unscrewed with little difficulty to expose the valve stem when checking tire pressure.

Medicine-Dropper Bulb Makes Emergency Grommet

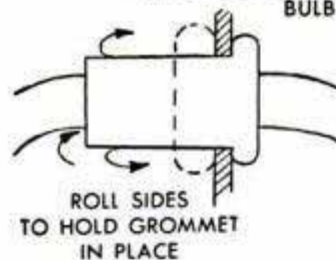
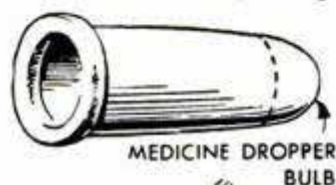

Lacking a rubber grommet to protect an electric cord which passed through a metal cabinet, one radio serviceman made one from a medicine-dropper bulb. The tip of the bulb was cut off and the bulb itself inserted through a hole drilled in the sheet

metal. The projecting end of the bulb was then rolled back on itself in order to provide a flange for holding the improvised grommet securely in place.

Roy M. Crabtree, Florence, Ala.

Wood-Chopping Safeguard



Nailed to a stump or chopping block as shown, a section of auto tire is all you need to eliminate the possibility of being injured by hurtling pieces while chopping kindling. The section is nailed so

that it arcs sufficiently to permit the pieces of kindling to be slipped under it.

Most screw-type jar lids, such as those used on olives, can be removed easily if they are first turned upside down and struck briskly two or three times on the palm of the hand.



Tool Made From Dowel and Wire Speeds Job of Pitting Cherries

Made from a piece of stiff wire and a short length of dowel, this simple tool will help considerably to speed up the otherwise tedious job of pitting cherries. The wire is bent as shown and inserted in holes drilled in one end of the dowel, after which the looped end of the wire is pounded flat for easy insertion in the cherry. The other end of the dowel is sanded smooth.

Cactus Having Artificial Blossoms Appears to Bloom Perennially

You'll find it very easy to make a small indoor cactus, which ordinarily blossoms only occasionally, perennially attractive by simply adorning it with small artificial flowers.



The flowers may be purchased in almost any department or ten-cent store and are attached to the spines of the cactus as shown. A realistic effect may be obtained, provided a proper selection of flowers is made.—Grover Brinkman, Okawville, Ill.

Beeswax Coating Binds Nail in Hole

If lubricated with melted paraffin, screws and nails can be driven in easily and removed later with little difficulty if necessary. When coated with beeswax, however, they can be driven in easily but will prove not only difficult to remove but also will have little tendency to work loose.

PLAN of the MONTH...



TACK BRASS GALLERY TO EDGE OF TOP WITH ESCUTCHEON PINS. SOLDER JOINT WHERE GALLERY EDGES MEET

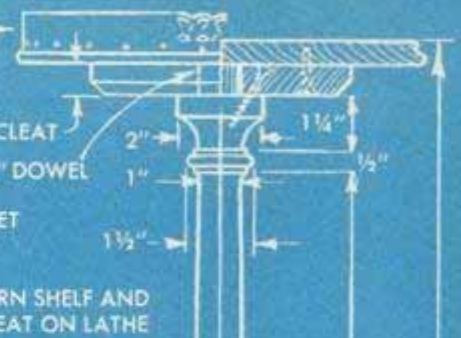

TURN SHELF AND CLEAT ON LATHE



NOTE: DRILL 1" HOLE IN TOP CLEAT FOR POST DOWEL. GLUE AND SCREW CLEAT TO POST FROM TOP OF CLEAT INTO POST. SCREW CLEAT TO TOP FROM BOTTOM SIDE OF CLEAT



TAPER FEET FROM 1 1/2" TO 1". ROUND TOP OF FEET AND CARVE BEAD AT BOTTOM

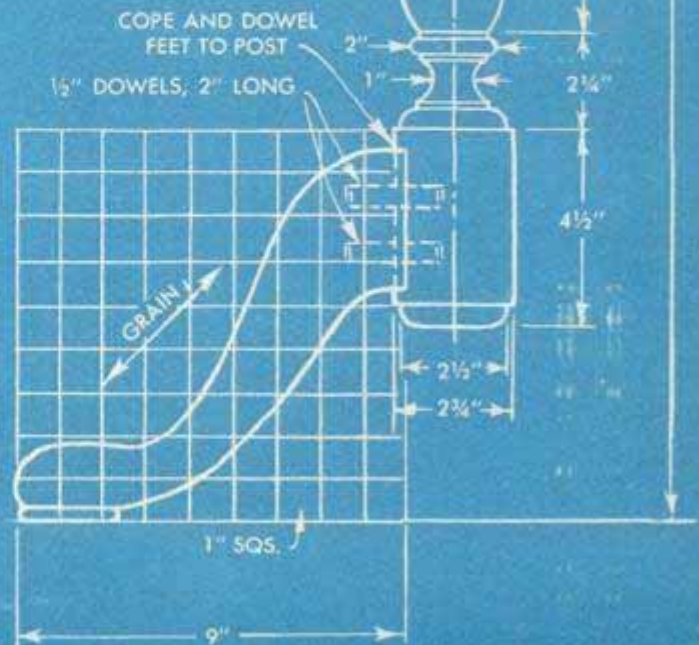

MATERIAL LIST

Triple pedestal

Mahogany plywood:

1 pc.—1/2" x 7 3/8" x 7 3/8"—Top shelf

2 pcs.—1/2" x 6 3/8" x 6 3/8"—Lower shelves

Mahogany lumber:

1 pc.—3/4" x 4" x 4"—Cleat

1 pc.—2" x 2" x 12 1/2"—Top post

1 pc.—3/4" x 4" x 18"—Shelf arm

1 pc.—2 3/4" x 2 3/4" x 17"—Bottom post

1 pc.—1 3/4" x 5" x 8"—Base

4 pcs.—1 1/4" x 2 3/4" x 9"—Legs

1 strip of brass gallery 7/8" x 22"

2 strips of brass gallery 7/8" x 18 7/8"

4 wrought-brass claw feet 1 3/16" x 2 7/32" x 1 3/16"

Single pedestal

1 pc.—1/2" x 9 3/4" x 9 3/4"—Shelf (mahogany plywood)

1 pc.—3/4" x 6" x 6"—Cleat

1 pc.—2 3/4" x 2 3/4" x 40 1/2"—Post

3 pcs.—1 1/2" x 3 1/4" x 12"—Legs

1 strip of brass gallery 7/8" x 28 5/16"

* Indicates finish sizes, allow 1/4" more for turning

Cut-Flower Arrangement in Vase Held Firmly by Vermiculite



Courtesy The Zonolite Company

If the arrangement of cut flowers in vases plays an important part in the decor of rooms in your house, you undoubtedly will welcome this means of preventing them from being upset and disarranged easily. All that is necessary is to place the stems in a vase containing vermiculite, a new mineral product which will hold them firmly in almost any position desired once it is soaked with water. Being both absorbent and granular, vermiculite not only absorbs sufficient water to supply the life requirements of the flowers with one filling, but also permits both air and water to circulate freely about the stems. When adding water to the material, soak it thoroughly and then drain off the excessive water. If you use an extremely shallow container, it may be necessary to lay a piece of chicken wire over the top to help support long stems.

Improved Screwdriver Bit

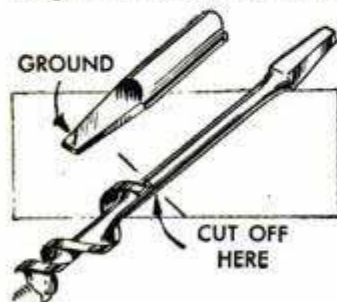

By cutting the shank from a damaged auger or twist drill, a screwdriver bit for a ratchet brace can be improvised in a short time, thus allowing you to go ahead with a job even though the hardware stores may be closed. With a hacksaw, cut off the shank at the flutes and then grind tapered flats on opposite sides of the shank to form the screw-

driver blade. Often, time can be saved in cutting the drill by deeply scoring the shank on all sides and breaking it from the body. Should you wish to harden the blade, heat it to a cherry red with a blowtorch and plunge the blade into cold water. The blade also may be formed on the cut end of the shank by heating and hammering instead of grinding. In this case, heat the end of the shank to a dull red and form the blade with a hammer. If desired, harden as above after forming.

D. A. Walker, Nashville, Tenn.

Cork Removed From Bottle With Jigsaw Blade

Retrieving a cork from inside a bottle very often can be done with a pin-end jigsaw blade. Insert the blade in the bottle, and with the latter tilted slightly

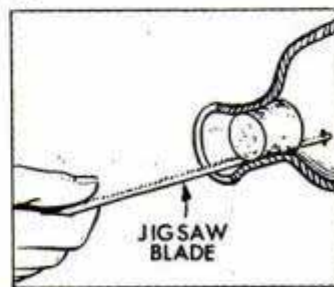

downward, use the toothed edge of the blade to work the cork into the neck of the bottle, after which the pin at the end will aid in drawing out the cork.

Pocket-Type Pencil Sharpener Attached to Inside of Drawer

A pocket-type pencil sharpener will always be on hand if it is screwed to the inside surface of a desk drawer. Drill a small hole through the body of the sharpener for the screw, and then thumbtack a small receptacle under the sharpener to catch the shavings.—John J. Rea, Urbana, Ill.

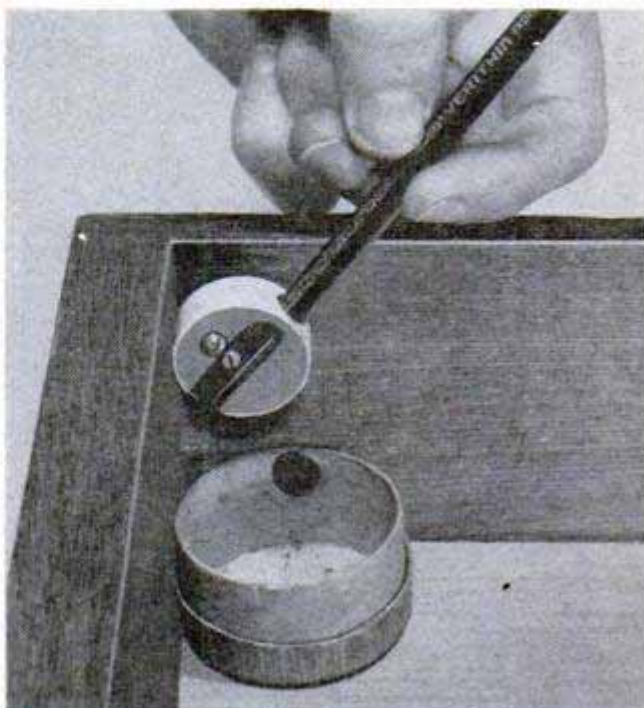



TWO-TONE TARGET

HERE'S A NOVEL plinking target for your .22-cal. rifle, using regular ammunition. When hit, a disk-harrow blade gives out a high-pitched ringing tone, but a bullet that passes through the square center hole in the disk strikes a piece of $\frac{1}{4}$ -in. flat steel suspended directly behind the disk. The lower tone of the flat piece records the high-scoring shot. Set up the target as shown in the illustration above with a high bank of earth directly back of it to stop stray shots harmlessly. Height of the target can range from 3 to 6 ft. above the ground and the firing point should be at right angles to the curved face of the disk. For open-sighted rifles the range can vary from 25 to 75 yd., with 50 yd. a good average. Accurate shooting can be done with scope-sighted .22s at much longer ranges. Flat steel rings welded to the concave face of the disk prevent ricochets when using

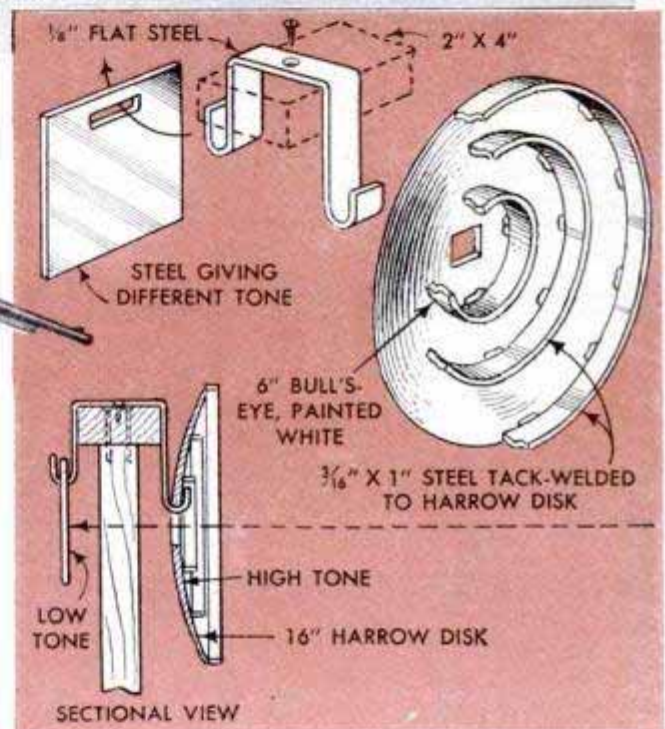

ordinary lead bullets. If gallery ammunition with splashproof bullets is used the rings are not necessary. However, gallery-type ammunition is practical only for short ranges. It should be understood, of course, that this target is suitable only for use with .22-cal. rifles chambered for cartridges no larger than .22 long rifle.

Leaky Gas Line on Stranded Truck Sealed With Clay in Emergency

Finding themselves stranded some 15 miles from the nearest ranch in a truck with a leaky gas line, two hunters were forced to rely mostly upon their wits to overcome the predicament in which they found themselves. Picking up a wad of damp clay, one of the men kneaded it in the palm of his hand until it had the consistency of putty. He then applied a layer of the clay over the defective portion of the line and allowed time for it to dry. With

the line temporarily but effectively sealed, the men resumed their journey with no further difficulty. Nearly all types of clay will serve in this emergency if pressed tightly into contact with the fuel line.

Elinore Lamach, Klamath Falls, Ore.

☐ To keep your lunch box looking like new, remove any rust with steel wool or fine sandpaper and then apply a coat or two of marine-type varnish to the metal.

STOP Those HEAT LOSSES

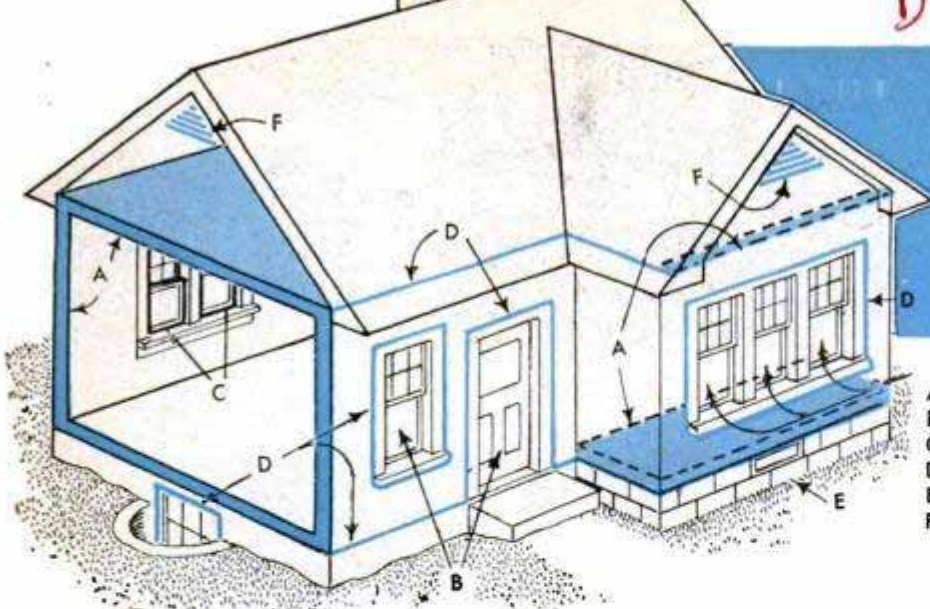

- A—INSULATION AND VAPOR BARRIERS;
- B—STORM SASH AND DOORS;
- C—WEATHER STRIPPING ON ALL SASH AND DOORS;
- D—ALL CRACKS CALKED;
- E—WALL ENCLOSES UNHEATED SPACE UNDER FLOOR;
- F—VENTS ABOVE INSULATION IN THE CEILINGS

By E. R. Haan

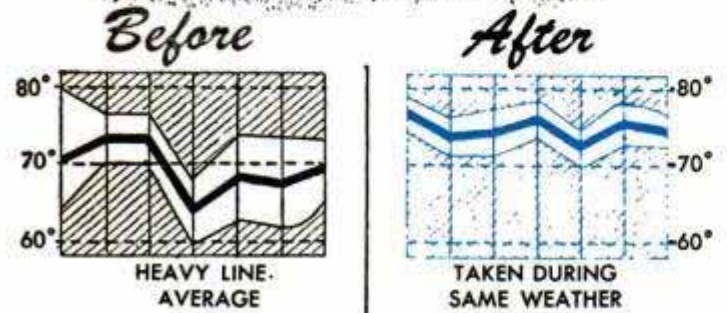

SEVEN-DAY RECORD OF TEMPERATURE VARIATIONS

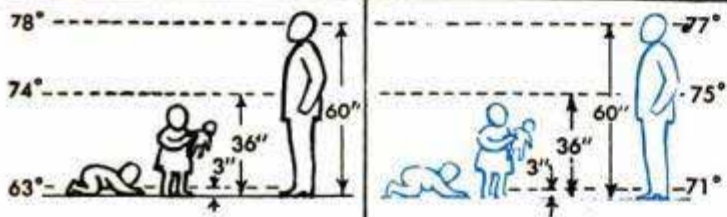

RECORD OF TEMPERATURE AT VARIOUS HEIGHTS

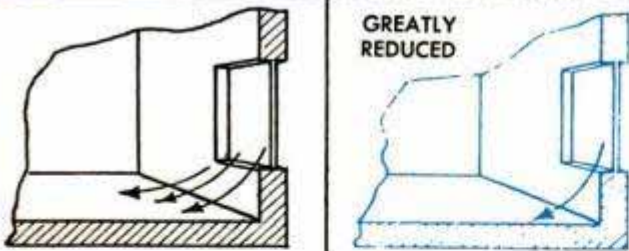

COLD DRAFTS NEAR FLOORS

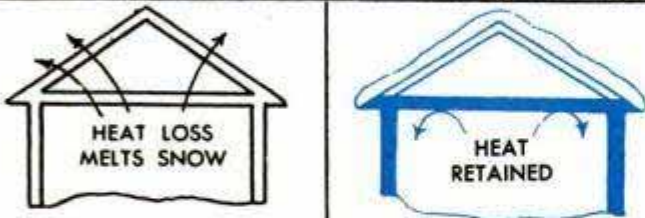

LOSS OF HEAT THROUGH ROOF



FUEL CONSUMPTION

ARE YOUR heating costs running too high and is it difficult or impossible to heat your home comfortably and uniformly in cold weather? In older homes installation of storm sash, weather stripping, and insulation and calking can reduce heat losses through the walls, ceilings and windows of the structure as much as 60 percent. Aside from the substantial saving, you will have a more comfortable, healthful home.

Insulation: Insulating values of different types of wall construction are given in Fig. 3, details A to J inclusive. Good insulating materials, properly installed, will last the life of the building and are resistant to fire, moisture and insect attack. There are four basic types, or kinds, of insulation—the loose-fill type, flexible batts, blanket and quilted forms, and the rigid-board and reflective metal-foil types. Many porous insulating materials are faced with a vapor barrier. Others require the installation of a separate barrier to prevent the passage of moisture.

Where to insulate: About 25 percent of the heat loss from the average uninsulated house is through the roof. Snow melts quickly from an uninsulated roof, even though the temperature is well below the freezing point. If it is desirable to insulate only a part of the house at one time, start with the top-floor ceiling or the roof, Fig. 1. Note also the details above and at the left.

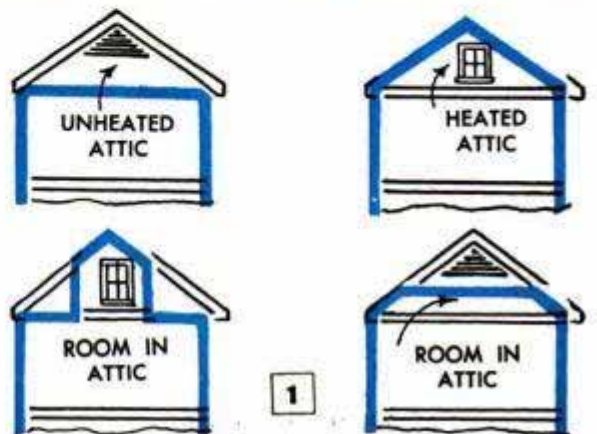

Insulation, storm sash, weather stripping and caulking can make older homes more livable and cut down costs

If you don't need a heated attic, insulate the ceiling, Fig. 2; if a warm attic is desired, insulate the roof. Rooms built in attics should be insulated above and on all sides facing unheated spaces. Next in importance to the roof or ceiling are the exterior walls. Include walls that separate living quarters from unheated spaces such as an attached garage or an attic stairway. Also insulate floors over unheated spaces, Fig. 4.

Importance of vapor barrier: If you live where the average January temperature is 35 deg. or less, condensation of moisture may occur if you insulate without vapor barriers. Moisture-laden air inside the house slowly penetrates the plaster and insulation and condenses to water or ice when it comes in contact with the cold inner surface of an exterior wall or roof, Fig. 6, A. Results of condensation are rotted wood, peeling paint, damage to inside walls and ceilings, and damage to insulation. To prevent this, install vapor barriers between the insulation and the heated interior of the house, Fig. 6, B. A vapor barrier may be a membrane (such as asphalt-saturated paper or felt, metal foil and waterproof wall covering) or simply vapor-resistant paint (such as aluminum paint, most lead-and-oil paints and spar varnishes). Ordinary tar paper and roofing felts are not suitable for this purpose. Insulation faced with vapor-barrier coverings, Fig. 5, can be installed directly between the studs or joists. The vapor barriers should also be used where air from a basement or crawl space can get into walls and pass upward to the attic. Walls of attic stairways must not be overlooked, and doors to attics should be weather stripped, painted or varnished, and sometimes insulated, too.

Venting spaces over insulation: When you insulate, be sure to ventilate the space

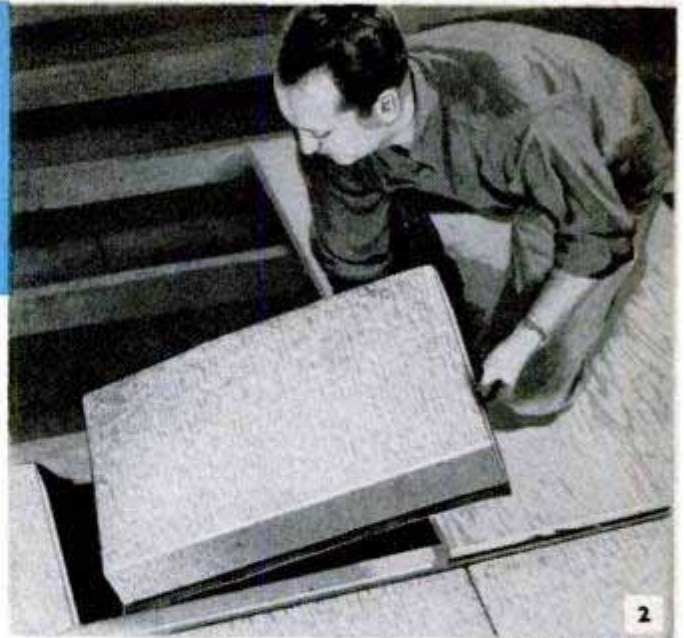

Courtesy Celotex Corp.

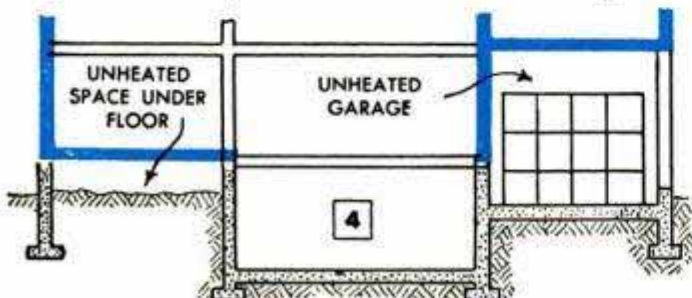
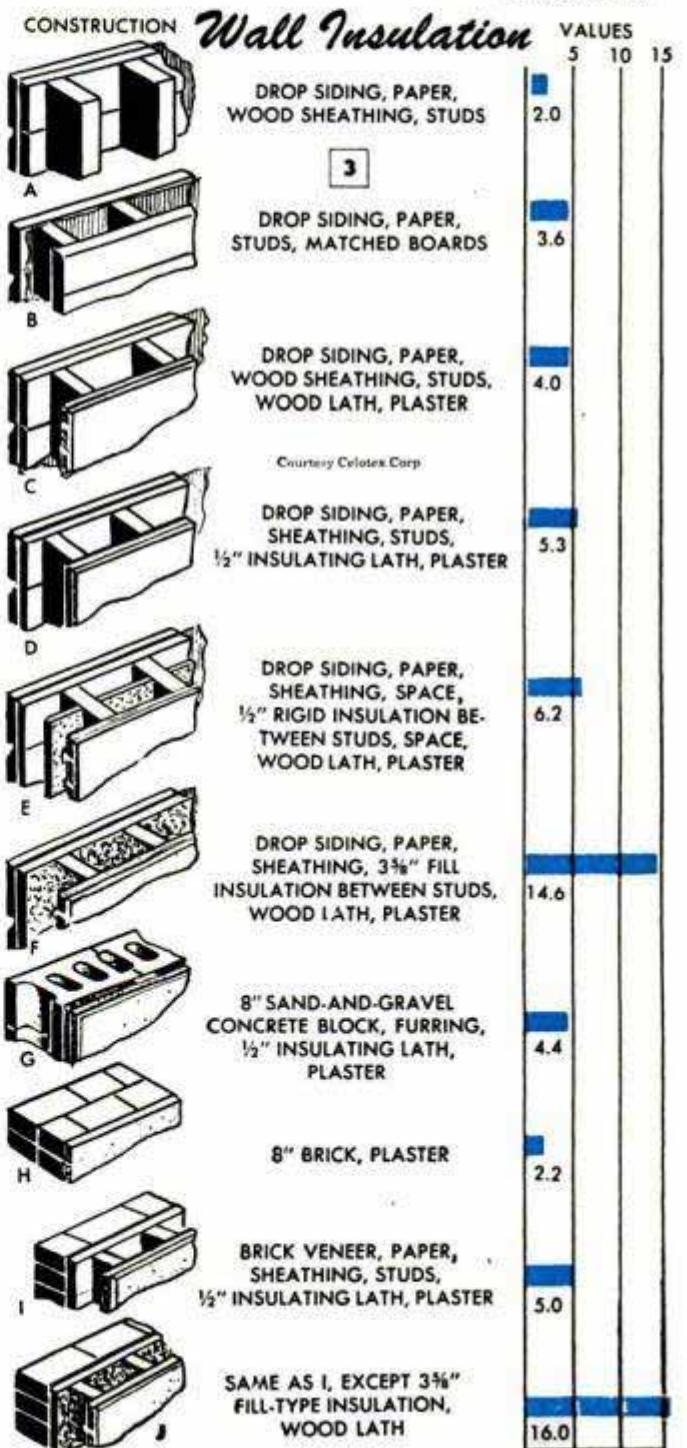



Courtesy United States Gypsum Co.

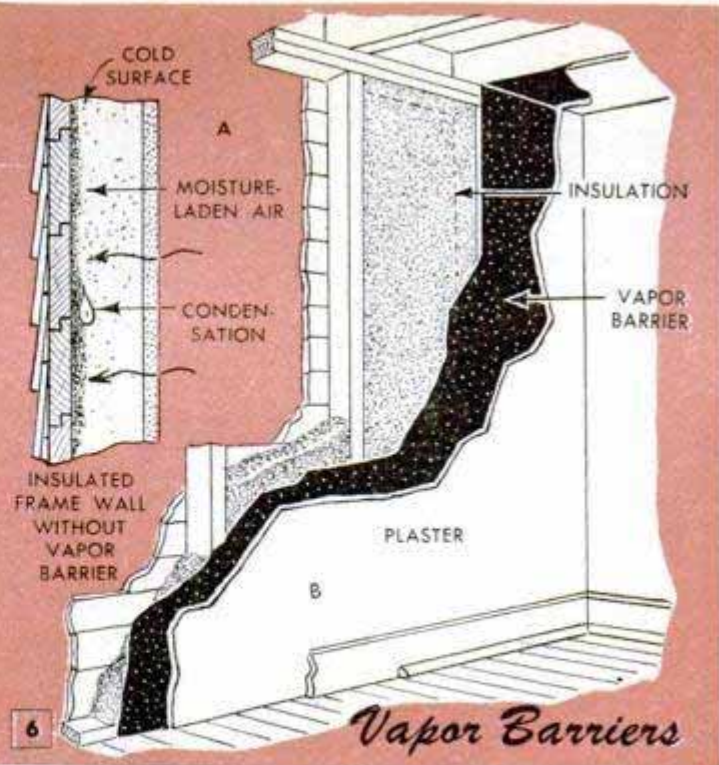

above insulated ceilings to minimize condensation on the underside of the roof. Fig. 7, A to F inclusive, shows several methods of doing this with louvers, roof vents and cornice vents. The area of the vents should be equal to at least 4 sq. ft. for every 1000 sq. ft. of attic floor area.

How much insulation? More insulation is needed in homes where winters are severe than where the climate is mild. For best results the thickness of insulation will depend on the kind of insulating material, the house construction, inside temperature to be maintained and other variable factors. It's best to consult a reputable dealer or contractor in your community who can advise you concerning the kind and quantity of insulation to install.

Loose fill: Loose-fill insulation comes in bags or bales. To cover a ceiling first install a vapor barrier, if necessary, directly on the ceiling. Cut the barrier to fit snugly

around all obstructions to minimize air leakage. Wedge it between joists or attach it to them with cleats nailed to the joists as in Fig. 8, A. Pour in the fill to a 4-in. thickness, Fig. 9, distributing it evenly with an improvised strike board that straddles the joists, Fig. 8. If the attic is floored, remove some of the floor boards, Fig. 8, B, so that the material can be distributed uniformly. If the area is finish-floored, it will be necessary to have a contractor blow the fill in. When this is done use water-resistant paint or wall covering on the underside of the ceiling to serve as a vapor barrier, if the climate requires it.

Insulating frame, stucco or brick-veneer walls of existing houses with loose fill generally is a job for a contractor as he has the equipment required to blow in the material as in Fig. 11. Strips of siding or other wall covering are removed temporarily and holes bored in the wall sheathing, Fig. 10.

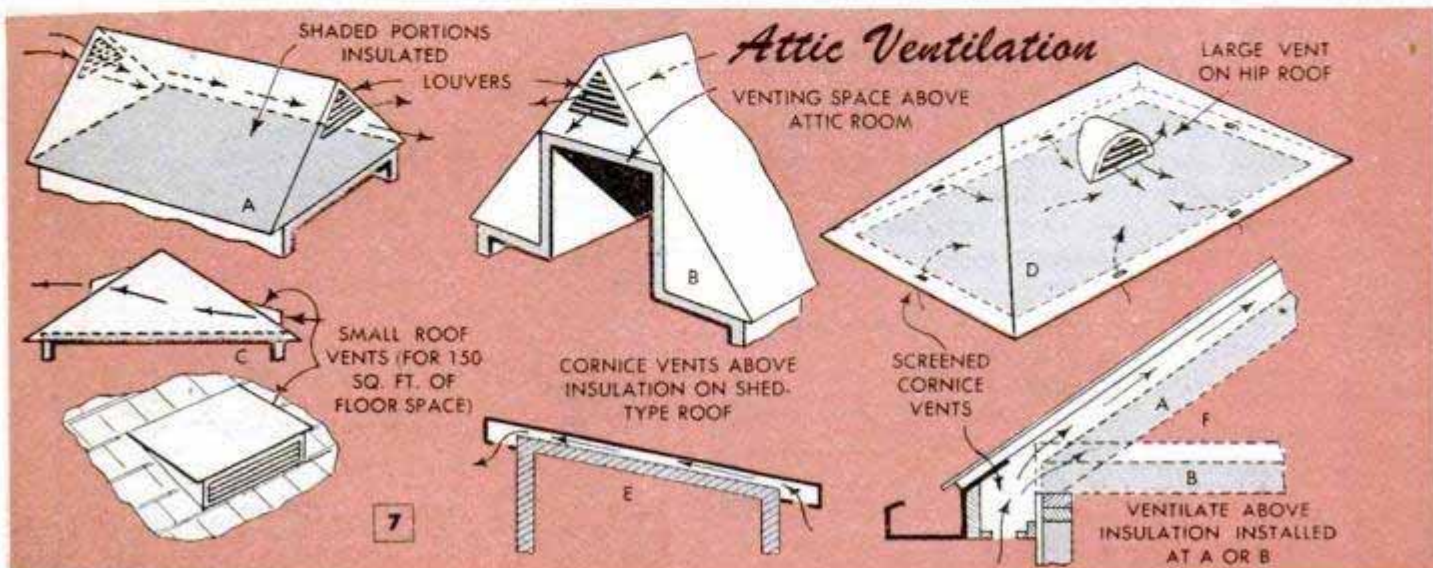

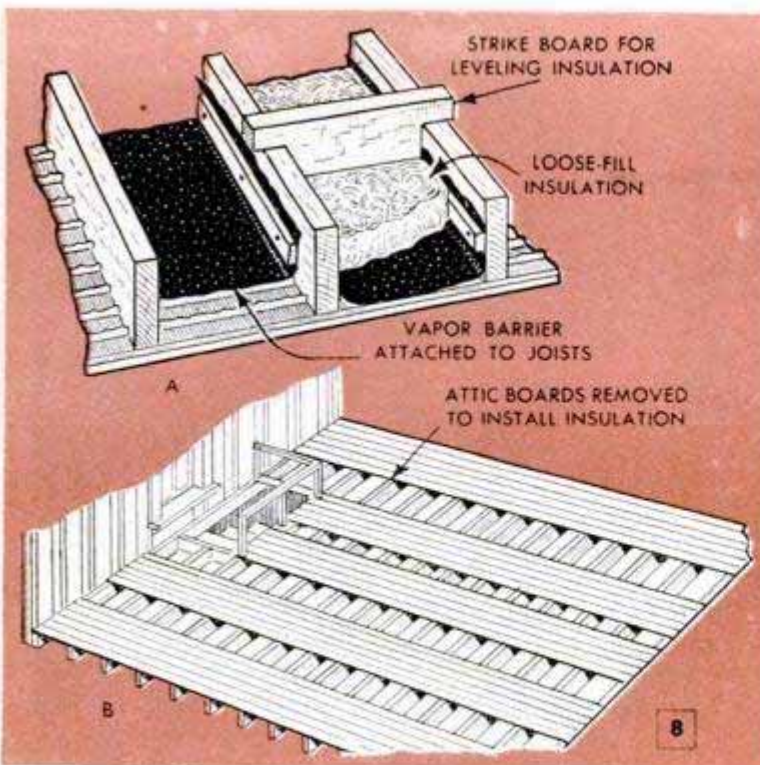

Be sure that all spaces are filled, including those under windows and fire stops.

Flexible insulation: Insulation in the batt, blanket and quilt forms comes in widths that fit snugly between studs, joists and rafters, and in lengths up to 48 in., or in rolls up to 100 ft. The thickness varies from $\frac{1}{2}$ to $3\frac{5}{8}$ in. When using flexible insulation, cut it to fit snugly around obstructions, placing it with the vapor barrier facing the inside of the house. Fill all spaces and push the ends of the batts together snugly. When insulating a sloping roof with batts or blankets, start at the eaves and work up as in Fig. 12. Make U-shaped barrier pockets to seal the spaces between rafters where they join the plate, tacking the pockets to the plate and to sides of the rafters as in Fig. 13, A. The lower end of the insulation fits in the pockets, which may fit tightly against the roof boards unless air is circulated from cornice vents. In this case space is left above the pockets and batts as shown in Fig. 13, B, and at A and B, detail F, in Fig. 7. The air space at B is left when only the floor is insulated. Detail C, Fig. 13, shows how quilt-type insulation is fastened with strips to the plate and rafters. If the vapor-barrier facing on batts has flanges at the ends, these should overlap each other. The side flanges are tacked or stapled to the rafters. Where a portion of the roof serves as a room ceiling, the wall covering will come directly against the vapor-barrier facing of the batts as in Fig. 13, D. When installing flexible insulation in walls, start at the bottom, filling all spaces between studs, and cut the batts or blankets as

Loose-Fill Insulation

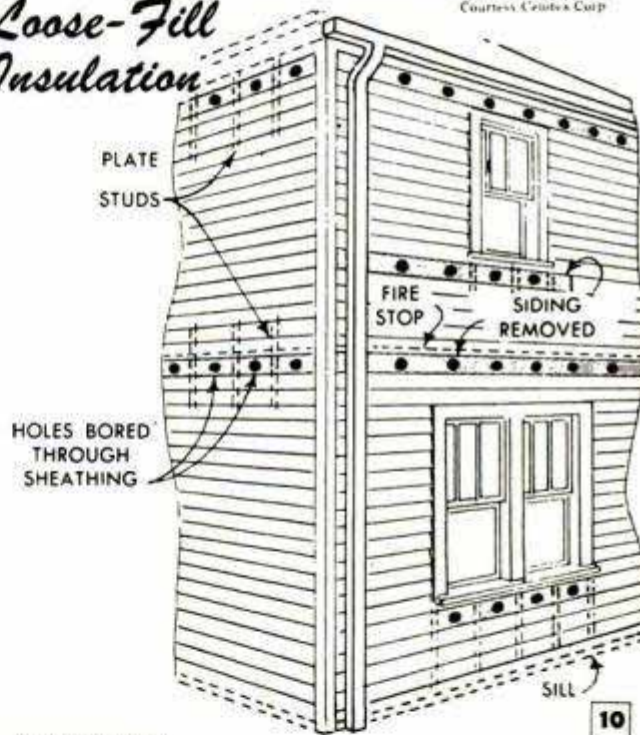

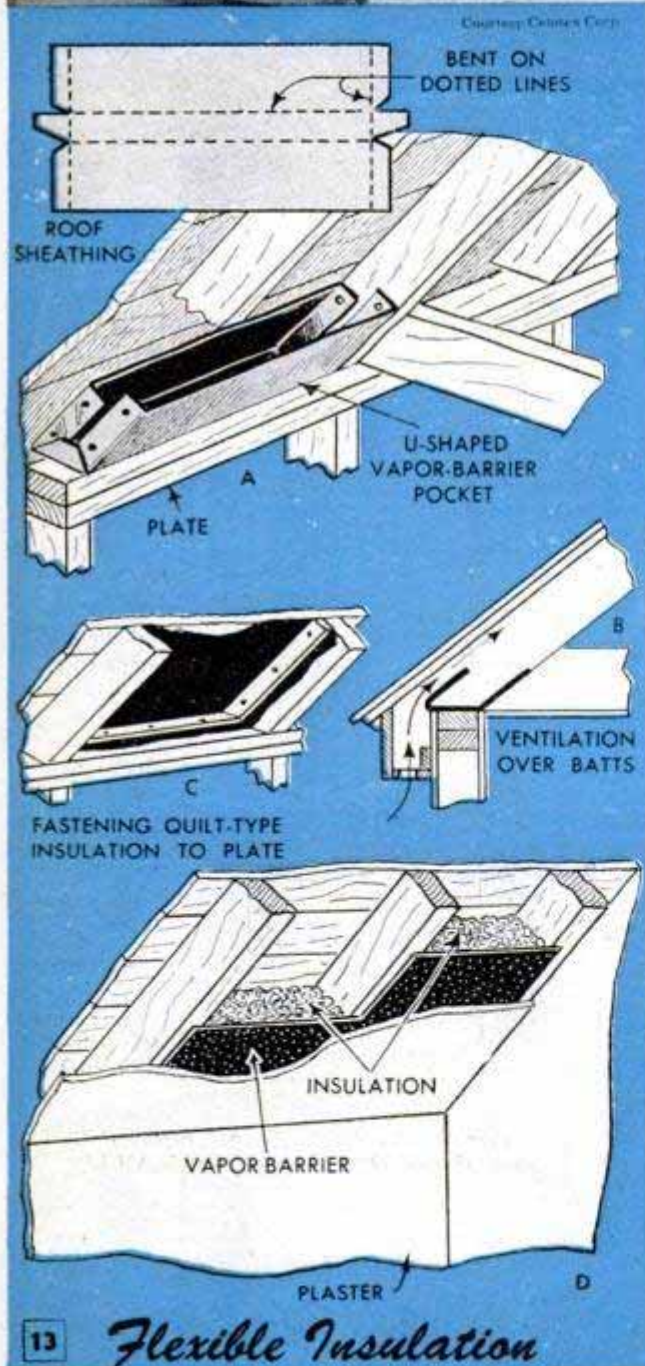

Courtesy United States Gypsum Co.

necessary to fit snugly into corners and against obstructions. If you encounter water pipes in exterior walls, place the insulation between them and the sheathing.

Rigid insulating board: When remodeling or adding a room in an attic, you have the opportunity to use rigid insulating board, Figs. 14 and 15. It also has a structural value, some forms being used as sheathing, some as a plaster base, and others having a finished surface to serve as a wall covering. The board ranges from $\frac{1}{2}$ to 1 in. in thickness and comes in sheets 4 ft. wide and up to 12 ft. long. It also is available in smaller panels or in squares. The edges of panels or squares may be square, beveled, rabbeted or tongue-and-groove. Small panels are arranged horizontally and are staggered so that the joints of adjacent rows come on different studs as in Fig. 15, A. As the panels usually have interlocking edges, no horizontal nailing supports are needed between studs. Large sheets should extend from floor to ceiling as in Fig. 15, B. When shorter sheets are used, cross supports for nailing are necessary. Nail sheets to the center supporting studs first then at the edges. Space the nails 4 to 6 in. apart and about $\frac{3}{8}$ in. from the edges, using special nails available for the purpose. When rigid insulating board is used between studs, joists or rafters, it is cut to fit snugly and nailed to 1-in. strips. It also is used under floors—either sub-floors or finish floors—leaving a $\frac{1}{8}$ -in. space between sheets to allow for expansion.

Insulating masonry walls: To insulate a masonry wall, first coat it with asphalt dampproofing compound. Then nail the insulating board to 1 x 2-in. furring strips spaced 16 in. on centers as in Fig. 16. Use



Courtesy Celotex Corp.

expansion sleeves or other screw anchors for attaching the furring strips to concrete. Thin blanket insulation can be inserted between the strips before attaching the board to obtain added insulating value.

Reflective foil: Reflective foil comes separate or as a facing on other forms of insulation and also as a facing on plaster-board. In insulating value it is roughly equivalent to $\frac{1}{2}$ -in. insulating board when exposed to an air space not less than 1 in. wide, Fig. 16. The foil also is an effective vapor barrier. Since it does not absorb heat like other forms of insulation, it is particularly useful in warm climates. Several sheets separated by air spaces also may be used. A small amount of dust on the foil does not greatly reduce its reflective power.

Storm sash: A properly fitted storm sash provides a dead-air space between it and the regular window, which acts as insulation. Tests at the University of Illinois have proved that a 20-percent fuel saving is possible in most homes when they are completely equipped with tight storm sash and storm doors. Another result is a 1 to 2-deg. temperature increase at the floor level. Besides saving heat, storm sash reduces condensation on windows.

If you cannot equip the entire house at one time, start by installing storm sash on the sides facing the prevailing wind direction. The inside surface of storm sash should fit tightly against the blind stop of the window casing, Fig. 18, but the sash should have $\frac{1}{8}$ -in. clearance around the edges, detail A, to compensate for swelling. If surface irregularities of contacting surfaces of sash and casing prevent a tight fit, you can seal the joint by using felt or sponge-rubber strips glued in a rabbet cut

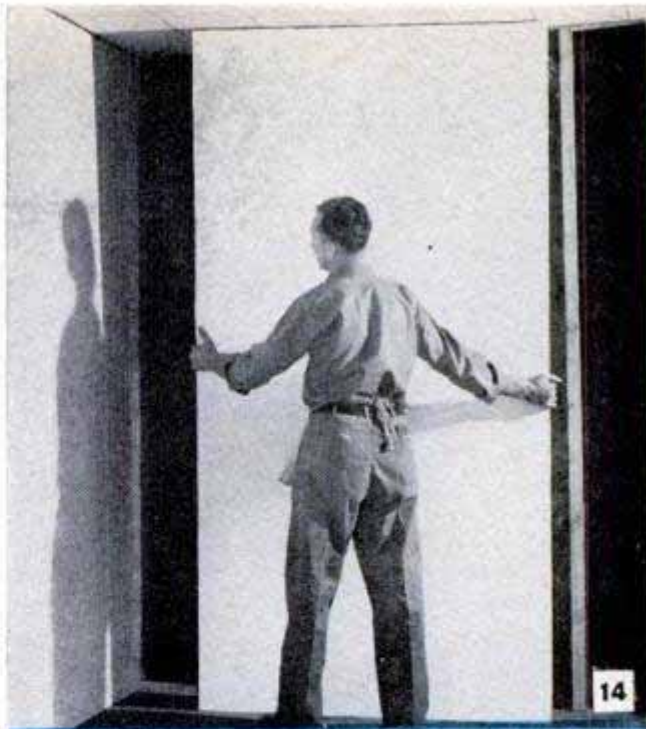

14

Courtesy Celotex Corp.

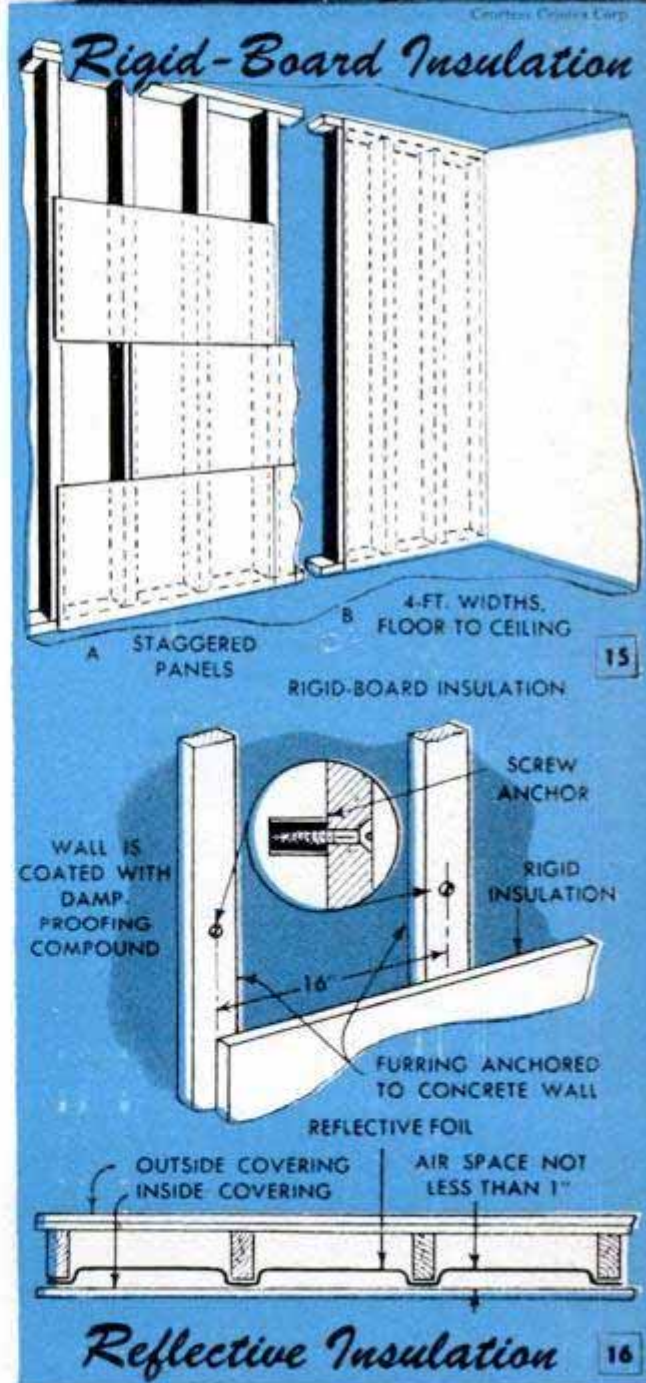



17

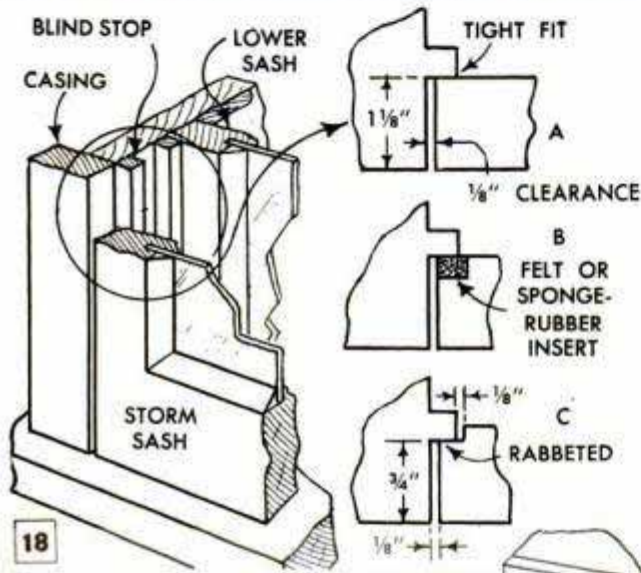

18

along the edge as in detail B. Edges of 1 1/8-in. sash frames are rabbeted to make them fit old-style 3/4-in. casings, as in detail C. Storm sash for double-hung windows is available in full length or in sections, Fig. 19. Divided sash can be passed through a window and hung from the inside of the house, eliminating the need of a ladder. To hold storm sash in place, use sash hangers at the top and hooks and eyes at the bottom. Where ventilation is desired, use sash adjusters to hold the sash open or lock it when closed. As an alternative you can use ventilating openings in the lower rail.

Metal-framed storm sash for metal casement windows are applied from the inside, Figs. 17 and 20. As they generally cover individual window sections only, they do not stop condensation on the frames. To prevent this you can use a wooden sash to cover the entire window as in the right-hand detail of Fig. 20. The use of dual panes in windows as a substitute for storm sash is effective in reducing heat loss by conduction but does not prevent air leakage at the edges of the window frame or stop condensation on the frames.

Weather stripping: All types of fabric, felt and rubber weather stripping are subject to wear and shrinkage which gives them only temporary value. Fig. 22 shows how to apply various kinds to a double-hung sash. Metal weather stripping, available in various widths, is easy to install and is permanent. Exposed ends are bent back slightly to avoid catching in the wood when the sash slides over them. Fig. 23 shows how this type of weather stripping is installed on a doorframe. Note that it is cut

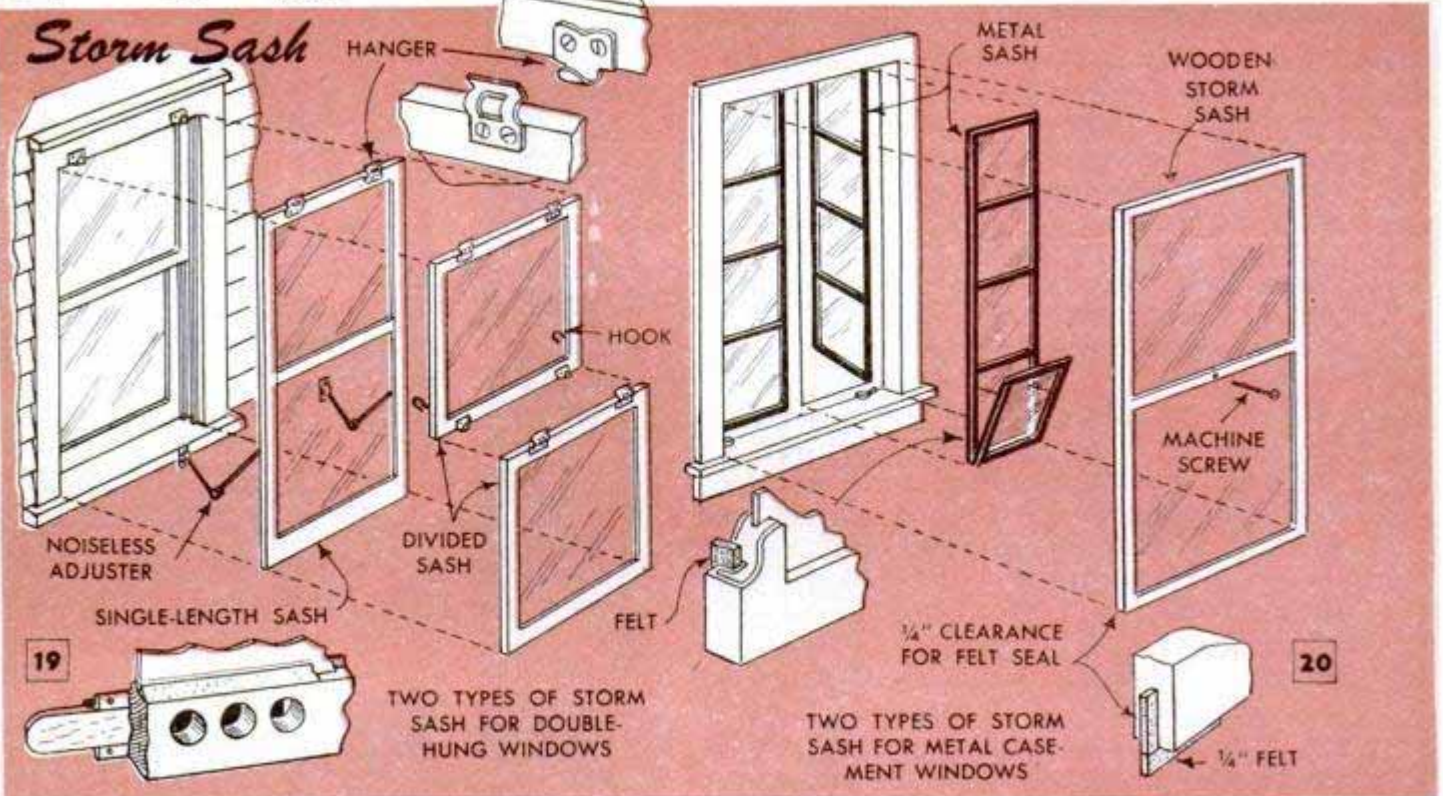

19

20

away at the striker plate. The threshold can be fitted with a wood or metal-backed felt weather strip but, for appearance and durability, a rigid metal weather strip consisting of two interlocking members is preferable. On wooden casement windows, felt or fabric weather strips go on the outside, but the flat-metal type is fitted in the same manner as on doorframes. If necessary, dress down edges of tight-fitting sash to provide clearance for the strips. On metal casement windows, the metal-framed storm sash usually has felt inserts which provide a tight seal and thus serve as weather strips. You can seal metal sash, however, by gluing rubber tape to the frame all around, using automotive rubber cement.

Calking: A fairly high percentage of heat is lost through spaces at window and door frames and through cracks at points where walls join roofs and foundations, or where pipes and conduits pass through walls. To reduce this loss fill narrow cracks with calking compound, using a calking gun as in Fig. 21 which forces the compound deeply into the cracks by pressure. Before calking, brush out loose particles of dirt from the crevices. Don't use the compound alone to fill wide cracks and openings as it will shrink and pull loose. Wide spaces must first be packed with oakum or jute before calking. Hammer this tightly in place with a blunt-edge tool so the filling is almost flush with the opening but leaves enough space to take a layer of calking compound as a final seal.

Curtain walls: If you have a basementless home built on piers instead of on a solid, continuous foundation and cold

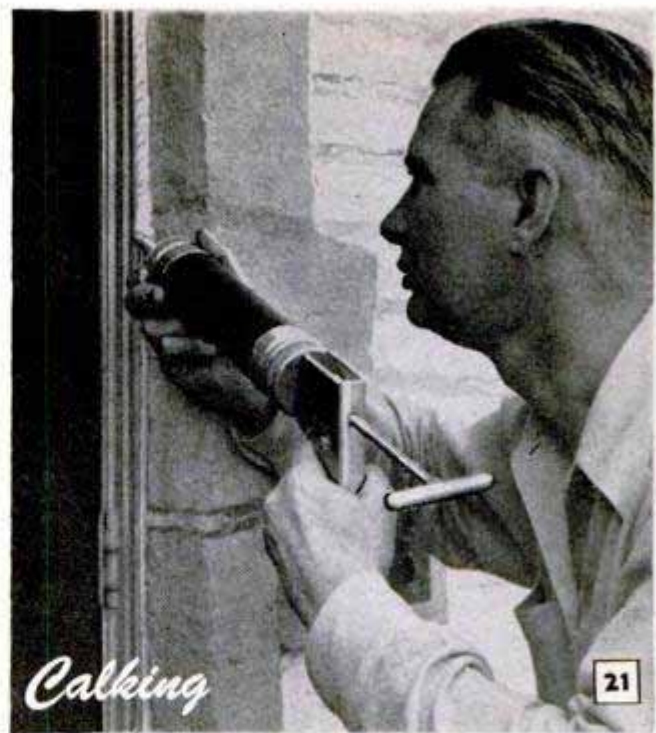

weather makes the floor uncomfortable, a curtain wall may be the solution to the problem. This should have vents for cross circulation during warm weather and, if necessary, be provided with an entranceway. In cold climates both a curtain wall and adequate insulation under the floor are necessary. When batts or blankets are used between the floor joists, the vapor barrier should be laid face up. The batts can be given added support by nailing wallboard or wire mesh to the underside of the joists. Floors of basementless houses need not be insulated if the heating pipes or ducts pass through the crawl space, or if the space is insulated on all sides. ★ ★ ★

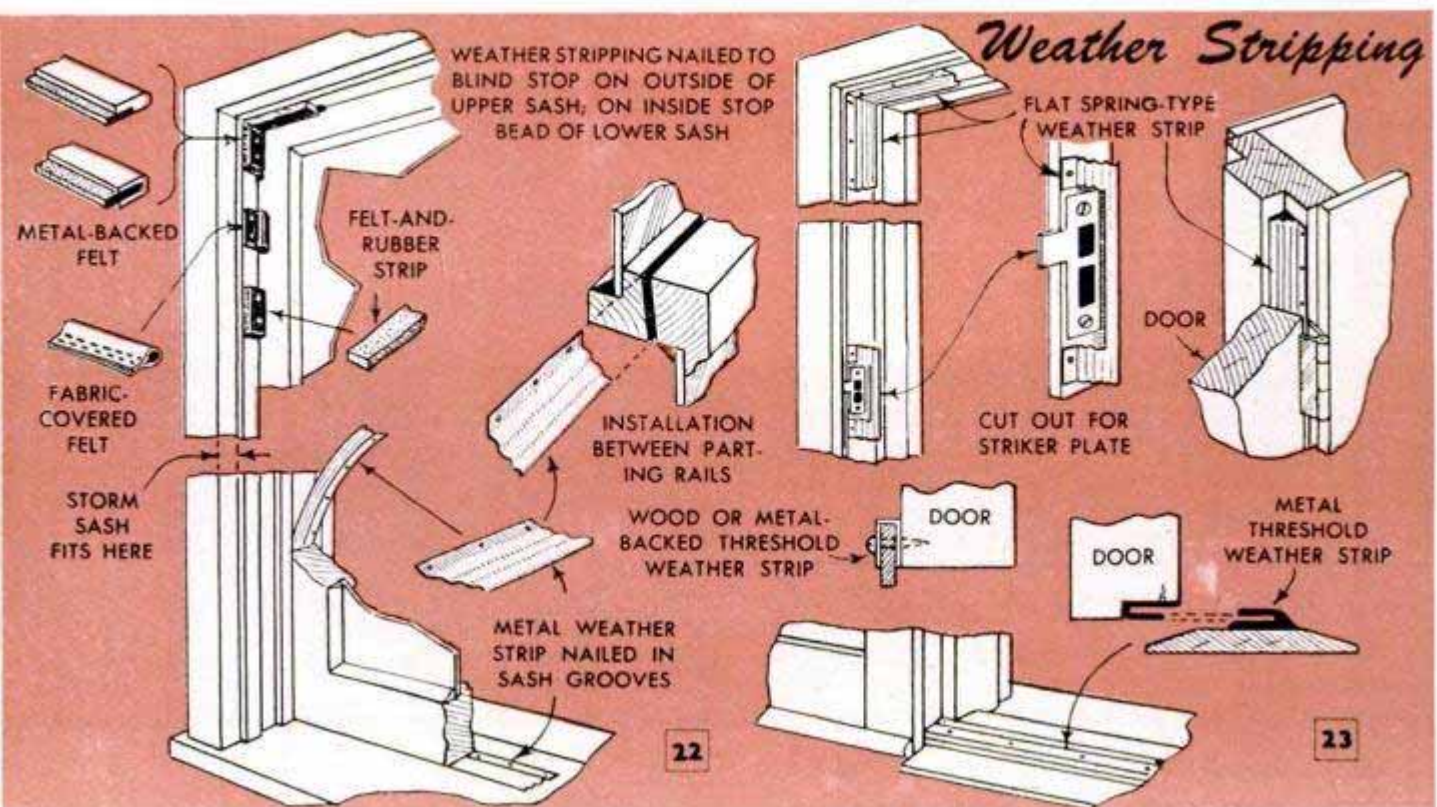

Motorcycle Stored in Basement With Aid of Portable Stand

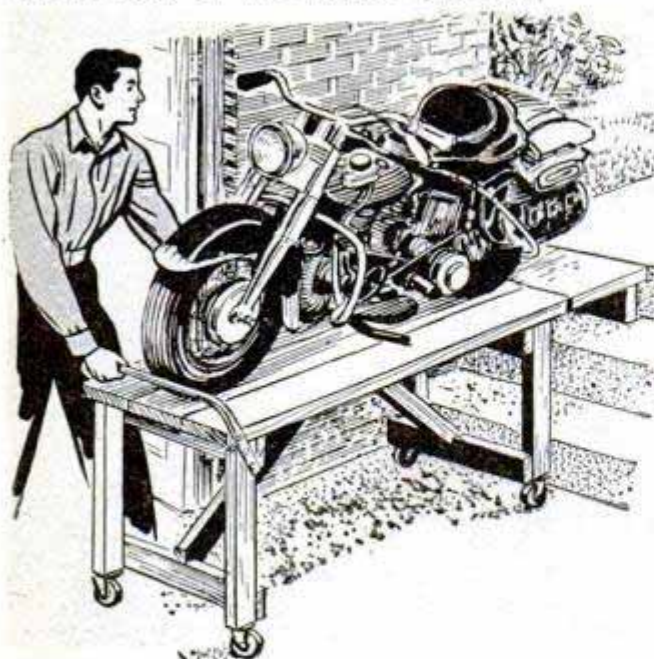

In order to bring a motorcycle into his basement for maintenance and storage, one owner built a wooden stand having a hinged ramp at one end which bridges the steps so the machine may be rolled upon it. The stand, which is provided with large casters on the legs, can be wheeled to any part of the basement where it then serves as a workbench whenever repairs are to be made. Built less than half the width of a stair well, the stand is moved to one side of the opening to allow room for use of the steps when the motorcycle is rolled on or off the ramp. A handle formed from electrical-conduit pipe is bolted to one end of the stand to aid when maneuvering it into position. Construction details will vary depending on the size and weight of the motorcycle as well as on the layout of the basement.

Sack Duster for Home Garden

Deciding that my small home garden was in need of dusting, I thought of an easy way to do the job with little more than a piece of burlap and a small quantity of insecticide powder. I cut out a square piece of the cloth, placed several scoopsful of the powder on it and then gathered up the corners which I clutched in one hand. Holding the sack thus formed above the plants, I pro-

Free How-to-Make-It Index

Write the Bureau of Information, *Popular Mechanics Magazine*, 200 E. Ontario St., Chicago 11, for your free copy of a complete index to all the how-to-do-it sections of *Popular Mechanics Magazine* for July 1950 through April 1952

ceeded to shake it gently, causing the powder to sift through and settle evenly over each of the plants.

Charles L. Stratton, Hollis, N. H.

Sandpaper Mask Around Keyhole Helps Guide Key at Night

Cut to fit around the keyhole of a door, a sandpaper mask will make it much easier to locate the hole for inserting a key in the dark. The roughened surface can be detected quickly by running the fingers over the area or by probing with the key itself until it grates against the sandpaper. The mask is attached with glue and painted to approximate the color of the finish of the lock.

Bess Ritter, New York City.



War-Surplus Vibration Dampeners Provide Typewriter Feet

I have found that small shear-type vibration dampeners of the type used during war-time for mounting delicate instruments in planes and tanks serve usefully as cushioned feet for standard and portable typewriters. Available in plentiful supply in war-surplus stocks, the dampeners are bolted in place where they effectively absorb and prevent transmission of vibrations from the typewriter to the table upon which the machine is rested.—Ken Murray, Colon, Mich.



Bobbins Stored on Nail

Here's one way to keep several bobbins together for locating them easily and also for making possible a quick, at-a-glance selection of the thread colors desired. All that's necessary is to slip the bobbins over a common nail and then press a cork over the pointed end to keep them in place. If one nail isn't enough to accommodate the bobbins on hand, use as many as are necessary and tie them together.—Don Nielson, Aurora, Neb.





FOLDAWAY CRIB

By
**Charles and
Bertram Brownold**

A TAKE-OFF on the space-saving idea of the in-a-door bed, this on-a-door crib will appeal to young parents living in limited quarters. Attached to the inside of a closet door, the crib, minus the sides, is designed to fold flat and to swing with the door. The closet, of course, provides convenient storage for the standard mattress and sides of the crib. The bottom of the crib consists of two hinged sections which are locked in the open position by the side panels. Holes for the side-panel dowels are aligned by clamp-

ing top and bottom rails together and boring at one time, drilling only about $\frac{1}{2}$ in. deep into the top rail. Glue, plus wedges driven in saw cuts made in the ends of the dowels, anchor the latter in the rails. Projecting dowel pins in the lower rails of the side panels fit registering holes in the bottom assembly and a pivoted metal fixture clamps the two together. Slotted flat-steel plates engage round-headed screws to attach the side panels to the end panel and closet door.

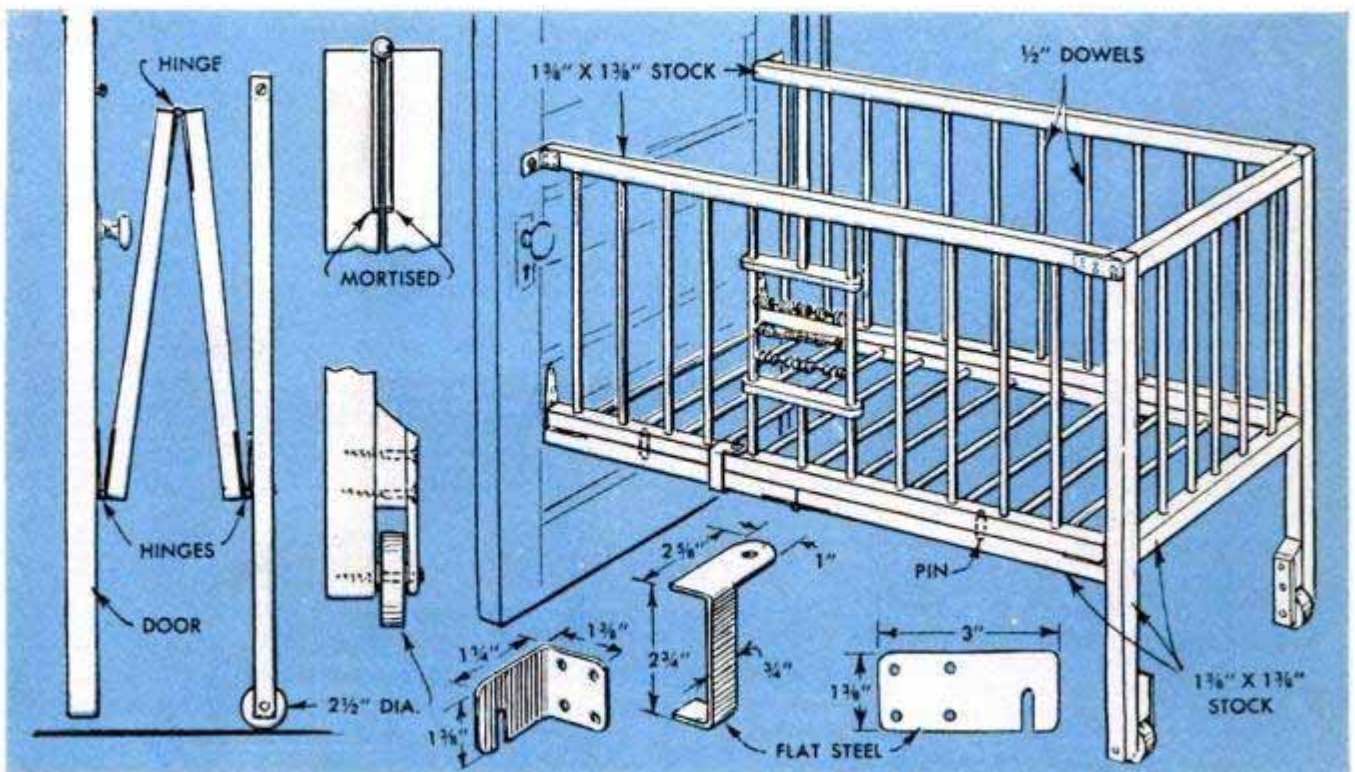

Shutters Used Inside Windows In Place of Venetian Blinds



The use of outdoor shutters mounted on the inside of clear-glass windows in place of Venetian blinds proved satisfactory in the bathroom of one home. Made attractive with a coat of white enamel, the shutters not only can be opened and closed easily but also may be completely concealed behind draw drapes if desired.

Grover Brinkman, Okawville, Ill.

Tamp Improvised From Scrap Parts



One farmer, preparing to begin construction of concrete floors and walks about his farm, found that an effective tamp could be improvised from materials found in a scrap pile. He simply welded a large

Have you heard?

There's a new type of heating that casts a blanket of warm air around the cold, exterior walls of a home. It's simple, it's clean and best of all it's comfortable. The ducts warm the floors and the outlets heat the perimeter, or outside walls. This low-cost forced-air heating system, big news in the home-building industry, is normally installed in houses built on a concrete slab, but the principles can be applied with great advantage to homes with basements. For details, see the feature article in the October issue.

gear from an old farm implement to the end of a length of pipe which formed the handle. A piece of shafting may be used in place of the pipe if desired.

Reshaping Hand-Plane Cap Iron

Accurate work cannot be done with a hand plane having a nicked chip breaker, or cap iron. A simple way of reshaping the breaker is to slacken the screw holding it to the plane iron and then place a piece of thin sheet metal over the plane iron to protect the cutting edge. Place a double-cut mill file under the edge of the breaker and on top of the sheet metal as shown. Then draw the file back and forth slowly to remove nicks and burrs from the edge of the chip breaker.

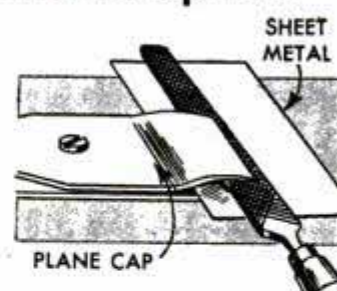

John Owen, Hawthorne, Fla.

Shield Under Coffee-Pot Handle Prevents Burned Fingers

A small shield fitted under the handle of a coffee pot to be heated over an open flame not only will prevent the flame from charring the handle but also will keep it from becoming hot enough to burn the fingers. First, the pins which secure the lower end of the handle must be removed. After applying cellulose tape around the pins to protect the metal, file the peened ends of the pins and then use a small punch and a hammer to loosen and remove them. These pins will have to be replaced. Now cut a piece of sheet metal, brass or aluminum—preferably metal matching that from which the pot is made—in the shape of a fan and punch holes in the narrow end to align with the pin holes. All that remains to be done then is to insert the shield under the handle and rivet in place.



Harry Suttle, Springfield, Ohio.

Substitute Brush for Electric Razor

If the small cleaning brush supplied with an electric razor has been lost or mislaid, use a pipe cleaner as a substitute. The pipe cleaner will do a reasonably good job of removing particles from the razor head and will not damage the razor.

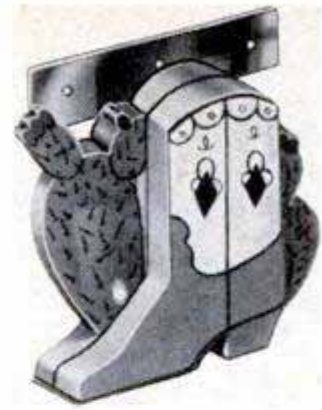
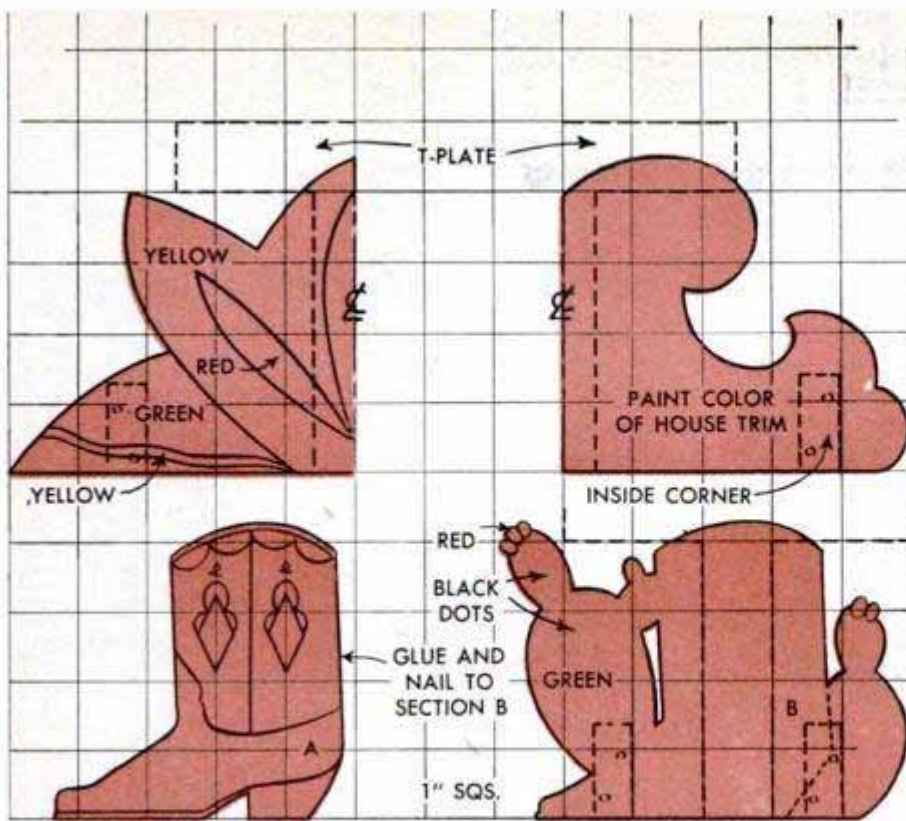

Jigsawed Boot Scrapers

By Roberta L. Fairall

AS EYE-CATCHING as their cast-iron counterparts and far less expensive, these attractive boot scrapers are made from $\frac{3}{4}$ -in. outdoor plywood and common mending irons. They can be turned out quickly for your own use or as a salable basement-shop product. Note that the cowboy-boot design consists of two parts, the boot, part A, being joined to the cactus background, part B, with waterproof glue. The detail below shows how large T-plates are screwed to the backs of the cutouts to serve as scraper blades. If you wish to mount the scraper on a wooden porch, fasten an angle bracket near each end of the cutout.

However, if the scraper is to be set in the lawn, screw 6-in. steel mending plates to the cutout and set the ends of the plates in concrete. Before attaching the hardware to the cutouts, locate and drill the pilot holes for the screws and paint the wood. Give the entire cutout a coat of flat-white paint and then paint to match the house or decorate in suggested colors. For the latter, use tube oil colors mixed with turpentine, 1 part, and spar varnish, 1 part.

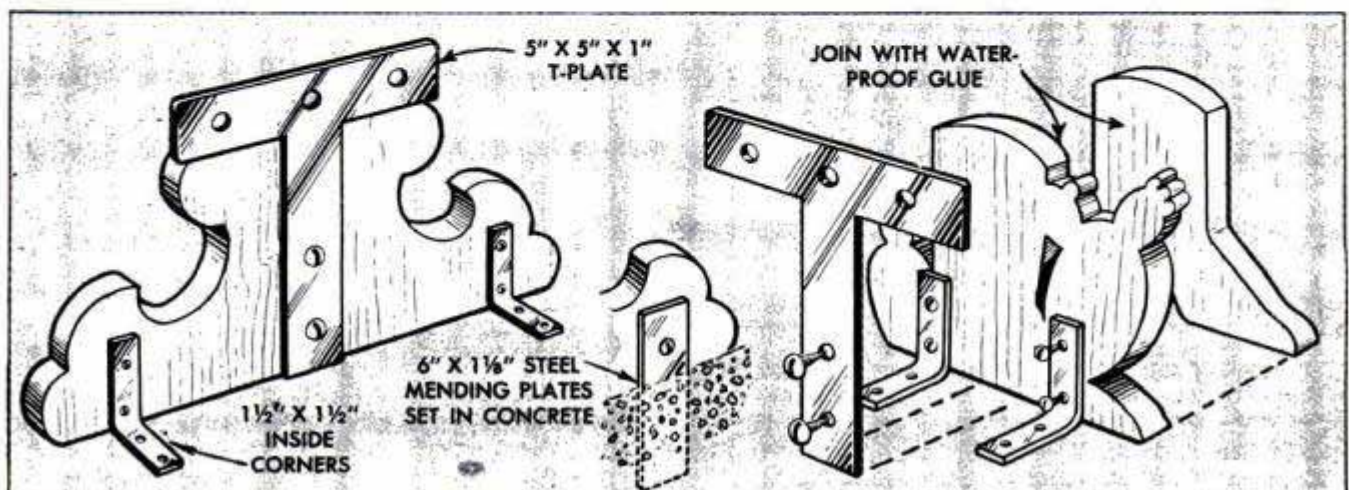

Section of Old Bicycle Frame Provides Workbench Stool

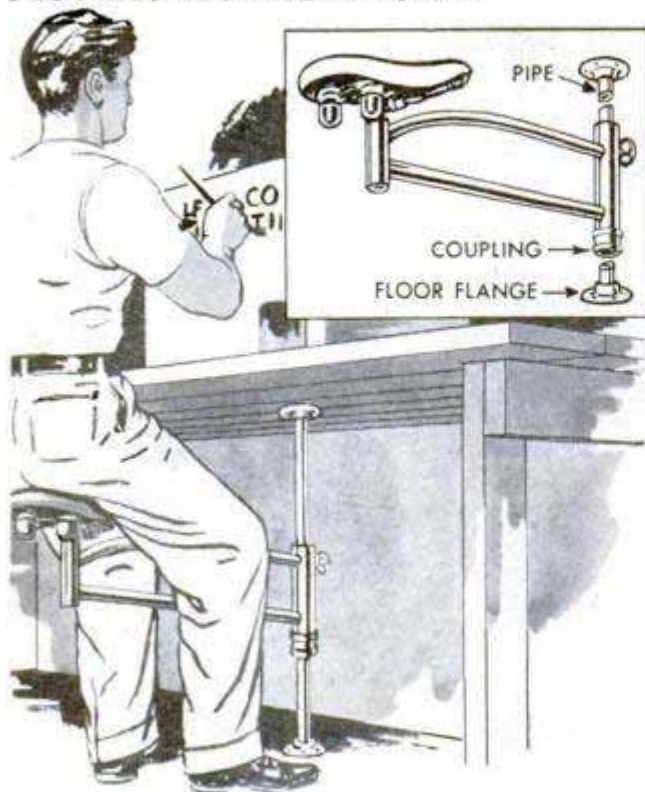

Mounted so that it pivots out of the way under a workbench when not in use, this handy seat is provided by cutting the saddle section from a discarded bicycle frame and installing it as shown. Two lengths of pipe are joined by a coupling and attached to the floor and underside of the bench by floor flanges. The pipe is cut in lengths which, when joined together with the coupling, will in turn permit the coupling to support the seat at the desired height. A hole is tapped in the pivoting joint to take a thumbscrew with which the unit may be locked in place under the bench.

Citrus Fruit Attracts Birds

If you want to attract large numbers of birds to your back yard during warmer weather, set out sections of citrus fruit at the feeding stations. Apparently many birds are especially fond of this type of food and will return again and again for the fruit. A wire soap dish nailed to a

Zooooom!

There goes a tiny model plane under such perfect control you can fly it around the living room. Driven by an ingenious hand-held motor, the craft will dive, climb and loop at a flick of your wrist. Actually the plane is powered by its own tether, a length of piano wire which constantly rotates to spin the propeller. This miniature flexible shaft is whirled by a battery-operated motor. Want to pilot the plane around your house? Don't miss this project coming up in October.

tree or to the side of a feeding station not only forms a convenient holder for the fruit but also serves as a perch. Because of its susceptibility to freezing temperatures, citrus fruit is not suitable for this purpose during cold weather.

R. M. Woodbury, Natick, Mass.

Extra Mantles Carried on Lantern

By attaching extra mantles to a gasoline lantern, you can safeguard against the possibility of being inconvenienced if one is broken when you are far removed from the source of a replacement. The extra mantles may be enclosed in a heavy envelope and taped to the bottom of the lantern as shown.

EXTRA MANTLES
IN ENVELOPE

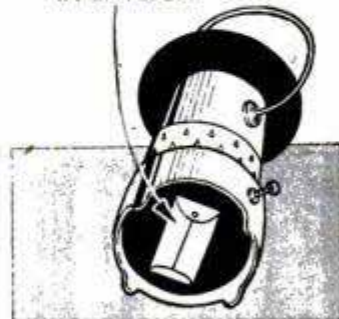

Charles A. Haugh, Fort Wayne, Ind.

"Rodding" Clogged Auto Radiator

When old auto radiators of the flat tubular type become clogged to such an extent that flushing will not remove the scale, they usually can be restored by rodding the tubes with a length of flat steel. Cut openings through the top with a fine-toothed hacksaw blade and bend the pieces back as shown. Then insert a length of thin sheet metal in each tube and work it through slowly, turning the metal strip as it progresses. If available, a short length cut from an old bandsaw blade is just the thing for this job. When all scale has been removed from the tubes, press the bent sections back into place and solder the joints. This accomplished, flush the radiator in the regular manner.

Richard Hanscom, Elmhurst, Ill.



WINDOW GARDEN

By Hi Sibley

BRIGHTEN UP a window in your home this winter with an attractive display of blooming flowers, grown easily in this simple-to-build indoor flower box. Fastened to the window sill with only two screws, the box is constructed so that the need for any other means of attachment, which might deface the wall or window frame itself, is eliminated. A feature of the galvanized-iron tank is a drain tube which is fitted to one side of the tank and slipped through a slot in the side of the box to allow excessive water to drain off through a channel cut in the window sash. The channel allows the window to be raised or lowered without interference from the tube. Copper screening laid over a stock-batten grid keeps the soil from sifting through.

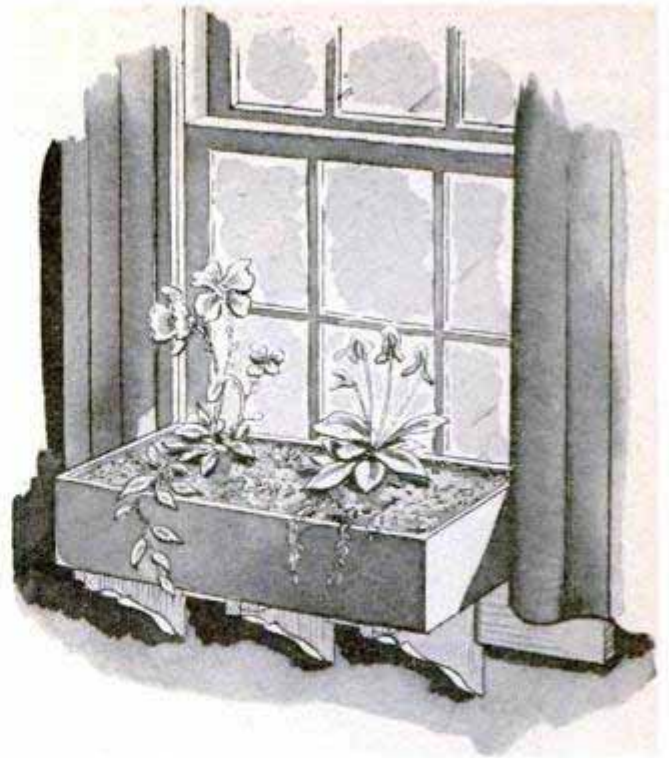

Braces for flower box, which are attached permanently to underside of box, provide support simply by resting against wall beneath window sill. They are cleated on sides as illustrated for added strength.

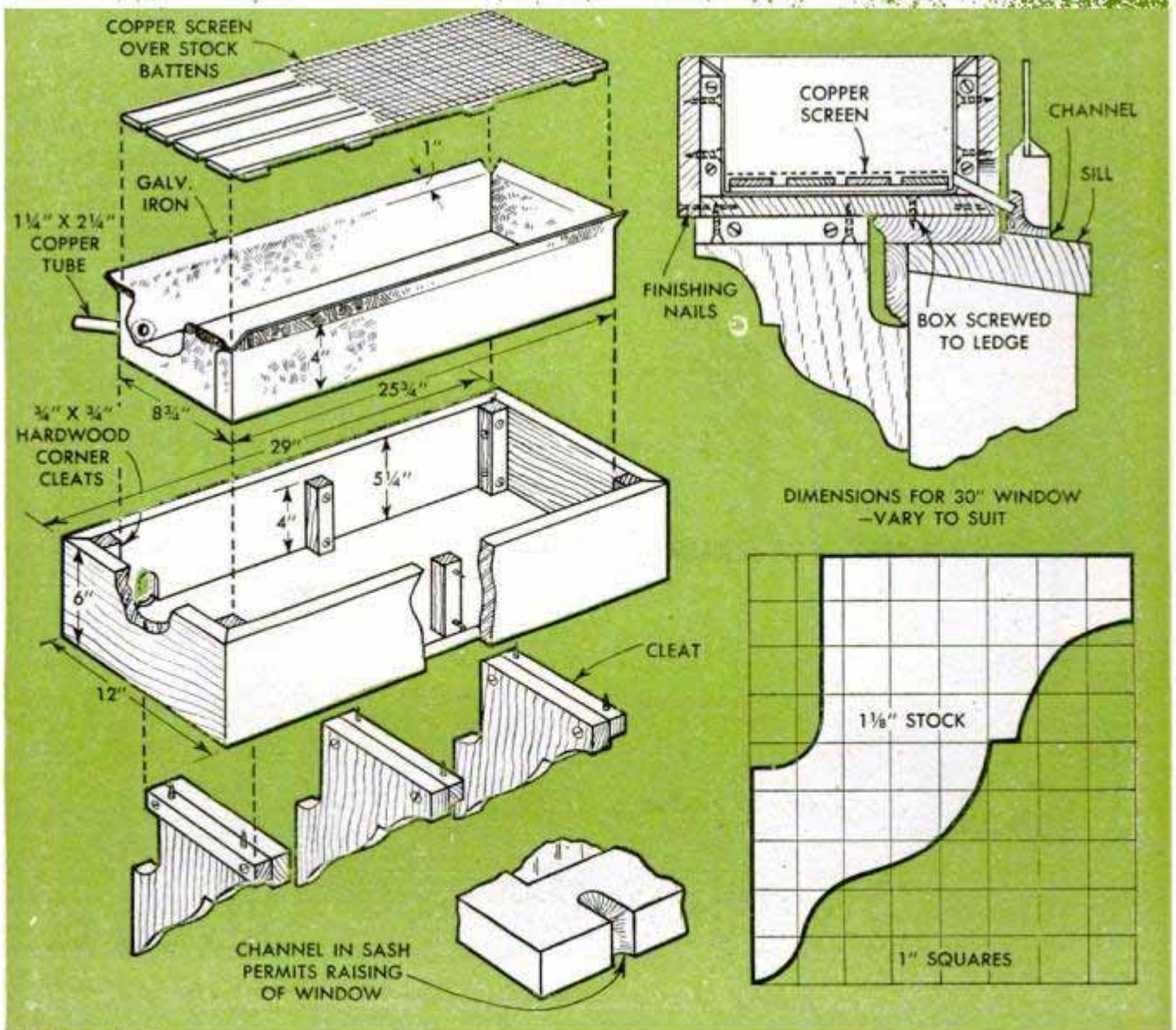

"SWITCHES"

By W. K. Mitchell and Howard B. Birt

OFTEN DESCRIBED as the unseen servants of the car, many of the vital electrical switches are hidden from view and few of them ever attract more than casual notice from the driver. The average modern passenger car contains at least 12 to 15 switches and a car fully equipped with accessories and "extras" may have two dozen or more. The switches not only start the engine, operate all the lights and blow the horn, but also control most of the accessories and safety devices, such as stop lights, neutral safety feature on cars with automatic transmissions, and directional turn signals.

The vast majority of automobile electrical switches fall into three types based on their method of operation. These types are mechanical, magnetic (solenoid), and vacuum, with mercury switches being used in some isolated cases. Of the three types mentioned above, the mechanical switches are the most numerous.

Mechanical Switches

The ignition switch, photo A, is a lock-type switch. Its contacts are locked in an open position when the ignition is turned off. In some cases a combination ignition and starter switch is used to actuate both the ignition and starter with a single motion of the ignition key.

The switches pictured at B and C are widely used for operating the headlights, parking lights and taillights. The push-pull type, B, has three positions—off, parking and bright—and in many installations it also includes a rheostat which is used to control the brightness of the instrument-panel lights. The rheostat is operated by rotating the control knob. Photo C shows

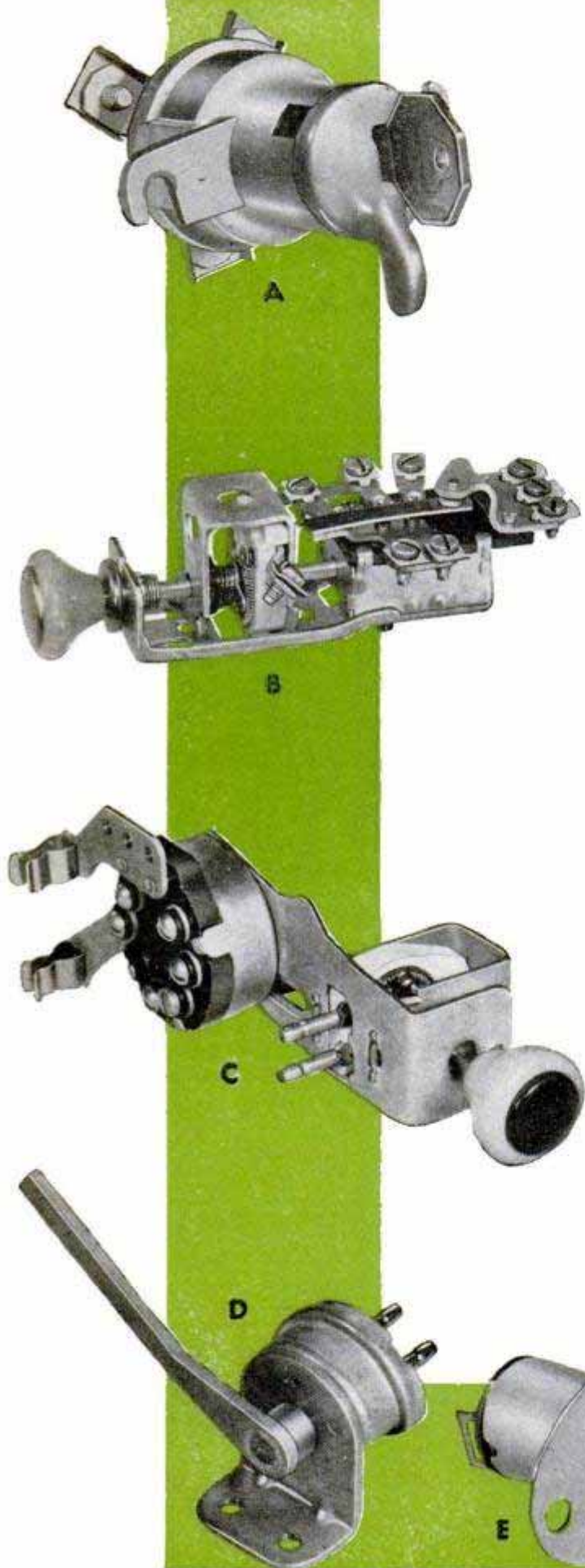

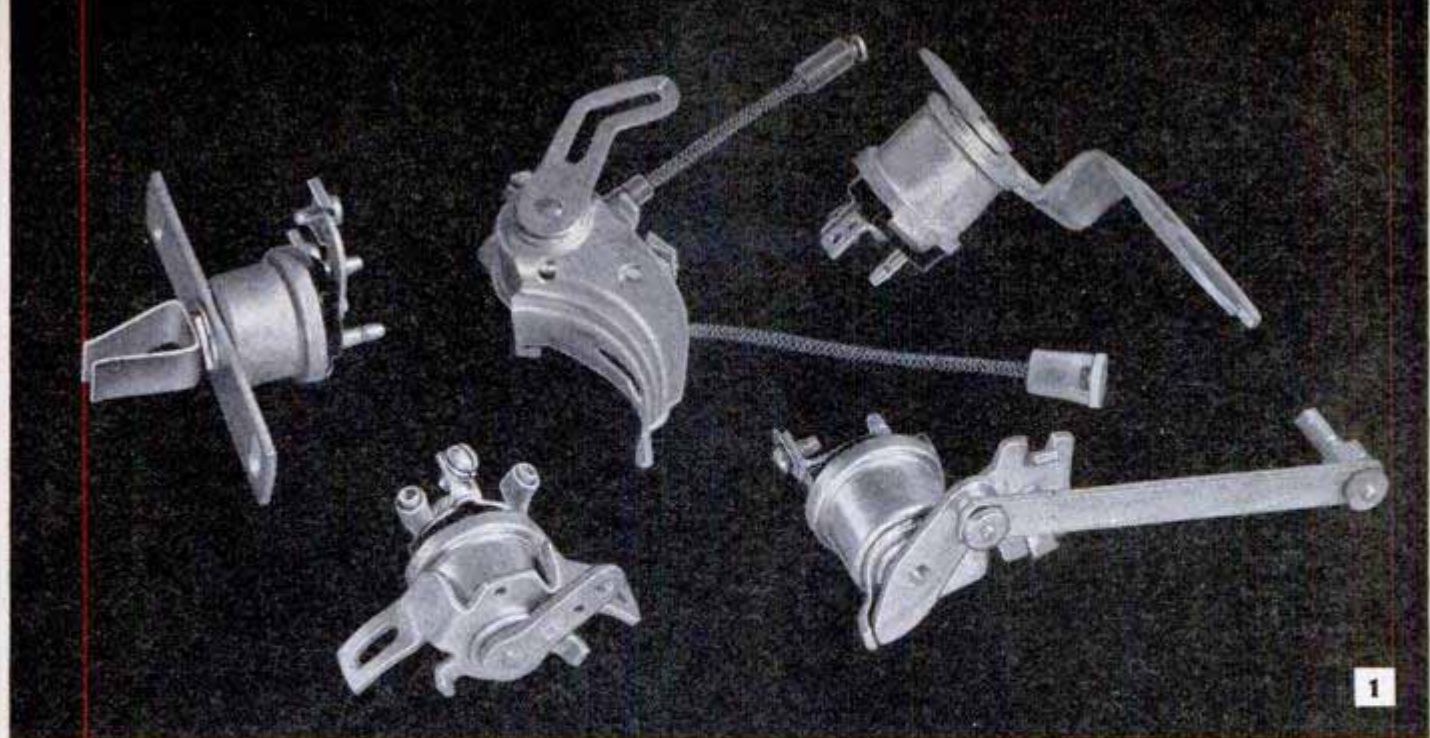

the push-pull, rotary-contact switch which is similar to the former type except that the contacts move in a circular path when the control rod is actuated. A thermostatic circuit breaker is incorporated in this switch to eliminate the need for fuses. The circuit breaker is a bimetal device that causes the lights to blink on and off instead of going out completely when a short circuit or overload occurs.

The mechanical stop-light switch, shown at D, is located so the switch lever is moved each time the brake pedal is depressed, thus causing the stop lights to turn on. When the pedal is released, the lever is returned and the circuit broken by spring tension. Another popular switch for this purpose, photo F, operates on changes in hydraulic pressure in the master brake cylinder.

The door-jamb switch, photo E, is a small, spring-loaded unit of the off-on type used to operate the dome light automatically. When the car door is opened the plunger is released to the "on" position, and when the door is closed the plunger is depressed to throw the switch to the "off" position.

The glove-compartment switch, G, is sim-

ilar in operation to the door-jamb switch except that the bulb receptacle is an integral part of the switch unit.

To control the headlight beams, a dimmer switch, photo H, alternately raises and lowers the beams with each successive depression of the switch. The latter normally is installed near the clutch pedal where it can be operated conveniently with the driver's left foot. Depression of the dimmer-switch button turns rotary contacts one full position inside the switch. When released, the spring-loaded button returns automatically to its original position. The switch is constructed so the contacts overlap, a new circuit being made before the previous one is broken. This feature prevents both beams from turning off at the same time. The switch is wired to the head lamps as shown in Fig. 3.

Heater switches, I, generally have four positions—off, high, medium and low—while most defroster switches have three positions—off, high and low. These switches contain small resistors which, by the switch action, are connected in series with the heater and defroster motors to provide speed control.

A neutral safety switch, J, is included

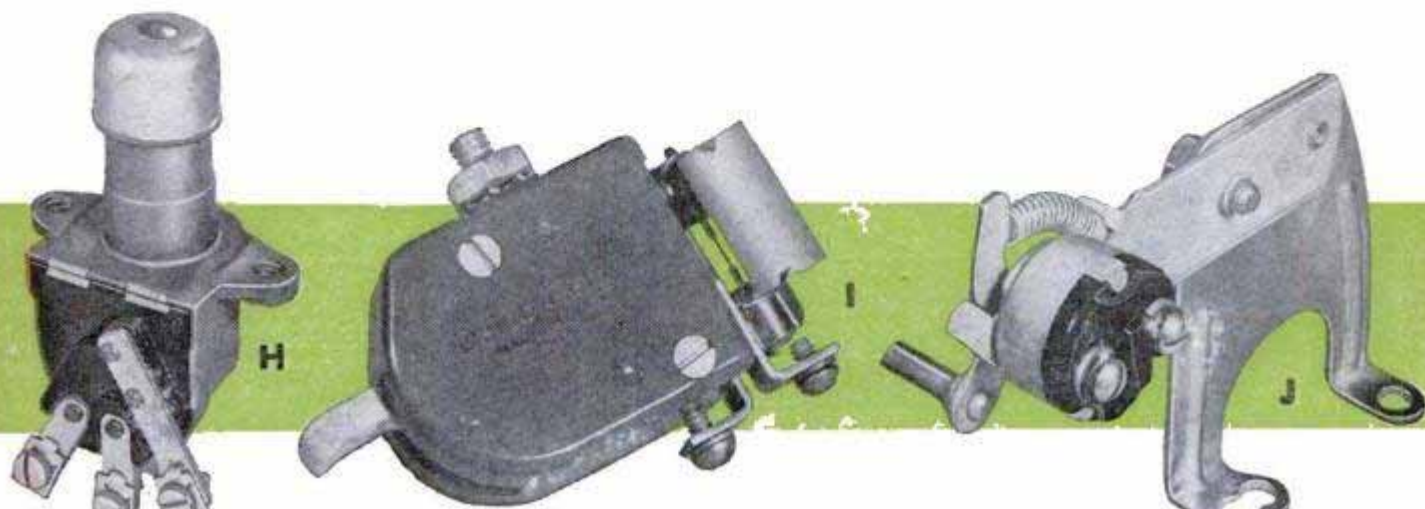

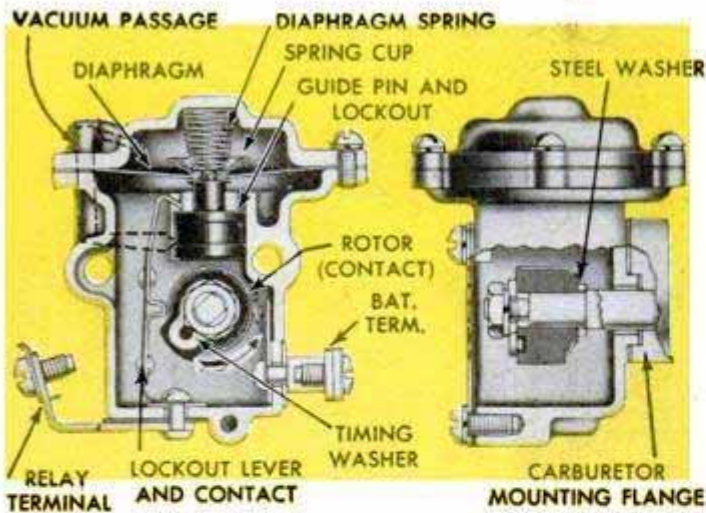

2

Above, carburetor-mounted vacuum switch is shown in cranking position assumed when throttle is open

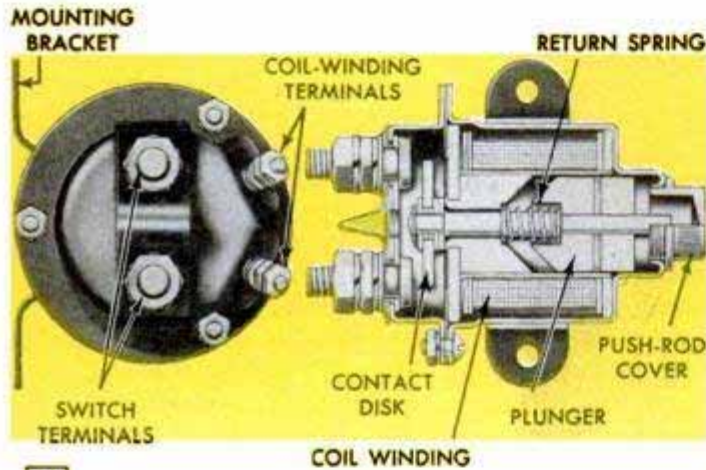

4

When magnetic field draws plunger into coil, above, contact closes circuit between battery and starter

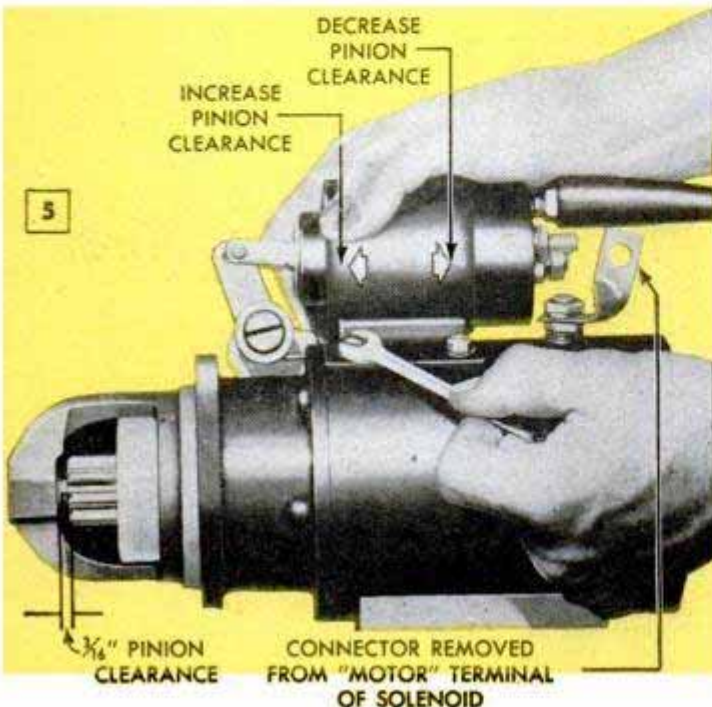

5

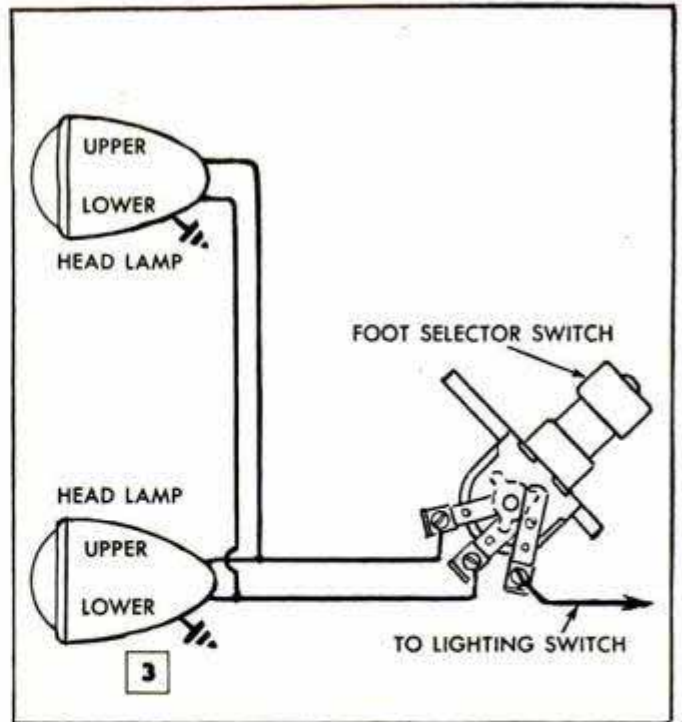

3

Photos and information courtesy Delco-Remy Division, General Motors Corp.

in cars equipped with automatic transmissions. It prevents starting of the engine unless the transmission is in "neutral" or "park" position. The switch is connected in series with the starter-control circuit and its contacts are closed only when the transmission is in the proper position. Fig. 1 pictures an assortment of specialized mechanical switches built for cars having automatic transmissions.

A direction-signal switch is installed in or on the steering column just below the wheel hub so a lever projecting from the switch can be moved easily by the driver whenever a turn is contemplated. Motion of this lever closes a circuit, causing the front and rear signal lights and a pilot light to operate. A thermal interruptor included in the circuit causes the signal lights to flash on and off. As the steering wheel is returned to the straight-ahead position, the switch lever automatically returns to the "off" position, thus discontinuing the signals. In most installations the direction signals are wired so they will operate only when the ignition switch is on.

Magnetic and Solenoid Switches

These switches are most frequently used to provide remote control of the starter. The magnetic switch is employed where the starter is equipped with a Bendix or other inertia-type drive. The solenoid switch is used in conjunction with starters having overrunning clutch-type drives which must be shifted into mesh mechanically. Both types are designed to perform electromagnetically a job which previously had to be done manually with starter pedals.

The magnetic switch, Fig. 4, consists of

a brass sleeve surrounded by windings that are energized by battery current when the remote-control switch is closed. The flow of current sets up a strong magnetic field which draws an iron core, or plunger, into the winding. This motion of the plunger closes a heavy circuit between the battery and the starter. The plunger is withdrawn to its original position by a return spring.

The solenoid switch is similar in principle to the magnetic switch but is more powerful. The movement of the plunger not only closes the starter-battery circuit but also shifts the starter pinion into mesh with the flywheel ring gear. This is done by means of linkage between the solenoid-switch plunger and starter shift lever.

Vacuum Switches

The vacuum starter switch, Fig. 2, is not so widely used as the other types. It operates on vacuum from the engine intake manifold and the throttle opening. The vacuum switch usually is mounted on the intake manifold or on the carburetor. The principal use of the vacuum switch is as a "lockout" to protect the starter. In this capacity it prevents the starter from being actuated while the motor is running. Such a precaution is needed on cars having the starter switch operated by extreme movement of the accelerator or clutch pedal, where the circuit could be closed inadvertently while the engine is running.

Switch Maintenance

Mechanical switches, with the exception of the direction-signal switch, do not lend themselves to maintenance and repair. In case of failure, they usually are easier and less costly to replace than to repair. Any motorist, however, can insure more trouble-free operation by occasionally checking mechanical switches on his car for loose or corroded contacts and freedom of moving parts. Mechanical stop-light switches which are exposed to road splash, for instance, are especially likely to stick or freeze in the closed position.

Direction-signal switches vary considerably in design and construction. In case of failure or improper operation, such switches should be checked exactly according to the manufacturer's instructions or turned over to an experienced automotive electrician.

The most important adjustment concerning the solenoid switch is correct cranking-motor clearance. Fig. 5 illustrates the correct method of making this adjustment. It must be made with the starter taken off the engine and clamped in a vise. Adjustment of pinion clearance is required whenever the starter has been dismantled and reassembled, or whenever the solenoid has been removed or replaced. ★ ★ ★

Emergency Flare Protects Driver While Making Tire Repairs

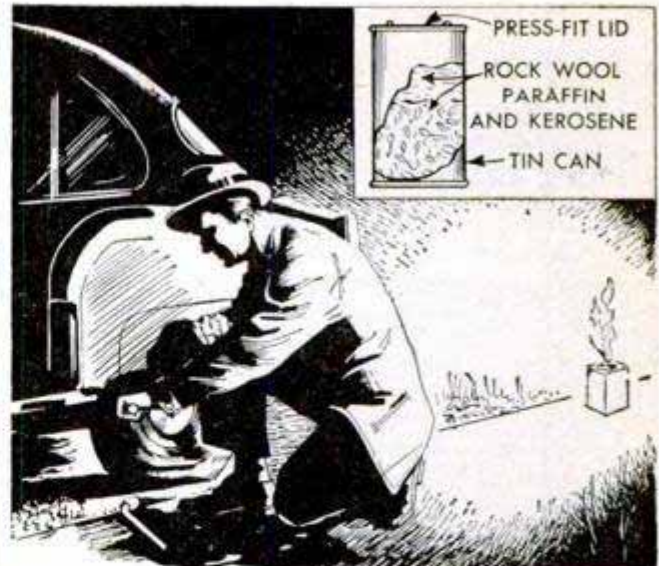

To give adequate protection while changing a tire at night, one motorist devised this emergency flare which will burn for more than an hour with a bright flame that can be seen for a half mile or more. He used a tall, square can of the type having a friction lid as a container for the smokeless fuel. The can should be in perfect condition with a tight-fitting lid. The fuel consists of pieces of paraffin and a small quantity of rock wool saturated with ordinary kerosene. The can is filled about half full of paraffin over which is packed sufficient rock wool to fill the can flush with the top opening. Then kerosene is poured into the can until the rock-wool "wick" is thoroughly saturated. If properly prepared, the flare can be carried in the car trunk without danger of leakage.

"Frock" Worn Over Wrist Watch Keeps Out Dirt

If you wish to wear your wrist watch while painting or working where it will be exposed to dust and grime, protect the watch by wrapping it with a piece of clear cellophane. Use cellulose tape to seal the ends.—R. F. Donovan, Guttenberg, N. J.



If you've often wished that you had black-and-white prints of favorite color slides, make this simple attachment and copy the slides with your camera

CAMERA ATTACHMENT COPIES

By **Walter E. Burton**

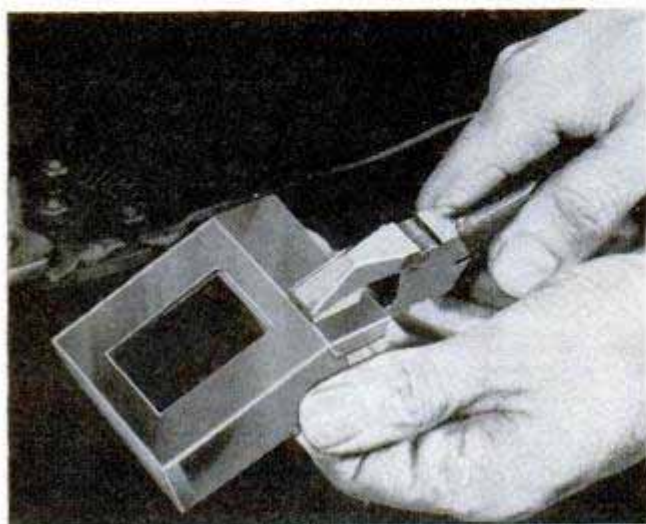

Although the original box was made of sheet metal, either cardboard or thin plywood can be used instead

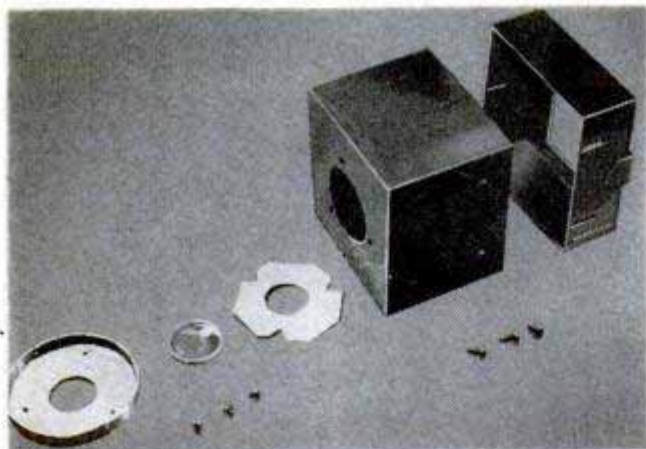

All parts of box assembly are pictured above, one shim-metal washer being inserted in lens cap. Below, note how washer which fits between cap and box is notched to clear machine screws driven as in detail

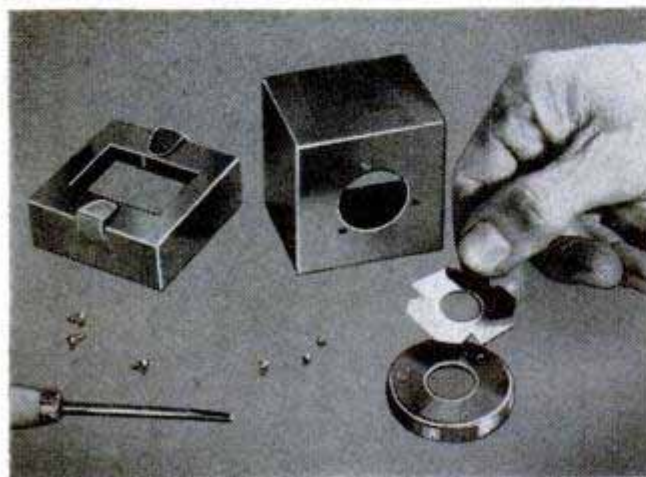

COPYING color slides is done in a matter of seconds with this copy extension which fits directly over the lens of your camera. Essentially, the attachment is a lightweight box containing a copy lens at one end and clips to hold a color slide at the other. Although the original model was designed for copying 35-mm. slides with a 35-mm. camera, varying the size of the box and the lens permits copying transparencies of different sizes. The attachment also can be used for reproducing movie frames and for photographing any small objects that can be illuminated by passing light through them. Samples of cloth and lace are typical subjects.

The sheet-metal box is made in two parts; a larger section which contains the copy lens and a smaller section, or cover, to which the transparency is clipped. The lens section telescopes into the cover to permit fine focusing, but even though the length of the box is adjustable to a certain extent, it should be made approximately the same as the focal length of the copy lens. In cross section, the box should measure slightly larger than the dimensions of the slide mounts it is intended to handle. The slide holder is anchored to the telescoping lens section with three sheet-metal screws. The latter pass through two slots in one side of the slide holder and one slot cut in the opposite side, as in the upper detail. The lower detail shows how shim-metal washers are used to provide a mount for the copy lens.

Use a good-quality copy lens preferably of the meniscus, or spectacle, type. These usually can be obtained from a dealer in surplus lenses. When the negative size of the camera is large enough, it is desirable to keep the copy image approximately the same size as the original transparency. To do this, the focal length of the copy lens must be the same as that of the camera lens. If it is shorter than that of the camera lens, an enlarged copy will be made, and if it is longer, the copy image will be smaller than the original. For example, when copying double-frame 35-mm. or bantam-

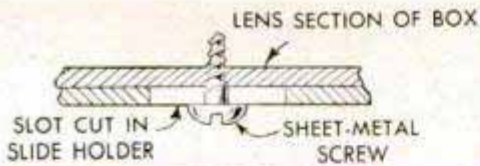

COLOR SLIDES

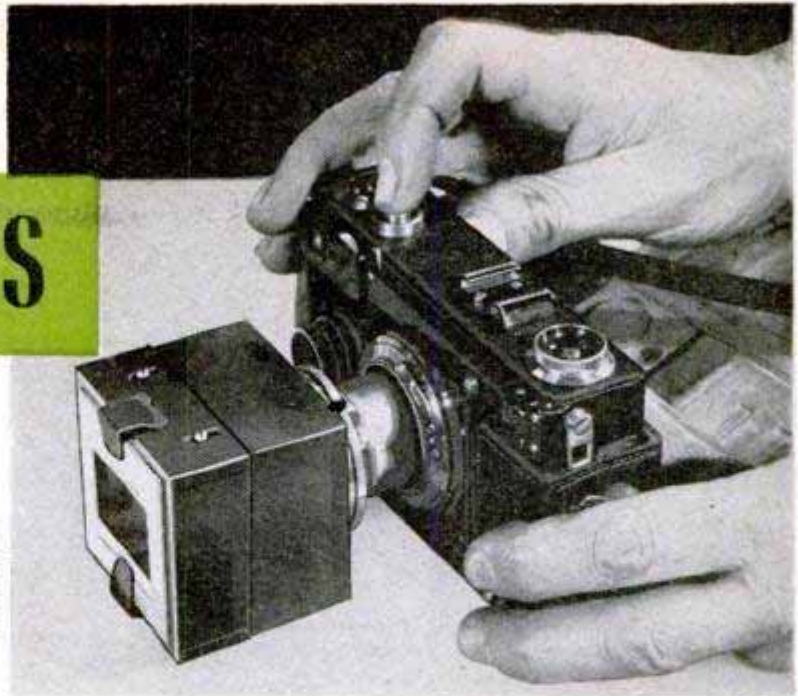
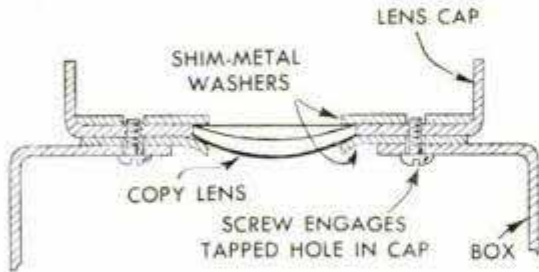

Photo above shows copy attachment in use on 35-mm. camera. Negative will be same size as transparency

size slides with a 35-mm. camera equipped with a 50-mm. (2-in.) lens, use a copy lens of 50 to 55-mm. focal length. In most cases, it is better to select the lens having the longer focal length so you will be certain of recording the entire area of the slide.

The distance from the copy lens to the slide must be adjusted carefully. This can be done by slipping a piece of ground glass under the slide clips and shimming it with cardboard strips to bring it in the same plane as the transparency. Then the lens is aimed at an object 200 ft. or more away and the telescoping box sections are moved together or apart as necessary to obtain a sharp image on the ground glass. When the image is sharp, the sheet-metal screws are tightened to lock the sections.

If you intend to copy both glass-mounted and cardboard-framed slides, adjust the box for the glass slides and use an empty cardboard frame as a spacer when copying the cardboard-framed slides, thus keeping both transparencies in the same plane. When making copies with a camera that does not have a focusing screen, set the camera lens at the infinity focusing position. The copy lens should be close to the front surface of the camera lens, but not touching it. The diameter of the copy lens should be at least as large as that of the camera lens.

To illuminate the transparency evenly, point the camera at the north sky in the daytime, or if you are copying indoors, aim one or more spot or flood lights at a non-glossy white surface, such as a large blotter. Then hold the camera so the transparency is 6 to 12 in. from the blotter. The correct exposure is determined by trial and error, but a small lens aperture (about f:16) must be used for maximum sharpness. ★ ★ ★



Above, tightening three machine screws locks parts in position. Shanks of screws engage slots in slide holder, as in upper detail. Below, clips bent from sheet metal and soldered to box hold slides in place

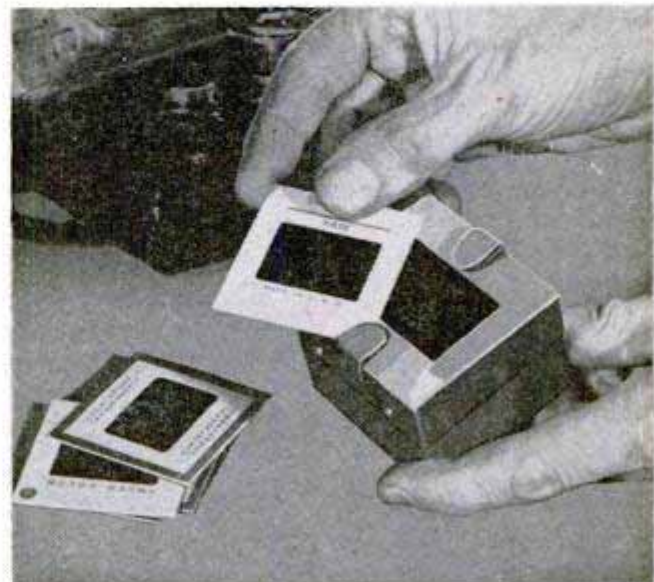



Drying Wet Negatives

You can dry negatives much faster if they are squeegeed to remove all surface moisture when they are hung up to dry. A windshield-wiper blade is ideal for this purpose. Roll film should first be hung in a drying position and then squeegeed as pictured in the photograph. Dry the rubber blade after each sweep, and continue the operation until there is no surface water left on the negatives. Cut film may be squeegeed in a similar manner. In this case, it is a good idea to use the fingers of the left hand to steady the film while sweeping off the water. Another method of drying cut film is to place it on a sheet of glass and run the squeegee over one side until all water has been removed. Then pick up the film, wipe off the glass and squeegee the other side. When using the latter method, you should hold one corner of the film with the fingers so that it can be picked up easily.

Popular Mechanics Bookshop

Here's a Tip . . .

. . . for the 12 million men who strike out across the fields and through the woods each year—the hunters and trappers of America. Among them you'll find a lad with a new shotgun tramping out in search of a rabbit run; an office worker who'll soon be waiting in his blind for the honk of Canadian geese; a big-game hunter toting a telescopic sight and a yen to bag a mountain goat or grizzly. Very likely you'll find yourself among these 12 million men. In *Guide to Good Hunting and Trapping*, Joe Godfrey, Jr., internationally known sportsman, provides something for you and every other sportsman.

Between the covers you'll find all the lure of the great outdoors. There's a section on hunting game animals from the lowly squirrel to that most ferocious quarry, the wild boar; a section on game birds containing complete maps of the great flyways and tips on decoys and calls; a section on guns and ammunition, with a special department on hunting with bow and arrow. There's a "Guide to Good Hunting Grounds," a section on the hunting dog and a good many pages on trapping which describe the tricks of professional trappers. For this invaluable book durably bound in cloth, just send \$3.00 to Popular Mechanics Press, 206 E. Ontario St., Chicago 11.

Want a Hobby?

Want a hobby that's inexpensive, profit-

able and downright fun? You'll find it in *Ornamental Casting*. In photos, drawings, and step-by-step instructions the book shows you how to cast almost any article in such varied materials as concrete, plaster and imitation marble. You can make literally thousands of beautiful and useful items from ash trays to lawn ornaments for a few cents apiece. And for real fun, try casting full-size, true-to-life busts of members of your family. *Ornamental Casting* contains copyrighted formulas and complete supply sources for the few inexpensive materials you'll need. Order now for \$3.00 from Popular Mechanics Press, 206 E. Ontario St., Chicago 11.

Ideas for Farmers

Farmers are finding hundreds of hints and kinks for saving time, money and energy in the fact-crammed *Farm Manual*. In the 284 pages of text, photos and drawings, you'll come across countless short cuts to better and more efficient farming. There's material of vital interest to every type of farmer, his wife and children. The *Farm Manual* contains a good many projects for making farm implements, articles on livestock and poultry management, instructions on vegetable storage and processing, and tips for the dairy farmer. Many county agents and agricultural teachers have endorsed this idea-crammed book and adopted it for work in their classes. For your copy, send \$3.00 to Popular Mechanics Press, 206 E. Ontario St., Chicago 11.

All books available from Popular Mechanics Book Department, 206 E. Ontario St., Chicago 11

COLLET ATTACHMENT

FOR THE METAL LATHE

By C. W. Woodson

AN INTERESTING turning project, this collet attachment for a 10-in. lathe permits rapid chucking of finished bar stock with precise accuracy. The three parts of the draw-in attachment, which are shown in Fig. 3, are readily machined on the lathe, but due to the difficulty of hardening and spring-tempering tool-steel collets it is better to purchase them ready-made. However, in the event you wish to machine a collet of mild steel or hard brass for occasional use, dimensions are given in Fig. 4.

Have at least one finished collet on hand when beginning work on the attachment, as the collet will serve as a gauge when taper-boring the closer to the correct angle, and the collet threads can be used to check the threaded end of the draw-in sleeve. In addition, the collet is necessary to determine the exact length of the sleeve in order to assure proper closing action when clamping the work in the collet. Note the cut-away detail, Fig. 6.

Start machining the collet closer, Fig. 1, by turning the No. 3 Morse Taper to fit the headstock spindle. As this may require considerable fitting, the tool-steel round used for this part should be a little longer than ordinarily necessary. After fitting the closer, slip it in the headstock spindle and drive the work with the spindle while turning and facing the large flange on the outer end. Then counterbore the center hole and turn the inside bevel to match the taper on

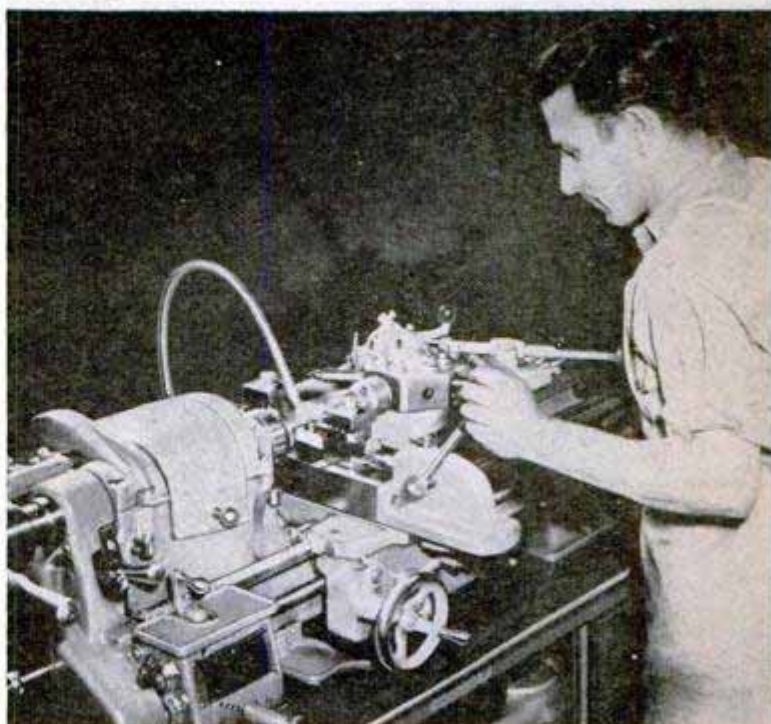
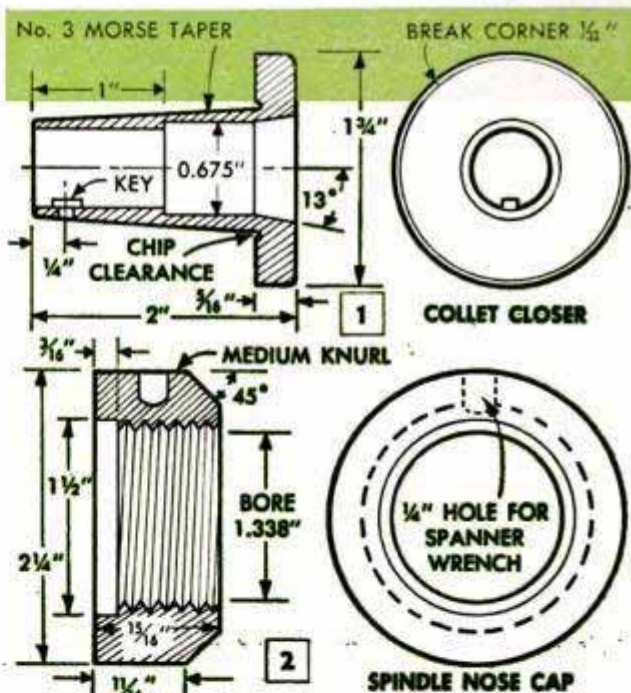
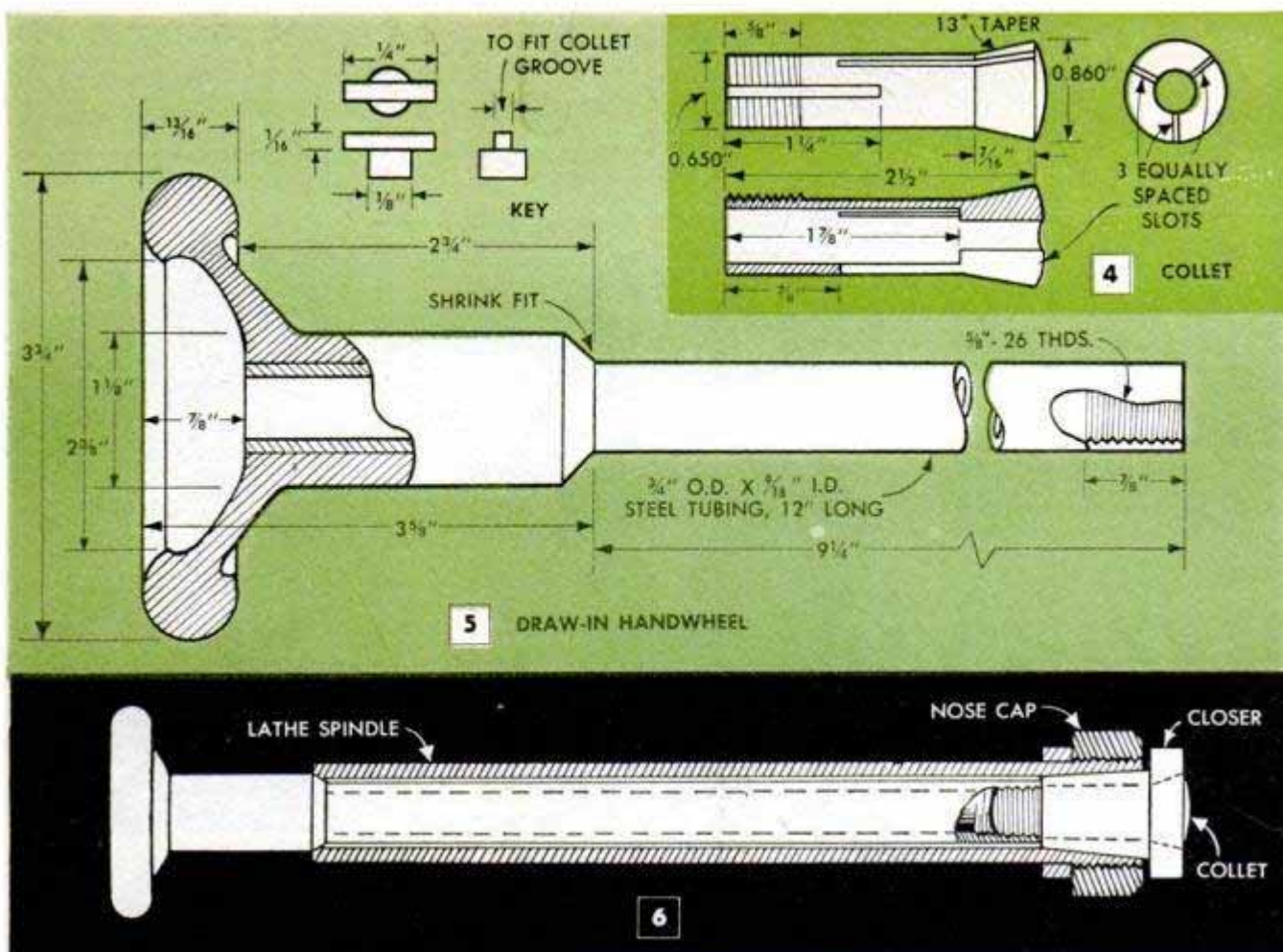

Photo courtesy South Bend Lathe Works



The drawing below shows how the finished parts of the collet attachment look and how they fit together. Note that the spindle nose cap is turned on the spindle before closer and collet are inserted





the collet head. Make the key, as in Fig. 5, and rivet it inside the tapered shank of the collet closer.

Chuck the draw-in sleeve to run dead true and cut the $\frac{5}{8}$ -26 internal threads. Run the threads with several light cuts and when nearing the finish dimension, check with the collet to determine the degree of interference between the two parts. They should engage lightly as otherwise the collet may turn in the closer when the handwheel is tightened. To locate the exact distance from the threaded end of the tube to the handwheel hub, insert the closer in the headstock spindle and slip the draw-in tube through the hollow spindle. Insert a collet in the closer, turning it into the tube, and

press the collet firmly against the closer. Mark the tube at the point where it projects from the opposite end of the headstock spindle.

Turn the handwheel and hub from a single piece of cold-rolled steel to the dimensions given in Fig. 5 and drill and ream the center hole for a shrink fit on the draw-in tube. The spindle nose cap, Fig. 2, not only protects the threaded end of the spindle while the lathe is in use, but also removes the collet closer from the spindle when it is backed off the threads. The cap is turned from a cold-rolled-steel bar and knurled for the handgrip. Then it is bored and threaded to fit the spindle. Drill a $\frac{1}{4}$ -in hole in the cap for a spanner wrench. ★ ★ ★

Barrel Partially Submerged in Pond Provides Ice-Free "Water Hole"

Precious time sometimes lost in chopping a hole through a frozen pond to obtain water frequently results in the total destruction of a burning farm building. To be ready at all times for such an emergency, one farmer creates a nonfreezing "water hole" in his pond each winter. In the fall he partially submerges a wooden barrel a few feet from the edge of the pond. Wooden members extending from two stakes driven approximately 2 ft. apart support the barrel, while a crosspiece nailed to the stakes supports the ends of two planks which

serve as a walk. The barrel is filled with a saltbrine solution so the water won't freeze and then the barrel is covered. Thus, when water is needed in a hurry, several blows with an ax against the sides of the barrel will cause it to collapse, leaving a hole in the ice in which a suction hose can be dropped.—H. H. Slawson, Chicago.

☞ When dismantling parts containing ball bearings, place the latter on a section of window screen as they are removed. This will prevent them from rolling away.

Substitute Stencil Ink



If you run out of stencil ink and have to ship cartons or crates in a hurry, buy a can of black or dark-brown shoe polish and a brush-type applicator. The polish provides an excellent substitute for the stencil ink, and because of its ready availability in a wide variety of stores it can be purchased quickly and at times when usual suppliers of stencil ink would be closed. In addition, the polish has the advantage of not flowing under the stencil when applied to cloth or especially soft wood, thus assuring a distinct, neat-appearing outline of the lettering.

G. E. Hendrickson, Argyle, Wis.

Giant Self-Feeder Containing Hay Saves Work on Dairy Farm

A dairyman near Fairfield, Iowa, has eliminated most of the work of feeding hay to his dairy herd by use of this large self-feeder. As shown in the photograph, the lower part of the feeder is made of concrete in which windows or openings are cast. As the hay is consumed at the openings, it settles down from above, thus keeping a supply available at all times.

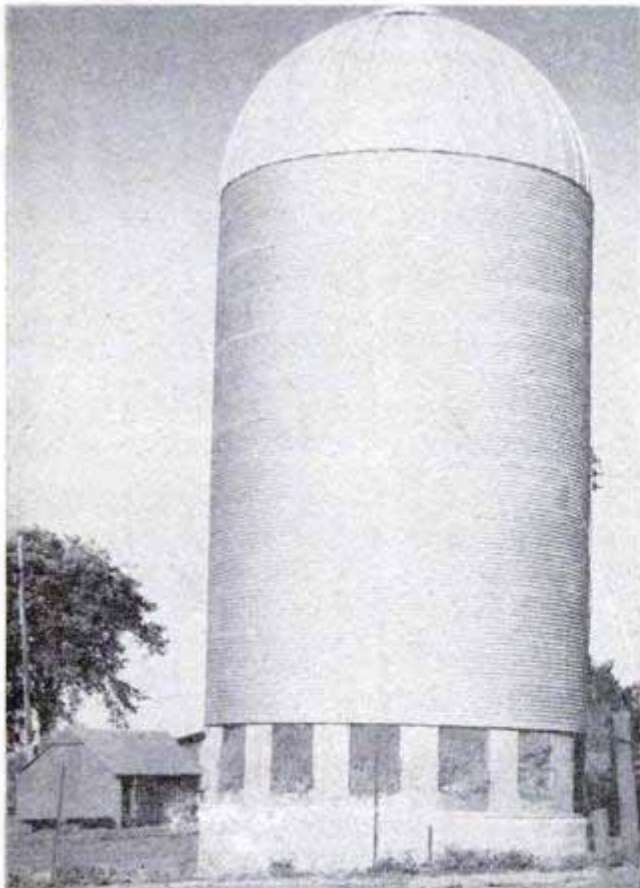

SEPTEMBER 1952

Car Frame Provides Useful Skid For Hauling of Heavy Objects

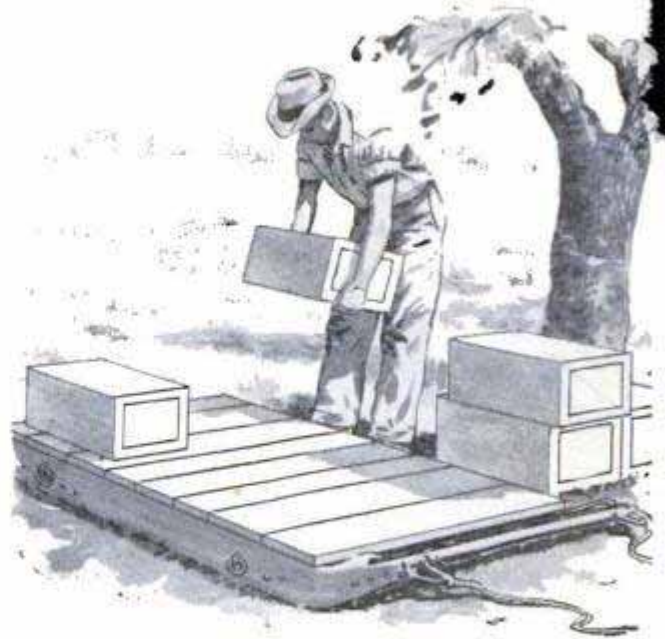

Much of the back-breaking work of moving heavy objects about a farm can be avoided by use of a rugged skid towed by a tractor. Such a skid may be made from an old car frame, which has been covered with heavy planks to provide a platform. Most car frames can be laid on the ground so that the bent ends of the frame act as runners. A skid like the one pictured is ideal for hauling sick animals from the pasture, wire fencing, sacks of feed, waterers, boxes of fruit and rolls of fencing.

A. M. Wettach, Mt. Pleasant, Iowa.

Toy Balloon Discourages Hens From Eating Eggs

Although many poultry men feel that the only cure for a hen that has the habit of eating eggs is the ax, one farmer claims that a fowl can be cured of this habit by placing an inflated toy balloon in the nest. A white, or very light-colored, balloon should be used and it should

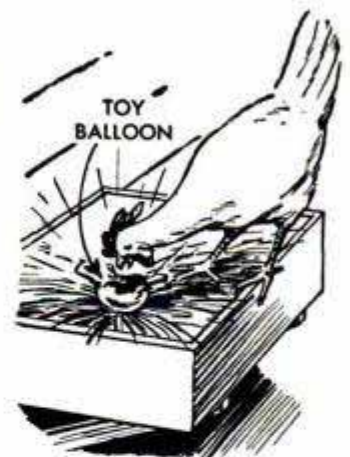

be anchored in place. The first time a hen tries pecking at the balloon, the resulting noise when it bursts usually proves startling enough to discourage her from ever repeating the experiment.

☐ When painting a house in summer, follow the shade around the building. Direct rays of hot sun may blister fresh paint.

195



American Floor Surfacing Machine Co. photo

CUTTING OFF is done easily freehand as shown above and below. Wherever possible cut is made on right end of work for maximum support

How to Use Your

By Sam Brown

PORTABLE ELECTRIC saws, which have largely displaced the handsaw for cutting building materials, are now made in smaller, lighter models suitable for use in the home workshop. These units, equipped with blades ranging from 6 to 8 in. in dia., are especially handy for crosscutting long boards which are difficult to handle on small stationary saw tables.

Those who contemplate building their own homes will find an electric handsaw a must for cutting framing, sheathing and roof boards accurately and speedily to the lengths and widths required. The smallest sizes having 6-in. blades will crosscut and rip 2 x 4-in. stock in a fraction of the time required for handsawing. Ordinarily, electric handsaws are used freehand, but accessory guides are available for ripping and crosscutting, also floor stands designed for converting the unit into a table saw which will do ripping, crosscutting, grooving, shaping, sanding and routing.

Crosscutting: To make this basic cut, the front edge of the base plate of the saw is placed on the work with the guide notch aligned with a pencil mark, Fig. 2. The blade is then started on the line or in the waste and the saw is pushed across the work, Fig. 4. Near the end of the cut, the guide notch runs off the work but you can still see the line through a window in the frame, Fig. 3.

With a right-hand saw mounting, cutting off should always be done at the right end of the work. This permits the wide portion of the base plate to rest on solid wood, as shown in Figs. 2 and 4. Fig. 1 pictures a typical building operation.

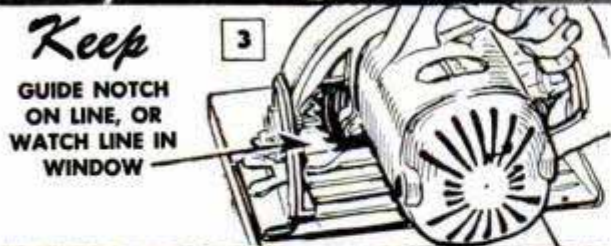
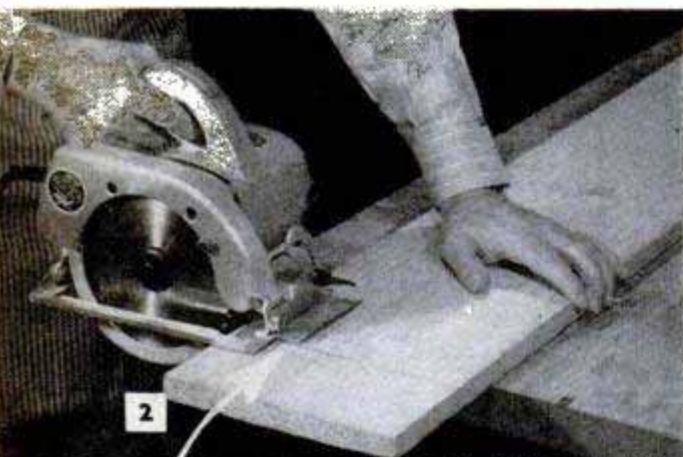

Keep
GUIDE NOTCH
ON LINE, OR
WATCH LINE IN
WINDOW

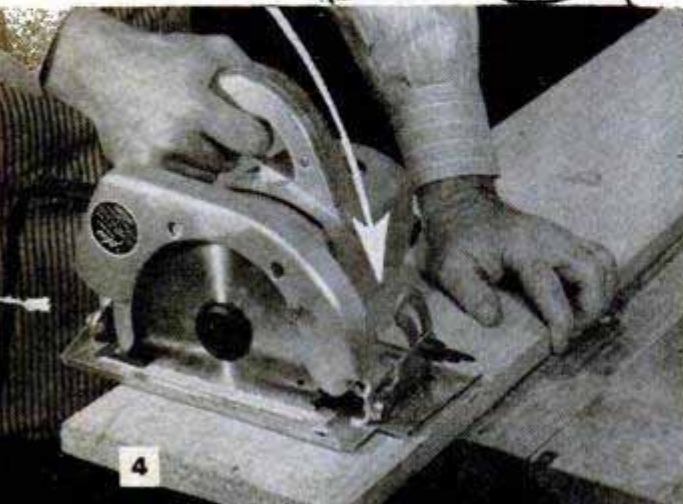

1. Right hand!

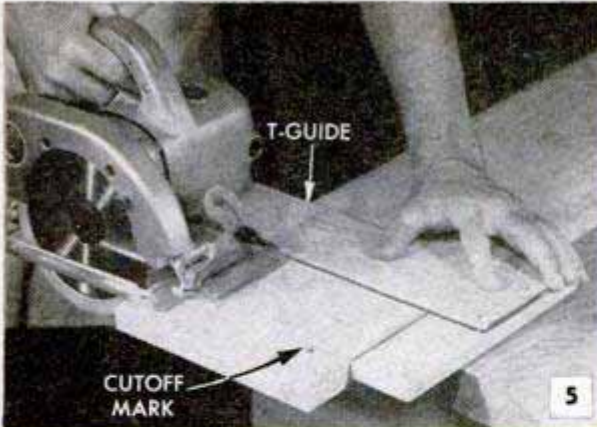

A T-GUIDE is handy for crosscutting. Guided cut is smoother

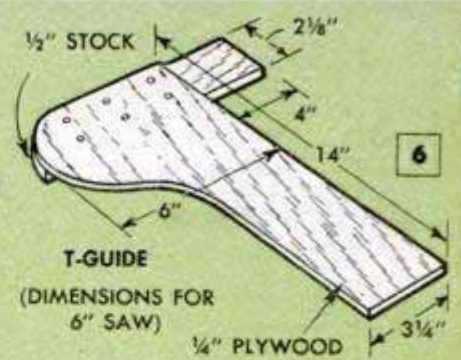

T-GUIDE (DIMENSIONS FOR 6" SAW)

1/4" PLYWOOD

Electric Handsaw

In coming up the opposite side of the roof, however, the operator has no choice—he must support the saw on the narrow part of the base plate.

Crosscutting near the center of a board is best done with a bench setup, as shown in Fig. 7. The T-guide shown in Fig. 6 is a valuable aid for all crosscutting operations. When you make this setup make the projecting part of the T-guide head a little longer than the width of the wide part of the base plate. The first cut will trim the projection in line with the blade. After that, set the head to a pencil line, Fig. 5, to make any cut. A separate T-guide should be made for angle cuts since these cut inside the vertical cut, Fig. 8. You will have to set the saw blade fairly shallow if you use 3/4-in. support blocks in the bench setup,



ANGLE CUTS can be made accurately with a special T-guide. Use separate notch on saw

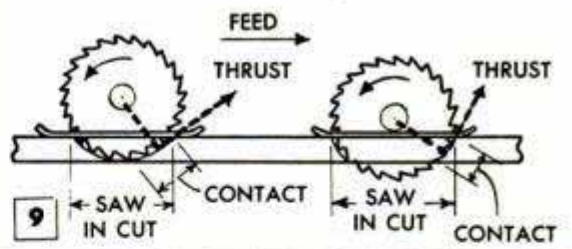

Average Specifications — ELECTRIC HANDSAWS

SAW DIA.	WEIGHT	VERTICAL CUT		MAX. 45° CUT	SPEED R.P.M.	REMARKS
		MAX.	MIN.			
4 1/2"	7 LB.	1 1/4"	0"	1"	6000	SMALLEST PRACTICAL UNIT. CUTS 1" HARDWOOD STOCK.
6"	11 LB.	2"	3/4"*	1 3/8"	5000	BEST SIZE FOR HOME SHOP. EASY TO HANDLE. CUTS 2" STOCK (EXCEPT AT 45°)
7 1/4"	16 LB.	2 3/8"	1/2"*	1 7/8"	5000	POPULAR SIZE FOR LIGHT CONSTRUCTION WORK. CUTS 2" STOCK AT ALL BEVELS
8 1/2"	18 1/2 LB.	2 7/8"	1/2"*	2 1/8"	4200	THE BUILDER'S SAW. MAKES ALL AVERAGE CUTS IN FRAMING STOCK
9 1/2"	20 LB.	3 1/4"	1"	2 1/2"	3800	HEAVY BUILDER'S SAW. BIG BLADE CUTS TIMBERS USED IN BRIDGE AND DOCK WORK

NOTE — AVERAGE SPECIFICATIONS ONLY. SOME UNITS WILL VARY

* SOME SAWS ADJUST TO ZERO

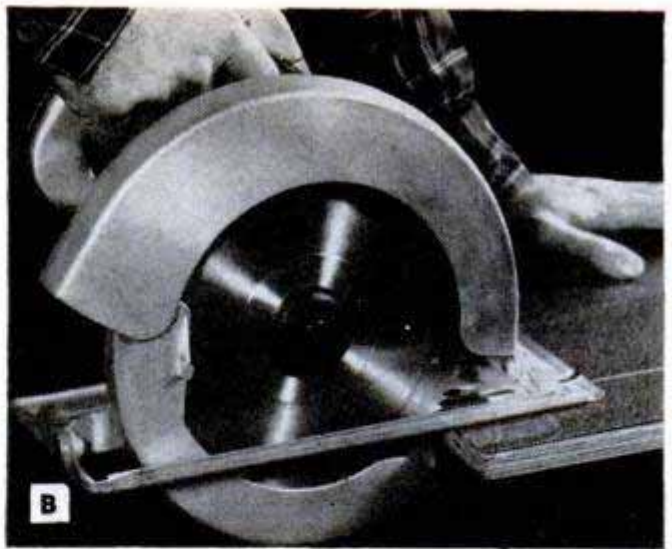
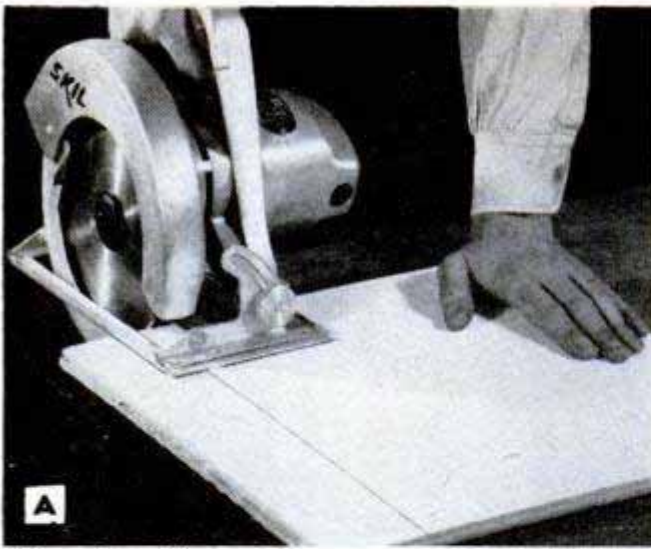

Skillsaw, Inc., photos

BUILDERS USE ELECTRIC HANDSAWS FOR CUTTING NEARLY

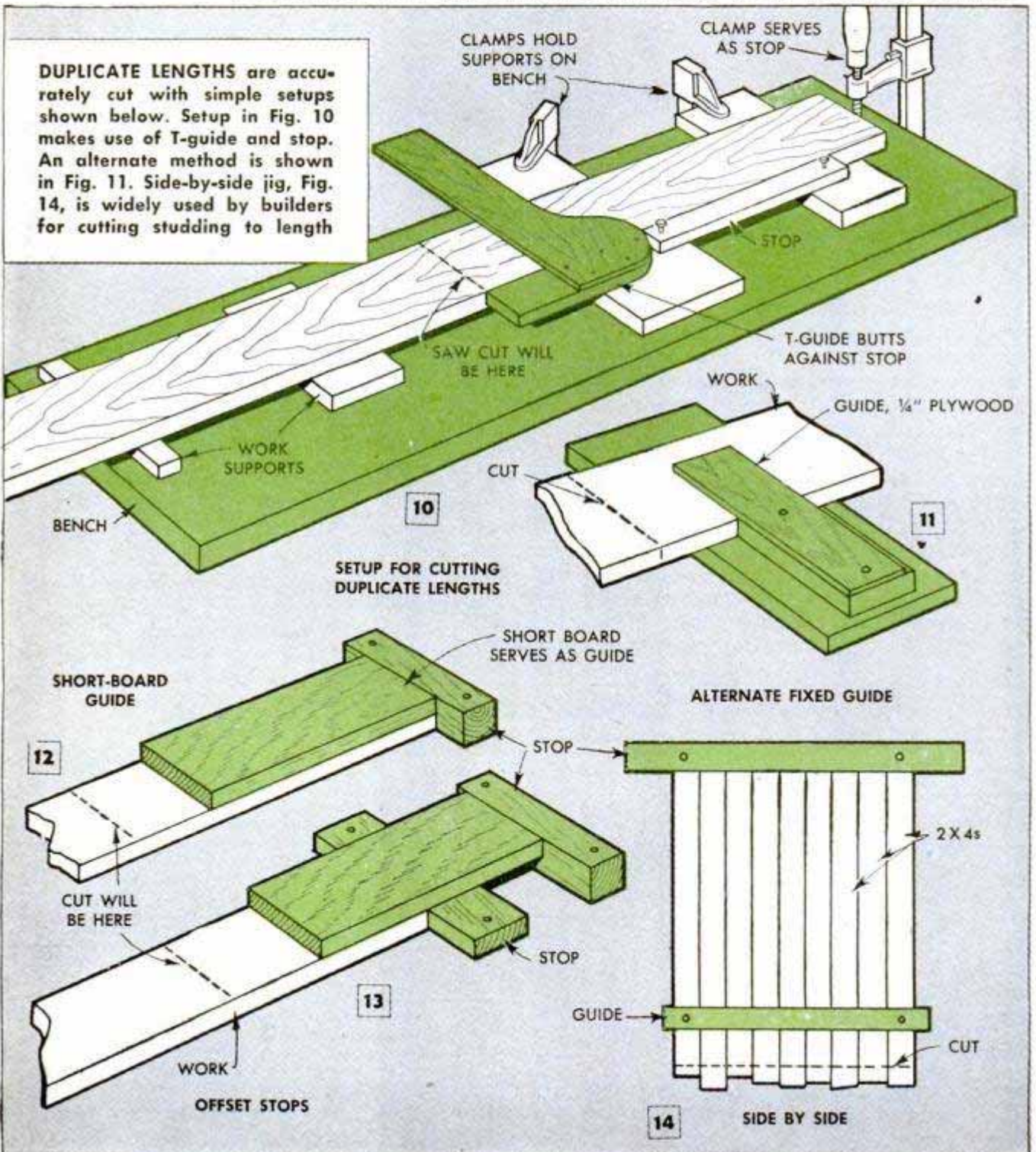

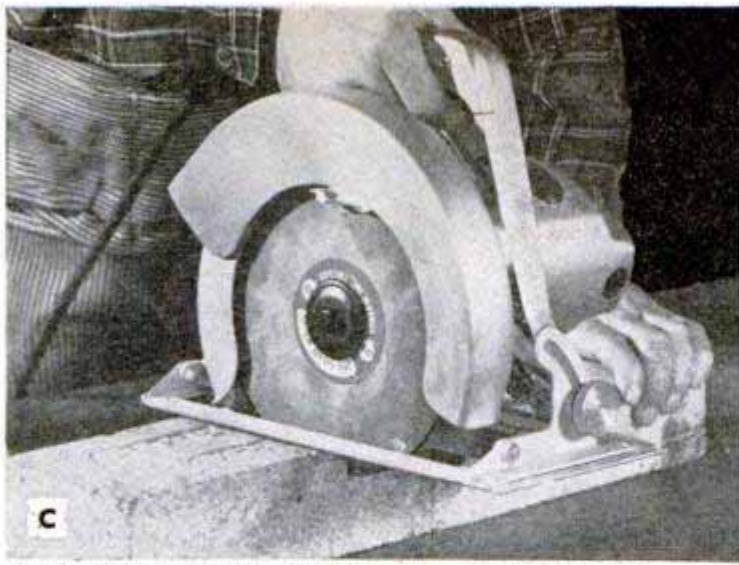

ALL TYPES OF BUILDING MATERIALS

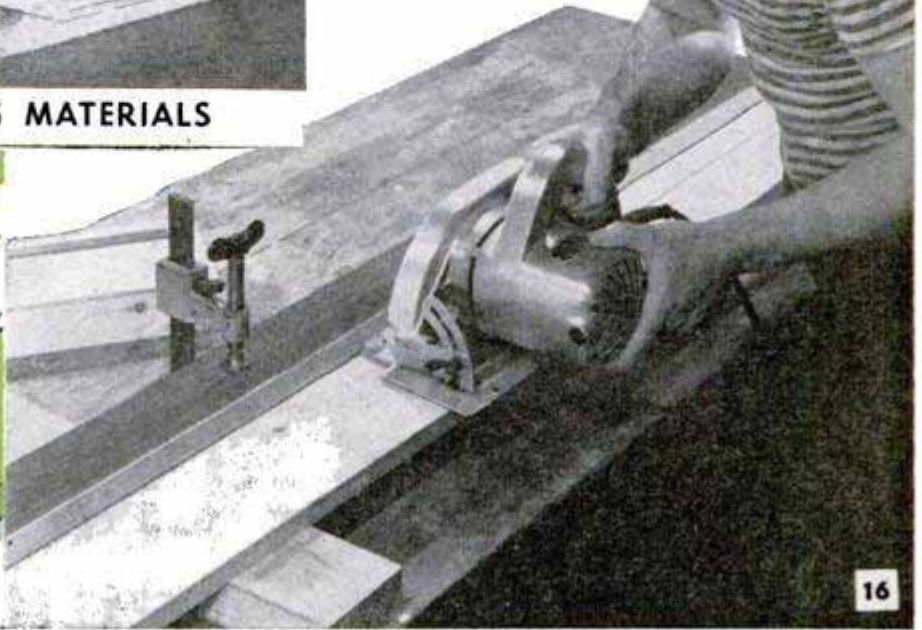
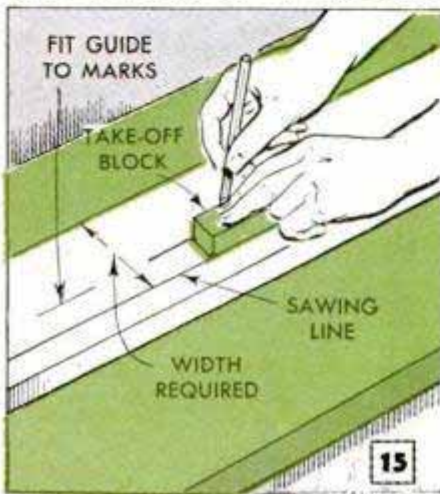

Fig. 7. In most work the support blocks should be cut from 2 x 4-in. stock.

Mechanics of cutting: Fig. 9 shows how the blade cuts. The thrust is forward and upward against the base plate. When the blade is set just to cut through the stock, it has a larger contact area and requires more power. On the other hand, the blade set to maximum depth tends to bind in the cut. For most work, a setting halfway between minimum and maximum projection is best. Because the tool is used freehand, it is highly important to keep the saw teeth sharp and correctly set. File the saw blade after each four hours of use and keep the set at $\frac{1}{64}$ in., or follow the manufacturer's recommendations for filing and setting the blade.

Duplicate lengths: If you are cutting three or four duplicate pieces, probably the best system is to mark each piece. But when you have 10 to 20 pieces to cut, it is worth-while to make a simple jig to assure uniform lengths. Fig. 10 shows a typical setup. Saw halfway through the first board and then mount the various stops as shown. In Fig. 12, the setup makes use of a short board. In Fig. 13, the arrangement is somewhat similar but uses the first board sawed as a guide in connection with offset stops.

The offset is the width of the wide part of the base plate (4 in. for a typical 6-in. saw). Fig. 14 shows a simple multiple-cutting setup used by builders for cutting studding to uniform lengths. Numerous other setups can be worked out.

Ripping: Ripping cuts can be made accurately with a ripping guide, Fig. 16, or with a guide strip, Fig. 15. Ripping with a guide strip is commonly done from right to left with the narrow part of the base plate bearing against the guide, Fig. 16. To make the setup you first pencil-mark the width of the strip required. Then using a take-off block of a width equal to the width of the narrow part of the base plate, mark the stock to locate the position of the guide strip, Fig. 15. In using the bench setup with support blocks, you can saw right through the blocks or shift as you approach them, as desired.

Notching: On a notching job, always work the two cuts to keep a solid support under the saw, as shown in Fig. 17 to 22 inclusive. Note in Fig. 19 how the wrong procedure requires supporting the saw on the narrow part of the base for the final cut. To clean a circular-sawed notch, it is necessary to saw a little beyond the line, Fig. 22. Always use the blade at its maximum depth



17

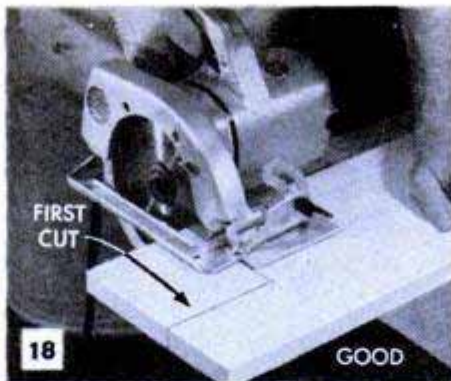

18

GOOD

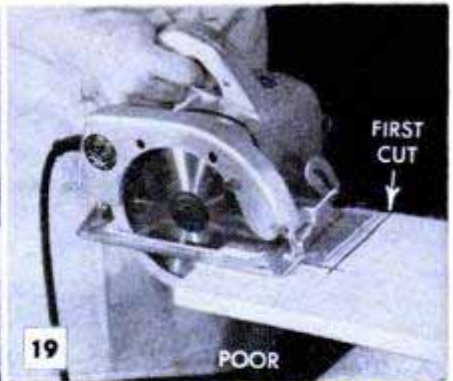

19

POOR

MAKE CUTS SO WIDE PART OF BASE PROVIDES SUPPORT

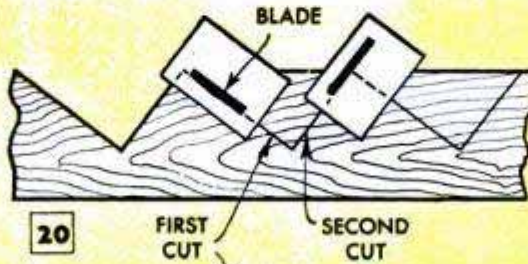

20

FIRST CUT

SECOND CUT

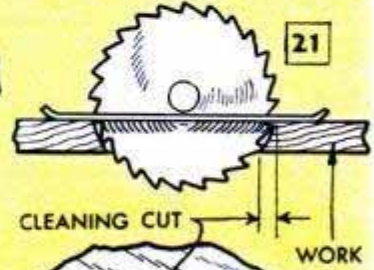

21

CLEANING CUT

WORK

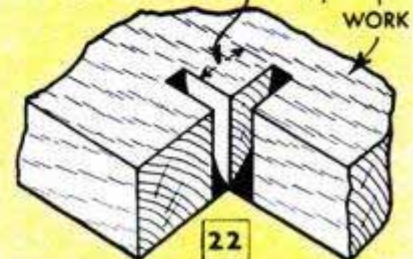

22

NOTCHING CUTS must be made in proper sequence so that wide part of base plate is supported on solid stock. Saw is set at maximum depth



23

SET SAW TO DEPTH

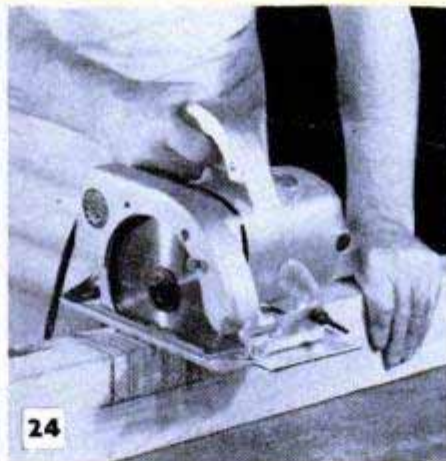

24

MAKE CUTS ABOUT 1/2" APART



25

CHISEL OUT WASTE WOOD

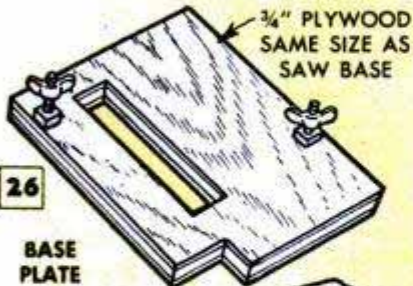

26

3/4" PLYWOOD
SAME SIZE AS
SAW BASE

BASE
PLATE

GROOVING AND RABBETING are easy operations with electric hand-saw. Cutting shallow grooves may require use of auxiliary base plate, Figs. 28 and 29, if the saw is of type that does not adjust to zero

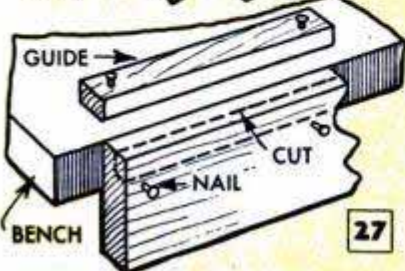

27

SETUP FOR RABBET



28

SET SAW TO DEPTH

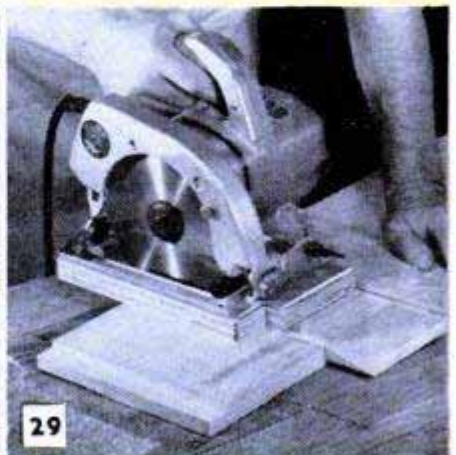

29

USE T-GUIDE TO SPACE CUTS



30

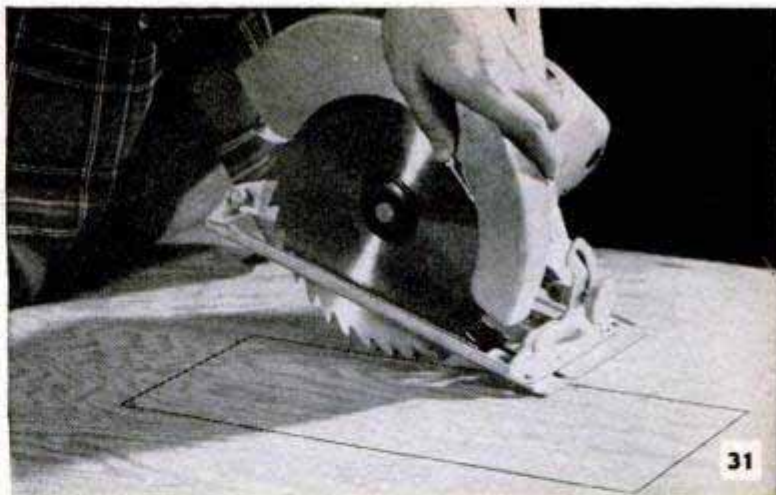

31

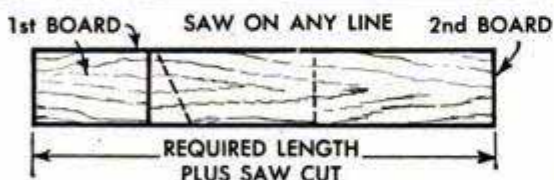

BUTT JOINTS AND POCKET CUTS are regularly made by builders. Butt joint is made by overlapping and clamping two boards as in photo above at the left. Joint will fit perfectly. Pocket cut is made by lowering saw into work

for this work in order to keep the cleaning cut at a minimum. A square-cornered notch is cut by following the procedure shown in Figs. 23, 24 and 25. Unless your saw adjusts to zero, it will be necessary to fit an auxiliary base, Figs. 26 to 29 inclusive, to cut shallow grooves. Instead of the auxiliary base, it is practical to use a $\frac{3}{4}$ -in. riser block nailed or held over the work. With this in place, use the T-guide to walk the saw kerfs across the work, as shown in Fig. 29. When you have a groove or rabbet in the edge of a board, support the work by nailing or clamping it to the edge of the bench top, Fig. 27. Then nail the guide in place and make the cut. The ripping guide also can be used for this operation.

Butt joint: Another job for the electric handsaw is the fitting of plain butt joints. Clamp the two boards or panels together to make the required length plus the saw kerf, and then saw any straight line across the assembly for a perfect joint, Fig. 30.

Pocket cut: This is another very useful electric-handsaw operation. The blade should be set at maximum depth to minimize the length of the cleaning cut. You can pivot the cut in from either the rear or front of the base, but the front pivot, Fig. 31, is perhaps the most practical for average work. The saw is backtracked a little to catch the nearest corner and then can be pushed along the guide line as in straight ripping or crosscutting.

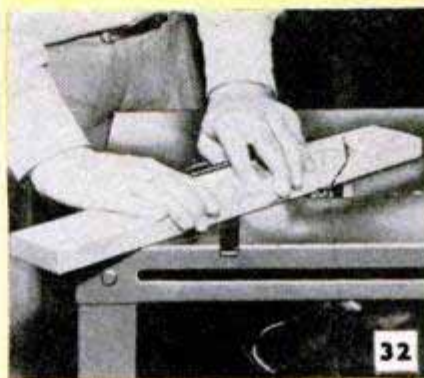

32

CONVERSION of electric handsaw into table saw is made possible by accessory table. Unit will perform common sawing operations, including shaping and sanding



33

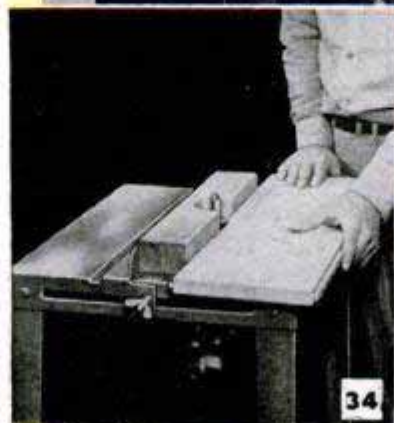

34

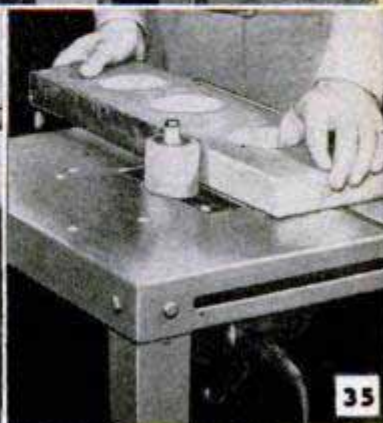

35

SHAPING

SANDING

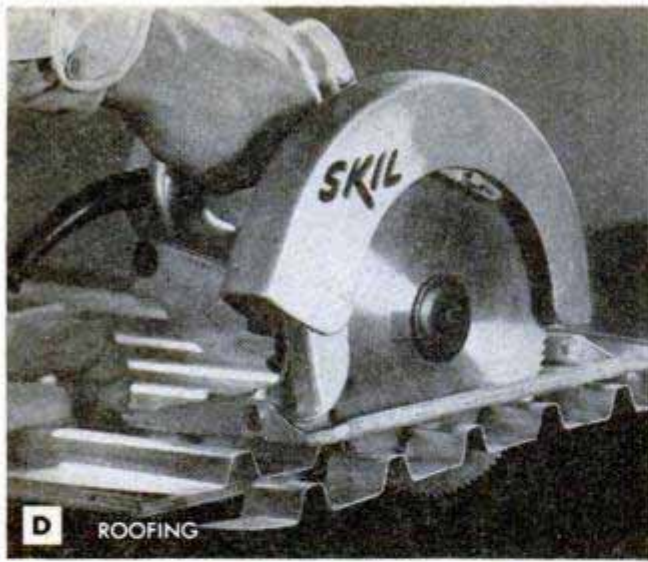

D ROOFING

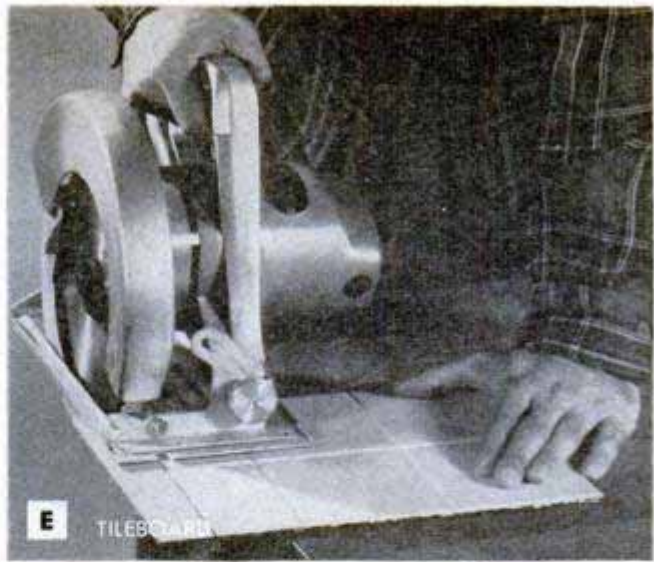

E TILECUTTER

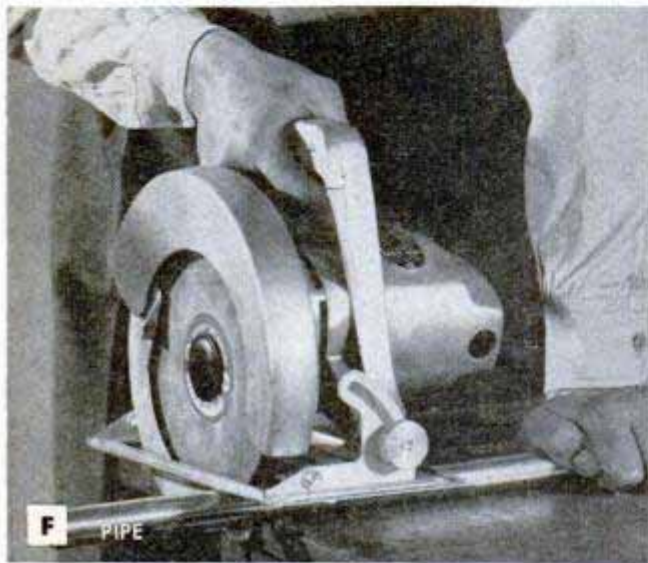

F PIPE

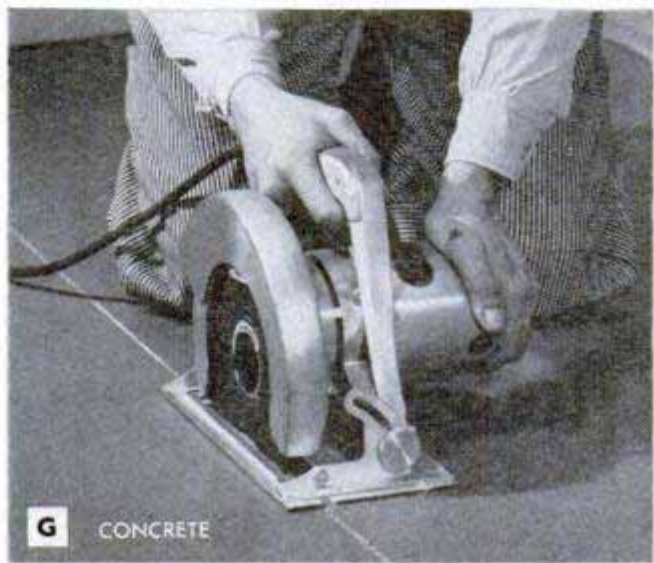

G CONCRETE

Then, after making two of the four cuts, it is sometimes advisable to nail a support across the pocket to keep the waste piece from falling out when the final cuts are made. The telescoping guard must be locked in the open position for this operation. If your saw does not have the guard lock, make one by tapping the frame and inserting a knurled screw to engage a hole drilled in the guard. Fit a light spring under the screw to prevent it from working loose.

Table saw: The electric handsaw can be used as a table saw by fitting it to an acces-

sory table supplied by the manufacturer. Figs. 32 to 35 inclusive show typical operations utilizing accessories which do ripping, crosscutting, shaping and sanding. These units often are the solution to the power-tool problem in the small shop. Photos A, B and C on pages 198 and 199, and also photos D to G above, show how the electric saw, operated manually, is used to cut almost any common building material, including masonry, metal and compositions. Special blades and abrasive wheels are available for cutting these materials speedily and accurately. ★ ★ ★

Oilstoning Saw Teeth After Filing Improves Performance of Blade

Performance of any saw blade will be much improved by oilstoning the points of the teeth after setting and filing. The same procedure also improves the cutting qualities of hollow-ground blades on which the teeth run without set. Lay the handsaw blade on a flat surface, such as a bench top, and slide the stone along the blade with the teeth, not against them. When stoning a hollow-ground circular blade be sure that the end of the stone does not ride on the raised

center portion, or hub. Use light pressure and apply the same number of strokes on each side of the blade. It is important to use a fine oilstone that is in good condition to avoid marking the saw blade or damaging the points of the teeth.

☞ To prevent battery terminals from corroding, cover them with a mixture of lubricating grease, four parts, and baking soda, one part.

Trailer Fitted With Tractor Tires Has Greater Load Capacity

Needing an exceptionally sturdy two-wheel tractor trailer, one farmer overcame several drawbacks of ordinary trailer construction by designing and building his own and equipping it with 11.25 x 24-in. tractor tires. The big tires enable the trailer to travel in soft fields and in muddy farm lanes without miring or cutting in deeply, even with heavy loads. The trailer body was taken from a dump truck and adapted for use on the trailer frame, which was built up by using the channel side members of an old car frame with the cross braces and a tubular drawbar welded in to form a rigid A-frame. The dump body pivots at a point just back of the axle and is held in the horizontal position by a lever-actuated release pin. Chains attached to the

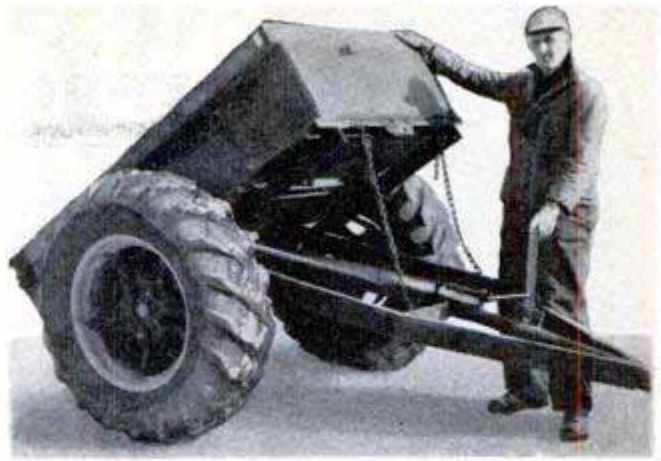

trailer frame limit the tilt of the body when the load is dumped.

A. E. Holden, Angola, Ind.

Separate Mandrel in Slip Roll Forms Sheet-Metal Tubing

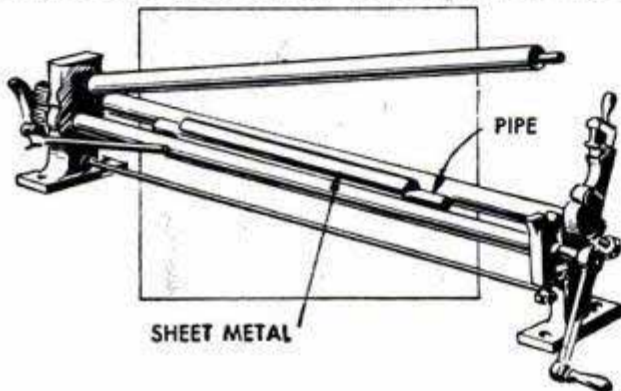

Tubing in various sizes is formed quickly in an ordinary slip roll by using a separate mandrel, such as a piece of steel shafting or pipe. Place the pipe, or shafting, between the rolls as indicated in the detail. Feeding the sheet metal around the mandrel will form a tube of the desired size. The diameter of the tubing can be varied by tightening the slip-roll adjustment. However, the mandrel used must be slightly smaller than the diameter of the rollers.

Hugh Lineback, Stillwater, Okla.

Roof Over Area Between Hog Houses Provides Shady "Breezeway"

Bridging an area between two portable hog houses, several lightweight sections of roofing, 10 and 12 ft. in length, provide a shady, comfortable "breezeway" for hogs. The framework supporting the sections consists of sheathing lumber laid over short 2 x 4 rafters and braced along the edges by 2 x 4 stringers. Sheets of galvanized roofing are nailed to the framework which, in turn, is nailed to the houses to secure them in place.



"Collet" Improved From Copper Tubing For Salvaging Broken Drills

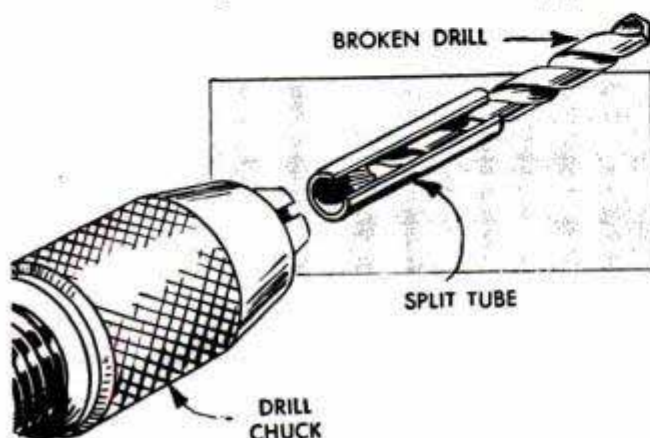

A broken drill often can be salvaged for continued use by inserting it in a "collet" made from a length of copper tubing to permit tightening it in a drill chuck. To make the collet, select a piece of tubing that has a diameter slightly smaller than that of the drill and slit it lengthwise along one side. Similar collets of various sizes also are useful for reinforcing small drills in chucks and for preventing dowel rods or thin-walled pieces of tubing from being crushed when gripped in a vise.

W. Shields, Bloomington, Ill.

TIP YOUR TOOLS WITH ... the wonder cutting metal of

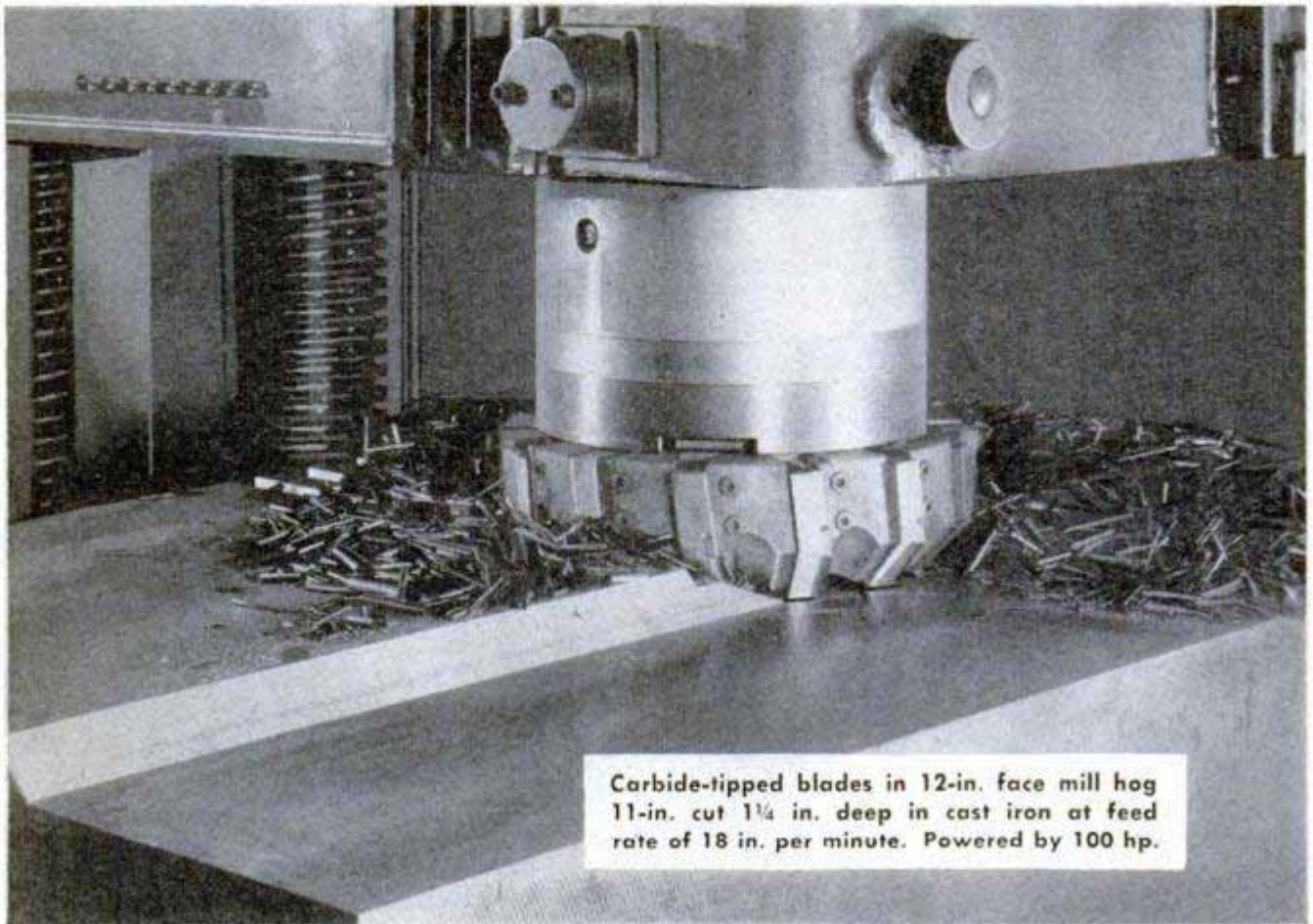

Carbide-tipped blades in 12-in. face mill hog 11-in. cut $1\frac{1}{4}$ in. deep in cast iron at feed rate of 18 in. per minute. Powered by 100 hp.

Photo courtesy The Ingersoll Milling Machine Co.

If you are planning to take on a basement subcontract to help Uncle Sam rearm for defense, tipping the cutting edges of your workshop machine tools with tungsten carbide will increase production up to 1000 percent. Carbide blanks cost but a few cents and brazing them to the tip of the tool shank is a simple job

By Wayne C. Leckey

Part I

NEARLY EVERYONE is aware of what happens when you strike a nail accidentally with your circular saw, or run your metal lathe too fast and burn the tip of the tool—the cutting edge is gone and the tool must be resharpened. But imagine being able to saw a nail accidentally, or to run a tool bit red-hot, without dulling it whatsoever! It sounds fantastic, but you can do just that with a comparatively new wonder metal called carbide, a sensational cutting alloy that has revolutionized indus-

Editor's note: There is a rather acute shortage of the two metals which are needed to make carbides—tungsten and cobalt. Therefore, in the event of full-scale war, curtailment of these materials for defense needs may mean that carbide blanks will be unavailable. However, as we go to press, these blanks can be purchased without priority.

try and accounted largely for the phenomenal mass-production capacity of this country.

As the machinist knows, the performance of a metal-cutting tool and its ability to operate at high speeds is in direct proportion to its ability to retain hardness at high temperatures. As the point of a metal-turning tool, for example, is subject to extreme conditions of both load and temperature, the cutting edge wears rapidly, requiring frequent sharpening. Since temperatures as high as 1600 deg. F. occur at the point of contact and readily draw the temper from carbon-steel tools, it is easy to see why they cannot be used at high speeds or subjected to great overloads and why output consequently is correspondingly low.

In the past 50 years there have been

CARBIDE industry

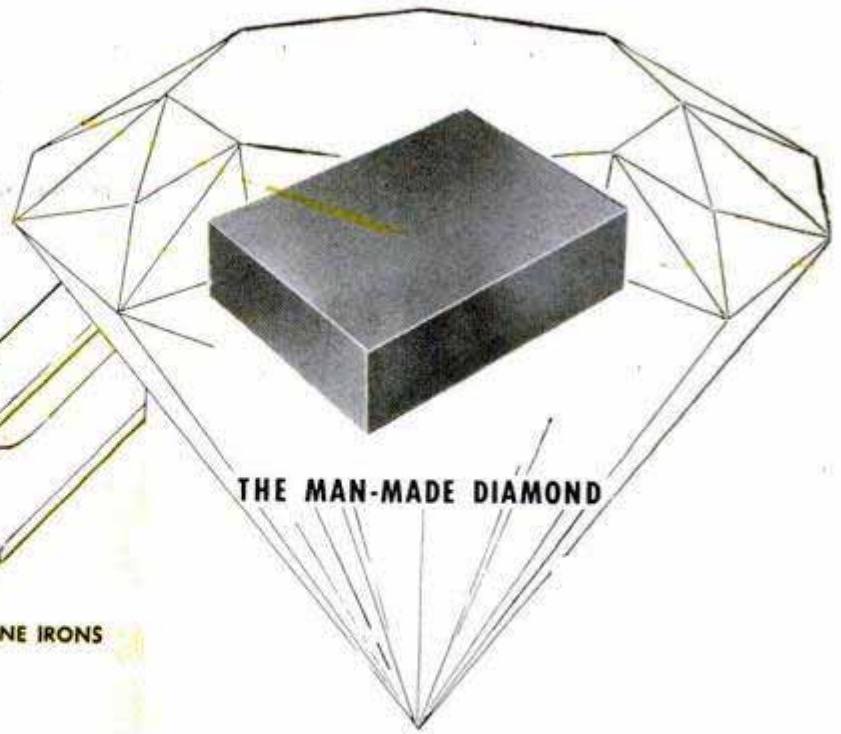

THE MAN-MADE DIAMOND



SAW BLADES

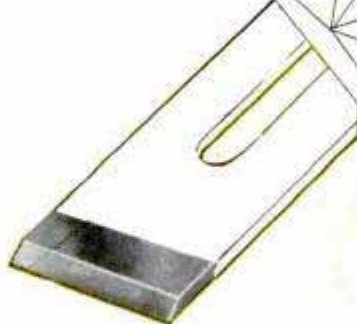

PLANE IRONS

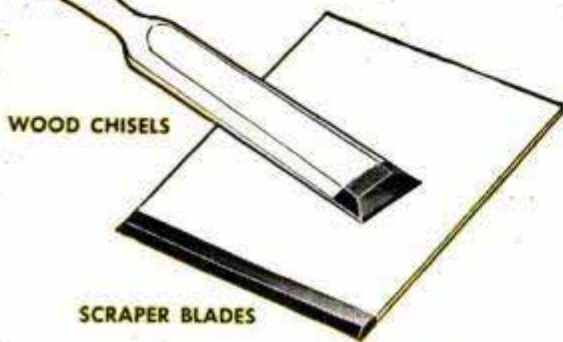

WOOD CHISELS

SCRAPER BLADES



LATHE CENTERS

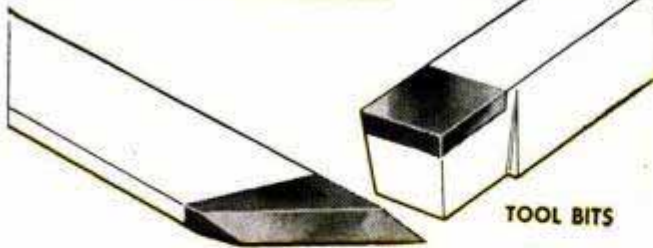

TURNING CHISELS

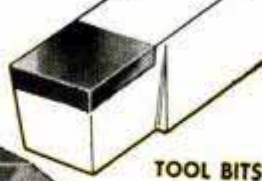

TOOL BITS

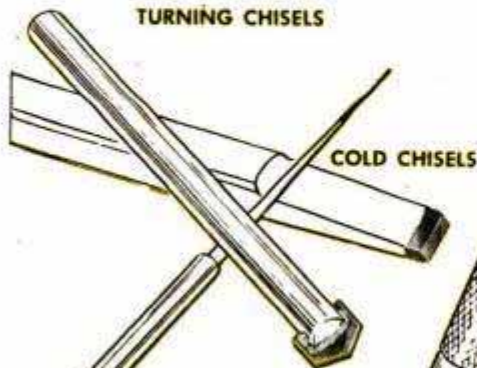

COLD CHISELS



MASONRY DRILLS

SCRIBERS



PRICK PUNCHES



Metal Turning

Capable of being operated at greater speeds than are possible with high-speed steel, carbide-tipped tool bits can be run red-hot without dulling the edge. Wood-turning chisels will hold their cutting edges indefinitely. Plastic will not "weld" when turning

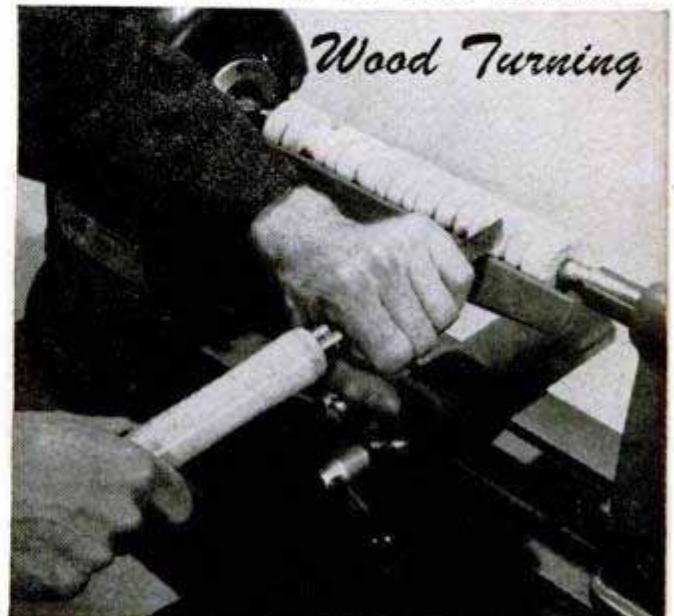

Wood Turning



Planing

Your plane stays razor-sharp once tipped with cast alloy and sharpened. A laborious job by hand, drilling holes in concrete is done in a jiffy with carbide drill



Concrete Drilling

three major developments in the field of metal-cutting tools—high-speed steel, cast cutting alloys and cemented carbides. Although high-speed and super-high-speed steels were a vast step over the use of carbon steel in the field of production, constant efforts were being made to develop an alloy of even greater productive capacity. In striving to obtain alloys that would have the ability to retain hardness at higher and higher temperatures, it was found that by combining suitable proportions of tungsten, chromium, cobalt, carbon and other metals, a property known as “red hardness” was imparted to the alloy, resulting in the cast alloys. As this property is increased, a tool can perform at correspondingly higher and higher speeds. Being superior to high-speed steel, cast alloys will function at cutting speeds about twice as great as those which are practical for high-speed steel. Thus, if 100 s.f.m. (surface feet per minute) is maximum for high-speed steel, the normal range for cast alloys would run from 100 to 200 s.f.m. Cast alloys work best under conditions where the cut is severe and the tool is heavily loaded—not so well for extremely light shaving cuts. The inherent hardness of cast alloy cannot be increased by heat treatment, as in the

TABLE OF SURFACE SPEEDS PER MINUTE

Surface Feet Per Minute	General H. S. Steel Cutting Range						General Tungst. Cutting Range						General Carb. & Cutting Range							
	40	50	60	70	80	90	100	110	120	140	160	180	200	210	300	350	400	450	500	600
	REVOLUTIONS PER MINUTE																			
1/4	611	764	917	1070	1223	1376	1528	1681	1833	2140	2444	2750	3056	3220	4184	5041	5900	6757	7614	9168
3/8	408	509	611	711	811	911	1018	1120	1223	1426	1630	1833	2037	2144	2750	3356	4000	4644	5288	6312
1/2	306	382	458	534	610	686	764	840	916	1070	1222	1376	1528	1681	2140	2596	3152	3708	4264	5128
5/8	244	306	367	428	489	550	611	672	733	856	978	1100	1222	1344	1681	2018	2356	2694	3031	3636
3/4	204	254	304	354	404	454	509	560	611	714	814	916	1018	1120	1376	1630	1884	2138	2392	2880
7/8	171	211	251	291	341	391	436	480	523	612	698	786	872	960	1184	1408	1632	1856	2080	2520
1	157	191	225	259	293	327	382	420	458	534	612	688	764	840	1037	1234	1431	1628	1825	2200
1 1/4	116	145	174	203	232	261	309	334	407	470	544	610	686	762	937	1112	1287	1462	1637	1960
1 1/2	122	151	180	209	238	267	305	326	366	428	488	550	612	674	820	966	1112	1258	1404	1680
1 3/4	111	139	167	195	223	251	277	305	332	388	444	498	552	606	732	858	984	1110	1236	1512
1 3/8	102	127	152	177	202	227	254	280	305	356	408	459	510	561	672	792	912	1032	1152	1392
1 3/4	87	109	131	153	175	197	218	240	262	306	350	392	434	476	576	684	792	900	1008	1224
2	76	95	114	133	152	171	191	210	229	266	304	342	380	418	504	590	676	762	848	1024
2 1/4	67	84	101	118	135	152	170	187	204	238	273	306	339	372	450	528	606	684	762	912
2 1/2	61	76	91	106	121	136	153	168	183	214	244	274	304	334	402	470	538	606	674	816
2 3/4	55	69	83	97	111	125	139	153	166	194	222	250	278	306	366	426	486	546	606	720
3	50	62	74	86	98	110	127	140	153	176	204	230	256	282	336	390	444	498	552	660
3 1/2	44	54	64	74	84	94	112	120	129	164	188	212	236	260	312	364	416	468	520	624
3 3/4	40	49	58	67	76	85	104	110	117	142	162	182	202	222	264	304	344	384	424	504
4	36	44	52	60	68	76	95	101	107	128	148	168	188	208	246	286	326	366	406	480
4 1/2	32	39	46	53	60	67	83	88	94	112	126	142	158	174	208	242	276	310	344	408
5	29	35	41	47	53	59	74	78	83	100	112	126	140	154	184	214	244	274	304	360
5 1/2	26	31	36	41	46	51	64	68	73	88	98	110	122	134	160	184	208	232	256	300

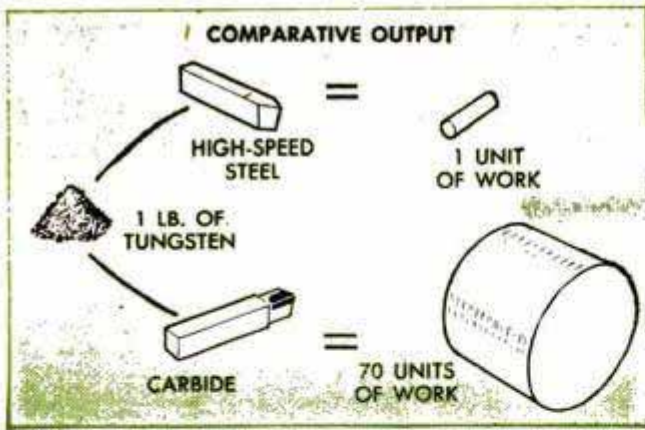

Comparative-output diagram shows clearly reason why cemented carbide has contributed such a phenomenal increase in production over common steel

case of high-speed steel. However, it can be ground with the same type wheels and in the same manner as required for grinding the latter. Also, as cast alloy is somewhat more brittle than high-speed steel and therefore more susceptible to breakage from shock and vibration, it is generally operated with less top and side rakes, as well as less front and side clearance angles. Marketed under such trade names as Stellite, Tantung, etc., cast alloy is manufactured in the form of either complete tools, similar in shape to a common high-speed tool bit, or small blanks for tipping purposes. Cast alloy is particularly recommended where the material being worked is wood, plastic, hard fiber or soft metal,

Actual manufacturer's report shows striking performance record between high-speed steel and cast alloy (Tantung) before cutting tool became dull



Tipped with teeth of diamond-hard carbide, your circular-saw blade will remain sharp indefinitely. Even striking a nail occasionally will not dull the blade



Above, constant sharpening of a scraper blade is not necessary when it is tipped with a carbide cutting edge. Below, slotted rod tipped with carbide blank, then ground properly and chucked in drill press, makes excellent drill for boring holes in glass and fiber

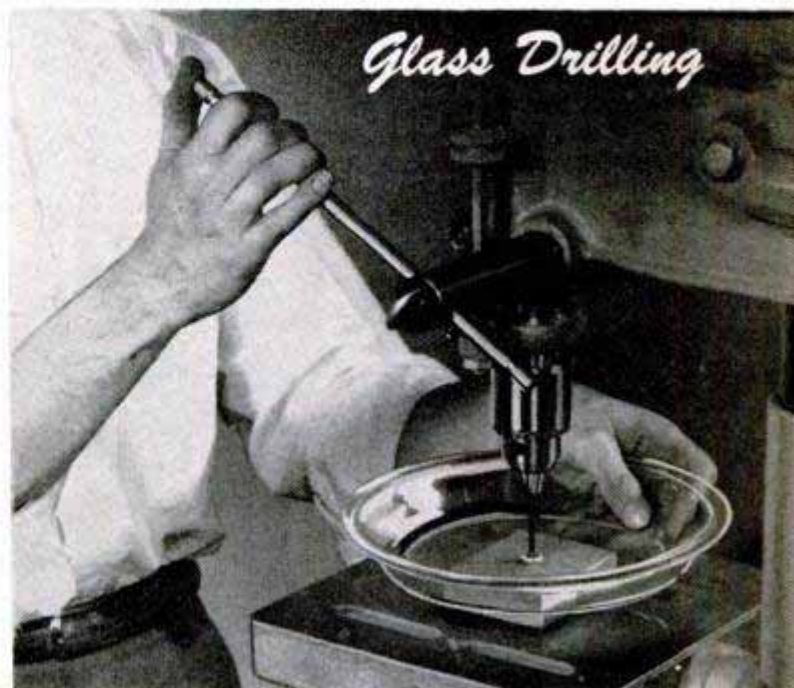
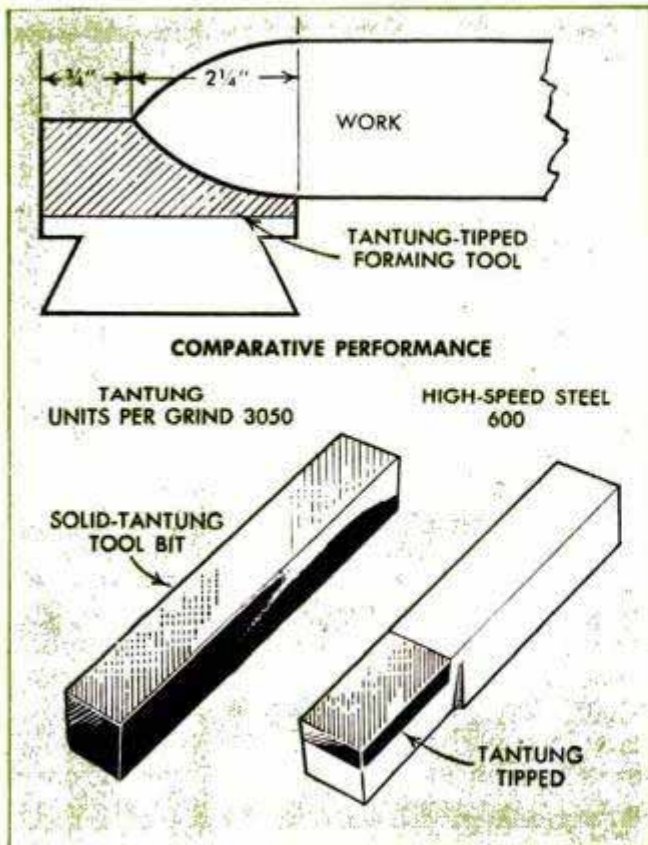

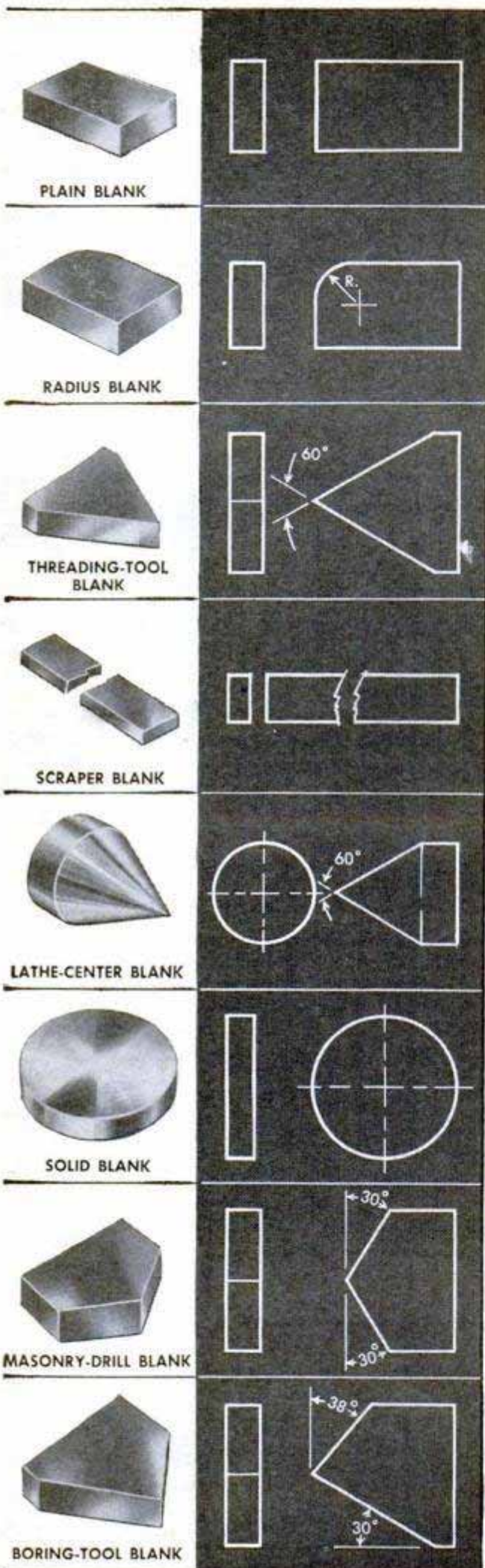

CUTTING SPEEDS TO USE FOR MACHINING VARIOUS MATERIALS

Material	Operation	Cutting-Speed Range (Surface feet per min.)
Gray cast iron	Heavy roughing	150 to 250
	General purpose	175 to 300
	Finishing	250 to 400
Malleable cast iron	General purpose	200 to 300
	Finishing	250 to 500
Steels: Carbon, low and medium alloy types, in usual hardness range for machining	Heavy roughing	125 to 250
	General purpose	175 to 300
	Finishing	250 to 350
	Precision boring	275 to 400
High manganese	General purpose	30 to 90
SAE 52100	Roughing	75 to 150
	Finishing	100 to 200
Annealed high-speed steel	General purpose	100 to 200
Stainless steel	Roughing	150 to 225
	General purpose	175 to 250
	Finishing	225 to 300
Aluminum	General purpose	500 to 1000
	Finishing	600 to 1500
Magnesium	General purpose	600 to 1500
Brass and bronze	General purpose	250 to 500
	Finishing	400 to 1000
Phosphor bronze SAE No. 64	General purpose	150 to 250
	Finishing	200 to 300
Plastics, plywood, casein products and carbon	General purpose	300 to 500
Asbestos, fiber, hard rubber, mica and hardboard	General purpose	200 to 400
Concrete, glass, porcelain, tile and transite	General purpose	100 to 200

and where it is not feasible to operate a particular machine at the high speed required for using cemented carbide.

In contrast, cemented carbide is considerably harder than cast alloy and approaches the hardness of the diamond. Capable of operating at high speeds and at a surface temperature of 1800 deg. F., the production-output potentialities are even greater, and cemented carbides consequently are employed wherever the particular machine tool can be safely operated at the high speed required. Cemented carbide consists of pure tungsten particles fused together with cobalt. These are mixed and pulverized in ball mills until the particles have been reduced to a diameter of 25 to 75 millionths of an inch. Using the processes of powder metallurgy, the powder is pressed in a carbide-lined die of suitable size and shape under pressure of 10-30 tons per sq. in. The resulting compact is fragile, but after heating to red heat in a furnace with a hydrogen atmosphere, it can be handled readily and ground, shaped or drilled. A second heating in specially designed furnaces, either hydrogen, atmosphere or vacuum, to temperatures of 2400 to 2800 deg. F. shrinks the compact and develops its full hardness of 85-93 Rockwell A. Small carbide tools often are made solid, especially when used in holders such as boring bars, but generally the carbide is

used as cutting tips which are brazed or clamped in steel-tool shanks.

Carbides as a cutting agent are by no means limited to machine-shop use — the handy man, carpenter and the craftsman in his basement shop can enjoy the use of this remarkable cutting alloy. Astounding as it may seem, the wood turner, for example, by tipping his chisels with carbide may need to resharpen them only once during a period of 10 years under normal usage. Lathe chisels tipped with carbide have been known to withstand continuous cutting 24 hours a day for a period of three months without sharpening. Those who like to work with plastic will find that the material will not "weld" to the cutting tool or burn the edge when it is tipped with carbide. Soft metals, including cold-rolled steel, can be turned freehand and at wood-turning speeds. Your power-saw blade when tipped with carbide will cut through rock maple like butter and you'll not be concerned about dulling the blade in ripping grit-covered, concrete-form boards, or accidentally striking a nail. Plane irons and wood chisels are two other excellent examples where these tools will hold their razor-sharp edges indefinitely. Hours of sharpening time can be saved by tipping paint and cabinet-scraper blades with carbide. Home-made drills tipped with carbide make play of drilling glass, porcelain, ceramics and concrete. In addition to being a remarkable cutting agent, the extreme hardness of carbide and its natural resistance to friction and corrosion make it ideal for all surfaces subject to excessive wear, such as your lathe tailstock centers and similar parts. Part II of this article will describe how easy it is to braze the blanks to your workshop tools using a small torch, and will explain how to grind the carbide tips after brazing. ★ ★ ★

Information courtesy Vascoloy-Ramet Corp.

Water Piped From Windmill Pump Cools Milk and Waters Stock



In order to cool small quantities of milk in warm weather, a farmer pipes water from a windmill pump into a large half-barrel in which a can of milk is placed. Another pipe, located several inches lower than the inlet pipe in the barrel, then carries the water into a concrete supply tank which, in turn, gravity-feeds a trough in the barnyard. With the windmill left in gear, the arrangement not only circulates cool water in the barrel continuously but also provides the stock with a constant supply of fresh water.

Joe Burkhart, Vinton, Iowa.

Hay Bales Protect Celery in Ground During Early Winter Months

One farmer uses damaged and weed-filled bales of hay to protect rows of celery in his garden during early winter months. The bales are placed end to end on both sides of a row of celery, about 6 in. from the plants, to form a continuous channel which then is capped with more bales. A bale at each end of the tunnel seals it against frost and cold air. Plants protected in this manner bleach white and stay crisp well into the winter months.

Sandpaper Facing on Miter Gauge Prevents "Creeping" of Work

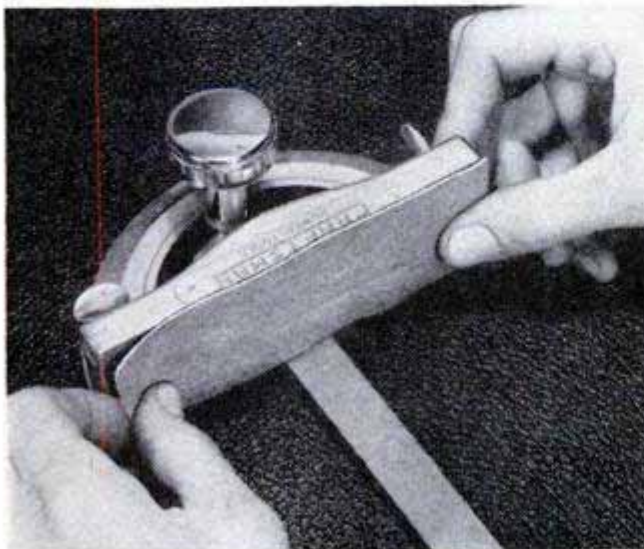

Home craftsmen and others who experience trouble with work "creeping" when mitering on a circular saw can overcome the trouble by facing the miter gauge with sandpaper, which will provide a nonslip surface against the work. Attach the paper with model-airplane cement or rubber cement, or adhesive used to attach abrasive paper to sanding disks.

Henry Hanscom, Elmhurst, Ill.

☞ When using a posthole digger in heavy, clay soil, the annoyance resulting from the sticky substance adhering to the blades can be eliminated by pushing the blades of the digger into a bucket containing oil-soaked gravel from time to time.

Garden Tools Stored Overhead in Racks Suspended From Ceiling



In order to store a large variety of gardening tools in a neat, orderly manner, one truck gardener devised overhead racks constructed of 2 x 4s for the purpose. Secured to a wall at one end, high enough off the floor to permit a man to walk beneath them, pairs of 2 x 4s are extended from the wall and joined together with boards to form frames which, in turn, are suspended from the ceiling by other boards. The frames are located in varying proximity to one another in order to make it possible for the tools, which may include hoes, rakes, spades, shovels and beet choppers, to be slipped in between them and stored upside down as shown. The size and number of racks necessary will be determined, of course, by both the quantity and shape of the tools to be stored. For simpler requirements, a small number of tools may be stored between two 2 x 4s extending from wall to wall across the back of a garage or shed. The tools are stored simply by slipping them up between the members and turning them a $\frac{1}{4}$ turn to hold them in place.

Loading Winch on Machinery Trailer Driven by Tractor Power Take-Off

A tractor-powered winch on a machinery trailer saves time and labor when loading heavy equipment for transport from farm to farm or from one field to another. The cable-winding drum is driven by a bevel gear mounted in a yoke and connected to a telescoping power take-off shaft. The drum shaft turns in sleeve bearings welded to angle-steel uprights which are bolted to the front cross member of the trailer frame. Note that the drum is mounted off-center on the trailer frame so that the take-off shaft will be centered when the trailer bed is tilted for loading. A spring latch holds the bed in a level position.

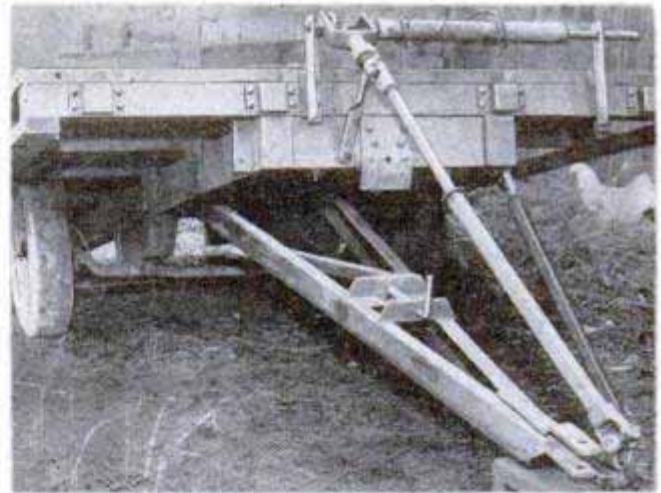

Gauge for Plane-Iron Holder Indicates Grinding Angle

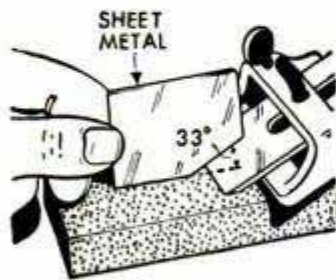

When a fixture is used to hold a plane iron or chisel for sharpening, it often is difficult to determine the proper angle to hold the tool to obtain the correct

honing angle. On plane irons this is especially important to satisfactory performance of the cutting edge after sharpening. The problem is solved easily with a sheet-metal setting gauge. To make the gauge cut a rectangular piece about $1\frac{1}{2}$ in. wide and

3 in. long from heavy sheet metal. Cut off one corner with tin snips, the angle of the cut being equal to the angle of the bevel at the cutting edge. Then lock the iron in the holder, place it on the oilstone and slide the gauge against the iron as shown in the accompanying illustration. This will indicate the angle at which the iron should be held as it is moved back and forth across the oilstone. If the bevel is rounded the plane iron should be ground before honing.

☐ A spoonful of pine oil, cedar oil or citronella added to paint, will repel bugs and insects from freshly painted areas.

TELEVISION TODAY

NOW that restrictions on television-station construction have been lifted, the sky line will soon take on a new look with the advent of UHF antennas of weird design. The one shown in photo A appeared in the recent Electronics Parts Show in Chicago. It is designed to receive both the VHF and UHF channels and is claimed to cover the entire spectrum of TV channels from 2 to 83. One of the new UHF indoor corner reflector types is illustrated in photo C.

The miniature TV receiver demonstrated by the young lady in photo B was designed by an English firm to emphasize the much larger picture provided by their 15 and 21-in.-tube domestic receivers. It consists of a cabinet built to about $\frac{1}{12}$ scale and uses a 1-in. picture tube powered externally by means of a cable connected to a standard TV chassis. A similar nonworking model has been authorized for installation in Queen Mary's dollhouse at Windsor. A number of these miniature working units have been constructed for dealers' displays and for trade exhibitions throughout the country.

A new three-station UHF translator to be installed in current G.E. television receivers is illustrated in photo D. The unit's station-selector switch and a UHF-station dial plate are mounted behind the present VHF tuning knob.

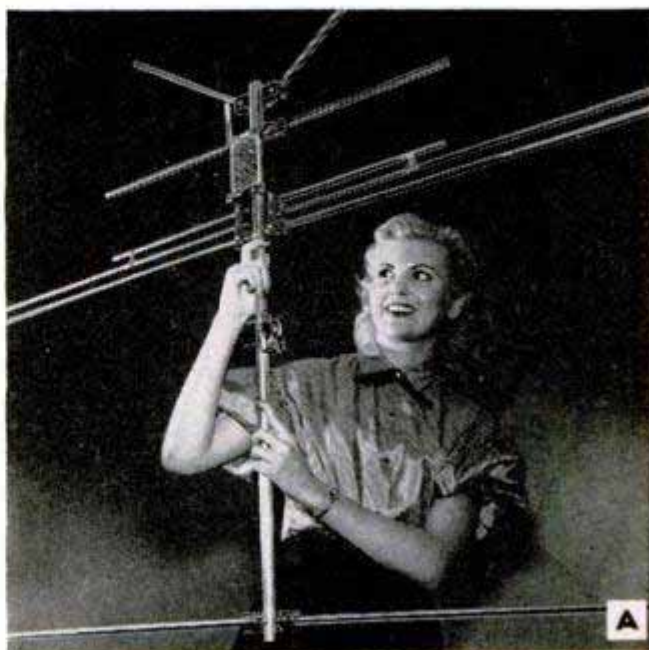

BATTERY ELIMINATOR FOR

By Lothar Stern

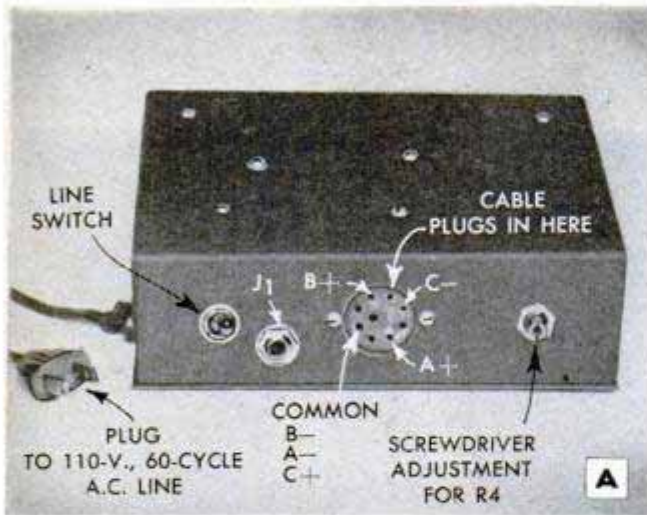
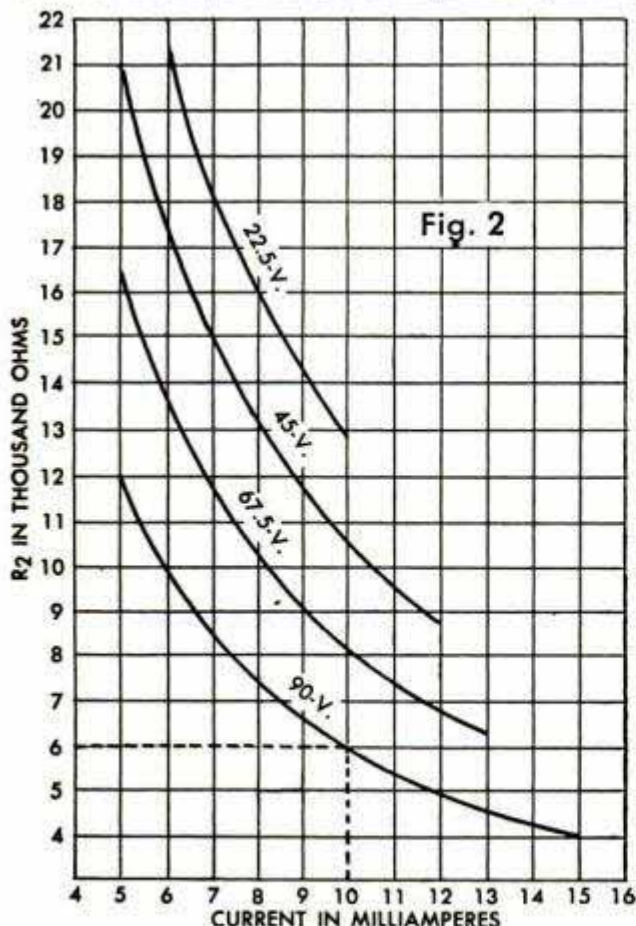

Fig. 1 RESISTANCE VALUES REQUIRED FOR VARIOUS VALUES OF FILAMENT CURRENT AND VOLTAGE

FIL. CURRENT	FILAMENT VOLTAGE			
	1.5-V.	6-V.	7.5-V.	9-V.
.05 AMP.	3000 OHMS	2880 OHMS	2850 OHMS	2820 OHMS
.1 AMP.	1500	1440	1425	1410
.15 AMP.	1000	960	950	940
.2 AMP.	750	720	712	705
.25 AMP.	600	575	570	566
.3 AMP.	500	480	475	470
.35 AMP.	420	410	400	395



THIS ELIMINATOR provides a simple, inexpensive method for operating battery sets on house current and thus extends their usefulness. It also can be used to power farm radios in areas where electrification makes battery operation no longer necessary. Only a few adjustments of the components are required to use this battery eliminator with most portables, farm sets, or civil-defense communications receivers, such as the one shown in photo B.

The values of the components depend upon the filament and B-plus voltages required for your particular set. You must know the number of tubes in your set; the current and voltage that the filament portion of the battery eliminator must furnish; the voltage and current required of the B-plus portion; and what bias voltage, if any, is necessary. Since these vary with different makes and models, a single eliminator unit cannot be built without including the many variable components shown in Fig. 3. Once individual requirements are determined, you can use less-expensive fixed components if you prefer to do so. All parts values for the adjustable universal model are given.

You should have the manufacturer's schematic of your set, or its Howard W. Sams Photofact folder for current and voltage data. In most battery sets the filaments of tubes will be in parallel; filament voltages and currents for each individual tube can be determined from any tube manual. If the filament circuit is in parallel, the total filament voltage is unchanged. The total current, however, is the sum total of the filament current required for each individual tube. Thus if your set uses four tubes and each requires .05 amp. at 1.5 volts, the battery eliminator must provide 2 amp. at 1.5 volts. The value of resistor R_1 determines the amount of current and voltage available for the filaments. Once you know the requirements of your set, the correct value of R_1 can be found from the table, Fig. 1. As the value of resistor R_1 is rather critical, a variable resistor is recommended and an ohmmeter should be used to set it to the correct value. After the eliminator is completed and connected to the radio, a voltmeter should be used to check the filament and B-plus voltage under load. The maximum output available here is 15 ma. (.015 amp.) at 90 volts. This output is suitable for the great majority of battery sets. By increasing the value of R_2 , the voltage output can be reduced to any desired value

PORTABLES AND FARM RADIOS

below 90 volts. The correct value for R_2 for your set can be found from the graph in Fig. 2; R_2 is not critical. The four curves in the graph represent various battery voltages. Suppose your receiver requires 10 ma. at 90 volts. Draw a vertical line from the point marked 10 on the horizontal axis until it intersects the 90-volt curve. A horizontal line to the vertical axis shows R_2 should be 6000 ohms (see dotted lines).

The C-negative biasing portion of the eliminator consists of a separate rectifier and filter system. Comparatively few battery sets require an external bias; if your receiver does not require it, the entire bias section in diagram Fig. 3 may be omitted. If required, use the adjustable-bias arrangement with values specified for R_3 and R_4 . The required bias voltage can be set with R_4 from 0 to -120 (with respect to the common B-point). All parts are mounted on a $7 \times 7 \times 2$ -in. metal chassis, as shown in photo C. An $8-32 \times 2$ -in. machine screw should be used to mount the large selenium rectifier. The type of output socket, see photo A, depends on the battery plugs used in your radio. A socket removed from your old battery pack will solve this problem. Follow whatever pin connections appear on the original. You will require the separate filament jack J_1 if a separate A-battery was used. Always be sure to turn the radio "on" before the battery eliminator. ★ ★ ★

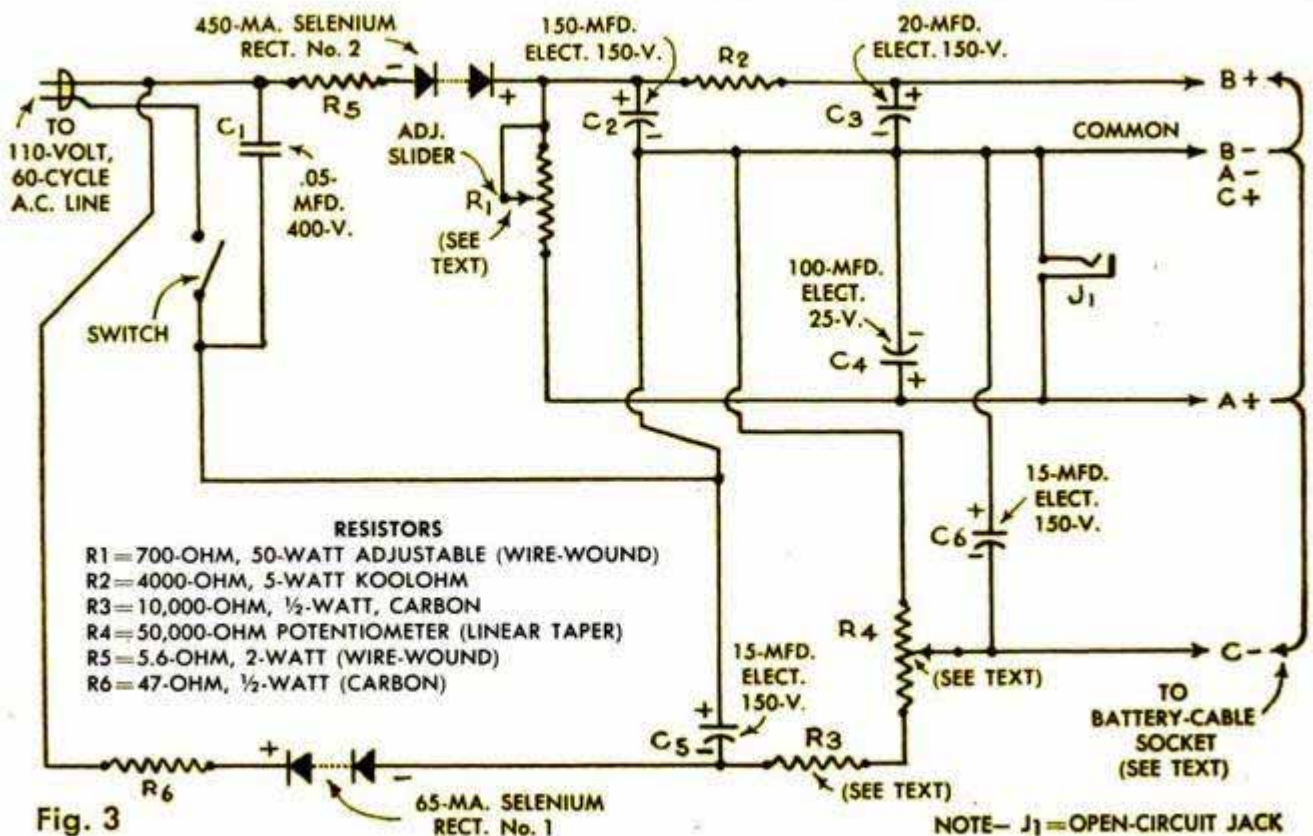

By Frank L. Brittin



A

Operating Characteristics

- Ranges.....5, 10, 30, 100 and 200 naut. mi.
- Range Markers.....2, 5 and 25 mi.
- R.-F. Operating Frequencies:
 - Transmitting 9375 (± 55) mc.
 - Receiving (search) 9375 (± 55) mc.
 - Receiving (beacon) 9375 (± 1) mc.
- Peak Power50 kw.
- Pulse-Repetition Rate and Length:
 - Search (5, 10, 30 mi.)
800 p.p.s., 0.75 microsec.
 - Search (100, 200 mi.) 200 p.p.s., 3.5 microsec.
 - Weather (all ranges) 200 p.p.s., 3.5 microsec.
 - Beacon (all ranges) 300 p.p.s., 2.25 microsec.
(*Pulses per second)
- Pencil-Beam Dimensions:
 - Approx. 6 deg. in horizontal plane; 7 deg. in vertical plane, measured between half-power points
- Antenna Scan Rate:

	Full Scan	Sector Scan
5, 10, 30 mi.	40/min.	90/min.
100, 200 mi.	15/min.	35/min.
- WeightApprox. 175 lb.
- Power Consumption:
 - 1000 va., 400 c.p.s., 115 v.;
 - 200 watts, 28-v. d.c.
- Indicators (2)5-in. CR tubes

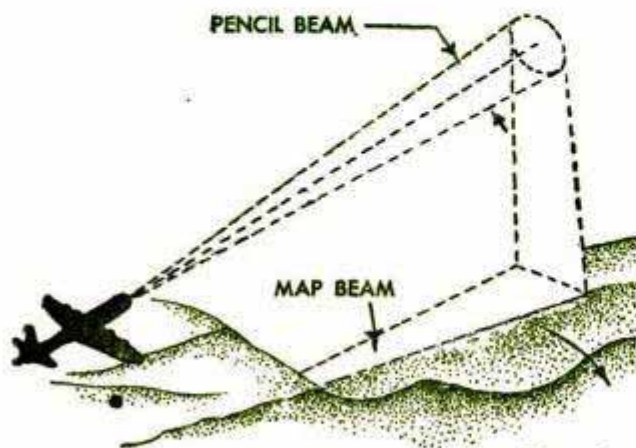

FIG. 1

SEEING-EYE radar of advanced design has already been the means of saving the crew and passengers of a Navy transport. This passenger-packed transport had just taken off in foggy weather when the control tower erred in instructing the pilot to make a right turn that would have taken him into the side of a hill. Fortunately, the plane was equipped with one of the new radar scopes for airplanes, and the pilot noticed the obstacle and made the correct turn. No statement was made as to where or when the incident occurred, except to advise that the field was not a military field.

One of these new lightweight radar collision-warning sets has been installed in the President's plane, the *Independence*, and on various military air transports. It is a marvel of compactness and efficiency and it is suitable for commercial aircraft. At the present time, however, this advanced R.C.A. equipment is being produced under Navy contract for military use only and is scheduled for production under an Air Force contract. Similar much heavier equipment has been used for some time in military combat aircraft. The advantage of this new unit is not only its light weight but also its simplicity of operation.

As a means of collision warning it will show mountains or other aircraft in the vicinity. As an accurate indicator of weather conditions, it will show the position of thunderheads and other cloud formations, thus enabling the pilot to avoid turbulent weather or to select a safe course through it. It provides a means of position location when standard landmarks are not visible; it can also pick up the signal of ground-based radar-range units.

According to engineers, the new unit permits the pilot to see a close-up view of a selected area as if he were using a powerful telescope that could penetrate through darkness and clouds. Another type of operation is that of mapping terrain. Through a special discrimination circuit, it shows the pilot the salient characteristics of the land over which he is flying.

The range of the system can be selected by the pilot for distances up to 200 miles from the plane. A selector switch permits the pilot to bring into view all obstacles and terrain within 5, 10, 30, 100 or 200 naut. mi. of his plane. When designed solely for navigation, obstacle and weather detection, the device weighs about 173 lb. before installation. It is pressurized to operate at altitudes up to 50,000 ft. and it is claimed

STEPS UP PLANE SAFETY

to be the first system of its kind to go into production that has both military and commercial application.

Signals from the radar antenna can be transmitted either in the form of a pencil beam for obstacle detection and general search or in the form of a vertical fan for mapping and navigational aid. The pencil beam, Fig. 1, has been compared to a flashlight with invisible rays which will show the pilot everything within a full circle of 400 mi. diameter. The beam can be raised or lowered to enable the pilot to look at the ground below and ahead of his plane or to measure the height of thunderheads and other clouds. The vertical fan position shows a picture of the ground up to a distance of 200 mi. ahead and to either side of the aircraft. The thin pencil beam, which is aimed horizontally, or approximately so, illuminates only potentially dangerous objects, or precipitation, which means those near or at the plane's own altitude. Thus the thin beam largely eliminates echoes from low terrain at critical times when the pilot is solely interested in seeing potentially dangerous storms or terrain at his flight altitude. Should the pilot spot a thunderstorm at that altitude, he can tilt the antenna and its beam to search for storm-free altitudes.

The three radar screens shown in Fig. 2 present a constant picture of everything in front of the airplane as it nears dangerous terrain. The warning shadow first appears



at the edge of the scope and, if no evasive action is taken, the terrain echo will invade the safety circle. When the shadow first appears along his flight path the pilot has advance warning, giving him plenty of time to climb out of danger. The range-azimuth indicator (radar scope) will show when he has reached a safe flight altitude.

Photo A shows Comdr. M. A. Mason, head of the Navy Bureau of Aeronautics Radar Section, and, right, W. B. Kirkpatrick, R.C.A. engineer, examining the simplified control box of the lightweight radar set. Photo B shows the complex arrangement of the radio and electronic components in the interior of the device. ★ ★ ★

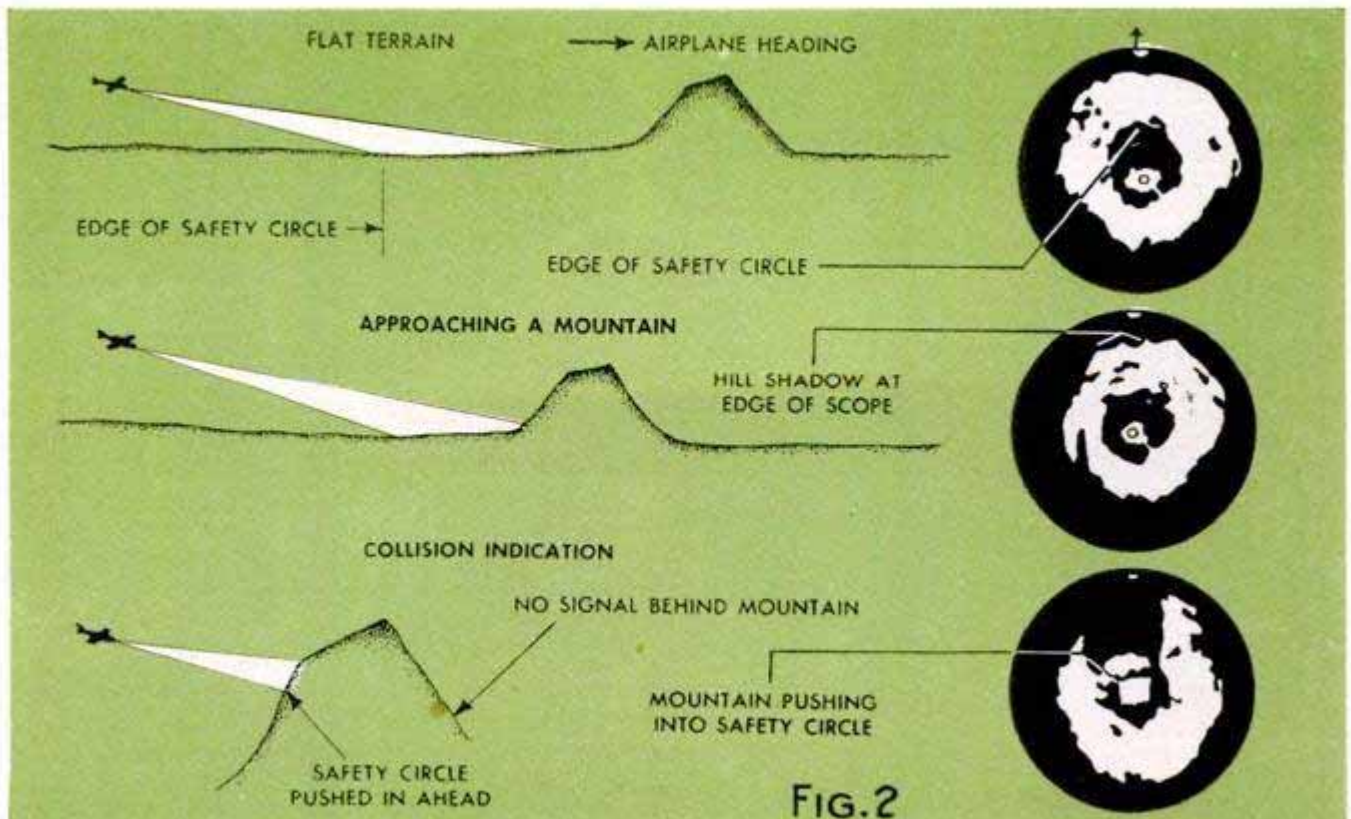
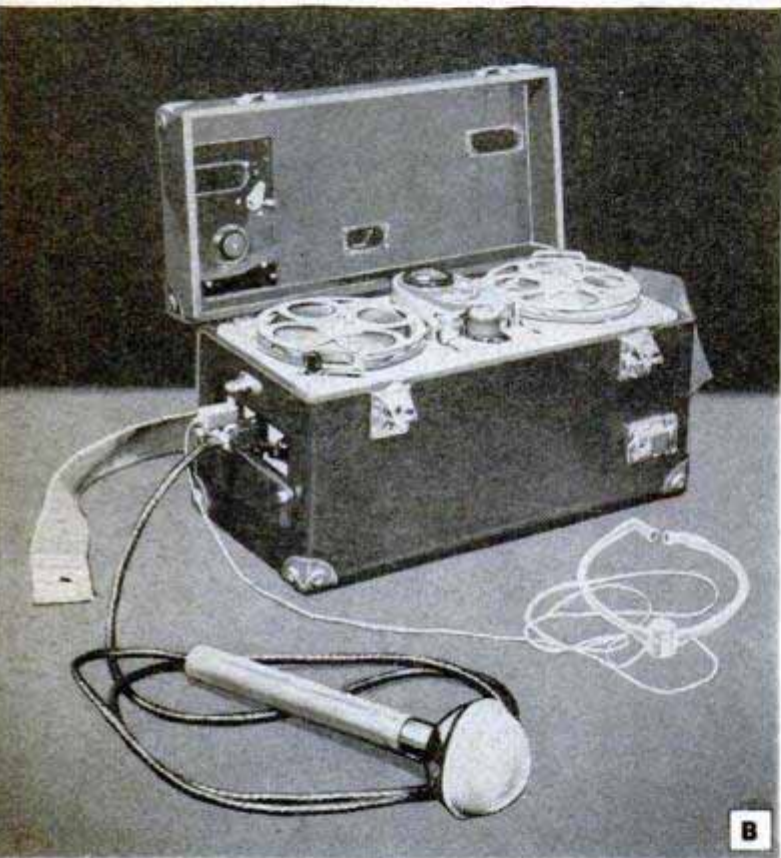

FIG. 2



A



B

Adventures in Sound

PERHAPS one of the first outstanding adventures in realistic sound reproduction was the fantastic "living presence" effects achieved in the Walt Disney movie *Fantasia*. Sound engineers have been working to obtain similar "three dimensional" effects in recording and reproduction for the music lover, teacher and high-fidelity enthusiast. Equipment recently demonstrated at the 1952 Audio Fair in Chicago employs an efficient binaural method of tape recording that seems to make recorded music originate in the room instead of in the headphones. In photo A, Eugene Carrington, a well-known sound engineer, is listening to a playback of tape-recorded music by this method. The binaural method is based on the premise that we listen to sounds with both ears—we therefore sense the location of the sounds and are able to concentrate on any one sound to the partial exclusion of others.

In recording, auditory perspective is preserved by using two microphones spaced about 8 in. apart. The output is fed through two separate channels in the recording amplifier and is recorded on two halves of a single 1/4-in. tape. In playback, each channel is fed separately into the earphones.

Many adventures in sound-recording reporting of on-the-scene events are heard on radio broadcasts. A lightweight, battery-operated, portable magnetic-tape recorder of English make used for this purpose is illustrated in photo B. A foundation kit for the efficient Williamson audio-amplifier unit, photo C, and the folded-horn corner enclosure for 8-in. loudspeakers, photo D, were focal points of interest to experimenters in sound who attended the Audio Fair.

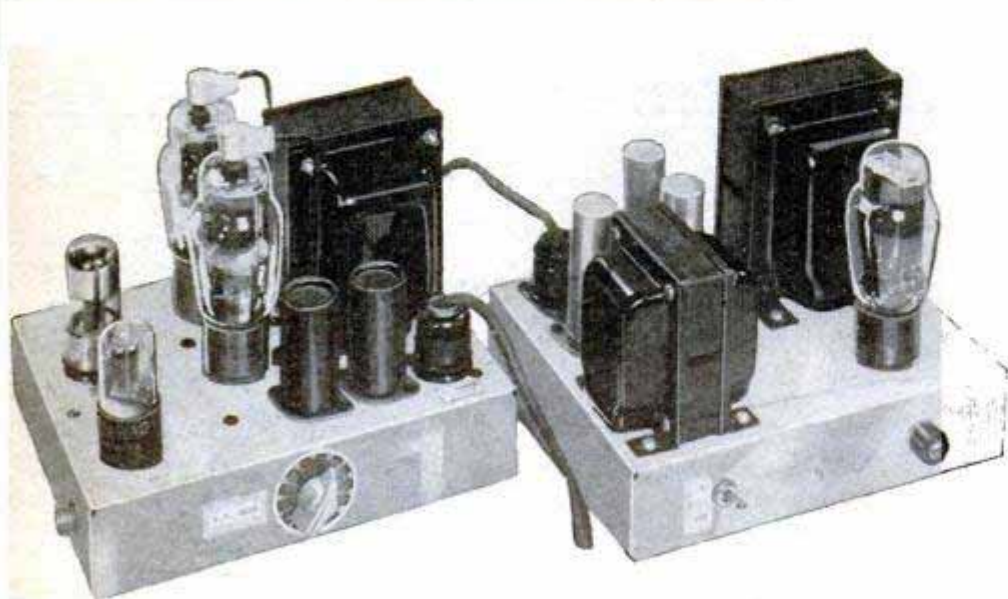

C

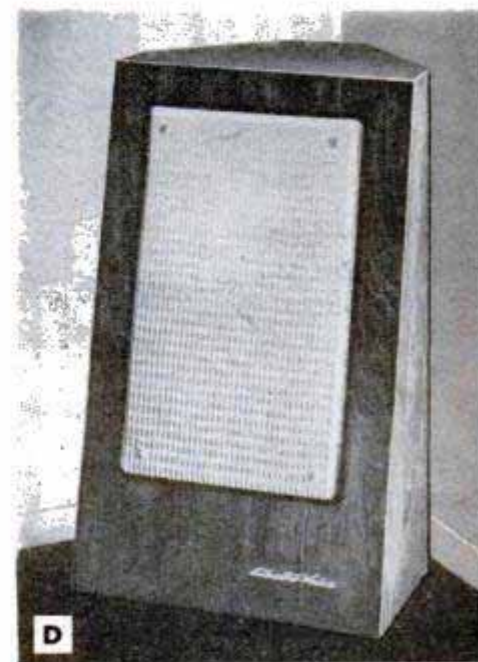

D

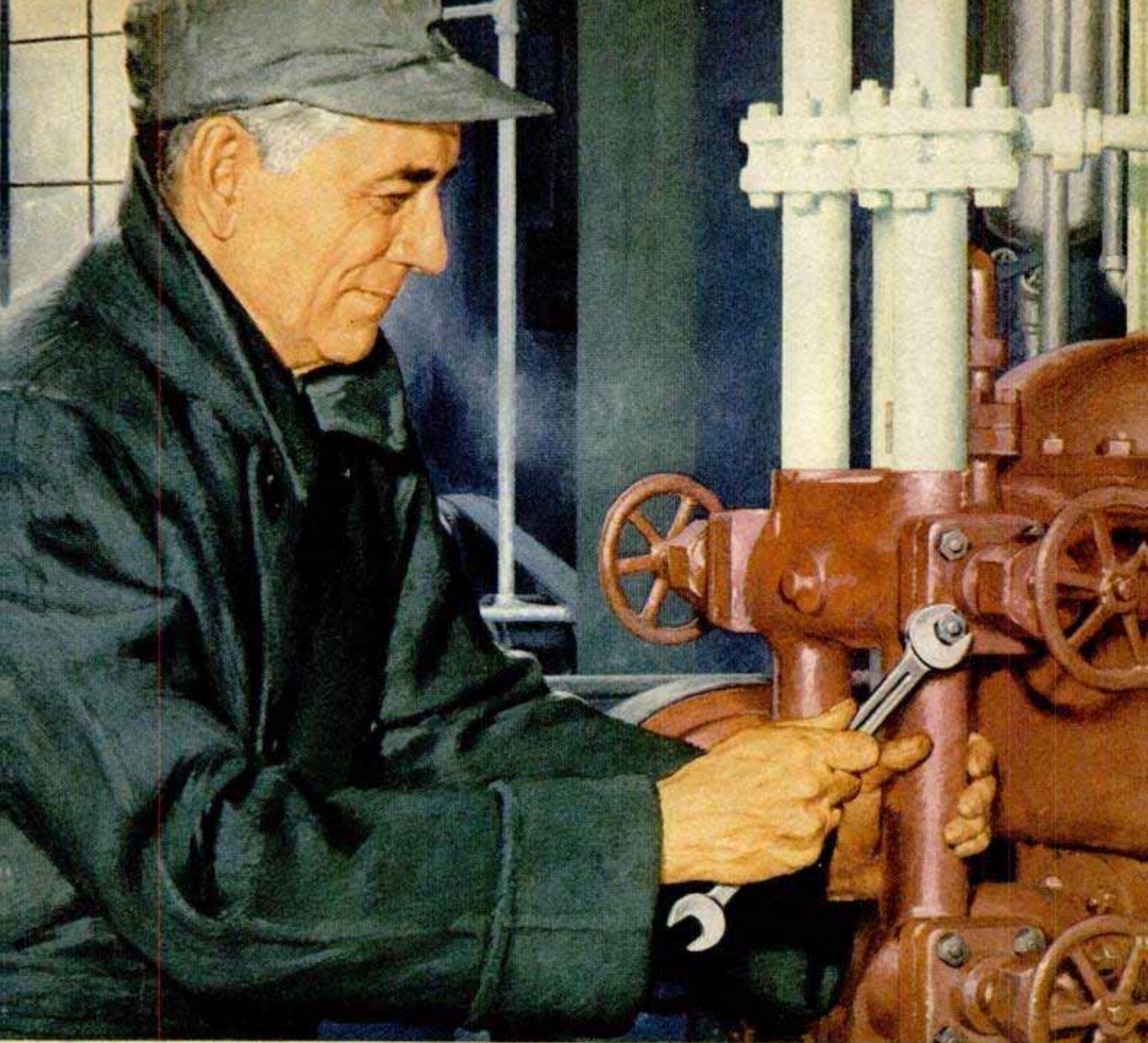

PERSISTENT IN PERFECTION . .

Your goal is a perfect job. Only the best of materials, the most careful workmanship, and the finest of tools are good enough for you. And you are quick to recognize the work of other real mechanics who, like yourself, are persistent in perfection.

Perfection is the standard to which Bonney wrenches are made. Mechanics call them America's finest—unmatched for lightness, strength, balance, and precision.

Bonney wrenches are the pride of the men who make them . . . the pride of the men who use them.



Persistent in perfection, refrigeration equipment manufacturers like Carrier, Frick, Norge, York, Refrigeration Corporation of America have revolutionized the processing and preservation of food.

BONNEY FORGE & TOOL WORKS



Piston Rings wear out, too



TOUGH..but oh so gentle !

TOUGH on oil-pumping
GENTLE on cylinder walls

And there's just one thing to do about worn-out piston rings—replace them! Fortunately, piston rings warn you when they begin to wear. You start using too much oil. Your engine begins losing power. The more you delay the more you'll pay.

Naturally you want the rings that are *tough* on oil-pumping, *gentle* on cylinder walls. You want the rings that will stretch out your engine's life. You want Hastings Piston Rings—the rings that are engineered exclusively for replacement service. They *stop* oil-pumping, *check* cylinder wear, *restore* engine performance—for a long, long time—and at surprisingly moderate cost. It's the best money you can spend on your car.

Play safe. Avoid a major overhaul later on. Go to your motor specialist and ask him for a piston ring check-up now.

HASTINGS MANUFACTURING CO., HASTINGS MICHIGAN; HASTINGS LTD., TORONTO
Makers of Piston Rings, Spark Plugs, Oil Filters, Casite, Drout

HASTINGS

MOTOR-ENGINEERED PISTON RINGS

Featuring Chrome for Heavy-Duty Service





Now You've **TWICE** the Reason
to Insist on

**THE BEST HOUSE PAINT
YOU CAN BUY!**



This sketch illustrates the greatly increased value of many residential properties in the last few years.

Doubled property values give you twice the reason to protect and beautify your house with the best house paint you can buy.

Don't be fooled about house paint claims. Many house paints cost less than famous SWP. But no house paint offers so much real quality at so little cost. That's because SWP is *Weatherated* . . . field-tested and laboratory-tested to withstand all that weather and wear have to offer. Tested toughness is built into SWP to keep your house looking better *longer*. And enough SWP for the average six-room house costs less than \$45.00!

Now is the time to paint your house with SWP. Look for the familiar "Cover-the-Earth" sign . . . the sign of a friendly Sherwin-Williams dealer who will recommend a reliable painting contractor, if you wish. He can help you with *interior* decoration too . . . ask for your free copy of the Home Decorator or ask to see the Paint and Color Style Guide.

IT'S WEATHERATED

SWP House Paint is tested rigorously for its ability to resist chalking, checking, cracking, fading and dirt collection.



NOW is the time to paint your house with

SHERWIN-WILLIAMS PAINT

A Kodak Miniature Color Camera—there's one for every budget



Fine, extra-thrifty "miniature"—The budget-priced Kodak Pony 828 Camera gives sharp black-and-white negatives . . . superb color slides on Kodachrome Film . . . gorgeous Kodacolor snapshots. Kodak Anaston $f/4.5$ Lens (Lumenized); Kodak Flash 200 Shutter with built-in "synch." Takes 8-exposure rolls. \$31.15. Kodak Field Case, \$7.00. Pony 135 Camera for 20- or 36-exposure 35mm. film, \$35.75. Kodak Flashholder fits both cameras, \$10.55.

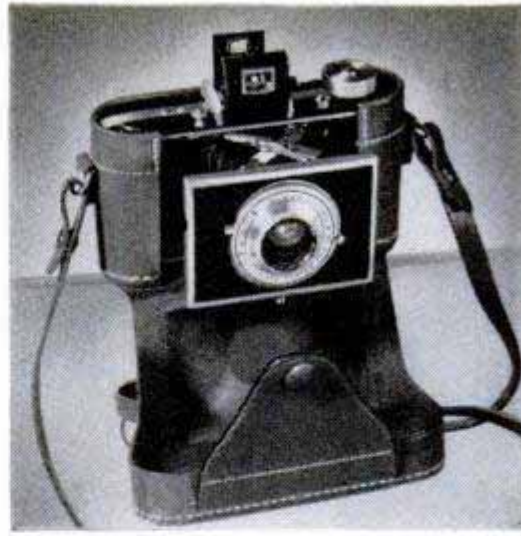

Smallest of the "miniatures" . . . and one of the best—The palm-size Kodak Flash Bantam $f/4.5$ Camera takes 8 exposures on black-and-white Kodak 828 Films, Kodachrome or Kodacolor 828 Film. Lens is superbly corrected Kodak Anastar $f/4.5$ (Lumenized). Flash synchronization is built into the $1/200$ shutter. Automatic film stop and body shutter release make for fast, simple operation. \$56.00. Kodak Flashholder, \$10.55. Kodak Field Case, \$7.00.

How to make the most of Autumn's

Every golden field, every fiery maple cries out to be "snapped" in color. So be sure to take along your camera—and plenty of color film—on Fall outings. You'll see great picture possibilities at every bend in the road.



Precision range-finder "miniature"—The Kodak Signet 35 Camera, with world-famous Ektar Lens ($f/3.5$), produces sharp, brilliant color slides for projection or full-color prints with 20- or 36-exposure Kodachrome 135 Film; also clear black-and-white pictures with Kodak 135 Films. Has feather-touch shutter release bar, shutter with speeds up to $1/300$, built-in flash synchronization. \$92.50. Flashholder, \$10.55. Kodak Field Case, \$8.50.



Ultra-fast "miniature" in a new model—The Kodak Retina IIa Camera now features rapid film-advance lever, built-in flash. Also has fast $f/2.0$ coated lens in a $1/500$ shutter, range and view finder combined in a single window, automatic double-exposure prevention, film stop, and counter. Takes 20- or 36-exposure black-and-white Kodak 135 Films or Kodachrome 135 Film. \$164.10. Flashholder, \$10.55. Kodak Field Case, \$10.50.

A projector or viewer—to show your color slides at their brilliant best

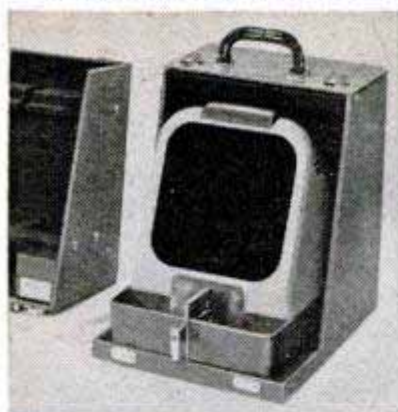

Kodaslide Table Viewer, Model A—Projector, screen, slide changer in one compact unit. Projects brilliant images even in a lighted room. Takes 75 cardboard or 30 double glass slides. \$97.50. Carrying case, \$27.50.

Kodaslide Table Viewer, 4X—Enlarges slides over four times on built-in screen. No fuss, no bother. Just snap it on and enjoy your handiwork. \$49.50. Carrying case, \$15.50.

Kodaslide Merit Projector—Budget-priced instrument for brilliant screenings. New jar-proof slide feeding; Kodak Projection Ektanon Lens, 5-inch $f/3.5$ (Lumenized); built-in elevation device; cool operation. \$26.10. Carrying case, \$9.50.

Kodaslide Projector, Master Model—Fast lenses and 1000-watt lamp can deliver more light to screen than any other 2x2-inch slide projector. Turbine-type fan cools both sides of slide. Choice of 4 projection lenses. From \$169.00. Carrying case, \$50.00.

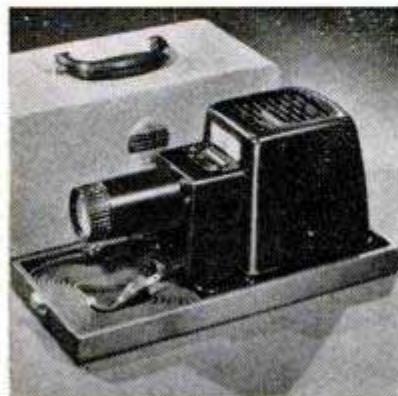

color-picture opportunities

Some suggestions for the perfectionist



If you want your subject to stand out sharply against a dark blue sky in color pictures, use a Kodak Pola-Screen. From \$6.75. Kodak Pola-Screen Viewer for previewing effect, \$6.75.

Kodak Skylight Filter—“Warms up” many color pictures. \$1.65 up. To cut bluishness in flash pictures with Kodachrome Film, Type A, try *Kodak Light Balancing Filter 81C*. From \$2.07.

Inexpensive kits adapt Kodak Tourist and Reflex Cameras for Kodachrome Film—Kodak Tourist Adapter Kit for deluxe model “Tourists,” \$13.25 (left), and the Kodak 828 Adapter for Kodak Reflex Cameras, \$4.59 (right), permit picture-taking in full color on Kodachrome or Kodacolor 828 Film.

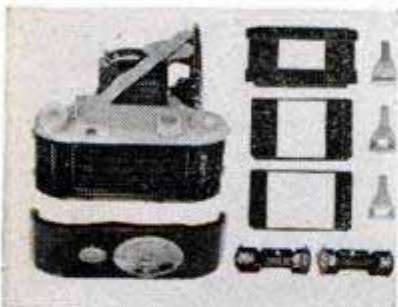

Kodak Auto-Release—Trips shutter, gets the photographer into the picture. \$3.86.



Deluxe file—Kodaslide Compartment File has 12 swing-out compartments for 240 cardboard or 96 glass slides. \$3.94.

Protects valuable slides—Inexpensive metal Kodaslide File Box holds 150 cardboard or 53 glass slides. \$1.57.



See your Kodak dealer for all your photo needs. He'll be happy to “talk shop” anytime you drop in.

Prices subject to change without notice and include Federal Tax where applicable.

EASTMAN KODAK COMPANY ROCHESTER 4, N. Y.

Kodak



Care and Feeding of Engines

BY S. P. CORP

ALIGN THAT ENGINE

When the engine is installed in a passenger car, rubber insulators are used at each engine mounting support. Support bolts are drawn down just enough to fasten the engine securely to the frame. The rubber insulators deaden engine noises and prevent them from being transmitted up into the car.

FRONT ENGINE MOUNTING BOLTS

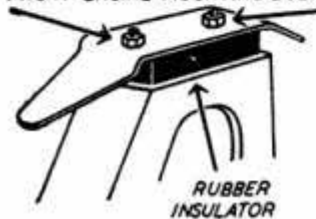

When engines are replaced, it is important that they be properly aligned, otherwise severe engine vibration will be felt in the car.

To correct such a condition, loosen the exhaust support brackets and all engine mounting bolts. Do not remove the bolts. Start the engine and accelerate

it a few times so that the engine will align itself. Then tighten engine mounting bolts and exhaust support brackets.

IT WON'T BE LONG

Before we talk to you again, there will be frost in the northern states. Between now and then, make these six checks to insure easy starting on the first cold morning:

1. Hydrometer-test your battery. If specific gravity is below 1.250, have it recharged. Be sure to see that battery cables are tight and not corroded. Clean cables are important to easy starting.
2. Check distributor cap for cracks. Clean cap and all wires; replace worn wires. Good ignition is vital to quick starting. Remove one wire from spark plug and hold $\frac{1}{16}$ " from engine block. Start engine. If spark jumps gap evenly, ignition is O.K. If erratic, check distributor points for correct spacing and replace any that are burned or pitted. See that all connections are tight.
3. Remove and clean all spark plugs, replacing any with cracked porcelain. Regap to car manufacturer's specifications. Install new gaskets, tighten plugs finger-tight, then use socket wrench just enough to squeeze the gasket.
4. If starter is sluggish, check brushes and commutator. A dirty starter can make the engine start hard.
5. Use a light oil for winter driving.
6. Depress clutch pedal for cold-weather starting.

INSTALL KROMEX RING SETS

To get all the winter power you need, install Sealed Power KromeX Ring Sets, specially engineered for late-model cars and trucks. Top compression rings and steel rails of oil rings have chrome faces to fight heat, friction, corrosion, and abrasion. Write Dept. G-9, Sealed Power Corp., Muskegon, Mich., for new free booklet, "MORE POWER, Less Oil, Less Gas."



What's It Like to Crash?

(Continued from page 132)

of stock cars just like yours—with a few safety devices added—do it all the time. With similar devices, Mr. Average Citizen could be equally safe in his own car. Such safety measures are the things we are testing now. They will have to be part of tomorrow's car if we're going to keep from wiping ourselves out on the highways."

For Junior, the Epping technicians have drawn up plans for a seat that is welded to the frame of the car—back end to the dashboard and low enough so that loose gear in the car will sail over his head in a crash. "Maybe he can't see out but at least he'll live to see another day."

Like the men who race stock cars, Epping technicians have removed the slides from the front seats on experimental cars and bolted all the seats to the chassis so they won't tear loose.

To prevent roof collapse in roll overs they are reinforcing the body with heavy steel uprights that, White believes, will allow a car to cartwheel a dozen times without collapsing. "Stock car racers also weld their doors shut," he says, "to keep them from popping open. While this isn't feasible for a family car, we are working on extra steel tongue locks that would work like those on emergency hatches in airplanes and do the same job. The car owner would have to keep them fastened while the car was in use."

Also like the stock-car racing drivers, all the occupants of tomorrow's car—Epping style—will wear webbed safety belts similar to those airplane passengers use. "They're not especially popular," says White, "but they certainly save lives by keeping a passenger pinned to his seat and preventing him from flying around in a crack-up." Several cars at Epping are equipped with these experimental belts, fastened to the framework and extending up at a 45-degree angle around the passenger's waist. "We've subjected them to a 4000-pound pull and they've held," the men reveal. "With three inches of play (which makes them quite comfortable) a passenger can roll with the shock, distribute his weight and keep from snapping his back as he would if the belt were tight."

One alternative to belts would be reversed seats for everyone but the driver—equally unpopular since few people enjoy riding backward. However, they work.

A lot of work at Epping will be aimed at that skull crusher, the dash panel. Buttons will be recessed so they can't bury themselves in a passenger's head and the panel

(Continued to page 226)

Savage-Stevens



"22's"

scoring hits everywhere

Here are three "22's" that are scoring *hits* for value, dependability and performance with shooters everywhere. See these three different style rifles at your dealer's... lightning-fast auto-loader... smooth operating slide action repeater... handy, reliable single shot. Write for free catalog of Savage, Stevens and Fox shotguns and rifles.

SAVAGE ARMS CORPORATION
Firearms Division • Chicopee Falls, Mass.

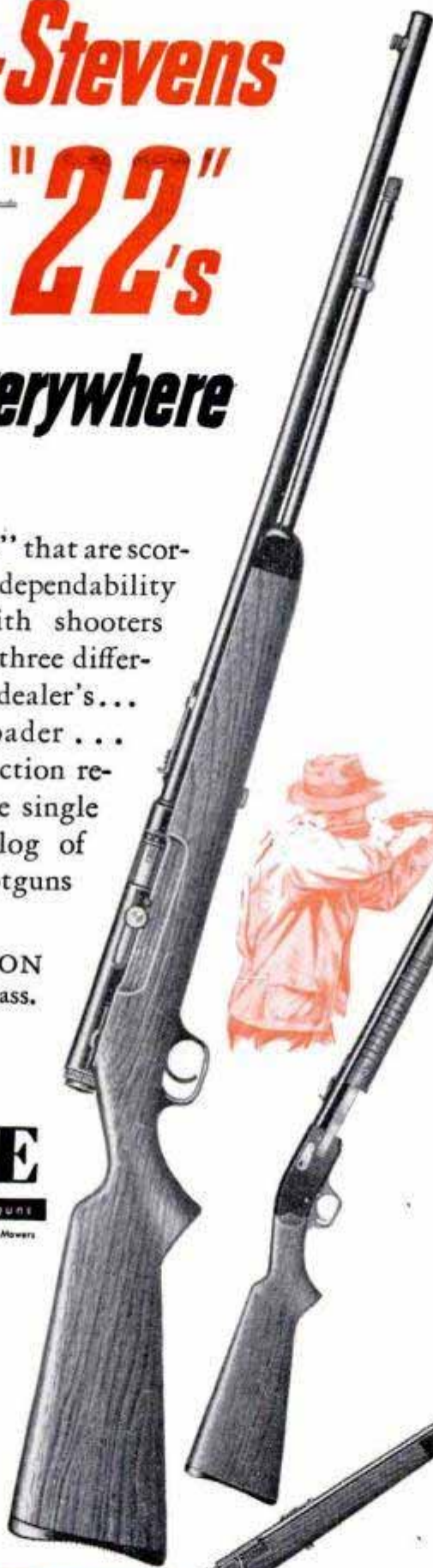

STEVENS MODEL 87

.22 cal. auto-loading rifle—for shooters who want an accurate, moderately priced semi-automatic. Just the rifle for rapid firing at small running game, or for plinking fun. "15 shots as fast as you can pull the trigger." Tubular magazine. Instantly adjustable as auto-loader, bolt action repeater, or single shot rifle. MODEL 85—same as Model 87 except 6 shot, with clip magazine. Both are "three-in-one" rifle values.



Sturdy, simple action—quickly disassembled, without tools, for cleaning.

SAVAGE MODEL 29

Short forearm stroke—slide travels only 1½" in loading and ejecting.



.22 cal. slide action repeating rifle. The famous "22" with the SHORT slide action. A flick of the wrist ejects and loads cartridge smoothly, surely—without disturbing aim or rifle position. Dependable, hammerless action... one-piece bolt removable without tools for cleaning... single take-down screw... walnut stock... extra long slide handle, vertically grooved for firm grip.

STEVENS MODEL 15

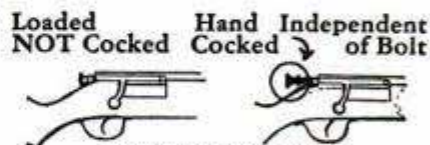

SAFETY FEATURE

.22 caliber single shot, bolt action rifle. Man's size, yet correctly proportioned for youngster's use also. Hand cocking action, independent of bolt, provides maximum safety. And here are some other features: bolt handle directly over trigger for fast operation; newly proportioned stock with handsome black-tip fore-end; 24" barrel; gold bead front and open rear sight with elevator.



Here's how for home painters



A quick, neat trick for painting window frames. Simply cut newspapers to exact size of window pane, soak in water for a few seconds—and then smooth onto the glass. You'll have perfect protection for the pane . . . can paint the wood

trim in no time. You'll get best results with beautiful Devoe Trim & Shutter Colors.

A play place for children—out of a pot of paint. On basement floor or discarded table, help kids paint roads, lakes, rivers. Make houses, boats, bridges from painted pieces of cardboard; trees from small bits of painted rubber sponge. Keeps the youngsters happy and occupied on rainy days.



Easy way to keep tabs on garden tools—paint them in bright colors. Makes them easier to find lying in the grass . . . easier to identify if Junior drags them over to the neighbor's. Use Devoe Mirrolac Enamel for bright lasting colors.

No strain to get rid of hard lumps in old paint. Mix paint . . . then cut piece of wire screen to size of can. Put screen into can and away it goes to the bottom—carrying lumps with it, leaving smooth strained paint above.



You can get all the painting accessories that you need—and many more helpful tips—at the sign of the Devoe Diamond. Why not stop in and see your Devoe Dealer very soon? You'll find his name listed in the Classified Phone Book.



Clinic for Homemakers

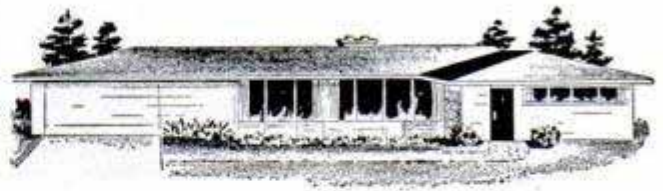

As a service to our readers in solving the hundreds of problems pertaining to a home—inside or out—the editors of *Popular Mechanics* invite you to present your problems to The Clinic Editor for help and advice. Address your questions to The Clinic Editor, *Popular Mechanics Magazine*, 200 East Ontario Street, Chicago 11, Ill.



Enclosing Open Foundation

Q—Our small home is built on a pier foundation, that is, the sills rest on individual piers about 24 in. high with open spaces between. We'd like to enclose this space in some way but building a continuous masonry foundation is expensive and wooden siding would rot. Isn't there a cheaper method?—R.A., W.Va.

A—Of course, the construction of a masonry foundation would result in a permanent job, provided it was built of good materials such as brick, stone or concrete blocks laid upon a footing of the required sectional size. The only other suggestion which we would consider practical is to enclose the space with a "curtain" wall of asbestos-cement board. This material is fireproof and very durable even when it is placed in direct contact with the ground. It will be necessary, however, to frame in a substantial nailing base between the piers. This should consist of a false sill directly below the permanent sill and just above the grade level. Nail in short studs between the sills and space them uniformly on centers so that the asbestos-cement board can be attached without cutting to smaller sizes.

Artesian Well

Q—What is an artesian well? Is it dug or drilled? Does the water always flow to the surface? I'm told that I can have an artesian well in this locality and that it will assure an adequate water supply for household use and also irrigation of a small garden plot. But so far the information I am able to obtain is conflicting. Can you advise?—W.M., Tex.



A—In general an artesian well is made by drilling to a water table, or water-bearing strata, from which water will be forced to the surface by hydrostatic pressure built up by an underground flow from a distant source. In the United States the term "artesian" generally is applied to wells that flow more or less continuously without the added lift supplied by a pump. So far as the possibility of bringing in an artesian well, the probable rate

(Continued to page 224)

Don't Guess About Your Future!

U.S. AIR FORCE



The Air Force needs trained Air Traffic Control Operators

Your United States Air Force is expanding rapidly. It needs **YOU** and your special technical knowledge. Your skill and "know how" can serve your country and yourself to best advantage in today's vital job of national defense.



The Air Force needs trained multi-engine Flight Engineers

Eliminate the guesswork from your future and advance in your technical field to more profitable and satisfying rewards with your U. S. Air Force.



The Air Force needs trained Ground Control Approach Operators



The Air Force needs trained Aircraft and Flight Mechanics

Here Are a Few of the Many Great Air Force Opportunities!

- RADIO AND RADAR MAINTENANCE
- AIRCRAFT ACCESSORIES MAINTENANCE
- WEATHER • ARMAMENT SYSTEMS
- FOOD SERVICE • WIRE MAINTENANCE
- MISSILE GUIDANCE SYSTEMS
- PHOTOMAPPING
- INTRICATE EQUIPMENT MAINTENANCE

- MUNITIONS AND WEAPONS • SUPPLY
- VEHICLE MAINTENANCE • METAL WORKING
- FABRIC, LEATHER AND RUBBER • MEDICAL
- BUDGETARY ACCOUNTING AND DISBURSING
- MARINE • FIREFIGHTING
- SECURITY AND LAW ENFORCEMENT
- CONSTRUCTION

Act Now!



MAIL COUPON TODAY for Full Information

AIRMAN PROCUREMENT
 Headquarters, U. S. Air Force, Washington 25, D. C.
 Please send me details about enlisting as an Air Force specialist.

NAME.....
 ADDRESS.....
 CITY..... ZONE..... STATE.....
 MY SPECIALTY IS:.....

Pointers for Home Painters Ceilings:

(Continued from page 222)

Before painting, loosen base plate of lighting fixtures—drape with small cloth to prevent splattering. Don't overload brush with paint.



Stand on plank across two ladders. Start in corner. Dip brush to one inch. Raise quickly. Use short, light strokes. Paint in areas about four feet square.



Use a commercial hand protector, for quick cleaning of hands when job is done. Remove stubborn paint with thinner. Wash with soap.



For storage, clean brush thoroughly with thinner. Then scrub bristles with warm water and cleaner. Rinse in clear water, comb bristles and wrap in paper and store.

JOB AFTER JOB you'll get best results with a well-tipped nylon paint brush. Durable Du Pont nylon bristles paint smoother . . . are clean and sanitary . . . never get brittle . . . don't break off even under the roughest treatment. And nylon bristles last from 3 to 5 times longer than ordinary bristles. Leading manufacturers make nylon paint brushes in all types and sizes. Look for the name **NYLON** on the handle. Be sure to pick the size brush designed for the job . . . and demand Du Pont nylon bristles.

150th Anniversary



Better Things for Better Living
... through Chemistry

The best brushes have
**DU PONT NYLON
BRISTLES**

of flow, and the necessary drilling depth are concerned, your local well-drilling contractor is in a better position to advise than we are. In general, the requirements are a deep bore, a suitable steel casing for lining the bore, and a cap or some other device incorporating a valve for controlling the rate of flow.

Unpleasant Odor

Q—We recently purchased a new bedroom suite in light blond wood and we have been puzzled by the unpleasant odor that seems to come from it, especially when the drawers in the chest and dresser are opened. Also we have the same odor in the living room of our house which has hardwood floors recently finished by the builder. What causes this and is there any remedy?—J.F., Mich.

A—We wonder if you are not referring to the odor of new finishing materials, which many individuals find disagreeable, especially in a closed room. However, there is another possibility. The odor may be caused by the slow dissipation of residues from certain chemicals used in bleaching the wood of both the bedroom furniture and the floor in the living room. There is no simple remedy that can be recommended, and probably none will be necessary in your case as the odor will dissipate in a comparatively short time, at least to such an extent that it will be no longer troublesome.

Masonry Wall Cracked

Q—My new home has cinder-block walls covered with stucco and the walls are cracked through on both sides of the house. However, the foundation has not settled or cracked and the corners of the building seem to check plumb. The stucco has loosened from the blocks near the cracks. What causes the walls to crack?—P.T., Iowa.



A—Usually there are a number of causes of masonry walls cracking in the manner you describe, but your statement that the foundation still is sound narrows the possibilities somewhat. We think it quite likely that the cracks are caused by the use of "green," or uncured, cinder blocks. A wall built of improperly cured blocks will tend to shrink along its entire length and will crack at the weakest point, which usually is near or under windows. In some cases damage resulting from such cracks is quite extensive and will require a major repair. There is little use in attempting to fill the cracks and repair the stucco until it is certain that all movement due to shrinkage has ceased. When this is so, it usually is possible to make a reasonably durable repair simply by filling the cracks with cement mortar and patching the stucco.

Nail Stains

Q—My home has been painted two years and now the siding is badly streaked with brownish stains. The stain streaks seem to originate at each nail head. How can I remedy this situation before I paint, which I plan to do next spring? Is it practical to remove the present nails and replace with aluminum nails?—O.P., Ill.

A—Rusted nail heads are the cause of the trouble you describe. Before you paint again, sand each nail head to remove the rust and then coat with aluminum paint. This will take a lot of extra time and labor, of course, but the treatment is quite effective. When doing this job use a fairly coarse abrasive, such as aluminum-oxide cloth. In most cases it is not practical to attempt removing the existing nails and replacing with aluminum nails. It could be done, of course, but it would be necessary virtually to remove all the siding and replace it in order to get at all the nails. This would result in considerable damage to the individual boards. We believe that if you follow the method outlined you will have no further trouble with staining.

EXPERTS HAVE PROVED

Auto-Lite **RESISTOR** Spark Plugs GIVE DOUBLE LIFE*

...smoother performance... quick starts... greater gas savings

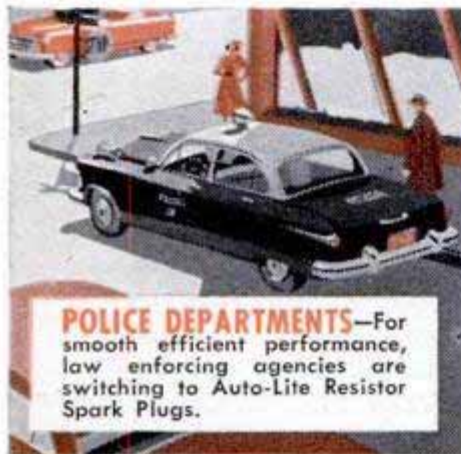

POLICE DEPARTMENTS—For smooth efficient performance, law enforcing agencies are switching to Auto-Lite Resistor Spark Plugs.



FIRE DEPARTMENTS—To get quick, sure starting, some of our nation's finest fire departments are insisting on Auto-Lite Resistor Spark Plugs.



CAB COMPANIES—Enthusiastic taxi firms report best performance in heavy city traffic after installing Auto-Lite Resistor Spark Plugs.



CAR ENGINEERS—After grueling laboratory and road tests, leading automotive engineers selected Auto-Lite Resistors as original factory equipment.



CAR OWNERS—Millions of car owners find Auto-Lite Resistor Spark Plugs give them advantages possible only in spark plugs with a built-in resistor.

EXPERTS have proved Auto-Lite Resistor Spark Plugs give smoother performance, quick starts, greater gas savings and *double life** . . . benefits important to every car owner. Discover for yourself these benefits by replacing your worn-out spark plugs with Auto-Lite Resistor Spark Plugs.

THE ELECTRIC AUTO-LITE CO.
Toledo 1, Ohio Toronto, Ont.

*Double life under equal service conditions when compared to spark plugs without a built-in resistor.

"Ignition Engineered"

AUTO-LITE

Resistor SPARK PLUGS



The Auto-Lite Line also includes Standard, Transport, Marine, Aircraft and Model Plane Spark Plugs.

Auto-Lite Spark Plugs—Patented U.S.A.

Tune in "Suspense!"...CBS Radio Mondays...CBS Television Tuesdays

14 Reasons Why GRAPHIC Gets Great Pictures!

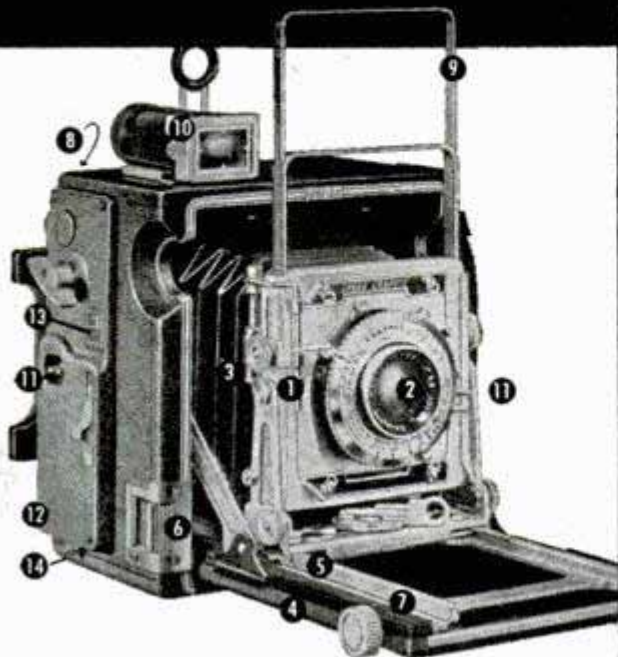

- | | |
|---|---|
| 1. Contortionist Front | 8. Ground Glass Focus |
| 2. Interchangeable Lenses | 9. Open Frame Viewfinder |
| 3. Double Extension Bellows | 10. Optical Viewfinder |
| 4. Drop Bed | 11. Built-in Flash Synch. |
| 5. Folding Infinity Stops | 12. Graflok Back |
| 6. Body Shutter Release with Shutter Selector Control | 13. Direct Reading Focal Plane Shutter Speeds |
| 7. Vernier Focusing Scale | 14. Governor Selector |

Speed Graphic (illustrated) has focal plane shutter with governed speeds to 1/1000th. Crown Graphic is identical, but without focal plane shutter . . . and costs less. Both available on terms as low as \$2.50 a week from many Graflok dealers.



SEE THE POPULAR CENTURY GRAPHIC TOO!

Lowest priced of the famous Graphics—but with many prize-winning Pacemaker features—including ground glass focus; built-in flash; coated, color-corrected lens and fast shutter. 2¼ x 3¼ . . .
ONLY \$108.00
Prices subject to change.

Graflex Inc., Dept. 125
Rochester 8, New York

Please send me details on:

Pacemaker Graphics _____ Century Graphic _____

Name _____

Street _____

City _____

County or Zone _____ State _____

GRAFLEX®

Prize-Winning Camera

itself will be made of special shock-absorbent material. Several things—among them balsa wood—are being tried. “We’re looking for stuff with a ‘slow memory,’” they explain, “that will slow down a human head without pitching it back again as does sponge rubber or leather padding.” Oddly enough, in laboratory tests an artificial skull bounced with force against a sponge-rubber pad mounted on concrete cracked wide open. When bounced on light-gauge steel raised off the floor, however, the shock was absorbed and the skull remained intact.

Though the car of tomorrow at Epping is still in the embryonic stage, experiments so far have indicated several other things it will have to have—windshields like those now being made by one car manufacturer, which are set in rubber and will pop out of their frames when given a whack from behind; breakaway steering posts that won’t spear or brain the driver when he’s rammed against them. White wants to do away with what he calls merry-go-round steering, too. “No one,” he says, “can control a modern car properly in an emergency with the steering ratio that requires complete revolutions of the wheel to veer slightly.” His car also will be stripped of protuberances like bumper guards and heavy chrome work, which in a crash often catch in the flashy protuberances of the second car and send both vehicles into violent fatal skids or flip overs. “Without such junk,” he points out, “our experiments have proven that cars will often slide past each other.”

Until people get over their fetish for chrome spears and gadgets jutting from all parts of the car, M.V.R. admits that manufacturers probably will not be able to force sanely equipped cars on the customers.

Meanwhile, they have a few tips gained from their hair-raising experiments that can save lives and limbs even in present-style cars. One man at Epping took his life in his hands and sat beside a driver who ran him through a panic stop from more than 60 miles per hour. By cradling his head in his arms and placing it firmly against the dashboard he came through in fine shape. “I felt a tremendous pressure but didn’t even sustain a bruise,” he reported. “But if I’d been just sitting there I’d

(Continued to page 228)

You Name It!

Here are the correct answers to the “You Name It!” photo quiz on pages 78 and 79:

1. Underside of spiny cactus; 2. Bud of maple tree; 3. Tree bark; 4. Rasp; 5. Aerial view of icebergs; 6. Tin foil; 7. Radiator; 8. Underside of squash; 9. Seed center of sunflower.

125,000 ELECT SHOPSMITH



Complete workshop in single unit outperforms and outsells individual power tools—some of SHOPSMITH'S 125,000 owners tell why

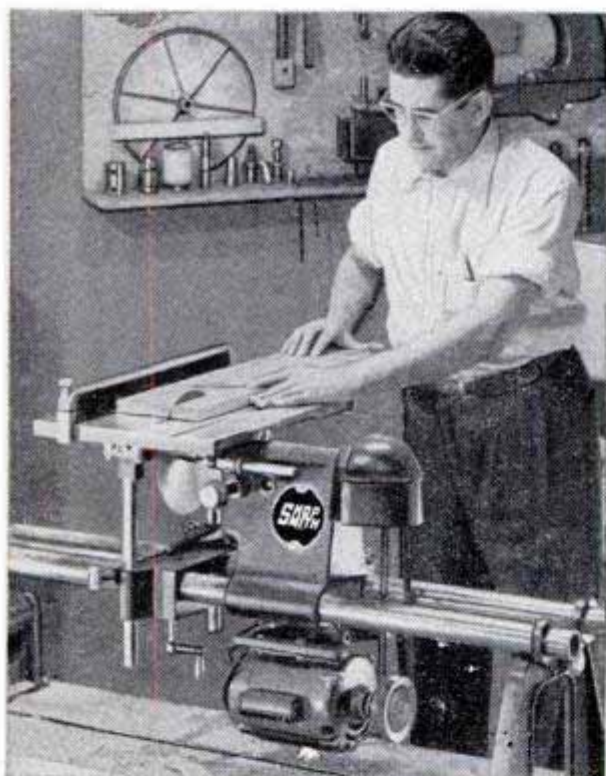

ONLY \$189.50

complete except for $\frac{1}{2}$ -hp. motor (\$34.50). You can see SHOPSMITH demonstrated at leading hardware and department stores or at any Montgomery Ward store.

GET
all the
FACTS
FREE

16-PAGE BOOK
filled with detailed
specifications,
accessories.



OWNER DEMONSTRATES SHOPSMITH "It's a home appliance for men," says SHOPSMITH owner Earl Swift. "Eight-inch circular saw. Twelve-inch disc sander. Thirty-three-inch wood lathe. Vertical and horizontal drill presses. Each a multi-purpose tool in itself and all engineered into one compact unit. No wonder it's America's largest-selling power tool!"

HOMEOWNER: "Thanks to SHOPSMITH, I can have a big-capacity power shop in my crowded basement. SHOPSMITH, mounted on retractable casters, can be rolled into a corner only 18" x 60"! It's a lot of shop in a little space!"

ENGINEER: "Precision is my business. I checked SHOPSMITH from spindle tip to tail-stock before I bought mine. It's built with the kind of precision you'd expect to find only in the largest machine tools. That spindle tip, for example, is machined to a tolerance of .0002". And that's real precision!"

EXPERIENCED WOODWORKER: "In woodworking, there's no substitute for the *right* tool. And with SHOPSMITH, you always have the *right* tool for any sanding, sawing, turning or drilling job. I've replaced my single-purpose tools with SHOPSMITH. It does jobs I couldn't begin to do with my other tools."

BEGINNER: "I don't know much about woodworking—or power tools. But I'm learning fast with SHOPSMITH. It's plenty easy to operate, no complicated adjustments. It's safe. Above all, it turns out work that makes me look like an expert."

CARPENTER: "Most of my work is on big projects. No flimsy, bronze-bearing tools for me. Take SHOPSMITH, now. There's a tool with the kind of capacity I can use. It can do 1001 jobs too big or too heavy for most home workshop tools."

MAGNA ENGINEERING CORPORATION, Dept. 220-B
at factory nearest you
12819 Coit Road, Cleveland 8, Ohio, OR
Menlo Park, California
Please send me free 16-page SHOPSMITH catalog.

Name _____

Address _____

City _____ State _____



POWR-KRAFT
POWER TOOL AND WELDING CATALOG

Montgomery Ward - 1952-53

FREE

WARDS 1952-53 POWR-KRAFT POWER TOOL AND WELDING CATALOG

48 PAGES OF POWER TOOLS and accessories for the beginner, advanced hobbyist and for production shops. Includes wood and metal working equipment, portable electric tools, welding supplies, motors. Famous brands such as Mall, Shopsmith, Beaver, Globe, and Dumore, plus full line of Wards Powr-Kraft tools. Send for this FREE Catalog today!

SPECIAL GET-ACQUAINTED OFFER



Until Oct. 15, 1952
Workshop Dispenser
\$1.00 Postpaid

Send for our new 1952-53 Power Tool Catalog and we'll send you this handy 8-jar workshop dispenser for only \$1, Postpaid. Complete with mounting bracket.

Montgomery Ward

CHICAGO • ALBANY • BALTIMORE • DENVER
FT. WORTH • KANSAS CITY • OAKLAND
PORTLAND, ORE. • ST. PAUL

Clip and mail coupon to nearest city above—NOW!

MONTGOMERY WARD, Dept. WM-PM9

- Please send me Wards free 1952-53 Powr-Kraft Power Tool and Welding Catalog.
- I am enclosing \$1.00. Send me Workshop Dispenser and Wards free Power Tool Catalog.

Name..... (Please PRINT Plainly)

Street Address or
Route and Box No.

Post Office..... State.....

have flown right out over the engine hood. Anyone sitting beside the driver who sees a crack-up coming almost unquestionably can save himself by this means if he thinks fast enough to do it."

Experiments with men and Mr. Willsoffen at Epping also have shown that the best way to sit in a car is with feet slightly apart and braced against the floor. Crossed legs are a sure invitation to hip injuries in a crack-up. The same goes for people who sit sideways and are thrown to the floor.

One of M.V.R.'s officials made a few simple changes on his Lincoln convertible which render it practically deathproof. First, out came the seat-adjusting mechanism and the seats were bolted to a cross member of the frame. A car-body repair shop made him a set of removable clamps to lock the hinged backs of the front seats while the car was in use. A safety belt for each passenger was anchored firmly to the floor of the car. A special chest strap for the seat beside the driver was installed so the passenger in that spot would not have his head pitched forward into the dashboard or through the windshield. A sheet-steel partition prevents the shrapnel in the trunk from coming through to murder anyone up front. "It is as safe," he declares, "as any convertible can be."

Fatigue, the cause of many accidents, is a continuous subject of study at Epping. Glaring reflections from the multitudinous chrome pieces on steering wheels, dashboards, hood ornaments; the ghost shadows on rakish, sloping, much-in-demand windshields; vibrations transmitted through floor boards and the hypnotism of the windshield wiper; the strain of trying to stay put under the wheel in the wide-open front seat of today's soft-riding car that heels like a sailing dinghy in a high wind on every turn—all are being measured for the wear and tear on a driver. And they cause plenty.

To prove what elimination of these hazards will do, Dean Fales, M.V.R.'s chairman, has removed them completely from his own car. Experts who have driven it claim it is the most eye-restful, untiring car they have ever had the pleasure to drive. The entire chrome dashboard is covered with flat black paint. So is the hood ornament, the chrome strip down its center, the hood itself and the wipers. The windshield is shaded by a long hood to eliminate shadows and reflections. The wheel rim has been covered with a sponge-rubber "sock" to absorb all vibration through the post. A body support and armrest covered with leather hems in the driver so he doesn't slide on turns or have to fight to stay under the wheel. "The wheel is more than just

(Continued to page 230)



★When *Marfak* is rubbed with a finger, it forms a fluid film. Yet it keeps a tough, protective "collar." That's what happens when bearings get *Marfak* chassis lubrication from your Texaco Dealer. The working lubricant is "sealed in." And there's protection for 1,000 miles or more! *Marfak* clings tight to points of wear and friction. It's compounded to resist wash-out, squeeze-out, jar-out. That's why you enjoy longer lasting "cushiony" driving ease. Get *Marfak* lubrication today. See your Texaco Dealer, *the best friend your car ever had.*

Faithfully yours
50
 for Fifty Years

THE TEXAS COMPANY
TEXACO DEALERS IN ALL 48 STATES

Texaco Products are also distributed in Canada and in Latin America



Good starting trio

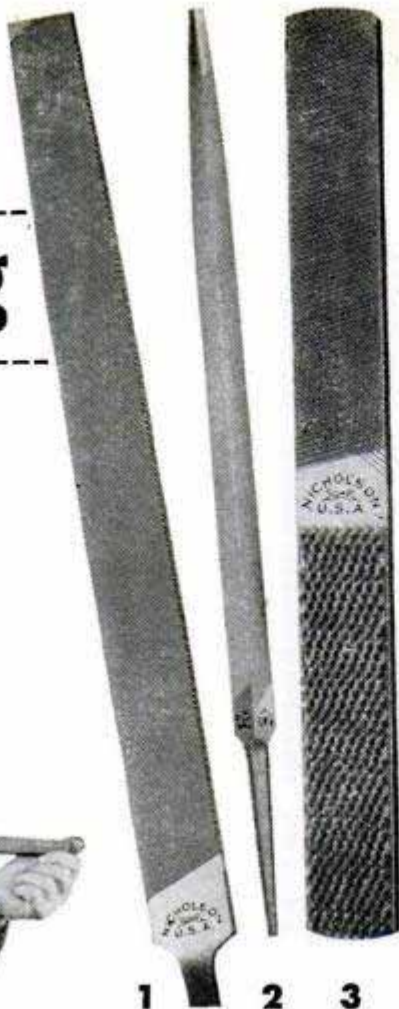

Starting a home workshop—for hobby-crafting, household fix-ups, or developing your skill as a professional mechanic? Here are three basic files you really need. Smart move for a good initial assortment of file types and cuts!

1. **MILL FILE** — For smooth-finishing metal and tool sharpening. Popular lengths, 8" and 10".
2. **SLIM TAPER** — Slender triangular file for saw sharpening and general filing in corners of 60° angle and wider. Popular lengths, 6" and 7".
3. **FOUR-IN-HAND File-Rasp** — Four different cutting surfaces! One side flat, other side half round. Half of each side file cut, other half rasp cut. For flat or curved surfaces of wood, brass, lead, etc. Popular length, 8".

Don't consider anything less than Nicholson or Black Diamond brand—the world's finest file quality. At *good hardware stores*.

FREE 48-page illustrated book, "File Philosophy," on kinds, use and care of files. Write for it.



NICHOLSON FILE COMPANY
22 Acorn Street, Providence 1, R. I.
(In Canada, Port Hope, Ont.)



NICHOLSON FILES FOR EVERY PURPOSE

vibration-free," Fales says. "The size of the grip has been enlarged to 1 1/8-inch diameter—just the same as ax handles and handle-bar grips. Anything smaller cuts off circulation and causes numbness—yet car buyers insist on their fancy, delicate, plastic works of art that an honest man can't get hold of."

A fatigue hazard that frequently is overlooked is about to get a meticulous examination at the Epping laboratories—carbon monoxide. Wind-tunnel tests already have shown that blowback exhaust fumes are sucked along the underside of every car by the air stream and slip in through drainage holes in the door bottoms, up beside the windows and into the car. "How many serious accidents have been caused by drivers who kept all the windows shut?" asks Andy White. "It would be interesting to know."

Right now, he's rigging up a test car with a mine safety detector in the center of the dash. When the CO in the car reaches the danger point of about .01 percent, it will trigger a red light on the panel and instantly shut off the motor.

Kerosene will be poured into the gas tanks of every style of car so they'll smoke furiously as they roar down the highway. Technicians will track the patterns of the exhaust at all speeds.

White firmly believes that monoxide, which only needs to be in a concentration of .02 percent to kill a man in a few seconds, is responsible for many persons' falling asleep over the wheel in modern automobiles that have ultrafancy air-conditioning systems. "The intake vents," he points out, "are nice and low under the headlights—right in line with the exhaust pipe of the car in front. Any man who keeps them open in bumper-to-bumper traffic is inviting death."

While monoxide fumes seldom penetrate a car in concentrations heavy enough to kill, White feels that it's almost a sure thing they are heavy enough to produce the kind of drowsiness that, in turn, produces accidents. If his road tests prove what he suspects, another suggestion will be added to the growing list of features. His goal is to make the car of tomorrow a safer, saner vehicle to carry our families and ourselves wherever we need to go without wondering whether we'll get there alive. ★ ★ ★

All States Approve Tinted Glass

All 48 states have officially approved the use of tinted heat-absorbing glass in automobiles. The last state to endorse such use was Massachusetts. At present, there are more than 300,000 cars equipped with tinted glass on the nation's highways.

Around the clock usefulness...

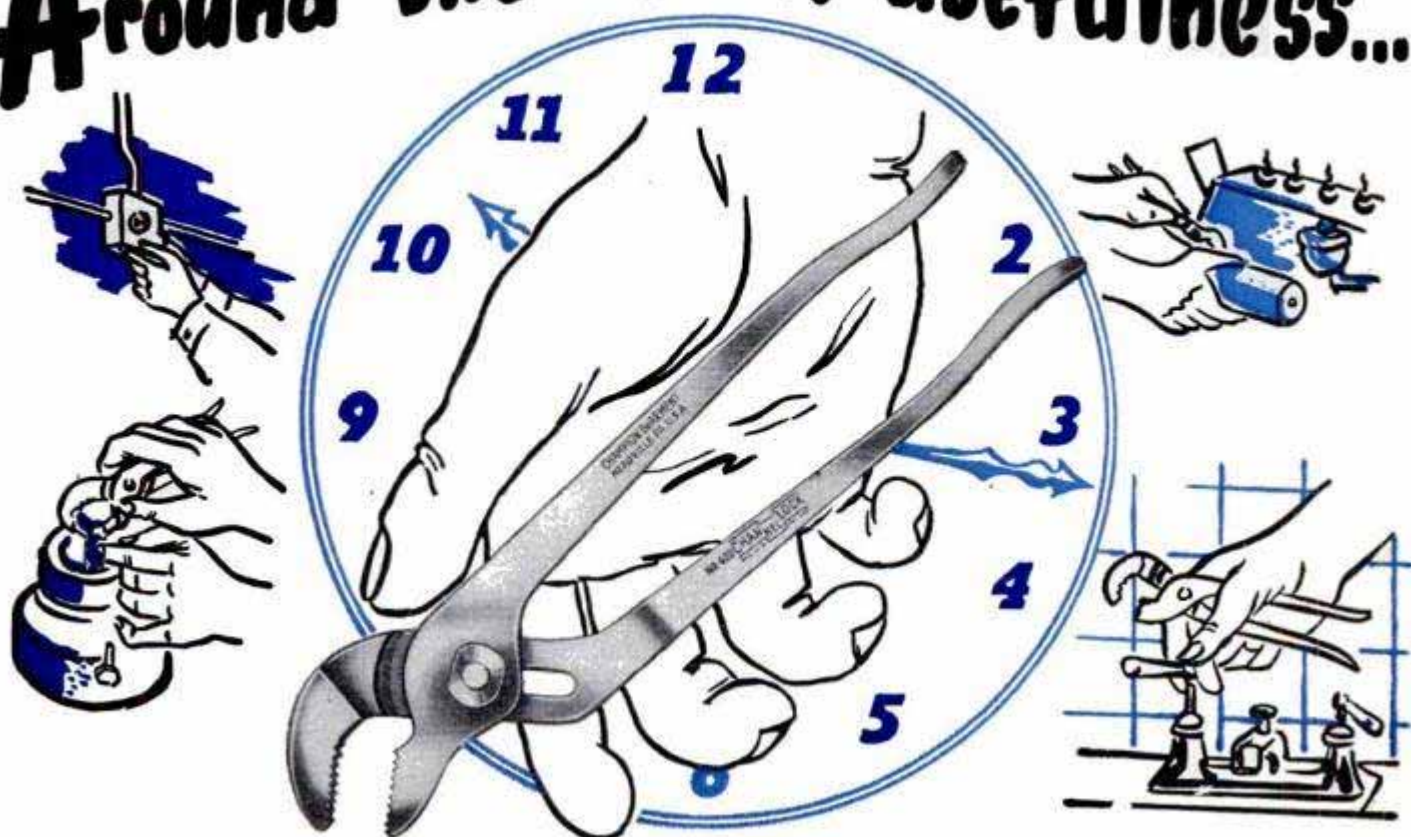

CHANNELLOCK PLIERS

Made only by CHAMPION DEARMENT!

No matter what the job—plumbing, electrical, automotive or whatever, Channellock pliers are handy to have around. The patented Channellock principle permits a wide range of size adjustments without decreasing gripping power or leverage.

Channellock pliers are made by Champion DeArment—for nearly 3/4 of a century manufacturers of highest quality tools.

Dad, Mom, or the kids will find plenty of uses for Channellock pliers.

And remember—Only Champion DeArment makes Channellock.

Send for Catalog D 15 today.

CHAMPION DEARMENT TOOL CO. • Meadville, Pa.

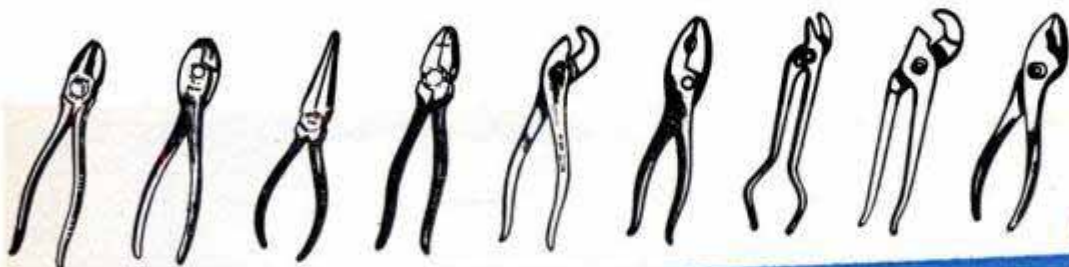

Channellock pliers are listed in the Yellow Pages of most Telephone Directories under "Tools"



Only CHAMPION DEARMENT...

makes

CHAN NEL LOCK

TRADE MARK REG.

U. S. PATENT OFFICE

**NOW AVAILABLE
TO YOU...**

THE FABULOUS REVOLUTIONIZED

Easy to convert old or even worn out tools into costly carbide tipped tools for modern hi-speed, close tolerance production at a fraction of the cost of new tools with these sensational conversion kits.

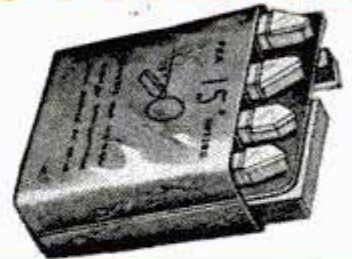

- | KIT
#1 | <p>3/16" 1/4" 5/16" 3/8" 7/16" 1/2"</p> | TUNGSTEN CARBIDE MASONRY DRILL KIT. Make your own fine Masonry Drill set from old carbon twist drills, broken masonry drill or any round or hexagon rod with this complete kit of six genuine tungsten carbide tips. Comes complete with instructions, Brazing alloys and Flux. YOU CAN MAKE TOOLS VALUED AT OVER \$12.00 FOR ONLY \$2.50 | | | | | | | | | | | | | | | | | | |
|---------------------|---|---|---------------|--------------|--------|---------------|--------|---------------|----------------|--------|--------------|------------------|----------|--------------|-----------------|-------------|-------------|---------------------|--|--|
| KIT
#2 | <p>Threading Round Nose Rt. Facing or turning Lt. facing or turning General Purpose</p> | TUNGSTEN CARBIDE METAL FORM TOOL BIT SET. Five tips, complete with instructions for tipping your present tools or making new tools from easily obtainable bar stock. You couldn't begin to buy such tools for the low cost at which you can now make your own. Includes Brazing alloys and Flux. COMPLETE KITS ONLY \$1.95 | | | | | | | | | | | | | | | | | | |
| KIT
#3 | <p>1/2" Spear Point 1/2" Skew 1/2" Cut Off 1/2" Round Nose 3/4" Gouge</p> | TANTUNG WOOD AND PLASTIC TURNING TOOL KIT. You can make the world's finest wood and plastic turning set from your present set—or from easy-to-obtain bar or pipe stock—with this 5 piece set. Comes complete with instructions, Brazing alloy and Flux. Tools of this quality would cost you over \$25.00. MAKE THEM YOURSELF FOR ONLY \$3.75 | | | | | | | | | | | | | | | | | | |
| KIT
#4 | | MAKE-YOUR-OWN SMALL TOOL KIT. One Tungsten Carbide rod approximately 1"x1/8" and one 2" by 1/8" diameter with which to make a host of wonder-working small tools. Easy-to-obtain rod makes unexcelled tools for marking, engraving, or Etching on hardest steels, porcelain, enamels or glass. Tip old prick punches. Make small turning and boring tools, guides, rollers, etc. Complete with instructions, Brazing alloy and Flux. ONLY \$1.95 | | | | | | | | | | | | | | | | | | |
| KIT
#5 | | TANTUNG. Consists of a bar of genuine VASCOLOY-RAMET Tantung 5/16" square by approximately 3" long plus a bar of Tantung 1/4" square and approximately 3" long to fashion priceless tools by making tips for your own old tools, solid form tools, chisels, etc. A platinum colored, jewel-like metal. Non-corrosive. You'll find unlimited uses for it in tool-making. ONLY \$3.95 | | | | | | | | | | | | | | | | | | |
| KIT
#6 | | TUNGSTEN CARBIDE LATHE AND GRINDER CENTER TIPS. Easily brazed onto your old centers—or you can make your own! This genuine Tungsten Carbide Lathe and Grinder Center Tip insures longest trouble-free accurate work. 1/4" by 7/16" Complete with instructions, Brazing alloy and Flux. TIPS ONLY \$1.70 each | | | | | | | | | | | | | | | | | | |
| KIT
#7 | | COMPLETE TOOLS FOR THE FIRST TIME. The finest metal forming tools the world has ever seen. Five tools plus handy silicon carbide hone in beautiful plastic case, 1/4" Shanks consisting of Threading, Round nose, rt. and lf. facing or turning and general purpose tools. Precision ground, diamond lapped. Designed to operate in regular tool holders without adjustment. ONLY \$4.95 | | | | | | | | | | | | | | | | | | |
| KIT
#8 | | STANDARD PRODUCTION TOOLS — TUNGSTEN CARBIDE
Choice of five different styles—four different sizes. When ordering give sizes and style wanted—state whether for steel or other materials.
<table border="1"> <thead> <tr> <th>STYLES</th> <th>SIZES</th> <th></th> </tr> </thead> <tbody> <tr> <td>THREADING #8A</td> <td>5/16"</td> <td>.....\$1.95</td> </tr> <tr> <td>ROUND NOSE #8B</td> <td>3/8"</td> <td>.....\$2.50</td> </tr> <tr> <td>RIGHT FACING #8C</td> <td>7/16"</td> <td>.....\$3.00</td> </tr> <tr> <td>LEFT FACING #8D</td> <td>1/2"</td> <td>.....\$3.50</td> </tr> <tr> <td>GENERAL PURPOSE #8E</td> <td></td> <td></td> </tr> </tbody> </table> | STYLES | SIZES | | THREADING #8A | 5/16" |\$1.95 | ROUND NOSE #8B | 3/8" |\$2.50 | RIGHT FACING #8C | 7/16" |\$3.00 | LEFT FACING #8D | 1/2" |\$3.50 | GENERAL PURPOSE #8E | | |
| STYLES | SIZES | | | | | | | | | | | | | | | | | | | |
| THREADING #8A | 5/16" |\$1.95 | | | | | | | | | | | | | | | | | | |
| ROUND NOSE #8B | 3/8" |\$2.50 | | | | | | | | | | | | | | | | | | |
| RIGHT FACING #8C | 7/16" |\$3.00 | | | | | | | | | | | | | | | | | | |
| LEFT FACING #8D | 1/2" |\$3.50 | | | | | | | | | | | | | | | | | | |
| GENERAL PURPOSE #8E | | | | | | | | | | | | | | | | | | | | |
| KIT
#9 | | WORLD'S FASTEST BORING MASONRY DRILLS
Ejects all dust from even the deepest hole. Never before such speeds for drilling concrete, brick, marble, tile, stone.
<table border="1"> <tbody> <tr> <td>WHEN ORDERING</td> <td>No. 9A 3/16"</td> <td>\$1.80</td> <td>No. 9D 3/8"</td> <td>\$2.15</td> </tr> <tr> <td>GIVE BOTH NO.</td> <td>No. 9B 1/4"</td> <td>\$1.80</td> <td>No. 9E 7/16"</td> <td>\$2.40</td> </tr> <tr> <td>AND SIZE</td> <td>No. 9C 5/16"</td> <td>\$1.95</td> <td>No. 9F 1/2"</td> <td>\$2.70</td> </tr> </tbody> </table> | WHEN ORDERING | No. 9A 3/16" | \$1.80 | No. 9D 3/8" | \$2.15 | GIVE BOTH NO. | No. 9B 1/4" | \$1.80 | No. 9E 7/16" | \$2.40 | AND SIZE | No. 9C 5/16" | \$1.95 | No. 9F 1/2" | \$2.70 | | | |
| WHEN ORDERING | No. 9A 3/16" | \$1.80 | No. 9D 3/8" | \$2.15 | | | | | | | | | | | | | | | | |
| GIVE BOTH NO. | No. 9B 1/4" | \$1.80 | No. 9E 7/16" | \$2.40 | | | | | | | | | | | | | | | | |
| AND SIZE | No. 9C 5/16" | \$1.95 | No. 9F 1/2" | \$2.70 | | | | | | | | | | | | | | | | |
| KIT
#10 | | A TIME SAVER TOOL SPECIAL! Genuine Carbide tipped Circle Cutter. Cuts the toughest metals, fibreglass and plastics with unbelievable speed and ease. Circles from 1" to 5" and 3/4" deep. Has 1/4" shank—a fine precision tool. SOLID CARBIDE CUTTING TIP ONLY \$6.50 | | | | | | | | | | | | | | | | | | |

CARBIDE TOOLS THAT HAVE PRODUCTION!



XL BOND GRINDING WHEELS

Due to the extreme hardness of Tungsten Carbide, regular grinding wheels will not adequately grind or sharpen your new Carbide tools. Until only recently, most Carbide grinding had to be done with fantastically costly Diamond wheels. Now a recent achievement of the Chicago Wheel and Mfg. Co. makes available to you a Silicon Carbide Grinding Wheel that closely approaches the performance of a Diamond Wheel—at a fraction of the cost. These Grinding wheels may be purchased with your Kit and Tools.



Specify whether for Carbide or Tantung.

XL-CARBIDE RECOMMENDED FOR CARBIDE
XL-TANTUNG RECOMMENDED FOR TANTUNG

4" x 1/2" WHEEL ONLY	\$1.75
5" x 1/2" WHEEL ONLY	\$2.50
6" x 1/2" WHEEL ONLY	\$3.00
7" x 1" WHEEL ONLY	\$4.90

Deluxe Tapered Cone Wheel for Precision Finishing
4" CONE WHEEL

BERNZ-O-MATIC BLOW TORCH
The handiest torch on the market. Ideal for brazing your tool tips. Instant heating propane gas torch — no priming or pumping. Pencil-flame type for concentrated heat in medium and light soldering, metal working, brazing, etc. Burns in any position at 2300°F. Throw-away cylinder lasts up to 15 hours burning time. Fits in any tool box; 10" long, 2 3/4" dia. Complete with loaded cylinder ready to operate. Be sure to order extra cylinders of Propane Gas fuel.



Torch \$6.95 — Replacement Cylinders \$1.95 ea.

All Carbides and Tantungs Used on Time Saver Tools are of the World's Finest Vascoloy-Ramet All-Purpose Grade

TIME SAVER TOOLS, INC.
DEPT. 29, MUNDELEIN, ILL.

By special arrangement with the world famous American Technical Society of Chicago, TIME SAVER TOOLS is able to offer the first authoritative text book on carbides designed to supply the man at the machine, the vocational student, the designer, and the engineer with a wealth of practical knowledge on carbide tools. Presented in understandable form for ready reference.

416 pages.

283 illus.

Washable

Cloth Binding

Price \$5.50

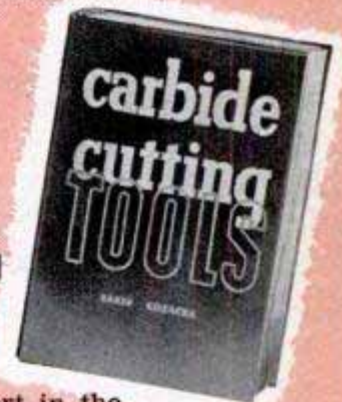

Become an expert in the use of carbide cutting tools. Text Book covers Converting to Carbides, Tipping a Carbide Tool, Grinding Single Point Tools, Carbide Tool Design, Cutting Speeds, Cutting Power, Coolants and Carbide Tools, Multiple-Edge Tool Design, Grinding and Use of Tools, etc. Book will be shipped directly by American Technical Society of Chicago.

TIME SAVER TOOLS, INC., Dept. 29, Mundelein, Illinois

Send me at once the material checked below. I enclose payment in full. Ship C.O.D. plus charges.

- | | |
|---|---|
| <input type="checkbox"/> KIT #1 @ \$2.50 ea. | <input type="checkbox"/> Masonry Drills—No. _____ |
| <input type="checkbox"/> KIT #2 @ \$1.95 ea. | Size _____ PRICE \$ _____ |
| <input type="checkbox"/> KIT #3 @ \$3.75 ea. | <input type="checkbox"/> KIT #10 @ \$6.50 ea. |
| <input type="checkbox"/> KIT #4 @ \$1.95 ea. | <input type="checkbox"/> XL Bond Grinding Wheels |
| <input type="checkbox"/> KIT #5 @ \$3.95 ea. | XL Carbide <input type="checkbox"/> XL TAN- |
| <input type="checkbox"/> KIT #6 @ \$1.70 ea. | TUNG <input type="checkbox"/> SIZE _____ |
| <input type="checkbox"/> KIT #7 @ \$4.95 ea. | 4" TAPERED CONE <input type="checkbox"/> |
| <input type="checkbox"/> STANDARD PRODUCTION | PRICE \$ _____ |
| TOOLS | <input type="checkbox"/> BERNZ-O-MATIC BLOW |
| Style _____ Size _____ | TORCH @ \$6.95 |
| Steel <input type="checkbox"/> Other <input type="checkbox"/> | <input type="checkbox"/> EXTRA CYLINDERS |
| Price \$ _____ | FUEL @ \$1.95 ea. |
| | TOTAL \$ _____ |

Text Book "CARBIDE CUTTING TOOLS" @ \$5.50

NAME _____

ADDRESS _____

CITY _____ ZONE _____ STATE _____

Starrett

FRICTION THIMBLE* MICROMETERS

Give You

- UNIFORM PRESSURE
- UNIFORM READINGS

Every Time



Starrett
Satin Chrome
Micrometer
No. 231-F
Range 0-1" by
.0001",
shown above.
Friction Thimbles
also available in
other sizes and styles.

*An improved friction stop mechanism built right into the thimble permits easy, one-hand operation — insures uniform contact pressure for every measurement. You get the same sure accuracy every time . . . plus 12 other big Starrett features including Satin Chrome Finish, Tapered Frame, Hardened Threads ground from the solid and stabilized and Hi-Micro Mirror-Lapped Finish on contact faces. See it at your Starrett Tool Distributor's.

SEND FOR IT — ONLY 10¢
Starrett "Tools and Rules" Book shows the right tools for any measuring job. 50 pages, 100 pictures, helpful reference tables. Address Dept. AP.



THE L. S. STARRETT COMPANY • ATHOL, MASS., U.S.A.



MECHANICS' HAND MEASURING TOOLS AND PRECISION INSTRUMENTS
DIAL INDICATORS • STEEL TAPES • PRECISION GROUND FLAT STOCK
HACKSAWS, BAND SAWS and BAND KNIVES



Revolver Grip Holds Ammunition

Six extra cartridges can be stored inside a plastic grip for a police revolver. A replacement for the standard grip, it has two halves which screw firmly together over the revolver handle. The extra rounds of ammunition are slipped into sockets in the base of the grip. They are held in place by a hinged metal plate.

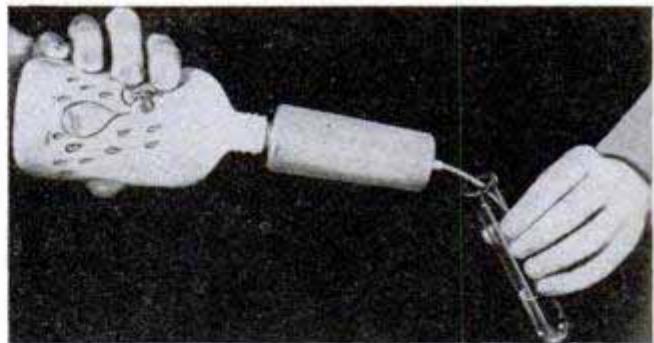

Shelf-Size Water Filter

Mineral-free water for laboratory use is provided by a compact deionization device resembling a clothes sprinkler. A squeeze of the hand forces ordinary tap water from a polyethylene bottle through a filter-stopper containing ion-exchange resins which grip and hold ionized impurities. The purifier eliminates minerals and salts of calcium, sodium, iron, magnesium and other metallic ions, as well as sulphate, bicarbonate and silicate. It supplies water suitable for use in blood chemistry, studying hydrogen ions, photographic processes, ion-free washing of laboratory apparatus, and storage batteries and steam irons. One filter purifies 20 gallons of water.

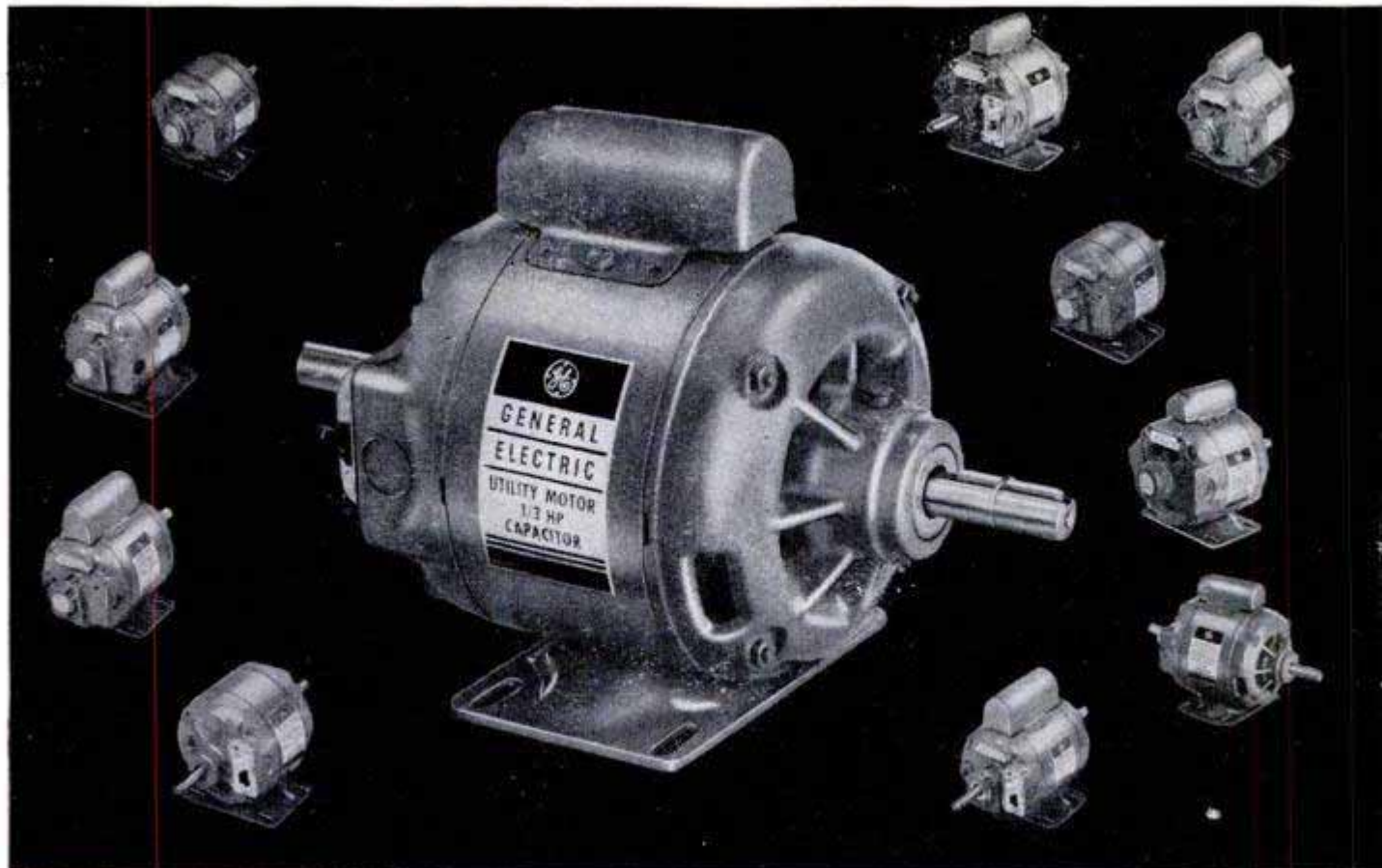

THE MOTOR YOU WANT IS A G-E MOTOR!

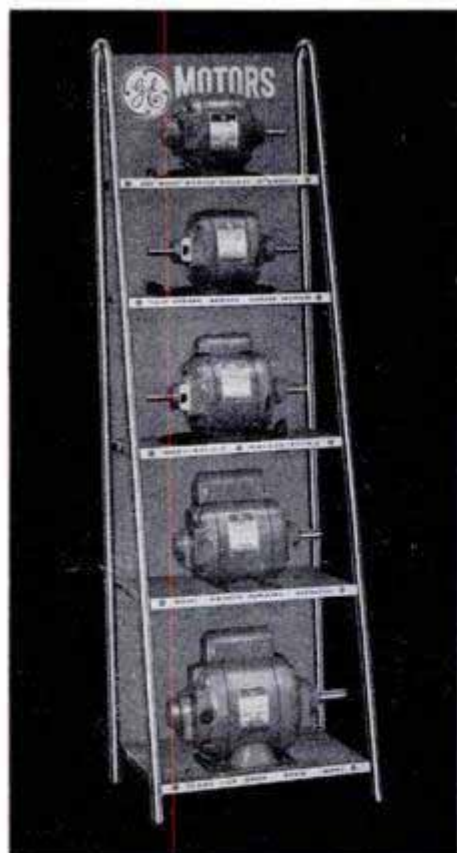

IT'S EASY to pick the right G-E motor for the job you want done from this G-E "Silent Motor Salesman." Look for it at your dealer's.

Whatever job you want done . . . run a lathe, pump, compressor, saw, grinder, fan, milking machine, lawn mower, you name it . . . home-made or purchased equipment . . . easy-start or hard-to-start . . . easy duty or hard duty . . . *the motor you want is a G-E motor!* Why? Because you know that G-E fractional-horsepower motors are made by the world's largest and most experienced motor manufacturer . . . made *right* to last longer with a minimum of care!

You can put your confidence in—

GENERAL  ELECTRIC

FREE!



SEND THIS COUPON TODAY!

Section 674-119, General Electric Co.,
Schenectady 5, N. Y.

Please send me a copy of your free 12-page booklet
on "How to Choose Your Motor."

NAME _____

PLEASE PRINT

STREET _____

CITY _____

ZONE _____ STATE _____

Money-Making Jobs...

ALL AROUND YOU!

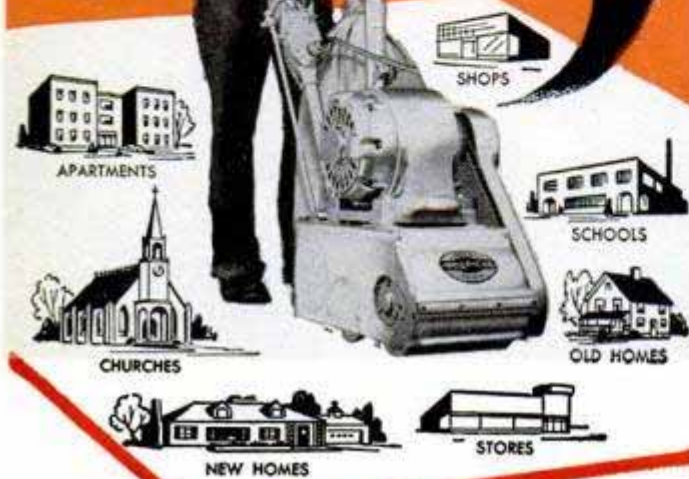

BE YOUR OWN BOSS! Big Money waiting for you today in floor surfacing! Hundreds of prospects near you! The floor next door may be your first job—and business mushrooms as folks tell others. Earn as high as \$50 and more a day sanding floors with an easy-to-run American Machine. Pleasant indoor work—steady the year round. A sound opportunity to get in something for yourself and be *your own boss!* No schooling—no experience needed. Only small investment in sander gets you started to success! Send coupon for “money-making booklet” entitled “Opportunities in Floor Surfacing”—enclose 25c in coin or stamps to cover handling.



AMERICAN FLOOR MACHINES

SEND!

The American Floor Surfacing Machine Co.
535 So. St. Clair St.
Toledo 3, Ohio

Enclosed find 25c in stamps or coin for booklet “Opportunities in Floor Surfacing”, telling me how I can start my own floor sanding business.

Name.....

Street.....

City..... State.....

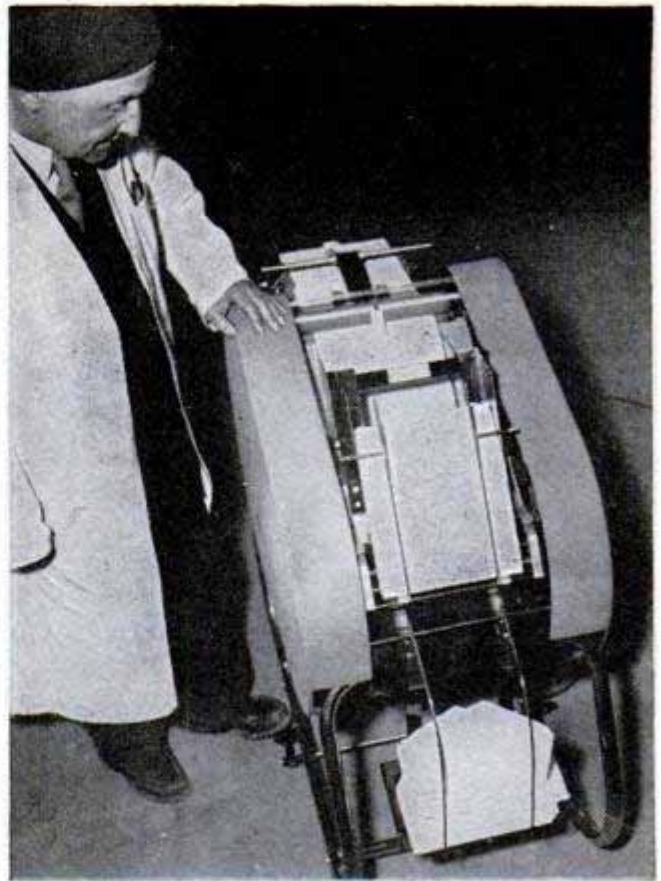

Mechanical Mail Clerk

If you have a great many letters to mail, you'll like a new German machine that folds and inserts letters in envelopes which are then sealed and stamped at a rate of 2000 an hour. Speed of the machine is controlled by a foot pedal, freeing both hands for feeding purposes.



Ink Dispenser

With a new ink-bottle cap the draftsman or artist can dispense writing fluid by the drop right into his pen. The bottle top, which replaces the standard top, has a rubber bulb and a stainless-steel dispensing tube. Light pressure on the bulb brings 20 drops of ink directly into the pen.



OUR WALLS
MADE ME
WAIL!

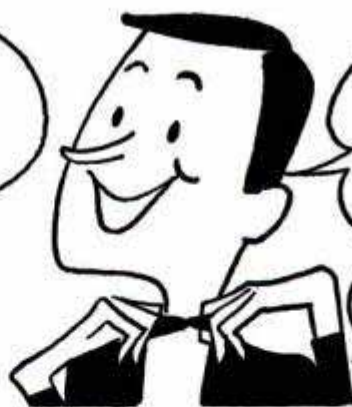

UNTIL I
DISCOVERED
GOLD BOND
**COLOR
TEXTURE!**

YES, WE HAD DRAB,
DULL, DINGY
OLD WALLS!



I ASKED MY NEIGHBORHOOD DEALER
WHAT TO DO. HE TOLD ME ABOUT
AMAZING GOLD BOND COLOR
TEXTURE...IN EIGHT NEW COLORS!

I JUST MIXED
IT WITH TAP
WATER...



... AND BRUSHED
IT ON. IT DECORATES
LIKE PAINT
AND COVERS
LIKE PLASTER



THEN I USED
A SPONGE TO
GET A DISTINC-
TIVE SWIRL FINISH



OR A ROLLER
DOES DOUBLE
DUTY. COVERS
AND TEXTURES IN
ONE OPERATION.



YOU CAN GET ENOUGH COLOR
TEXTURE FOR AN AVERAGE
ROOM FOR ABOUT **\$4.85!**

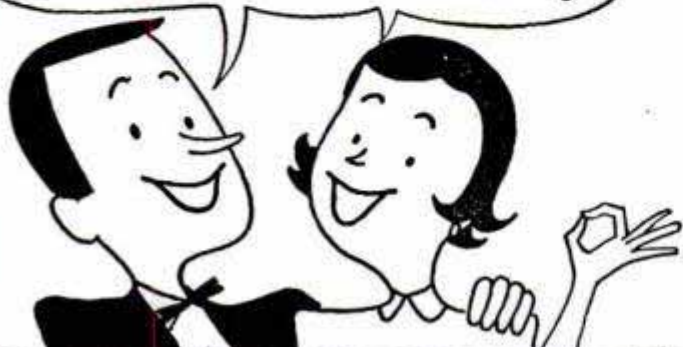

NATIONAL GYPSUM COMPANY
BUFFALO 2, NEW YORK

AVAILABLE AT
YOUR LOCAL
GOLD BOND
LUMBER AND
BUILDING
MATERIAL DEALER
OR PAINT STORE

You'll build or
remodel better with

Gold Bond

LINCWELDER

★ MAKES MONEY
★ SAVES MONEY

**WELDS • SOLDERS
CUTS • BRAZES
CHARGES BATTERIES**

**Welds any thickness
of metal**

**Pays for
itself**

Robert J. Maas of
Custar, Ohio, says,
"Just the savings in
cash I made last year
by repairing and build-
ing farm equipment
more than paid off the
cost of my "Lincwelder".
Don't know how I ever
got along without it."

**FOR FARMS • GARAGES
REPAIR SHOPS**

Fast, Easy Repairs on Cast Iron and Steel



LOWEST PRICED WELDER

"Lincwelder" AC-180-C Lincoln
Arc Welder with Arc Booster . . .
sells for only \$150* . . . less than
other welders of like capacity.
(Price varies to \$156 on West
Coast). Accessories \$20 extra.



Above Left: Repairs spring tooth with
simple butt weld using "Fleetweld 47" elec-
trode. Above Right: Crack in engine block is
fixed in a few minutes with "Ferroweld"
electrode.

- **Wide Range** . . . handles $\frac{1}{16}$ " to $\frac{5}{16}$ " electrodes.
- **Simple to Operate** . . . has Arc Booster for
no stick start.
- **Easy to Install** . . . operates on 230 volt
single phase line.
- **Approved** . . . by Underwriters' Laboratories.

Build by

THE LINCOLN ELECTRIC COMPANY

The World's Largest Manufacturer of
Arc Welding Equipment
Cleveland 17, Ohio

ORDER NOW

Fill out
and mail to
Dept. 195,
The Lincoln
Electric
Company,
Cleveland
17, Ohio

- Ship me the "Lincwelder" AC-180-C and accessories \$176.00.
Enclosed is check money order
 Send me free bulletin on the "Lincwelder" AC-180-C.

Name _____

Address _____

City _____ State _____

195

It's News: Plant Bites Bug

(Continued from page 69)

bushes, for instance, are said to grow faster than ordinary under the stimulus of the extra phosphorus they absorb.

The systemics have no effect on large insects, so they are harmless to bees, ladybugs or other predatory, parasitic insects known to prey on sucking insects. This selective characteristic is very desirable. The insecticides work with the parasites that are used in biological control instead of against them.

Entomologists are hoping that the mites, thrips and other insects won't develop a resistance to the systemics similar to the resistance that some insects have acquired to DDT. A resistant housefly now metabolizes DDT into harmless products and almost seems to flourish on a diet of it. Probably the systemics won't have a similar history. When used in recommended proportions, they are so lethal that insects just don't get sick and then recover, meanwhile acquiring an immunity. They die and that's the end of them.

One new organic phosphate systemic is toxic only for a short time, a matter of days instead of weeks. It was tailor-made to fill the need for an insecticide that could be used late in the season to quell an infestation, then vanish before harvest time.

At present, the materials cost some \$30 a gallon, which is enough to treat eight acres or so of most crops. Considering that one application lasts for weeks, the price isn't excessive and probably will come down when large domestic production begins.

Today entomologists are experimenting with fluorine compounds in addition to the phosphates. They are investigating, too, a number of fluorophosphates and a new series known as carbamates. And they are working on systemic fungicides that would be taken up by the sap stream to protect an entire plant against injury by fungi.

They are beginning to speculate on still other possibilities. There's a chance, suggests Doctor Metcalf, that systemics can be developed which would protect domestic animals against pests that trouble them. Harmless to the animals themselves, the insecticides possibly would be added to their ordinary food and would keep them free of ticks, lice or biting flies for weeks or months at a time. ★ ★ ★

Braille can now be printed more inexpensively by depositing plastic dots on paper of any weight instead of embossing the symbols on high-quality Manila paper, the British National Institute for the Blind reports.

Here's why— *it's so easy*
to buy

TIMKEN

Silent Automatic
HEAT

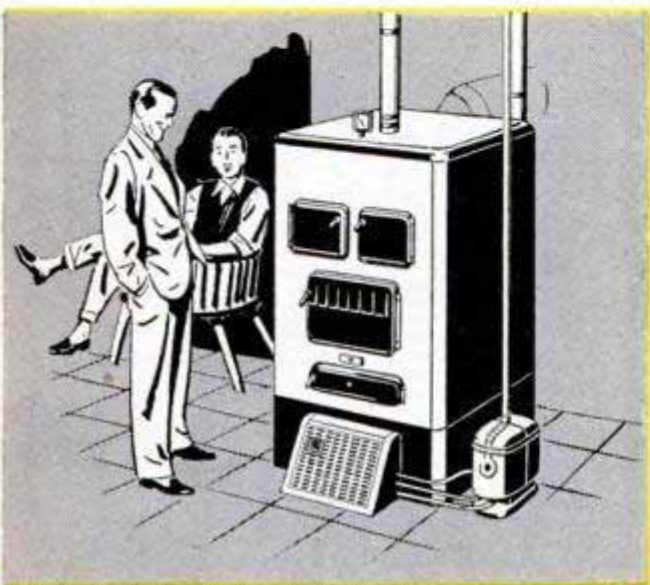

It takes so little time
to gain a lifetime of
thrifty heating comfort!

There's no fuss, no muss, no bother when you install Timken Silent Automatic Heat. Factory-trained mechanics can install a conversion burner expertly in your present furnace or boiler in less than a day. Naturally, it will take a little longer if a complete unit is needed. And there's a complete line of oil- and gas-fired furnaces and boilers, oil and gas conversion burners to choose from!

EASY TERMS AVAILABLE!
NOTHING DOWN—36 MONTHS TO PAY!

Why wait! *Now* is the time to buy the finest home improvement of all—Timken Silent Automatic Heat! You can install this money-saving, work-saving heating equipment in your present home *now* and enjoy the clean, convenient comfort of automatic heat for years to come. It's easy as one-two-three! (1) It takes only a few hours to convert your present heating plant to thrifty Timken Silent Automatic Oil or Gas Heat. (2) You can make use of easy credit terms, if desired—nothing down, up to 36 months to pay! (3) Once your Timken Silent Automatic is installed all you need do is set the thermostat—and forget it! You'll get all the heat you want—when you want it—automatically!

Take advantage of this easy way to an easier home life now! Your local Timken Silent Automatic Dealer is listed in the "yellow pages." Phone him today or mail the coupon below.

TIMKEN

Silent Automatic
HEAT

OIL • GAS • COAL

TIMKEN SILENT AUTOMATIC DIVISION

The Timken-Detroit Axle Company • Jackson, Michigan
The Timken-Detroit Axle Company of Canada, Ltd., Toronto, Ont.



MAIL THIS COUPON TODAY FOR ILLUSTRATED LITERATURE!

Timken Silent Automatic, Jackson, Michigan
Please mail illustrated literature. I am interested in:

PM9



NAME _____ (type of equipment)

STREET ADDRESS _____

CITY and STATE _____

If you are a student, please check here () for special information.

CAN YOU JUDGE
AN EGG BY ITS
SHELL?



Neither Can You Judge the Safety of
a Tire By Its Outside Appearance

TO **SAVE** TIRES
and perhaps **YOUR LIFE—**

**INSIST ON
INSIDE-OUT
INSPECTION**



Your BOWES Dealer Is Equipped for Complete Inspection

The Bowes "Seal Fast" dealer is a trained tire repairman. He has the most modern equipment for the job. He will quickly and efficiently check your tires inside and out for hidden breaks that cause blowouts, small holes that gather dirt and water, resulting in tire rot. Any necessary repairs will be made by the sure, dependable Bowes method. Remember, you can't judge an egg by its shell. Insist on *inside* and *out* inspection—save tires and, perhaps, **YOUR LIFE**. See your BOWES tire repairman **NOW**—and be sure.

DRIVE IN WHERE
YOU SEE THIS
EMBLEM

BOWES



BOWES "SEAL FAST" CORP., INDIANAPOLIS 7, INDIANA

"Soup Up" Your Car?

(Continued from page 122)

torque. Edmunds will tell you that it's the application of these principles that counts, for there are no secrets in the basic data.

Second, the engineers in Detroit are constantly revising motors and many of them have tested Edmunds' equipment in their research. They often have differences of opinion that lead them to their own conclusions, and they have been known to be astounded at Edmunds' results. In the long run, they are building great volumes of cars and must make their designs fit production and price limits.

When Chrysler brought out its 180-horsepower engine, Edmunds called up all his backlog of research and experimentation to design his own manifold and other items for it. With the new additions the same engine puts out 214 horsepower with no increase in gas consumption in the city and slightly better economy in open-road driving. The 190-horsepower Cadillac engine is the newest challenge to Edmunds' skill.

Edmunds tries to stress to anybody who will listen that he doesn't make hot-rod equipment. He is only interested in getting better performance, smoother operation and more power for hills and traffic for the average driver. Through arrangements with distributors and a big mail-order company, Edmunds parts are available here and abroad. Any competent mechanic can install them with the explicit instructions. In addition, people come from all over the West to have work done in the shop. The record is held by a driver who came from Peru via the Pan-American highway to have his stock Olds improved for the Mexican road race!

Edmunds talks eloquently about his aims for better compression ratios (he gets 8.5:1 from his equipment) with better fuels and correct combustion-chamber design. He scarcely ever makes a sketch but holds long conversations with his patternmakers, who translate his ideas into wood forms.

The business of souping up automobile motors can probably cause as hot a debate as any discussion of politics with nearly as many conclusions. The back-yard motor minds create horsepower using the same principles as the mass-producer, Eddie Edmunds, and it might be a toss-up to decide who is looking over whose shoulder. More important is the fact that both are giving the stock car a run for its money. ★ ★ ★

☞ On Jan. 1, 1952, the scheduled airlines of the United States had a total fleet of 1253 aircraft.

LOOK WHAT'S NEW FOR '52!

in World Famous

LIONEL TRAINS

AND LOOK...GET A REAL ENGINEER'S CAP LIKE THIS FOR YOUNG RAILROADERS. SEE EXTRA SPECIAL COUPON BELOW



- Brand-New Diesels!
- New Train Sets!
- New Accessories!
- Plus the Realism...Advanced Engineering...exclusive features that only Lionel brings you!

Model railroaders everywhere know that only Lionel Trains look and sound *and perform* like the real thing—the only trains with real R.R. Knuckle Couplers, Die-cast Trucks, Solid Steel Wheels and built-in Two-Tone Whistle. The most realistic of smoke-puffing steam loco's, the most authentic Diesels. See them at your Lionel Dealer's...*now!*

Special and Extra Special Coupon Offers

.....GET YOURS IN NOW!

Special offer below. Extra-Special in box at right. Enclose correct amount and be sure to write your name and address clearly.

LIONEL TRAINS, P.O. Box 9, Dept. U, New York 46, N.Y.

- I enclose 25¢ for catalog offer below—
1. The new 36-page full color Lionel catalog.
 2. Rule Book (including signals) for Model Railroaders.
 3. Model R.R. Town Building Kit—Stores, etc.
- OR
- I enclose 50¢ for catalog offer above plus engineer's cap

TWO OFFERS CHECK ONE

Name _____
 Address _____
 City _____ Zone _____ State _____

EXTRA-SPECIAL COUPON OFFER!



ALL for 50¢

Official Engineer's Cap, in striped denim, plus 5 R.R. insignia emblems to wear on it, together with Catalog, Rule Book and Building Kit, all for only 50¢.

✓ Check Cap Size here

SMALL MEDIUM LARGE



World's Most Complete!
1953 ALLIED
 TV & RADIO CATALOG

FREE!

Everything in TV & Radio
 At Lowest Prices

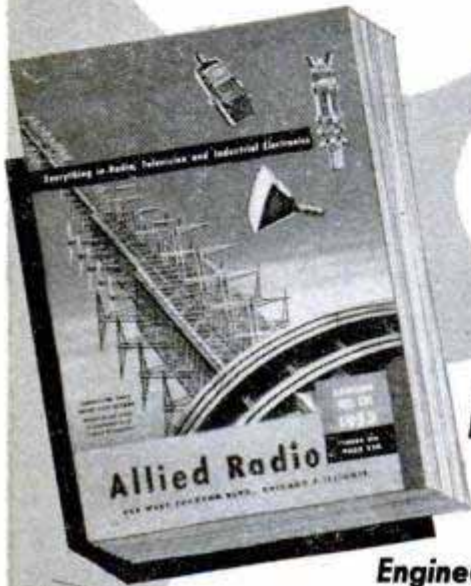

236 PAGES
VALUE-
PACKED

Everything for
Experimenters,
Builders,
Amateurs,
Servicemen,
Engineers, Soundmen

Send for ALLIED's big 236-page 1953 Catalog, the value-packed guide to everything in TV and Radio! Latest home radios, TV equipment, Amateur supplies, High-Fidelity Sound, P.A. Systems, new recorders, test instruments, builders' kits—plus the world's largest stocks of electronic parts, tubes, tools and books.

Get more for your money—
 send today for your **FREE**
 1953 ALLIED Catalog!



SEND FOR
FREE
CATALOG

ALLIED RADIO

ALLIED RADIO CORP., Dept. 5-JJ-2
 833 W. Jackson Blvd., Chicago 7, Illinois

Rush FREE 1953 ALLIED 236-Page Catalog.

Name _____

Address _____

City _____ Zone _____ State _____

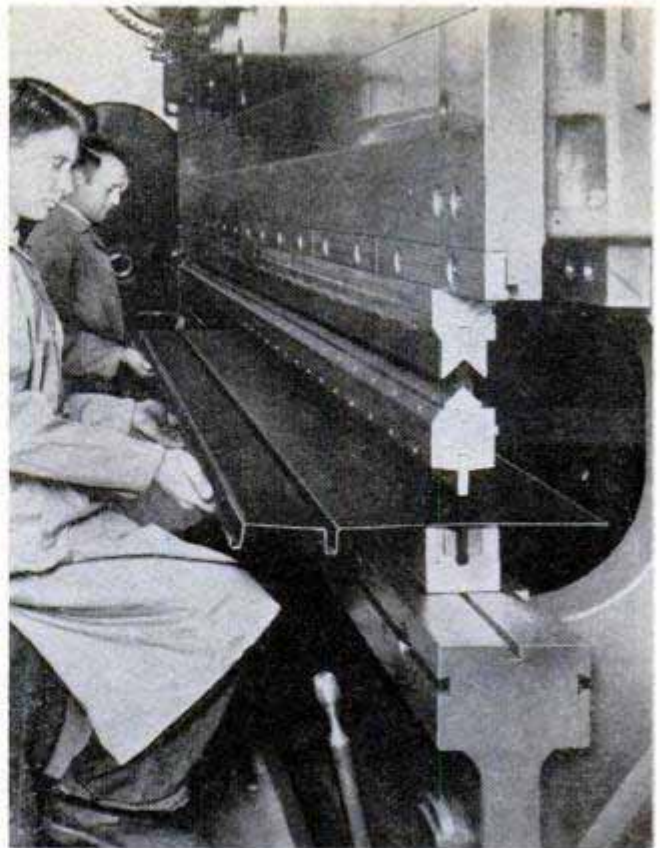

This machine presses out a roof deck from sheet of metal. The double-deck dies operate at high speed forming flange on the top and ribs on the bottom

The Tools That Make Tools

(Continued from page 103)

Milling machines were trained to cut gears in fantastic shapes, the entire process guided by an automatic feeding device. Nuts, bolts and screw machines became fully automatic, and began spewing out their products by the thousands. The turret lathe, with a different tool in each face of its many-faced turret, could drill, turn, bore, face, chamfer and recess a piece of stock without its being removed from the chuck (meantime, as the saying went, singing a rousing chorus of *Over There*).

One of the ironies of the machine-tool industry is that every time it does a bang-up job, it also bangs itself right on the head. In turning out the tools of war, it likewise had to turn out thousands upon thousands of its own progeny. Came the Armistice, and industry that had been buying thousands of machine tools to turn out planes, tanks, ships and guns, found itself with enough tools on its hands to last through 10 years of peace. The same tools that had made weapons now went to work making autos, radios and oil burners. And there were still enough left over, when the time came, to make automatic washing machines and electric refrigerators. That was another irony of the machine-tool business.

(Continued to page 244)

Your entire foot
RESTS IN COMFORT
 while you work!

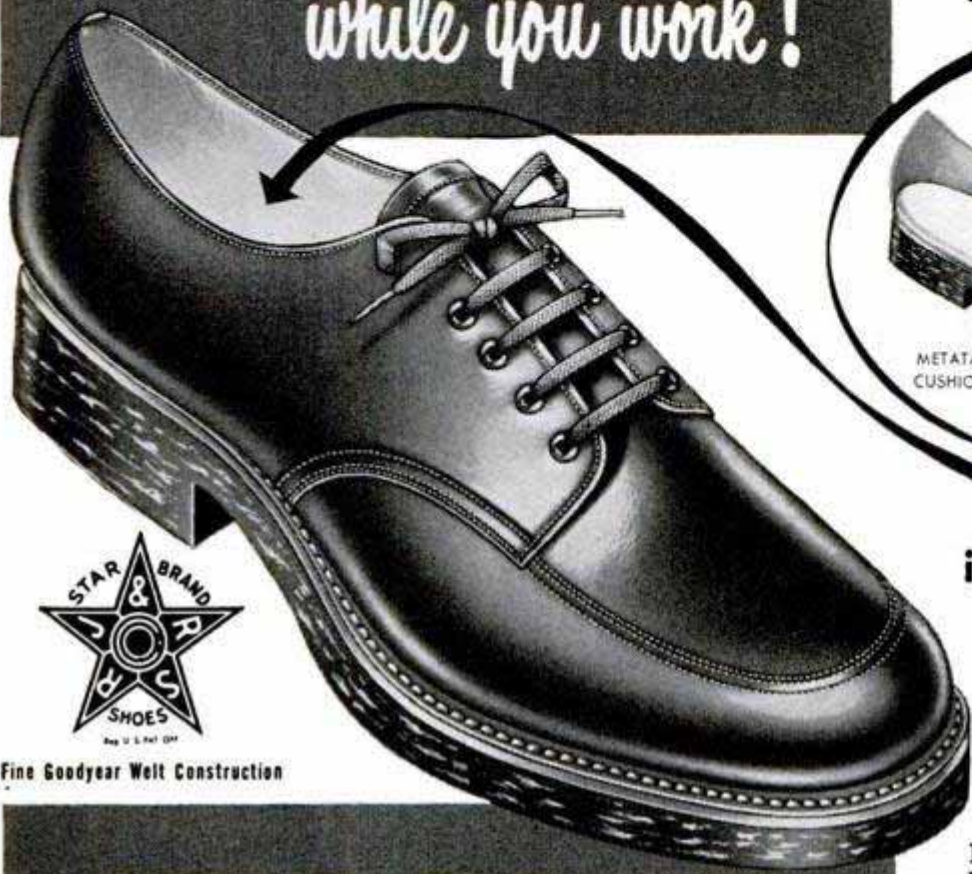

Fine Goodyear Welt Construction

STAR BRAND
Cush-N-Bilt
WORK SHOE No. 286

here's how the
Cush-N-Bilt innersole
 rests your feet while you work

Resilient innersole, made of a molded cushion of extra soft sponge rubber is covered with a walking surface of genuine cowhide leather. It rises on the inside, gives snug support and comfort to the arch. Metatarsal pad massages and relaxes busy muscles. Your entire foot rests in comfort while you work!



it's new! it's different!
cushion innersoles
of sponge rubber
 absorb work shock
 reduce foot-fatigue

If you do the kind of work that's hard on the feet . . . you'll really appreciate this amazing new shoe. Specially designed to reduce foot fatigue, it has extra-soft cushion innersoles that give you the feel of pillowed comfort! Its built-in steel shank, metatarsal and "cookie" arch pads both support and rest your feet while you work. Uppers are made of pliable genuine cowhide leather; corded soles and heels are non-slip and oil-resistant. Looks like a dress shoe . . . but it's specially constructed for rare comfort, extra duty and extra long wear!

EXPERTLY FITTED by your local Star Brand shoe dealer!

- ✓ **OIL-RESISTANT, NON-SKID CORDED SOLES AND HEELS**
- ✓ **SOFT, SUPPLE FULL-GRAIN LEATHER UPPERS** (cordovan colored)
- ✓ Built in **STEEL SHANK ARCH SUPPORT** braces the arch, holds down foot-fatigue!

built for the man
 who works on
HARD CONCRETE
or OILY SURFACED
 floors, pavements, etc.

FOR DEALER NEAREST YOU, WRITE: Roberts, Johnson & Rand, DIV. OF INTERNATIONAL SHOE COMPANY - ST. LOUIS 3, MO.

FOR FASTER, EASIER SOLDERING—



Snap-on
BRINGS YOU THE NEW
VARI-HOT
Electric Soldering Iron

2-Speed Element Reaches Soldering Heat In 40 Seconds

This 110-115 volt AC-DC iron goes to work fast! Pressing the button shoots a booster charge of 100 watts within the tip—brings it to soldering temperature in just 40 seconds! Then, only 25 watts maintain normal tip temperature comparable to conventional irons drawing 100 watts. For heavier soldering jobs, full current is always available by pressing the button.

The Vari-Hot iron is light—only 10 ounces—a boon in continuous soldering operations. Adjustable rest on shaft permits laying iron down with no danger of burning surfaces. Shock-proof Durez handle. Tapered chisel type tip plated with “Vanderloy” provides extreme durability to tip. 28-32 volt AC-DC model also available for aviation use off airplane power supply.

For home shop or professional use, there is no finer iron! Not sold in stores—buy direct from Snap-on Branch (in 42 principal cities) or order direct from factory. Send remittance with order form below.

ONLY \$7.75

—at your local Snap-on branch or order direct from factory.



*Snap-on is the trademark of Snap-on Tools Corporation.

SNAP-ON TOOLS CORPORATION

8062-I 28th Avenue, Kenosha, Wisconsin

I enclose check (or money order) for \$7.75. Send me post-paid one Vari-Hot Soldering Iron.

NAME.....

ADDRESS.....

CITY.....ZONE...STATE.....

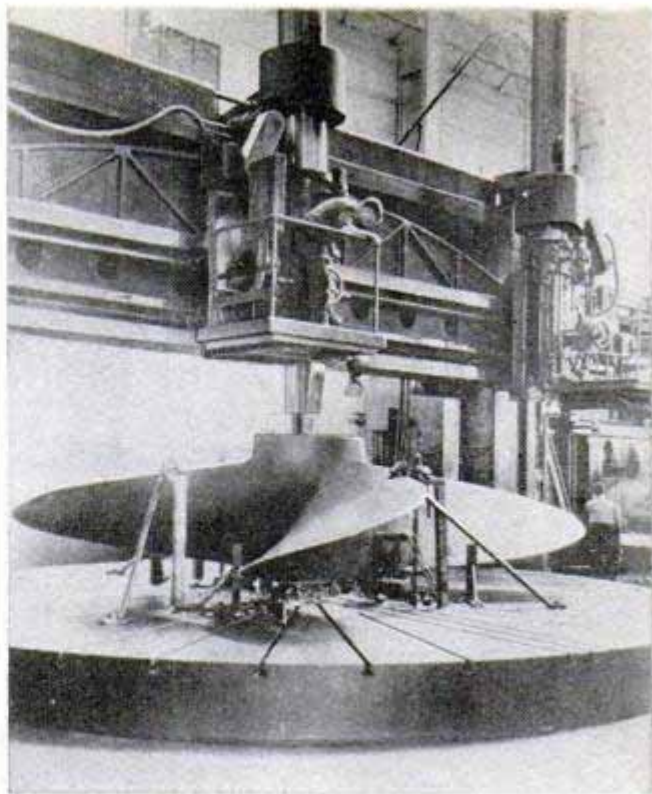

Big propeller is bored by 25-foot vertical boring and turning mill — high-precision machine operation

Because of the great accuracy that must be built into these machines, they are so accurately made themselves they seldom wear out despite almost constant use.

The machine-tool industry, resigned to being a “feast or famine” industry, went quietly to sleep during the famine years. When it woke up about 10 years later, it hardly knew itself. The basic arts were still there. It was still a small industry—about 250 firms and 20,000 men—but what an industry it was!

Gone were the overhead belts and pulleys. Gone was most of the grease and oil. Gone was the dangerous, backbreaking work of manhandling heavy castings. Gone was the laborious hand-feeding of cutting tools. So improved were the new machines—and consequently so complicated—that it took an engineer to understand them.

“The long lull in production was disastrous to us financially,” explains Tel Berna, general manager of the National Machine Tool Builders’ Association, “but it gave us time to look over our own shops. We have always been a skilled industry, but it suddenly dawned on us that our skilled workers were wasting more time and energy on manual labor than they were on the skills they had spent years in acquiring. So we came to the obvious conclusion that the less manual labor they had to perform, the more time they would have to use their skill.”

The result was the installation of more

(Continued to page 246)

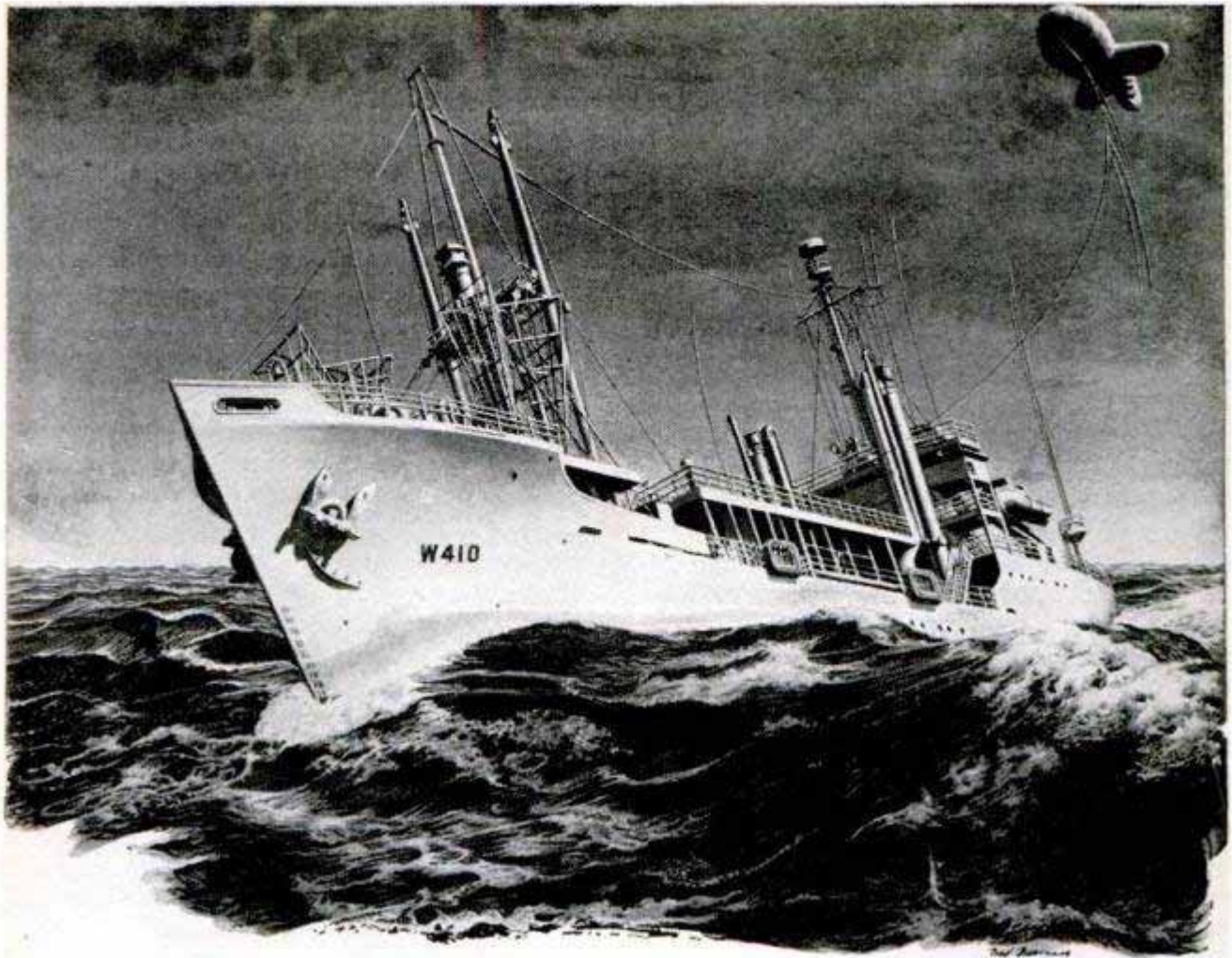

The U.S.C.G. Cutter *Courier*—armed with Truth, not guns—will use its RCA transmitter to beam messages of hope to Iron Curtain countries, and will also be a good-will ambassador to the free nations.

Freedom's clear voice goes to sea

When broadcasting Freedom's message to Iron Curtain countries, transmitters must contend with deliberate radio interference, created to "jam" the air. Aboard the Truth Ship *Courier*, a powerful RCA transmitter fills most of one cargo hold, while a second hold contains Diesel generators which produce 1,500,000 watts. Amidship, a special deck is the launching platform for a barrage balloon carrying the antenna high aloft.

The *Courier's* radio voice will follow regular schedules, so that listeners—often tuning

in at serious risk—will know when broadcasts are coming through. These people are seeking the Truth, and want to hear it despite a thousand jamming stations built in an effort to keep Freedom's messages from penetrating the Iron Curtain.

Development of broadcast equipment for use on land and sea is only one example of RCA pioneering in research and engineering. It is your assurance of finer performance in all products and services of RCA and RCA Victor.

* * *

See the latest in radio, television and electronics at RCA Exhibition Hall, 36 West 49th Street, N.Y. Admission is free. Radio Corporation of America, RCA Building, Radio City, New York 20, N.Y.



RADIO CORPORATION OF AMERICA
World Leader in Radio—First in Television

automatic feeding devices to relieve that drudgery; more conveyors to manipulate the heavy stock; a more scientific grouping of machines so that work could be passed rapidly from one machine to the next; more safety devices to protect the workers from possible harm; more self-powered machines to eliminate dangerous belts; and—what was the industry coming to?—bright lights, fresh air, and more gaily painted machines, walls and floors. Even the massive milling machine, anchored firmly in huge concrete footings, came out in a blue-and-yellow housing that was, of all things, streamlined. The workmen loved it.

Evolution of Transfer Machine

Having rearranged their shops to provide a faster flow of stock from one machine to the next, the toolmakers now began to regroup their tools. A lathe began to feed directly into a drill press, a transfer table grabbing a piece of finished lathe work, shifting it over to the drill press and centering it automatically under the drill. When that worked out fine, they added a boring machine to the process by the simple expedient of adding another transfer table. Then, to cut down on transfer tables, they began grouping their machines in a circle, and letting one table—*are you getting dizzy?*—pass the work around to each ma-

chine, an automatic feeder passing in new stock as an automatic conveyor carried away the finished work.

Today at Ford Aircraft Corp., to name but one of a dozen producers, a single transfer machine passes an aluminum airplane cylinder head to 19 separate machine tools which bring to bear upon it 99 different cutting tools.

There is only one thing that prevents the carrying of the transfer-machine idea to even more fantastic lengths—the failure of a single cutting tool can tie up the whole works. Most manufacturers still prefer to schedule their work so that the failure of any one machine or cutting tool will not stop the rest. Otherwise, as the machine-tool makers will assure you, the dream of pouring a hopper full of various ores into one end of a mill and having a finished car, untouched by human hands, come out the other is a possibility today.

In case the transfer machines have you in a whirl, consider the electronic machine-tool operator. This eerie machine records on tape every move made by a skilled workman in producing a finished part. Then, just as a tape recording can faithfully reproduce a piece of music over and over, so can this tape reproduce the workman's skill in piece after piece. If this is not enough,

(Continued to page 248)



**Go high, wide and handsome on
the world's best motorcycle!**

HARLEY-DAVIDSON

HYDRA-GLIDE®

For the greatest sport in the world, spine-tingling thrills and pleasure-packed adventure, ride a Harley-Davidson. If you've ever broken a frisky colt, or hankered to, you know what we mean. You'll make the dirt fly at field meets, club events and endurance runs.

You'll pal with the greatest bunch of red-blooded, fun-loving guys and gals in any sport. Go barreling along over highways and byways. Get going . . . see your dealer and take a buddy along. Or send 25 cents for illustrated literature and a copy of the ENTHUSIAST Magazine, filled with exciting action pictures and stories. HARLEY-DAVIDSON MOTOR CO., Dept. P, Milwaukee 1, Wisconsin.



DO IT TODAY! SWITCH TO

MILD

KENTUCKY CLUB



*"Look! Another man switched to Kentucky Club—
the thoroughbred of pipe tobaccos."*

Notice how much better your pipe tastes—how much fresher your mouth feels when you switch to Kentucky Club. Look for the blue tin with the picture of the red-coated rider. Send for free catalog showing fine pipes and how to get them at big savings. Mail Pouch Tobacco Co., Wheeling, West Va. Dept. 94

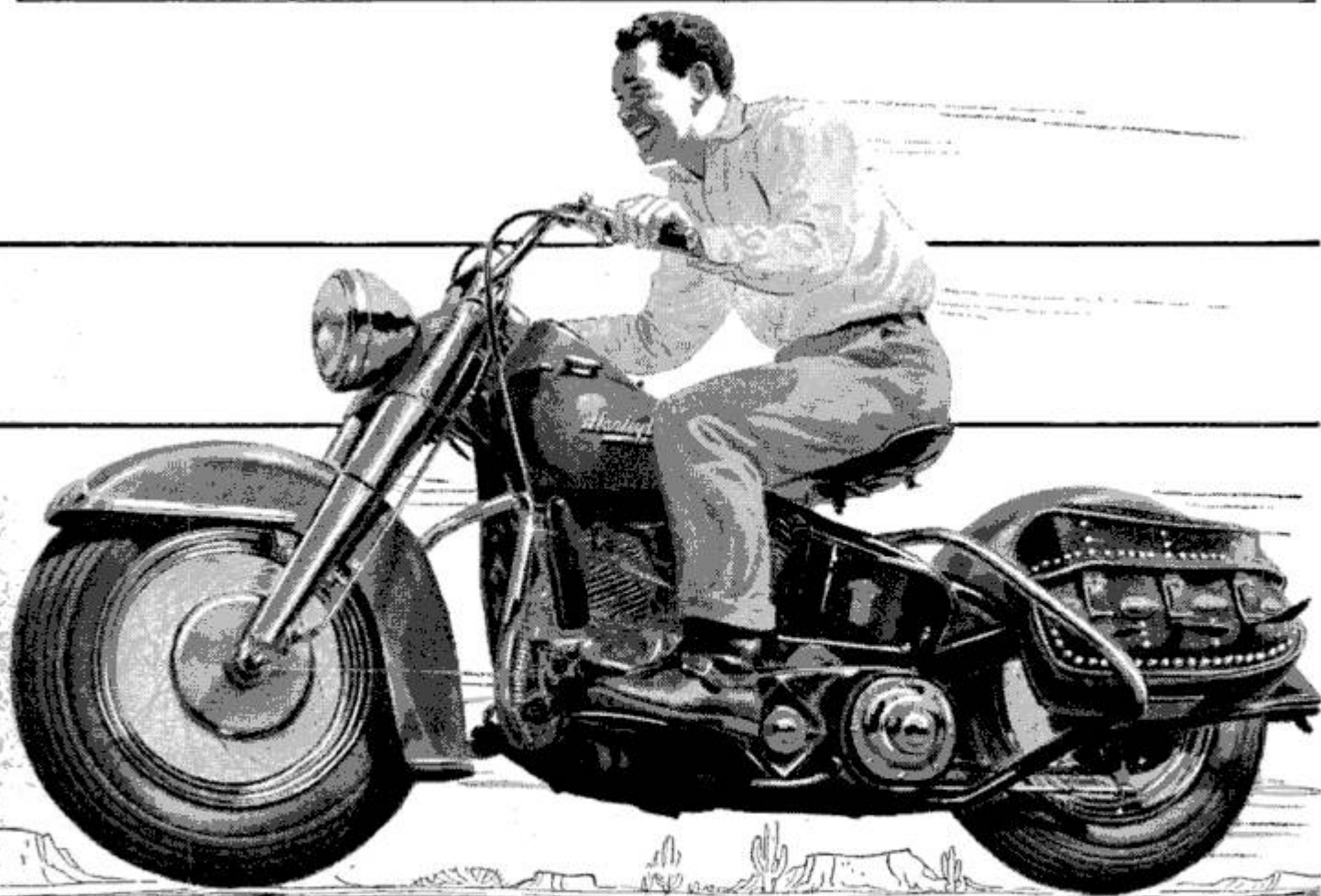



"One double fudge sundae...
and a tube of 'DUCO' CEMENT!"

Fix it for keeps WITH DU PONT DUCO CEMENT

REG. U.S. PAT. OFF.



DOLLY LOST HER HEAD? ... It's
no great catastrophe!
Put her back together
with "Duco" Cement.



**REPLACE A COM-
PACT MIRROR**
with easy-to-use
Duco" Cement and
it will stay in place
for keeps.



**UMBRELLA
HANDLES** will come
off ... but they go
back on permanently
when fixed with
"Duco" Cement.



**MAKE FISHING
LURES** and secure
loose line guides with
tough, waterproof
Du Pont "Duco"
Cement.

**STRONG, TRANSPARENT
FLEXIBLE, WATERPROOF**



**BETTER THINGS FOR BETTER LIVING
... THROUGH CHEMISTRY**

Massachusetts Institute of Technology will compute mathematically the path a cutting tool will have to make to produce a desired part, record these computations on a piece of tape (one computation for each .0005 inch of tool travel!) and feed this tape to the electronic machine-tool brain!

Today there is only one limit on the size of the work that can be turned out by the machine-tool industry. That limit is best described in a question: If we build it, can you carry it away?

For instance, down in New Castle, Pa., the United Engineering and Foundry Company recently gave birth to Big Ajax, a single prodigious casting weighing a staggering 472,000 pounds. The pit in which it was cast was big enough to make a basement for a big house, and two months after the metal was poured the casting was still shimmering in a thousand-degree heat wave. Two huge overhead cranes, each big enough to snatch up a locomotive, picked it up when it was finally cool, using a hoisting cradle made of chains so massive that each link was six feet long and thick as a telephone pole.

There is something mighty fine about that picture. Puny little man — it would take 50 of him to lift one link of his chain — walking away with 472,000 pounds of casting. But watch him now! He takes that casting and machines it with the same ease that the machine-tool worker of 1902 would machine the bed of a printing press. When Big Ajax finally becomes the frame of a forging press, his hundreds of parts will fit together in a towering mass of steel so accurately assembled it will take an electronic scanner to discover an error as great as you will find in a precision-built wrist watch.

Engineers Held Their Breath

Yes, the machine-tool men could handle Big Ajax with ease, but could he be hauled away? Fortunately, he could, though engineers held their breath while they calculated what he might do to some of the railroad bridges and trestles he would have to cross. A special flatcar, one of the two in the United States, with 24 wheels arranged to distribute the weight evenly along its 90-foot length, was brought in. Ajax settled down for his trip, and so did a few railroad ties, but it was a close squeak. What if he needs a big brother, say one twice his size?

That is not a hypothetical question. The 20 machine tools mentioned earlier are of a breed that doesn't know when to stop growing. They started in life as a blacksmith's hammer, their size being limited only by the smithy's brawny arm. They

(Continued to page 252)

BUILD YOUR OWN ARC WELDER OR LIGHT PLANT

DELCO D-C GENERATOR

Save \$250 to \$500



\$15.50 Instruction included. Rated 200 Amps, 28 Volts, 2300 R.P.M. Ship. approx. 30 lbs. Stock No. 707.

PRICE F.O.B. K.C., MO.

CONVERTS TO ARC WELDER 200-250 AMP. OR LIGHT PLANT CAP. LOAD 5000 WATTS

Stock No. 711 D. C. Generator R-1 Jack & Heintz, rated 300 Amp. 30 Volts. Gov't cost \$300.00. Instruction for converting to welder or light plant incl. Also instructions and diagram for converting the R-1 or Delco generator to Combination Welder and Light Plant Included. Only **\$25.50**

Carbon Pile GENERATOR VOLTAGE REGULATOR
For use with 24 or 32 Volt D.C. Generators. Also recommended for the P-1 and R-1 type generators in "build your own" Light plant. Only, postpaid. **\$6.95**

R-21 HEAVY DUTY RHEOSTAT
Brand New for regulating voltage on ELECTRIC WELDERS, model trains, electric blankets, lights, control photoflood lamps, etc. Rated 16-32-ohms. Size 3 1/2" x 2 1/2" postpaid. **\$6.95**

WEAVERS HYDRAULIC HAND PUMP
BRAND NEW INCL. BUILT IN CHECK & RELIEF VALVE. For hydraulic jacks, presses, hoist, etc. For operating hydraulic cylinders to pump oil or hydraulic fluid under pressure, and is capable of delivering 1000 lbs. pressure. Wt. 10 1/2 lbs. A **\$9.95** (add \$50.00 val. Instr. incl. Price)

Valuable Gears — Bargains — Speed Reducers
10-1 or 5-1 ratio, 90 degree angle. Shaft driven 1/2" spline shaft with 3 mounting holes 5/16". Gears held in forged and machined aluminum housing with two needle bearings, one bronze bearing, and three high speed shielded bearings. Rated **\$5.95** postpaid

TREMENDOUS GEAR BARGAIN
Equipped with ball bearings on all shafts. There are 3 shaft connections. The angle shafts are 60 degrees to right and left. Gear-1 ratio Drive will transmit 10 H.P. Ideal for various farm attachments & other machinery. Wt. 10 lbs. Price. **\$7.50**

New Ampidyne MOTOR GENERATOR. Use as 24/32 D.C. motor, pulls 1/2 HP. Applicable for 110 V. A.C. by simple change in connection. Applicable to independent and rural lighting. Instructions incl. Wt. 30 lbs. Cost over **\$7.50**

SENSATIONAL SELSYNS
Two or more connected together, work perfectly on 110 V. A.C. For weather vanes, rotating directional antennas or controlling distance operations. Complete with diagram and instructions. Wt. 3 1/2 lbs. PER PAIR **\$7.95** Postage paid

Hydraulic Solenoid Control Valve
BENDIX, No. 81560 24V. D.C. For remote control operation and to operate one single action or double action hydraulic cylinders with 24 V. D.C. Recommended pressure 800 to 1500 P.S.I. connections are .550"-18thd. Also applicable for 115 V.A.C. Instructions, Diagrams & Data incl. **\$3.50 ea. \$6.50 pair** value.

BRAND NEW KIDDER HY-PRESSURE CYLINDER
Valve and safety locking pin. Applicable as tire inflator, fire extinguisher, spray painting, life raft, etc. Shatterproof. Size 1 1/2" x 2 3/8". Wt. 3 lbs. (add 50c Postage) **\$2.95**

RIGHT ANGLE DRIVE with 1 to 1 ratio through 90 degree bevel gears. Drive and take off shaft are 3/8" dia., Self lubricating. Size 3 1/2" x 2 1/2" x 1 1/2". Rated 1/2 H.P. at 1750 R.P.M. Ideal for use with power tools, etc. Has three mounting holes on 1-5/16" center. Price. **\$3.50** paid

CUNO OIL FILTER — Brand New
Aircraft type. Filters oil without cartridge replacements. Just turn handle and cartridge is clean. Standard 3/4" inlet and outlet ports to accommodate 12 gallons per minute. STOP CHANGING OIL. Instructions **\$4.95** post-incl.

ELECTRIC MOTORS
Stock No. 1CA24 is 1/2 H.P. 24 V. D.C. R.P.M. 2500 Gov't cost **\$5.50**
New Gov't cost **\$75.00**
Stock No. 2832 is 1/4 H.P. 28 V. D.C. R.P.M. 4000 with simple instructions to convert to 28-32 Volt A.C. Gov't cost **\$3.95**
\$82.84. New **\$3.50**
Stock No. 4949 is 1/8 H.P. 24 V. D.C. 2000 R.P.M. Mfg. by Pesco applicable for 115 V. A.C. Instructions incl. Base **\$3.50** mounted
DELCO MOTOR 6 Volt DC handles 6" fan blade. Use as windshield wiper, toy application, etc. Shaft is 1/2" in dia., 1 1/4" long. Size 5"x3" two mounting studs. 1200-2000 RPM New **\$2.35** (add 50 cents postage)

ECLIPSE MOTOR & GEAR UNIT
Brand New including 24V. D.C. Motor. Gear ratio 4:1. Can be adapted for 2:1, 40:1 & 20:1. Ideal for GARAGE DOOR OPENER, HOIST, PUMP JACK, HAY-LIFT, LAWN MOWER DRIVE, DRIVE FOR POST DRILL, etc. Gear unit applicable for 110 A.C. Diagrams & instructions incl. Gov't cost \$221.00. Wt. 23 lbs. **\$9.95** f.o.b. only. **\$9.95** KC.Mo.

BEAM ROTATOR MOTOR
Brand New with complete operating instructions for use on 110V. 60 cycles. Powerful highly geared motor for TV aerials, ham, FM, etc. Light weight, rugged. Ideal for operating ventilating louvers, furnace dampers, and check drafts. Including instructions. **\$7.95**

VICKERS CONSTANT DIS-PLACEMENT HYDRAULIC PUMPS. Brand New Stock No. PP-713-20. For any type liquid pumping job. 375 gal. per hr. at 3750 R.P.M. 1000 P.S.I. .410 cu. in. per rev. Gov't cost \$100.00. **\$17.50** post-data and instr. incl.

VACUUM AIR HYDRAULIC GENERAL PURPOSE PUMP. Large volume heavy duty, for water, oil, insecticides and as AUTOMOBILE DRAIN-CASE PUMP. Capacity 150 G.P.H. will draw 26" mercury. With high overload factor. For direct drive, readily replaced with a pulley. 3/4" pipe thread. Data & instruction incl. Stock #75. Wt. 12 lbs. **\$15.50** Now.

Adel Self-Priming ELECTRIC PUMP
For pumping light oils, oil burners, fluid metering, fuel pump, tool post grinder, coolant, pressure lubricating pump, etc. 1/30 H.P. rated 1200 R.P.M. Applicable for 24 V. D.C./A.C. or use on 110 Volt A.C. Size 6 3/4" x 3 1/2" x 3 1/4". rated 3 G.P.H. Diagram and instr. **\$9.95** post-incl. \$50.00 val.

ROTARY PUMP For pumping WATER FROM LILY POOLS, OR BASEMENTS SUMPS, pumping lubricants. Applicable for Garden & lawn sprayers. For use with hydraulic cylinders, vacuum, in dental lab, etc. Capacity 180 G.P.H., 200 lb. pressure, 29 in. vacuum. 500 to 3000 R.P.M. Steel shaft Std. 1/2 in. (Add 150c Stock #101. Instr. incl.) **\$6.95** postage

PESCO CENTRIFUGAL HEAVY DUTY PUMP
Including built in motor. Applicable for 24 V. D.C./A.C. or 110 V. A.C. The motor is explosion proof constructed for gasoline fuel, oils, water, fuel booster, etc. 3/4" hose connection. Rated capacity 400 G.P.H. Instructions incl. Gov't cost \$172.00 **\$9.95** Stock #659

PESCO FOUR VANE ROTARY LARGE VOLUME UTILITY PUMP
For Water, Oil, Insecticides, etc. including built in relief and by pass valve. Capacity 400 G.P.H. 1/2" drive spline shaft. 3/4" pipe inlet and outlets. Rotates either direction or in any position. Engineering data incl. **\$7.95** post-Stock #600 only

INSECTICIDE PUMP SPRAYER AND FIRE EXTINGUISHER. Four Gallon size includes approx. 3 ft. of high pressure hose with fine mist nozzle. Used, good condition built to give years of heavy duty service. Wt. 15 lbs. **\$2.95** ea. add postage

HYDRAULIC FLUID Mfg. by R. M. Hollinghead or Saenoy Vacuum to exact Gov't spec. **\$1.75** Per gal. Wt. 10 lbs. Add postage.

HYDRAULIC PRESSURE GAUGE for high pressure hyd. systems Range 0 to 2000 P.S.I. 2 1/4" dia. 1 1/4" deep. Con- **\$3.50** Post-connections are 1/2"

ROMEC WOBBLE PUMP. Hand lever operated. Ideal for camp, farm, ranch, for fuel transfer to boat, etc. New **\$8.50** post-paid

VOLTMETER D.C. The basic element of this meter is 30 Volt DC Voltmeter with zero center. Internal resistance is 300 Ohms. Dial may be easily calibrated to **\$3.50** post-paid D.C. Volts. New. Price **\$3.50** post-paid

Stratopower Constant Displacement HEAVY DUTY PUMP
For operating Hydraulic cylinders, hydraulic motors on tractors, Bulldozers, Construction machinery, Lift trucks. For fuel or oil transfer. Industrial applications, etc. Delivers up to 400 G.P.H. at 3750 R.P.M. Rated 1250 to 1400 P.S.I. 3750 to 4500 R.P.M. HAS BUILT IN RELIEF AT HEAD. Rotation either direction without adjustment. \$100.00 value. Engineering data and instr. **\$15.50** incl. Stock #37. Wt. 8 lbs.

Stock No. 512
Double action hydraulic cylinder 2 1/4" Bore, 4" Stroke, Dia. 3/4" shaft including built in Hydraulic control valve which may be operated with rod or lever. Clevis mounting. Overall length shaft retracted 14". **\$9.95** f.o.b. value. Wt. 9 lbs. **\$9.95** KC. Mo.
Stock No. 472 — Double action with built in overload relief. 1" bore, Stroke 4". Shaft 7/16" dia. Length 8 3/4". A tremendous **\$4.50** post-bargain

Stock #575 — Single action 2 1/4" Bore, Shaft 2 1/4", 6" stroke hydraulic or air operated. Use as snubber or brake. **\$5.95** f.o.b. \$35.00 value.

Stock #303 — Double Action 2" Bore, Stroke 1 1/4". Dia. 1 1/2". Overall length shaft retracted 23". 2000 lbs. capacity with 1000 PSI gives 2800 lbs. with our f.o.b. Stratopower. Wt. 14 lbs. **\$14.95** KC. Mo.

Stock No. 12 Hydraulic Cylinder Double Action output 12500 lbs. with 1000 P.S.I. input. Gives 17584 lbs. with our STRATOPOWER PUMP 1400 P.S.I. or will produce 34168 lbs. with 3000 line pressure. Can also be operated on low pressure system. 4" Bore, 10 3/4" Stroke 1-5/16" Shaft, clevis mounting. O. Gov't cost **\$25.50** f.o.b. \$300.00. **\$25.50** KC. Mo.

PESCO HYDRAULIC FLOW EQUALIZER & PRESSURE BALANCER VALVE. Brand New. Guarantees equal flow and equal pressure for Two cylinders or Two systems. Capacity 360 G.P.H. 1500 P.S.I. Data & instructions incl. A **\$75.00** value. **\$14.50** post-paid Stock 1-D-397 only

HYDRAULIC CONTROL VALVES
Adel Precision #B-10329. For controlling 2 single action or 1 double action cylinder. Including toggle lever. When lever is in one direction it puts pressure on one cylinder connection and opens exhaust, from opposite cylinder. When lever is released it returns to the neutral position and locks **\$8.95** Post-VICKERS. Brand new.

VICKERS Four Way Hyd. Control Valve #137
For two double action cylinders allowing operator to raise or lower the both cylinders simultaneously or raise one and lower the other at predetermined rate **\$14.50** post-and speed.

FOUR WAY HYDRAULIC CONTROL VALVE
Poppet type Valve shuts off on neutral position. Has 3/4" A.C. Tube ports -9/16- 20 thread, capacity 1500 P.S.I. Brand new **\$5.95** post-Stock #1032.

PESCO PRESSURE AND RELIEF CONTROL VALVE. Brand new. Designed with 3 ports and external pressure adjustment. Relief valve is spring loaded, and adjustable for controlling pressure regulation. Has two ports for normal flow, one for relief line to fluid supply or to pump inlet. No. 575. Engineering data incl. A terrific bargain! Only **\$4.95** post-paid

Large Volume hydraulic pressure relief valve. 3/4" ports, spring loaded. Range 1250 P.S.I. adjustable up to 3000 P. S. I. **\$4.95** postpaid Brand New.

FOUR WAY VALVE
Solenoid operated on 24 Volt DC. Applicable for 115 V. A.C. Off in neutral position. For operating double action hyd. cylinders, remote control, etc. Has 1/4" tube ports. Instructions incl. Brand New **\$8.95** post-Stock #324

VICKERS PRESSURE RELIEF VALVE. Brand new adjustable for protecting hydraulic systems using positive displacement pumps. 1/2" AC tube size tapped 3/4-18 thread. Stock No. 501 **\$5.50** Postpaid.

VICKERS UNLOADING VALVE Brand New—By passes full amount output of the pump while the cylinder is not in operation. Takes starting load off of electric motor driving the pump. 1/2" AC TUBE PORTS **\$8.95** post-(3/4"-18" thread. Price.

Hydraulic Accumulators — Bendix Ball Type. Dia. 5 1/2". Built to stand 2000 P.S.I. Stock #A-65. Wt. 4 lbs. only **\$6.95**
BENDIX ACCUMULATOR. Ball Type. Dia. 10 1/2". Built to stand 2000 P.S.I. Wt. 13 lbs. Stock #A-85. Only **\$15.50**



GENERAL SALVAGE CO., 2922 E. 27 St., Dept. 729 Kansas City, Mo.

Higher Compression boosts

"Here's why it makes the Ford V-8 the most powerful engine in Ford's field," says Dr. Roy K. Marshall*

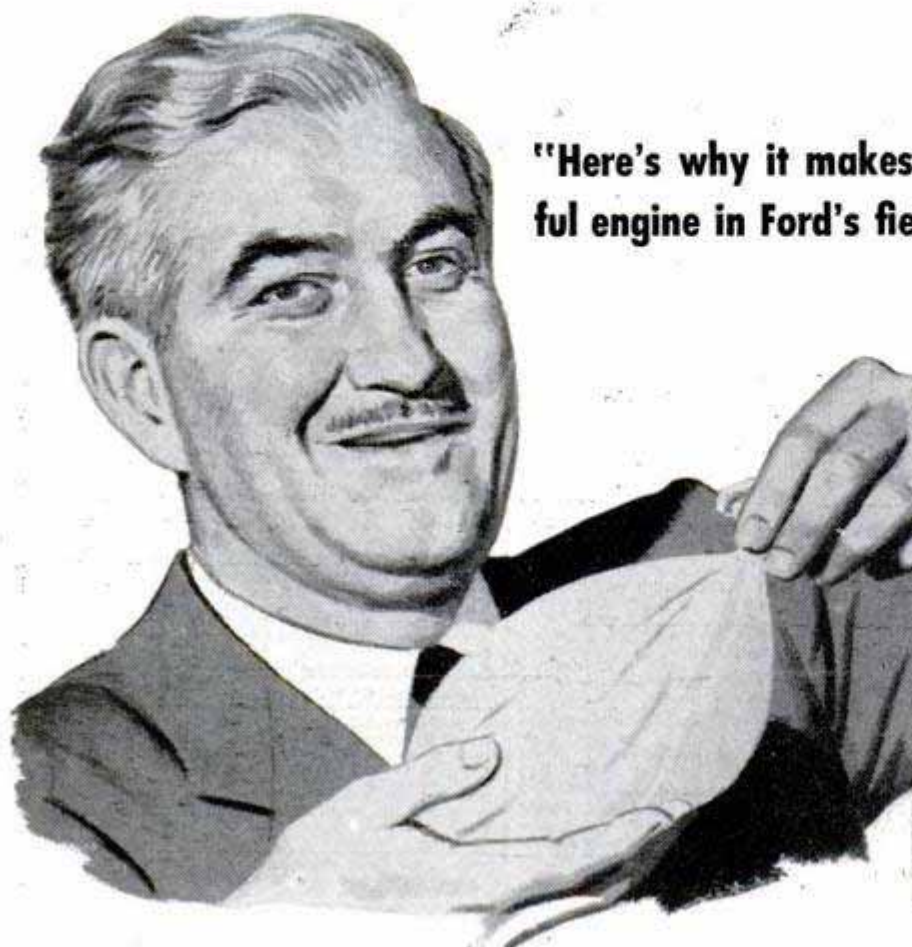

"When I fill a balloon with just enough air so that its shape is filled out, I find pricking it with a pin causes the air to leak out slowly. Now if I take the same amount of air and compress it in a smaller space by squeezing the balloon, I find pricking it

causes the balloon to pop. That's because the tiny molecules of air have been pushed closer together. When I pricked the balloon, in their rush to get out of cramped quarters they forced themselves through the hole much faster (and with more force, too)."

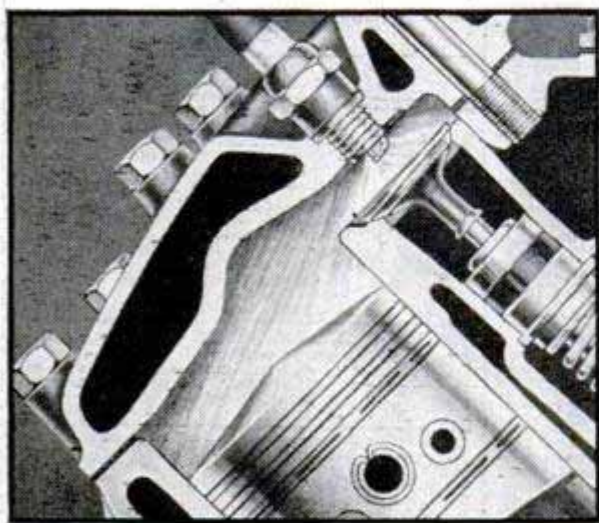

"This experiment is a very simple explanation of what we mean when we speak of the Ford Strato-Star V-8's higher compression. With Power-Contoured Combustion Chambers and new high-lift valves, Ford engineers have made it possible to feed gas more quickly into the cylinders and pack it in more tightly. This higher compression is the big reason for the greater horsepower in the 1952 Strato-Star V-8. And you get it with the economy of regular gasoline."

**Noted science editor, educator and TV commentator, Dr. Marshall is nationally famous for his simplified explanations of complicated things.*

FORD V-8 Power!

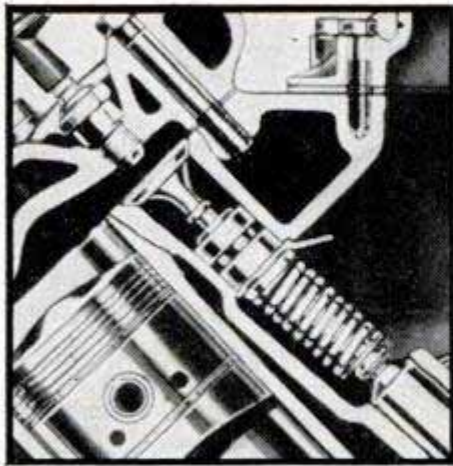

Free-turning Valves. "Ford's unique low-friction valve keepers permit free-turning of the valves. This automatic rotation minimizes warpage, wear and sticking."

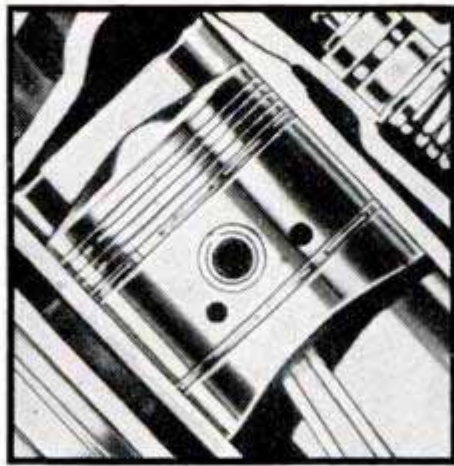

Super-fitted Aluminum Alloy Pistons. "Ford's pistons are exceptionally efficient. Their lighter weight means less shock on main and rod bearings. Controlled expansion keeps clearance between piston and cylinder walls precise at all times."

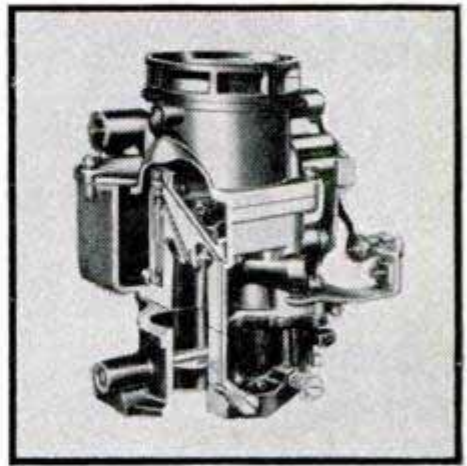

Dual Downdraft Carburetor. "The V-8's carburetor is actually two units in one. This design gives greater air velocity for better vaporization of the fuel into a more combustible mixture from idle through highest speeds."

*You can pay more . . .
but you can't buy better!*



FORD V-8 FACTS

- *It's the only V-8 in the low-price field.*
- *It's the type of engine offered in America's finest cars.*
- *Ford has been building V-8's for 20 years and has built more than all other makers combined.*

White sidewall tires optional at extra cost. Equipment, accessories and trim subject to change without notice.

It's Easy to Install a **CABINET LOCK!**

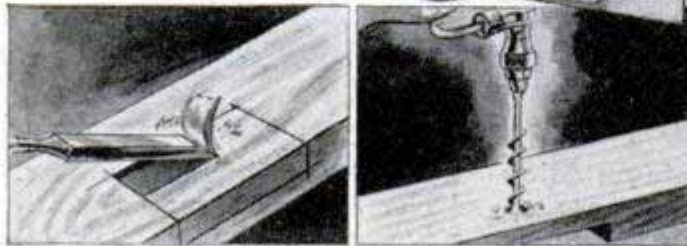
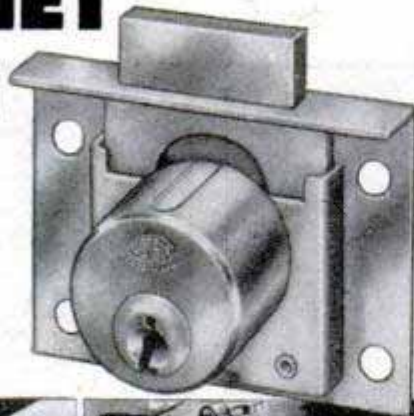

1. Mark out, and mortise door or drawer to receive lock.

2. Drill one hole.

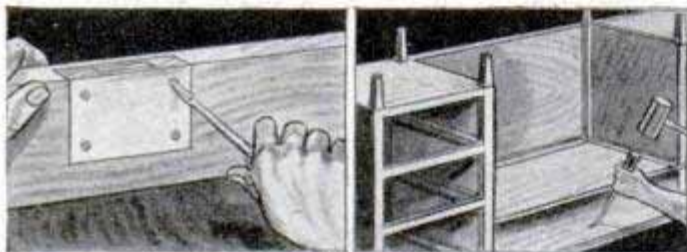

3. Screw on the lock.

4. Cut hole to receive bolt, or attach strike, if desired.

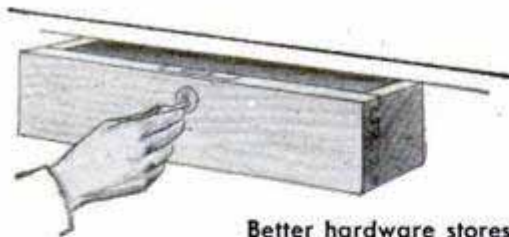

Better hardware stores everywhere have Corbin Cabinet Locks for all your cabinet work including

**DESKS, DRAWERS, CHESTS,
WARDROBES, GUN CASES,
CABINETS, TOOL BOXES**

Get the Corbin Cabinet Locks you need soon. They keep valuable papers secure . . . protect your guns and tools . . . keep children away from harmful medicines and caustics.



Corbin Cabinet Lock Division
The American Hardware Corporation
New Britain, Connecticut, U. S. A.

could be used for pounding out everything from horseshoes and plowshares to copper pots and pans, and even for punching holes in metal. With the addition of power, they became drop hammers, punch presses and stamping machines that could produce everything from tin cups to steel helmets and car frames and bodies. By 1940 they had grown to prodigious size, spitting out crankshafts, axles, molded tank armor and shell cases. Engineers thought they had grown up. Actually, they were just creeping out of diapers.

As, for instance, the extrusion press at the Aluminum Company of America's Lafayette, Ind., works. This press can bring to bear upon a solid block of heated aluminum a pressure equal to the weight of 156 loaded coal cars. Under this weight the aluminum turns to the consistency of butter (actually it remains as hard as ever, even while yielding like butter) and flows into every crevice of a die that can be as much as 90 feet long. To make a pipe 20 inches in diameter by 100 feet long, the giant press has but to lean on a billet containing the necessary amount of metal and the pipe will come squirting past the die like a string of macaroni.

Or take an airplane wing with its hundreds of rivets and machined parts. Split it in half lengthwise and make a die of each half. Insert the die beneath a hydraulically operated press. Squish! Squish! There are the two halves with all their hundreds of parts. Joined together they make a wing as light and smooth as ever, and capable of supporting a Diesel locomotive at the extreme tip.

Want some more? Well, just in case either half of this wing, or any other part that might be produced, should be warped a little, the machine-tool makers have another machine to true it up. This new machine, which is still nameless, can do a two-way stretch job—get this—using a three-million-pound pull in any direction, or in several directions at once, to bring the extruded part back into line.

Working an Alloy Like Clay

More than that, they have machines that can take the hardest alloy that you can imagine, spin it around a few times and stretch it out just as ancient potters could take a lump of soft clay and stretch it into a bowl on a potter's wheel. This "rotary draw former" is being used in sizes up to 100 tons by Pratt & Whitney, General Electric, General Motors and several other companies engaged in turning out parts for jet engines. It was designed by C. J. Bath, president of the Cyril Bath Machinery

(Continued to page 254)

Compare FEATURES . . . PRICE!

CRAFTSMAN REG. U. S. PAT. OFF. Tilting Arbor Bench Saw

Saw Only
\$60.00*
Cash

With blade, miter gauge,
rip fence, two pulleys,
V-belt — \$6.00 Down



BALL BEARINGS
Double row of grease-sealed precision ball bearings NEVER need lubrication! These "Super-lubricated" bearings give you a smooth, easy-running arbor that needs no attention . . . that maintains accuracy . . . and that takes less power.

Complete Outfit
\$125.00*
Cash

With guard, motor,
extensions, bench,
light and Powr-Panl
\$12.50 Down



FLOATING DRIVE
Greatest improvement in tilting arbor saws in years! Floating motor mount smothers vibration, makes tilting easier, protects motor from sawdust, controls belt tension. Motor easily removed.



Handy Accessories for Your Bench Saw

New CRAFTSMAN Molding Cutter Head, \$4.98, and Cutter Bits (styles \$2.50 per set, up). Make your own moldings! Head made from machined piece of cold rolled steel. Vise grip safety lock for safe operation, easy blade replacement. Self-aligning blades. With Allen wrench. Fits most bench saws with 1/2, 3/8, or 3/4-in. arbors. 1-in. wide bits cut styles as shown.

Sears Easy Payment Plan makes it easy for you to buy your Bench Saw NOW . . . pay for it as you use it!

CRAFTSMAN Carbide-tipped Saw, \$10.95 and up. New! Safer — has only 8 teeth projecting only .020 in. above non-cutting edge. Tungsten carbide tipped blades last 20 times longer than ordinary circular saw blades! No need to resharpen at frequent intervals. For ripping, cross-cutting or mitering. 5 3/8 to 10-in. diameters; all arbor sizes.

Plus all these other Features

Big 20x17-inch table of cast semi-steel . . . larger area than any other saw we know of in this price range. Precision ground surface, machined sides. Replaceable insert for dadoing, sanding, grinding. Grooved on both sides of blade for miter gauge.

ONE wheel controls BOTH angle and depth of cut. High-speed tilting adjustment; high-speed depth adjustment. No locking device needed. Automatically maintains correct tilt and depth.

ONE lever locks fence BOTH front and back . . . squares fence against table for perfect alignment.

Included with Saw: 8-inch combination blade (1/2-in. bore) which gives maximum 2 1/2-in. depth of cut, tilts any angle to 45°; miter gauge; rip fence; machine and motor pulleys; V-belt; motor mount.

Complete Outfit as shown: Saw; saw guard assembly; CRAFTSMAN 1/2-H.P. 3450 R.P.M. capacitor motor (110-120 volt 60-cycle AC); 2 table extensions; tool bench; tool light; remote-control Powr-Panl. Come in, see this saw at your Sears Retail Store today.

*The Sears retail store nearest you will furnish exact prices which will not exceed O.P.S. ceiling prices.

CRAFTSMAN Hand and Power Tools by **SEARS, ROEBUCK and CO.**
Famous for fine quality . . . precision performance . . . low price!

The Best

IN 1869...



DANIEL C. STILLSON

WALWORTH
GENUINE
STILLSON

The Best today

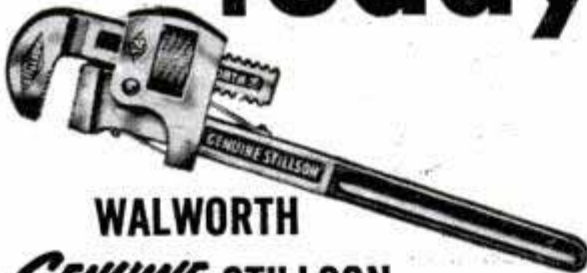

WALWORTH
GENUINE STILLSON

Daniel C. Stillson invented the famous Stillson Wrench while an employee of the Walworth Company in 1869. Walworth has continuously manufactured and improved this famous wrench since that time. Today's GENUINE Stillson is better . . . stronger than ever before, thanks to its original unbeatable design, and the latest metallurgical improvements.

Get a Walworth GENUINE Stillson from your dealer today!

The Stillson Diamond Trade Mark
identifies the
Walworth Genuine Stillson



*No shop is complete without
Genuine Stillson Wrenches*

WALWORTH

New York, N. Y.

VALVES . . . PIPE FITTINGS . . . WRENCHES

Company, and is just another example of what machine-tool makers can do when they let their imaginations rove from the orbit that was regarded as fixed in the magic year of 1902.

What about the basic arts? What happened to the lathes, planers, shapers, milling machines and drills?

Toolmakers had been cutting metal in their own happy way for a hundred years and everyone was satisfied. Then came World War II. What had been good enough before was no longer good enough. One tremendous mountain of metal had to be cut up into war machines and the existing tools just couldn't do it. There were two ways of solving the problem—they could double the machines in existence, or they could double the production of existing machines. As it turned out, they did both, and then some.

Take the matter of the cutting tool, for example. For so many years that it was taken for granted, a piece of steel only slightly harder than the workpiece was used as a cutting tool. Plowing its way through solid metal, this tool would become so hot that even with all kinds of liquid coolants pouring over it, its cutting edge would soften, wear away, or even snap off completely. It could only move through metal so fast before becoming white hot, a condition that made it as soft as the metal it was cutting. The result was a breakdown of the tool, a shutdown of the machine while awaiting a new tool or the sharpening of the old, and a serious hitch in production all the way down the line. Since this was a condition that had existed since the days of the first machine tool, most machine-tool men were resigned to the fact that it would always exist.

Fortunately, there were a few who thought otherwise. They began with the idea of creating a tool that would last longer. What they ended up with was a tool into which was brazed a cutting point made of tungsten carbide. This little block of metal was so hard that it not only resisted the heat of friction created by cutting but preserved its keenness even when the speed of a machine was increased by as much as 300 percent. The result was that all machine tools that could use tungsten-carbide cutting tools did so, shifting into high gear and reducing to minutes work that had previously taken hours. The hobbing machine, a freak cousin of the milling machine, now could cut teeth in a gear blank as big as a merry-go-round in about the same time that its 1902 ancestor could cut a transmission gear for a single-cylinder horseless carriage.

(Continued to page 256)

CAR OWNERS SHOVE \$10 BILLS IN YOUR POCKET..

When you show them America's greatest
auto seat cover values!

Including

BAMBOO

Newest Seat
Cover Sensation!



BIG MONEY, FULL OR SPARE TIME!

Want extra money—plenty of it day after day? Then rush your name and address at once for Free Sample Outfit that will start you taking orders from car owners everywhere for Key expertly tailored Auto Seat Covers. EXCLUSIVE NEW PATTERNS to fit every make and model car. No one can compete with you in wide choice, in quality—and in expert tailoring that makes covers fit like a pair of gloves. And when you quote prices that are only a fraction of what the customer expects to pay, brother! You make money hand over fist writing up the fast orders! Line includes nationally advertised sensations like BLACK EBONY Saran, in the new Black and Silver Watermelon Stripes, beautiful beyond description BAMBOO, luxurious, brilliant FIESTA, colorful BULL FIGHTER PLAIDS,

plus many other exclusive patterns to choose from, all at unbelievably low prices. It's no trick at all to make big money whether you sell full time or just in spare time. OPPORTUNITY TO SELL AT WHOLESALE TO GARAGES, SERVICE STATIONS, ETC.

RUSH NAME FOR FREE OUTFIT

GIVE MAKE, YEAR AND MODEL OF YOUR CAR. No experience needed. Make all the extra money you need easily just by showing! Every car owner a "hot" prospect. YEAR AROUND STEADY PROFITS. No investment to make. Actual seat covers given to producers for OWN use! Write for Free Selling Kit and actual samples TODAY!

KEY PRODUCTS CORP., Dept. 49

800 NORTH CLARK STREET

CHICAGO 10, ILLINOIS

KEY PRODUCTS CORP.,

Dept. 49

800 N. Clark St., Chicago 10, Ill.

Rush Free Sample Outfit at once. (If you own a car include the following information):

Make Year Model

Name _____

Address _____

City _____ State _____



FIESTA



BULLFIGHTER



BLACK EBONY

If you like
fine tools



...get



The minute you take hold of a GREENLEE tool, you can "feel" the fine quality and extra craftsmanship that goes into its making.

And when you put it to work, you'll immediately see how GREENLEE tools are built to speed your jobs and help you finish them off with a skillful touch.

The next time you buy Auger Bits, Chisels, Gouges, a Spiral Screw Driver, an Automatic Push Drill, a draw knife, or other fine hand tools . . . "get GREENLEE" . . . at better hardware and building supply dealers across America.



HANDY WOODWORKING CALCULATOR... ONLY 25c

Converts linear to board feet, gives nail specifications, tool sharpening tips, compares woods, answers countless other questions in seconds.

GREENLEE TOOL CO., 2109 Columbia Avenue
ROCKFORD, ILLINOIS; Enclosed is 25c (not stamps), send Handy Calculator to:

NAME.....

ADDRESS.....

CITY..... STATE.....

More than that, the harder, sharper cutting tools made possible the use of improved alloys being developed by the metallurgists. Some of these alloys, such as those used in the intense heat of jet engines, are hard enough to fold up an old-style cutting tool on contact. Now a strange race is on—the metallurgists seek still harder, more durable metals while the tool-makers, resolved not to get caught short again, seek even harder, sharper tools.

With each improvement in machine tools, new skills and techniques had to be mastered. This worked two ways. As giant tools became more and more automatic, some jobs that had called for the utmost skill on the part of the operator were reduced to button-pushing. This opened whole new fields to the unskilled or semi-skilled worker, a fortunate thing because the production of machine tools—a matter of months—far exceeded the production of skilled workers—a matter of years.

Challenge to Workers

On the other hand, skilled workers were confronted with fantastic challenges and opportunities. Upon them depended the production and maintenance of the complex monsters demanded by their highly technical trade. Although button-pushing would run the machine once it was made, the making of it was still dependent upon the basic arts, the mastery of which did not come from button-pushing. The machine-tool man of today has to master all the tricks of his 1902 predecessor and support them all with a working knowledge of metallurgy, engineering and the new processes constantly appearing in shops elsewhere. Also, to his job he must bring an active imagination capable of foreseeing new ways of improving his work even when it means inventing still-newer machines.

One of the brightest rays of hope in this respect does not come beaming out of the machine-tool shop at all but from the home workshop. The thousands of men who came under the spell of machine tools during World War II could not shake off the fascination when they returned to their regular jobs after the emergency. There is something wonderfully satisfying about doing beautiful precision work. Some say it is because a perfectly machined piece of work is as close to perfection as man can come. Whatever the cause, there has been an astounding, almost overwhelming, increase in power tools in the home workshop. To give just one example, in 1947 Robert and Frank Chambers set out to sell a multipurpose home-workshop tool invented by Dr. Hans Goldschmidt. Called

(Continued to page 258)

HOW TO MODERNIZE YOUR KITCHEN—



save

1/3

or even more!

PUT DOWN **GOLD SEAL®**
LINOLEUM TILE AND
 YOUR WORK'S DONE FOR GOOD!



PUT UP **GOLD SEAL**
CONGOWALL® YOURSELF
 NOTHING LIKE IT, NOTHING TO IT.



It's the right tile to lay over a wood floor! Gold Seal Inlaid Linoleum Tile is *flexible* . . . takes the up-and-down movement of the average wood floor without a strain. Can't snap, chip, or shatter, as brittle tiles do!

Easy installation! These tiles are precision-cut—*true 90-degree squares* . . . practically fit themselves into place. Trim easily with a knife for odd-shape areas. No heating or hack-sawing needed!

Greaseproof to household fats and oils! *Won't* pit, soften, discolor or disintegrate.

Easy to look at . . . easy to walk on! It's quiet, resilient . . . not clattery or tiring. Gold Seal Linoleum Tile comes in 21 beautiful glowing colors, all in *true-square 9" x 9"* tiles. All backed by the Gold Seal money-back guarantee of satisfaction!

Gold Seal Congowall looks, feels and cleans like expensive ceramic tile . . . never needs re-finishing, repairing, or repainting.

Yet tough and sturdy as it is, Congowall is flexible, easy to handle. Just paste it up . . . *that's all!* Congowall's patented duplex backing *locks it to the wall* and keeps it there, smooth and tight. That's one of the big reasons why Congowall is up successfully right now in more than 5,000,000 homes!

Sixteen true tile colors . . . plus brand new Ivy and Vine patterns. Congowall costs only about \$7 for 10 feet, wainscot-high . . . and the Gold Seal *guarantees* complete satisfaction or your money back!

FREE! Special do-it-yourself decorating booklet . . . 16 pages of full-color pictures, ideas, suggestions . . . easy-does-it hints for *all rooms*. Instruction booklet, too!



CONGOLEUM-NAIRN INC.

© KEARNY, N. J.

MAKERS OF GOLD SEAL GUARANTEED FLOOR AND WALL COVERINGS

-----MAIL COUPON TODAY-----

Congoleum-Nairn Inc.
 Kearny 12, N. J.

Please send me FREE Decorating
 Booklet and Instructions.

Name _____

Address _____

City _____ Zone _____ State _____

the Shopsmith, the tool could become, with a few simple adjustments, a wood lathe, circular saw, vertical or horizontal drill press, and disk sander. With extra equipment it could be converted into a jig saw, mortiser, drum sander, jointer-shaper, buffer, or any number of other machines. They started out with 10 handmade models priced at \$200 (since reduced) and in their first year of operation achieved sales of more than \$3,000,000.

They are not alone in their success. Manufacturers of power drills with multi-purpose attachments for sawing, sanding and buffing are enjoying a phenomenal boom. Power saws, metal-working lathes and all manner of other tools are moving into the home in unprecedented numbers. Machine-tool makers have found a gold mine in the home workshop, and the home workshop has found a gold mine in power tools. Incidentally, the same accuracy and quality goes into the manufacture of home tools as in the making of production models, for one very good reason—precision-built machinery assembles so much easier than cheap stuff that manufacturers can't afford to produce anything but the best.

So as the machine-tool industry moves into its next 50 years, it is proceeding in two directions. In industry the tools are becoming so gigantic and complex that

their cost is running into millions of dollars for one machine. In the home workshop they are becoming so inexpensive that every home craftsman can afford them. Strangely enough, both the industrial tools and the home tools are the product of a new philosophy that guides the machine-tool makers. That is the philosophy of better and better products at lower and lower costs. Gone is the mistaken idea that a machine tool is still good if it is still in good working order. Today it is good only if there is no other machine that can do the work better and cheaper. No matter if the new machine costs many thousands of dollars, if it can produce a better airplane in less time and at less cost, then all the other machines become obsolete. They must make way for the new king.

With this kind of enlightened thinking, the marvels yet to come are more staggering than those so faithfully reported by *Popular Mechanics* since 1902. But, and this is the wonderful thing about it, no matter how fantastic the machine-tool world might become, its roots from now on will be firmly planted in the home workshop. Instead of being led by a few brilliant scientists, it will be supported by the ingenuity of millions of home craftsmen. On that healthy foundation, the prospects for its future become unlimited. ★ ★ ★

SAVE YOUR CAR—IT MAY HAVE TO LAST A LONG TIME



Mechanics agree that most engine wear occurs because oil drains into the crankcase during stops. This gives acids a chance to attack unprotected metal and is the cause of DRY STARTING* which wears out engines . . . leads to costly repairs.

To prevent "Engine Ulcers," use Miracle Power in gas and

oil. Miracle Power contains colloidal synthetic graphite in suspension. This graphite clings to metal . . . holds oil . . . lubricates parts even if oil is absent . . . protects them against DRY STARTING and acid etching. And you save gas and oil because better lubricated parts waste less power.

Try Miracle Power next time you get gas.

Miracle Power Division

THE AP PARTS CORPORATION
760 AP BUILDING, Toledo 1, Ohio

THE AP PARTS CORPORATION
760 AP Building, Toledo 1, Ohio

Enclosed find \$_____ for which please send me *postpaid*:

_____ trial cans of Miracle Power at 75c each (1 for gas, 1 for oil)

Please send me free literature on making my car last longer.

Name _____

Address _____

City _____ Zone _____ State _____

At gas stations, garages, Kaiser-Frazer, Ford and other car dealers or use this coupon for introductory offer.

GROBAN'S
ALL FULLY
GUARANTEED

WAR SURPLUS BARGAIN SPECIALS

ALL
ITEMS
BRAND
NEW

PREPARE NOW FOR POWER FAILURE! IMMEDIATE DELIVERY

LARGE STOCK GENERATING PLANTS MANY SIZES

FOR YOUR EMERGENCY OR GENERAL UTILITY POWER SUPPLY

for HOME • FARM • COMMERCIAL and INDUSTRIAL USE

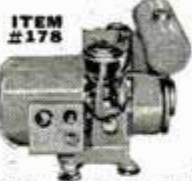

ITEM #178
citer. Air tank for the 60 cu. ft. compressor is mounted above generator. Control panel contains AC voltmeter, ammeter, circuit breaker, terminals, oil pressure and water temperature gauges, battery ammeter, ignition switch and start button. Complete unit mounted on steel skid. Shipping wt. 1000 lbs. An outstanding buy. F.O.B. Chicago.

Item #178—350 watt—110 volt—60 cycle A.C. direct coupled to 1 cylinder Mico engine. 125.00

Item #343—Model 60 Fordair Compressor with 5 KW Generator. Consists of a Ford V-8, electric starting, liquid cooled gas engine with 4 cylinder and 4 compressor cylinders. Engine directly connected to a 5KW, 120 Volt, 60 Cycle AC, Single Phase Katlight generator with built-in ex-

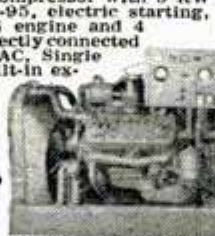

995.00

Item #201—PE 95-G—10 KW—110/220 Volt 60 Cycle A.C.—Single Phase. Totally enclosed. Onan generator direct coupled to Willys Jeep, 4 cylinder, water cooled engine, push button start. Instrument panel with engine and generator instruments, circuit breaker, controls, etc. Uses 8 volt car battery. (Battery not incl.) Skid mounted. Ship. wt. 1500 lbs. F.O.B. Chicago.

Item #345—5 KW—120/240 Volt—60 Cycle, AC—Single Phase—Onan self-excited generator direct coupled to an Onan V-4 liquid cooled, 4 cylinder, 4 cycle, gas engine with oil bath air cleaner, governor, 12 volt electric starting circuit. Control panel contains

an AC voltmeter, 2 AC ammeters, start-stop buttons, engine oil pressure gauge, and panel light switch. Complete unit totally enclosed and skid mounted. Ship. wt. 800 lbs. F.O.B. Chicago. 595.00



ITEM #183

Item #183—3000 to 4000 WATT GENERATOR SET — FEATURES — Power for your home or business. Simply connect to power panel or house circuit. • Constant voltage regardless of load. • Push button start or stop. • Easily made full automatic start or stop. SPECIFICATIONS—Size 19" x39" x48". Steel skids, weatherproof housing, requires no building. Wt. 725 lbs. • Hercules 4-cyl. 10 HP gasoline engine. Load governor. Oil filter. Quiet muffler. 6-volt starter, gen-



ITEM #300

erator. • Hobart 115 volt, 60 cycle, 3,000 to 4,000-watt generator. Furnishes either single or three-phase power, 2 or 3 wire. • Panel contains oil gauge, voltmeter, ammeter, circuit breaker, voltage regulator, start button. Today's Cost Over \$1,200.00. SALE PRICE, F.O.B. Chicago. 465.00

Item #300—Model C1B—3 KW—110 Volts D.C. This mighty mite develops 3 KW—28.5 amps. D.C. Standard Delco generator direct coupled to a Model ZEP Briggs and Stratton 1 cylinder, 5-7 HP, air cooled, rope starting gas engine. Instruments include voltage control rheostat and voltmeter. 295.00

HYDRAULIC SPEED REDUCER

(ITEM #115) WITH FINGERTIP CONTROL

USE FOR: • Reamer Drives • Midget Cars • Feed Mills • Canning Machines • Conveyors • Lathes • Milling Machines • Motor Boats • Cream Separators • Garden Tractors • Pumps



Variable output speeds from 0 to input speed available by moving control handle. Locking handle maintains setting. Use input power of 1/4 to 1 1/2 H.P. This Westinghouse-Oil Gear Unit consists of a variable displacement hydraulic pump feeding a fixed displacement hydraulic motor. Adjustable relief valves set at factory for 100 inch pounds of torque may be reset up to 180 inch pounds. Independent reverse control allows full output power and speed selection in either direction of rotation. Shafts measure 3/8" diam., include keyway. Input rotation is counter-clockwise facing shaft. Recommended input speed not to exceed 750 R.P.M. Over-all dimensions, 7 1/2" x 7 1/2" x 11 1/2". Gov't acquisition cost, \$428.00. Ship. wt. 31 lbs. Complete with 2 qts. of oil and full instructions. 54.50

General Motors — Allison CENTRIFUGAL PUMP

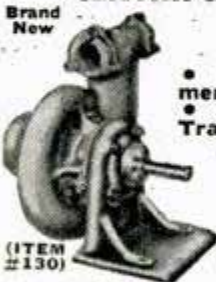

ITEM #130

200 GALLONS PER MINUTE
• For Draining Basements • Fire-Fighting • Irrigation • Fuel Transfer • Swimming Pools • Home Water Systems • Dewatering

This General Motors-Allison Centrifugal Pump — designed for use on U.S. Air Force Mustang Fighters, now converted for commercial, home, and industrial high volume pumping applications. Inlet, 2 1/2" standard pipe thread, twin outlets with 1 1/4" pipe thread, ball bearing supported 3/4" shaft. Easy, fast simple priming. Rotation, counterclockwise facing shaft. Shipping wt. 35 lbs. Gov't acq. cost \$145.00. F.O.B. Chicago. 39.50

BRAND NEW HYDRAULIC EQUIPMENT

AIRCRAFT QUALITY

Large supply of new labor-saving, economical hydraulic equipment in many types and sizes. Use these positive, highly efficient smooth pressure hydraulics on presses, arbors, lifts, loaders, power control, positioning, brakes, plastic dies, auto frame alignment, etc. etc.



ITEM #126

ITEM #126—Four-way, open center control valve with built-in adjustable relief valve. Factory set at 1000 P.S.I., spring loaded neutral position, for use with one double acting cylinder. In neutral position cylinder is locked and pump unloaded. Fully balanced butterfly type, smooth positive, easy operation, can be used as single unit or mounted in series of any combinations desired. Has 3/4" pipe thread inlet and outlet, 1/2" pipe thread cylinder ports. Newly manufactured to our specifications. Shipping weight 8 1/4 lbs. An outstanding buy! F.O.B. Chicago. 21.50



ITEM #160

ITEM #160—PESCO GEAR TYPE HYDRAULIC PUMP—Compact —Powerful—Reliable. Especially designed for belt drive from fan belt, power take-off, drive pulley, electric motor or small gas engine. Equally suitable for direct coupling. Pedestal type mounting with two bolt holes for 3/4" hold-down bolts. Standard 1/2" pipe thread inlet and outlet ports. Delivers 4.5 GPM at 1000 PSI at 2800 RPM with 3 HP. Will actuate one Item #6, 3" bore, 24" stroke cylinder in 10 seconds. Hardened steel gears turn in dense oilite bronze bearings. Rotation—clockwise facing shaft. Guaranteed trouble-free service. Ship. wt. 6 lbs. 22.50

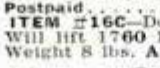

ITEM #127

ITEM #127—Double acting hydraulic cylinder, 1" bore, 1" stroke, 1/2" diam. shaft, 1/4" tubing thread ports. Over-all length closed—6 1/2". Clevis mounting at both ends. Perfect for clamping and feeding. 5.95



ITEM #166

ITEM #166—Double acting hydraulic cylinder, 1 1/2" bore, 26" stroke. Will lift 1760 lbs. with 1000 PSI line pressure. Weight 8 lbs. A \$55.00 value. Now only. Postpaid. 16.95



ITEM #42

ITEM #42—Double action hydraulic cylinder, 4" bore, 18" stroke. Rated lift capacity with 1000 PSI line pressure is 12,500 lbs. Ship. wt. 30 lbs. F.O.B. Chicago. An Excellent Buy for 32.50



ITEM #103

ITEM #103—Double acting hydraulic cylinder, 2 1/2" bore, 17" stroke. Clevis mounting. Will lift 4900 lbs. with 1000 PSI line pressure. 1 1/4" diam. shaft, 3/8" tubing thread ports. Overall length closed 28". Ship. wt. 11 lbs. F.O.B. Chicago. 21.50



ITEM #6

ITEM #6—Double action hydraulic cylinder, 3" bore, 24" stroke, will lift 7070 lbs. with 1000 PSI line pressure. Steel barrel, 1 1/8" stainless steel shaft. 28.00



ITEM #29KJ

ITEM #29KJ—Gear Type Hydraulic Pump. Ideal in industrial applications and for operating all hydraulically powered farm implements including loaders, stackers, swathers, plows, etc. Delivers 1000 PSI (may be set at lower PSI if desired). 12 GPM at 400 RPM. Maximum operating speed 800 RPM—rotation counter clockwise. Has built-in relief valve, permanent or torque bar mounting, 1" diameter shaft, 3/4" pipe tap inlet, 1/2" pipe tap outlet. Ship. wt. 22 lbs. F.O.B. Chicago. 45.50

NEW, Model 353 D. C. ARC WELDER

DUAL RANGE for Stationary or Portable Use. HEAVY DUTY RANGE TO 250 AMPS. NEW 'MAGIC TERMINAL' FOR LOW CURRENT 30 TO 100 AMPS. IDEAL FOR FARM • FACTORY • GARAGE • WORKSHOP

These precision engineered D.C. Arc Welders contain the highest quality War Surplus aircraft components built to exacting government specifications. They are light in weight, have over-sized lifetime grease-sealed ball bearings, air cooled commutator, dial type rheostat for easy pin-point control, a high-low rheostat switch, reactor coil for even arc and the new 'MAGIC TERMINAL' low current welding range for welding lighter materials. Designed for many years of trouble-free service. Run welder from drive pulley or power take off of a tractor or Jeep, 7 1/2 HP electric motor or 10 HP gas engine at 2500 R.P.M. Uses two V-belts or flat belt. Continuous output rating 200 amps. Intermittent welding rating 250 amps., 30 volts. This sensational price includes double V or flat belt pulley and complete operating instructions. Ship. wt. 107 lbs. \$350.00 Value. Item #65. F.O.B. Chicago Now only... 119.50



Welds Anything From Auto Fenders To Tractor Frames

FREE: NEW WAR SURPLUS BARGAIN CATALOG

ORDER DIRECT FROM AD — SEND PAYMENT OR PURCHASE ORDER TODAY — SATISFACTION GUARANTEED

GROBAN SUPPLY CO. 1139 SO. WABASH AVE., CHICAGO 5, ILL. DEPT. PM-9

SELF-CONTROL STARTS HERE



AND TO RESTORE
CAR PERFORMANCE

OIL-CONTROL STARTS HERE

To stop oil-pumping, replace worn engine
connecting rod bearings

Engine performance, like team performance, depends on the harmony of all the working parts.

You get poor engine performance when main and connecting rod bearings are worn. They let excess oil reach combustion chambers, burn to carbon on pistons, rings, valves and spark plugs. *Performance goes up in smoke!*

With an oil-pumper, check for worn bearings! Give the piston rings a chance to do their own job. Genuine Federal-Mogul bearings are engineered for the job of oil-control. They restore engine power and performance. *Ask your mechanic!*

FEDERAL-MOGUL SERVICE
(Division of Federal-Mogul Corporation)
DETROIT 13, MICHIGAN



CONTROL OIL-PUMPING

WHERE IT STARTS—REPLACE WITH

FEDERAL-MOGUL

OIL CONTROL BEARINGS



Ice-Cube Airport

(Continued from page 138)

blasting caps in the air near by. Sure enough, the geophones registered the shock waves in the ice. But Ewing and Press noticed something else, too. Where the ice was thin, the vibration frequencies were short and fast. On thick ice they were longer and slower.

At this stage the Air Force stepped in, financing more tests on Lake Superior and then a full-blown experiment from a base at Barter Island, just under the Arctic Circle. As finally evolved, here's how it works: A plane flies out over the ice field to a spot that looks good for a base or landing strip. As the plane circles, a crew member parachutes down several geophones specially equipped with radio transmitters to broadcast whatever the geophone hears. Next, a small explosive charge, timed to go off just above the surface of the ice, is tossed from the plane.

The shock waves transmitted to the ice by the exploding bomb are picked up by the geophones and broadcast to the plane. The comparative velocities of the sound waves give the thickness and strength of the ice. Within minutes the crew knows just what the ice below will support.

The scientists also used geophones to measure ice drift. Spotting them at varying distances from each other, they would cut a hole in the ice and lower an explosive charge on a wire. When the charge went off, each geophone would pick up the train of shock waves at split-second differences in time. Knowing the bomb's exact location, they could calculate just how far, how fast and in what direction the ice was moving.

A phenomenon that gave the scientists trouble, and has long plagued explorers, is the "gray out" or "white out." It's a low-hanging mist that hugs the ground and looks for all the world like a smooth snowy surface. A man traveling on the ice pack stands a chance of walking into an ice wall or disappearing into a hole.

Despite these hazards, the mystery that long closed the Arctic off from the rest of the world is being torn away. Air transport has made wide and fast travel through the ice country possible. Each successive expedition is affirming Fridtjof Nansen's early claim, based on 11 years' experience north of the Arctic Circle, that the Arctic is generally among the least stormy regions of the world.

No longer regarded as just a daring goal—with reaching it considered an end in itself—the mythical North Pole has become a roadside sign for global travel. ★ ★ ★

Steel Assortment for Homecraft Work Shops

the marvelous Sure Spec

tinker-pak



an assortment of finest quality carbon and alloy steels

The Tinker Pak

—12 pieces each approximately 12" long—\$2.75 (weight 5 lbs.)

The Super Tinker Pak

—12 pieces each approximately 36" long—\$4.95 (weight 15 lbs.)

Each Pak contains high quality bars from 3/16" to 1/2" diameter; flats from 1/8" x 3/16" to 1/4" x 1/2"; seamless tubing from 1/4" to 1 3/8" outside diameter.

see what you can repair!

- Door Stops
- Baby Carriages
- Small Motors
- Lawn Mowers
- Toys
- Appliances
- Automobiles
- Farm Machinery
- Garden Tools
- Sleds
- and dozens more!



look what you can make:

- Small Tools
- Cabinet Handles
- Towel Racks
- Furniture Braces
- Axles for Children's Vehicles
- Hinges
- Door Fasteners
- Fish Spears
- Gun Racks
- TV Aerials
- Outdoor Grills
- and many many more!

SATISFACTION IS GUARANTEED, so get a Tinker Pak from your hardware store today. If he does not stock, send your order and hardware dealers name to —

SOLAR STEEL CORPORATION

Tinker Pak, Dept. P, Union Commerce Bldg., Cleveland, Ohio

Enclose Check or money order. No C.O.D.'s. Shipping charges extra.



It's ready! JUST ADD WATER

SAKRETE

© SAKRETE—P. O. Box 11, St. Bernard 17, O.

PRE-MIXED CONCRETE & MORTAR IN A BAG!

At Lumber, Building Material and Hardware Dealers . . .

HOBART "all 'round" WELDING...gets BIG PAYING jobs!

Go anywhere with trailer type gas drive welder

Don't let opportunity pass you by! Set up your own welding shop—get in on one of today's fastest growing, biggest paying businesses. Opportunities are unlimited.

Have your own BIG PAYING business

Hobart "simplified" welding makes learning easy, yet gives you an all 'round welder of top performance and dependability. Write for free booklet "Better Welds."

Build a GOOD business reputation with

Write today!

HOBART BROTHERS CO., BOX M-92, TROY, OHIO

HOBART WELDERS

Build the Best! EASY TO ASSEMBLE BOAT KITS



NEW CATALOG

- OVER 40 PAGES, INCLUDES ALL YOU NEED TO BUILD YOUR OWN
- 1-BOAT KITS—30 MODELS
 - 2-MARINE HARDWARE
 - 3-MARINE ENGINES
 - 4-MARINE CONVERSIONS
 - 5-PAINTS & COLOR CHARTS

All For Only 35c, SEND COIN TODAY

ROWBOATS

8-10-12-14 FT.
\$39 up



OUTBOARDS

8 Models 12 to 18 FT.



INBOARDS & CABIN CRUISERS
16 TO 23 FT.

NEW 18 FT. OUTBOARD CABIN CRUISER

FAST VEE BOTTOM HULL SPEEDS UP TO 25 M.P.H. — ROOMY CABIN, WITH TOILET, SLEEPS TWO —

U-MAK-IT PRODUCTS

703 P-WHITTIER ST.,

Bronx 59, N. Y. City



40,000,000 IN DAILY USE

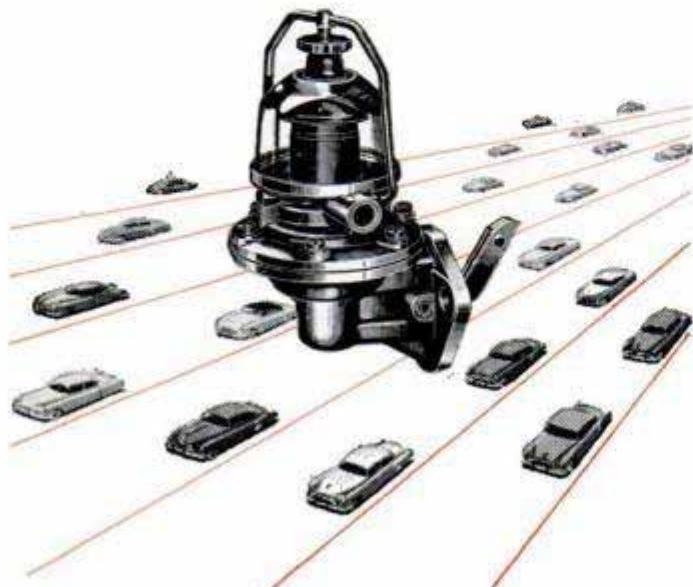

Wherever you drive on the highways of America, more than 90 per cent of the cars and trucks you see rely upon AC Fuel Pumps for a steady supply of fuel.

More than 40,000,000 in daily service testify to the popularity of AC Fuel Pumps, among engineers and owners alike.

Since AC introduced fuel pumps, 25 years ago, more than 100,000,000 have been built, establishing an unparalleled record for reliability the world over. There's none better.

AC

**ORIGINAL
EQUIPMENT ON
9 OUT OF 10
CARS ON THE
ROAD**

**FUEL
PUMPS**

**AMERICA'S
FIRST AND
FINEST**



AC SPARK PLUG DIVISION GENERAL MOTORS CORPORATION

The Owners Report on the 1952 Nash

(Continued from page 94)

car that will outclass them all."—Lincoln, Ill., owner.

"For day-long trips, the Ambassador is the most comfortable car I've ever driven. But I wish it were about four inches narrower."—Elmwood Park, Ill., plant superintendent. (Many owners of other makes also complain to us that U.S. cars are too wide and bulky.)

And now for my own test of the Nash Ambassador: From the Nash factory at Kenosha, Wis., this test included normal city driving through Chicago, Indianapolis, Denver and other cities, some rough-road testing on detours and roads washed out by floods, a number of miles in the mud on roads being repaired in southern Utah, several hours of rainy weather and desert conditions in Utah and Nevada, as well as climbing over Loveland Pass (11,992 feet) and Vail Pass (10,601 feet) in the heart of the Colorado Rockies, then via Zion National Park through Las Vegas to Los Angeles, a distance of 2765 miles including some off-highway testing.

The model tested was the Ambassador Custom Golden Airflyte four-door sedan. It has a 121¼-inch wheelbase and was Hydra-Matic equipped. (Nash also offers a three-speed transmission and an overdrive unit if desired.)

The 6-cylinder overhead-valve engine with a high compression ratio of 7.3:1 develops 120 horsepower and has a displacement of 252.55 cubic inches. The engine is extremely free of vibration. The carburetor and manifold are mounted on the right side of the engine, with unconventional horizontal carburetion.

The car is economical (see economy chart). Nash advertises that regular gas is satisfactory and I found it to be so. I could not make the car "ping" on regular gasoline, nor was there any evidence of overheating in the mountains, the desert and at high speeds across the Midwest when the temperature was over 100 degrees.

Roadability is above average and the front suspension system, (new on the Ambassador and Statesman this year) gives a smooth, comfortable ride with minimum sidesway on corners. Nash uses coil springs in the rear instead of leaf springs and the handling of the car over all kinds of roads changed my ideas about rear coil springing, which I had disliked previously.

The car has average acceleration to about 60 miles per hour, but acceleration above 60 is particularly good. It cruises easily

(Continued to page 264)



GRAVELY
makes tough
jobs **EASY!**

Powerful!

5-HP Gravely Tractor powers 20 tools—does every lawn, garden, and field job easier, better! All-gear drive, Reverse. New "Power vs Drudgery" Book-let FREE. Write for it today!



GRAVELY

BOX 963 DUNBAR, W. VA.

FIELD-TESTED FOR 31 YEARS

**AMAZING NEW INVENTION
KILLS ALL TYPES OF INSECTS**



Keeps rooms of more than 10,000 cubic feet free from annoying insect pests. Tiny as a light bulb, just plug it in any 100 volt AC or DC outlet. Scientifically, automatically, kills all insects.

**SILENT • ODORLESS • QUICK
GUARANTEED FOR 10 YEARS**

New Mortane is non-injurious to humans, pets, plants. Finished quality appliance. Carries iron-clad, must-work 10 year guarantee. Free: Over 240 hours supply Mortane crystals included. Refills guaranteed always available. Over 240 hours supply 50¢ — over 1000 hours supply \$1.95. Send \$0.95 check, M.O., or sent C.O.D. Satisfaction absolutely guaranteed.

VOLUME SALES OUTLET 1209-M OREGON AVE., PHILA. 48, PA.

MONEY for MEN ALL DATA FREE

THE PLASTEX Industry needs manufacturers on small scale and for big production of Lamp and Clock Stands, Art Goods and Novelties in Plastex and Marble imitation. Experience unnecessary. The material makes regular 10¢ store sellers. Rubber moulds furnished for speed production. Small investment brings good returns. We are now placing big Chain Store Orders with manufacturers. Ambitious men have chance for real prosperity. Our Free booklet will interest and benefit you.

PLASTEX INDUSTRIES, Dept. A
3400 Third Ave. New York 56, N. Y.

5 BIG POWER TOOLS in ONE

8" TILTING TABLE SAW

30" LATHE

HORIZONTAL DRILL PRESS GRINDER SANDER

RETAIL PRICE \$125.00
FACTORY TO YOU \$79.95

SUPERSHOP is a PRECISION-BUILT WORKSHOP. 100% ball bearings. All running parts precision ground. Big capacity. Extra rugged. Amazing value. Write for FREE catalog.

BUY ON EASY PAYMENTS

POWER TOOLS, INC. 139 YATES AVENUE
BELOIT, WISCONSIN

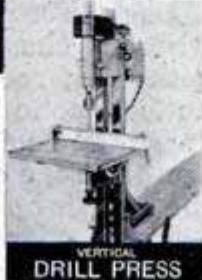

VERTICAL DRILL PRESS

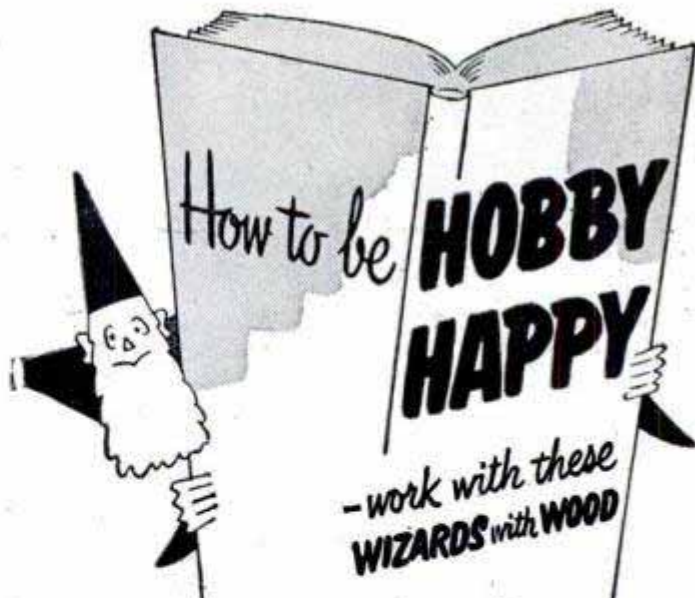

Do you make or mend things of wood? Then you want them to turn out reliably right. To succeed every time, use Weldwood Glue, Firzite and Satinlac. Ask for them at hardware, paint or lumber dealers.

Gets that blond or pickled effect—

Produce those magical "woody" effects — on hard wood or soft, plywood or solid lumber with White Firzite. For light pastel tones, tint with Colors-in-Oil. (On fir plywood stain jobs, tame that wild grain with Clear Firzite.)



WHITE FIRZITE®

Gets that Natural-Wood Finish

—without shellac or varnish. On furniture, panelling or woodwork, there's nothing like Satinlac. Brings out natural grain and color beauty of any plywood or solid wood. Avoids that "built-up look; will not turn yellow or darken with age. "Water-clear," easy to brush or spray, dries ready for next coat in 2 or 3 hours.



SATINLAC®

The Wood Glue you can rely on!

To make things or fix things, use Weldwood Glue for all wood-to-wood bonds. Makes joints stronger than the wood itself. Mixes easily with water. Stain-free, rot-proof...highly water-resistant!



WELDWOOD®
PLASTIC RESIN GLUE

Pints, Quarts,
Gallons

United States Plywood Corporation,
Dept. 121, 55 West 44th St., New York 36, N.Y.

Send me free leaflets on Weldwood Glue, Firzite and Satinlac.

NAME _____

ADDRESS _____



OWN YOUR BUSINESS

Start in Spare Time with a FOLEY SAW FILER

Here is a steady repeat CASH business you can start at home in your basement or garage, while you are working at your regular job. No experience is necessary to turn out perfect cutting saws—"the first saw I sharpened came out 100%. I think the Foley Saw Filer is a marvel of perfection," writes Clarence E. Parsons. Every saw you sharpen will bring you new customers. You will find you can make up to \$3 or \$4 an hour—\$20 to \$30 a week in your spare time as a starter.

With a Foley Saw Filer you can file all hand saws, also band and cross-cut circular saws. It is easy to operate—simple adjustments—no eye-strain. Patented jointing principle evens up all irregular teeth and makes an old saw cut just like new.

This Free Book

Shows How to Start

"MONEY MAKING FACTS" shows you how to get plenty of saws to file without canvassing, and how you can develop into a general repair shop that will be your own business. This is a helpful, practical book that tells just what to do—send for your free copy today. No salesman will call.



Send for **FREE BOOK**

**FOLEY MFG. CO., 919-2 Foley Bldg.
Minneapolis 18, Minn.**

Send me free book "MONEY MAKING FACTS."

Name _____

Address _____

at 80 to 90 miles an hour by speedometer which is fast by about 7 percent. Top speed of 102-104 miles per hour was indicated by the speedometer and could be maintained for miles on long, open stretches.

I like the narrow but long (28 inches) instrument panel. There is a sponge-rubber cushion across the entire front of the dash which, while rather narrow, does serve as a crash pad, offering some protection in case of accident.

The body is roomy and has excellent head clearance. You can get in or out without knocking your hat off. Forward vision is fine, through a wide, curved, single-piece windshield. Rear vision is good, as the back

1952 NASH GOLDEN AIRFLYTE SPECIFICATIONS

	Statesman	Ambassador
ENGINE		
Type	6 cyl., in-line, L-head	6 cyl., in-line, OHV
Bore and stroke.....	3 1/8 in. x 4 1/4 in.	3 1/2 in. x 4 3/8 in.
Piston displacement	195.58 cu. in.	252.55 cu. in.
Brake horsepower	88	120
Compression ratio	7.0:1	7.3:1
Transmission	3-speed conventional; conventional with overdrive or 4-speed Dual-Range Hydraulic Drive optional	
GENERAL		
Steering ratio	20:1	20:1
Steering wheel, lock to lock.....	3 1/2 turns	3 1/2 turns
Turning radius	21 ft., 2 in.	22 ft., 4 in.
Brakes	Conventional hydraulic with riveted linings	
Tire size	6.70 x 15	7.10 x 15
Recommended tire pressure.....	24 lb.	24 lb.
Weight (4-dr. sedan, unladen).....	3045 lb.	3480 lb.
Wheelbase	114 1/4 in.	121 1/4 in.
Tread, front	55 1/2 in.	55 1/2 in.
Tread, rear	59-11/16 in.	60 1/2 in.
Height overall (unladen).....	61 3/4 in.	62 1/4 in.
Width overall	78 in.	78 in.
Length overall	202 1/4 in.	209 1/4 in.
Road clearance	7 1/2 in.	8 in.
CAPACITIES		
Oil	5 qt.	6 qt.
Water	15 qt.	18 qt.
Gasoline	20 gal.	20 gal.
INTERIOR DIMENSIONS		
Front-seat width	65 in.	65 in.
Rear-seat width	64 1/2 in.	64 1/2 in.
Headroom, front	37 1/2 in.	37 1/2 in.
Headroom, rear	36 in.	36 in.
Legroom, front	41 1/2 in.	41 1/2 in.
Legroom, rear	37 3/8 in.	37 3/8 in.

window wraps around each side. The vision directly in front of the wheels is excellent because of the sloping hood.

As optional equipment Nash cars have an Airliner reclining seat for passenger rest on long drives. The bed feature is another detail that appeals to vacationists, tourists and sportsmen.

Nash is a pioneer in unit construction, whereby chassis and frame are welded together. It reduces squeaks and rattles (I noticed none in my 2765-mile Nash test) and in an accident it affords better protection than the conventional design in which the body is bolted to the chassis.

The Bendix servo-type brakes showed no

(Continued to page 266)

SURPLUS MACHINE SHOP TOOLS AT PRICES YOU CAN AFFORD

SET 12 different size H. S. straight shank Drills. 1/4" to 1 1/2", lengths up to 7". Only... **\$3.98**

HIGH SPEED MORSE TAPER SHANK DRILLS



SET 9E

15 Different Size High Speed Morse Taper Shank Drills up to 9/16" with No. 1 and 2 tapers. New and used. \$50 value. Priced at only... **\$6.49**

SET 20 Different Size High Speed Morse Taper Shank Drills from 1/4" to 1". New and used. \$70 value. Priced at only... **\$12.95**

SET 10 Different Size High Speed Morse Taper Shank Drills from 1/2" to 1 1/4". New and used. \$50 value. Priced at only... **\$9.95**

SET 8 Different Size High Speed Morse Taper Shank Drills from 1" to 2". 37E with No. 3, 4, and 5 tapers. New and used. \$125 value. Priced only... **\$29.95**

HIGH SPEED STRAIGHT SHANK CHUCKING REAMERS



SET 20 Different Size High Speed Straight Shank 16E Chucking Reamers up to 1 1/2". New and used. Priced at only... **\$7.95**

SET 15 Different Size High Speed Straight Shank 18E Chucking Reamers from 1/4" to 1". New and used. Priced at only... **\$7.95**

HIGH SPEED WOODRUFF KEY SEAT CUTTER

SET 5 different size cutters. Can be used as mounted milling 4E cutter or circular saw. All with 3/8" and 1/2" shanks, widths up to 1 1/4", dia. up to 1". New and used. Ppd. Priced at only... **\$3.95**



NEW HIGH SPEED COMBINATION DRILL AND COUNTERSINKS

SET 8 selected sizes from A1 to F2 (3/64" drill x 1/8" body to 3/16" drill x 7/16" body) 60° angle of countersink. New cost on these countersinks 75c to \$2.50 ea. Priced to you Ppd. at only... **\$3.98**

6 SLITTING SAWS WITH MANDREL

SET 6 different size high speed Slitting Saws, 5 pcs. 2 3/4" dia. x 1" arbor, plus 1 pc. 5" dia. x 1 1/2" arbor. Thickness from .040 to .071. Cuts wood, aluminum, brass, steel, etc. PLUS SPECIAL MANDREL which enables use of saws in 1/4" or 1/2" electric drill. \$25 value. PPD. Only... **\$4.95**

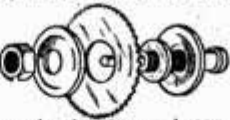

7 selected, sharp H. S. Slitting Saws as above to use on your own mandrel or milling machine. New and used. Ppd. A bargain at... **\$4.95**

100 MOUNTED POINTS

SET 1/8 and 3/32 shanks, as-21E sorted shapes and sizes... **\$8.98**



DOUBLE-END END MILLS

SET 4 right hand H. S., 3/8" straight shank End Mills up to 3/8" dia. **\$3.98**

New Rotary FILE MIX

7 different pcs., High Speed 1/4" shank, PPD... **\$4.49**



SET 14 different pcs., as above, PPD... **\$8.79**

NEW CARBIDE TIP MASONRY DRILL

Carbide tip goes through any masonry. Set of 5 bits containing two 7/32" & three 1/4", all five, \$10 value, only... **\$2.75**



60 TO 1 GEAR BOX 5/16" dia. input shaft, 1/2" dia. output shaft with removable sprocket. Wt. 6 lbs. PPD... **\$6.49**

PESCO HYDRAULIC GEAR TYPE PUMP

Rated at 3 GPM. 3750 RPM, 1500 PSI. 1/2" drive spline. Gov't cost over \$90. Yours for only... **\$9.49**



Money-Back Guarantee—All Mdse. Mixture of New and Reconditioned Unless Specified New. All items (unless marked PPD) will be shipped F.O.B. Tulsa.

Write For Free Catalog Describing Thousands of Bargain Cutting Tools.

NEW 360° SWIVEL TYPE TOOL HOLDER AND BORING BAR

Here is a tool that will do the work of a left, right and straight tool holder, plus a boring bar, all for a fraction of its original cost, post paid to you.

TOOL A takes a 5/16" sq. bit or 5/16" dia. boring tool. Shank size 9/16"x1"x4 1/4". PPD. Only... **\$3.29**

TOOL B takes a 3/8" sq. bit or 3/8" dia. boring tool. Shank size 5/8"x1-3/16"x5 3/4". PPD. Only... **\$3.95**

TOOL C Cut-off blade holder for 3/32"x3/4" blade. Shank size 1/2"x1"x4 1/2" (can be changed to fit other size cut-off blades). PPD. Only... **\$2.25**

TOOL BIT SPECIAL: 12 H.S. 3/16" sq. x 2 1/2" new tool bits. PPD... **\$1.95**

NEW VEEDER ROOT COUNTERS (non-reset type)

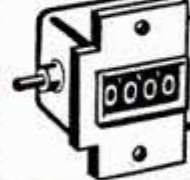

• 3-digit, clock-wise rotation type... **\$1.49**

• 4-digit, clock-wise rotation type... **\$1.89**

• 5-digit, clock-wise rotation type... **\$2.49**

• 5-digit, ratchet type... **\$2.89**

A counter for punch presses, motor RPM, gadget experimentation, etc.



NEW WIRE WHEELS!

8" dia. x 5/8" arbor—arbor adjustable to larger sizes. One coarse and one fine. These 2 pieces at only... **\$2.29**

Bargain Tool & Shop Mixes! PPD

• DRILL BITS Over 300 pcs. (2 lbs.) of used H. S. drill bits up to 1/4". Most require sharpening. Ideal for pin punches, drift pins, etc. Less than 1c ea. at... **\$2.95**

• 10-1/4" SHANK DRILLS H.S., 1/4" to 1/2" new and used surplus... **\$4.95**

• 8 H.S. TAPS Std. & pipe up to 5/8" **\$2.95**

• 12 FILES up to 12" length, a buy at **\$3.49**

• 30 GRINDING WHEELS — 1/4" arbor, 4" dia. MAX... **\$3.29**

• LARGE HAND REAMER MIX: 10 different sizes — 15/16" to 1 3/4", all new, Wt. 37 lbs. A fraction of new cost, F.O.B. Tulsa **\$22.50**

SURPLUS VALUES

SLEEPING BAG Heavy weight, quilted. Mummy style. 9.95
ADD 25c FOR MAILING

HUNTING KNIFE 5 1/4" stainless steel blade. Leather sheath. 98¢
ADD 10c FOR MAILING

PARKA COAT 16.95
Warm, light weight quilted lining. Zipper and button front. Sizes 36 thru 46, ADD 25c FOR MAILING

SEND FOR FREE CATALOG

NATIONAL JOBBING CO.
1112 Howard St. Dept. M-9 Omaha, Nebr.

SAY YOU SAW IT IN POPULAR MECHANICS

AS LOW AS \$950

"Brownlee" SECTIONAL LOG CABINS

Easy to Erect, Saving Labor Costs!

Save money on your log cabin! Get a "Brownlee"—the cabin that you can erect yourself! Shipped in sections, with doors and windows installed. White cedar logs, pre-treated. Impervious to moisture. Termite resistant. Weather-proof. Factory-caulked exterior walls. Complete materials furnished for erection. A variety of attractive designs—two to five rooms—as low as \$950. Also lodges, camp buildings and tourist cabins. Send 25c today for catalog. (Some territories still open to dealers.)

Send 25c for CATALOG!

THE BROWNLEE CO.
3508 Guardian Bldg. Detroit 26, Mich.

ACE TOOLS

No. 8-A SET

Be permanently toolled-up for every operation on your Metal Cutting Lathe.

No. 8-A Ace Tool Set for 9" and 10" Swing Lathes—fits shank size 3/4" x 3/4". Includes Turning, Cutting-off, Boring, Knurling and Threading Tools with high speed cutters, blades and wrenches. 8 complete tools in fitted steel case—nothing else to buy. See your local dealer or order direct.

ARMSTRONG BROS. TOOL CO.
5268 W. Armstrong Ave., Chicago 30, Ill. **\$26.95**

evidence of fading at high speeds or in the Rocky Mountains. Drums are 10 inches in diameter with an unusual application on the front brakes, there being two widths of lining—the primary shoe has 2-inch lining and the secondary shoe 2½-inch lining. I do not like the location of the narrow brake pedal. It is too far on the right and too close to the foot throttle. In automatic-transmission cars, I can't understand why manufacturers do not move the brake pedal to the left of the steering column for use with the left foot.

The heating and ventilating system is efficient and convenient. Just in front of the windshield is a wide slot for entry of air.

While the location of the cigarette lighter in front of the steering column didn't bother me as a nonsmoker, my passenger was disturbed each time he had to reach across the car to use it.

The glove compartment is a sliding drawer mounted in the center and is a good arrangement. The radio is also in the center of the instrument panel with speakers on either side.

I like the quick-acting handles which require only two turns to open or close the windows and the attractive, curved armrests which also serve as door handles.

The driving position is extremely comfortable and the seats are wide. The cush-

ions are deep and long enough to give good support under the knees. There is little body rumble or wind noise even at high speeds.

The starter switch on the Hydra-Matic model is operated by lifting the shift lever. The indicator must be in neutral (N) position before the engine will start. This is a safety feature that I like.

The Hydra-Matic transmission is the new Dual-Range unit. Driving position No. 4 provides four forward speeds for normal driving. Below 60 miles an hour, quickly depressing the throttle automatically shifts the unit down to third speed. In driving position No. 3, fourth gear is locked out for quick acceleration, city driving and hilly country.

Low gear is available for extremely heavy pulling and for braking assistance. Low and reverse positions are side by side, which makes it easy to rock the car in mud or snow.

The hub of the steering wheel is large and partially obstructs the numerals on the gearshift quadrant. Either the hub should be smaller or the quadrant raised so that it can be seen more easily, as even a tall person must lean forward to see the entire quadrants.

In a terrific rainstorm between Price,

(Continued to page 282)

UNCLE WALTER

IT SMELLS GRAND



TAKE ONE WHIFF!
(FOR THIS YOU'VE YEARNED!)

IT PACKS RIGHT



PACK YOUR PIPE—
NOW YOU HAVE EARNED

IT SMOKES SWEET



—HAPPINESS FOR ALL CONCERNED!
—with Sir Walter Raleigh!

IT CAN'T BITE!

SIR WALTER RALEIGH'S BLEND OF CHOICE KENTUCKY BURLEYS IS EXTRA-AGED TO GUARD AGAINST TONGUE BITE, AND SIR WALTER RALEIGH NEVER LEAVES A SOGGY HEEL IN YOUR PIPE. STAYS LIT TO THE LAST PUFF.



*It costs
no more
to get
the best!*

SPECIAL LIMITED TIME OFFER!

FREE
of extra cost

BUFFING COMPOUND
with **Dico Buffs**

Take this ad to your Hardware Dealer ... buy one or more Dico Buffs (4" or larger) ... and he will give you a tube of Dico TC6 Buffing Compound—*absolutely free*. "How-to-buff" Manual free with each packaged Buff, too. Take advantage of this offer today, because ...



Dico

IT'S FUN TO BUFF AT HOME WITH DICO BUFFS and COMPOSITIONS

To Dico Dealers

This authorizes you to supply Dico Compound from your stock, as offered above. Send this ad, with your name and address, and we will mail replacement stock, postpaid.

DIVINE BROTHERS CO., Dept. B-952, Utica, N.Y.



CAPE COD CHAIRS
TRELLISES • ARBORS
DUTCH WINDMILLS

Chairs style B-C-A PLANS 50c Ea., all 3 only \$1.00. 12 different trellis designs PLAN of all 12 only 50c. Unique PLAN only 75c. Unique PLAN only 75c. Unique PLAN only 75c.

Authentic 40" high Dutch Windmill Detailed 40" high Lighthouse having copper lantern, ideal for garden or on lake shore of summer home. Large detailed PLAN 75c. **SPECIAL** all plans above \$3.00 val. Only \$2.50. Send 10c for catalog

Craftsman's Model Co. Dept. P44 DELAFIELD, WIS.

Clark EXPANSIVE BIT

CUTS BETTER • COSTS LESS!

Accurate, fast; cuts smooth holes in hard or soft wood. Chrome vanadium steel blades, all chrome body. No. 250, 1/2"-1 1/2", \$1.89; No. 251, 7/8"-3", \$2.19. **GUARANTEED.** At your dealer or write Dept. PM9

ROBERT H. CLARK COMPANY • Beverly Hills, California

VARIABLE SPEED HYDRAULIC POWER TRANSMISSION

It has Infinite Speeds 0 to 550, Reverse, Automatic Overload Protection; Adjustable Torque up to 180 inch pounds. 5/8" Input and Output Shafts. It will handle 1/2" to 1 1/2" H.P. Motor. Case measures 7 1/2" long, 7" high 6 1/2" wide. **VALUE OVER \$300.** Shipping Wt. 25#. On C.O.D. Orders we require a 10% only **\$54.50** Deposit. Fob. Chicago

DIRZIUS MACHINE SHOP "F" 1423-25 So. 52nd Ave., Cicero 50, Ill.

MADE RITE CORPORATION

Trailer Running Gear

58" 2 TON AXLE \$8.00 RETAIL **SPECIAL PRICE TO DEALERS PAT PENDING.**

F.O.B. 6454 EPWORTH BLVD. DETROIT 10, MICHIGAN

NOW—40 different CUTS with AMAZING, NEW Warren

DADO SAWING WASHERS
On Your Saw Blade

Just dial widths to cut parallel grooves perfectly smooth. No warp, vibration or trick screws. Strengthens blade, perfect balance. **GUARANTEED!** At your dealer's or order direct. Give arbor size—1/2", 3/8", 3/4", 1".

Send for free booklet

WARREN WASHERS COMPANY
Dept. 29, Box 98 North End Station, Detroit, Mich.

ONLY \$4.95 PER SET

SEPTEMBER 1952

LOOK FOR THE NAME **UTICA**



IT MEANS

INDUCTION HARDENED WRENCH JAWS

Ordinary adjustable wrenches, subject to hard usage, burr over at the jaw edges. **UTICA's** process hardens the jaws in just these *vital* areas (indicated by arrows). Tests show that **UTICA's** last up to 10 times as long as ordinary adjustable wrenches.

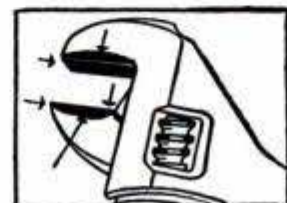

Dark areas are induction hardened for longer wear.

Your hardware dealer has **UTICA** adjustable wrenches or can get them for you. Insist on **UTICA**—the longer lasting adjustable wrench.

UTICA

DROP FORGE AND TOOL CORPORATION
NEW YORK

UTICA 4.

IT PAYS TO BUY QUALITY TOOLS
and the world's best tools are made in U.S.A.

BRIKCRETE

Local Manufacturers Have Broad Opportunities

Brikerete manufacturers operate compact, self-contained plants under franchise privileges in protected territories. Each is an independently owned unit in a country-wide chain, using local materials and local labor to supply the world's most modern masonry for local building needs.

Brikerete is rich in sales appeal because it is ahead in design, style, size, color, economy. Easily the preferred masonry. But because local production eliminates economic wastefulness, Brikerete can be sold at a lower-than-lumber price. Yet still allow a generous profit margin.

Brikerete offers much to men looking for a community enterprise on a nominal investment. We supply complete equipment; easy terms when desired. Liberal cooperation. Write today for Brikerete Book No. 2—while territory is still open.

BRIKCRETE ASSOCIATES, INC.
4679 Division Avenue, S.
Grand Rapids 8, Mich. 82

STOP THAT OIL EATER!

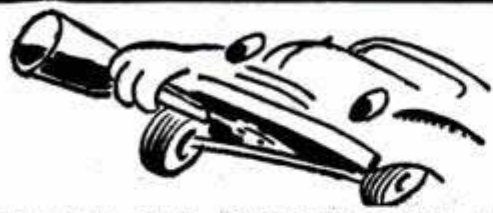

GET NEW CAR PERFORMANCE WITH PISTON SEAL WITHOUT COSTLY OVERHAULING

Piston Seal—the amazing compound that forms a self expanding, pliable lubricating seal around pistons that compensates for wear. Eliminates oil burning, restores power and compression. Can be applied in a few minutes.

GOOD FOR 10,000 MILES



SIMPLY REMOVE SPARK PLUG AND SQUEEZE

FOR COMPLETE, FREE DETAILS WRITE TO

RICHIE DISTRIBUTING CO. 11916 Madison Ave., Dept. J, Cleveland 7, Ohio

FREE!

GREEN MANURES CHART & BOOK

Tell How to Do Wonders

WOULD you like to increase greatly the fertility of certain areas of your soil? Here's how you can — easily, at low cost! From early Spring to late Fall, sow one green manure crop after another and work them into the soil when they are young, green and rich in protein and chlorophyll.

Rye, buckwheat, various clovers, vetches, soy beans, sunflower, millets, barley, oats, Sudan grass, sorghums, etc., etc. can be used. You'll be amazed at the tremendously increased fertility of your soil — how much easier it is to work, and how much more moisture it holds, how it is protected from erosion, how much better crops it grows! It's better than composting or buying manure — and only a fraction of the cost and work!

Which ones to sow? For sweet and sour, heavy and light soils? For different sections of country and time of year? When to sow — how deep? How much seed? Whether or not to use lime and fertilizers? When to work into the soil? How to do it easily? All these and many other questions are answered in the big, easy-to-follow FREE CHART we have had prepared for our friends and customers by Dr. T. H. Everett of the N. Y. Botanical Gardens. Also included FREE is 68-page illustrated book that gives everything you'll want to know about 50 different crops you can grow for green manure and soil improvement.

Right now is the ideal time of year to do wonders for your soil. Just send name and address for FREE CHART and BOOK. No obligation whatever.

ROTOTILLER, Inc.

Dept. 209B, Troy, N. Y.

Makers of the World-Famous Rototiller*

*Trademark Registered

LAWNMOWER SHARPENER OPERATORS

Increase your output...
Year 'round business!

NEW BED KNIFE GRINDER

sharpens all STRAIGHT EDGE TOOLS

New Ideal Bench Grinder doubles your output of sharpening jobs, speedily grinds straight blade knives. Sharpens all kinds of straight edge tools and ice skates. Write for FREE, fact-filled folder.



THE FATE-ROOT-HEATH COMPANY
Dept. PM9, Plymouth, Ohio

WAR BARGAINS
Over 200 terrific values!
SURPLUS ALSO FACTORY SURPLUS
SEND FOR FREE Catalog
SIoux FALLS SURPLUS STORE
SIoux FALLS, S.DAK.

2 TELEPHONES \$25.95



Inter-communication handsets, two wire system. Included, Two 3 volt batteries, 50 ft. of wire and simple wiring instructions. Additional wire 1 cent per ft. or \$25.00 per mile. Complete list of telephone parts, switchboards, handsets, etc. Write:

TELEPHONE ENGINEERING CO., 1 Bank Bldg., Simpson, Pa.

HOBBYISTS! SHOPMEN! Special ONLY \$54.50

PALMGREN "HOBB-E" Rotary, Index, Milling Table
Ideal for Model Parts or Shop Work

Mill-Grind-Drill-Index-Rout curved or straight-Rabbit and Mortise on drill press or lathe. 8" Table, 4" Cross Feed, 360° Rotation, Accurately Graduated. Bolts to table. Order NOW! SAVE \$100. Only \$54.50. Less Rotary Feed \$43.75. Write for "HOBB-E" Tool Circular.

CHICAGO TOOL and ENGINEERING CO.
8365 South Chicago Ave. Chicago 17, Ill.



BUILD ARC WELDER FROM OLD GENERATOR

For Light or Heavy Work. 75-200 amps. No previous experience needed. Complete PLANS 35c, Electrical & War Surplus Catalog included. Or, Catalog, FREE.

LEJAY MANUFACTURING CO.
1347 LeJay Bldg., Minneapolis 8, Minn.



NO FROZEN PIPES

When You Use **WRAP-ON** ELECTRIC HEATING CABLE
Protects to 35° Below Zero



No more worry, expense or inconvenience from frozen pipes! Just wrap plastic coated cable around exposed or shallow underground pipes and plug into 115 volt outlet. Maintains low heat — like electric blanket. Uses only small current. Thermostat turns on only when needed. No radio or TV interference. Low prices — complete with connections. Satisfaction or money back.

G-Q Electric Seed Bed Heater. Seeds are up in 30 hours — root cuttings in 6 days. You cut germination time 2/3 — transplant 2 weeks sooner. Uses house current. Thermostat control. Easy installation. Write for catalog and FREE folder on seed bed construction.

GRO-QUICK SALES

11143-2 MORANG AVE., DETROIT 24, MICH.
Tuxedo 5-5828

Free Catalog



EASIEST way to STRIP PAINT

Here's all you do: Apply Wonder-Paste with a paint brush over the old finish. Let it soak in... Soon you have a soft, moist mass that you can peel off cleanly and quickly with a putty knife. Unlike a torch, no scorched spots remain to be sanded. Wonder-Paste won't harm wood, metal, fabric or your hands. At better paint and hardware stores.

Write for literature

WONDER-PASTE

Over 3,000,000 cans sold—it must be good!

Wilson-Imperial Company, 119 Chestnut Street, Newark 5, N. J.



GIANT BALLOONS

Genuine govt. surplus weather & target balloons. Have fun or make money with 'em. Great sport in back yard or for parties, picnics, dances, fairs, etc. Great attention getters, it'll bring the crowds to business events, conventions, exhibitions, trade shows; for lodges, civic occasions or school functions. Thousands of satisfied customers from coast to coast! Order now at these low prices.

3 Ft. Dia. 39c — 6 Ft. Dia. 79c — 13 Ft. Dia. \$1.39

Add 10% for handling & delivery
Calif. residents please add sales tax

WAR ASSETS DIV. VOLUME SALES CO.

Dept. M-9-52, 3930 Sunset Blvd., Los Angeles 29, Calif.



BUILD FINE GRANDFATHER CLOCK NOW

The simple sensible Red-i-Kut way as thousands have — **SAVE HALF. SHOP TESTED PLANS "SPIRIT OF THE CENTURY"** Narrow waist — 83" tall or stately straight side **"SPIRIT OF AMERICA."** EASY-TO-FOLLOW photopack PLANS tell all—plus BROCHURE of heavy brass weight Westminster, tube chime, movements, gorgeous dials, 3/4" solid mahogany case kits. Send \$1.00 today — Both plans \$1.50 NOW.

KUEMPEL CHIME CLOCK CO., #4 Kuempel Bldg., Minneapolis 16, Minn.

PRECISION T.C. PARALLEL CLAMPS

Made of the finest quality for the craftsman. Hardened throughout. Metal clips to hold screw in place on return.

Opening	Price Each
5/8"	\$1.10
1"	1.35
1 1/2"	1.55
2"	1.90
2 1/2"	2.15
3 1/2"	3.85

PREPAID
DELIVERY

IMMEDIATE SHIPMENT
ON ALL ORDERS



Dealers and distributors
write for details.

PRECISION

T. C. COMPANY
1305 S. Laramie Ave., Cicero 50, Ill.

Build your own SMITH Compressor

Operates spray guns, rock drills, tampers, paving breakers, sandblasting . . . Uses only 1 gallon of gas an hour!



Save Money—build your own Smith Air Compressor! Famous the world over! Capacity 60 cu. ft.; pressure up to 100 lbs. per sq. inch. Just order the Smith Compressor Head and Accessories with complete instructions for assembling. All you need is a Ford Motor and shop facilities. Head equipped with high speed compressor valves; automatic unloading and idling.

Write for complete information!

GORDON SMITH & COMPANY, Inc.
410 College Street • Bowling Green, Ky.

NEW!

FOR
FARMS
HOMES
RESORTS
SHOPS



Handiest . . . Foolproof
Fire Protection

ALLENCO

Fire Hose Station

delivers plenty of water, quickly within 12,000 square feet! No maintenance, always ready. Compact, steel cabinet like medicine chest, recessed or wall-mounted.

Adjustable nozzle locked on hose, 30 to 75-foot length on instant-release rack, with "faucet-valve" connected to regular water supply, all in rugged steel cabinet . . . **LOW PRICED!**

FREE BOOKLET.

Write for *Defense Against Fire*
Get your Fire Hose Station NOW . . . if your hardware or plumbing dealer can't supply you, write . . .

W. D. ALLEN Manufacturing Co.

569 West Lake Street, Chicago 6



BETTER MEASURE
WITH
LUFKIN



The thousands upon thousands of men who use precision tools will tell you that there are none better than Lufkin. For measurements that are accurate use Lufkin precision tools. See the complete line of Lufkin tapes, rules, and precision tools at your hardware or tool store.

BUY **LUFKIN** TAPES • RULES • PRECISION TOOLS
at your hardware or tool store

THE LUFKIN RULE CO., SAGINAW, MICHIGAN
132-138 Lafayette St., New York City • Barrie, Ont.

THE LUFKIN RULE CO., Dept PM, Saginaw, Michigan
Please send me the fascinating booklet, "The Amazing Story of Measurement." Enclosed find 10¢ (no stamps) to cover handling and mailing.

NAME _____

ADDRESS _____

CITY _____ STATE _____

**FOR YOUR HOME'S SAKE
DON'T MAKE THIS MISTAKE**



Use **RUST PROOF NEVER-STAIN**
ALUMINUM NAILS

Yes, for less than \$4.00*, you can avoid costly premature repainting. When you use "Never-Stain" ALUMINUM NAILS on the siding of your home, you are insured against unsightly rust spots and streaks. No countersinking and puttying necessary — a \$60 to \$75 additional saving.

When you build or remodel, insist on lifetime "Never-Stain" ALUMINUM NAILS.

*For the wood siding on the average 5-room house.



NICHOLS WIRE & ALUMINUM CO.
DAVENPORT, IOWA

**CAR HARD
TO START?**

Get **EASY STARTING**
... Smoother Engine
Performance ... Save Gas!
with **SENSATIONAL NEW**

SISSON
Electrimatic
CHOKE

Positive, dependable electric choking gives quick, easy starts every time in any weather. Smoother warm-up... no stalling... no flooding... no seasonal adjustment! Fits any car equipped for automatic choking. \$5 complete.



INSTALL IT YOURSELF
Get **FREE** Illustrated Folder

Sisson Choke, 1652 Ohio Avenue
Anderson, Indiana

Please send me **FREE** illustrated Electrimatic folder
 I enclose \$5 (check or money order) for one Sisson Electrimatic Choke with complete instructions

Car Make _____ Year _____ Cyl. _____
Carburetor Make _____
Name _____
Address _____
City _____ Zone _____ State _____

HOLD-E-ZEE
The Original
**AUTOMATIC GRIP
SCREWDRIVERS**

Hold, start and set up screws in unhandy places. Gripper instantly released by **SPRING ACTION**, sliding up out of way when not in use. Highest quality throughout.



New Models FOR RECESSED HEAD SCREWS  

UPSON BROS., INC., ROCHESTER 4, N.Y. At Leading Dealers Everywhere



**BUILD
YOUR OWN
MACHINE TOOLS
CASTINGS-DRAWINGS**

Catalog with complete construction drawings of this 7 inch bench lathe with plain slide rest, 25 cents postpaid, or send one dollar for drawings of three lathes, three milling machines and six inch crank shaper. Refund on castings order.

Build your own JET ENGINE!



Order these plans today
1. JET PROPELLED BICYCLE, Assemble your own. Photo and instructions, \$1.00.
2. HOW TO MAKE EXPERIMENTAL JET ENGINES. Seven sheets drawings with information and instructions \$2.95.
3. BOTH OF ABOVE in one order \$3.75. SEND NO MONEY. Order both at once \$3.75 C.O.D. in USA plus e.o.d. postage. Send check or Money Order and we pay postage. Get other information too. Rush Order.

J. HOUSTON MAUPIN, Dept. 55, Tipp City, Ohio

ONE-MAN SAWMILL LOW \$50⁰⁰ AS... 50⁰⁰ DOWN

Take BELSAW Portable Sawmill right to the trees—turn out valuable lumber for local yards—do "custom sawing" for neighbors. BELSAW lasts a lifetime. No crew needed. Power with old auto engine. Beginners get excellent results. Send postcard for **FREE BOOK**, "How To Make Lumber."
BELSAW MACHINERY CO.
117 8117 Field Bldg. 315 Westport Rd, Kansas City 2, Mo.

WHEELS JUVENILE, INDUSTRIAL, AGRICULTURAL
Write for Literature and Price List.
CIRCLE METAL MFG. CO.
4266 E. Pacific Way, Los Angeles 23, Calif.

A REVOLUTIONARY CATCH FOR CUPBOARD DOORS!

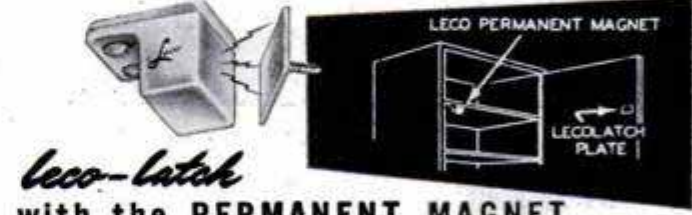

Leco-latch with the **PERMANENT MAGNET**

No Moving Parts • No Springs • Absolutely Trouble Free
Utilize the continuous energy of the Permanent Magnet. It will work for you silently and efficiently for the rest of your life! Lasts forever — nothing to get out of order... Works perfectly — even if doors sag or warp... Doors open easily—without snap, noise or jerk... Holds doors in place firmly, yet gently... Easily installed... Improves appearance. See your local lumber or hardware dealer, or write to

LABORATORY EQUIPMENT CORPORATION ST. JOSEPH 12, MICHIGAN

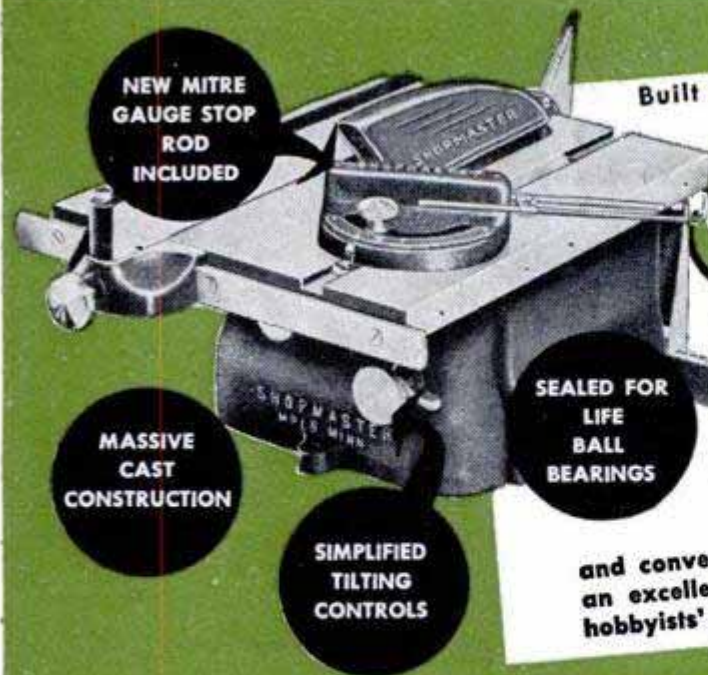

NEW MITRE GAUGE STOP ROD INCLUDED

MASSIVE CAST CONSTRUCTION

SIMPLIFIED TILTING CONTROLS

SEALED FOR LIFE BALL BEARINGS

Built for economy-minded hobbyists who demand... **QUALITY PLUS!**

SHOPMASTER

8" TILTING ARBOR SAW

A new Shopmaster tool at a new low price. Durably constructed of rugged cast aluminum alloy with large table working surface. Has visible and convenient operating mechanism. It's an excellent all-around tool for the new hobbyists' workshop.

\$49.95

Slightly lower Zone 1.

FREE

Complete catalog of the famous quality Shopmaster tools.

Other famous **SHOPMASTER TOOLS**



20" TILTING TABLE JIG SAW



TABLE SIZE SPINDLE SHAPER



20" TABLE SIZE SABER SAW



12" DRILL PRESS



BELT AND DISC SANDER



10" SWING WOOD TURNING LATHE



12" TILTING TABLE BAND SAW



10" TILTING ARBOR SAW



1214 THIRD ST. SOUTH • MINNEAPOLIS, MINNESOTA

ELECTRICITY *Anywhere*

FOR PORTABLE, EMERGENCY OR HOME USE

ONAN Electric Plants generate 110-volt, 60-cycle current for homes, farms, cabins and resorts beyond the highline. Lightweight, portable plants cut costs, speed work for contractors. Standby plants protect units against power failure. 400 to 55,000 watts. Gasoline or Diesel-powered. Priced from \$219.00.

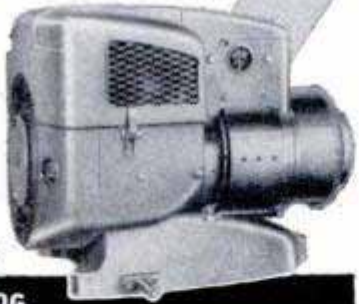

WRITE FOR CATALOG

D. W. ONAN & SONS INC.
5861 UNIVERSITY AVE., MINNEAPOLIS 14, MINN.

NEW—Sensational! GEIGER COUNTER



"The SNOOPER"
LOW PRICE ONLY **\$24.95**
COMPLETE

Find a fortune in uranium with this new, super-sensitive Geiger Counter. So small it fits in the palm of the hand or in the hip pocket, and yet more sensitive than many large, expensive instruments. Weighs only 1 1/4 lbs. Uses flashlight battery. Low price includes earphone, radio active sample, instructions. Sold with ironclad moneyback guarantee.

ORDER YOURS TODAY—Send \$5.00 with order or payment in full to save C.O.D. Write for free catalog on treasure finders for gold, silver, etc. and larger, more elaborate Geiger Counters.

Dealer Inquiries Invited **PRECISION RADIATION INSTRUMENTS**
2235 PM So. La Brea, L.A. 16, Calif.



When Screws Won't Stay TIGHT, Use SMOOTH-ON

Apply Smooth-On No. 1 Iron Cement to screw threads and into the screw hole. Insert and tighten up the screw. It will take hold and, when set, will **STAY TIGHT**, for Smooth-On expands slightly as it hardens, wedging the screw in place. This is only one small use for this general-purpose iron cement. With it you can stop leaks and seal cracks in cast metal parts, tighten loose knobs, casters, tool and utensil handles, make many auto repairs. Buy it in 1 1/4-oz., 7-oz., 1-lb. or larger size at your hardware store. If they haven't Smooth-On, write us.

FREE 40-page Repair Handbook

Many original uses for Smooth-On around the house, on the car, etc. Simple directions. 170 illustrations. Send postcard for YOUR free copy.

SMOOTH-ON MFG. CO., Dept. 37J
570 Communipaw Ave., Jersey City 4, N. J.

Do it with **SMOOTH-ON**
THE IRON CEMENT OF 1000 USES



WHAT--ME BUILD A HOME IN WINTER?



Yes! Build in the winter months because you'll save plenty of cold cash. No longer is winter considered the off-season for building. Actually it is the most convenient time of the year, thanks to PEASE-FABRICATED HOMES, for they can be put under roof and enclosed—safe from the weather—in one day's time.

Plan to build this winter and escape the delays and higher costs that are part and parcel of building during the rush-season. Labor is more generally available in the winter months and you'll be further favored by more competition among plumbers, electricians, painters, and other craftsmen.

Learn about advantages of winter building PEASE-FABRICATED HOMES. Write for our money saving booklet "How To Build PEASE-FABRICATED HOMES in Winter."

PEASE-FABRICATED HOMES

Shipped complete in easy to erect sections. Do the work yourself or have it done. Either way, you save. Choose from 2, 3 and 4 bedroom homes. Write today.

WRITE TO
PEASE WOODWORK COMPANY
Winter Building Division No. 910
CINCINNATI 23, OHIO

Free to mechanics DURO-CHROME TOOL CATALOG



NEW
pocket-
book of tool
"best sellers"

Send today for this Pocket-Size Catalog filled with pictures and descriptions of Duro-Chrome Quality regular and special tools, preferred by professional mechanics, and on sale at your dealer's. Also contains tool tips that help make you a better mechanic. All yours without cost or obligation.

also
makers of
nationally advertised
DURO POWER TOOLS

clip this coupon now to get FREE copy
MAIL TO DURO METAL PRODUCTS COMPANY
2649 N. Kildare Ave. Chicago 39, Illinois.

Write your name and address in margin space

\$900 DOWN DELIVERS Brand New 29 Pct. ARGUS C-3 OUTFIT

Balance as little as \$612 per month!



ONLY THE GENERAL could give you so much: Argus C-3 Camera, Flashgun, Carrying Case, 35mm. Projector, 4 Filters, Filter Holder, Sun Shade, 10 Flash Bulbs, 6 rolls Ansco or Kodak reloads, 1 roll Color Film, 1 - 30"x40" screen, copy of "This is Photography".

ALL BRAND-NEW \$9950
FOR ONLY

Use the General's famous
"Pay as You Shoot" Plan

\$900 DOWN - BALANCE
\$612 MONTHLY

Mail order with down payment and short note about yourself, your occupation, age, employer for last two years, and two references. Write today!

The GENERAL CAMERA CO.
Mail Order Div., Dept. M92, Chicago 45, Ill.

NEW! CHEAP! OIL BURNER

SWEEPING THE COUNTRY!

SALESMEN BIG MONEY SLIPS INTO ANY COAL RANGE, STOVE OR FURNACE. Amazing quick, intense heat. By finger-tip control. Cheaper than coal. No more shoveling coal or ashes. SENT ON TRIAL. Prove it pays for itself quickly by what it saves. \$1 bonus for testing. We'll let you try one in your own home for one month. Write for details today. NORTHWEST MFG. CO., 360-L Main, Mitchell, S. Dak.



WINFIELD ARMS CORP.
Distributors for Western Arms Corp.

ROOM M-9, 409 EAST PICO BLVD., LOS ANGELES 15, CALIF.



Gerstner TOOL CHESTS
A Genuine Gerstner Chest provides outstanding care for the good tools of Machinists and Tool-makers. Free Catalog.
GERSTNER TOOL CHESTS
452 Columbia St. Dayton 7, Ohio



INJECT NEW LIFE INTO OLD FURNITURE JOINTS

Glue Injector complete with drill. Drill in handle makes a tiny hole to heart of joint—plunger creates syringe action forcing glue thru steel pressure tip into and around joint under great pressure. Mends furniture and toys quickly, without disassembly. Use standard furniture glue. \$1.65 PPD. No COD's please.

ARTCRAFT PRODUCTS CO.
BOX 876P CLEVELAND 22, OHIO

Ball-Bearing SPEED WHEELS



JUVENILE WHEELS (No bearing, solid tires)
4" 40c 8" 65c
5" 45c 7" 75c
(Semi-pneumatic tire, ball bearing)
8 x 1.25... 1.85 10 x 1.25... 2.20
8 x 1.75... 1.95 10 x 1.75... 2.30
8 x 2.00... 2.20 10 x 2.00... 2.65
12 x 1.75... 3.45

INDUSTRIAL WHEELS
Lug Base, Semi-Pneumatic tire
5 x 1.75... 3.65 10 x 2.00... 6.10
6 x 2 SW... 3.45 10 x 2.75... 5.15
6 x 2.00... 4.00 12 x 2.00... 6.90
8 x 2.00... 5.20 12 x 3.00... 9.20
8 x 2.50... 5.40 16 x 4.00... 15.15
Smooth Base, Pneumatic tire and tube
8 x 3.00... 11.00 12 x 4.00... 12.10
10 x 2.75... 6.80 4.00 x 8... 13.10
10 x 3.50... 10.55 14 x 4.50... 13.40

Dealers, Jobbers, and Manufacturers! Our new prices will interest you.

Available Now - CASTERS
Write for circulars on all wheels.
Prices F.O.B. our plant.
JIM BROWN TOY COMPANY
1095 HOME AVENUE AKRON 10, OHIO

POPULAR MECHANICS

FIXIN' IS FUN

WITH **TON GRIP** IN YOUR HAND!

Model 10-W \$2.60

WISE-GRIP WRENCH

Squeeze lever shut — and click! — VISE-GRIP locks to the work with Ton-Grip! Can't slip. Easily adjusts to ratchet action. Clamps, turns, twists, pulls, cuts. Does jobs no other tool can do — faster, easier! 7" and 10", with or without cutter. Only \$1.85 to \$2.60 at your dealer.

Manufactured Only By

PETERSEN MFG. CO., Dept. P-9, DeWitt, Nebr.

SHEET METAL BRAKES

Angles, flanges, Pittsburgh locks, 24 G. steel, heavier aluminum. Cam locking, Portable for bench, job or mount on truck. Truss braced steel. Express collect. 30", 65 lbs. \$26.50. 36", 75 lbs. \$31.00. 48", 100 lbs. \$45.00. Portable stands, 32" hi, 35 lbs. \$8.00. 12" BRAKE fits in vise. Forms compound bends in 20 G. steel. Not illustrated. \$12.50, P.P.

IRON BENDER forms hooks, angles, eyelets, etc. Capacity 1/4x2" 5/16x1 1/2", 10 parts, all steel, only \$10.00 Post Paid (Immediate delivery. Order direct, cash or COD, or send for folder)



VYKE BRAKE CO., P-1116 So. 27th ST., Omaha 5, Nebr.

DEPENDABLE CRAFT SUPPLIES

WRITE FOR CATALOG SINCE 1928

LEATHER CRAFT • PLASTICS • POTTERY CRAFT • BLOCK PRINTING • BELT CRAFT • TEXTILE COLORS • POWER TOOLS • WOOD BURNING • INSTRUCTION BOOKS • ETC.

DWINNELL CRAFT SHOP
Dept. PM-952, Wheeling, W. Va.



HOME OWNERS' OIL BURNER SERVICE

Prepare now for cold weather. Save \$\$\$. We can help you. ILLUSTRATED MANUAL which SHOWS YOU HOW to properly avoid or correct oil burner trouble in Space Heaters, Water Heaters, Furnaces, having vaporizing or pot-type burners. Available now at \$2.95. Cash with order. Corrections for other types by correspondence at nominal charge. Money back guaranteed. Parts for most makes for sale. Give make, model, serial number when writing. Home Oil Burner Service, Box 355, Milford, Mich.

6 GREAT SHAW "DU-ALL"

Plow
Plant
Cultivate
Mow
Rake
Cut
Trees
Saw Wood



Walking or Riding Tractors 1 1/2, 3, 5 H.P. walking models. 5, 8, 12 H.P. riding tractors. Get just the power you need in Shaw extra strength superior traction machines. All wanted tools, attachments. Dependable for nearly 50 years. See a Shaw dealer. Write for FREE literature, low prices—today.

SHAW Mfg. Co. 668-G N. 4th St., Columbus, O.

GREATEST SAVING EVER OFFERED!

U. S. GOV'T SURPLUS

"BARGAIN BOOK"

SAVE ON WINTER NEEDS!

It's loaded with bargains in genuine Gov't Surplus for farm-home-industry. Save up to 85% on clothing, hardware, sporting goods, etc. The "Book of the Year". Send 10c for yours today.

500 BARGAINS
• FARMS • SPORTS
• HOME • SHOP

MAIL TODAY Only 10¢

FISLER SALES CO.

723 WALNUT ST., DESK M-9, KANSAS CITY, MO.

EVERY ELECTRIC DRILL A POWERFUL PORTABLE SAW

JOIN THE THOUSANDS who SAVE WORK — SAVE TIME and do the job BETTER with

ONE 100,000,000 "ARCO SAW"

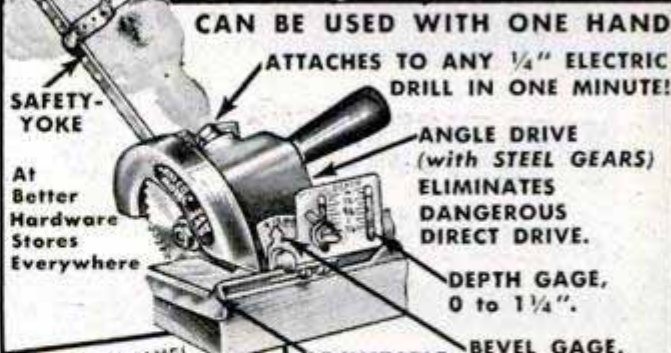

WHAT A VALUE!
No. 445 "ARCO-SAW" (shown) \$1.50 with ALL GAGES & 4" "HYCARBON" Cross-cut Blade.
No. 444 "ARCO-SAW" — same as above, less gages. Has accurate visual guide \$0.95

90-DAY FACTORY GUARANTEE

READ WHAT ENTHUSIASTIC "ARCO-SAW" USERS SAY:

Best of all my tools. H.D., Wauwatosa, Wis.
...a wonderful time saver...very simple to operate.M.H., L.I., N.Y.
...haven't used a handsaw since I purchased the "ARCO-SAW". D.S., West Roxbury, Mass.

If not available at your dealer, TRY "ARCO-SAW" on our FREE 10-DAY NO RISK GUARANTEE. If you are not completely satisfied, simply return "ARCO-SAW" for a full refund.

GET "ARCO-SAW" TODAY at your dealer or send us check or M.O. (Postpaid). C.O.D.'s — postage extra. Write for literature of other tools.

DEALERS: Write for nearest wholesaler.

ARROW METAL PRODUCTS CO.

DEPT. PM-9, 140 WEST BROADWAY, N.Y. 13, N.Y.

RESET LOOSE HINGES



EASY! Fill old screw holes with Plastic Wood. Let dry and drive screws back in. Plastic Wood holds firmly, lastingly. Handles like putty, hardens into wood.



P.S. Lubricate bikes, trains, skates and wagons with 3-IN-ONE OIL

TAKE LESS THAN 1 MINUTE TO

Keep Paint Brushes
Like **NEW!**

Store Them Dry.
They Stay Soft
and Flexible
**READY FOR
INSTANT USE!**

PROCESS 33

INSTANT PAINT BRUSH CLEANER

- Quickly cleans fresh paint from a paint brush or roller.
- You can paint instantly with another color—or store brush dry—it will stay soft.
- Economical—can be used again and again.
- Safe for all brushes and rollers.

Pint 59¢ Quart 98¢ G. N. COUGHLAN CO.
West Orange, N. J.

Wherever Paint is Sold

ELMER'S wonderful!

ELMER'S Glue-All is wonderful for mending and making so many things. It's white magic for strong, invisible gluing of: furniture, wood, paper, fabric, pottery, leather, linoleum, etc. Dries in a jiffy! Wonderful for kids because it washes off hands and clothing instantly. Non-staining—and so pleasant and easy to work with. Get a trial-size bottle of ELMER'S Glue-All today—another Borden's product that belongs in your home.



If it's Borden's,
it's GOT to be good

**ELMER'S
GLUE-ALL**

ASSOCIATION OF A DIVISION OF MONEY
★
Guaranteed by
Good Housekeeping
AS SHOWN AS ADVERTISED THEREIN

Borden's



PUMP WATER FAST!

DRAIN WASH TUBS, CELLARS, CISTERNS
IRRIGATE—FILL TANKS—DRAW WELL WATER



Pumps 2800 GPH. 420 GPH at 75' High or 1600 GPH from 25' well. Sturdy, Rustproof Alloy Metal. Six Blade Impeller. Uses any 1/8 to 1/2 H.P. Motor. Will not leak or clog. Fits any garden hose. Immediate Money Back Guarantee. Send Check, M.O., or C.O.D. **895** IN U.S.

MOORE MANUFACTURING CO.
SWEDSBORO 1 NEW JERSEY

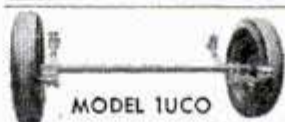

AXLE ASSEMBLIES

Ideal axles for farm implements, carts and trailers of all kinds

\$65.29 Less Tires
F.O.B. Factory

Solid steel construction with springs and saddles—U-bolts and shackles—spring bolts and brackets—hubs and bearings and 15" or 16" Wheels—shipped complete, ready for use

HAMMER BLOW TOOL COMPANY

Wausau 131
Wisconsin

Black & Decker Utility Tools

for HOMES • FARMS • WORKSHOPS

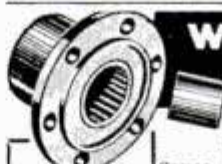

WARN HUB CAP MAKES 2 JEEPS OUT OF 1

\$20.00

Prepaid
U.S., Canada

Ends front wheel drag on 4-wheel drive Willys Station Wagons, Pick-ups and Jeeps

Saves gas up to 5 miles per gallon, tire wear, front axles, increases speed and power. Stops shimmy—front wheels coast out of gear! 4-wheel drive handles, performs, climbs like 2-wheel. Install or remove WARN HUB CAPS in 10 minutes. Polished aluminum, guaranteed. Rush check, M.O., or C.O.D. Write for circular.

WARN MFG. CO., P. O. Box 6064A, Seattle 88, Wash.

I need 500 Men

To Wear and Show

Made-to-Measure SUITS



Pay No Money—Send No Money

My plan is amazing! Just take a few easy orders for my sensational values in made-to-measure suits—and get your own suits **without a penny cost** and make money too! Men can't resist the outstanding style, long wear and low price of my made-to-measure suits. You need no experience. Spare time pays big profits. Rush name and address today for complete details. **Big Free Sample Outfit** contains 150 actual woolen samples, style illustrations, etc. Write now!

PIONEER TAILORING CO., Dept. K-1116
Congress & Throop Sts., Chicago 7, Ill.



Send for this BIG NEW Hunt's WOODWORKERS CATALOG NO. 19

ONLY
15c

NEW LOW PRICES

Offers greatest selection of fine domestic and imported woods—and hundreds of woodworkers items at bargain prices!

You'll save time and money with this big, new catalog. Contains everything wood craftsman needs. Shows 32 rare and fancy woods in color...43 veneer designs...275 scroll patterns...multicolor inlays, overlays, bandings...all kinds of tools, machinery, cabinet hardware, ornaments, mouldings...and pages of valuable tips, ideas, information, instruction. Send for your copy NOW. Only 15c—refundable on your first order.

144 PAGES
QUICK
DELIVERY

• on maple, poplar, oak, mahogany, red cedar, cherry, walnut, and many others—
• all properly seasoned and kiln dried.

MAIL THIS COUPON—TODAY!

CRAFTSMAN WOOD SERVICE CO.
2729 S. Mary St., Dept. A9
Chicago 8, Illinois

Send me the big, new, money-saving Catalog No. 19. Enclosed is 15c—refundable on my first order.

Name _____
Address _____
City _____ Zone _____ State _____

**ONE SET-UP
for all work**

**"YANKEE"
VISES**



You line up work just once in a "Yankee" Vise, then follow through with every operation. Used with swivel base on bench for hand work, quickly removed from base for machine work. Its two-in-one use-value makes it popular in home shops. Four jaw widths: 1 1/2", 2", 2 3/4" and 4".

Get FREE "Yankee" Tool Book. North Bros. Mfg. Co., Dept. 4, W. Lehigh Ave., Philadelphia 33, Pa.

"YANKEE" TOOLS **STANLEY** THE TOOL BOX NOW PART OF OF THE WORLD
Reg. U.S. Pat. Off.

NORTH BROS. MFG. CO., Philadelphia 33, Pa.

Get Your Copy **BIG NEW CATALOG FREE!**



... Tandy's new 64-page Instruction Book and Leathercraft Catalog. How to make 50 items, including lacing braiding, plaiting and beading. 20,000 items completely illustrated, jam-packed with BARGAINS!

FREE WRITE TODAY



"Leaders in Leathercraft"

Tandy LEATHER COMPANY
WE SELL FOR LESS - SINCE 1919
P.O. BOX 791-CV. Ft. Worth, Tex.

Life Time **WALL TILE** Plastic
34c Per Square Foot **34c**
Buy Direct & Save

Modernize your kitchen or bathroom. We teach you, instructions free. Earn big money modernizing your neighbors' homes with Plastic Wall Tile. Send \$2.00 for kit of samples—20 smart colors—complete with instructions. Cost of kit credited against first order.

MONEY BACK GUARANTEE

O'NEIL TILING CO., Dept. T, 1521 W. 87th St., Chicago 20, Ill.

Get the handy

TORIT ACETYLENE BLOWPIPE OUTFIT

for soldering and all small jobs requiring heat

Consists of torch, 4 tips, soldering copper, hose, connections for acetylene tank, and instructions for use.

Ideal for garages, repair shops, home workshops, etc. Ask for free literature on Torit Outfit No. 23 or order now. Sent postpaid for only



\$12.00

TORIT MANUFACTURING CO.

273 Walnut St. • St. Paul 2, Minn.

*"I built our modern
bedroom for only \$76.50**

**saved \$301 with
my SKIL Home Shop
Saw and Sander"**

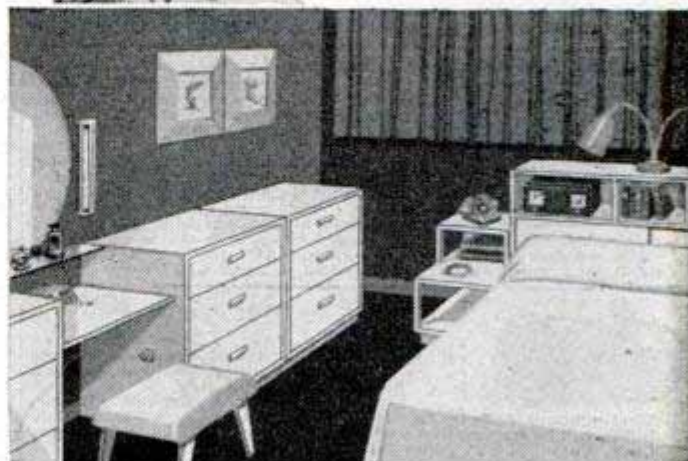

Want a real feeling of accomplishment? Get yourself a SKIL Home Shop Saw and watch your wife's eyes light up when you make your own beautiful furniture.

Take this modern bedroom—detailed in SKIL-Chart No. 109. You can build it in no time with the simple-to-follow instructions and a SKIL Saw to cut sawing time and work 90%! You see, it's easy to bevel, miter and rip even 2-inch lumber with your SKIL Home Shop Saw. All adjustments are simple and quick.

Even the lowest priced SKIL Saw is by far the most powerful saw at *anywhere* near its price. You save money building things for yourself. So much so that your SKIL Saw quickly pays for itself. Add this to the fun and pride of creating things, and you see *why* you should get started now. Send coupon with 10¢ for SKIL-Chart No. 109—today!



SKIL Deluxe Home Shop Saw—Model 586—\$59.50. 6" saw. SKIL Saw table (right) and accessories easily convert this saw to tilting arbor bench saw, sander and shaper.



SKIL Home Shop Belt Sander \$68.00

SKIL home shop Tools

Prices subject to change without notice. *Bedsprings and mattress extra. Price includes materials only, and varies locally.

Made only by Skilsaw, Inc., 5033 Elston Avenue, Chicago 30, Ill.
In Canada: Skilltools, Ltd., 3601 Dundas Street West, Toronto 9, Ont.

**Skilsaw, Inc., Dept. C-92
5033 Elston Ave., Chicago 30, Ill.**

I enclose 10¢. Please send SKIL-Chart No. 109 showing how to build the above modern bedroom furniture.

Name _____

Street _____

City _____ State _____

WAR SURPLUS AND OTHER BARGAINS SAVE UP TO 90%

LOW VOLTAGE CIRCUIT TESTER

Made for U. S. Ordnance Dept. to rigid specification. Portable steel hand-carrying unit is a self-contained trouble shooting device for making a complete and rapid check of the generator battery circuit, incl. any circuit & voltage regulators. Battery voltage, regulators, cut-out settings & generator performance easily determined. It's great for garages, mechanics, truck fleet owners, boat and marine mechanics. Can be used on any 6 or 12 volt system. Approx. Govt. cost \$175. NEW. Complete with instruction book, only **\$32.50**. Shpg. Wt. 20 lbs.



PORTABLE WELDER

Will weld, braze, solder & cut all metals up to 3/16". No experience needed, full instructions included. Weld iron, steel, brass, aluminum and other metals. Plug into any 110 Volt A.C. or D.C. line. Save 100's of hrs. and lots of \$\$ doing repair for yourself and others. Great for any mechanic, hobbyist, etc. Not a toy. Comes complete with electrode and carbon holders and an ample supply of electrodes, carbons, flux and necessary components to do a thorough welding job of any type. This ALL NEW unit can't be duplicated for many times its modest price of **\$12.00**



electrodes, carbons, flux and necessary components to do a thorough welding job of any type. This ALL NEW unit can't be duplicated for many times its modest price of **\$12.00**

D.C. GENERATORS

Finest aircraft quality . . . heavy duty . . . lifetime grease-sealed ball bearings. Terrific for truck and marine use, for welders, plating, D. C. Appliances, lights, etc. Type P-1, Mfd. by Ford, General Electric, Westinghouse & Delco-Remy. Rated 200 Amps., 28 Volts, 2500 RPM., can be "reved" up to 300 Amps. Shpg. Wt. 53 lbs. Approx. Govt. Cost \$350 . . . New to you . . . **\$21.50**



WILLARD WET PLATE BATTERY

Extra-long life, rechargeable battery. 2 V., 20 Amps. Great for portable radios, mobile units, bell circuits, alarm systems, rural telephones, Strobe bulbs, etc. Only 5" high. Visible ball float hydrometer built in Lucite case. Shipped dry (wt. 3 1/2 lbs.) . . . any battery service will supply standard battery electrolyte. Used singly or in multiples. ALL NEW! Now only **\$1.95** ea.



MICROMETERS

Chrome plated, precision engineered, carefully tooled to give long life. All new 0-1" capacity—**\$2.25** ea 1-2" capacity—**\$3.50**.



Send 25c for 1952 catalog. Bargains for everyone. Check, Money Order or Cash. 25% deposit on C.O.D. orders. Prices F.O.B. Culver City, Calif., unless otherwise stated.

AIRBORNE SALES CO., INC., Dept. PM 952
8501 Stellar Dr. Culver City, Calif.

Say You Saw It in Popular Mechanics

4 TOOLS IN 1
The Complete METAL WORK SHOP FOR HOME AND PLANT

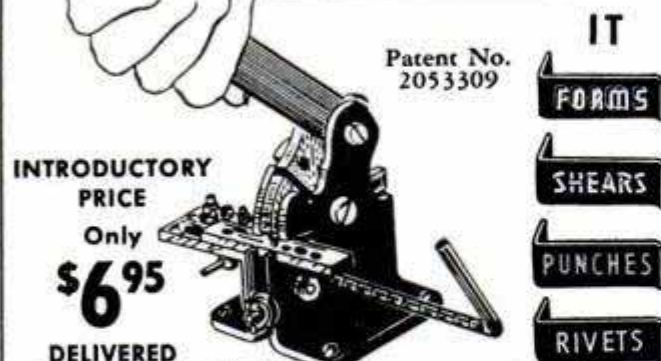

Patent No. 2053309

IT

FOAMS

SHEARS

PUNCHES

RIVETS

INTRODUCTORY PRICE

Only **\$6.95**

DELIVERED

Ideal for hobbyists, craftsmen, repair shops, garages, model mfgs., experimental labs, etc. Handles metals up to 1/4" thickness depending upon hardness. Shipped complete with 1/8", 3/16" and 1/4" punches and riveting dies. Check or money order must accompany order. No C.O.D.'s. Money will be refunded if not fully satisfied.

ALBERT J. TATU CO.

85 Columbia Dr. Dept. F Williamsville 21, N.Y.

ask your dealer for **Red Devil**
FP-33
Keeps Floors
Gleaming



\$64.50

Tackles any job—scrubbing, waxing, polishing, buffing, sanding . . . any surface. Twin 6" brushes—no bucking, no sideslip. Write for free folder Dept. PM.

RED DEVIL TOOLS, IRVINGTON 11, N. J., U. S. A.



The Modern PLASTIC for lasting Home Repairs

PERMANENTLY mends cracks or holes in wood, tile, stone or plaster. Sticks and stays put—Does not chip, shrink or fall out. Easy to use. Economical. Mold it, chisel it, polish or paint it. If unobtainable from your lumber, paint or hardware dealer, the big 4-lb. can will be sent you post-paid (in U.S.) for only \$1.25. Full money-back guarantee, order now.

DONALD DURHAM CO.
Box 804-U, Des Moines, Iowa



NEW SMALL PARTS CABINET

Metal bound. Baked green enamel. Green plastic drawers. Removable dividers. At hardware stores. Write for free catalog—complete Waterloo line of metal boxes and cabinets. Waterloo Valve Spring Co., Waterloo, Ia.

FREE CRAFT CATALOG



120 PAGES . . . Craft Supplies, Tools, Designs, Instruction Books from America's Largest, Most Complete Handcraft Stock.

Send for your free copy NOW!

GRIFFIN CRAFT SUPPLIES

5626-A Telegraph Ave • Oakland 9, Calif.

FUN FOR EVERYONE!



The Easy Way to Build Your Own **OUTDOOR FIREPLACE**

Food Cooked Outdoors Tastes Better . . . offers real enjoyment for the entire family . . . perfect for entertaining guests! It's easy and economical to build your own Cook Nook. Just add the masonry (any design you prefer) around the Majestic all-metal unit and start cooking! See your dealer today or send check or M. O.

SEND FOR free DESIGN BULLETIN!
Big Selection of easy-to-follow designs

Model OF-28 only **\$20.95**
21" x 26" x 13 1/2"



The Majestic Co.
359 Erie St., Huntington, Ind.

SAVE 50% - THOUSANDS HAVE ASSEMBLED

\$42^{UP} PACKAGED BOAT KITS



27 MODELS

Dinghies, skiffs, racers, inboards, outboards and cruisers. Assemble your own boat, it's easy, it's fun!

All parts pre-cut or pre-fabricated from finest materials. Get all the facts from our big 24 page catalog. See how Packaged Boats are built, how they perform, how exclusive construction features make assembly easy. Includes specifications, performance data plus hardware and paints.

SEND 25¢ for NEW 24 PAGE CATALOG

CUSTOM-CRAFT - DEPT. 7 - BUFFALO 7, N. Y.

BOAT PLANS Over 50 modern plans and full size patterns. Racing classes, cruisers, inboards, outboards, sail boats. By famous designers. 6' to 30'. DESIGN CATALOG 35¢. Design Catalog and boat building handbook, \$1.00

MARINE MART - DEPT 7 - BUFFALO 7, N. Y.

BUY DIRECT - SAVE 25%



Only **\$14.95** F.O.B. Rock Island, Illinois

All metal Wood Lathe with large 8" swing, 24" between centers, 3-speed head stock. Order today or write for FREE Literature!

QUAD CITY PRODUCTS COMPANY
P. O. Box 42, Rock Island, Illinois



Reduce RADIO NOISES NEW CLEAR-TONE LINE-NOISE ELIMINATOR
SIMPLY PLUG Radio or Appliance cord into Noise Eliminator and plug into wall socket. Enjoy reception FREE from many distracting noises. Send No Money, pay postman \$1.25 each (2 for \$2.00) plus postage or send cash and we'll mail postpaid. Try 5 days, money back if not delighted. Many hundreds of satisfied users. Send for yours today. 2 for \$2.00
MERIT SALES, Dept. J-30, 4225 Eldone Dr., Baltimore 29, Md. \$2.00



TRY THE NATION'S No. 1 WELDER'S GLOVE

You will be convinced

These gloves are made from ① finest grades of chrome split leather (also made in one-finger and full mitten styles). ② The back is cut in one piece eliminating seams on back of hand which burn through and rip when exposed to heat. ③ Wool heat breaker stitched inside back provides good insulation against heat during entire life of glove. ④ Seams are welted for extra strength at all points of greatest wear. ⑤ Thumb seam full-welted. Try STEEL-GRIP quality.

Steel-Grip INDUSTRIAL Safety Apparel

To be Sure of the Genuine Demand This Trade Mark

INDUSTRIAL GLOVES COMPANY
a corporation
1403 Garfield Street, Danville, Illinois
(In Canada, Safety Supply Co., Toronto)



\$5.95
Per set AT YOUR HARDWARE DEALER (Slightly higher west of Rockies)

Gift Set of 3 popular

GENSCO Swedish WOOD CHISELS

An ideal set of one 1/2", one 3/4" and one 1" Gensco Swedish wood chisels in attractive metal edged gift box. The perfect starting set for every home craftsman or as a gift for any man that works with wood.

Strip-off plastic coating means every chisel is perfect when you buy it.



Only Gensco chisels have size marked on every handle.



AT ALL LEADING HARDWARE STORES

GENSCO TOOL DIVISION

General Steel Warehouse Co., Inc.
1832 North Kostner Avenue, Chicago 39, Ill.

WEL-BILT FOLD-A-WAY STAIRWAY



- SAVES SPACE
- IDEAL FOR SMALL HOMES
- ADDS EXTRA ROOM AT SMALL COST

Every home should have a WEL-BILT STAIRWAY. Wasted attic space can be easily converted into valuable storage space, extra bedroom or playroom for the children.

Wel-Bilt Stairways come assembled. THEY ARE easy to install at little expense, and easy to operate.

SOLD BY LEADING LUMBER DEALERS FROM COAST TO COAST

Manufactured by **THE WEL-BILT PRODUCTS COMPANY**
P. O. Box No. 95
MEMPHIS, TENNESSEE

STRONG
EFFICIENT
SAFE

The easy way to paint!

Speedy Sprayer



Favorite of home owners and craftsmen for 20 years! SPEEDY SPRAYER gives your work that professional paint finish everyone admires. Sprays paint, enamel, varnish, lacquer, etc. . . . 4 to 7 times faster than hand brushing! Lightweight, portable, uses any 1/4 H.P. motor. Improved diaphragm principle assures clean, oil-free air. You'll find dozens of time and money saving uses for SPEEDY SPRAYER, including spraying insecticides 2-4-D and DDT. Complete outfit, without motor, only \$32.50.

ONLY
\$32.50
LESS
MOTOR

At leading hardware, lumber, and auto supply dealers. FREE—write for handy booklet "How to Spray."

W. R. BROWN CORPORATION
2635 N. Normandy • Chicago 35, Ill.

2 DRILLS in 1

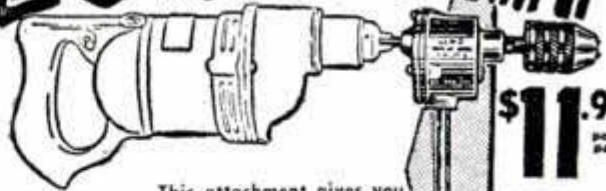

\$11.95
post paid

This attachment gives you two drills in one. It converts any 1/4 inch electric drill to 1/2 inch capacity. Reduction gears reduce the drill speed 5 to 1, the average speed of a 1/2 inch drill, and thereby increases the power. Absolutely indispensable for all shop work and home craftsmen.

G. M. CO. MANUFACTURING, INC.
1308 43rd AVE.
LONG ISLAND CITY 1, NEW YORK

Send check or Money Order
Satisfaction guaranteed
Order yours now

CARBURETOR TOO RICH MAKES MOTORIST TOO POOR



Car owners who are wasting money, getting poor gas mileage due to over-rich mixtures, will be pleased to learn how to save gasoline by **VACU-MATING OVER-RICH MIXTURES**. Vacu-Matic fits all cars, trucks and tractors. Automatic and operates on the supercharge principle. Easily installed in a few minutes.

SALESMEN WANTED! Big Profits

For FREE particulars, how you can install one on your own car for introducing, just send your name and address on a postcard to **VACU-MATIC, 7617-1934 W. State St., WAUWATOSA, WIS.**

**Wheels
Wheels**



**Wheels
Wheels**

5" Disc Wheel 5/8" Tire 5/16" or 3/8" sleeve 30c ea.
6" Disc Wheel 5/8" Tire 5/16" or 3/8" sleeve 35c ea.
7" Disc Wheel 3/4" Tire 3/8" sleeve 45c ea.
8" Disc Wheel 1 1/8" Tire 1/2" sleeve 70c ea.
7" Disc Wheel 1" Tire 1/2" ball bearing 80c ea.
8" Disc Wheel 1 1/8" Tire 1/2" ball bearing \$1.00 ea.
9" Disc Wheel 2" semi-pneum. T. 1/2" B.B. \$1.35 ea.
10" Disc Wheel 1.75 semi-pneum. T. 1/2" B.B. \$1.50 ea.
12" Disc Wheel 1.75 semi-pneum. T. 1/2" B.B. \$1.85 ea.
Above wheel prices includes hub cap. Plus Postage, C.O.D.'s accepted.
AXLES—Sizes 5/16 in., 3/8 in., 1/2 in.—Cut to size—End holes drilled.

UNITED WHEEL STAMPING CO.
12131 S. PEORIA STREET PM-9 CHICAGO 43, ILLINOIS

MUTUAL INVESTMENT FUNDS

Investors **MUTUAL**
Investors **STOCK FUND**
Investors **SELECTIVE FUND**

FACE AMOUNT CERTIFICATE COMPANY

Investors
SYNDICATE OF AMERICA

For prospectuses of any of these investment companies, check one of the boxes below:

Investors **DIVERSIFIED SERVICES, INC.**
Established 1894

206 ROANOKE BUILDING, MINNEAPOLIS 2, MINNESOTA

INVESTORS MUTUAL INVESTORS SELEC. FUND
 INV. SYND. OF AM. INVESTORS STOCK FUND

Please send the prospectus describing the investment company or companies checked above.

NAME _____

ADDRESS _____

CITY _____ STATE _____ ZONE _____

BRONZE FOUNDRY



Schools and Home Workshops

Make your own castings of aluminum, copper, bronze, silver. Foundry sets are available in three sizes including 2400 Deg. F. blast Furnaces. \$22.50; \$29.50; and \$42.00. f.o.b. Kansas City. Free Circular.

KANSAS CITY SPECIALTIES CO. P. O. Box 6022, DEPT. P-9
KANSAS CITY, MO.

DE LUXE KNIFE
SIX BLADES

Including Can Opener,
Cork Screw, Cap Lifter

Finest steel.
Pearl White
Handles. 3 1/2 in.
Closed.

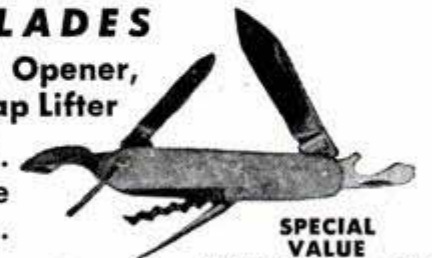

SPECIAL VALUE
At \$2.95 Postpaid

Tool—Hobby—Sporting—Catalog. 10c

TRADER LEWIS

105 E. DELAGUERRA ST., SANTA BARBARA, CALIF.

Amazing HUNTER SCREW HOLDING SCREW DRIVER



Here's one tool every craftsman, carpenter and mechanic needs...the original non-slip, screw-holding screwdriver by HUNTER. Simply place tip in screw slot and push gently: screw is firmly wedged to blade tip. Easy to start screws in most difficult places. Holding mechanism is all internal, fully automatic. Tough 4140 Chrome Moly shaft, Shockproof, plastic handle, 8 1/4" long, .040 thick point for #7 to #10 screw slots—best for most uses. Fully guaranteed.

\$1.98 POSTPAID

Smitty DRIVER for ALLEN HEADS

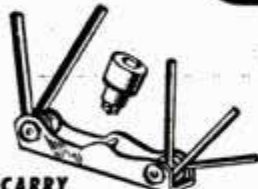

CARRY IN YOUR POCKET

"Wouldn't sell mine for \$5 if I couldn't get another" —say thousands of daily users. Fits all standard Allen type or socket-type bolts and screws. Handle gives great leverage. Equal to a whole kit of socket head wrenches. 5 sizes of shafts, each swing out like a knifeblade. Fits setscrews #10 to 3/16" inclusive, cap screws #5 to 3/16" inclusive. **\$1.50** POSTPAID. SATISFACTION OR REFUND. SEND TODAY.

HUNTER TOOLS

BOX 7395 LUGO STATION • Los Angeles 23, California

Buy the Mechanic's FIRST Choice

...EMPIRE LEVELS

For Home, Farm, all Trades



See Empire Levels at your dealer.

Empire No. 151 Aluminum Level: Adjustable vial cases, twin levels, plumbs, 45° vials — 24" — \$7.50.



EMPIRE LEVEL MFG. COMPANY

10930 West Potter Rd., Dept. PM., Milwaukee 13, Wis.



MAGNETS LIFT 225 lb.

GENUINE ALNICO—NEVER WEAKENS

AMAZING, PERMANENT MAGNETS—WILL NOT WEAKEN! NON-ELECTRIC Retrieve guns, tackle, tools and other steel items from lake, river, plating tanks, drains or other hard-to-reach spots. Recover drills, taps, etc. from sweeping. Clear alley of harmful tacks, nails. Many other uses. Pays for itself quickly. GUARANTEED. Try any magnet one week. Money refunded if you are not well pleased.

No. M-725 (Weights 54 oz.) Has pull of 225 lbs. on steel block. \$15.00
No. M-675 (Weights 49 oz.) Has pull of 175 lbs. on steel block. \$10.50
No. M-650 (Weights 41 oz.) Has pull of 150 lbs. on steel block. \$ 8.50
No. M-30 Hobbyist assortment of six small magnets... \$ 1.50

Send Money Order or Check. We pay postage. No C.O.D.'s. MIAMI MAGNET COMPANY, 3240 N. W. 27th Ave., Miami 42, Fla.

SAVE

UP TO 90%

Atomic, Aircraft & Jet Plants use for most precise work. Compare to any selling 2 & 3 times our price.

Mechanics & Machinists PRECISION TOOLS

HELIOS 6" Vernier CALIPER



8.95

Hardened tool steel; friction lock; inside, outside & depth measurements in 100ths. 22.50 value.

TOOL-MAKERS' MACHINISTS' SOLID SQUARES

Guaranteed 100% accurate. Finest Sheffield polished steel with Tool Hardened Blade. Each in protective case. WE ARE DIRECT IMPORTERS.

2"	\$ 2.19	SEND TODAY FOR BIG FREE CATALOG SURPLUS BARGAINS
3"	2.39	
4"	2.89	
5"	3.19	
6"	3.39	
8"	7.95	
10"	11.45	
12"	13.70	

UNCONDITIONAL MONEY-BACK GUARANTEE

Cash Orders Postpaid. 50% Dep. on C.O.D.'s.

TRANSCONTINENTAL SALES CO., INC.

Dept. PM-9 947 S. Broadway, Los Angeles 15, California

Congress Pulleys

Standard equipment on Bendix, Frigidaire, Hamilton, General Electric and many other appliances

LOOK FOR THIS DISPLAY



Congress quality costs no more! Insist on the drive preferred by most original equipment manufacturers. There is a difference! Congress Drives are electrolytically plated, diamond-bored and tested for trueness.

Buy Congress V-Belts and Pulleys from your local supplier.



Q-D Sheaves — Heavy Duty and Steel Cable V-Belts—FHP Drives

CONGRESS DRIVES DIVISION

TANN CORPORATION

World's Largest Manufacturer of FHP Pulleys
DETROIT 34, MICHIGAN

INSULATE YOUR HOME

For As Low As

\$67.60*



"I did it myself in an afternoon"

Yes, you can insulate your home yourself and save \$50-\$100 installation costs. Zonolite vermiculite Insulating Fill easily pours from the bag between attic joists and sidewall studs—flows snugly around pipes, wiring, braces, eliminates money-draining heat leaks—keeps winter heat IN... summer heat OUT! Saves up to 40% on fuel. It's fireproof—snuffs out flame—termiteproof, rotproof, rodent-proof—permanent. Mail coupon today for FREE BOOKLET!

*(cost of insulating attic in average home)



ZONOLITE COMPANY, Dept. PM-92
135 S. LaSalle St., Chicago 3, Ill.

Gentlemen: Please send me, free-of-charge, booklet HI-20, "Your Home—Its Comfort and Protection."

Name.....
Address.....
City..... Zone..... State.....

SEE YOUR LUMBER OR BUILDING SUPPLY DEALER

For Discriminating Users



Scientists, explorers and engineers choose Burgess Batteries where lives depend on battery power, because they are recognized as best by the experts. Insist on using Burgess Batteries in your flashlight. Burgess Battery Company, Freeport, Ill.; Niagara Falls, Can.

A Quality Dry Battery For Every Purpose

22 CALIBER

CARBINES

SMALL PRICE

BIG VALUE

That's the quick story of Mossberg's two fast-handling, 7-shot, 5 lb., 22 caliber carbines. And note hinged forend, which serves as hand grip or ground support. Choice of bolt action repeater or automatic.

YOUR MOSSBERG DEALER WANTS TO SHOW YOU THESE
Just see how much quality Mossberg gives you for so little

Model #142 (BOLT ACTION) \$23.95
(\$24.95 West of Rockies)

Model #152 (AUTOMATIC) \$29.95
(\$30.95 West of Rockies)

Both above with peep sight

Model #152K . . . Same prices as #152, but with OPEN SIGHTS

Send for FREE catalog. No sales at factory.

O.F. Mossberg
® & SONS, Inc.

29709 St. John St., New Haven 5, Conn.

STEEL AIR TANKS

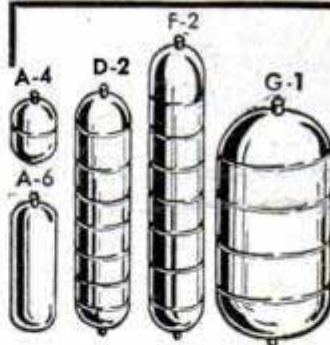

Steel pressure tanks suitable for compressors, pneumatic units, gases, hydraulics, and liquids. Rated at 500 lbs. per square inch pressure. 1/4" standard pipe thread openings on tank ends as shown.

			Size	Wt. Lbs.	Internal Volume	Price
A-4	Carbon Steel	New	7 1/2" x 5 1/4"	1 1/2	104 cu. in.	\$1.50
A-6	Carbon Steel	New	14 1/2" x 5 1/2"	3 1/4	280 cu. in.	3.50
D-2	Stainless Steel	New	24" x 6"	5	500 cu. in.	5.50
D-2A	Carbon Steel	New	24" x 6"	5	500 cu. in.	4.50
F-2	Stainless Steel	New	45" x 6"	11	1000 cu. in.	9.50
F-2A	Carbon Steel	New	45" x 6"	11	1000 cu. in.	5.50
G-1	Stainless Steel	New	24" x 12"	18	2100 cu. in.	11.50
G-1A	Stainless Steel	Used	24" x 12"	18	2100 cu. in.	9.50

Prices F.O.B. Chicago. Include approx. postage on orders paid for in advance. C.O.D. orders enclose 25%, balance sent C.O.D.

U. A. S. Corp. Dept. PM-9, 5637 W. 63rd Pl. Chicago 38, Illinois

MAKE YOUR OWN TRAILER

or shop wagon with this sturdy aero. tire, tube and wheel with bearings for \$8.50 complete. Tires OD 10 1/2" high, 3 1/2" wide. Bore for axle 5/8".

WRITE FOR FREE CATALOG on other sizes with stub axles and other farm tires. Wheel barrow and Trailer manufacturer inquiries invited.



HARMO TIRE & RUBBER CO.

Part #218
804 HAMMOND BLDG.,
Dept. PM
DETROIT 26, MICH.

CAR OWNERS! This informative folder tells all about the pre-winter cooling system service every car needs. For a free copy write to

PEAK® ANTI-FREEZE, CSC, Terre Haute, Indiana

SAWHORSE made Quicker... Easier... Better with NEW **Spee-Dee** BRACKETS

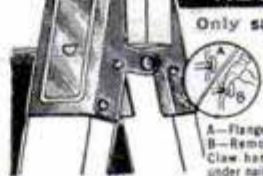

Only sawhorse brackets having flanged nail holes for easy disassembling! Takes dressed or common 2x4 lumber. Employs nails to secure assembly. No complicated instructions. Produce sturdy sawhorse that won't fall apart when lifted by the rail! Use for ping-pong, picnic tables; platforms; carpenter's horse, etc. \$2 pr. At Hdwe., Bldg. Supply stores. If not stocked, write Dalton Mfg. Co., 20 S. Central, St. Louis 5, Mo.

AVOID SEPTIC TANK TROUBLES

d-CON Rid-X
Prevent Clogging, Back-ups, Offensive Odors in Septic Tanks, Cesspools, Outdoor Toilets. One Treatment lasts months. Guaranteed. \$1.69 at Hardware and Drug Stores.
d-CON CO., Inc., Chicago 11, Ill.

SAY YOU SAW IT IN POPULAR MECHANICS

MAKE UP TO \$5 AN HOUR WITH **EASISHARP**

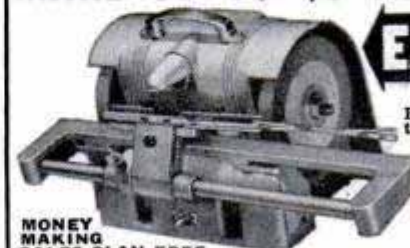

MONEY MAKING SALES PLAN FREE

Big profits in your spare time sharpening scissors. We show you how to start making money immediately. This is your chance now to have your own business with Easisharp. Sharpen a pair of scissors in less than two minutes! A child can operate it. Weighs only 10 lbs. Every home, barber, tailor, dressmaker — everybody uses scissors and all need sharpening two to four times a year. Don't let some one else get ahead of you. Write immediately to
SERR-EDGE MACHINE CO., 9731 Lorain Ave., Cleveland, Ohio

GIGANTIC MAIL SALE

WAR SURPLUS
EXCESS INVENTORY
BANKRUPT STOCK

Second immense building, recently completed, doubles capacity, enables us to offer more and greater values!

POWER PLANTS & GENERATORS

- Master Plants, 5KW, 115-230 v, 60-c, 4-cyl. engine, manual start. Cost over \$1100. **\$531.70**
- Onan Plants, 5KW, 115-v, 60-c, 4-cyl. engine, push button start. Cost over \$1400.00 **\$689.50**
- Burdex Plants, 2KW, 115-v, 60-c. Special **\$297.50**
- Homelite Plants, 1.5KW, 115-v, 60-c. Special **\$199.50**
- Kato Generators, 5KW, 115-v, 60-c, with control panel, drive pulley, etc. 1800 RPM. 1 phase. Cost \$550. **\$259.50**
- Burdex Generators, 115-v, 60-c. Ball bearing, 500-w, \$94.50; 1000-w, \$134.90; 2000-w, \$159.50.

•• Many other plant bargains in catalog.

Winches - Clutches - Blocks

- Boat, dock, business hand winch, 1-4 gear ratio. Special **\$19.95**
- Farm-Truck-Contractor heavy duty hand winch. Dual ratio 1-3, 1-9. Finest cast steel construction. Special **\$29.98**
- Chain Hoist. Lever type 3000 lb. capacity. **\$19.48**
- Winch Cable, 1/4" super-flexible (4000 lbs. cap.) 50' with load hook **\$9.90**
- Army Snatch Block, 13,000 lb. Special **\$12.95**
- Clutch, 6 H.P. Many uses. **\$14.95**

WELDING GENERATOR KITS

- \$276 Aircraft 200-250 amp, 28-v, generators. Complete with cooling fan, field rheostats and "How To Build" welder instructions. **\$24.65**

PHONES - CITY and RURAL

- Rural Magneto. Compact oak case. Wall, (a) 3 bar, 1000-ohm, \$9.95; (b) 4-5 bar 1600-ohm, \$13.90. CITY up-right desk, with bells \$4.99. Phone only, \$2.69.

Order From Ad, or Write for 4 FREE Catalogs!

OUR 30-YEAR POLICY: • Everything Guaranteed Satisfactory • We Pay Shipping Charges in U. S.

BURDEN PAYS ALL SHIPPING CHARGES

AIR COMPRESSOR UNITS

- Paint, blow up tires, control terminals, clean greasy engines, blow dust, etc. Build your own or buy ready-built units.
- DeLuxe Air Kit. Consists stainless tank 12"x24", finest 1-cyl. 3 cfm piston compressor, valves, gauge, fittings, hose, excellent paint gun, blow gun, pressure regulator, chuck and "How To Build Portable Outfit." Special **\$45.49**
- Economy Air Kit. Same as above except 6"x24" tank and no regulator or paint gun. Each **\$31.90**
- Air Components. Top quality, 1-cyl. piston comp. **\$20.50**; 2-cyl. pis. comp. **\$49.50**; Adj. Auto pressure switch, **\$4.95**; pressure regulator, **\$2.65**; Adj. safety valve, **\$1.95**; Pressure gauges, 0-160 lbs. **\$1.89**.

TRACTOR WEED SPRAY OUTFITS

- Leading make. All stainless steel. 7-row outfit. Guaranteed finest unit made. List \$225.50. Special Fall Closeout. **\$129.50**
- 5-row all-brass outfit **79.50**

SUPER BARGAINS

- Duro 110-v Hand Hi-Speed Ball Bearing Grinder and Kit. List \$24.50. Sale. **\$13.40**
- Hydraulic Tractor Contour Level. Mounts on tractor. Plow on perfect contour. No surveying. List \$46. Sale **\$16.90**
- Polished Laminated Plane Propellers (New) Many uses—snow sleds, boats, etc. Cost over \$150.00. Sale **\$12.95**

FREE CATALOG

SPECIAL FOR THE MONTH

• Plane Landing Lights. Amazingly bright, narrow searchlight beam over 400,000 candle power!! Operate on 110-v AC or DC. EXTRA SPECIAL **\$2.99**



WATER PUMPS AND SYSTEMS

- Save up to 60%. Ask us for expert advice on your problem. Pumps for wells, basements, wood spraying, septic tanks, garden irrigation, etc.
- Centrifugal Pumps. Cast iron, stainless steel shaft. bronze impeller, ball bearings. No. 75, 3/4" **\$18.90**; No. 100, 1" **\$28.90**; No. 150, 1 1/2" **\$35.60**
- Bronze Rotary Pumps. Low pressure. (25 lbs. max.) Self priming. No. 12, 1/2" **\$12.75**; No. 34, 3/4" **\$16.95**; No. 101, 1" **\$22.95**; Hi-Pressure type (150 lbs. max.) No. 612, 1 1/2" **\$14.50**; No. 634, 3/4" **\$20.95**; No. 610, 1" **\$27.95**
- Irrigation War Surplus Pump. 10,000 g.p.h. 2 1/2" intake. Two 1 1/2" outlets. Spe. **\$39.50**
- Burdex Shallow Well System. 110-volt, 60-c, 300 g.p.h. 40 lbs. pressure, fully automatic. Easy to install **\$69.50**
- Adj. Auto. Pressure Switch. **\$4.95**; 3/4" foot valve, **\$2.49**; pressure gauge 0-60 lbs. **\$1.89**; also hose, strainers, etc., at real savings.
- Hand Pump. Lever type, high capacity. Pump basements, tanks on farms, etc. Cost \$35. **\$27.80**

ARMY HOT AIR HEATERS

Forced air type. Burns gasoline, kerosene or fuel oil. Thermostatic control. 110-v. blower. Tremendous heat output (40,000 BTU.) Compact portable size 17 1/2" high, 21" long. Wt. 44 lbs. Cost over \$190.00. Sale **\$59.50**

Miscellaneous Surplus Bargains

- Tachometer, 0-3000 r.p.m. Direct rd. **\$6.79**
- Drawing Sets. Finest quality, 13-pc. **9.89**
- Clock Timer Switch, 110-v, 60-c. **4.72**
- Heater Elements, 110-v, 2000-w. **.99**
- Immersion Heater Elements, 110-v, 800W **3.95**
- Army 12' Guy-Turnbuckles. Useful. 10 for **3.89**
- Motors, 110-v, 80 r.p.m. **8.95**
- Hydraulic 19" Cylinders (Cost \$90) **18.49**
- D.C. Welding Generators (250 amp.) **95.90**
- Magneto Farm Telephones, 1600 ohm. **13.80**
- Battery Chargers, 110-v **4.95**
- Engineers Hand Level **5.84**
- Surveyors Precision Level **37.95**
- Air-Operated Power Grease Gun **29.85**
- Hundreds of other bargains in tools, electronic items, radio, etc.

BURDEN SALES COMPANY

813 "O" ST.,

LINCOLN, NEBRASKA

FAMOUS RAJO HEADS

Gives your '41 to '52 Chevie
25% MORE POWER.



Better fuel economy, "Good Eight Power", and immediate accelerator response at both traffic and road speeds. **\$169.50**

SCHUCK'S

7th at Bell St.
Seattle 1, Wash.

Mail this ad with check or money order
Dealers inquiries invited.

INSIDE-OUTSIDE PAINT PEELER

"Paint-Dozer"

\$9.95
complete



Strip paint to bare wood at rate of 6-10 feet per minute! Big 16 sq. in. heating area blisters paint... attached rear blade strips it off in one continuous motion! Ideal for house exteriors, boats, cabinets, all woodwork. Excellent painter's tool! Faster, neater than blow-torch! Operates on household electric current. Even beginners do fast, clean work with "Paint-Dozer". Has long-lasting ceramic 1,000° Hi-Temp heating element; heavy stamped-steel construction; Marinite insulation; pistol-grip hardwood handle. Complete with front and rear detachable blades and skids; groove and ridge cleaners; 8 ft. neoprene cord; safety stand; attachable front guide handle for horizontal work. Fully guaranteed! Order from your dealer, or write today for this professional tool. Fast shipment.

OTTO KONIGSLOW MFG. CO., DEPT. T1
3610 PERKINS AVENUE • CLEVELAND 14 • OHIO



BETTER LIVING

... at new low cost!

Join thousands of happy, worry-free and rent-free New Moon owners. Move to top paying jobs, enjoy travel and vacation fun — a home completely furnished and ready to live-in, including kitchen, bath and automatic heating system. Own a New Moon on our rent-like payment plan and enjoy all the comfort and advantages of genuine home ownership at once. Free! Write today for literature describing the complete line of New Moon apartment homes.

Member of



REDMAN TRAILER CO.
40 BRIDGE ST., ALMA, MICH.

The Owners Report on the 1952 Nash

(Continued from page 266)

Utah, and Zion National Park, I found that water seeped in at one corner of the windshield, but I've never driven in a worse storm. We drove over dirt and gravel roads for many miles and the car handled very well on the slippery, muddy roads. We did find that with no pan there was little protection under the engine. In the severe rainstorm, water and mud splashed up on the engine—so much, in fact, that twice when we stopped, the starter would not operate until the solenoid plunger was cleaned. Better shielding of the electrical units from below the engine should be provided for all-weather efficiency.

The steering ratio is satisfactory, with $3\frac{1}{2}$ turns from lock to lock. The turning radius is long, because of the skirted front wheels. I would prefer a shorter turning radius, eliminating the front-wheel skirts.

The outside door handles are new and different. Squeezing the handle opens the door. I am not sure how they would operate in freezing weather.

The spare tire is carried in a recess in the trunk floor—a satisfactory position unless the trunk is filled with luggage when you need the tire. I would prefer it mounted vertically. Luggage space is large and the jack is neatly clamped to the body side, thus eliminating rattles.

I found the 20-gallon gas tank (and Nash needs it far less than some others) to be a fine feature, especially when driving at night over mountain and desert highways where service stations are not too numerous. The gas-filler cap is concealed under a hinged lid above the right taillight.

The 1952 Nash is a sound, well-engineered automobile with many excellent and several exclusive features. I'm still looking for the car that has no faults—and probably looking in vain—but Nash has many features I'd certainly want incorporated in my ideal passenger car. ★ ★ ★

Full-Color Wirephotos Sent by Fast Method

Full-color wirephotos and radiophotos will be sent in one transmission if a new method proves successful. The process requires use of two photoelectric-eye scanners which sweep across the photograph simultaneously. One has a current output which varies with the color being scanned and the amount of that color. The other has a current output which varies with the density or tone independent of color.



THE MECHANICAL HAND...

1. GRIPS LIKE A VISE

... a wrench-like grip that doesn't slip. Compound leverage multiplies power along entire length of jaws.

2. CUTS WIRE EASILY

... outside cutters cut wire even when it tightly hugs a flat surface.

3. HOLDS NUTS LIKE A WRENCH

... powerful parallel jaws and extra leverage prevent rounding corners.

4. GETS INTO TIGHT SPOTS

... small nose of jaws permits working in close quarters.

5. UNKINKS WIRE

... run wire between jaws, from either end, to straighten or pull it.

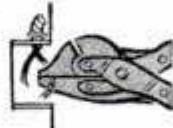

SARGENT
of New Haven

SARGENT AND COMPANY
New York
NEW HAVEN, CONN.
Chicago

Builders Hardware and Fine Tools Since 1864



*Amazing
Tests
Prove*

SYNCRO SANDERS DO MORE WORK PER SQUARE INCH OF SANDING PAD SURFACE THAN SANDERS COSTING TWICE AS MUCH

No. 504

\$19.95

In material removal tests for portable electric sanders conducted in the Syncro laboratory—on most of the leading, medium priced sanders on the market today—it was proven conclusively that sanders manufactured by Syncro Corporation remove more material per square inch of sanding pad surface than sanders costing more than twice as much. This is your proof that Syncro Sanders are your best buy.

and

Syncro Power Units are guaranteed against burn out all during ownership or replaced Free! Platen or paper carrier is designed to do ALL finish sanding . . . not just large flat surfaces. The light weight of the Syncro Sander makes it ideal, and much less tiresome for vertical sanding use. Perfect for smoothing seams on dry walls. NOT an orbital type sander. Buy Syncro at hardware or postpaid, complete \$19.95.

No. 504-D in METAL CASE

Sturdy 9"x5" metal case holds "504-D", 10 sandpapers, polish pads, cord. At hardware or postpaid..... **\$22.95**

QUALITY SANDERS By

SYNCRO

CORPORATION

DEPT. D-92, OXFORD - MICHIGAN, USA.



THE EASY WAY TO DRILL & SAW

**Powerful
Cummins #190 Electric
DRILL & SAW KIT**
Factory Guaranteed

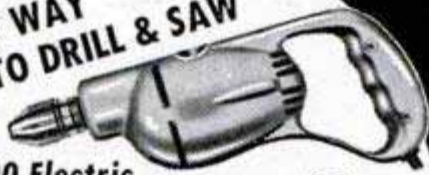

Includes 1/4" Drill (1700 RPM, 115 V. AC-DC); 4" Saw Attachment (Adjustable); 1/4" Capacity Jacobs Chuck; 3 Steel Twist Drills; Horizontal steel drill stand, which converts drill into bench grinder, buffer, polisher, sander, etc. Attractively packaged. Instructions included.



Only **\$19.95**

\$27.95 Value
**DANDY
FOR HOME &
SHOP USE**
10 day
money back
guarantee

Postage 50c additional. 3% sales tax in N.Y.C. Send check or M.O. COD's, \$5 deposit.

GOLDEN ELK PRODUCTS CO.

12 East 41st St., N.Y.C. (17), HA 9-7810

CHAMPIONS

CHOICE of the EXPERTS

for

Dependability, Performance
and Long Life

INSIST ON CHAMPIONS
FOR YOUR CAR!

CHAMPION SPARK PLUG COMPANY, TOLEDO 1, OHIO
SEPTEMBER 1952



Start a Business in Your Backyard



Earn BIG MONEY MAKING BUILDING BLOCKS

General Concrete Vibrator BLOCK MACHINE

CAPACITY 1000 BLOCKS A DAY

only **\$218** LESS MOTOR
F.O.B. PLANT
SHIPPING WEIGHT 400 LBS.



Here is a business you can start on a small capital—in your own backyard—that earns 100 to 150% profit, with unlimited opportunities. Make concrete or cinder blocks. Millions used for homes, factories, public buildings, garages. Sell all you make to building trade. Do it with a General—and you're headed for success.

1000 BLOCKS A DAY

The General is a high speed, power-driven block machine at amazingly low cost. Rugged all-steel construction. Simple to operate indoors or outdoors. Makes superior 3 core type block meeting all code requirements. Produces up to 1000 blocks per day. Full operating instructions and mixing formulas supplied. Write for FREE details.

Wonderful
Book Written
& Illustrated
by Experts



GENERAL ENGINES CO.

DEPT. M-92 • 307 HUNTER ST. • GLOUCESTER, N. J.

Includes floor plans for 6 beautiful, easy to build concrete block bungalows. Shows ways to save money. How to lay blocks, lay out building lines, mix concrete, build steps, porches and concrete floors. Mail coupon at once with \$1.

Name.....
Address.....
City..... Zone..... State.....

GRINDS • CARVES • ENGRAVES
DRILLS • ROUTS • SHARPENS
**DREMEL Electric
MOTO-TOOL**

**FASTEST MOST POWERFUL TOOL
in its class—Approx. 27,000 r.p.m.**

Most practical tool a man can own—more powerful than any similar tool you can buy. Works well in wood, plastics, and metal. For home maintenance jobs you'll wonder how you got along without it. For model making it's a must. And for general shop operations it saves time and money. Compare it, try it, buy it. You be the judge!

Check These Important Features

- Oilless sealed bearings • Dynamically balanced armature • Shockproof, Bakelite housing • Dust-filtered air cooling system • Sturdy 110-120 V., A.C.-D.C. motor • Wt. only 13 oz. • A precision tool widely used in industry for many years.



**MOTO-TOOL
No. 2
(with 1 emery
wheel point)
\$16.50**

**MOTO-TOOL KIT No. 2
With 23 Accessories
(High-Speed Steel Cutters,
Grinding Wheels, Polishers)
\$23.50**



WHERE TO BUY MOTO-TOOL: If your dealer cannot supply you, send remittance in full for postpaid shipment. Or, send only \$2; pay postman balance plus postage and COD fee. Money back if not delighted after 5 days' trial.
DREMEL MFG. CO., Dept. 112-J, RACINE, WIS.



Introducing the

**Nova-Vita
horizontal-sliding window**

The panes of this window—framed in satin-finish aluminum sash—ride on nylon shoes over fiberglas tracks! These features mean beauty, efficient performance, lifetime money savings. Fully closed, the two panes lock automatically and are tamper-proof. Opened, both panes are removable in a matter of seconds—for full ventilation or for washing. There are no sash balances or counterweights, no operating cranks, no projecting hinges. And a Vinyl gasket has eliminated all puttying forever! Standard equipment with each window: an aluminum tension screen; wood window frame, sill and drip cap—all assembled, toxic treated, ready to install in opening. Sizes for every room. Write today for fully illustrated literature. Department 21B, NOVA SALES CO., Trenton 3, N. J.



**MAKE
Big
MONEY
WITH THE** *Universal* **LAWN MOWER
GRINDER!**

Enjoy a profitable lawn mower sharpening business of your own. No previous experience needed. Place a hand or power mower on the UNIVERSAL GRINDER. With only ONE SET-UP you quickly grind the stationary blade and all the reel blades to proper clearance WITHOUT REMOVING A SINGLE BLADE from the mower.



PROOF

G. Spurlock, of Arkansas, writes: "I have my Universal Grinder two months and made a net profit of \$227.00".
C. E. Hardy of Miss. writes: "I am doing a fine business with the Universal Grinder. I spent 40¢ for a newspaper ad and have done nearly \$500.00 of business." Write today for FREE FACTS about Big Profits in Lawn Mower Sharpening.

**ROGERS MFG. CO., DEPT. M-92
LINDSEY, OHIO**

SAW SERVICE MEN
Put your business on a better paying basis by installing . . .
ACME SAW SHOP EQUIPMENT
—Acme Circular Saw Sharpeners
—Acme Hand Saw Filers, etc.
Send For Free Literature
**MAX MFG. CO. 138 Stockton Ave.
San Jose, Calif.**

1 1/2" F:3.2 TELEPHOTO LENS \$9.95 post-paid
for 8mm Revere, Keystone, DeJur, etc.
Nothing like this excellent imported lens is available at less than 2 1/2 times as much! Four elements, coated and color corrected assure definition equal to that produced by most expensive 'brand' lenses. Satin finish mount for neat appearance. Fits turret and non-turret Revere, Keystone, DeJur, Perflex, Franklin and Kodak Reliant cameras, is as simple to use as your normal lens, yet brings object three times as close, is indispensable for distance shots. Leather case 75¢.
NEW: 7mm f:2.5 coated wideangle lens, fits most 8mm cameras, easily worth \$40.00. \$19.95
Cash orders postpaid. Include \$2. deposit with C.O.D.'s
SPIRATONE, Dept. PM. 49 W. 27 St. N.Y. 1, N.Y.

Start a NEW BUSINESS!
or Add to your present
Repair Business
SHARPEN DULL PIPE WRENCHES
PIPE TAPS & DIES
"GUM" CIRCULAR SAWS
Write for Information
**J. C. MOORE INDUSTRIES
BOX M 276 FREDONIA, PA.**

Find **HIDDEN TREASURES**
GEIGER COUNTERS for Uranium Detection. (see at left) **TREASURE DETECTORS** for gold, silver, etc. Lightweight, ultra sensitive. None finer at ANY PRICE.
Information FREE.
Detection co.
5631 Cahuenga, No. Hollywood, Calif.

DRIVING COMFORT at its best!
The New Electric Throttle
With Foot Control
The Electric Throttle ("Speed-selector") sets whatever speed you choose electrically — releases instantly at a touch on the toe-button, or by applying foot brake. Banish foot and back strain for good! Install it yourself. Price, \$17.50 F.O.B. Check or C.O.D. Ten day money-back guarantee. Several State franchises open. Dealer inquiries invited. Give car, make, and year.
WRITE FOR DETAILS
D & M MFG. CORP., Anderson, Ind.



Almost Overnight!



YOUR OWN PROSPEROUS BUSINESS OR PLENTY OF SPARE TIME CASH!

\$25 per week, easy, in spare time. Make \$10,000 per year . . . or more! . . . full time!

Here's your chance to get in on the ground floor with an established, mass-sales product! Our Automatic Defroster, with genuine Telechron timing motor, converts any refrigerator to "Automatic Self-Defrost" in just 3 minutes. No tools . . . just plug in. We furnish striking proof it pays for itself in savings! All you do is make quick installations for FREE TRIAL . . . 4 out of 5 who try it are glad to buy it!

PROSPECTS EVERYWHERE! Write for Free Details! The whole country is sold on automatic defrost! Over 25 million refrigerators need conversion. You risk nothing. Start spare-time, let us help you grow big. Let us rush you full details of big profits, our amazing FREE TRIAL PLAN, and how you can get started! No obligation, Send us your name today! **Time Products Co., 1350 N. Jackson St., Milwaukee, Wis., Dept. P9.**



x-acto®

HOBBY KNIVES and TOOLS

SEND 15¢ TO COVER POSTAGE FOR NEW ILLUSTRATED 28-pg. CATALOG X-ACTO CRESCENT PRODUCTS CO. INC., 440 FOURTH AVE., N. Y. 16, N. Y.

DRAINS Cellars, Laundry Tubs; CIRCULATES Oil; IRRIGATES Gardens

Original "Type P" Pump has 2400 GPH capacity. 360 GPH 75' high, or 1500 GPH from 25' well. Use any 1/8 to 1/2 HP motor. DOES NOT CLOG. 1" intake; 3/4" outlet.

Postpaid if cash with order. (West of Miss. add 50c.) Motor coupling included. **MONEY BACK GUARANTEE** Also Gear Pumps in all sizes.

\$6.95



LABAWCO PUMPS, BELLE MEAD 7, N. J.

LEARN FASCINATING

Leathercraft

Make your own bags, belts, wallets, etc. Learn fascinating, profitable leathercraft in spare time. Send 25c for valuable Catalog, has over 200 photographs, (refunded first purchase).

BURTONS LEATHERCRAFT

Dept. PM-9, 1755 1/2 Glendale Boulevard, Los Angeles 26, Calif.

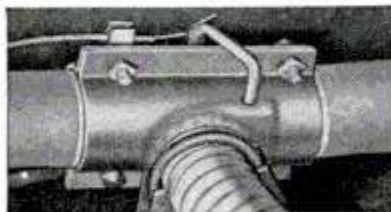

HURRICANE CUT-OUT EXHAUST

This specially engineered cut-out enables you to install special pipes and mufflers without removing the original muffler.

Now control your exhaust tone from a dash control button. Cut back into your original muffler in restricted areas at will. Fits all exhaust pipes from 1 3/4" to 2 1/4" size.

This cut-out is well constructed; actually strengthens exhaust pipe; made of heavy plate steel, designed for easy installation—no special tools required. Sent post-paid for only \$6.95 check or money order. Satisfaction guaranteed or your money back.

ST. LOUIS PRODUCTS CO., Box 24-AJ, Normandy 21, Mo.

You CAN START A \$40 A DAY BUSINESS IN YOUR SPARE TIME



Andy Phillips says...

"MY BELSAW CIRCULAR SAW SHOP gives me BIG PROFITS at LOW expense . . . I can run 35 to 40 circular saws in an 8-hour day . . . That makes me \$40 cash."

NEW ATTACHMENT OFFERS "BIG EXTRA PROFITS!"

New precision attachment for sharpening planer and jointer knives, plane irons, wood chisels and drill bits brings you up to \$4 an hour from the first day.

You can start this REPEAT CASH business in your own home or garage while you are working at your regular job. Easy to operate, no experience needed. "Pays for itself from just 65 jobs." — *Harvey Jensen*

For as little as \$15 down payment, you can get your BELSAW CIRCULAR SAW SHOP rushed to you.

FREE book tells how

YOU can start making money the very day your BELSAW CIRCULAR SAW SHOP arrives. Earn \$4 to \$5 an hour in your SPARE TIME sharpening & setting circular saws for builders, lumber yards, factories... Plus BIG EXTRA CASH, precision grinding planer and jointer knives, plane irons, wood chisels and drill bits. Hundreds of jobs in your own neighborhood. No extra equipment needed, no canvassing. Send today for your Free copy of "Life-Time Security."



BELSAW MACHINERY CO

60-C Field Building

Kansas City 2, Mo.

The NEW Model 50 UTILITY TESTER

FOR REPAIRING ALL ELECTRICAL APPLIANCES-MOTORS

an all-around electrical trouble shooter



- Measures A.C. and D.C. Voltages, A.C. and D.C. Current, Resistances, etc.

- Will measure the current consumption while the appliance under test is in operation. The appliance or utility may be plugged directly into the front panel receptacle. A special pair of insulated clip-end leads is included for motors, etc.

- Incorporates a sensitive direct-reading resistance range which will accurately measure all resistances commonly used in electrical appliances, motors, etc. This range will enable continuity checks and tests for shorts and opens.

- Will test thermostats, radio tube filaments, bulbs, fuses, fluorescents, condensers, switches, field coils, circuit breakers, lighting systems, etc.

Handsome round cornered molded bakelite case 3 1/8" x 5 7/8" x 2 1/4". Complete with all test leads and instructions.

\$13.90

SHIPPED ON APPROVAL

No Money With Order — No C.O.D.

Try it for 10 days before you buy. If completely satisfied send \$3.90 and pay balance at rate of \$2.00 per month for 5 months — No Interest or Carrying Charges Added. If not completely satisfied, return to us, no explanation necessary.

SUPERIOR ELECTRONIC CO., INC.

Dept. D-28 • 227 FULTON STREET • NEW YORK 7, N.Y.

How To Make Lumber More Valuable To You

On doors, windows, flooring

Treat all sides and edges with Cuprinol before you paint—Cuprinol resists moisture and minimizes the swelling and shrinking of fitted millwork.

On stakes, porches, steps, gutters

Wherever wood is used, especially in contact with masonry or the earth, Cuprinol treatment will prevent rot and termite attack, and greatly lengthen the service of the lumber.

On plywood wherever used

A coat of "Clear Cuprinol" forms a protective layer against dampness to prevent grain raising and checking, and consequently provides a lasting smooth finish beneath paint, varnish or stain.

For boats and wharves

Cuprinol treatment is unusually effective, either in salt water or fresh, against marine growth and boring insects as well as against rot. It is widely used here and abroad in wooden boat construction and for the protection of canvas, mooring lines and other rope.

CUPRINOL®

THE NAPHTHENATE
WOOD PRESERVATIVE



It is moisture resistant, deeply penetrating for surface use, of extra strength and quality, harmless to handle, and an excellent priming coat. "Green Cuprinol" contains copper. "Clear Cuprinol" zinc. Carried by Lumber dealers and Marine Supply stores, and by many Hardware and Paint stores, in gallons and quarts. Or write for information.

CUPRINOL, 5 Elm Street, Simsbury, Conn.

For Better Work — FASTER — EASIER

THE ZEPHYR Electric Drill



only \$18.95

Handy... Speedy... Powerful. Has many uses around the home... in the shop... on the farm. Built to Last. Full 1/2" Capacity.

DRILL STANDS Add Many Uses for Zephyr Drill



Horizontal Drill Stand— for Polishing, Buffing, Grinding, etc.

Price \$1.00

Adjustable Vertical Drill Stand— for drill press operations
Price \$10.95

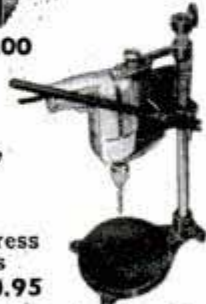

De Luxe Electric Work Saver Kit

Includes above ZEPHYR Drill, plus 28 accessories for buffing, cleaning, drilling, grinding, mixing paint, polishing, sanding, sharpening, waxing, and wire brushing.

Price \$27.35

At Hardware, Implement, and Building Materials Dealers, and Department Stores—or Write Direct



PORTABLE ELECTRIC TOOLS, INC.

324 West 83rd Street, Chicago 20, Illinois

In Canada: Portable Electric Tools, Ltd., Toronto, Ont.



FILE SAWS THE RIGHT WAY
SUPER FILER No. 9
BEVEL GUIDE
USED AS JOINTER

GRIND all circle saws 6" to 10" with correct beveled wheel Fits your saw table \$8.95



SUPER DRILL GRINDER
Sharpens round shank drills 3/32 to 1/2", 6" long Grinds old drills like new in 4 different point angles using hand power grinders \$2.95
At dealers or postpaid FREE FOLDERS

TRU-CIRCLE Saw Set — Automatically sets teeth 10° or more \$2.95

A. D. MCBURNEY, 317 E. 4th St., Los Angeles 14, Calif, Dept. A-21

LOOK FOR THIS SELF-SERVICE DISPLAY



Fuller's famous unbreakable amber handles top the finest steel screw drivers and wood chisels. Fully guaranteed. At hardware stores everywhere. Wholesale Distributors: Write for Catalog Pages & Prices. FULLER TOOL COMPANY, INC., 3522 Webster Ave., Bronx 67 World's largest makers of Amber-Handle Tools EXPORT SALES DEPT., JOHN H. GRAHAM CO., 105 Duane Street New York, U. S. A.

FINISH IT WITH CABOT'S STAIN WAX

Stains and waxes in one application. Ideal for home projects, cabinets, unfinished furniture. Easy to apply Write today for color card. New Blond Shades... Glacier Blue Ivory, White Seashore Gray Natural Also maple, walnut, mahogany, redwood. SAMUEL CABOT, INC. 962 Oliver Bldg., Boston 9, Mass.



HULL AUTO COMPASSES ALSO SAVE THE DAY IN STRANGE CITY TRAFFIC

Watching for road signs in city traffic calls for an extra pair of eyes... and every intersection is an opportunity to make a wrong turn. Here, as on the open road, Hull Auto Compass drivers sail confidently through. Write for local dealer's name, free literature.

HULL MFG. CO. *Beaconlite* 16.95
P. O. Box 246-D-9
Warren, Ohio *STREAMLINE* 14.95

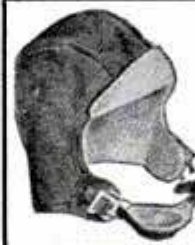

REAL LEATHER NAVY HELMET

NO HOOKS, TUBES OR HOLES

Brand new NAVY helmet of rich Cordovan Brown leather lined with soft warm fleece. Detachable chin strap. Ideal for flyers, cyclists, farmers, hunters. Children love them! Cost Gov't \$10.00 Small, medium, large sizes. Send cash, chk., 25% dep. plus postage on COD. Money back guarantee. \$2.00 pp

GRAND-HAWTHORNE SURPLUS
1439 S. E. Grand, Dept. PM9-52, Portland, Oregon

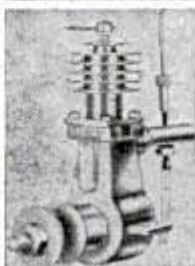

Our 523rd Advertisement
REAL DIESEL ENGINE

\$2.95 • for planes, boats, midget cars • 7500 RPM: 1/7 HP; ht. 3 1/2"; wt. 5 oz.

• precision machined for smooth operation

You just can't beat this price for a precision diesel engine! Streamlined, compact, easy to install. Thousands of satisfied users all over the world. Fast delivery if you ORDER TODAY! Send \$2.95 plus 25c postage.

GOTHAM HOBBY CORP. Dept. P, 107 E. 126th St. New York 35, N. Y.



CI

COLORCRETE

Drab or dirty masonry—concrete, stucco, etc., becomes gleaming white. Or there's a range of sparkling colors—ivory, cream, pink, blue, green, and 25 more. Colorcrete is fused to masonry surfaces under pneumatic pressure. Stays put and stays beautiful. Highly water resistant. Used for more than a quarter century.

There's Profit-Appeal in Stucco Spraying

The business of applying Colorcrete is a community enterprise, with special appeal to men of limited capital. Equipment is compact, simple to operate, practically wear-proof. Work is easy, interesting and rich in profit potentials. Broad opportunities for development. We supply all equipment and full instructions.

No experience or special ability needed. Write or wire today for the Opportunity Book.

COLORCRETE INDUSTRIES, INC.
570 Ottawa Ave.
Holland, Mich.

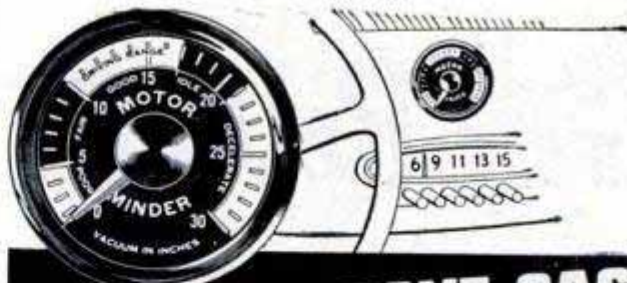

WANT TO SAVE GAS, CUT REPAIR BILLS?

New, Stewart-Warner MOTOR MINDER

Shows You How . . . As You Drive Every Mile You Drive!

Made only by Stewart-Warner! Motor Minder tells you at a glance how to get more miles per gallon . . . how to spot engine trouble in advance. Clearly marked, illuminated Motor Minder dial warns against below par performance of spark plugs, carburetors, valves, timing, piston rings, manifold and other troubles. Gives a constant check on engine performance with the same accuracy factory-trained mechanics use in motor tune-ups. Easily attached on instrument panel or steering post. Install yours today.

Now only \$10.95 at Your Local Dealer, or Write:

STEWART-WARNER

Instrument Division, Dept. N-92
1840 Diversey Parkway, Chicago 14, Ill.

STEEL TOOL BOXES

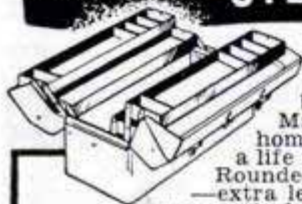

With the Famous "Grip-Loc" Handle!

When "Grip-Loc" handle is up, box is locked—tools can't spill. Made for Mechanics—for shop or home. Sturdy, heavy duty—will last a life time. Built to carry up to 700 lbs. Rounded corners. Trays for small tools—extra length for long handled tools. 24 gauge steel. Built-in continuous hinges—sturdy suit case bolts. Wrinkle enamel two-tone finish. Smooth enamel trays. Hip roof cantilever design. 17" length. \$9.50. 21" length, \$10.50. Shipped postpaid. Order today. If your dealer can't supply you, order direct. **MASTER MECHANICS SALES, Box 31, WOODSTOCK, ILLINOIS**

DO MORE PLANING JOBS WITH LOW-COST BELSAW \$215.00



AMAZING 12 1/4-IN. PLANER Does All Ordinary Planing Mill Jobs. Provides attachments for Jointing, Rabbling, Tongue, Groove, Matching. 12 1/4 x 6-in. capacity, 3-knife solid round all-steel cutterhead. Power feeds at 24 feet per minute, 42 cuts per inch. Provides for full line of accessory attachments—Grind and Joint knives IN THE CUTTERHEAD WITHOUT REMOVING.

BELSAW MACHINERY CO.
1019 Field Bldg., 315 Westport Rd., Kansas City 2, Mo.

FREE BOOK

MODERN LAWN MOWER SHARPENER

Service departments of leading Lawn Mower manufacturers use the Modern Lawn Mower Sharpener. One lever moves lawn mower into grinding position. Gasoline and oil remain in engine while sharpening, no dismantling of wheels, roller or handle. The Modern is a precision bed knife grinder—no extra grinder to buy. Imitated but never equalled—Compare before you buy. If it isn't a Modern it can't be Modern

(Prices subject to change without notice)

MODERN MFG. CO.
160 N. Fair Oaks - Pasadena 1, Calif.



WRITE FOR FREE BOOKLET 10D

\$263.00
with motor
F.O.B.
PASADENA



MAKE YOUR POWER-SAW MORE VERSATILE

with BEHR-MANNING CUT-OFF WHEELS
Cut Sheet Metal, Bar Stock, Metal Tubing, Building Blocks, Insulation Board and Ceramics.

Do more jobs with machine speed and accuracy. BEHR-MANNING RESINOID* Cut-Off Wheels fit most stationary and portable power-saws. No edges to dull—they stay sharp because they're all solid abrasive. Two types available ALUNDUM® for all metals, and CRYSTOLON® for non-metallic materials. At most hardware stores, or write direct, giving wheel size and material to be cut.

Send 10c for "How to Sharpen." Covers all shop tools. Write Behr-Manning Corp., Troy, N. Y., Dept. PM-9.

® * Trade marks



BEHR-MANNING

division of NORTON Company

▲COATED ABRASIVES▲SHARPENING STONES▲PRESSURE-SENSITIVE TAPES



Refinish

without drudgery or danger



IT'S FAST! IT'S CLEAN! Sold at leading paint, hardware and department stores.

Product of
The KLEAN-STRIP Co., Inc.
 2340 S. Lauderdale • Memphis 6, Tenn.

SAY YOU SAW IT IN POPULAR MECHANICS

BUILD YOUR OWN POWER TOOLS—TILT/ARBOR SAW

Exclusive GIL-BILT Build-It-Yourself Features

- No machining—build easily with hand tools only
- No blueprint reading—step-by-step pictorial plans, full scale patterns, actual photographs
- Sturdy wood, aluminum, and steel construction
- Capacity and performance of commercial saws selling for \$60 and up

BANDSAW

BELT SANDER

SAVE \$50.
OR MORE

GIL-BILT 10-INCH TILTING ARBOR SAW

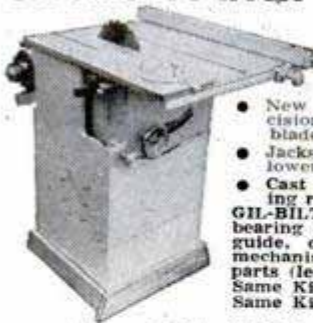

- 27x28 in. table, 13 1/2 in. capacity in front of blade
- 10 in. blade cuts 3 1/4 in. deep, tilts full 45 degrees
- Floor model 34" high, table always stays level

- New Departure ball bearing arbor, 3/4" precision shaft turned down for 5/8" bore blades, alum. housing, shipped ready to run
- Jackscrew and 4 1/2 in. dia. handwheel lowers and raises blade
- Cast aluminum miter gauge and self-aligning rip fence guide

GIL-BILT Metal Parts Kit includes Plans, ball bearing arbor, miter gauge and bar, rip fence guide, dado insert, lock knobs, jack screw mechanism and handwheel, and all other metal parts (less blade).....\$20.95
 Same Kit with 10" Combination Blade \$24.90
 Same Kit with 8" Combination Blade \$23.90

GIL-BILT 12-INCH BAND SAW



- Cuts to center of 24 inch circle
- Handles stock up to 6 inch thick
- 18x18 inch table tilts 45 degrees
- Lower wheel and drive pulley runs on sealed New Departure Ball Bearings; Upper wheel runs on two 5/8" bore Oilite Bronze bearings.

- Upper wheel tension and tilt mechanism of cast aluminum, completely assembled.
- Upper and lower blade guides. Each has ball thrust bearing, self-lub. bronze jaws
- Rigid cast aluminum wheels fully machined ready-to-install. Heavy rubber tires.
- Uses standard 78 inch blades up to 3/4 in. wide.
- Fully enclosed mechanism for utmost safety.

GIL-BILT Metal Parts Kit includes Plans, rubber tires, aluminum wheels, 1/4 in. blade, ball bearing spindle, tilt mechanism, blade guides, table tilt segments, and all other metal parts.....\$21.95
 Return Kits in 10 days for refund if not satisfied.

(Prices include postage within 300 miles. Over 300 add 5%)
 Also available—Plans and Parts Kit for Belt Sander and 8" Tilt/Arbor Saw. Order Plans at \$1.00 each—Send postpaid anywhere in the world or write for FREE descriptive catalog.

GILLIOM POWER TOOLS P. O. Box 1-PJ, Lambert Field St. Louis 21, Missouri

AIR COMPRESSORS

Portable 2-Cyl. Piston Type
WESTINGHOUSE

Reg. \$60.50 **24.50**

Model T-1 Complete

Brand new surplus special at an amazing low price. Westinghouse double-piston type 6.54 CFM volume, 2" bore, 1 1/2" stroke. Runs off power take-off or 1/2-hp motor. Equipped with the V-type direct-drive pulley and belt. For farm, home, industry, painters. Instructions and parts manual included. Send check or money order (parcel post weight 23 lbs.). A complete line of genuine Westinghouse spare parts.

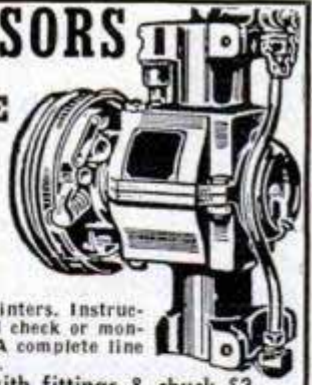

AIR HOSE—to fit, 25-ft. length with fittings & chuck \$3
 'Cutler Hammer' Automatic Pressure Switch for Electric Motors up to 1 HP. Complete with overload control (\$12 Val.)...\$6.50

PRESSURE TANK ASSEMBLY.. \$10.95

6"x24" steel tank 400-lb. test, two 1/4" openings, complete including air gauge, 20-ft. hose with fittings, relief valve, 4-way cross, nipples, copper tubing & brass fittings for connecting to compressor. Shipping weight 15 lbs.

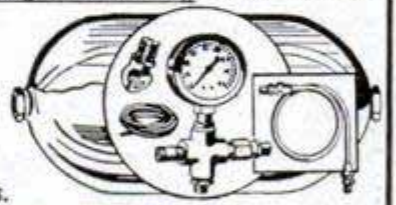

NATIONAL EQUIPMENT CO. Westinghouse Ave., Dept. C
 — Wilmerding, Pennsylvania —



Anybody Handy With Tools Can Build
LEATHER LOUNGES FOR KITCHENS AND RESTAURANTS

Frames, springs, filling, construction simplified.

Send \$5.00 for complete plans and instructions, or 10¢ for brochure.

STEFAN GALENSKI

Designer & Manufacturer

BUFFALO 12, NEW YORK

2221 BROADWAY

SET-UP—KNOCKDOWN SAWHORSE with Jiffy BRACKETS



No nails or bolts... use 2x4's for legs. 2x4 or wider for crossbar. Rugged, sturdy, easy to move, saves storage space. Sold by hardware and building material dealers, or order direct.

GRAND HAVEN STAMPED PRODUCTS CO., Grand Haven, Mich.

PAINTER'S KIT!

Includes Cabinet and wood

scrapers, supply of all grades sand paper and patented holder, Jak-Knife scraper, Putty Knife, Wall Scraper, Lucite Scraper, Paint can hook, etc. All of this in an all steel utility box. Only \$3.98. Cash or C.O.D. IMPERIAL SALES, 480 Lexington Ave., Dept. P-480, New York 17, N. Y.

HELPFUL BOOKS

Send post card asking for FREE catalog

Popular Mechanics Press, 200 E. Ontario, Dept. 601, Chicago 11

Stop Foot Odor and Discomfort with Chloro-Foam Insoles

Embarrassing foot odor is instantly destroyed... Aching, burning feet are eased... CHLORO-FOAM, Sensational New Insoles are finest quality, sock-soled, Goodyear Airfoam... Specially treated with magic Chlorophyll... Fits all type shoes, boots and ladies' shoes... Ladies' insoles can be trimmed to fit open toe shoes... De-odorize, comfortize your feet with CHLORO-FOAM INSOLES NOW!!

Order today... State size and width of shoes, number of pairs desired — 79c each pair.

Send money order or check to:

CHLORO-FOAM PRODUCTS, 4555 Delmar, St. Louis 8, Mo.

Satisfaction Guaranteed... Immediate Delivery.
 Distributors Wanted

DON'T MISS THIS AND
THE NEXT 3 PAGES!

Read All About 40 Famous

How • To • Do • It

Books

from the Presses of
Popular Mechanics



*Fifty Years of
Book Publishing Service
to Information-Seeking
America*

On the next three pages are
described and pictured forty
POPULAR MECHANICS BOOKS

prepared by authoritative and able writers under the supervision
of **POPULAR MECHANICS EDITORS.**

When he founded **POPULAR MECHANICS MAGAZINE** a half century ago, Mr. H. H. Windsor, Sr., began the publication of practical, down-to-earth **HOW-TO-DO-IT** books. Since then Popular Mechanics has continued to feature the publication of books of this type. Each book is prepared on the same practical foundation as is the magazine, under its famous slogan — **WRITTEN SO YOU CAN UNDERSTAND IT.** All texts are backed up with pictures, plans and diagrams that make every point unusually clear, even for those with little or no familiarity with the subject.

POPULAR MECHANICS BOOKS are abreast of the times, covering the latest inventions and developments. They describe methods and materials; explain processes and procedures; provide short cuts and easier ways of doing time-honored jobs and specifically serve the needs of **INFORMATION-SEEKING AMERICA** with actual **HOW-TO-DO-IT** information and instruction. They save time and effort and save and make money for millions of users of all ages and from all walks of life.

Please turn the page. You, too, will no doubt find the answers to your problems, or perhaps, find greater enjoyment of your interests in **POPULAR MECHANICS HOW-TO-DO-IT BOOKS.**

**HOME BUILDING
AND REPAIRS
FARMING
MOTORING
AND AUTO CARE
HOBBIES
HOME WORKSHOP
SPORTS
HOME WORKSHOP
CRAFT PROJECTS
SKILLS
TRADES**

POPULAR MECHANICS PRESS • Chicago

Popular Mechanics HOW TO DO IT BOOKS

HOME BUILDING AND MAINTENANCE • FARMING • BETTER JOBS • SKILLS
HOME WORKSHOP • HOBBIES • AUTO CARE • PASTIMES • ETC.



Endorsed by leading agriculturists, County Agents, Vo-Ag teachers and others.



FARMING • FARM WORKSHOP

FARM MANUAL Contains hundreds of practical articles and ideas for everyday use on the farm. Covers the making of implements and equipment, maintaining the home, the farm workshop, livestock and poultry, vegetable storage and processing, etc. Gives time and money-saving farm hints and kinks. Something for every member of the farm family. Steps up farm efficiency, increases production and improves appearance. Here is the experience of hundreds of successful farm operators brought together into one handy, easy-to-read, easy-to-use, working handbook by the editors of Popular Mechanics. It will make and save money for you. Now in its fourth printing. Over 140,000 copies sold. This book should be on every farm. **\$3.00**

HOME MAINTENANCE

LAWN AND GARDEN For every home owner, with practical instruction based on proven methods for landscaping and growing fine lawns and gardens. 176 pages. Illus. **\$2.50**

HOW TO PAINT By Sam Brown. Covers all types of paint application. Illustrated. **\$2.50**

WHAT TO MAKE WITH CONCRETE All types of concrete work for the home owner. Kinks, short cuts for builders. 112 pages. Illustrated. **\$2.00**



HELP FOR CAR OWNERS, MECHANICS

MOTORIST'S HANDBOOK 535 practical articles of helpful information that can easily save you hundreds of dollars every year, make your car run better and look better too. Covers models 1940-1950. Illus. **\$2.00**

MANUAL FOR PLYMOUTH OWNERS Get the most out of your car investment. Covers the Plymouth from bumper to bumper—explains how parts operate, what can go wrong, what repairs are necessary, how to avoid trouble. Illustrated. **\$3.50**

MOTORIST'S FIX-IT BOOK Simplified instruction for car owners. Can easily save hundreds of dollars every year. Illustrated. **\$2.00**



OUTDOORS AND SPORTS BOOKS

HOW TO TEMPT A FISH

Section by Joe Godfrey, Jr., world famous authority. A lifetime of valuable fishing information in a single book. 20 pages of best fish lures in actual colors. 525 illustrations. **\$2.00**



OUTDOOR SPORTS MANUAL Over 200 helpful articles for the hunter, trapper, fisherman, camper, archer and boatman. 334 illustrations. **\$2.00**

23 BOATS YOU CAN BUILD Plans, building instructions and material requirements for 23 different boats that anyone can build at home. Over 500 pictures. **\$2.00**

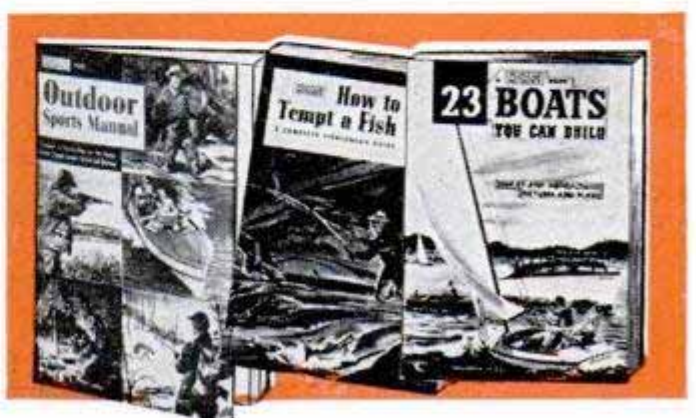

HOME BUILDING

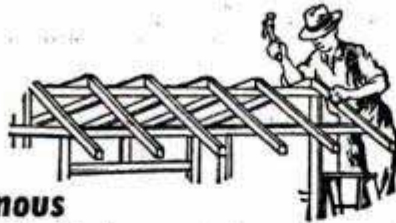

Popular Mechanics Famous "Build-It-Yourself" Books that Save Over One-Half Home Building Costs

YOUR HOME AND HOW TO BUILD IT YOURSELF Hundreds of amateur builders have built this home with the aid of this book. Typical 6-room Colonial home with garage, breezeway and basement. Can be built by any man handy with tools. Many pictures in actual colors. \$3.00

CONCRETE BLOCK HOUSE

Built in many localities by amateur builders, complete with plumbing, electrical wiring and heating for less than \$3650. Five good sized rooms and ideal for family of four. Half of book is pictures and diagrams. \$2.00

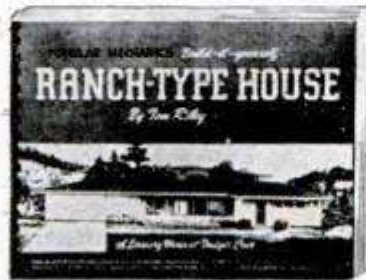

RANCH HOUSE BOOK

Exciting new ranch type house, finished inside and out with plywood. Fully insulated. Can be built in two easy stages by amateur. Five rooms with bath and utility room and car port, about \$5000. Added garage, breezeway and third bedroom, about \$2500. Heating, wiring, equipment included. Designed by famous West Coast architect. Plenty of pictures. \$3.50



HOBBIES, PROFITABLE IDEAS

RADIO, TV AND ELECTRONICS HANDBOOK by Popular Mechanics Electronics Editor. A book for set owners, experimenters, students, experienced men. 566 illustrations. \$2.50

MONEY-MAKING HOBBIES Tells how to have fun and make hobbies pay their own way and a profit. 132 different things. \$2.00

PHOTO HANDBOOK Better pictures. Gadgets you can make. Proven darkroom helps. Camera tricks. 465 illustrations. \$2.00

MONEY FROM IDEAS A practical book for every man with an active inventive mind who believes he has ideas that can be patented. \$2.50



WHAT TO MAKE

WHAT TO MAKE Now 12 volumes. An annual selection of craftsman projects such as furniture, toys, games, gifts, etc. More than 3000 different projects in the 12 volume set. Fully illustrated. Each volume \$1.75. Set of 12 volumes. \$18.00

WHAT TO MAKE FOR CHILDREN 175 things dad and mother and other members of the family can make for the young folks at home. Fully illustrated. \$2.00

EDUCATIONAL BOOKS FOR BOYS

YOUNG CRAFTSMAN Over 450 different projects for boys of all ages. Brings out the inherent creativeness in every boy and stimulates imagination. More than 1100 illustrations. \$2.00

BOY MECHANIC Hundreds of things a boy can make at home at little or no cost. Detailed plans and hundreds of pictures. Teaches boys to think and work with their hands, making such things as autos, boats, models, games and craftwork. \$2.00



Home Workshop Books • Projects for Home Craftsmen and Windsor Press Publications on NEXT PAGE

HOME WORKSHOP and CRAFT BOOKS for FUN and PROFIT

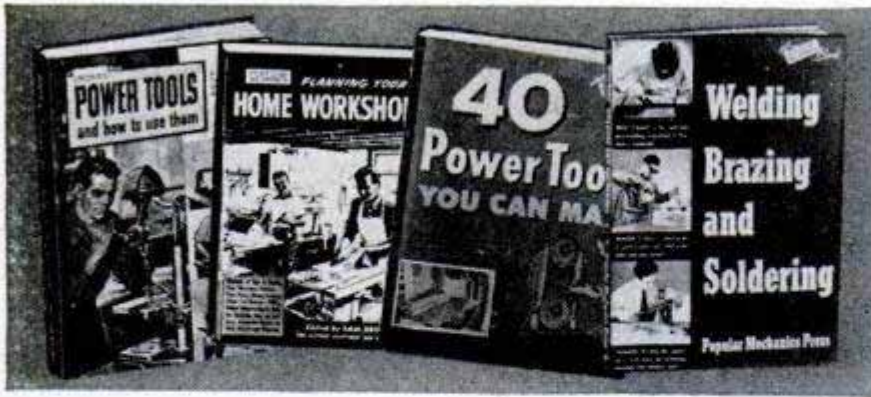

**PRACTICAL, HELPFUL
INFORMATION FOR
THE HOME
WORKSHOP
FAN**

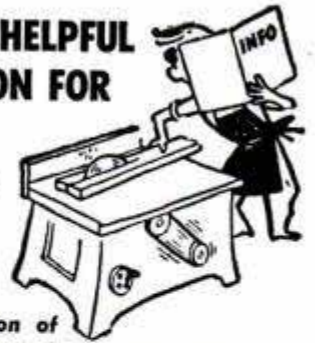

Here is a selection of books that lead the field in all-time popularity. Nothing else like them. Superbly Illustrated.

POWER TOOLS AND HOW TO USE THEM A practical guide to the selection and operation of home workshop machines. Includes exciting projects in many materials. **\$2.50**

40 POWER TOOLS YOU CAN MAKE Tells how to make your own power tools from scrap and discarded materials at small cost. New edition with added tools. **\$1.50**

WELDING, BRAZING AND SOLDERING Shows you how to make your own equipment and use it effectively on jobs of all kinds. 1950 edition. **\$1.75**

PLANNING YOUR HOME WORKSHOP Edited by Sam Brown. Tells how to set up a shop on a limited budget and get the most out of it in fun and efficiency. **\$2.50**

FASCINATING CRAFT PROJECTS

CHRISTMAS HANDBOOK A wonderful collection of Ideas, Gifts, Decorations, Toys—You can make at home. Informative and practical. Illustrated. **\$2.00**

100 BEAUTIFUL PIECES OF FURNITURE YOU CAN BUILD Scale drawings and instructions for living, dining and bedroom suites and occasional furniture. Plates in actual colors. 320 illustrations. **\$3.00**

YOU CAN MAKE A STRADIVARIUS VIOLIN Complete instructions and 8 full size plans. Tells where to get materials and how to make your own tools. Illustrated. **\$3.50**



Handy Order Form

MAIL TO POPULAR MECHANICS PRESS
OR ORDER FROM YOUR BOOKSELLER

POPULAR MECHANICS PRESS

Dept. 80, 200 East Ontario Street, Chicago 11

Check Titles Wanted

- | | | | |
|--|--------|---|--------|
| <input type="checkbox"/> Boy Mechanic | \$2.00 | <input type="checkbox"/> Planning Your Home Workshop | \$2.50 |
| <input type="checkbox"/> Concrete Block House | 2.00 | <input type="checkbox"/> Power Tools and How to Use Them | 2.50 |
| <input type="checkbox"/> Concrete Handbook | 2.00 | <input type="checkbox"/> Radio, TV and Electronics Handbook | 2.50 |
| <input type="checkbox"/> Farm Manual | 3.00 | <input type="checkbox"/> Ranch Type House Book | 3.50 |
| <input type="checkbox"/> Forty Power Tools You Can Make | 1.50 | <input type="checkbox"/> 23 Boats You Can Build | 2.00 |
| <input type="checkbox"/> How to Paint | 2.50 | <input type="checkbox"/> Welding, Brazing, Soldering | 1.75 |
| <input type="checkbox"/> How to Tempt a Fish | 2.00 | <input type="checkbox"/> What to Make, Volume | 1.75 |
| <input type="checkbox"/> Lawn and Garden | 2.50 | <input type="checkbox"/> What to Make, 12 Volume Set | 18.00 |
| <input type="checkbox"/> Manual for Plymouth Owners | 3.50 | <input type="checkbox"/> What to Make for Children | 2.00 |
| <input type="checkbox"/> Money From Ideas | 2.50 | <input type="checkbox"/> You Can Make a Stradivarius Violin | 3.50 |
| <input type="checkbox"/> Money Making Hobbies | 2.00 | <input type="checkbox"/> Young Craftsman | 2.00 |
| <input type="checkbox"/> Morris's Fix-It Book | 2.00 | <input type="checkbox"/> Your Home and How to Build It Yourself | 3.00 |
| <input type="checkbox"/> Morris's Handbook | 2.00 | | |
| <input type="checkbox"/> One Hundred Beautiful Pieces of Furniture | 3.00 | | |
| <input type="checkbox"/> Outdoor Sports Manual | 2.00 | | |
| <input type="checkbox"/> Photo Handbook | 2.00 | | |

Enclosed is remittance for \$_____ for which please send postpaid, Popular Mechanics Books as checked to the left. (Orders for \$2.00 or more may be sent COD, postage and charges extra.)

MONEY BACK IF NOT SATISFIED

Name _____

Address _____

Postal Zone _____

City _____ State _____

WELD IT YOURSELF! IN A JIFFY!

**Weld, Cut, Braze, Solder
IRON, STEEL, BRONZE, BRASS,
ALUMINUM & OTHER METALS**

Tool and Equipment breakdowns are always annoying and costly. Don't let them bother you. Get a Dynamic Arc Welder. You can do expert work on your very first job. Welders operate from any properly wired 110 V. AC line. The handiest "tool" in your workshop. A Dynamic Welder will save its low cost over and over again in time and money.

**DYNAMIC INDUSTRIAL type
transformer Arc Welder
75 amp. output for Industrial or Workshop use.**

**DYNAMIC
WELDER CO.**
Dept. D2-JC, 13 E. 23rd St.
Chicago 16, Ill.



Everything YOU NEED

One low price gives you a complete welding outfit ready to use. Save Money! Buy direct! Sold on 10 day money back guarantee. Send today for FREE details.

GREATEST TOOL TEAM VALUE EVER OFFERED!

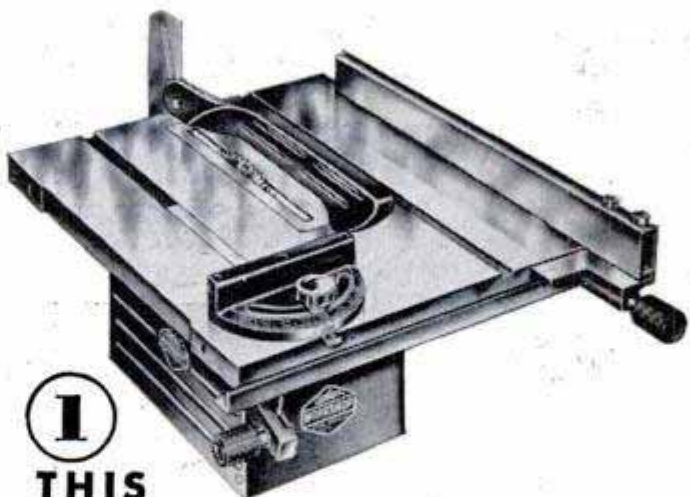

1

THIS

WORKSHOP 8" SAW

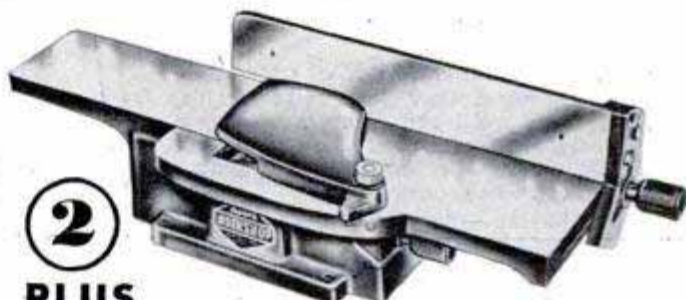

2

**PLUS
THIS**

WORKSHOP 4" JOINTER

The 2 Tools Most Men Buy First!

Both for ONLY \$52.50!

A good saw and jointer-planer are the tools most men buy first—because they are the basic tools needed for building household equipment, remodeling and repairing. Now you can buy both these 2 great tools for the almost unheard of low price of just \$52.50! This team handles all your straight, angle, and double-angle sawing, plus all edging, truing, and surfacing operations—does them faster, easier, and more accurately than you could ever do them by hand. You'll save money from the start on shelves, cupboards, cabinets, scores of furniture and home repair projects. See these sensational tool values at your dealer's. Or send a postcard for a catalog today!

(Price is f.o.b. Kalamazoo, Mich.)

ATLAS PRESS COMPANY

Atlas 824 North Pitcher Street, Kalamazoo, Michigan
DEPENDABLE QUALITY TOOLS SINCE 1911

Free Details and "How to Weld"

BOAT WORRIES? FIBERGLASS YOUR BOTTOM



FIBERGLASS your own boat, easily, at low cost. Save your old rowboat—protect your new cruiser. End boat upkeep, sure-cure for hull problems. Add strength, speed, 100% watertight, ends caulking, painting, hull upkeep. Rot-proof, worm-proof, weather-proof. Almost indestructible. Lasts lifetime of the boat. Simple instructions give new easier method of applying, how to add permanent fade-proof color. FIBERGLASS patching kits now available. Write today for free booklet of information—cost, application, how to order, etc.

STANFORD'S FIBERGLASS CO.,

Dept. PM-9, 1412 W. BURBANK BLVD., BURBANK, CALIF.



MARVEL

Mystery Oil

- Frees Sticky Valves
- Stops Hydraulic Valve Clatter

Buy it at your favorite gas station

"SURE SHOT GUN CASE TREATMENT"

A new proven chemical process that prevents

RUST ON GUNS

It's radically different. The case is treated instead of the gun. This odorless chemical vaporizes slowly. The vapor seeks out and attaches itself as an invisible rust preventing film, to all metal gun parts, including the action and bore. Protection is complete. A \$1.00 2 fl. oz. bottle treats one gun case for one year. Money back guarantee. At your dealer or direct from—

**BAYPORT CHEMICAL COMPANY, DEPT. 26
LINDEN HILLS STATION, MINNEAPOLIS 10, MINN.**





**WANT TO
SAVE GAS? 1/2 MILLION
NOW USE GANES**

**AMAZING
GANE
NEEDLE** | **TRY ONE FREE
IN YOUR CAR!**

TRY BEFORE YOU BUY!

MANY GANE NEEDLE USERS REPORT UP TO 25% more mileage, faster pickup, easier starting and smoother idling.

NOW TEST A GANE NEEDLE IN YOUR CAR for ten days, then compare your mileage and performance. If satisfied, send \$1.50 per needle (8 cyl. cars take 2). If not satisfied, just return it—fair enough! Since authorities differ on its merits and some users report no improvement, **TRY BEFORE YOU BUY!** (Gane Needle replaces idling adjustment screw in carburetors—easily installed in a few minutes.)

WRITE TODAY. ENCLOSE NO MONEY. PAY POSTMAN NOTHING. Just send us your name, address, and make and year of car.

**NATIONAL AUTOMOTIVE RETAIL CORP., Dept. J-9
350 W. Washington Blvd. Venice, California**

FREE 

Auto Economy Manual
Tells how to save gas, tires, brakes, etc. Also introduces many new economy products. (Sent absolutely free to all who try Gane Needles.)

HOW TOUGH **HOW SOFT**



CAN WORK GLOVES BE?
WEAR

**WOLVERINE
PIGSKINS
AND SEE!**

**A
NEW PAIR
FREE
IF THEY DRY OUT
HARD and STIFF**

Imagine! Buckskin-soft comfort in work gloves PLUS amazing extra wear that saves money! It's all yours in *Wolverine Pigskins* because Wolverine's exclusive triple-tanning process tans comfort into choicest domestic pighide, but doesn't tan the toughness out! See your dealer and look 'em over.

FREE *Wolverite Pencil* No Obligation
Who is your dealer? Just write for his name and we'll send you a genuine *Wolverite Mechanical Pencil* 100% FREE of cost. Offer limited to continental U.S.A. . . . write today to
WOLVERINE—Box J6-9—Rockford, Michigan



Say You Saw It in
POPULAR MECHANICS

**RELIEVES
HEADACHE
NEURALGIA
NEURITIS PAIN**

FAST



Here's Why...

Anacin® is like a doctor's prescription. That is, Anacin contains not one but a combination of medically proved active ingredients. Anacin is specially compounded to give FAST, LONG LASTING relief. Don't wait. Buy Anacin today.

NATIONALLY KNOWN

PET 1/4" #77



Factory Guaranteed
ELECTRIC DRILL

Bright Chrome Finish. 1600 RPM. 110-120 V., A.C. D.C. 1.6 AMP.



COMPLETE DE LUXE
38 PIECE KIT
only
\$17.95
\$27.95 Value

Includes above Drill, plus 37 accessories. Drills, buffs, cleans, grinds, mixes paint, polishes, sands, sharpens, waxes, wire brushes, etc. Sturdy steel case. Instructions included.



Postage 50c additional. 3% sales tax in N.Y.C. Send check or M.O. COD's, \$5 deposit.

GOLDEN ELK PRODUCTS CO.
12 East 41st St., N.Y.C. (17), HA 9-7810

DRILL ALONE
only
\$12.95
\$17.95 Value

**LABOR-SAVING
FOR HANDYMAN AND
HOUSEWIFE**

10 day money
back guarantee

KING MIDGET

WORLD'S LOWEST PRICED
2 PASSENGER AUTO



Drive it for 75c per week. Amazing performance. Surprising comfort. All steel construction. Ready to run or assemble it yourself with our bolt together parts. Rider agents wanted, earn your car free. Send 25c for detailed literature or \$1 (refunded first order) for actual assembly book and service manual filled with photos, drawings, specifications, etc.

MIDGET MOTORS MFG. CO. ATHENS, OHIO

Over 800 items listed! Over 200 illustrations! Accurate, detailed, scale models of warships, tanks & planes. PLUS model railroad equipment.

ALL IN AUTHENTICAST CATALOG VOL III ONLY 35c
COMET METAL PRODUCTS CO., INC.
91-04 132nd St. Richmond Hill, N. Y.

AMAZING NEW CHEMICAL MAKES

OLD BUMPERS LIKE NEW!

Not a Paint! Not a Polish! Looks like expensive chrome plating!
Wonderful new chemical puts chrome-like finish on car bumpers, door handles, trim, etc. No electricity—no plating tanks—no acids needed. Just smooth it on and watch it gleam! Takes a brilliant polish JUST LIKE CHROME—no simple child can do it. **REFINISH BUMPER IN 10 MINUTES!** WORKS LIKE MAGIC—finish lasts for years. Increases resale value of your car and adds NEW beauty to other chrome plated or metal items. **TRY AT OUR RISK. SEND NO MONEY!** Just send name and address. Pay postman amazing low price of \$1.50 plus few cents postage for each kit ordered, or send cash and we pay postage. Try kit 10 days. If not delighted return for instant refund!
BUMPER RE-NU CO., Rm. 40, Box 147, Dept. A-3, Hamtramck, Mich.

\$1.50

TOOLS AT WHOLESALE

PROFESSIONAL MECHANICS HAND TOOLS

Farm, Household and Special Tools

TOP QUALITY, FACTORY GUARANTEED

Write Today for
FREE CATALOG

MECHANICS CO-OP
Dept. X Oakland 8, Calif.

Make Money
SELLING
Eshelman
TRACTORS
and DOING
GARDEN
WORK

SNOW PLOW
PLOWS
CULTIVATES
HARROWS
HAULS
SPRAYS
SAWS
DOZER
MOWS
CUTS
ROLLS
TILLS
RAKES



FOR BETTER
LAWNS
and GARDENS
also POWER MOWERS
and RIDING TRACTORS
Women can operate it.

Also Power Reverse Free Catalog. Write Eshelman, Dept. 313, 119 Light St., Baltimore 2, Md.

100 200 300 POWER
Triple Turret MICROSCOPE
\$14.95 Ppd.

Laboratory Model — The instrument that amazed biology instructors. Excellent optical qualities, adjustment, solid construction. A lifetime bargain for students, schools, labs, amateur researchers. Anyone can now own one! (Performance cannot be duplicated for \$75.) Uses: animal, plant and mineral research. Study plant cells, microscopic animal life, crystal structure. See the complex anatomy of tiny insects, larvae, eggs. An absolute necessity in hundreds of fascinating fields. Shipped in hardwood cabinet.



NAVY TYPE MARK XX
20 POWER TELESCOPE
\$9.95 Ppd.

\$30 value. Fine optically ground achromatic lenses, fully coated. Same power as standard artillery observers spotting scope. Precision all metal construction. Rust and salt spray resistant. A valuable ship and boat owner's possession at a price everyone can afford. Excellent scope for rifle range or hunting. Shipped in choice of pigskin case or hardwood cabinet.



FREE CATALOG: WORLD'S GREATEST VALUES IN QUALITY OPTICS. MICROSCOPES, ACCESSORIES, PREPARED SLIDES, MAGNIFYING GLASSES, LOUPES, BINOCULARS, EVERY ITEM A BARGAIN! SENT ON REQUEST OR INCLUDED WITH YOUR ORDER.

MONEY-BACK 10-DAY GUARANTEE ON ALL ITEMS. SEND CHECK, CASH OR MONEY ORDER. 20% DEPOSIT REQUIRED ON ALL C.O.D.'S. CALIF. RESIDENTS ADD 3% STATE TAX.

40 TO 600 POWER

15 Combinations! Professional
MICROSCOPE \$29.95
Model #635 Ppd.

At last! The FIRST instrument with this range of performance ever offered under \$125. Every feature needed for advanced university, pre-med and medical school use. Triple revolving turret containing 10X, 20X and 40X achromatic objective lenses. Achromatic condenser, 6-aperture revolving iris. Two-side plano and concave substage mirrors. Solid base, excellent precision construction. Complete with fitted hardwood case. With 15X eyepiece (giving 150X, 300X & 600X) less mechanical stage.



SET OF EXTRA EYEPIECES
\$9.95 Ppd.

For above model #635 microscope. 4X, 5X, 8X, 12X interchangeable eyepieces in hardwood case, giving a total in all of 15 different powers from 40X to 600X. Complete set of 4 in case.

MODEL #400 MECHANICAL STAGE \$14.95 Ppd.

Shown on model #635 microscope. Made only for this instrument. This is an optional accessory which allows you to move the slide microscopically right, left, up or down without touching slide. This calibrated stage cannot be duplicated for less than \$45. (If microscope is ordered without mechanical stage, we will fit your instrument with fine spring steel, clip-type slide holders.) Shipped in fitted hardwood case.

the **AKRON** 4400 SUNSET BLVD. LOS ANGELES 27, CALIF. OPTICAL DEPT. ← 9-P

CHOOSE FROM PROFESSIONAL QUALITY

WESTCRAFT TOOLS

AT WESTERN AUTO

SAY YOU SAW IT IN
 POPULAR MECHANICS

You CAN Take It With You!

BECKER Self-Contained SPRAY GUN

NOTHING ELSE TO BUY
 TAKE IT ANYWHERE—the first completely portable spray gun. Needs no compressor, motor, or electrical outlet. Pressure-powered with an inexpensive CO2 cartridge that sprays up to 21 liquid ounces, depending on viscosity. Extra cartridges, 10 for \$1, postpaid, or buy from your dealer.

PAINTS • VARNISHES • ENAMELS
MOTH-PROOFS • INSECTICIDES

Every home needs a Becker Spray Gun for dozens of jobs in the house, workshop, garden or garage. Complete instructions furnished for effective results. Order yours today for the season ahead.

HOW TO ORDER—If your dealer can't supply, send \$15.95 and we ship postpaid—or \$2 now and pay postman balance plus postage and fee. Money back if not delighted after 5 days' trial.

SULLIVAN-BECKER CO.
 Dept. 112-J, Kenosha, Wis.



ONLY
\$15.95
 with 3 cartridges



it's easy to
 connect
 Tubing with

IMPERIAL TOOLS

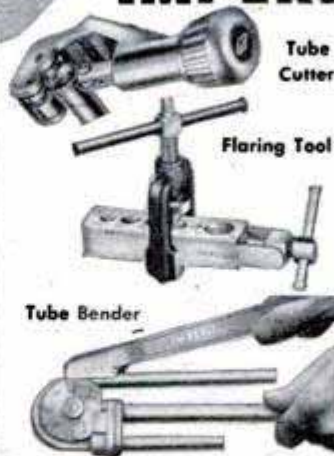

Use the quality tools preferred by skilled mechanics everywhere — tube cutters, flaring tools and tube benders that get jobs done faster, better, easier. Simple instructions in the Imperial Tube Working Handbook show you the short cuts. Ideal for connecting tubing for cars, trucks, tractors, oil burners, gas appliances, LP-Gas, plumbing, refrigeration, etc. Get these Imperial Tools for your work or hobby now. Economically priced.

See your dealer or write today!

Send 10c for VALUABLE HANDBOOK & CATALOG

THE IMPERIAL BRASS MFG. CO.
 1212 W. Harrison St., Chicago 7, Ill.

Send me 32-page Imperial Tube Working Handbook and Catalog today — also name of nearest dealer. Enclosed find 10c to cover postage and handling.

Name _____
 Street _____
 City _____ Zone _____ State _____





BARGAINS

Brand New, top quality glasses. All have precision ground optics, durable lightweight bodies. Moisture and dust proofed. Achromatic!

Coated! Featherweight!

16x50 COATED \$69.50

The ultimate in a fine binocular. Tremendous power. Featherweight (weighs only 27 ounces!). Precision made in every detail. COATED, providing sharper, brighter images. Individual focus. Objective lens is 50mm (2 inches) across!

ALL are COATED

Same Model CENTER FOCUS, IND. RIGHT EYE
10x50 - \$49.50 12x50 - \$59.50

7x50 CLEAR, CRISP

"Day and Night" glass. Has greater light transmission. Field of 375 ft. at 1,000 yds. Water-Dust proofed. Weighs only 31 oz.! A tremendous performer. Now Popularly priced. \$36
Same model center focus with ind. right eye. \$39.50



ALL COATED and LIGHT WEIGHT

BARGAINS!

BARGAINS!



- 8x15 \$16.95
- 6x30 \$27.95
- 7x18 \$19.95
- 7x35 \$42.95
- 7x35 \$46.95
- 8x30 \$37.50
- 8x40 \$39.50
- 8x40 \$49.50
- 10 Power \$24.95
- 10x30 \$39.50
- 20x \$8.95
- 4 oz. Pocket. \$16.95
- 16 oz. Economy 4 1/2"x6" \$27.95
- Pocket ALL CHROME \$19.95
- All around use 5"x6 1/2" \$42.95
- Center Focus \$46.95
- Center Focus \$37.50
- More Power \$39.50
- Streamlined 24 oz. \$49.50
- Pocket 7 1/2 oz. \$24.95
- 18 1/2 oz. \$39.50
- Telescope 7 1/2 oz. Pkt. size \$8.95



GERMAN WORLD'S LIGHTEST
8x30 4"x5 1/4" 11 Oz. \$39.50
7x35 5"x6" 14 Oz. \$7.50
20x56 9 1/2"x6" 27 Oz. \$9.50

Made in GERMANY, optical center of the world! COATED. Higher Weight! Center focus, prismatic binoculars with individually focusing right eye piece. Follow moving objects faster, easier. Enjoy clearer, sharper, brighter images.

SIX TELESCOPES IN ONE!



15 to 40 POWER COATED American made Wollensak telescope. Instant focusing at 15x, at 20x, 30 and 40x, etc. Turn power tube to click - no guesswork. Telescope measures 9" closed, 27" when extended. Weighs only 18 oz.! Has rust proof chrome tubes. All 12 optic surfaces are COATED. See 29 bullet holes clearly at 300 feet. Use also for astronomical observation. \$30.75 price includes fine leather case. Tax FREE!



UNITED "Seal of Quality" etched only into UNITED Binoculars. Proof they are BEST-BY-TEST. Insist on it!

30 DAY FREE TRIAL

If not fully satisfied return for full refund! Cash orders rushed postpaid, on C.O.D.'s include \$2.00 deposit. Add Federal Tax. Prices of all of above include handsome genuine leather case and straps. SAVE by buying direct from UNITED "America's Outstanding Binocular Retailer."

FREE CATALOG

FREE! 36 page - 3 color binocular catalog listing over 60 different style binoculars, the Best By Test from 3 continents! UNITED has served over 100,000 Sportsmen. Buy UNITED and SAVE.

UNITED BINOCULAR CO., United Bldg., 9043 S. Western Ave., Dept. ARF-5208, Chicago 20 Display Sales Rooms open 9:00-3:30 Mon. thru Fri. DEALERS WANTED

SAVE UP TO \$100.00 on your Storm Windows

Assemble Combination Redwood or Aluminum Storm Windows Yourself! **\$6.50* EACH**

These patented storm windows regularly sell for \$22.75 assembled. Now only \$6.50 knocked-down and shipped to you. With only screen cloth and glass to buy locally, your total storm window cost is only about \$8.50 each. Upper and lower sash snap out from inside for easy washing. Screen replaces top or bottom sash during warm months—self storing in upper portion in winter. Frame stays in year 'round. No storage problem whatsoever. Only top-quality kiln-dried redwood. All standard window sizes. Write for descriptive bulletin today, or send cash, check, or money order, for quick delivery. We pay freight. Satisfaction guaranteed or money back.

*Redwood 24/24 glass - others, slightly higher.
Dealers:
A few choice areas are still available
BUCKEYE SCREEN & WEATHERSTRIP COMPANY
1380 SOUTH 22nd STREET, COLUMBUS, OHIO

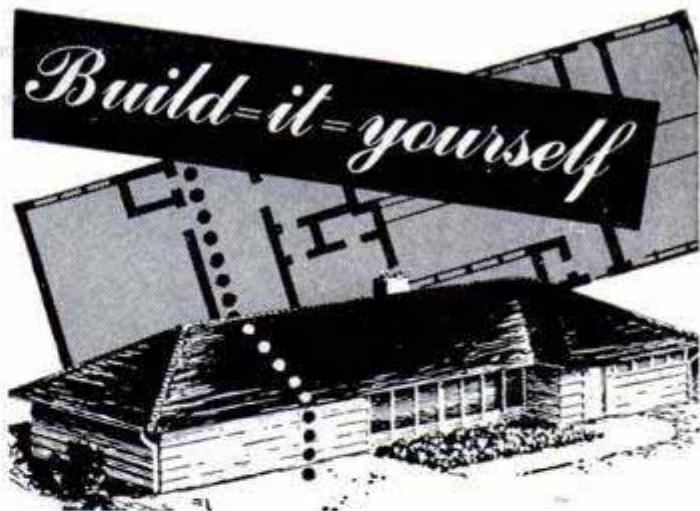

Popular Mechanics Famous RANCH-TYPE HOUSE

Save Thousands of Dollars by Building This Beautiful Home Yourself

Join the more than 100,000 families who have built their own homes in the past few years doing all or most of the work themselves and you can save more than 50% of usual building costs! Here is a dream home designed by the noted architect John J. Whelan, designer of the Drew Pearson home, especially for amateur home builders. You can build the basic five room unit for approximately \$5000. Carport may be converted into third bedroom and breezeway and garage added at your leisure. Basic house is to the right of the dotted line in the picture above; expansion is to the left. House fully expanded is 81 feet long and 29 feet wide.

Order Book and Plans - Save \$7000 to \$10,000

Book gives complete step by step instruction. Hundreds of pictures, photos and diagrams, showing every phase of construction, guide you from start to finish. Ten working size blueprints give floor plans, elevations, notes on construction, framing, lumber list, specifications, plumbing and wiring diagrams.

than he spends for material.

Order Book, Plans Now
Use the handy coupon below to order RANCH-TYPE HOUSE BOOK AND PLANS. Read the book; study the plans and then be prepared to go right ahead when you are ready to build. Even if you have the house mainly built by others you can enjoy a tremendous saving by using the instructions and blueprints.

Read How and See How - Simplified Instruction
You read "how-to-do-it" in the book and see how it looks in actual pictures. You follow the plans for dimensions. You make use of labor-saving kinks, special methods.

No Previous Building Experience Required
Any ordinary handy man, using simple tools, can build this house with little or no assistance. And at the same time, save more

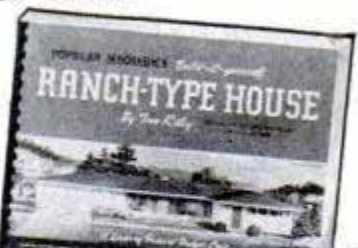

Order on this Handy Coupon

POPULAR MECHANICS PRESS, Dept. RH
200 East Ontario St., Chicago 11, Ill.

Send at once my copy of the Ranch-Type House Book and Plans as checked below:

- Remittance enclosed Send C.O.D. (postage extra)
- Ranch-Type House Book \$ 3.50
- Set of 10 Blueprints 13.50
- Book and Blueprints 15.00
- Duplicate Set of Blueprints 5.00

Name _____
Address _____
City _____ Zone _____ State _____

POPULAR MECHANICS

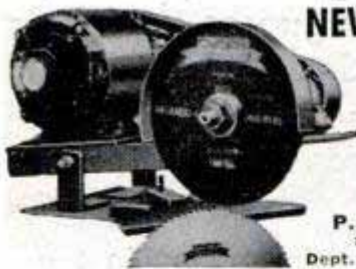

NEW SAW SHARPENER

Improved #64 Hand Gummer sharpens all types circular saws 4" to 20" diam. Ideal for saw shops. Self-Centering adjustment for quick, easy set-ups. Complete with 1/4 HP motor, 1 grinding wheel & cord. \$79.50 FOB Portland. Wt. 70#. SEND FOR FREE LITERATURE.

P. T. HOBBS MACHINERY
8375 N. INTERSTATE AVE.
Dept. P.M.-61, PORTLAND 17, OREGON

DON'T RISK PAINT FAILURE

Get Free Book! No need for poor paint results. Fact-filled book, written by experts, tells what aluminum paint to use inside and out, on metal, masonry and wood. Costs you nothing, can save you dollars. Write for "Paint it Bright."

Aluminum Company of America, 1718-J Gulf Bldg., Pittsburgh 19, Pa.



BUY LU-MAR ALL-PURPOSE PUMP

To fill outboard motors, lawnmowers, etc. \$3.00 postpaid, less can. Strainer and shut-off, 75c. Money-back guarantee.

LUCAS METAL PRODUCTS CO.
952 Exchange St. Rochester 8, N.Y.



BATTERIES!—START

—a factory at home and re-cast junk batteries into new; latest achievement. We supply complete instructions and everything needed. Large daily profits!

BATTERY LABORATORIES, Dept. PM, Minneapolis 4, Minn.



SEND ME

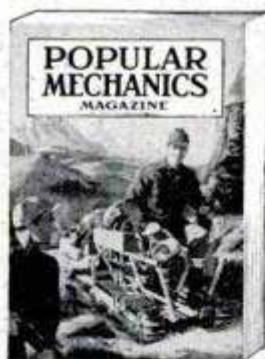

every month so I am sure to see each new issue. Here's

- \$3.50 for 1 year
 \$8.00 for 3 years

name _____

address _____

city _____

zone _____

state _____

B-92

Hand this order to your newsdealer or send it to

POPULAR MECHANICS
200 East Ontario St. Chicago 11, Ill.

The Inside Story

of water heater corrosion

Ordinary Tank

Glass-Surfaced-Steel Tank

This is my soft touch!



Ruthless Rust

I keep rust out!



Four B.I.

Permaglas[®]

Automatic Water Heater

glass-surfaced steel tank is fully protected against rust

You can see how you save money when you buy an A.O. Smith *Permaglas* Water Heater. All the sparkling, clean hot water you want—and no replacement problem every few years!

Though "Ruthless Rust" wrecks thousands of ordinary water heaters each year—he can't touch a *Permaglas* because of its exclusive Four B. I. Protection. For your protection, get the full *Permaglas* story before you buy any water heater. It won't cost you a penny—it can save you plenty!

COSTS NO MORE than ordinary water heaters

the **ONLY** water heater with **Four B.I.** protection, Four Basic Improvements by A. O. Smith:

1. Glass-surfaced steel tank can't rust because *glass can't rust!*
2. Absence of dissimilar metals inside tank!
3. Interior tank fittings shielded from electrolytic action... the cause of all corrosion!
4. "Neutrolizer"... the anti-corrosion stand-by protector!

For your copy of "Murder in the Tank" write: A. O. Smith Corp., Dept. PM-952, Kankakee, Illinois.



A.O. Smith

PERMAGLAS-HEATING PRODUCTS

Gas, Electric and LP-Gas Models.



Manufacturers also of A. O. Smith
GAS Conversion Burners,
Home-Heating Boilers,
Warm-Air Furnaces and
Commercial Water Heaters

WHY PAY MORE for an ELECTRIC SHAVER?

WHISK AWAY EVEN A 7 DAY BEARD
WITH THE WHISKER ELECTRIC SHAVER

Precision-built,
with .002"
thin blade that
shaves all
beards
smoothly,
closely.



Whether you shave once a day,
or once a week you'll like WhiskER Electric Shaver. Its clipper-like blade is designed for all beards, is definitely less irritating. 110v AC model; no TV or radio interference. See your barber or dealer. If he cannot supply you, send \$15.95—we pay postage; or send \$2, you pay balance plus postage and COD. 10-day money-back guarantee.



CADET ELECTRIC HAIR CLIPPER
Cuts hair, removes superfluous hair from legs and under arms. The same fine quality clipper used and sold in many beauty shops. See your shop, or dealer. If you prefer, send \$10.95—we pay postage; or \$2, you pay post-man balance, postage and C.O.D.

ELECTRO TOOL CORP., Dept. W522-J, Racine, Wis.

How To Hold

FALSE TEETH

More Firmly in Place

Do your false teeth annoy and embarrass by slipping, dropping or wobbling when you eat, laugh or talk? Just sprinkle a little FASTEETH on your plates. This **alkaline** (non-acid) powder holds false teeth more firmly and more comfortably. No gummy, gooey, pasty taste or feeling. Does not sour. Checks "plate odor" (denture breath). Get FASTEETH today at any drug store.

LUTHY AERO TYPE SPARK PLUGS

ALUMINUM OXIDE INSULATORS

Material developed during World War II for high speed combat aircraft. Aluminum Oxide Insulator cools very rapidly, is stronger, has greater resistance to moisture and reduces breakage to a minimum. Correct Gap setting and proper heat range for your automobile, truck, tractor, hot-rod and stock car.

**PACKED IN
ENGINEERED SETS**

Packed in Sets of 4 or 8
Correctly gapped for the model
and year of ALL CARS

**ORDER A SET OF THESE
SENSATIONAL PLUGS NOW**

- Longer Life
- High Speed Performance
- More Economy

Satisfaction Guaranteed

3/4 and Full Race Grind Cams

DEALERS AND DISTRIBUTORS WRITE FOR FRANCHISE

LUTHY AERONAUTICAL SALES CO. JACKSON, MICH.

Send me a set of ___ plugs. Enclosed is \$ _____

NAME _____ ADDRESS _____

YEAR OF CAR _____ MAKE AND MODEL _____



The product 15 years of spark plug manufacturing and development

MORE R.P.M.

3 POWER ELECTRODES

A Scientist Diagnoses the Flying Saucer

(Continued from page 95)

signal is 5000 megacycles. There appears to be a definite connection between the anomalies in the two systems.

There is one interesting aspect in the reports on the flying saucers. About 100 years ago the famous Durham lights appeared over northern England. The century before, "lights" were seen by the French. Now, Americans are seeing weird lights, calling them flying saucers and attaching wholly unjustified significance to them.

The curious angle to these apparitions is that in every case the lights were seen by the people of the leading nation of the world at the time. When France was a great power, her people saw them. When England was dominant in the world, the English saw them. Today, the United States is in its prime and we see them.

It may well be that people who have most to lose from a change are the very ones most likely to see mirages. Perhaps a psychologist will explain why the inhabitants of the leading power in the world are most susceptible to strange sights in the sky.

Up to this point we have only mentioned the lights which appear at night. Flying saucers have also appeared in the daytime. But in every case the source was found to be a meteorological balloon, a very high flying aircraft or particles of dust or spiders which float lazily through the air in the general vicinity of the sun. The daytime appearances of these objects have not been a problem—the problem is strictly one of the night lights and these can be explained as mirages.

The next time you hear or read of flying saucers ask yourself a question: Why do not the people of the other countries see these objects? With the answer will come an understanding which will remove the fear and hysteria the flying saucers have engendered. ★ ★ ★

Noncritical Magnet Material

Powerful permanent magnets can now be made of a new alloy called bismanol which is composed of the noncritical bismuth and manganese. The name, bismanol, combines contractions for the two materials plus a suffix, nol, denoting the Naval Ordnance Laboratory at White Oak, Md., where the alloy was developed. Navy scientists report the new material has as high a coercive force, or resistance, to demagnetization as any known substance. But bismuth and manganese are nonmagnetic alone.



Honestly now—
would you prefer
a shrinking
violet?

The advertisers in this magazine all claim their products are "tops." They are full of pride in their brand names.

Every so often you meet someone who objects to what he calls the "boastfulness" of advertising, but *most* of us Americans like it.

We like it because we know that deep *pride* in things well made goes way back into the factories and is reflected in the fine products we have to choose from when we go to buy the things we use in our homes or on our persons.

We like it because we know that pride is a spur to make better merchandise; and that it is the driving power that keeps men striving each to outdo the other in new ideas, new and better ways of doing things. The end result is a steady stream of new and better means to make life comfortable; more and better jobs for us to earn the means of buying them.

We will take the *Proud* ones—and let some other land cultivate the shrinking violets.

Brand Names Foundation
INCORPORATED

A non-profit educational foundation • 119 West 57th Street, New York 19, N. Y.

20 POWER
7½ oz.
TELESCOPE
\$7.95



Precision ground optics are hard-coated to reduce glare, assure maximum brightness. Sturdy metal construction despite light weight. By no means a toy, but an advanced 6 element optical instrument, with a 2 lens, fully achromatic objective, 2 erecter lenses, a 2 element Ramsden eyepiece. Pocket size 6¾", extends to 15¼", threaded fittings, chrome-plated inner tubes. A must for vacationing, outdoor sports, hunting, boating, observing races, etc.

6X PENSCOPE

Coated, fits pocket like fountain pen, is always handy. Eyepiece, objective and erecting system in satin-finished neat extension chrome barrel bring objects 6 times closer, magnifying 36 times!

\$3.95



COMBINATION SPECIALS!

56.515 for SEPESCOPE MICROSCOPE and 6X PENSCOPE for \$10.95



TRIPLE REVOLVING
100X - 200X - 300X
MICROSCOPE

\$14.95 A microscope suitable for students, schools, hobbyists. All metal construction, left and right hand focusing, body tilt adjustment, adjustable piano sub-stage mirror, 3 objectives on turret instantly making possible desired magnification. Comes complete with one specimen and wooden box. Your friends will guess you invested 5 times the moderate amount of \$14.95!

20X — 40X — 60X
MICROSCOPE \$2.95

Precision-ground optics make this adjustable microscope indispensable for field use. Helps you examine minerals, gems, insects, etchings—in fact you'll be able to find a million uses for this instrument. Select power you want, then turn knurled knob until you obtain pinpoint focus. Sells elsewhere for up to 70% more!

Cash orders postpaid. Include \$2. deposit with C.O.D.'s
SPIRATONE, Dept. PM, 49 W. 27 St., N. Y. 1, N. Y.

BIG LEATHER & CRAFT CATALOG!

1000's of items for Leathercraft, Textile Painting, Copper Tooling, Kits, Projects, Tools, Supplies, Etc. Send 25c (refunded with 1st order) to:
RUSSO HANDICRAFT SUPPLIES Dept. 3-CD, 245 S. SPRING
LOS ANGELES 12, CALIF.



Treasure and Minerals

Easily located with new Lightweight M-Scope Detector. Superior performance, lowest price, monthly payment plan.

FREE LITERATURE

FISHER RESEARCH LAB., INC.
PALO ALTO CALIF.

SAY YOU SAW IT IN POPULAR MECHANICS

**DRIVE FOREVER
AND NEVER CHANGE
YOUR OIL!**

WITH AMAZING,
FULLY GUARANTEED
TISSU-PAK
OIL FILTER

Keeps engine oil sparkling clean. Eliminates expensive oil changes and costly element replacements. Inexpensive to buy. Easy to install on all gasoline engines up to 14 quarts crankcase capacity—automobiles, trucks, tractors, stationary and marine engines.

Enthusiastic testimonial from thousands of individual and fleet users. Write today for FREE "Tissu-Pak Facts." Mailed immediately.

HENDERIZE, INC. ● 5667-B1 Freeport Boulevard
Sacramento, California

NEW!
**ALL ABOUT
TELEVISION**



Service Your TV Set Yourself and Save Hundreds of Dollars . . . Save on the Purchase of a New Set!

Here's the brand new book that tells and shows you how 9 times out of 10 you can service your TV set yourself and save the \$5 to \$25 fee charged by professional repairmen for service calls.

Here are famous step-by-step instructions by John Derby, famous television engineer, which make it possible for you to locate trouble quickly and repair it in the matter of minutes. Hundreds of "show-how" photos, drawings and diagrams actually show you just how to go about making most TV repairs.

A special illustrated section contains actual photographs of imperfect TV pictures. By comparing the picture on your set with those in the book you immediately identify the trouble and then by following Derby's instructions you make the adjustment or repair which will give you perfect reception once again.

Find out how to install your own antenna at a savings of as much as \$20 . . . how to replace burnt-out picture tubes . . . how to get the best reception in outlying areas . . . how to save money when buying a new set . . . what to look for when you purchase a TV set.

Go with Derby into TV studios and see stars in action . . . see how television shows are produced and what goes on "behind the scenes."

No other TV book on the market is so comprehensive and so chock-full of valuable information. No other book can save you so much money.

Send just \$3.00 for your copy of "All About Television." Read it for seven full days and unless you agree that it can save you hundreds of dollars and enable you to service your TV set yourself just slip it back in its wrapper and return it to us for a full refund. Use the handy order blank today.

Order on this Handy Coupon

POPULAR MECHANICS PRESS
200 E. Ontario Street, Chicago 11, Ill.

Remittance for \$3.00 enclosed. Rush postpaid my copy of "All About Television." Unless it is entirely satisfactory I may return it within seven days for a full refund.

NAME _____

ADDRESS _____

CITY _____ ZONE _____ STATE _____

Send C.O.D. (Postage extra)

New MOTOR BARGAINS for Home, Farm & Industry



ALL NEW MOTORS WITH ONE YEAR FACTORY GUARANTEE

All are 110 V. or 110/220 V. 60 cy. 1 ph. A.C. Motors. Write for FAN CIRCULAR: Listing Blades, Guards, Motors, ALL SIZES: Attic, Window or Room Cooler

1/2 H.P.	Dayton, 3450 RPM IND type . . . \$18.50
	Westinghouse, DBL shafts, 1725 RPM \$22.50
3/4 H.P.	Westinghouse, dbl. shafts, 3450 RPM \$23.50
	Eicor, capacitor type ball brg., 1725 RPM \$32.50
1 H.P.	General Electric, cap. ball brg. dbl. shafts, 1725 RPM . . . \$34.50
	General Electric, cap. type, 3450 RPM \$34.50
1 1/2 H.P.	Eicor, 1750 RPM, cap. type \$52.00
	Dayton, 3450 RPM, cap. type \$57.00
2 H.P.	Dayton, 3450 RPM, cap. type, dbl. shaft \$62.50
	Westinghouse, ball brg. cap. type, 1725 RPM \$67.50
2 H.P.	Dayton, 3450 RPM, rep. ind. . . . \$67.50
	Dayton, 3450 RPM, rep. ind. . . . \$75.00
	Leland, 1725 RPM, rep. ind., ball brg. . . \$79.00

C. MARSHALL SALES
3546 W. Fullerton Ave., Dept. P-9, Chicago 47



16 TO 1 SPEED REDUCERS

For Display Table — Barbecue Spits — Toy Auto Gear Box — Experimental Uses, Etc. Gears Enclosed in Aluminum Housing. Bronze Gear, Hardened Worm. Input Shaft 1/4 in. Output Shaft 3/8 in. Speed Reducer R 161. . . \$3.95 Paid

• New Explosion Proof Motors •

Underwriters approved, Class I, Group D, explosion proof motors, Westinghouse and Leland makes, heavy duty repulsion induction and capacitor types. For pumping gasoline, lacquer or use on jobs where motor is exposed to hazardous fumes or material, abrasives, dirt and dust. All 5/8" shaft, 1750 RPM.

No. EP-25, 1/4 HP, 110/220V, 60 cy., 1 ph.	\$23.50
No. EP-33, 1/3 HP, 110/220V, 60 cy., 1 ph.	\$28.50
No. EP-333, 1/3 HP, 220 volt, 60 cy., 3 ph.	\$32.50
No. EP-32, 1/2 HP, 32V, direct current.	\$33.50
No. EP-115, 1/2 HP, 115V, direct current.	\$37.50
No. EP-230, 1/4 HP, 230V, direct current.	\$24.50
No. EP-233, 1/3 HP, 230V, direct current.	\$27.50

All prices F.O.B. Chicago

Volume Blowers for Heating, Ventilating, Exhausting

Blowers for forced drafts, heating boosters, exhausters, coolers, dryers and dust collectors, 110 volt A.C., 50/60 cycle motors.

*Midget Blower: 5 CFM 2 in. Wheel . . .	\$ 5.95
*50 CFM Blower: 3 inch Wheel . . .	\$ 9.75
*75 CFM Blower: 4 inch Wheel . . .	\$11.25
*250 CFM Blower: 5 inch Wheel . . .	\$22.50
*600 CFM Blower: 6 inch Wheel . . .	\$38.50
*1000 CFM Blower: 8 inch Wheel . . .	\$52.00
*1500 CFM Blower: 9 inch Wheel . . .	\$72.00

*These Blowers with Motors shipped Post Paid. Larger sizes are F.O.B.



SAY YOU SAW IT IN POPULAR MECHANICS



YOU CAN BUILD A VIOLIN FOR PLEASURE OR PROFIT

Now you can build a rich toned mellow violin modeled after a famous "Strad." YOU CAN MAKE A STRADIVARIUS VIOLIN contains 8 full scale plans plus complete instructions. You work directly from the plans with no confusing scale of dimensions to translate. Detailed instructions for each step including varnishing and stringing—oven shows how to build your own tools. Cloth bound. Order today from

POPULAR MECHANICS PRESS . . . \$3.50
200 EAST ONTARIO STREET, CHICAGO 11, ILLINOIS

WALKIE TALKIES! — \$4.99 COMPLETE SET OF 2 POCKET SIZE — ELECTRONIC VOICE POWERED



No tubes, batteries, adjustments. Guaranteed to work anywhere up to 1/4 mile with extra wire. Swell for room to room—garage to house, etc. Your own private, talk-listen phone. Not war surplus. Brand new. Guaranteed. Two complete units with interconnecting wire — READY TO USE!

SEND \$1.00 deposit and pay postman \$3.99 plus postage charges or send \$4.99 for postpaid delivery. Available only by mail from MIDWAY COMPANY, Dept. WPM-9, Kearney, Nebraska

OWN A... CHEVROLET?

FIX IT YOURSELF!

Popular Mechanics Magazine has just published a new Owners Manual covering all models and years of Chevrolet Cars. So accurate mechanics use it. So simple a woman can understand it.

Save money on your Chevrolet repairs. Prevent trouble. Enjoy care-free driving. Increase trade in value. Avoid major repairs by fixing minor troubles before they get serious. Get sparkling performance at all times. Has 288 pages, more than 300 photos, diagrams, tables, charts, breakdown drawings, plus clear, non-technical directions that make all repairs simple as A B C. Written by Ed Packer with assistance of General Motors Corporation. Shows you how to diagnose Chevrolet troubles by feel, sound, sight, smell and performance. Simple trouble shooting. Permanent repairs. Emergency repairs. Plus "How to get value from garages."



MONEY BACK IF IT DOESN'T SAVE MORE THAN ITS COST!

One minor repair will save the cost ten times over. Read it. Then you decide. If you don't see that you'll save more than the cost, send it back for refund. SEND NO MONEY. Send postcard. Ask for CHEVROLET Manual. Postman will deliver C.O.D. for \$3.50 plus postage. Or, save postage by sending \$3.50 with your order. Send today. Save its cost on your next repair.

POPULAR MECHANICS PRESS
200 E. Ontario Dept. 187 Chicago 11, Illinois

Buy the Best...WISS!



for all sheet metal cutting

WISS Metal Master Compound Action Snips

#M-3. Easily cuts 18 gauge sheet metal. Cuts curves and circles as well as straight. Ideal for the home workshop. \$4.25. Rubber grips recommended, 60¢ extra.

WISS Straight Cut Snips

#9. Crucible steel inlaid blades. The basic snips for straight metal cutting. Gun metal handles. Overall length 12 1/2". \$5.25.

WISS Combination Snips

#V-13. Solid steel, with gray japanned handles. Cuts curves and irregular shapes with ease. Handy pocket size. 7" long. Accurately tempered jaws and strong bolts. \$1.85.



Prices slightly higher Denver and West



Quality for more than a Century

J. WISS & SONS CO. • NEWARK 7, N. J.



BRAND NEW ARMSTRONG TIRES

GUARANTEE

You get a written 18 month Bond with every Armstrong tire and tubes. Ironclad guarantee against blowouts... stone bruises, glass cuts, etc. Adjustments against any road hazard. Armstrong costs never more than monthly guarantee rate. Famous Armstrong guarantee is the finest in the industry... offers greatest protection. S&S Tire Co. are Direct Factory Distributors. You Buy Direct and Save. Order by Mail.

4 ply TRACTOR

Tires - Tubes	
9 x 24	38.49 5.20
10 x 38	67.50 8.70
11 x 36	69.22 9.71
550 x 16	13.74 1.93
500 x 15	12.47 1.70

Brand New Black Walls 4 ply	FULL PRICE	Brand New Heavy Duty Butyl Tubes
640 x 15	12.01	1.79
650 x 15	13.94	1.97
670 x 15	12.52	1.97
710 x 15	13.90	2.04
650 x 16	10.89	1.77
650 x 16	14.38	2.02
550 x 17	12.02	1.87
550 x 18	11.65	1.87
475 x 19	11.07	1.78
450 x 21	11.04	1.73

Brand New White Wall Tires 4 ply	FULL PRICE
640 x 15	17.15
670 x 15	18.14
710 x 15	20.08
760 x 15	21.97
800 x 15	24.19
820 x 15	25.12

Brand New First Line Heavy Duty Truck Tires — First Quality	Price
650 x 20 8 ply	31.47
700 x 20 8 "	34.30
700 x 20 10 "	42.28
750 x 20 8 "	43.14
750 x 20 10 "	50.14
825 x 20 10 "	59.54
825 x 20 12 "	70.66
900 x 20 10 "	71.74
900 x 20 12 "	83.45
1000 x 20 12 "	90.84
1100 x 20 12 "	106.57
1000 x 22 12 "	95.68
1100 x 22 12 "	112.67
1100 x 24 12 "	117.25

(All prices F.O.B. plant.)

Order by mail — Send check or M.O. All tires unconditionally guaranteed.

S&S TIRE CO. 1400 HADDON AVE. CAMDEN 3, N. J.

FURNITURE REPAIR KIT

Save Money! Repair sagging Sofa and Chair bottoms. Kit contains heavy Webbing, Webbing Stretcher, Tacks, Bottom Cloth & easy-to-follow Instructions. Chair \$2.50 - Sofa \$3.50 - Sofa, 2 Chairs \$7.00 P.P.

STYLECRAFT UPHOLSTERY CO., 140 MAIN ST., E. ORANGE, N. J.

YES! SEND

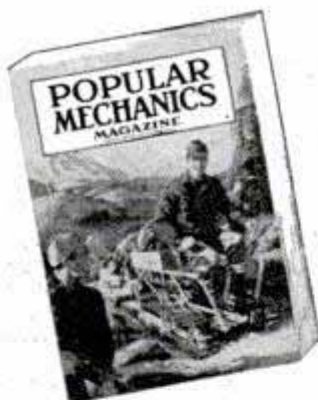

directly to my door every month

I am enclosing

- \$3.50 for 1 year
 \$8.00 for 3 years

name _____

address _____

city _____

zone _____

state _____

A-92

Hand this order to your newsdealer or send it to

POPULAR MECHANICS

200 East Ontario St.

Chicago 11, Ill.

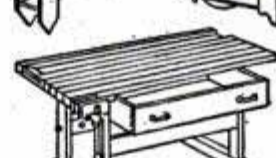
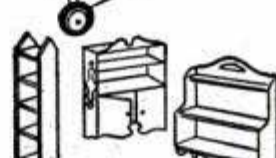
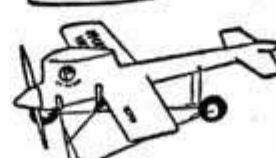

YOU CAN MAKE THESE WITH POPULAR MECHANICS PLANS AND BLUEPRINTS

- 501—Colonial Grandfather's Clock. 50c
- 507-508—Doll-House, 5-Rooms, Open staircase, fireplace... \$1.00
- 526—Queen Anne Coffee Table: True replica of antique... 50c
- 528—Duncan Phyfe Console Table: 30 in. high... 50c
- 529—Lawn Chair: Southern Style... 50c
- 533—Three Attractive Corner Shelves: Scroll-sawed... 50c
- 596—Three Hanging Type Shelves: Hold books, china, etc... 50c
- 661—Rocking Horse: Scroll-sawed from plywood... 50c
- 707—12 Ft. Rowboat: Flat-bottom, four seats... 50c
- 795—Two handsome Cedar Chests... 50c
- 811-812—16 Ft. Canoe: Canadian type, cedar planking... \$1.00
- 813-814—Pops Outboard Racer: 10 ft. long, stepped bottom... \$1.00
- 828-835—Sovereign of the Seas: English warship model... \$4.00
- Sovereign of the Seas: Instruction Book... \$1.00
- 836—12 in. Bandsaw: Uses plywood, cuts two in. stock... 50c
- 839—Mirose Corner Cabinet: Old Colonial design... 50c
- 846-848—Governor Winthrop Desk: True copy of original... \$1.50
- 896-897—Three Easily Made Workbenches—Simple construction... \$1.00
- 906-909—Midget Auto: 58 in. wheelbase, 1/2 to 3/4 h.p... \$2.00
- 910—Circular Saw Table: Hardwood, 24" x 36" Stationary... 50c
- 917—Outdoor Fireplaces: Several simple but practical... 50c
- 920-922—Lawn and Garden Furniture: Swings, arbors, tree seat... \$1.50
- 923—Indoor Fireplaces: Standard Sizes... 50c
- 926-927—Venetian Blinds: Three different styles... \$1.00
- 930—Quilted Rug Frame... 50c
- 933—Cape Cod Cupboard: 4 ft. wide, 5 ft. 8 in. high... 50c
- 935—Knee-Hole Desk: 40 in. long, 30 in. high, 3 1/2 in. wide... 50c
- 936—Modern Coffee Table: 24 in. long, 15 in. wide... 50c
- 952—Child's Crib in Maple... 50c
- 958—Colonial Corner Cupboard... 50c
- 961—Hanging China Cabinet: 38 in. long, 40 in. high... 50c
- 969—Combined Chest and Writing Desk, 35 1/4 in. high... 50c
- 970—Modern Clothes Chest: Built of plywood... 50c
- 977—Bookcase in Chippendale Style: 47 in. high, 10 in. wide... 50c
- 978—Lawn Chair on Wheels: Lightweight, easy to wheel... 50c
- 981—Colonial Wall-Shelf: 30 in. high, 19 in. wide... 50c
- 984—Duncan-Phyfe Drop-Leaf Table: Reproduction of historic piece... 50c
- 986-987—Utility Trailers: Built of old auto parts... \$1.00
- 989-990—Speedy Motor Scooter: Gas engine, 40 to 60 miles on gal. of gas... \$1.00
- 991—Gun Cabinet: Handy cabinet includes rack for rifles... 50c
- 993—Twin-Deck Beds: 6 ft. 4 in. long, 3 1/2 ft. wide... 50c
- 1106-1112—SEACRAFT—25 FT. CABIN CRUISER: Adaptable as sport fisher, express cruiser, or utility boat. Cruises at 15 knots with marine engine or converted auto engine. Cabin sleeps four. Galley has fresh-water tank, sink, and cook stove. Set of seven large-sized blueprints scaled 1 in. per ft. plus 40-page two-color illustrated booklet, only... \$10.00
- 1011—Fireplace Fittings: Andirons, log rack, etc... 50c
- 1080-1081—Banta: 12 Ft. Plywood Runabout: Vee-Bottom, 3-passenger... \$1.00
- 1086—Black Forest Corner Shelf: Scroll-sawed... 50c
- 1089-1090—Home-Constructed Freezing Unit: reaches minus 30 degree temp... \$1.00
- 1091-1096—17 ft. trailer, 7 ft. wide. Steel chassis... \$3.00
- 1102-1105—Midget Trailer: "Tear-drop" body. Sleeping quarters for two... \$2.00
- 1113-1114—Gold Rush of '47: The A.M.A. Open Class B Record Holder Plane Model... \$2.00

FILL OUT AND MAIL THIS COUPON NOW

POPULAR MECHANICS COMPANY, Dept. 19
200 E. Ontario St., Chicago 11

Please send the following plans _____

I am enclosing \$ _____

Name _____

Address _____

BUY from C&H - you'll save and be sure!

HOT ROD SUPERCHARGER

Extra soup and go at a price you can't afford to miss! SEE HOW SIMILAR SUPERCHARGER is used in PICTURE and article on p. 67 AUG '50 issue of POPULAR MECHANICS. Mfr'd by Borg-Warner. Specifications: 7 1/2" deep, 7" high. Wgt. 17 lbs. Compact and sturdy, 4 base mounting holes, 3/4" outlet, 5/8" shaft with female Loveloy coupling. Priced today at \$85. OUR SPECIAL SALE PRICE \$31.00

ALARM HORNS • SIRENS

Motor driven (not a vibrator). Heavy duty with great power and long life. Adjustable for high, medium or low tone. 110 v. AC current. Weather proof. For alarm or signal horn on boats, school yards, factories, air raid siren, etc. Lists at \$47. Our price NEW \$24.95



POWER and HAND WINCHES

For—BOATS, TRUCKS, FARMERS, LOGGERS, CONTRACTORS, ETC.
Hand winch, 3-1 ratio, 600 lb. pull, drum has 1 3/8" spool, 6" flange, takes 7/8" of 3/16" cable, stop locking pawl, wgt. 26 lbs. \$16.95
Ball bearing Hand winch, low ratio 1-1, high ratio 3-1, 600 lb. pull \$29.50
Same as above with bronze worm gear, 2 speeds, 1-1 & 12-1, and hand brake—\$39.50
1/2 HP electric ball bearing model; releasing brake starts motor, brake on-motor off; compact gear box, 12 rpm drum speed. \$135.00
3/4 HP, same as above, 3" drum. \$165.00
Heavy duty, 10-1 ratio, double drum model with jaw-type clutch, wgt. 280 lbs. \$49.95
CABLE, 1/4" preformed stainless steel aircraft, 100 ft. or less. 17c/ft.
Over 100 ft. 15c/ft.

ORDER DIRECT from this ad! All prices F.O.B. Milwaukee, 25% deposit required on all C.O.D. orders. No C.O.D.'s under \$10.00. Many other bargain items not listed. Write for our FREE CIRCULARS!

SAVE OVER 50%

ON THESE BRAND NEW WAR SURPLUS POWER UNITS

BE PREPARED for any emergency!

300 WATT 110-220 volt AC, 60 cycle light plant powered by 1 HP gas engine, direct drive, mounted base, wgt. 40 lbs. Ideal for campers, P. A. systems, house trailers, etc. Equipped with handle for easy carrying \$99.00
750-1000 WATT 110 volt AC, powered by Briggs & Stratton gas engine. \$169.00
1000-1200 WATT 110 volt AC. \$194.00
2000-2500 WATT 110 volt AC, 60 cycle, slow speed generator, 5.10 HP Briggs & Stratton gas engine, NEW \$294.50
To make 110-220 add \$40. for transformer.
2500-3000 WATT 110 volt AC, 60 cycle, Leland generator—runs at slow speed (1800 r.p.m.) for longer life, 8.25 HP Briggs & Stratton gas engine. You can rely on this plant for all average home needs—freezer, stoker, pump, hot plate, radio, etc.—and overloads from starting motors. Reconditioned and fully guaranteed. \$295.00, NEW. \$345.00
Plants same as above, built in 1951, with tools and spare parts. Lists at \$790. Our price \$426.
To make 110-220 add \$48. for transformer.
3000 WATT 110-220 volt with push button starter. Starter battery is automatically charged by plant. Gas engine same as in plant above \$465.00
5000 WATT 120 volt, 60 cycle AC, Hercules 4 cyl. gas engine, Hobart generator, completely automatic, radio & TV filtered, power cable plug, exhaust pipe and manual. Lists at \$1800. Our price \$795.—Extra parts & tools \$25. 150' reel 2-wire 26 rubber cable with connectors \$90. 150' 3-wire remote control cable & switch \$25. Plant complete with parts & 2 reels of cable \$895. To make plant 110-220v. add \$75. for transformer.



RUBBER HOSE

Long wearing GOODRICH 2 ply 2" I.D., 25 ft. lengths worth \$25. Only \$4.95; 3 lengths for \$12.00.



CLUTCHES

For motor scooters, motor bikes, lawn mowers, etc. Centrifugal action enables electric motor or small gas engines to handle heavy starting loads. 3" A belt pulley, NEW. 5/8" bore \$9.95; 3/4" bore \$10.95; 1" bore \$11.95



THROW-OUT FRICTION DISC CLUTCH

Twin disc throw-out type. Ideal for power link with gas engines and electric motors from 3/4 to 1 1/2 hp. 1-7/16" shaft bore—can be bushed to suit. Overall length 4". 5 1/2" plate with 6 mounting holes. Wgt. 4 lbs. Lists at \$44. Used like new only \$15.95



HEAVY DUTY RUBBER ELECTRIC CABLE

(Nothing less than 50 ft.)
4 Wire #18 Neoprene standard, per ft. 7c
2 Wire #14 18 ft. with plug \$3.00
2 Wire #14 50 to 225 ft., per ft. 16c
2 Wire #12 12 ft. with plug \$3.50
3 Wire #10 75 ft., per ft. 23c
3 Wire #10 80 to 225 ft., per ft. 30c
4 Wire #10 75 ft. length, per ft. 35c
2 Wire #6 150 ft., with connector. \$ 90.
2 Wire #4 75' reel and connectors. \$ 70.
2 Wire #4 Concentric 50 to 250 ft. underground, per ft. 60c
1 Wire #10 Rubber, 50-300', per ft. 94c
15 Cond. #18 GE Stranded 50-300' O.D. 1 1/2" per ft. 50c
BOOSTER FANS fit any 8", 9", 10" furnace pipe. 1500 rpm motor with 6" cord, mounting frame, 7" blade. Motor 110 volt 60 cycle 1550 rpm. Easy to install. Silent operation. Warm those rooms with long runs. List \$11.95. Our price \$6.95

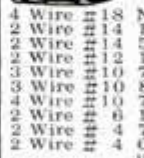

High Volume BLOWERS

Top performance for forced draft, ventilating, exhausting, cooling and drying, 110 volts AC, Intake 2 1/2" discharge 2 1/2", 75 cu. ft. per min. \$10.95. Intake 3 1/2", discharge 2 1/2", 150 cu. ft. per min. \$14.95



C&H ELECTRIC MACHINE Co. Inc.
434j W. Juneau Ave., Milwaukee 3, Wisconsin

VICKERS PUMP BARGAINS!
• Vickers MF9 Hyd. Pump/Motor, 1000 PSI, .310 cu. in. per rev. 5 GPM at 3750 RPM. Rotates either direction. Female spline. 3/4" pipe ports. New. \$90 value. \$22.95
Wt. 7 lb.
• Vickers MF10 Hyd. Pump/Motor, 1000 PSI, .378 cu. in. per rev. 6 GPM at 3600 RPM. Rotates either direction. Flat tongue drive. 3/4" pipe ports. New. Wt. 5 lb. \$17.50
• Aviator's Oxy. Outfits. New. Bail out type. \$5.95
Wt. 4 lb.
ORDER FROM THIS AD! Prices F.O.B. St. Louis. FREE Incl. post. with check or M.O. Catalog
MONEY BACK GUARANTEE!
Edw. Aguado Trdg. Co. 689-M Arcade Bldg., St. Louis 1, Mo.

BURN WATER IN YOUR CAR
FREE LITERATURE ON REQUEST!
AGRICULTURAL DEPT. EXPERTS SAY WATER-ALCOHOL INJECTION BOOSTS MILEAGE!
Stop Ping! Improve mileage of all cars and trucks. Use regular gas with the new Octa-Gane water-alcohol injector. WRITE TODAY!
NEWHOUSE, Dept. 80-9, 5805 E. Beverly Blvd. Los Angeles, Calif.

HELPFUL BOOKS
Send post card asking for FREE catalog
Popular Mechanics Press, 200 E. Ontario, Dept. 601, Chicago 11

TRANSFORMER WELDER \$18.95 FOB QUINCY
Complete with everything. Ready to plug in. 110 volts A.C., 15-30 amps. 3 heats. Welds metal from 1/16" to 1/4" using 1/16" to 3/32" standard rods. Guaranteed unconditionally. 10-day trial. No C.O.D. We also make welder for 16-22 gauge metal, \$3.95; 3/4" metal \$6.45.
ESSAY MFG. CO., INC., Dept. 51, Quincy 69, Mass.

PRESS FLASH CAMERA OUTFIT
The only camera with a built-in flash unit. This combination comes absolutely complete, nothing else to buy. Includes: SPARTUS PRESS FLASH Camera • Zipper gadget bag • 4 flash bulbs — easily removed, easily replaced • Roll of 120 film — gives you 8 big prints 2 1/4 x 3 1/4 in crisp detail. \$19.80.
SHIPPED ON APPROVAL
NO MONEY WITH ORDER — NO C.O.D.
If completely satisfied send \$3.80 and pay balance at rate of \$4.00 per month. — NO INTEREST OR CARRYING CHARGES ADDED. If not completely satisfied return, no explanation necessary
KAPNER HARDWARE, Inc., Dept. A-48, 2248 Second Ave., N.Y. 29, N.Y.

LAWN ORNAMENT-NOVELTY PATTERNS
28 Lawn Ornament Patterns, 25c. Other Patterns; 15-20" high; Dutch Girl, Dutch Boy, Pirate, Bull Terrier, Mexican Girl, Mexican Boy, Dwarf, Penguin, Flower Girl, 10c each. 25 Novelty Patterns, 30c. All 62 Full Size Patterns, \$1.00 Postpaid.
Strother Pattern Service, Dept. DA-8, Box 129, Belington, W. Va.

ELECTRIC MOTOR BARGAINS!
1/2 HP 1750 or 3450 RPM 19.75
1 1/2 HP 3450 RPM 47.50
2 HP 3450 RPM 65.00
3 HP 3450 RPM 77.50
All prices F.O.B. Immediate Delivery
Every Motor Fully Guaranteed
Heavy Duty, Repulsion Induction and Capacitor Types, 110-220 Volts, 60-cycle. Single-phase. Standard Makes (G.E., Wagner, Leland, Westinghouse, etc.). Rush your order TODAY—large stock of motors—1 & 3 phase. 32-v. direct current bargains. Prices f.o.b.
ROBERTS ELECTRIC CO., 649 W. Grand, Dept. 31, Chicago, Ill.

IS YOUR CAR HALF SAFE?

Get a THRU-VU Swivel
Mirror Positioner

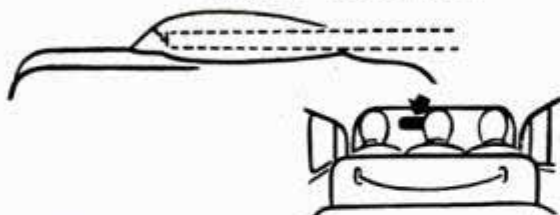

- adjustable for driver height and for load in rear
- sees around extra passengers
- installed in a minute
- always clear vision to the rear

End the annoyance and danger of not having clear rear vision—always! THRU-VU Positioner enables you to move your rear view mirror to keep the rear window in line with your eyes under all conditions of load. Necessary on all standard model cars as well as custom jobs. Send cash, check or money-order. State year and make of car.

Make your car
fully safe . . . only \$1³⁵
send for THRU-VU TODAY

RENTSCHER AUTOMOTIVE PRODUCTS

2752 N. Elston Ave., Chicago 47, Illinois

MAGNETS OF ALL TYPES — 10c UP
AMAZINGLY POWERFUL!!
6 ounce horseshoe magnet—\$1.50.
Our Leader, 1 lb. magnet lifts 40
lbs. \$2.95. New alloy—will not weak-
en! Useful for lifting valuables from tanks,
lakes, or rivers easily! 7 small magnets \$1.25 with
list of many shop and home uses. Satisfaction guaranteed.
E. EYRICH, 1219 W. MEINECKE AVE., MILWAUKEE, WIS.



\$19.95

THE NEW Regency VB-1 Voltage Booster

Get peak performance from your TV set or any electrical device drawing 350 watts or less. Maintains full 117 volt power supply. Insures full size TV picture when low line voltage shrinks picture size.

Available at all Radio Dealers or write:
I.D.E.A., INC., REGENCY DIVISION
7900 Pendleton Pike, Indianapolis 26

BE YOUR OWN BOSS

Make Hundreds of \$ Spare or Full Time Work

You can make
simply and
cheaply



BUSTS



GARDEN URNS



NOVELTIES



TILE



STATUARY

NO EXPERIENCE NEEDED

Here is the ideal business with no previous experience or large investment required and no high-priced equipment to buy. A business that will return dollars for the pennies you invest.

YOU CAN CAST ANYTHING

With *Flexible Mold Making and Ornamental Casting*, an amazing fact-packed book, you learn how you can cast practically any article in concrete, plaster, imitation marble or any other casting material using a marvelous new process. You can make ash trays, novelties, garden and lawn ornaments and hundreds of other highly profitable items that cost you but a few cents and sell for as much as \$5.00 and more. Why you can even make true-to-life full-sized busts of your neighbors and friends.

NO EXPENSIVE MOLDS TO BUY

Why buy high-priced molds from others? Learn how you can make your own molds quickly, easily and inexpensively with materials that can be used over and over. You get copyrighted formulas, complete instructions and detailed how-to-do-it photographs as well as complete sources of supply for the few inexpensive materials you need. This is the only book printed in America today that contains instructions for making profitable papier-mache casts.

MONEY BACK GUARANTEE

Start on your road to extra income and independence today. Send only \$3.00 for your copy of *Flexible Mold Making and Ornamental Casting*. Complete satisfaction guaranteed or your money refunded within seven days.

POPULAR MECHANICS PRESS, Dept. 46
200 E. ONTARIO ST., CHICAGO 11, ILL.



NEW POPULAR MECHANICS MAGAZINE LIBRARY FILE

Brand New, Grand New
Way to Preserve Each and Every
Issue of Popular Mechanics

Now you can preserve every treasured issue of Popular Mechanics in these ingenious, custom-built storage files. Constructed to look like an attractively bound book, Popular Mechanics Magazine Library Files afford neat, orderly, flick-of-the-finger convenience. Handy reference index printed on back records the exact location of selected articles, diagrams, etc. A "must" for every reader of Popular Mechanics Magazine. A sensational Popular Mechanics value scoop. Order yours today. Use the handy coupon.

Only
70c

PER SET OF 2

(set holds 12 issues)
POSTAGE PAID

5 sets only \$3¹⁰

10 sets only \$6⁰⁰
POSTPAID

USE THIS COUPON...MAIL TODAY

Popular Mechanics Magazine, Dept. PL
200 East Ontario Street, Chicago 11, Illinois

PS-52

Please rush PREPAID _____ set Popular Mechanics Magazine
Library Files. (QUANTITY)

Remittance for \$ _____ is enclosed.
(AMOUNT)

Name _____

Address _____

City _____ Zone _____ State _____

Build the MONOGRAM SUPERKIT F-51 Mustang



16 to 26 Plastic Parts in Each Kit

ONLY **89c**

17 Other Thrilling Models — Flying and Solid • Jet Power Racers • Ships

Here's thrilling fun for all kids 8 to 80 years old. Genuine SUPERKIT scale model airplanes including the famous F-51 Mustang shown above. Easiest of all to build yet most detailed models ever produced. Kits contain completed wings with double airfoil, smooth carved bodies, precision-cut balsa parts, plastic 3 and 4 bladed props, pilots, canopies, cannon, rockets, bombs, display stand and other plastic parts. Complete catalog of 18 planes, including jets, 5 jet power race cars and 5 U.S. fighting ships FREE in every kit. Be sure you get Monogram Models.

MONOGRAM MODELS, Dept. 16, 3421 W. 48th Place, Chicago 32

RUPTURE-EASER

Reg. in U.S. Pat. Off. **FOR MEN, WOMEN AND CHILDREN**
Pat. No. 2606551



A strong, form fitting, washable support. Back lacing adjustable. Snaps up in front. Adjustable leg strap. Soft, flat groin pad. No steel or leather bands. Unexcelled for comfort. Also used as after-operation support. Give measure around the lowest part of the abdomen. State right or left side or double. We pay postage except on COD's. **PIPER BRACE CO.**
811 Wyandotte Dept. PM-92 Kansas City 6, Mo.

Right or Left Side **\$3.95**
Double **4.95**

BUTANE-PROPANE GAS ON YOUR CAR



Save up to 1/2 and get powerful Hi-Octane operation! Simple combination system (easily installed) can switch to gasoline instantly while running! Equipment for all cars—trucks.

SEND \$2.00 for our complete "How to do it" booklet, instructions, photographs and special prices. (refunded on parts order) **ORDER NOW — TODAY.**
LPG PRODUCTS CO., Dept. PM-9, KEARNEY, NEBR.

WHEN YOU BUY BY MAIL

Every issue of **POPULAR MECHANICS** contains many products and services which you can obtain by mail. However, there are important points to check on to make sure you get quick and satisfactory service.

In writing to an advertiser:

Be sure your address and the advertiser's are correct and readable . . .
Tell the advertiser exactly what you want — include size, number, color, etc., if required . . .
Send the correct remittance — however, don't send cash through the mails — use a check or money order.

Taking time to check these points will help you get quicker replies and better results — and will make it well worth your while if you buy by mail!

LOOK what you can DO

with **DURON**
T. M. Reg. U. S. Pat. Off.
THE HARDBOARD OF 1,001 USES



Work **DURON** Hardboard just like wood . . . only neater, and less costly! For **DURON** is a *wood-fiber base plastic sheet* that gives you the strength of wood — but with real savings in time and money. No special tools or skills required . . . no sanding or painting (except to change its color). Here's your open door to new accomplishments in your workshop: furniture, cabinets, toys — *anything* is easier, quicker, less expensive with **DURON**!

See your lumber dealer or send for these two free folders. Packed with useful shop information. Write: **United States Gypsum Co., Dept. 143-5, 300 W. Adams St., Chicago 6, Illinois.**



UNITED STATES GYPSUM
The Greatest Name in Building

Watch for these
DANGER SIGNS
of Worn-Out Shock Absorbers



Play Safe—Replace With New
MONRO-MATIC
SHOCK ABSORBERS

The Only Shocks with Automatic Adjustment

Don't take chances. Check your shock absorbers now and install new MONRO-MATICS if replacements are needed. They give a smoother, safer ride over any road.

EASY TO INSTALL

It takes only a few minutes to install MONRO-MATICS on the average car. Clip this ad and send with your name and address for installation and service manual.

Guaranteed for one year or 15,000 miles

MONROE

MONROE AUTO EQUIPMENT CO., Dept. A MONROE, MICH.

best white tape made

ONLY **98¢***



The new "Evans White-Tape" has everything you'll find in tapes costing over \$1.50—plus.

- snow-white blade with bold, legible, jet-black numerals and graduations. Graduated in 32nds for first 6 inches.
- sturdy die-cast case heavily chrome-plated, calibrated for quick reading inside and outside measurements.
- blade 1/2" wide made of finest high carbon steel—tempered—Bonderized—enamelled—baked.
- blade replaceable in seconds—without tools—without even opening case. And Evans replacement blades cost far less.
- every "Evans White-Tape" is unconditionally guaranteed.
- exclusive Evans automatic brake gives smoother push-pull action with absolutely no "creeping" of tape into case.
- underside is white, too. Mark with ordinary pencil, remove mark with flick of thumb.
- unheard-of low price*: 10-ft. \$1.49; 8-ft. \$1.19; 6-ft. 98¢. Prices higher in far west and Canada.

Evans & CO. • Elizabeth, N.J. • Montreal, Que. © 7429
Makers of Evans 6-ft. Folding Rule and Folding Yardstick

STOPS LEAKS PERMANENTLY

Cut your fixture replacement, water and fuel bills with Economy Renewable Seats. Make economical, permanent repairs quickly and easily with the Junior Kit (illus.). Repair bathroom, kitchen and laundry fixtures. Everything you need included in steel box. This is a natural for the "Fixit" shops — get extra income from making permanent repairs on your customers' faucets.

Senior Master Kit also available—repairs faucets and valves up to 1" pipe.

Write for illustrated circular.
JUNIOR KIT, only \$22.50
with 15 assorted Renewable Seats.
"Less than the cost of a set of kitchen sink fixtures."

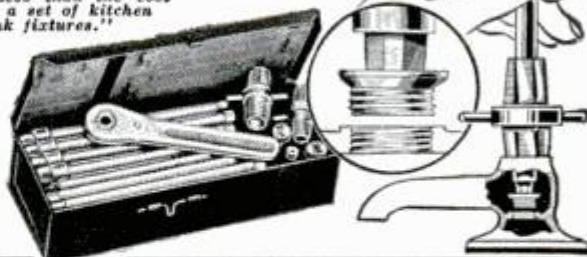

ECONOMY VALVE SEAT CO.
1430 N. Keating Ave. Chicago, Ill.

STOP THIEVES!



Protect Your
LIFE • HOME • AUTOMOBILE • PROPERTY
With **ACME BURGLAR ALARMS**

ANYONE CAN INSTALL ACME BURGLAR ALARM KITS - EACH PART OR KIT IS SUPPLIED WITH VERY SIMPLE INSTRUCTIONS - WRITE US YOUR BURGLAR ALARM REQUIREMENTS.

Write for Free Illustrated Folder
ACME ALARMS ••• 7033 CLYDE AVE. Chicago, 49 Ill.

make your own **Gems** **29.50**
F.O.B.

All necessary lapidary equipment is furnished, including a super-charged diamond blade for sawing, and all wheels for grinding, shaping and polishing; also complete instructions. The complete equipment as shown, less motor and belt, for only \$29.50, f.o.b., Burlington, Wisconsin. Write today for information and literature.

B&I MANUFACTURING CO.
Dept. S Burlington, Wis.



ANVIL A THOUSAND USES IN THE HOME SHOP



Miniature of Blacksmith's anvil. Complete with horn and swage hole. 5 3/4" x 2 1/4" x 3 3/4". Base tapped and threaded for bench mounting. **\$3.95**

POST PAID
CHECK OR
MONEY ORDER

STURDY MFG. CO., Crystal Lake, Ill.

Print Your Own

Cards, stationery, circulars, tags, labels, photo and movie titles, advertising, etc. Save money. **Print for Others, Good Profit!** easy rules sent. Raised Printing like Engraving, too. Sold direct from factory only. Write for free catalog of outfits and all details. **KELSEY PRESSES, M-37, Meriden, Conn.**



TRUE "PERIMETER" HEATING

The leading hot water baseboard heating. For new homes or old. Folder on request to Dept. PM-9, Warren Webster and Company, Camden 5, N.J.

Webster
PERIMETER FORCED HOT WATER
BASEBOARD HEATING

BUY WHOLESALE FROM FACTORY SAVE 50-85%



Portable LIGHT PLANT

PUSH BUTTON START
500-700 watts 110-120 v. — 60 cyc. A.C. Powered by a sturdy dependable easy starting, air cooled 1 1/4 hp. gas engine. No wiring necessary. Just plug in and operate. Plenty of current for any oil burner, freezer, brooder, pump, emergency lights, etc. which require up to 700 watts. Ideal for Civil Defense, Fire Dept., trailers & camps. Complete with voltmeter and built-in winding to charge 6 v. auto batteries. Wt. 85 lbs. Fully guaranteed. Be prepared if war or storm knocks out power lines.

(Item 24) **\$143.50**
Reg. \$275.00 value.
700-800 Watt Plant (Item 44) **\$169.95**
Same as above but greater output.
1000-1200 Watt Plant (Item 45) same as Item 24, but larger generator & engine **\$199.50**

GIANT 2000-2500 WATT PLANT

110-120 V. 60 cyc., A.C. Absolutely the best made — exclusive dynamically balanced armature; heavy windings developed up to 5000 watt overload for motor starting. Skid-mounted — portable. Powered by easy starting Briggs or 6 hp. Wisconsin engine — complete with all accessories; engine easily disconnected for other uses. Big outlet box, voltmeter, no wiring necessary. Ample current for all purposes. Factory warranty and instructions included. Wt. 220 lbs. Reg. \$585.00. Special at

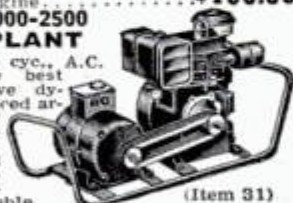

\$299.50
With Electric Self Starter (Item 179) \$359.50
GENERATOR ONLY and control box. **\$169.50**
Drive it with your engine or tractor.

3000-3500 WATT PLANT

(Item 198) 110-220 v. — 60 cyc. A.C. with Wis. Engine, push button start. Wt. 370 lbs. Heavy duty. **\$399.50**
Generator only for belt drive, **\$239.50**
Wt. 115 lbs. (Item 198A)

HI-LINE 6000 WATT PLANT

(Item 162) Push Button Start, 110-230 v. 60 cycle A. C. A brute of a power plant with rugged 13 hp. Wisconsin engine. Plenty of electricity for ranges, water heaters, freezers, pumps, machinery, etc. Affords both 110 and 220 volts. Ideal where heavy current is needed. Wt. 590 lbs. Easily worth \$995.00. With self starter, **\$645.00**
Factory Spec. **\$645.00**
Generator and control box only, belt driven. Use your engine or tractor. **\$345.00**
Wt. 240 lbs.

Write for information on any sizes not listed. **AUTOMATIC.** Any of our light plants can be furnished with full automatic controls for as little as \$100.
Buy Wholesale—Direct From Factory—World's Largest Direct Selling Light Plant Factory
You can pay more — but you can't buy better.

MASTER AIR COMPRESSOR

(Item 209) High pressure type for large volume of air for heavy duty service. For paint spraying, inflating truck and auto tires, greasing, and the hundreds of other jobs done by compressed air. Piston type, 2"x2" compressor with built-in air filter. Master built with high-strength alloys and precision bearings. Stainless steel tank, 12" x 24" 2100 cu. in. cap. Safe up to 500 lbs. Equipped with automatic switch that starts and stops motor to maintain desired pressure (up to 150 lbs.) and check valve, safety valve, gauge, shut-off valve, 20 ft. air hose and tire chuck. Beautifully balanced on ball bearing wheels and rubber tires. Note low factory prices.

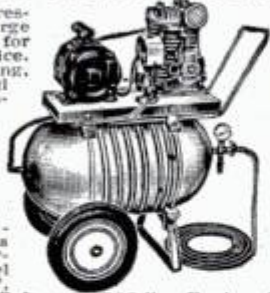

With 1 1/2 hp 110 v. A.C. motor **\$99.50**
(Reg. \$175.00) (Item 209)
With 1/2 hp motor **\$119.50**
(Reg. \$199.50) (Item 209A)
With 2 hp Briggs Gas Engine (Reg. \$199.50) (Item 209B), **\$109.50**
Compressor only (2"x1 1/4") (top quality) (Item 209C) **\$20.50**
Larger Compressor (2"x2") (none better) (Item 209D) **\$24.50**
Giant Compressor (twin 2 1/2"x2") (Item 209E) **\$54.50**
A complete line of spray guns and air tanks available at factory prices.

IMMEDIATE DELIVERY—ALL ITEMS

HEAVY DUTY D-C ARC WELDER



(Item 38) Use as portable or shop welder. Up to 300 amps. Senior model. Made for years of trouble-free, continuous service. Will handle light or heavy jobs. Easily welds up to 1/2" plate using 1/4" rods. Built-in air-cooling system. Arc is easy to strike and hold, because of specially designed arc stabilizer. Hi-lo switch and dial control gives wide range of welding heats. Run welder at 2000 rpm. with tractor, jeep or 15 hp. gas engine, or 7 hp. elec. motor. Complete with instructions, gear, and double V belt or flat pulley. You can pay more, but you can't buy a better **\$99.75**
welder. Wt. 110 lbs. \$400 value at

DUAL CONTROL MODEL same as above but with built-in dual rheostat for low heat soldering, brazing, welding, Spec. **\$119.50**

WELDING KIT. Two 10 ft. leads, welding helmet, electrode holder, ground clamp. Sold only with welder at

EXTENSION CORD (Item 16) 40 ft. heavy duty, made of specially insulated No. 14 2-conductor wire. So tough that you can drive over it and yet flexible and easy to handle. Resists oil, grease or water. extends electricity up to 400 ft. without voltage drop. Use indoors or out. Complete with heavy rubber plug and outlet. Wt. 2 1/2 lbs. Usually \$4.50—Special 40 ft. **\$1.99** Comb: 2-40 ft. and 1-20 ft. (total 100 ft.) **\$4.95** 100 foot length (one piece) **\$4.85** WIRE ONLY (Item 50) No fittings, 100 ft. **\$4.00**

HEAVY DUTY POWER CABLE #12-2 Cond.—stranded, very flexible, rubber covered, special outside conductor for grounding power tools, etc. Finest heavy duty power cable made. U.S. Surplus. **\$6.95** 50 ft. (Wt. 8 lbs.) Item 199 100 ft. (Wt. 16 lbs.) Item 200 **\$12.95**

79 Pc. CARPENTER'S TOOL SET



Professional quality. A complete set of Master Mechanic tools featuring the famous Stanley brand. All neatly arranged in a beautiful sturdy 32" hvy. steel tool box. Set includes: Powerful 1/2" Electric Drill (optional), 3 Stanley Wood Chisels, 20" Spring Steel Saw, Steel Bench Vice, Tin Shears, 9 Drill Bits, Sharpening Stone, 8" Plane, 24" Stanley Level, Hack-saw, Stanley Rule, 5 Double End Wrenches, 13 Ass't'd. Hack-saw Blades, Stanley Hand Drill, 10" Vice Wrench, Comb. Square, Stanley Hammer, Stanley Ratchet Brace, Coping Saw, 7 Coping Saw Blades, Steel Wrecking Bar, 4 Screw Drivers, Offset Screw Driver, Nail Set, 4 Ass't'd. Files, 8 Pc. Allen Wrench Set, Auger Bit Set and many other tools. Worth at least \$150.00 if purchased separately. Save cost of tools on one or two jobs. A terrific value. Wt. 41 lbs. Item 242 **\$39.50**
(without Electric Drill) **\$49.50**
Wt. 45 lbs. Item 242A
(incl. Electric Drill) **\$8.95**
Wt. 15 lbs. Item 243
(Tool Box only)

POTTER'S WHEEL



Power Driven — Foot pedal speed control
New compact modern design. Precision built to meet exacting requirements of professional artists — the finest wheel ever built. Mechanism fully enclosed for safety and to exclude moisture and clay. Foot-controlled variable speed drive provides instant, smooth speed range of 30 to 150 rpm. Equipped with adjustable arm rests. Easy to operate — even for handicapped persons. Reversible 10" throwing head — back side recessed for casting plaster bats. Larger 18x18" throwing table; wedging wire attached; removable water cup inside. Heavy bronze bearings pre-lubricated, sturdily built for long, dependable service. Use 1/2 hp motor (not incl.). Shipped fully assembled—just mount wheel and motor on table or sheet of 3/4" plywood. Self storing—tip up on edge. Wt. 45 lbs. List price \$125. Factory special. **\$64.50**

Factory Prices on Catalog Items
Send 10¢ for **BIG 1953** catalog.
Hundreds of bargains

MASTER SNOW BLOW

It's a lawn mower
It's a power sickle
It's a cultivator



Here at last is a power unit that does everything at a price that can't be matched. Built-in power takeoff to drive pumps, saws, generators, etc. Safety clutch—can't burn out. More versatile and efficient than tractors costing twice as much. Basic self propelled 2 hp tractor with Briggs engine. Only **\$119.50**

Item 206 or Clinton famous engine. Only **\$119.50**
Snow Blow **\$29.50**
Rotary Tiller **\$42.50**
Sickle Bar-Mower **\$42.50**
Bulldozer **\$11.25**
Lawn Mower Hitch **\$ 4.50**
Cultivator **\$ 8.75**
Freight prepaid to most areas. Easy payment plan available.

COMMANDO BIKE MOTOR

(Item 90) New, super-modern 1952 model. This job is the Cadillac of all bike motors. Sensational Auto-Clutch prevents killing motor at each stop. Also selects proper ratio on hills. Mounts behind and drives rear wheel with Dynarotor. Free Wheeling lever permits pedaling if desired. Rear Mounting eliminates fumes, heat, dirt, and hard steering. Easily installed in 15 minutes with home tools. Sturdy, trouble-free, easy starting, light weight, Airplane type engine; up to 15 miles per gallon. Fully guaranteed for fun or profit. Ideal for deliveries, paper routes, messenger service, etc. Ride to work and save. Dealer inquiries invited. The Commando Captain, **\$99.75**
1 cylinder 1 1/2 hp.
The Commando General, **\$125.00**
2 cylinder 3 hp. (Item 91)
All Commandos shipped prepaid in U.S.

32 pc. SOCKET SET

32-pc. Socket Set (Item 59) Highest quality guar. non-breakable sockets made by Husky. Beautifully matched chrome alloy, absolutely the best. Complete range of 21 sockets from 1/4" thru 7/16" in 1/4" drive and 7/16" thru 1-1/16" in 1/2" drive; 2 extensions, reversible 1/2" ratchet, adaptor bit, slide head, all angle coupling, 2 end wrenches, 1/4" speeder handle and sturdy metal tool box. For prof. mechanics who want the best. Wt. 14 lbs. Easily worth \$41.50. While they last. **\$16.95**



45 pc. SOCKET SET

(Item 205) Contains a complete set of sockets in 1/2" drive, 3/4" drive and 1/4" drive, plus all necessary extensions, handles, speeders, reversible ratchets, etc.; all uncond. Guaranteed against breakage. Beautifully matched chromed thin wall alloy sockets in a sturdy handsome steel tool box. Wt. 17 lbs. List Price \$62.90. Factory Special. **\$26.95**

3/8" DRIVE 15 Pc. SOCKET SET

(Item 201) Same top qual. as above—includes 7 sockets 3/8" thru 3/4", reversible ratchet, extension, flex. handle, cross bar, 3 punches, metal tool box. Wt. 5 lbs. List Price \$18.96. Our Spec. **\$9.95**

HYDRAULIC JACKS

(Item 208) Heavy duty, precision built, smooth, positive acting with built-in relief valve. Hi-Lift with screw extensions. Govt. surplus at a fraction of orig. cost. (Handle included.)
1 1/2 ton (Item 208) **\$6.45**
Wt. 11 lbs.
3 ton (Item 208A) **\$9.45**
Wt. 15 lbs.
5 ton (Item 208B) **\$11.45**
Wt. 17 lbs.

HEATING & VENTILATING FAN

(Item 10) Easily installed in furnace pipes. Forces even heat to all rooms. Over range, removes kitchen smoke and odors. Powerful continuous duty motor, 110-120 v. A.C. Quiet, super efficient fan moves huge volume of air (400 to 600 c.f.m.) 8" Fan, wt. 5 lb. **\$6.35**; 9" Fan, wt. 6 lbs. **\$7.45**; 10" Fan, wt. 7 lb. **\$8.45**; 12" Fan, wt. 8 lbs. **\$9.45**.
Heavy-duty 12" fan, enclosed motor, suitable for spray booths, restaurant exhausts, poultry houses, and other difficult applications. Wt. 12 lbs. Item 10D **\$12.95**



All items brand new. Prices f.o.b. Chicago area. 10 day Money back guarantee. Send check or M. O.
MASTER MECHANIC MFG. CO., DEPT. 92A, Burlington, Wis.

this **ONE** GOVERNOR

fits ALL popular
farm & industrial
gasoline engines



PIERCE LONG RANGE Universal Governor

● Instant variable speed selection and accurate engine control at any speed setting within 1200 to 2600 RPM. Higher and lower ranges obtainable by simple change of pulley. Also "constant speed" operation.

● Accurate, dependable speed control for engines operating corn shellers, drag lines, hoists, arc welders, trucks and tractors with power take-offs, etc.

Write for Complete Information

DEALERSHIPS
AVAILABLE

"World's Most
Experienced Governor
Manufacturer"

**THE PIERCE
GOVERNOR CO., Inc.**
1700 Ohio Avenue, Box 1000
Anderson, Indiana, U. S. A.

ONLY
\$39.50

Pulley extra:
4"—\$1.70
5"—\$1.75

Send Check or
Money Order.
State Make,
Model of engine.

It's NEW, BIGGER, Better The DELTAGRAM...

• 6 GREAT ISSUES Only \$1.00 •

SEND FOR FREE "Get Acquainted" Copy

For only a dollar you get a whole year of Deltagrams—over 100 shop-tested plans, scores of fine projects and many valuable tips on home repairs and care of fine tools. Delta spent months and thousands of dollars to find out what you homecraftsmen want in a magazine—and the new Deltagram is the answer to your demand: 6 wonderful issues each year—truly a treasure house of fun and profit. Send \$1.00 today for your 1 year subscription! Or, if you prefer, first write for a free "sample" copy. Delta Power Tool Division, Rockwell Manufacturing Co., 502K N. Lexington Ave., Pittsburgh 8, Pa.

REPAIR *Your Own* BOWLING BALL



Cuts, chips, deep scratches easily repaired by you with this factory-process kit. Repair is permanent, lasting. Takes only a few minutes. SEND \$1 FOR COMPLETE KIT. We pay postage.

221 Fourth N. E.,
HUB-VICTOR CANTON 2, Ohio



G E A R S

In Stock - Immediate Delivery

Gears, speed reducers, sprockets, thrust bearings, flexible couplings, pulleys, etc. A complete line is carried in our Chicago stock. Can also quote on special gears of any kind. Send us your blueprints and inquiries.

Send for Complete Catalog No. 10

CHICAGO GEAR WORKS
440-50 N. Oakley Blvd., CHICAGO 12, ILL.

POSTPAID
ANYWHERE
IN U.S.A.

WE FURNISH ALL MACHINED METAL PARTS, EVERY SCREW,
NUT, BOLT, WASHER, AND COMPLETE PLANS FOR THIS...

BIG 10" POWER SAW



\$10.95 FULL REFUND IF
LESS GUARD NOT SATISFIED
& WOOD IN 10 DAYS

ASSEMBLE
IT YOURSELF
WITH SIMPLE HOUSEHOLD TOOLS!

COMPLETE PLANS 10c
MARCUS-POLLAKE
DEPT. N, ROYERSFORD, PA.

Catalog of 3000 Novelties 10c

Send 10c for amazing catalog of novelties, live animals, scientific supplies, hobbies, funmakers, planes & boats, looms, magic tricks, joke articles, unusual seeds, gadget timesavers, cameras, optical goods, projectors, movies, lucky jewelry, religious novelties, disguises, musical instruments, stamps, coins, puzzles, fortune tellers, radios, auto & bike accessories, telescopes, magnifiers, compasses, banks, smokers' gadgets, artists' supplies, printing sets, engines, motors, shockers, knives, billfolds, fireworks, guns, rifles, sports, books, games, plants, etc. Send name, address & 10c to
JOHNSON SMITH & CO., Dept. 547, Detroit 7, Michigan



CUT BUILDING COSTS 2/3! Make Your Own Concrete BLOCKS and BRICKS To Use or Sell

New superior moulds make absolutely square, true, easy-to-lay blocks which will pass any building code. Production is fast... easy. One durable \$30 machine will make four 5"x8"x12" blocks per minute—1,000 a day. Pays for itself in one day! Sell blocks for big profit... or save 2/3 building cost for yourself. POST CARD BRINGS FREE FOLDER.

ECONOMY MFG. CO.
DEPT. P STONE MOUNTAIN, GA.

MAKE
OLD FURNITURE
NEW AGAIN

ARCHER
Pol-mer-ik

100% PURE LINSEED OIL



FREE BOOK

Refinish,
beautify,
polish
all woods.
"101 Handy
Hints." Send
for today.

ARCHER • DANIELS • MIDLAND CO.
603 Roanoke Building, Minneapolis 2, Minn.

Why Pay List Prices? BUY WELLWORTH PRODUCTS . . . SAVINGS UP TO 50%

Wellworth AIR COMPRESSOR For Farm and Home Workshop



Compressor has 2" bore, 1 3/4" stroke, 2.8 cfm up to 150 lb. pressure. Motor required: 1/4 h.p. at 100 lbs.; 1/2 h.p. at 125 lbs.; 3/4 h.p. at 150 lbs. or equivalent gas engine. V-belt cast iron pulley, intake muffler and cleaner, bronze bearings, splash lubrication. Wt. 16 lbs. Price of compressor as described **\$20.50**



COMPLETE OUTFIT. Compressor, pressure tank 6x24", air gauge, air chuck, 20 ft. hose, pop valve, copper tubing with 4 brass flared fittings for connecting compressor to tank, 4-way cross and 3 nipples. **\$32.45**
COMPLETE OUTFIT, wt. 30 lbs. Same outfit with 12x24" tank **\$39.95**
Equipment less Compressor Tank only with 6x24" tank **\$12.45** 6x24" **\$ 6.25** with 12x24" tank **\$19.95** 12x24" **\$14.50**

MODEL 200 COMPRESSOR

2 1/2" x 2", 2.55 to 4.80 c.f.m. up to 150 lb. pressure. Operates with 1/2-1 1/2 HP motor. **\$27.95**
Special Price
Shipping wt. 24 lbs.

MODEL W7 COMPRESSOR

2 cylinder 2 1/2"x2". 5.10 to 8.50 c.f.m. up to 150 lb. pressure. Operates with 1/2-3/4-1-1 1/2 HP motor. **\$54.50**
Special Price
Shipping wt. 45 lbs.

Wellworth V-BELT CLUTCH

Takes starting load off engine or motor. "A" belt, 2.35 pitch diameter, 3/8" bore, ball bearing. Positive action. Price **\$7.50**. 3/4" bore, **\$8.50**. Bushing for 1/2" shaft, 15c.



MERCURY CLUTCH

3" A-belt pulley. Centrifugal action for heavy loads. 5/8" bore. **\$22.50** list. Special Price **\$9.95**



"Wellworth" BLOWER BARGAIN

Quiet operating. Double wheel inlet, double width blower. For heating, ventilating, cooling air washing, exhausting and forced draft. DIMENSIONS: 12" wheel; outlet, 13 1/4" x 11 3/4"; inlet 8 3/4". Height 19". Width 18". Depth 16 1/2". C.F.M. 1/4" S.P. 1600; outlet vel. **\$27.50**
1575. Wt. 45 lbs. **BLOWER LESS MOTOR AND DRIVE**
With belt and variable speed pulleys, \$2.50 extra.

CONTINENTAL GAS ENGINE

Red Seal, 1 1/2 HP with 6 to 1 reduction gear. Operates at 450 R.P.M. For lawn mowers, scooters, garden tractors, pumps, compressors, generators, etc. List Price \$79.50. Shipping wt. 54 lbs. **\$47.50**
SPECIAL PRICE



WISCONSIN GAS ENGINE

Big Saving. 1952 model. A.K.N. 3 to 6 H.P. Wt. 75 lbs. **\$89.50**



AUTOMATIC COMPRESSOR UNIT WITH 22 GALLON TANK

1/2 H.P. heavy duty capacitor motor. AC 110/220 volt, 60 cycle, 2x1 3/4 inch piston type compressor, splash feed lubrication. 14"x32" tank, automatic pressure switch, CFM 2.8 at 100 lb. pressure, or 150 lbs. pressure for intermittent duty. Check valve, safety valve, air regulator with gauge and filter, 20 ft. air hose with air chuck for inflating tires. V. belt drive. Mounted on 2 wheels, ball bearing, with 2"x8" semi-pneumatic tires. Portable with handle. Shipping wt. 150 lbs.



With 1/2 h.p. motor **\$160 Value**
\$98.50 Less Motor **\$79.50** With 1 1/2 h.p. gas engine **\$124.50**

1/2 H. P. HEAVY DUTY MOTOR



PORTABLE SPRAY OUTFIT

EXTERNAL ATOMIZING GUN Paint Sprayer mounted on 7 1/2"x25 inch tank, 1/2 H.P. 110 V. 60 cy. Heavy duty motor with overload relay, 10 ft. cord and plug, V belt drive, Piston type Compressor with 2 Compression rings, 1 oil ring, 2 inch bore, 1 3/4 inch stroke, displacement 2.86 C.F.M. at 60 lbs. pressure. Safety valve, Gun external atomizing. Flat and round spray, quart cup; maintains 35 to 40 lbs. working pressure. Oil and water extractor, 1 air gauge, 20 ft. heavy duty two-braid air hose with leakproof fittings. Complete with carrying handle. Wt. 75 lbs.
OUTFIT LESS MOTOR \$52.00 **COMPLETE OUTFIT \$67.50**
Spray Gun and 20 ft. hose **\$12.95**

2000-2500 WATT LIGHT PLANT Heavy Duty Windings

110 v., 60 cy., A.C., takes starting overload up to 5000 watts. Floating Base for Automatic Belt Adjusting, 2-Groove Engine Pulleys, V-Belts, Bolts, etc. 5 H.P. Wisconsin or Briggs & Stratton Model 14 Engine. Voltmeter, 2 plug-in receptacles. Portable Tubular Steel Skid Type Carrier. Dim.: L 34 3/8" x W 17" x H 20". Wt. 180 lbs. **\$299.50**
Generator only, with voltmeter, 2 plug-in receptacles. Ship. Wt. 75 lbs. **\$169.50**
500 WATT GENERATOR, wt. 55 lbs. **\$99.50**
5000 to 6000 W. GENERATOR, 110/220V. Wt. 225 lbs. **\$325**

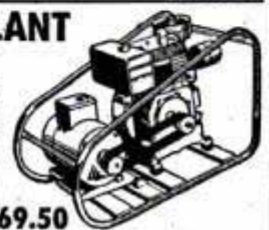

LELAND GENERATORS

2500 to 3000 watts, 110 v. 60 cy. single phase 1800 r.p.m., self excited. Fungus treated for long life. 1951 model. Brand new, in original factory crate. Ship. wt. 135 lbs. **\$195**
List \$325. SPECIAL PRICE



PRICES F.O.B. CHICAGO. MONEY BACK GUARANTEE. SEND CHECK OR MONEY ORDER TODAY. PROMPT SHIPMENT. WRITE FOR FREE CATALOG.

WELLWORTH TRADING CO.

1832 S. WABASH AVE., Dept. D-952, CHICAGO 16, ILL.

V-PLEX AUTOMATIC CLUTCHES

Get smooth pickup for your power mower, motor scooter or garden tractor . . . with only throttle control. Prevent stalling engine, cut belt wear, permit no-load idling. Easily installed on 1/2, 3/8, 3/4" gas engine shafts. Factory-tested. See dealer or write for folder. PM9.



V-PLEX CLUTCH DIVISION — Hagerstown, Indiana

SPECIAL FOR HOBBYISTS, JEWELERS & WATCHMAKERS, TOOL & DIE MAKERS

SWISS NEEDLE FILES

Genuine Swiss files in all shapes for fine precision work. Full dozen 5 1/2 inch needle files to a set.

ORDER BY MAIL TODAY!

STURDY TOOL & HARDWARE CO.
Sole Distributors for U.S.A.
156 Chambers St., New York 7



ONLY **\$3.60** POSTPAID set of 12

INTERNATIONAL ROTARY HI-SPEED COPE-SAW DRILL-BIT IT DRILLS IT SAWS IT REAMS



DRILL, SAW, REAM . . . metal, pipe, wood, plastic, Transite, etc. Use with any electric drill, slow drill press, lathe or milling machine. Drills own starting hole—upper part of bit is used to cut, saw or ream circles, ovals, squares or scrolls. Easy to operate. Ideal for carpenters, mechanics, electricians, plumbers, hobbyists, many others. Abrasive resistant, high speed steel. Flutes ground from solid. Will withstand severe continuous use without breaking. Resharpener at no charge. Takes place of up to \$50 in tools. 3/4" diameter, 2" cutting sections, total length 3 1/2". Also available specially designed for wood or metal and in 2 1/2" and 1 1/2" lengths. Write for details. Specify all-purpose bit. Shipped same day. Money-back guarantee. Dealer inquiries invited.

SEND CASH, CHECK OR MONEY ORDER
Manufactured and distributed by:
INTERNATIONAL TWIST DRILL CORP.

618 Wyandotte, Rm. 635, Kansas City 6, Mo.

only **\$3.95** POST PAID

Schupack's AMAZING TOOL BARGAINS! ALL BRAND NEW MERCHANDISE

112 PIECE ASSORTMENT \$3.95



FOR ELECTRIC GRINDER
 \$10.00 VALUE — ONLY
 Here's what you get! Mounted Stones on 1/8" shank, Drum Sander, Sanding Sleeves for sander, Rotary Cutters, Wire Scratch Brush, Bristle Brushes, Circular Saw, Buffing Wheel, Grinding Wheel, Rubber Polishing Wheel, Cut-off Wheels, Rubber Cylinder, Mandrels to fit above tool, asst'd. Sanding Discs, Sharpening Stone, etc.

FLEXIBLE SHAFT — ONLY \$4.95



Post-paid
 Fits all electric drills & hand power tools. 35 3/4" long. Oilite bearings. Core of specially wound, high carbon steel wire in flexible steel casing. Will accommodate tool shafts up to 1/8" dia. For lathes, electric drills, etc.



SURPRISE VALUE 100 Pieces FOR ELECTRIC GRINDERS \$1.00

Post-paid
 Grinding Wheels, Cut-off Wheels, Sanding Discs, Mounted Stones, Sharpening and Honing Stones, Rotary Cutting Burs, Abrasive Cartidges, Mandrels, and many other items.



2 DRUM SANDERS \$1.50

Post-paid
 With 12 Bands in Assorted Grits, 1 1/2" dia. x 1" long on 1/8" arbor with 12 bands



18 ROTARY CUTTERS \$5.85

Post-paid
 Assorted sizes cutter on 1/8" or 3/32" shank. Will fit all hand grinders. Ideal for cutting wood, metal, or plastic. Brand new.

12 MOUNTED WHEELS and points on 1/8" Shank \$2.95



Post-paid
 For grinding on plastic, wood, soft and hard metals. Regular \$8.40 List Val. 12 wheels on 1/8" Shank \$3.60

18 MOUNTED POINTS ON 3/32" SHANK \$2.50



12 MINIATURE CUTTERS \$1.00

Post-paid
 FOR CUTTING WOOD, PLASTIC, or METAL. Actual size, Ass't. shapes on 3/32" shank. For die makers, home workshop, etc.

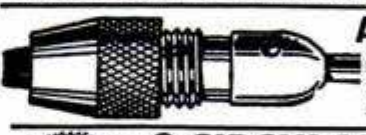

ADAPTER CHUCK \$1.50

Post-paid
 With 2 interchangeable collets opening from 3/32" to 0, on 1/4" mandrel. Price each only.



2 CIRCULAR SAWS ON 2 MANDRELS — \$1.50

Post-paid
 ALL AT ONE LOW PRICE
 1" diameter saws on 1/8" Mandrels. For cutting wood, plastic, or soft metals. Order at once!

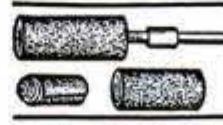

20 ABRASIVE ROLLS, cloth, and 1/8" mandrel for grinding, sanding, deburring metal, plastic, wood or rubber, ONLY..... \$1.00

Post-paid



7 HIGH SPEED TWIST DRILLS \$1.00

Post-paid
 15 DRILLS FOR ONLY \$2.00! Order Today!
 7 Popular Sizes — up to 1/4". Brand new, ideal for home or shop use. Fits all standard chucks.

NEW ILLUSTRATED CATALOG 10c.

SCHUPACK SUPPLY CO., 7331 COTTAGE GROVE AVE., DEPT. M-34 CHICAGO 19, ILL. SEND CHECKS OR M. O. NO COD'S PLEASE

AIR LIFT PROTECT YOUR CAR WITH The Sensational Pneumatic Spring Booster

- For Overloads
- For Improved Roadability
- For Trailer Hauling
- For Sagging Springs

ECONOMICAL AND EASILY INSTALLED
 Inflates with Air — Same as a Tire
 Thousands in Use — Guaranteed

GIVE YOUR CAR A LIFT — WITH AIR LIFT

See Your Dealer or Write
AIR LIFT CO.
 2330 W. MAIN STREET
 LANSING, MICHIGAN



WELD BRAZE, SOLDER, and CUT \$14.75 F.O.B. complete!



No experience needed. Follow simple instructions, weld on iron, steel, bronze, brass, aluminum, and other metals. Plugs into any properly wired 110 volt A.C. or D.C. line. Make or save time and money doing repair work for yourself and others. Repair men, farmers, tinsmiths, home and auto owners, hobbyists, etc., say FOUR-WAY pays for itself over and over. Order today or send for Free details.

Larger Equipment Available on Request
FOUR-WAY WELDER COMPANY, Dept. F2-JC
 2326 S. Michigan Ave. • Chicago 16, Illinois

ORDER NOW 10 DAY TRIAL

SAY YOU SAW IT IN POPULAR MECHANICS

SAVE MONEY TEST YOUR OWN RADIO AND TELEVISION TUBES AT HOME!!!



CONDUCTANCE TUBE TESTER

No tube manual or knowledge of tubes necessary — tests all tubes — 100% accurate for direct shorts, opens, burned out tubes. Buy it—Try it—if not satisfied, return in 5 days — Money cheerfully refunded.

ONLY \$4.98
 SEND NO MONEY — ORDER C. O. D. plus postage, or send check, cash or money order & we pay postage.
E-Z TESTER Co. DEPT. P.M:9 MACON, GA.

Patent Pending
 ALSO AVAILABLE!
CONDENSER TESTER
 CHECKS SHORTED, OPEN AND LEAKY CONDENSERS **6.98**

SUNGLASS SPECIAL

Genuine ARMY AIR FORCES



SUNGLASSES
HERE'S THE
REAL MCCOY!

ARMY AIR FORCE 6 base, Precision Polished & Ground, Glare-free color lens with leather case to be attached to belt. Gold plated adjustable frame. Pearlized sweat bar and pads. **NOW ONLY 395**

AIRFORCE TYPE SUNGLASS

Ground & polished processed glass lenses. Gold plated frame with Pearlized sweat bar and nose pads. Cable ear pieces, simulated leather case. **ONLY 195**



AVIATORS (AN-630) WINDPROOF & DUSTPROOF **GOOGLES**

Chamois lined, rubber covered frames. Replaceable GROUND LENSES in either clear, green or amber. Has non-fogging breathers in frame. Adj. nose bar. Specify lens color. **USED 195 NEW 275**



9 PIECE DRAWING SET

Suitable for the architect, student, draftsman, artist etc. Contains 9 separate pieces including: one 5 1/2" compass with pen & pencil parts; one 3 1/4" divider; one each - 3/4" bow divider, bow pencil & bow pen with wheel adjustment & reversible needle point; one 4 1/4" ruling pen with extra handle; capsule of extra leads. All in a 2 flap, velvet lined pocket book case. **598**

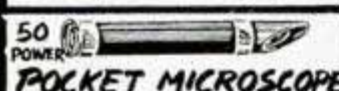

50 POWER **POCKET MICROSCOPE**
A real Palley Bargain. Extremely sharp 50 power magnification. Ideal for students, geologists, mineralogist etc. **349**



20 POWER TELESCOPE
Top quality import. Coated Lenses. Bright, clear image & wide field of view. **895**

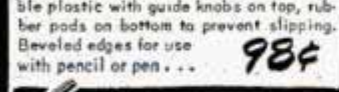

AIR CORPS **PARALLEL RULER**
A valuable asset to the navigator, engineer, draftsman or mechanic. Heavy, durable plastic with guide knobs on top, rubber pads on bottom to prevent slipping. Beveled edges for use with pencil or pen. . . . **98¢**

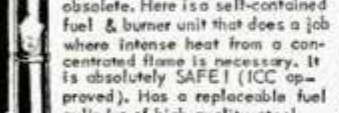

AMAZING BERNZ-O-MATIC TORCH
It makes the old "blow-torch" obsolete. Here is a self-contained fuel & burner unit that does a job where intense heat from a concentrated flame is necessary. It is absolutely SAFE! (ICC approved). Has a replaceable fuel cylinder of high quality steel **PENCIL FLAME Type** - with 10 hour cylinder and (1) burner unit **ONLY 695**
EXTRA FUEL CYLINDERS. . . . 195



230 PAGE CATALOG
1000's of ITEMS! Fully ILLUSTRATED! For the MECHANIC, SPORTSMAN, HOBBYIST, HOME OWNER, etc.
War Surplus - Factory Closeouts and General Merchandise Values!
Save on Hardware, Hand & Power Tools, Gadgets, Sports Equipment, Hydraulics, etc. SEND 50¢ for HANDLING & MAILING.

SAVE UP TO 85% IN WAR SURPLUS



AIR CORPS RUBBER BOATS
Genuine USAAF equipment and made to Gov't specifications. An ideal boat for ocean, lake or pool. Safe, lightweight and easy to pack. Thoroughly reconditioned and ready for use.
1 MAN **1895** 5 MAN **3995** 7 MAN **5995**

COLLAPSIBLE OARS **295 PR.** AIR PUMP **395** PADDLES **59¢ PR.**

100% KAPOK FILLED SLEEPING BAG

HERE'S WESTERN CRAFTSMANSHIP AT ITS BEST! Bag has olive green, water repellent cover - Rannelette lining. Filled with 3 lbs. of GENUINE KAPOK. Has zipper down one side and across bottom. Can "double-up" with another bag. Has two air mattress pockets. Large head flap can be used as head canopy. Size 36" x 80". **1850**



FAMOUS RICHOFLEX CAMERA

10 DAY FREE TRIAL - MONEY BACK GUARANTEE
RECOMMENDED AS A TREMENDOUS "BUY" by a leading independent research firm. Produces results comparable to most expensive reflex cameras. Foolproof to operate. Has all-metal body - leather covered. 80mm precision matched f:3.5 color corrected, coated lenses. Built-in wide field magnifier. ASA synchronized shutter. Speeds: 1/25, 1/50, 1/100 and B. Reflex focusing. Built-in flash synchronization for all standard equipment. Takes 12 exposures, 2 1/4" x 2 1/4", on 120 film. Price includes genuine leather case with "snap-off" front. **ONLY 3850**

NYLON FISHLINE

STRONG - LIGHTWEIGHT - NYLON FISHING LINE. ROT-PROOF and WATERPROOF . . .
1500 ft. 10 lb. Test **\$1.59**
1500 ft. 25 lb. Test **2.25**
750 ft. 45 lb. Test **3.29**
300 ft. 72 lb. Braided **\$3.79**

JEEP CANS

FOR RESERVE GAS SUPPLY - Holds 5 GAL. Has screw top and will take standard flexible nozzle. . . **139 EA.**
FLEXIBLE NOZZLE **49¢**

NAVY Sealed Beam LAMP

U.S. NAVY Portable Search-spot light. Has pistol grip & aiming sight. Makes an ideal search, spot or emergency for auto, boat, camp, etc.
12V. light - 4" lens . . . **429**
24V. light - 4" lens . . . **479**
Set of 3 filters: red, green, amber. (specify type lamp) **99¢**

NEW! EMERGENCY LAMP

Be ready for that "emergency" or power failure. Self contained, battery operated. Has 2 bulbs in reflector - glass lens. Off-on switch - metal body. Completely lights average room. Ideal for camping trips, cabin, tents, garages, etc. Price complete (without batteries). **325**

PRESSURE TANKS

G-1 - Stainless steel, shatterproof & rustless. Has reinforcing ribs & is pressure tested to 400 PSI, with high safety factor. Has 1/4" pipe ports in both ends. Ideal for use as a buoy, drinking water supply, underwater fishing, diving, painting, cooking, or spraying. **1025**
G-1 - 12 1/2" x 24" ONLY **1025**
D-2 Tank - 500 cu. in. cap. . . . **395**
A-4 Tank - 104 cu. in. cap. . . . **195**

SWIM FLIPPERS

Top quality rubber. Has pebble tread bottom. Adjustable heel strap. **795 PR.**
Sizes: Small, Med Large.

DIVING MASK

Soft rubber mask fits over eyes. Heavy duty glass shield. Adj. headband. **259** **269** **395**

FLOATING KNIVES

Handy for use above or under water. Will float. Cannot be lost. Fine quality steel blade. **495**
Flat Blade **495** (B) Dagger **495**
SMOKE Breathing TUBES - Plastic, with rubber mouthpiece. Allows breathing under water. Straight type . . . **195**
CURVED TYPE - Has automatic seal when immersed. **\$2.95**

NAVY WADING SUIT

We've sold hundreds for stream & surf fishing. Also to ranchers, oil fields or where necessary to protect body or clothes from moisture silt, muck etc. Made of rubberized canvas. Has vulcanized seams, built-in rubber gloves and boots. Sizes: Small, Med., Large. **795 NEW**
CONVERTED Fisherman's Model - Made to waist length with bib and suspenders for greater arm freedom. **995**

LEATHER BELT KITS

Made of bark tanned, top grain cowhide. Worn on your belt. Convenient & handy for carrying your small tools. Sturdy & durable. Re-inforced with rivets.
"A" - ELECTRICIANS KIT - 7 POC-KETS. For tools, tape, pencil etc. **349**
"B" - RADIO & TV REPAIRMANS KIT - Has 1 large & 2 small pockets. For use by all mechanics, technicians, etc. **279**

RADIO BARGAINS

RADIO MIX
A veritable "TREASURE CHEST" for "ham" operators and experimenters. Contains: Headset, Mike Button, Trans. Wire, Insulators, Switches, Condensers, Rheostats, Terminals, Jump Cable, etc. Approx. 8 packed lbs. **for ONLY - 249**

RADIO HEADSET

HS-30U - Two magnetic type receivers in watertight brass case. Soft rubber inserts in each receiver to fit into wearers' ear. Pliable steel head band. Ideal for communications, divers, workers in noisy compartments, etc. . . . **NEW. 395**

USAF THROAT MICROPHONE

Genuine USAF type T-30-0 Gives distinct voice reproduction for aircraft or amateur radio broadcasting. Consists of two microphones, mounted on rubber neckpiece elastic neck band. Operates between 100 & 300 ohms. . . **139**

MICROPHONE

Telephone type, highly sensitive with excellent, clear tone. This was the Signal Corps favorite. An ideal instrument for the radio "ham" and professional recording studio, broadcasting, home recording, public address, etc. . . . Complete with cord & plug. **329 NEW**

SIGNAL CORPS TEL. KEY

The new model J5A with ball type, flame-proof, metal key. Perfectly balanced to permit positive contact with minimum effort. An ideal instrument for "ham" or professional use. A BUY at . . . **NEW 189**

NAVY SOUND-POWER PHONE SET

Used by the Navy for flight deck and gunnery control. An ideal emergency communication system because they require no power supply. Perfect for office-to-shop house-to-garage or barn, or any point-to-point within 1/2 mile radius. These sets are fully sound powered. A set includes 2 phones on chest plate, two headsets, button switches, 35' of cable. . . **995**

RADIO ANTENNA REEL

For tuning beam antenna. Powered by 1/8 HP, 24V, GE motor, engaged to gear reduction only when electrical contact is made. Operated in either direction. Ideal for auxiliary power take-off. 150 RPM at take-off. Used for opening & closing doors etc. **675**
A tremendous value. **NEW 875**

ALNICO SPEAKER

Permanent magnet type. 4" diameter. 2 wire hook-up. Ideal for small radios, inter-com systems, test equipment etc. **NEW 249**

EYE LOUPES

An indispensable aid in fine inspection work. Available in 2 1/2, 2 3/4, 3, 4 & 5 power. each **99¢**

Palley SUPPLY CO. 2263 EAST VERNON AVENUE DEPT. PM-9 LOS ANGELES 58, CALIF. Order From This Ad. Pay by M.O. or check. P.O.'s accepted from D&B firms. 1/2 deposit with C.O.D.'s. All Prices FOB Los Angeles.

HELPFUL BOOKS

EVERY MACHINIST SHOULD HAVE



Check *free* catalogs wanted:

- | | |
|--|--|
| <input type="checkbox"/> 14" South Bend Drill Presses | <input type="checkbox"/> 14½" South Bend Lathes |
| <input type="checkbox"/> 9" South Bend Lathes | <input type="checkbox"/> 16" South Bend Lathes |
| <input type="checkbox"/> 10" South Bend Light Ten Lathes | <input type="checkbox"/> Series 900 & 1000 South Bend Turret Lathes |
| <input type="checkbox"/> 10"—1" Collet—South Bend Lathes | <input type="checkbox"/> No. 2H South Bend Turret Lathes |
| <input type="checkbox"/> 13" South Bend Lathes | <input type="checkbox"/> 7" South Bend Shaper |
| <input type="checkbox"/> Attachments and Accessories for South Bend and other lathes | <input type="checkbox"/> Information on Rental-Free Motion Picture Films |

Check handbooks wanted — indicate cash enclosed _____



- | |
|---|
| <input type="checkbox"/> How to Run A Drill Press—25c |
| <input type="checkbox"/> How To Run A Lathe—25c |
| <input type="checkbox"/> How To Run A Shaper—25c |
| <input type="checkbox"/> South Bend Machine Shop Course—50c |

Please print name and address.

Name _____ Street _____

City _____ Zone _____ State _____

SOUTH BEND LATHE

SOUTH BEND 22, INDIANA • BUILDING BETTER TOOLS SINCE 1906



Kyle Rote SAYS...

"Buy

**Prest-o-lite
hi-level
Battery...**

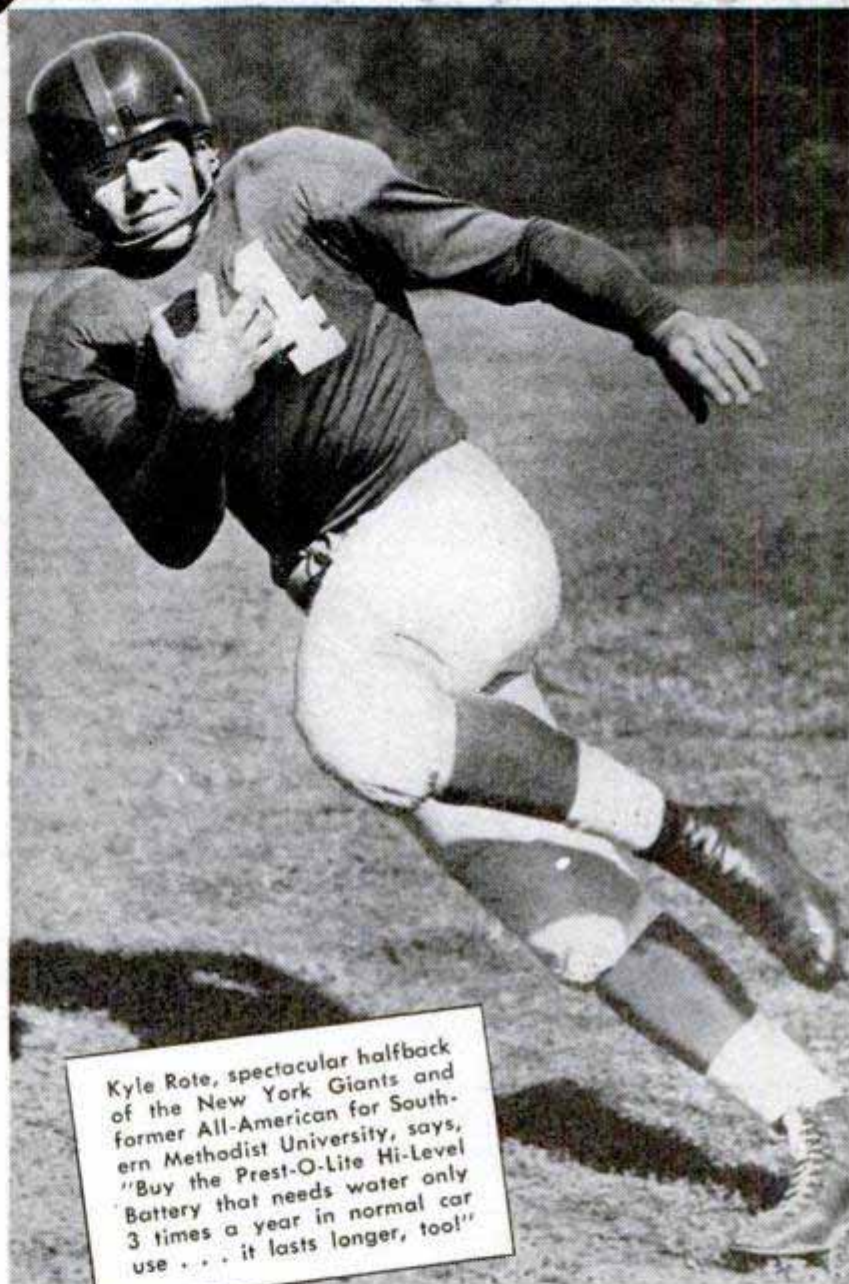

Kyle Rote, spectacular halfback of the New York Giants and former All-American for Southern Methodist University, says, "Buy the Prest-O-Lite Hi-Level Battery that needs water only 3 times a year in normal car use . . . it lasts longer, too!"

needs water only 3 times a year

IN NORMAL CAR USE

...lasts longer, too!"



*See your
Prest-O-lite Dealer
for
Free Pro-Football
Schedules*

PREST-O-LITE BATTERY COMPANY, INC.

TOLEDO 1, OHIO

Why did you change to Camels, RICHARD CARLSON?

"I tried *Camels* as my steady smoke to see how they suited my throat. They get on fine with my *throat*, pack after pack, and you can't match them for *taste!*"

RICHARD CARLSON

Smoke only Camels for 30 days... see for yourself how well

Camels agree with your throat!



● See for yourself why Camel is America's most popular cigarette — leading all other brands by billions. Smoke only Camels for thirty days and see how Camel's rich flavor pleases *your* taste... see how Camel's cool mildness agrees with *your* throat, pack after pack! Prove to yourself in your own "T-Zone" how mild and flavorful Camels are!

TEST
CAMELS IN
YOUR "T-ZONE"
(T FOR THROAT,
T FOR TASTE)



R. J. Reynolds Tobacco Co., Winston-Salem, N. C.

CAMEL leads all other brands by billions!