

POPULAR
MECHANICS

MAGAZINE

WRITTEN BY MEN WHO KNOW HOW TO USE AND IT

REG'D TRADE MARK GREAT BRITAIN NO. 40626

REG. U.S. PAT. OFF.



Three-Eyed Camera
Page 120

Fifty Years of Exploration
By **LOWELL THOMAS**

The Owners Report on the
DE SOTO

For the Home Owner



Illustrated above: Commander V-8 Starliner.

White sidewall tires and chrome wheel discs optional at extra cost.

An exciting eye-ful and amazingly thrifty!

THIS trim, sleek, jet-streamed new Studebaker has the look of a lot of money—and the lure of a lot of money saving.

You never drove a more impressive gas economizer. Every inch of this Starliner's clean-lined structure is free from power-wasting surplus weight.

How thrifty the 1952 Studebakers are was proved in this year's Mobilgas Economy Run.

The Champion and Commander V-8 with overdrive, optional at extra cost, beat all cars entered in the standard classes in actual gas mileage.



New "swept-back" styling enlivens all 1952 Studebakers. Overdrive or Automatic Drive optional at extra cost.

See Studebaker for '52

Studebaker, South Bend 27, Indiana, U. S. A.

Now everyone can find

Ring-Free Oil

Call Western Union, ask for Operator 25—and you'll soon get nearest Macmillan Oil dealer's location—without charge!

It's the strangest thing.

There are thousands of big, red "M" signs displayed from Coast to Coast—at independent service stations, garages and car dealers selling Macmillan Oil.

Yet we get hundreds and hundreds of letters from motorists asking where they can buy Macmillan Oil—motorists too preoccupied by traffic to notice the Macmillan signs they pass every day.

So we have decided to make it still easier for you to know where you can buy Macmillan Oil.

At no cost to you, we have arranged with Western Union to help you find the location of your nearest Macmillan dealer.

All you have to do is pick up your phone, call Western Union by number, ask for Operator 25, give her your name, address and phone number.

Your inquiry will come direct to my desk and within an hour the information you want will be on its way to you. No letter to write. No charge to you for this service.

You want Macmillan Oil because it pays for itself in the gas it saves. We want you to have it.

Let's get together. Why not call Western Union *right now?*



President

MACMILLAN PETROLEUM CORPORATION

530 W. 6TH STREET, LOS ANGELES

50 W. 50TH, NEW YORK

• 624 S. MICHIGAN, CHICAGO

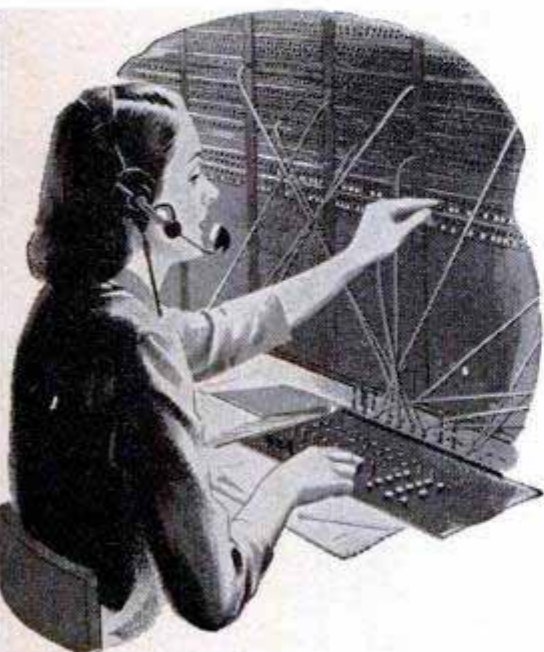

FROM THE OFFICE OF
R. S. MACMILLAN, PRESIDENT

Our Money-Back Guarantee is as strong as we can express it. Here it is:

Macmillan Ring-Free Motor Oil is guaranteed to increase the horsepower of your motor, give more miles per gallon of gasoline, make your motor run smoother, reduce wear and repair; because it removes carbon, cleans the motor, and reduces friction fast by thorough lubrication.

Try a fill and if you are not satisfied that Ring-Free is doing these things, your money will be refunded by your dealer immediately.

How can we make that Guarantee? Because the results of Dynamometer (the testing machine accepted by the automobile industry) tests on hundreds and hundreds of cars like yours showed that motorists get an average of 8% more power from the same amount of gasoline after changing from whatever brand of oil they have been using to Macmillan Ring-Free Motor Oil.

At 25¢ a gallon, 8% means 2¢ saved. Over a normal drain period, that means \$2.00 saved—enough to buy a refill of Macmillan. What could be fairer?



Don't Guess About Your Future!

U.S. AIR FORCE



The Air Force needs trained Air Traffic Control Operators

Your United States Air Force is expanding rapidly. It needs *YOU* and your special technical knowledge. Your skill and "know how" can serve your country and yourself to best advantage in today's vital job of national defense.



The Air Force needs trained multi-engine Flight Engineers

Eliminate the guesswork from your future and advance in your technical field to more profitable and satisfying rewards with your U. S. Air Force.



The Air Force needs trained Ground Control Approach Operators



The Air Force needs trained Aircraft and Flight Mechanics

Here Are a Few of the Many Great Air Force Opportunities!

- RADIO AND RADAR MAINTENANCE
- AIRCRAFT ACCESSORIES MAINTENANCE
- WEATHER • ARMAMENT SYSTEMS
- FOOD SERVICE • WIRE MAINTENANCE
- MISSILE GUIDANCE SYSTEMS
- PHOTOMAPPING
- INTRICATE EQUIPMENT MAINTENANCE
- MUNITIONS AND WEAPONS • SUPPLY
- VEHICLE MAINTENANCE • METAL WORKING
- FABRIC, LEATHER AND RUBBER • MEDICAL
- BUDGETARY ACCOUNTING AND DISBURSING
- MARINE • FIREFIGHTING
- SECURITY AND LAW ENFORCEMENT
- CONSTRUCTION

Act Now!

MAIL COUPON TODAY for Full Information

AIRMAN PROCUREMENT

Headquarters, U. S. Air Force, Washington 25, D. C.

Please send me details about enlisting as an Air Force specialist.

NAME

ADDRESS

CITY ZONE STATE

MY SPECIALTY IS:

Popular Mechanics Magazine

Registered in U. S. Patent Office and Canada

H. H. WINDSOR, Founder

H. H. WINDSOR, JR., Editor and Publisher

Volume 98

AUGUST 1952

Number 2

Address all communications to:
200 East Ontario Street, Chicago 11, Illinois

Managing Editor.....Roderick M. Grant
Assistant Managing Editor.....Wayne Whittaker
Shop Notes and Crafts Editor.....James R. Ward
Radio-Television, Electronics Editor.....Frank L. Brittin
Associate Editor, Aviation.....Aubrey O. Cookman, Jr.
Associate Editor.....Clifford B. Hicks
Associate Editor.....Arthur R. Railton
Assistant Shop Notes and Crafts Editor.....Wayne C. Lecky
Automotive Editor.....Siler Freeman
Art Director.....Frank Beatty

Assistant Editors

W. Clyde Lamme Frank N. Stephany Carlton H. Ihde
Theodore A. Daum Elsie L. Domin Elliott H. McCleary
Eastern Editor.....Richard F. Dempewolf
Empire State Bldg., Room 2906, New York City 1
Western Editor.....Thomas E. Stimson, Jr.
302 23rd St., Santa Monica, Calif.
London Manager.....Douglas W. Wedderspoon
Eagle House, Jermyn St., London S. W. 1, England
Director, Bureau of Information.....Allan Carpenter
200 E. Ontario St., Chicago 11

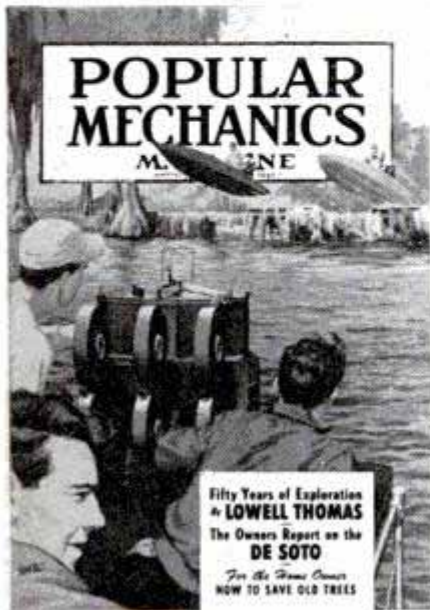

this month's cover

RACY OUTBOARDS roar up ramps to leap across our cover and zoom full speed toward a strange, turreted mechanism. Actually it's three movie cameras mounted as a single unit, with the three lenses aimed so they cover the entire field of human vision. Later the three films will be projected simultaneously on a huge "wrap around" screen, a curved surface three times as wide and half again as high as a conventional screen. As a viewer you'll find yourself actually in the middle of the lake and far off to the right you'll spot the outboards. They'll angle across the screen toward you, leap the ramps and disappear somewhere so close over your left shoulder you may whirl around to see what's happening. The technique is called Cinerama. It combines a curved screen and stereophonic sound to produce a three-dimension spectacle of amazing reality. You'll find details on page 120

IN THIS ISSUE

Shall We Move to Another Planet?	- - -	65
Lightning Trappers	- - - - -	72
Ride 'Em, Lumberjack!	- - - - -	81
The Owners Report on the '52 DeSoto	- - -	88
Fifty Years of Exploration	- - - - -	94
What's New for Your Home	- - - - -	102
Concrete That Promises Miracles	- - - - -	112
Movies on a Curved Screen Wrap You in Action		120
TV Comes to the Small Town	- - - - -	128
Chemists Mix a Powder to Doctor Ailing Soil		136
Rainbows by the Million	- - - - -	145

For the Craftsman

Modern Console Has Mirror Back	- - -	149
How to Build Retaining Walls	- - - - -	153
Small Boats Go Inboard	- - - - -	167
Bracing Saves Old Trees	- - - - -	173
Know Your Car's Nervous System	- - - - -	182
Spot Analyzer for Better Enlargements	- - - - -	187
How to Use Hand Punches	- - - - -	191
How to Cut Sheet Metal	- - - - -	196
Shopping for Tools	- - - - -	204
Radio, TV and Electronics	- - - - -	207
Clinic for Homemakers	- - - - -	218

Other items, and manufacturers of available products described, are listed on pages 12, 14 and 16

Published monthly by Popular Mechanics Company, 200 E. Ontario St., Chicago 11, Ill. H. H. Windsor, Jr., president; William Harrison Fetridge, vice-president; D. F. Windsor, vice-president and secretary-treasurer; H. H. Windsor III, vice-president; Clover L. Perkins, advertising manager; Alan M. Deyoe, circulation manager. Single copy in the United States and Canada, 35 cents; subscription rates in United States and possessions, Canada, Philippines and countries of the Pan-American Postal Union, 1 year \$3.50; 2 years, \$6.00; 3 years, \$8.00. To all other countries add \$1.00 a year over United States prices for overseas postage. If you plan to move, notify us at least 30 days in advance so you will not miss an issue. Give both your old and new addresses. Entered as Second Class Matter, September 15, 1903, at the Post Office at Chicago, Illinois, under Act of March 3, 1879. Entered as Second Class Matter at Post Office Dept., Canada. Registered as Second Class Matter at the Post Office at Mexico, D. F., Mexico, June 20, 1950. Copyright 1952 by Popular Mechanics Company. Copyright under International Copyright Union. Copyright in France. All rights reserved under Pan-American Copyright Union. Printed in the United States of America.

Completed Popular Mechanics Ranch Type House and exact scale pictorial room and suggested furnishing layout. To right of dotted line is BASIC HOUSE. Expansion to the left. Designed for easy building in two convenient steps.

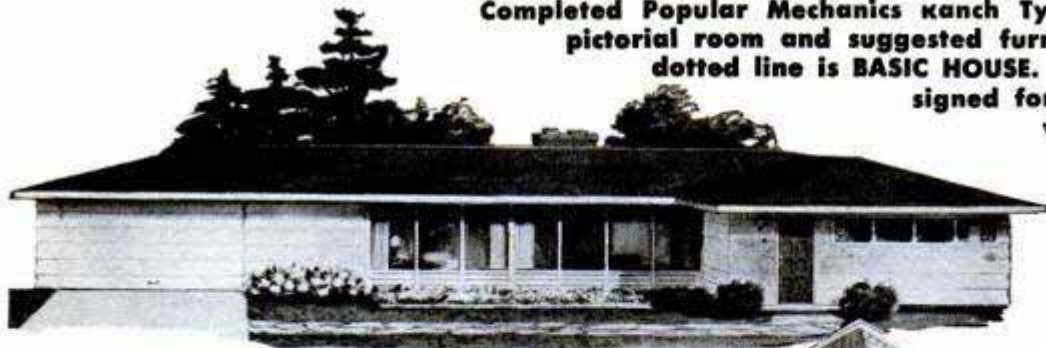

Basic house includes living room, dining area, two bedrooms, kitchen, bath, utility room and car port. Can be built for about \$5000.

More than 100,000 families have built their own homes in the past few years, doing all of the work, or most of it themselves. Right now, one of every five homes being built is at least partially owner-built. This proves that you too, if you can use hammer and saw, can build your own home and save more than one-half of the cost.



**Add
When You
Need More
Room**

When expanding you add garage and breezeway, and car port becomes third bedroom. About \$2500.

**Build the Basic
House First**



Build this
**Popular Mechanics
RANCH HOUSE
Yourself!**
Save Over One-Half

**Beat the High Cost of Home Owning
It's Easier Than You Think**

Here is a dream home that can become a reality without too much worry about money. Build this beautiful Ranch Type Home yourself. Simply follow the Popular Mechanics RANCH TYPE HOUSE BOOK AND PLANS. You can save \$7,000 to \$10,000 and have one of the most desired homes of these times. You can build it all now—or part of it—and add garage, breezeway and another bedroom later on without affecting the basic house.

**Modern Design • Fully Finished • All-Season
Build this Home Anywhere and Save**

Designed for Popular Mechanics by John F. Whelan, famous West Coast architect and designer of homes and entire villages. It's a year 'round house, 81 feet long and 29 feet wide. Fully insulated. Finished outside and inside with durable plywood and requires no plastering. Brick "island wall" and big fireplace in living room. Heating, unique ventilating system and latest development in electric wiring included. A dream home that can easily come true and a home that can grow with the family.

Reduced size illustrations from book. Building roof truss on floor for easy construction. Mrs. Tom Riley, Portland, Oregon, shingles the roof on her Popular Mechanics Ranch Type House



**Get this Newest Popular
Mechanics "Build-It-Yourself"
Book and Building Plans and Save
Many Thousands of Dollars**

Book gives complete step by step instruction in simple language. Hundreds of pictures, actual photos and diagrams, showing every phase of construction, guide you from start to finish. Ten working size blueprints give floor plans, elevations, notes on construction, framing, lumber list, specifications, plumbing and wiring diagrams.

part of it. And at the same time, save in labor costs, more than he spends for material.

Order Book and Plans Now

Use the handy coupon below to order your copy of the RANCH-TYPE HOUSE BOOK AND PLANS. Read the book; study the plans and then you will be prepared to go right ahead when you are ready to build. Even if you have the house mainly built by others, you can still enjoy a tremendous savings by using the instructions and blueprints from Popular Mechanics.

**Read How and See How —
Simplified Instruction**

You read "how-to-do-it" in the book. You see how it looks in actual pictures. You follow the plans for dimensions and details. You make use of labor-saving kinks and special methods developed especially for the project.

**No Previous Building
Experience Required**

Any ordinary handy man, using only simple tools, can build this house with little or no assistance and enjoy every

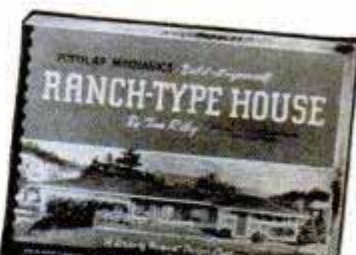

Use This Handy Order Coupon

**POPULAR MECHANICS PRESS, Dept. 70
200 East Ontario St., Chicago 11, Ill.**

Send at once my copy of the Ranch-Type House Book and Plans as checked below:

- | | |
|--|--|
| <input type="checkbox"/> Remittance enclosed | <input type="checkbox"/> Send C.O.D. (postage extra) |
| <input type="checkbox"/> Ranch Type House Book | \$ 3.50 |
| <input type="checkbox"/> Set of 10 Blueprints | 13.50 |
| <input type="checkbox"/> Book and Blueprints | 15.00 |
| <input type="checkbox"/> Duplicate Set of Blueprints | 5.00 |

Name _____

Address _____

City _____ Zone _____ State _____

NEED A NEW FLOOR?

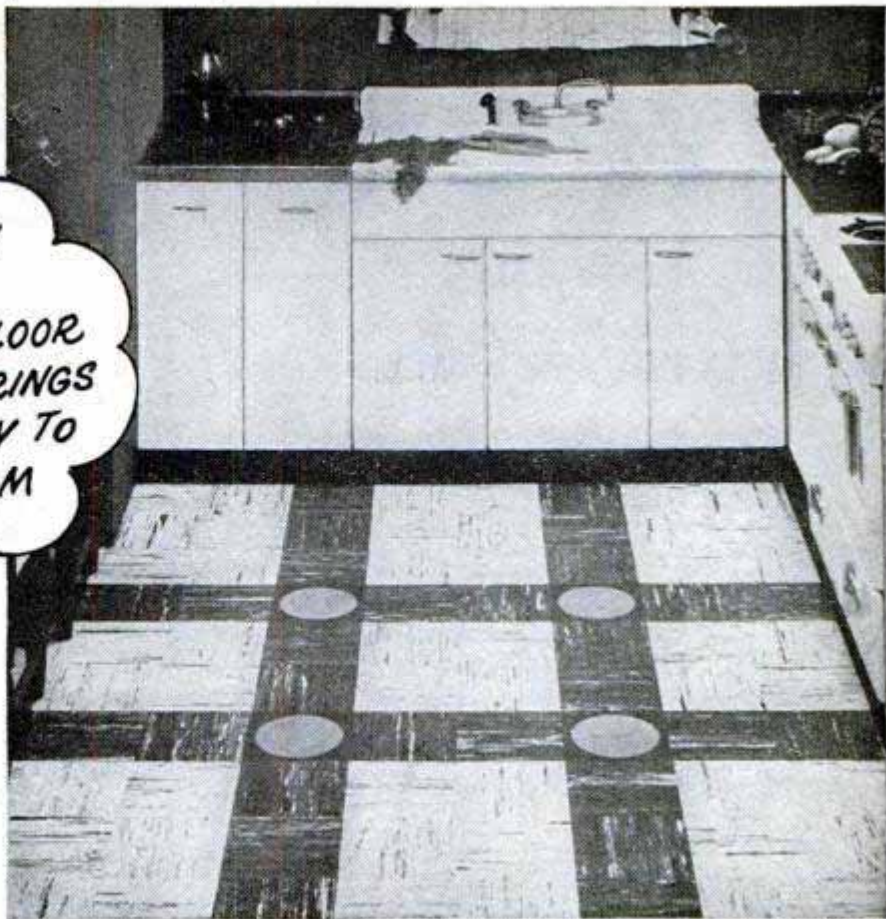

IT'S MONEY-SAVING FUN TO

A long-lasting colorful floor like this for only \$22⁵⁰*

INSTALL YOUR OWN

KENTILE FLOOR

Home handy men (and women) of all ages are finding that it's so easy to lay their own Kentile Floors! The tiles go down one by one ... a few at a time or whole rooms all at once. And, as soon as it's down, the floor is ready for immediate use.

The smart, modern beauty of the 26 light bright Kentile colors lasts for the life of the floor ... colors are permanent because they go clear through to the back of each tile. And, no floor is easier to clean ... just mild soap and water plus an occasional no-rub waxing brings out all the sparkling, decorator beauty.

To find out just what it will cost you to lay a Kentile Floor in any room of your house, consult your Kentile Dealer. He's listed under Floors in your classified phone directory. In Canada, T. Eaton Co., Ltd.

**Price quoted is for a 8' x 9' kitchen. Your floor may cost considerably less or slightly more depending on the colors you choose and the size of your room.*



This handy KEN-KIT gives me all the tools I need to do a real workman-like job

FREE BOOKLETS. Send for your copies of the Kentile Self-Installation Folder and the Kentile Color Line. Learn how easy it is to install your own Kentile Floor and see the 26 modern colors you can choose from. Kentile, Inc.; Dept. G-8, 58 2nd Ave., Brooklyn 15, N. Y.

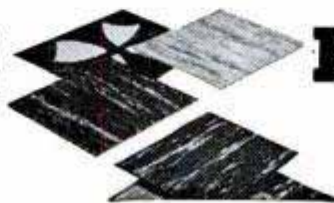

KENTILE.

The Asphalt Tile of Enduring Beauty 

● **an ounce of**
PYROIL
prevents

- METAL TO METAL WEAR ● BATTERY DRAIN
- RUST AND CORROSION ● FOULED SPARK PLUGS
- COSTLY REPAIR BILLS

A few ounces of Pyroil in the gas tank, a pint in the crank case—and you'll prevent a lot of car "ailments." That's why an ounce of Pyroil prevention is well worth a "pound" of costly cure in repair shops.

When you add gas or oil—add Pyroil—add miles to your car.

Pyroil for Aircraft Engines

Use Aircraft Pyroil B for lubricating oil, Aircraft Pyroil A for gasoline.

GIVEN! An attractive Pyroil metal savings bank—takes coins up to 50c pieces. **MOTORISTS**, it's yours for the asking—sent postage paid.



Manufactured and Guaranteed by Pyroil Company, 150 Pyroil Bldg., La Crosse, Wisconsin.

Canadian Distributors: Central Purchasing Agencies, Ltd., Toronto, Ontario

PYROIL COMPANY
 150 Pyroil Bldg., La Crosse, Wisconsin
 I want my car to last and run properly. Please tell me more about Pyroil and how it can accomplish this for me.

Name _____

Address _____

City or Town _____ State _____



in this corner.....

THE EDITORS



Most Popular Mechanic Is Pop!

We don't often break into poetry. But here's a verse by Hilda Butler Farr that appeared not long ago on the sports page of the Chicago Tribune in Arch Ward's column, "In the Wake of the News":

POPular Mechanics

At anything mechanical
 I'm really quite a flop!
 And have no gifts along these lines,
 I leave it all to Pop.

The ribbon which I try to fix
 In my typewriter, too,
 Will never work the way it should
 Regardless what I do.

The car will start out beautifully
 And then . . . decide to stop:
 I've no idea what can be wrong,
 I leave it all to Pop.

I cannot fix a toaster cord
 Whatever type or brand,
 And cannot drive a nail without
 I drive it through my hand

At anything mechanical
 I'm really quite a flop!
 And have no gifts along these lines . . .
 I leave it all to Pop.

Letter to the Editor:

I duly received my Golden Anniversary issue of *Popular Mechanics*. I can only describe it as a truly wonderful issue. Your standard work is splendid and I always look forward to the next issue. I cannot claim that I have been a reader for 50 years—owing to difficulty during the late war—but I can claim nearly 40.

Your article on page 231, "Drivers Check Their Speedometers With Giant Meter on

(Continued to page 8)

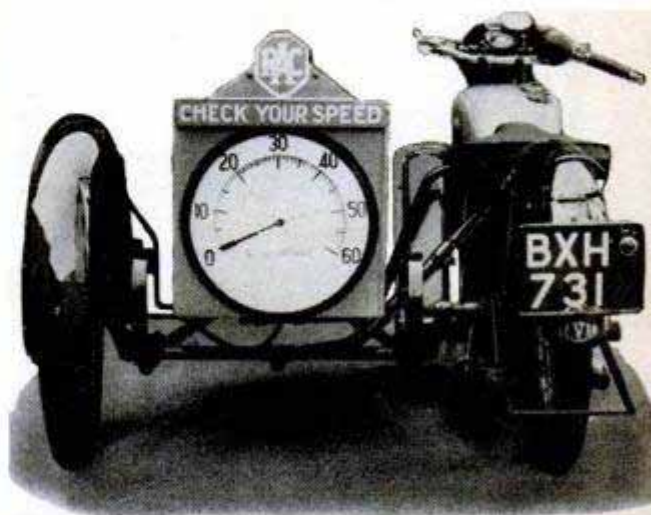

This **FREE SAMPLE LESSON** will prove you can become an expert **BOOKKEEPER... ACCOUNTANT** OR **C.P.A.**



This well-paid
LaSalle-trained
Accountant's
success could
be yours.

FREE SAMPLE LESSON

We offer you this free sample lesson so that you can *prove to yourself* that you CAN master Accountancy—quickly, thoroughly—in spare time at home.

You will see exactly how LaSalle's famous "Problem Method" works . . . how you are led step-by-step through actual accounting work—*learning by doing* and not by study of theory alone. First you tackle easy problems, then more difficult ones—until soon you master them all. And at every step you have the close personal guidance of LaSalle's large staff of C.P.A. instructors.

HIGHER ACCOUNTANCY

By the LaSalle Problem Method..

• Practical Accounting

Assignment I

THE BALANCE SHEET



QUOTING from the "Journal of Accountancy," the authoritative organ of the professional accountants of the United States:
"...the accounting profession is probably the best paid in the world. If there be a profession in which the average compensation is higher, it is not known to us."
"There is need for accountants. There is ample compensation for accountants. There is no prospect that the supply will overtake the demand within the lifetime of even the youngest of us."

LaSalle Extension University
A Correspondence Institution
CHICAGO

THIS SAME LESSON HAS STARTED HUNDREDS OF THOUSANDS toward well-paid accounting careers—in business, government, and as C.P.A.'s. Even without previous knowledge, progress is rapid—earning power climbs fast. This sample lesson shows why.

If you have been envying the high incomes and good jobs enjoyed by thousands of men and women Accountants today... incomes ranging from \$4,000 to \$10,000 and more per year... why not launch such a career for yourself?

Do you doubt that you can?

Then let us send you—without cost or obligation—the same Lesson Number One with which LaSalle has started several hundred thousand

men and women toward successful accounting careers. We want you to see for yourself how this remarkable method, originated by LaSalle, makes Accountancy simple, interesting, practical, and certain . . . how it leads you step-by-step to a complete mastery of Accounting—and on up to the coveted degree of Certified Public Accountant if you so aspire.

It doesn't matter whether you've had previous bookkeeping experience, or whether you don't know a debit from a credit. Whether you wish to qualify as an expert bookkeeper, advanced accountant, cost accountant, auditor, government accountant, income tax specialist, or public accountant . . . you'll find in LaSalle's Problem Method the exact plan to prepare you rapidly and inexpensively—in spare hours at home—without losing a day from your present job.

So right now, today . . . if you are an adult, employed, and earnestly ambitious for rapid advancement in this highest-paying of all professions . . . send your name and address on the coupon below. We'll send the free sample lesson—plus our 48-page book outlining today's career opportunities and how you can qualify for them. A coupon like this has started many thousands toward greater success. It can do the same for you. Mail it today!

Clip Coupon... Mail TODAY!

LaSalle Extension University . . . A Correspondence Institution

Dept. 864-H, 417 S. Dearborn Street, Chicago 5, Illinois

YES, I want to see how LaSalle's "Problem Method" works.. how I can qualify for high-pay Accountancy positions. Send Free Sample Lesson — also your 48-page book, "Accountancy, the Profession That Pays"

...all without cost or obligation

Name.....

Street Address.....

City, Zone & State.....

Present Position.....

This One



162E-EB8-PY2Y

**Nearly 10%
of all C.P.A.'s
in the U.S. have
been trained by the
LaSalle Problem
Method**

GOOD-PAY JOBS IN 5 BIG FIELDS

If you were an expert accountant right now, chances are you would find yourself among the highest-paid of all professional men and women. Surveys show that accountants earn more than those in other major professions.

There are five big fields of opportunity open to Accountancy-trained men and women . . . opportunities that are wide open and highly inviting, offering maximum income and job security in good times or bad. And under LaSalle's "Problem Method" you can start earning while still learning—either in spare-time or full-time employment . . . or in business for yourself with no capital required.

Get the latest information by sending for our 48-page book, "Accountancy, the Profession That Pays" . . . plus free sample lesson. The coupon at right will bring both to you without cost or obligation. LaSalle Extension, 417 S. Dearborn St., Chicago 5, Ill.

THEY NEED YOU



A typical interview...

where Embry-Riddle students are pre-selected for essential, good-paying jobs in aviation even before their training is completed... they step right into their jobs as soon as they graduate!

...AND YOU CAN QUALIFY IN SIX MONTHS!

EMBRY-RIDDLE OFFERS YOU COMPLETE 6-MONTHS TO 2-YEAR COURSES...NOW!

Your Career is Waiting!

The high regard of Embry-Riddle training by the leading airlines and the entire aviation industry is demonstrated time and again by the big demand for Embry-Riddle graduates.

There's an important high priority job in aviation waiting for you...however, if you do enter the services, Embry-Riddle training will definitely give you rating advantages.

Thousands of Air Force men are Embry-Riddle trained.



AIRCRAFT & ENGINE MECHANICS

Vast numbers of properly trained A & E Mechanics are urgently needed. Our C.A.A. approved school with a quarter-century experience assures your quickest advancement. Embry-Riddle students learn fast with modern equipment, including jet...live aircraft, airline-size hangars.



AERONAUTICAL DESIGN AND TECHNOLOGY

Embry-Riddle's accelerated 26-mo. Aeronautical Design and Technology Course provides finest training available. Technicians with management responsibility enjoy highest salaries!



COMMERCIAL PILOT

Embry-Riddle trained pilots benefit from our years of experience with 30,000 students...the best instructors, up-to-date aircraft, superb year-round flying weather. Also Instrument and Instructor's ratings.



A & E COMBINED WITH COMMERCIAL PILOT

Airmen with dual pilot-engineering ability are needed by aviation companies and operators. Embry-Riddle combination training offers you the most in your aviation career.



Embry Riddle

International

SCHOOL OF AVIATION

MIAMI 30, FLORIDA

CLASSES ARE BEGINNING NOW...SEND THIS COUPON TODAY!

Dean of Enrollments - Dept. 99
Embry-Riddle School of Aviation
Miami 30, Florida

Please Print

NAME _____

ADDRESS _____

CITY _____

STATE _____ AGE _____

I am interested in...

- A & E Mechanic
 - Commercial Pilot
 - Aeronautical Design and Technology
 - A & E Combined with Commercial Pilot
 - A & E Combined with Private Pilot
- Check One Veterans Non-Veterans

TRAIN IN MIAMI - AIR CAPITAL OF THE WORLD

(Continued from page 6)

Police Car" . . . I enclose a photo of a similar arrangement that I designed and produced for the Royal Automobile Club, London. This was prepared 15 years ago when the 30-mile-per-hour limit was enforced.

I might mention I was appointed Chief Engineer to the Royal Automobile Club (R.A.C.) in 1903 and served in that capacity for 44 years. I retired in 1947.

F. W. Hudlass,
Barnes, England

Letter to the Editor:

Have just read through your 50th Anniversary issue and think it is better than anything here. . . . One notes here in England the growing number of GIs about and hopes the war clouds of Russia may drift away in the moonlight of some good American horse sense.

C.S. Potts,
Roxwell, Chelmsford, Essex

Letter to the Editor:

The accompanying photo shows the Goeltzschtalbrucke, "bridge across the Valley of Goeltzsch," which joins the towns of Reichenbach and Plauen into the so-called



Vogtland of Saxony in Germany. It is one of the few bridges which outlasted World War II. The bridge was built during the years 1846 to 1851.

To erect the viaduct, 26 million bricks were necessary. Length of the bridge is 578 meters . . . height from the river to the track is 78 meters. The cost was 6.6 million marks, of which expenses for scaffolding amounted to 300,000 marks.

In peacetime, the viaduct was crossed by 34,000 trains yearly.

Hans F. Kutschbach,
24 Huebichweg,
Bad Grund/Harz,
Germany (British Zone)

(Continued to page 10)



Picture yourself going places



You've done it often. Call it day-dreaming if you like, but you've seen yourself in a bigger job — giving orders and making decisions — driving off in a smart new car — buying your family a fine home.

There's nothing wrong with dreams. But how about making them come true? *You can do it*, if you're willing to try!

Look around you. The men who are going places are the *trained* men. They've learned

special skills that bring them better jobs and higher pay. It's the men *without* training whose dreams never come true.

What are you going to do about it? Just wait and wish? If you really *want to succeed*, you can get the training you need by studying at home in your spare time. International Correspondence Schools offer you a course in just about any field you choose, giving you the practical plus the bedrock facts and theory. No skimming or skimping! And you'll be earning while you learn. Students report better jobs and more pay within a few months.

Look over the list of subjects in the coupon below. Pick out the one that interests you most — the one that holds the greatest future for you. Then mark the coupon, and mail it today. *Find out* what I. C. S. can do for you. It costs only a stamp or postcard, but it's the first step if you want to go places!

DON'T let these poor excuses make you **FAIL**

1. I never got started.
2. I want a good time.
3. I don't want any responsibility.
4. I can't stick to it.
5. I haven't enough education.
6. I don't know where to get training.



SMARTEST THING HE EVER DID

"I noticed that the trained men held the better jobs. That's when I decided to take an I. C. S. course. Enrolling with I. C. S. was one of the smartest things I ever did. The position as Plant Engineer I hold today is largely due to the 'know-how' derived from my I. C. S. texts. I. C. S. can help any man who will study."

L. P. S., Elkhart, Ind.

GOING INTO THE ARMY OR NAVY?

Earn more pay, win a higher rating, quicker promotion by having this specialized knowledge and credit. I. C. S. courses have helped thousands advance in the services.

INTERNATIONAL CORRESPONDENCE SCHOOLS



BOX 5532-L, SCRANTON 9, PENNA.

Without cost or obligation, please send me the booklet about the course BEFORE which I have marked X:

Please send information about I.C.S. employee training for companies.

- | | | | | |
|---|---|---|---|---|
| <p>ART</p> <ul style="list-style-type: none"> <input type="checkbox"/> Commercial Art <input type="checkbox"/> Magazine and Book Illustrating <input type="checkbox"/> Cartooning <input type="checkbox"/> Show Card and Sign Lettering <input type="checkbox"/> Fashion Illustrating AUTOMOTIVE <input type="checkbox"/> Automobile, Mechanic <input type="checkbox"/> Auto-Elec. Technician <input type="checkbox"/> Auto Body Rebuilding and Refinishing <input type="checkbox"/> Diesel—Gas Engines AVIATION <input type="checkbox"/> Aeronautical Engineering Jr. <input type="checkbox"/> Aircraft Engine Mechanic <input type="checkbox"/> Airplane Drafting BUILDING <input type="checkbox"/> Architecture <input type="checkbox"/> Arch. Drafting <input type="checkbox"/> Building Contractor <input type="checkbox"/> Estimating <input type="checkbox"/> Carpenter and Mill Work <input type="checkbox"/> Carpenter Foreman <input type="checkbox"/> Reading Blueprints <input type="checkbox"/> House Planning <input type="checkbox"/> Plumbing | <ul style="list-style-type: none"> <input type="checkbox"/> Heating <input type="checkbox"/> Steam Fitting <input type="checkbox"/> Air Conditioning <input type="checkbox"/> Electrician BUSINESS <input type="checkbox"/> Business Administration <input type="checkbox"/> Certified Public Accountant <input type="checkbox"/> Accounting <input type="checkbox"/> Bookkeeping <input type="checkbox"/> Stenography and Typing <input type="checkbox"/> Secretarial <input type="checkbox"/> Federal Tax <input type="checkbox"/> Business Correspondence <input type="checkbox"/> Personnel and Labor Relations <input type="checkbox"/> Advertising <input type="checkbox"/> Retail Business Management <input type="checkbox"/> Managing Small Business <input type="checkbox"/> Sales Management <input type="checkbox"/> Salesmanship <input type="checkbox"/> Traffic Management CHEMISTRY <input type="checkbox"/> Chemical Engineering <input type="checkbox"/> Chemistry <input type="checkbox"/> Analytical Chemistry <input type="checkbox"/> Petroleum—Nat'l Gas <input type="checkbox"/> Pulp and Paper Making <input type="checkbox"/> Plastics | <p>CIVIL, STRUCTURAL ENGINEERING</p> <ul style="list-style-type: none"> <input type="checkbox"/> Civil Engineering <input type="checkbox"/> Structural Engineering <input type="checkbox"/> Surveying and Mapping <input type="checkbox"/> Structural Drafting <input type="checkbox"/> Highway Engineering <input type="checkbox"/> Reading Blueprints <input type="checkbox"/> Concrete Construction <input type="checkbox"/> Sanitary Engineering DRAFTING <input type="checkbox"/> Aircraft Drafting <input type="checkbox"/> Architectural Drafting <input type="checkbox"/> Electrical Drafting <input type="checkbox"/> Mechanical Drafting <input type="checkbox"/> Structural Drafting <input type="checkbox"/> Sheet Metal Drafting <input type="checkbox"/> Mine Surveying and Drafting ELECTRICAL <input type="checkbox"/> Electrical Engineering <input type="checkbox"/> Electrician <input type="checkbox"/> Electrical Maintenance <input type="checkbox"/> Electrical Drafting <input type="checkbox"/> Electric Power and Light <input type="checkbox"/> Lineman HIGH SCHOOL <input type="checkbox"/> High School Subjects | <ul style="list-style-type: none"> <input type="checkbox"/> College Preparatory <input type="checkbox"/> Mathematics <input type="checkbox"/> Commercial <input type="checkbox"/> Good English MECHANICAL AND SHOP <input type="checkbox"/> Mechanical Engineering <input type="checkbox"/> Industrial Engineering <input type="checkbox"/> Industrial Supervision <input type="checkbox"/> Foremanship <input type="checkbox"/> Mechanical Drafting <input type="checkbox"/> Machine Design-Drafting <input type="checkbox"/> Machine Shop Practice <input type="checkbox"/> Tool Design <input type="checkbox"/> Industrial Instrumentation <input type="checkbox"/> Machine Shop Inspection <input type="checkbox"/> Reading Blueprints <input type="checkbox"/> Toolmaking <input type="checkbox"/> Gas—Electric Welding <input type="checkbox"/> Heat Treatment—Metallurgy <input type="checkbox"/> Sheet Metal Work <input type="checkbox"/> Sheet Metal Pattern Drafting <input type="checkbox"/> Refrigeration POWER <input type="checkbox"/> Combustion Engineering <input type="checkbox"/> Diesel—Electric <input type="checkbox"/> Electric Light and Power | <ul style="list-style-type: none"> <input type="checkbox"/> Stationary Steam Engineering <input type="checkbox"/> Stationary Fireman RADIO, TELEVISION, COMMUNICATIONS <input type="checkbox"/> General Radio <input type="checkbox"/> Radio Operation <input type="checkbox"/> Radio Servicing—FM <input type="checkbox"/> Television <input type="checkbox"/> Electronics <input type="checkbox"/> Telephone Work RAILROAD <input type="checkbox"/> Locomotive Engineer <input type="checkbox"/> Diesel Locomotive <input type="checkbox"/> Air Brakes <input type="checkbox"/> Car Inspector <input type="checkbox"/> Railroad Administration TEXTILE <input type="checkbox"/> Textile Engineering <input type="checkbox"/> Cotton Manufacture <input type="checkbox"/> Rayon Manufacture <input type="checkbox"/> Woolen Manufacture <input type="checkbox"/> Loom Fixing <input type="checkbox"/> Finishing and Dyeing <input type="checkbox"/> Textile Designing HOME ARTS <input type="checkbox"/> Dressmaking and Designing <input type="checkbox"/> Cookery <input type="checkbox"/> Tea Room Management |
|---|---|---|---|---|

Name _____ Age _____ Home Address _____

City _____ State _____ Working Hours _____ A.M. to _____ P.M.

Occupation _____

Special tuition rates to members of the Armed Forces. Canadian residents send coupon to International Correspondence Schools Canadian, Ltd., Montreal, Canada.

Afraid your hair won't pass her caress test?



**Grooms hair,
never
greases it**



The proof is in
the palm of your hand!



Important moment—when she runs her fingers through your hair! Will she do it once—and never again? Test *yourself*, and see. Rub your palm across your hair. Pick up an annoying film of oil or grease? If so—be warned—and change to Mennen Cream Hair Oil. Lightly blended to keep hair neatly groomed, and leave no trace. Contains lanolin. Helps remove dandruff scales and relieves dry scalp. Get a bottle today, and pass the caress test tonight!

MENNEN
Cream Hair Oil **FOR MEN**

(Continued from page 8)

Letter to the Editor:

When the March *Popular Mechanics* reached us, I was struck by an inaccuracy in the letter accompanied with a photograph from Roy Whitehouse of San Marcos, Calif. The leaping sea beast shown is evidently not a shark. What strikes first is the shape of the tail which is not that of a selachian fish, with asymmetrical fins, but the tail of a teleosteanlike fish. The mouth also is clearly not that of a shark (whose lower jaw is receding). The lower jaw of the animal shown juts forward and the forehead is typical of that of a sea mammal similar to the porpoise.

Dr. Richard Ajy,
Guam Memorial Hospital,
Agana, Guam, Marianas Islands

Doctor Ajy knows his Teleostei. The curator of fishes at Chicago's Natural History Museum confirms that the subject appears to be a member of the porpoise family.—The Editor.

Letter to the Editor:

Just picked up the June issue of *Popular Mechanics* and saw beginning on page 136 "The Cars They Drive Are Classics."

Do you know the Classic Car Club of America was organized a few months ago for owners of cars made between 1925 and 1942, as well as those who are interested in them?

As executive director and founder of the Classic Car Club of America, I should like to report that we do not permit on the exhibition line any cars that have been hopped up or whose bodies have been altered beyond the original design. All cars must be in prime condition and fully restored before they can be placed on the line. Also, we do not discriminate against any of the smaller cars such as the Model-A Ford, Plymouth, Chevrolet, Erskine, or Rockne.

Edward A. Moran,
3629 Oxford Ave.,
Riverdale, N. Y.

Don't Wait for This to Happen!

If you're concerned about the world of tomorrow, you'll be interested to know that, at the present rate of increase, the mass of the earth will have doubled by the year A.D. 3,000,000,000,000,000. Showers of meteoritic dust add 6000 metric tons to the earth daily, an average of one gram per square foot every 3000 years. That adds up to three million-billion years before the earth's mass is doubled.

WHAT Every AUTO MECHANIC Wants to Know

A motor vehicle is a machine of many parts, each part designed and constructed for its own special function. All good mechanics, like good doctors, should know the working theory and operation of each part and understand what causes trouble and how to remedy it.

LET AUDELS AUTO GUIDE SOLVE YOUR PROBLEMS

Every auto mechanic, helper, serviceman and operator can use a copy of AUDELS AUTOMOBILE GUIDE. The information it gives saves time, money and worry. Highly indorsed by all users. It presents the whole subject of auto mechanics from A to Z in plain language and simple terms.

This Big Practical Book gives full information with working diagrams covering the principles, construction, ignition, service and repair of modern cars, trucks and buses.

A complete Guide of 1800 pages, with over 1500 illustrations showing inside views of the working parts, with instructions for service jobs. Diesel engines, Fluid and Hydra-matic drives fully explained.

IT PAYS TO KNOW HOW TO

How to fit pistons—How to locate engine knocks—How to fit connecting rod bearings—How to service main bearings—How to recondition valves—How to time valves—How to adjust fan belts—How to adjust carburetors & chokes—How to rebuild a clutch—How to service automatic transmissions—How to service brakes—How to adjust steering gear—How to cope with ignition troubles—How to service distributors—How to time ignition—How to "tune up" an engine.

INFORMATION IN A HANDY FORM

73 INTERESTING CHAPTERS—Read this partial list of subjects on which practical information is fully given for quick reference under the headings as shown below. Ready Reference Index.

All Parts of an Automobile—Automotive Physics—The Gas Engine—Gas Engine Principles—Multi-Cylinder Engines—Horse Power—Automobile Engines—Stationary Parts—Moving Parts—Pistons—Piston Rings—Connecting Rods—Crank Shafts—Valves—Valve Gear—Cams and Cam Action—Valve Timing—Cooling Systems—Fuel Feed Systems—Dual Fuel Feed—Mixture—Carburetors—Carburetor Service—Automatic Choke—Super-Chargers—Transmissions—Special Transmissions—Fluid and Hydra-matic Drives—Clutches—Universals and Propeller Shafts

A Ready Reference

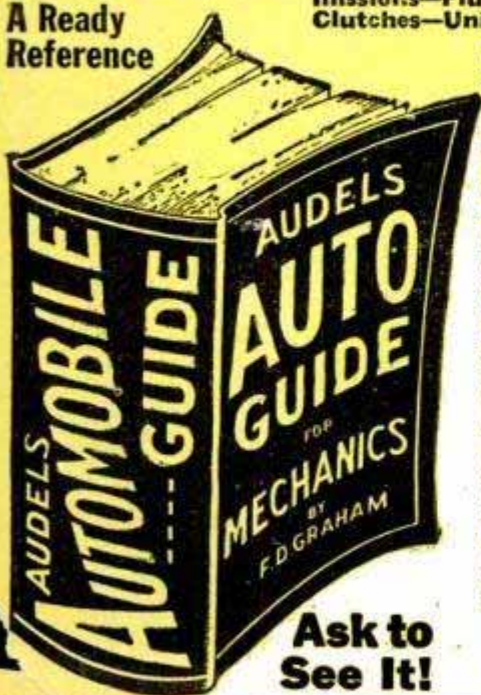

Ask to See It!

—The Differential—Rear Axles—Rear and Front Suspension—Running Gear—Brakes—Wheel Alignment—Knee Action—Steering Gear—Tires—Lubricants and Lubrication—Automotive Electricity—Ignition Systems—Magneto Ignition—Spark Plugs—Ignition Coils—Distributors—Automatic Spark Control—Ignition Timing—Generators—Starters—Generator and Starter Testing—Lighting Systems—Storage Batteries—Charging and Testing—Diesel Engines and Trouble Shooting.

7 DAYS' FREE TRIAL
TO GET THIS ASSISTANCE FOR YOURSELF SIMPLY FILL IN AND MAIL COUPON TODAY.

\$4 COMPLETE
PAY \$1 A
ONLY 1 MO.



O.K. SAY READERS.....

"Well Worth the Price" "SAVED ME \$50"
"Most Useful and Complete"
"It has my Highest Recommendation"
"The Best Money can Buy"
"Easy for the Mechanic to Understand"

Sent on 7 Days Approval

Step up your own skill with the facts and figures of your trade. Audels Mechanics Guides contain Practical Inside Trade Information in a handy form. Fully illustrated and Easy to Understand. Highly Endorsed. Check the book you want for 7 DAYS FREE EXAMINATION. Send No Money. Nothing to pay postman.

CUT HERE MAIL ORDER

AUDEL, Publishers, 49 W. 23 St., NEW YORK 10, N. Y.

Please send me postpaid for FREE EXAMINATION books marked on below. If I decide to keep them I agree to mail \$1 in 7 Days on each book or set ordered and further mail \$1 monthly on each book or set until I have paid price, otherwise I will return them.

- TRUCK & TRACTOR GUIDE, 1299 Pages . . . \$ 4
- AUTOMOBILE MECHANICS GUIDE, 1800 Pages . . . 4
- DIESEL ENGINE MANUAL, 575 Pages . . . 2
- MACHINISTS HANDY BOOK, 1650 Pages . . . 4
- WELDERS GUIDE, 400 Pages . . . 1
- BLUE PRINT READING, 416 Pages . . . 2
- MATHEMATICS & CALCULATIONS, 700 Pages. . . 2
- SHEET METAL PATTERN LAYOUTS, 1100 Pages . . . 4
- SHEET METAL WORKERS HANDY BOOK, 388 Pgs. . . 1
- MECHANICAL DRAWING GUIDE, 160 Pages . . . 1
- MECHANICAL DRAWING & DESIGN, 480 Pages . . . 2
- AIRCRAFT WORKER, 240 Pages . . . 1
- TELEVISION SERVICE MANUAL, 384 Pages . . . 2
- RADIOMANS GUIDE, 914 Pages . . . 4
- ELECTRONIC DEVICES, 216 Pages . . . 2
- ELECTRIC MOTOR GUIDE, 1000 Pages . . . 4
- ELECTRIC WIRING DIAGRAMS, 272 Pages . . . 1
- ELECTRICIANS EXAMINATIONS, 250 Pages . . . 1
- ELECTRIC POWER CALCULATIONS, 425 Pages. . . 2
- HANDY BOOK OF ELECTRICITY, 1440 Pages. . . 4
- ELECTRIC DICTIONARY, 9000 Terms . . . 2
- ELECTRIC LIBRARY, 7000 Pages (12 Book Set) 18
- MARINE ENGINEERS HANDY BOOK, 1258 Pgs. . . 4
- SHIPFITTERS HANDY BOOK, 250 Pages . . . 1
- REFRIGERATION & Air Conditioning, 1280 Pgs. . . 4
- MILLWRIGHTS & MECHANICS GUIDE, 1200 Pgs. . . 4
- POWER PLANT ENGINEERS GUIDE, 1500 Pages . . . 4
- ENGINEERS & FIREMANS EXAMS, 525 Pages . . . 1
- PUMPS, Hydraulics & Air Compressors, 1658 Pgs. . . 4
- ENGINEERS LIBRARY (3 Book Set) . . . 9
- MECHANICAL DICTIONARY, 950 Pages . . . 4
- GARDENERS & GROWERS GUIDES (4 Book Set) 6
- CARPENTERS & BUILDERS GUIDES (4 Book Set) 6
- PLUMBERS & Steamfitters Guides (4 Book Set) 6
- MASONS AND BUILDERS GUIDES (4 Book Set) 6
- PAINTERS & DECORATORS MANUAL, 450 Pgs. . . 2
- HOUSE HEATING GUIDE, 1000 Pages . . . 4
- OIL BURNER GUIDE, 384 Pages . . . 1

Name _____
Address _____
Occupation _____
Employed by _____

AUDEL, Publishers, 49 W. 23 St., New York 10, N. Y.

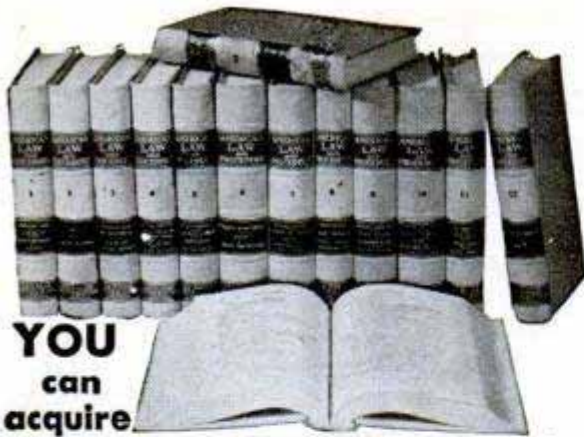

YOU
can
acquire

LAW NIGHTS AT HOME! L. L. B. DEGREE

LaSalle's famous Law Library—used as reference in many Law libraries and Law offices—has enabled thousands to master Law surprisingly fast, in spare hours at home, for business and professional advancement.

These 14 remarkable volumes, compiled by leading professors and lawyers, cover the whole basic field of Law in condensed, orderly, simplified manner.

You advance rapidly with this great library, plus special lectures furnished. We guide you step-by-step with personalized Problem Method of instruction . . . you learn by doing—handling legal problems—not by memorizing rules.

Send for two FREE 48-page booklets, "Law Training for Leadership," and "Evidence," answering questions about Law and its value to you, and telling how LaSalle Law graduates are winning rapid advancement in business and public life. Mail coupon below. No obligation.

LA SALLE EXTENSION UNIVERSITY A Correspondence Institution

417 S. Dearborn St. Dept. 864-L Chicago 5, Ill.

Send me your two FREE booklets described above, without obligation.

Name.....Age.....

Street.....

City, Zone & State.....

ENGINEERING DEGREE IN 27 MONTHS

Big Demand for Graduates

Aeronautical, Chemical, Civil, Electrical, Mechanical and Radio Engineering (inc. TV and Electronics)

Hundreds of young men are earning B. S. ENGINEERING DEGREES annually in this recognized institution — year around operation. New terms start quarterly. Many students earn a major part of their college expenses in this large industrial center.

Low tuition. Competent instruction. Thorough, intense, practical program. Modern, well-equipped laboratories including new physics laboratory and modern wind tunnel. Individualized instruction emphasized.

Government approved for G.I.'s. Engineering preparatory courses. Students from 48 states and 21 foreign countries. Enter September, December, March, June. Send coupon for free catalog and full information. Enroll now.

SEND COUPON TODAY

INDIANA TECHNICAL COLLEGE

582 E. Washington Boulevard
Fort Wayne 2, Indiana

Please send me free information on B.S. Engineering Degree in 27 months as checked.

Aeronautical, Chemical, Civil, Electrical,
 Mechanical, Radio-Television

Name.....

Address.....

WHERE-TO-BUY-IT INDEX

Source of supply appears after items commercially available

AUTOMOTIVE

Truck proving ground.....	77
Detroit listening post.....	87
Car cooling-system cleaner has thermostatic shutoff (Trippe Mfg. Co., 609 W. Lake St., Chicago 6).....	100
Huge pile-up occurs in stock-car race.....	100
Italian Fiat.....	100
Italian speedster.....	101
Spotlight halts only fast drivers.....	106
Multideck parking lot.....	111
Five miles a minute? Watch the hot rods at Bonneville.....	114
Composite sports car.....	133
Marine sergeant builds three-wheeled roadster.....	135
Workshop accompanies Paris cabby.....	142
Eight-wheel Jeep takes steepest hills (Hickey Enterprises, 10827 Wright Rd., Southgate, Calif.).....	144

AVIATION

Largest military helicopter carries 20 troops.....	93
Geiger-tube altimeter.....	116
Giant jet helicopter ready for first flight.....	116
"Siamese twin" light plane.....	117
Homemade hot-air unit warms hospital planes.....	125
Safety-belt release to aid pilots.....	126
Army helicopters flown across Pacific.....	127
Two-piece bird startles soldiers.....	127
Navy Cougar.....	133

ELECTRICAL DEVICES

Calculator "tests" nonexistent motor.....	70
Generator armatures wound in two minutes by machine (Boyer Auto Electric, 5429 S. Denker Ave., Los Angeles 62, Calif.).....	77
Electric currents pump hot metal.....	107
G.E. develops lightweight motor with aluminum and nylon (General Electric Co., Schenectady 5, N. Y.).....	127
Stethoscope amplifies heart sounds (Electronic Stethoscope Corp., 1316 Sherman Ave., Evanston, Ill.).....	135
Neon chandelier has flowing lines (Osram-Works, Hardenbergstr. 9, Berlin-Charlottenburg 2, British Sector, Germany).....	148
Brighter fluorescent lamps (General Electric Co., Nela Park, Cleveland 12, Ohio).....	238

FARM AND GARDEN

Spiked disk aerates soil (Ohio Machine Products, Inc., Columbus 11, Ohio).....	101
Bellows duster (Champion Sprayer Co., 6509 Heintz Ave., Detroit 11, Mich.).....	110
Electric mower (Electric Mower Co., Corsicana, Tex.).....	110
Wheels for garden rake (Niles Corp., 232 Weber St., South Bend 17, Ind.).....	110
Dual-tractor unit steered by differential.....	141
Giant leaf shredder does job of 20 maintenance workers.....	148

HOUSE AND HOME

Rinse stops static generation in synthetic-fiber garments (Electro-Chemical Products Corp., 60 Franklin St., East Orange, N. J.).....	70
Window balancer (RCS Tool Sales Corp., Joliet, Ill.).....	102
Furnace timer unit (Skuttle Mfg. Co., 4099 Beaufait Ave., Detroit 7, Mich.).....	103
Plastic shelf (Brittain Products Co., 380 E. Exchange St., Akron, Ohio).....	103
Automatic card shuffler (Globe Distributors, Dept. A (31D), Box 103, East Moline, Ill.).....	103
Flowerpot jacket (Anglers Products Co., 45-22 162nd St., Flushing 58, N. Y.).....	103
Cleaning tool (Arrow Mfg. & Sales Co., 1018 N. Fairfax Ave., Los Angeles 46, Calif.).....	103
Tack maker (McKee-Burns, 634 S. Western Ave., Los Angeles 6, Calif.).....	103
Fruit cutter (Elron Products, 156 W. Chicago Ave., Chicago 10).....	104
Razor blades (Longhorn Novelties, 1403 Calhoun, Fort Worth, Tex.).....	104
Sock driers (Lee-Rowan Co., 6301 Etzel Ave., St. Louis 14, Mo.).....	104
Sharpener (Robeson Cutlery Co., Inc., 140 Main St., Perry, N. Y.).....	104
Nonslip clamp (Household Gadgets, Inc., 41 Broad St., New York City 4).....	105
Egg cooker (McKee Glass Co., Jeannette, Pa.).....	105
Zipper-repair kit (Gaylord, Fifth Ave. and Hamilton, Pittsburgh 6, Pa.).....	105
Insecticide dispenser (Lethelin Products Co., Inc., 15 Mac-Queten Parkway, South, Mount Vernon, N. Y.).....	105
Blender (Mrs. Dorothy Damar, 829 Damar Bldg., 22 Treat Place, Newark 2, N. J.).....	105

INDUSTRY

Remote control permits lift-truck operator to raise self (Baker Industrial Truck Div., Baker-Raulang Co., 1250 W. 80th St., Cleveland, Ohio).....	76
Lift-truck attachment eliminates pallets (Clark Equipment Co., Battle Creek, Mich.).....	125
Mica-flake insulation adapts to fine work (General Electric Co., Pittsfield, Mass.).....	127
Upside-down oil jet improves metal cutting.....	134
Curved-hole drill.....	135
Tool detects minute scratches (General Motors Corp., Detroit 2, Mich.).....	142

(Continued to page 14)

You Practice COMMUNICATIONS I send you parts to build this transmitter



As part of my Communications Course you build this low power broadcasting transmitter, learn how to put a station "on the air," perform procedures demanded of Broadcast Station operators, make many tests.

This is just part of the equipment my students build. You keep all parts I send.

You Practice Radio SERVICING on this modern radio you build with parts I send

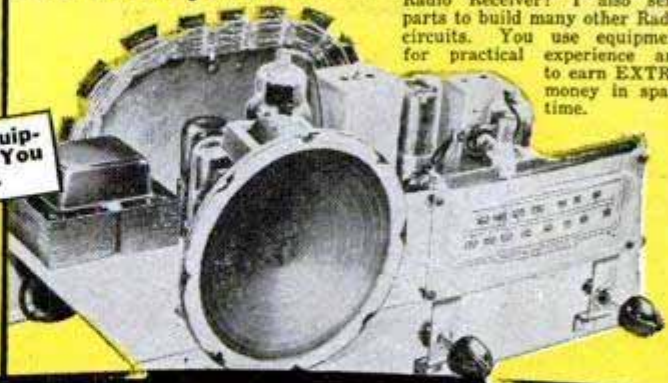

As part of my Servicing Course, I send you the speaker, tubes, chassis, transformer, loop antenna, EVERYTHING you need to build this modern, powerful Radio Receiver! I also send parts to build many other Radio circuits. You use equipment for practical experience and to earn EXTRA money in spare time.

BE A RADIO-TELEVISION TECHNICIAN

NOW! Advanced Television Practice

New, special TV kits furnished to build high-definition SCOPE . . . RF OSCILLATOR with flyback power supply . . . complete TV set . . . many other units. You see pulse, trapezoidal, saw-tooth wave forms. Get valuable PRACTICAL EXPERIENCE locating and correcting TV troubles. Mail coupon for facts, pictures and prices!

Learn Servicing or Communications Practice at Home in Spare Time



Do you want good pay, a job with a bright future and security? Would you like to have a profitable shop or store of your own? If so, find out how you can realize your ambition in the fast growing, prosperous RADIO-TELEVISION industry. Even without Television, the industry is bigger than ever before. 90 million home and auto Radios, 3100 Broadcasting Stations, expanding use of Aviation and Police Radio, Micro-wave Relay, Two-way Radio for buses, taxis, etc., are making opportunities for Servicing and Communications Technicians and FCC-Licensed Operators.

Television is TODAY'S Good Job Maker

In 1950, over 5,000,000 TV sets sold. By 1954, 25,000,000 TV sets estimated. Over 100 TV Stations now operating. Authorities predict 1,000 TV Stations. This means more jobs, good pay for qualified men all over the United States and Canada.

Many Make \$10 Extra a Week in Spare Time

Keep your job while training. Hundreds of successful RADIO-TELEVISION TECHNICIANS I trained had no previous experience, some only a grammar school education. Learn Radio-Television principles from illustrated lessons. Get PRACTICAL EXPERIENCE—build valuable multimeter—experiment with circuits common to Radio and Television. Keep all equipment. Many students make \$5, \$10 extra a week fixing neighbors' Radios in spare time. SPECIAL BOOKLETS start teaching you the day you enroll.

Send Now For 2 Books FREE—Mail Coupon

Send now for my FREE DOUBLE OFFER. You get actual servicing lesson to show you how you learn at home. Also my 64-page book, "How to Be a Success in Radio-Television." Read what my graduates are doing, earning; see equipment you practice with at home. Send coupon in envelope or paste on postal. J. E. SMITH, President, Dept. 2HA, National Radio Institute, Washington 9, D. C. Our 39th Year.

Good for Both—FREE

MR. J. E. SMITH, President, Dept. 2HA National Radio Institute, Washington 9, D. C.

Mail me Sample Lesson and 64-page Book about How to Win Success in Radio-Television. Both FREE. (No Salesman will call. Please write plainly.)

Name.....Age.....

Address.....

City.....Zone.....State.....

Approved for training under G. I. Bill

The ABC's of
SERVICING



I TRAINED THESE MEN

"I have been operating my own Servicing business. In two years I did \$14,000 worth of business; net profit \$6,850. Have one full time employee, an NRI student."—PHILLIP G. BROGAN, Louisville, Ky.

"Four years ago, I was a bookkeeper, with a hand-to-mouth salary. Now I am a Radio Engineer with a key station of the American Broadcasting Company network."—NORMAN H. WARD, Ridgefield Park, New Jersey.

"When halfway through the NRI course, I made \$5 to \$8 a week fixing sets in my spare time. Am now selling and installing Television sets and antennas."—E. J. STREIT-ENBERGER, New Boston, O.

"My first job was operator with KDLR, obtained for me by your Graduate Service Dept. I am now Chief Engineer of Police Radio Station WQOX. I never hesitate to endorse NRI."—T. S. NORTON, Hamilton, Ohio.

EXTRA PAY IN ARMY, NAVY, AIR FORCE

Knowing Radio, TV, Electronics can help you get extra rank, extra prestige, more interesting duty at pay up to several times a private's base pay. You are also prepared for good Radio-TV jobs upon leaving service. Mail Coupon TODAY.

Have Your Own Business

Many N.R.I. trained men start their own Radio-Television sales and service business without capital. Let me show you how you, too, can be your own boss, have a good income from your own shop. Send coupon for FREE book now!

Tested Way to Better Pay

YOU SHAVE CLEANER

IN 1/2 THE TIME

"Get it over with" fast with Schick Injector, world's only razor specially engineered to give you "Twice Over" smoothness with "Once Over" Shaving!



No movable parts that get out of adjustment, no detachable parts that can be dropped or misplaced. Specially designed to "fit" your face—under nose, around lips!

Today, get your complete razor kit:

- ★ Gold-Plated Razor
 - ★ 12 Scalpel-sharp "Gold Pack" Blades
 - ★ Handy Travel Case
- Big \$1.75 Value. Now Only

98¢

Only razor offering these 4 advantages

1. EXTRA SHARP, EXTRA THICK, HEAVY DUTY BLADES

2. SAFETY GUARD SMOOTHS DOWN SKIN—TEES UP WHISKERS

3. AUTOMATICALLY CHANGES BLADE

4. AUTOMATICALLY LOCKS BLADE

SCHICK INJECTOR RAZOR & BLADES

©1952, Eversharp Inc. 350 Fifth Ave., N. Y. C

(Continued from page 12)

MARITIME

Nonsinkable boat (Continental Copper and Steel Industries, Inc., Perth Amboy, N. J.).....	76
Two-piece boat	126
German tripod crane.....	141

SPORTS

Fishing with bow and arrow.....	80
Parasol hat	93
Brief-case picnic grill (House of Ideas, Racine, Wis.).....	99
Head hammock (Consumer's Shopper, 47 Linderman Ave., Kingston, N. Y.).....	101
Easily portable "teepee" serves as sun-and-wind shelter (Wahl Products, Inc., 600 Randall St., Eau Claire, Wis.).....	106
Golf accessories holder (Kaddy Rak, 3214 N.E. Hancock, Portland 12, Ore.).....	106
Belt clip carries golf balls (Ball-Klip Mfg. Co., Box 324, Boulder, Colo.).....	107
Sportsman's chair cooks meals.....	125

MISCELLANEOUS

Pack-horse litter	70
Most authentic map.....	71
Railroad puts wind to work.....	71
Record iron production.....	77
You name it!.....	78
Discover new element in stars.....	93
Saws fight fires.....	106
Science sees "life" molecules.....	107
Windowless water meter is read by use of magnetic fields.....	107
House of pipe.....	108
Pencil contains rubber stamp (Elsart Novelties, Box 374, Radio City Station, New York City 19).....	109
Scooter-style bicycle	109
Mechanical egg salesman.....	118
Fish "magnet" guides fingerlings downstream.....	118
Weather watchers in Hawaii.....	119
Print-washing chemical (Brown-Forman Industries, Box 1080, Louisville, Ky.).....	126
Rail midget and giant.....	126
Combination viewer-projector shows color slides (Three Dimension Co., 4555 W. Addison St., Chicago 41).....	133
Chilean power	143
Oklahomans build oil-pipe and sheet-metal church.....	143
X-ray microscope	148

Craftsman and Shop Notes Index

AUTOMOTIVE

Balancing weights colored to match wheel rim.....	156
Tips for trailerites.....	178
Replacing generator brushes.....	181
Headlight shell holds flashlight to make repairs under car.....	189
Wrist guards for car washer.....	206

FARM

Improvised pig brooder.....	194
Effective "scarecrow" for orchards.....	194
Chick watering fountain anchored by large spike.....	194
Livestock loading chute adjusts to any height.....	195
Sectional-type door in granary provides lighted work area.....	202
Wheel-hub guards for hayrake made from old tire.....	202
Moldboard extensions roll furrows during high-speed plowing.....	202
Land leveler	203

FISHING

Keeping moths from trout flies.....	160
Propeller-driven fishing boat.....	160
Where to find natural baits.....	170
Snagproof fishhook	186

GARDENING

Waterproof garden markers.....	152
Herbs cured in paper bag.....	170
Milk cartons protect plants.....	179
Lawn-chair cushion has straps for holding magazines.....	186
Ashes keep cutworms from plants.....	189

HOUSE AND HOME

Storm curtain of plastic cloth rolls up when not needed.....	152
Pipe extension on garden hose aids cleaning of eaves trough.....	156
Insulation pulled under attic floor with steel tape measure.....	157
Solving home problems.....	158
Removing rust stains on sink.....	166
Oil applied to shingle roof with garden sprayer.....	169
Ash tray for game room.....	176
Salt shaker from beverage bottle.....	179
Storing extension ladder.....	180
Baby crib improvised from basket.....	186

OFFICE, SHOP AND STORE

Stamp for deleting printing.....	157
Compass used to draw parallel lines saves repeated measuring.....	166
Oil can used without removing cap.....	172

(Continued to page 16)

IMPORTANT NOTICE—It is the intention of this magazine to provide its readers with information regarding the latest developments in the mechanical arts. We take no responsibility as to whether the disclosures contained in our articles are covered by patents and advise readers to investigate this subject before making, using, or selling any of the products, machines, or processes described in order to avoid possible liability for patent infringements.



INVENTORS

Learn how to protect your invention. The U. S. Patent Laws provide that any new and useful art, machine, article of manufacture, or composition of matter, or any new and useful improvement thereof, may be patented if the act of invention is involved. Therefore, every inventor with a valuable invention should take advantage of the Patent Laws and proceed for patent protection in order to safeguard his rights.

A patent gives the inventor the exclusive right to prevent others from making, using, or selling the invention claimed in the patent for a period of seventeen years.

The Patent Laws were enacted for the benefit of the inventor to give him protection for the features of his invention which are patentable. These features must be properly and concisely set forth and claimed in a formal application for patent, in order to comply with the requirements of the Patent Laws. For that reason, unless the inventor is familiar with patent matters, he should engage a competent registered patent attorney or agent to represent him. We are registered to practice before the U. S. Patent Office and are prepared to serve you in the handling of your patent matters.

A specially prepared booklet entitled "Patent Guide for the Inventor", containing detailed information with respect to patent protection and procedure, together with a "Record of Invention" form will be promptly forwarded to you without obligation upon request.

CLARENCE A. O'BRIEN & HARVEY JACOBSON

Registered Patent Attorneys

21-H DISTRICT NATIONAL BUILDING

WASHINGTON 5, D. C.

VOTE TODAY FOR THE FUTURE YOU WANT!

AMERICAN SCHOOL,
Dept. GC45, Drexel at 58th, Chicago 37, Ill.
Without obligation, please send FREE and postpaid, full particulars about the subject checked below.

- | | | |
|--|---|---|
| <input type="checkbox"/> Accounting | <input type="checkbox"/> Drafting—Building Trades | <input type="checkbox"/> Plastics Engineering |
| <input type="checkbox"/> Air Conditioning | <input type="checkbox"/> Drafting—Machine Trades | <input type="checkbox"/> Plumbing—Practical |
| <input type="checkbox"/> Architecture & Building | <input type="checkbox"/> Electrical Engineering | <input type="checkbox"/> Private Secretary |
| <input type="checkbox"/> Automobile Technician | <input type="checkbox"/> Electricity—Practical | <input type="checkbox"/> Refrigeration |
| <input type="checkbox"/> Batter Foremanship | <input type="checkbox"/> Electronics—Industrial | <input type="checkbox"/> Retail Merchandising |
| <input type="checkbox"/> Bookkeeping | <input type="checkbox"/> High School Courses | <input type="checkbox"/> Salesmanship—Outside |
| <input type="checkbox"/> Business Management | <input type="checkbox"/> Machine Shop Operations | <input type="checkbox"/> Sheet Metal Work |
| <input type="checkbox"/> Contracting | <input type="checkbox"/> Mathematics & Slide Rule | <input type="checkbox"/> Tool Making |
| <input type="checkbox"/> Diesel Technician | <input type="checkbox"/> Mechanical Engineering | |

NAME..... OCCUPATION.....
HOME ADDRESS..... APT.....
CITY..... STATE.....

THIS IS YOUR BALLOT Find the subject that interests you most and then... Check, Sign and Mail Today

• Today, choose the job you want — and prepare for it in spare time at home. Or if you are already engaged in the work you like best, start training now for quicker promotion. In hours you might otherwise waste, gain the knowledge and skill that can help you to get ahead faster, make more money, and have greater security.

Training Backed by 55 Years of Experience

For over half a century American School has helped ambitious men and women toward success by providing specialized training for commercial and technical advancement. Its study program for you has been planned by experts with years of experience in the subject you select and they will give you needed guidance every step of the way.

Don't Delay Your Start

Give serious thought to the list of training courses listed above. Pick the opportunity that interests you, check it and add your name and address. (Check more than one if you are undecided as to which appeals most.) Finally clip out and mail the "ballot" and full information will be supplied, without cost or obligation.

AMERICAN SCHOOL
DEPT. GC45, DREXEL AT 58th, CHICAGO 37, ILL.

THE SOONER YOU START, THE SOONER YOUR GOAL CAN BE REACHED

(Continued from page 14)

Sections of garden hose aid in handling glass.....	180
Magnets support price cards on merchandise displays.....	202
Quick-changing restaurant sign mounted on Venetian blind.....	206

PAINT AND PAINTING

Emergency bail for paint can.....	156
Storing small amounts of paint.....	160
Battery clip supports brushes in cleaning-fluid can.....	166
Sawdust absorbs varnish remover.....	180
Paint roller spin-cleaned by chucking in electric drill.....	203

TOOLS

Make your own V-block.....	180
Metal guard on bow saw prevents hand injury.....	185
Make your own lathe dog.....	195
Magnetic nail driver (Howard Van Orden, 141 Godwin Ave., Paterson, N. J.).....	205
Combination saw filing and jointing jig (A. D. McBurney, 317 E. 4th St., Los Angeles 13, Calif.).....	205
One-drop oiler (Dispensing Devices Corp., 720 Delaware St., Kansas City, Mo.).....	205
Air-powered nut runner (Garvin Bros., Inc., Box 536, South Bend 24, Ind.).....	205
True-pitch level (Frank Donovan Co., 9 S. Clinton St., Chicago).....	205
Putty remover (Upright Glass Cutting Co., 5410 W. Harrison St., Chicago 14).....	205
Single-post drill jig (Esco Engineering Corp., 1940 E. Woodbridge, Detroit 7, Mich.).....	205
Flexible round file (Tec Imports, 14404 Addison St., Van Nuys, Calif.).....	205

WOODWORKING

Outdoor snack tables and lantern.....	161
Child's lap desk helps teach orderly habits.....	163
Plan of the month—tool boxes.....	164
Boomerang table.....	176

WORKSHOP HINTS

Threaded pipe serves as rasp.....	156
Battery clip holding abrasive simplifies sanding of small surfaces.....	157
Lathe dog supports round work for accurate center drilling.....	163
Clamps from roller skates used to hold glued work.....	170
Improvised pipe vise.....	172
Nuts on tap serve as stop to prevent breakage.....	186
Adapter holds bar stock in three-jaw chuck.....	194
Tapping holes in sheet metal.....	201
Oil reservoir in jaw of steady rest lubricates work automatically.....	206
Pliers protect condenser when soldering leads.....	206

MISCELLANEOUS

Scrub brush for cleaning shoes adds safety feature to ladder.....	152
Wooden boats caulked with soap when taken from dry storage.....	156
"Crystal" lamp base from dime-store glassware.....	157
Can opener provides handy tool for rounding sharp edges.....	160
Hot water frees cleaning patch stuck in barrel of gun.....	162
Badge attached to coat with pencil clip.....	163
Reproduction of craftsman cover used in making calendar.....	163
Nailheads protected when set by wooden thread spool.....	166
Renewing points of wax crayons.....	169
Modelmaker's magnifying glass.....	170
Leather sleeve on bridle reins speeds hitching horse to post.....	172
Elbows in drain line provided by chipping ends of clay tile.....	172
Carton fastener saves time.....	176
Guard ropes erected quickly on stakes coiled at one end.....	176
Solderless ground connection for radios and lightning rods.....	181
Screen staples reinforced with length of wire.....	185
Holes punched in popcorn sacks prevent theater disturbances.....	185
Nail set for emergency use.....	185
Sealing knots in lumber.....	186
Clothespins make practical spiles for tapping maple trees.....	189
Testing flash-gun cells.....	190
Box camera in tray on tripod takes stereoscopic pictures.....	190
Salvaging scaffolding lumber.....	202

Radio-Television, Electronics

Radio links for rural phones.....	207
Tiny salesman's pal a.c.-d.c. super uses "printed circuit" in audio stage.....	208
Homemade TV antennas.....	211
Communications receiver (Hammarlund Mfg. Co., Inc., 460 W. 34th St., New York City 1).....	212
Multimeter testing unit (Allied Radio Corp., 833 W. Jackson Blvd., Chicago).....	212
Experimental UHF-antenna systems (Radio Corporation of America, Camden, N. J.).....	212
High-fidelity amplifier (Bell Sound Systems, Inc., 555 Marion Rd., Columbus 7, Ohio).....	212

☐ Week-end driving in Wisconsin's resort areas is more enjoyable for the motorist because of an order restricting travel of heavy trucks on certain main highways between 1 p.m. and 10 p.m. on Saturdays and 9 a.m. and 10 p.m. on Sundays and holidays during the summer months.

INVENTORS

If you believe that you have an invention, you should find out how to protect it. The first step is to have a search made of the prior pertinent U. S. patents. If a report on this search indicates that the invention appears patentable you can apply for a patent, and the specifications and claims should be prepared.

The firm of McMorrow, Berman & Davidson, with offices in Washington, D. C., is qualified to take the necessary steps for you. We can make a preliminary search on your invention, advise you whether we think it can be patented, and prepare your application for patent.

Unless you are fully familiar with the U. S. Patent Laws, we recommend that you engage the services of a Registered Patent Attorney to protect your interests. The patent laws are *your* laws. A patent gives you the right to prevent others from making, using or selling the invention claimed in your patent for a period of 17 years.

Use these patent laws for your protection. Investigate whether your invention can be patented. If you have what you believe to be an invention, we suggest that you have this firm make a search for you.

Send for a copy of our Patent Booklet entitled "How To Protect Your Invention," containing information about patent protection and patent procedure. Along with this we will also send you an "Invention Record" form, for your use in writing down and sketching details of your invention. We will mail them promptly. No obligation. They are yours for the asking.

McMORROW, BERMAN & DAVIDSON

Registered Patent Attorneys

PATENTS • COPYRIGHTS • PATENTS

135-A VICTOR BUILDING, WASHINGTON 1, D. C.



BUNK!

NOBODY IS JUST "Naturally"

SKINNY!

Give Me 15 Minutes A Day And I'll Give YOU A New Body

WOULD you believe it? I was once a skinny 97-pound weakling. I was ashamed to strip for sports or for a swim. Girls snickered at me behind my back. Folks said I was just "naturally-born skinny!"

Then I discovered my marvelous new muscle-building system—"Dynamic Tension." And it turned me into such a complete specimen of manhood that today I hold the title, "The World's Most Perfectly Developed man."

WHAT'S MY SECRET?

When you look in the mirror and see a healthy, husky fellow smiling back at you—then you'll be astonished at how fast "Dynamic Tension" gets results! And you'll be using the method which many great athletes use for keeping in condition—prize fighters, wrestlers, baseball and football players, etc.

"Dynamic Tension" is the easy natural method that you can practice in the privacy of your own room—just 15 minutes each day—while your scrawny chest and shoulder muscles begin to swell . . . those spindly arms and legs bulge . . . and your whole body starts to feel full of zip, self-confidence, new energy!

FREE My 32-Page Illustrated Book is Yours — Not for \$1.00 or 10c — But FREE

Send NOW for my famous book, "Everlasting Health and Strength," 32 pages, packed from cover to cover with actual photographs, valuable advice, answers to many vital questions. Page by page it shows what I can do for YOU. This book is a real prize for any fellow who wants a better build. Yet I'll send you a copy absolutely FREE. Just glancing through it may mean the turning point in your whole life! Rush the coupon to me personally:

Charles Atlas, Dept. 8V, 115 East 23rd St., New York 10, N. Y.

CHARLES ATLAS, Dept. 8V, 115 East 23rd St., New York 10, N. Y.

Send me—absolutely FREE—a copy of your famous book, "Everlasting Health and Strength"—32 pages, crammed with actual photographs, answers to vital health questions, and valuable advice to every man who wants a better build. I understand this book is mine to keep, and sending for it does not obligate me in any way.

Name _____ Age _____
 (Please print or write plainly)
 Address _____
 City _____ State _____

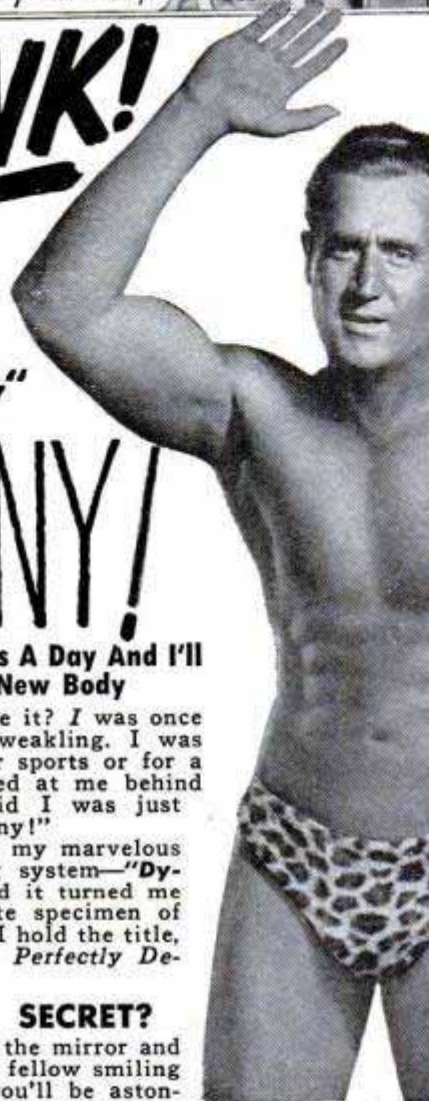

Charles Atlas

Awarded the title of "The World's Most Perfectly Developed Man."

TUBE GIVEN WITH EVERY TIRE AT NO EXTRA COST



Why Pay More!

SUMMER SPECIALS — AT LOW PRICES
 SAVE TIME — SAVE MONEY — SEND THIS AD

GOOD USED TIRES "Not recapped."

19 YEARS AT THIS ADDRESS

Be Wise—A TRIAL OF ONE TIRE WILL CONVINCE YOU.



19 MONTHS WRITTEN GUARANTEE

600-16 \$4.02	820-15 \$5.32	600-20 \$7.02	32x6(8) \$8.52
650-16 4.42	700-15 4.32	650-20 7.62	32x6(10) 9.82
700-16 5.02	670-15 4.52	700-20 8.42	900-20 13.22
650-15 4.02	710-15 4.72	750-20 8.42	1000-20 13.82
760-15 5.02	550-17 5.52	825-20 14.02	1100-20 14.82

EXTRA SPECIALS 29 MONTHS WRITTEN GUARANTEE

600-16 \$5.42	550-15 \$6.02	700-15(6) \$8.92	700-20 \$11.82
600-16 (6) 6.52	640-15 6.12	750-16(8) 12.72	750-20(8) 12.42
650-16 5.82	670-15 6.12	700-17 10.02	750-20(10) 14.82
650-16 (6) 6.92	710-15 6.12	750-17 12.02	825-20 18.42
700-16 6.72	760-15 6.42	750-15 14.02	900-20 18.72
750-16 6.42	800-15 6.72	825-15 16.02	1000-20 19.72
525-18 5.72	820-15 6.72	600-20 8.82	1100-20 20.72
550-17 5.72	670-16 6.32	650-20 9.82	1200-20 23.72
650-15 5.72	760-16 6.82	32x6(8) 10.02	1000-22 19.62
700-15 6.42		32x6(10) 13.82	1100-22 21.72

WHITEWALLS \$1.00 ea. EXTRA MILITARY TREAD 750-20 15.12

Thousands of tires shipped all over U.S.A. All tires shipped F.O.B. Phila. Send Check or M.O. with this ad, Dept. 2.

STANDARD 834 N. Broad St., Philadelphia 30, Pa.

MONEY MEN ALL DATA FREE

THE PLASTEX Industry needs manufacturers on small scale and for big production of Lamp and Clock Stands, Art Goods and Novelties in Plaster and Marble imitation. Experience unnecessary. 1/2" material makes regular 10¢ store sellers. Rubber moulds furnished for speed production. Small investment brings good returns. We are now placing big Chain Store Orders with manufacturers. Ambitious men have chance for real prosperity. Our Free booklet will interest and benefit you.

PLASTEX INDUSTRIES, Dept. A
 3400 Third Ave. New York 56, N. Y.

GET INTO TELEVISION

BIG JOBS AT TOP PAY

Earn to \$125 as a TV service man! Over 20,000 jobs waiting now—100,000 by 1955! C.T.I. trains you at home. You build (and keep) a 16-in. receiver. Parts sent. Free job placement. Write for valuable booklet

COMMERCIAL TRADES INSTITUTE, Dept. T 2-8
 1400 Greenleaf Avenue • Chicago 26, Illinois

LEARN MEAT CUTTING
 At Home — In Spare Time

Get into the vital meat industry. Concise, practical Home Training based on 25 years proven instruction methods used at National's famous resident school. Prepares you for bigger pay as Meat Cutter, Supervisor, market manager or more money in your own store. Go as rapidly as your spare time permits. Diploma. Start NOW to turn your spare hours into money. Send for FREE bulletin today. No obligation.

NATIONAL SCHOOL OF MEAT CUTTING, INC., Div. U-143, Toledo 4, Ohio

Learn **CARTOONING**

HAVE FUN! MAKE MONEY! Cash in on your sense of humor at HOME — BY MAIL. No experience needed to start. Write today for FREE TRIAL LESSON and full particulars.

MOON Gag Cartoon School, Dept. C, Fall Creek, Wis.



SHINE WITHOUT 'POLISH'

New Invention! • Sells Like Wild



SAMPLES FOR AGENTS Sample offer sent immediately to all who send name at once. Hurry. Postcard will do. SEND NO MONEY—just your name. KRISTEE CO., Dept. 693, AKRON 8, OHIO

Tired of the same old job?

Sure, you are. Anybody gets tired of standing still in the same place. But don't get the idea that just quitting your present job and going somewhere else will take you out of the rut.

The trouble may be *inside yourself*. You're restless because you want to get ahead — make more money — do more interesting work. All right — why not?

Look around you. The men who are advancing are the trained men. They've learned special skills that bring them higher pay. It's the men without training who stick in the same old job.

What are you going to do about it? Just wait and hope for something better to come along? If you really *want to succeed*, you can get the necessary training by studying at home in your spare time.

International Correspondence Schools offer you a course in practically any field you choose, giving you the practical plus the bedrock facts and theory. You'll earn while you learn. Students report better jobs and more pay within a few months.

Read carefully the list of subjects in the coupon below.

Pick out the field of study that interests you most — the one with the greatest future for you. Then mark and mail the coupon, and *find out* what I. C. S. can do for you. All it costs is a stamp or postcard, yet it may be the most important step you've ever taken!



wide choice of courses

I. C. S. offers a total of 391 different courses — 391 roads to advancement. Among them is the one you want. You'll find the lessons modern, simple, easy to understand. Each one you study takes you farther along the road to knowledge and success.

machine operator to shop foreman

"When I enrolled for my I. C. S. course in Carpentry and Millwork, I was a machine operator. Today, eleven months later, I am a shop foreman. As a consequence my salary has been increased 73.3%."



Why Home Study?

When you learn the I. C. S. way, your time is your own. Arrange your schedule to suit yourself. No tiresome traveling to and from school. No classes missed because of other engagements. Home study through I. C. S. has proved out for millions of ambitious men and women. You, too, can use it to get ahead!

INTERNATIONAL CORRESPONDENCE SCHOOLS



BOX 5534-L, SCRANTON 9, PENNA.

Please send information about I.C.S. employee training for companies.

Without cost or obligation, please send me the booklet about the course BEFORE which I have marked X:

- | | | | | |
|---|---|---|---|---|
| <p>ART</p> <ul style="list-style-type: none"> <input type="checkbox"/> Commercial Art <input type="checkbox"/> Magazine and Book Illustrating <input type="checkbox"/> Cartooning <input type="checkbox"/> Show Card and Sign Lettering <input type="checkbox"/> Fashion Illustrating AUTOMOTIVE <input type="checkbox"/> Automobile, Mechanic <input type="checkbox"/> Auto-Elec. Technician <input type="checkbox"/> Auto Body Rebuilding and Refinishing <input type="checkbox"/> Diesel — Gas Engines AVIATION <input type="checkbox"/> Aeronautical Engineering Jr. <input type="checkbox"/> Aircraft Engine Mechanic <input type="checkbox"/> Airplane Drafting BUILDING <input type="checkbox"/> Architecture <input type="checkbox"/> Arch. Drafting <input type="checkbox"/> Building Contractor <input type="checkbox"/> Estimating <input type="checkbox"/> Carpenter and Mill Work <input type="checkbox"/> Carpenter Foreman <input type="checkbox"/> Reading Blueprints <input type="checkbox"/> House Planning <input type="checkbox"/> Plumbing | <ul style="list-style-type: none"> <input type="checkbox"/> Heating <input type="checkbox"/> Steam Fitting <input type="checkbox"/> Air Conditioning <input type="checkbox"/> Electrician BUSINESS <input type="checkbox"/> Business Administration <input type="checkbox"/> Certified Public Accountant <input type="checkbox"/> Accounting <input type="checkbox"/> Bookkeeping <input type="checkbox"/> Stenography and Typing <input type="checkbox"/> Secretarial <input type="checkbox"/> Federal Tax <input type="checkbox"/> Business Correspondence <input type="checkbox"/> Personnel and Labor Relations <input type="checkbox"/> Advertising <input type="checkbox"/> Retail Business Management <input type="checkbox"/> Managing Small Business <input type="checkbox"/> Sales Management <input type="checkbox"/> Salesmanship <input type="checkbox"/> Traffic Management CHEMISTRY <input type="checkbox"/> Chemical Engineering <input type="checkbox"/> Chemistry <input type="checkbox"/> Analytical Chemistry <input type="checkbox"/> Petroleum — Nat'l Gas <input type="checkbox"/> Pulp and Paper Making <input type="checkbox"/> Plastics | <p>CIVIL, STRUCTURAL ENGINEERING</p> <ul style="list-style-type: none"> <input type="checkbox"/> Civil Engineering <input type="checkbox"/> Structural Engineering <input type="checkbox"/> Surveying and Mapping <input type="checkbox"/> Structural Drafting <input type="checkbox"/> Highway Engineering <input type="checkbox"/> Reading Blueprints <input type="checkbox"/> Concrete Construction <input type="checkbox"/> Sanitary Engineering DRAFTING <input type="checkbox"/> Aircraft Drafting <input type="checkbox"/> Architectural Drafting <input type="checkbox"/> Electrical Drafting <input type="checkbox"/> Mechanical Drafting <input type="checkbox"/> Structural Drafting <input type="checkbox"/> Sheet Metal Drafting <input type="checkbox"/> Mine Surveying and Drafting ELECTRICAL <input type="checkbox"/> Electrical Engineering <input type="checkbox"/> Electrician <input type="checkbox"/> Electrical Maintenance <input type="checkbox"/> Electrical Drafting <input type="checkbox"/> Electric Power and Light <input type="checkbox"/> Lineman HIGH SCHOOL <input type="checkbox"/> High School Subjects | <ul style="list-style-type: none"> <input type="checkbox"/> College Preparatory <input type="checkbox"/> Mathematics <input type="checkbox"/> Commercial <input type="checkbox"/> Good English MECHANICAL AND SHOP <input type="checkbox"/> Mechanical Engineering <input type="checkbox"/> Industrial Engineering <input type="checkbox"/> Industrial Supervision <input type="checkbox"/> Foremanship <input type="checkbox"/> Mechanical Drafting <input type="checkbox"/> Machine Design-Drafting <input type="checkbox"/> Machine Shop Practice <input type="checkbox"/> Tool Design <input type="checkbox"/> Industrial Instrumentation <input type="checkbox"/> Machine Shop Inspection <input type="checkbox"/> Reading Blueprints <input type="checkbox"/> Toolmaking <input type="checkbox"/> Gas — Electric Welding <input type="checkbox"/> Heat Treatment — Metallurgy <input type="checkbox"/> Sheet Metal Work <input type="checkbox"/> Sheet Metal Pattern Drafting <input type="checkbox"/> Refrigeration POWER <input type="checkbox"/> Combustion Engineering <input type="checkbox"/> Diesel — Electric <input type="checkbox"/> Electric Light and Power | <ul style="list-style-type: none"> <input type="checkbox"/> Stationary Steam Engineering <input type="checkbox"/> Stationary Fireman RADIO, TELEVISION, COMMUNICATIONS <input type="checkbox"/> General Radio <input type="checkbox"/> Radio Operation <input type="checkbox"/> Radio Servicing — FM <input type="checkbox"/> Television <input type="checkbox"/> Electronics <input type="checkbox"/> Telephone Work RAILROAD <input type="checkbox"/> Locomotive Engineer <input type="checkbox"/> Diesel Locomotive <input type="checkbox"/> Air Brakes <input type="checkbox"/> Car Inspector <input type="checkbox"/> Railroad Administration TEXTILE <input type="checkbox"/> Textile Engineering <input type="checkbox"/> Cotton Manufacture <input type="checkbox"/> Rayon Manufacture <input type="checkbox"/> Woolen Manufacture <input type="checkbox"/> Loom Fixing <input type="checkbox"/> Finishing and Dyeing <input type="checkbox"/> Textile Designing HOME ARTS <input type="checkbox"/> Dressmaking and Designing <input type="checkbox"/> Cookery <input type="checkbox"/> Tea Room Management |
|---|---|---|---|---|

Name _____ Age _____ Home Address _____
 City _____ State _____ Working Hours _____ A.M. to _____ P.M.
 Occupation _____

Special tuition rates to members of the Armed Forces. Canadian residents send coupon to International Correspondence Schools Canadian, Ltd., Montreal, Canada.

WHAT SECRET POWER DID THIS MAN POSSESS?

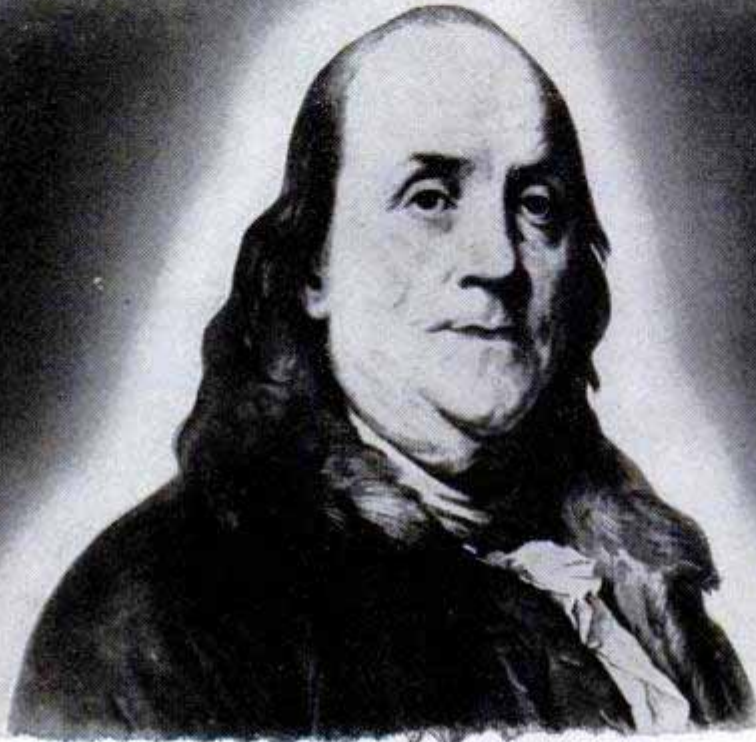

Benjamin Franklin
(A Rosicrucian)

WHY was this man great? How does anyone—man or woman—achieve greatness? Is it not by mastery of the powers within ourselves?

Know the mysterious world within you! Attune yourself to the wisdom of the ages! Grasp the inner power of your mind! Learn the secrets of a full and peaceful life! Benjamin Franklin—like many other learned and great men and women—was a Rosicrucian. The Rosicrucians (NOT a religious organization) first came to America in 1694. Today, headquarters of the Rosicrucians send over seven million pieces of mail annually to all parts of the world.

The Rosicrucians

SAN JOSE • (AMORC) • CALIFORNIA

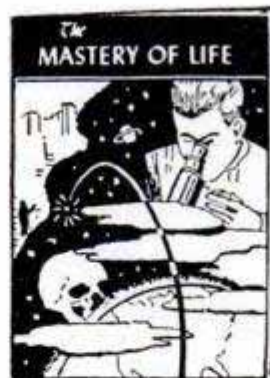

THIS BOOK FREE!

Write for YOUR FREE COPY of "The Mastery of Life"—TODAY. No obligation. No salesmen. A non-profit organization. Address: Scribe H.G.W.

SEND THIS COUPON

Scribe H.G.W.
The ROSICRUCIANS (AMORC)
San Jose, California

Please send me the free book, *The Mastery of Life*, which explains how I may learn to use my faculties and powers of mind.

NAME _____

ADDRESS _____

CITY _____

ZONE _____ STATE _____

THESE MEN ARE GETTING PRACTICAL TRAINING IN **ELECTRICITY**

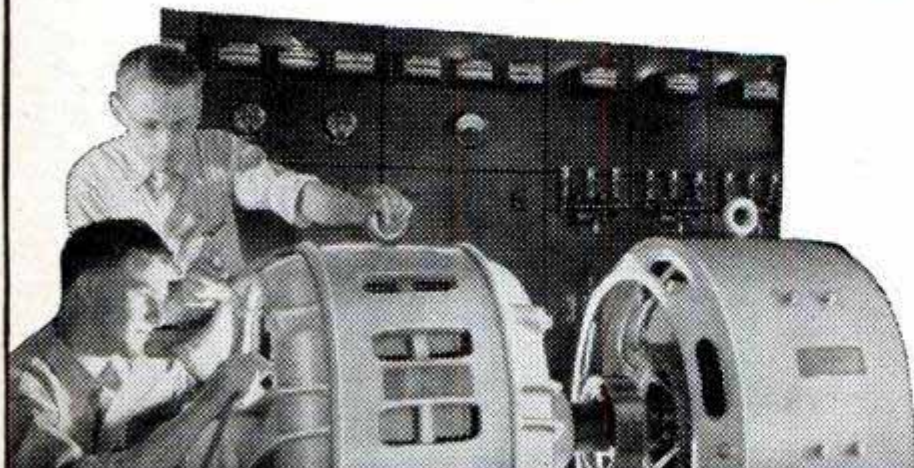

On Real:

**A.C. and D.C. MOTORS
GENERATORS
SWITCHBOARDS
CONTROLLERS
WIRING JOBS
APPLIANCES
ELECTRONIC UNITS**

(Shown at left—Instructor explaining operation and testing of a large Motor Generator in our A.C. Department.)

AND **TELEVISION-RADIO**

On Real:

**TELEVISION SETS
RADIO RECEIVERS
F.M.
(Frequency Modulation)
RECORD CHANGERS
AUTO RADIOS
PUBLIC ADDRESS Systems**

(Right—Instructor helping students check the wiring and trace circuits of television receivers.)



Trained Men Needed for Defense and Military Programs

ELECTRICITY—RADIO—TELEVISION—ELECTRONICS—VITAL in defense program. Trained men whether 16 or up to 50 needed. **TRAIN QUICKLY** for better rating if drafted—Vital job in industry if not.

FINANCE PLAN for non-veterans. G. I. Approved. Special plan for men of draft age.

NOT "HOME-STUDY" COURSES! At Coyne you learn on real, full-size equipment. Trained instructors show you how, then you do typical jobs yourself. We don't teach by mail.

CLIP COUPON NOW for big new illustrated Coyne book. Check whether interested in **ELECTRICITY** or **TELEVISION-RADIO** or both. No obligation; no salesman will call. Get vital facts now!

B. W. COOKE, President



**Mail Coupon for
BIG FREE BOOK!**



B. W. COOKE, President
COYNE SCHOOL
500 S. Paulina St., Chicago 12, Ill. Dept. C2-72H

Send **BIG FREE** book and details of your training offer. This does not obligate me and **no salesman will call.** I am interested in:

ELECTRICITY **TELEVISION-RADIO**

NAME

ADDRESS.....

CITY.....STATE.....

COYNE [SCHOOL]

**A TECHNICAL TRADE INSTITUTE
CHARTERED NOT FOR PROFIT
Established 1899
500 S. Paulina Dept. C2-72H
Chicago 12, Illinois**

ELECTRICITY ★ TELEVISION ★ RADIO ★ REFRIGERATION ★ ELECTRONICS

SCRAM! You SKINNY SCARECROW!

The boys Shouted at me—
ONLY A FEW WEEKS AGO!

"I was a SKINNY, scared, girl-shy skeleton. Now I feel and look great. Pal, do as I did, right NOW! Mail the Coupon below.

I gained 53 lbs. of MIGHTY MUSCLE

6 1/2 inches on my CHEST;

3 inches on each ARM

You can do it in 10

minutes a day and WIN

This 15" Tall SILVER

TROPHY!"



Roger D. Hirsch
New York



ROGER HIRSCH was an 112 lb. 6 ft. weakling LOOK AT HIM NOW!

MAN! aren't YOU as SICK and TIRED as I and thousands of MIGHTY JOWETT HE-MEN were of being SKINNY?

Come on, Pal, Give me 10 pleasant minutes of fun a day and I'll give YOU a NEW HE-MAN BODY for your Old Skeleton Frame.

NO! I don't care how skinny or flabby or how young or old you are I want to MAKE YOU OVER by the SAME METHOD I turned myself from a wreck to a Champion of Champions.

YES! You'll see INCH upon INCH of MIGHTY MUSCLE added to YOUR ARMS. Your CHEST deepened. Your BACK AND SHOULDERS broadened. You'll gain SOLIDITY, SIZE, POWER, SPEED! You'll become an ALL-American HE-MAN, a WINNER in everything you tackle—or my Training won't cost you one cent!

Develop YOUR 520 MUSCLES! Gain Lbs., INCHES, FAST!

Friend, I've made a LIFETIME STUDY of every way known to develop your body. Then I devised my "5-WAY PROGRESSIVE POWER" the only method that builds you 5-ways fast. You save YEARS and DOLLARS by Mailing Coupon NOW.



GEORGE F. JOWETT
Champion of Champions



"IN 90 DAYS

You changed me from a SKINNY wreck to a MIGHTY HE-MAN. With ONE hand I can NOW lift overhead a boy weighing 115 lbs."

John Jacobson, JR. - ARK.

"10 Minutes a day and I am a NEW STRONG MAN! I have a big 49 in. CHEST, powerful 17 inch ARMS a 32 inch WAIST."

Felipe Montoya - Cal.



FREE if you mail COUPON NOW

1. MUSCLE METER

2. JOWETT'S Photo

Book of Famous

Strong Men—

"Nerves of Steel,

Muscles of Iron,"

packed with pho-

tos of miracle he-

men whom Jowett

guided from weak-

lings to muscular

power. Read thrill-

ing adventures of

Jowett, himself.

Mail Coupon NOW!

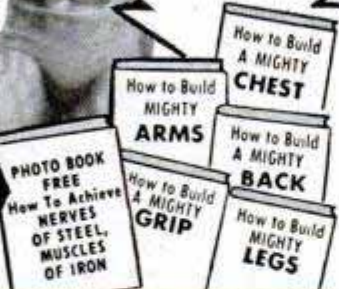

AMAZING

ALL 5

Picture-packed courses while the supply lasts—only

10c

MILLIONS SOLD at \$1 and more

FREE PHOTO BOOK of Famous Strong Men and a MUSCLE METER

Dept. PM-28

"Jowett Courses greatest in World for Building All-Around HE-MEN."

—R. F. Kelley
Physical Director

Name _____ Age _____

Address _____

City _____ Zone _____ State _____

JOWETT INSTITUTE OF PHYSICAL TRAINING
230 FIFTH AVENUE, NEW YORK 1, N. Y.

George: Send me FREE Photo Book of Strong Men, a Muscle Meter, plus all 5 HE-MAN Building Courses: 1. How to Build a Mighty Chest; 2. Mighty Arm; 3. Mighty Grip; 4. Mighty Back; 5. Mighty Legs—all in One Volume "How to Become a Mighty He-Man." I enclose 10c. (No C.Q.D.'s)

MAKE EXTRA MONEY

PLASTICS

LEARN AT HOME

LEARN HOW TO MAKE fast-selling PLASTIC NOVELTIES FURNITURE JEWELRY



SIGNS TOYS LAMPS

WRITE TODAY!

There are RICH OPPORTUNITIES for MEN and WOMEN with "know-how" in Plastics. Interstate's new Plastics course tells and shows how to make hundreds of fast selling items out of Plastics. Gives complete training in fabrication, casting, lamination, molding, internal carving, etc., in simple, easy, step-by-step language and pictures. Plastics and Fabricating Kits for 23 valuable Plastic items come with training at no extra cost. START A PLASTICS BUSINESS OF YOUR OWN. No other industry holds such promise for the future. You can make big money manufacturing novelties, toys, signs, etc., in your own home in spare or full time. Don't wait! Learn NOW how Interstate's Plastics Training qualifies you for success in the Plastics field.

PLASTICS AND SUPPLIES FURNISHED FOR 23 VALUABLE PROJECTS

INTERSTATE TRAINING SERVICE

Dept. 3CH

Portland 13, Oregon



Bar Bells

Buy Direct From Factory

Write for free booklet and price list

\$8.95 up

INDEPENDENT IRON WORKS

2416 East 23rd Street, Los Angeles 58, Calif.

Dept. B

A "GOOD HAND" HELPS YOU SUCCEED!

LEARN TO WRITE WELL



beautifully written, plus special pen-point for shaded writing.

OUR 53rd YEAR

Only 10c

Handwriting quickly improves with our easy-to-understand picture lessons! Put your spare time to good use; send today for FREE BOOKLET, "How to Become a Good Penman," or check volume wanted below at \$1 each: Business Writing Artistic Writing Card Writing Bird & Design Flourishing Engrossing Alphabets. COMPLETE SET \$4.50. Ask for price list of penman's supplies.

TAMBLYN SCHOOL of PENMANSHIP

S. A. Ziller, Pres., 442 Ridge Bldg., Kansas City, Mo., USA

MEN! WHY BUY YOUR NEXT SUIT?

GET IT AS A BONUS

MAKE BIG CASH PROFITS, TOO! Just show beautiful fabrics and latest fashions to friends. They'll order fast. You keep up to \$11.50 profit per suit. Perfect fit and satisfaction guaranteed. Send no money—get complete selling outfit FREE. Start earning big cash profits and Bonus Suit or Pants at once. Write today! O.K. TAILORING CO., 325 S. Market St., DEPT. 136, CHICAGO 6, ILLINOIS



Learn TATTOOING At Home

Earn extra MONEY—Tattoo blood types and designs in your community. Splendid opportunity in every town. Prepare in spare time. Practical instructions. Send 25c for details and list of Tattoo Supplies. No obligations. ZEIS SCHOOL OF TATTOOING • 728 Leslie, Rockford, Ill.



FUN FOR EVERYONE!



The Easy Way to Build Your Own OUTDOOR FIREPLACE

Food Cooked Outdoors Tastes Better... offers real enjoyment for the entire family... perfect for entertaining guests! It's easy and economical to build your own Cook Nook. Just add the masonry (any design you prefer) around the Majestic all-metal unit and start cooking! See your dealer today or send check or M. O.

Model OF-28 only 21" x 26" x 13 1/2" \$20.95



The Majestic Co.

359 Erie St., Huntington, Ind.

SEND FOR free DESIGN BULLETIN! Big Selection of easy-to-follow designs

NOW AT HOME IN SPARE TIME!
Get the "BASICS" you've missed!



LEARN RADIO *plus* TELEVISION AND ELECTRONICS

**LEARN IT THOROUGHLY! FROM AMERICA'S
 MOST COMPLETE HOME TRAINING SCHOOL!**

**You Get All The Parts
 -Even Tubes-** for this modern
 Superheterodyne Receiver - and lots of
 other equipment. And you get to keep it!

Let **NATIONAL SCHOOLS**—the famous resident-training school founded in 1905—train you as you want to be trained. One of the largest schools of its kind, National is located in Los Angeles—center of Radio-Television world! You learn from lessons prepared by men who are successful Radio and Television technicians.



**ONLY NATIONAL SCHOOLS GIVES YOU THIS
 PROFESSIONAL MULTI-TESTER!**

You get this amazing new testing instrument! Ready to use! Simple to operate. Accurate and dependable. And—it's light enough to carry around—so you can use it at home or on service calls.

**HERE ARE ONLY A FEW OF THE
 GOOD-PAYING JOBS YOU CAN CHOOSE!**

- Radio Station Engineer
- Inspector Technician
- District Service Manager
- Service Specialist
- Aircraft Radio Inspector
- Special Gov't Positions
- Own Your Own Repair Shop
- Sound Truck Operator

Attention! Men Going into the Service Soon!
 With this training you can get into *special* service classifications—with higher pay and grade—fast!

FREE SERVICE FOR GRADUATES!

National Schools helps you find your place in the field of your choice. We help you start toward the good pay you've dreamed of. Get the training you should have. Mail the coupon for the facts—today.

NATIONAL SCHOOLS
 LOS ANGELES 37, CALIFORNIA • ESTABLISHED 1905
 In Canada: 193 E. Hastings St., Vancouver, B.C.

MAIL THIS COUPON TODAY—WITHOUT FAIL!

NATIONAL SCHOOLS, Dept. RB-82
 4000 South Figueroa Street
 Los Angeles 37, California

Mail in envelope
 or paste on
 postal card

Mail me FREE the book mentioned in this ad. Also a free sample lesson. I understand no salesmen will call on me and that there is no obligation.

NAME _____ AGE _____

ADDRESS _____

CITY _____ ZONE _____ STATE _____

Vets! Check here if released from service less than 4 years ago.

You Train at Home—In Your Spare Time!
 National Schools Shop-Method Home Training gives you basic and advanced instruction in all the phases of Radio-Television-Electronics.

You learn fast from hundreds of diagrams and pictures. All instructions are written by experienced technicians who work in Radio and TV every day. All instructions have been developed and tested in National Schools' own big labs and studios, which are equipped with the latest RCA equipment. No wonder this National Schools course is so up-to-date, practical, easy!

**We Teach You How To Make Welcome
 Extra Money—While You Learn!**

Many National Schools students—men like you—make plenty of extra dollars in spare time! Fixing neighbors' radios and appliances—and other ways we teach you. You can earn while you learn!

**LOOK! WE SEND YOU ALL
 THESE PARTS!**



With famous National Schools Shop-Method Home Training, you learn *by doing*—the easy, practical, interesting way. The way you want to learn. We send you many parts—all of modern professional quality. You do lots of practical experiments. You advance day by day, step by step. The free book tells you all about it. Answers all your questions. Use the coupon. And do it now—while you're thinking of it.

**DON'T PUT
 IT OFF!
 GET THE
 BIG SALARY
 YOU HAVE
 ALWAYS
 WANTED!**

**Today's Shortage of Trained Technicians
 Creates Chance of a Lifetime For You!**

Think of it! With guided missiles, radar, and other electronic devices so important to defense! And with over 90,000,000 radios, over 12,000,000 TV sets. With more than 3100 radio stations...over 100 TV stations—and more building every day. Men are wanted in Radio-Television-Electronics—America's fastest-growing field—act quickly!

**Job Security! Big Money! For YOU!
 in Today's Expanding Industries!**

National Schools graduates—men just like you—are earning good money all over the country. Why not you? Enjoy your work—rather than having to drag along in just any old job. Mail coupon today—find out how easy it is.

**National Schools Has Trained 1000's of
 Successful Men! Why Not YOU?**

In almost every state—and many foreign countries—National Schools graduates are filling big jobs with national companies. Or running their own successful businesses. National Schools Shop-Method Home Training is *complete* training. You can take advantage of today's great opportunities in Radio-Television-Electronics—fast.



SEND
NO MONEY
•
MORE THAN
4000 PAGES
•
2750
PICTURES

On
Approval

**9 BIG COMPLETE BOOKS
BUILDING, ESTIMATING, CONTRACTING**

Examine this Up-to-Date Edition for 10 days. See how these nine books supply easily understood training that will help you to get a better job and make more money, or start a profitable business for yourself. Think what a BIG help it will be to have them handy for use in solving all sorts of building problems. Learn to draw plans, estimate, do all-new construction and modern remodeling to meet fast growing demand. More than 4000 pages of practical, pay-raising information with 2750 helpful illustrations, on such subjects as blueprint reading, concrete forms, masonry, carpentry, steel square, electrical wiring, plumbing, heating, painting, and hundreds more. In our more than 50 years we have never offered more complete building information. Send the coupon TODAY. (A year's consulting privileges with our engineers now given with these books without extra cost.)

AMERICAN TECHNICAL SOCIETY—Publishers Since 1898
Dept. GC19, Drexel Ave., at 58th St., Chicago 37, Ill.

I would like to examine your 9-Volume Set of Building, Estimating, Contracting Books. I will pay the delivery charges only, but if I choose I may return them express collect. If after 10 days' use I prefer to keep them, I will send you \$3 and pay the balance at the rate of only \$4 a month until \$34.80 has been paid. Include consulting service as offered above.

Name _____

Address _____

City _____ State _____

Please attach letter giving employer's name and address (if self-employed give business man reference). Men in service please give home address.

**Learn this
Profitable
Profession**



**IN 90 DAYS
AT HOME
Money-Making Career Open
to Men and Women, 18 to 60**

Hundreds of men and women between 18 and 60 make \$10 to \$20 in a single day giving scientific Swedish Massage and Hydro-Therapy treatments. There is big demand from doctors, hospitals, sanatoriums and clubs. Graduates earn large full time income from these or in private practice in their own offices. Others make good money from home treatments given in spare time. Learn this interesting money-making profession in your own home, through our home study course. Same instructors as in our nationally known resident school. You can win independence and prepare for future security by qualifying for your Graduation Certificate. Course can be completed in 3 to 4 months. Many earn while they learn. Begin your training at once.



NEW 32-PAGE BOOKLET FREE

Fill in the coupon below (please print name and address) and mail it for your FREE copy of 32-page Information Booklet. If you act at once we will include Anatomy Charts and Success Booklet which supply additional information you should have. All will be sent postage paid.

THE COLLEGE OF SWEDISH MASSAGE
Dept. 264K, 41 E. Pearson St., Chicago 11, Illinois

Please send me FREE and postpaid New 32-Page Illustrated Booklet, Anatomy Charts and Success Booklet at once.

Name _____ Age _____

Address _____

City _____ State _____

NEW "PAINT PEN"

**PAINT STRIPING TOOL
Works like a Fountain Pen
Stripes with Paint instead of Ink!**

This amazing new "PAINT PEN" is a Paint Striping Tool that makes it easy to do expert striping on furniture, bikes, model planes, autos, signs, toys, linoleum, wall board, etc. Makes plain, painted walls look like tile. Paint straight, curved, circular or evenly spaced parallel lines the same way a professional painter does. Simply fill Tubular Glass Paint Fountain with any color paint and wheel tip feeds paint evenly. Tips interchangeable — jaws split apart for easy cleaning. Tool complete with tip for 1-16 inch stripe only \$1.00 postpaid. Other complete tools with 1-64, 1-32, 5-64, 1-16, 5-64, 3-32, 1-8 inch tips, \$1.50 ea. Extra tips, 75c each. Complete KIT with 7 tips, \$5.00. C.O.D.'s postage collect. Here's the handiest tool in your whole painter's kit. Get yours today.



Paint
STRAIGHT,
CURVED OR
PARALLEL LINES

Home Craftsmen

Just the tool you've been waiting for! New Paint Striping Tool gives "professional" results every time, yet simple and easy to use as a fountain pen. Adjustable guide keeps lines straight as an arrow. Just as easy to make curves or free hand designs. Adds new beauty and finished look to everything you paint. Send \$1 now!

Only
\$1.00

WENDELL MFG. CO., Dept. 3-O
4234 LINCOLN AVENUE, CHICAGO 18, ILL.

\$5000.00 IN PRIZES DRAW MY HEAD

1st & 2nd PRIZES
COMPLETE \$130 ART COURSE
80 OTHER VALUABLE PRIZES
Your Drawing Judged and Answered
Take this test and try for a thrilling prize. Discover if you have profitable Art talent. You may gain a lifetime of happiness and high earnings if you mail your drawing today. Amateurs only. Our present students not eligible. Copy this girl 4" to 6" high in pen or pencil, and mail to us. None returned. Winners notified. New \$5,000 Contest each month. Your drawing will be entered in Contest for month in which we receive it. Send your drawing now with your name, address, age, occupation. Enter today.
WALLER ART EXCHANGE Studio 127, 1000 N. Charles St. Baltimore-1, Maryland



LAW FREE BOOK



Your FREE copy of "The Law-Trained Man" shows how to gain prestige and greater earnings through Blackstone home law study. All instruction material furnished including 16-volume Law Library written by 65 well-known law authorities. Lawyers, judges among our graduates. LL.B. degree. Low cost; easy terms. Write today.
BLACKSTONE COLLEGE OF LAW 225 N. Michigan Ave. Dept. 50C, Chicago 1, Ill.
A Correspondence Institution Founded in 1890

Hand Guide!

POSITIVELY controls movement of hand until one's Penmanship is quickly corrected. Inexpensive. Write,

OZMENT (INVENTOR), 34-P, ST. LOUIS, MO. (BX665)

AVIATION

The aircraft industry urgently needs trained personnel. Here is YOUR opportunity for a rewarding and interesting future. Study Aeronautical Engineering, Engineering Drafting, Airplane and Engine Mechanics (approved by C.A.A.). Outstanding faculty, modern equipment. Part-time employment. Free placement service. Big demand for graduates. 23rd year. Founded by Curtiss-Wright. Write for free bulletin and "Opportunities in Aviation"

AERONAUTICAL UNIVERSITY

Dept. 75, 1905 Prairie Avenue, Chicago 16, Illinois



**U. S. ARMY
POCKET
CAN OPENER**

Used in the Foxholes of the World... The G.I.'s BIGGEST LITTLE HELPMATE. Worth a million when you need it. Does the work of can openers 10 times its size. Actual Size →
Send remittance and stamped self-addressed envelope for mailing. We'll include FREE illustrated folder of other exceptional surplus values.

25c each

FOLDS FLAT Fits Key Ring

KAUFMANN ARMY-NAVY
318 W. 42nd St., New York 36, N.Y.



Now IN YOUR OWN HOME Learn

TELEVISION RADIO

the Amazingly Effective
D.T.I. WAY

**—with the aid of BOTH
HOME EQUIPMENT
and HOME MOVIES**

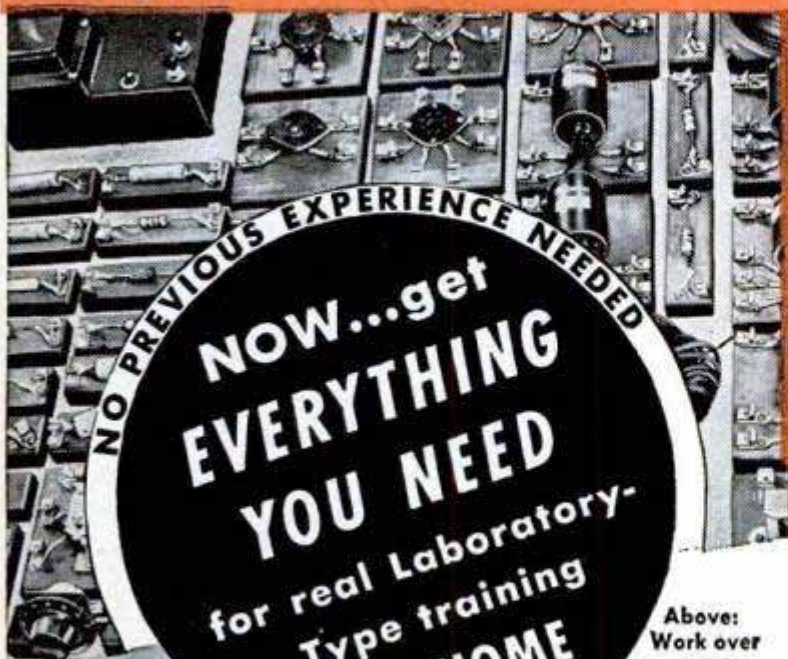

NO PREVIOUS EXPERIENCE NEEDED
**NOW...get
EVERYTHING
YOU NEED**
for real Laboratory-
Type training
AT HOME

Above:
Work over
300
fascinating
experiments
with this
equipment

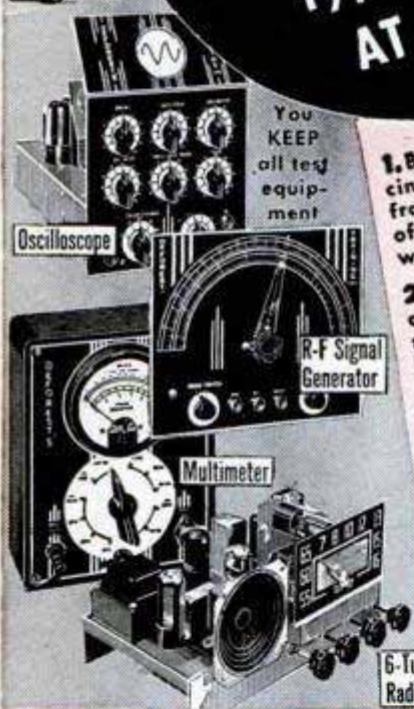

1. Build over 300 fascinating experiments from 16 BIG SHIPMENTS of Electronic-Radio parts which you KEEP.
2. Build valuable commercial-type test equipment—as shown to the left—which you KEEP. This includes a quality OSCILLOSCOPE—a must for Television work.
3. Use a 16 mm. movie projector and new series of Hollywood produced instructive movies—a wonderful aid to help you grasp important fundamentals faster...easier...better.
4. Enjoy well-illustrated, easy-to-read lessons with handy FOLD-OUT diagrams.
5. Get an honest-to-goodness EMPLOYMENT SERVICE to help you get a good job after graduating—or assistance in starting your OWN SALES AND SERVICE BUSINESS. Mail coupon today for the complete details.

What will mailing the coupon below *do for YOU?* Just this! You'll find out about one of today's most remarkable...practical ways to prepare to get into America's amazing billion dollar opportunity field of TELEVISION-RADIO-ELECTRONICS. You'll see how to get into fascinating work that pays well...that offers one of America's most promising futures...that enables you to start your own business almost "on a shoe string," if you prefer this to a job opportunity.

And above all, you'll get some GOOD NEWS especially welcomed by men anxious to earn REAL MONEY in this thrilling field. For you'll see that NOW you can get the kind of practical, laboratory-type training so desirable for making real progress in Television-Radio-Electronics...and WITHOUT LEAVING HOME.

You'll see that DeForest's Training, Inc. sends everything needed to set up your own HOME LABORATORY. You get and keep the same type of basic electronic equipment used in our modern Chicago Training Laboratories. You get home training that includes the knowledge and experience gained from training thousands of students first hand in Chicago. And to top it all, you use DTI's amazingly effective and exclusive home training aid—INSTRUCTIVE MOVIES. But why not get the complete story? Mail coupon today for information-packed literature.

MODERN LABORATORIES
If you prefer, get all your preparation in our new Chicago Training Laboratories—one of the finest of its kind. Ample instructors, modern equipment. Write for details!

MILITARY SERVICE!
If you're subject to military service, the information we have for you should prove very helpful. Mail coupon today.

**Get BOTH of these colorful,
information-packed folders
FREE**



DeFOREST'S TRAINING, INC.
AFFILIATED WITH
De Vry Technical Institute
CHICAGO 14, ILLINOIS

DeFOREST'S TRAINING, INC. Dept PM-8-1
2533 N. Ashland Avenue, Chicago 14, Ill.

I would like valuable, information-packed folders showing how I may get started toward a good job or my own business in Television-Radio-Electronics.

Name..... Age.....
Street..... Apt.....
City..... Zone..... State.....

*Mail Coupon
Today*

GET THE WORLD'S LEADING

RADIO & TV CATALOG

★
FREE

★
1952

212-Page
Edition

★
ALLIED'S

**BIG COMPLETE
BUYING GUIDE**

Save on Everything
in Radio and TV

NEW
UP-TO-DATE
SEND FOR IT NOW



**Everything for Experimenters,
Builders, Amateurs, Servicemen,
Engineers and Soundmen**

Send for ALLIED'S 212-page 1952 Catalog, the value-packed guide to everything in Radio and Television! Latest home radios, TV equipment, Amateur supplies, P.A. Systems, Hi-Fidelity Sound, recorders, test instruments, builders' kits—plus the world's largest stocks of electronic parts, tubes, tools, books and diagrams. Get more for your money—send today for your FREE 1952 ALLIED Catalog!



Get Radio's Leading
Buying Guide Today

FREE!

ALLIED RADIO

ALLIED RADIO CORP., Dept. 5-H-2
833 W. Jackson Blvd., Chicago 7, Ill.

Rush FREE 1952 ALLIED 212-Page Catalog.

Name _____

Address _____

City _____ Zone _____ State _____



EVERY PASSENGER TIRE
**UNCONDITIONALLY
GUARANTEED**
plus TIRE INSURANCE FREE

Here's DOUBLE proof that we bear the loss if your passenger tire wears out within the guarantee period or is damaged in any way (except willfully). Don't take risks: we send FREE insurance certificate PLUS written unconditional guarantee with your order.

10% off ON TWO OR MORE USED TIRES

LOW COST QUALITY TIRES
Unconditional Six Months' Guarantee plus Tire Insurance Free

600-16	650-16	550-17
600-15	640-15	475-19
650-15	550-16	710-15
550-15	670-16	760-15
\$3.50	\$3.75	\$3.95
ea.	ea.	ea.

BETTER GRADE PASSENGER TIRES
Unconditional One Year Guarantee plus Tire Insurance Free

600-16	700-16	700-15	550-16
600-16(6)	600-15	750-16	475-19
650-16	650-15	550-15	550-17
640-15	710-15	820-15	475-19
670-15	760-15	670-16	760-16
\$5.59	\$7.59	\$5.59	\$5.95
6.50	5.59	12.25	5.75
5.79	5.59	5.59	5.75
5.95	6.50	7.50	7.75
5.95	6.75	6.95	

MUD AND SNOW TIRES
TWO YEAR WRITTEN GUARANTEE

600-16	900-16	750-20 Reg.	\$15.95
650-16	650-16(6)	650-15	6.50
\$6.95	\$12.95		
7.50	9.50		

EXTRA VALUE TRUCK TIRES
ONE YEAR WRITTEN GUARANTEE

600-20	750-20	825-20	1100-20
650-20	32x6(8)	900-20	1100-22
700-20	32x6(10)	1000-20	750-20(10)
\$10.75	\$14.50	\$21.50	\$26.95
11.75	11.75	19.50	24.50
12.50	12.50	20.00	18.00

Complete line of High Mileage Tires in stock. Write for price list for sizes not listed. Take off 10% on orders for two or more tires. All prices F.O.B. Richmond, Va.
MAIL ORDERS PROMPTLY FILLED. Send check or money order with this ad. **THE SAFTYRE CO.** Dept. PM, 1801 E. Broad Street, P.O. BOX 2254, RICHMOND, VA.

**BECOME AN EXPERT IN
TRAFFIC**

Traffic men earn \$4,000 to \$10,000 and up. Thousands of firms need experts on rates, tariffs, regulations. We train you thoroughly in spare time at home for executive traffic jobs. Personal training under traffic authorities. Placement counsel and help. Write for free 48-page book "Traffic Management—the Fast Growing Profession."

LASALLE Extension University, 417 So. Dearborn St. A Correspondence Institution Dept. 864-T, Chicago 5, Ill.

GET THIS SUIT AS A BONUS!



Sell popular Smith tailored-to-measure suits. Make up to \$10.00-\$15.00 daily taking orders from friends. You get paid 3 times—(1) when you take the order and pocket the cash profit, (2) when we pay you an EXTRA cash bonus, (3) when you get your own suit as an added bonus, without cost. No experience needed. Send for FREE selling kit and sample line. Write fully, give age, sales exp., etc.
W. D. SMITH & CO., Dept. D
833 W. Jackson Blvd., Chicago 7, Ill.

Watch Repairing Pays Big Money Learn at home

Watch repairers in great demand. Train step-by-step in 10 easy lessons. We furnish all tools and 15 jewel watch and practice movement. Turn spare time into cash. A licensed school. Low cost. Send for FREE book today.

ILLINOIS SCHOOL OF WATCH REPAIRING
2870 Elston Ave., Dept. PM-82, Chicago 18, Ill.

NO CAR TROUBLE IS HARD TO FIND...



when you have MOTOR'S new "Trouble Shooter" Handy, pocket-size indexed manual lists 2000 CAUSES of car troubles and tells WHERE to look for them. For instance, suppose Fan Belt is noisy; index leads you instantly to 7 things that can be wrong. In same way, "Trouble Shooter" covers engines, clutches, brakes, ignition, rear axles, overdrives, etc. Section on automatic transmissions alone is worth more than price of book! Spiral binding; book stays open while you work.

SEND NO MONEY. Try book at our risk. Just mail your name and address to: MOTOR Book Dept., Box EE, 250 West 55th St., New York 19, N. Y. Pay post-man \$1 plus C.O.D. chg. Use 7 days. If not delighted, your \$1 back. (Or save C.O.D. cost by sending \$1 now. Same money-back guarantee.)



WOULDN'T TAKE \$1000 FOR COURSE
 "The lessons are so simple that anyone can understand them. I have learned to play by note in a little more than a month. I wouldn't take a thousand dollars for my course."
 *S. E. A., Kansas City, Mo.



PLAYS ON RADIO
 "I can't keep from telling you that I have a good position playing from KTHS, Hot Springs, Ark., every morning."
 *J. S., Okla.



PLAYS AT DANCES
 "The Piano course I'm taking is the 3rd course with your school. Previously I took Saxophone and Clarinet. Since then I've played a lot of dance jobs."
 *E. A., Lake View, Iowa

THOUSANDS NOW PLAY who never thought they could!

You, too, can play any instrument by
 this **EASY A-B-C METHOD**

YOU think it's difficult to learn music? That's what thousands of others have thought! Just like you, they longed to play some instrument. But they denied themselves the pleasure—because they thought it took months and years of tedious study to learn.
 And then they made an amazing discovery! They learned about a wonderful way to learn music at home — without a private teacher — without tedious study — and in a surprisingly short time. They wrote to the U. S. School of Music about this remarkable short cut method. A free print and picture sample actually showed them how easy it was to learn.
 The result? Over 850,000 people have studied music at home this simple, A-B-C way. They have found the key to good times, popularity and profit.
 And that's what you can do right now. Simply mail the coupon. Get the proof that you, too, can learn to play your favorite instrument — quickly, easily, in spare time at home. Just read the fascinating illustrated booklet — examine the print and picture sample. Tear out

the coupon now, before you turn the page. Instruments supplied when needed, cash or credit. **U. S. SCHOOL OF MUSIC, Studio B308, Port Washington, N. Y.** 54th Successful year (Established 1898.)
 *Actual names on request. Pictures by professional models.

FREE! Print and Picture Sample

**U. S. SCHOOL OF MUSIC,
 Studio B308, Port Washington, N. Y.**

Send me Free Book and free Lesson-Sample. No salesman is to call upon me. I'm interested in playing (name instrument).....
 I do I do not—have an instrument now.

Name.....
 (please print)

Address.....

SENSATIONAL OPTICAL BARGAINS HAND SIGHTING LEVEL

Handy! Simple to Use!
 Projects a level line of sight—invaluable for laying out drains, ditches, foundations, gardens; for contour plowing and soil erosion work. Accurately designed and calibrated. Used wherever grades must be established or level line necessary over an appreciable distance. Directions included.

Stock No. 105-H.....\$2.50 Postpaid

SLIDE PROJECTOR SETS Consists of all unmounted lenses you need to make the following size projectors:
 Stock #4029-H—35 mm.....\$2.85 Postpaid
 Stock #4038-H—2¼"x2¼".....\$3.35 Postpaid
 Stock #4039-H—2½"x3½".....\$3.35 Postpaid

SIMPLE LENS KITS —Include plainly written, illustrated booklet showing how you can build lots of optical items. Use these lenses in photography and for dozens of other uses in experimental optics, building TELESCOPES, low power Microscopes, etc.
 Stock #2-H—10 lenses.....\$ 1.00 postpaid
 Stock #5-H—45 lenses.....5.00 postpaid
 Stock #10-H—80 lenses.....10.00 postpaid

We Have Literally Millions of War Surplus Lenses and Prisms for Sale at Bargain Prices. Numerous Types of Instruments, Too! Write for **FREE CATALOG-H**

EDMUND SCIENTIFIC CORP., Barrington, N. J.

SHORTHAND IN 6 WEEKS AT HOME

WRITE 120 WORDS PER MINUTE

Age No Obstacle

Famous Speedwriting Shorthand system. No symbols, no machines. Uses ABC's. Easiest to learn and use. Qualify at home in spare time. Fast preparation for a better position and a sound, substantial future. Nationally used in leading offices and Civil Service; also by executives, writers, speakers, lawyers, scientists, college students. Over 100,000 taught by mail. Also typing.

The very low cost will surprise you

29th YEAR
 Schools in over 260 cities
 Write for **FREE** Booklet to:



MASTERS SPEEDWRITING IN FEW SHORT WEEKS
 "In my work as a writer I had long felt the need for a knowledge of shorthand, but had no time to learn it. One day I read a Speedwriting advertisement and decided to enroll. Within just a few short weeks I mastered Speedwriting and now its speed and accuracy are proving invaluable."
 —Joseph J. Kudlac, Clifton, N. J.

FALSE TEETH STAY TIGHT EVEN AFTER DRINKING HOT COFFEE!

● Mrs. J. P. writes: "I was delighted to find Staze held my teeth tight *even after hot coffee!*"

Staze is fluid-resistant . . . contains "aqua-trol," which holds back moisture penetration. Thus, it holds false teeth tighter, longer. With Staze, thousands now bite into corn and steak — enjoy all the hot coffee they want.

Even if plates are old and loose, Staze holds them tighter. Many denture wearers say that with Staze old plates seem to hold better than when new. At drugstores, or write **STAZE, Box PM-7, Stamford, Conn., for free tube.**

Speedwriting
 Dept. 1508-2, 55 West 42 St., N. Y. 36

We teach you FREE!



We put you in Business!

HERE'S THE BIG OPPORTUNITY FOR YOU! Learn a new and fascinating occupation... a wonderful hobby... and MAKE MONEY AT THE SAME TIME! OPERATE AT HOME OR IN A SMALL SHOP! AND... the complete instructions... books, lessons and personal guidance COST YOU NOTHING! We teach you FREE how to make the most beautiful jewelry you have ever seen: door-knobs imbedded with interesting objects, nite-lites, book-ends, coasters, name-plates, ash trays, paper weights, statues, figurines, souvenirs, novelties, gadgets, etc... an endless variety of high-quality, highly saleable products out of LIQUID MARBLE, TRANSPARENT GEM-LIKE LIQUID PLASTIC, CERAMICS, PLASTER, COMPOSITIONS, STONE, ETC. All without tools or machinery! The manufacture of these lovely objects is as easy as pouring water out of a glass! And—you learn how ABSOLUTELY FREE! The only limitation is your own IMAGINATION! No special talents or experience are required!

You get more than the FREE INSTRUCTIONS! We also show you methods of selling your finished work... even selling part of it to us! Start on a shoestring! And overnight, become established in one of the most fascinating and profitable occupations in existence!

Just send 25c for our big catalog, "CASTING MATERIALS, MOLDS, ETC." — and you're on your way! Along with the catalog we will include the book, "THE ART AND BUSINESS OF CASTING" absolutely FREE! And—surprising details on an amazing, exclusive Plasticast offer guaranteeing your success! DON'T DELAY! This could be the most important step of your lifetime! WRITE TODAY!

PLASTICAST CO. (DEPT. C)

P. O. Box 6737 (WRITE TO NEAREST ADDRESS) P. O. Box 987
Chicago, 80, Ill. Palo Alto, Calif.
CANADIAN CUSTOMERS: Send 35c for catalog to Canadian Ind. PLASTICS, 1056 1/2 W. Pender St., Vancouver, B. C.



No Experience Needed To PRINT YOUR OWN POST CARDS

The GEM STENCIL DUPLICATOR saves money... gets results quickly! Hundreds of uses for every type of business and organization. We ship the GEM complete with all supplies, Guide Board for accurate printing and 60-page Book of Ideas at the special low price of only \$8.50 (a \$15 value)



FREE TRIAL OFFER

Our 21st Year

Use the GEM FREE at our expense! SEND NO MONEY. Write and complete GEM outfit will be sent you postpaid. After ten days, send us only \$8.50 or return the GEM. You must be satisfied!

BOND EQUIPMENT CO. Dept. 48
6633 Enright • St. Louis 5, Mo.

RUPTURED?

Get Relief This Proven Way

Why try to worry along with trusses that gouge your flesh—press heavily on hips and spine—enlarge opening—fail to hold rupture? You need the Cluthe. No leg-straps or cutting belts. Automatic adjustable pad holds at real opening—follows every body movement with instant increased support in case of strain. Cannot slip whether at work or play. Light. Waterproof. Can be worn in bath. Send for amazing FREE book, "Advice To Ruptured" and details of liberal truthful 60-day trial offer. Also endorsements from grateful users in your neighborhood. Write:

CLUTHE SONS, Dept. 31, Bloomfield, New Jersey.

LEARN WATCH REPAIRING



AT HOME. By our modern and original system of instruction you can learn every part of the **WATCH REPAIRING TRADE AT HOME.** Prepare yourself for a well-paying position or start in business after completing our course of instruction. Good watch repairers are in demand and generally earn very good salaries. For particulars apply to the **WISCONSIN SCHOOL OF WATCH REPAIRING**, 759 N. Milwaukee, Dept. 8, Milwaukee 2, Wis.

REAL ESTATE

BE A BROKER
PAYS BIG! SEND FOR FREE, BIG, ILLUSTRATED CATALOG NOW! Graduates report making substantial incomes. Start and run your own business quickly. Men, women of all ages, learn easily. Course covers Sales, Property Management, Appraising, Loans, Mortgages, and related subjects. **STUDY AT HOME** or in classrooms in leading cities. Diploma awarded. Write TODAY for free book! No obligation.
WEAVER SCHOOL OF REAL ESTATE (Est. 1936)
Suite 300 Law Bldg. Dept. PM Kansas City, Mo.



ONLY 2 SHINES A YEAR AND SHE GLEAMS LIKE NEW!

\$1.00 BRINGS YOU BOTH CANS!

Yes sir—give your car the glow that rests your elbow! Use LACQUER CLEANER, the amazing pre-wax cleaner, and LACQUERWAX, the famous car finish protector. It's 5 times faster and easier to apply than ordinary paste waxes. One treatment lasts 6 months or longer.

LACQUERWAX contains no lacquer, but this hard, liquid wax is CLIMATEPROOF! Its brilliant luster shines right thru hot sun and driving rain. You can't wash it off—it won't spot! It brings out and preserves the full beauty of your car's finish. Use the LACQUER CLEANER first to remove dead paste wax and dirt, then LACQUERWAX for the beauty treatment. BOTH 10 oz. cans—ample to do your complete car—for ONLY \$1. Mail coupon NOW!

LACQUERWAX CO. (Dept. PM-8)
31 SPRUCE ST., HARTFORD 3, CONN.
Gentlemen: My dollar bill, check or money order is enclosed for the 2 ten oz. cans—LACQUERWAX & CLEANER.
Name
Address
City..... Zone.... State.....
LACQUERWAX

START YOUR OWN ELECTRICAL APPLIANCE REPAIR BUSINESS



Repair electrical appliances of friends and neighbors. Service electrical equipment in factories, stores, etc. Work full or part time! New Shop Method home-training system. Rush name today for **FREE BOOK** and special form for getting Electronic Kit, Valuable Heating Element Kits, Advisory Service and Illustrated Instructions on new easy-payment plan. Pay later from **EARNINGS WHILE LEARNING.** Rush name today.

CHRISTY TRADES SCHOOL
4432 N. Kedzie, Dept. D-903, Chicago 25

GET INTO **AUTO-DIESEL** & **ALLIED MECHANICS** *Master All Phases*

JOBS LIKE THESE ARE AVAILABLE TO TRAINED MECHANICS. CHOOSE THE FIELD YOU LIKE BEST

GET COMPLETE TRAINING FOR:

Automotive Motor Tune-Up • General Garage Mechanic • Agricultural Implements Mechanic • Diesel Engine Rebuilding • Diesel Fuel Injection • Auto Engine Rebuilding • Auto Electrical Service • Parts Dealers • Bus & Truck Lines • Industrial Maintenance • Contracting and Excavating • Business of Your Own • AND MANY OTHERS!

SHOP-METHOD HOME TRAINING BY AN ESTABLISHED RESIDENT SCHOOL TRAINS YOU FOR ALL OPPORTUNITIES IN AUTO & DIESEL INDUSTRIES!

Opportunity is everywhere for the trained Auto-Diesel Mechanic. Highways throng with cars, buses, trucks, tractors. Garages and service stations are busy. Farm machinery is "going Diesel." Factories, ships, farms, railroads, general industry, are dependent on engine power. Here's a dynamic, fast-growing field that needs trained men who know all phases: installation, operation, maintenance and repair. Now—National Schools offers you a practical, all embracing Auto-Diesel Mechanic's Course, including all these advantages:



COMPLETE SHOP-METHOD HOME TRAINING COVERS

DIESELS—High Speed and Heavy Duty SEMI-DIESELS—Gasoline and Special Fuel Engines AND ALLIED MECHANICS!

- | | |
|-----------------------|------------------------|
| Basic Lesson Texts | Engine Service Manuals |
| Diesel Installations | Engine Repair |
| Operation-Maintenance | Drive Systems |
| Diesel Chart Manual | Diesel Electric Power |
| Spare Time Lessons | Thermodynamics |

AND YOU CAN EARN WHILE YOU LEARN!

With our practical Master Shop-Method Home Training, you study at home in your spare time. You get Spare Time Work Lessons showing you how to earn while you learn, for extra money and experience. You learn by DOING.

DRAFT AGE? Services offer better ratings, more pay to men with training. Start now—if called while training, we'll make satisfactory adjustment for you.



FREE BOOK and SAMPLE LESSON show how we train you! SEND FOR THEM TODAY!

WE GIVE YOU TOOLS OF YOUR TRADE

TO MAKE YOUR TRAINING COMPLETE, WE GIVE YOU PROFESSIONAL QUALITY TOOLS AND EQUIPMENT, INCLUDING ALL-METAL TOOL BOX! THEY ARE PART OF YOUR INSTRUCTION, YOURS TO KEEP! DON'T MISS THIS OPPORTUNITY OF A LIFETIME! GET THE FACTS—MAIL THE COUPON NOW!

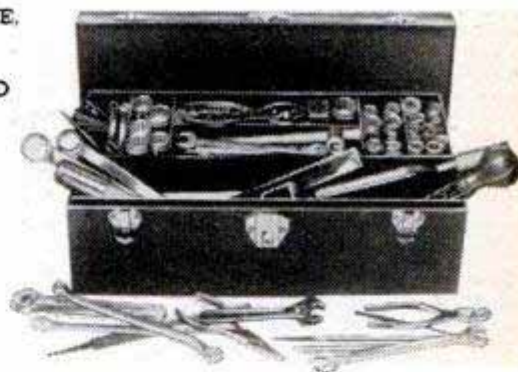

NATIONAL SCHOOLS

LOS ANGELES 37, CALIFORNIA • ESTABLISHED 1905
In Canada: 193 E. Hastings St., Vancouver, B.C.



FIND OUT NOW...MAIL COUPON TODAY

NATIONAL SCHOOLS, Dept DB-82
4000 South Figueroa Street
Los Angeles 37, California

Mail in envelope or paste on postal card

Mail me FREE the book "My Future in Automotive-Diesel & Allied Mechanics" and the Sample Lesson. I understand no salesman will call on me.

NAME _____ AGE _____

ADDRESS _____

CITY _____ ZONE _____ STATE _____

TIGHTEN LOOSE FIXTURES

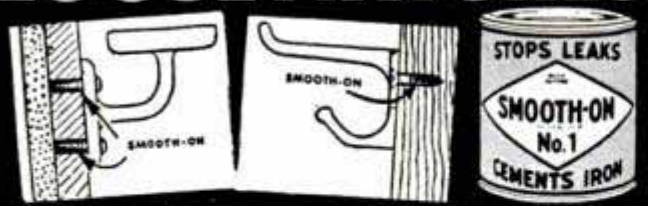

Smooth-On No. 1 Iron Cement applied to your loose hinges, door handles, coat hooks, drawer pulls, knobs, casters, bathroom fixtures, tool and cutlery handles, will tighten them and keep them tight. • Get Smooth-On No. 1 in 1 1/4 oz., 7 oz., 1 lb. or larger sizes at your hardware store. If they haven't it, write us.

FREE Repair Handbook

40 pages, 170 illustrations. Shows you how to make numerous household repairs quickly and easily. Directions are simple, brief.

80 347

SMOOTH-ON MFG. CO., Dept. 37
570 Communipaw Ave., Jersey City 4, N. J.



Do it with
SMOOTH-ON
IRON CEMENT

STOP THAT OIL EATER!



GET NEW CAR PERFORMANCE WITH
PISTON SEAL
WITHOUT COSTLY OVERHAULING

Piston Seal—the amazing compound that forms a self expanding, pliable lubricating seal around pistons that compensates for wear. Eliminates oil burning, restores power and compression. Can be applied in a few minutes.

GOOD FOR 10,000 MILES



SIMPLY REMOVE SPARK PLUG AND SQUEEZE

FOR COMPLETE, FREE DETAILS WRITE TO

RICHIE DISTRIBUTING CO. 11916 Madison Ave., Dept. H, Cleveland 7, Ohio

ELECTRONIC WALKIE TALKIES



• **TWO WAY.** Set consists of two (2) "transceivers" ready to hook up. No license needed! Simply attach wire coil (included in each set) to terminals and talk between any two points. Operates anywhere. Clear voice transmission guaranteed.

• **BROADCAST OVER HOME RADIO.** Either or both Walkie-Talkies can be hooked up so you can "broadcast" from your own radio speaker. Mystify your friends—plan your own radio programs and announcements.

• **RECEIVE LOCAL BROADCASTS.** Your Walkie Talkies can easily be converted to the broadcast band and thus serve as your own private radio receiver. The REMCO plug-in crystal adapter and special aerial attachment will permit reception on broadcast frequencies. Adapter and aerial attachment only \$1.98 (Optional). Sets are ruggedly constructed of high quality injection molded plastic; engineered for utility and extra long service. This is not a kit but a genuine communication system. Guaranteed—or your money refunded in full. Send check, cash or money order. For C.O.D. orders enclose \$1 deposit.



only **\$3.49** postpaid
2 SETS COMPLETE

EMPIRE MDSG. CO. Dept. P-2
63 Central Avenue, Ossining, N. Y.

FOR SPARE TIME PROFITS OR A FULL TIME CAREER

LEARN UPHOLSTERING

Learn at home in months! Earn spare time money—or start a shop! Easy lessons show how. Tools and materials to build ottoman included. Low terms. Write for valuable booklet today!

COMMERCIAL TRADES INSTITUTE, Dept. U 2-8
1400 Greenleaf Avenue • Chicago 26, Illinois

TASOPE PHOTO-ENGRAVING PLANTS



Establish your own profitable PHOTO-ENGRAVING business. Make cuts for newspapers, printers, and advertisers. Make etched name plates, plaques etc. Instructions furnished, no experience necessary. Sold direct from factory since 1931. First five hundred cuts sold locally or by mail will pay for plant and pay you well for your time. Write for FREE catalog.

Material Cost Of This Cut 5¢
Selling Price \$1.00 And Up

TASOPE DEPT. PM5, AURORA, MO.

ENGINEERING DEGREE IN 27 MONTHS

INDIANA TECHNICAL COLLEGE

B. S. DEGREE. Aeronautical, Chemical, Civil, Electrical, Mechanical and Radio Engineering (inc. TV and Electronics). Drafting, 1-yr. G.I. Gov't approved. Low rate. Earn board. Large industrial center. Students from 48 states, 21 countries. Demand for graduates. Enter September, December, March, June. Write for catalog, 1682 E. Washington Boulevard, Fort Wayne 2, Indiana.

LEARN AT HOME TO MOUNT BIRDS



Animals, Heads, Fishes, Pets; to TAN. Be a Taxidermist. Profit and FUN.

Hunters, save your valuable TROPHIES. Mount ducks, squirrels, everything. Learn to TAN for leather and furs. Wonderful HOBBY Have a HOME MUSEUM.—BIG PROFITS mounting for others. INVESTIGATE NOW.

FREE BOOK With 100 fine game pictures. NOW absolutely FREE. Write TODAY.

Send Postal TODAY for FREE BOOK. State AGE. **N. W. SCHOOL OF TAXIDERMY, Dept. 2508, Omaha, Neb.**



If you can draw, your future is secure

America's 12 Most Famous Artists

now test your art talent!



This exciting test, printed on 8 large pages of 11" x 14" drawing paper, has over 50 illustrations. It tests you seven ways to show your sense of design, composition, form, observation, imagination, originality and picture sense. Yours if you act today.

Thousands paid \$1.00 to take this amazing test. To meet the ever-increasing demand for artists needed for higher-paying jobs, this talent test is now offered **FREE. Quantity limited. Write today!**

FAMOUS ARTISTS COURSE

Studio 6-H, Westport, Connecticut

Without obligation, I would be pleased to receive the Famous Artists Talent Test.

Mr. _____
 Mrs. _____ Age _____
 Miss _____ (please print)
 Address _____
 City _____ Zone _____ State _____



Free Fall Catalog

READY AUGUST 1

Fully illustrated, 108 pages, showing Hunting Footwear, Clothing, and fifty-five other leather and canvas specialties of our own manufacture for campers and hunters.

L. L. Bean, Inc.

104 Main St., Freeport, Maine

INSURED TIRE SERVICE

POPULAR BRANDS

FREE

INSURANCE POLICY given with each used tire sold. We guarantee the amount of service you pay for.

Tube Given Free with Each Used Passenger Tire Upon Request

SPECIAL! Deduct 10% on orders for Two or More used tires

YOU CAN'T LOSE!!

Super Quality		Rugged Performance		15 Months Insured Service	
600x16	\$4.55	670x15	\$5.25	700x16	\$5.55
650x15	4.95	670x16	5.35	710x15	5.45
650x16	5.95	700x15	5.40	760x15	5.95

Supreme Quality. Nothing Finer		30 Months Insured Service	
450x20	5.95	450x21	6.25
600x16	5.65	650x15	5.75
650x16	5.95	670x15	5.95
700x16	7.75	700x15	5.75
750x16	12.50	710x15	6.50
550x17	5.75	760x15	6.95
525x18	5.45	820x15	7.50
650x19	8.75	475x19	5.75

GOODYEAR SUPER CUSHION

600x16	9.95	670x16	10.75	760x15	13.95
650x15	10.95	700x15	12.95	760x16	13.95
650x16	10.95	700x16	13.95	820x15	14.95
670x15	10.95	710x15	12.95	590x15	9.95

Factory Rebuilt. Guaranteed and Insured for 18 Months

MIDLAND TIRE SALES

1141 W. Randolph St., Dept. PM, Chicago 7, Ill.
 Speedy shipments on Mail Orders. Insurance Policy sent with each order. Deduct 10% on orders for 2 or more used tires. Send CHECK or MONEY ORDER with this ad.

GREER SHOP TRAINING

2230 So. Michigan Blvd. Chicago 16, Illinois

Leader in Practical Training for 50 Years

Gain success by learning a trade offering security and high pay—go into business for yourself.

Get the "Know-how" at Greer

You learn in our new, large, modern shops by working with latest tools and equipment of the trade — tear down, inspect, repair and rebuild... under supervision of experts. Greer founded 1902. Over 51,000 successful grads. Part time, full time, day and evening. E-Z terms. Mail coupon today.

CLIP COUPON . . . MAIL TODAY

Greer Shop Training—2230 South Michigan Chicago 16, Illinois Desk 213

Please send information about trade checked:

In our Chicago Shops:

<input type="checkbox"/> Machinist	<input type="checkbox"/> Auto Mechanics
<input type="checkbox"/> Welding—Gas Arc	<input type="checkbox"/> Diesel Mechanics
<input type="checkbox"/> Body, Fender	<input type="checkbox"/> Tool & Die
<input type="checkbox"/> Diesel Mechanics	<input type="checkbox"/> Refrigeration & Air-conditioning
<input type="checkbox"/> Auto Mechanics	<input type="checkbox"/> Machine Shop
<input type="checkbox"/> Refrigeration	<input type="checkbox"/> Piano tuning
<input type="checkbox"/> Plastics	<input type="checkbox"/> G.I. appr. for Vets dischgd. after 7-25-47

Or learn at home—extension courses:

Diesel Refrigeration Plastics

Name _____
 Address _____
 City _____
 State _____

You CAN BECOME A MECHANICAL ENGINEER

B.S. DEGREE IN 36 MONTHS

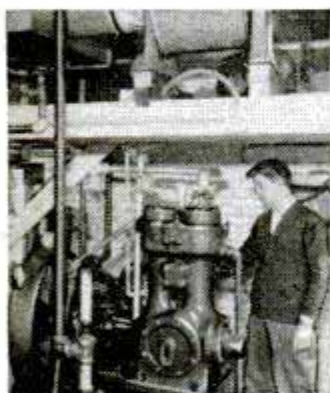

Prepare NOW for a wide range of career objectives as a MECHANICAL ENGINEER by enrolling at this 49-year-old technical institute and college. Through the option of year-round study you can obtain your B.S. degree in 36 months. Functional electives

aid you to qualify for (1) research, design, and teaching; (2) production, manufacturing, and operations; (3) sales and management.

ENGINEERING ASSOCIATE

Mechanical Technician — 12 Months

This practical technician course trains you for responsible positions in industry or your own business. Complete in itself, but also applies as full credit toward the degree program.

SERVICE-PREPARATORY COURSES

aid you in meeting admission requirements to technician and engineering programs

Ambitious young men with deficiencies in academic study or background can now qualify for these fields because of specially designed SERVICE-PREPARATORY courses. 3 to 6 months. Save valuable months by enrolling NOW. TERMS OPEN OCT., JAN., APRIL, JULY

Military, academic, or practical training evaluated for advanced credit.

NON-PROFIT • FOUNDED IN 1903

MILWAUKEE SCHOOL OF ENGINEERING



MILWAUKEE SCHOOL OF ENGINEERING
Dept. PM852, 1025 N. Milwaukee
Milwaukee, Wisconsin

Without obligation send Bulletin on Mechanical Engineering (BS°); Catalog for Electrical Engineering (BS°); major in Electronics; Power; "Your Career"; Occupational Guidance Bulletin on: Radio-TV Electrical Power Welding Heating, Refrigeration, Air Conditioning.

Name.....Age.....

Address.....

City.....Zone.....State.....

If veteran, indicate date of discharge.....



FULLY GUARANTEED TIRES COST LESS!

Nationally famous FIRESTONE, GOODRICH, U. S. ROYAL, GOODYEAR, and other makes. Every tire selected and inspected for your safety.

New Tread Tires Guar. 24 Mos. (White Walls \$2.00 Extra)

550x16	8.98	600x16(6)	10.98	650x20(8)	20.95	700x16(6)	15.48
550x17	8.98	650x15	10.98	640x15	9.98	710x15	11.48
600x15	8.98	650x16	11.48	670x15	10.98	760x15	12.48
600x16	8.98	650x16(6)	13.48	700x15	12.48	820x15	13.98

GOOD TIRES GUARANTEED 12 MONTHS

600x16	4.14	700x16	5.14	32x6(8)	8.84	825x20	14.24
650x16	4.54	670x15	4.74	32x6(10)	10.84	900x20	13.34
650x15	4.34	650x20	7.84	750x20(8)	8.54	1000x20	14.14
700x15	4.64	700x20(8)	8.94	750x20(10)	9.94	1100x20	16.14

AAA PREMIUM GRADE GUARANTEED 18 MONTHS

550x15	5.48	700x15	5.98	760x15	5.58	750x20(10)	14.98
600x16	5.28	700x16	6.78	550x17	5.48	825x20	18.68
600x16(6)	6.58	700x16(6)	7.98	600x20	9.78	900x20	18.98
640x15	5.68	750x16(6)	8.98	650x20	10.88	1000x20	19.98
650x16	5.78	800x15	6.88	700x20	12.88	1000x22	21.98
650x16(6)	6.98	820x15	7.48	32x6(8)	10.48	1100x20	20.98
650x15	5.98	710x15	6.09	32x6(10)	12.48	1100x22	21.98
670x16	6.18	550x18	5.98	750x20(8)	12.98	1100x24	23.98

MILITARY AA Guaranteed 12 Months—

900x16	10.69	1000x20	19.98
750x20	10.98	1100x20	21.98

SPECIAL

600x16	9.98
600x16(6)	10.98
700x15(6)	16.98
750x20(8)	25.98

AAA GUARANTEED 18 MONTHS

900x16	14.98	750x20	16.48
--------	-------	--------	-------

Passenger Tubes—Water Tested—All Sizes.....**.95**
Truck Tubes—Water Tested—All Sizes.....**2.45**

Largest stock of used tires in the East. Thousands of satisfied customers. Write for sizes not listed. **MONEY ORDER OR CHECK WITH ORDER.** NO C.O.D.'s

PYRAMID TIRE CO.
1333-35 North 5th St.
Dept. M., Phila. 22, Pa.

"YOU ARE UNDER ARREST!"

Help Bring Crooks to Justice Through Scientific
CRIME DETECTION!

We have taught thousands this exciting, profitable, pleasant profession. Let us teach you in your own home. Learn Finger Printing, Firearms Identification, Police Photography, Secret Service Methods thoroughly, quickly, at small cost. Over 800 of all American Bureaus of Identification employ 1. A. S. students or graduates. We can prepare you for this fascinating work, during spare time. Write today, stating age, for "Blue Book of Crime."

INSTITUTE OF APPLIED SCIENCE, 1920 Sunnyside Ave., Dept. 135-C, Chicago 40, Ill.

SELL Custom - Made Personal CHRISTMAS CARDS

Limited number of men and women wanted to make exceptional profits with big Album presentation of highest quality Personalized Christmas Cards from \$9 to \$23 per 100. Exclusive designs reproduced with finest craftsmanship. Added profits with lower-priced "Personals" and big line of top-value Box Assortments. Write fully for samples. **WALLACE BROWN, 225 Fifth Ave., Dept. P-155, New York 10, New York**

BE A LOCKSMITH

Learn Locksmithing and Keymaking from Experts in Your Spare Time at Home! Locksmiths in big demand! No layoffs, no slow seasons! Age no disadvantage. Year-round, steady income in this permanent, respected field. Full or part time. Practical, illustrated lessons show how to make money even while learning! All materials, special tools supplied. (Send for FREE BOOKLET.)

INSTITUTE OF LOCKSMITHING, Dept. P-33 15 PARK AVE. RUTHERFORD, N. J.
Lic. & Approved State of N.J. VA Approved

LEFAX POCKET-SIZE TECHNICAL DATA BOOKS \$1. EACH

Printed on loose leaf, six hole, 6 3/4" x 3 3/4" bond paper, each book contains about 140 pages of technical data, presenting condensed, accurate and essential data for the student, engineer, technical worker and business man.

- | | | |
|--------------------|------------------|--------------------|
| Architecture | Building Constr. | Piping Data |
| Home Heating | Radio | Surveying Tables |
| Illumination | Television & FM | Trig-Log Tables |
| Electrician's Data | Electricity, AC | Metallurgy |
| Builder's Data | Electricity, DC | Analytic Chem. |
| Lumber Data | AC Motors and | Highway Eng. |
| Air Conditioning | Generators | Mech. of Materials |
| General Math. | Transformers, | Pwr. Trans. Mach. |
| Math. Tables | Relays, Meters | Thermodyn. Tbls. |
| Physics | Hydraulics | & Charts |
| Chemical Tables | Surveying | Phys. & Thermo- |
| Metals | Mech. Drawing | dyn. Data |
| Gen. Chemistry | Machine Design | Phys. & Org. Chem. |
| Reinf. Concrete | Machinists Data | |

Write for FREE catalogs (over 2000 listings). See for yourself how helpful LEFAX can be to you. Send \$1 for each book, (or \$5 for any six books listed above) to

LEFAX DEPT. PM-12 PHILADELPHIA 7, PA.

SAVE 50% - THOUSANDS HAVE ASSEMBLED

\$42^{UP} PACKAGED BOAT KITS

27 MODELS



Dinghies, skiffs, racers, inboards, outboards and cruisers. Assemble your own boat, it's easy, it's fun!

All parts pre-cut or pre-fabricated from finest materials. Get all the facts from our big 24 page catalog. See how Packaged Boats are built, how they perform, how exclusive construction features make assembly easy. Includes specifications, performance data plus hardware and paints.

SEND 25¢ for NEW 24 PAGE CATALOG

CUSTOM-CRAFT - DEPT. 7 - BUFFALO 7, N. Y.

BOAT PLANS PATTERNS ▶ Over 50 modern plans and full size patterns. Racing classes, cruisers, inboards, outboards, sail boats. By famous designers. 6' to 30'. DESIGN CATALOG 35¢. Design Catalog and boat building handbook, \$1.00

MARINE MART - DEPT 7 - BUFFALO 7, N. Y.

Learn ACCOUNTING
Business Administration

Bookkeeping, secretarial and allied subjects at home in your spare time or attend nationally approved resident school. Write for FREE Success Book giving complete information about courses, plans, rates and employment opportunities.

Hills BUSINESS UNIVERSITY AND EXTENSION SCHOOL
619 W. MAIN ST. OKLAHOMA CITY 2, OKLAHOMA

FOR BIG MEN ONLY!



SIZES 10 to 16 WIDTHS AAA to EEE

We SPECIALIZE in large sizes only — sizes 10 to 16; widths AAA to EEE. Loungers; Dress Oxfords; Moccasins; Cushion Crepe; High and Low Work Shoes; Slippers; Rubbers; Overshoes; Sox. Enjoy the finest in fit, comfort, style at amazingly low cost. Sold by mail only. Write for FREE Style Book TODAY!

KING-SIZE, Inc., 941, Brockton, Mass.

RADIO Engineering. All phases radio & electronics theory & practice; television; FM; broadcasting; servicing; aviation, marine & police radio. Prepare for high pay: 18-month course equal in radio content to 4 yrs. college. Enter Jan., March, June, Sept. Regular campus life. Write for catalog.

VALPARAISO TECHNICAL INSTITUTE, Dept. D, Valparaiso, Ind.

Get into Good Paying AUTO BODY and FENDER WORK



BIG DEMAND in Auto Body and Fender work. Start training now in your spare time at home for good pay work. Practical shop experience included. U. E. I. Training covers metal work, welding, painting, etc. Placement service—or we will show you how to start your own shop. Behind U. E. I. TRAINING is a large national organization founded 1927. Write today for FREE FACTS—No obligation.

Write for Free Facts

AUTO-CRAFTS DIVISION • UTILITIES ENGINEERING INSTITUTE
2523 SHEFFIELD AVE., DEPT. XC-14, CHICAGO 14, ILLINOIS

BECOME AN Electrical Engineer



- Major in Electronics or Power B. S. Degree in 36 months
- Television Technician Certificate in 18 months

FOLLOW THIS PLAN
By 1954 there will be at least two positions for every engineering and technician graduate. Enter these opportunities early . . . earn your B. S. Degree in 36 months through optional year 'round study.

TELEVISION TECHNICIANS are needed throughout America's fastest growing industry. You become a Radio Technician in 12 months. In 6 additional months become a Radio-Television Technician. These Technician Courses are complete in themselves and can be applied as one-third of the B. S. Degree program. Recent developments forecast unlimited opportunities for TV technicians and engineers.

TERMS OPEN OCTOBER, JANUARY, APRIL, JULY
Military, Practical, or Academic training evaluated for advanced credit. Faculty of specialists. Over 48,000 former students from all states and 23 overseas countries. Nonprofit. Founded in 1903.

MILWAUKEE SCHOOL OF ENGINEERING

MILWAUKEE SCHOOL OF ENGINEERING
Dept. PM-852, 1025 N. Milwaukee
Milwaukee 1, Wisconsin

Without obligation send Catalog for Electrical Engineering, B. S. Degree, major in Electronics; Power; "Your Career"; Occupational Guidance Bulletin on: Radio-TV Electrical Power Mechanical Engineering Welding Heating, Refrigeration, Air Conditioning Preparatory.

Name.....Age.....

Address.....

City.....Zone.....State.....

If veteran, indicate date of discharge.....



FREE BOOK AND ACTUAL SAMPLE

Screen Print, Dept. 28
1010 So. Los Angeles St.
Los Angeles 15, California
Dear Mr. Nowak: Please rush me FREE BOOK,
ACTUAL SAMPLES, and your amazing new PRINTING PLAN

Name _____
Address _____
City _____ State _____



IT'S AMAZING! I'll show you
how to make up to \$12.50 per hour

PRINTING WITHOUT A PRINTING PRESS

Print paper
of all kinds

PRINT
BANNERS

PRINT
FABRICS

PRINT
INSTRUMENTS

PRINT
SIGNS

FOR SALE

YOU
CAN PRINT
ANYTHING
WITH



AMAZING NEW COLOR PRINTING METHOD
A fascinating new miracle-way to print—a secret method that lets you print colorful signs, posters, banners, drapes, wallpaper, flags, glass, fabrics—ANYTHING without an expensive printing press or costly equipment. This new process is revolutionizing the entire printing industry—it's one of America's fastest-growing businesses—it's your "chance of a lifetime" to make Big Money Now! Be the FIRST in your area to profit. The secret can be yours—Just mail the coupon above today!

EASY TO LEARN! NO EXPERIENCE NECESSARY!
Simple fascinating method! No artistic ability needed. It's possible for anyone (young or old) to make up to \$50 PER WEEK printing in SPARE TIME alone—AT HOME!

START YOUR OWN BUSINESS—BE YOUR OWN BOSS
Wouldn't you be happy if you could take only one hour of your time and \$1.00 worth of materials—and sell your printing for \$15 or more. It's that easy! It's amazing! Your home can be your office—No selling because there's a huge demand everywhere. **GOVERNMENT CONTRACTS AVAILABLE TO BID.** Biggest opportunity in America—costs you nothing to receive all CONFIDENTIAL FACTS—Mail coupon today!

SCREEN-PRINT, Dept. 28
1010 S. Los Angeles St., Los Angeles 15, Calif.

High School at Home

Many Finish in 2 Years

No classes. No time wasted going to and from school. Progress as fast as your time and abilities permit. Standard H. S. texts supplied. Thousands enroll each year in this 55-year-old school. Send for FREE descriptive booklet.

AMERICAN SCHOOL, Dept. HC45
Drexel at 58th St., Chicago 37, Ill.

Without obligation, please send FREE descriptive booklet.

Name _____
Address _____

BE AN ARTIST!

Draw for Money — We teach you HOW in your own home. Commercial Art, Designing, Cartooning — all in one complete course. Trained Artists are capable of earning \$75, \$100 and more a week. No experience necessary. Our famous method has helped thousands since 1914. TWO ART OUTFITS furnished. Low tuition, easy terms. Write today.

MAIL COUPON FOR FREE BOOK

WASHINGTON SCHOOL OF ART
Studio 128F, Washington 5, D. C.

Name _____ Age _____
Street _____
City _____ Zone _____ State _____

I am interested in your New Trial Plan

20 POWER! 7½ OUNCES

2½ TIMES STRONGER THAN BINOCULARS USED
OFFICIALLY BY THE U. S. ARMED FORCES

Whisper Weight—7½ ounces. Easy to hold—Easy to focus. Ideal for indoor, outdoor sports, vacationing, trips, long distance spotting. Pocket size measures only 6¼" closed 13½" open.



NOT A CHEAPLY MADE TOY TELESCOPE. But an all metal, precision machined (threaded fittings throughout) Precision ground, achromatic telescope that invites comparison. Bears the famous UNITED "Seal of Quality" because they are UNI-COATED, assuring buyers that an application of magnesium fluoride has been applied to the interior sides of the VITAL front Achromatic and rear Ocular lens so users can view distant objects (even those miles away) clearer, brighter and in sharper detail than ever before. Made in American occupied Japan where skilled German optical craftsmen tutored local optical workmen in advanced techniques. It explains why the quality is so high and the price so low. **UNCONDITIONALLY GUARANTEED.** Try for 30 days. If not absolutely satisfied return for an immediate unquestioned refund of your money. Introductory price.....

\$8.95

Cash orders postpaid. C.O.D.'s include \$2.00 deposit Tax Free
UNITED BINOCULAR CO.
United Bldg., 9043 S. Western Ave., Dept. ARF-5008, Chicago 20

OWN a Business

If employed, start part time. Alert dealers can gross \$5 hourly profit on own service plus \$3 on EACH serviceman. Clean, revive, mothproof rugs & upholstery on location. No shop needed. Services nationally advertised. Repeat customers. Easy to learn. Quickly established. Easy terms. Send today for FREE booklet. No obligation.

DURACLEAN CO.,
2-168 DURACLEAN BLDG.,
DEERFIELD, ILL.

STUDY INDUSTRIAL DESIGN

You can train at Art Center School in California with practicing professionals for upper-level jobs in INDUSTRIAL DESIGN. Recent graduates have been added to the staff at General Motors, Chrysler, Raymond Loewy, Henry Dreyfuss, etc. Majors in transportation, general product design, structures, community development, furniture design, packaging, display, 4-year degree courses. Learn to combine imaginative design with technical proficiency, coordinate utility and beauty. Stimulating environment. Field trips. Advantages of mild Southern California climate and nearby holiday spots. Coed. Placement service. Write for catalog.

ART CENTER SCHOOL, Edward M. Adams, Director
5353 WEST THIRD STREET, LOS ANGELES 5, CALIFORNIA

Make BIG MONEY!
RAISE CHINCHILLA RABBITS!
Cash Markets Supplied for Your Production
FREE - Illustrated Booklet - WRITE TODAY!
ROCK HILL RANCH, SELLERSVILLE 36, PA.
World's Largest Breeder of Chinchilla Rabbits

STUDY TO BE A DOCTOR of Psychology or Metaphysics

Obtain a Ps.D., Ms.D., D.D., or Ph.D. degree. Be a Teacher, Lecturer or Accredited Practitioner. Teach others how to achieve Health, Happiness and Contentment. Chartered by State. Write for FREE book telling how.

THE NEOTARIAN COLLEGE OF PHILOSOPHY
Desk 8, Pickwick Building Kansas City 6, Missouri

When You • You Can Earn More in • LEARN WATCHMAKING LEARN By KCSW's Outstanding Method

WRITE TO
Don't let a lay-off catch you. **START NOW TO LEARN WATCHMAKING AT HOME IN YOUR SPARE TIME.** Earn extra money as you learn, repairing clocks and watches. You will be building your own business right at home.

Write for information on KCSW's HOME STUDY COURSE

KANSAS CITY SCHOOL OF WATCHMAKING
1218 Admiral Blvd. Kansas City 6, Missouri



Turn YOUR Spare Time Into CASH WITH STARK FRUIT TREES

MEN—WOMEN make welcome EXTRA CASH in spare hours, evenings, weekends. Take easy orders from friends and neighbors, others for world-famous Stark Fruit Trees, Apples, Pears, Peaches, Cherries, Plums and others. Sensational quick-bearing U. S. Patent Varieties. Also amazing new Stark DWARF Fruit Trees. Enormous demand. Added income selling Stark Shrubs, Vines, Roses to home owners. Join Stark Bro's—America's largest, oldest nursery—now in our 137th year.

FREE SEND NO MONEY for GIANT SALES OUTFIT

Rush name and address today for FREE STARK MONEY-MAKING SALES OUTFIT. Everything you need, including large, full color Photo Plate Book. No experience is needed. Write at once, best selling weeks just starting.

STARK BRO'S DESK 5583, LOUISIANA, MO.

CARBURETOR TOO RICH MAKES MOTORIST TOO POOR



Car owners who are wasting money, getting poor mileage due to over-rich mixtures, will be pleased to learn how to save gasoline by VACU-MATING OVER-RICH MIXTURES. Vacu-Matic fits all cars, trucks and tractors. Automatic and operates on the supercharge principle. Easily installed in a few minutes.

SALESMEN WANTED! Big Profits

For FREE particulars, how you can install one on your own car for introducing, just send your name and address on a postcard to VACU-MATIC, 7617-1925 W. State St., WAUWATOSA, WIS.

THE ROAD DOCTOR

Gets You There In Time, On Time

A small and compact, light-weight item, scientifically designed to overcome about 80% of your IGNITION TROUBLE on the road, caused by failure of DISTRIBUTOR POINTS. Its true purpose is to relieve this added strain on these parts, and in an EMERGENCY allow you to continue on your way. EASILY installed in one minute. SPEND \$1.98 WISELY. Money back guaranteed. Branch #4, P. O. Box 447, Philadelphia 5, Penna.

Learn TELEVISION-ELECTRONICS RADIO

2 Big Books

FREE

Train at Home—Get Big Kits of Radio Parts! Prepare now in spare time. Practical instruction. Approved for Veterans. Write for details and 2 Radio Books—ALL FREE! Rush name today! **SPRAYBERRY ACADEMY OF RADIO** Dept. 10-M 111 No. Canal Chicago 6, Illinois



How to Make Money in PHOTOGRAPHY

Unique, low-cost LEARN-BY-DOING method and INDIVIDUAL attention trains you quickly at home in spare time. Start making money in photography at once!

We show you how. Our 42nd year. Big FREE colorful book gives full facts. Write TODAY! Resident Training also available. **NEW YORK INSTITUTE OF PHOTOGRAPHY** Dept. 49, 10 W. 33 St., New York 1 N.Y.



WAR SURPLUS BARGAINS

WAR SURPLUS BARGAINS

\$500,000.00 INVENTORY for QUICK LIQUIDATION

Surplus items—hundreds of them for home, shop, factory, farm and outdoor use. New items, used items, reconditioned items—all at tremendous savings—all priced for quick sale.

Page After Page of Values

This big catalog shows page after page of amazing money saving values. Write for your copy today. Send 10c to cover postage, mailing, etc. Write today!

10c

STARK'S

Dept. 509 So. STATE STREET
CHICAGO 5, ILLINOIS

NIA Wins Him Salary Rise

"I am in labor relations, but on the side, I do the 'Life' and 'Look' type of picture stories for the company magazine. Shortly after enrolling in NIA, I received a written commendation and a salary increase for 'the human relations' value of my stories and articles. Besides bringing salary increases of more than \$650.00 and 5 written commendations from the home office, writing, as NIA teaches it, has enabled me to get the attention of company executives who would not have otherwise known me."—A. W. Henning, 1128 Vine St., St. Charles, Mo.



How do you know you can't WRITE?

Have you ever tried?

Have you ever attempted even the least bit of training under competent guidance?

Or have you been sitting back, as it is so easy to do, waiting for the day to come when you will awaken all of a sudden to the discovery, "I am a writer"?

If the latter course is the one of your choosing, you probably never will write. Lawyers must be law clerks. Doctors must be internes. Engineers must be draftsmen. We all know that, in our time, the egg does come before the chicken.

It is seldom that anyone becomes a writer until he (or she) has been writing for some time. That is why so many authors and writers spring up out of the newspaper business. The day-to-day necessity of writing—of gathering material about which to write—develops their talent, their background and their confidence as nothing else could.

Learn to Write by writing

NEWSPAPER Institute training is based on the New York Copy Desk Method. It starts and keeps you writing in your own home, on your own time. Week by week you receive actual assignments, just as if you were right at work on a great metropolitan daily. Your writing is individually corrected and constructively criticized. Thoroughly experienced, practical, active writers are responsible for this instruction. Under such sympathetic guidance you will find that (instead of vainly trying to copy some one else's writing tricks) you are rapidly developing your own distinctive, self-flavored style—undergoing an experience that has a thrill to it and which at the same time develops in you the power to make your feelings articulate.

Many people who should be writing become awestruck by fabulous stories about millionaire authors and therefore, give little thought to the \$25, \$50, and \$100 or more than can often be earned for material that takes little time to write—stories, articles on business affairs, travel, business, home and shop crafts, and scientific activities, hobbies, etc.—things that can easily be turned out in leisure hours, and often on the impulse of the moment.

A chance to test yourself FREE

Our unique FREE Writing Aptitude Test tells whether you possess the fundamental qualities necessary to successful writing—acute observation, dramatic instinct, creative imagination, etc. You'll enjoy taking this test. The coupon will bring it, without obligation. Newspaper Institute of America, One Park Avenue, N.Y. 16, N. Y. (Founded in 1925)

Free

Newspaper Institute of America
One Park Avenue, New York 16, N. Y.

Send me, without cost or obligation, your FREE Writing Aptitude Test and further information about writing for profit as promised in Popular Mechanics, August.

Mrs. }
Miss }
Mr. }

Address.....
(All correspondence confidential. No salesman will call on you.)

77-M-362

Copyright 1951 Newspaper Institute of America

INVENTORS

Your first step—if you consider your invention to be something of importance—is to have a search made of pertinent, prior U. S. patents. If our search report indicates probable patentability of your invention, you may apply for a patent which gives you the right to exclude others from making, using or selling your invention as claimed for a term of 17 years.

This firm is registered to practice before the U. S. Patent Office and is available to assist in the preparation of the necessary drawings, specification and claims.

Ask for a copy of our instructive booklet "Patent Protection for Inventors" and our convenient "Evidence of Invention" form. No obligation.

VICTOR J. EVANS & Co. *Merlin M. Evans*
REGISTERED PATENT ATTORNEY
730-J MERLIN BUILDING, WASHINGTON 6, D. C.

INVENTORS

IF YOU WISH TO PROTECT YOUR INVENTION, You should take steps to protect it by a U. S. Patent. Write me for "INVENTION RECORD" form

CARL MILLER
REGISTERED PATENT ATTORNEY
WOOLWORTH BLDG., 35th FLOOR, 82A
NEW YORK CITY

INVENTORS

Send for
PATENT INFORMATION
Book and
INVENTOR'S RECORD
without obligation

GUSTAVE MILLER
82-PM WARNER BUILDING
WASHINGTON 4, D. C.

REGISTERED PATENT ATTORNEY

Patent Attorney & Advisor
U. S. NAVY DEPT. 1930-1947
ASSOCIATE EXAMINER
U. S. PAT. OFF. 1922-1929
PATENT LAWYER

INVENTORS

Before you make any effort to market your invention, you should take the first steps toward proceeding for patent protection.

I shall be pleased to furnish you with information relative to patent procedure, upon request from you, and this will be without any obligation on your part.

PATRICK D. BEAVERS
Registered Patent Attorney
934 Columbian Building Washington 1, D. C.

INVENTIONS WANTED AT ONCE

If you want to market, or sell, your invention for cash or royalties, we may be able to help you. Write for Free Booklet. Send no drawings. We also welcome hearing from firms wishing to review inventions in their field.

GLOBAL MARKETING SERVICE
1404 Mitchell Street Dept. PD Oakland 1, Calif.



PATENTS
C. A. SNOW & CO.
REGISTERED PATENT ATTORNEYS
WRITE FOR INFORMATION TO
428 SNOW BUILDING, WASHINGTON 1, D. C.

INVENTORS

Whether an invention is patentable can be substantially determined by a search of the U. S. Patent records. Without obligation, write for information explaining the steps you should take to secure a patent.

JOHN N. RANDOLPH
Registered Patent Attorney
201 Columbian Building, Washington 1, D. C.

INVENTORS

If you have working models, blue prints, or patents, covering "special use" parts or assemblies for Chevrolet, Ford, or Plymouth Cars, it will be to your advantage to get in touch with us. Write us at the factory. Dept. PM

 **NATIONAL MACHINE WORKS, INC.**
P. O. BOX 4305 AUTOMOTIVE PARTS MANUFACTURERS OKLAHOMA CITY 9, OKLA.



SPORTONE MUFFLERS

Ford & Chevrolet.....	\$ 4.45
All other popular cars.....	5.45
V-8 Dual Sets.....	15.95
Chromed Silentips.....	2.95

(Please state make & year of car on all orders.)
SANDEE MUFFLER CO.
5643 Corryne Place • Culver City, California

HELPFUL BOOKS

Send post card asking for FREE catalog
Popular Mechanics Press, 200 E. Ontario, Dept. 601, Chicago 11

Attention:

READERS WHO WELCOME
BETTER OPPORTUNITIES FOR
LIVING AND GIVING

Beginning with the September issue, *Popular Mechanics* is adding a shopping section. We are calling it "Shopping for Living and Giving." The merchandise and services offered will be packed with personality—all kinds of articles to make your living and giving richer.

Look for it in the September issue

BRAND NEW! THE ENGINEERS' ILLUSTRATED THESAURUS
 JUST PUBLISHED IN 1952
 By HERBERT HERKIMER

A Book That Shows You Over 8000 ILLUSTRATIONS AND DESIGNS of Mechanical Movements, Devices, Contrivances and Details

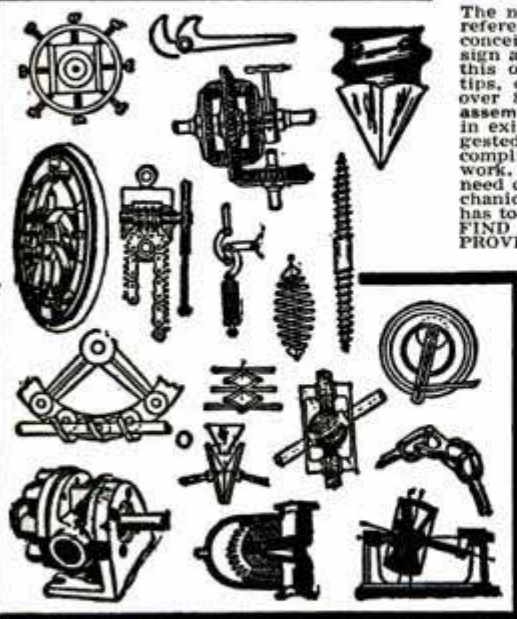

The newest, largest, most comprehensive and useful reference work of its kind ever put together. Every conceivable kind of mechanical motion, machine design and detail is briefly explained and illustrated in this one-volume encyclopedia. Here at your fingertips, classified and arranged for easy reference—are over 8000 illustrations, the largest collection ever assembled; and as far as known the only work now in existence which aims to provide side by side suggested sketches of various methods in use for accomplishing any particular mechanical movement or work. Every engineer, inventor or mechanic finds the need of devising, simplifying or improving some mechanical process, method or detail. In doing this, he has to rely on memory or experience. HERE HE WILL FIND COUNTLESS SUGGESTIONS, TESTED AND PROVEN, FOR ACCOMPLISHING WHAT HE SEEKS.

PARTIAL CONTENTS

FASTENERS: Anchors, Bolts, Screw and Nut Design Types, Commercial Nuts, etc. Nails and Spikes, Clamps and Locking Devices, Chucks and Grips, Keys and Cotter. Man-holes, Hand-holes, Covers, Doors, Riveted and Miscellaneous Joints. **ADJUSTING DEVICES, SUPPORTS AND STRUCTURES:** Machine Frames and Bedplates, Frames of Welded Design, Girders, Columns and Struts, Bridge Trusses. **BASIC MECHANICAL MOVEMENTS:** Kinematic Chains, Application of Energy to Machines, Levers, Parallel and Straight-Line Motions, Links and Connecting Rods, Guides and Slides, Cams, Tappets and Wipers, Toothed and Epicyclic Gearing, Rolling Contact and Friction Gearing, Pawls and Ratchets, Shifting and Reversing Gears, Circular and Reciprocating Motion. **ELEVATORS, DERRICKS, CRANES, CONVEYORS:** Slingers, Feeders, Bucket Ele-

vators, Conveyors. **TRANSMISSION OF LIQUIDS AND GASES:** Reciprocating-Pump and Pump Valves, Packings, Rotary Pumps, Refrigerating Compressors and Valves, Steam Traps and Separators. **COMBUSTION:** Mechanical Stokers, Vaporizing Oil Burners. **PRIME MOVERS:** Steam-Engine Valves and Valve Gears, Steam Turbines, Principles of Gas Turbines, Rockets and Jet Propulsion, Diesel-Engine, Hydraulic Turbine, Compressed-Air Power, Sea-Wave Power. **TRANSPORTATION:** Vehicle Bodies, Underframes and Trucks, **INDUSTRIAL PROCESSES:** Weighing, Measuring, Pressure, Speed and Heat Measurements, Crushing and Grinding, Sifting, Screening, Straining, Chopping, Slicing and Mincing Apparatus, Mixers, Washing and Winding Apparatus, Cutting Tools, Sanitation; Water Closets and Septic Tanks. **ELECTRICAL APPLIANCES:** Static Electricity, Magnetism, Electromagnets, Batteries, Transformers; Induction Coils, Telephones, Measuring Instruments, Generators, Alternating-Current Motors, Direct-Current Motors and Generators, Infrared and Electric Heating, Electromagnetic Apparatus, Inductance and Capacitance, Electron Tubes, Radio Communications Systems, Cathode and X-Ray Tubes. **HEATING, COOLING, AND AIR CONDITIONING:** Steam, Hot-Water Systems, Radiant Hot-Water, Radiant, Warm-Air Hook-Ups, Unit Heaters, Ventilators, Air Conditioners, Refrigeration Systems. If you work with machinery of any kind, you need this **ENGINEER'S ILLUSTRATED THESAURUS** by Herbert Herkimer —580 pages, durably printed and bound in cloth. Price

\$6.95

Order by mail. If payment sent with order, we pay postage; or sent c.o.d. plus delivery charges. Money back if not fully satisfied. **HOMECRAFTS, 799 Broadway, Dept. 336, New York 3, N. Y.**

Develop Hidden Earning Power
STUDY LAW
 at home! LL.B. Degree

Qualify yourself in spare time for advancement, greater earnings, business success. Now, more than ever, legal ability is in demand! Easy-to-understand step-by-step lessons and text material furnished — invaluable for permanent reference. Over 40 years expert instruction. 114,000 students enrolled. Easy payments. Find out now, at no cost, how study of law can help you. Write today for FREE Book "Law and Executive Guidance."

AMERICAN EXTENSION SCHOOL OF LAW
 Dept. PM-53, 646 N. Michigan Ave., Chicago, Ill.

UNLIMITED OPPORTUNITIES IN
ENGINEERING
 DEGREE
 IN 27 MONTHS

Study Engineering in this world-famed school, established 1884. Demand for our graduates exceeds supply. Growing shortage of engineers. No field offers greater opportunities for responsible, lucrative positions. **Bachelor of Science Degree** in Mechanical, Civil, Electrical, Chemical, Aeronautical, Radio (Television) Engineering; Business Administration and Accounting. Also 36-weeks certificate course in Surveying and Drafting. **Personalized Instruction.** Accelerated courses. Non-essentials eliminated. For ambitious, earnest students. Earn your degree in the shortest possible time. Preparatory courses. Placement service.

Extensive Campus. Well equipped, new and modernized buildings; up-to-date labs. Low cost. New terms start quarterly. Enter September, January, March, June.

Write today for free catalog and special information.



TRI-STATE COLLEGE

482 College Ave. ANGOLA, INDIANA

EARN MORE IN
DRAFTING



More Opportunities for Employment and Promotion

"Here I am at work making good money as a draftsman. I'm glad I sent the coupon to Chicago Tech for that Free Trial Lesson and found out how easy it is to learn Drafting in spare time at home. Today I feel secure in my job because the draftsman's work comes first on any new project. And, in addition, draftsman can't be replaced with machines. What's more, I feel I'm slated for promotion and more pay, because I see so many draftsmen advancing to high-pay jobs."

LEARN IN SPARE TIME — AT HOME!
 (or at the College in Chicago)

A few hours of pleasant home study every week—that's all. No interference with your present job. All the tools you need; drawing outfit included. With Chicago Tech's help, you train yourself step by step. This tested method—developed over 48 years of C.T.C. progress—prepares men quickly for good positions in industry.



FREE INFORMATION—SEND COUPON
 To prove to you how easy it is to learn Drafting at home by the Chicago Tech method, we will send you this FREE TRIAL LESSON. No charge for this lesson, now or later. Fill out and mail coupon, or send post card today.

CHICAGO TECHNICAL COLLEGE

K-250 Tech Bldg., 2000 So. Michigan Ave., Chicago 16, Illinois

Mail me FREE Lesson with information about big opportunities in DRAFTING.

Name _____ Age _____
 Address _____
 City _____ Zone _____ State _____

"THIS IS THE BEST DEAL I EVER HAD—

**I made \$36¹²
in 2 hours"**

Selling Science's New Midget Miracle "Presto" Fire Extinguisher says A. E. Paugh, Greeley, Colorado. Many others "cleaning up" — so can YOU!



A. E. PAUGH

OVER 11,000 people died in fires last year. An eager public has been waiting for a practical new kind of fire extinguisher. Now it's here! Tiny "Presto" is about the size of a flashlight. Does the job of bulky extinguishers that cost 4 times as much and are 8 times as heavy. Ends fires fast as 2 seconds. Fits in palm of hand. Never corrodes. *Guaranteed for 20 years!* Sells for only \$3.98!

You can make good money showing this new discovery to civil defense workers, owners of homes, cars, boats, farms, etc., and to stores for re-sale. Stanley Hyman reports making over \$1000 a month. H. J. Kerr, \$20 a day.



Science's New Midget Miracle "PRESTO" refills.

OVER ONE MILLION SOLD!

What's the secret of "Presto's" amazing power? It's a new wonder chemical developed during the war, found to be 1.5 to 6 times as effective as chemical contents of other extinguishers on an equal weight basis. Makes possible, for the first time, an extinguisher that is small, light, and amazingly effective.

Help supply the demand for this important new discovery. Write for FREE Sales Kit. No obligation; no capital required. But don't put it off. Every day you hesitate may cost you \$10, \$15, or even \$50 you could be making.

Send postcard or letter to: MERLITE INDUSTRIES, Inc., Dept. 58, 201 East 16th Street, New York 3, N. Y. IN CANADA: Mopa, Co., Ltd., 371 Dowd St., Montreal 1, P. Q. (If you want demonstration sample too, send \$2.50. Money back if you wish. Returnable for FREE refills.)

**BUILD A \$15,000
A YEAR FUTURE!**

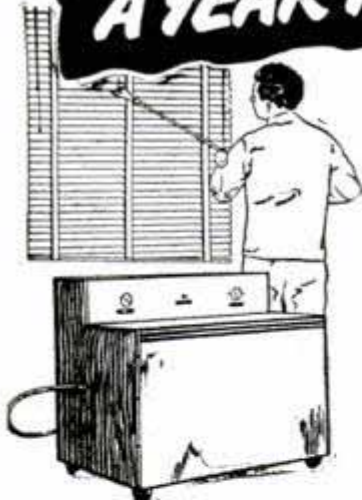

**IN THE EXCITING
NEW BUSINESS OF
LAUNDERING
VENETIAN
BLINDS**

There is big money to be made cleaning Venetian Blinds and a permanent, fast growing, Lifetime Business, besides.

An amazing new kind of business of your own in a field that is growing like mad. Millions of Venetian Blinds need laundering at regular intervals.

With our new patented machine, you can start small—using your basement, garage or utility room to begin with. You can expand as your business increases by leaps and bounds. Income up to \$200.00 daily already being made by others. Small investment for equipment starts your own lifetime business—and monthly payment plan permits you to pay for it as you grow.

FREE Get all the facts about this sensational new kind of machine that launders blinds so fast that your charges are unbelievably low. People would rather send blinds to you than do the work themselves. Yet, you make 700% profit on every blind you clean. Get names of successful owners near you. Get details of the full amazing plan without obligation. Be first in your territory to start a business that has brought \$15,000 PROFITS the first year to others. Wire today or send name on postcard.

VENETIAN BLIND LAUNDRY EQUIPMENT CO. INC.
442 N. SENECA ST. DEPT. 108 WICHITA 12, KANSAS

**"How to
Become a
Mail Order
Millionaire"**



Read the inside facts about hundreds of "little fellows" who are running Mail Order businesses from their homes—many making \$20,000 and more every year! Learn how small investments (\$16.80 in one case!) have mushroomed into profits of thousands. This incredible reprint from *Mechanix Illustrated* will be sent absolutely free, along with details showing how you can quickly master the secrets of getting orders and money in your daily mail, in a business that's all yours. Rush name today. A postcard will do.

**SENT
FREE!**

RUSH NAME ON
POSTCARD TODAY

The L. W. SURVEY Dept. 18, Chicago 26, Ill.

MAKE MONEY! Sell Warm **LEATHER** Jackets

Rush Card TODAY for FREE SELLING OUTFIT! Sell warm leather jackets to truckers, milkmen, gas stations, etc. Men really go for these fast-selling garments of Horsehide, Capeskin, Suede, Nylon, and 100% Wool. Warm quilted linings, fur collars! As our man in your community, you make **BIG MONEY** on every sale, yet you don't invest one cent. Rush card NOW... start building your own big profit-making business right away. CONSOLIDATED SHOE SYSTEM, Box CD-26, Chippewa Falls, Wis.

**DECORATE YOUR LAWN WITH
FLORIDA FLAMINGOS**

Made of lightweight nonrust metal, 30 in. high and enameled flamingo red. \$7.90 pair postpaid. Money back guarantee. Send remittance to:

CERTIFIED PRODUCTS CO.
Dept. 33, Louisville 11, Ky. Agents Wanted.

BIG LEATHER & CRAFT CATALOG!
1000's of items for Leathercraft, Textile Painting, Copper Tooling, Kits, Projects, Tools, Supplies, Etc. Send 25c (refunded with 1st order) to:

RUSSO HANDICRAFT SUPPLIES Dept. 2-CD, 245 S. SPRING LOS ANGELES 12, CALIF.

**MAKE MONEY with
Bostonian SHIRTS**

Take orders for famous line finest quality dress and sport shirts. Also women's mantilla blouses. All styles, fabrics, colors, sizes. *Low Prices. No experience needed.*

FREE Big, beautiful Sales Kit with actual fabric samples. Send no money, but rush name now! **Bostonian Mfg. Co.,** 89 Bickford St., Dept. R-40, Boston 30, Mass.

**"How to Make Money with
Simple Cartoons"**

A book everyone who likes to draw should have. It is free; no obligation. Simply address **FREE BOOK**

CARTOONISTS' EXCHANGE
Dept. 98D Pleasant Hill, Ohio

Learn PHOTOGRAPHY at Home

Splendid opportunities. Prepare in spare time. Practical basic training. Long-established school. Send for free book, "Opportunities in Photography." No obligation.

AMERICAN SCHOOL OF PHOTOGRAPHY, 835 Diversey Pkwy., Dept. 135C, Chicago 14, Ill.

INTERNATIONAL ROTARY

I-SPEED COPE-SAW DRILL-BIT

IT DRILLS IT SAWS IT REAMS



DRILL, SAW, REAM . . . metal, pipe, wood, plastic, Transite, etc. Use with any electric drill, slow drill press, lathe or milling machine. Drills own starting hole—upper part of bit is used to cut, saw or ream circles, ovals, squares or scrolls. Easy to operate. Ideal for carpenters, mechanics, electricians, plumbers, hobbyists, many others. Abrasive resistant, high speed steel. Flutes ground from solid. Will withstand severe continuous use without breaking. Resharpens at no charge. Takes place of up to \$50 in tools. 1/2" diameter, 2" cutting sections, total length 3 1/2". Also available specially designed for wood or metal and in 2 1/2" and 1 1/2" lengths. Write for details. Specify all-purpose bit. Shipped same day. Money-back guarantee. Dealer inquiries invited. **SEND CASH. CHECK OR MONEY ORDER** Manufactured and distributed by: **INTERNATIONAL TWIST DRILL CORP.** 618 Wyandotte, Rm. 634, Kansas City 6, Mo.

only **\$3.95** POST PAID

60 POWER TELESCOPE \$3.95

VARIABLE EYEPIECE 20 x 40 x 60 — BRASS BOUND

NEW! Three telescopes in one. 3 different magnifications. 20 power for ultra-bright images with 40 and 60 power for extra range. Guaranteed to bring distant objects, people, sports events, ships, moon, stars, etc. 60 times as close.



Most powerful for any eyepiece. 5 Sections. Closes to 1 ft. long. Contains 4 ground and polished lenses. Also used as a powerful compound microscope. Directions included. Mass production enables us to offer this instrument at amazing price of \$3.95 complete. Ready for immediate use. We pay postage. Get yours now.

CRITERION CO., Dept. PMB 5, 331 Church St., Hartford 3, Conn.

TELEVISION Needs You For Top Pay Jobs!

Learn How You Can Qualify With Our 2 FREE BOOKS
WRITE: Radio Television Training Association
(State age) 1629 Broadway, New York 19, N.Y. Dept. R-28

GREAT PROFITS

MAKE YOUR OWN RUBBER MOLDS

X.L. RUBBER MOLDS

will realize your great profits quickly!

WRITE FOR NEW FREE CATALOG

YOU can EASILY learn to cast thousands of perfect plaques, book ends, figurines, ash trays, etc. IT'S EASY, FUN, PROFITABLE!

X.L. Rubber. Pts. \$2.50; Qts. \$4.00 (postage extra). Models and enough for 3 molds \$1.50 prepaid.

Address Dept. 2
3403 S. Madison St.
Muncie, Ind.

SEND FOR FREE FACTS

WHAT WOULD HAPPEN If You Lost Your Valuable Papers?

You can be safe—get a photo copy of your birth certificate, marriage license, service discharge papers, diplomas, blue prints, house plans, and any other papers of value to you. Keep these photo copies in a separate place—they are your proof of their existence in case of loss. Send them today before you forget, and enclose \$1.00 for each page to be copied. Your papers and photo copies will be returned within 24 hours.

LOCATED IN CHICAGO'S LOOP

K&B PHOTO COPY SERVICE

175 W. JACKSON BLVD. DEPT. PM-82
CHICAGO 4, ILLINOIS

FREE

10-DAY TRIAL

DO YOUR OWN

HOUSE CARPENTRY

SAVE TIME AND MONEY

This Easy Way

Every step of carpentry in and around a house is clearly explained and illustrated in this big, useful book. Shows you how to build forms for foundations, footings, walls, steps, walks — How to build sills, girder supporting posts and girders — How to figure loads for house framing — How to lay out, cut and erect floor joists — How to lay flooring — How to frame outside and inside walls, allowing for openings — How to check the plumb of studs — How to brace and sheathe up outside walls — How to erect ceiling joists — How to frame around a chimney and stair well — How to lay out rafters for a gable roof, dormer roof, porch roof — How to sheathe gable ends and rafters — How to build cornices — How to lay shingles — How to build porches and bays — How to apply siding — How to frame up inside walls — How to construct stairs — How to place trim around windows and doors — How to fit and hang sash — How to hang doors — How to make closets, shelving and built-in equipment — How to lay finished wood flooring, linoleum flooring — How to hang a set of garage doors—How to insulate.

Over 600 Illustrations Show You Just What To Do and How To Do It

If you have a hammer, saw and plans, just follow the step-by-step directions and do any house carpentry job from foundation forms to interior trim. Here, in one remarkable volume, is the practical know-how that saves you time and money on house carpentry jobs of every description.

"I built my entire 5-room house myself with no other instruction except your book."—James Sidwell, Twin Falls, Idaho.

USE IT FOR TEN DAYS FREE

Send No MONEY

Don't send us a penny. Just mail coupon and get "HOUSE CARPENTRY" for 10 days FREE trial. If not delighted, send book back to us and owe nothing. If you keep it, entire cost is only \$4.75 plus few cents postage. Mail coupon below for your free-trial copy.

MAIL THIS COUPON

SIMMONS-BOARDMAN PUBLISHING CORP., PM-852
30 Church Street, New York 7, N. Y.

Send me for 10 DAYS' FREE TRIAL, "House Carpentry and Joinery" I will either return it in 10 days and owe nothing, or send only \$4.75 (plus shipping charges) in full payment.

Name _____
Address _____
City _____ State _____

SAVE! Send \$4.75 with this coupon and we pay postage. Same return and refund privilege.

SAY YOU SAW IT IN POPULAR MECHANICS

Want a Government Job?

START \$3,270.00 TO \$3,795.00 A YEAR

Prepare NOW for next exams

MEN — WOMEN

Thousands appointments being made. 32-page Book FREE.

Mail Coupon Today. SURE.

FRANKLIN INSTITUTE
 Dept. L-83, Rochester 4, N. Y.
 (Not Gov't Controlled)
 Sirs: Rush without charge, (1) 32-page book with list of U. S. Government Jobs; (2) Tell me how to qualify for one.
 Name.....
 Address..... Age.....

FOR YOUR
TECHNICAL AND VOCATIONAL TRAINING

Come to the
UNIVERSITY OF HOUSTON

One of America's large and most modern universities. Select from these fascinating fields: aeronautics air conditioning & refrigeration auto body and paint auto mechanics auto upholstery & trim diesel drafting electricity electronics machine shop photography radio stationary engineering television welding woodworking furniture upholstery.

PREPARE FOR YOUR FUTURE NOW . . . with very latest methods and equipment, at modern U. of Houston College of Technology. Entrance: high school diploma, or over 18 and ability to profit from instruction. Beautiful campus—250 wooded acres in Houston, Texas—city of tomorrow. Full college activities, sports, social life. Day or night, short or longer courses. Co-op work-study programs . . . earn part of tuition and expenses with part-time job in your own career field, while you learn. Personal vocational counselling. Diploma on completion and all credits apply towards Bachelor of Applied Science Degree. Job placement assistance. Sept., Feb., June semesters. Mail ad now for Free fully-illustrated brochure. No obligation. Mark X before choice of subject. **Do it today!**



ADMINISTRATION BUILDING

University of Houston, College of Technology
Dept. 182 — HOUSTON 4, TEXAS

FREE SAMPLE LESSON

WATCHMAKING

CHICAGO SCHOOL OF WATCHMAKING
1608 Milwaukee, Dept. 182, Chicago 47, Illinois

Show me without obligation how I can learn watch repairing at home. Rush free sample.

Name.....
Address.....
City..... Zone..... State.....

DRAFTING PAYS Big MONEY

Learn at home in spare time. Drafting offers excellent salaries, unlimited advancement opportunities, constant employment. Light, pleasant work vital in war effort. CTS gives you 50 illustrated drafting books, professional instruments, drafting table, everything you need. Send name now for FREE book and special PAY LATER form.

Christy Trades School,
4432 N. Kedzie, Dept. DB-1503
Chicago 25.

BRAND NEW 30 DAY FREE TRIAL High Power BINOCULARS

Finest Precision Optics
Featherlight
Money Back Guarantee
Easy Pay Plan
Leather Case Incl'd.

33 MODELS \$14.95 up

BUSHNELL Binoculars

Free! Catalog & Book "How to Select Binoculars"
Dealer Inquiries Invited

Bushnell Bldg., Dept. M48
Pasadena 1, Calif.

FREE GUIDE "How to Select Binoculars"

NAME..... CITY.....
ADDRESS..... STATE.....

How to Always Have **HOT WATER**

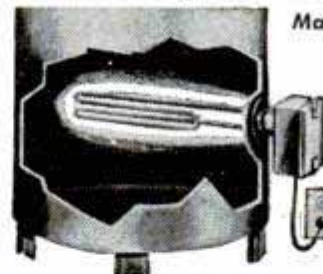

Make Your Own Automatic Electric Water Heater **\$19.95** now for only

Money back in 10 days if not delighted.

INSTALL IN 5 MIN.

Why suffer without hot water? Enjoy lots of it to wash, bathe, shave. Heater keeps water HOT in your present tank. Turns ON when needed—shuts OFF when water is heated. No flue, dirt, fire! No disturbing or draining of tank or pipes. Ideal for 30-gal. tanks! Heater screws into any size boiler tap as shown. Plugs into outlet . . . 1320 w. 110 v. AC. (Also 2000 w. 220 v. model for BX cable \$19.95) . . . works automatically thereafter. Temperature adjustable between 120 to 180

ONE YEAR GUARANTEE
All Parts U. L. Approved

degrees. Replaces coal, oil, gas in home, store, summer cottage, green house, farm, barn, stock tank, poultry scalding, factory. Uses only 1/4 to 1/2¢ electricity per gallon hot water. Why burn expensive main furnace unit for hot water? Send check or M. O. NOW; save postage, shipping charges. **ORDER NOW . . . TODAY.**

COLLOID EQUIPMENT CO., INC. Dept. PMS, 50 Church Street, New York 7, N. Y.

WALKIE TALKIES! — \$4.99 COMPLETE SET OF 2

POCKET SIZE — ELECTRONIC VOICE POWERED

No tubes, batteries, adjustments. Guaranteed to work anywhere up to 1/4 mile with extra wire. Swell for room-to-room—garage to house, etc. Your own private, talk-listen phone. Not war surplus. Brand new. Guaranteed. Two complete units with interconnecting wire — **READY TO USE!**

SEND \$1.00 deposit and pay postman \$3.99 plus postage charges or send \$4.99 for postpaid delivery. Available only by mail from **MIDWAY COMPANY, Dept. WPM-8, Kearney, Nebraska**

WARN HUB CAP MAKES 2 JEEPS OUT OF 1

Ends front wheel drag on 4-wheel drive Willys Station Wagons, Pick-ups and Jeeps

Saves gas up to 5 miles per gallon, tire wear, front axles, increases speed and power. Stops shimmy—front wheels coast out of gear! 4-wheel drive handles, performs, climbs like 2-wheel. Install or remove WARN HUB CAPS in 10 minutes. Polished aluminum, guaranteed. Rush check, M.O., or C.O.D. Write for circular.

\$20.00
Prepaid U.S., Canada

WARN MFG. CO., P. O. Box 6064A, Seattle 88, Wash.

23 KARAT KEY CHARM

"A BOOT OF GOLD" **50c** INCL. TAX & POSTAGE

HANDICRAFTERS MFG. CO.
1229 13th AVE., OAKLAND, CAL.

How to Get Better Paint Jobs!

Send for free illustrated 24-page booklet—tells how to buy and apply right aluminum paint for all jobs around the house. We don't make paint, but prepared this booklet to help you get better results with aluminum paint. Write for free book "Paint it Bright".

ALUMINUM COMPANY OF AMERICA,
1718H Gulf Building, Pittsburgh 19, Pa.

•• A SHOE BUSINESS IN YOUR HAND! ••

EARN \$60 WEEKLY WITH ONLY 3 SHOE ORDERS A DAY!

Make more money with famous 30 year old company. Show complete line quality shoes for men, women, children. Commissions to \$4.00 per pair, PLUS Cash Bonus to 75¢ per pair. PLUS Paid Vacation! Smash hit styles with magic comfort heel-toe cushion are selling dynamite. No experience or investment needed. Actual shoe samples supplied without cost. Write TODAY for full information and FREE 72 page Fall Catalog.

THE BIGGEST SELLER IN 30 YEARS

HEEL TOE CUSHION

TANNERS SHOE CO., 102, Boston 10, Mass.

MEN WANTED!



Make \$15-\$20 in Few Hours Spare Time—up to \$210.00 a Week FULL TIME—with Amazing D-FROST-O-MATIC!

Millions of housewives want this sensational new Automatic Refrigerator Defroster! No more messy hand defrosting! Just plug in D-FROST-O-MATIC and refrigerator is defrosted automatically every night! Sales easy, sure when you leave D-FROST-O-MATIC on FREE TRIAL—housewives won't let you take it out! Saves money, food, time, work! **Big profits for you—up to \$210.00 a week full time—\$15 to \$20 in just a few spare hours!** Start spare time and build big, prosperous business . . . quickly, easily!

SELLY of California started in his spare time and now sells 1500 D-Frost-O-Matics a month!

Rush Name Today for Profit Details and FREE TRIAL PLAN!

More than **29,000,000** prospects waiting! Rush your name and address today. We'll airmail exciting facts, proof and sure-profit Free Trial plan. No obligation. Write today.

D-FROST-O-MATIC, Dept. L-6
173 W. Madison Street, Chicago 2, Ill.

WHAM-O SPORTSMAN



35-LB. PULL!

HITS LIKE A RIFLE—KILLS RABBITS, SQUIRRELS. Powerful, silent, accurate. For hunting, target, routing pests. Sportsman's choice sold world over!



HUNTING SLINGSHOT

Heavy duty 7" ash stock. 40 steel balls, extra rubber, target. GUARANTEED. At dealers, or send \$1.50 to Wham-O Mfg. Co. Box 87, South Pasadena, Calif. * Professional model of Nat'l Slingshot Assn.

Thrilling Work COLORING PHOTOS

Fascinating vocation learned at home by those with aptitude. Thrilling pastime. National method brings out life-like colors. Free booklet.

NATIONAL PHOTO COLORING SCHOOL
835 Diversey Pkwy., Dept. 135C, Chicago 14

NEW! READ ALL ABOUT SPORTS CARS!



Learn the amazing secrets of the world's most spectacular new cars in this brand new book! 160 pages of photos and action stories: road racing, designing, technical data, all by experts! Send only 85¢ (75¢ plus 10¢ postage, handling) to SPEED & SPORT, 5959-P Hollywood Blvd., Los Angeles 28, Calif. Big CUSTOM CARS, HOT RODS, HOW TO BUY A CAR books also available at 85¢ each. ORDER TODAY!

HELPFUL BOOKS

Send post card asking for FREE catalog
Popular Mechanics Press, 200 E. Ontario, Dept. 601, Chicago 11

TRY 30 DAYS AT OUR RISK!

Low in cost

New Advertising Machine Prints and Illustrates Gov't Post Cards

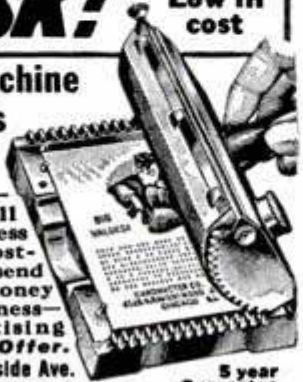

FREE Send name—learn how all types of business are boosting sales with Post-card Advertising. We'll also send **FREE** illustrated book of money making ideas for your business—complete, unique advertising plans—and 30-day Trial Offer.

CARDMASTER CO., 1920 Sunnyside Ave. Dept. 138 CHICAGO 40, ILLINOIS

5 year Guarantee

521 DIFFERENT STAMPS-25¢

SPECIAL IMPORTED COLLECTION INCLUDES THIS*



UNITED NATIONS FIRST DAY COVER

PLUS

You get the very first stamp issued—on a colorful cover—cancelled at the special UN office on the first day of issue! It's a historic souvenir you'll be proud to place in your album—a rarity that only one collector in 100,000 can have! And you also get hundreds of other unusual stamps and sets from all over the world—521 all-different stamps—ALL yours for only 25¢ to introduce our Bargain Approvals. Money back if not delighted. And you also get, FREE, our 36-page Midget Encyclopedia of Stamp Collecting!

U.S.A.—\$1-\$5 1931 top values. ALLIED MILITARY GOV'T—Cpl. set (9). MONACO—Pope Pius triangle, set of 2. FRANCE—Anti-Communist set. KOREA, ISRAEL, INDONESIA—special issues.

SEND 25¢ TODAY ASK FOR LOT FO-1
ZENITH CO., 81 Willoughby St., Brooklyn 1, N.Y.

NEW LOW PRICES on these powerful NEW 1953

MIDWEST TELEVISION

Super Powered for "FRINGE" AREAS

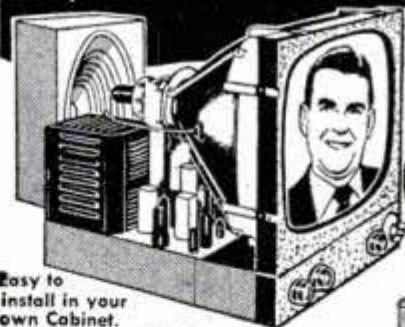

Mammoth 20-Inch Rectangular PICTURE

Easy to install in your own Cabinet.



30 DAYS TRIAL



Midwest offers a sensational new 1953 line of beautiful consoles and complete chassis for easy installation in your own cabinet. Mammoth 20-Inch Television at low Factory Prices, and on 30 Days Trial.

Buy DIRECT from the MIDWEST Factory and SAVE!

SEND THIS COUPON For FREE MIDWEST 1953 Catalog

MIDWEST RADIO & TELEVISION CORP.
Dept. 25T, 909 Broadway, Cincinnati 2, Ohio

NAME _____
ADDRESS _____
CITY _____ ZONE _____ STATE _____

MAKE this Beautiful OTTOMAN Yourself!



Send for **FREE BROCHURE AND FREE FABRIC SAMPLES**

To save many, many \$\$\$ all you need is scissors and a hammer! No special tools required to make this big, comfortable Ottoman that adds beauty to any room.

Now available in Eastern's Exclusive Do-All Kit. Kit contains everything in pre-fabricated form, including hardwood frame, springs, rubberized hair, and choice of attractive fabrics.

Eastern's easy-to-follow Instruction Manual—over 60 photos—makes it amazingly easy to build—no special skills necessary.

Don't confuse this Ottoman with small flimsy footstools. This is a large, sturdy, well designed piece of furniture, measuring 23" x 17" x 14" high, built for years of service.

Write for free illustrated Brochure today!

EASTERN SCHOOL OF UPHOLSTERY
DEPT. M 555 BROADWAY, NEW YORK CITY.



TALK-SING-PLAY OVER YOUR RADIO

with the real Radio Mike! Attaches in a jiffy—full instructions given! Swell for "parties"—"cut in" on or "kid" regular network programs or put on your own broadcasts! Amaze your friends—real fun. Beautiful Metallic Plastic 6 in. high!

12 RADIO BROADCAST LESSONS GIVEN with each mike
SEND NO MONEY Just pay postman \$3.99 COD plus postage or send \$3.99 and we pay postage! Radio Mike is available only from us by mail—guaranteed. Midway Co., Dept. MPM-B, Kearney, Nebr.

Famous 15 and 17 Jewel **\$16.95** PLUS TAX
BULOVA WATCHES
PRACTICALLY WHOLESALE TO YOU



UNLIMITED WRITTEN GUARANTEE

Were Up to **\$59.50**
SAVE \$42.55

Also Choice Of
• Benrus • Gruen
• Waltham or
• Elgin Watches

You get these unredeemed **UNLIMITED** guaranteed Bulova and other movements in latest style Yellow Gold Cases at this sensationally low price because we bought out **SURPLUS STOCKS** of leading New York and Md. jewelers. Order now while they last. Specify make preferred and whether men's or ladies'! Only \$16.95, plus \$1.70 tax. Order right now.

FREE TRIAL OFFER! WEAR AT OUR RISK!
Money back guarantee in 10 days if not delighted!

SEND ONLY \$1 with order. Pay balance C.O.D. plus postage. Or we pay postage if you enclose \$16.95 plus \$1.70 tax.

UNLIMITED Guarantee—17 Jewel Swiss

WRIST WATCH

Worn by Army, Navy & Marines

Originally \$59

\$14.95 Plus \$1.50 Tax

New Incablock, Shock-Protected
WATER-DUST PROOF

FREE! Handsome Expansion band with orders.
MARYLAND DISTRIBUTORS, Dept. 396
501 E. BALTIMORE ST., BALTIMORE 2, MD.
Write for Free Watch and Diamond Ring Catalog — Practically Wholesale Prices.

NEW AUTOMATIC DEFROSTER

ONLY **\$7.95** YOU MAKE UP TO \$4 ON EVERY FAST SALE!



Millions of defroster attachments sold at \$12.50 and \$9.95. Now — with new guaranteed **HOLWIN** at \$7.95 demand reaches new high peak. Men selling as many as 10 and 12 a day — right now. Your profits big — as high as \$4.00 cash on every sale. Converts any old style refrigerator into automatic defroster in 10 seconds. Just plug in. Terrific demonstrator. Women crazy for it at this price.

NO CHARGE for complete selling kit and offer of sample demonstrator. Rush name. If you've ever sold anything you'll clean up with **HOLWIN**. All mailed Free. Send name today for \$140-a-week opportunity.
DEFROSTER SALES CO., 415 La Salle St., Dept. H-8-O, Chicago 10, Ill.

FREE SEND NAME Don't buy until you're satisfied. Rush name for free sales kit. Offer of demonstrator sample to all who answer this ad. Sales skyrocketing every day. Rush name for big money.

Success-Winning VOICE!



Sound like the **HE-MAN** you are

STRENGTHEN your voice this tested scientific way. Yes—you may now be able to improve the **POWER** of your speaking and singing voice... in the privacy of your own room! Self-training lessons, mostly silent. No music required.

FREE BOOK Write TODAY for Eugene Feuchtinger's great booklet "How to Develop a Successful Voice." It's absolutely FREE! You must state your age. Booklet mailed postpaid in plain wrapper. No salesman will call. Send your name and age **RIGHT NOW!** Perfect Voice Institute, 210 S. Clinton St., Studio HY-2, Chicago 6, Ill.

THE ART OF DRAWING

Fascinating learn-by-doing lessons in drawing, painting, illustrating and commercial art. Prepared for YOUR instruction and enjoyment in spare time at home. Purpose: To turn amateur talent into **PROFESSIONAL** skill. Cost? Surprisingly low. Send for **FREE** illustrated booklet, "Building a Future" in Art.

Write today.

GRANT SCHOOL of ART Dept. A82, 225 N. Michigan Avenue, Chicago 1, Illinois

Our 513th Advertisement

REAL DIESEL ENGINE

\$2.95 • for planes, boats, midget cars
• 7500 RPM; 1/7 HP; ht. 3 1/2"; wt. 5 oz.
• precision machined for smooth operation

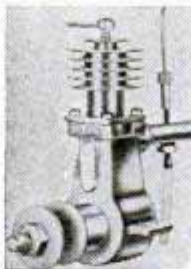

You just can't beat this price for a precision diesel engine! Streamlined, compact, easy to install. Thousands of satisfied users all over the world. Fast delivery if you **ORDER TODAY!** Send \$2.95 plus 25c postage.

GOTHAM HOBBY CORP. Dept. P, 107 E. 126th St. New York 35, N. Y.

Powerful Motor



One of the smallest precision motors ever built yet does **GIANT-SIZED JOBS**. Drives Model Planes, Boats, Construction Sets, Working Models, Trains and Cars, etc., with amazing speed up to 6800 R.P.M. (or as little as 50 R.P.M.), using the reduction gears that come with this exciting set. The **MIGHTY MIDGET** does hundreds of jobs. It's a Honey. Looks exactly like a Big Motor, yet measures 1"x1 1/4" and weighs one ounce. For only \$2.98, **YOU GET LOTS MORE** with this Mighty Midget. You get a complete set of 10 gears and pulleys and a transparent multi-ratio gear box as well as a battery clip with two batteries and instructions. **NO SHOCKS, SPARKS, NO SHORTS, NO TRANSFORMER NEEDED.** Reverses immediately, too! Endless hours of fun. Enclose check or money order for \$2.98 for this entire set and we will pay postage. C.O.D. orders plus postage.

IMPERIAL SALES CO., Room 1115

480 LEXINGTON AVE. DEPT. M-192 N. Y. 17, N. Y.

TOOL & INDUSTRIAL ENGINEERING

DEGREE IN 26 MONTHS

TOOL ENGINEERING (BTE) IN 26 MONTHS
TOOL & DIE DESIGN IN 10 MONTHS



The Allied Institute, the oldest Tool Engineering school in America, confers the degree of Bachelor of Tool Engineering in only 26 months. Time may be shortened by credits from other institutions, industrial experience, or approved courses in the armed forces.

ALLIED MEETS INDUSTRIAL APPROVAL

The Allied Institute of Technology has been approved by the American Society of Tool Engineers for aiding and assisting the professional advancement of Tool Engineering Education. The Institute has complied with established requirements for the Administration of a Tool Engineering curriculum, as set forth by ASTE and American Industry.

Housing and Employment assistance given while attending school.



Write for free information

ALLIED INSTITUTE of TECHNOLOGY

1338-42 S. Michigan Ave. Dept. PM-8 Chicago 5, Illinois

MAKE MONEY FAST IN ONLY SPARE TIME - SHOWING CAR OWNERS SENSATIONAL NEW Auto Seat Covers



including

BLACK EBONY

AMERICA'S NEWEST

SEAT COVER SENSATION

EVERY CAR OWNER A PROSPECT

Want extra money—plenty of it day after day? Then rush your name and address at once for Free Sample Outfit that will start you taking orders from car owners everywhere for Key expertly tailored Auto Seat Covers. Show **EXCLUSIVE NEW PATTERNS** to fit every make and model car. No one can compete with you in wide choice, in quality—and in expert tailoring that makes covers fit like a pair of gloves! And when you quote prices that are only a fraction of what the customer expects to pay, brother! You make money hand over fist writing up the first orders! Line includes nationally advertised sensations like **BLACK EBONY** Saran, beautiful **BAMBOO**, brilliant **FIESTA**, colorful **BULL FIGHTER PLAIDS**, plus many other exclusive patterns to choose from, all at unbelievable low prices.

RUSH NAME FOR FREE OUTFIT

GIVE MAKE, YEAR AND MODEL OF YOUR CAR

No experience needed. Make all the extra money you need easily just by showing! Every car owner a "hot" prospect. **YEAR AROUND STEADY PROFITS**. No investment to make. **Actual seat covers given to producers for OWN USE!** Write for Free Selling Kit valued at \$2.00 and actual samples TODAY!

KEY PRODUCTS CORP., Dept. 48
800 N. Clark St., Chicago 10, Illinois

Own Your Own Home



1-2 BEDROOMS as low as \$69000

NOW you can build YOUR OWN HOME at a price you can afford... Sturdy, fireproof, termite proof, concrete block and wood construction. Ideal for average family. Working plans include Living Room, Kitchen, Bath, and 1 or 2 Bedrooms.

• Complete designs, easy working plans, material lists, and illustrated step-by-step instructions to build ALL Sunny-Cal Homes **Only \$100 PPD.** MONEY BACK GUARANTEE

SUNNY-CAL Homes

1621 N. Cahuenga Blvd., Dept. 1
Hollywood 28, California

GET INTO BUSINESS for Yourself!

METALIZING BABY SHOES

AT HOME IN SPARE TIME

Make your home your headquarters. Start now, full or part time. Famous Warner Success Plan backed by old established company tells everything—Facts cost nothing, now or ever. Time is precious. Big money waiting for serious minded men, women. **SEND NAME ON A PENNY POSTCARD!** I want you to read Complete WARNER Success Plan entirely at my risk. Read the facts—then decide. Rush name today. Write to Ray E. Brandell.

WARNER ELECTRIC CO., 1512 Jarvis Ave.
DEPT. 3-0, Chicago 26, Illinois



FREE!

Offer of **COMPLETE MONEY MAKING PLAN**
Send No Money

GET MORE POWER!

Fisher's Compression SEAL **\$3.95** postpaid

- Stop Burning Oil!
- Restore Compression!



A small amount of Fisher's Compression SEAL in each cylinder bore will give you the economies of smooth, powerful (new car) performance and reduced oil consumption. Only takes minutes to apply... yet adds 10,000 more miles of economical driving pleasure to your car. A \$100,000 insurance policy is your assurance it cannot harm the finest engine.

SATISFACTION GUARANTEED

Full purchase refunded, if not completely satisfied. Why pay more when you can get Fisher's Compression SEAL... for less. No oil solvent baths necessary!

Send cash, check or M.O. today. Only \$3.95 postpaid. Free Folder. Dealers Inquire!

ADVANCED ENGINEERING Dept. PM-8, Box 7013
Los Angeles 37, Calif.

GROW Living MIDGET TREES!

EARN \$1000 PER HOUR!

- AT HOME
- IN SPARE TIME
- NO EXPERIENCE NEEDED



It's new! Amazing! At last, the secret of growing miniature (MING) trees can be yours. **FULL GROWN, dwarf trees**—only a few inches high. Beautiful miniature fir, orange, oak, Chinese elm, peach, pine, cypress—any kind! **ALL BLOOM** and even **BEAR FRUIT**. All perfect healthy specimens—but miniature in size! Make costly home decorations and expensive centerpiece. **(SOLD FOR OVER \$1,500 EACH)** Big demand. Costs only pennies—takes only minutes per week. **IT'S EASY!** Fun! A new fascinating hobby—a new fabulous \$\$\$\$ business. Send for free secret plan details and real seed.

HELP US FILL HUGE DEMAND!

These trees are being demanded by **STORES CLUBS • HOTELS • FLORISTS • HOUSEWIVES • INTERIOR DECORATORS • COLLECTORS • HOBBYISTS**—A Big Money Opportunity FOR YOU.

FREE! GENUINE SEED AND PLAN!



NATIONAL NURSERY GARDENS, Dept. M8

8463 South Van Ness

Inglewood 4, Calif.

Rush me **FREE** plan and seed **IMMEDIATELY!**

Name _____

Address _____ Zone _____

City _____ State _____



**A MUST FOR EVERY FARM FAMILY!
SAVES MONEY FOR HOME OWNERS
A PRICELESS GIFT TO SEND TO
A FAMILY ON THE FARM!**

POPULAR MECHANICS

FARM MANUAL

**Farm Help That Works
Every Day in the
Year For
Only \$3**

*A Thousand and
One Ideas You Can
Use on the Farm!*

Popular Mechanics Farm Manual is packed with practical ideas and usable information that can easily be worth hundreds of dollars to every farm family and to home owners everywhere. Here are a few of the things it covers:

Farm Machinery and Implements

How to make tractors, scoops, scrapers, cordwood saws, buckrake, power driven elevator, "Farm-ette" — odd job tractor, hoists, dump trucks, spreaders, seed-grain duster, posthole auger, etc.

Farm Workshop Equipment and Repairs

Welding on the farm, soldering, workshop power saws, home built air compressor, small shop forge, workbenches, curing gas engine troubles, hydraulic rams, drive your own wells, etc.

Poultry and Livestock

How to build poultry houses, incubators, brooders, at low cost, feeding, stock care hints, hog care gadgets, etc.

Vegetable Storage — Processing

All-winter vegetable storage, preparing food for home-freezer storage, how to make your own home freezer, charts, guides.

Farm Home Improvement

Fencing, repairing electrical appliances, plumbing, electrical wiring, saving coal, painting, curing leaky basements, hanging wall paper, making garden tools, garages, working with concrete, painting, etc.

Farm Hints and Kinks

Forty pages of illustrated practical ideas, short cuts, etc., that will save time, labor and money around every farm and city home.

POULTRY HOUSES You Can Build



Keep Your Tractor Rolling

MECHANICAL "Hired Man"



INCUBATORS



Farm Dump Truck Saves Shoveling Oil Load



Storing Vegetables for Winter



**Use This Book to Step up Farm Efficiency—
Increase Farm Production—Improve Farm
Appearance—Save Time, Labor, Money!**

This is the book that thousands of farmers and home owners have waited for. It is the experience of hundreds of successful operators brought together in one handy, easy-to-read, easy-to-use, working handbook by the editors of Popular Mechanics. It is brimful of short cuts, labor-saving ideas, ingenious apparatus and methods that will simplify the day's work and lighten some of the more tedious chores, make money and save money for you.

**284 FACT
PACKED PAGES
•
HUNDREDS OF
ILLUSTRATIONS
•
FULL SIZE
Library Binding**

HELPS IN THE FIELD — IN THE BARN — IN THE HOME

Every department of the farm is covered in the Farm Manual. Every member of the family will find in it something that he or she can use to tremendous advantage in farm operation, maintenance and improvement, from the building and care of equipment to painting the farm home and fast freezing fruits and vegetables. It covers all farm buildings, the farmhouse and other homes and is of interest equally to the woman looking for home improvement, beauty and convenience and the man striving for easier and more profitable operation.

ORDER TODAY — FOR YOURSELF — FOR A GIFT

Use the coupon below. Mail it today. Book will be sent at once, post-paid if you include payment with your order. If you don't think the Farm Manual is worth even more than you paid for it after five days' use, send it back by mail and your money will be refunded. This may be the best investment you ever made. Rush coupon today.

MAIL COUPON • Money Back if Not Satisfied

Popular Mechanics Press, Dept. 49C
200 East Ontario St., Chicago 11, Ill.

- Send _____ copies of the Farm Manual at once.
 Remittance (\$3.00 each) enclosed. Send postpaid. Add 15% if outside U.S.A.
 Send C.O.D. (\$3.00 each) plus delivery charges. U.S.A. only.
 (If sent as a gift to another, send name and address on separate sheet.)

Name _____
 Address _____
 City _____ Zone or Route _____ State _____

**WORLD'S
BEST
WANT AD
MEDIUM**

CLASSIFIED Advertisements



Advertisements in this section 85 cents per word, each insertion, minimum 10 words, payable in advance. To be inserted under proper classification, copy must be in our office the 20th of the second month preceding date of issue
F. W. Johnson, Manager, Classified Advertising
Popular Mechanics Magazine, 200 East Ontario Street, Chicago 11, Illinois

YOU'LL PROFIT

By reading and answering the classified ads in this section. Hundreds of opportunities for you to make and save money

AUTOMOBILES, MIDGET CARS

"SPEED Equipment." Save up to 50%. Hollywood mufflers \$4.95, dual mufflers \$18.95, header kits \$9.95, cut outs \$6.95, dual intake manifolds \$12.95, chrome stacks \$1.25, racing cams \$29, hi-compression heads \$18.95, water injectors \$5.95, customizing kits \$1.98. Thousands of accessories. Catalog plus Soup-Up Handbook 25c. Alquist Engineering, Milford 24P, Penna. Dealers wanted.

SPECIAL, Hot rod cam shaft regrinding. Many \$23.50 exchange. Auto Electric Service, Box 54, Anderson, Ind.

INTERESTED In antique automobiles? Send for free sample copy. Franson's Motor News, Eugene, Oregon.

MAKE Ford use diesel fuel. \$5.00 for plans. Refiner, Box 292, Columbus, Nebr.

SPEED Equipment from the world's largest firm. 25c for huge catalogue. Newhouse Automotive Industries, Los Angeles 22.

HOP Up, the monthly magazine that leads the field for hot rods, custom cars, speed secrets and racing information. Send 20c for sample copy or subscribe now, \$2.00 year. Write Dept. PM, 530 Colorado Blvd., Glendale 4, Calif.

LATEST 1952 Edition! Just out—100 new pages! Get world's largest auto accessory and parts catalog and save money. Over 50,000 items, including Hollywood accessories, hi-speed equipment, rebuilt engines, all parts and accessories for all cars and trucks. We have that hard-to-get part! Jam packed with bargains. Completely illustrated. Send 25c (refundable). J. C. Whitney, 1919 Archer, Chicago 16.

SERVICYCLE \$15. Midget car \$10. Dart motorscooter \$17, less engines; two cylinder opposed 5 horsepower engine \$20, others \$7.50 up (mailorder only). Send 25c for catalogue number 47, listing these and hundreds of other bargains in midget cars, motorscooters, outboard motors, homebuilders parts, plans, etc. (35c by first class mail). Midget Motors Directory, Athens, Ohio.

SAVE—California custom accessories headquarters. Buy direct from original designers. Chrome dash panels, electric push button door-trunk conversions, fender skirts, dual mufflers, lowering kits, speed-dress up equipment. 40 page catalog, hundreds of photos—25c. Eastern Auto, 3319A South Grand, Los Angeles 7, Calif.

CHEVROLET Owners—Save money; make your Chevy run better, last longer! Get Popular Mechanics big Manual for Chevrolet Owners by Ed Packer today. 304 pages: hundreds of illustrations. Find out how to make your own repairs; keep your Chevy in tip-top shape. First minor adjustment or repair saves you many times cost of book. Send \$3.50 today to Popular Mechanics Press, Dept. 108, 200 E. Ontario, Chicago 11, Ill.

AUTO SUPPLIES AND EQUIPMENT

CUSTOM Grills, beautifully chromed, massive design. Ford, Mercury, 49-52. Free literature. Gilbertcrafts, 15 Jessie Street, Brockville 4, Ontario.

NEVER Change your oil! Full details free. Thousands of users. New oil filter. Dept. PI, Henderize, Inc., 5667 Freepoint Blvd., Sacramento, California.

SOUPED Up Mercury block assembly \$295.00. Circular free. Auto Parts Service, West Salem, Ohio.

REMANUFACTURED Engines. New car guarantee. Marvin, Box 5046, Cleveland 1, Ohio.

LACHAPPELLE'S Treatment (patented). For \$3.00 puts babbitt bearings on the pistons for 100,000 miles. Write for data. Ferns Products, 8120-B Walnut Dr., Los Angeles 1, Calif. Cuba, Luis Izaguirre, San Carlos 178, Cienfuegos.

MOTORIST Save gasoline by vacuumating overrich mixtures. Fits all cars. For free particulars write Vacuumatic, Dept. 1926, Wauwatosa, Wis.

SPEEDOMETERS—Exchanged \$6.95. Western Speedometer Exchange, 10452 Magnolia Blvd., North Hollywood, Calif.

WOLF Whistle auto horn. Precision constructed. No holes to drill. Fits any gasoline engine. \$3.00 prepaid. Charter Oak, 256A 145 Ave., St. Petersburg 6, Fla.

ELECTROPLATE Metals, non-metals. Portable electroplater, plating salts, formulas, instruction manual, \$5.95. Tyco Metals, Box 13231-BF, Houston 19, Texas.

RENEW Your old motor, keep that new motor young for only \$3.00. Use Lachapelle's (patented) motor treatment. Puts babbitt-type bearings on pistons, valves, rings. Cuts gas and oil consumption. \$3.00 prepaid. Circular free. Joe Dillon, Authorized Warehouse Distributor, Box 323, Bridgeport, Ohio. Dealers and agencies wanted.

AMERICAN Auto Parts Co. Inc., has for immediate shipment parts for military trucks, Jeeps, Dodge, Chevrolet, GMC, Studebaker, 4 wheel and 6 wheel drive; some "hard to get" items. Write for parts catalogue, giving name of trucks. Dept. PM, 1830 Locust, Kansas City, Mo.

SPEED Equipment. Edelbrock, Offenhauser, Navarro heads, manifolds, Winfield cams, dual ignition points. Chev. 37-51, Ford 49-51. Deepstone mufflers, headers, dual muffler sets, Mallory coils, distributors. Speed catalogue 25c. Urzi's Auto Supply, San Jose, California.

FIBERGLAS-Plastics for bodies and hard tops. Professional instructions free with order. Write leading suppliers. Industrial Plastics, 4425 Linden Street, Oakland 8, California.

"WATER Injection." Airflow needles. Economy methods. Free illustrated information. Neher Industries, La Verne, Calif.

BUY Racing heads, dual manifolds, hot coils, etc., without money. Information free. Newhouse Automotive Industries, Los Angeles 22.

BRAKE Floaters for Chevrolet, Ford and Mercury cars insure more powerful brakes, soft pedal, cure squeal. Write Super Brake-Floater Company, 4022 West Lake Street, Chicago 24.

LIGHT Your Powerglide and Dynaflo dials. Information free. Gaiser, Box 25, Kokomo, Ind.

HOW To buy speed equipment without money. No selling. Information free. Newhouse Automotive Industries, Los Angeles 22.

NEW And used guaranteed parts for civilian and army cars and trucks. Largest stock in America. Mail orders. Pioneer Auto Wrecking Co., 734 W. 13th Ave., Denver, Colorado.

AUTO "Liqui-Moly" makes oil 300% more efficient. Protects bearings even if all your oil burns up. Higher speeds. Tighter bearings. Less heat. Less friction. Contains no graphite. A hot rods dream. ½ pt. \$1.15 prepaid. Case lots on request. Convincing literature free. Hal-Gas Auto Products, Box 912, Fonda, N. Y.

SIRENS. Air horns! Bermuda bells. Free accessory catalog. McCanna Company, 200-PM East 21st, New York 10.

TIRES: Wholesale. Major brands. Free list. Field Tire, Downingtown 3, Penna.

BODY And fender men: Five time saving tools you can make yourself—Plans \$1.00. Shuman, 3117 Division Street, Los Angeles 65, Calif.

CHEVROLET Owners: Stop tappet noise with Kaye Tappet Silencers. Quality product. Easy to install. Money-back guarantee. Complete set \$5.95 postpaid. Kaye Products, 1321B So. Layton Blvd., Milwaukee, Wis.

AUTO Radios at wholesale. List free. Regent, 801 W. Erie, Philadelphia.

MOTORISTS Are reporting three to five more miles per gallon. Guaranteed, gasoline vaporizer, increases power; easier starting. \$3.50. Turb-O-Vane, Stockton, California.

BRUSH Plating outfits connect to a battery. No tanks or shop required. Free particulars. Gunmetal Co., Ave. J., Decatur, Ill.

AUTO Parts and accessories. Briggs Automotive Engineering of Chicago, P.O. B. 3454 Merchandise Mart, Chicago 54, Ill.

AUTO TRAILERS

BUILD Your own trailer! Plans for all kinds. Illustrated catalog 10c. Jim Dandy, 125-M, Wausau, Wisconsin.

MOTORCYCLES, BICYCLES, MOTORSCOOTERS AND SUPPLIES

WHIZZERS \$20; Midget car \$15; motor-scooter belt drive \$6; 3-wheel scooter car \$39.50. Send 25c (35c first class mail) for catalog #21 jammed with sensational bargains in wheels, motors, clutches, motor-scooters, midget cars, motorbikes, etc. Gail, 538 Erie, Toledo, Ohio.

WHIZZER Motor \$5; Cushman motor-scooter \$15; Indian motorcycle \$30; engines \$3 up; motorbike frame \$3. Rush 25c (35c first class mail) for catalog #952 listing many other amazing bargains in motors, midget cars, motorscooters, motorbikes, etc. Associated, Box 1764-CS, Toledo, Ohio.

REBUILT Gasoline engines. \$19 to \$39. Cauffiel Motor Industries, Temperance, Michigan.

BUZZZZ Magazine. Describes, illustrates motorcycling completely. \$2.00 year. 20c copy. 5424-A Sawyer, Chicago 25.

RECONDITIONED Motorcycles and motors. Chromium accessories. Complete stock Indian parts. Expert rebuilding. Fast service. Indian Motorcycle Sales, Kansas City 1, Mo.

HARLEY-Davidsons—All models and prices. Genuine late and old model supplies. Expert service. Send 25c for bulletin. Knuth's, 1753 Muskego, Milwaukee, Wis.

MONKEYS, Baby Ringtail \$49, a musing white faced \$45. Shipped immediately. Shehyn's Pets, Silver Springs, Florida.

HAMSTERS, Official breeding information free. Exceptional profits. Golden Hamstery, Box 604 Edgewater, Cleveland, Ohio.

BEAUTIFUL Pure white pedigreed police puppies. Ansonia Kennels, Mose, N. D.

RABBIT Raising pays. Free illustrated literature tells how. Old Mill Rabbit Farm, Elmhurst 2, Illinois.

GOLDEN Hamsters, bear strain. Pedigree stock. Breeders, laboratory or pet stock. Shipped express anywhere. Price list free. Charles E. Bowser, Smoke Run, Penna.

EARN Up to \$400 monthly raising Angora or New Zealand rabbits. Plenty markets. Particulars free. White's Rabbitry, Newark, Ohio.

HAMSTERS—Golden or spotted. Cages and equipment. Free illustrated details. Lakeview Hamster Colony, Newfield, New Jersey.

BOOKLET "Treatise on Breeding and Raising Canaries"—\$1.00. Audubon Publishing Co., 3449-PM N. Western, Chicago 18, Illinois.

MAKE Big money! Raise Chinchilla rabbits. Cash markets supplied. Write today! Rockhill Ranch, Sellersville 15, Penna.

MINK Raising information free. Complete. Lake Superior Mink Farm, Superior, EEl, Wisconsin.

A Practical beginning to successful rabbit raising. 48 page illustrated booklet. Dime. American Rabbit Breeders Association. 36 AR & CBA Bldg., Pittsburgh, Penna.

PLANTS, SEEDS, NURSERY AND GARDEN SUPPLIES

FRUIT Trees! Stark Bro's sensational new "Dwarfs." Also standard size, exclusive patented, trade-marked varieties produce abundant, larger, better apples, peaches, pears. All fruit faster growing, quicker bearing. Also beautiful ornamental trees and shrubs. Get giant new colorphoto catalog free. Stark Bro's., Dept. 30083, Louisiana, Missouri.

CORSAGE Materials. Flower arrangers' supplies. Artificial flower parts. House plant helps. Free catalog. Floral Art, Dept. PMJ, Teaneck, New Jersey.

FARMS, FARM LANDS, REAL ESTATE

NEW Free fall catalog just off press! Farm and country real estate bargains, good pictures, many states, easy terms, many equipped, businesses. For special service, state requirements, desired location. United Farm Agency, 1408-PM Consumers Bldg., Chicago 4, Ill.

FARM And business catalog free! Big new edition. Over 1000 bargains from \$1000 up. Maine to Florida. West's, M8, Pittsburgh 17, Penna.

\$5 ACRE. \$5 Monthly buys 40 acres good Missouri land. Lists mailed free. Write Mr. Armstrong, Shook 34, Mo.

FARM, Ranch, hunt, fish on your own land in beautiful Calif., Oregon and Washington. Now available, several thousand choice acres from \$10 to \$25 per acre, full price, including 100% oil and mineral rights. Low, easy terms. Send only 10c (coin) for full details, catalog, photos. Pacific Lands, Box 2350-BW, Hollywood 28, California.

STROUT'S Two catalogs. Farms, homes, businesses. 3646 bargains, 31 states. East and midwest green cover; west coast edition yellow. Either free. World's largest. Strout Realty, 7-M So. Dearborn St., Chicago 3, Ill.

\$5.00 MONTHLY Buys 40 acres near town; price \$200.00. Free list. Box 425-P, Carthage, Missouri.

FARM-Ranch opportunities. Favorable conditions, Washington, Minnesota, Montana, Idaho, Oregon, North Dakota. Literature, farm descriptions. Specify which state. J. W. Haw, 119 Northern Pacific Ry., St. Paul 1, Minn.

HOMESITES \$300 — Convenient payments. California's finest garden section. On Morro Bay's scenic shores. Wonderful fishing, boating, bathing. Fertile soil, softest water, temperate climate, congenial community. Free literature. Richard Otto, Department M, San Luis Obispo, Calif.

POULTRY, FARM SUPPLIES

KNOW How to raise poultry for profit. Read Poultry Industry. Every issue packed with helpful hints and practical suggestions. Latest articles on breeding, feeding and management. Subscribe now, 1 year 50c, 3 years \$1.00. U. S. funds or checks payable at a New York or Boston bank. Poultry Industry, Dept. PM, 376 Boylston St., Boston 16, Mass.

EARN \$4 To \$12 hourly. Terrific profits in chick and turkey sexing, culling, captionizing. School G.I. approved. Write Pilch's School, Box SSC-10, Thompsonville, Conn.

PROFITABLE OCCUPATIONS

MEN, Women visit foreign countries on modern ships. Big pay, adventure, excitement. Experience unnecessary. Details free. Davenport, 1170-A2 Broadway, New York 1, N. Y.

ALASKAN Jobs! Over 100 new construction contracts with names, addresses companies hiring. Thousands needed. Highest wages. Military, private construction, mining, fishing, lumbering, aviation, railroads, homesteading. Skilled, unskilled workers. Write today. Our information accurate. \$1.00 complete. Alaskan Opportunities (PM), Box 362, Kenmore, Washington.

FOREIGN Employment construction men, building trades, helpers, office men, others, interested in foreign projects. High wages, quarters, transportation. Send \$1 for foreign construction compendium and application forms. Foreign Service Bureau, Dept. PM8, Metuchen, New Jersey. (Not an employment agency—No fees.)

WANT A diesel job? New opportunities to increase income. Higher pay. More money. We can help you qualify. Tools. Shop method home training. Write today! Diesel. Tractor, Heavy Equipment Division, Interstate Training Service, Dept. 3H, Portland 13, Oregon.

SEND For big, new 1952 illustrated catalog that will show you how to turn your spare time into cash—making quick-selling, highly profitable lamps. Every home a prospect. Hundreds doing it, you can, too. No experience or special tools required. Catalog No. 7 contains 56 pages filled with shades, shade frames, figurines and bases, oil lamp converters, boring compound, and dozens of similar items. Also all kinds of sockets, cords, pipes, harps, finials, bases, and hundreds of other parts—everything you need. Special 8-page section shows 6 beautiful lamps in kit form, ready to assemble. You buy wholesale, sell at retail. Make big profits. Send 25c today for new 1952 catalog and wholesale price list, you'll be glad you did. The 25c will be refunded on your first order. Gearon Co., Dept. 500-B8, 27 S. Desplaines, Chicago 6, Ill.

CHINCHILLAS For sale. \$1000 to \$1500. Terms. Slasor's Chinchillas, Box 377, New Philadelphia, Ohio.

MEN—Women. "Everybody likes candy." Learn to make professionally. Tools and supplies. (Our 42nd year.) Ragsdale Candies, D6, East Orange, New Jersey.

MUSHROOMS Grown. Boxes, barrels. Manureless process 50c. Spawn \$1.00. Gordons, 553 William, Winnipeg, Manitoba.

PRINT Without a printing press. Big profits! See page 34.

GROW Mushrooms. Boxes, basements, gardens, lawns, grasslands. Instructions 35c. Mushroom spawn \$2.14. New manureless process \$2.50. Send for complete 3 item new kit \$4.99. No. c.o.d. please. Guaranteed fresh spawn or your money refunded. Thomas Co., Dept. 79, 3604 30th Ave. S.W., Seattle, Wash.

GROW Mushrooms. Cellar, shed, and outdoors. Spare. full time, year round. We pay \$3.50 lb. We paid Babbitt \$4,165 in few weeks. Free book. Washington Mushroom Ind., Dept. 99, 2954 Admiral Way, Seattle, Wash.

\$10,800 PROFITS! Your own mailorder business! No capital risk! "Success plan" (worth \$2) free! Write today! Treasury, 149 Storer, New Rochelle L-1, New York.

WANTED! At once! Home producers by manufacturers in our clearing house service. Become a sub-contractor casting plastic products for these companies. Thousands of easy to make items required. Cash in at home, without previous experience. For details, write Plastic Service Guild, Dept. PM5, East Boston 28, Mass.

BE The Popular Mechanics representative in your neighborhood and earn big profits in your spare time. Write Popular Mechanics Magazine, Room 408M, 200 E. Ontario St., Chicago, Ill.

MAKE Flexible molds! Cast plaques, bookends, figurines! Free sample! H. Tooker, 630-M Chestnut, Hamilton, Ohio.

ALASKA—Last American frontier. \$1.00 brings 1952 business directory, government map, construction projects military and civilian, homestead and highway facts, hunting-fishing-game rules, mining, aviation. List of firms hiring. How-when-where to apply. Alaska Opportunist, P.O. Box 883-P, Hollywood 28, California.

FOREIGN And Latin American employment. 1952 "Foreign Service Directory" gives up-to-minute facts on military and civilian construction, government jobs, major oil listings, aviation, transportation, steamship lines, mining, importers, exporters, how-when-where to apply, application forms, hot list firms hiring. \$1.00 postpaid. Global Reports, P.O. Box 883-P, Hollywood 28, Calif.

FREE Book "505 Odd, Successful Businesses." Work home. Expect something odd! Pacific, Oceanside, Calif.

RAISE Pheasants on the \$100 week plan. Little capital and space can make you independent. Free details. Great Central Game Management System, Columbus 1, Kansas.

\$40.00 WEEKLY Made growing mushrooms, fresh, dried. Dominion patent 331583. Free spawn. North American, 169P Yonge, Toronto, Canada.

BOOKS, PERIODICALS, PICTURES, POSTCARDS

ANY Book you want, we have it or will get it. 1/4 million stock. Write for free directory describing our complete book service. Shorey Book Store, 815-3rd Ave., Seattle 4, Wash.

BOOKS Supplied. Used. Out-of-print. Catalogue free. Balliol, Box 85, Station K, Toronto, Canada.

SEND 10c For list 3000 book bargains. Joseph Chobot, 2921 W. Vine, Milwaukee 8, Wis.

TECHNICAL And scientific books. Educational Aids, Dept. 308, Box 248, Temple City, Calif.

FAME Fortune possible! Read 9 amazing books! French's, 1253 Halstead, Muscatine, Iowa.

FREE Catalog, 400 popular books. Bargain prices. Books Publishing Co., 56 W. 24th, New York 10.

CRIMINAL Law interest you? Want to be deputy sheriff, patrolman, criminal investigator? Prepare now for coming examinations. Study true criminal cases at home. Free details. Pacific Institute, 2328 Santa Clara, Alameda, Calif.

SWAP, Sell, buy anything through adv. in Swapper's Journal, Box 197, Hazleton, Penna. Write for free copy.

INTELLIGENT Adults! New serious book: Should fatherhood begin at forty? 256 pages. Index, bibliography. Nice cloth binding. \$3.25 postpaid. Brower, 83; 426 E. Girard Ave., Philadelphia 25.

FREE Catalogue. Special interesting books. Melvin Powers, 1324 Wilshire, Hollywood 17P, California.

BOOKHUNTERS! All subjects. Send wants! Jaher Book Service, 620-P East 178 Street, New York 57.

MAGAZINES (Back dated)—Foreign, domestic — Arts, books, booklets, subscriptions, etc. Catalog 10c (refunded). Cicerone's, 86-22 Northern Blvd., Jackson Heights, N. Y.

BOOK "Breeding of Parakeets" and cage-bird magazine—\$1.00. Audubon Publishing Co., 3449-PM N. Western, Chicago 18, Illinois.

BOOKHUNTERS! Scarce, unusual, miscellaneous books supplied. Atlantic Book Service, Lawrence Avenue, Charlestown 29, Massachusetts.

GAMES AND ENTERTAINMENT

FORTUNE Telling game for girls. Hours of fun. \$1.00 postpaid. Ginger's novelties, 3344 S. May St., Chicago 8, Illinois.

MAGIC TRICKS, PUZZLES, JOKER NOVELTIES

NEW Book—"84 Card Tricks," 25c. Bryan, Box 209, Ayer, Mass.

"FUN With newspaper," completely illustrated, 35c. Rocky Nelson, Route 2, Cedar Rapids, Iowa.

MAGIC Monthly, year 25c. New 1952 magic catalogue 10c. New joke lists 5c. Magic Factory, Minneapolis 2, Minn.

3 CARD Monte trick and catalog 25c. Sterling Magic, Royal Oak, Mich.

512-PAGE Catalogue of 2500 tricks, pocket, parlor, stage. World's finest magic. Send \$2.00 for catalogue (refunded first \$8.00 order). Kanter's, M-1311 Walnut, Philadelphia 7.

VENTRILQUISM Self taught. Quick, easy instructions, 25c. "Ventriloquist," Cal Allen, Texas.

FREE Trick and large illustrated catalog 35c. Lerro Magic, 8111 Fifth Avenue, Brooklyn 9, N. Y.

WORLD'S Largest magic shop. Special: Big \$2 book of professional magic tricks, only \$1. Includes mailing lists. Holden's, M220 West 42nd St., New York.

BIG Fun kit! Tricks, jokes, novelties, books. Real clever stuff. Howls galore, \$1.00. Johnson, 414 McRae, Wilmington, N. C.

LATEST Magic for pocket, parlor, stage. Catalog 500 tricks, only 10c. Unequaled magic service for 30 years. Douglas Magicland, Dept. 1, Dallas, Texas.

PROFESSIONAL Catalog, 124 pages, 25c. Williams, 900 Plymouth, Ellwood City, Penna.

COINS, TOKENS, CURRENCY

OLD Money wanted. Do you know that coin collectors pay up to \$100.00 for certain U. S. cents? And high premiums for all rare coins? We buy all kinds. Send 4c for large coin folder. May mean much profit to you. Numismatic Co., Dept. 20, Fort Worth, Texas.

WHAT Are your coins worth? Amazing Fell's United States coin book. Everything on every single coin minted—Worth, value, how to sell, speculating, investment; other valuable facts on coins. Cloth-bound, 150 illustrations. Send no money. Pay postman only \$1.50 (plus postage) or \$1.50 postpaid (refundable). Order now! Fell Publishers, 386M5 4th Ave., New York 16, N. Y.

COIN Collector's Magazine. Largest independent, over 1000 pages per year. Sample copy 30c; \$3.00 per year. Hewitt, 7320-J Milwaukee Ave., Chicago 31.

40 DIFFERENT Coins, \$1.00. 100 different bills, \$1.00. Oddehon, Box 482, St. Louis, Mo.

SAMPLE Copy, "Coin Collector's" magazine, wooden nickel and foreign money 10c. Lawrence Brothers, Anamosa, Iowa.

SET Nine Japanese invasion notes for U. S. \$2.00. Catalogue thousands of coins, 25c. Shultz, Salt Lake 10, Utah.

GET Profit and pleasure in collecting old coins. Send 10c for 56 page illustrated coin catalog. You'll be delighted with it. Send for it now. B. Max Mehl, 370 Mehl Bldg., Fort Worth Texas. Largest rare coin establishment in U. S. Established 52 years.

FREE! Foreign coin, banknote and coin collectors illustrated catalog to approval service applicants. Send 3c postage. Tatham Coinco, Springfield 30, Mass.

FIFTY Assorted Indian cents, \$1.50. Rare 1931-S cents, \$1.00. Giant fifty-two page illustrated bargain catalog, 10c. Ben's PM Department, 31 North Clark, Chicago 2.

STAMP COLLECTING

FREE Complete set of famous Americans, flags, parks and presidentials to approval buyers. Send 3c for 15 of the above stamps plus full particulars. Triboro Stamp Company, 145 Nassau Street, Dept. 108, New York 38, N. Y.

BONANZA 1/4c To 10c approvals @. 185 Puritan, Highland Park 3, Mich.

EXCHANGE Stamps universe. Particulars free. Exchangers, Bry 126, Seine, France.

1000 FOREIGN Stamps, 500 varieties \$1.00. Anderson, Box 855, Mountain Home, Tenn.

FREE! Monaco nude set 3. This popular set offered to new approval applicants. M. Moulblow, 740 Hegney, Bronx 56, N. Y.

FIRST U. S. (1847) government reissues 5c, 10c, plus giant bargain U. S. collection—only 5c to applicants U. S. approvals. Metropolitan, Box 312G, Jackson Heights, N. Y.

SURPRISE Packets 25c. All different! Eugene Elmgren, 2003 East 4th Street, Superior, Wisconsin.

SAN Marino—25 different 5c with approvals. DeRespini, G.P.O. Box 771X, New York 1.

SAN Marino collection free. 25 different, old and new issues, airmails, commemoratives, high values—Absolutely free with approvals. Viking, 130-ZZ Clinton Street, Brooklyn, New York.

20 DIFFERENT B.W.I. 25c. Approvals accompany. Rahmer, Box 123P, Rome, N. Y.

VATICAN'S Colorful Cardinals complete, plus three 1947 airm, only 20c with approvals. Fred Pittsley, South Montgomery, Napa, Calif.

NEED Higher wages? Not when buying our stamps. Try our books of 1000 at 1c and 2c each, or economy U. S. approvals. Clark, Box 544-P6, Muskegon, Mich.

COLLECTION At a standstill? Let us show you our top quality 1c to 5c approvals. Many satisfied customers. Write today. References appreciated. Roseland Stamp Co., Dept. 10-D, Spring Lake, Michigan.

UNITED States stamps nearly 100 years old, Roosevelt set, others, 40c value—only 5c to applicants United States approvals. Wakonda, Box 272K, Jackson Heights, N. Y.

SENSATIONAL! Set each Honduras, Martinique, Guadeloupe, Guiana, also \$2, 000,000 stamp. Brunei, over 100 different others. Everything 10c with approvals. Whitehead, 315P South 5th Ave., Canton, Illinois.

FANTASTIC—Zanzibar, Borneo, Liberia, Sarawak, Fezzan, and over 100 different others. Everything 10c with approvals. Cut rates on fine large groups of world different stamps from 100 to 20,000. Thompson, 5708 Osseo Road, Minneapolis, Minn.

PENNY Approvals that satisfy. Neil Gronberg, Box 5441-P, Philadelphia 43, Penna.

FREE Price list. Povilauskas, 212 E. 3 St., New York 9, N. Y.

HUNGARY — 1 Lb. \$5.00 (Cat. value \$100.00). Alan Atha, Moberidge, S. Dakota.

SPAIN'S Goya nude set 25c with approvals. Royal Stamp Company, Tamagua, Penna.

50 MINT—Including Monaco giant bicolors, given approval applicants. Broadmoor Stamp Co., Pittsburgh 34, Penna.

U. S. Illustrated bargain list free. Stone, 45 Bromfield, Boston 8, Mass.

EXCHANGE—Send 100 stamps, 25c and self-addressed stamped envelope. We send 100 different. MacKellar, Box 4683, Los Angeles 24, California.

SHEPARD Stamp News. One year 20c. Sample free. Box 1147, Chicago.

TRUMAN, MacArthur, Hitler, Mussolini commemoratives; free to "approval buyers." William Deem, Ravenswood, W. Va.

GIGANTIC Collection free. Includes triangles, early United States, animals, commemoratives, British Colonies, high value pictorials, etc. Complete collection plus big illustrated magazine all free. Send 5c for postage. Gray Stamp Company, Dept. PM, Toronto, Canada.

100 VARS. Better than average foreign, plus worthwhile premium, 25c. C. Ritchie, Watertown, South Dakota.

SEVEN Triangles and assortment choicest beauties. Everything 10c with approval. Stan Bubenias, 27a James Ave., Clark Cranford, N. J.

100 DIFFERENT France 10c. Approvals. Aronson, 91 Marion, Brookline 46, Mass.

300 STAMPS For only 10c.—This mammoth value includes airmails, pictorials; stamps from strange countries cataloguing up to 25c each! Also approvals. Mystic Stamp Company, Camden 80, New York.

FIVE Triangles free with approvals. Exotic Stampco, Box 2104, Miami 12, Florida.

FREE "Stamp Finder." Tells instantly country to which any stamp belongs. 32 pages profusely illustrated. Garcelon, Calais 17, Maine.

FREE Stamp "circus" giants, pygmies, kangaroos, snakes, rhinoceros, ostriches, with approvals. Niagara Stamp Company, 17 Queensway, Niagara on the Lake, Can.

ALBUM! Holds over 1000 stamps! Only 10c! Stampmart, Hartford 1, Conn.

307 ALL Different—Only 15c! Beautiful collection: commemoratives, triangles, high values, bicolored stamps, etc. Garcelon, Calais 400, Maine.

1000 UNIQUE Colorful attractive book mounted stamps 1c - 2c each. Rushed. Niagara Stamp Company, 11 Queensway, Niagara on the Lake, Canada.

100 DIFFERENT U. S. 25c. Approvals. Buckeye, Box 53, Mansfield, Ohio.

77 DIFFERENT United States—25c. Approvals. Utechts, 1143-D North Keeler, Chicago 51.

FLAG Stamp—Free with hygrade U. S. approvals. Wenigman, 1933 Patterson, Chicago 13.

OLD Scarce U. S. seconds on approval. Slightly defective. Bargain prices. Hernefield, Clintonhill Station, Newark 8, N. J.

STAMPS Wanted. Collections, duplicates, surplus stock, mint and used. Good grades only. Buy outright if bargain. What have you? Write us details. Vanroy Shirk, Lebanon, Penna.

WORLDWIDE Variety packets 100 10c; 500 60c; 1,000 \$1.25; 2,000 \$3.25; 5,000 \$13.75. Philatelic House, 189 Merrick Rd., Rockville Centre, N. Y.

1/2—1—2c APPROVALS. Bargains galore! Cole, 43A Rinewalt, Buffalo 21, N. Y.

40 DIFFERENT U. S. commemoratives, airmails 25c. Seidenberg, 944, Appleton, Wis.

FREE Sample—Interesting, informative, illustrated! National Stamp News, Anderson, South Carolina.

AMAZING Offer! 500 United States stamps—including commemoratives, air mails, high denominations to \$5.00. Only 15c to approval applicants! Illustrated bargain lists free. Mystic Stamp Co., Dept. 80, Camden, New York.

POLAR Bear triangle, giant George Washington, six colored Ecuador, Arctic triangle, first American commemorative, Corsica, Devils Island, others. Everything free with approvals. Capital Stamps, Little Rock 2, Ark.

FREE — Illustrated catalog! Kenmore, Milford, C-57, N. H.

"HOW To Recognize Rare Stamps." Free book illustrated! Kenmore, Milford, H-57, N. H.

FREE. Scott's International Album. Other big premiums. Full particulars with approvals. Raymax, 68-Z Nassau St., New York 38.

500 EXOTIC Japan stamps—10c. Kenmore, Milford, J-57, N. H.

DIFFERENT 500, 35c; 1000, \$1.00; 2000, \$2.00; 5000, \$10.00 with approvals at wholesale to clear. K. S. Holmes, London, Can.

U. S. Army and Navy heroes on stamps; 10c with United States approvals. Locust, Box 305-T, Harmon-on-Hudson, New York.

U. S. Price list free. P. Wetterquist, 1635—13th Avenue, Rockford, Illinois.

100 DIFFERENT Spain 25c. Penny approvals included. Reed, Box 980, Chicago 90, Ill.

50,000 STAMP Grabbags 25c each. Anderson, 630B Bingham, Reading, Penna.

FREE Collection — Over 100 different stamps of world; commemoratives, animals, natives, ships, famous men, others all to approval buyers; also Scott albums, catalogs. Bell Stamp Service, Dept. S-2, Bell, Calif.

START Your own stamp business. Send for free circular. Donald Shepard, Box 1147, Chicago.

FREE! Powerful magnifying glass. Jamestown Stamp, Jamestown 202, New York.

200 DIFFERENT Including Roosevelt triangle, 5c to approval applicants. M. Avalon Stamp Company, Springfield, Mass.

NICARAGUA Sports, Costa Rica agriculture sets 10c with approvals. Seminole Stamps, Box 1138-P, Coral Gables 34, Fla.

UNITED States approvals—Select, used, mint. Kingsbury, South Woodbury 2, Vt.

50%-75% DISCOUNTS! Approvals from 33,000 collection—1/2c up! Schur, Box 235, Buffalo 12, N. Y.

NOTHING Free. Just good stamps reasonable. Send dime for seventy-four page catalog. Ben's Stamp Shop, 31 N. Clark, Chicago 2.

WOW! 203 All different Germany 10c! Zeppelins, semipostals, airmails, high values, etc. to new customers. Jamestown Stamp, Jamestown 512, New York.

WORLD'S Largest stamp (7 1/2 x 14 inches). A real curiosity! Retail for 50c, only 3c to approval applicants. Tatham Stamp Co., Springfield 30, Mass.

ANTIQUES, RELICS, INDIAN GOODS, CURIOS

4 PERFECT Arrowheads \$1.00; perfect pipe \$2.50, \$5.00; tomahawk \$3.00; knife 50c. Catalog 10c. H. Daniel, Lamar, Ark.

PRECIOUS STONES, MINERALS

"GENUINE" Red Arizona rubies (garnets). Send quarter for packet. Bitner's, Box 1025B, Scottsdale, Arizona.

GEMSTONES, Mineral specimens. Every variety. Lowest prices. Postcard brings free booklet. Plummer's, 4720 Point Loma Ave., San Diego 7, Calif.

FIND Tungsten, mercury, uranium with Mineralight. Free brochure. Write Dept. PM8 Ultra-Violet Products, South Pasadena, California.

GEMS, Precious and semi-precious, genuine, from world-wide sources. Deal direct, no overhead, save money. Catalog 10c. Hill Co., 5450-G Portland Rd., Salem, Oregon.

GEMCUTTING, Silvercraft authority. Illustrated magazine tells how. Cut rocks, make jewelry. 150 ads illustrating equipment, offering gems for collectors, cutters. Postal brings literature. Lapidary Journal, Drawer B, Palm Desert, Calif.

HOBBIES AND COLLECTIONS

50 DIFFERENT Army embroidered patches \$1. Other bargains. Insignia Mart, 703A Broadway, New York 3, N. Y.

UNUSED Matchbook covers—100 different \$1.00 36-page catalog 25c. Charles Edelman, 1311C East 84, Cleveland 3, Ohio.

INVENTING Can be an interesting and profitable hobby. Write for complete particulars. Institute of American Inventors, Dept. 40-E 631-E St. N.W., Washington 4, D. C.

CAMERAS, PHOTO SUPPLIES

BUY Photographic supplies wholesale. Films, cameras, projectors, binoculars. Expert camera repairing. Free catalog. Capitol Photo Supplies, 2428 Guadalupe, Austin, Texas.

PHOTOGRAPHY For pleasure or profit. Learn at home. Practical basic training. Long established school. Write for free booklet. American School of Photography, 835 Diversey Pkwy., Dept. 343C, Chicago 14.

PHOTOGRAPHERS — Volume business, good profits, assured from scratch with proven plan. Small cost; quick results. Studio A, Box 4255, Tower Grove Station, St. Louis 16, Mo.

ADD "Spice" to home projection shows with colorful old-time Nickelodeon slides. 2x2. Write for free list. Nickelodeon Co., New Fleidner Bldg., Portland 5, Oregon.

BASS Says: Trading since 1910. Used but good as new buys: 8mm. B.&H. Sportster \$52.50; 16mm. Keystone A-7, F:2.5 lens \$37.50; Voigt 35mm. Vito II, flash shutter, Skopar F:3.5, like new \$38.50; Kodak Reflex F:3.5 lens, like new \$88.50; Contax I, F:2 Sonnar \$87.50; 3 1/4x4 1/4 Speed Graphic, Skopar F:4.5, Ibsor shutter, \$52.50. Satisfaction guaranteed. Bass Camera Co., Dept. AG, 179 W. Madison St., Chicago 2.

FREE Photographic bargain book packed with hundreds of sensational values in still and movie cameras, lenses and latest accessories. Super savings for you in new and used equipment. Liberal trade-in allowances, too, on your equipment. Write now for your free copy to Central Camera Company, Dept. 9L, 230 S. Wabash Ave., Chicago 4. (Photographic headquarters since 1899.)

PHOTO FINISHING

EIGHT 5x7 Or five 8x10 enlargements from your negatives \$1.00. Willart Enlargers, Box 967, Little Rock, Ark.

GUARANTEED Quality. Fast service. Eight jumbos in beautiful super pak plastic ring binder albums only 35c. Send for free mailers and particulars of our complete photo finishing service. Grand Fotos, G.P.O. Box 1410, New York 1, N. Y.

8 CONTACTS 30c. Jumbos 40c. 12, 45c; jumbos 55c. Reprints 4c; jumbos 5c. Western Photo, Dept. PM-82, Box 298, San Francisco 1, Calif.

JUMBO Album pictures. A nickel a picture—Roll or reorder. Free mailers. Nichols, Tyler, Texas.

THREE Professional copies of any photo \$1.00. Portrait paper. Nelson's, 670 No. 8th E., Provo, Utah.

NOW! Get jumbo size prints for 5c, includes developing. Comes in keepsake album. 8 exposure roll, 40c; 12-60c; 16-80. Mailers free. Crown, Box 392, Augusta, Ga.

DOUBLE Size prints 8 exposure roll 30c; 12, 45c; 16, 55c. Same day service. Send for free mailers. Emerson Photo, Box F, Emerson, N. J.

SPECIAL Offer, 8 exposure roll 25c; 12 exposure 40c. Super pak albums. Post-L-Pix, Box 1D, Worcester 4, Mass.

8 OVERSIZE Snapshots from roll, 25c with this ad. Foto's, Box 8, Aurora 1, Ill.

JUMBO Album prints—8 exp., 35c; 12, 50c. Free mailer 35mm (36), \$1.00. Flash-Foto, Box 36-M, Brooklyn 4, N. Y.

SATISFACTION guaranteed! Eight jumbo size prints mounted in album, 35c—12 to 16 exposure rolls, 50c. Free mailers, quick service, finest developing, finishing. Crown Studios, Box 1223-PM, Dallas, Texas.

FAST—Same day service! 8 oversized prints in attractive plastic-bound book only 35c; 12-50c; 16-60c. Satisfaction guaranteed. Free exposure guide with first order. Pic-Sure, Box 899-B, Philadelphia 5, Penna.

NEW—16 Oversize contact prints, or 8 jumbos in album 25c. (Trial.) Album Studios, Weatherford, Okla.

8 OR 8 Picture roll 35c, 12 or 16 picture roll 55c. Each roll printed and developed. Handy album pack. If you fail to get pictures on your film a new roll will be sent you without extra cost. Send coin with roll. No c.o.d.'s. Mailing containers sent free. DeLuxe Film Service, Box 1268-A, Shreveport, Louisiana.

BEAUTIFUL Enlargement from each picture on 8 exposure roll 35c. Cut Rate Photos, Dept. B-4, Janesville, Wis.

TWO Beautiful prints from each picture on 8 exposure roll 35c. Thirty-one years of satisfied customers. Quick service. Lens Photos, Dept. J-4, Janesville, Wis.

MAIL Us your films. Prompt service. 8 exposures developed and printed 30c. Foto Art Studio, Box 406, San Francisco, Calif.

16 PRINTS Or 8 jumbos from roll, 25c with this ad. S. Skrudland, Lake Geneva, Wis.

MOTION PICTURES AND SOUND EQUIPMENT

FREE Movies. Thousands of subjects. Interesting. Entertaining. Fascinating. New directory, only 50c. National Cine, 126 Lexington, New York 16, N. Y.

TAPE Recorders at bargain prices! Eighteen makes. 1200 feet plastic tape \$2.10. Write Magnetic Recorders Co., 7120-A Melrose Avenue, Los Angeles 46, Calif.

WE Have it! Send 10c for special listings, and sample film strip. Reyelle, Box 12, Hammels, N. Y.

BARGAINS 16MM. sound films. Also for exchange. Bedner, 5300 So. Talman, Chicago.

CLEARANCE Sale of 16mm. films. Want a real buy in 16mm. sound films? Take advantage of the I.C.S. 1952 clearance sale of 16mm. sound features, comedies, cartoons, novelties, musicals. New, used. Send for our giant list "A" today stating machine you own (make and model). Institutional Cinema Service, Inc., 1560-PM Broadway, New York 19, N. Y.

LEARN Free lance, educational, Hollywood, and television film technique at home. State licensed. Write for free catalog. Motion Picture Institute, Birmingham 4, Michigan.

5000 NEW-Used 8-16mm. silent-sound films. International, 2120 Straus, Brooklyn 12.

8-16MM. Silent-sound films. Complete rental library. All latest subjects. Free catalogue, sample film 10c. Garden Film, 317 West 50th, New York 19.

RENT 16MM. sound films, 50c reel. Large selection; free catalog. Film Service, 128 Chestnut St., Roselle Park, N. J.

GUARANTEED Fresh 8mm. roll, magazine; 16mm. roll, magazine movie films. Color, b&w. Free catalog. ESO-S, 47th Holly, Kansas City 2, Missouri.

MOVIE Camera film: 8mm. roll \$1.50, 16mm. 100' \$3.00. Free processing. Better Films, 742 New Lots, Brooklyn, N. Y.

MUSIC AND MUSICAL INSTRUMENTS

SONGWRITERS—Competition demands modern harmony and singable melodies. Send poems for creative evaluation. Jimmy Seaver, Room 410, 203 N. Wabash, Chicago.

LEARN Piano, Beginners 18 week course \$2.95 (refundable). Immediate results. Stuart Studios, 1227 Morris, Union, N. J.

SONGWRITERS: New, different, honest. Send song lyrics. Dick Reynolds, Leonard 6, Texas.

YOUR Words and our music—A winning combination! Send poems. Free examination. Song Promotion Guild, 350-N Broadway, New York 13.

MUSIC Written to your words. Send poem and \$5.00. E-Z Publishers, 1133 Broadway, New York 10.

ACCORDIONS—Save 50% off. Cash or terms. New and used. All brands. Wholesale to everyone. Free catalogue. Del Principe, 29 South Cicero, Chicago 44, Ill.

ELECTRIC Guitars, amplifiers, wholesale. Free catalog. Carvin PM, Baldwin Park, Calif.

PLAY Accordion the modern way from records. No instructor necessary. Send for circular P. Pagani, 289 Bleecker, New York 14, N. Y.

YOUR Voice made loud, clear and powerful with my diaphragm exerciser. Inexpensive. Write, Inventor "Oz," 34V, Box 665, St. Louis, Mo.

SWING Piano—By mail, 30 self-teaching lessons \$3. (Samples.) Phil Breton Publications, P.O. Box 1402, Omaha 8, Nebr.

SENSATIONAL Free booklet, "How To Write And Sell Songs." Get the facts first. Poems examined free. Reliable Music Service, Box 430-P, Hollywood 28, Calif.

1952 ACCORDIONS — Wholesale. Free catalog. American Accordion Center, 5329 Belmont, Chicago.

POEMS Wanted for musical setting. Send poems for free examination. Five Star Music Masters, 630 Beacon Bldg., Boston, Mass.

LYRICS Set to music and recorded. Free examination. Cherrier Recording, 732 So. Norton, Los Angeles, California.

MUSIC Arranged. Songs printed. Frank Wildt, Music Publisher, Lancaster, Penna.

POPULAR Songs. How to write and sell them. Write for free booklet Successful Songwriting. Gateway Songs, Box 2470, Hollywood 28, Calif.

SONGWRITERS! Protect your ideas! Hold all songs; poems! Write for Safe Correct Procedure first! Song Service, Dept. P, 333 W. 56th St., New York 19, N. Y.

POEMS Wanted. Broadcast consideration. Sooner Song Co., 22PM North West 8th, Oklahoma City 2.

SONGWRITERS! Send poems, songs. Music Service, 243 West 72nd St., PM, New York 23.

POEMS Wanted to be set to music. Free examination. Send poems. McNeil, Master of Music, 510-PM S. Alexandria, Los Angeles, California.

WRITE Songs. Big money and reputation. Write for information. J. Gordon Pub. Co., 4700 South California Avenue, Chicago.

WANTED! Poems for musical settings. Write Songwriters' Service, Clifton, N. J.

RADIO AND TELEVISION

BUILD 15 Radios—Only \$1.30 each. Experience unnecessary. Home radio and TV course includes trouble shooting and servicing lessons, radio principles, code instructions, practical radio building and repairs. You build and keep receivers, transmitters, amplifiers, test equipment and code oscillator. All parts, tools, instructions supplied, including radio tester and electric soldering iron. Send for big, new time and money saving catalog and radio TV repair guides. Enclose 25c. Progressive Electronics Co., 497 Union Ave., Dept. PM-21, Brooklyn 11, N. Y.

ABOVE All, the best TV pictures depend on the efficiency of the lead-in wire. 100 ft. coil Sullivan's 300 ohm activated TV lead-in wire with important instruction sheet \$2.00 postpaid. The Sullivan Electric Co., 1223 First Ave., Seattle 1, Wash.

REPAIR Radios quickly and easily without extensive study and expensive equipment, or your money back. Complete simplified instructions \$1.00. Details free. Slate's Radio Service, Corsicana, Texas.

LEARN Code, theory for amateur, commercial FCC exams. Free information. American Electronics, 1451 Wilkins, Dept. PM-8, New York City 59.

ONE Tube loudspeaker radio diagrams 25c. Net-Loc, 44 Walker, Cambridge 38, Mass.

TELEVISION Towers direct from factory. Write Youngstown Steel Towers Co., Youngstown 8, Ohio.

15 TESTED One-tube circuits 25c, including "Radiobuilder" catalog. Laboratories, 1131-C Valota, Redwood City, Calif.

ENJOY Color TV screen. Send \$1. Mention screen size. Zingo Products, Johnstown, New York.

MAKE Simple, tubeless, batteryless, distance-getting crystal radios. Crystal and illustrated instructions 25c postpaid. Allen, 427-P, Clinton, Mo.

TV And FM antennas. Yagi, conical, bow-tie, mounts, accessories. Lowest prices. Wholesale Supply Co., Lunenburg 1, Mass.

BUSINESS OPPORTUNITIES

RAISE Earthworms—Profitable business. Free folder. Midwest Earthworms, Box 452, Elmhurst, Ill.

I Made a great success in the collection agency business. I can teach you too, quickly. Write me. George H. Cole, Syracuse 2, N. Y.

WALL Tile dealers. Save money! Buy new bevel edge plastic wall tile direct from manufacturers. Artistic Tile, 3010 Irving Pk., Chicago 18, Illinois.

OVER 700% Profit making finished pictures in 2 minutes on the spot in daylight with new PDQ camera, without darkroom. No experience needed. Simple directions teach you quickly. Write PDQ Camera Co., 1161 N. Cleveland Ave., Dept. XPM, Chicago 10, Illinois.

START Your own business on credit. Your own boss. 1586 of our dealers sold \$5,000 to \$27,500 in 1951. We supply stocks, equipment on credit. 200 home necessities. Sales experience unnecessary. Pleasant, profitable business backed by world-wide industry. Write Rawleigh's, Dept. H-U-PPM, Freeport, Ill.

\$5 AN Hour and more possible in your home. You can paint it with suede. Fabulous new business. Spare or full time. Spray on rainbow colors. Auto dashboards and trunks, signs, radios, toys, figurines, lamps, etc. Beautified with amazing new 3rd dimensional plush-like finish with touch-appeal as well as eye-appeal. I'll send you complete, step-by-step plans and equipment, including high-velocity spray gun for no-risk examination in your own home. Send no money, just name and address. Coast, 1004-AR S. Los Angeles St., Los Angeles 15.

AMAZING Genuine crushed cedar powder! Cedarizes closets, trunks, drawers! Applied like paint; laboratory guaranteed. Hardware, paint, building supply dealers buy quantities. Attractively packaged; tremendous profit potential! Exclusive distributors; investment for merchandise only. Write for samples, details. Millen Mfg., 91-X Summit, Brookline, Mass.

BIG Profits in birdhouses. Accurate scale plans for six different houses 50c. Lokenor, 211 Ship Ave., Beachwood, N. J.

INVESTIGATE Distribution opportunity nationally advertised food supplement. Continual high income. Agency development, retirement plan. 75% repeat business. Details \$1.00, refundable. Ja-Ri Corporation, 1014 Franklin St., S.E., Grand Rapids 7, Mich.

SPECIALIZED Magazines help you to success. Get latest copies through our easy-to-get-acquainted service. Hundreds of business, professional, advertising, agricultural, amusement, architecture, art, astronomy, athletics, automotive, aviation, baking, banking, barber, beauty shop, beverage, fashion, food, home craft, insurance and others covering all interests. Send for list today. It's free. Commercial Engraving Publishing Company, 34C North Ritter, Indianapolis 19, Indiana.

MAIL Order business—Your opportunity. "How To Build Your Own Mail Order Business." Beginner's idea-book tells "how." 25c postpaid. Promptly refunded if not satisfied. Albert Zimmer, 206 Central Ave., Lockland 15, Ohio.

LEARN Silk screen printing; invisible reweaving; repair dolls; make rubber stamps; repair sewing machines. Natural rubber for molds. Free sample. Universal, Box 1076-a, Peoria, Ill.

"MAIL Order Journal." Published monthly. Sample free. R. Mac Callum, 492 44th Street, Oakland 9, Calif.

MAKE \$6.73 Every time you sell one—And they're amazingly easy to sell! We have new adding machines in original factory cartons you can sell for only \$14.95 and you make 45%. They're executive model portables, precision built with automatic clearance, direct subtraction, fully guaranteed. Send for life size color photo with full details. Write today to Lightning Adding Machine Co., Inc., Dept. P20, 1260 West Second Street, Los Angeles 26, Calif.

MAIL Selling opportunities galore! Free! Wehner, Box 142-A, Roxbury 19, Mass.

40% DISCOUNT (Jobber-dealer plan). Power mowers. County agency. Extra profit. Rotacut-51, Excelsior Springs, Mo.

HOW And where to obtain capital? Free details. Star Service, Wapakoneta, Ohio.

MAKE Perfumes at home. Write, "Carey Laboratories," 1914 Chouteau PM-8, St. Louis 3, Missouri.

BUILD Steady income as publisher. Interesting facts, sample periodical 25c. Darnell, Box 566, Jackson, Tennessee.

MAKE 100% Profit selling names. Send \$1.00 for sample name list and instructions. E. C. Ellison, 409 Hazel Street, Warren, Penna.

OPERATE Profitable mailorder business. Write Jasco, 2623-M Columbus, New Orleans 19, Louisiana.

SPARE Time, home operated mail order business. Successful beginner's plan. Lynn, 10420-M National, Los Angeles 34, Calif.

MAKE Perfume. Profitable mailorder business. Catalogue free. "International," 6347 Parnell-PM-8, Chicago 21, Illinois.

NATURAL Molding latex. Extra thick. Free sample. W. Wooley, 115-A Donald, Peoria, Ill.

MAKE Money from newspaper clippings. Siegel, Box 183 PM, New York 2.

START Home mailing business. Little capital required. Instructions telling how, 25c (refundable.) Siwaslian, 4317C Gleane, Elmhurst 73, N. Y.

ADVERTISING Book matches—Cash in on big demand; sell union label matches. Cuts for all businesses and political parties. Free powerhouse selling kit, low prices, protection guaranteed on repeat orders. Cash commissions. Superior Match Co., Dept. MX-852, 7530 Greenwood, Chicago.

POPCORN Poppers, peanut roasters, candy floss. Sno-Konette, Northside Co., Indianola, Iowa.

EARN 400% Selling attractive low priced watches. Free salesman's sample. Result Sales, 580 Fifth Ave., New York 36A.

AUTOMOTIVE Specialties. Sell to bus, truck and boat lines. Contractors, garages, filling stations. Unlimited sales with high percentage repeats. Treanor Corporation, 4012 Truman Road, Kansas City, Mo.

BRONZE Baby shoes. No equipment needed. Start in your home. Big profits, little investment. Samples submitted. Metalizers, 2449 North Broadway, Wichita, Kansas.

WATERLESS Hand cleaners. Highly profitable home mailorder and mfg. business. Simply add water to concentrates or ready-packed under your own label. Everything furnished. Western B Aircraft, Los Angeles 19.

EARN Money painting figurines. Instruction book \$1.00. Louis Crisafulli, 121-A Western Parkway, Irvington, New Jersey.

START A home business in spare time. Make extra money. Experience not essential. Literature free. Chas. Stevenson, St. Marys, W. Va.

FISHWORM Breeding. Manual \$1.00 postpaid. Literature free. Haase, Kent, Ohio.

ELECTROPLATE Novelties, giftwares, baby shoes, autoparts, mirrors. Easy, inexpensive home processes. Portable electroplater, plating salts, formulas, instruction manual, \$5.95. Free booklet. Tycos Metals, Box 13231-MG, Houston 19, Texas.

SPARE Time business! Sell colorful decalcomania home decorations for kitchens, bath, nurseries, gifts, etc. Friends, neighbors buy on sight. Millions sold every year. Start earning real money now. Up to 100% profit. Send postcard for sales plan plus test assortment on approval. Send no money. Decal Art Co., Dept. PM-8, 344 N. Lorel, Chicago 44, Ill.

LEARN Basement waterproofing and concrete masonry painting. Eliminates 1000 hour apprenticeship. Earn specialists spare time maximum. First lesson \$1. Certificate on completion of course. Be a dependable block coater. John Baumgardner, 7350 Cooley Lake Rd., Pontiac 11, Mich.

BOOKKEEPERS Be independent operating our simplified system. Dominion, 74 Sparks, Ottawa 4, Canada.

LEARN Sewing machine repair. Electricity, rent, sell spare time. Make "big money" like our other men-women do. New machines, motors, parts wholesale. Details free. Taylor Service, Hamilton PM-8, Ohio.

IMPORT-Export! Opportunity, profitable, world-wide, mail-order business from home, without capital; or travel abroad. Established World Trader ships instructions for no-risk examination. Experience unnecessary. Free details. Mellinger 28, Los Angeles 24.

\$500.00 MONTHLY! Operate mail-telephone collection service for businessmen and doctors, spare-time. Free details. Financial, B-740-W, Chicago 90.

START Business without capital! Reliance, 15-A Park Row, New York 38, N. Y.

LIST Your name to receive mail-order offers, samples, money-making propositions. Write Paragon, Box P-2194, Houston, Texas.

MAKE Money! Small home-made pill makes big glass of fizzing pop. Formula and quick selling method \$1.00. Write: Formula, Box 398, Erie, Penna.

EARN Extra money operating mailing-addressing service. Also type manuscripts for authors. Particulars free. L. Torrey, Melrose 76, Mass.

THROWN Away! Tons of ground rubber by recappers. Make it into plastic rubber! 1000 uses! Easy. Inexpensive. Start profitable business! Instructions with samples \$1.00. Ceeten Products, 242-X, Crozet, Va.

EXTRA Money. Spin angora wool at home. Angora House, PM, Springfield, Ill.

BIG Profits selling Hollywood stars perfume. Full particulars free. Emly, Box 319 PM-8, North Hollywood, California.

SAWDUST. Turn it into cash. Twenty methods. Instructions 50c. Charles Company, 12-DAG, Norwood, Ohio.

SMALL Investment in Artkote molds puts you in \$5.00 hour stone facing business. Sample mold \$2.00. Dividend Company, Liverpool, N. Y.

FIX Typewriters. Free booklet describes our modern, inexpensive home-study course. Factory methods taught. Write: Typewriter, 8915 Corbet, Tarentum, Penna.

MAKE Money at home. Many ideas to choose from. All proven successful. Big folder free. Write. Palenchar, 1435 John, Whiting, Ind.

LEARN Metalizing baby shoes, jewelry, gifts. Bronze, gold, silver. Complete success plan free. Kiktavi Building, 7217-PM South Broadway, Los Angeles 3.

FREE Formula and instructions for making newest big profit perfume specialties from tap-water. Write today. Decasto of Hollywood, PM3, 1535 North Hudson Avenue, Hollywood 28, California.

300% PROFIT Or more. Send for pattern to make wallet from 1 pc. of leather. No sewing. Scissors and pattern needed only. \$1.00 check or money-order. S.E.B., Box 33, Westville, N. J.

MUSHROOMS Grown. Boxes, barrels. Manureless process 50c. Spawn \$1.00. Gordons, 553 William, Winnipeg, Manitoba.

MAKE Money at home mailing catalogs—Fast-selling publications, merchandise. Everything furnished. Orders filled. Big earnings. Sample, information 25c. Sterling, Great Neck 12, N. Y.

SELL By mail to automobile owners. Millions of prospects. Fast selling items. Everything furnished. Write: Eastern, Box 142-P, Dorchester 24, Mass.

MAKE Money at home mailing cards, circulars. Everything furnished. Start at once with almost no investment. Paton, Box 55-P, New York 23, N. Y.

BIG Profits making new greaseless doughnuts. Start in kitchen. Wholesale to grocers and cafes. Free plans. M. Ray Company, 3605 South 15th Ave., Minneapolis 7, Minnesota.

REPRESENT Us in your area. Write for descriptive folder. International Trading Center, 1900 Euclid, Cleveland 15, Ohio.

PRINT Without a printing press. Big profits! See page 34.

RESILVERING Mirrors, formula 50c; two-way lookout mirrors, (No one sees you), 50c; coppered mirrors, 50c. All \$1.00. Nelko-Mir, Box 3462, Chicago 54.

AMAZING, Refinish auto dash. Grain appears like magic. Details free. Modern Aids, 248 So. Main, Jamestown, N. Y.

BIG Money and fun growing live miniature Ming trees on your window sill. Write for free rare tree seed and plan. National Nursery Gardens, 8463 South Van Ness, Inglewood 4, California.

SEA-Shell for making gifts, novelties, jewelry. Catalog 10c. Instruction book of 155 photographed designs \$1.10. Giftcrafts, Box 4550-PX, Coral Gables, Florida.

MAKE Your home workshop pay up to \$6.00 hourly for your spare time. Even more with wife's help, and she'll love it! Details free. The Old House, Box 8, Spring, Texas.

FLEXIBLE Rubber moulds for plaster and Marbleite figurines. Sample and large illustrated catalog 25c, refunded on first order. K-C Novelties, Dept. 23, Easthampton, Mass.

MAKE Money spare or full time, casting metal toys and novelties. Big wholesale and chain store demand for autos, soldiers, ashtrays, banks, etc., keeps manufacturers busy. Production moulds furnished for up to 100 and more castings per hour. No experience or special place necessary. Write for information and illustrations of patterns needed. Metal Cast Products Co., Dept. A, 1696 Boston Road, New York 60, N. Y.

\$200 WEEKLY Reported! No selling. Free booklet. T. J. Surface, Roanoke 4, Virginia.

GROW Mushrooms. Boxes, basements, gardens, lawns, grasslands. Instructions 35c. Mushroom spawn \$2.14. New manureless process \$2.50. Send for complete 3 item new kit \$4.99. No c.o.d. please. Guaranteed fresh spawn or your money refunded. Thomas Co., Dept. 80, 3604 30th Ave. S.W., Seattle, Wash.

EARN Money at home with your typewriter! Spare time! Details free. Edwards, Publisher, 3915-PM 12th, Des Moines 13, Iowa.

CASH Income from your backyard! Details free. Pickett's, Florence, Kentucky.

FREE Illustrated course casting novelties genuine latex for molds. Major Chemical and Latex Co., 25 Allerton Street, Boston 19, Mass.

ESCAPE Wage slavery. Easily. Operate your own profitable lifetime business. Free literature. Corley, H285 Carlton, East Rutherford, New Jersey.

WHY Not make extra dollars repairing zippers? Excellent profits uncrowded field. Details free. Texas Specialty Company, 204-B Texas, Texarkana, Texas.

FREE Folder—100 ways to make money in silk screen printing. National, Box 88-PM, Dorchester 22, Mass.

SELL By mail to women—Real merchandise. Everything furnished, orders filled. Big profits. Charles, Box 32-S, New York 63, N. Y.

YOUR Own mail order business offers unlimited earning possibilities. Exciting details free. Smith Sales, Box 121P, Terre Haute, Ind.

HAVE Home mail business! Success assured by helpful idea-mailbox service. Booklet 25c. Details free. NMD Agency, Box 88-M, Dorchester 22, Mass.

START Mailorder bookshop—Build your future. 25c brings booklet, samples, exciting ideas. General Publications, Ossining, New York.

NEW Ideas and items. 25c brings samples to retail for \$1.00. Specialties, Box 475E, Park Ridge, Illinois.

BECOME Contractor associated with national organization. Man experienced in roof repairs, waterproofing, coatings. Operate own business under our trade name. Franchise protection. "Luster-Kote," 19417 Derby, Detroit 3, Michigan.

START A Venetian blind laundry. Profit opportunity for lifetime business. New machine method. Free booklet on request. P. C. Co., 442 N. Seneca, Wichita 12, Kans.

MAKE Money at home as renewal headquarters for all magazines. Liberal commissions. No experience. No capital needed. Supplies furnished. Write for free catalog. McGregor Magazine Agency, Dept. 500B, Mount Morris, Ill.

START Home manufacturing business. Make cleaners, soaps, polishes, cosmetics. Free literature. Kemix, Park Ridge, Ill.

MAKE Tough, durable plastic—1c pound. Makes attractive floors, walls, built-ins, roofs. Build good home, \$150.00 room. Bays Laboratory, Oklahoma City 9.

LIQUID Molding rubber, \$2.95 quart, \$9.95 gallon prepaid! Plastercraft Supply Company, 3051 St. Clair Ave., Cleveland 14, Ohio.

LIQUID Rubber, make flexible molds. Free sample. Chaney, 1130 E. 16th St., Jacksonville 6, Fla.

NEW Exceptionally profitable plans, ideas for home operated mail business. Rush name. Miller, 1772-P Carlyon Road, East Cleveland 12, Ohio.

MAKE Flexible molds! Cast plaques, bookends, figurines! Free sample! H. Tooker, 630-R Chestnut, Hamilton, Ohio.

21 POPCORN, Candy apple formulas, proven money-makers. Send \$1 today for formulas, catalog of money-making ideas. Concession Supply, 3916 Secor, Toledo, Ohio.

RECAST Old batteries into new. Latest achievements. Battery Laboratories, Minneapolis.

READ "Advance"—The voice of mail order. Offers money-making opportunities, sources of supply, personal guidance, etc. Issued monthly. Sample copy 35c. Yearly subscription \$2.00. Advance Publishing Company, 313 East 21st Street, Suite 450, New York 10, N. Y.

BOOKKEEPERS—Earn \$5000 yearly part time. Sell, operate new sensational CPA bookkeeping service. Kern, 4942 Vineland, North Hollywood, Calif.

GOOD Paying business silvering mirrors, plating autoparts, reflectors, bicycles, bathroom fixtures, etc., by late method. No tanks or shop required. Outfit furnished. Free booklet. Gunmetal Co., Ave. H, Decatur, Illinois.

POPCORN And potato chip equipment. Long Eakins Company, 5260 High, Springfield 99, Ohio.

BUY Wholesale. Thousands articles. Supply directory, 10c. Idealso, Park Ridge, Illinois.

EARN Extra money! "Homeworker Magazine" tells how. Sample 25c. Sizemore, Box 7, 4917 Kostner, Chicago 30.

BOOKKEEPERS, Keep books, small firms spare time. Manual latest technique by C.P.A., \$3.00. Modern Business, Box 406, Youngstown 1, Ohio.

FREE Book "505 Odd, Successful Businesses." Work home! Expect something odd! Pacific, Oceanside, Calif.

\$46 FROM Square foot plywood; jigsaw necessary. Write: Woodarts, Bridgewater, Mass.

EXTRA Money—No selling, operate vendors. Amazing profits, details free. Silver King, Suite 220, 622 Diversey, Chicago 14.

BUY It wholesale! Manufacturers, distributors offer 850,000 items. Literature free. Olsen, 1231-A East Third St., Duluth 5, Minn.

EARTHWORM Breeding? First, get unusual story. "An Earthworm Turned His Life." Free. Earthmaster, Dept. 14, El Monte, Calif.

INCOME From local information. No selling. Write Neherco, La Verne, Calif.

UNPAINTED Bookends, plaques, statues, figurines. List. Haverty Products, 823-17th St., Altoona, Penna.

OPERATE Profitable mail order business. Write Walter Service, 4159-A East 112th, Cleveland 5, Ohio.

DOLLARS In personalized baby record books. Sell by mail. Use same literature we do. No-Co-Ro, Oakland 6, Calif.

MADE \$24,500 Using money making plans from Schemer Magazine, world's oldest mailorder publication. Box 275M, Canfield, Ohio. Year \$2.00. Sample 20c.

MINK Raising information free. Complete. Lake Superior Mink Farm. Superior, EE1, Wisconsin.

COPUBLISH Leading m.o. paper. Latest copy Mail Sale Advertiser, details, dime. Vanroy Shirk, Lebanon, Penna.

COLORGLAZED Concrete pottery made without molds. Patented method. Cemetery products, novelties, tiles. Basement leak-sealing. Money-making projects. Booklet, details free. Men only. National Potteries Company, Grand Rapids, Minnesota.

MONEYMAKING OPPORTUNITIES

595 MONEY Making secrets. Send stamp. Book Service, P.O. Box 453, Port Chester, N. Y.

TIE-Breaker picture puzzles exposed, \$2.00. Wenograd, Box 1495, Philadelphia 5, Penna.

REAL Live Mexican jumping beans. Big profits. Mann's, 5330 No. Natoma, Chicago 31.

CHURCHES, Clubs, organizations, receive \$130.00 plus 12 card tables free. Unique Gift Plan, Pine Hill, New Jersey.

BE Independent, be secure, have your own profitable business—Earn \$20.00 and more a day making beautiful, fast-selling lamps at home. No equipment needed. Illustrated course teaches you quickly. Course, parts catalog, wholesale price list—only \$2. Gearon Co., Dept. 200-B8, 27 S. Desplaines, Chicago 6, Ill.

SCHUHMACHER Matmakers. Convert old tires into dollars. Devote full or spare time. S and S Patents, Inc., 1307 North Clark St., Chicago 10, Ill.

LUCRATIVE Self employment. Over 100 ways. 25c. Elhil, Assonet 1, Mass.

GROW Miniature dwarfed trees. Instructions 50c. Metro, Box 103-PG, Berwyn, Illinois.

FREE! Several money making offers, copy Home Mailorder Plan. Jenkins, Lucasville, Ohio.

FREE! Radio advertising. Pay stations commissions on orders or leads received. No investment. Hundreds of stations do this. Mishek, Waseca 2, Minn.

GET Money making offers. All parts United States. Trial listing 10c, 3 months 25c, year \$1. Powell, 5713-A Euclid, Cleveland 3, Ohio.

HOW To get your mail order advertising free revealed by famous expert. Also other "inside" secrets. Free details. Benson Barrett, 1751-A Morse, Chicago 26.

EARN Money evenings, copying and duplicating comic cartoons for advertisers. Adservice, Argyle 1, Wisconsin.

MAKE Money—Sewing and assembling at home. Liebig Industries, Beaver Dam 10, Wisconsin.

GROW Mushrooms. Boxes, basements, gardens, lawns, grasslands. Instructions 35c. Mushroom spawn \$2.14. New manureless process \$2.50. Send for complete 3 item new kit \$4.99. No c.o.d. please. Guaranteed fresh spawn or your money refunded. Thomas Co., Dept. 81, 3604 30th Ave. S.W., Seattle, Wash.

BOOKKEEPERS Earn \$100.00 week operating bookkeeping-tax service. Details free. Universal, Box 664-M, Springfield, Missouri.

BRAND New sure fire money maker. Write Post-Rite, Box 802, Sioux Falls, S. Dak.

SELL Titania gems \$9.75 carat, wholesale. More brilliant than diamonds. Free catalogue. Diamonite, 1404M Mitchell, Oakland 1, Calif.

\$10,800 PROFITS! Your own mailorder business! No capital risk! "Success plan" (worth \$2) free! Write today! Treasury, 149 Storer, New Rochelle PM-1, New York.

MAKE Perfume—Everything supplied, no equipment needed. Sample fragrance, details free. Genmerco, Box 142-PM, Dorchester 24, Mass.

\$100-\$200 WEEKENDS No selling or manufacturing. Brennan, 4025-Z Lanker-shim, North Hollywood, California.

WONDER Liquid—New—Not rubber or plastic. Own a profitable business making several different products. Amazing results. Details \$1.00. Mutual Service, 270 Villa St., Elgin, Ill.

50,000 ARTICLES Wholesale. Source directory, dime. Nelko, Box 3462-DR, Chicago 54.

FREE Book "505 Odd, Successful Businesses." Work home. Expect something odd! Pacific, Oceanside, Calif.

BE Appointed State Notary Public now! Details: Stationers, Helotes, Texas.

PUBLISH Your own magazine. Hand-some 52 page format, well edited, illustrated. Cost low as \$1.00 month. Brings you prestige, profits. 25c brings sample, details. National, Ord, Nebr.

READ Progressive Mailtrade, the magazine that tells how to make money by mail. Dime brings sample and special offer. Progressive Mailtrade, Box 357, Sheboygan, Wisconsin.

BE The Popular Mechanics representative in your neighborhood and earn big profits in your spare time. Write Popular Mechanics Magazine, Room 408M, 200 E. Ontario St., Chicago, Ill.

FORMULAS, PLANS, ETC.

AMAZING Values. Best, latest formulas. Catalog free. Nelko, 3462-P Merchandise Mart, Chicago 54.

FREE Formula catalog latest money makers. Western Chemical, Salem, Oregon.

REAL Manufacturing formulas. Lists free. Cummings, Chemist, Gordon Ave., Syracuse 4, N. Y.

FORMULAS; All kinds. Latest, best. Literature free. Kemixal, Park Ridge, Ill.

TESTED Formulas. Interesting descriptive booklet free. Pont, Box 635-PM, Terre Haute, Indiana.

AMAZING Book! 10,000 formulas, trade secrets. \$3.98 postpaid. Free literature. K. Paullin, Loudonville, Ohio.

FREE Blueprint Catalog! Hundreds of projects—motor scooter, furniture, toys, birdhouses, radios, garden furniture, power tools, boats, workbenches, home freezer, many more! Send postcard to Popular Mechanics Press, Dept. 103, 200 E. Ontario, Chicago 11, Ill.

PLASTICS

NEW Liquid casting plastic. Clear, colors. Embed flowers, insects, coins. Saw, drill, carve. Send 25c for wholesale catalog and new sales manual showing how to make money at home. Castolite, Dept. J-101, Woodstock, Illinois.

PLASTIC, Sheets, rods, tubes, etc. Free list. Plastic Supply Co., 2901 N. Grand Blvd., St. Louis 7, Mo.

LUCITE, Plexiglas. Any size sheets, masked. Square foot (12 x 12) cost, 1/16" \$1.20; 1/8" \$1.40; 3/16" \$1.75; 1/4" \$2.08. Include 10% postage. Almac Plastics, 230 Fifth Ave., New York 1, N. Y.

CHEMISTRY

AMAZING New book of science. Experiments, formulas and catalogue of laboratory supplies. Only 25c. National Scientific Co., Dept. 16, 2204 W. North Ave., Chicago 47, Illinois.

BRAND New, spectacular chemical and fireworks experiments manual. Complete set-ups and instructions \$1.00. Chemi-Tech Laboratories, 568 Riley Street, Buffalo 8, New York.

NEW Idea chemical and apparatus outfits for home experimenting. Photo-scales, microscopes, chemicals, biological and laboratory supplies in small quantities. Catalog 25c. Established 1931. John H. Winn, 124A West 23rd Street, New York, N. Y.

CHEMICALS And apparatus for industrial, analytical, and private laboratories. Catalog 20c. Dept. M-50, Biological Supply Co., 1176 Mt. Hope Ave., Rochester 20, N. Y.

ILLUSTRATED Catalog: Chemistry, mineralogy, biology. 10c. Tracey Laboratories, Evanston, Illinois.

AGENTS WANTED

NATIONALLY Advertised vinylite plastic raincoats. Men's, women's. Samples \$2.50. Yale Clothing, Meriden, Conn.

SELL Friends amazing value Christmas, all occasion greeting cards, new type gift wrappings, gifts that are different. Make up to \$1.00 a box. Bonus. Experience unnecessary. Request feature samples on approval and free samples name imprinted Christmas cards, stationery, napkins. New England Art Publishers, North Abington, 703-B, Mass.

AMAZING Money making offer—\$50 or more selling 100 boxes America's leading Christmas cards. Samples on approval. Complete line. Free samples personal Christmas cards and stationery. Sensational bonus. Write, Lorain Art Studios, Dept. 107, Vermillion, Ohio.

MAKE Wedding profits. Sell invitations, napkins, matches. Samples free. Dunbar's, Middlebush 3, N. J.

DO You need money? \$35 is yours for selling only 50 boxes of our 300 Christmas card line. This can be done in a single day. Free samples: Other leading boxes on approval. Many surprise items. Experience unnecessary. Free samples personalized Christmas cards, stationery, napkins. Write today. It costs you nothing to try. Cheerful Card Co., 10 White Plains, New York.

QUICK Extra cash! Sell America's outstanding line of Christmas box assortments and personalized lines. Plus hundreds of extra profit items. Monogram playing cards, wedding invitations, gift items, deluxe album of exclusive cards, nylon hosiery. Write today for 60 free samples in six beautiful portfolios. Gift catalog included. Elmcraft Chicago, Dept. 3, 5930 S. Western Ave., Chicago 36, Ill.

CASH In on your spare time! Sell beautiful new Regal Christmas greeting cards and gift assortments. No experience necessary. Costs nothing to get started. Show wonderful samples to friends, relatives, neighbors. Merely take orders and pocket up to 100% profit. Write today for samples on approval. Regal Greetings, Dept. 62, Ferndale, Michigan.

MAKE \$1000 with reproductions of famous perfumes. Write Perfumers 48, Box 5334, Chicago 80, Illinois.

AGENTS Sell world's modern sewing machine. Free details. Damata, 3 Spring Valley Road, West Roxbury 32, Mass.

NEED Money? \$50.00 yours, sell only 100 boxes new Xmas cards. Other amazing offers. Free samples imprinted cards. Feature box assortments on approval; over 100 profitable items. Work with a national leader. Pen-'N'-Brush, Dept. PM-8, 139 Duane St., New York City 13.

AT Last! Something new and sensational in Christmas cards. Make extra money fast! Show satins, velours, metallics. Gets easy orders. Pays up to 100% cash profit. 30 free samples. With name 50 for \$1.25. Big line. Amazing new glo-in-the-dark ornaments, personalized matches, stationery. Several \$1.00 boxes on approval. Puro Greetings, 2801 Locust, Dept. 240-K, St. Louis, Mo.

JUST Out! New thrilling sensation in Christmas cards. Make big money! Show lustre foils, satins, brilliants. Amazing values bring easy orders! Magic glo-in-the-dark ornaments, personalized stationery, matches. 30 free samples. With name 50 for \$1.25. Several \$1.00 boxes on approval. Joy Greetings, 507 N. Cardinal, Dept. 60-B, St. Louis, Mo.

CALL On friends with sensational Christmas cards in handy assortments. Price, \$1.00. Profit up to 50c. Also popular-priced personal Christmas cards, everyday assortments, etc. Samples on approval. Wallace Brown, Dept. P-4, New York 10, N. Y.

AMAZING Big profits selling exclusive Sunshine Christmas cards. Nationally famous 21 for \$1.00 assortment is unequalled, sells on sight. Other tremendous Sunshine values: merry holly-day, nature prints, Park Avenue kromekotes, scripture text, gift wraps, stationery, etc. Send for samples on approval. Earn big money now! Sunshine Art Studios, Dept. PM-8, Springfield 1, Mass.

BIG Profits selling welding outfits to farmers and machine shops. Free catalog. Eagle Welding, 5085 Broadway, Chicago 40, Illinois.

CASH—For yourself or your organization. Quick, easy, pleasant. No experience necessary. Spare time, full time, it's the sure way to make money. Everybody buys exclusive, exquisite new 1952 Elmira Christmas line—De Luxe Christmas assortments, 5 name imprinted Christmas card lines, all-occasion cards, gift wrappings, gift items, books, personalized stationery, napkins, matches from \$1.00 up. High quality. Low cost. Save friends, neighbors, co-workers time and money. Start making extra cash at once—with no investment. We supply everything—Free samples, money-making kit, bonus, money-saving offers, assortments on approval, 42 page catalog. Promptest service ensures recommendation to others. Write today. Elmira Greeting Card Company, Elmira C-110, New York.

MAKE Money introducing world's cutest children's dresses. Big selection adorable styles. Low prices. Complete display free. Rush name. Harford, Dept. H-2341, Cincinnati 25, Ohio.

BUY Wholesale—Catalog appliances, jewelry, etc. 25c (refund with first order). E. C. Ellison, 409 Hazel Street, Warren, Penna.

ABSOLUTELY Free! Big package actual sample fabrics and style presentation of dresses, lingerie, hosiery, etc. Take orders. Commissions big. Send no money. Melville Co., Dept. 7492, Cincinnati 25, Ohio.

SELL Dress fabrics to friends, neighbors. Stylish, beautiful materials. Year round profits. No experience needed. Free details. National, 640 Broadway, Dept. M, New York 12.

BIG Profit selling Xmas and everyday cards, novelties, personalized napkins, stationery, etc. Sample free. Boxes on approval. Victory Studios, Box 344, Mount Vernon, New York.

AGENTS Proposition for auto Liqui-Moly. Details under Auto Supplies.

100% PROFIT. Independent selling. Pas-Cal Vitamins, Box 203-S, Altadena, Calif.

AGENTS Act now! Sell quality hand-made ties \$6.25 dozen. Illustrations free. General Products, 11 No. Pearl, BBI, Albany, N. Y.

100% PROFIT Selling sensational "ironing aids" to housewives plus other money makers. Catalog free. Sunshine Sales, Dept. PM-2, Loudonville, Ohio.

BIG Bargains! Terrific profits! Selling new-used clothing. Suits \$1.75, pants 35c, topcoats \$1.00, dresses 20c, shoes 20c. As little as \$25 starts you. No experience necessary. Free wholesale catalog: Superior, 1250-A Jefferson, Chicago 7.

FREE—Sample new shaving cream for men and women. Sensational seller. Baby Gay, Beaver Dam 1, Wisconsin.

MAN To earn \$90 week up. Long needed invention. Advertised Saturday Evening Post, Colliers. Prospects everywhere. Full or part time. Exclusive. No investment. Free samples. Write Red Comet, Inc., Dept. 21-C, Littleton, Colorado.

BIG Daily profits. Free sales kit. Sell personal initialed buckles with belts, cap badges, tie clasps, etc. Choose from 3000 emblems. Hook-Fast, Box 480PM, Roanoke, Va.

NEW Bathroom deodorizer. Hangs on wall. Banishes odors bathroom, kitchen. Lightning seller. Samples sent on trial. Kristee 151, Akron, Ohio.

NEED Extra cash? Free sales kit. Sell personal initialed buckles with belts, cap badges, tie clasps, etc. Choose from 3000 emblems. Hook-Fast, Box 1425PM, Providence, R. I.

SHINE Shoes without "polish." New invention. Lightning seller. Shoes gleam like mirror. Samples sent on trial. Kristee 150, Akron, Ohio.

MEXICAN Feather pictures. Sell on sight; 200% profit! Free details. Sample 20c stamps. (No coins). Sylviap, Apartado 9036, Mexico City.

PRINTING—Salesbooks, envelopes. Free illustrated catalog. Erscoc, Dept. PM, Bronx 72, N. Y.

AGENTS — 300% Profit selling genuine gold window letters; stores and offices. Free samples. Metallic Sign Letter Co., 431-D North Clark, Chicago.

YOU Will make more money day after day, year after year selling DuPont nylons priced to sell and repeat. Details free. Write today. Arch Hosiery, 104 N. Fifth St., Philadelphia P6, Penna.

MEXICAN Feather pictures. High profit! Fast sellers! Adelphi, Box 57-B, Belle Rose 6, N. Y.

STATE And local distributors wanted for "Blue Blaze"—Battery proven by years actual road service. Guaranteed for 30 months; non-prorated. Write Blue Blaze, 2817 Jeffries, Los Angeles 65, California.

BE A money maker. Use your home as magazine headquarters. Liberal commissions. No experience. No capital needed. Everything furnished. Write for free catalog. McGregor Magazine Agency, Dept. 500A, Mount Morris, Ill.

GOLD Lacquered and silver sign letters. Windows, doors, trucks. Standard sizes. Penny and up samples. Atlas-P, 544 West 79th, Chicago 20.

YOUR Own business—Used suits \$1.50; topcoats 50c; shoes 12 1/2c; ladies' coats 30c; dresses 10c. Enormous profits. Catalog free. Moro, 558-AA Roosevelt, Chicago 7.

CALIFORNIA Sweet smelling beads. Sensational sellers. Free particulars. Mission, 2328PM West Pico, Los Angeles 6, Calif.

\$50 WEEKLY Selling finest razor blades, other items. Free details. Edisans, Box 274, Far Rockaway, N. Y.

MAKE Tremendous profits with fast-selling costume jewelry! Buy direct! Sell your friends, neighbors and customers at big savings to them! Write for our free catalog! Penn Jewelry, Dept. P, 826 W. Lacka., Scranton, Penna.

EXCELLENT Sideline for printing and advertising salesmen. Decalcomania name plates in small quantities. Great demand. Also, make money with our line of automobile initials and sign letters. Free samples. "Ralco" XL-Roxbury, Boston 19, Mass.

AGENTS: Stamping names on key protectors. Sample 25c. Stamping outfits, checks, social security and name plates. Hart Mfg. Co., 303 Degraw St., Brooklyn, N. Y.

SALESMEN, Distributors, fast selling costume jewelry direct from factory. Big picture catalog, free. Pickcraft, M19 Bank, Attleboro, Massachusetts.

HIGH-GRADE SALESMEN

GET Into million dollar work clothes business! Earn big money now, unlimited future! Sell finest-quality embroidered uniforms and work clothes to factories, garages, service stations, lumber yards, everybody! Huge profits possible. No experience needed. Gorgeous selling kit, actual fabric samples, everything free! Write Topps, Dept. 538, Rochester, Indiana.

MAKE \$3000 Next 60 days selling 1953 calendars, advertising specialties and executive gift line. Season on. Big commissions advanced. Outfit free. Meyerson Calendar, 605-PM Washington, Chicago 6.

MAKE Money with fast-selling Bostonian shirts. Blouses too. Spare time, full time. Sales kit free. Bostonian, 89 Bickford, Dept. R-10, Boston 30, Mass.

MONEY Making opportunity! Take big profit orders for world famous patented varieties fruit trees. Also flowering shrubs, roses, vines. Big sales outfit free. Stark Bros., Desk 30183, Louisiana, Missouri.

SELL Big money maker to men and women. Easy handwork makes fast-selling useful articles. Sample free. Sunmade Company, Brockton 64, Massachusetts.

BEST Source for nylons. Rich Co., 215 W. 98, New York 25.

WANT To make real money? You can positively make \$50 a day and up selling a brand new item going to every type of food and beverage store, factories, laboratories, hospitals, etc. First time advertised. Samples furnished. Utility Durawear, 53 West Jackson Blvd., Dept. PM-8, Chicago, Ill.

ANYONE Can sell Hoover DuPont nylon uniforms for beauty shops, waitresses, doctors, nurses, others. In white and colors. Exclusive styles. Top quality. Low priced. Exceptional income. Real future. Equipment free. Write fully. Hoover, Dept. D-100, New York 11, N. Y.

IS \$210 A week worth a postcard to you? Then rush card with name and address for special free trial plan that sells amazing new automatic refrigerator defroster "like hot cakes!" Write to Mr. Lewis, D-Frost-O-Matic Corp., Dept. L-102, 173 W. Madison, Chicago 2, Ill.

ADVERTISING Book matches—Cash in on big demand; sell union label matches. Cuts for all businesses and political parties. Free powerhouse selling kit, low prices, protection guaranteed on repeat orders. Cash commissions. Superior Match Co., Dept. M-852, 7530 Greenwood, Chicago.

AD Matches! Sell amazing designs—20, 30, 40 and 240-light book matches. Bigger spot cash commissions; every business a prospect. Low prices for high quality. Repeats. Start without experience; men, women; full, part time. Buy nothing! Sales kit furnished. Match Corp., Dept. PM-32, Chicago 22, Illinois.

I'LL Put a "shoe store business" in your pocket! Nation's leader trains you to make big money! Fit men, women. Free sample outfit. Write today! Mason Shoe Co., Dept. MA-8, Chippewa Falls, Wis.

\$114.50 COMMS. Four trial orders weekly. Surefire demonstration new guaranteed factory reroofing. No cash invested. Company carries accounts. Only steady, reliable, capable salesmen considered. Box 1766-PM, Cleveland, Ohio.

SIDELINE For energetic salesmen—Sell advertising specialties, calendars. Earn \$500 monthly easy. Big commissions advanced, bonuses. Samples furnished. Continental Calendar, 542-L So. Dearborn, Chicago.

WORLD'S Shortest bookkeeping system. Copyrighted, 25c each. Mixon, Box 2048, Los Angeles 53, California.

NEW Jobs open in selling! Send name, address for five free issues of Opportunity Magazine's money-making guide, listing hundreds of companies who'll pay you well, full or part-time. No experience needed. Opportunity, 28 E. Jackson, Dept. 17, Chicago 4, Ill.

EDUCATIONAL AND INSTRUCTION

WANT A diesel job? New opportunities to increase income. Higher pay. More money. We can help you qualify. Tools. Shop method home training. Write today! Diesel, Tractor, Heavy Equipment Division, Interstate Training Service, Dept. 3H, Portland 13, Oregon.

WORK For U.S. gov't. Men, women. Start high as \$73 week. 37,000 jobs open! Qualify now! Experience usually unnecessary. Get free 32-page book showing jobs, salaries, requirements, sample tests. Write today! Franklin Institute, Dept. M-24, Rochester, N. Y.

BOOKKEEPERS! Increase your earnings! Operate your own simplified "Dollar-A-Week" bookkeeping and tax service. Full or spare time. Details free. No obligation. Ellis, Box 200-H, Cedar Grove, North Carolina.

MAKE Up to \$45-\$55 week as a trained practical nurse! Learn quickly at home. Booklet free. Chicago School of Nursing, Dept. M-8, Chicago.

"HOW To Break and Train Horses"—A book every farmer and horseman should have. It is free; no obligation. Simply address Beery School of Horsemanship, Dept. 1108, Pleasant Hill, Ohio.

LISTEN, Learn a language by Linguaphone. At home, quickly, easily, master Spanish, French, German, Russian, Japanese; any of 29 languages through Linguaphone World's-Standard Conversational Method. Add to service, job, travel opportunities. A million home study students. Send for free book. Approved for veterans' training. Linguaphone Institute, 8308 Radio City, N. Y. 20.

HOME Study course, drugless therapy. Free literature. Institute of Drugless Therapy, Tama, Iowa.

HIGH School—No classes. Study at home. Spare time. Diploma awarded. Write for free catalog HF-23, Wayne School, 2527 N. Sheffield, Chicago 14, Ill.

OWN A collection agency. Big money. Franklin Credit, Roanoke 7, Virginia.

WELDING Training pays at Hobart welding school, Box M-822, Troy, Ohio. VA contract. Best equipment. Catalog free.

LEARN Priceless secrets of technical metaphysics. Easy, simple. Write Canada School of Technical Metaphysics, 2532 McKenzie St., Vancouver, B.C., Canada, for amazing information.

OIL Coloring photographs can be a fascinating hobby or profitable sideline for those with artistic talent. Learn at home. Easy simplified method. Send for free booklet. National Photo Coloring School, 835 Diversey Parkway, Dept. 344C, Chicago 14, Illinois.

WONDER Drugs! Cures! Lifesaving knowledge! Free booklet! Bijou, Box M44-1727, Hollywood 28, California.

DRAFTING—Learn easily at home. Monroe Institute, PM-8, Alton, Illinois.

LEARN Auctioneering in classes or by mail. Earn big commissions. Sample lesson free. Nelson Auction School, Renville P. Minnesota.

WAKE Up your personality with our amazing "Human Behavior Control" plan. Many surprisingly pleased. Write for fascinating free lecture. No obligation. Personal Psychology, Box 1924-E, Louisville 1, Ky.

INCREDIBLE! Become mental superman overnight! Free booklet! Bijou, Box 1727-MU, Hollywood 28, California.

FREE Directory. 1952 stepping stone to success. Box 3542, Station B, Winnipeg, Canada.

USED Correspondence courses and educational books bought, sold, rented. Catalog free. Educational Exchange, Summerville, Ga.

MEDICAL Laboratory technicians in great demand. We train you in your own home. Catalogue free. Imperial Technical Institute, Box 973-J, Austin, Texas.

UNIVERSITY Degrees by residence and correspondence. Golden State University, Hollywood, Calif.

BE A real estate broker. Study at home or in classrooms in leading cities. Write for big illustrated free book today. Weaver School of Real Estate, Suite 304 Law Bldg., Kansas City, Mo.

MIDLAND Linotype School, Charles City, Iowa. Civilian and Veteran Courses. Free placement. Established 1909.

USED Correspondence courses and books sold and rented. Money back guarantee. Catalog free. Courses bought. Lee Mountain, Pisgah, Alabama.

SECRET Investigation. Experience unnecessary. Investigators particulars free. George Wagner, M125 West 86th, New York 24.

FASCINATING, Entertaining once-in-a-lifetime book! "Fifty Years of Popular Mechanics." Tremendously exciting story of most fabulous years in American history. Describes birth of auto, radio, airplane, television; hundreds of other inventions and world shaking events. Nostalgic old time ads and prediction of fabulous inventions to come next fifty years. Giant size—500 pages; 8½"x11". Order now while stock still available. Send \$5.00 to Popular Mechanics Press, Dept. 109, 200 E. Ontario, Chicago 11, Ill.

PIANO Tuning pays. Learn this profitable profession at home. Our Tonometer and mechanical aids make learning easy. No knowledge music necessary. Diploma granted. Largest and oldest school—53rd year. G.I. approved. Write for booklet. Niles Bryant School, 78 Bryant Bldg., Washington 16, D. C.

INVESTIGATOR Training. Phillips Secret Service System, 1917-B North Kenneth, Chicago 39.

PLAYS, STORIES, MANUSCRIPTS

WRITERS—Will purchase original articles for publishing "How to Make It" booklets on tube or crystal radios, mechanics, chemistry, etc. Submit to Wayne Wallace, Alva Allen Company, Clinton, Mo.

MUSICAL Comedy plays. Dorby Publications, P.O. Box 131, Brier Hill, New York.

LOOKING For a book publisher? Write for free booklet PM3. Vantage Press, 230 West 41, New York.

BEGINNING Writers: Let us show you how to get \$1 to \$20 checks in your daily mail doing simple spare time writing. Experience unnecessary. Details free. W. Herwell, 7016 Euclid, Cleveland 3, Ohio.

I Want new writers to cash checks of \$1 to \$100 offered daily. The easiest way to write for pay. No previous experience necessary. Free details. Saunders M. Cummings, 468-11 Independence Bldg., Colorado Springs, Colo.

SPECIAL SERVICES

CANADA—Letters remailed 35c, 4—\$1.00. Employment columns, business opportunities. Montreal, Toronto, Ottawa, airmailed \$1.00 each. Galvin, Carleton Place, Ontario, Canada.

HOLLYWOOD. Your letter remailed 25c coin. Stone, Box 1733-P, Hollywood 28, Calif.

INFORMATION On any matter. Ferguson Research, 116-14 141 St., South Ozone Park, N. Y.

LETTERS Retailed 25c each. Los Angeles help wanted or other classified columns airmailed \$1.00. Russ DeJohn, 8408 Arrington Ave., Rivera, California.

REMAIL Your letters 25c each. Business Service, Box 508, Great Falls, Montana.

CARTOONING, COMMERCIAL ART, SHOWCARD WRITING, SIGN PAINTING

"HOW To Submit Cartoon Roughs," 25c. Martin Mantell, 600 Hayes, Hazleton, Penna.

"HOW To Make Money With Simple Cartoons"—A book everyone who likes to draw should have. It is free; no obligation. Simply address Cartoonists' Exchange, Dept. 98-C, Pleasant Hill, Ohio.

LEARN Sign painting at home. Test lesson free. Ben Kerns, Box 812-P.M., Greenville, S. C.

CHALK Talks. Laugh producing program, \$1.00. Catalog 10c. Balda The Cartoonist, Oshkosh, Wisconsin.

ADVERTISING AGENCIES, LETTER WRITERS, FOR ADVERTISERS

MAILING Lists—1000, \$3.00. Calsen, Box 97, Ruidoso, New Mexico.

NAMES: Cash customers 1000, \$3.50 up. Bolaine Sales, Box 5004, St. Paul.

RADIO Advertising pays! Special no-risk plan. Send product description and 25c for details. Broadcast, Box 432, Detroit 31, Michigan.

ADVERTISE: 24 Words, 100 Canadian newspapers \$5.50. Lists free. Advertising Bureau, 10511-C Springfield, Chicago 43.

ADS Placed in out of town newspapers and magazines. Low rates. Catalogue free. Ideas that pay. Baker Advertising Agency, Successors Ankrum Agency, 189 W. Madison, Chicago 2.

ADVERTISERS! Reach nearly 18,000,000 readers. 25 Sunday national key newspapers. 18 words, \$59.00. "Terrific pullers." 20 popular newspapers. \$11.50. Free booklet. Special—One inch display 2,-821,198 circulation. \$51.10. Newmark's Advertising Agency, (Established 1893), 217-7th Ave., New York 11.

MAILING Lists; \$5.00-1000 up. Write Dixie Service, King, N. C.

RUBBER STAMPS AND OFFICE SUPPLIES

SET Of 9 collection and reminder stamps \$1.95. Free catalog. Postage refunded. Escocs, 8 Holt, Dayton 7, Ohio.

RUBBER Stamps. Send for catalog. Excello, Box 500, Shreveport, Louisiana.

LINE 25c; 2-45c; 3-65c. Stamp Works, Auburn, Nebraska.

3 LINES 50c; Pads 35c; signature \$2.35. Stamp-Right, Wauwatosa, Wis.

TYPEWRITERS, DUPLICATORS, OFFICE DEVICES

RECONDITIONED Typewriters, printing devices, office machines, equipment. DixieGraph, King, N. Car.

PRINTING, MULTIGRAPHING, MIMEOGRAPHING GUMMED LABELS

LETTER Heads, envelopes, statements, bill heads, \$3.95 per 500. Samples, estimates, prices. Mullins Letter Press, Robinson, Illinois.

100 LETTERHEADS, 100 Envelopes \$2.00. Paul Stearns, 74 Williams, Brooklyn 7, N. Y.

PRINTING. Send wording for free estimate. Bixler, 752 Benson, Frankfort, Ky.

LETTERHEADS, Envelopes, cards, labels—100, \$1.00; 250, \$2.00. Vaprint, Harrisonburg, Va.

100 LETTERHEADS, 100 Envelopes, \$2.00. Morris, Box 331, Lake Charles, La.

FREE Samples, prices. Letterheads, envelopes, cards, circulars. Sutton Printing, Box 858-M, Waycross, Georgia.

500 PRINTED Stickers with your name and address 50c, 1,500—\$1.00. Free samples. Boozinny Press, 152-B Victor, Detroit 3, Mich.

CIRCULARS—5000 5 $\frac{1}{2}$ x8 $\frac{1}{2}$, \$18; 3 $\frac{3}{4}$ x5 $\frac{1}{2}$, \$8.25; folders, books. Garrison Press, Harrisonburg, Va.

BETTER Printing! Large catalog free. Nationwide, 2337 Bath Avenue, Brooklyn 14.

1000 BUSINESS Cards \$2.50 prepaid. Samples free. Reliable Print Shop, 905 E. Jefferson, Louisville 6, Ky.

GUMMED Labels, stationery. Free list. Reed, Box PM-135, Spiro, Okla.

MIMEOGRAPHING—Letters, pricelists, formulas, instructions. Lowest prices. Lem's Letter Shop, 5710 Stanton, Detroit 8.

125 8 $\frac{1}{2}$ x11 LETTERHEADS And 125 6 $\frac{3}{4}$ envelopes \$2.00, postpaid, 250 of each \$3.50. Going Print Shop, Box 1544A, Muskogee, Oklahoma.

500 4x2 $\frac{1}{4}$ FOUR Line gummed stickers 50c. Red border \$1.00. Moritz Printery, Saginaw, Mich.

PRINTING OUTFITS AND SUPPLIES

DO Your own printing. Save money. Simple rules. We supply everything. Print for others; good profit. Raised printing like engraving too. Have home shop. Details free. Kelsey Presses, V-11, Meriden, Conn.

PRESSES, Type, cabinets, supplies. List for stamp. Lincoln Press Company, 220-J Hartwell, Fall River, Mass.

MAKE Your own self-molding rubber printing cuts. Plexirubber, Argyle 1, Wis.

PRINTING Presses, type, supplies. Lists 3c. Turnbaugh Service, Loysville, Penna.

PATENT ATTORNEYS

INVENTORS—If you believe you have an invention, we can make a preliminary search on your invention and advise you whether we think it can be patented. Send for copy of our patent booklet "How to Protect Your Invention" and "Invention Record" form. No obligation. McMorro, Berman & Davidson, Registered Patent Attorneys, 134-X Victor Building, Washington 1, D. C.

C. A. Snow & Co.—M427, Snow Building, Washington 1, D. C. Registered Patent Attorneys. Write for information.

PATENTS. "Proof of Invention" free. E. E. Vrooman, Registered Patent Attorney, 507 McKim Building, Washington 5, D. C.

INVENTORS—If you consider your invention to be something of importance, take steps to protect it with a United States Patent which gives you the right to exclude others from making, using and selling your invention as claimed. "Patent Protection for Inventors" outlines steps to take to secure patent protection. Mailed promptly without obligation. Victor J. Evans & Co., Merlin M. Evans, Registered Patent Attorney, 731-J Merlin Building, Washington 6, D. C.

INVENTORS: Learn how to protect your invention. Special booklet "Patent Guide for the Inventor" containing detailed information concerning patent protection and procedure together with "Record of Invention" form will be promptly forwarded to you upon request—without obligation. We are registered to practice before the U. S. Patent Office and prepared to serve you in the handling of your patent matters. Clarence A. O'Brien & Harvey Jacobson, Registered Patent Attorneys, 21B-G District National Building, Washington, D. C.

"INVENTOR'S Guide" free. Frank P. Ledermann, Registered Patent Attorney, 154 Nassau Street, New York.

REGISTERED Patent attorney offers services. Sanders, 6430 Evans, Chicago 37, Ill.

INVENTORS—For "Invention Record" form, contact Carl Miller, Registered Patent Attorney, Woolworth Building, New York.

INVENTORS: When you are satisfied that you have invented something of value write me, without obligation, for information as to what steps you should take to secure a patent. Write Patrick D. Beavers, Registered Patent Atty., 935 Columbian Bldg., Washington 1, D. C.

INVENTORS: Without obligation, write for information explaining the steps you should take to secure a patent. John N. Randolph, Registered Patent Attorney, 203 Columbian Bldg., Washington 1, D. C.

CANADA—Ramsay Company Registered, 273 Bank Street, Ottawa, Canada.

FOR INVENTORS

INVENTORS—If you believe you have an invention, we can make a preliminary search on your invention and advise you whether we think it can be patented. Send for copy of our patent booklet "How to Protect Your Invention" and "Invention Record" form. No obligation. McMorro, Berman & Davidson, Registered Patent Attorneys, 134-W Victor Building, Washington 1, D. C.

INVENTORS—If you have a valuable invention, you are advised to authorize a preliminary search through appropriate classes of United States patents. This firm is registered to practice before the Patent Office and is available to make such search and report to you concerning the probable patentability of your invention. Instructive booklet with "Evidence of Invention" form sent upon request. Victor J. Evans & Co., 732-J Merlin Building, Washington 6, D. C.

PATENT Searches, \$5.00, including patent copies. Prompt and accurate reports. Patent Service Institute, 945-A Pennsylvania Avenue, Washington 4, D. C.

INVENTORS! For "Copyright, Design and Patent Guide" contact Mr. Metzler, 11 West 42nd, New York 18.

INVENTIONS Sold—Hundreds of manufacturers need ideas, patented or unpatented, list free. Invention Bureau, 208-M Clinton, Oak Park, Illinois.

PATENT Searches \$5.00, 48-hour service. For free record of invention forms write Miss Ann Hastings, P. O. Box 176, Washington 4, D. C.

INVENTORS—Send for free patent information book and inventor's record. Registered Patent Attorney, Associate Examiner, Patent Office 1922-29; Patent Attorney & Advisor, Navy Department 1930-47. Gustave Miller, 82A Warner Building, Washington 4, D. C.

PATENT Owner representative. Years of experience. Can I help you? Charles A. Scott, 773PM Garson Avenue, Rochester 9, N. Y.

BE Safe. Get temporary protection (not a patent) on your idea. Cost \$2.75. Free information. Box 113, Cedarburg, Wis.

PATENT Searches \$5.00. Protection forms free. Patent drawings prepared. Write Patent Engineering Service, 1404 New York Avenue N.W., Washington 5, D. C.

INVENTORS: Learn how to protect your invention. Special booklet "Patent Guide for the Inventor" containing detailed information concerning patent protection and procedure together with "Record of Invention" form will be promptly forwarded to you upon request—without obligation. We are registered to practice before the U. S. Patent Office and prepared to serve you in the handling of your patent matters. Clarence A. O'Brien & Harvey Jacobson, Registered Patent Attorneys, 21A-G District National Building, Washington, D. C.

ELECTRONIC Problems, devices, advice. Free information. Registered Engineer, 5208-A Onacrest, Los Angeles 43.

INVENTORS: Without obligation, write for information explaining the steps you should take to secure a patent on your invention. John N. Randolph, Registered Patent Attorney, 203 Columbian Bldg., Washington 1, D. C.

PATENT Searches \$5.00. 48-hour service. Protection forms free. Write Raymond L. Smith, Patent Searcher, 410 Bond Building, Washington 5, D. C.

SEARCHES—Put your patent searches in the hands of a registered patent attorney or agent, as he qualifies to give a worthwhile patentability report. Record of invention form upon request and information on patent protection. Patrick D. Beavers, Registered Patent Attorney, 936 Columbian Bldg., Washington 1, D. C.

INVENTORS—For "Invention Record" form, contact Carl Miller, Registered Patent Attorney, Woolworth Building, New York.

INVENTORS: If you have an invention for sale, patented or unpatented, write Institute of American Inventors, Dept. 40A, 631-E St. N.W., Washington 4, D. C.

CASH In on your ideas! Learn which inventions are profitable: how to sell or finance and market your invention. Send only \$2.50 for the big 144-page book "Money From Ideas," a primer on inventions and patents by a real, successful inventor. Popular Mechanics Press, Dept. 104, 200 E. Ontario St., Chicago 11, Ill.

INVENTIONS WANTED

MARKETING Aid—Nation wide. Patented, patent pending. Booklet free. Market Contacts, 719-A2 Magnolia, Tupelo, Miss.

PROTECT And sell your inventions. Details of our unique 4-point program and list of needed inventions free. Inventors Sales, 200-M Clinton, Oak Park, Illinois.

INVENTIONS Wanted. Patented or unpatented. Write for details. Global Marketing Service, 1404 Mitchell Street, Oakland 1, Calif.

INVENTIONS Wanted. Patented or patent pending. 21 years experience promoting inventions. National Service Bureau, 3120 Meramec, St. Louis 18, Mo.

INVENTIONS Wanted by manufacturers. Patented-pending only. Free details. Inventors Exchange, Dept. B, Hartford 1, Conn.

INVENTIONS Promoted. Patented or unpatented. Established 1911. Write Adam Fisher Company, 61 Enright, St. Louis, Mo.

INVENTORS: Hundreds of manufacturers have requested our assistance in locating marketable new products. Complete information free. Institute of American Inventors, Dept. 40-D, 631-E St. N.W., Washington 4, D. C.

PATENTS FOR SALE

FOR Sale. Patent revolving what not shelf. Arthur Marks, Oxford, Fla.

INVENTORS: Test the commercial value of your patented or unpatented inventions, quickly and inexpensively. Write for free information. Institute of American Inventors, Dept. 40-B, 631-E St. N.W., Washington 4, D. C.

MANUFACTURING

WE Manufacture patented plastic items on royalty basis. Write for details. Baine's Ltd., P.O. Box 51, San Antonio 6, Texas.

ENGRAVING. Models, small lot manufacturing. Designing. Specialty Machine, 1600 Junction, Racine, Wis.

MODELS—Small lot manufacturing. Metals, plastics, etc. Milburn, Burlington, Kentucky.

MODELS, MODEL SUPPLIES

POWER Models. Unusual steam, gasoline and traction engines. Metals, tools, accessories. Catalog 50c. Chas. Cole, Ventura, Calif.

IMMEDIATE Delivery on big 60 page 1952 "HO" model railway catalog of parts, car kits, locomotives, diesels, etc. Listing thousands of items in stock. Price 35c. Dept. W, All-Nation Hobby Shop, 182 North LaSalle St., Chicago 1, Ill.

SHIP Models—Most complete line in New England. Kits, fittings, plans, books, tools, engines, motors. Illustrated catalog 25c. James Bliss & Co., Inc., Dept. SM, 342 Atlantic Ave., Boston 10, Mass.

BRASS Gears and model supplies for the inventor. Send 10c for catalog. Pierce Model Works, Tinley Park, Ill.

STEAM Engines, boilers, castings. Catalog 25c. Anton Bohaboy, 2297 Price, Rahway 7, N. J.

SHIP And yacht model fittings; blueprints. Send 25c for illustrated catalog No. 27—listing hundreds of items. A. J. Fisher, 1002-1 Etowah Ave., Royal Oak, Mich.

LIONEL, American Flyer, illustrated catalog free. Ben's PM Department, 134 North Dearborn, Chicago 2.

SHIP Models and yacht supplies complete. Large 64 page catalogue 30c. Bill Wild's, 510 East 11 St., New York City 9.

STEAM Locomotives, 1 1/2", 1", 3/4", 1/2" 1/4" scales. Castings, rail, steam fittings! Thorough drawings with instructions. Catalog 50c. Little Engines, Wilmington, California.

HOME CRAFTSMEN

LEATHERCRAFT, Copper tooling, textile painting, beadcraft, shellcraft. Many other crafts. Big free catalog shows everything you need. Kit Kraft, 7373 Melrose, Hollywood 46, California.

16 NEW Lawn chairs, 22 picnic tables, benches, trellises, etc. All 38 plans with necessary full size patterns, \$1.00. Mastercraft 83M, 7041 Olcott, Chicago 31, Ill.

PARATOL Supreme "706-G" molder. Newly developed compound. The toughest rubber ever made for molding purposes. Supreme molds, precision reproductions, double strength. For the operator who wants the finest. There is no substitute. Direct to consumer prices: \$3.00 per quart, 1 gal. cans \$9.00, 5 gal. cans \$8.75 per gal., 4 oz. samples 50c to cover mail handling. U.S.A. only. Testworth Products Corp., Dept. B, P.O. Box 482, Itasca, Ill.

STENCILS, 15 Assorted for textiles, furniture, etc., \$1.00. Catalog 300 designs 25c, refundable first order. Marion Specialties, Box 141, Halesite, N. Y.

FULL Size patterns. Furniture, toys, whatnots. Illustrated folder 10c. Willard's, Canoga Park 83, California.

90 ALL New, full size lawn ornament and novelty patterns, up to 20" high. Only \$1.00. Mastercraft 82M, 7041 Olcott, Chicago 31, Illinois.

LEATHERCRAFT For pleasure or profit. Make easy-to-assemble purses, belts, gloves, woolskin toys, 100 other items for gifts or to sell. Send 10c today for big catalog. Largest leathercraft stock in U.S. J. C. Larson Co., 820 S. Tripp, Dept. 2350, Chicago 24.

OUR Biggest leather and craft catalog yet! 1000's of items. Send 25c (refunded with first order). Russo Handicraft Supplies, Dept. 8-C, 245 S. Spring, Los Angeles, California.

89 FULL Size jig saw patterns of beautiful shelves, ornaments, toys, novelties. Plus "How, Where to Sell." Only \$1.00. Mastercraft 84M, 7041 Olcott, Chicago 31, Illinois.

70 WOODWORKING Patterns \$1.00. Mosbro Patterns, 44-M Victor, Mimico, Ontario.

FREE Form corner shelves. Six full-size plans \$1.00. Echo Acres Industries, P.O. Box 184, La Grange, Illinois.

EXCITING New books: "Shellcraft Designing," 35c; "Shellcraft Novelties," 60c; both 90c. Henri B. Dorsman, Rt. 1, Newark, Delaware.

LAMP Size Cypress knee \$1.00. Cy Products, Ella Street, Lafayette, La.

LEATHERCRAFT—New stylecraft folder free. New kits illustrated. Piligree belts, billfolds, purses, etc. Send 25c new catalog. Refunded first order. Apache Leather Co., 2804 East Washington St., Phoenix, Arizona.

MINIATURE Furniture kits. Colonial reproductions. Solid cherry. Catalog 20c. Culver Miniatures, 194 61st St., Dept. A, Niagara Falls, N. Y.

HAWAIIAN Full size patterns, Polynesian bowls, trays, perfume flacons, costume jewelry. Easily made by home craftsmen. Hawaiian recipes, party suggestions, all for \$1.00. Trader Hall's, Dept. M, Box 155, Honolulu 10, Hawaii.

SHELLCRAFT Catalogue and eighteen late designs 25c, refunded first order. Rice's Shellcraft, Dept. B, 1711 N. Mills St., Orlando, Florida.

30 LAWN Ornament patterns. Ready cut. Full size. Color indicated. \$1.00 postpaid. Lincoln Craft Studio, Columbia, Conn.

LEATHERCRAFTERS: Beautiful tanned snake skins, kits, finished products. Tex Harris Snake Farm, Box 424, Warsaw, Indiana.

FREE Shellcraft catalog, Shell instruction book 35c. "Secors," Bradenton Beach, Florida.

LEATHERCRAFT. Tremendous stock of leather, tools, supplies, and kits. In leather business over forty years. Send 10c for big catalog. Sax Bros., 1111 No. 3rd, Dept. PM, Milwaukee 3, Wisconsin.

"TOPS" In everything for leathercraft. Low priced kits, leathers, tools, lacing. Catalog 10c. Crown Leathers, 22 Spruce Street, New York 38.

FREE Information. How to make money with jig saw. Write Jigsawers, 117-M Worth, New York 13.

WHOLESALE Shellcraft book 15c. Large shellcraft kit \$1.85 postpaid. Shell-Art Novelty, 5th and Moore, Philadelphia 48, Penna.

KNOCKDOWN Cedar chests. Lumber and veneers. Free price list. Giles & Kendall Company, Huntsville, Ala.

LEATHER, Tools, lacings, supplies. Free catalog. National Handicraft, 199 William St., New York 7.

MAKE Your own leather belts, billfolds, purses from easy-to-work low-priced leathers. Abundant supply. Big catalog free. Tandy Leather, Box 397-C, Tulsa, Okla.

MAKE IT YOURSELF

WINDOW Fan kits—All parts necessary to make 30 inch fan except motor and box. \$17.50 postpaid. Free circular. Imperial Wood Products, Bay Saint Louis, Mississippi.

HURRICANE — Wire fabric window guards, protective, durable, lightweight, low costs. No skill, no special tools or materials required. Quickly made. Instructions \$1.00. Pohler's Saw Shop, P.O. B. 383, Hollywood, Florida.

GRANDFATHER Clock easily built. Big savings. See ad on page 231.

SMALL Apartment size circular home. Includes living room, bedroom, kitchen, bath, fireplace. Can be built for \$1000. Plans \$1.00. Portercraft, Box 87A Mt. Washington, Cincinnati 30, Ohio.

MACHINERY Plans handbook. Formulas, tables 25c (refundable). Satisfaction guaranteed. Kimo, Box 307-P, New York 19.

BUILD Inexpensive concrete blockmaker. Motor, hand. Write: C. Lee, Mountain View, Oklahoma.

FREE Handbook. Build sawmills, block machines, freezers, tractors, scooters. Nichols Company, Purvis 2, Miss.

MAKE Your own "Stone-Veneer." Economical. Easily made, quickly applied. Looks like genuine stone. Transforms any home into one of excellent beauty. Formulas, illustrations, patterns. Alburg, Box 17, Carrollton, Mich.

SEND 25c Today for new large catalogue of supplies for 21 popular crafts. Dept. D-11, Dearborn Leather Company, 8625 Linwood Avenue, Detroit 6, Michigan.

BUILD Your own "tractor." Free information. Eltraco, D-1, Camptonville, California.

HOMES You can build for \$4500 to \$7046. Books that take you through every step. Popular Mechanics Famous Concrete Block House, \$2.00. Your Home and How to Build It Yourself, \$3.00. Also full-sized builder's plans for each home at nominal price. Popular Mechanics Press, Dept. 102, 200 E. Ontario St., Chicago 11, Ill.

WATCHES, OLD GOLD, JEWELRY

WATCHES Completely repaired \$4.50. Guaranteed. Berkowitz, 1150 Castlehill, Bronx 61, N. Y.

SAVE 50%! Benrus, Bulova watches. Free catalog. Sherry's, 290-D North-west 36th, Miami, Florida.

HIGHEST Prices paid for old gold, silver, platinum, diamonds, watches, gold teeth, spectacles. Cash immediately. Goods returned if offer unsatisfactory. United Smelting Works (The Old Reliable), 39-B South State, Chicago 3.

RHINESTONES. Jewelry settings, cameo, sequins, beads. Send 10c for illustrated catalog. J & M Novelties, Dept. CJ-3, Griffith, Ind.

10 HIGH-Grade Swiss ladies' and gents' wristwatches needing minor repairs, \$18.00. Write for prices. B. Lowe, Holland Bldg., St. Louis 1, Mo.

JEWELRY Making can be a profitable hobby—Send 20c for our latest illustrated catalog. Milady-Fair Co., G.P.O. Box 1328, New York City.

WATCHMAKERS'—Jewelers' tools. Free instructions, catalog. Bengal Company, Culver City, California.

WATCHMAKERS Journal contains instructive articles for watchmakers and beginners. \$1.00 year. Sample copy 20c. Dean Co., Box 3218, Daytona Beach, Fla.

WATCHES Completely repaired electrically \$4.50. Guaranteed. Air service. SwissAmerican Watch Hospital, 2940 Lincoln, San Diego, Calif.

UNREDEEMED Diamond, 1-carat, \$295. 30-day refund. Free catalog. Broff's Diamond Loan Association, 411 Smithfield, Pittsburgh, Penna.

5000 JEWELRY Styles, you can easily make yourself—Pins, earrings, bracelets, rings, matched ensembles. Instructions and catalog 10c. Barrys, 101 Ardsley Court, Newark, N. J.

HIGHEST Cash paid for old, broken jewelry, gold teeth, watches, silverware, diamonds, spectacles, platinum. Free information. Satisfaction guaranteed. Rose Smelting Company, 29-A East Madison, Chicago.

TOBACCO, SMOKERS' SUPPLIES

HERE'S Tobacco you will appreciate. Long broad fire cured. Good aroma. Prepaid 10 lbs. \$7. Seconds smoking and chewing, 4 lbs., \$3.00. Farmers Tob. Pool, Martin, Tenn.

CIGARETTES—Roll 200 mild-satisfying for 75c. Particulars free. Pete Moberly, Box 850, Owensboro, Kentucky.

FOR SALE—MISCELLANEOUS

VON Schrader rug cleaner \$295.00. Lam-berson, 312 W. Broad, Hazleton, Penna.

TEA—One pound \$2.50. Free delivery. Greenland Tea Co., Darjeeling, (India).

THE World's most amazing catalog. 230 fantastic pages of sensational bargains at savings up to 85% in war surplus and factory close-outs. Values in general merchandise such as clothing, housewares, hand and power tools, foam rubber, outdoor and camping equipment, photo supplies, plastics, metals, hydraulic cylinders, valves, pumps and many hundreds more. Send only 50c to cover handling and mailing. Palley Supply Co., Rm. 14, 2263 E. Vernon Ave., Los Angeles 58, Calif.

CHROME Cabinet hardware. Bathroom accessories. Push button spraying enamel. Write Box 89, Troy 2, Ohio.

SAVE Money on army, navy and factory surplus. Write today for new 48-page illustrated catalog. Tennusa Sales Co., Dept. AN, 1451 Market, Chattanooga, Tenn.

WANTED—MISCELLANEOUS

WANTED To buy: Old automobile catalogs, and folders. Send list of makes and years for cash estimates. Lewis Mayer, Munith, Michigan.

SCRAP Mercury (quicksilver) tantalum, bismuth, tungsten. Metallurgical Products Company, Established 1909. 35th & Moore Sts., Philadelphia 45, Penna.

PERSONAL

BORROW By mail. Loans \$50 to \$600 to employed men and women. Easy, quick. Completely confidential. No endorsers. Repay in convenient monthly payments. Details free in plain envelope. Give occupation. State Finance Co., 323 Securities Bldg., Dept. P-14, Omaha 2, Nebr.

SAN Francisco—Your address. Mail forwarded, outgoing letters remailed, \$3 mo. TBS, 742 Market St., San Francisco, Calif.

FEET Sweat? Throw off odor? Quick relief. Money-back guarantee. \$1.00. Red-O-Lent Co., 1359 No. Mackubin St., St. Paul 3, Minn.

LETTERS Remailed or replies forwarded 25c each. Monthly rates \$2.00. McLaughlin, 369 Welch, Columbus 7, Ohio.

LETTERS Remailed 25c. Also private receiving address. Monthly rates. Shanks, Box 3110-D, San Francisco 19, California.

PRINT Without a printing press. Big profits! See page 34.

"HAPPINESS" Magazine gives you 12 vital secrets for happier, more successful living. Sample copy 25c. Complete details free. Wayne Publishers, Box 4216-M, Jacksonville, Florida.

MEXICAN Law practice. Reliably conducted. Box 1736, El Paso, Texas.

MEXICAN Law. General Practice Attorney, 1203 Arizona St., El Paso, Texas.

"HOW Can I find out?" You can! Information discreetly developed. Any matter, person, problem, anywhere. Worldwide. Officially licensed, bonded service. Established 1922. Reasonable. Confidential. William Herman, 170 Broadway, New York.

HERE'S How and where to borrow \$50.00 to \$300.00 by mail. Confidential. Free particulars. Postal Finance Company, Dept. 45, Sioux City, Iowa.

MISCELLANEOUS

LEATHERCRAFT. Everything needed by beginners, advanced hobbyists and professional leatherworkers. Largest stock of supplies in U. S. Moderate-priced tooling leathers, top quality calfskins, tools, supplies, kits. Send 10c for big catalog. J. C. Larson Co., 820 S. Tripp, Dept. 2351, Chicago 24.

ORGANIZERS Wanted for debating clubs. Great opportunity. Thursday Evening Club, 324 Newbury St., Boston, Mass.

"PIXIE Packets" for children 7-14. A different craft kit each month. Yearly subscription \$5.00. Entertaining, educational, excellent gift. Write for free literature. Pixie Packets, Dept. P-2, 4909 Woolworth, Omaha 6, Nebr.

LEATHER Jackets repaired. New knit, zippers or relined. Work fully guaranteed. Jackets made to order. Free circular. Taubers, 689 Mission, San Francisco 5, Calif.

PERSONALIZE — Decorate glassware. Easily etch beautiful designs, monograms, initials in three minutes. Write for free folder. Etchall, Inc., Columbia 4, Missouri.

MONEY—Back guarantee. Automatic card shuffler: Canasta, etc. \$3.27. M. Baker, 4206 West Carroll Ave., Chicago 24-P, Ill.

RECEIVE Magazine, samples, catalogues. Mails from firms everywhere. Name listed 25c. Rorick, Box 86, Cincinnati 26, Ohio.

CESSPOOL, Septic tank trouble? Start leaching process by instilling Sursolvent, the miracle reconditioner. Saves pumping. Reduces odors. Opens clogged drains. Reclaims old systems to a condition approaching newness. Simple to use. Write for information. Electric Sewer Cleaning Co., Boston 34, Mass.

HOUSES Of earth, no priorities on dirt. Build it yourself. Complete instructions, 20 illustrations. Based on government engineering findings. Fireproof, ratproof, termiteproof. Mailed on receipt of \$2.00. A. B. Lee, Box 171, Washington, D. C.

INSTRUCTIONS For building Radio Treasure Finder, \$1.00. Wyss, 104½ Frances, St. Joseph, Missouri.

INCREDIBLE! Become mental superman overnight! Free booklet! Bijou, Box 1727-M, Hollywood 28, California.

48 STATE Decals \$3.00; 15—\$1.00; sample 10c. Ace Novelty Co., Box #101-M, Richmond, Indiana.

WHERE To search for buried treasures (maps—pictures). Only \$2. Treasure Press, Dept. D, Crown Point, Indiana.

WONDER Drugs! Cures! Lifesaving knowledge! Free booklet! Bijou, Box M4-1727, Hollywood 28, California.

SMASH That old worry habit with our amazing "Human Behavior Control" plan. Many helped. Write for unusual free lecture. No obligation. Personal Psychology, Inc., Box 1924-M, Louisville 1, Kentucky.

GENUINE Japanese Geisha dolls. 14" high. \$9.95. Money order only. Mrs. M. Kirby, Box 16, Azabu, Tokyo, Japan.

YOUR Leather jacket renovated expertly. Free circular. Berlew Mfg. Co., Dept. 8, Freeport, N. Y.

TELEVISION Mail order service. Faster than local service. Savings. Protect yourself. Read Reader's Digest, June. Details: Cywar Television Service, West Point Pleasant, New Jersey.

BUY Direct, save. Shirt and pants uniforms \$6.98, coveralls \$6.25. Lettering and emblems free. Money back guarantee. Lowest price in country. Free catalog. Eastern Sales, Chelsea St., Everett, Mass.

UNBREAKABLE Plastic squeeze dispenser bottle of Formula 52 liquid hand cleaner. For workshop, car, fishing kit—anywhere. Refillable. Cleaner removes grease, dirt, ink, etc., with or without water. Pint \$1.50, ½ pint \$1.00, postage paid. La Dana, 705 So. 16th St., Omaha, Nebr.

FREE Catalog! War surplus clothing. Amazing bargains. N. Y. Clothing Co., New York 29A.

NOISE. New ear sound filter stops loud noises, passes ordinary sounds. Protect your hearing, increase efficiency, comfort. No wires, batteries, lasts indefinitely. Not hearing-aid. Free details. Anza Co., 3560A 20th St., San Francisco 10, California.

RECEIVE Mammoth mails, magazines, catalogs! Three months 25c, year 50c. Wadell's Directory, 341B East 76th, New York 21.

UNDERWATER Exploring, spearfishing! Beginner's illustrated handbook. How make equipment, where buy, how use for exciting fun! Join Aquamen's Club. Membership and advice, certificates for reports fish caught, depths attained. For all this rush one dollar to Underwater World, Box 475B, Huntington, New York.

HAWAIIAN Coconuts. Mailed anywhere in U.S. \$1.00 each. Letters and cards remailed from Honolulu 25c each. H. Wright, Box 173, Lahaina, Maui, T. H.

SELECTIVE Metal and mineral detector. Revolutionary design. Distinguishes metals from black magnetic sands. Readily detects metals under salt water. Free literature. Gardiner Electronics Company, Department 12, 2018 N. Dayton, Phoenix, Arizona.

GOLD, Silver, metal detectors. Geiger counters for uranium. Mineralights. Sensational new fully guaranteed models. None finer. Information free. Detector Co., 5631 Cahuenga Blvd., North Hollywood, California.

OUTDOOR Toilets, cesspools, septic tanks cleaned, deodorized with amazing new product. Just mix dry powder with water; pour into toilet. Safe, no poisons. Save digging, pumping costs. Postcard brings free details. Burson Laboratories, Dept. C-36, Chicago 22, Illinois.

TREASURE Finders for gold, silver and minerals. Money back guarantee, best available. Also Geiger counters for uranium prospectors, free information. Write Goldak Company, 1541 West Glenoaks, Glendale 1, Calif.

PANNING Gold lesson and catalogue. Beginner's supplies, books, "maps where to go" free. Old Prospector, Box 729D1, Lodi, Calif.

TREASURE—M-Scope Geiger counters, mineral locators. Why buy something inferior when you can buy the best at a lower price? Backed by years of experience. Fully guaranteed by factory. Detects minerals, metals, gold, silver, coins. Payment plan available. Proven superior performance. Free 16 page illustrated booklet. Fisher Research Lab., Inc., Palo Alto, California.

SAVE 75% ON



WORK CLOTHES!

SURPLUS STOCK FROM
MIDWEST SUPPLY FIRM!

Terrific values you've got to see to believe!

SHIRTS 79c

Made to sell for 2.99! Now Only 4 for \$2.99

What a buy! 4 for the price of one! These shirts, though used, are washed, sterilized and ready for long, tough wear. In blue or tan. Send name, address, neck size.

PANTS to match

Sold for 3.95 now only **99c**
Unbelievable Bargains! Send waist measure and inside leg length. 4 for \$3.75

COVERALLS . . . wear 'em used and save plenty! Originally 5.95. Now only . . . **\$1.79**
Send chest measurement.

SATISFACTION GUARANTEED! Money back if you're not convinced these are bargains you can't beat! You can't lose so order TODAY for immediate delivery! Pay postman or send money with your order and save postage.

GALCO SALES CO. Dept. 18

5713 Euclid Ave. • Cleveland 3, Ohio

Readers—Watch For This!

Beginning in the big September issue of POPULAR MECHANICS MAGAZINE, there will be a new section called — "Shopping for Living and Giving."

In this new section you will find added opportunities to satisfy your needs and wants by mail. The merchandise and services presented will be different from most of those previously available to you through the pages of Popular Mechanics.

Watch for this wonderful new shopping section in the September issue!

**POWERMASTER*
HUNTING
CROSSBOW**

KILLS ALL BIG NORTH
AMERICAN GAME-
DEER, BEAR
ETC.

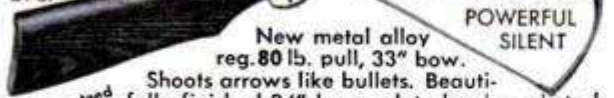

postpaid \$18.95
with 3
arrows

New metal alloy
reg. 80 lb. pull, 33" bow.

guaranteed Shoots arrows like bullets. Beautifully finished 34" heavy duty hardwood stock. Crafted to meet highest archery requirements. As large manufacturers we can mass produce this \$45 value crossbow for only \$18.95. Precision trigger action, flat trajectory, pinpoint accuracy. Hunters knock down game at 200'. Cocks easily. Beginners shoot more accurately than professional archers. Silent, this powerful weapon permits extra shots at game. Adaptable for harpooning. Includes 3 arrows, instructions. Extra arrows 60c ea. **MONEY BACK IF NOT COMPLETELY SATISFIED.** Send \$18.95 in check, cash, or M.O. to **TECHRITE CORP., Box K12, South Pasadena, Calif.**
*Professional Model of National Crossbow Ass'n.

LOCKSMITHING & Key Making

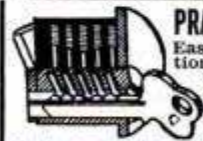

PRACTICAL UP-TO-DATE COURSE—ONLY \$4.95

Easy-to-learn modern information for self-instruction. How to work on locks, de-code, make master-keys, repair, install, service, etc. For every handyman, home owner, carpenter, mechanic, service station operator, fix-it shop, hardware dealer, gunsmith, 53 plain illustrated lessons. **FULL PRICE ONLY \$4.95. SEND NO MONEY.** Just pay postman plus G.O.D. postage. Or send \$4.95 with order, we'll ship postpaid. Satisfaction guaranteed or refund. **NELSON-HALL CO., 210 S. Clinton St., Dept. HY-2, Chicago 6, Ill.**

**Secrets of VENTRILOQUISM
Now Revealed!**



Easy to learn in 60 to 90 days with our Home Study Course. **RESULTS GUARANTEED.** Make Money! Be Popular! Have Fun! Big Opportunity! Radio, Television, Stage Appearances! For FREE Information regarding price and terms, WRITE. You must state your age. Dummy Catalog 25c. **FRED MAHER SCHOOL OF VENTRILOQUISM**
Box 36, Studio H Kensington Station
Detroit 24, Michigan

BIG OPPORTUNITIES IN METAL TRADES

- Drafting
 - Tool & Die Designing
 - Tool & Die Making
 - Machinist Trade
- Only 60 school days—360 hours—of practical Training. Allied will train you easily and quickly for these important trades and place you on a good paying job. Write for **FREE BOOKS**, a postcard will do. Indicate preference — Resident or Home Study. Approved for Vets.

ALLIED SCHOOL OF MECH. TRADES, Dept. PM-BA
1338 SO. MICHIGAN AVENUE, CHICAGO, ILL.

**Say You Saw It in
POPULAR MECHANICS**



THIS MAN...
... is taking out of the machine a Plastic Sealing Job — ordered by mail — only 11c in material cost brings back \$2.58 in cash by mail. Capacity of machine: **\$25.00 profit per hour of operation.**

Get info.. PLASTIC LAMINATING AT HOME!

Get **ORDERS** and **CASH** from your mailman—do work in **SPARE TIME** at home — or expand into **FULL TIME** business. Send coupon for Free facts about the newest and most fascinating of all home operated businesses. For the first time a simplified machine brings the fabulous profits of **Plastic Sealing and Plastic Laminating** within the reach of the small operator. Anyone can learn to operate the machine with a few minutes practice — then with our **Magic Mail Plan** can get mail orders pouring in daily with cash in every envelope. **No canvassing—no selling.** We even

**Make \$20 to \$30 a Day by..
MAGIC MAIL PLAN!**

Make Thousands of Beautiful Art Creations

- COSTUME JEWELRY • CIGARETTE BOXES
TRAYS • CANDLESTICKS • COASTERS
LAMP BASES • BOOK ENDS...ALL IN
SPARKLING COLORED PLASTIC**



supply the circulars you mail to bring back cash and orders. Don't waste a minute. Rush your name. We'll send you **FREE** and postpaid, pictures, prices, details, and all the facts you need to start. Mail coupon or send name on postcard. No charge. **Warner Electric Co., 1512 Jarvis Av., Dept. L-10-0, Chicago 26, Ill.**

WARNER ELECTRIC CO., 1512 Jarvis Av.
Dept. L-10-0, Chicago 26, Ill.

At no cost to me, please rush complete details postage prepaid. I am under no obligation.

Name _____
Address _____
City _____ Zone _____ State _____



**WORK IN
COOL
SAN DIEGO**

Illustrated
book sent
FREE

San Diego offers you California living at its best — and Convair gives you the top working conditions. Employee Retirement Plan. Group Insurance. Two weeks vacation. Eight holidays annually. Free Housing Office and much more — plus that wonderful San Diego climate. These classifications now open for you:

- | | |
|-----------------------------|-------------------------------|
| 1. TOOL DESIGNERS | 8. FIELD & SERVICE MECHANICS |
| 2. TOOL PLANNERS | 9. AIRCRAFT MECHANICS |
| 3. PATTERN MAKERS | 10. AIRCRAFT ELECTRICIANS |
| 4. TOOL & DIE MAKERS | 11. IBM TAB MACHINE OPERATORS |
| 5. JIG AND FIXTURE BUILDERS | 12. INSPECTORS |
| 6. MACHINISTS | |
| 7. LOFTSMEN | |

CONVAIR

Send this coupon for **FREE** book and details:

Employment Office 700
Consolidated Vultee Aircraft Corporation
3302 Pacific Hiway
San Diego, California

NAME _____
OCCUPATION _____
ADDRESS _____
CITY _____ STATE _____

Become a Doctor of PSYCHOLOGY

Win the degree of Ps.D. Teach the secret of contentment, happiness. Solve mental worries. Experience the revelation of truth. Chartered college. Individual help. Write for **FREE** book. **COLLEGE OF UNIVERSAL TRUTH, 5153-B North Clark St., Chicago.**

BIG PAY, BIG FUTURE IN NEON SIGNS—SCIENTIFIC GLASS BLOWING

- Neon Signs
- Industrial Glass Blowing
- Radio & Television Servicing
- Electrical Equipment Servicing

Neon Sign making is a big, fast growing industry. Prepare quickly in our modern, well equipped shops for high paying jobs. Scientific Glass Blowing offers exceptionally fine opportunities in Electronic industry, manufacturing of Laboratory Apparatus, Atomic Energy Commission, Television Industry. **Low Monthly Payments or Pay After Graduation Plan.** Approved for Veterans. **WE HELP PLACE YOU ON GOOD JOBS.** Write for free Facts today.

PRACTICAL TRADES INSTITUTE, Dept. PM-8 — 2550 Indiana Ave., Chicago 16, Ill.

SAVE GAS

WITH A FUEL PRESSURE REGULATOR!

THIS REVOLUTIONARY NEW ACCESSORY STOPS GAS WASTE CAUSED BY FUEL PUMP PULSATION. ELIMINATES CARBURETOR FLOODING AND FUEL "SURGE." STOPS THE ANNOYANCE AND POWER LOSS CAUSED BY "MOTOR CUT-OUT." Many users claim up to 25% gas saved. Regulator s-m-o-o-l-h-s fuel flow . . . prevents vapor lock and percolating.

It pays for itself in a few weeks with gas saved, by eliminating frequent carburetor tuning and by reducing engine and carburetor wear. Fits all cars and trucks.



3 BOOKS FREE
With each order: Big Speed Equipment Catalog plus "Economy Driving Manual" plus famous "150 Miles Per Gallon Book"—a regular \$1.75 value free with order.

NEWHOUSE AUTOMOTIVE INDUSTRIES
Dept. BR-8, 5805 E. BEVERLY BLVD., LOS ANGELES 22, CALIF.



BEFORE AFTER
Only **\$5.95** post-paid
(or send \$1. balance COD)



WHY SUFFER TONGUE BITE?

Cost 3 times as much to build as the best of old-fashioned pipes. But **KILL TONGUE BITE, STOP DRINK.** FREE circular tells WHY. Write:

KLEENSMOK PIPES
P.O. No. M597, Tenn.
Johnson City, Tenn.
R-Reg. U.S. Pat. Off. Pat's. and Pat's. Pend.

Build Your Own Motorized Workshop

This Famous Book Shows How to DO IT!



NEW EDITION



Easy-to-Make 40 Different Power Machines

Make them yourself—lathes, drill presses, sanding machines, shaper, circular, band and scroll saws and other power tools — from wood, pipe, and discarded parts that cost little or nothing. Get the new edition of "Forty Power Tools You Can Make" even though you have the older edition. This new book has 20 new tools. Make yourself up-to-date, efficient power machines that will save you hundreds of dollars. Send \$1.50 with order and save high C. O. D. charges. Your money back if not satisfied.

POPULAR MECHANICS PRESS, 200 E. Ontario St., Chicago 11, Ill.

Tool and Die Design Training

\$8,000 to \$15,000 YEARLY INCOME!

Acme training has been fully proved in practice through its fine resident schools. Acme graduates report outstanding promotions, resulting in higher salaries. Progress is sure and easy through Acme's famous "Cope" System.

Prepare yourself in your spare time for a secure position of responsibility and high earnings, and qualify at a time when you will have every opportunity to rise to a position in the \$8-15,000 per year salary bracket. Be successful — go farther faster!

Detailed information upon request.

ACME SCHOOL OF DIE DESIGN

(Correspondence Division, Dept. M)

8 N. JEFFERSON STREET

DAYTON 2, OHIO

New Opportunities for You

... in Popular Mechanics "Shopping for Living and Giving"

Yes—in the September issue, a brand new Popular Mechanics shopping section will be unwrapped, displaying new and different merchandise and services for better living and giving—for you and your friends.

WATCH FOR THIS WONDERFUL NEW SHOPPING SECTION IN YOUR SEPTEMBER ISSUE!

YES! SEND



directly to my door every month

I am enclosing

- \$3.50 for 1 year
- \$8.00 for 3 years

name _____
address _____
city _____ zone _____ state _____ A-72

Hand this order to your newsdealer or send it to
POPULAR MECHANICS
200 East Ontario St. Chicago 11, Ill.

DON'T MISS THIS AND
THE NEXT 3 PAGES!

Read All About 40 Famous

How • To • Do • It

Books

from the Presses of
Popular Mechanics



*Fifty Years of
Book Publishing Service
to Information-Seeking
America*

On the next three pages are
described and pictured forty
POPULAR MECHANICS BOOKS

prepared by authoritative and able writers under the supervision
of **POPULAR MECHANICS EDITORS.**

When he founded **POPULAR MECHANICS MAGAZINE** a half century ago, Mr. H. H. Windsor, Sr., began the publication of practical, down-to-earth **HOW-TO-DO-IT** books. Since then Popular Mechanics has continued to feature the publication of books of this type. Each book is prepared on the same practical foundation as is the magazine, under its famous slogan — **WRITTEN SO YOU CAN UNDERSTAND IT.** All texts are backed up with pictures, plans and diagrams that make every point unusually clear, even for those with little or no familiarity with the subject.

POPULAR MECHANICS BOOKS are abreast of the times, covering the latest inventions and developments. They describe methods and materials; explain processes and procedures; provide short cuts and easier ways of doing time-honored jobs and specifically serve the needs of **INFORMATION-SEEKING AMERICA** with actual **HOW-TO-DO-IT** information and instruction. They save time and effort and save and make money for millions of users of all ages and from all walks of life.

Please turn the page. You, too, will no doubt find the answers to your problems, or perhaps, find greater enjoyment of your interests in **POPULAR MECHANICS HOW-TO-DO-IT BOOKS.**

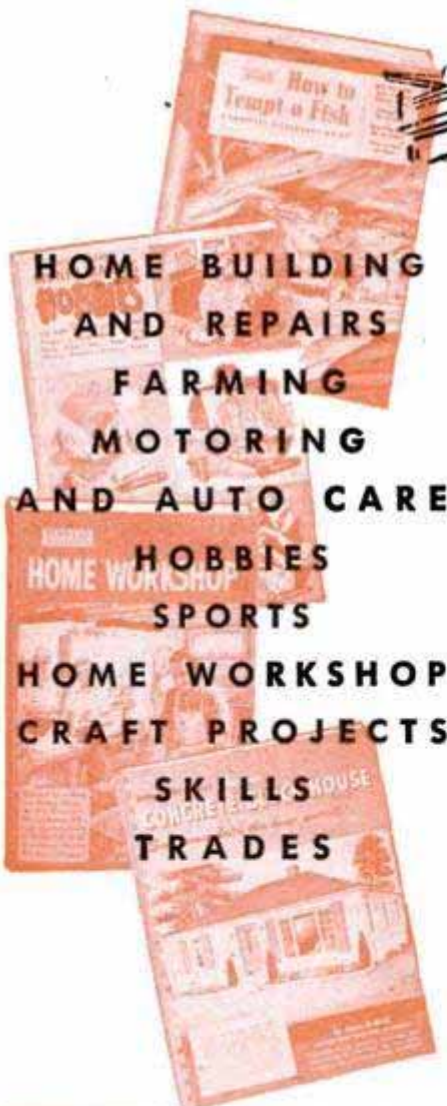

POPULAR MECHANICS PRESS • Chicago

Popular Mechanics

HOW TO DO IT BOOKS

HOME BUILDING AND MAINTENANCE • FARMING • BETTER JOBS • SKILLS
HOME WORKSHOP • HOBBIES • AUTO CARE • PASTIMES • ETC.

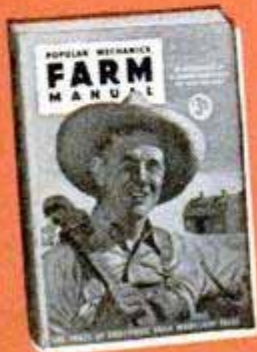

Endorsed by leading agriculturists, County Agents, Vo-Ag teachers and others.



FARMING • FARM WORKSHOP

FARM MANUAL Contains hundreds of practical articles and ideas for everyday use on the farm. Covers the making of implements and equipment, maintaining the home, the farm workshop, livestock and poultry, vegetable storage and processing, etc. Gives time and money-saving farm hints and kinks. Something for every member of the farm family. Steps up farm efficiency, increases production and improves appearance. Here is the experience of hundreds of successful farm operators brought together into one handy, easy-to-read, easy-to-use, working handbook by the editors of Popular Mechanics. It will make and save money for you. Now in its fourth printing. Over 140,600 copies sold. This book should be on every farm. **\$3.00**

HOME MAINTENANCE

LAWN AND GARDEN For every home owner, with practical instruction based on proven methods for landscaping and growing fine lawns and gardens. 176 pages. Illus. **\$2.50**

HOW TO PAINT By Sam Brown. Covers all types of paint application. Illustrated. **\$2.50**

WHAT TO MAKE WITH CONCRETE All types of concrete work for the home owner. Kinks, short cuts for builders. 112 pages. Illustrated. **\$2.00**



HELP FOR CAR OWNERS, MECHANICS

MOTORIST'S HANDBOOK 535 practical articles of helpful information that can easily save you hundreds of dollars every year, make your car run better and look better too. Covers models 1940-1950. Illus. **\$2.00**

MANUAL FOR PLYMOUTH OWNERS Get the most out of your car investment. Covers the Plymouth from bumper to bumper—explains how parts operate, what can go wrong, what repairs are necessary, how to avoid trouble. Illustrated. **\$3.50**

MOTORIST'S FIX-IT BOOK Simplified instruction for car owners. Can easily save hundreds of dollars every year. Illustrated. **\$2.00**



OUTDOORS AND SPORTS BOOKS

HOW TO TEMPT A FISH

Section by Joe Godfrey, Jr., world famous authority. A lifetime of valuable fishing information in a single book. 20 pages of best fish lures in actual colors. 525 illustrations. **\$2.00**



OUTDOOR SPORTS MANUAL Over 200 helpful articles for the hunter, trapper, fisherman, camper, archer and boatman. 334 illustrations. **\$2.00**

23 BOATS YOU CAN BUILD Plans, building instructions and material requirements for 23 different boats that anyone can build at home. Over 500 pictures. **\$2.00**



HOME BUILDING

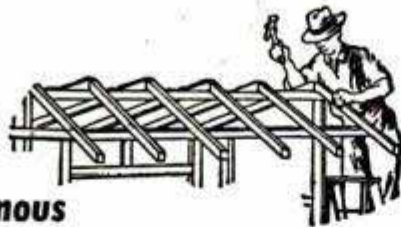

Popular Mechanics Famous "Build-It-Yourself" Books that Save Over One-Half Home Building Costs

YOUR HOME AND HOW TO BUILD IT YOURSELF Hundreds of amateur builders have built this home with the aid of this book. Typical 6-room Colonial home with garage, breezeway and basement. Can be built by any man handy with tools. Many pictures in actual colors. \$3.00

CONCRETE BLOCK HOUSE

Built in many localities by amateur builders, complete with plumbing, electrical wiring and heating for less than \$3650. Five good sized rooms and ideal for family of four. Half of book is pictures and diagrams. \$2.00

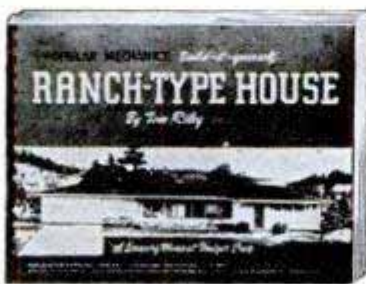

RANCH HOUSE BOOK

Ready Sept. 1.

Exciting new ranch type house, finished inside and out with plywood. Fully insulated. Can be built in two easy stages by amateur. Five rooms with bath and utility room and car port, about \$5000. Added garage, breezeway and third bedroom, about \$2500. Heating, wiring, equipment included. Designed by famous West Coast architect. Plenty of pictures. \$3.50

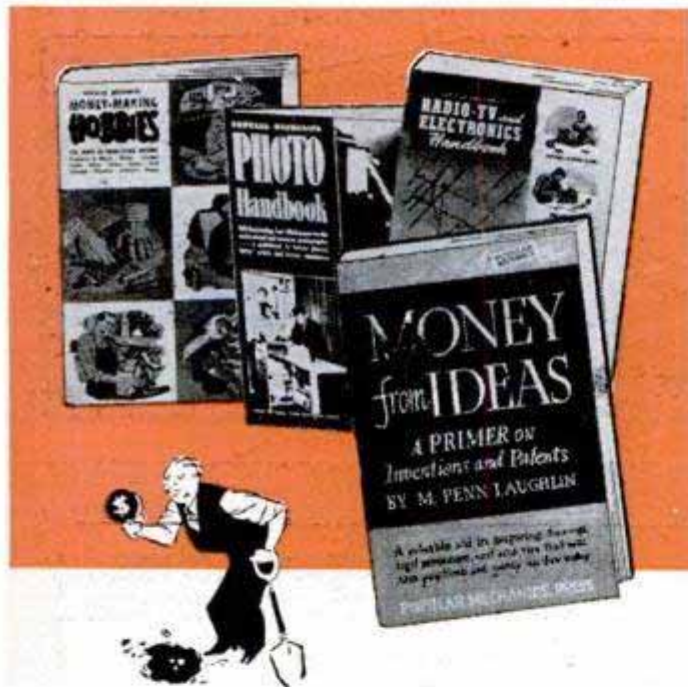

HOBBIES, PROFITABLE IDEAS

RADIO, TV AND ELECTRONICS HANDBOOK by Popular Mechanics Electronics Editor. A book for set owners, experimenters, students, experienced men. 566 illustrations. \$2.50

MONEY-MAKING HOBBIES Tells how to have fun and make hobbies pay their own way and a profit. 132 different things. \$2.00

PHOTO HANDBOOK Better pictures. Gadgets you can make. Proven darkroom helps. Camera tricks. 465 illustrations. \$2.00

MONEY FROM IDEAS A practical book for every man with an active inventive mind who believes he has ideas that can be patented. \$2.50

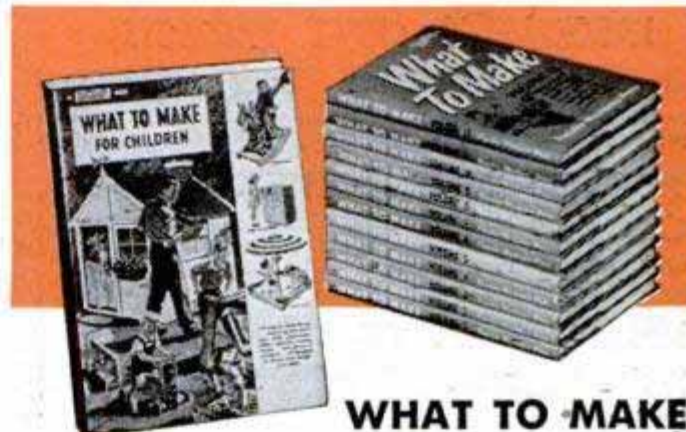

WHAT TO MAKE

WHAT TO MAKE Now 12 volumes. An annual selection of craftsman projects such as furniture, toys, games, gifts, etc. More than 3000 different projects in the 12 volume set. Fully illustrated. Each volume \$1.75. Set of 12 volumes. \$18.00

WHAT TO MAKE FOR CHILDREN 175 things dad and mother and other members of the family can make for the young folks at home. Fully illustrated. \$2.00

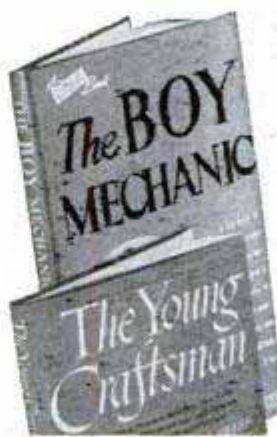

EDUCATIONAL BOOKS FOR BOYS

YOUNG CRAFTSMAN Over 450 different projects for boys of all ages. Brings out the inherent creativeness in every boy and stimulates imagination. More than 1100 illustrations. \$2.00

BOY MECHANIC Hundreds of things a boy can make at home at little or no cost. Detailed plans and hundreds of pictures. Teaches boys to think and work with their hands, making such things as autos, boats, models, games and craftwork. \$2.00

Home Workshop Books • Projects for Home Craftsmen and Windsor Press Publications on NEXT PAGE

HOME WORKSHOP and CRAFT BOOKS for FUN and PROFIT

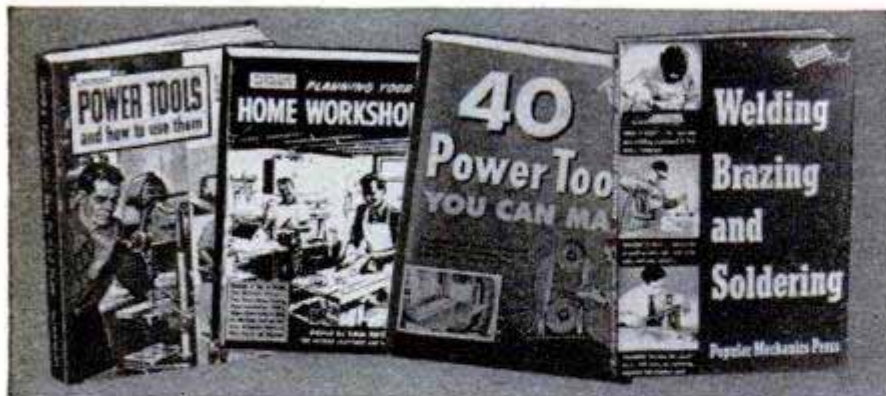

**PRACTICAL, HELPFUL
INFORMATION FOR
THE HOME
WORKSHOP
FAN**



Here is a selection of books that lead the field in all-time popularity. Nothing else like them. Superbly Illustrated.

POWER TOOLS AND HOW TO USE THEM A practical guide to the selection and operation of home workshop machines. Includes exciting projects in many materials. **\$2.50**

40 POWER TOOLS YOU CAN MAKE Tells how to make your own power tools from scrap and discarded materials at small cost. New edition with added tools. **\$1.50**

WELDING, BRAZING AND SOLDERING Shows you how to make your own equipment and use it effectively on jobs of all kinds. 1950 edition. **\$1.75**

PLANNING YOUR HOME WORKSHOP Edited by Sam Brown. Tells how to set up a shop on a limited budget and get the most out of it in fun and efficiency. **\$2.50**

FASCINATING CRAFT PROJECTS

CHRISTMAS HANDBOOK A wonderful collection of Ideas, Gifts, Decorations, Toys—You can make at home. Informative and practical. Illustrated. **\$2.00**

100 BEAUTIFUL PIECES OF FURNITURE YOU CAN BUILD Scale drawings and instructions for living, dining and bedroom suites and occasional furniture. Plates in actual colors. 320 illustrations. **\$3.00**

YOU CAN MAKE A STRADIVARIUS VIOLIN Complete instructions and 8 full size plans. Tells where to get materials and how to make your own tools. Illustrated. **\$3.50**



Handy Order Form

MAIL TO POPULAR MECHANICS PRESS
OR ORDER FROM YOUR BOOKSELLER

POPULAR MECHANICS PRESS

Dept. 80, 200 East Ontario Street, Chicago 11

Check Titles Wanted

- | | | | |
|--|--------|---|--------|
| <input type="checkbox"/> Boy Mechanic | \$2.00 | <input type="checkbox"/> Planning Your Home Workshop | \$2.50 |
| <input type="checkbox"/> Christmas Handbook | 2.00 | <input type="checkbox"/> Power Tools and How to Use Them | 2.50 |
| <input type="checkbox"/> Concrete Block House | 2.00 | <input type="checkbox"/> Radio, TV and Electronics Handbook | 2.50 |
| <input type="checkbox"/> Concrete Handbook | 2.00 | <input type="checkbox"/> Ranch Type House Book | 3.50 |
| <input type="checkbox"/> Farm Manual | 3.00 | <input type="checkbox"/> 23 Boats You Can Build | 2.00 |
| <input type="checkbox"/> Forty Power Tools You Can Make | 1.50 | <input type="checkbox"/> Veterinary Guide for Farmers | 3.50 |
| <input type="checkbox"/> How to Paint | 2.50 | <input type="checkbox"/> Welding, Brazing, Soldering | 1.75 |
| <input type="checkbox"/> How to Tempt a Fish | 2.00 | <input type="checkbox"/> What to Make, Volume | 1.75 |
| <input type="checkbox"/> Lawn and Garden | 2.50 | <input type="checkbox"/> What to Make, 12 Volume Set | 18.00 |
| <input type="checkbox"/> Manual for Plymouth Owners | 3.50 | <input type="checkbox"/> What to Make for Children | 2.00 |
| <input type="checkbox"/> Money From Ideas | 2.50 | <input type="checkbox"/> You Can Make a Stradivarius Violin | 3.50 |
| <input type="checkbox"/> Money Making Hobbies | 2.00 | <input type="checkbox"/> Young Craftsman | 2.00 |
| <input type="checkbox"/> Motorist's Fix-It Book | 2.00 | <input type="checkbox"/> Your Home and How to Build It Yourself | 3.00 |
| <input type="checkbox"/> Motorists Handbook | 2.00 | | |
| <input type="checkbox"/> One Hundred Beautiful Pieces of Furniture | 3.00 | | |
| <input type="checkbox"/> Outdoor Sports Manual | 2.00 | | |
| <input type="checkbox"/> Photo Handbook | 2.00 | | |

Enclosed is remittance for \$_____ for which please send postpaid, Popular Mechanics Books as checked to the left. (Orders for \$2.00 or more may be sent COD, postage and charges extra.)

MONEY BACK IF NOT SATISFIED

Name _____

Address _____

Postal Zone _____

City _____ State _____

WANT TO **SAVE GAS?** $\frac{1}{2}$ MILLION NOW USE GANES

← **AMAZING GANE NEEDLE** | **TRY ONE FREE IN YOUR CAR!**

TRY BEFORE YOU BUY!

MANY GANE NEEDLE USERS REPORT UP to 25% more mileage, faster pickup, easier starting and smoother idling.

NOW TEST A GANE NEEDLE IN YOUR CAR for ten days, then compare your mileage and performance. If satisfied, send \$1.50 per needle (8 cpl. cars take 2). If not satisfied, just return it—fair enough! Since authorities differ on its merits and some users report no improvement, **TRY BEFORE YOU BUY!** (Gane Needle replaces idling adjustment screw in carburetors—easily installed in a few minutes.)

WRITE TODAY. ENCLOSE NO MONEY. PAY POSTMAN NOTHING. Just send us your name, address, and make and year of car.

NATIONAL AUTOMOTIVE RETAIL CORP., Dept. J-8
350 W. Washington Blvd. Venice, California

PORTABLE GARAGE



\$6.95

VINYL PLASTIC

USE IT ANYWHERE!

• Goes wherever your car goes • Folds compactly • Keeps rain, snow, dust, salt air, sun or sleet away • Protects your car's finish • Durably constructed of vinyl plastic that is long wearing and tough • Nylon thread grommets for extra security • Spring-tite, elasticized bottom, holds securely in all kinds of weather • Fits all makes and models • Direct from manufacturer • Enclose check or money order for \$6.95, or sent C.O.D.

10-Day Money Back Guarantee

MARDO SALES CORP., PL 5-1161

480 LEXINGTON AVE., DEPT. 287 NEW YORK 17, N. Y.

LEARN MEAT CUTTING

through actual practice. Profitable Meat Cutting and Self Service Meats taught easily, quickly. **LEARN BY DOING** at Toledo in just eight short weeks under actual market conditions. For beginners or men with experience. All subjects taught thoroughly and completely. Diploma. Job help. Get store of own. People must eat. School in operation over 25 years. Approved for GI training. Send today for **FREE** illustrated catalog. No obligation. **NATIONAL SCHOOL OF MEAT CUTTING, Dept. 50-H, Toledo 4, Ohio**

BULLET BLADE
SWEDISH STEEL *Knife* 2 FOR \$1 post paid

Ideal for tackle box, dressing small game, novelty letter opener. Tempered 1 1/2" blade locks in shell. Get one for yourself, your boy!

WINFIELD ARMS CORP.
Distributors for Western Arms Corp.

ROOM PB-8, 409 EAST PICO BLVD., LOS ANGELES 15, CALIF.

NOW LEARN TV-RADIO Servicing AT HOME!

EARN WHILE YOU LEARN

No previous training needed... new simplified lessons! Top instruction from one of the largest schools of its kind! Send for **FREE** sample lessons and full details — start yourself on a profitable, interesting career **TODAY!**

CRESCENT SCHOOL
500 PACIFIC ST. • BROOKLYN 17, N. Y.

HELPFUL BOOKS

Send post card asking for **FREE** catalog

Popular Mechanics Press, 200 E. Ontario, Dept. 601, Chicago 11

Learn BAKING At Home

Baking is one of America's high industries in wages. Nearly depression-proof. Thorough basic home course lays sound foundation. If you have aptitude, write for **FREE** BOOKLET, "Opportunities in Commercial Baking."

NATIONAL BAKING SCHOOL
835 Diversey Pkwy. Dept. 135C Chicago 14



Exotic Natives — at work and play in far away and mysterious lands.

Fierce Jungle Beasts — against a background of steaming tropic forests.

Thrilling Foreign Scenes — beautiful and unusual sights from every corner of the globe.

Free THIS PRIZED AND VALUABLE SET OF 50 FRENCH COLONIAL STAMPS

Now Sent **FREE** to Secure Names for Our Mailing List

WHAT a GIFT! **FIFTY** colorful stamps from every corner of the far-flung French Empire — darkest Africa to the headline hot spot — Indo-China! Every continent represented. Each stamp is **different**. Each stamp worth **REAL MONEY!** Total Price — in Standard Catalog — guaranteed to be at least \$1.00, yet **ALL ARE YOURS FREE!** But you must act at once. The demand is great, our supply limited. We'll also include other interesting offers for your inspection — **PLUS** a **FREE** copy of our helpful book, "How to Collect Stamps."

This offer may have to be withdrawn soon — so rush coupon **TODAY** to:

Littleton Stamp Co., Dept. PM-8, Littleton, N. H.

Also FREE—

Helpful illustrated book, "How to Collect Postage Stamps." Packed with expert advice on how to get started; where and how to find rare stamps; how to mount them, trade them, etc.



LITTLETON STAMP CO., Dept. PM-8, Littleton, N. H.

Send—**FREE**—set of 50 French Colonial Stamps and informative booklet, "How to Collect Stamps."

Name.....

Address.....

City..... State.....



A bit about "Bite"

WITH FISHERMEN, the more "bites"—the better! When fighting fish smack their lines—it's a thrill!



WITH PIPE SMOKERS—the *less* "bite" the better. Prince Albert is specially treated to insure against tongue bite!

Bite's Out Pleasure's In

**THERE'S MORE TOBACCO
IN EVERY TIN!**



R. J. Reynolds
Tobacco Co.,
Winston-Salem,
N. C.

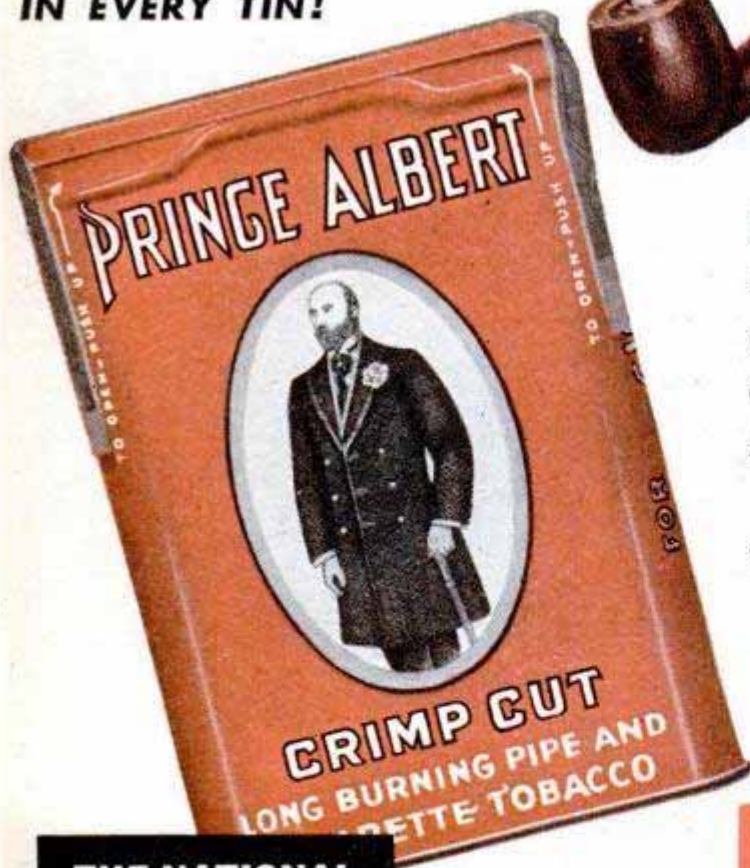

Prince Albert is made to give you more smoking enjoyment. P. A.'s choice tobacco is treated by the patented* "No-Bite" process which means more *real* smoking comfort.

Great for "makin's" cigarettes, too! Buy P.A. today!

*Process Patented July 30, 1907

**THE NATIONAL
JOY SMOKE**

**MORE MEN SMOKE
PRINCE ALBERT**

THAN ANY OTHER TOBACCO

WRITTEN SO YOU CAN UNDERSTAND IT
VOL. 98 NO. 2

Don't forget to ask for a transfer when you book passage on that space ship! Our scientists come up with fantastic possibilities as they study the question . . .

Shall We Move to Another Planet?

By Thomas E. Stimson, Jr.

THE TIME IS coming when mankind will have to reconstruct the solar system.

That's the startling assertion of Fritz Zwicky, professor of astrophysics at the California Institute of Technology.

Professor Zwicky says that we may have to rearrange the planets and in some cases rebuild them to fulfill our future requirements for living space.

Not even Mars could be colonized on a large scale at present because it lacks a suitable atmosphere. It may pay to send Mars off on a tangent past some other planet to draw off an atmosphere and then return the red planet to its present orbit.

To make one of the large outer planets habitable would be an even more tremendous task. The planet would have to be

Glenn L. Martin
Co. photo



← Prof. Fritz Zwicky operates 18-inch telescope at Palomar Observatory. Right, a nose view of a towering "Viking" rocket that climbs 135 miles

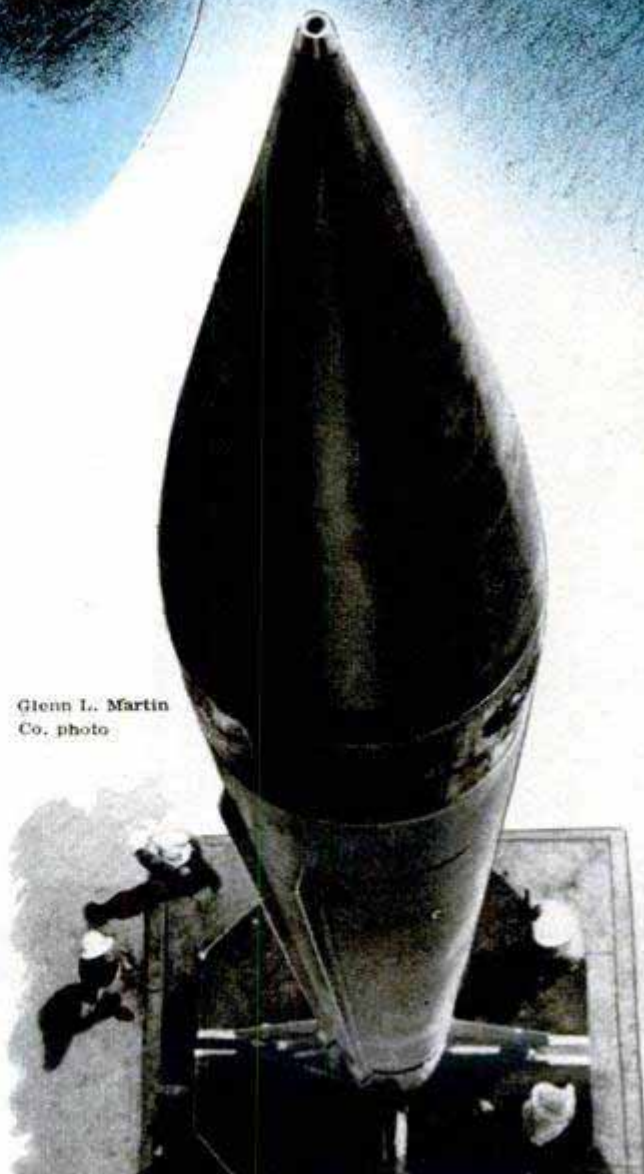

Left, North American Aviation photo
Below, U. S. Army Ordnance photo

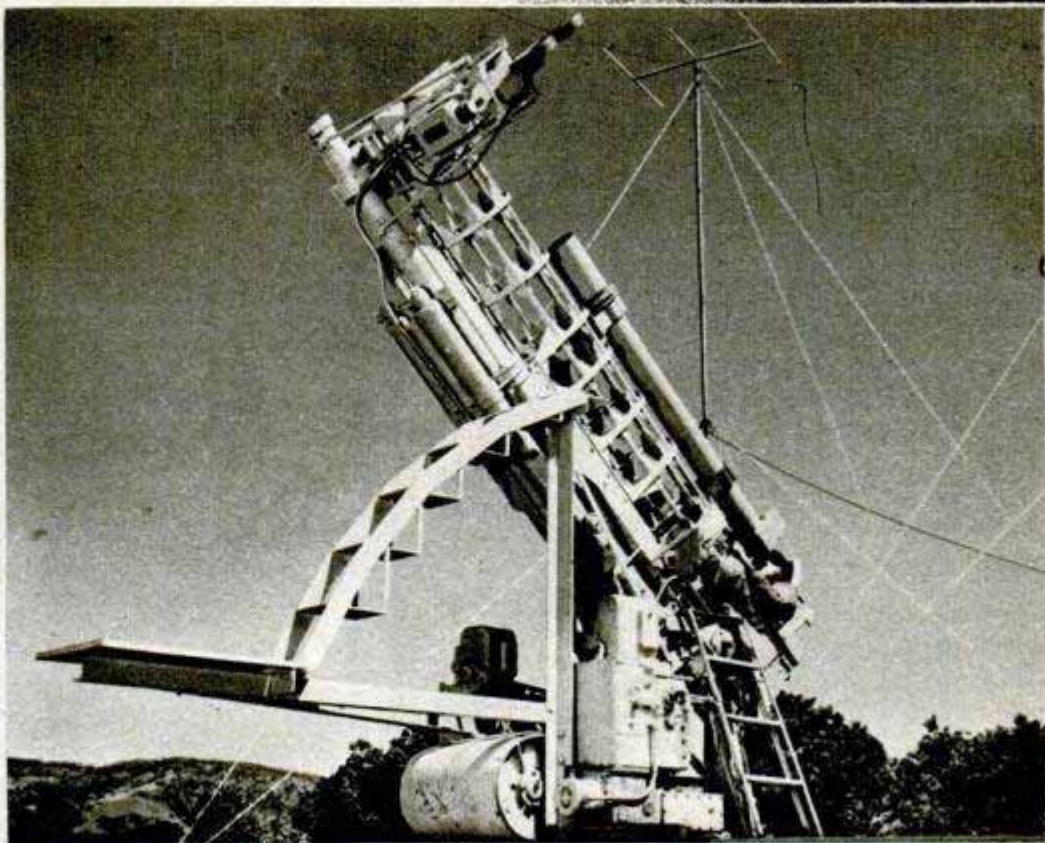

↑ Big telescope-camera takes close-up research photos of rockets at altitudes above 100 miles

← High-acceleration rocket starts its long climb, blazing gases from its tail leaving a fiery sky trail

Right, Navy research men crouch behind wall as an artificial meteorite is fired in penetration test

Below, in a movie version of take-off, rocket uses thrust of its main motor plus rockets on launcher

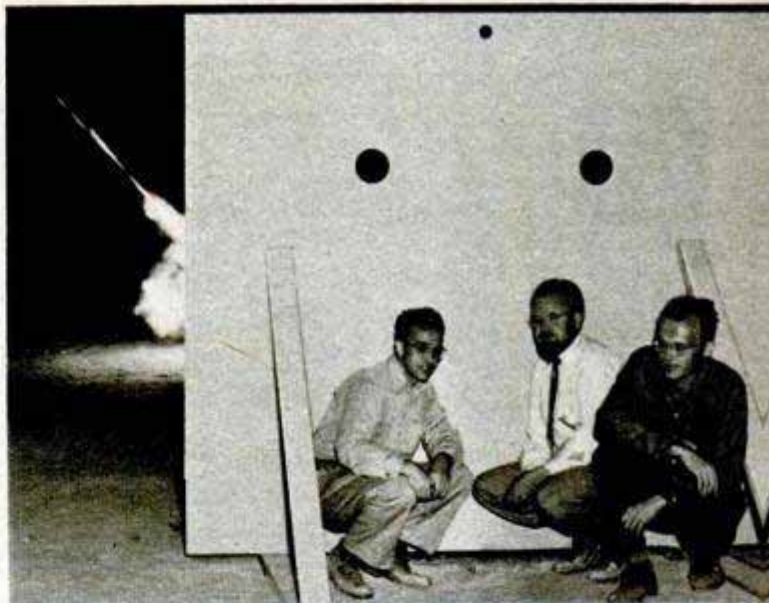

Paramount Pictures Corp. photo

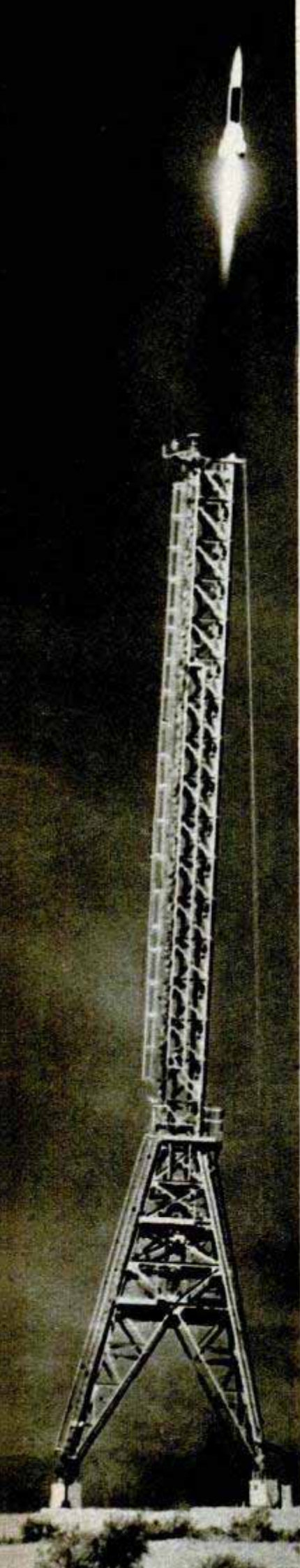
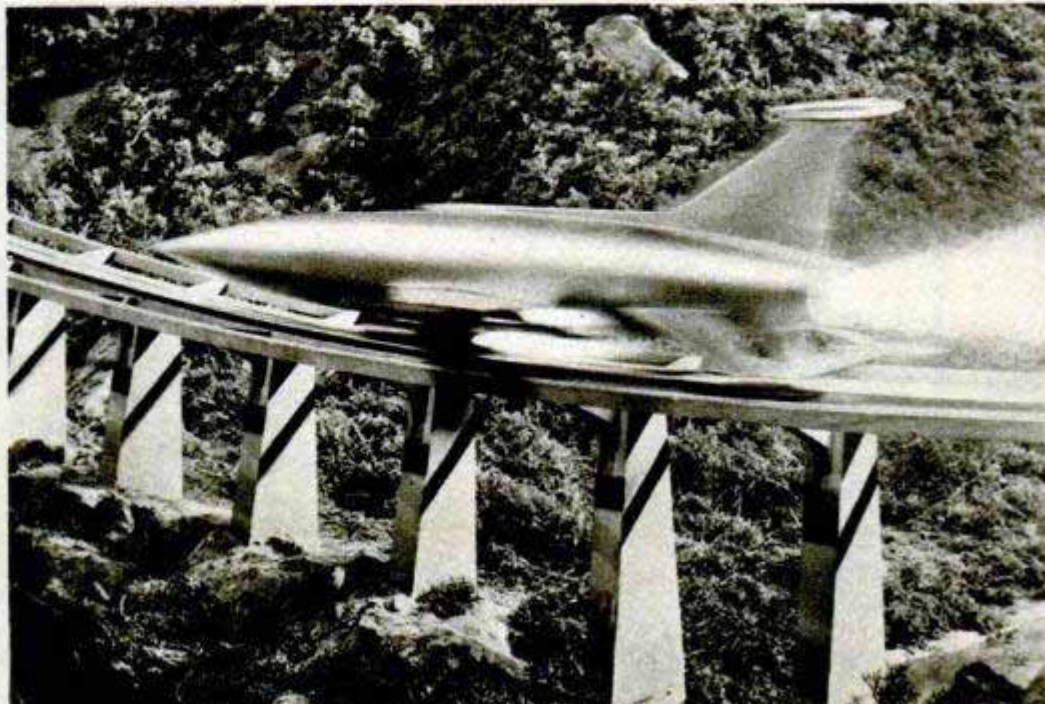

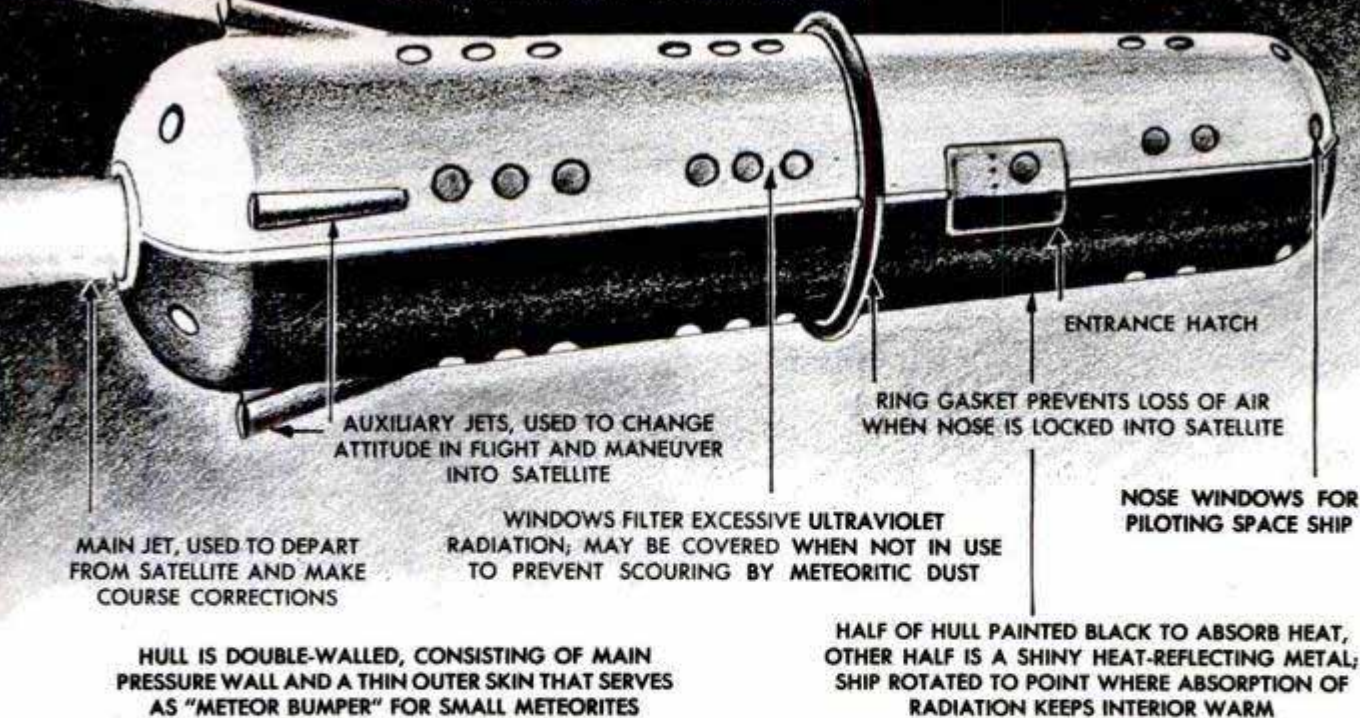

MAIN JET, USED TO DEPART FROM SATELLITE AND MAKE COURSE CORRECTIONS

AUXILIARY JETS, USED TO CHANGE ATTITUDE IN FLIGHT AND MANEUVER INTO SATELLITE

WINDOWS FILTER EXCESSIVE ULTRAVIOLET RADIATION; MAY BE COVERED WHEN NOT IN USE TO PREVENT SCOURING BY METEORITIC DUST

ENTRANCE HATCH

RING GASKET PREVENTS LOSS OF AIR WHEN NOSE IS LOCKED INTO SATELLITE

NOSE WINDOWS FOR PILOTING SPACE SHIP

HULL IS DOUBLE-WALLED, CONSISTING OF MAIN PRESSURE WALL AND A THIN OUTER SKIN THAT SERVES AS "METEOR BUMPER" FOR SMALL METEORITES

HALF OF HULL PAINTED BLACK TO ABSORB HEAT, OTHER HALF IS A SHINY HEAT-REFLECTING METAL; SHIP ROTATED TO POINT WHERE ABSORPTION OF RADIATION KEEPS INTERIOR WARM

Artist's concept of space ship is a huge cylinder. Streamlining would be of no value in frictionless space

broken apart or shrunk to about the size of earth to provide a comfortable surface gravity. It would have to be endowed with a useful atmosphere. Finally, it would have to be moved closer to the sun, at about earth's orbit, where it could absorb enough solar radiation for our needs.

These are fantastic ideas, but are they absurd? Not necessarily, Professor Zwicky believes. He points out that unlimited power will be available when nuclear fusion is achieved and that no fundamental principle seems to stand in the way of using nuclear fusion on a large scale. (Fusion is the combining of light elements into heavier ones, as is done in the sun, in contrast to the present nuclear-fission processes in which heavy atoms are split into lighter ones.)

With nuclear fusion, he continues, it should be possible to create and control a jet that would approach the proportions of those produced in minor stellar eruptions. This would be the tool with which the planetary system would be juggled about. A tremendous lopsided jet on the surface of a planet could divert the body from its accustomed motion. Jets might also be used to decrease the mass of the planet or to increase the masses of its satellites.

Professor Zwicky's conclusions arise from what he terms "morphological thinking," the orderly listing of all possible solutions to a given problem. Most devices and processes in the past were invented helter-skelter, he asserts, and yet nothing can be thought of that is not already waiting for us in the morphological box. Instead of attacking a problem haphazardly, it is wiser to state the problem formally and then to consider all possible solutions not prohibited by the laws of nature.

One might confidently start work tomorrow on the theoretical and mathematical problems of rebuilding the planetary system, the Caltech astrophysicist says, since enough knowledge is available to guarantee that very little of the work will be found later to have been done in vain.

"However, there is one danger," he declares. "Through poor handling of the operations, or maliciously, the earth itself might be exploded. We must be concerned with the stabilization of large bodies against nuclear fusion as well as with the processes of ignition."

Several centuries may elapse before mankind is ready to test Professor Zwicky's proposals; long before then, many scientists are convinced, we'll be able to fly regularly to the moon and will have explored Mars and Venus. One of these feats may be accomplished during the next 50 years. Today hundreds of research workers in this country alone are engaged directly or indirectly in solving the highly involved problems of astronautics.

Research on long-range military rockets has yielded much information about propellants and power plants suitable for space flight. The principles of astrogation, or space navigation, have been worked out by astronomers. Study is being given to "canned air" and the other problems of living in empty space. The scouring of meteoritic dust on windows and the graver hazards of heavy primary cosmic-ray radiation and collisions with meteors are subjects of research.

Even the legal aspects of laying claim to celestial bodies have been discussed.

One of the phenomena to which space travelers will be subjected is weightlessness,

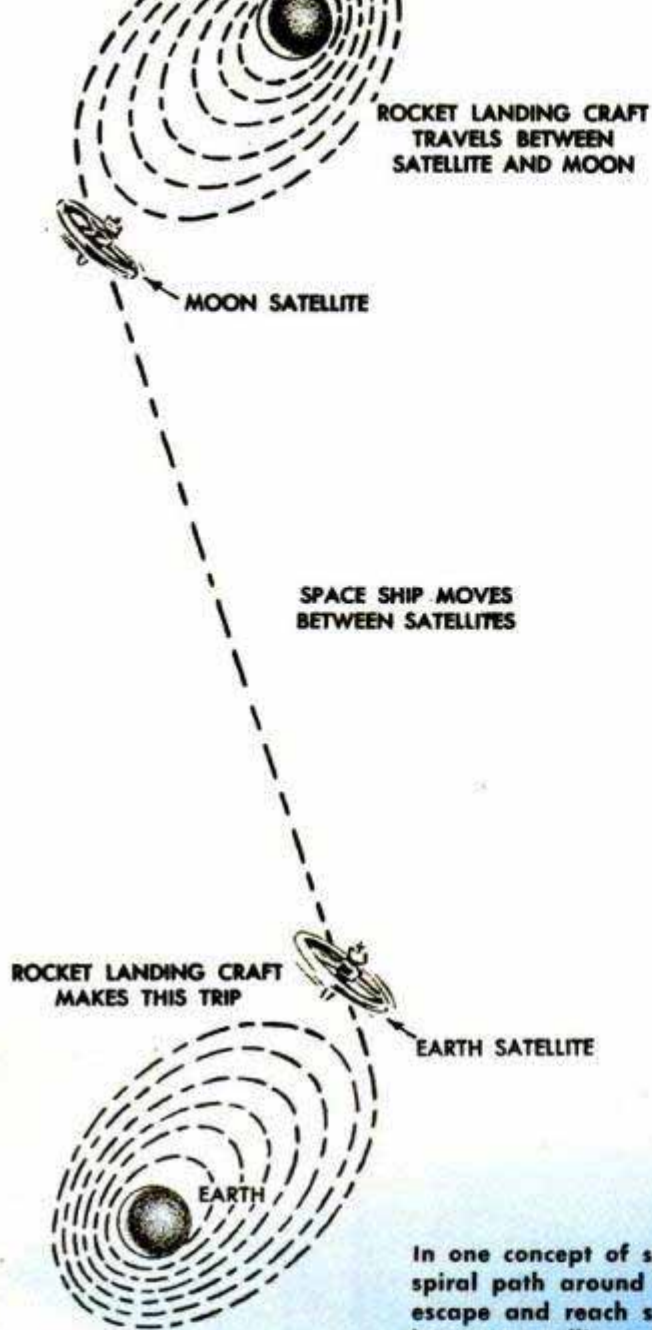

In one concept of space travel, a rocket would take spiral path around earth, accelerating until it could escape and reach satellite. Space ship would travel between satellites, another rocket would land on moon

a condition now engaging the special attention of the space-medicine division of the Air Force School of Aviation Medicine at Randolph Field, Tex.

"Zero gravity will give one the sensation of falling into a bottomless pit, no matter how tightly he holds on to his seat," a member of the space-medicine team remarks. "A sudden transfer to the gravity-free state will not be recommended for weak souls, though one may count on a gradual adaptation to the strange sensation of being in a perpetual fall."

Weightlessness is a far more serious condition than might be supposed. The space-medicine scientists are concerned, among other things, about the possibility that a person in a gravity-free state would suffocate in his own breath. There would be no circulation of air in a room that has zero gravity; hence after a person had expelled a few lungfuls of air, he would be rebreathing his own exhaust gases. Some kind of forced circulation would have to be provided, not only for humans but for such devices as heat exchangers.

It would be possible today to build an unmanned step rocket that would escape from earth, never to return, or to shoot a few people in an ionocruiser to an altitude of 200 miles, from which height the winged rocket could glide slowly back to earth. Even an unmanned rocket that could crash-land on the moon is a marginal possibility with today's knowledge. But round-trip flights through space must wait until more

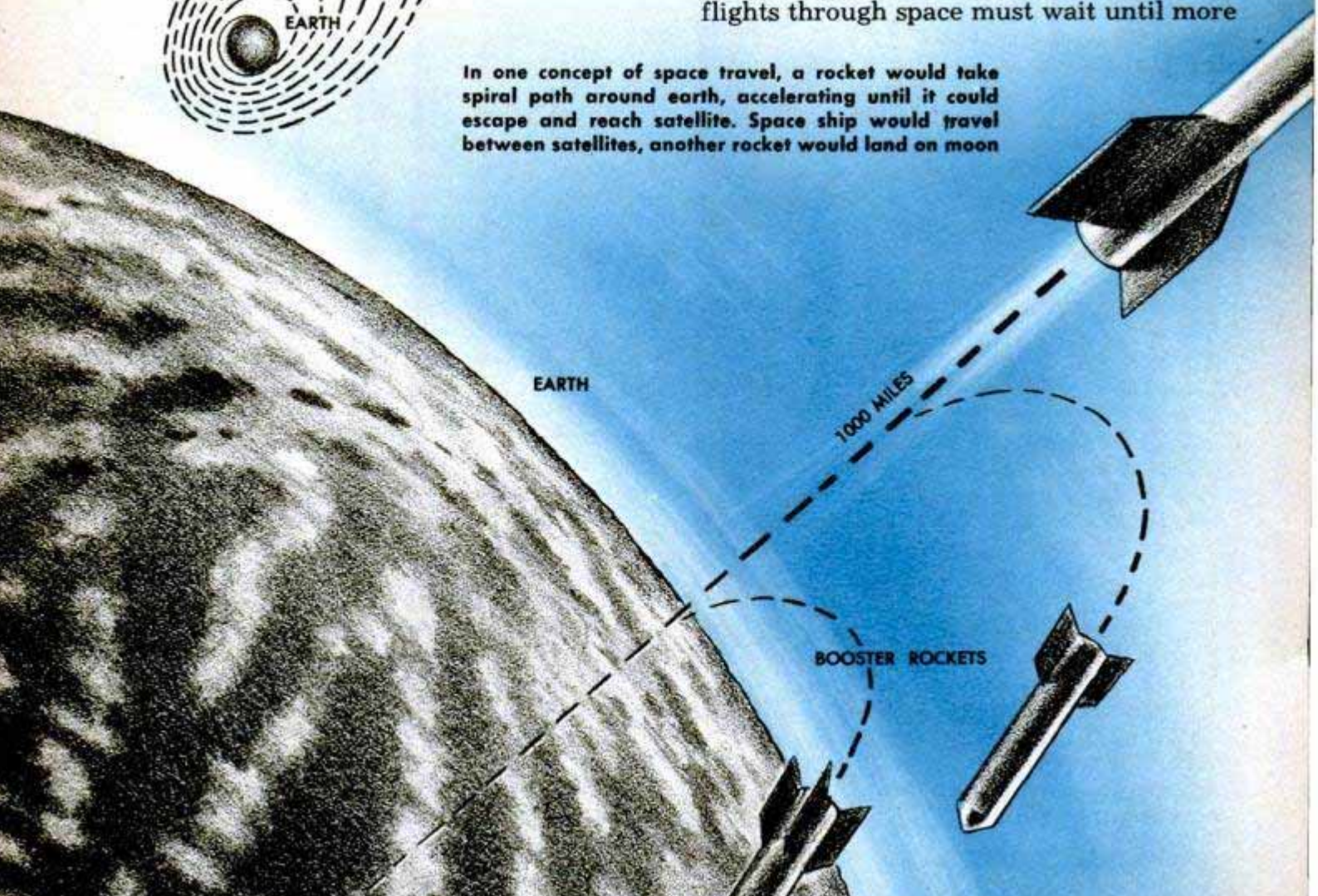

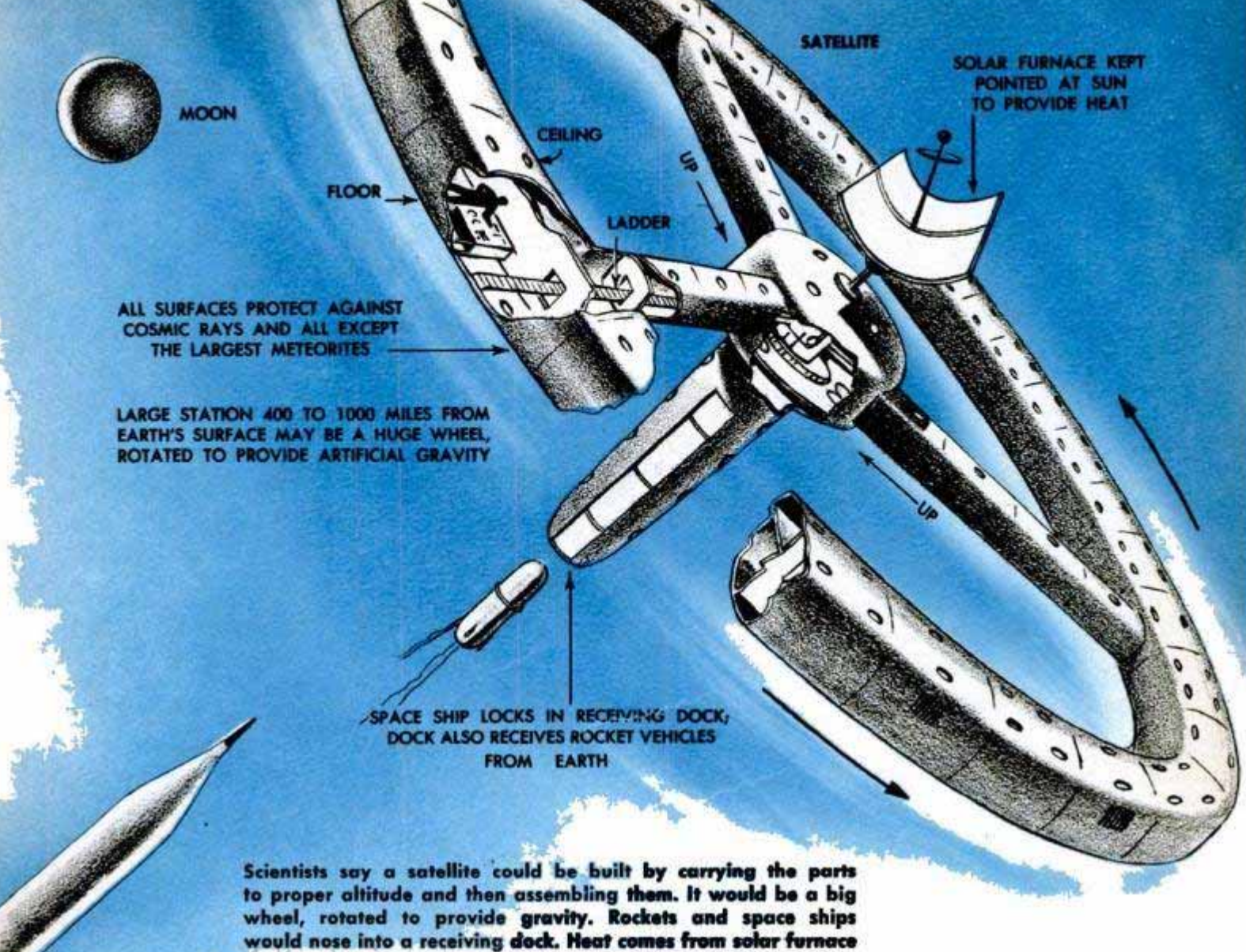

ALL SURFACES PROTECT AGAINST COSMIC RAYS AND ALL EXCEPT THE LARGEST METEORITES

LARGE STATION 400 TO 1000 MILES FROM EARTH'S SURFACE MAY BE A HUGE WHEEL, ROTATED TO PROVIDE ARTIFICIAL GRAVITY

SPACE SHIP LOCKS IN RECEIVING DOCK, DOCK ALSO RECEIVES ROCKET VEHICLES FROM EARTH

Scientists say a satellite could be built by carrying the parts to proper altitude and then assembling them. It would be a big wheel, rotated to provide gravity. Rockets and space ships would nose into a receiving dock. Heat comes from solar furnace

efficient propellants have been developed.

To escape from earth a rocket must move at the rate of 25,000 miles per hour, about five times the speed attained by the nose section of one of the bumper rockets fired at White Sands Proving Ground. The speed of escape from the moon is a mere 5300 miles per hour because of the smaller size of that body.

The theory of space travel is based on the idea that after a rocket gets away from earth it would continue to travel at its escape speed without the use of power. It would become a celestial body whose path and ultimate speed would be governed by the pull of the sun and planets. To reach a particular target, such as the moon, it would be necessary to fire the rocket at a predetermined time in a certain direction.

Professor Zwicky suggests that chemical energy for attaining escape speed may be found in the excited atomic particles that exist high in the earth's exosphere. If these could be utilized in a ductlike motor it might be possible to drive a rocket at greater and greater speeds as it circles the earth, finally escaping into space without discomfort from high accelerations. Until we learn differently, he concludes, there

is even the possibility that space itself contains some form of energy or matter that could be used for propulsion. This would greatly simplify solving the problems of navigation.

Present research on power, however, is along orthodox lines. An atomic power plant might be one solution, although by itself this energy would not be sufficient. Anthony J. Nerad of the General Electric Research Laboratory suggests that an efficient propellant may be found in the metallic hydrides. These compounds contain large amounts of hydrogen in chemical combination with a metal. Volatilized and expanded in some kind of motor, the hydrogen may prove much more efficient than any rocket propellant we now have.

Rocket scientists generally agree that we won't take off from earth and fly directly to such a destination as the moon. A trip like that would be made in three stages utilizing two transfer points.

Stage one would be the lift from earth to a satellite station possibly 1000 miles out. A rocket of moderate acceleration and probably conventional appearance might be used. Stage two would be the long trip

(Continued to page 224)



Pack-Horse Litter

Injured mountain climbers are brought down to a hospital safely on a basket litter that is fastened securely to the back of a pack horse. The injured person lies flat on

the litter and is carried down steep trails quickly. Designed by Elmer Jensen, operator of the Frontier Pack Station at June Lake, Calif., the litter already has been used to bring a Boy Scout out of the mountains when stricken with appendicitis.

Rinse Stops Static Generation in Synthetic-Fiber Garments

Simply by adding a teaspoonful of a new chemical to each quart of rinse water when you do the laundry, you can eliminate the tendency of synthetic fibers to develop static electricity. Thus rinsed, garments of

nylon and other synthetic fibers won't crackle, cling uncomfortably to the body or create sparks when removed. One rinsing lasts indefinitely, or until the next washing.

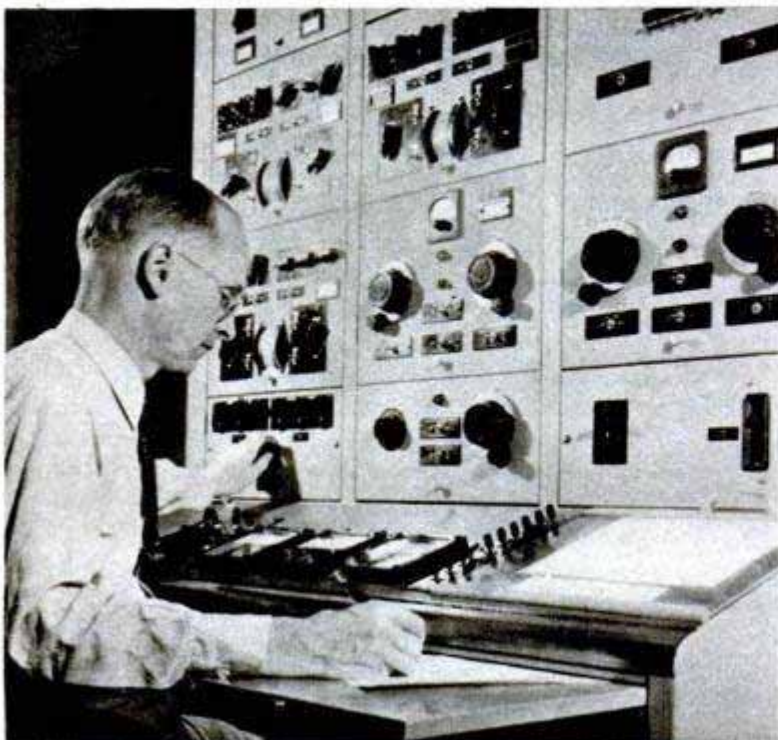

Calculator "Tests" Nonexistent Motor

Electric motors that have not yet been built are "tested" by a calculating machine developed at Westinghouse. Previously, expected performance had to be computed by engineers with pencil and slide rule, a job that took several days. The calculator does the same operation in more detail in a few hours. Engineers create an electrical "model" of the motor and by varying the elements of the model they can determine effects of temperature, overloading or a short circuit on the new design.

Discovery of an oil field near Umiat, Alaska, containing an estimated 30 to 151 million barrels, has been confirmed by the Navy.



Most Authentic Map

Recently completed, a map of the Western Hemisphere incorporates the findings of explorers, navigators, surveyors and aerial photographers, making it the most up-to-date map in existence. The map, measuring 51 by 34 inches and printed in eight colors, was prepared by the American Geographical Society. One inch on the map represents about 200 miles on the earth's surface. A unique feature is the map's pro-

jection, invented especially for the Western Hemisphere. Since making a map means plotting part of a spherical surface on a flat piece of paper, no map can be entirely free from distortion. The new projection uses two focal points, one in the North Atlantic and another in the South Pacific. The result is a map in which all land areas are nearly true to scale. Measuring the distance between two points requires only a ruler as a straight line always represents the "great circle."

Railroad Puts Wind to Work

Automatic signals at a junction point of the Chicago and Eastern Illinois Railroad south of Chicago are operated by electricity made by the wind. Two small windmills, one at each approach to the junction, charge batteries that power the signals. Use of windmills saved the railroad 104,000 feet of wire and eliminates considerable maintenance required by overhead wires.





Lightning

Trappers

Lightning made by man, three million volts of it, crackles across these 22 insulators in a laboratory test

By Jack Andrews

IT'S OPEN SEASON on lightning at Westinghouse and General Electric. From June to September, engineers from the research laboratories of these two companies go out trapping thunderbolts.

Their traps are set in several hundred choice locations spread over a dozen states — atop skyscrapers, smokestacks, forest-

Lab lightning strikes model power line. Struck wire carries no power, is grounded to protect other lines

fire lookout towers and other potential targets of the powerful arc. Special recording devices take down vital statistics about the flashes and from this data science is developing a better understanding of nature's spectacular electrical discharges.

The engineers are interested in lightning because it can disrupt modern living completely. When the use of electricity in homes and factories was rare, a break in electrical service caused no great hardship. But today most of the comforts of our homes are run by electricity and hospitals and factories are entirely dependent upon it. Whole towns become almost helpless when power goes off for a few minutes.

Lightning is trapped by a number of special instruments — fulchronographs to record the amount of current and the shape of the bolt; cathode-ray oscillographs to record the intensity of the current; magnetic

links to "fingerprint" the stroke, and special cameras to take pictures of it.

Lightning engineers, however, rely most heavily upon the fulchronograph. The word is a combination of Greek and Latin—*fulmen* meaning lightning, *chrono* meaning time and *graph* meaning a picture. Encased in a box 18 inches square, this device consists principally of an electric motor and a slotted aluminum wheel. The number of blades magnetized and the amount of magnetization in each tell the engineers a lot about each lightning bolt they "capture."

One of the most elaborate outdoor thunderbolt traps is located 535 feet above the ground on the roof of the University of Pittsburgh's Cathedral of Learning. Here lightning racing down the 50-foot steel mast is channeled through various protective devices to test their efficiency. Six special instruments take its "fingerprints," snap its

Four million volts of electricity are made to leap across the gap between these two spheres in lightning lab





Ben Franklin invented the lightning rod about 200 years ago. Science now proves him right. Above, with no protection, tower on model splits open. Below, with it, the 2.4 million volts go harmlessly to ground

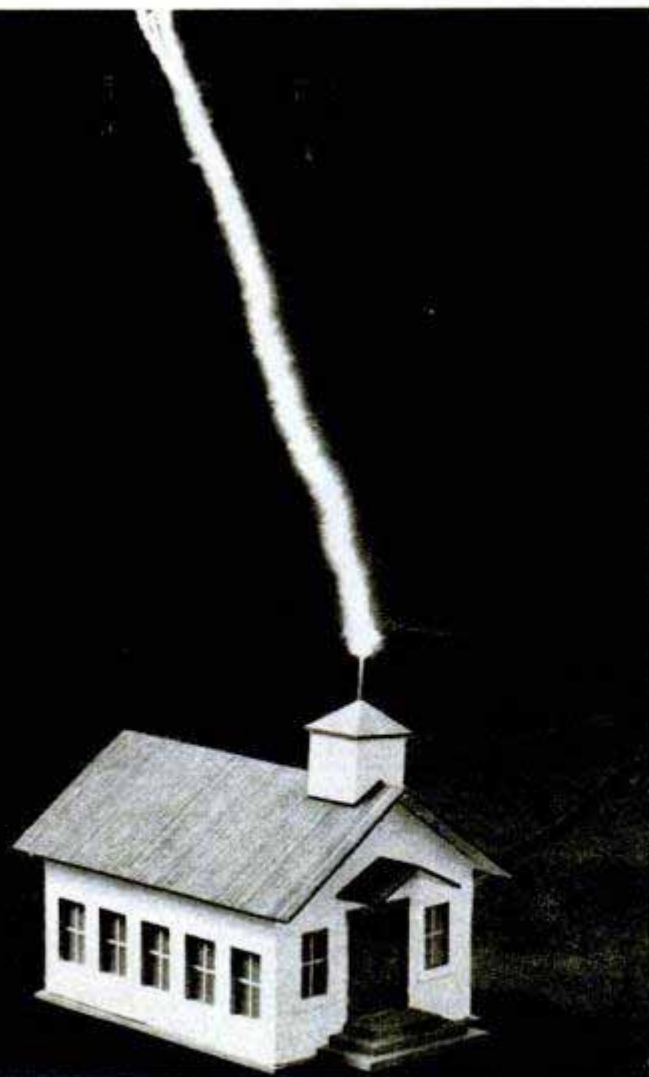

"picture" and examine its "calling card"—all of which information the engineers take to their laboratories and study.

It was atop the University of Pittsburgh's tower in 1947 that engineers trapped a lightning superbolt, thought to be the largest ever recorded. It consisted of five separate surges, at least one of which contained an estimated 345,000 amperes of electricity. This is equal to the current flowing into 200,000 average homes.

Other direct-stroke stations are maintained in such locations as the top of the Empire State Building in New York City and the 585-foot smelter stack of the Anaconda Copper Mining Company in Anaconda, Mont.

From studies of both natural and man-made lightning, we now have a pretty good idea of what causes thunder and lightning and how they behave.

The energy of strong upward currents in thunderclouds separates the electrical charges found there. The positive charges are carried into the top regions of the cloud; the negative charges accumulate in the lower regions. In addition, the earth's surface contains positive charges. The electrical force produced by these two sets of charges tries to pull them back together again. This starts a giant spark which is called a lightning discharge.

Most lightning flashes leap from one cloud to another across a pathway five to ten miles long. The flashes that do most of the damage, however, are those that arc between the clouds and the earth. These are five miles or less in length and, contrary to common opinion, spurt from the ground upward to the sky. An invisible stroke moves slowly from the clouds down to earth to start the phenomenon. When it touches the ground, a brilliant flash, which we call lightning, spurts upward from earth to the heavens.

Each square mile in the United States receives 10 lightning strokes a year, on the average. Areas most frequently hit are the Rocky Mountain states and the deep South. Least frequently struck are states of the West coast, New England and the middle Atlantic seaboard.

Westinghouse engineers have discovered two kinds of lightning—"cold" and "hot." The cold variety shatters trees and makes a loud report. This explosive kind of lightning is called cold because it expends its high electric current in one brief burst that is insufficient to ignite anything. Hot lightning is quieter but it burns trees and barns because it stretches a relatively low current over a longer period of time.

To the eye, thunderbolts look like one single, blinding flash. In most cases, however, there are at least two electrical dis-

charges over the same path and sometimes as many as 40. They appear to be one because they repeat their triphammer blows in the wink of an eyelid.

This information gathered in lightning traps has been used to build improved protective devices ranging all the way from giant lightning arrestors two stories high and circuit breakers weighing 12 tons to tiny insulators no larger than a pack of cigarettes.

General Electric recently completed a \$2,000,000 high-voltage engineering laboratory at Pittsfield, Mass. Westinghouse engineers create lightning in three laboratories—Sharon and Trafford, Pa., and Sunnyvale, Calif.

During World War II, Westinghouse developed a wire "umbrella" to shield vital explosives plants and oil-storage centers. When thunderstorms threatened prior to this, munitions executives dismissed their workers, crossed their fingers and prayed that they wouldn't get a direct hit. The new device increases protection several hundred percent.

By charting lightning strokes, engineers

have discovered that every 50 miles of power lines in the United States are hit by lightning on an average of 50 times a year. Each stroke has a potential voltage of between 20 and 30 million volts.

With this information, research men have been able to build equipment that will prevent lightning strokes from short-circuiting transmission systems and disrupting electrical service. Remember a few years ago when the lights in your home flickered or went out during a thunderstorm? Today, properly designed power lines are likely to be put out of service only once every five to ten years.

The most effective defense is the lightning arrestor which protects power-transmission, telephone and telegraph circuits. One of the newest types sends the lightning down and around a "spiral staircase" to dissipate its energy. It's more efficient, less costly to install and easier to maintain. For use on a 230,000-volt power line, the new arrestor stands 10 feet high.

At Westinghouse's Trafford laboratory, a three-foot model of a 32-foot cabin cruiser

(Continued to page 222)

Lightning left this lacy pattern on grass, proving it is positive. Negative stroke would form round pattern



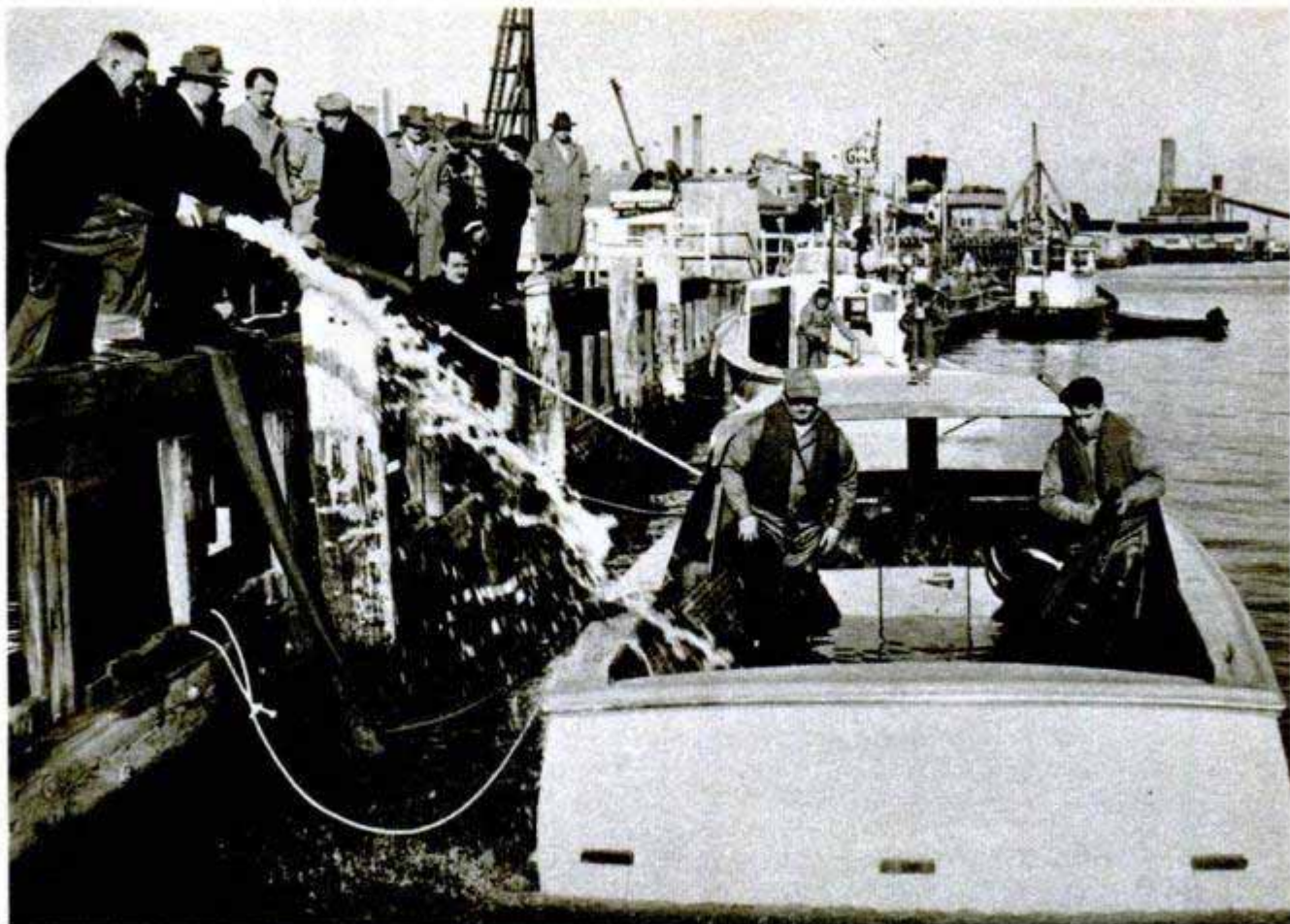

Nonsinkable Boat

Water by the thousands of gallons can be pumped into a new nonsinkable cabin cruiser and will run right out again. The craft was designed as a government patrol or utility boat but will be available in pleasure-craft models. Water pumped into the boat rises to a height of 18 inches in the cabin section. When it reaches this point

it runs out wide scuppers in the after end of the self-bailing cockpit. Even if the scuppers are plugged, the craft stays on an even keel with three feet of water in the hull. The secret of the boat's buoyancy is a pair of steel air tanks built under the cockpit deck. The power plant is encased in a steel watertight compartment and the boat can be operated under its own power even when the engine is deep under water.

Remote Control Permits Lift-Truck Operator to Raise Self



Drivers of lift trucks can now stand on a pallet and operate the lifting mechanism by remote control. Available as an attachment, the device permits the operator to remove stock from hard-to-reach bins. The control unit clamps over the tie bar when not in use and its cable, housed on a retractable reel under spring tension, cannot become entangled.

Sources of supply for available products described in this issue are listed in the index starting on page 12. Sources of further information on other articles in the magazine are listed in the WHERE-TO-FIND-IT LIST, which is available without charge from Bureau of Information, *Popular Mechanics Magazine*, 200 East Ontario St., Chicago 11



Test truck makes hundreds of wrenching turns in the figure-eight test. Outrigger prevents it from rolling over

Truck Proving Ground

Going nowhere, there's a fleet of trucks rolling 24 hours a day around a 7¼-mile paved track in Arizona to pile up a total of 34,000 miles a week. It's all part of the test program for International trucks. In addition to the paved track, there are a four-mile dirt track and a number of special test areas, including a series of steep grades and a strenuous figure-eight test course. An

air-cleaner test area subjects the trucks to extremely abrasive road dust. Usually, about 30 trucks drawn at random from production lines are undergoing tests at one time. Temperatures in the area have a 100-degree range. A long nine-percent grade was manufactured on the desert proving ground to provide a test run for the complete gear range. More than 130,000 cubic yards of fill were required to produce the long, even grade.

Generator Armatures Wound in Two Minutes by Machine

Experienced operators can wind generator armatures in two minutes with a compact winding machine that is powered by a small electric motor. Normally, a skilled worker requires 30 minutes to wind an armature. The machine handles all standard automotive armatures except those of starter motors. The six leads are held out by the machine while the final turns are being made so they are accessible when the job is completed. An automatic tensioning device controls the feeding of wire from supply spools.

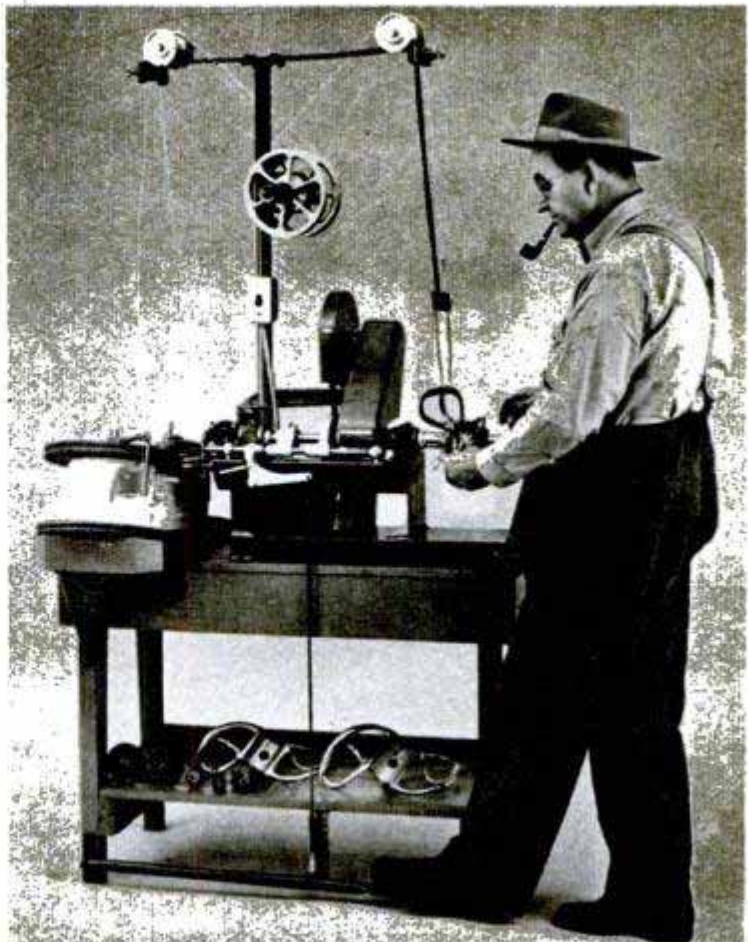

Record Iron Production

Record quantities of iron were produced in the United States last year. Lake Superior mines yielded 80.7 percent of the more than 130 million net tons produced, with Western mine output increasing to 9.3 million net tons. In addition, 11.4 million net tons were imported, principally from Chile, Sweden, Canada, Brazil, Venezuela, Algeria, British West Africa, Mexico, Tunisia and Liberia.

You Name It!

Things are not what they seem. Take a look through the camera's eye and sometimes even the commonest objects appear strange and weird. . . . See how many you can identify, then check your list with the answers on page 222

1.	_____
2.	_____
3.	_____
4.	_____
5.	_____
6.	_____
7.	_____
8.	_____
9.	_____

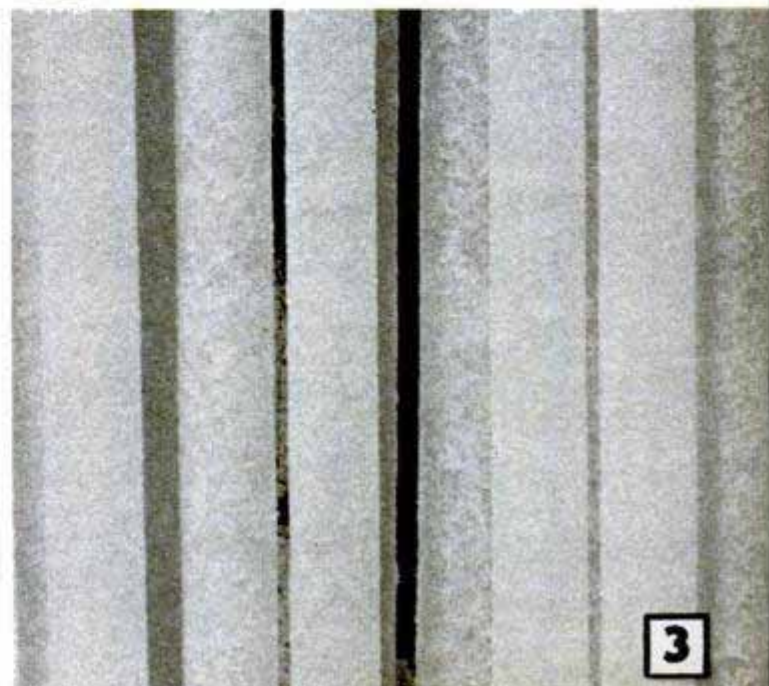
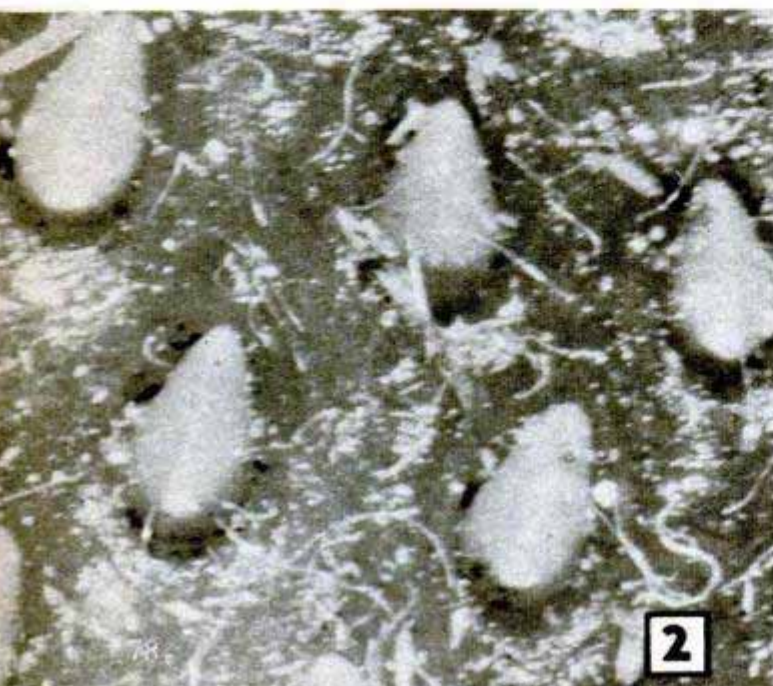
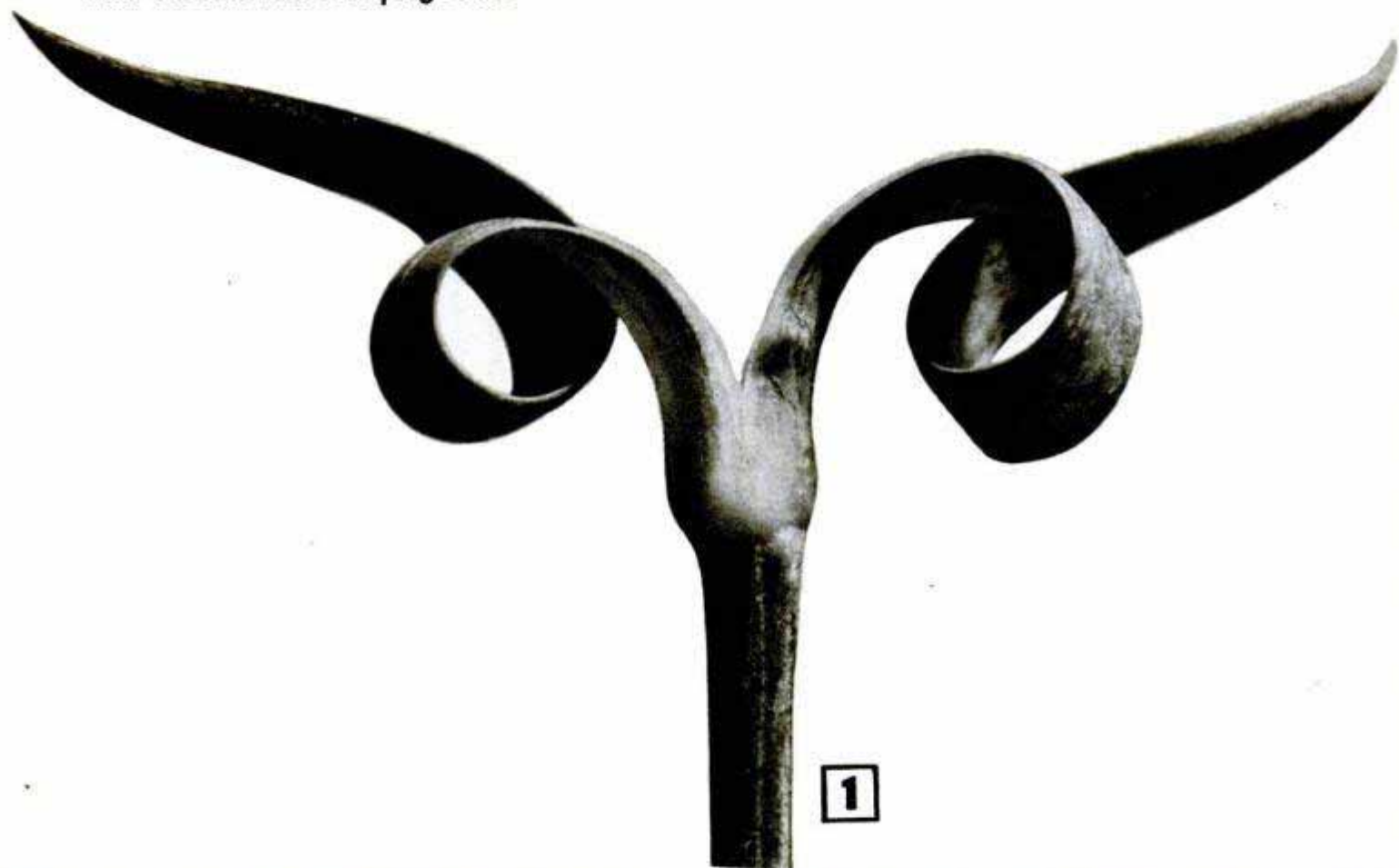

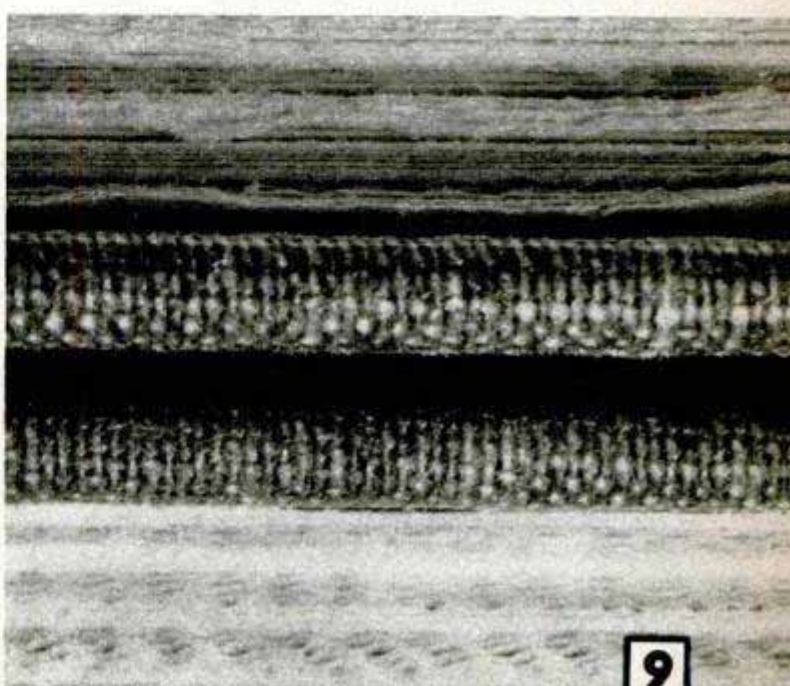
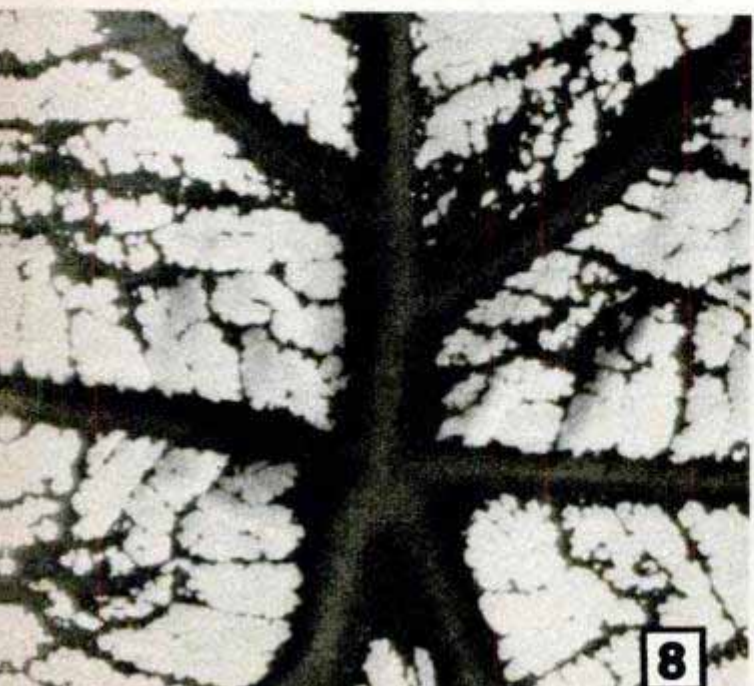
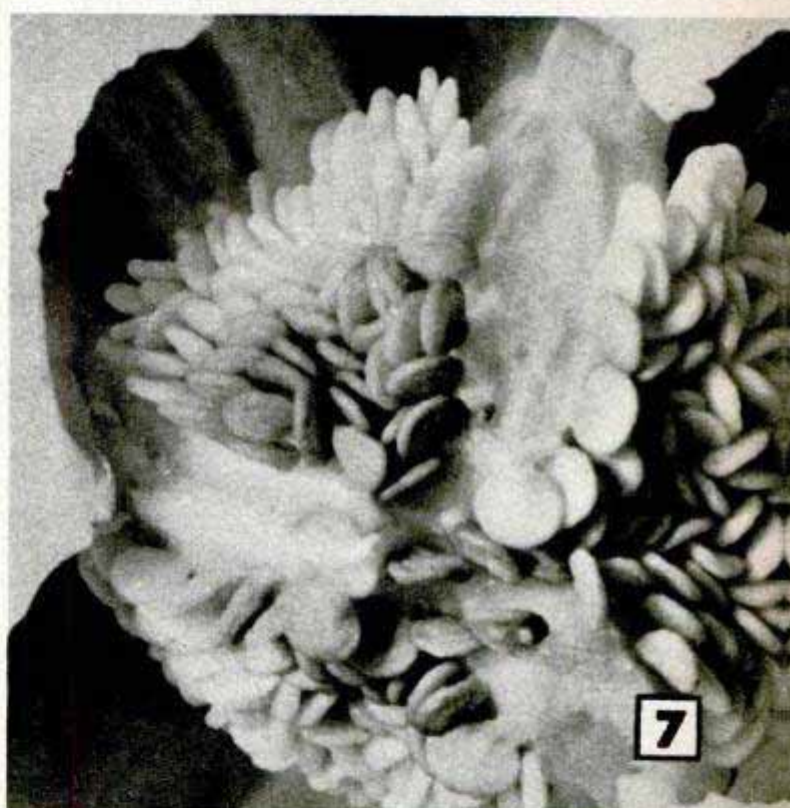
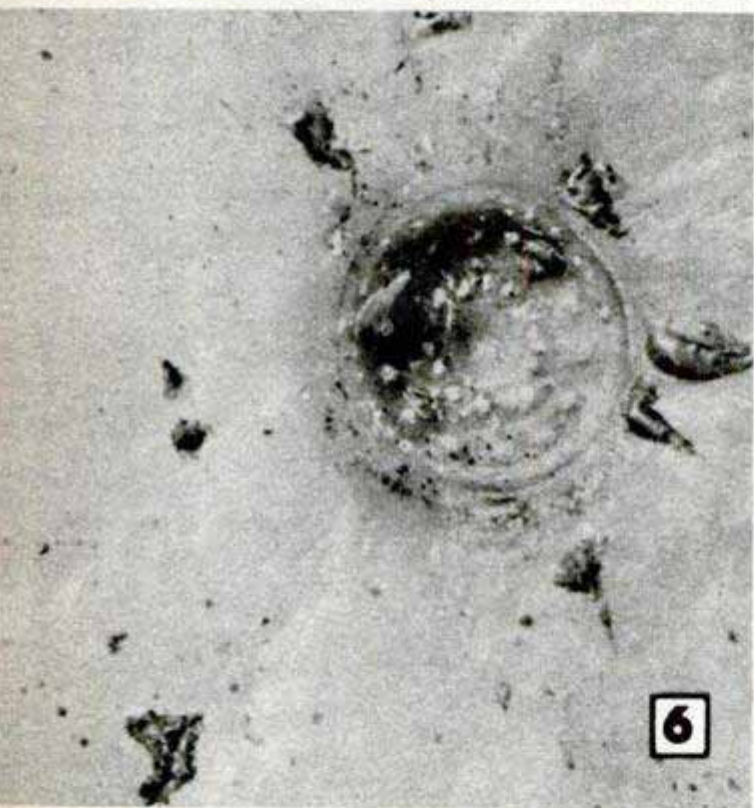
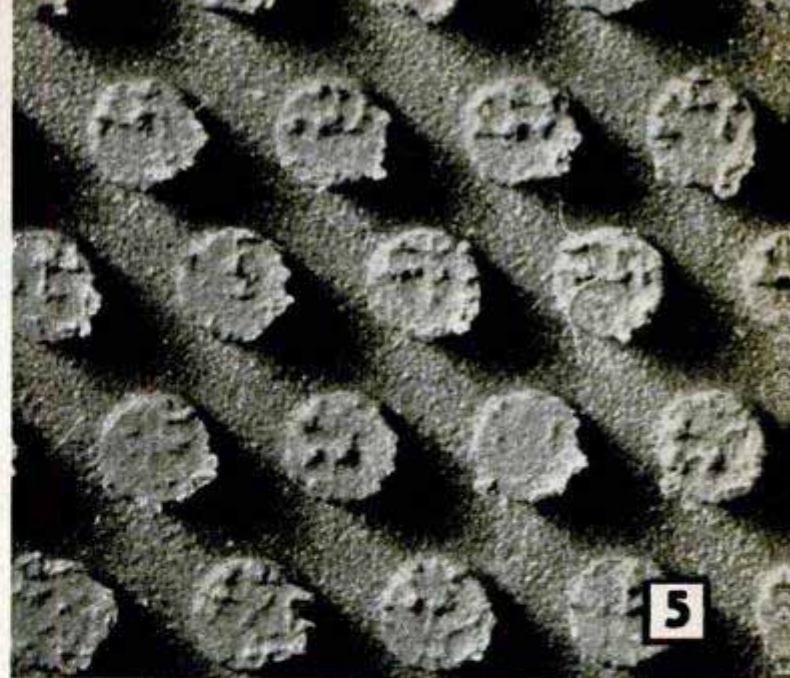
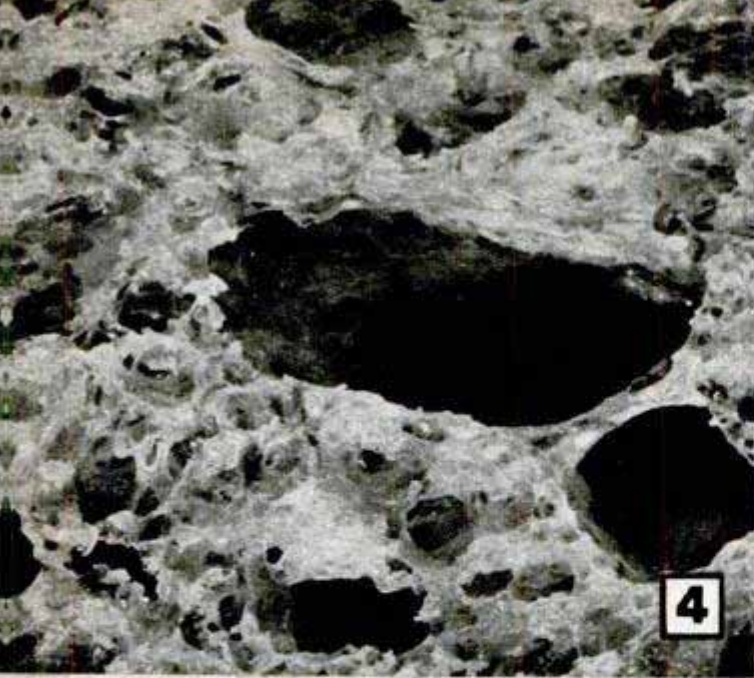

FISHING WITH BOW AND ARROW

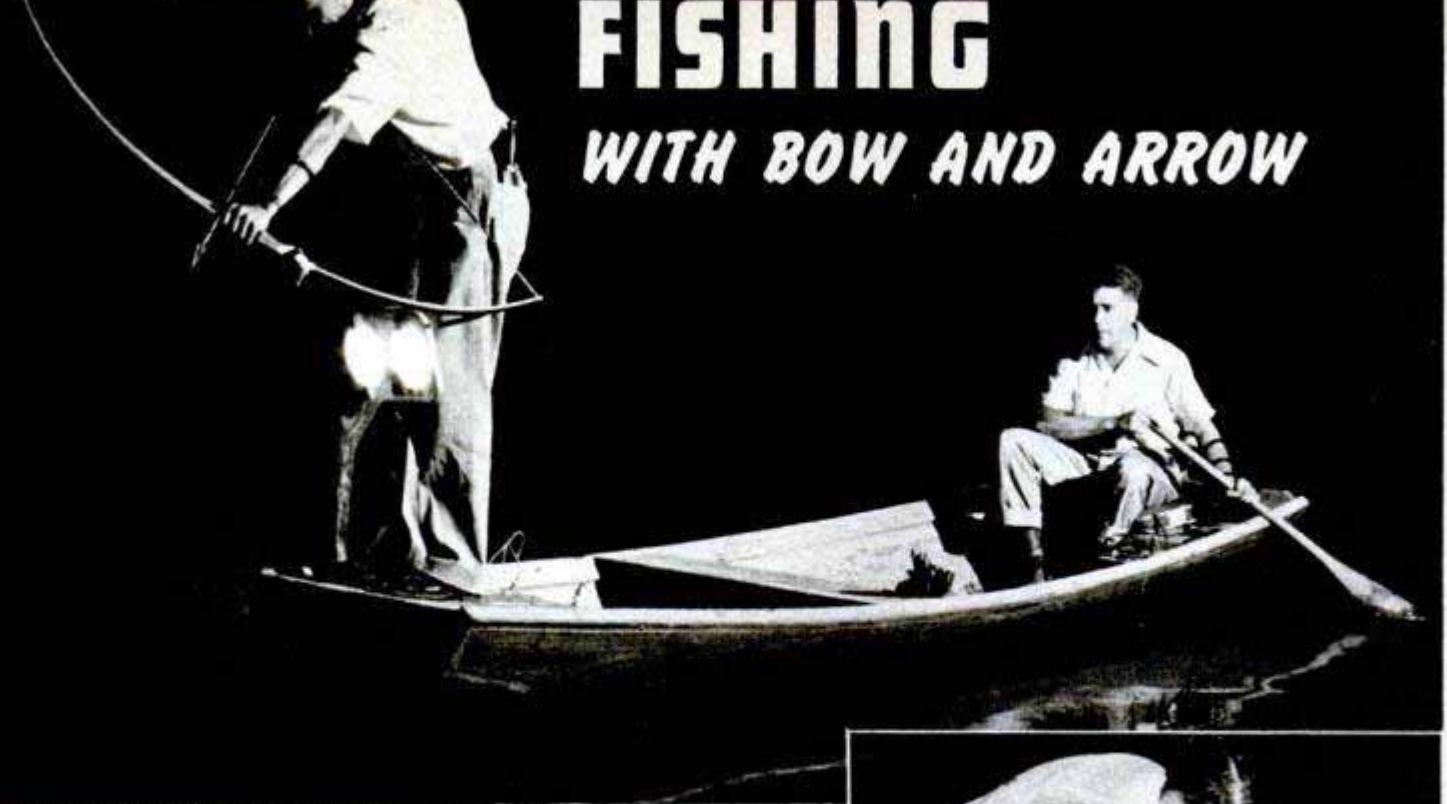

St. Louis Post-Dispatch photos

Bow drawn, hunter watches for shadowy outline of gar to cross light beam. Below, one hunter clamps light to bow

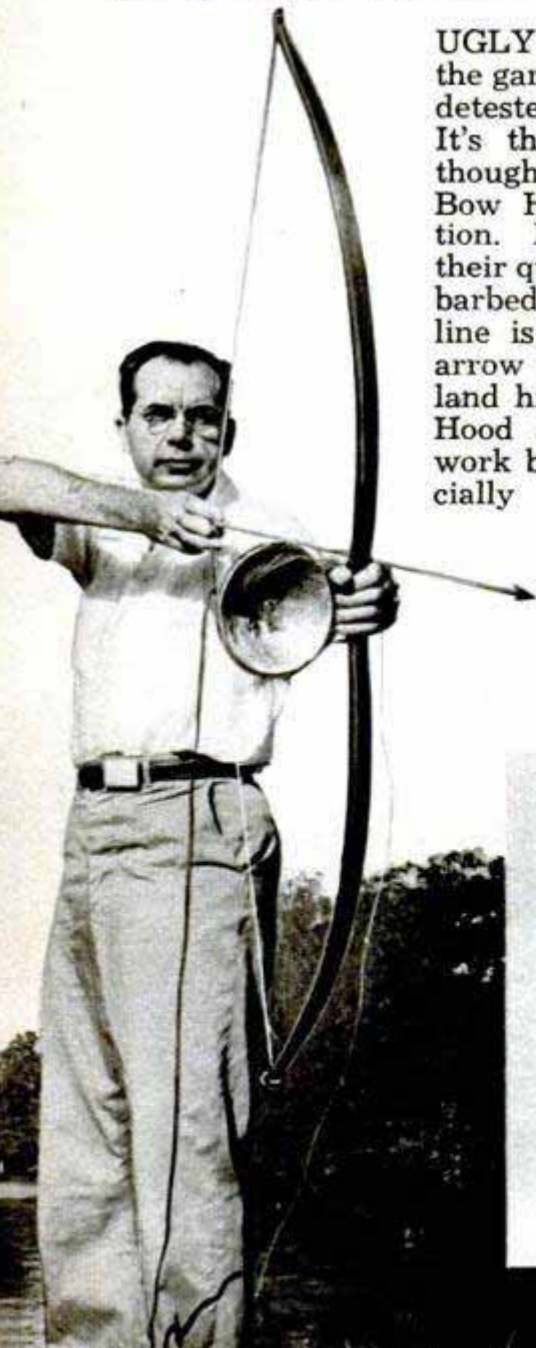

UGLY and unpalatable, the gar is a predatory fish detested by most anglers. It's the special target, though, of the Arkansas Bow Hunters' Association. Members harpoon their quarry at night with barbed arrows. A nylon line is connected to the arrow so the hunter can land his fish. The Robin Hood anglers do their work by the light of specially rigged headlights.

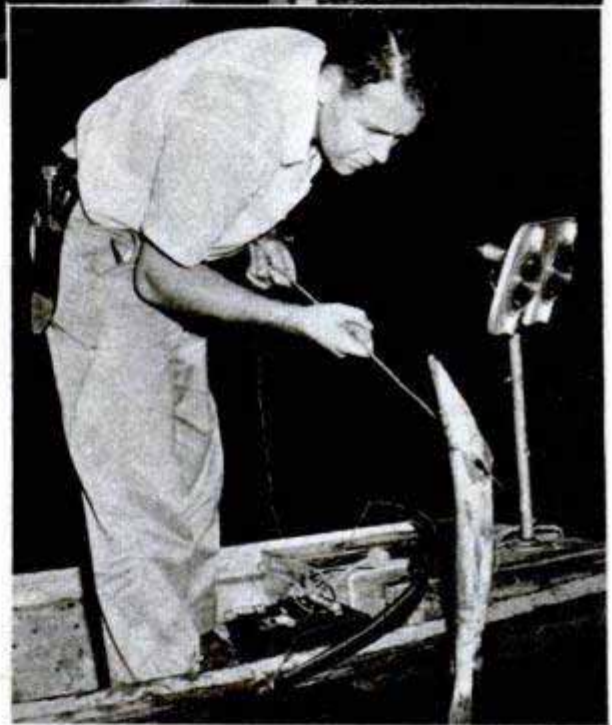

When the hunter gets a bull's-eye he drags in his fish with a nylon line attached to the arrow. Below, a few of the heavily barbed wood and aluminum arrows the archers use. The one in center has a hinged barb that opens after a hit

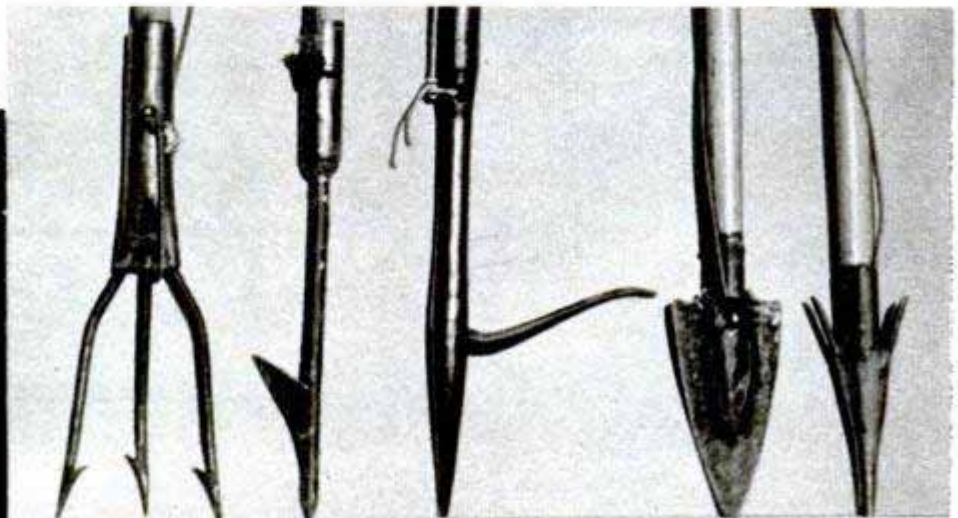

Ride 'em, LUMBERJACK!

By Rafe Gibbs



RIDE IT, Larry!" megaphoned a spectator with cupped hands at the annual rodeo held in Orofino, Idaho.

Larry Nelson was not aboard the hurricane deck of a bucking bronco. He was maneuvering his feet nimbly on a whirling log to avoid a ducking in the improvised pond set up in the center of the loggers' rodeo grounds.

In the Pacific Northwest now when you say "rodeo" you must differentiate between the horse-bucking and saw-bucking varieties. The town of Orofino, wrapped in the timbered mountains which today form the world's greatest stand of white pine, holds one of the country's top shows annually during Lumberjack Days. It's four

With more than a half century in the woods behind him, this old-timer is still a sharp man with an ax

Quick stop, and under he goes! In Idaho, even youngsters learn birling. One of rodeo's feature events is for boys





Older "jacks" usually win this contest. Trick is to roll logs down the skidway without knocking over iron spikes

hours of fast action by men of the timber.

Stocky, well-muscled Nelson, who is mayor of Priest River, Idaho, is also a grade-A white-water man who clings to a spinning log like a wood tick. He challenged big Bert Curtis, mayor of Orofino and chief warden of the Clearwater and Potlach timber protective associations, to a special birling contest as a feature of the 1951 Orofino rodeo. Curtis hadn't been on a log for years. He was a game loser. Besides, his loyal supporters tucked him into a Mae West lifejacket before they sent him out on the slick log with Nelson.

"Big push" of the lumberjack show is

Even city officials get into the act. Laurence Nelson, mayor of Priest River, shows the spectators how to ride a spinning log

Melvin Snook, logger and state senator. "To watch a loggers' rodeo is to watch the story of logging itself," Snook told us. "You note, for instance, that the most skilled men on a bobbing log are generally older lumberjacks and that the fastest operators of a modern power saw usually are younger 'jacks' born to the mechanical age."

Birling, which is one of the oldest of lum-



berjack sports, appears simple—from the dry side lines. Two men step on a floating log and try to spin each other off. But there are intricate reverses, quick stops and quicker starts, twists and turns that require plenty of know-how. Different kinds of logs, too, call for different techniques. A pine, for instance, has a different roll from a spruce.

Winner of the 1951 birling contest at Orofino was 60-year-old Harry Shepherd of St. Maries, Idaho, who wrote new chapters to the book of birling as he pivoted on the buckskin (a peeled log). Shepherd's hair is as white as a snowshoe rabbit in winter but on a log he looks young. In fact, as he skipped and twisted he showed all the grace of a dancing master. He sent his first three opponents splashing into the drink without even getting his own feet wet.

Old-timers tell about two evenly matched jacks who went at it all day, knocked off for dinner and supper and finally quit—still dry—when clouds erased the moonlight.

Birling contests are a natural outgrowth of the business of riding logs down the river. And in northern Idaho there is still

business to be done. Come spring and high water, logs are floated down-river to feed the Potlatch Lumber Company's giant mill at Lewiston.

The jacks and logs of this part of the country have been used in the filming of Edna Ferber's epic *Come and Get It* and other logging movies. Although truckers pretty much have displaced river rats in most parts of the country, northern Idaho still boasts men who can ride the timber through white water and green. They are lured to Orofino during Lumberjack Days like bears to a honey tree.

Some of the kids around Orofino are pretty good on a log, too, because grandpa shows them how it's done at the old swimmin' hole on the Clearwater River. One of the birling contests at the rodeo was for boys only.

Maybe it was the kids who taught grandpa a new trick. For years, birlers counted heavily on calked boots to keep them on a log. But now even the old-timers are shifting to rubber-soled tennis shoes—same as the lads wear. Among the birlers at Orofino, there were only two who wore boots

Though old-time jack is still king of the rodeo, mechanical equipment is replacing him in the woods. Here a big loader juggles 32-foot logs





Jacks are only as good as their tools so old-timers continually sharpen saws, whet axes to knife edges

with spurs on the soles. Champion birler Shepherd? He wore tennis shoes.

Another contest in which the old-timers have the edge is the "tail down." It's a race against time in rolling three logs of different sizes down a skidway. The logs must pass between spikes placed at the sides of the skidway without knocking over one spike. This calls for expert maneuvering of the rolling logs with a peavey.

"The old boys usually shine at this because a lot of the younger jacks have never



Finest load of logs of the year, scrubbed to catch the eye of a woodsman, is auctioned off during rodeo

had to prod a log down a skidway into a river or flume," explained Don Fridley, rodeo official. "Logs now usually are removed from the woods by loading them on trucks with mechanical equipment."

A giant mechanical loader with a swinging crane was demonstrated at the rodeo. It picked up 32-foot logs and laid them on a truck without a log being touched by hand. The demonstration of speed and power would have drawn plaudits from Paul Bunyan and turned his blue ox green but,

Event for the lumber "jills"—gang-sawing with a crosscut. Winners say housework keeps them in top shape!

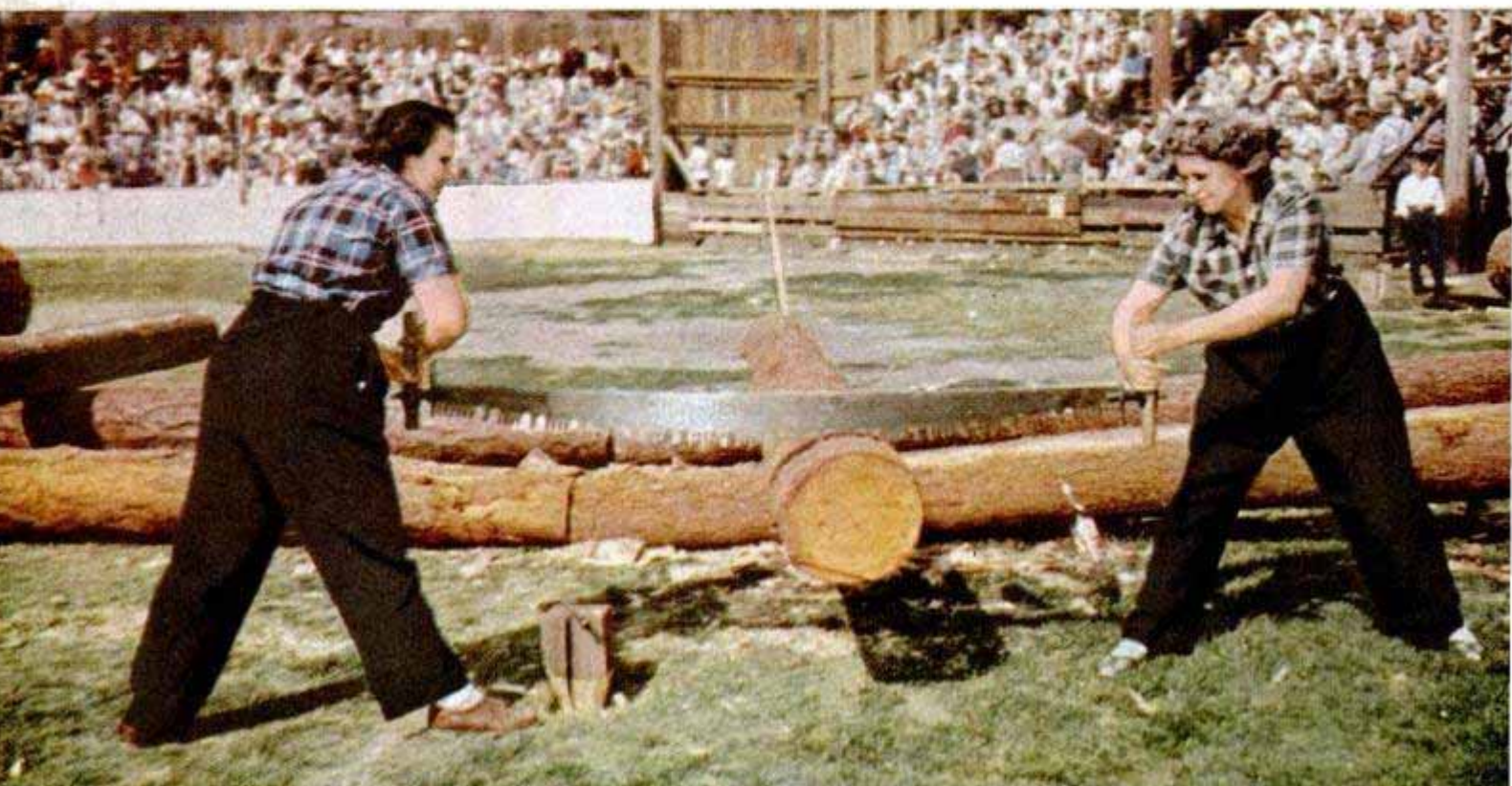

oddly enough, king at the rodeo was the jack with the simplest of all woods tools—the double-bitted ax.

No pet golf club, baseball bat or fishing pole is more highly prized or better cared for than the ax of the lumberjack. Many a jack has gone to bed with his ax tucked in beside him.

The axes at the rodeo were shining bright. They came wrapped in buckskin or flannel so the fine edges, put on through many hours of touching up with a whetstone, would not be lost in a moment's juggling in the back end of a car.

"Can you shave with it?" a man asked 73-year-old Fred Fuger as he carefully thumbed his ax—as much a part of him as his big gold watch.

"Well now, I can and I have," said Fuger. "But I don't put a shaving edge on it when I'm going into a wood-chopping contest. Too fine and too easy to chip. About knife sharpness is right."

The experts at Orofino point out that most people who chop wood use the wrong technique—all arm and no leg play.

"Chopping wood is better exercise than swimming—if it's done right," commented W. O. Donner. He spoke with authority for he has been chopping wood for 33 years. At 58, his body still is tapered like a college athlete's.

"Man's got to put his whole length into each whack," said Donner. "Let the swing start at the feet and work its way up. Develop a rhythm. Take the same stroke each time."

The legs of most athletes go first. So, too, with lumberjacks. Only their legs usually don't go as fast, for instance, as do those of boxers.

Some of the ax-swinging jacks at Orofino are in their 60s and 70s but their lower limbs are still as sturdy as those of a hickory. But you also can see a tremble starting in some legs. And, even though the arms still swing mightily, you know that when the leg tremble starts the finish inevitably must follow.

As gray-thatched Fuger put it, "I don't expect to win any more in the contests that require strong legs. Just like to mix it with the boys. Take the tail-down contest, though. With the right breaks, I mighta won it. Folks say I'm the best little man with a struggle bar on the river."

The chopping contest was won, as the experts predicted, by a young jack named Delbert Roby from Kamiah, Idaho. He whacked through a log more than a foot in diameter in 1 minute and 14 seconds. If you think that isn't fast time, try to beat it.

Meet All-Around Champion Delbert Roby. Master of ax and saw, he was crowned mightiest man of woods

Roby has both sturdy arms and legs. In fact, he's plain sturdy all over. At 27, he is a trim 170 pounds—same weight he had when he first entered the woods at 16.

He went on from the wood chopping to gain enough points to be crowned All-Around-Champion Lumberjack. His strongest events were with the power saw—but the power saw didn't come easy to him at first.

During World War II, Roby took time out from the woods to serve in the South Pacific as a paratrooper.

"When I came back in '46, things had changed," said Roby. "Power saws—that's what everybody was talking. I didn't understand 'em so I sharpened and oiled my old crosscut. But I soon saw I was behind the times and behind in money making. I switched to the power saw. At first the saw seemed heavy and hard to handle. But I kept telling myself I had parachuted with more weight on my back. Once I got used to the power saw, I more than doubled my output."

There are jacks in the woods today who make more than \$1000 a month with a power saw. Recently a jack serving on a jury in Orofino lost more income during the trial than any of the other 11 good men and true. The high earnings of some of the experts are due to the pay scale based on output with a crosscut.

Not all jacks, however, are turning to the power saw. Take Jack Kearns, 66, for instance. He has been logging for more than a half century. Starting in New York State



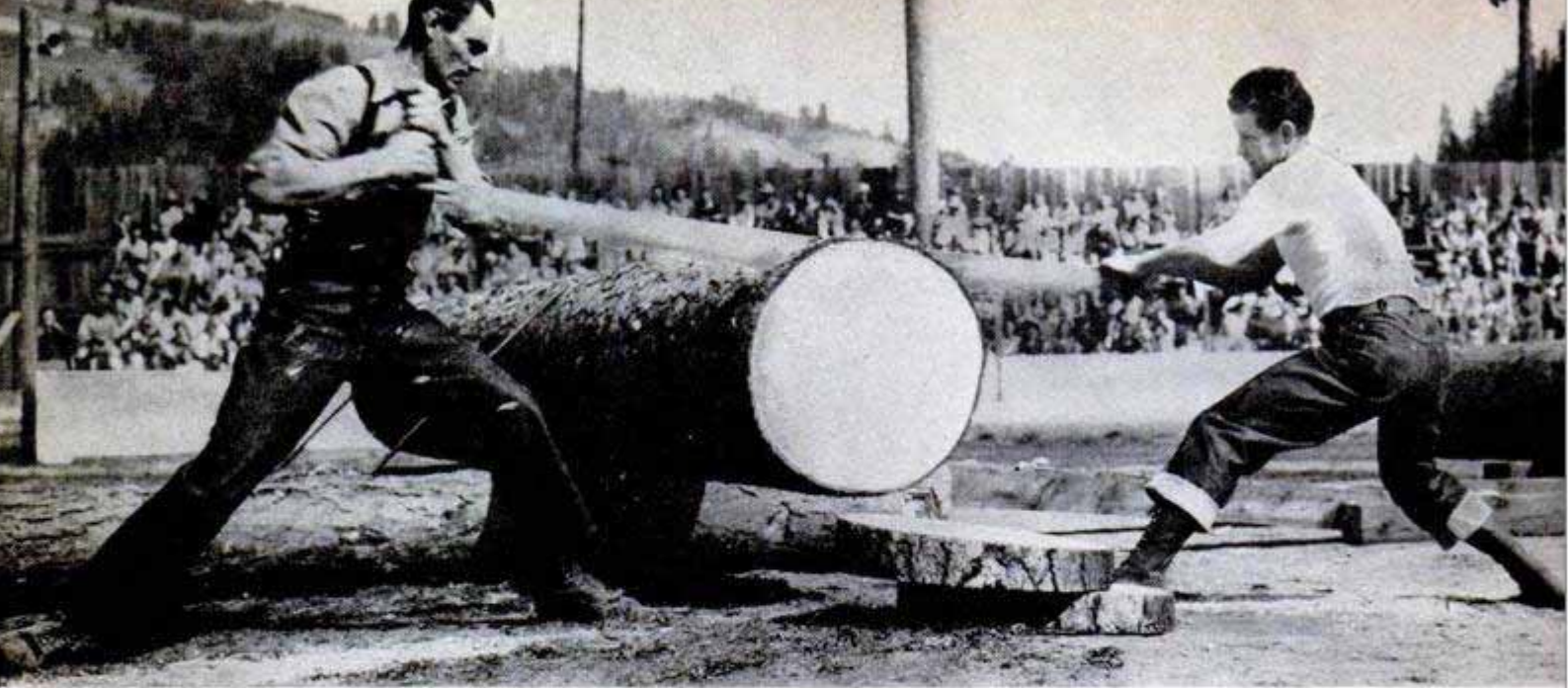

In this event four husky arms and shoulders aren't nearly as important as teamwork learned in the woods

at 15, he moved to Michigan in the boom days there. When the logging scene shifted west, he came to Idaho. He's always used the ax and crosscut.

"Guess I'll keep on till I'm too old for the woods," said Kearns. "I might switch if my legs were stronger. Funny thing, I can walk better on a pond now than I can on a sidewalk."

The weight of the power saws, which has bothered some jacks, is being whittled down. The saws, which have blades on a moving chain and are operated by a gasoline motor, come in three primary sizes—three, five and seven-horsepower. The three-horsepower now has been trimmed to less than 25 pounds. Even a seven-horsepower weighs only about 55 pounds.

"The secret in cutting timber fast with a power saw is not to overload the motor," said Roby. "The motor should always be kept at full power. The cut should be even and clean. With a power saw, you don't need an ax to do the notching in felling a tree. And you undercut the notch instead of overcutting it. That makes for a more even break. Too, with a power saw, you can work in tighter places than with a crosscut. Takes up only about half the space."

Roby took second in the saw-bucking, which is pushing a crosscut by your lonesome. Then he teamed up with attractive Dorothy Roby in the Jack and Jill contest with a crosscut. They took first.

Next came the power-saw events in the

(Continued to page 216)

In the power-sawing contest, wood cakes for the legendary Paul Bunyan are sliced expertly off the log

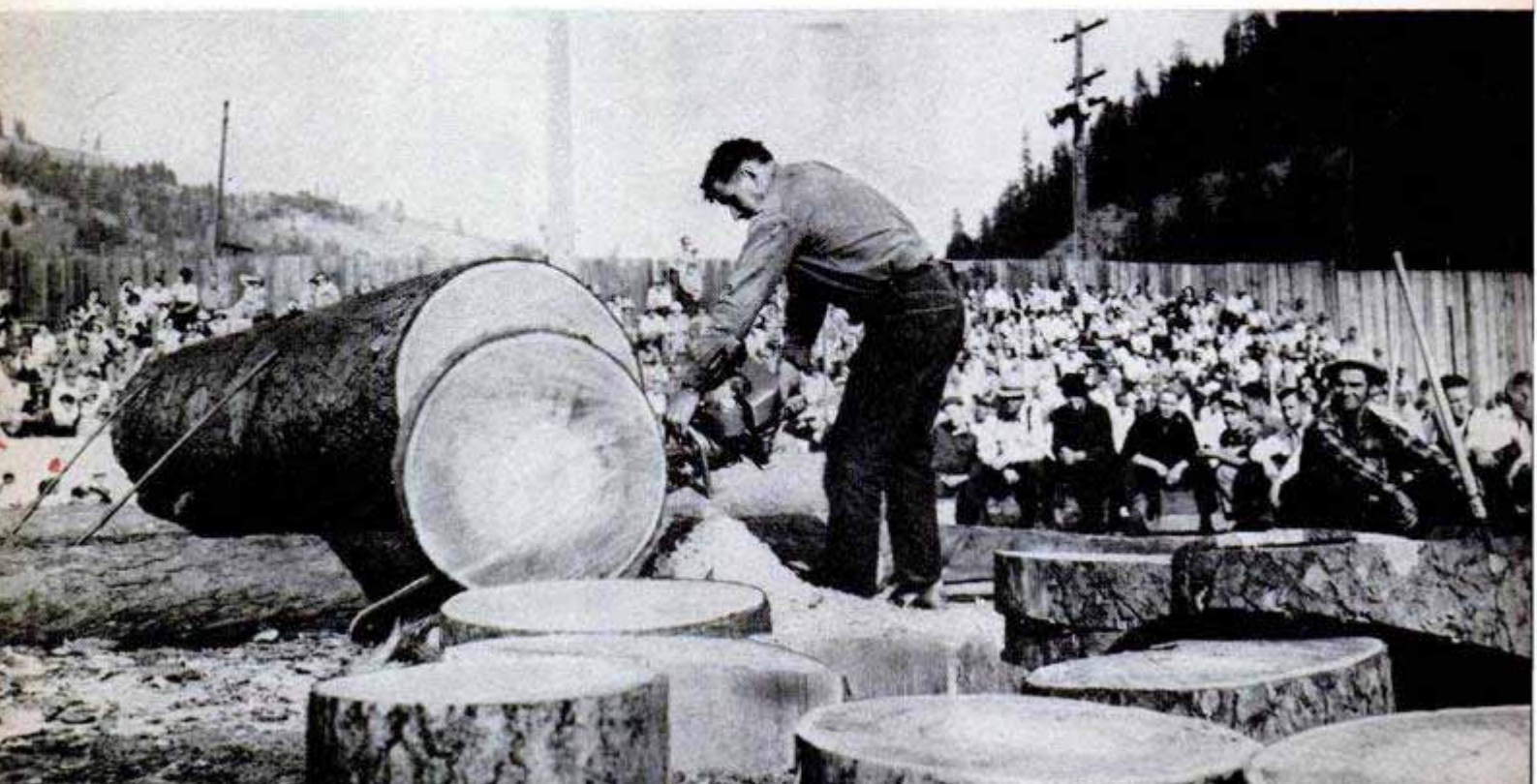



Detroit Listening Post

By Siler Freeman

CHRYSLER this month starts tapering off production for the earliest change-over since the end of the war. The various divisions will wind up 1952 schedules and, come another month or so, new and different models will begin to emerge from the lines.

The Chrysler cars will be more changed than perhaps any time in the company's history. For one thing, the Imperial and New Yorker models will be quite a bit shorter. The Saratoga, the short-wheelbase member of the Chrysler eight-cylinder line, will be dropped. The Windsor will be the "small" car of the line.

Chrysler will kick off what is probably the most intensive model changeover in many years for the industry. Before the year is out, the customers will be offered better engines, greater fuel economy and easier driving.

Why all this furor when sales have been good and production restricted? Because competition is back and even the sales managers are admitting it. Mere order taking is over and it is now a battle for buyers with all of the salesman's art called back into play.

The customer will get a break in more than one way on his 1953 model. Not only will he be offered something other than a face-lifted model but he will get a better choice of what he wants to go along with it. No longer will he have a Super De Luxe pushed in his lap when all he wants is just a standard car. Accessories will be his own choice—not those on which the factory and dealer can make the biggest margin of profit.

More and more it becomes apparent that the automobile business is returning to normal. Even before the new models come out, some of the manufacturers have seen the light and are honoring orders as they come from dealers. The high ratio of these so-called de luxe cars will go down as the buyer climbs back into the saddle.

On one score, however, relief doesn't seem around the corner for the customer and that is on price. No one can promise that tags will come down in the foreseeable future. Because the car makers are pour-

ing a lot of money into body dies and transfer machinery to make V-8 engines, and because the costs of labor and materials are drifting higher, reductions will be rare.

On the other hand, with competition ahead appearing stiff and the drive for sales bitter, there can be no important price increases on the new models as this would defeat the goal the industry has set—another big year for production and sales.

There is a glimmer of hope. The dealers have been vociferous and aggressive in their efforts to preserve their historic markup on cars, which usually runs in the neighborhood of 24 percent. They have told the factories through their dealer councils they will fight any attempt to shave their discounts. Why? Because they too recognize the sign that normalcy is returning.

The result of the ever-increasing cost of new automobiles has been a notable downgrading of buyers; a Dodge customer takes a Plymouth, a Buick prospect becomes a Chevrolet buyer. Certain accessories are hardly ever passed up, such as heater, radio and direction signals, while windshield washers, foam-rubber upholstery and fancy seat covers are snubbed.

On the other hand, the trend to such high-cost items as power steering and automatic transmissions is not being turned aside. At least one more company will offer power steering to its buyers before the year is out. Buick has extended it to its Super series. Dodge, embellished with a new V-8 engine for 1953, will get the Chrysler-type power steering. It is already in the Chrysler and DeSoto lines.

An important change may come in the power-steering devices. Both Gemmer, which makes Chrysler's power steering, and Saginaw steering division, which makes General Motors' version, are looking into an electrically operated unit.

The argument against the hydraulic device is the possibility of leaks, which would destroy its effectiveness. Of course, there is never a steering failure when the power unit goes out because in both the Chrysler and G.M. versions the regular steering unit takes over at once.

I am the owner of a 1952 DeSoto, Deluxe Custom Fire Dome Eight
 It is equipped with: Conventional trans. (Fluid Drive) Tip-Toe Shift
 Fluid-Torque Drive and: Hydraguide Power Steering Power Brak
 I have owned it approximately 2 months. Speedometer mileage is n
 Having tried both kinds, I find that my DeSoto operates satisfactorily using:
 regular gasoline premium (high test) gasoline
 My average gasoline mileage is 14-15 m.p.g. for city driving, and
18 m.p.g. for country driving.



I CHANGE OIL every 2000 miles.
 I change oil every _____ miles, but also ADD OIL every Do not add oil.

Roadability and handling qualities are: Excellent Good Unsatisfactory
 Maneuverability in traffic seems to be: Excellent Good Unsatisfactory
 Acceleration is: Exceptional Very Good Average Poor
 Curb and road clearance is: Satisfactory Too High Too Low



Here are my main reasons for purchasing a DeSoto: This is my 3rd D
good service, low maintenance cost, reliability

Particular features I like are: The body styling in general Oriflow shock absorbers
 Chair-height seats Quality of interior finish, upholstery, etc. New
 color combinations New "Air-Vent" hood treatment

Specifically, what do you dislike about your DeSoto? Power steering has too much
back-lash, chatters on ordinary road.

Have you ever owned a DeSoto before? Yes No How many? 2

Would you buy another DeSoto? Yes Possibly No

How do you rate your dealer service? Excellent Good Average

How do you rate your DeSoto, generally? Excellent Good Average



GENERAL INFORMATION

What type of engine would you prefer in your next new car? In-line V-type

Number of cylinders: 6 8 Valves: Side Overhead

Are you satisfied with the horsepower rating of your DeSoto (146 or 160)? Yes No

Approximately what H.P. rating would you prefer in your next new car?

What improvements would you like to see in your next car? Quiet the back
in the power-steering unit.

Based on your present experience, which transmission would you prefer? :

Overdrive Tip-Toe Shift Fluid-Torque Drive Other type automatic

This questionnaire will be tabulated fairly, and your name will be held in strict confidence. We request that you attend to each question listed. Thank you.

Please mail promptly to:

FLOYD CLYMER
 1268 SO. ALVARADO ST.
 LOS ANGELES 6, CALIF.

My Name: _____
 Address: _____
 City & State: Nashua, N.H.
 Occupation: State Man

(Please write your personal comments on reverse side.)



The '52 DeSoto owner who filled out this questionnaire was just about average on gas consumption. Some of the new Fire Dome Eight models are at right



This Minnesota owner of a V-8 tells Clymer the most important feature of the car to him is power steering

THE OWNERS REPORT ON THE '52 DESOTO

The true test of an automobile begins when the owner takes the wheel. This is another report from owners of 1952 cars who answered questionnaires sent by *Popular Mechanics* to 1000 DeSoto owners from coast to coast

By **Floyd Clymer**

MOST CAR OWNERS have strong faith in the products of their favorite automobile corporation. A great many are avid Chrysler fans; of these, a substantial number favor DeSoto year after year over all other makes, as our owners' survey clearly showed.

Many agreed almost word for word with the West Los Angeles, Calif., sheet-metal worker who said: "The main reason I bought a 1952 DeSoto was because I believe Chrysler products are the best . . . the over-all picture of the car appealed to me." Other enthusiastic comments were similar to that of a Long Beach, Calif., salesman: "Can't think of any improvements right now—this is the most satisfactory car I have ever owned or driven."

A Roxbury, Mass., mailman wrote: "I have owned nine different makes since 1919 and I find this DeSoto the best of all." "The DeSoto is everything I want in an automobile—tough, economical, attractive, and it operates smoothly under all conditions," enthused a Durham, N.C., minister.

A school official in Clarksville, Tenn.,

observed: "The seats are good for posture. With finger-pressure steering, I am able to drive 600 miles in a day and not feel tired."

A frank answer to the question "Why did you buy a DeSoto?" came from a Chicago service-station owner: "Because I am lazy and it handles easily." Said a Carnegie, Okla., mechanic: "I am well pleased with my DeSoto. I believe it is a real car; it has the power and driving qualities of any bigger car."

"It can do everything but sit up and bark," remarked a Silver Spring, Md., woman accountant.

"Power steering (Hydraguide) is a dream and a great help to women drivers on long trips and in parking. This is my first DeSoto, but from now on it's DeSoto for me," said a Chino, Calif., housewife.

"After driving the DeSoto I doubt if I'll ever get a smaller car again. The smooth Fluid Drive is a new experience in driving for me," said a Des Moines, Iowa, pressman.

"I like DeSoto's Tip-Toe Shift because it gives you a choice of speed in shifting gears. It saves me from fatigue on trips,"



The new DeSoto Fire Dome V-8 engine produces 160 horsepower and is similar to the Chrysler 180-horsepower engine but on a smaller scale

Percentages From PM Poll

Owners of Custom and De Luxe models (6-cyl.)	68%
Owners of Fire Dome models (V-8)	32%
Owners having Tip-Toe Shift with Fluid Drive	81%
Owners having conventional Fluid Drive	15%
Owners having Fluid-Torque Drive	4%
Owners having Hydraguide power steering	17%
Owners having power brakes	9%
Average gasoline mileage in country:	
6-cyl. models	17.7 m.p.g.
V-8 models	17.1 m.p.g.
Average gasoline mileage in city:	
6-cyl. models	14.1 m.p.g.
V-8 models	13.6 m.p.g.
Use regular gasoline	62%
Use premium gasoline	38%
Change oil	100%
Average mileage for change of oil	1450
Add oil (also change periodically)	4%
Average mileage for adding one quart	930
Roadability excellent	81%
good	19%
unsatisfactory	0%
Maneuverability excellent	64%
good	35%
unsatisfactory	1%
Acceleration exceptional	23%
very good	37%
average	37%
poor	3%
<i>(Includes all models — 6-cylinder and V-8)</i>	
Road clearance satisfactory	92%
too high	2%
too low	6%

BEST-LIKED FEATURES

Chair-height seats	81%
Oriflow shock absorbers	69%
Body styling in general	56%
Interior finish, upholstery	38%
Paint and color combinations	31%
"Air Vent" hood design	26%

(These percentages are based on answers to direct questions asked in questionnaires)

OWNERS' RATING OF CAR

Excellent	59%
Good	30%
Average	10%
Poor	1%

GENERAL INFORMATION

Owners preferring the following on next new car:

V-type engine	67%
In-line engine	33%
Eight cylinders	63%
Six cylinders	37%
Overhead-valve arrangement	71%
Side valve location	29%
No increase in horsepower output	90%
Average horsepower output desired	140

(Respective DeSoto horsepower figures—116 and 160—were tabulated for those owners who expressed satisfaction with present horsepower ratings)

Automatic-transmission unit	87%
Conventional transmission with overdrive	10%
Conventional transmission only	3%
Tip-Toe Shift with Fluid Drive exclusively	52%
Tip-Toe Shift with Fluid-Torque Drive	31%
Other type of automatic transmission	17%

(Percentage of the 87% preferring automatic-transmission units)

Previous DeSoto owners	52%
Have owned five or more DeSotos previously	17%
Will buy another DeSoto	64%
Might buy another DeSoto	34%
Will not buy another DeSoto	2%
Dealer service rated excellent	51%
good	25%
average	20%
poor	4%

Most frequent objections:

1. Slow shifting of gears in automatic transmission
2. Lack of acceleration, power (6-cyl. models)
3. Body fitting, assembly, styling

Improvements desired in next new car (in order of preference):

1. New body styling
2. Increased gasoline economy without sacrificing power
3. Better body assembly and tighter construction
4. One-piece windshield design
5. Increased acceleration and power
6. Quicker-shifting automatic transmission
7. Easier steering—power-assisted or otherwise

Main reasons for purchasing DeSoto:

1. Previous satisfactory ownership
 34% |
2. Mechanical features—engine, transmission
 26% |
3. Styling features—interior, exterior
 25% |
4. Riding qualities, comfort of seating
 22% |
5. Reputation of Chrysler Corporation
 16% |
6. Roadability, driving ease, handling qualities
 15% |

(The above percentages represent unsolicited comments. Some commented on more than one feature)



Clymer found the DeSoto V-8 to be one of the fastest stock sedans that he has tested. Body styles of the Six are same as the V-8



Cowl extends far down and forward directly above passenger's feet—a feature Clymer does not like



Clymer approves of DeSoto's big and convenient doors. He also likes hand holds to aid passenger

was the opinion of a Cleveland, Ohio, draftsman.

Naturally, some DeSoto owners have their pet peeves and dislikes about the car:

"The DeSoto has a very slow getaway with automatic transmission in high range. . . . In my case the dealer service has been terrible."—Chicago machinery assembler.

"The styling needs more flair."—Greensboro, N. C., salesman.

"They should remove the hump from the floor in front or depress it."—Jersey City, N. J., production manager.

"The front seat at the wheel throws the driver into an uncomfortable position, or else he rides at the extreme rear of the seat."—Harrisburg, Va., court reporter.

"Chrysler products have little eye appeal, no over-all beauty."—Roanoke Rapids, N. C., jeweler.

"For \$3000 I expected more value. Not getting it, I am disappointed; particularly when the car is falling apart."—Baltimore, Md., attorney.

"I don't think this car should be in the shop so much, considering its cost."—Denver, Colo., airline pilot.

"The price of the car and others in its class is about to force me into the smaller-car bracket."—Richmond, Va., salesman.

"I dislike the fact that I can depend only on the hand brake when parking, especially in parking on a grade."—Torrington, Conn., toolmaker.

"The Fluid Drive plus Tip-Toe Shift is absolutely no good. You can't buy a DeSoto with conventional transmission and overdrive."—Detroit truck driver. [Yes, you can, says DeSoto. Conventional transmission and overdrive are available on Custom and Fire Dome 8 models.]

"I was told I would get anywhere from 14 to 16 miles per gallon in the city and 18 to 20 in the country and it hasn't come near this."—Lake Worth, Fla., fireman. [DeSoto won Class E in the recent A.A.A. Mobilgas Economy Run—1415 miles from Los Angeles to Sun Valley, Idaho—averaging 21.2777 miles per gallon at 40 miles per hour average speed.]

Economy Test

1952 DeSoto Fire Dome V-8
Tip-Toe Shift — Fluid-Torque Drive
MILES PER GALLON

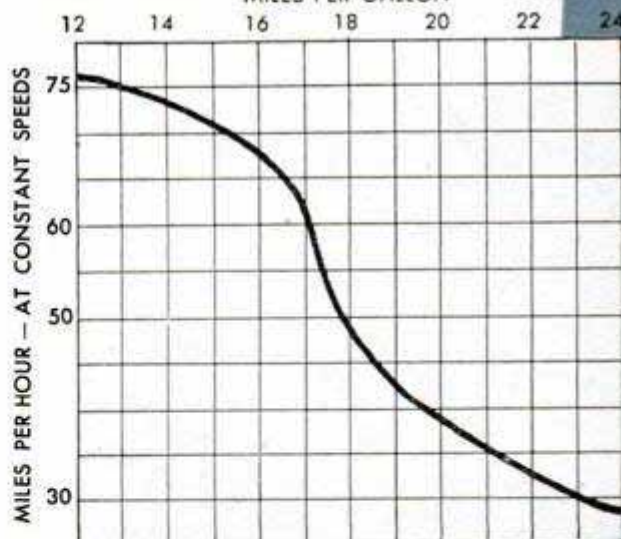

"The car has good economy for its size and horsepower," says Floyd Clymer, who backs his statement with this economy test made at varying speeds. A DeSoto V-8 won first place in Class E in the 1952 Mobilgas Economy Run from Los Angeles to Sun Valley, Idaho (1415 miles), with 54.7368 ton m.p.g. and 21.2777 actual m.p.g. The average speed of all the competing cars in the race was 40 m.p.h.

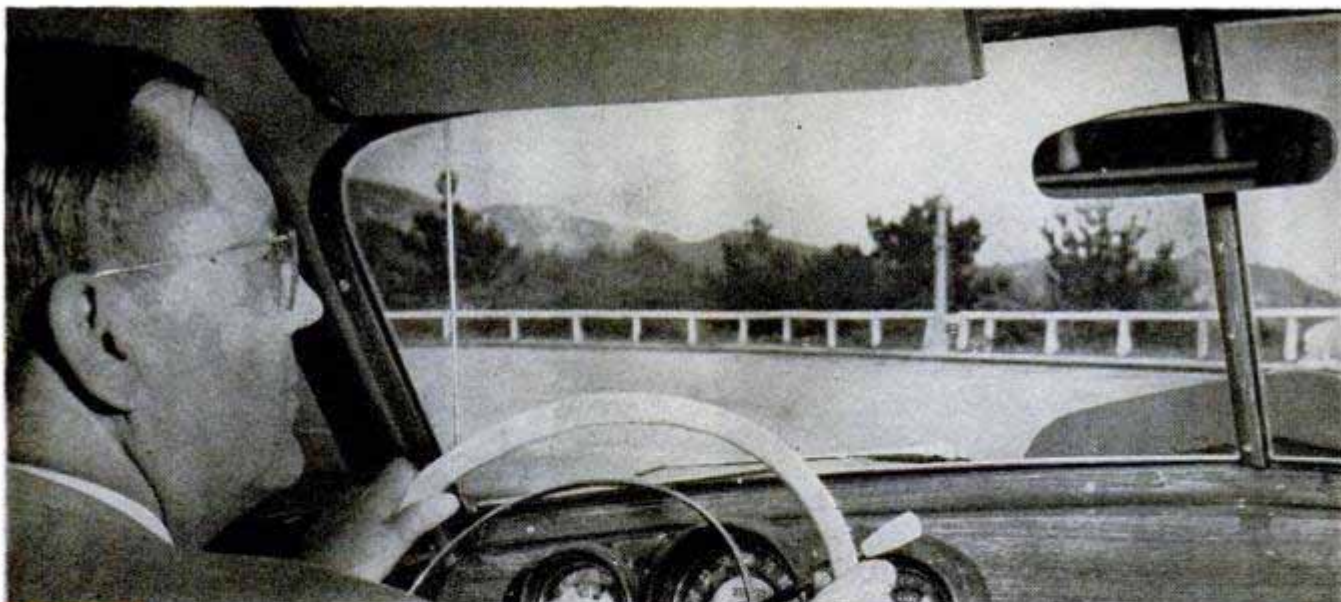

Acceleration Test

1952 DeSoto Fire Dome V-8
Tip-Toe Shift — Fluid-Torque Drive

¼ mile
from zero

21. seconds

½ mile
from zero

32.50 seconds

0 to 30
m.p.h.

4.70 seconds

0 to 60
m.p.h.

15.20 seconds

All tests for acceleration on the Fire Dome V-8 were made starting in top gear with Fluid-Torque Drive. Top speed by speedometer was 107 m.p.h. (actual top speed was about nine percent less)

DeSoto windshield comes in two pieces but offers good vision; all the controls are within easy reach

"The car was delivered with the wheels improperly balanced." — Nashville, Tenn., mechanical engineer.

Quite a few owners—such as a Durham, N. C., tailor; a Muskogee, Okla., oil driller; and a Kensington, Conn., machinist—said they would prefer a one-piece curved windshield instead of the present two-piece shield.

The National Broadcasting Company will be glad to know that at least one owner said he bought a DeSoto because of the Groucho Marx show.

Here are some more random comments:

(Continued to page 240)

Below, Clymer makes a fast short turn aided by the power steering on test car. Only takes two fingers





Largest Military Helicopter Carries 20 Troops

Nearly doubling the load-carrying capacity of previous military helicopters, the new Piasecki Work-Horse is the largest ever built for the armed forces. Twenty armed soldiers can be carried on assault missions in the 52-foot fuselage. A cargo compartment 20 feet long is provided by folding the seats against the aircraft's sides.

Equipment too bulky to be loaded inside can be carried externally in a sling. A 1425-horsepower Wright Cyclone engine turns two coequal rotors at the front and rear of the fuselage. Piasecki is also building a 40-passenger helicopter that will have a detachable pod almost as large as a cross-country bus.

Parasol Hat

Made of bamboo and paper, a sun parasol that attaches to the head is popular at Japanese sporting events. It is eight inches in diameter and sells for 30 yen, which is about 10 cents in U. S. money. Some of the parasol hats carry printed advertisements.



Discover New Element in Stars

Technetium, the first chemical element to be discovered through atomic bombardment, is now known to exist in the red S-type stars. Photographs taken at the Mount Wilson and Palomar observatories show several technetium lines in the spectra of these bodies. This may indicate that there is a stable form of technetium. The type produced by bombardment is unstable. Known as element 43, it was first identified here in a piece of molybdenum that had been bombarded with neutrons in the University of California cyclotron. If the technetium in the stars is also unstable, it apparently means either that the S type of stellar existence is relatively short (mere hundreds of thousands of years) or that the little-known heavy elements of zirconium and barium in these stars somehow produce a continuous supply of technetium.

The WHERE-TO-FIND-IT LIST, available without charge from our Bureau of Information, 200 East Ontario, Chicago 11, lists sources of further information which are not given on pages 12, 14 and 16



Lowell Thomas, noted world traveler and author of this article, paused for this picture on trail in Tibet

The author indicates a few "white spots" on the map below awaiting further exploration, but he points out that future explorers will turn to space and deep seas

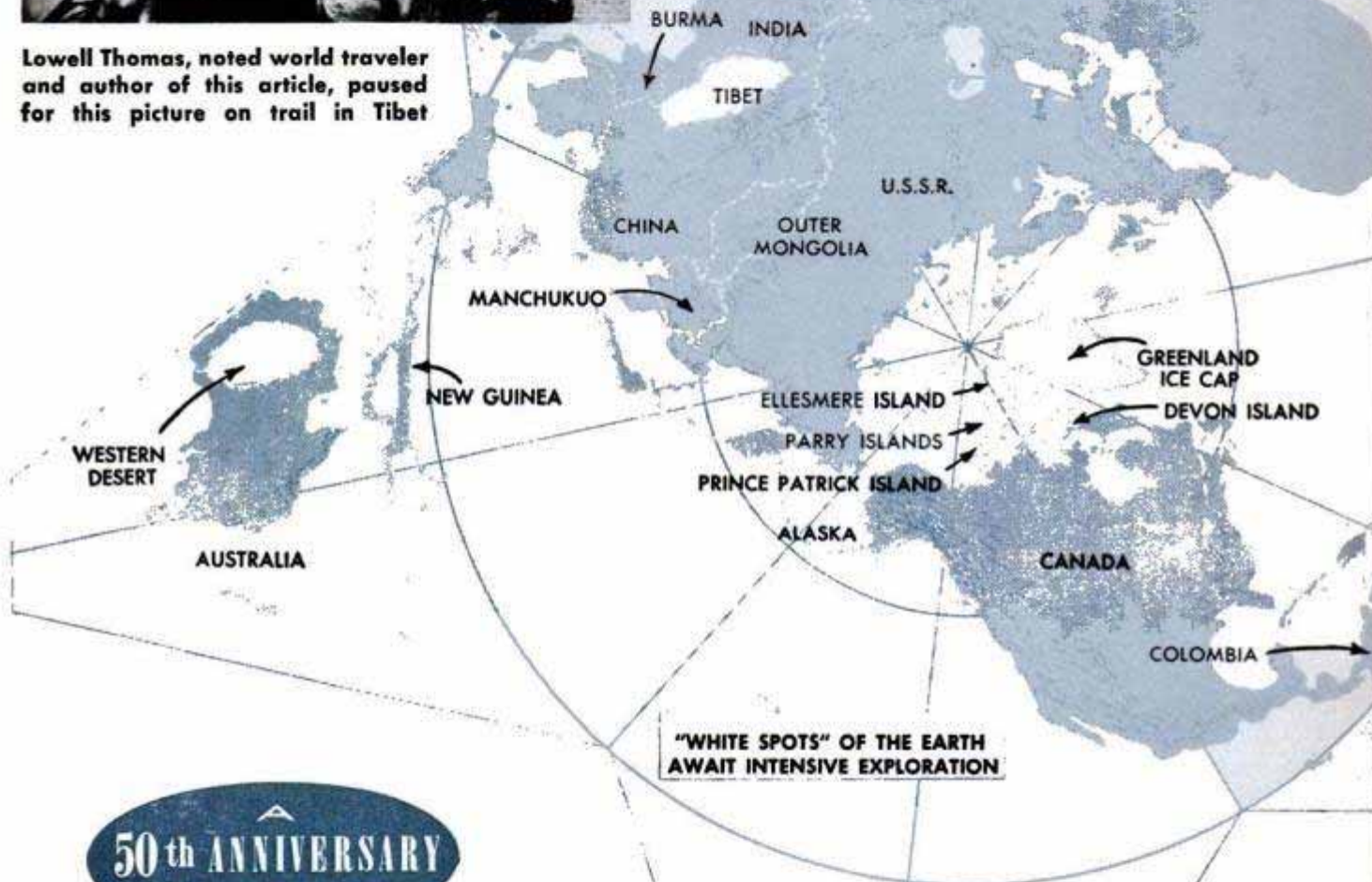

A
50th ANNIVERSARY
FEATURE

FIFTY YEARS OF

By Lowell Thomas

TWELVE streamlined Arctic-ized Navy ships slipped out of the Panama Canal harbor of Balboa one morning in December 1946 and swung south toward the "White Continent."

This—Rear Adm. Richard E. Byrd's fifth expedition to the Antarctic, Operation High Jump—was to be "exploration with a difference." Stowed in the hangar deck of the carrier *Philippine Sea* were a Navy helicopter and a fleet of the latest landplanes and seaplanes for photomapping the Antarctic icecap. Each plane would carry five cam-

eras—one pointed straight down, two at an angle of 30 degrees from the horizontal, and two focused on the instruments, one on the clock and the other on the altimeter. These three-dimensional photos could then be pieced together to give a perfect map of the icecap, its lofty mountains and chasms—a detailed map of areas where no human foot had been.

As the fleet edged its way into the first pack ice, the helicopter soared aloft to act as the "eyes" of the icebreaker *Northwind* leading the cavalcade of ships. A sub-



Lowell Thomas, Jr., holds microphone while he and his father make recording of a Tibetan monk blowing quaint ceremonial trumpet

marine, the *Sennet*, put out into the Southern Ocean to act as the expedition's mobile radio weather station. Aboard the ships were some of the latest wartime scientific devices to make life easier at Little America, base camp on the Bay of Whales. There were insulated prefabricated houses, Caterpillar tractor snowmobiles, ice tractors for drawing teams of sleds and a magnetometer—an instrument for mapping from the air the terrain under the polar ice fields. Personal comforts included polar clothing, snow goggles, electric blankets and even Christmas turkeys! "Modern steam-heated

While the crew paddles, author Thomas catches up on his writing aboard native craft while navigating the murky rivers of the Malay jungle

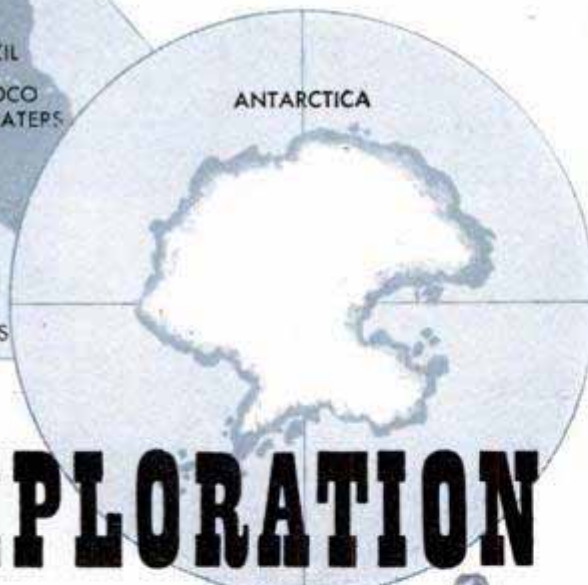

EXPLORATION

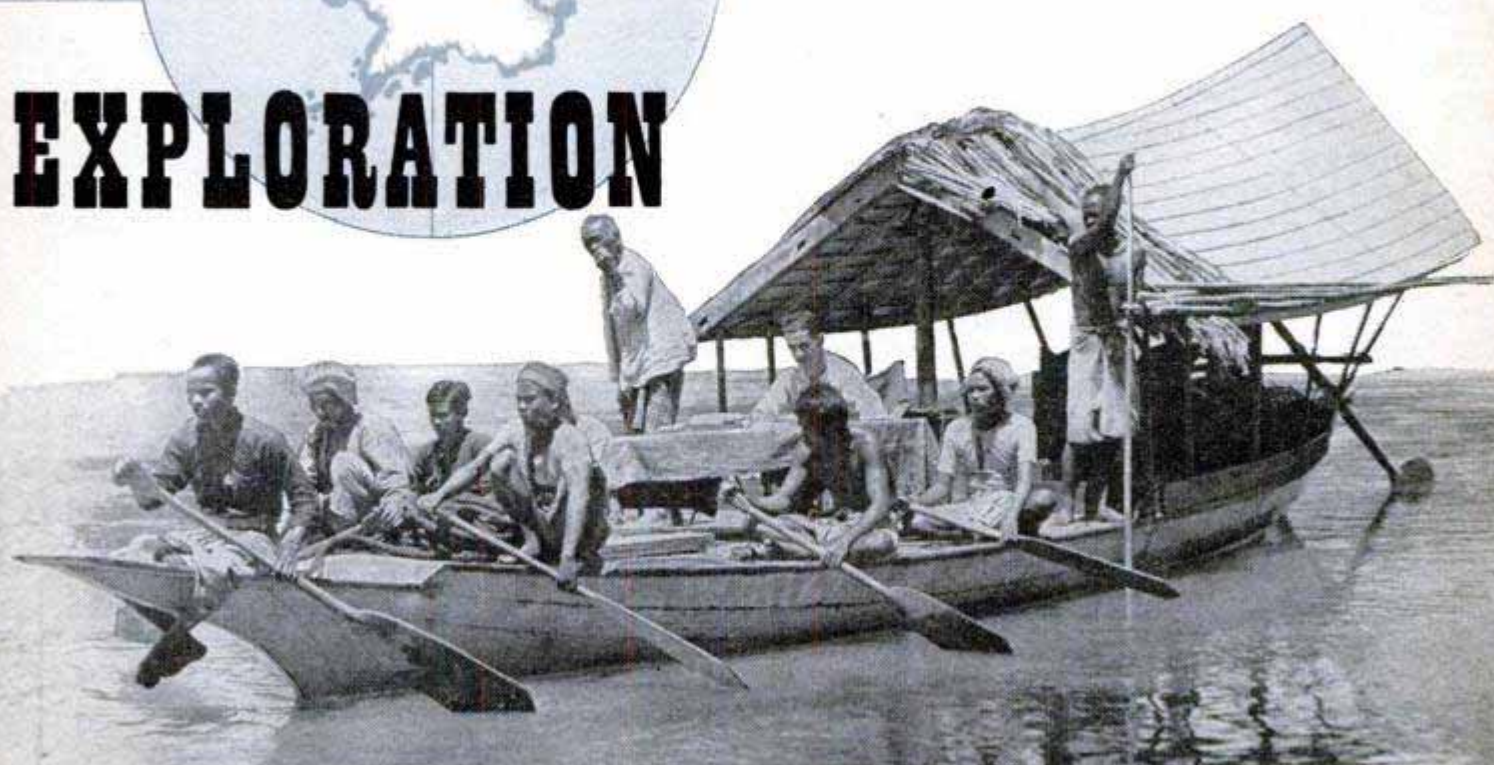



Peary upon his return from discovering North Pole in 1909. Right, Roald Amundsen at the South Pole in 1911, where he planted the Norwegian flag. This ended the great race to find the two Poles, which gained worldwide attention during the early 1900s. Lowell Thomas says explorers of today travel in luxury compared to the hardships endured by old explorers



Bettmann Archive photos

exploring," as one observer described it.

I was talking recently to Sir Hubert Wilkins, our top expert on Arctic clothing, about the special suits. He told me that the Arctic-equipped serviceman today carries 193 pieces of clothing which weigh 192 pounds! Wilkins' opinion is that the Eskimos were right in the first place. There is nothing to beat fur and skins. Hence, military researchers are hunting for a material that will resemble these skins. Their idea is to use air cells to provide an insulating vapor barrier.

All this is a far cry from the brave navigators who sailed uncharted seas in search of unexplored continents no more than a few decades ago, their crews ravaged by sickness, exposure and a diet of salty meat and moldy biscuits. Or, worse, the foot-slogging expeditions through tropical rain forests, ravaged by fever and plagued by hunger.

As I walk through the entrance hall of the American Geographical Society's home in New York, I am always struck by the tremendous advances in exploration since

the turn of the century when *Popular Mechanics* made its first appearance. On the walls before me are the names of illustrious men who have received the awards of the society — Scott, Shackleton, Peary, Amundsen, Byrd, Wilkins, Roy Chapman Andrews, Ellsworth, D'Abruzzi, to name only a few. There was no steam-heated exploring for these men in their endeavors.

Only a short 50 years ago the greatest ambition of every explorer was to be the first to reach the Poles — via crude sleds, dogs, their own legs and Eskimo clothes for protection. Eight times Robert E. Peary faced the icy winds of that northern waste and was beaten back. In 1909, he set out for his ninth and last try. Peary was 52—by no means young for Arctic exploring—and had lost all but two of his toes from frostbite. On the final leg of the 500-mile sledge trip, he battled fierce, icy gales across the ice. With him was only Matt Henson, his famous Negro companion who had accompanied him on all his previous attempts, and four Eskimos. Henson is an old friend of mine. I once asked him on a

broadcast why Peary should have selected him out of all his party for that epic trip? "Why," he said, "I was the only guy who didn't have frozen feet. Peary with his missing toes was half-frozen all the time!"

On April 6, 1909, they reached their goal—the North Pole conquered at last! The secret of Peary's success was his ability to live as an Eskimo. He built snow igloos, wore Eskimo seal furs and trapped the seals—a real Nanook of the North. Also, he had a team of rugged outdoorsmen like Henson, Donald MacMillan and Bob Bartlett.

As soon as the news of Peary's triumph reached the "outside," the eyes of the world were turned south. Within two years the race for the South Pole was on. It was Capt. Robert Falcon Scott, a British naval officer, who led the first streamlined spearhead into the White Continent. Scott's plans were to roar over the ice with the first motor sledges. Shetland ponies would carry his baggage. His ship, the *Terra Nova*, was loaded with knockdown huts and all the latest scientific gear for conquering the snowy wastes.

At the same time, Roald Amundsen, a Norwegian, was getting set for the same dash. But he followed Peary's example, taking only the simplest equipment—dog teams, skis and sleds.

A year later the tragic story of the race between these two men was told. Scott, with four companions, dogged by misfortune and appalling weather, and dragging their own sledges, reached the Pole to find the Norwegian flag flying above an empty tent. Amundsen, with eight companions on skis, their sledges drawn by dogs, had beaten him by a month. With heavy hearts, the Englishmen turned for their base—800

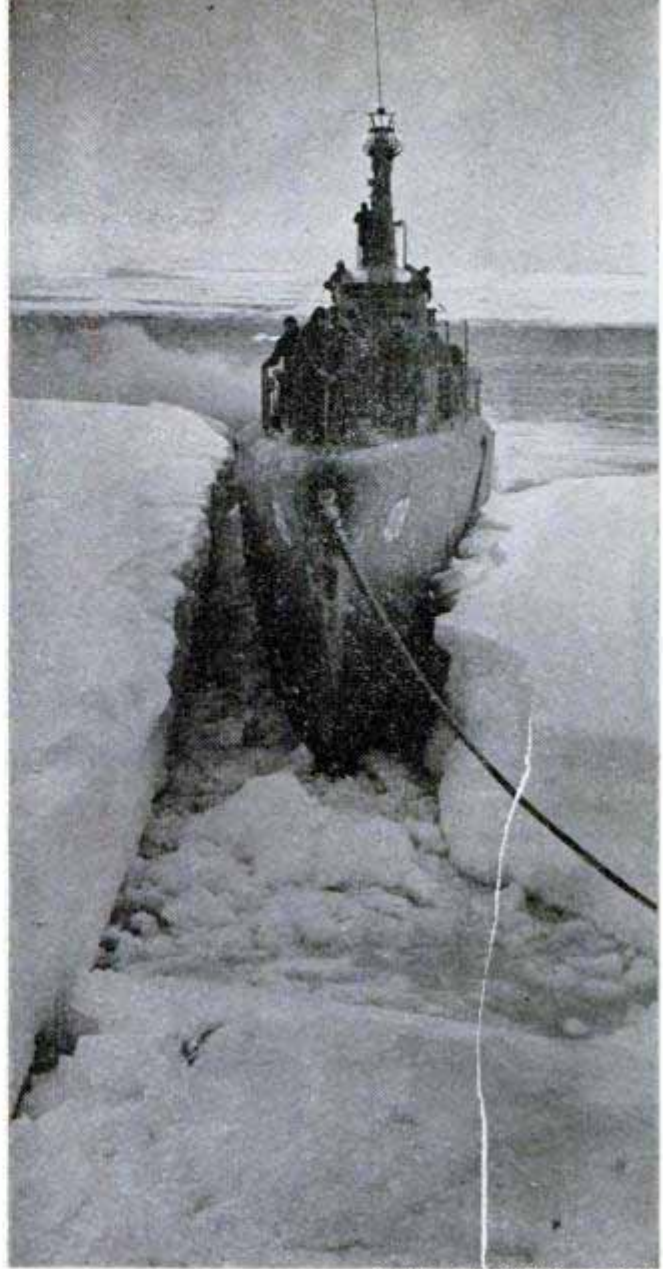

Department of Defense photo

During the Byrd expedition to the Antarctic, the submarine *Sennet* had to be rescued by Coast Guard. Below, Roy Chapman Andrews made the headlines when he discovered these dinosaur eggs in Gobi Desert





Department of Defense photos

Airborne magnetometer is used by explorers for mapping terrain under polar ice fields. It was used by Byrd in Antarctic



Portable generators provided valuable electricity for explorers in Little America. Below, trimetragon cameras installed in PBM-5 provided aerial photos for perfect map of Antarctic



miles of solid dragging on foot in the face of a screaming blizzard. They never made it. Eight months later their bodies were found frozen in a tent nine miles from a supply cache. Beside Scott's body lay his diary telling the whole poignant story and ending with the heroic words: "It seems a pity, but I do not think I can write more."

With World War I came enormous strides in the field of aviation. Three pioneer flyers in particular saw the key that the airplane would provide to the mysteries of the world—Sir Hubert Wilkins, Admiral Byrd and Lincoln Ellsworth. As early as 1897 an attempt had been made by a Swede, Dr. S. A. Andree, to fly to the North Pole in a balloon steered by sails and guide ropes, but this ended in tragedy. Empty message buoys from the craft were picked up years later—but no sign of the balloon was ever found.

But in April 1926, the *Chantier*, a relic of the World War I wooden Liberty ship fleet, steamed out of New York harbor. Stowed in her hold was a Fokker monoplane, the *Josephine Ford*, and aboard were Admiral Byrd, then a Commander, and his navigator Floyd Bennett. At King's Bay, Spitsbergen, the plane was put ashore. Just after midnight on May 9, 1926, the two flyers took off and headed north in perfect weather. Fifteen and a half hours later they were back in Spitsbergen—the first men in history to fly over the North Pole.

A few days later another American, Lincoln Ellsworth, with the Norwegian, Captain Amundsen of South Pole fame, took off from Spitsbergen in an airship, the *Norge*. Whereas Byrd on his flight returned to Spitsbergen after reaching the Pole, Amundsen and Ellsworth kept straight on and, after 72 hours in the air, sighted the coast of Alaska and landed at Teller near Bering Strait.

Byrd's No. 1 moment of glory was still to come. Immediately after the North Pole flight, he confided to Amundsen that his next ambition was to fly over the South Pole. On Jan. 1, 1929, a base was chosen on the Bay of Whales and christened Little America. A radio station was soon set up and elaborate equipment, including five planes, husky dogs, a snowmobile

and large stores of food and clothing, were landed on the Antarctic icecap. After reconnoitering up the Liv Glacier Canyon, Byrd's dream came true. He made the first flight over the Pole—on Nov. 28, 1929. At the controls of the three-engine Ford monoplane was a modern Viking, Bernt Balchen.

In some ways the most unusual polar attempt was the undersea voyage of Sir Hubert Wilkins. An aviator of worldwide experience and a veteran explorer, Wilkins wanted to reach the North Pole under the ice in the submarine *Nautilus*. He failed largely because the sub was an old one and inadequate for the job. I once asked Wilkins the reason for abandoning his novel attempt. His reply: "The captain's teeth!" Knowing from experience that intense cold always brings on savage toothache, Wilkins insisted that all his men see their dentists. Only one man failed, and when they submerged beneath the icy waters of the Arctic Ocean the captain of the *Nautilus* was in such agony that they were forced to turn back before reaching their goal.

Some of the greatest boons ever provided to explorers have come out of World War II, especially in aviation and in the way of clothing and food. Last summer I took time off from my radio work for a journey to the subarctic with the Juneau Ice Field Research Project, sponsored by the American Geographical Society in Alaska. There I participated in some unusual flights from a vast glacier. These were made by C-47s—spectacular jet-assisted take-offs from the neve surface and over the crevasses of a 750-square-mile ice field. Planes dropped supplies by parachute to us on the icecap. One of the chief purposes of the expedition was the study of glaciers. Leader Maynard Malcolm Miller and his colleagues gouged out cores of glacial ice with an oil rig from several hundred feet down! These ice cores are fabulous. They're like translucent glass and hard as rock. This big expedition, which hopes to continue its work for 50 years, is trying to find out how fast the glaciers are receding. All of which has much to tell us about the changes in the world's climate and the gradual warming up of the earth. Without modern exploration methods, such discoveries would remain locked forever from man's knowledge.

If you think mechanization is spoiling the high adventure of exploration, you're wrong. There is nothing dull about the tale that came out of the Alaskan wilderness of four Bureau of Reclamation geologists exploring for power-dam sites in the territory's wild canyons. They were finally rescued by helicopter after a series of incredible experiences. Daryl Roberts, Ade Jaskar, Terrence Robbins, Harry Johnson

(Continued to page 252)

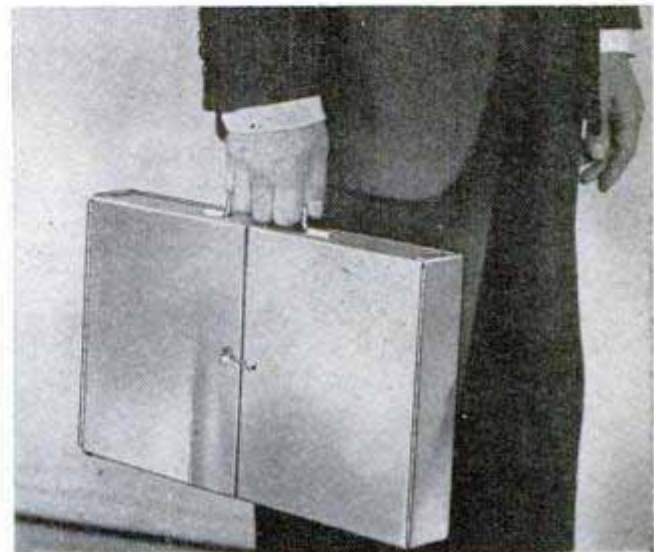

Brief-Case Picnic Grill

Light, sturdy and so compact that it folds into a small package resembling a brief case, a charcoal-and-wood grill is designed especially for picnickers. Meat may be grilled on one of two lower levels while other food is cooked on top. A charcoal pan situated in the base of the unit is easily removed after the fuel is burned. Weighing only nine pounds, the unit has over two square feet of cooking space.

Ice-Cube Airports

Drifting on the Arctic Ocean are three massive islands of ice, the cause of both chilling alarm and interesting speculation by our military strategists. These three ice-cube islands probably have been circling the Pole for thousands of years. Unlike polar pack ice, they are relatively smooth, and already are level enough to serve as landing fields for military aircraft. One of them is 20 miles long, 20 miles wide and 200 feet thick. To whom do these unsinkable carriers belong? How can they be used? Can they help solve the mysteries that still swirl about the polar region? You'll find some strange answers in a feature in the September issue of *Popular Mechanics*.

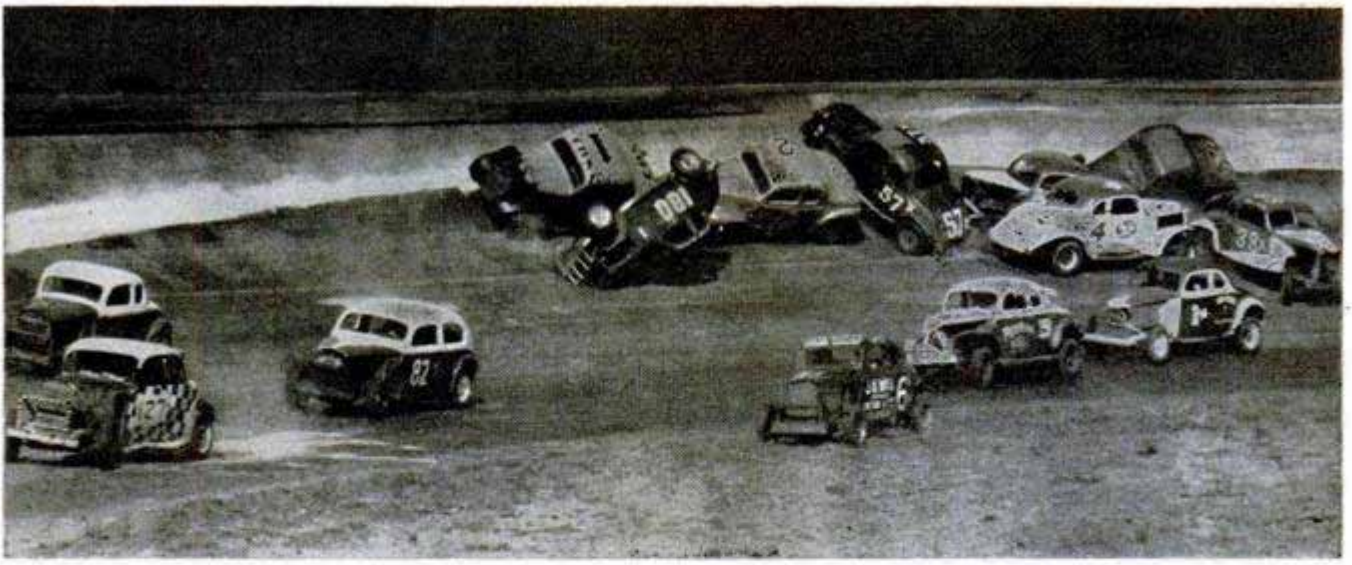

Huge Pile-Up Occurs in Stock-Car Race

Stock-car race fans at Oakland, Calif., got more than they expected when 11 cars piled up in the first lap of a race. A photographer shot the accident as it happened. In the photograph, one car is rolling over, an-

other has completely reversed its course, a third is climbing the embankment and the others are mixed together like the ingredients of a tossed salad. No one was injured in the remarkable crash.

Italian Fiat

Featuring a special body built by the Ghia factory of Turin, the Italian Fiat 1400 has the same unbroken lines as the newest American cars. Its four-cylinder engine has a displacement of 1395 cubic centimeters (85.09 cubic inches), about twice that of the smallest American car. A one-piece curved windshield and completely recessed door handles are incorporated in the new body.

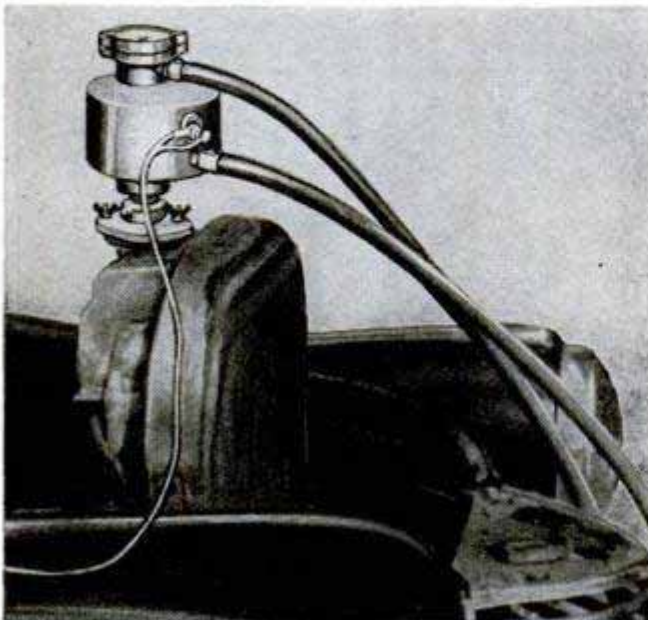

Car Cooling-System Cleaner Has Thermostatic Shutoff

Automobile engines and radiators are flushed and cleaned safely by a clamp-on device that operates with no outside connections except to a water supply. A thermostatic control automatically shuts off the engine if the temperature rises above 190 degrees, thus preventing engine damage from overheating. A special chemical is placed in the mixing chamber atop the radiator and is fed into the system as the engine operates.

☐ From 1900 to 1951, the U. S. automotive industry produced 116,413,562 motor vehicles, according to the Automotive Manufacturers Association.

Head Hammock

Sand is kept out of sunbathers' hair by a simple but effective cradle for the head. Made of canvas and two wire frames which open and collapse like the hinges of a scissors, the open ends of its frame are connected by strips of canvas. The lower piece acts as a strut to prevent further expansion of the frame. The upper strip is a miniature hammock which serves to keep the head elevated inches above the ground. Air circulates freely around the back of the head and neck.

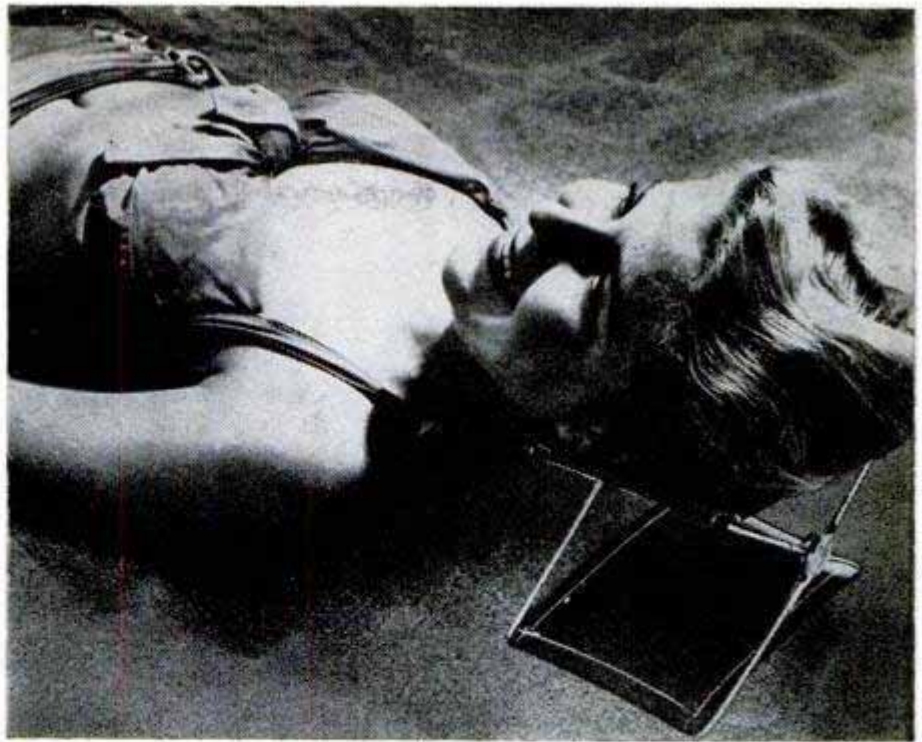

Italian Speedster

Touring Europe's racing circuit this year is a Mercedes Model 300 SL that features an aluminum body 50 inches high. Its 2996-cubic-centimeter engine develops 170 horsepower. Three carburetors feed gasoline into the engine, which has an 8 to 1 compression ratio. Doors are cut into the top and extend down only to the lower edge of the windows. Hinged at the top, they pivot upward.

Spiked Disk Aerates Soil

Operated like a lawn mower, a spiked disk cuts thin slots in the lawn to aerate the soil. The tool can be weighted with a heavy rock. As it moves across the lawn the spikes loosen the earth and enable water to sink into the turf instead of running off. If the aerator is used before re-seeding or top dressing, the seed and fertilizer settle into the perforations and can't be washed away. Use of the aerator does not alter the appearance of the lawn, as the turf hides the thin slots.



Sources of available products described in this issue are listed on pages 12, 14 and 16. Sources of further information on other articles are listed in our free WHERE-TO-FIND-IT LIST. For your copy just write to the Bureau of Information, Popular Mechanics, 200 East Ontario Street, Chicago 11

WHAT'S NEW FOR Your Home

A four-page "shopping section" dedicated to modern homemakers

1. WINDOWS lift out for washing or painting when equipped with a balancer that eliminates sash cords and weights. Two spring-loaded fingers on each sash exert enough pressure against the jamb to hold the window up. Sash is removed by forcing it against the fingers to compress springs and free opposite stile

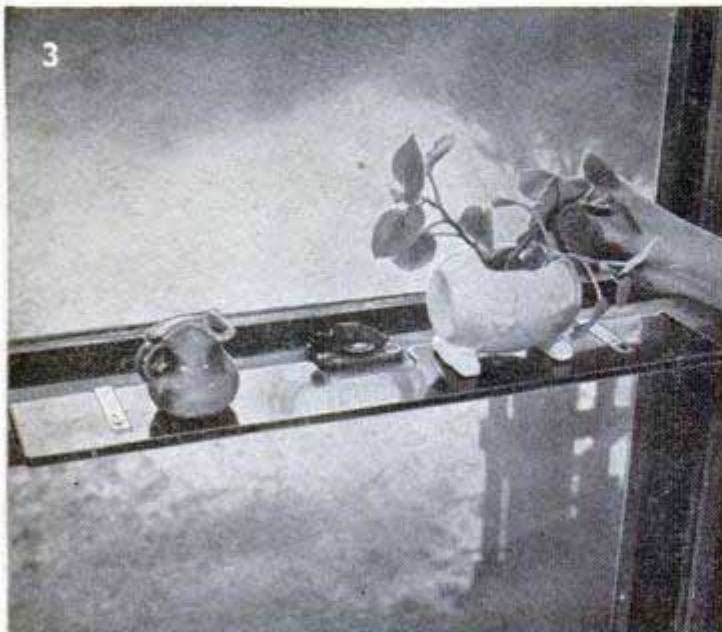
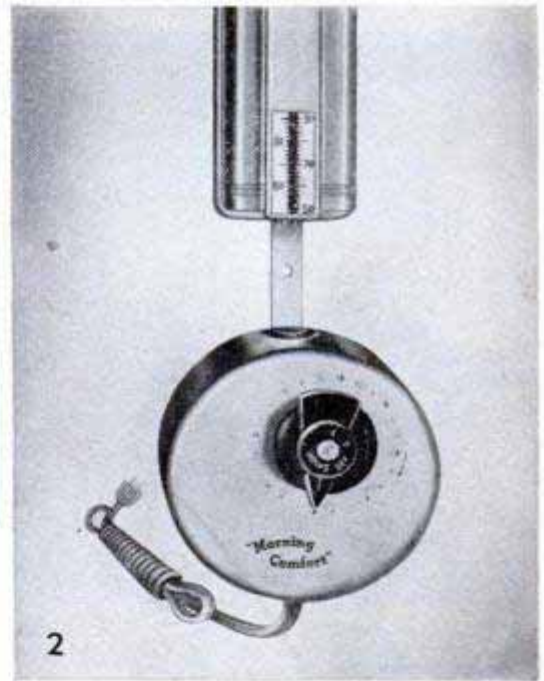

2. FURNACE HEAT is turned down at bedtime, back up in the morning by a timer unit that hangs below the thermostat. You set it to the hours you want. At night, heat from a coil on top of the unit fools the thermostat by raising thermometer reading 10 degrees above room temperature. In the morning, the coil turns off automatically and furnace comes on

3. SHELF that hooks over the rail of a window sash is wide enough to support planters, bric-a-brac or other items. The shelf, made of plastic, comes in a variety of colors. Supporting the shelf are a pair of metal strips that slip into the opening between the sashes. Two projecting lugs provide additional support against the inner surface of the lower sash

4. SHUFFLER handles up to four decks of playing cards at one time, riffling them automatically when the crank is spun a few times. You simply put one half of the cards on one side, half on the other side and turn the handle to complete the shuffle. The device is made of plastic and is four inches high, eleven inches long. It operates noiselessly

5. JACKET for a clay flowerpot, below, dresses it up in colorful style. Cut to form tapered cylinders that fit snugly around standard sizes of flowerpots, the Vinylite plastic covers come in various colors and designs. Snap fasteners hold them securely in place. The durable plastic sheeting is not stained by water or chemicals and wipes clean with a sponge

6. CLEANING TOOL has a wide variety of uses. It has two foam-rubber pads that clean both sides of Venetian-blind slats at once but that is not all. The two halves of the cleaner separate so you can use them individually. One has a rubber squeegee to wipe windows dry after the pads have cleaned them. The pads and squeegee can be replaced when worn

7. TACK MAKER carries its own supply of thread to speed the task of tacking material to a pattern. It has a curved needle so the tacks can be sewed in without lifting the material or pattern. A built-in cutter snips the thread which is wound on a round sewing-machine bobbin that holds enough thread to make 400 tacks without the needle being rethreaded

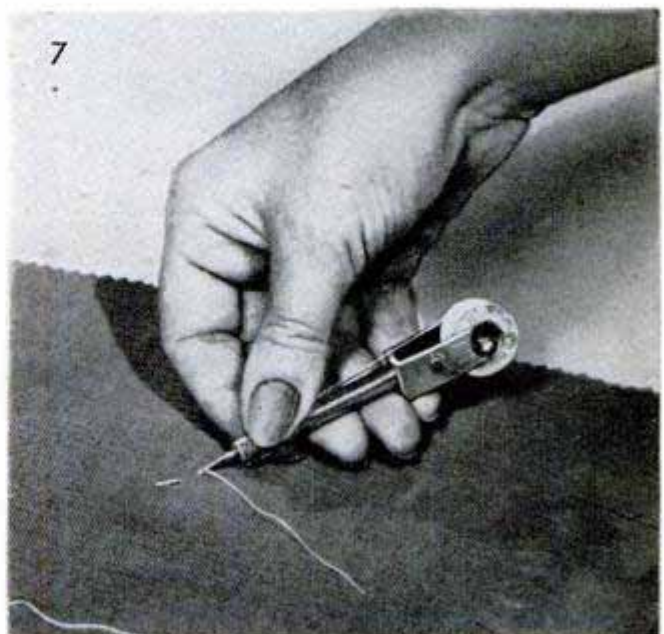
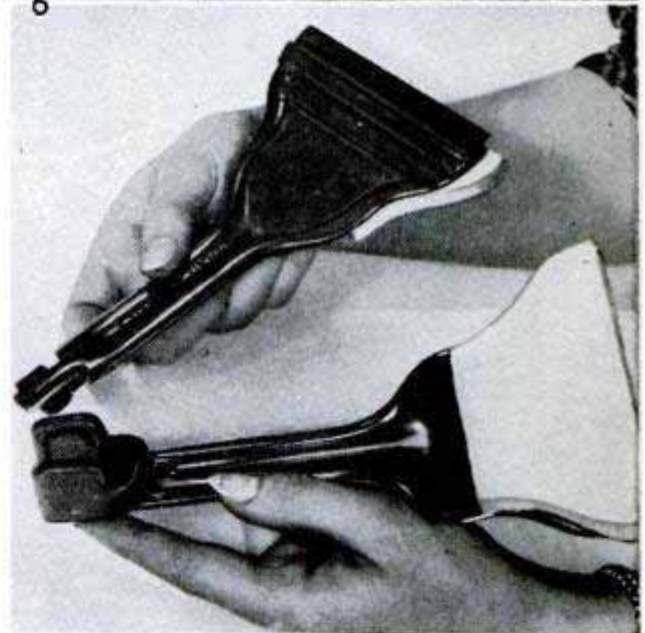

WHAT'S NEW FOR Your Home

Continued from preceding page



8

8. **FRUIT CUTTER**, above, is so simple it's hard to believe! You merely place it over the fruit and press down on the two handles. It cores the apple or pear and cuts it into 15 perfect wedges in one motion. It also does a fine job of slicing French fries, too

9. **RAZOR BLADES** whisk off whiskers when honed on a sharpener with four abrasive surfaces. Blades are placed over two pegs which rotate as the case is slid back and forth along a string, moving the blade in a circular motion over the honing surfaces

10. **SOCK DRIERS** adjust to all sizes between 10½ and 13 in men's socks. The toe of the frame is made of Tenite plastic tubing which is moved forward or back by means of a notched indicator rod that shows sizes. They're available in women's sock sizes also

11. **SHARPENER** provides the housewife with a quick way of eliminating dullness from kitchen knives. It is a wooden stick containing an abrasive hone and has blocks at each end to prevent accidents and to guide the knife blade at the proper sharpening angle

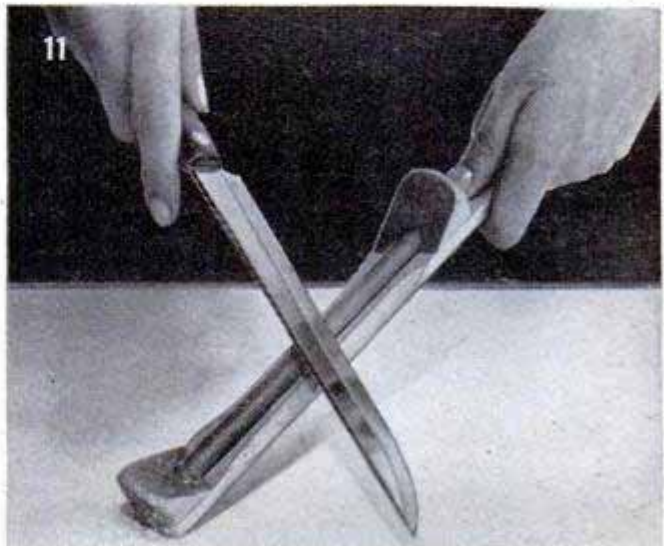
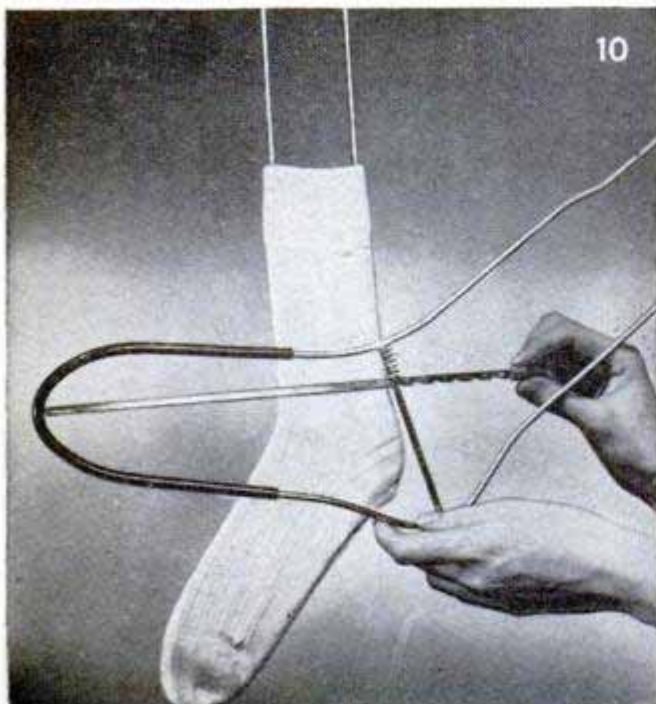

12. NONSLIP CLAMP lightens the chore of putting up storm windows or screens. You don't have to carry them upstairs — you merely clamp the device on the frames and pull them up. A sliding lock prevents the clamp from opening and also provides a quick release

13. EGG COOKER makes a "soft boiled" egg that is shell-less. Actually, it isn't boiled. You break the egg into a cup, put on the lid and slip the cup into the metal holder. Lower it into a pan of water kept just below boiling. The egg is served in the cup, too

14. ZIPPERS are repaired at home in a few minutes with a foolproof metal tool that has no moving parts. It opens and closes the teeth efficiently so you can replace jammed or broken sliders. You don't have to remove the Zipper from the garment to make repairs

15. INSECTICIDE dispenser shoots out a fine spray of dust when the molded rubber cap is squeezed. The cap is designed to fit on a standard package of the insecticidal powder and is reusable. Concentration of dust is controlled by the amount of pressure used

16. BLENDER attaches to the bottom of a beater element on an electric mixer and chops up fruits, meats or vegetables. It purees foods, too. Three cutting edges chop the food into small bits quickly. Two small hooks hold the cutter firmly in position while in use

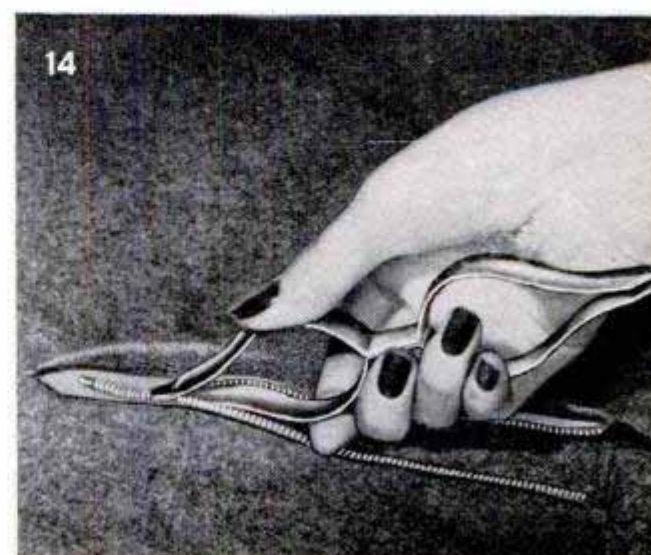



Weyerhaeuser Timber Co. photo

Saws Fight Fires

When flames break out near logging operations on a Springfield, Ore., tree farm, ordinary power saws are quickly converted to portable fire fighters. Small but effective fire-engine pumps are brought up, saw bars are removed from saw motors and fire pumps attached in a matter of seconds. Soon water drawn from near-by ponds and streams is combatting the blaze. If the fire is in a hard-to-reach section, the 97-pound seven-horsepower units and the smaller five-horsepower motor-pumps are easily carried there.

Easily Portable "Tepee" Serves as Sun-and-Wind Shelter

With a collapsible "tepee" you can carry your sun-and-wind screen right with you. The little shelter is designed for beach and sports use. It consists of three six-foot poles covered with waterproof material. Rolled up for storage or transportation, the shelter measures less than five inches in diameter and weighs only six pounds. Two of the shelters can be pitched together to form a complete tent or one can be used as an open shelter.



Golf Accessories Holder

Easily attached to the handle of a golf-bag cart, a new accessories holder accommodates a score pad, tees, pencils and cigarettes. There is a special slot for lighted cigarettes and a clip which holds an extra golf ball. A solid writing surface is provided for use in marking scores.

Stoplight Halts Only Fast Drivers

Motorists in Virginia are protected by a new stoplight in use at a dangerous curve near Natural Bridge. Normally red, the light's time interval is designed to make drivers halt if they are traveling too fast to go around the curve safely. A car approaching the curve passes over a detector in the highway which sends an impulse to the stoplight. If the car is moving 25 miles an hour or less, the light turns green before the motorist has to stop. Those traveling faster must stop until the "go" signal is flashed.

Electric Currents Pump Hot Metal

Large quantities of liquid metal are pumped through a tube by a simple electromagnetic instrument developed at Argonne National Laboratory. The new pump is being used to move a metal coolant through the experimental breeder-reactor at the Atomic Energy Commission's testing station in Idaho. It is a length of stainless-steel tubing that has two copper bars soldered on opposite sides. This assembly is placed between the poles of an electromagnet. The tubing is connected with inlet and outlet pipes. The current passes through the liq-

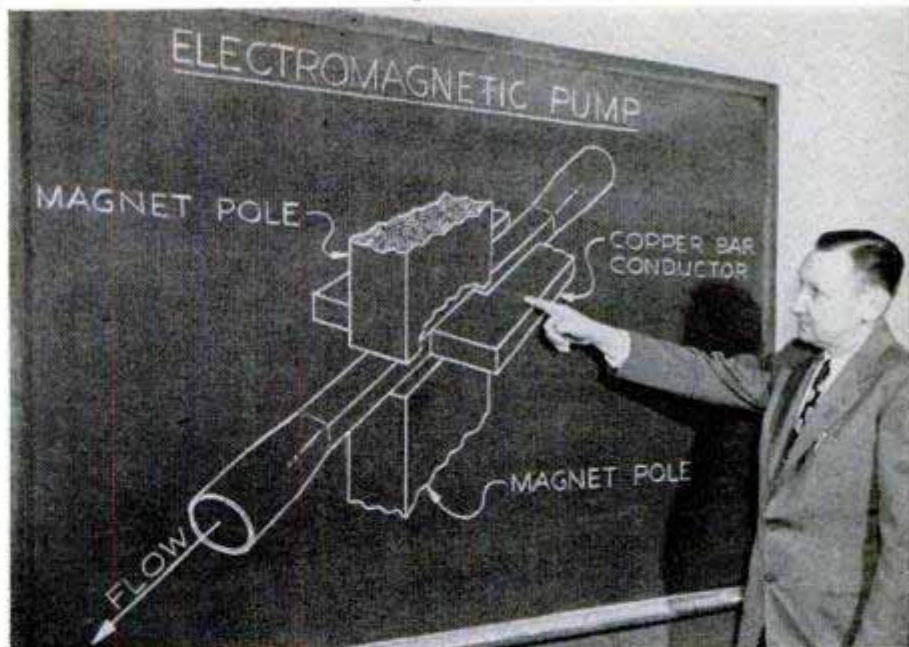

uid metal, developing in it a longitudinal thrust. The pump will move liquid metals at a temperature of 750 degrees F.

Windowless Water Meter Is Read by Use of Magnetic Fields

Completely sealed water meters with no glass windows or dials to leak dirt and moisture are read magnetically. The man who reads the meters carries a cylindrical device about the size of a teacup which has the conventional meter dials built into it. He places the device on top of the meter head. Magnetic fields set up inside the meter spin the dials on the reading device

to show how much water has been used. The meter can be read underwater and there is no possibility of leakage. Any water meter can be adapted to the reading system by substituting a magnetic head for the standard dial-equipped head. The inventor, J. Mack Hood of Corpus Christi, Tex., says it takes only three minutes to convert any water meter to his system.

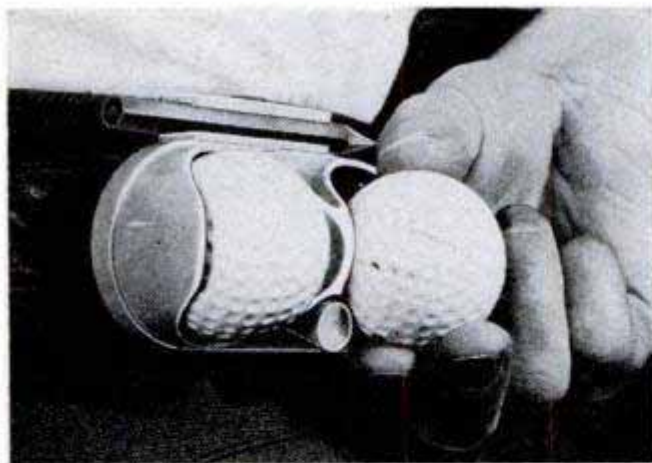

Belt Clip Carries Golf Balls

Golfers who dislike carrying loose tees and balls in their pockets can slip them into a plastic holder that fastens to the belt or waistband. The little kit has built-in space for two golf balls, a tee and a pencil for scoring. The items are gripped securely in their pockets, yet snap easily in and out of place.

Science Sees "Life" Molecules

For the first time scientists have seen the giant chemical molecules that apparently are of tremendous importance in affecting heredity and the changing of one disease into another. Scientists of the National Cancer Institute have announced that, through the electron microscope, they have seen a single nucleic-acid molecule. This type of molecule is found in the heart of living matter, particularly in the chromosomes and genes of all cells that pass on the stream of life. The molecules also are major constituents of viruses and have the strange property of changing one type of bacteria into another.

Tools That Make Tools

... that make everything else. Next month an Anniversary feature takes a long look at that grandsire of all industries, the fashioning of machine tools. It's the story of a single tool with 99 cutting edges, the tale of a man who lost two fortunes trying to shave away a tenth of a thousandth inch, the account of one tool four stories high. Above all, it's the story of the most precise craftsmen on earth. Don't miss this exciting feature in the September issue.

HOUSE OF



John F. Wagner of Johnstown, Pa., designer and builder of "pipe dream" house, uses steel pipes as both structural members and part of heating system

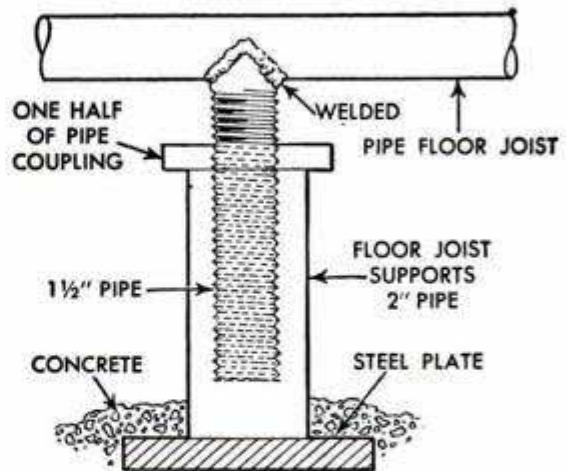

TURNING THE COUPLING RAISES AND LOWERS HOUSE TO REMEDY SETTLING

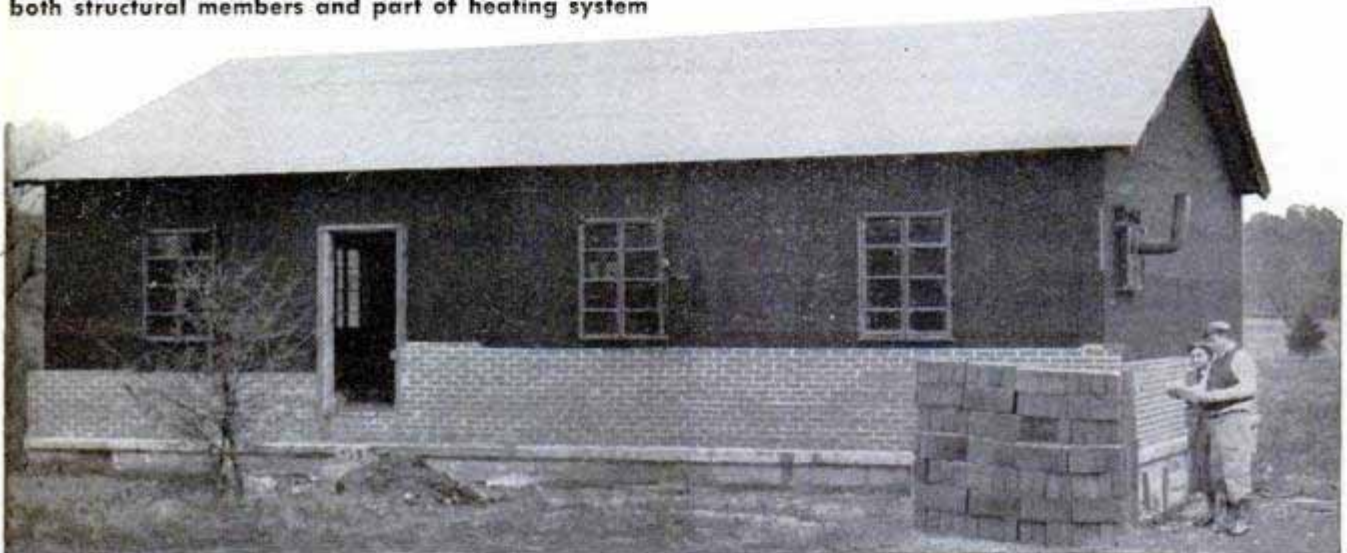

Wagner is covering the outside of his house with brick. The Celotex beneath the brick is fastened to the pipe framework. He estimates the cost at \$5000

Below, skeleton of the pipework is shown before any covering went on the house. The Celotex was attached to the framework by iron studs brazed to the pipe

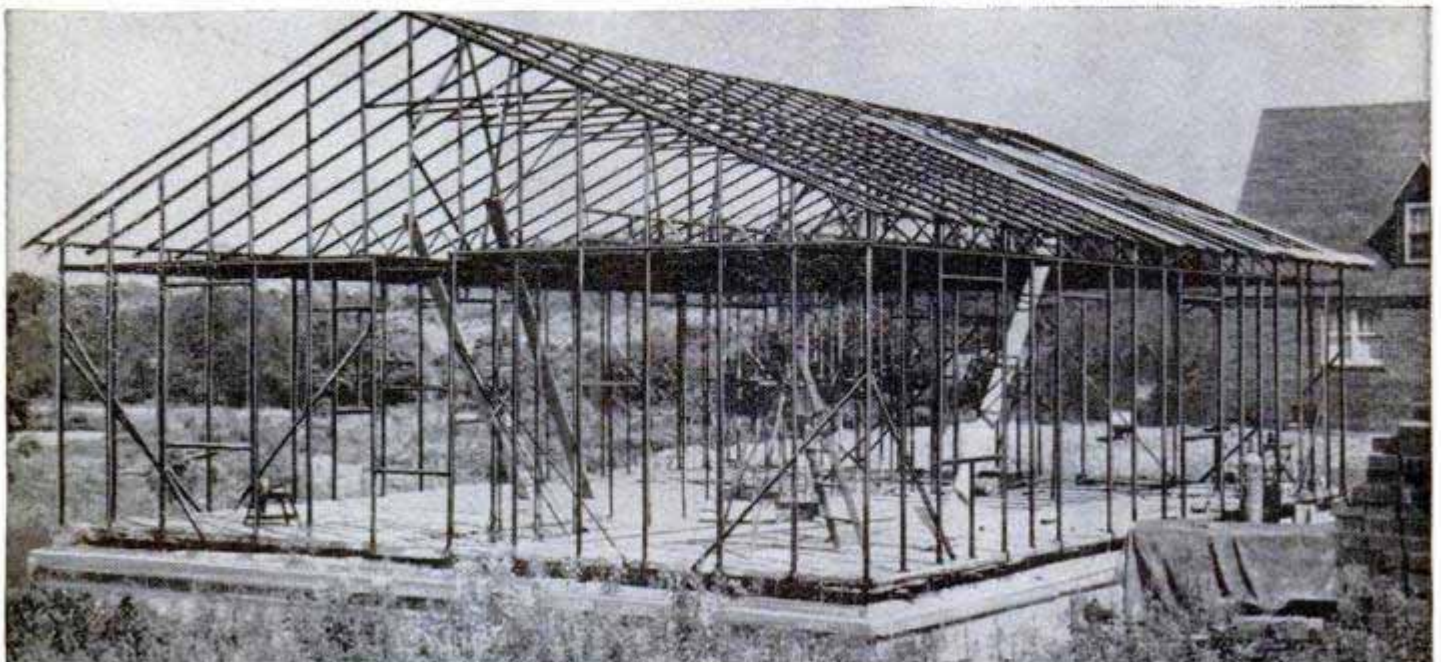

PIPE

A JOHNSTOWN, PA., pipe fitter is making his "pipe dream" of an ideal home come true.

John F. Wagner is building his house around a framework of pipe. The home will be constructed so that not only will the pipes serve as an integral part of the house, they also will be used as a heating and cooling system.

Wagner plans eventually to put pipes into the ground for removing the heat of the earth to heat his home in what he terms reverse-cycle refrigeration. And he figures the house will only cost \$5000!

The Johnstown man purchased a lot in Armagh, Indiana County, to put his pipe dream into reality. When completed, the house will be fireproof, termiteproof and rodentproof. In addition, it will be many times stronger than a house built of wood. Each of the 1¼-inch pipes used in the framework is able to stand a 6500-pound strain.

"Still another advantage will be my home's ability to withstand an atom-bomb blast to a far greater extent than the ordinary type of home," Wagner pointed out. "Built of brick and metal, the house will stand tremendous pressure."

Wagner has fastened Celotex to the outside of the pipe framework by means of iron studs brazed to the pipe. Inside, wire lath will be wired to the pipe uprights and covered with plaster.

The floor, consisting of concrete with heating pipes embedded, will be finished with tile or linoleum.

Wagner declared he will be able to raise or lower the home's interior temperature by 20 degrees with a valve system. By circulating cold water through a condenser from a well located next to the foundation of the building, the enterprising pipe fitter believes he will be able to chill the liquid within the framework to cool the house.

For the present, the heating system will consist of an oil-fired boiler coupled with a circulating pump to push hot water through pipes in the walls, floors and ceilings.

Wagner hopes one day to mass-produce his pipe-dream house. ★ ★ ★

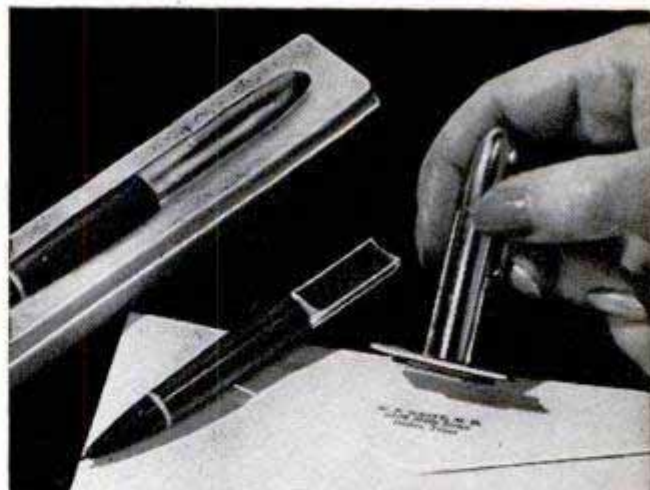

Pencil Contains Rubber Stamp

Compactly fitted inside the barrel of an automatic pencil, a rubber stamp and pad provide you with a convenient means of printing your name and address. The inking pad is so designed that when the pencil is closed the rubber die presses against it and always is ready to use. Despite its smallness, the stamp can be made with as many as three lines of type.



Scooter-Style Bicycle

Pedal crank, chain and rear wheel of a new-type bicycle are encased in metal to keep the rider from getting dirty. There is a small tool compartment behind and above the front wheel. The scooter-style cycle was developed in Berlin's west sector.

☐ Since 1940, the number of electric-trolley coaches in use in the United States has increased 132 percent.



Electric Mower

Weighing only 12 pounds, a new electric mower cuts grass up to six inches tall and has a capacity of 3000 square feet per hour under normal lawn conditions. The motor

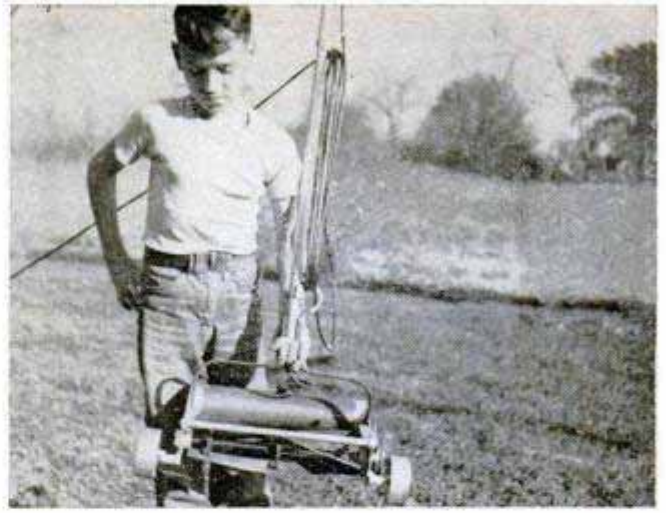

is built into a cylindrical housing behind the blades. The mower cuts a 14-inch swath and will operate with as much as 300 feet of cord. Its light weight makes it convenient to use around shrubbery and flower beds.

Wheels for Garden Rake

Small plastic wheels which fit onto the end prongs of an ordinary garden rake keep the raking level constant. The adjustable rollers permit the rake to travel along at a regulated depth so that objectionable growth or debris is combed out and desired growth is left standing. Because sufficient pressure can be applied, a definite cultivation level is maintained. The rake does not dig in or jump over parts of the terrain. A clamping device permits the rollers to be adjusted up or down and then locked at the desired raking depth.

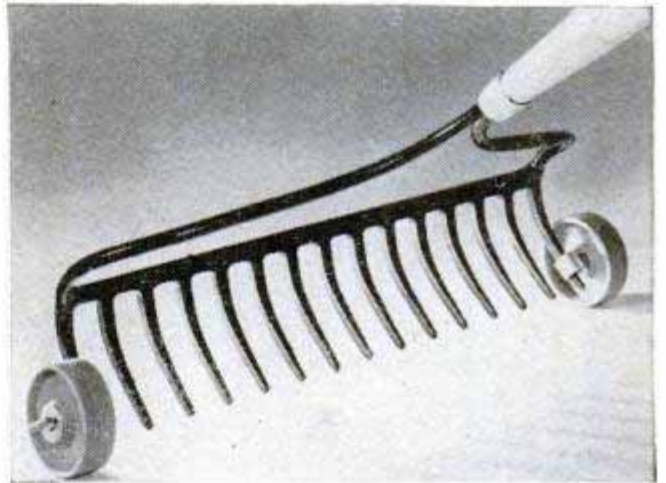

Bellows Duster

Bellows provide air pressure for a handy plant duster. Easily and quickly filled, the lightweight unit holds up to eight pounds of powder. Adjustment is possible to provide a uniform flow from a fine fog of spray to a heavy cloud. Extension pipes permit spraying in hard-to-reach places. The sprayer weighs only five pounds when empty.

Watermelons only eight inches in diameter—compact enough to fit easily into the average refrigerator—have been developed by scientists at the University of California.

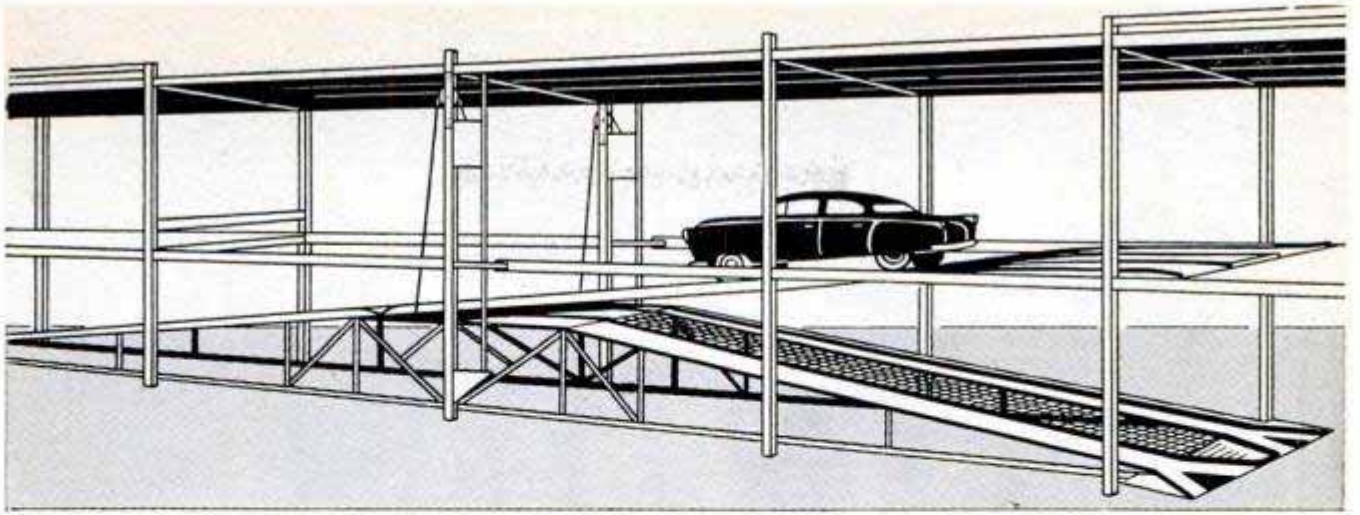

Ramp positioned, above, for interfloor travel and, below, raised for cars moving between sections on same level

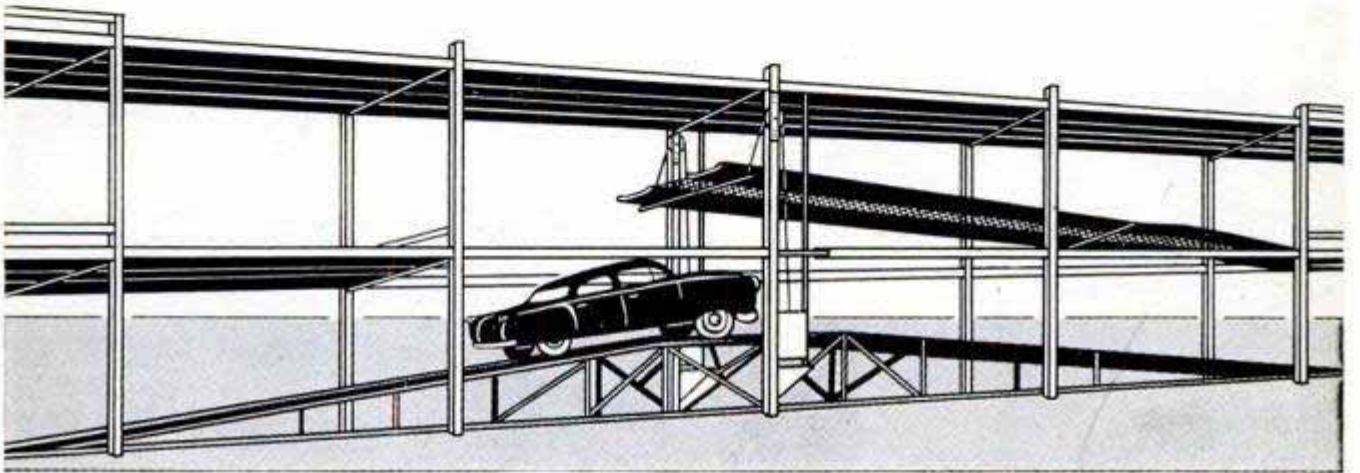

MULTIDECK PARKING LOT

PARKED CARS are delivered to owners within three minutes, even during peak rush hours, at a new three-level parking lot in Beverly Hills, Calif. Attendants ride a vertical hoist to reach cars on the upper floors.

The upper half of each ramp is hoisted up out of the way by an electric motor when an attendant needs to use the ramp as a driveway to move a car from one side of the building to the other. All ramps can be converted for "up" operation during an incoming rush, then changed to "down" position for quick delivery of cars. The attendants use slide poles to return to street level after parking a car.

The patented multideck structure has 412 large individual stalls, each with steel guide curbs to protect the cars. The structure is fabricated from assemblies of four basic shapes, weighs 600 tons and can be assembled in 600 man-hours. Costs are said to amount to half or less of a comparable steel-and-concrete parking building. The three-level building parks

four times as many cars as can be parked on the surface alone and the structure can be disassembled and moved to another site at low cost if the need arises.

The individual car stalls at the Beverly Hills lot are 8 feet, 4 inches wide and average 17 feet, 9 inches in length. A 2-foot-wide walk between each stall separates the parking spaces.

Steel curb guides protect cars as they travel on ramps. Sets of rollers spin under the wheels and slide them into position

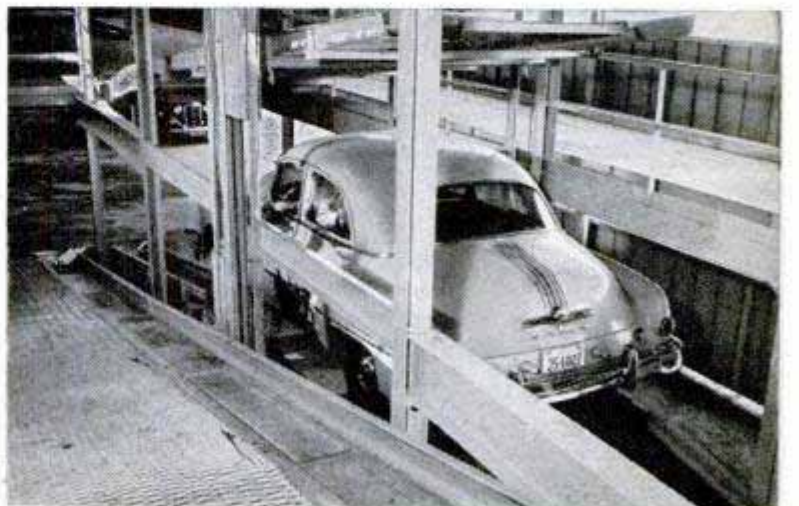

All-concrete home of Arthur C. Avril has floors of new concrete that's easy on feet and can be waxed like wood

By George Laycock

From a laboratory at the University of Cincinnati comes word of a new . . .

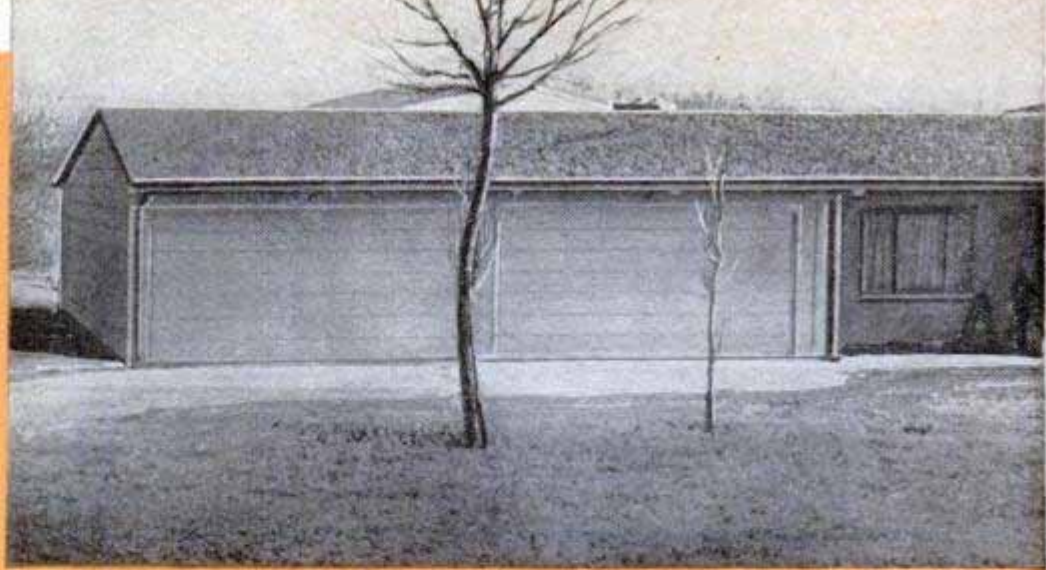

CONCRETE THAT

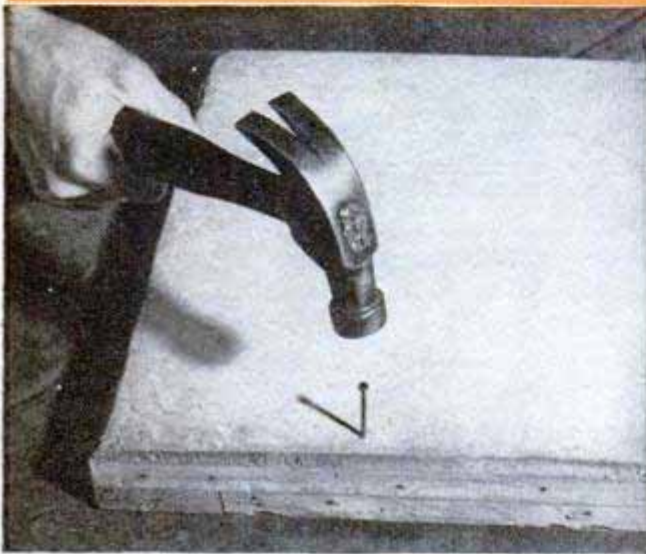

Nails can be driven into the "wonder concrete" only an inch from edge of slab without cracking surface. They can be pulled out the same as from wood. Below, Robert Howe, who developed the concrete, tests the strength of bond between it and a piece of wood

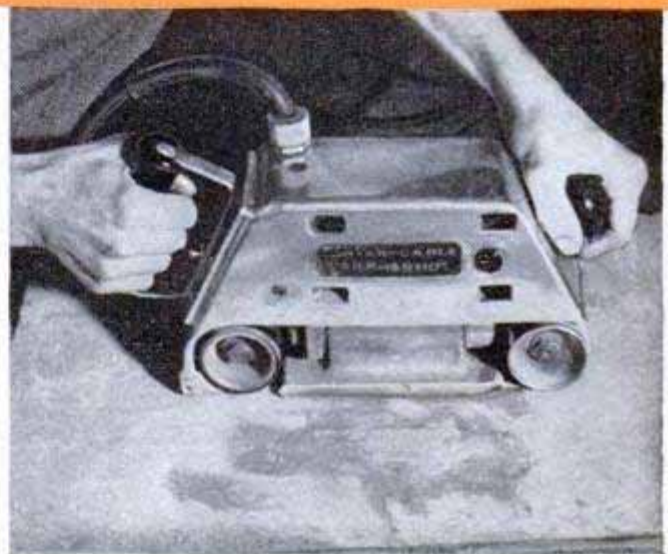

This concrete has many of the same qualities as wood. Here it is being sanded like a wood floor



MEN HAVE MADE concrete for so many centuries that anything new in concrete comes as a surprise. Into the building scene now comes a concrete development with an exciting scientific story behind it. It is the story of a concrete that may revolutionize the plans for homes you and thousands of others hope to build.

This concrete came from a laboratory on the campus of the University of Cincinnati. It was developed through the skill of a youthful civil-engineering instructor with a yen for research.

Bob Howe, the scientist who concocted this new building material, had a big job. The job was dreamed up in the beginning by Arthur C. Avril, the energetic president of Sakrete, Inc., a firm manufacturing ready-mixed concrete. Avril was in the process of building a home. Because he admittedly is partial to concrete, he wanted the entire house made of it.

When it came to building the floor, Avril ran into trouble. He wanted to use radiant



Photos by George Laycock

PROMISES MIRACLES

heating. But ordinary concrete is hard on feet and rugs would cut down the heating efficiency. "What we need," said Avril, "is a special concrete for this job."

He took his problem to the University of Cincinnati. Bob Howe went into his laboratory with a collection of standard-sized concrete forms, a group of complicated measuring machines and an open mind.

Six months later he produced a concrete that met all of Avril's specifications. The concrete, which is now being groomed for its commercial debut, has most of the good properties of wood used for flooring. It can be sanded, stained, painted, polished, waxed and in general decorated to fit any room. A floor made of it is waxed about once every two years. It makes a beautiful floor that need not be covered with rugs and it is easy on the feet for it is almost as resilient as wood.

If the need arises, the homeowner even can drive nails into this concrete without chipping it, then pull them out leaving no larger hole than would be left in wood.

In addition to being a good material to work with, the concrete Bob Howe invented is inexpensive and has at least twice the tensile strength of ordinary concrete. It also contains an ingredient with which it can be bonded to wood, metal or other concrete. This makes it especially valuable for use in laying new floors over old ones.

Most concrete floors are poured at least two inches thick to keep them from cracking. But not this one. It won't crack though poured only $\frac{3}{8}$ inch thick. Avril says the concrete will furnish flooring at far below the cost of hardwood.

What are the possibilities for the future of such a concrete? They seem unlimited. In home building it can bring several advantages, especially radiant heating, with-

in reach of thousands of middle-class home builders. And it should be a boon to industry where large floor areas and rising costs demand a strong, durable flooring material at reasonable cost.

One large Hollywood studio is interested in resurfacing all of its studio floors with the concrete. "Wood floors," the movie executives say, "cost too much to maintain."

The concrete had its first real test in Avril's recently completed home on the outskirts of Cincinnati. The entire floor of this rambling, single-story, nine-room home is a layer of the new concrete poured over a layer of ordinary concrete in which the heating pipes are embedded. The Avrils have home-tested it for every quality they ordered. They've stained it different colors to match the rooms. They've lived on it and found it comfortable on the feet. The heat, with separate controls for each room, comes up through the floors for constant comfort.

Floors made of anything but concrete in this house would be out of place—the whole house is concrete. The walls are of concrete poured in place between forms held by columns made of concrete. The roof, also poured in place, is supported by pre-poured concrete beams. The concrete roof is covered with a layer of slag for added insulation and beauty.

Avril, who plans to turn his search for a better floor into a major industrial enterprise, is not telling just what it is in his concrete that makes it different. But he believes that Bob Howe mixed a concrete with a future. Home builders who have seen the concrete in use and have studied its properties and advantages agree with him. They're admitting that after centuries of concrete construction (the Romans used it) there is now a new concrete that promises miracles. ★ ★ ★

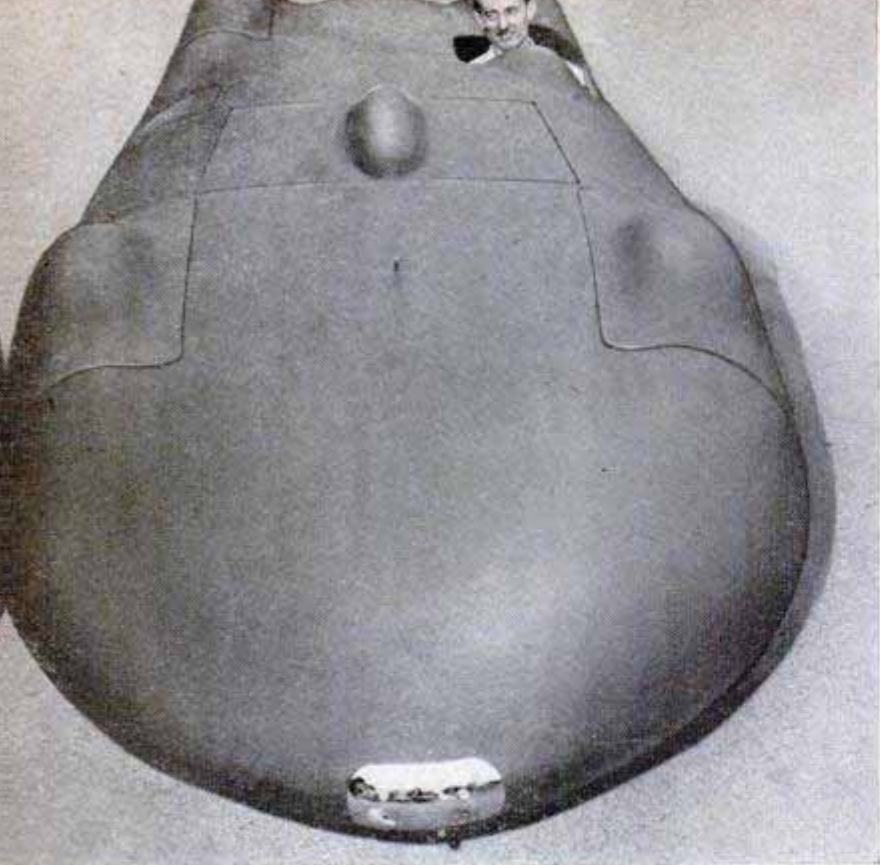

CAN A HOT ROD go 300 miles an hour?

Amateur speedsters will find out this month at the national speed trials on Bonneville Salt Flat, Utah. One thing is certain—last year's mark of 230 miles an hour will go by the boards.

At least four unlimited-class streamliners will vie for top speed honors. Each of them represents a year of part-time work by its owners, usually two or three young men who pool talent and cash to compete for the hot-rod "Oscar."

The ultra streamliner shown here may be this year's champ. Its owners and builders, Harold Post and Doug Hartelt, both of Orange, Calif., predict it will do better than 275 miles an hour. ★ ★ ★

Sleek as a porpoise, the Post-Hartelt hot rod is 20 feet long. Plastic bubble will protect driver's head during speed trials

FIVE miles a minute?

Watch the Hot Rods at Bonneville

Flush fenders or wheel covers unbolt for tire changes. The fuel tank is also removable for filling. In place, it is flush with body. The engine burns a special nitro-methanol mixture

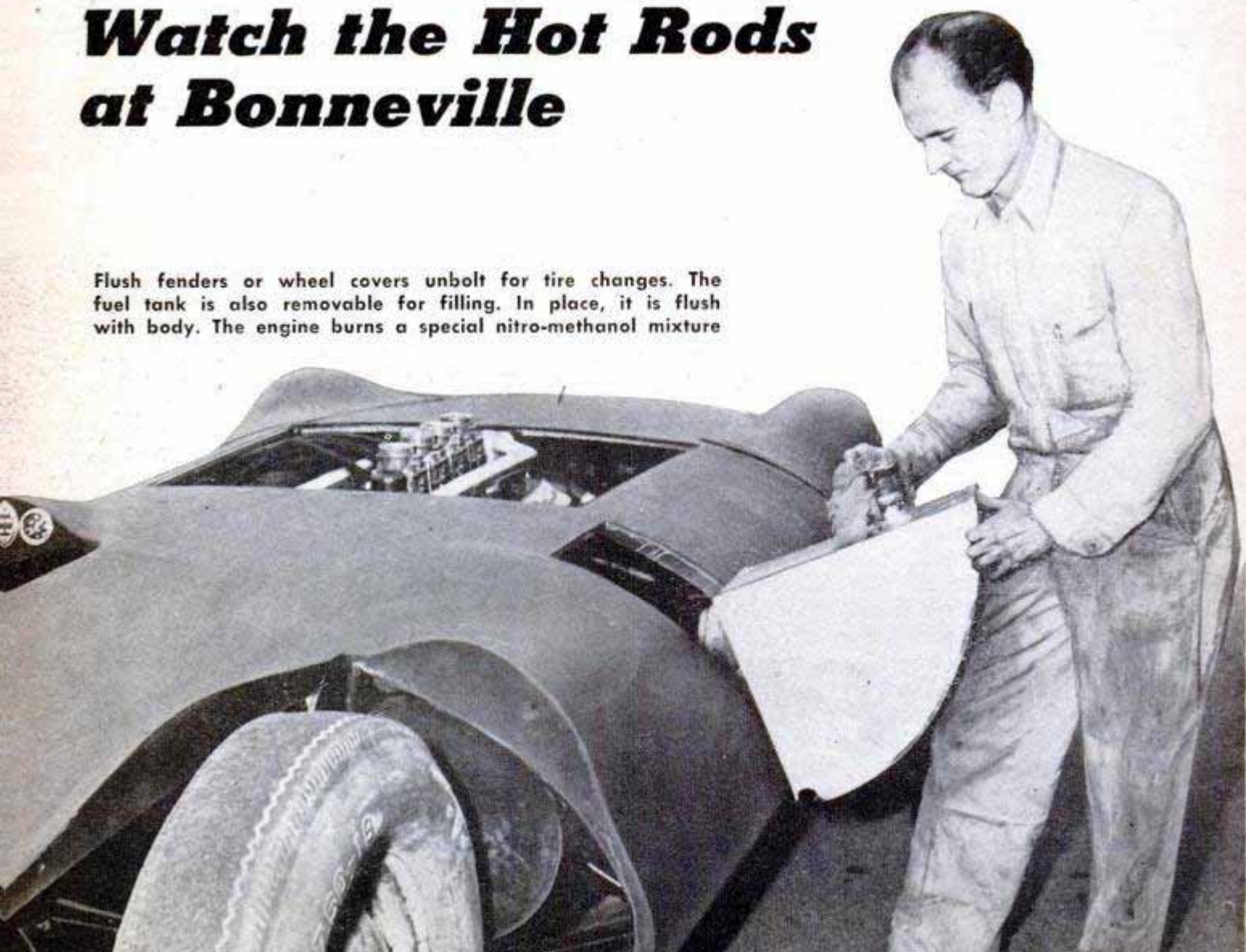



Instruments are few on the tiny dashboard. At 275 miles an hour, the driver can't be looking at dials



Full-race Mercury engine is used in some trials, but in unlimited competition, a Chrysler V-8 replaces it

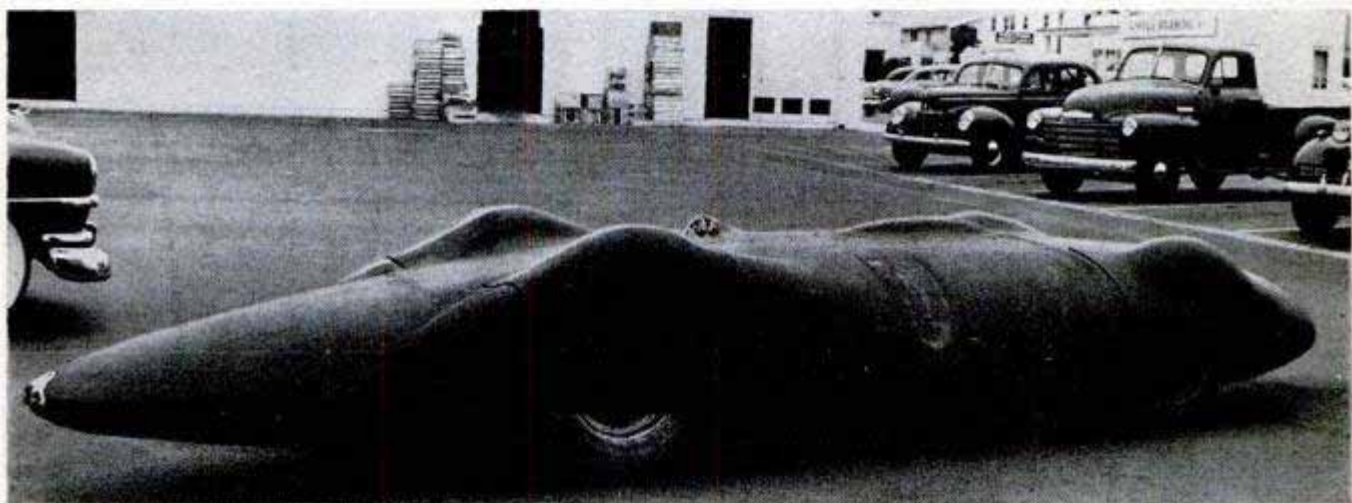

Side view of the Post-Hartelt hot rod displays its extreme streamlining. "Patch" on side is fuel tank

Below, polio victim Chet Herbert holds model of two-engine streamliner he plans to enter at Bonneville

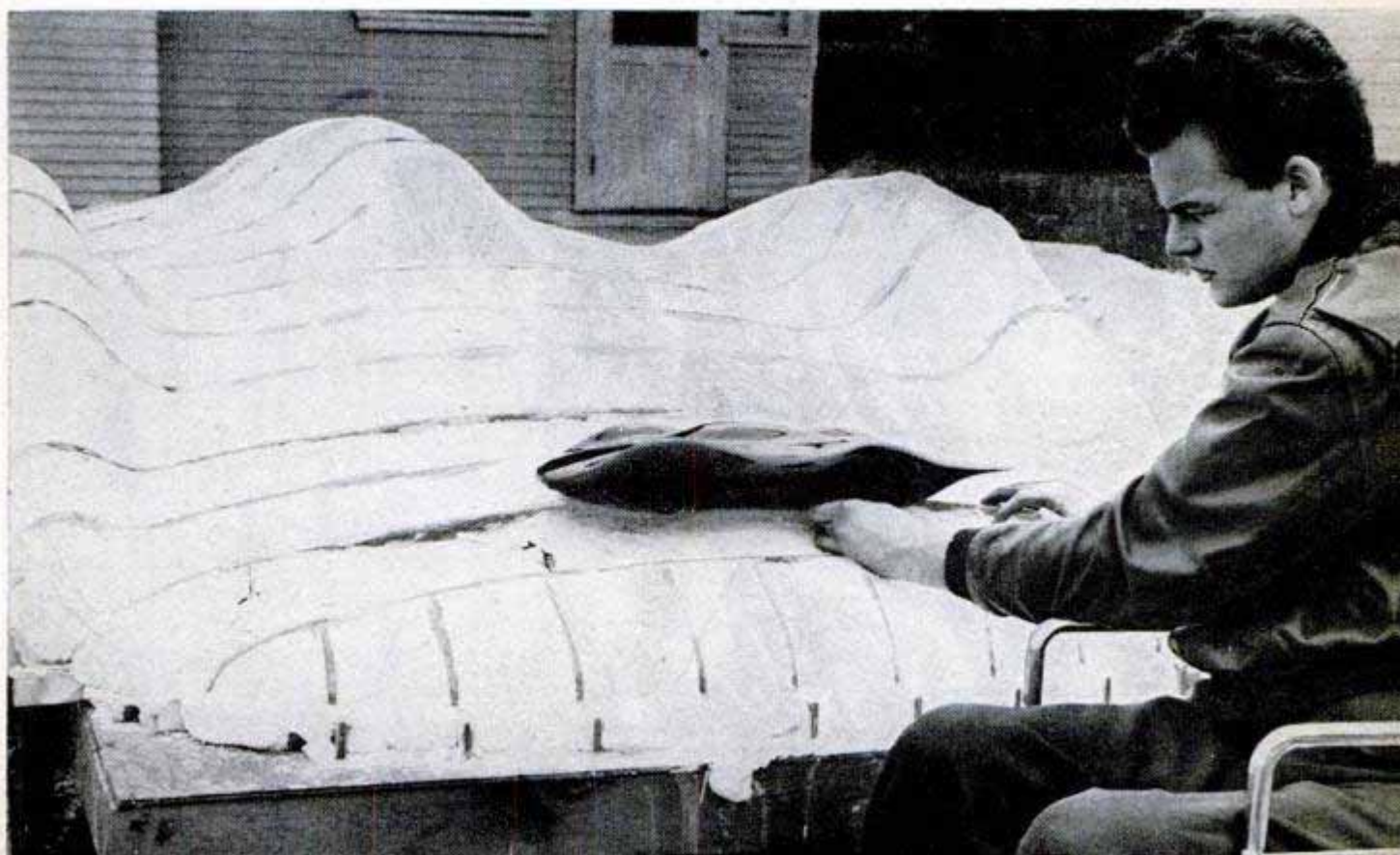

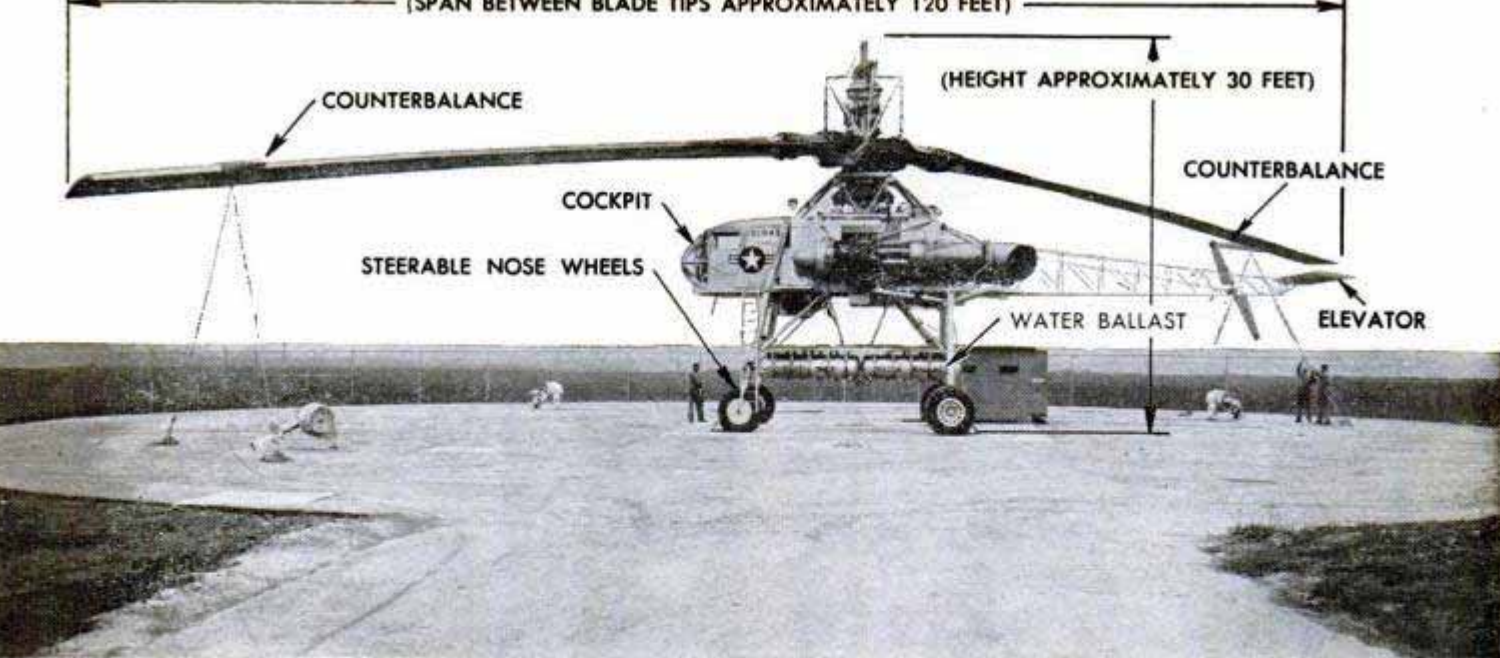

Tied down during ground tests, the huge XH-17 dwarfs near-by workers. During earlier experiments it broke loose from its moorings and was slightly damaged

Giant Jet Helicopter Ready for First Flight

Initial flight tests are near for the world's largest helicopter, the jet-powered XH-17. An estimated 120 feet in rotor-blade span and 30 feet high, it was built for the U. S. Air Force at Howard Hughes' Culver City, Calif., aircraft plant. The huge "flying crane" straddles its cargo like a lumber lift, picking up loads by attachments to its landing gear and fuselage. It is designed for short-range movement of heavy military equipment, including artillery, tanks, bridge sections and trucks. During ground tests the cargo space has been filled with water ballast tanks. Power from two modified General Electric turbojet engines spins a pair of air compressors inside the fuselage. The compressed air is lifted up through the rotor shaft and out to exhaust tips on the trailing edges of the two rotor blades, almost at their outboard ends. Fuel is burned at this point, in much the same way that an afterburner operates, and flames stream from the whirling blades. Single, projectile-shaped extensions from the leading edge of each blade act as counterbalances. The 40,000-pound craft has two steerable nose wheels and two sets of dual landing wheels. A small airfoil at the tail serves as an elevator.



Air from compressors run by two turbojet engines is lifted up through the rotor shaft, above, and out to the rotor-blade tips. Fuel is burned at the exhaust outlets, providing a jet effect that turns the blades

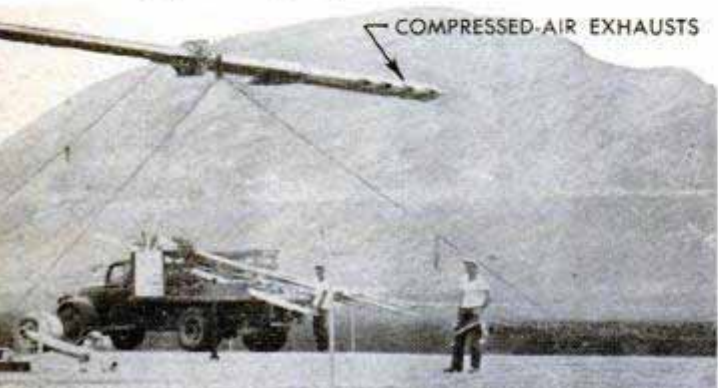

Geiger-Tube Altimeter

Geiger tubes may help future pilots know their height more accurately at extreme altitudes. It is estimated that the new altimeter won't be more than 1000 feet off at 30 miles above the ground. Conventional aneroid-type altimeters are unreliable at very high altitudes because there air-pressure changes are small for corresponding changes in height.

Right, latest model of the Wagner twin-engine plane has only one tail and fuselage. Below, close-up shows how one propeller shaft is extended slightly so the blades can overlap. Experts said this wouldn't work out

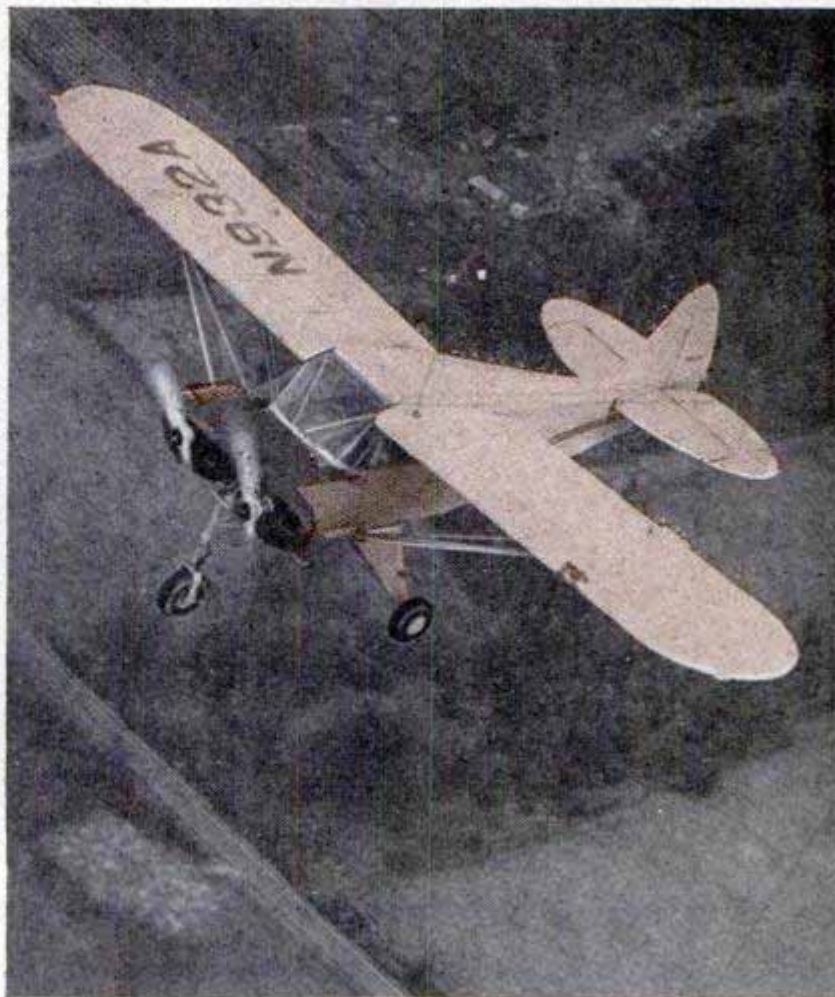

“SIAMESE TWIN” LIGHT PLANE

WHEN Harold Wagner of Portland, Ore., wanted a two-engine plane, he got it the hard way—by hooking two Piper Cubs together under one wing! He tossed aside the advice of experts and mounted the two fuselages so close together that the propellers overlap. One prop is set about two inches in front of the other by means of

a short spacer shaft. The experts said such a design would cause dangerous turbulence but Wagner has not found it so. He already has designed another “Siamese twin” plane, this one having only one fuselage and tail. It, too, has the overlapping propellers and will carry four persons at 160 miles an hour. It has a 2000-feet-per-minute rate of climb.

Two used airplanes joined together under one wing gave the Oregon pilot the twin-engine plane he wanted



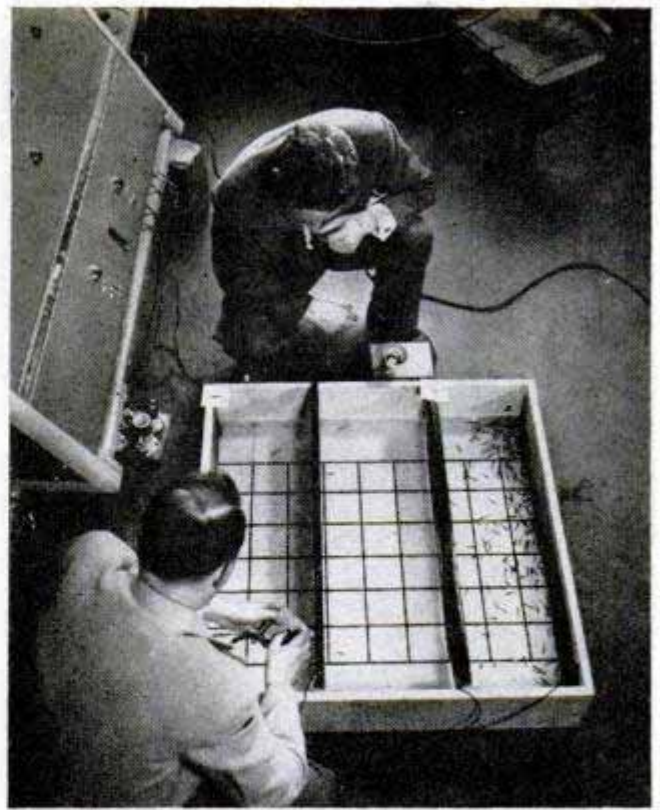
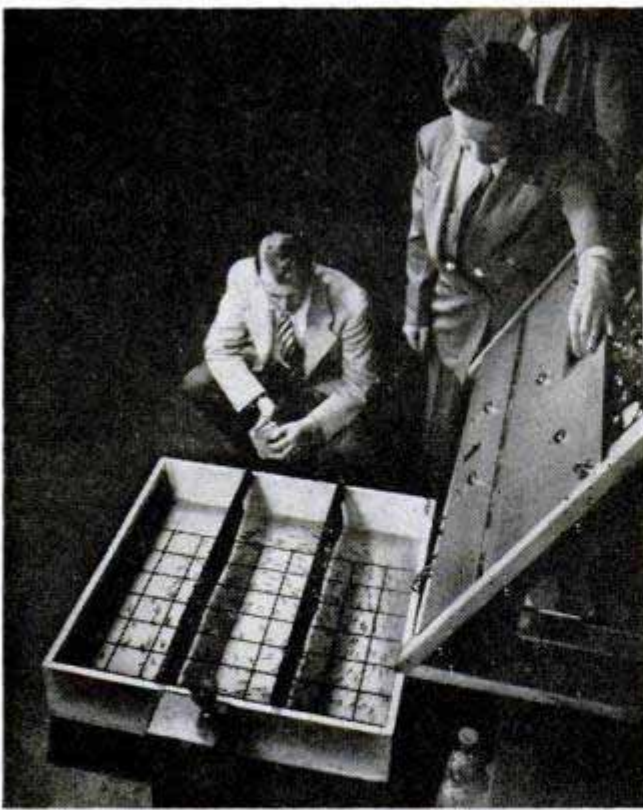

Fish can be controlled electrically. They are made to swim in circles, left, or attracted to one side, right

Fish "Magnet" Guides Fingerlings Downstream

Salmon fingerlings can be guided safely downstream by electricity, biologists of the U. S. Fish and Wildlife Service believe. These scientists have discovered that the fish are, in effect, little magnets. The head of the fish is negative and the tail positive. By setting up underwater electrical impulses of positive polarity, the scientists can attract the baby fish away from dangerous areas such as spillways and turbines. Cer-

tain electric waves can be used to stun fish and by current changes the stunning can be selective—male salmon reportedly being stunned while the female remain unharmed. With this knowledge, the scientists hope to cut down the number of fingerling salmon that are killed on their way to the ocean. Current estimates are that about 95 percent never reach the ocean because they are killed in power penstocks.



Mechanical Egg Salesman

You can buy eggs any time of the day or night at an automatic egg store based on the coin-operated vending principle. The egg machine was built for Kenneth Downing, a farmer at Los Gatos, Calif. When the proper amount of coins is placed in the machine, an open door exposes a carton of eggs. The customer has a choice of two grades of eggs. When the price per dozen requires pennies, the machine charges to the nickel and change is included in the carton.

Sources of available products described in this issue are listed on pages 12, 14 and 16. Sources of further information on other articles are given in the WHERE-TO-FIND-IT LIST, available from Bureau of Information, *Popular Mechanics Magazine*, 200 East Ontario St., Chicago 11

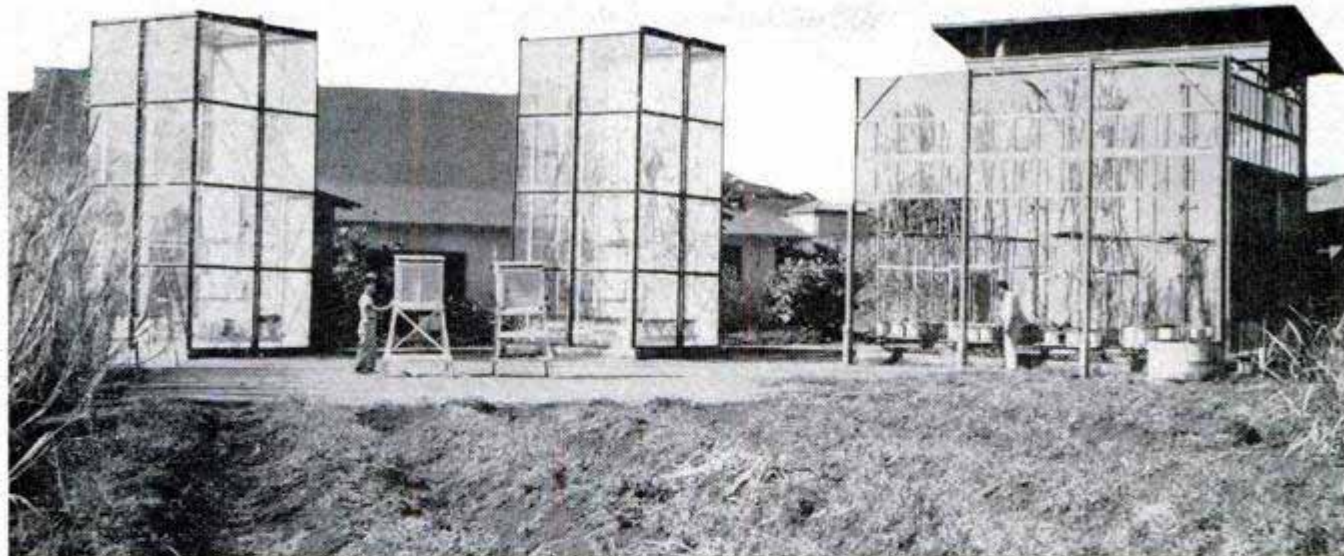

Sugar cane is raised in weather-controlled glass houses to determine the effect of temperature on its growth

Weather Watchers in Hawaii

HAWAII'S WEATHER, supposedly ideal, is under investigation as a result of vagrant tricks. The research is sponsored by the sugar industry, which produces a crop that accounts for about half the territory's export income. The weather in Hawaii plays tricks; for example, one section of

Honolulu has had 120 inches more rainfall in one year than another section only a few miles away. Scientists, with the help of some unique instruments, hope to determine the weather pattern so they can predict cycles, rainfall, humidity, wind direction and velocity, and sunshine duration.

Left, worker measures cane grown under varying conditions. Right, photochemical instruments gauge sunlight

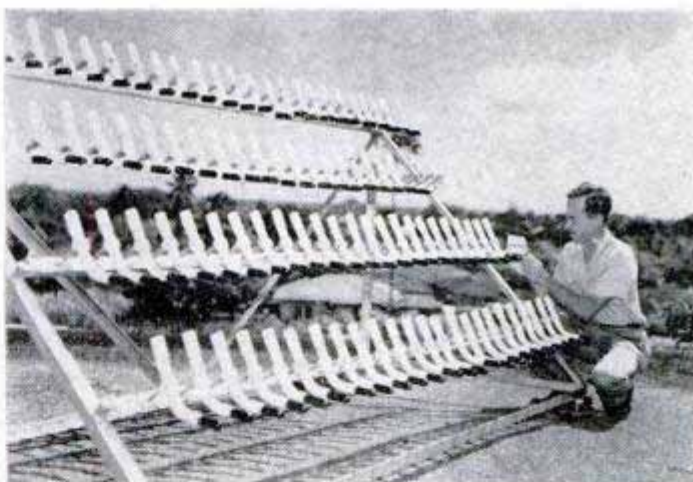

↓ Complicated recording instrument constantly determines the relationship between the sunlight and wind



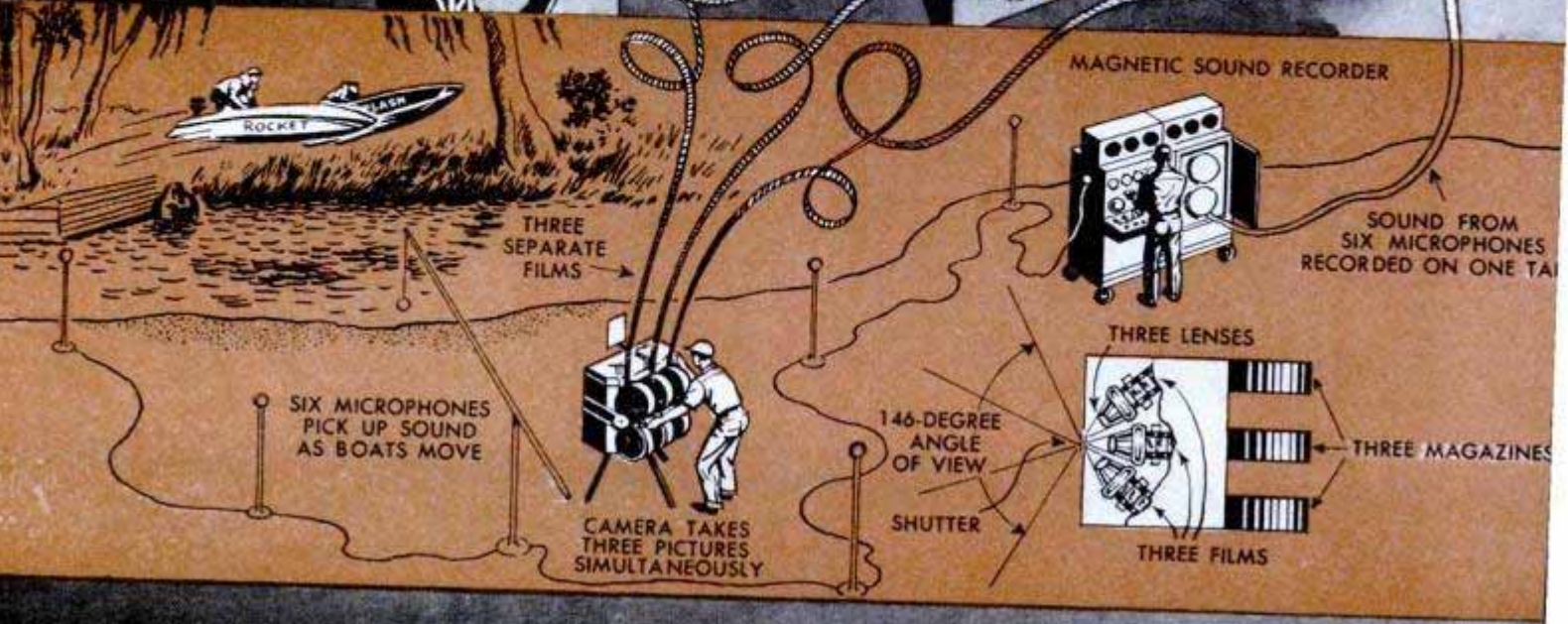
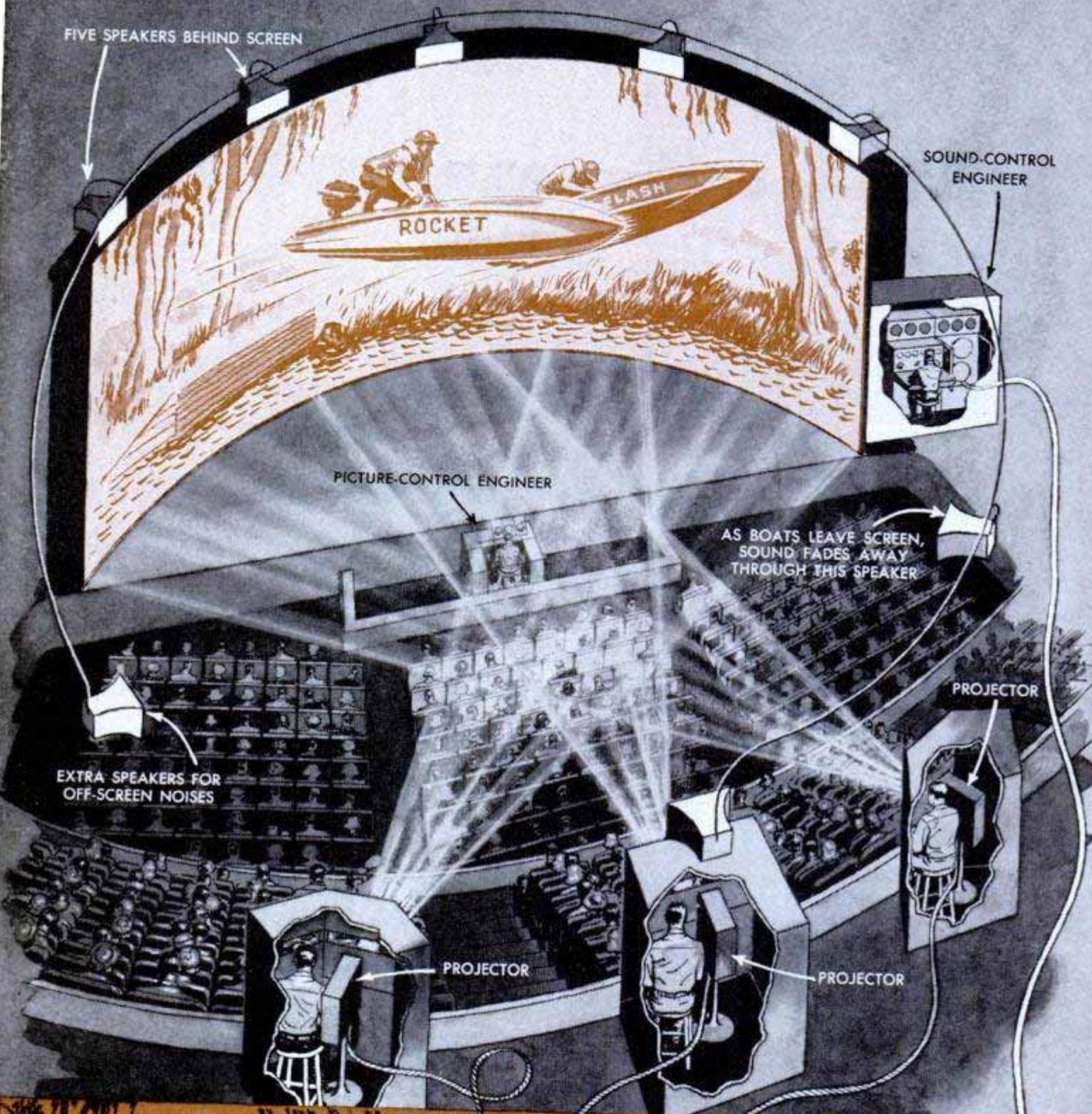

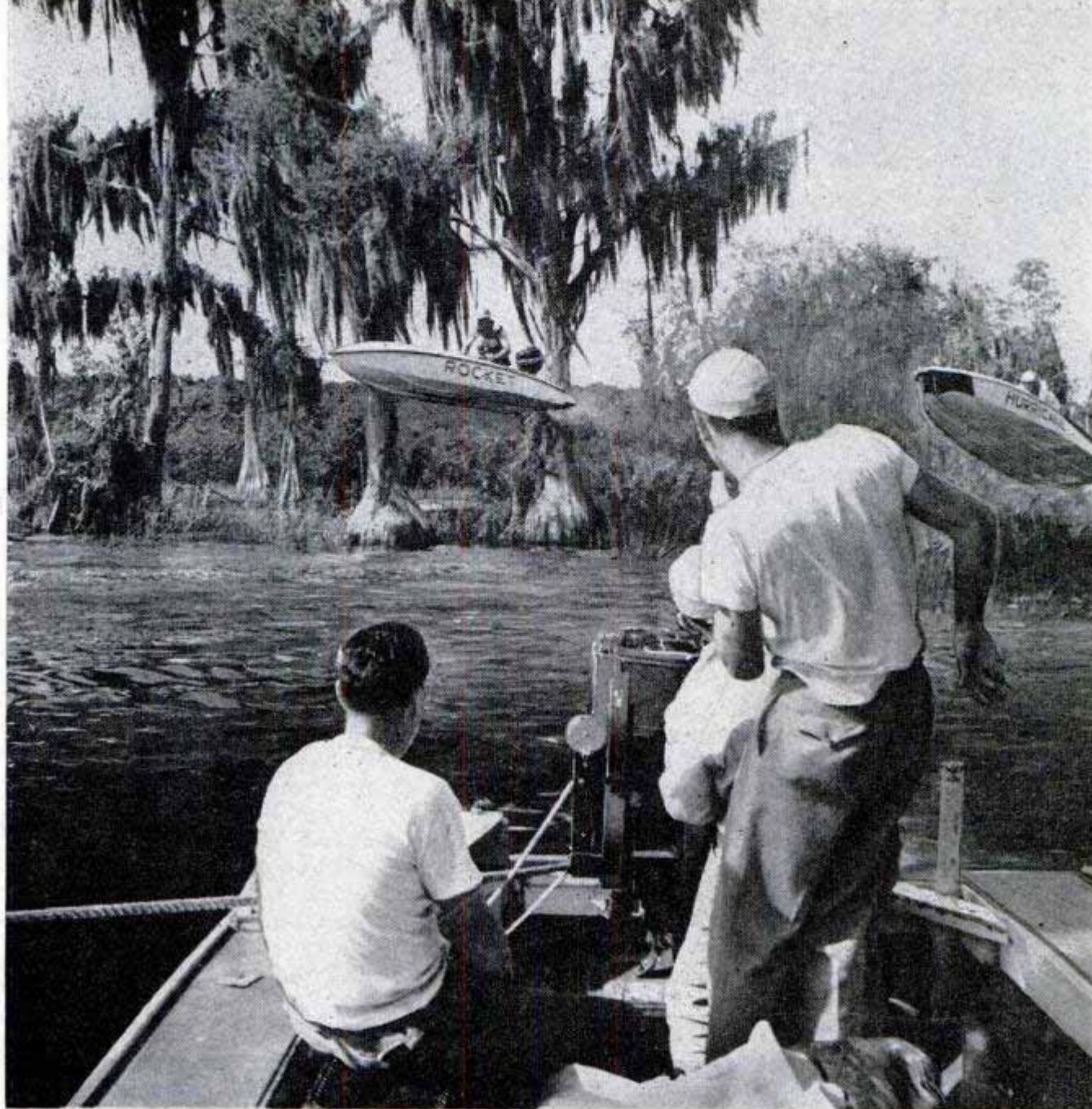

Cinerama camera, foreground, photographs flying boats at famed Cypress Gardens with startling realism

Movies on a Curved Screen Wrap You in Action

By Richard F. Dempewolff

IMAGINE WALKING into a movie theater and suddenly finding yourself in the middle of a startlingly real battlefield. Guns roar on all sides. Tanks thunder along ahead of you. On each side of you, soldiers creep through mud. A machine gun crackles behind you. In the corner of your eye you catch a glimpse of action and turn to see a hand-to-hand encounter so close to your left side you'd swear you could reach

out your hands and touch the combatants.

That's the experience some movie-goers will have this fall. The biggest revolution in motion pictures since the advent of sound will emerge from a laboratory on Long Island, N. Y., where it has been under development for several years. Already two theaters—one in New York, another in London—are equipped for public showings. Equipment for two more is all set for installation. Production films are ready to start rolling. Its developers hope that eventually it will become the movie makers' answer to

♦ These drawings tell the full Cinerama story, from shooting scenes on location to the theater showing



Cypress Gardens photo

To increase the realism, the crew cut a canoe in half and mounted the big camera on a water-level platform

TV. And what an answer it promises to be!

The new movies, called Cinerama, are not stereoscopic. They don't have to be. The huge curved screen, more than three times as wide and half again as high as the standard theater screen, wraps the viewer in the center of the scene. The picture, projected from three booths, encompasses everything a normal person would see with his own eyes if he were standing where the camera was. Result—a three-dimensional illusion created by the viewer's own visual clues. And no one needs to wear the glasses that

are needed for true stereoscopic projection.

To heighten realism, the Reeves Soundcraft Corp., owner of Cinerama, has added stereophonic, or "three dimensional," sound. If a person on the left side of the screen is talking, that's where the voice comes from. A gunshot on the right comes from that side. An airplane approaching from behind the audience roars overhead and its sound follows it as the image reaches the screen and zooms off toward the horizon far in the background.

So real does the picture seem that you're

Rear view of the camera shows the unusual arrangement of reels made necessary by the use of three films

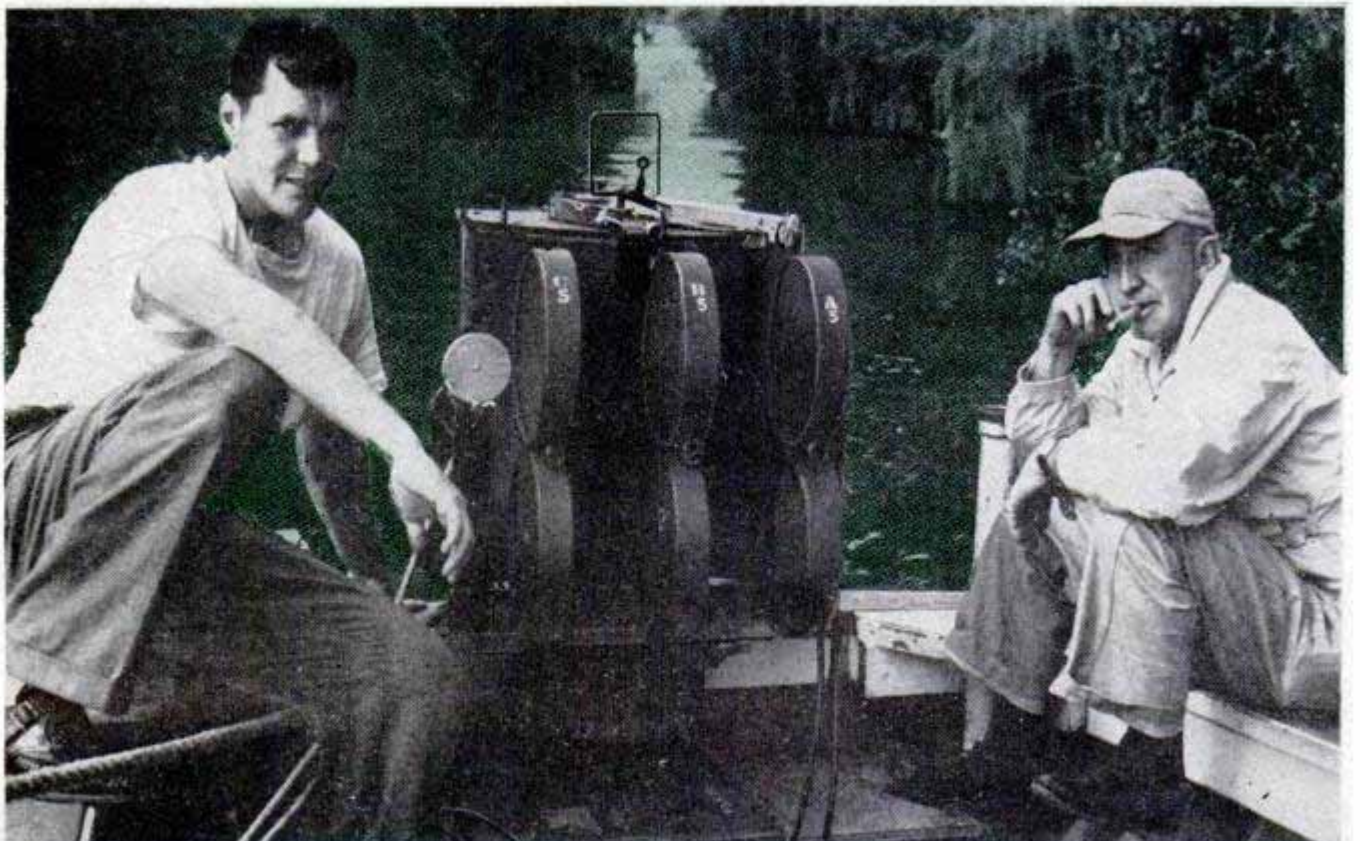

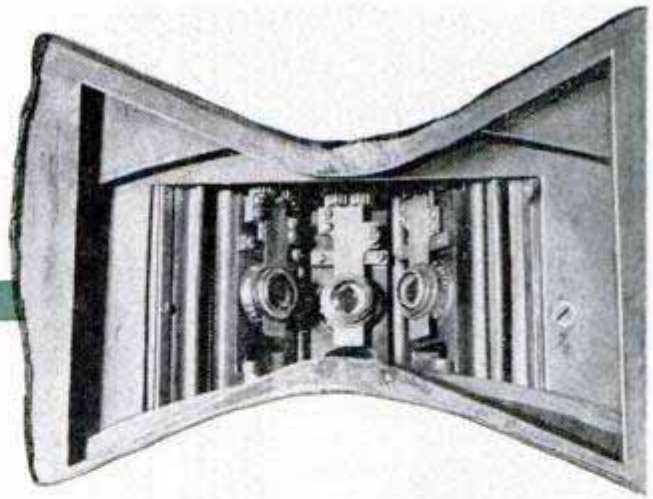
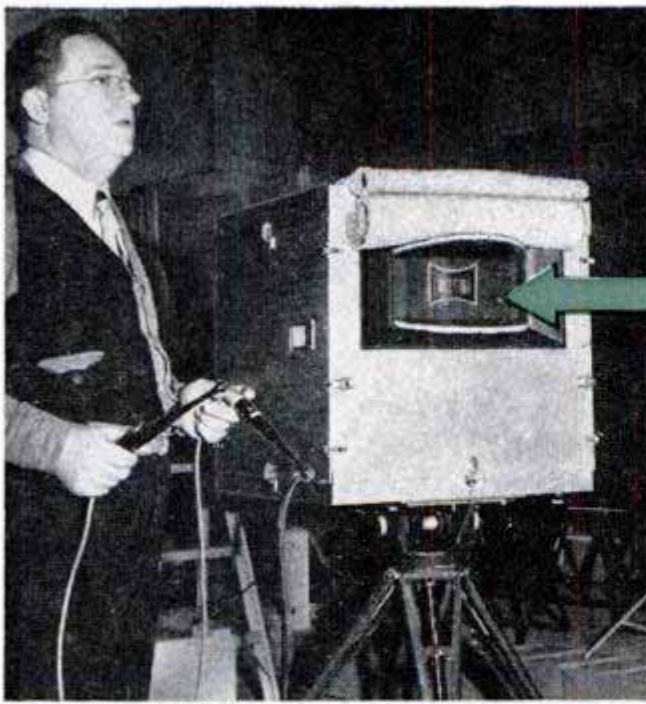

Three lenses look out through the hourglass-shaped slot in the camera front. Each lens covers about a third of the 146-degree angle of "vision." A single shutter is used. It rotates in front of the lenses at the point where their lines of view cross. Thick layers of absorbent material muffle noise from motor chamber

not in a Cinerama show more than a few minutes before you react physically. You are in a boat at Cypress Gardens, Fla., surrounded by tropical flowers and swamp jungle. A wisp of Spanish moss dangles in front of you, so you reach out to swat it aside. You lean sideways to right yourself as the boat tips when someone else steps into it. You duck so you won't smack your head as it carries you under a footbridge.

Across the lake at the boat jumps, racy outboards roar up from behind you, zoom up ramps, fly into the air right in front of you and plunge into the lake again. You duck to avoid the spray that showers toward you. The boats speed off to the left

Stereophonic recording unit puts the sounds from six individual microphones on a six-track magnetic tape



of the screen and the sound follows them.

Cinerama is the result of 15 years of research and the expenditure of millions of dollars. Its inventor, Fred Waller, is a mechanical and photographic wizard. He's the father of the first photographic printer and timer, which, incidentally, is still being used. He created a still camera to take a 360-degree picture and a remote-recording wind-direction-and-velocity indicator.

Most famous of Waller's inventions is an aerial-gunnery trainer used by the Navy in World War II. In it, the trainee sat beneath a domelike hood, or sky screen, on which five synchronized projectors threw movies of enemy planes that dove on the

During projection, a picture-control engineer keeps the three films synchronized by watching three disks





When viewed by the audience, the 1100 overlapping strips of the Cinerama screen look solid, but from an angle you can actually see through it. Below, the sounds are recorded by six tracks on a single tape



gunner every which way. The trainer was a step along the road to Cinerama but the theory behind it dates back to Waller's early days in his father's commercial-photography shop in New York City. "Even then," he says, "I had a hunch that three-dimensional photography was possible without stereoptic gadgets."

Later, as head of Paramount's trick-film department, Waller began to use wide-angle lenses for special effects. "I noticed that they produced a faint three-dimensional effect," he says, "and figured it was a clue." He began to study sight in people to find out why they saw the things they did. He hung flaps over the peak of a cap and experimented to see how far he could see to each side. It was quite a bit. He walked around with one eye patched to see if he still had vision in depth. He did.

"I learned," he reveals, "that sight depends on experience; the eye lens paints a crude picture on the retina and the brain fills in details that it knows from experience should be there."

Stereovision, Waller explains, is largely fiction. For most persons it exists in an area of only $1\frac{1}{2}$ degrees and for a distance of a mere 20 feet. One-eyed people, of course, have none. And yet they get what they think is three-dimensional sight. They drive cars and gauge distances as well as anyone. How? "By scores of visual clues that tell their brains what to see," Waller says. "One object overlays another and tells them it's nearer; moving objects increase and decrease in size; angle parallax and a host of other things tip them off to what they should see."

Waller figured that if he could devise cameras and projectors to duplicate peripheral vision (the entire field of a pair of human eyes), the human brain would do the rest since most of the visual clues by which people place themselves and the objects around them in space would be there. Anyone looking at such a picture would feel he was standing in the middle of a real scene. He would be the camera.

The inventor's first attempts to make such a camera looked mighty odd. One had seven lenses. It took a wide picture, all right, but the projected image was distorted on a standard screen.

"Then," says the inventor, "a New York World's Fair exhibitor asked me to make him a projected-picture display inside a sphere, just to be different. He barely mentioned it when I knew I had the answer to my environmental movies. I'd been using flat screens only because I was so accustomed to them. Obviously, a person sees a curved view in real life."

Sure enough, the World's Fair exhibit

(Continued to page 234)

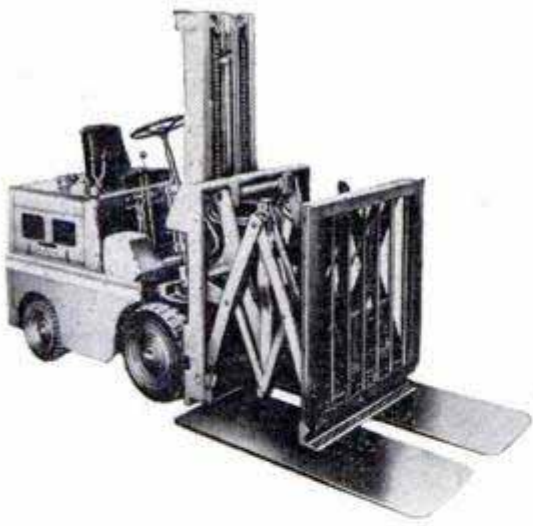

Lift-Truck Attachment Eliminates Pallets

Conventional pallets aren't needed when a new attachment is used on gas or electric lift trucks. Loads are handled on inexpensive cardboard sheets. When the truck approaches the load, a rack moves forward. It works like a pair of tongs—a jaw on the

rack opens and grips one edge of the cardboard sheet; then as the rack retracts, the load is drawn onto the carrying plate. When the load is to be discharged, the rack simply moves forward to shove it off the plate.

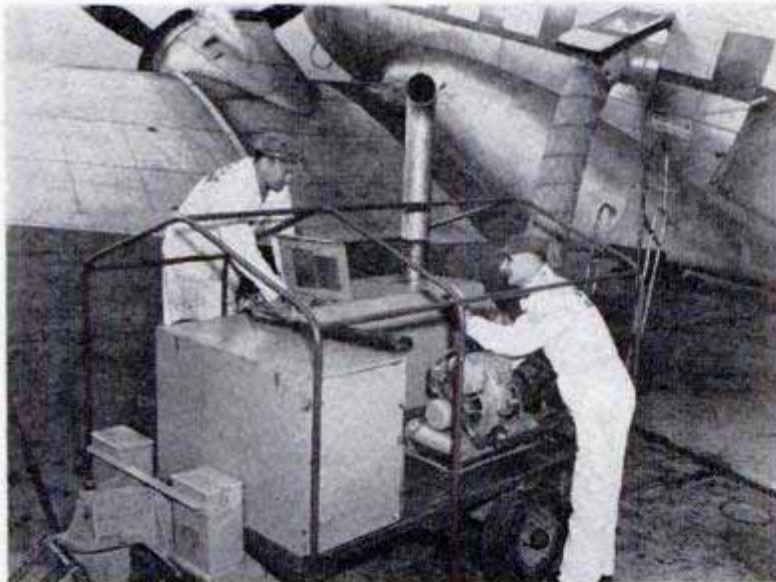

U. S. Air Force photo

Homemade Hot-Air Unit Warms Hospital Planes

Korean battle casualties are kept warm during stopovers on their airborne way to U. S. hospitals by a novel homemade heater. An airplane's heating system stops working when its engines are turned off. The mobile unit, designed and built by M/Sgt. J. J. Zaludek and Sgt. William Janton of Andrews Air Force Base, was made largely from scrap. Heat is blown into parked aircraft through an accordion-type canvas duct fitted with a metal shield that is inserted in one of the plane's windows.

Sportsman's Chair Cooks Meals

Although Glenn F. Butler of Detroit, Mich., always enjoyed duck hunting and ice fishing, he suffered from the cold weather. To warm him on his expeditions he developed an aluminum chair with a heating unit beneath the seat. The chair weighs 17 pounds and can be strapped to the sportsman's back. The legs are constructed to serve as runners on the ice. One heating unit warms the chair—and the sitter—in cold weather but Butler adds additional units inside the seat to cook his meals, heat his tent and dry his clothing. The chair is fueled with alcohol. A baffle between the heat source and the surface of the seat toasts his sandwiches while he sits. Soup can be warmed simultaneously in the heating compartment.





Two-Piece Boat

Joined by a hinge amidships on each side, a two-piece plywood rowboat is helping Army Engineers in their flood-control work. Each half is about 10 feet long and can be used alone if necessary. A long pin joins the two sections of hinge. In working over flooded land, the boats often are damaged at the front end. With the two-part boat, the passengers can move into the undamaged stern, unhinge the other and abandon it. The boat is designed for use with a 20-horsepower motor and will accommodate six persons.

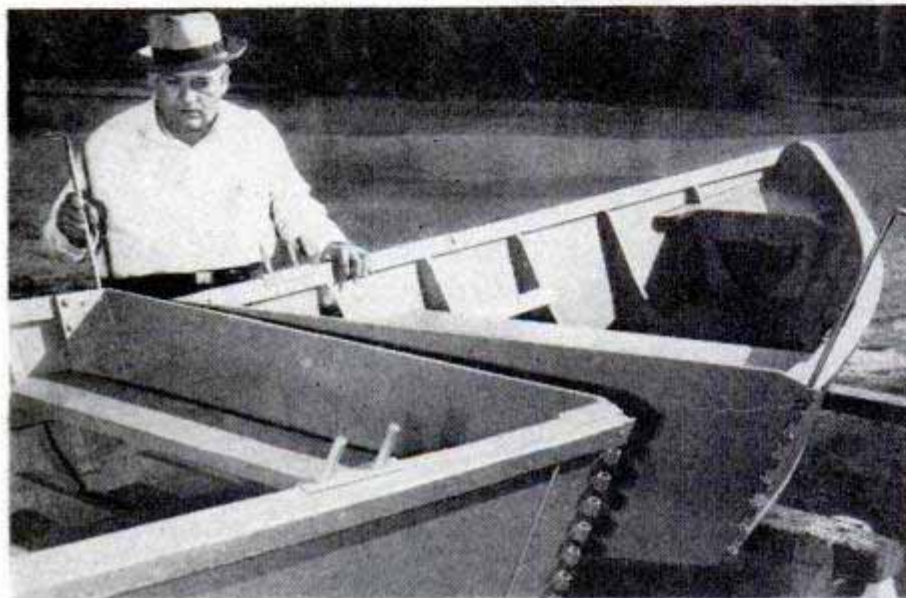

Safety-Belt Release To Aid Pilots

Seconds after a pilot and his seat are ejected from an airplane, a new device automatically unfastens his safety belt. A cord attached to the floor is pulled and sets off a small powder charge after five seconds' delay. The exploding powder automatically opens the belt.

Rail Midget and Giant

When General Electric finished two powerful electric freight locomotives for the Pennsylvania Railroad, it rolled out one of its midget engines for comparison. The small locomotive will haul ore far beneath the earth in a mine. A battery supplies it with five horsepower. The new giant engine will barrel along on the surface, its 2500 horsepower pulling a long freight train at 65 miles an hour. In comparison, top speed of the mine locomotive is only four miles an hour.

¶ Converting hypo salts into a chemically different compound that can be rinsed out of paper and emulsion quickly, a new photographic chemical developed by Brown-Forman Industries cuts print-washing time and water consumption as much as 80 percent.



Army Helicopters Flown Across Pacific

When H-19 helicopters were needed in Korea, the Air Force knew how to get them there in a hurry—fly them! But the copters were passengers this time as they were stripped down and packed into a C-124 Globemaster aircraft. The loading was done at Westover Field, Mass.

Mica-Flake Insulation Adapts to Fine Work

Sheets and tapes made of mica flakes are available as thin as .006 inch for electrical insulation. They can be impregnated with resins and bonded to paper, glass or cloth. Resulting from a new General Electric process which generates a force within the flakes that holds them together, a more uniform thickness and the absence of voids give the new product better dielectric strength than present machine and hand-laid mica insulation.

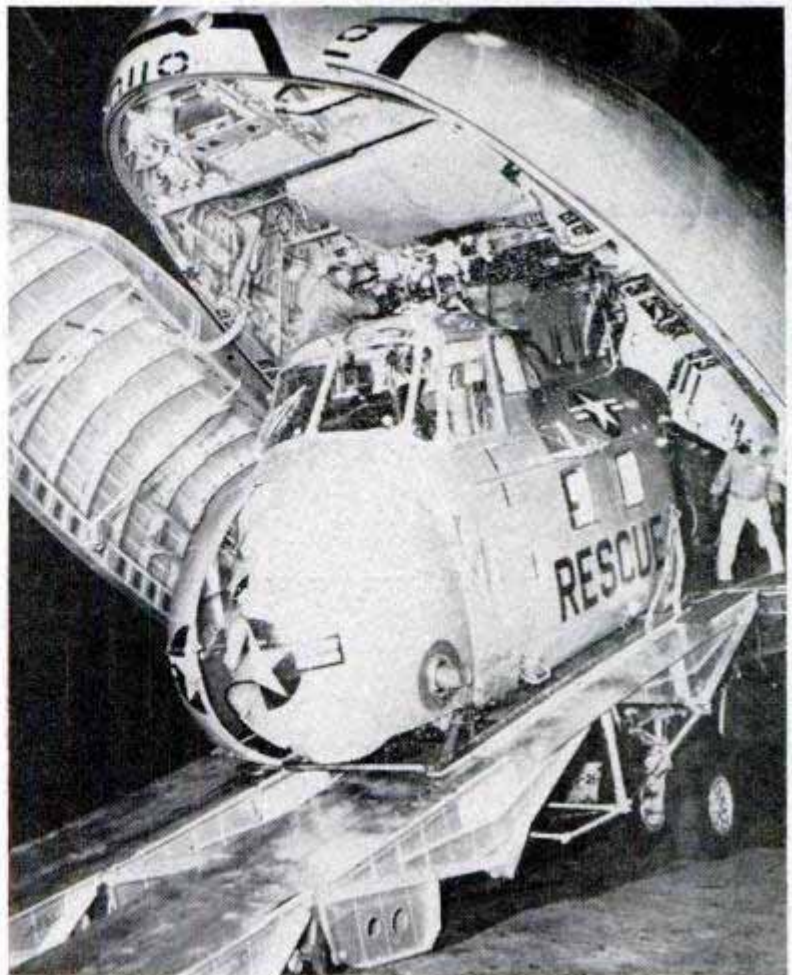

G. E. Develops Lightweight Motor With Aluminum and Nylon

Pound for pound, a new lightweight electric motor will do about twice as much useful work as existing motors of the same type. The new fractional-horsepower motor, developed by General Electric, will power motorized tools, oil burners, office

appliances, farm and dairy equipment, pumps, blowers and other types of equipment. Weight is saved by a reduction in size, by the use of aluminum in structural parts and by more effective ventilation. Nylon is used in the insulation system.

U. S. Marine Corps photo



Two-Piece Bird Startles Soldiers

United Nations infantrymen did a double take when they saw what appeared to be a giant bird soaring through the air with its prey clutched underneath. A second look showed it to be a Marine helicopter carrying the fuselage of another helicopter at the end of a cargo hook. The fuselage was being salvaged from a near-by crash landing in which no one had been injured.

Sources of supply for available products described in this issue are listed in the index, which starts on page 12. Sources of further information on other articles in the magazine are listed in the WHERE-TO-FIND-IT LIST, which is available without charge from the Bureau of Information, *Popular Mechanics Magazine*, 200 E. Ontario St., Chicago 11



Can Hometown, U.S.A., afford its own TV station? For more than two years, Hoosier pioneers have been proving it can. Writing their own rules, they are showing the nation what happens when . . .

TV

COMES TO THE SMALL TOWN

By Norman Sklarewitz

WHEN THE FCC "defrosted" its ban on TV-station licenses, the first question most of us asked was: "Does our town get a station?" The second question was: "If we do get one, can we afford to run it?"

The first question is easy to answer—the FCC has listed the communities that will get channels. It's the second question that's tough—everybody knows that TV stations cost money, plenty of money, to build and operate. But in Bloomington, Ind. (population: 28,163), there are some electronic pioneers who have been breaking a trail for the industry and proving that TV is not a monopoly of the big cities—and proving it at a profit!

These pioneers operate WTTV, the nation's first small-town television station, one that will be a blueprint for prospective station owners the nation over.

If you think it surprising that this small

Monroe County town has a TV station, then get set for a few more jolts. This past winter, the station moved to new studios and boosted its power to 5000 watts—enough to cover almost one third of the entire state. What's more, its 650-foot antenna is perched atop a 707-foot hill. The combined elevation makes this tower higher than the million-dollar rigs on the Empire State Building!

By most TV standards, WTTV is one of the industry's gray-bearded veterans. Its history goes all the way back to the primeval days of 1948. It was then that a successful electronics manufacturer, Sarkes Tarzian, got interested in the potential of local television.

Tarzian was already closely associated with the manufacturing side of the business. In Bloomington and in several other Midwestern cities, he owned small plants



Above, much equipment in the WTTV control room is "homemade." Man in rear is both production manager and local newscaster

Opposite page, the complete studio during a telecast. At left of camera, announcer does a commercial while a hobby program awaits cue at rear. Right, artist makes cards for use in tomorrow's commercials

where tuner units, selenium rectifiers, air trimmers and tubes were made. He himself had invented and perfected the techniques for mass-producing many of these.

This, plus the fact that "Mr. T." already owned WTTT, a 5000-watt radio station in Bloomington, made his curiosity about video natural. Unlike the situation today, when moneyed backers are scrambling for broadcasting channels, Tarzian had no trouble at all getting a spot on the sparsely settled TV band. At the time, in fact, three channels were available in Indianapolis with no takers.

His inquiries about bringing TV to Bloomington, however, were greeted by every reaction from laughing disbelief to dire warnings. Well-backed network stations were losing thousands of dollars a day in New York and Chicago, he was told. Besides, there was no talent in Monroe County. And where do you get TV cameramen and transmitter engineers? Lastly, someone pointed out that there weren't even any sets around.

These were indeed sound arguments. But they made little impression on Tarzian. He applied for and got channel 10 on the VHF band. Then he buckled down to make a TV station in Bloomington.

First he called in his plant engineers and outlined his ideas to them. Here were practical-minded technicians. When they said they'd back him up, Tarzian was ready to

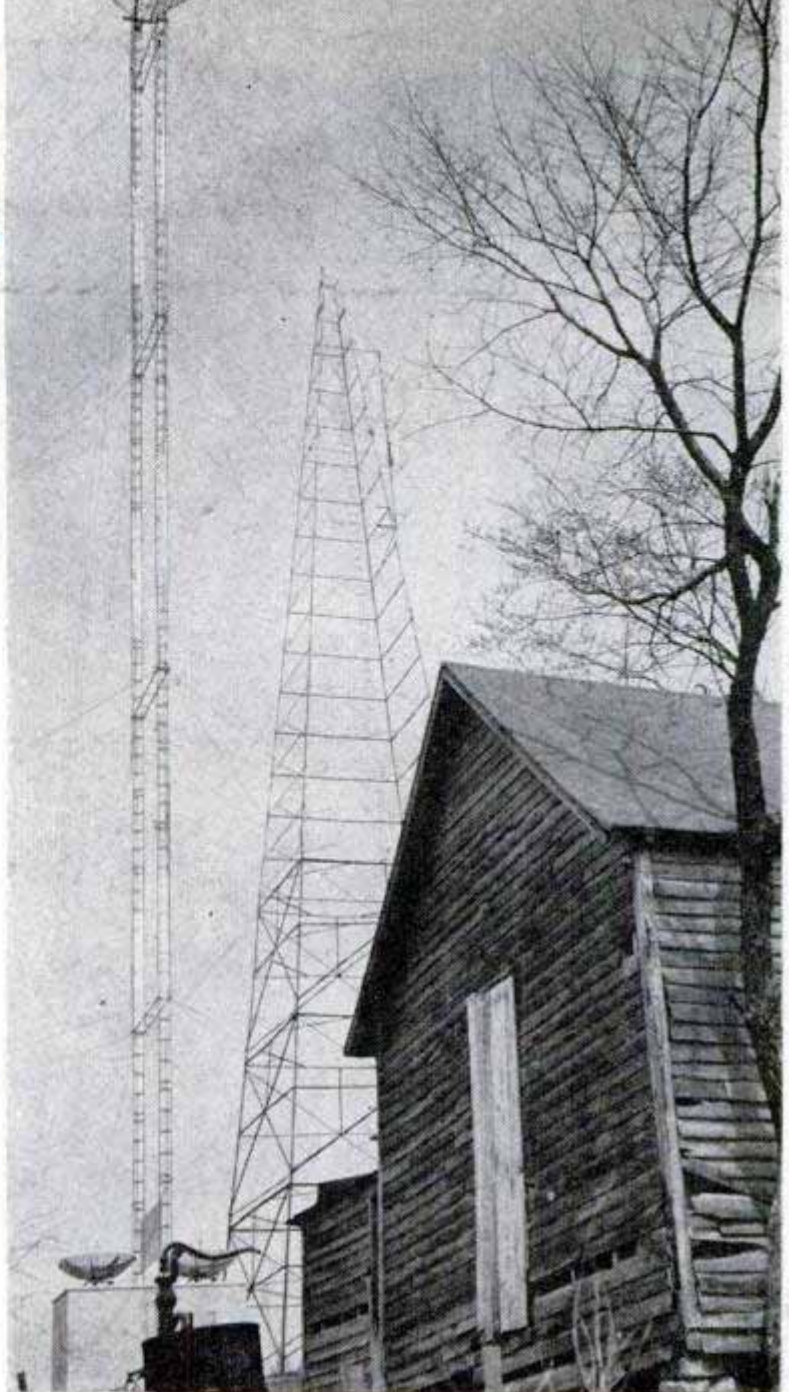

Above, microwave station near Pikes Peak, Ind., relays network shows to Bloomington from Cincinnati (see map below). Tower at left is used. Windmill tower at right was original installation. Transmitter is inside block house under "dishpans" at tower base



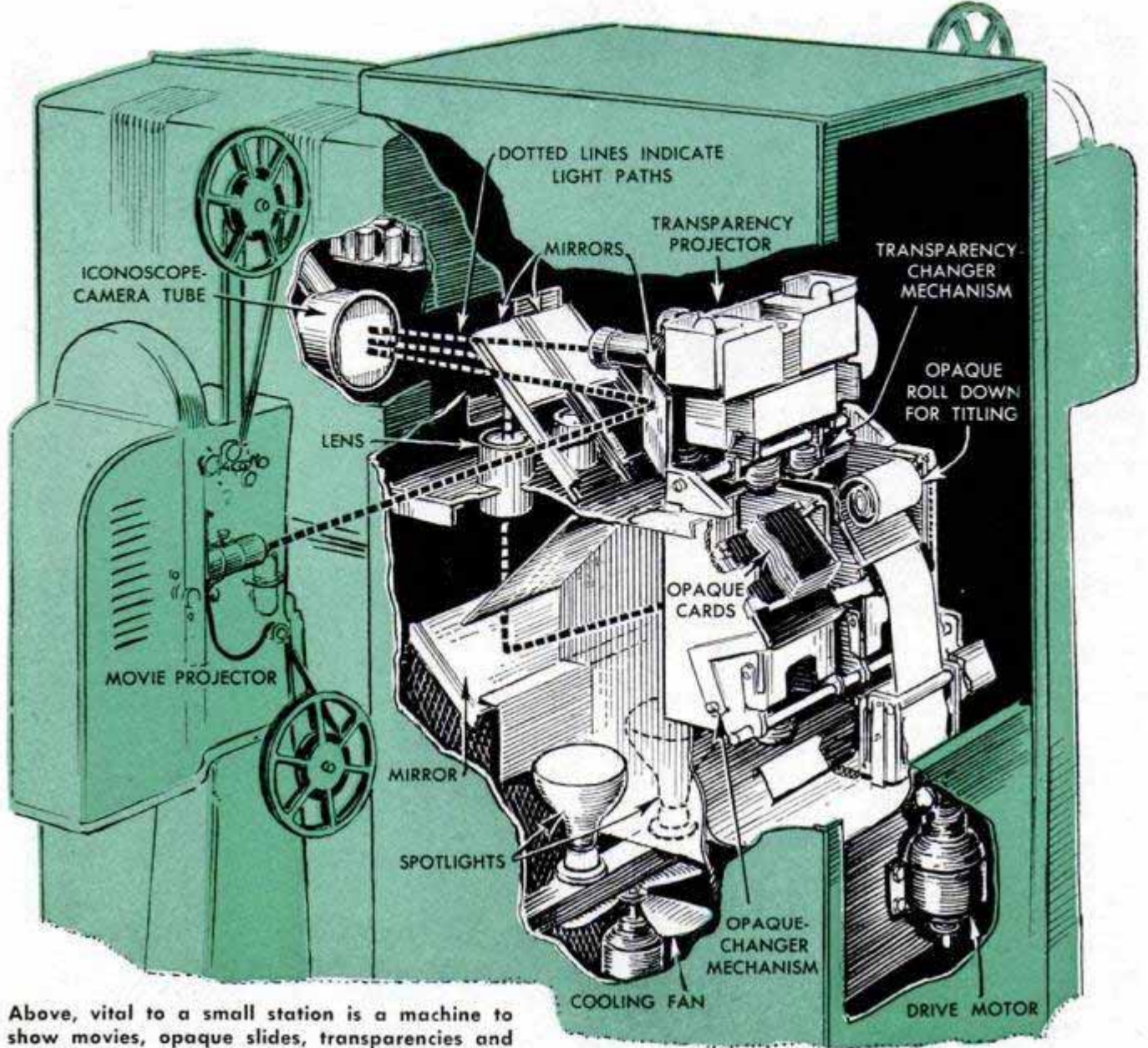

Above, vital to a small station is a machine to show movies, opaque slides, transparencies and title "roll downs" through one iconoscope. Below, the original homemade pickup camera at WTTV



go. An empty drugstore was rented for studio space and to house the transmitter. Then his crew set out to get the electronic gear together that would put this dream on the air.

They immediately discovered there was no such thing as a commercially made channel-10 transmitter. If they wanted one, there was only one way to get it—build it themselves. The engineers huddled briefly and decided to chance it. Mort Weigel, a young 250-pound Hoosier electronics wizard, took over as chief engineer. Soldering irons burned late into the night during the next few months as the transmitter, video monitors, control panels and the antenna were fashioned.

As the back-shop gear took shape, one of the men dropped in to see Tarzian with a studio-equipment catalog. There was one item that stopped them—studio pickup camera. Price tag: \$15,000!

"How much are the parts for the thing?" asked Tarzian.

The technician checked: About \$4000.

"Then go ahead and have some fun; build one of them, too," said the boss.

That soon became a habit. A fancy overhead-microphone boom costs \$500. With scrap pipe and a little ingenuity, the WTTV gang put one together for \$28.30. Bathroom fluorescent fixtures made fine studio lights. And soundproofing? Well, any similarity between papier-mache hamburger cartons and the wall covering at WTTV is strictly no coincidence.

Time was growing near when the transmitter would be ready. That meant the problems of programming and talent had to be met next. This time the answer came from no farther away than the city limits of Bloomington. Like every small town, it had its share of talented young people—singers, dancers, lads with a yen to be announcers or producers.

Marc Williams, a young Bloomington boy, took over as news director; Charles Haines came from the Indiana University art department to be part-time art director; a local truck driver turned up as Uncle Dale, master of ceremonies for *Happy Valley Folks*, a variety show that later pulled a healthy 1200 cards and letters in one week.

From farms and rural-route addresses

Below, the weekly *Hayloft Frolics* is the biggest WTTV production. It even has a man on the mike boom!

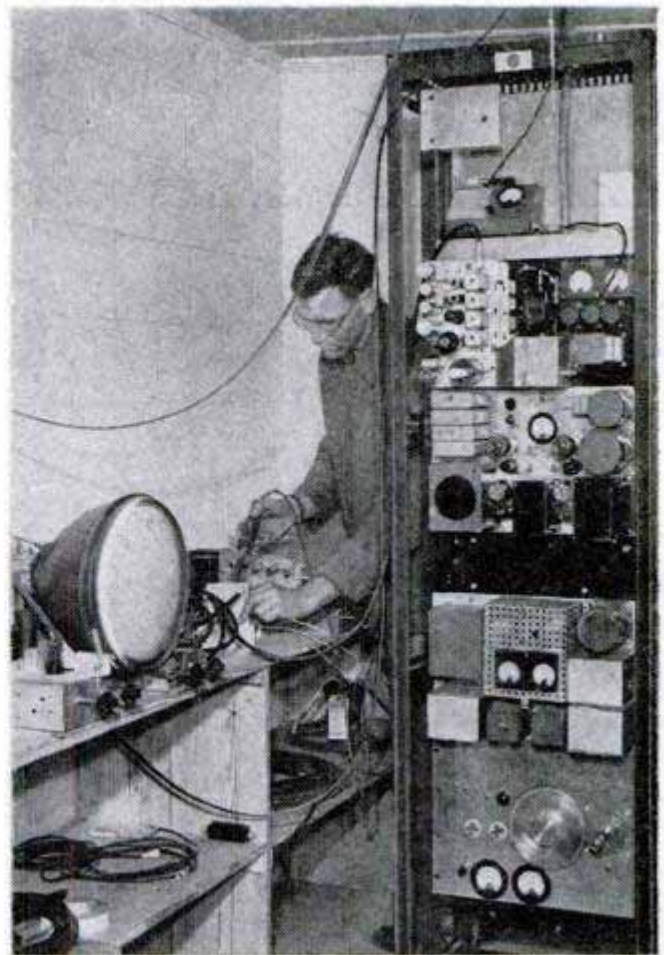

Above, inside one of relay stations. Picture tube at left has been operating 24 hours a day for two years

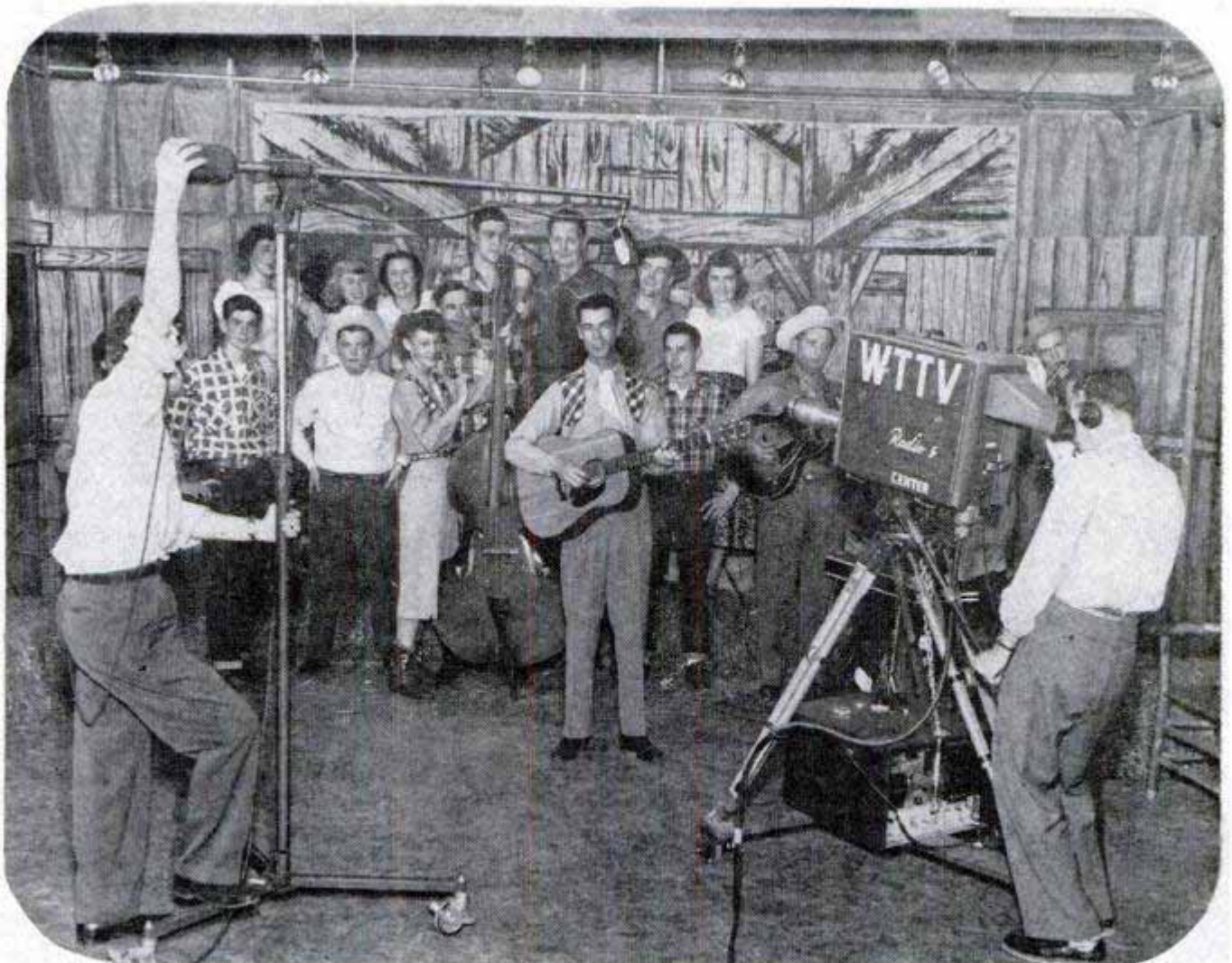

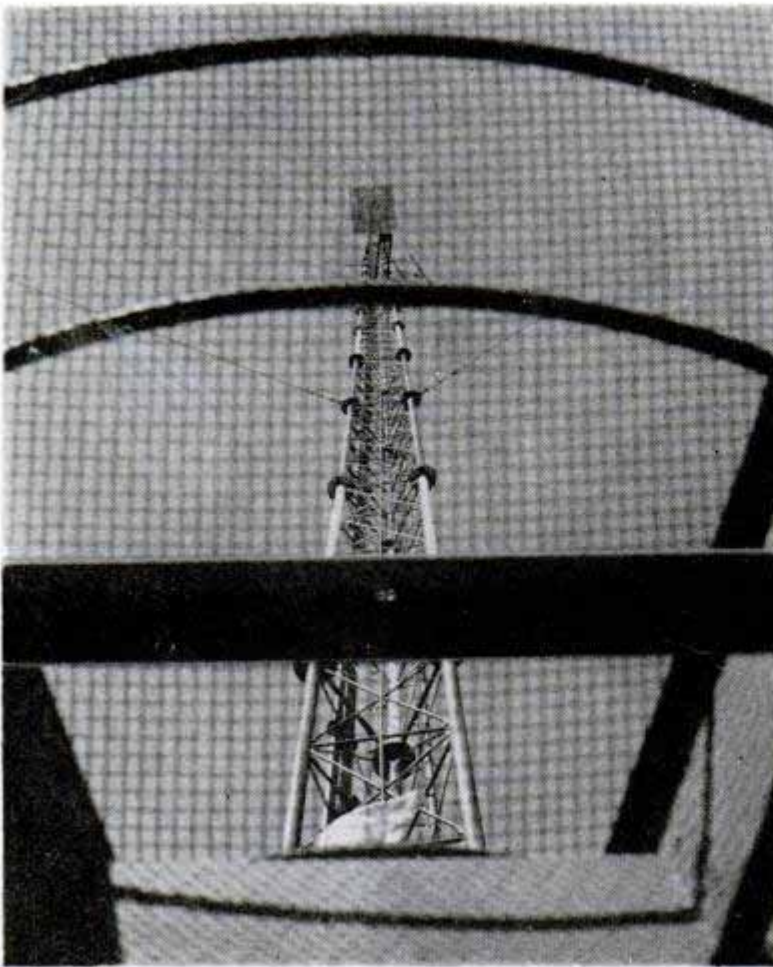

Looking straight up the 650-foot antenna mast. Pattern is made by mesh of microwave dishpan antenna at mast base. Square object on tower is reflector that sends microwave signal down to dishpan. WTTV's antenna is atop mast far above reflector

Below, original WTTV transmitter was made under direction of station's chief engineer, shown here at lathe in the studio workshop. Today, the station has a new commercial transmitter

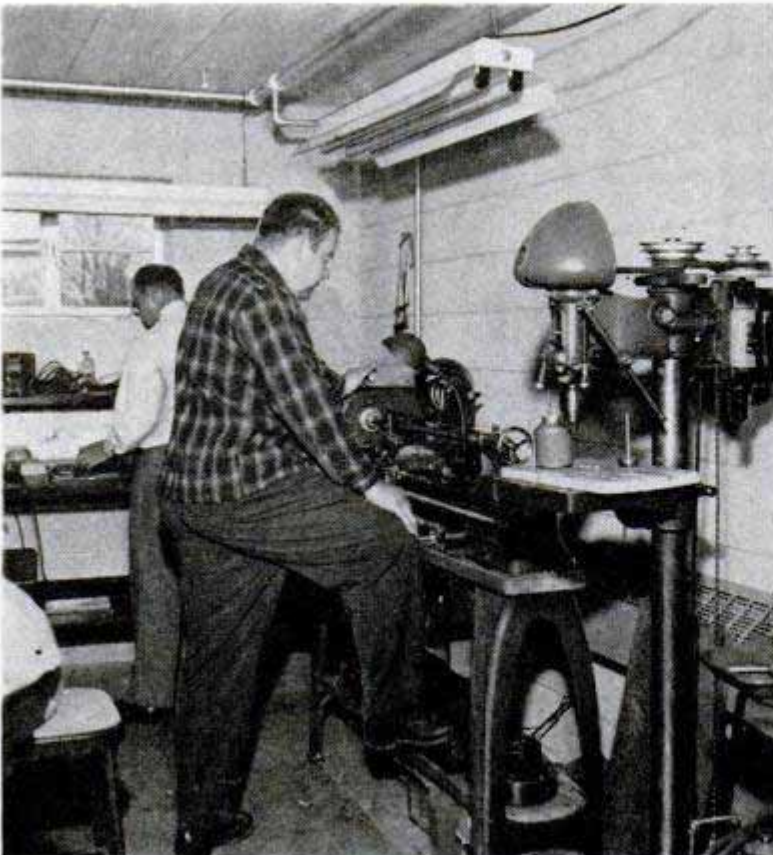

came the copy chief and film director, script writers and producers. Farthest import was 26-year-old Bob Petranoff from Indianapolis, who became program manager.

Finally in November 1949, WTTV went on the air, first broadcasting for only a few hours each evening and then rapidly increasing its programming as technical and creative details were worked out. There were, at one time, only 200 TV sets in that listening area of 90,000 people. These were mostly owned by wealthy families who occasionally could pick up the Indianapolis station. Yet Tarzian had created his station for the benefit of the entire community.

So he bought out entire stocks of sets and loaned them to drugstores, bowling alleys, hospitals and clubrooms. It didn't take long for television to win a place in Bloomington. Today there are over 10,500 TV sets among the city's 14,000 families.

About a year after WTTV started broadcasting, Tarzian thought of the advantages of having network shows on WTTV. There was, of course, no chance of getting a coaxial cable. The answer to this problem was a private system of microwave relay towers that brought in programs of all four networks from Cincinnati.

It wasn't too long before the bustling station and its staff outgrew the original drugstore studios. Once more the Tarzian crew made plans for a new installation.

The new WTTV building is one story high and made of concrete brick. It has one main studio, four offices and separate rooms for studio control, film projection and transmitter operations. Despite its simple layout and inexpensive design, the building is an efficient center for all station operations.

Some of the original improvisations in equipment made when the station was first developed are still in use. The same "homemade" studio pickup camera is supplemented by one other commercial camera. But the same video-control equipment and audio-control gear that put the original station on the air are doing equally well now.

Immediately behind the studio building is the transmitter tower. Its antenna puts out a solid signal

(Continued to page 228)

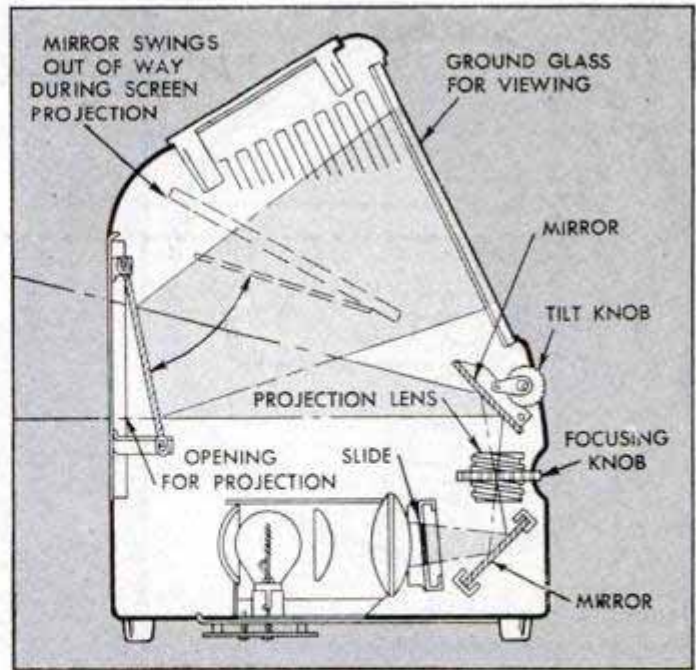
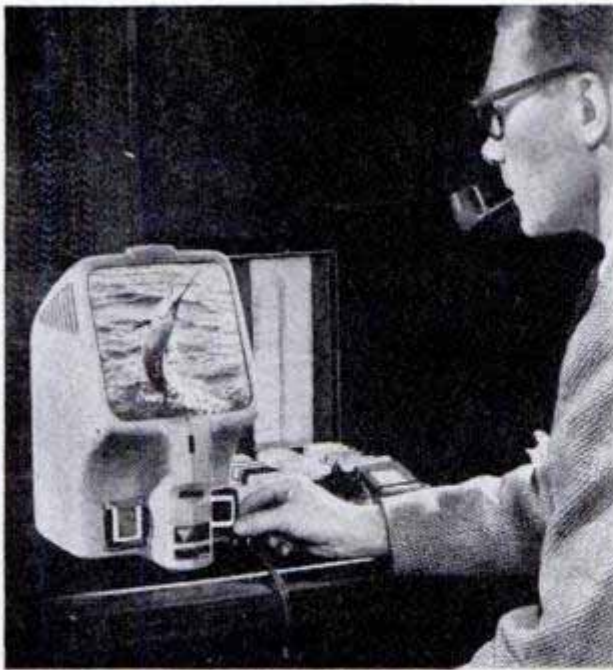

Combination Viewer-Projector Shows Color Slides

Color-slide fans can make one machine do double duty now that a combination viewer-projector has been perfected. The device, designed to take all types of two-by-two-inch slide mounts, throws a clear, bright image on its seven-inch-square view-

ing surface. Simply by changing the position of a mirror in the optical system, you convert the viewer into a projector that fills a 40-inch screen from a distance of only eight feet. It is available in either a convection-cooled or air-cooled model.



Composite Sports Car

Taking parts from 10 different American-made passenger automobiles, Julio Castellano of Tampa, Fla., assembled a sleek sports car. Powered by a highly tuned Mercury engine, the automobile has been clocked at 110 miles per hour. It has an over-all length of 16 feet, is 42 inches high and weighs 2600 pounds. Among 35 entries in an auto show sponsored by the Tampa Sports Car Club, Castellano's hybrid won first place.

Navy Cougar

Top speeds close to 700 miles per hour are expected of the swept-wing Cougar, latest of the Navy's fighting jets. The Navy officially admits it is much faster than the Panther, a straight-wing jet with a top speed of around 650 miles per hour. The new Grumman plane has a ramjet unit hooked to the back end of its Pratt and Whitney turbojet engine which serves as an after burner to supply 40 percent more power on take-off and as much as 100 percent more power at



high speed and altitude. A slotted leading edge on its 33-foot wing permits it to land at speeds that may approximate 120 miles per hour.

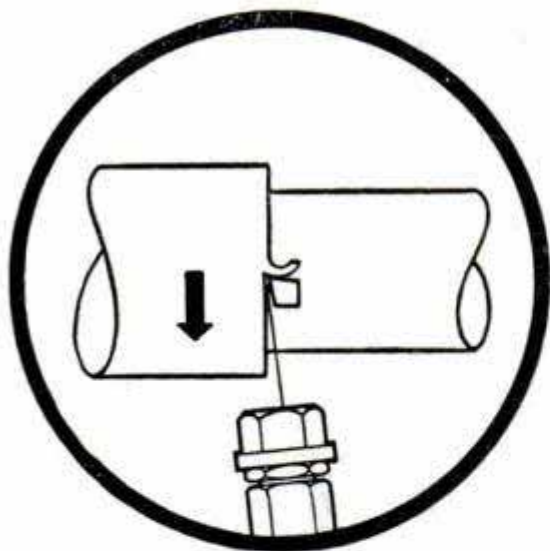
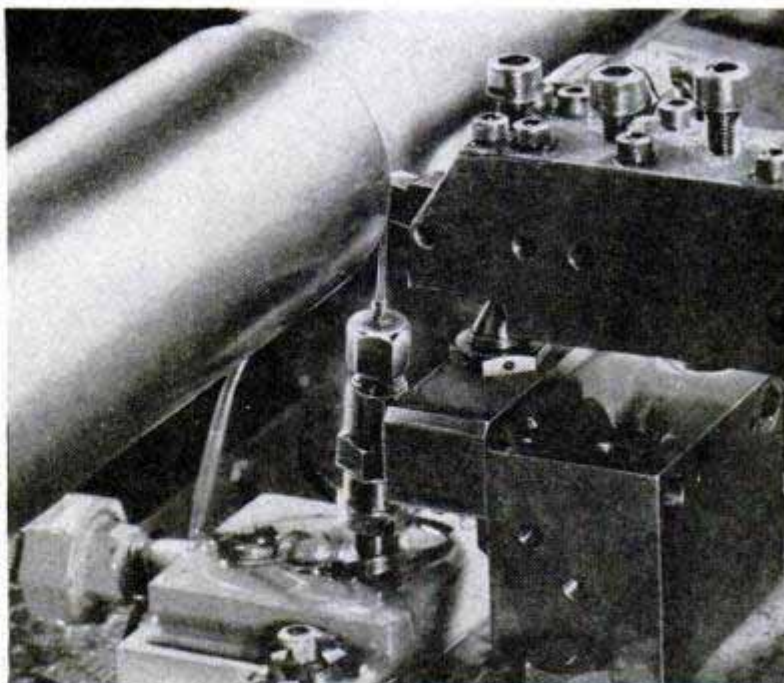

Diagram and photo show how tiny jet of oil is forced between the chip and tool's cutting edge, lubricating the contact point



Upside-Down Oil Jet Improves Metal Cutting

SIMPLY BY changing the direction of a jet of oil, research engineers have developed a new method of lubricating metal-cutting tools. The development may increase the life of the cutting tools 300 to 1200 percent. Developed by the Gulf Oil Corporation, the method uses a high-speed jet of oil directed against the tool from below instead of

Great amount of smoke generated by new method proves that special oil actually reaches edge of tool

above. As the oil strikes the hot edge of the tool it is changed to a vapor which is forced to the actual point of contact between the tool and the work surface. Because more heat is carried away under the new method, more smoke is generated. Shower heads which produce a thin curtain of liquid serve as smoke quenchers.

Smoke is quenched by unique shower head which drops curtain instead of river of liquid around edge

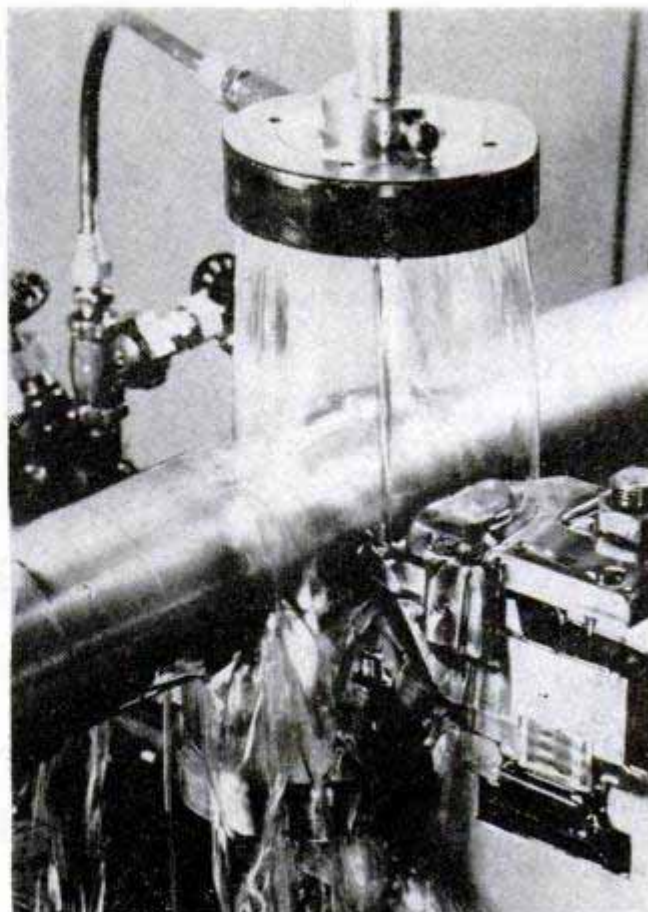
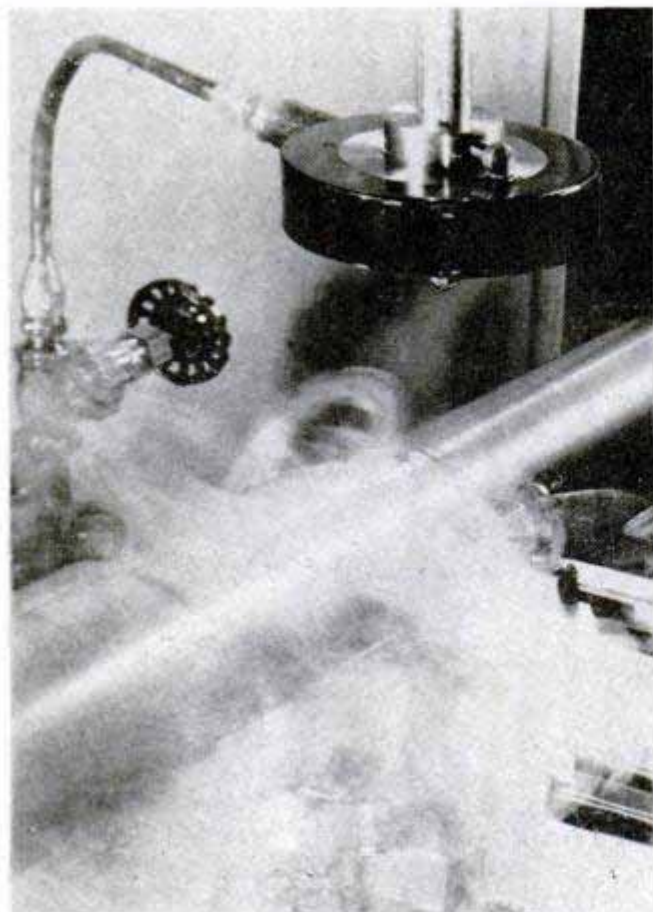

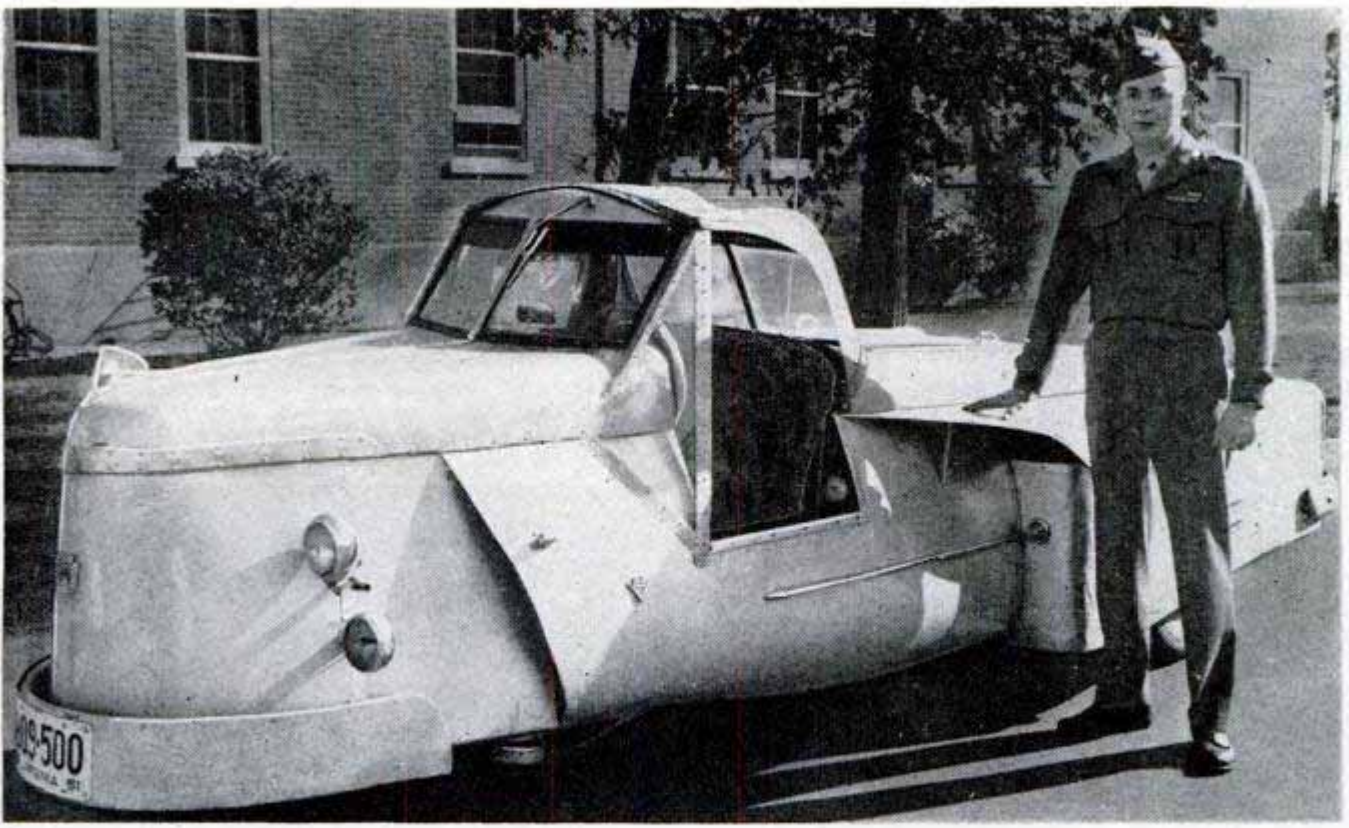

Marine Sergeant Builds Three-Wheeled Roadster

Spare-time effort for four years and \$2000 were expended by Marine Sgt. Roy J. Harris to get a "good, substantial car" embodying his ideas. His creation is a sleek, three-wheeled roadster that does 70 miles an hour with ease and averages about 21 miles to the gallon. Harris, master of five trades, found he needed all of them in building his car. He did all the body styling and metalwork himself, along with the engineering jobs required. The 2600-pound vehicle underwent seven changes in its front-wheel suspension before Harris was satisfied. Powered by a Ford V-8 engine, the

novel automobile has hydraulic brakes, heater, radio and most of the conveniences found in standard models.

Battery-Operated Stethoscope Amplifies Heart Sounds

Heart sounds are amplified greatly by a new battery-operated stethoscope. The device makes audible some sounds that are not heard with conventional instruments. A hand-size plastic housing placed against the body contains an amplifier, two batteries and a switch.

Curved-Hole Drill

Curved holes can now be drilled through steel castings by a hot electric arc. The technique was devised at Westinghouse in order to make possible the recording of internal temperatures at certain places in metals which could not be reached through a single straight hole. The ambling aperture is made by attaching to a standard disintegrating machine a curved, hollow electrode in whose exact radius and shape the hole is to be. A stream of water ejected through the electrode simultaneously with the electric current washes away the molten metal.

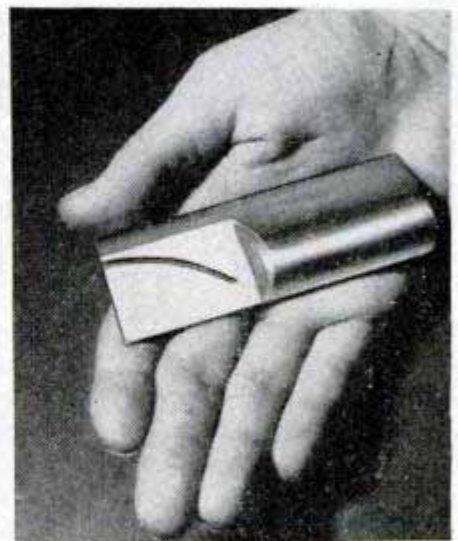
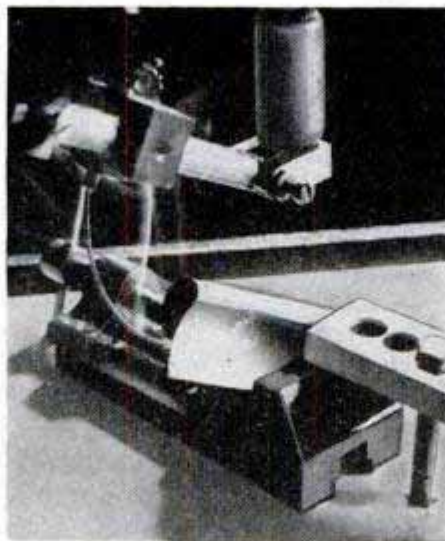

☐ In 1950, according to the latest census figures, homeowners exceeded renters for the first time, occupying about 53 percent of all homes.

Chemists Mix a Powder

To Doctor Ailing Soil



Dr. David Mowry, codiscoverer of Krilium, and the wet-sieving machine that tested 5000 combinations of soil and chemicals. Treated soil is put on sieves and sloshed up and down in water to test its stability

Right, the soil conditioner will control erosion on bare slope. It is dissolved in water and sprayed over the soil along with the grass seed. It forms a plastic film on the surface to keep soil in place until the vegetation takes over

By Arthur R. Railton

WHAT DID RAIN do to your garden last spring? Did it turn the topsoil into an oozy, slick mud that clung to shoes and fingers? Then did the summer's sun bake that same soil into clods so hard you couldn't tell them from rocks?

If so, and if you've about decided to let the back-yard "ranch" run to weeds next year, don't give up yet—relief is here. You can laugh at such problems now. And your laughter is by courtesy of some scientist "farmers" who do their "farming" in a Day-

ton, Ohio, industrial area that sprouts more smokestacks than cornstalks.

These scientists have ripped a page from nature's recipe book, substituted ingredients here and there to increase effectiveness and come up with a product called Krilium, a soil conditioner. It was the first of several new conditioners introduced to the public this year.

It is the claim of Krilium's makers, the Monsanto Chemical Company, that a pound of this concentrated soil conditioner is more

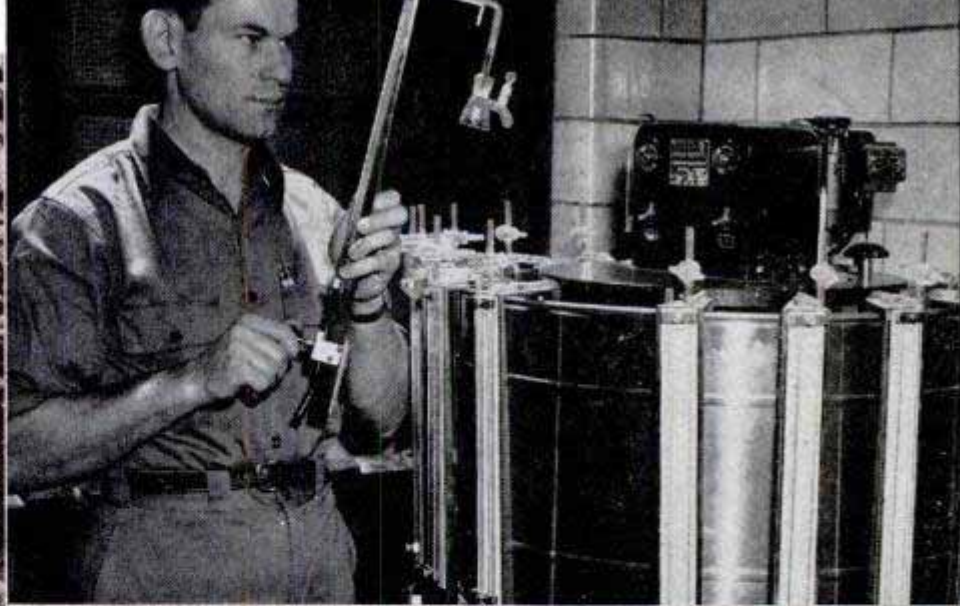

effective than 200 to 500 pounds of nature's stabilizers, such as peat moss. Whether you're a California truck farmer or a window-box gardener in the Bronx, you're a potential user of Krilium.

It is a sweet-smelling, pinkish powder that could conceivably turn muddy rivers into clear streams, useless clay into fertile fields. It's a synthetic soil stabilizer that possibly could enable man to reverse the washing-away process of erosion and to start replenishing the earth's diminishing layer of topsoil. These are some of the big dreams for Krilium. What it can do for you is no dream though—it can make your gardening simpler, easier and more relaxing and at the same time it may boost yields.

Krilium's base is a modified compound of vinyl acetate (commonly used in safety glass) and maleic acid (an ingredient of paints). Other chemical soil conditioners

Top, Dr. Mel Hedrick, the other codiscoverer of the conditioner, reads scale on a Warburg apparatus used in the research. It provides a controlled miniature garden where effects of soil conditioners are studied

are based on a hydrolyzed polyacrylonitrile.

What the soil conditioner does is prevent the waferlike clay particles from slaking down or laminating under the pounding of raindrops by "welding" them into irregular clumps. An analogy can be made between the soil particles and bricks to explain this action. When bricks are dumped on the ground from a truck, they are arranged in a disorderly pile with hundreds of air spaces between them. Krilium-treated soil particles arrange themselves in the same way. When bricks are stacked up neatly by the bricklayer, they take up less space and have no air spaces between them. Untreated clay particles get like that during a



Untreated

Treated



Untreated



Treated

Flowers show more rapid growth in Krilium-treated soil. These are poinsettia plants at three months

pounding rain. When the earth dries, these compacted particles form a hard crust that sheds water like a shingled roof. Plant roots don't get much-needed water. Puny seedlings can't break through the hard crust. Wide cracks appear and through them the lower-level moisture that does exist evaporates more rapidly.

When the soil particles are Krilium-treated, they can't slake down. The chemical forms a bonding agent that makes them cling to each other at haphazard angles,

Hard-crusted soil at left hinders the emergence of radish seedlings while loose treated soil does not

providing thousands of air spaces for the collection and retention of water. These particles are like thousands of subminiature sponges. The soil becomes crumbly and absorbent. When wet it doesn't stick to your fingers or to gardening tools. You can take a handful of the saturated soil and squeeze clear water out of it! When the soil dries, it remains crumbly. Weeding is effortless—at least as effortless as weeding can be. The weeds pull up easily. Cultivation by hand is no longer a back-breaking

Although costly at present, the conditioner is actually a money saver for such specialized users as nurseries

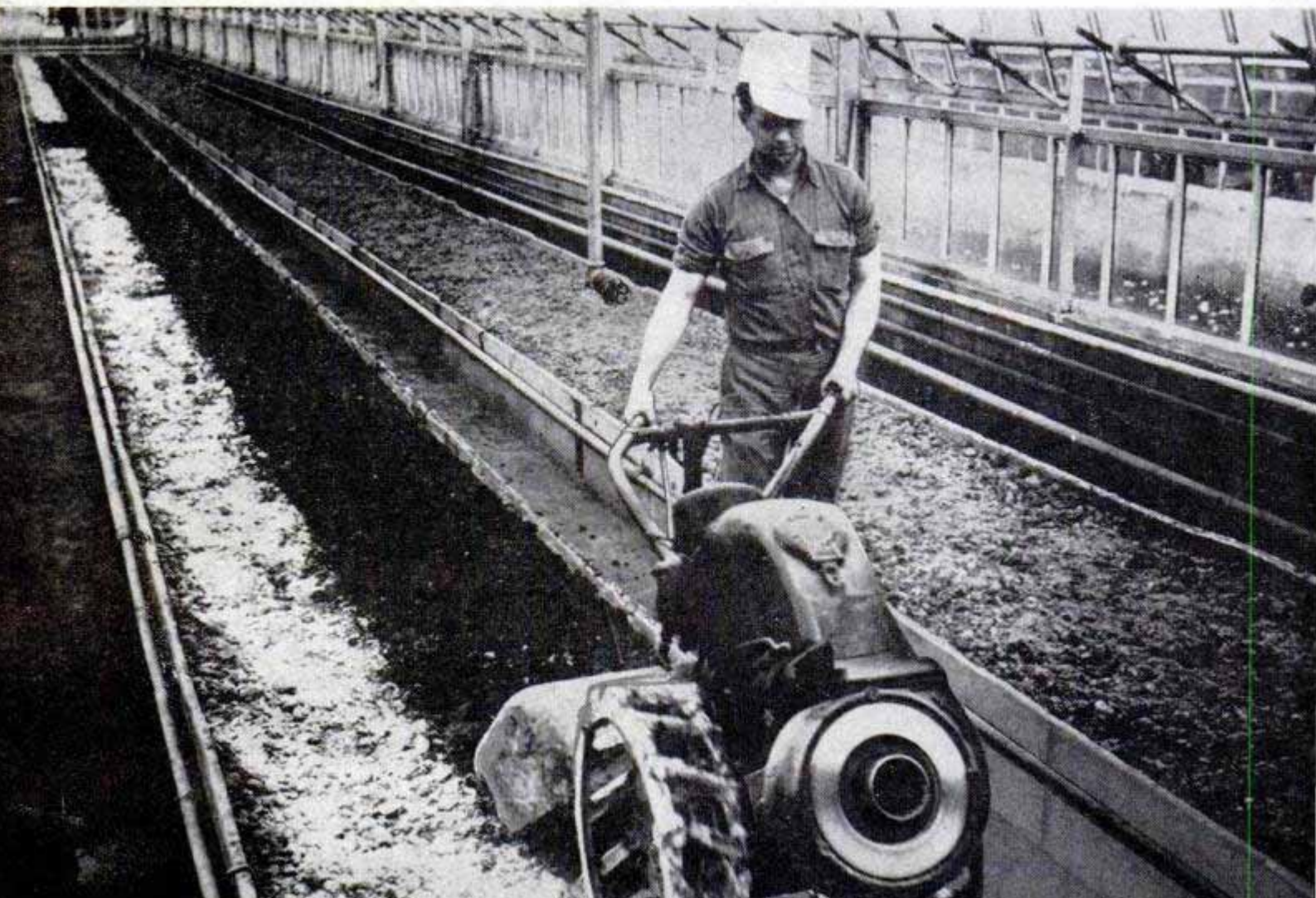



Untreated

Treated

Treated soil can't pack down as at left because the Krilium "threads" tie particles in irregular lumps

chore because the soil turns over easily.

Tiny seedlings can push through the loose soil instead of having to break through a hard crust. There's increased air circulation around the roots. In test after test, these benefits have meant bigger crops and fewer failures. The scientists are quick to add, however, there's absolutely no fertilizer value to Krilium. You have to feed the crops with nutrients as before.

One of the codiscoverers of Krilium, Dr. Mel Hedrick, said in describing the effects of slaked-down soil, "Seeds planted in such soils don't have a chance. The crust not only acts as a barrier to the circulation of air and water necessary for germination, but if a seedling does appear, it will probably break its neck trying to push through the hard crust."

The second scientist in the two-man team responsible for Krilium, Dr. David Mowry, explains that nature has several soil conditioners of her own. These are gums that produce stable aggregation of particles. Such gums are formed by the decomposition of organic materials such as manures, peat moss, compost and humus. But the gums are minor by-products of the decomposition and are not available in quantities. It takes many tons of organic material to produce one ton of these gums. Furthermore, the gums themselves decompose rapidly and have to be renewed frequently.

Krilium makes the work of shoveling and raking tons of these materials unnecessary. It is 100 to 1000 times more effective per pound for aggregation than the organics and its useful life is much longer—test plots show continued effectiveness after more than three years.

Because Krilium takes much of the backache out of back-yard gardening it will be a boon to the hobby gardener.

There's a word of caution to be added here. Krilium makes crops grow better—

but it makes weeds grow better, too. So don't get the idea that the magic chemical will eliminate all work from your rows of lettuce and radishes.

At present, the chemical is not going to appeal much to the farmer with acres of land. It is economically beyond reach because it would cost about \$1000 an acre for the best results. Scientists at Monsanto are studying ways to improve the chemical's effectiveness to cut down its cost. They are also working out cheaper methods of application. Tests are being run on mixing the chemical only in the seed rows instead of over the whole garden. This would provide easy emergence without the expense of full-scale treatment.

But the price is no great obstacle to the back-yard gardener. He can afford to spend \$5 or so to make his garden plot easier to work and more productive. This is not an annual expense—he does it only once and it lasts for a number of years.

Another potential user is the large-scale greenhouse operator, who already has an investment of about \$70,000 to \$200,000 an acre. He has to replace over 50 percent of the soil with natural conditioning materials annually. Both material and labor costs are terrific on such an operation.

Home gardeners will find the chemical excellent for treating the soil in flowerpots and window boxes



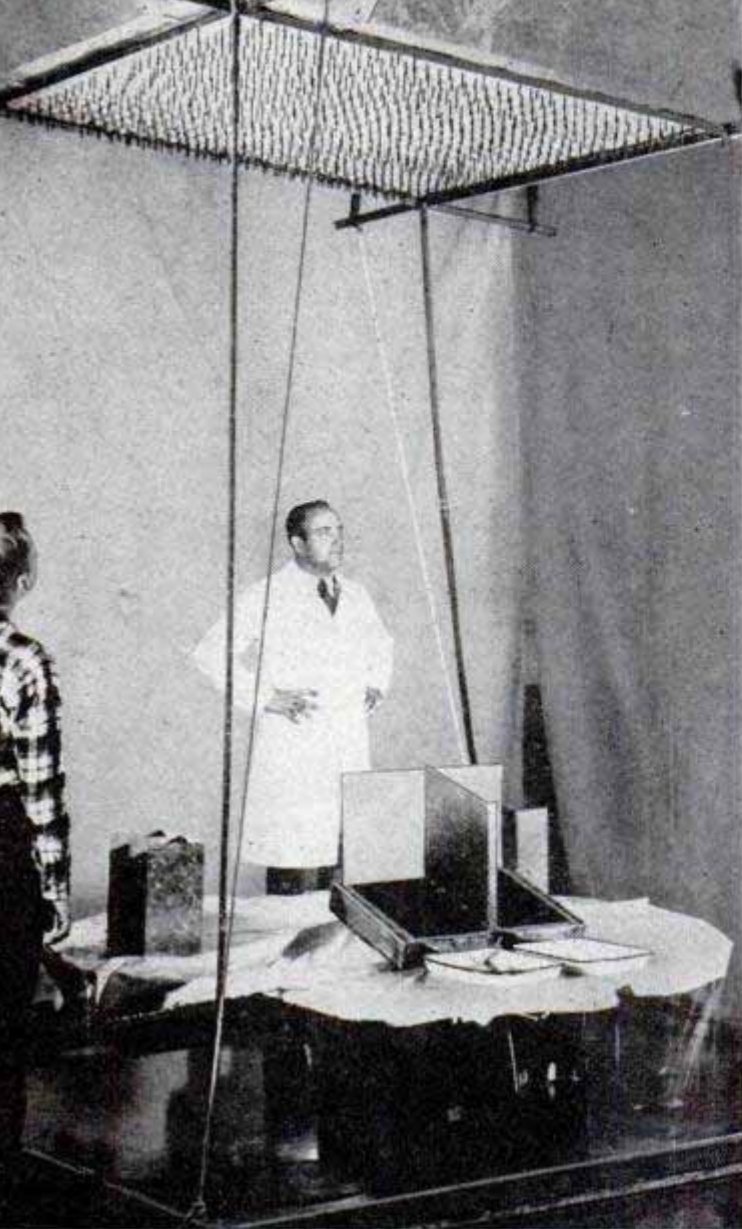

Treated soils were tested under this rain-making machine that duplicates nature's rainfall. Below, soil at left was untreated. Notice the runoff and splatter. Soil in right flat was mixed with Krilium

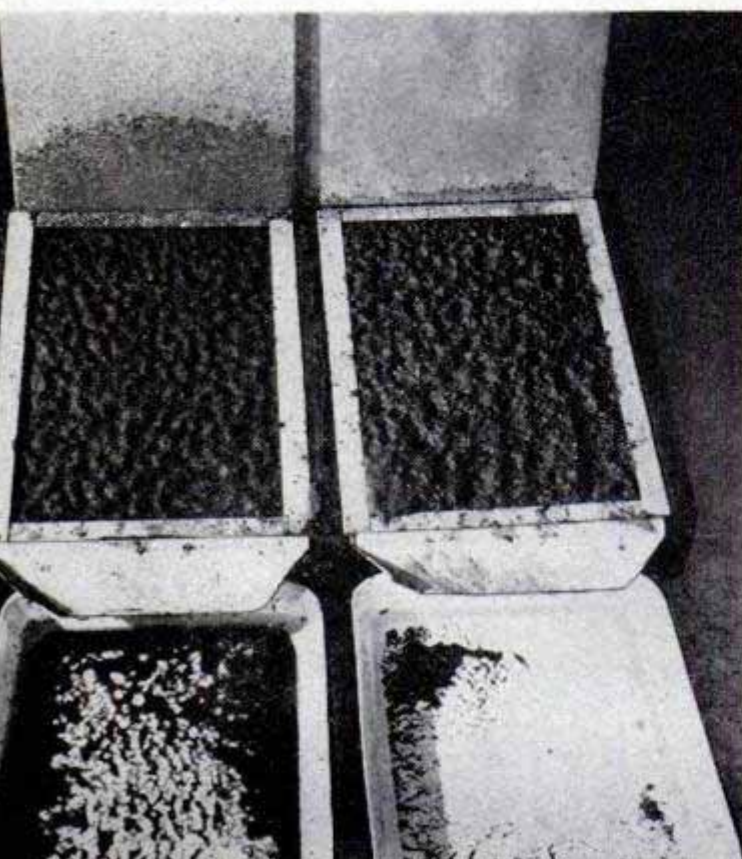

Krilium will do the job cheaper and faster. Then there are farmers who specialize in high-cash crops for canners and quick-freeze plants. They can afford to use the chemical because of the high per-acre return on the land. Other farmers who could increase their profits greatly by getting the crops to market a few weeks early will jump at the chance of using the new soil conditioner. They will be able to work the soil earlier without danger of its freezing up, as it does when worked wet. Krilium-treated soil can be worked when wet because it doesn't compact.

The new chemical may also eliminate much of the crop rotation that is done to improve soil structure.

But the scientists, being the precise persons they are, want it to be made clear that Krilium is no cure-all. It is definitely not a magic material that you sprinkle over the ground and *presto!* you have huge yields without further ado. It won't help your lawn to sprinkle Krilium on top of the sod, for example. Nor will it help to mix it with water and sprinkle it over the grass. The chemical has to be worked into the soil evenly when the soil is dry and to the depth normally reached by the root structure. There's no easy way out.

Krilium also is used to prevent erosion. Mixed with water and grass seed, it is sprayed over steep slopes. The solution forms a plastic coating over the soil which reduces washing away of soil and seed.

In the world of sports, Krilium will make groundkeepers happy. Base paths on baseball diamonds dry out more quickly after rain, smooth over more easily and provide a more dependable surface for bouncing balls. Furthermore, the soil doesn't cling to the cleats of players' shoes.

It may even mean the end of the mudder at the race track! This is probably an exaggeration, but it will make the track surface less soggy during rains and will help it dry out more quickly when the rain stops. Playgrounds, footpaths, barnyards and other areas subject to usage in all kinds of weather will be less muddy when Krilium-treated. Clay tennis courts, if properly treated, can be used almost immediately after a heavy rain.

The scientists who discovered the chemical don't want you to be fooled. Don't expect it to do everything. Remember there are certain soils for which Krilium won't do anything. It works best on clay soils.

It'll make poor soil better and that means more food for the world. Important as that is, Krilium has another merit that will appeal to mothers. As one young mother said after hearing about it: "If it will keep the mud off the kids' shoes this fall, I'll nominate it for a Nobel Peace Prize!" ★ ★ ★



Dual-Tractor Unit Steered by Differential

Using the principle developed for taxiing multiengine aircraft, a New Mexico farmer designed and patented a rig that steers a dual-tractor unit by controlling engine speed. The steering wheel does not turn the wheels at all—it simply increases

and decreases engine speeds in relation to each other. For a left turn, the left-hand tractor throttles down and the right-hand tractor accelerates, thus pivoting the unit around to the left. Swivel-type mountings increase maneuverability.

German Tripod Crane

Handling ships' cargoes at the port of Bremen, Germany, is a strange crane mounted on three stiltlike legs. The crane moves along three tracks on the pier. Its tripod construction allows access to the area directly under the crane, an advantage over conventional cranes. The machine has a carrying capacity of three tons. The glass-enclosed driver's cab projects like a balcony high up on the turret. A further advantage of the three-leg crane over conventional ones with four-point support is that it easily adjusts to slight displacements of the runway. The crane also is lighter in weight and less expensive to operate than ordinary cranes.

☞ America's known reserves of liquid petroleum were increased by 2.7 billion barrels during the last year.

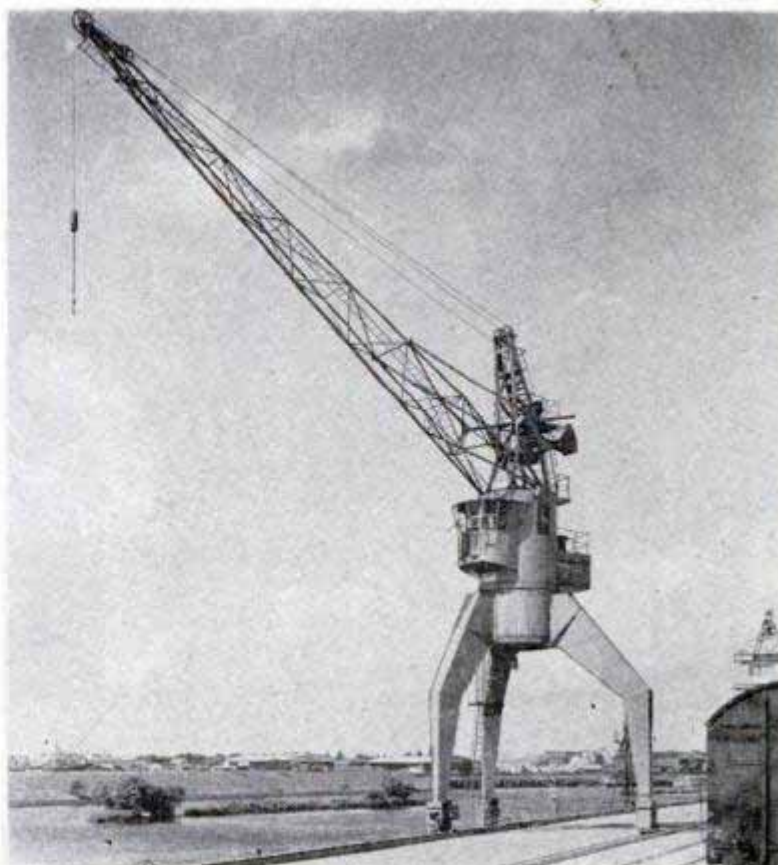



Tool Detects Minute Scratches

Scratches as small as one millionth of an inch are detected by a new portable precision instrument. It was developed to insure accuracy of highly finished surfaces of machined parts. A stylus is fitted to an electronic pickup. When the stylus is drawn across the "peaks" and "valleys" of a machined surface, the microscopic up-and-down motion is transformed into electrical signals which are recorded on a meter dial.

Workshop Accompanies Paris Cabby

Pierre Alidiere, a 60-year-old Paris cabby, isn't one to allow business to interfere with pleasure. Pierre's pleasure—and avocation—is inventing. Installed next to the driver's seat of his old hack is a miniature workshop where he tinkers on new gadgets and inventions and does any odd repair jobs his cab needs. Alidiere has worked up 89 major inventions, many of them patented. On the roof of his taxi is a windmill which drives a 12-volt generator continuously feeding a spare battery used to power the refrigerator, lights and radio when the engine is shut off. He filched the tubing from his wife's aspirator to make a combination speaking tube and loudspeaker through which he can shout warnings at jaywalkers. An old Klaxon horn—protect-



ed by a wire salad basket and located just above the windshield—emerged as a ventilating unit.





Oklahomans Build Oil-Pipe and Sheet-Metal Church

There's a unique story behind a strange structure that rises out of the plains of western Oklahoma. Back in 1947, members of the Hopewell Baptist Church wanted a new building but didn't have enough money to hire architects, carpenters and stonemasons. One member persuaded an instructor and a student in Oklahoma University's department of architecture to turn out plans for the church. Then farmers, roustabouts and pipe-liners of the oil country scoured the countryside for materials, find-

ing many of them in the oil fields. Month after month the men reported for work on the church after completing their own day's work. The completed building is cone-shaped and has a framework made of oil-well pipe. Windowpanes are fashioned from auto plate glass and the interior walls are lined with galvanized sheet iron. The chandelier is handmade from baking tins, pipe, wire and pieces of glass. Though they started from scratch, the members now value their church at \$50,000.

Chilean Power

Water power from the perpetually snow-capped Andes is helping make the industries of Chile independent of imports of oil by producing millions of kilowatts of electricity. The water pours down the mountainsides in large penstocks to spin turbines and generators. Because of the difficult terrain in which the generating stations are located, most of the construction work had to be done with a minimum use of labor-saving machinery.

¶ Columbia University is developing treatments to make textiles resistant to fire through the use, oddly enough, of compounds of phosphorus — the same element used to start fires in match heads and incendiary bombs.

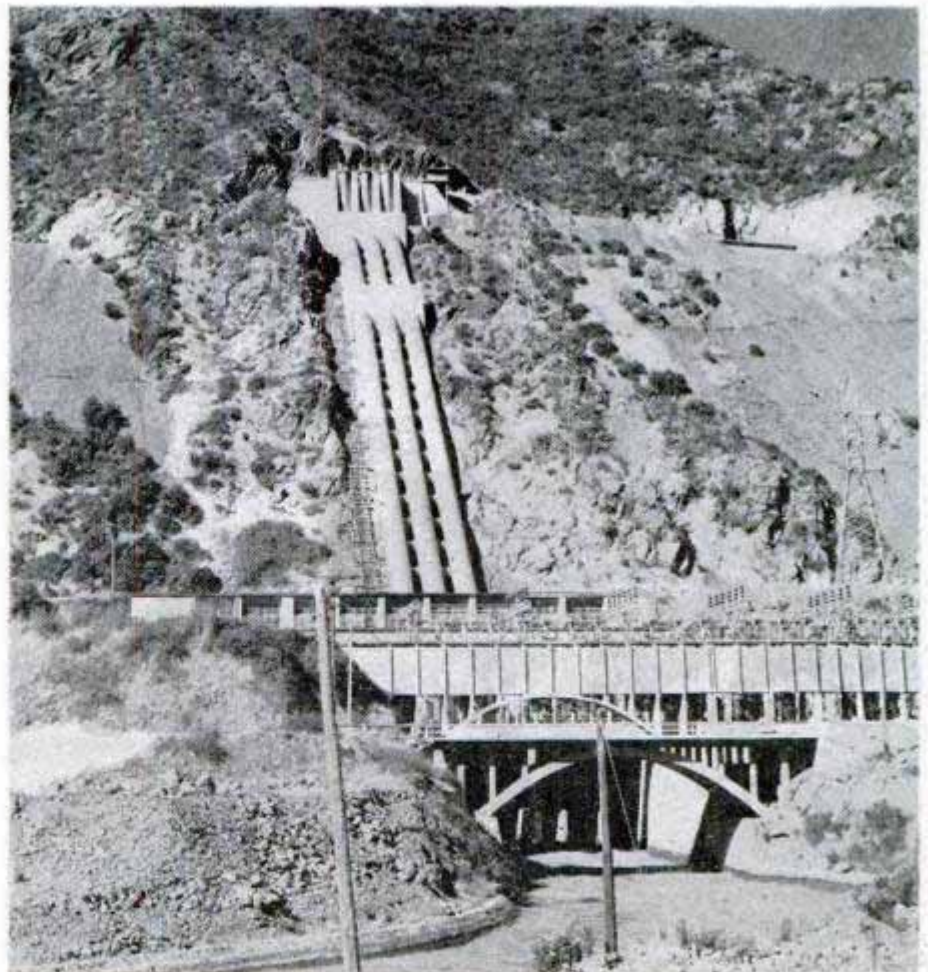

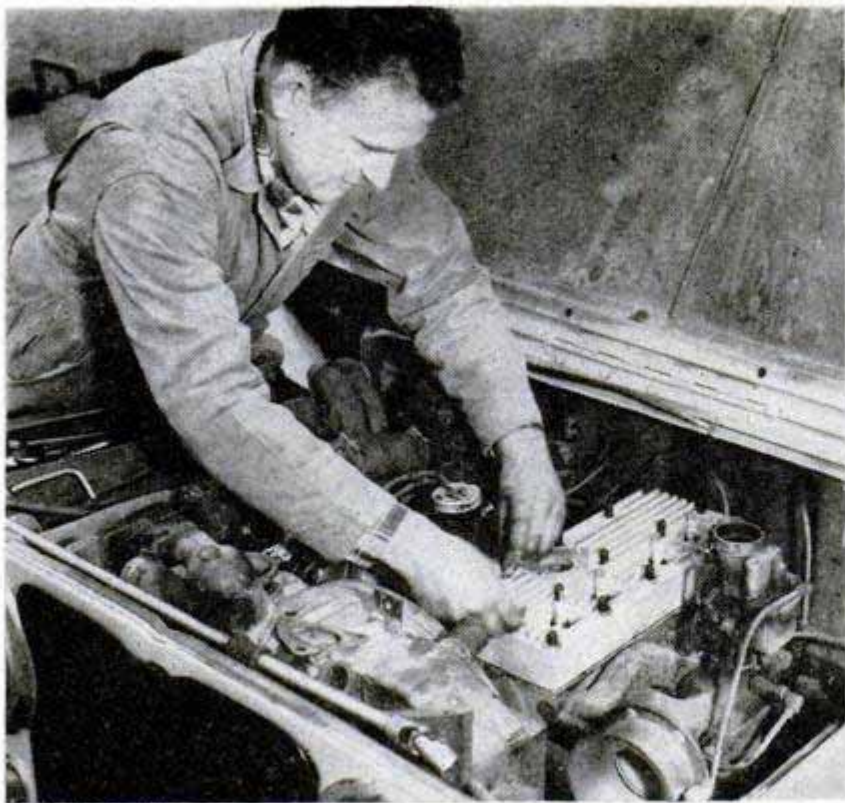

Hot Rod Magazine

Installation of a high-compression head provides the extra power needed for high performance when all eight wheels are used. The same head also fits the engine of a Henry J automobile. Below, the "beefed up" Jeep easily conquers an incline too steep for other cars to climb

Eight-Wheel Jeep Takes Steepest Hills

SPORTSMEN and farmers who attach eight wheels to a standard four-wheel-drive Jeep can climb practically any hill and plow through mud without stalling. The Jeep will storm over the top of the steepest incline like a motorcycle. Steering is not affected materially when the Jeep is in motion. The extra wheels are attached to the standard wheel bolts without special tools or a jack by means of heat-treated aluminum spools and extender bolts. The dual wheels may be used on the rear alone or all around, in which case a high-compression head is fitted to the engine to provide additional power. The same head also fits the Henry J.



Along with its unique hill-climbing qualities, the eight-wheeler can plow through mud without stalling

RAINBOWS BY THE MILLION

By Richard H. Syring

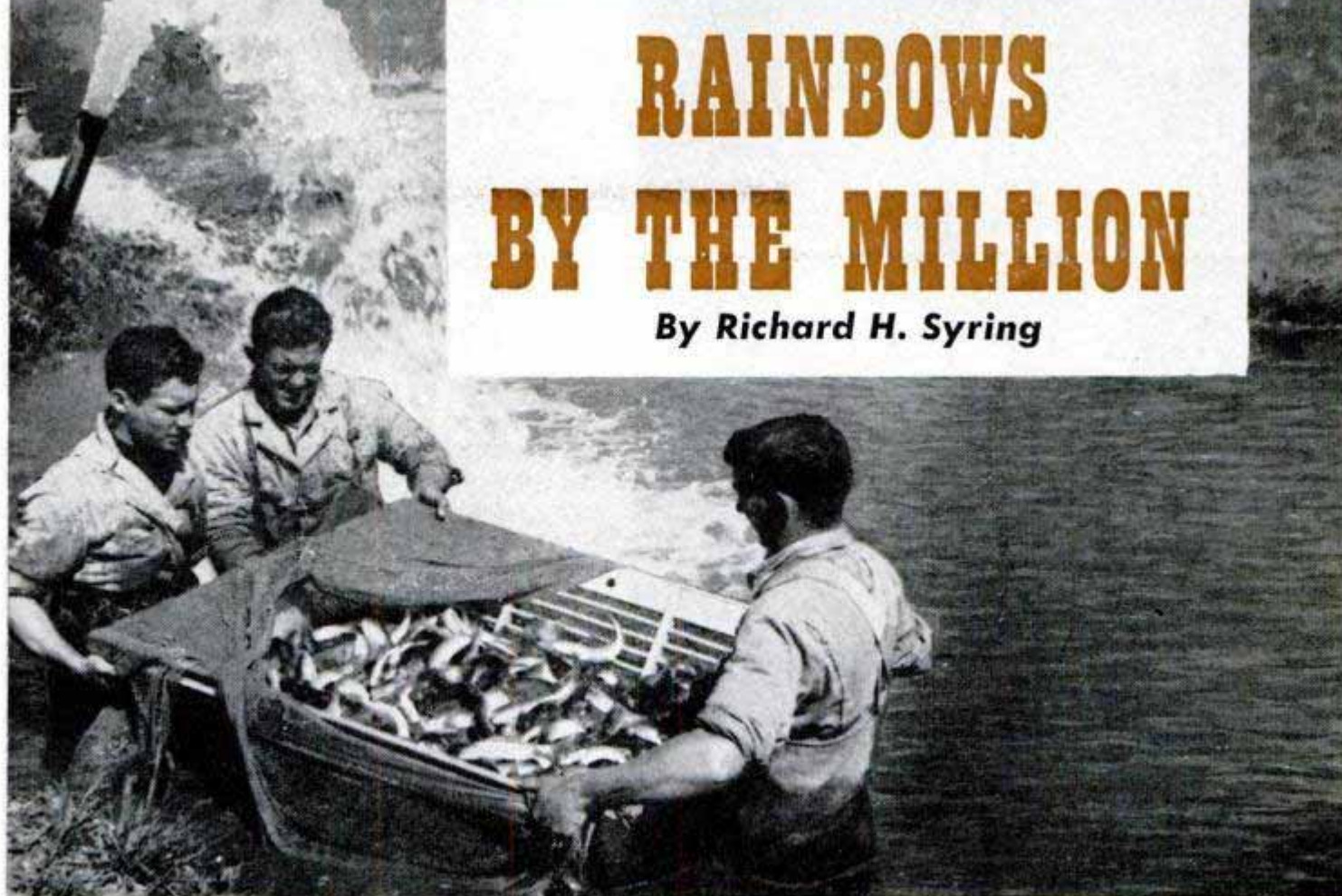

Here's one way to go trout fishing—not very sporting, perhaps, but there's no doubt that it's successful

BBETTER THROW that fishing pole away. If you want trout, why not raise 'em? And make a little money, too. But you may want to begin on a much smaller scale than Paul K. Christman of Reno, Nev.

Christman does it in a big way. His Xman Trout Ranch is reputed to be the largest in the world. All year 'round, he has 2,500,000 rainbow trout growing bigger

in ponds on the 29-acre ranch located in the shadows of the high Sierra mountains.

Each day workers scoop up several thousand of these palatable beauties. Twenty minutes after they leave the water they are eviscerated, packaged and quick-frozen. When that rainbow lands in its cellophane jacket, it is approximately one year old. In this piscatorial paradise the trout grow

Water flows between ponds through spillways. Unwanted materials are removed by these self-cleaning weirs

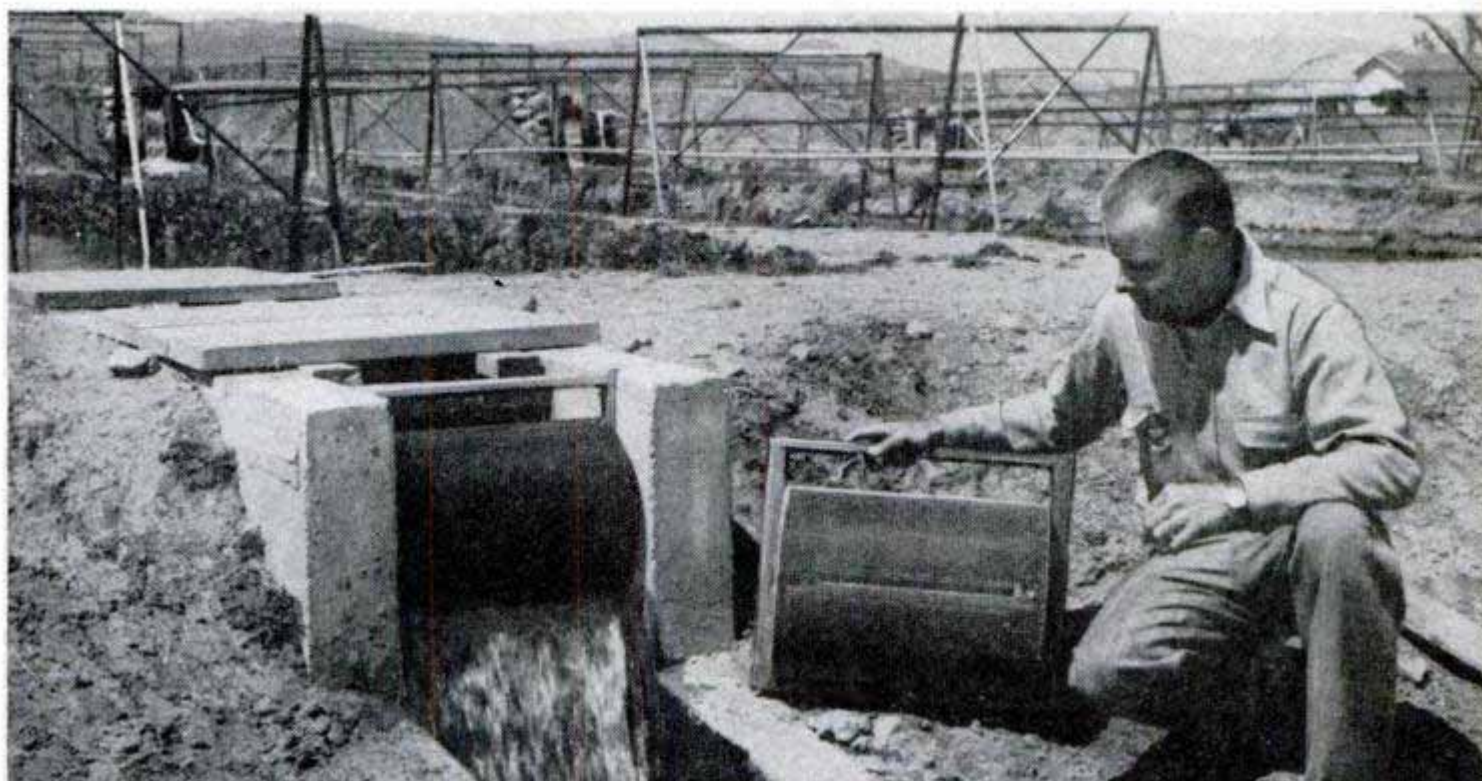

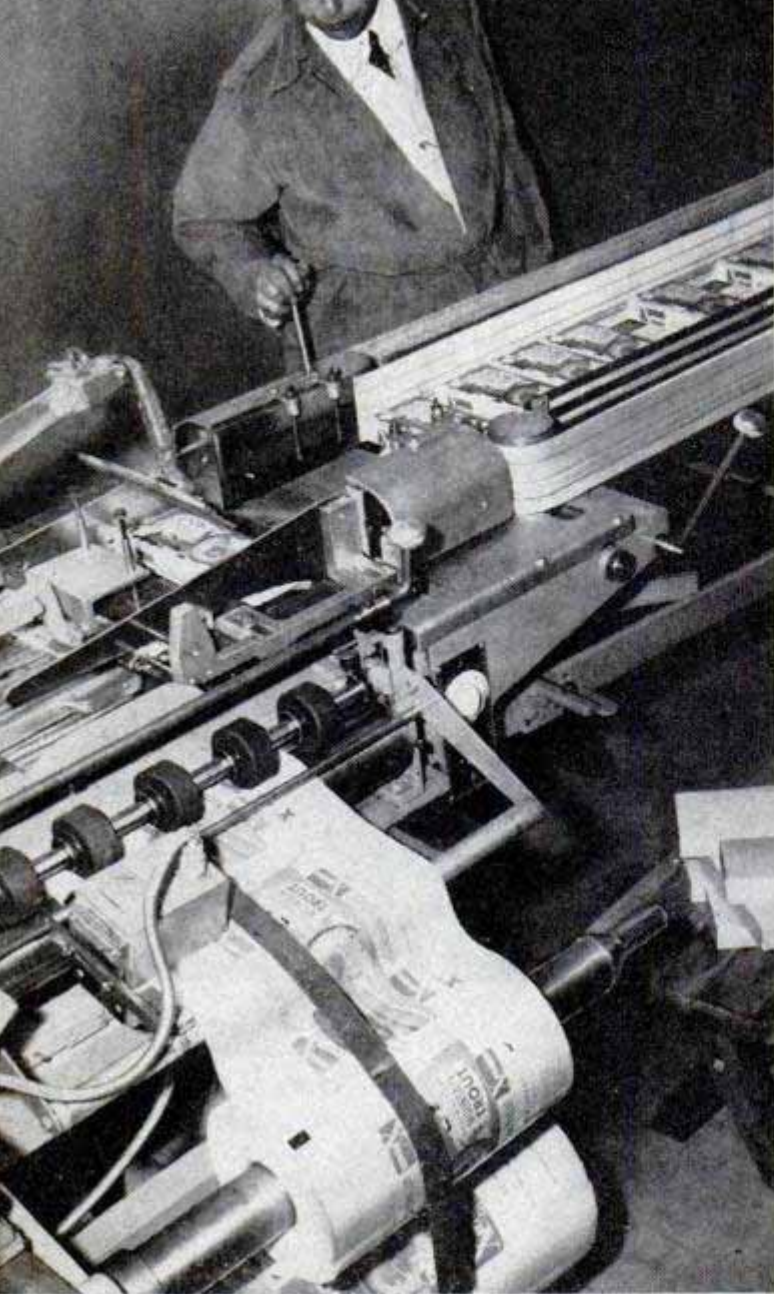

One-pound boxes, containing four frozen trout, are automatically wrapped at the ranch. Below, the eggs are hatched in these troughs in the incubation room

from a tiny egg to $\frac{1}{4}$ pound in just about 12 months.

The Xman Trout Ranch has an annual capacity of 400,000 pounds. Fresher than those from a fisherman's creel, Xman trout have created a carriage-trade demand that exceeds the supply.

Thirty-six trout ponds, each 20 feet wide, 125 feet long and $3\frac{1}{2}$ feet deep, are located 12 to a terrace. These ponds and a main 200-foot reservoir are supplied with fresh well water at about 58 degrees F.

Extra oxygen is added to the water by throwing it high in the air from six-inch header pipes. Another system of pipes with spray outlets is suspended over the ponds to provide additional aeration when needed. The incoming well water is piped to the ponds on the upper terrace. It flows by gravity through revolving weirs, located in concrete outlets, into ponds on the two lower terraces and into the reservoir.

Each spillway between the ponds has a self-cleaning screen. Paddle wheels within each weir, operated on a reverse gear, draw off moss, algae and other unwanted materials that may prove hazardous to fish life into an irrigation ditch.

The paddle wheels further aerate the water and the weirs prevent the fish from moving to the next pond. Trout must be separated according to size since the larger fish often try to eat the smaller ones.

The rainbow eggs come by air from Idaho, Montana and Canada. An average ice-packed shipment is about 250,000 eggs on small screen-bottomed trays covered with cheesecloth. The eggs are so small that it takes 390 to make an ounce.

On arrival, the "green" eggs, so-called because of their early stage of development



and not their color, are placed immediately in troughs of fresh water in the incubation room. In five to seven days, the embryos, now called "fry," break from the egg sacs. They lie on the trough bottoms for 15 to 20 days, feeding on the remains of the egg sacs. After the sacs are consumed, the fry rise to the surface and then are fed finely ground beef liver. A hatch of 95 percent of the eggs is considered normal.

The tiny fry are fed once an hour for the next two weeks. Then feeding is reduced to three times daily, later twice daily. As soon as the fry show an ability to eat well, they are moved to outside rearing ponds. At this stage they are one inch long and are known as "fingerlings." Not until they are two to three inches long are they called trout. When the trout are six to seven inches long, they go into the larger growing ponds.

Everything possible is done to make life safe and comfortable for the pampered trout. They grow healthier faster if water temperature is kept at 58 to 60 degrees F. In summertime, ponds are covered with Army surplus camouflage nets to keep off the sun's rays. When oxygen in the water tests low, the sprays are turned on to stir up the water.

Trout are affected by the seasons, too. They eat less and use less oxygen in the winter. Rainbows are fed a balanced diet once daily, consisting mainly of ground beef, wheat, wheat germ, yeast and vitamin B₁₂. Every day some 1500 to 2000 pounds of these ingredients are put through a grinder and fed to the trout.

Only 40 pounds of trout are taken from the water at any one time. The fish are caught with a seine, which allows the smaller trout to escape, or with a hand net. The smaller fish that escape are recaptured and placed in pools with fish of their approximate size.

Once the trout are out of the water permanently, general manager William Mulheron's big crew works speedily. Tubs of trout are hurried to the cleaning room, where two men clean four trout a minute!

From the cleaning tubs, the trout go through a cold-water bath and then to the packaging tables, each to be sealed separately in cellophane. With four rainbows to the package, these one-pound packages go through a wrapping and labeling machine at the rate of 1800 an hour.

Then the trout are ready for freezing. Packages are stacked on metal racks and moved to the quick-freeze room where the fish are frozen at 30 degrees below zero.

Usually, a day's operation completely loads the freezer. The next day, the frozen cartons of fish are cased and stacked in low-temperature storage. Then they're ready for shipment. ★ ★ ★



No, it's not spaghetti—it's a balanced ration for trout, containing beef, yeast, wheat germ, vitamins



After cleaning, the custom-raised trout are weighed and packaged. Below, fresh from the last pond, the year-old beauties are on their way to your kitchen





Giant Leaf Shredder Does Job of 20 Maintenance Workers

With a combination vacuum cleaner, hammer mill and composting unit, the University of Illinois has solved its annual leaf-raking headaches. A machine devised by R. S. Chamberlin of the university staff sucks up the fallen leaves, grinds them and blows them back to the ground where they

serve as a valuable soil conditioner. Leaf collecting on the 450-acre campus with its 4000 trees formerly took a dozen men six weeks' time. Pulled by a tractor, the Chamberlin machine does the work of 20 men hourly and eliminates all the trucking and burning that formerly were necessary.

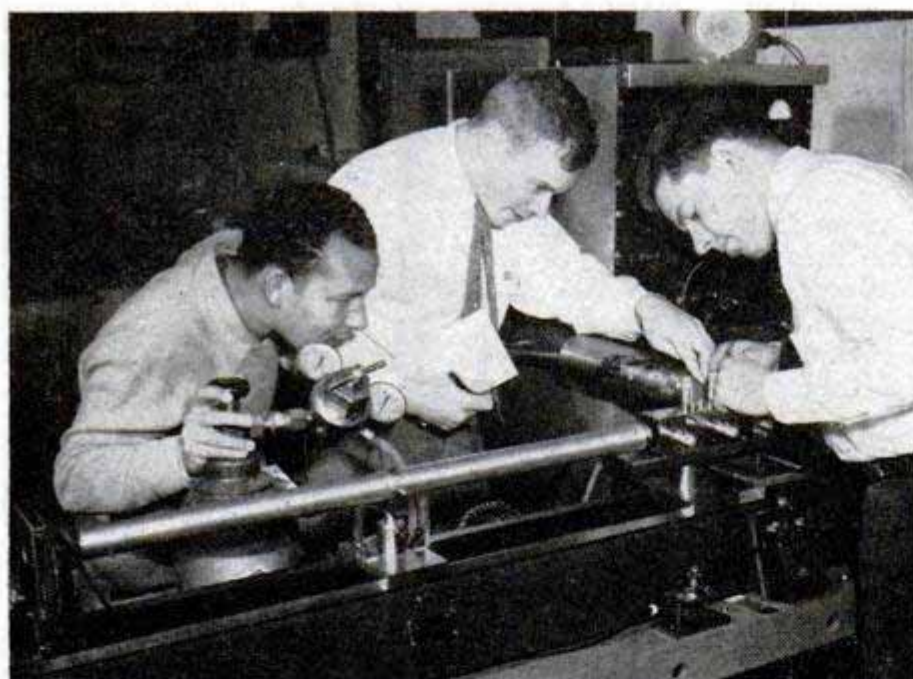

Specimen is placed in microscope. X rays pass through tube to film, left

X-Ray Microscope

Providing a magnification of 150 diameters, an X-ray microscope developed at Stanford University gives a distinct image to objects a hundred-thousandth of an inch in size. Its four mirrors have to be exceedingly accurate—not deviating more than a millionth of a centimeter from a perfect contour. Performance of the microscope lies between that of the best optical microscope and the electron microscope. It operates in helium and can be used on living tissue without injury.

Neon Chandelier Has Flowing Lines

Neon tubes shaped to smooth flowing curves form chandeliers in modern German buildings. Because of the adaptability of the neon tube, many interesting shapes can be created with the tubes of light. In one Berlin shop, a neon chandelier illuminates a stairway. Other uses include a large ceiling fixture in a new theater.





Modern Console Has Mirror Back

By Keith Vining

FOR BRIGHTENING dark hallways or adding a decorative detail to an expanse of plain wall, this modern console table has several functional features of novel application. Hinged compartments alternate with mirror-backed shelves in a staggered design that is both attractive and useful. It will be noted that the design permits several variations. For example, the top compartment and shelf may be omitted and all parts duplicated and assembled into two matching end tables suitable for use with a modern sofa. Or, an extra compartment and shelf may be added to make a

“highboy” of distinctive modern design. In either case the construction procedure is essentially the same. Before cutting stock, note that the top shelf is step-rabbeted on the back edge, the step extending only $\frac{1}{2}$ the width. All other shelves are rabbeted also, the single rabbet extending only $\frac{1}{2}$ the width. The same size single rabbet is cut on the back corners of the divider. Here the rabbets are run the full length of the piece on both corners. When the parts are assembled the edges of the mirrors are housed in the rabbets. Lay out the shelves, also the top, as in the upper detail on the

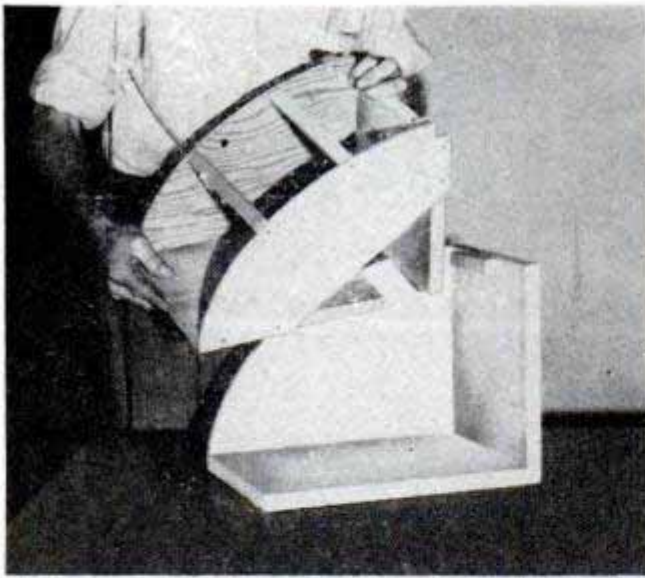

After assembling the bottom, back and one end of each compartment, the frontpiece is fitted over a form

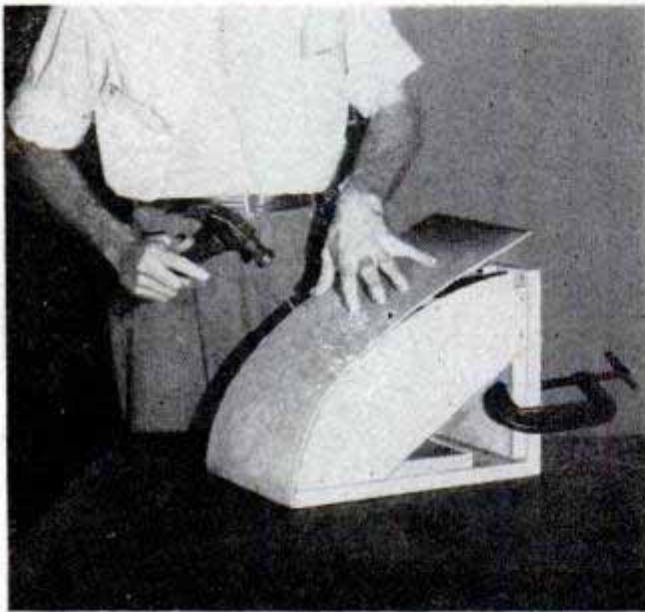

Above, compartment frontpiece is glued and nailed in place with brads. Heads are set below surface and holes filled. Below, after bandsawing to contour and applying facing, bottom frame is nailed to shelf



opposite page. Note that the two center shelves and divider are notched so that they interlock when assembled. Bandsaw the parts to the rough size and notch them so that they slide smoothly together. Then plane and sand the curved edges to the finish dimensions. Rabbet the back edges of the top, shelves and dividers. The stopped rabbets are cut by marking the center of the work and then making a witness mark on the ripping fence of the saw table directly above the center of the arbor. After the dado head has been set to cut to the required depth, the ripping fence is brought up and locked at the correct position. The work is then run over the dado head and stopped when the marks on the work and the fence coincide.

The back panel is framed on both sides with a rabbeted strip that houses the edges which otherwise would be exposed. These strips are screwed to the shelves and the top when the parts have been positioned for assembly. Note that the lower ends of the strips are notched to fit over the ends of the bottom facing. The bottom frame consists of six pieces of scrap stock which are sandwiched or stacked to three thicknesses with the ends overlapping at the center. After gluing, the frame is bandsawed to contour laid out from the dotted line in the upper detail on the opposite page. Save all the waste pieces and use them as clamp blocks when gluing the plywood facing strip in place. Attach the base to the cabinet with nails or screws and glue as in the lower photo at the left.

The back and endpiece of each compartment are of $\frac{3}{4}$ in. stock, and are joined with a rabbeted joint as shown in the detail. The bottoms are of $\frac{1}{2}$ -in. plywood, the front edges being sawed and finished to the same curve as the shelves. Now, before attaching the curved plywood fronts, clamp each partly assembled compartment in place and drill holes for the hinge screws through the compartment backs and into the rabbeted back strips. Wedge each compartment in place to assure that the hinge screws are properly located. Then make the assembly form, shown in the top and center photos at the left, and use the form to shape the plywood frontpieces. Clamp the form in place inside the compartment, spread glue on the joining surfaces and then nail the plywood to the bottom, side and back with small brads. Set the heads of the brads and fill the holes. Make and attach the compartment handles as in the upper left-hand detail on the opposite page. Sand the exposed parts thoroughly and round all edges slightly. Finish the cabinet with an undercoater and two coats of enamel in the color desired. Then slide the mirrors into place in the rabbets. ★ ★ ★

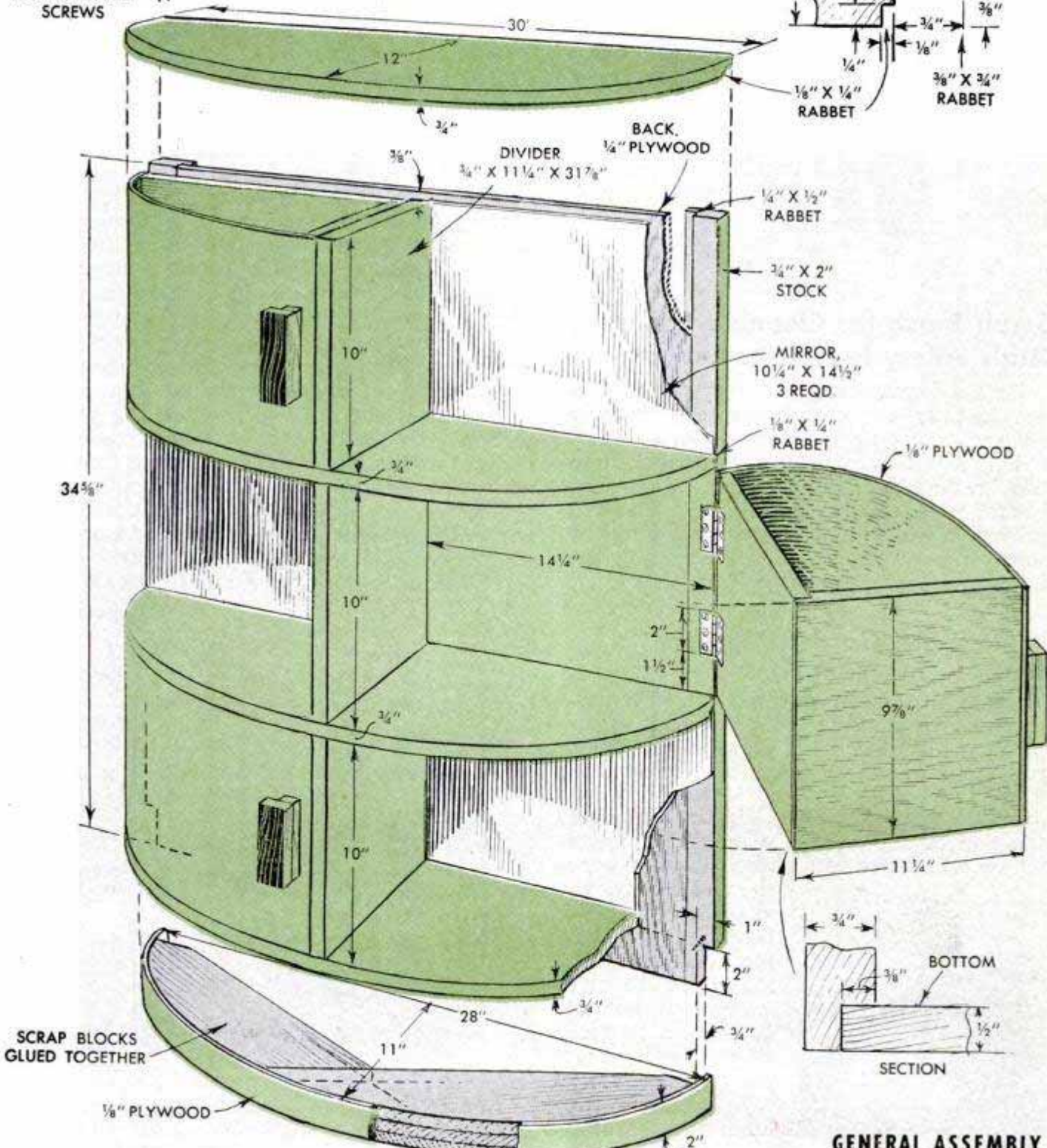
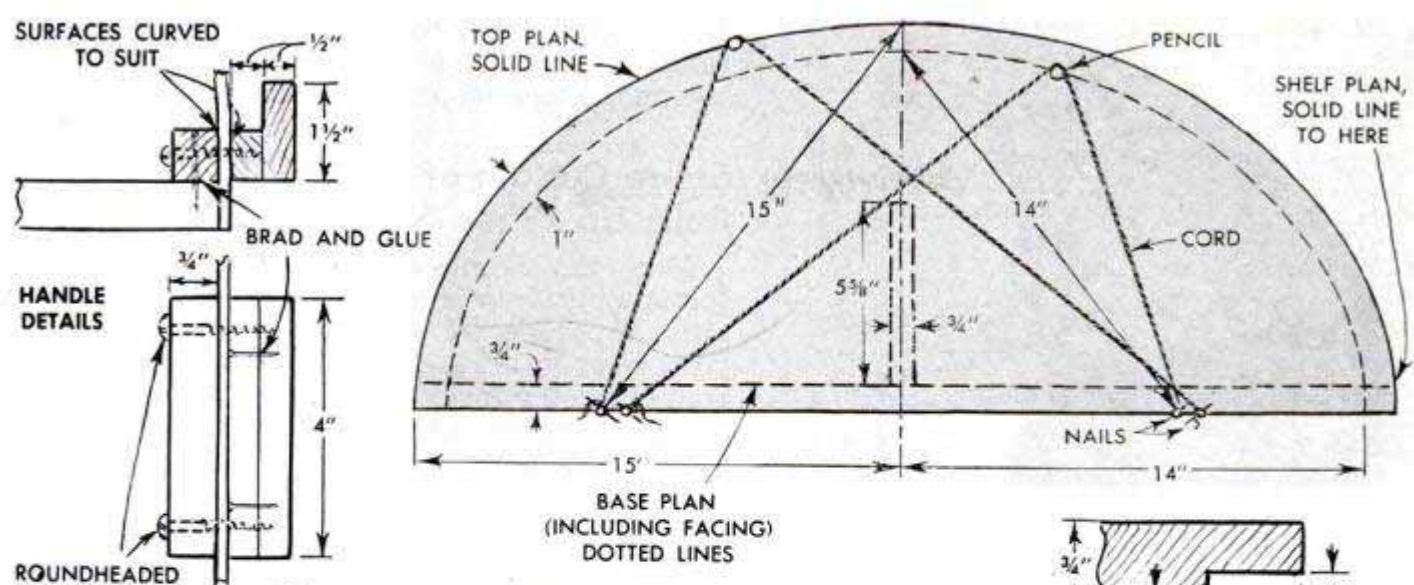

GENERAL ASSEMBLY



Scrub Brush for Cleaning Shoes Adds Safety Feature to Ladder

As a safeguard against the possibility of accidentally slipping because of muddy shoe soles when going up or down a ladder, nail a small, inexpensive scrub brush to the lower ladder rung as indicated. The brush, when placed in this position, will provide a convenient means for wiping the soles of your shoes before ascending the ladder.—Bess Ritter, New York City.

Waterproof Garden Markers

Your garden markers will stay legible throughout the season if each label is protected with an inverted glass vial. After printing the necessary data on the label, roll the paper and insert it face-side-out in a small vial of the type in which tablets and lozenges are sold. Then slip the vial over the end of a pencil or a length of dowel which will serve as a stake. Tape or wire

the vial to the dowel so there will be no danger of its being accidentally knocked to the ground. If the vial is wired to the stake, use a small piece of cellulose tape to keep the label from falling



out of position. A flat stake can be substituted for the dowel simply by wiring or taping the vial to one side of the stake.

Storm Curtain of Plastic Cloth Rolls Up When Not Needed

Many new homes similar to my own unfortunately were not provided with canopies or porches for protecting the entrance from blowing rain. Not only can a driving rain cause the inside door to warp and the veneer to crack and peel, but it also can force water under the door and damage the flooring, as it did in my house. For a time I tried replacing the screen section of the combination door with the storm section every time storm clouds gathered—a tedious and time-consuming job, indeed. To eliminate the necessity of this routine, I fitted a window-shade roller with a piece of plastic cloth which was long enough to cover the screen portion of the door completely. The roller was mounted at the top of the door with regular brackets, while finishing nails were driven in the lower part of the door to anchor the bottom end of the cloth when it is drawn. After hemming the bottom edge of the curtain to receive the slat from an old window shade, I drilled holes in the slat to make it possible to slip the end of the curtain over the nails. Now, at the first signs of an approaching storm, I simply draw the curtain and hook it over the nails to provide the protection desired. After the storm has passed, the curtain is slipped off the nails and rolled up, making normal use of the screen door possible again in a matter of seconds. In winter the brackets are removed and stored together with the curtain and roller.

Thomas P. Ramirez, Fond du Lac, Wis.

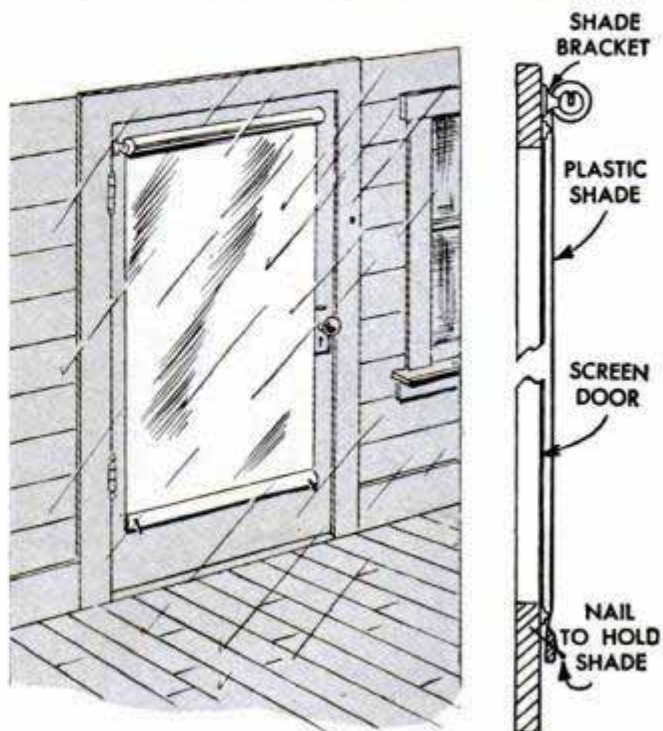

How to Build RETAINING WALLS

By E. R. Haan

SLOPING LAWNS often can be given a much better appearance by edging them with easily built retaining walls of stone or concrete. On lawns having steep banks, which make them subject to fast erosion and also difficult to cut, retaining walls afford the additional advantages of reducing erosion and simplifying maintenance considerably.

Many applications: Fig. 1 shows how a low flagstone retaining wall is used to obtain two level terraces instead of a sharp drop in grading across the front of a house. Note how the wall pictured in Fig. 2 eliminates a steep bank along an entrance drive and front sidewalk. Fig. 3 shows a retaining wall which is used to protect an old, valuable tree where the grade all around the tree was lowered to blend in with street paving. Foundation terraces, Fig. 4, which often are used to enclose flowers or shrubs, are particularly desirable where a house is set on a high foundation. The terrace and its plantings give a lower, more modern appearance to the house. Another application is to separate adjoining lots with a low retaining wall to make each one more nearly level. A lawn having a pronounced slope may be divided similarly into several level or slightly sloping terraces.

Drainage and frost precautions: Lack of good drainage and damage from frost can ruin a good retaining wall within a few years. Walls built of loose flagstones automatically provide drainage through the joints, Fig. 6, detail B. However, a solid wall holds water behind it and requires draitile along the base on the inside of the wall as in detail C. The tile is led to a lower location, such as a dry well or a sewer. Even with proper drainage provided, soil frequently holds enough moisture by capillary attraction to permit some expansion by frost. Loose-stone walls have sufficient flexibility to move with the soil upon freezing and thawing. For example, the one pictured in Fig. 5 has kept its original shape and position for 17 years in a climate where alternate freezing and thawing occur frequently during winter. To withstand lateral pressure of freezing soil, solid walls

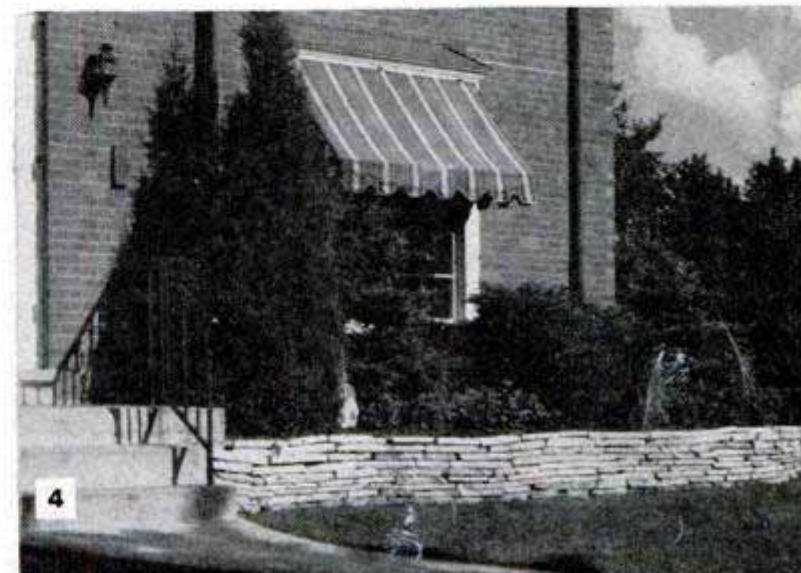
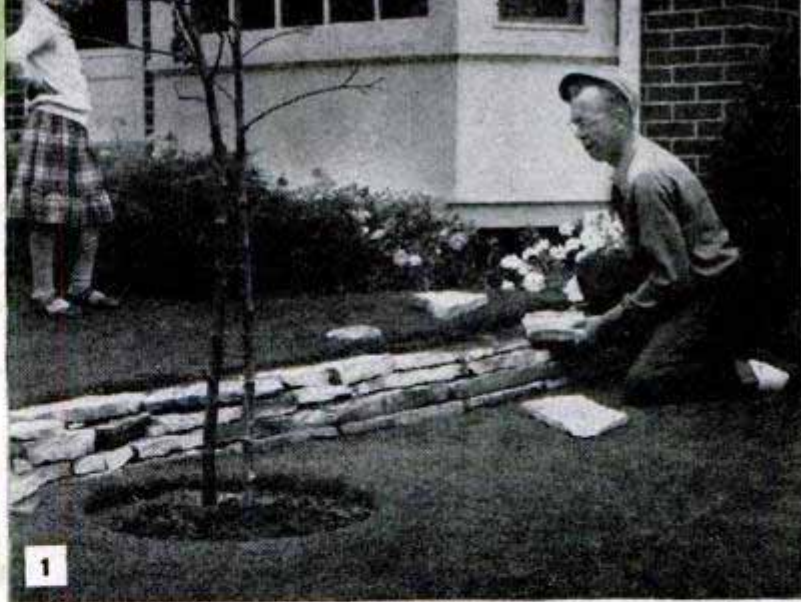



5



7

should be built much wider at the base than at the top, as in detail C, the inner side sloping acutely. This side, if smooth, will further help to relieve lateral pressure as it will allow freezing ground to slip upwards as it expands.

Loose-flagstone walls: Retaining walls of flagstone, built loosely without mortar, are the easiest to construct. Start by laying the stones on undisturbed earth rather than on loose fill which will settle. The stones of each course should be of relatively equal thickness, as in Fig. 6, detail A, to keep the wall level. However, for variation, a few stones the thickness of two or three courses may be placed in the wall at random. Set the stones so that straight, flat edges will be exposed.

When it becomes necessary to chip a stone to get a straight edge, use a cold chisel and a hammer. The basic idea of fracturing stone is quite similar to glass cutting. First score a guide line on each side, one directly over the other, by running the chisel along a straight edge. Next, nick both edges about $\frac{1}{8}$ in. deep to connect the scored lines. Then lay the stone flat on the ground and tap it with the hammer and chisel to make the score lines about $\frac{1}{8}$ in. deep. After thus deepening the score lines continuously, tap with sharper blows from the center toward the edges. If this is done care-

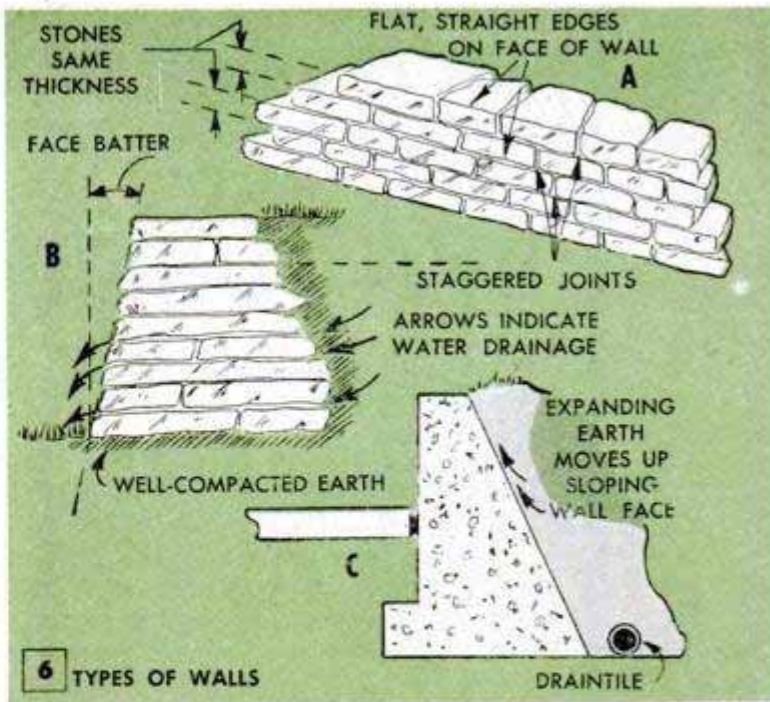

fully, the stone will fracture straight across like the one shown in Fig. 7. This can be accomplished in just a few minutes. Scoring confines the fracture where it is wanted and tapping weakens the stone. Don't try to make a straight break with a few heavy blows, as the line of fracture cannot then be controlled.

Joints between stones in any course should be bridged by stones of the course above, in the manner that bricks and shingles are laid. It also is best to lay the stones either level or at a very slight forward pitch for proper drainage. If the face of a wall is vertical it will appear to lean forward, this illusion becoming more apparent if the wall is higher than 3 ft. Therefore, on walls over a foot high the face should be given some inclination or "face batter," varying from 1 to 4 in., or even more, per foot of height.

The width of a loose-stone wall may be as little as 8 in. if the wall does not exceed a height of 1 ft. A 10 to 12-in. width is better for a wall 2 ft. high, and a 12 to 16-in. width for a 3 or 4-ft. wall. Spread some soil over each course to "bed" the next course. This also permits creeping rock-garden plants to take root and spread. The plants will keep the soil from washing out of the crevices during heavy rains. In many cases foliage adds to the over-all appearance of a retaining wall.

Solid-masonry walls: Solid retaining walls higher than 3 ft. generally are built of concrete, as pictured in Fig. 8. If a brick or stone facing is desired this can be added. Fig. 9, detail A, shows a cross section of a properly designed concrete wall. The base should extend just below the point to which frost penetrates, and it should be poured on firm, undisturbed earth. If the excavation

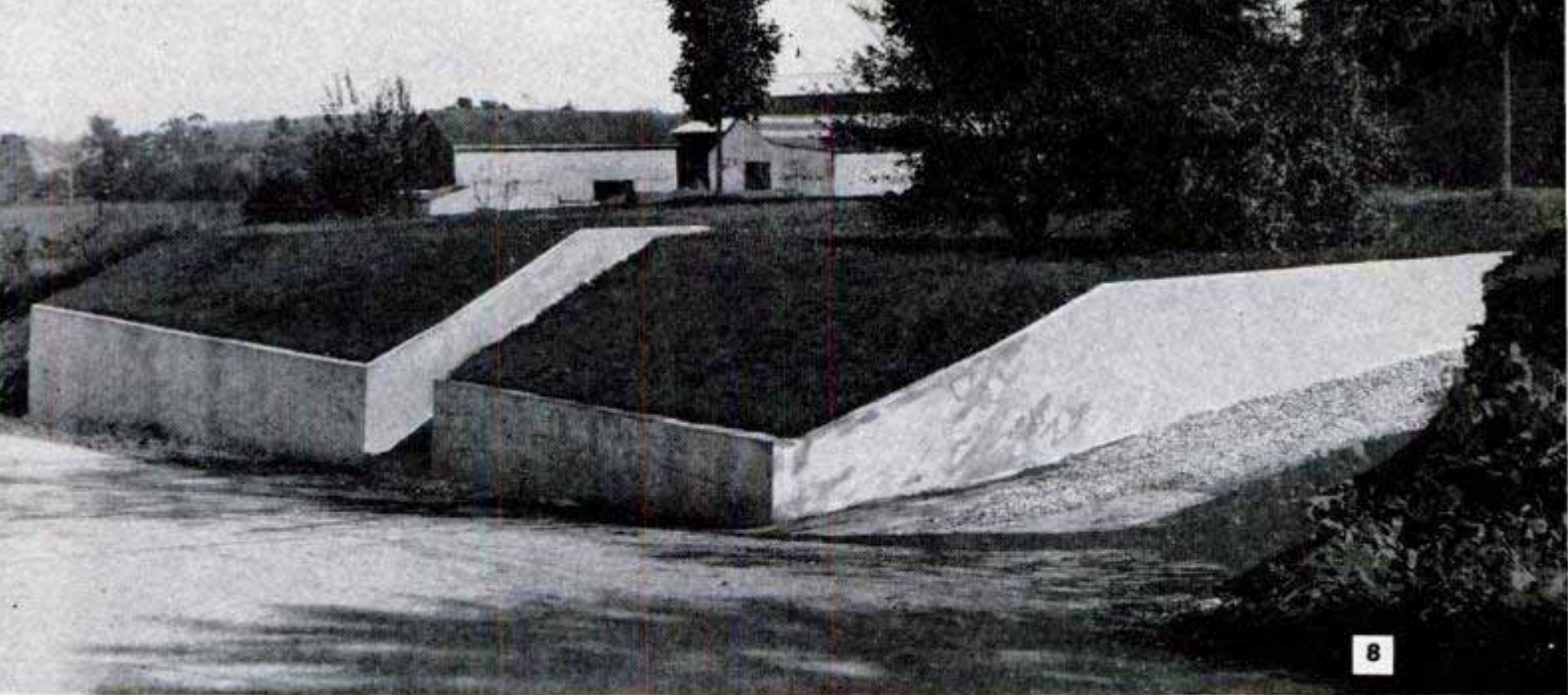

8

Photo courtesy Portland Cement Association

is accidentally carried too low, don't fill with earth but increase the depth of the wall instead. Lay draitile at the inside of the wall at base level as in details A and B. Butt the tile together and provide a slight drainage pitch. The latter can be checked with a level. Then put a 4-in.-wide strip of tar paper over each joint, detail C, to prevent earth from falling inside the tile. Finally, cover the tile with a 12-in. layer of gravel or crushed stone.

Walls less than 5 ft. high should have a minimum top thickness of 5 in., while those over 5 ft. high should have a top at least 8 in. thick. The base width of a solid-masonry retaining wall should be approximately $\frac{2}{3}$ of the wall height. Thus, the bases of walls 3, 4, 6 and 8 ft. high should be 2, 2½, 4 and 5½ ft. wide respectively. As in the case of the stone walls, face batter of ½ in. or more per foot of height is desired so that the face will not appear to lean outward.

Large retaining walls of concrete are major undertakings and should be built by concrete contractors. However, the average homeowner can build forms for small retaining walls as in Fig. 9, detail D. Get ready-mixed concrete if you can, to eliminate the backbreaking labor of mixing by hand. If you mix your own concrete, use a mix consisting of 1-part portland cement, 2¾ parts of clean, sharp sand and 4 parts of gravel or crushed stone, the latter being no larger than 1½ in. in diameter. After these ingredients have been well mixed, add 6¼ gal. of clean water per sack of cement if the sand is damp; 5½ gal. if it is wet. Keep the forms soaked with water for a week after pouring the concrete so it can cure slowly to attain maximum strength.

★ ★ ★

☐ A coat of thin shellac applied to the hard covers of children's books will help them to withstand the hard usage they receive.

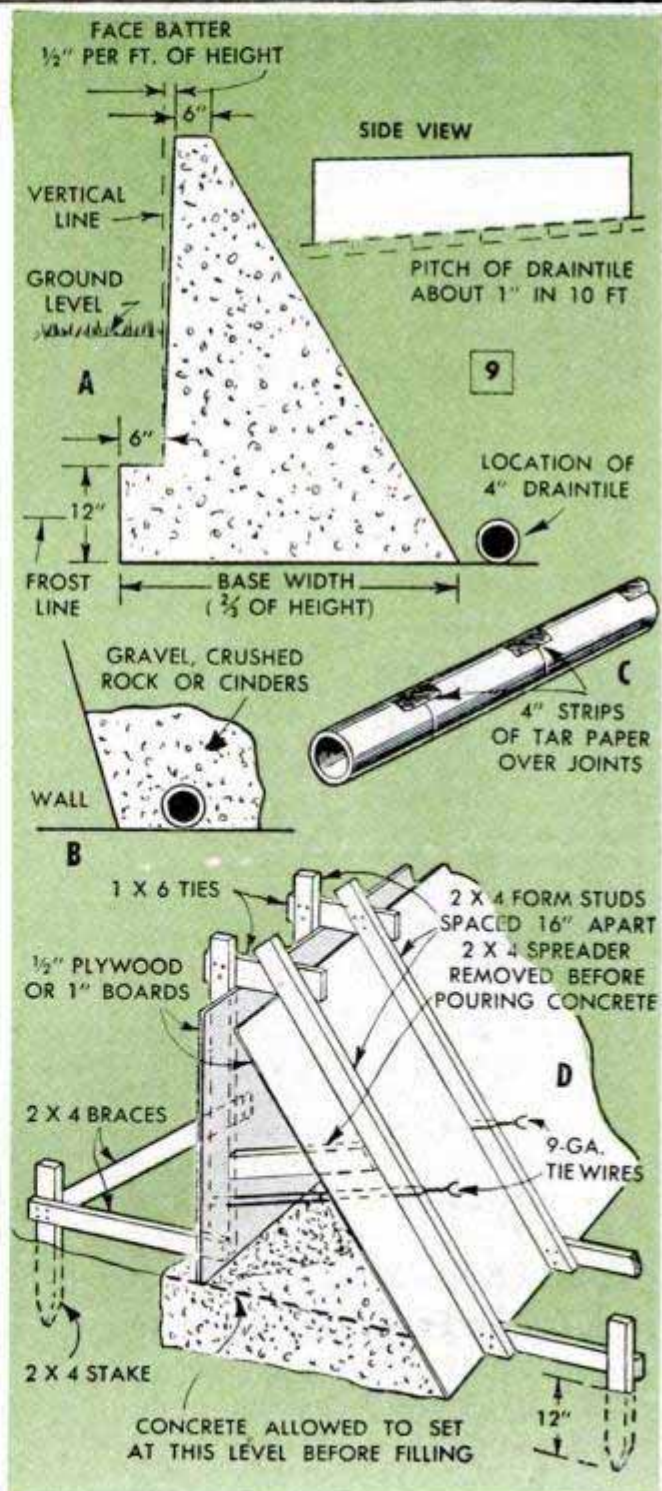

Pipe Extension on Garden Hose Aids Cleaning of Eaves Trough

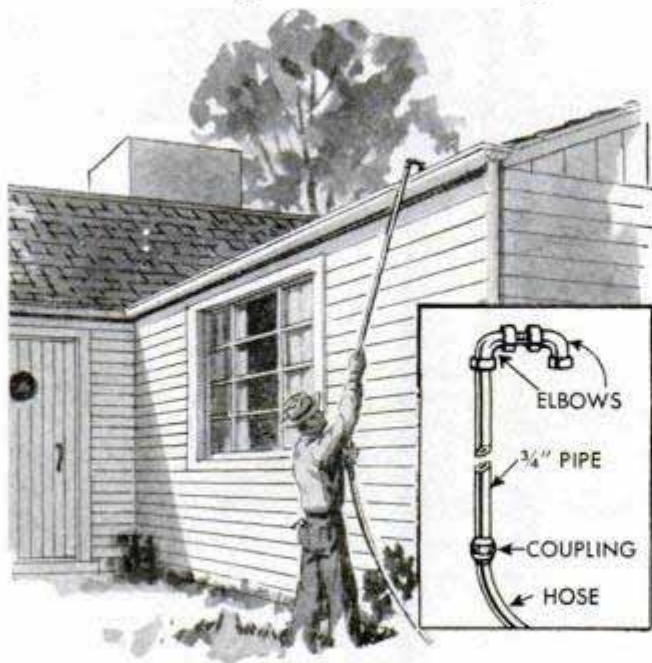

The cleaning of eaves troughs on a one-story, ranch type of house can be accomplished with little difficulty provided you equip yourself with this handy pipe extension for use with a garden hose. Consisting of a 6-ft. length of $\frac{3}{4}$ -in. pipe fitted with a coupling at one end and two elbows at the other as shown, the extension makes it possible to stand on the ground while flushing leaves, sticks and dirt from the troughs.—Ed Packer, Chicago.

Balancing Weights Colored To Match Wheel Rim



Although essential, car-wheel weights are always rather unsightly and more especially so when installed on light colored rims. One car owner has adopted the practice of coating the

weights at regular intervals with a touch-up enamel selected to match the color of the wheel rims. The matching enamel effectively camouflages the weights so that they are not noticeable, even at short distances.

R. Hanscom, Elmhurst, Ill.

Wooden Boats Caulked With Soap When Taken From Dry Storage

When used on a wooden boat that has been in dry storage, oakum and other caulking compounds harden and frequently cause the planking to become warped when

it expands again in the water. To avoid this, one boat owner caulks the seams temporarily with ordinary yellow laundry soap. The soap not only closes the seams but also seals them while the planks expand and gradually force the soap from the seams. Once the planks have returned to their normal size, the boat is removed from the water again to allow caulking of any leaky seams with a regular filler.

Kenneth O'Meara, Ft. Lauderdale, Fla.

Threaded Pipe Serves as Rasp

Lacking a rasp to remove the burr and true several holes in a piece of soft wood, one craftsman found an effective substitute in a length of threaded pipe. The pipe, which is threaded throughout its entire length, is of the type used in the construction of lamps and is applied to the work in the same manner as a rasp. Almost any threaded pipe or rod may be used if the threads are fine and sharp.—Victor Lamoy, Upper Jay, N. Y.

THREADED PIPE

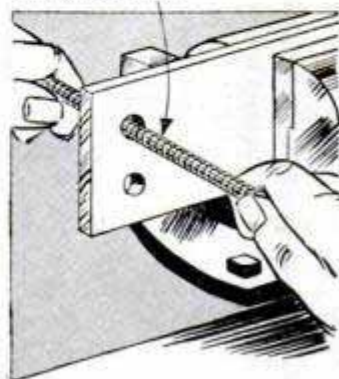

Emergency Bail for Paint Can

It's an easy matter to provide a bail for a paint can so that it can be hung from a ladder or held in the hand easily. Just form a bail from a piece of stiff wire, such as coat-hanger wire, and bend the ends upward to fit under the edge of the opening in the top of the can. Be sure that the ends of the bail are bent so that they fit snugly under the depressed part of the can top. This will help prevent the possibility of the bail slipping out.



"Crystal" Lamp Base From Dime-Store Glassware



Four small tumblers, three ash trays and a candy dish, all of inexpensive glass, form an attractive lamp base when assembled on a length of $\frac{3}{8}$ -in. fixture pipe. The glass parts are center-drilled, assembled on the pipe and locked in place with a nut and washer. To bore through the glass, chuck a short length of brass or steel tubing in a hand drill or drill press, and rotate with medium pressure against an oil-and-emery mixture applied to the glass. Use a putty ring to confine the abrasive to the center of the work. Raise the tubing occasionally so the abrasive can be applied directly to the cut, and if you use a drill press, run it at low speed.

A. R. Black, McKeesport, Pa.

Insulation Pulled Under Attic Floor With Steel Tape Measure

When installing blanket insulation between the joists of an attic floor, it is not necessary to remove all the floor boards. Just remove enough of the boards from both sides of the floor to permit working the insulation under the remaining boards. Set the roll of insulation on one side of the floor with the loose end placed between the joists. Then clamp a spring-type trouser hanger to the end of the insulation. From

the opposite side of the room, insert a steel tape measure under the flooring between the same pair of joists. Pay out the tapeline until you are able to grasp the end of the tape at the side of the room nearest the roll of insulation. Then slip the ring on the end of the tape over the trouser-hanger hook, and use the tape as a line to pull the insulation along under the flooring and gradually across the room.

Battery Clip Holding Abrasive Simplifies Sanding of Small Surfaces

In various workshop projects where the sanding of small surfaces is required, a twin-jaw battery clip often can serve to good advantage as a miniature sanding block. After cutting a narrow strip of sandpaper slightly wider than the clip itself, place it in the jaws of the clip as shown and stretch it tight.—John J. Rea, Urbana, Ill.

Stamp for Deleting Printing

An old rubber stamp from which the type faces have been removed will come in handy for deleting lines of printing on outdated cards or letterheads. Evenly cut, the rubber base leaves a near-solid imprint when inked and applied to paper in the usual way.—Frank Shore, New York City.

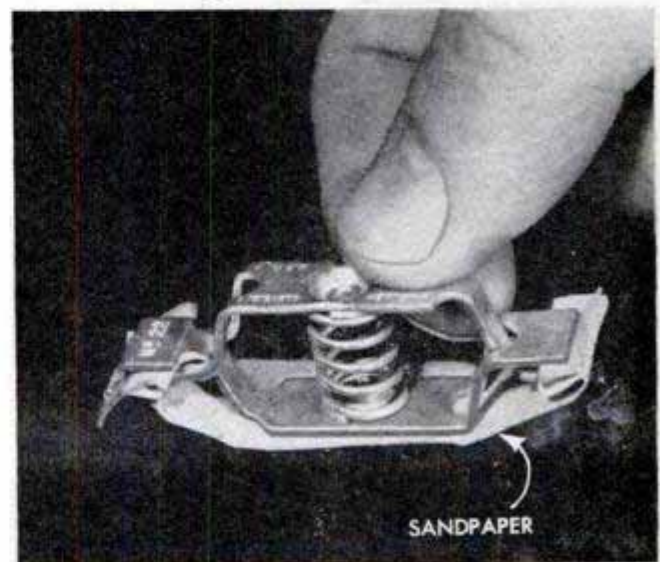

Solving Home Problems...



BALL-POINT PEN

BALL-POINT PEN with ink cartridge removed provides a handy tracing stylus. Pen is ideal when using carbon paper to trace faded embroidery transfers on cloth, as point will not cut through paper transfer

DEFROSTING REFRIGERATOR is speeded considerably by using an electric hair drier to melt ice from coils. Plug drier cord into near-by outlet and direct blast of warm air into and around the ice-cube compartment



MAGAZINE PAGES may be removed quickly and neatly, as above, by using a length of string having a button tied to one end. Button keeps the string from slipping out of place when the loose end is pulled

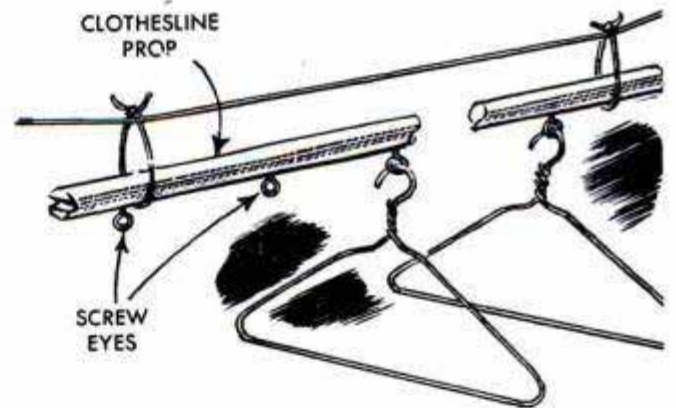

HANGER RACK made from clothesline prop, above, keeps garments aired on wire hangers from sliding together. Screw eyes driven into sides of prop receive hanger hooks. Rack is tied or wired to line

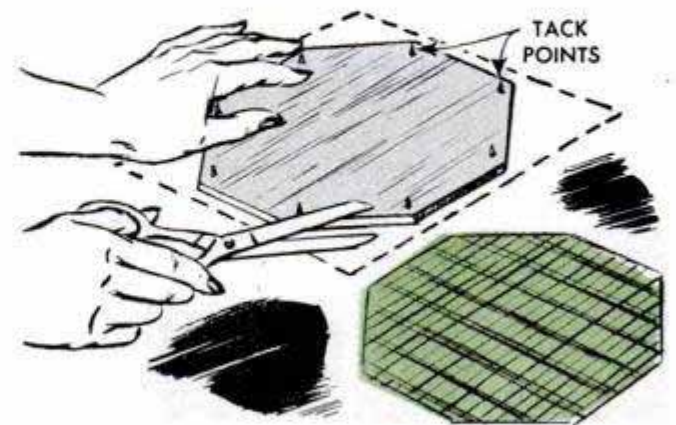

CUTTING QUILT PIECES to exact size is done rapidly with aid of a plywood pattern which holds the cloth in place while cutting. Points of carpet tacks driven through the pattern at all corners anchor the fabric

WHEN REDECORATING, you can be sure that new fabrics will harmonize with the paint used if a paint sample is carried with you to the store. A wooden tongue depressor dipped in paint and allowed to dry forms easily carried paint swatch

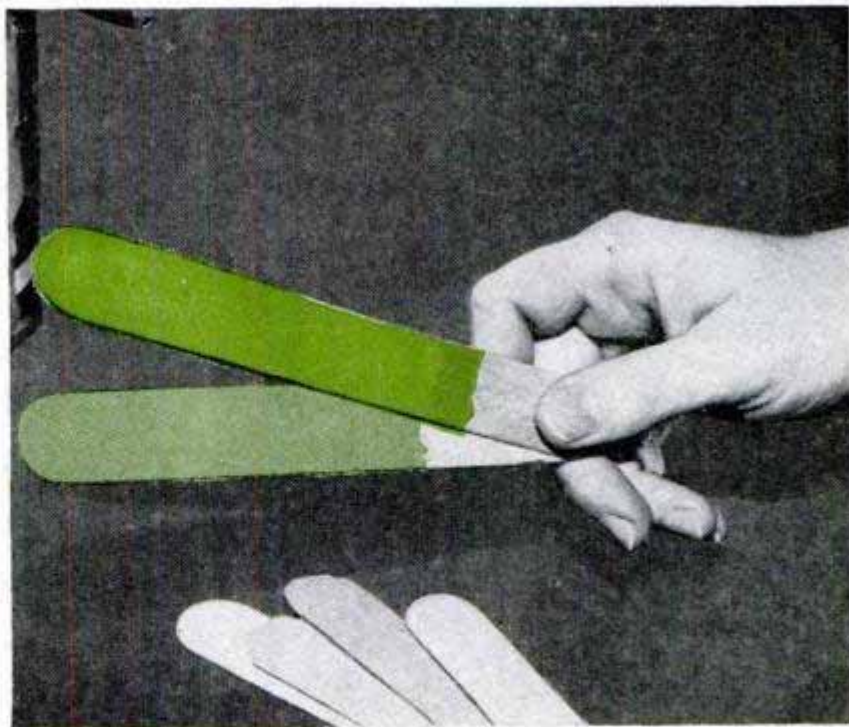

SAFE CHILDREN'S SOFTBALL for indoor play is made by rolling up three or four pairs of discarded socks. Use final sock to form a cover, turning back the cuff and then stitching it to retain the shape of the ball

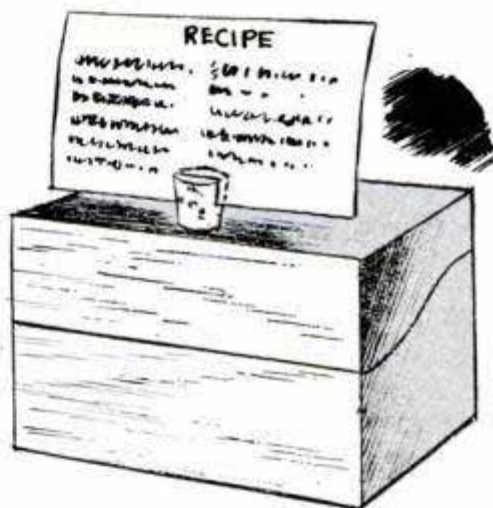

SLOTTED CORK attached to lid of file box provides a convenient holder for recipe cards in addition to serving as a knob. Fasten the cork with glue and wood screw, driving latter from the underside of the lid

Popular Mechanics Household Hints

HEAVY COATING of paraffin helps keep furniture casters from scratching hardwood floor. To apply, rub each caster wheel with a softened cake of paraffin

TO ATTAIN a better shoe shine, coat the shoes with paste before removing them for the night. Then polish next morning when the wax has dried thoroughly

LIPSTICK STAINS will wash readily from towels and napkins if the lipstick has been loosened by rubbing white petroleum jelly or glycerin into the stained cloth

WHEN SEWING SILK or any other material which has a tendency to slide on the machine table, slip a pillow case over the table leaf to help hold the material in its position

FOOD STAINS won't damage the cover of your favorite cookbook if the outside of the cover is coated with thin shellac. Shellacked surface can be wiped clean with damp cloth

RUBBER SHEET is held in place on crib mattress by strips of muslin sewed along the edges. Muslin strips should be wide enough to permit tucking securely under mattress

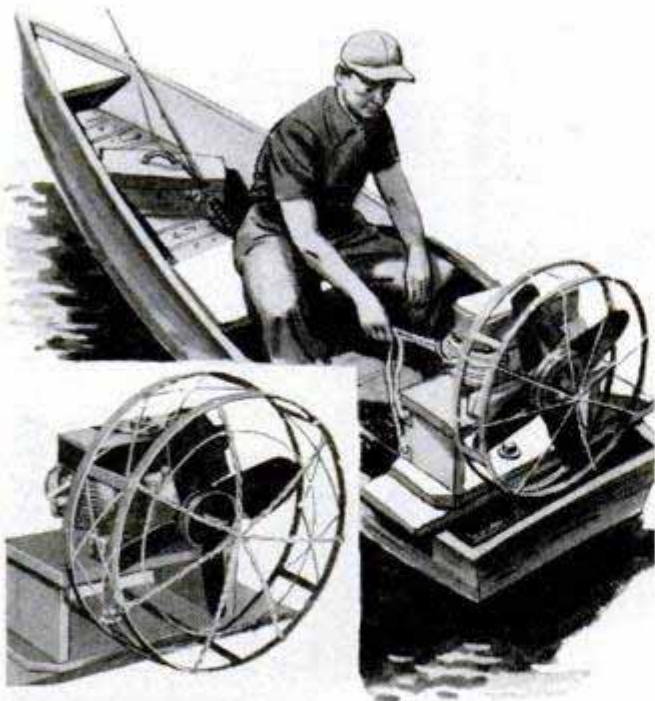

Propeller-Driven Fishing Boat

Requiring a boat of exceptionally shallow draft for river fishing, one fisherman designed and built this flat-bottom job to his own specifications and then eliminated the conventional rudder and propeller of the regular outboard motor by rigging an air drive. This consists of a 1-hp. high-speed engine of the air-cooled type mounted on a pivoted base and fitted with a propeller, or air screw, made by adapting a 1946 Ford cooling fan. The fan is mounted on the engine crankshaft and fitted with a guard made from $\frac{1}{8} \times \frac{3}{4}$ -in. flat steel. The engine and propeller are mounted on an open hardwood base which is pivoted on a sub-base attached to the gunwales of the boat about 12 in. in front of the transom. Steering lines attached to the ends of the pivoted base permit the boat to be steered simply by swinging the engine and propeller right or left by means of the lines. Although this arrangement served the purpose of the original builder, it could be elaborated if desired by attaching the steering lines to a conventional steering-wheel assembly.

Charles W. Martz, Williamsport, Pa.

Storing Small Amounts of Paint

Saving left-over paint often proves worth-while for touch-up jobs around the house, but the paint usually oxidizes quickly if left in its original can. To prevent a skin from forming on top of the paint, pour it into glass jars having screw-type lids which will make an airtight seal. Various sizes of these jars are used to package food products, some of them holding as much as a quart. However, for especially small quantities of paint, baby-food jars having press-on lids with rubber seals provide con-

venient containers. Although the clear-glass jars permit easy selection of the particular color of paint desired, it is best to label the jars with type of paint and color name if several similar colors are kept on hand. Use gummed paper or adhesive tape for a label or write directly on the glass with a grease pencil.

George H. Plough, Woods Hole, Mass.

Can Opener Provides Handy Tool For Rounding Sharp Edges

A can opener of the type shown may be converted into a useful tool for rounding sharp edges on furniture. First, break off the rim grip and drill a $\frac{1}{4}$ -in. hole at the opposite end of the slot. Then, using a rat-tail file, bevel the hole to form a sharp cutting edge where it meets the outer curved surface of the opener. The tool also makes a handy point-pusher for use in glazing when held so that its outer curved end fits snugly in the palm of the hand.—Norbert Engels, South Bend, Ind.

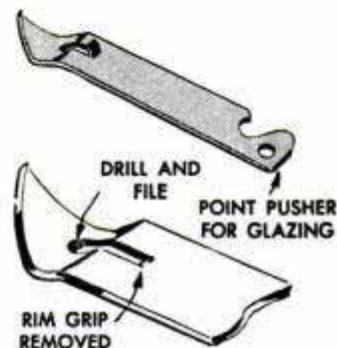

Keeping Moths From Trout Flies

No longer need you worry about moths getting at your favorite trout flies from one fishing season to the next. Simply store the flies in an air-tight can and add a few moth crystals. A 1-gal. paint can makes an excellent container for this purpose. A can which previously had contained a water-soluble paint can be cleaned very easily with soap and water. Be sure to clean the cover and groove thoroughly so that the cover will fit tightly.

Clyde Allison, Cadillac, Mich.



Outdoor SNACK TABLES AND LANTERN

By Roberta L. Fairall

ON SWELTERING summer nights when informal dining on the lawn is in order, nothing makes entertaining so convenient as a set of these take-apart snack tables. Consisting of but three interlocking parts, each table is set up and dismantled easily, and best of all, the tables can be stored flat on a closet shelf. To lend a festive air to the informal setting, tin-can "Japanese" lanterns lighted with insect-repellent candles may be hung from nearby tree branches when dusk takes over.

There's nothing to making the tables. The particular design of the half-lapped legs permits them to be cut in duplicate by tacking both pieces together. The half-lap slots, of course, must be cut individually, unless you may be cutting a stack of right-hand or left-hand legs. Outdoor plywood, $\frac{1}{4}$ in. thick, is the best material to use, although not essential. Common fir plywood, well painted, will last a long time. Like the legs, the tops of the tables can be cut in quantity

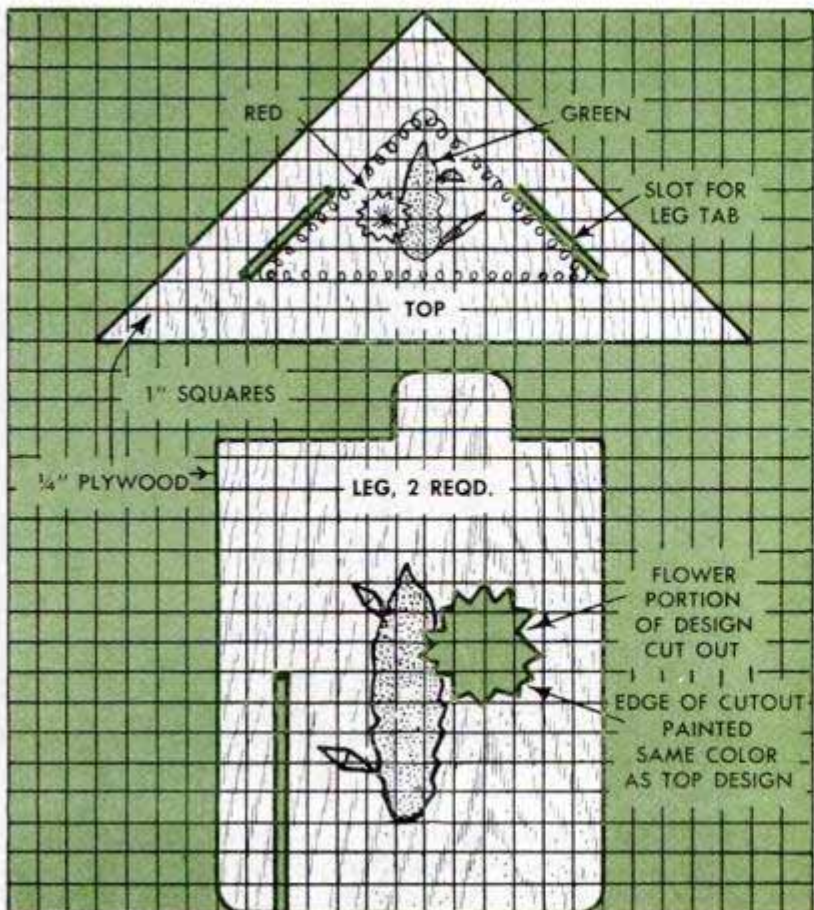
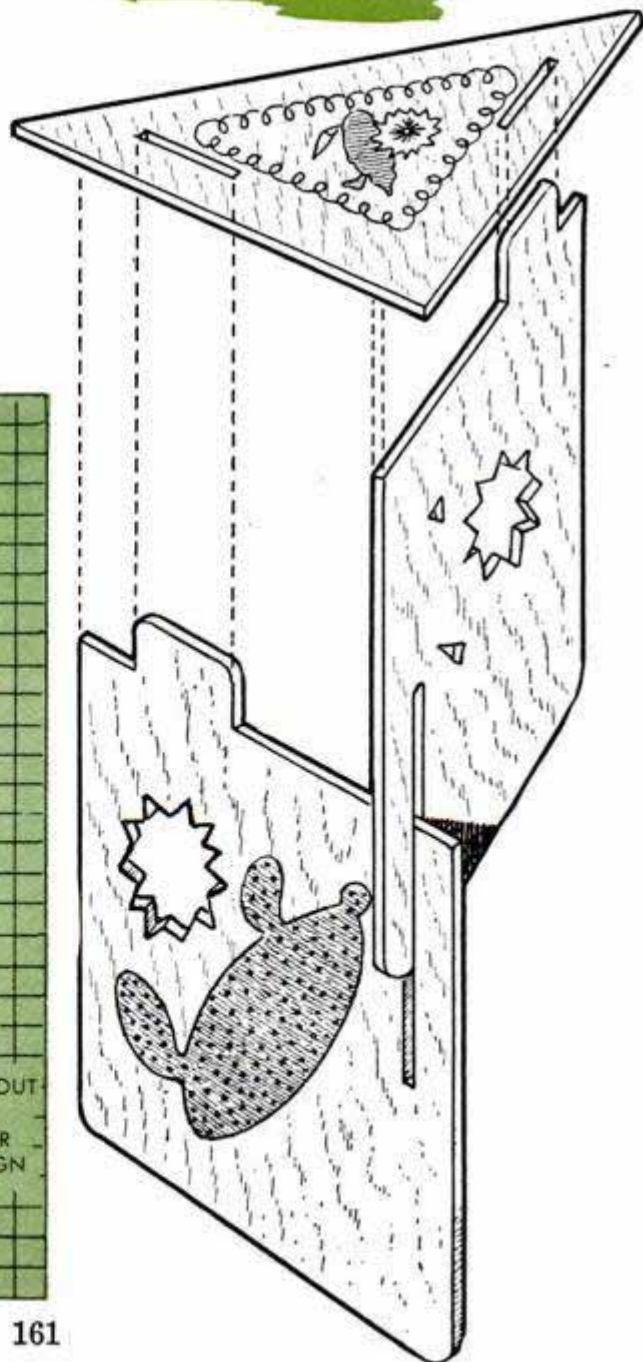

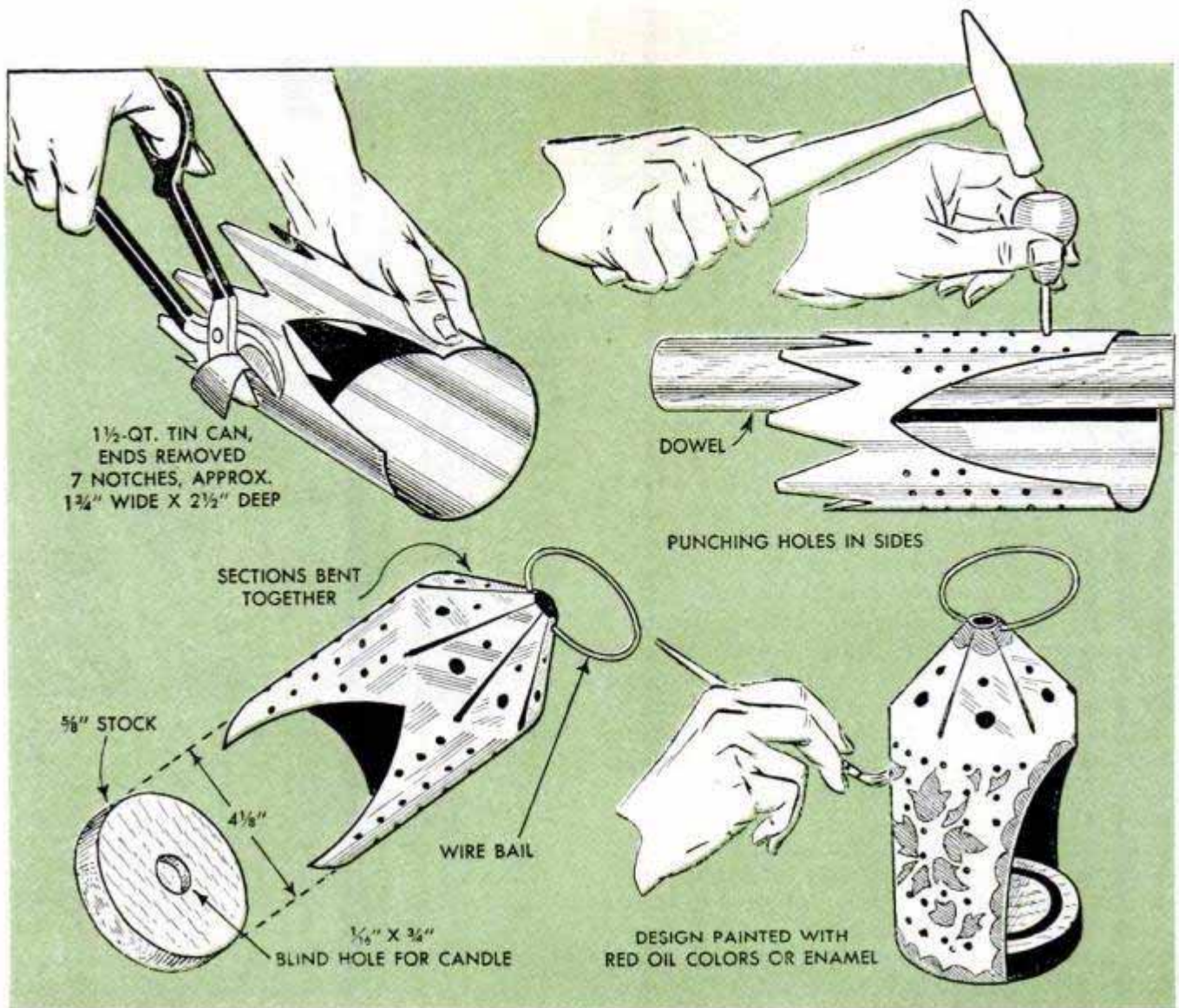

and slotted at the same time. Perhaps, it would be best to make the parts for one table first, and then after a trial fit, use them as master patterns in laying out the others. As for decoration, designs may be jigsawed right in the legs as indicated in the squared drawing, or appropriate decals can be selected and used to add a decorative touch. A coat of varnish over the decals, as well as over any painted designs, will protect them.

Each lantern is formed from a 1½-qt. tin can. Starting out as pictured in the details above, both ends of the can are removed and then seven serrations, 1¾ in. wide and

2½ in. deep, are made around one end. Then, cutting up from the opposite end, a V-shape opening is made for inserting a candle. After this, rows of 1/8-in. holes are made around the sides of the can, using a pointed tool such as an ice pick. The serrated end of the can is formed to a conical shape and a wire bail is provided for hanging. A wooden disk recessed in the center to hold a candle is inserted in the open end of the can and tacked in place to complete the lantern. Either painted designs or gaily colored decals can be used to decorate the lanterns. A coat of varnish or paint will protect the wooden disk. ★ ★ ★

Hot Water Frees Cleaning Patch Stuck in Barrel of Gun

A cleaning patch that has become stuck in the barrel of a rifle may be removed in most instances by soaking it with hot water poured down the barrel. One way of doing this, without causing an excessive amount of water to run down the outside of the barrel and possibly burn one of the hands, is by using a small funnel and a cloth. Place the funnel over the muzzle and wrap a cloth around both the funnel spout and the end

of the barrel. This not only will soak up most of the water that escapes but also will protect your hand. When the patch has been extricated, the barrel and the mechanism of the gun, needless to say, must then be dried and oiled thoroughly. After drying the bore with several more patches, use a soft cloth or, if available, compressed air to dry the gun mechanism.

H. Leeper, Canton, Ohio.

Child's Lap Desk Helps Teach Orderly Habits

This novel desk which is small enough to be held on a child's lap provides a handy container for drawing materials, school supplies and numerous other articles and treasured keepsakes. In addition, the desk helps to encourage neat, orderly care of personal possessions. Requiring only the simplest tools in its construction, the lap desk consists simply of a box containing built-in partitions and fitted with a hinged cover. The cover and bottom are cut from $\frac{3}{8}$ -in. plywood, while $\frac{1}{4}$ -in. plywood is used for the partitions. A 60-in. length of $\frac{3}{4}$ -in. stock, $3\frac{1}{2}$ in. wide, is cut into four pieces which make up the sides of the box.

Other supplies that will be needed are a pair of surface cabinet hinges, 1-in. brads, screws, glue, stain, shellac and wax. Use flatheaded screws driven in countersunk holes and cover the screwheads with wood putty. The partitions are assembled with brads and glue. Extra partitions may be added for bottles of ink and paints, as well as grooved wooden trays for pens, pencils and brushes. When assembled, smooth both the inside and outside surfaces of the box with sandpaper and apply stain in any color desired. Next, give the outside of the box a coat of shellac and, when dry, wax it to provide a smooth finish. — Mrs. H. T. Holmes, St. Clair Shores, Mich.

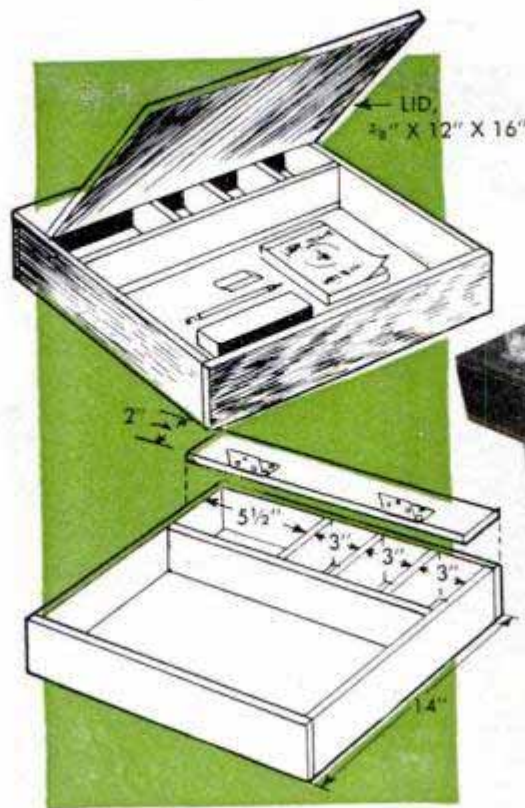

Badge Attached to Coat With Pencil Clip

When attending a convention or similar gathering where ribbon badges are worn, you can easily forestall the possibility of damaging your clothing as a result of having such a badge torn off accidentally. Simply fold the top edge of the ribbon over the breast pocket and secure it with the clip of a pen or pencil. This also is helpful when a ribbon is supplied without a pin or if the pin has been lost.

Reproduction of Craftsman Cover Used in Making Calendar

After obtaining the $10\frac{1}{4} \times 13\frac{3}{8}$ -in. color reproduction of the cover for the Craftsman section of the 50th Anniversary issue of *Popular Mechanics*, one reader used the picture in making an attractive calendar for his home. A $\frac{1}{2}$ -in. strip was trimmed from the top of the backing and $\frac{3}{4}$ -in.



strips removed from the sides. Two holes were punched near the top for the cord and a 1952 calendar pad glued near the bottom.

Arthur Trauffer, Council Bluffs, Iowa.

Lathe Dog Supports Round Work For Accurate Center Drilling



An ordinary lathe dog makes a handy drill-press vise for holding round, hexagon or square stock for center drilling. The tail of the dog drops into a slot in the drill-press table to prevent the work from turning. The body of the dog holds the work in a vertical position for centering of the drill bit. Long rods of small diameter can be inserted through the hole in the drill-press table and held securely in position with the dog.

PLAN of the MONTH...

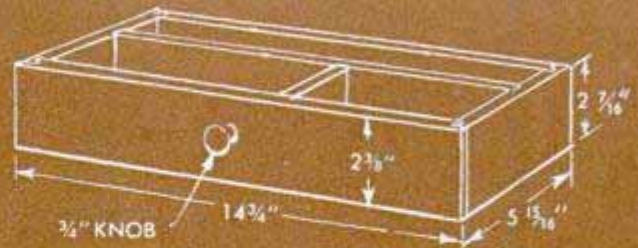
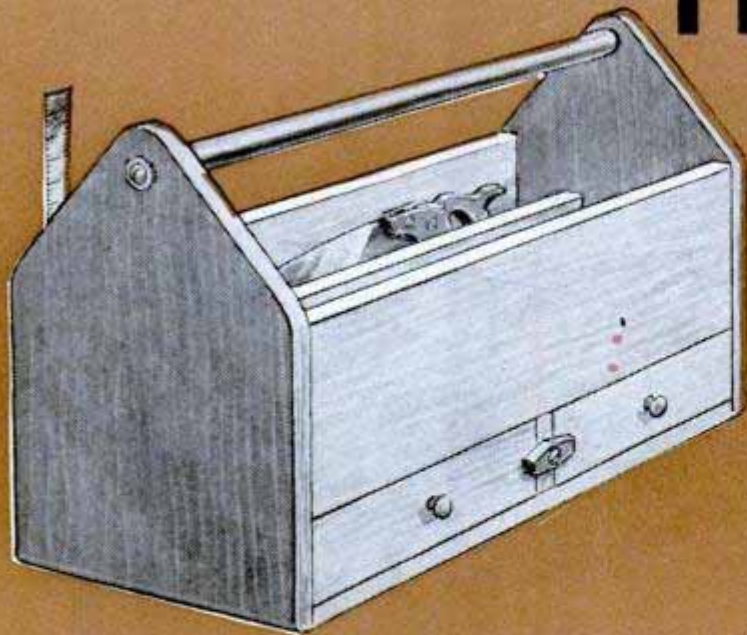

PARTITION ONE DRAWER FOR NAIL SETS, DRILLS AND BITS. LEAVE THE OTHER UNDIVIDED FOR WOOD CHISELS

OPEN TOOLBOX

Clear lumber

- 2 pcs.— $\frac{3}{4}$ " x $9\frac{1}{2}$ " x $13\frac{3}{8}$ "—Ends
- 1 pc.— $\frac{3}{4}$ " x $9\frac{1}{2}$ " x $30\frac{1}{2}$ "—Bottom
- 1 pc.— $\frac{3}{4}$ " x $8\frac{1}{2}$ " x $30\frac{1}{2}$ "—Back
- 1 pc.— $\frac{3}{4}$ " x 6 " x $30\frac{1}{2}$ "—Partition
- 1 pc.— $\frac{3}{4}$ " x 6 " x $30\frac{1}{2}$ "—Front
- 2 pcs.— $\frac{3}{4}$ " x $2\frac{3}{8}$ " x $14\frac{3}{4}$ "—Drawer fronts
- 1 pc.— $\frac{3}{4}$ " x 6 " x $2\frac{1}{2}$ "—Drawer divider
- 2 pcs.— $\frac{1}{2}$ " x $1\frac{15}{16}$ " x $14\frac{1}{4}$ "—Drawer backs
- 4 pcs.— $\frac{1}{2}$ " x $2\frac{7}{16}$ " x $5\frac{7}{16}$ "—Drawer sides
- 2 pcs.— $\frac{1}{2}$ " x $5\frac{3}{16}$ " x $14\frac{1}{4}$ "—Drawer bottoms
- 2 pcs.— $\frac{3}{4}$ " x $\frac{3}{4}$ " x $5\frac{1}{4}$ "—Glue blocks

Waterproof plywood

- 1 pc.— $\frac{1}{4}$ " x 6 " x $30\frac{1}{2}$ "—Bottom

Hardwood

- 1 pc.— $\frac{3}{8}$ " x $\frac{5}{8}$ " x $1\frac{3}{4}$ "—Turn key
- 1— 1 " x $31\frac{1}{4}$ "—Dowel
- 2— $\frac{3}{4}$ "-dia. knobs

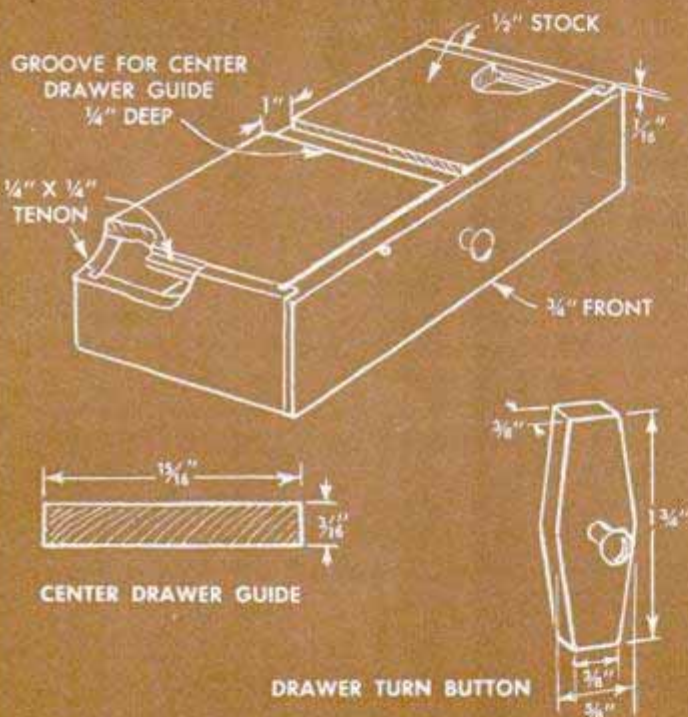

BORE HOLE $\frac{3}{8}$ " DEEP FOR 1" DOWEL HANDLE

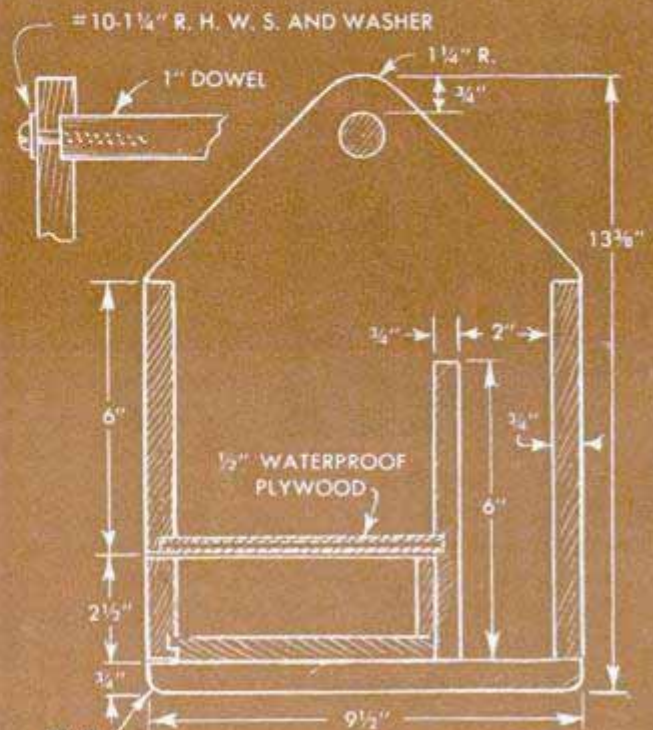
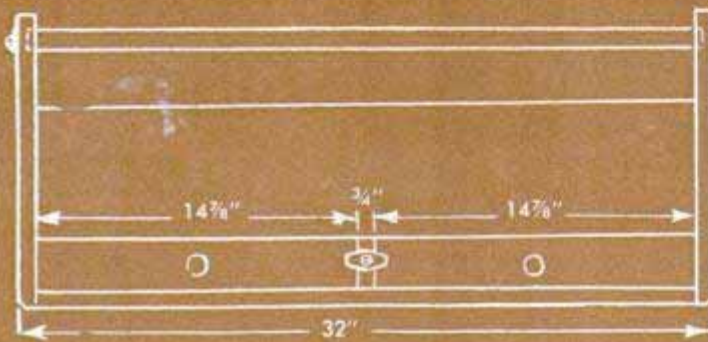

..Tool Boxes

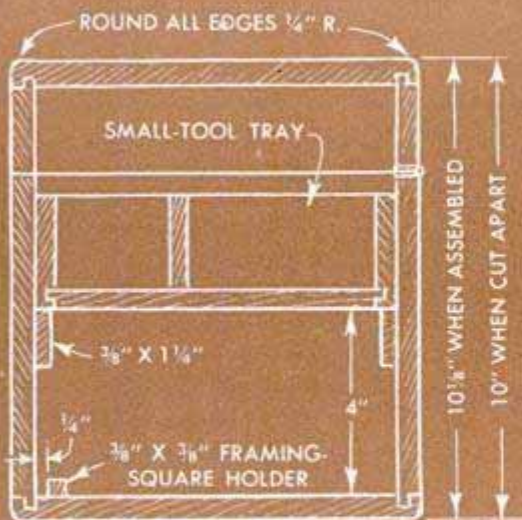

CLOSED TOOLBOX

Clear lumber or waterproof plywood

- 2 pcs.— $\frac{1}{2}$ " x 9" x 32"—Top and bottom
- 2 pcs.— $\frac{1}{2}$ " x $9\frac{1}{2}$ " x 32"—Sides
- 2 pcs.— $\frac{1}{2}$ " x $8\frac{3}{8}$ " x $9\frac{1}{2}$ "—Ends
- 2 pcs.— $\frac{1}{2}$ " x $2\frac{1}{2}$ " x 12"—Tool-tray ends
- 2 pcs.— $\frac{1}{2}$ " x $2\frac{1}{2}$ " x $6\frac{1}{2}$ "—Tool-tray side
- 1 pc.— $\frac{1}{2}$ " x 2" x $11\frac{3}{8}$ "—Tool-tray partition
- 1 pc.— $\frac{1}{4}$ " x 2" x $2\frac{3}{4}$ "—Tool-tray partition
- 1 pc.— $\frac{1}{2}$ " x $6\frac{1}{2}$ " x $11\frac{3}{8}$ "—Tool-tray bottom

Clear lumber

- 1 pc.— $\frac{3}{8}$ " x $1\frac{1}{4}$ " x 31"—Tool-tray rail
- 1 pc.— $\frac{3}{8}$ " x $1\frac{1}{4}$ " x 29"—Tool-tray rail
- 1 pc.— $\frac{3}{8}$ " x $\frac{3}{8}$ " x 31"—Framing square strip
- 1 pc.— $\frac{3}{4}$ " x $1\frac{1}{2}$ " x 7"—Saw block
- 1 pc.— $\frac{3}{8}$ " x $\frac{5}{8}$ " x $1\frac{1}{4}$ "—Turn key
- 2 prs.—1" x $1\frac{1}{2}$ " butt hinges
- 1 suitcase handle with fittings
- 1 suitcase flush lock
- 2 suitcase bolts
- 8 suitcase corners, $1\frac{1}{4}$ " x $1\frac{1}{4}$ " x $1\frac{1}{4}$ "

$\frac{3}{4}$ " X $1\frac{1}{2}$ " X 8" BLOCK WITH TWO SAW KERFS TO HOLD HANDSAWS

$\frac{1}{4}$ " X 2" SLOT IN LEFT FRONT CORNER OF TOP FOR END OF FRAMING SQUARE

TURN BUTTON

BLOCK TO FIT SAW HANDLE

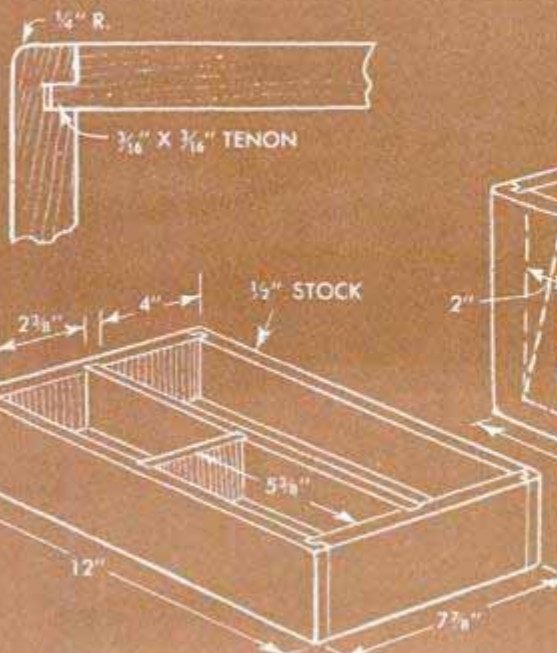
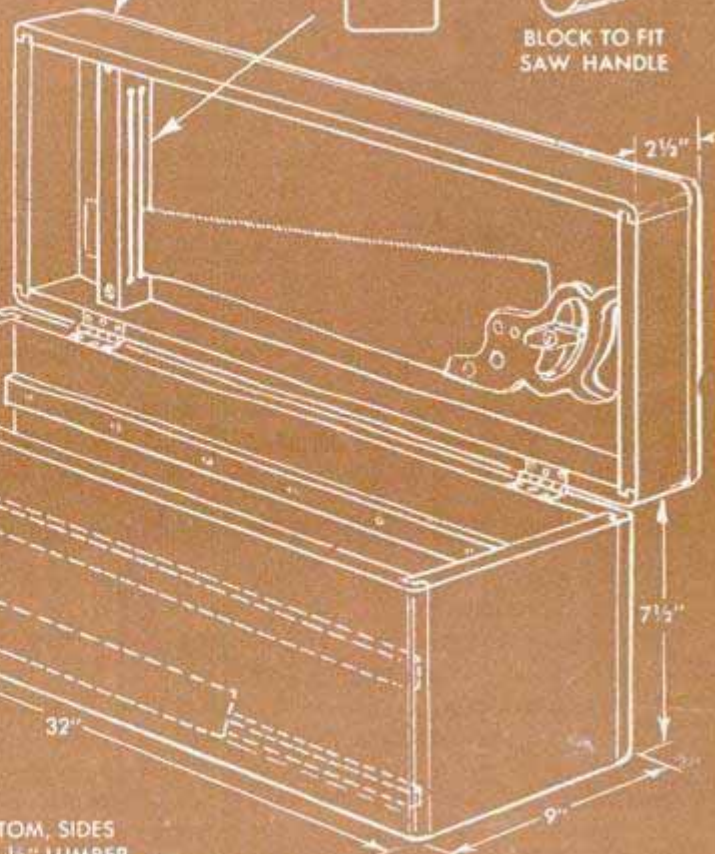
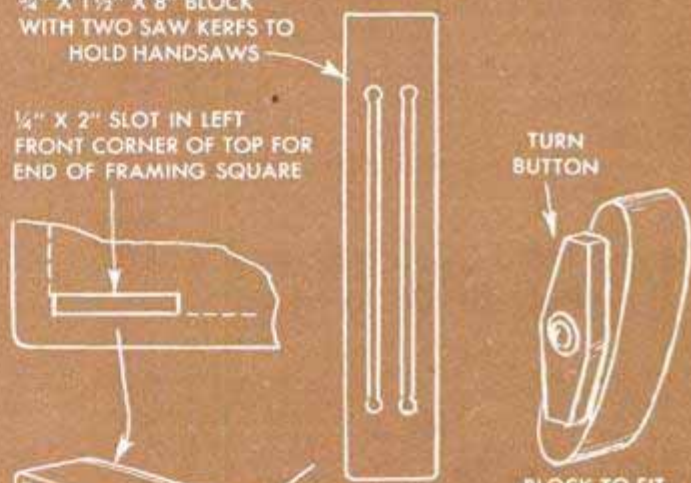

REMOVABLE SMALL-TOOL TRAY

TOP, BOTTOM, SIDES AND ENDS $\frac{1}{2}$ " LUMBER OR WATERPROOF PLYWOOD

Compass Used to Draw Parallel Lines Saves Repeated Measuring



Using a ruler and a compass, it's a simple matter to scribe a series of straight, parallel lines without first measuring for each line. Adjust the compass to the desired spacing and mark the initial line on the work by running a pencil along the ruler. Next, reverse the position of the compass and, without moving the ruler, mark the second line by holding the point of the compass against the edge of the ruler. This provides two parallel lines that are spaced uniformly. To rule additional lines of the same spacing, align the ruler on the last line drawn and repeat the operation as described. If the compass is of the friction-joint type as pictured in the illustration, take care that you do not press down hard enough to cause the legs of the compass to spread accidentally.

Nailheads Protected When Set By Wooden Thread Spool

Furniture nails having decorative or large enameled heads more often than not prove difficult to set without damaging the heads with the final blows of the hammer. In order to keep from marring the nails, one amateur upholsterer holds a wooden

thread spool vertically against the nailhead while he finishes driving the nail. The wood cushions the blows from the hammer, leaving the nailhead unmarred, while the hole in the spool serves to center it on the rounded head of the nail.

Work Held During Edge Planing With Pair of C-Clamps



Lacking a bench vise with which to hold boards for edge planing, one craftsman used two C-clamps to improvise a vise. As in the drawing, he locked one of the clamps in a vertical position against the side of the work with the

second clamp. He then tightened the vertical clamp to the edge of the bench top. The clamp used to fasten the work to the bench must be small enough so that its top edge does not interfere with the plane.

Removing Rust Stains on Sink

Rust stains on porcelain-enameled sinks can be removed with a dilute solution of hydrochloric (muriatic) acid applied with a cloth swab. Rub the solution lightly onto the stained surface, allow it to remain from three to five minutes, then wash the surface with a soda-water solution to remove the acid residue. *Caution: Do not permit any of the acid solution to come in contact with the skin.*

Battery Clip Supports Brushes In Cleaning-Fluid Can

In order to prevent the bristles of small brushes from becoming bent over and twisted when left in a can of cleaning fluid, suspend the brushes from a two-way battery clip of the type shown. A length of stiff wire, inserted through the center of the clip, rests on the edges of the can. If a two-way clip is not available, improvise one simply by screwing two regular clips together and drilling a hole for the wire.

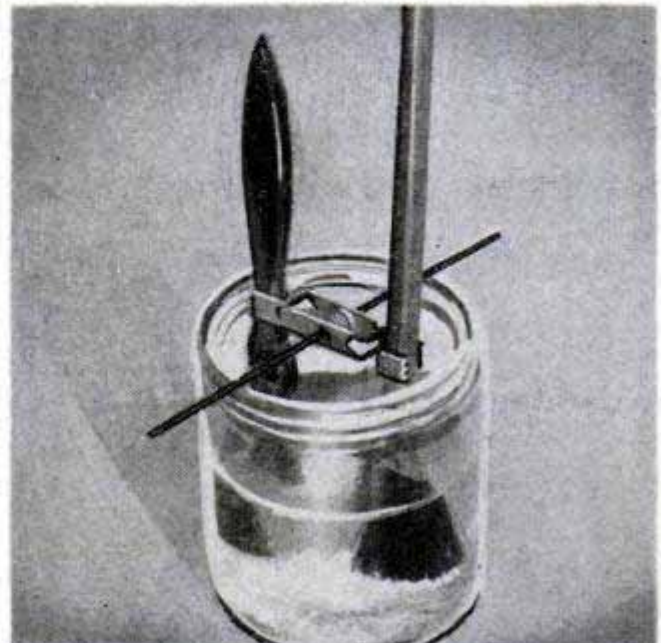



SMALL BOATS Go Inboard

By *Elon Jessup*

ALL THE FUN of piloting an expensive inboard boat can be yours by powering your skiff, rowboat or outboard with an air-cooled engine of the single-cylinder utility type. These efficient little engines are self-contained units and require no conversion for inboard mounting in any open boat under 16 ft. in length, and their availability in sizes ranging from $\frac{1}{2}$ hp. up makes them suitable for inboard mounting in hulls down to 7 ft. in length. Several of the larger engines are supplied with special marine equipment, including a clutch and reverse gear. A 2 to 3-hp. engine will handle a 12 or 14-ft. boat at good cruising speeds in quiet water.

Installation of the engine in the average open boat usually is quite simple. There are no fuel or water lines to plan and install and no battery to be mounted, therefore all that is necessary is to bolt the engine to suitable bearing blocks attached to the bottom of the boat. A typical installation in a small flat-bottom skiff is shown in the lower details on the following page. Before the engine is placed, several points should be considered. An air-cooled engine should

not be installed under a deck or behind a bulkhead, as it will quickly overheat. Neither should it be placed in a well or compartment. Many users install the engine at the center of the boat, or slightly forward of midships, depending on the location of the seats, and operate it without any cover. The only disadvantage in this type of installation is that the unprotected engine may be drowned out during a sudden rain squall, or stop at a critical moment should water be shipped in rough weather. A recommended type of protective covering is shown on the following page. Screened openings at the front and back permit free circulation of air and a hinged cover over the top protects the engine from rain and driven spray, while permitting easy access to the starting cord. The covering, or hood, which is designed to lift off quickly when making repairs or adjustments, is attached with small hooks to a frame built around the engine.

Nearly all small engines of the air-cooled type will operate satisfactorily when tilted at an angle of 10 deg. A greater degree of tilt usually is not advisable. For this reason it will be necessary to connect the engine to the inboard end of the propeller shaft

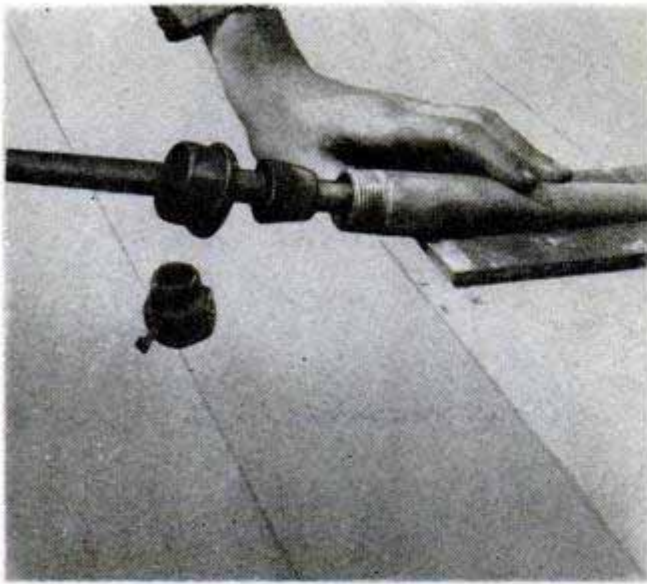

In some installations a rigid shaft log will serve the purpose, but usually the adjustable type is best

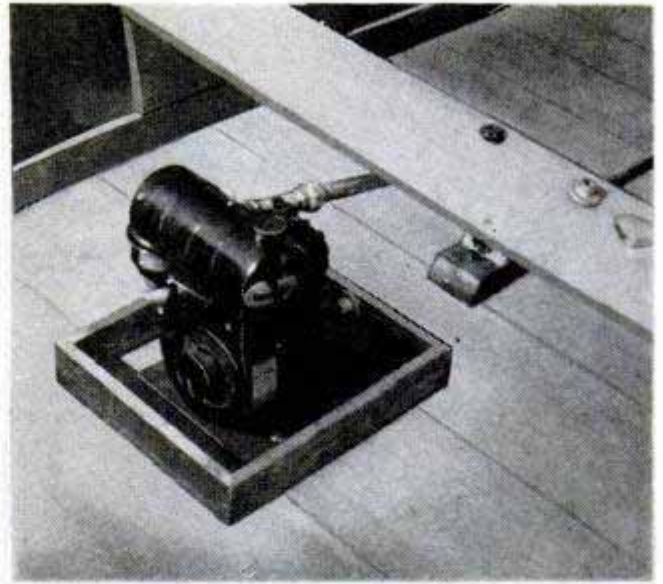

In many instances the engine can be bolted directly to the floor of boat without using tapered timbers

with a marine-type flexible coupling. On most small boats it is advisable to use a self-aligning shaft log and adjustable propeller strut. Some small boat hulls will permit fitting a skeg which can be drilled lengthwise for the propeller shaft. When mounting the shaft in a skeg, some builders simply fit the outer end with a nonscoring, or cutless, bearing. However, it usually is better to carry the underwater end of the shaft in a flange-mounted stuffing box. When obtainable, it is advisable to use a monel-metal propeller shaft. The cutaway

view below shows the shaft mounted in a rigid shaft log and fitted with an improvised inboard bearing. In flat-bottom boats this type of installation generally proves satisfactory, although in some cases an inboard strut will provide a steadier mounting for the shaft.

In a pleasure boat, some means of leading the exhaust to the side or stern of the boat is desirable. Usually a length of gas-tight flexible tubing will serve the purpose. When tubing is used, the regular muffler is removed and the tubing connected directly to the exhaust port. Generally the best plan is to extend the tube to the side of the boat and then carry it back to the stern board, or transom. For a neat job, drill a hole through the transom somewhat larger than the tubing, then lead the end of the tube through a brass or bronze exhaust flange attached to the outer surface of the transom. In an open utility boat many own-

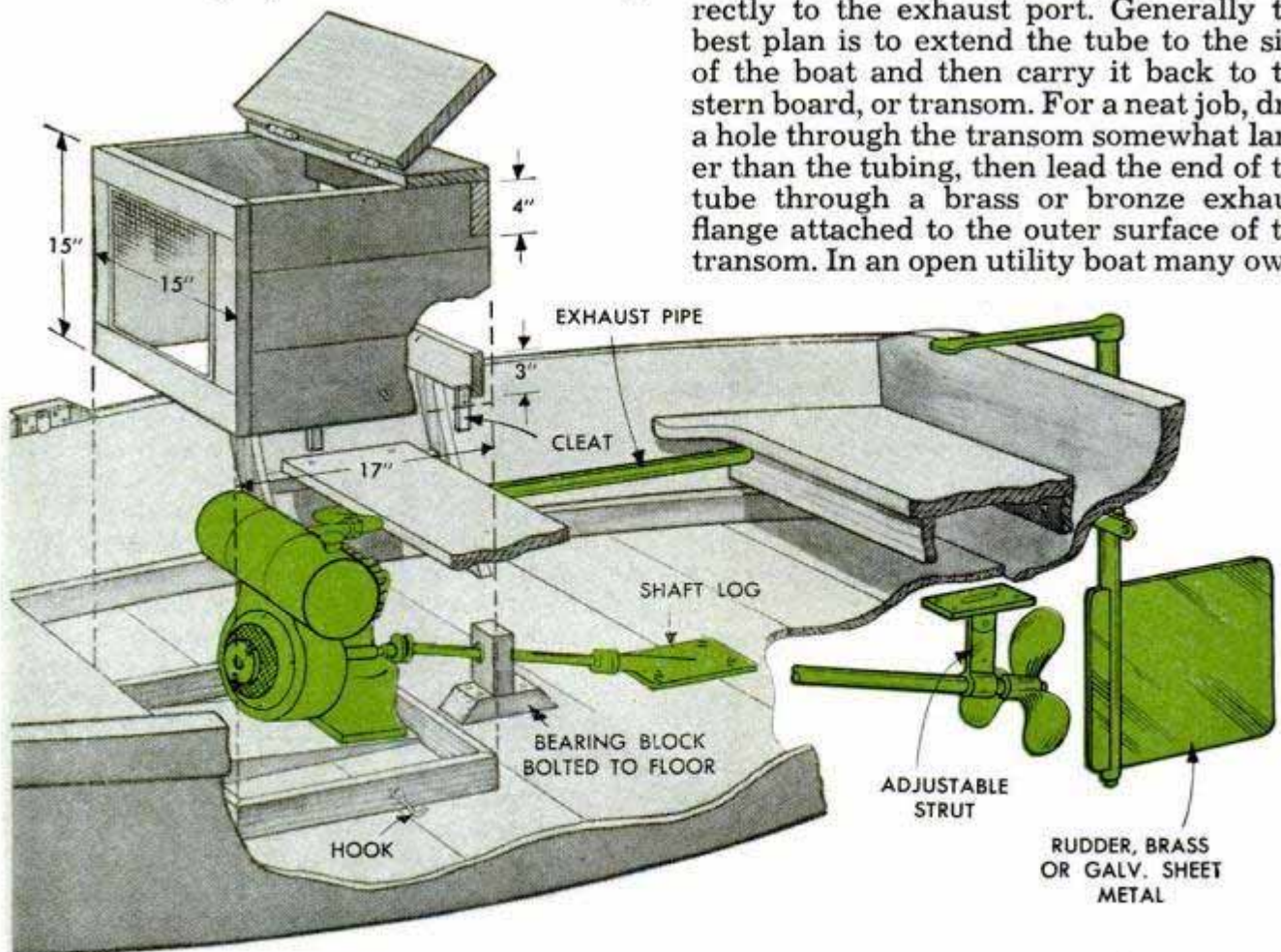

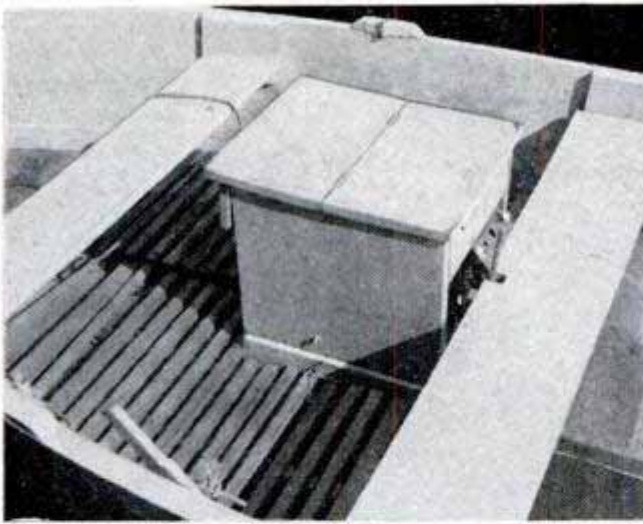

Top of the engine cover or hood should be hinged for easy access to starting cord. Note the open ends

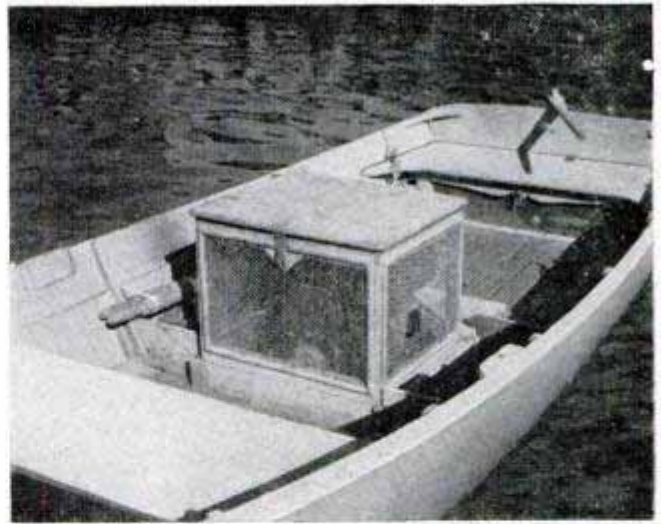

This hood is screened on all four sides, permitting ample circulation of air to the engine cooling fan

ers either omit the exhaust line entirely or install one made from ordinary pipe. In any case be sure that the exhaust line does not touch the wood at any point along its length. Wrap the pipe with several layers of sheet asbestos at the point where it passes through the transom.

A rudder of the tiller-controlled type, shown in the detail on the preceding page, is available as a unit from marine-supply dealers. Ordinarily the rudder size should

be about 10 x 12 in. and it can be installed on the outside of the transom, or inboard, as desired. Rope-and-drum steering units often are installed in place of the tiller. Two-bladed bronze propellers of the general-purpose type are quite often used in inboard installations. For small engines, the propeller size can range from 6 to 10 in. depending on the power of the engine and the size and type of the boat. Always carry a pair of oars for emergencies. ★ ★ ★

Oil Applied to Shingle Roof With Garden Sprayer

Applied easily with a garden sprayer of the type that is carried by means of a strap slung over the shoulder, a mixture consisting of 2 parts each of kerosene and crankcase oil, and 1 part creosote provides one homeowner with a very satisfactory, durable dressing for shingle roofs. First, the oils are poured into a 5-gal. can and mixed together by shaking the can. The dressing is then strained through a fine-mesh cloth when filling the sprayer tank in order to remove any particles or sediment that might possibly clog the spray nozzle. The oil is applied with pressure sufficient to drive it well into the joints between the shingles as well as over the butt ends of the

shingles where the greatest weathering occurs. Beginning at the ridge and backing away from the work while spraying the roof above, care should be taken to direct the spray in such a way that there will be little possibility of spattering the sides of the building. Naturally, the job should not be attempted whenever there are strong breezes blowing. Since oil causes the rubber gaskets and hose to deteriorate, it is a good idea after the job is finished to rinse the parts with gasoline and then wash them in water containing a strong detergent or soap. When finished, rinse the parts again—this time using clear water.

Clinton R. Hull, Costa Mesa, Calif.



Renewing Points of Wax Crayons

With a little supervision, children will have fun reshaping and repointing their worn and bent wax crayons. A pan of warm water and another one of cold are all that is needed to do the job. First, place the crayons in the pan of warm water. This will soften them and loosen the paper wrappers for easy removal. It is then a simple matter to straighten the crayons and point both ends or taper them as desired. When finished, simply drop the crayons into the pan of cold water to harden them.

Herbs Cured in Paper Bag



To prevent loss of leaves when curing herbs, spread the fresh clippings on a newspaper until the stems shrink and the leaves are partially dry. Then tie the clippings in bunches, invert each bunch in a paper bag and tie

the mouth of the bag securely about the bunched stems. Store the bags in a dry place until the herbs are needed. Then shake the bag lightly before untying to loosen the dried leaves from the stems.

John J. Rea, Urbana, Ill.

Modelmaker's Magnifying Glass

Mounted on the shade of a gooseneck lamp, a pocket-size magnifying glass is of considerable help to modelmakers when



assembling small parts or carving intricate designs. The glass is clamped to the bead of the shade with a double-end battery clip so that the lens is slightly below the shade. The lamp brightly illu-

minates the work, and as the glass does not have to be held by the hobbyist, both hands are left free for handling the work. The glass is brought to almost any desired position by adjusting the gooseneck.

Joel Miles, Denver, Colo.

Clamps From Roller Skates Used to Hold Glued Work

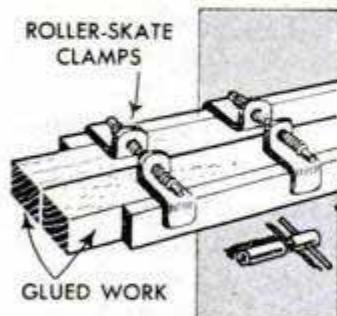

Toe clamps of the type used on roller skates will prove useful in many instances where pressure must be applied to glued joints. It usually is possible to remove them

from the skates simply by unscrewing the threaded rods all the way, after which they are reassembled with the clamp jaws. Strips of wood should be placed under the jaws to prevent them from marring the work. The clamps are easily replaced on the skates.—Walter Burton, Akron, Ohio.



CATERPILLAR

Many fishermen regard tent caterpillars as the best live bait for pan fish. Look for them in low-growing shrubs and small trees along fence rows

Where To Find NATURAL BAIT

By Russ Jenkins

ALTHOUGH NATURAL baits usually are plentiful in and near lakes, ponds and small streams during the fishing season, the trick in catching them is in knowing where to look. Lively insects, such as grasshoppers and crickets, are quite easily spotted in sunny, open areas along the stream or lake shore while small green frogs suitable for bait are fairly easy to locate anywhere along a stream bank. However, many of the best live baits will require a more diligent search. Don't waste time digging for earthworms and grubs in sandy or clay soils. If you're in the woods, search for them under rotted logs, around old stumps and weathered sawdust piles. Clams, and also hellgrammites, will be found in the stream bed, the hellgrammites under stones and submerged logs and the clams on the muddy bottom of sluggish streams near the shore. Crayfish are caught easily with a minnow net along the stream bank. Minnows can be taken with drop nets and seines, but most fishermen rely on a trap made especially for the purpose. Look for tent caterpillars in low-growing shrubs and also in walnut trees. When the "tents," which are observed easily from a distance, are located, cut off the limb close to the tent and you have a supply of live bait for a day's fishing. Nearly all live baits will remain alive and healthy for several days if kept in containers with moist earth, rotted wood and other materials which approximate closely the conditions of their natural habitat.



WORM

Earthworms, or angleworms, will be taken by nearly all small game fish. Dig for them under rotted logs, around old stumps and under leaf mold



GRUB

In and under old rotted logs are the places to find grubs if you're in the woods. They also will be found around edges of weathered sawdust piles



FROG

Catching a green frog is a neat trick at any time but it can be done if you move quickly. Fishermen catch them with a landing net along streams



CRAYFISH

Crayfish can be caught with a minnow seine along banks of sluggish streams where water is shallow. Move stones and sunken logs to dislodge them



MINNOW

Minnows are easily taken with a net or seine, but most fishermen rely on a trap made especially for the purpose. Set trap in shallow water near shore



CRICKET

Few small game fish can resist a lively cricket when the insect is properly hooked and tossed onto the surface of a still pool of clear water



CLAM

Sandstrom

Clams are located easily on the bottom in 3 to 5 ft. of water. When cut into strips, the flesh of the clam is an excellent bait for most game fish



GRASSHOPPER

A day's bait supply of 'hoppers can be taken in a few minutes with a piece of mosquito netting loosely attached to a wire frame having a handle

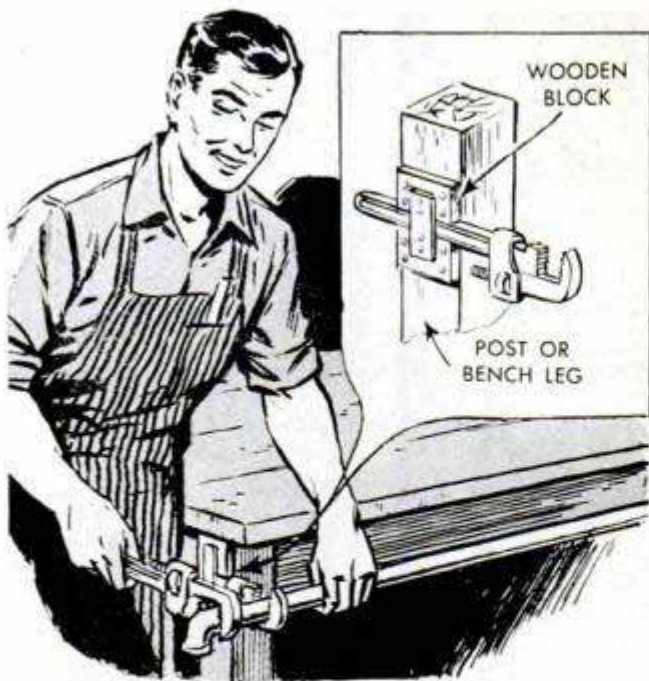

Improved Pipe Vise

Rather than buy a pipe vise for use on a simple plumbing job that required cutting and threading pipe, one home craftsman improvised a vise from a pipe wrench. He fitted the wrench handle into a 3-piece bracket which was screwed to a wooden post in the basement. The bracket blocks should be of hardwood and must be spaced so that when the wrench handle is inserted, it will be held tightly. Of course, the pipe-wrench vise also may be mounted on a bench or table leg as shown in the illustration.—Harry N. Pederson, Chicago.

Leather Sleeve on Bridle Reins Speeds Hitching Horse to Post



You can quickly hitch a riding horse to any nearby post if the reins have been fitted with a leather sleeve, or loop, which is used to draw them tightly around the post. The loop is a narrow piece of leather wrapped around

the reins and riveted loosely enough so it will slide easily. To keep the loop from slipping off the reins, the free ends of the reins are joined together with a buckle or by folding them double and riveting them together.

☞ To prevent the ends of lamp cords from becoming frayed, simply dip them in shellac and let dry before connecting the wires to the plug or socket.

Oilcan Used Without Removing Cap

More often than not, the plastic cap on a small can of household oil eventually becomes lost. After having this happen several times, I found a way of preventing it. When a new can of oil is purchased, I first back off the cap about 1½ turns and drill a tiny hole in the side near the tip. This permits the can to be used without removing the cap completely and, since the hole in the cap is below the end of the spout, screwing the cap all the way



down seals the can effectively. In addition to the advantage of not having to remove the cap, the partially removed cap permits a measured amount of oil to be applied.

Ken Murray, Colon, Mich.

Elbows in Drain Line Provided By Chipping Ends of Clay Tile

When installing drain tile around foundations, one builder chips the ends of two clay tiles at a 45-deg. angle in order to form a right-angle elbow. First, the end of each tile is marked at a 45-deg. angle as pictured. Then the waste is broken away in small pieces with an ordinary adjustable wrench having jaws set to an opening slightly greater than the tile thickness. After the tile are laid, the right-angle joint is covered with a strip of roll roofing.

Peter G. Gordon, Lansing, Ont., Can.

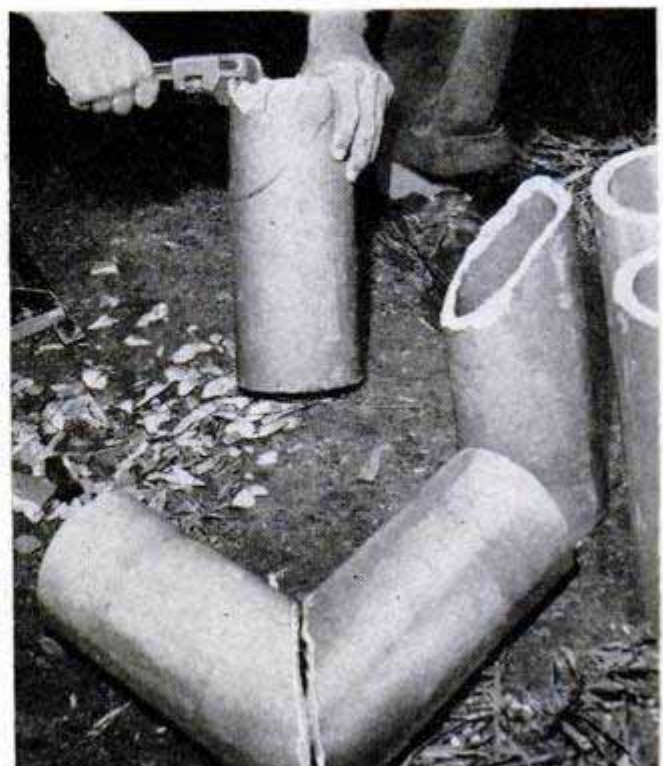

BRACING

Saves Old Trees

By Raymond Schuessler

BEFORE you cut down the venerable shade tree that's showing signs of old age, take time to examine it closely. Cabling and rod bracing may save it for many more years of usefulness by providing mechanical support for weakened crotches and large, spreading branches.

Tight V-crotches are a frequent source of trouble in both young and old trees which grow with multiple, or divided, trunks. Major limbs that begin growth very nearly parallel to each other often develop a seam, or joint, of nonconnecting tissue at the division point. This results from the squeezing and crushing of the cambium layer and bark as growth progresses. Eventually the affected tissues die, leaving an open seam. When the limbs become loaded with ice, or when the foliage is thoroughly wet down by a heavy rainstorm, the joint may break and cause irreparable damage to the tree.

A second ranking source of trouble in older trees is a decayed or damaged trunk caused by a fungus attack or partially healed wounds. Sometimes trunks and large limbs will be split by the twisting stresses of high winds or sleet storms. Such damage should be repaired immediately or the tree will be lost.

The two general methods of tree bracing are cabling and rod bracing. Although each tree presents an individual problem, the two methods have several common applications. Where trees stand in close proximity, inter-tree cabling combined with rodding, Fig. 1, is frequently used to stabilize younger trees and promote proper top formation. In older trees the methods are sometimes combined to distribute stresses which might cause damage to the individual trees, especially in open, windswept locations on large lawns or estates.

Utilizing the same principle, inter-branch



cabling of several types is used to support the tops of large individual trees. Typical applications are shown in Fig. 2. The cables are installed high in the branches to equalize the load on structurally weak crotches. As a rule, the most efficient for general use is the triangular system, Fig. 2. When the cables are installed care must be taken to locate them so that they do not touch other branches or the trunk of the tree as damage may result.

The location of the cables in relation to the length of the branches depends to some extent on the structure of the tree, but it's

Where trees of the same age are grouped closely together, inter-tree cabling frequently is used to stabilize growth and aid top formation. Large, individual trees are often guyed with cables, as in left-hand detail



a safe rule to place the screw eyes, or lags, about $\frac{2}{3}$ the distance from the crotch to the end of the limb. Holes for the screw eyes should be drilled so when the eyes are installed the parts will be in a straight line. Otherwise the screw eyes will be bent when subjected to strain. After measuring the distance between the screw eyes to determine the length of each cable, it is cut to length and eye-spliced as in Fig. 4, A, B, C and D. For average spans, $\frac{1}{4}$ -in. cable is suitable for supporting limbs up to 6 in. in dia. For larger limbs, use $\frac{5}{16}$ or $\frac{3}{8}$ -in. cable.

After installation, the cables should be under sufficient tension to hold them taut when the limbs are swayed by wind. To accomplish this, the limbs are roped to the tree trunk and raised somewhat above their normal position before cabling. In some cases this will require the aid of a tackle block.

Fig. 3 illustrates three methods of rod bracing in common use. To avoid weakening the limbs, the single-bolt method is the most widely used as it requires drilling only one hole in each of the limbs affected. The rod used is continuously threaded with a square thread similar to a lag screw. Usually it is cadmium-plated and comes in sizes ranging from $\frac{5}{8}$ to 1 in. in dia. Ordinarily

a hole slightly smaller than the diameter of the rod is drilled through both limbs at a point ranging from 18 to 36 in. above the crotch and the rod is turned in until one end projects an inch or so. Then, it is cut off to the required length and the ends coated with a special tree-wound dressing.

In some cases where the limbs are exceptionally large, it will be necessary to countersink diamond-shaped washers, or plates, over both ends of the rod and draw tight with nuts as in the lower left-hand detail in Fig. 5. In making the countersinks use a sharp chisel to produce a clean wound that will heal quickly. Fill the countersinks with tree-wound dressing.

Split trunks and large limbs are sometimes salvaged by use of lip and cross bolts installed across the break as in the upper left-hand details in Fig. 5. Large hollow trunks are frequently braced in this manner before being filled with tree cement. In order to be fully effective, rods used without nuts and washers should turn into at least 4 in. of sound wood in small trees and 6 in. of wood in larger trees. It's a good idea to coat the rods with wound dressing before turning them into place.

In some rare instances it is desirable to bolt two limbs tightly together, or a few

Details below show common methods of cabling and rodding large limbs within the treetop to support a spreading top and prevent crotch breakage. This type of cabling also prevents damage during high winds

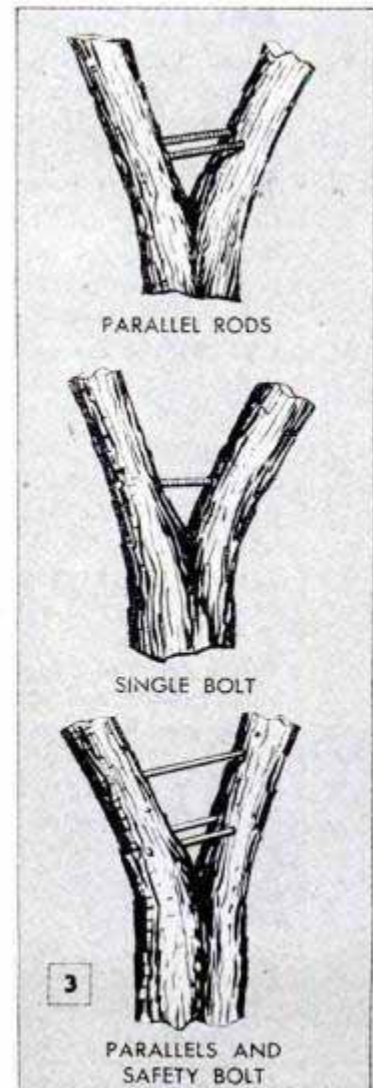
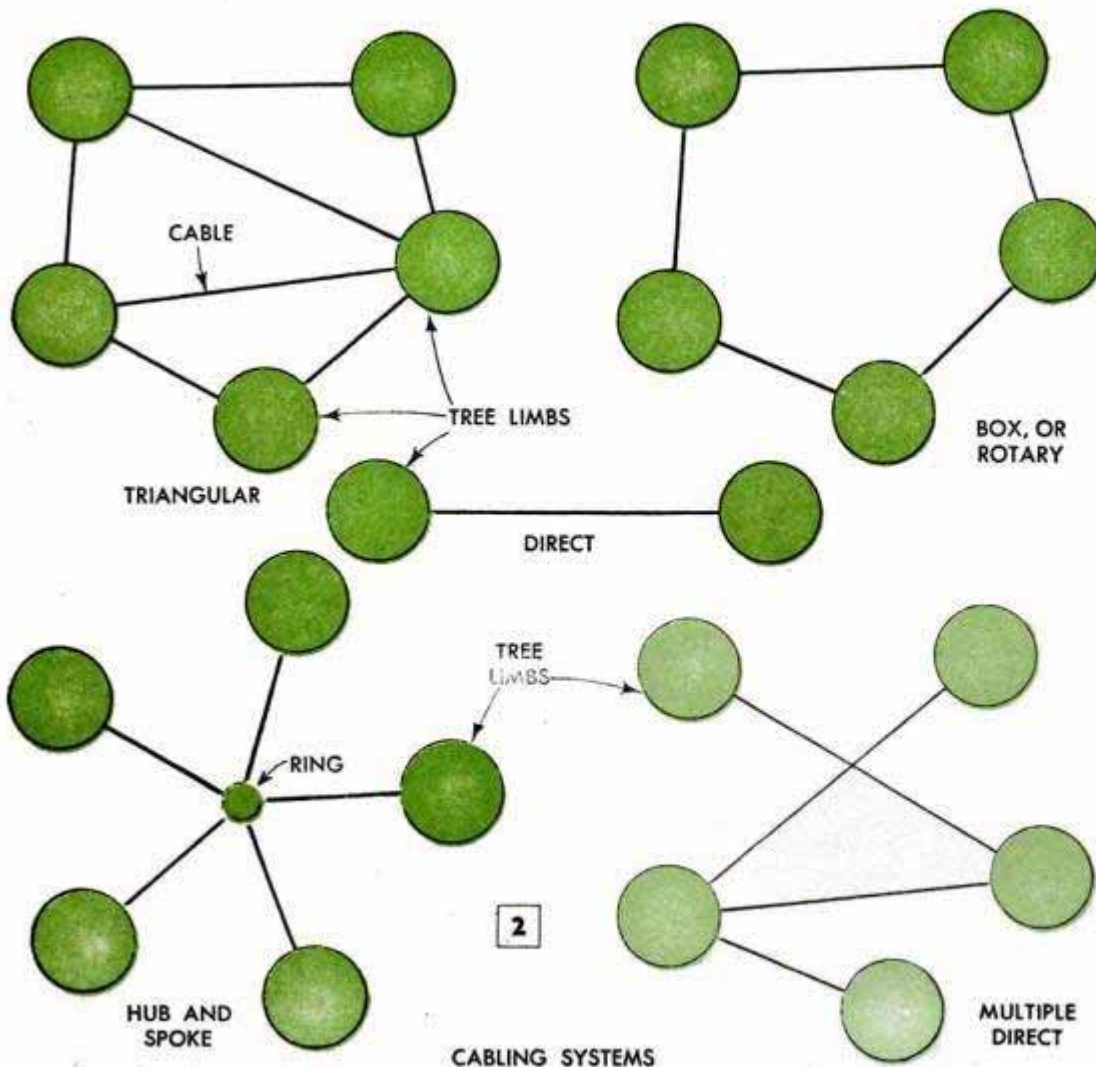

inches apart, as in the upper right-hand details in Fig. 5. Usually this is done to preserve for a time the form of an old tree. In younger trees one of the interfering limbs should be removed. The limbs should never be forced together and bolted. Only when they are touching at some point is it permissible to insert the bolt without a spacer. In some cases they are separated and bolted together with a spacer between as in the center detail.

Large limbs that rub together during windstorms can be separated by means of the slide arrangement shown in the lower right-hand detail, Fig. 5. A strip or block of hardwood is bolted to one of the limbs, preferably the lower one, and a long U-bolt made from smooth steel rod is fitted into two holes drilled in the upper limb as shown. Thread both ends of the rod before bending, the thread length being slightly greater than the diameter of each limb. After the rod has been bent to the U-shape, run nuts down to the limit of the threads on both ends and place washers over the nuts. Then insert the bolt in the holes and turn nuts onto the projecting ends as shown. It is of the utmost importance to treat all tree wounds immediately to prevent the entrance of insects and disease-producing

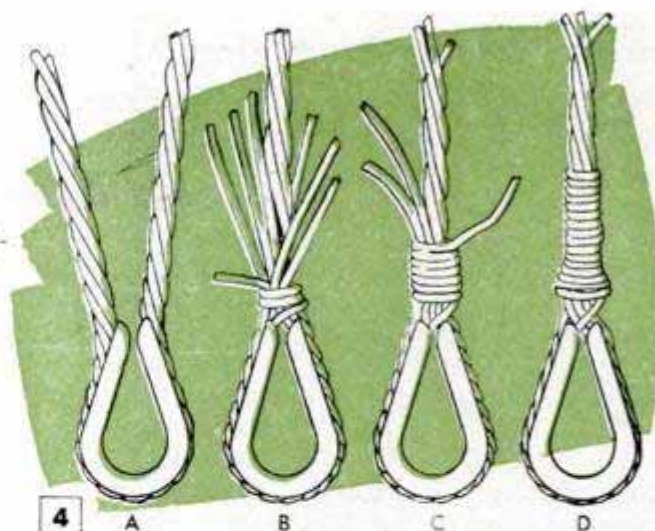

4 STEPS IN MAKING EYE SPLICE IN 7-WIRE STRAND

Cables anchored to limbs will require an eye splice at each end. Details show how to make a 7-wire splice

organisms. Wounds made by cutting through the bark into the cambium layer must be sealed at once with a special dressing made for the purpose, or with a dressing made by mixing dry bordeaux with raw linseed oil to make a paste sufficiently heavy to stay in place when spread with a putty knife or small trowel. Destroy the unused portion of this mixture. ★ ★ ★

In many instances, split limbs and hollow trunks of older trees are reinforced by lip and cross-bolting as detailed below. Special threaded rods are used for this type of bracing on both old and young trees

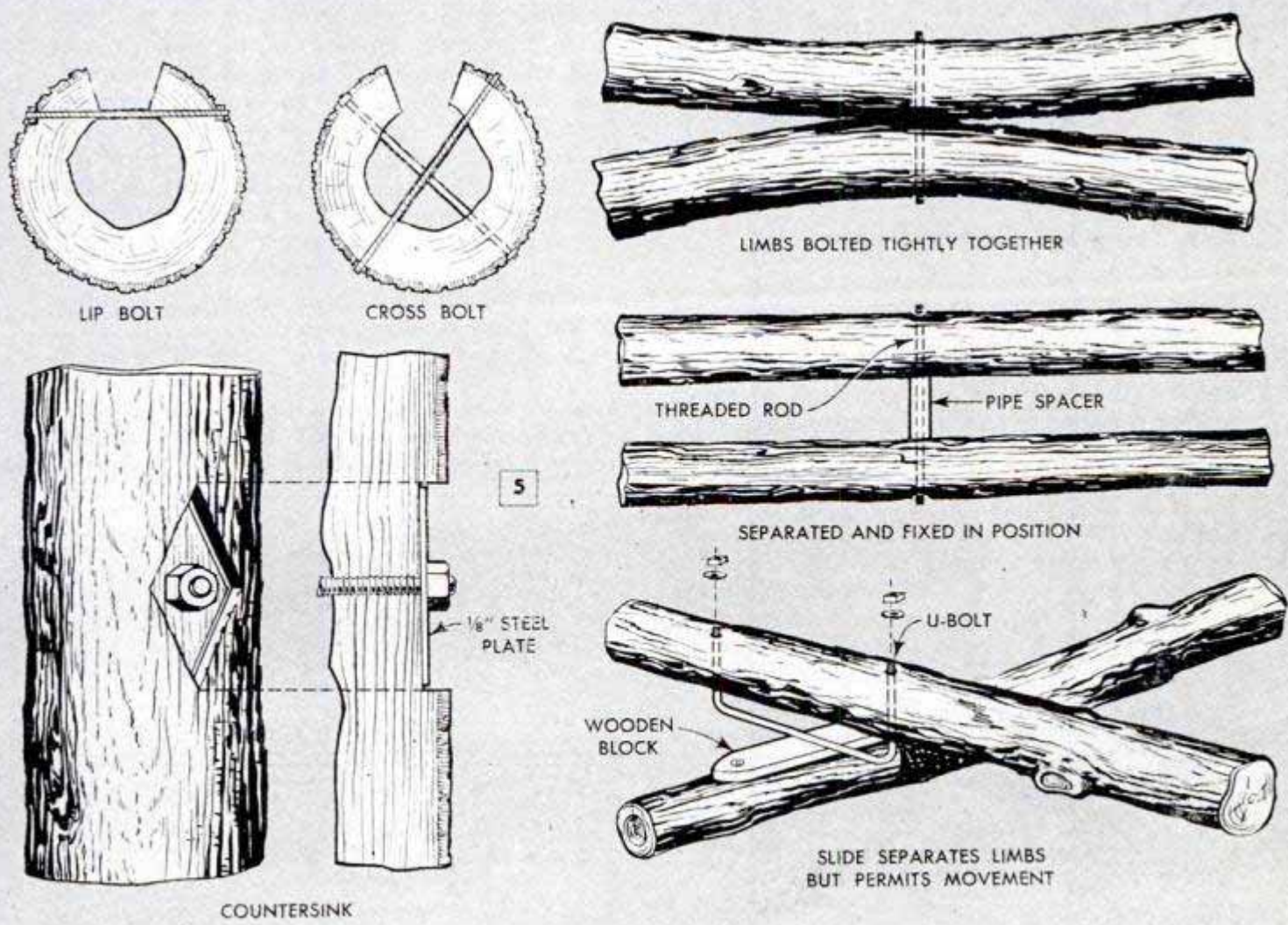

LIMBS BOLTED TIGHTLY TOGETHER

THREADED ROD PIPE SPACER

SEPARATED AND FIXED IN POSITION

WOODEN BLOCK

U-BOLT

SLIDE SEPARATES LIMBS BUT PERMITS MOVEMENT

Carton Fastener Saves Time

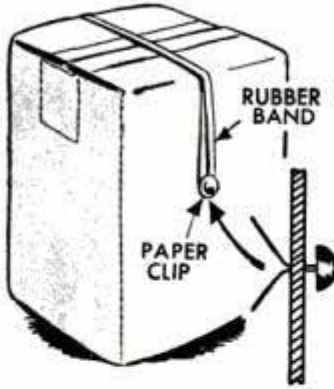

If a cardboard carton in which various items are stored must be opened from time to time, this simple means of holding down the cover flaps with a rubber band will save you considerable bother. A button-type paper fastener is inserted in each of two opposite sides of the box, after which the ends of a large rubber band are passed over the top of the carton and looped around them. To open the carton, the band is lifted and swung over one side.

Guard Ropes Erected Quickly On Stakes Coiled at One End

Supported by steel stakes coiled at one end approximately $2\frac{1}{2}$ turns as shown, guard ropes for an athletic field or parking area can be erected or taken down in a matter of minutes.

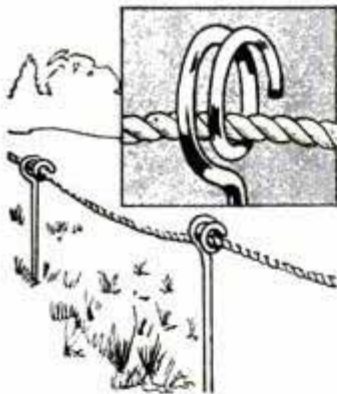

After the area to be used has been marked off, the stakes are pushed into the ground and the rope is twisted into the coils. — G. E. Hendrickson, Argyle, Wis.

Ash Tray for Game Room

Symbolic of a card or game room, this novel ash tray is made from a couple of dominoes, four glass marbles and a jar cover. After cementing the dominoes together, the marbles are attached to serve as feet for the tray. It is a good idea to sand each marble and also indent the surface of each domino where the marbles are to be cemented to it. This may be done by holding the marble in position on the domino, placing a small block of wood over it and then striking with a hammer.

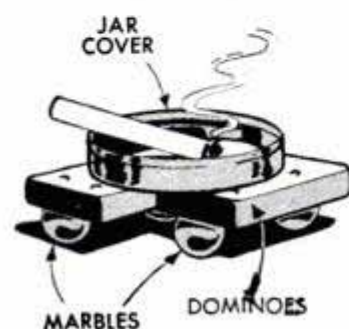

The jar cover should then be sanded where it is to be cemented to the dominoes. Any good household cement will do. — Frank Shore, New York City.

BOOMERANG TABLE

By Tom Riley

DUBBED "BOOMERANG" because of the characteristically shaped legs, this unique piece of functional furniture is the practical answer to the space problem in today's combination living-dining room. It serves as a swank cocktail table and a spacious dining table all in one. The particular shape of the hinged legs provides extreme rigidity when the table is raised to the dining position, and due to their being offset 12 deg., no hardware is required to lock the legs in place.

Its utter simplicity of construction stems from the fact that the ready-made top is a flush-type door. A $1\frac{3}{8}$ or $1\frac{3}{4}$ -in. interior, or hollow-core, door is recommended and all that the top requires is a $\frac{1}{4}$ -in. facing strip glued to the edges. The drawing on the opposite page shows how this is mitered at the corners, and also shows how the twin leg units are put together, each individual leg being cut as indicated from a 36-in. length of $1\frac{3}{4}$ -in. stock. Plywood "stretchers," $\frac{3}{4}$ in. thick, fit into stopped rabbets cut in the inner corners of the legs to tie the latter together. Hinging the leg assemblies to the underside of the door completes the table. Center these under the top and allow about $\frac{1}{8}$ -in. clearance between the legs when the table is in the low position. Furniture glides on ends of legs are optional.

A simple way to obtain a bleached finish with either birch or oak is to give the table a coat of white resin sealer, then sand to the tone desired and follow with two coats of clear resin sealer, varnish or wax.

These two drawings show how the boomerang-shaped legs swing to convert the table from a low cocktail table to a roomy dining table in a matter of seconds

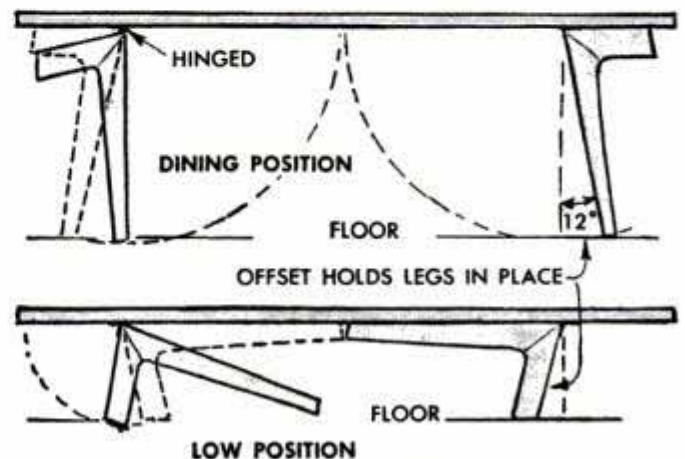

POPULAR MECHANICS

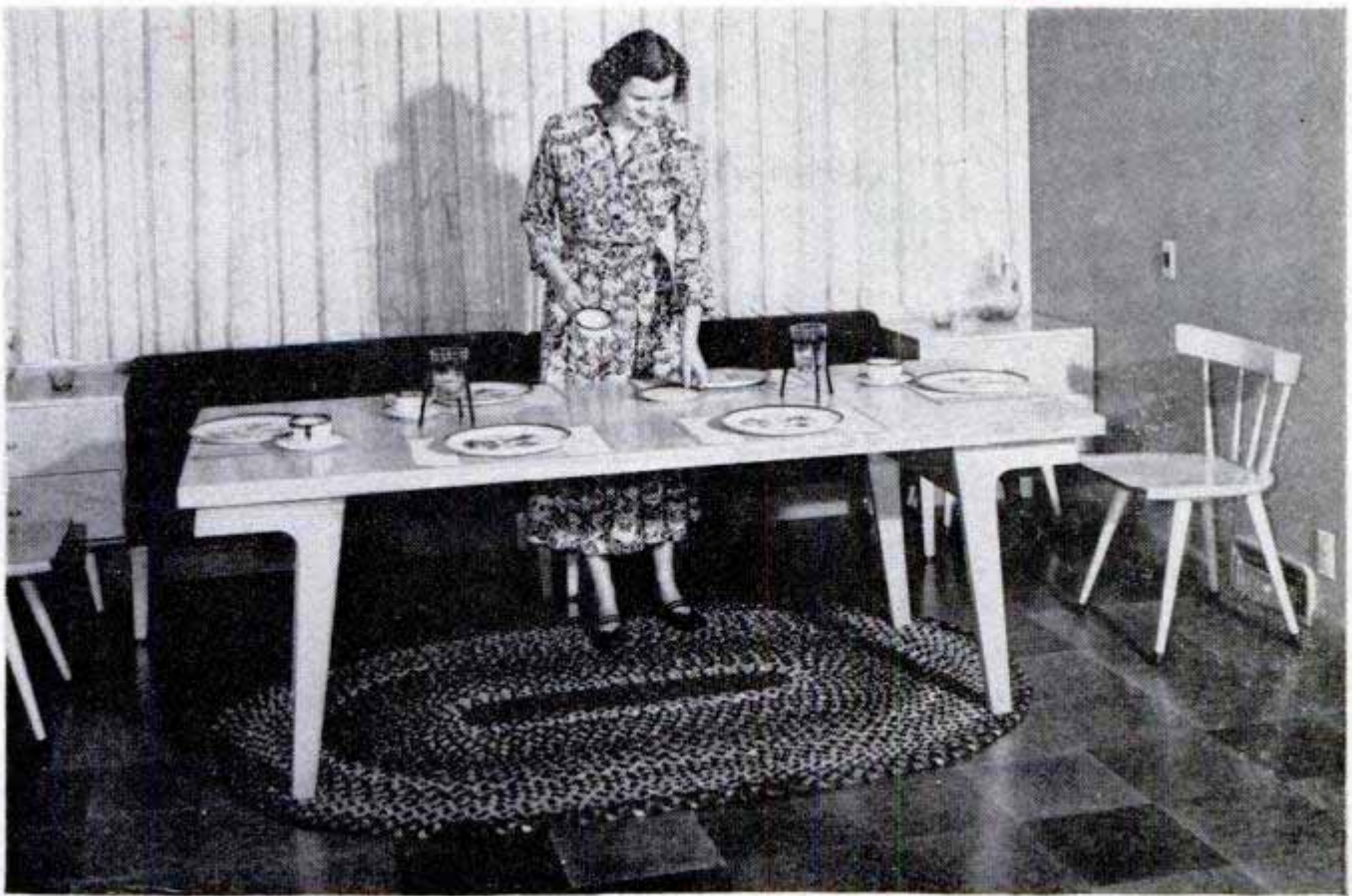

Because of the many requests for construction plans on how to build the boomerang table featured among the open-house furnishings of the PM Ranch House in Portland, Ore., we show on these pages how this unique, smart-looking table is made for today's living-dining rooms

Designed expressly for Popular Mechanics Magazine by John J. Whelan, R.A.

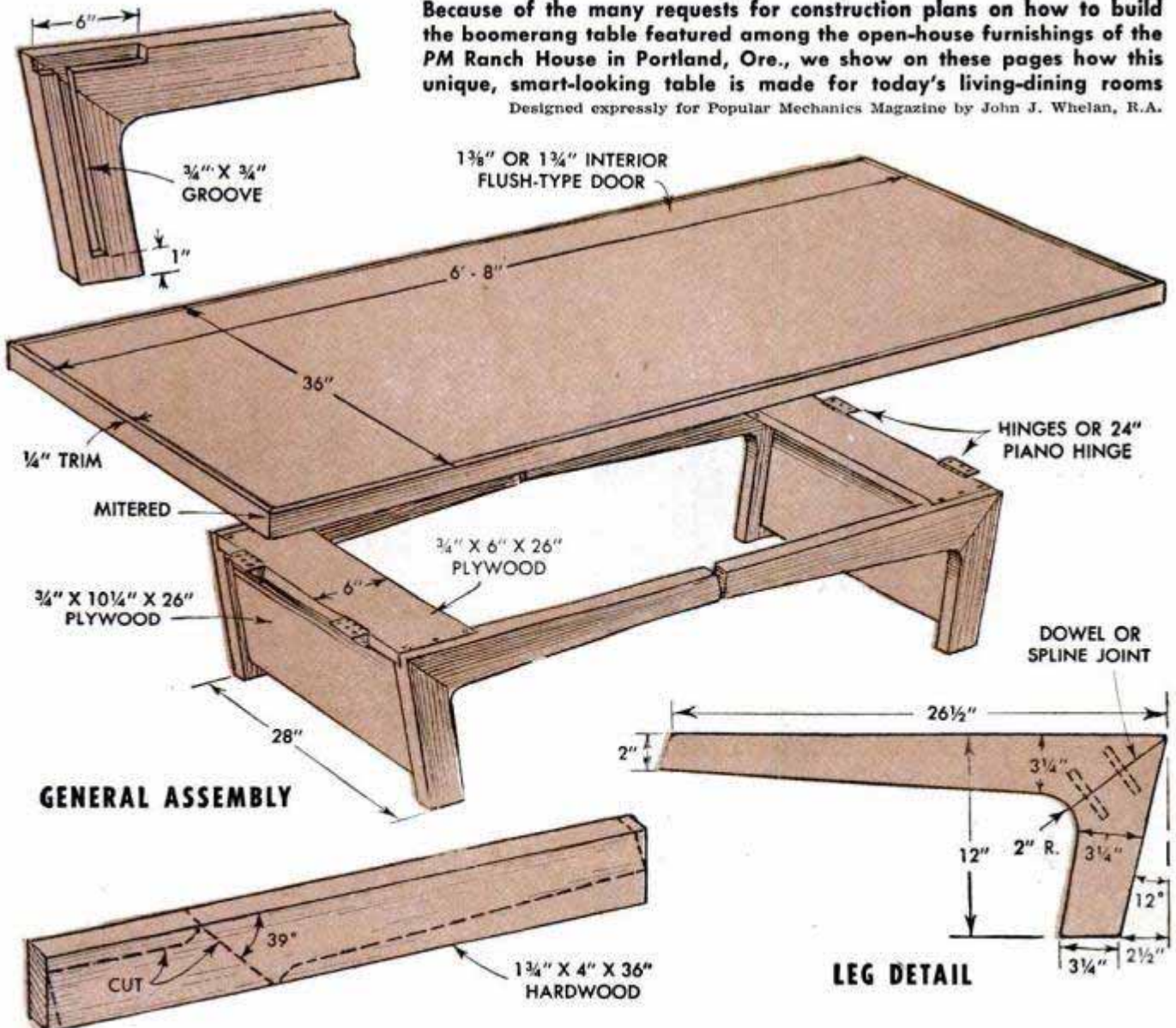

10 Tips for Trailerites

You can back up the car to engage a trailer hitch without help if a mirror is fastened to the front of the trailer directly over the hitch. In this way you can see hitch through rear-view mirror of car

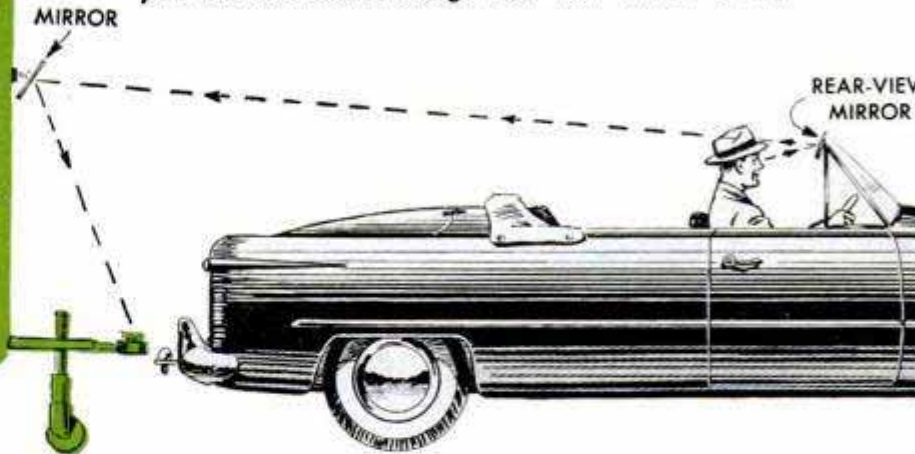

PLASTIC BOWL COVER



Desert sand and road dust are kept from filtering through trailer chimney by slipping a plastic bowl cover over the chimney cap



Ceiling hammock made from scrap of netting holds odds and ends, above. Netting is tied to screw eyes. Below, sectioned carton keeps jars and bottles from tipping and spilling



Trailer check list will save trouble caused by forgetting to take care of necessary preparations before driving away. Tack list to inside of trailer door

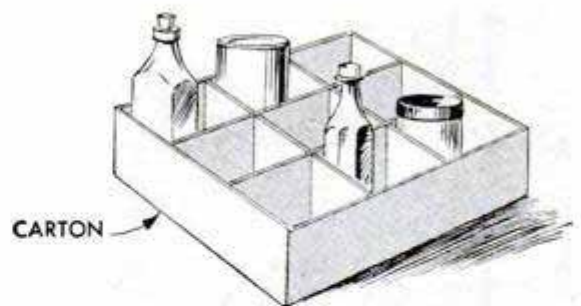

Trousers and ties won't fall to floor while traveling if trousers are clipped to hangers with spring-type clothespins and ties are wrapped around hanger, as shown below



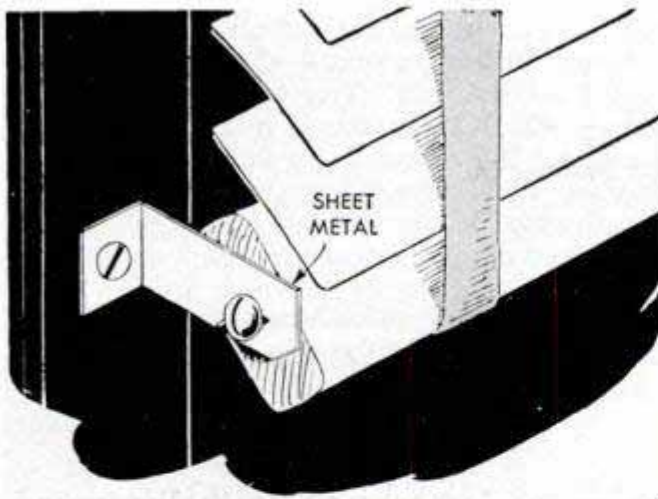

To keep a blind from rattling, fasten sheet-metal brackets to window frame and drive screws in ends of lower blind rail. Screws engage notches in brackets

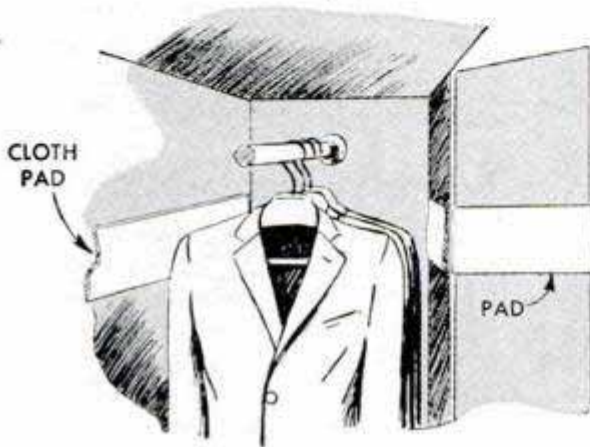

If garments stored in trailer closet rub against walls and become worn at shoulders, tack cloth pads to walls and door of the closet, as above. Make pads from scraps of fabric or use an ironing-board cover

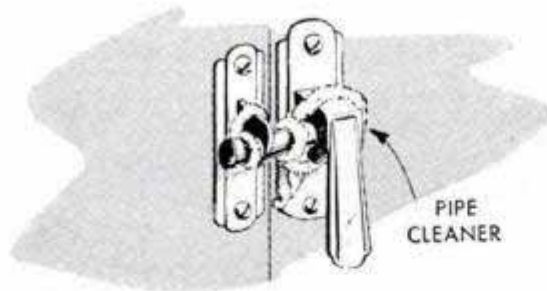

Cupboard latch that slips open can be secured by wrapping with pipe cleaner, above. Colored yarns strung between thumbtacks, below, decorate map and also show extent of travels at a glance

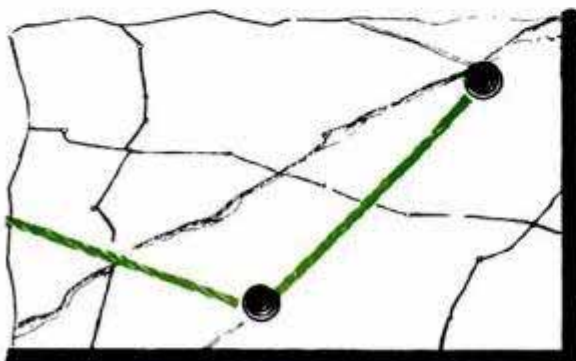

Milk Cartons Protect Plants

Young plants can be protected from frost by covering the tender shoots with jackets cut from quart milk cartons. Cut a wedge-shaped section from opposite sides at the center of the empty container, thus leaving a pair of prongs extending from each jacket. The prongs are pressed into the ground to anchor the jackets in place, as indicated by the dotted lines in the drawing. It's a good idea to start washing out and saving milk cartons a month or two before spring planting and cutting out the jackets whenever you have time. In that way, you will be ready with individual coverings for each plant when late-spring frosts are predicted.

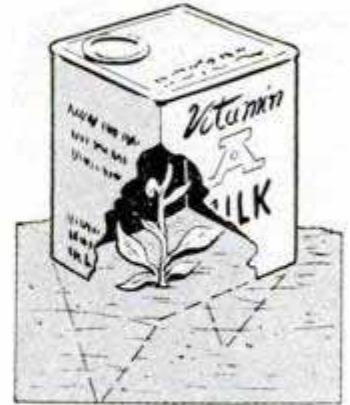

George Kapitan, Bronx, N. Y.

Salt Shaker From Beverage Bottle

Having a generous capacity that makes it ideal for picnics and outdoor barbecues, this jumbo salt shaker is improvised from a 4-oz. fruit-juice bottle. Both the bottle and its press-on cap are washed and dried thoroughly. Then a $\frac{1}{4}$ -in. disk is cut from the center of the cork cap liner and a $\frac{1}{16}$ -in. hole is drilled through the metal exposed by cutting away the liner. The inside of the cap, including the cork liner, is coated with clear lacquer and the outside is painted in an appropriate color. After the bottle is filled with salt, the cap is replaced, its edges being clamped securely against the neck of the bottle with a pair of pliers. Although the lacquer will protect the metal to a considerable extent, it eventually will corrode. However, a new cap may be made in a few minutes when the original is no longer usable.



Walter E. Burton, Akron, Ohio.

Thin stock is dressed easily on a jointer if the work is backed with a 2 x 4 of the same length. Be sure that the stock does not extend beyond either end of the backing, thus causing it to splinter.

Sections of Garden Hose Aid in Handling Glass

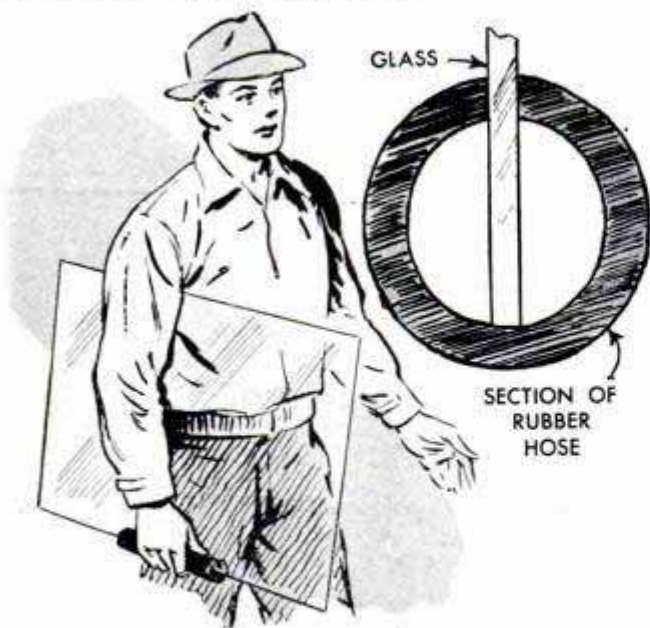

One homeowner found that a section of garden hose solved the problem of handling and carrying large, heavy panes of glass without causing discomfort to the hands. Cut 8 to 10 in. long, the section is slit lengthwise so that it may be slipped over the edge of the glass as shown. Longer sections may be utilized to provide protection for the bottom edges of glass which is to be placed in storage.

Make Your Own V-Block

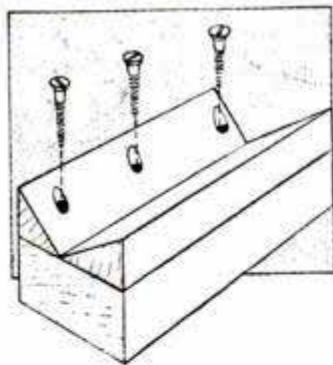

If you are starting your home workshop on a limited budget, chances are you will do without some of the less important accessories, at least for a while. For example, if your initial investment in power

tools includes a drill press, you probably plan on buying a metal V-block in the future. However, to serve the purpose temporarily, a good V-block can be made from

Versatility . . .

It's hard to beat the electric handsaw as an all-around tool. Tops for building construction, the portable power saw now is coming into its own as a home-workshop tool. Even the man who owns one may not realize the variety of jobs it can do. A feature next month tells how this handful of whirling power can be used for conventional cuts as well as for forming butt joints, notching, making pocket cuts — even for sawing pipe, brick, cement and tileboard.

two blocks of hardwood which will take care of any occasional drilling job you might have to do. The triangular-shaped pieces which form the V of the block pictured in the detail are cut from a single square block by sawing it diagonally, lengthwise. When the two pieces are glued and screwed to the top of a short section of 2 x 4, they will form a 90-deg. angle. Note that the screwheads are driven into counterbored holes so that they will not interfere with the work.

Hugh Lineback, Stillwater, Okla.

Sawdust Absorbs Varnish Remover

After applying varnish remover and allowing it to "work," experienced refinishers sprinkle the surface of the work with fine sawdust to absorb the thick-gummy residue. The mass is then removed with a scraper or stiff-bristle brush.

Storing Extension Ladder

The problem of where to store a long extension ladder is solved easily by suspending it from the joists in a basement or garage. All you need are four L-hooks pivoted to the joists by means of heavy screws. The hooks are bent from 1/4-in. iron rod. In use, the hooks are swung outward and one rail of the ladder placed upon two of them, after which the opposite rail of the ladder is raised upward and the other hooks swung under it. The outer ends of the hooks should be bent to form a slight U-shape so that there is no possibility of the ladder slipping off of them.

Perry W. Trout, Kansas City, Mo.

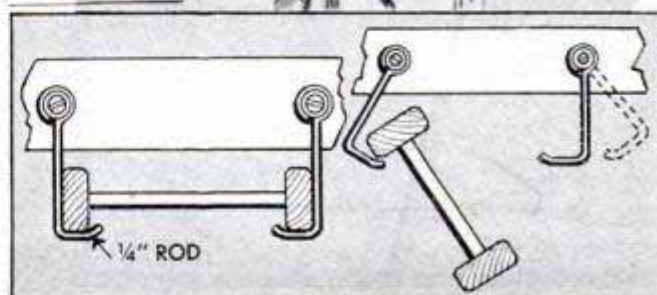
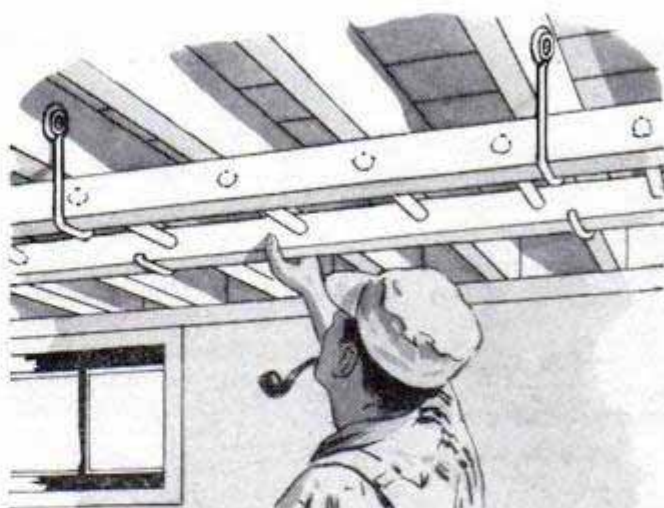

Replacing

GENERATOR BRUSHES



By Ed Packer

TO KEEP the car generator in good running condition, it is best to check the brushes occasionally. They should be replaced when worn to half their original length. Although the generator should be removed from the car to replace the brushes, it is not necessary to completely disassemble the unit. Simply remove the two through bolts which run the length of the generator housing and pull out the armature assembly. Then clean the commutator with 0/0 sandpaper and scrape any dirt from between the copper sections. This can be done with a piece of hacksaw blade, the sides of which have been ground slightly to reduce the width of the teeth. Use the blade to saw gently between the sections until a white dust is produced by the sawing. Before installing the new brushes, tape a piece of sandpaper around the commutator, as in the photo at the right. Then insert the commutator shaft in the end frame and place the brushes in their holders. Move the commutator back and forth in an arc of about an inch or so until the faces of the brushes are cut to the radius of the sandpaper. Doing this will insure that the entire surface of each brush comes in full contact with the commutator, and thus prevent overheating. Check to see that the brush lead is replaced in the holder in its original position, making sure that the terminal under the screw does not bind the brush. Also be sure that the terminal does not stand out from the brush holder far enough to become grounded on the generator frame. After it is replaced in the car, the generator should be repolarized by sending battery current through it. This can be done by momentarily "flashing" a

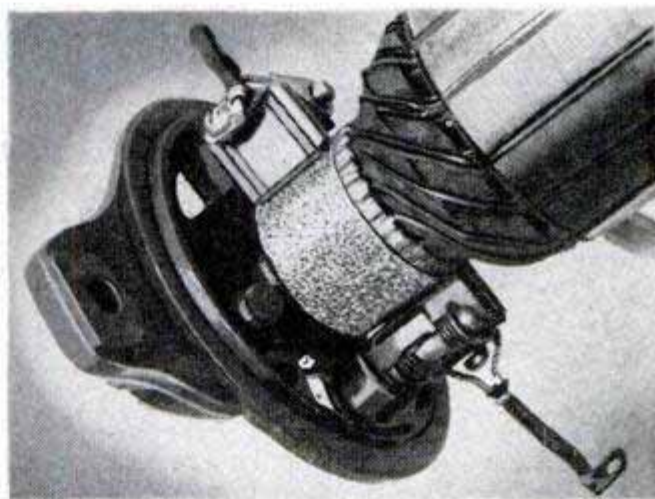

jumper wire from any hot lead (the starter terminal of the B post of the regulator) to the A terminal of the generator. The generator is properly positioned when the fan belt is aligned with the generator pulley and belt tension allows $\frac{1}{2}$ in. of up-and-down movement in the belt halfway between the fan and generator pulleys.

Solderless Ground Connection For Radios and Lightning Rods

A tight ground connection for lightning rods, radio and TV sets can be made by drilling two transverse holes $\frac{1}{4}$ in. apart and $\frac{1}{2}$ in. from the top of the ground rod. The bared end of the wire is inserted in the lower hole, bent back on itself and inserted in the top hole. Then the metal at the end of the rod is upset by hammering in order to clamp the wire in the holes.

Arthur Trauffer, McClelland, Ohio.

KNOW YOUR CAR'S NERVOUS SYSTEM



TRUCK-TYPE HORN



HORN RELAY



PASSENGER-CAR HORNS, MATCHED SEASHELL TYPE



BUS-TYPE HORN

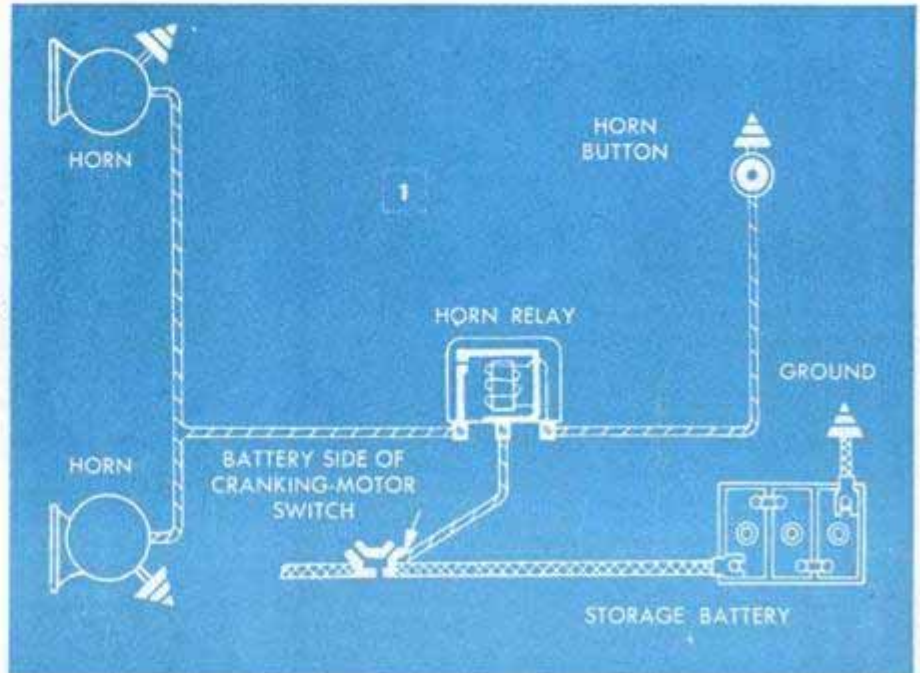

"THE HORNS"

By W. K. Mitchell and Howard B. Birt

ALMOST WITHOUT EXCEPTION, modern passenger cars are equipped with electrically operated horns of the vibrating-diaphragm type. In most cases the horns are mounted in pairs somewhere in the motor compartment and usually as near the front of the car as possible. Where a pair of horns is used, a musical, blended tone can be provided. Matched horns used on General Motors cars, for instance, are tuned to the musical notes E flat and G, which have been found to produce a pleasing and yet effective warning signal. Examples of three widely used types of horns are shown in the photos above. The passenger-car horns pictured are known as the "sea shell" type because of their distinctive shape.

Conventional electric horns operate on a magnetic principle similar to that of a door buzzer used in your home. Current from the battery flows through the windings within the horn power plant when the circuit is completed at the horn button, or ring, on the steering wheel. See the wiring diagram, Fig. 1.

The magnetic attraction of the armature

toward the pole causes a tension and slight movement of the diaphragm. The movement opens the contact points in series with the horn winding, breaking the circuit. See the cutaway drawing of a horn in Fig. 3. When the current is interrupted, the armature returns to its original position, relieving the tension on the diaphragm. The slight return movement of the armature and diaphragm allows the contact points to close, again completing the circuit. This cycle is repeated many times per second, the same as in your door buzzer and results in a rapid vibration of the diaphragm, which produces sound. The pitch or tone of the horn depends on the number of vibrations per second—the more rapid the vibration, the higher the pitch.

In one respect the electric horn is similar to the auto starter, in that it is deliberately designed to operate under a terrific overload for short periods of time. A typical passenger-car horn will draw approximately 18 amp. of current while sounding. Naturally, it cannot be operated continuously over a prolonged period of time without

danger of burning electrical connections.

Because of this high-amperage consumption, a relay and two electrical circuits are used to operate the horns. The relay, which is pictured in Fig. 2 with its cover removed, is merely a switch that is actuated electrically by means of the horn button or ring on your steering wheel. A low-amperage current flows from the relay to the horn button and back to the relay, passing through a coil, or electromagnet, in the relay when the button is depressed. This current energizes the coil, which then attracts the relay armature and closes the contact points, or switch, inside the relay. These points are wired into the second, or high-amperage circuit which operates the horns. The horns will continue to sound as long as the horn button is depressed. The reason for the two circuits is to make as direct an electrical connection as possible between the horns and battery, thus permitting full voltage at the horns while avoiding the need for running heavy wiring to the horn button. Heavy wire would be necessary, of course, if the relay was not used.

All too often horns are replaced unnecessarily when trouble occurs, simply because the checking and adjustment procedures generally are not understood. Actually, it is a fairly simple matter to check and adjust the horns, the horn relay and the horn circuit. Any mechanically minded motorist can maintain his horns in top-notch operating condition and make necessary adjustments, without special equipment.

Should either or both horns become inoperative, or operate only intermittently, a thorough check should be made. First make sure the battery is charged sufficient-

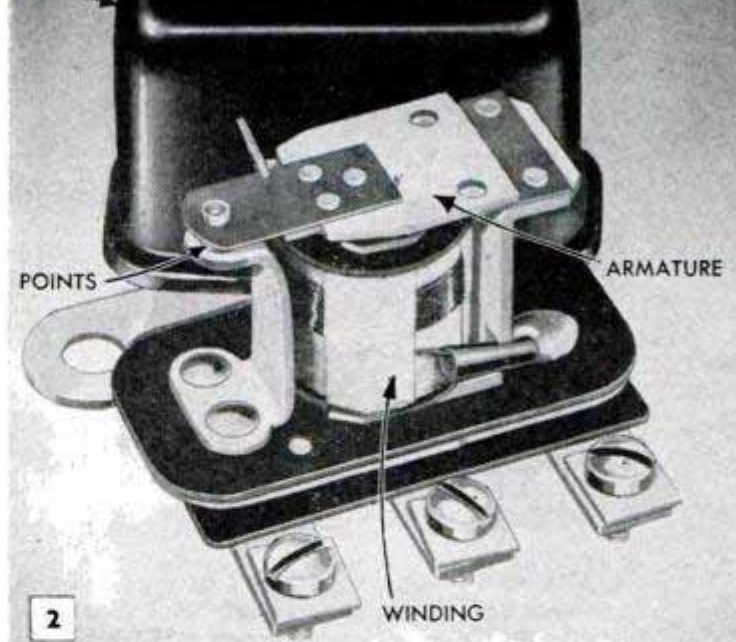

Photos and information courtesy Delco-Remy Division, General Motors Corp.

ly to crank the engine. If it is not, it must be recharged before the horn checks and adjustments can be made satisfactorily.

Clean and tighten all connections in the horn wiring circuit, including grounds. Look for frayed insulation, or breaks in the wiring. If necessary, check for defective wiring by connecting separate test leads from the horn to the battery.

A loose connection or poor contact at the horn button may cause the horn to operate intermittently. Shunt around the horn button to determine whether there is poor contact at the horn-button switch.

If the above procedures do not locate the source of trouble, check and adjust the horn relay. This entails checking the point opening, the air gap and closing voltage, or low amperage circuit. Checks and adjustments

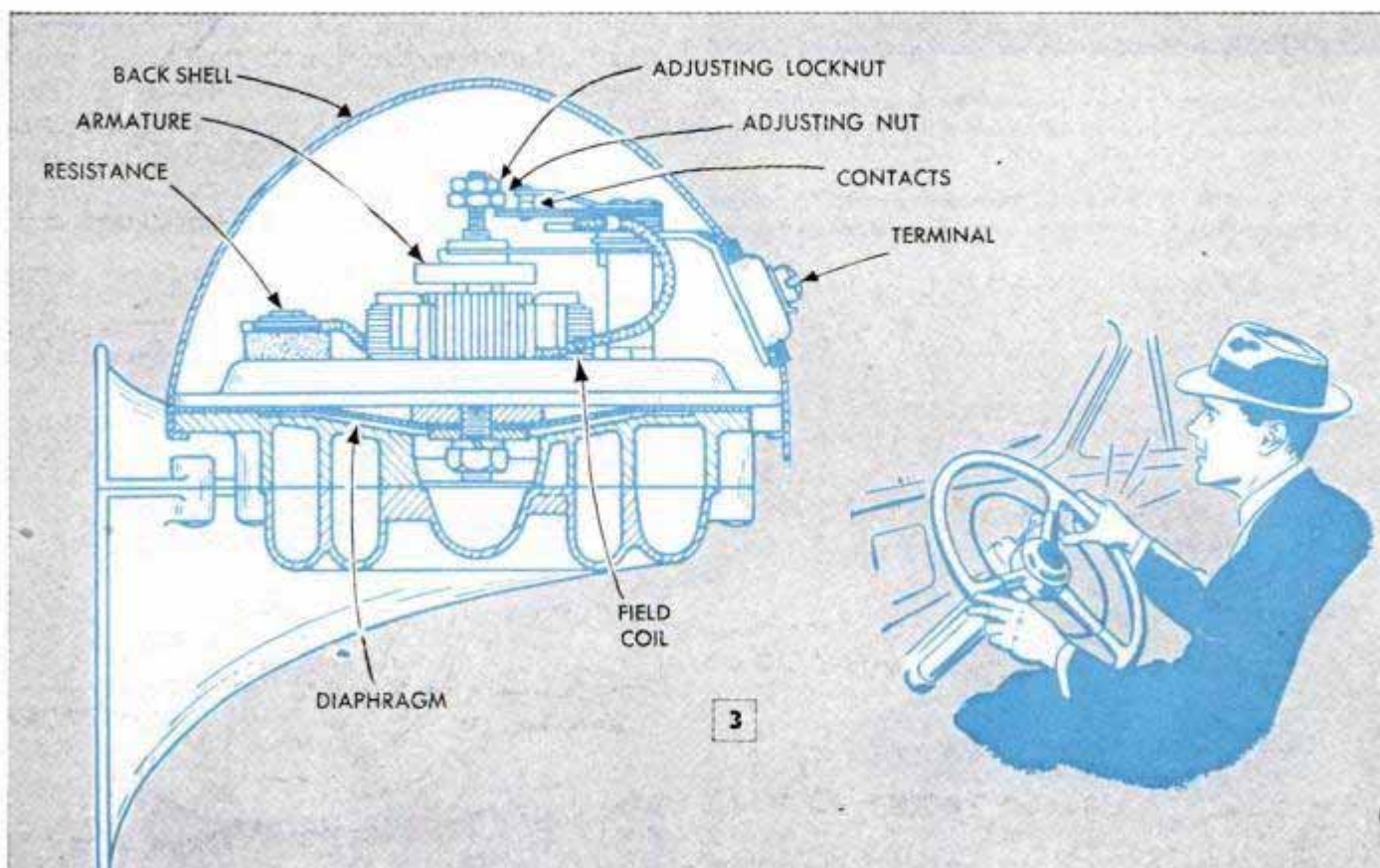

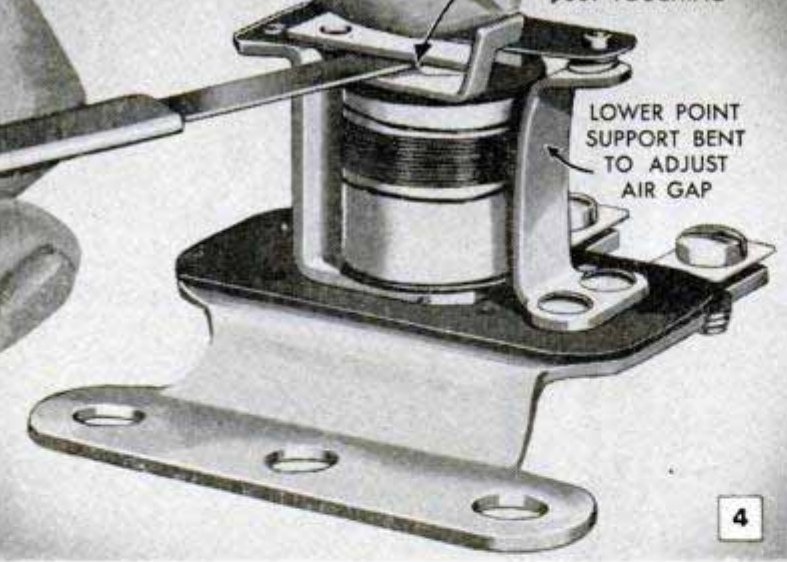

Relay air gap is checked with gauge, as shown above, with points barely touching. Lower point support is bent to adjust gap to manufacturer's specifications

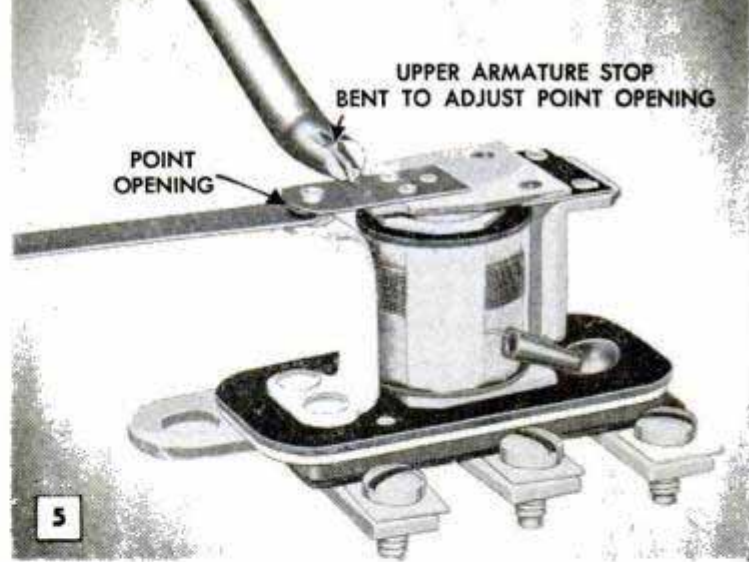

If check indicates that relay contact-point opening is causing trouble, opening can be adjusted by bending upper armature stop with tool slotted at one end

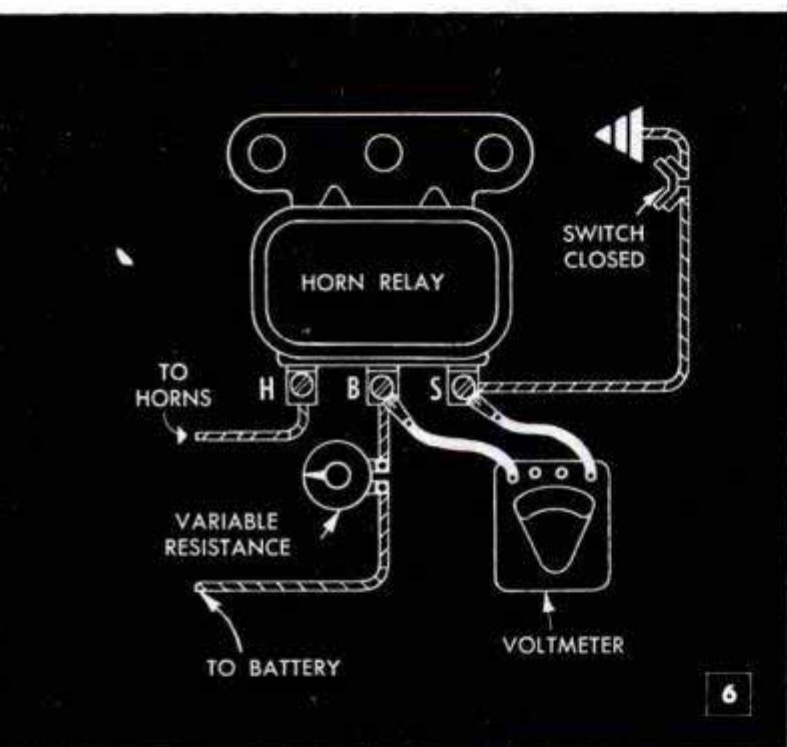

Wiring diagram shows how voltmeter and variable resistance are connected to check relay closing voltage

Bending armature-spring post downward increases closing voltage. Bending it upward decreases voltage

of the air-gap and contact points openings are made with the battery disconnected.

Check the horn-relay air gap with the points barely touching, as in Fig. 4, and adjust by bending the lower point support. Check the relay contact-point opening and adjust, if necessary, by bending the upper armature stop, as in Fig. 5.

To measure the horn-relay closing voltage, connect a variable resistance of 10 ohms, and a voltmeter, as shown in Fig. 6. With the horn button closed, slowly decrease the amount of resistance and note the closing voltage. Adjust the closing voltage to manufacturer's specifications by bending the armature-spring post with a slotted tool as in Fig. 7. Bending it downward increases the closing voltage and bending it upward decreases the closing voltage.

Fig. 8 indicates the proper method of adjusting a typical, seashell-type electric horn. Remove the horn back shell and check for loose or broken wiring or defective soldering. Make sure there is no dirt, metal shavings, or other foreign material in the air gap. Clean the air gap if necessary. Then insert a .007-in. gauge, not

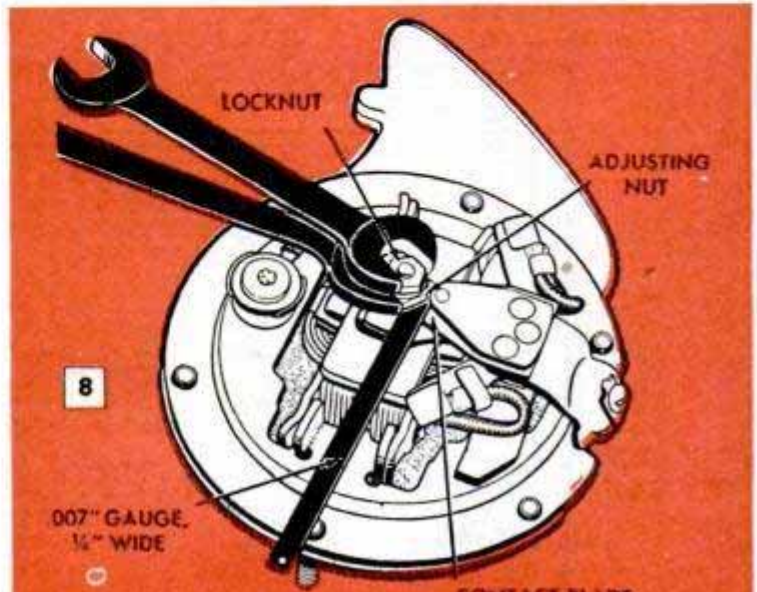
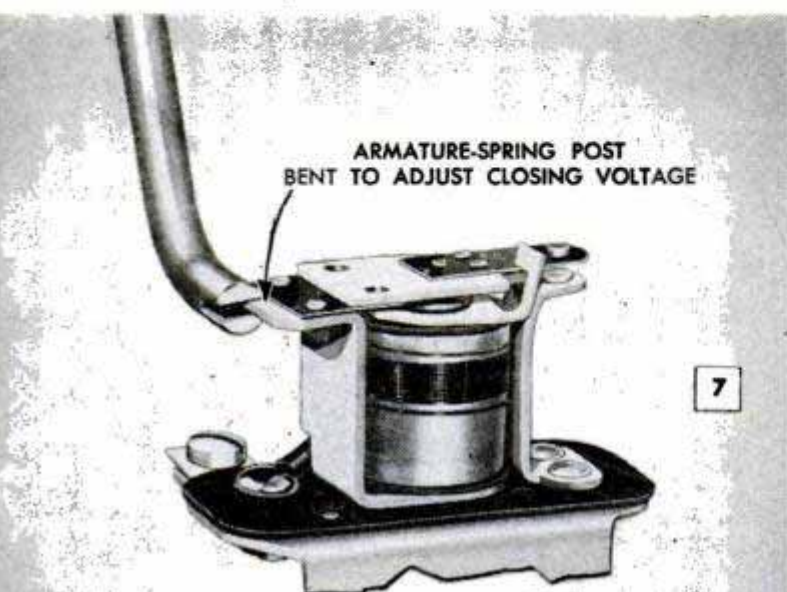

more than $\frac{1}{4}$ in. wide, between the adjusting nut and the contact blade. Loosen the locknut and turn the adjusting nut down until the horn will not blow. Back off the adjusting nut (slightly less than $\frac{1}{10}$ turn) and tighten the locknut. See if horn will blow. Repeat this procedure until the horn just barely blows. Then remove the gauge and replace the cover.

If it is found that a low place has been worn on the adjusting nut where the contact blade vibrates against it, either replace the nut or turn it over so that the worn place is on the top side. Otherwise, the worn portion of the nut may prevent obtaining perfect adjustment.

Occasionally a passenger-car horn gets "stuck," and blows continuously—frequently when the car is unoccupied. In most cases this is caused by a short circuit in the horn button, or horn-button wiring. It can be caused, however, by stuck contact points in the horn relay, or other maladjustments. In such an emergency, the battery, or "hot," wire should be removed quickly from the center horn-relay terminal. This will disconnect the horn from the battery and silence the horn until a complete checkup can be made to locate the trouble. The bare end of the battery lead should be tied back or taped so that it cannot short circuit against any metal part.

The above checks and adjustments are simple and, if properly followed, will make it possible almost without exception to locate and correct horn troubles, and thus save the cost of replacing the horns. ★ ★ ★

Holes Punched in Popcorn Sacks Prevent Theater Disturbances

In order to prevent disturbances caused by children inflating and bursting empty popcorn bags in a theater, one operator provided holes in the bottom of each bag. This was done by stacking several bags at a time and making the holes with a ticket punch. Any punch that will make a small hole may be used.

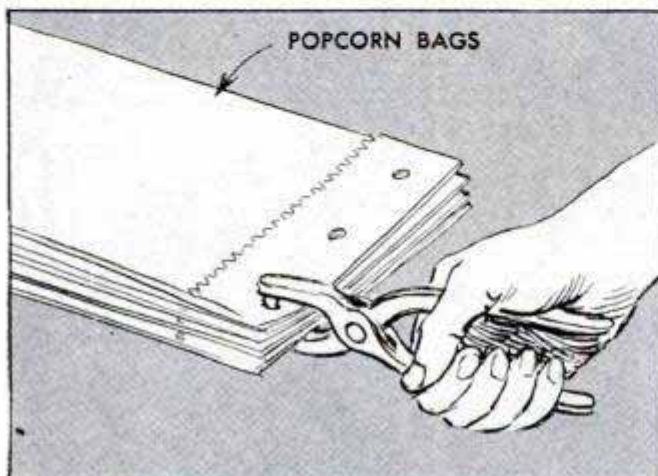

Screen Staples Reinforced With Length of Wire

To help prevent screen wire from being torn loose around the staples, reinforce them with a length of piano or stove-pipe wire. Lay the wire along the edge of the screen and secure it with staples as shown. Molding may be nailed over it afterwards, if desired.

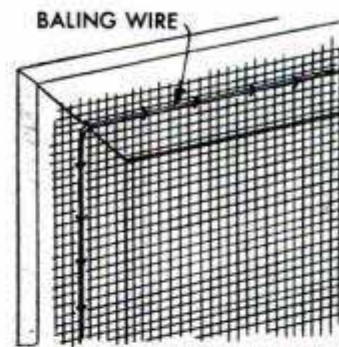

A. H. Waychoff, Phoenix, Ariz.

Metal Guard on Bow Saw Prevents Hand Injury

Woodmen, railroad workers and others who use bow saws for heavy work avoid painful hand injuries by fitting a sheet-metal guard on the saw frame



at the point where it is normally grasped for one-hand operation. The guard prevents the fingers from being caught between the frame and the material being cut should the blade suddenly slip or skid when sawing unsupported work. The guard is made from heavy sheet metal or $\frac{1}{8}$ -in. flat steel bent to a U-shape with the ends drilled and taper-reamed to fit tightly over the tubular saw frame. If desired, the guard can be tack-welded to the frame to hold it securely in place.

Nail Set for Emergency Use

If you wish to set a nail when no nail set is available, try using the head of another nail on the head of the driven nail as shown. Another simple way of setting a nail is by filing the point of a large nail and utilizing it in the same manner as you would a nail set.



R. F. Donovan, Guttenberg, N. J.

☐ A brown or black eyebrow pencil rubbed over spots on black and brown furniture, worn-out areas on handbags, gloves, shoes and belts will camouflage the spots. Follow by rubbing with soft cloth or tissue napkin.

Baby Crib Improvised From Basket



A laundry basket and a household broom are all that is needed to furnish you with a portable and inexpensive crib for rocking a baby to sleep at home or when traveling. The basket is supported at both ends by the broom which is placed across two chairs as shown.—Rose Edwards, Columbia, Mo.

Lawn-Chair Cushion Has Straps For Holding Magazines

Annoyed by having newspapers and magazines blown away frequently when left in the seat of a lawn chair, one homeowner attached elastic straps to the back cushion of the chair to hold the periodicals in place. The straps can be made from cloth, if desired, and strong thread is recommended for use when sewing the straps to the cushion.

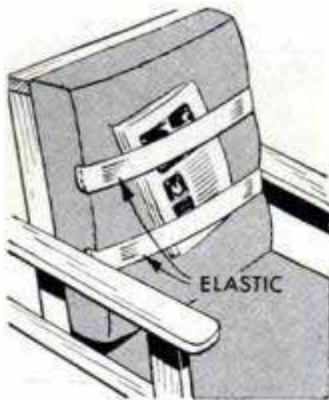

Nuts on Tap Serve as Stop To Prevent Breakage

Snapping off a tap in a blind hole won't happen if two nuts are used as a depth stop. Normally, there is no way of telling when the tap touches the bottom of the hole, but the stop makes it easy to watch the depth of the tapping operation and to stop the tap as soon as the nuts touch the surface of the work. The nuts are simply run onto the tap a

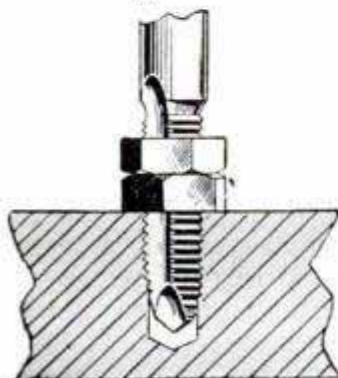

predetermined distance and jammed together to lock them in place. In the case of a deep hole, it is recommended to back out the tap occasionally to clear the chips, as the nuts will hinder, to some extent, proper clearing of the tap.

Fred Lettino, Astoria, L. I., N. Y.

Sealing Knots in Lumber

Knots in lumber eventually will "burn" through if covered directly with ordinary oil paint. This may be prevented by giving each knot a preliminary coat of shellac before painting.

Snagproof Fishhook

Troubled by his tackle continually snagging on logs and water plants when fishing a bait deep in the water, one fisherman devised this snagproof hook. It consists of an ordinary eyed fishhook fitted with a sliding guard made from stainless-steel wire. One end of the wire is twisted to form a tight coil that slips over the point of the hook when the guard is in position. The other end of the wire is bent back on itself to form an eye to which the line is tied. The free end of the wire is then given a few turns around the standing part to secure the eye, and the end is then bent to form a friction catch which is forced through the eye of the hook. This holds the guard in place as shown in the upper detail. When a fish takes the bait, the added tension on the hook releases the friction catch and permits the guard to slide through the eye of the hook as in the lower detail thus barring the barbed point.

Herbert E. Fey, New Braunfels, Tex.

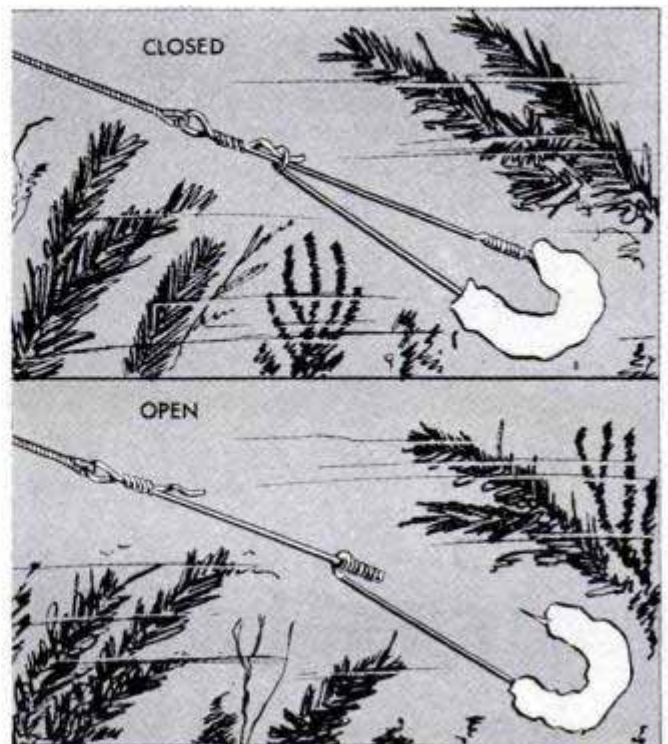

Actual-size, sample test print showing four different exposures of 5-sec. variation. Correct exposure time (15 sec.) is determined by the best tone of four exposures

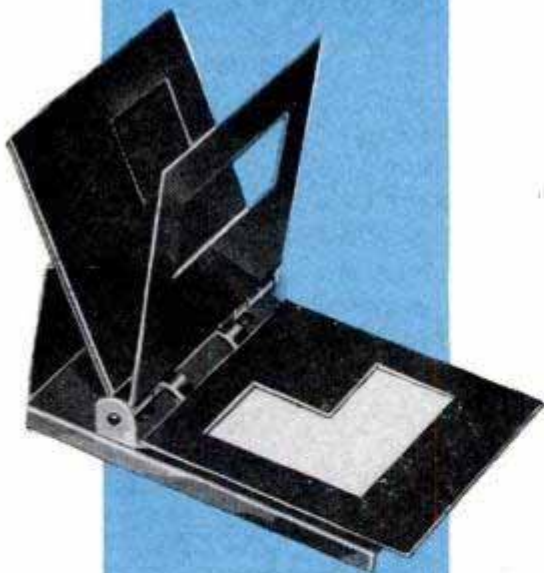
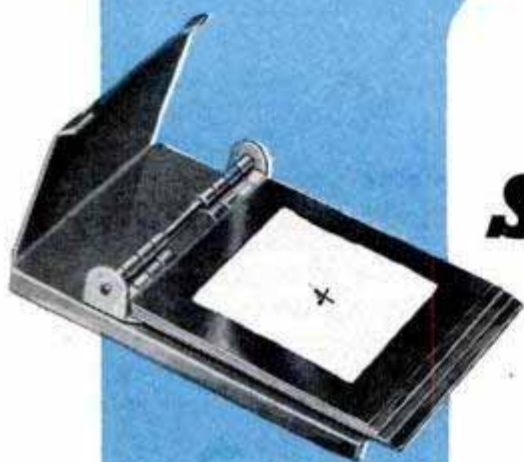
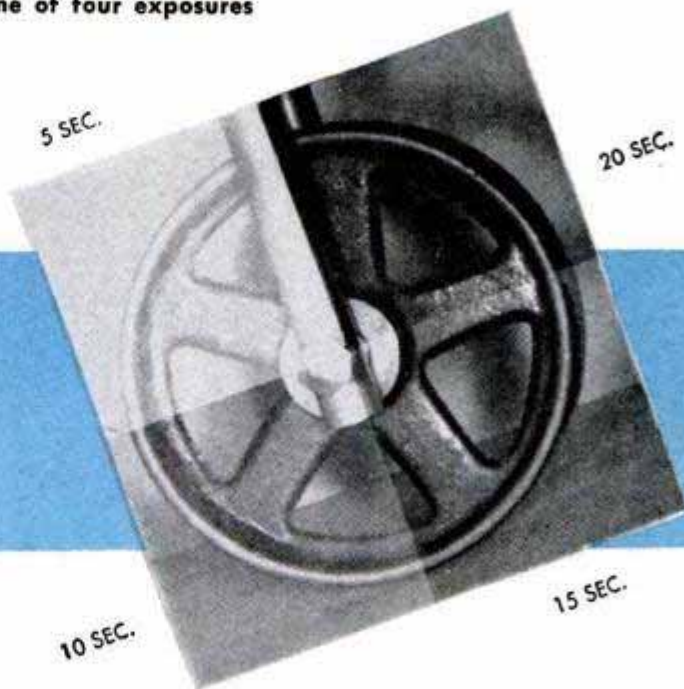

SPOT ANALYZER ***For BETTER*** ***ENLARGEMENTS***

By Hugh Smiley, Jr.

WHILE ITS COST is somewhat insignificant compared to that of other darkroom materials, enlarging paper is still too expensive to waste unnecessarily, especially in the case of large-size sheets. Yet many times the home-darkroom enthusiast wastes whole sheets of paper in determining the correct exposure. Not only can you save paper with a spot analyzer but you will be better able to judge the density of the negative beforehand. As a result, the tonal quality of your enlargements will be improved considerably.

Based on the test-wedge principle of test printing, this unique analyzer, which uses only a 2-in.-square piece of printing paper, permits four separately timed print areas to be made around a central point. By varying the exposure time five seconds for each area and then developing the test print, the exposure best suited to the density of the negative can be readily determined by analyzing the tonal qualities of each separate exposure. In the sample test print shown above, you'll note that the correct exposure for that particular negative would be approximately 15 seconds. If desired, a second test print may be made, using separate exposures of 12, 14, 16 and 18 seconds which will give a closer comparison of tones to determine the exact exposure. Thus, the saving in time and material is considerable, as exposure, development and emulsion

Stop guessing the right exposure for your enlargements. Make sure beforehand by analyzing a multiple test print

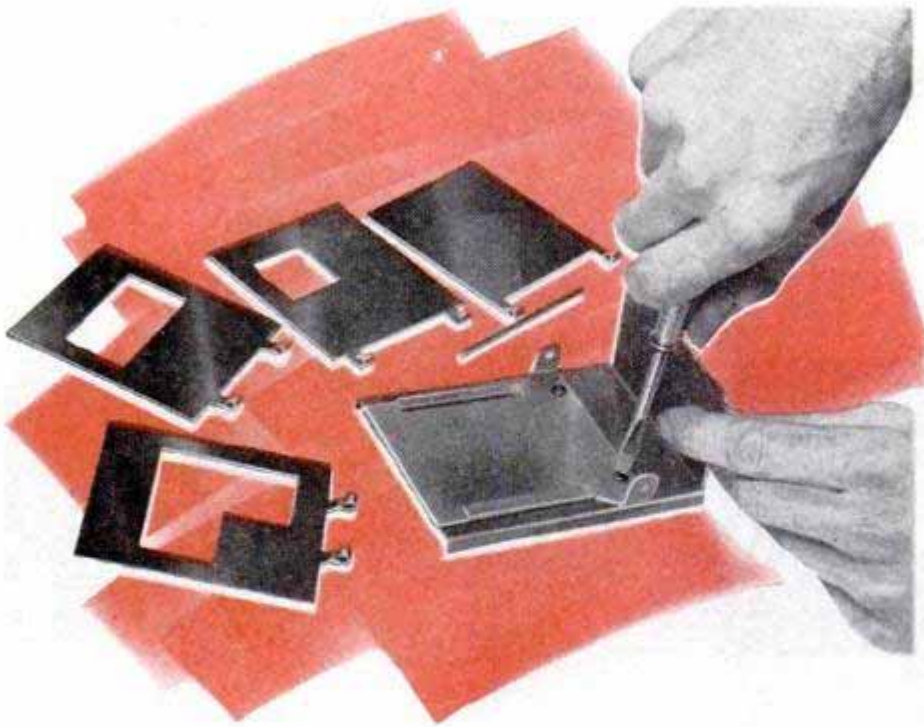

Here are all the parts cut and ready for final assembly. Two sheet-metal screws are used to fasten the paper holder to the base member

conditions are identical in both the test and the final print.

In use, the analyzer is placed on the enlarger base and spotted under any portion of the image desired. With the enlarger turned off, load the analyzer with printing paper. Then with all the masks raised up, turn on the enlarger for the chosen interval (five seconds is about average). Follow by lowering the second mask over the exposed paper and make a second exposure of five seconds. Do this with the third mask, being careful in each case to avoid moving the analyzer. The test print is developed in the usual way and after a short fixing, it can be viewed safely under white light.

Patterns for the five parts required to make the analyzer are pictured below and on the facing page. The original parts were cut from 18-ga. sheet aluminum, although other metal can be used. The masks are

made to hinge independently by forming the extending tabs over a pin. This is done by clamping all four masks together in their proper order and then forming offsets in the tabs by pressing them in a vise and against a metal backing strip. The top photo in the series on the opposite page shows how the tabs are hammered over the edge of the same backing strip, after which the forming is completed by hammering the ends of the tabs over a length of $\frac{1}{8}$ -in. brazing rod. Channels which hold the paper in place are formed over a steel rule or similar shim stock as pictured in the lower photo of the series. Mark the overlapping window locations in the three masks on the cover of the analyzer so they will center over the test paper. Assemble the masks and drill a tiny hole through the stack at each corner of the windows. This method permits accurate spotting of the windows in each mask for perfect registry, after which each one is carefully cut out and filed square. Two self-tapping screws hold the base assembly together, and beads of solder on the ends of the hinge pin hold it in place. The underside of the masks should be painted flat black to kill light reflections on the test paper. The analyzer is completed by cementing a 2-in. square of white paper to the cover and then inking a cross mark in the center to serve as a target. The paper provides a white area on which the image can be focused sharply before loading the analyzer with printing paper and making individual exposures. ★ ★ ★

lapping window locations in the three masks on the cover of the analyzer so they will center over the test paper. Assemble the masks and drill a tiny hole through the stack at each corner of the windows. This method permits accurate spotting of the windows in each mask for perfect registry, after which each one is carefully cut out and filed square. Two self-tapping screws hold the base assembly together, and beads of solder on the ends of the hinge pin hold it in place. The underside of the masks should be painted flat black to kill light reflections on the test paper. The analyzer is completed by cementing a 2-in. square of white paper to the cover and then inking a cross mark in the center to serve as a target. The paper provides a white area on which the image can be focused sharply before loading the analyzer with printing paper and making individual exposures. ★ ★ ★

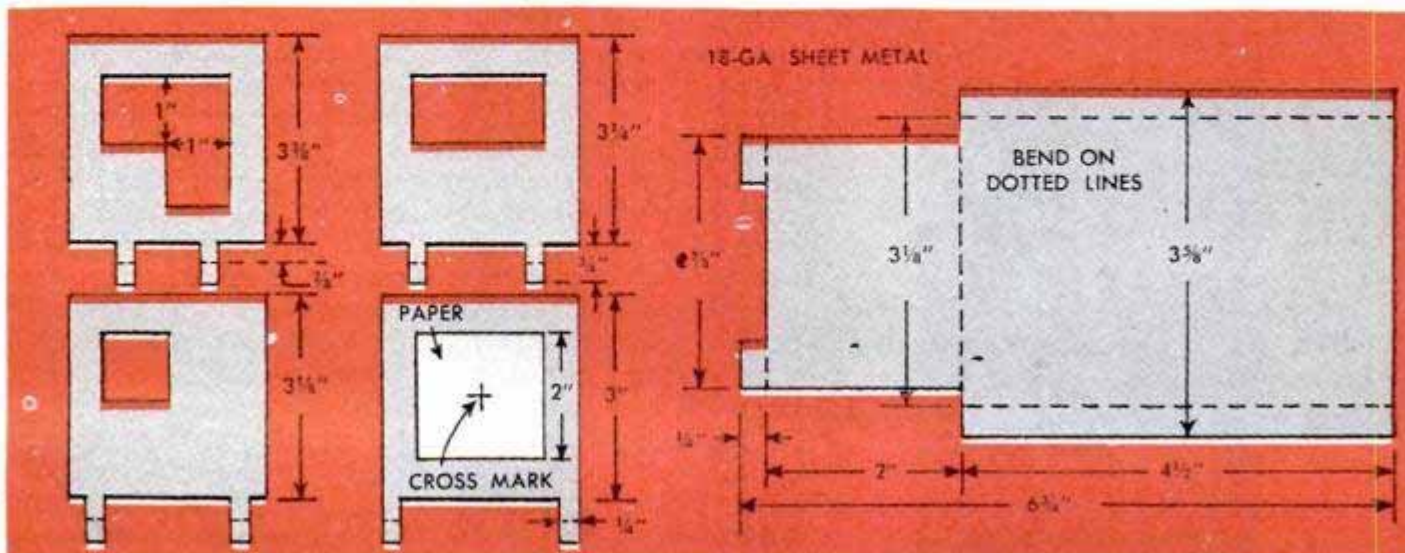

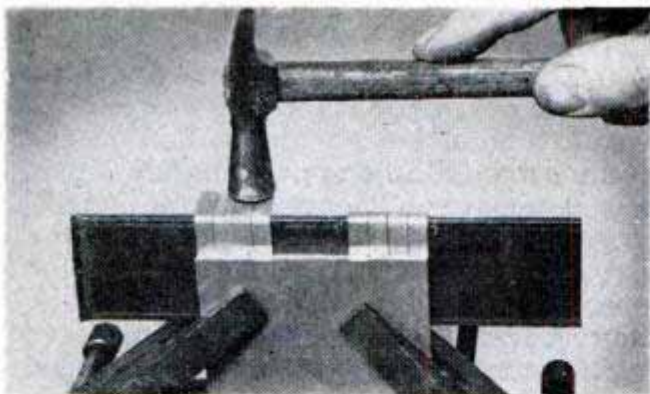

Offset hinge tabs on masks are formed by clamping stack to backing plate and hammering tabs over edge

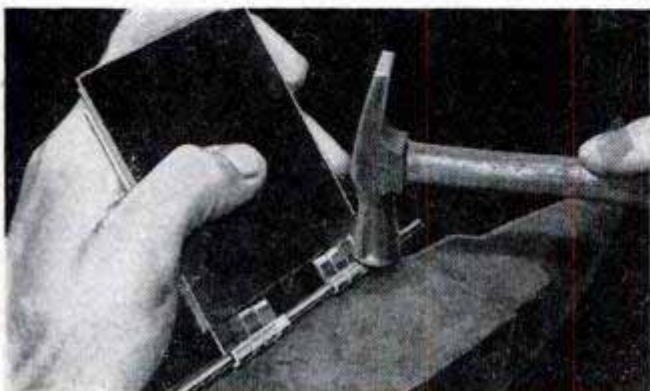

Brazing rod, which serves as hinge pin, is used in forming eyes in ends of tabs by tapping metal around it

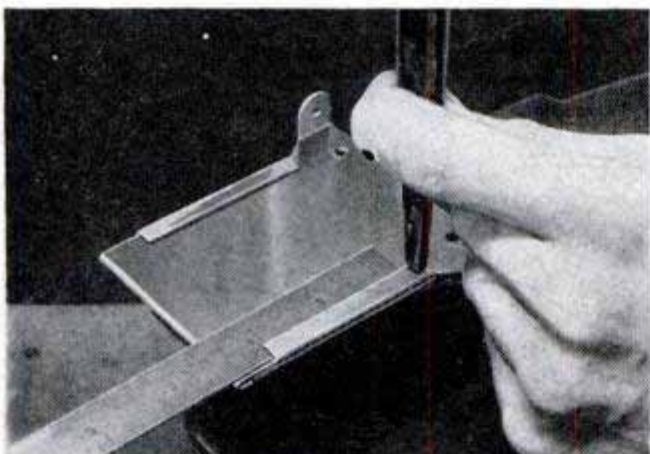

Channels which guide the paper are formed by bending the metal over a suitable shim such as a steel rule

Clothespins Make Practical Spiles For Tapping Maple Trees

Anyone having a few maple trees which they wish to tap to obtain the sap for syrup or sugar need not bother cutting and grooving special pegs to be used as spiles. Common clothespins not only make excellent spiles which wedge firmly in place, but also provide a natural hook for the bail of the pail. Clothespins are inserted at a slight angle to permit the sap to flow out through the slot in the pin.



Ashes Keep Cutworms From Plants

Instead of attempting to protect tomato plants from cutworms with bulky paper wrappings or various collar contrivances, I simply scoop out an inch or more of topsoil within a radius of approximately 3 in. around each plant and fill the hole with sifted coal or coke ashes. The ashes repel the pests quite effectively, permitting the plants to grow unmolested to full maturity without being damaged or destroyed. Care should be exercised when scooping out the soil to prevent the possibility of exposing or damaging the roots.

Edward Copplestone, Saugus, Mass.

Headlight Shell Holds Flashlight To Make Repairs Under Car

When it is necessary to use a flashlight under a car, an old headlight shell will provide an ideal support for directing the light in almost any direction desired. Also, it will be found useful for supporting a flashlight when changing tires on the road after dark. If a shell is not available, any bowl-shaped utensil set upright with the light placed against the side will do the job nicely. — G. E. Hendrickson, Argyle, Wis.

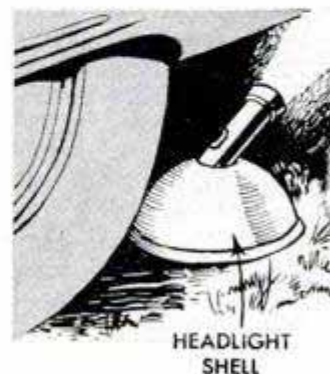

HEADLIGHT SHELL

Applied with the brush that comes with the bottle, nail polish can be used for making incidental markings on various objects for identification.

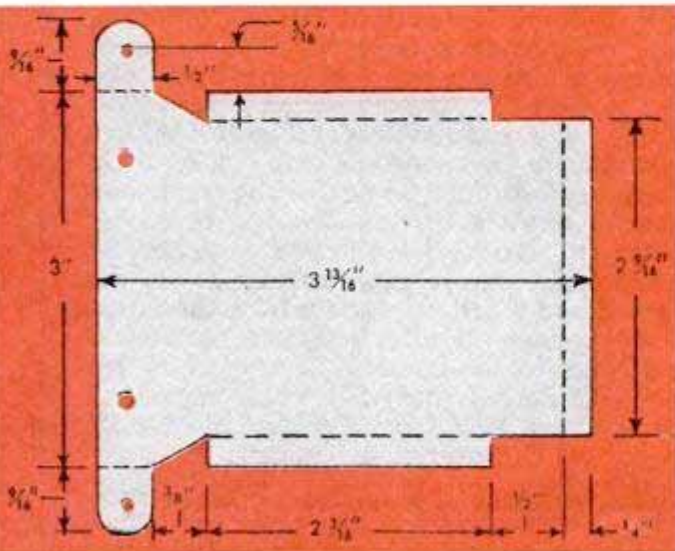

Box Camera in Tray on Tripod Takes Stereoscopic Pictures



Do you know that excellent stereoscopic pictures for viewing in a stereoscope can be made with your box camera? All you

need is a shallow wooden tray mounted on a tripod. For the average 120-size box camera, a tray measuring 5 in. deep and 6 in. wide will do. In each individual case, the tray must be of a size which will allow the lens axis to be shifted approximately $2\frac{1}{2}$ in. for each exposure. The tray is made by nailing $\frac{1}{8}$ x 1-in. strips around three sides of a base of $\frac{1}{2}$ -in. wood. A hole is made in the center of the tray for the tripod screw and counterbored to recess the nut flush. In making stereo shots, the camera is placed at one side of the tray as illustrated and the first exposure made. After advancing the film, the camera is shifted to the opposite side of the tray and the second exposure is made. Needless to say, the subject must remain in the same position for each exposure.

Testing Flash-Gun Cells

To be sure that your flash gun won't misfire, always check the strength of the dry cells before shooting an important picture. A pocket ammeter carried in your photo kit allows you to check the cells in a few seconds, and any cell which reads less than 10 amps, should be replaced.

Popular Mechanics Bookshop

Bugs in Your TV Set?

Your television picture isn't quite up to par. It's beginning to blur a little, the edges are fading off, or you can't seem to keep it centered on the screen. Or perhaps you snap on the set and *poof!*—no picture at all. You figure you're in for a sizable repair bill and, just as bad, you'll miss your favorite programs for a good many days.

All About Television is a book written in plain language for the average set owner, the man who may never have replaced a radio tube in his life. It tells you what to look for in buying a new set, how to install an antenna, how to diagnose reception troubles. It takes you step by step through the various (and surprisingly simple) repairs you can make yourself. Best of all, it tells you when you really do need a serviceman. The cost of one service call will pay the price of *All About Television* several times over. Only \$3.00 for a clothbound edition. Order by mail from Popular Mechanics Press, 204 E. Ontario St., Chicago 11.

Power Tools

Whether you're planning the purchase of your first power tool or already have an up-to-snuff workshop, you'll find a heap of

information tailored to your own needs in *Power Tools and How to Use Them*. On the first page you start laying out your shop, and succeeding sections give detailed information on virtually every power tool available for the home workshop, from the smallest tools for hand carving to precision milling machines. As a topper you'll find many projects for power tools. Order from Popular Mechanics Press, 204 E. Ontario St., Chicago 11, (clothbound \$2.50).

"Kinks" and Hints for Craftsmen

There's something special in the sparkling new 1953 edition of that famous old title, *Popular Mechanics Shop Notes*. A complete course of instruction for lathe operators, it's written for this edition by James R. Ward, PM's shop notes and crafts editor. And that's just one feature in a book crammed with know-how for the workshop man. There's a section devoted to power tools you can make yourself, another on drill presses, many pages of interest to the farmer and a full department for the automobile owner—besides hundreds of "kinks" and hints for craftsmen. The price of this 240-page book is only \$1.00 at your newsstand or by mail from Popular Mechanics Press, 204 E. Ontario St., Chicago 11.

All books available from Popular Mechanics Books Dept., 204 E. Ontario St., Chicago 11

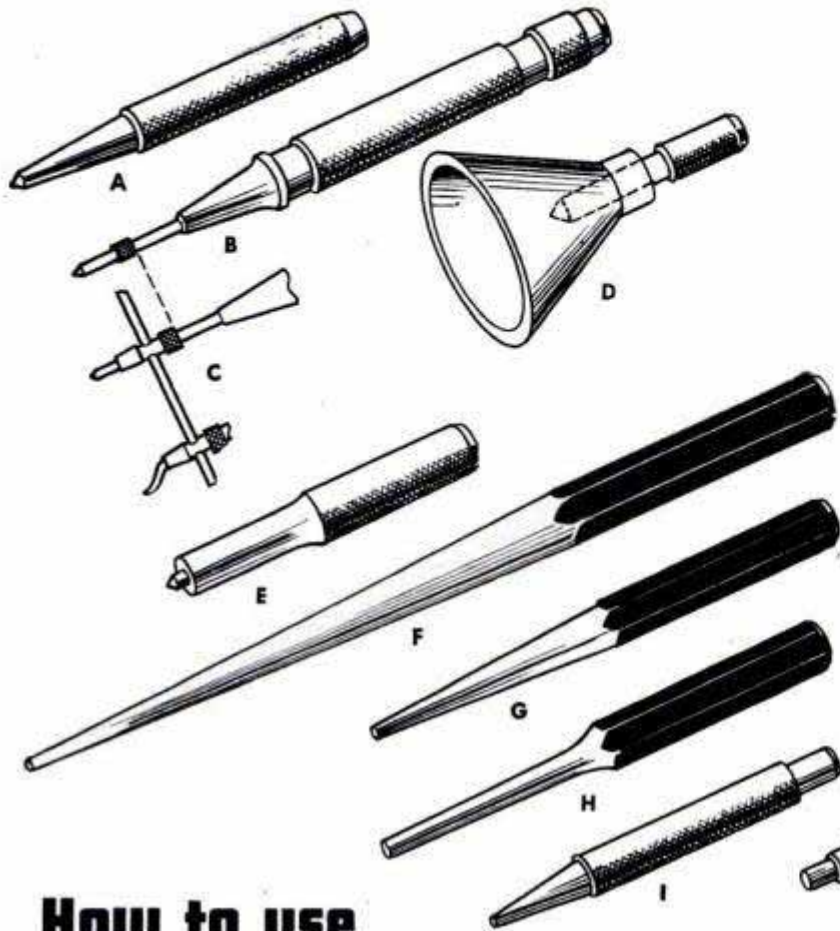

How to use HAND PUNCHES

ACCURATE LAYOUTS on metal begin with precise punch marks made on the surface. The accuracy of the indentations determines to a certain extent the accuracy of the work, especially when starting drills and laying off with scribes and dividers from a center line or base line. That's why diemakers, machinists and others who regularly use center punches and prick punches in layout work take special care to prevent damage to the needle-sharp points. Various types of punches in common use are shown above, in details A to L inclusive. Details A, B, C, D and E show sharp-pointed punches. The others, F to L inclusive, classify as punches but are used for various types of work.

Center punches: The details at the right, A to D inclusive, show methods of using sharp-pointed punches in layout work and in making indentations in metal for starting drills. One trick in setting the point of the punch accurately is shown in detail C. The punch is inclined so that the point is seen readily, and after locating the point, the punch is returned to the vertical position

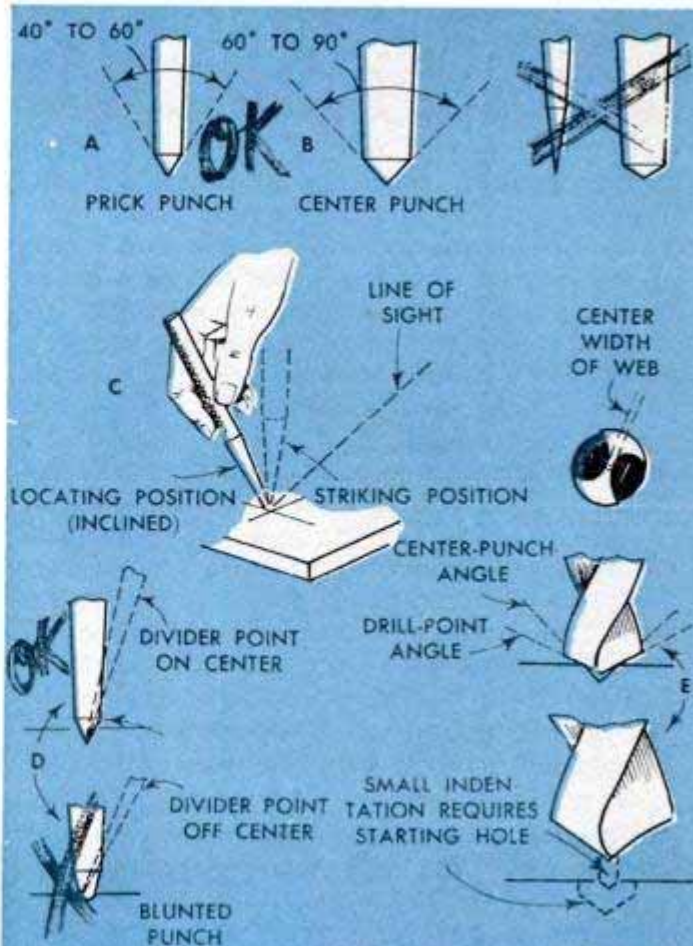

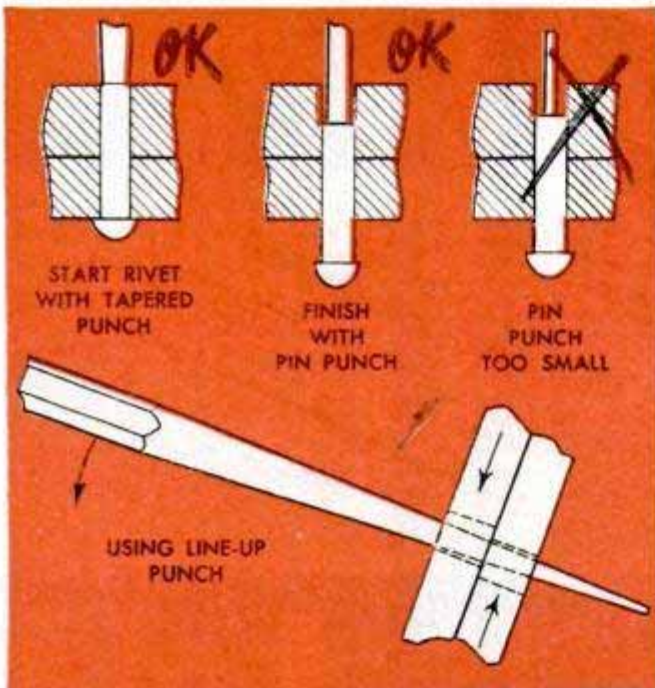
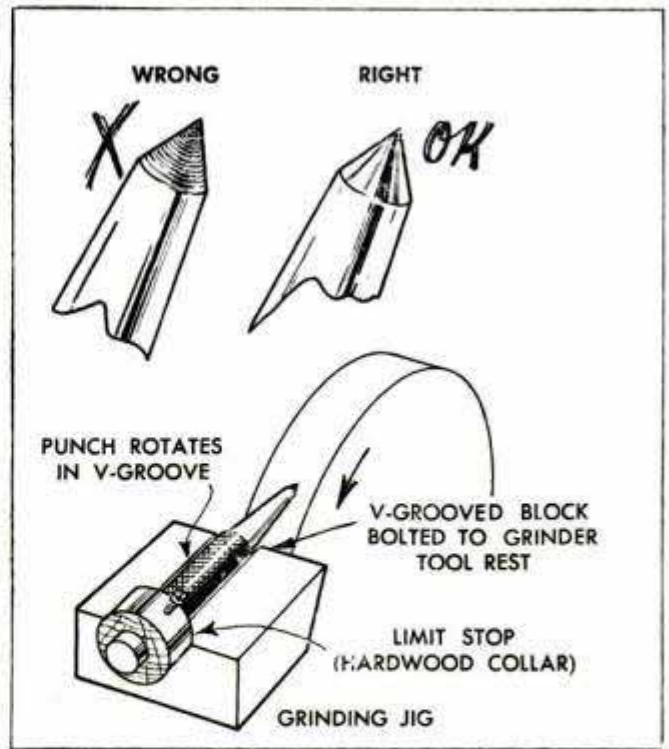

before striking with the hammer. In hole layout, the holes are located with light prick-punch marks and if large holes are to be drilled, starting holes or pilot holes are first drilled to assure concentricity. Indentations in the metal to anchor one leg of dividers should be made with a needle-sharp punch, as otherwise the dividers may shift. Sharp-pointed punches should always be ground concentrically so that the point will be located exactly on the axis. A simple grinding jig made as in the right-hand detail above will do the trick. A similar jig is pictured in use in the photo at the left. The punch is guided by a V-grooved block of hardwood and grinding depth is limited by a hardwood collar attached to the barrel, or body, of the punch by means of a setscrew. Octagon punches can be concentrically ground by slipping the body of the punch into a short length of tubing. In the upper details on the preceding page, de-

tail B shows one type of automatic center punch which is a favorite with machinists. No hammer is required as pressure on the movable sleeve, which serves also as the handle, compresses a spring. When pressure is built up to a certain point a striker is released. The striker delivers a sharp blow on the point. This type of punch also is supplied with adjustable spacing arms, detail C, which are used to locate and punch centers equidistantly along a scribed line. The bell punch, detail D on the preceding page, is self centering and is made especially for marking centers on round stock. A similar type, detail E, is supplied in a range of shank sizes and is designed for laying out registering holes on matching pieces of stock.

Pin, machine and lineup punches: Pin punches are used for driving out pins, rivets and keys. They come in a wide range of sizes and have straight round shanks and flat faces. Machine and lineup punches are similar except that the shanks are tapered. The shanks of lineup punches are much longer than either the pin or machine punches. In starting a rivet or pin, first use the machine punch to start, or "break" the rivet. Then finish driving it out with a pin punch. The reason for this procedure is that the tapered shank of the machine punch has much greater strength than the straight shank of the pin punch. In driving out pins and rivets, select a pin punch having a shank diameter only slightly smaller than the rivet or pin, as otherwise the shank may be broken. Lineup punches are used to align parts which are to be bolted together as in machine assembly. The long tapering shank will enter holes which are out of register and by moving the punch sidewise the

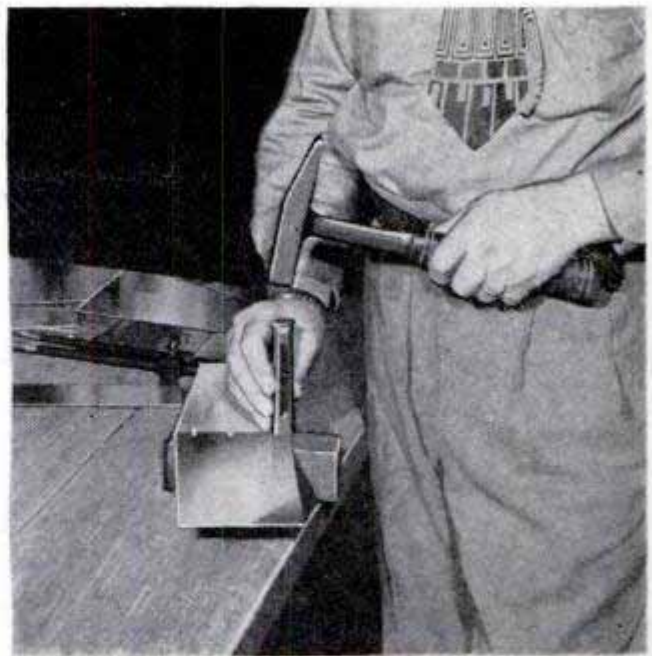
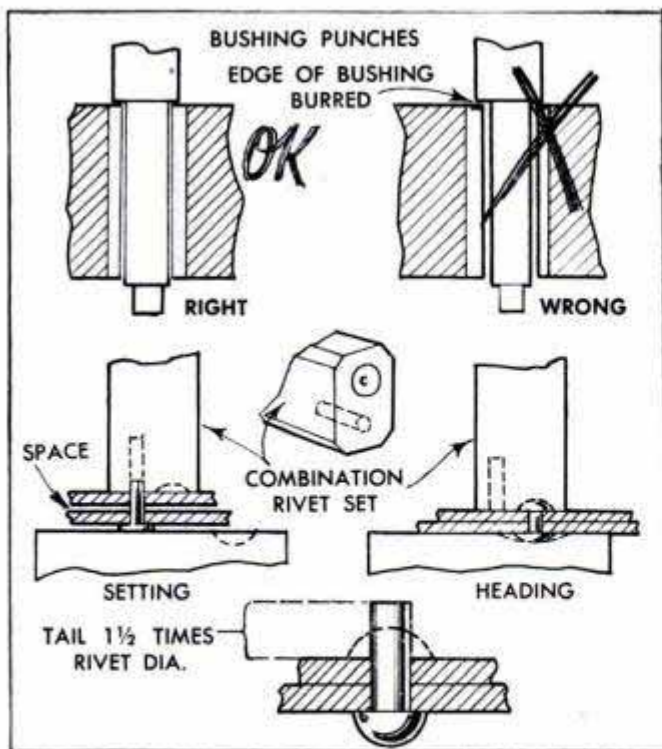

holes can be brought into line and the bolt inserted.

Bushing punches, or drivers: Small bushings usually are inserted or driven out with a bushing punch, or driver, as in the upper details above. Generally these punches have stepped shanks of two or more diameters and are supplied in a variety of sizes. The important thing in driving bushings is to use a punch of the correct size. If the punch is too small, the end of the bushing may be upset or burred.

Riveting punches, or sets: The combination setting and heading punch shown in the lower details above is widely used in hand riveting. It is rectangular in shape and has a hole drilled in the end to take the tapered point of the solid rivet in a fairly snug fit. A shallow concavity, or "dimple," ground in the same end of the punch is used to head the rivet after setting. Flat-headed solid rivets are backed with a rivet bolster or anvil. Round-headed rivets fit into dimples ground in the bolster. It is important that the tail of the rivet project only $1\frac{1}{2}$ times its diameter after setting. If shorter, the upset end will have greatly lessened holding power.

Tubular-rivet header: Tubular rivets, and also split rivets, are headed with a tool like that shown in the upper details at the right. The header is turned with a short projection at one end which enters the hollow end of the rivet. A concave groove turned in the end of the header at the base of the projection turns, or rolls, the rivet edge down to form a clinching rim. On soft materials, such as fabrics and leather, thin washers are sometimes placed over the end of the rivet before clinching.

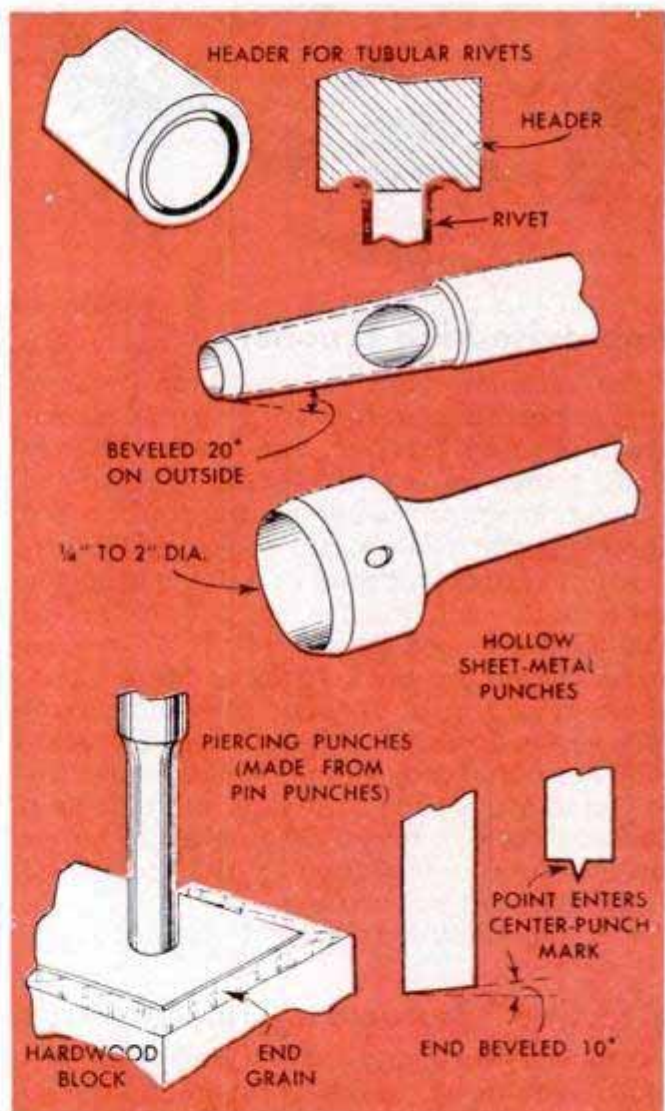

Hollow and piercing punches: The center and lower details above show two common types of hollow punches and the solid piercing punch. The hollow punches have beveled cutting edges and are made for both metals and fabrics. Piercing punches are used to form rivet holes and for decorative work on sheet metal. They must be sharpened often at the bevel indicated. ★ ★ ★



Improved Pig Brooder

To eliminate the necessity of training newly born pigs to find their way to a centrally located brooder, one farmer utilizes heat lamps mounted inside galvanized buckets in improvising a separate brooder for each pen. The metal socket of an extension cord is soldered in a hole cut in the bottom of each bucket and fitted with a 250-watt infrared heat lamp. Bails are removed from the buckets and soldered near the bottom rims to suspend the buckets upside down from the rafters over the pens. The lamps not only supply heat to warm the sow and attract the little pigs, but also help to keep the pen dry. The number of lamps used will be determined by the amount of heat required in each pen.

A. M. Wettach, Mt. Pleasant, Iowa.

Effective "Scarecrow" for Orchards

Crows, blue jays and other birds destructive to orchards can be frightened away by hanging 4-in. squares of roofing paper on lengths of clothesline which are strung between the trees. Using one or more lengths of line, depending on the size of the orchard, tie from 12 to 24 squares on each line, spacing the squares about 2 ft. apart. For best results, hang the squares two or three weeks before the fruit is ready for picking, as it is likely that the scarecrow will lose much of its effectiveness if left up long

enough for the birds to become accustomed to it. If you wish, try substituting squares of sheet aluminum for the roofing paper. The reflective metal not only will sparkle in the sunlight, thereby adding to its effectiveness, but also will withstand weathering better than the roofing paper.

Charles L. Stratton, Hollis, N. H.

Chick Watering Fountain Anchored by Large Spike

A watering fountain for small chicks that are permitted to run in open pens can be anchored in a level position on uneven ground by means of a large spike soldered to the bottom of the fountain. As a result of this, when the spike is pushed into the ground, the fountain may be maintained in a vertical position without the need for blocking. A harrow tooth or a railroad spike with the head removed may be adapted easily to serve the purpose.



Adapter Holds Bar Stock In Three-Jaw Chuck

When a four-jaw independent chuck is not at hand to hold square bar stock, a universal chuck can be adapted with this simple two-piece fixture. It consists of nothing more than a steel disk broached with a square hole and sawed in half. When placed around the work, the V-notch in each half of the disk automatically centers the work as the chuck jaws are tightened. Size of the work to be chucked determines the size of the fixture. A disk 1 3/4 in. in dia. will accommodate up to 1-in.-sq. stock.

C. W. Woodson, Miami, Fla.

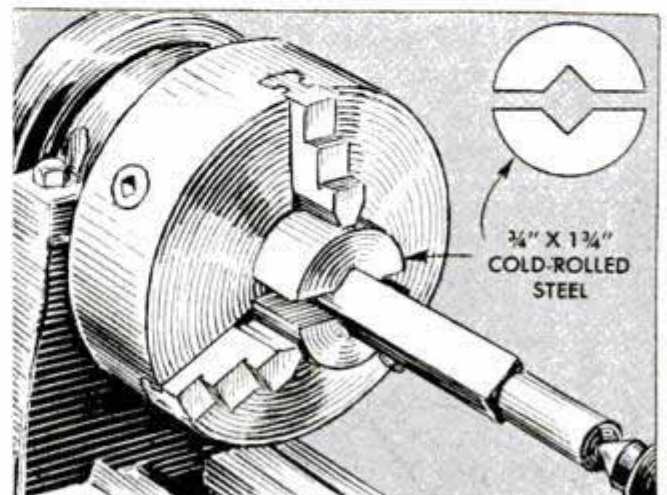

Make Your Own Lathe Dog

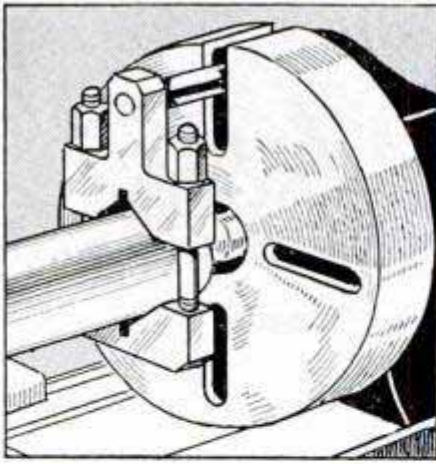

FOR THE metalworker who enjoys making his own lathe accessories more for the experience gained than an actual saving over the price of a commercial item, here's a simple lathe dog that can be made from scraps of steel usually found around the shop. Being adjustable, the dog will accommodate both round and square work from 1 in. up to 2 in. in size. The main body and movable jaw are cut from $\frac{5}{8}$ -in. cold-rolled steel. The 45-deg. V-notch in both parts is machined at one time while the parts are clamped together in the shaper vise. Likewise, the holes for the clamping studs are drilled with the parts clamped together to assure accurate alignment. The holes in the body are reamed to provide a nice sliding fit over the studs.

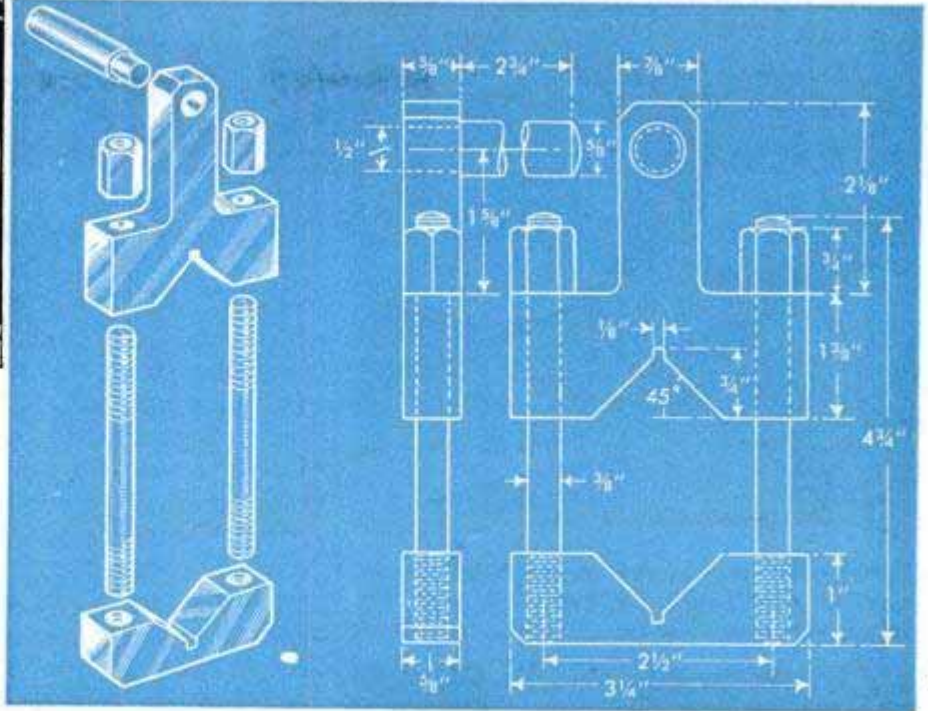

The driving tail which fits the faceplate slot, is turned from $\frac{5}{8}$ -in. steel rod and shouldered at one end for a drive fit in the body. Two locknuts, $\frac{3}{4}$ in. long, are used to cap the ends of the studs. If desired, these may be made from $\frac{5}{8}$ -in. hexagon steel rod, center-drilled and bored before threading with a $\frac{3}{8}$ -in.-16 tap. The studs are cut to length from $\frac{3}{8}$ -in. drill stock and threaded at each end. When tightening the dog, draw both nuts to the same tension.

C. W. Woodson, Chicago.



Livestock Loading Chute Adjusts to Any Height

A farmer's cooperative built this special loading chute to speed up the sorting and loading of livestock into trucks. As pictured, the original was built in a corner of the sorting yard and is permanently housed in a roofed structure open at both ends. The lower end of the chute, or ramp, is pivoted so that it can be raised to any truck-bed height by means of a hand-operated windlass. A ratchet and dog on the windlass drum locks the upper end of the chute at any height. When the truck has been backed into position and the chute raised, covering boards, or tread plates, hinged to the top end are turned over to bridge the gap between the end of the truck bed and the chute, thus preventing injury to the animals. A counting gate is hinged to the lower end of the chute. Many farmers in the community served by the cooperative have built smaller chutes of the same design for loading hogs and sheep at the farm.

HOW TO CUT

Sheet Metal

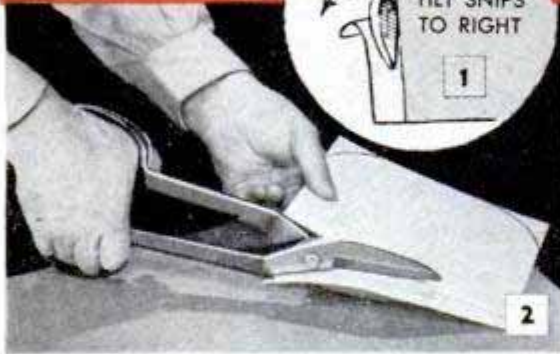

Snips should be held square with work, except aviation type which cut best with right tilt. Below, vise mounting aids in cutting thick stock

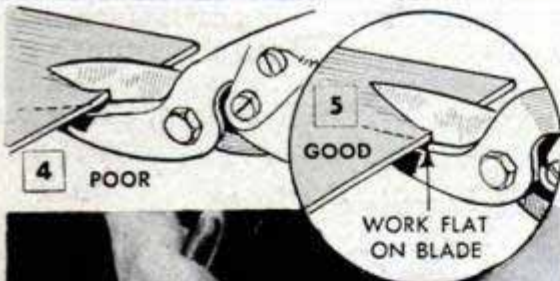
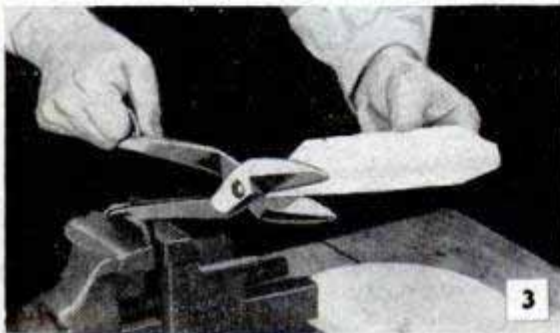

JUST AS IN woodworking, the fundamental process in working with sheet metals is cutting the stock to specified dimensions or shapes. In some instances, such as making ornamental cutouts and plain overlays, the whole job is confined to cutting operations, but more often cutting is simply a preliminary step to bending, spinning, hammering and other operations needed to complete the project.

Snips are basic tools: Whatever other sheet-metal cutting tools you may have, there is always need for a pair of snips. Several popular styles are shown in Fig. 7, of which the combination snips, A and C, are favorite all-purpose tools for straight or curved cutting. Aviation-pattern snips with compound leverage are rapidly gaining in popularity. These snips make a clean cut with much less hand pressure than required for regular snips. When using snips, the blades should be held at right angles to the work, as shown in Fig. 2. If you run off the line, a slight tilt to the right, Fig. 1, will free the work pressure and allow the blades to return to the line.

Snips with a broad cutting bevel, C and D, Fig. 7, work best if tilted a little to the right throughout the cutting operation. Fig. 5 shows how the right tilt locates the lower face of the work flat on the blade. When cutting heavy materials with snips, a one-handed action with the free handle held in vise, Fig. 3, will give extra power.

Slitter and portable shear: These two are power tools and both work on the same principle, having one fixed and one moving blade, as shown in Figs. 8 and 13. The slitter is a bench tool. In a small unit, it is powered with a 1/4-hp. motor which is belted to the machine with driving and driven pulleys of the same size, giving 1725 strokes per minute. It is a fast-cutting machine

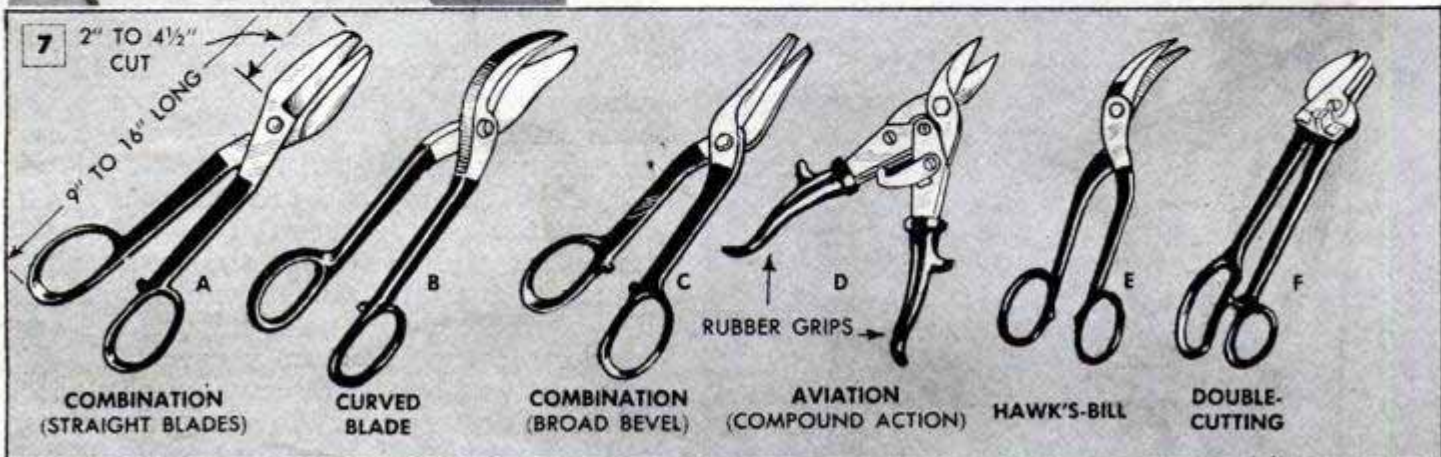

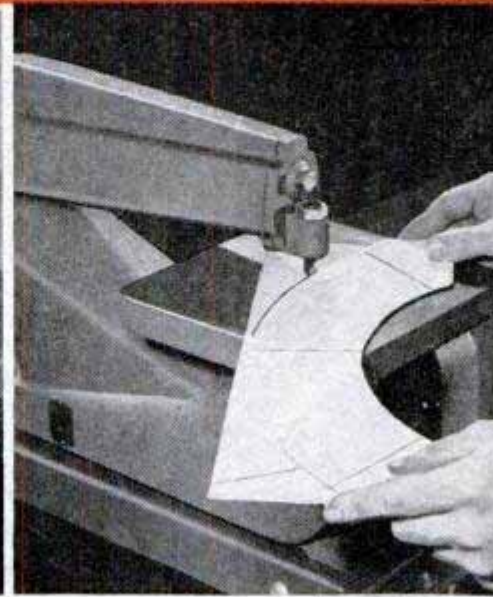
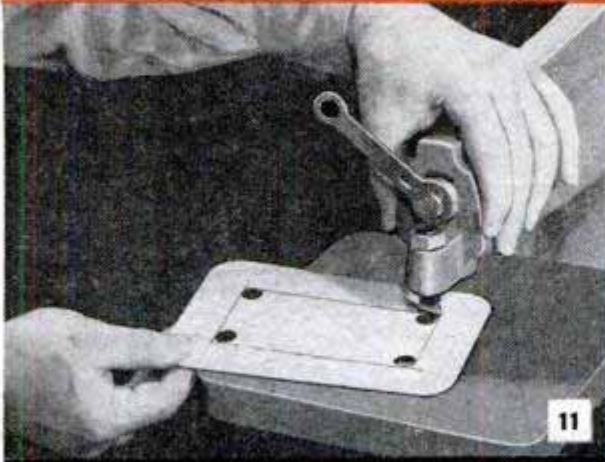
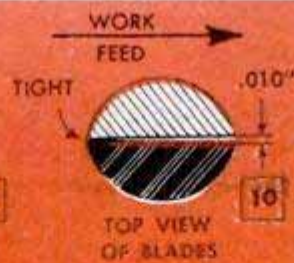
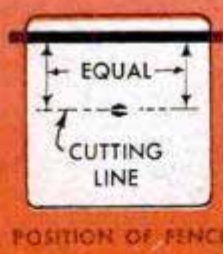
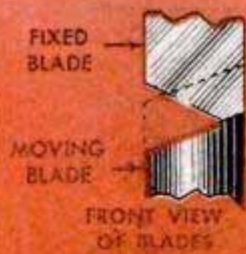

SLITTER AND PORTABLE SHEAR are fast cutters. Both work on the same principle, each having one fixed blade and one moving blade

when properly operated but requires some practice in manipulating the work and adjusting the blades. The blades will cut best if set tight on the infeed side and slightly open at outfeed side, as shown in the top view, Fig. 10. The feed rate should be smooth and uniform and the operator must guard against any tendency to lift the front edge of the work as this will invariably cause jamming.

It is practical to fit a plywood table over the regular metal table and in this way gain needed work surface for large pieces. Although straight cutting with a fence is fast and accurate, it is important that the fence be set parallel with the flat side of the blades, Fig. 9. If the fence is only slightly out of line, the work may jam.

The cutting head of the portable shear is detailed in Fig. 13 and the shear is pictured in Fig. 14. This is a convenient, fast-cutting tool and the most important point in operating technique is to keep the work flat on the fixed blade. It will make inside cuts but requires a rather large hole in the stock to admit the shoe. Neither shear nor slitter is capable of

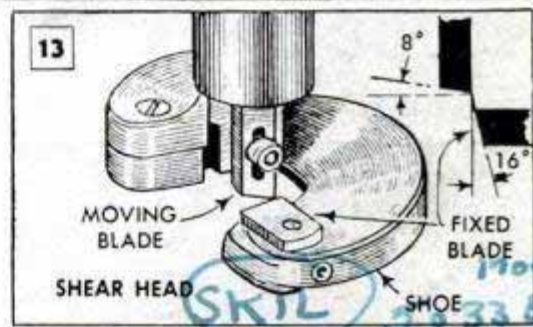

Tool Data	SNIPS	SLITTER	PORTABLE SHEAR	PORTABLE NIBBLER	HAND PUNCH	RING SHEAR	BAND SAW	JIG SAW
THICKNESS CAPACITY	21 GA. (.032")	20 GA. (.035")	18 GA. (.049")	18 GA. (.049")	20 GA. (.035")	20 GA. (.035")	ABOUT 3"	ABOUT 1/4"
CUTTING SPEED per Min.	ABOUT 24"	UP TO 120"	UP TO 120"	UP TO 80"	UP TO 40 STROKES	UP TO 120"	UP TO 120"	ABOUT 30"
MINIMUM RADIUS	ABOUT 3/4" (AVIATION)	ABOUT 3"	ABOUT 3"	ABOUT 2"		ABOUT 3/4" (1/2" BLADE)	1/2"	WILL MAKE ANY CUT
KIND OF WORK	GENERAL	GOOD FOR FAST ROUGH WORK	GENERAL	STRAIGHT AND CURVES - GOOD FOR NOTCHING	HOLES AND SHORT STRAIGHT CUTS	GOOD FOR CIRCLES AND RINGS	GENERAL - FAST CUTTING	INTRICATE CUTOUTS - INSIDE CUTS

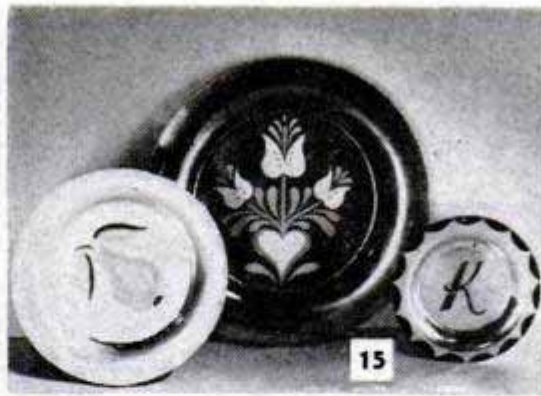

Ring shear does perfect circle work needed for plates and lamp shades. Photo below shows extension strip clamped to work to provide a pivot for swinging large segment

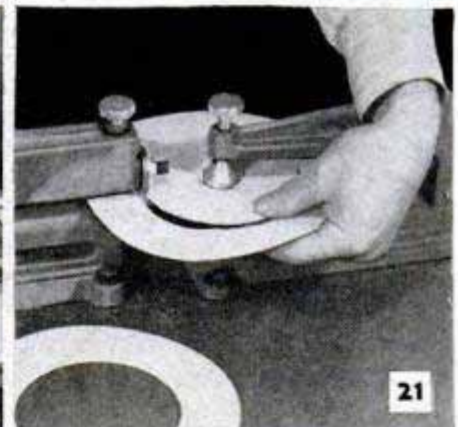
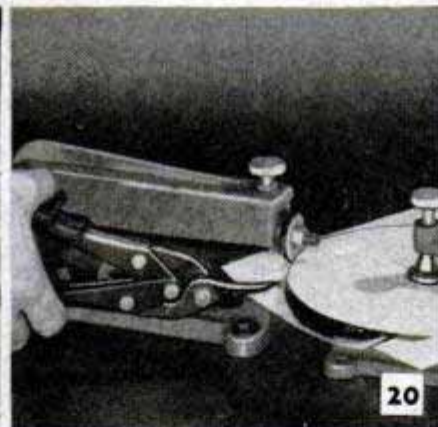
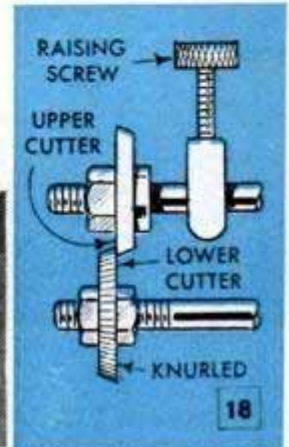
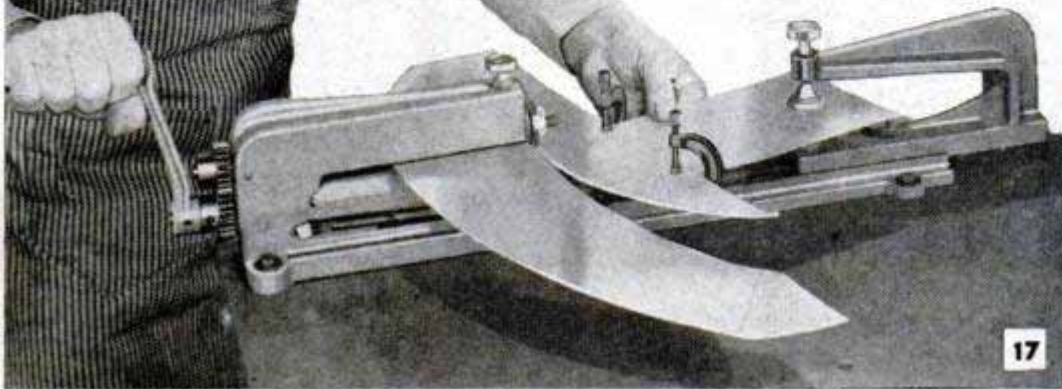

Circles are cut by using a pivot, which is an accessory to the shear. Cut may be started at edge of work, as in bandsawing, or top cutter can be forced through work at any point. To prevent distortion, inside cuts are made with minimum overlap of the cutters. On outside cuts, snip away the waste as cut progresses

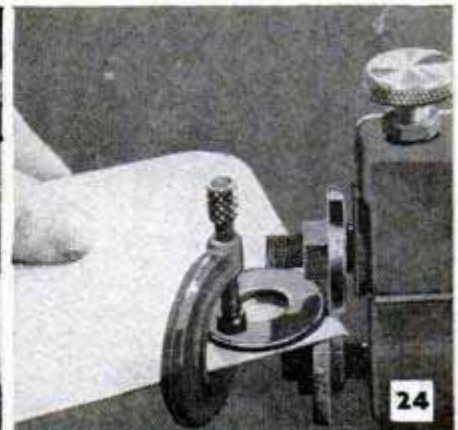
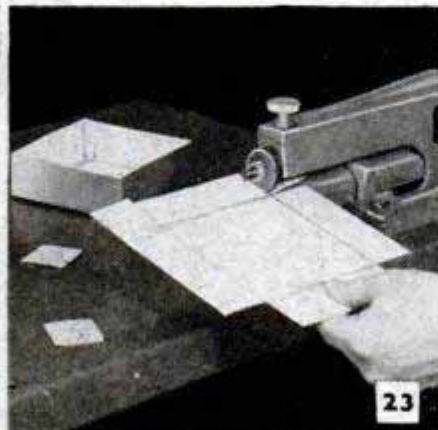
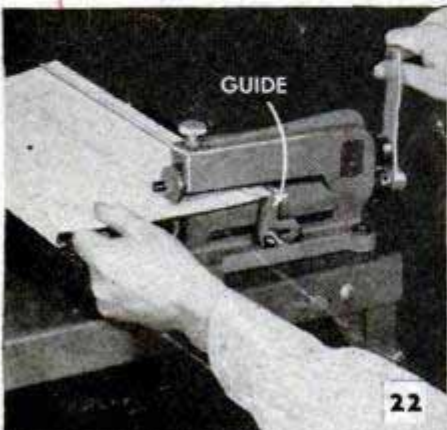

Straight cuts can be made freehand by following a pencil line, but a better way is to improvise a guide as in left-hand photo. Center photo shows how notches are cut to form box corners. Right-hand photo shows how a curved guide can be used to form a true radius. In this case, an ordinary washer served the purpose

5033 Eiston
Chgo
30

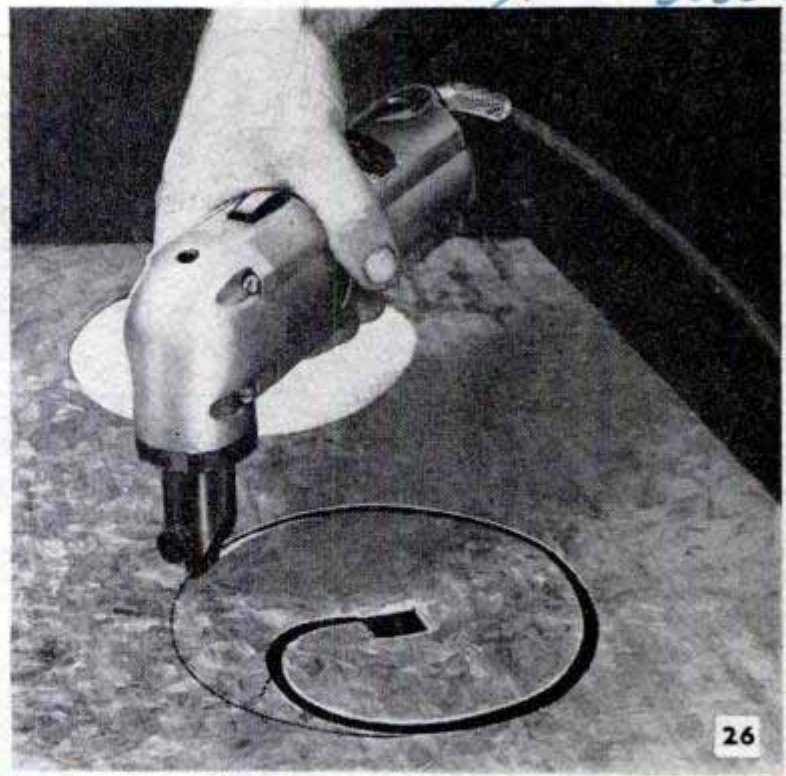
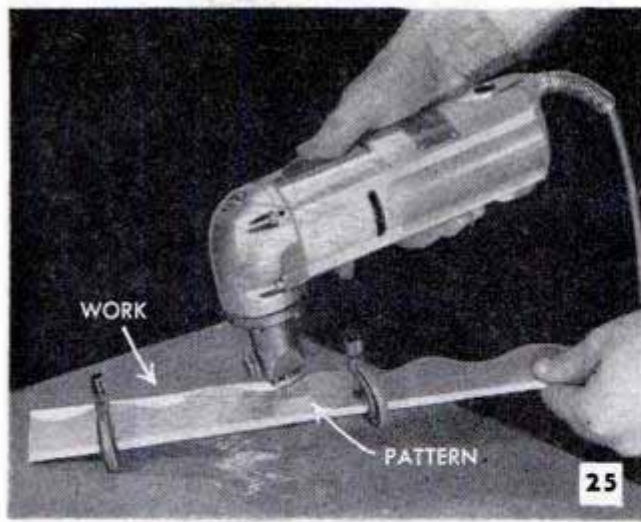

making sharp curves. Such work must be done by making a series of tangent cuts to the dimension line and cutting away the waste.

Ring shear: One of the best tools for cutting sheet metal is the ring-and-circle shear, Fig. 17. It cuts fast, is noiseless and does perfect work in cutting circles and rings needed for many metal projects. Fig. 18 shows the cutting head, consisting of two hardened steel wheels which are interchangeable. The knurled wheel will leave a slight track on the work but the interchangeable feature permits mounting this wheel to run on the waste stock.

When cutting a circle, the work is clamped in the pivot jig, after which the raising screw is turned to force the cutter through the work, Fig. 19. After that, you just turn the crank. It usually is advisable to cut away the waste, or off-fall, in sections, Fig. 20. Inside cuts are made in the same manner, as shown in Fig. 21. When used with the guide, Fig. 22, the ring shear



A portable nibbler can be used freehand or with a pattern as in the upper left-hand photo. Square housing permits unit to be mounted in vise as in photos

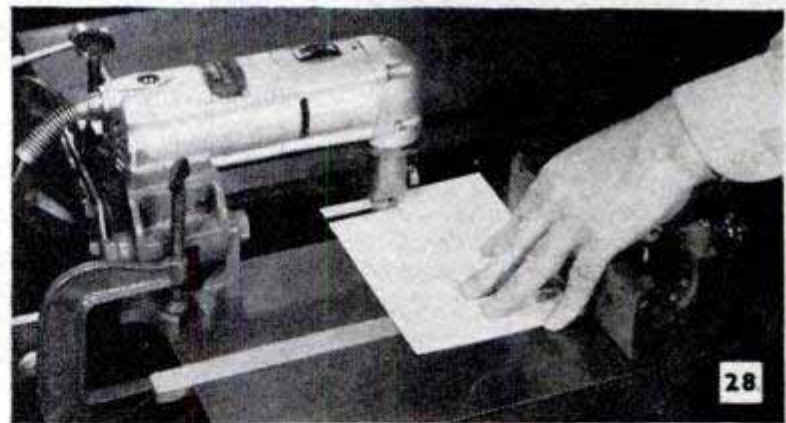

Used with a spacer board and stop on circular-saw table, the nibbler can be set up to make a variety of attractive notched borders. Work is held in place with thumbtacks

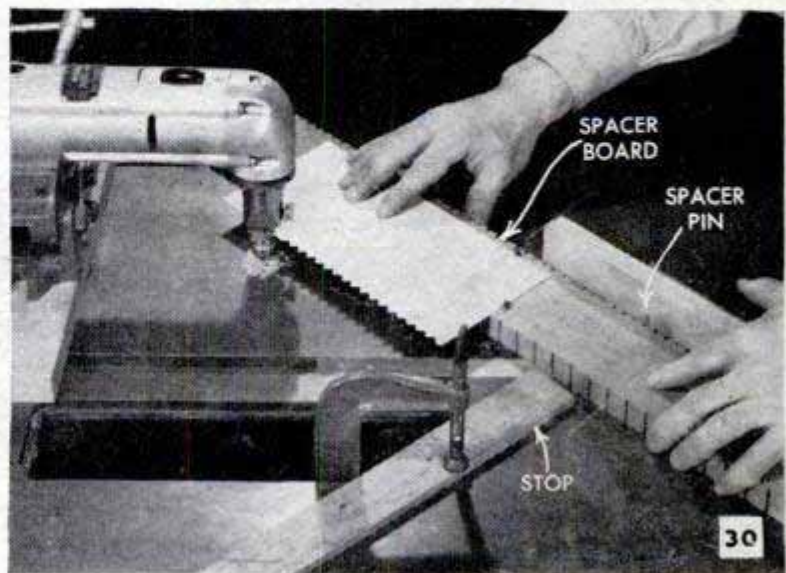



Hand-operated punch makes clean, round holes for rivets or decorative effects. Square dies are available for certain type punches, also accessory shear blades in various sizes

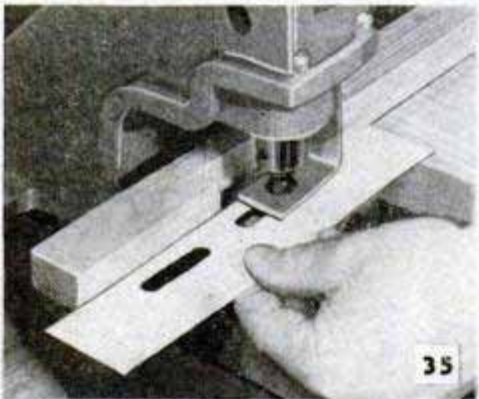
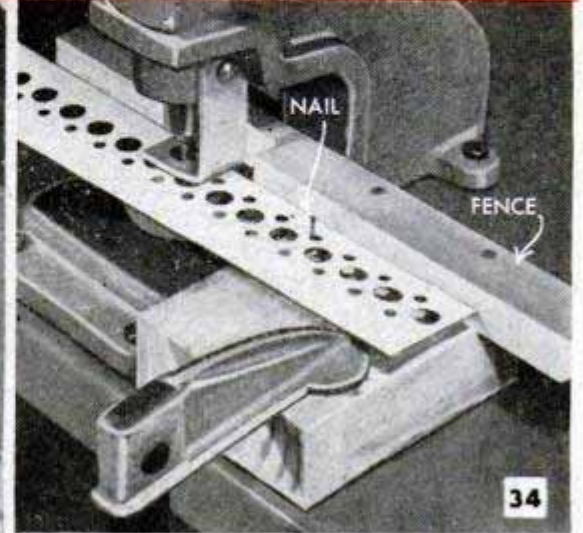
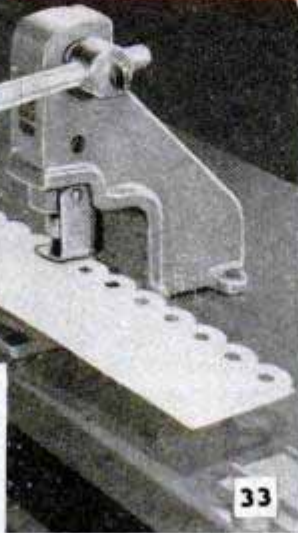
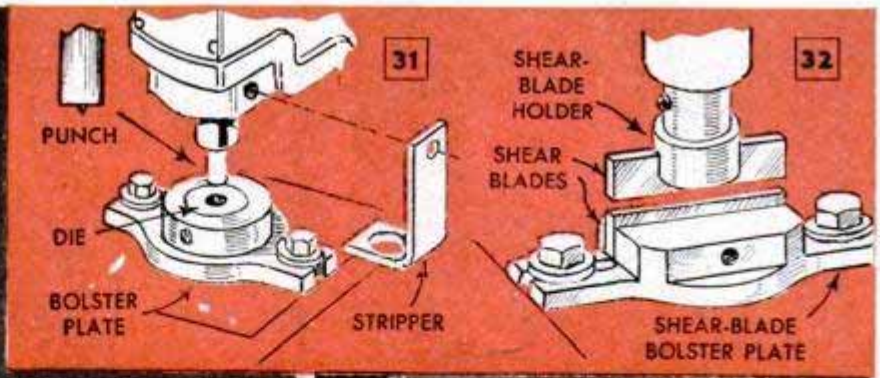

A hand punch does accurate slotting



Above, cutting in from edge with shear. Below, notching edge with shear blade

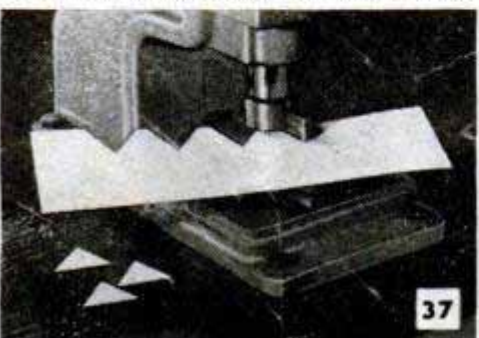

does clean, straight cutting. Fig. 23 shows a notching operation and Fig. 24 shows how a pattern can be used. In this instance a washer serves as a guide for rounding corners.

Portable nibbler: Punching tools, which include the nibbler, Fig. 26, and the hand punch, Fig. 33, work with the least distortion of the material and make the cleanest edge of all metal cutters. The portable nibbler is simply a power-operated punch. As shown in Fig. 27, the die is carried on an extension of the frame, while the punch oscillates rapidly up and down through the die. In the portable tool, the most popular type of punch is a rectangular shape measuring $\frac{1}{16} \times \frac{1}{4}$ in., with rounded edges. The slight serrations left by this type of punch are so small that the edge requires a minimum of finishing. Because of its easy portability, the nibbler is widely used in cutting large patterns and cutouts on sheet sizes which are impractical to handle on a bench machine. But it does the smaller, more intricate jobs equally well. Cutting without distortion and with no exposed parts, it will work circles down to the size of a dime. Inside cuts can be made with a 1-in. starting hole, as in Fig. 26. The use of a metal or wood pattern is practical and fast repetitive work can be done in this manner, the edge of the cutterhead riding the pattern as in Fig. 25. Many portable nibblers have a square motor housing to permit vise mounting. A good setup of this kind can be made on the circular-saw table, as shown in Fig. 28. With the work thumb-tacked to a spacer board, the saw-table setup is ideal for ornamental notching, as shown in Figs. 29 and 30.

Hand-operated punch: This is one of the handiest tools in the shop and does a variety of jobs with suitable accessories. Its prime job is to punch round holes in sizes from $\frac{1}{8}$ to $\frac{1}{2}$ in., advancing by sixteenths. Fig. 31 shows the setup. Each punch has a tiny point at

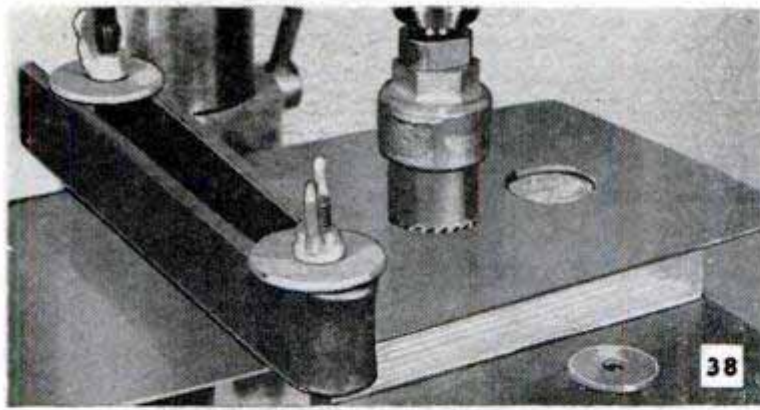

Hole saw is useful drill-press accessory for cutting clean holes. Also is used with portable drill

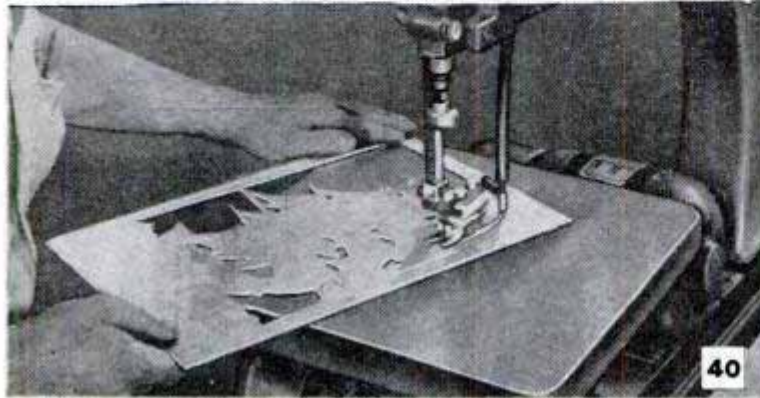

Jigsaw is best for intricate cutouts in sheet metal. A 15-tooth blade does rapid work in medium stock

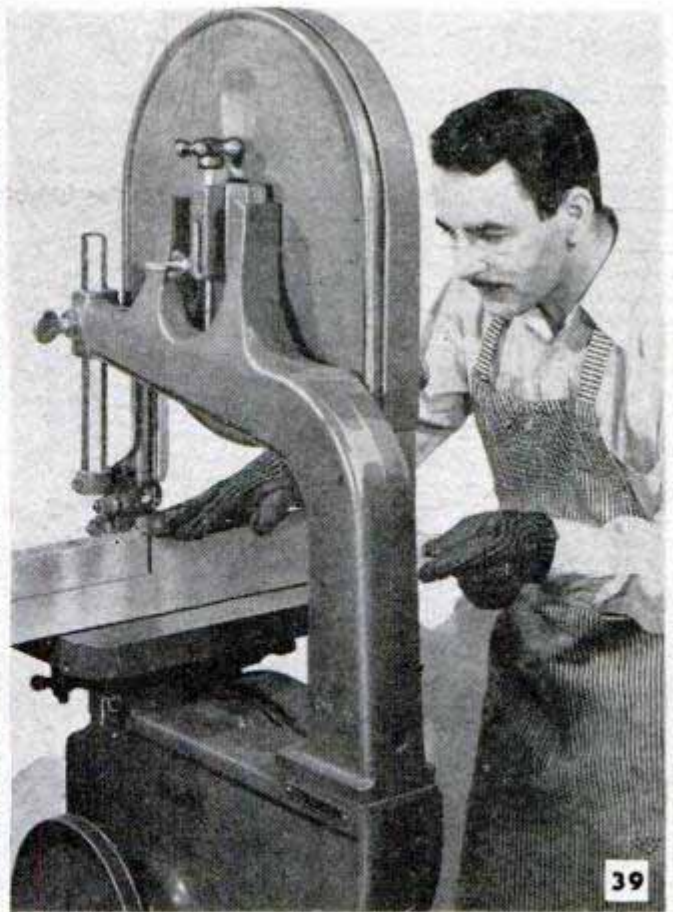

Bandsaw used as friction saw cuts fast and accurately on sheet metals of all kinds up to 1/8 in. thickness

the center, and this centers on punch marks made on the work. Instead of prick-punching each center mark, it is possible in repeat patterns to use a fence and guide pin, as shown in Fig. 34. After the first 4 in. of the pattern have been punched out in the usual manner, succeeding holes can be worked very rapidly. Employing a series of punched holes with the work guided along a fence, the hand punch does excellent slotting, as shown in Fig. 35. Unlike a similar operation done with drills on the drill press, the holes can be as closely spaced as desired, without distortion or runover.

A handy accessory for the hand punch is a set of shear blades, Fig. 32. With these you can do straight-line cutting, notching and internal cutting. The shear-blade bolster plate can be used in either of two positions, as shown in Figs. 36 and 37, to suit the work.

Bandsaw and jigsaw: More familiar to the average worker, these power tools do excellent work in metal. Ordinary wood or metal-cutting bandsaw blades run at woodcutting speeds can be used to cut aluminum up to 1/16 in. thick. For fast cutting of heavier black and galvanized sheet metal up to 1/8 in. thick, the technique of friction sawing on the bandsaw is excellent. This is done with a regular metal-cutting blade, 18 teeth per inch, run at 2800 to 3000 f.p.m. Galvanized sheet stock can be cut in this

way as fast as the hand can push the work, Fig. 39. For conventional bandsawing of sheet metal, the speed should be reduced to approximately 200 f.p.m., using a 24 or 32-tooth blade.

The jigsaw cuts much more slowly than the bandsaw but is the best tool for making intricate cutouts involving short-radius curves. The fastest cutting is obtained with a hardened and set metal-cutting blade with about 15 teeth per inch. For finer but slower work, 30 or 32-tooth blades should be used. Medium speed can be used for soft metals. But use only the slow speeds for sheet steel.

Other equipment: The tools described fall far short of covering the full line-up of sheet-metal cutting tools. A worth-while extra is a set of hole saws, which can be used in an electric portable drill or drill press, Fig. 38, for cutting accurate holes in sheet metal. Of the various methods, snips, ring shear and punch are the 1-2-3 selection—assuming that you already have jigsaw and bandsaw. ★ ★ ★

Tapping Holes in Sheet Metal

Tapped holes in sheet metal will grip screws more securely if the metal is punched instead of drilled. The use of a prick punch forms a burr which produces a "thickness" several times that of the metal itself, thus accommodating additional threads.

Sectional-Type Door in Granary Provides Lighted Work Area

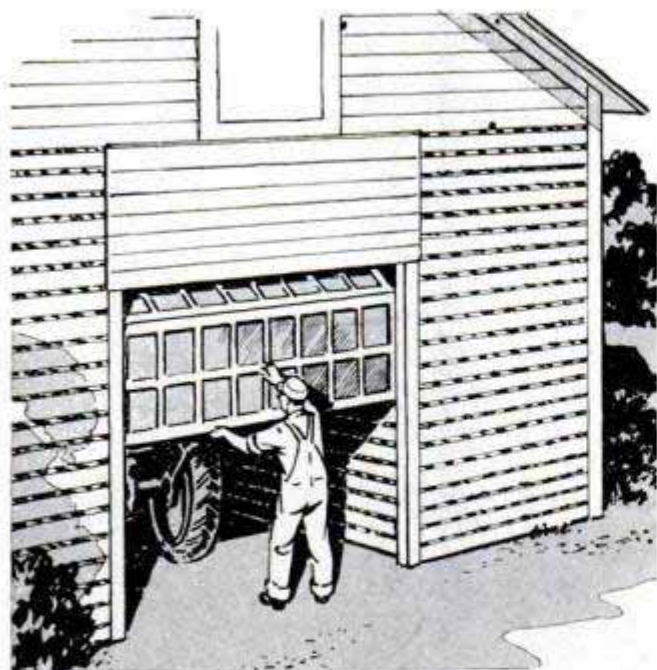

Wanting a comfortable place where he could do such jobs as repair farm equipment and grind feed regardless of the weather, one farmer utilized the driveway of his granary by installing a sectional door in which several rows of plywood panels had been replaced with glass. Being glazed, the door can be closed in stormy weather and still provide ample light for working.

Magnets Support Price Cards On Merchandise Displays

Small bar magnets taped to the backs of price cards will make it possible for the cards to be attached quickly to a display of foods or other products in tin cans. The same idea can be useful in many ways. For example, the magnets are ideal for mounting

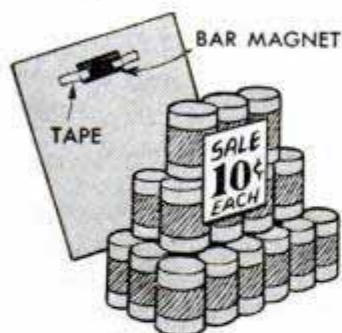

display cards or other information on home appliances such as refrigerators and stoves, as well as on tools and metal equipment. — Leonard W. Mitchell, St. Clair Shores, Mich.

Salvaging Scaffolding Lumber

Finding that a large percentage of the lumber used for scaffolding was badly damaged by hammer blows while being dismantled, one contractor supplied his workmen with lengths of sand-filled rubber hose to knock down the scaffolding. Use of the hose for this purpose distributed the force of the

blows across the surface of the boards so that splitting and splintering of the wood was practically eliminated. He utilized ordinary garden hose which was cut into sections about 18 in. long. After filling the hose with sand, the ends of the sections are plugged with corks or wooden dowels. The plugs are held in place with nails driven through the sides of the hose and into the plugs.

Wheel-Hub Guards for Hayrake Made From Old Tire

Halves of an old tire that have been placed over the axle next to the wheels of a hayrake will help keep hay from wrapping around the wheel hubs. First, the tire is cut in half around its circumference and then each section placed over the axle with the rounded side facing the wheel. — Clinton Hull, Costa Mesa, Calif.



Moldboard Extensions Roll Furrows During High-Speed Plowing

As an aid in plowing under heavy trash and cover crops, and also in preventing ridging of loose soils when plowing at higher speeds, many farmers equip tractor plows with moldboard extensions, or wings, bolted to the outer ends of the moldboards. The top edges of the extensions are bent so that when in place they incline slightly forward as pictured. In this position the extensions catch the top, or land edge, of the furrow as it is turned by the curved moldboard and "flip" it completely over. In high-speed plowing this action prevents ridging caused by soil being thrown on top of that turned by the preceding furrow, and also buries loose surface trash effectively and uniformly.



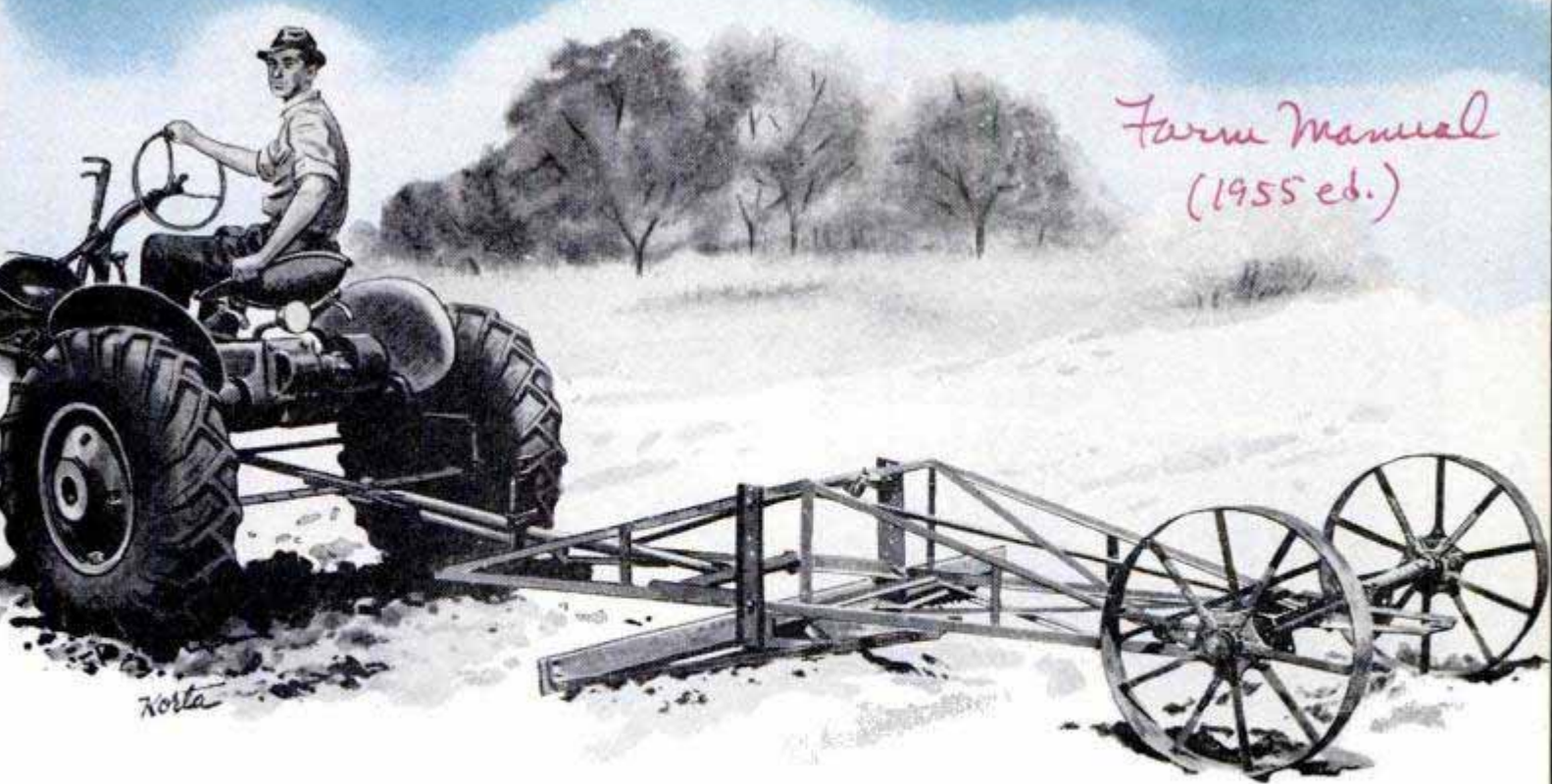

LAND LEVELER

By L. H. Houck

TRUCK FARMERS and others who require a perfectly level seedbed make extensive use of a land leveler when preparing the soil for planting. Levelers also are used to face terraces, build up low spots as well as fill and level dead furrows and back furrows in large plowed fields. The unit pictured was built in a farm shop and consists of an angle-steel frame of the truss type, welded at all stress points and fitted with a tubular-steel drawbar. Trailing wheels of large diameter are mounted at the rear end of the frame on a tubular axle. These carry the scraper blade at a uniform height and permit easy transport from field to field. The blade consists of a $\frac{1}{4}$ -in. steel plate, 6 in. wide and 8 ft. long welded to a length of 2-in. angle which extends the full length of the blade along the lower edge. The blade is bolted to the frame in a

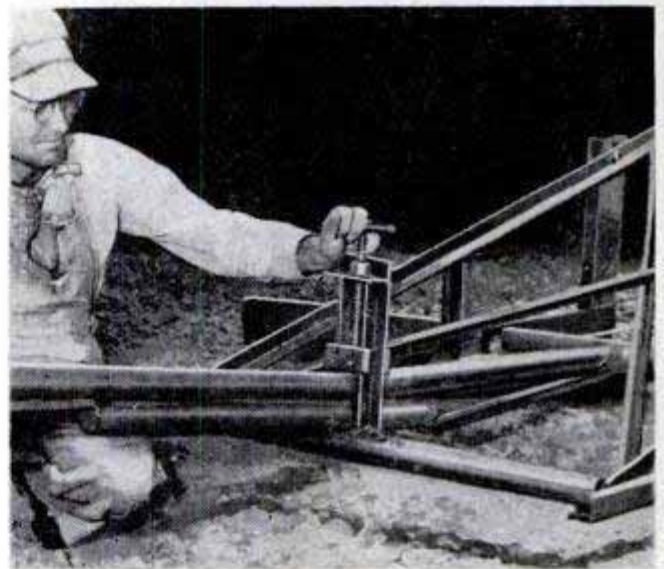

vertical position and at right angles to the direction of travel. The photo above pictures the screw adjustment for raising and lowering the blade. Turning the T-handle raises or lowers the forward end of the frame and adjusts the blade to the desired height for work or transport.

Paint Roller Spin-Cleaned by Chucking in Electric Drill

Seeking a means of cleaning a paint roller quickly and thoroughly after soaking it with solvent, I eventually hit upon the idea of adapting the roller so that it could be spun at high speeds in a portable electric drill. First, I removed the shaft from the roller and replaced it with a snug-fitting bolt that was long enough to extend a couple of inches from one end of the roller. Then I turned a nut on the threaded end of the bolt and tightened it against the end of the roller. Before chucking the bolt in

the drill, I obtained a bucket in which the roller could be spun, and also a piece of cardboard for covering it. After cutting a hole in the cardboard, I inserted the roller and turned on the power. In a matter of minutes both the paint and solvent had been thrown from the roller and deposited against the sides of the bucket. An otherwise messy job thus completed, I then removed the bolt and reassembled the roller and handle unit.

Dr. M. M. Thompson, Toledo, Ohio.

SHOPPING FOR TOOLS

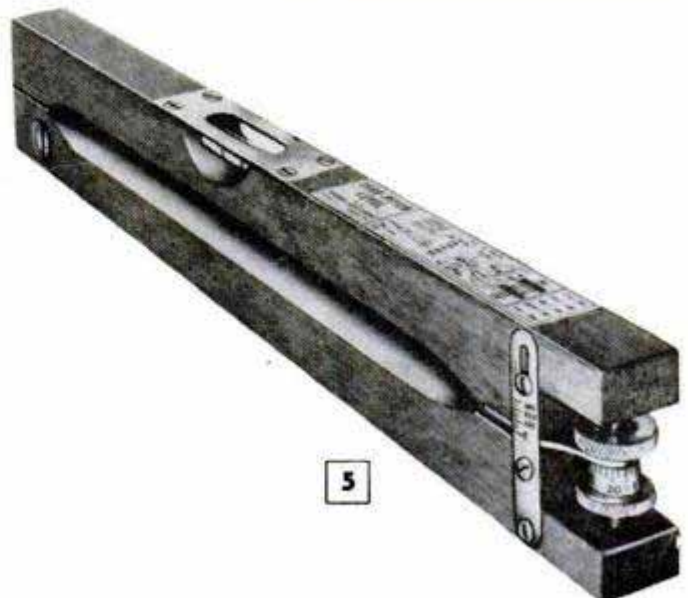
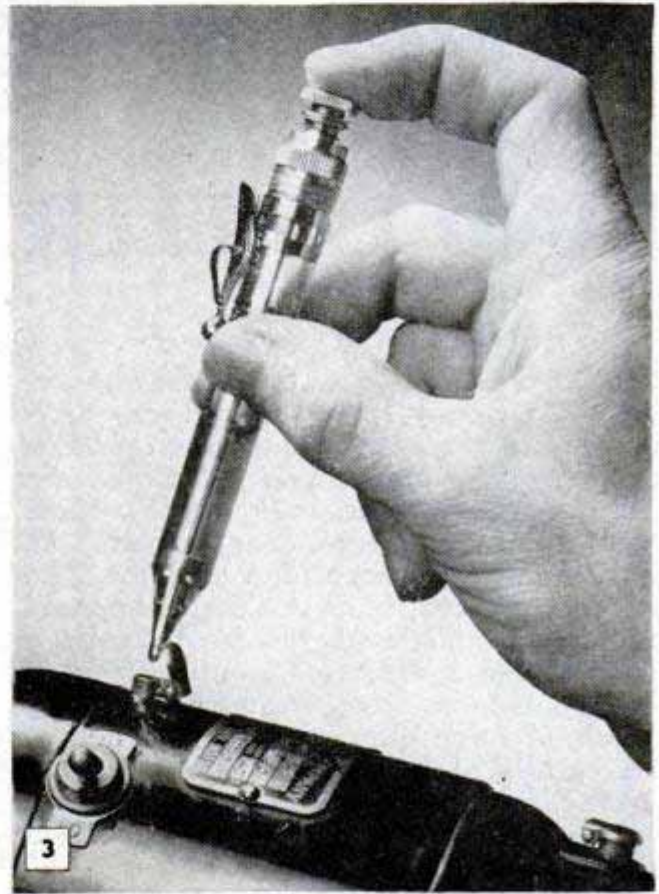
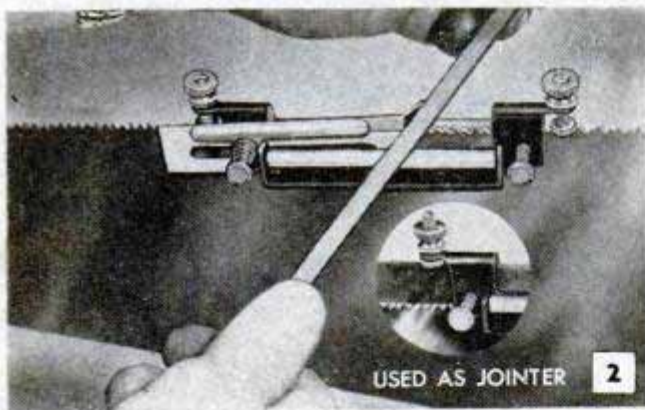
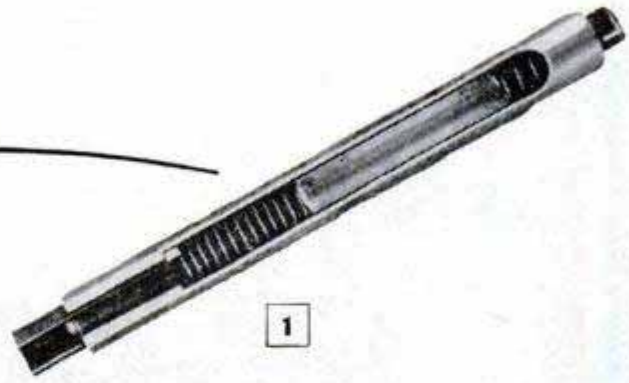
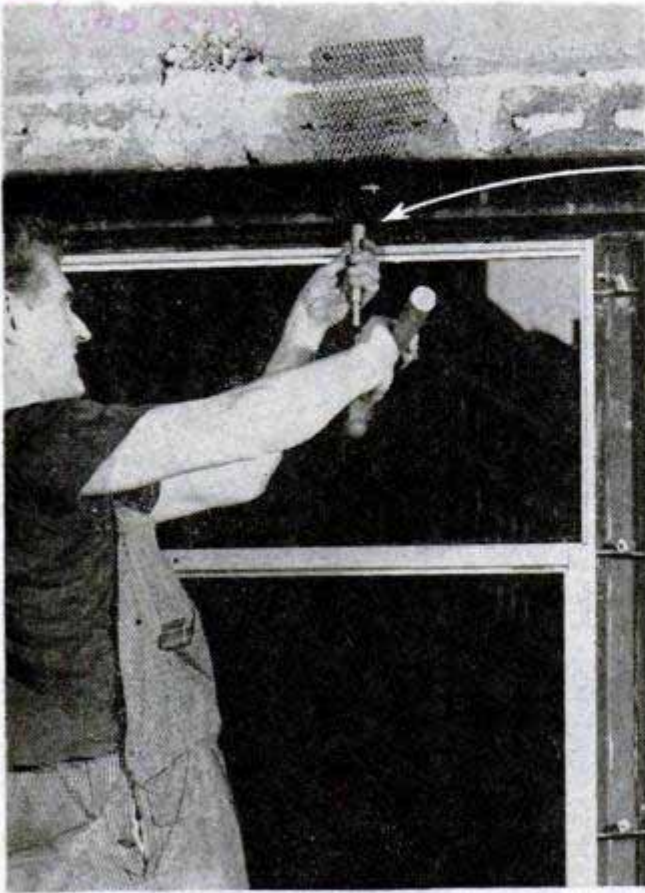

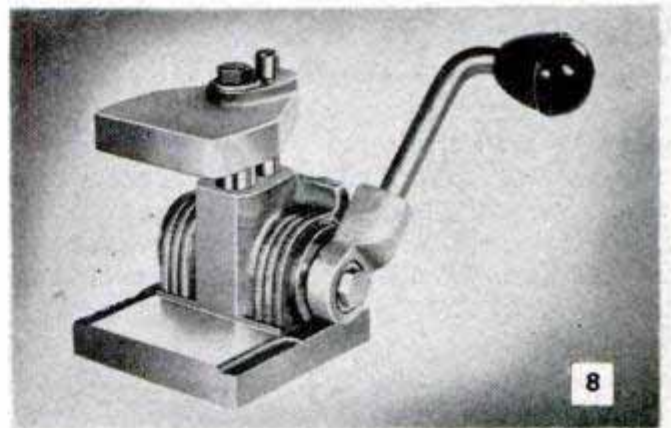
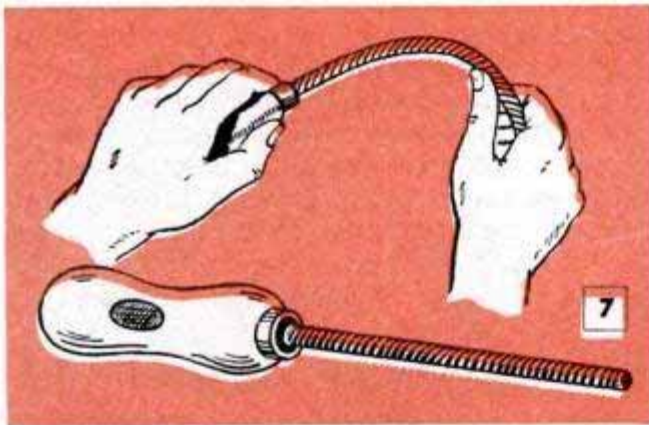
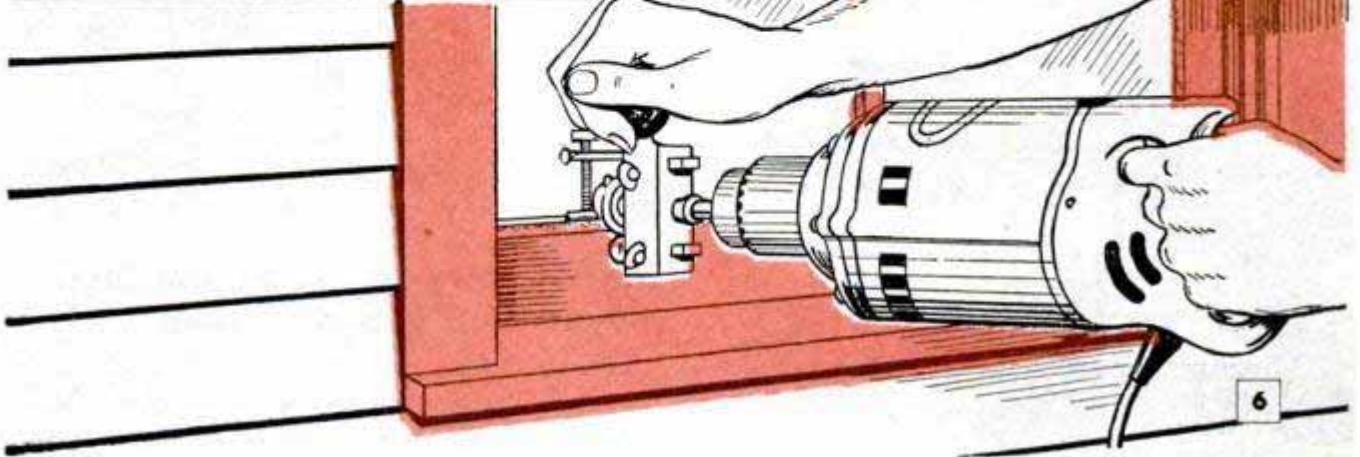
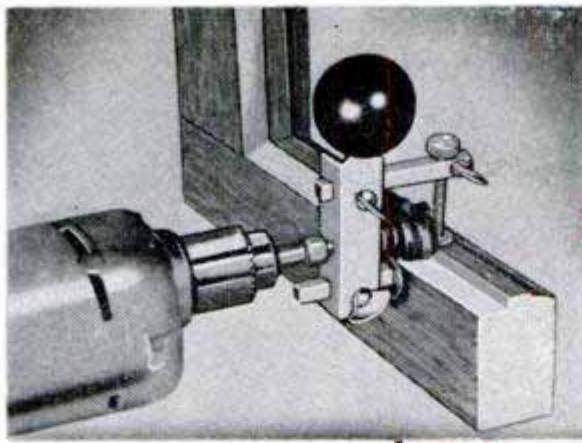

1. MAGNETIC NAIL DRIVER enables lathers to fasten metal lath to concrete and other masonry materials without breakage and without endangering themselves and others with flying nails. Tool has magnetic core which holds nail in alignment as it is driven

2. COMBINATION SAW FILING AND JOINTING JIG permits hand filing and jointing of handsaw blades with accuracy and uniformity nearly equal to machine filing. Jig is equipped with a depth adjustment and bevel guide for holding file at the correct angle

3. ONE-DROP OILER has transparent plastic barrel and spring-loaded plunger which gives positive control of the amount of oil ejected at each plunger stroke. Plunger screws into barrel when not in use, preventing leakage of oil when carried in the pocket or kit

4. AIR-POWERED NUT RUNNER for small, precise work has standard deflection-type torque wrench that is easily removed for inspection. Especially designed for production jobs where precise torque control is essential to prevent distortion and breakage of small parts

5. TRUE-PITCH LEVEL makes it easy for plumbers and builders to determine the exact pitch of long runs of pipe and drain tile. Consists of two parts hinged at one end and provided with a locking-screw adjustment. A chart gives readings for various settings

6. PUTTY REMOVER is supplied as an attachment for a portable electric drill. Removes old putty from window sash, leaving a clean, smooth rabbet for reglazing. Depth and width of cut are controlled by a simple adjustment. Cutter is easily replaced when dulled

7. FLEXIBLE ROUND FILE cuts in any direction and can be bent to fit the contour of concave or convex surfaces. Special shape of the cutting teeth prevents clogging in soft, hard-to-file metals such as lead and soft aluminum. File is available in six sizes

8. SINGLE-POST DRILL JIG has a positive camming lock that reduces loading and unloading time to a matter of seconds. Base and top plate are accurately machined and the angle of back to base is milled at 90-deg. to permit unit to work in two positions



Wrist Guards for Car Washer

Resembling somewhat slices of pineapple from a can, these sponge-rubber drip guards can be slipped over the wrists to prevent water from running down the arms while washing a car. The pieces are cut from $\frac{1}{2}$ -in. sponge rubber and measure 5 in. in diam. Oval-shaped holes are cut so that they fit snugly over the wrists.

Oil Reservoir in Jaw of Steady Rest Lubricates Work Automatically

By providing an oil reservoir in the vertical jaw of your lathe steady rest, lubricant is fed to the work automatically. As shown in the detail, the reservoir is made by drilling a $\frac{1}{8}$ -in. hole lengthwise through the center of the jaw and is filled through an oilhole drilled at an angle at the upper end. A heavy oil should be used, of course, so that it does not run too freely from the jaw. In fact, the reservoir could be packed with grease or a special lathe-center lubricant, relying on friction to provide sufficient heat to cause the grease to seep downward and oil the work. Note in the detail that the hole running through the center of the jaw is chamfered slightly to help retain the oil at the point of bearing.

Richard Hanscom, Elmhurst, Ill.

❏ Instead of using special layout ink and scriber to make rough layouts on metal surfaces, one machinist has found that the job can be done much faster if a ball-point pen is used.

Pliers Protect Condenser When Soldering Leads

Considerable damage to condensers can be caused by heat from a soldering iron, particularly in instances where short leads are being soldered. To minimize the amount of heat that reaches the condenser, grip the bare wire between the iron and the condenser with a pair of pliers as indicated in the illustration. In this way, most of the heat will be absorbed by the plier jaws. — David Findlay, New York City.

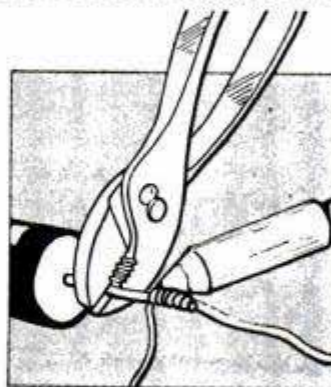

Quick-Changing Restaurant Sign Mounted on Venetian Blind

Operating a small restaurant that ordinarily lists its menu and prices on a wall sign, one owner found that the time spent each day in changing the sign from luncheon to dinner prices could be saved by posting midday prices on one side of a Venetian blind and the evening prices on the other. This made it possible to effect the change in a matter of seconds by merely pulling the cord which reverses the position of the slats. Menu entries may be lettered on strips of drawing paper with ink or colored sign paints and then fastened to the slats with large paper clips or strips of tape.

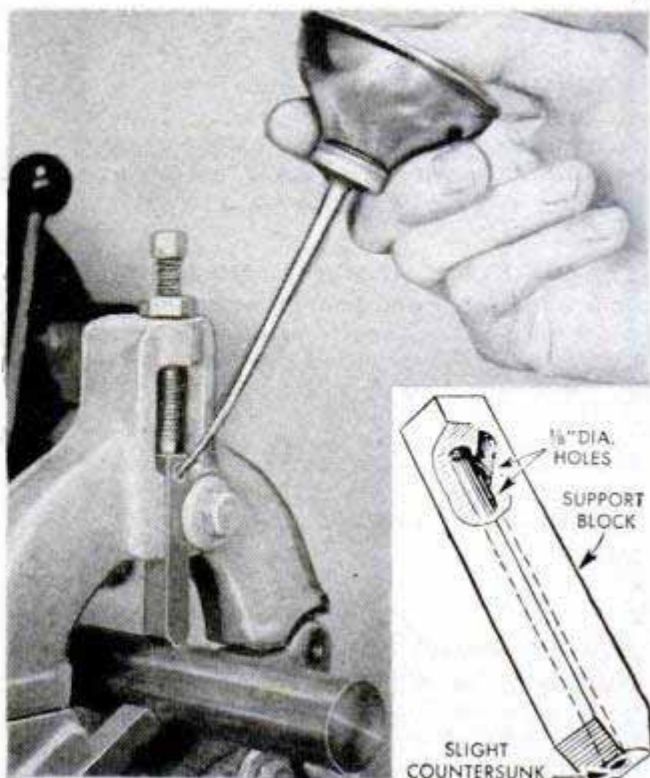

RADIO LINKS FOR RURAL PHONES

EXPERIMENTAL USE of radio instead of poles and wires for some parts of rural-telephone systems was proposed by the Rural Electrification Administration to find out whether a radio link is more economical and efficient than usual installations in remote areas.

The Technical Standards Division of REA, in conjunction with General Electric, recently developed and completed the installation of such an experimental radio-telephone link for the Fredericksburg and Wilderness Telephone Co., Inc., Chancellor, Va. It interconnects the remote community of Alsop, Va., with the central office of the company at Chancellor, a distance of about 10 miles. The signalling and terminating equipment interconnects the radio circuit with the telephone-exchange equipment.

Directional antennas are installed on a wooden pole; similar equipment is installed at Alsop. One link in the system is shown in the photos. In photo A, the transmitting and receiving equipment is being hoisted into position outside the company's unattended central dialing office at Five Mile Forks, Va. Photos B, C and D show REA engineers checking the installation and sorting out the tubes by means of which 10 subscribers on a party line can dial their neighbors via the air waves or talk to any of 350 subscribers on the automatic system.

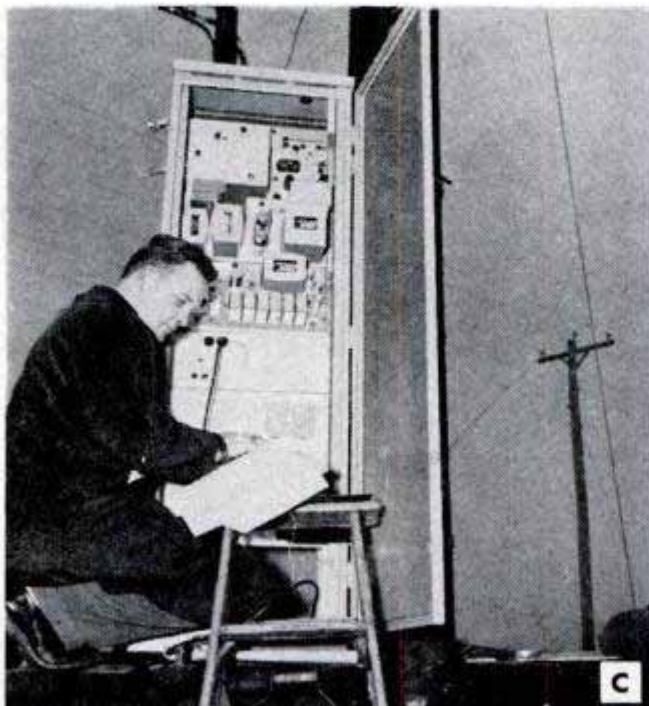
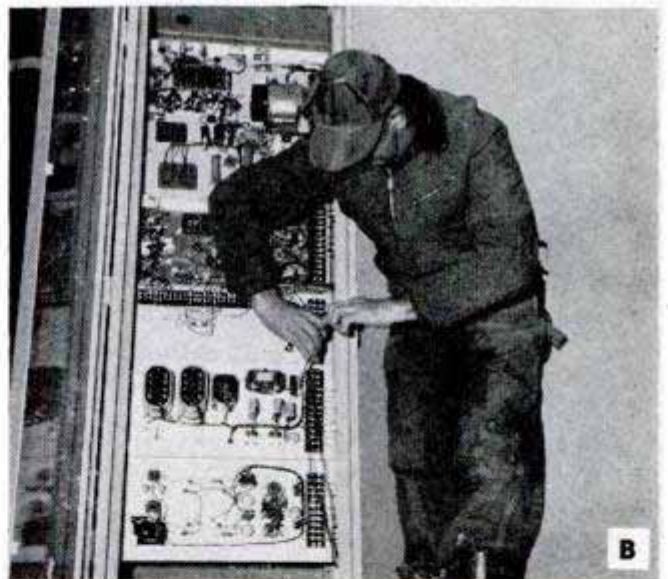
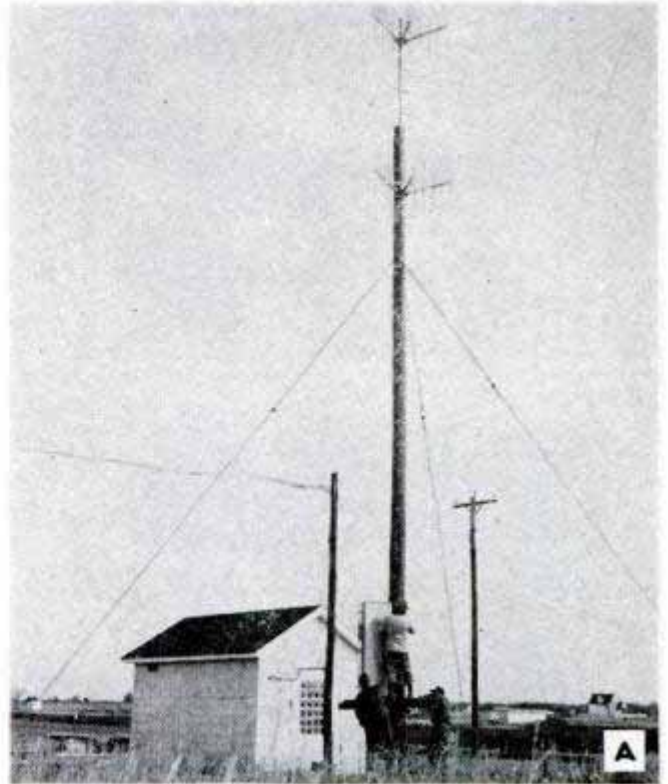

TINY SALESMAN'S PAL A.C.-D.C. SUPER USES "PRINTED

By S. A. Johnson



WHETHER you are an honest-to-goodness salesman—on the road most of the time—or a once-a-year vacation traveler, you will find this little set a real companion. It is a sensitive five-tube super broadcast receiver so compact that it takes up very little room even in a brief case, as illustrated in photo C.

The extreme compactness of the set stems from careful layout and the selection of the now readily available "printed circuit" unit, which is only $1\frac{5}{16} \times \frac{7}{8} \times \frac{1}{8}$ in. This Centralab Audet output stage is the equivalent of eight standard parts and provides both the coupling capacitors and resistors for that portion of the circuit. The PC-150 Audet unit, illustrated in Fig. 2, has seven numbered leads. Its position in the circuit diagram, Fig. 2, is indicated with heavy lines. The printed circuit is priced at 59 cents in current radio-parts catalogues. Another component part which makes this tiny set possible is a Grayburne "Ferri-Loopstick" iron-core antenna coil that eliminates the need for a bulky, conventional loop antenna. Only a 2-ft. wire is necessary. It boosts the sensitivity and signal-to-noise ratio, mounts in any position and is easily adjusted. Miniature-type tubes are employed in the conventional super-heterodyne circuit and these tubes are chosen so the filament voltages add up to 110, making it possible to eliminate a line-cord resistor. The detachable line cord and plug used is a TV-type power cord that merely plugs into the power connector shown in photo E. Photos A, B, C, D and F are various views of the completed receiver. They should be studied carefully before starting construction. The miniature i.f. iron-core transform-

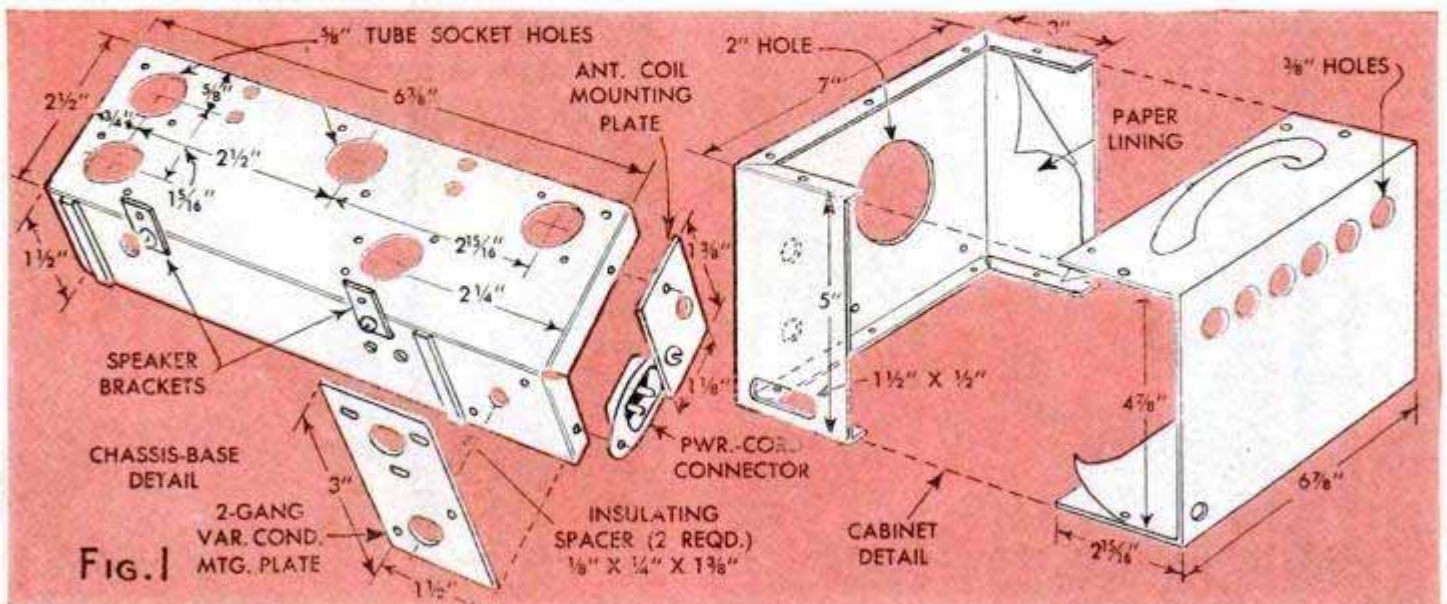
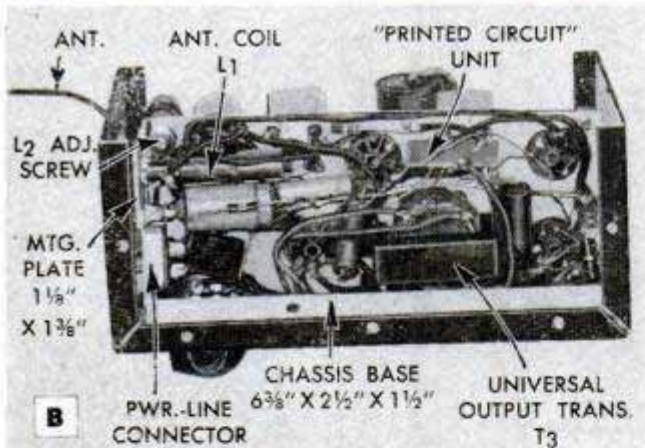

CIRCUIT" IN AUDIO STAGE

ers provide easier adjustment for alignment than was possible with trimmers and padders. These midget i.f. transformers can be either Miller type 12-C1, 455-kc. input and 12-C2, 455-kc. output units or equivalent Meissner types. The oscillator coil is a Meissner universal-type No. 14-1040. Charts for terminal connections come with all of these coils. The speaker output transformer is an ordinary universal type with six taps on the secondary. A midget-superhet two-gang variable condenser (C^{12} and C^{13}) is employed. The capacity of the r.f. section is 10.5 to 364 mmfd. and the oscillator section is 7.6 to 132.6 mmfd. These are listed in radio parts-house catalogues for about \$1.25.

The chassis base detailed in Fig. 1 fits into the small metal cabinet, which is actually a "Flexi-mount" case measuring approximately 3 x 5 x 7 in., as shown in radio catalogues. If the builder wishes to make his own, the actual dimensions are given in Fig. 1. This plain aluminum case was given a coat of black crackle paint. The handle is an ordinary chrome-plated drawer pull.

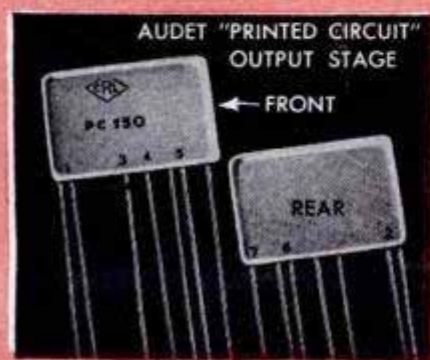
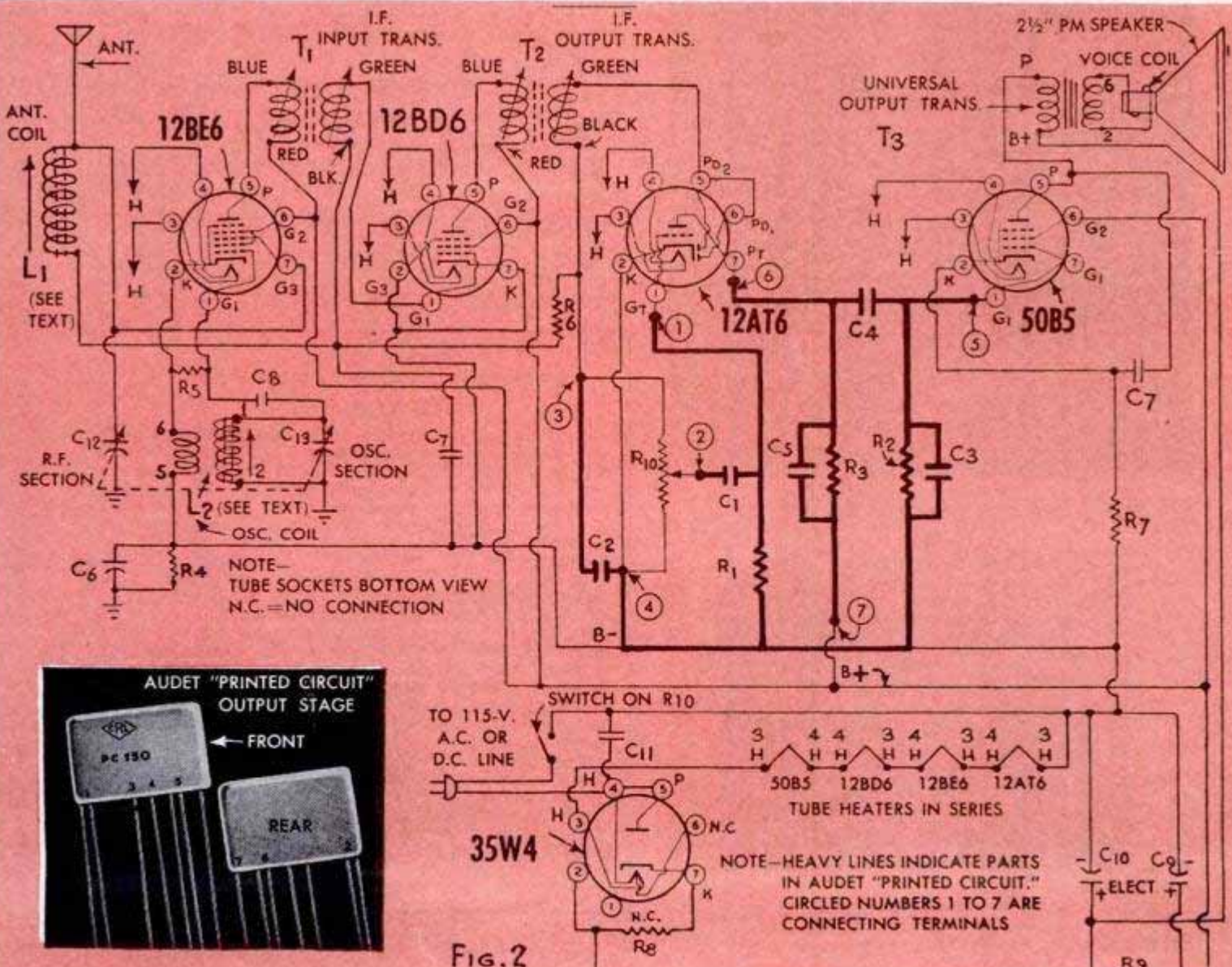
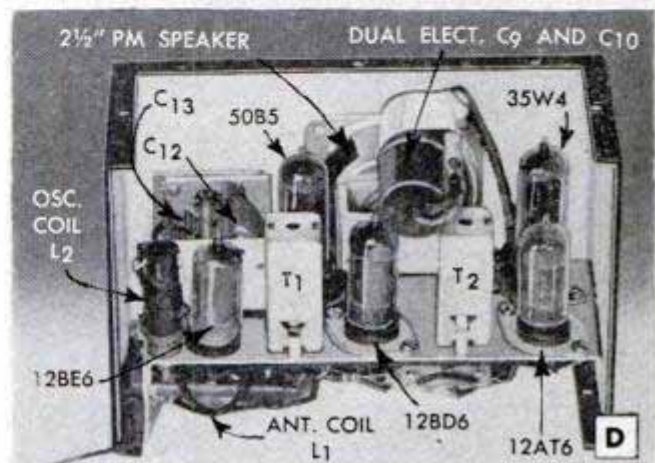

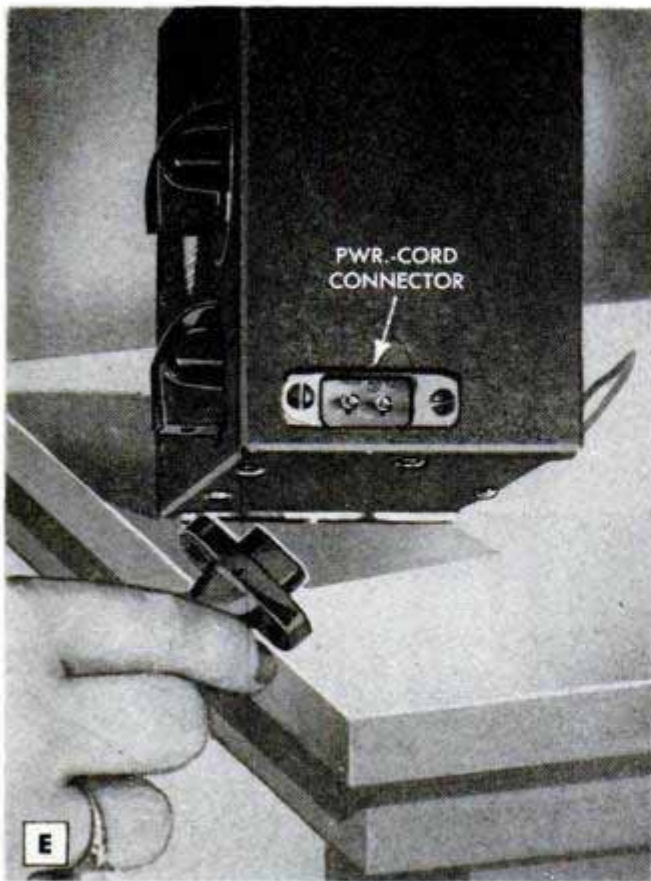

CAPACITORS

- 1—2 MFD. 400-V. TUBULAR PAPER TYPE (C6)
- 1—.02 MFD. 400-V. TUBULAR PAPER TYPE (C7)
- 1—100 MMFD. CERAMIC TYPE (C8)
- 1—30 MFD. ELECTROLYTIC 150-V (C9)
- 1—50 MFD. ELECTROLYTIC 150-V (C10)
- NOTE—C9 AND C10 (IN A DUAL UNIT)
- 1—.05 MFD. 200-V TUBULAR PAPER TYPE (C11)
- 1—2-SECTION MIDGET SUPERHET VARIABLE WITH 27-PLATE R.F. SECTION 10.5 TO 364 MMFD. (C12)
- 15-PLATE OSC. SECTION 7.6 TO 132.6 MMFD. (C13)
- NOTE—CAPACITORS (CONDENSERS) C1 TO C5 ARE IN THE AUDET TYPE PC-150 "PRINTED CIRCUIT" UNIT

RESISTORS

- 1—220,000-OHM ½-WATT CARBON (R4)
- 1—47,000-OHM ½-WATT CARBON (R5)
- 1—3.3-MEGOHM ½-WATT CARBON (R6)
- 1—150-OHM ½-WATT CARBON (R7)
- 1—27-OHM ½-WATT CARBON (R8)
- 1—1000-OHM 1-WATT CARBON (R9)
- 1—1-MEGOHM MIDGET-TYPE AUDIO-TAPER VOLUME CONTROL WITH SWITCH (MALLORY MIDGETROL) (R10)

Although not difficult to build, this construction article is not intended for beginners. Because of limited space, the actual layout must be followed closely. Please note that only the variable condensers C¹² and C¹³, and capacitor C⁶, are grounded directly to the chassis base. The electrical "ground" (B-negative) is carried on a bare No. 12 bus-bar wire across the center of the chassis and is supported by means of two single-lug terminal strips. Terminal No. 4 on the printed circuit connects to this bus bar, also all other negative-B connections indicated in the schematic circuit, Fig. 2. This bus bar keeps the line voltage off the chassis base. As a further safety precaution, the cabinet is lined with light cardboard to eliminate accidental shorts. Use flexible insulated wire for the antenna.

To align the set, rotate the variable condenser with volume on full until you pick up a station with the condenser plates "closed" as far as possible. Next, adjust the iron core in the oscillator coil so the station falls on the dial at approximately the proper point for that station. If the set does not oscillate, reverse connections 5 and 6 on oscillator coil L². Now tune in a station at the high end (condenser almost open) and "peak up" that station by adjusting the iron core in the antenna coil. Always adjust the antenna coil with the 2-ft. flexible antenna wire attached. It should not be necessary to adjust the i.f. transformers as they are preset at the factory; any further adjustment should be slight.

The trimmers on the variable condenser are not used. They should be fully "opened." Detailed student material list R-412 is available from *Popular Mechanics* Radio and Electronics department upon receipt of ordinary letter postage. ★ ★ ★

Popular Mechanics

RADIO-TV and ELECTRONICS HANDBOOK

is written for millions of radio and TV-set owners, radio beginners, students and experimenters by Frank L. Brittin, Radio-TV and Electronics Editor of *Popular Mechanics*. You need no knowledge or experience to put the information contained in the book into immediate money-saving use.

Learn how you can install TV antennas, how to adjust and tune TV receivers, and how to make radio repairs and TV-tube replacements, eliminating unnecessary service calls.

Find out how you can build your own radio sets, amplifiers and many other useful electronic devices. There are complete instructions, detailed material lists and pictorial and schematic diagrams to guide you. Find out how you can join the ever-growing ranks of amateur radio "hams."

Over 500 photographs, drawings and diagrams illustrate the 160 fact-packed pages of the new second printing. Glossaries of commonly used radio and TV terms and color codes are included. Order your copy of RADIO-TV and ELECTRONICS HANDBOOK today from your local bookstore or send your order direct to Popular Mechanics Press. Price \$2.50.



HOMEMADE TV ANTENNAS

By John B. Ledbetter, W8YBG

UNLIKE ORDINARY broadcast-band roof-antenna systems, where almost any length of wire will bring in programs, TV antennas are critical in design as they must tune to the VHF (very high frequency) band.

None of the commonly used VHF-television types are difficult to make if the set owner or experimenter has the necessary data for the length of the elements and the spacing between such elements. For a long time, radio hams have been making Yagi-type directive arrays with parasitic elements cut for their bands. It is one of the favorite TV receiving types today.

A very simple and seldom-seen type of TV receiving antenna is the loop variety shown in photo A and detailed in Figs. 1-A and 2-A. This type is quite directional and is effective in eliminating ghosts coming from the back or sides. Orientation is critical, but once it is properly adjusted for best reception, it will provide excellent pickup. A complete chart of dimensions for all VHF television channels is given for this loop. Although the loop will work best on the channel for which it is cut, it also may be used efficiently on several stations if they are located in the same general direction.

(Continued to page 232)

CHANNEL	INSIDE DIAMETER (inches)	TUBING LENGTH (inches)	CHANNEL	INSIDE DIAMETER (inches)	TUBING LENGTH (inches)
2	66	207	8	20	63
3	57 $\frac{3}{4}$	181	9	19 $\frac{1}{2}$	61
4	53	166 $\frac{1}{2}$	10	18 $\frac{3}{4}$	59
5	46	145	11	18	57
6	42 $\frac{3}{4}$	134	12	17 $\frac{3}{4}$	55
7	20 $\frac{3}{4}$	65	13	17 $\frac{1}{4}$	54

CHART FOR LOOP A
Tubing lengths for each channel

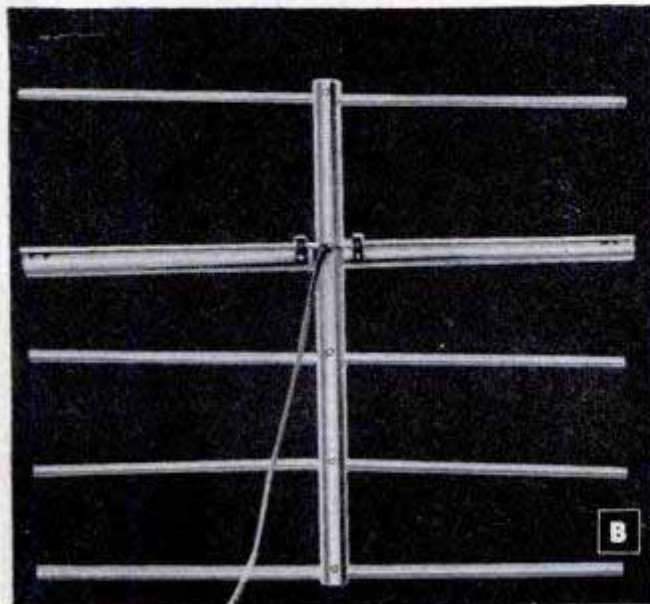

AUGUST 1952

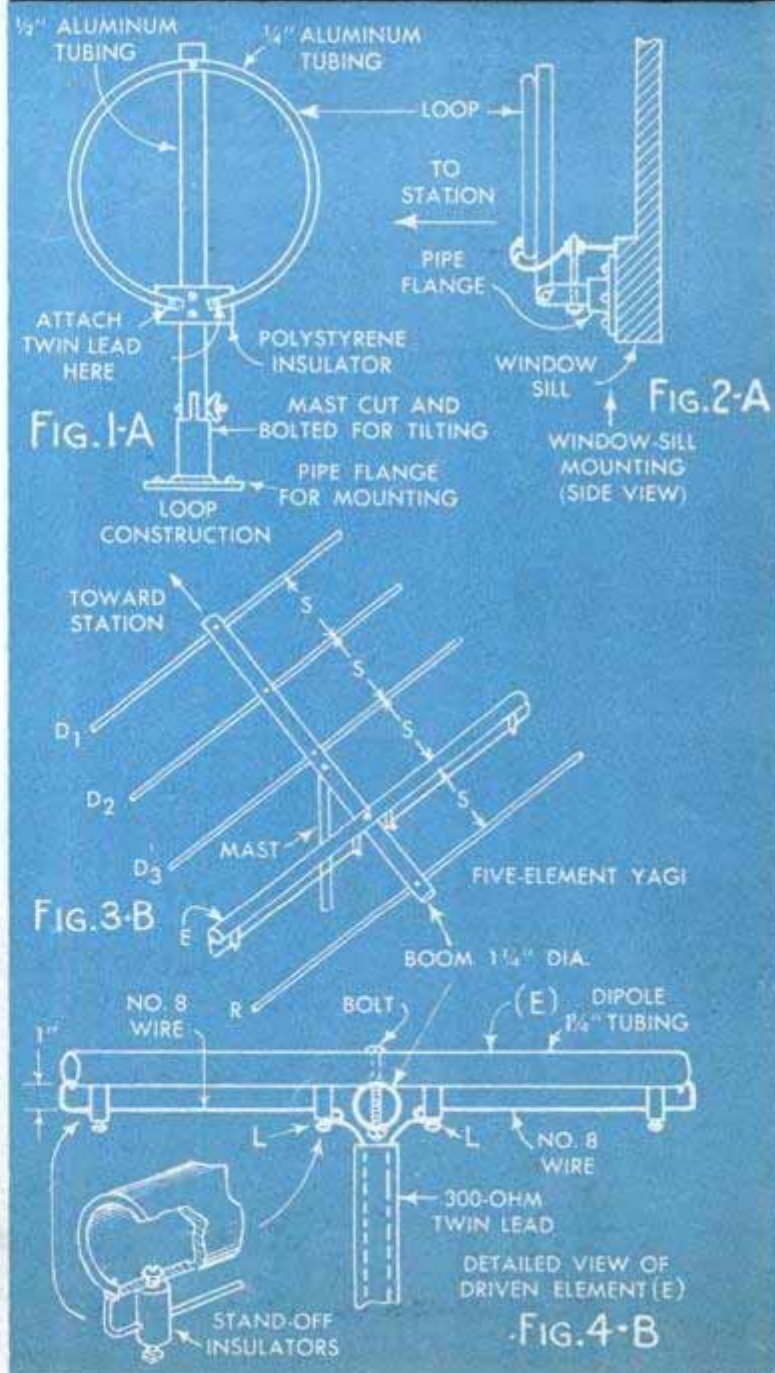
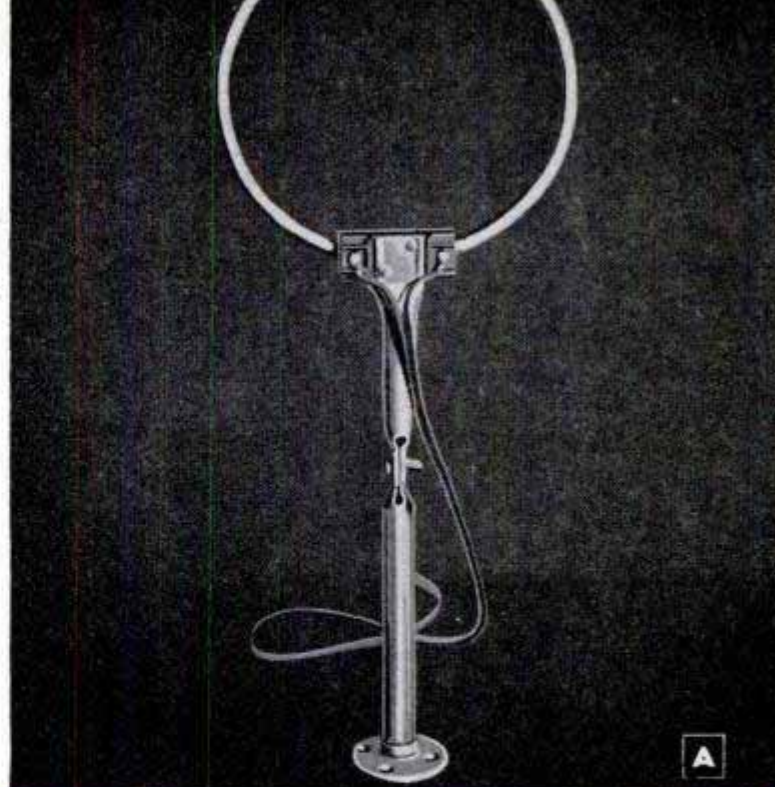

Radio, TV and Electronics Today



AMATEUR radio operator Andy Sannella W2AD, photo A, whose orchestra was originally identified with the Lucky Strike Hit Parade, is admiring the new Hammarlund Super Pro model SP-600-JX communications receiver recently demonstrated at the I.R.E. convention. This new model of the well-known Super Pro is claimed to have image rejection of 74 db or better throughout the entire 0.54 to 54 mc. range of the receiver. Sensitivity averages 1.25 microvolts on a 30-percent modulated signal with a 10:1 signal to noise-power ratio. Operation on any of six crystal-controlled fixed frequency channels within the range of the receiver is immediately available. Double conversion above 7.4 mc. is featured.

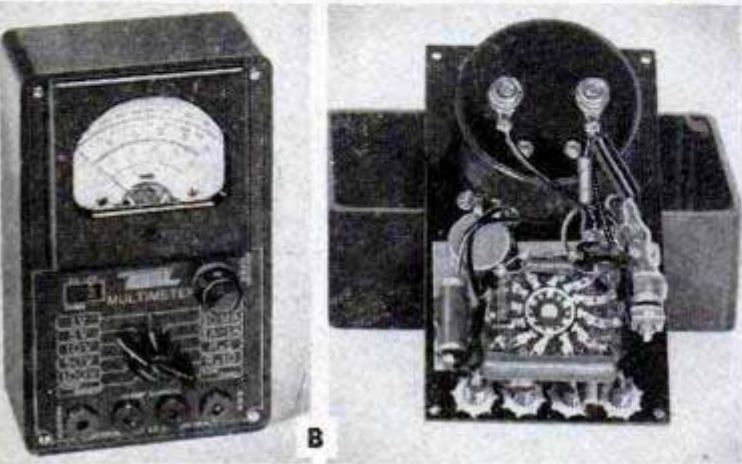

A versatile low-cost multimeter, assembled from an Eico kit, appears in photo B. This handy test meter for the experimenter, student or serviceman has 31 different 1000 ohms-per-volt ranges. It provides a.c./d.c. voltage ranges from zero to one volt, up to 0-5000 volts; current readings up to 1 amp.; resistance ranges in ohms 0-500, 0-100,000 up to 1 megohm.

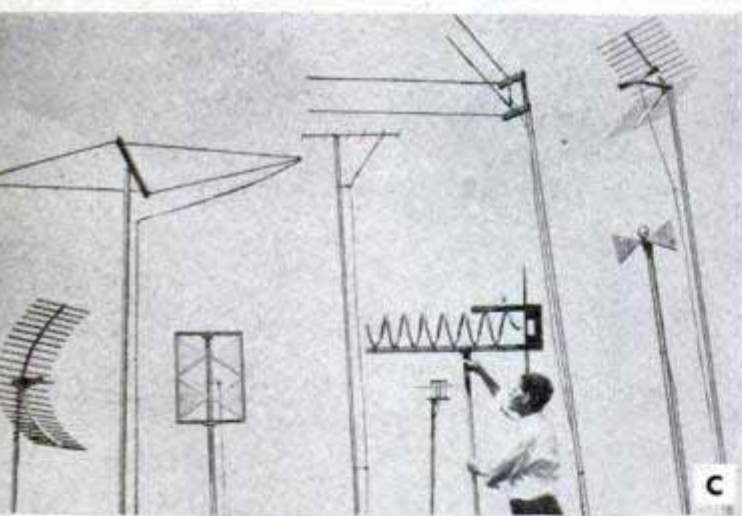

Fashions in new UHF antennas are forecast by the strange-looking designs shown in photo C. These experimental UHF-TV antennas built by RCA engineers at Stamford, Conn., bear such colorful titles as "Bow Tie," "Double Vee," "Corner Reflector" and "Yagi."

The remote-control unit of the Bell high-fidelity amplifier shown in photo D enables owners of custom-built phono-radio and television combinations to switch to and from radio (or television) or phono recordings, without stirring from their chairs.



**Protect the Increased Value
of Your Home with**

**THE BEST HOUSE PAINT
YOU CAN BUY!**

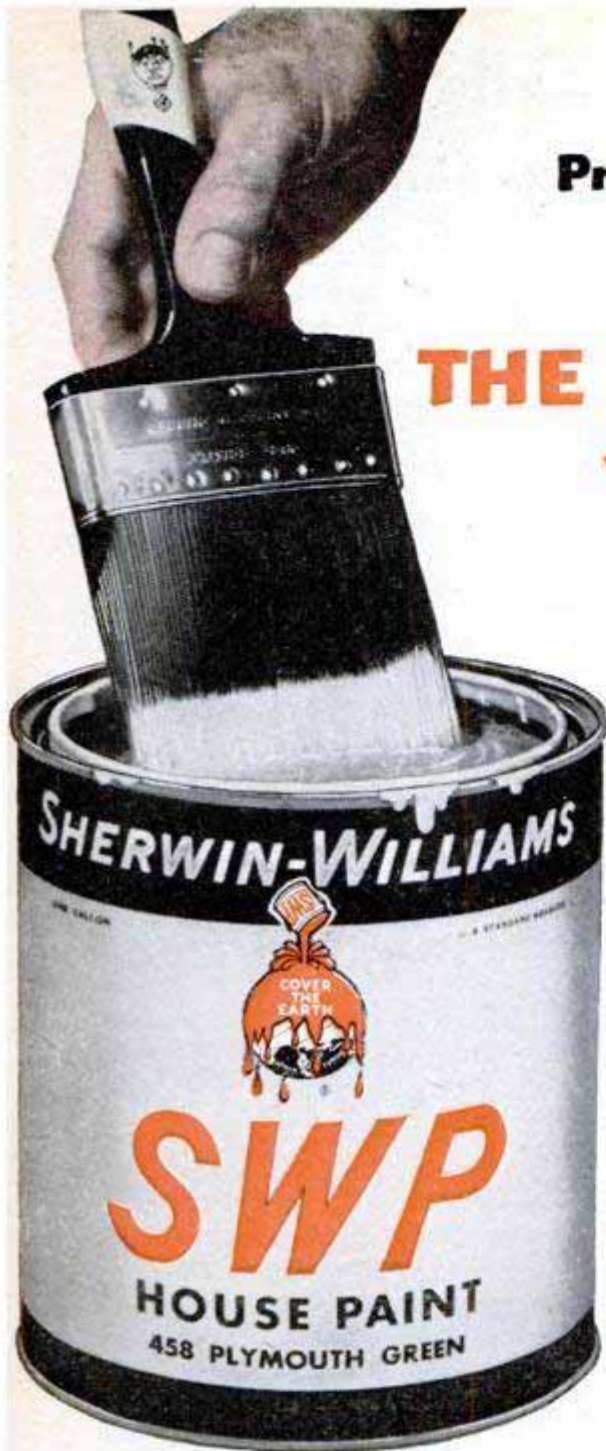

This sketch illustrates the greatly increased value of many residential properties in the last few years.

Don't gamble with ordinary house paint when the best costs so little. Protect the increased value of your home with the best house paint you can buy.

Many house paints cost less than famous SWP. But no house paint offers so much real quality at so little cost. That's because SWP House Paint is *Weatherated* . . . rated by the toughest of testing procedures to withstand the worst that weather and wear can offer. Tested toughness is built into SWP for lasting beauty and protection. And enough SWP for the average six-room house costs less than \$45.00!

Now is the time to paint your house with SWP. Look for the familiar "Cover-the-Earth" sign . . . the sign of a friendly Sherwin-Williams dealer who will recommend a reliable painting contractor, if you wish. He can help you with *interior* decoration, too. Ask for your free copy of the Home Decorator or ask to see the Paint and Color Style Guide.

IT'S WEATHERATED

SWP House Paint is tested rigorously for its ability to resist chalking, checking, cracking, fading and dirt collection.



NOW is the time to paint your house with

SHERWIN-WILLIAMS PAINT

Before-and-After shots prove it... filters are "worth their weight in gold"

It's almost like magic—what a filter over your camera lens can do. If you're looking for an easy and inexpensive way to add new life and sparkle to your pictures, Kodak Wratten Filters are the answer.

The pictures on this page show just four

examples of how a Kodak filter gives *punch* to an ordinary black-and-white snapshot. Your Kodak dealer will be glad to tell you about the more than one hundred varieties of Kodak Wratten Filters that are supplied for many photographic fields. Prices start at \$1.65.



Normal photograph—This snapshot has good composition but little else. The sky is especially flat.



Taken with Yellow (K2) Filter—The picture now has life and quality. Clouds are well defined.



Normal photograph—Again this is a nice album snapshot—everything in order, but without real life.



Taken with Yellow (G) Filter—Here you see even more sky emphasis, thanks to more powerful filter.

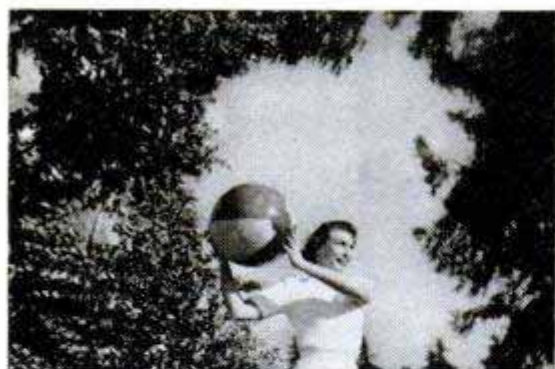

Normal photograph—Here you need a green filter to emphasize foliage and clouds and improve skin tones.

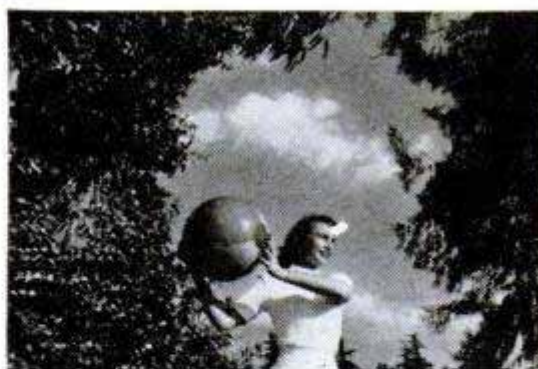

Taken with Green (X1) Filter—See the difference? It's a simple matter to do the same for your snapshots.



Normal photograph—A "bare" lens has missed the excitement of this potentially dramatic shot.



Taken with Red (A) Filter—This filter gives you the ultimate in startlingly dramatic contrast.



Normal Close-up



With Kodak Portra Lens 1+



With Kodak Portra Lens 2+



With Kodak Portra Lens 3+

For extreme close-ups—Kodak Portra Lenses 1+, 2+, and 3+ give pronounced close-ups of subjects with both still and movie cameras. Place one in front of your camera lens to step up its power for short-range photography of people, nature studies, and

table-top subjects. Kodak Portra Lenses are graduated in power, as their numbers indicate. To secure even stronger effects, the lenses may be used in combination. The pictures above show you how you can "move in" with a Kodak Portra Lens. From \$2.59.

Other inexpensive lens attachments do amazing tricks too

Why stop at filters? Why not go on and discover all the new thrills awaiting you and your camera when you use other inexpensive lens attachments? Some of them are shown on this page. Others, like a Kodak Telek Lens, Diffusion Disk, or Close-up Attachment, you can see at your Kodak dealer's.

Once you get in the habit of using lens attachments, you'll never be satisfied with just a plain snapshot. That's because you'll know that so much more is possible—simply by slipping an inexpensive attachment over the lens of your camera. Try it once and you'll buy the idea right from the start.



"Warm up" your color shots with a Kodak Skylight Filter—With this filter you get warmer-tone pictures of subjects photographed in open shade and on overcast days. Use it, too, to reduce the bluish cast that often appears in distant mountain and marine scenes. And if you ever have occasion to take pictures of sunlit snow scenes, you'll find the Skylight Filter highly valuable. Prices start at \$1.65.



Reproduction from normal color transparency



Reproduction from color transparency using Pola-Screen

Darken the sky in your color pictures—A Kodak Pola-Screen does the trick—in color or black-and-white. Also, it serves to subdue reflections from glass, wood, water, and other non-metallic surfaces. The effect your Pola-Screen will have on the picture may be predetermined by looking through the Kodak Pola-Screen Viewer—a miniature screen which fits over the indicator handle of your Pola-Screen. Varying degrees of sky-darkening can be obtained by rotating the screen. Price of Viewer, \$6.75; Pola-Screens, from \$6.75.



Your Kodak dealer is trained and experienced—ready to give you valuable help in your hobby of photography. He'll be happy to see you and give you advice at any time.

Prices are subject to change without notice

EASTMAN KODAK COMPANY, ROCHESTER 4, N. Y.

Kodak



Care and Feeding of Engines

BY S. P. CORP

GENERATOR MAINTENANCE

Your generator is a busy power plant. It must keep the battery in full charge, supply ignition, and operate lights and electrical equipment. Regular lubrication, inspection, and cleaning are necessary for dependable generator performance.

LUBRICATION should consist of 3 to 5 drops of medium engine oil each time the car is lubricated. Avoid over-oiling, which is worse than lack of oil.

INSPECTION is needed every 5000 miles. Clean generator and inspect generator fan and ventilating holes. Holes should be open and free from dirt.

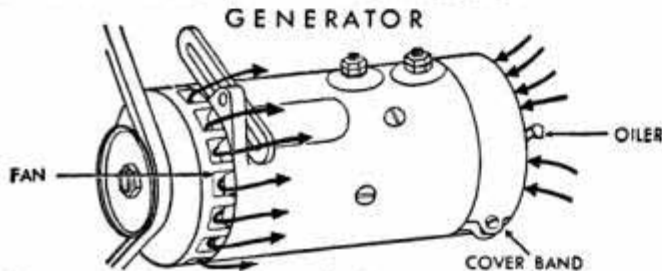

Air must circulate through the generator, taken in at the rear and expelled at the front. Remove cover band and check brushes and commutator; if oil-soaked and worn, replace them. Check inside of cover band for spots of solder, which would indicate generator has been running hot. If you find such spots, have complete charging circuit checked for high charging rate. If twice-a-month specific gravity readings of battery show between 1.260 and 1.280, generator is behaving perfectly.

REAR WHEEL SQUEAK

If you hear a single sharp squeak as you start your car in reverse, one of the rear wheel hubs is loose. On most cars, hubs are fastened to a keyed, tapered rear axle shaft. The outer axle nut holds hub tight. A loose nut will allow hub to work on taper, wear the key and keyways, causing the squeak.

Remove hub cap, cotter pin and nut. Tighten nut to next cotter pin hole and install a new cotter pin. Failure to do this will allow hub to work on taper, key, and keyways, resulting in an impact loading which causes undue stress on all parts in the drive unit, eventually resulting in breakage.

INSTALL KROMEX RING SETS

To get maximum ring mileage under the high engine speeds, high combustion temperatures, and high compressions of late-model cars and trucks, be sure to use Sealed Power Kromex Ring Sets. They have chrome where it counts, to fight heat, friction, corrosion, abrasion. Write for your free copy of new illustrated booklet, "MORE POWER." Dept. G-8, Sealed Power Corp., Muskegon, Mich.



Ride 'em, Lumberjack!

(Continued from page 86)

three classes—three, five and seven-horsepower. Contestants must start with a dead motor, get it purring, then rush over to a log and begin slicing away.

Motors are finely tuned before the contests and usually start instantly. But sometimes a motor sputters, then goes dead.

Then there's the matter of running into big knots in a log. Two are bad. Three are good—that gets you another chance.

With the three-horsepower saw, Roby had knotty problems and didn't place. But in the five and seven-horsepower events he was in top form and took first in both. These events clinched for him the title of All-Around-Champion Lumberjack.

Two other champions of particular note were Mrs. Gladys Johnson and Mrs. Mary Gentry, housewives and sisters who placed first in the women's gang-sawing with a crosscut. For three years now they have bested all the younger women in the area.

"We don't practice," said Mrs. Johnson. "Housework keeps you in shape for sawing. Only thing to remember is not to ride the saw—let it glide. And work together. When my sister and I were kids we were often at odds. But as you grow older you learn the importance of teamwork."

Perhaps the biggest event of the whole show was not held on the rodeo grounds. This was the annual log auction.

For weeks, lumbermen of the area keep their eyes peeled for choice logs and put them on a truck to compete for the prize load. The logs are scrubbed carefully—just like fat cattle in a livestock show. Then the huge trucks with their mammoth loads are jockeyed expertly down Main Street through the crowds and to the judges.

Many of the loads are donated or partly donated by lumber companies and auctioned off to provide prize money for the rodeo contestants. The auctioneering is done by probate judge Ben H. Bear, who raps his cane on a load of logs with the same commanding force that he uses in gaveling attention in the courtroom.

"Look at those long-stemmed American beauties fresh from the forest," he cries. "Got a bid of \$105 per thousand. Who'll make it \$110?"

The 1951 prize load, wheeled into town by the White Pine Lumber Company, was beautifully grained yellow pine—8320 feet of it. The load drew the high bid of \$117.75 per thousand feet but the real tribute came from 72-year-old S. R. Wheeler, a retired lumberjack standing in the crowd. He said, with a sigh, "How I'd like to get a saw into that pine!"

★ ★ ★

Otto Graham SAYS...

"Buy

Prest-o-lite

hi-level

Battery...

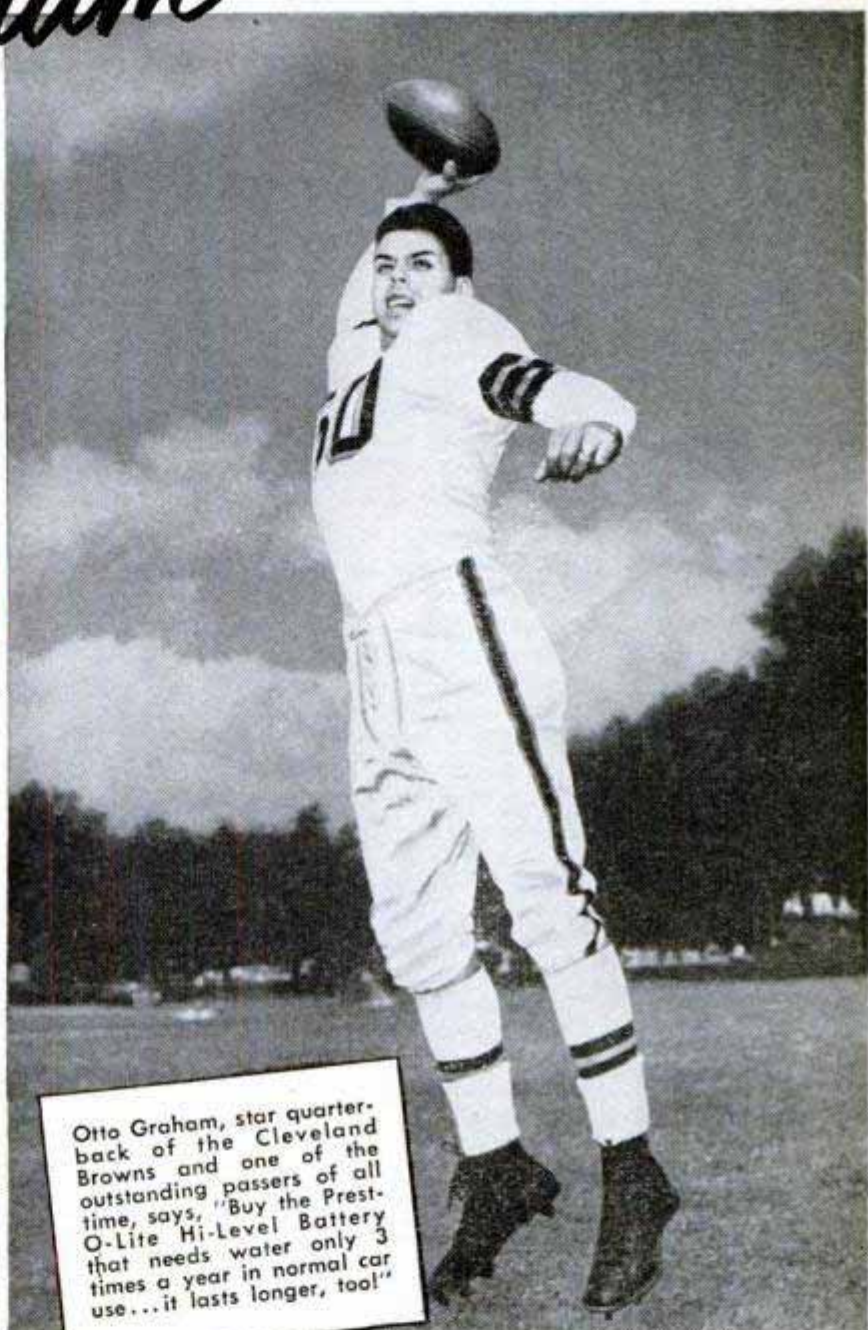

Otto Graham, star quarterback of the Cleveland Browns and one of the outstanding passers of all time, says, "Buy the Prest-O-Lite Hi-Level Battery that needs water only 3 times a year in normal car use... it lasts longer, too!"

needs water only 3 times a year

IN NORMAL CAR USE

...lasts longer, too!"



*See your
Prest-O-lite Dealer
for
Free Pro-Football
Schedules*

PREST-O-LITE BATTERY COMPANY, INC.

TOLEDO 1, OHIO

Here's how for home painters



How to burn off housepaint without burning the wood. A blowtorch gets rid of blisters quickly—but often burns wood too. A simple trick to prevent this: attach a screen wire to nozzle of blowtorch. This will spread flame evenly, prevent

deep burning of wood at any one place. Here's another helpful hint: with new Devoe Wonder-1-Coat House Paint—you get 2-coat beauty and protection in just one coat! (Only bare patches of wood need a prime coat.)



Quick way for cleaning paint off windows. Just take an ordinary pencil eraser, work it down to a chisel edge on fine sandpaper—and presto you have a paint wiper. Devoe Trim & Shutter paints are tops for sash, by the way. Easy to apply

—quick, hard-drying. Re-coating seldom necessary in less than 5 or 6 years.



Revive that old fiber rug. Give it a new look—by painting it. Put newspapers underneath, choose your favorite color and paint it right on the floor. Simple—and economical! Use Devoe Mirrolac Enamel. Great beauty and wear-resistance are

features of this unique paint. Available in many colors.



You don't need an eagle eye when painting stripes. Attach two strips of flat masking tape to the surface you want to paint—leaving a blank area in-between. Paint this area . . . let dry . . . then zip off masking tape for a neat straight stripe!

Consult the Devoe Library of Colors for color choice—over 200 shades!

You can get all the painting accessories that you need—and many more helpful tips—at the sign of the Devoe Diamond. Why not stop in and see your Devoe Dealer? He's listed in the Classified Phone Book.

**DEVOE
PAINT**

Clinic for Homemakers

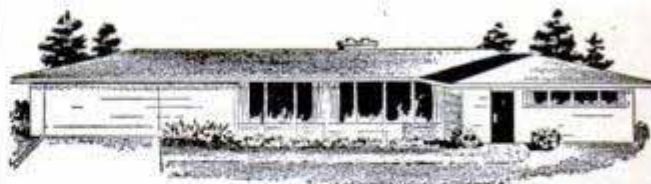

As a service to our readers in solving the hundreds of problems pertaining to a home—inside or out—the editors of *Popular Mechanics* invite you to present your problems to The Clinic Editor for help and advice. Address your questions to The Clinic Editor, *Popular Mechanics Magazine*, 200 East Ontario Street, Chicago 11, Ill.



Removing Paint

Q—I'm having trouble removing paint from walls and ceilings of two rooms in preparation for redecorating. The paint was blistered in spots and this came off easily. But on all other areas it adheres firmly and paint remover works so very slowly that the job apparently is going to take weeks of time. Isn't there some faster method I can use?

—M. M., Md.

A—Evidently the walls and ceilings are coated with several heavy applications of oil-base paint. The undercoats probably are many years old and have become thoroughly oxidized. The question that comes immediately to mind is, why bother to remove the paint from those areas where it adheres firmly to the wall? It would seem much simpler to brush or scrape off all the loose material and sand the depressions out to a featheredge. This would produce a surface suitable for papering, or, if you wish to redecorate with paint, use a texture paint in whatever color desired. The texture paints will conceal minor wall and ceiling defects quite effectively. When applying this material be sure to follow the instructions in all details.

Bandsaw-Blade Runout

Q—I have a small bandsaw (10-in. wheels) in my home workshop and I have trouble with the blade twisting when making a cut. I bought the machine new and it has had very little use. In order to saw at all in any thickness of stock, the piece must be turned at an angle with the table. The blade cuts slowly, heats and seems to burn the edges of the stock. What is wrong and how can I cure the trouble?—R. N., N. H.

A—The trouble you describe is known to the trade as blade runout and is commonly caused by the set teeth on one side of the blade becoming dulled. This can happen in a number of ways, such as striking a nail or other hard obstruction embedded in the stock. Also the blade can be dulled in this manner by careless handling when colling and uncolling or when storing in drawers with other tools. Blades for larger machines are simply reset and filed to correct the defect, but due to the inexpensiveness of blades for smaller machines this is hardly worth-while, as the cost of renewing the blade would be as much, or possibly more, than the cost of a new blade. We suggest that you replace the damaged blade with a new one of the same length and width.

(Continued to page 220)

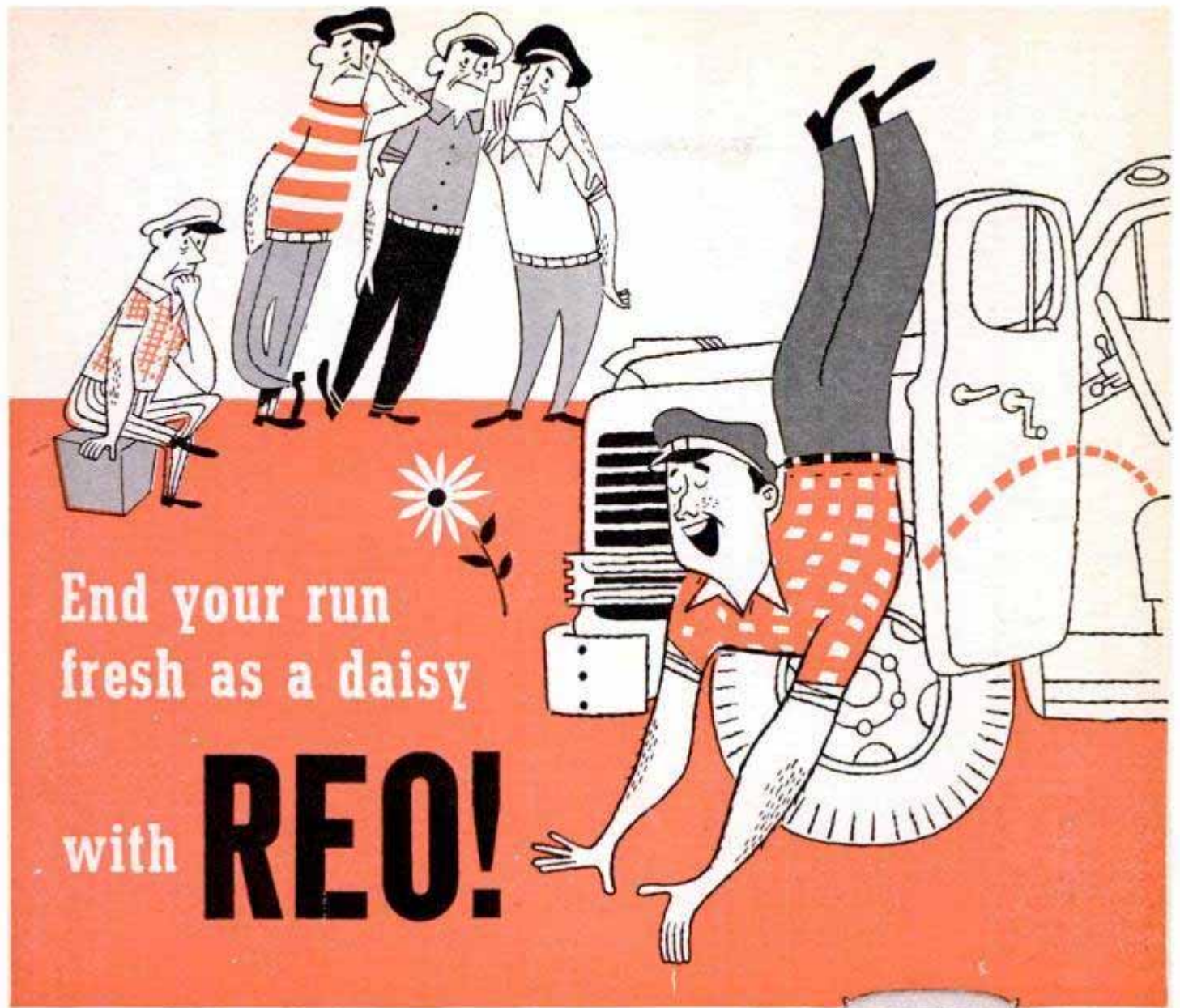

End your run
fresh as a daisy

with **REO!**

It's a fact... *Gold Comet* power sends you zooming up tough grades with far less shifting than ordinary trucks. Sturdy roadability, turn on a dime radius and that smooth riding quality means you can really enjoy after-work hours when you drive... REO!

The boss'll enjoy new dependability, new operating profits with REO *Gold Comet* power, too. Easy maintenance, low gas and oil consumption and bigger payloads through Reo "More-Load-Design" add up to...



REO
...best truck buy
for '52

REO MOTORS, INC., LANSING 20, MICHIGAN

Western Pine built-ins keep a child's room tidy!



looking for remodeling ideas?

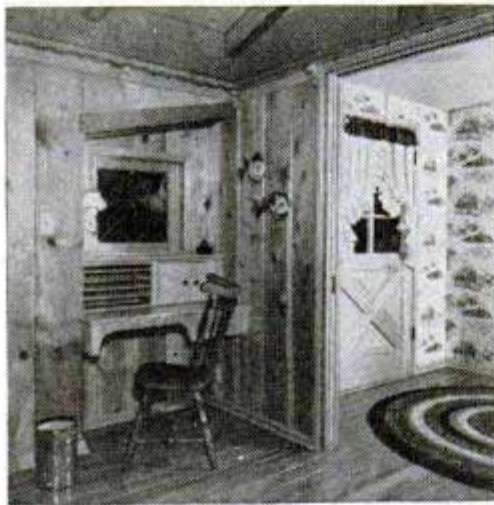
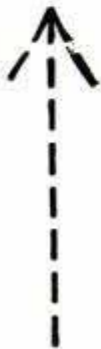

A useful entrance-hall nook you can build

WHETHER you're planning to "do-over" an attic . . . panel a wall . . . build handy cabinets that add charm and sparkle to a kitchen . . . here's real help for you!

Big NEW—and FREE—24-page book, "Enchanting Homes of Western Pines," contains hundreds of suggestions for building and remodeling with the woods of the Western Pines*. Here are 68 pictures, some in full color, with details of exteriors and interiors to inspire you and assist you.

Home craftsmen have found that smooth textures and straight, even grain make the woods of the Western Pines* a joy to use in any workshop project. They're light to handle, cut and work easily, and take paint, stain or wax beautifully. And they add *lifetime loveliness* wherever they are used!

Before you start work on those bookshelves, built-ins, hallways, bunk bedrooms, breakfast nooks, or basement dens, send for your FREE copy of "Enchanting Homes of Western Pines." Write to WESTERN PINE ASSOCIATION, Dept. 536-N, Yeon Bldg., Portland 4, Oregon.

These are the Western Pines

- *IDAHO WHITE PINE
- *PONDEROSA PINE
- *SUGAR PINE

(Continued from page 218)

Renailing Warped Flooring

Q—The hardwood floors in my new home are $\frac{3}{8}$ in. thick and have warped, or cupped, so much that they are unsightly. At the same time the individual boards seem to have shrunk across the width, leaving joints open as much as $\frac{1}{8}$ in. I have sanded and refinished the floors once but still the boards seem to be warping in the same manner as before. What can be done to prevent this?—A. S., Idaho.



A—You do not say whether the flooring has been laid over a concrete slab or over a conventional wooden subfloor. We would be inclined to suspect that the presence of moisture under the floor is the cause of the trouble, but the method of eliminating the defect depends on the floor construction. As we view the problem from the information at hand, it appears to have no simple solution. Although, it might be possible to effect a cure by taking up the flooring and renailing it, we hesitate to recommend this procedure as it is a slow and rather difficult process and is certain to result in some damage to the individual floor boards. Some homeowners with this problem have drilled and counterbored the floor boards for screws. After the screws are driven, the counterbored holes are filled with hardwood plugs of a contrasting color. It will be necessary to locate the screw holes in an irregular pattern over the whole of the floor area. A regular pattern of contrasting plugs is seldom attractive. As an example, where two boards are butt-joined drill four screw holes, two in the end of each board. Then if there is another butt joint in the same course, drill only two screw holes, one in the end of each board. When the floor is sanded and finished the effect is similar to that of a ranch-plank floor, although, of course, the floor boards are not of random widths as is the case with ranch-plank flooring.

Soundproofing Basement Ceiling

Q—I'm planning a recreation room in my basement and would like to soundproof the ceiling over the recreation-room area. I'm told that the soundproofing material must be placed between the floor joists and that the ceiling should be lathed and plastered. This would be expensive. Is there any simpler, less expensive way to do this?—B. U., Ind.



A—There are several types of ceiling tiles now available which are said to possess soundproofing qualities suitable for such an installation as you are contemplating. These tiles are quite simple to install, as they are attached to furring strips nailed to the floor joist. Special fasteners, developed for the purpose, hold the individual tiles in place. If the ceiling joists are uniformly spaced on 16-in. centers, the tile can be attached directly to the joists without the necessity of installing furring strips. However, this spacing must be carefully checked beforehand and when installing the tile care must be taken to assure that they do not "gain" on the width between the joists as otherwise you may end up with several open joints. If there is any variation in the distance between the joists it is advisable to install furring strips. In handling the tile be especially careful not to break or otherwise damage the edges and corners. When installing the tile it is important to follow the manufacturer's instructions in all details.

AMAZING!

Now you can raise 8 TONS with a twist of your wrist!

PERMA-JACK'S NEW action corrects sagging beams quickly!



● The Timken Thrust roller-bearing does it—makes it easy for you to stop squeaking floors, cracking plaster, sagging beams. Five exclusive features—no other floor leveling device has 'em. Rated at 8 tons for your safety—yet independent testers loaded Perma-Jack over 12 tons, before the first minor sign of stress appeared. Clip coupon for the free booklet that gives you Perma-Jack's secret of easy, safe beam-bolstering.

5-COUNT 'EM-5 EXCLUSIVE FEATURES

- 1 Easy-action Timken Thrust Roller Bearing
- 2 Easy-Turning Acme Square Screw Threads
- 3 Extra-Heavy Top and Base Plates
- 4 Two Extra-Heavy Support Pins
- 5 Anti-Rust Baked Enamel Finish Inside and Out

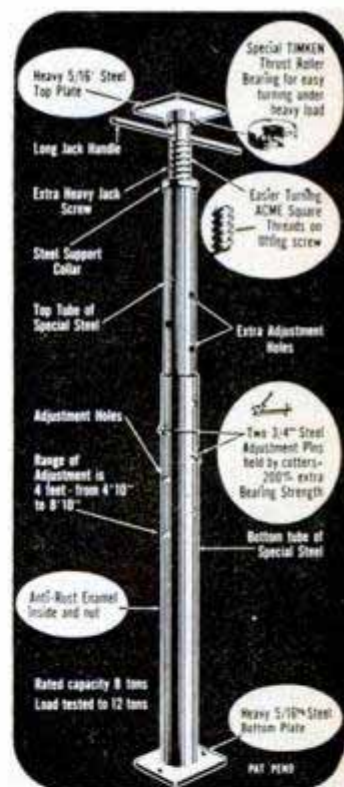

Over a million Perma-Jacks have been used in homes, garages, farm and commercial buildings, for quick, economical, permanent repair. Two sizes (Perma-Jack 4'10" to 8'10"—Perma-Jack Special 21" to 36") fit every need.

SEND COUPON for the illustrated folder that shows you how Perma-Jack can help you save substantial repair costs on your property.

PERMA-JACK CORPORATION 1111 E. 200th ST. CLEVELAND 17, O.



PERMA-JACK CORPORATION

1111 EAST 200th STREET
CLEVELAND 17, OHIO

FREE Sure, send the booklet that explains Perma-Jack's action, shows me how to save money on repairs, to:

NAME _____

ADDRESS _____

CITY _____ ZONE _____ STATE _____

PERMA-JACK CORPORATION 1111 E. 200th ST. CLEVELAND 17, O.



**DON'T LET
A FIRE
HAZARD
HITCH
A RIDE
IN YOUR
CAR!**

You have a fire-bug for a passenger when you drive a car with defective wiring. Neglected wires do cause automobile

fires. Millions of dollars worth of cars, trucks and buses go up in smoke every year. National Safety Council figures tell the same story all over the country—with "caused by defective wiring" fires running as high as 92%.

Don't play with fire. See that *your* wires and cable are checked *today*. Not only to prevent fire, but to prevent hard starting, poor engine performance, battery failure. When wiring is bad, install new genuine Wiry Joe Wires and Cables.

Write now for this valuable free booklet!

THE CRESCENT COMPANY, Inc.
Pawtucket, Rhode Island



Please send me my free copy of "The Effect of Defective Wiring on Car Performance."

NAME _____

ADDRESS _____

CITY _____ ZONE _____ STATE _____

Lightning Trappers

(Continued from page 75)

was hit repeatedly by a three-million-volt charge in the tests. The best protection against its fury proved to be short lengths of aluminum on the mast and the stern light, grounded over the side of the boat with copper wire.

Westinghouse's newest lightning laboratory is located at Sunnyvale, Calif., where custom-made 12-foot arcs blast industrial equipment to test its capacity to withstand the heaviest strokes of natural lightning.

Huge 2.4-million-volt surges of crackling electricity are produced by a 25-foot-high impulse generator. Four heavy, brightly colored plastic columns support 24 banks of capacitors—storehouses of electricity. Gleaming chrome spark gaps, heavy resistors and other equipment mounted on five smaller inner columns make the whole thing look like a modernistic Christmas tree.

Lightning bolts are fired from this machine into miniature haystacks and barns, setting them afire. They literally disintegrate wooden planks. They blast the bell towers off model country schoolhouses that lack lightning protection.

But when "di-ion gaps" are provided for power-line transformers carrying electricity into the schoolhouse, the multimillion-volt charge is dissipated harmlessly. The lights in the schoolhouse don't even flicker.

But lightning can be dangerous if care is not taken. Some 400 deaths are reported in the United States each year from this cause. Of course, this doesn't begin to compare with 33,000 household and 40,000 traffic deaths annually, but this figure could be reduced materially if people would realize the power of lightning.

If you don't want to be that one American in 365,000 who is killed by lightning each year, heed these safety precautions:

When a storm threatens, keep off golf courses. Don't ride bicycles or horses in

(Continued to page 224)

You Name It!

Here are the correct answers to the "You Name It!" photo quiz on pages 78 and 79:

1. Tendrils of a carnation
2. Ripe strawberry
3. Spaghetti
4. Whole-wheat bread
5. Table-tennis paddle
6. End of grapefruit
7. Interior of red pepper
8. Section of anthurium leaf
9. Ends of books



A "CLOUDBURST" in this 100-foot water tunnel proves the effectiveness of advanced methods of sealing against moisture, dust and drafts. Bodies move past high-pressure water jets that douse them from every angle. This is typical of the thoroughness with which all Chrysler Corporation cars are built.

A CAR'S BODY TELLS A LOT ABOUT A CAR'S REAL WORTH TO YOU

Chrysler Corporation engineers, stylists, and production men work together, so that body and chassis form a perfectly balanced unit — created from the start for your safety, comfort and *driving and handling ease*.

The way a door latches and holds . . . the amount of head and leg room you get . . . the comfort of the seats . . . breadth of vision

. . . ease of getting in and out — all these are easily read guides to the worth of any car.

In a Plymouth, Dodge, De Soto or Chrysler, you get a superior body — and a superior chassis — engineered to give you the greatest worth for your money. You can prove this for yourself just by calling your nearby dealer and driving one of these great cars.

CHRYSLER CORPORATION engineers and builds PLYMOUTH, DODGE, DE SOTO, CHRYSLER CARS & DODGE TRUCKS

Chrysler Marine & Industrial Engines • Oilite Powdered Metal Products • Mopar Parts & Accessories
Airtemp Heating, Air Conditioning, Refrigeration • Cycleweld Cement Products



CHRYSLER CORPORATION ENGINEERS follow through each step in body construction. Here an engineer studies the double welding of a Dodge body, one of the many things that mean safer and quieter cars for you.



THE NEW C-200. Advanced body designs are created to learn practical applications of new concepts of style, comfort, fabrics and fittings, performance and safety. The Chrysler C-200 is the prototype of a dramatic new convertible.



—yours with these Wizards with Wood

Making something that needs finishing? Mending something that needs gluing? If it's made of wood ask for Firzite, Satinlac and Weldwood Glue. At hardware, paint and lumber dealers—or mail coupon for leaflets.

The Wood Glue you can rely on!



To make things or fix things, use Weldwood Glue for all wood-to-wood bonds. Makes joints stronger than the wood itself. Mixes easily with water. Stain-free, rot-proof...highly water-resistant!

WELDWOOD®
PLASTIC RESIN GLUE

Gets that blond or pickled effect—



Produce those magical "woody" effects—on hard wood or soft, plywood or solid lumber with White Firzite. For light pastel tones, tint with Colors-in-Oil. (On fir plywood stain jobs, tame that wild grain with Clear Firzite.)

WHITE FIRZITE*

Gets that Natural-Wood Finish



—without shellac or varnish. On furniture, panelling or woodwork, there's nothing like Satinlac. Brings out natural grain and color beauty of any plywood or solid wood. Avoids that "built-up look; will not turn yellow or darken with age. "Water-clear," easy to brush or spray, dries ready for next coat in 2 or 3 hours.

SATINLAC*

Pints, Quarts,
Gallons *Trade Marks

United States Plywood Corporation,
Dept. 93, 55 West 44th St., New York 36, N.Y.
Send me free leaflets on Weldwood Glue, Firzite
and Satinlac.

NAME _____

ADDRESS _____

exposed locations. Avoid shelter under isolated trees. Avoid exposed locations on hilltops. Stay out of water, either indoors or outdoors. Get indoors. Take shelter in a large building or house but stay away from chimneys or fireplaces. If a storm develops while you are motoring, stay in your car. Steel-topped automobiles, busses and trains are the safest places you can be. If you must get out, avoid having one foot touching the ground while the other touches the car. You'll make a good conductor from the metal car to the earth.

Stay away from electrical fixtures, lights, telephones, radios, television sets and other electrical conductors. But there's no point in rushing around turning off lights, radios and appliances. It won't protect them if lightning comes. An electrical discharge that's jumped thousands of feet in the air won't stop at a switch that has a gap only a fraction of an inch wide.

One popular error, given false authenticity by some science books and teachers, is that lightning rods prevent lightning by warding away the negative bolt with positive charges from the earth. What the lightning rod does is convey the charge to the ground quickly, keeping it from the structural parts of the building.

Karl B. McEachron, former head of General Electric's high-voltage laboratory gives this reassuring advice: "If you heard the thunder, the lightning did not strike you; if you saw the lightning, it missed you; and if it had struck you, you would not have known it." ★ ★ ★

Shall We Move to Another Planet?

(Continued from page 69)

through space to a comparable satellite station just off the moon, in some kind of space ship with contours determined by factors other than streamlining, which is of no value in frictionless space. The last stage of the trip would be the descent to the moon in a vehicle that uses rockets for maneuvering in order to land.

The idea of satellite stations was first proposed by German scientists who showed that if an object were placed in an orbit around the earth at a speed based upon altitude, the object would continue to circle the earth without power. Its centrifugal pull would exactly balance the gravitational pull of the earth.

An orbital station at 350 miles' altitude would have to move at 16,200 miles per hour to maintain its position; at 4000 miles' altitude the artificial moon would require an initial speed of 13,320 miles per hour.

(Continued to page 226)

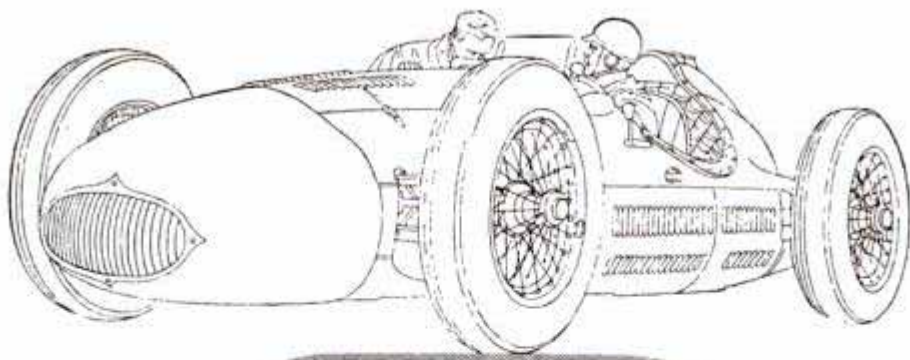

CHAMPION

SPARK PLUGS

SCORE 22ND VICTORY

IN INDIANAPOLIS

"500"!



Troy Ruttman driving the Champion-equipped Agajanian Special won the 1952 Indianapolis 500 Mile Race with a record breaking average of 128.922 miles per hour. Nine of the first ten cars to finish this fastest "500" were Champion-equipped.

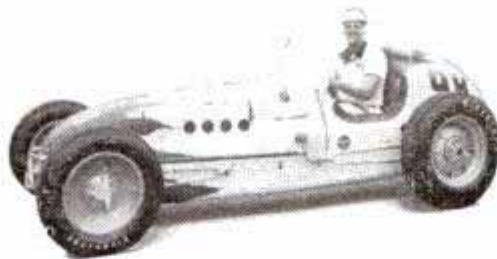
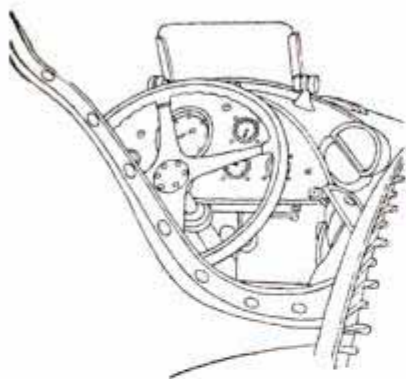

FOLLOW THE EXPERTS
Use the spark plugs champions use!

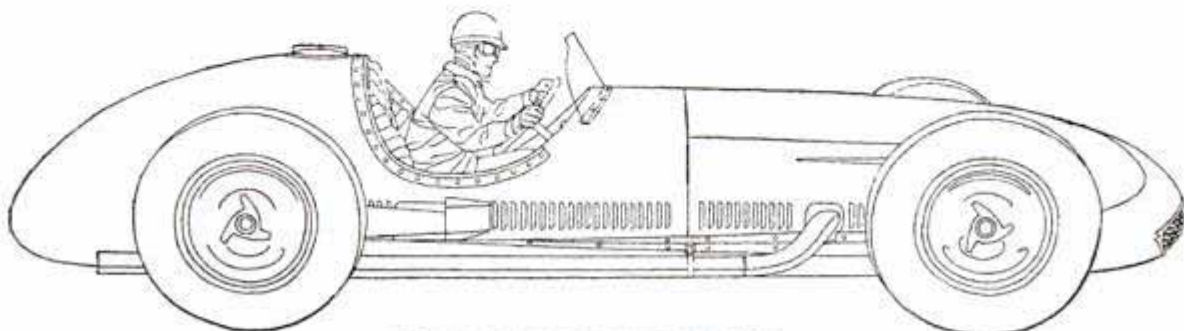
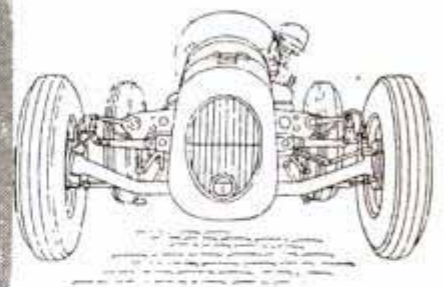

Cracked Ceilings?

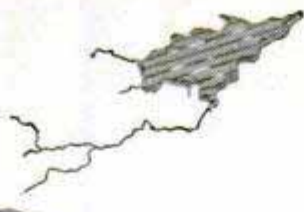

Finishing an Extra Room?

YOU Can Apply Modern Ceilings Easily with **NEW UPSON CEILING TILES**

INSTALL THEM YOURSELF!

Re-cover right over cracked plaster on 12" furring strips. In new construction, apply direct to joists. Positive, permanent application is quick and easy with color pins that match the neutral ivory finish. 6-ply laminated construction. Crackproof! For kitchen and bathroom ceilings, too.



WASHABLE AND WATERPROOF!



Syntho-surface coating proved by abrasion tests equal to two coats of aged oil base paint! Stands repeated washings! Even grease and oil spots can be removed with gasoline. Can be painted if you like—one coat covers. High insulating, light reflecting qualities! Send 10c and coupon for idea booklet on home improvement!

THE UPSON COMPANY

3168 Upson Point, Lockport, N. Y.

I enclose 10c for 32-page Idea Booklet. Include Instruction Sheet for Applying Upson Ceiling Tiles.

Name _____

Street _____

City _____

State _____



UPSON Ceiling Tiles are 12" square and 3/8" thick with square corners, Shad-O-Beveled edges.

Dr. Wernher von Braun, chief developer of the German V-2 and now a research consultant for the Army, suggests that a suitable altitude for a satellite would be some 1037 miles out from the earth's surface. He believes that the station itself might resemble 20 railroad cars parked in a circle. Rotation of this odd structure would create centrifugal force that would give people in the hollow rim a condition of gravity. A solar furnace at the hub of the wheel would be kept pointed at the sun, obtaining needed amounts of heat.

Doctor von Braun thinks that the satellite could be made of plastic materials carried aloft in a collapsed state by transport rockets, to be inflated after assembly. The transport rockets would be about 200 feet tall and each would carry a 30-ton payload.

Eventually, it is believed, there will be a number of satellite stations revolving around the earth at different altitudes for different purposes. Within 15 years we could put an unmanned satellite on an orbit about 400 miles up, in the opinion of W. B. Bergen, chief engineer of the Glenn L. Martin Company. Later, men could be shot aloft to live on board the satellite.

Such stations would be of great value for astronomical purposes, as television-relay points and even as military-observation points. There's a suggestion that other nations are thinking along those lines.

Dr. Heinz Haber, one of those doing space-medicine research for the Air Force, thinks that the first satellites will be small instrument carriers. They will report back to earth the conditions aloft until transmitting power is exhausted. His estimate is that a rocket of 200-ton thrust, as compared to the 20-ton thrust of a V-2, could serve as the prime booster of a multiple-stage rocket which could establish a satellite. He notes that rockets of that thrust already are being planned.

A means would have to be found to bring the instrument satellites back to earth "to avoid contamination of this planet's immediate surroundings with stray objects."

The job of getting a person safely back to earth from a larger satellite will be almost as difficult as the task of getting him aloft. The problem is to find a way of dropping down through the atmosphere slowly enough to avoid incandescence. Considerable heat erosion occurs on the nose of a two-stage rocket fired to an altitude of only 250 miles, and the nose of a V-2 is reported to glow dull red from frictional heat.

Dr. Fred L. Whipple of Harvard College Observatory calculates that an ordinary chicken feather fluttering earthward from a height of 1000 miles would pick up enough

(Continued to page 228)

BUY WHOLESALE FROM FACTORY SAVE 50-85%



Portable LIGHT PLANT

PUSH BUTTON START
500-700 watts 110-120 v. — 60 cyc. A.C. Powered by a sturdy dependable, easy starting, air cooled 1 3/4 hp. gas engine. No wiring necessary. Just plug in and operate. Plenty of current for any oil burner, freezer, brooder, pump, emergency lights, etc. which require up to 700 watts. Ideal for Civil Defense, Fire Depts.; trailers & camps. Complete with Voltmeter and built-in winding to charge 6 v. auto batteries. Wt. 85 lbs. Fully guaranteed. Be prepared if war or storm knocks out power lines.

(Item 24) etc. which require up to 700 watts. Ideal for Civil Defense, Fire Depts.; trailers & camps. Complete with Voltmeter and built-in winding to charge 6 v. auto batteries. Wt. 85 lbs. Fully guaranteed. Be prepared if war or storm knocks out power lines.
Reg. \$275.00 value..... **\$143.50**
700-800 Watt Plant (Item 44)..... **\$169.95**
Same as above but greater output.
1000-1200 Watt Plant (Item 45) same as Item 24, but larger generator & engine..... **\$199.50**

GIANT 2000-2500 WATT PLANT

110-120 V. 60 cyc., A.C. Absolutely the best made — exclusive dynamically balanced armature; heavy windings develop up to 2000 watt overload for motor starting. Skid-mounted — portable. Powered by easy starting Briggs or 6 hp. Wisconsin engine — complete with all accessories; engine easily disconnected for other uses. Big outlet box, voltmeter, no wiring necessary. Ample current for all purposes. Factory warranty and instructions included. Wt. 225 lbs. Reg. \$585.00. Special at..... **\$299.50**
With Electric Self Starter (Item 179) **\$359.50**
GENERATOR ONLY and control box..... **\$169.50**
Drive it with your engine or tractor.....
TRANSFORMERS — Convert 110 v. A.C. to 220 v. Capacity 2 kva. Simple hook-up. Regularly \$55. Our price — when purchased with light plant..... **\$27.50**
Purchased separately \$34.50.

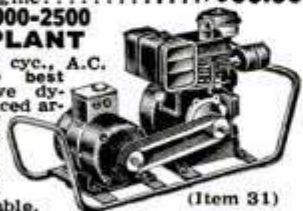

(Item 31)

HI-LINE 6000 WATT PLANT

(Item 162) Push Button Start, 115-230 v. 60 cycle A. C. A brute of a power plant with a rugged 13 hp. Wisconsin engine. Plenty of electricity for ranges, water heaters, freezers, pumps, machinery, etc. Affords both 110 and 220 volts. Ideal where heavy current is needed. Wt. 590 lbs. Easily worth \$995.00. With self starter. **\$645.00**
Generator and control box only, belt driven. Use your engine or tractor..... **\$345.00**
Wt. 240 lbs.
Write for information on any sizes not listed AUTOMATIC. Any of our light plants can be furnished with full automatic controls for as little as \$100.
Buy Wholesale — Direct From Factory — World's Largest Direct Sellers of Light Plants.
You can pay more — but you can't buy better

MASTER AIR COMPRESSOR
(Item 209) High pressure type for large volume of air for heavy duty service. For paint spraying, inflating truck and auto tires, greasing, and the hundreds of other jobs done by compressed air. Piston type, 2"x2" compressor with built-in air filter. Master built with hi-strength alloys and precision bearings. Stainless steel tank, 12" x 24". 2100 cu. in. cap. Safe up to 500 lbs. Equipped with automatic switch that starts and stops motor to maintain desired pressure (up to 150 lbs.) and check valve, safety valve, gauge, shut-off valve, 20 ft. air hose and tire chuck. Beautifully balanced on ball bearing wheels and rubber tires. Note low factory prices.
With 1 1/2 hp 110 v. A.C. motor..... **\$98.50**
(Reg. \$175.00) (Item 209).....
With 1 1/2 hp motor..... **\$119.50**
(Reg. \$199.50) (Item 209A).....
With 2 hp Briggs Gas Engine (Reg. \$199.50) (Item 209B)..... **\$109.50**
Compressor only (2"x1 3/4") (top quality) (Item 209C)..... **\$20.50**
Larger Compressor (2"x2") (none better) (Item 209D)..... **\$24.50**
Giant Compressor (twin 2 1/2"x2") (Item 209E)..... **\$54.50**
A complete line of spray guns and air tanks available at factory prices.



IMMEDIATE DELIVERY—ALL ITEMS HEAVY DUTY D-C ARC WELDER

Use as portable or shop welder. Up to 300 amps. Senior model. Made for years of trouble-free, continuous service. Will handle light or heavy jobs. Easily welds up to 3/4" plate using 1/4" rods. Built-in air-cooling system. Arc is easy to strike and hold, because of specially designed arc stabilizer. Hit-to-switch and dial control gives wide range of welding heats. Run welder at 2600 rpm. with tractor, jeep or 15 hp. gas engine, or 7 hp. elec. motor. Complete with instructions, guar. and double V belt or flat pulley. You can pay more, but you can't buy a better welder. Wt. 110 lbs. \$400 value at..... **\$99.75**

DUAL CONTROL MODEL same as above but with built-in dual rheostat for low heat soldering, brazing, welding. Spec. **\$119.50**
WELDING KIT. Two 10 ft. leads, welding helmet, electrode holder, ground clamp. Sold only with welder at..... **\$10.50**

EXTENSION CORD (Item 16) 40 ft. heavy duty, made of specially insulated No. 14 2-conductor wire, so tough that you can drive over it and yet flexible and easy to handle. Resists oil, grease or water. Extends electricity up to 400 ft. without voltage drop. Use indoors or out. Complete with heavy rubber plug and outlet. Wt. 2 1/2 lbs. Usually \$4.50—Special 40 ft. **\$1.99**
Comb: 2-40 ft. and 1-20 ft. (total 100 ft.) **\$4.95**
100 foot length (one piece)..... **\$4.85**
WIRE ONLY (Item 50) No fittings, 100 ft. **\$4.00**

HEAVY DUTY POWER CABLE #12—2 Cond.—stranded, very flexible, rubber covered, special outside conductor for grounding power tools, etc. Finest heavy duty power cable made. U.S. Surplus.
50 ft. (Wt. 8 lbs.) Item 199..... **\$6.95**
100 ft. (Wt. 16 lbs.) Item 200..... **\$12.95**

79 Pc. CARPENTER'S TOOL SET



Professional quality. A complete set of Master Mechanic tools featuring the famous Stanley brand. All neatly arranged in a beautiful sturdy 32" hvy. steel tool box. Set includes: Powerful 1/4" Electric Drill (optional), 3 Stanley Wood Chisels, 29" Spring Steel Saw, Steel Bench Vise, Tin Shears, 9 Drill Bits, Sharpening Stone, 8" Plane, 24" Stanley Level, Hack-saw, Stanley Rule, 5 Double End Wrenches, 13 Ass'd. Hack-saw Blades, Stanley Hand Drill, 10" Vise Wrench, Comb. Square, Stanley Hammer, Stanley Ratchet Brace, Coping Saw, 7 Coping Saw Blades, Steel Wrecking Bar, 4 Screw Drivers, Offset Screw Driver, Nail Set, 4 Ass'd. Files, 8 Pc. Allen Wrench Set, Auger Bit Set and many other tools. Worth at least \$150.00 if purchased separately. Save cost of tools on one or two jobs. A terrific value.
Wt. 41 lbs. Item 242 (without Electric Drill)..... **\$39.50**
Wt. 45 lbs. Item 242A (incl. Electric Drill)..... **\$49.50**
Wt. 15 lbs. Item 243 (Tool Box only)..... **\$8.95**

CARRY-IT COMPRESSOR

A hi-pressure (up to 125 lbs.) 2x1 3/4" Air Compressor powered by a 1/2 h.p. capacitor motor. Built-in 500 cu. in. steel tank tested to 400 lbs. Perfect portable air supply for paint spraying, insecticides, tire inflation, etc. Complete with safety valve, gauge, shut-off valve and all fittings. Definitely superior to outfits selling for \$100.00 or more.
Item 226. Wt. 55 lbs. **\$59.50**
Factory Special.....
Item 226A. Wt. 30 lbs. Same unit without Motor..... **\$45.00**
Item 241. Accessory Kit—20" Air Hose, Tire Chuck and hi-quality paint spray gun..... **\$10.00**

Factory Prices on Catalog Items
Send 10¢ for BIG NEW catalog. We have hundreds of bargains

MASTER GARDENER \$119.50

It's a lawn mower
It's a power sickle
It's a cultivator
It's a plow
It's a Snow Blow
It's a rotary tiller
It's a bulldozer

Here at last is a power unit that does everything at a price that can't be matched. Built-in power takeoff to drive pumps, saws, generators, etc. Safety clutch—can't burn out. More versatile and efficient than tractors costing twice as much. Basic self propelled 2 hp tractor with Briggs or Clinton famous engine. Only. **\$119.50**
Rotary Tiller..... **\$42.50**
Sickle Bar Mower..... **\$42.50**
Bulldozer..... **\$11.25**
Snow Blow..... **\$29.50**
Freight prepaid to most areas. Easy payment plan available.

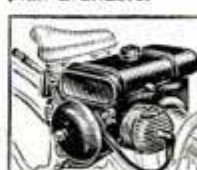

COMMANDO BIKE MOTOR (Item 90)
New, super-modern 1952 model. This job is the Cadillac of all bike motors. Sensational Auto-Clutch prevents killing motor at each stop. Also selects proper ratio on hills. Mounts behind and drives rear wheel with Dynarotor. Free Wheeling lever permits pedaling if desired. Rear Mounting eliminates fumes, heat, dirt, and hard steering. Easily installed in 15 minutes with home tools. Sturdy, trouble-free, easy starting, light weight. Airplane type engine; up to 150 miles per gallon. Fully guaranteed for fun or profit. Ideal for deliveries, paper routes, messenger service, etc. Ride to work and save. Dealer inquiries invited.
The Commando Captain..... **\$99.75**
1 cylinder 1 1/2 hp.....
The Commando General..... **\$125.00**
2 cylinder 3 hp. (Item 91).....
All Commandos shipped prepaid in U.S.

32 pc. SOCKET SET

32-pc. Socket Set (Item 59) Highest quality guar. non-breakable sockets made by Husky. Beautifully matched chrome alloy, absolutely the best. Complete range of 21 sockets from 1/4" thru 7/16" in 1/4" drive and 7/16" thru 1-1/16" in 1/2" drive; 2 extensions, reversible 1/2" ratchet, adaptor bit, slide head, all angle coupling, 2 end wrenches, 1/2" speeder handle and sturdy metal tool box. For prof. mechanics who want the best. Wt. 11 lbs. Easily worth \$41.50. While they last. **\$16.95**

45 pc. SOCKET SET

(Item 205) Contains a complete set of sockets in 1/2" drive, 3/8" drive and 1/4" drive, plus all necessary extensions, handles, speeders, reversible ratchets, etc.; all uncond. guaranteed against breakage. Beautifully matched chromed thin wall alloy sockets in a sturdy handsome steel tool box. Wt. 17 lbs. List Price \$62.90. Factory Special..... **\$26.95**

3/4" DRIVE 15 Pc. SOCKET SET

(Item 201) Same top qual. as above—includes 7 sockets 3/8" thru 3/4", reversible ratchet, extension, flex. handle, cross bar, 3 punches, metal tool box. Wt. 5 lbs. List Price \$18.96. Our Spec..... **\$9.95**

DUAL TUBE LIFE SAVERS

(Item 54) NEW APPROVED TYPE made by Genl. Tire for Navy. Each has 2 rubber tubes for double protection. Easily inflated by mouth to 55 in. Wear one around waist as comfortable life saver. Adjustable safety buckles fit adults or children. Tie several together for raft or big luxurious mattress. Invaluable on boats or beach. Wt. 2 lbs. each. Our spec. (a fraction of cost) 99¢ each, 6 for..... **\$5**

HEATING & VENTILATING FAN

(Item 10) Easily installed in furnace pipes. Forces even heat to all rooms. Over range, removes kitchen smoke and odors. Powerful continuous duty motor, 110-120 v. A.C. Quiet, super efficient fan moves huge volume of air (400 to 600 c.f.m.) 8" Fan, wt. 5 lb. **\$6.35**; 9" Fan, wt. 6 lbs. **\$7.45**; 10" Fan, wt. 7 lb. **\$8.45**; 12" Fan, wt. 8 lbs. **\$9.45**
Heavy-duty 12" fan, enclosed motor, suitable for spray booths, restaurant exhausts, poultry houses, and other difficult applications. Wt. 12 lbs. Item 10D..... **\$12.95**



All items brand new. Prices f.o.b. Chicago area. 10 day Money back guarantee. Send check or M. O. **MASTER MECHANIC MFG. CO., DEPT. 80A Burlington, Wis.**

KEEP YOUR TOOLS FREE FROM RUST!

THE FRIGIDAIRE ELECTRIC DEHUMIDIFIER

ends moisture damage in Workshops,
Basements, Darkrooms



Compact size—put it
anywhere—18¼" high—
20½" long—11¾" wide

Put a permanent end to moisture damage the instant you plug in this amazing device. Stops mold, rust, mildew. Protects equipment, luggage, furniture. Positively controls moisture in any closed area up to 8,000 cubic feet. No messy

chemicals to bother with. Operates on pennies a day. Uses refrigeration principle. Powered by world-famous Frigidaire Meter-Miser compressor with 5-Year Protection Plan. See your Frigidaire Dealer or write for special folder giving full details. Frigidaire Division, General Motors Corp., 1529 Amelia St., Dayton 1, O.

Greatest tool values CATALOG

FREE



AUTO
SERVICE
MEN

FARM
MECHANICS

PROFESSIONAL
MECHANICS

WORKSHOP
HOBBYISTS

This brand-new book gives you full information on High-Quality, Low-Price Indestro Tools your dealer can supply. The very newest designs in regular or special hand tools, tool sets and complete tool chests; every tool finely made, properly heat-treated, ground and polished for years of satisfying service. Insist on Indestro, the choice of professional shop men.

send coupon for INDESTRO catalog

FILL OUT AND MAIL NOW FOR FREE COPY

Send to INDESTRO MANUFACTURING CORP.
N. Kildare at Schubert, Chicago 39, Ill.

Write your name and
address in margin space

speed to become charred from friction with the atmosphere while still high above the earth. The assumption is that parachutes supporting a sealed cabin would melt and disintegrate. The best solution may be to use rocket motors as brakes, retarding the descent to a safe, cool speed.

No one knows how much it will cost to put the first satellite on station, or set foot on the moon, or make the first two-year-plus round trip to Mars. Only one thing seems certain, and that is that science is on its way toward doing those things.

In this connection, Dr. H. Strughold of the Air Force space-medicine group observes that "the conquest of the outskirts of the atmosphere and eventually space is a revolutionary event comparable only to the transition of aquatic animals to the land in geological times. This transition took at least 100 million years. It took only a millionth of that time for man to invade the boundary lines of space." ★ ★ ★

TV Comes to the Small Town

(Continued from page 132)

covering a 75-mile area with good reports coming in from as far away as 100 miles.

The radio-relay "dishpan" to pick up network shows is beamed eastward from here toward Columbus and Osgood, Ind., and then Cincinnati, Ohio, where the network stations are located.

Don't get the idea that because it's a small-town station, WTTV relies entirely on network productions or on washed-out movies either. It has its share of top network shows and its also has a cowboy serial for the youngsters during the day. But every week there are 40 to 44 local shows originating in WTTV's single studio. That studio is 25 by 50 feet and looks like an oversize garage. One end, which serves as a prop-storage room, is partitioned with rough burlap draperies. On the air, the draperies serve as a backdrop and look real luxurious!

One of the lessons learned at the old studio building was that TV programs can require some strange props and scenery often gets rather large. So the new building has garage-type double doors in the outside wall of the main studio. These can be rolled back to permit trucks to back right up—literally "on stage." (Considering the fact that one farm-bureau show had live cattle and sheep as "stars," this feature takes on added importance!)

One cameraman is all WTTV needs. There have been times when two cameras were used on the same show, but to pare

(Continued to page 230)

How Creative Designing Gives You "Something Extra And Better:"

WESTCRAFT "POWER-TWIST" SCREWDRIVER

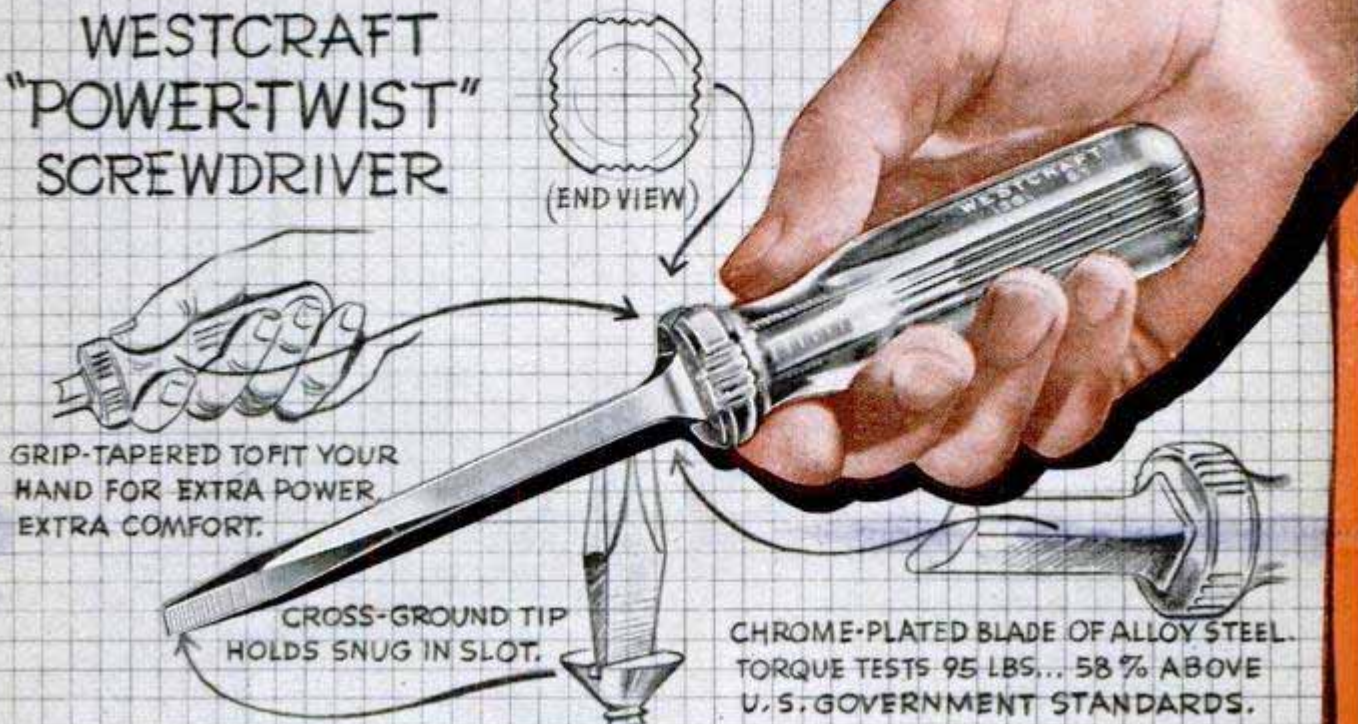

GRIP-TAPERED TO FIT YOUR
HAND FOR EXTRA POWER,
EXTRA COMFORT.

CROSS-GROUND TIP
HOLDS SNUG IN SLOT.

CHROME-PLATED BLADE OF ALLOY STEEL.
TORQUE TESTS 95 LBS... 58% ABOVE
U. S. GOVERNMENT STANDARDS.

Long, anti-blister handle of clear chip-proof Tenite snugles into your palm like an egg . . . gives this screwdriver new extra power to turn toughest screws easier! (Compare, and see how you can tighten screws up to a full twist further than with old-style screwdrivers!) Perfectly balanced functional design. Chrome-plated alloy steel blade of square stock for modern styling, extra strength! (HR1361) **85c**

WESTCRAFT 6" "POWER-GRIP" PLIER



50% more gripping power, 38% more leverage from exclusive patented jaw design. Precision tooled from alloy steel . . . so accurate you can pluck a hair! (HR1124) **95c**



WIZARD ELECTRIC 1/4" DRILL

Whirls through wood, metal, plastic in a flash! More accurate. 1250 r.p.m. motor for ideal speed-power balance. Alloy steel-cut gears. 3-jaw chuck. Trigger switch. (HR1379) **\$12.48**

CHOOSE FROM OVER 1,100

Wizard-Westcraft Tools SOLD ONLY BY Western Auto

NOTE: WESTERN AUTO ASSOCIATE DEALERS OWN THEIR OWN STORES AND SET THEIR OWN PRICES. TERMS AND CONDITIONS. PRICES MAY VARY DUE TO DIFFERENCES IN LOCAL CONDITIONS. IF YOU DO NOT KNOW THE LOCATION OF YOUR NEAREST WESTERN AUTO STORE, WRITE WESTERN AUTO SUPPLY CO., 2107 GRAND, KANSAS CITY, MO. (PK82) (PS92)

→ STORES AND ASSOCIATE STORES

START!

and

GO!

with



**HESTER BATTERY DISCHARGED IN CAR
STARTS 809 TIMES AFTER 5 MINUTES REST**

In a recent test, a stock Hester Battery was deliberately discharged by engaging the starter on a car, with the switch off, until the battery refused to turn the engine over. The battery was allowed to rest for 5 minutes, the car was then started and the engine stopped immediately. This operation was repeated 809 times before the battery failed. Conclusive proof that the Hester Battery has great ability to renew its energy. For extra power and long-life, Start! and Go! with Hester!

For the name of your nearest dealer or for jobbing arrangements write

HESTER BATTERY MFG. CO.
Nashville 10, Tennessee

send for **FREE CATALOG**



America's Foremost
money-making
MECHANICS'
TOOLS

It's easy to own the same "pay-off" tools used and endorsed by America's top-earning mechanics throughout the automotive, aviation and industrial fields! Snap-on tools help you handle every repair job faster, easier, better. And they LAST . . . pay for themselves over and over again! Start building your own tool set now with basic Snap-on units—add others any time. Genuine Snap-on tools are never sold in stores—direct to users only. Mail coupon for free catalog.



SNAP-ON TOOLS CORPORATION
8062-H 28th Ave., Kenosha, Wisconsin
Send me free catalog of Snap-on tools.

Name _____
Address _____
City _____ Zone _____ State _____

costs and also to allow time for camera overhauls, the station is now on one-camera operation.

When the cameraman wants to change from one lens to another, he often does it while you watch—and it's done so quickly that you scarcely notice the transition. Or, if necessary, the video-control engineer cuts in a still picture or an opaque slide while the change is made. Another technique is to black out the screen for a couple of seconds while the camera is dollyed across the studio to a new position. Surprisingly enough, none of these techniques is objectionable or, in most cases, even apparent to the viewer at home.

Pay-roll expense is kept down by doubling in brass. The production manager is also the newscaster and, at times, acts as the video engineer. The night station manager is the sportscaster and also does commercial announcing. The audio engineer is station-break and spot-commercial announcer and, at intervals, reads the weather forecast. The video engineer has his own afternoon cowboy-movie show and is the director and master of ceremonies of the station's most ambitious weekly program, *Hayloft Frolics*. This program has built up an audience over an area 200 miles in diameter. Telephone calls from viewers 100 miles away are frequently received during the telecast.

Although camera rehearsals are rarely held, the shows move along smoothly with plenty of sparkle. There's a personal approach that appeals to the Bloomington audience. The local viewers know the men and women at the station and when a performer (while on camera) says: "Earl, come in closer to get a better view for the people at home," the viewer knows that he is talking to the cameraman, who perhaps lives on the same street and belongs to the same church he does.

So now, almost four years after the original plans were laid, WTTV has settled down to the staid life of being a regular part of southern Indiana's entertainment and educational life. But the lessons learned by its staff are going to be utilized in countless ways during the coming months. As hundreds of new stations come into being, the industry's most valuable commodity will be theirs—experience. This is the one thing that cannot be bought . . . it comes only with weary hours of trial and error. ★ ★ ★

Discovery in Mexico of maize pollen grains believed to be 25,000 years old points up the possibility that agricultural Indians lived in Central America during that period and cultivated the plant.

GENERATING PLANTS.

IMMEDIATE DELIVERY • LARGE STOCK • MANY SIZES
FROM 350 WATTS TO 25 KVA
 Item #347-PE-201-1000 Watts-120 Volts-60 Cycle AC-Single Phase, and .3 KVA, 14.6 Volts-20 Amps, DC for battery charging. Model A, Leland Generator, belt driven by a Briggs & Stratton 1 cylinder air cooled, rope starting, 2.7 HP gas engine at 1800 RPM. Control panel contains AC voltmeter, cycle meter, DC ammeter, rheostats, receptacles and terminals. Overall dimensions, 36"x19"x24". Ship. wt. 250 lbs. F.O.B. Chicago... **225.00**



GROBAN'S BRAND NEW UNCONDITIONALLY GUARANTEED WAR SURPLUS BARGAIN SPECIALS

Brand New

GENERAL MOTORS - ALLISON

CENTRIFUGAL PUMP

200 GALLONS PER MINUTE

• For Draining Basements • Fire-Fighting • Irrigation • Fuel Transfer • Swimming Pools • Home Water Systems • Dewatering

This General Motors-Allison Centrifugal Pump—designed for use on U. S. Air Force Mustang Fighters, now converted for commercial, home, and industrial high volume pumping applications. Inlet, 2 1/2" standard pipe thread, twin outlets with 1 1/4" pipe thread, ball bearing supported 3/4" shaft. Easy, fast simple priming. Rotation, counterclockwise facing shaft. Shipping wt. 35 lbs. Gov't acq. cost \$145.00. F.O.B. Chicago. NOW ONLY... **39.50**



(ITEM #130)

Aircraft Quality HYDRAULIC EQUIPMENT

ITEM #160-PESCO GEAR TYPE HYDRAULIC PUMP—Compact—Powerful—Reliable. Especially designed for belt drive from fan belt, power take-off, drive pulley, electric motor or small gas engine. Equally suitable for direct coupling. Pedestal type mounting with two bolt holes for 3/8" hold-down bolts. Standard 1/2" pipe thread inlet and outlet ports. Delivers 4.5 GPM at 1000 PSI at 2800 RPM with 3 HP. Hardened steel gears turn in dense oilite bronze bearings. Rotation—clockwise facing shaft. Guaranteed trouble-free service. Ship. wt. 6 lbs. F.O.B. Chicago... **22.50**



ITEM #126—Four-way, open center control valve with built in adjustable relief valve. Factory set at 1000 P.S.I., spring loaded neutral position, for use with one double acting cylinder. In neutral position cylinder is locked and pump unloaded. Fully balanced plunger type, smooth, positive, easy operation, can be used as single unit or mounted in series of any combinations desired. Has 3/4" pipe thread inlet and outlet, 1/2" pipe thread cylinder ports. Newly manufactured to our specifications. Shipping weight 8 1/4 lbs. An outstanding Buy! F.O.B. Chicago... **21.50**

ITEM #42—Double action hydraulic cylinder, 4" bore, 18" stroke. Rated lift capacity with 1000 PSI line pressure is 12,500 lbs. Ship. wt. 30 lbs. F.O.B. Chicago. An Excellent Buy for... **32.50**

New Model 353 D. C. ARC WELDER

— Dual Range **D. C. ARC WELDER** for Stationary or Portable Use. **HEAVY DUTY RANGE TO 250 AMPS. NEW 'MAGIC TERMINAL' FOR LOW CURRENT 30 TO 100 AMPS. IDEAL FOR FARM • FACTORY • GARAGE • WORKSHOP**
 These precision engineered D.C. Arc Welders contain the highest quality War Surplus aircraft components built to exacting government specifications. They are light in weight, have over-sized lifetime grease-sealed ball bearings, air cooled commutator, dial type rheostat for easy pin-point control, a high-low rheostat switch, reactor coil for even arc and the new 'MAGIC TERMINAL' low current welding range for welding lighter materials. Designed for many years of trouble-free service. Run welder from drive pulley or power take off of a tractor or Jeep, 7 1/2 HP electric motor or 10 HP gas engine at 2500 R.P.M. Uses two V-belts or flat belt. Continuous output rating 200 amps. Intermittent welding rating 250 amps, 30 volts. This sensational price includes double V or flat belt pulley and complete operating instructions. Shipping weight 107 lbs. \$350.00 Value. Item #65. F.O.B. Chicago Now only... **119.50**
 Welds Anything From Auto Fenders To Tractor Frames

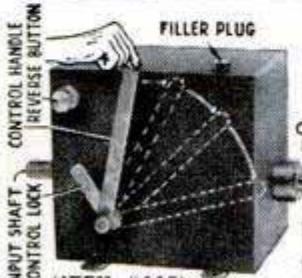

HYDRAULIC SPEED REDUCER WITH FINGERTIP CONTROL

USE FOR • Reamer Drives • Midget Cars • Feed Mills • Canning Machines • Conveyors • Lathes • Milling Machines • Motor Boats • Cream Separators • Garden Tractors • Pumps
 Variable output speeds from 0 to input speed available by moving control handle. Locking handle maintains setting. Use input power of 1/4 to 1 1/2 HP. This Westinghouse-Oil Gear Unit consists of a variable displacement hydraulic pump feeding a fixed displacement hydraulic motor. Adjustable relief valves set at factory for 100 inch pounds of torque may be reset up to 180 inch pounds. Independent reverse control allows full output power and speed selection in either direction of rotation. Shafts measure 3/8" diam., include keyway. Input rotation is counter-clockwise facing shaft. Recommended input speed not to exceed 750 R.P.M. Over-all dimensions, 7 1/2"x7 1/2"x11 1/2". Gov't acquisition cost, \$428. Ship. wt. 31 lbs. Complete with 2 qts. of oil and full instructions. F.O.B. Chicago... **54.50**

ORDER DIRECT FROM AD — SEND PAYMENT OR PURCHASE ORDER TODAY—SATISFACTION GUARANTEED
 FREE: 48-PAGE BARGAIN CATALOG. Write Today!

GROBAN SUPPLY CO. DEPT. PM-8
1139 SO. WABASH AVE., CHICAGO 5, ILL.



MAGNETS LIFT 225 LBS.

GENUINE ALNICO—NEVER WEAKENS

AMAZING, PERMANENT MAGNETS—WILL NOT WEAKEN! NON-ELECTRIC
 Retrieve guns, tackle, tools and other steel items from lake, river, plating tanks, drains or other hard-to-reach spots. Recover drills, taps, etc. from sweeping. Clear alley of harmful tacks, nails. Many other uses. Pays for itself quickly. **GUARANTEED**. Try any magnet one week. Money refunded if you are not well pleased.
 No. M-725 (Weighs 54 oz.) Has pull of 225 lbs. on steel block. **\$15.00**
 No. M-675 (Weighs 49 oz.) Has pull of 175 lbs. on steel block. **\$10.50**
 No. M-650 (Weighs 41 oz.) Has pull of 150 lbs. on steel block. **\$ 8.50**
 No. M-30 Hobbyist assortment of six small magnets. **\$ 1.50**
 Send Money Order or Check. We pay postage. No C.O.D.'s.

MIAMI MAGNET COMPANY, 3240 N. W. 27th Ave., Miami 42, Fla.



HURRICANE CUT-OUT EXHAUST

This specially engineered cut-out enables you to install special pipes and mufflers without removing the original muffler.
 Now control your exhaust tone from a dash control button. Cut back into your original muffler in restricted areas at will. Fits all exhaust pipes from 1 3/4" to 2 1/4" size.
 This cut-out is well constructed; actually strengthens exhaust pipe; made of heavy plate steel designed for easy installation—no special tools required. Sent post-paid for only \$6.95 check or money order. Satisfaction guaranteed or your money back.
ST. LOUIS PRODUCTS CO., Box 24-AH, Normandy 21, Mo.



BUILD FINE GRANDFATHER CLOCK NOW

The simple sensible Red-i-Kut way as thousands have — **SAVE HALF. SHOP TESTED PLANS "SPIRIT OF THE CENTURY"** Narrow waist 8 3/4" tall or stately straight side **"SPIRIT OF AMERICA."** **EASY-TO-FOLLOW photopack PLANS** tell all—plus **BROCHURE** of heavy brass weight Westminster, tube chime, movements, gorgeous dials, 3/4" solid mahogany case kits. Send \$1.00 today — Both plans \$1.50 NOW.
KUEMPEL CHIME CLOCK CO., #4 Kuempel Bldg., Minneapolis 16, Minn.

SAY YOU SAW IT IN POPULAR MECHANICS

DYNAMIC POWER TOOL COMBINATION



INCLUDES: Cummins 1/4" Electric Drill; Cummins Saw Attachment; Combination Saw Blade; Set of Drills; Lambs Wool Bonnet; 6 Sanding Disks; Steel Arbor and Attachments; Cloth Buffing Wheels; Grinding Wheel; Wire Wheel Brush; Steel Paint Mixer; Steel Bench Stand; Portable Steel Carrying Case.
 Price of Dynamic Power Tool Combination complete is \$26.95

SHIPPED ON APPROVAL NO MONEY WITH ORDER—NO C.O.D.

Try it ten days before you buy. If completely satisfied then send \$2.95 and pay balance at rate of \$4.00 per month for 6 months—**No Interest or Carrying Charges Added**. If not completely satisfied, return to us, no explanation necessary.

KAPNER HARDWARE INC.
 Dept. A-46, 2248 Second Ave., New York 29, N. Y.
 Please rush 1 Dynamic Power Tool Combination. I agree to pay \$2.95 within 10 days after receipt and \$4.00 per month thereafter.
 Name _____
 Address _____
 City _____ Zone _____ State _____

P & C Hot Forged Tools

make tough jobs **EASY!**

Built by master craftsmen, P & C tools are "muscle saving" and "fun to use." They get into small openings, fit nuts and screws snugly, balance perfectly in the hand. And special analysis alloy steels plus scientific heat treating makes them stay on the job longer. Look for the P & C rotary tool display unit and get "the best tools money can buy."

Write for handy pocket catalog. Complete data on some 300 P & C Tools.



P & C Hand Forged Tool Co.
Box 5926 H
Portland 22, Ore.

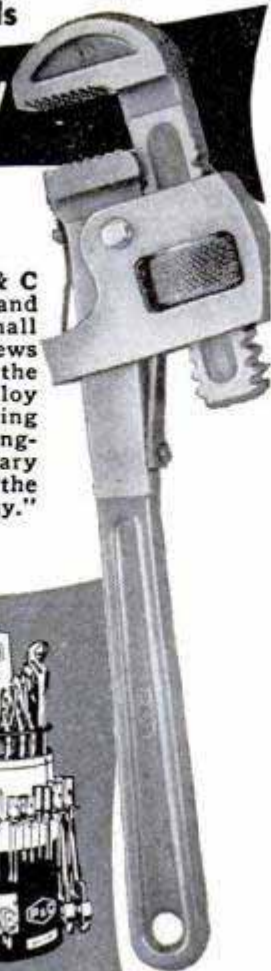

Homemade TV Antennas

(Continued from page 211)

It may be mounted on a window sill, as indicated in Fig. 2-A, or it may be mounted inside a closet or in the attic. Try several positions when mounting it and adjust it for the best pickup on the weakest station. The upper section of the mast can be lengthened to support the loop, as in Fig. 1-A, or it may be terminated at the insulator block, as shown in photo A. Any length of 300-ohm twin lead can be used.

CHANNEL	Element lengths in inches					SPACING (s)
	D1	D2	D3	E	R	
2	94.5	95.1	96.0	103.4	106.3	44.5
3	85.0	85.8	86.6	90.5	96.0	38.5
4	77.4	78.1	78.9	82.4	87.4	35.1
5	67.4	68.0	68.7	71.7	76.1	35.6
6	62.5	63.1	64.9	66.6	67.3	28.3
7	29.7	30.0	30.2	31.6	33.5	13.5
8	28.7	29.0	29.3	29.9	32.4	13.0
9	27.8	28.0	28.3	28.5	31.4	12.6
10	26.9	27.1	27.4	27.6	30.4	12.2
11	26.1	26.4	26.6	26.9	29.5	11.8
12	25.1	25.6	25.8	26.0	28.6	11.5
13	24.6	24.9	25.1	25.9	27.8	11.2

CHART B

Yagi element lengths for each channel

Get "inboard control" with this FULL SHIFT outboard

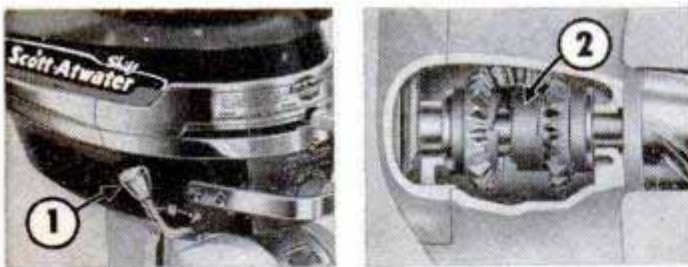

A **SCOTT-ATWATER SHIFT MOTOR** gives you all the maneuverability of an inboard cruiser—forward, neutral, reverse. Convenient shift lever (1) moves gear selector (2) right to engage reverse gear, left for forward. When selector is centered, motor is in neutral—the propeller doesn't turn. This full shift comes on four Scott-Atwaters, 5 to 16HP. Another reason why...

You get MORE with Scott-Atwater!

SEND FOR FREE CATALOG! Dept. 94, Scott-Atwater Mfg. Co., Inc., Minneapolis 13, Minn.

Name.....
Address.....
City.....State.....

(Export Dept.—American Steel Export Co., 347 Madison Ave., N.Y. 17, N.Y.)

The five-element Yagi shown in photo B and detailed in Figs. 3-B and 4-B is very popular in weak-signal locations and fringe areas. It is critical but will give excellent results on the channels for which it is cut. It is highly directional and a separate unit should be used for each channel. Three or four of these Yagi units may be mounted on the same mast if it is properly guyed and the antenna units are spaced approximately 30 in. apart. Best results will be obtained when separate lead-ins are run from each antenna. In this case coaxial cable is run for each antenna unit to a coaxial-type switch at the receiver. See chart B for element lengths and spacing for each TV channel. The three directors D1, D2 and D3, also the reflector R, are made of 1/2-in. aluminum tubing. The top section of the folded-dipole element (E) is 1 1/4-in. aluminum tubing and the bottom section is No. 8 copper wire. The boom, also 1 1/4-in. sturdy aluminum, is drilled at the spacing shown in chart B. Fasten each element with a brass bolt from top to bottom and use lock washers to insure a tight fit. Bolt the driven element (E) to the top of the boom and use 1-in. polystyrene insulators to support the No. 8 wire. Connect the 300-ohm twin lead at L and L (insulator terminal screws, see Fig. 4-B). Use TV stand-off insulators to relieve strain on the lead-in and to prevent it from swaying. ★ ★ ★

DRY OUT DAMP WORKSHOPS!

Amazing little Fedders Electric Dehumidifier dries damp rooms without messy chemicals! Plugs in like a radio, removes up to 3 gals. of moisture from the air every 24 hours. Stops damage from rust, mildew, rot, warp. Protects tools, wood, guns, luggage, furniture, linens. Compact and portable. 15" wide, 22½" high, 13¼" deep. No service worries. Runs for a few pennies a day. Write today for FREE illustrated booklet. Fedders-Quigan Corp., Dept., PM-5, Buffalo 7, N. Y.



fedders

A GREAT NAME
IN COMFORT

POWER MOWERS & KITS

FREE PLANS

LOW FACTORY PRICES DIRECT TO YOU

Build your own quality mower with our **LOW COST KITS, Parts, Engines. Free Plans** guide you. 3 and 4 Wheel Kits, complete. Parts precision finished, ready to use. Write **TODAY** for Free Plans, Low Prices, Parts List and Guarantee.

3 & 4 Wheel Model 4 Wheel Direct Drive

America's Finest Power Mowers completely assembled in 3 and 4 wheel models. Belt or direct drive. 18" and 20" sizes. Nationally known make engine. Latest improved features, sturdy construction and money back guarantee fully described in color folder. Write today.



▼ **TRIANGLE MANUFACTURING CO., Box M-16, Fort Scott, Kansas**

Clark EXPANSIVE BIT

CUTS BETTER • COSTS LESS!

Accurate, fast; cuts smooth holes in hard or soft wood. Chrome vanadium steel blades, all chrome body. No. 250, ½"-1½", \$1.89; No. 251, ¾"-3", \$2.19. **GUARANTEED.** At your dealer or write Dept. PM8

ROBERT H. CLARK COMPANY • Beverly Hills, California

Black & Decker Utility Tools

for HOMES • FARMS • WORKSHOPS

RICHARDSON

priced for you in '52

This new low priced 21-foot Sportsman model has been designed with the outdoor man in mind. Write to Dept. P for free literature.

RICHARDSON TRAILER MFG.
Elkhart CO., Inc. Indiana

WAR SURPLUS AND OTHER BARGAINS SAVE UP TO 90%

AIRCRAFT NAVIGATIONAL DRAFTING MACHINE



Designed for plotting navigation problems and adaptable to surveying layouts & general drafting room use. Vernier hub graduated 0° to 360° by 1', will lock unit at any desired degree. (AN5750). Mfg. by Bruning Wallace. Non-magnetic K-Monel bands are not subject to corrosion. ALL NEW. Complete with fitted hardwood case incl. spare parts. Wt. 11 lbs. Approx. Govt. Cost \$150. **WHILE THEY LAST! ALL yours for just \$47.50.**

"BALTIC" SWEDISH TOOLMAKERS VERNIER CALIPER

New low price due to lower import duty!

ULTRA PRECISION—0.6" in .001 graduations. Quick, accurate depth, inside, outside measurements, line engraving. Extra heavy rule, hand-fitted sliding head, no side play. Rockwell C.60, lapped measuring surfaces. For the extra particular mechanic who must have the best—used and recommended by most critical experimental & research machinists at Lockheed, Douglas, Bendix, GM, RCA, General Electric. Save 60%! A \$37.50 value—only **\$14.75**, leather case incl. Also a standard grade Mauser Design Caliper made in Germany. For the production machinist, 0-6" in thousandths. Money back guarantee. Only **\$10.95**, leather case incl.

10 LBS. ASSORTED MIX

A must for the hobbyist, machine shop or farm. Aircraft quality assorted nuts, bolts and washers. ALL NEW. Approx. value \$20, so how can you possibly go wrong at the Airborne price of **\$2.75**.

MICROMETER

Chrome plated, precision engineered and carefully tooled to give long life ...

all new. 0-1" capacity, \$2.25.
1-2" capacity, \$3.50 Each.

ALL NEW HIGH SPEED DRILLS

Fractional & numbered. Nationally known brand. Set of 30, assorted sizes, an \$18 value for only **\$3.50** complete.

STRAIGHT SHANK DRILLS—10 different sizes High Speed Straight Shank Jobber length drills, ¼" to ½" (shank same diameter as drill). Here's a \$25 value you can have for **\$3.50**.

WIRE GAUGE DRILLS—Between 45 and 60. Highest quality steel. You'll recognize the brand. Hard to get sizes valued at \$7.50. Airborne gives you a set of 12 for just **\$1.50**

Set from ¼" to 33/64". Five sizes with ¼" shanks. You'll surely want this set for the low, low price of **\$3.00**.

Send 25c for 1952 catalog. Bargains for everyone. Check, Money Order or Cash. 25% deposit on C.O.D. orders. Prices F.O.B. Culver City, Calif., unless otherwise stated.

AIRBORNE SALES CO., INC., Dept. PM852
8501 Stellar Dr. Culver City, Calif.

FUN FOR BOYS FROM 8 TO 80

DREMEL Electric COPING SAW

CUTS SCROLLS LIKE MAGIC—SANDS AS IT SAWS

BLADE FACES 4 WAYS

MAKE YOUR OWN JIG SAW

JUST GUIDE IT!

Only \$5.85 with 3 saw blades

PLANS FREE! **SAFE! AS A HANDSAW**

For home, hobby, repair work—no other tool pleases so much for so little cost. Works in any direction—delivers 7,200 strokes per minute smoothly, effortlessly. Saws through ¾" medium-hard wood at a foot-a-minute speed. Touch-of-the-trigger, foolproof action. Only 2 moving parts, never needs oiling. Uses 110-120 V., A.C. Free plans, packed with each saw, for six useful woodworking projects and for making your own jig saw.

WHERE TO BUY DREMEL TOOLS

Dremel Tools are sold everywhere. If your dealer cannot supply you, send remittance in full and we will ship postpaid. Or send only \$2, and pay post-man balance plus postage and fee. Money back if not delighted after 5 days' trial.

DREMEL MFG. CO., Dept. 112-H, RACINE, WIS.

For Better Work — FASTER — EASIER

THE
ZEPHYR
Electric Drill



only \$18⁹⁵

Handy... Speedy... Powerful. Has many uses around the home... in the shop... on the farm. Built to Last. Full 1/4" Capacity.

DRILL STANDS Add Many Uses for Zephyr Drill



Horizontal Drill Stand— for Polishing, Buffing, Grinding, etc.

Price \$1.00



Adjustable Vertical Drill Stand— for drill press operations
Price \$10.95



De Luxe Electric Work Saver Kit

Includes above ZEPHYR Drill, plus 28 accessories for buffing, cleaning, drilling, grinding, mixing paint, polishing, sanding, sharpening, waxing, and wire brushing.

Price \$27.35

At Hardware, Implement, and Building Materials Dealers, and Department Stores—or Write Direct



PORTABLE ELECTRIC TOOLS, INC.

324 West 83rd Street, Chicago 20, Illinois

In Canada: Portable Electric Tools, Ltd., Toronto, Ont.

You'll be **KING**
of the open road!

Ride the NEW

Cushman
EAGLE

50 miles per hour

75 miles per gal.

3/4¢ per mile total operating cost

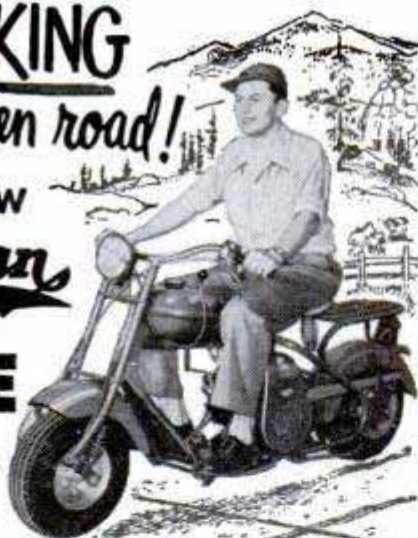

It's a treat to ride the Cushman "EAGLE"—smartly styled, with superb riding comfort, and low cost transportation all in one great new Cushman. The "EAGLE" is unmatched for performance. Operates for less than one penny per mile. You'll save time, money and eliminate high cost maintenance. Go everywhere on a Cushman "EAGLE." Work, school, errands, deliveries—hundreds of uses. It's great for the open road. Go Cushman in 52!

Write for new FREE illustrated literature
See your nearest Cushman Dealer

CUSHMAN MOTOR WORKS, INC.

924 No. 21st St.

LINCOLN, NEBRASKA

Movies on a Curved Screen
Wrap You in Action

(Continued from page 124)

produced a startling three-dimensional effect. Out of it grew the gunnery trainer—and Cinerama, which is simply a photographic view of the scene as a human pair of eyes would see it. The picture Cinerama reproduces is 146 degrees wide and 55 degrees deep, close to that seen by two eyes, which cover at best some 165 degrees by 60 degrees. No lens known can cover such a field without distortion. Hence, the Cinerama camera has three 27-millimeter lenses set at 48-degree angles. Each takes a third of the picture's total width, exposing its own reel of 35-millimeter film housed in one of the three magazines that jut from the back of the camera.

The lenses are arranged on a mount like a three-section picture frame. The one in the center points straight ahead. Those on each side point in so that the left lens takes the right side of the picture and the one on the right takes the left side. A single rotating shutter whirling in front of the lenses at the point where their lines of view cross makes simultaneous exposures on each film. Focus and diaphragm controls adjust settings on all lenses simultaneously.

To merge the three films into a single picture on the big 51 by 26-foot screen, three standard projectors in balcony booths throw the images from each film onto the screen. The projector on the right fills in the left third of the screen, the one on the left fills in the right third and the one in the center shoots straight ahead.

Because the screen is curved, there should be distortion and fuzziness, but there isn't. Great depth of focus of the projector lenses keeps the picture sharp. Distortion caused by reflected light bouncing off a screen to the eyes of the viewer has been licked by a Waller trick. The screen is not one great sheet but is made up of 1100 vertical strips of perforated tape, set at angles like a Venetian blind turned sideways. Reflected light bounces off a louver and goes behind the screen. You can sit right at the edge of the Cinerama screen, look up at a tight angle, and figures still look round and full just as they would if you saw them from a seat farther back.

Running three movie reels side by side simultaneously to make one picture poses some problems. If one projector is a fraction of a frame off kilter, the pictures look wiggly. And how to hide the lines where the films come together? This is solved by what the boys call "jiggilos." These are comblike bits of steel that fit in each projector at the

(Continued to page 236)

"TESTED AND TRIED" FOR A SMOOTHER RIDE!



Your car never gets sluggish with a can of Marvel Mystery Oil in the crankcase or gas tank. Marvel peeps up the motor... eliminates hydraulic valve clatter... adds years to the life of your engine. Power zooms through for more miles per gallon in all kinds of weather.

MARVEL MYSTERY OIL
use in any top cylinder oiler

MARVEL MYSTERY OIL
TOP CYLINDER LUBRICATOR
REINFORCED LUBRICATION

BULL DOG JACKS

Makes parking or hitching trailers and heavy farm implements an easy, one-man job

Model No. 60-F
Only \$15.75
Post Paid
(when paid in advance)

All steel construction—heavy duty ball bearing swivel action... raise and lower with crank... complete with bracket, ready to install

HAMMER BLOW TOOL COMPANY

Wausau 13H Wisconsin

Print Your Own

Cards, stationery, advertising, etc. Save money. Print for others, good profit; easy rules sent. Raised printing like engraving, too. Sold direct only. Write for free details. Kelsey Presses, F-37 Meriden, Conn.

Shoots glaziers' points
into hardest wood
ask your dealer for
Red Devil
diamond point driver



RED DEVIL TOOLS, IRVINGTON 11, N. J., U. S. A.

NEW—Sensational! GEIGER COUNTER



"The SNOOPER"
LOW PRICE ONLY **\$24.95**
COMPLETE

Find a fortune in uranium with this new, super-sensitive Geiger Counter. So small it fits in the palm of the hand or in the hip pocket, and yet more sensitive than many large, expensive instruments. Weighs only 1 1/4 lbs. Uses flash-light battery. Low price includes earphone, radio active sample, instructions. Sold with ironclad moneyback guarantee.

ORDER YOURS TODAY—Send \$5.00 with order or payment in full to save C.O.D. Write for free catalog on treasure finders for gold, silver, etc. and larger, more elaborate Geiger Counters.

Dealer Inquiries Invited **PRECISION RADIATION INSTRUMENTS**
2235 PM So. La Brea, L.A. 16, Calif.

The NEW Model 50 UTILITY TESTER FOR REPAIRING ALL ELECTRICAL APPLIANCES-MOTORS an all-around electrical trouble shooter

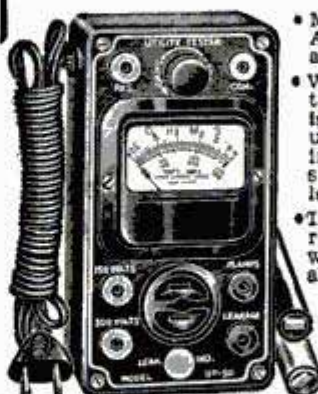

- Measures A.C. and D.C. Voltages, A.C. and D.C. Current, Resistances, etc

- Will measure the current consumption while the appliance under test is in operation. The appliance or utility may be plugged directly into the front panel receptacle. A special pair of insulated clip-end leads is included for motors, etc.

- Incorporates a sensitive direct-reading resistance range which will accurately measure all resistances commonly used in electrical appliances, motors, etc. This range will enable continuity checks and tests for shorts and opens.

- Will test thermostats, radio tube filaments, bulbs, fuses, fluorescent, condensers, switches, field coils, circuit breakers, lighting systems, etc.

Handsome round cornered molded bakelite case 3 1/8" x 5 7/8" x 2 1/4". Complete with all test leads and instructions.

\$13.90

SHIPPED ON APPROVAL
No Money With Order — No C.O.D.

Try it for 10 days before you buy. If completely satisfied send \$3.90 and pay balance at rate of \$2.00 per month for 5 months — No Interest or Carrying Charges Added. If not completely satisfied, return to us, no explanation necessary.

SUPERIOR ELECTRONIC CO., INC.
Dept. D-25, 227 Fulton Street, New York 7, N. Y.

Please rush 1 Model 50. I agree to pay \$3.90 within 10 days after receipt and \$2.00 per month thereafter.

Name _____
Address _____
City _____ Zone _____ State _____

Say You Saw It in Popular Mechanics

Your **ELECTRIC DRILL** Trims
HEDGES — SHRUBS — GRASS
with **ROTO-TRIM**
DRILL ATTACHMENT

FITS ANY
1/4" DRILL

Today's Greatest
Hedge Trimmer VALUE **\$10.95**
Yours, Postpaid, for only **\$10.95** (Less Drill!)

Keep your whole yard neatly tailored... trim hedges, shrubs, and hard-to-reach grass easily and smoothly with this new, inexpensive drill attachment. ROTO-TRIM quickly converts any 1/4" drill into an easy handling, keen-cutting Hedge Trimmer.

Quality Built throughout. Rigid steel and aluminum construction with smooth-running hardened steel gears and cam in one-piece case. Cutting blades are 10" long, of high-carbon steel, heat-treated, precision ground and designed for maximum safety and efficiency.

Easy to Use! Quickly attached to drill—flats simplify chucking. Light weight and precision balance make ROTO-TRIM much easier to handle than more expensive trimmers. Handle turns blade to any angle.

Order TODAY! Don't miss this chance to get your ROTO-TRIM Hedge Trimmer Attachment while still available at today's low price of \$10.95.

UNCONDITIONAL 10-DAY MONEY BACK GUARANTEE! Send check, cash or M. O. and we'll ship postpaid — direct from factory to you.

Dept. 852 **ROTEX COMPANY** 837 WEST DAVIS DALLAS 8, TEXAS



BARGAINS

Brand New, top quality glasses. All have precision ground optics, durable lightweight bodies. Moisture and dust proofed. Achromatic!

Coated! Featherweight!

16x50 COATED \$69.50

The ultimate in a fine binocular. Tremendous power. Featherweight (weighs only 25 ounces!). Precision made in every detail. COATED, providing sharper, brighter images. Individual focus. Objective lens is 50mm (2 inches) across!



ALL are COATED

6x30 16 oz. Economy	\$27.95
7x35 All around use	42.95
7x50 31 1/2 oz. Sharp, bright, Bargain	36.00
7x50 Center Focus, Sale priced	39.50
8x30 17 oz. Clear, crisp	32.50
8x30 Center Focus	37.50
8x40 Streamlined	51.50
10x30 18 1/2 oz.	39.50
10x50 35 oz. More Power	62.00
12x50 35 oz. Reaches out	65.00
12x50 Center Focus, 25 oz.	67.50

6X-10X POCKET

ALL 3 ARE COATED, precision PRISM Binoculars. Superb craftsmanship. Superior in every detail.



10x They Are New! \$24.95
WEIGHS 7 1/2 OZ.! Palm sized. Full 10 Power. Color corrected. Achromatic lens. Perfect balance. Another UNITED first in revolutionary binocular developments.

6x DUO-TONE \$16.95
Illustrated. Weighs only 4 oz.! Yet has field of 375 ft. at 1000 yds.!

7x ALL CHROME \$21.95
Sturdy. Precision made. Sharp, clear vision! Sale priced.

SIX TELESCOPES IN ONE!

15 to 40 POWER
tube to click — no guesswork. Telescope measures 9" closed, 27" when extended. Weighs only 18 oz.! Has rust proof chrome tubes, large 40mm objective lens. All 12 optic surfaces are COATED. See .22 bullet holes clearly at 300 feet. Use also for astronomical observation. \$30.75 price includes fine leather case. Tax FREE!



UNITED "Seal of Quality" etched only into UNITED Binoculars. Proof they are BEST-BY-TEST. Insist on it!

UNCONDITIONALLY GUARANTEED! 30 DAY FREE TRIAL!
If not fully satisfied return for full refund! Cash orders rushed post-paid. On C.O.D.'s include \$2.00 deposit. Add Federal Tax. Prices on all of above include handsome genuine leather case and straps. SAVE by buying direct from UNITED "America's Outstanding Binocular Retailer" FREE 36 page—3 color binocular catalog lists over 60 different style binoculars, the Best by Test from 3 continents! UNITED has served over 100,000 Sportsmen! Buy UNITED and SAVE.

UNITED BINOCULAR CO.
9043 S. Western, United Bldg., Dept. ARF-5108, Chicago 20
Display Sales Rooms open 9:00-3:30 Mon. thru Fri. Dealers Wanted

side of the film track and jiggle up and down along the edges of the film at high speed. Like a photographer working a dodging mask under his enlarger to blend clouds from one negative into a scene from another negative, these saw-toothed dodgers fade the edges of the three Cinerama films where they join and blend them together so there's no sign of a joint.

Keeping those three films synchronized is something else. It's done by a servo mechanism hooked up to a control panel at which the control engineer sits. In front of him are three disks, one for each camera, marked with a pointer and the projector designation, "A," "B" and "C." If all three are in sync, the disks rotate and the pointers on their rims all pass marker points simultaneously. If one pointer lags or gains, the engineer knows he's got an off-kilter picture and adjusts the proper projector by remote control.

The big job comes at the start of the show in getting all the projectors to start together. It's done by the engineer and projectionists talking signals back and forth in the theater over an intercom.

The stereophonic sound that heightens the realistic illusion of Cinerama is as unusual as the movies. When the shooting crew is in the field, five microphones are placed to cover all the action that the camera sees. A sixth is placed well to one side or behind the camera to pick up the sound of people's voices or roaring engines that may be approaching or leaving the scene. Each mike makes an individual magnetic recording on a six-track sound tape. In the theater, five speakers—one for each of the five mikes that cover the action—are arranged behind the screen. Each speaker reproduces the sounds picked up by the mike that was in a similar position on the set. Three other speakers, one on each side wall and another in the rear of the theater, reproduce the off-stage noises that the sixth mike picked up. As a motor boat, for instance, roars across the set, the noise of its engine will be picked up by each of the mikes successively. And that's the way the sound comes out in the theater—moving sound that travels across the screen and roars away behind you.

Critics of Cinerama have decried the bulk and awkwardness of the big camera and the fact that it takes 4 1/2 times as much film to turn out a picture. Each frame is half again the height produced by a standard 35-millimeter lens and the film runs at 26 frames a second instead of 24 (to eliminate flicker which would be noticed out of the corner of the eye). Harry Squire, Cinerama's director of photography, Jack

(Continued to page 238)

BRIKCRETE



Local Manufacturers Have Broad Opportunities

Brikcrete manufacturers operate compact, self-contained plants under franchise privileges in protected territories. Each is an independently owned unit in a country-wide chain, using local materials and local labor to supply the world's most modern masonry for local building needs.

Brikcrete is rich in sales appeal because it is ahead in design, style, size, color, economy. Easily the preferred masonry. But because local production eliminates economic wastefulness,

Brikcrete can be sold at a lower-than-lumber price. Yet still allow a generous profit margin.

Brikcrete offers much to men looking for a community enterprise on a nominal investment. We supply complete equipment; easy terms when desired. Liberal cooperation. Write today for Brikcrete Book No. 2—while territory is still open.

BRIKCRETE ASSOCIATES, INC.

4679 Division Avenue, S.
Grand Rapids 8, Mich. 82

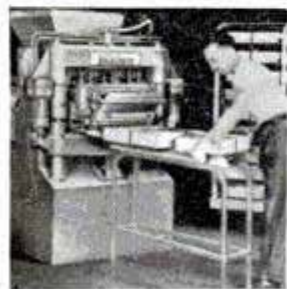



Honestly now— would you prefer a shrinking violet?

The advertisers in this magazine all claim their products are "tops." They are full of pride in their brand names.

Every so often you meet someone who objects to what he calls the "boastfulness" of advertising, but *most* of us Americans like it.

We like it because we know that deep *pride* in things well made goes way back into the factories and is reflected in the fine products we have to choose from when we go to buy the things we *use* in our homes or on our persons.

We like it because we know that pride is a spur to make better merchandise; and that it is the driving power that keeps men striving each to outdo the other in new ideas, new and better ways of doing things. The end result is a steady stream of new and better *means* to make life comfortable; more and better jobs for us to earn the means of buying them.

We will take the *Proud* ones—and let some other land cultivate the shrinking violets.

Brand Names Foundation

INCORPORATED

A non-profit educational foundation • 119 West 57th Street, New York 19, N. Y.

REMODEL . . . Kitchens-Bathrooms



Do it yourself with easy-to-install MARLITE Wall Panels

It's easy to modernize old walls and ceilings with plastic-finished Marlite panels. Beautiful Marlite never needs redecorating, cleans with a damp cloth. Big panels 5/32" thick and 4' wide, lengths to 12', go up fast over any wall. Cut and fit with ordinary carpenter tools. 63 color and pattern combinations at your lumber store now!

MARSH WALL PRODUCTS, INC., Dept. 842, DOVER, OHIO
Subsidiary of Masonite Corporation



Write for FREE
"How-to-do-it"
instructions and
Color Folder

Marlite
PLASTIC-FINISHED
WALL and CEILING PANELS



BETTER LIVING

. . . . at new low cost!

Join thousands of happy, worry-free and rent-free New Moon owners. Move to top paying jobs, enjoy travel and vacation fun — a home completely furnished and ready to live-in, including kitchen, bath and automatic heating system. Own a New Moon on our rent-like payment plan and enjoy all the comfort and advantages of genuine home ownership at once.

Free! Write today for literature describing the complete line of New Moon apartment homes.

Member of



REDMAN TRAILER CO.
40 BRIDGE ST., ALMA, MICH.

Priestly, technician, and Marty Philbin, electrician, laugh at such talk.

"Sure it takes more film per minute," says Squire, "but when we do a take, the whole countryside is covered. There's no extra shooting to cover details. We shot the whole La Scala opera in two days—got the entire stage on film as close up as you could ask. You could see the perspiration on the singers' lips. It would have taken six Hollywood crews at least a month to do a standard movie that caught all the details we got. Can you imagine how much film they'd have to shoot?"

Nobody denies the size and intricacy of the camera. It's big and complicated. With its padded aluminum blimp to drown motor noise, it measures about a yard square and weighs close to 200 pounds. But Squire, who has circled the globe eight times and trundled standard cameras into jungles to shoot films for Frank Buck, operates the Cinerama camera on all kinds of perches. The camera has ridden in a helicopter, lashed to an open hatch. On the bow of a speedboat, it was catapulted through a wall of blazing gasoline. To get a close-up of a girl in a canoe, the boys chopped a canoe in half, rigged an outboard platform between the sawed-off end and the bow of a camera boat and the camera rode at water level.

According to Squire, there's no place a regular camera can go that the Cinerama box can't go, too. But he treats it mighty carefully because it's the only one in existence. There is another one in the making but if anything happens to this one meanwhile, there will be no more Cinerama pictures for a while.

The Cinerama potential is big. Whole Broadway shows photographed and shipped around to bring the finest talent in show business to every small town; military-training films that give a recruit the feeling of things he'll face before he faces them; travelogues that will not just show people what a foreign country is like but "take" them there and "put" them in the middle of it.

One movie expert put it this way: "Cinerama is going to dump the whole world in the lap of the people—and vice versa."

★★★

Brighter Fluorescent Lamps

Forty percent more light is shed by fluorescent lamps that utilize 360-cycle current rather than the conventional 60. A magnetic converter developed by General Electric steps up the frequency of the current in the same manner that a transformer increases voltage.

SURPLUS MACHINE SHOP TOOLS AT PRICES YOU CAN AFFORD

HIGH SPEED MORSE TAPER SHANK DRILLS



Reconditioned and sharpened—ready to go! Many drills with extra lengths of flute. Immediate delivery. These drills are priced as low as 25% of your present cost and shipped post paid to you.

Size in in.	Twist Lgth.	Price	Size in in.	Twist Lgth.	Price
37/64	6 1/4	\$1.00	1-11/64	7 3/4	\$3.95
19/32	4 1/4	1.00	1-3/16	7 1/2	3.95
39/64	6 1/4	1.06	1-13/64	8 1/2	4.14
21/32	6	1.19	1-7/32	8 1/2	4.14
11/16	4 1/2	1.31	1-15/64	7 1/2	4.51
23/32	5	1.44	1-21/64	5 1/2	5.38
47/64	5	1.57	1-11/32	9 1/2	5.38
3/8	5	1.57	1-27/64	6	9.95
49/64	4 1/2	1.64	1-15/32	8	6.13
51/64	5 1/2	1.85	1-17/32	7	7.16
13/16	22	8.00	1-9/16	10 1/2	7.50
27/32	5 1/2	1.91	15/8	10 1/2	8.50
55/64	5 1/2	2.02	1-11/16	12	9.13
7/8	4 1/4	2.02	1 3/4	5	6.00
57/64	5 1/4	2.12	1 7/8	9	11.56
15/16	5 1/4	2.20	1-15/16	11	12.95
15/16	9 3/4	4.00	1-31/32	10	13.95
61/64	4 1/8	2.42	2 1/8	10	15.00
31/32	4 3/4	2.42	2 7/32	11	16.50
63/64	5	2.50	2 1/4	10 3/4	17.50
1-1/32	6	2.76	2-9/32	7 1/4	16.00
1-3/64	8	2.82	2-5/16	7	16.25
1-1/16	7 1/4	2.82	2 3/8	9	18.00
1-5/64	7 3/4	3.33	2-7/16	11	21.50
1-3/32	6	3.33	2-15/32	13	23.50
1-7/64	9	4.00	2 1/2	11	25.00
1-7/64	18 1/2	8.50	2-13/16	14 1/2	27.50
1 1/8	8 1/2	4.00	3	10	30.00
1-5/32	6 1/2	3.76	4	9	34.50

Large quantities available in every size. 5% DISCOUNT ON PURCHASES OF \$50 OR MORE. 10% DISCOUNT ON PURCHASES OF \$100 OR MORE.

HIGH SPEED WOODRUFF KEY SEAT CUTTER



SET 5 different size cutters. Can be used as mounted milling 4D cutter or circular saw. All with 3/8" and 1/2" shanks, widths up to 1/4", dia. up to 1". New and used. Ppd. Priced at only..... \$3.95

6 SLITTING SAWS WITH MANDREL

SET 6 different 34D size high speed Slitting Saws, 5 pcs. 2 3/4" dia. x 1" arbor, plus 1 pc. 5" dia. x 1/2" arbor. Thick nesses from .040 to .071. Cuts wood, aluminum, brass, steel, etc. PLUS SPECIAL MANDREL which enables use of saws in 1/4" or 1/2" electric drill. \$25 value. PPD. Only... \$4.95



7 selected, sharp H. S. Slitting Saws as above to use on your own mandrel or milling machine. New and used. Ppd. \$4.95 A bargain at.....

HIGH SPEED STRAIGHT SHANK CHUCKING REAMERS



SET 20 Different Size High Speed Straight Shank 16D Chucking Reamers up to 1 1/2". New and used. Priced at only..... \$7.95

SET 15 Different Size High Speed Straight Shank 18D Chucking Reamers from 1/4" to 1". New and used. Priced at only \$7.95

100 MOUNTED POINTS

SET 1/8 and 3/32 21D shanks, assorted shapes and sizes..... \$8.98



DOUBLE-END END MILLS

SET 4 right hand H. S., 3/8" straight 29D shank End Mills up to 3/8" dia. \$3.98

Money-Back Guarantee—All Mdse. Mixture of New and Reconditioned Tools Unless Specified Brand New — All Orders Are Shipped PPD Saving You Up to 25% on Total Delivered Cost.

Write For Free Catalog Describing Thousands of Bargain Cutting Tools.

NEW 360° SWIVEL TYPE TOOL HOLDER AND BORING BAR



Here is a tool that will do the work of a left, right and straight tool holder, plus a boring bar, all for a fraction of its original cost. Post paid to you.

TOOL A takes a 5/16" sq. bit or 5/16" dia. boring tool. Shank size 9/16"x1"x4 3/4". PPD. Only..... \$3.29

TOOL B takes a 3/8" sq. bit or 3/8" dia. boring tool. Shank size 5/8"x 1-3/16"x5 3/4". PPD. Only..... \$3.95

TOOL C. Cut-off blade holder for 3/32"x3/8" blade. Shank size 1/2"x1"x4 1/2" (can be changed to fit other size cut-off blades). PPD. Only..... \$2.25

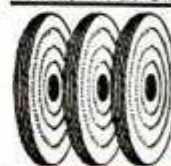

New Buffing Wheels

Approx. 5/16" thickness. PPD!

5 pcs. 7" dia.	\$1.70
5 pcs. 8" dia.	\$1.70
5 pcs. 9" dia.	\$2.00
5 pcs. 10" dia.	\$2.50
5 pcs. 12" dia.	\$2.50

Large quantity available at an enormous saving!

Bargain Tool & Shop Mixes! PPD

DRILL BITS Over 300 pcs. (2 lbs.) of used H. S. drill bits up to 1/4". Most require sharpening. Ideal for pin punches, drift pins, etc. Less than 1c ea. at..... \$2.98

2-8" WIRE WHEELS coarse and fine, 5/16" thick, 3/8" bore, pair only... \$2.29

10-1/4" SHANK DRILLS H. S., 1/4" to 1/2" new and used surplus..... \$4.95

7 ROTARY FILES H. S. 1/4" shanks \$4.49

30 GRINDING WHEELS 1/4" arbor, 3" dia. max.—w/mandrel..... \$3.29

12 FILES up to 12" length, a buy at \$3.49

300 SPRINGS all types and sizes... \$1.79

8 H. S. TAPS Std. & pipe up to 3/8" \$2.95

4 MILLING CUTTERS H. S., up to 3" dia. x 1" arbor..... \$3.98



SCOOP-R-CHARGER

Smart! New! Engineered to give you the very latest! An upper hood air-scoop which directs a stream of fresh air directly to carburetor for increased horsepower. Cooler motor—better gas mileage—more efficient carburetion. Minimizes the danger of vapor lock. Eliminates need for propping hood open for extreme summer driving.

Gives your car the customized appearance of the finest in the automotive field. Replaces the original hood ornament.

Comes chrome plated ready for installation, with modern plastic ornament. Easy installation instructions included. Fits '49 thru '52 Ford, Chevrolet, Plymouth, Mercury and Oldsmobile; '47-'52 Studebaker; '46-'52 Kaiser-Frazer. State make and year of car. Price \$9.95 Post Paid. Send check or money order. Satisfaction guaranteed.

ST. LOUIS PRODUCTS CO., Box 24-MH, Normandy 21, Mo.

© 1952 St. L. P. Co.

MAKE Big MONEY WITH THE

Universal LAWN MOWER GRINDER!

Enjoy a profitable lawn mower sharpening business of your own. No previous experience needed. Place a hand or power mower on the UNIVERSAL GRINDER. With only ONE SET-UP you quickly grind the stationary blade and all the reel blades to proper clearance WITHOUT REMOVING A SINGLE BLADE from the mower.

PROOF

G. Spurlock, of Arkansas, writes: "I have my Universal Grinder two months and made a net profit of \$227.00".

C. E. Hardy of Miss. writes: "I am doing a fine business with the Universal Grinder. I spent 40c for a newspaper ad and have done nearly \$500.00 of business." Write today for FREE FACTS about Big Profits in Lawn Mower Sharpening.

ROGERS MFG. CO., DEPT. M-82 LINDSEY, OHIO

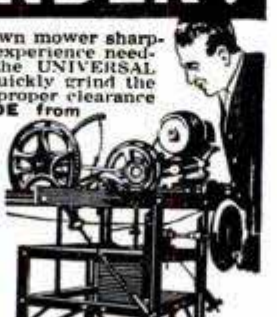

T & T TOOL 221 W. SECOND TULSA, OKLA.

SIMPLE DESIGN and FEWER PARTS MEAN TROUBLE FREE PERFORMANCE!

Ride a Bike - it's Fun!

For lasting satisfaction you can't beat a Bendix* Coaster Brake. Built to give you quicker stops—easier pedaling and longer coasting—it's the outstanding performer in its field. Your bicycle dealer will put on the brake you want—so just say "Bendix Coaster Brake." *REG. U. S. PAT. OFF.

DOUBLE THE FUN WITH A Bendix COASTER BRAKE

ECLIPSE MACHINE DIVISION of Elmira, New York

FOR SURE QUICK STARTS

INSIST ON BOWES



Corrodeless TERMINAL Battery Cables



Most battery cable trouble starts at the terminal because of corrosion or bad fit. Bowes "Seal Fast" battery cable terminals positively will not corrode. They are specially engineered, tailored to fit the posts snugly, assuring longer cable life and full power from your battery. Stop battery cable trouble before it begins. For sure, positive starts insist on Bowes "Corrodeless Terminal" Battery Cables—then you'll get all the power your battery is designed to give you.

BOWES DEPENDABLE SPARK PLUGS

Assure

SMOOTHER MOTORING

There is a Bowes Spark Plug specially designed for your car! Oversize Special Alloy Electrode—with welded construction for positive connection assures longer life. One-piece, leakproof construction.

Every Bowes Plug is individually tested to assure complete motoring efficiency. **INSIST ON BOWES SPARK PLUGS FOR SMOOTHER MOTORING.**

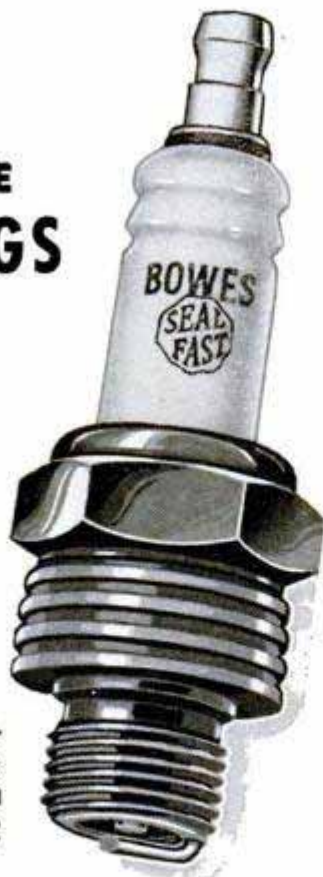

BOWES "SEAL FAST" CORPORATION
INDIANAPOLIS 7, INDIANA

The Owners Report on the '52 DeSoto

(Continued from page 92)

"My DeSoto gives me better gas mileage than any of the six-cylinder Chryslers. It has wonderful power."—Frederick, Md., salesman.

"I formerly was an aircraft mechanic. I appreciate the valve inserts, chrome-plated piston rings, full-pressure lubrication and floating oil filter, among other features. However, the engine makes a great deal of noise and uses an unusual amount of oil and gas no matter how conservatively I drive."—Hampton, Va., sales engineer.

"The DeSoto Tip-Toe transmission, in my opinion, is just one 'click' away from perfect. Sometimes it doesn't click full and you have some hesitation in shifting gears."—Los Angeles cafe owner.

"Of all the cars I have driven, none can compare with my new DeSoto Fire Dome."—Chicago lather.

"The maneuverability of the Fire Dome 8 with its power steering is exceptional."—Miami, Fla., executive.

"I have had considerable experience with Chrysler engines in my 14 years in the Coast Guard and have found them most dependable in boats, cars and other installations. They are economical on repairs and maintenance, and fuel consumption for the horsepower is very good."—New London, Conn., Coast Guard officer.

"A car is no better than the service it gets. My dealer realizes that and gives excellent service."—Denver, Colo., loan official.

"The car is just the right size—not too large, not too small."—Detroit lawyer.

"I've been a mechanic all my life and Chrysler offers the most advanced engineering in the industry. DeSoto is tops and I've owned 27 makes before my last three DeSotos."—Los Angeles fireman.

Among suggestions made by owners were:

"This car could be shortened to a 122-inch wheelbase and still ride well enough. This would give a shorter turning radius, a little less weight and would make a more maneuverable car for a salesman. The body and finish is good, but the car should be streamlined more for greater eye appeal."—Fort Dodge, Iowa, salesman.

"Car needs a face-lifting."—Baltimore, Md., bank official.

"I would like to see brighter colors in the upholstery."—Fairmont, W. Va., grocer.

"How about an accelerator pedal for each foot for relaxation on long trips?"—Detroit office manager. [Not a bad suggestion for any new car.]

(Continued to page 244)

EVERY 1/4" ELECTRIC DRILL
A PORTABLE SAW IN ONE MINUTE!

NEW! No. 445 "ARCO-SAW" for
DEPTH & BEVEL CUTS

At
Better
Hardware
Stores
Every-
where

11.50
with
all GAGES &
4" "HYCAR-
BON" Cross-
cut Blade.

No. 444 "ARCO-SAW", same as
above—less gages. Has
accurate visual guide. **9.95**
No. 444G Depth-Bevel-Rip Gage.
Easily attaches to any No. 444
"ARCO-SAW" 1.95
Extra "HYCARBON" Blades. 4"
Crosscut or 4" Combination 1.60

CAN BE USED WITH ONE HAND!
"ARCO-SAW" works like a
high priced Portable Saw.
RIGHT ANGLE GEAR
DRIVE eliminates clumsy,
dangerous direct drive with
drill sideways.

CUTS 1-1/4" or 2x4 by
turning over
CHECK THESE EXPENSIVE FEATURES:
Depth gage graduated from 0
to 1 1/4" depth (for grooves,
dados). Bevel gage graduated
from 0 to 45° angle (for dove-
tails, bevels). Rip gage with
sideways adjustment. Visual
guide with adjustment to follow
lines on both straight and bevel
cutting. **90-DAY FACTORY
GUARANTEE.**

**UNCONDITIONAL 10-DAY
MONEY BACK GUARANTEE**

ORDER TODAY at your dealer
or send us check or M.O. (Post-
paid). C.O.D.'s—postage extra.

DEALERS—Write
for nearest jobber.

ARROW METAL PRODUCTS CO.

Dept. PM-8, 140 West Broadway, N. Y. 13, N. Y.



**"BEST SANDER I'VE USED
IN 40 YEARS OF
DECORATING"**

Follow Master Decorator
Jokela's advice—get
the amazing new
"504" SYNCRO—
only sander with
Double Arc Motion
DOUBLING sanding
action! Only \$19.95
at dealers or postpaid
from factory. Circular
Free! SYNCRO Corp.,
Dept. D-82, Oxford, Michigan, U.S.A.



**CHECK YOUR FILTER
WHEN YOU
CHECK YOUR OIL!**

**BUY wix
OIL FILTER CARTRIDGES**

FIBERGLAS BOAT COVERING

The answer to your boat upkeep problems. Permanently
stops leaks, painting, worm and barnacle damage. Gives
your boat greater strength, longer life, more speed,
more beauty. Apply it yourself. Choice of colors.
Free folder.

Permafex Plastics, 1536 Sixth Avenue, West, Bradenton, Florida

CRESCENT TOOLS
Give Wings to Work

**ASK YOUR
HARDWARE
DEALER**

Get the handy
TORIT ACETYLENE BLOWPIPE OUTFIT
for soldering and all small jobs requiring heat

Consists of torch, 4 tips, soldering
copper, hose, connections for
acetylene tank, and instructions
for use.

Ideal for garages, repair shops,
home workshops, etc. Ask for
free literature on Torit Outfit No.
23 or order now. Sent postpaid
for only



\$12.00

TORIT MANUFACTURING CO.

273 Walnut St. • St. Paul 2, Minn.

Start a Business in Your Backyard



**Earn BIG MONEY
MAKING
BUILDING BLOCKS**

**General Concrete Vibrator
BLOCK MACHINE**

CAPACITY 1000 BLOCKS A DAY

only \$218 LESS MOTOR
F.O.B. PLANT

SHIPPING WEIGHT 400 LBS.



Here is a business you can start on small
capital—in your own backyard—that earns
100 to 150% profit, with unlimited oppor-
tunities. Make concrete or cinder blocks.
Millions used for homes, factories, public
buildings, garages. Sell all you make to
building trade. Do it with a General—and
you're headed for success.

1000 BLOCKS A DAY

The General is a high speed, power-driven
block machine at amazingly low cost. Rugged
all-steel construction. Simple to operate in-
doors or outdoors. Makes superior 3 core
type block meeting all code requirements.
Produces up to 1000 blocks per day. Full
operating instructions and mixing formulas
supplied. Write for FREE details.
Dealer Inquiries Invited

**Wonderful
Book Written
& Illustrated
by Experts**

**HOW TO
BUILD
YOUR OWN
CONCRETE
BLOCK
HOME**
Only 1 Prepaid

GENERAL ENGINES CO.

DEPT. M-82 • 307 HUNTER ST. • GLOUCESTER, N. J.

Includes floor plans for 6 beautiful, easy to build
concrete block bungalows. Shows ways to save
money. How to lay blocks, lay out building lines,
mix concrete, build steps, porches and concrete
floors. Mail coupon at once with \$1.

Name.....
Address.....
City.....Zone...State.....

AT LAST!



**Chisels and bits
in one handy kit!**

**Only
\$13.50**
Money
back
guarantee

Brand new. Nothing like it on the market. A rich
Cherry Wood fitted case containing six Acrabore
Auger Bits and three Witherby Woodchuck Chisels
—and in the most popular sizes. This kit keeps
the tools in one place—always handy. Protects
cutting edges too.
Woodchuck Chisels made of special crucible steel.
They take and hold an extremely sharp edge.
Handles are tough, red Tenite.
Acrabore Auger Bits are precision machined. Bor-
ing is fast and clean.
Fine tools, made by Witherby and Acrabore, two
of New England's most reputable manufacturers.
Try your hardware store. If not available, send
\$13.50 to us. We pay postage. No C.O.D.'s.

WITHERBY - Acrabore
105 DUANE STREET • NEW YORK 8, N. Y.

Low friction and

Dr. Roy K. Marshall* tells how low friction design gives you more power from less fuel.

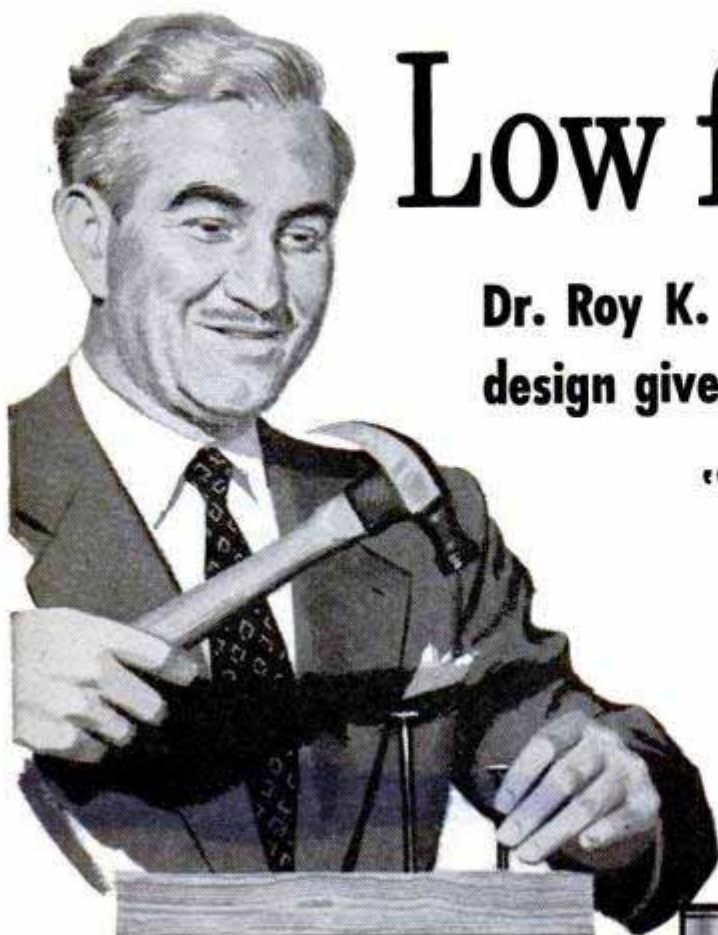

**Noted science editor, educator, and TV commentator, Dr. Marshall is nationally famous for his simplified explanations of complicated things.*

"Now the same low-friction principle has been used by Ford engineers in designing the all-new high-compression Mileage Maker Six. First they shortened the distance the pistons travel (stroke) to nearly half a mile less travel in every mile of driving, for 30% less friction and longer engine life. They designed new *free-turning overhead valves* for more even wear of both valves and valve seats and less chance of the valves sticking. *Valve guides are an integral part of the cylinder head*, not separate pressed-in pieces as in many engines. This design permits a very accurate bore and more rapid heat transfer. In fact, tests show exhaust valves run about 100° cooler."

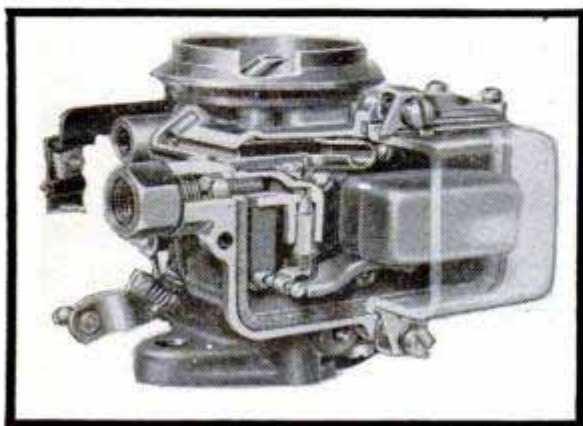
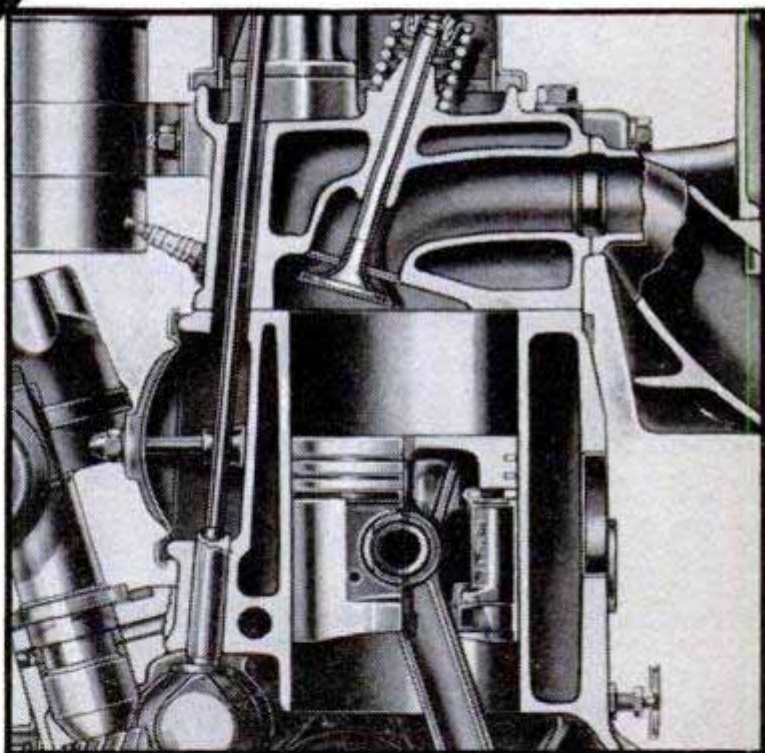

"All in all you get less friction and more usable energy . . . which adds up to more power for less money. The new Ford SIX proved this by out-saving all other Sixes in its class in the 1952 Mobilgas Economy Run.

"Ford's new unit-design carburetor with compact, easily-removed metering section to simplify servicing, is part of Ford's 'easy breathing' carburetion system. The gas mixture is fed more directly into the combustion chambers through the new overhead valves."

You can pay more but you can't buy better!
POPULAR MECHANICS

the FORD SIX

101-HORSEPOWER
MILEAGE MAKER SIX

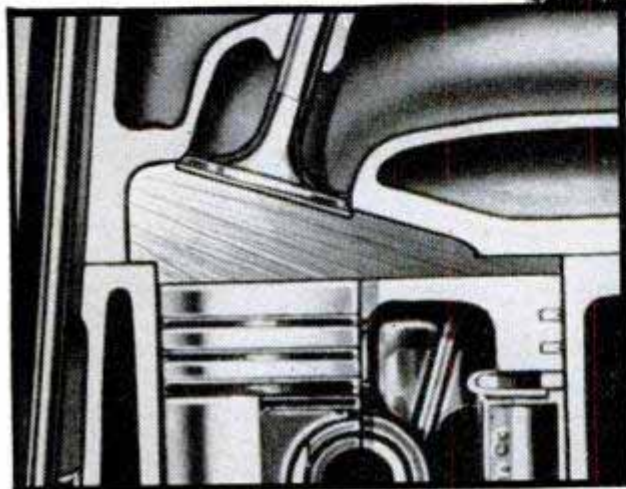
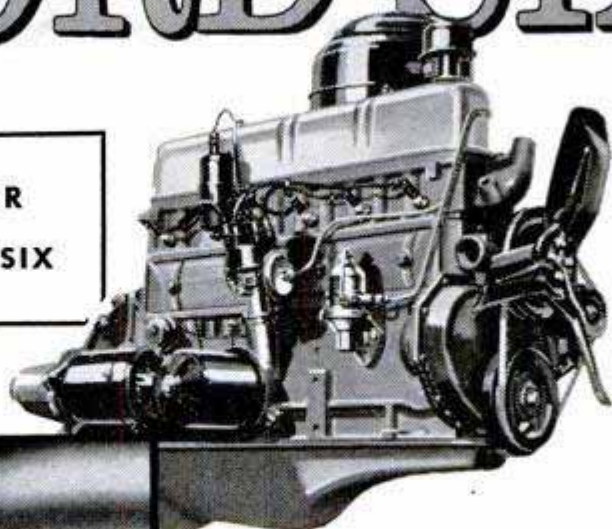

"Ford's Loadomatic Ignition, with distributor driven directly from camshaft, gives more accurate timing. And the new Power-Contoured Combustion Chambers, with spark plugs between intake and exhaust valves, control combustion so that the fuel burns evenly, completely.

"Ford engineers call this single control of fuel feeding, spark timing and combustion the Automatic Power Pilot . . . it gives you more 'go' with regular gas."

"Unlike most other engines, the Ford SIX crankcase extends deep down below the crankshaft for more support and rigidity. The flat base also permits a more effective seal between crankcase and oil pan.

"And Ford's built-in filter (exclusive with the Ford SIX in its field) cleans all the oil before it reaches vital bearing surfaces, eliminates the need for external or internal oil lines.

"For a real driving thrill, ask your dealer to let you 'Test Drive' the only all-new high-compression, low-friction SIX on the road."

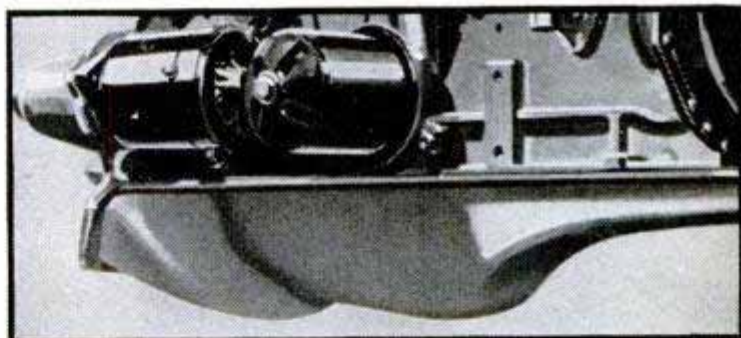

White sidewall tires optional at extra cost. Equipment, accessories and trim subject to change without notice.

The easy way to paint!

Speedy Sprayer



Favorite of home owners and craftsmen for 20 years! SPEEDY SPRAYER gives your work that professional paint finish everyone admires. Sprays paint, enamel, varnish, lacquer, etc. . . . 4 to 7 times faster than hand brushing! Lightweight, portable, uses any 1/4 H.P. motor. Improved diaphragm principle assures clean, oil-free air. You'll find dozens of time and money saving uses for SPEEDY SPRAYER, including spraying insecticides 2-4-D and DDT. Complete outfit, without motor, only \$32.50.

ONLY \$32.50 LESS MOTOR

At leading hardware, lumber, and auto supply dealers. FREE—write for handy booklet "How to Spray."

W. R. BROWN CORPORATION
2635 N. Normandy • Chicago 35, Ill.

TAKE LESS THAN 1 MINUTE TO

Keep Paint Brushes Like **NEW!**

Store Them Dry. They Stay Soft and Flexible
READY FOR INSTANT USE!

PROCESS 33
INSTANT PAINT BRUSH CLEANER

- Quickly cleans fresh paint from a paint brush or roller.
- You can paint instantly with another color—or store brush dry—it will stay soft.
- Economical—can be used again and again.
- Safe for all brushes and rollers.

Pint 59¢ Quart 98¢

G. N. COUGHLAN CO.
West Orange, N. J.

Wherever Paint is Sold

Lastly, in reply to the question "Specifically, what do you dislike about your DeSoto?" a Chicago salesman said, "Don't like to pay for it."

And now for my own test: I put the Fire Dome V-8 four-door sedan through its paces for 430 miles over good highways, winding roads in the mountains, in the desert and on back trails of the hills in southern California and northern Mexico. I

1952 DESOTO SPECIFICATIONS

	De Luxe and Custom	Fire Dome V-8
ENGINE		
Type	6-cyl., in-line, L-head	8-cyl. 90° V, incl. OHV
Bore and stroke	3-7/16 in. x 4 1/2 in.	3 1/2 in. x 3-11/32 in.
Piston displacement	250.6 cu. in.	276.1 cu. in.
Brake horsepower	116	160
Compression ratio	7.0:1	7.1:1
Transmission	3-speed conv. on De Luxe; Tip-Toe Shift with Fluid Drive std. on Custom (opt. on De Luxe), conv. with overdrive opt.	3-speed conv. opt.; conv. with overdrive; Tip-Toe Shift with Fluid Drive or Fluid-Torque Drive
GENERAL (All figures on 4-dr. sedans)		
Steering ratio	18.2:1 mechanical 16.2:1 with Hydroguide	18.2:1 mechanical 16.2:1 with Hydroguide
Steering wheel, lock to lock	5 1/2 turns mech. 3 1/2 turns with Hydroguide	5 1/2 turns mech. 3 1/2 turns with Hydroguide
Turning radius	20 ft., 2 in.	20 ft., 2 in.
Brakes	Hydraulic with bonded linings. Vacuum booster opt. on Custom	Hydraulic with bonded linings. Vacuum booster opt.
Tire size	7.60 x 15	7.60 x 15
Recommended tire pressure	24 lb.	24 lb.
Weight (unladen)	3550 lb. (De Luxe) 3660 lb. (Custom)	3760 lb.
Wheelbase	125 1/2 in.	125 1/2 in.
Tread, front	56-5/16 in.	56-5/16 in.
Tread, rear	59-9/16 in.	59-9/16 in.
Height, over-all (unladen)	65 1/2 in.	65 1/2 in.
Width, over-all	74 7/8 in.	74 7/8 in.
Length, over-all	208 3/8 in.	208 3/8 in.
Road clearance	7 1/2 in.	7 1/2 in.
INTERIOR DIMENSIONS		
Front-seat width	61 1/4 in.	61 1/4 in.
Rear-seat width	57 7/8 in.	57 7/8 in.
Headroom, front	38 in.	38 in.
Headroom, rear	36 1/2 in.	36 1/2 in.
Legroom, front	41 7/8 in.	41 7/8 in.
Legroom, rear	41 1/2 in.	41 1/2 in.
CAPACITIES		
Oil	5 qt.	5 qt.
Water	15 qt. (less heater)	22 qt. (less heater)
Gasoline	17 gal.	17 gal.

abused it, did everything I could to find its faults, and I'm convinced it's a rugged, well-designed and well-built car which owners will like and find a "toughie" under the most severe conditions.

The Chrysler Corporation knew what it was doing when it installed the new and exceptionally well-engineered V-8 power plant in the DeSoto chassis, thus offering Chrysler performance in a lower-priced and slightly smaller car.

There are a lot of things I like about the new DeSoto, such as the roominess, vision,

(Continued to page 246)

Announcing the NEW...POPULAR MECHANICS MAGAZINE LIBRARY FILE



Check these Outstanding Features

- 1 Convenient size; measures 6 $\frac{3}{4}$ " wide, 3 $\frac{3}{4}$ " thick x 10" high. Ideal for tabletop, shelf or bookcase storage.
- 2 Special Reference Index Form, printed on back, records exact location of selected articles, diagrams and other information.
- 3 Date Label Stickers—enough to index ten years issues, furnished FREE.

NEW! NOVEL! INEXPENSIVE!
Never before so much convenience and utility at such a low price. So act now. Place your order today!

INGENIOUS CUSTOM-BUILT STORAGE FILE

A Sensational Popular Mechanics Value Scoop!

Now you can preserve every issue of Popular Mechanics Magazine in orderly, chronological sequence... indexed and ready for instant reference! Made of high quality kraft fibre board, printed in rich colors and constructed to look like an attractively bound book, Popular Mechanics Magazine Library Files enhance the reference value and double the usefulness of your collection of Popular Mechanics Magazines.

Serviceable, convenient, handsome in appearance, Popular Mechanics Magazine Library Files make every volume and article instantly accessible. No more hunting for the issue or special data you want. No misplaced copies. A "must" for every reader of Popular Mechanics. Order now for immediate delivery. Use the handy coupon below.

PER SET OF 2
(Set holds 12 issues)

Only

70¢

POSTAGE PAID

5 SETS **\$3.10**
ONLY

10 SETS **\$6.00**
ONLY

POSTPAID

Best of all, production economies by the distributor service organization appointed by us to serve your needs—plus our large volume purchases—makes the phenomenally low cost of the Libraries possible.

USE THIS COUPON...Mail Today

POPULAR MECHANICS MAGAZINE, Dept. PL
200 East Ontario Street, Chicago 11, Illinois

PS-52

Please rush PREPAID _____ sets Popular Mechanics Magazine Library Files.

Remittance for \$ _____ is enclosed.
(AMOUNT)

PRICES — 1 set (2 files) Holds 1 yr's. issues only \$.70
5 sets (10 files) Holds 5 yr's issues only \$3.10
10 sets (20 files) Holds 10 yr's issues only \$6.00

Includes Prepaid Parcel Post anywhere in U.S. and Possessions

Name _____

Address _____

City _____ Zone _____ State _____



If
you could



Badly rusted in
just one year!
Ordinary
water heater

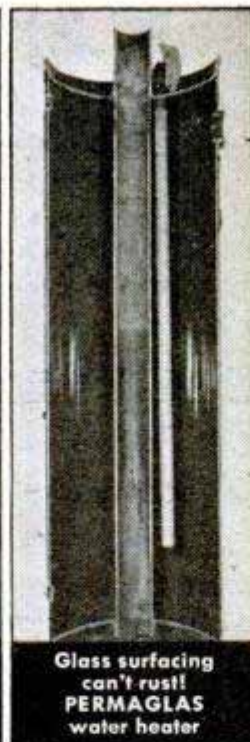

Glass surfacing
can't rust!
PERMAGLAS
water heater

look inside your water heater
you'd know why people are buying A. O. Smith

Perm Maglas[®]

Automatic Water Heaters

You'd be shocked if you could see the rust-pitted interior of an ordinary water heater after only a year's use . . . like the one above. No wonder ordinary water heaters are soon replaced!

Only a Perm Maglas water heater, with glass-surfaced steel tank, is fully protected against rust . . . because GLASS CAN'T RUST! Be safe. Buy an A. O. Smith Perm Maglas gas or electric model in adequate size for all your hot water needs for years to come.

COSTS NO MORE than ordinary water heaters

the **ONLY** water heater with **Four B.I.** protection,
Four Basic Improvements by A. O. Smith:

1. Glass-surfaced steel tank can't rust because *glass can't rust!*
2. Absence of dissimilar metals inside tank!
3. Interior tank fittings shielded from electrolytic action . . . the cause of all corrosion!
4. "Neutrolizer" . . . the anti-corrosion stand-by protector!

For complete information on Perm Maglas automatic water heaters, write: A. O. Smith Corp., Dept. PM-852, Kankakee, Illinois.

A.O. Smith

PERMAGLAS-HEATING PRODUCTS

Manufacturers also of A. O. Smith
GAS Conversion Burners,
Home-Heating Boilers,
Warm-Air Furnaces and
Commercial Water Heaters



Gas, Electric and LP-
Gas Models. UL and
AGA Approved.

chair-height seats and extremely comfortable driving position. There is a lot of leg-room, and a tall man can get in and out of a DeSoto without knocking his hat off. I do not like the panel that extends forward and down—actually it is a continuation of the instrument panel—reaching nearly to the floor above the feet. There are two slots in this panel where the air is expelled from the heater.

The doors open by a twisting motion of the handle and can be closed easily. I especially like the quick operation of the windows, as only two complete turns of the crank handle are required to raise or lower them. The seat cushions extend far forward under the knees and are as comfortable as those in any car in which I have ridden. All glass in the test car was slightly tinted (an optional feature) to help reduce sun glare.

The windshield is two-piece, which some may not like, but it is more economical to replace than the curved one-piece type. The windshield wipers are electric, which insures steady operation regardless of the throttle opening in hilly country. They have two speeds, slow and fast, and are controlled by a lever on the cowl.

The instruments are well-located. The heater is excellent, and controls are within easy reach of the driver. As in all Chrysler products, the cowl ventilator is retained. I prefer this type because less dirt, dust and fumes enter the car. Tunnel vents on either side of the engine, which are found in some other cars, are much lower to the ground than a cowl ventilator.

The radio is excellent. A neat map light located below the left side of the cowl comes on when either front door is opened. Glove-compartment space is average.

The starter is operated by a turn of the ignition key with the right hand—a very convenient arrangement. The starter will not operate when the car is in gear, which is good. The choke is automatic.

My test car had Tip-Toe Shift with Fluid-Torque Drive, which multiplies the torque, thus affording faster acceleration and quicker power response than with ordinary Fluid Drive. Operation is smooth; there is no noticeable jerk in shifting—only a click when the throttle is released and the automatic shift into high gear takes place. However, the up-shift into high is sluggish and much too slow.

Downshifts from top gear are quite noticeable when the throttle is depressed to engage the lower gear (below 57 miles per hour.) A gear-shift lever still is used, offering selection of two forward positions (one for regular use and one for heavy pulling

(Continued to page 248)

YOU SAVE time...money...
annoyance with ***GENUINE***
FORD PARTS because...



**Genuine Ford Parts are made right to
fit right to last longer – and**
TRACK TESTED TO PROVE IT!

You're smart to make *sure* that replacement parts used in your Ford are Genuine Ford Parts. They're made exactly to Ford specifications. They're tested and proved in grueling tests on the Ford test tracks by the men who built your Ford. No other replacement parts can offer you all these advantages. It pays to keep your Ford *all* Ford.



Available at
all Ford Dealers and
selected independent
garages.
Look for this sign.



Drive in where you see this sign

***LET'S GET
ACQUAINTED***

AMAZING NEW INVENTION KILLS ALL TYPES OF INSECTS SCIENTIFICALLY • AUTOMATICALLY

New!
20TH CENTURY
BUG WEAPON



ONLY \$6.95 COMPLETE
COST ONLY PENNIES A MONTH TO OPERATE

MORTRON WITH MORTANE MEANS DEATH

TO DISEASE-CARRYING, DESTRUCTIVE AND ANNOYING PESTS

More powerful than DDT. Yet harmless to humans, pets, and plants. Only pennies a day will protect more than 10,000 cu. ft. of space from flies • roaches • mosquitoes • ants • moths • termites • spiders • silverfish • Japanese Beetles • thousand leggers • chicken lice and hundreds of others. Kills for hours after removing plug.

ODORLESS • SILENT • MYSTERIOUS



Simple to operate. Just fill with Mortane wonder crystals, then plug in any 110 volt AC or DC outlet. Clean and small enough to be hung on wall of the susstest place. Perfect for business establishments—farm buildings—restaurants—groceries . . . any place where the insect problem exists.

"AMAZING!" Users Say

"Has completely cleared the roaches out, also keeps flies out."
—Mrs. C. I. Thompson,
Moline, Kansas

"With MORTRON working, your worries from this source (insects) are under control."
—J. S. Reynolds,
Daytona Beach, Fla.

"It works like a charm. I am amazed at its results."
—Mr. Jules Pinto,
Atlantic City, N. J.

FREE!

240 hours supply Mortane wonder crystals with machine.

TESTS PROVE RESULTS

Prominent testing companies found 80% of insects dead after 7 minutes — 100% of insects dead after 9 minutes. Over 1/2 million satisfied users.

DID YOU KNOW?

Medical authorities suspect the house fly and cockroach as carriers of the much-dreaded POLIO. ACT NOW. SEND COUPON TODAY

REFILLS GUARANTEED ALWAYS AVAILABLE

Over 240 hour supply 50¢; Over 1000 hour supply \$1.95. Order extra supply. Mortane wonder crystals always available.

10-YEAR GUARANTEE

Not a gadget — not a half-way measure. Not to be compared with flimsy, untried imitations. Mortron is a finished quality appliance. Carries an ironclad 10-year must-work guarantee.

DOUBLE GUARANTEE

NO RISK 7 DAY TEST

#1 Factory Guaranteed for 10 years. #2 Test MORTRON for one week. Mortron must kill pests to your satisfaction. It must outperform any unit regardless of price. Or return within one week for \$6.95 refund without question. Enclosed find check, M.O. or cash for _____. Send me the new miracle bug weapon. NO EXTRA CHARGES. SEND C.O.D. I'LL PAY POSTAGE

Name _____
Address _____
City, State _____

VOLUME SALES OUTLET, 1209 Oregon Ave., Phila. 48, Pa.

For Your Health's Sake Mail Coupon Now!

or quicker acceleration) and reverse. DeSoto still has two foot pedals. One is the clutch pedal, which DeSoto has marked the Safety Clutch and which now has been eliminated in other automatic-transmission installations. It must be depressed before either of the shift-lever positions or reverse is engaged. Once engaged, the clutch can be forgotten and the car can be controlled from a standstill to top speed and down again by throttle and use of the brake.

The hydraulic brakes which Chrysler pioneered are tops, and very little pedal pressure is required, especially when the brakes are power-assisted. The emergency brake is on the driver's left, and close ratchet graduations and a pivoted bracket make it easy to operate and convenient to reach. The hand lever operates a band brake on the propeller shaft; personally, I would prefer an emergency brake which acts on the rear wheels instead of the propeller shaft.

The center dome light is well-located and operates by a switch on the driver's side.

The test car had the 160-horsepower V-8 engine with overhead valves and hemispherical combustion chambers, which DeSoto calls the Fire Dome. It is a new Chrysler development. A high-compression ratio (7.1 to 1) is used, yet regular gasoline is satisfactory. The acceleration is extremely good. There is no noticeable vibration. The engine is flexible and throttles down to a walk in high gear. Actually, it is the same as the Chrysler Fire Power with a slightly smaller bore and displacement (276.1 cubic inches and 160 horsepower for DeSoto, compared to 331.1 cubic inches and 180 horsepower for Chrysler). The DeSoto, 250 pounds lighter than the Chrysler Saratoga, offers approximately the same performance in acceleration, power and top speed because of the cars' nearly identical horsepower-to-weight ratios. The reliable six-cylinder DeSoto engine also is available for the 126-inch wheelbase chassis (same as the Chrysler Saratoga). The body styles are identical for either power plant—thus DeSoto caters to either six or eight-cylinder-minded buyers, and installation of either engine is, of course, economical and practical from a manufacturing standpoint.

I couldn't make the car squeak, rattle or overheat and found only a few things I disliked. The test car was equipped with Hydraguide power steering (designed and built by Gemmer—long-time makers of good steering units). Until you get used to it, there is a definite inclination to "oversteer." In power steering, the ratio is excellent. Movement of the steering wheel from lock to lock requires only 3½ turns.

(Continued to page 250)

MONTH AFTER MONTH, YEAR AFTER YEAR, YOU SEE OUR AD.
REMEMBER IT'S DANGEROUS to pay less if you want the finest (nonskid) USED tires.

GOOD YEAR  **Firestone** 

GOODRICH, UNITED STATES, GENERAL & OTHERS, NOT RECAPS
DOUBLE WARRANTY & UNCONDITIONAL GUAR. ON PASS. TIRES

Our policy is to select your tires so carefully, as if our very future depended on the service given by that particular tire.

FREE TUBE WITH EVERY GOOD GRADE & FINEST GRADE, TRUCK & PASSENGER TIRE

GOOD GRADE TIRES—GUAR. 20 MONTHS (Not Just 6 or 12 Mos.)	
600-16 \$4.14	820-15 \$5.44
650-16 5.42	700-15 4.54
700-16 5.04	670-15 4.48
650-15 4.44	710-15 4.68
760-15 5.04	550-17 4.64

FINEST GRADE 30 MONTHS GOLDEN RULE GUARANTEE BOND (NOT JUST 24 MONTHS) THIS GRADE MADE US WORLD FAMOUS	
600-16 \$5.48	700-16 (6) \$8.78
600-16 (6) 7.38	475-19 5.08
650-16 5.98	640-15 5.08
650-16 (6) 8.28	670-15 5.68
700-16 6.48	710-15 5.88
750-16 9.78	760-15 6.08
525-18 5.08	300-15 6.58
550-17 4.98	820-15 6.68
650-15 5.39	670-16 6.38
700-15 5.58	760-16 7.58

MILITARY MUD-SNO TREAD	
750-20 \$10.08	750-20Rg. \$16.68
600-16Std. 6.18	600-16Rg. 9.98
900-16Std. 10.08	900-16Rg. 16.68

BLATT BLATT BLDG., GIRARD & LANCASTER AVES.
DEPT. PM, PHILADELPHIA 31, PA.
Send check or money order. Send this ad with order. We won't ship a tire we wouldn't use. "3 GENERATIONS OF 'TIRE BLATT'S'"
Shipments RUSHED Down South, Up North and Far West

Save Time!!! Save Money!!!
SEND FOR THIS BIG, NEW
Woodworkers Catalog No. 19

ONLY **15c** New low prices...great selection of fine domestic and imported woods...bargains in hard to get supplies--144 pages of items and ideas for woodworkers. Quick delivery on mahogany, walnut, maple, cherry, poplar, oak, red cedar, and others properly seasoned, kiln dried. Send 15c for your copy--TODAY. Dept. A-8

CRAFTSMAN WOOD SERVICE CO.
2729 S. MARY STREET • CHICAGO 8, ILLINOIS

POSTPAID ANYWHERE IN U.S.A. WE FURNISH ALL MACHINED METAL PARTS, EVERY SCREW, NUT, BOLT, WASHER, AND COMPLETE PLANS FOR THIS...

BIG 10" POWER SAW

\$10.95 FULL REFUND IF LESS GUARD & WOOD IN 10 DAYS NOT SATISFIED

COMPLETE PLANS 10c
MARCUS-POLLAK
DEPT. N, ROYERSFORD, PA.

ASSEMBLE IT YOURSELF WITH SIMPLE HOUSEHOLD TOOLS!

READERS — WATCH FOR THIS!

Beginning in the big September issue of **POPULAR MECHANICS MAGAZINE**, there will be a new section called — "Shopping for Living and Giving."

In this new section you will find added opportunities to satisfy your needs and wants by mail. The merchandise and services presented will be different from most of those previously available to you through the pages of *Popular Mechanics*.

Watch for this wonderful new shopping section in the September issue!

RELIEVES PAIN OF HEADACHE • NEURALGIA NEURITIS

FAST

The way thousands of physicians and dentists recommend



Anacin® relieves headache, neuralgia, neuritis pain fast because Anacin is like a doctor's prescription—that is, Anacin contains not just one, but a combination of medically proven, active ingredients in easy-to-take tablet form. Thousands have been introduced to Anacin through their own dentist or physicians. If you have never used Anacin, try these tablets yourself for incredibly fast, long-lasting relief from pain. Don't wait. Buy Anacin today.

BUILD AN ARC WELDER FROM OLD GENERATOR

For Light or Heavy Work. 75-200 amps. No previous experience needed. Complete **PLANS 35c**, Electrical & War Surplus Catalog included. Or, Catalog, 10c.

LEJAY MANUFACTURING CO.
1347 LeJay Bldg., Minneapolis 8, Minn.



OWN A... PLYMOUTH?

FIX IT YOURSELF!

Popular Mechanics Magazine has just published a new **Owners Manual** covering all 1941 to 1952 models of Plymouth cars. So accurate mechanics use it... so simple a woman can understand it.



Save money on your Plymouth repairs. Prevent trouble. Enjoy care-free driving. Increase trade-in value. Avoid major repairs by fixing minor troubles before they get serious. Get sparkling performance at all times. Has 272 pages, more than 350 photos, diagrams, tables, charts, breakdown drawings, plus clear, non-technical directions that make all repairs simple as ABC. Written by Ed Packer with assistance of Chrysler Corporation. Shows you how to diagnose Plymouth troubles by feel, sound, sight, smell and performance. Simple trouble shooting. Permanent repairs. Emergency repairs. Plus, "How to get value from garages."

MONEY BACK IF IT DOESN'T SAVE MORE THAN IT COSTS!

One minor repair will save the cost ten times over. Read it. Then you decide. If you don't see that you'll save more than the cost, send it back for refund. **SEND NO MONEY.** Send postcard. Ask for **PLYMOUTH Manual**. Postman will deliver C.O.D. for \$3.50 plus postage. Or, save postage by sending \$3.50 with order. Send today. Save its cost on your next repair.

POPULAR MECHANICS PRESS
200 E. ONTARIO DEPT. 18 CHICAGO 11, ILLINOIS

The Saws You Want



at the prices you
want to **PAY!**

RETAIL SELLING PRICES	
For Rip, Cut-Off, Easy-Cut and Combination Saws.	
6" - \$1.75	9" - \$2.65
7" - 2.00	10" - 3.15
8" - 2.15	12" - 4.35

Supplied with Round or
Special Shape Holes

As listed in Simonds
Catalog "B"

SIMONDS SI-CLONE SAWS

Best buy in years for home-workshoppers, contractors, and schools... these *guaranteed* saws of Simonds famous quality. 13 types, including carbide-tipped, dado heads, and metal-cutting saws, up to 12" diameter, with round or special-shaped center holes for all electric hand saws. Look at these prices...and try to beat them at Simonds quality level! Drop in on your hardware dealer today...tell him you "want to see Simonds SI-CLONE line."

Guarantee
Made of SIMONDS STEEL
fully guaranteed against
any defect in material or
workmanship.

SIMONDS
SAW AND STEEL CO.

FITCHBURG, MASS.

Factory Branches in Boston, Chicago, San Francisco, and
Portland, Ore. Canadian Factory in Montreal, Que.

Until one becomes used to its operation, the required movement of the wheel is so slight that it is confusing. After rounding a turn, the car does not right itself as nicely as a car with conventional steering; slight help from the driver is necessary to straighten the wheels to normal position.

As the power-steering unit operates only when the engine is running, the wheels turn very hard when the engine is not in operation. Effortless power steering definitely is here to stay, but the unit price still is high—slightly less than \$200. Women especially will like Hydraguide steering because of the slight steering-wheel pressure required and because, with the unit, parking can be accomplished with as little effort as driving on the highway. One finger will turn the wheel even when the car is in a standing position.

The sedan I tested had excellent roadability although, like most Chrysler products, the front end seemed quite flexible and there is some "float" at high speeds. And the new DeSoto certainly does have high speed! It is one of the fastest stock four-door sedans I have ever driven. On long stretches the speedometer would read 105 to 107 miles per hour—but, as on all other makes, I found it fast by about nine percent.

The self-compensating shock absorbers, called Oriflow, which DeSoto uses are the same as those on other Chrysler products. They are excellent shocks and certainly provide a comfortable ride at all speeds and under all road conditions.

The trunk space is large and the lid opens easily. The hood is locked from the front end. I would prefer an inside lock, which prevents theft of under-hood units. The hood is counter-balanced and stays open without the use of a rod, and I like this arrangement. The air scoop at the front of the hood on the new DeSoto is not only attractive but it is not a "phony." It serves to direct a steady flow of fresh air to the air-cleaner intake.

The front and rear bumpers are massive and of the wrap-around type. Rear fenders, as in other Chrysler products, are not a part of the body but are removable, which is an advantage if they have to be replaced. The body is solid and well-built. Doors fit well; the test car was dust-tight and water-tight.

I experimented with both premium and regular gasolines of two brands. Although 39 percent of DeSoto owners reported they use premium gasoline, I found regular gasoline to be satisfactory.

The car has good economy for its size and horsepower (see my Economy Chart). In the 1952 A.A.A.-supervised Mobilgas

(Continued to page 252)



Try YOUR Voice! Talk! Sing! Play! It's Fun! Over 100 Practical Uses!

Broadcast Thru ANY Radio!

Test & improve your voice, playing, thrill & fool friends. Do acts, surprise programs, imitate Crosby or Hope, announce games & events, be disc jockey, etc. Practice broadcasting, be popular. Educational, over 100 practical uses. Users say: "Riot of fun—many other uses too!" "Bargain—does the work of \$50 unit."

- How do YOU Sound?
- Public Address Amplifier
- Intercommunication System
- Jokes, Party Fun, Home Entertainment
- Secret Detectaphone, Overhear Others
- Announce People and Events



Use with 1, 2 or more radios for powerful public address system, music amplifier, etc. Use to overhear private conversations, baby or burglar alarm. Used by show barkers. Talk as you walk! Improve personality! Speak better! Sing & Play better! Learn techniques worth many dollars. Do "fake" broadcasts. "Call all cars!" Used for home, school, games, office, shop, etc., etc. Wonderful for announcing games, events, etc. Saves you time & money! Even make money renting it out for games, parties, dinners, speeches.



New Micro-Vox Wireless Microphone

Use It Anywhere! Broadcast to Car & Portable Radios Too! \$8.98 Complete!

No Wiring! No Connections! Do Not Touch Radio—Works Normally

NEW SELF-CONTAINED PORTABLE TRANSMITTER. Broadcasts over ANY radio within 75 feet. Even talk from one car to another! No adapters; no experience needed. High fidelity, professional tone, adjustable volume. Tuning dial. READY FOR IMMEDIATE USE. Electronic 1-tube unit, complete with long-life replaceable batteries. Beautiful walnut plastic housing, 6-in. high. Operates indoors or outdoors. Uses war-surplus parts; limited supply. Amazingly low-priced. (Better still, save by ordering 2 for only \$16.95) **\$8.98**

Send to: JOHNSON SMITH & CO.

Dept. 540

Detroit 7, Michigan

MOTORIZE YOUR BOY'S WAGON FOR \$18.70

Make it REALLY USEFUL and LOTS OF FUN for him

SEND CHECK OR MONEY ORDER DIRECT TO FACTORY



Boys from five to twelve safely run and enjoy a motorized wagon. Learn many lessons they can use later. Entire cost only \$18.70, if you now have wagon and motor. Any small gas engine is suitable. Price includes all pulleys, belts, shafts, and instant clutch. We have new wagons and motors available. WAGON CAN BE CONVERTED IN LESS THAN AN HOUR.

With a small ELECTRIC motor, wagon makes enjoyable and never falling entertainment in the recreation room. Can be safely operated by a four year old.

Money cheerfully refunded ANY TIME YOU CAN TAKE THE WAGON AWAY FROM THE CHILDREN

AMERICAN DROP FORGE 12675 HAGGERTY ROAD BELLEVILLE, MICHIGAN



MAKE all the MONEY YOU WANT—FAST!

Make up to \$4.00 a pair selling exclusive Cushion Shoes

New 3-Sole style sensation! 2 Full Leather soles, hand hammered tap sole, heel-to-toe cushion arch support. Fast sellers in dress, work, sport shoes. ONLY Cushioned Paratroop Boot. Big spare time income. No experience or investment needed. Samples to producers. Write NOW for FREE Outfit.

PARAGON SHOE CO.

718 Columbus Ave., Boston, Mass.

FREE OUTFIT

Say You Saw It in Popular Mechanics

NOW—40 different CUTS with AMAZING, NEW



Warren
DADO SAWING WASHERS
On Your Saw Blade
Just dial widths to cut parallel grooves perfectly smooth. No warp, vibration

or trick screws. Strengthens blade, perfect balance. GUARANTEED! At your dealer's or order direct. Give arbor size—1/2", 3/8", 3/4", 1".

Send for free booklet

WARREN WASHERS COMPANY
Dept. 28, Box 98 North End Station, Detroit, Mich.

ONLY **\$4.95** PER SET

SHEET METAL BRAKES

Forms angles, flanges and Pittsburgh locks. 26 gauge steel, heavier aluminum. Cam locking. Portable, can be bolted to bench, or clamped to edge of truck. All steel, reinforced. Shipped Exp. Coll. 30" size. Wt. 54 lbs., \$26.50. 36", Wt. 66 lbs. \$31.00.



48", Wt. 100 lbs. \$45.00. Floor mountings, portable, 32" high, 30 lbs. \$7.00. 12" BRAKE. Fits in vise to form difficult compound bends, up to 20 gauge steel. Not illustrated \$12.50 PP. Forms hooks, angles, eyelets, etc. Capacity 1/4 x 2", or 5/16 x 1 1/2". 10 parts all steel \$10.00 PostP.

Immediate Delivery. Order direct, cash, or C.O.D. or send for folder. **VYKE BRAKE CO., P-1116 So. 27th St., Omaha 5, Nebr.**

5 BIG POWER TOOLS in ONE

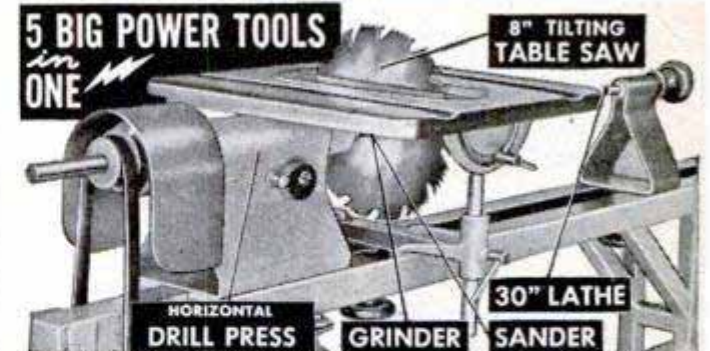

RETAIL PRICE \$125.00 **\$79.95**

FACTORY TO YOU

SUPERSHOP is a PRECISION-BUILT WORKSHOP. 100% ball bearing. All running parts precision ground. Big capacity. Extra rugged. Amazing value. Write for FREE catalog.

BUY ON EASY PAYMENTS

POWER TOOLS, INC.

138 YATES AVENUE
BELOIT, WISCONSIN



VERTICAL DRILL PRESS



WYTEFACE
TRADE MARK
STEEL TAPES

No squinting, no guessing when you use WYTEFACE Steel Tapes. Jet black markings (foot numbers in red) on a white background. Easier to read in *any* light. Faster, more accurate measurements. Rust-resisting, hard to kink, simple to clean.

Protected by U. S. Patent 2,089,209

K+Σ

"I'll take the WHITE one every time!"

KEUFFEL & ESSER CO.

How To Make Lumber More Valuable To You

On doors, windows, flooring

Treat all sides and edges with Cuprinol before you paint—Cuprinol resists moisture and minimizes the swelling and shrinking of fitted millwork.

On stakes, porches, steps, gutters

Wherever wood is used, especially in contact with masonry or the earth, Cuprinol treatment will prevent rot and termite attack, and greatly lengthen the service of the lumber.

On plywood wherever used

A coat of "Clear Cuprinol" forms a protective layer against dampness to prevent grain raising and checking, and consequently provides a lasting smooth finish beneath paint, varnish or stain.

For boats and wharves

Cuprinol treatment is unusually effective, either in salt water or fresh, against marine growth and boring insects as well as against rot. It is widely used here and abroad in wooden boat construction and for the protection of canvas, mooring lines and other rope.

CUPRINOL®

THE NAPHTHENATE
WOOD PRESERVATIVE



It is moisture resistant, deeply penetrating for surface use, of extra strength and quality, harmless to handle, and an excellent priming coat. "Green Cuprinol" contains copper. "Clear Cuprinol" zinc. Carried by Lumber dealers and Marine Supply stores, and by many Hardware and Paint stores, in gallons and quarts. Or write for information.

CUPRINOL, 5 Elm Street, Simsbury, Conn.

Economy Run from Los Angeles to Sun Valley, Idaho (1415 miles), a DeSoto V-8 won first place in Class E with 54.7368 ton-miles per gallon and 21.2777 actual miles per gallon. (Average speed of all competing cars was 40 miles per hour, and the average gas mileage for 26 contestants was 22 miles per gallon.)

In addition to our survey by mail, I personally interviewed many owners and for the most part found them to be staunch enthusiasts. Included in our mail survey were 52 percent DeSoto repeat owners. Because DeSoto is a member of the Chrysler family, owners were assured of good dealer-service representation; 76 percent of the owners reported excellent or good dealer service, 20 percent said they secured average service and only 4 percent said their DeSoto dealer service was poor—a very low percentage.

After the severe test I gave the DeSoto Fire Dome V-8, I would rate it as an excellent automobile and good value in the present market. ★ ★ ★

Fifty Years of Exploration

(Continued from page 99)

and their guide, Frank Swanda of Anchorage, set out July 9, 1950, from their base camp at Devil's Canyon, where they'd been set down by helicopter, with everything modern science could supply for comfort and speed. Two big Douglas aluminum "air skiff" boats (air-lifted to the base camp) with big outboard motors carried them, their .375 Magnum bear guns, survey equipment and modern rations into the current of the canyon river. For two days they pushed, poled and dragged their boats over sand bars that hadn't shown in the aerial survey they'd made before the trip. By July 13, they'd surveyed two dam sites and finally hit deep water. At the mouth of the Tyone River, they picked up their last cache of gasoline, dropped in advance by float plane.

Then they began to encounter boulders and white water. The rapids boiled faster as they proceeded and drenched them with spray. They stopped often to bail. As the lead boat bearing Roberts and Johnson rounded a bend, it hit three shore-to-shore swells that sent the craft wheeling crazily. The load shifted and in a moment it had capsized. Minutes later the second boat did exactly the same. Gone were their guns and supplies—deep in the heart of unexplored bear country. Choking, they were swept down the rapids clinging to the keels of the upset boats. Roberts and Johnson

(Continued to page 254)



Quantity Purchase! Save Over Half!

16-INCH ELECTRIC FAN WITH FULL 2-YEAR GUARANTEE

Buy at less than wholesale . . . and beat the heat this summer. This gleaming, modern beauty with large 16-inch blade span will air-condition homes, shops, offices, hotels, churches, stores, etc. Extremely quiet, powerful motor costs less than a penny a day to operate. Gleaming 18" guard and best grade Torrington "Varified" blade. Complete with 6 ft. cord and plug with convenient switch in the line. 110-volt 60 cycle AC. Base and column are handsomely finished. Unit stands 25" overall. Adjustable head can be tilted in any position. Shipped knocked down to save shipping costs. Assemble in five minutes with screw driver and pliers. Weight 18 lbs. Satisfaction Guaranteed. Order NOW - this price can't be equalled.

\$1975 Post paid

\$1.00 additional West of Rockies

SAME DAY SHIPMENT

DEALERS WANTED . . . WRITE FOR QUANTITY DISCOUNTS

ROBERTS ELECTRIC CO., 849 W. Grand, Dept. 19, Chicago



MAKE YOUR OWN! WITH

GRIFFIN LEATHERCRAFT KITS

Best assortment of tools, materials in U. S. A. Send 25¢ for 116-page catalog. (money refunded first order)

GRIFFIN CRAFT SUPPLIES

SINCE 1924

5626-A Telegraph Ave., Oakland 9, Calif

HASTINGS

STEEL-VENT PISTON RINGS

The best money you can spend on your car!

Build your own JET ENGINE!



SEND NO MONEY

Order these plans today

1. JET PROPELLED BICYCLE. Assemble your own. Photo and Instructions, \$1.00.
2. HOW TO MAKE EXPERIMENTAL JET ENGINES. Seven sheets drawings with information and Instructions \$2.95.
3. BOTH OF ABOVE in one order \$3.75. SEND NO MONEY. Order both at once \$3.75 C.O.D. in USA plus c.o.d. postage. Send check or Money Order and we pay postage. Get other information too. Rush Order.

J. HOUSTON MAUPIN, Dept. 55, Tipp City, Ohio

Easy-to-Build Old-Time Autos!

FREE! Write for Your Copy of Our 4-Color FOLDER

Authentic models—6" to 10½" in length—to assemble in your leisure hours! All our kits include shaped parts, wheels, lights, horn, radiator, etc. and Instructions. Choice of 16 antique autos—\$1.95 to \$3.95 each.



1904 OLDSMOBILE \$1.95

IF YOU ORDER DIRECT, add 25c for postage and handling.

Hudson Miniatures' "OLD TIMERS" Antique Auto Sets
SCRANTON HOBBY CENTER, Dept. 14, Scranton 10, Pa.

ELECTRICITY Anywhere

FOR PORTABLE, EMERGENCY OR HOME USE

ONAN Electric Plants generate 110-volt, 60-cycle current for homes, farms, cabins and resorts beyond the highline. Lightweight, portable plants cut costs, speed work for contractors. Standby plants protect units against power failure. 400 to 55,000 watts. Gasoline or Diesel-powered. Priced from \$219.00.

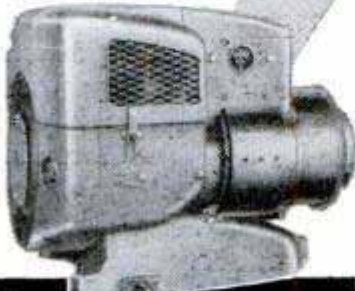

WRITE FOR CATALOG

D. W. ONAN & SONS INC.

5860 UNIVERSITY AVE., MINNEAPOLIS 14, MINN.

Make Your Shop More Useful

WITH
Atlas

PRECISION
TOOLS

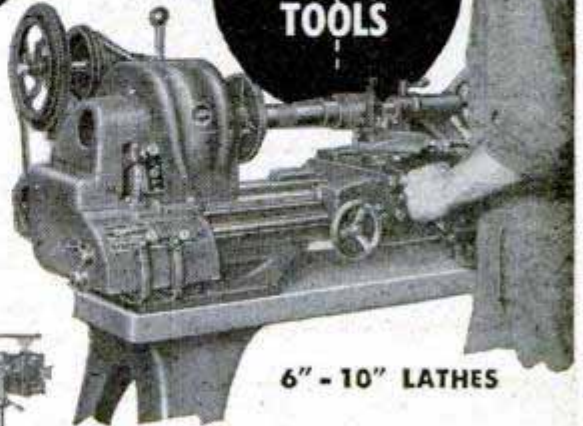

6" - 10" LATHES



DRILL PRESSES



MILLING MACHINES



SHAPERS

Atlas are the ideal tools for machine shops, small parts production, experimental labs, and home shops. Look them over thoroughly if you need the wide range of operations they provide at low cost.

Atlas 10" lathes, for example, give you *wider speed selection* and *greater versatility* than any other low cost lathe. Timken bearings, heavy precision-ground bed ways, back-gear power, wide threading range, V-belt drive — assure you of dependable precision production and lasting accuracy. Atlas drill presses, millers, and shapers are thoroughly proven companion tools to complete your shop equipment.

Fill in and send the coupon below for latest catalogs. See why Atlas tools are today's best buy.

Send For New
FREE
Catalog

ATLAS PRESS COMPANY

824 N. Pitcher St.
Kalamazoo, Mich.



ATLAS PRESS CO., 824 N. Pitcher St., Kalamazoo, Mich.

Please send latest information on Atlas tools.

- 10" lathe; 6" lathe; drill press;
 miller; shaper;

NAME _____

ADDRESS _____

CITY, STATE _____

**AT LAST... a genuine
PLASTIC LAMINATE
you can apply
YOURSELF!**

LAMIDALL®

**for walls, top surfaces
and 101 other uses!**

You've seen Lamidall on restaurant counters, on table tops and on walls of stores, offices and homes... wherever attractive, durable surfaces are needed. You can get Lamidall in beautiful wood grains and colorful patterns in easy-to-handle, easy-to-work panels up to 4' x 12'. You can cut it, drill it, and easily bond it to other surfaces. See Lamidall display at your lumber—floor and wall covering dealer.

**SPECIAL
OFFER**

**Send only \$1.00
for large trial panel!**

Send \$1.00 TODAY for a 11 1/2" x 47 1/2" panel. Specify wood grain or pattern, either light or dark shade. Shipped express collect.

**TOUGH 1/8" THICK
STRUCTURAL PANELS**

with a hard, durable, glass-smooth plastic surface that resists abuse, stains and heat...easy to cut and apply!

Here are a few ways you can use Lamidall:

- WALLS
- COUNTER TOPS
- TRAYS
- SHELVES
- WINDOW SILLS
- SHADOW BOXES
- TOYS
- SEWING BOXES
- DOOR KICK PLATES
- HOT DISH PADS
- FURNITURE
- CUT-OUT LETTERS

WOODALL INDUSTRIES INC.

3518 OAKTON STREET • SKOKIE, ILL.

**THE EASY WAY
TO DRILL & SAW**

**Powerful
Cummins #190 Electric
DRILL & SAW KIT**

Factory Guaranteed

Includes 1/4" Drill (1700 RPM, 115 V. AC-DC); 4" Saw Attachment (Adjustable); 1/4" Capacity Jacobs Chuck; 3 Steel Twist Drills; Horizontal steel drill stand, which converts drill into bench grinder, buffer, polisher, sander, etc. Attractively packaged. Instructions included.

Postage 50c additional.

Send check or M.O. COD's, \$5 deposit.

GOLDEN ELK PRODUCTS CO.

12 East 41st St., N.Y.C. (17), HA 9-7810

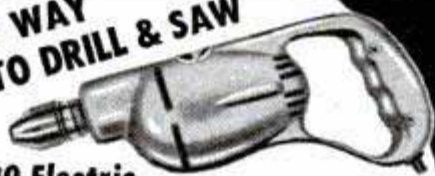

Only
\$19.95
\$27.95 Value
**DANDY
FOR HOME &
SHOP USE**
10 day
money back
guarantee

**It's NEW, BIGGER, Better
The DELTAGRAM...**

• 6 GREAT ISSUES Only \$1.00 •

Priceless information at a wonderful bargain price—The New, Bigger, Better Deltagram!—With more than 100 shop-tested projects, complete plans, "how to do it" instructions—6 times yearly all for only \$1. Nothing like it at any price!

•

**Subscribe now... write to
DELTA POWER TOOL DIVISION
Rockwell Manufacturing Company
502H N. Lexington Avenue
Pittsburgh 8, Pennsylvania**

finally left their rocketing craft and hit for shore. They made it just as the other boat hurtled past, flipped over and whirled in a shallow eddy where Jaskar and Swanda managed to beach it. But Robbins was picked up by the current and carried off. He came ashore several miles downstream after Herculean efforts.

For a week the men, all their supplies and guns gone, lived off the subarctic wilderness and a few items that had washed ashore after the upset—a can of powdered milk, baking powder, a sack of soaked flour, a can of dried eggs, a waterproof container of matches and a tarpaulin. One musette bag contained survey instruments and paper clips. From the latter, Jaskar fashioned fishhooks. They made rods of willow, leaders of bits of blasting wire Swanda had in a pocket, and line pulled from the tarpaulin. They swatted flies for bait. With this gear, they caught 74 fish during their sojourn in the wilderness.

Their distress signal was a series of driftwood poles in the form of an X, with an orange lifejacket placed at each tip. Cooking utensils came from gas and oil cans. They whittled ladles from crate wood and made forks from willow branches. Meanwhile, with their meager supply of instruments, they proceeded to survey near-by Vee Canyon for a dam site.

July 17 had been set as the date for helicopter search in case they hadn't come back. But no helicopter showed. Actually, two pilots of the famous Tenth Rescue Squadron had flown one in, sighted the abandoned boat on a beach and tried to land beside it. But they crashed. Two more men were lost in the wilds. Next day another Tenth Rescue C-47, looking for the lost helicopter, spotted both parties. Another helicopter went out and the entire group came back to civilization intact.

Later in the year, the same group went back to finish the job on Vee Canyon. This time, they went in by helicopter but once again cracked up on landing. They shot birds with their bear guns and lived on a cache of supplies they found in an old prospector's hut until once again they were rescued by helicopter. Dull? Hardly. And as a result of their persistence and courage, Vee Canyon has been proved a feasible site for a power dam which one day may be a key to opening the vast Alaskan wilderness. That's exploring today—the kind that pays off. By the way, the airmen of the Tenth Rescue Squadron have saved some 2000 lives in the past few years since Bernt Balchen organized that fabulous group.

(Continued to page 256)

BUILD YOUR OWN POWER TOOLS - TILT/ARBOR SAW



TILT/ARBOR SAW BANDSAW BELT SANDER
 ● 27x28 in. table stays level. Blade tilts full 45 degrees. ● 10 in. blade cuts 3 1/4 in. deep, jack-screw depth adjustment. ● Floor model, 34 in. table height.
SAVE \$50. OR MORE

● New Departure ball bearing arbor, 3/4 in. precision shaft, ready to run, 5/8 in. bore blades. ● Quick positioning, self-aligning rip fence guide. ● Sturdy wood, steel and aluminum construction. ● No machining—build easily with hand tools only. ● Capacity and performance of floor saws selling for \$150.00 and up!

GIL-BILT Metal Parts Kit, includes Plans, ball-bearing arbor, cast aluminum miter gauge and bar, rip fence guide, machined lock knobs, jackscrew mechanism with 4 1/2 in. hand-wheel, and all other metal parts (less blade) \$20.95
 Same Kit with 10" combination blade..... 24.90
 If not satisfied, return Kits in 10 days for refund of purchase price.

(Prices include postage up to 300 miles. Over 300 add 5%)

GIL-BILT Step-by-Step pictorial plans (No blue-print reading required), full scale patterns, actual photographs for above **10" TILT-ARBOR SAW, 12" BAND SAW, BELT SANDER, 8" TILT/TABLE SAW** \$1.00 each, postpaid anywhere in the world. ALL 4 Plans for \$3.00, or write for FREE descriptive catalog.

COMPLETE PLANS only \$1.00 EACH

GILLIOM POWER TOOLS P.O. Box 1-PH, Lambert Field, St. Louis 21, Missouri



CAPE COD CHAIRS TRELLISES • ARBORS DUTCH WINDMILLS

Chairs style B-C-A PLANS 50c Ea., all 3 only \$1.00. 12 different trellis designs PLAN of all 12 only 50c. Au-140" high Lighthouse having copper lantern, ideal for garden or on lake shore of summer home. Large detailed PLAN 75c. **SPECIAL** all plans above \$3.00 val. Only \$2.50. Send 10c for catalog **Craftsman's Model Co.** Dept. P43 DELAFIELD, WIS.

250 POWER.....

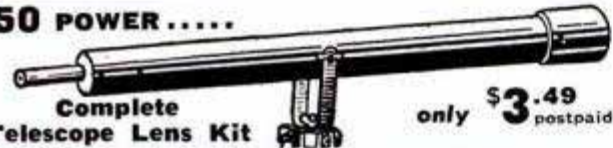

Complete Telescope Lens Kit only \$3.49 postpaid
 Conquer Space, Explore the Universe, Planets, Moon Craters, New Stars, etc. Complete Lens Kit consists of 80 inch focal length ground and polished objective lens, eyepiece lenses for 50 POWER, 100 POWER, 150 POWER, 200 POWER, 250 POWER, and all necessary lens fittings. Easy to make from simple step by step instructions. (Tripod and mount not included.) Money back guarantee.

BUSSE SALES CO., Hartford, Conn., Dept. PM5

DRAINS Cellars, Laundry Tubs; CIRCULATES Oil; IRRIGATES Gardens

Original "Type P" Pump has 2400 GPH capacity. 360 GPH 75" high, or 1500 GPH from 25" well. Use any 1/8 to 1/2 HP motor. DOES NOT CLOG. 1" intake; 3/4" outlet.
 Postpaid if cash with order. (West of Miss. add 50c.) Motor coupling included. **MONEY BACK GUARANTEE**
 Also Gear Pumps in all sizes.



LABAWCO PUMPS, BELLE MEAD 7, N. J.

WHEELS

JUVENILE, INDUSTRIAL, AGRICULTURAL

Write for Literature and Price List. CIRCLE METAL MFG. CO. 4266 E. Pacific Way, Los Angeles 23, Calif.

NEW 3 DIMENSIONAL ILLUMINATED VIEWER FOR 6x13 CM. STEREO CAMERA OWNERS

Film size: 2 Vues on 620 or 120 (2 1/4 x 2 1/4"). Complete with Mounting Kit, template, instructions.

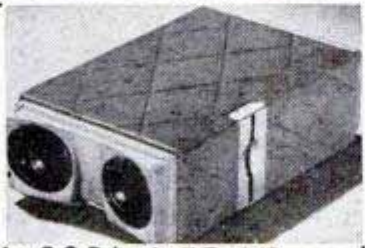

Postpaid in U.S.A. No C.O.D.'s **\$42.50** Money Refunded Guarantee.....
 Now stereo pictures for all camera owners: box, miniature or press. Send 50c and name and type of your camera. Full instructions how you can make stereo vues sent to you.

SYNTHETIC VISION CORPORATION
 4505 ARCADIA BLVD. DAYTON, OHIO

NEW! ALL ABOUT TELEVISION

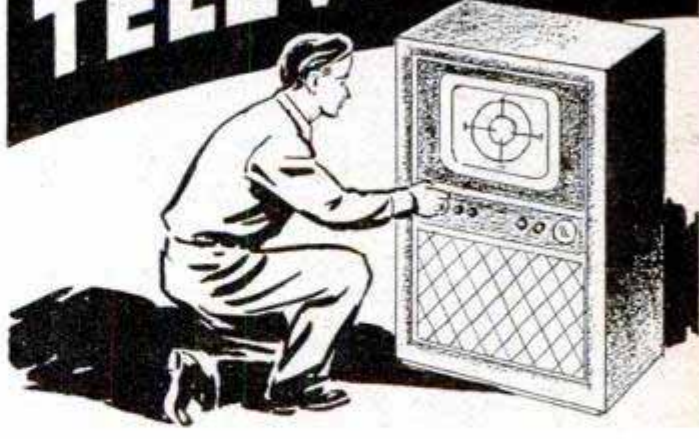

Service Your TV Set Yourself and Save Hundreds of Dollars... Save on the Purchase of a New Set!

Here's the brand new book that tells and shows you how 9 times out of 10 you can service your TV set yourself and save the \$5 to \$25 fee charged by professional repairmen for service calls.

Here are famous step-by-step instructions by John Derby, famous television engineer, which make it possible for you to locate trouble quickly and repair it in the matter of minutes. Hundreds of "show-how" photos, drawings and diagrams actually show you just how to go about making most TV repairs.

A special illustrated section contains actual photographs of imperfect TV pictures. By comparing the picture on your set with those in the book you immediately identify the trouble and then by following Derby's instructions you make the adjustment or repair which will give you perfect reception once again.

Find out how to install your own antenna at a savings of as much as \$20... how to replace burnt-out picture tubes... how to get the best reception in outlying areas... how to save money when buying a new set... what to look for when you purchase a TV set.

Go with Derby into TV studios and see stars in action... see how television shows are produced and what goes on "behind the scenes." No other TV book on the market is so comprehensive and so chock-full of valuable information. No other book can save you so much money.

Send just \$3.00 for your copy of "All About Television." Read it for seven full days and unless you agree that it can save you hundreds of dollars and enable you to service your TV set yourself just slip it back in its wrapper and return it to us for a full refund. Use the handy order blank today.

Order on this Handy Coupon

POPULAR MECHANICS PRESS
 200 E. Ontario Street, Chicago 11, Ill.

Remittance for \$3.00 enclosed. Rush postpaid my copy of "All About Television." Unless it is entirely satisfactory I may return it within seven days for a full refund.

NAME _____

ADDRESS _____

CITY _____ ZONE _____ STATE _____

Send C.O.D. (Postage extra)

40 TO 600 POWER

15 Combinations! Professional

MICROSCOPE \$29.95

Model #635

Ppd.

At last! The FIRST instrument with this range of performance ever offered under \$125. Every feature needed for advanced university, pre-med and medical school use. Triple revolving turret containing 10X, 20X and 40X achromatic objective lenses. Achromatic condenser. 6-aperture revolving iris. Two-side plano and concave substage mirrors. Solid base, excellent precision construction. Complete with fitted hardwood case. With 15X eyepiece (giving 150X, 300X & 600X) less mechanical stage.

SET OF EXTRA EYEPIECES \$9.95 Ppd.

For above model #635 microscope 4X, 5X, 8X, 12X interchangeable eyepieces in hardwood case, giving a total in all of 15 different powers from 40X to 600X. Complete set of 4 in case.

MODEL #400 MECHANICAL STAGE \$14.95 Ppd.

Shown on model #635 microscope. Made only for this instrument. This is an optional accessory which allows you to move the slide microscopically right, left, up or down without touching slide. This calibrated stage cannot be duplicated for less than \$45.

(If microscope is ordered without mechanical stage, we will fit your instrument with fine spring steel, clip-type slide holders.) Shipped in fitted hardwood case.

100 200 300 POWER

Triple Turret MICROSCOPE \$14.95 Ppd.

Laboratory Model - The instrument that amazed biology instructors. Excellent optical qualities, adjustment, solid construction. A lifetime bargain for students, schools, labs, amateur researchers. Anyone can now own one! (Performance cannot be duplicated for \$75.) USES: animal, plant and mineral research. Study plant cells, microscopic animal life, crystal structure. See the complex anatomy of tiny insects, larvae, eggs. An absolute necessity in hundreds of fascinating fields. Shipped in hardwood cabinet.

FREE CATALOG: WORLD'S GREATEST VALUES IN QUALITY OPTICS. MICROSCOPES, ACCESSORIES, PREPARED SLIDES, MAGNIFYING GLASSES, LOUPEs, BINOCULARS. EVERY ITEM A BARGAIN! SENT ON REQUEST OR INCLUDED WITH YOUR ORDER.

MONEY-BACK 10-DAY GUARANTEE ON ALL ITEMS. SEND CHECK, CASH OR MONEY ORDER. 20% DEPOSIT REQUIRED ON ALL C.O.D.'S. CALIF. RESIDENTS ADD 3% STATE TAX.



the AKRON 4400 SUNSET BLVD. OPTICAL DEPT. 8-PM
LOS ANGELES 27, CALIF.

MODERN LAWN MOWER SHARPENER

Service departments of leading lawn mower manufacturers use the Modern Lawn Mower Sharpener. One lever moves lawn mower into grinding position. Gasoline and oil remain in engine while sharpening, no dismantling of wheels, roller or handle. The Modern is a precision bed knife grinder—no extra grinder to buy. Imitated but never equaled—Compare before you buy.

If it isn't a Modern it can't be Modern

(Prices subject to change without notice)

MODERN MFG. CO.

160 N. Fair Oaks - Pasadena 1, Calif.



WRITE FOR FREE BOOKLET 10D

\$263.00
with motor
F.O.B.
PASADENA

INSIDE-OUTSIDE PAINT PEELER

"Paint-Dozer"

\$9.95
complete



Strip paint to bare wood at rate of 6-10 feet per minute! Big 16 sq. in. heating area blisters paint... attached rear blade strips it off in one continuous motion! Ideal for house exteriors, boats, cabinets, all woodwork. Excellent painter's tool! Faster, neater than blowtorch! Operates on household electric current. Even beginners do fast, clean work with "Paint-Dozer". Has long-lasting ceramic 1,000° Hi-Temp heating element; heavy stamped-steel construction; Marinite insulation; pistol-grip hardwood handle. Complete with front and rear detachable blades and skids; groove and ridge cleaners; 8 ft. neoprene cord; safety stand; attachable front guide handle for horizontal work. Fully guaranteed! Order from your dealer, or write today for this professional tool. Fast shipment.

OTTO KONIGSLOW MFG. CO., DEPT. T

3610 PERKINS AVENUE . . . CLEVELAND 14 • OHIO

PERHAPS one of the most exciting and mysterious regions of the world is Central Asia—that waste of deserts and mountains from Afghanistan and Tibet to the tundra and deserts of Mongolia and Siberia. Roy Chapman Andrews, a young American naturalist, first struck out into the Gobi Desert in 1916, jogging along on his camel with lines of Mongolian ponies bringing up the supplies. The wilderness was so vast, however, he decided on some swifter form of travel. Back in the States, he staggered the exploring world with the announcement that he was going back to follow up his prehistoric discoveries, and do it with automobiles! On all sides he was laughed at—impossible, they said. But young Doctor Andrews was not to be put off by the cynics. In Detroit he met the Dodge Brothers and unfolded his plans for a motor caravan. They liked the idea. Soon Andrews was back in the Gobi, bouncing along in his Dodges. Sure, some of the cars had flats, and others bogged down in the sands, but they were always hauled out. The gamble had paid off big and Andrews returned to America with one of this century's most sensational paleontological discoveries—giant eggs of the dinosaur! Since then automobiles have helped open vast unexplored areas of the world's deserts with those romantic names—the Gobi, the Takla Makhan, the Kalahari, the Sahara, the Atacama (over which I flew this past summer) and the Arabian (where I went with T. E. Lawrence and Emir Feisal some 36 years ago). Today it seems only a matter of time—and politics—before all these desert lands are completely explored.

Of all the historic parts of the world, Central Asia has always held more fascination for me than any other area. What lies behind the 20,000-foot Himalayan peaks? In the '20s I crossed Baluchistan and Waziristan, and thence to Afghanistan—the first time the Amir of the Afghans had ever allowed his country and people to be filmed. On that expedition Amanullah, King of Kabul and Light of the World, paraded his court and courtiers before our cameras.

It was not until the summer of 1949 that I was able to set out on the trip I had always dreamed of making—across the Himalayas to Tibet and then by caravan over the roof of the world to the capital of the Dalai Lama's hermit kingdom, the fabulous city of Lhasa. It seemed a chance in a million when permission came through for Lowell, Jr., and me to make the "forbidden journey." Again, of course, we had our cameras and were able to bring back a color film of those strange and mysterious people in a land where a fourth of all males

(Continued to page 258)

NO MORE BURNED-OUT ENGINES DUE TO LACK OF OIL! NO MORE RAISING THE HOOD! NO MORE OIL WORRY!

OIL-D-CATOR is more than a gadget . . . It operates on a novel but simple pneumatic-hydraulic principle so you can check the oil level from the driver's seat without raising the hood and before starting the engine.

It's neat, compact, and can be installed in about 5 minutes. All fixings are included and no tools are needed.

Get yours today for a worry free drive.

GUARANTEED COMPLETELY RELIABLE

*Fords and Chevrolets only
State year and number of cylinders.*

\$4.95

COMPLETE. PREPAID.
Cash, check, or money order.



Pat. App. for

Reg. Trade Mark

OIL-D-CATOR CO.
BOX 406, WILMINGTON, DELAWARE

GIGANTIC SURPLUS SALE!

- Power Plants
- Hand Winches
- Chain Hoists
- Telephones
- Binoculars
- Barometers
- Air Compressors
- Water Pumps
- Electric Tools
- Contour Levels
- Flood Lights
- Air Grease Guns
- Paint Spray Outfits
- Gasoline Chain Saws
- Weed Spray Outfits
- Magnetic Recorders
- Hydraulic Units
- 100s other items

We pay all freight. Rush card for illustrated bargain sale catalog. Send today.

FREE
CAT-
ALOG

BURDEN SALES COMPANY

812 "O" ST.

LINCOLN, NEBRASKA

Life Time **WALL TILE** Plastic
Per Square Foot **34c**
Buy Direct & Save **34c**

Modernize your kitchen or bathroom. We teach you, instructions free. Earn big money modernizing your neighbors' homes with Plastic Wall Tile. Send \$2.00 for kit of samples—20 smart colors—complete with instructions. Cost of kit credited against first order.

MONEY BACK GUARANTEE

O'NEIL TILING CO., Dept. T, 1521 W. 87th St., Chicago 20, Ill.

BUY LU-MAR ALL-PURPOSE PUMP

To fill outboard motors, lawnmowers, etc. \$3.00 postpaid, less can. Strainer and shut-off, 75c. Money-back guarantee.

LUCAS METAL PRODUCTS CO.
952 Exchange St. Rochester 8, N.Y.



Treasure and Minerals
Easily located with new Lightweight M-Scope Detector. Superior performance, lowest price, monthly payment plan.

FREE LITERATURE

FISHER RESEARCH LAB., INC.
PALO ALTO CALIF.

PRECISION SPEEDOMETERS FOR OUTBOARDERS



Accurate within 1% — corrosion resistant — easily installed. Four models to choose from, each providing an absolutely accurate check on performance. No. 204, red steel case, 0-35 miles . . . \$7. No. 201, 0-35 miles . . . \$12; No. 202, 10-50 miles . . . \$14; No. 205, 20-70 miles \$18.90. (Polished aluminum cases.) Write for FREE Outboard catalog. Also describes complete line of fine boat fittings and propellers for superior performance of all outboard motors old or new. Michigan Wheel Co., Dept. PM-58, Grand Rapids, Mich.

NEW 1952 KING MIDGET AUTO

World's Lowest Priced 2 Passenger Car Drive it for 75c per week. Amazing performance. Surprising comfort. All steel construction. Full accessories, top and heater. Ready to run or assemble it with our bolt together parts. Send 25c for detailed literature or \$1 (refunded first order) for actual assembly book and service manual filled with photos, drawings, specifications, etc.



MIDGET MOTORS MFG. CO.
ATHENS, OHIO

HELPFUL BOOKS

Send post card asking for FREE catalog

Popular Mechanics Press, 200 E. Ontario, Dept. 601, Chicago 11

OWN A... CHEVROLET?

FIX IT YOURSELF!

Popular Mechanics Magazine has just published a new Owners Manual covering all models and years of Chevrolet Cars. So accurate mechanics use it. So simple a woman can understand it.



Save money on your Chevrolet repairs. Prevent trouble. Enjoy care-free driving. Increase trade in value. Avoid major repairs by fixing minor troubles before they get serious. Get sparkling performance at all times. Has 288 pages, more than 300 photos, diagrams, tables, charts, breakdown drawings, plus clear, non-technical directions that make all repairs simple as A B C. Written by Ed Packer with assistance of General Motors Corporation. Shows you how to diagnose Chevrolet troubles by feel, sound, sight, smell and performance. Simple trouble shooting. Permanent repairs. Emergency repairs. Plus "How to get value from garages."

MONEY BACK IF IT DOESN'T SAVE MORE THAN ITS COST!

One minor repair will save the cost ten times over. Read it. Then you decide. If you don't see that you'll save more than the cost, send it back for refund. SEND NO MONEY. Send postcard. Ask for CHEVROLET Manual. Postman will deliver C.O.D. for \$3.50 plus postage. Or, save postage by sending \$3.50 with your order. Send today. Save its cost on your next repair.

POPULAR MECHANICS PRESS

200 E. Ontario Dept. 187 Chicago 11, Illinois

AMAZING TOOL BARGAINS!

ALL BRAND NEW MERCHANDISE

112 PIECE ASSORTMENT FOR ELECTRIC GRINDER \$3.95

\$10.00 VALUE — ONLY **Post-paid**
 Here's what you get! Mounted Stones on 1/8" mandrel, Drum Sander, Sanding Sleeves for sander, Rotary Cutters, Wire Scratch Brush, Bristle Brushes, Circular Saw, Buffing Wheel, Grinding Wheel, Rubber Polishing Wheel, Cut-off Wheels, Rubber Cylinder, Mandrels to fit above tool, asst'd. Sanding Discs, Sharpening Stone, etc.

12 MOUNTED WHEELS and points on 1/8" Shank, \$2.95

Post-paid
 For grinding on plastic, wood soft and hard metals. Regular \$8.40 List Val. 12 wheels on 1/8" Shank \$3.60

18 MOUNTED POINTS ON 3/32" SHANK \$2.50

SCHUPACK SUPPLY CO., 7331 Cottage Grove, Dept. M-33 Chicago 19, Ill.

NEW 1952 Illustrated Catalog 10c

PRECISION T.C. PARALLEL CLAMPS

Made of the finest quality for the craftsman. Hardened throughout. Metal clips to hold screw in place on return.

Opening	Price Each	PREPAID DELIVERY
5/8"	\$1.10	IMMEDIATE SHIPMENT ON ALL ORDERS
1"	1.35	
1 1/2"	1.55	
2"	1.90	
2 1/2"	2.15	
3 1/2"	3.85	



Dealers and distributors write for details.

PRECISION T. C. COMPANY
 1305 S. Laramie Ave., Cicero 50, Ill.

Say You Saw It in Popular Mechanics

BE YOUR OWN BOSS

Make Hundreds of \$ Spare or Full Time Work

NO EXPERIENCE NEEDED

Here is the ideal business with no previous experience or large investment required and no high-priced equipment to buy. A business that will return dollars for the pennies you invest.

YOU CAN CAST ANYTHING

With *Flexible Mold Making and Ornamental Casting*, an amazing fact-packed book, you learn how you can cast practically any article in concrete, plaster, imitation marble or any other casting material using a marvelous new process. You can make ash trays, novelties, garden and lawn ornaments and hundreds of other highly profitable items that cost you but a few cents and sell for as much as \$5.00 and more. Why you can even make true-to-life full-sized busts of your neighbors and friends.

NO EXPENSIVE MOLDS TO BUY

Why buy high-priced molds from others? Learn how you can make your own molds quickly, easily and inexpensively with materials that can be used over and over. You get copyrighted formulas, complete instructions and detailed how-to-do-it photographs as well as complete sources of supply for the few inexpensive materials you need. This is the only book printed in America today that contains instructions for making profitable papier-mache casts.

MONEY BACK GUARANTEE

Start on your road to extra income and independence today. Send only \$3.00 for your copy of *Flexible Mold Making and Ornamental Casting*. Complete satisfaction guaranteed or your money refunded within seven days.

POPULAR MECHANICS PRESS, Dept. 46
 200 E. ONTARIO ST., CHICAGO 11, ILL.

You can make simply and cheaply



BUSTS



GARDEN URNS



NOVELTIES



TILE



STATUARY

are monks and lamas. We visited and photographed the Dalai Lama's palace — the Potala, nearly as high as the Empire State Building — and Drepung — largest monastery in the world, home of 10,000 monks — in a highly civilized country where there isn't a wheel, except a prayer wheel.

Although we covered well-trodden caravan trails across the 17,000-foot passes to the Forbidden City, one innovation we can lay claim to was the first use of radio recording. We sent back to CBS a complete account of our progress across the Himalayas and our near-tragic return journey to India — when my horse hurled me down onto a boulder and broke my hip in eight places, on a lofty and remote pass far from any medical aid.

The past 50 years have provided some of the most exciting adventure and mystery stories in the history of exploration. A perennial newspaper headline is the "Discovery of Colonel Fawcett." Endless travelers claim to have seen or heard of Fawcett alive in the wilds of South America — and I seem to have had a share of the stories on my broadcasts, too! In 1925, Col. Percy Fawcett, an Englishman, went into the jungles of Brazil's Matto Grosso to look for the ruins of a lost civilization.

During mapping expeditions in Bolivia, Peru and Brazil, Fawcett heard tales of a forgotten race of white Indians. Intrigued by the idea that these might be old Inca survivors of El Dorado, the mythical City of Gold, Fawcett persuaded the Royal Geographical Society in London to help him finance an expedition. On May 20, 1925, a report was sent by the expedition from deep in the Matto Grosso saying that they were heading into the Indian country beyond the Rio das Mortes — the River of Death. After that — no more. It was not until two years later that rumors began to circulate about the fate of Colonel Fawcett and his son. Rescue expeditions set out but the jungle never gave up the secret of the lost seekers of El Dorado. Last spring the Brazilian government proudly announced that it had cleared up the mystery by finding the bones of Colonel Fawcett. It now appears, however, that the jawbone was not that of the colonel, or so says his London dentist. Late in summer while in Brazil, I discussed this with South American explorers — two priests who had just walked in and flown out of the same unknown. It took them 80 days on foot to reach the nearest settlement where a plane could pick them up. They were still optimistic that the Fawcett mystery will be solved.

Much of the Amazon basin — that vast confusion of swamps and jungle where

(Continued to page 260)

"My Dad's smarter'n your Dad"



BETTY: He is not!

BILLY: He is too. How about that wrench your Dad bought last week? It's already broken—and today he had to borrow one from my Dad.

BETTY: What of it?

BILLY: Well, if he'd bought a *good* wrench, like the one *my* Dad has, it wouldn't be broken now.

BETTY: Oh, you think you're pretty smart, don't you?

I'm not saying *I'm* smart, but my Dad is. He says people who buy tools at bargain counters are just throwing money away. He gets all his tools at the hardware store, and he always looks for the brand name before he buys. He wouldn't even pay *one penny* for a wrench like your Dad bought—because there's no brand name on it.



POPULAR MECHANICS



**OVER 700%
PROFIT!**
WITH THE
**PDQ CHAMPION
PHOTOMASTER**

Makes finished pictures in 2 minutes.
Takes and finishes 30 to 40 everlasting, black and white or sepia photos an hour. No dark room. Guaranteed not to fade. Photos taken on "SUPER SPEED" direct positive paper. Picture size 2 1/2 x 3 1/2 in. Complete, easy-to-operate portable photo studio. Size 4 1/2 x 5 x 10. Wt. 6 lbs. **700% PROFIT.** Write quick, get details about the great **PDQ CHAMPION PHOTOMASTER.**

P D Q CAMERA CO.

1161 N. CLEVELAND AVE. Dept. PM-8 CHICAGO 16, ILL.

BeMaCo Dependable

**AUTOMATIC
SAW SET**

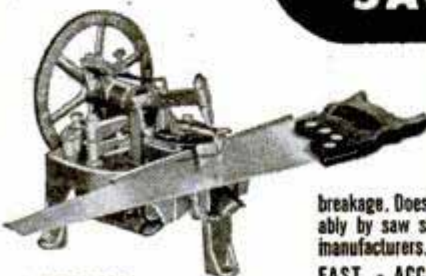

Sets 400 teeth per minute on hand or band saws 4 to 16 point. Hammer and anvil action sets teeth accurately and uniformly... No tooth breakage. Does a perfect job. Used profitably by saw shops everywhere and saw manufacturers. Every machine guaranteed!

FAST - ACCURATE - DEPENDABLE

★ INCREASES
PROFITS

BEAVER MFG. CO.

Saw Machine Div. #13-M
800 SO. ISIS AVE. • INGLEWOOD, CALIF.

**PLEASE
SEND ME**

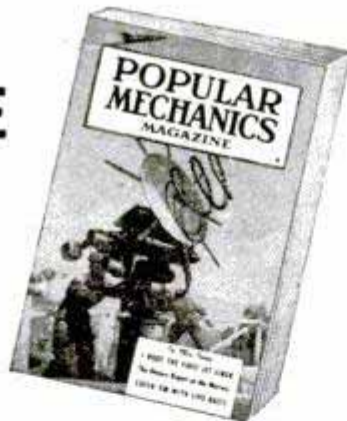

for the
time checked.
I am enclosing . . .

1 year \$3.50
2 years \$6.00

name _____

address _____

city _____

zone _____

state _____

C-72

Hand this order to your newsdealer or send it to

POPULAR MECHANICS
200 East Ontario St. Chicago 11, Ill.

huge anaconda snakes, electric eels, sting rays, alligators and flesh-eating piranha fish lie in wait for the unwary—is still largely a blank on our maps. Today, an Anglo-American expedition is high in the Andes of Peru searching for the source of the river.

No matter what happens to exploration, people will always debate the question, "Who got there first?" Right now there's a squabble in the making over the discovery of the Orinoco. Recently a party of French scientists led by a Venezuelan, a Doctor Cruxent, claimed to have reached the true headwaters after hacking their way through dense jungle and the gorges of the Sierra Parima. They were blazing a trail first sought in 1618 by Sir Walter Raleigh. Their claim came back by radio and the newspapers were full of the dramatic feat. But here's the twister. Another expedition, headed by an American, Dr. Herbert S. Dickey, now claims that they already had been there in 1931. Doctor Dickey, an entomologist, and one of my colleagues of the Explorers Club, says that he was hunting for natives to act as sculpture models and reached Tama Tama at the river's source in Brazil on July 28, 1931, more than 20 years ago. So now the barbed words will fly again.

PERHAPS our generation may be the last of terrestrial explorers, or nearly so. Already exploring is becoming three-dimensional—into the oceans, the skies, ice-caps and the bowels of the earth. We need scientific investigation of weather conditions, glaciology, more meteorology and an urgent search for more oil and rare minerals such as uranium. Though less than half the earth's surface actually has been surveyed, geographers using airplanes and helicopters will be able, fairly easily, to fill in the gaps in Africa and South America (regions over which I flew only recently) and in New Guinea, Arabia, Central Asia and Alaska. Then there is still two thirds of Antarctica that remains unseen by human eye. Modern equipment and techniques—the air drop, the helicopter, guided missiles, the bulldozer, wonder drugs, the jet plane—all provide help in key with the fast tempo of our time for the modern explorer, help undreamed of 50 years ago. Television, too, for already they are lowering a special TV-camera bathoscope into the nethermost depths of the ocean.

Further research into existing data is moving fast. One phase of this work is the idea under study by the armed services of using moving ice floes as landing fields on the Polar Ocean. This scheme was developed

(Continued to page 262)

NEW! CHEAP! **OIL BURNER**
SWEEPING THE COUNTRY!

SALESMEN BIG MONEY! SLIPS INTO ANY COAL RANGE, STOVE OR FURNACE

Amazing quick, intense heat. By finger-tip control. Cheaper than coal. No more shoveling coal or ashes. SENT ON TRIAL. Prove it pays for itself quickly by what it saves. \$1 bonus for testing. We'll let you try one in your own home for one month. Write for details today. **NORTHWEST MFG. CO., 360-K Main, Mitchell, S. Dak.**

make your own Gems 29.50 F.O.B.

All necessary lapidary equipment is furnished, including a super-charged diamond blade for sawing, and all wheels for grinding, shaping and polishing; also complete instructions. The complete equipment as shown, less motor and belt, for only \$29.50, f.o.b., Burlington, Wisconsin. Write today for information and literature.

B&I MANUFACTURING CO.
Dept. S Burlington, Wis.

NOW-FIXIN' IS EASY!

No Other Tool Does So Much So Easily!

Locks with Ton-Grip. Clamps, twists, turns, pulls, cuts, ratchets, holds. Only \$1.85 to \$2.60 at your dealer.

Mfg'd. Only By **PETERSEN MFG. CO., INC., Dept. P-8, DeWitt, Nebr.**

Model 10-W \$2.60
7" and 10", cutter optional.

ELECTRIC WELDER
AC or DC 110 Volts

"The Little Marvel" All-Metal welder. 5-year written guarantee. Welds 1/8" thick metal or money back. Repairs tanks, tools, fenders, machine parts, etc. Comes complete with everything—fods, unit, eye shield, and directions. We also make a welder for 16 to 22 gauge metal... \$3.95 complete welder \$18.95. On C.O.D.,

\$6.45 Complete

plete. Transformer postage extra.

ESSAY MFG. CO., Inc., Dept. 51, Quincy 69, Mass.

MAKE ANY SIZE FOLDAWAY TABLE, WORK BENCH ETC.

with **FOLDAWAY FOLDING LEGS!** TUBULAR STEEL

COMPLETE 30" LEGS \$7.98 PLUS POSTAGE FOR 12" WEIGHT OR SHIPPED EXPRESS COLLECT ORDER TODAY!

SHIPPED COMPLETE, READY TO FASTEN TO YOUR TOP IN A MINUTE - FOLDS FLAT, EASY TO CARRY AND STORE - RUBBER TIPPED - MAKE A SMART PING PONG TABLE - DISPLAY, MODEL, TRAIN, PICNIC OR BANQUET TABLE

THE DIAMOND MFG. CO. Dept. P.M. 1100 ALTAMONT AVE. SCHENECTADY 7, N. Y.

JUST OUT! **1952 EDITION**

It's New! It's Different! Get world's largest Auto Accessory & Parts Catalog and save money. Over 50,000 items, including Hollywood Accessories, Hi-Speed Equipment, Rebuilt Engines, all parts & accessories for all cars & trucks. We have that Hard-To-Get part! Jam packed with bargains. Completely illustrated. (100 pages) Send 25c (refundable).

J. C. WHITNEY & CO., 1917-XP Archer Ave., Chicago 16, Ill.

Say You Saw It in Popular Mechanics

Anybody Handy With Tools Can Build **LEATHER LOUNGES FOR KITCHENS AND RESTAURANTS**

Frames, springs, filling, construction simplified.

Send \$5.00 for complete plans and instructions, or 10¢ for brochure.

STEFAN GALENSKI
Designer & Manufacturer
2221 BROADWAY BUFFALO 12, NEW YORK

Earn BIG MONEY
BE YOUR OWN BOSS

EXCLUSIVE FRANCHISE in your trade area
Large, SUCCESSFUL tire service organization!

Hook up with this coast-to-coast network of established O.K. Rubber Welders. Finest patented tire recapping equipment. In-shop training. Mass purchasing benefits. Year 'round advertising aids. Consumer preference. Over 1100 affiliated tire shops now making top money. An opportunity to join a successful, profit-sharing outfit.

WRITE FOR DETAILS TODAY
O.K. RUBBER WELDERS; Central Division
Dept. PM8, P.O. Box 111, Littleton, Colorado

LAWNMOWER SHARPENER OPERATORS

Increase your output...
Year 'round business!

NEW BED KNIFE GRINDER
sharpens all STRAIGHT EDGE TOOLS

New Ideal Bench Grinder
doubles your output of sharpening jobs, speedily grinds straight blade knives. Sharpens all kinds of straight edge tools and ice skates. Write for FREE, fact-filled folder.

THE FATE-ROOT-HEATH COMPANY
Dept. PM8, Plymouth, Ohio

EASIER QUICKER BETTER

ROOF FRAMING
Poulsen Method

ROOF FRAMING
Rafter Length and Cuts Without Use of Square!

Lay out any type of roof more accurately and in only one-fifth of the time required by other methods. Get the **POULSEN METHOD OF ROOF FRAMING**. It will save your time and make money for you. Valuable tables—54 of them—starting with one-quarter inch rise per foot of run—simplify all roof framing problems. Tables give common, hip, valley and jack rafter length and necessary cuts in a jiffy without calculation. Learn also how to measure rafters from top and edge—definitely and accurately. No need to bother with centers and making adjustments for cuts.

For Amateur and Professional

Every handyman, repairman, amateur carpenter and professional builder needs this **POULSEN METHOD** book. It saves four-fifths of all roof layout time and labor. Everything is already worked out for you in simple, easy-to-use tables. Cloth bound. Book has 90 pages and many illustrations. Besides the tables it contains every other bit of roof information a carpenter, whether amateur or journeyman, should have.

Money Back Guarantee

Clip this ad and send with your name and address and \$3.00 for your copy postpaid today. Money back if not fully satisfied.

POPULAR MECHANICS PRESS
DEPT. RF 200 E. ONTARIO ST. CHICAGO

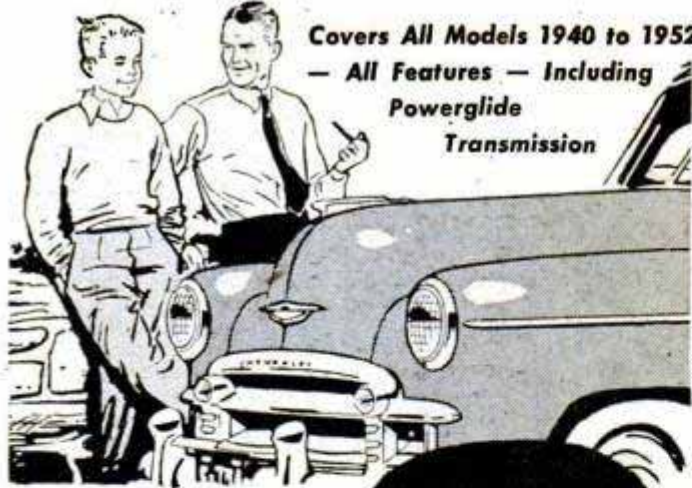

Covers All Models 1940 to 1952

— All Features — Including
Powerglide
Transmission

Get the NEW Popular Mechanics Owner's Manual

If you drive a Chevrolet—any model—1940 to 1952—get this new owner's manual today. It will save you money on repairs and service; give you safe, economical and trouble-free motoring and protect your investment in your Chevrolet by keeping it constantly at top value. Can easily be worth hundreds of dollars to you in a single year.

Learn All About Chevrolet's Powerglide Automatic Transmission

Know Your Chevrolet Valve-in-Head Engine and How It Operates

Understand Chevrolet's Center Point Steering and Unitized Knee-Action.

Protect Your Investment. Know Your Chevrolet.

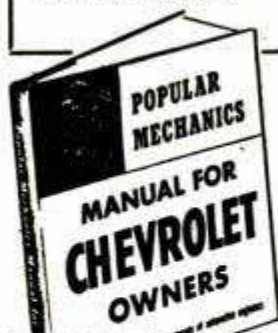

Chevrolet Owners

Spend Less to Own
and Drive Your Car

Official, Authoritative Bumper to Bumper Information

Prepared by a noted automotive authority and Popular Mechanics editors with the full cooperation of Chevrolet engineers and service specialists. Covers all phases of Chevrolet operation, service and maintenance. 304 pages of practical information and hundreds of photos, diagrams, charts, and sectional views, make every part, every operation, easy to understand. Complete index enables you to put your finger on the information you want instantly.

Prevents Costly Repairs

Explains everything about your car; what can go wrong; how proper adjustment and servicing should be done; how to prevent major troubles and costly repairs later on. Even if you don't service your car at home the manual will save you important money on every day operation.

Mail Coupon Today

Mail coupon now. Send only \$3.50 for prepaid delivery or you can pay postman, plus charges. See money back guarantee in coupon.

POPULAR MECHANICS PRESS
200 East Ontario St., Chicago

Send Manual for Chevrolet Owners at once. If not satisfactory I will return it within 5 days and you will refund full purchase price.

Remittance for \$3.50 enclosed. Send C.O.D.

Name _____

Address _____

City _____ State _____

at first by a Russian explorer, Ivan Papanin, who in 1937 set up a camp on the ice at the North Pole and subsequently drifted over a thousand miles on an ice floe before being rescued nine months later off the east coast of Greenland. Since then our own airmen have spent a great deal of time on the ice floes of the Polar Sea.

With all this speed of discovery, you may wonder what will be left to explore in 50 years. Plenty!

Since Plato told the story of a lost submerged continent, Atlantis, men have wondered about the mysteries of the mountains and valleys of the ocean. In spite of the great strides made in oceanographic work with echo-sounding and other electronic devices, we still have only the sketchiest knowledge of the topography of the ocean depths and of its inhabitants. Nearly three quarters of our planet is covered by water—dark, silent, at enormous pressure and undisturbed since the beginning of time.

As far as I know, only two men have ever entered this region of mystery—Dr. William Beebe and Otis Barton. Knowing that no diving suit could withstand the pressure a half mile down (over 1100 pounds to the square inch) Beebe and Barton designed a steel ball, known as a bathysphere, for their first descents off the Bermudian isle of Nonsuch where I visited Will Beebe and party. The bathysphere was built of 1½-inch steel with fused quartz windows and was equipped with a two-way telephone line and power lines for a searchlight. The question of air supply was solved by the use of oxygen tanks with chemicals to absorb the moisture and expended air. Manned by the two scientists, the steel globe was lowered to a depth of 3028 feet in the ocean off Bermuda and the searchlight was switched on. Before their eyes was revealed a parade of horrific and grotesquely shaped fish and crustaceans. Since then Barton designed a new sphere, the bathoscope, and in the summer of 1949 descended still farther, to 4500 feet in the Pacific off the coast of California. As Beebe summed it up after one of his dives: "The only other place comparable to these marvelous nether regions must surely be naked space itself, out far beyond the atmosphere—where the blackness of space, the shining planets, comets, suns and stars must really be closely akin to the world of life as it appears to the eyes of an awed human being, in the open ocean, one half mile down."

To the reader of 1900, the idea of a visit to the moon was just a Wellsian fantasy, but much that Jules Verne and Wells predicted is now history. *Around the World*

(Continued to page 264)

SOUND POWERED PHONES

No batteries needed. Your voice generates current. O.K. for 25 miles. Perfect intercom for shop, office, farm, darkroom. WAR SURPLUS. Orig. Govt. Cost \$58.00 ea.

\$10.95
Each

MONEY BACK GUARANTEE

Postage Prepaid on Cash Orders

Semlers' ASSOCIATED SURPLUS

Dept. PM-80, 5730 Wilshire Blvd., Los Angeles 36, Calif.

HOBBYISTS! SHOPMEN! Special **ONLY \$54.50**

PALMGREN "HOBB-E" Rotary, Index, Milling Table
Ideal for Model Parts or Shop Work

Mill-Grind-Drill-Index-Rout curved or straight. Lubet and Mortise on drill press or lathe. 8" Table, 4" Cross Feed, 360° Rotation, Accurately Graduated. Bolts to table. Order NOW! SAVE \$100. Only \$54.50. Less Rotary Feed \$43.75. Write for "HOBB-E" Tool Circular.

CHICAGO TOOL and ENGINEERING CO.
8365 South Chicago Ave. Chicago 17, Ill.



SOUTH BEND LATHES • SHAPERS DRILL PRESSES



Send for catalog on Lathes (9" to 16-24"), Shapers or Drill Presses. **SOUTH BEND LATHE** South Bend, Ind.

CASH IN YOUR SPARE TIME!

BIG MONEY IN OWN BUSINESS

YOU CAN MAKE UP TO \$40 a DAY sharpening and setting circular saws for factories, builders, lumber yards—with

NEW BELSAW COMPLETE CIRCULAR SAW SHOP. Low Cost, only \$15 down, sharpens 4 to 6 saws an hour. No experience needed! Instructions Furnished. Send Postcard Today for FREE BOOK. BELSAW MACHINERY CO 3704 Field Bldg. Kansas City 2, Mo.



FOR AN EASIER WASHDAY... TIGHTEN YOUR LINES THE "E-Z" WAY



E-Z LINE HOLDER 3 FOR \$1.00
DOZ. \$3.50
POSTPAID
E. S. GRAVES, BOX 1423, MINNEAPOLIS 6, MINN.

RUBBER STAMPS Direct to You!

Handle mounted, made-to-order, rubber stamps. Low prices. Rapid service. Write FREE catalog type styles.

WALLACE STAMP CO. 644 Venice Blvd. Dept. P-8 Los Angeles 15, Calif.

FREE CATALOG

WAR BARGAINS SURPLUS

Over 200 terrific values! ALSO FACTORY SURPLUS

SEND FOR FREE Catalog

SIoux FALLS SURPLUS STORE SIoux FALLS, S. DAK.

LEATHERCRAFT and many other crafts

SHELLCRAFT easy to do
TEXTILE PAINTING profitable too
Send for FREE **BIG CATALOG TODAY**
complete supplies everything you need

KIT KRAFT 7373 Melrose Ave. Dept. 29 Hollywood 46, Calif.

ORDER YOURS TO-DAY!

LUTHY AERO TYPE Spark Plugs With LUM-OX (Aluminum Oxide) INSULATORS



Airplane Type
3 point electrodes
SENSATIONAL PERFORMANCE
MORE R.P.M.

8 CYL. SETS **\$7.12**

6 CYL. SETS **\$5.34**

LIST PRICE \$1.00 each

Luthy Aeronautical Sales Company
302 Cooper Street,
Jackson, Michigan

Canadian address—
Box 394, Hamilton, Ontario

Packed in engineered sets. Correct gap setting and proper heat range. Satisfaction Guaranteed.

AIRPLANE WHEEL ASSEMBLIES



These wheel assemblies are all new, and of heavy duty construction. Depending on load desired to carry, they are ideal for House Movers, Farms, Trailers, Carts, Wheelbarrows, etc.

Complete with Wheel, Tire, Tube and Bearings

- Size 26:00, 10 ply tire, smooth tread, uses tapered axle size 3 in. x 2 1/2 in. 10 1/2 in. wide. Overall height 26 in. Static Load 6,300 lbs. Weight 54 lbs., Price \$47.50 ea.
- Size 23:00, 8 ply, smooth tread. This size complete with axle. Overall height 22 in., axle width 10 in. Static Load 4,700 lbs. Weight 70 lbs., Price \$37.50 ea.
- Size 8:00 x 4, 4 ply, smooth tread—uses straight 1 1/4 in. axle, 6 in. wide. Overall height 17 in. Static Load 900 lbs. Weight 13 lbs., Price \$27.50 ea.
- Size 17:00, 6 ply, smooth tread. Uses tapered axle, size 2 in. x 1 3/4 in. 8 in. wide. Overall height 17 in. Static Load 2,000 lbs. Weight 18 lbs., Price \$17.50 ea.
- Size 5:00 x 4, 6 ply, smooth tread. Uses straight 5/8 in. axle. 3 1/4 in. wide. Overall height 13 in. Static Load 1,800 lbs. Weight 8 lbs., Price \$12.50 ea.
- Size 10 1/2 x 4, 6 ply ribbed tire. Uses straight 5/8 in. axle. 3 1/4 in. wide. Overall height 10 1/2 in. Static Load 1,200 lbs. Weight 8 lbs., Price \$9.95 ea.

Prices F.O.B. Chicago. Include approx. postage on orders paid for in advance. C.O.D. orders enclose 25% balance sent C.O.D.

U. A. S. Corp. Dept. PM8, 5637 W. 63rd Pl. Chicago 38, Illinois

WAR SURPLUS BARGAINS



HOT ROD SUPERCHARGER

Extra soup and go at a price you can't afford to miss! Mfr'd by Borg-Warner. Specifications: 7 1/2" deep, 7" high. Wgt. 17 lbs. Compact and sturdy, 4 base mounting holes, 3/4" outlet, 5/8" shaft with female Lovejoy coupling. Priced today at \$85. Our special SALE PRICE \$31.00



ALARM HORNS • SIRENS

110 v. AC motor driven (not a vibrator). Heavy duty with great power and long life. Adjustable tone—high, med. and low. For boats, school yards, factories, air raid siren, etc. Weather-proof. List \$47. Our price NEW... \$24.95

Automatic Electric Rat Trap—110v. with magnetic trap door. Iried and proven design—NEW on the market. Ends dead rat odor, takes up to 22 rats a night, galvanized... \$24.95

LIGHT PLANTS

- 300 Watt 110-220 volt AC, Wgt. 40 lbs.—portable \$99.
- 750-1000 Watt, 110 v. AC, Briggs & Str'n eng. \$169.
- 1000-1200 Watt 110 v. AC, only \$194
- 2500-3000 Watt, 110 v. AC, Slow speed (1800 r.p.m.) Island generator for longer life. Recond'nd and fully guaranteed \$295. NEW \$345.
- Plants built in 1951 with tools and spare parts, \$426.
- 5000 Watt 120 v. AC, 4 cyl. gas engine, Hobart generator. List today \$1910.00. Used \$675.00. NEW, only \$895.00.

WINCHES

- 1,000 lb. cap. Hand oper. \$12.95 (ALSO AVAILABLE in models with 24-1, 54-1 and 80-1 ratios.)
- Hand operated, ball-bearing model. 1500 lb. cap. 3-1 ratio, hand brake, 2 speeds... \$39.50
- 4000 lb. double drum. Hand operated... \$59.50
- 1000 lb. electric drive... \$129.50
- 4000 lb. electric drive... \$188.50
- Single drum, 3/4 HP motor, 110 or 220 AC. Start-stop-reverse switch, Ratio 12-1. NEW... \$125.00
- Double drum model... \$135.00

RUBBER HOSE

GOODRICH 2 ply 2" I. D. 25 ft. lengths worth \$25. Only \$4.95 3 lengths for \$12.00



Write today for free catalog. Thousands of \$\$ saving buys.

C&H ELECTRIC MACHINE Co. Inc.

4341 W. Juneau Ave., Milwaukee 3, Wis.

It's a cinch to Install!



**Combustioneer[®]
AUTOMATIC
HUMIDIFIER**

A few dollars, your own tools, a couple of hours will give your home all the benefits of healthful, protective *automatically humidified air!* Yes, in your *present* warm-air furnace—coal, gas or oil! No plumbing necessary!

Exclusive Combustioneer features... Twin-Valves of stainless steel, can't rust, corrode or leak... "Noverflow", prevents water dripping *inside* furnace... big "Thirsty-Thick" ceramic plates for larger water evaporation area... Selector Dial for positive humidity control... Water pan of heavy non-corroding metal.

Low Prices! Model CH-300, 4 plates for 13" to 20" plenum (width or length), \$20. CH-200, 6 plates for 22" to 25" plenum, \$22, F.O.B. Springfield, Ohio. Prices include 10 feet of tubing, saddle valve and adjustable hinge face plate. Immediate shipment. Check or Money Order. **Combustioneer DIV. THE STEEL PRODUCTS ENGINEERING CO. 1255 W. COLUMBIA STREET, SPRINGFIELD, OHIO**

	<p>Pesco Positive Displ. Hydraulic Pump Gear type. No. 1P-349. Aircraft quality. Rated 1500 PSI. .227 cu. in. per revolution. 1 GPM at 1500 RPM. Operating speed, 3750 RPM. Splined shaft. Rotation either direction with slight adjustment. 3/4" pipe ports. Has mtg. flange with 4 bolt holes. Size, 5-9/16" x 3 1/2". Used, guaranteed serv-iceable. Wt. 4 lbs. ONLY... \$7.95</p>	<p>Hyd. Cylinder New! Dbl. acting, 3" bore, 8 1/2" stroke. Length 21 1/2" closed. Has adjustable dampener check valves, eye bolt mtg. Lifts approx. 7000 lb. using 1000 PSI. Std. pipe threads. 888 valve. Wt. 10 lb. ONLY... \$17.95</p>
	<p>AVIATOR'S OXYGEN OUTFITS Brand New! Bail out type. Consists of all metal tank, brass release valve, 0-3000 lbs. gauge and breather hose, all enclosed in khaki colored canvas bag. Capacity, 1800 lbs. Tanks not filled. Ideal for emergency oxygen supply for airmen, mountaineers, firemen, paint shop workers, diving outfits, etc. Shipping weight, 4 lbs. ONLY... \$5.95 Refill Fitting for Aviator's Oxygen Mask—Demand type. Oxygen Type A-14, 24" rubber tube. Bottle... \$1.95 Brand new! Only... \$1.95 Order From This Ad! Prices F.O.B. St. Louis. Incl. post. with check or M.O. MONEY BACK GUARANTEE! FREE Catalog</p>	

Edw. Aguado Trdg. Co. 689-L Arcade Bldg., St. Louis 1, Mo.



**New! ELECTRONIC
WALKIE-TALKIE
Communication SYSTEM**

- No Batteries \$ **3.95**
- No Plug-In **3** complete

Perfect for room to room, house to garage, etc. No batteries, no tubes. Complete two way telephone system. Works at amazingly long distances. Handy pocket size. Electronic voice powered. No license or permit needed. **Two units complete with wire, ready to use.** Quantity limited. Order today.

SEND NO MONEY!
Just send name, address and pay postman, plus postage, or send check or money order. We ship postage paid. Same money back guarantee.

**YOUNG PRODUCTS, DEPT. 576
2605 ELMHURST, DETROIT 6, MICH.**

in *Eighty Days* has been reduced to "Around the World in Less than Eight Days." Already scientists are talking seriously about trips to the moon, and even to Mars and Venus, aboard atomic-powered rocket ships. Outer-space exploration may well be the big field for tomorrow's young scientists. Today we are preparing the way for it.

At the Air Force School of Aviation Medicine in San Antonio, Tex., regular symposiums on space medicine are dealing with the problems man will meet. The earth's atmosphere is a cushion protecting man from the terrific temperature variations of outer space, from meteors, and from ultraviolet, cosmic and X rays. To leave this cozy earth will be as hard for mankind as it was for the first prehistoric fish to flop out of water and survive on dry land.

It's doubtful that man's body will change to meet the climates and hazards of outer space, so he'll have to take his environment with him—in a capsule. Even living in a capsule, he'll have trouble. At the high getaway speeds needed for space travel, friction of the air on the skin of a rocket ship, scientists know, will encase the craft in a film of 1000-degree temperature for the first 30 miles. So they're devising refrigeration units—like those used on jet fighters—to counteract it. One suggestion is to use frigid liquid oxygen as a coolant.

Everyone knows about the problem of weight when a space-exploration crew some day leaves the earth's gravitational field. In the science-fiction movies, rocket crews bounce around gaily, using their newfound weightlessness for incredible feats of bravery. In real life, it won't be funny. The first space explorers will find it a stumbling, clumsy nuisance. It will take plenty of practice before they can make their arms, legs and bodies function sensibly.

Air is another hazard. Where will they get it? To bring in the thinly scattered gas particles of outer space and compress them to a breathable consistency is one suggestion. But at a mere 100,000 feet, there's enough pure ozone floating around to poison a whole space crew in no time. Bottled air probably will be the answer, according to space scientists.

Biggest dangers are the mysterious rays of space. Vulnerable crews will have to be shielded from ultraviolet and X rays from the sun. Even at the heights we reached in the Himalayas, the ultraviolet rays gave us trouble. Still more of a potential danger are the cosmic rays, consisting of many heavy particles or whole atoms, traveling with fantastic speed and unleashing vast

(Continued to page 266)



NEW SMALL PARTS CABINET

Metal bound. Baked green enamel. Green plastic drawers. Removable dividers. At hardware stores. Write for free catalog—complete Waterloo line of metal boxes and cabinets. Waterloo Valve Spring Co., Waterloo, Ia.

SAW SERVICE MEN

Put your business on a better paying basis by installing . . .

ACME SAW SHOP EQUIPMENT

- Acme Circular Saw Sharpeners
- Acme Hand Saw Filers, etc.

Send For Free Literature

MAX MFG. CO. 138 Stockton Ave. San Jose, Calif.



BE YOUR OWN BOSS!!!

Make big money! Get ahead in something for yourself! Be a floor surfacing contractor and sand both new and old floors. No experience needed. High earnings, steady work with a future! Write for booklet "Opportunities in Floor Surfacing," enclosing 25 cents in coin or stamps to cover handling.

AMERICAN

FLOOR SURFACING MACHINE CO.

535 So. St. Clair Street • Toledo 3, Ohio



Gerstner TOOL CHESTS



The Ideal Chest for the good tools of Machinists and Tool-makers. Free Catalog.

GERSTNER TOOL CHESTS
452 COLUMBIA ST., DAYTON 7, OHIO

DEPENDABLE CRAFT SUPPLIES

- LEATHER CRAFT • PLASTICS • POTTERY CRAFT • BLOCK PRINTING • BELT CRAFT • TEXTILE COLORS • POWER TOOLS • WOOD BURNING • INSTRUCTION BOOKS • ETC.

DWINNELL CRAFT SHOP
Dept. PM-852—Wheeling, W. Va.

WRITE FOR CATALOG SINCE 1928



BRONZE FOUNDRY

Schools and Home Workshops

Make your own castings of aluminum, copper, bronze, silver. Foundry sets are available in three sizes including 2400 Deg. F. blast Furnaces. \$22.50; \$29.50; and \$42.00. f.o.b. Kansas City. Free Circular.

KANSAS CITY SPECIALTIES CO. P. O. Box 6022, DEPT. P-8 KANSAS CITY, MO.

7" Tilting Arbor Saw

One of Shopmaster's complete line of quality-built tools at the remarkably low price of **4795** Slightly lower zone 1



SHOPMASTER, INC.

1214 Third St. S., Minneapolis, Minn.

FIX YOUR FORD

FIX YOUR FORD and SAVE

Brand new handbook for owners and mechanics by Bill Toboldt, Editor, Motor Service Magazine. Covers all Ford V-8's and 6's, 1932 to 1932. Gives you the know-how of hundreds of Nation's top Ford service men. Includes repair and service short-cuts and kinks, tune-up specifications, how to increase gas and tire mileage, make car run better, last longer, worth more. Hot rods and speed-ups too. Simplified. Packed with pictures. If you drive a Ford you need this book. Clip this ad and mail with name, address and \$2.50. Money back in 5 days if you want it.

Goodheart-Willcox Co., Dept. 184, 1321 S. Michigan Ave., Chicago 5

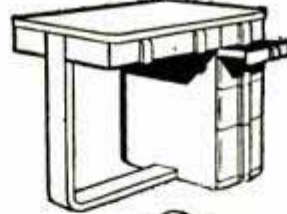

YOU CAN BUILD THESE PROJECTS WITH POPULAR MECHANICS PLANS AND MASONITE PRESWOOD

Here are plans designed for use with Masonite Preswood, the "Wonder Wood of 1000 Uses." Only simple tools are needed for these practical projects. Preswood is strong, cannot split or crack and may be finished by painting, varnishing, etc. Select your projects and mail order coupon today.

- H-212—Modern Desk. Five drawers, typewriter slide. Top measures 25" by 35 3/4".25c
- H-111—Magazine Basket. Scrollsawed oak-leaf design.25c
- H-107—Baby Sleigh. Fits small sled. Hand bar and footrest.25c
- H-205—Chariot Scooter. Dashing steeds lend plenty of action to sidewalk scooter.25c
- H-209—Record Cabinet. Two shelves for 10" and 12" record albums.25c
- H-208—Warm Dog House. Insulated walls. Floor space about 25" by 33".25c
- H-202—Vegetable Bin. Easy to build. 24" high, 12" wide and 32" high25c
- H-204 A & B—Doll House. Front and back removable for easy access to interior. 2 Plans50c
- H-1—Dog Bed. For small and medium-sized dogs. High sides prevent drafts. Simple construction25c
- H-2—Bird Feeder and Wren House. Swings in breeze to prevent food blowing away.25c
- H-3—Garden Windmill. Figure cranks car when propeller rotates.25c
- H-4—Parkway Numbers. Pleasing dog silhouette has house numbers on each side.25c
- H-5—Noah's Ark. Makes big hit with tiny tots.25c
- H-6—Lawn Ornaments. Gaily painted, scrollsawed figures.25c
- H-7—Kitchen Utensils. Handy dispensers for soap chips, powdered soap, etc.25c
- H-8—Photo Frames. Frame can be varied in size to suit different pictures.25c
- H-9—Mirror Frames. Dress up old mirrors with attractive frames.25c
- H-10—Magazine Basket. Has two compartments.25c
- H-11—Scrollwork Waste Basket. Sides interlock with each other.25c
- H-12—Snack and Beverage Trays. Simple construction.25c
- H-101—Tea Cart and Table. Each has two removable trays.25c
- H-102—Bed Tray. Top can be tilted for reading.25c
- H-103—Martin House. Eight 6x6 compartments.25c
- H-104—Clothes Hangers. Clown, Eskimo and cowboy designs for children's clothes.25c
- H-105—Clothes Hamper. Neat, strong, well ventilated.25c
- H-106—Child's Rocker. Sides scrollsawed to resemble ducks.25c
- H-108—Bric-a-brac Cabinets. Corner and wall design.25c
- H-109—Sewing Box and Tool Tray. Similar basic design varied to suit purpose.25c
- H-110—Waste Basket. Two designs.25c
- H-112—Bird and Animal Designs. 30 designs for lawn ornaments.25c
- H-201—Toy Chest. About 36" long, 24" wide and 24" high.25c
- H-203—Ski-Jump Toss Game. Played by two or four with bean bags.25c
- H-206—Window Valances. Four designs for children's rooms.25c
- H-207—Novel Shoe Racks. Cat, dog and cowboy designs painted in gay colors form sides.25c
- H-210—Tool Chest. Long enough for several hand saws.25c
- H-211—Child's Clothes Hamper. Hinged beak on bird-front hamper.25c

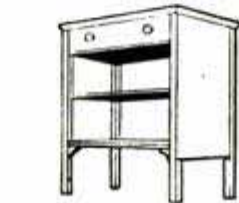
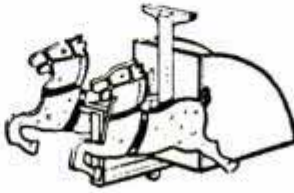

USE THIS HANDY COUPON

POPULAR MECHANICS PRESS
200 E. Ontario St., Chicago 11, Ill.

Send the following plans _____

_____ I enclose \$ _____

NAME _____

ADDRESS _____

CITY _____ ZONE _____ STATE _____

NATIONALLY KNOWN

PET 1/4" #77



**Factory Guaranteed
ELECTRIC DRILL**

COMPLETE DE LUXE

38 PIECE KIT

only
\$17.95

\$27.95 Value

Includes above Drill, plus 37 accessories. Drills, buffs, cleaners, grinds, mixes paint, polishes, sands, sharpens, waxes, wire brushes, etc. Sturdy steel case. Instructions included.

Postage 50c additional. 3% sales tax in N.Y.C. Send check or M.O. COD's, \$5 deposit.

GOLDEN ELK PRODUCTS CO.
12 East 41st St., N.Y.C. (17), HA 9-7810



Bright Chrome Finish. 1600 RPM. 110-120 V., A.C. D.C. 1.6 AMP.

DRILL ALONE

only
\$12.95

\$17.95 Value

**LABOR-SAVING
FOR HANDYMAN AND
HOUSEWIFE**

10 day money
back guarantee

EASY TO ASSEMBLE BOAT KITS 30 MODELS

**NEW 18 FT. OUTBOARD
CABIN CRUISER**

Other models 8 to 23 Ft.

Rowboats, Outboards, Inboards

NEW CATALOG Only 35c. SEND COIN TODAY

U-MAK-IT PRODUCTS 703P-WHITTIER ST.
Bronx 59, N. Y. City



✓ Easy to make
Saves flash bulb cost
Stops action

**Build your own
ELECTRONIC FLASH**

Sprague booklet C-703 shows you how to build up-to-the-minute Electronic Photo Flash units using the very latest low-voltage circuits. Step-by-step instructions. Send 35¢ today for this invaluable guide for the advanced amateur and professional photographers.



SPRAGUE PRODUCTS COMPANY
247 Marshall St., North Adams, Mass.

HELPFUL BOOKS

Send post card asking for **FREE** catalog

Popular Mechanics Press, 200 E. Ontario, Dept. 601, Chicago 11

Regular 25¢ Package Sent

FREE

Original
RUM and MAPLE

PIPE MIXTURE

- **GOOD** ... by itself
- **GOOD**... as a mixer with other tobaccos!

Send Postcard To
RUM & MAPLE TOBACCO CORP.
(Dept. C) 100 E. 16th St.
New York 3, N. Y.



**BUY RUM & MAPLE
CIGARETTES**

amounts of energy. No one knows their origin, but it's somewhere far in the outer reaches of space. The earth's atmosphere slows them so that few cosmic rays ever reach our planet and those that do are spent. But up there in space, they'll riddle every part of a human body in a flash unless the space planners can find a new armor that will stop them.

In any event, the future of such inter-planetary exploration for the present seems to be safe in the hands of scientists, engineers and airmen. There will be time enough to argue such plebian questions as "Who owns space?" when the basic problems are solved.

Until then, there will be plenty of work for explorers right here on our tiny piece of space. In spite of the fact that few "white spots" are left to plant a flag on, we keep finding new things in our own uncharted wildernesses.

Last year alone, scores of expeditions came back with libraries of new knowledge. On the Caspian Sea in Iran, the bones of three Stone Age persons were found in a cave where the roof dropped on them 75,000 years ago. In Iraq, busy archeologists uncovered a 7000-year-old town, oldest known to exist, even older than Ur of the Chaldees. Its age was pin-pointed by radioactive-carbon measurement, an atomic-age measuring boon to scientists that is revolutionizing this kind of work.

Across the burning sands of Arabia's Rub Al Khali desert, explorers are talking of what they think may have been the Queen of Sheba's ancient city—a ruined city of alabaster temples and palaces in the desert sands of Mareb, in Yemen.

Exploring scientists also learned that the huge Chubb crater in northern Quebec is the biggest hole ever left by a meteor.

Surprises keep turning up. On a previously unexplored island near Bermuda, ornithologists found living cahows—ocean birds believed extinct for 300 years. Oceanographers discovered undersea mountains 11,000 feet high near the Orkney Islands. They also found life existing six miles under the sea in the Johnson Deep off the Philippines.

We could go on for pages just naming the exploration feats of 1951. And the chances are that when the year 2000 rolls around, we still will only have scratched the surface of Mother Earth's secrets. No matter what happens, there will always be room for good scientific explorers—men whose curiosity about this world in which we dwell won't let them sit by the fireside any longer than it takes to tell the folks back home about their last trek "beyond the utmost purple rim." ★ ★ ★



GEARS

In Stock - Immediate Delivery
Gears, speed reducers, sprockets, thrust bearings, flexible couplings, pulleys, etc. A complete line is carried in our Chicago stock. Can also quote on special gears of any kind. Send us your blueprints and inquiries.

Send for Complete Catalog No. 10
CHICAGO GEAR WORKS
440-50 N. Oakley Blvd., CHICAGO 12, ILL.

Your BOY WILL LOVE IT! NEW BULLDOZER TRACTOR



Give your youngster the thrill of accomplishment. He'll do all kinds of "play work" with this NEW Tractall Bulldozer Tractor. Chain Driven. SOLD DIRECT. Write for FREE literature today.

INLAND MFG. CO., 164 Ellicott St., Dept. PM-8, Buffalo 3, N.Y.

VARIABLE SPEED

HYDRAULIC POWER TRANSMISSION



It has Infinite Speeds 0 to 550. Reverse. Automatic Overload Protection; Adjustable Torque up to 180 inch pounds. $3/4$ " Input and Output Shafts. It will handle $1/2$ " to $1 1/2$ " H.P. Motor. Case measures $7 1/2$ " long, 7" high $6 1/2$ " wide. VALUE OVER \$300. Shipping Wt. 25#. On C.O.D. Orders we require a 10% only \$54.50 Deposit. Fob. Chicago

DIRZIUS MACHINE SHOP "E" 1423-25 So. 52nd Ave., Cicero 50, Ill.

SILVER SOLDER TORCH & KIT \$7.95



JOINS ALL METALS PERMANENTLY
Do your own repairing. KIT includes one tube silver solder paste and 10 5-in. lengths silver solder alloy. Heat-test ALCOHOL TORCH known. 2700° F. flame. Operates in any position. Indoors or out. Pint of special fuel included. Complete outfit ready for use \$7.95 postpaid. TORCH alone with pint of special fuel \$6.85. KIT alone \$1.65. Instructions included.

AMERICAN PRODUCTS CORP., 422 S. Dearborn, Dept. 3-G, Chicago

INSTALL A ZAK AUTO FIREMAN

Stop Destructive Automobile Fires

A new Quick-Release Battery Terminal. Simple to use—Fast acting safety device protects you and your family from electrical fires—horn shorts—Costly ignition repairs. May save you hundreds of dollars.

See illustrated story on page 88 June issue, POPULAR MECHANICS. Send for your ZAK AUTO FIREMAN today—satisfaction guaranteed—complete instructions—only \$1.00 Postpaid.

PARK SALES, P. O. Box 73, Forest Park, Illinois



New 1 H.P. Gas Engine

• Power Products Model #1000, 2 cycle, 1 cyl. 2700-3800 R.P.M. Suitable for all small portable power needs.

Immediate delivery. (reg. list price \$59.75 ea.)

F.O.B. Spfld., Mass. \$24.95 each—No C.O.D.'s

Remit with order

G. & Y. INDUSTRIES, 159 Ferry St., Springfield, Mass.

AMAZING NEW "TUBELESS" RADIO

Money Back Guarantee COMPLETE KIT \$8.95

Plays anywhere. Needs no batteries. Gets distant stations clearly. Germanium Crystal Diode eliminates costly radio tubes. Special selector switch for best reception. Head phones, aerial kit included. Nothing else to buy. Assembled in minutes. Send \$1.00 deposit now, we'll mail C.O.D. for balance.

JAEGER & CO.
P. O. BOX 246 SKOKIE, ILL.

ONE-MAN SAWMILL LOW \$50.00 AS... \$50.00 DOWN

Take BELSAW Portable Sawmill right to the trees—turn out valuable lumber for local yards—do "custom sawing" for neighbors. BELSAW lasts a lifetime. No crew needed. Power with old auto engine. Beginners get excellent results. Send postcard for FREE BOOK, "How To Make Lumber."

BELSAW MACHINERY CO
1117 Field Bldg. 315 Westport Rd, Kansas City 2, Mo.



FILE SAWS THE RIGHT WAY

SUPER FILER No 9

BEVEL GUIDE

USED AS JOINTER

SO EASY to joint and file saws like new. 2 hardened steel rollers keep teeth same height. All teeth cut. saw runs true and smooth... \$2.95

GRIND all circle saws 6" to 10" with correct beveled wheel. Fits your saw table \$8.95



SUPER DRILL GRINDER

Sharpens round shank drills $3/32$ to $1/2$ ". 6" long Grinds old drills like new in 4 different point angles using hand power grinders \$2.95 At dealers or postpaid **FREE FOLDERS**

TRU-CIRCLE Saw Set - Automatically sets teeth 10° or more \$2.95

A. D. McBURNEY, 317 E. 4th St., Los Angeles 14, Calif, Dept. A-20

Attention:

READERS WHO WELCOME BETTER OPPORTUNITIES FOR LIVING AND GIVING

Beginning with the September issue, *Popular Mechanics* is adding a shopping section. We are calling it "Shopping for Living and Giving." The merchandise and services offered will be packed with personality—all kinds of articles to make your living and giving richer.

Look for it in the September issue

SEND ME

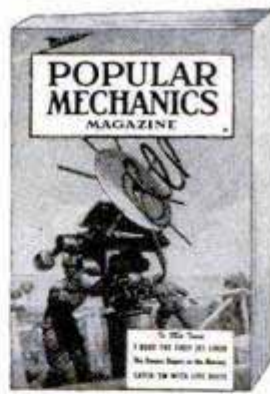

every month so I am sure to see each new issue. Here's

- \$3.50 for 1 year
- \$8.00 for 3 years

name _____
address _____
city _____ zone _____ state _____

Hand this order to your newsdealer or send it to

POPULAR MECHANICS
200 East Ontario St. Chicago 11, Ill.

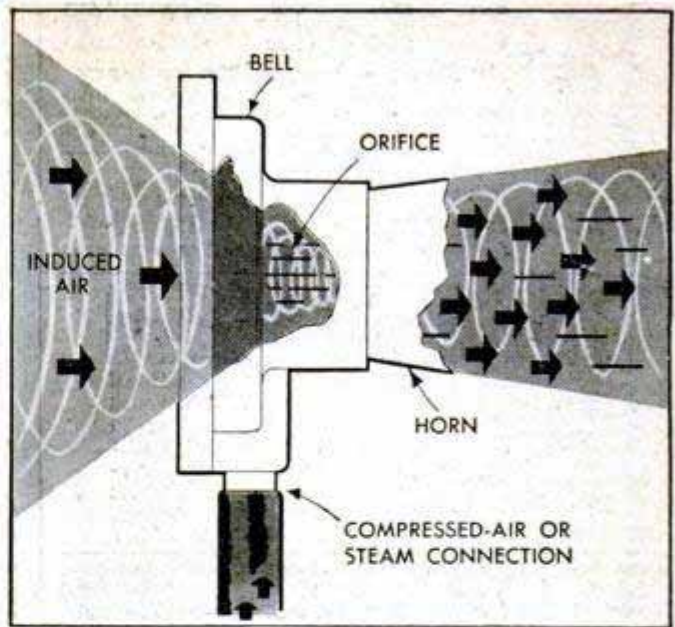

Emergency Air Mover Provides Quick Ventilation

Huge volumes of air can be moved quickly by a portable instrument designed for use when emergency ventilation is required. The simple, horn-shaped device will introduce fresh air into an enclosure or will remove air contaminants from confined areas. There are no moving parts in

the instrument. Compressed air or steam from any supply source is introduced into the bell-shaped base. Fed through a side inlet, the steam or air expands through an orifice and is discharged through the "horn," drawing with it a large volume of clean, fresh air.

Nonspill Cup Solves Hospital Feeding Problem

All liquids, including thick soups, can be fed to bedridden patients without danger of gagging or spilling when a new plastic cup is used. The patient sucks on a spout built into the cap of the cup and the flow of liquid is regulated by an air-control valve on the cap. If the user is semiconscious or too weak to draw the liquid himself, it can be poured into the mouth by drops. There is no danger of choking or gagging as the air valve controls the flow. Each time the attendant presses the valve about 20 drops of liquid are released through the spout.

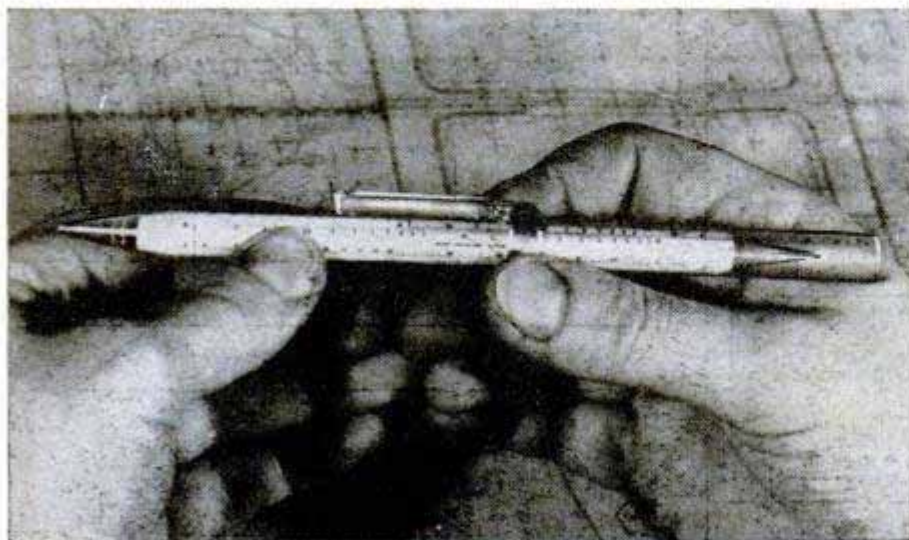

Slide-Rule Pencil

All the functions of a slide rule are built into a new two-color mechanical pencil. Various scales for the slide rule are printed around the pencil, and a calibrated transparent tube is slipped along the pencil to find the desired information. The pocket clip serves as a magnifying lens to aid in reading the scale. The pencil also serves as a handy depth gauge.

2 DRILLS in 1



\$11.95
POST PAID

This attachment gives you two drills in one. It converts any 1/4 inch electric drill to 1/2 inch capacity. Reduction gears reduce the drill speed 5 to 1, the average speed of a 1/2 inch drill, and thereby increases the power. Absolutely indispensable for all shop work and home craftsmen.

Send check or Money Order
Satisfaction guaranteed
Order yours now

G. M. CO. MANUFACTURING, INC.
1308 43rd AVE.
LONG ISLAND CITY 1, NEW YORK



Sport-Fun-Thrills!

Swing into the saddle of a powerful Harley-Davidson motorcycle — for a thrilling, action-packed ride. See your dealer, or send 25 cents for literature and copy of Enthusiast Magazine.

HARLEY-DAVIDSON MOTOR CO.
Dept. P, Milwaukee 1, Wis.

HARLEY-DAVIDSON

HYDRA-GLIDE

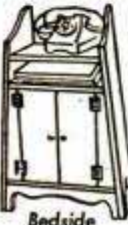

NEW! EARLY AMERICAN DESIGNS

Series C—15 plans 25¢

Colonial adaptations. Fun to make — easy to follow. Each project comes complete with photo and working drawing on 8 1/2 x 11 sheet. Send 25c to: Stanley Tools, 382A Elm Street, New Britain, Connecticut. In Canada: Stanley Tool Co. of Canada Ltd., 382A Stanley Street, Roxton Pond, Quebec.

STANLEY
Reg. U.S. Pat. Off.

WONDER-PASTE

Paint Remover

The modern, easy way to strip paint, varnish, enamel, lacquer, etc.
AT PAINT AND HARDWARE STORES

BUILD YOUR OWN FAN

One-piece cast aluminum propellers for cooling and ventilating.

Size Inches	Polished 2 Blade	Polished 3 Blade	Unpolished 2 Blade	Unpolished 3 Blade	Bore Inches
15	\$3.00	\$4.00	\$2.50	\$3.00	1/2, 3/8, 5/8
18	3.75	5.00	3.00	4.00	1/2, 3/8, 5/8
20	4.00	5.50	3.25	4.50	1/2, 3/8, 5/8
24	4.50	6.50	4.00	5.50	1/2, 3/8, 5/8

Write for pamphlet on larger fan blades, wire guards, fan bases, shutters, pillow blocks, exhaust fan frames, etc. Dealers, write for discount.

KLOPPENBORG ALUMINUM FDY., Dept. PM-528, Davenport, Iowa

FAMOUS RAJO HEADS

Gives your '41 to '52 Chevie 25% MORE POWER



Better fuel economy, "Good Eight Power", and immediate accelerator response at both traffic and road speeds. **\$169.50**

SCHUCK'S

7th at Bell St.
Seattle 1, Wash.

Mail this ad with check or money order
Dealers inquiries invited.

Last Year's Profit

\$3,000!

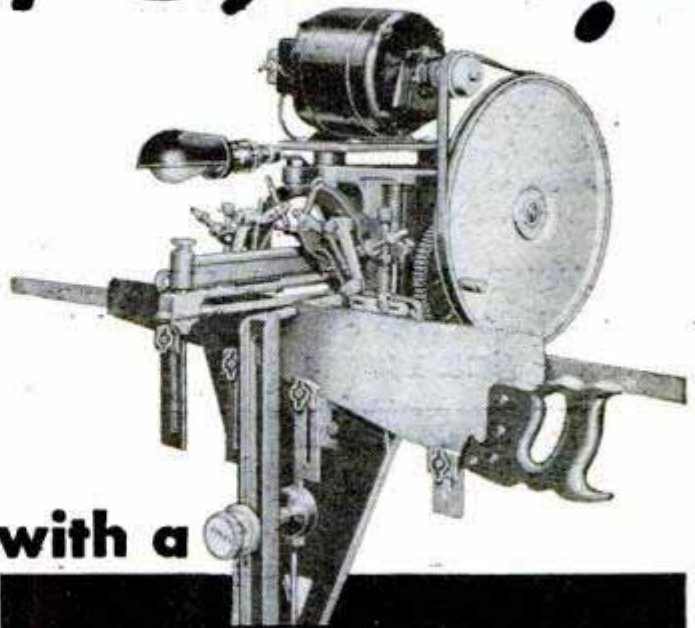

with a

FOLEY automatic SAW FILER

"Last year's profit amounted to \$3,000. Not so bad for a one-man outfit" — from Chas. C. Hough. James B. Williams wrote us—"I made \$765 last year filing saws, and it sure comes in handy. I do this work in my spare time." Men in communities of all sizes make up to \$3 or \$4 an hour with the Foley Saw Filer working full time or part time.

It's no trick to take care of the saw filing for your neighborhood hardware or lumber dealer — plus looking after the saws for farmers, townspeople, manual training departments and factories. The Foley files all hand saws, also band and cross-cut circular saws. It's a cash business, no canvassing, no eyestrain and no experience needed.

FREE BOOK

Shows How to Start

"MONEY MAKING FACTS" shows just how you can start at home in your spare time working in your basement or garage. It's an immediate cash business that can develop into a full-time repair shop. Send coupon today — no salesman will call.



Send Coupon for **FREE BOOK**

FOLEY MFG. CO., 816-2 Foley Bldg. Minneapolis 18, Minn.

Send me free book "MONEY MAKING FACTS"

Name _____

Address _____

New Opportunities for You

... in Popular Mechanics
"Shopping for
Living and Giving"

Yes—in the September issue, a brand new *Popular Mechanics* shopping section will be unwrapped, displaying new and different merchandise and services for better living and giving—for you and your friends.

**WATCH FOR THIS WONDERFUL
NEW SHOPPING SECTION IN YOUR
SEPTEMBER ISSUE!**

MADE RITE CORPORATION
Trailer Running Gear



58" 2 TON AXLE \$8.00 RETAIL SPECIAL PRICE TO DEALERS PAT PENDING.
F. O. B. 6454 EPWORTH BLVD.
DETROIT 10 MICHIGAN



AMAZING NEW POCKET SIZE RADIO!

NO TUBES, BATTERIES OR ELECTRIC
"PLUG-INS" NEEDED. "TUNES IN" MOST
LOCAL RADIO STATIONS with STATIC-FREE
CLEAR TONE. Has new perma-crystal diode
and TINY SELF-CONTAINED SPEAKER
PHONE—A marvelous real tiny pocket size
radio to take with you anywhere you go —
FOR REAL FUN AND ENJOYMENT. GUAR-
ANTEED TO WORK and should last for years!
SEND \$1.00 (Cash, M.O., Ck.) and pay
postage or send \$4.99 for p.p. delivery.
COMPLETE ready to play. By mail only from:
Midway Company, Dept. PPM-8, Kearney, Nebr.

Unlimited Capacity

Only SHOPSMITH has hori-
zontal drill, with 4" quill
feed, time-saving jigs, un-
limited capacity. Rugged
unit converts to saw,
sander, lathe and verti-
cal drill press. Write for
free catalog.

SHOPSMITH, Dept. 209-B
12819 Colt Rd., Cleveland 8, O.



HOME OWNERS' OIL BURNER SERVICE

Prepare now for cold weather. Save \$\$. We can help you. ILLUSTRAT-
ED MANUAL, which SHOWS YOU HOW to properly avoid or correct oil
burner trouble in Space Heaters, Water Heaters, Furnaces, having va-
porizing or pot-type burners. Available now at \$2.95. Cash with order.
Corrections for other types by correspondence at nominal charge. Money
back guarantee. Parts for most makes for sale. Give make, model, serial
number when writing. Home Oil Burner Service, Box 355, Milford, Mich.



ROADSIGNS CAN FAIL YOU BUT NOT YOUR HULL AUTO COMPASS

● Frequently damaged highway signs are one of countless
reasons motorists easily lose directions, drive worthless, angry
miles the wrong way. The one sure guide, every mile, is a
Hull Auto Compass. Write for local dealer's name, free
literature.

MORE HULLS IN USE THAN
ALL OTHERS COMBINED

HULL MFG. CO. P.O. BOX 2488
WARREN, OHIO

Baconlite \$6.95
ILLUMINATED
STREAMLINE \$4.95
STANDARD (see ad)

HELPFUL BOOKS

Send post card asking for FREE catalog
Popular Mechanics Press, 200 E. Ontario, Dept. 601, Chicago 11

MAGNETS

OF ALL TYPES — 10c UP
AMAZINGLY POWERFUL!!
6 ounce horseshoe magnet—\$1.50.
Our Leader, 1 lb. magnet lifts 40
lbs. \$2.95. New alloy—will not weak-
en! Useful for lifting valuables from tanks,
lakes, or rivers easily! 7 small magnets \$1.25 with
list of many shop and home uses. Satisfaction guaranteed.
R. EYRICH, 1219 W. MEINECKE AVE., MILWAUKEE, WIS.

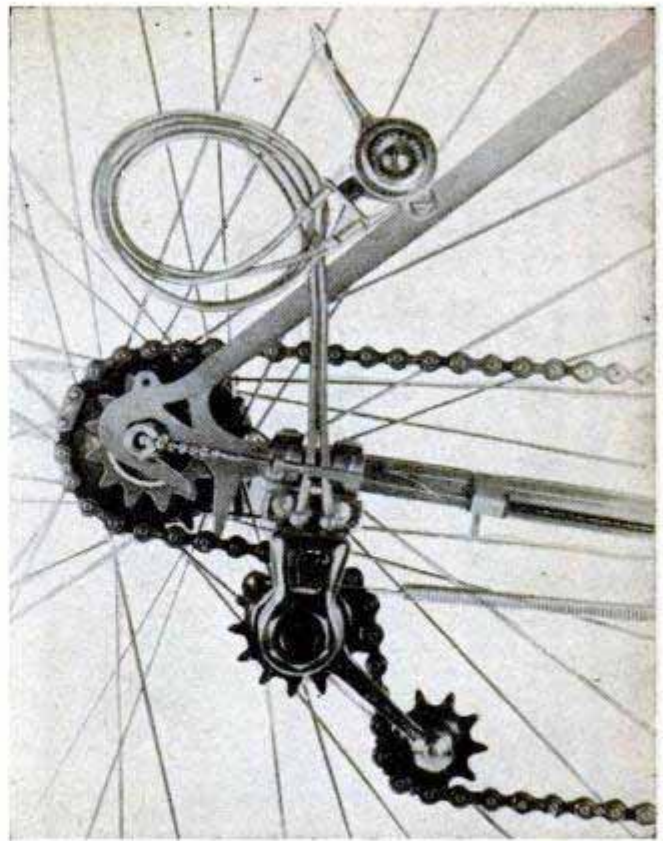

Six-Speed Shift for Bikes Developed in England

Cyclists can boost their average speed on
long trips from 10 to 20 miles an hour with
a six-speed gearing unit developed in Eng-
land. Now available in this country, the
shifter uses two rear sprockets to provide
a range of gearing from 9 to 32 feet per
revolution of the pedals. It mounts easily
on lightweight bikes now fitted with three-
speed hubs.

"Pencil" Tabulator

By use of a "pen-
cil" which can
"count" to 999, tiny
dots and other
small objects can
be tabulated
quickly. The regis-
tering pencil is
useful in counting
and marking bomb
hits, trees and
other objects in
photographs; in
enumerating blood
cells and bacterial



cultures; in counting parts of assemblies in
blueprints; and for totaling words in tele-
grams and manuscripts. The stylus point
of the pencil marks the object counted and
registers on a running dial of three wheels.
Only one pound of pressure is required per
mark.



**THE ONLY
SPARK PLUG
WITH PATENTED
CORALOX
INSULATOR**



LAWN ORNAMENT-NOVELTY PATTERNS

28 Lawn Ornament Patterns, 25c. Other Patterns; 15-20" high; Dutch Girl, Dutch Boy, Pirate, Bull Terrier, Mexican Girl, Mexican Boy, Dwarf, Penguin, Flower Girl, 10c each. 25 Novelty Patterns, 30c. All 62 Full Size Patterns, \$1.00 Postpaid. Strother Pattern Service, Dept. CZ-8, Box 128, Belington, W. Va.

DO MORE PLANING JOBS WITH LOW-COST BELSAW \$215.00



AMAZING 12 1/4-IN. PLANER Does All Ordinary Planing Mill Jobs. Provides attachments for Jointing, Rabbeting, Tongue, Groove, Matching. 12 1/4 x 6-in. capacity, 8-knife solid round all-steel cutters. Power feeds at 24 feet per minute, 42 cuts per inch. Provides for full line of accessory attachments—Grind and Joint knives IN THE CUTTERHEAD WITHOUT REMOVING.

FREE BOOK

BELSAW MACHINERY CO.
1019 Field Bldg., 315 Westport Rd., Kansas City 2, Mo.

ZIP GREASE INJECTOR

with replaceable tip—Zip it's on, Zip it's off. For the hard to reach places. Fits standard hydraulic adapters. Introductory offer \$1.00. R. L. Moyer Sales, 1401 W. 113th Street, Los Angeles 47, Calif.



NEW FAST LIGHT WEIGHT TRENCHER



Portable DITCH-WITCH digs 4" to 6" clean, even ditches to 42" depth in every type soil. Complete unit—self propelled—outdigs 8 men. 3 economical, rugged models. Write for illustrated literature.

THE CHARLES MACHINE WORKS
Perry, Oklahoma



STARRETT "Tools and Rules" BOOK

Describes and illustrates the precision methods skilled mechanics use. Only one dime. Write Dept. AP.

THE L. S. STARRETT CO., Athol, Mass., U. S. A.

WANTED!

MEN AND WOMEN TO EARN SPARE TIME MONEY

Many Popular Mechanics neighborhood representatives are making extra cash for easy, after-hours work. A few more are needed. For details, write:

POPULAR MECHANICS
ROOM 408
200 E. ONTARIO STREET
CHICAGO 11, ILLINOIS

"The Washday Sweetheart"



ATTACHMENT OF A BEYOND OF WORRY
Guaranteed by Good Housekeeping
AS ADVERTISED THEREIN

Your wife deserves a dependable **LIFETIME CLOTHESLINE**

- Won't rot, rust, or crack
- Won't sag or stretch
- Holds all types of clothes pins
- Once up—always up
- Won't soil washing

NICHOLS NEVER-STAIN Aluminum CLOTHESLINE

Solid or Stranded

Available at Your Neighborhood Store in 50 to 300-ft. Lengths.

By the makers of NEVER-STAIN Aluminum Nails
NICHOLS WIRE & ALUMINUM COMPANY
DAVENPORT, IOWA

STOPS TAPPING NOISE

... on **CHEVROLET and BUICK CARS**

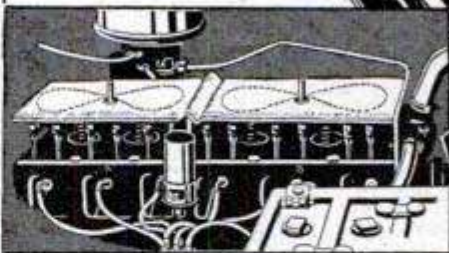

EASY TO INSTALL

The installation of a VAL-VIN-HED Silencer does these important jobs: Stops valve tapping noise . . . provides constant overhead lubrication . . . reduces friction, lessens moisture condensation and assures you of quieter, more efficient operation. A Silencer for Chevrolet cost only \$2.95, Buick \$3.50. Get one at your garage or from factory direct. **JOE L. ESTES CO.,** Dept. PM-8, Winder, Ga.



VAL-VIN-HED
Silencer

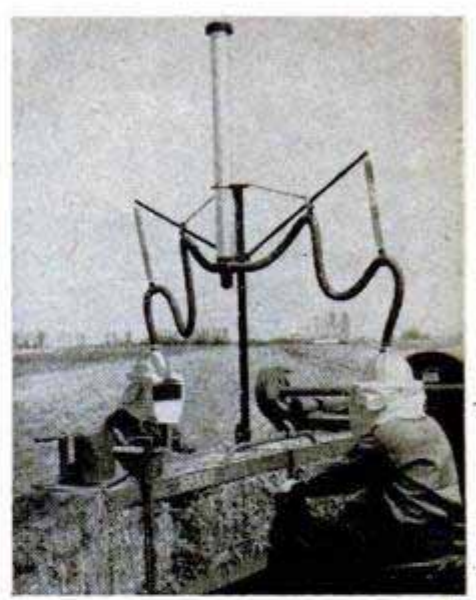
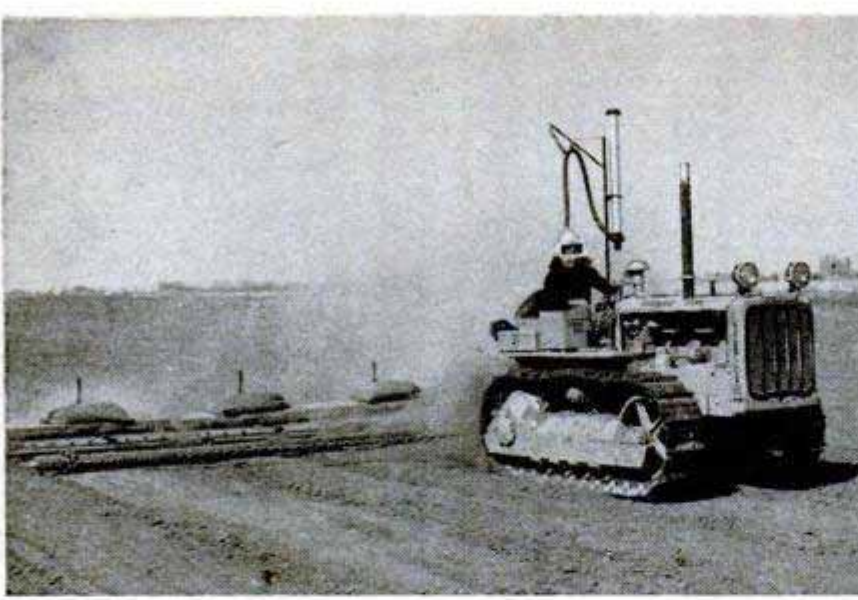

Air-Filtering System for Farm Workers

Farmers can work in "air conditioned" comfort thanks to an air-filtering system that removes the dust from air breathed by operators of tractors, balers and combines. The air is drawn into the system through a tall vertical pipe and forced by a small electric pump through a filter to

remove a high percentage of the dust. The clean air is then piped to a lightweight helmet through a flexible hose. There is enough room inside the helmet for the wearer to smoke as he works. The continuous flow of air downward over the face keeps the smoke out of the worker's eyes.

Tests With Trucks May Settle Road-Damage Controversy

For two 10-hour shifts daily, eight heavy trucks are speeding around a pair of specially built tracks in Idaho to settle a long-standing squabble on how much heavy trucks damage roadways. The test roads are dumbbell-shaped and 2½ miles in circumference. The black-top roadbed varies from 6 to 22 inches, including a crushed-rock base. Until early winter, trucks of

varying weight will constantly circle the tracks at 35 miles per hour. The tests will be resumed next spring after freezing and thawing has softened up the roadways. Sponsors of the \$500,000 project include the Western Association of Highway Officials, the trucking industry, petroleum haulers, the U. S. Bureau of Public Roads and a highway-research body.

Portable Wheel Aligner Uses Beam of Light for Fast Checking

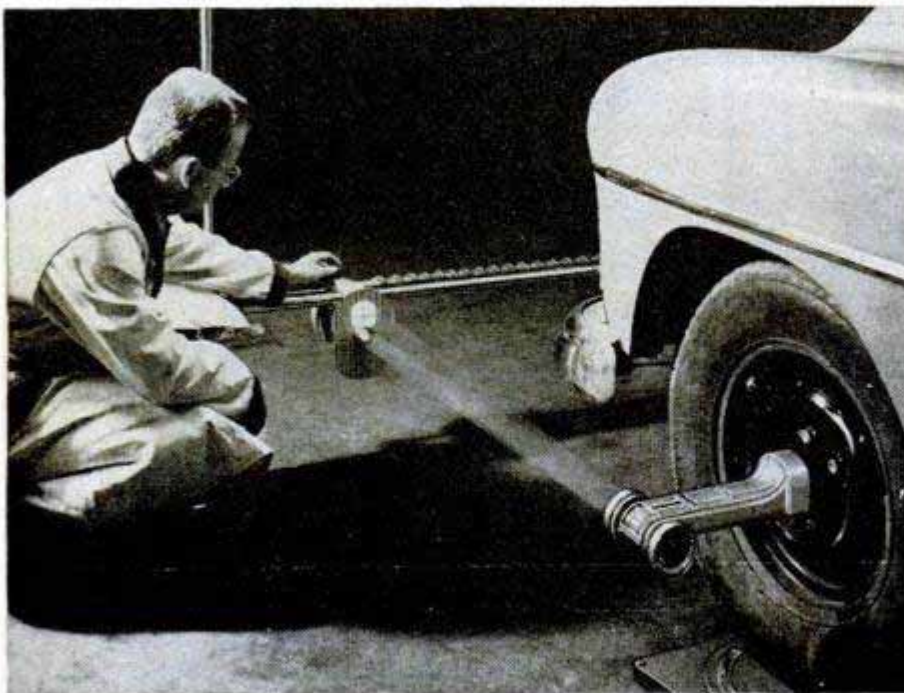

All a mechanic has to do to prepare a car for a wheel-alignment check with a new gauge is to run the front wheels onto a pair of turntables and remove the hub caps. A checking gauge is placed against the wheel hub and is held there securely by a permanent magnet inside the gauge. Camber and caster are checked by two levels. Toe-in is measured by a light beam projected from a target to a mirror on the gauge. The beam is reflected back and the location of the spot shows amount of toe-in.

WELLWORTH BARGAINS - ALL NEW EQUIPMENT

the Big 3-Wellworth COMPRESSORS

2 compression and one oil ring. aluminum alloy connecting rod. Stainless steel valves with brass seats and retainers. Cool-flo cylinder head, spray mist lubrication to every moving part. V groove fly wheel. One year guarantee.

MODEL W800. 2" bore, 1 3/4" stroke, 2 to 2.8 c.f.m. up to 150 lbs. pressure. Operates with 1/4 or 1/2 HP **\$20.50** motor. Reg. price \$25.50...
Shipping wt. 16 lbs.

MODEL W200
2 1/2"x2", 2.55 to 4.80 c.f.m. up to 150 lb. pressure. Operates with 1/2-1/2-3/4 HP motor. Reg. price \$36.50
Special Price... **\$27.95**
Wt. 24 lbs.

MODEL W7
2 cylinder 2 1/2"x2", 5.10 to 8.50 c.f.m. up to 150 lb. pressure. Operates with 1 1/2-3/4-1-1 1/2 HP motor. Reg. price \$67.50.
Special price... **\$54.50**
Wt. 45 lbs.



PORTABLE AUTOMATIC COMPRESSOR UNIT

1/2 h.p., 2.8 c.f.m. at 100 lbs. pressure. 20 ft. hose & tire chuck. Wt. 90 lbs. \$175. list. Complete as shown
\$98.50
Regulator gauge & filter **\$8.95**

AIR TANK and Accessories

— 24 1/2"x12 stainless with 20 ft. hose, air gauge, safety valve, copper tubing & fittings, air chuck, 4 way cross, wt. 25 lbs.

\$19.75
Tank Only **\$14.50**



Red Seal Continental Gas Engine

Rated 1 1/2 to 2 HP with 6 to 1 reduction gear. Operates at 450 R.P.M. For lawn mowers, scooters, garden tractors, pumps, compressors, generators, etc. List Price
\$79.50. Shipping wt. 54 lbs. **\$47.50**
SPEC. PRICE.....
Same engine at 2600 r.p.m. **\$47.50**

WISCONSIN GAS ENGINE

Big saving. 1952 model. A.K.N. 3 to 6 H.P. Wt. 75 lbs. **\$89.50**

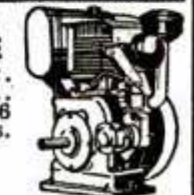

Wellworth V-BELT CLUTCH

Takes starting load off engines or motors. When speed is reached, a flip of handle shifts clutch from idling to driving position. Handles "A" belts, 2.35" pitch diameter, 5/8" bore. Ideal for use with lawn mowers, garden tractors, home workshop motors, etc. 3 1/4" long. Safe, easy to mount, sealed ball bearings, positive action. Shpg. wt. 3 lbs. **\$7.50**

BUSHING FOR 1/2" SHAFT 15c
SAME CLUTCH FURNISHED WITH 3/4" BORE **\$8.50**

PRICES F.O.B. CHICAGO. MONEY BACK GUARANTEE. SEND CHECK OR MONEY ORDER TODAY. PROMPT SHIPMENT. WRITE FOR 36 PAGE CATALOG - FREE

WELLWORTH TRADING CO.
1832 S. WABASH AVE., Dept. D-852, CHICAGO 16, ILL.

MERCURY CLUTCH

3" A-belt pulley. Centrifugal action for heavy loads. 5/8" bore. \$22.50 list. Special... **\$9.95**
3/4" bore. **\$10.95**

PAINT SPRAY UNIT

598 Value— **\$67.50** only.....

1,000 - 1/10 and 1/20 H.P. GEAR HEAD MOTORS

Bargain, Write for Circular

BARGAINS IN LIGHT PLANTS, GENERATORS, AIR COND. and FURNACE BLOWERS.



It's ready!
JUST ADD
WATER

SAKRETE

PRE-MIXED
CONCRETE & MORTAR IN A BAG!

© SAKRETE—P. O. Box 11, St. Bernard 17, O.

At Lumber, Building Material and Hardware Dealers . . .



\$\$\$ PROFITS with "all 'round" HOBART WELDING

Goes anywhere!
Trailer type gas drive welder.

The demand for welding has never been so great—and is only just beginning. Profit opportunities are unlimited. You, too, can cash in on it! Set up your own welding shop—the smart way—with a

Hobart welder. Only a performance-proven, long lived, all round welder can assure maximum jobs, bigger profits. Write for FREE booklet "How to Get Better Welds."



HOBART welders **HOBART BROS. CO., Box M-82, TROY, O.**

KEEP COOL THIS SUMMER WITH THESE C-BREEZE FAN BARGAINS

TWO YEAR GUARANTEED + ATTIC FANS + WINDOW FANS + AIR CIRCULATORS + EXHAUST FANS

All units complete with new 110 v 50/60 cy 1 ph. motors.

30 - 36 - 42 - 48 INCH ATTIC FANS AND MOTORS
30 in. Attic fan complete 7500 cfm 1/4 hp motor #SF02 \$62.50
36 in. Attic fan complete 9600 cfm 1/2 hp motor #SF03 73.00
42 in. Attic fan complete 12000 cfm 1/2 hp motor #SF04 97.00
48 in. Attic fan complete 16200 cfm 1/2 hp motor #SF05 135.00

12 - 16 - 20 - 24 INCH WINDOW FANS
12 inch reversible window fan—fits any 25 in. window—mesh guarded—1200 cfm—110 ac motor #1C912 — \$32.50
16 inch window fan—guarded blade—fits any 24 to 32 in. window, 110 v ac motor. #4F224 — \$29.75
20 inch Electrically switch reversible Window fan—fits any 30 to 40 in. window. Guarded 20 in. blade. 2000 cfm. Electrically reversible. 110 v ac motor #4F229—\$43.50
24 inch Belt drive Window or Attic fan—Guarded 24 in. 4500 cfm blade—1/4 hp motor. #5F84 — \$59.00

20 Inch High and Low Stand C-Breeze Air Circulators
20 in. blade Chrome low stand—wall or shelf fan. 3000 cfm—110 v ac motor. #2F76 — \$23.50
20 in. blade 8 ft. Hl stand floor fan. 3000 cfm #2F115—\$43.50

12 - 16 INCH EXHAUST FANS ON SHUTTERS
12 in. guarded blade—1000 cfm exhaust fan and shutter 110 v ac motor. #4F179 — \$24.50
16 in. guarded blade — 2000 cfm exhaust fan and shutter 110 v ac motor. #4F228 — \$37.50

Above units are complete — all accessories included — Federal Excise Taxes Paid. For prompt shipment order by number Above Special Prices are F.O.B.
Write for FAN CIRCULAR: Listing Blades, Guards, Motors, ALL SIZES: Attic, Window or Room Cooler



16 to 1 SPEED REDUCERS
For Display Table—Barbecue Spits—Toy Auto Gear Box — Experimental Uses, Etc. Gears Enclosed in Aluminum Housing. Bronze Gear, Hardened Worm, Input Shaft 1/4 in. Output Shaft 3/8 in. Speed Reducer #R 161... **\$3.95** Post Paid

• **New Explosion Proof Motors** •
Underwriters approved, Class I, Group D, explosion proof motors, Westinghouse and Lealand makes, heavy duty repulsion induction and capacitor types. For pumping gasoline, lacquer or use on jobs where motor is exposed to hazardous fumes or material, abrasives, dirt and dust. All 5/8" shaft, 1750 RPM.
No. EP-25, 1/4 HP, 110/220V, 60 cy., 1 ph. \$23.50
No. EP-33, 1/2 HP, 110/220V, 60 cy., 1 ph. \$28.50
No. EP-333, 1/2 HP, 220 volt, 60 cy., 3 ph. \$32.50
No. EP-32, 1/2 HP, 32V, direct current \$33.50
No. EP-115, 1/2 HP, 115V, direct current \$37.50
No. EP-230, 1/4 HP, 230V, direct current \$24.50
No. EP-235, 1/2 HP, 230 V, direct current \$27.50

All prices F.O.B. Chicago
C. MARSHALL SALES
3546 W. Fullerton Ave., Dept. P-8, Chicago 47

Volume Blowers for Heating, Ventilating, Exhausting

Blowers for forced drafts, heating boosters, exhausters, coolers, dryers and dust collectors. 110 volt A.C., 50/60 cycle motors.

- Midget Blower: 5 CFM 2 in. Wheel . . . \$ 5.95
- 50 CFM Blower: 3 inch Wheel . . . \$ 9.75
- 75 CFM Blower: 4 inch Wheel . . . \$11.25
- 250 CFM Blower: 5 inch Wheel . . . \$22.50
- 600 CFM Blower: 6 inch Wheel . . . \$38.50
- 1000 CFM Blower: 8 inch Wheel . . . \$52.00
- 1500 CFM Blower: 9 inch Wheel . . . \$72.00

*These Blowers with Motors shipped Post Paid. Larger sizes are F.O.B.

INSTALL A "MILE-O-METER"

LEARN HOW TO SAVE GAS AND TUNE YOUR OWN MOTOR . . .

"Mile-O-Meter" on the dashboard registers miles per gallon faithfully at all speeds, under every driving condition . . . Will show what speed your engine delivers its maximum power. Can save you many gallons of gas . . . Provides constant check on engine condition — Warns you of operating imperfections for 31 different motor adjustments . . . Nationally advertised in leading magazines and newspapers . . . Can be installed in a few minutes . . . transferred from old to new car. Fine watch precision . . . Order yours today!



STD. Model
\$9.75
2 3/4" Dia. Ppd.
Fed. Tax Incl.

HUGE 24 PAGE INSTRUCTION MANUAL AND MILEAGE CALCULATOR INCLUDED FREE!



Installation requires no experience . . . becomes a constant companion on every trip. Saves cost in a short time. This professional gauge is a must!

\$14.95 DELUXE MODEL with Chrome Ring
3 3/4" Dia. Ppd. Fed. Tax. Incl.

GALE HALL ENGINEERING Dept. 213

BOSTON 18, MASS.

DELUXE MODEL NOW ILLUMINATED

WELD
BRAZE, SOLDER,
and CUT →

ONLY
\$1475
F.O.B.
complete!



No experience needed. Follow simple instructions, weld on iron, steel, bronze, brass, aluminum, and other metals. Plugs into any properly wired 110 volt A.C. or D.C. line. Make or save time and money doing repair work for yourself and others. Repair men, farmers, tinsmiths, home and auto owners, hobbyists, etc., say FOUR-WAY pays for itself over and over. Order today or send for Free details.

Larger Equipment Available on Request
FOUR-WAY WELDER COMPANY, Dept. F2-HC
2326 S. Michigan Ave. • Chicago 16, Illinois

ORDER
NOW
10 DAY
TRIAL

OVERHAUL YOUR MOTOR in 10 minutes



WITH A
MOTOR
"RENEW" KIT

- INCREASES COMPRESSION
- STOPS PISTON SLAP
- STOPS OIL BURNING
- FREES VALVES, RINGS AND PISTONS

RENEW WITH "COMPRESSION SEAL"!

This proven motor treatment gives up to 15,000 miles of powerful, knock free performance to any car. Squeezed into cylinders, it forms a long wearing, lubricating seal by filling in worn places between cylinder walls and pistons. This increases engine compression, cuts oil and gas waste and eliminates the need of costly overhaul and ring jobs.

CLEANSE WITH MOTOR "PURGE" FORMULA!

Your engine will run smoother, cooler and more efficiently once flushed with Motor "Purge". When poured into cylinders it cleans, quiets and frees rings, valves and pistons from gums, carbons and varnish.

A MOTOR "RENEW" KIT TREATMENT . . . REVITALIZES AND INCREASES THE LIFE OF ANY ENGINE!

FREE AUTO MANUAL WITH EACH ORDER!

Manual tells how to save gas, oil, brakes and tires through simple economy secrets . . . introduces many new products.

FULL 10 DAY
"MONEY BACK" GUARANTEE!
DEALER INQUIRIES INVITED!

\$6.95 (Postpaid \$1 C.O.D. deposit)

ENGINE PRODUCTS MFG. CO., Dept. PMK-8
5807 E. Beverly Blvd., Los Angeles 22, Calif.

A FULL YEAR'S SUPPLY Sent Prepaid FOR

ALL BRAND NEW **44** SIZES 1/16-1/4

USE IN HAND OR ELECTRIC DRILL

Fast cutting tool steel
TWIST DRILLS
Hardened tempered. Will drill
• STEEL
• ALUMINUM
• IRON
• WOOD AND
• PLASTICS

\$2

AUTOMATIC RATCHET SCREW DRIVER WITH 2 BITS.
one Phillips one Normal
A \$6 Value
For **\$2.25**

HEAVY DUTY ALL PARTS NICKEL PLATED

SPECIAL WITH THIS AD— BOTH SCREWDRIVER & 44 DRILLS, ALL FOR \$4 Prepaid

Send Check or M.O. to Dept. M. Bargains Unlimited, 673 Broadway, N.Y. 12

MAKE YOUR OWN TRAILER

or shop wagon with this sturdy aero. tire, tube and wheel with bearings for \$8.50 complete. Tires OD 10 1/2" high, 3 1/2" wide. Bore for axle 5/8".



WRITE FOR FREE CATALOG

on other sizes with stub axles and other farm tires. Wheel barrow and Trailer manufacturer inquiries invited.

HARMO TIRE & RUBBER CO.

Part #218
804 HAMMOND BLDG.,
Dept. PM
DETROIT 26, MICH.

CRAFTSMAN

REG. U.S. PAT. OFF.

HAND and POWER TOOLS

Famous for fine quality . . . precision performance . . . lower price! Buy them NOW . . . at Sears convenient Retail Stores . . . located in principal cities throughout the United States.

SEARS, ROEBUCK and CO.

NEW, IMPROVED CALCULATOR FOR WOODWORKERS only 25c

Instantly gives information on lumber, nails, concrete mixes, painting materials, etc. Convenient, simple to read. Just set dial for nail specifications, to convert linear to board feet, find bit sizes for screws, compare characteristics of woods. 6" diameter heavily varnished cardboard. Send 25c, no stamps, please to Greenlee Tool Co., 2108 Columbia Avenue, Rockford, Illinois.

6 GREAT SHAW "DU-ALL"

Plow
Plant
Cultivate
Mow
Rake
Cut
Trees
Saw Wood

Walking or Riding Tractors
1 1/2, 3, 5 H.P. walking models.
5, 8, 12 H.P. riding tractors.
Get just the power you need in Shaw extra strength superior traction machines. All wanted tools, attachments. Dependable for nearly 50 years. See a Shaw dealer. Write for FREE literature, low prices—today.

SHAW Mfg. Co. 4508 Front St., Galesburg, Ks.
668-G N. 4th St., Columbus, O.

SAY YOU SAW IT IN POPULAR MECHANICS

GIANT BALLOONS

Genuine govt. surplus weather & target balloons. For fun or profit. Great sport in the back yard; or for parties, picnics, dances, fairs. Money-makers whenever you want to attract a crowd for lodges, civic events, school functions, conventions, exhibitions, trade shows. Special purchase makes these low prices possible.

3 Ft. Dia. 39c — 6 Ft. Dia. 79c — 13 Ft. Dia. \$1.39

Add 10% for postage and handling
California residents please add Sales Tax

WAR ASSETS DIV. VOLUME SALES CO.

Dept. PM-8-52, 3930 Sunset Blvd., Los Angeles 29, Calif.

HYDRAULIC Special

COMPLETE HYDRAULIC POWER UNIT!!

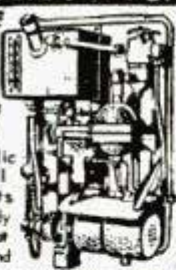

Complete hydraulic pumping unit. All necessary parts assembled & ready to work at a great saving in time and cost to you. Delivers 3 1/2 GPM at 1500 PSI or 1800 RPM. (Other volumes and pressures can be obtained by simple adaptations) Unit consists of a gear pump driven by a 2 1/2 HP, DC motor (4000 rpm max.), relief valve, pressure unloading switch, filter, accumulator, reservoir with sight gauge & complete plumbing. Mounted on 19" x 25" aluminum panel. Complete with 24V-DC motor (Other motors of any current can be adapted) **4995**

HYDRAULIC CYLINDER SPECIAL

Gives 20,000 lb. thrust (push-pull) using 1500 PSI line pressure as obtained from our hyd. pumps. Or will produce 40,000 lb. thrust with 3000 lb. line pressure. Can ALSO BE OPERATED ON LOW PRESSURE AIR SYSTEMS. 4" bore, 1 1/2" dia. piston shaft, 18" stroke, length: 30 3/4". Equipped with ball bearing loaded clevis type mounting and swivel type high pressure steel pipe bracket for easy use. Ideal for road, farm & shop machinery, presses etc. Cost gov't **2995** \$390.00

No. 3 DOUBLE ACTION CYLINDER - Bore is 1" - Shaft is 1/2". Has a stroke of 2 1/4" to 4". Stroke can be adjusted with internal sleeve stops. Overall length is 8 1/2". Will take 1500 lbs. continuous duty. 3000 lbs. intermittent. Will lift or push up to 1100 lbs. **575**

We carry the World's largest supply of Special Hydraulic Equipment featuring over 20,000 cylinders in 61 sizes and types. Can also supply all accessories such as Pumps, Valves, Tanks, Hoses and Fittings. Write for information.

BENDIX HYDRAULIC PUMP AND MOTOR 1950

Has 3 1/2 GPM capacity at 600 PSI. Motor is 1 1/2 HP, 24V, DC. Operates on either 12 or 32V, DC current. Has built-in relief valve adj. to 1500 PSI. This unit ideal for bait tanks, hyd. lifts, portable loaders etc. Cost gov't approximately \$350.00.

VICKERS HYDRAULIC VARIABLE DISPLACEMENT PUMP GENERATOR

May be used as an elec. motor driven type pressure generator in an hyd. system where a varying volume is desired with a non-pulsating flow. Will give max. volume at pressure settings between 600 & 900 PSI by simple adjustment screw. Pump housing serves as reservoir for system. Has built in compressed air supercharger to make system independent of outside atmospheric pressure. Rotation, left hand only. Max. speed for continuous duty 3750 RPM. Displacement .484 cu. in. per revolution or approx. **3250** 4 GPM at 1750 RPM.

SAVE UP TO 85% ON WAR SURPLUS "GADGETEER'S HEAVEN"

ELECTRIC GYRO

Turns up to 50,000 RPM. Electric drive motor is integral part of balance wheel. Has double end shaft to drive precision tools or machinery at precise, controlled speeds. Ball bearing mounted. Runs on high or low voltage. Ideal for experimental work, labs, hobbyists, technicians, etc. **495**

3 SPEED TRANSMISSION

Converts a high RPM, low power input into low, RPM, high torque output. Has 2 take-off shafts at 4 to 1 & 16 to 1 ratio. Gear box has worm drive bronze gears & throw-out clutch. Will operate forward or reverse directions. Adaptable to many uses on power machinery. **1995**

90° TRANSMISSION

Has 1 1/2 to 1 gear reduction through bevel gears. Pre-lubricated bearings in dust proof housing. A positive lever controlled clutch... Size 7" x 6" 3/4" take-off shaft. **395** NOW ONLY

180° OFFSET GEAR DRIVE

For use where high power at low take-off RPM is desired. Ideal for revolving radio or TV antenna etc. Has 85 to 1 gear ratio. **675** New **1295**

HYDRAULIC HAND PUMP

Hand operated. Operating pressure 1000 PSI. Capacity 1.6 cu. inch per cycle. \$55.00 Value - **Only 1075**

AGASTAT TIME DELAY RELAY

Has 24V DC, energizing coil which operates a double pole, single throw relay switch. Holds circuit closed from fraction of second to 15 seconds by means of adj. set screw. Ideal for animated signs, displays, electric locks etc. **225**

MAKE YOUR OWN ARC WELDER

Use this top quality, precision built R-1 generator. An aircraft generator that originally cost the government approximately \$400. Gives 300 to 400 amps at 27 volts. Ideal to convert for all welding, light or heavy up to 5/8" thickness. Free conversion instructions with each unit. **2795**

OTHER AIRCRAFT GENERATORS

X-10 12 to 15 Volts 50 Amps \$12.95
X-11 27 VOLTS . . . 200 AMPS \$15.95
X-12 27 VOLTS . . . 100 AMPS \$25.00 NEW
X-13 . . . 27 VOLT. 140 AMP. **1695**
X-14 . . . 27 VOLT. . . 75 AMP. **1595**

Also available - complete DC Arc Welder. 300 amps continuous, 350-400 amps intermittent. Write today for details.

NEW ILLUSTRATED 230 PAGE - 1952 CATALOG

1000's of WAR SURPLUS, Factory Close-Outs and General Merchandise Values. For the mechanic, sportsman, hobbyist, home owner etc. BIG SAVINGS on clothing, housewares, hardware, farm rubber, hand & power tools, outdoor equipment, plastics, gadgets & a huge stock of hydraulic supplies. **Send Only 50¢** (for mailing & handling)

GADGET MIXES

GADGET MIX - Rivets, Spacers, Bolts, Screws, Gears, Wheel Bearings, Springs and Clamps. No. 106, 5 lbs. **1.19**

BEARING MIX. No. 170A. Approx. 20 needle, Ball & Roller Bearings. New & Used. Sizes: 1/2" to 4". Some of these cost Gov't \$10 a piece. Never such a value! 5 lbs. ONLY **1.59**

FILE MIX - Ten assorted Files - 4" to 12". Includes Vixens, half rounds, mills, bastards, etc. - in seconds and used but good condition. 1 Vixen alone is worth our price for entire mix. **99¢**

IMMERSION HEATER

Designed for installation in water base fluids, as in coffee urns, sterilizers, humidifiers etc. Has two copper-sheathed, tubular heat elements, silver soldered into head. A 3-heat type. 3000 watt, 230v, 2" pipe thread collar. **A PALLEY Value 1200**

WESTINGHOUSE AIR COMPRESSOR

1000's now in use for spraying, inflating, air tools, in garages, laboratories, shops & on trucks, tractors, jeeps, etc. Lightweight but powerful. Operates on 1/2 HP, gas or electric motor. Runs either direction. Delivers approx 3.27 CFM at 500 RPM or 6.54 CFM at 1200 Rpm. Has 2" bore, 1 1/2" stroke. We have motors, tanks and fittings to adapt this unit. **2395**

AIRCRAFT CABLE

Rust resistant, alloyed steel. Extra flexible. Pre-formed, 7 x 19 strand. On reels.

1/16" - 4 1/2 ft. (7x7)	7/32" - 11 1/2 ft.
5/64" - 5 ft. (6x7)	1/4" - 12 1/2 ft.
3/32" - 5 1/2 ft.	9/32" - 15 ft.
1/8" - 7 ft.	5/16" - 16 1/2 ft.
5/32" - 7 1/2 ft.	3/8" - 18 ft.
3/16" - 10 1/2 ft.	1/2" - 20 ft.

SPECIAL 3/16" cable, 18 feet long, with tumbuckle ends. **99¢**

Stainless Steel Cable - Pre-Formed
1/16" 7 ft. | 5/32" 20 ft.
1/8" 18 ft. | 3/16" 23 ft.

Bronze Cable - Not Pre-Formed
1/16" - 5 ft. | 5/16" - 23 ft.
1/4" - 17 ft. | 1/2" - 38 ft.

ELECTRIC MOTORS

606 - DELCO MOTOR

1/50 HP, 24v DC, 1.6 amp. turns 3000 RPM. Has adj. overspeed contactor to stabilize and control speed. Length 5 1/2". Diam. 3". **ONLY 495**

SANSELL MOTOR

27 volts, 16 amps, 1/5 H.P. reversible, series wound on motor. 3800 RPM, shaft 9/32" diameter. 12 spline. 4-1/8" x 2-3/8" ONLY **395**

SURPLUS MOTORS

No. 500 - New 1/2 HP - 27 volt, DC-AC. This motor can be readily adapted to deliver up to 1/2 HP on 110 volts AC by the simple method of rearranging armature brush-leads. Free Diagram with each order. A SENSATIONAL VALUE. **595**

GEAR HEAD MOTOR

Heavy duty, G. E. GEAR HEAD motor. 2 HP, 24V, DC, 125 amp., reversible motor or drives a reduction gear unit giving 36 to 1 ratio at take-off. Also will operate on 6 or 12 volts.

36 to 1 G.E. (306 shaft RPM) **1095**
26 to 1 Eclipse (130 shaft RPM)
40 to 1 Eclipse (170 shaft RPM) **EACH**

LEAR GEAR HEAD MOTOR - Lear 24 volt DC, 7.6 amp, series wound reversible motor with overload clutch. Motor turns 11,000 RPM driving thru a 10 to 1 gear reduction box which turns the final take-off shaft 1100 RPM. Adjustable limit switches control limit of travel. Take-off shaft adapts to flex or rigid drive. **1750**

ELECTRIC ACTUATOR

Hundreds of uses for any mechanical device needing controlled 2 way action. Opens, closes, raises or lowers doors... windows, gates, valves... **CTU-2 Foote Linear Actuator. 24 Volt, DC, 8500 RPM, 1/8 HP - series wound motor. 4-1/2" stroke in 13-1/2 seconds. Compression & tension loads up to 750 lbs. Adjustable micro switch for limits of travel. Overall lgth. retracted 11 inches. **795****

EASTMAN ACTUATOR

Has a 1/8 HP, 24V, DC, 10,000 RPM motor & push-pull actuator. Actuator has a 4" travel through a reduction gear box. Has adjustable limit switches and forward and reversing reversing relays. Overall length extended, 20"; retracted 25 1/2". **1295**

FIRE EXTINGUISHER

Kiddle Lux - CO² Type. Built to Gov't specifications. Heavy, shatter-proof case. Recent hydro-static test. Reconditioned and fully charged. LIKE NEW! READY FOR INSTANT USE! **3 1/2 lb. size with Swing Nozzle . . . 17.95**
7 1/2 lb. size with Horn 23.75
10 lb. size with new Squeeze Grip Handle & 3 1/2 ft. flex hose with Horn 29.75
15 lb. size with Wheel Control . . . 37.95
15 lb. size with Squeeze Grip Handle, 4 ft. flex hose, Plastic Horn . . 42.50

Order From This Ad. Pay by M.O. or check. P.O.'s. accp'd. from D&B firms. 1/2 deposit with C.O.D.'s. All Prices FOB Los Angeles.

PALLEY SUPPLY NEW MAIL ADDRESS 2263 E. VERNON AVE. Dept. PM-B CO. LOS ANGELES 58, CALIF.

SAVE 70%

SACRIFICE SALE!

**MUST RAISE CASH!
CREDITORS DEMAND PAYMENT!**



FREE

German made
KLAROVIS
3 X 40 mm
yours FREE with glasses
of any watch with purchase
any domestic Compare to
claiming 18 mile ranges and
selling to \$9.95. Yours to
keep even if you return
watch for refund!

Frankly, we're in a tight fix! Thousands of 17 jewel precision-built watches came in too late for last Christmas and far too early for the next! Our creditors won't wait! They demand payment NOW. Our misfortune is your lucky break! Buy now! Save up to \$70.00 on one watch!

10 DAY FREE TRIAL

Examine... check... appraise any THORESEN watch for 10 days at no risk whatsoever! Full price back if not delighted. **SEND NO MONEY**—Pay price plus postage on arrival. Or send check, cash or money order for quick, prepaid delivery and **SAVE MORE!** Given: **COBRA** Expansion band with every watch, also instructions, Guarantee Certificate and gift shown. Rush coupon now! Prices subject to rise after present over-stock is exhausted. References: Jewelers Board of Trade, Better Business Bureau or any national bank. Buy with confidence! Thoresen's is a reliable, nationally known firm. Address:

THORESEN DIRECT SALES, Dept. 6-H-300

131 WEST 33rd STREET

NEW YORK 1, N. Y.

FAMOUS RECIPRO-REGISTER CHRONOGRAPH 1995

TIMES: SPORTS • PHOTOGRAPHY • LAB WORK • SHOP WORK, ETC.

This is the **Recipro-Register Chronograph**—the BEST brand available anywhere in the world today! Thousands of proud owners paid much, much more because this is the Prince of modern watches — the last word in magnificent styling. Case made of Triple Chroming with lasting **Stainless Steel** back! Precision engineered in the highest traditions of Swiss craftsmanship! A smart, slim unusual timepiece of functional beauty. It's the **"CHRONOGRAPH THAT REMEMBERS!"** Freezes result while movement continues to keep time!

CHECK FEATURES WITH \$71.50 WATCHES!

- 5 Multifunction Dials
- Luminous No.'s & Hands
- Hairline Sweep Second
- Unbreakable Crystal
- 17 Jewels
- Chrome & Steel
- 5 Hands
- Incabloc
- Split Second Calibration
- 2 Clutch Operation
- Anti-Magnetic
- Shock Protected

DON'T PAY \$71.50 or more to a credit jeweler around Christmas time! Get the Genuine, Original **RECIPRO-REGISTER** at our **SACRIFICE PRICE** for cash—\$19.95 plus 10% tax, total **\$21.95** (while stocks last). **YOU SAVE OVER \$41.00.** Given: Nationally advertised \$4.95 **COBRA** expansion band, gift case, instructions and our written guarantee as well as German made **KLARO-VIS** field glasses! Don't lose this bargain of a lifetime—send **TRIAL COUPON**—**NOW!** Check Number **233.**



17 JEWELS • EXTRA-THIN, AND MODERN AUTOMATIC WATCH 14.95 plus tax

The month, date, weekday, hour, minute and second are yours at a glance with this Swiss engineering triumph! An impressive, very thin Date Changes Automatically! Date gears are precision and quality. Patented design for smooth long-life operation.

SPECIAL QUALITY FEATURES
• 17 Jewel Swiss movement
• Stainless Steel Back • Unbreakable Crystal • Thin, Streamlined Design • Luminous Hands & No.'s. • Rugged Construction
Compare with other calendar watches selling for \$59.50, and if you are not thrilled with its performance, return for full price refund! While they last, we're sacrificing them at only \$14.95, plus \$1.50 tax, a total of only \$16.45. Where, oh where can you get a value like this? Better rush that Coupon now! Order by number **243-C.**



17 Jewel Incabloc WATER & SHOCK Resist Watch 12.95 plus tax

A favorite with Marines, Sailors, Soldiers, Aviators and sportsmen! Drop it, wet it, jolt it at work or play! It actually runs under water! This is no ordinary watch—it is a splendid timepiece made according to exacting standards in reputable Swiss factories. Thousands sold at much higher prices.

COMPARE WITH WATERPROOFS AT \$59.50
• Incabloc Protected • Shock Absorbing • Water Gasket • 17 Jewels—Accurate! • Luminous Hands & No.'s. • Unbreakable Crystal • It's smaller, thinner, more accurate, better made than many competitors watches selling for much more. **DO NOT CONFUSE** with cheap models! This is a guaranteed quality timepiece — You're satisfied! Best of all, you save \$46.55 during our sensational Sacrifice Sale! Only \$12.95 plus \$1.30 tax, total: \$14.25. Quantity limited! Order at once by number **224.**



SEND NO MONEY! Mail Coupon now for home trial!

THORESEN DIRECT SALES, Dept. 6-H-300

131 West 33rd Street, New York 1, N. Y.

RUSH watches) checked on 10 DAY TRIAL. Send following **FREE** of extra cost with each and every watch purchased: 1. Reg. 4.95 **COBRA** Band. 2. **KLAROVIS** German Glass. 3. Guarantee Certificate. 4. Gift Box. 5. Instructions.

- Payment enclosed. Send prepaid. Send C.O.D., plus post.
 No. 233 CHRONOGRAPH—\$21.95 No. 224 INCABLOC—\$14.25
 No. 243-C CALENDAR—\$16.45

You are to refund **FULL PURCHASE PRICE** if I am not delighted, keeping the "Klarovis" as your gift to me.

NAME _____
ADDRESS _____
TOWN _____ STATE _____

UNCONDITIONAL GUARANTEE

EXCLUSIVE OF PARTS!

FREE repair service ANYTIME if needed by skilled watchmakers—for the **LIFETIME** of this firm. No cost ever for "handling" adjustment or service. **FREE** annual oiling and timing service. **THORESEN** makes **LIFETIME FRIENDS!** Remember: If you are not satisfied with your purchase after 10 day trial, return for full price refund. Our written Guarantee Certificate enclosed with every watch!



"We have been using your book on Auto Repair for the past year and feel like it is a third man around the shop."—F. M. Scott, Stanwood, Wash.



"Fixed motor in 30 minutes another mechanic had worked on half a day."—C. Auberry, Murfreesboro, Tenn.



"Instructions so clear, have no trouble learning anything about any car. Now working as mechanic in big plant."—S. Ordoñez, San Francisco, Calif.



"So easy to understand—have done jobs with Manual I would not have attempted without it."—C. L. Venerstrom, Hazel Park, Mich.



"I have found my MOTOR Manual a wonderful help. It has put me in a position to do every job."—S. L. Sharpless, Los Angeles, Cal.

THOUSANDS OF MEN ARE RAVING ABOUT THIS GIANT GUIDE!

Now YOU Can Be a "Cracker-jack" at Auto Repairs!

BRAND-NEW
1952
EDITION!

Thousands of Easy-to-Follow Step-by-Step Pictures

Easy-Step-by-Step Instructions Show How to do ANY Job on ANY Car—from 1935 through 1952!

THOUSANDS of men are raving about MOTOR'S BIG NEW ILLUSTRATED AUTO REPAIR MANUAL! It enables them to do any job FASTER and better; do MORE jobs; make MORE money!

Whether it's on a 17-year-old "jalopy" or a brand-new 1952 beauty, YOU, too, can "breeze through" any repair job quickly, easily, right! Just look up the make, model, and job in the quick index—and go to it!

Everything You Need to Know to Repair Any Car!

This NEW 1952 REVISED edition has MORE REPAIR INFORMATION THAN EVER—right up to the minute! Over 800 big pages, 2400 "This-Is-How" pictures—clear drawings, diagrams, cut-away photos that lead you every step of the way. Over 200 "Quick-Check" charts containing more than 38,000 essential repair specifications. Over 225,000 service and repair facts. Clear, simple directions. You can't go wrong!

Any man—even a green beginner—can do a good job. If you're a top-notch mechanic, you'll find yourself tackling jobs now that you wouldn't touch before!

Earn More Money! Win Greater Prestige!

The editors of MOTOR'S Manual have put together the "Know-How" from over 170 Official Factory Shop Manuals; "boiled it down" into one handy book!

Includes ALL Automatic Transmissions (including new Dual Range Hydra-Matic). Covers the newest Carburetors, Engines (including new De Soto, Lincoln, Ford) . . . Chokes . . . Fuel Pumps . . . Oil Filters . . . Starting Motors . . . Generators . . . Distributors . . . Clutches . . . Universals . . . Axles . . . Brakes . . . Power Steering . . . Shock Absorbers, etc.

Valuable help in Body Service, Factory Specifications and Adjustment Tables, Tune-up Charts, Tables of Measurements and Clearances, Overhauling and Replacement Facts—AND MUCH, MUCH MORE.

Used by Armed Forces, hundreds of thousands of auto service men! YOU'LL want it, too, once you see its over 800 giant pages—almost a foot high!—its 2400 close-up pictures! Try it on the following UNCONDITIONAL GUARANTEE:

Try Book for a Week FREE

Send No Money. Pay nothing to postman. Test book in your own garage or shop. It's GUARANTEED to pay for itself in 7 days. If it doesn't, just return the book, and owe nothing. You don't risk a penny. Rush coupon for your free-trial copy of this great money-saving Manual. MOTOR Book Dept., Desk 1J, 250 West 55th St., New York 19, N. Y.

SEND NO MONEY!
TRY BOOK FREE!
FOR A WEEK FREE!



COVERS 851 MODELS—ALL THESE MAKES:

- Buick
- Cadillac
- Chevrolet
- Chrysler
- Crosley
- De Soto
- Dodge
- Ford
- Frazier
- Henry J
- Hudson
- Kaiser
- Lafayette
- La Salle
- Lincoln
- Mercury
- Nash
- Nash Rambler
- Oldsmobile
- Packard
- Plymouth
- Pontiac
- Studebaker
- Terraplane
- Willis

ALSO complete tune-up adjustments for American Bantam, Auburn, Austin, Cord, Graham, Hupmobile, Pierce Arrow, Reo.

USED BY U.S. ARMED FORCES

Same FREE 7-Day Offer on MOTOR'S TRUCK and TRACTOR REPAIR MANUAL

Covers EVERY job on EVERY gasoline-powered truck and farm tractor made from 1935 thru 1951, 2567 pictures, 105 big 8 1/2 x 11-inch pages, 300,000 facts. Used by Armed Forces. All types Gasoline Engines, Fuel Systems, Governors, Lubrication Systems, Ignition Systems, Starters, Generators, Clutches, Transmissions, Axles, Torque Dividers, Transfer Cases, Brakes, Steering, etc. Check proper box in coupon for free trial.



MAIL COUPON NOW FOR 7-DAY FREE TRIAL

MOTOR Book Dept., Desk 1J, 250 West 55th Street, New York 19, N. Y.

Rush to me at once: (Check box opposite book you want)

- MOTOR'S New AUTO REPAIR MANUAL. If O.K. I will remit \$1 in 7 days (plus 35c delivery charge), then \$2 monthly for 2 months, and a final payment of 95c a month later. Otherwise I will return book postpaid in 7 days. (Foreign price, remit \$8 cash with order.)
- MOTOR'S New TRUCK AND TRACTOR REPAIR MANUAL. (Described at left.) If O.K. I will remit \$2 in 7 days, and \$2 monthly for 3 months, plus 35c delivery charge with final payment. Otherwise I will return book promptly. (Foreign price, remit \$10 cash with order.)

Print Name Age

Print Address

City & Zone No. State

SAVE 35c delivery charges by enclosing WITH COUPON check or money order for full payment of \$5.95 for Auto Repair Manual (or \$8.00 for Truck and Tractor Manual). Same 7-day return-for-refund privilege applies.

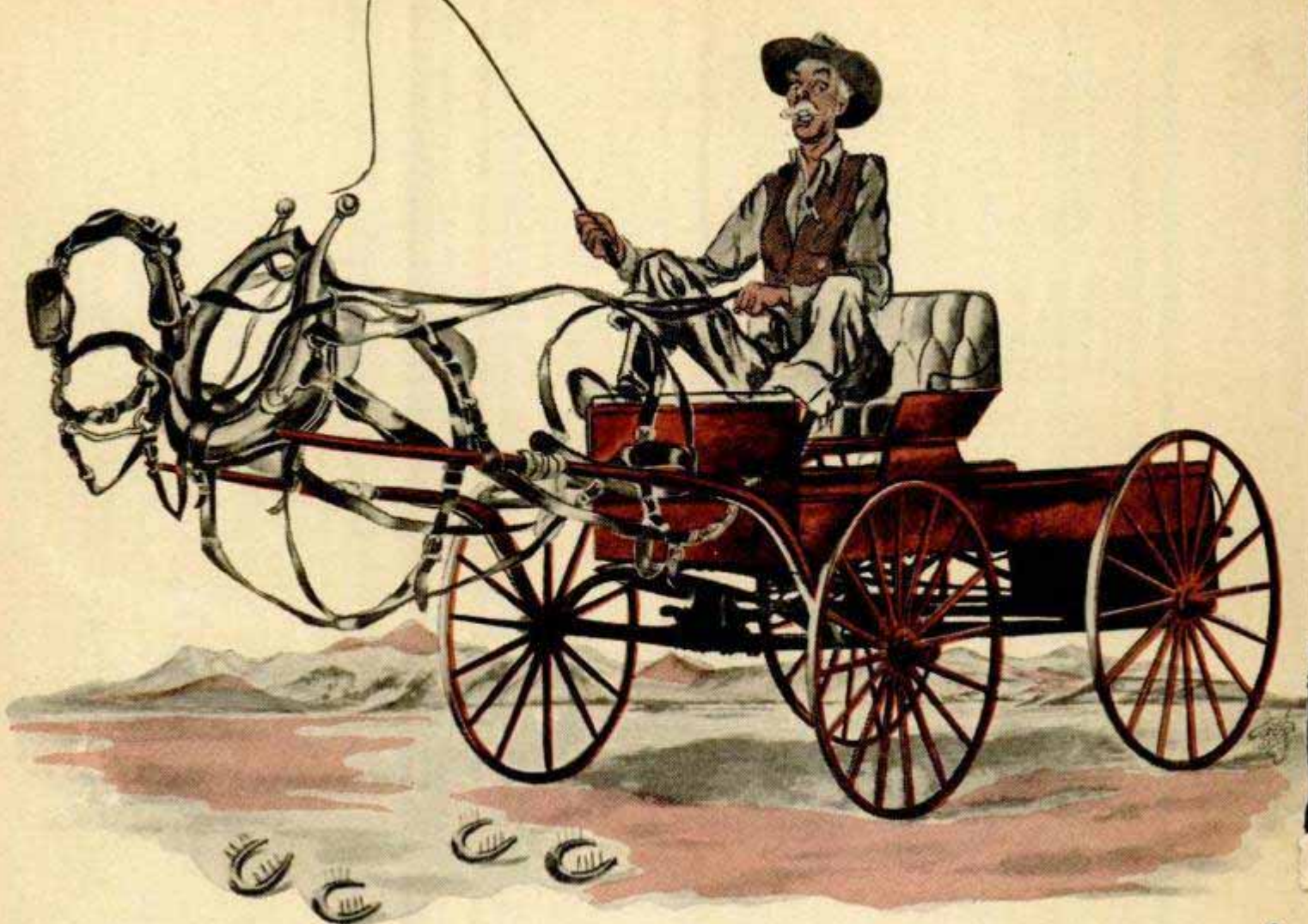

Your horsepower can disappear, too!

There's nothing mysterious about lost horsepower . . . it happens to the best of buckboards . . . and automobiles!

Few people recognize engine wear until more and more oil is required. But oil isn't the only thing that disappears. You lose horsepower, too—which is costly and embarrassing, on hills and in traffic.

Fortunately, you no longer have to humor a tired or oil-thirsty engine. Ask any Doctor of Motors, any reliable mechanic, to install Perfect Circle's *new* 2-in-1 Chrome Piston Ring Set.

The 2-in-1 set lasts over twice as long as ordinary rings, restores pickup, gives positive oil control and assures sustained power for thousands of *extra* miles. Perfect Circle Corporation, Hagerstown, Indiana. The Perfect Circle Co., Ltd., Toronto, Ontario.

Perfect Circle

PISTON RINGS

The Standard of Comparison

Solid chrome protects these wearing surfaces. Normal pressure and alternate HiPressure springs (for both compression cylinders) packed with each oil ring.

