

POPULAR MECHANICS MAGAZINE

WRITTEN SO YOU CAN UNDERSTAND IT

JULY 1952

35 CENTS

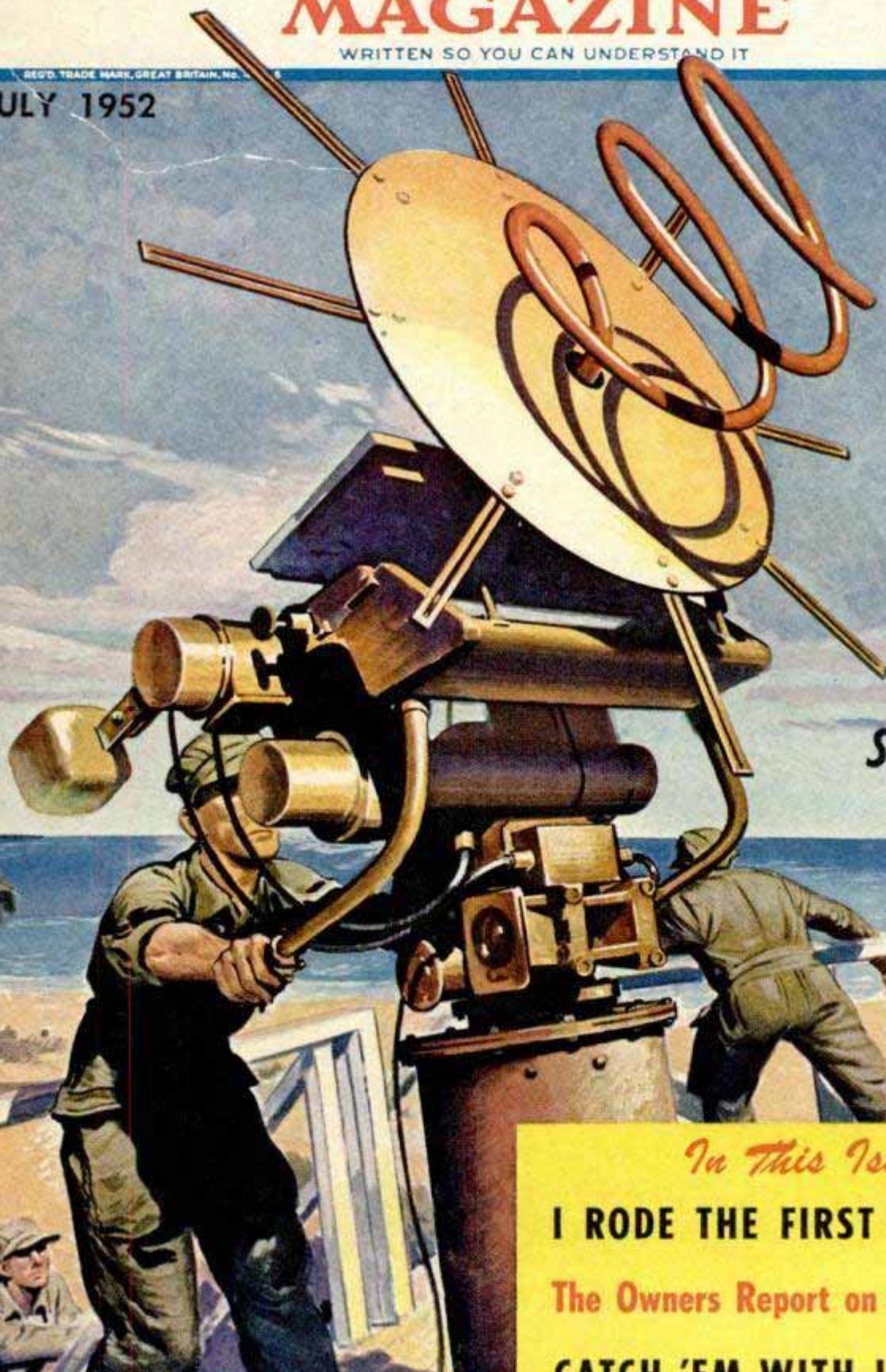

See Page 109

In This Issue

I RODE THE FIRST JET LINER

The Owners Report on the Mercury

CATCH 'EM WITH LIVE BAITS

Genuine Ford Pistons and Rings are
TRACK TESTED
IN AN ICEBOX ON WHEELS



Freezing cold is duplicated at all times of year in Ford's test-track iceboxes to give Genuine Ford Parts the toughest testing possible



You'd never drive your car 5 miles at 70 m.p.h. after an all-night freeze in a 20-below-zero icebox. But that's what Ford's testing engineers do at all times of year to test wear of Ford's controlled-expansion Pistons and Rings . . . to be sure that they will take the punishment of your everyday driving.

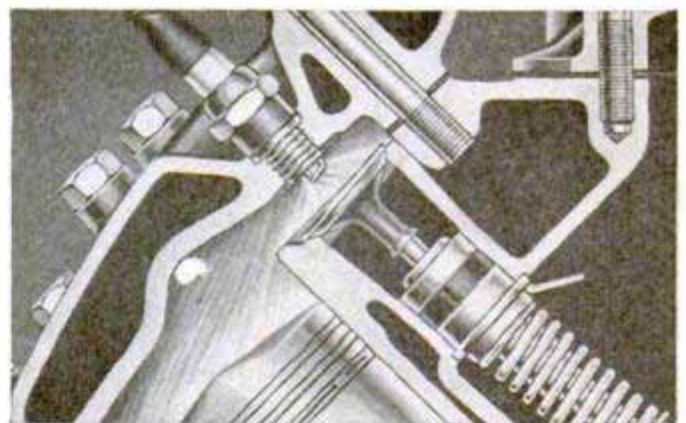

In this test, the ignition is mistimed, forcing the piston to take sledge-hammer jolts from exploding gas . . . only one of the many tests Genuine Ford Pistons and Rings get in the lab. The same kind of punishment is given all Genuine Ford Parts. Ask for them! They're made right to fit right to last longer.

"Specify the parts that
are **TRACK**
TESTED"

Available at all Ford Dealers and selected independent garages. Look for this sign.



Guess how much gas it takes just to overcome engine friction?

10%? 25%? 40%?

Even if you guessed the highest figure (40%), you would still be too low. At 40 miles per hour on a level road, automotive engineers tell us, 50% of your gasoline is used up just in overcoming engine friction.

In other words, only half of your gas, under those conditions, is making your car go. The other half is overcoming engine friction.

Well! It seems pretty obvious that anything that reduces that friction is very desirable—to make your car go faster, or farther, or climb a steeper hill.

So you will be personally interested in tests made on hundreds and hundreds of cars like yours—tested on a Dynamometer—the testing machine accepted by the automobile industry.

These tests showed that motorists got an average of 8% more power from the same amount of gasoline after they changed from whatever brand of oil they had been using to Macmillan Ring-Free Motor Oil.

Please read that paragraph again. And then consider this:

- 1 At 25¢ a gallon for gasoline, that 8% means a saving of 2¢.
- 2 Over a normal period between oil changes, that means a saving of \$2.00.
- 3 That \$2.00 is enough to pay for a refill with Macmillan Oil.

Even that isn't the whole story, for while it is reducing friction, Macmillan also reduces deposits of carbon, gum, sludge and varnish in the engine.

That means higher compression, better piston seal, less likelihood of ping.

It means less oil, lower repair bills, and keeping your car newer longer.

Stop in for a Macmillan refill wherever you see the big red "M" outside an independent service station, garage or car dealer's place of business. Start getting less friction and more savings, now.

Macmillan
President

MACMILLAN PETROLEUM CORPORATION
530 W. 6TH STREET, LOS ANGELES
50 W. 50TH, NEW YORK • 624 S. MICHIGAN, CHICAGO

Available at over 25,000 dealers wherever you see the sign of this big red "M."



THE TRANSISTOR

A picture report of progress

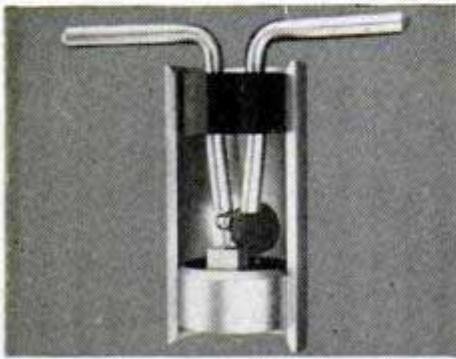

FIRST TRANSISTORS were of this point contact type (picture about twice life size). Current is amplified as it flows between wires through a wafer of germanium metal. These transistors are now being made at the Allentown plant of Western Electric, manufacturing unit of the Bell System. They will be used in a new selector which finds the best routes for calls in Long Distance dialing.

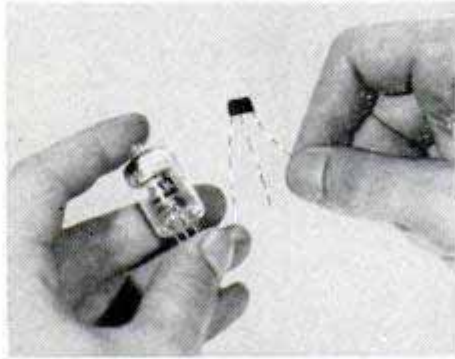

NEW JUNCTION TRANSISTORS, still experimental, also use germanium but have no point contacts. Current is amplified as it flows through germanium "sandwich"—an electron-poor layer of the metal between two electron-rich ends. This new transistor runs on as little as *one-millionth* of the power of small vacuum tubes.



MUCH HAD TO BE LEARNED, especially about the surface of germanium and the effect of one part in a million of alloying materials. Transistors promise many uses—as amplifiers, oscillators, modulators . . . for Local and Long Distance switching . . . to count electrical pulses.



ASSEMBLY PROBLEMS, such as fixing hair-thin wires to barely visible germanium wafers, are solved by new tools and mechanized techniques. Finished transistors withstand great vibration and shock. Engineers see many opportunities for these rugged devices in national defense.



MOIST PAPER AND COIN generate enough current to drive audio oscillator using junction transistors. Half as big as a penny matchbox, an experimental two-stage transistor amplifier does the work of miniature-tube amplifiers ten times larger.

A tiny amplifying device first announced by Bell Telephone Laboratories in 1948 is about to appear as a versatile element in telephony.

Each step in the work on the transistor . . . from original theory to initial production technique . . . has been carried on within the Laboratories. Thus, Bell scientists demonstrate again how their skills in many fields, from theoretical physics to production engineering, help improve telephone service.

BELL TELEPHONE LABORATORIES

Improving telephone service for America provides careers for creative men in scientific and technical fields.



Popular Mechanics Magazine

Registered in U. S. Patent Office and Canada

H. H. WINDSOR, *Founder*

H. H. WINDSOR, JR., *Editor and Publisher*



this month's cover

NO, THAT STRANGE corkscrew mounted on a gun director doesn't fire shells in a spiral trajectory. Actually, it's an antenna which picks up a remarkable amount of information at one time. These antennas are spotted on a long string of islands in the blue Caribbean and serve as the "ears" of our program to develop and test guided missiles. In Florida, at climactic "Moment X," the firing-control officer presses the ignition button and a mushroom of dust billows out beneath one of the big missiles. The monster rises slowly, then suddenly streaks off across the sea. Inside, a radio transmits all kinds of data — speed, fuel consumption, skin temperature and pressure. Each of the weird corkscrew antennas receives this information during its sector of the long flight. In this way the performance of the experimental missile can be rated. For a close-up of our "Thousand-Mile Target Range" turn to the story on page 109

Published monthly by Popular Mechanics Company, 200 E. Ontario St., Chicago 11, Ill. H. H. Windsor, Jr., president; William Harrison Fudge, vice-president; D. F. Windsor, vice-president and secretary-treasurer; H. H. Windsor III, vice-president; Clover L. Perkins, advertising manager; Alan M. Deyoe, circulation manager. Single copy in the United States and Canada, 35 cents; subscription rates in United States and possessions, Canada, Philippines and countries of the Pan-American Postal Union, 1 year \$3.50; 2 years, \$6.00; 3 years \$8.00. To all other countries add \$1.00 a year over United States prices for overseas postage. If you plan to move, notify us at least 30 days in advance so you will not miss an issue. Give both your old and new addresses. Entered as Second Class Matter, September 15, 1903, at the Post Office at Chicago, Illinois, under Act of March 3, 1879. Entered as Second Class Matter at Post Office Dept., Canada. Registered as Second Class Matter at the Post Office at Mexico, D. F., Mexico, June 20, 1950. Copyright 1952 by Popular Mechanics Company. Copyright under International Copyright Union. Copyright in France. All rights reserved under Pan-American Copyright Union. Printed in the United States of America.

JULY 1952

Volume 98

JULY 1952

Number 1

Address all communications to:
 200 East Ontario Street, Chicago 11, Illinois

Managing Editor.....Roderick M. Grant
 Assistant Managing Editor.....Wayne Whittaker
 Shop Notes and Crafts Editor.....James R. Ward
 Radio-Television, Electronics Editor.....Frank L. Brittin
 Associate Editor, Aviation.....Aubrey O. Cookman, Jr.
 Associate Editor.....Clifford B. Hicks
 Assistant Shop Notes and Crafts Editor.....Wayne C. Leckey
 Automotive Editor.....Siler Freeman
 Art Director.....Frank Beatty

Assistant Editors
 W. Clyde Lamme Frank N. Stephany Arthur R. Railton
 Carlton H. Ihde Theodore A. Daum Elsie L. Domin
 Elliott H. McCleary

Eastern Editor.....Richard F. Dempewolf
 Empire State Bldg., Room 2906, New York 1, N. Y.

Western Editor.....Thomas E. Stimson, Jr.
 302 23rd St., Santa Monica, Calif.

London Manager.....Douglas W. Wedderspoon
 Eagle House, Jermyn St., London S. W. 1, England

Director, Bureau of Information.....Allan Carpenter
 200 E. Ontario St., Chicago 11

IN THIS ISSUE

These Roving TV Men	65
Photography Then and Now	72
The Owners Report on the 1952 Mercury	84
I Rode the First Jet Liner	90
Pack up for Camp	100
Thousand-Mile Target Range	109
Boom in the Big Triangle (II)	114
What's New for Your Home	120
The Making of an Organ	124
Trillion-Dollar Mile of Brains	129
Salt-Water Farmers	141

For the Craftsman

Cut-Flower Arrangement	145
Building a Playhouse	154
Outdoor Kitchens	171
Catch 'em With Live Baits	176
Know Your Car's Nervous System	181
Build This 35-mm. Tin-Can Projector	186
Knurling on Your Lathe	191
Roll 'em up With a Slip Roll	196
Shopping for Tools	204
Radio, TV and Electronics	207
Clinic for Homemakers	218

Other items, and manufacturers of available products described, are listed on pages 12, 14 and 16

WHY DO IT THE HARD WAY? by BUSTER



There's a CRESTOLOY WRENCH for EVERY JOB

Looks like Buster is playing "Eenie, Meenie" with his open end wrenches. On a great many jobs, he could save a lot of time if he had a couple of CRESTOLOY Wrenches handy. A flip of his thumb and he would have the right size without searching or fumbling. CRESTOLOY Wrenches are made a third thinner and twice as strong because they're forged of special steel. In sizes from 4 to 24 inches, single and double end styles. Almost 50 million sold to date.

See your Hardware Dealer.

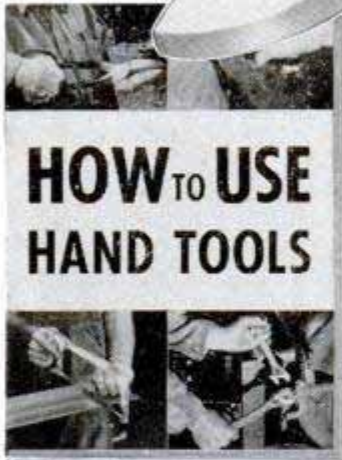

**HOW TO USE
HAND TOOLS**

◀ **FREE BOOK!**

Has all the answers. It tells what tools to use and how to use them. Fully illustrated. A postcard will bring it to you. Send today.

CRESCENT TOOLS

Give Wings to Work

*Sign of the Artisan
Symbol of Excellence*



Crescent is our trade-mark, registered in the United States and abroad, for wrenches and other tools. Sold by leading distributors and retailers everywhere and made only by **CRESCENT TOOL COMPANY, JAMESTOWN, NEW YORK**

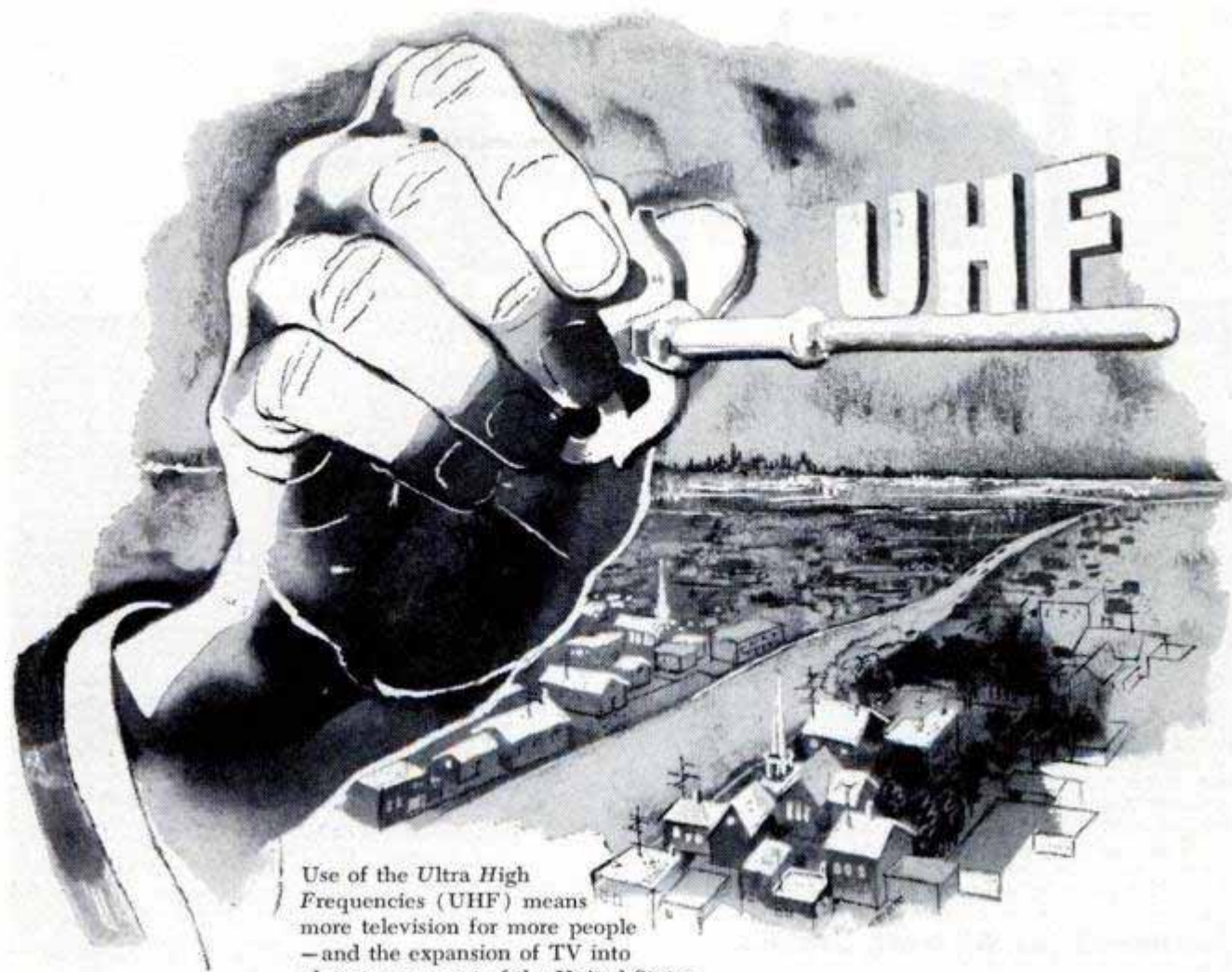

Use of the *Ultra High Frequencies (UHF)* means more television for more people — and the expansion of TV into almost every part of the United States.

This "master key" opens television's doors — *in millions of additional homes*

Now the "green light" is official. Television can expand into UHF. Behind this decision are years of research and engineering, tested and proved at the first UHF station to operate on a regular daily basis—RCA's "Tower on Success Hill," near Bridgeport, Connecticut.

Key to nationwide TV coverage, UHF provides 70 new channels for about 1500 new stations. Equally important, the ultra high frequencies can be utilized without diminishing service in today's 17 million television homes. More channels, more sta-

tions, mean more programs for present audiences—as well as television for the millions now beyond its reach.

Already, RCA has designed the equipment needed to broadcast UHF television, and is ready with instruments for home reception. This preparedness comes from more than 25 years of television pioneering, and represents an investment of approximately \$3,000,000 in UHF alone—including the vital studies at "Success Hill."

See the latest in radio, television, electronics at RCA Exhibition Hall, 36 West 49th Street, N. Y. Admission is free. Radio Corporation of America, RCA Building, Radio City, New York 20, N. Y.



RADIO CORPORATION OF AMERICA

World Leader in Radio—First in Television

This One



2TAX-DKN-KKJA

the Low Cost of **PYROIL** prevents the High Cost of **Repairs!**

Your car can get "smashed up"—inside as well as out. When piston rings and cylinder walls are exposed to condensation and rust — when metal rubs against raw metal — it's causing serious damage that will be mighty costly to replace or repair. Pyroil prevents this. When your motor becomes clogged with dirt and carbon deposits, your car loses efficiency. Pyroil cleans your motor and keeps it clean. Even when your car is not being used, your motor deteriorates unless it has the damage-preventing protection of Pyroil.

Pyroil contains the special property of making oil adhere to exposed engine parts, preventing needless wear-and-tear — friction — "dry starts". To prevent the high cost of repairs — add low cost Pyroil — add miles to your car.

Pyroil for Aircraft Engines

Use Aircraft Pyroil B for lubricating oil, Aircraft Pyroil A for gasoline.

GIVEN! An attractive Pyroil metal savings bank—takes coins up to 50¢ pieces. **MOTORISTS**, it's yours for the asking—sent postage paid.



Manufactured and Guaranteed by Pyroil Company, 143 Pyroil Bldg., La Crosse, Wisconsin.

Canadian Distributors: Central Purchasing Agencies, Ltd., Toronto, Ontario

PYROIL COMPANY
143 Pyroil Bldg., La Crosse, Wisconsin
I want my car to last and run properly. Please tell me more about Pyroil and how it can accomplish this for me.

Name _____

Address _____

City or Town _____ State _____



in this corner.....

THE EDITORS



WHEN THE FCC "defrosted" the television ban, the big question was, "Can the small city afford its own TV station?" Sarkes Tarzian of Bloomington, Ind. (pop., 28,163), answered that question more than two years ago. The answer—an emphatic



"yes." Now Bloomington's station WTTV is being studied as a blueprint for small-city television. Operating at a profit for two years, it combines network shows and local programs. Tarzian built a relay system that brings network programs to Bloomington from Cincinnati, 100 miles away. Read how "TV Comes to the Small Town" in next month's *Popular Mechanics*.

Admiral Peary's Citation

Coincident with our 50th Anniversary celebration this year, *Popular Mechanics* presented to the widow of Adm. Robert E. Peary a citation electing the discoverer of the North Pole to our Hall of Fame. The following acknowledgment was received from his daughter, Mrs. Marie Peary Stafford:

Your letter to my mother, Mrs. Robert E. Peary, received just as she was recovering from a week's illness, proved a real "shot in the arm!" Mother is 89 and very pessimistic about anyone ever remembering my father or what he accomplished. She feels that the world is moving so fast and in such confusion that no one has time to think of the past. So you see how happy your spontaneous tribute made her.

By a curious coincidence, the day before your letter arrived a friend found in her attic and gave me a copy of *Popular Mechanics* for May 1912, in which the leading article was "What the World Gains by the Discovery of the Poles," by Rear Adm. Robert E. Peary.

(Continued to page 8)



How these 18 Experts can help you

Get into a High Pay ACCOUNTING CAREER

LaSalle's famous staff of Accounting authorities are helping thousands prepare for fast promotions and bigger pay. They can do the same for you!

If your heart is set on a larger income and all that it means . . . better home—fine car—larger bank account—more of the good things of life. . . .

If that's your ambition and you are really serious about it, then you owe it to yourself to get the REAL FACTS about Accountancy, and the many good-pay opportunities that can be YOURS through LaSalle's famous Problem Method plan.

It matters not whether you've had a single day of experience in this field—or whether you have already started but want to climb higher. LaSalle's expert training is designed to take you *from where you are . . . to where you want to be . . .* in higher positions and a lifetime career of security and good income.

WHY YOU CAN'T FAIL TO GAIN

You see on this page a panel of experts who know Accounting from A to Z . . . all the way from simple bookkeeping, on up through advanced accounting, cost accounting, auditing, income tax, and coaching for the C.P.A. degree. These are only part of LaSalle's instruction staff. But what is most important to you . . .

...THESE C.P.A. EXPERTS KNOW HOW TO IMPART THEIR KNOWLEDGE TO OTHERS...HOW TO HELP YOU PREPARE QUICKLY YET THOROUGHLY FOR SUCCESS IN THIS VERY LUCRATIVE FIELD

The proof? What stronger proof could there be than



more than 3,500 Certified Public Accountants (approximately 10% of the U.S. total) who have trained with LaSalle? Or the hundreds of thousands of men and women whom LaSalle has helped qualify rapidly for more money, a brighter future, in a high-pay-lifetime career? These thousands came to us with different backgrounds of experience and varying degrees of ambition. Many have reported raises and promotions after only a few weeks of training. Thousands of them have written to say they are now earning 50% more—even *double* their former incomes—often in less than a year. These letters are published in book form for your inspection. They were written by real people, with real income, problems and ambitions—people who might be your next-door neighbor.

Yes, if you are really sincere in wanting to better your position—start your income climbing—enjoy a lifetime career of high standing and high reward—this friendly staff of experts can help you.

SEND FOR FREE SAMPLE LESSON... ALSO BIG 48-PAGE BOOK OF LATEST INFORMATION ABOUT CAREER OPPORTUNITIES

You don't have to wonder what LaSalle's Accountancy plan is like. You will be sent a free sample lesson, which does not obligate you in any way. Study it—keep it—see for yourself how simple, clear, and easy it is to master. This is an actual lesson right out of the regular training—to show you exactly how LaSalle's Problem Method has trained more than 1,275,000 men and women from all walks of life.

Also . . . the 48-page book, "Accountancy, the Profession That Pays," gives all the latest facts about the new and growing opportunities in five different fields of profitable employment.

This can be an important day in your life. A coupon like the one below has started hundreds of thousands of men and women toward a bigger job, a larger income. It can do the same for you.

Mail the Coupon Today!

LA SALLE
EXTENSION UNIVERSITY
A Correspondence Institution
417 S. Dearborn St., Dept. 764H, Chicago 5, Ill.

Send free Sample Lesson in Accounting—also, 48-page free book, "Accountancy, the Profession That Pays" . . . all without cost or obligation.

FREE 48-PAGE CATALOG

FREE SAMPLE LESSON

Name.....Age.....
Address.....
City & Zone.....State.....

HIGHER ACCOUNTANCY
By the LaSalle Problem Method
Practical Accounting
Assignment 1
THE BALANCE SHEET

THEY NEED YOU



A typical interview...

where Embry-Riddle students are pre-selected for essential, good-paying jobs in aviation even before their training is completed... they step right into their jobs as soon as they graduate!

...AND YOU CAN

QUALIFY IN SIX MONTHS!

EMBRY-RIDDLE OFFERS YOU COMPLETE 6-MONTHS TO 2-YEAR COURSES...NOW!

Your Career is Waiting!

The high regard of Embry-Riddle training by the leading airlines and the entire aviation industry is demonstrated time and again by the big demand for Embry-Riddle graduates.

There's an important high priority job in aviation waiting for you...however, if you do enter the services, Embry-Riddle training will definitely give you rating advantages. Thousands of Air Force men are Embry-Riddle trained.



AIRCRAFT & ENGINE MECHANICS

Vast numbers of properly trained A & E Mechanics are urgently needed. Our C.A.A. approved school with a quarter-century experience assures your quickest advancement. Embry-Riddle students learn fast with modern equipment, including jet...live aircraft, airline-size hangars.



AERONAUTICAL DESIGN AND TECHNOLOGY

Embry-Riddle's accelerated 26-mo. Aeronautical Design and Technology Course provides finest training available. Technicians with management responsibility enjoy highest salaries!



COMMERCIAL PILOT

Embry-Riddle trained pilots benefit from our years of experience with 30,000 students...the best instructors, up-to-date aircraft, superb year-'round flying weather. Also Instrument and Instructor's ratings.



A & E COMBINED WITH COMMERCIAL PILOT

Airmen with dual pilot-engineering ability are needed by aviation companies and operators. Embry-Riddle combination training offers you the most in your aviation career.



CLASSES ARE BEGINNING NOW...SEND THIS COUPON TODAY!

Dean of Enrollments - Dept. 99
Embry-Riddle School of Aviation
Miami 30, Florida

Please Print

NAME _____

ADDRESS _____

CITY _____

STATE _____ AGE _____

I am interested in...

- A & E Mechanic
 Commercial Pilot
 Aeronautical Design and Technology
 A & E Combined with Commercial Pilot
 A & E Combined with Private Pilot

Check One Veteran Non-Veteran

TRAIN IN MIAMI...AIR CAPITAL OF THE WORLD

(Continued from page 6)

The citation . . . is lovely and we are very proud of it. What a beautiful job you made of it! And wasn't it fitting that it should arrive practically on the anniversary of the discovery of the Pole—April 6, 1909? We both thank you from our hearts.

Marie Peary Stafford.

Letter to the Editor:

I wish to advise you the name of the mechanical parking garage described in your May issue is Park-O-Mat, not Pigeonhole. Pigeon Hole is a trade name which, we understand, is copyrighted by a Seattle firm. There is no connection between their company and Park-O-Mat.

Richard L. Sinclair, President,
Park-O-Mat Services, Inc.,
Washington, D. C.

Mercury Tested in Hawaii

Floyd Clymer leaves no corner unturned in his efforts to put the new models to rigorous tests for you. The proving grounds of Detroit, the mountain switchbacks of Colorado, Arizona deserts are his regular beats.



When the Mercury's turn came up, Mr. Clymer and his wife put the car through its paces in Hawaii as well as on state-side highways. His "Owners Report" on the Mercury is in this issue. Next month he reports on the DeSoto.

Letter to the Editor:

Having just read the article "There's a Knack to Mountain Driving," my reaction is that the author didn't hit enough of the nails on the head.

May I suggest . . . a list of the more important specific things about auto care and handling in desert or mountain driving?

1. A full ignition checkup is essential;

(Continued to page 10)

A TRUE I. C. S. STORY *taken from an actual letter*



I was a World War II pilot . . .



A prisoner of war in Germany . . .



Back home, I was hired by National . . .

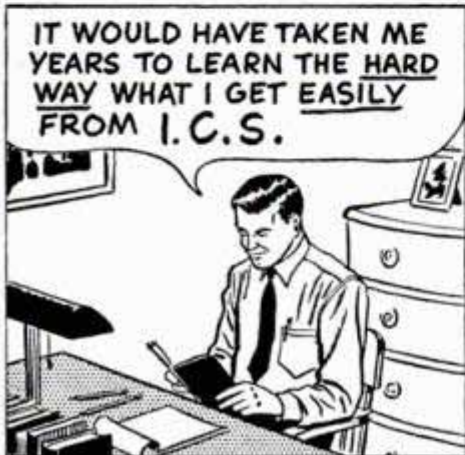

Studied with I. C. S. in my spare time . . .



I. C. S. sent reports to my employer . . .

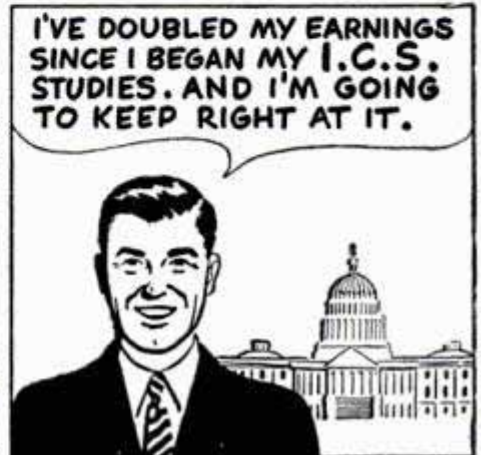

I am now Washington District Manager.

Parke Wright
PARKE WRIGHT

How have you done since the war? Start now to get the training that leads to advancement. Mail coupon *today!*

INTERNATIONAL CORRESPONDENCE SCHOOLS

BOX 5530-L, SCRANTON 9, PENNA.

**I. C. S. has trained
5,918,692
men and women**

Without cost or obligation, please send me full particulars about the course BEFORE which I have marked X:

- | | | | |
|---|--|--|--|
| <input type="checkbox"/> Air Conditioning | <input type="checkbox"/> Chemistry, Analytical | <input type="checkbox"/> Heat Treatment of Metals | <input type="checkbox"/> Stationary Engineering |
| <input type="checkbox"/> Heating | <input type="checkbox"/> Chemistry, Industrial | <input type="checkbox"/> Industrial Engineering | <input type="checkbox"/> Power Plant Engineering |
| <input type="checkbox"/> Plumbing | <input type="checkbox"/> Food-Plant Sanitation | <input type="checkbox"/> Industrial Instrumentation | <input type="checkbox"/> Stationary Fireman |
| <input type="checkbox"/> Refrigeration, Domestic | <input type="checkbox"/> Petroleum Production and Refining | <input type="checkbox"/> Industrial Metallurgy | Textile Courses |
| <input type="checkbox"/> Refrigeration & Air Conditioning | <input type="checkbox"/> Pulp and Paper Making | <input type="checkbox"/> Machine Shop Inspection | <input type="checkbox"/> Cotton Manufacturing |
| <input type="checkbox"/> Steam Fitting | <input type="checkbox"/> Civil Engineering | <input type="checkbox"/> Mechanical Drafting | <input type="checkbox"/> Design Finishing |
| <input type="checkbox"/> Aeronautics Courses | <input type="checkbox"/> Bridge and Building Foreman | <input type="checkbox"/> Mechanical Engineering | <input type="checkbox"/> Loom Fixing |
| <input type="checkbox"/> Aeronautical Engineer's, Jr. | <input type="checkbox"/> Highway Engineering | <input type="checkbox"/> Millwrighting | <input type="checkbox"/> Mold-Loft Work |
| <input type="checkbox"/> Aircraft Drafting & Design | <input type="checkbox"/> Reading Structural Blueprints | <input type="checkbox"/> Patternmaking—Wood, Metal | <input type="checkbox"/> Reading Shop Blueprints |
| <input type="checkbox"/> Aircraft Mechanic | <input type="checkbox"/> Sanitary Engineering | <input type="checkbox"/> Reading Shop Blueprints | <input type="checkbox"/> Sheet-Metal Drafting |
| <input type="checkbox"/> Engine Mechanic | <input type="checkbox"/> Structural Drafting | <input type="checkbox"/> Sheet-Metal Drafting | <input type="checkbox"/> Sheet-Metal Worker |
| <input type="checkbox"/> Architecture | <input type="checkbox"/> Structural Engineering | <input type="checkbox"/> Ship Drafting | <input type="checkbox"/> Ship Fitting |
| <input type="checkbox"/> Architectural Drafting | <input type="checkbox"/> Surveying and Mapping | <input type="checkbox"/> Tool Designing | <input type="checkbox"/> Toolmaking |
| <input type="checkbox"/> Building Estimating | <input type="checkbox"/> Communications Courses | <input type="checkbox"/> Welding—Gas and Electric | <input type="checkbox"/> Business Courses |
| <input type="checkbox"/> Contractor's Building | <input type="checkbox"/> Telegraphy | <input type="checkbox"/> Radio Courses | <input type="checkbox"/> Accounting |
| <input type="checkbox"/> House Planning | <input type="checkbox"/> Telephony | <input type="checkbox"/> Electronics | <input type="checkbox"/> Advertising |
| <input type="checkbox"/> Art Courses | <input type="checkbox"/> Electrical Courses | <input type="checkbox"/> FM and Television Servicing | <input type="checkbox"/> Bookkeeping |
| <input type="checkbox"/> Commercial Art | <input type="checkbox"/> Electrical Drafting | <input type="checkbox"/> Radio, General | <input type="checkbox"/> Business Administration |
| <input type="checkbox"/> Magazine Illustrating | <input type="checkbox"/> Electrical Engineering | <input type="checkbox"/> Radio Operating | <input type="checkbox"/> Business Correspondence |
| <input type="checkbox"/> Show Card and Sign Lettering | <input type="checkbox"/> Electric Light and Power | <input type="checkbox"/> Radio Servicing | <input type="checkbox"/> Business Law |
| <input type="checkbox"/> Automotive Courses | <input type="checkbox"/> Lighting Technician | <input type="checkbox"/> Railroad Courses | <input type="checkbox"/> Certified Public Accounting |
| <input type="checkbox"/> Automobile | <input type="checkbox"/> Practical Electrician | <input type="checkbox"/> Car Inspector and Air Brake | <input type="checkbox"/> Commercial |
| <input type="checkbox"/> Auto Electric Technician | <input type="checkbox"/> Diesel Engines | <input type="checkbox"/> Diesel Locomotive | <input type="checkbox"/> Cost Accounting |
| <input type="checkbox"/> Auto Body Rebuilding & Refinishing | <input type="checkbox"/> Internal Combustion Engines | <input type="checkbox"/> Locomotive Engineer | <input type="checkbox"/> Federal Tax |
| <input type="checkbox"/> Chemical Courses | <input type="checkbox"/> Mechanical Courses | <input type="checkbox"/> Railroad Section Foreman | <input type="checkbox"/> Foremanship |
| <input type="checkbox"/> Chemical Engineering | <input type="checkbox"/> Forging | | <input type="checkbox"/> High School and College |
| | <input type="checkbox"/> Foundry Work | | <input type="checkbox"/> Industrial Supervis'n |
| | | | <input type="checkbox"/> Motor Traffic |
| | | | <input type="checkbox"/> Personnel—Labor Relations |
| | | | <input type="checkbox"/> Postal Civil Service |
| | | | <input type="checkbox"/> Retailing |
| | | | <input type="checkbox"/> Retail Business Management |
| | | | <input type="checkbox"/> Salesmanship |
| | | | <input type="checkbox"/> Secretarial |
| | | | <input type="checkbox"/> Sales Management |
| | | | <input type="checkbox"/> Stenography |
| | | | <input type="checkbox"/> Traffic Management |

Name _____ Age _____ Home Address _____
 City _____ State _____ Working Hours _____ A.M. to _____ P.M.
 Present Position _____ Employed by _____

Special tuition rates to members of the Armed Forces. Canadian residents send coupon to International Correspondence Schools Canadian, Ltd., Montreal, Canada.

NOW YOU CAN BUILD IT WITH CONCRETE BLOCKS



This practical guide shows every step from how-to-plan to how-to-build with one of the most abundant and economical building materials known to man. Over a hundred pictures and cut-away diagrams show exactly what to do and what not to do. Tells how to plan, place corner block, make foundations easily, how to paint for special purposes. A picture story of everything in building any type of structure with concrete blocks, easily and inexpensively.

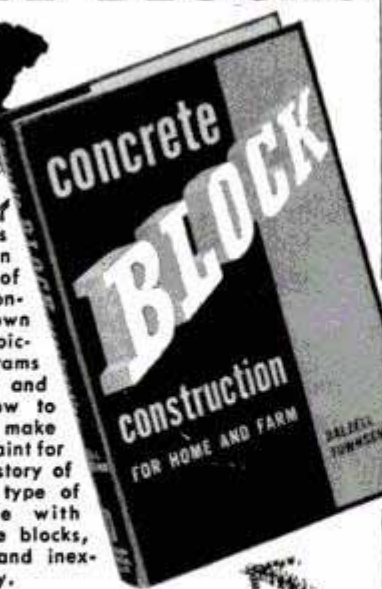

Here's how little this book costs you... or if you don't keep it after 10 days trial, return it and you owe nothing. **\$2.75**

Here's how to apply Mortar

CARPENTRY FOR EVERYONE



A clear explanation of modern carpentry construction including framing, roof constructions, general carpentry work, exterior and interior finish of buildings, building forms and working drawings, and farm buildings. Covers everything you need to know about lumber, tools, joints and splices, floors, stairs, partitions, rafters, etc. Gives short cuts and tricks used by the master carpenter. Easy to understand. 504 pages, 580 illustrations. **\$2.50.** Use 10 day no-cost trial coupon below.

INSTALL & REPAIR YOUR OWN PLUMBING

How to Design and Install Plumbing by A. J. Matthias, Jr. A completely up-to-date guide that fits the needs of the beginner yet so complete that even the master plumber can pick up some new tricks of the trade. Contains hundreds of illustrations, full size blueprints, specifications and instructive details for septic tanks, storm drainage, soil pipe, water supply, fixtures, traps, drains, pumps, etc. An outstanding feature is complete design and installation of plumbing in a modern six-room, two bath residence. 349 illustrations, 442 pages. **\$3.95.** Use coupon.

Mail this coupon today—10 days trial at no cost to you

American Technical Society, Dept. CB-19
848 East 58th Street, Chicago 37, Illinois

Please rush me the following books I'm checking below to examine at home. If I'm not convinced these books will help me save thousands of dollars by doing my own building and planning, I may return the books and owe nothing.

- | | | | |
|---------|--------------------------|--|--------|
| Examine | <input type="checkbox"/> | CONCRETE BLOCK CONSTRUCTION FOR HOME AND FARM..... | \$2.75 |
| at home | <input type="checkbox"/> | CARPENTRY | \$2.50 |
| at no | <input type="checkbox"/> | HOW TO DESIGN AND INSTALL PLUMBING | \$3.95 |
| cost. | | Other How-to-do-it books, profusely illust. | |
| | <input type="checkbox"/> | Painting and Decorating | \$1.75 |
| | <input type="checkbox"/> | Electric Wiring—Residential and Farm..... | \$3.95 |
| | <input type="checkbox"/> | How to Insulate Home & Farm Bldgs... .. | \$3.00 |
| | <input type="checkbox"/> | Bricklaying—Skill and Practice..... | \$3.00 |
| | <input type="checkbox"/> | Steel Square | \$2.25 |

Name _____

Address _____

City _____ State _____

Ten day no-cost-trial. If I keep books, will remit by check or money order.

Send C.O.D. Same return privilege—money refunded.

I'm enclosing \$_____ now to save postage—same return privilege—money refunded.

(Continued from page 8)

- As a rule, new spark plugs and points;
- Special carburetor jet and mixture for mountain driving.

Beyond these, and the timely points given about overdrive, brakes and other precautions, drivers should note that older cars tend to have more difficulties with overheating—even two years' use may clog a radiator. If a car tends to run hot in normal driving, and especially if it overheats in city traffic:

1. Make sure timing is okay (This should be done anyway.);
2. Just as a precaution, use a good radiator cleaner. (If any overheating occurs when you start mountain or desert driving, the cheapest solution is to have the radiator rodded out—ordinary backflushing does not work.);
3. If you have side panels on the hood, they should be removed for driving in the West.

An alternate plan for adequate ventilation would be to insert a block to hold the front of the hood open about two or three inches and tie the hood down. This must be done with a secure knot and at least two or three turns of the rope. Loosening possibly would let the hood cover tear off.

With this method, however, I traveled in a '39 Pontiac (with a '47 engine) last July through Las Vegas, 127-degree temperature at Hoover Dam, Bryce Canyon, Zion, Grand Canyon and a 45-mile stretch in low and second gear over the Durango-to-Ouray Million-Dollar Highway in Colorado, pulling a heavily loaded camp trailer without any difficulty.

There are one or two extra tricks I picked up from the 8500 miles we drove.

Carry water. And keep the supply full. Even a car in good condition, new or old, will reach boiling temperature under some conditions. To prevent loss of water:

1. If you stop at the end of a climb, keep the motor running for about five minutes, preferably with the hood wide open. If it is really hot, or the water already is boiling, after opening the hood take some spare water and pour it onto the radiator shell so it trickles down the front. This quickly lowers the temperature through evaporation.
2. The thermostat usually slows circulation. Have it removed for hot summer driving;
3. A quick device I developed before hitting the desert on the return east was this method for holding the hood open—I used one of the round, squat paper containers, such as are used for cottage cheese, inserting it between hood and frame where the hold-down is located. With a rope pulled down tightly from hood to bumper, this made a secure emergency device.

Kenneth M. Hazen,
Alliance, Ohio.

PLUMBERS & STEAM FITTERS



AUDELS PLUMBERS & STEAM FITTERS GUIDES. This valuable set explains in practical concise language the principles, advances and shortcuts of the trade—based on good practice. Includes careful detailed instructions on how to figure & calculate various jobs. A quick reference: saving time & money. A complete Trade course.

Over 1,670 Pages—
3,642 Trade Illustrations

Practical Trade Information on:

Soldering, tinning, Joint wiping, bending, beating, Pipe—iron—steel, threading, Mathematics, tables, physics, Materials—iron, steel, copper, brass, lead, tin, antimony, etc. Sheet metal—galvanized—plate, Sanitation, syphonage, tanks, Drainage, sewage, purification, Fixtures—bath—kitchen, Pipe fittings, soil pipe, tools, Laying out work, Roughing, Screwed fittings, flanges, joints, Pipe bending, examples, Elbows, Heating, ventilation, air conditioning, refrigeration, Water supply, mains, wells, tanks, Gas-fittings, Sheet metal work, problems, methods, Brazing, heating, lead burning, Welding, various welds, methods, Black-smithing, forges, tools, Copper Tubing, Marine Pipe Fitting & Oil Burners, **HIGHLY ENDORSED—ASK TO SEE THEM. TO GET THIS ASSISTANCE FOR YOURSELF, FILL IN AND**

MAIL ORDER

AUDEL, Publishers, 49 W. 23rd St., New York 10, N. Y. Mail Audels Plumbers' Guides, 4 vols, on 7 days' free trial, if O. K. I will remit \$1 in 7 days and \$1 monthly until \$6 is paid. Otherwise I will return them. No obligation unless I am satisfied.



4 \$6
VOLS. COMPLETE
PAY ONLY \$1 A MO.

Name _____
Address _____
Occupation _____
Employed by _____ 43

AUDELS Carpenters and Builders Guides 4 vols. \$6



Inside Trade Information for Carpenters, Builders, Joiners, Building Mechanics and all Woodworkers. These Guides give you the short-cut instructions that you want—including new methods, ideas, solutions, plans, systems and money saving suggestions. An easy progressive course for the apprentice and student. A practical daily helper and Quick Reference for the master worker. Carpenters everywhere are using these Guides as a Helping Hand to Easier Work, Better Work and Better Pay. To get this assistance for yourself, simply fill in and mail **FREE COUPON** below.

Inside Trade Information on:

How to use the steel square—How to file and set saws—How to build furniture—How to use a mitre box—How to use the chalk line—How to use rules and scales—How to make joints—Carpenters arithmetic—Solving mensuration problems—Estimating strength of timbers—How to set girders and sills—How to frame houses and roofs—How to estimate costs—How to build houses, barns, garages, bungalows, etc.—How to read and draw plans—Drawing up specifications—How to excavate—How to use settings 12, 13 and 17 on the steel square—How to build hoists and scaffolds—skylights—How to build stairs—How to put on interior trim—How to hang doors—How to lath—lay floors—How to paint.



AUDEL, Publishers, 49 W. 23rd St., New York 10, N. Y. Mail Audels Carpenters and Builders Guides, 4 vols., on 7 days' free trial, if O.K. I will remit \$1 in 7 days and \$1 monthly until \$6 is paid. Otherwise I will return them. No obligation unless I am satisfied.

Name _____
Address _____
Occupation _____
Employed by _____ 43

WHAT ALL AUTO MECHANICS WANT TO KNOW

1800 PAGES

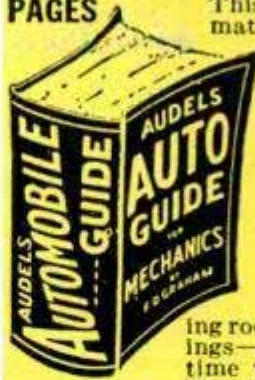

This Big Practical Book gives full information with working diagrams covering the principles, construction, ignition, service and repair of modern cars, trucks and buses.

Diesel Engines, Hydramatic & Fluid Drives Fully Explained.

A complete Guide of 1800 pages, with over 1500 illustrations showing inside views of working parts, with instructions for service jobs.

IT PAYS TO KNOW

How to fit pistons—How to locate engine knocks, How to fit connecting rod bearings—How to service main bearings—How to recondition valves—How to time valves—How to adjust fan belts—How to adjust carburetors and chokes, How to rebuild a clutch—How to service automatic transmissions—How to service brakes—How to adjust steering gear—How to cope with ignition troubles—How to service distributors—How to time ignition—How to "tune up" an engine.



\$4 COMPLETE • PAY \$1 A MO. TO GET THIS ASSISTANCE FOR YOURSELF SIMPLY FILL IN AND MAIL COUPON TODAY.

Step up your own skill with the facts and figures of your trade. Audels Mechanics Guides contain Practical Inside Trade Information in a Handy Form. Fully illustrated and Easy to Understand, Highly Endorsed. Check the book you want for 7 DAYS FREE EXAMINATION. Send No Money. Nothing to pay postman.

MAIL ORDER

AUDEL, Publishers, 49 W. 23 St., NEW YORK 10, N. Y. Please send me postpaid for **FREE EXAMINATION** books marked (x) below. If I decide to keep them I agree to mail \$1 in 7 Days on each book or set ordered and further mail \$1 monthly on each book or set until I have paid price, otherwise I will return them.

- AUTOMOBILE MECHANICS GUIDE, 1800 Pages \$ 4
- TRUCK & TRACTOR GUIDE, 1299 Pages . . . 4
- DIESEL ENGINE MANUAL, 575 Pages . . . 2
- MACHINISTS HANDY BOOK, 1650 Pages . . . 4
- WELDERS GUIDE, 400 Pages . . . 1
- BLUE PRINT READING, 416 Pages . . . 2
- MATHEMATICS & CALCULATIONS, 700 Pages. 2
- SHEET METAL PATTERN LAYOUTS, 1100 Pages 4
- SHEET METAL WORKERS HANDY BOOK, 388 Pgs. 1
- MECHANICAL DRAWING GUIDE, 160 Pages . . 1
- MECHANICAL DRAWING & DESIGN, 480 Pages 2
- AIRCRAFT WORKER, 240 Pages 1
- TELEVISION SERVICE MANUAL, 384 Pages . . 2
- RADIOMANS GUIDE, 914 Pages 4
- ELECTRONIC DEVICES, 216 Pages 2
- ELECTRIC MOTOR GUIDE, 1000 Pages 4
- ELECTRIC WIRING DIAGRAMS, 272 Pages . . . 1
- ELECTRICIANS EXAMINATIONS, 250 Pages. . 1
- ELECTRIC POWER CALCULATIONS, 425 Pages. 2
- HANDY BOOK OF ELECTRICITY, 1440 Pages. . 4
- ELECTRIC DICTIONARY, 9000 Terms 2
- ELECTRIC LIBRARY, 7000 Pages (12 Book Set) 18
- MARINE ENGINEERS HANDY BOOK, 1258 Pgs. 4
- SHIPFITTERS HANDY BOOK, 250 Pages 1
- REFRIGERATION & Air Conditioning, 1280 Pgs. 4
- MILLWRIGHTS & MECHANICS GUIDE, 1200 Pgs. 4
- POWER PLANT ENGINEERS GUIDE, 1500 Pages 4
- ENGINEERS & FIREMANS EXAMS, 525 Pages . 1
- PUMPS, Hydraulics & Air Compressors, 1658 Pgs. 4
- ENGINEERS LIBRARY (3 Book Set) 9
- MECHANICAL DICTIONARY, 950 Pages 4
- GARDENERS & GROWERS GUIDES (4 Book Set) 6
- CARPENTERS & BUILDERS GUIDES (4 Book Set) 6
- PLUMBERS & Steamfitters Guides (4 Book Set) 6
- MASONS AND BUILDERS GUIDES (4 Book Set) 6
- PAINTERS & DECORATORS MANUAL, 450 Pgs. 2
- HOUSE HEATING GUIDE, 1000 Pages 4
- OIL BURNER GUIDE, 384 Pages 1



Check NOW!

You Can Look Over Any Guide In Your Own Home — Start the Easy Payments If Satisfied

MAIL THIS TODAY



Name _____
Address _____
Occupation _____
Employed by _____ 43



All Privates, Brass,
and Even Mules... Know
PROTO means
PROfessional
TOols!

Accurate manufacture is a big reason why PROTO tools are professional tools. Close tolerances are met with precision machines and advanced methods in modern factories. As a result, the tools fit properly and operate smoothly, making them faster, safer and easier to use. Field-tested designs, PROTO-specified alloy steels and scientific heat treatment are more reasons why you get professional quality when you buy tools from your PROTO dealer. Send 10¢ for 68-page catalog to

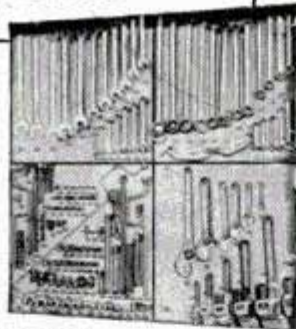

The PROTO Line Includes Wrenches, Pliers, Screwdrivers, and Many Others.

PLUMB TOOL COMPANY

2255U Santa Fe Ave., Los Angeles 54, Calif.

5286



Eastern Factory—Jamestown, N.Y.

WHERE-TO-BUY-IT INDEX

Source of supply appears after items commercially available

AUTOMOTIVE

Two million accidents 16
 "Innerspring tube" 71
 Right-view mirror aids motorists (Right-View Mirror Co., 74 Southern Heights Blvd., San Rafael, Calif.) 71
 English car's trunk opens by push button 71
 Antiskid stabilizer (Safety Auto Stabilizer, 324 N. Vermont Ave., Los Angeles 4, Calif.) 79
 Fender de-denter (Blackhawk Mfg. Co., 5325 W. Rogers, Milwaukee 1, Wis.) 79
 Motorcycle acrobats 80
 Interchangeable lenses adapt glasses for night or day driving (Eye Savers, Inc., 115 N. George St., York, Pa.) 82
 Detroit listening post 83
 Exhaust deflector (Arvin Industries, Columbus, Ind.) 89
 Aerodynamic bumper 89
 Nash Rambler Greenbrier is combination sedan and station wagon 108
 Amphibious German automobile takes streams in stride 113
 Self-propelled trailer is easily maneuverable 122
 Detector uses ultraviolet light to spot leaks in engine block (Allen Electric and Equipment Co., 2101 N. Pitcher St., Kalamazoo, Mich.) 137

AVIATION

Toothbrushes "fly" 70
 Automatic pilot flies jets 82
 Giant B-60 jet longer and taller than B-36 98
 Sub-chasing airplane 99
 Traveling-bag oxygen unit (Scott Aviation Corp., 292 Erie St., Lancaster, N. Y.) 113
 Canvas strip acts as escape slide for airborne patients 134
 French built jet-powered light touring plane 134
 Pilot's rear-view mirror helps avoid accidents during take-off 140
 Quicker autopilots 140
 Navigator's "secretary" 144
 Titanium withstands jet heat 144

FISHING

Scientists say fish ignore weather and barometer 89
 Fish from a seagoing couch (George Romilly, Romilly Reefer, Palm Beach, Fla.) 95
 Underwater sonic detector pin-points fish 104
 Real fish (Actual Lure Co., Inc., 117 Rogues Path, New York City) 135
 Plastic fins (Actual Lure Co., Inc., 117 Rogues Path, New York City) 135
 All-purpose reel (Magic Spinning Reel Co., 1745 Wazee St., Denver, Colo.) 135
 Magnifying lens (Alex Taylor & Co., Inc., 22 E. 42nd St., New York City 17) 135
 Angler's hatband (Hawk-Eye Tackle Products, 2615 Scio Rd., Dexter, Mich.) 135
 Shrimp lure (Martin Bait Co., P. O. Box 1928, Amarillo, Tex.) 135

FARM AND GARDEN

Tractor hitch grabs implements 81
 Lawn sprinkler has built-in stake (Curtice Appliance Co., Inc., 357 Santa Fe Drive, Denver, Colo.) 89
 Mower attachment distributes weed killer (Red-E Tractor Co., Richfield, Wis.) 89
 Chemicals sprayed from hose (Melnor Metal Products Co., Inc., 112 Lafayette St., New York City 13) 108

HOBBIES AND NOVELTIES

Beachcomber's hobby in Guam becomes a business in Ohio 138
 Matchless cigarette 144
 Glass bows for archers (Paul Bunyan Glass Products, 1307 Glenwood Ave., Minneapolis 5, Minn.) 250

HOUSE AND HOME

Water buckets (Ett-Barr Co., P. O. Box 401, Pasadena 18, Calif.) 120
 Grapefruit knife (Doerr Sales Co., Centerville, S. D.) 120
 Child tether (C. H. Baldwin Co., Box 275, Lansing 2, Mich.) 120
 Plant feeder (Aero-Feeder Co., 3809 Nicollet Ave., Minneapolis 9, Minn.) 120
 Shoeshiner (Saulbert, Inc., 109 Broad St., New York City 4) 120
 Water heater (Bendix Home Appliance, Div. Avco Mfg. Corp., South Bend 21, Ind.) 121
 Balance bar (MacLeod Safety Device, Libertyville, Ill.) 121
 Outdoor thermometer (Taylor Instrument Companies, 95 Ames St., Rochester 1, N. Y.) 121
 Tie-on frame (Simpli Frame, Inc., 141 West 54th St., New York City) 121
 Bug light (Brass-Copper Lighting Mfg. Co., 609 E. 55th St., Los Angeles 11, Calif.) 121
 Bookshelf (Saker Industries, Harrington Park, N. J.) 121

MARITIME

Microwave lighthouse for small ships 78
 King-size propane bottles 78
 Powerful British "Squid" throws pattern of depth charges 99
 Underwater windows 240

MILITARY

Army engineers build model bridge 79
 Field gun in miniature built by British engineers 104
 Armored battle jacket 144

RAILROADING

Seabees make rail-car dumper out of scrap material 70
 Locomotive junk piles 105
 French track layer 140

(Continued to page 14)



BE A SUCCESS AS A RADIO-TELEVISION TECHNICIAN

2 FREE BOOKS SHOW HOW MAIL COUPON

America's Fast Growing Industry Offers You

EXTRA PAY IN ARMY, NAVY, AIR FORCE

If you expect to go into military service, mail coupon NOW. Knowing Radio, TV, Electronics can help you get extra rank, extra prestige, more interesting duty at pay up to several times a private's base pay. You are also prepared for good Radio-TV jobs upon leaving service. IT'S SMART TO TRAIN WITH N. R. I. NOW. Mail Coupon TODAY.

1. EXTRA MONEY IN SPARE TIME

Many students make \$5, \$10 a week extra fixing neighbors' Radios in spare time while learning. The day you enroll I start sending you SPECIAL BOOKLETS to show you how to do this. Tester you build with parts I send helps you service sets. All equipment is yours to keep.

I TRAINED THESE MEN

Shop Specializes in Television. "Have my own shop. Am authorized serviceman for 7 large manufacturers, do servicing for 7 dealers. N. R. I. enabled me to build enviable reputation." P. MILLER, Maumee, Ohio.

NRI Graduate Doubles Salary. "Am with Station WKBO as transmitter operator. More than doubled salary since starting in Radio full time. N. R. I. has been helpful to me." A. HERR, New Cumberland, Pa.

\$10 Week in Spare Time. "Before finishing course. I earned as much as \$10 a week in Radio servicing in spare time. I recommend N. R. I. to everyone who shows interest in Radio." S. J. PETRUFF, Miami, Florida.

Gets First Job Through N.R.I. "My first job was operator with KDLR, obtained for me by your Graduate Service Dept., I am now Chief Eng. of Police Radio Station WQOX." T. S. NOR-TON, Hamilton, Ohio.

2. GOOD PAY JOB

Your next step is a good job installing and servicing Radio-Television sets or becoming boss of your own Radio-Television sales and service shop or getting a good job in a Broadcasting Station. Today there are over 90,000,000 home and auto Radios. 3100 Broadcasting Stations are on the air. Aviation and Police Radio, Micro-Wave Relay, Two-Way Radio are all expanding, making more and better opportunities for servicing and communication technicians and FCC licensed operators.

3. BRIGHT FUTURE

And think of the opportunities in Television! In 1950 over 5,000,000 Television sets were sold. By 1954 authorities estimate 25,000,000 Television sets will be in use. Over 100 Television Stations are now operating, with experts predicting 1,000. Now is the time to get in line for success and a bright future in America's fast-growing industry. Be a Radio-Television Technician. Mail coupon for Lesson and Book—FREE.



I Will Train You at Home

Read How You Practice Servicing or Communications with Many Kits of Parts You Get!



I send you many valuable Kits of parts for PRACTICAL EXPERIENCE. They "bring to life" theory you learn in my illustrated texts. As part of my Servicing Course, you build a complete, powerful Radio Receiver, a Multitester useful in earning extra spare time money, AM and FM Signal Generator, etc. In my Communications Course, you assemble a low-power Broadcasting Transmitter that shows you how to put a station "on the air," a Wavemeter, etc. This and other equipment I send you, is yours to keep.

This is just part of the equipment my students build. You keep all parts I send.

NOW! Advanced Television Practice

New, special TV kits furnished to build high-definition SCOPE . . . RF OSCILLATOR with flyback power supply . . . complete TV set . . . many other units. You see pulse, trapezoidal, saw-tooth, wave forms. Get valuable PRACTICAL EXPERIENCE locating and correcting TV troubles. Mail coupon for facts, pictures and prices!

Keep your job while training at home. Hundreds I've trained are successful RADIO-TELEVISION TECHNICIANS. Most had no previous experience; many no more than grammar school education. Learn Radio-Television principles from illustrated lessons. Get PRACTICAL EXPERIENCE—build valuable Electronic Multitester for conducting tests; also practice servicing Radio or operating Transmitters—experiment with circuits common to Radio and Television. At left is just part of the equipment my students build with many kits of parts I furnish. All equipment is yours to keep. Many students make \$5, \$10 a week extra fixing neighbors' Radios in spare time.

Mail Coupon For 2 Books FREE

Act Now! Send for my FREE DOUBLE OFFER. Coupon entitles you to actual lesson on Servicing; shows how you learn Radio-Television at home. You'll also receive my 64-page book, "How to Be a Success in Radio-Television." You'll read what my graduates are doing, earning; see photos of equipment you practice with at home. Send coupon in envelope or paste on postal.

J. E. SMITH, Pres., Dept. 2GA, National Radio Institute, Washington, D. C.

Good for Both—FREE

Mr. J. E. SMITH, President, Dept. 2GA
National Radio Institute, Washington 3, D. C.

Mail me Sample Lesson and 64-page Book about How to Win Success in Radio-Television. Both FREE. (No salesman will call. Please write plainly.)

Name _____ Age _____

Address _____

City _____ Zone _____ State _____

Approved Under G. I. Bill



Will You Let Me PROVE I Can Make YOU a New Man?

LET ME START SHOWING RESULTS FOR YOU

What a difference!

"Have put 3 1/2 in. on chest." — F. S., New York.

For quick results I recommend CHARLES ATLAS

"Recommend you for quick results!" — W. G., N. J.

GAINED 29 POUNDS

"Did weigh 141. Now 170." — T. K., N. Y.

I COULD fill this whole magazine with enthusiastic reports from OTHERS. But what you want to know is — "What can Atlas do for ME!"

15 MINUTES A DAY

Just give me 15 minutes of your spare time daily. That's all I ask. And even in that short time I'll start giving RESULTS. And it will be the kind of RESULTS that you (and anyone else) can SEE, FEEL, MEASURE with a tape.

I myself was once a 97-pound weakling — sickly, half-alive. Then I discovered "Dynamic Tension." And I won the title, "The World's Most Perfectly Developed Man!"

"Dynamic Tension" has done so much for other fellows that I simply ask you to let me prove that it can make a New Man of YOU — that it can start new inches of power pushing out your chest — build up your shoulders to champion huskiness — put new, hard, firm muscles on your biceps — make those stomach muscles of yours hard ridges!

FREE My 32-Page Illustrated Book is Yours — Not for \$1.00 or 10c — But FREE

Send for my book, "Everlasting Health and Strength," 32 pages, packed with actual photos, valuable advice. A real prize for any fellow who wants a better build... but yours FREE! Rush coupon to me personally: Charles Atlas, Dept. 8U, 115 East 23rd St., New York 10, N.Y.

**CHARLES ATLAS, Dept. 8U,
115 East 23rd St., New York 10, N. Y.**

Send me—absolutely FREE—your famous book, "Everlasting Health and Strength"—32 pages, crammed with photos, answers to vital questions, valuable advice. I understand book is mine to keep, and sending for it does not obligate me in any way.

Name _____ Age _____
(Please print or write plainly)

Address _____

City _____ State _____

MISCELLANEOUS

Steel buys groceries.....	96
Foresee larger coal output.....	99
They put the home town on skids.....	106
Slip-on shower unit adds to back-yard fun (Knickerbocker Rubber Co., 6101 S. May St., Chicago 21).....	108
Fuel from paper-mill waste.....	108
Print flattener (Brown-Forman Industries, 1908 Howard St., Louisville 1, Ky.).....	113
Texas juggernaut.....	122
Tree researchers may discover what makes sap flow.....	123
Wannigans ride on rubber pontoons in north woods log drives.....	123
X-ray movies help doctors.....	128
Cathode-ray-tube machine "writes" book in one minute (Consolidated Vultee Aircraft Corp., San Diego 12, Calif.).....	136
Superstrength concrete.....	136
Coal pipe line.....	137
Concrete wall panel.....	140

Craftsman and Shop Notes Index

AUTOMOTIVE

Sleeve "guards" protect clothing during emergency repairs.....	162
Pressure applied with car jack aids in removing tire.....	175
Toweling stitched to cloth gloves makes car polishing easy.....	194
Ammonia neutralizes battery acid.....	203

FARM

Old horse-drawn disk harrow adapted to tractor lift.....	158
Removable fence fastened with staples and nails.....	166
Spading fork with mitten "flag" located easily in field.....	194
Barn doors kept from swinging by concrete "blister".....	200
Skid platform at waterer provides dry ramp.....	200
Chute connecting supply barrel with trough permits hog feeding through fence.....	202
Ground wires stapled to fence posts protect stock from lightning.....	202
Ear corn impaled on spikes kept clean for poultry.....	206
Horseshoes used as "latches" to hold trough against fence.....	206

GARDENING

Homemade rotor-type mower is self-propelled.....	163
Farm-implement wheels make sturdy "fences" for flower beds.....	166
"Growing" garden umbrella.....	167
Area of garden plant growth confined by enclosing roots.....	170

HOBBIES AND NOVELTIES

Rope lettering on address plaque suggests nautical theme.....	158
Animal tracks in plaster.....	168
Souvenir coins and silver wire used in making unique bracelet.....	185

HOUSE AND HOME

Tire-chain "mop" scours cistern.....	149
Vinegar prevents paint flaking from new garbage container.....	153
Extra pan secures pie covering.....	158
Solving home problems.....	160
Rubber hose cushions stepladder.....	166
Handle for carrying lawn chair.....	170
Floors shellacked before waxing to prevent discoloration.....	175
Pieces of padding from carpet used to repair worn hanger.....	179

JIGS, GAUGES AND FIXTURES

C-clamp forms emergency calipers.....	149
Automatic pencil has needle point for scoring exact measurements.....	149
Putty holds wrench close at hand until needed for saw adjustment.....	158
C-clamp stops on steel square simplify rafter layout.....	162
Worn leather-punch anvil replaced by copper rivet.....	162
Leather case holding slipstone used to strop blade edges.....	166
Can opener provides staple puller.....	180
"Vise" holds washers for filing to required thickness.....	193
Pipe elbow on blowtorch burner directs flame vertically.....	194
Registering holes drilled in metal with aid of aligning clamps.....	200
Radius gauge.....	201
Feeler blade mounted on dial gauge controls travel of contact button.....	202
Parts cleaned in converted washing machine.....	203

OFFICE, SHOP AND STORE

Sandpaper trimming block.....	170
Drawing board supported on kitchen stool.....	170
Folding rule provides "frame" for keeping blueprint flat.....	194
Wallpaper rolls tied easily when held on handy rack.....	200

RECREATION

Film cartridge made into reel suitable for still fishing.....	153
Can lids anchor picnic blanket spread on sand at beach.....	153
Outboard-motor carrier.....	159
"Wading pool" made from tire and tarpaulin provides outdoor recreation for tiny tots.....	175
Sinkers weight minnow net for deep seining.....	180

(Continued to page 16)

IMPORTANT NOTICE—It is the intention of this magazine to provide its readers with information regarding the latest developments in the mechanical arts. We take no responsibility as to whether the disclosures contained in our articles are covered by patents and advise readers to investigate this subject before making, using, or selling any of the products, machines, or processes described in order to avoid possible liability for patent infringements.

INVENTORS

Learn how to protect your invention. The U. S. Patent Laws provide that any new and useful art, machine, article of manufacture, or composition of matter, or any new and useful improvement thereof, may be patented if the act of invention is involved. Therefore, every inventor with a valuable invention should take advantage of the Patent Laws and proceed for patent protection in order to safeguard his rights.

A patent gives the inventor the exclusive right to prevent others from making, using, or selling the invention claimed in the patent for a period of seventeen years.

The Patent Laws were enacted for the benefit of the inventor to give him protection for the features of his invention which are patentable. These features must be properly and concisely set forth and claimed in a formal application for patent, in order to comply with the requirements of the Patent Laws. For that reason, unless the inventor is familiar with patent matters, he should engage a competent registered patent attorney or agent to represent him. We are registered to practice before the U. S. Patent Office and are prepared to serve you in the handling of your patent matters.

A specially prepared booklet entitled "Patent Guide for the Inventor", containing detailed information with respect to patent protection and procedure, together with a "Record of Invention" form will be promptly forwarded to you without obligation upon request.

CLARENCE A. O'BRIEN & HARVEY JACOBSON

Registered Patent Attorneys

21-G DISTRICT NATIONAL BUILDING

WASHINGTON 5, D. C.

VOTE TODAY

FOR THE FUTURE YOU WANT!

AMERICAN SCHOOL.
Dept. GB45, Drexel at 58th, Chicago 37, Ill.
Without obligation, please send FREE and postpaid, full particulars about the subject checked below.

- | | | |
|--|---|---|
| <input type="checkbox"/> Accounting | <input type="checkbox"/> Drafting—Building Trades | <input type="checkbox"/> Plastics Engineering |
| <input type="checkbox"/> Air Conditioning | <input type="checkbox"/> Drafting—Machine Trades | <input type="checkbox"/> Plumbing—Practical |
| <input type="checkbox"/> Architecture & Building | <input type="checkbox"/> Electrical Engineering | <input type="checkbox"/> Private Secretary |
| <input type="checkbox"/> Automotive Technician | <input type="checkbox"/> Electricity—Practical | <input type="checkbox"/> Refrigeration |
| <input type="checkbox"/> Better Foremanship | <input type="checkbox"/> Electronics—Industrial | <input type="checkbox"/> Retail Merchandising |
| <input type="checkbox"/> Bookkeeping | <input type="checkbox"/> High School Courses | <input type="checkbox"/> Salesmanship—Outside |
| <input type="checkbox"/> Business Management | <input type="checkbox"/> Machine Shop Operations | <input type="checkbox"/> Sheet Metal Work |
| <input type="checkbox"/> Contracting | <input type="checkbox"/> Mathematics & Slide Rule | <input type="checkbox"/> Tool Making |
| <input type="checkbox"/> Diesel Technician | <input type="checkbox"/> Mechanical Engineering | |

NAME..... OCCUPATION.....
 HOME ADDRESS..... AGE.....
 CITY..... STATE.....

THIS IS YOUR BALLOT
Find the subject that interests you most and then... Check, Sign and Mail Today

• Today, choose the job you want — and prepare for it in spare time at home. Or if you are already engaged in the work you like best, start training now for quicker promotion. In hours you might otherwise waste, gain the knowledge and skill that can help you to get ahead faster, make more money, and have greater security.

Training Backed by 55 Years of Experience

For over half a century American School has helped ambitious men and women toward success by providing specialized training for commercial and technical advancement. Its study program for you has been planned by experts with years of experience in the subject you select and they will give you needed guidance every step of the way.

Don't Delay Your Start

Give serious thought to the list of training courses listed above. Pick the opportunity that interests you, check it and add your name and address. (Check more than one if you are undecided as to which appeals most.) Finally clip out and mail the "ballot" and full information will be supplied, without cost or obligation.

AMERICAN SCHOOL
 DEPT. GB45, DREXEL AT 58th, CHICAGO 37, ILL.

THE SOONER YOU START, THE SOONER YOUR GOAL CAN BE REACHED

(Continued from page 14)

TOOLS

Put your jigsaw to work.....	150
Polishing-head lathe	195
Expanding arbor (Asco Corp., 17718 Waterloo Road, Cleveland 19, Ohio)	204
Magnetic pick-up tool (Airborne Sales Co., Dept. EI, Culver City, Calif.)	204
Self-indexing turret (Globe Heat-Seal, Inc., 3380 S. Robertson Blvd., Los Angeles 34, Calif.)	204
Preformed silver brazing rings (Lucas-Milhaupt Engineering Co., 5051 S. Lake Drive, Cudahy, Wis.)	204
Protractor level (J. H. Scharf Mfg. Co., 6120 Binney, Omaha, Neb.)	205
Planer-jointer-molder (Toolkraft Corp., Plainfield St., Springfield, Mass.)	205
Handy storage rack (Toolcraft Products Co., 5098 Tennyson St., Denver 12, Colo.)	205
New cabinet scraper (Fletcher-Terry Co., Export Dept., 21 West St., New York City 6)	205
Self-locking anchor nut (Kaynar Mfg. Co., Inc., East 16th and Griffith, Los Angeles, Calif.)	205

WOODWORKING

Finishing knots in inferior lumber.....	149
Cutting an open mortise.....	163
Plan of the month—suitcase picnic bench.....	164
Removing wood chips from blind holes.....	166

WORKSHOP TIPS

Abrasive recemented to disk sander by heating with lighter	157
Dulling of cutting edge on chisel prevented by cardboard sheath	180
Hollow rivet doubles as punch.....	180
Salvaging damaged lathe mandrel.....	194
Push stick guides turning square over circular saw to slot end.....	203
Felt washer oils lathe center.....	206
Leather-punch dies protected with can scabbard.....	206
Marks identifying left-hand nuts lessen possibility of damage.....	206

MISCELLANEOUS

Pointed section of bamboo holds small flagpole.....	162
Valve cores kept in tire pump.....	170
Drain stoppers form rubber feet.....	170
Cotton removed from bottle with wooden match.....	180
Light mounted on paper cutter simplifies trimming operation.....	190
Handy spoon for dry chemicals.....	190
Inexpensive repairs remedy shop motor failure.....	202
Upsetting of chemical bottle prevented by wire loop.....	203

Radio-Television, Electronics

Emergency device (Wright Mfg. Co., Box 6567, Houston, Tex.)	207
Photographic radiation detector badges (Eastman Kodak Co., Rochester 4, N. Y.)	207
Mobile unit (Radiation Counter Laboratories, 5122 Grove, Skokie, Ill.)	207
Versatile preamplifier modernizes phono-radio combinations.....	208
Small metal dollies for radio service bench.....	210
TV tuner (Standard Coil Products Co., Inc., 2311 N. Pulaski Rd., Chicago 39)	211
Five-element antenna (Technical Appliance Corp., Sherbourne, N. Y.)	211
FM-AM tuner unit (Collins Mfg. Co., Westfield, N. J.)	212
Self-holding test prods (United Technical Laboratories, Morristown, N. J.)	212
Circuit tester (Paul J. Steffen Co., 201 N. Wells St., Chicago 6)	212
Tip Jack (Insuline Corp. of America, 3602 35th Ave., Long Island City, N. Y.)	212
Single loop metal locator (Fisher Research Laboratory, Inc., 1961 University Ave., Palo Alto, Calif.)	212

Two Million Accidents

Nearly two million casualties, the worst automobile-accident toll in history, were recorded in 1951 and of this total 37,100 were fatalities. This death figure is an increase of 1600 over the 1950 mark. Excessive speed was the most dangerous mistake in driving by a tremendous margin, accounting for 13,000 deaths and 570,000 injuries. Saturday was the most dangerous day for driving and more persons were killed during the hour from six to seven p.m. than in any other hour. Ninety percent of the drivers involved in accidents were males.

INVENTORS

If you believe that you have an invention, you should find out how to protect it. The first step is to have a search made of the prior pertinent U. S. patents. If a report on this search indicates that the invention appears patentable you can apply for a patent, and the specifications and claims should be prepared.

The firm of McMorrow, Berman & Davidson, with offices in Washington, D. C., is qualified to take the necessary steps for you. We can make a preliminary search on your invention, advise you whether we think it can be patented, and prepare your application for patent.

Unless you are fully familiar with the U. S. Patent Laws, we recommend that you engage the services of a Registered Patent Attorney to protect your interests. The patent laws are *your* laws. A patent gives you the right to prevent others from making, using or selling the invention claimed in your patent for a period of 17 years.

Use these patent laws for your protection. Investigate whether your invention can be patented. If you have what you believe to be an invention, we suggest that you have this firm make a search for you.

Send for a copy of our Patent Booklet entitled "How To Protect Your Invention," containing information about patent protection and patent procedure. Along with this we will also send you an "Invention Record" form, for your use in writing down and sketching details of your invention. We will mail them promptly. No obligation. They are yours for the asking.

McMORROW, BERMAN & DAVIDSON

Registered Patent Attorneys

PATENTS • COPYRIGHTS • PATENTS

1359 VICTOR BUILDING, WASHINGTON 1, D. C.

I GAINED 53 LBS. OF SHAPELY POWER-PACKED MUSCLES



Roger Hirsch now

Which of these 2 ME'S is YOU?

THAT 112 LB.-6 FT. SPINDLE-ARMED SISSY WAS ME A FEW SHORT WEEKS AGO

NO! friend you don't have to be SKINNY any more just mail NOW the FREE coupon below as I did. Soon YOU can add

6½ inches to your CHEST 3 inches to each ARM



and the rest in proportion just as I did.

You Can WIN This 15" tall SILVER TROPHY As I Did in 10 MINUTES of Fun a Day!

Come on, PAL, NOW YOU GIVE ME

10 PLEASANT MINUTES A DAY IN YOUR HOME ...AND I'LL GIVE

YOU a NEW HE-MAN BODY For Your OLD SKELETON FRAME.

1917 George F. Jowett

World's Greatest Builder of HE-MEN



GEORGE F. JOWETT "Champion of Champions" 4 Times Winner Parlor Man Contest

NO! I don't care how skinny or flabby you are; if you're a teen-ager, in your 20's or 30's or over; if you're short or tall, or what work you do. All I want is JUST 10 EXCITING MINUTES in your home to MAKE YOU OVER by the SAME METHOD I turned myself from a wreck to a Champion of Champions.

YES! You'll see INCH upon INCH of MIGHTY MUSCLE added to YOUR ARMS. Your CHEST deepened. Your BACK AND SHOULDERS broadened. From head to heels, you'll gain SOLIDITY, SIZE, POWER, SPEED! You'll become an ALL-Around, ALL-American HE-MAN, A WINNER in everything you tackle—or my Training won't cost you one solitary cent.

Develop YOUR 520 MUSCLES Gain Pounds, INCHES, FAST!

Friend, I've traveled the world. Made a LIFE-TIME STUDY of every way known to develop your body. Then I devised the BEST by TEST, my "5-WAY PROGRESSIVE POWER" the only method that builds you 5-ways fast. You save YEARS, DOLLARS like movie star Tom Tyler did. Like champ Roger Hirsch did. Like MANY THOUSANDS like you did. SO Mail coupon NOW!

THIS MAY BE YOUR LAST CHANCE TO GET FOR ALL 5 10¢ PICTURE PACKED COURSES MILLIONS HAVE BEEN SOLD FOR \$1 AND MORE



BOTH FREE FOR QUICK ACTION!

1. Photo Book of STRONG MEN 2. MUSCLE METER

"Jowett Courses greatest in World for Building All-Around HE-MEN" —R. F. Kelley Physical Director

JOWETT INSTITUTE OF PHYSICAL TRAINING, DEPT. PM-27 230 FIFTH AVENUE, NEW YORK 1, N. Y.

Dear George: Please mail to me FREE Jowett's Photo Book of Strong Men and a Muscle Meter, plus all 5 HE-MAN Building Courses: 1. How to Build a Mighty Chest. 2. How to Build a Mighty Arm. 3. How to Build a Mighty Grip. 4. How to Build a Mighty Back. 5. How to Build Mighty Legs—Now all in One Volume "How to become a Mighty HE-MAN." ENCLOSED FIND 10¢ FOR POSTAGE AND HANDLING (no C.O.D.'s).

NAME _____ AGE _____
 ADDRESS _____
 CITY _____ ZONE _____ STATE _____

FUN FOR EVERYONE!



The Easy Way to Build Your Own OUTDOOR FIREPLACE

Food Cooked Outdoors Tastes Better... offers real enjoyment for the entire family... perfect for entertaining guests! It's easy and economical to build your own Cook Nook. Just add the masonry (any design you prefer) around the Majestic all-metal unit and start cooking! See your dealer today or send check or M. O.

SEND FOR free DESIGN BULLETIN! Big Selection of easy-to-follow designs

Model OF-28 only 21" x 26" x 13½" \$20.95



The Majestic Co. 359 Erie St., Huntington, Ind.



The Modern PLASTIC for lasting Home Repairs

PERMANENTLY mends cracks or holes in wood, tile, stone or plaster. Sticks and stays put—Does not chip, shrink or fall out. Easy to use. Economical. Mold it, chisel it, polish or paint it. If unobtainable from your lumber, paint or hardware dealer, the big 4-lb. can will be sent you post-paid (in U.S.) for only \$1.25. Full money-back guarantee, order now.

DONALD DURHAM CO.

Box 804-S, Des Moines, Iowa

REAL ESTATE BE A BROKER

PAYS BIG! SEND FOR FREE, BIG, ILLUSTRATED CATALOG NOW! Graduates report making substantial incomes. Start and run your own business quickly. Men, women of all ages, learn easily. Course covers Sales, Property Management, Appraising, Loans, Mortgages, and related subjects. STUDY AT HOME or in classrooms in leading cities. Diploma awarded. Write TODAY for free book! No obligation. WEAVER SCHOOL OF REAL ESTATE (Est. 1936) Suite 300 Law Bldg. Dept. PM Kansas City, Mo.



LAW FREE BOOK



Your FREE copy of "The Law-Trained Man" shows how to gain prestige and greater earnings through Blackstone home law study. All instruction material furnished including 16-volume Law Library written by 65 well-known law authorities. Lawyers, judges among our graduates LL.B degree. Low cost, easy terms. Write today.

BLACKSTONE COLLEGE OF LAW 225 N. Michigan Ave. Dept. 50B, Chicago 1, Ill. A Correspondence Institution Founded in 1890



Start as high as \$3,795.00 a year!

U.S. GOVERNMENT JOBS



Veterans Get

Preference / FRANKLIN INSTITUTE, Dept. K-83, Rochester 4, N. Y. (Not Govt. Controlled)

Men—Women Prepare NOW for next examinations Mail-Coupon today sure. / Name _____ Street _____ Address _____ Age _____

WILL YOU BE CLIMBING?

OR

STUCK?

WHAT you'll be doing *one year* from today depends on what you do *today*.

Take advantage of today's opportunities and you're sure to move ahead. Put off doing anything about them and you chance being left behind.

The opportunities open to trained men are greater today than at any time in the past five years. Skilled technicians and specialists are the *men of the hour*. And thousands of them are I. C. S. students.

Start now! Study at home, in your spare time, with the world's largest school—I. C. S. Mail the coupon today for full information. It may be later than you think!

INTERNATIONAL CORRESPONDENCE SCHOOLS

**I. C. S. has trained
5,918,692
men and women**

BOX 5531-L, SCRANTON 9, PENNA.

Without cost or obligation, please send me full particulars about the course BEFORE which I have marked X:

- | | | | | |
|---|---|--|---|--|
| Business Courses | <input type="checkbox"/> Refrigeration, Domestic | Communications Courses | <input type="checkbox"/> Ship Drafting | <input type="checkbox"/> Ship Fitting |
| <input type="checkbox"/> Accounting | <input type="checkbox"/> Refrigeration & Air Conditioning | <input type="checkbox"/> Telegraphy | <input type="checkbox"/> Tool Designing | <input type="checkbox"/> Toolmaking |
| <input type="checkbox"/> Bookkeeping | <input type="checkbox"/> Steam Fitting | <input type="checkbox"/> Telephony | <input type="checkbox"/> Welding—Gas and Electric | |
| <input type="checkbox"/> Business Administration | <input type="checkbox"/> Architecture | Electrical Courses | Radio Courses | |
| <input type="checkbox"/> Business Correspondence | <input type="checkbox"/> Architectural Drafting | <input type="checkbox"/> Electrical Drafting | <input type="checkbox"/> Electronics | |
| <input type="checkbox"/> Business Law | <input type="checkbox"/> Building Estimating | <input type="checkbox"/> Electric Light and Power | <input type="checkbox"/> FM and Television Servicing | |
| <input type="checkbox"/> Certified Public Accounting | <input type="checkbox"/> Contractor's Building | <input type="checkbox"/> Lighting Technician | <input type="checkbox"/> Radio, General | <input type="checkbox"/> Radio Operating |
| <input type="checkbox"/> Commercial | <input type="checkbox"/> House Planning | <input type="checkbox"/> Power House Electric | <input type="checkbox"/> Radio Servicing | |
| <input type="checkbox"/> Federal Tax | Art Courses | <input type="checkbox"/> Practical Electrician | Railroad Courses | |
| <input type="checkbox"/> Foremanship | <input type="checkbox"/> Commercial Art | <input type="checkbox"/> Practical Lineman | <input type="checkbox"/> Car Inspector and Air Brake | |
| <input type="checkbox"/> High School and College | <input type="checkbox"/> Magazine Illustrating | <input type="checkbox"/> Diesel Engines | <input type="checkbox"/> Diesel Locomotive | |
| <input type="checkbox"/> Industrial Supervision | <input type="checkbox"/> Show Card and Sign Lettering | <input type="checkbox"/> Internal Combustion Engines | <input type="checkbox"/> Locomotive Engineer | |
| <input type="checkbox"/> Motor Traffic | Chemical Courses | Mechanical Courses | <input type="checkbox"/> Locomotive Machinist | |
| <input type="checkbox"/> Personnel—Labor Relations | <input type="checkbox"/> Chemical Engineering | <input type="checkbox"/> Forging | <input type="checkbox"/> Railroad Section Foreman | |
| <input type="checkbox"/> Postal Civil Service | <input type="checkbox"/> Chemistry, Analytical | <input type="checkbox"/> Foundry Work | Stationary Engineering Courses | |
| <input type="checkbox"/> Retail Business Management | <input type="checkbox"/> Chemistry, Industrial | <input type="checkbox"/> Heat Treatment of Metals | <input type="checkbox"/> Power Plant Engineering | |
| <input type="checkbox"/> Sales Management | <input type="checkbox"/> Food-Plant Sanitation | <input type="checkbox"/> Industrial Engineering | <input type="checkbox"/> Stationary Fireman | |
| <input type="checkbox"/> Salesmanship | <input type="checkbox"/> Petroleum Production & Refining | <input type="checkbox"/> Industrial Instrumentation | <input type="checkbox"/> Stationary Steam Engineering | |
| <input type="checkbox"/> Secretarial | <input type="checkbox"/> Plastics | <input type="checkbox"/> Industrial Metallurgy | Textile Courses | |
| <input type="checkbox"/> Stenography | <input type="checkbox"/> Pulp and Paper Making | <input type="checkbox"/> Machine Shop Inspection | <input type="checkbox"/> Cotton Manufacturing | |
| <input type="checkbox"/> Traffic Management | Civil Engineering | <input type="checkbox"/> Mechanical Drafting | <input type="checkbox"/> Designing, Finishing | |
| Aeronautics Courses | <input type="checkbox"/> Highway Engineering | <input type="checkbox"/> Mechanical Engineering | <input type="checkbox"/> Loom Fixing | <input type="checkbox"/> Rayon Manufacturing |
| <input type="checkbox"/> Aeronautical Engineer's, Jr. | <input type="checkbox"/> Reading Structural Blueprints | <input type="checkbox"/> Millwrighting | <input type="checkbox"/> Textile Engineering | |
| <input type="checkbox"/> Aircraft Drafting and Design | <input type="checkbox"/> Sanitary Engineering | <input type="checkbox"/> Mold-Loft Work | <input type="checkbox"/> Woolen Manufacturing | |
| <input type="checkbox"/> Aircraft Mechanic | <input type="checkbox"/> Structural Drafting | <input type="checkbox"/> Patternmaking—Wood, Metal | | |
| <input type="checkbox"/> Engine Mechanic | <input type="checkbox"/> Structural Engineering | <input type="checkbox"/> Reading Shop Blueprints | | |
| Air Conditioning | <input type="checkbox"/> Surveying and Mapping | <input type="checkbox"/> Sheet-Metal Drafting | | |
| <input type="checkbox"/> Heating | | <input type="checkbox"/> Sheet-Metal Worker | | |
| <input type="checkbox"/> Plumbing | | | | |

Name _____ Age _____ Home Address _____

City _____ State _____ Working Hours _____ A.M. to _____ P.M.

Present Position _____ Employed by _____

Special tuition rates to members of the Armed Forces. Canadian residents send coupon to International Correspondence Schools Canadian, Ltd., Montreal, Canada.

WHAT SECRET POWER DID THIS MAN POSSESS?

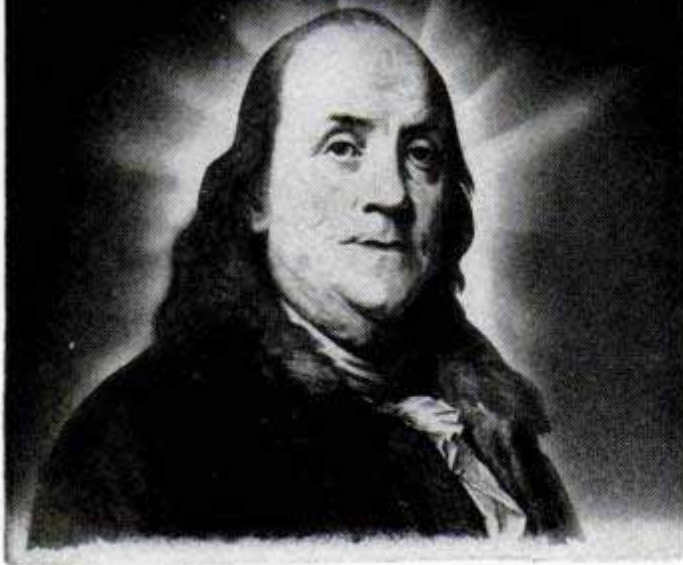

BENJAMIN FRANKLIN
(A Rosicrucian)

WHY was this man great? How does anyone—man or woman—achieve greatness? Is it not by mastery of the powers within ourselves? Know the mysterious world within you! At-tune yourself to the wisdom of the ages! Grasp the inner power of your mind! Learn the secrets of a full and peaceful life!

Benjamin Franklin—like many other learned and great men and women—was a Rosicrucian. The Rosicrucians (NOT a religious organization) first came to America in 1694. Today, headquarters of the Rosicrucians send over seven million pieces of mail annually to all parts of the world. Write for YOUR FREE COPY of "The Mastery of Life"—TODAY. No obligation. No salesmen. A non-profit organization. Address: Scribe G.X.F.

THIS BOOK FREE!

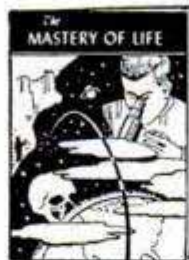

The ROSICRUCIANS

SAN JOSE • (AMORC) • CALIFORNIA

SEND THIS COUPON

Scribe G.X.F.
The ROSICRUCIANS (AMORC)
San Jose, California
Please send me the free book, *The Mastery of Life*, which explains how I may learn to use my faculties and powers of mind.

Name _____
Address _____
City _____

TUBE GIVEN WITH EVERY TIRE AT NO EXTRA COST



Why Pay More!

SUMMER SPECIALS — AT LOW PRICES
SAVE TIME — SAVE MONEY — SEND THIS AD

GOOD USED TIRES "Not recapped."

19 YEARS AT THIS ADDRESS

Be Wise—A TRIAL OF ONE TIRE WILL CONVINCE YOU.



19 MONTHS WRITTEN GUARANTEE

600-16 \$4.02	820-15 \$5.32	600-20 \$7.02	32x6(8) \$8.52
650-16 4.42	700-15 4.32	650-20 7.62	32x6(10) 9.82
700-16 5.02	670-15 4.52	700-20 8.42	900-20 13.22
650-15 4.02	710-15 4.72	750-20 8.42	1000-20 13.82
760-15 5.02	550-17 5.52	825-20 14.02	1100-20 14.82

EXTRA SPECIALS		29 MONTHS WRITTEN GUARANTEE	
600-16 \$5.42	550-15 \$6.02	700-15 (6) \$8.92	700-20 \$11.82
600-16 (6) 6.52	640-15 6.12	750-16 (8) 12.72	750-20 (8) 12.42
650-16 5.82	670-15 6.12	700-17 10.02	750-20 (10) 14.82
650-16 (6) 6.92	710-15 6.12	750-17 12.02	825-20 18.42
700-16 6.72	760-15 6.42	750-15 14.02	900-20 18.72
750-16 7.42	800-15 6.72	825-15 16.02	1000-20 19.72
525-18 5.72	820-15 6.72	600-20 8.82	1100-20 20.72
550-17 5.72	670-16 6.32	650-20 9.82	1200-20 23.72
650-15 5.72	760-16 6.82	32x6(8) 10.02	1000-22 19.62
700-15 6.42		32x6(10) 13.82	1100-22 21.72

WHITEWALLS \$1.00 ea. EXTRA

Thousands of tires shipped all over U.S.A. All tires shipped F.O.B. Phila. Send Check or M.O. with this ad. Dept. 2.

STANDARD 834 N. Broad St., Philadelphia 30, Pa.

HICKORY ACRES
6-WKS. OLD
STARTED

CAPONS

Easy, Profitable to Raise

Wonderful, tender capon meat brings top prices — makes finest eating. Easy to raise in back yard, on farm, or with other chicks. Hickory Acres 6-Wks. Old Capons are your best buy. Cost less than day old turkeys — easier to raise. Write for prices, information.



HICKORY ACRES CAPON FARM
BOX PM, WINDSOR, MISSOURI

A "GOOD HAND" HELPS YOU SUCCEED!



LEARN TO WRITE WELL

Handwriting quickly improves with our easy-to-understand picture lessons! Put your spare time to good use; send today for FREE BOOKLET, "How to Become a Good Penman," or check volumes wanted below at \$1 each: Business Writing Artistic Writing Card Writing Bird & Design Flourishing Engraving Alphabets. COMPLETE SET \$4.50. Ask for price list of penman's supplies.

Only 10¢

TAMBLYN SCHOOL OF PENMANSHIP
S.A. Ziller, Pres., 442 Ridge Bldg., Kansas City, Mo., USA

LEARN WATCH REPAIRING



AT HOME. By our modern and original system of instruction you can learn every part of the **WATCH REPAIRING TRADE AT HOME.** Prepare yourself for a well-paying position or start in business after completing our course of instruction. Good watch repairers are in demand and generally earn very good salaries. For particulars apply to the

WISCONSIN SCHOOL OF WATCH REPAIRING
759 N. Milwaukee, Dept. 7, Milwaukee 2, Wis.

It Really Works
LURES, TRAPS, KILLS FLIES

BIGSTINKY OUTDOOR FLY TRAP!

Big Stinky's control fluid aids in producing potent scent attractive to pesty flies — lures those in immediate vicinity — traps, then kills them! It's self-regenerative — feeding on the flies it kills. It really works!

Get Big Stinky now
At Leading Dealers Everywhere!

THE DIOPTRON CO. MILWAUKEE 1, WISCONSIN



LEARN

ELECTRICITY AND ELECTRONICS

ON REAL EQUIPMENT
IN THE GREAT SHOPS OF **COYNE**



ALSO TRAINING IN
RADIO-TELEVISION
Plays a Vital Roll in Nation's Defense

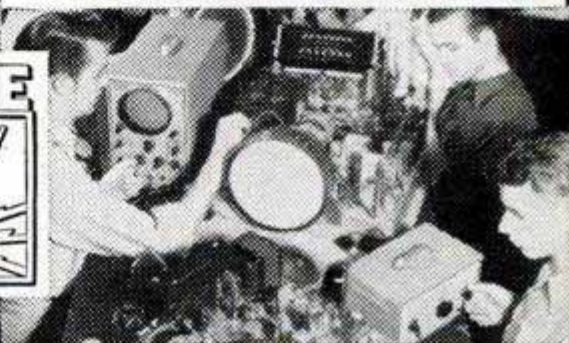

The tremendous growth of this new field is almost unbelievable. New stations are rapidly bringing television to all parts of the country. RADIO-TELEVISION and ELECTRONICS are vital to our Defense Program. Unusual opportunity to get in on ground floor of this vital field that also offers a world of opportunities for a real future when the emergency is over. Train quickly on actual equipment at Coyne by practical-technical methods. Get big Free Book today.

ELECTRICITY-

The Power Behind Our Defense Program

A great opportunity field and vital to Defense. Thousands of trained Electrical men needed in good jobs with a real future when the emergency is over. Why be satisfied with a "no future" job? Get Free Book that tells how thousands have prepared quickly for a good job with a real future in Electricity at Coyne.

TRAIN QUICKLY AT COYNE FOR VITAL FIELDS

ELECTRICITY-RADIO-TELEVISION-ELECTRONICS-VITAL in Industry and Armed Forces. TRAIN QUICKLY for better rating, if drafted—vital job in Industry, if not. Trained men whether 16 or up to 50 needed. Many men with physical handicaps can qualify. Prepare now for steady, well paid, essential jobs in A FIELD THAT ALSO OFFERS A REAL FUTURE WHEN THE EMERGENCY IS OVER.

Not "Home-Study"

We do not teach by mail. All training is given in our Great Training Shops in Chicago, plus necessary theory. No advanced education or previous experience needed.

START NOW—PAY LATER

Enroll now, pay most of tuition later. If you need part-time work to help out with living expenses while at Coyne, we'll help you get it. G.I. approved.



1 You are TOLD the how and why of each job.



2 You're shown how to do typical jobs by trained instructors.



3 You DO practical job YOURSELF on equipment.

Mail Coupon for Big FREE BOOK

Whether you prefer Electricity or Television-Radio, train on actual equipment, at Coyne. Fill in and mail coupon TODAY. Paste it on a penny postcard if you wish. A big fully illustrated booklet and complete details will come by return mail. No salesman will call.



B. W. COOKE, President
COYNE SCHOOL A TECHNICAL TRADE INSTITUTE
CHARTERED NOT FOR PROFIT
Established 1899
500 S. Paulina Dept. B2-72H
Chicago 12, Illinois
ELECTRICITY ★ TELEVISION ★ RADIO ★ REFRIGERATION ★ ELECTRONICS

B. W. COOKE, President
COYNE SCHOOL
500 S. Paulina St., Chicago 12
Dept. B2-72H
Send your BIG FREE BOOK and details of your training offer. This does not obligate me and no salesman will call. I am interested in
 ELECTRICITY TELEVISION-RADIO
NAME.....
ADDRESS.....
CITY.....STATE.....

C. T. C. TRAINING IN DRAFTING

PREPARES FOR
PROMOTION
•
MORE MONEY
•
SUCCESS



"Here I am at work making good money as a draftsman. I'm glad I sent the coupon to Chicago Tech for that Free Trial Lesson and found out how easy it is to learn Drafting in spare time at home. Today, I feel secure in my job. What's more, I feel I'm slated for promotion and more pay."

LEARN IN SPARE TIME—AT HOME!

(or at the College in Chicago)

A few hours of pleasant home study every week—that's all. All the tools you need; drawing outfit included. This tested method—developed over 48 years of C.T.C. progress—prepares men quickly for good positions in industry.



FREE INFORMATION—SEND COUPON

To prove to you how easy it is to learn Drafting at home, we will send you this FREE TRIAL LESSON. Mail coupon or send post card today.

CHICAGO TECHNICAL COLLEGE

H-250 Tech Bldg., 2000 So. Michigan Ave.
Chicago 16, Illinois

Mail me FREE Lesson with information about big opportunities in DRAFTING.

Name _____ Age _____

Address _____

City _____ Zone _____ State _____



BUILD FINE GRANDFATHER CLOCK NOW

The simple sensible Red-i-Kut way as thousands have—SAVE HALF. SHOP TESTED PLANS "SPIRIT OF THE CENTURY" Narrow waist, 83" tall or stately straight side "SPIRIT OF AMERICA." EASY-to-FOLLOW photopocket PLANS tell all—plus BROCHURE of heavy brass weight Westminster, tube chime, movements, gorgeous dials, 3/4" solid mahogany case kits. Send \$1.00 today — Both plans \$1.50 NOW.

KUEMPEL CHIME CLOCK CO., #4 Kuempel Bldg., Minneapolis 16, Minn.

INVENTORS

Before you make any effort to market your invention, you should take the first steps toward proceeding for patent protection.

I shall be pleased to furnish you with information relative to patent procedure, upon request from you, and this will be without any obligation on your part.

PATRICK D. BEAVERS

Registered Patent Attorney

934 Columbian Building Washington 1, D. C.

INVENTORS

Your first step—if you consider your invention to be something of importance—is to have a search made of pertinent, prior U. S. patents. If our search report indicates probable patentability of your invention, you may apply for a patent which gives you the right to exclude others from making, using or selling your invention as claimed for a term of 17 years.

This firm is registered to practice before the U. S. Patent Office and is available to assist in the preparation of the necessary drawings, specification and claims.

Ask for a copy of our instructive booklet "Patent Protection for Inventors" and our convenient "Evidence of Invention" form. No obligation.

VICTOR J. EVANS & Co. *Merlin M. Evans*

REGISTERED PATENT ATTORNEY

730-H MERLIN BUILDING, WASHINGTON 6, D. C.



PATENTS

C. A. SNOW & CO.

REGISTERED PATENT ATTORNEYS
WRITE FOR INFORMATION TO
428 SNOW BUILDING, WASHINGTON 1, D. C.

INVENTORS

Whether an invention is patentable can be substantially determined by a search of the U. S. Patent records. Without obligation, write for information explaining the steps you should take to secure a patent.

JOHN N. RANDOLPH

Registered Patent Attorney

201 Columbian Building, Washington 1, D. C.

INVENTORS

Send for
PATENT INFORMATION

Book and
INVENTOR'S RECORD

without obligation

GUSTAVE MILLER
72-PM WARNER BUILDING
WASHINGTON 4, D.C.

REGISTERED PATENT
ATTORNEY

Patent Attorney & Advisor
U. S. NAVY DEPT. 1930-1947

ASSOCIATE EXAMINER
U. S. PAT. OFF. 1922-1929

PATENT LAWYER

SAY YOU SAW IT IN POPULAR MECHANICS

INVENTORS

IF YOU WISH TO PROTECT YOUR INVENTION, You should take steps to protect it by a U. S. Patent. Write me for "INVENTION RECORD" form

CARL MILLER
REGISTERED PATENT ATTORNEY

WOOLWORTH BLDG., 35th FLOOR, 72A
NEW YORK CITY

TRAIN AT HOME IN YOUR SPARE TIME

DON'T PUT IT OFF...MAIL TODAY!

GET THE MONEY AND SECURITY YOU'VE ALWAYS WANTED!



L. J. ROSENKRANZ, President, National Schools, the man who has trained many, many men like YOU. Men who now own successful, respected businesses of their own. Men who hold important, high-paying positions in famous companies. You CAN be a success. Mail coupon for more details.

Let Me Show You How! Mail the Coupon for My FREE Books!

Each book has page after page in color. Gives you the complete story about my proved training method... tells how quickly it can train you for a secure, high-paying job. Don't wait. Get the facts. Send today for my valuable books on Radio-Television or Automotive-Diesel. Check the coupon at right and mail it to me today. Absolutely no obligation.

NO SALESMAN WILL CALL!

I'll send you a FREE SAMPLE LESSON TOO, if you act fast! Shows how easy it is to learn with National Schools Home Training.



NATIONAL SCHOOLS, Dept. B-72
4000 South Figueroa Street
Los Angeles 37, California

Mail in envelope
or paste on
penny postal card

Send me Free the book checked below and the sample lesson. I understand no salesman will call on me.

- "MY FUTURE IN RADIO-TELEVISION & ELECTRONICS" OR
- "MY FUTURE IN DIESEL-AUTOMOTIVE & ALLIED MECHANICS."

NAME _____ AGE _____

ADDRESS _____

CITY _____ ZONE _____ STATE _____

Check here if you were released from the service less than 4 years ago.

Let National Schools - a resident-training school for nearly 50 years - train you at home for today's unlimited opportunities in Radio-TV or Automotive-Diesel. National Schools is one of the largest schools of its kind in the world. It has 4 big buildings of modern shops and labs. Its faculty is considered tops. You learn fast from easy lessons - all perfected under actual shop conditions. Approved for eligible vets.



Earn Extra Money while you're learning! I'll show you how!
EASY TERMS • FREE GRADUATE SERVICE
Mail coupon today - find out more!

WHICH HIGH-PAYING FIELD DO YOU WANT?

TODAY'S SHORTAGE OF TRAINED TECHNICIANS CREATES CHANCE OF A LIFETIME FOR YOU... IN EITHER FIELD!

RADIO-TELEVISION & ELECTRONICS

OR

AUTOMOTIVE-DIESEL AND ALLIED MECHANICS

JOB SECURITY! BIG MONEY! FOR YOU IN TODAY'S EXPANDING INDUSTRIES!

Think of it! With guided missiles, radar and other electronic devices so important to national defense. With big, new developments in color TV. With over 90,000,000 home and auto radios, over 12,000,000 TV sets. With more than 3100 radio stations...over 100 TV stations - and more building every day - imagine the terrific opportunity you have!

You Train at Home - In Your Spare Time

With National Schools Master Shop Home Training, you master all phases of Radio-Television-Electronics. You learn fast from hundreds of pictures and diagrams. All lessons have been developed and tested in National Schools famous shops and labs. No wonder your National Schools training is so up-to-date, practical, interesting. And so easy!

LOOK! WE SEND YOU ALL THESE PARTS! -and you keep them!



We send you lots of standard professional parts. You do lots of practical experiments. You learn step by step. Until you can build the big Superheterodyne Receiver you see above - and other important test units. Mail the coupon - today.

Only National Schools Gives You This Professional Multi-Tester



You get this factory-made new Multi-Tester... an important instrument every Radio-TV man must have.

GREATEST DEMAND FOR TRAINED MEN IN HISTORY! NOW IS YOUR CHANCE!

What an opportunity! With over 8 million older cars needing big service and repair jobs. With defense industry having more high-paying jobs than they can fill. With the Armed Forces offering quick advancement to trained mechanics. YOU ARE NEEDED as never before! Now you can get the good pay, security, the satisfaction of doing what you want to do! Don't delay - mail the coupon NOW!

Right in Your Own Home!

You learn all about Gasoline Engines, Diesel and Special-Fuel Engines, Automotive Tune Up, General Garage Mechanics, Auto Electrical Service. You get complete training for this great, growing industry.

Yet National Schools Home Training is easy! Because it's based on actual shop methods in National Schools big resident school. Mail the coupon for more details - NOW.

National Schools Gives You All These Tools

You start out owning the tools of your trade. A kit of standard, professional tools and equipment. They're all part of your course!

-And you keep them - they're yours!



I Offer You All These!

Basic Lesson Texts. Diesel Installation & Maintenance Instructions. Spare Time Lessons. Engine Service Manuals. Engine Repair Drive Systems. Diesel Electric Power Texts. Special Thermodynamic Instruction.

Attention: Men Going into the Service Soon!

With National Schools training in Radio-Television or Automotive-Diesel, you have the opportunity to get into special service classifications. That means higher pay and grade, more prestige - right away! This is important - so be sure to mail the coupon today without fail.

WHICH OF THESE HIGH-PAYING JOBS WOULD YOU LIKE?

- MOTOR TUNE UP SPECIALIST
- DIESEL ENGINE SPECIALIST
- FARM EQUIPMENT MECHANIC
- YOUR OWN GARAGE OR REPAIR SHOP
- GENERAL GARAGE MECHANIC
- PARTS DEALER
- AUTO ENGINE REBUILDING
- FUEL INJECTION SPECIALIST

You can have secure jobs like these. Just mail the coupon - and find out!

NATIONAL SCHOOLS TECHNICAL TRADE TRAINING SINCE 1905 LOS ANGELES 37, CALIFORNIA

We teach you FREE!



We put you in Business!

HERE'S THE BIG OPPORTUNITY FOR YOU! Learn a new and fascinating occupation... a wonderful hobby... and MAKE MONEY AT THE SAME TIME! OPERATE AT HOME OR IN A SMALL SHOP! AND... the complete Instructions... books, lessons and personal guidance COST YOU NOTHING! We teach you FREE how to make the most beautiful jewelry you have ever seen: door-knobs imbedded with interesting objects, nite-lites, book-ends, coasters, name-plates, ash trays, paper weights, statues, figurines, souvenirs, novelties, gadgets, etc... an endless variety of high-quality, highly saleable products out of LIQUID MARBLE, TRANSPARENT GEM-LIKE LIQUID PLASTIC, CERAMICS, PLASTER, COMPOSITIONS, STONE, ETC.! All without tools or machinery! The manufacture of these lovely objects is as easy as pouring water out of a glass! And—you learn how ABSOLUTELY FREE! The only limitation is your own IMAGINATION! No special talents or experience are required!

You get more than the FREE INSTRUCTIONS! We also show you methods of selling your finished work... even selling part of it to us! Start on a shoestring! And overnight, become established in one of the most fascinating and profitable occupations in existence!

Just send 25¢ for our big catalog, "CASTING MATERIALS, MOLDS, ETC."—and you're on your way! Along with the catalog we will include the book, "THE ART and BUSINESS OF CASTING" absolutely FREE! And—surprising details on an amazing, exclusive Plasticast offer guaranteeing your success! DON'T DELAY! This could be the most important step of your lifetime! WRITE TODAY!

PLASTICAST CO. (DEPT. C)

P. O. Box 6737 (WRITE TO NEAREST ADDRESS) P. O. Box 987 Chicago, 80, Ill. Palo Alto, Calif.
CANADIAN CUSTOMERS: Send 35¢ for catalog to Canadian Ind. PLASTICS, 1056½ W. Pender St., Vancouver, B. C.



RELIEVES HEADACHE NEURALGIA NEURITIS PAIN

FAST



Here's Why...

Anacin® is like a doctor's prescription. That is, Anacin contains not one but a combination of medically proved active ingredients. Anacin is specially compounded to give FAST, LONG LASTING relief. Don't wait. Buy Anacin today.

AVIATION

The aircraft industry urgently needs trained personnel. Here is YOUR opportunity for a rewarding and interesting future. Study Aeronautical Engineering, Engineering Drafting, Airplane and Engine Mechanics (approved by C.A.A.). Outstanding faculty, modern equipment. Part-time employment. Free placement service. Big demand for graduates. 23rd year. Founded by Curtiss-Wright. Write for free bulletin and "Opportunities in Aviation".

AERONAUTICAL UNIVERSITY

Dept. 75, 1905 Prairie Avenue, Chicago 16, Illinois

Learn this Profitable Profession



IN 90 DAYS AT HOME

Money-Making Career Open to Men and Women, 18 to 60

Hundreds of men and women between 18 and 60 make \$10 to \$20 in a single day giving scientific Swedish Massage and Hydro-Therapy treatments. There is big demand from doctors, hospitals, sanatoriums and clubs. Graduates earn large full time income from these or in private practice in their own offices. Others make good money from home treatments given in spare time. Learn this interesting money-making profession in your own home, through our home study course. Same instructors as in our nationally known resident school. You can win independence and prepare for future security by qualifying for your Graduation Certificate. Course can be completed in 3 to 4 months. Many earn while they learn. Begin your training at once.



NEW 32-PAGE BOOKLET FREE

Fill in the coupon below (please print name and address) and mail it for your FREE copy of 32-page Information Booklet. If you act at once we will include Anatomy Charts and Success Booklet which supply additional information you should have. All will be sent postage paid.

THE COLLEGE OF SWEDISH MASSAGE
Dept. 264H, 41 E. Pearson St., Chicago 11, Illinois

Please send me FREE and postpaid New 32-Page Illustrated Booklet, Anatomy Charts and Success Booklet at once.

Name _____ Age _____

Address _____

City _____ State _____

MAKE YOUR OWN!

WITH

GRIFFIN LEATHERCRAFT KITS

Best assortment of tools, materials in U.S.A. Send 25¢ for 116-page catalog. (money refunded first order)

GRIFFIN CRAFT SUPPLIES

SINCE 1924

5626-A Telegraph Ave., Oakland 9, Calif

"How to Become a Mail Order Millionaire"



Read the inside facts about hundreds of "little fellows" who are running Mail Order businesses from their homes—many making \$20,000 and more every year! Learn how small investments (\$16.80 in one case!) have mushroomed into profits of thousands. This incredible reprint from *Mechanix Illustrated* will be sent absolutely free, along with details showing how you can quickly master the secrets of getting orders and money in your daily mail, in a business that's all yours. Rush name today. A postcard will do.

SENT FREE!

RUSH NAME ON POSTCARD TODAY

The L. W. SURVEY 7070 North Clark Street, Dept. 17, Chicago 26, Ill.

**NOW... GET EVERYTHING YOU
NEED TO LEARN AND MASTER**

TELEVISION

**RADIO-ELECTRONICS
...AT HOME!**

Use REAL commercial-type equip-
ment to get practical experience

Your future deserves and needs every advantage you can give it! That's why you owe it to yourself to find out about one of the most COMPLETE, practical and effective ways now available to prepare AT HOME for America's billion dollar opportunity field of TELEVISION-RADIO-ELECTRONICS. See how you may get and keep the same type of basic training equipment used in one of the nation's finest training laboratories... how you may get real STARTING HELP toward a good job or your own business in Television-Radio-Electronics. Mail the coupon today for complete facts — including 89 ways to earn money in this thrilling, newer field.

ABOVE: Build and keep a real 17 INCH commercial TV receiver. Optional after completing regular training at moderate added cost.

D.T.I., ALONE, INCLUDES BOTH MOVIES and HOME LABORATORY. In addition to easy-to-read lessons, you get the use of HOME MOVIES — an outstanding training advantage — plus 16 big shipments of Electronic parts. Perform over 300 fascinating experiments for practical experience. Build and keep real commercial-type test equipment shown at right.

Get BOTH of these information packed publications FREE!

89 WAYS TO EARN MONEY IN TELEVISION RADIO ELECTRONICS

YOU GET ALL 6

MODERN LABORATORIES

If you prefer, get all your preparation in our new Chicago Training Laboratories—one of the finest of its kind. Ample instructors, modern equipment. Write for details!

MILITARY SERVICE!

If you're subject to military service, the information we have for you should prove very helpful. Mail coupon today.

ACT NOW! MAIL COUPON TODAY!

DE FOREST'S TRAINING, INC. DEPT. PM-7-1
2533 N. Ashland Ave., Chicago 14, Ill.

Without obligation, I would like your Opportunity News Bulletin showing "89 Ways to Earn Money in Television-Radio-Electronics"; also, the folder showing how I may prepare to get started in this thrilling field.

Age.....
Name..... Apt.....
Address..... State.....
City..... Zone.....



Here's the REAL THING!

SET UP YOUR OWN HOME LABORATORY



R-F Signal Generator



Oscilloscope

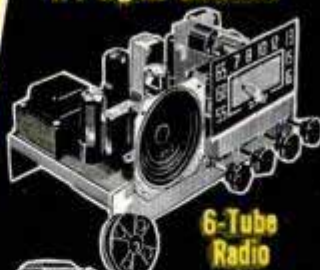

6-Tube Radio



Multimeter



Home Movies

"ONE OF AMERICA'S FOREMOST TELEVISION TRAINING CENTERS"

De FOREST'S TRAINING, INC.
CHICAGO 14, ILLINOIS
A De VRY INSTITUTION

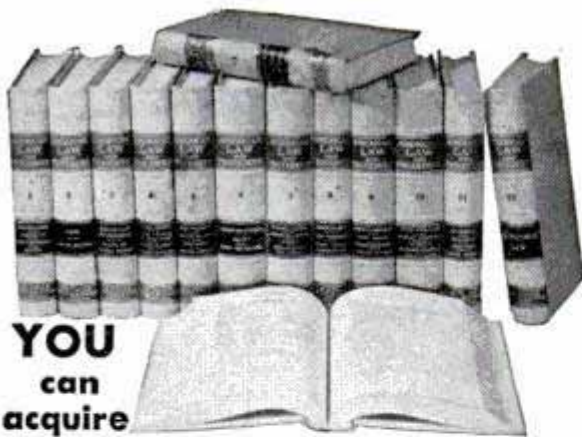

**YOU
can
acquire**

LAW NIGHTS AT HOME! L. L. B. DEGREE

LaSalle's famous Law Library—used as reference in many Law libraries and Law offices—has enabled thousands to master Law surprisingly fast, in spare hours at home, for business and professional advancement.

These 14 remarkable volumes, compiled by leading professors and lawyers, cover the whole basic field of Law in condensed, orderly, simplified manner.

You advance rapidly with this great library, plus special lectures furnished. We guide you step-by-step with personalized Problem Method of instruction . . . you *learn by doing*—handling legal problems—not by memorizing rules.

Send for two FREE 48-page booklets, "Law Training for Leadership," and "Evidence," answering questions about Law and its value to you, and telling how LaSalle Law graduates are winning rapid advancement in business and public life. Mail coupon below. No obligation.

LA SALLE EXTENSION UNIVERSITY A Correspondence Institution

417 S. Dearborn St. Dept. 764L Chicago 5, Ill.

Send me your two FREE booklets described above, without obligation.

Name.....Age.....

Street.....

City, Zone & State.....

UNLIMITED OPPORTUNITIES IN ENGINEERING DEGREE IN 27 MONTHS

Study Engineering in this world-famed school, established 1884. Demand for our graduates exceeds supply. Growing shortage of engineers. No field offers greater opportunities for responsible, lucrative positions.

Bachelor of Science Degree in Mechanical, Civil, Electrical, Chemical, Aeronautical, Radio (Television) Engineering; Business Administration and Accounting. Also 36-weeks certificate course in Surveying and Drafting.

Personalized Instruction. Accelerated courses. Non-essentials eliminated. For ambitious, earnest students. Earn your degree in the shortest possible time. Preparatory courses. Placement service.

Extensive Campus. Well equipped, new and modernized buildings; up-to-date labs. Low cost. New terms start quarterly. Enter September, January, March, June.

Write today for free catalog and special information.



TRI-STATE COLLEGE

472 College Ave. ANGOLA, INDIANA

**Count
Telegraph
Wires
In The
Distance**

20 POWER All Purpose TELESCOPE

Weights Only 7½ Ounces! Tremendous 20 Power (2½ times that of Official U. S. Armed Forces Binoculars!) COATED. Whisper Weight—Easy to hold—Easy to focus. Ideal for indoor, outdoor sports, vacationing, trips, long distance spotting. Pocket size—measure only 6¼" closed, 13½" open. NOT A CHEAPLY MADE TOY TELESCOPE! But an all metal precision machined (threaded fittings throughout), precision ground achromatic telescope that invites comparison. Bears the famous UNITED "Seal of Quality" because Now you can view distant objects (even those miles away) clearer, brighter and in sharper detail than ever before. UNCONDITIONALLY GUARANTEED. Try for 30 days. If not absolutely satisfied in every way return for an immediate unquestioned refund of your money. Introductory price \$8.95 (tax free)! Cash orders postpaid. COD's include \$2.00 deposit. UNITED BINOCULAR CO., 9043 S. Western Ave., Dept. ARF-4808, Chicago 20



**A
R
E
A
L
B
A
R
G
A
I
N**



Bar Bells

Buy Direct From Factory

Write for free booklet
and price list

\$8.95
up

INDEPENDENT IRON WORKS

2416 East 23rd Street, Dept. B
Los Angeles 58, Calif.

—ARE YOU—

The "Take a Chance Type?"

If so don't read any further. This AD is only intended for car owners too smart to be caught short, on a LONELY road, after dark, miles from nowhere, with IGNITION TROUBLE. This COULD happen to YOU. Would you spend \$1.69 to get out of such a JAM? Why not prevent it by carrying a "ROAD DOCTOR" in the glove compartment—requires less than 1 minute to install. Be safe, not sorry—ORDER ONE TODAY. Satisfaction guaranteed or money refunded.

THE ROAD DOCTOR,

Branch #4, P. O. Box #447

Phila. 5, Penna.



X.L. RUBBER MOLDS

will realize you great profits quickly!

WRITE FOR NEW FREE CATALOG

YOU can EASILY learn to cast thousands of perfect plaques, book ends, figurines, ash trays, etc. IT'S EASY, FUN, PROFITABLE! X.L. Rubber, Pts. \$2.50; Qts. \$4.00 (postage extra). Models and enough for 3 molds \$1.50 prepaid.



SEND FOR FREE FACTS

PLASTIC ARTS STUDIO

Address Dept. 2
3403 S. Madison St.

Muncie, Ind.



BOYS! MAKE YOUR OWN RADIO

Make your own simple, tubeless, batteryless Crystal Radio. SEND 25c for a GENUINE MELOMITE CRYSTAL with complete illustrated instructions for making your own set. Crystal sent postpaid with instructions and our own publication, "THE MAGIC CRYSTAL" which is full of news, diagrams, questions and answers of interest.

SEND 25c FOR YOUR CRYSTAL TODAY!

ALVA ALLEN RADIO Dept. PM-7 Clinton, Mo.

RUPTURED?

Get Relief This Proven Way

Why try to worry along with trusses that gouge your flesh—press heavily on hips and spine—enlarge opening—fail to hold rupture? You need the Cluthe. No leg-straps or cutting belts. Automatic adjustable pad holds at real opening—follows every body movement with instant increased support in case of strain. Cannot slip whether at work or play. Light. Waterproof. Can be worn in bath. Send for amazing FREE book, "Advice To Ruptured" and details of liberal truthful 60-day trial offer. Also endorsements from grateful users in your neighborhood. Write:

CLUTHE SONS, Dept. 31, Bloomfield, New Jersey.

CAR REPAIRS NOW MADE EASY

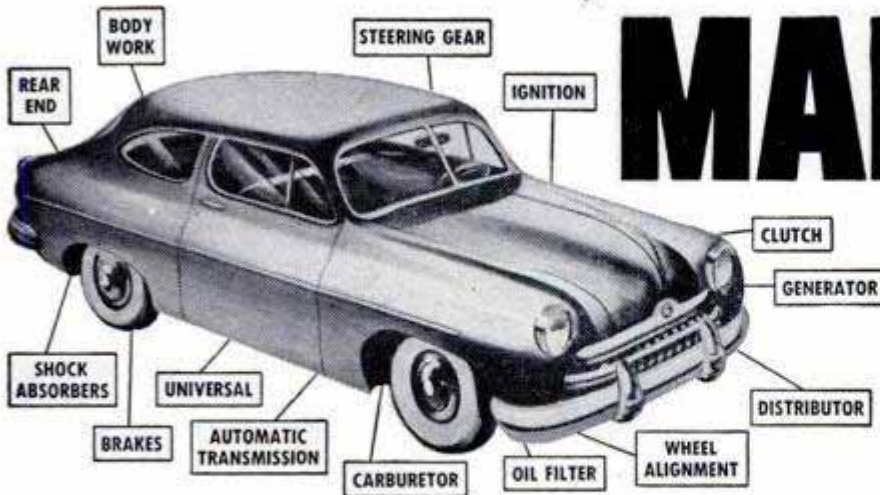

Here's How To Fix Any Part of Any Car

Now - Whether You're a Beginner or Expert Mechanic - You Can "Lick" Any Auto Repair Job! Giant Guide Shows HOW - with 2400 Pictures and Step-by-Step Instructions

YES, fixing cars is a "cinch" when you have **MOTOR'S BRAND-NEW AUTO REPAIR MANUAL!** You just turn to the handy index, follow the clear, illustrated instructions and—Presto! the job is done. Covers everything from simple carburetor adjustment to complete overhaul—**INCLUDES EVERY CAR FROM 1935 thru 1952.**

Over 2,000 Pictures! So Complete, So Simple, You CAN'T Go Wrong!

NEW REVISED Edition covers everything you need to know to repair 851 car models, 780 giant pages, 2400 "This-Is-How" pictures. Over 200 "Quick-Check" charts—more than 38,000 essential repair specifications. Over 225,000 service and repair facts. Instructions and pictures are so clear you *can't* go wrong!

Even a green beginner mechanic can do a good job with this giant manual before him. And if you're a top-notch mechanic, you'll find shortcuts that will amaze you. No wonder this guide is used by the U. S. Army and Navy! No wonder hundreds of thousands of men call it the "Auto Repair Man's Bible"!

Same FREE Offer on MOTOR'S New Truck and Tractor Manual

BRAND-NEW Edition! Covers EVERY job on EVERY popular-make gasoline-powered truck and farm tractor made from 1936 thru 1951. Over 1400 pictures, 925 pages, 300,000 facts. **FREE 7-DAY Trial.** Check proper box in coupon.



Meat of Over 170 Official Shop Manuals

Engineers from every automobile plant in America worked out these time-saving procedures for their own motor car line. Now the editors of **MOTOR** have gathered together this wealth of "Know-How" from over 170 Official Factory Shop Manuals, "boiled it down" into crystal-clear terms in one handy indexed book!

Try Book FREE 7 Days

SEND NO MONEY! Just mail coupon! When the postman brings book, pay him

nothing. First, make it show you what it's got. Unless you agree this is the greatest time-saver and work-saver you've ever seen—return book in 7 days and pay nothing!

Mail coupon today!
Address: **MOTOR Book Dept., Desk 1H, 250 West 55th Street, New York 19, N. Y.**

Just a Few of the Many Letters of Praise



"Fixed motor another mechanic had worked on half a day. With your Manual I did it in 30 minutes."
—C. AUBERRY, Tenn.

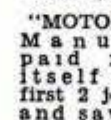

"MOTOR'S Manual paid for itself on first 2 jobs, and saved me valuable time by eliminating guess-work."
—W. SCHROP, Ohio.

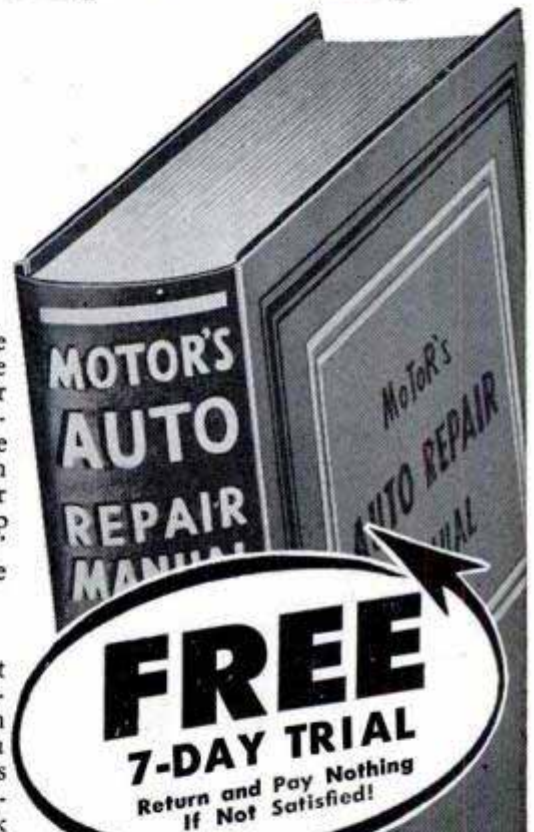

Covers 851 Models—All These Makes

Buick	De Soto	Hudson	Mercury	Plymouth
Cadillac	Dodge	Kaiser	Nash	Pontiac
Chevrolet	Ford	Lafayette	Nash Rambler	Studebaker
Chrysler	Frazier	La Salle	Oldsmobile	Terraplane
Crosley	Henry J	Lincoln	Packard	Willys

Also tune-up adjustments for others

MAIL COUPON NOW FOR 7-DAY FREE TRIAL

MOTOR Book Dept., Desk 1H, 250 West 55th Street, New York 19, N. Y.

Rush to me at once: (Check box opposite book you want)

- MOTOR'S New AUTO REPAIR MANUAL.** If O.K. I will remit \$1 in 7 days, (plus 35c delivery charge)—then \$2 monthly for 2 months, and a final payment of 95c a month later. Otherwise I will return book post-paid in 7 days. (Foreign price, remit \$8 cash with order.)
- MOTOR'S New TRUCK & TRACTOR REPAIR MANUAL.** (Described at left.) If O.K. I will remit \$2 in 7 days, and \$2 monthly for 3 months, plus 35c delivery charge with final payment. Otherwise I will return book promptly. (Foreign price, remit \$10 cash with order.)

Print Name..... Age.....

Print Address.....

City & Zone No..... State.....

SAVE 35c delivery charges by enclosing WITH COUPON check or money order for full payment of \$5.95 for Auto Manual (or \$8.00 for Truck Manual). Same 7-day return-refund privilege applies.

FOR YOUR
**TECHNICAL AND VOCATIONAL
TRAINING**

Come to the
UNIVERSITY OF HOUSTON

One of America's large and most modern universities. Select from these fascinating fields: aeronautics air conditioning & refrigeration auto body and paint auto mechanics auto upholstery & trim diesel drafting electricity electronics machine shop photography radio stationary engineering television welding woodworking furniture upholstery. **PREPARE FOR YOUR FUTURE NOW . . .** with very latest methods and equipment, at modern U. of Houston College of Technology. Entrance: high school diploma, or over 18 and ability to profit from instruction. Beautiful campus—250 wooded acres in Houston, Texas—city of tomorrow. Full college activities, sports, social life. Day or night, short or longer courses. Co-op work-study programs . . . earn part of tuition and expenses with part-time job in your own career field, while you learn. Personal vocational counselling. Diploma on completion and all credits apply towards Bachelor of Applied Science Degree. Job placement assistance. June, Sept., Feb. semesters. Mail ad now for Free fully-illustrated brochure. No obligation. Mark X before choice of subject. **Do it today!**



ADMINISTRATION BUILDING

University of Houston, College of Technology
Dept. 172 — HOUSTON 4, TEXAS

Worry of
FALSE TEETH

Slipping or Irritating?

Don't be embarrassed by loose false teeth slipping, dropping or wobbling when you eat, talk or laugh. Just sprinkle a little **FASTEETH** on your plates. This pleasant powder gives a remarkable sense of added comfort and security by holding plates more firmly. No gummy, gooey, pasty taste or feeling. It's **alkaline** (non-acid). Get **FASTEETH** at any drug store.

**Make Garden Masonry
for Spare-Time Profits**

Millions of homes can use these Ornamental products—urns, vases, flower boxes, bird baths, lawn seats, flagstones, etc. Easily made of sand and cement. Permanently glazed in a range of smart colors. Distinctive—attractive—quick selling.



**Eye-Appeal Makes for
Cash-and-Carry Sales**



Selling prices allow 200% to 300% mark-up on basic costs.

Only a small investment needed for supply of molds.

Easily set up in shed or garage. Write immediately for catalogue OM and price list.



Colorcrete Industries, Inc.
710 Ottawa Ave., Holland, Mich.

**ENGINEERING DEGREE IN
27 MONTHS**

**INDIANA
TECHNICAL
COLLEGE**

B. S. DEGREE, Aeronautical, Chemical, Civil, Electrical, Mechanical and Radio Engineering (inc. TV and Electronics). Drafting, 1-yr. G.I. Gov't approved. Low rate. Earn board. Large industrial center. Students from 48 states. 21 countries. Demand for graduates. Enter September, December, March, June. Write for catalog. 1672 E. Washington Boulevard, Fort Wayne 2, Indiana.

TELEVISION Needs You For Top Pay Jobs!

Learn How You Can Qualify With Our 2 FREE BOOKS
WRITE: Radio Television Training Association
(State age) 1629 Broadway, New York 19, N.Y. Dept. R-27



**LEARN MEAT CUTTING
At Home — In Spare Time**

Get into the vital meat industry. Concise, practical Home Training based on 25 years proven instruction methods used at National's famous resident school. Prepares you for bigger pay as Meat Cutter, Supervisor, market manager or more money in your own store. Go as rapidly as your spare time permits. Diploma. Start NOW to turn your spare hours into money. Send for FREE bulletin today. No obligation.

NATIONAL SCHOOL OF MEAT CUTTING, INC., Div. U-142, Toledo 4, Ohio

WORK CLOTHES BARGAINS!

Special Offer

FREE 10 DAY TRIAL



WORK SHIRTS
79c
3 for \$2.29

Blue, Tan, White
Measure Neck & Arm



WORK PANTS
99c
3 for 2.69

Blue, Tan, White
Measure Waist & Leg



SHOP COATS
\$1.79
3 for \$5

Blue, Tan, White
Send Chest Measure



COVER ALLS
\$1.98
3 for \$5.49

Blue, Tan, White
Send Chest Measure

WHAT A BUY! Surplus stock from a big midwest supply firm makes these gigantic savings available to you! Sturdy, serviceable work clothes, though used, have been washed, thoroughly sterilized and reconditioned. Every garment made of long-wearing wash materials, strongly sewn, with reinforced stitching at points of strain. When ordering please state measurements under item.

SEND NO MONEY! Just send name, complete address, clothing desired (state how many of each), and your color choice (also 2nd color choice). We will ship immediately. Pay postman, plus postage when your order arrives. Or, enclose cash, check or money order, and We Pay Postage. Keep 10 days. Return for full refund of purchase price if not completely satisfied. Order TODAY at our risk!

YOUNG DISTRIBUTING CO.

Dept. 487

2605 Elmhurst, Detroit 6, Mich.

EVEN IF YOU DON'T KNOW A NOTE OF MUSIC NOW...

You Can Learn Your Favorite Instrument This Easy A-B-C Way

No special talent, no previous musical training needed. This remarkable U. S. School home-study method is so successful because you learn to play by playing real tunes by note, right from the very start.

Once you start a U. S. School Course you look forward to the time you spend on your lessons. No tiresome exercises. No long-winded explanations. Instead of hard work, learning to play becomes a happy pastime. You begin with simple



EASY AS A-B-C



melodies. As you improve, you take up more advanced tunes. Sooner than you ever dared hope you're thrilled to find yourself playing many popular numbers by note. And no matter which instrument you take up, the cost is only a few pennies a day.

FREE BOOK AND FREE LESSON-SAMPLE

If you honestly want to learn music, to be invited everywhere, and get lots more fun out of life, send in the coupon below for our FREE 36-page Book and Free Lesson-Sample. They give full details. (Special prices on instruments to our students.) U. S. SCHOOL OF MUSIC, Studio B307, Port Washington, N.Y. (Now in Our 54th Successful Year)



U. S. School of Music, Studio B307, Port Washington, N. Y.

Send me FREE BOOK and FREE Lesson-Sample. No obligation—and no salesman is to call upon me. I'm interested in playing (name instrument)

I do I do not—have instrument now.

Name _____ (please print)

Address _____

City _____ State _____
(Please state Zone No. (if any))

TASOPE PHOTO-ENGRAVING PLANTS



Establish your own profitable PHOTO-ENGRAVING business. Make cuts for newspapers, printers, and advertisers. Make etched name plates, plaques etc. Instructions furnished, no experience necessary. Sold direct from factory since 1931. First five hundred cuts sold locally or by mail will pay for plant and pay you well for your time. Write for FREE catalog. TASOPE DEPT. PM5, AURORA, MO.

Material Cost
Of This Cut 34c
Selling Price
\$1.00 And Up

Learn TATTOOING At Home

Earn extra MONEY—Tattoo blood types and designs in your community. Splendid opportunity in every town. Prepare in spare time. Practical instructions. Send 25c for details and list of Tattoo Supplies. No obligations. ZEIS SCHOOL OF TATTOOING • 728 Leslie, Rockford, Ill.



BOOST YOUR EARNING POWER WITH

DIESEL

Train Now For This Big Pay Trade!

Are you mechanically inclined? Then you'll like DIESEL! You'll like working on these modern engines... pulling down the big pay of DIESEL-TRAINED men. Train at home for Diesel opportunities with simple, practical UEI Training. Learn DIESEL engine operation, fuel systems, repairs, maintenance PLUS Scientific Motor Tune-up. Course includes shop training in our big, well-equipped shops, working on Diesel engines. Write now for FREE booklet!

UTILITIES ENGINEERING INSTITUTE (Founded 1927)
2521 Sheffield Avenue, Dept. DC-21, Chicago 14, Illinois



TIRES • TIRES • TIRES

GUARANTEED WHOLESALE VALUES

UNCONDITIONALLY GUARANTEED

plus TIRE INSURANCE FREE!



10% OFF ON TWO OR MORE USED TIRES Here's DOUBLE proof that we bear the loss if your passenger tire wears out within the guarantee period (if fully). Don't take risks: we send FREE insurance your order.

LOW COST QUALITY TIRES

Unconditional Six Months' Guarantee plus Tire Insurance Free			
600-16 \$3.50 ea.	650-16 \$3.75 ea.	550-17 \$3.95 ea.	
600-15	640-15	475-19	
650-15	550-16	710-15	
550-15	670-16	760-15	

BETTER GRADE PASSENGER TIRES

UNCONDITIONAL ONE-YEAR GUARANTEE plus TIRE INSURANCE FREE			
600-16 \$5.59	700-16 \$7.59	700-15 \$5.59	550-16 \$5.95
600-16(6) 6.50	600-15 5.59	750-16 12.25	550-17 5.75
650-16 5.79	650-15 5.59	550-15 5.59	475-19 5.75
640-15 5.95	710-15 6.50	820-15 7.50	760-16 7.75
670-15 5.95	760-15 6.75	670-16 6.95	

MUD AND SNOW TIRES

2 YEAR WRITTEN GUARANTEE			
600-16 \$6.95	900-16 \$12.95	750-20 Reg. \$12.50	Spec. \$15.95
650-16 7.50	650-16(6) 9.50	650-15 6.50	

QUALITY TRUCK TIRES

ONE YEAR WRITTEN GUARANTEE			
600-20 \$10.75	750-20 \$14.50	825-20 \$21.50	1100-20 \$26.95
650-20 11.75	32x6(8) 11.75	900-20 19.50	1100-22 24.50
700-20 12.50	32x6(10) 12.50	1000-20 20.00	750-20(10) 18.00

EXTRA MILEAGE TRUCK TIRES

Two Year Written Guarantee			
750-16-8 \$16.50	650-20 \$16.75	750-20(10) \$23.50	1100-20 \$32.50
700-17 16.50	700-20 17.50	825-20 25.75	1000-22 29.75
750-17 19.75	32x6(8) 16.75	36x8 27.50	1100-22 32.50
700-18 19.50	32x6(10) 17.50	900-20 26.50	
600-20 15.50	750-20(8) 18.50	1000-20 29.75	

SPECIAL — CUSTOM RECAPS — SPECIAL

Two Year Unconditional Guarantee plus Tire Insurance Free			
600-16 \$8.95	650-15 \$10.95	700-15 \$11.95	760-15 \$11.95
650-16 10.95	670-15 10.95	710-15 11.45	820-15 13.50

All prices F.O.B. Richmond, Va.

SAFTYRE CO., INC.,

"FOR THAT SAFE TIRE"

MAIL ORDERS PROMPTLY FILLED.

Send check or money order with this ad.

Dept. P.M-1 1801 E. BROAD ST., P. O. BOX 2254, RICHMOND, VA.

You CAN BECOME A MECHANICAL ENGINEER

B.S. DEGREE IN 36 MONTHS

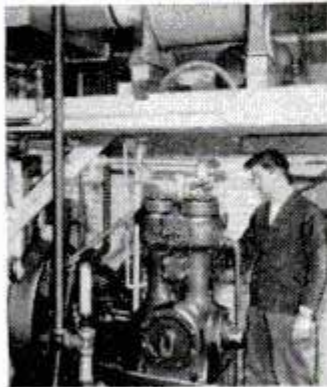

Prepare NOW for a wide range of career objectives as a MECHANICAL ENGINEER by enrolling at this 49-year-old technical institute and college. Through the option of year-round study you can obtain your B.S. degree in 36 months. Functional electives

aid you to qualify for (1) research, design, and teaching; (2) production, manufacturing, and operations; (3) sales and management.

ENGINEERING ASSOCIATE

Mechanical Technician — 12 Months

This practical technician course trains you for responsible positions in industry or your own business. Complete in itself, but also applies as full credit toward the degree program.

SERVICE-PREPARATORY COURSES

aid you in meeting admission requirements to technician and engineering programs

Ambitious young men with deficiencies in academic study or background can now qualify for these fields because of specially designed SERVICE-PREPARATORY courses. 3 to 6 months. Save valuable months by enrolling NOW.

TERMS OPEN JULY, OCTOBER, JANUARY, APRIL
Military, academic, or practical training
evaluated for advanced credit.

MILWAUKEE SCHOOL OF ENGINEERING



MILWAUKEE SCHOOL OF ENGINEERING
Dept. PM752, 1025 N. Milwaukee
Milwaukee, Wisconsin

Without obligation send Bulletin on Mechanical Engineering (BS°); Catalog for Electrical Engineering (BS°); major in Electronics; Power; "Your Career"; Occupational Guidance Bulletin on: Radio-TV Electrical Power Welding Heating, Refrigeration, Air Conditioning.

Name.....Age.....

Address.....

City.....Zone.....State.....

If veteran, indicate date of discharge.....

SAVE 50% - THOUSANDS HAVE ASSEMBLED \$42^{UP} PACKAGED BOAT KITS



27 MODELS

Dinghies, skiffs, racers, inboards, outboards and cruisers. Assemble your own boat, it's easy, it's fun!

All parts pre-cut or pre-fabricated from finest materials. Get all the facts from our big 24 page catalog. See how Packaged Boats are built, how they perform, how exclusive construction features make assembly easy. Includes specifications, performance data plus hardware and paints.

SEND 25¢ for NEW 24 PAGE CATALOG

CUSTOM-CRAFT - DEPT. 7 - BUFFALO 7, N. Y.

BOAT PLANS ▶ Over 50 modern plans and full size patterns. Racing classes, cruisers, inboards, outboards, sail boats. By famous designers. 6' to 30'. DESIGN PATTERNS CATALOG 35¢. Design Catalog and boat building handbook, \$1.00

MARINE MART - DEPT 7 - BUFFALO 7, N. Y.

SHORTHAND IN

Famous Speedwriting Shorthand. 120 wpm. No symbols; no machines. Uses ABC's. Easiest to learn, write, transcribe. Low cost. 100,000 taught by mail. Age no obstacle. Also typing. 29th year. Write for FREE booklet to:

Speedwriting
Dept. 1507-2
55 W. 42 St., N. Y. 18, N. Y.

6
WEEKS
AT HOME

STUDY TO BE A DOCTOR of Psychology or Metaphysics

Obtain a Ps.D., Ms.D., D.D., or Ph.D. degree. Be a Teacher, Lecturer or Accredited Practitioner. Teach others how to achieve Health, Happiness and Contentment. Chartered by State. Write for FREE book telling how.

THE NEOTARIAN COLLEGE OF PHILOSOPHY

Desk 8, Pickwick Building Kansas City 6, Missouri

GET THIS SUIT AS A BONUS!

Sell popular Smith tailored-to-measure suits. Make up to \$10.00-\$15.00 daily taking orders from friends. You get paid 3 times—(1) when you take the order and pocket the cash profit.—(2) when we pay you an EXTRA cash bonus.—(3) when you get your own suit as an added bonus, without cost. No experience needed. Send for FREE selling kit and sample line. Write fully, give age, sales exp., etc.

W. D. SMITH & CO., Dept. D
833 W. Jackson Blvd., Chicago 7, Ill.



Learn UPHOLSTERING

FOR FULL OR SPARE TIME PROFIT

Easy to learn at home! Easy to start a shop, or earn spare-time profits! Complete tool set, all materials to build ottoman, included with lessons. Low terms. Write for valuable booklet today!

COMMERCIAL TRADES INSTITUTE

1400 Greenleaf Ave. • Dept. U2-7 • Chicago 26, Ill.

"How to Make Money with Simple Cartoons"



A book everyone who likes to draw should have. It is free; no obligation. Simply address

FREE BOOK

CARTOONISTS' EXCHANGE
Dept. 97 Pleasant Hill, Ohio

BRIKCRETE



Local Manufacturers Have Broad Opportunities

Brikrete manufacturers operate compact, self-contained plants under franchise privileges in protected territories. Each is an independently owned unit in a country-wide chain, using local materials and local labor to supply the world's most modern masonry for local building needs.

Brikrete is rich in sales appeal because it is ahead in design, style, size, color, economy. Easily the preferred masonry. But because local production eliminates economic wastefulness, Brikrete can be sold at a lower-than-lumber price. Yet still allow a generous profit margin.

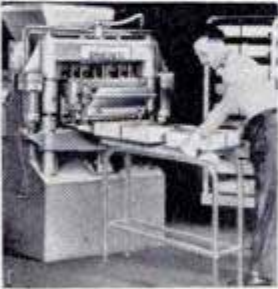

Brikrete offers much to men looking for a community enterprise on a nominal investment. We supply complete equipment; easy terms when desired. Liberal cooperation. Write today for Brikrete Book No. 2—while territory is still open.

BRIKCRETE ASSOCIATES, INC.
4679 Division Avenue, S.
Grand Rapids 8, Mich. 82

RUPTURE



RELIEF...OR YOUR MONEY BACK
Original, patented Web, copied but never matched. Users say it's best ever. Relief or no cost to you. Write:

WEB TRUSS CO., Dept. M-7, Hagerstown, Md.



Treasure and Minerals
Easily located with new Lightweight M-Scope Detector. Superior performance, lowest price, monthly payment plan.

FREE LITERATURE
FISHER RESEARCH LAB., INC.
PALO ALTO CALIF.



CARTOONING

HAVE FUN! MAKE MONEY! Cash in on your sense of humor AT HOME—BY MAIL! No experience needed to start. Write today FOR FREE TRIAL LESSON and full particulars.
Moon Gag Cartoon School, Dept. M, Fall Creek, Wis.

High School at Home

Many Finish in 2 Years

No classes. No time wasted going to and from school. Progress as fast as your time and abilities permit. Standard H. S. texts supplied. Thousands enroll each year in this 55-year-old school. Send for FREE descriptive booklet.

AMERICAN SCHOOL, Dept. HB45
Drexel at 58th St., Chicago 37, Ill.

Without obligation, please send FREE descriptive booklet.

Name _____
Address _____

BECOME AN Electrical Engineer

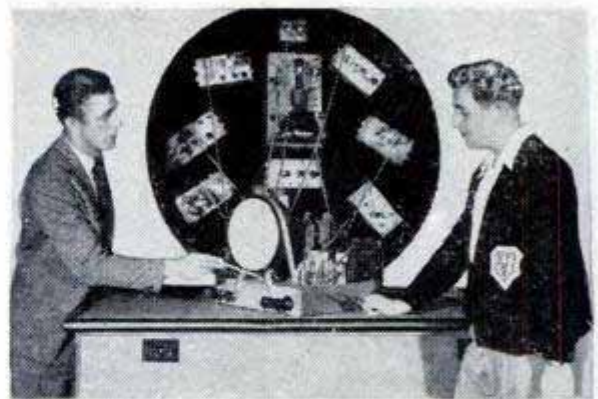

- Major in Electronics or Power B. S. Degree in 36 months
- Television Technician Certificate in 18 months

FOLLOW THIS PLAN

By 1954 there will be at least two positions for every engineering and technician graduate. Enter these opportunities early... earn your B. S. Degree in 36 months through optional year 'round study.

TELEVISION

TECHNICIANS are needed throughout America's fastest growing industry.

You become a Radio Technician in 12 months. In 6 additional months become a Radio-Television Technician. These Technician Courses are complete in themselves and can be applied as one-third of the B. S. Degree program. Recent developments forecast unlimited opportunities for TV technicians and engineers.

TERMS OPEN OCTOBER, JANUARY, APRIL, JULY
Military, Practical, or Academic training evaluated for advanced credit. Faculty of specialists. Over 48,000 former students from all states and 23 overseas countries. Nonprofit. Founded in 1903.

MILWAUKEE

SCHOOL OF ENGINEERING

MILWAUKEE SCHOOL OF ENGINEERING
Dept. PM-752, 1025 N. Milwaukee
Milwaukee 1, Wisconsin

Without obligation send Catalog for Electrical Engineering, B. S. Degree, major in Electronics; Power; "Your Career"; Occupational Guidance Bulletin on: Radio-TV Electrical Power Mechanical Engineering Welding Heating, Refrigeration, Air Conditioning Preparatory.

Name _____ Age _____

Address _____

City _____ Zone _____ State _____

If veteran, indicate date of discharge _____



SAVE TIME - MONEY

With your bookkeeping

Now You Can
Keep Books Easily
Without Outside Help!

TAS is an originally new weekly record of purchases, expenses, distribution, income, profit or loss, payroll, non-deductible expenditures, bank balance, depreciation, etc. Easy-to-follow instructions and facsimile page help you keep books for yourself or partnership for full year. Excellent for small business and professional men.

HOW YOU CUT COSTS WITH THIS MONEY-SAVING RECORD BOOK

TAS is workable because it is a simplified set-up for bookkeeping, a record for the entire year, that you may keep with you at all times—in your car, on the job, at home, in the shop, office or store. You will be delighted with TAS the first week you use it. Bookkeepers in many localities use TAS for all their small accounts. They praise TAS as a time, money and space saver.

Fits Auto Glove Compartment

ONLY
\$7.50

TAS

10-Day Money
Back Guarantee

TAS, Dept. PM-16
1310 71st Street, Houston 11, Texas

Here is my Money Order for \$_____. Please
rush me _____ copy(s) of TAS' new money-saving
yearly record book postpaid. If I am not entirely
satisfied within 10 days, I will return the merchandise promptly for a full refund.

NAME _____
Please print or type

STREET _____

CITY _____ STATE _____

MAKE EXTRA
MONEY

PLASTICS

LEARN
AT HOME

LEARN HOW
TO MAKE
fast-selling
PLASTIC
NOVELTIES
FURNITURE
JEWELRY

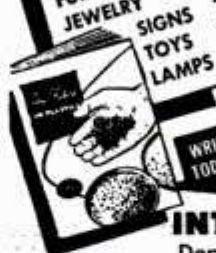

There are RICH OPPORTUNITIES for MEN and WOMEN with "know-how" in Plastics. Interstate's new Plastics course tells and shows how to make hundreds of fast selling items out of Plastics. Gives complete training in fabrication, casting, lamination, molding, internal carving, etc., in simple, easy, step-by-step language and pictures. Plastics and Fabricating Kits for 23 valuable Plastic items come with training at no extra cost. **START A PLASTICS BUSINESS OF YOUR OWN.** No other industry holds such promise for the future. You can make big money manufacturing novelties, toys, signs, etc., in your own home in spare or full time. Don't wait! Learn NOW how Interstate's Plastics Training qualifies you for success in the Plastics field.

PLASTICS AND SUPPLIES FURNISHED
FOR 23 VALUABLE PROJECTS

INTERSTATE TRAINING SERVICE
Dept. 3CG Portland 13, Oregon

WHY DON'T YOU WRITE?

Writing short stories, articles on business, sports, hobbies, travel, shop crafts, local and club activities, etc., will enable you to earn extra money. In your own home, on your own time, the New York Copy Desk Method teaches you how to write the way newspaper men learn—by writing. Our unique "Writing Aptitude Test" tells whether you possess the fundamental qualities essential to successful writing. You'll enjoy this test. Write for it, without cost or obligation.

NEWSPAPER INSTITUTE OF AMERICA
SUITE 5592-L, ONE PARK AVENUE, NEW YORK 16, N. Y.

OWN a Business

If employed, start part time. Alert dealers can gross \$5 hourly profit on own service plus \$3 on EACH serviceman. Clean, revive, mothproof rugs & upholstery on location. No shop needed. Services nationally advertised. Repeat customers. Easy to learn. Quickly established. Easy terms. Send today for FREE booklet. No obligation.
DURACLEAN CO., 2-167 DURACLEAN BLDG., DEERFIELD, ILL.

EARN MORE MONEY

Train for an exciting career in professional photography! Study at home in your spare time. You don't need a high school diploma. Everyday common sense is all you need to understand the simple, down-to-earth, fully illustrated and diagrammed lessons in the famous NYI Home Study Course. 90 ways to Earn While You Learn! Let us show you our success-tested method. Write for your copy of our big colorful book today. Personal attendance courses in New York. 42nd Year.

N. Y. INSTITUTE OF PHOTOGRAPHY
Dept. "49" 10 W. 33rd St. CH 4-3462

MANUFACTURE BUILDING BLOCKS

Easy to start your own profitable business. General high speed, low cost Concrete Vibrator Block Machine produces 1000 blocks in 8-hour day. All sizes and shapes. Complete details FREE. Mail \$1 for wonderful book, "How to Build Your Own Concrete Block Home."

Only \$218

GENERAL ENGINES CO.
307 HUNTER ST., M-72 GLOUCESTER, N. J.

How to Always Have HOT WATER

Make Your Own Automatic Electric Water Heater now for only \$19.95

Money back in 10 days if not delighted.

INSTALL IN 5 MIN.

Why suffer without hot water? Enjoy lots of it to wash, bathe, shave. Heater keeps water HOT in your present tank. Turns ON when needed—shuts OFF when water is heated. No flue, dirt, fire! No disturbing or draining of tank or pipes. Ideal for 30-gal. tanks! Heater screws into any size boiler tap as shown. Plugs into outlet . . . 1320 w. 110 v. AC. (Also 2000 w. 220 v. model for BX cable \$19.95) . . . works automatically thereafter. Temperature adjustable between 120 to 180 degrees. Replaces coal, oil, gas in home, store, summer cottage, green house, farm, barn, stock tank, poultry scalding, factory. Uses only 1/4 to 1/2 c electricity per gallon hot water. Why burn expensive main furnace unit for hot water? Send check or M. O. NOW: save postage, shipping charges. ORDER NOW . . . TODAY.

ONE YEAR GUARANTEE
All Parts U. L. Approved

COLLOID EQUIPMENT CO., INC. Dept. PM7, 50 Church Street, New York 7, N. Y.

POPULAR MECHANICS

BUILD A \$15,000 A YEAR FUTURE!

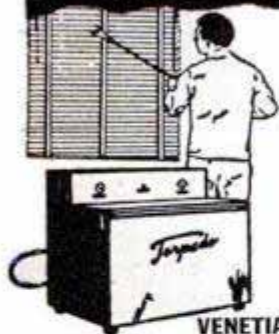

In the exciting new business of LAUNDERING VENETIAN BLINDS

Send name, get pictures, profits, prices, facts—all Free—showing how to start on small investment in basement or garage. Big demand—high profits—spare or full time. Others NOW MAKING \$15,000 a year. FREE! Learn all about machine and easy time-pay plan. Get names of successful men near you so you can investigate. Rush name now.

VENETIAN BLIND LAUNDRY EQUIPMENT CO., Inc.
442 North Seneca Street, Dept. 107, Wichita 12, Kansas

THE ART OF DRAWING

Fascinating learn-by-doing lessons in drawing, painting, illustrating and commercial art. Prepared for YOUR instruction and enjoyment in spare time at home. Purpose: To turn amateur talent into PROFESSIONAL skill. Cost? Surprisingly low. Send for FREE illustrated booklet, "Building a Future" in Art.

Write today.

GRANT SCHOOL of ART Dept. A72, 225 N. Michigan Avenue, Chicago 1, Illinois

STUDY AT HOME

WITH AN EDUCATIONAL INSTITUTION

Courses in ARTS AND SCIENCES: Philosophy; Education; Letters; Public Health; Medical Jurisprudence; Psychology; Sociology; Physics; Chemistry; Geology; Pol. Science; Theology; Law; Business and Commerce; Accounting; Mathematics; Statistics; Agriculture. Courses in ENGINEERING: Electrical, Civil, Mechanical, Drafting, Architectural, Automotive, Steam, Diesel, Aeronautical, Radio, Structural, Mining, Industrial, Petroleum, Marine, Refrigeration, Air Conditioning, Chemical. Send for free catalog.

McKinley-Roosevelt Incorporated, 4610-K32, Sheridan Rd., Chicago 40, Illinois



BE A LOCKSMITH

Learn Locksmithing and Keymaking from Experts in Your Spare Time at Home! Locksmiths in big demand! No layoffs, no slow seasons! Age no disadvantage. Year-round, steady income in this permanent, respected field. Full or part time. Practical, illustrated lessons show how to make money even while learning! All materials, special tools supplied. FREE BOOKLET.

INSTITUTE OF LOCKSMITHING, Dept. P-32
15 PARK AVE. RUTHERFORD, N. J.
Lic. & Approved State of N.J. VA Approved

60 POWER TELESCOPE \$3.95

VARIABLE EYEPIECE 20 x 40 x 60 — BRASS BOUND
NEW! Three telescopes in one. 3 different magnifications. 20 power for ultra-bright images with 40 and 60 power for extra range. Guaranteed to bring distant objects, people, sports events, ships, moon, stars, etc. 60 times as close. Most powerful for any-where near the moon. ey. 5 Sections. Closes to 1 ft. long. Contains 4 ground and polished lenses. Also used as a powerful compound microscope. Directions included. Mass production enables us to offer this instrument at amazing price of \$3.95 complete. Ready for immediate use. We pay postage. Get yours at once. CRITERION CO., 438 Asylum St., Hartford 3, Conn., Dept. PMB4

WANT TO Write Stories

Articles Mysteries? FREE BOOK tells how you learn at home



Would you be willing to spend a few hours a week learning to write so you may earn \$300-\$1200 a year part-time? Or many thousands full-time? FREE book, "Art of Writing Salable Stories" tells how to get started writing short stories, radio-TV scripts, articles, business items. Many students earn while learning (A.B. Aretz sold first 2 stories for \$255). Endorsed by famous authors, scores of successful graduates; approved for veterans. Send today for FREE book (no salesman will call). PALMER INSTITUTE OF AUTHORSHIP, Founded 1917
1680 N. Sycamore Hollywood 28, Calif. Desk T-72

GET THE WORLD'S LEADING RADIO & TV CATALOG

★
FREE
★
1952
212-Page
Edition



★
ALLIED'S
BIG COMPLETE BUYING GUIDE
Save on Everything
in Radio and TV

NEW
UP-TO-DATE
SEND FOR IT NOW

Everything for Experimenters, Builders, Amateurs, Servicemen, Engineers and Soundmen

Send for ALLIED's 212-page 1952 Catalog, the value-packed guide to everything in Radio and Television! Latest home radios, TV equipment, Amateur supplies, P.A. Systems, Hi-Fidelity Sound, recorders, test instruments, builders' kits—plus the world's largest stocks of electronic parts, tubes, tools, books and diagrams. Get more for your money—send today for your FREE 1952 ALLIED Catalog!



Get Radio's Leading Buying Guide Today

FREE!

ALLIED RADIO

ALLIED RADIO CORP., Dept. 5-G-2
833 W. Jackson Blvd., Chicago 7, Ill.

Rush FREE 1952 ALLIED 212-Page Catalog.

Name _____
Address _____
City _____ Zone _____ State _____



BETTER LIVING

... at new low cost!

Join thousands of happy, worry-free and rent-free New Moon owners. Move to top paying jobs, enjoy travel and vacation fun — a home completely furnished and ready to live-in, including kitchen, bath and automatic heating system. Own a New Moon on our rent-like payment plan and enjoy all the comfort and advantages of genuine home ownership at once. **Free!** Write today for literature describing the complete line of New Moon apartment homes.

Member of



REDMAN TRAILER CO.
40 BRIDGE ST., ALMA, MICH.



SEND NO MONEY
• MORE THAN 4000 PAGES
• 2750 PICTURES

9 BIG COMPLETE BOOKS BUILDING, ESTIMATING, CONTRACTING

Examine this Up-to-Date Edition for 10 days. See how these nine books supply easily understood training that will help you to get a better job and make more money, or start a profitable business for yourself. Think what a BIG help it will be to have them handy for use in solving all sorts of building problems.

Learn to draw plans, estimate, do all-new construction and modern remodeling to meet fast growing demand. More than 4000 pages of practical, pay-raising information with 2750 helpful illustrations, on such subjects as blueprint reading, concrete forms, masonry, carpentry, steel square, electrical wiring, plumbing, heating, painting, and *hundreds more*.

In our more than 50 years we have never offered more complete building information. Send the coupon TODAY.

(A year's consulting privileges with our engineers now given with these books without extra cost.)

AMERICAN TECHNICAL SOCIETY—Publishers Since 1898
Dept. GB19, Drexel Ave. at 58th St., Chicago 37, Ill.

I would like to examine your 9-Volume Set of Building, Estimating, Contracting Books. I will pay the delivery charges only, but if I choose I may return them express collect. If after 10 days' use I prefer to keep them, I will send you \$3 and pay the balance at the rate of only \$4 a month until \$34.80 has been paid. Include consulting service as offered above.

Name _____

Address _____

City _____ State _____

Please attach letter giving employer's name and address (if self-employed give business man reference). Men in service please give home address.

WAR SURPLUS BARGAINS!

WAR SURPLUS BARGAINS

\$500,000.00 INVENTORY for QUICK LIQUIDATION

Surplus items—hundreds of them for home, shop, factory, farm and outdoor use. New items, used items, reconditioned items—all at tremendous savings—all priced for quick sale.

Page After Page of Values

This big catalog shows page after page of amazing money saving values. Write for your copy today. Send 10c to cover postage, mailing, etc. Write today!

SEND TODAY FOR YOUR COPY

10c

STARK'S Dept. 509 So. STATE STREET
PM7 CHICAGO 5, ILLINOIS

"I HAVE EARNED \$1520 AN HOUR"
AN AVERAGE OF

with Science's New Midget Miracle, the Presto Fire Extinguisher, says W. F. Wydalis, Ohio

Many others "cleaning up" — so can you! Amazing tiny new extinguisher ends fires fast as 2 seconds. Guaranteed 20 years! Sells for only \$3.98! Write for FREE Sales Kit. No obligation. Merlite Industries, Inc., Dept. 57, 201 East 16th Street, New York 3, N. Y. (If you want a regular Presto to use as a demonstrator send \$2.50. Money back if you wish.)

Learn ACCOUNTING

Business Administration

Bookkeeping, secretarial and allied subjects at home in your spare time or attend nationally approved resident school. Write for FREE Success Book giving complete information about courses, plans, rates and employment opportunities.

Hills BUSINESS UNIVERSITY AND EXTENSION SCHOOL

619 W. MAIN ST. OKLAHOMA CITY 2, OKLAHOMA

"BEAT HIGH BUILDING COSTS"

Send \$3.98 for complete, easy to follow PLANS of modern one or two bedroom dwelling, YOU can build in your spare time.

VON'S

206 1/2 S. 9th STREET
LAS VEGAS, NEVADA

"YOU ARE UNDER ARREST!"

Help Bring Crooks to Justice Through Scientific CRIME DETECTION!

We have taught thousands this exciting, profitable, pleasant profession. Let us teach you in your own home. Learn Finger Printing, Firearms Identification, Police Photography, Secret Service Methods thoroughly, quickly, at small cost. Over 800 of all American Bureaus of Identification employ I. A. S. students or graduates. We can prepare you for this fascinating work, during spare time. Write today, stating age, for "Blue Book of Crime."

INSTITUTE OF APPLIED SCIENCE, 1920 Sunnyside Ave., Dept. 135-B, Chicago 40, Ill.

NO CAR TROUBLE IS HARD TO FIND...

when you have MOTOR'S new "Trouble Shooter"

Handy, pocket-size indexed manual lists 2000 CAUSES of car troubles and tells WHERE to look for them. For instance, suppose Fan Belt is noisy; index leads you instantly to 7 things that can be wrong. In same way, "Trouble Shooter" covers engines, clutches, brakes, ignition, rear axles, overdrives, etc. Section on automatic transmissions alone is worth more than price of book! Spiral binding; book stays open while you work.

\$1

SEND NO MONEY. Try book at our risk. Just mail your name and address to: MOTOR Book Dept., Box DV, 250 West 55th St., New York 19, N. Y. Pay postman \$1 plus C.O.D. chg. Use 7 days. If not delighted, your \$1 back. (Or save C.O.D. cost by sending \$1 now. Same money-back guarantee.)



10% MORE BUILT-IN POWER!

U. S. Testing Laboratory report proves Burgess Flashlight Batteries contain more active ingredients than two other leading brands. Selected best quality materials guarantee longer-lasting bright light. Buy BURGESS at better dealers everywhere. Burgess Battery Company, Freeport, Illinois—Niagara Falls, Canada.

SEALED IN STEEL and Plastic



BURGESS FLASHLIGHT BATTERIES



30 DAY FREE TRIAL

High Power BINOCULARS

Finest Precision Optics
Featherlight
Money Back Guarantee
Easy Pay Plan
Leather Case Incl'd.

33 MODELS
\$14.95 up

BUSHNELL Binoculars

Free! Catalog & Book
"How to Select Binoculars"
Dealer Inquiries Invited
Bushnell Bldg., Dept. M-47
Pasadena 1, Calif.



BE YOUR OWN BOSS!!!

Make big money! Get ahead in something for yourself! Be a floor surfacing contractor and sand both new and old floors. No experience needed. High earnings, steady work with a future! Write for booklet "Opportunities in Floor Surfacing," enclosing 25 cents in coin or stamps to cover handling.

AMERICAN

FLOOR SURFACING MACHINE CO.
325 So. St. Clair Street • Toledo 3, Ohio

100 POWER... Telescope Lens Kit COMPLETE ONLY \$3.00

NEW 3 IN 1 VALUE! Build a 45X and 100X Astronomical telescope! Converts to 45X Terrestrial telescope! Explore the wonders of the sky. View distant objects on earth. Kit consists of 47mm dia. 50 1/2" focal length ground and polished objective lens, 100X eyepiece lens, 45X eyepiece lens, easy building instructions. Mounting and tripod not included, easily made. Money Back Guarantee.

LEMAR SCIENTIFIC CORP., Dept. D77, 3412 W. Jackson Blvd., Chicago 24

Learn TELEVISION-ELECTRONICS

2 Big Books
FREE

Train at Home—Get Big Kits of Radio Parts!
Prepare now in spare time. Practical instruction.
Approved for Veterans. Write for details and 2
Radio Books—ALL FREE! Rush name today!

RADIO
SPRAYBERRY ACADEMY OF RADIO
Dept. 10-L 111 No. Canal Chicago 6, Illinois

When You **• You Can Earn More in •**
WATCHMAKING
LEARN By KCSW's Outstanding Method

WRITE TO

Don't let a lay-off catch you. **START NOW TO LEARN WATCHMAKING AT HOME IN YOUR SPARE TIME.** Earn extra money as you learn, repairing clocks and watches. You will be building your own business right at home.

Write for information on KCSW's HOME STUDY COURSE

KANSAS CITY SCHOOL OF WATCHMAKING
1218 Admiral Blvd. Kansas City 6, Missouri

45 TON LOCK Bars Thieves

Yet Almost Invisible.
Now Made
for YOUR HOME!



"SAFETY-SET"

T. M. REG. © 1948

Metropolitan police expert says, "Inadequately secured windows with old fashioned, conventional 'locks,' account for 90% of all burglaries!"

YOUR HOME? Have you experienced the terror and despair of a wrecked home? Valuables gone, wanton destruction in the wake. If you have, don't let it happen again! If you haven't, protect yourself now!

"SAFETY-SET," the latest miracle of modern crime prevention, consists of two powerful, slim (almost invisible) inserts of finest steel—scientifically heat-treated to withstand 90,000 (45 tons) lbs. pressure per square inch. Yet you can install a set (two per window) in less than three minutes. Windows lock closed, or five inches open.

ENJOY YOUR SLEEP—spend week ends away, vacations in perfect peace of mind. Once "SAFETY-SET" is installed, the strongest burglar on earth can't pry his way into your home. "SAFETY-SET" IS A SPLIT-POSITIVE LOCK! THE ONE LOCK all burglars respect.

Send check, cash or money order for this special offer: **6 SETS POSTPAID . . . \$1.95**
(complete instructions included—additional sets (per window) 30c ea.)

"SAFETY-SET" WINDOW LOCK COMPANY

Dept. B, Box 19125, La Tijera Station, Los Angeles 43, California

GROW Living MIDGET TREES!

EARN \$10.00 PER HOUR!

- AT HOME
- IN SPARE TIME
- NO EXPERIENCE NEEDED



It's new! Amazing! At last, the secret of growing miniature (MING) trees can be yours. FULL GROWN, dwarf trees—only a few inches high. Beautiful miniature fir, orange, oak, Chinese elm, peach, pine, cypress—any kind! ALL BLOOM and even BEAR FRUIT. All perfect healthy specimens—but miniature in size! Make costly home decorations and expensive centerpieces. (SOLD FOR OVER \$1,500 EACH) Big demand. Costs only pennies—takes only minutes per week. IT'S EASY! Fun! A new fascinating hobby—a new fabulous \$\$\$\$ business. Send for free secret plan details and real seed.

HELP US FILL HUGE DEMAND!

These trees are being demanded by STORES CLUBS • HOTELS • FLORISTS • HOUSEWIVES • INTERIOR DECORATORS • COLLECTORS • HOBBYISTS—A Big Money Opportunity FOR YOU.

FREE! GENUINE SEED AND PLAN!

NATIONAL NURSERY GARDENS, Dept. M7

8463 South Van Ness

Inglewood 4, Calif.

Rush me FREE plan and seed IMMEDIATELY!

Name _____

Address _____

Zone _____

City _____

State _____



GREER SHOP TRAINING

2230 So. Michigan Blvd.
Chicago 16, Illinois



Leader in Practical Training for 50 Years

Gain success by learning a trade offering security and high pay—go into business for yourself.

Get the "Know-how" at Greer

You learn in our new, large, modern shops by working with latest tools and equipment of the trade — tear down, inspect, repair and rebuild... under supervision of experts. Greer founded 1902. Over 51,000 successful grads. Part time, full time, day and evening. E-Z terms. Mail coupon today.

CLIP COUPON . . . MAIL TODAY
Greer Shop Training—2230 South Michigan
Chicago 16, Illinois Desk 213

Please send information about trade checked:
In our Chicago Shops: Auto Mechanics
 Body, fender Repair Diesel Mechanics
 Welding—Arc, gas Tool & Die
 Refrigeration & Air-conditioning
 Machine Shop Piano tuning
G.I. appr. for Vets dischgd. after 7-25-47

Or learn at home—extension courses:
 Diesel Refrigeration Plastics

Name _____

Address _____

City _____

State _____ Age _____



FREE AVIATION BOOK . . .

You can cash in on America's fast-expanding industry—AVIATION. SPARTAN has trained thousands for well-paid jobs. You can qualify in a remarkably short time for employment with an airline, manufacturer of planes or aviation equipment. SPARTAN has calls for more graduates than are available. If you have ability, ambition and the necessary training, there is no limit to the success you can achieve.

Investigate the many opportunities and training required. Write for FREE BOOK

SPARTAN
SCHOOL OF AERONAUTICS
TULSA, OKLAHOMA

MAIL COUPON TODAY

Spartan School of Aeronautics
Tulsa, Oklahoma Dept. PM-72

Please send me complete information on: Course _____

Name _____ Age _____

Street _____

City _____ State _____



INSTALL A "MILE-O-METER"

LEARN HOW TO SAVE GAS AND TUNE YOUR OWN MOTOR . . .

"Mile-O-Meter" on the dashboard registers miles per gallon faithfully at all speeds, under every driving condition . . . Will show what speed your engine delivers its maximum power. Can save you many gallons of gas . . . Provides constant check on engine condition — Warns you of operating imperfections for 31 different motor adjustments . . . Nationally advertised in leading magazines and newspapers . . . Can be installed in a few minutes . . . transferred from old to new car. Fine watch precision . . . Order yours today!



STD. Model
\$9.75
2 3/4" Dia. Ppd.
Fed. Tax Incl.

HUGE 24 PAGE INSTRUCTION MANUAL AND MILEAGE CALCULATOR INCLUDED FREE!



Installation requires no experience . . . becomes a constant companion on every trip. Saves cost in a short time. This professional gauge is a must!

\$14.95 DELUXE MODEL with Chrome Ring
3 1/4" Dia. Ppd. Fed. Tax. Incl.

GALE HALL ENGINEERING Dept. 199

BOSTON 18, MASS.

DELUXE MODEL NOW ILLUMINATED

LEARN MEAT CUTTING

through actual practice. Profitable Meat Cutting and Self-Service Meats taught easily, quickly; LEARN BY DOING at Toledo in just eight short weeks under actual market conditions. For beginners or men with experience. All subjects taught thoroughly and completely. Diploma. Job help. Get store of own. People must eat. School in operation over 25 years. Approved for GI training. Send today for FREE illustrated catalog. No obligation. NATIONAL SCHOOL OF MEAT CUTTING, Dept. 50-6, Toledo 4, Ohio

LEARN TO MOUNT BIRDS

ANIMALS, FISH, PETS

Be a Taxidermist. Save your hunting TROPHIES. Have a fine home-museum. Hunters, save and MOUNT your beautiful DUCKS, QUAIL, DEER, TAN skins, FURS. Great Fun. Spare-time PROFITS. **FREE BOOK** Tells ALL about it. 100 fine wild-game pictures. 48 pages. SEND TODAY, don't delay. Get this WONDERFUL FREE BOOK, MEN AND BOYS. Learn Taxidermy. Double your hunting pleasure. Rush letter or POSTAL today. STATE YOUR AGE. N. W. SCHOOL OF TAXIDERMY, Dept. 2507, Omaha, Neb.

AMAZING COMFORT—NO SPECIAL FITTING

RUPTURE-EASER

Reg. in U.S. Pat. Off. (A Piper Brace Product)
For MEN, WOMEN and CHILDREN

Right or Left Side **\$3.95**
Double **\$4.95**

A strong, form fitting washable support. Back lacing adjustable. Snaps up in front. Adjustable leg strap. Soft, flat groin pad. No steel or leather bands. Unexcelled for comfort. Also used as after operation support. Mail orders give measure around the lowest part of the abdomen and state right or left side or double. We Prepay Postage Except on C.O.D.'s.

Over 400,000 Satisfied Users! **10 Day Trial Offer**
Money-back guarantee if you don't get blessed relief
Delay may be serious — ORDER TODAY!
PIPER BRACE CO.
811 Wyandotte Dept. PM-72 Kansas City 6, Mo.

Learn BAKING At Home

Baking is one of America's high industries in wages. Nearly depression-proof. Thorough basic home course lays sound foundation. If you have aptitude, write for FREE BOOKLET. "Opportunities in Commercial Baking."
NATIONAL BAKING SCHOOL
Dept. 135B 835 Diversy Pkwy. Chicago 14

MONTH AFTER MONTH, YEAR AFTER YEAR, YOU SEE OUR AD.

REMEMBER IT'S DANGEROUS to pay less if you want the finest (nonskid) USED tires.

GOOD YEAR Firestone

GOODRICH, UNITED STATES, GENERAL & OTHERS, NOT RECAPS

Our policy is to select your tires so carefully, as if our very future depended on the service given by that particular tire.

FREE TUBE WITH EVERY GOOD GRADE & FINEST GRADE, TRUCK & PASSENGER TIRE

GOOD GRADE TIRES — 16 MONTHS GOLDEN RULE GUARANTEE

600-16	\$4.14	820-15	\$5.44	600-20	\$7.14	32x6(8)	\$8.64
650-16	5.42	700-15	4.54	650-20	7.94	32x6(10)	9.94
700-16	5.04	670-15	4.74	700-20	8.54	900-20	13.94
650-15	4.44	710-15	4.94	750-20	8.64	1000-20	13.94
760-15	5.04	550-17	4.64	825-20	15.92	1100-20	14.94

FINEST GRADE, 29 MONTHS GOLDEN RULE GUARANTEE BOND THIS GRADE MADE THE BLATT NAME "WORLD FAMOUS"

600-16	\$5.29	700-16(6)	\$8.75	6	TO 14 PLY TRUCK TIRES
600-16(6)	7.85	550-15	5.60	700-15(6)	\$10.00
650-16	6.12	640-15	5.65	750-16(8)	9.90
650-16(8)	8.85	670-15	5.95	750-16	10.75
700-16	6.42	710-15	6.17	750-17	13.02
750-16	7.75	760-15	6.27	750-15	19.08
525-18	5.92	800-15	6.84	825-15	25.12
550-17	5.64	850-15	6.80	600-20	9.40
650-15	5.60	670-16	6.42	650-20	9.80
700-15	6.05	760-16	6.94	32x6(8)	12.25
WHITEWALLS	52 ea.	EXTRA	32x6(10)	12.02	1100-22
					19.95

Buy the "Right" **TRUCK TIRES** Std. Guar. 16 Mos. Rugged Guar. 30 Mos. **MILITARY MUD-SNO TREAD**

For "Your" Job	750-20	\$10.	750-20Rg.	\$16.64
8-10-12-14-Ply	600-16	Std. 6.75	600-16Rg.	9.95
DEPEND ON US	900-16	Std. 10.	900-16Rg.	16.00

BLATT BLATT BLDG., GIRARD & LANCASTER AVES. DEPT. PM, PHILADELPHIA 31, PA. Send check or money order. Send this ad with order. We won't ship a tire we wouldn't use. The name to trust in rubber. Shipments RUSHED Down South, Up North and Far West

WRITE 3 WORDS MAKE \$6.00 PROFIT—

—on 10-Second Demonstration to merchants. Write on glass with amazing Magic Crayon—Presto!—5 color advertising message takes fire, glows like brilliant Neon. Three sales daily bring \$18 profit. Rush name for FREE Sales Kit. **MAXILUME CO., 125 W. Hubbard, Dept. L-8-M, Chicago 10, Ill.**



MONEY for MEN ALL FREE

THE PLASTEX Industry needs manufacturers on small scale and for big production of Lamp and Clock Stands, Art Goods and Novelties in Plastex and Marble imitation. Experience unnecessary. Lgc material makes regular 10c store sellers. Rubber moulds furnished for speed production. Small investment brings good returns. We are now placing big Chain Store Orders with manufacturers. Ambitious men have chance for real prosperity. Our Free booklet will interest and benefit you.

PLASTEX INDUSTRIES, Dept. A
3400 Third Ave. New York 56, N. Y.

140 POWER.....

Complete Telescope Lens Kit only \$2.95 postpaid

Conquer space. Explore the universe, planets, Moon craters, New stars. Complete lens kit consists of 54 inch focal length ground and polished objective lens, 140 power astronomical Eyepiece lenses, 100 power Eyepiece lens, 20X lens and all necessary lens fittings. Easily assembled from instructions. Money back Guaranteed.

BUSSE SALES COMPANY, Hartford 3, Conn., Dept. PM3

LOCKSMITHING & Key Making

PRACTICAL UP-TO-DATE COURSE—ONLY \$4.95
Easy-to-learn modern information for self-instruction. How to work on locks, de-code, make master-keys, repair, install, service, etc. For every handyman, home owner, carpenter, mechanic, service station operator, fix-it shop, hardware dealer, gunsmith, 53 plain illustrated lessons. **FULL PRICE ONLY \$4.95. SEND NO MONEY.** Just pay postman plus C.O.D. postage. Or send \$4.95 with order, we'll ship postpaid. Satisfaction guaranteed or refund.

NELSON-HALL CO., 210 S. Clinton St., Dept. GY-2, Chicago 6, Ill.

Easy-to-Build Old-Time Autos!

FREE! Write for Your Copy of Our 4-Color FOLDER

Authentic models—5" to 10 1/2" in length—to assemble in your leisure hours! All our kits include shaped parts, wheels, lights, horn, radiator, etc. and instructions. Choice of 18 antique autos—\$1.95 to \$3.95 each.

IF YOU ORDER DIRECT, add 25c for postage and handling.
Hudson Miniatures' "OLD TIMERS" Antique Auto Sets
SCRANTON HOBBY CENTER, Dept. 14, Scranton 10, Pa.



ALL are COATED

6x30 16 oz. Economy \$27.95
7x35 All around use 42.95
7x50 3 1/2 oz. Sharp, bright, Bargain. 36.00
7x50 Center Focus, Sale priced 39.50
8x30 17 oz. Clear, crisp 32.50
8x30 Center Focus 37.50
8x40 Streamlined 51.50
10x30 18 1/2 oz. 39.50
10x50 35 oz. More Power 62.00
12x50 35 oz. Reaches out 65.00
12x50 Center Focus, 25 oz. 67.50

6X-10X POCKET ALL 3 ARE COATED, precision PRISM Binoculars. Superb craftsmanship.



SIX TELESCOPES IN ONE! **POWER** 15 to 40

American made Wollensak telescope. Instant focusing at 15x, at 20x, 30 and 40x. Turn power tube to click—no guess work. Telescope measures 9" closed, 27" when extended. Weighs only 18 oz.! Has rust proof chrome tubes, large 40mm objective lens. All 12 optic surfaces are COATED. See .22 bullet holes clearly at 300 feet. Use also for astronomical observation. \$30.75 price includes tax and fine leather case. All binoculars bear the UNITED "Seal of Quality". Proof they are the BEST-BY-TEST.

UNCONDITIONALLY GUARANTEED! 30 DAY FREE TRIAL

If not fully satisfied return for full refund! Cash orders rushed postpaid. On C.O.D.'s include \$2.00 deposit. Add Federal Tax. Prices on all of above include handsome genuine leather case and straps. **UNITED BINOCULAR CO., 9043 S. Western, United Bldg., Dept. ARF-4908, Chicago 20, Display Sales Rooms open 9:00-3:30 Mon. thru Fri. DEALERS WANTED.**

BARGAINS

Brand New, top quality glasses. All have precision ground optics, durable lightweight bodies, moisture and dust proofed. Color corrected Achromatic lens.

Coated! Featherweight!

16x50 \$66.95 COATED

The ultimate in a fine binocular. Tremendous power. Featherweight (weighs only 25 ounces!). Precision made in every detail. COATED providing sharper, brighter images. Individual focus. Objective lens is 50mm (2 inches) across!



10x They Are New \$24.95 WEIGHS 7 1/2 OZ.! Palm sized. Full 10 Power. Color corrected. Achromatic lens. Perfect balance. Another UNITED first in revolutionary binocular developments.

6x DUO-TONE \$16.95 Illustrated. Weighs only 4 oz.! Yet has field of 375 ft. at 1000 yds.!

7x ALL CHROME \$21.95 Sturdy. Precision made. Sharp, clear vision! Sale priced.

WATCHMAKING

Learn at home • **FREE sample lesson**
CHICAGO SCHOOL OF WATCHMAKING
1608 N. Milwaukee Avenue Dept. 172 Chicago 47, Ill.

SAY YOU SAW IT IN POPULAR MECHANICS

UNLIMITED WRITTEN GUARANTEE! 14 95
17 JEWEL WRIST WATCH 14 95 Plus 1.50 Tax

WAR ON PRICES! **FORMERLY SOLD FOR \$59.00**
INCABLOC SHOCK PROTECTED WATER & DUST PROOF

Worn by ARMY, NAVY & MARINES
Luminous dial . . . sweep second hand . . . Super Accurate. Imported Swiss precision movement and case. You get these brand new FULLY GUARANTEED watches now for a small fraction of the original price. You save \$44, because we bought-out surplus stock! Don't delay.

10 DAY FREE TRIAL!

WEAR AT OUR RISK! MONEY BACK IF NOT DELIGHTED. SEND ONLY \$1 DOWN PAYMENT with order. Pay balance to postman on arrival plus postage. Send check or M.O. for full amount and we pay postage. Men's Style \$14.95 plus \$1.50 tax, total \$16.45. Ladies' and nurses' style \$16.95 plus \$1.70 tax, total \$18.65. Order now at this low price.

FREE! Handsome Expansion Band with Order
MARYLAND DISTRIBUTORS, Dept. 393
501 E. Baltimore St., Baltimore-2, Maryland
Write for Free Watch and Jewelry Catalog at Almost Wholesale Prices



NEW! ALL ABOUT TELEVISION



Service Your TV Set Yourself and Save Hundreds of Dollars . . . Save on the Purchase of a New Set!

Here's the brand new book that tells and shows you how 9 times out of 10 you can service your TV set yourself and save the \$5 to \$25 fee charged by professional repairmen for service calls.

Here are famous step-by-step instructions by John Derby, famous television engineer, which make it possible for you to locate trouble quickly and repair it in the matter of minutes. Hundreds of "show-how" photos, drawings and diagrams actually show you just how to go about making most TV repairs.

A special illustrated section contains actual photographs of imperfect TV pictures. By comparing the picture on your set with those in the book you immediately identify the trouble and then by following Derby's instructions you make the adjustment or repair which will give you perfect reception once again.

Find out how to install your own antenna at a savings of as much as \$20 . . . how to replace burnt-out picture tubes . . . how to get the best reception in outlying areas . . . how to save money when buying a new set . . . what to look for when you purchase a TV set.

Go with Derby into TV studios and see stars in action . . . see how television shows are produced and what goes on "behind the scenes."

No other TV book on the market is so comprehensive and so chock-full of valuable information. No other book can save you so much money.

Send just \$3.00 for your copy of "All About Television." Read it for seven full days and unless you agree that it can save you hundreds of dollars and enable you to service your TV set yourself just slip it back in its wrapper and return it to us for a full refund. Use the handy order blank today.

Order on this Handy Coupon

POPULAR MECHANICS PRESS
200 E. Ontario Street, Chicago 11, Ill.

Remittance for \$3.00 enclosed. Rush postpaid my copy of "All About Television." Unless it is entirely satisfactory I may return it within seven days for a full refund.

NAME _____

ADDRESS _____

CITY _____ ZONE _____ STATE _____

Send C.O.D. (Postage extra)

WANT TO **SAVE GAS?** ^{1/2} MILLION NOW USE GANES

AMAZING GANE NEEDLE TRY ONE FREE IN YOUR CAR!

TRY BEFORE YOU BUY!

MANY GANE NEEDLE USERS REPORT UP to 25% more mileage, faster pickup, easier starting and smoother idling.

NOW TEST A GANE NEEDLE IN YOUR CAR for ten days, then compare your mileage and performance. If satisfied, send \$1.50 per needle (8 cyl. cars take 2). If not satisfied, just return it—fair enough? Since authorities differ on its merits and some users report no improvement, TRY BEFORE YOU BUY! (Gane Needle replaces idling adjustment screw in carburetors—easily installed in a few minutes.)

WRITE TODAY. ENCLOSE NO MONEY. PAY POSTMAN NOTHING. Just send us your name, address, and make and year of car.

NATIONAL AUTOMOTIVE RETAIL CORP., Dept. J-7
350 W. Washington Blvd. Venice, California

FREE
Auto Economy Manual
Tells how to save gas, tires, brakes, etc. Also introduces many new economy products. (Sent absolutely free to all who try Gane Needles.)

STUDY INDUSTRIAL DESIGN

You can train at Art Center School in California with practicing-professionals for upper-level jobs in INDUSTRIAL DESIGN. Recent graduates have been added to the staff at General Motors, Chrysler, Raymond Loewy, Henry Dreyfuss, etc. Majors in transportation, general product design, structures, community development, furniture design, packaging, display, 4-year degree courses. Learn to combine imaginative design with technical proficiency, coordinate utility and beauty. Stimulating environment. Field trips. Advantages of mild Southern California climate and nearby holiday spots. Coed. Placement service. Write for catalog.

ART CENTER SCHOOL, Edward M. Adams, Director
5353 WEST THIRD STREET, LOS ANGELES 5, CALIFORNIA

FOAM RUBBER CUT SHAPES

All shapes and sizes for chairs, upholstered furniture, window seats, garden furniture. Mattresses and mattress pads, pillows, auto seat toppers, car cushions, etc. Lowest factory prices.

Send for FREE ILLUSTRATED CATALOG
RIOR RUBBER CO., Dept. 201 50 E. Cermak Rd. Chicago 16, Ill.

Anybody Handy With Tools Can Build
LEATHER LOUNGES FOR KITCHENS AND RESTAURANTS
Frames, springs, filling, construction simplified.

Send \$3.00 for complete plans and instructions, or 10¢ for brochure.

STEFAN GALENSKI
Designer & Manufacturer
2221 BROADWAY BUFFALO 12, NEW YORK

Watch Repairing Pays Big Money Learn at home

Watch repairers in great demand. Train step-by-step in 10 easy lessons. We furnish all tools and 15 jewel watch and practice movement. Turn spare time into cash. A licensed school. Low cost. Send for FREE book today.

ILLINOIS SCHOOL OF WATCH REPAIRING
2870 Elston Ave., Dept. PM-72, Chicago 18, Ill.

Say You Saw It in Popular Mechanics

Wheels Wheels
Wheels Wheels

5" Disc Wheel 5/8" Tire 5/16" or 3/8" sleeve 30c ea.
6" Disc Wheel 5/8" Tire 5/16" or 3/8" sleeve 35c ea.
7" Disc Wheel 3/4" Tire 3/8" sleeve 45c ea.
8" Disc Wheel 1 1/8" Tire 1/2" sleeve 70c ea.
7" Disc Wheel 1" Tire 1/2" ball bearing 80c ea.
8" Disc Wheel 1 1/8" Tire 1/2" ball bearing \$1.00 ea.
8" Disc Wheel 2" semi-pneum. T. 1/2" B.B. \$1.35 ea.
10" Disc Wheel 1.75 semi-pneum. T. 1/2" B.B. \$1.50 ea.
12" Disc Wheel 1.75 semi-pneum. T. 1/2" B.B. \$1.85 ea.
Above wheel prices includes hub cap. Plus Postage, C.O.D.'s accepted.
AXLES—Sizes 5/16 in., 3/8 in., 1/2 in.—Cut to size—End holes drilled.

UNITED WHEEL STAMPING CO.
12131 S. PEORIA STREET PM-7 CHICAGO 43, ILLINOIS

Develop Hidden Earning Power

STUDY LAW

at home! LL.B. Degree

Qualify yourself in spare time for advancement, greater earnings, business success. Now, more than ever, legal ability is in demand! Easy-to-understand step-by-step lessons and text material furnished — invaluable for permanent reference. Over 40 years expert instruction. 114,000 students enrolled. Easy payments. Find out now, at no cost, how study of law can help you. Write today for FREE Book "Law and Executive Guidance."

AMERICAN EXTENSION SCHOOL OF LAW

Dept. PM-52, 646 N. Michigan Ave., Chicago, Ill.

Secrets of VENTRILOQUISM Now Revealed!



Easy to learn in 60 to 90 days with our Home Study Course. RESULTS GUARANTEED. Make Money! Be Popular! Have Fun! Big Opportunity! Radio, Television, Stage Appearances! For FREE information regarding price and terms, WRITE. You must state your age. Dummy Catalog 25c.
FRED MAHER SCHOOL OF VENTRILOQUISM
Box 36, Studio G Kensington Station
Detroit 24, Michigan



MASTER MIND!

Learn Short-Cut Mathematics
Juggle figures, do baffling number tricks. Make people gasp at your marvelous lightning-quick mind. Multiply 4 figures by 4 figures without using old-fashioned multiplication! Big cloth-bound volume; fully illustrated course.
Sharpen up Your Brain Power
Includes worked-out problems, answers, etc. Sensational bargain, only \$1.95, postpaid or COD plus postage. Satisfaction guaranteed or refund. Order this amazing "Short-Cut Mathematics" today!
NELSON-HALL CO., 210 S. Clinton St. **\$1.95**
DEPT. 2GY-2 CHICAGO 6, ILL. Complete

NEEDLE MAGIC! ASTOUNDING!

You'll get a BANG out of this trick!
Amaze your friends 5 WAYS

Now for the first time in history you can thread a needle in a tube, blindfolded, behind your back, or IN THE DARK! And it sews like any other hand-sewing needle. Full directions enclosed. Attractively packaged. Only 50c in coin, Postpaid.

SPEED-EYE NEEDLE CO.

2316 N. Clark St. Chicago 14, Illinois

NOW LEARN TV-RADIO Servicing AT HOME!

EARN WHILE YOU LEARN
No previous training needed
... new simplified lessons!
Top instruction... one of the largest schools of its kind!
Write Today For Free Sample Lesson and Details. Dept. B-7

PAY AS LITTLE AS **\$5** mo.
TOTAL COST AS LOW AS **\$100**

CRESCENT SCHOOL

500 PACIFIC ST. BROOKLYN 17, N. Y.

WANT TO BE PAID FOR "GIVING AWAY" NYLONS AT 49¢?

That's all they cost if they run or snag within guarantee period up to THREE MONTHS! Just write orders. We deliver and collect. Earn up to \$26 weekly in spare time. Advance cash and big bonus. No experience needed. Write for FREE sample stocking and money-making outfit postage prepaid.

KENDEX CORP. • BABYLON 646, N. Y.

Revell HIGHWAY PIONEERS

SOUVENIRS OF THE GASLIGHT YEARS



□ 1909 STANLEY STEAMER 69c



□ 1910 MODEL "T" FORD 69c

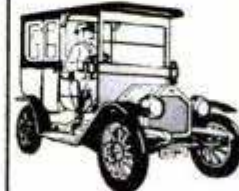

□ 1910 CADILLAC LIMOUSINE 89c



□ 1914 STUTZ "BEARCAT" 89c

NOW! YOU CAN AFFORD THE FASCINATING ANTIQUE CAR CRAZE!



Join the fun of building and collecting miniature antique gas buggies with low-cost Revell HIGHWAY PIONEERS. Yes, everyone from 7 year old Junior to Grandma gets a thrill out of constructing these "souvenirs of the gaslight years." Realistic and authentic in every detail—yet easy to build. No previous experience needed! All parts prefabricated of durable plastic in 1/8" scale —no carving, sanding, or tedious hours of shaping and forming. Just assemble and then finish in your favorite paint job. They're wonderful as shelf and mantelpiece models, and for craft projects such as book ends, lamps, shadow boxes, etc. 8 super-detailed kits... more coming every month—you'll want to build them all!

All shipments prepaid. Money back guarantee. At toy, hobby, and dept. stores, or order direct. No C.O.D.'s, please.

- 1910 MODEL "T" FORD ... 69c
- 1909 STANLEY STEAMER ... 69c
- 1910 CADILLAC LIMOUSINE ... 89c
- 1914 STUTZ "BEARCAT" ... 89c
- 1915 "T" FORD SEDAN ... 89c

only 69¢ & 89¢

SUDLER COMPANY
1000A SOUTH MANHATTAN PLACE
LOS ANGELES 19, CALIFORNIA



FREE!

PRIZED SET OF 4 OFFICIAL United Nations Stamps

"First Issue" Stamps Sent FREE To Get Names for Mailing List

MAIL coupon at once. Get this set of 4 newly-issued United Nations Stamps. NO COST TO YOU! Most talked about stamps of the year! Can be used in ONLY ONE post-office in entire world—official U.N. station in New York. Supply limited. We'll also include other interesting offers for your inspection, PLUS FREE book, "How to Collect Stamps." This offer may have to be withdrawn soon. So rush coupon NOW to: Littleton Stamp Co., Dept. PM-7, Littleton, N. H.

Littleton Stamp Co., Dept. PM-7, Littleton, N. H.
Send — FREE — set of 4 United Nations Stamps and informative booklet, "How to Collect Stamps."

Name.....
Address.....
City..... State.....

Completed Popular Mechanics Ranch Type House and exact scale pictorial room and suggested furnishing layout. To right of dotted line is BASIC HOUSE. Expansion to the left. Designed for easy building in two convenient steps.

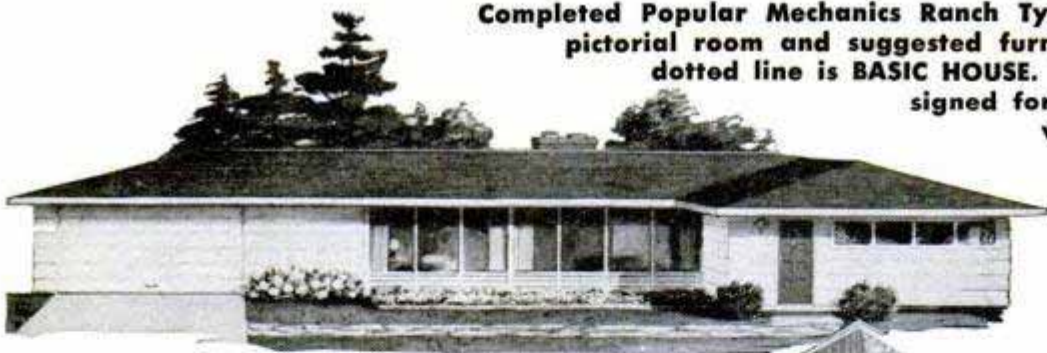

Basic house includes living room, dining area, two bedrooms, kitchen, bath, utility room and car port. Can be built for about \$5000.

More than 100,000 families have built their own homes in the past few years, doing all of the work, or most of it themselves. Right now, one of every five homes being built is at least partially owner-built. This proves that you too, if you can use hammer and saw, can build your own home and save more than one-half of the cost.



Add
When You
Need More
Room

When expanding you add garage and breezeway, and car port becomes third bedroom. About \$2500.

Build the Basic
House First



Get this Newest Popular
Mechanics "Build-It-Yourself"
Book and Building Plans and Save
Many Thousands of Dollars

Book gives complete step by step instruction in simple language. Hundreds of pictures, actual photos and diagrams, showing every phase of construction, guide you from start to finish. Ten working size blueprints give floor plans, elevations, notes on construction, framing, lumber list, specifications, plumbing and wiring diagrams.

part of it. And at the same time, save in labor costs, more than he spends for material.

Order Book and Plans Now

Use the handy coupon below to order your copy of the RANCH-TYPE HOUSE BOOK AND PLANS. Read the book; study the plans and then you will be prepared to go right ahead when you are ready to build. Even if you have the house mainly built by others, you can still enjoy a tremendous savings by using the instructions and blueprints from Popular Mechanics.

**Read How and See How —
Simplified Instruction**

You read "how-to-do-it" in the book. You see how it looks in actual pictures. You follow the plans for dimensions and details. You make use of labor-saving kinks and special methods developed especially for the project.

**No Previous Building
Experience Required**

Any ordinary handy man, using only simple tools, can build this house with little or no assistance and enjoy every

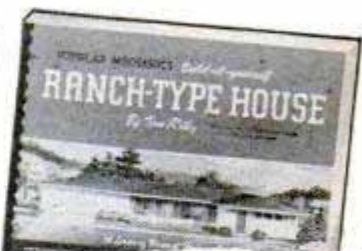

Use This Handy Order Coupon

**POPULAR MECHANICS PRESS, Dept. 70
200 East Ontario St., Chicago 11, Ill.**

Send at once my copy of the Ranch-Type House Book and Plans as checked below:

- | | |
|--|--|
| <input type="checkbox"/> Remittance enclosed | <input type="checkbox"/> Send C.O.D. (postage extra) |
| <input type="checkbox"/> Ranch Type House Book | \$ 3.50 |
| <input type="checkbox"/> Set of 10 Blueprints | 13.50 |
| <input type="checkbox"/> Book and Blueprints | 15.00 |
| <input type="checkbox"/> Duplicate Set of Blueprints | 5.00 |

Name _____
Address _____
City _____ Zone _____ State _____

Beat the High Cost of Home Owning It's Easier Than You Think

Here is a dream home that can become a reality without too much worry about money. Build this beautiful Ranch Type Home yourself. Simply follow the Popular Mechanics RANCH TYPE HOUSE BOOK AND PLANS. You can save \$7,000 to \$10,000 and have one of the most desired homes of these times. You can build it all now—or part of it—and add garage, breezeway and another bedroom later on without affecting the basic house.

**Modern Design • Fully Finished • All-Season
Build this Home Anywhere and Save**

Designed for Popular Mechanics by John F. Whelan, famous West Coast architect and designer of homes and entire villages. It's a year 'round house, 81 feet long and 29 feet wide. Fully insulated. Finished outside and inside with durable plywood and requires no plastering. Brick "island wall" and big fireplace in living room. Heating, unique ventilating system and latest development in electric wiring included. A dream home that can easily come true and a home that can grow with the family.

Reduced size illustrations from book. Building roof truss on floor for easy construction. Mrs. Tom Riley, Portland, Oregon, shingles the roof on her Popular Mechanics Ranch Type House



Build this
Popular Mechanics
RANCH HOUSE
Yourself!
Save Over One-Half



**OVER 700%
PROFIT!**
WITH THE
**PDQ CHAMPION
PHOTOMASTER**

Makes finished pictures in 2 minutes.

Takes and finishes 30 to 40 everlasting, black and white or sepia on "SUPER SPEED" direct positive paper. Picture size 2 1/2 x 3 1/2 in. Complete, easy-to-operate portable photo studio. Size 4 1/2 x 5 x 10. Wt. 6 lbs. **700% PROFIT.** Write quick, get details about the great PDQ CHAMPION PHOTOMASTER.

P D Q CAMERA CO.

1161 N. CLEVELAND AVE. Dept. PM-7 CHICAGO 16, ILL.



1952 EDITION

It's New! It's Different! Get world's largest Auto Accessory & Parts Catalog and save money. Over 50,000 items, including Hollywood Accessories, Hi-Speed Equipment, Rebuilt Engines, all parts & accessories for all cars & trucks. We have that Hard-To-Get part! Jam packed with bargains. Completely illustrated. (100 pages) Send 25c (refundable).

J. C. WHITNEY & CO., 1917-XP Archer Ave., Chicago 16, Ill.

Catalog of 3000 Novelties 10c

Send 10c for amazing catalog of novelties, live animals, scientific supplies, hobbies, funmakers, planes & boats, looms, magic tricks, joke articles, unusual seeds, gadget timesavers, cameras, optical goods, projectors, movies, lucky jewelry, religious novelties, disguises, musical instruments, stamps, coins, puzzles, fortune tellers, radios, auto & bike accessories, telescopes, magnifiers, compasses, banks, smokers' gadgets, artists' supplies, printing sets, engines, motors, shockers, knives, billfolds, fireworks, guns, rifles, sports, books, games, plants, etc. Send name, address & 10c to: **JOHNSON SMITH & CO., Dept. 534, Detroit 7, Michigan**

Over 800 items listed! Over 200 illustrations! Accurate, detailed, scale models of warships tanks & planes. PLUS model railroad equipment

ALL IN AUTHENTIC CATALOG VOL III ONLY 35c

COMET METAL PRODUCTS CO., INC.

91-04 132nd St. Richmond Hill, N. Y.

Learn PHOTOGRAPHY at Home

Splendid opportunities. Prepare in spare time. Practical basic training. Long-established school. Send for free book, "Opportunities in Photography." No obligation.

AMERICAN SCHOOL OF PHOTOGRAPHY, 835 Diversey Pkwy., Dept. 135B, Chicago 14, Ill.

WHY SUFFER TONGUE BITE?

Cost 3 times as much to build as the best of old-fashioned pipes. But **KILL TONGUE BITE, STOP DRINK.** FREE circular tells WHY. Write:

KLEENSMOK PIPES

P.O. No. M597,

Johnson City, Tenn.

R-Reg. U.S. Pat. Off. Pat.'s. and Pat.'s. Pend.

Thrilling Work COLORING PHOTOS

Fascinating vocation learned at home by those with aptitude. Thrilling pastime. National method brings out life-like colors. Free booklet.

NATIONAL PHOTO COLORING SCHOOL

835 Diversey Pkwy., Dept. 135B, Chicago 14



**START YOUR OWN
ELECTRICAL APPLIANCE
REPAIR BUSINESS**

Repair electrical appliances of friends and neighbors. Service electrical equipment in factories, stores, etc. Work full or part time! New Shop Method home-training system. Rush name today for **FREE BOOK** and special form for getting Electronic Kit, Valuable Heating Element Kits, Advisory Service and Illustrated Instructions on new easy-payment plan. Pay later from **EARNINGS WHILE LEARNING.** Rush name today.

CHRISTY TRADES SCHOOL

4432 N. Kedzie, Dept. D-803, Chicago 25

**PLEASE
SEND ME**

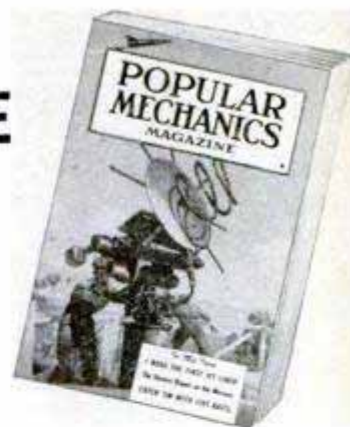

for the
time checked.

I am enclosing . . .

1 year \$3.50

2 years \$6.00

name _____

address _____

city _____

zone _____

state _____

C-72

Hand this order to your newsdealer or send it to

POPULAR MECHANICS

200 East Ontario St.

Chicago 11, Ill.

**DEPENDABLE
CRAFT SUPPLIES**



LEATHER CRAFT • PLASTICS • POTTERY
CRAFT • BLOCK PRINTING • BELT CRAFT •
TEXTILE COLORS • POWER TOOLS • WOOD
BURNING • INSTRUCTION BOOKS • ETC.

DWINNELL CRAFT SHOP

Dept. PM-752—Wheeling, W. Va.



SAY YOU SAW IT IN POPULAR MECHANICS

**ENGINEERING DEGREE IN
27 MONTHS**

Big Demand for Graduates

Aeronautical, Chemical, Civil, Electrical, Mechanical and Radio Engineering (inc. TV and Electronics)

Hundreds of young men are earning B. S. **ENGINEERING DEGREES** annually in this recognized institution — year around operation. New terms start quarterly. Many students earn a major part of their college expenses in this large industrial center.

Low tuition. Competent instruction. Thorough, intense, practical program. Modern, well-equipped laboratories including new physics laboratory and modern wind tunnel. Individualized instruction emphasized.

Government approved for G.I.'s. Engineering preparatory courses. Students from 48 states and 21 foreign countries. Enter September, December, March, June. Send coupon for free catalog and full information. Enroll now.

SEND COUPON TODAY

INDIANA TECHNICAL COLLEGE

572 E. Washington Boulevard
Fort Wayne 2, Indiana

Please send me free information on B.S. Engineering Degree in 27 months as checked.

Aeronautical, Chemical, Civil, Electrical,
 Mechanical, Radio-Television

Name _____

Address _____

SEND ME

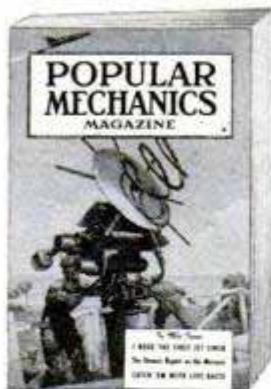

every month so I am sure to see each new issue. Here's

- \$3.50 for 1 year
- \$8.00 for 3 years

name _____
 address _____
 city _____ zone _____ state _____ B-72

Hand this order to your newsdealer or send it to

POPULAR MECHANICS
 200 East Ontario St. Chicago 11, Ill.



TALK-SING-PLAY OVER YOUR RADIO
 with the real Radio Mike! Attaches in a jiffy—full instructions given! Swell for "parties"—"cut in" on or "kid" regular network programs or put on your own broadcasts! Amaze your friends—real fun. Beautiful Metallic Plastic 6 in. high!
12 RADIO BROADCAST LESSONS GIVEN with each mike
SEND NO MONEY Just pay postman \$3.99 COD plus postage or send \$3.99 and we pay postage! *Radio Mike* is available only from us by mail—guaranteed.
 Midway Co., Dept. MPM-7, Kearney, Nebr.

TRIAL PLAN makes it easy to start

HERE'S THE AMAZING WAY TO

BE AN ARTIST



Let us **PROVE** we can teach you to draw at home in your spare time!

Commercial Art, Designing, Cartooning—all in one complete course—only WSA offers you this art training, famous since 1914. TWO big artist's outfits furnished. Send today for new, illustrated free booklet that shows how you can enjoy a profitable art career—read the success stories of our graduates.

MAIL COUPON FOR FREE BOOK

WASHINGTON SCHOOL OF ART
 Studio 127F, Washington 5, D. C.
 Send Free Book, "Art for Pleasure & Profit."
 No salesmen. (Please print)

Name _____ Age _____
 Street _____
 City _____ Zone _____ State _____
 I am interested in your new Trial Plan



SENSATIONAL OPTICAL BARGAINS HAND SIGHTING LEVEL

Handy! Simple to Use!

Projects a level line of sight—invaluable for laying out drains, ditches, foundations, gardens; for contour plowing and soil erosion work. Accurately designed and calibrated. Used wherever grades must be established or level line necessary over an appreciable distance. Directions included.

Stock No. 105-H.....\$2.50 Postpaid

SLIDE PROJECTOR SETS Consists of all unmounted lenses you need to make the following size projectors:

- Stock # 4029-H—35 mm.....\$2.85 Postpaid
- Stock # 4038-H—2 1/4"x2 1/4".....\$3.35 Postpaid
- Stock # 4039-H—2 1/4"x3 1/4".....\$3.35 Postpaid

SIMPLE LENS KITS—Include plainly written, illustrated booklet showing how you can build lots of optical items. Use these lenses in photography and for dozens of other uses in experimental optics, building TELESCOPES, low power Microscopes, etc.

- Stock # 2-H—10 lenses.....\$ 1.00 postpaid
- Stock # 5-H—45 lenses.....5.00 postpaid
- Stock # 10-H—80 lenses.....10.00 postpaid

We Have Literally Millions of War Surplus Lenses and Prisms for Sale at Bargain Prices. Numerous Types of Instruments, Too! Write for FREE CATALOG-H

EDMUND SCIENTIFIC CORP., Barrington, N. J.

WHAM-O SPORTSMAN

\$1.50 POSTPAID 35-LB. PULL!

HITS LIKE A RIFLE—KILLS RABBITS, SQUIRRELS.
 Powerful, silent, accurate.
 For hunting, target, routing pests.
 Sportsman's choice solid work over!



HUNTING SLINGSHOT

Heavy duty 7" ash stock.

40 steel balls, extra rubber, target.

GUARANTEED. At dealers, or send \$1.50 to

Wham-O Mfg. Co. Box 8T, South Pasadena, Calif.

* Professional model of Nat'l Slingshot Assn.

SLINGSHOT AMMUNITION

.22 CALIBER STEEL PELLETS.

Improve your aim. Each pellet uniform in size. Ideal for hunting rabbits, squirrels, etc. Send \$1.00 for large 2 lb. pack containing over 1100 shots.

SLING-AMMO, Box 491, Metuchen, New Jersey

RADIO

Engineering. All phases radio & electronics theory & practice; television; FM; broadcasting; servicing; aviation, marine & police radio. Prepare for high pay: 18-month course equal in radio content to 4 yrs. college. Enter Jan., March, June, Sept. Regular campus life. Catalog.

VALPARAISO TECHNICAL INSTITUTE, Dept. D, Valparaiso, Ind.

HULA POPPER • GETS BIG BASS

ACTION-PACKED WITH FULL CONTROL POPS, PLUNKS, JERKS, MAKES NOISE



WRITE FOR BIG FREE COLOR CATALOG

FRED ARBOGAST & CO., INC., 2257 W. NORTH ST., AKRON 3, OHIO

BIG LEATHER & CRAFT CATALOG!

1000's of items for Leathercraft, Textile Painting, Copper Tooling, Kites, Projects, Tools, Supplies, Etc. Send 25c (refunded with 1st order) to:

RUSSO HANDICRAFT SUPPLIES Dept. 1-CD, 245 S. SPRING LOS ANGELES 12, CALIF.



POSITIVELY controls movement of hand until one's Penmanship is quickly corrected. Write,

OZMENT (INVENTOR), 34-P, ST. LOUIS, MO. (BX665)

BURN WATER IN YOUR CAR



With The OCTA-GANE INJECTOR

This amazing all bronze, "fog type", exhaust operated PRESSURE injector will burn water, alcohol or both. It is adjustable to burn up to one gallon of water with every 10 gallons of gasoline. U.S. Agricultural Dept. Scientists say: "The gasoline mileage of new high compression auto engines can be increased up to 30% with alcohol-water-gasoline fuels."



Complete with 1 1/2 gal. tank **Only \$27.45 ppd.**

(Or send \$2, balance C.O.D.) List car make, year, # cyl.

WRITE FOR FREE ILLUSTRATED LITERATURE

DEALER INQUIRIES INVITED
 World's Largest Firm Specializing in Hi-Performance and Hi-Mileage Equipment for All Makes of Cars.
NEWHOUSE AUTOMOTIVE INDUSTRIES
 Dept. 80-7, 5805 E. Beverly Blvd., Los Angeles 22, Calif.

LITTLE Rocket Radio

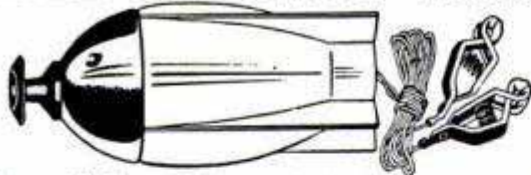

This tiny radio has no tubes or batteries and needs no electricity. Powered by a Germanium Diode which was developed for radar. Has tremendous qualities for picking up radio signals. Beautiful and colorful plastic case. Will work anywhere you go and pick up programs from local stations. Only \$3.98 postpaid or on C.O.D. Pay postman plus delivery charges. Wonderful for children and a practical gift. Mardo Sales, 480 Lexington Ave., Dept. R-114, New York, N.Y.

Build your own JET ENGINE!



SEND NO MONEY

Order these plans today

1. JET PROPELLED BICYCLE. Assemble your own. Photo and instructions, \$1.00.
2. HOW TO MAKE EXPERIMENTAL JET ENGINES. Seven sheets drawings with information and instructions \$2.95.
3. BOTH OF ABOVE in one order \$3.75. SEND NO MONEY. Order both at once \$3.75 C.O.D. in USA plus c.o.d. postage. Send check or Money Order and we pay postage. Get other information too. Rush Order.

J. HOUSTON MAUPIN, Dept. 55, Tipp City, Ohio

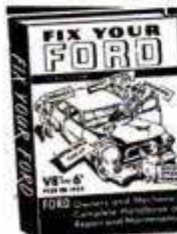

FIX YOUR FORD and SAVE

Brand new handbook for owners and mechanics by Bill Toboldt, Editor, Motor Service Magazine. Covers all Ford V-8's and 6's, 1932 to 1952. Gives you the know-how of hundreds of Nation's top Ford service men. Includes repair and service short-cuts and kinks, tune-up specifications, how to increase gas and tire mileage, make car run better, last longer, worth more. Hot rods and speed-ups too. Simplified. Packed with pictures. If you drive a Ford you need this book. Clip this ad and mail with name, address and \$2.50. Money back in 5 days if you want it.

Goodheart-Willcox Co., Dept. 183, 1321 S. Michigan Ave., Chicago 5

DAN LURIE
"America's Most Muscular Man"
—on television's "Big Top"



FAMOUS DAN LURIE

BARBELLS

with 4 courses—low factory prices
50 lb. set... \$ 8.48 | 150 lb. set... \$20.48
100 lb. set... 13.98 | 200 lb. set... 25.98

Write for Free Catalog Order by Mail; 50% with order, bal. C.O.D. Extra wts. 13c per lb., F.O.B. plant
DAN LURIE BARBELL CO.
1701-M7 Pitkin Ave., Dept. 259-G, Brooklyn, N. Y.

Success-Winning VOICE!

Sound like the HE-MAN you are

STRENGTHEN your voice this tested scientific way. Yes—you may now be able to improve the POWER of your speaking and singing voice... in the privacy of your own room! Self-training lessons, mostly silent. No music required.

FREE BOOK Write TODAY for Eugene Feuchtinger's great booklet "How to Develop a Successful Voice." It's absolutely FREE! You must state your age. Booklet mailed postpaid in plain wrapper. No salesman will call. Send your name and age RIGHT NOW! Perfect Voice Institute, 210 S. Clinton St., Studio GY-2, Chicago 6, Ill.



HOME OWNERS' OIL BURNER SERVICE

Prepare now for cold weather. Save \$\$. We can help you. ILLUSTRATED MANUAL which SHOWS YOU HOW to properly avoid or correct oil burner trouble in Space Heaters, Water Heaters, Furnaces, having vaporizing or pot-type burners. Available now at \$2.95. Corrections for other types by correspondence at nominal charge. Money back guarantee. Parts for most makes for sale. Give make, model, serial number when writing. Home Oil Burner Service, Box 355, Milford, Mich.

MAGNETS OF ALL TYPES — 10c UP
AMAZINGLY POWERFUL!
1/2 lb. magnet lifts 25 lbs. \$1.95.
Our Leader, 1 lb. magnet lifts 40 lbs. \$2.95. New alloy—will not weak-
en! Useful for lifting valuables from tanks, takes, or rivers easily! 7 small magnets \$1.25 with list of many shop and home uses. Satisfaction guaranteed.
R. EYRICH, 1219 W. MEINECKE AVE., MILWAUKEE, WIS.

SELL GOLD & SILVER WINDOW LETTERS

300% PROFIT! Fast, easy sales to stores, offices, doctors, lawyers, etc. Individual orders for merchants interested in saving \$\$\$ doing their own window lettering. Letters easily applied on glass, wood, metal with varnish-gum (not water). Won't wash off; withstands frost. Write for samples.
METALLIC SIGN LETTER CO., 431-A N. Clark St., Chicago 10, Ill.

MEN... WOMEN!
Learn the Secrets of

NELS IRWIN - Director of Instruction

AUTO TRUNKS DASHBOARDS

JEWELRY SILVERWARE CABINETS

TURN TABLES

LAMPS GLASS POTTERY

NEW THIRD DIMENSIONAL FINISH...

for PROFIT and Pleasure...

A SENSATIONAL NEW HOME BUSINESS
A NEW INDUSTRY... A NEW MIRACLE FINISH!
MAKE \$5 to \$10 PER HOUR and more!

Covers: WOOD PLASTER - METAL PLASTER - RUBBER FABRICS - Any Surface

FLOK-KRAFT

PROFESSIONAL SECRETS CAN BE YOURS
At last, secrets of amazing miracle finish can be yours! Huge profits waiting to be tapped in this tremendous new field. Flok-Kraft, a truly third-dimensional finish, gives a velvety, luxurious surface to: radios, lamps, toys, signs, store displays, figurines, auto dashboards. A 1001 items on every hand easily — quickly beautified, increased in value with Flok-Kraft. Make old objects beautiful — saleable, make new ones worth much more. This soft, rich covering can be applied to any surface, even if old or worn.

YOU CAN LEARN IN A FEW DAYS
Make to \$5.00—yes! even \$10.00 and more an hour. Complete and easy-to-understand Flok-Kraft instructions show you how to start on the road to big money, full or spare time.

WE FURNISH EVERYTHING YOU NEED TO START
In addition to full step-by-step instructions, a complete Flok-Kraft kit and equipment enables you to start at once to build a successful business of your own right in corner of your basement, garage, service porch or kitchen.

Read What Others Say About FLOK-KRAFT

"Received the flok-kraft outfit and everyone that saw it is very enthused. I only had it about thirty minutes and got an order for a hundred dollar job. Mr. C. H., Maryland"

"Got \$52.50 for those 7 auto trunk interiors for about 4 hours work. \$7.50 per trunk." J. O. Mo.

"... I have received my order of Flok and Accessories and believe me, I'm very pleased and happy as I've made myself MORE than the cost of my supplies already, and I've still got more jobs to do." Cpl. G. W. S., Carolina

GRASP THIS LIFETIME OPPORTUNITY TODAY
I'll arrange to send you everything you need to start—for leisurely, no-risk examination in your home. You owe it to yourself to investigate. Write today for FREE details, Sample, Plan, etc. Everything I send you now is FREE of charge and postpaid. Airmail is faster. **COAST INDUSTRIES, Dept. 27, 1004 S. Los Angeles St., Los Angeles 15, Calif.**

Years to Examine without Risk!
Examine in your own home—then decide. The complete instructions, the full starting kit of materials and full equipment and full details on how you can open your own business, spare or full time—EVERYTHING will be sent you to EXAMINE AT OUR RISK!

MAIL COUPON NOW — SEND NO MONEY! JUST NAME AND ADDRESS

FREE! Booklet, Sample, Plan!

COAST INDUSTRIES, Dept. 27, 1004 S. Los Angeles St. Los Angeles 15, California

Gentlemen: Please rush me FREE details, sample, etc., I understand that everything you send is free and that I'll be under no obligation now or ever.

NAME _____
STREET _____
CITY _____ STATE _____



*Trained
Technicians...*

ARE CLEARED TO COME IN!

Special skills expertly maintain the global operations of our expanding United States Air Force. It is special skills of trained craftsmen, behind the flying skills, that keep our modern air power aloft to defend our nation.

Men with training as former specialists in any Service . . . or non-veterans with special technical talents . . . are needed *now* to support our ever-growing air might. Radio, radar and other communications specialists, weather, armament, automotive maintenance, medical technicians and many technical skills are urgently needed . . . now . . . today!

For your specialized "know-how," your

Air Force offers greater opportunities for advancement, security and a rewarding sense of an important job well done.

Here, briefly is the story: If qualified, you can enter the Air Force in an attractive grade, according to your present ability. The Air Force will tell you exactly what your initial rank and pay grade will be before you join-up. Veterans, if qualified, enter in their old grade or better and will skip basic training and be assigned initially to a nearby Air Force Base.

For the rest of the story in detail, consult your local U. S. Army-U. S. Air Force Recruiting Station immediately, or *mail coupon today!*

MAIL COUPON TODAY for Full Information

AIRMAN PROCUREMENT
 Headquarters, U. S. Air Force
 Washington 25, D. C.

Please send me details about U. S. Air Force specialists.

NAME _____

ADDRESS _____

CITY _____ ZONE _____ STATE _____

SPECIALTY _____



**WORLD'S
BEST
WANT AD
MEDIUM**

CLASSIFIED Advertisements



Advertisements in this section 85 cents per word, each insertion, minimum 10 words, payable in advance. To be inserted under proper classification, copy must be in our office the 20th of the second month preceding date of issue
F. W. Johnson, Manager, Classified Advertising
Popular Mechanics Magazine, 200 East Ontario Street, Chicago 11, Illinois

YOU'LL PROFIT

By reading and answering the classified ads in this section. Hundreds of opportunities for you to make and save money

AUTOMOBILES, MIDGET CARS

"SPEED Equipment." Save up to 50%. Hollywood mufflers \$4.95, dual mufflers \$18.95, header kits \$9.95, cut outs \$6.95, dual intake manifolds \$12.95, chrome stacks \$1.25, racing cams \$29, hi-compression heads \$18.95, water injectors \$5.95, customizing kits \$1.98. Thousands of accessories. Catalog plus Soup-Up Handbook 25c. Alquist Engineering, Milford 14P, Penna. Dealers wanted.

HOT Rod cam shaft regrinding. Auto Electric Service, Box 54, Anderson, Ind.

MAKE Ford use diesel fuel. \$5.00 for plans. Refiner, Box 292, Columbus, Nebr.

BUILD, Reshape your own sports bodies with plastic (Fiberglass-Polyester). Catalog 10c. Gem-O'-Lite, Box 686C, North Hollywood, California.

AUTOMOBILE Literature—Old, new and foreign; glossy photos; shop manuals; data books; free motor magazines. Write today; get on free mailing list. Auto Maniacs, Stockbridge, Mich.

BUILD Midget auto. Complete drawings, pictures and list of parts \$1.00. Lee's Midget Autos, 3301 Dupont Ave. So., Minneapolis, Minnesota.

SPEED Equipment from the world's largest firm. 25c for huge catalogue. Newhouse Automotive Industries, Los Angeles 22.

HOP Up, the monthly magazine that leads the field for hot rods, custom cars, speed secrets and racing information. Send 20c for sample copy or subscribe now, \$2.00 year. Write Dept. PM, 530 Colorado Blvd., Glendale 4, Calif.

LATEST 1952 Edition! Just out—100 new pages! Get world's largest auto accessory and parts catalog and save money. Over 50,000 items, including Hollywood accessories, hi-speed equipment, rebuilt engines, all parts and accessories for all cars and trucks. We have that hard-to-get part! Jam packed with bargains. Completely illustrated. Send 25c (refundable). J. C. Whitney, 1919 Archer, Chicago 16.

SERVICYCLE \$15, Midget car \$10, Dart motorscooter \$17, less engines; two cylinder opposed 5 horsepower engine \$20, others \$7.50 up (mailorder only). Send 25c for catalogue number 47, listing these and hundreds of other bargains in midget cars, motorscooters, outboard motors, homebuilders parts, plans, etc. (35c by first class mail). Midget Motors Directory, Athens, Ohio.

SAVE—California custom accessories headquarters. Buy direct from original designers. Chrome dash panels, electric push button door-trunk conversions, fender skirts, dual mufflers, lowering kits, speed-dress up equipment. 40 page catalog, hundreds of photos—25c. Eastern Auto, 3319A South Grand, Los Angeles 7, Calif.

POWERCAR Junior—Real children's auto! See details under "Motorcycles, Bicycles."

CHEVROLET Owners—Save money; make your Chevy run better, last longer! Get Popular Mechanics big Manual for Chevrolet Owners by Ed Packer today. 304 pages; hundreds of illustrations. Find out how to make your own repairs; keep your Chevy in tip-top shape. First minor adjustment or repair saves you many times cost of book. Send \$3.50 today to Popular Mechanics Press, Dept. 108, 200 E. Ontario, Chicago 11, Ill.

AUTO SUPPLIES AND EQUIPMENT

SPEED Equipment. Edelbrock, Offenhauser, Navarro heads, manifolds, Winfield cams, dual ignition points. Chev. 37-51, Ford 49-51. Deeptone mufflers, headers, dual muffler sets, Mallory coils, distributors. Speed catalogue 25c. Urzi's Auto Supply, San Jose, California.

FIBERGLAS-Plastics for bodies and hard tops. Professional instructions free with order. Write leading suppliers. Industrial Plastics, 4425 Linden Street, Oakland 8, California.

AUTOMATIC Starter switch for cars having solenoid switches only. Works from gear shift and so handy you will be thrilled with it. Special get-acquainted price \$7.50. Write for information. Louis F. Jezek, Route 3, Box 192, Temple, Texas.

*MOTORIST! Protect your radiator and motor block. "NoRustAtol." Best since 1929. Frees cooling system of rust and scale. Prevents its formation. Harmless to any part of cooling system. Works in water or antifreeze. Does not evaporate. One treatment lasts all summer. Only \$1.00 postpaid. NoRustAtol Company, 481 Marion Street, Denver 18, Colorado.

AMAZING—Anti-static cloth. Eliminates annoying shocks from plastic seat covers. Retards dust collection inside radios, TV, on furniture. Many uses. \$1.00 postpaid. Rebecca Chaney, P.O. Box 92, Collegeville, Penna.

RUBBERIZED (transparent) coating. Keeps Auto bumpers (all chrome) gleaming bright. No polishing. Prevents exhaust gas blackening. Sells every gas station. 250% profit. Rubber Products, Dept. 44, New Haven, Conn.

CAR Washer. Finished job ten minutes. No drying. Mailed postpaid \$2.25. Delta Distributors, Moreauville, Louisiana.

"WATER Injection." Airflow needles. Economy methods. Free illustrated information. Neher Industries, La Verne, Calif.

7.50-1 HI-Compression heads. Fords \$25 pair. Plymouth \$20. Others. Write. F.O.B. Auto Parts and Service Co., West Salem, Ohio.

SPEEDOMETERS Exchanged \$6.95. Western Speedometer Exchange, 10452 Magnolia Blvd., North Hollywood, Calif.

HURRICANE Exhaust cut-out. Prepaid \$4.95. Kapelle, 3015 California, Topeka, Kansas.

89c GUARANTEED Fire extinguishers sell fast. Costing \$5.89 dozen, \$49.90 gross. Scheall, 263-X, Duluth, Minnesota.

LACHAPELLE'S Treatment. (Patented.) For \$3.00 puts babbitt bearings on the pistons. Free data. Ferns, 8120-B Walnut Dr., Los Angeles 1, Calif. Cuba, Luis Izaguirre, San Carlos 178, Cienfuegos.

BUY Racing heads, dual manifolds, hot coils, etc., without money. Information free. Newhouse Automotive Industries, Los Angeles 22.

BRAKE Floaters for Chevrolet, Ford and Mercury cars insure more powerful brakes, soft pedal, cure squeal. Write Super Brake-Floater Company, 4022 West Lake Street, Chicago 24.

LIGHT Your Powerglide and Dynaflo dials. Information free. Gaiser, Box 25, Kokomo, Ind.

WHEEL Alignment recorder. Drive over, \$22.50. Guaranteed. Align-A-Matic, 62 Gaston St., West Orange, N. J.

FAST Getaway? Completely new tuneup formulae! You'll beat them all at getaway. get more mileage! Complete cost, \$1.00. Johnson, Box 657, Rio Grande City, Texas.

MOTORIST Save gasoline by vacuumating overrich mixtures. Fits all cars. For free particulars write Vacuumatic, Dept. 1918, Wauwatosa, Wis.

AMAZING New patented product, restores compression, reduces oil burning, adds new life to engine. Motoloy actually metal plates worn pistons, rings, valves. No tools needed. Safe, economical. Guaranteed 50,000 miles! Details free! Garden State Sales, Inc., Garwood 1, N. J.

HOW To buy speed equipment without money. No selling. Information free. Newhouse Automotive Industries, Los Angeles 22.

RUST Remover—Amazing imported Jen-o-lite. Rust and scale disappear off any metal surface; automotive or household. Non-toxic, money-back guarantee. 8 oz. bottle includes brush. 95c plus postage. General Auto Supply Co., East 36th St. at Carnegie Ave., Cleveland 15, Ohio.

BOLTS, Nuts, screws, washers, cotters, speednuts, gaskets. Send requirements. Federal, 3863 Tenth Avenue, New York 34.

NEW And used guaranteed parts for civilian and army cars and trucks. Largest stock in America. Mail orders. Pioneer Auto Wrecking Co., 734 W. 13th Ave., Denver, Colorado.

AUTO "Liqui-Moly" makes oil 300% more efficient. Protects bearings even if all your oil burns up. Higher speeds. Tighter bearings. Less heat. Less friction. Contains no graphite. A hot rods dream. 1/2 pt. \$1.15 prepaid. Case lots on request. Convincing literature free. Hal-Gas Auto Products, Box 912, Fonda, N. Y.

SIRENS. Air horns! Bermuda bells. Free accessory catalog. McCanna Company, 200-PM East 21st, New York 10.

GASOLINE Economizer. Automatic. For all Ford V-8's and Mercury cars only. latter through 1948 models. \$4.95 each. No c.o.d.'s please. Palmer Sales Company, 6218 Clayton Avenue, St. Louis 10, Mo.

BE Independent, save money. Grind crankshafts without disassembling engine. New hand operated tool \$3.75. Literature. D. McGee, 719 Cascade, Wenatchee, Wash.

CAR-Hammock, convert your car into a double bed at any time. Universal, works on 2 or 4 door sedans, club coupes and convertibles. No cutting your seats or soiling interior. Folds up when not in use for storage in trunk of car. Send \$2.00 for complete plans and illustrations to Auto Bed Company, 301 West 6th Street, Panama City, Fla.

OVERHEAD Valve adjustment is fast, simple, easy with Peelzit-Seezit tappet tool. Postpaid \$2.85. Guaranteed satisfaction. Free circular. Atmars-Mechanico, 3561-M Lakeshore, Oakland 10, Calif.

REMANUFACTURED Engines. New car guarantee. Marvin, Box 5046, Cleveland 1, Ohio.

TIRES: Wholesale. Major brands. Free list. Field Tire, Downingtown 3, Penna.

BODY And fender men: Five time saving tools you can make yourself—Plans \$1.00. Shuman, 3117 Division Street, Los Angeles 65, Calif.

FRENCH Revolver \$2; .22 rifle \$5; 1824 musket \$8; double-barrel 12 gauge \$10; arrowhead collection 70c. Rush 25c (35c first class mail) for catalog #510 listing other bargains in guns (new and old), swords, relics, etc. Jetsco, Box 1682-CS, Toledo, Ohio.

CAST Iron molds—For casting fishermen's sinkers. Free illustrated booklet. Reading Instrument Co., Box 78, Reading, Penna.

120 PROFUSELY Illustrated pages antique pistols, swords, daggers, armor, etc. 50c. Robert Abels, M860 Lexington Ave., New York 21.

SHOTGUNS, Rifles, Revolvers, 500 modern, obsolete. Also cartridges. Each list 10c coin. Ed Howe, 52 Main, Coopers Mills, Maine.

5000 BARGAINS, Firearms, binoculars, war relics. Catalog 50c. Smith Firearms, Runnemede, N. J.

MOLDS. (For fisherman's sinkers, squids, jigs and lures.) Handled and hinged. Quality fishing tackle. Free catalogue. E. L. Sweet & Son, Tonawanda, New York.

BINOCULARS, TELESCOPES, MICROSCOPES, MAGNIFIERS

SAVE 50% On new binoculars! Free catalog. Free book, "How to Select Binoculars." Write today! Bushnell's, 43-M-37 Green, Pasadena 1, California.

TERRIFIC Values. Binoculars, telescopes, microscopes, \$3.95 up. Request free money saving catalog. Criterion, Hartford, Conn. Dept. P4.

SAVE 50% German, French binoculars, telescopes. Send for free catalog. Continental Trading, 652-P Diversey, Chicago.

ERECTOR Converts any astronomical telescope to terrestrial use. \$2.00. Telescope Camera Co., Manorville, N. Y.

BUILD A 100X, 45X astronomical telescope that converts to a 45X terrestrial telescope! Inexhaustible source for thrills! 3 perfect ground and polished lenses; complete instructions for easy building. Money back guarantee. \$3.00. Lemar Scientific Corp., Dept. D73, 3412 W. Jackson Blvd., Chicago 24, Ill.

POWERFUL Telescope easily made. Perfect lenses, erector and instructions for making 40, 100, 200 and 400 power telescope. \$6.00. Telescopic Camera Co., Manorville, N. Y.

SAVE! Free 24-page, 3 color binocular catalog. 60 different models. United Binoculars, A-4508, 9043 S. Western, Chicago 20. Display Rooms open Mon. thru Fri. 9:00-3:30.

WAR Surplus bargains, binoculars, telescopes, sextants, millions of lenses, prisms, reticles, eyepieces, objectives, etc. Mail 10c for big "Catalog CH." Send \$1.00 for Stock CH—10-piece lens kit and big instruction booklet. Edmund Scientific Corp., Barrington, N. J.

MAKE Your 6" telescope reflector. Glass, abrasives, instructions—\$8.50. F. Cameron, Box 65, Inwood 96, N. Y.

REFLECTING Telescopes, 60X, completely assembled \$29.75. Guaranteed observatory clearness. Free information. Skyscope, 475 Fifth Avenue, New York 17.

AMAZING Prices, imported precision binoculars. Free trial. Pricelist, folder "Selecting Binoculars" free. Prentiss Importers, Mercury Bldg., Los Angeles 25, Calif.

POWERFUL Astronomical telescopes easily made. Perfect lenses and instructions; 100X \$3.00; 100X and 200X \$4.00; 100X, 200X and 400X \$6.00. Full power, clear vision guaranteed. Instructions alone 10c. Suffolk Science Service, Riverhead, N. Y.

BINOCULARS, Telescopes, microscopes. Our 20th year of leadership in optical values. Bargain catalog free. Brownscope Co., 24 West 45th Street, New York.

REFLECTOR Telescope kits, refractors. Free illustrated bulletin. Esco Products, 911 Willow Ave., Hoboken, N. J.

GIANT Astronomical telescope with 6 ft. tripod \$15.00, f.o.b. factory. 100 power. (10,000 area magnification). Clear vision, full power guaranteed. Ready for use. Suffolk Science Service, Dept. BT, Riverhead, N. Y.

TAXIDERMISTRY

MODERN Taxidermist Magazine, Greenfield Center 2, N. Y. Devoted entirely to taxidermy, photos, articles, methods. Trial year's subscription, \$1.00.

PETS—DOGS, BIRDS, RABBITS, HAMSTERS, ETC.

BIG Profits. Raise guinea pigs. Free booklet. Taylors, B426A, Hapeville, Ga.

GOLDEN Hamsters, bear strain. Pedigree stock. Breeders, laboratory or pet stock. Shipped express anywhere. Price list free. Charles E. Bowser, Smoke Run, Penna.

BIG Profits—Raise rabbits. Free booklet. Tayco Rabbitry, Hapeville, Georgia.

FAMOUS Angoras, Chinchillas, White Giants! World's most profitable rabbits. Finest heavy-producing prize-winners. Catalog free. P. M. Grinsteeds, Edwardsville, Illinois.

67 VARIETIES—Pigeons, peafowls, rabbits. Booklet 10c. Houck's, Tiffin 23, Ohio.

BOXERS, St. Bernards, Hof Kennels, 5136 Cascade Rd. S.E., Grand Rapids 6, Mich.

BEAUTIFUL Pure white pedigreed police puppies. Ansonia Kennels, Mose, N. Dak.

RABBIT Raising pays. Illustrated literature tells how. Old Mill Rabbit Farm, Elmhurst, Illinois.

"STOP Mange." Keep mange away from your dog. Electro all metal collar prevents "mange." Approved by eminent veterinarian. Send neck size with two dollars and collar with lock will be sent postpaid. Send order to—Bailey, P.O. Box #26, Waltherboro, S. C.

STANDARD Rabbit Journal, B-241-M, Milton, Penna. Year \$1.00, sample dime, beginner's manual 25c.

EARN Up to \$400 monthly raising Angora or New Zealand rabbits. Plenty markets. Particulars free. White's Rabbitry, Newark, Ohio.

HAMSTERS—Golden or spotted. Cages and equipment. Free illustrated details. Lakeview Hamster Colony, Newfield, New Jersey.

BOOKLET "Treatise on Breeding and Raising Canaries"—\$1.00. Audubon Publishing Co., 3449-PM N. Western, Chicago 18, Illinois.

MAKE Big money! Raise Chinchilla rabbits. Cash markets supplied. Write today! Rockhill Ranch, Sellersville 15, Penna.

MINK Raising information free. Complete. Lake Superior Mink Farm, Superior, EEl, Wisconsin.

A Practical beginning to successful rabbit raising. 48 page illustrated booklet. Dime. American Rabbit Breeders Association. 36 AR & CBA Bldg., Pittsburgh, Penna.

PLANTS, SEEDS, NURSERY AND GARDEN SUPPLIES

CORSAGE Materials. Flower arrangers' supplies. Artificial flower parts. House plant helps. Free catalog. Floral Art, Dept. PMJ, Teaneck, New Jersey.

FARMS, FARM LANDS, REAL ESTATE

NEW List stock farms, central Arkansas. Ideal for stock. Good markets. Owen Farm Agency, Conway, Arkansas.

CHEAP, Profitable orchards, farms, ranches, homes, in beautiful, healthful, fertile Ozarks. Free literature, lists, information. Write, Barnsley, Clarksville, Ark.

UNITED Farm Agency's big free summer catalog of farm and country real estate bargains can help you plan soundly for your future security in the country. Good pictures, many states, easy terms, many equipped, growing crops included. For special service, state requirements, desired location. Write for your catalog today, it's free! United Farm Agency, 220 South State St., Chicago 4, Ill.

5 ACRES And independence. Book, 45 chapters. "How to" select, finance, stock, develop, etc. small farms. Send \$1.00 today for this amazing book, postpaid. Landcraft, Cole Camp, Mo.

FARM And business catalog free! Big new edition. Over 1000 bargains from \$100 up. Maine to Florida. West's, M-7, Pittsburgh 17, Penna.

FARM, Ranch, hunt, fish on your own land in beautiful Calif., Oregon and Washington. Now available, several thousand choice acres from \$10 to \$25 per acre, full price, including 100% oil and mineral rights. Low, easy terms. Send only 10c (coin) for full details, catalog, photos. Pacific Lands, Box 2350-BW, Hollywood 28, California.

STROUT'S Two catalogs. Farms, homes, businesses. 3646 bargains, 31 states. East and midwest green cover; west coast edition yellow. Either free. World's largest. Strout Realty, 7-M So. Dearborn St., Chicago 3, Ill.

\$5.00 MONTHLY Buys 40 acres near town; price \$200.00. Free list. Box 425-P, Carthage, Missouri.

FARM-Ranch opportunities. Favorable conditions, Washington, Minnesota, Montana, Idaho, Oregon, North Dakota. Literature, farm descriptions. Specify which state. J. W. Haw, 119 Northern Pacific Ry., St. Paul 1, Minn.

HOMESITES \$300—Convenient payments. California's finest garden section. On Morro Bay's scenic shores. Wonderful fishing, boating, bathing. Fertile soil, softest water, temperate climate, congenial community. Free literature. Richard Otto, Department M, San Luis Obispo, Calif.

POULTRY, FARM SUPPLIES

FUEL Oil, gas burners for any fire box. Small cook stoves, ranges, heaters, brooders. Gravity flow, natural draft. \$14, \$16, \$20. Sievert, 710 N. Main, Los Angeles 12, Calif.

KNOW How to raise poultry for profit. Read Poultry Industry. Every issue packed with helpful hints and practical suggestions. Latest articles on breeding, feeding and management. Subscribe now, 1 year 50c, 3 years \$1.00. U. S. funds or checks payable at a New York or Boston bank. Poultry Industry, Dept. PM, 376 Boylston St., Boston 16, Mass.

PROFITABLE OCCUPATIONS

\$4 TO \$10 Hour spare-time in billion-dollar adjustment field. Qualify now! Write today. Universal Schools, M-59, Box 8202, Dallas 5, Texas.

CONSTRUCTION Workers. Want to make better jobs? Longer jobs? Latest information. Jobs breaking. Jobs underway. North, south, east, west. The best. Big job list. Accurate. Up to date. Send one dollar. Dempster's Construction Scout News, Dept. 268-JH, Bridgeport, Ill.

MEN, Women, visit foreign countries on modern ships. Big pay, adventure, experience unnecessary. Valuable guide \$1.00. Davenport, 1170-A1 Broadway, New York 1, N. Y.

FOREIGN Employment construction men, building trades, helpers, office men, others, interested in foreign projects. High wages, quarters, transportation. Send \$1 for foreign construction compendium and application forms. Foreign Service Bureau, Dept. PM7, Metuchen, New Jersey. (Not an employment agency—No fees.)

WANT A diesel job? New opportunities to increase income. Higher pay. More money. We can help you qualify. Tools. Shop method home training. Write today! Diesel, Tractor, Heavy Equipment Division, Interstate Training Service, Dept. 3G, Portland 13, Oregon.

FOREIGN Jobs. Contracts underway and soon starting in Africa, South America, Canada, England, Europe, South Pacific, Middle East, Mexico and Alaska. Send \$1.00 for foreign job news, information, application forms, etc. DCS Foreign Job News, Dept. 268-JK, Bridgeport, Ill.

GROW Mushrooms. Boxes, basements, gardens, lawns, grasslands. Instructions 35c. Mushroom spawn \$2.14. New manure-less process \$2.50. Send for complete 3 item new kit \$4.99. No. c.o.d. please. Guaranteed fresh spawn or your money refunded. Thomas Co., Dept. 79, 3604 30th Ave. S.W., Seattle, Wash.

ALASKA! Over 100 new construction contracts just released, with names and addresses companies hiring. Employment information on government agencies, mining, fishing, lumber, aviation, railroads. Also homesteading. Our information accurate. \$1.00 complete. Alaskan Opportunities (PM), Box 362, Kenmore, Wash.

START A buying service. Buy wholesale thousands nationally advertised products. Make big profits selling at sizable discounts. Send postcard for details. American Buyers' Service, 631-R Linden, Buffalo, N. Y.

GROW Mushrooms. Cellar, shed, and outdoors. Spare, full time, year round. We pay \$3.50 lb. We paid Babbitt \$4.165 in few weeks. Free book. Washington Mushroom Ind., Dept. 99, 2954 Admiral Way, Seattle, Wash.

SEND For big, new 1952 illustrated catalog that will show you how to turn your spare time into cash—making quick-selling, highly profitable lamps. Every home a prospect. Hundreds doing it, you can, too. No experience or special tools required. Catalog No. 7 contains 56 pages filled with shades, shade frames, figurines and bases, oil lamp converters, boring compound, and dozens of similar items. Also all kinds of sockets, cords, pipes, harps, finials, bases, and hundreds of other parts—everything you need. Special 8-page section shows 6 beautiful lamps in kit form, ready to assemble. You buy wholesale, sell at retail. Make big profits. Send 25c today for new 1952 catalog and wholesale price list, you'll be glad you did. The 25c will be refunded on your first order. Gearon Co., Dept. 500-B7, 27 S. Desplaines, Chicago 6, Ill.

MONEY In rabbits. Booklet for dime. Mohican, Box 68, Poquonock Bridge 3, Conn.

MUSHROOMS Grown. Boxes, barrels. Instructions 50c. Spawn \$1.00. Manureless process. \$2.00. Gordons, 553 William, Winnipeg, Manitoba.

\$10,800 PROFITS! Your own mailorder business! No capital risk! "Success plan" (worth \$2) free! Write today! Treasury, 149 Storer, New Rochelle L-1, New York.

WANTED! At once! Home producers by manufacturers in our clearing house service. Become a sub-contractor casting plastic products for these companies. Thousands of easy to make items required. Cash in at home, without previous experience. For details, write Plastic Service Guild, Dept. PM5, East Boston 28, Mass.

BE The Popular Mechanics representative in your neighborhood and earn big profits in your spare time. Write Popular Mechanics Magazine, Room 408M, 200 E. Ontario St., Chicago, Ill.

MAKE Flexible molds! Cast plaques, bookends, figurines! Free sample! H. Tooker, 630-M Chestnut, Hamilton, Ohio.

FOREIGN And Latin American employment. 1952 "Foreign Service Directory" gives up-to-minute facts on military and civilian construction, government jobs, major oil listings, aviation, transportation, steamship lines, mining, importers, exporters, how-when-where to apply, application forms, hot list firms hiring. \$1.00 postpaid. Global Reports, P.O. Box 883-P, Hollywood 28, Calif.

FREE Book "505 Odd, Successful Businesses." Work home. Expect something odd! Pacific, Oceanside, Calif.

"EVERYBODY Likes candy"—Learn to make professionally. (Our 40th year.) Ragsdale Candies, D6, East Orange, New Jersey.

ALASKA—Last American frontier. \$1.00 brings 1952 business directory, government map, construction projects, military and civilian, homestead and highway facts, hunting-fishing-game rules, mining, aviation. List of firms hiring. How-when-where to apply. Alaska Opportunist, P.O. Box 883-P, Hollywood 28, California.

RAISE Pheasants on the \$100 week plan. Little capital and space can make you independent. Free details. Great Central Game Management System, Columbus 1, Kansas.

\$40.00 WEEKLY Made growing mushrooms, fresh, dried. Dominion patent 331583. Free spawn. North American, 169P Yonge, Toronto, Canada.

BOOKS, PERIODICALS, PICTURES, POSTCARDS

FREE Catalogue. Special interesting books. Melvin Powers, 1324 Wilshire, Hollywood 17P, California.

BOOKS For sale. Used. Out of print. Catalogue free. Balliol, Box 85, Station "K," Toronto, Canada.

FORGINGS—Practical handbook for draftsmen and designers on designing, dimensioning, tolerancing, forgings. Only complete authoritative text. Accepted by industry. \$2.00. Send check or money order. Satisfaction guaranteed. Allied Press, 1338 So. Michigan, Chicago, Ill.

BOOK Bargains. All subjects. Send stamp. Vallon, 63 Perry, New York 14.

CATALOG 400 Popular books. Bargain prices. 10c. Books Publishing Co., 56-F W. 24th St., New York 10.

BOOKHUNTERS! All subjects. Send wants! Jaher Book Service, 620-P East 178 Street, New York 57.

MAGAZINES (Back dated)—Foreign, domestic — Arts, books, booklets, subscriptions, etc. Catalog 10c (refunded). Cicerone's, 86-22 Northern Blvd., Jackson Heights, N. Y.

BOOK "Breeding of Parakeets" and cage-bird magazine—\$1.00. Audubon Publishing Co., 3449-PM N. Western, Chicago 18, Illinois.

BOOKHUNTERS! Scarce, unusual, miscellaneous books supplied. Atlantic Book Service, Lawrence Avenue, Charlestown 29, Massachusetts.

MAGIC TRICKS, PUZZLES, JOKER NOVELTIES

BEAUTIFUL Magic cigarette case. Fill with cigarettes, close, reopen and presto! Cigarettes have vanished. Magic case and illustrated circular, 50 cents. Royall's, 1920 Heights Boulevard, Houston, Texas.

VENTRILOQUISM Taught. 3c stamp brings particulars. Smith, 801 Bigelow, Peoria 5, Ill.

LATEST Magic, jokes, etc. 64 page catalogue 25c. Top Hat, 529M Main, Evanston, Illinois.

MAGIC Monthly, year 25c. New 1952 magic catalogue 10c. New joke lists 5c. Magic Factory, Minneapolis 2, Minn.

3 CARD Monte trick and catalogue 25c. Sterling Magic, Royal Oak, Mich.

GENUINE Wooden nickels, magic catalogue and trick, all for 35c. Fun 'n Magic, 511 N. St. Marys, San Antonio, Texas.

512-PAGE Catalogue of 2500 tricks, pocket, parlor, stage. World's finest magic. Send \$2.00 for catalogue (refunded first \$8.00 order). Kanter's, M-1311 Walnut, Philadelphia 7.

VENTRILOQUISM Self taught. Quick, easy instructions, 25c. "Ventriloquist," Cal Allen, Texas.

FREE Trick and large illustrated catalogue 35c. Lerro Magic, 8111 Fifth Avenue, Brooklyn 9, N. Y.

WORLD'S Largest magic shop. Special: Big \$2 book of professional magic tricks, only \$1. Includes mailing lists. Holden's, M220 West 42nd St., New York.

BIG Fun kit! Tricks, jokes, novelties, books. Real clever stuff. Howls galore. \$1.00. Johnson, 414 McRae, Wilmington, N. C.

LATEST Magic for pocket, parlor, stage. Catalog 500 tricks, only 10c. Unequaled magic service for 30 years. Douglas Magicland, Dept. 1, Dallas, Texas.

PROFESSIONAL Catalog, 124 pages, 25c. Williams, 900 Plymouth, Ellwood City, Penna.

BE A magician. Large professional magic catalogue of latest tricks, 35c. Ireland, C-109 North Dearborn, Chicago 2.

COINS, TOKENS, CURRENCY

COIN Collecting: Exciting and very profitable hobby. Four old, all different U. S. coins no longer minted, catalog and details \$1.00. M & L Coin Sales, Box 333, Sparta, Michigan.

WHAT Are your coins worth? Amazing Fell's United States coin book. Everything on every single coin minted—Worth, value, how to sell, speculating, investment; other valuable facts on coins. Cloth-bound, 150 illustrations. Send no money. Pay postman only \$1.50 (plus postage) or \$1.50 postpaid (refundable). Order now! Fell Publishers, 386M4 4th Ave., New York 16, N. Y.

OLD Money wanted. Will pay fifty dollars for nickel of 1913 with Liberty head (not buffalo). We pay cash premiums for all rare coins. Send 4c for large coin folder. May mean much profit to you. Numismatic Co., Dept. 20, Fort Worth, Texas.

30 DIFFERENT Coins \$1.00. 66 different bills \$1.00. Oddehon, Box 482, St. Louis, Mo.

48-PAGE Book, prices we pay for coins, only 50c. Cook Coins, Box 181, Jackson, Mississippi.

"COIN Collector's" greatest magazine. Foreign money and wooden nickel 10c. Lawrence Brothers, Anamosa, Iowa.

SET Nine Japanese invasion notes for U. S. \$2.00. Catalogue thousands of coins, 25c. Shultz, Salt Lake 10, Utah.

GET Profit and pleasure in collecting old coins. Send 10c for 56 page illustrated coin catalog. You'll be delighted with it. Send for it now. B. Max Mehl, 370 Mehl Bldg., Fort Worth Texas. Largest rare coin establishment in U. S. Established 52 years.

FREE! Foreign coin, banknote and coin collectors illustrated catalog to approval service applicants. Send 3c postage. Tat-ham Coinco, Springfield 30, Mass.

FIFTY Assorted Indian cents, \$1.50. Rare 1931-S cents, \$1.00. Giant fifty-two page illustrated bargain catalog, 10c. Ben's PM Department, 31 North Clark, Chicago 2.

COIN Collector's Magazine. Largest independent, over 1000 pages per year. Sample copy 30c; \$3.00 per year. Hewitt, 5450-J Clark, Chicago 40.

STAMP COLLECTING

FREE—50 Mint, including San Marino set, Marinus set, approval applicants. Broadmoor Stamp Co., Pittsburgh 34, Penna.

YOU Stretch your dollar when buying our mounted 1c and 2c foreign approvals. Also U. S. at bargain prices. Don't delay, write today. Roseland Stamp Co., Dept. 10-C, Spring Lake, Michigan.

COLLECT Scandinavia, 111 different. Rare value, 25c. Olson, 801 Ninth Chester, Cleveland 14, Ohio.

100 VARS. Better than average foreign, plus worthwhile premium, 25c. C. Ritchie, Watertown, South Dakota.

DEALERS—Wholesale list. Postage 3c. Frank, 5031 Queensberry, Baltimore 15, Maryland.

FREE: Mint British Colonies from Tonga, Seychelles, Brunel, Transjordan, Sarawak, Solomon Islands, Caymans, Gilbert Ellice—Free with approvals. Viking, 130-Z Clinton Street, Brooklyn, N. Y.

FREE Complete set of famous Americans, flags, parks and presidentials to approval buyers. Send 3c for 15 of the above stamps plus full particulars. Triboro Stamp Company, 145 Nassau Street, Dept. 107, New York 38, N. Y.

CANADIAN Collection free — Includes early Victorian issues, jubilees, high values, commemoratives, special issues, Newfoundland, pictorials, etc., etc., together with Philatopic Magazine all free. Send 5c postage. Empire Stamp Company, Dept. PM, Toronto, Canada.

300 DIFFERENT Given free with approvals. Postage 3c. Windsor Stamps, 1435 East 67th Place, Chicago 37.

TRIANGLES! 5 Beautiful, bicolored bird triangles, only 3c to new approval applicants. T. Moublow, 740 Hegney, Bronx 56, N. Y.

1/2 CENT Approvals. Povilauskas, 212 E. 3rd St., New York 9, N. Y.

IS Your hobby too expensive? Are high prices keeping your collection on the shelf? Try our 1c and 2c foreign approvals in books of 1,000, or U. S. at bargain prices. Clark, Box 544-P5, Muskegon, Mich.

FINE Approvals. Fast, personal service. What countries do you prefer? I'll send their stamps. Skinner, 438 Locust, Long Beach 12, California.

300 DIFFERENT French Colonies. \$1.00. Scott, 2653 Midwood, Toledo 6, Ohio.

HIGHEST Prices paid for collections, accumulations. Stanwill Company, Fostoria, Ohio.

FREE—30 Different, to applicants for unbeatable U. S. approvals. Sparta, Box 1082, Rochester 3, N. Y.

FREE With approvals. Beautiful Israel and U. S. packet. Stamps, 1463 Drexel, Miami Beach 39, Florida.

COLLECTION Builders used complete famous Americans, flags, Roosevelts, plus 100 different commemoratives. All for \$3.13 cash. Valerga, 2374 29th Street, Astoria 5, N. Y.

APPROVALS! Jumbo foreign selections, or low price U.S. Panther's Prompt Stamp Service, Dorchester 24, Mass.

ITALY—100 Different 5c with approvals. DeRespinis, G.P.O. Box 771P, New York 1.

GERMANY B257-69, Warplanes, tanks; free to approval buyers. William Deems, Ravenswood, West Virginia.

SEVEN Triangles and assortment choicest beauties. Everything 10c with approval. Stan Bubenka, 27a James Ave., Clark Cranford, N. J.

SCOTT Looseleaf U.S. album \$2.50! Fine used flag set 75c! Both \$3.00! Catalog free! "Stamps by Mail," 2133 Lunt, Chicago 45.

50 DIFFERENT U.S. commemoratives. \$2.00 catalog value. Good foreign. Both \$1.00. Hager, Box 10, Buffalo 11, N. Y.

100 NETHERLANDS. All different. Beautiful assortment. 10c with approvals. Thomson's, Box 4074-P, Miami, Florida.

HUNGARIAN Bird set. Triangles. 3c with approvals. Timpeg, 2388 Westcliffe, Walnut Creek, California.

105 DIFFERENT Including triangles 10c. Approvals. List free. Philatelic House, Rockville Centre, N. Y.

EXCHANGE—Send 100 different stamps, 25c and self-addressed stamped envelope. We sent 100 others. MacKellar, Box 4683, Los Angeles 24, California.

100 DIFFERENT France 10c. Approvals. Aronson, 91 Marion, Brookline 46, Mass.

1000 ITALIAN Fine large pictorials \$2.00. Beverini, Caselpostale, Ge-Pegli, Italy.

1000 CANADA Off paper 50c. 500 mixed stamps 10c. Approvals. Mantle Stamp Company, London, Canada.

12 FOREIGN Stamps picturing General MacArthur, 20c. Approvals. Walter Sandberg, Whitehall, Michigan.

MAGAZINE "Stamp World," year subscription 50c. Fuld, P.O. Box 75(P), New York 58, N. Y.

155 DIFF. Finland Olympic, Iceland, Scandinavia, \$1.00. Epaivio, Mantta, Finland.

ARMENIA Pictorials, worth 75c, free with approvals. Sunvalue, 1735 S.W. 11th Street, Miami, Florida.

COLLECTOR Offers big collection, album, etc., other items, bargains. All or part, cash or terms. Write for list. W. Kennell, Box 157-1, Pateros 1, Wash.

BIG Bag mixed stamps. Enormous quantity. \$1.00. Longacre Shop, 583 1/2 Sixth Avenue, New York City 11.

FREE! 25 Different Switzerland with swell approvals. Kardell, 209 Bower, Santa Fe, New Mexico.

300 STAMPS For only 10c.—This mammoth value includes airmails, pictorials; stamps from strange countries cataloguing up to 25c each! Also approvals. Mystic Stamp Company, Camden 80, New York.

FIVE Triangles free with approvals. Exotic Stampco, Box 2104, Miami 12, Florida.

FREE "Stamp Finder." Tells instantly country to which any stamp belongs. 32 pages profusely illustrated. Garcelon, Calais 17, Maine.

FREE—"German war issues," cataloging \$10.82 to approval buyers. Royal Stamp Company, Tamaqua, Penna.

FREE Stamp "circus" giants, pygmies, kangaroos, snakes, rhinoceros, ostriches, with approvals. Niagara Stamp Company, 17 Queensway, Niagara on the Lake, Can.

ILLUSTRATED U.S. list. 6c postage. Olson, 801 Ninth-Chester, Cleveland 14, Ohio.

ALBUM! Holds over 1000 stamps! Only 10c! Stampmart, Hartford 1, Conn.

307 ALL Different—Only 15c! Beautiful collection: commemoratives, triangles, high values, bicolored stamps, etc. Garcelon, Calais 400, Maine.

1000 UNIQUE Colorful attractive book mounted stamps 1c - 2c each. Rushed. Niagara Stamp Company, 11 Queensway, Niagara on the Lake, Canada.

100 DIFFERENT U. S. 25c. Approvals. Buckeye, Box 53, Mansfield, Ohio.

77 DIFFERENT United States—25c. Approvals. Utechts, 1143-D North Keeler, Chicago 51.

TEN Dandy sets 10c. Approvals. Faszold, 423c Cameron, St. Louis Co. 15, Mo.

FLAG Stamp—Free with hydrate U. S. approvals. Wenigman, 1933 Patterson, Chicago 13.

OLD Scarce U. S. seconds on approval. Slightly defective. Bargain prices. Hernefield, Clintonhill Station, Newark 8, N. J.

STAMPS Wanted. Collections, duplicates, surplus stock, mint and used. Good grades only. Buy outright if bargain. What have you? Write us details. Vanroy Shirk, Lebanon, Penna.

WORLDWIDE Variety packets 100 10c; 500 60c; 1,000 \$1.25; 2,000 \$3.25; 5,000 \$13.75. Philatelic House, 189 Merrick Rd., Rockville Centre, N. Y.

200 DIFFERENT. Triangle, airmail, pictorials, etc.; 10c. Carlton's, Tujunga, Calif.

1/2—1—2c APPROVALS. Bargains galore! Cole, 43A Rinewalt, Buffalo 21, N. Y.

40 DIFFERENT U. S. commemoratives, airmails 25c. Seidenberg, 944, Appleton, Wis.

FREE Sample—Interesting, informative, illustrated! National Stamp News, Anderson, South Carolina.

AMAZING Offer! 500 United States stamps—including commemoratives, air mails, high denominations to \$5.00. Only 15c to approval applicants! Illustrated bargain lists free. Mystic Stamp Co., Dept. 80, Camden, New York.

FREE Very large Japan Flying Geese Stamp. Approvals included. Hathaway, P.O. Box 211-P, Hempstead, New York.

POLAR Bear triangle, giant George Washington, six colored Ecuador, Arctic triangle, first American commemorative, Corsica, Devils Island, others. Everything free with approvals. Capital Stamps, Little Rock 2, Ark.

FREE—Illustrated catalog! Kenmore, Milford, C-57, N. H.

"HOW To Recognize Rare Stamps." Free book illustrated! Kenmore, Milford, H-57, N. H.

FREE. Scott's International Album. Other big premiums. Full particulars with approvals. Raymax, 68-Z Nassau St., New York 38.

500 EXOTIC Japan stamps—10c. Kenmore, Milford, J-57, N. H.

DIFFERENT 500. 35c; 1000, \$1.00; 2000, \$2.00; 5000, \$10.00 with approvals at wholesale to clear. K. S. Holmes, London, Can.

U. S. Army and Navy heroes on stamps; 10c with United States approvals. Locust, Box 305-T, Harmon-on-Hudson, New York.

110 DIFFERENT Hitlers, Roosevelt, Liberia, Haiti, etc. with approvals 10c. Buckey, 208 Ludlow Bldg., Dayton 2, Ohio.

U. S. Price list free. P. Wetterquist, 1635—13th Avenue, Rockford, Illinois.

100 DIFFERENT Spain 25c. Penny approvals included. Reed, Box 980, Chicago 90, Ill.

50,000 STAMP Grabbags 25c each. Anderson, 630B Bingaman, Reading, Penna.

FREE Collection—Over 100 different stamps of world; commemoratives, animals, natives, ships, famous men, others all to approval buyers; also Scott albums, catalogs. Bell Stamp Service, Dept. S-2, Bell, Calif.

START Your own stamp business. Send for free circular. Donald Shepard, Box 1147, Chicago.

FREE! Powerful magnifying glass. Jamestown Stamp, Jamestown 202, New York.

200 DIFFERENT Including Roosevelt triangle, 5c to approval applicants. M. Avalon Stamp Company, Springfield, Mass.

NICARAGUA Sports, Costa Rica agriculture sets 10c with approvals. Seminole Stamps, Box 1138-P, Coral Gables 34, Fla.

UNITED States approvals—Select, used, mint. Kingsbury, South Woodbury 2, Vt.

50%-75% DISCOUNTS! Approvals from 33,000 collection—1/2c up! Schur, Box 235, Buffalo 12, N. Y.

NOTHING Free. Just good stamps reasonable. Send dime for seventy-four page catalog. Ben's Stamp Shop, 31 N. Clark, Chicago 2.

WOW! 203 All different Germany 10c! Zeppelins, semipostals, airmails, high values, etc. to new customers. Jamestown Stamp, Jamestown 512, New York.

WORLD'S Largest stamp (7 1/2 x 14 inches). A real curiosity! Retail for 50c, only 3c to approval applicants. Tatham Stamp Co., Springfield 30, Mass.

ANTIQUES, RELICS, INDIAN GOODS, CURIOS

4 PERFECT Arrowheads \$1.00; perfect pipe \$2.50, \$5.00; tomahawk \$3.00; knife 50c. Catalog 10c. H. Daniel, Lamar, Ark.

INDIAN Beadwork, leathers, beads, feathers, moccasins, wigs, supplies; buying direct from Indians; prices reasonable. Free list. Pawnee Bill's Indian Trading Post, Box 35-P, Pawnee, Oklahoma.

PRECIOUS STONES, MINERALS

FORTUNES Made in minerals! Identify minerals the quick, easy way. Field guide, \$1.00 prepaid. Clarke Books, 1817 Calif. St., Denver 2, Colo.

PROSPECTOR'S Handbook: Identify mineral ores quickly, positively, \$1. Research, Box 1124-PM, Knoxville, Tenn.

GEMSTONES, Mineral specimens. Every variety. Lowest prices. Postcard brings free booklet. Plummer's, 4720 Point Loma Ave., San Diego 7, Calif.

FIND Tungsten, mercury, uranium with Mineralight. Free brochure. Write Dept. PM8 Ultra-Violet Products, South Pasadena, California.

JADE, Agates, titanite, gems, hobbyists supplied, gem cutting machines. Free list. North West Gems, Box 305, Tacoma 1, Washington.

GEMS, Precious and semi-precious, genuine, from world-wide sources. Deal direct, no overhead, save money. Catalog 10c. Hill Co., 5450-G Portland Rd., Salem, Oregon.

GEMCUTTING, Silvercraft authority. Illustrated magazine tells how. Cut rocks, make jewelry. 150 ads illustrating equipment, offering gems for collectors, cutters. Postal brings literature. Lapidary Journal, Drawer B, Palm Desert, Calif.

HOBBIES AND COLLECTIONS

AMAZING—New fascinating hobby; collector's assortment of 57 authentic military insignia, ribbon bars, embroidered patches, naval rates; all branches armed forces. All for only \$1. Extra gift free with order! Pritt Co., 16 West 27th Street, Dept. M72, New York City.

LATEST Series hillbilly matches 25c. Free lists. Yeingst, 502 Parkway, Harrisburg, Penna.

WANTED—Cigarette, tobacco cards. Write Charles Bray, East Bangor, Penna.

UNUSED Matchbook covers—100 different \$1.00 36-page catalog 25c. Charles Edelman, 1311C East 84, Cleveland 3, Ohio.

INVENTING Can be an interesting and profitable hobby. Write for complete particulars. Institute of American Inventors, Dept. 40-E 631-E St. N.W., Washington 4, D. C.

CAMERAS, PHOTO SUPPLIES

PHOTOGRAPHERS—Volume business, good profits, assured from scratch with proven plan. Small cost; quick results. Studio A, Box 4255, Tower Grove Station, St. Louis 16, Mo.

GOVERNMENT Surplus equipment, film, paper, chemicals. Mogul's, 112 W. 48, New York.

PHOTOMURALS. Your negative or ours. Catalogue 25c. Photomammoth Murals, Dept. M, 12048 Vanowen Street, North Hollywood, California.

ADD "Spice" to home projection shows with colorful old-time Nickelodeon slides. 2x2. Write for free list. Nickelodeon Co., New Fieldner Bldg., Portland 5, Oregon.

BASS Says: Trading since 1910. Used but good as new buys: 8mm. B.&H. Sportster \$52.50; 16mm. Keystone A-7, F:2.5 lens \$37.50; Voigt 35mm. Vito II, flash shutter, Skopar F:3.5, like new \$38.50; Kodak Reflex F:3.5 lens, like new \$88.50; Contax I, F:2 Sonnar \$87.50; 3 1/4 x 4 1/4 Speed Graphic, Skopar F:4.5, Ibsor shutter, \$52.50. Satisfaction guaranteed. Bass Camera Co., Dept. AG, 179 W. Madison St., Chicago 2.

BUY Photographic supplies wholesale. Films, cameras, projectors, enlargers, binoculars. Free catalog. Capitol Photo Supplies, 2428 Guadalupe, Austin, Texas.

FREE Photographic bargain book packed with hundreds of sensational values in still and movie cameras, lenses and latest accessories. Super savings for you in new and used equipment. Liberal trade-in allowances, too, on your equipment. Write now for your free copy to Central Camera Company, Dept. 9L, 230 S. Wabash Ave., Chicago 4. (Photographic headquarters since 1899.)

PHOTO FINISHING

DOUBLE Size prints 8 exposure roll 30c; 12, 45c; 16, 55c. Same day service. Send for free mailers. Emerson Photo, Box P, Emerson, N. J.

8 CONTACTS 30c, Jumbos 40c, 12, 45c; jumbos 55c. Reprints 4c; jumbos 5c. Western Photo, Dept. PM 72, Box 298, San Francisco 1, Calif.

BILLFOLD Pictures colored, 25 cents each. Color Nook, Box 169, Des Moines, Iowa.

SPECIAL Offer, 8 exposure roll 25c; 12 exposure 40c. Super pak albums. Post-L-Pix, Box 1D, Worcester 4, Mass.

COPY Negative 30c; pictures from negatives 20 W.S. \$1; 12, 4x5, \$1; 8 5x7, \$1; 5 8x10, \$1; Margarita Bros., 203 Pitman, Fall River, Mass.

EIGHT Jumbo prints in album, 35c; 12, 50c; 16, 65c. Reprints, 5c. Free mailers. Southwestern Photo, Box 386, Tyler, Tex.

A Nickel a picture. Jumbo album. Example: 8 on roll, or 8 reprints—8 nickels. Free mailers. Nichols, Tyler, Texas. Est. 1901.

8 OVERSIZE Snapshots from roll, 25c with this ad. Foto's, Box 8, Aurora 1, Ill.

8 KEEPSAKE Oversize deckle-edge snapshots from roll 40c, 12 exposure 55c or 2 each contact size same prices. Reprint 4c, oversize 5c. Keepsake Photographic Laboratories, Box 7968P, Kansas City 3E, Mo.

8 EXPOSURE Oversize in plastic ring album 40c; 12 exp. 55c; 16 exp. 70c. Snapshots, Box 1469, York, Penna.

JUMBO Album prints—8 exp., 35c; 12, 50c. Free mailer 35mm (36), \$1.00. Flash-Foto, Box 36-M, Brooklyn 4, N. Y.

FREE Roll of film with each developing order. 75c develops and prints 8 jumbos. Sent first class mail postage paid. Oxford, 3042 Greenmount Avenue, Baltimore 18, Maryland.

SATISFACTION guaranteed! Eight jumbo size prints mounted in album, 35c—12 to 16 exposure rolls, 50c. Free mailers, quick service, finest developing, finishing. Crown Studios, Box 1223-PM, Dallas, Texas.

FAST—Same day service! 8 oversized prints in attractive plastic-bound book only 35c; 12-50c; 16-60c. Satisfaction guaranteed. Free exposure guide with first order. Pic-Sure, Box 899-B, Philadelphia 5, Penna.

NEW—16 Oversize contact prints, or 8 jumbos in album 25c. (Trial.) Album Studios. Weatherford, Okla.

6 OR 8 Picture roll 35c, 12 or 16 picture roll 55c. Each roll printed and developed. Handy album pack. If you fail to get pictures on your film a new roll will be sent you without extra cost. Send coin with roll. No c.o.d.'s. Mailing containers sent free. DeLux Film Service, Box 1268-A, Shreveport, Louisiana.

BEAUTIFUL Enlargement from each picture on 8 exposure roll 35c. Cut Rate Photos, Dept. B-4, Janesville, Wis.

TWO Beautiful prints from each picture on 8 exposure roll 35c. Thirty-one years of satisfied customers. Quick service. Lens Photos, Dept. J-4, Janesville, Wis.

MAIL Us your films. Prompt service. 8 exposures developed and printed 30c. Foto Art Studio, Box 406, San Francisco, Calif.

16 PRINTS Or 8 jumbos from roll, 25c with this ad. S. Skrudland, Lake Geneva, Wis.

MOTION PICTURES AND SOUND EQUIPMENT

MAGNETIC Film recorder. Assemble yourself. Precision parts. Full instructions furnished. Nationally famous make. Send \$1.00 for catalog. Box 707, North Hollywood, California.

DON'T Buy a tape recorder before writing Dressner, 624M East 20th Street, New York 9, New York.

WE Have it! Send 10c for special listings, and sample film strip. Reyelle, Box 12, Hammels, N. Y.

SALE 8-16-35 Shorts, features, quality sound, silent films, equipment, new, used, reels, cans 5, \$1.00, 1600' 50c. Auricon film recorder \$295. Free library membership. Catalogues. Mogull's, 112 W. 48, New York.

LEARN Movie projection, management. Free catalog. Theatre Institute, Elmira, New York.

FREE Movies. Thousands of subjects. Interesting. Entertaining. Fascinating. Latest directory—only 50c. National Cine Society, 126 Lexington Avenue, New York 16, N. Y.

BARGAINS 16MM. sound films. Also for exchange. Bedner, 5300 So. Talman, Chicago.

CLEARANCE Sale of 16mm. films. Want a real buy in 16mm. sound films? Take advantage of the I.C.S. 1952 clearance sale of 16mm. sound features, comedies, cartoons, novelties, musicals. New, used. Send for our giant list "A" today stating machine you own (make and model). Institutional Cinema Service, Inc., 1560-PM Broadway, New York 19, N. Y.

LEARN Free lance, educational, Hollywood, and television film technique at home. State licensed. Write for free catalog. Motion Picture Institute, Birmingham 4, Michigan.

5000 NEW-Used 8-16mm. silent-sound films. International, 2120 Strauss, Brooklyn 12.

8-16MM. Silent-sound films. Complete rental library. All latest subjects. Free catalogue, sample film 10c. Garden Film, 317 West 50th, New York 19.

RENT 16MM. sound films, 50c reel. Large selection; free catalog. Film Service, 128 Chestnut St., Roselle Park, N. J.

GUARANTEED Fresh 8mm. roll, magazine; 16mm. roll, magazine movie films. Color. b&w. Free catalog. ESO-S, 47th Holly, Kansas City 2, Missouri.

MOVIE Camera film: 8mm. roll \$1.50, 16mm. 100' \$3.00. Free processing. Better Films, 742 New Lots, Brooklyn, N. Y.

MUSIC AND MUSICAL INSTRUMENTS

ACCORDIONS—Save 50% and up. Cash or terms. New and used. All brands. Wholesale to everyone. Free catalogue. Del Principe, 29 South Cicero, Chicago 44, Ill.

ELECTRIC Guitars, amplifiers, wholesale. Free catalog. Carvin PM, Baldwin Park, Calif.

PLAY Accordion the modern way from records. No instructor necessary. Send for circular P. Pagani, 289 Bleecker, New York 14, N. Y.

YOUR Voice made loud, clear and powerful with my diaphragm exerciser. Inexpensive. Write, Inventor "Oz," 34V, Box 665, St. Louis, Mo.

SWING Piano—By mail, 30 self-teaching lessons \$3. (Samples.) Phil Breton Publications, P.O. Box 1402, Omaha 8, Nebr.

YOUR Words and our music. A winning combination! Send poems. Free examination. Song Promotion Guild, 350-M Broadway, New York 13.

SONGWRITERS. Collaboration offer. Newart Publications, GPO Box 1226, Syracuse, New York.

PLAY Accordion the Phil Baker way. No musical background needed. Ask for circular. Music Publishers, 289 Bleecker, New York 14, N. Y.

SENSATIONAL Free booklet, "How To Write And Sell Songs." Get the facts first. Poems examined free. Reliable Music Service, Box 430-P, Hollywood 28, Calif.

1952 ACCORDIONS — Wholesale. Free catalog. American Accordion Center, 5329 Belmont, Chicago.

POEMS Wanted for musical setting. Send poems for free examination. Five Star Music Masters, 630 Beacon Bldg., Boston, Mass.

LYRICS Set to music and recorded. Free examination. Cherrier Recording, 732 So. Norton, Los Angeles, California.

MUSIC Arranged. Songs printed. Frank Wildt, Music Publisher, Lancaster, Penna.

POPULAR Songs. How to write and sell them. Write for free booklet Successful Songwriting. Gateway Songs, Box 2470, Hollywood 28, Calif.

SONGWRITERS! Protect your ideas! Hold all songs; poems! Write for Safe Correct Procedure first! Song Service, Dept. P. 333 W. 56th St., New York 19, N. Y.

POEMS Wanted. Broadcast consideration. Sooner Song Co., 22PM North West 8th, Oklahoma City 2.

SONGWRITERS! Send poems, songs. Music Service, 243 West 72nd St., PM, New York 23

POEMS Wanted to be set to music. Free examination. Send poems. McNeil, Master of Music, 510-PM S. Alexandria, Los Angeles, California.

WRITE Songs. Big money and reputation. Write for information. J. Gordon Pub. Co., 4700 South California Avenue, Chicago.

WANTED! Poems for musical settings. Write Songwriters' Service, Clifton, N. J.

SONGWRITERS. Amazing free offer of "wonder wheel" jiffy composer! Also, complete song service for poems and songs. Details free. J. Barnes, Box 490, Times Square Station, New York 36, N. Y.

RADIO AND TELEVISION

ANTENNAS. Television. Most talked about. Sensational. For outermost fringe areas. "Ray-scope" circular mailed. AC Electric, 39 Sherman, Stamford, Conn.

USED Nationally advertised TV sets. All makes. All size screens. Write for prices and catalog. TV Shacks, 2931 East 7 Mile Road, Detroit 34, Michigan.

BUILD 15 Radios—Only \$1.30 each. Experience unnecessary. Home Radio & T.V. Course, includes trouble-shooting and servicing lessons, radio principles, code instructions, practical radio building and repairs. You build and keep receivers, transmitters, amplifiers, test equipment, code oscillator. All parts, tools, instructions supplied including radio tester and electric soldering iron. Write for full particulars and receive absolutely free your copy of "Radio & TV Repair Guide." No obligation. Progressive Electronics Co., 497 Union Ave., Dept. PM-20, Brooklyn 11, N. Y.

PASS FCC amateur radio exams. Leads to profitable career. Simple, quick recorded, home study course for theory and code, lowest cost. Details free. American Electronics, Dept. PM, 1451 Wilkins Ave., New York City.

ENJOY 3 Color television screen now. Send \$1 for 17" or under, \$1.50 for 20", \$2.00 for 21". New! Solid color screens! Amber, blue, or green. Same prices. State screen size. Order direct, save 50%. Zingo Products, TV Dept., Johnstown, New York.

AMAZING Electric eye. Unlimited uses. \$3.50 postpaid. Instructions included. Springfield Enterprises, Department M-7, Box 54, Springfield Gardens 13, New York.

\$30 TELEVISION Boosters only \$18.95. Faria, 2006 Oglethorpe, Hyattsville, Md.

MAKE Simple, tubeless, batteryless, distance-getting crystal radios. Crystal and illustrated instructions 25c postpaid. Allen, 427-P, Clinton, Mo.

TV And FM antennas. Yagi, conical, bow-tie, mounts, accessories. Lowest prices. Wholesale Supply Co., Lunenburg 1, Mass.

BUSINESS OPPORTUNITIES

OKURA With liquid rubber pays 200%. New miracle transparent coating protects, preserves, glamorizes floors, walls, linoleum, furniture, autos. Resists acids, soap, water, alcohol. Waterproofs wet basements. Big seller. Everyone needs. Rubber Products, New Haven 49, Conn.

RESILVERING Mirrors, formula 50c; two-way lookout mirrors, (No one sees you), 50c; coppered mirrors, 50c. All \$1.00. Nelko-Mir, Box 3462, Chicago 54.

INVISIBLE Reweaving — Big profit, big demand, easy-to-learn with low-cost complete course—nothing else to buy, ever. Details free, write today: Fabricon, Dept. N-5, 8342 S. Prairie Ave., Chicago 19, Ill.

OPERATE Your own profitable mail-order business. Everything furnished. Particulars free. Alfred Haseman, Beecher, Illinois.

\$5 AN Hour and more possible in your home. You can paint it with suede. Fabulous new business. Spare or full time. Spray on rainbow colors. Auto dashboards and trunks, signs, radios, toys, figurines, lamps, etc. Beautified with amazing new 3rd dimensional plush-like finish with touch-appeal as well as eye-appeal. I'll send you complete, step-by-step plans and equipment, including high-velocity spray gun for no-risk examination in your own home. Send no money, just name and address. Coast, 1004-AP S. Los Angeles St., Los Angeles 15.

BIG Money and fun growing live miniature Ming trees on your window sill. Write for free rare tree seed and plan. National Nursery Gardens, 8463 South Van Ness, Inglewood 4, California.

TRADE Magazines help you to success. Get latest copies through our easy-to-get-acquainted service. Hundreds of business, professional, advertising, construction, educational, hobby, machinery, sport, stationery, store display, sign, taxidermy, telephone, textile, tobacco, vocational education, window display, woodworking, writer and others covering all interests. Send for list today. It's free. Commercial Engraving Publishing Company, 34C North Ritter, Indianapolis 19, Indiana.

AMAZING, Refinish auto dash. Grain appears like magic. Details free. Modern Aids, 248 So. Main, Jamestown, N. Y.

SEA-Shell for making gifts, novelties, jewelry. Catalog 10c. Instruction book of 155 photographed designs \$1.10. Giftcrafts, Box 4550-PX, Coral Gables, Florida.

LEARN Mail order business, little capital. Sample copy 10c. Main, 157 Britannia, Hamilton, Canada.

MAKE Your home workshop pay up to \$6.00 hourly for your spare time. Even more with wife's help, and she'll love it! Details free. The Old House, Box 8, Spring, Texas.

GET Smart, buy fast selling items, wholesale. 1130 Broadway, New York.

GET \$3.00 Orders. Keep money. Orders filled free. Corcoran, 2233 N. Winchell, Portland 17, Oregon.

YOUR Own business with a minimum investment. A national organization offers you this opportunity in the fast growing soft ice cream business with possible profits from \$8,000 to \$15,000 per season. For full particulars write to: Dari-DeLite, 1524 Fourth Avenue, Rock Island, Illinois.

CHINCHILLAS (No rabbit). Raise anywhere. Pleasant, profitable. Information. Chinchillas, Ithaca, Michigan.

MAIL Order business—Your opportunity. How to build your own mail order business. Beginner's idea-book tells how. 25c post-paid. Promptly refunded if not satisfied. Albert Zimmer, 206 Central Ave., Lockland 15, Ohio.

I Made a great success in the collection agency business. I can teach you too—Quickly. Write me. George H. Cole, Syracuse 2, N. Y.

SPARE Time profits can be yours. Lewis Bartlett, Richland, Georgia.

SEWING Machines, big money! Spare time. "Hang out your shingle" at home. Learn repair, electrify, trade, sell. New machines, motors, cabinets, parts furnished. Free details. Taylor Service, Hamilton PM-7, Ohio.

EARN 400% Selling attractive low priced watches. Free salesman's sample. Result Sales, 580 Fifth Ave., New York 36B.

START Your own business on credit. Your own boss. 1586 of our dealers sold \$5,000 to \$27,500 in 1951. We supply stocks, equipment on credit. 200 home necessities. Sales experience unnecessary. Pleasant, profitable business backed by world-wide industry. Write Rawleigh's, Dept. G-U-PPM, Freeport, Ill.

IMPORT-Export! Men—women. Instructions from established world trader shipped for no-risk examination. Opportunity profitable world-wide mail-order business from home without capital; or travel abroad. Experience unnecessary. Free details. Melinger, 1715-BF, Los Angeles 24.

OPERATE Profitable mailorder business. Write JPMCO, 2623 Columbus, New Orleans 19, Louisiana.

FLEXIBLE Rubber moulds for plaster and Marbleite figurines. Sample and large illustrated catalog 25c, refunded on first order. K-C Novelty, Dept. 23, Easthampton, Mass.

A Post card may bring the opportunity you are waiting for. Vending machines, part or full time. Small investment. Write for catalogue. Schoenbach Enterprise, Dept. 11, 1645 Bedford Ave., Brooklyn 25, N. Y.

FIX Typewriters. Free booklet describes our modern, inexpensive home-study course. Factory methods taught. Write: Typewriter, 7915 Corbet, Tarentum, Penna.

MAKE Money spare or full time, casting metal toys and novelties. Big wholesale and chain store demand for autos, soldiers, ashtrays, banks, etc., keeps manufacturers busy. Production moulds furnished for up to 100 and more castings per hour. No experience or special place necessary. Write for information and illustrations of patterns needed. Metal Cast Products Co., Dept. A, 1696 Boston Road, New York 60, N. Y.

HOW And where to obtain capital? Free details, Star Service, Wapakoneta, Ohio.

HOME Work! Men! Women report \$7.50 hour! Get these valuable free facts on this gorgeous piece invisible reweaving occupation right now! Simplicity, 894 Main, Buffalo 2, N. Y.

PRINT Without a printing press. Posters, banners, greeting cards, toys, glassware, neckties, anything! New easy revolutionary method. No special equipment or experience needed. Work full or spare time at home. No selling. We set up your own local business. Wonderful money making opportunity. Free sample. Profitable ideas, beautifully illustrated plan free. Write: Screen-Print, 1010-M Los Angeles Street, Los Angeles 15.

\$200 WEEKLY Reported! No selling. Free booklet. T. J. Surface, Roanoke 4, Virginia.

TO \$35.00 Weekly. Spare time, home mailing work. Lynn, 10420-M National, Los Angeles 34, California.

HOW To set up and run a mirror shop! Resilvering mirrors. Making chipped glass nameplates. Electroplating salts and recitifiers. John Sprinkle, V60, Marion, Ind.

LIQUID Marble—Colorful, glossy! Molded, brushed, sprayed! Cast novelties, statuary, colored tiles. Flexible molds. Composition floors. Particulars free. Marbleizing Service, Edwardsville, Illinois.

NEW! Mailorder plan 25c. Refundable. Angel Gonzalez, 945 Fox Street, Bronx 59, New York.

LIFE Opportunity for serious, qualified man. See our display ad, page 233, this issue. O.K. Rubber Welders.

START Your own mailorder business with hundreds of live repeat hobbycraft items. No stock to carry. We pack and ship for you. Send 25c for details. Write Dept. PM 25, Mail Order Service, 845 S. Wabash, Chicago 5, Ill.

GROW Mushrooms. Boxes, basements, gardens, lawns, grasslands. Instructions 35c. Mushroom spawn \$2.14. New manure-less process \$2.50. Send for complete 3 item new kit \$4.99. No c.o.d. please. Guaranteed fresh spawn or your money refunded. Thomas Co., Dept. 80, 3604 30th Ave. S.W., Seattle, Wash.

MAKE Perfume. Profitable mailorder business. Catalogue free. "International," 6347 Parnell-PM-7, Chicago 21, Illinois.

EARN Money at home with your typewriter! Spare time! Details free. Edwards, Publisher, 3915-PM 12th, Des Moines 13, Iowa.

YOU Can sell brand new adding machines for only \$14.95! Yes! You can sell 'em and make \$6.73 on every sale. They're executive model portables, precision built, fully guaranteed. For life-size color photo and all details, write to Lightning Adding Machine Co., Inc., Dept. P-19, 1260 W. Second St., Los Angeles 26, Calif.

MAKE Money at home mailing literature offering fast-selling books and merchandise. Everything supplied at low cost. Rush name. Gloger, 318 Green, Watertown, Wis.

START Business without capital! Reliable. 15-A Park Row, New York 38, N. Y.

FEW Dollars starts profitable home businesses; 50 kinds; local; mail order; details free. Natmerch, Box 1975-AG, Little Rock, Ark.

MAKE Perfumes at home. Write "Carey Laboratories," 1914 Chouteau PM-7, St. Louis 3, Missouri.

SELL Printing by mail. We fill orders. Free plans, samples. Sutton Printing, Box 853-G, Waycross, Georgia.

CASH Income from your backyard! Details free. Pickett's, Florence, Kentucky.

FREE Illustrated course casting novelties genuine latex for molds. Major Chemical and Latex Co., 25 Allerton Street, Boston 19, Mass.

ESCAPE Wage slavery. Easily. Operate your own profitable lifetime business. Free literature. Corley, H285 Carlton, East Rutherford, New Jersey.

SMALL Investment in Artkote molds puts you in \$5.00 hour stone facing business. Sample mold \$2.00. Dividend Company. Liverpool 3, N. Y.

OPERATE "Escalator" mailorder system, selling our products or any products. Fastest, most revolutionary mailorder system known. Write: Selbyco, Decatur 158, Ill.

WHY Not make extra dollars repairing zippers? Excellent profits uncrowded field. Details free. Texas Specialty Company, 204-B Texas, Texarkana, Texas.

OPERATE Employment agency from home or office. Unlimited possibilities. Free details. Gordon Publishers, Box 23, Pawtucket, R. I.

THROWN Away! Tons ground rubber by recappers. Make into plastic rubber. 1000 uses! Easy! Inexpensive! Start profitable business! Instruction, samples \$1.00. Cee-ten Products, 242-W, Crozet, Va.

HOW And where to obtain capital. Particulars free. Star Service, Wapakoneta, Ohio.

PROFITABLE Home business. Electroplate novelties, autoparts, mirrors, baby shoes, etc. Portable Tyco electro-plater \$5.95, including plating salts, formulas, instruction manual. Free booklet. Tyco Metals, Box 13231-MF, Houston 19, Texas.

BUY Wholesale thousands nationally advertised products at big discount. Sent free "The Wholesale Plan." American Buyers' Service, 628-R Linden, Buffalo, N. Y.

OLD Car tires, turn them into dollars. Details free. Fenn, B129MB, Embarrass, Wis.

NATURE'S Best fish bait—"Soft" crawfish! Process and store at home. Instructions \$1.00. Bryan's, Box 2025, South Bend 15, Indiana.

SELL By mail. Ideas galore in "The North Wind." Sample copy free. Gerlach, Box 245, Sheboygan, Wis.

TIN-Cans. Turn them into cash. Nine methods. Instructions 50c. Charles Company, 12-DAF, Norwood, Ohio.

FISHWORMS—200, \$1.00. Breeders 100; \$1.00. Breeder's Manual \$1.00. Literature free. Haase, Kent, Ohio.

LIST Your name to receive mailorder offers, samples, money-making propositions. Write Paragon, Box P-2194, Houston, Texas.

GOOD Income. Produce own product. No gadget. No racket. Dignified staple business. Fast growing industry. Easy \$15.00 daily profit. Free literature and personal letter. Box 373M, Tinley Park, Ill.

FREE Folder—100 ways to make money in silk screen printing. National, Box 88-PM, Dorchester 22, Mass.

SELL Over radio stations. Pay radio stations commission on orders received. Over 400 radio stations do this. Data 10c. Refundable. Mishek Co., Waseca 2, Minn.

STUDENTS—A profitable business of your own. Full details \$1.00. Bluestone, P.O. Box 862, Fort Smith, Arkansas.

NEW Products wanted for sheet metal fabrication and/or marketing. Platt & LaBonia Co., North Haven, Conn.

SAIL Ho! Be a merchant seaman. Men 16-55. No experience necessary. Enjoy world-wide travel and romance plus big pay. All information and entrance instructions in "Seafarer's Guide." Limited edition. Only \$2.10. Now is your opportunity. Don't delay. Seaways, P.O. Box 1231, Baltimore 3, Md.

SELL By mail to women—Real merchandise. Everything furnished, orders filled. Big profits. Charles, Box 32-S, New York 63, N. Y.

YOUR Own mail order business offers unlimited earning possibilities. Exciting details free. Smith Sales, Box 121P, Terre Haute, Ind.

UPHOLSTERY—Instructions, information \$1.00. Upholstery Supply, Box 5066, Nashville, Tenn.

START Your own mailorder business, anywhere, on small capital. Unlimited opportunities. Send for interesting literature. Metro, Box PM-1794, Houston, Texas.

HAVE Home mail business! Success assured by helpful idea-mailbox service. Booklet 25c. Details free. NMD Agency, Box 88-M, Dorchester 22, Mass.

SELL Your products by radio! No risk! Pay commission. 400 nationwide broadcasters! Simon-P-10, 48 Fifth Ave., Pelham 65, N. Y.

NATIONALLY Known corporation will buy outright or finance and promote sale on royalty basis of any desirable new device, formula, preparation, cosmetic or invention. Write to President, 10 E. Coulter Street, Philadelphia 44, Penna.

START Mailorder bookshop—Build your future. 25c brings booklet, samples, exciting ideas. General Publications, Ossining, New York.

BIG-Paying home mailorder business. Details free. Jackson, Newfoundland, Ky.

1001 OPPORTUNITIES Club, 1495-P Westchester Ave., New York 72, offers real money making ideas. Free information.

NEW Ideas and items. 25c brings samples to retail for \$1.00. Specialties, Box 475E, Park Ridge, Illinois.

OVER 700% Profit making finished pictures in 2 minutes on the spot in daylight with new PDQ camera, without darkroom. No experience needed. Simple directions teach you quickly. Write PDQ Camera Co., 1161 N. Cleveland Ave., Dept. XPM, Chicago 10, Illinois.

BECOME Contractor associated with national organization. Man experienced in roof repairs, waterproofing, coatings. Operate own business under our trade name. Franchise protection. "Luster-Kote," 19417 Derby, Detroit 3, Michigan.

OPERATE Profitable collection agency business. Free circular. Financial, B-740-M, Chicago 90.

MAKE, Sell, nameplates, house numbers, flasher signs. Crabtree, Newport News 221, Va.

MAKE Money at home or travelling. Full particulars free. Emly Enterprises, Box 319, North Hollywood, California.

MAKE 400% Profit selling "Snocones." Complete information. Snocones, P.O. Box 838, Atlanta, Ga.

START A Venetian blind laundry. Profit opportunity for lifetime business. New machine method. Free booklet on request. F. C. Co., 442 N. Seneca, Wichita 12, Kans.

MAKE Money at home as renewal headquarters for all magazines. Liberal commissions. No experience. No capital needed. Supplies furnished. Write for free catalog. McGregor Magazine Agency, Dept. 500B, Mount Morris, Ill.

WATERLESS Hand cleaners. Highly profitable home mfg. and route business. Simply add water to concentrates, or ready-packed under your label. Dispensers at cost. Western B Aircraft, Los Angeles 19.

START Home manufacturing business. Make cleaners, soaps, polishes, cosmetics. Free literature. Kemix, Park Ridge, Ill.

LIQUID Rubber, make flexible molds. Free sample. Chaney, 1130 E. 16th St., Jacksonville 6, Fla.

MAKE Tough, durable plastic—1c pound. Makes attractive floors, walls, built-ins, roofs. Build good home. \$150.00 room. Bays Laboratory, Oklahoma City 9.

LIQUID Molding rubber, \$2.95 quart, \$9.95 gallon prepaid! Plastercraft Supply Company, 3051 St. Clair Ave., Cleveland 14, Ohio.

HOME Business opportunity mailing literature to new mothers. Everything furnished. Big earnings. Orders filled. Delray, Box 3852M, Columbus 13, Ohio.

FIGURINE Molds and many others, liquid rubber, statuary plasters, flock finishes, Glo-candle wax, etc. Illustrated catalog and "Plastercraft" manual free. Blue Rapids Supply, Blue Rapids, Kansas.

NEW Exceptionally profitable plans, ideas for home operated mail business. Rush name. Miller, 1772-P Carlyon Road, East Cleveland 12, Ohio.

MAKE Flexible molds! Cast plaques, bookends, figurines! Free sample! H. Tooker, 630-R Chestnut, Hamilton, Ohio.

21 POPCORN, Candy apple formulas, proven money-makers. Send \$1 today for formulas, catalog of money-making ideas. Concession Supply, 3916 Secor, Toledo, Ohio.

RUBBER Molds! New catalog illustrating over 100 professional molds, 10c. Castcraft Studios, 508-P Marion St., Brooklyn 33, N. Y.

RECAST Old batteries into new. Latest achievements. Battery Laboratories, Minneapolis.

READ "Advance"—The voice of mail order. Offers money-making opportunities, sources of supply, personal guidance, etc. Issued monthly. Sample copy 35c. Yearly subscription \$2.00. Advance Publishing Company, 313 East 21st Street, Suite 450, New York 10, N. Y.

MAKE Money sharpening saws and lawnmowers. Start at home. Free book, "Money Making Facts," tells how. Victor Foley Company, Columbia Heights, Minn.

BOOKKEEPERS—Earn \$5000 yearly part time. Sell, operate new sensational CPA bookkeeping service. Kern, 4942 Vineland, North Hollywood, Calif.

GOOD Paving business silvering mirrors, plating autoparts, reflectors, bicycles, bathroom fixtures, etc., by late method. No tanks or shop required. Outfit furnished. Free booklet. Gunmetal Co., Ave. H, Decatur, Illinois.

POPCORN And potato chip equipment. Long Eakins Company, 5260 High, Springfield 99, Ohio.

BUY Wholesale. Thousands articles. Supply directory, 10c. Idealco, Park Ridge, Illinois.

EARN Extra money! "Homeworker Magazine" tells how. Sample 25c. Size more, Box 7, 4917 Kostner, Chicago 30.

BOOKKEEPERS, Keep books, small firms spare time. Manual latest technique by C.P.A., \$3.00. Modern Business, Box 406, Youngstown 1, Ohio.

FREE Book "505 Odd, Successful Businesses." Work home! Expect something odd! Pacific, Oceanside, Calif.

\$46 FROM Square foot plywood; jigsaw necessary. Write: Woodarts, Bridgewater, Mass.

EXTRA Money—No selling, operate vendors. Amazing profits, details free. Silver King, Suite 220, 622 Diversey, Chicago 14.

BUY It wholesale! Manufacturers, distributors offer 850,000 items. Literature free. Olsen, 1231-A East Third St., Duluth 5, Minn.

\$25 WEEKLY Working two hours daily. No canvassing. No manufacturing. Lycke, Box 2471-A, Cleveland 12, Ohio.

EARTHWORM Breeding? First, get unusual story. "An Earthworm Turned His Life." Free. Earthmaster, Dept. 14, El Monte, Calif.

MONEY In new greaseless doughnuts. Start in kitchen. No smoke. Sell stores. Free recipes. M. Ray Company, 3605 South 15 Ave., Minneapolis 7, Minnesota.

INCOME From local information. No selling. Write Neherco, La Verne, Calif.

UNPAINTED Bookends, plaques, statues, figurines. List. Haverty Products, 822-17th St., Altoona, Penna.

OPERATE Profitable mail order business. Write Walter Service, 4159-A East 112th, Cleveland 5, Ohio.

DOLLARS In personalized baby record books. Sell by mail. Use same literature we do. No-Co-Ro, Oakland 6, Calif.

MADE \$24,500 Using money making plans from Schemer Magazine, world's oldest mailorder publication. Box 275M, Canfield, Ohio. Year \$2.00. Sample 20c.

MINK Raising information free. Complete. Lake Superior Mink Farm. Superior, E.E.1, Wisconsin.

COPUBLISH Leading m.o. paper. Latest copy Mail Sale Advertiser, details, dime. Vanroy Shirk, Lebanon, Penna.

COLORGLAZED Concrete pottery made without molds. Patented method. Cemetery products, novelties, tiles. Basement leak-sealing. Money-making projects. Booklet, details free. Men only. National Potteries Company, Grand Rapids, Minnesota.

MONEYMAKING OPPORTUNITIES

ULTRA-Blue 7"x11" signs. 2000 slogans. Comedy, general, religious. 100 signs, \$7.00; sell 50c each. Every merchant a sure buyer! Lowy, 812 Broadway, Dept. 678, New York 3.

REAL Live Mexican jumping beans. Big profits. Mann's, 5330 N. Natoma, Chicago 31.

EARN Money evenings, copying and duplicating comic cartoons for advertisers. Adservice, Argyle 1, Wisconsin.

PROFIT With National Imprint Directory; 75 imprint sources 25c. Schneider, 1227 Woodlawn Ave., Louisville 8, Ky.

25%-50% COMMISSIONS Taking magazine subscriptions. Free details, write: Ccurier, 40-69A 97th Street, Corona 68, New York.

CHURCHES, Clubs, organizations. Receive \$130 plus 12 card tables free. Unique Gift Plan, Pine Hill, New Jersey.

MAKE Money—Sewing and assembling at home. Liebig Industries, Beaver Dam 10, Wisconsin.

BE Independent, be secure, have your own profitable business—Earn \$20.00 and more a day making beautiful, fast-selling lamps at home. No equipment needed. Illustrated course teaches you quickly. Course, parts catalog, wholesale price list—only \$2. Gearon Co., Dept. 200-B7, 27 S. Desplaines, Chicago 6, Ill.

GROW Mushrooms. Boxes, basements, gardens, lawns, grasslands. Instructions 35c. Mushroom spawn \$2.14. New manufacture process \$2.50. Send for complete 3 item new kit \$4.99. No c.o.d. please. Guaranteed fresh spawn or your money refunded. Thomas Co., Dept. 81, 3604 30th Ave. S.W., Seattle, Wash.

VACATION With pay. Earn while traveling. Box 414, Logansport, Indiana.

BUY Wholesale thousands nationally advertised products at big discount. Sent free "The Wholesale Plan." American Buyers' Service, 627-R Linden, Buffalo, N. Y.

FREE Mailorder, money making, homework offers. Address, William Woodrow Jenkins, Lucasville, Ohio.

BOOKKEEPERS Earn \$100.00 week operating bookkeeping-tax service. Details free. Universal, Box 664-M, Springfield, Missouri.

595 MONEY Making secrets. Send stamp. Book Service, P.O. Box 453, Port Chester, N. Y.

BRAND New sure fire money maker. Write Post-Rite, Box 802, Sioux Falls, S. Dak.

MAGIC Key to permanent income. Sure fire plan tells how, copy 25c. Guiding Star, Box 5944M, Los Angeles 55, Calif.

FREE! Radio advertising. Broadcast over 500 stations without investment! Jakiela, 2145 Potomac, Chicago 22-P.

SELL Titania gems \$9.75 carat, wholesale. More brilliant than diamonds. Free catalogue. Diamonite, 1404M Mitchell, Oakland 1, Calif.

HOW To get your mail order advertising free revealed by famous expert. Also other "inside" secrets. Free details. Benson Barrett, 1751-A Morse, Chicago 26.

TEN Catalogs, Confidential price list. Name brands, premium prices. Complete investment \$2.50. D. E. Mann & Co., 1539 1/2 W. Devon Ave., Chicago 26, Ill.

\$10,800 PROFITS! Your own mailorder business! No capital risk! "Success plan" (worth \$2) free! Write today! Treasury, 149 Storer, New Rochelle PM-1, New York.

MAKE Perfume—Everything supplied, no equipment needed. Sample fragrance, details free. Gemmerco, Box 142-PM, Dorchester 24, Mass.

FOUNTAIN Pen repairing. Send 50c for Penkit; includes sac, point with instructions for repairing. Penmart 96, Boulder City, Nevada.

\$100-\$200 WEEKENDS No selling or manufacturing. Brennan, 4025-Z Lanker-shim, North Hollywood, California.

WONDER Liquid—New—Not rubber or plastic. Own a profitable business making several different products. Amazing results. Details \$1.00. Mutual Service, 270 Villa St., Elgin, Ill.

50,000 ARTICLES Wholesale. Source directory, dime. Nelko, Box 3462-DR, Chicago 54.

FREE Book "505 Odd, Successful Businesses." Work home. Expect something odd! Pacific, Oceanside, Calif.

BE Appointed State Notary Public now! Details: Stationers, Helotes, Texas.

PUBLISH Your own magazine. Handsome 52 page format, well edited, illustrated. Cost low as \$1.00 month. Brings you prestige, profits. 25c brings sample, details. National, Ord, Nebr.

READ Progressive Mailtrade, the magazine that tells how to make money by mail. Dime brings sample and special offer. Progressive Mailtrade, Box 357, Sheboygan, Wisconsin.

BE The Popular Mechanics representative in your neighborhood and earn big profits in your spare time. Write Popular Mechanics Magazine, Room 408M, 200 E. Ontario St., Chicago, Ill.

FORMULAS, PLANS, ETC.

MAGIC Furniture polish. This polish has sold for \$10. Price of formula \$1. P.O. Box 74, Cleveland, Georgia.

AMAZING Book! 10,000 formulas, etc. \$3.98 postpaid. Free literature. K. Paullin, Loudonville, Ohio.

REAL Manufacturing formulas. Lists free. Cummings, Chemist, Gordon Ave., Syracuse 4, N. Y.

FORMULAS; All kinds. Latest, best. Literature free. Kemixal, Park Ridge, Ill.

TESTED Formulas. Interesting descriptive booklet free. Pont, Box 635-PM, Terre Haute, Indiana.

FREE Formula catalog. Anything analyzed \$25.00. Western Chemical, Salem, Oregon.

FREE Blueprint Catalog! Hundreds of projects—motor scooter, furniture, toys, birdhouses, radios, garden furniture, power tools, boats, workbenches, home freezer, many more! Send postcard to Popular Mechanics Press, Dept. 103, 200 E. Ontario, Chicago 11, Ill.

PLASTICS

NEW Liquid casting plastic. Clear, colors. Embed flowers, insects, coins. Saw, drill, carve. Send 25c for wholesale catalog and new sales manual showing how to make money at home. Castolite, Dept. H-101, Woodstock, Illinois.

PLASTICS—Everything, retail, wholesale prices. Catalog 10c. Gem-O-Lite, Box 686L, North Hollywood, California.

PLASTIC, Sheets, rods, tubes, etc. Free list. Plastic Supply Co., 2901 N. Grand Blvd., St. Louis 7, Mo.

LUCITE Plexiglas. Any size sheets, masked. Square foot (12 x 12) cost, 1/16", \$1.20; 3/16", \$1.40; 3/16", \$1.75; 1/4", \$2.08. Include 10% postage. Almac Plastics, 230 Fifth Ave., New York 1, N. Y.

CHEMISTRY

BRAND New, spectacular chemical and fireworks experiments manual. Complete set-ups and instructions \$1.00. Chemi-Technix Laboratories, 568 Riley Street, Buffalo 8, New York.

AMAZING New book of science. Experiments, formulas and catalogue of laboratory supplies. Only 25c. National Scientific Co., Dept. 16, 2204 W. North Ave., Chicago 47, Illinois.

NEW Idea chemical and apparatus outfits for home experimenting. Photo-scales, microscopes, chemicals, biological and laboratory supplies in small quantities. Catalog 25c. Established 1931. John H. Winn, 124A West 23rd Street, New York, N. Y.

CHEMICALS And apparatus for industrial, analytical, and private laboratories. Catalog 20c. Dept. M-50, Biological Supply Co., 1176 Mt. Hope Ave., Rochester 20, N. Y.

ILLUSTRATED Catalog: Chemistry, mineralogy, biology. 10c. Tracey Laboratories, Evanston, Illinois.

HELP WANTED

TIRED Of no money, second rate jobs? Like to start a real career with a life-time of high salaries? Write me about two growing fields that need men. Ed Howes, Dept. 272, 456 W. Santa Barbara Ave., Los Angeles 37, Calif.

AGENTS WANTED

CASH—For yourself or your organization. Quick, easy, pleasant. No experience necessary. Spare time, full time, it's the sure way to make money. Everybody buys exclusive, exquisite new 1952 Elmira Christmas line—De Luxe Christmas assortments, 5 name imprinted Christmas card lines, all-occasion cards, gift wrappings, gift items, books, personalized stationery, napkins, matches from \$1.00 up. High quality. Low cost. Save friends, neighbors, co-workers time and money. Start making extra cash at once—with no investment. We supply everything—Free samples, money-making kit, bonus, money-saving offers, assortments on approval, 42 page catalog. Promptest service ensures recommendation to others. Write today. Elmira Greeting Card Company, Elmira C-109, New York.

AMAZING Miracle auto polish—Plastone! New scientific discovery contains pure carnauba wax, genuine plastic plus silicones! Sensational money maker! Nationally advertised! Sold by leading firms. Used by America's largest organizations. Only \$1 retail. 100% profits. Sales experience unnecessary. Exceptionally easy sales. High repeat sales. Choice protected territories. Once in a life time opportunity for large steady earnings. Only limited number of agents accepted. Write today. Plastone Company, 2950 W. Grand, Dept. PM-7, Chicago 12, Illinois.

AMAZING Big profits selling exclusive Sunshine Christmas cards. Nationally famous 21 for \$1.00 assortment is unequalled, sells on sight. Other tremendous Sunshine values: merry holly-day, nature prints, Park Avenue kromekotes, scripture text, gift wraps, stationery, etc. Send for samples on approval. Earn big money now! Sunshine Art Studios, Dept. PM-7, Springfield 1, Mass.

PHOTO-Salesmen, agents. Sell beautiful hand colored plastic enlargements and sensational new photo compacts, rings, bracelets, lockets, etc. Collect deposit, we deliver. Profitable sideline. Send card for free sample kit. Novel Portrait Co., 3343 North Ave., Chicago, Ill.

BIG Daily profits. Free sales kit. Sell personal initialed buckles with belts, cap badges, tie clasps, etc. Choose from 3000 emblems. Hook-Fast, Box 480PM, Roanoke, Va.

MAKE Extra money for yourself, club or church. Up to 100% profit selling big value Christmas, all-occasion greeting card assortments to friends, others. 7 leading 21 card \$1.00 boxes, religious and novel cards. Gift wrappings, ribbons, stationery, napkins, animated books, sewing kits, unusual gifts. Over 150 items. Bonus plan. Experience unnecessary. Write for samples on approval, special offers. Hedenkamp, 361 Broadway, Dept. PM-22, New York.

GUARANTEED 200,000 Mile ring, valve job! Restores compression! Stops oil pumping! Send \$3.00 for \$6.00 package and sales offer! Nerlino, 1505 Lincoln, Laredo, Texas.

AMAZING Money making offer—\$50 or more selling 100 boxes America's leading Christmas cards. Samples on approval. Complete line. Free samples personal Christmas cards and stationery. Sensational bonus. Write. Lorain Art Studios, Dept. 107, Vermilion, Ohio.

CALENDARS, Advertising novelties, matches. All styles, including religious, varnished, 12 sheet, girls. Hundreds of advertising novelties, book matches, etc. Fleming Calendar Co., Sales Division, 6539 Cottage Grove, Chicago 37, Ill.

DO You need money? \$35 is yours for selling only 50 boxes of our 300 Christmas card line. This can be done in a single day. Free samples. Other leading boxes on approval. Many surprise items. Experience unnecessary. Free samples personalized Christmas cards, stationery, napkins. Write today. It costs you nothing to try. Cheerful Card Co., 10 White Plains, New York.

NEW Bathroom deodorizer. Hangs on wall. Banishes odors bathroom, kitchen. Lightning seller. Samples sent on trial. Kristee 151, Akron, Ohio.

PRINTING, Salesbooks, envelopes. Free illustrated catalog. Ersco, Dept. PM, Bronx 72, N. Y.

JUST Out! New thrilling sensation in Christmas cards. Make big money! Show lustre foils, satins, brilliants. Amazing values bring easy orders! Magic Glo-in-the-Dark ornaments, personalized stationery, matches. 30 free samples. With name 50 for \$1.25. Several \$1.00 boxes on approval. Joy Greetings, 507 N. Cardinal, Dept. 60-A, St. Louis, Mo.

MAKE Money introducing world's cutest children's dresses. Big selection adorable styles. Low prices. Complete display free. Rush name. Harford, Dept. H-1341, Cincinnati 25, Ohio.

CASH In on your spare time! Sell beautiful new Regal Christmas greeting cards and gift assortments. No experience necessary. Costs nothing to get started. Show wonderful samples to friends, relatives, neighbors. Merely take orders and pocket up to 100% profit. Write today for samples on approval. Regal Greetings, Dept. 25, Ferndale, Michigan.

ABSOLUTELY Free! Big package actual sample fabrics and style presentation of dresses, lingerie, hosiery, etc. Take orders. Commissions big. Send no money. Melville Co., Dept. 7433, Cincinnati 25, Ohio.

NEED Extra cash? Free sales kit. Sell personal initialed buckles with belts, cap badges, tie clasps, etc. Choose from 3000 emblems. Hook-Fast, Box 1425PM, Providence, R. I.

MAKE Wedding profits. Sell invitations, napkins, matches. Samples free. Dunbar's, Middlebush 3, N. J.

GASOLINE Mileage book, copyrighted. Tells how many miles you get per gallon. Shows if you are using more gas than you should. What causes poor mileage. Book can also be used to advertise products. Also copyrighted instruction on "Learn how to remember." Exclusive distributorship possible. Send 25c for both samples. Cla-Field Sales, P.O. Box 5213, New Orleans, La.

AT Last! Something new and sensational in Christmas cards. Make extra money fast! Show satins, velours, metallics. Gets easy orders. Pays up to 100% cash profit. 30 free samples. With name 50 for \$1.25. Big line. Amazing new Glo-in-the-Dark ornaments, personalized matches, stationery. Several \$1.00 boxes on approval. Puro Greetings, 2801 Locust, Dept. 240-J, St. Louis, Mo.

SHINE Shoes without "polish." New invention. Lightning seller. Shoes gleam like mirror. Samples sent on trial. Kristee 150, Akron, Ohio.

EXTRA Money! Make up to \$1.00 a box selling amazing value Christmas, all occasion greeting cards, gift wrappings, gifts. Bonus. Surprise offer. Experience unnecessary. Request feature samples on approval, free samples name imprinted Christmas cards, stationery, napkins and free catalog. New England Art Publishers, North Abington 702-A, Mass.

CALL On friends with sensational Christmas cards in handy assortments. Price, \$1.00. Profit up to 50c. Also popular-priced personal Christmas cards, everyday assortments, etc. Samples on approval. Wallace Brown, Dept. N-4, New York 10, N. Y.

WORLD'S Finest product! The Holy Bible. Exclusive Good Shepherd edition. High immediate earnings. Unlimited future. Sell on easy payments. You will be proud of your work! Write, Barrett, Box 2579 P.M., Dallas, Texas.

NEED Money? \$50.00 yours, sell only 100 boxes new Xmas cards. Other amazing offers. Free samples imprinted cards. Feature box assortments on approval; over 100 profitable items. Work with a national leader. Pen-'N-Brush, Dept. PM-7, 139 Duane St., New York City 13.

DOUBLE Your income. Sell both guaranteed nylons and Christmas cards. Even beginners make big money with this unbeatable line Fanmour greetings, imprint stationery, napkins, children books, gifts and hosiery. Free samples of imprint greetings and catalog. Complete selling outfit on approval. Fanmour, 200 Fifth Avenue, Dept. PM-7, New York 10.

100% PROFIT Selling sensational "Ironing aids" to housewives plus other money makers. Catalog free. Sunshine Sales, Dept. PM-1, Loudonville, Ohio.

BUY Wholesale thousands nationally advertised products at big discount. Sent free "The Wholesale Plan." American Buyers' Service, 629-R Linden, Buffalo, N. Y.

SELL Beautiful chenille flowers and novelties. Catalog free. Midwest Supply Co., Box 2193, Casper, Wyoming.

POWER Mower—\$41.80. Delivered. Tax free. Sell friends, neighbors. Rotacut-RP, Excelsior Springs, Mo.

MEXICAN Feather pictures. Sell on sight; 200% profit! Free details. Sample 20c stamps. (No coins). Sylviap, Apartado 9036, Mexico City.

QUICK Extra cash! Sell America's outstanding line of Christmas box assortments and personalized lines. Plus hundreds of extra profit items. Monogram playing cards, wedding invitations, gift items, deluxe album of exclusive cards, nylon hosiery. Write today for 60 free samples in six beautiful portfolios. Gift catalog included. Elmcraft Chicago, Dept. 3, 5930 So. Western Ave., Chicago 36, Ill.

PRINTING—Salesbooks, envelopes. Free illustrated catalog. Ersco, Dept. PM, Bronx 72, N. Y.

AMAZING But true! We pay you daily cash for giving women privilege wearing wonderful nylon stockings at our risk. These beautiful sheer nylons cost nothing unless satisfactory! Yet, you get advance cash plus huge bonus that increases your earnings by 40%. Postcard brings you free sample stocking and complete money-making outfit. No obligation. Kendex, Babylon 13, N. Y.

VITAMINS! Yours free with big easy profits. Send postcard. VimVite, 2910C Beverly Boulevard, Los Angeles 4, Calif.

AGENTS — 300% Profit selling genuine gold window letters; stores and offices. Free samples. Metallic Sign Letter Co., 431-D North Clark, Chicago.

YOU Will make more money day after day, year after year selling DuPont nylons priced to sell and repeat. Details free. Write today. Arch Hosiery, 104 N. Fifth St., Philadelphia P6, Penna.

MEXICAN Feather pictures. High profit! Fast sellers! Adelphi, Box 57-B, Belle-rose 6, N. Y.

STATE And local distributors wanted for "Blue Blaze"—Battery proven by years actual road service. Guaranteed for 30 months; non-prorated. Write Blue Blaze, 2817 Jeffries, Los Angeles 65, California.

BE A money maker. Use your home as magazine headquarters. Liberal commissions. No experience. No capital needed. Everything furnished. Write for free catalog. McGregor Magazine Agency, Dept. 500A, Mount Morris, Ill.

GOLD Lacquered and silver sign letters. Windows, doors, trucks. Standard sizes. Penny and up samples. Atlas-P, 544 West 79th, Chicago 20.

YOUR Own business—Used suits \$1.50; topcoats 50c; shoes 12 1/2c; ladies' coats 30c; dresses 10c. Enormous profits. Catalog free. Moro, 558-AA Roosevelt, Chicago 7.

CALIFORNIA Sweet smelling beads. Sensational sellers. Free particulars. Mission, 2328PM West Pico, Los Angeles 6, Calif.

\$50 WEEKLY Selling finest razor blades, other items. Free details. Edisons, Box 274, Far Rockaway, N. Y.

MAKE Tremendous profits with fast-selling costume jewelry! Buy direct! Sell your friends, neighbors and customers at big savings to them! Write for our free catalog! Penn Jewelry, Dept. P, 826 W. Lacka., Scranton, Penna.

EXCELLENT Sideline for printing and advertising salesmen. Decalcomania name plates in small quantities. Great demand. Also, make money with our line of automobile initials and sign letters. Free samples. "Ralco" XL-Roxbury, Boston 19, Mass.

AGENTS: Stamping names on key protectors. Sample 25c. Stamping outfits, checks, social security and name plates. Hart Mfg. Co., 303 Degraw St., Brooklyn, N. Y.

SALESMEN, Distributors, fast selling costume jewelry direct from factory. Big picture catalog, free. Pickcraft, M19 Bank, Attleboro, Massachusetts.

HIGH-GRADE SALESMEN

\$114.50 COMMS. Four trial orders weekly. Surefire demonstration new guaranteed factory reroofing. No cash invested. Company carries accounts. Only steady, reliable, capable salesmen considered. Box 1766-PM, Cleveland, Ohio.

WANT To make real money? You can positively make \$50 a day and up selling a brand new item going to every type of food and beverage store, factories, laboratories, hospitals, etc. First time advertised. Samples furnished. Utility Durawear, 53 West Jackson Blvd., Dept. PM-7, Chicago, Ill.

GET Into million dollar work clothes business! Earn big money now, unlimited future! Sell finest-quality embroidered uniforms and work clothes to factories, garages, service stations, lumber yards, everybody! Huge profits possible. No experience needed. Gorgeous selling kit, actual fabric samples, everything free! Write Topps, Dept. 537, Rochester, Indiana.

IS \$210 A week worth a postcard to you? Then rush card with name and address for special free trial plan that sells amazing new automatic refrigerator defroster "like hot cakes!" Write to Mr. Lewis, D-Frost-O-Matic Corp., Dept. K-102, 173 W. Madison, Chicago 2, Ill.

SIDELINE For energetic salesmen—Sell advertising specialties, calendars. Earn \$500 monthly easy. Big commissions advanced, bonuses. Samples furnished. Continental Calendar, 542-L So. Dearborn, Chicago.

ADVERTISING Book matches—Cash in on big demand; sell union label matches. Cuts for all businesses and political parties. Free powerhouse selling kit, low prices, protection guaranteed on repeat orders. Cash commissions. Superior Match Co., Dept. M-752, 7530 Greenwood, Chicago.

MAKE Big money—Season starting. Sell 1953 calendars, advertising specialties and executive gift line. Experience unnecessary. Commissions advanced. Outfit free. North American Calendar, 605-AA Washington, Chicago 6.

CUT Your own hair device. Beat high prices. Cut family's hair. Quick seller. Good profit. Barbour, 134 South Jefferson, Peoria, Illinois.

FREE Wholesale catalog. 6000 tested sellers comprising sporting goods, hardware, automotive supplies, premiums, luggage, gifts and jewelry. Write for free wholesale book using your letterhead stating line of business operated. Quality Products, 4-52 Jarvis, Le Center, Minnesota.

AD Matches! Sell amazing designs—20, 30, 40 and 240-light book matches. Bigger spot cash commissions; every business a prospect. Low prices for high quality. Repeats. Start without experience; men, women; full, part time. Buy nothing! Sales kit furnished. Match Corp., Dept. PM-31, Chicago 22, Illinois.

WORLD'S Shortest bookkeeping system. Copyrighted, 25c each. Mixon, Box 2048, Los Angeles 53, California.

\$100.00 WEEKLY Selling synthetic granite-marble grave monuments. Amazing proposition. Write immediately. Burton, 2500 Fisher, Fort Worth, Texas.

NEW Jobs open in selling! Send name, address for five free issues of Opportunity Magazine's money-making guide, listing hundreds of companies who'll pay you well, full or part-time. No experience needed. Opportunity, 28 E. Jackson, Dept. 17 Chicago 4, Ill.

SALESMEN: \$100.00 More weekly on present job using "amazing secret." Postcard brings startling information. Brennan, 4025-C Lankershim, North Hollywood, Calif.

EDUCATIONAL AND INSTRUCTION

WIN A well-paid job in travel—Step into a new world of glamorous opportunities! Today more Americans are "going places" than ever before in history. As a result the hotel and institutional field is surging ahead to new prosperity. Successful Lewis graduates are "making good" everywhere in luxurious hotels, resorts, restaurants, clubs, defense housing projects. Free book explains how to qualify at home for a well-paid position in this ever-growing business where you are not dropped because you are over 40; shows how you are registered free of extra cost in the Lewis National Placement Service. Write today. Lewis Hotel Training School, Room VL-395, Washington 7, D. C. (Now in its 36th year).

LISTEN—Learn a language by Linguaphone. At home, quickly, easily, correctly master Spanish, French, German, Russian, Japanese—any of 29 languages through Linguaphone Conversational Method. Add to service, job, travel opportunities. Send for free book. Approved for Veterans' Training. Linguaphone Institute, 8307 Radio City, New York City.

WANT A diesel job? New opportunities to increase income. Higher pay. More money. We can help you qualify. Tools. Shop method home training. Write today! Diesel, Tractor, Heavy Equipment Division, Interstate Training Service, Dept. 3G, Portland 13, Oregon.

MAKE Up to \$45-\$55 week as a trained practical nurse! Learn quickly at home. Booklet free. Chicago School of Nursing, Dept. M-7, Chicago.

"HOW To Break and Train Horses"—A book every farmer and horseman should have. It is free; no obligation. Simply address Beery School of Horsemanship, Dept. 1107, Pleasant Hill, Ohio.

BOOKKEEPERS! Increase your earnings! Operate your own simplified "Dollar-A-Week" bookkeeping and tax service. Full or spare time. Details free. No obligation. Ellis, Box 200-G, Cedar Grove, North Carolina.

A College degree by home study. B.A. and M.A. degrees. Previous credits recognized. Remain employed and still attain a college education. Low cost, pay-as-you-learn plan. State chartered. Fremont College, Santa Fe 8A, New Mexico.

HIGH School—No classes. Study at home. Spare time. Diploma awarded. Write for free catalog HF-22, Wayne School, 2527 N. Sheffield, Chicago 14, Ill.

TIRED Of no money, second rate jobs? Like to start a real career with a lifetime of high salaries? Write me about two growing fields that need men. Ed Howes, National Schools, Dept. 472, 4000 S. Figueroa St., Los Angeles 37.

WELDING Training pays at Hobart Welding School, Box M-722, Troy, Ohio. VA contract. Best equipment. Catalog free.

PRACTICAL Nursing—Learn easily at home, spare time. Big demand, good earnings. High school not necessary. Write for free facts. Wayne School, Dept. FG-10, 2525 Sheffield, Chicago 14, Ill.

MEDICAL Laboratory technicians in great demand. We train you in your own home. Catalogue free. Imperial Technical Institute, Box 973-J, Austin, Texas.

BECOME A Doctor of Psychology or Metaphysics. Teach secret of contentment, happiness. Win degree of Ps.D. or Ms.D. Solve mental worries. Free book. College of Universal Truth, 5153-C North Clark, Chicago.

INCREDIBLE! Become mental superman overnight! Free booklet! Bijou, Box 1727-MTT, Hollywood 28, California.

UNIVERSITY Degrees by residence and correspondence. Golden State University, Hollywood, Calif.

INVESTIGATORS Trained, men-women, learn fascinating profession. Spare time study. Big pay. Folders free. Investigator, Box 490, Times Square Station, New York 36, N. Y.

BECOME Expert draftsman. Details free. Monroe Institute, PM-7, Alton, Illinois.

WONDER Drugs! Cures! Lifesaving knowledge! Free booklet! Bijou, Box M33-1727, Hollywood 28, California.

SMASH Worries, fears and problems with our "Thought and Behavior Control" home-study method. Many helped. Rush request for amazing free lecture in plain wrappers. Personal Psychology, Inc., Box 1924-M, Louisville 1, Ky.

SEMANTOGRAPHY, Simple logic-semantic for everyone. Recommended by eminent scholars. Send 80 cents for 15,000 word brochure first lesson. Semantography Institute, Box 167, Yellow Springs, Ohio.

USED Correspondence courses and educational books bought, sold, rented, catalog free. Educational Exchange, Summerville, Ga.

LEARN Priceless secrets of technical metaphysics. Easy. Simple. Write Canada School of Technical Metaphysics, 2532 McKenzie St., Vancouver, B. C., Canada, for amazing information.

BE A real estate broker. Study at home or in classrooms in leading cities. Write for big illustrated free book today. Weaver School of Real Estate, Suite 304 Law Bldg., Kansas City, Mo.

MIDLAND Linotype School, Charles City, Iowa. Civilian and Veteran Courses. Free placement. Established 1909.

PROFIT From secrets of Eastern Wisdom. Learn Yoga at home. Become physically fit, mentally dominant, financially independent. Send 25c for first lesson. Insight School, Dept. PM, 1144 Ashland, Evanston, Illinois.

HOME Study course, drugless therapy. Free literature. Institute of Drugless Therapy, Tama, Iowa.

\$8-15,000 YEARLY Not unusual for Acme-trained tool and die designers! Industry desperately needs competent men. You can learn quickly by easy home study. No art ability required. Acme graduates go farther faster in tool and die designing. Famous "Cope" system includes same methods and texts used by our resident schools to train tool and die designers. Write today for free literature. Acme School of Die Design, 8 N. Jefferson Street, Dayton 2, Ohio.

USED Correspondence courses and books sold and rented. Money back guarantee. Catalog free. Courses bought. Lee Mountain, Pisgah, Alabama.

PIANO Tuning pays. Learn this profitable profession at home. Our Tonometer and mechanical aids make learning easy. No knowledge music necessary. Diploma granted. Largest and oldest school—53rd year. G.I. approved. Write for booklet. Niles Bryant School, 78 Bryant Bldg., Washington 16, D. C.

SECRET Investigation. Experience unnecessary. Investigators particulars free. George Wagner, M125 West 86th, New York 24.

INVESTIGATOR Training. Phillips Secret Service System, 1917-B North Kenneth, Chicago 39.

FASCINATING, Entertaining once-in-a-lifetime book! "Fifty Years of Popular Mechanics." Tremendously exciting story of most fabulous years in American history. Describes birth of auto, radio, airplane, television; hundreds of other inventions and world shaking events. Nostalgic old time ads and prediction of fabulous inventions to come next fifty years. Giant size—500 pages; 8½"x11". Order now while stock still available. Send \$5.00 to Popular Mechanics Press, Dept. 109, 200 E. Ontario, Chicago 11, Ill.

PLAYS, STORIES, MANUSCRIPTS

LOOKING For a book publisher? Write for free booklet PM3. Vantage Press, 230 West 41, New York.

BEGINNING Writers: Let us show you how to get \$1 to \$20 checks in your daily mail doing simple spare time writing. Experience unnecessary. Details free. W. Herwell, 7016 Euclid, Cleveland 3, Ohio.

I want new writers to cash checks of \$1 to \$100 offered daily. The easiest way to write for pay. No previous experience necessary. Free details. Saunders M. Cummings, 468-11 Independence Bldg., Colorado Springs, Colo.

SPECIAL SERVICES

HOLLYWOOD Postmark! Have fun! Letters, cards, remailed 25c each. 8 scenic postcards \$1.00. Stadler, Box 2335, Hollywood 28, California.

TEXAS, Letters remailed 25c. Houston help wanted columns and business opportunities mailed \$1.00. Huebner, 1112 Danube, Houston, Texas.

N.Y.C. Remail. Letters 25c, newspapers \$1.00. Taylor, Broadway, Tarrytown, N. Y.

FLORIDA. Letters, cards remailed 25c. Morgan, Box 6197, Orlando, Florida.

LETTERS Remailed Atlantic City 25c each. 2 scenic postcards 25c. Lucas, Box 1115, Atlantic City, N. J.

INFORMATION Concerning any matter. Ferguson Research, 116-14 141 St., South Ozone Park 36, N. Y.

LETTERS Remailed New York City 25c each. 2 scenic postcards 25c. Berrson, 380 92d St., Brooklyn, N. Y.

CLASSIFIED Section four big Texas newspapers, \$1.00. Pennebaker Advertising, Kerrville, Texas.

REMAIL Your letters 25c each. Business Service, Box 508, Great Falls, Montana.

SURPRISE Friends. Ten Hollywood view cards \$1; address, stamp, return for free remailing. Letter remailed 25c coin. Stone, Box 1733-P, Hollywood 28, Calif.

CARTOONING, COMMERCIAL ART, SHOWCARD WRITING, SIGN PAINTING

EARN Money evenings, copying and duplicating comic cartoons for advertisers. Advserice, Argyle 1-A, Wisconsin.

UP To \$4.50 per hour, spare time, if you can do small, readable lettering. National Artists Bureau, 801 North Marsalis, Dallas 3, Texas.

NINE Cartoon charts make cartooning easy. 400 illustrations 25c coin. Randall, 312 First, Peoria, Illinois.

LEARN Sign painting at home. Test lesson free. Ben Kerns, Box 812-P.M., Greenville, S. C.

CHALK Talks. Laugh producing program, \$1.00. Catalog 10c. Balda The Cartoonist, Oshkosh, Wisconsin.

ADVERTISING AGENCIES, LETTER WRITERS, FOR ADVERTISERS

MAILING Lists, free details. Townsend Enterprises, 42-09 222nd Street, Bayside, New York.

NAMES: Cash customers, 1000-\$3.50. Bolaine Sales, Box 5004, St. Paul, Minn.

"ADVERTISING Doesn't cost—it pays" in our various magazines. Samples, 25c. Mention product, services. Wright Publications, 2270 Hubbard, Memphis 8, Tenn.

ADVERTISE: 24 Words, 100 Canadian newspapers \$5.50. Lists free. Advertising Bureau, 10511-C Springfield, Chicago 43.

ADS Placed in out of town newspapers and magazines. Low rates. Catalogue free. Ideas that pay. Baker Advertising Agency, Successors Ankrum Agency, 189 W. Madison, Chicago 2.

ADVERTISERS! Reach nearly 18,000,000 readers. 25 Sunday national key newspapers. 18 words, \$59.00. "Terrific pullers." 20 popular newspapers, \$11.50. Free booklet. Special—One inch display 2,-821,198 circulation. \$51.10. Newmark's Advertising Agency, (Established 1893), 217-7th Ave., New York 11.

MAILING Lists; \$5.00-1000 up. Write Dixie Service, King, N. C.

RUBBER STAMPS AND OFFICE SUPPLIES

LINE 25c; 2-45c; 3-65c. Stamp Works, Auburn, Nebraska.

3 LINES 50c; Pads 35c; signature \$2.35. Stamp-Right, Wauwatosa, Wis.

TYPEWRITERS, DUPLICATORS, OFFICE DEVICES

RECONDITIONED Typewriters, printing devices, office machines, equipment. DixieGraph, King, N. Car.

PRINTING, MULTIGRAPHING, MIMEOGRAPHING, GUMMED LABELS

SEEING Free distinctive printing samples is believing. Prices. McDonald, 545 N. Oakland, Pasadena 4, California.

100 LETTERHEADS 8 $\frac{1}{2}$ x11, 100 Envelopes size 10, \$2.00. Gliest Co., 145 East Philadelphia, Youngstown 7, Ohio.

100 PRINTED Envelopes or paper, business, personal \$1.00. Botsford Printery, Botsford, Conn.

BILLHEADS. Statements, letterheads, 5 $\frac{1}{2}$ x8 $\frac{1}{2}$, 2000, \$8.95; 4000, \$15.25, postpaid. Free samples. Community Press, East Aurora 3, N. Y.

BETTER Printing! Large catalog free. Nationwide, 2337 Bath Avenue, Brooklyn 14.

QUALITY Mimeographing 8 $\frac{1}{2}$ x11, \$1.35 hundred. Limit 30 lines, 4c each additional line. 250, \$2.45. 500, \$3.60. 1000, \$5.75. Remailing, forwarding 25c each. Sinclair Advertising, Dept. A, Box 762, New Orleans, La.

NEED Printing? Request samples, prices. Gooch, 202PM, Hernando, Miss.

100 LETTERHEADS, 100 Envelopes \$1.95. Hurt and Fosse, Blue Ridge, Virginia.

8 $\frac{1}{2}$ x11 LETTERHEADS. 500, \$2.50; 1000, \$4.00. Samples. D'Yarmett Printing, Newark, Ohio.

500 PRINTED Labels with your name and address 50c; 1500, \$1.00. Shipping labels 3x4 $\frac{1}{4}$ ", 2000, \$5.00. Boozinny, 152-B Victor, Detroit 3, Mich.

1000 BUSINESS Cards \$2.50 prepaid. Samples free. Reliable Print Shop, 905 E. Jefferson, Louisville 6, Ky.

QUALITY Printing, postpaid. Free samples, prices. Sutton Printing, Box 853-M, Waycross, Georgia.

GUMMED Labels, stationery. Free list. Reed, Box PM-135, Spiro, Okla.

BOOKLETS, Circulars, letterheads, envelopes. Estimates free. Lonelm Printers, Paulding, Ohio.

MIMEOGRAPHING—Reasonable. Any copy. Mailers Service, Box 606-A, Chicago 90, Ill.

LETTERHEADS, Envelopes, statements, circulars, etc. Prices, samples. Mercury Press, Box 69, Marengo, Iowa.

MIMEOGRAPHING—Letters, pricelists, formulas, instructions. Lowest prices. Lem's Letter Shop, 5710 Stanton, Detroit 8.

125 8 $\frac{1}{2}$ x11 LETTERHEADS And 125 6 $\frac{3}{4}$ envelopes \$2.00, postpaid. 250 of each \$3.50. Going Print Shop, Box 1544A, Muskogee, Oklahoma.

500 3 $\frac{1}{2}$ x2 $\frac{1}{4}$ FOUR Line gummed stickers 50c. Red border \$1.00. Moritz Printery, Saginaw, Mich.

PRINTING OUTFITS AND SUPPLIES

MAKE Your own self-molding rubber printing cuts. Plexirubber, Argyle 1, Wis.

PRESSES, Type, cabinets, supplies. List for stamp, Lincoln Press Company, 220-I Hartwell, Fall River, Mass.

PRINT Your own cards, stationery, circulars, advertising. Save money. Simple rules. Print for others, nice profit. Raised printing like engraving too. Have home shop. Details free. Kelsey Presses, L-11, Meriden, Conn.

PRINTING Presses, type, supplies. Lists 3c. Turnbaugh Service, Loysville, Penna.

PATENT ATTORNEYS

INVENTORS! Learn how to protect your invention. Special booklet "Patent Guide for the Inventor" containing detailed information concerning patent protection and procedure together with "Record of Invention" form will be promptly forwarded to you upon request—without obligation. We are registered to practice before the U. S. Patent Office and prepared to serve you in the handling of your patent matters. Clarence A. O'Brien & Harvey Jacobson, Registered Patent Attorneys, 21B-G District National Building, Washington, D. C.

INVENTORS—If you consider your invention to be something of importance, take steps to protect it with a United States Patent which gives you the right to exclude others from making, using and selling your invention as claimed. "Patent Protection for Inventors" outlines steps to take to secure patent protection. Mailed promptly without obligation. Victor J. Evans & Co., Merlin M. Evans, Registered Patent Attorney, 731-H Merlin Building, Washington 6, D. C.

INVENTORS—If you believe you have an invention, we can make a preliminary search on your invention and advise you whether we think it can be patented. Send for copy of our patent booklet "How to Protect Your Invention" and "Invention Record" form. No obligation. McMorrow, Berman & Davidson, Registered Patent Attorneys, 134-T Victor Building, Washington 1, D. C.

"INVENTOR'S Guide" free. Frank P. Ledermann, Registered Patent Attorney, 154 Nassau Street, New York.

REGISTERED Patent attorney offers services. Sanders, 6430 Evans, Chicago 37, Ill.

PATENTS. "Proof of Invention" free. E. E. Vrooman, Registered Patent Attorney, 507 McKim Building, Washington 5, D. C.

INVENTORS—For "Invention Record" form, contact Carl Miller, Registered Patent Attorney, Woolworth Building, New York.

INVENTORS: When you are satisfied that you have invented something of value write me, without obligation, for information as to what steps you should take to secure a patent. Write Patrick D. Beavers, Registered Patent Atty., 935 Columbian Bldg., Washington 1, D. C.

C. A. Snow & Co.—M-427, Snow Building, Washington 1, D. C. Registered Patent Attorneys. Write for information.

INVENTORS: Without obligation, write for information explaining the steps you should take to secure a patent. John N. Randolph, Registered Patent Attorney, 203 Columbian Bldg., Washington 1, D. C.

CANADA—Ramsay Company Registered, 273 Bank Street, Ottawa, Canada.

FOR INVENTORS

INVENTORS—If you believe you have an invention, we can make a preliminary search on your invention and advise you whether we think it can be patented. Send for copy of our patent booklet "How to Protect Your Invention" and "Invention Record" form. No obligation. McMorrow, Berman & Davidson, Registered Patent Attorneys, 134-V Victor Building, Washington 1, D. C.

INVENTORS—If you have a valuable invention, you are advised to authorize a preliminary search through appropriate classes of United States patents. This firm is registered to practice before the Patent Office and is available to make such search and report to you concerning the probable patentability of your invention. Instructive booklet with "Evidence of Invention" form sent upon request. Victor J. Evans & Co., 732-H Merlin Building, Washington 6, D. C.

INVENTORS: Learn how to protect your invention. Special booklet "Patent Guide for the Inventor" containing detailed information concerning patent protection and procedure together with "Record of Invention" form will be promptly forwarded to you upon request—without obligation. We are registered to practice before the U. S. Patent Office and prepared to serve you in the handling of your patent matters. Clarence A. O'Brien & Harvey Jacobson, Registered Patent Attorneys, 21A-G District National Building, Washington, D. C.

ELECTRONIC Problems, devices, advice. Free information. Registered Engineer, 5208-A Onacrest, Los Angeles 43.

INVENTORS! For "Copyright, Design & Patent Guide" contact Mr. Metzler, 11 West 42nd, New York 18.

PATENT Searches, \$5.00, including patent copies. Free protection forms, 48 hour service. Accurate and reliable results. All inventor's services. Patent Service Institute, 945-A Pennsylvania Avenue, Washington 4, D. C.

PATENT Searches \$5.00. Protection forms free. Patent drawings prepared. Write Patent Engineering Service, 1404 New York Avenue N.W., Washington 5, D. C.

INVENTORS—Let us help you sell your idea. Send 25c for our successful sales plan. Write Visioneering, Inc., Wells Bldg., Milwaukee, Wisconsin, Dept. M.

INVENTION—Three months trial \$1, sample 50c. Covers the field of patents, markets, ideas, digs out answers for readers. If you're an inventor or gadgeteer, or hope to be one, or want to protect an idea, "Invention" can help you. 253 Bridge, Corning, N. Y.

INVENTORS—Sell your invention direct to manufacturers. Without obligation write National Patent Sales Company, Dept. D, Box 370, Richmond, Virginia.

INVENTORS—Send for free patent information book and inventor's record. Registered Patent Attorney. Associate Examiner, Patent Office 1922-29; Patent Attorney & Advisor, Navy Department 1930-47. Gustave Miller, 72A Warner Building, Washington 4, D. C.

INVENTORS! Let me help you develop ideas in medicine, chemistry, electronics. Confidential, ethical consultation service. Write Dr. Arthur L. Dunn, Box 24, Elmwood Station, Omaha 6, Nebraska.



DIVING GEAR

The very same as used by Uncle Sam's Underwater Commandos, as you saw them in the exciting movie, "THE FROGMEN".

- AQUA-LUNG Jr.**, self-contained diving unit, for free swimming down to 300 ft., up to 30 min. **99.95**
- STANDARD Model**, good for one hour's diving. **150.00**
- NAVY type**, 2-tank block, for 2 hours' diving. **275.00**
- FROGMAN SUITS**—to keep diver warm and dry to 55° temp. Short arms and legs **32.50**. Same with hood, illustrated above **42.50**. Frogman suits for colder water—long arms and legs **39.50**. Same with hood and boots **54.50** (When ordering give height and weight.)
- ARBALETE**, powerful, economical, accurate, rubber powered, silent spear-gun which won all internatl. competitions during last 4 yrs. Free spear range: 35 ft. **25.00**
- ARBALETE DeLUXE**, four slings, double power, range 50 ft. **35.00**
- FRENCH CHAMPION DIVE MASK**, 100% watertight seal on any face, free of synthetic rubber, extra wide vision. **4.95**
- SQUALE**, the only shatterproof glass mask, Navy standard. **6.95**
- FLOATING DAGGER**—cork handle, sharp stainless blade. **4.95**
- SNORKLE** tube allowing breathing with face under water, without disturbing vision (see drawing). **1.95**
Same with automatic water-seal ball attachment. **2.95**
- DEPTH GAUGE**, indicates depth of dive down to 160 feet, easy reading. **3.50**
- UNDERWATER FLASHLIGHT**, pressure-proof. **2.95**
- "SHALLOW WATER DIVING"**, most comprehensive book on the subject, shows all eqmt. **2.50**
- "I Dive for Treasure"** by Lt. Rieseberg. **3.00**
- "The Sea Around Us"** by Rachel Carson. **3.50**
- "Diving to Adventure"** by Hans Haas. **3.75**
- "Deep Diving"** by Sir Robert H. Davis. **9.95**
- Self-Contained Diving digest**. **.95**

U. S. DIVERS CO.

Dept. PM-7
1045 BROXTON AVENUE
W. LOS ANGELES 24, CAL.
Orders accepted from D&B firms.

Order from this ad. Prices
F.O.B. Los Angeles. In Calif.,
add 3 1/2% tax. All sales final.

2 in 1 ZING SHOT THE NEW HUNTING SLING-SHOT THAT SHOOTS ARROWS, TOO.

Folds instantly

Double Fun!
A powerful hunting sling shot and an accurate arrow shooter all-in-one. Fine for target practice outdoors or indoors. Complete with target, .25 cal. pellets, instructions. Guaranteed.
At dealers or send \$2.50 to
Dept. M, Zing Mfg. Co., 84 So. 1st St., San Jose, Calif.

250 Post Paid

Sensationally New For 1952!
MIDWEST Television
and 5 Wave Band Radios

Mammoth 20-INCH
Rectangular PICTURE

EASY TERMS
Beautiful consoles and complete chassis for easy installation in your own cabinet.

30 DAYS TRIAL — FACTORY-TO-YOU
MIDWEST RADIO & TELEVISION CORP.
Dept. 25R, 909 Broadway, Cincinnati 2, Ohio

SEND THIS COUPON For FREE MIDWEST 1952 Catalog

NAME _____
ADDRESS _____
CITY _____ ZONE _____ STATE _____

LEARN MORE AND EARN MORE!
"How-to" Books at BIG SAVINGS

- BUILD IT YOURSELF**—100 good ideas for home comfort. **\$1.00**
- PROJECTS IN WOOD**—easy work for the amateur craftsman. **\$1.25**
- REFRIGERATION SERVICE-MAN'S MANUAL**—complete, up-to-date. **\$5.00**
- GUIDE TO BETTER REFRIGERATION**—companion book to the Manual. **\$2.50**
- SLIDE RULE & HOW TO USE IT**—with answers and 5-place log tables. **\$1.75**
- PRACTICAL PLANE TRIGONOMETRY**—adaptable to needs of student or worker. **\$2.00**
- THE MIRACLE OF TELEVISION**—story of TV and its future opportunity. **\$2.50**
- THE GUN DIGEST**—latest information on rifles, shotguns, revolvers, etc. **\$2.00**
- PITMAN SHORTHAND SELF-TAUGHT**—with 500 wk. sheets, binder, 86 value. **\$2.95**
- AIRCRAFT YEAR BOOK**—official reference work on American Aviation, 85 value. **\$2.00**
- FLIGHT-AVIATION ENGINES**—fundamentals, design and construction, 84 value. **\$2.00**
- PROGRESSIVE ELECTRICITY**—beginner's manual for quick-learning. **\$2.00**
- PROGRESSIVE SHOPWORK**—self-teaching, well-illustrated, streamlined. **\$2.00**
- GARDEN MANUAL**—growing your own vegetables at low cost. \$1.75 value. **\$1.00**
- COVERTS & CASTS**—hunting & fishing book, beautiful pictures, 85 value. **\$2.95**
- HOME BOOKS — NEW ERA HOUSES**, Designs, plans, 4 books, 85 value, all for. **\$2.95**

Mark books wanted and mail this ad with check, money order or currency, to
WILCOX & FOLLETT COMPANY
DEPT. PM-7 1255 S. WABASH AVE. CHICAGO 5, ILL.

New COMBO Wrist Watch
A "Once In A Blue Moon" Value —
with Unconditional GUARANTEE!
(Exclusive of Parts)

Fine Timekeeper PLUS precision stop-watch with sweep second hand to time races, operations, moving objects, etc. Perfect for time-study work. Rugged movement in handsome, non-magnetic, shock-resistant stainless steel case. "SOLD EVERYWHERE AS HIGH AS \$17.00." Our Price \$7.75 plus 10% tax (Total \$8.53). Send check or money order now and we will pay postage. Or we will send C.O.D., plus charges. Act Quickly.
MARDO SALES CORP., Dept. 042
Plus Tax 480 Lexington Ave., New York 17, N.Y.

\$7.75

Get into.. PLASTIC LAMINATING AT HOME!

Get ORDERS and CASH from your mailman—do work in SPARE TIME at home—or expand into FULL TIME business. Send coupon for Free facts about the newest and most fascinating of all home operated businesses. For the first time a simplified machine brings the fabulous profits of Plastic Sealing and Plastic Laminating within the reach of the small operator. Anyone can learn to operate the machine with a few minutes practice—then with our Magic Mail Plan can get mail orders pouring in daily with cash in every envelope. **No canvassing—no selling.** We even

Make Thousands of Beautiful Art Creations
COSTUME JEWELRY • CIGARETTE BOXES
TRAYS • CANDLESTICKS • COASTERS
LAMP BASES • BOOK ENDS...ALL IN SPARKLING COLORED PLASTIC

THIS MAN ..
... is taking out of the machine a Plastic Sealing Job—ordered by mail—only 1lb in material cost brings back \$2.58 in cash by mail. Capacity of machine: **\$25.00 profit per hour of operation.**

Make \$20 to \$30 a Day by.. MAGIC MAIL PLAN!

supply the circulars you mail to bring back cash and orders. Don't waste a minute. Rush your name. We'll send you FREE and postpaid, pictures, prices, details, and all the facts you need to start. Mail coupon or send name on postcard. No charge.
Warner Electric Co., 1512 Jarvis Av., Dept. L-10-M, Chicago 26, Ill.

WARNER ELECTRIC CO., 1512 Jarvis Av.
Dept. L-10-M, Chicago 26, Ill.
At no cost to me, please rush complete details postage prepaid. I am under no obligation.

Name _____
Address _____
City _____ Zone _____ State _____

DON'T MISS THIS AND
THE NEXT 3 PAGES!

Read All About 40 Famous
How • To • Do • It
Books

from the Presses of
Popular Mechanics

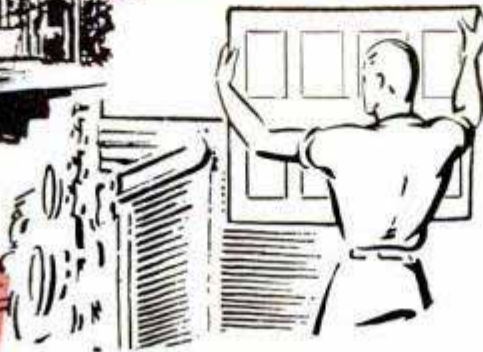

*Fifty Years of
Book Publishing Service
to Information-Seeking
America*

On the next three pages are
described and pictured forty
POPULAR MECHANICS BOOKS

prepared by authoritative and able writers under the supervision
of **POPULAR MECHANICS EDITORS.**

When he founded **POPULAR MECHANICS MAGAZINE** a half century ago, Mr. H. H. Windsor, Sr., began the publication of practical, down-to-earth **HOW-TO-DO-IT** books. Since then Popular Mechanics has continued to feature the publication of books of this type. Each book is prepared on the same practical foundation as is the magazine, under its famous slogan — **WRITTEN SO YOU CAN UNDERSTAND IT.** All texts are backed up with pictures, plans and diagrams that make every point unusually clear, even for those with little or no familiarity with the subject.

POPULAR MECHANICS BOOKS are abreast of the times, covering the latest inventions and developments. They describe methods and materials; explain processes and procedures; provide short cuts and easier ways of doing time-honored jobs and specifically serve the needs of **INFORMATION-SEEKING AMERICA** with actual **HOW-TO-DO-IT** information and instruction. They save time and effort and save and make money for millions of users of all ages and from all walks of life.

Please turn the page. You, too, will no doubt find the answers to your problems, or perhaps, find greater enjoyment of your interests in **POPULAR MECHANICS HOW-TO-DO-IT BOOKS.**



POPULAR MECHANICS PRESS • Chicago

Popular Mechanics

HOW • TO • DO • IT BOOKS

HOME BUILDING AND MAINTENANCE • FARMING • BETTER JOBS • SKILLS
HOME WORKSHOP • HOBBIES • AUTO CARE • PASTIMES • ETC.

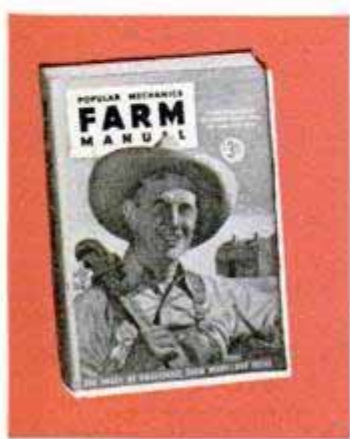

Endorsed by leading agriculturists, County Agents, Vo-Ag teachers and others.



FARMING • FARM WORKSHOP

FARM MANUAL Contains hundreds of practical articles and ideas for everyday use on the farm. Covers the making of implements and equipment, maintaining the home, the farm workshop, livestock and poultry, vegetable storage and processing, etc. Gives time and money-saving farm hints and kinks. Something for every member of the farm family. Steps up farm efficiency, increases production and improves appearance. Here is the experience of hundreds of successful farm operators brought together into one handy, easy-to-read, easy-to-use, working handbook by the editors of Popular Mechanics. It will make and save money for you. Now in its fourth printing. Over 140,000 copies sold. This book should be on every farm. **\$3.00**

HOME MAINTENANCE

LAWN AND GARDEN For every home owner, with practical instruction based on proven methods for landscaping and growing fine lawns and gardens. 176 pages. **Illustr. \$2.50**

HOW TO PAINT By Sam Brown. Covers all types of paint application. **Illustrated. \$2.50**

WHAT TO MAKE WITH CONCRETE All types of concrete work for the home owner. Kinks, short cuts for builders. 112 pages. **Illustrated. \$2.00**



HELP FOR CAR OWNERS, MECHANICS

MOTORIST'S HANDBOOK 535 practical articles of helpful information that can easily save you hundreds of dollars every year, make your car run better and look better too. Covers models 1940-1950. **Illus. \$2.00**

MANUAL FOR PLYMOUTH OWNERS Get the most out of your car investment. Covers the Plymouth from bumper to bumper—explains how parts operate, what can go wrong, what repairs are necessary, how to avoid trouble. **Illustrated. \$3.50**

MOTORIST'S FIX-IT BOOK Simplified instruction for car owners. Can easily save hundreds of dollars every year. **Illustrated. \$2.00**



OUTDOORS AND SPORTS BOOKS

HOW TO TEMPT A FISH

Section by Joe Godfrey, Jr., world famous authority. A lifetime of valuable fishing information in a single book. 20 pages of best fish lures in actual colors. 525 illustrations. **\$2.00**



OUTDOOR SPORTS MANUAL Over 200 helpful articles for the hunter, trapper, fisherman, camper, archer and boatman. 334 illustrations. **\$2.00**

23 BOATS YOU CAN BUILD Plans, building instructions and material requirements for 23 different boats that anyone can build at home. Over 500 pictures. **\$2.00**

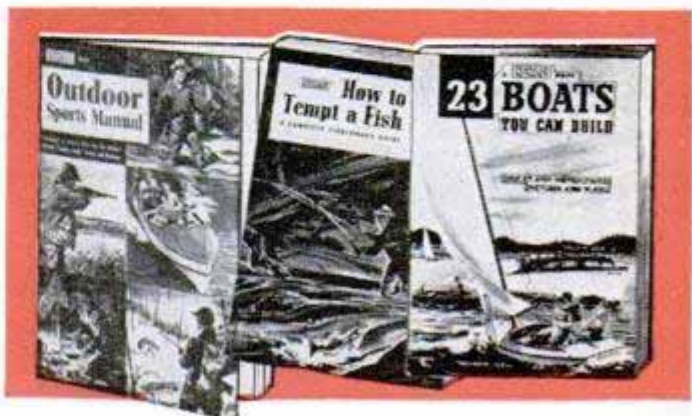

HOME BUILDING

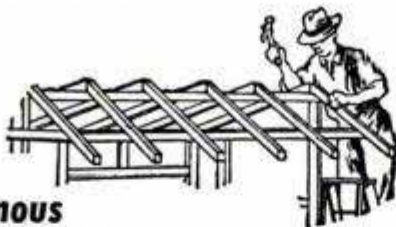

Popular Mechanics Famous "Build-It-Yourself" Books that Save Over One-Half Home Building Costs

YOUR HOME AND HOW TO BUILD IT YOURSELF Hundreds of amateur builders have built this home with the aid of this book. Typical 6-room Colonial home with garage, breezeway and basement. Can be built by any man handy with tools. Many pictures in actual colors. \$3.00

CONCRETE BLOCK HOUSE

Built in many localities by amateur builders, complete with plumbing, electrical wiring and heating for less than \$3650. Five good sized rooms and ideal for family of four. Half of book is pictures and diagrams. \$2.00

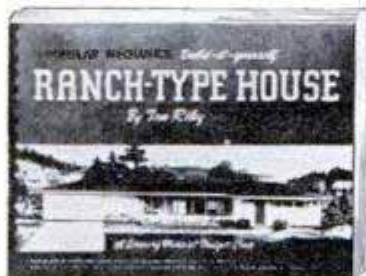

RANCH HOUSE BOOK

Ready Sept. 1.

Exciting new ranch type house, finished inside and out with plywood. Fully insulated. Can be built in two easy stages by amateur. Five rooms with bath and utility room and car port, about \$5000. Added garage, breezeway and third bedroom, about \$2500. Heating, wiring, equipment included. Designed by famous West Coast architect. Plenty of pictures. \$3.50

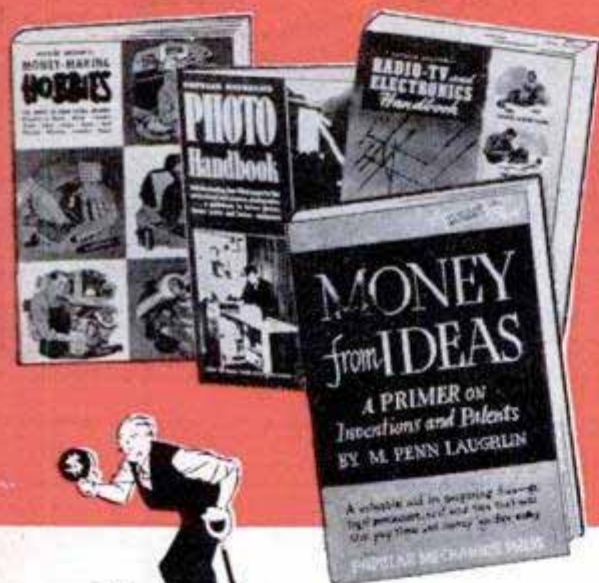

HOBBIES, PROFITABLE IDEAS

RADIO, TV AND ELECTRONICS HANDBOOK by Popular Mechanics Electronics Editor. A book for set owners, experimenters, students, experienced men. 566 illustrations. \$2.50

MONEY-MAKING HOBBIES Tells how to have fun and make hobbies pay their own way and a profit. 132 different things. \$2.00

PHOTO HANDBOOK Better pictures. Gadgets you can make. Proven darkroom helps. Camera tricks. 465 illustrations. \$2.00

MONEY FROM IDEAS A practical book for every man with an active inventive mind who believes he has ideas that can be patented. \$2.50

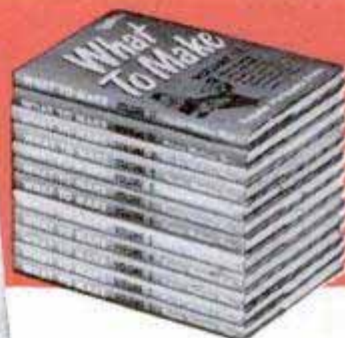

WHAT TO MAKE

WHAT TO MAKE Now 12 volumes. An annual selection of craftsman projects such as furniture, toys, games, gifts, etc. More than 3000 different projects in the 12 volume set. Fully illustrated. Each volume \$1.75. Set of 12 volumes. \$18.00

WHAT TO MAKE FOR CHILDREN 175 things dad and mother and other members of the family can make for the young folks at home. Fully illustrated. \$2.00

EDUCATIONAL BOOKS FOR BOYS

YOUNG CRAFTSMAN Over 450 different projects for boys of all ages. Brings out the inherent creativeness in every boy and stimulates imagination. More than 1100 illustrations. \$2.00

BOY MECHANIC Hundreds of things a boy can make at home at little or no cost. Detailed plans and hundreds of pictures. Teaches boys to think and work with their hands, making such things as autos, boats, models, games and craftwork. \$2.00

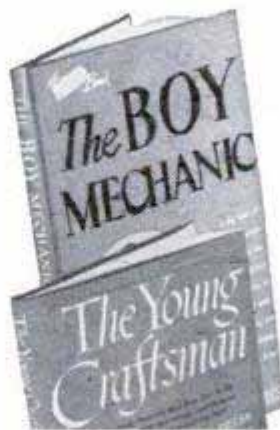

Home Workshop Books • Projects for Home Craftsmen and Windsor Press Publications on NEXT PAGE

HOME WORKSHOP and CRAFT BOOKS for FUN and PROFIT

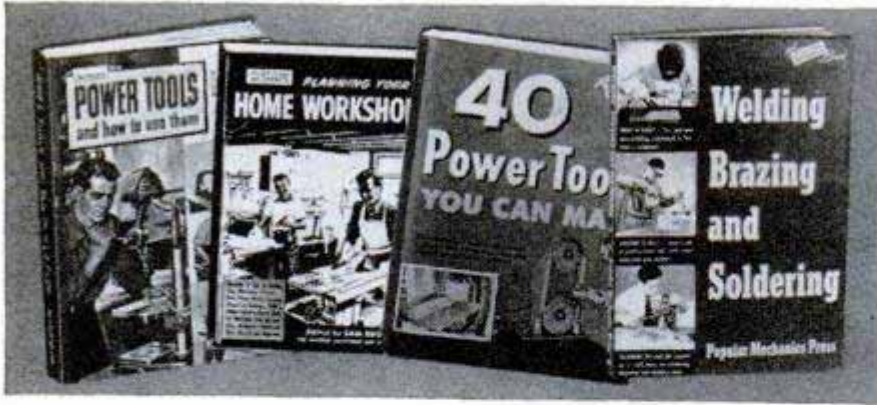

PRACTICAL, HELPFUL INFORMATION FOR THE HOME WORKSHOP FAN



Here is a selection of books that lead the field in all-time popularity. Nothing else like them. Superbly Illustrated.

POWER TOOLS AND HOW TO USE THEM A practical guide to the selection and operation of home workshop machines. Includes exciting projects in many materials. **\$2.50**

WELDING, BRAZING AND SOLDERING Shows you your own equipment and use it effectively on jobs of all kinds. 1950 edition. **\$1.75**

40 POWER TOOLS YOU CAN MAKE Tells how to make tools from scrap and discarded materials at small cost. New edition with added tools. **\$1.50**

PLANNING YOUR HOME WORKSHOP Edited by Sam Brown. Tells how to set up a shop on a limited budget and get the most out of it in fun and efficiency. **\$2.50**

FASCINATING CRAFT PROJECTS

CHRISTMAS HANDBOOK A wonderful collection of Ideas, Gifts, Decorations, Toys—You can make at home. Informative and practical. Illustrated. **\$2.00**

100 BEAUTIFUL PIECES OF FURNITURE YOU CAN BUILD Scale drawings and instructions for living, dining and bedroom suites and occasional furniture. Plates in actual colors. 320 illustrations. **\$3.00**

YOU CAN MAKE A STRADIVARIUS VIOLIN Complete instructions and 8 full size plans. Tells where to get materials and how to make your own tools. Illustrated. **\$3.50**



Handy Order Form

MAIL TO POPULAR MECHANICS PRESS OR ORDER FROM YOUR BOOKSELLER

POPULAR MECHANICS PRESS

Dept. 80, 200 East Ontario Street, Chicago 11

Check Titles Wanted

- | | | | |
|--|--------|---|--------|
| <input type="checkbox"/> Boy Mechanic | \$2.00 | <input type="checkbox"/> Planning Your Home Workshop | \$2.50 |
| <input type="checkbox"/> Christmas Handbook | 2.00 | <input type="checkbox"/> Power Tools and How to Use Them | 2.50 |
| <input type="checkbox"/> Concrete Block House | 2.00 | <input type="checkbox"/> Radio, TV and Electronics Handbook | 2.50 |
| <input type="checkbox"/> Concrete Handbook | 2.00 | <input type="checkbox"/> Ranch Type House Book | 3.50 |
| <input type="checkbox"/> Farm Manual | 3.00 | <input type="checkbox"/> 23 Boats You Can Build | 2.00 |
| <input type="checkbox"/> Forty Power Tools You Can Make | 1.50 | <input type="checkbox"/> Veterinary Guide for Farmers | 3.50 |
| <input type="checkbox"/> How to Paint | 2.50 | <input type="checkbox"/> Welding, Brazing, Soldering | 1.75 |
| <input type="checkbox"/> How to Tempt a Fish | 2.00 | <input type="checkbox"/> What to Make, Volume | 1.75 |
| <input type="checkbox"/> Lawn and Garden | 2.50 | <input type="checkbox"/> What to Make, 12 Volume Set | 18.00 |
| <input type="checkbox"/> Manual for Plymouth Owners | 3.50 | <input type="checkbox"/> What to Make for Children | 2.00 |
| <input type="checkbox"/> Money From Ideas | 2.50 | <input type="checkbox"/> You Can Make a Stradivarius Violin | 3.50 |
| <input type="checkbox"/> Money Making Hobbies | 2.00 | <input type="checkbox"/> Young Craftsman | 2.00 |
| <input type="checkbox"/> Motorist's Fix-It Book | 2.00 | <input type="checkbox"/> Your Home and How to Build It Yourself | 3.00 |
| <input type="checkbox"/> Motorists Handbook | 2.00 | | |
| <input type="checkbox"/> One Hundred Beautiful Pieces of Furniture | 3.00 | | |
| <input type="checkbox"/> Outdoor Sports Manual | 2.00 | | |
| <input type="checkbox"/> Photo Handbook | 2.00 | | |

Enclosed is remittance for \$_____ for which please send postpaid, Popular Mechanics Books as checked to the left. (Orders for \$2.00 or more may be sent COD, postage and charges extra.)

MONEY BACK IF NOT SATISFIED

Name _____

Address _____

Postal Zone _____

City _____ State _____

TOOL & INDUSTRIAL ENGINEERING

DEGREE IN 26 MONTHS



- BACHELOR OF TOOL ENGINEERING DEGREE IN 26 MONTHS
- TOOL & DIE DESIGN IN 10 MONTHS

The Allied Institute, the oldest Tool Engineering school in America, permits candidates to complete degree work in only 26 months. Time may be shortened by advanced credit given for prior training in other schools or the Armed Forces.

CREDIT IS ALSO GIVEN FOR ACCEPTED EXPERIENCE YOU HAVE ALREADY GAINED IN INDUSTRY.

The Allied Institute of Technology has been approved by the American Society of Tool Engineers for aiding and assisting the professional advancement of Tool Engineering Education. The Institute has complied with established requirements for the Administration of a Tool Engineering curriculum, as set forth by ASTE and American Industry.

Housing and Employment assistance given while attending school.



Write for free information
ALLIED INSTITUTE of TECHNOLOGY

1338-42 S. Michigan Ave. Dept. PM-7 Chicago 5, Illinois



Illustrated book sent FREE

WORK IN COOL SAN DIEGO

San Diego offers you California living at its best — and Convair gives you the top working conditions. Employee Retirement Plan. Group Insurance. Two weeks vacation. Eight holidays annually. Free Housing Office and much more — plus that wonderful San Diego climate. These classifications now open for you:

- | | |
|-----------------------------|-------------------------------|
| 1. TOOL DESIGNERS | 8. FIELD & SERVICE MECHANICS |
| 2. TOOL PLANNERS | 9. AIRCRAFT MECHANICS |
| 3. PATTERN MAKERS | 10. AIRCRAFT ELECTRICIANS |
| 4. TOOL & DIE MAKERS | 11. IBM TAB MACHINE OPERATORS |
| 5. JIG AND FIXTURE BUILDERS | 12. INSPECTORS |
| 6. MACHINISTS | |
| 7. LOFTSMEN | |

CONVAIR

Send this coupon for FREE book and details:

Employment Office 700
Consolidated Vultee Aircraft Corporation
3302 Pacific Hiway
San Diego, California

NAME _____
OCCUPATION _____
ADDRESS _____
CITY _____ STATE _____

SAVE GAS

WITH A FUEL PRESSURE REGULATOR!

THIS REVOLUTIONARY NEW ACCESSORY STOPS GAS WASTE CAUSED BY FUEL PUMP PULSATION. ELIMINATES CARBURETOR FLOODING AND FUEL "SURGE." STOPS THE ANNOYANCE AND POWER LOSS CAUSED BY "MOTOR CUT-OUT." Many users claim up to 25% gas saved. Regulator s-m-o-o-t-h-s fuel flow... prevents vapor lock and percolating.

It pays for itself in a few weeks with gas saved, by eliminating frequent carburetor tuning and by reducing engine and carburetor wear. Fits all cars and trucks.



BEFORE AFTER
Only \$5.95 post-paid

3 BOOKS FREE

With each order: Big Speed Equipment Catalog, plus "Economy Driving Manual" plus famous "150 Miles Per Gallon Book"—a regular \$1.75 value free with order.

NEWHOUSE AUTOMOTIVE INDUSTRIES

Dept. BR-7, 5805 E. BEVERLY BLVD., LOS ANGELES 22, CALIF.

SHINE WITHOUT 'POLISH'

New Invention! • Sells Like Wild



Replaces messy pastes, liquids. Simply glide over shoes—and PRESTO! —you have a lustrous, long-lasting shine. No mess. No fuss. No soiled hands. Clean, Handy, WORKS LIKE MAGIC! For Men's, Women's and Children's Shoes. Low priced. Lightning seller!

SAMPLES FOR AGENTS Sample offer sent immediately to all who send name at once. Hurry. Postcard will do. **SEND NO MONEY—just your name.** KRISTEE CO., Dept. 693, AKRON 8, OHIO

PORTABLE GARAGE

VINYL PLASTIC \$6.95

USE IT ANYWHERE!



• Goes wherever your car goes • Folds compactly • Keeps rain, dust, salt air, sun or sleet away • Will withstand Extreme weather without cracking and protects your car's finish • Perfect for storage of Cars, Furniture, Machinery Equipment • Durably constructed of vinyl plastic that is long wearing and tough • Nylon thread grommets for extra security • Spring-tite elasticized bottom, holds securely in all kinds of weather • Fits all makes and models • Direct from manufacturer • Enclose check or money order, or sent C.O.D. • 10-day money-back guarantee.

MARDO SALES CORP.

480 LEXINGTON AVE., DEPT. 105, NEW YORK 17, N. Y.

JULY 1952



AMAZING NEW RADIO

COMPLETE AS SHOWN—NO TUBES—BATTERIES OR ELECTRIC "PLUG-INS" NEEDED —Has new Crystal Diode and speaker-phonel Selective Clear tone. Gets local stations most anywhere you go. Should last for years. Send \$1.00 and pay postman \$3.99 C.O.D. postage or send \$4.99 for p.p. delivery. GUARANTEED. Rush order now!

MIDWAY CO.
DEPT. PPM-7 KEARNEY, NEBR.

Say You Saw It in POPULAR MECHANICS

Save Money on **HOW-TO-DO-IT BOOKS**

4 For \$2
2 For \$1

The latest, most practical information at lowest cost. Big 100-page, fully illustrated books. All four for only \$2. Any two for only \$1. Equal in contents and usable information to books selling for \$2.00 each and more. Plain, durable covers instead of expensive fancy bindings save you money—give you bigger value. Now ready — HOUSE WIRING MADE EASY — PLUMBING SIMPLIFIED — PAINTING AND DECORATING — SPRAY PAINTING FOR THE AMATEUR. Practical, up to date and complete information that shows you how to do professional-like jobs with no previous experience. Clip this ad and

mail with name and address and \$2 for four books — \$1 for two. Money back if not satisfied. FREDERICK J. DRAKE & CO., Dept. 7-B, 117 Green Bay Rd., Wilmette, Ill.

Mechanics know...



Perfect Circle's 2 in 1 chrome piston ring set

doubles the life of cylinders, pistons and rings!

America's Doctors of Motors—your reliable mechanics—know that Perfect Circle's new 2-in-1 Chrome Set marks a new high in piston ring performance! Here's why:

First, because *solid* chrome plating protects the top compression rings *and* oil ring rails . . . resists wear under severest operating conditions!

Second, because only the 2-in-1 Chrome

Set provides two interchangeable expander springs with every oil ring . . . allowing each mechanic to select the correct spring pressure—either **NORMAL** or **HIPRESSURE**—for every installation!

Find out why Perfect Circle's 2-in-1 Set is the most recommended ring set in piston ring history! Ask your Doctor of Motors to install it in your car—for double life, lasting power, and new oil economy!

SOLID CHROME PROTECTS THESE WEARING SURFACES

Perfect Circle

PISTON RINGS

The Standard of Comparison



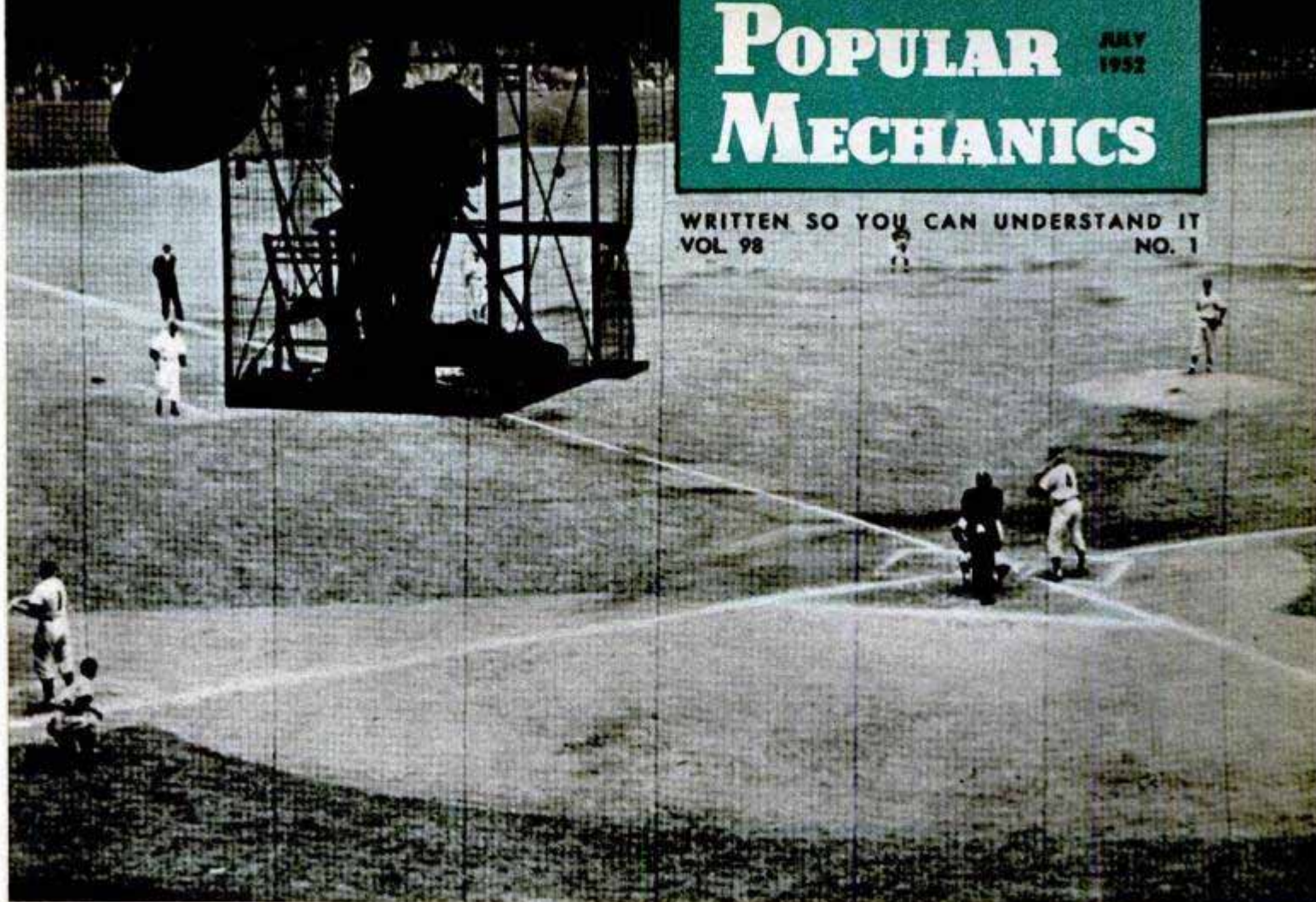

To cover the World Series, cameraman worked inside a cage with glass front to protect lens from foul balls

These Roving TV MEN...

By Richard F. Dempewolff

TELEVISION'S electronic eyes are on the prowl. They've thrown away their blinders, busted out of studio prisons and gone aroaming.

Recently, armchair spectators saw a mock war while it actually was in progress aboard an aircraft carrier 35 miles at sea. Over the shoulders of sweating firemen, they watched buildings crumple in the great New Jersey propane explosion. From coast to coast, fans saw trees crash and shingles fly from roof tops during the East Coast hurricane of 1949. They have visited the Statue of Liberty, Broadway shows, great military bases and hundreds of other places—including the White House.

To the average American familiar with newsreels, "remote" TV shows may seem routine. But to the rugged crews of the mobile units who must trundle one to three tons of equipment in roaring vans to every assignment, each remote is a saga in human endurance. Typical remote teams like those headed by supervisor Sam Levin for CBS-

Remote crewmen call this miniature back-pack camera a "creepy peepy." It's no bigger than a large movie camera. Unit sends own signal to mobile van





Mass of cables and terminals inside the van would baffle anyone but the remote engineers. This man is ready to run out the cable. Below, cables from the "studio on wheels" are installed to sports press box

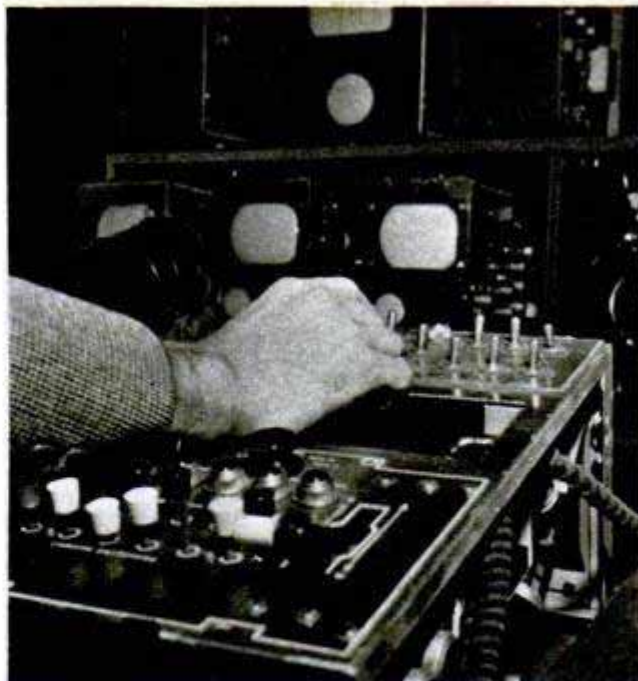

Inside the mobile unit, the director chooses best picture from three monitors and switches it on air

TV and technical directors Jim Davis and Herb Reidel of NBC have climbed steeples and clung to the tops of 200-foot radio masts to fasten and hold their big "dish" transmitters against buffeting winds so you'll get a picture of some out-of-the-way place.

How do you get a finicky TV signal from deep under water to five million TV fans across the country? "We want a live show on board a submarine that will submerge and surface again," NBC officials told field engineers one day. "Can you do it?" No one had ever tried it before. They said they didn't know—but did it. Aboard the sub *USS Trumpetfish*, standing off a Brooklyn pier, the boys rigged coaxial cable from two cameras inside the craft through the spare periscope, then strung it across the water on a row of floating oil drums to a big mobile van on the dock. From the truck's roof-top antenna the picture was beamed by microwave to the R.C.A. Building, thence to the NBC studios and out to the nation. It worked.

But the latest attempt in fancy "live" remotes happened on Ed Murrow's CBS-TV show *See It Now* a few months ago aboard the submarine *Sablefish*—two miles out and 55 feet deep in Long Island Sound. From living-room easy chairs, fans were supposed to see an outboard view of the *Sablefish* spouting geysers of white foam as she disappeared beneath the surface. Then, suddenly, they were to be inside the diving hulk where, in sloping, cramped quarters, they'd watch crewmen spin ballast controls as the sub leveled off. They would also see the torpedo crew load and fire a dummy "water slug" from yawning tubes and watch as the U-boat surfaced again.

Unlike the *Trumpetfish* stunt, there were



no cables or strings attached to the *Sablefish* when she dove for the TV audience. "We did it the hard way," said a CBS-TV engineer. Using the sub's electronic facilities and snorkel, the signal was relayed by microwave from three cameras in the submerged craft to an LSM 200 feet away. From here video and audio engineers sent the program via microwave link to a mobile unit on shore, two miles away. Thence the signal was bounced to the Empire State mast and finally to the *See It Now* studio, where it was put on the network.

Through it all, Comdr. J. T. Burke, skipper of the *Sablefish*, saw his usually tidy ship cluttered with a ton of TV equipment. At every hatchway through which power lines passed, axes lay ready so the cable could be severed at a moment's notice. Unfortunately, bad weather made the job of keeping antennas focused on each other aboard the heaving ships almost impossible, and marred the experiment with several long blackouts. But at least CBS proved it could be done.

The average TV mobile unit preparing for a remote looks like something between a busy transcontinental moving company and a firehouse at alarm time. Walk into the NBC garage almost any Saturday before a football telecast and you'll find Jim Davis and his crew embroiled in what looks like utter confusion. They start before dawn. Snarls of cable strew the floors. Cameras (usually three or four), monitoring sets, huge lens cases, tools and spare electronic gear are stacked up ready to be loaded into a 25-foot van. Eight to eleven men comprise the crew—technical director, two to five cameramen, video engineer, audio engineer, maintenance engineer, transmitter engineer and receiver engineer.

"The one requisite for a mobile man is a strong back," says Davis. "Then if he happens to be an expert engineer besides, and has no qualms about emergencies, he may qualify."

At the field those hundred-pound cameras in 12 by 26-inch cases—plus big view finders, 30-pound tripods and massive lenses—are slung over shoulders and trundled to sturdy but precarious-looking

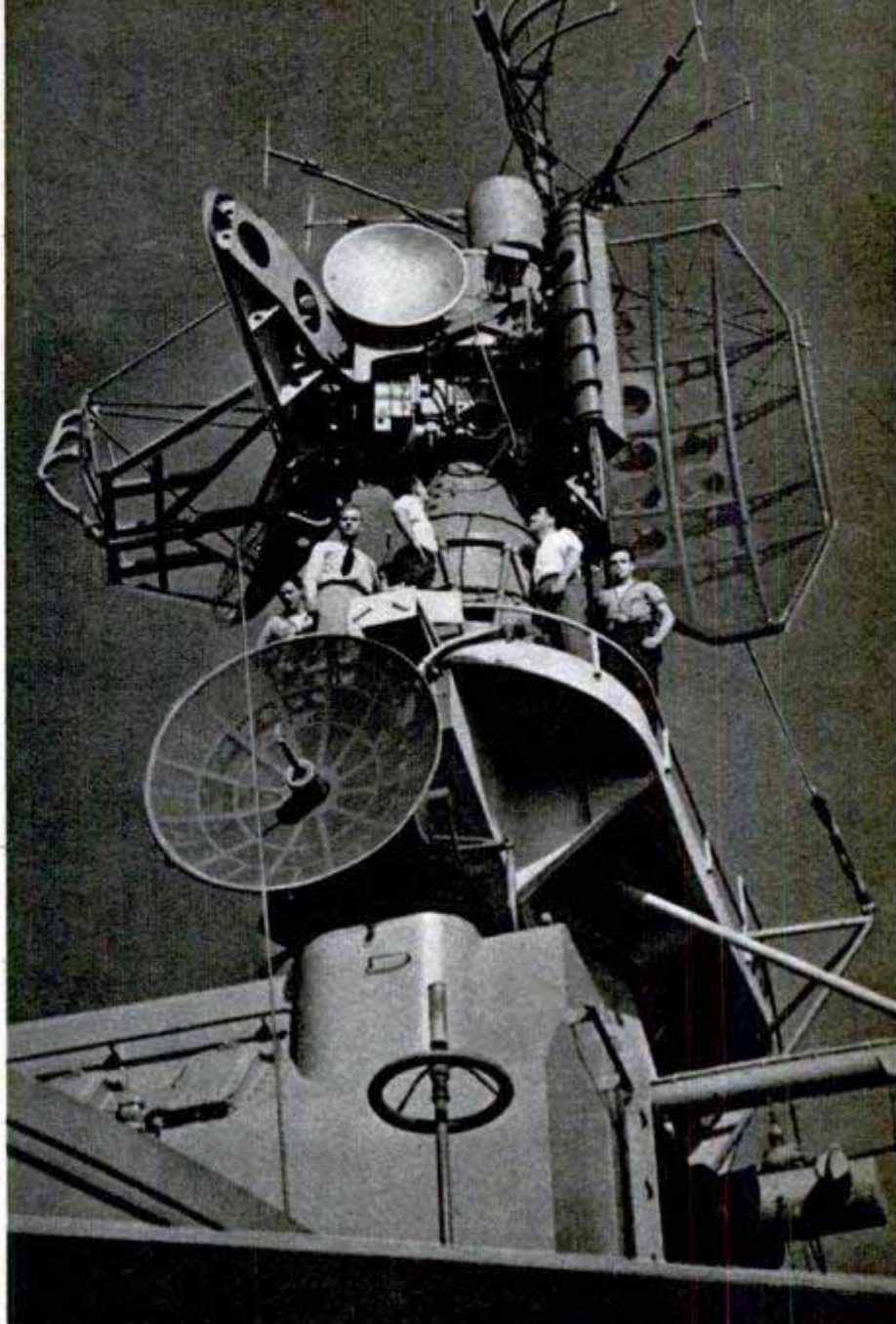

Mounted on a carrier's rotating mast, a TV dish antenna beams full view of mock war to armchair viewers. Below, three-foot "zoomar" lens brings in close-ups. When operator slides rod, lens stays in focus while picture moves in or farther away



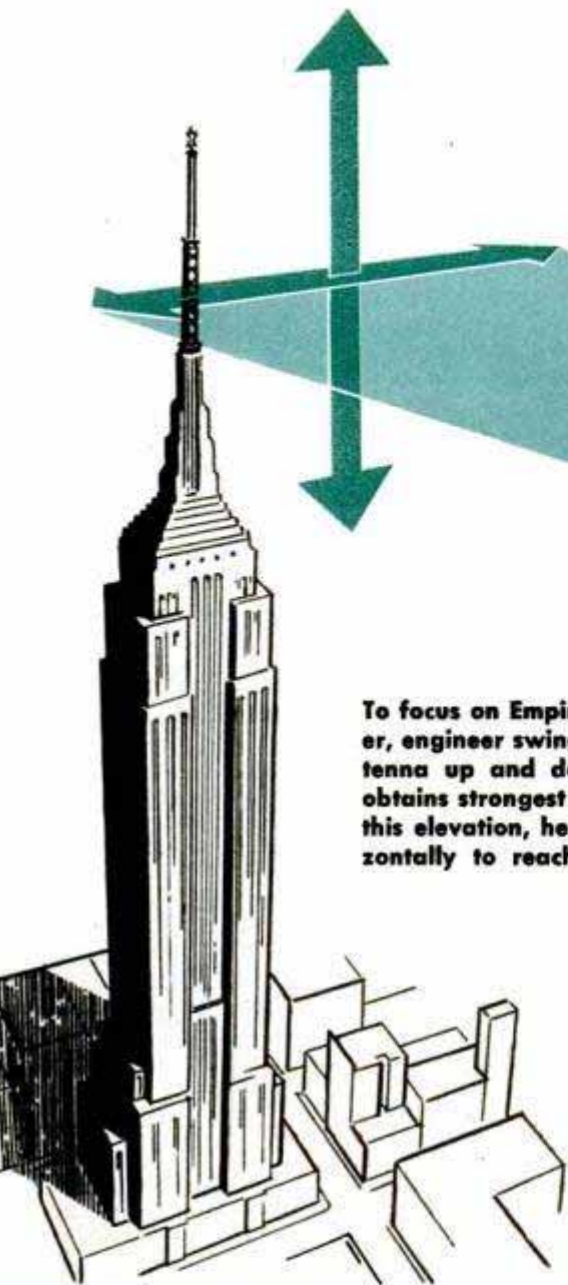

To focus on Empire State Tower, engineer swings "dish" antenna up and down until he obtains strongest signal. Using this elevation, he swings horizontally to reach focal point

perches on the rim of the stadium wall. Heavy cable by the hundreds of yards is strung from each camera to the truck below by human flies hanging out over space.

Sitting astride the press-box roof, the transmitter engineer, who has hoisted up his four-foot dish antenna by rope, hand over hand, is busy "panning," or focusing, it on the R.C.A. tower 20 miles away.

Meanwhile, cameramen are "scanning out" their cameras—centering the image on the used part of the tube. If they don't, you may get a white glare around the edges of the picture on your set at home. Minute alignments on some 24 camera controls—like focus, target control, brightness—must all be checked before the show starts. Cameras must be warmed up for half an hour. And cameras have a memory—a camera that has been aimed at a scoreboard for a half hour, for instance, then suddenly is moved to pick up a scene on the field, may show the new scene firmly implanted against a ghostly scoreboard background.

By game time—some eight hours after they set out—everything is ready to roll. All but the cameramen gather in the semi-gloom of the mobile van. Over the hum of radio voices, the video engineer gives orders to his cameramen via radio headset: "Number three, fade that referee. Number one, pick up the skirmish on the far side of the 40-yard line." The big three-foot "zoomar" lens closes in on the skirmish 100 yards away and fills the screen with three players who are arguing.

All three cameras are going continually.

Down goes a sub under the eye of the camera. Cable run through periscope brings picture from inside sub



In the WNBT truck, "video" is watching the pictures on the row of monitors that divides the truck in half. Beside him sits the audio engineer, "mixing" sound with the picture and feeding it into the circuit. Behind him, the director stands at a table studded with switches. Red and white button lights flash on and off as he watches all the monitors, selects the best picture coming in at any moment and puts that one on the air by flicking his finger switches. Or one picture, such as a scoreboard, may be superimposed on another.

Actually, things like sports events are considered duck soup by these men. A week before the game, the supervisor can go out, check camera positions, power sources, line-of-sight or telephone-company connections and it's only a matter of two or three hours to set up when the time comes. This is no guarantee, of course, that there

(Continued to page 242)

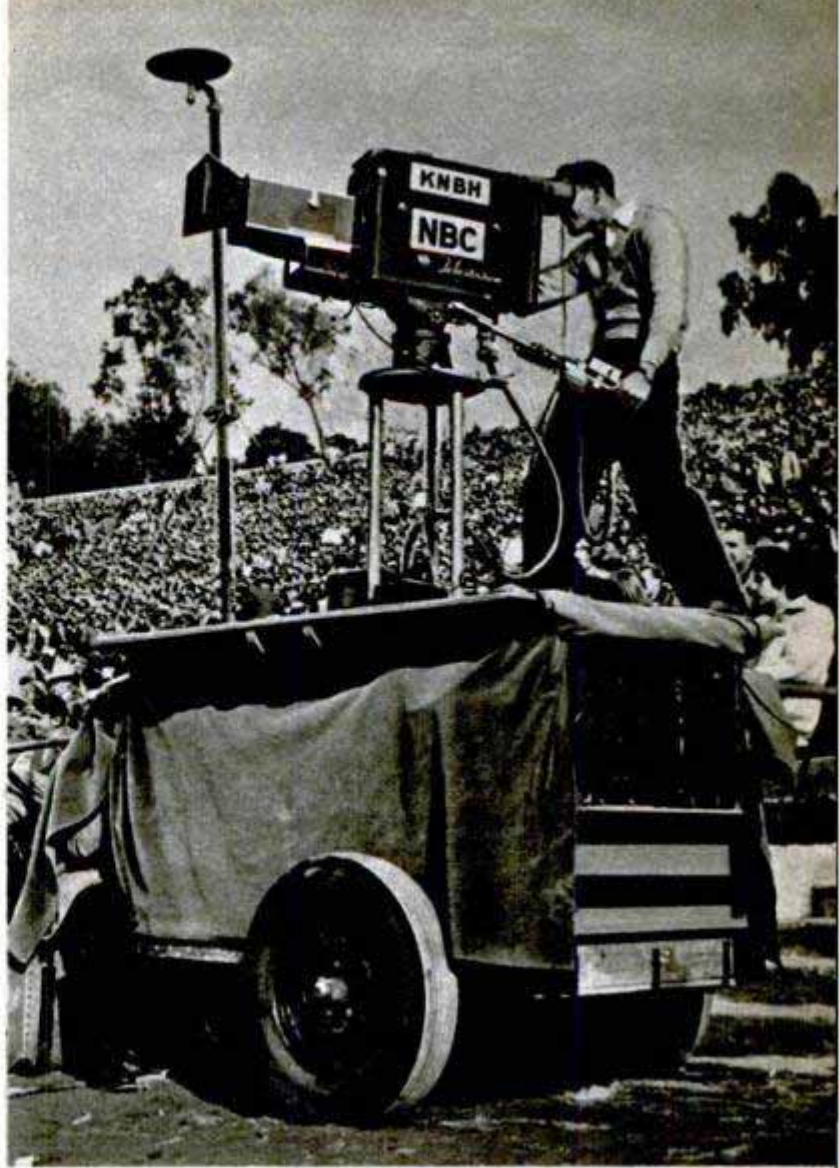

Engineers rigged "walkie pushie" which carries storage batteries to beam the signal to mobile van. Below left, there's scarcely room for cameraman aboard sub. Below, announcer's monitor hoisted to press box

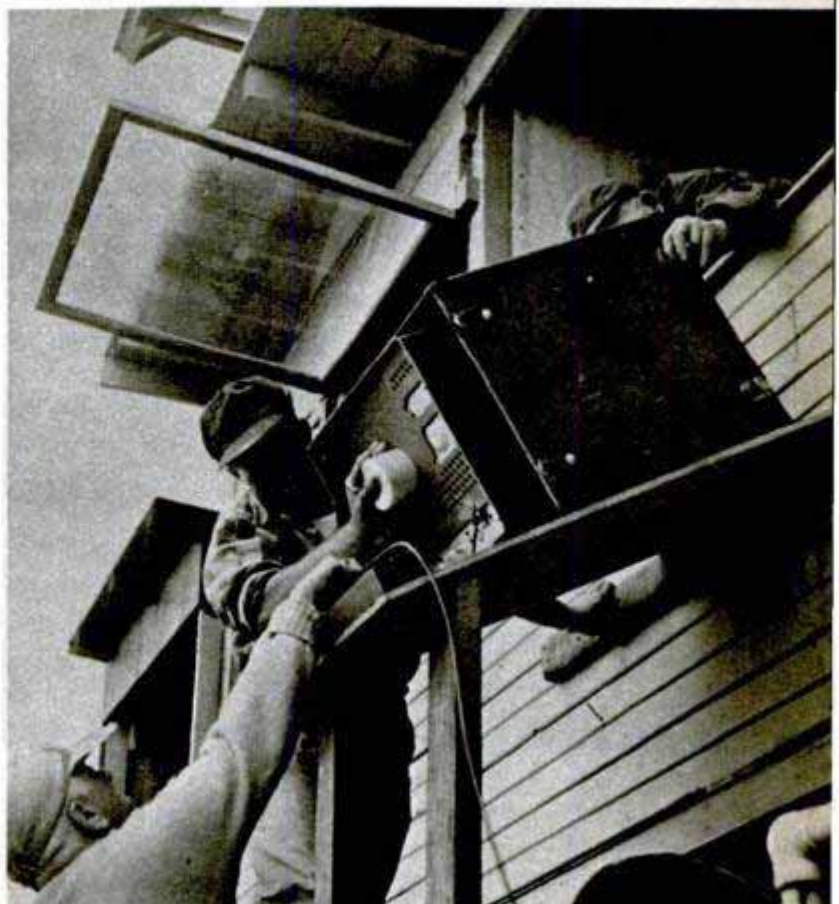
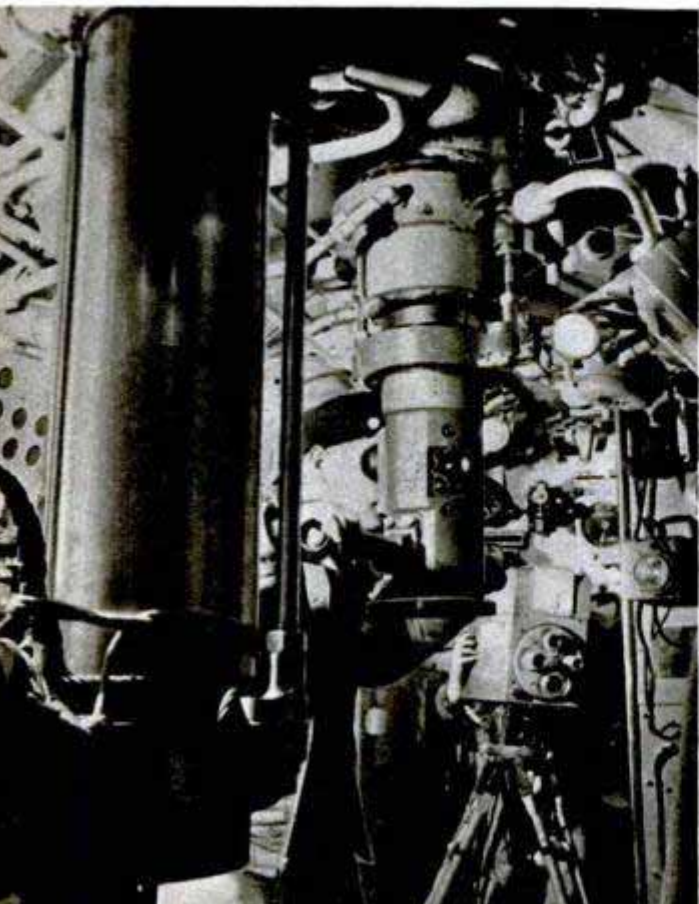

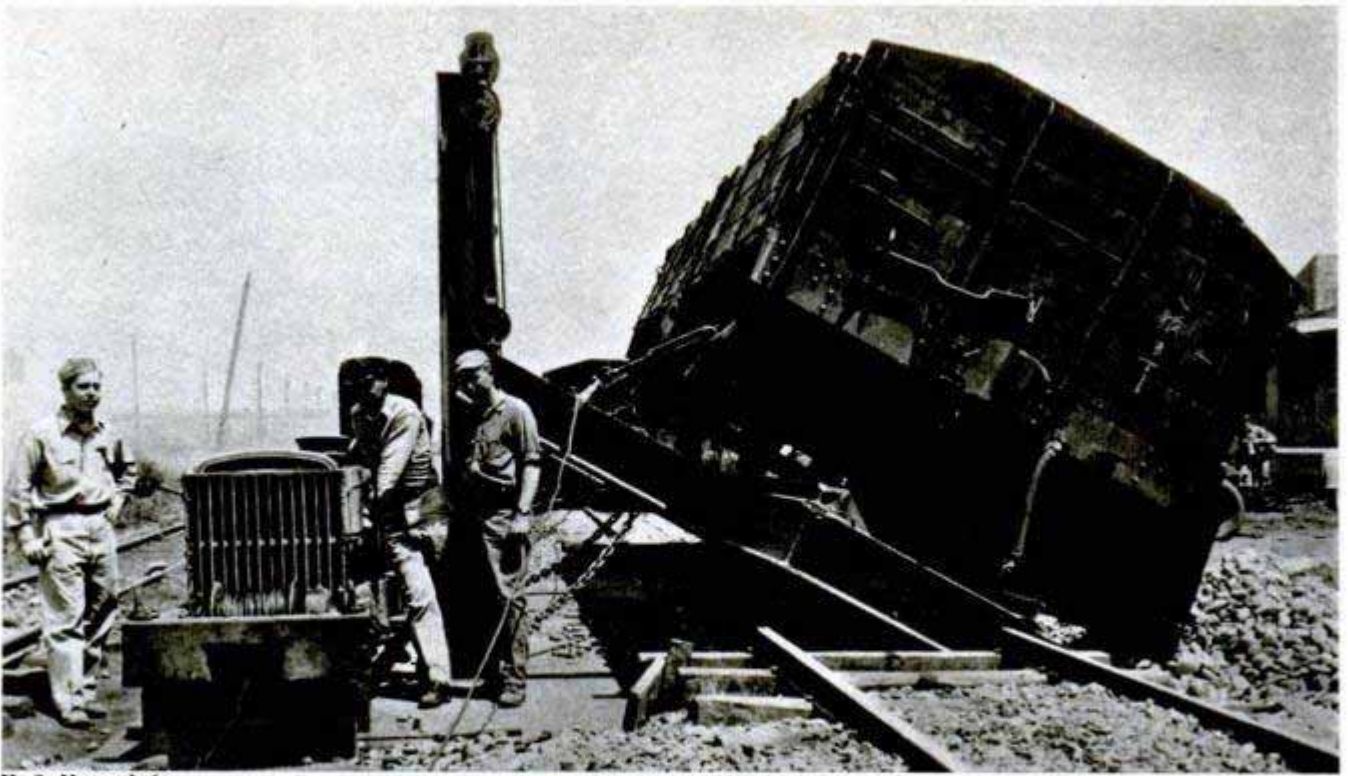

U. S. Navy photo

Seabees Make Rail-Car Dumper Out of Scrap Material

Built by the Seabees from scrap material, a railroad-car dumper at Atsugi, Japan, unloads 100 cars every eight hours. It is a car-length concrete slab laid under a spur track with a framework of 12-inch steel I-beams embedded in the slab. The

track section is tilted 35 degrees by two winches operated with rear-drive shafts powered by a scrapped truck. Three men are needed to operate the equipment. A complete unloading cycle can be accomplished by the crew in five minutes.

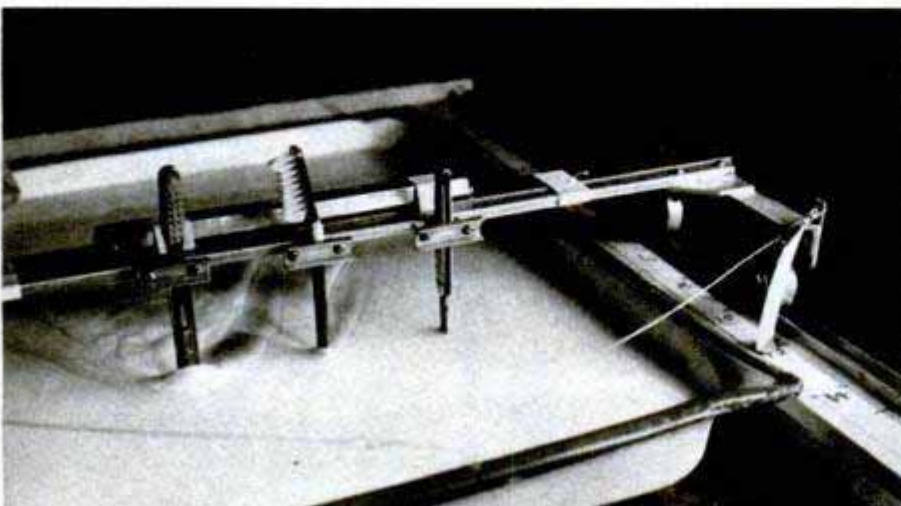
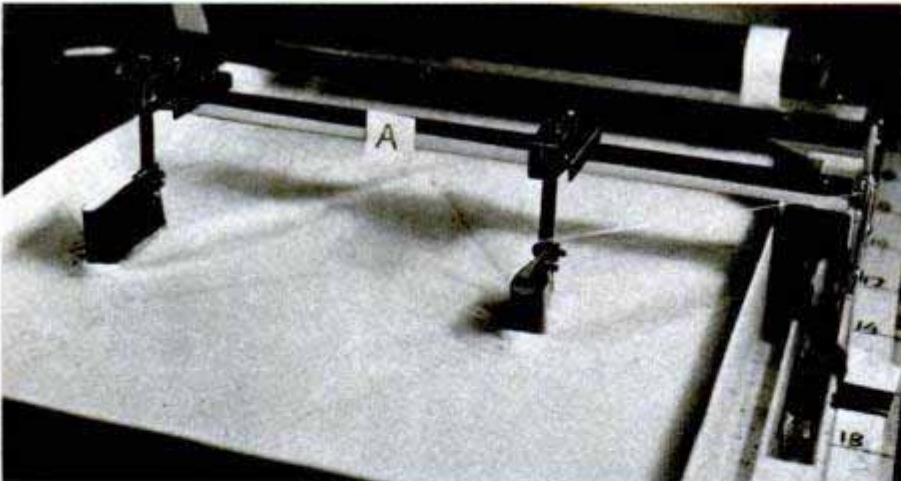

Toothbrushes "Fly"

Toothbrushes, a jack-knife and milk aren't usually thought of as aviation-research aids but that is how they were used by the Lockheed Aircraft Corporation. The brushes and knife were pulled through a pan of milk in tests that proved wave patterns successfully could be photographed. Substituting scale models of proposed wing sections for the brushes and knife, from such photographs engineers can tell how the real wing will perform in flight. Milk was used instead of water because the wave patterns in it could be photographed more easily.

☐ Aluminum is now being used for the bases of incandescent electric bulbs instead of scarcer brass, being conserved for military uses.



"Innerspring Tube"

Motorists need worry no longer about blowouts, according to an Italian inventor. Antonio Pieroni, a Neapolitan, has designed a spring which fits into the tire casing, re-



placing the tube. The steel spring has two smaller springs to give the tire extra "bounce." The inventor says his "inner-spring tube" can be installed in ordinary tires and will cushion the automobile like normal tubes.

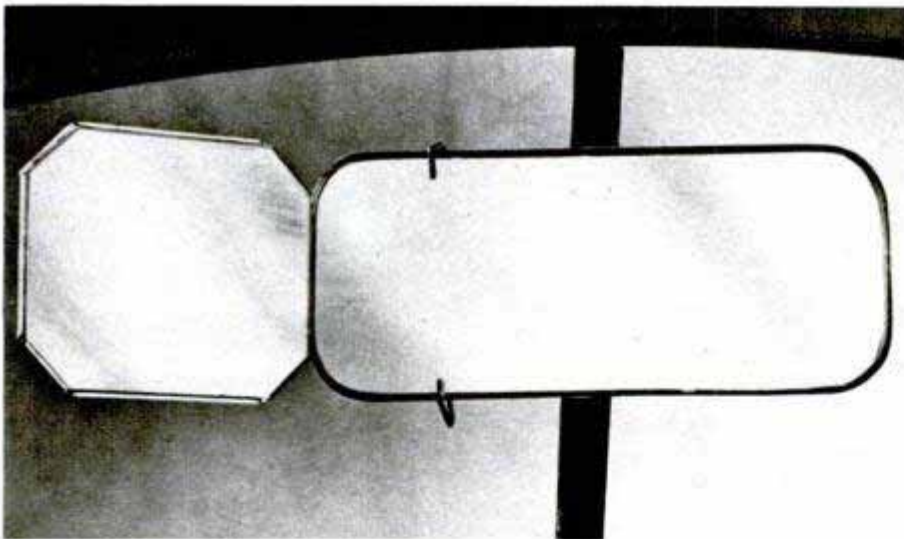

Right-View Mirror Aids Motorists

Clipped to the left side of a standard rear-view mirror, a small metal mirror provides a view to the right and right rear. Such a view is especially useful when changing lanes in traffic along multilane boulevards or when parking. The polished-metal mirror has a spring clip that fastens it to mirrors of various sizes.

English Car's Trunk Opens by Push Button

Touching a button at the front side of the rear seat opens the trunk compartment of the new Vauxhall Velox, an English automobile.

World registration for trucks is now 16,685,000, double the number in use in 1940, according to the Automobile Manufacturers Association.



PHOTOGRAPHY

then and

Yesterday's portraits required daylight, reflectors and steady posing. Below, taking a snapshot in the 90s



A
50th ANNIVERSARY
FEATURE

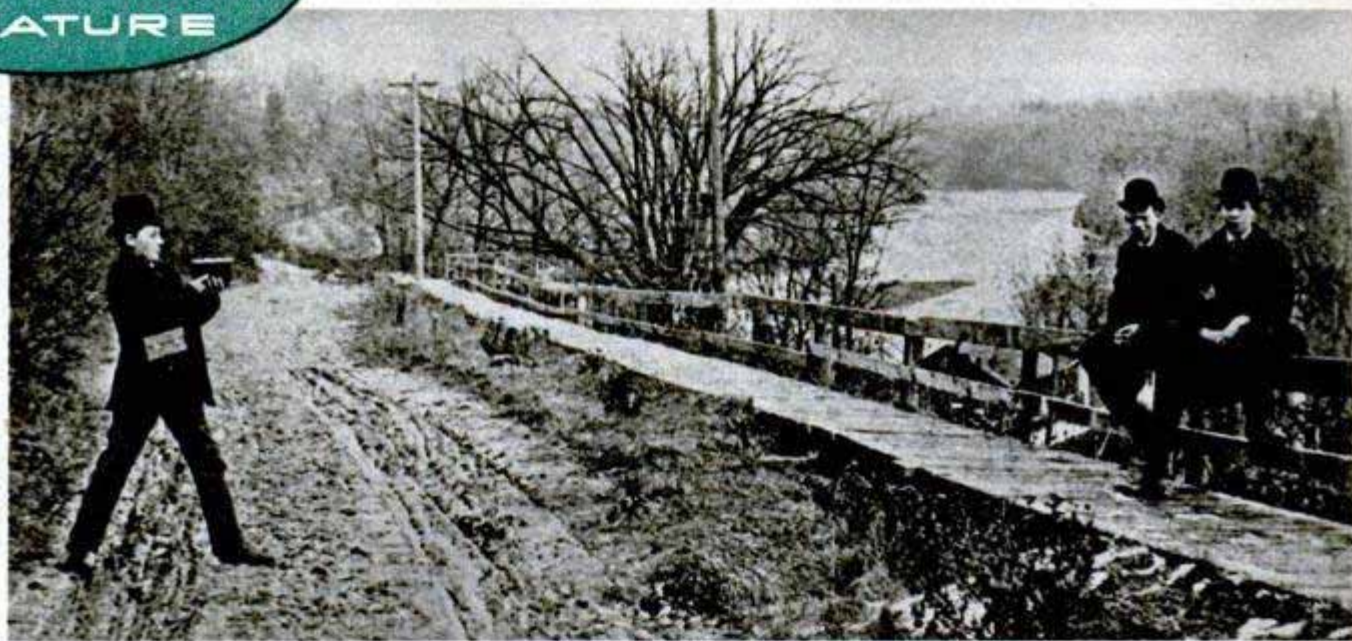

By

Valentino Sarra and Beaumont Newhall

(photographic
illustrator)

(Curator,
George Eastman House)

X-RAY PHOTOGRAPHY was news when *Popular Mechanics* first appeared in 1902 — an illustrated article about the new miracle appeared in the third number. Four weeks later a full-page photograph of the moon was featured as "The Most Remarkable Picture Ever Obtained." It was taken through the Yerkes Observatory 40-inch telescope, then the world's largest.

Today, X-ray photographs are routine and we take slow-motion pictures of the interior of the human body showing the beating of the heart and the pumping of the lungs. Today, also, photography is a

vital part of astronomy. Exposures made on special photographic plates reveal galaxies in the heavens unknown in 1902. But for photography, they would have remained invisible to the eye even through the most powerful modern telescopes.

The scope of photography has increased enormously during the past half century until it has become an indispensable means of communication and research. Educational methods have been revolutionized by it and today we can "travel" around the world in pictures without leaving home.

Let us go back 50 years. Dry plates and

now

But today, with an electronic flash setup providing ample light, color portraits can be made during a dance routine



film had displaced the older processes. Daguerreotypes on metal plates, calotype negatives on paper, and collodion or wet plates were as mysterious, as useless and as obsolete then as now. Roll film was still limited to amateur use. George Eastman had simplified his Kodak camera of 1888 by supplying film spooled for daylight loading, and with the dollar Brownie camera he had removed the one obstacle to the universal practice of photography—its expense.

The professional and the advanced amateur used plates. The emulsion did not have the light sensitivity known today but action pictures could be taken in bright sunlight. Panchromatic emulsion, sensitive to all colors, was the newest thing. Most photographers, however, preferred the standard orthochromatic emulsions which were insensitive to red.

Cameras were bewildering in their variety, ranging from simple boxes to highly precise instruments such as the French Sigriste camera with a focal-plane shutter that had 120 settings between $\frac{1}{30}$ and $\frac{1}{5000}$ second. Popular then as now was the reflex camera, which enabled the photographer to see the picture on a ground glass right up to the moment of exposure. Tripod cameras, complete with swing backs, rising and tilting fronts, were almost identical to those of today.

The amateur cameraman of 1902 calculated his exposures from tables, ingenious slide rules or with meters which measured the light by the time taken for a piece of sensitive paper to darken to a standard tint. Most professionals scorned such aids and were proud of their ability to judge expo-

sure. If you asked a photographer what size diaphragm he was using, he might answer, "About the size of a dime." The modern system of marking lens openings by fractions of the focal length was still a novelty.

Indoor portraits were taken under a skylight. A few studios boasted of electric lights but these were cumbersome arc lamps. Flashlight photography was so dangerous, old-timers will tell you, that a first-aid kit for burns always was carried in the camera case. Every flash filled the room with smoke and until it was aired out a second photograph could not be taken. So bags hung on umbrella frames were made to contain the flash—and the smoke. When the flash exploded, babies cried. When the smoke bag was dumped out the window, neighbors called the fire department.

Back in his darkroom, the photographer would develop the plates in a tray, inspecting the image by a ruby light which, if he was progressive, might be electric. Scientists told him he could calculate optimum developing time and thus eliminate inspecting the image as it developed. But the average photographer clung to his old habits. Many amateurs enjoyed the convenience of the new Kodak Daylight Developing Machine, announced in *Popular Mechanics* for November 8, 1902. Photographs advertising the tank showed a Gibson girl developing film by the side of a lily pool or at the village watering trough.

Negatives generally were printed by contact, either with printing-out paper on which the image was formed visibly during exposure to sunlight or with developing-out paper which had the advantage that it



Above, one of the earliest uses of the photograph as a social force was the poster that appealed for nurses during World War I. It was made by Lejaren a Hiller, "the father of illustrative photography"

Below, photo from an early advertisement shows one of the first Kodak daylight developing tanks in use



could be exposed by artificial light and hence commonly was called "gaslight paper." Enlarging was growing in popularity; the first photographic "how to do it" in *Popular Mechanics* told how to make an enlarger with a camera and a carbide bicycle lamp. But if a big picture was needed, a big negative usually was made, even if it meant coating a plate 8 feet by 4½ feet.

Color photography was more theoretical than practical in 1902 so far as the average photographer was concerned. Only one technique enjoyed any popularity at all and that was the screen-plate process of John Joly. A negative was taken through a screen ruled with fine red, green and blue lines placed in contact with the plate. After ordinary development, a black-and-white positive was made from the negative, which was bound in contact with the color screen.

Moving pictures, a novelty only seven years earlier, had progressed to the point where they could tell a story. Early readers of this magazine could see such films as *The Great Train Robbery* made for Edison in 1903.

But the state of photographic technique

Below, three famous cameras. From top to bottom—the first Brownie, the French Sigriste camera of 1900, and the inventor's model of the Speed Graphic camera
George Eastman House photos

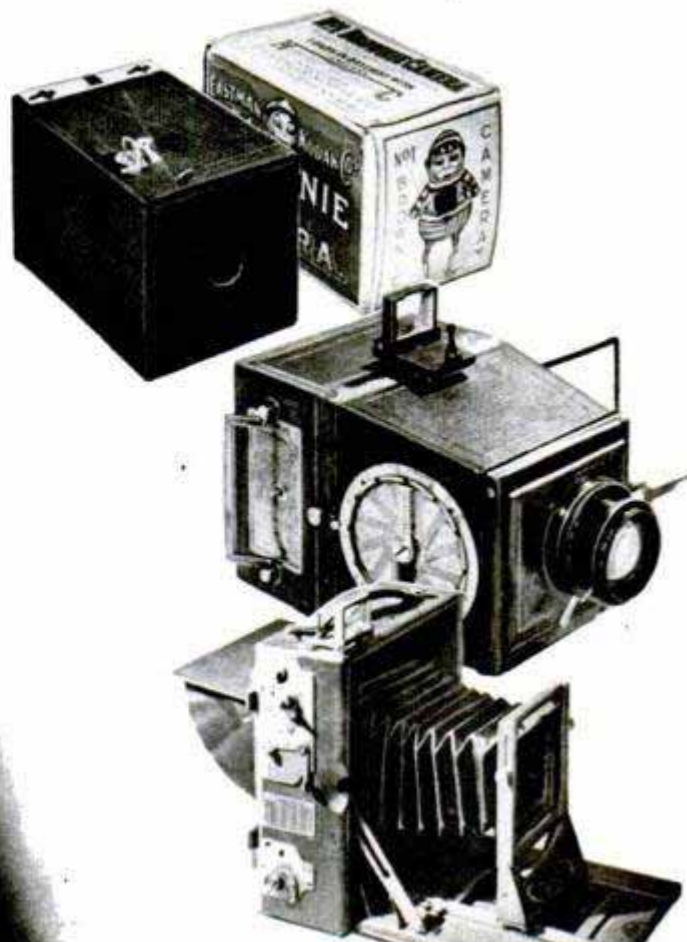

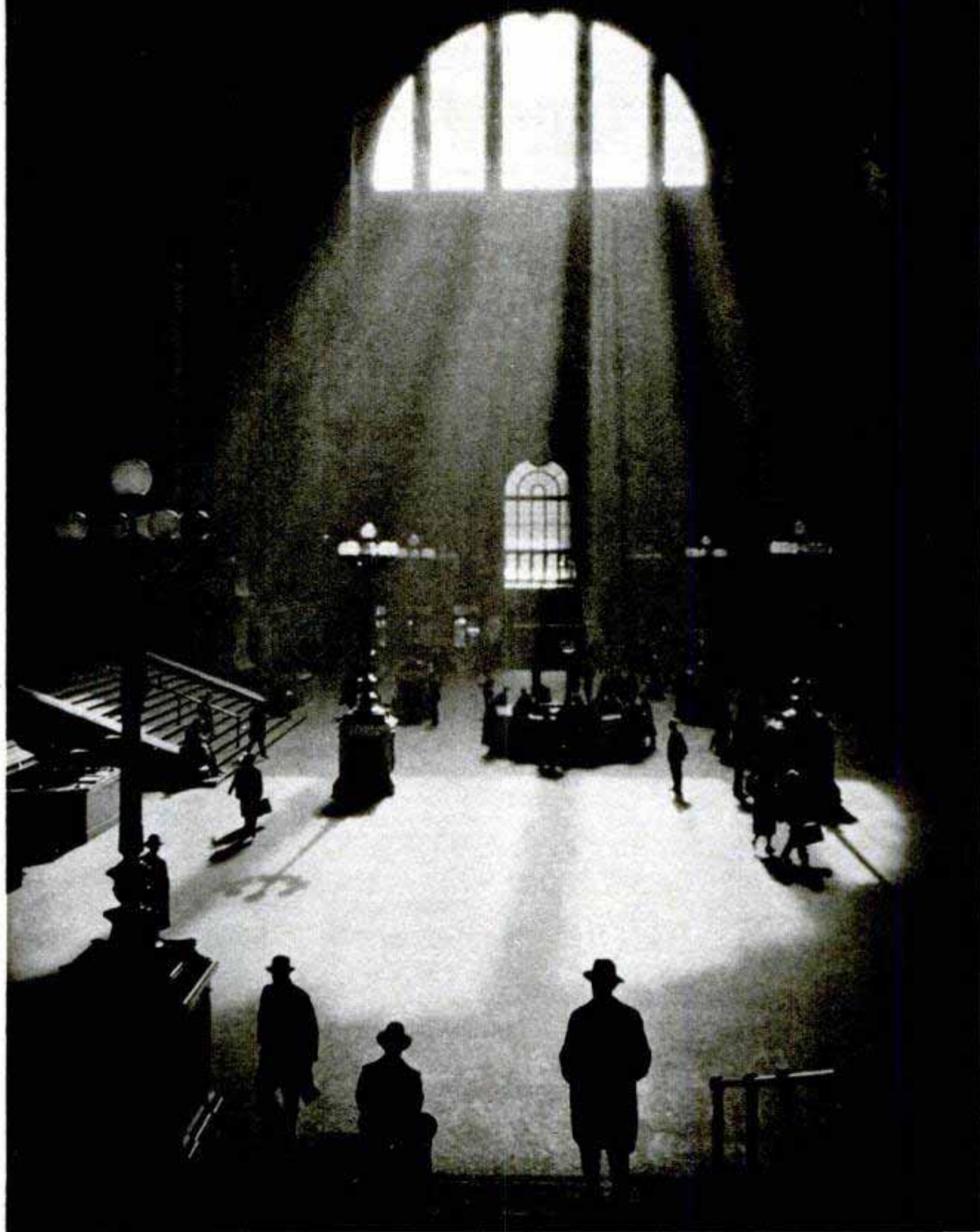

In artistic hands, a camera is as responsive as a brush. This famed picture is by D. J. Ruzicka (1926)

Below, left to right — the famed Leica;
the Stereo Realist, three-dimensional
camera; Land "print a minute" camera



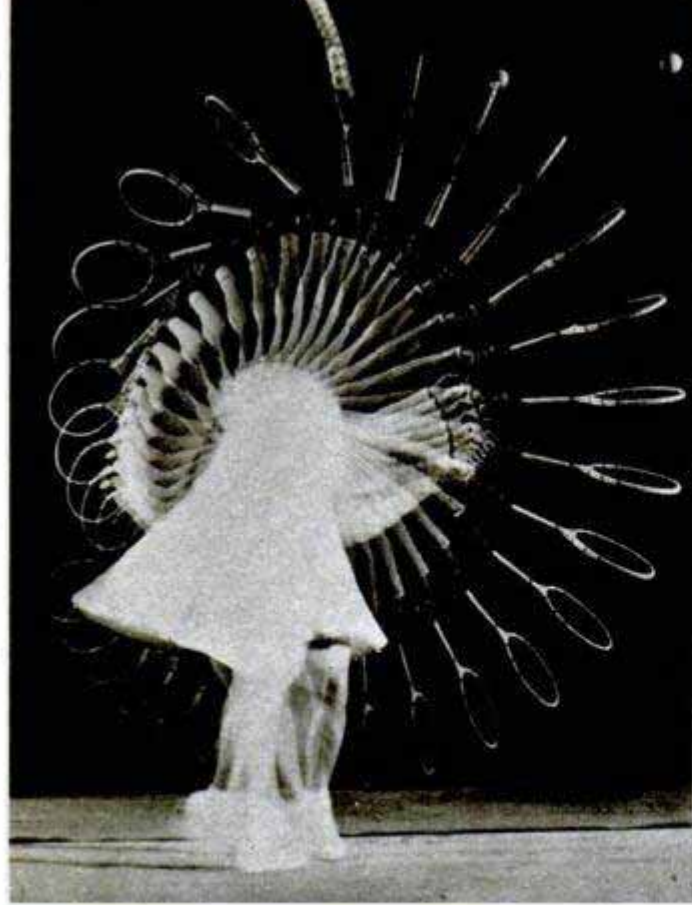

M.I.T. photo
 Dr. Harold E. Edgerton used his invention, the electronic flash, to make this photo of a tennis service by multiple exposure

in 1902 was by no means primitive. Indeed, we can point to no radically new discovery except the invention of color film during the past 50 years. Rather, the first half of the 20th century has been a period of refinement of techniques and the broadening of the field of photography.

Technically, this is the era of film which,

except for specialized scientific uses, has replaced glass as a support for light-sensitive gelatin emulsion. Panchromatic emulsion has become universal and its speed increased beyond the dreams of the photographer of 1902.

The most notable advance in camera design has been the precision miniature camera for taking small negatives of such quality that detailed enlargements can be made from them. Small cameras, however, were not an innovation even in 1902. The Kombi camera, for example, which took 25 negatives 1 1/8 inches in diameter and weighed but four ounces was sold in quantities at the World's Fair in Chicago in 1893. But the definition of the negatives was not critical and the techniques of enlarging had not been perfected. At the time of World War I, several independent experimenters designed cameras to take still pictures on 35-millimeter motion-picture film. Only one of these designs is remembered today—Oscar Barnack's Leica, conceived in 1914 and put on the market in 1924. The little camera, which took 36 negatives, 1 by 1 1/2-inch, on a single loading of film, at once met with competition. Quick, accurate focusing was assured by coupling an optical range finder with the movement of the lens. This made possible large-aperture lenses of such great light-passing power that snapshots could be taken under ordinary room illumination. The candid camera became a fad. Actors complained of the clicking of shutters at the theater. Unflattering pictures flooded the press and for a while the miniature camera was barred from the White House.

Another miniature camera that has met

(Continued to page 252)

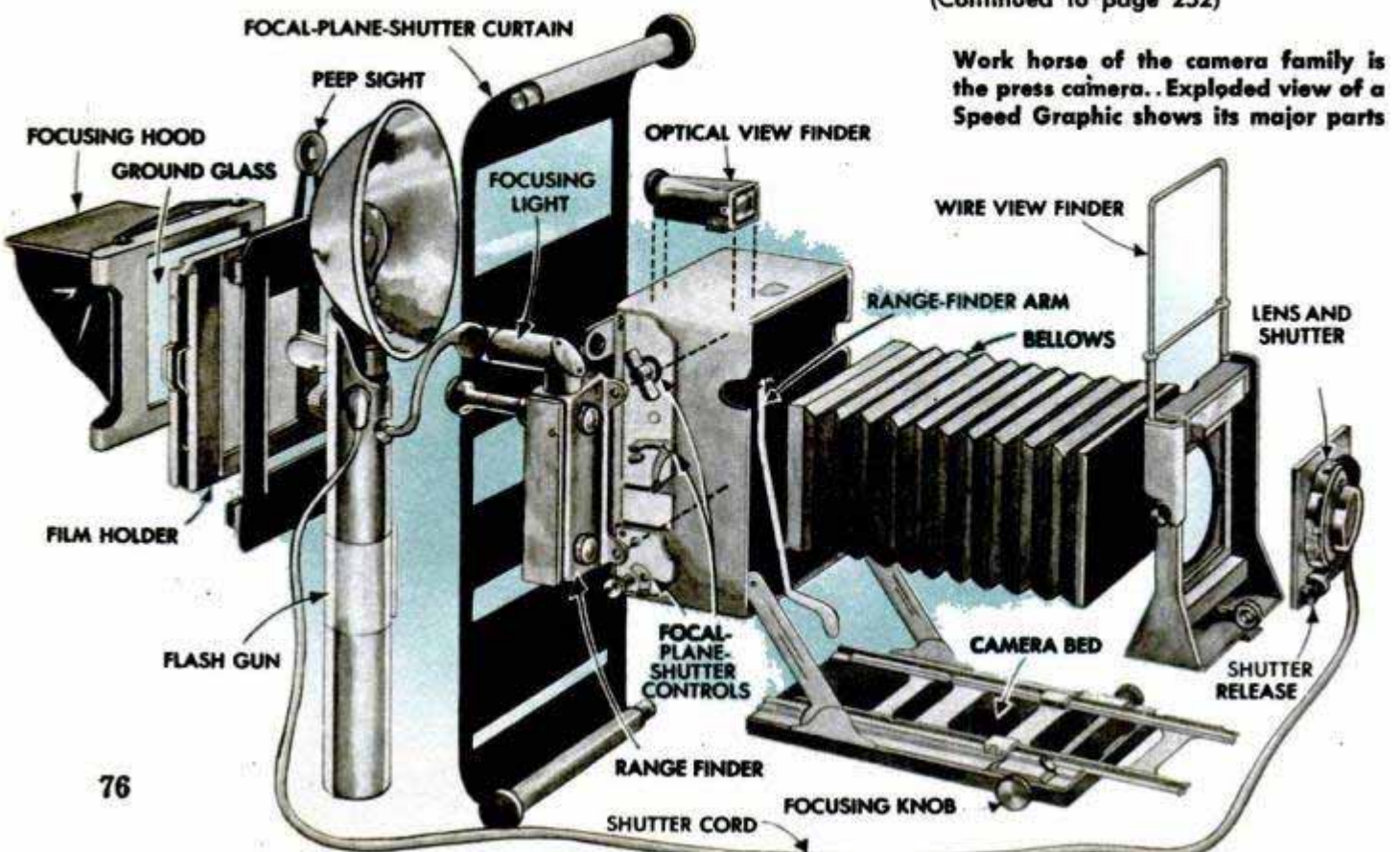



News photos bring the world into your home daily. One of the best was a shot of the burning Hindenburg

Commercial photography is a modern art form. Tops in the field is author Sarra, who made this photograph

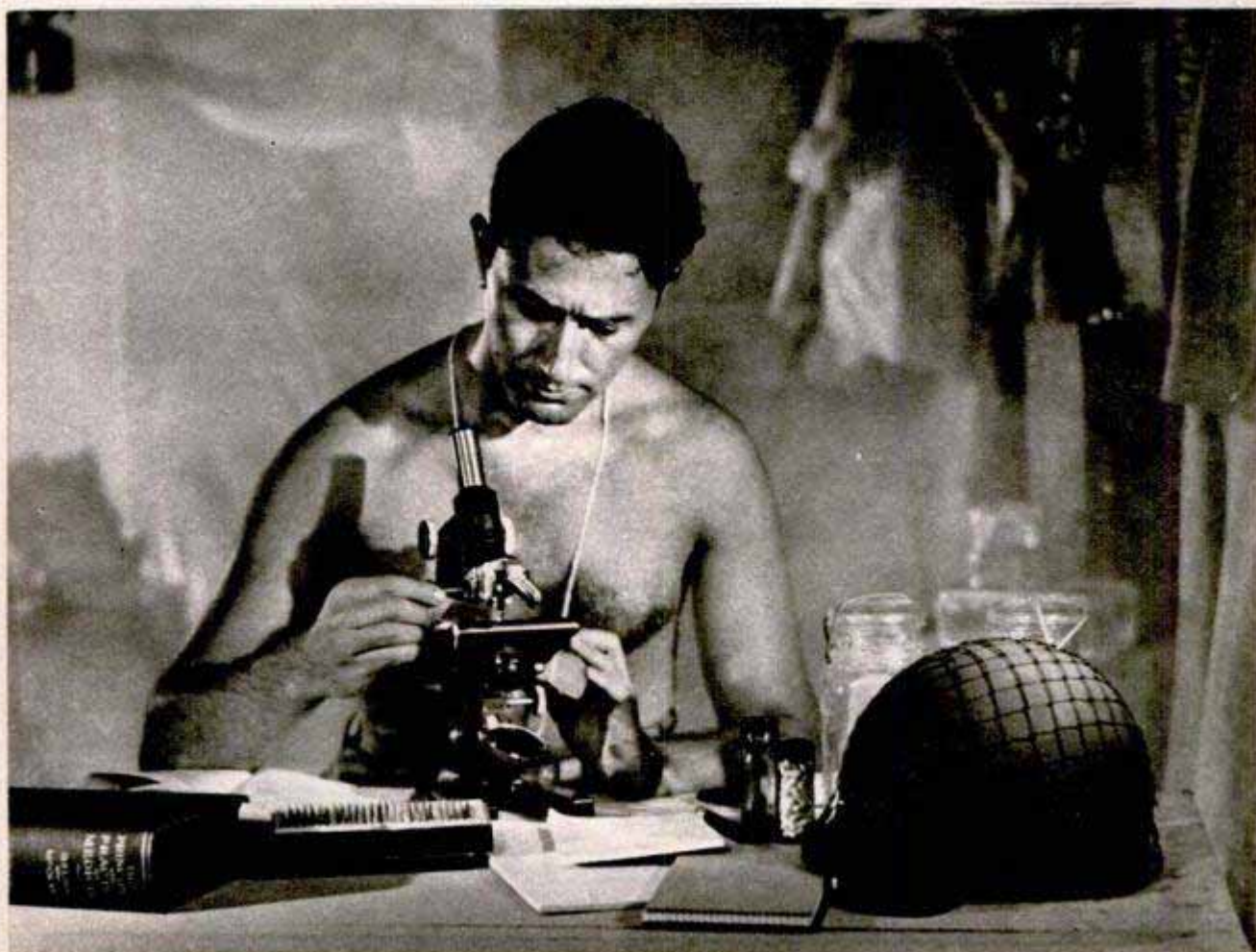

Photo courtesy of Bausch & Lomb Optical Co.



Crew member holds the receiver and positions it for the continuous signal heard when ship is on the beam



Metal baffle box of the beamed antenna is pointed straight out to sea. Box at rear houses the switch

Microwave Lighthouse for Small Ships

Designed for ships too small to take advantage of radar, a new microwave lighthouse developed by Canada's National Research Council is going into service. It will aid in blind navigation when weather blankets conventional lighthouses. The transmitter is a small seven-kilowatt pulse type that can be placed on a private wharf or jetty to provide homing bearings. Many can be used in one vicinity without chan-

neling difficulties. It is coded in the same manner as the aeronautical radio-range system. Receivers on ships approaching hear one signal to the left of the beam and another to the right. Only a continuous signal is heard when the ship is directly in the path of the beam. The equipment provides bearings accurate to $\frac{1}{4}$ degree. The Canadian government will install and maintain the transmitters.



King-Size Propane Bottles

Weighing 50 tons each, huge metal bottles are one ship company's answer to the problem of shipping propane gas by water. Made of $1\frac{3}{4}$ -inch steel, the bottles are 36 feet high and hold 30,841 gallons of liquid propane at their safe capacity—80 percent full. The bottles are lowered into divided compartments in the tanker's hull like pop bottles in a wooden case. Their fat necks jut six feet above deck level. The space remaining around each bottle is then filled with regular liquid cargo such as oil or gasoline.

Over \$250,000 was paid out last year to uranium-ore producers under the Atomic Energy Commission's incentive-bonus program.

Information not listed on articles in the index frequently is listed in the WHERE-TO-FIND-IT INDEX, which is available to readers without charge from Bureau of Information, *Popular Mechanics*, 200 East Ontario Street, Chicago 11

Army Engineers Build Model Bridge

Built to an exact $\frac{3}{4}$ -inch scale, a model of an Army line-of-communication bridge will be given tests to show up design faults before construction of the actual bridge begins. The bridge is of suspension design and its towers flex to adjust to load strain. Built by Army engineers, the model required 7000 man-hours to complete but is expected to reduce actual construction time once work is started on the big bridge.

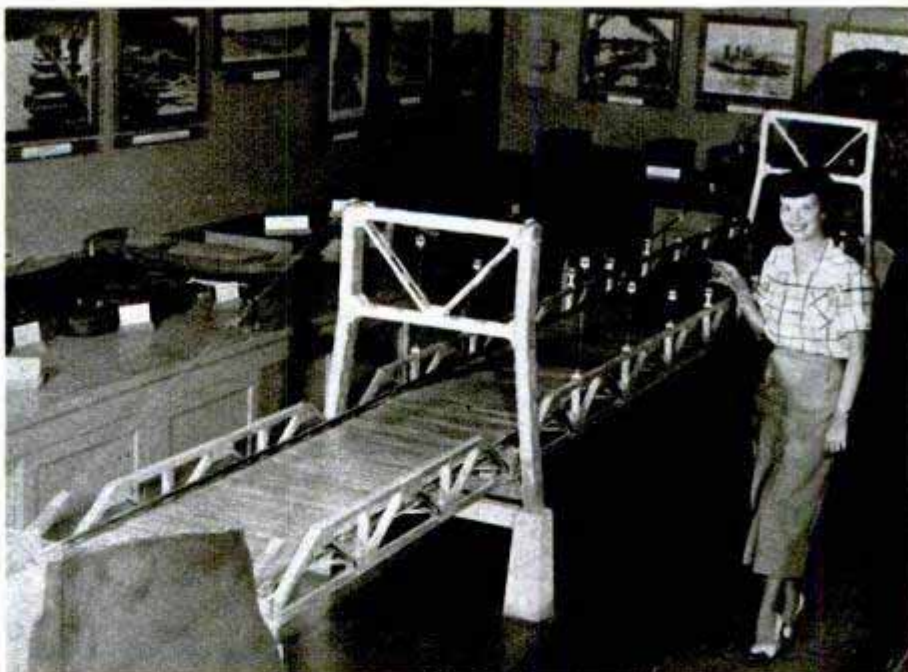

Photo by Roy Williams



Antiskid Stabilizer

Skidding on wet streets or ice is reduced by a new auto stabilizer. The unit also reduces lateral bouncing and steadies a car on sharp turns. It consists of a steel tube attached under the rear of the car. Inside each end of the tube is a strong spring and between the springs is a 30-pound counterweight mounted on ball bearings. The weight tends to remain motionless when the rear of the car develops a sudden side motion. The effect is to exert a sustained thrust in the direction opposite the skid.

Fender De-Denter

Dents in automobile fenders are pushed out smoothly and without tearing by a powerful spreader that operates with hydraulic pressure. The tool, shaped like the jaws of an alligator, has a spreading range of almost 12 inches and is slender enough to work in hard-to-reach corners. Nineteen inches long, the jaws slip up inside fenders and rear decks where a hammer and dolly cannot be used. A hand pump develops 10 tons' pressure.





Motorcycle Acrobats

In West Berlin, the motorcycle cops can put on a flashy show that would even interest a motorist with a fistful of traffic tickets. At a sports festival, members of the motorcycle corps did all kinds of spectacular acrobatic stunts while racing at top speed on their cycles. They ripped wheels off their machines, jumped through fiery hoops and rode two-high with "no hands"

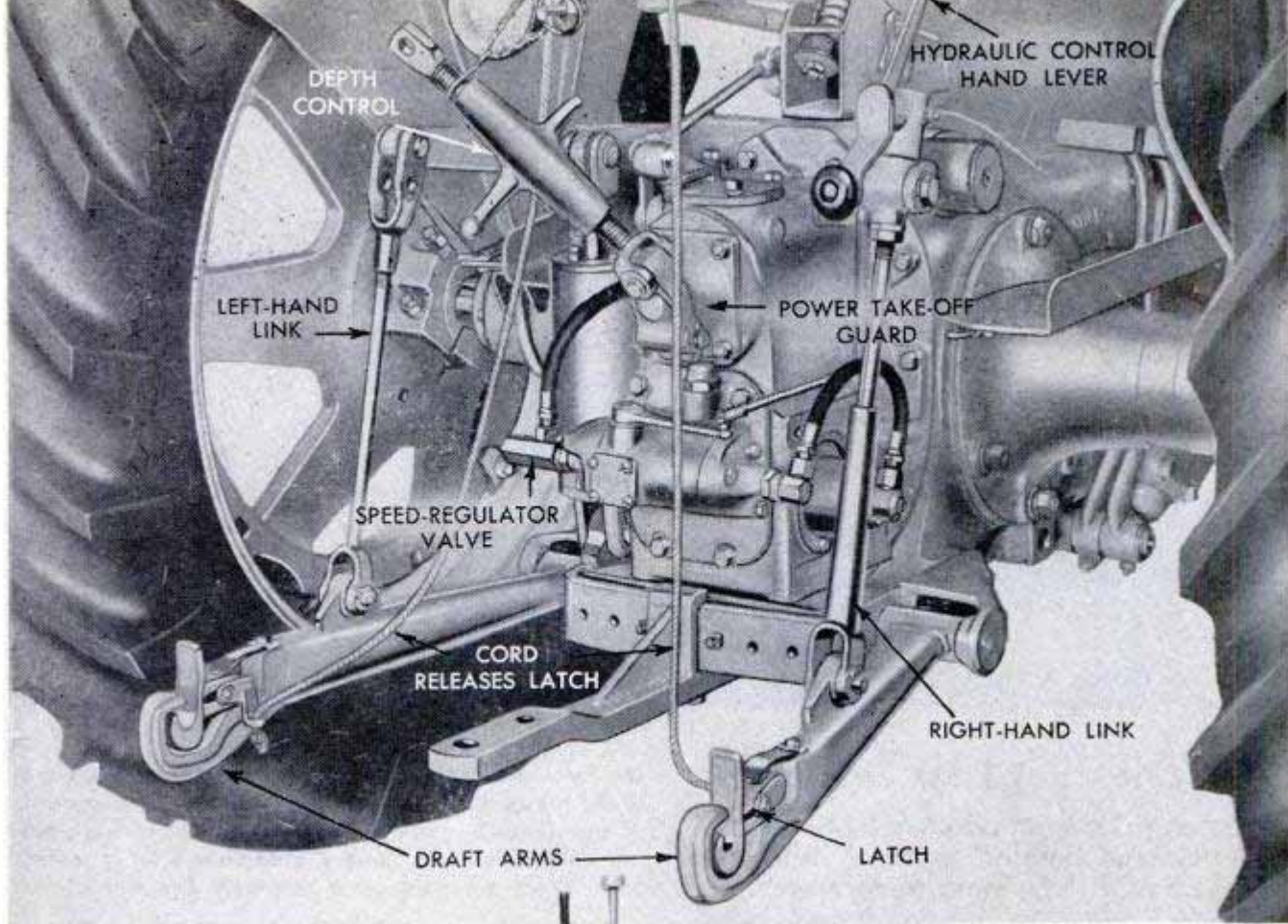

Close-up shows parts of hitch and other equipment. From seat, farmer merely operates latch cords and depth control to pick up or drop implements. Right, utility carrier is loaded, then lifted off ground, moved to the point desired, lowered, unloaded

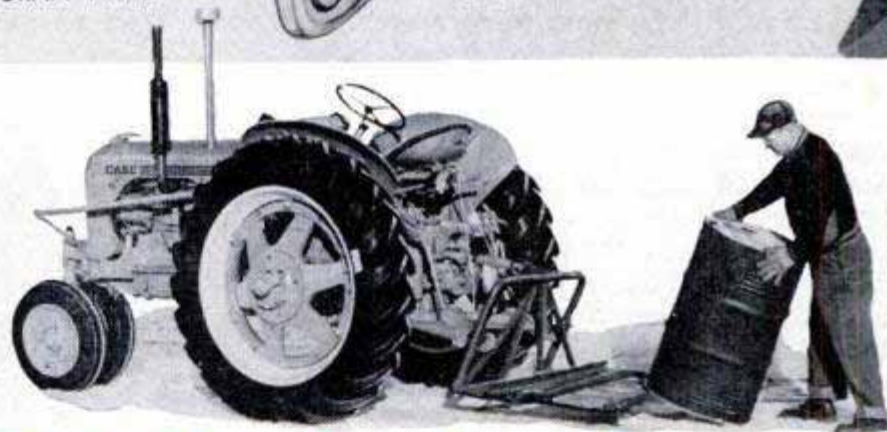

Tractor Hitch Grabs Implements

CURRENT MODELS of Case tractors have a simple, quick-coupling hitch, making it possible for the farmer to seize or drop mounted implements without leaving his seat. The operator can back into a plow, lift it off the ground, carry it to the field and drop it at any time to pick up another implement. The larger models also are equipped with a continuously operating hydraulic system, making the lift independ-

ent of the transmission, and a "live" power take-off so that stopping the tractor or changing gears has no effect on the power delivered to the implement. A new line of implements, most of them mounted, is available for use with the tractors. They include a breakaway contour plow, which is automatically released if the implement strikes a stump or rocks,* and a utility carrier for moving almost any type of material.

Mounted plow is carried high off ground. Right, if it strikes obstruction in use, it is automatically released

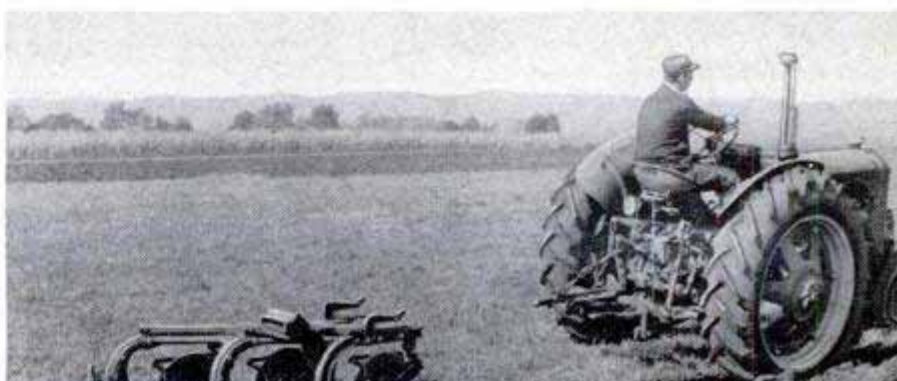



Automatic Pilot Flies Jets

Relieving Navy jet pilots of 90 percent of the "stick and rudder" part of flying, an automatic pilot lets them devote more attention to navigation and gunnery. It holds the plane automatically at any desired altitude, heading and attitude in flight. To put it into operation, the pilot simply touches a button. It will hold the plane to within 25 feet of any altitude up to 10,000 feet. The autopilot will return the plane to level flight from any attitude up to 75 degrees in pitch or bank at the touch of a button. A miniature control stick permits the pilot to take over at any time. With a slight, fingertip movement of the stick he can make the plane climb, turn or dive in a smooth coordinated motion. The control also is used in manual flight to stabilize the plane and improve its steadiness as a gun platform.

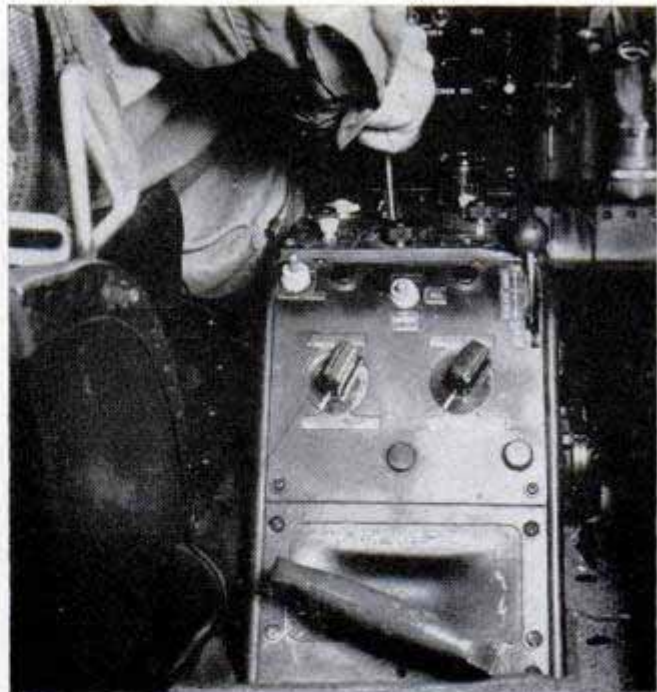

Left, component parts of the new automatic jet pilot. The three motors which move the control surfaces are in the foreground. Above, pilot can take over control of the plane by moving the tiny control stick visible just below his hand. Below, automatic pilot is tested on a flight simulator that responds like a real jet



Interchangeable Lenses Adapt Glasses for Day or Night Driving

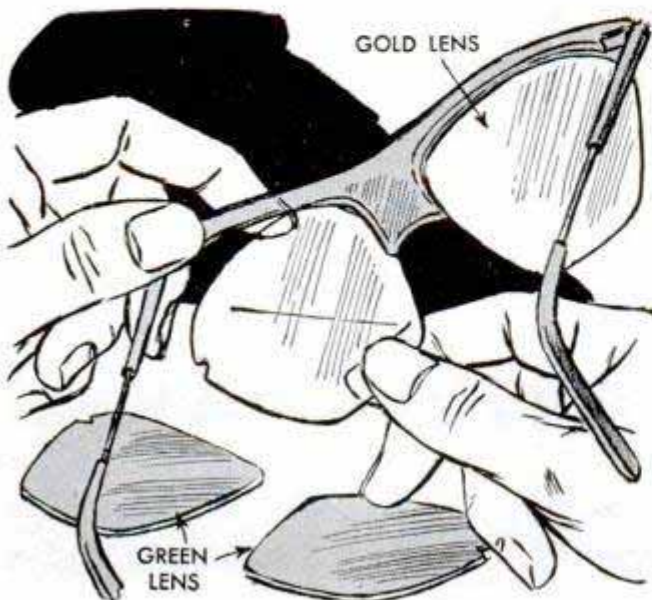

Two pairs of interchangeable lenses fit the same eyeglasses designed for driving comfort. During the day the motorist uses a pair of green lenses to cut down the glare of the sun. At night he simply slips these lenses out of the frame and inserts a new pair, tinted gold. These lenses filter out most of the ultraviolet rays from artificial light—thus reducing headlight glare—and at the same time increase depth perception in fog and at dusk.

Sources of available products described in this issue are listed on pages 12, 14 and 16. Sources of further information on other articles are listed in our free WHERE-TO-FIND-IT LIST. For your copy just write to the Bureau of Information, *Popular Mechanics*, 200 East Ontario Street, Chicago 11



Detroit Listening Post

By Siler Freeman

ALTHOUGH THE 1952 models still have several months to go, the auto industry's attention is being turned now toward the 1953 cars. The first in the field for a change will be Chrysler. The company is expected to start showing its line some time in October, possibly with a press preview as early as September.

Chrysler's change this year not only will be extensive but may prove quite startling, according to earliest hints on the part of some high officials of the corporation. Every line will have complete new body styling and Dodge and Plymouth probably will have even more than sheet-metal changes.

When the present bodies were introduced in 1949 as a complete change from the old lines, K. T. Keller, then president, took responsibility for the styling. It was known that some of his aides were not disposed favorably and the reaction from the public seemed to back them in their criticism.

Now there is a new team at Chrysler. Keller has been replaced with a smooth Texan, L. L. Colbert. Dodge has a young new president, W. C. Newberg. Plymouth also has acquired a much younger chief, Jack Mansfield.

The Dodge and Plymouth lines have experienced the hardest sledding against their competition. Chrysler and DeSoto were given new engines, power steering and other mechanical advances to talk up against their rivals. But Dodge was disappointed on its V-8 engine and Plymouth even lacked an automatic transmission.

The 1953 Chrysler line is supposed to make up for any past deficiencies. Chrysler is known to have several new stylists on its pay roll and the results soon will be seen. Next year is expected to bring back some of the old-time rivalry unknown since before the war. And Chrysler will equip its dealers with the ammunition to hold their own in the sales field.

G.M.'s new-car announcements may come considerably later than Chrysler's. Three of the divisions will have sheet-metal changes and at least two will have new engines. Tool and die

shops in this area are filled with work and the pressure is on to get the stuff out as fast as possible.

At least one company now using G.M.'s Hydra-Matic is pushing hard to bring out its own automatic transmission. But because engines and transmissions require so much tooling, there is some doubt that the necessary machinery can be procured in time for the next model change.

Ford and Nash probably will stand on their completely redesigned body styles now on the streets. The usual face lifting is to distinguish what will be labeled 1953 models and the change-overs can be made at will.

The introduction of a high-compression V-8 engine in both the Ford and Mercury lines will distinguish their 1953 cars. Lincoln may show slight changes but the division will be pushing ahead with the new Continental for the company's golden-anniversary celebration next June.

Nash, however, probably will show a restyled Rambler. Prototypes are running around already—disguised, of course, but recognizable. Pinin Farina's touch will be apparent in the new Rambler just as it has changed the looks of the 1952 Nash.

The rest of the industry probably will go to minor changes and introduce their 1953 line before the end of the year. It all depends on sales, whether the elimination of Regulation W will continue to aid sales or whether they will need a shot in the arm to revive interest in the fall.

Trucks are following the passenger cars in offering accessories which are finding favor with the public. The trucks are heading for high-compression engines, tinted-glass windshields, automatic transmissions and power steering.

G.M.C. has introduced a 7.2:1 engine about 500 pounds lighter than any of comparable power. Ford is experimenting with a butane-operated engine. International Harvester, G.M.C. and Ford already are using automatic transmissions on their light trucks and G.M.C. uses Hydra-Matic on its six-by-six military truck.



Clymer approves of Mercury's big windshield for visibility

THE POPULAR MECHANICS MOTOR SURVEY
AS CONDUCTED BY FLOYD CLYMER

I am the owner of a 1952 Mercury, Custom Monterey Special Custom
 Equipped with: Conventional transmission Overdrive Merc-O-Matic Drive
 I have owned it approximately 2 months. Speedometer mileage is now 7000.
 Having tried both kinds, I find that my Mercury operates satisfactorily using:
 regular gasoline premium (high test) gasoline m.p.g. for city driving, and
 My average gasoline mileage is $\frac{17}{19}$ m.p.g. for country driving.

I CHANGE OIL every _____ miles, but also ADD OIL every _____ miles.
 I change oil every 2000 miles.

Roadability and handling qualities are: Excellent Good Unsatisfactory
 Maneuverability in traffic seems to be: Excellent Good Unsatisfactory
 Acceleration is: Exceptional Very Good Average Poor
 Corb and road clearance is: Satisfactory Too High Too Low

Here are my main reasons for purchasing a Mercury: new 1952 model
increased engine horsepower - attractive styling
 Particular features I like are: New, distinctive body styling Combined front bumper and grille Centralized, unit-type instrument panel "Space-Planned" interior and appointments Gas filler cap located behind front fender License plate bracket New paint & color combinations offered "Overhead" and _____ and _____ Body styling

Specifically, what do you dislike about your Mercury? Body styling
similar to the Ford - No inside door

Have you ever owned a Mercury before? Yes No How Many? _____
 Would you buy another Mercury? Yes Possibly No
 How do you rate your dealer service? Excellent Good Average Poor
 How do you rate your Mercury, generally? Excellent Good Average Poor

GENERAL INFORMATION
 What type of engine would you prefer in your next new car? In-line V-type
 Number of cylinders: 6 8 Valves: Side Overhead Yes No
 Are you satisfied with the horsepower rating of your Mercury (125 hp)? about 125
 Approximately what horsepower rating would you like in your next car? Body styling
 What specific improvements would you like to see in your next car? Body styling
 Based on your present experience, which transmission would you prefer? Standard trans. Other type automatic transmission
 Overdrive Merc-O-Matic Drive

This questionnaire will be tabulated fairly, and we request that you attend to each question. Please mail promptly to:

FLOYD CLYMER
1268 SO. ALVARADO ST.
LOS ANGELES 6 CALIF.
(Please write in your pen)

This was the No. 1 reason (44 pct.) for buying a '52 Mercury

The OWNERS

Better than average (see percentage chart)

Nobody in survey wanted six cylinders

77 percent agreed with this owner on horsepower



HHEY, DETROIT! Are you listenin'? Despite the great race between automobile manufacturers for more and more horsepower, 77 percent of the 1952 Mercury owners who answered our 1000-questionnaire survey want *no increase in horsepower output*. The present Mercury horsepower rating is 125.

A loud minority, however, demands more horsepower in future cars. Could it be this minority that has bent the ear of the automotive engineers?

Sixty-two percent of our replies came from previous Mercury owners and 93 percent said they would or might buy another Mercury; only 7 percent said they would not be interested.

Many Mercury owners were proud that their make was one of the few to offer complete styling changes in 1952. A farmer near Hartford City, Ind., said, "I think the 1952 Mercury is the most advanced in styling of any car, with the best automatic transmission of any of them."

"I am well pleased with my new Mercury," wrote a Newark, N. J., plant superintendent. "It has everything I want in the way of an automobile—styling, pep and power."

The new styling was the principal reason why persons who had never owned one bought a Mercury this time. A Lexington, Mass., salesman echoed the opinion of many when he wrote, "I think the 1952 Mercury is the best-looking car on the road."

Owners of all makes have their personal complaints and Mercury owners followed form in this respect. The most common fault reported in the survey was that the engine is quite noisy.

Another objection stated a few times, such as in questionnaires returned by a Neenah, Wis., maintenance worker and a Manchester, Conn., newspaper district manager, was that the dashboard, when lit at night, is reflected on the windshield, cutting down vision.

Several owners, such as a Denver, Colo., spot welder, mentioned that they wished Mercury's hood locked from the inside. Others, including a Hyattsville, Md., electrician, observed that the windows steamed too easily.

A Baltimore, Md., equipment salesman wrote, "Recently I weighed my Mercury at 3780 pounds with gas and a few items of junk in the trunk. I get 13.4 miles per gallon of gas and I should have a lot more

REPORT on the '52 MERCURY

The true test of an automobile begins when the owner takes the wheel. This is another report from owners of 1952 cars who answered questionnaires sent by Popular Mechanics to 1000 Mercury owners from coast to coast

By Floyd Clymer



Seventy-eight percent of owners in survey liked the new body styling of the '52 Mercury — the massive front end with wrap-around bumper, new ornaments

Percentages From PM Poll

Owners of Custom models	79%
Owners of Monterey Custom models	21%
Owners having Mercomatic drive	60%
Owners having conventional transmission and overdrive	29%
Owners having conventional transmission only	11%
Average gasoline mileage in country	18.5 m.p.g.
Average gasoline mileage in city	15.3 m.p.g.
Owners using premium gasoline	51%
Owners using regular gasoline	49%
Owners who change oil	97%
Average mileage for change of oil	1380
Owners who add oil (also change periodically)	5%
Average mileage for adding oil	960
Roadability excellent	64%
good	32%
unsatisfactory	4%
Maneuverability excellent	67%
good	32%
unsatisfactory	1%
Acceleration exceptional	21%
very good	56%
average	20%
poor	3%
Curb and road clearance satisfactory	92%
too high	6%
too low	2%

Best-Liked Features

Overhead-mounted brake pedal	88%
New body styling	78%
Gas filler-cap location	72%
Centralized instrument panel	63%
Interior and appointments	46%
Paint and color combinations	38%
Combined bumper and grille	36%

(These percentages are based on answers to direct questions on the questionnaire . . . some answered several)

Owners' Rating of Car

Excellent	50%	Average	13%
Good	31%	Poor	6%

General Information

Owners preferring the following on next new car:	
V-type engine	97%
In-line engine	3%

After a high-speed run on the desert, Clymer stops to measure actual temperature of water. The counter-balanced hood lifts easily and requires no support

Eight cylinders (none wanted six cylinders)	100%
Overhead valves	78%
Side valves	22%
No increase in horsepower output	77%
Average horsepower output desired	141 h.p.

(Present Mercury horsepower rating—125—was used for owners indicating satisfaction with present horsepower)

Automatic transmission	57%
Conventional transmission with overdrive	33%
Conventional transmission only	10%
Mercomatic drive exclusively	86%

(The above figure means 86% of the 57% preferring automatic transmissions)

Other type or make of automatic transmission	14%
Previous Mercury owners	62%
Will buy another Mercury	58%
Might buy another Mercury	35%
Will not buy another Mercury	7%
Dealer service rated excellent	35%
good	34%
average	23%
poor	8%

Most frequent objections: 1. Front bumper-grille combination and rear-fender height; 2. Body fitting and assembly; 3. Automatic transmission hum, engine noise

Improvements desired in next new car (in order of preference): 1. Minor styling changes, interior and exterior; 2. Better gasoline mileage; 3. More powerful engine for increased acceleration and speed; 4. Overhead valves; 5. Easier steering—power-assisted or otherwise; 6. Better body fitting and workmanship; 7. Cigar lighter located closer to driver; 8. Increased headroom and/or legroom; 9. Quieter engine and/or automatic transmission

Main reasons for purchasing 1952 Mercury:

1. Body styling—interior and exterior	44%
2. Previous satisfactory ownership	36%
3. Reputed economy of operation	18%
4. Mechanical features—engine, transmission, etc.	17%
5. Roadability, driving ease, handling qualities	13%

(The above percentages represent unsolicited comments—some commented on more than one feature)



Acceleration Test

1952 Mercury 4-Door Sedan
With Mercomatic Drive

¼ mile from zero	21.80 sec.—Drive range only
	21.10 sec.—Low and Drive
½ mile from zero	33.10 sec.—Drive range only
	32.40 sec.—Low and Drive
0 to 30 m.p.h.....	5.10 sec.—Low range only
0 to 60 m.p.h.....	19.10 sec.—Drive range only
	18.90 sec.—Low and Drive

(In tests using both Low and Drive, shift from Low to Drive was made at about 30 m.p.h.)

Top Speed (by speedometer) _____ 95-97 m.p.h.

Actual top speed about 7% less (speedometer variation)

horsepower than 125 pulling me around.”

A Honolulu owner said, “I’ve owned ten cars in six years . . . five of them Mercurys. From now on nothing but Mercury for me. . . . It beats them all for operation and Mercomatic is by far today’s best automatic transmission, with no jerks in changing.”

An Army sergeant at Fort Bragg, N. C., made this suggestion: “I think the Mercury people should reduce the rattles in the doors, body and under parts. My car has only a very few minor rattles at the present time because the car is new, but I feel I am going to have to visit the garage constantly to prevent development of minor rattles.”

A Waterloo, Iowa, special investigator and a Chicago housing administrator agreed that “the fit of the Mercury’s doors is not perfect.” The first noted that “water comes in when the car is washed and runs down the door panel.” He also remarked, “I think they should remove the top half of the horn ring, as it blocks the view of the instrument panel.”

A San Diego, Calif., trucker wrote: “The Mercury is fine in most qualities compared



In making the acceleration test, left, Clymer used a barrage of seven stop watches, above, for accuracy



Above, special measuring device indicates specific fuel consumption over measured mile at given speed. Below, testing the Mercury over a rocky side road

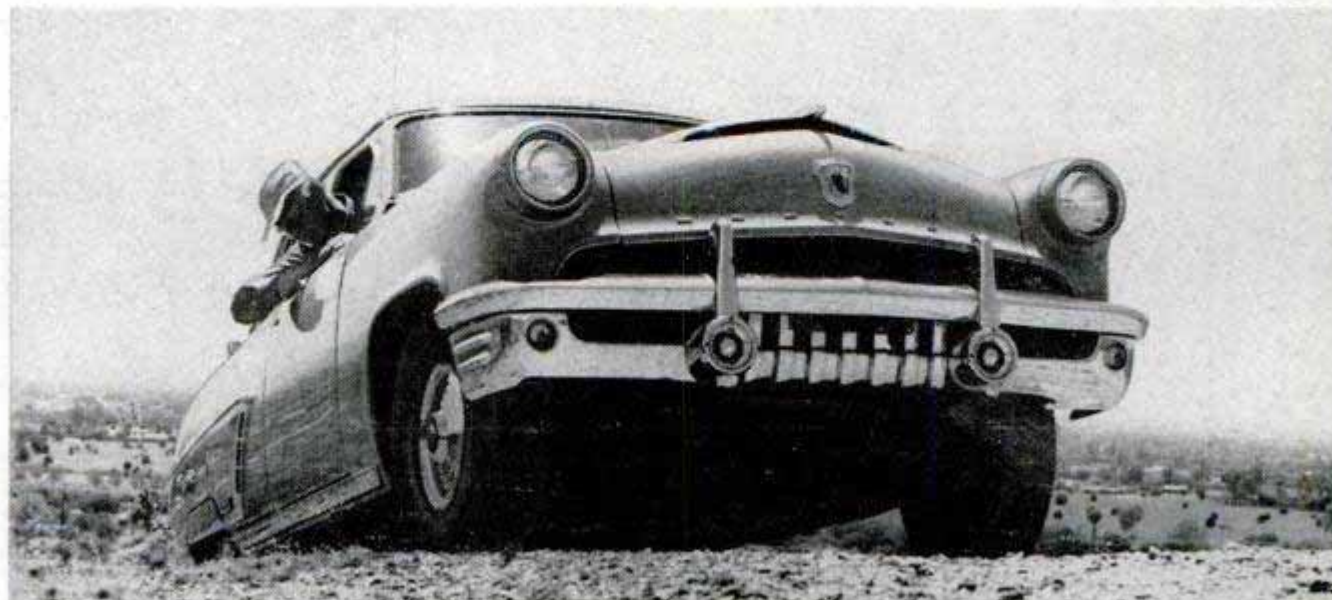

Economy Test

1952 Mercury 4-Door Sedan
With Mercomatic Drive

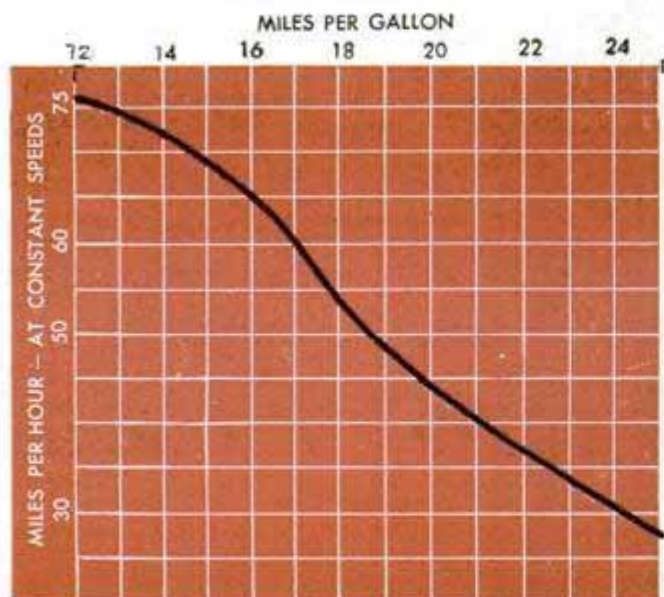

At 50 m.p.h. Clymer's economy test of the Mercury agrees with average in owner survey — 18.5 m.p.g.

to other cars in its class of horsepower-to-weight ratio. Yet it needs more power, especially when in overdrive on the hills." (Some owners in the survey said they want more horsepower. The average horsepower rating desired by those owners answering our question in regard to that was 141. Many owners also want overhead valves.)

In roadability and handling qualities, Mercury scored high with 64 percent rating it excellent. Average gasoline mileage



Mercury's compact instrument panel is arranged for quick viewing; heater controls are on either side

computed from all replies was 18.5 for country driving and 15.3 for city driving.

From West Hyattsville, Md., a soil scientist wrote: "The 1952 Mercury has overcome most of the shortcomings of the 1949-51 models. Visibility and seating are much improved. . . . Better assembly. . . . Easy access to all components under the hood that need servicing is a distinct advantage. The additional power will get you out of

(Continued to page 258)

For full-passenger-load test, Clymer filled innertubes with 50 pounds of sand and placed them in rear of car



Mower Attachment Distributes Weed Killer

Weed killer is spread over the lawn as you mow it with a distributor that attaches to either hand or power reel-type mowers. The mower roller applies the liquid to the plants. A perforated brass tube is mounted above the roller and the weed killer drops onto the roller as you mow. The supply tank attaches to the mower handle. A guard covers the perforated tube, protecting it against clogging. By applying the solution directly, the attachment eliminates "drift" from sprays that may damage shrubs.



Scientists Say Fish Ignore Weather and Barometer

Refuting age-old theories, scientists now say that fish pay no attention to the weather and the barometer reading has no effect on how many fish you catch. Dr. George W. Bennett, an aquatic biologist, tried to correlate a 12-year creel census from a private fishing club with changes in the barometer

reading. He found that there wasn't any relationship. A Michigan scientist studied the results of 4000 individual fishing trips and said the barometer reading had no effect on the catch. Two Iowa researchers tried to correlate wind, clouds and rain with fish activity. They just couldn't do it.



Lawn Sprinkler Has Built-in Stake

Featuring a metal stake pivoted to its underside, a plastic lawn sprinkler can be set up on the ground or held in the hand. The stake is adjustable to hold the sprinkler at any angle. The flared plastic head is resistant to breakage and corrosion.

Exhaust Deflector

Corrosive automobile-exhaust gases are kept away from chrome surfaces by a porcelain-coated tail-pipe extension. The porcelain protects the extension from corrosion. It is available in six colors.

Aerodynamic Bumper

Shaped so that downward pressure is exerted on it by the air at high speeds, an aerodynamic bumper is said to increase the stability of a light car. Invented by a former German airplane maker, the bumper actually makes the front end of the car weigh more at high speeds. He calls it the "Aeloran" and will make it for a wide range of car models.



Production of all antibiotic drugs now totals more than 63 tons a month.



Boarding Comet, *Popular Mechanics'* representative was only American on world's first jet-airliner flight

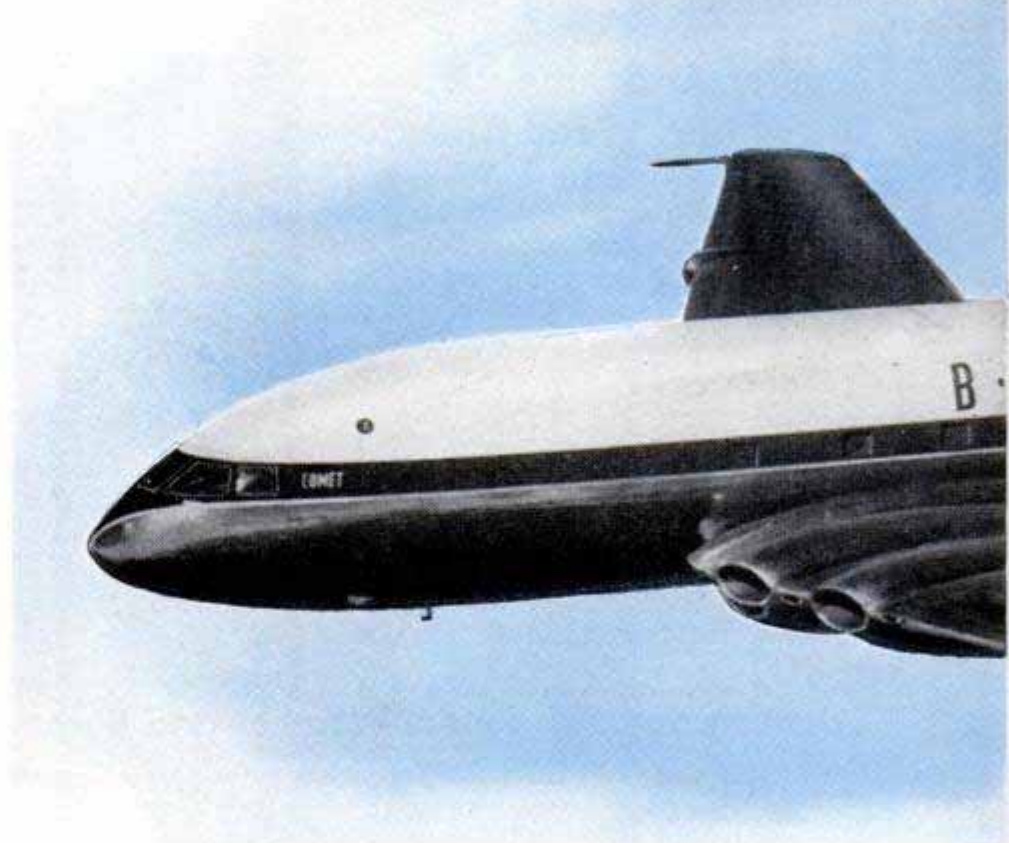

By Aubrey O. Cookman, Jr.

I RODE THE FIRST

SCHEDULED eight-mile-a-minute travel in the stratosphere is here. I did it, and from now on so can you.

As *Popular Mechanics'* representative, I was a passenger on the world's first regular jet-airliner flight that took off from London for Johannesburg, South Africa. That trip officially established a radically new mode of travel that in this decade will become commonplace. I was the only American on the inaugural flight.

London Airport was buzzing with excitement as the first group of paying passengers for the 36-passenger De Havilland Comet jet liner trooped through Customs. Thousands of spectators crowding every vantage point within sight of the aircraft knew the flight would make history. A small army of photographers and pressmen encircled the waiting Comet.

We riders knew we were guinea pigs, in a sense, but we were proud of it. We hadn't been urged to go. A large bump of curiosity was our common failing. The eldest, whose son set records flying to South Africa years ago, had applied for his "first flight" seat through Cook's travel agency two years before. My own request had been in six months.

Our fellow passengers included businessmen, a dentist, a chemist, engineers, a policewoman and a composer. Regular airline life insurance was available at the usual

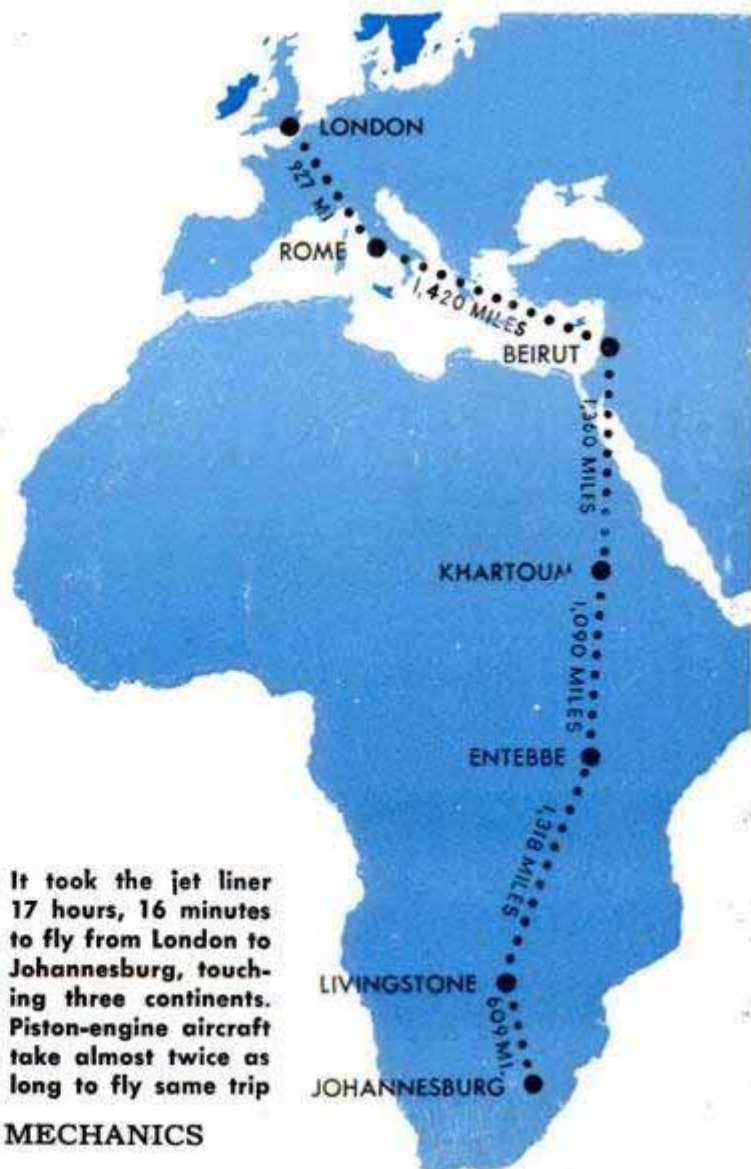

It took the jet liner 17 hours, 16 minutes to fly from London to Johannesburg, touching three continents. Piston-engine aircraft take almost twice as long to fly same trip

Pressurized for eight-mile-high travel, the sleek new jet transport cruises above weather at 490 miles an hour

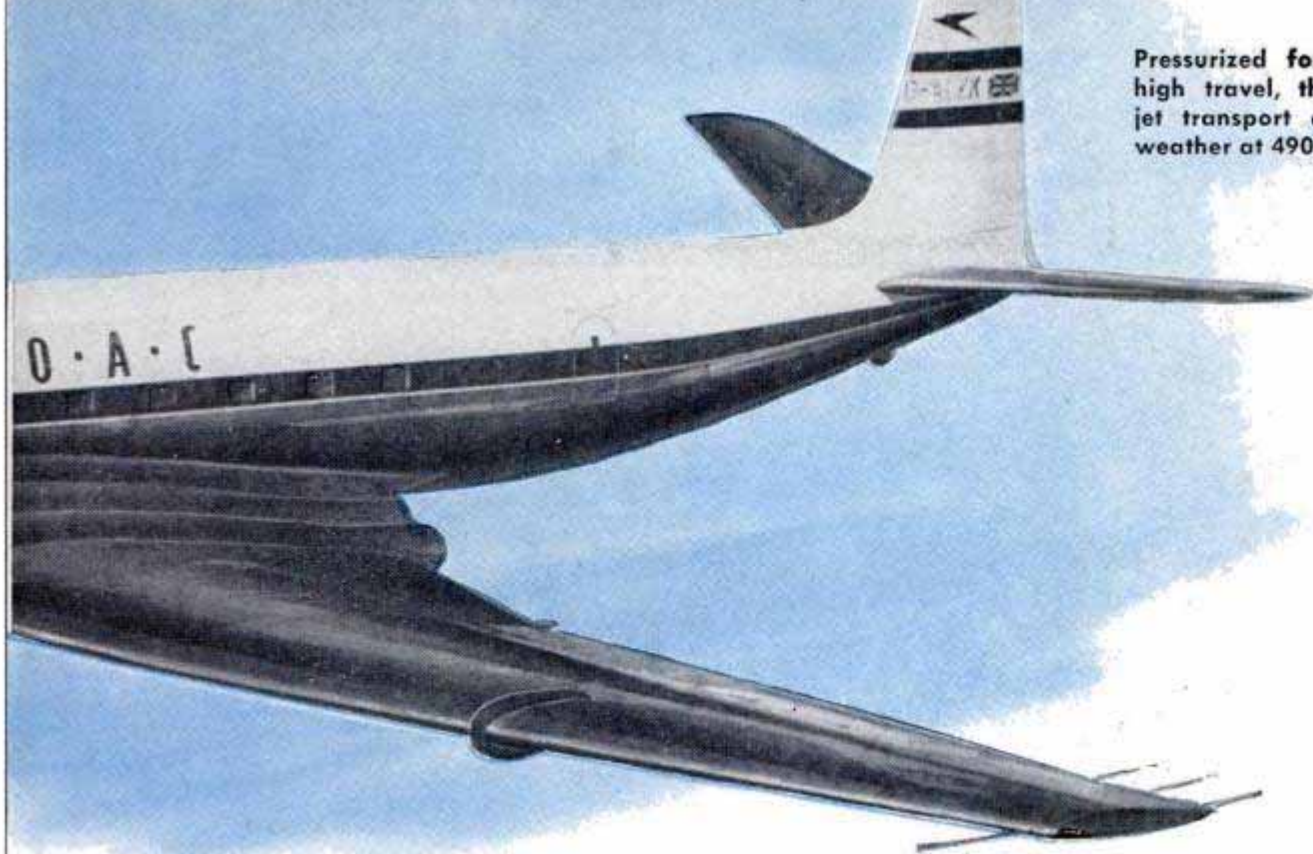

JET LINER

rate and I suspect a few snapped it up. The odds were all in our favor and we knew it.

The sleek, graceful Comet looked fit and eager to go. Where the propellers normally are located were four gaping, oval mouths—the inlets to its powerful turbojet engines—waiting to gulp in air. As soon as the inaugural ceremonies ended we filed up the steps and to our assigned seats. Mine was

No. 10, about five feet from the left inboard engine. Intermittent rains and a gray sky, familiar to Londoners, didn't make it an ideal flying day.

By 3:05 p.m. the crowd was pushed back sufficiently to allow Capt. A. M. A. Majendie to give the signal for the engine start. Then, for the first time, the Comet began to perform differently from a conventional

One officer at the flight controls always wears an oxygen mask as a safeguard against pressurization failure





With propellerless jet craft, engines are nearer the ground and accessible for maintenance without platforms

piston-engine liner. Instead of the usual thudding vibrations and noise there was only a low whine. Outside we saw spectators clapping hands over their ears but inside the sound wasn't loud enough to interfere with ordinary conversation. In about 2½ minutes we began taxiing slowly for the take-off start.

As soon as we were lined up on the runway, the engines were run up to full power—10,250 revolutions per minute. The power of the whine grew stronger but there was still no vibration. The brakes were released

suddenly and we raced down the runway like a scared rabbit. I timed our wheels coming off the ground just 32 seconds after the initial forward thrust. It was 3:12 p.m.

Take-off length of the Comet varies from place to place because of altitude and temperature differences but under normal conditions at London Airport—with a full load of passengers and cargo—it gets off in approximately 3800 feet. That is about average for transports of the same gross weight, 105,000 pounds.

Initially, the Comet moved upstairs at

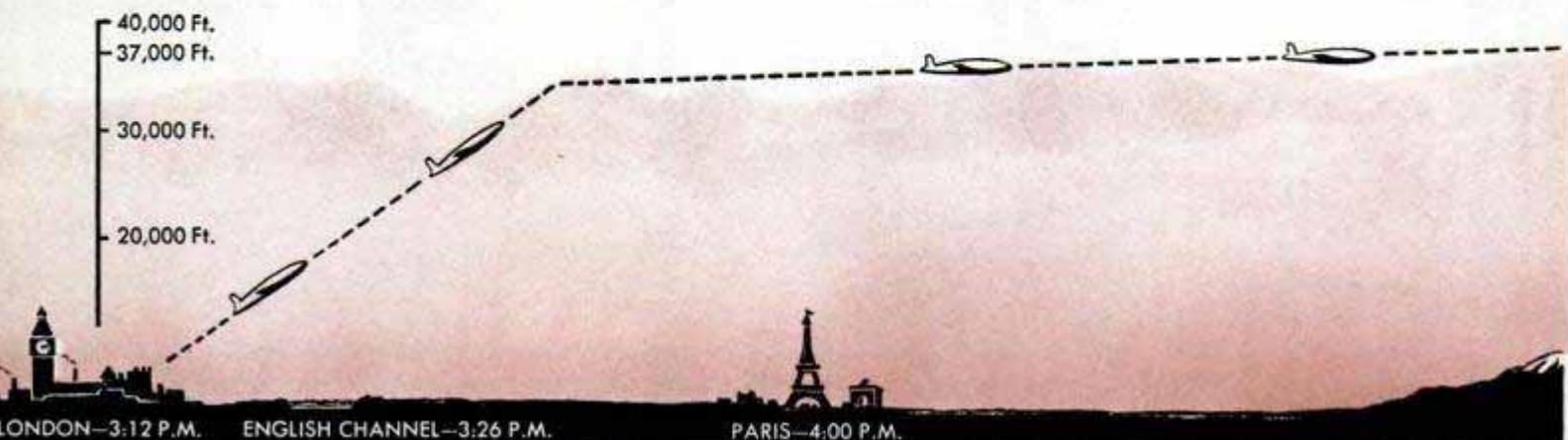

With his Comet at 40,000 feet, Capt. A. M. A. Majendie talks high-altitude flying with author

better than 2000 feet a minute, but because of its fast climbing speed the nose-tail angle was never steeper than 30 degrees. At about 5000 feet we began breaking through the first of the cloud cover layers. There was some bumpiness and the clouds sliding quickly by the windows kept us aware of our speed.

Fourteen minutes after take-off my British seat-mate, Bert Hardy, reported we were already over the English Channel. This is about half the time it ordinarily takes to reach the Channel. Paris, well behind us, was sighted through a cloud break as we straightened out to make our run for Rome, 48 flying minutes from London. It was 4:00 p.m. British time.

By now we had reached the jet's most economical operating altitude, the neighborhood of 35,000 feet, and the sky I'd always known as blue suddenly was indigo. Stars were visible in the dark reddish-blue sky overhead although it was only late afternoon. You experience an eerie feeling of "other worldliness" as you glide almost noiselessly high above a cloud carpet that blots out all sight of the earth and water below. It took word from the captain to yank me back to reality.

It was a message passed back from the cockpit telling the passengers that we were then at 39,000 feet, while the cabin pressure remained as at 8000 feet and that our ground speed had moved well above 450 miles an hour. He added apologetically, "We are now in the stratosphere—the mild turbulence you may have noticed a short while ago was experienced in passing through the tropopause." We habitually



earthbound creatures were pleased and thrilled by the explanation.

I decided to get up and take a look around our floating home. Up forward the crew members, wearing helmets with built-in earphones, huddled at their posts. Three of the four were using oxygen masks. The British Overseas Airways Corporation has a rule that during all Comet flights, at least one man must wear an oxygen mask. This guarantees that either the pilot or copilot will always be on an independent oxygen supply. In the event of pressurization failure, a remote possibility, the crew quickly could nose the plane down to a safe height without danger of blacking out. Their working quarters, easily the quietest section of the plane, are arranged compactly and looked more commodious than most cockpits.

Just behind the crew is a pantry from which a steward and a hostess conduct

Fuel economy is greatest at extreme altitude, where the plane encounters less drag. The Comet climbs quickly, as this London-Rome flight profile indicates

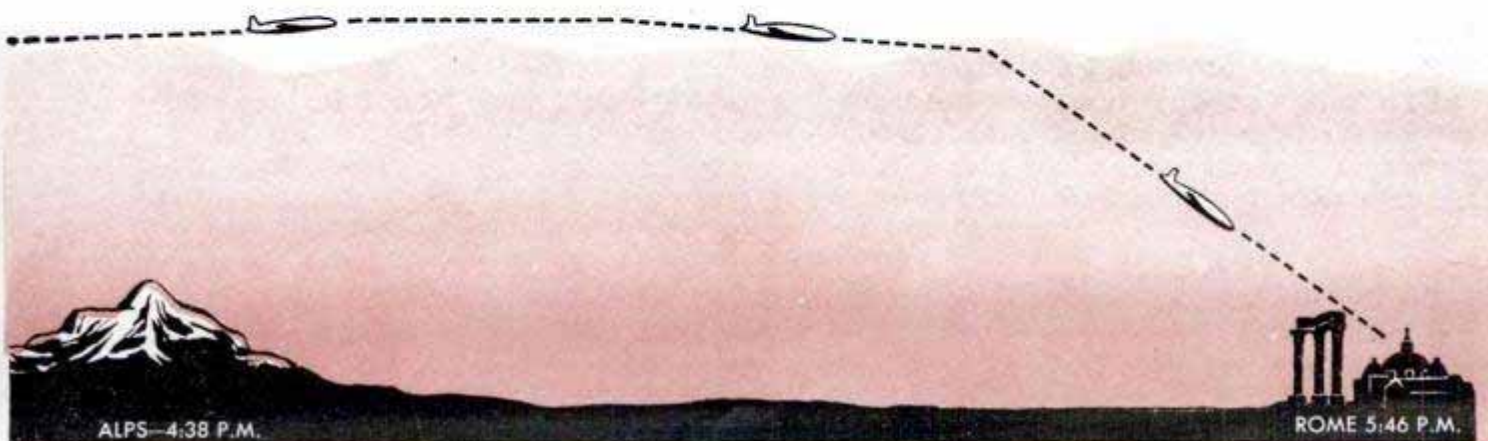



Measuring specific gravity of kerosene at Rome to determine accurate weight of fuel needed to Beirut



Photo made through cabin window as inaugural flight moved above cloud formations at about 25,000 feet

feeding and refreshment operations. Next in line is the front passenger cabin, which seats two sets of four passengers at tables flanking the aisle. The remaining 28 passengers are in the main cabin. Unlike its performance features, the Comet's passenger appointments aren't unique. It isn't a luxury craft for extra-fare service.

At about 4:30 p.m. we were having tea and cakes somewhere slightly above 40,000 feet when the captain came back to chat with the passengers. He assured us that we were traveling "quite a good bit" higher and faster than commercial passengers ever had. Unexpected 50-mile-an-hour head winds, Majendie added, were holding us back (to a mere 450 miles per hour). Later the Comet responded to this pat on the back with a 525-mile-an-hour burst of speed.

While the captain was with us, there was a momentary break in the cloud pattern and we gazed at some of the tallest peaks of the Alps, many thousands of feet below us. I remembered flying between them one other day when they seemed mighty tall, but from my new perch they looked like the sand hills youngsters build at the beach.

Over Italy the sky was clear and the sunlight formed lights and shadows as we began to drift down, vibrationless, toward Rome's Ciampino airfield. We were still over 150 miles away as the inboard engines were throttled down to ease our descent.

Extremely careful flight planning is a must with Comets. Their per-hour fuel consumption is about three times that of comparable piston planes and long waits in stacks above airports would make them uneconomical to fly.

During the letdown the captain sent the stewardess back to tell us not to be alarmed about the strange deceleration "grab" we were soon to feel. It would just be the air brakes, strips of metal about 15 feet wide,

flipping up from the wing surface to slow our descent. Another pair beneath the wings was doing the same job.

We touched down with beautiful softness, at about 90 or 100 miles an hour, to mark the end of the first leg of a 6724-mile trip to Johannesburg, South Africa. It was 5:46 p.m. The captain announced we'd ticked off nearly 1000 ground miles from London in 2 hours and 34 minutes, close to half the present commercial running time. But he was "disappointedly disturbed" because we were 10 minutes behind the fastest schedule ever mapped.

As we were moving away from the airplane for the Rome pause in the flight, a fuel truck sped by with a "drink" for the thirsty Comet. Underwing pressure fueling shoots up to 21 tons of kerosene into it, at two points accessible from the ground, at a rate of 150 gallons a minute.

Cabin heating is supplied by hot air bled directly from the engine compressors, instead of from separate combustion heaters and blowers. This is the same source of the hot air used in de-icing the wings and tail.

Range limitations will keep the Comet off trans-Atlantic routes but a new and more powerful engine, the Rolls-Royce Avon, will extend the range of those now on the production line to over 2000 miles with safe margins. The present Ghost engine's rating of 5000 pounds thrust on a test bed at sea level is roughly equivalent to 10,000 horsepower. The Avon has a 6500-pound rating.

After the flight I toured the De Havilland factory at Hatfield, England and saw the 22nd Comet starting on the line. At this writing no pure-jet airliner is known to have been flown in the U. S., which means that England probably has a three to five-year lead on the rest of the world in this newest, fastest and smoothest kind of air transportation. ★ ★ ★

FISH

From a Seagoing Couch



"Romilly Reefer" weighs only 46 pounds, is easily lifted by its chrome handles or carried like a suitcase from place to place

TIRED FISHERMEN now can lie prone, paddle to good fishing grounds and watch the fish through a Plexiglas porthole until a likely victim appears. Then, without budging from position, the fishermen reach out, grasp a self-supported fishing rod before them, unreel and look through the underwater window as they drop the bait within easy reach of the evening's supper. Spear fishermen, scientists and life-guards also find the craft a useful tool.

Right, swivel socket holds any standard rod; the porthole allows view of fish below; two-bladed oar propels craft. Below, fishing is done lying down



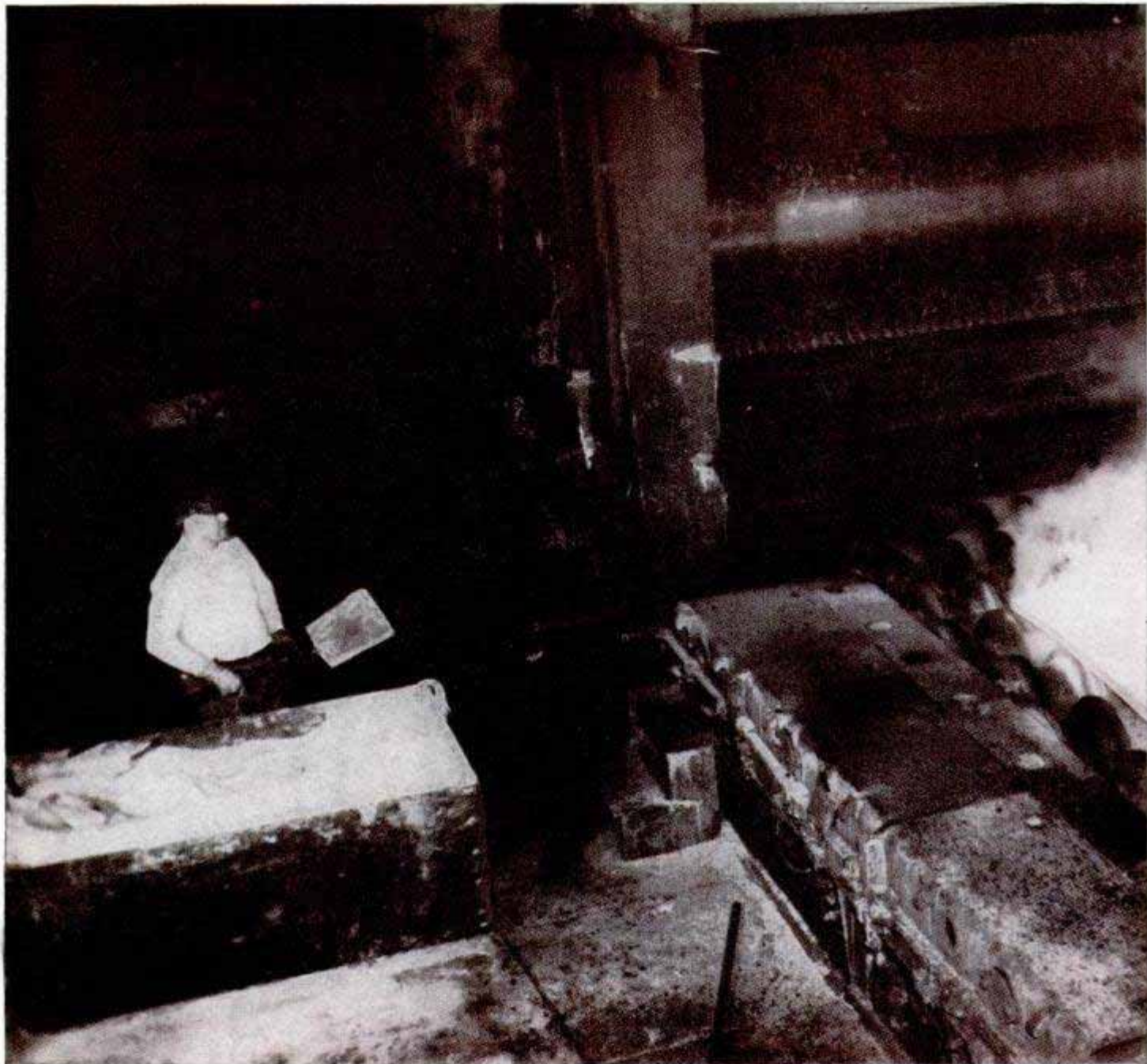

Salt is more than a seasoning. Wet salt thrown on hot steel plates explodes and knocks loose the hard scale

STEEL BUYS GROCERIES

By Albert A. Brandt

SURPRISING TO MOST is the fact that the iron and steel industries are large-scale consumers of groceries and other homely items frequently found on the housewife's shopping list.

Among the edibles used in enormous quantities by the steelmakers are, for example, corn syrup, molasses, flour, suet and salt. Somewhat less palatable are soap, palm oil, and lanolin, the latter a rust inhibitor.

And, of course, the steel industry like any householder uses plenty of water and air. Five billion gallons of water alone figure daily in producing steel. Four tons of air are required for a ton of iron, as against 3½ tons of iron ore, limestone and coke.

One large foundry maintains a standing order for flour with local bakeries. Since steel is less finicky than the average housewife, sweepings—flour that falls to the bakery floor in the course of turning out bread, pies and cakes—are perfectly acceptable. The flour becomes dough, which is used to seal up apertures in the steel flasks enclosing the sand molds in which liquid metal is cast.

Foundries also use large quantities of stick molasses and corn syrup to bind together the sand in the molds.

About 25,000 tons of palm oil are used annually as a protective coating and lubricant for cold-rolled steel and tin plate. In

making tin plate, bran, sprinkled on flannel-covered rolls, absorbs excess palm oil and adds luster to the surface. At least one company, after using the bran for this purpose, thriftily sells its bran to cattle-feed firms.

Soap is used as a lubricant in drawing wire through dies, and suet lubricates machines making nuts and bolts. In mills that turn out steel plate, wet salt is thrown on the hot metal. The water in it is converted into steam in minute but powerful explosions which knock loose hard scale.

Not a grocery item—but of great interest to the average housewife nevertheless—is the diamond. The industrial grade—costing anywhere from \$12 to \$20 a carat—is used in large quantities for many purposes, such as “dressing up” dies.

Who would think, to look at a piece of gleaming steel, that it was no stranger to Main Street’s grocery store? ★ ★ ★

Wire drawer, right, inspects soft flaky soap used as a lubricant in pulling the wire through a die to thin it. Below, flour sweepings are made into dough that seals the openings in steel flasks

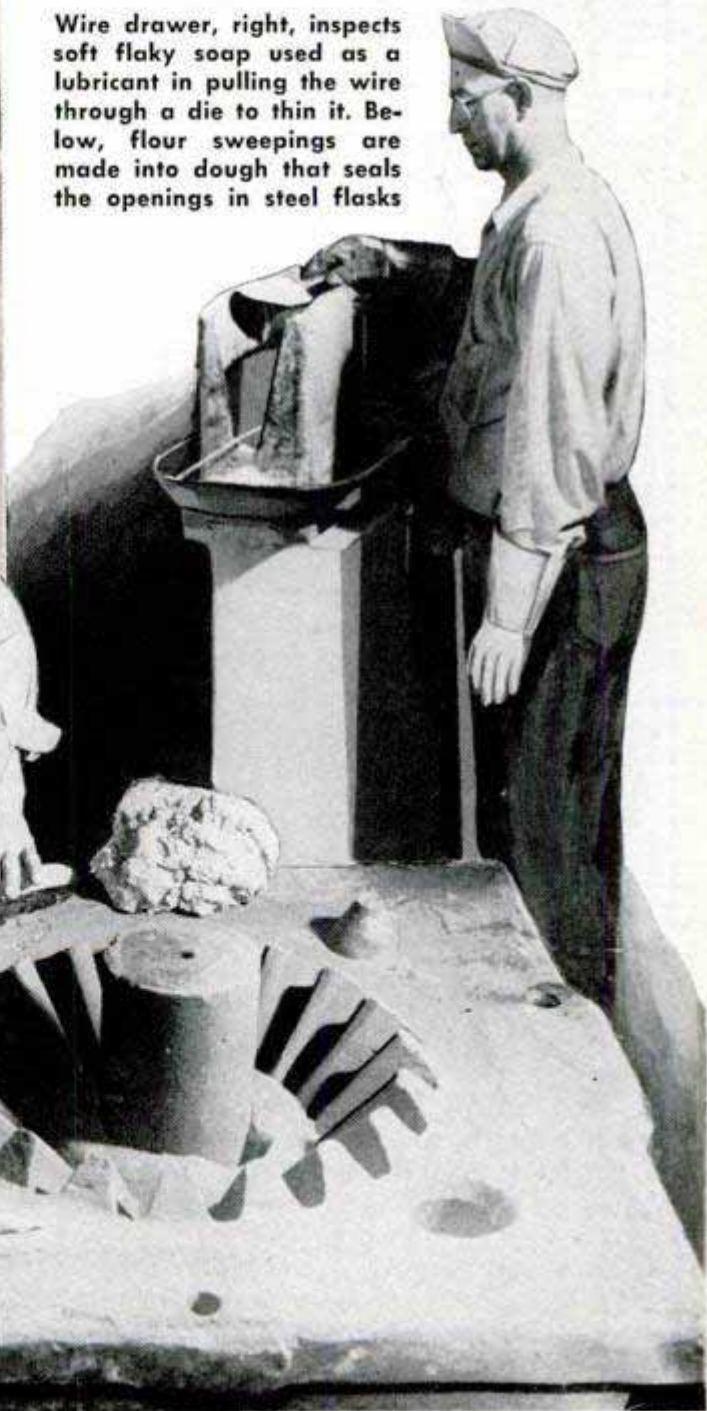
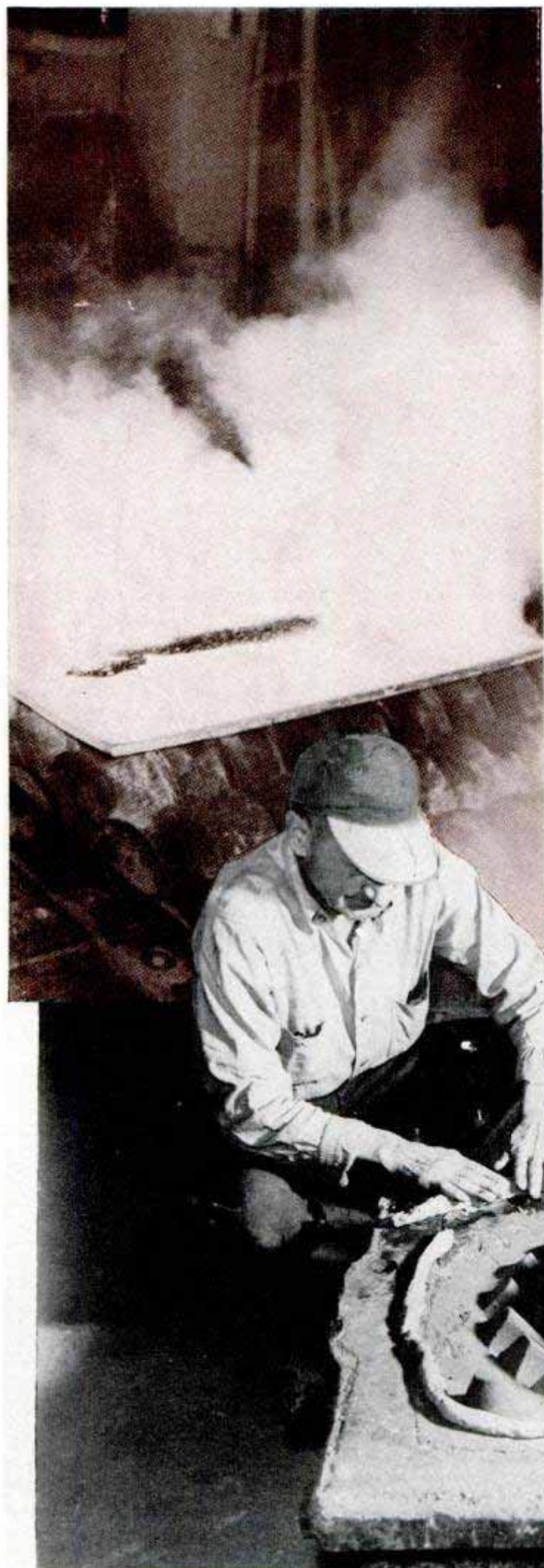



U. S. Air Force photos

Figures of men beside the B-60's nose emphasize the tremendous size of the largest pure-jet U.S. bomber



Just after take-off, the B-52's eight main landing wheels and its big wing flaps are still extended

Giant B-60 Jet Longer and Taller Than B-36

More structural details have been revealed about two new U. S. jet superbombers, the B-52 and the B-60. Each has eight Pratt & Whitney J-57 engines, swept-back wings and will fly 550 to 600 miles an hour. The B-60 has a 206-foot wingspan and is 171 feet long and 50 feet high, making it longer and taller than the B-36. Like the B-36, the world's largest bomber, it was built by Consolidated Vultee. The Boeing B-52's wingspan is 185 feet, length 153 feet and height 40 feet. It has two pairs of port wheels retracting forward into the fuselage and two sets of starboard wheels folding

back. Small outrigger landing gears near the wing tips maintain balance on the ground. The angle of the B-52's horizontal tail surfaces can be altered considerably to give better high-speed control.

Sources of available products described in this issue are listed on pages 12, 14 and 16. Sources of further information on other articles are listed in the WHERE-TO-FIND-IT INDEX, which is available without charge to readers upon request to the Bureau of Information, *Popular Mechanics Magazine*, 200 East Ontario Street, Chicago 11, Illinois

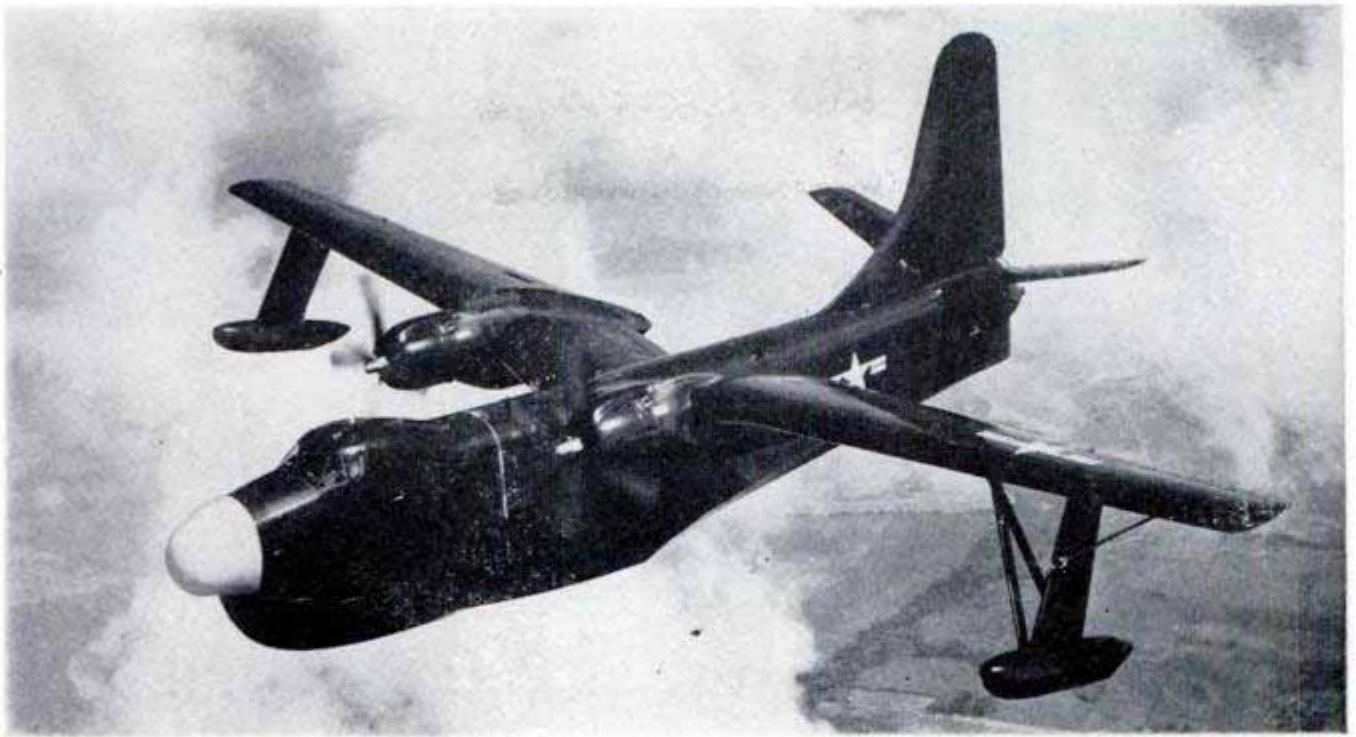

Sub-Chasing Airplane

Enemy submarines will have to be sharp to elude a new Navy hunter-killer seaplane patrol bomber, the first aircraft designed and built especially for antisubmarine warfare. Designated the Martin P5M, or Marlin, the plane carries the most modern radar and other detection equipment plus a supply of depth charges, torpedoes and rockets. Hull length of the Marlin is 90 feet, wingspan is 118 feet. The crew of seven is provided with eating and sleeping facilities for extended overwater searches. In-

side the thimble-shaped nose of the plane is the most powerful airborne search radar in any American plane. Two retractable fins in the stern aid maneuverability on the water and serve as a landing brake.

Foresee Larger Coal Output

By 1975, industry spokesmen predict, annual U. S. coal production will have doubled. Continuous mining machines will triple individual miners' outputs. Increased electricity needs and chemicals and fuels made from coal will swell demand.

Powerful British "Squid" Throws Pattern of Depth Charges

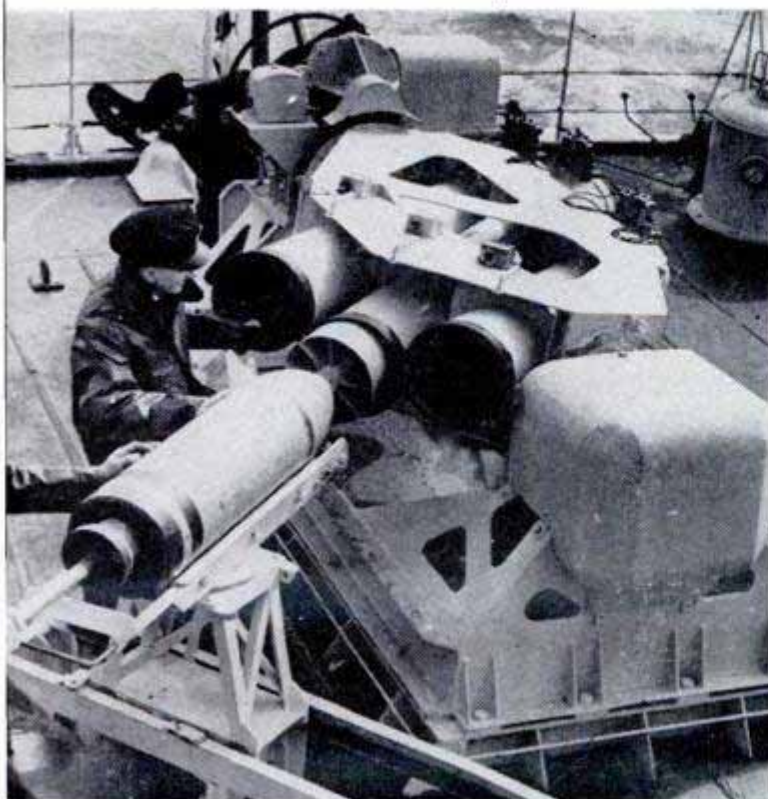

Underwater bombs that can crack the toughest hull are fired by the "Squid," Britain's powerful new antisubmarine weapon. Previously on the secret list, it is a multibarreled mortar which throws a pattern of charges ahead of the ship.

Adventure . . .

. . . is the trademark of America's foremost travel author, Lowell Thomas. An authority on exploration, Thomas recently took the "forbidden journey" across the roof of the world, that vast and little-known area hidden behind the 20,000-foot Himalayan peaks. In next month's issue, Thomas combines his own adventures with the strange tales of other famous men. "Fifty Years of Exploration" is an exciting story that takes you from the howling wastes of the North Pole to the tangled depths of the Amazon basin. He points out the vast, lonely areas of the globe that still challenge our explorers and describes what may happen when man starts out into that greatest unknown of all, outer space itself. Don't miss this exciting feature.

A black and white photograph of a person fishing in a river. The person is wearing a hat and waders, standing in the water. The background shows a forest of evergreen trees and a rocky shoreline. The image is framed by a white text box on the right side.

PACK UP FOR CAMP

By Claude M. Kreider

Photos by Ray Chapin

OLD-TIME CAMPERS miss the wide running boards and flat fenders of early day cars, upon which about everything could be carried. But the modern, streamlined automobile has possibilities for transporting a compact camping outfit which will insure comfort and access to the charming back-country roads denied the trailerite. Good hunting, fishing and solitude can be found only far from the "black top" pavement.

Compact camping equipment, which fits snugly into almost any car, will insure all the comforts of home and guarantee the three essentials for camping comfort—shelter, bed and food. With proper planning the car will ride well and have ample power. Here is how it is done with a complete outfit for three persons carried in a sedan or club coupe.

A duffel bag for each person—and perhaps one or two small suitcases—will fit on the rear floor. On top of these goes a tightly rolled umbrella tent which need weigh only 30 pounds although erecting to an 11 by 11-foot ground space. Three sleeping bags—of down or wool, each with an air mattress—

complete the back-seat load, leaving space for odd items such as cameras, binoculars and lunch kit slipped between the soft, protecting bundles.

In the spacious trunk you pack the "kitchen," a two or three-burner gasoline stove, icebox, can of extra gasoline, food box (one with hinged lid to be used for a kitchen table is best) and a gasoline lantern. On top — and last — go telescoping tent poles, tent pegs, ax and shovel. Chairs and a folding table complete the trunk load.

When camp is made the last items come out first. After clearing the ground with shovel and ax, if necessary, the tent is erected, kitchen set up in one corner or outside, as desired, and the sleeping bags laid out. This carefully worked out method places everything where it belongs with one handling. We often have sat down to supper 30 minutes after the car stopped. For speed, and to prevent duplication of effort, each person has his assigned duties.

A tent is not cold, as often believed. The umbrella type of good design has a tight-fitting flap with slide fastener and an extra awning to stretch out for a "front porch." The material should repel the hardest rain if thoroughly waterproof. Test it at home with a stream of water from a hose to be sure.



Two umbrella tents, an Army shelter tent and a nylon tarp windbreak afford ample cover for a large party. Below, all the essentials for comfortable camping





When an auto trunk is properly packed, you'll find it accommodates all the kitchen equipment with ease

Air mattresses are warm, too, with about three inches of "dead" insulating air beneath you. A 10-pound down-filled bag or a 15-pound wool-filled bag will insure comfort down to frost temperature. A party of three can sleep nicely in the 11-foot tent. The bags are stacked at one side when cooking and dining are to be done inside.

For the third person in a mixed party, a

little Army-type shelter tent weighing about four pounds and rolling down to the size of a blanket will accommodate a sleeping bag plus personal duffel. It will be warm, snug and stormproof. Two families with their own cars and tents can arrange a "village" that is the last word in comfort. Tents are faced together. The awnings are joined and held up at center with two extra

Unloading and erecting the tent first provides an opportunity to place everything where it belongs

With proper arrangement there is plenty of room in an 11 by 11-foot umbrella tent for cooking and dining





Within five minutes an umbrella tent can be pegged out on all sides and raised with a jointed center pole

telescoping poles to form a central dining room. A light, nylon tarp stretched along one side keeps out the breeze.

Food is no problem for the modern auto camper. Staples are carried in the food box while fresh supplies and other needed items are added along the way. Even a long stay far from supplies can be managed by taking concentrated food such as rice, package soup, dried fruit, canned butter, instant

coffee, egg powder, rye biscuits and other long-lasting breadstuffs.

If you like hot biscuits and corn bread—even camp cake and pies—take a folding reflector baker and the necessary prepared ingredients for these items. They will all bake to a golden brown in a few minutes in the handy baker, which folds to an inch thick and weighs only two or three pounds.

(Continued to page 234)

When tents are faced together, awnings can be attached and supported to add a spacious central dining room





Underwater Sonic Detector Pin-Points Fish

W. M. Ross, Seattle electronics engineer, started out to develop an underwater sonic device to locate sunken outboard motors but wound up with an apparatus which pin-points fish, underwater obstructions and shore lines. The instrument differs from conventional sonar equipment in presenting information on a cathode-ray tube and also on a graph. It transmits extraordinarily high-frequency sound waves

through the water, then picks up echoes which bounce off fish, rocks and shore lines. During a demonstration for Navy sonar experts, Ross' invention pin-pointed a 50-gallon steel drum at 1200 feet, a 20-gallon can at 900 feet and submerged bars and pilings. It also drew an accurate profile of the shore line. Ross has used his instrument to help him navigate the Alaskan coast and to locate schools of fish.



Field Gun in Miniature Built by British Engineers

Complete to the last rivet is a scale model of a British field gun built by five men of the Royal Electrical and Mechanical Engineers serving with the British forces in Germany. The model, made of scrap brass, is built to a scale $\frac{1}{2}$ the size of its prototype, the British 25-pounder. The men stripped a full-size gun, measured each part, then reproduced it in exact scale, using only two power tools—a small lathe and an electric drill. To make the rivets, they chucked the smallest cabinetmaker nails in a hand drill and dressed them down to size with files. The tiny breechblock slides down smoothly to expose the chamber and the extractors

fall back with the metallic click so familiar to gunners. Hidden inside the gun is a fully operative recoil mechanism. The dial sight is another example of fully detailed instrument work. The gun, given two coats of silver plate, was selected as the annual trophy to be awarded the best artillery regiment in Germany.

If you do not find the information you need in the index on pages 12, 14 and 16, sources of further information are available without charge from *Popular Mechanics*. Write to the Bureau of Information, 200 East Ontario Street, Chicago 11

LOCOMOTIVE JUNK PILES

Thousands of locomotives move yearly to railroad scrap piles

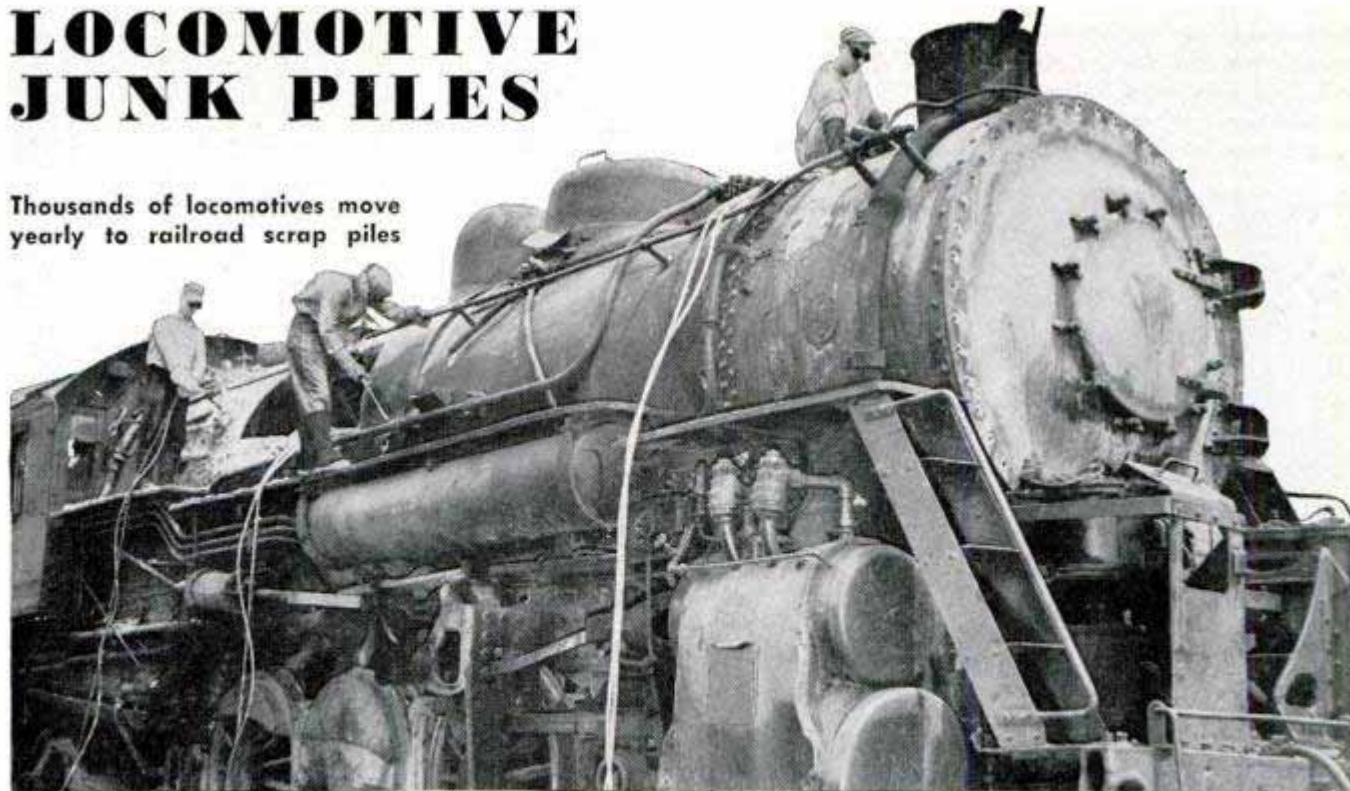

ONCE AGAIN American railroads are selling outmoded rolling stock to add to the nation's dwindling scrap piles. The record-high steel-production rate had the major steel mills scraping the bottom of their stock piles last summer—when normally they begin increasing their inventories for

the winter. Nearly 15 million tons of scrap were used during the first six months of 1951, an amount equal to about half the steel in all New York's skyscrapers. From the railroads' scrap yards, most of the reclaimed metal is sent to steel mills. Some parts are saved to repair engines still in use.

Cutting torches quickly convert once-powerful rolling stock into mounds of urgently needed steel scrap

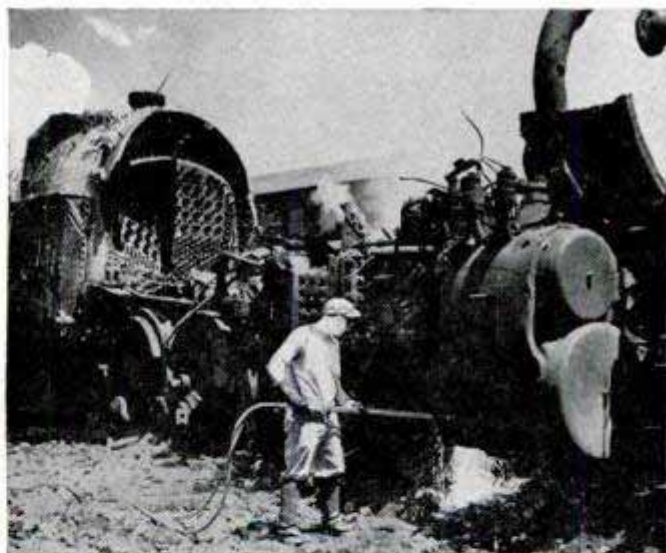

One worn-out locomotive and tender may yield as much as 360,000 pounds of heavy metal of melting grade

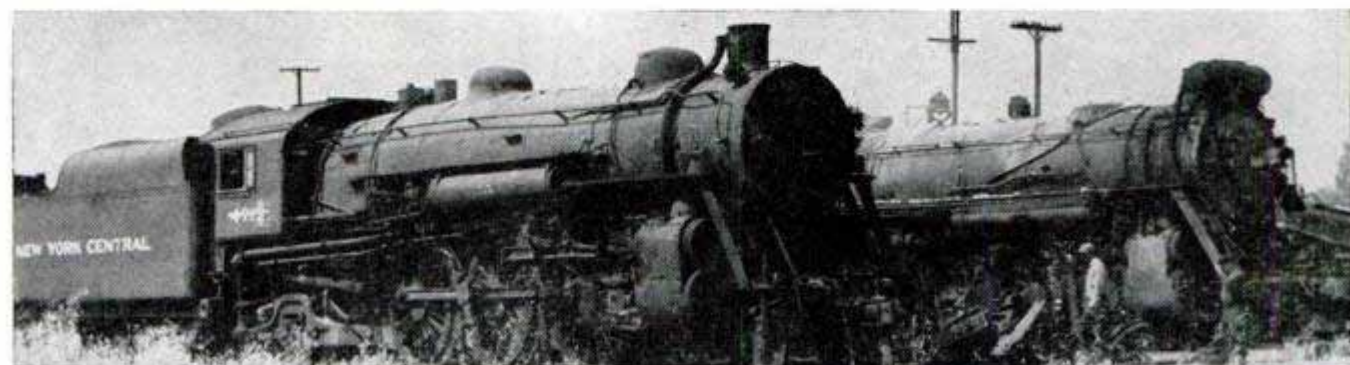

Right, packing everything, house included, for a 165-mile trip (see map below) is cold work when the air is a frigid 20 below zero

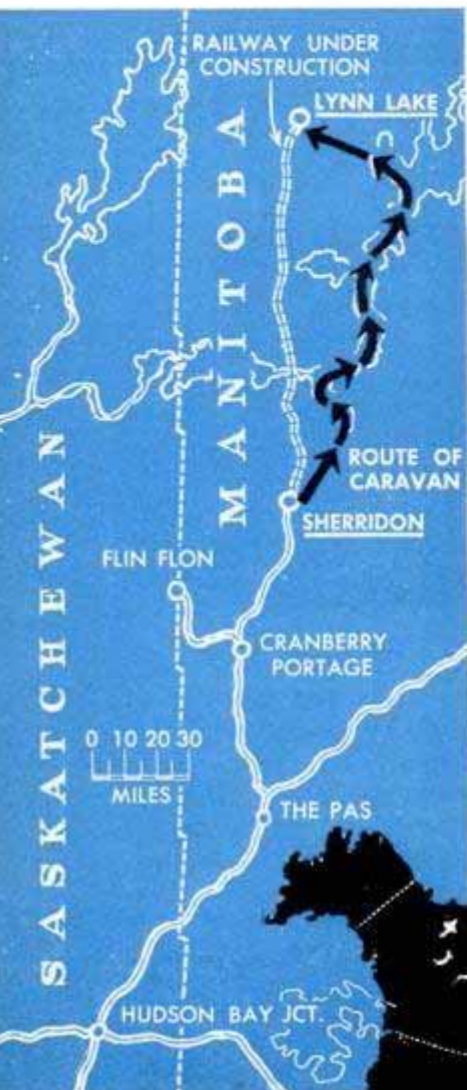

They Put the HOME TOWN ON SKIDS

weights. A chain of lakes provides a ready-made highway most of the way.

Involved are around 20,000 tons of material. Powerful tractors, huge sleighs and rugged men perform what is said to be the biggest job of its kind. Trail blazers put in stretches of corduroy over low spots in the marshland and prepare approaches to the lake shores. Long tractor "swings" (trains of sleighs) haul up to 1600 tons each trip. The 165-mile route is covered in 50 hours at a cost of \$40 a ton. The bill is financed by the mine company and will be repaid by the workers.

The large mine buildings were dismantled and reassembled at Lynn Lake. Houses can be moved intact. The first ore shipment is expected in October 1953 when a rail connection to the south is completed.

Under normal conditions Sherridon would have been abandoned but the high cost of materials plus current shortages have made moving cheaper than rebuilding. Lynn Lake will have a population of 1600 when the mine is in full operation.

Still on the map, Sherridon will remain as a railway point and perhaps a small settlement will spring up there. But there will be no abandoned houses staring forlornly on weed-covered streets. Sherridon refuses to become a ghost town. ★★★

By Lyn Harrington

Photos by Richard Harrington

GHOST TOWNS are common to mining—they "give out" with the ore that created them. But there's one mining town in Canada that refuses to become a ghost even after its ore has been exhausted.

Sherridon was established in central Manitoba in 1926. Its copper and nickel mine supported the community but the vein has run out. New deposits have been found at Lynn Lake, 165 miles to the north. So Sherridon residents are packing their houses in a wholesale moving operation that will take two years. About 250 buildings and 1200 persons are making the trek, which is limited to the three midwinter months each year when the thick, hard ice on the lakes will support the tremendous

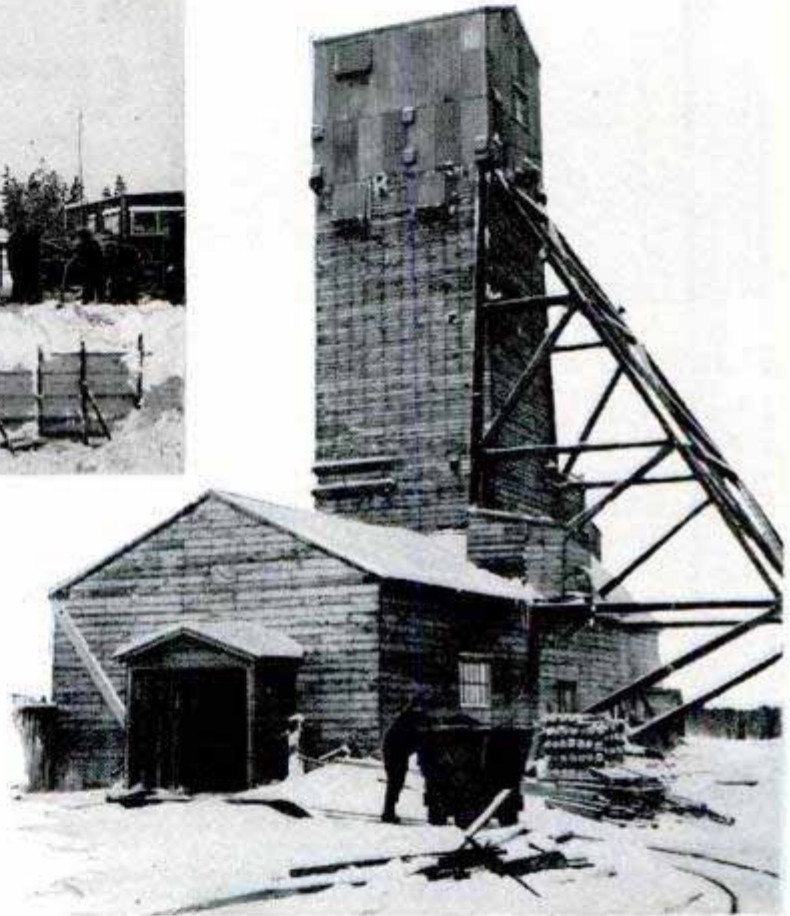

Top, two "cats" are needed to haul a two-story house. The frozen lake surface is a smooth "highway" here but the journey has just begun. Above, at the other end of the trek, a one-story house is lowered on its new foundation at Lynn Lake. Some owners, like this one, were able to get in their foundations before the freeze. Right, the mine head at Lynn Lake. This building was dismantled and hauled over the frozen ice to the new mine site. Below, a long train of sleighs, called a "swing," requires a pair of tractors to pull it up the hills



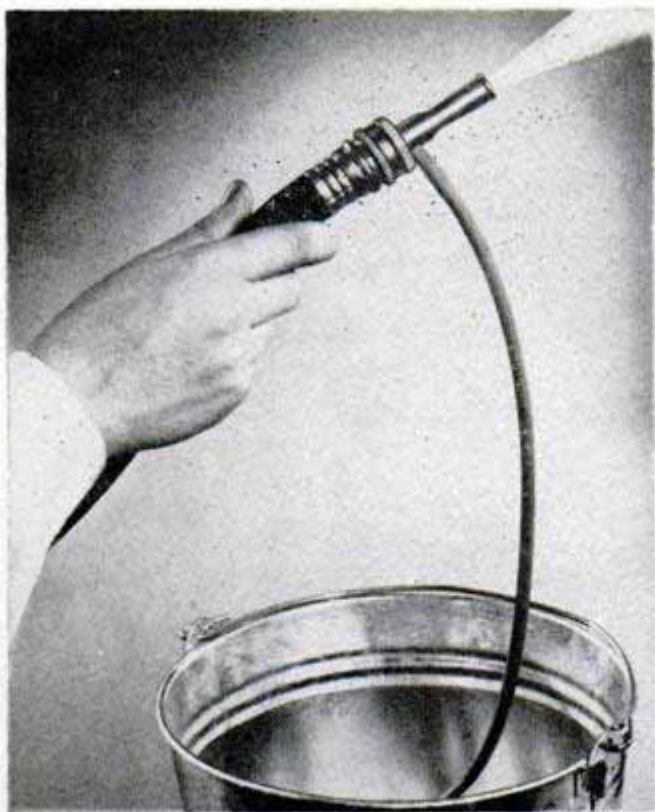

Chemicals Sprayed From Hose

Insecticides, weed killers and other chemicals can be mixed and dispensed through the garden hose with a new suction attachment. The brass nozzle is threaded onto the hose. A flexible tube runs from it to a bucket or other container holding the chemical. When the faucet is turned on, the chemical solution is drawn up through the tube and mixed with the water. The attachment can be used to spray the lawn, trees and shrubbery, and to mix detergents with water for cleaning cars and windows.



Slip-On Shower Unit Adds to Back-Yard Fun

Quickly attached to any faucet, a shower unit increases the fun provided by a back-yard wading pool. A special mounting bracket is nailed to a wall or post and the hose slipped into it. The shower head can be adjusted to any angle. It is also useful as an extra shower for the basement or summer cottage.

Fuel From Paper-Mill Waste

Pollution of the country's rivers by paper mills will be reduced by a furnace which will burn sulphite liquor, a waste product of the industry. Research has disclosed that an eight-foot horizontal cylinder is a satisfactory furnace when lined with firebrick. The liquor is sprayed into the furnace through an oil-burner nozzle.

Nash Rambler Greenbrier Is Combination Sedan and Station Wagon



Utility and economy are the big features of Nash Motors' 1952 Rambler Greenbrier sedan. This all-purpose car is said to travel 30 miles per gallon of gasoline at average highway speeds. It combines the comfort of a sedan with the cargo-carrying space of a station wagon. With the tail gate closed and the backrest of the rear seat folded forward, the luggage space available measures 5 feet, 1½ inches. The Greenbrier has a six-cylinder L-head, 82-horsepower engine with a compression ratio of 7.25 to 1.



Spewing flame and black smoke, a rocket-powered Matador pilotless bomber roars out over the South Atlantic

Radar eyes are pointing skyward from a string of coral islands in the Caribbean to clock the guided missiles of tomorrow's war along a . . .

Thousand-Mile Target Range

By Theodore L. Taylor

A PEACEFUL SEAWAY, interrupted only by a spattering of small coral islands, stretches from the desolate knob of Florida coastland at Cape Canaveral to the western tip of Puerto Rico. But Communist capitals can eye it with alarm.

This 1000-mile swath of tropical water, the only U. S. testing ground for long-range guided missiles, may shape the pattern of future wars. Even now, it's a mighty deterrent against aggression.

The custodian of this path is AFMTC,



Route of the guided missiles from the Air Force test center at Cape Canaveral, Fla., passes the western tip of Puerto Rico. The stars mark down-range tracking stations

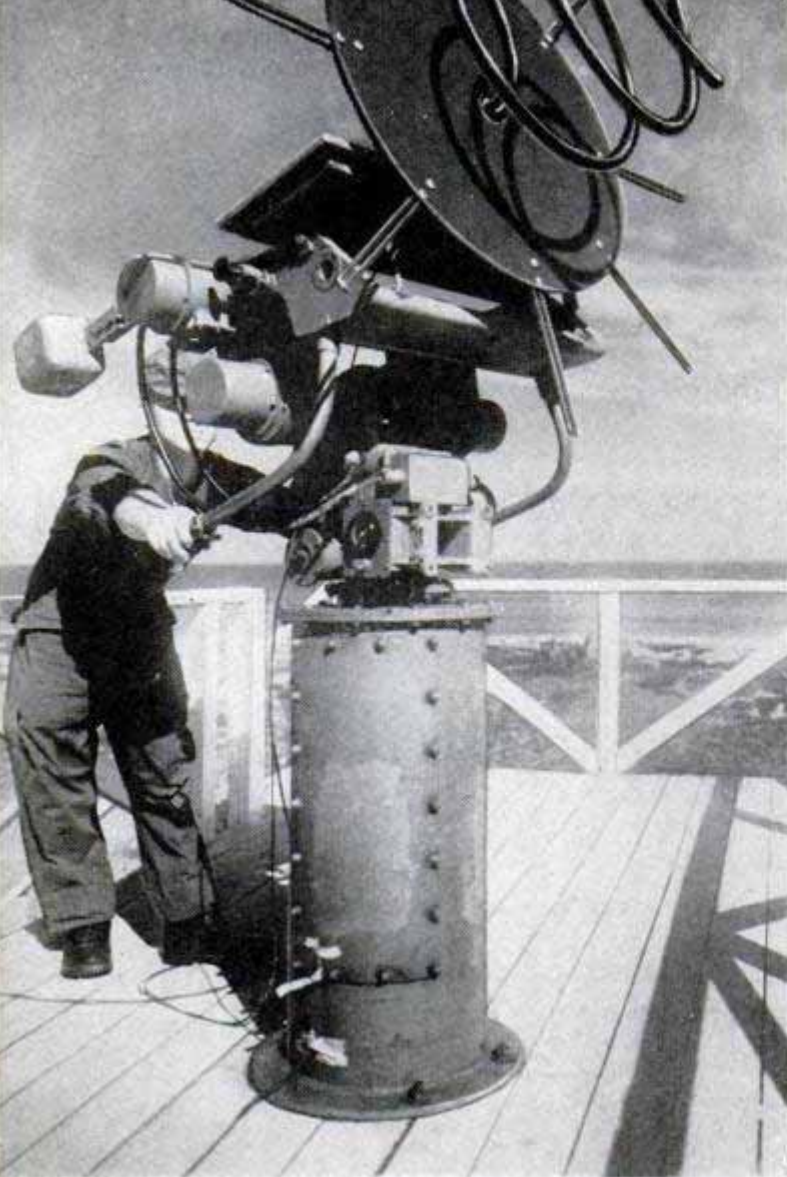

Antenna, above, picks up signals from missile and relays them to a telemetry unit where the information is tape-recorded. Below, the arrangement of facilities at a typical island instrumentation station

properly called Air Force Missile Test Center, comprising three mainland activities with seven island instrumentation stations. It's the military's answer to push-button-warfare research and development.

Long-range pilotless weapons roar up from the launching area at Canaveral several times a month and by late next year planning may demand a speed up. While the Air Force has the housekeeping and management job for the sprawling proving operation, the range is available to all service and private agencies for extensive research purposes.

The launching area at Canaveral, set in sand dunes and palmetto scrub a few hundred yards from the ocean, is the brain of the test flights but the tiny down-range island stations are the vital heart of AFMTC. As the missiles dart past the mainland instrumentation station at Point Jupiter, 20 miles north of West Palm Beach, Fla., and head toward the islands, performance data is recorded.

This data is the reason for AFMTC's existence. From the sheaves of information gathered after each test firing, improved push-button weapons will be built.

The islands, on a heading of 127 degrees from Canaveral, are the looking and listening posts for the rocket-powered flights. AFMTC reaches south via stations on Grand Bahama island, Eleuthera, San Salvador, Mayaguana, Grand Turk, the Dominican Republic and Puerto Rico. Ships carrying construction equipment to the stations now ply azure waters where the skull and crossbones formerly fluttered.

Permanent installations are being completed. They'll be self-contained units to



TYPICAL OBSERVATION STATION



Missiliers check reports from range-clearance planes and boats before giving "all clear" signal for firing

house and work the missilemen. Maj. Gen. William L. Richardson, USAF, commanding general of AFMTC, is certain that the missile business is here to stay. Almost 6000 military and civilian personnel are attached to AFMTC.

The necessity for the gigantic development is pointed up clearly by the fact this country could not test missiles with a range of more than 175 miles prior to the birth of Canaveral in 1949. Inland ranges, such as

those at White Sands and Holloman Air Force base in New Mexico, are limited geographically for distance flights and the Navy's Point Mugu in California offers no instrumentation for long-range research over the Pacific.

Although AFMTC's range is restricted presently to 1000 miles, flights of double that distance easily could be attained simply by turning the missile northward and rerunning the length of the test ground. By

Weird, domed concrete building 100 yards from launching pad houses crew that sends the missiles skyward



moving the line of flight northeastward and recalibrating tracking instruments, the missiliers could fire their weapons more than 10,000 miles into the South Atlantic, veering by the Lesser Antilles and continuing past South America out over an almost endless sea. Ships could track in the absence of island instrumentation stations.

Missile launching and flying is one of the most complicated operations on earth. The biggest task is exact coordination in tracking and recording flight data once the missile leaves its roosting place on the Florida cape and zooms south. Timing is a sacred item to the missiliers and this new breed of man talks and lives in the quantity of split seconds.

When a shoot is chalked on the schedule boards, getting-up time at Canaveral and the down-range stations is shortly after midnight. The smell of midnight coffee and frying eggs hangs over Patrick Air Force Base, near-by supporting facility, and the mess at Canaveral. Activity begins several hours later—missiles usually are launched in the early morning when air turbulence and static are least—and the shoot takes place any time after 6:30 a.m., depending on visibility, wind and general weather conditions.

First to commence operations are range-clearance personnel. "Polly" planes, so nicknamed because their loudspeakers verbally warn ships away from the range, crisscross the ocean looking for strayed vessels. Each of the down-range stations has a Polly craft teamed with a radar plane to clear its area. The missile won't be fired until the all-clear signal is passed to the



German-developed "Askania" camera simultaneously notes missile's trajectory, time of passage and speed

firing-control officer stationed at Canaveral.

While the missile glistens in the glare of spotlights at the launching site, communicators, radarmen and instrumentmen at the down-range stations warm up equipment and calibrate instruments. Tests are far too costly to afford an instrument or human failure when the missile is in flight. Weather has figured in, too. The meteorological personnel have been at work for several days on forecasts.

One by one, the down-range stations report readiness. An elaborate radio network keeps information flowing up and down the

(Continued to page 236)

Radar does a major share of the tracking job, with towers and mobile units dotting the islands. Plotting boards with moving pens trace the elevation and line of flight



Traveling-Bag Oxygen Unit

Higher flying in smaller unpressurized personal airplanes is possible with a new oxygen unit that is carried in a smart-looking traveling bag. It permits the pilot to take full advantage of radio-navigation instruments and to fly more comfortably and economically at higher, smoother altitudes. In the bag is an oxygen cylinder, a supply gauge, a regulator and outlets for four persons. Either disposable or rubber masks can be used. The case need not be opened for use since a V flap and Zipper fastener provide easy access to the unit.



Print Flattener

Glossy prints remain flat after drying when treated with an anticurling chemical that gives a permanent flexibility to the emulsion. A three-minute treatment in the solution completely eliminates any need for mechanical straightening or pressing. Prints can be rolled or bent sharply without cracking the emulsion. The surface is said to have added gloss and sparkle and yet is more receptive to re-

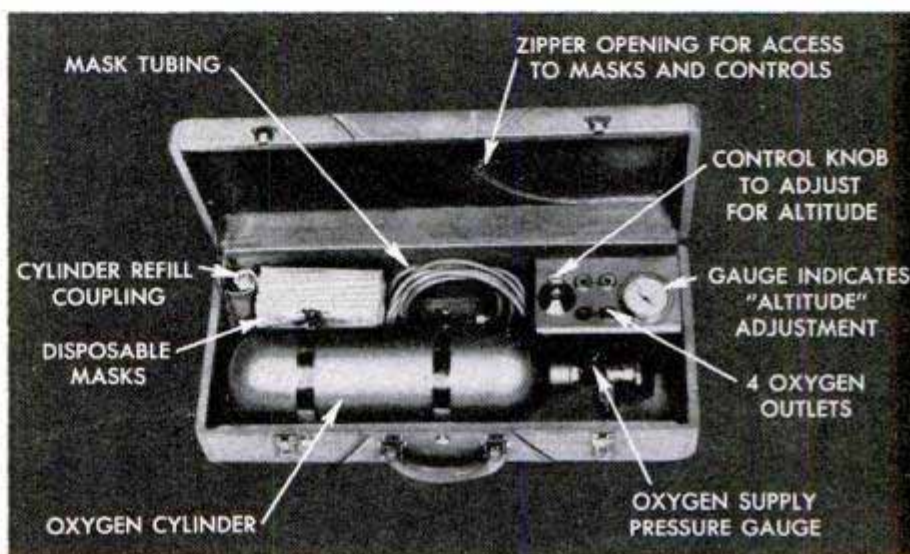

touching or spotting colors. The chemical accomplishes all this by balancing the moisture content of both emulsion and paper to prevent the tight curling that so often occurs after ferrotyping.

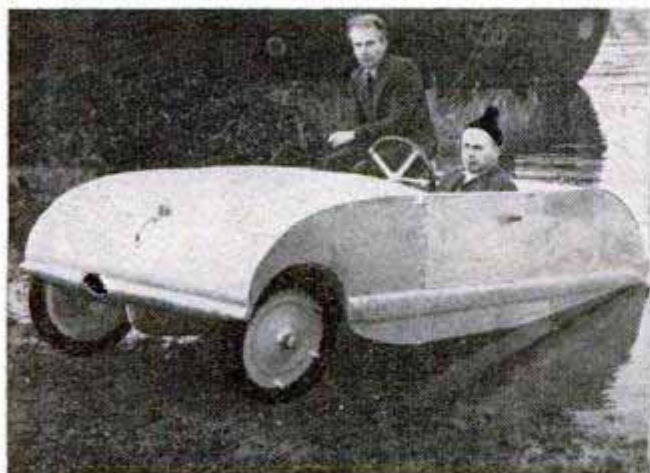

Amphibious German Automobile Takes Streams in Stride

Rivers are highways for an amphibious car built by a German mechanic. All moving parts, except the wheels, are within the body or hull. Brakes, transmission, steer-

ing system and control cables are all inside where they are unaffected by salt water. No changes are necessary when driving from land to water or back again.

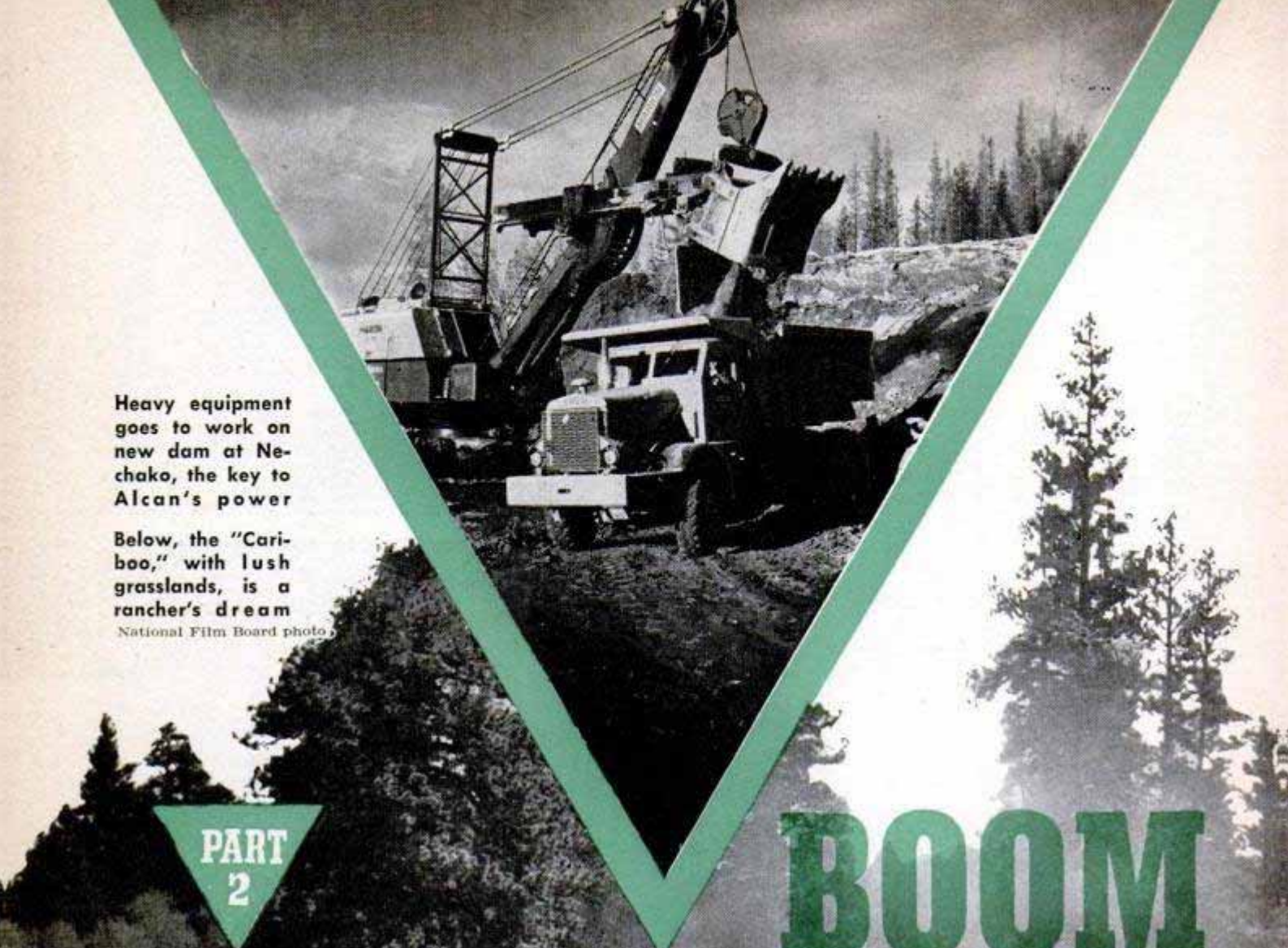

Heavy equipment goes to work on new dam at Nechako, the key to Alcan's power

Below, the "Cariboo," with lush grasslands, is a rancher's dream

National Film Board photo

PART
2

BOOM



YOU CAN'T MEASURE the industrial boom in Canada's big triangle by statistics alone. Like the gold-rush days in America, the real story is in the people—the sourdoughs, lumberjacks and construction workers—and how they live now that industry is surging into this vast area of 150,000 square miles.

Town planners from New York, who are working out blueprints for a city of 50,000 at Kitimat, approached the job with grave doubts. They hoped the building problems at this Alcan smelter site would not parallel those of Prince Rupert.

Anchored on rock-bound hillsides and deep muskeg, many Rupert homes have foundations 15 feet higher on one side than the other. You can't build on sidehill muskeg without facing the disturbing prospect of rolling out some morning to find your house in a neighbor's back yard. Consequently, muskeg must be cleared out and the foundations, either concrete or wood piles, pinned firmly on rock.

During the war, when Rupert's population soared every day, the city administration suffered along with the house hunters. Now there's a repetition of those wartime



Snowmobiles roll across the surface of Athabasca Glacier to show tourists one of the sights near Jasper Park. Industry also uses these unique vehicles to solve transportation problems within the triangle

IN THE BIG TRIANGLE

By Harry Rowed

Trainload of paper rumbles along a wharf at Powell River, a coastal papermaking port. The triangle boasts some of world's biggest lumber and paper mills

National Film Board photo

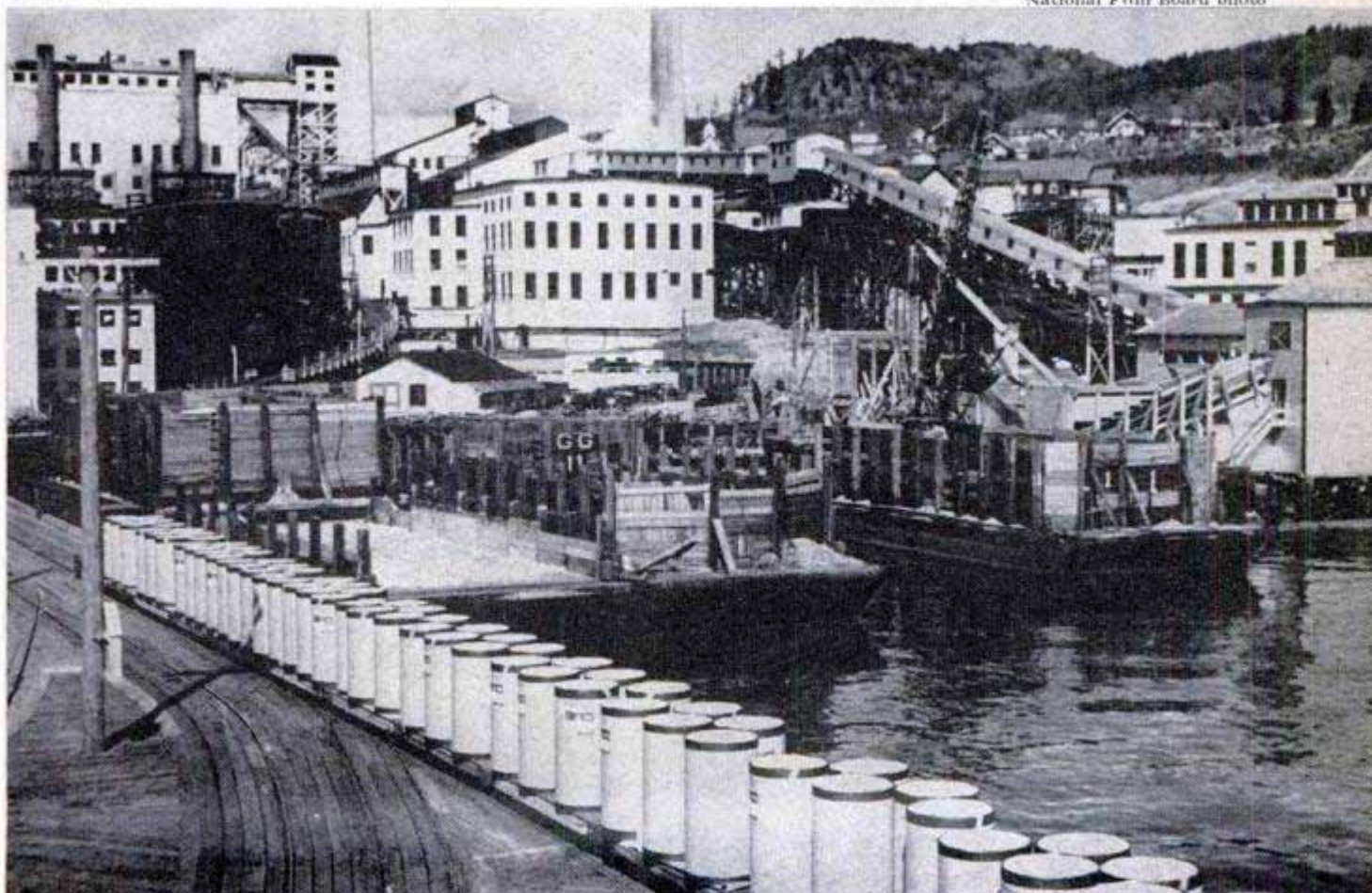



troubles all along the north line of the triangle. It's eased off but in early developments last year some situation-grasping owners asked as high as \$150 per month for a shack without benefit of indoor plumbing—and got it!

The record-shattering influx caught the triangle's housing and hotel accommodations complacently moving along on a plane of steady but unexciting progress. It's an old story now about the contractor who casually asked at the Tweedsmuir Hotel on Burns Lake for a dozen rooms for four years. Even more disquieting were the happenings of the following week when—unheralded—trainload after trainload of massive road-building equipment was dumped over the open flats between the depot and the lake.

Burns Lake, a frontier lumbering and agricultural town, the proclaimed gateway to Tweedsmuir Park, gawked as its stature overnight assumed that of a rollicking city bursting its seams. Men followed the equipment—young engineers, truckers, camp attendants and hell-for-leather rivermen.

"Caught us, too," commented a Mountie. "Total accommodation in our jail was four. Saturday night was never our loneliest night in the week. We've crowded in as many as 17, with more unwilling applicants waiting for space."

The road machinery and most of the men had been shunted in from Vanderhoof, 90 miles east and the jumping-off point for the Nechako dam site. Vanderhoof had been the scene of the most feverish activity of the entire Alcan project. Before work could commence on the dam, a road of 60 miles had to be driven through wild bush and rock-bound country. And with spring breakup only a few weeks away, the contractors faced the urgency of moving in heavy equipment while they still had frozen turf to support the loads.

A red-bearded trapper entered the Nechako saga here. Engaged by the contractors, Tom Taerum, a transplanted Kansan who had migrated north in the early 1900s, frowned over a sketch map of the area, then pulled on snowshoes. Plodding ahead through forests and along frozen streams, he led the first bulldozers to the ice-blocked Grand Canyon.

Frantic days and nights followed as thousands of tons of machinery and supplies poured in over the wandering "Taerum's Trail." Twelve weeks after the first engineers stepped off the train at Vanderhoof, road workers had transformed the narrow pilot road into a wide highway. Trucks sped into Nechako at 50 miles an hour.

Here's a tourist's-eye view of one of many trestles along the Canadian National, which serves the area



At Prince George, a lumberjack looks over a building directory which reflects the city's main industry

Work never has let up since those first exciting days of pioneering last spring. For Nechako holds the key to Alcan's production date. While Kemano's first horsepower can be developed from near-by water sources, the main reservoir will become a reality only after the final plugging of the Nechako.

Deadline for the dam's completion is early this winter. To meet that date, heavy equipment pounding at the job includes 14 oversize shovels up to 3½ yards, 14 end-dump earth carriers, 72 huge trucks including 22-ton Euclids, and 22 Caterpillar and International tractors. One thousand men working in two 10-hour shifts are manning these machines and carrying out a myriad of other vital jobs. Harry Jomini,



People? There are Indians, shown here, Swiss, Dutch, Norwegians, Germans, Poles, Americans among others

resident engineer for Alcan, contrasts Nechako's manpower to that required to build the Great Pyramid of Egypt. It's estimated that the pyramid required the hand labor of 100,000 men over a period of 30 years under the merciless lash of slave foremen.

Newest trucks to be rushed into Nechako incorporate a feature which construction men believe will cut expense and boost cold-weather output. Action of frost on gravel loads was slicing into total cubic yardage as part of each load froze solidly to the metal truck bodies. So a system has been devised to utilize the heat from the exhaust gases. Carried through a series of baffles under the floor and along the sides of the trucks, the fumes warm the entire

In the area are some of the great ice fields of the continent. Sports include hunting, fishing, mountain climbing



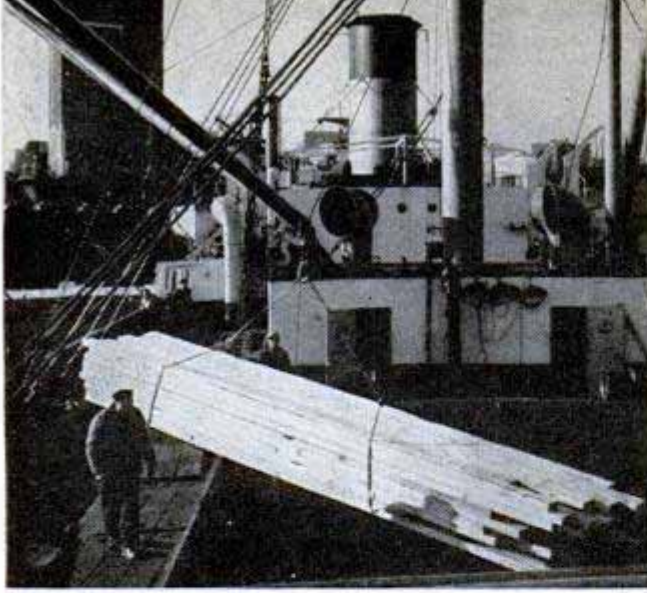

Timber products, one of the area's greatest sources of wealth, are loaded at Vancouver for Great Britain

surface contacted by gravel. Formerly, the trucks had to be chipped clean with hand tools or, as an alternative, the boxes were sprayed with a hot brine mixture between loads.

First to feel the stimulus of the Nechako, the district surrounding Vanderhoof has comparatively flat terrain suited to agriculture and ranching. The village has the only grain elevator in central British Columbia but the small wheat shipments are hardly measure of her grain-growing capacity in the future.

The 350 miles from McBride to Prince Rupert, including Vanderhoof, is being recognized as extremely desirable agricultural land. The Canadian government, with experimental farms throughout the area,

has introduced quick-maturing garden seeds and coarse grains to withstand early frosts. Illustrative of possibilities are the records of a prospering Dutch settlement near Houston. Oat crops there last year yielded as high as 155 bushels to the acre. Garden seeds, mainly turnips, returned their growers \$300 from single-acre plots.

There is a dairy future, too, in this country and an established home market for small fruits, particularly in the areas serving new industries. Fruits and vegetables, for example, are in demand at Terrace, the hustling town of 2500 where woodland operations of Columbia Cellulose are based and where the proposed railway and highway from Kitimat are almost certain to join the Canadian National Railway line to Prince Rupert.

In his fast-moving best seller, *Grass Beyond the Mountain*, Richard Hobson, Jr., of Vanderhoof, tells of his discovery in the mid-30s of a fabulously rich bunch-grass country covering four million acres. This successful rancher-author and a partner found the area in central British Columbia after months of search north of the Chilcotin cattle ranges, deep inside the triangle and 225 miles from the nearest rail line. For 70 miles in one direction and 100 in another, the pair explored the immense tract of luxuriant grasslands.

While the region described by Hobson is still remote and undeveloped, the triangle's interior, south from the setting of the story, remains the answer to the ranchers' dreams. The "Cariboo's" parklike forest lands, gently undulating grazing country and ample waterways annually produce

Tourist cars of Canadian National Railway have observation platforms for full view of magnificent scenery





Alcan photo

Steel barges cruise the Tahtsa River. They were shipped to the area in sections, then welded on the job

thousands of well-fed Herefords for Canadian and world beef marts. Like southern Alberta, the southern Kamloops district and Texas, this is cowboy country from the first whip of the lariat.

Imbued with the romance of the gold-rush era, the Cariboo is riding host to increasing numbers of tourists who favor the "yi, yi, yippee" of the dude-ranch corrals or an afternoon's fishing with a sourdough guide. And with no intention of sidetracking her cowboys, her prospectors or her visitors, the comely Cariboo also is encouraging industrial suitors. She's thinking particularly of new enterprises which could

follow development of power resources along the Quesnel and Fraser.

The turbulent Fraser ranks as the biggest river system in the triangle. Rising at Moose Lake in Yellowhead Pass and plunging into the green depths of a narrow gorge near Mount Robson, Fraser waters flow northwest to Prince George before swinging left and south to seek passage to the Pacific coast. The rough-and-tumble course ends near New Westminster and Vancouver, the big cities of the triangle and principal shipping, manufacturing and distribution centers.

(Continued to page 228)

SS Prince George, shown passing under suspension bridge near Vancouver, carries many tourists to Alaska

Canadian National Railways photo

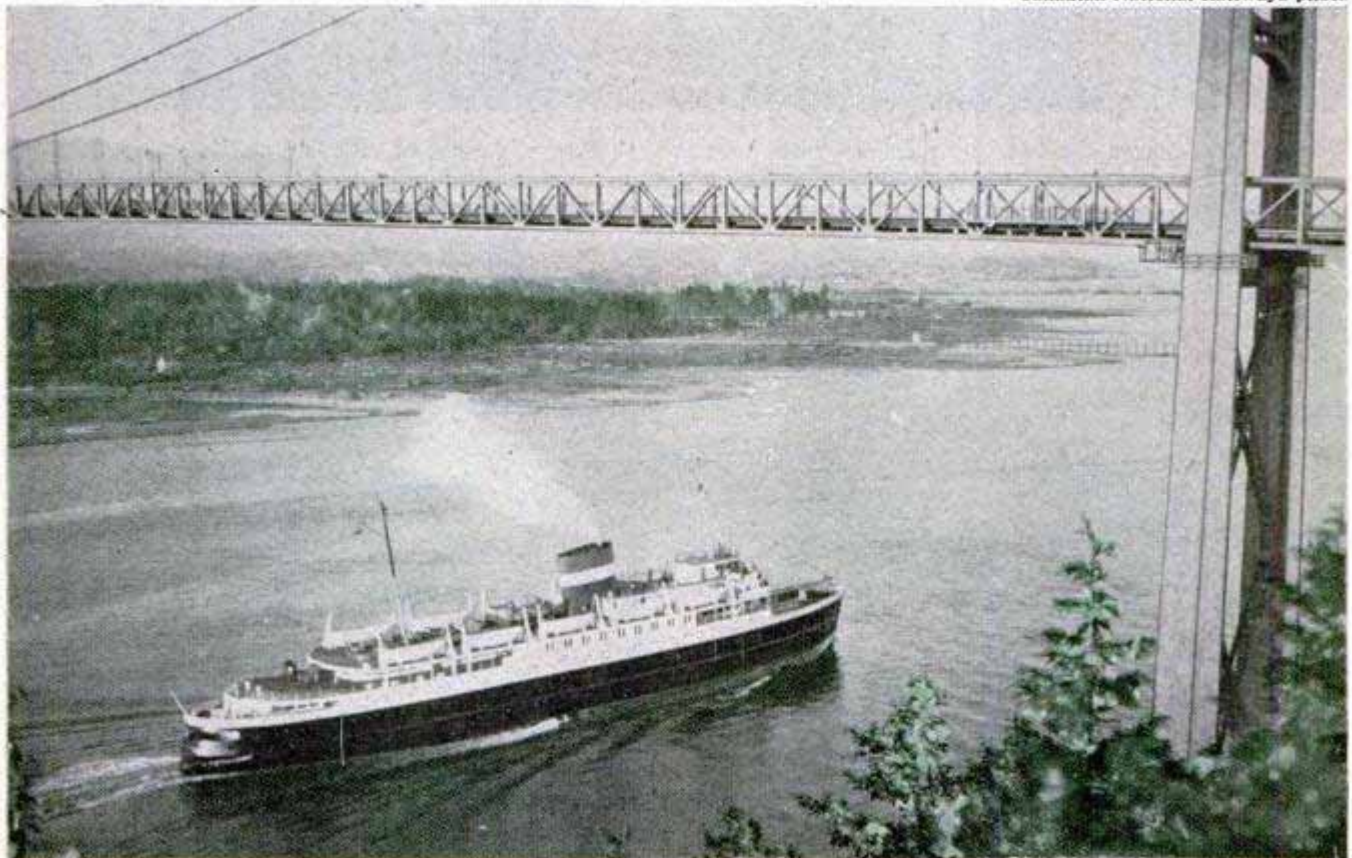

WHAT'S NEW FOR Your Home



WATER BUCKETS you wear around the waist make cleaning easier. Plastic apron has three watertight pockets for wash water and rinses

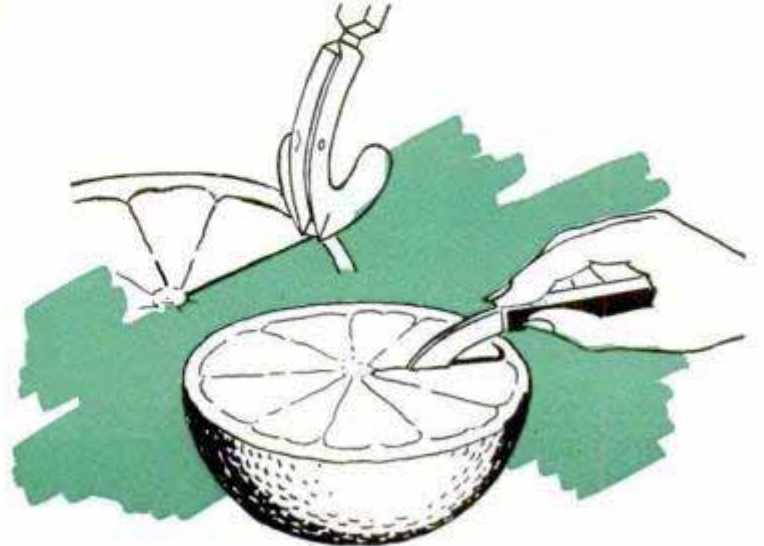

GRAPEFRUIT KNIFE has twin parallel blades that cut fruit from each side of web in one motion. You push down and forward toward core, keeping web in slot between blades



CHILD TETHER gives the youngster freedom of movement yet keeps him out of harm's way. He cannot become tangled in cord nor can he get close to the stake or counterweight. Cord remains gently tight at all times

PLANT FEEDER directs water to roots of plant. Fertilizer is dissolved in water in cup on the top



SHOESHINER has polish inside handle. A roller spreads it on shoe; attached buffer adds the shine



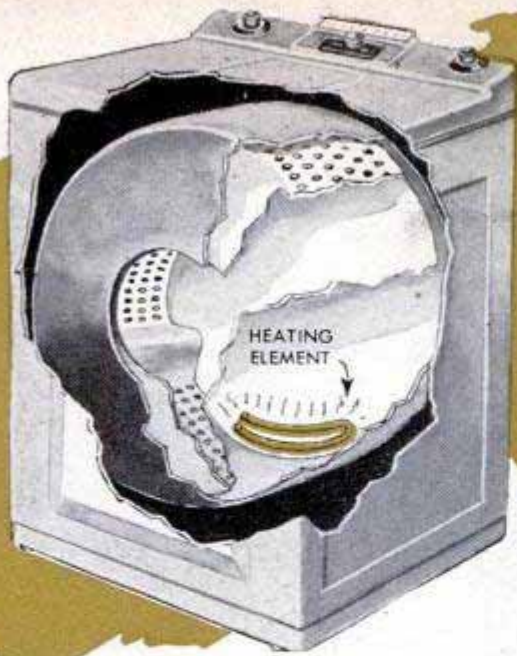

WATER HEATER inside an automatic washer keeps temperature of water at 145 degrees during washing. It also replaces the heat lost on lengthy pipe runs



BALANCE BAR clamps to top of stepladder to provide a handgrip while you wash or paint the ceiling. With it, you can work near the ladder top in safety

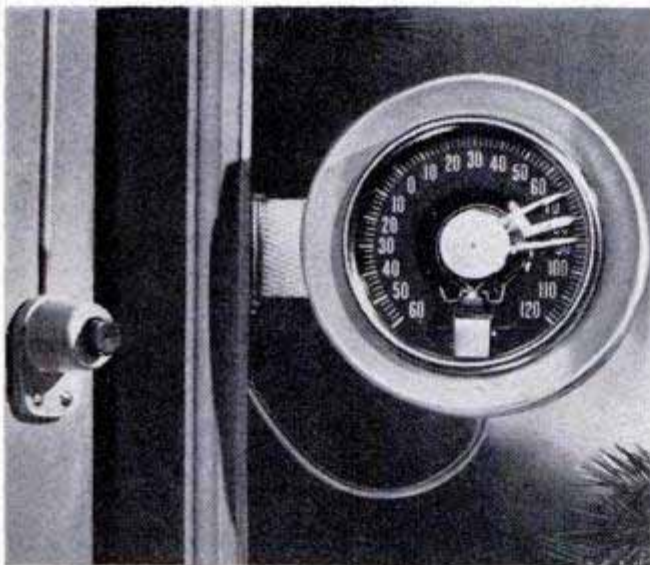

OUTDOOR THERMOMETER with maximum-minimum pointers is reset from indoors by pressing a button



BUG LIGHT kills by heat. Insects flying around light crash into reflector wings and fall into bowl

TIE-ON FRAME for pictures is simply four clear-plastic corners held tightly in position by twine

BOOKSHELF for the kitchen keeps cookbook out of way, holding it open at desired page for reference

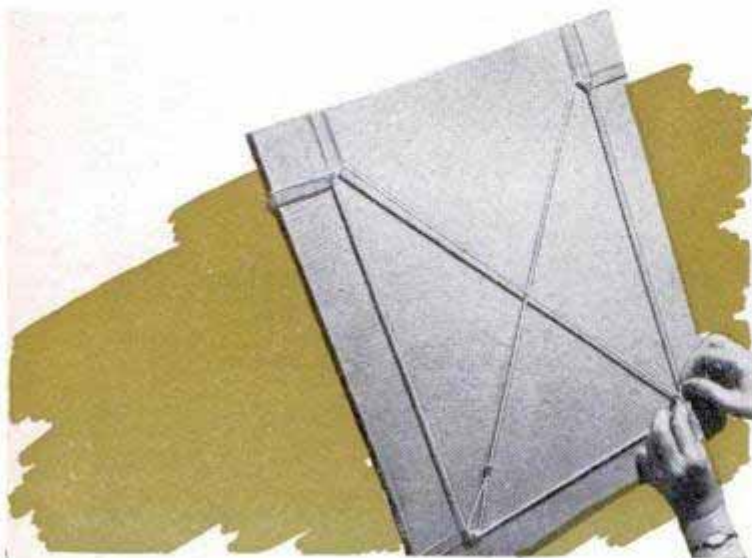



Texas Juggernaut

Everything's done on a big scale in Texas and a mammoth 52-ton brush cutter fits into the picture perfectly. It's a twin tractor that develops 270 horsepower and has a drawbar pull of 65,000 pounds. Two Caterpillar tractors are joined in Siamese-twin fashion to form the unit. The brush-clearing implements consist of a funnel-shaped front end which knocks down trees and brush and guides them between the tractor treads. A three-foot ground clearance allows the tractor to pass over the brush without excessive use of power. At the rear, a heavy-duty root plow has a large double-V

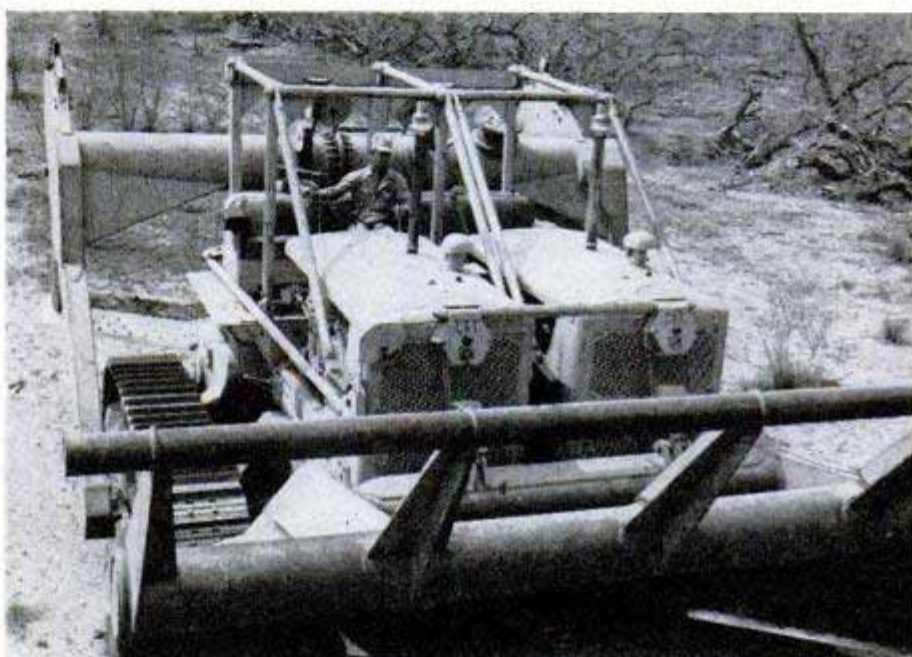

blade that is pulled through the earth about 16 inches below the surface, cutting stumps and roots below the bud ring.

Self-Propelled Trailer Is Easily Maneuverable

Nothing pulls a huge alfalfa trailer in Arlington, Calif. It pulls itself. The power plant, a Dodge truck engine, is mounted beneath the trailer bed. The front axle is mounted on a turntable and steering is accomplished with an aircraft hydraulic ram. The driver sits on a folding seat directly above the trailer tongue. The self-propelling feature is used only for short hauls and for jockeying at loading and unloading platforms. For trips over the highway, a truck tows the trailer and the driver can use the trailer's power plant



to assist the truck in climbing steep grades. Cables enable the unit to be controlled remotely from the truck cab. Average load of the trailer is 11 to 14 tons.



Left, pump in shelter at far left varies internal pressure of tree in experiments with ways to increase gum yield. Right, close-up of punch-hole taps. Top tubes show gum pressures; bottom tubes show flow volumes

Tree Researchers May Discover What Makes Sap Flow

Science is trying to increase the flow of sap in southern slash pine in order to increase production of naval stores like resin and turpentine. In experiments at the Research Center, Lake City, Fla., Dr. C. S. Schopmeyer and his colleagues are measuring such factors as internal sap content of the tree and variations in gum viscosity. They study methods of stimulating gum flow by injection of chemicals, including

sulphuric acid. All tests are made in an airtight circuit. Exact measurements are made possible by a complex system of taps in the tree trunk. With a vacuum pump, Schopmeyer can increase or decrease the "blood pressure" of the tree and change the flow of sap. When he learns what makes the sap flow, he's sure he can increase the flow to make the slash pine work harder to supply man's needs.

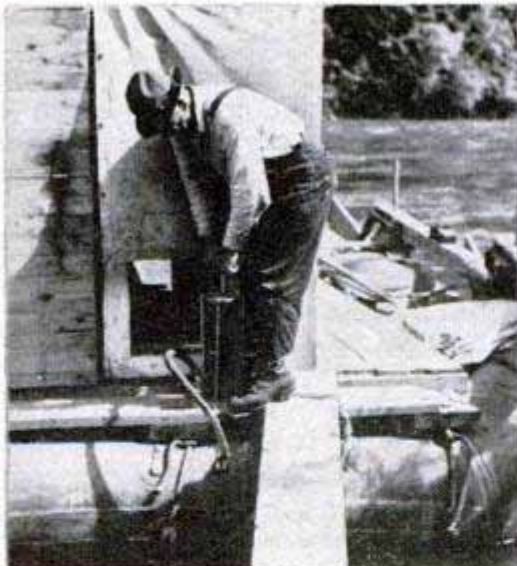

Wannigans Ride on Rubber Pontoons in North Woods Log Drives

Wannigans, the bargelike bunk and cook-houses that float along behind northwestern log drives, have gone modern—they now float on inflated rubber pontoons. Nine giant war-surplus pontoons are needed to support two bunkhouses and one cook-house, enough room for a crew of 32 lum-

berjacks. Two sweeps at each end of the wannigan steer the clumsy-looking vessel in fast water. The use of rubber pontoons saves considerable labor. Previously, the rafts were supported by huge logs fastened together. With pontoons, the wannigans ride higher and are easier to maneuver.



Each Sunday, churchgoers raise their voices in song to inspiring notes from pipe organs, large and small

THE MAKING OF AN **Organ**

Pipe organs are usually custom-made and require expert planning

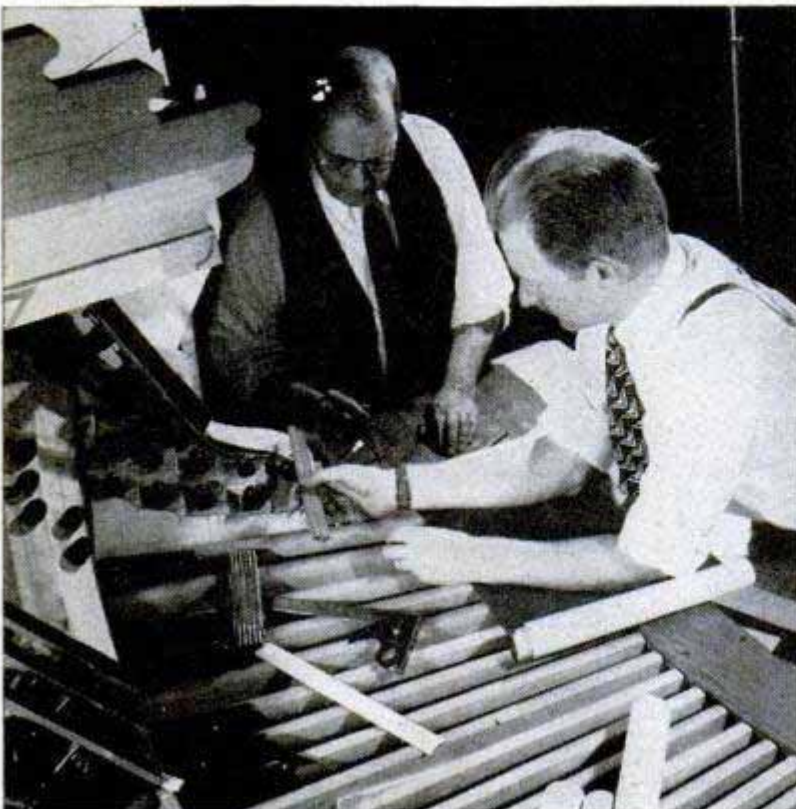

PIPE ORGANS are like people—there are no two of them alike. Not many are even the same size. They range from a few hundred pipes to as many as ten thousand.

Each instrument is built to fit into a certain space in the building. Every organist has his own idea of what should be included in the instrument. Therefore, each organ is an original design, differing from all others.

But there are basic similarities. All pipe organs operate by air passing through the pipes from a reservoir, or wind chest. Pipe size determines pitch, while the material (wood or metal) determines quality. The organ keyboard is a complex electrical switchboard which, through miles of wire, controls air valves to hundreds of pipes varying from the pencil-size flutes to the towering diapasons. ★ ★ ★

Three Lions photos

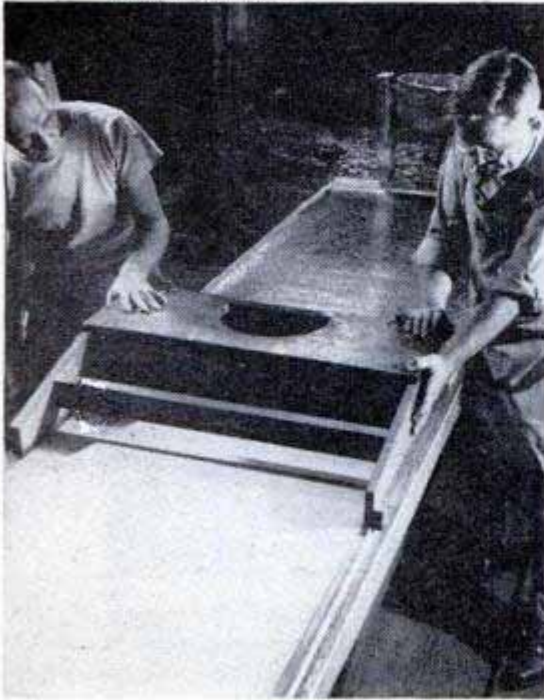

Molten metal for pipes flows from a sliding wooden box through a narrow slit onto a strip of linen. Width of slit and speed the box is moved determine thickness of the pipe metal



When cool, the metal is rolled around mandrils of correct diameter and cut to length. Longitudinal seam is soldered and pipe is ready



Next comes the task of making the pipes musical. The tuning is done in a voicing room. Pitch is changed by raising or lowering the sleeves at the pipe ends. Pipes in last row provide standard pitch for tuning



Above, after the tuner has marked the exact length of the air column needed to provide the true pitch, the flange is bent at right place



Wooden pipes are tested by a woman tuner in this manner. To provide the wide range of voices in the organ, both wooden and metal pipes have to be used



Woodworking is an important part of the organ-maker's art. These men are installing wooden pipes in organ for the final test of pitch, control and volume

Setting up the keyboard is a delicate task. Each key controls an electric circuit in the modern pipe organ

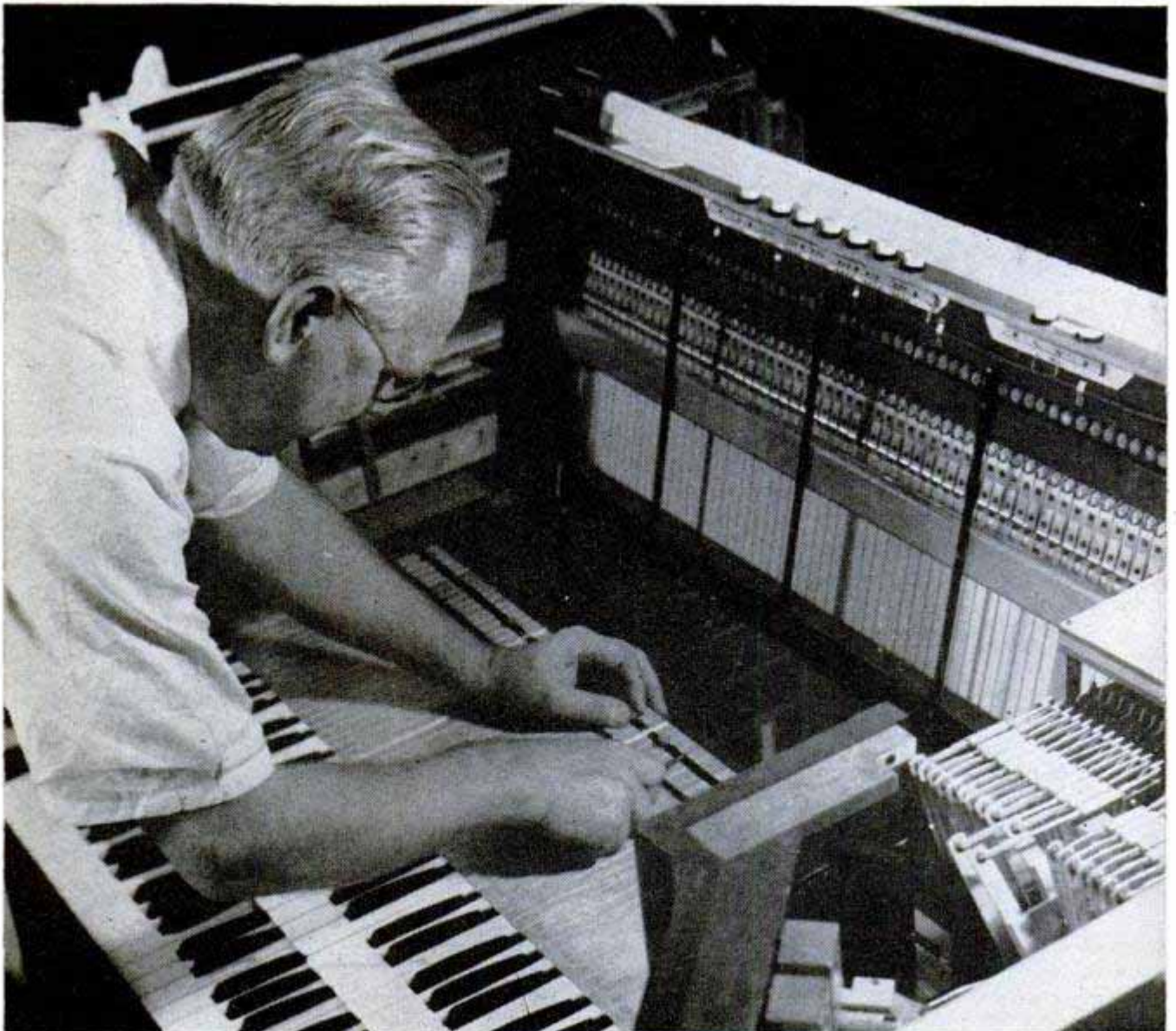

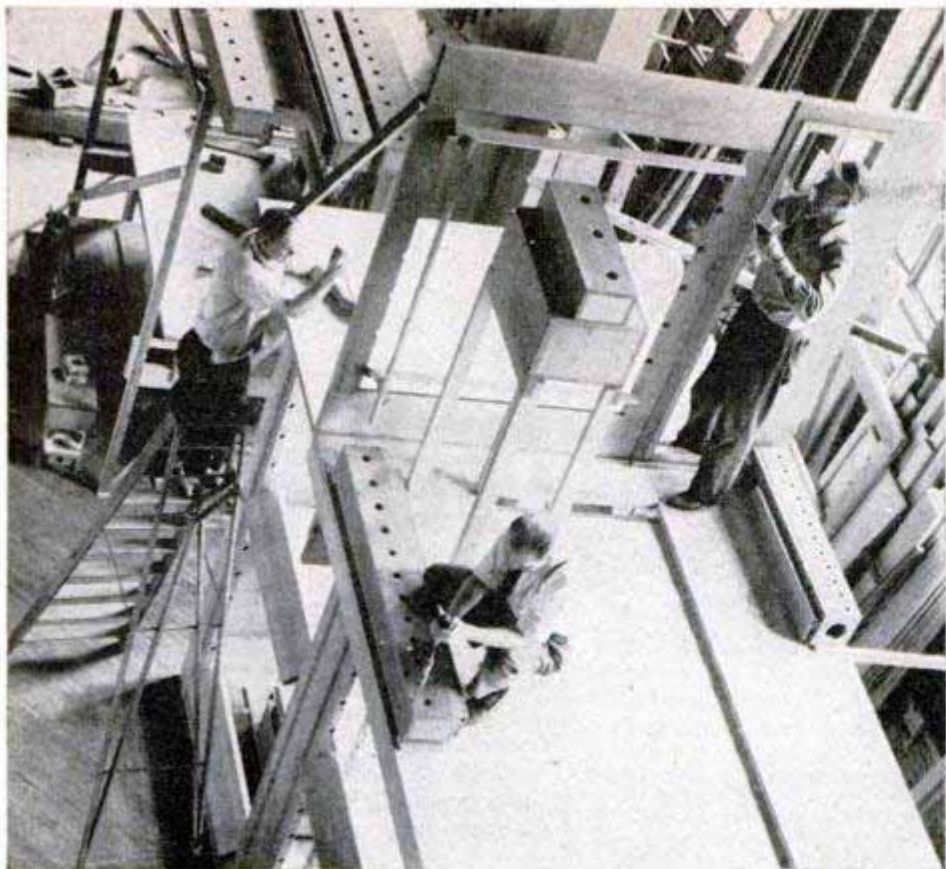

In size, the pipe organ makes every other musical instrument look puny. The men are erecting the frame which will support the pipes



Air is introduced into each pipe by means of an electrically controlled valve operated by the keyboard. The organ expert above is working on one part of the control-valve mechanism

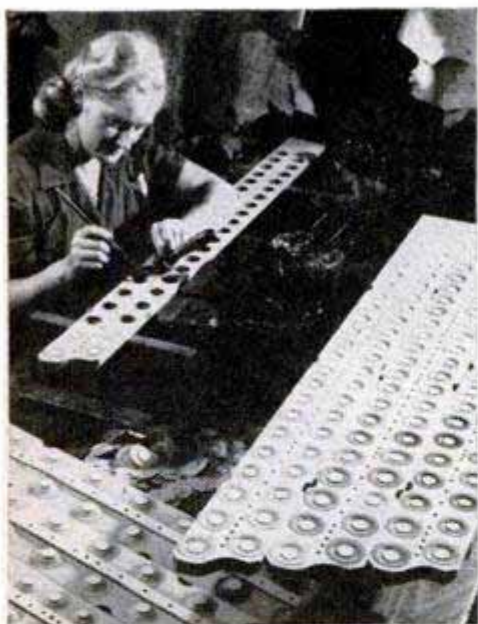

Above, most of the work in an organ has to be done by hand. The valves being cut here will regulate the air flow to pipes

Right, pipes are assembled on a wind chest. Photographs in this series were made at the Aeolian-Skinner Organ Co., Boston, Mass.

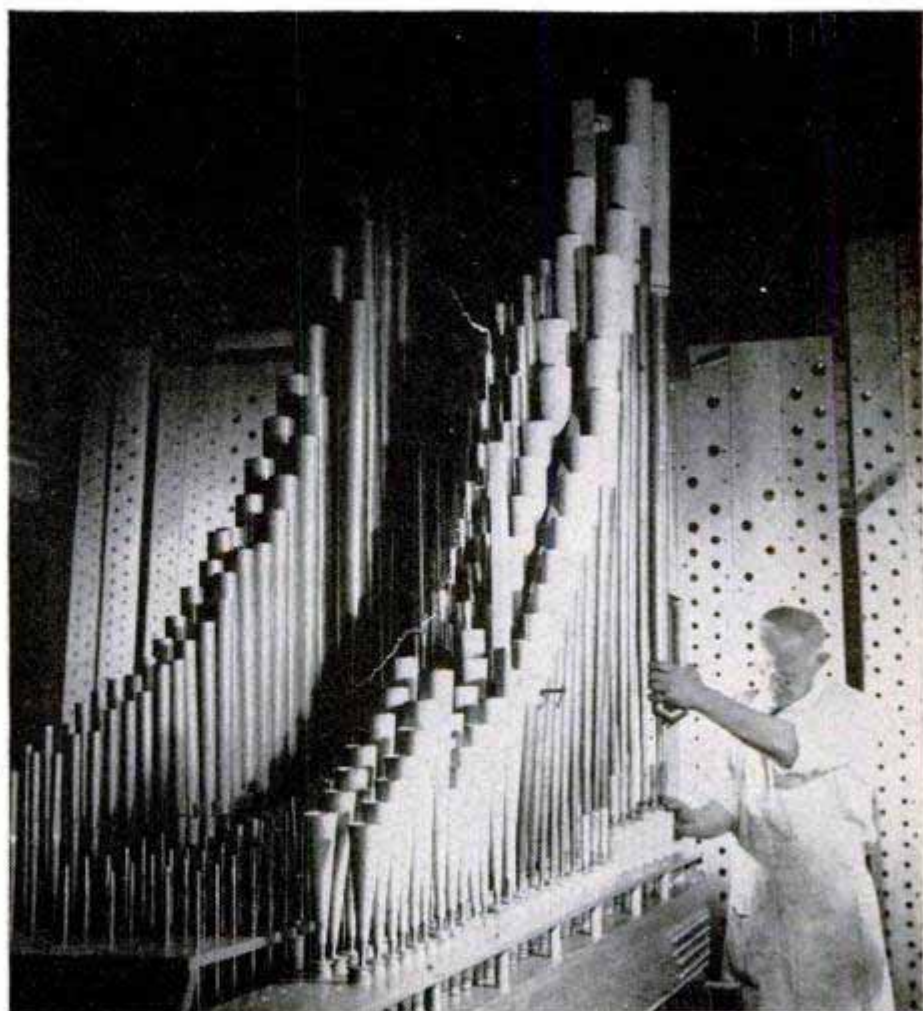

X-Ray Movies Help Doctors

DOCTORS see clearly how various parts of the body appear while in motion with a large X-ray movie camera that uses 70-millimeter film. This film width is twice that of commercial movie film and is large enough to permit direct, leisurely study of each frame as a transparency. The images, sharp and in great detail, provide consecutive motion views of an injured part of the body for diagnosis. The camera was developed at the University of Rochester.

Consecutive frames of hand in motion illustrate the sharpness of the image. The camera is a valuable new tool for diagnosis and study of heart disease

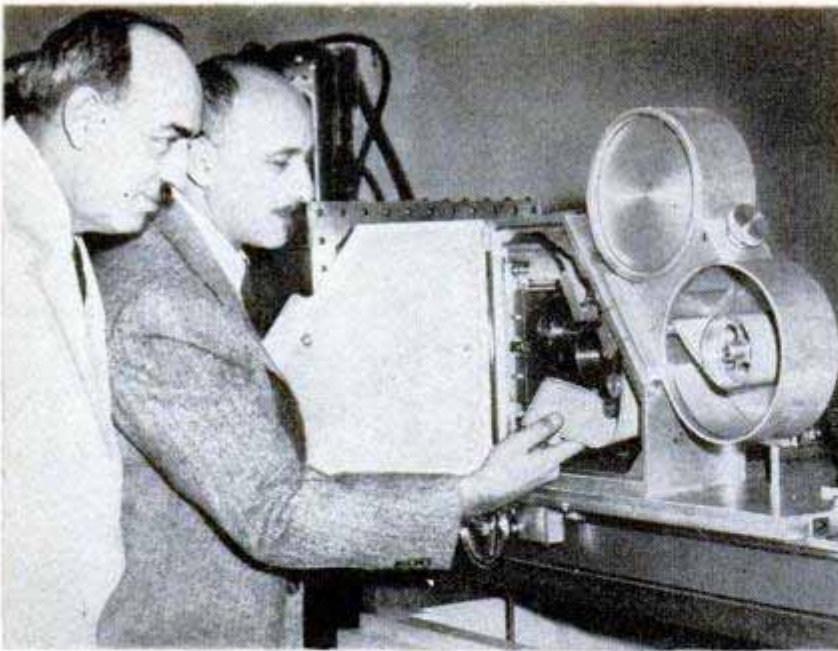

Unusual width of the film is shown by Sydney A. Weinberg, designer of the X-ray movie camera, believed to be the largest in use today

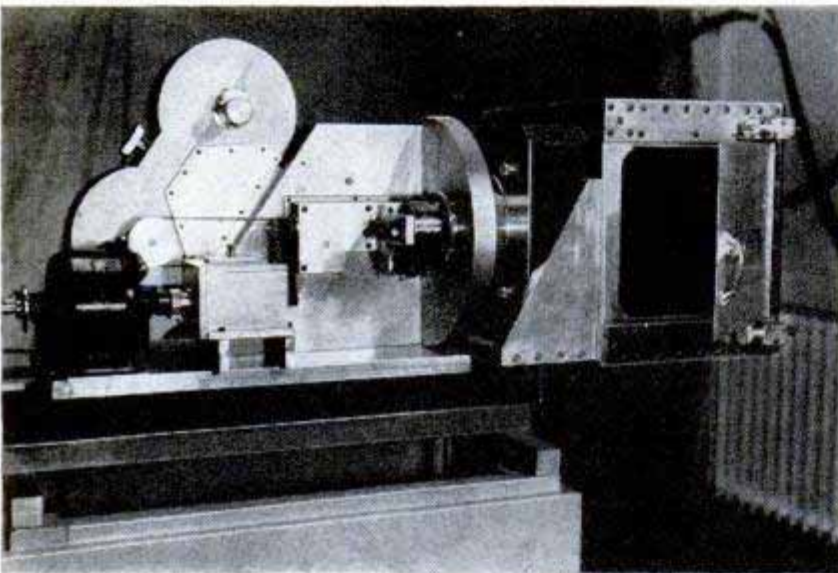

Above, side view of the large camera, showing the motor, gearbox and commutator for triggering X-ray beam. Below, subject is posed for the movies with help of a fluoroscope. At right is X-ray tube

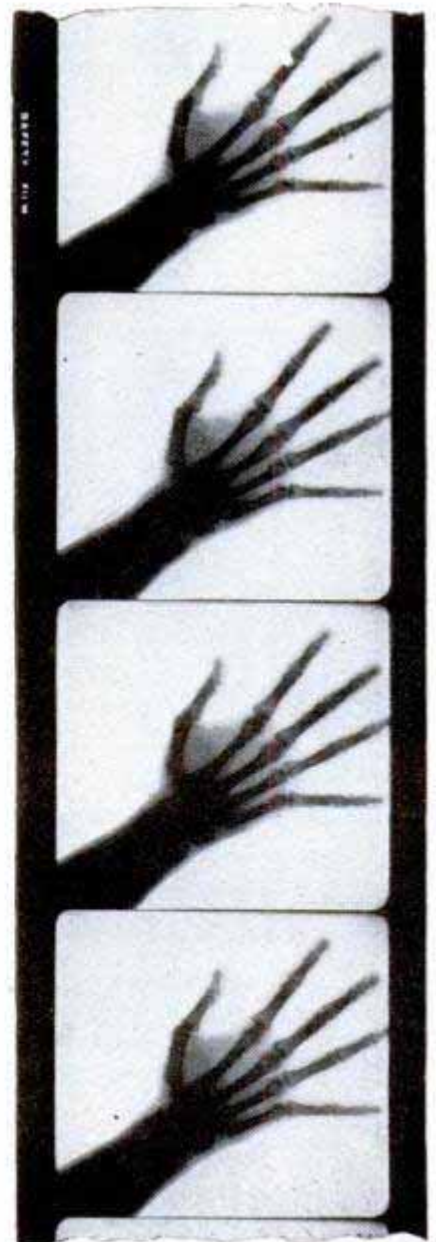
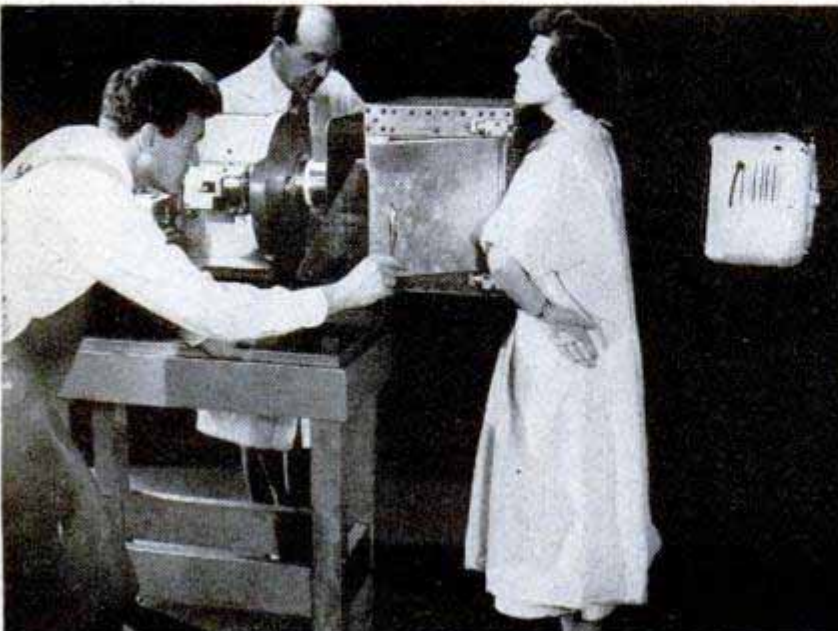

TRILLION-DOLLAR MILE OF BRAINS

By Ovide Desmarais

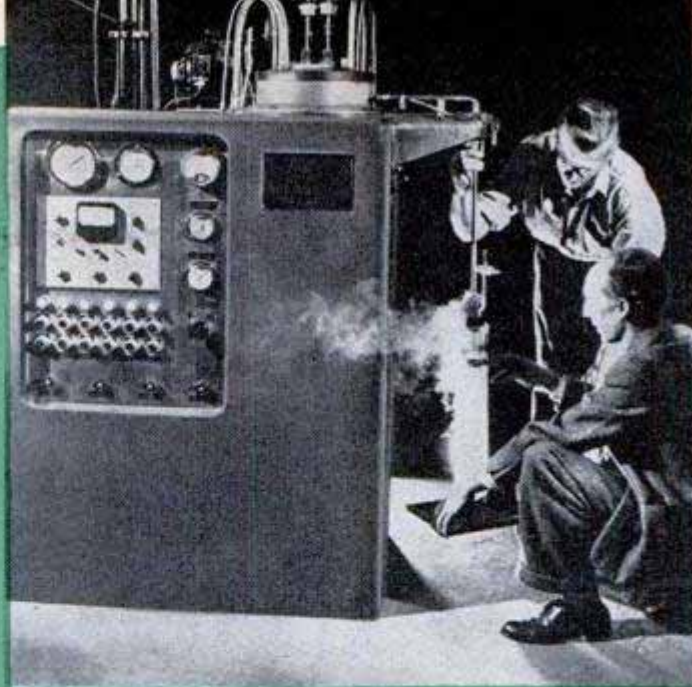

From this unique instrument, a cryostat, comes liquid helium at the fantastic temperature of -452 degrees F.

DID YOU KNOW that the world's greatest concentration of diversified scientific brain power is located along a short stretch of the Charles River almost within sight of Boston's fashionable Back Bay?

With more than a half dozen major research institutions sprawled along Cambridge's Memorial Drive and a cluster of smaller independent laboratories (the National Research Council lists some 130 man-

ufacturers as maintaining staffed industrial-research labs here), this short strip of river front is known as "Research Row." It is a concentration of top brains in the fields of pure and applied science.

To the tourist on the rubberneck bus, the strip is known also as the "Trillion Dollar Mile."

Two outstanding educational institutions, Massachusetts Institute of Technology and

Buildings along this short stretch of the Charles River house outstanding concentration of scientific minds



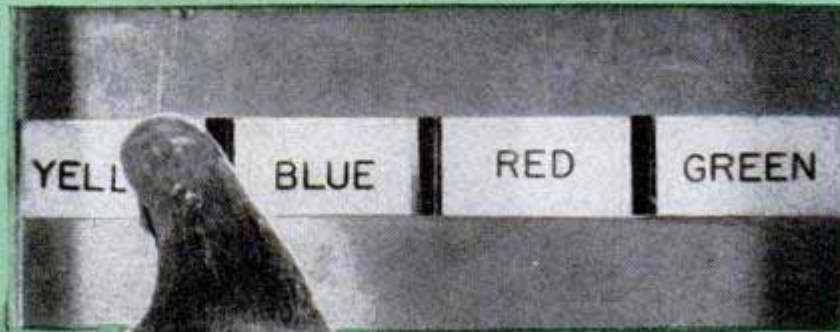
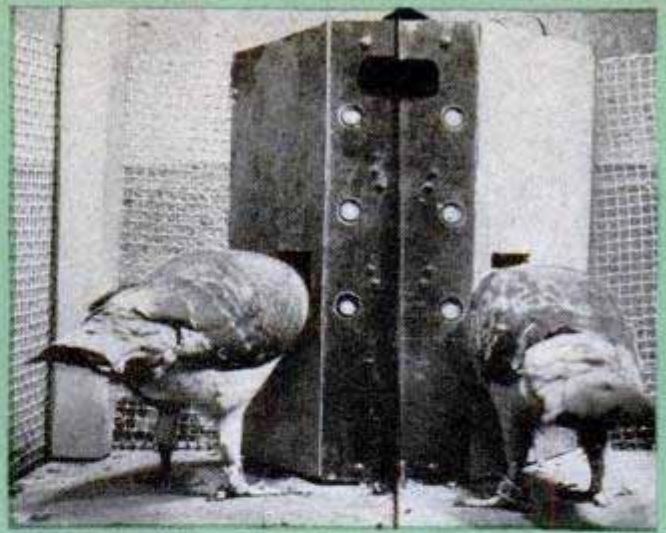
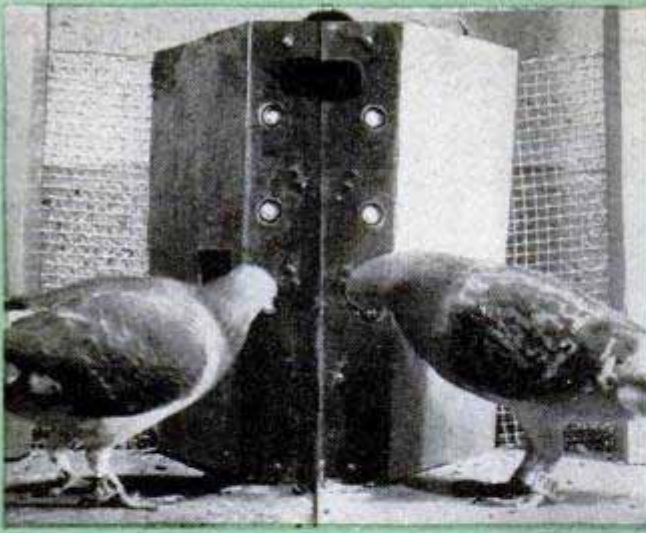

Harvard lab teaches pigeons to cooperate. In top photos, birds must peck matching buttons to get food. Doors then fly open automatically. Center, this bird must peck color on panel that matches color of light shining in cage. Below, pigeons play Ping-pong by pecking ball back and forth. When player misses, ball rolls into his trough, opening feeding station of opponent

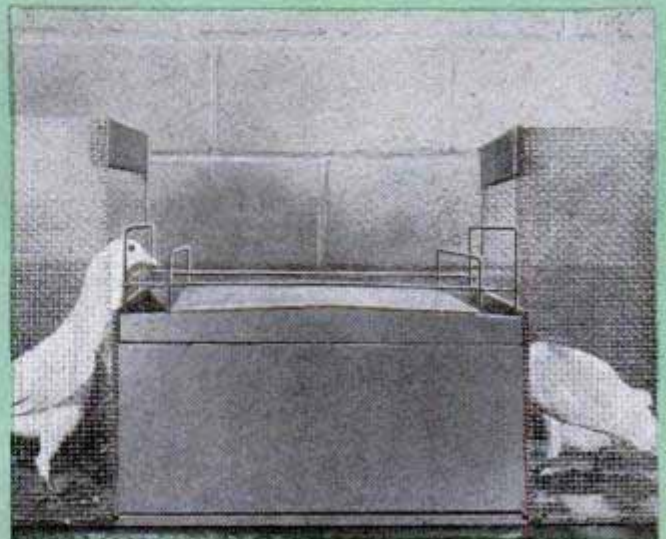
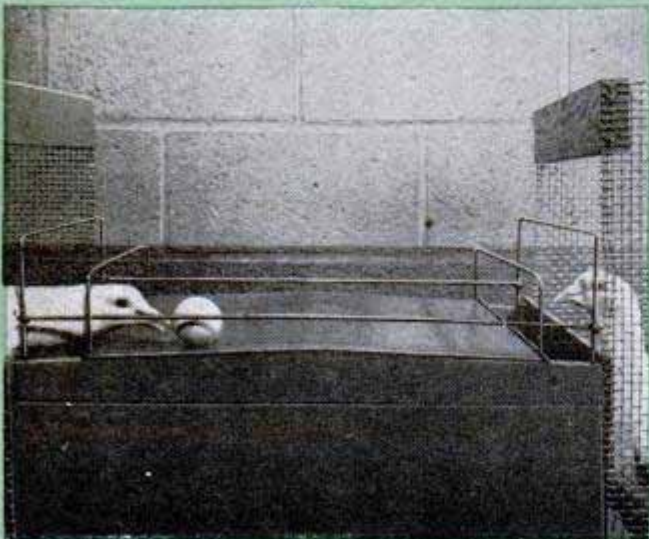



"Bessie," who lives at Harvard, is a huge mathematical brain that can solve riddles in physics in a flash

Harvard University, are part of Research Row.

Much of their research is in basic scholarly fields—investigations in broad areas of theoretical study designed to further fundamental knowledge rather than to develop immediately a specific consumer product. Both institutions receive yearly government and business contracts or grants totaling millions.

It was M.I.T. that provided the impetus which sent metropolitan Boston to the top as a research center. At a time when the Hub was slipping away to the rim of the financial universe during the 20s, M.I.T. started to export scientific knowledge. The experiment has paid off.

M.I.T., considered one of the greatest research centers in the world, handled war-

research contracts totaling \$100,000,000 and from its laboratories came contracts for production of more than \$3,000,000,000 of new weapons. More than 1600 of its 3000 faculty members devote themselves entirely to research and it is estimated that around \$14,000,000 will go into research this year. Harvard will spend between \$5,500,000 and \$6,000,000.

There is no limit to the array of biggest and "firstest" in every branch of science these two schools can claim.

Everybody at Harvard is engaged in some sort of research. Whether it be teaching pigeons to play Ping-pong or probing into the love life of fruit flies, the Harvard scientist with his baggy tweeds, horn-rimmed glasses and cropped haircut enjoys freedom of action rarely found anywhere

Seated at control panel, research workers at M.I.T. check tests in the Navy's huge supersonic wind tunnel

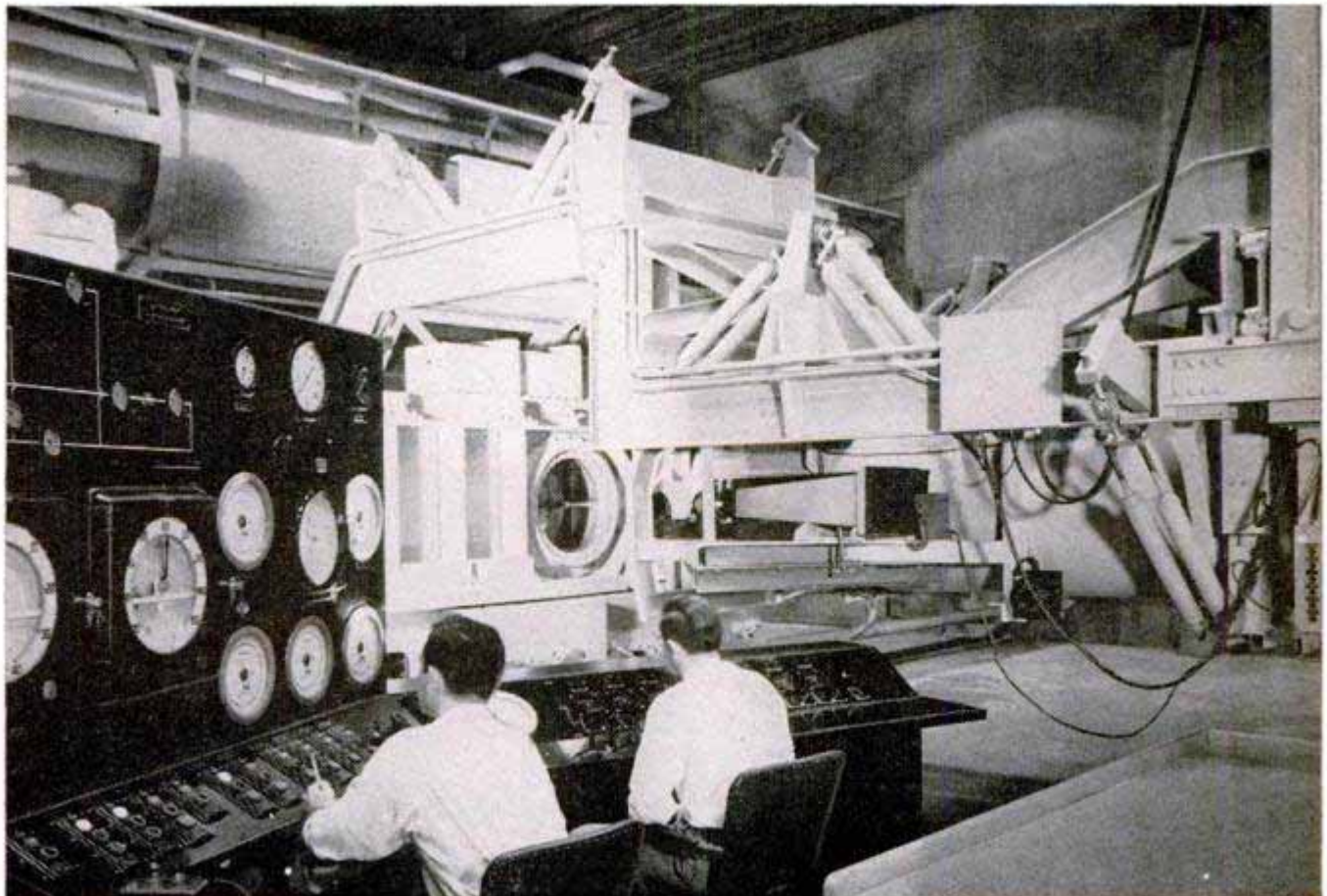



Famous Land camera, developed on Research Row, takes a picture which can be peeled off back in one minute

else in the academic or scientific world.

The iron lung was developed at the Harvard School of Public Health by Dr. Philip Drinker some 24 years ago and a little over a year ago a team of Harvard scientists developed the electrophrenic respirator for bulbar-poliomyelitis victims.

The new respirator is about the size of a portable radio and can operate on ordinary house current. It is not a substitute for the

iron lung but it can be used in some cases where the iron lung is ineffective.

Called EPR, the new device artificially induces breathing by sending an electrical current through the phrenic nerve in the patient's neck. When current is applied to the nerve, irregular breathing is induced. By suspending the irregular breathing, something the iron lung cannot always do, the new machine provides superior treat-

Breathing is induced by the electrophrenic respirator, which passes electrical current through nerve in neck

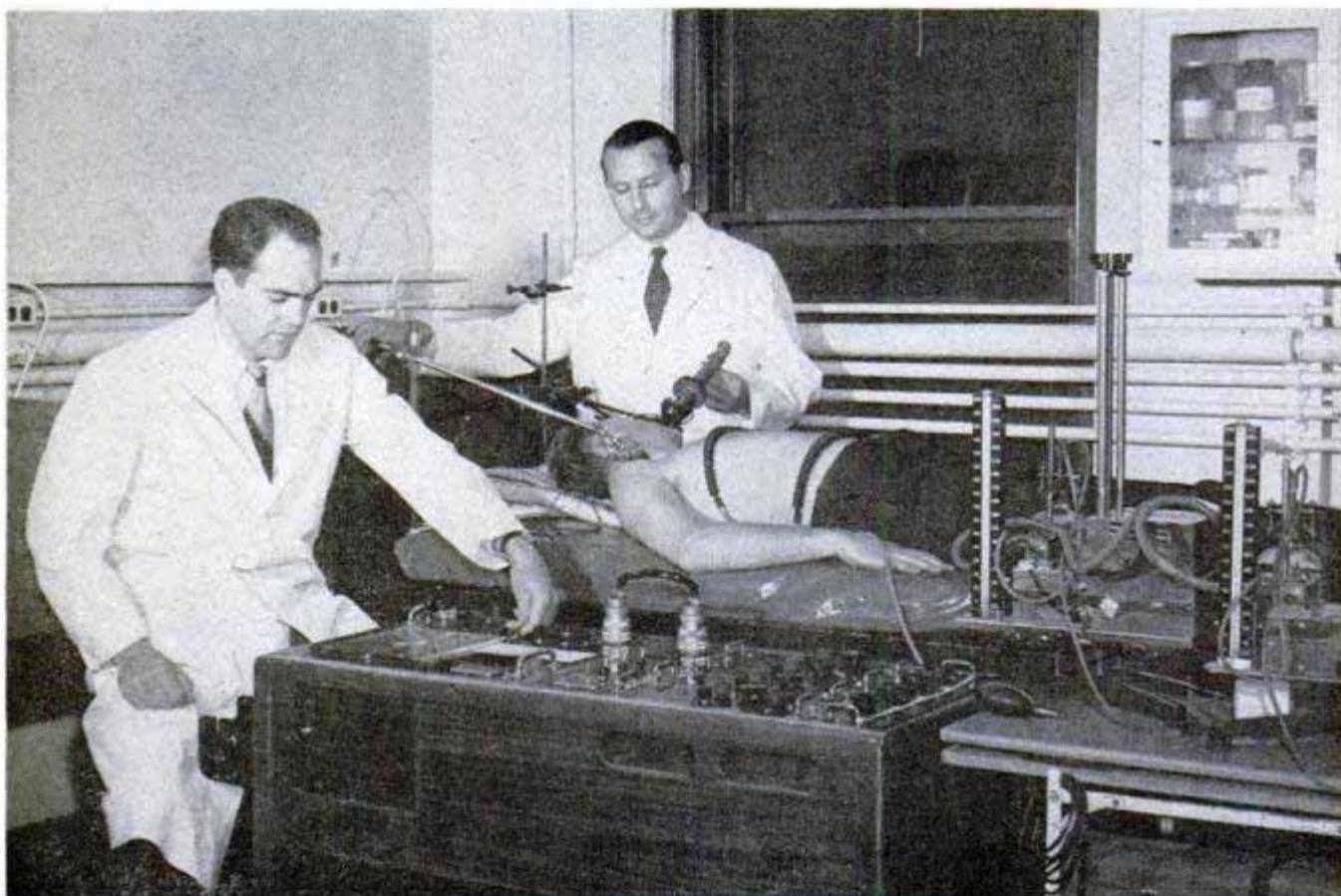

ment in bulbar cases. However, it cannot be used in the more common spinal cases because the phrenic nerve is inoperative.

EPR also is used in cases of brain tumors and overdoses of sleeping pills or anesthetics—all causes of paralyzed breathing muscles.

M.I.T.'s much-publicized wind tunnel for research on problems of high-speed flight is the largest of its kind at any university. Constructed under the auspices of the Navy Bureau of Ordnance, the tunnel is designed to provide air speeds ranging to four times that of sound—up to 3000 miles per hour. It took three years and \$2,600,000 to take the idea from the blueprint stage to the modernistic supersonic laboratory.

When in operation, dry air is circulated in the wind tunnel by two large centrifugal compressors driven by electric motors of 10,000 total horsepower. It requires approximately 3000 gallons of water per minute to cool the various machines within the lab.

Research completed in the wind tunnel on scale models has contributed greatly to the present design of high-speed missiles and aircraft of both piloted and automatically guided types. The students trained in the laboratory today will be the aero-

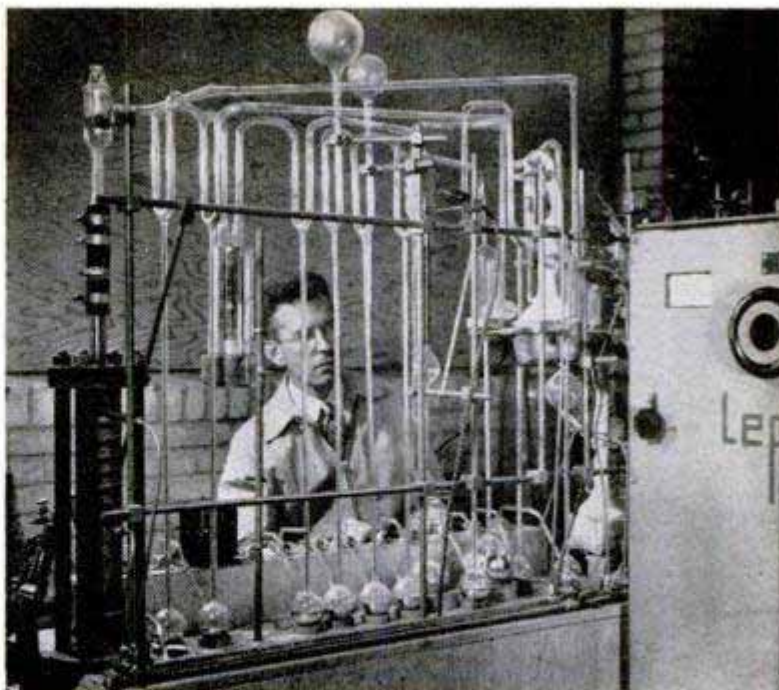

Sensitive vacuum apparatus measures gases in materials such as titanium, detects impurities up to one part in 10 million

ballistics specialists of tomorrow's supersonic planes and missiles.

Also at M.I.T. is the world's lowest-temperature freezer (15 cubic feet), which can cool its contents to minus 452 degrees F. and hold them at that temperature indefinitely.

Known as a cryostat, the new cooler was designed by Dr. Samuel C. Collins, who based it largely on principles he used for

(Continued to page 222)

Burglarproof safes? From this bank of special driers on Research Row comes penicillin in enormous quantities

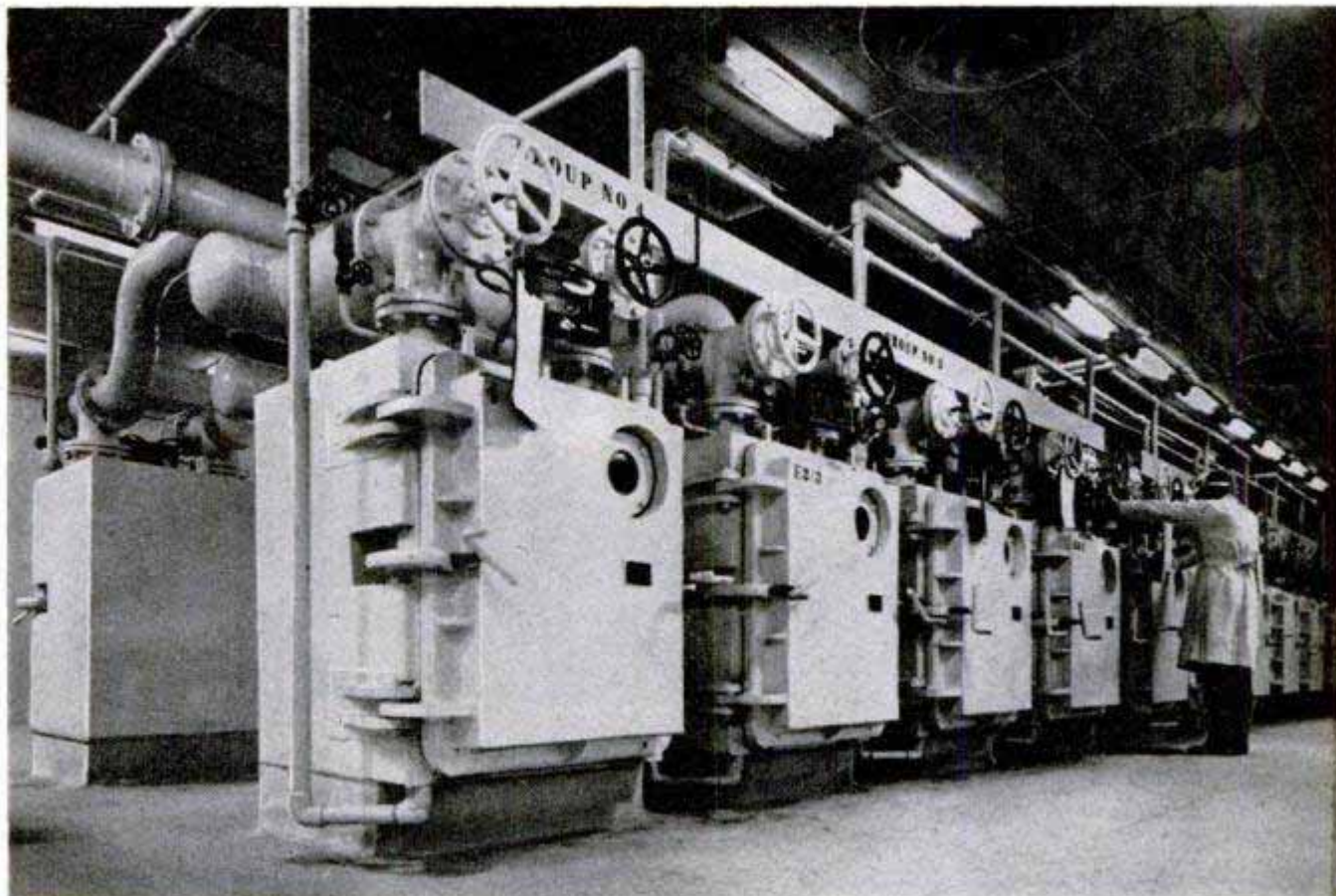



U. S. Navy photo

Canvas Strip Acts as Escape Slide for Airborne Patients

After a crash landing, Navy litter patients can be slid to safety down a strip of heavy duck canvas. Now carried aboard all VR-3 evacuation aircraft, one end of a 26 x 3½-foot canvas strip is hooked to floor rings near the cargo door. Two or more crew-

men hold the other end tautly away from the airplane while other crewmen gently slide the litter patients down from the nine-foot height. When not in use the total weight of the slide and its container is 30 pounds.



French Build Jet-Powered Light Touring Plane

What is believed to be the world's first jet-powered light touring plane has been produced in France. Weighing less than a

ton, the Sipa 200's top speed is said to exceed 200 miles and its range is between 300 and 500 miles.

"This Page for FISHERMEN"

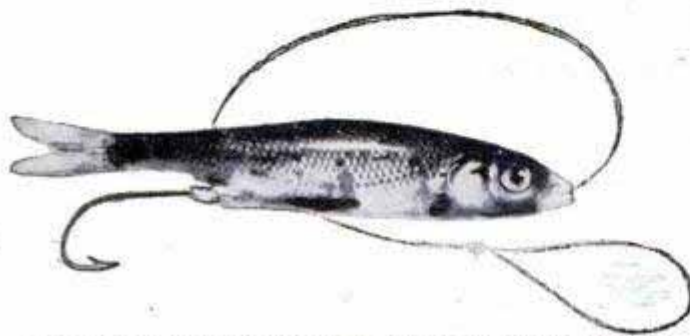

▲ **REAL FISH** preserved in tough transparent plastic is weighted properly for use with spinning reels

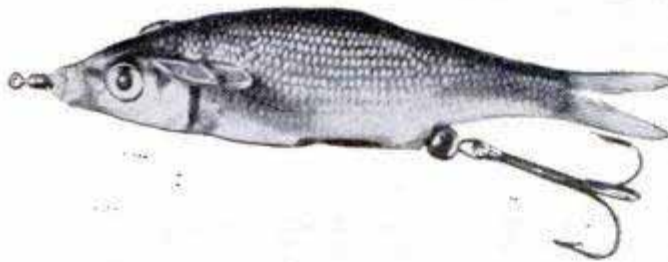

▲ **PLASTIC FINS** fastened just above the gills give this preserved fish lure an up-and-down motion

MAGNIFYING LENS built into a fly box makes it easy to select a new fly and tie it to the leader

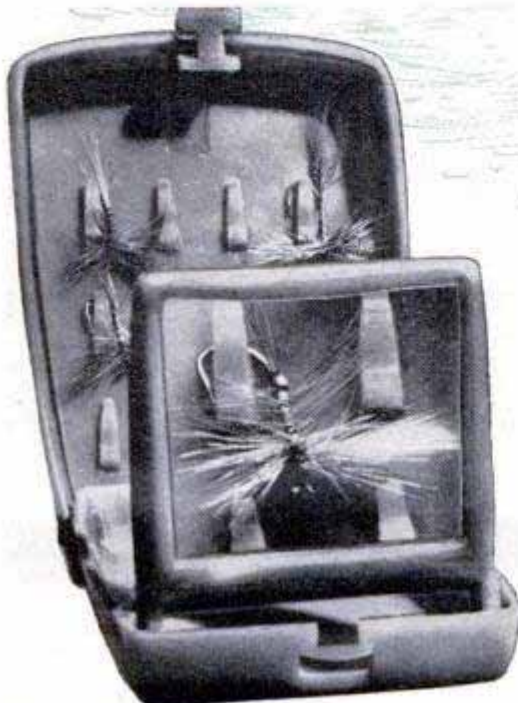

ALL-PURPOSE REEL has interchangeable spools, giving angler single reel for spinning, fly and bait casting



ANGLER'S HATBAND holds 12 flies on wire loops. When leader is slipped through loop, fly is threaded

SHRIMP LURE made of plastic has jointed body which bends, then straightens out when the line is tugged

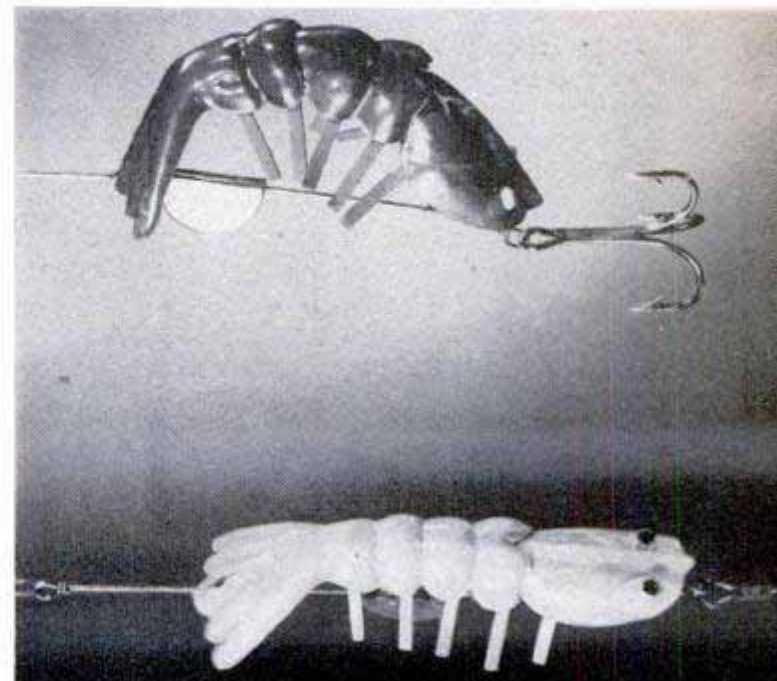

Cathode-Ray-Tube Machine "Writes" Book in One Minute

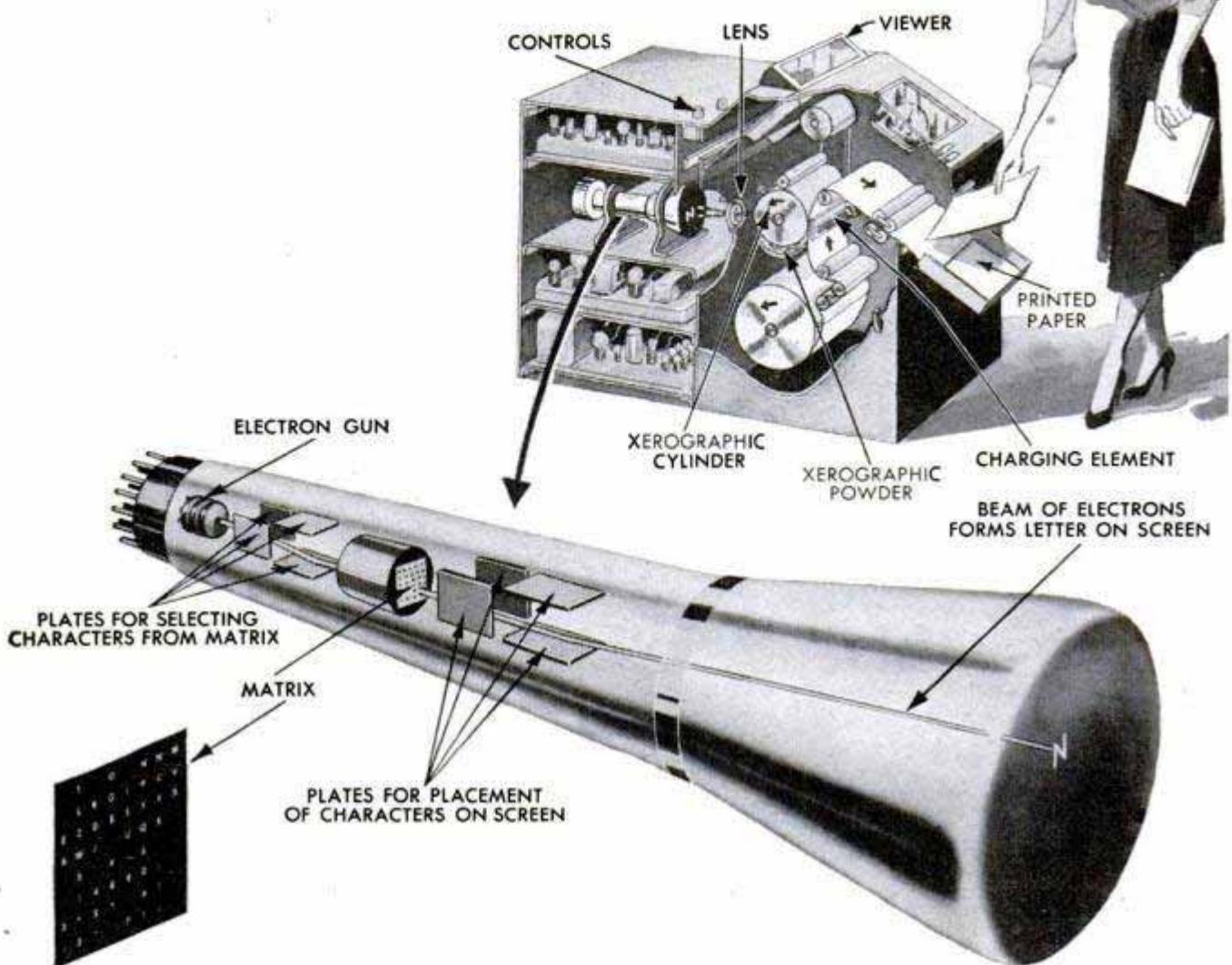

AUTOMATICALLY recording numbers and letters at a speed of 10,000 characters a second, a cathode-ray machine provides a method of taking down the "dictation" of electronic laboratory instruments. Heart of the amazing printing device is a cathode-ray tube basically like the one in your television set. A copper matrix containing stencil openings in the shape of letters and numerals is located between the electron gun at the tube base and the fluorescent screen at the viewing end. A stream of electrons is fired at the screen through the matrix, which does what a stencil does when you are painting with a spray gun. It holds back all the "paint" (in this case the electrons) beyond the outlines of the letter or numeral to be printed. Two deflection systems are used, one in front of the matrix to guide the beam to the proper character and another between the matrix and the screen to direct the image to the desired spot on the screen. Copies of this information can then be made either by a camera or by a xerographic printer. The

electron-sensitive xerographic cylinder picks up powder electrostatically and transfers it to paper where it is set permanently by heat in much the same way printing ink is transferred to paper by type (see *Popular Mechanics*, January 1949, page 91). At the rate of 10,000 characters a second, the machine could "write" a book a minute!

Superstrength Concrete

Plastic can be used to make concrete for roads, floors and masonry twice as strong as the conventional mixture, according to a report from the Massachusetts Institute of Technology. The new mixture, which contains polyvinyl plastic, is self-curing in air at ordinary temperatures and humidities. Used as a mortar to repair cracks, the mixture is from three to ten times as strong as ordinary mortars.

Production of synthetic textile fibers in the United States will total about 400 million pounds annually by 1953.

Coal Pipe Line

Crushed and mixed with water to form a slurry, coal is hauled by pipe line on an experimental basis near Cadiz, Ohio. The pipe, 12¾ inches in diameter, carries from 7000 to 9000 tons of coal daily. Pumps keep the water-borne coal moving under pressure. The operation is being conducted by the Pittsburgh Consolidation Coal Company as a test prior to designing a commercial-size pipe-line system. If the test, which will last a year, proves such a haulage method to be feasible, the coal industry will have, for the first time, a means of competing with oil and gas transportation costs.

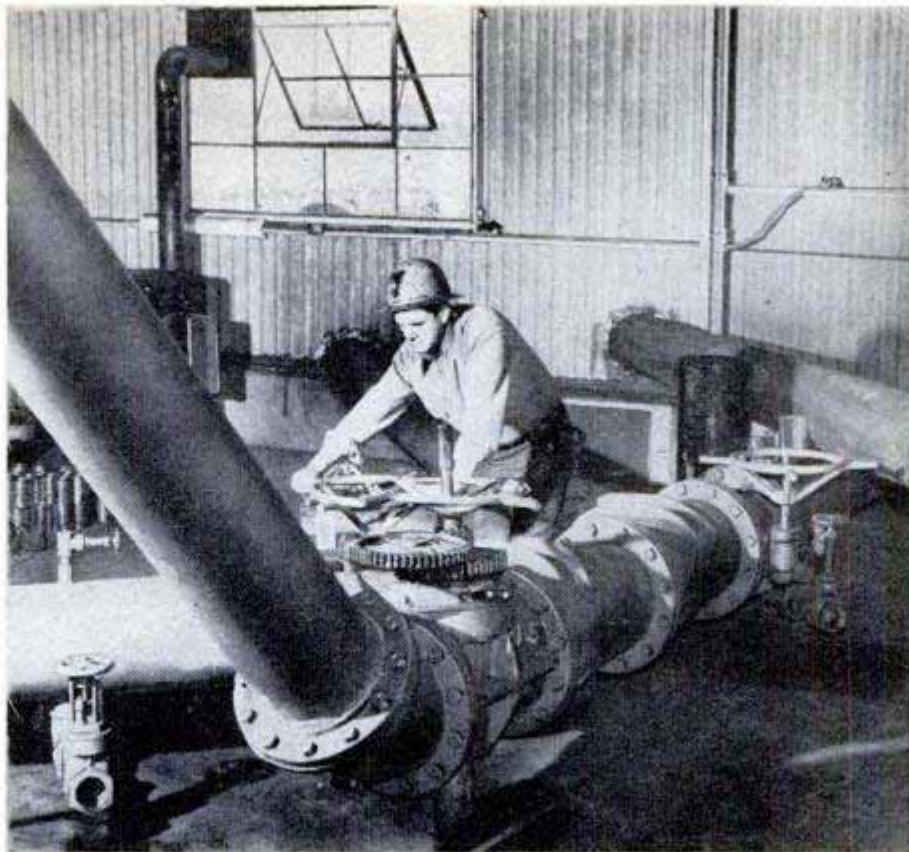

Detector Uses Ultraviolet Light to Spot Leaks in Engine Block



With an ultraviolet light, small cracks in auto-engine blocks and radiators are readily detected. In testing an engine's cooling system, a small quantity of highly soluble fluorescing powder is mixed with water in the radiator. The resultant solution circulating through the system will seep through any crack or crevice that may exist. By passing the ultraviolet-light beam over the area to be examined, this seepage will be discovered quickly because of its bright glow. Other uses for the light in the detection of water leaks include tanks, boilers, water-processing units, or any application where it is possible to add fluorescing powder to water in the unit.

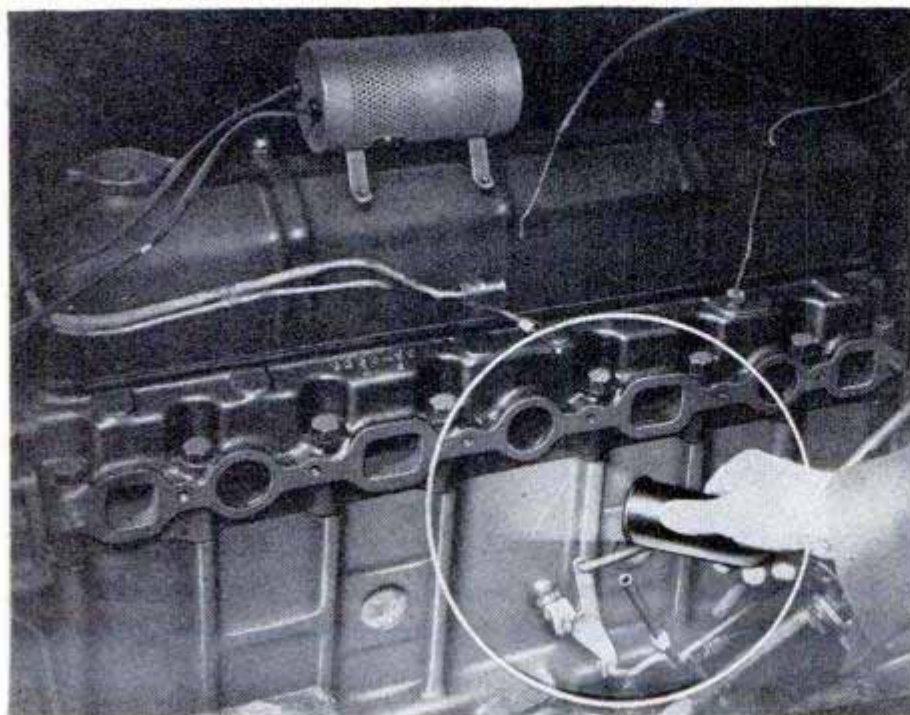

Information not listed on articles in the index often is listed in the WHERE-TO-FIND-IT LIST, available without charge from Bureau of Information, *Popular Mechanics*, 200 E. Ontario St., Chicago 11

Beachcomber's Hobby

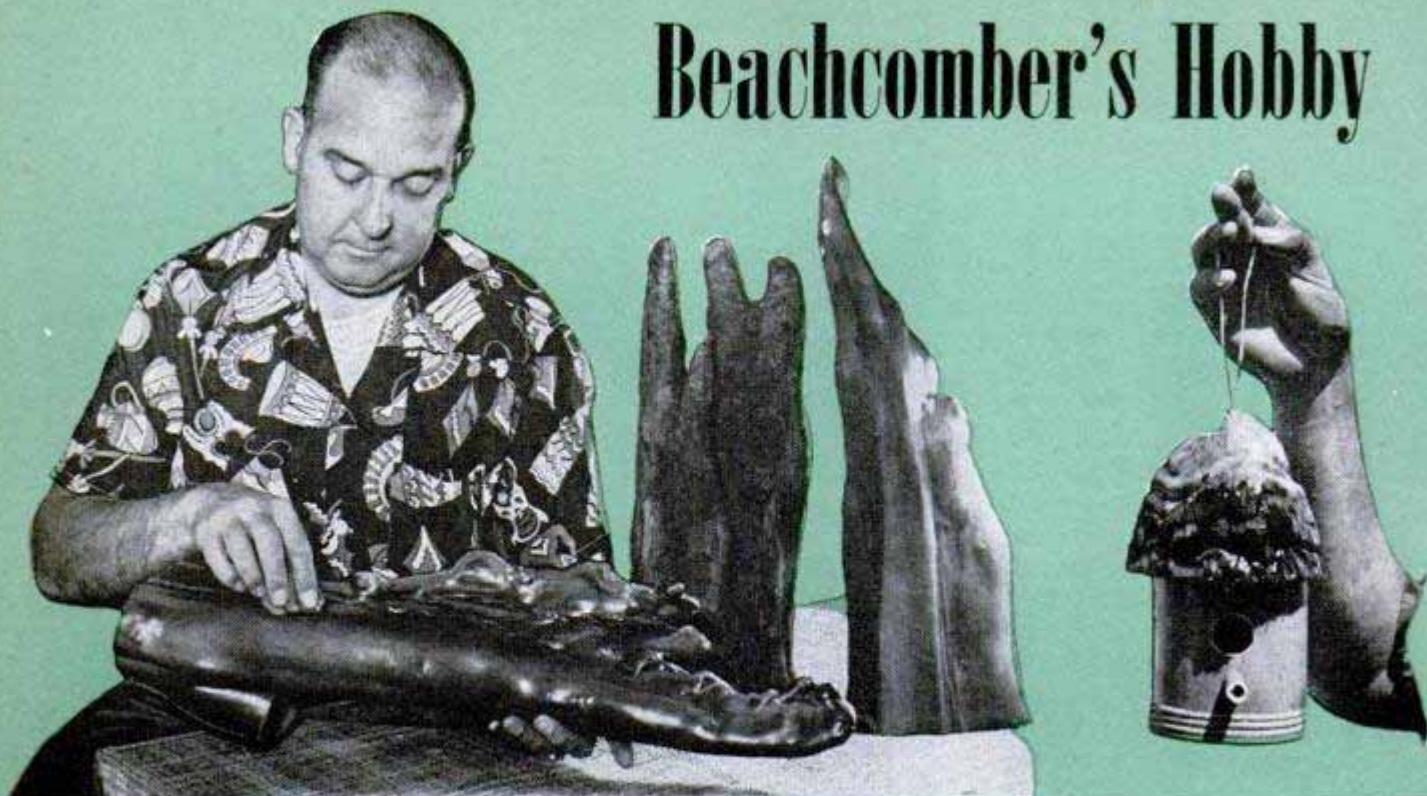

Cypress knees become modernistic figurines and bamboo stems become birdhouses in the hands of Sam Long

BIRDHOUSES, bamboo, the island of Guam, nail kegs, coconuts, cypress knees and a hobby of making things are ingredients that were combined to launch Sam E. Long in a spare-time business. The same ingredients gave Cuyahoga Falls, Ohio, and vicinity a new word for the local vocabulary—"Samboo."

In the days of World War II, Sam Long was connected with a hospital unit on Guam. In his spare time he made cups, cigarette holders and similar novelties from bamboo, coconuts and other tropical materials. One day he found a tiny coconut that would make a novel salt shaker. Then he spent six months locating another nut of

Unattractive nail keg at right is sanded like the one at left, then converted into a knockabout TV stool

Heavy lengths of bamboo are smoothed out, handles applied and presto!—they become odd drinking mugs



in Guam Becomes a Business in Ohio

By Walter E. Burton



Long's items are either kits or finished gifts. All are made from unusual materials—corks, fish nets, rattan

similar size for a matching pepper shaker.

The war over, Long returned to his work of selling drugs for a Chicago manufacturer and to his hobby of making things in his basement workshop. One day he stopped at a hardware store to get some small screws and noticed that several very crude birdhouses on a counter were tagged at what, to him, seemed a ridiculously high price. "Why don't you get some decent birdhouses to sell?" he asked the proprietor. "I could make better ones than those with my feet."

The hardware man grinned. "Why don't you?" he challenged. "Make me a good birdhouse and I'll gladly send these back."

So Sam Long was in the birdhouse business. Recalling his days on Guam, he decided to use a section of a large bamboo stem for the main part of the house, topped by half a coconut to give the effect of a thatched roof. But he had no raw materials. He located a man in Florida who could supply bamboo and coconuts and before long the hardware dealer had a stock of birdhouses that really were attractive. The cost, however, of the large-diameter bamboo from the Florida source was so high the venture seemed doomed to failure.

For a considerable time Long, irked by many fruitless hours of searching for hobby supplies, had toyed with the idea of starting a little business of supplying other craftsmen with hard-to-get materials such as rare woods, special glues and nails and screws not normally stocked by hardware

stores. So he rented a small building and laid in some craft supplies. To round out his stock he added ash trays, planters, birdhouses and other novelties made from bamboo, cypress knees, corks and similar "tropical" materials. Then he sat back to wait for an influx of craftsmen.

But, instead of men, women came! They weren't interested in rare woods and veneers but seemed intrigued by the unusual ash trays and candleholders. So Sam Long had to make a complete switch in his plans. He studied the wants of his customers and developed a number of items that have become popular as bridge prizes, wedding gifts and home furnishings. His customers now include men but the women still purchase most of his wares.

Because he uses bamboo for many of the gadgets he makes, Long has dubbed his enterprise Samboo, which denotes both his chief material and his own name.

Long still devotes his full working time to his sales territory and spends his week ends and evenings working at his hobby business. When he is too busy making things to attend the store during evening hours, he lets his 12-year-old son Nickie be storekeeper. As a sideline, the boy makes and colors little plaster figurines and makes many sales to his dad's customers.

Most of the Samboo products are made of materials that are romantic, exotic, tropical in nature. From weather-beaten cork fish-net floats picked up along the Pacific

(Continued to page 216)

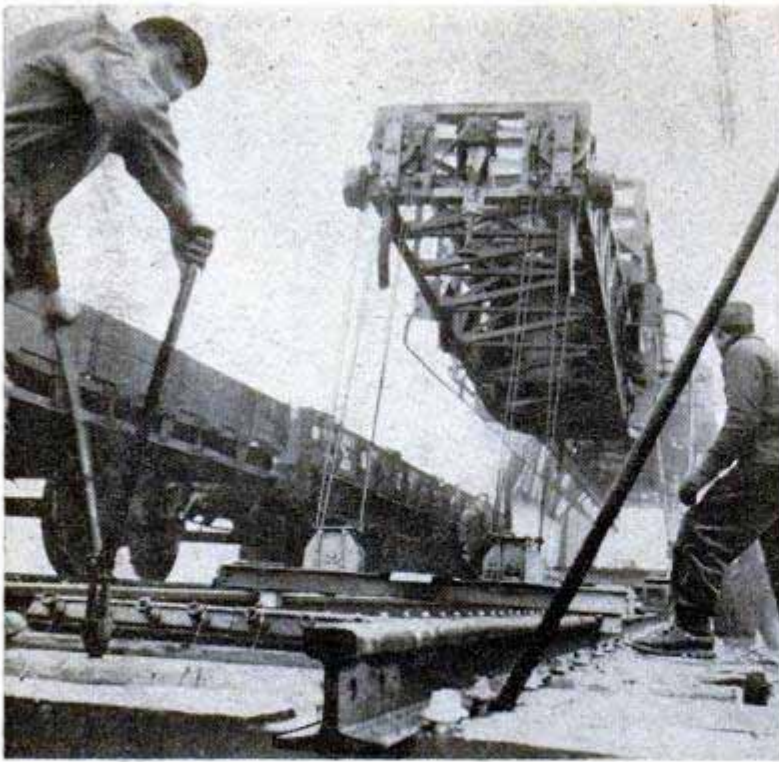

French Track Layer

Sections of railroad track, complete with rail and cross-ties, are laid in one piece by a huge machine being used by the French National Railroads. Each section is about 60 feet long and is assembled in the shops and carried to the site on flatcars. The machine straddles the track and lowers it into place on the roadbed.

Concrete Wall Panel

Concrete slabs with center layers of glass fiber are cutting construction costs and, at the same time, providing an insulated wall. The five-inch slab is keyed on all four edges. One side has a muslin-cloth facing, the other a rough broom finish.

Pilot's Rear-View Mirror Helps Avoid Accidents During Take-Off

Extensive flight testing has demonstrated the value of a new rear-view mirror for airplane pilots. It is mounted in a transparent-plastic bubble above and ahead of the pilot. Developed by the Civil Aeronautics Administration's Technical Center at Indianapolis, the mirror permits the user to tell at a glance, on the runway, whether to proceed or make way for an airplane that is coming in to land. In the air he can spot an overtaking aircraft soon enough to allow himself plenty of time to turn out of its path.

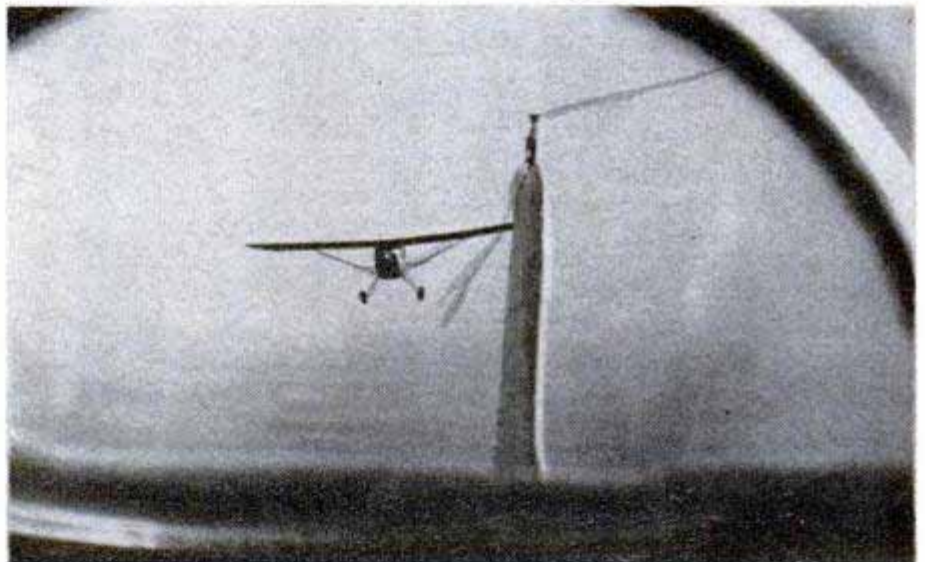

Quicker Autopilots

More accurate bombing is possible with new, faster-reacting automatic pilots that assume control several miles closer to the target. The bombardier can make a five-degree heading change twice as fast and have more pre-drop maneuvering time, permitting better evasive action. Today's high air speeds necessitated the new autopilot.



Salt-Water Farmers

Rich kelp bed off California coast awaits the cutters; some beds reach down to a depth of almost 100 feet

By Shep Shepherd

IF YOU HAPPEN to be fishing somewhere off the coast of California, you may see a strange-looking craft go by totting a deck load of sauerkraut. The crew will be salt-water farmers coming in from the harvest. But that's kelp they're carrying, no matter how much it looks like kraut.

This odd phase of agriculture has been going on ever since the late 1920s when Philip R. Park, touring England and Europe, saw fat cattle passing over lush grass to feed on kelp (seaweed) that had washed ashore on the Channel Islands. Amazed at this unusual behavior, Park took samples of the seaweed and made tests to determine its content. The results revealed a remarkable ash and mineral content of 32 elements, chief among them being iodine, potassium, chlorine and protein.

The experiments, extended to various kinds of kelp, eventually disclosed the giant kelp of California coastal waters to be superior in quality and quantity. Shortly thereafter, the *C. L. Arques* made its appearance busily stuffing its maw from the kelp beds off Dana Point, Point Dumes and other productive areas off the California coast.

The *C. L. Arques* was

originally designed as a Sacramento River freighter. She is 70 feet long and powered by two diesel engines. The cabin, galley, engine room and quarters are crowded into one third of her aft end. The remaining space forms a spacious hold extending down to her beam. Into this compartment



In San Pedro harbor, a cutter prepares to unload its harvest



The giant claw in ship's hold easily moves a half ton of kelp with each swipe and reaches any part of hold

the mowers and conveyors can cram 150 tons of kelp. At her prow the 10-foot-wide conveyor can be raised or lowered by controls from the wheelhouse. In cutting position the lower end of the conveyor extends four feet below the surface. Attached just in front of the conveyor belt at the lower end are cutting blades taken from ordinary farm mowing machines. Similar blades work in a vertical position on either side. The mowers, cutting a swath 10 feet wide and 4 feet deep, clip kelp neatly at the sides and lose little, if any, of the freed seaweed.

Five men form the crew. The captain handles the ship's wheel during the harvesting. One man controls the big iron

claw which pulls the kelp back into the hold as it comes aboard. Another crewman acts as lookout to spot obstacles such as floating debris and lobster traps and also to remove any unwanted objects. One man is cook and one is engineer. These two alternate with the outside workers.

The ship times its departure (usually midnight) to arrive at the kelp beds at day-break. Cutting must be done in the early hours when there is no wind. Heavy seas would smash the wooden slats of the conveyor belt. Once in the kelp the boat cruises slowly back and forth, the mowers clip away and ton after ton of seaweed comes piling over the conveyor. By nine or ten o'clock the hold is loaded to the brim, the conveyor is hoisted from the water and cleaned and the *C. L. Arques* chugs back to port. When she has been lashed alongside the dock a big swinging crane drops a double-jawed hook into her load and begins transferring kelp to a hopper from which it starts through the processing plant.

At the San Pedro plant the kelp is chopped, dried, sterilized and shredded. It comes out of the plant in packaged form as cattle, hog and poultry feed and as Parkelp, a cereallike food for human consumption.

The *C. L. Arques* soon found competitors in the kelp beds as similar operations sprang up along the coast. The Kelp Organic Products Company operates a cutter out of Point Hueneme. Probably the biggest operator in the kelp farming business today is the Kelco company of San Diego.

Kelco operates two cutters, each with a load capacity of 300 tons. This company concentrates on the chemical values to be



Mower blades from farm machinery clip the kelp on sides and below surface as it comes into conveyor

obtained from kelp. Their products are used in the manufacture of ice cream, salad dressings and similar items. One product is valuable as a suspension agent for penicillin. Another is effective in causing coagulation of blood in persons who are free bleeders. This same product, by a slight chemical alteration, serves as effectively in reducing coagulation in cases of blood clot. During World War II 86 percent of Kelco's output went to the armed services.

Sportsmen and commercial fishermen watched the kelp-cutting operations with a critical eye. Soon complaints began coming in to the State Fish and Game Department that the cutters were destroying fish. Fish and Game began a series of tests.

Not only have the investigations apparently disproved claims of damage, they have established that, in some respects at least, kelp cutting seems beneficial. Divers report that where no cutting has been done the kelp plants (70 to 100 feet long) grow no leaves below the surface of low tide. Plants growing in beds that have been cut begin to put out new leaves at ever-increasing depths with each new cutting, thus creating better cover and protection for fish.

Alfalfa of the sea, as kelp is often called, reaches the surface from depths sometimes



Big claw (shown on opposite page) is operated by an intricate system of levers and cables on the cutter

exceeding 100 feet. Its roots attach themselves to rocks or ledges where the plant clings, deriving its life-giving elements from the water and sun near the surface. Kelp, cut to a depth of four feet, will reach the surface again in 48 to 60 hours. ★ ★ ★

Two of the busiest men on cutter are the skipper (in window) and crewman who operates the loading claw

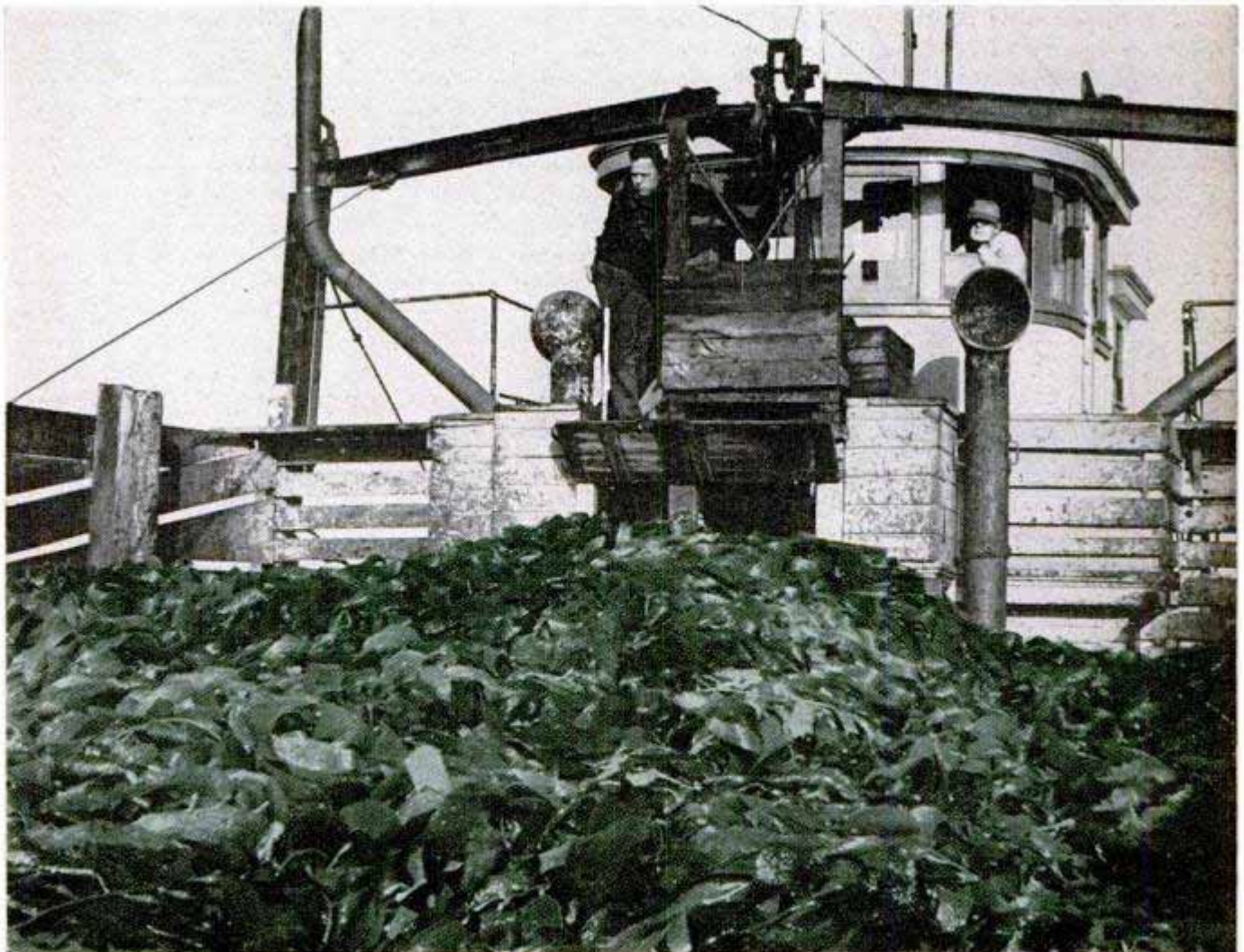



Armored Battle Jacket

Under test by Army combat troops is an armored battle jacket, proved by ballistic experiments to be superior to other types of armor tested in Korea. The new jacket, made of laminated nylon with a waterproof outer shell, reaches to the waist. It is made without sleeves and may be worn inside or outside other clothing. One advantage of the eight-pound jacket is its flexibility; it is more adaptable to the movements of its wearer than previous battle-tested jackets made of rigid panels set into pockets. In preliminary tests the garment resisted .45-caliber bullets at point-blank range and stopped almost all fragments from grenades bursting three feet away.

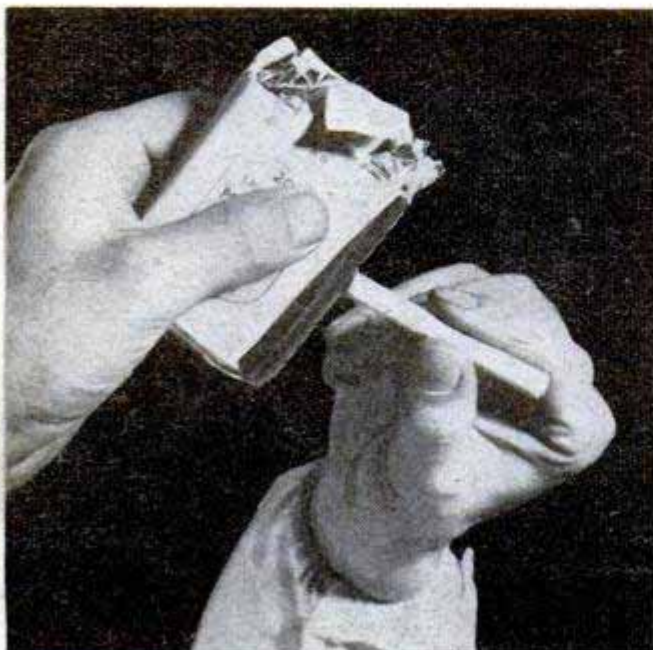

Navigator's "Secretary"

Tired of juggling computing equipment during rough, hurricane-hunting missions, Air Force navigator Lt. Bruce Parker built himself a plastic "secretary." Rectangular in shape, the device, which is called an econoputer, holds all the loose equipment essential for navigation. The master watch is held in a pocket in the lower left-hand corner. Two strips of frosted glass serve as permanent scratch pads. The time, distance and rate computer and compass rose are set into the plastic for quick use. Mounted bristle-side-up is a section of a shoe brush. Parker uses the bristles to hold pencils, dividers and other small instruments used in solving navigation problems. He is a member of the Air Weather Service's famed "Hurricane Hunter" squadron stationed at Bermuda.

Matchless Cigarette

Cigarettes containing tobacco saturated with a secret material light when rubbed gently against the side of the pack. There is no flame and no need to puff the fire into the cigarette. The material was invented by Ernest Heimo, a Swiss manufacturer of chemicals.

Titanium Withstands Jet Heat

With a melting point of 3137 degrees F., titanium may lick some of the problems of high-temperature jet engines, rocket motors and gas turbines. Its melting point isn't as high as molybdenum's 4760 degrees, but it probably will be preferred where strength is not too important, according to Battelle Institute researchers.

the

POPULAR
MECHANICS

CRAFTSMAN

Cut-Flower Arrangement

By Frank N. Stephany

FOR CENTURIES cut flowers have been used to bring a little of the outdoors into the home and add a touch of life to comparatively gloomy rooms. Today, with the trend toward bright, well-lighted homes, flowers have assumed a new and different purpose in interior decorating. Walls of exposed brickwork and wood paneling, plain

White gladioli and eucalyptus set in heavy white vase add touch of summer beauty to an unused hearth



PM color photos by Paul T. Hutchinson
Flower arrangements by Ben Kanil





Yellow gladioli combine with green and brown of magnolia leaves to decorate top of radio cabinet. Copper planter forms base for massive arrangement

Tulips and daffodils, pictured at the right and below, are anchored by needle holders. Carnations and pittosporum, lower right, are held with poultry wire



lines of furniture upholstered in solid-color fabrics, modern draperies and appointments—all rely to a great extent on the inherent beauty of the material. But even with interesting finishes and gaily colored paints, the treatment often becomes monotonous unless offset by a few accents of the natural colors and designs found only in flowers. The graceful curves of foliage and the delicate lines of blossoms provided by nature form the perfect complement to the modern interior.

While the homeowner often has a practically unlimited source of cut flowers in his garden, the apartment dweller finds that he must purchase most of his. This, unless done carefully, can become an expensive item. However, by keeping in mind a few basic points in flower arranging, the homeowner will derive increased satisfaction from his garden and the apartment dweller will find that by buying flowers in smaller quantities and using them wisely he can achieve the desired effect at a surprisingly low cost.

One of the most frequent errors in arranging flowers is the attempt to fill the container with too many blossoms. You will discover quickly that using fewer cuttings is, in itself, an important step toward smoothing out the kinks in flower arranging. As a general rule, several blossoms along with some foliage will afford a more pleasing result than a large bouquet and, in addition, the arrangement is much easier to handle. Notice in the photographs that even in the larger displays the number of actual cuttings used is comparatively few.

Another thing that will get you off to the right start is cutting the stems to different lengths before attempting to arrange

Simple arrangement of iris, daffodils and stocks is set in plain green vase to add life to corner table



Note how camellia leaves add weight to base of snapdragon arrangement. Red background sets off flowers

them. Keep in mind that the tallest stem should be topped with a bud or one of the smaller blossoms. Below this should come the medium-sized blooms, and finally, the larger flowers at the base of the arrangement. Occasionally try combining long-stemmed flowers, such as gladioli, with round, or button, blossoms. This usually will result in an exceptionally pleasing design. Also, attempt to group the colors, using the lighter hues near the top of the arrangement. Darker flowers, as you will notice, tend to appear heavier than the lighter ones.

Make the most of the natural curves of the flower stems and, in most cases, it is effective to keep the design somewhat off-center in the container, balancing it with

Clear-glass vase is used as a container for white roses. Visible stems are part of the arrangement



Pompons, or baby mums, in a pale-yellow vase form attractive arrangement for top of TV cabinet. Year-round modern design, below, utilizes purchased materials, including Hawaiian wood rose, sand-blasted grape-root bark and a little moss



larger blossoms or foliage toward the base of the arrangement. Every design should have a center of interest, or focal point, and also a point at the base from which the flowers and leaves appear to stem.

The arrangement will be governed to a great extent by the particular container used, and it should be made in keeping with the container. In this way, the flowers will neither look top-heavy nor be subordinated to the container. A worth-while rule to follow in order to attain a pleasing balance is to make the high point of the arrangement about $1\frac{1}{2}$ times the height of a tall container, or $1\frac{1}{2}$ times the width of a shallow container. This, too, may vary according to the types of flowers or branches used. An elaborate container is likely to detract from the flowers and until you've gained experience in flower arranging, it is safest to keep the containers simple.

Held in an inexpensive glass vase, the simple arrangement of daisies and iris, below, left, is exceptionally attractive. Comparatively large iris blossom at top of design is sufficiently delicate so arrangement does not appear top heavy. Below, right, pressed palm and yarrow are embedded in sand

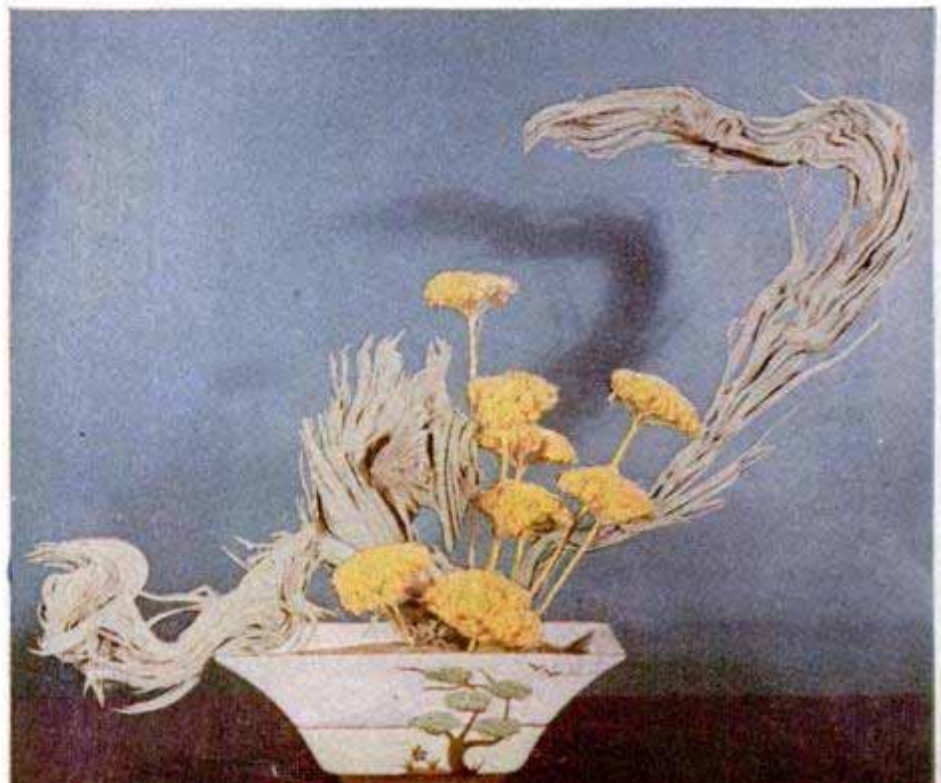

Flowers that wilt readily should be cut in the morning or early evening, and if there is a delay before they can be arranged, cut back the stems slightly and place them in cold water for an hour or so. Always use a sharp knife to cut flowers and don't touch the cut ends when handling them. It is a good idea to cut back the stems slightly each day when changing the water. When the flowers are arranged in a vase, the ends of the stems should be cut at an angle. However, when needle holders are used, the stems may be cut straight across and daily cutting back eliminated.

Needle holders are available with very fine or fairly coarse points. The fine points are best for live flowers, while the coarse points are suited for anchoring branches and dried leaves. Holders come in a variety of shapes and sizes, and are fastened to the container with modeling clay. The clay always should be allowed to dry before re-using to anchor a new arrangement.

Hardware cloth and poultry wire also will come in handy for holding arrangements in wide-mouthed containers. If wire is not at hand, stems cut from shrubbery can be wedged in the container to serve as holders. Cut the leaves from the shrubbery, using only the bare stems.

Flower arranging requires imagination along with a certain amount of planning to attain the maximum effect. For instance, when arranging a table centerpiece that will remain on the table during dinner, keep it low enough not to obstruct the view of the people at the table. Of course, if the centerpiece will be removed when dining, its size will be limited only by good taste and the proportions of the room and furniture. With a little thought to background colors, purpose of the particular arrangement and the setting in general, flower designs may be used to add a refreshing touch to your home throughout the year. You will find that dried flowers, berries, prepared leaves and an occasional purchase from the local florist will keep your favorite flower setting well-filled during the winter.

If you have the space, it is well to have a special garden for cutting, locating it in a spot where removing the blossoms will not detract from the appearance of the yard. In addition to the ever popular gladioli and roses, there are many annuals and perennials suitable for cut flowers. The following are a few of the more common varieties. Annuals: aster, carnation, chrysanthemum, larkspur, marigold, nasturtium, pansy, petunia, phlox (annual), poppy, stock, sweet pea and zinnia. Perennials: chrysanthemum (Shasta daisy), coral-bells, ground clematis, iris, Japanese anemone, lily of the valley, mistflower, peony, smooth aster and sweet William. ★ ★ ★

C-Clamp Forms Emergency Calipers

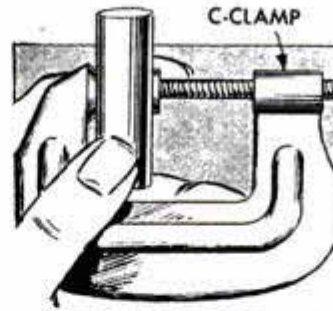

When no calipers are at hand, a small C-clamp can be used as a substitute provided the measurements are not critical. Just close the clamp lightly over the work, then re-

move it, being careful not to disturb the setting, and measure the distance between the clamp pads.—Tom Griberg, Moline, Ill.

Finishing Knots in Inferior Lumber

Low-grade lumber, such as pine, hemlock, and other woods having encased knots which are loose, often can be salvaged by anchoring the knots with shellac or glue. Cut a shallow groove around each loose knot with a chisel and fill the depression with shellac or thin glue. After this has settled into the open space around the knot and hardened, fill the depression flush with the surface, using a prepared wood filler or stick shellac colored to match the wood. Then sand to a smooth surface.

Edwin M. Love, Palmdale, Calif.

Tire-Chain "Mop" Scours Cistern

A tire chain tied to the end of a strong pole makes an effective tool for scouring cisterns. A better job can be done with a chain than with a broom or brush, and the flexible pole makes it easy to manipulate the chain against the cistern walls.

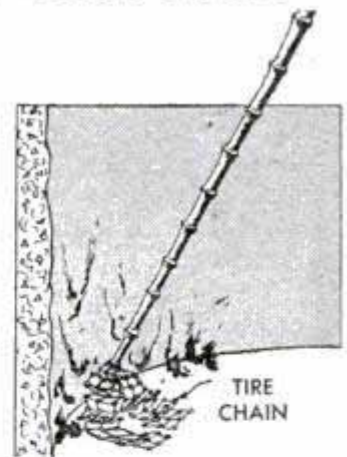

Automatic Pencil Has Needle Point For Scoring Exact Measurements

Fitted with a darning needle in place of the lead, an automatic pencil will enable you to score more precise measurements

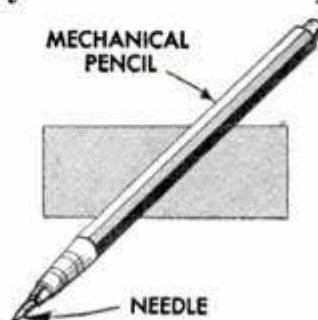

on wood than are possible with a pencil when doing repair work requiring exacting dimensions. The needle may be retracted into the pencil when it is not in use.

Put Your JIGSAW To Work

By R. J. DeCristoforo

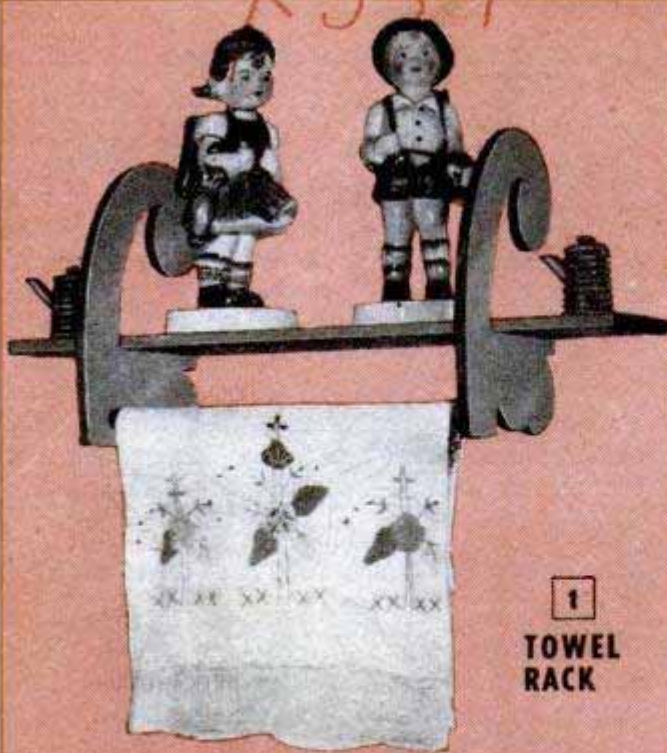

1
TOWEL RACK

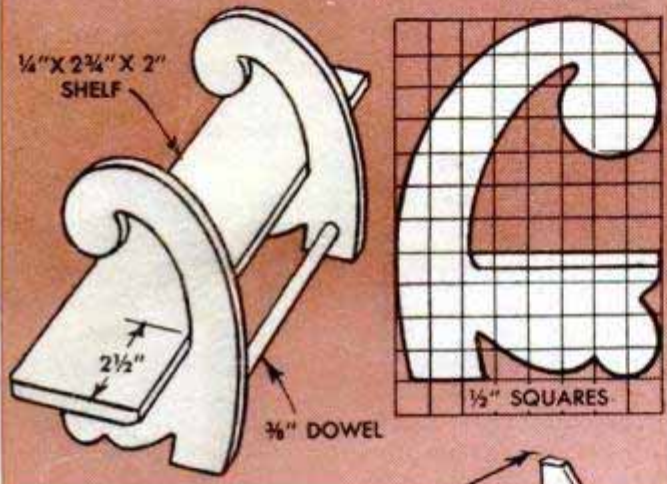

THERE'S EXTRA money in the basement workshop, and these eight attractive projects are just the thing to turn a woodworking hobby into real profit. By making samples of each item and taking them to local gift shops and variety stores, you will find most of the dealers glad to handle part, if not all, of the line. The simplicity of construction and design of these projects not only lends itself to mass production, but also makes them ideal for woodworking classes as well as individual one-evening projects for the home craftsman.

Although a coping saw will handle the scrolled designs, quantity production of the novelties requires the use of a jigsaw or a bandsaw. Templates of hardboard or heavy cardboard should be made for the various parts as this will eliminate the need for laying out the pieces each time a project is made. Multiple cutting of duplicate parts wherever possible will speed the work.

The stock used in most of the original projects was salvaged from orange crates and apple boxes, utilizing both the thin side and bottom slats along with the heavier endpieces. After the parts are cut out, the wood is sanded thoroughly with fairly coarse paper. Then, when the joints have been glued and nailed, and the corners rounded, the entire project is sanded with a fine-grit paper. The wood may be finished by

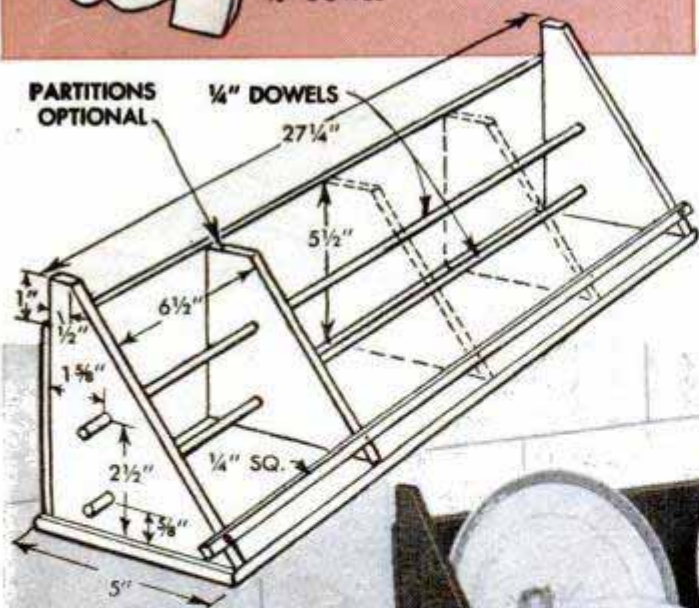

2
CUP-AND-SAUCCER RACK

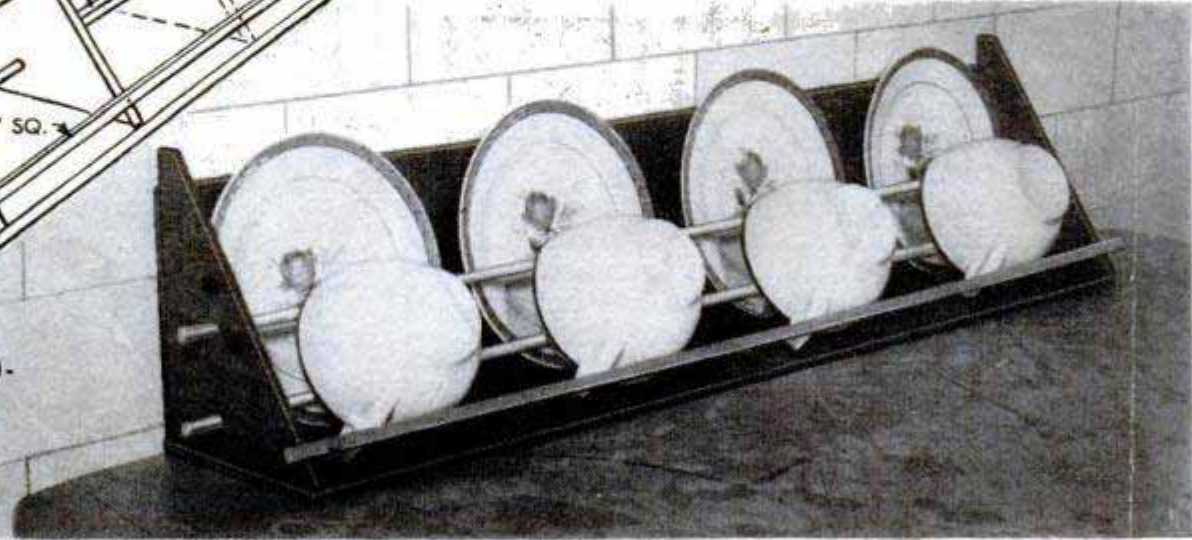

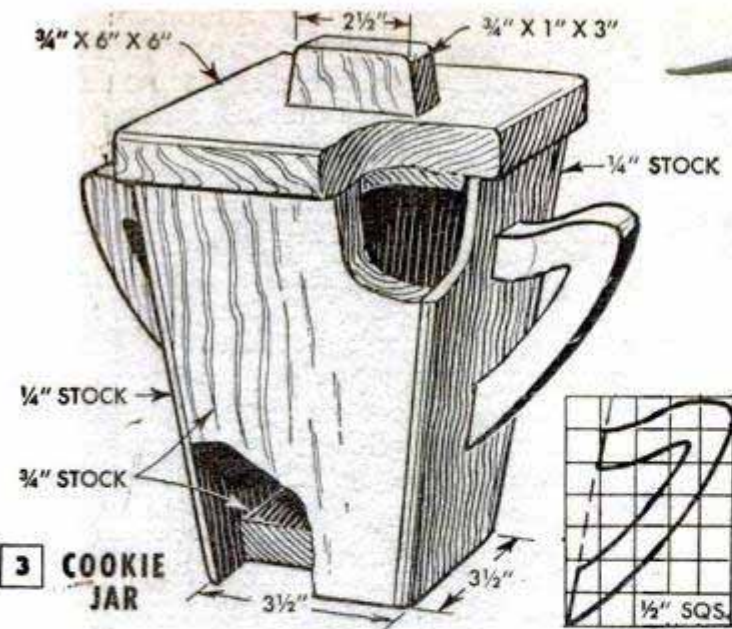

3 COOKIE JAR

staining or enameling, an especially attractive finish being applied to the crating by coating it with a maple oil stain. The depth of color is controlled by the length of time the stain is allowed to remain on the surface before it is wiped off. The stain is followed with a coat of clear shellac which is rubbed with fine steel wool after it dries. Finally, a coat of paste wax is applied over the shellac.

The flowerpot holder and the dinner gong incorporate inexpensive stamped-metal ash trays which can be purchased in sets. In the projects shown in the photographs, 3/4-in. hard maple was used for the wall bracket of the flowerpot holder and the Chinese-styled frame of the dinner gong. The maple may be stained or given a natural oil finish. To apply the latter, sand the surface, coat with hot linseed oil or sweet oil and then rub in the oil with a felt pad. The ash-tray support for the flowerpot is drilled and screwed to a flat which is cut on the top of the scrolled bracket. A rubber washer is inserted under the head of the screw to prevent any water leakage from seeping through the hole in the ash tray.

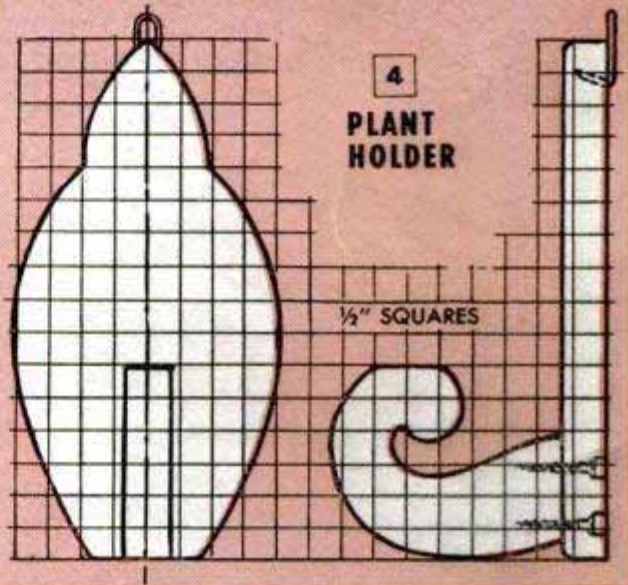
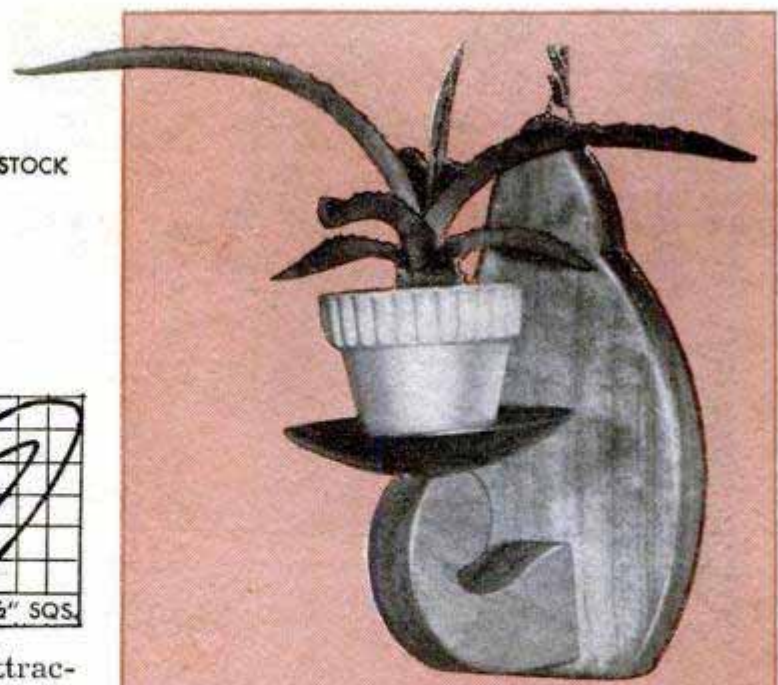

4 PLANT HOLDER



5 TIDBIT SERVER

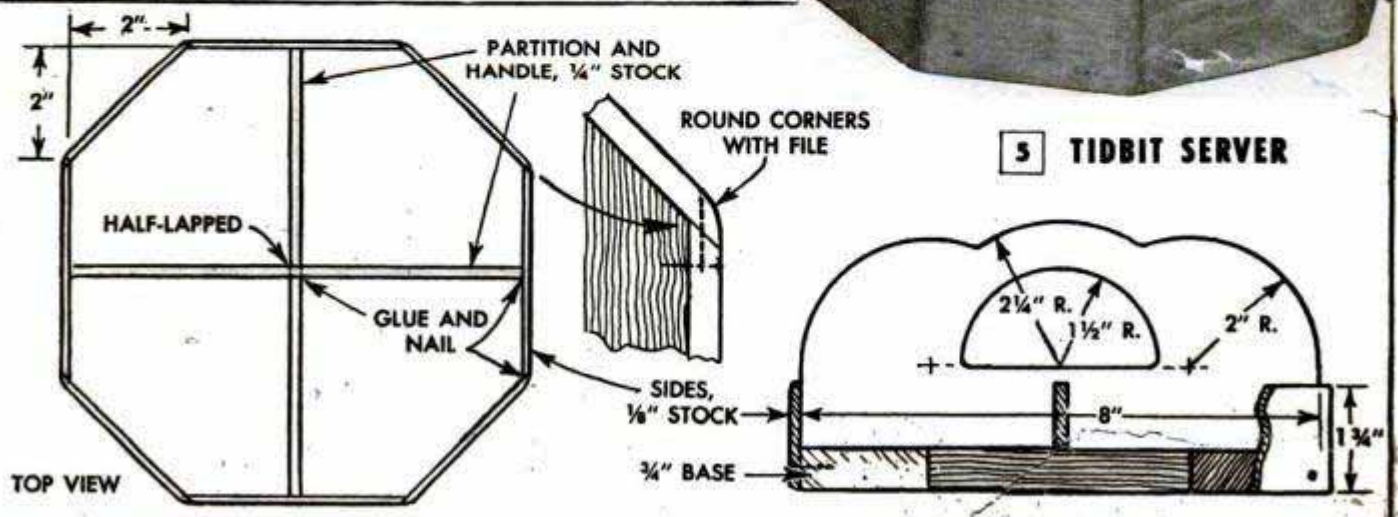

TOP VIEW

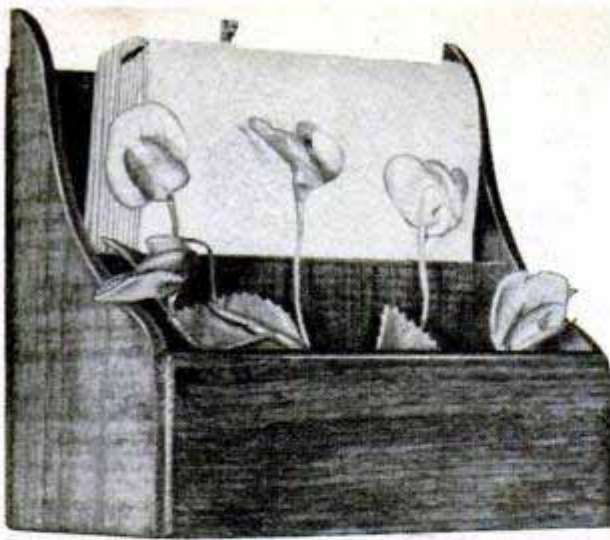

The towel rack, plant holder and flower-and-napkin holder all can be hung from the wall by drilling surfaces that come in contact with the wall and driving brads in the wall at corresponding points. The wood should be drilled to receive the brads at a slight upward angle. The wall pieces may be hung by an alternate method using a picture hook and staple. The staple is driven into the wood and bent upward to engage the picture hook, as shown in the photo of the flowerpot holder.

When making the cookie jar, fasten the handles to two sides with glue and screws before assembling the jar. The wooden jar will be easier to keep clean when in use if it is lined with pieces of cardboard wrapped in wax paper. Cut the cardboard liner sections so they will drop from the jar when it is turned upside down, but still fit snugly enough to retain the cookie crumbs.

Artificial flowers are used in the front section of the flower-and-napkin holder, the stems being inserted in sand or a frog made from a piece of wire mesh. However, if lined with sheet metal, the front of the holder will also serve as an attractive ivy planter. ★★★

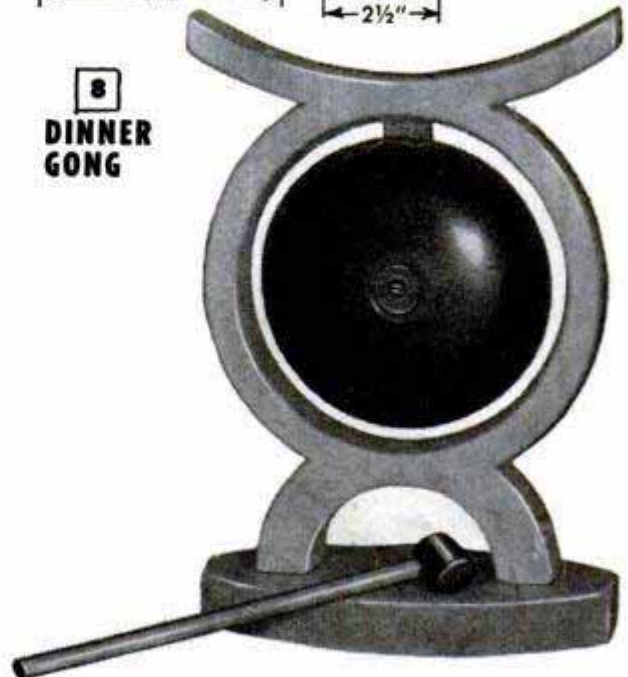
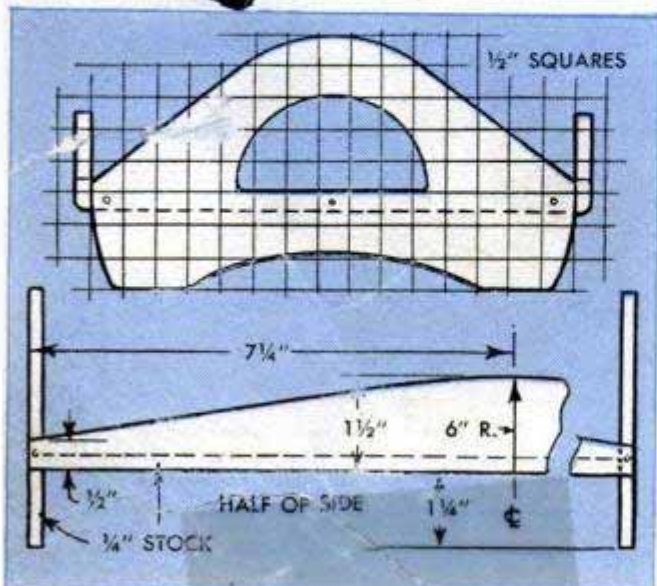
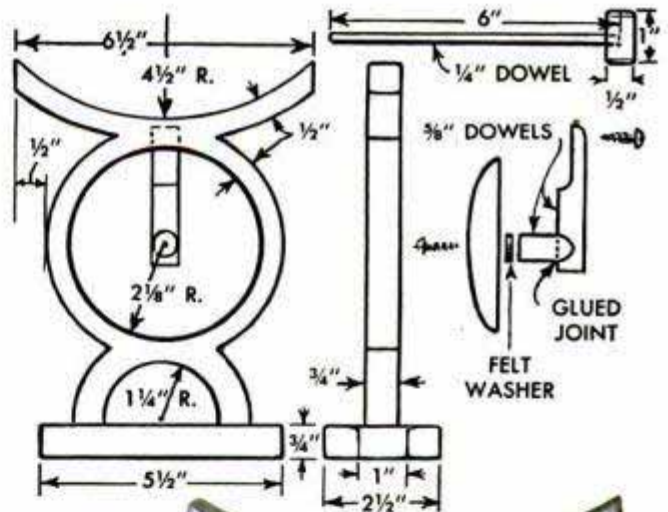
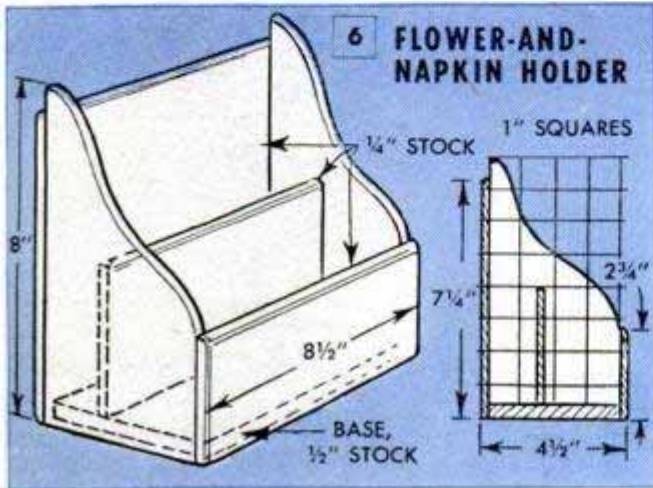

8 DINNER GONG

Can Lids Anchor Picnic Blanket Spread on Sand at Beach

To prevent the wind from disarranging a blanket or picnic cloth spread on the sand at a beach, make a set of "anchors" from gallon-can lids for use during your next outing. After drilling a hole near the rim of each lid, pass a short length of cord through it and then tie it at one end. Upon arrival at the beach, the remainder of the cord is used for tying a lid to each corner of the blanket. When the blanket has been spread on the sand, force the lids into the sand and cover them over. It's a good idea to moisten the sand around the lids in order to anchor them more effectively. If the blanket is to be spread on grass, a hand ax will prove useful as a means for cutting slots in the soil for insertion of the lids. Should can lids be unavailable, small jars or bottles will serve as well. Simply tie the jars to corners of the blanket, fill them with sand to provide extra weight and bury them.—G. E. Hendrickson, Argyle, Wis.



Vinegar Prevents Paint Flaking From New Garbage Container

A new garbage container can be made to last longer right from the beginning by rustproofing it in the following manner: First paint the can, inside and out, with common household vinegar. This mild acid coating is used to "etch" the galvanized metal and thereby roughen the smooth surface. If this is not done, subsequent coats of paint will not bond properly and will eventually flake off. Similarly, flaking is quite common in the case of new house gut-

ters which are painted as soon as installed without first being etched. Roofing cement that has an asphalt base is superior to any paint as a preservative. Coat the entire can with cement and give both surfaces of the bottom an extra-heavy application. As an additional stunt to prolong life of the can, place a disk cut from wrapping paper in the bottom of the can and replace it each time the can is emptied.

Robert F. Funk, Sacramento, Calif.

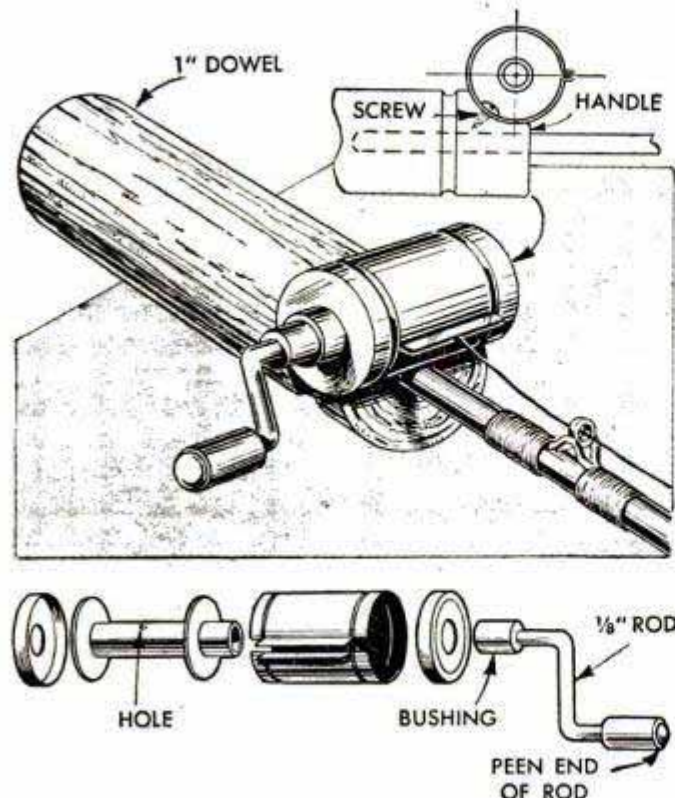

Film Cartridge Made Into Reel Suitable for Still Fishing

Save wear and tear on your better fishing tackle by letting the youngsters use an old rod equipped with this improvised reel. Satisfactory for still fishing, the reel consists simply of a metal 35-mm. film cartridge fitted with a crank bent from a length of $\frac{1}{8}$ -in. rod. The film spool is drilled to permit tying the fishline and the latter is brought through the slot in the side of the cartridge. One end of the crank is pressed tightly into a bushing which in turn is pressed into the end of the spool. If these parts do not fit together tightly enough to prevent slipping, they should be brazed or drilled and pinned. Before assembling the reel, the cartridge case is screwed to a length of dowel which has been drilled to form a handle for the rod. Note that the end of the dowel is cut away as indicated in the upper detail to suit the radius of the spool.

John Paszkiet, Chicago.



up. Toys you can make

BUILDING A PLAYHOUSE

Made mostly from material salvaged from 12 furniture boxes and 40 lettuce crates, this take-apart playhouse cost the Rev. Charles D. Shedd of Ponca City, Okla., a mere \$11.20. House comes apart in sections for moving

A DAUGHTER'S HERO is in the making when Dad sets to work building this little "dream home" for the No. 2 boss of the family. A home of her own in which to copy Mommie will make her the proudest little housekeeper in the neighborhood. True, this pint-sized cottage is apt to cost more than Dad would be willing to invest if he were to order all of the material from a lumberyard. But by rounding up a number of good-sized wooden packing boxes, which usually can be had for little or nothing from local merchants, building costs will barely dent the pocketbook.

The one-room floor plan measures approximately 4 x 6½ ft., and the house is so designed that it can be taken apart in sections for storing or moving. You'll note in the drawings that the various members specified for the wall framing are common lumberyard sizes, being 1 x 2, 2 x 2, etc. Although it is possible to build up these sizes from random widths and lengths of box lumber, as was done by the Rev. Mr. Shedd, those unable to obtain scrap wood suitable for the framing members will have a minimum of cutting if the stock sizes given are used. Common No. 2 grade lumber will be satisfactory for these pieces and considerably less expensive than select stock. As you may know, 1 x 2 material actually measures ¾ in. x 1½ in. This holds true with all lumberyard sizes, 2 x 2 being 1½ in. x 1½ in. square, etc. The thin material taken from lettuce crates is used as

siding, the ends of the pieces being butted against 1 x 2 battens which are nailed to the face of 2 x 2 studs.

Both ends of the house are made exactly alike, a 16 x 16-in. window being framed in each one. The back and front walls are of the same over-all size and differ only in that a door and a window are framed in the front wall. While the front and back walls are shown in two separate sections bolted together at the center to further aid in storing the dismantled house, they can be made in one section where the storage problem is of no concern. Totalling 80 in. over all, the front-wall framework pictured in the drawing on page 156 includes the thickness of the end walls. The sectional detail above the same drawing shows how flat-headed bolts are installed to lock the four walls together at the corners. Note that 1 x 2 strips are nailed to the studs wherever indicated to provide nailing surfaces for the ends of the siding. Note also how 1 x 2 corner boards are nailed only to the corners of the end walls. Each wall can be finished complete and then all four bolted together, or the skeleton framework of each wall may be bolted to the other wall frames first, and then the siding applied. In the latter case, the floor of the house should be made ready for bolting the walls to it. As the detail shows, the floor is simply a 2 x 6 frame set on edge and floored over. Holes are made in the lower members of the wall-section frames to slip over bolts

protruding through sides of the floor platform. It might be well to creosote the underside of the floor platform to preserve it against rot. Regardless, the house should be elevated off the ground by erecting it on bricks placed at the corners.

Door and window frames are built up in the manner indicated, a frame being made in each case to fit the particular opening and then faced with a $\frac{3}{4}$ -in. casing. Window sash are made by framing a pane of $\frac{1}{4}$ -in. crystal glass with wooden strips grooved to fit over the edge of the glass. Two small hinges at the bottom of each sash will permit opening. If desired, small screens can be made for the windows. The door is sided with slats taken from lettuce crates so it will match the rest of the house and is hinged to swing inward and fitted

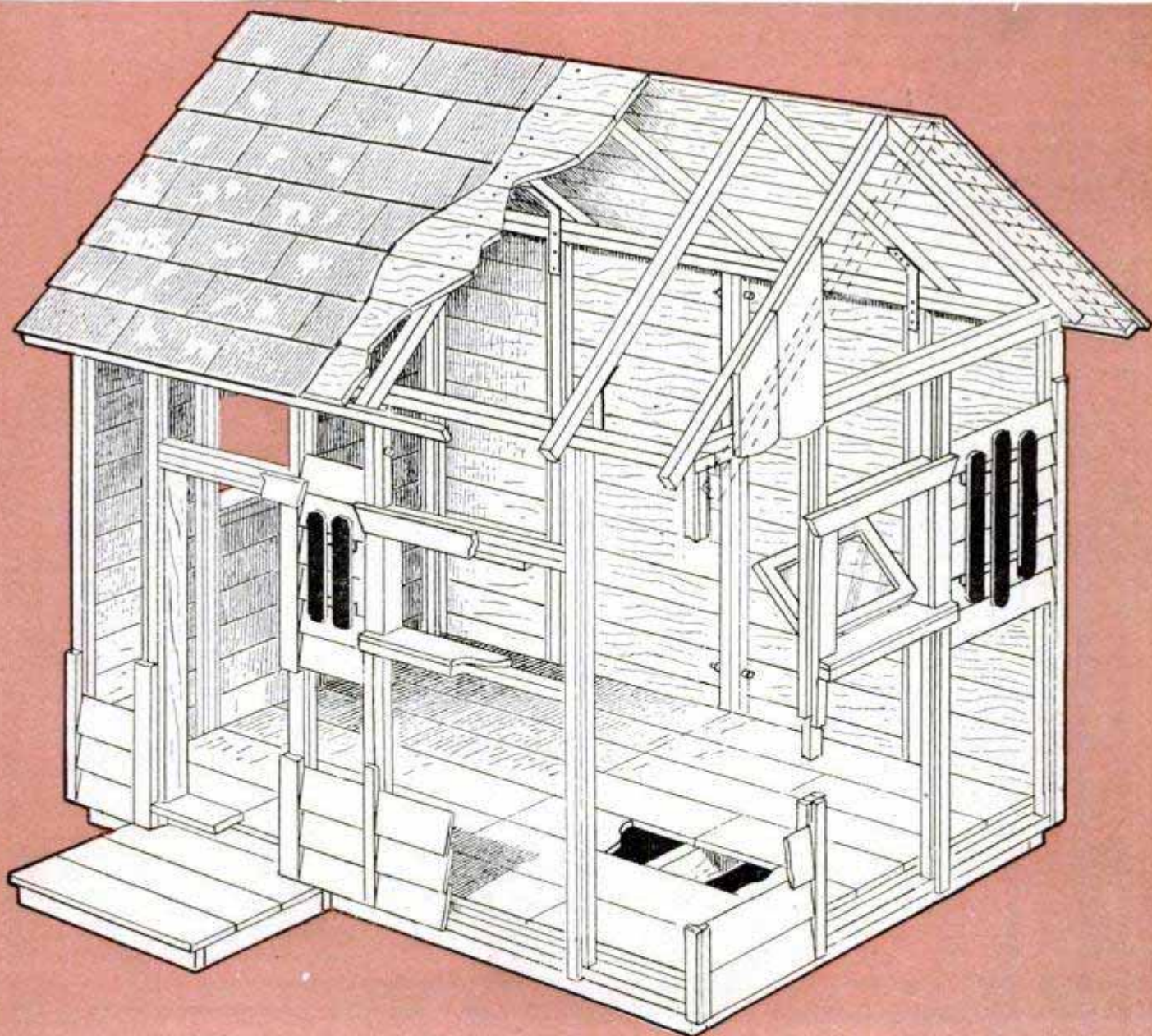
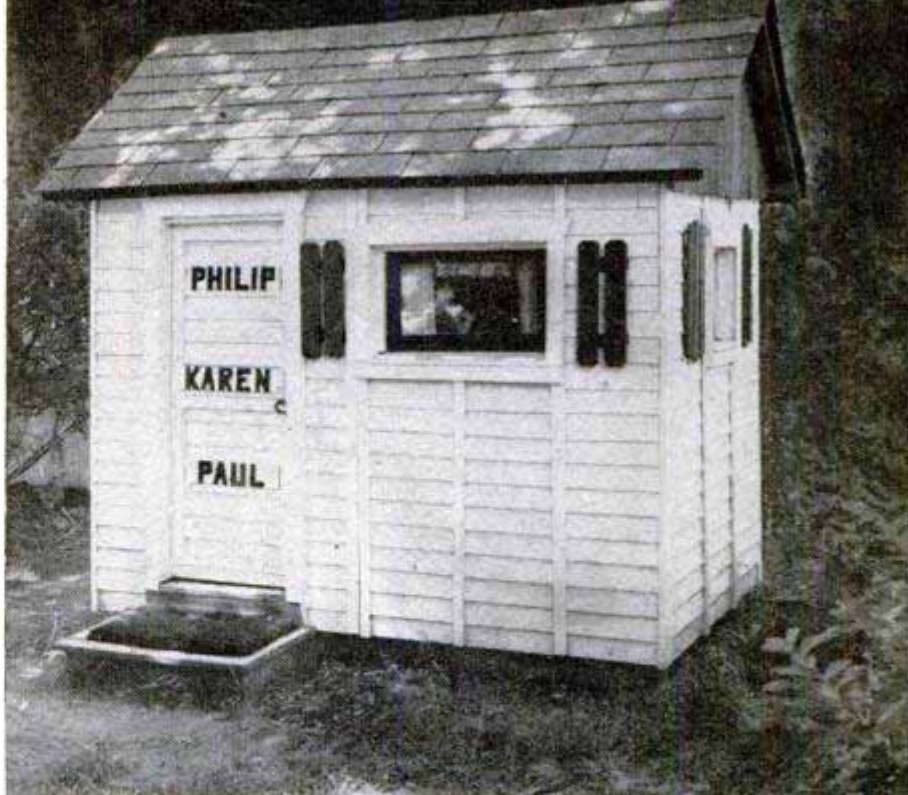



Curtained windows, throw rug and regular play furniture complete the interior of this cozy cottage

with a knob and lock. Final treatment of the outside includes the addition of shutters to the windows and a stoop in the front of the door.

The removable roof of the house is made in one piece and is attached by means of steel straps and screws. Roof framing requires fourteen 2 x 2 rafters, four being used at the ends of the overhang. Note that the rafters at the gables are joined together with a 2 x 2 plate to provide nailing surfaces for the vertical batten boards. Rounding the lower ends of these boards adds a decorative touch to the gable ends. The roof boards overhang the gables about 6 in. and are first applied, then sawed off

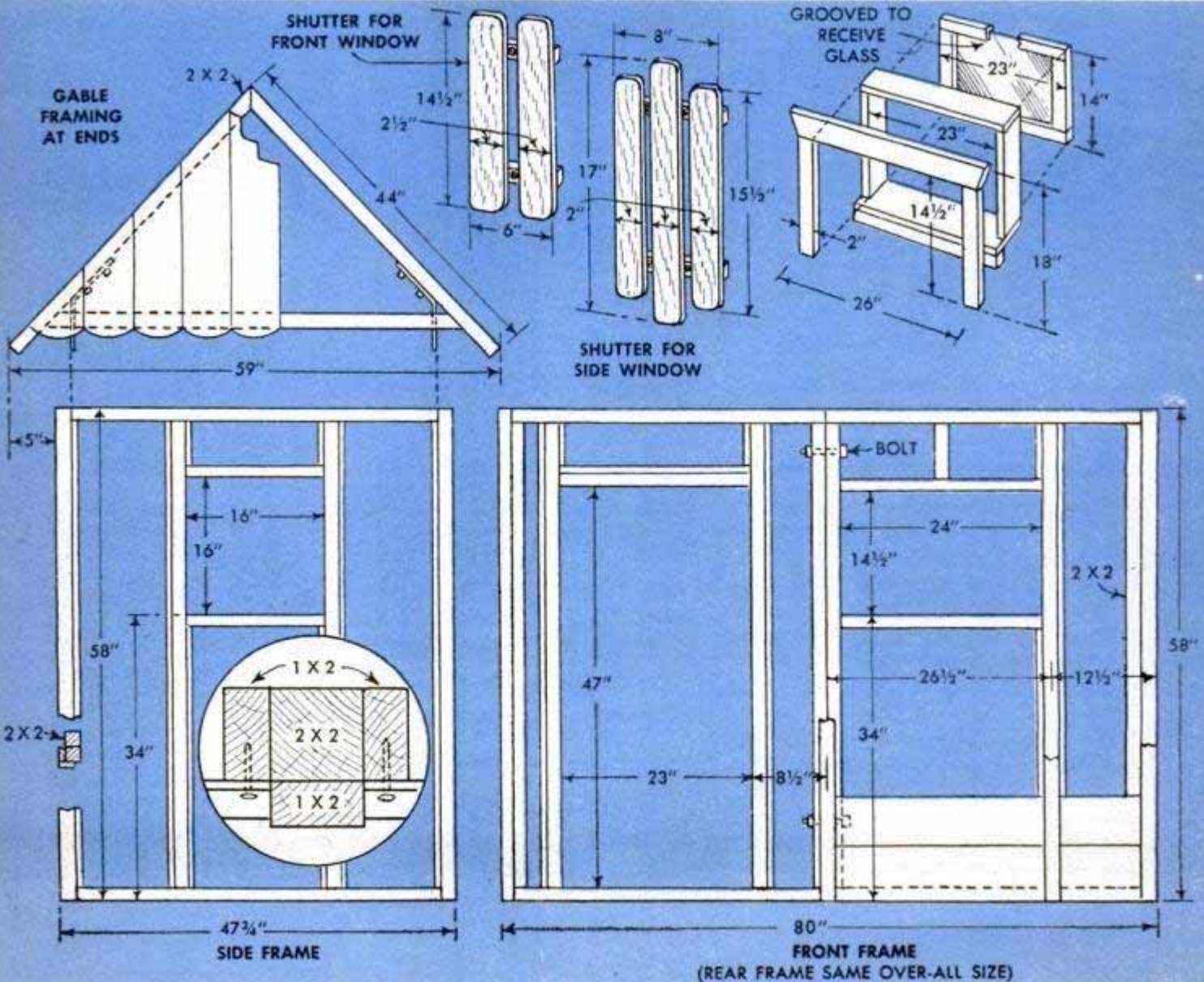
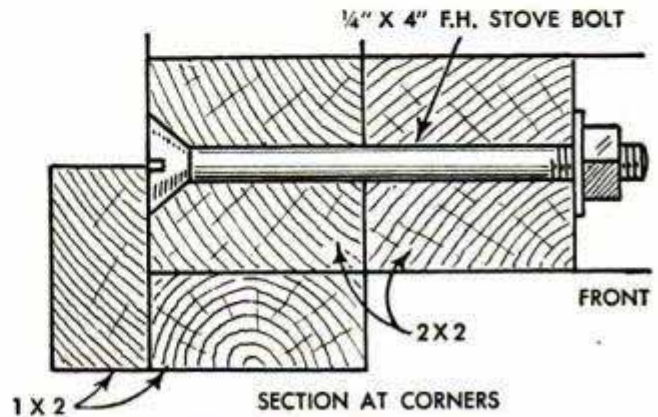

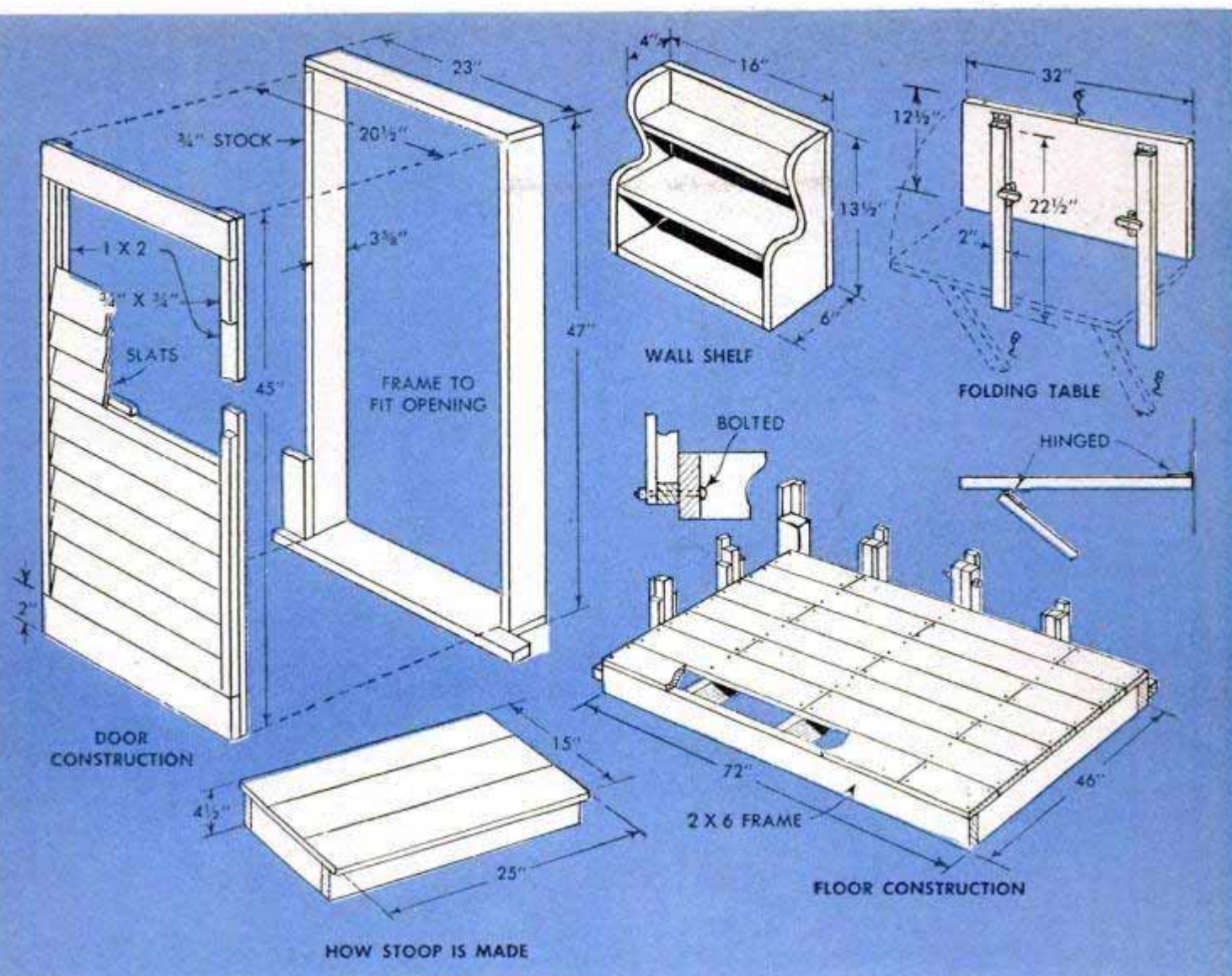

evenly at the ends and finally nailed to 2 x 2 rafters fitted flush with the ends. Regular roll roofing or asphalt shingles are used on the roof. The details show how a little shelf and folding table can be made to supplement regular play furniture. The top of the table is hinged along the back edge in a manner that will allow it to fold upward and flat against the wall when not

in use. Two wooden turn buttons attached to the underside of the table are provided for holding the hinged supports in place, and hooks and screw eyes are used to lock the table in the folded position as well as in a setup position. A scrap of linoleum may be added to the table top. A long extension cord plugged into a garage outlet will permit the house to be lighted. ★ ★ ★

Abrasive Recemented to Disk Sander by Heating With Lighter

If you own a disk sander and have a basement workshop, you know what summer dampness does to the abrasive paper—the paper invariably pulls away at the edge of the disk. As the paper is generally held with a stick-type adhesive which is applied by friction heat, it usually is necessary to pull off the paper disk, recoat the sander disk and replace the paper. However, there's a quicker way of recementing the pulled-away portions by simply using heat from a cigarette lighter. Held near the paper for a few seconds, the flame will warm the adhesive on the back of the paper and again make it sticky so the paper can be pressed down firmly with the thumb.



Rope Lettering on Address Plaque Suggests Nautical Theme



An address plaque or sign of the type commonly used to identify and locate resort property can be given a nautical touch by forming the letters with $\frac{1}{4}$ or $\frac{3}{8}$ -in. rope. A small ship silhouette cut from hardboard or thin plywood may be added if desired. After cutting the board to the dimensions required, sand it smooth and apply a coat of paint. Now dip the rope in paint of any color that will contrast with the painted surface of the board. While the rope is drying, pencil in all lettering and numerals on the board, at the same time avoiding any sharp turns that would be difficult to form with the rope. As you lay out the rope, staple it to the board. Then apply a coat of shellac to finish the job. The unit may be supported by a flat-steel bracket bent at a right angle at one end and bolted to a tree or post. Steel is drilled and tapped to take screw eyes.—A. E. Fenn, Chicago.

Old Horse-Drawn Disk Harrow Adapted to Tractor Lift

For maneuverability in small fields and farm gardens many farmers adapt old horse-drawn disk harrows for direct attachment to the tractor hydraulic lift. This permits the implement to be raised and carried on the tractor lift when turning or backing into corners at the headlands, thus eliminating the difficulties of turning with a drawbar-towed implement in close quarters. Also, the problem of transporting separate units on the highway or from field to field is solved in this way, too. The photo shows clearly how a 10-ft. single disk harrow was adapted to use with the Ford-tractor lifting mechanism by cutting the disk drawbar and welding on parts to form a hitch suitable for use with this particular tractor. Other adaptations to fit different

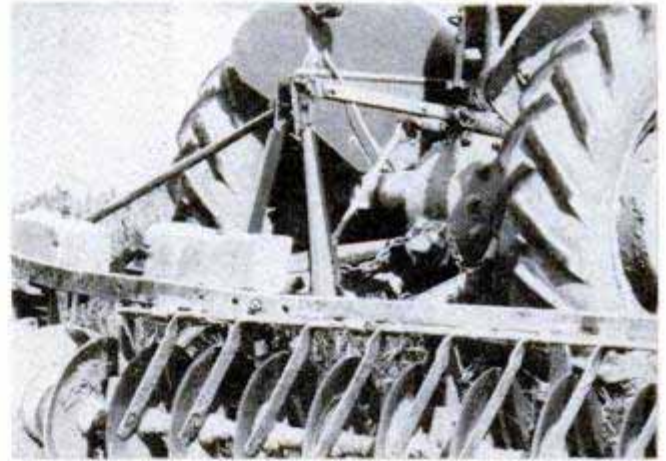

types of tractor lifts also are possible and may be made with little difficulty.

A. M. Wettach, Mt. Pleasant, Iowa.

Putty Holds Wrench Close at Hand Until Needed for Saw Adjustment

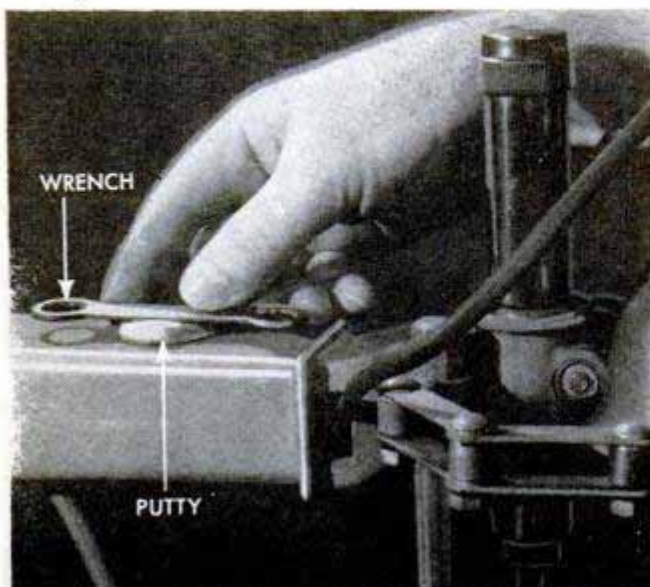

Pressed into a lump of tacky weather-strip putty, a wrench may be held in a convenient location for ready use on a jig or band saw, or other power-driven tool. Neither the wrench nor the putty will jar loose easily, and the arrangement eliminates the possibility of vibration noises.

Extra Pan Secures Pie Covering

To carry a pie or cake and at the same time protect it from dust in the air, cover it with a cloth or wax paper and set it in another pan of the same size. With the loose ends tucked in between the pans, the covering will be kept in place and provide an effective covering during normal handling.—B. Franklin, Azusa, Calif.



OUTBOARD-MOTOR CARRIER

Tired of lugging his heavy outboard motor around and more concerned that it might be damaged in carting it loosely in the trunk of his car, Tommy Stenger of Los Angeles, Calif., took care of the situation by building this combination two-wheel carrier and cart. With the cart serving as a cradle for the motor, the whole thing is lifted into the trunk for safe cartage. The cart is tailored to fit the particular motor used

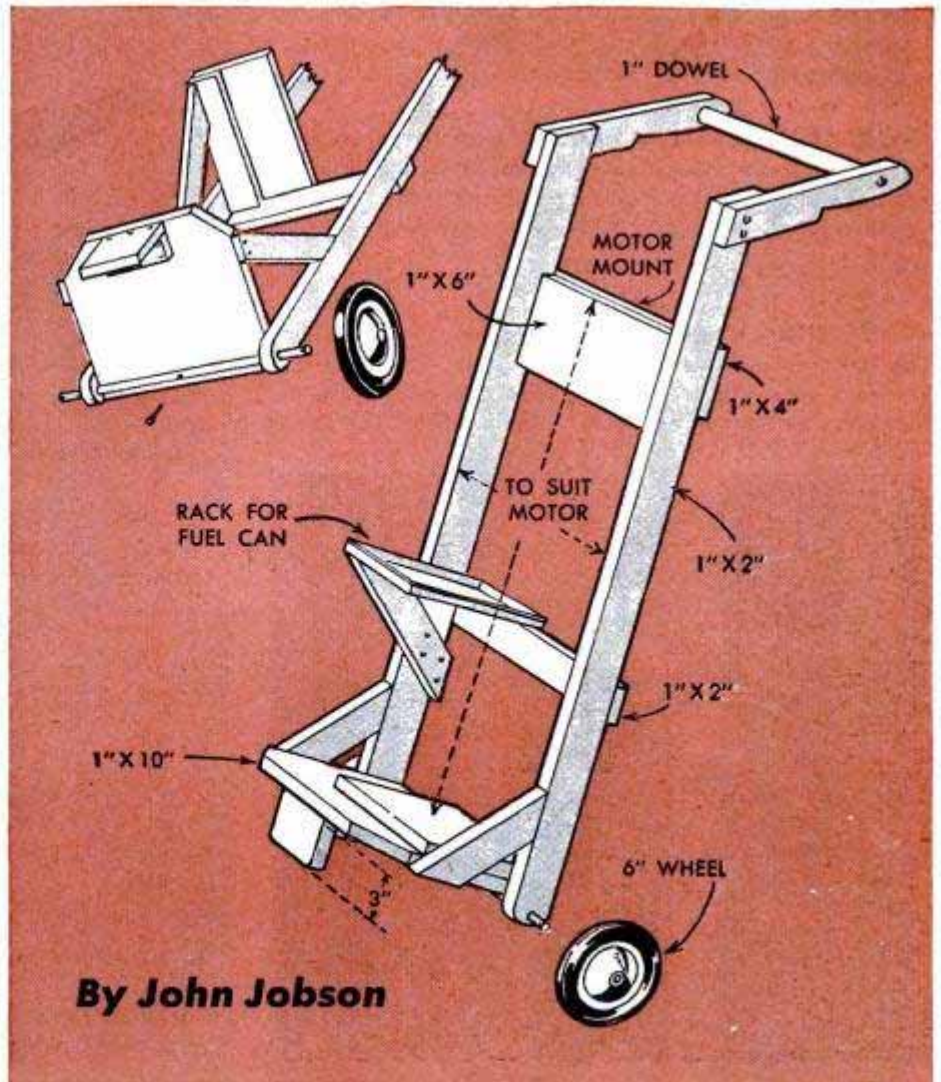
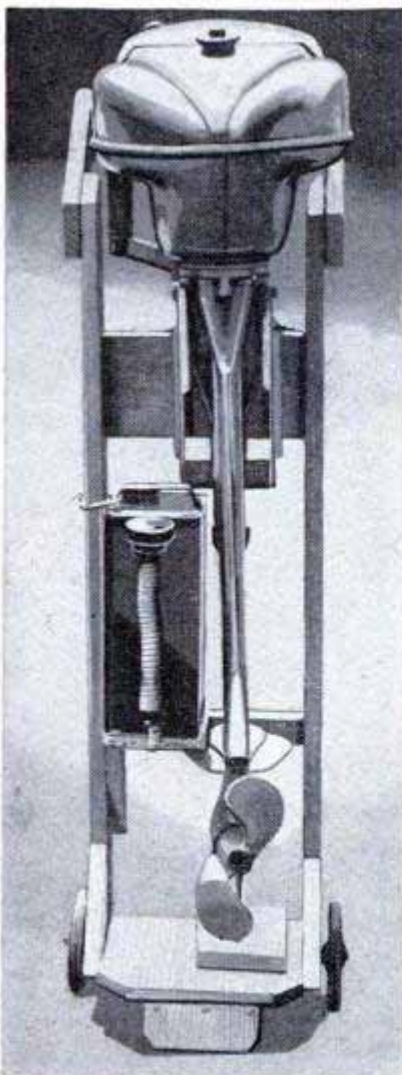

Solving HOME PROBLEMS

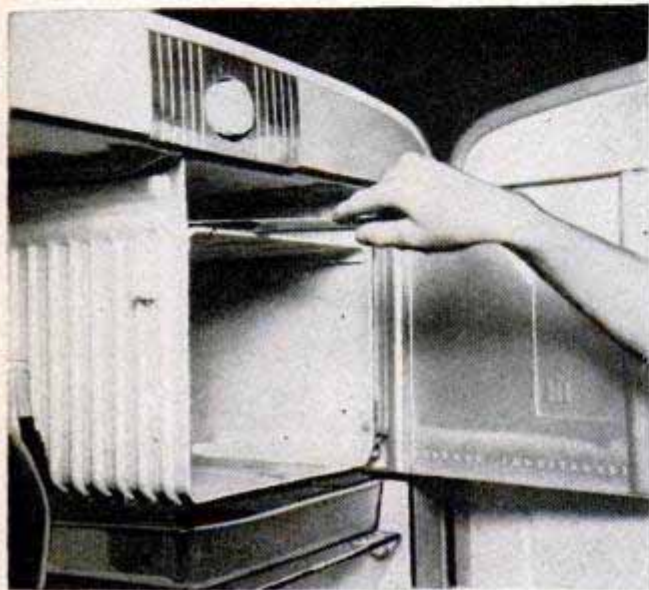

DEFROSTING A REFRIGERATOR is speeded by using a discarded windshield-wiper blade as a squeegee to remove excess water from the coil unit. Wiper permits access to places usually hard to reach with a cloth

SOME WINDOW-SCREEN LATCHES are easily turned by children and the screen pushed out. To avoid this, drive a screw in the parting stop and a hook in the screen. Then wire the hook to the head of the screw



PINCUSHION ON SEWING MACHINE is always within easy reach. To make cushion, wrap several turns of heavy flannel or felt around arm of machine at point where it will not interfere with thread



SPRINKLE KERNELS OF POPCORN lightly with warm water an hour or two before popping. Regardless of popping method, this will reduce the number of unpopped kernels and improve flavor

TO PROLONG LIFE OF CHECKERBOARD, cover playing surface with a coat of clear shellac. In addition to forming protective finish, shellacked surface is cleaned simply by wiping with damp cloth



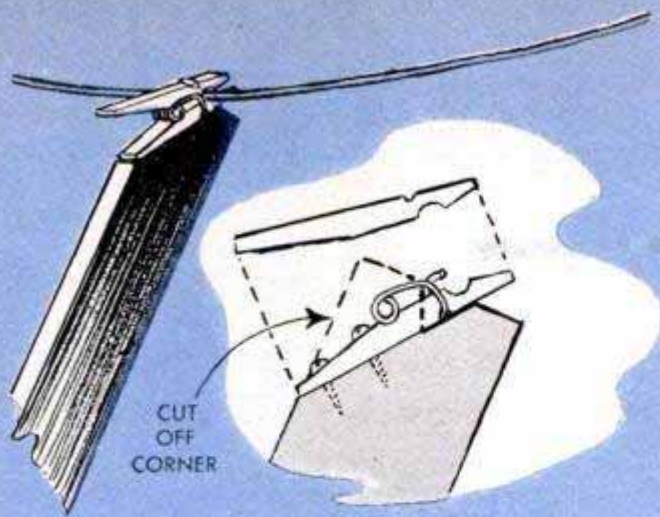

FITTING THE TOP OF A CLOTHES POLE with a spring-type clothespin provides a positive grip to keep the pole from slipping out of place or falling to the ground. Clothespin is screwed to beveled edge of pole

STORED LOOSELY in a sewing basket or drawer, a razor blade is a dangerous tool. To protect your hands and aid in finding the blade, keep it in a covered box of the type in which aspirin are sold

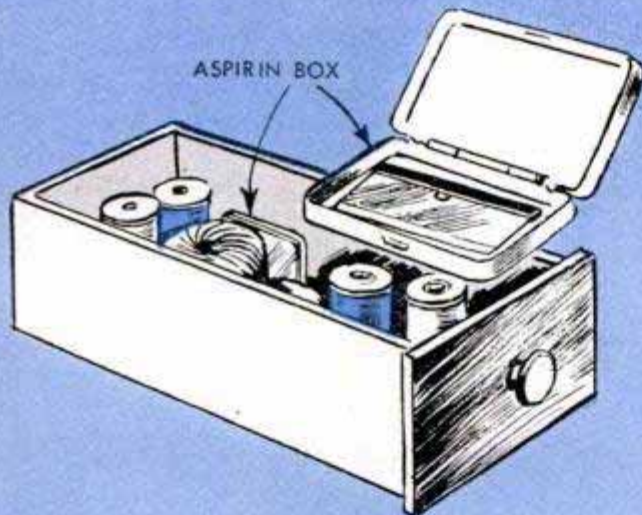

WINDOW SCREENS can be kept clean with only an occasional dusting if given a coat of liquid wax before they are put up. Apply wax with a pad of cheesecloth or toweling tacked to a wooden block

IF THE RING FASTENER on a measuring-spoon set should break, or become bent to the point where it interferes with separating the spoons, cut it off and replace it with an ordinary notebook ring

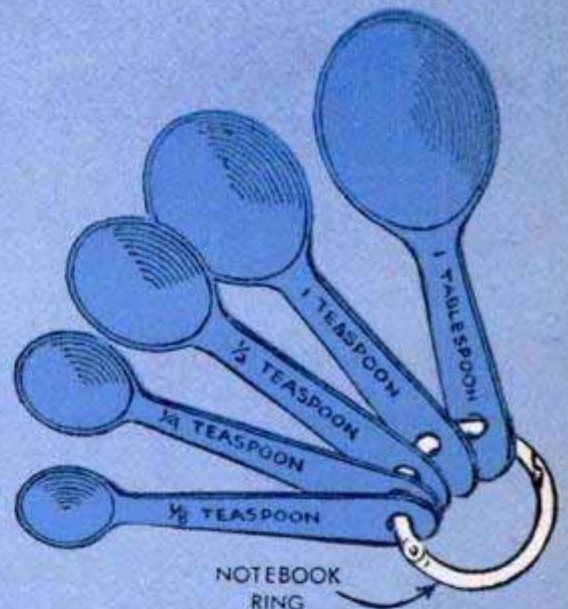

Popular Mechanics Household Hints

- **EXTRA BATCHES OF ICE CUBES** can be frozen and then stored in food compartment of refrigerator by removing cubes from trays and wrapping in metal foil
- **FINGERNAIL POLISH** keeps small screws in eyeglass frames from working loose. Remove screws and place a drop of polish in each hole. Then replace screws
- **SPONGE MOP** can be improvised from sponge and clamp-type handle of ordinary yarn mop. Just clamp a large cellulose or natural sponge to handle
- **TO KEEP FLIES OUT** of the house while painting the outside window trim, stand the screen on the inside window sill. Tie screen in place or hold with a prop
- **BLACK CRACKLE FINISH** used on many metal objects is cleaned easily by coating it with black liquid shoe polish, wiping off the polish before it dries
- **WHEN WET UMBRELLAS** must be placed in the hall, set a paper drinking cup under the tip of each one to retain the water that would drip to the floor

Pointed Section of Bamboo Holds Small Flagpole



A holder made from a short length of bamboo will help to prevent breaking the staff of a small lawn flag when forcing it into the ground. The holder is cut from the end of a fishing pole and pointed as indicated so that it can be driven like a tent stake. In instances where large flags are used, a short length of pipe of suitable diameter may be used in the same manner.

C-Clamp Stops on Steel Square Simplify Rafter Layout

To make it unnecessary to keep checking the placement of a framing square in using the step-off method of laying out the length of a rafter, one amateur home builder

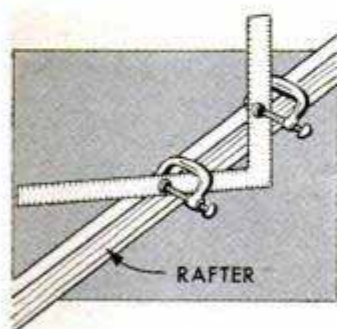

attaches two C-clamps to the square to serve as stops. In this way, the square is simply moved along the edge of the work from one mark to the next. As an example, suppose the desired pitch calls

for a 4-in. rise and a 12-in. run on the framing square. One of the clamps is placed on the 4-in. mark on the tongue of the square and the other is placed on the 12-in. mark

on the beam, or long end, of the square. The clamps are adjusted so that the 4 and 12-in. marks arrive at the very edge of the work when the clamps bear against the rafter. The method eliminates the chance of being off slightly in placing the square each time it is moved.

R. Harrison, Edmonton, Alta., Can.

Sleeve "Guards" Protect Clothing During Emergency Car Repairs

One motorist slips a pair of sleeves cut from a discarded jacket over the sleeves of his clothing to protect them from dirt and grease while checking and working on the engine of his car. Facings were added to both ends of the sleeves after which elastic was inserted to help keep the sleeves in place when worn. Taking up little room, they are carried in the glove compartment of the car so that they are available at all times.—Blanche Campbell, Las Vegas, Nev.

Worn Leather-Punch Anvil Replaced by Copper Rivet

When the soft copper or brass anvil of a leather punch wears to a point where it no longer can be dressed with a file, remove and replace it with a large flat-headed copper rivet. Usually the original anvil is removed easily with a pin punch. Then place the rivet in the hole and force it home by closing the leather punch on it lightly. Cut off the projecting end of the rivet and peen it flush.—Ken Murray, Colon, Mich.

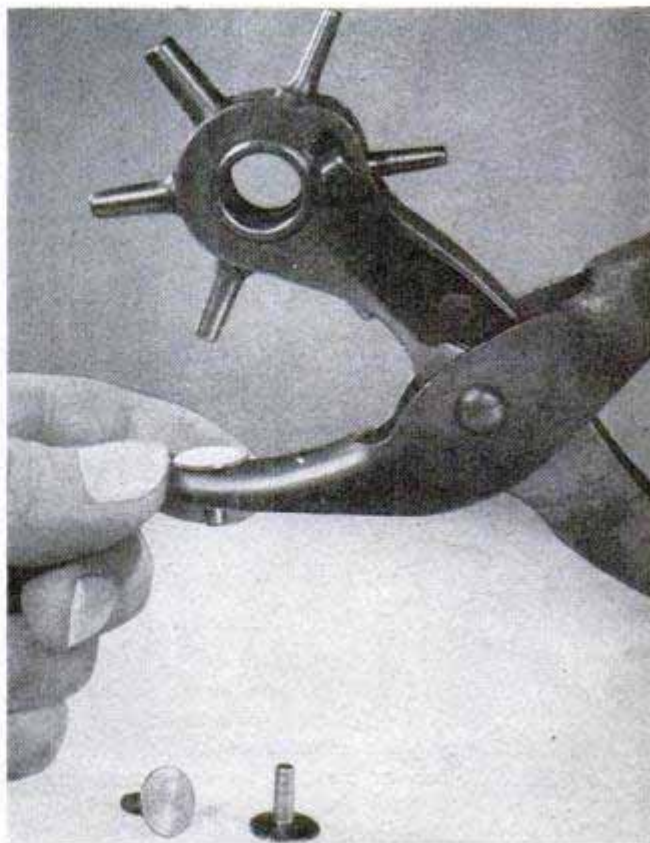

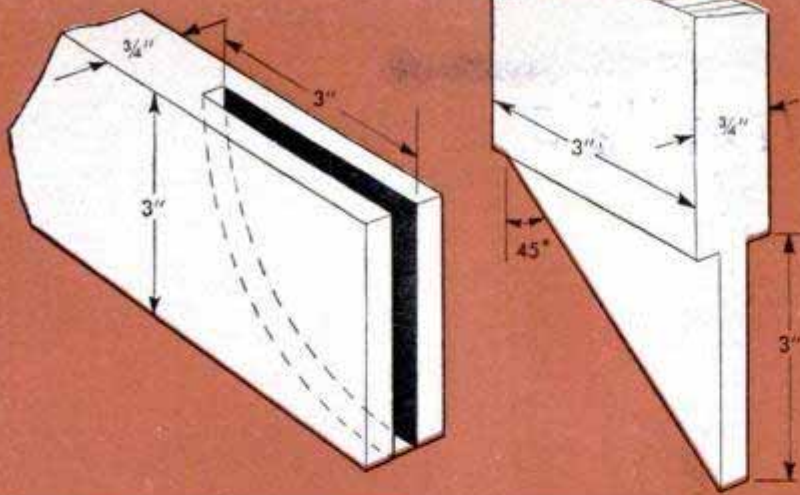

CUTTING AN OPEN MORTISE

By Dick Hutchinson

ON CERTAIN types of work, such as joining the frames of small cabinet doors or screens, it is possible to halve the time required to make either a housed mortise-and-tenon or a through mortise-and-tenon joint. Lay out the work as you would in making a through mortise-and-tenon, then lower the saw blade to a height above the table equal to the width of the stock. Measure from the point where the saw teeth pass through the table back along the blade a distance equal to the width of the stock and make a light pencil mark on the table. Clamp a stop to the table with its inner edge as close to the

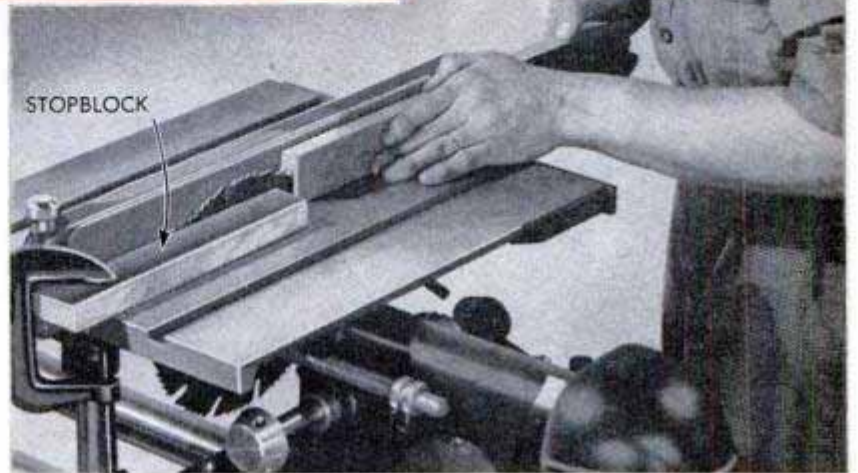

Stopblock shown clamped to the saw table stops each cut at precisely the same depth to form curved-bottom slot in the stock

blade as possible, the end being located flush with the pencil mark. Then make successive cuts in the ends of the frame stiles, running up to the stop at each pass. Cut the matching tenons in the regular way, making sure that the thickness of each one is equal to the width of the slot. Then cut the tenons at a 45-deg. angle as shown in the detail. Although the joint can be pinned it will be somewhat stronger if glue is used.

Homemade Rotor-Type Mower Is Self-Propelled

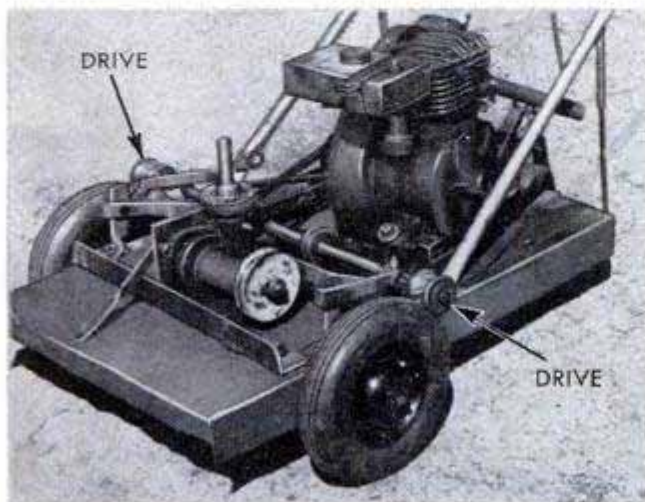

Utilizing parts from a discarded lawn mower, one owner of a homemade rotor-type mower built a friction-drive mechanism that uses the ratchets on the original shaft to obtain the necessary differential action. Steel rollers mounted on the ends of the shaft and welded to the pinions have a friction tread obtained by running uniformly spaced bead welds diagonally on the face of each one. The friction shaft is driven by a V-belt from the rotor shaft and is pivoted so that it can be raised and lowered by a lever mounted on one handle bar. In the lowered position the rollers contact the tire treads and drive the mower forward.

L. H. Houck, Jefferson City, Mo.

PLAN of the MONTH...



MATERIAL LIST

Tempered hardboard

- 2 pcs.— $\frac{1}{4}$ " x 14" x 36"—Table tops
- 2 pcs.— $\frac{1}{4}$ " x 12" x 32 $\frac{1}{2}$ "—Bench tops

Lumber

- 4 pcs.— $\frac{3}{4}$ " x 1 $\frac{3}{4}$ " x 34 $\frac{1}{2}$ "—Table-top rails
- 4 pcs.— $\frac{3}{4}$ " x 1 $\frac{3}{4}$ " x 14"—Table-top rails
- 4 pcs.— $\frac{3}{4}$ " x 1 $\frac{1}{2}$ " x 31"—Bench-top rails
- 4 pcs.— $\frac{3}{4}$ " x 1 $\frac{1}{2}$ " x 12"—Bench-top rails
- 8 pcs.— $\frac{3}{4}$ " x 1 $\frac{3}{4}$ " x 14 $\frac{7}{8}$ "—Bench legs
- 4 pcs.— $\frac{3}{4}$ " x 2 $\frac{5}{8}$ " x 6 $\frac{15}{16}$ "—Top bench-leg rails
- 4 pcs.— $\frac{3}{4}$ " x 1 $\frac{3}{4}$ " x 8 $\frac{3}{8}$ "—Bottom bench-leg rails
- 4 pcs.— $\frac{3}{4}$ " x 1 $\frac{1}{4}$ " x 11 $\frac{3}{4}$ "—Bench pivot braces
- 4 pcs.— $\frac{3}{4}$ " webbing strap 13" long
- 1 length of $\frac{3}{8}$ " dowel

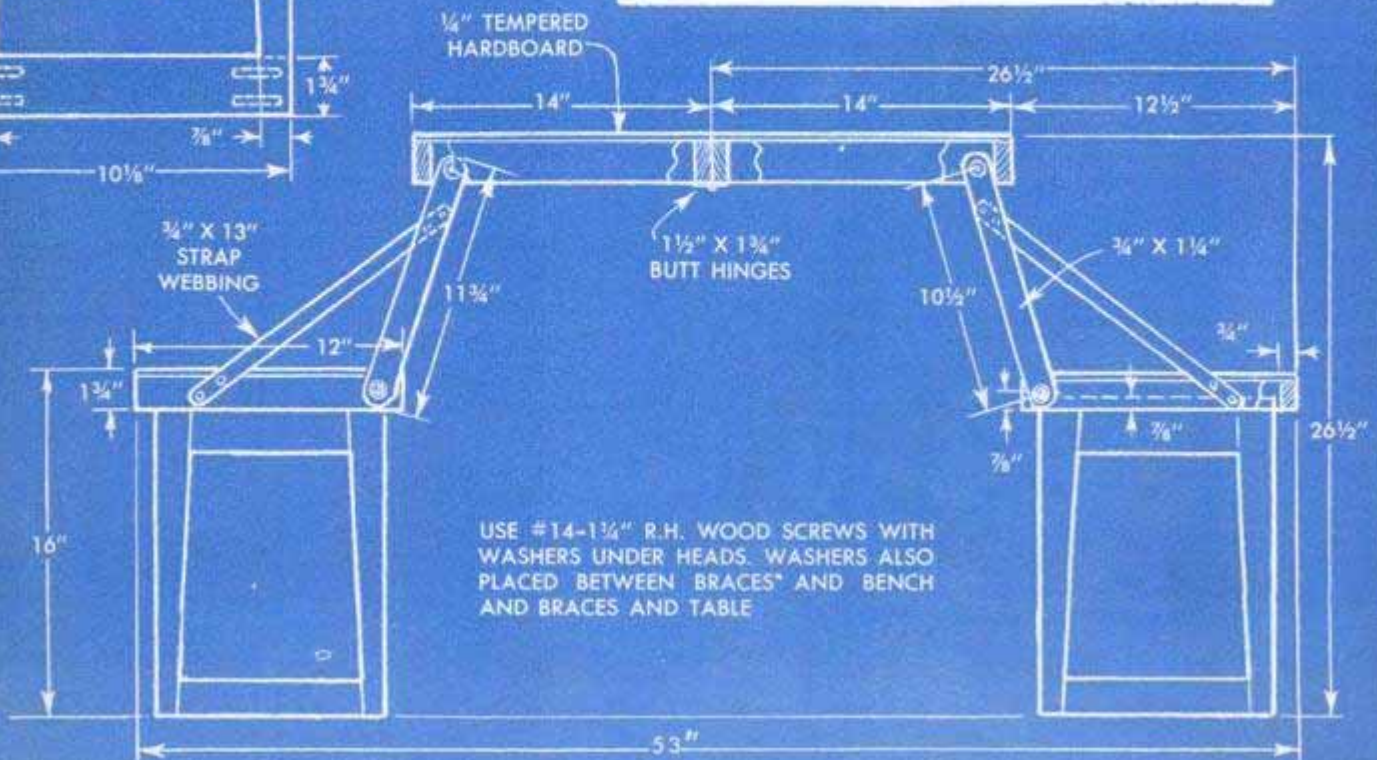
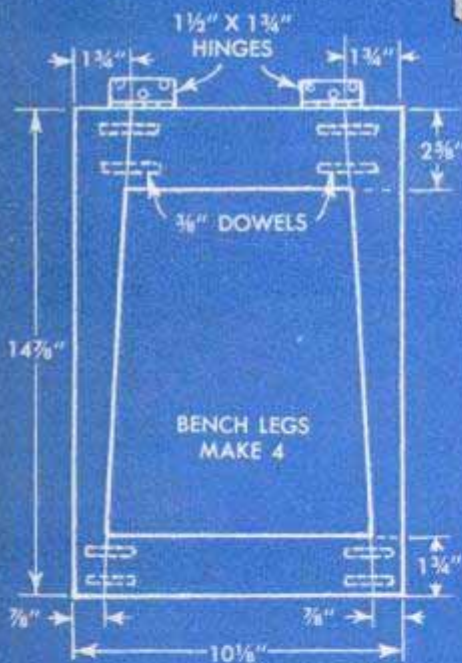

USE #14-1 $\frac{1}{4}$ " R.H. WOOD SCREWS WITH WASHERS UNDER HEADS. WASHERS ALSO PLACED BETWEEN BRACES AND BENCH AND BRACES AND TABLE

...Suitcase Picnic Bench

Have you ever packed a picnic basket and hurried off to the park only to find all the tables and benches taken? Such a situation will be of little concern when you have your own picnic table packed away in a compact "suitcase" measuring only 4½ x 14 x 36 in. It's small enough to fit nicely in the car and light enough to carry easily. Set up, the unit provides a 28 x 36-in. table flanked by two attached benches. The whole thing is designed so that the benches nest in the two halves of the table top. Regular card-table leg braces are used on the benches to permit the legs to fold flat inside the bench tops. Wooden links pivot the benches to the table, and strap webbing provides check straps to keep the bench tops level with table.—John Bergen, Chicago

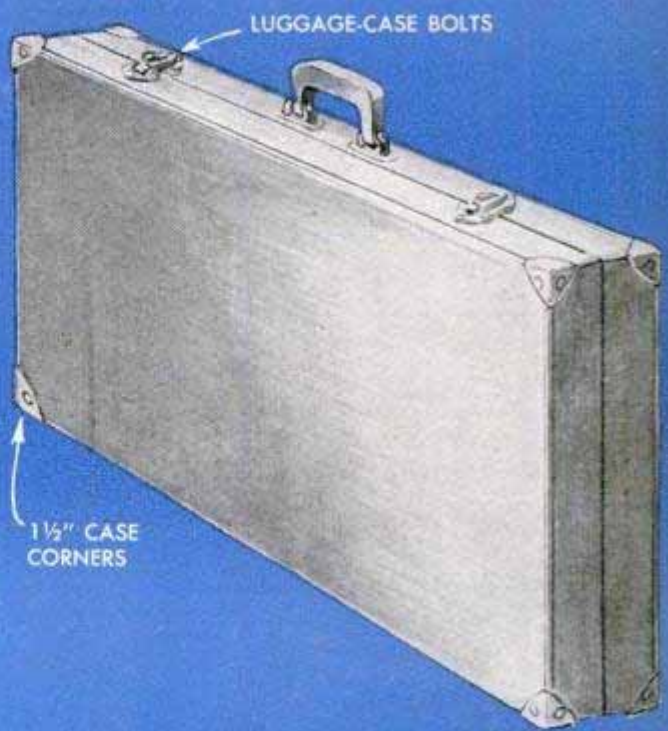

USE WATERPROOF GLUE IN ASSEMBLY OF CASE AND BENCHES

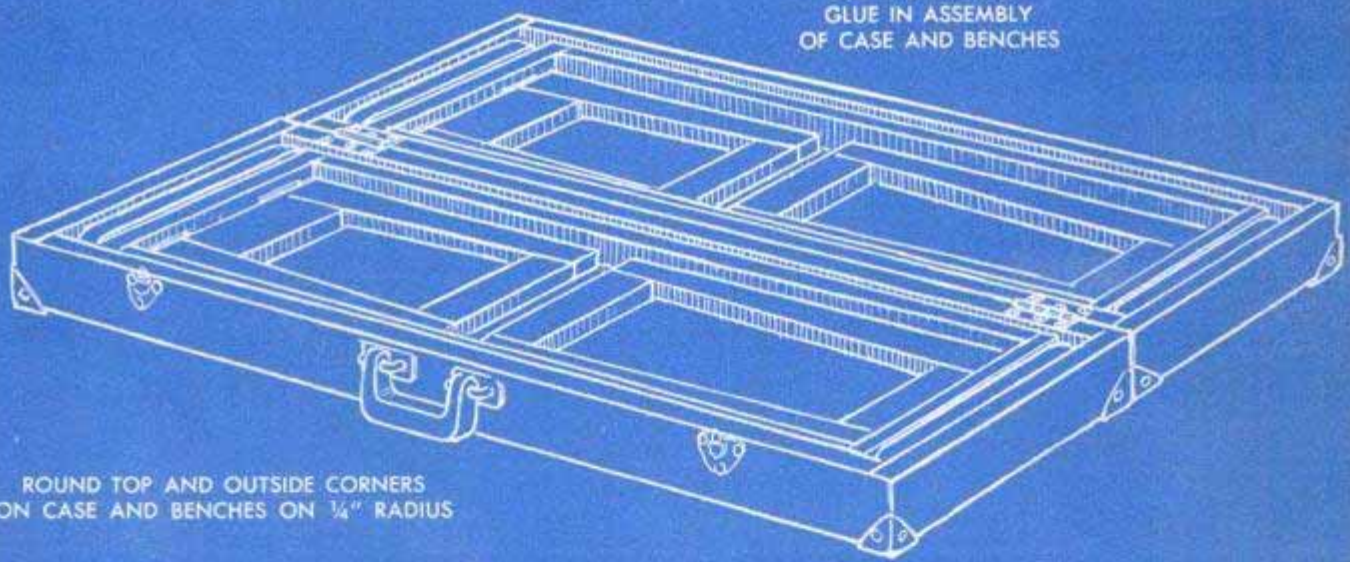

ROUND TOP AND OUTSIDE CORNERS ON CASE AND BENCHES ON ¼" RADIUS

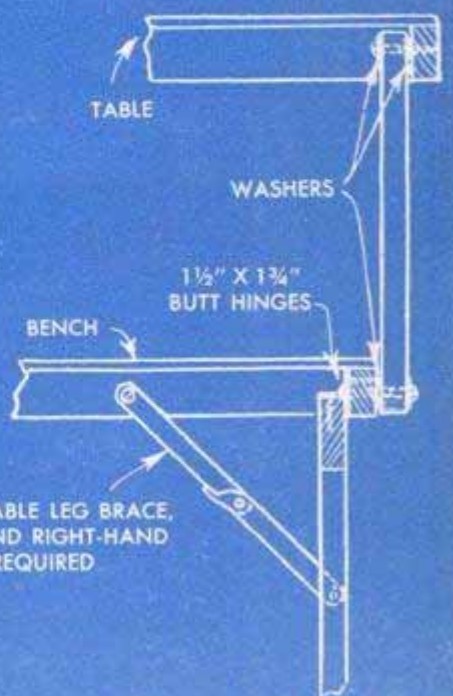
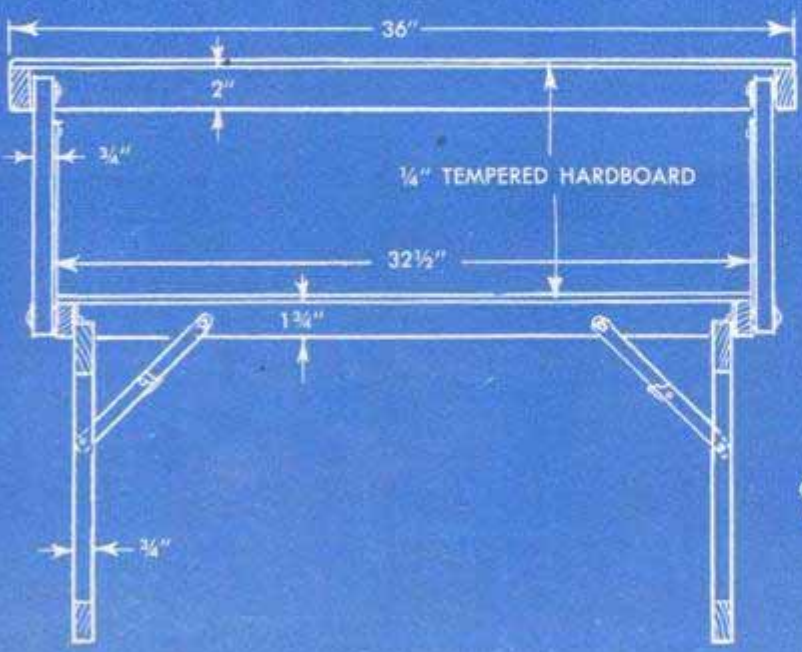

CARD-TABLE LEG BRACE, LEFT AND RIGHT-HAND REQUIRED

Farm-Implement Wheels Make Sturdy "Fences" for Flower Beds

To protect her flower beds, one rural housewife had durable enclosures made from several discarded steel wheels from farm implements. First, an acetylene torch was used to cut the hub sections free from the spokes where they were joined. Then the spokes were heated at the rims and bent back at right angles to form legs. This done, the wheels were placed over the flower beds and then painted.

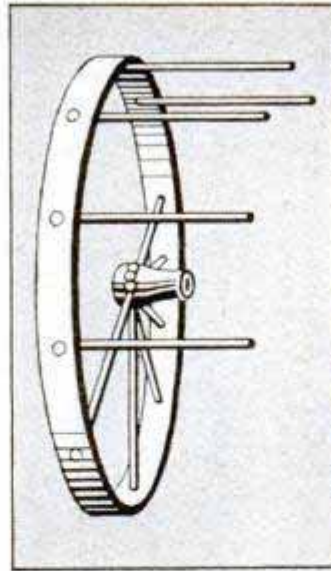

Removing Wood Chips From Blind Holes

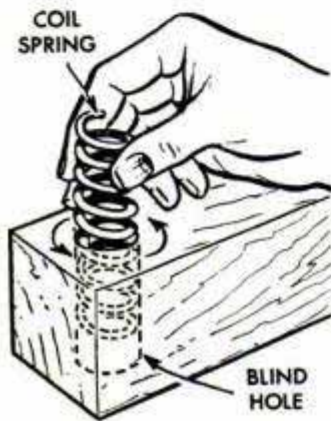

The difficulty of removing wood chips from a blind hole, especially in work too large to turn upside down, can be overcome by inserting an open-coil spring in the hole and giving it a few turns. This will cause the chips to become enmeshed in the

spring and permit removing them by lifting out the spring. If a hole is quite deep, it may be expedient to clamp the spring in a bit brace for turning.

A. H. Waychoff, Phoenix, Ariz.

Removable Fence Fastened With Staples and Nails

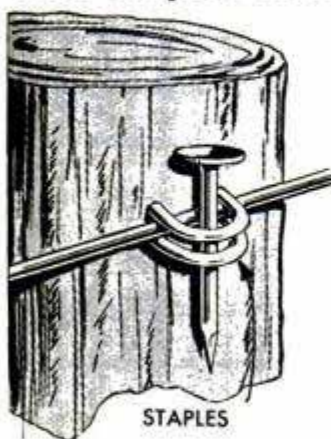

When a section of fence that may be removed easily is needed, considerable time and expense can be saved by using staples and nails to hold it in place. Two staples are driven into the fencepost above and below the wire where support is

desired and a roofing nail having a large head is inserted through the staple. The fence is unfastened by simply removing the nails.—Hugh Lineback, Stillwater, Okla.

Rubber Hose Cushions Stepladder

Leaning a stepladder against a wall is likely to result in marring the paint or paper. To prevent this, just cushion the edge of the top step by fitting it with a section of garden hose slit lengthwise.

T. P. Ilari, Louisville, Ky.

Leather Case Holding Slipstone Used to Strop Blade Edges

By making this useful dual-purpose leather case for a slipstone, you not only can provide protection for the stone when it is not being used but you can also utilize the outside of the case for stropping purposes. The case is cut from a piece of medium-weight leather and shaped around the thick edge of the stone, the ends being joined and stitched together at the thin edge. When the case is used for stropping, the stone is left inside the case. Before the case is stored it should be wrapped in wax paper to prevent it from being marred by dirt and grit.

John M. Avery, Dexter, N. Y.

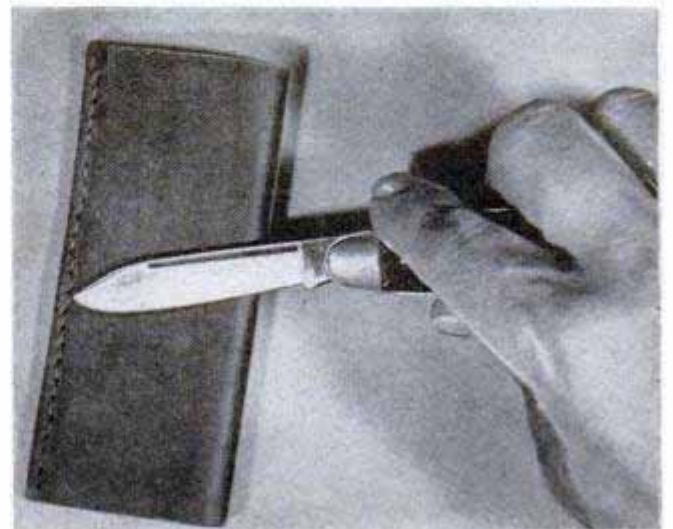

"Growing" GARDEN UMBRELLA



FRAMEWORK ASSEMBLED
FROM No. 6 GALV. WIRE

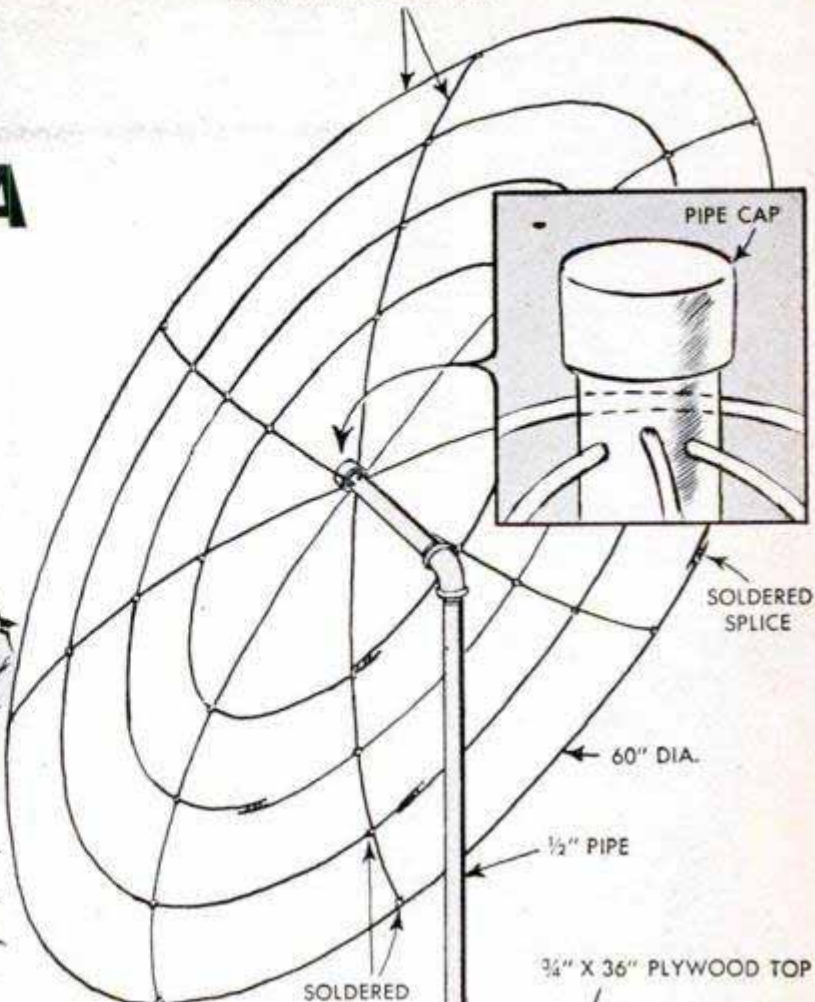

FEATURING GROWING vines that climb its supporting standard and fan out to form a novel sunshade, this garden umbrella will become the center of attraction in any garden. Its base is cut from a small keg with legs formed from 1-in. flat steel attached to the bottom with screws. Four notched wooden supports hold up the table top which is provided with an opening large enough to permit vines to climb the standard. A steel brace across the opening, together with a wooden block centered at the bottom of the keg, holds the pipe standard upright. Eight holes, drilled near the top of the standard, accommodate the wire ribs of the umbrella which are soldered to the pipe, and to each other, for additional stability. Several vines that are suitable for use with the umbrella include: Morning-glory, honeysuckle, Virginia creeper, Wistaria and (for tropical climates) Bougainvillea.

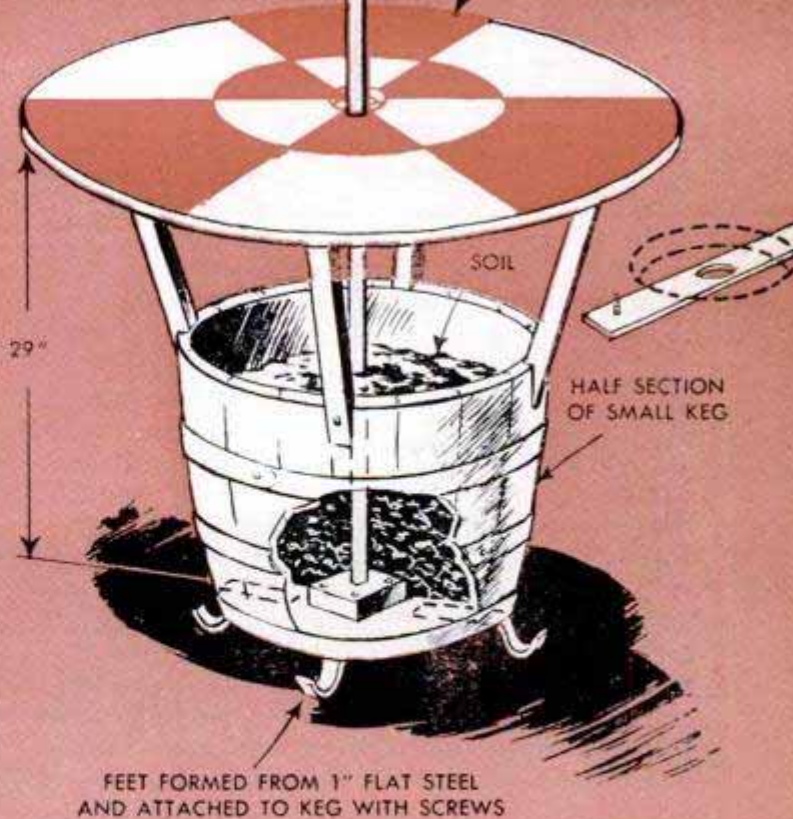

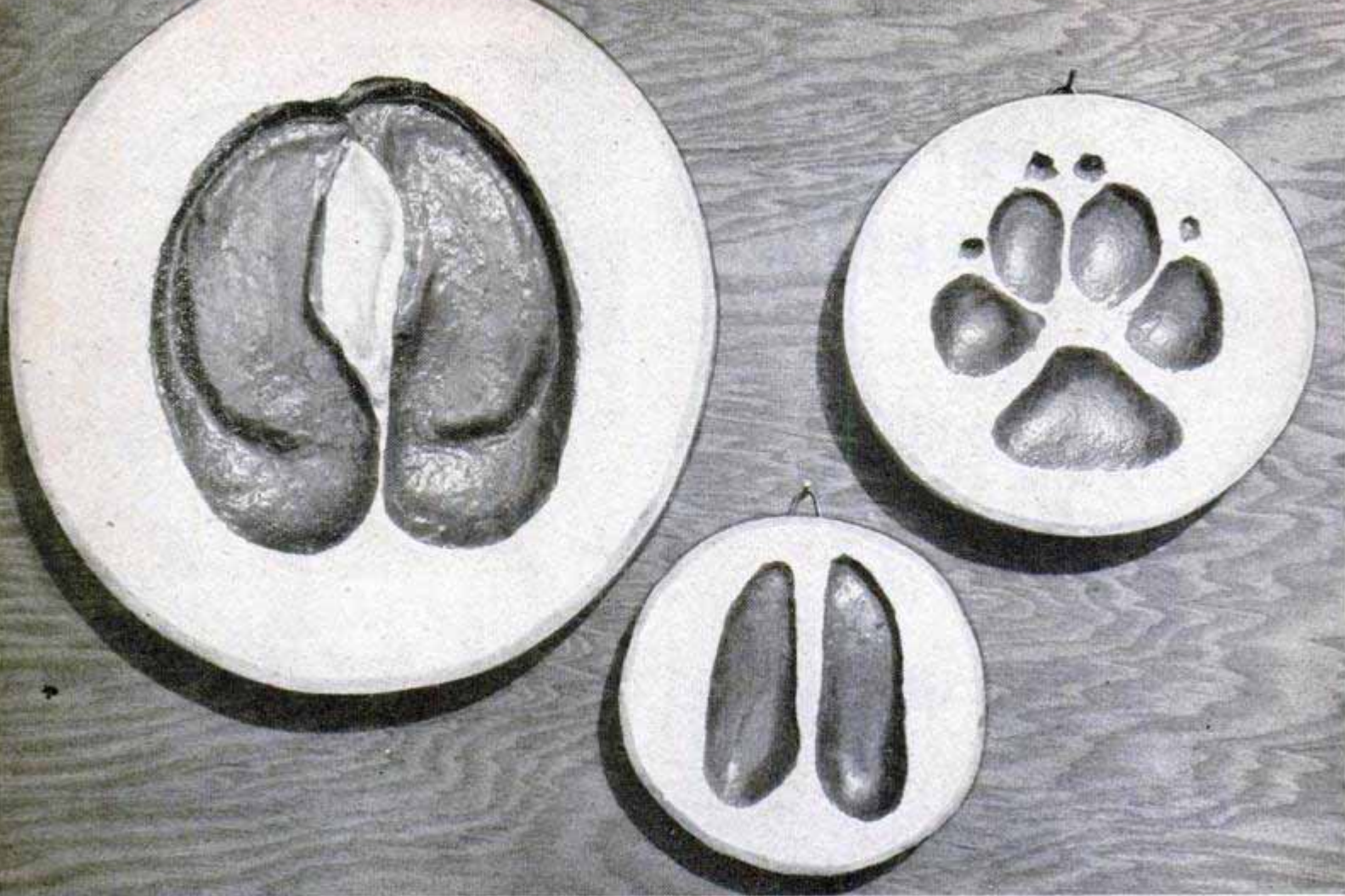

ANIMAL TRACKS in PLASTER

By Tom McHugh

PLASTER CASTS taken from tracks made by pets or game animals in snow, sand and earth can be made into attractive colored plaques for the den or recreation room. Tracks of wild animals are located along stream banks where the soft mud at the water's edge usually retains a sharp, well-defined imprint of the tracks of both large and small animals. In more remote areas, look for tracks along game trails and around dens. After selecting a suitable imprint in firm earth, carefully clean out all loose material. Make a shallow retaining wall around the imprint, using a strip of thin sheet metal or cardboard, holding it in place with stakes broken from small twigs. If the imprint is in soft, wet earth, dust the surface with talcum powder to keep the plaster from sticking. Mix plaster of paris to the consistency of thick cream and begin pouring at one side of the wall so that the plaster will flow over the imprint, thus excluding air bubbles. Pour and level quickly to a depth of $\frac{1}{2}$ to $\frac{3}{4}$ in., the thickness of the cast depending to some extent on the size and depth of the imprint and the na-

ture of the surrounding area. Allow the plaster plenty of time to set, then remove the retaining wall and lift the plaster cast carefully to avoid breakage at the sharp edges. Clean the cast with a toothbrush and fill any holes or other imperfections with a plaster-patching stick or with a thin mixture of plaster. When thoroughly dry, apply two coats of shellac. This completes the negative cast and from this you can make a number of positives, if desired.

To make a negative cast of an imprint in snow, spray the imprint and the surrounding area with cold water and allow it to freeze. Then mix the plaster with cold water and pour in the manner just described, using a somewhat larger retaining wall to prevent cracking the frozen snow near the imprint. As soon as the plaster has set, remove the cast but don't attempt to clean off the snow and ice that adhere to the surface. Invert cast in a pan and take it into a warm room where the snow will melt and free the cast. To make a negative cast in sand, spray the track and the surrounding area with sodium silicate (water glass) and allow to dry for 5 to 15 min. Then proceed as before.



Above, after locating a suitable imprint in firm earth, enclose it in a retaining wall made from thin sheet metal held in place with a rubber band. Below, clean the negative cast with an old toothbrush to remove all loose material that may adhere to it



Above, pour the plaster mixture at the edge of the wall and allow it to flow over the imprint. This helps to prevent the formation of air bubbles. Below, bevel the edges of the negative cast slightly and fill any holes that may have formed with thin plaster



To make positive casts from the negative cast in the form of plaques such as those pictured on the opposite page, the procedure is equally simple. Make a new retaining band of sheet metal about $1\frac{1}{4}$ in. wide, hold it in a circular form with rubber bands and place on top of several thicknesses of newspaper. The form's inside diameter should be slightly larger than the diameter of the negative cast.

If the plaques are to be mounted on the wall, slot the sheet-metal band and insert a wire loop before pouring the plaster. This will form a hanger as shown on the opposite page. Pour a plaster mixture into the ring to a depth of $\frac{3}{4}$ to 1 in. and allow to set partially. While the plaster is setting, coat the negative cast with light mineral oil. When the plaster has set to the consistency of soft putty, press the negative cast into it firmly, then move slightly from side to side to prevent bonding. Leave in position a few minutes, then remove carefully. Clean the positive cast and after it is dry paint the surface and depressions in contrasting colors. The negative cast also can be used to impress realistic animal tracks in the surface of concrete flagstones before the concrete sets. ★ ★ ★



Above, realistic tracks can be imprinted in flagstones with positive cast. Below, paint positive with contrasting colors after applying two coats of shellac



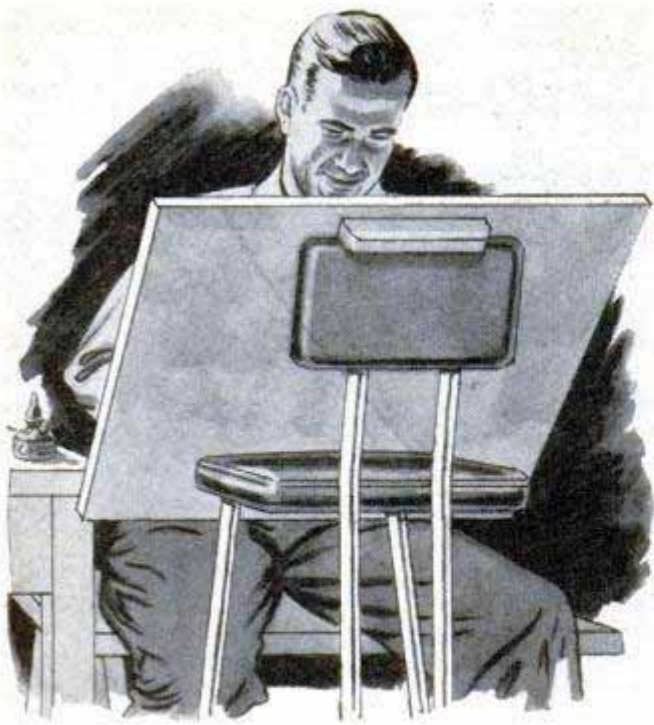

Drawing Board Supported On Kitchen Stool

If you are crowded for space and need some place to use a drawing board occasionally, your kitchen can be converted into a "studio." If you use a flat drawing board, it can be supported on a kitchen stool or the high chair. Location of the cleat will be determined by the height desired for the board when it is in the position used for working.

Sandpaper Trimming Block

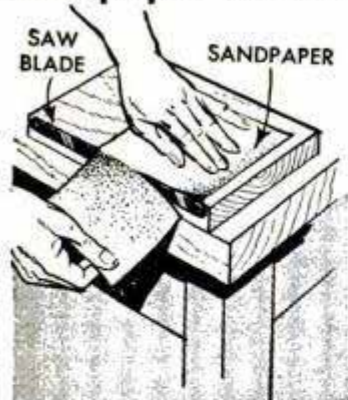

of wood. Allow the teeth to protrude slightly above the edge to form a cutting edge.

Victor Lamoy, Upper Jay, N. Y.

Area of Garden Plant Growth Confined by Enclosing Roots

Plants that spread by sending new growth up from the roots may be confined to a certain area by boxing-in their roots with pieces of slate roofing or sheets of tin sunk vertically into the ground. Tin may be obtained by slitting and flattening large cans.—Michael Fey, New York City.

Valve Cores Kept in Tire Pump

One way for cyclists to be sure of having a supply of valve cores on hand is to drill a hole in the handle of the tire pump. The hole should be drilled slightly deeper than the length of the cores to accommodate a small cork.

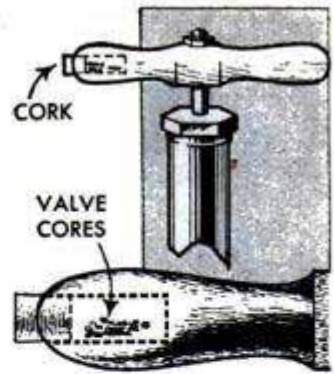

If a suitable cork is not available, use a piece of adhesive tape to cover the hole.—William B. Eagan, Louisville, Ky.

Drain Stoppers Form Rubber Feet

When rubber feet are needed to cushion the corners of a heavy chest, the legs of a table or the base of a machine, they can be improvised in a jiffy from common drain stoppers. All you have to do is to cut off the rubber projection

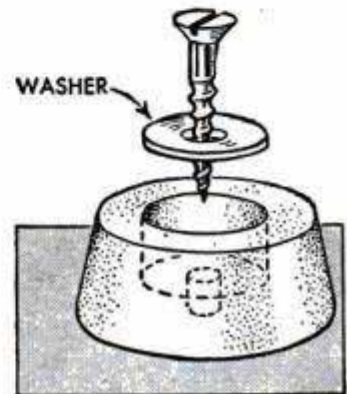

holding the ring and then drill a hole through the stopper for a wood or machine screw. The recess in the stopper provides a perfect counterbored hole for the screw head. Washers are used under the heads of the screws when attaching the feet so that they will not pull off.—Paul Will, Chicago.

Handle for Carrying Lawn Chair

Screwed to a side member of a lawn chair, a window-sash lift provides a means of carrying the chair as well as hanging it on a wall or from a shelf or joist in the basement. When attaching the sash lift be sure that it is not screwed to a member that will interfere with folding of the chair.

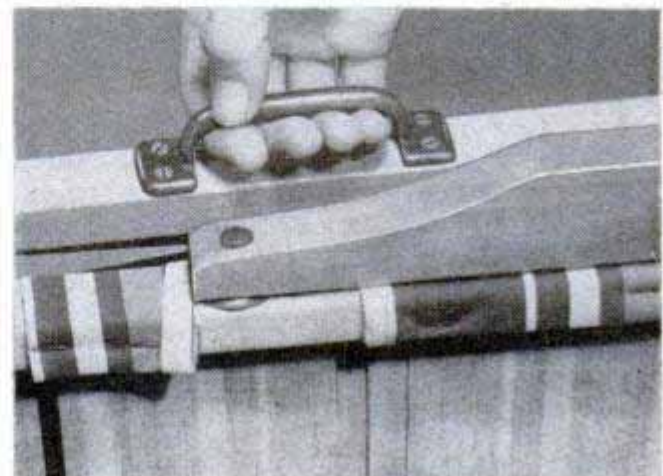

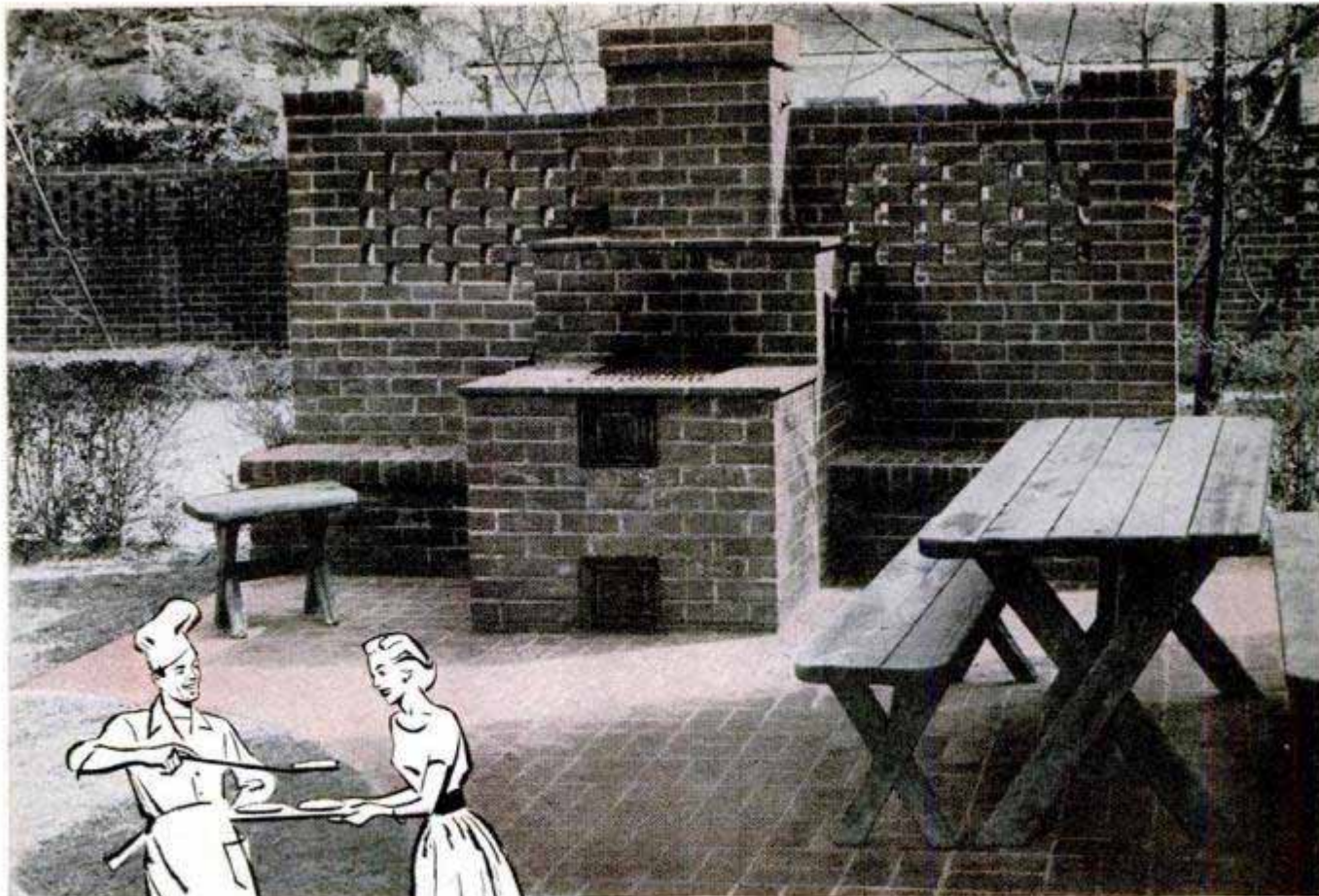

Brick and stone fireplaces built into outdoor living rooms are made both decorative and useful by the addition of simple design details

OUTDOOR KITCHENS

By Hi Sibley

IN THE MODERN trend to outdoor living the simple fireplace has evolved into a complete open-air-kitchen unit fitted with grill, charcoal and wood grates, and work tops especially designed for the convenience of barbecue chefs. When built as a permanent unit of stone or brick, the kitchen also serves as an attractive terminal feature of the garden plan. The types pictured above and at the right are examples of units that fulfill this twofold purpose. Both units have the same basic design features, but it will be noted that the structural details have been worked out to suit individual settings. In both designs the stepped construction provides ample work space and the overhangs introduce horizontal shadow lines that give a feeling of width.

Kitchens pictured above and below are of similar basic design but structural details have been worked out to suit individual settings. Note offsets and overhangs in the walls

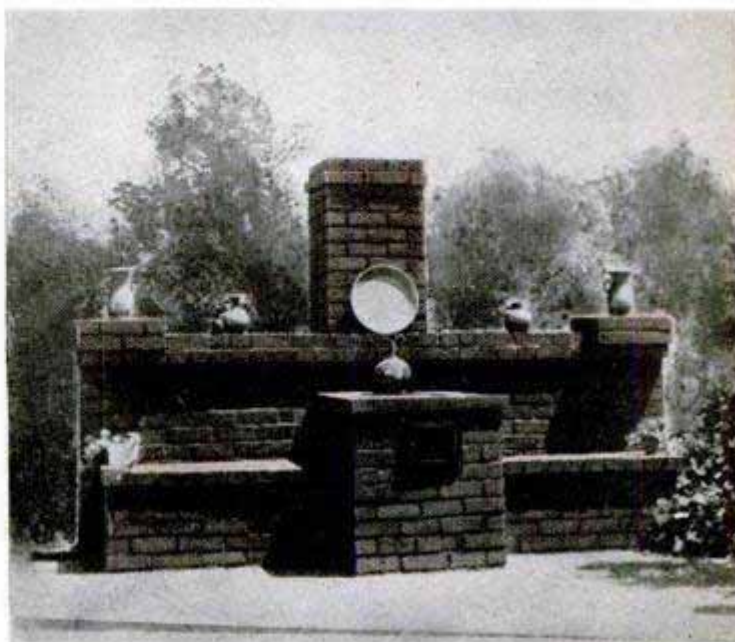

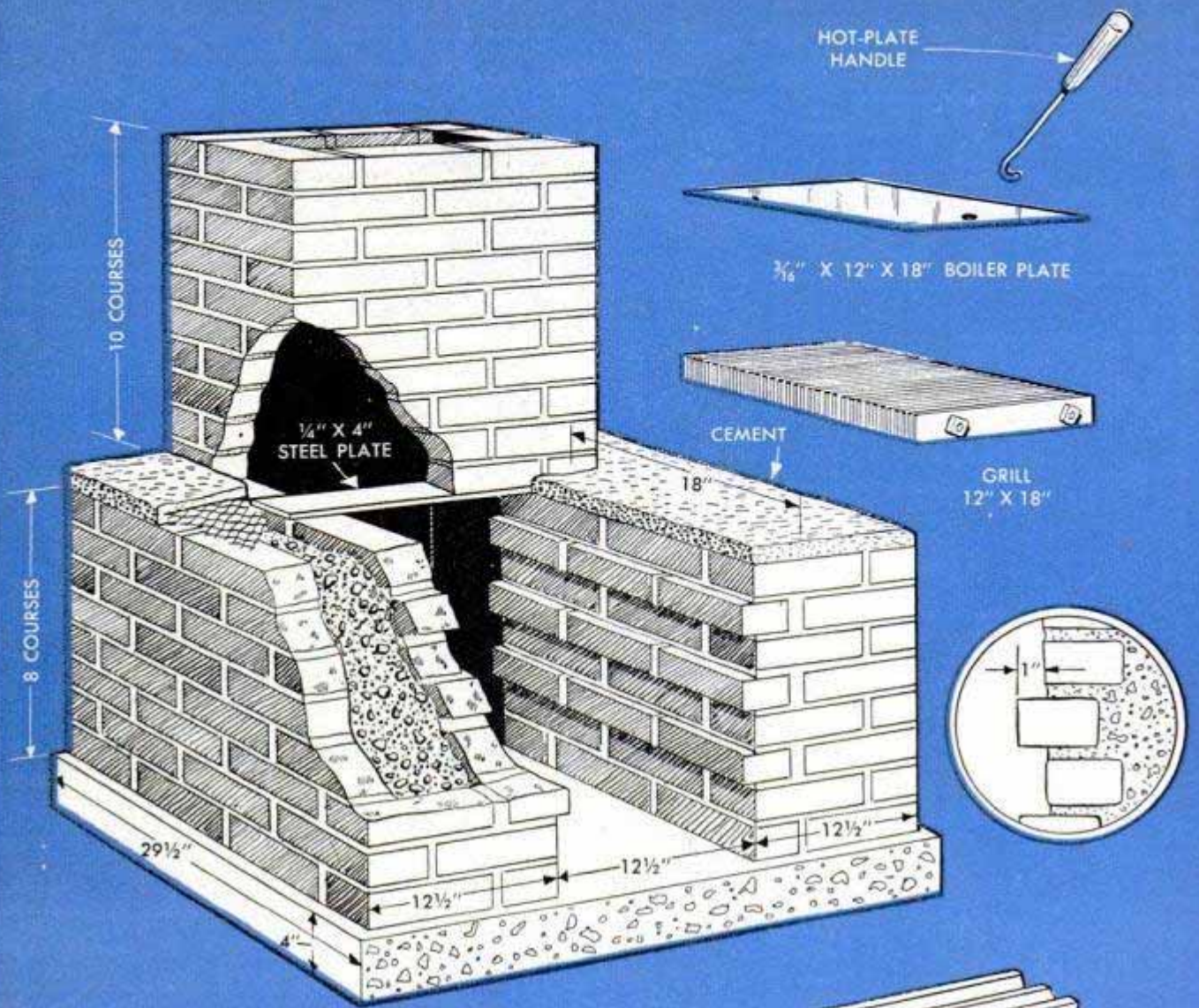

1

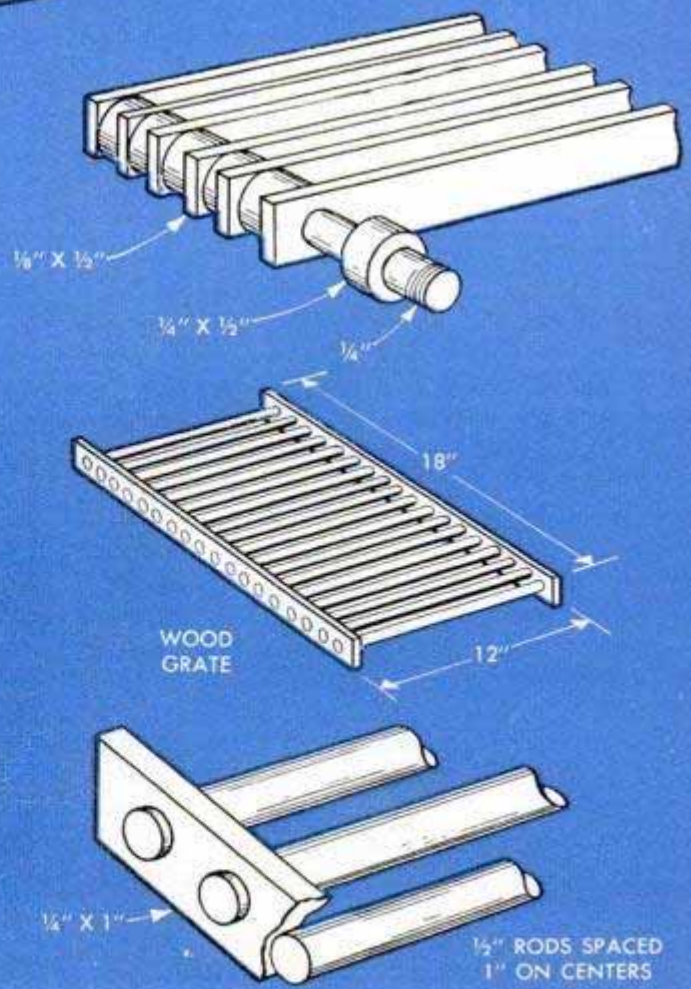
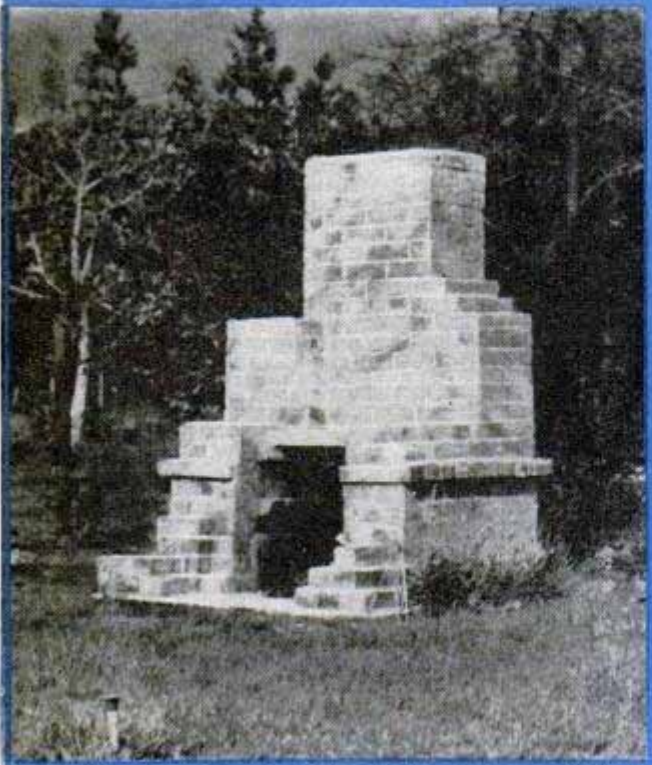

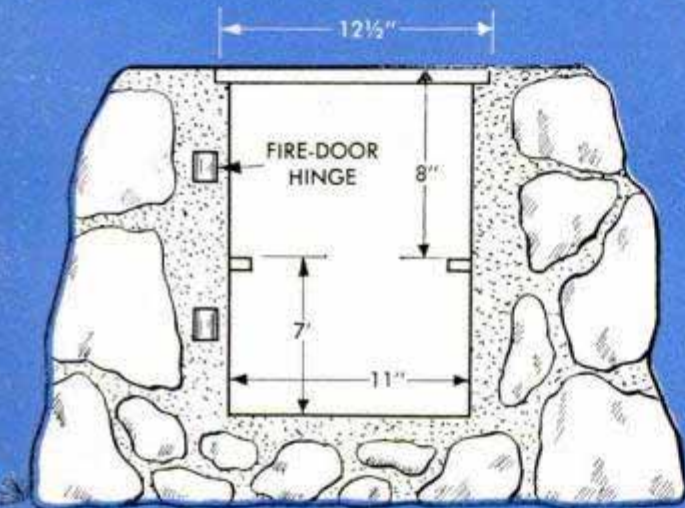
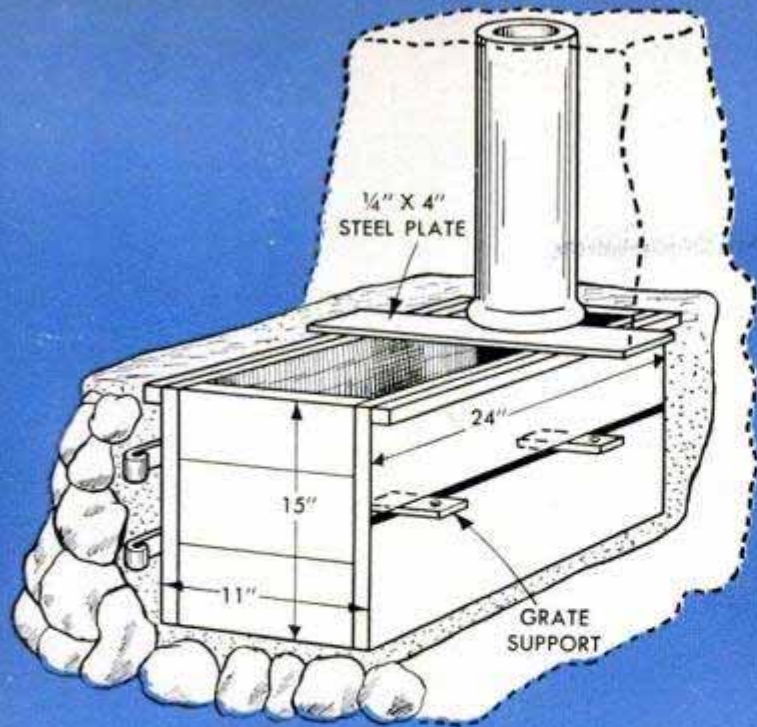

2

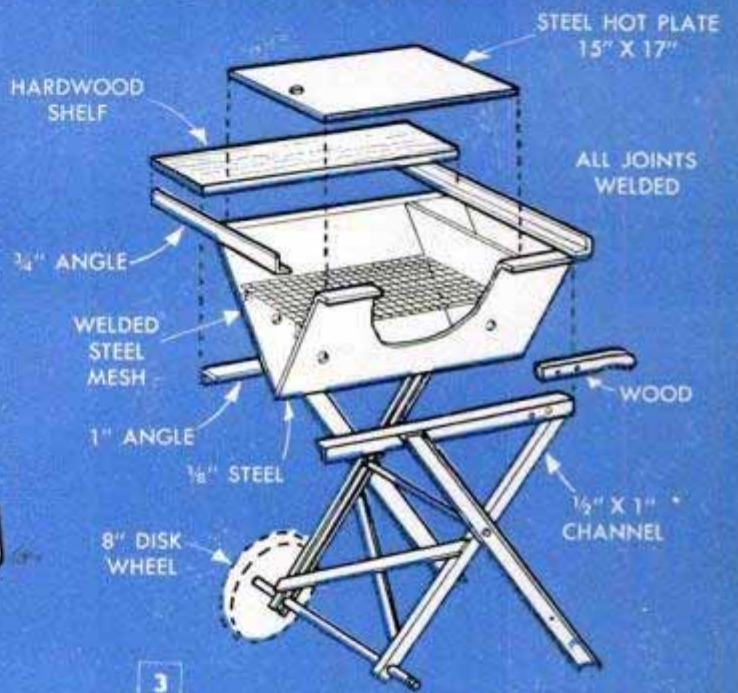

3

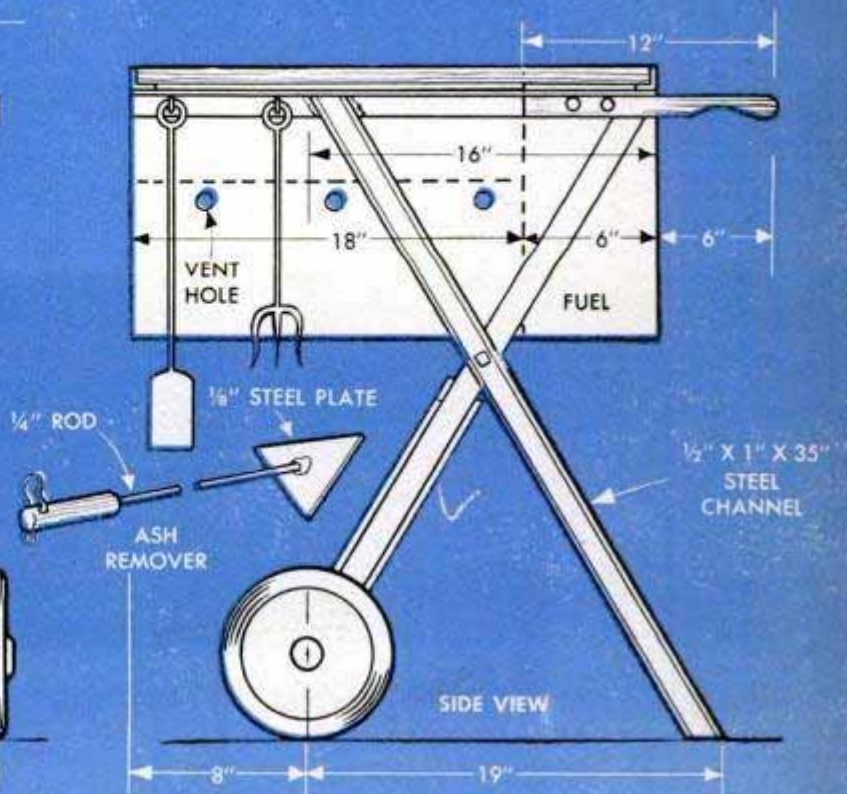
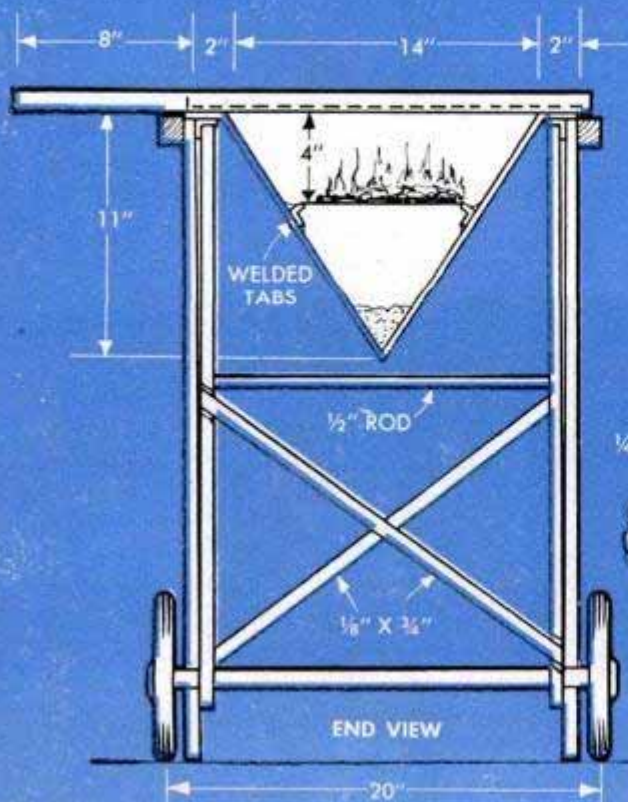

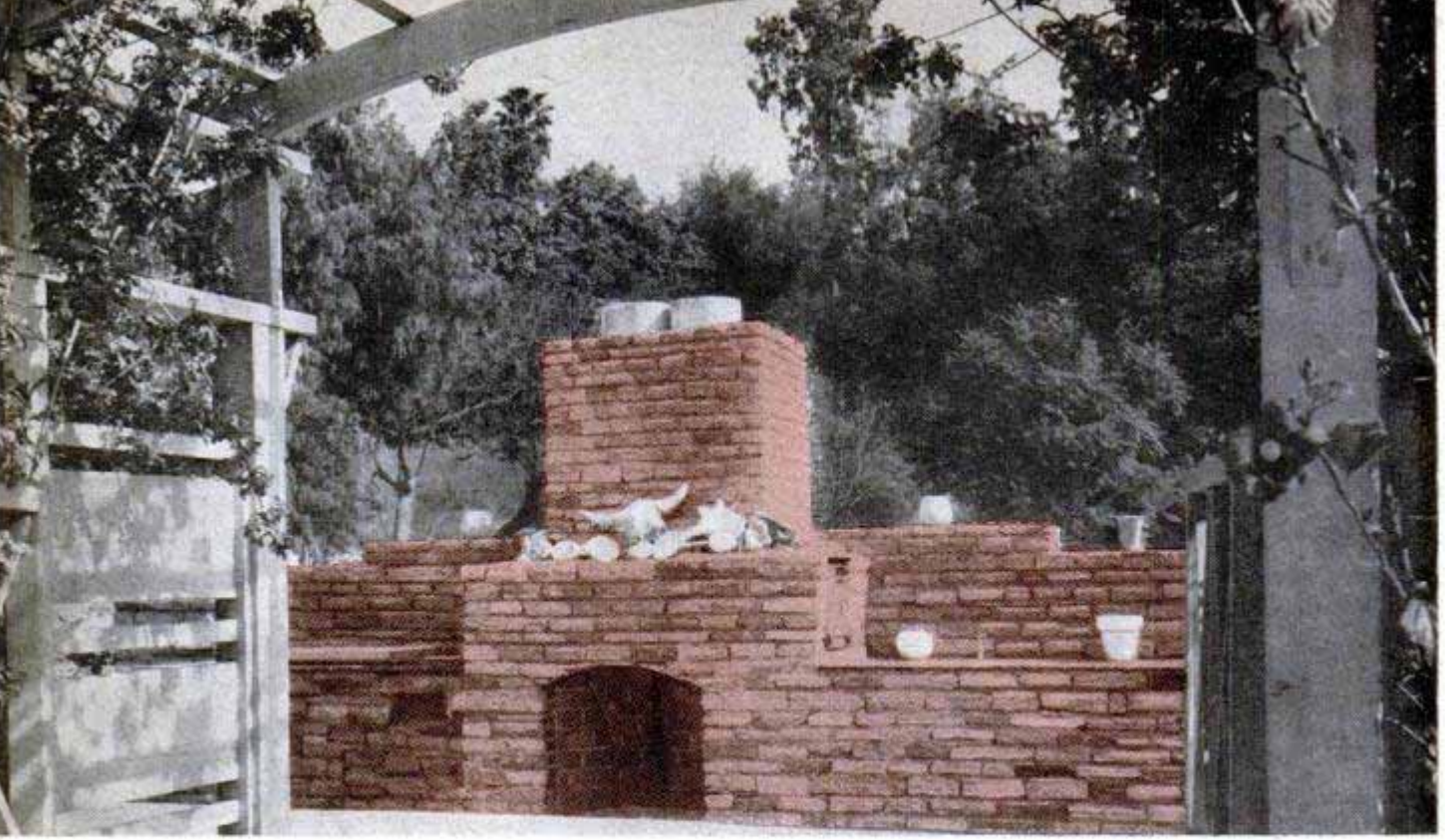

Offset walls extending each way from the fireplace opening enclose the outdoor dining room and provide space for utensils or decorative pottery. Constructed of selected flat stone of varying thicknesses



Above, picnic chefs often prefer a simple brazier because of its easy portability and open-fire atmosphere. Below, another true fireplace constructed of field stone. An open-work trellis frames the structure and also provides a slat shade. Note stone arch over fireplace opening

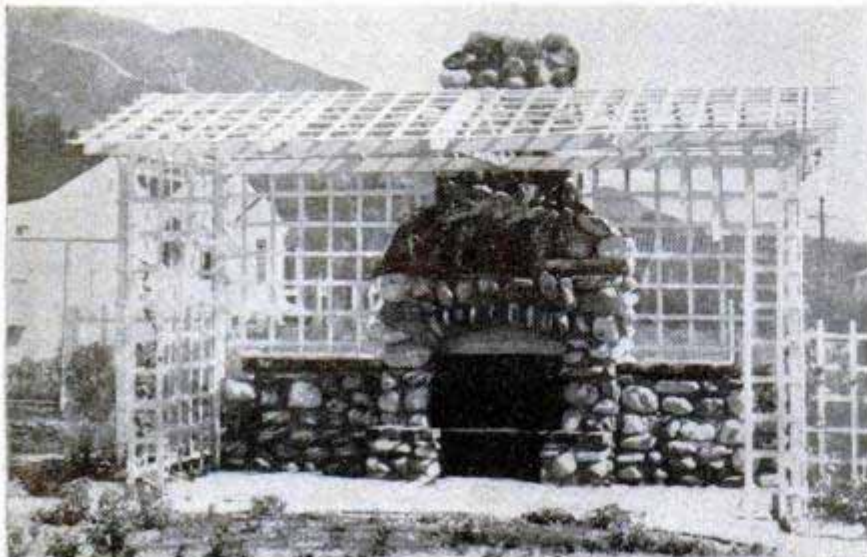

Typical construction of a fireplace with brick and rubble is shown in Fig. 1. Other details show construction of a grill and hot plate. A fairly common method of building a fireplace of natural stone is shown in Fig. 2. In this case, a wooden box serves as the form for the cement and stone work. The box form is built of rough lumber and is later burned out when the concrete has cured.

The principal advantages of the barbecue cart, Fig. 3, are portability and the small storage space required when the cart is not in use. As will be seen from the details, the cart is simple in construction and is especially adapted for use as a charcoal grate or grill. The unit is of all-metal construction except the wheels, shelf and handles. A novelty among outdoor kitchens is the simple brazier pictured at the left. The units pictured above and at the left are true fireplaces with an offset forming a mantel. Offset walls extending on both sides enclose the outdoor dining room. If desired, a swinging iron crane can be installed inside the fireplace opening. ★ ★ ★

Set up easily and inexpensively in any backyard, this "wading pool," which utilizes a large tire and a piece of waterproof canvas, will provide tiny tots with delightful hours of healthful, outdoor recreation. A truck or tractor tire is used to form the sides of the pool. After selecting the site—one that is partly shaded from the sun is best—dig a shallow hole in the ground similar in size to the inside rim of the tire and then drape the tarpaulin over it. Spread it over the sides and bottom of the hole, tucking the edges under the casing itself as indicated in the detail. This done, use a garden hose to fill the pool with water.—Bess Ritter, New York City.

"Wading Pool" Made From Tire and Tarpaulin Provides Outdoor Recreation for Tiny Tots

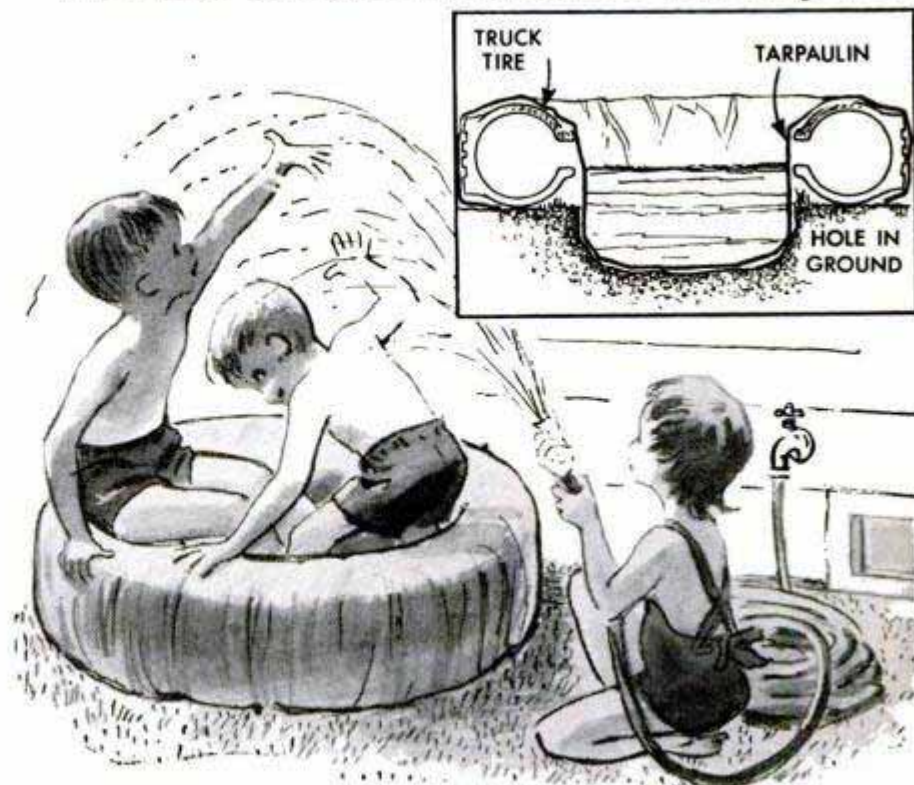

Floors Shellacked Before Waxing to Prevent Discoloration

To keep a new floor, or one that has been newly sanded, in a natural-wood finish protected only with wax, give the wood at least one coat of white shellac before applying the wax. Better still, apply one coat and sand it lightly before applying a second coat. After the last coat has dried, go over the floor lightly with fine sandpaper to smooth any irregularities that remain. Use a damp-dry cloth after each sanding to pick

up any dust which will cause the shellac coat to be rough. The final sanding will produce a glasslike surface for the wax. The shellac will seal the pores of the wood against dirt which penetrates a waxed surface and gradually discolors the wood. Floors having several layers of wax should be cleaned and given a fresh application. Use a sponge dampened with turpentine to remove the old layers.



Pressure Applied With Car Jack Aids in Removing Tire

The most difficult step in repairing an automobile tire—that of loosening it from the rim—may be accomplished quite simply by using a bumper jack placed under a bumper as shown. Sufficient pressure can be exerted with the jack to force the bead loose from the rim at one point. The valve core is removed first to deflate the tire completely as only a few pounds of air remaining in a tire having, for instance, a slow leak, can make its removal from the rim practically impossible. Once part of the tire has been separated from the rim, it then is a simple matter to work the rest of it free.

☐ A slight bruise on a piece of furniture can be removed by using a damp ink blotter. Just place the latter over the spot and press it lightly with a hot iron.

Catch 'em with **LIVE BAITS**



By Vlad Evanoff

USUALLY GAME fish can be induced to strike at almost any properly selected artificial lure you can toss at them. But when you've given every plug or spinner in the tackle box a try without getting a single strike—and every fisherman has had such days—it's your cue to dust off a few tricks with live baits. Record catches have been made with natural lures hooked and fished by approved methods and every angler knows of at least one wise old lunger that always ignored every artificial lure thrown at him but finally fell for a properly presented live bait.

Few panfish, and even trout, can resist a lively worm or nymph and if a run of bad luck in good bass water forces you to turn to a frog or crayfish for bait you may

Spotted salamanders are highly prized by live-bait fishermen but are rather difficult to find. Look for them under stones along banks of streams and lakes

L. W. Brownell photos



be in for a surprise. One of the most popular of the live baits is the common earthworm, or angleworm. It will be taken by nearly all fresh-water fish and is easily obtained by digging in rich, damp soil at any time from early spring to late fall. It also can be kept and propagated if desired. The largest of the common earthworms is the dew worm, or nightcrawler. This worm is one of the best live baits for black bass, panfish, big trout and catfish.

As a rule you'll find dew worms on the lawn or in the garden only after nightfall and most anglers seek them after a heavy rain. By walking softly and using a small flashlight to locate them, you can obtain all the dew worms you'll need for a full day's fishing. Common earthworms can be

The hellgrammite, an insect in larval form, is rated as tops in live baits for black bass, trout and panfish. It is hooked under the band for the best results



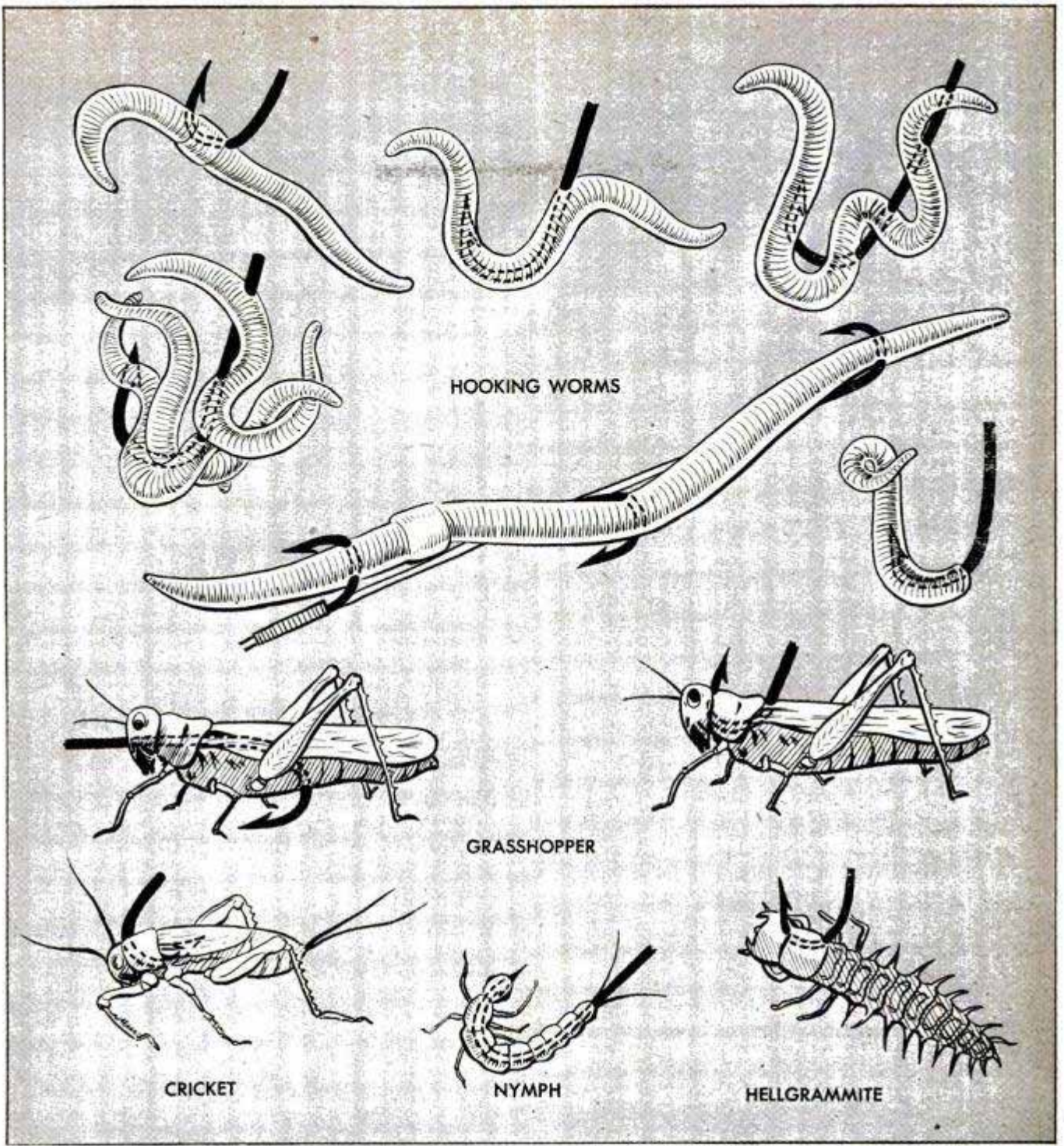

HOOKING WORMS

GRASSHOPPER

CRICKET

NYMPH

HELLGRAMMITE

Leopard frogs, also other kinds, are favorite live baits for bass fishermen. They are easily caught along stream banks by using a landing net or a dip net

A grasshopper dropped lightly onto the surface of a quiet pool may take fish when all other baits fail. The smaller ones usually are more acceptable to game fish

American Museum of Natural History photos

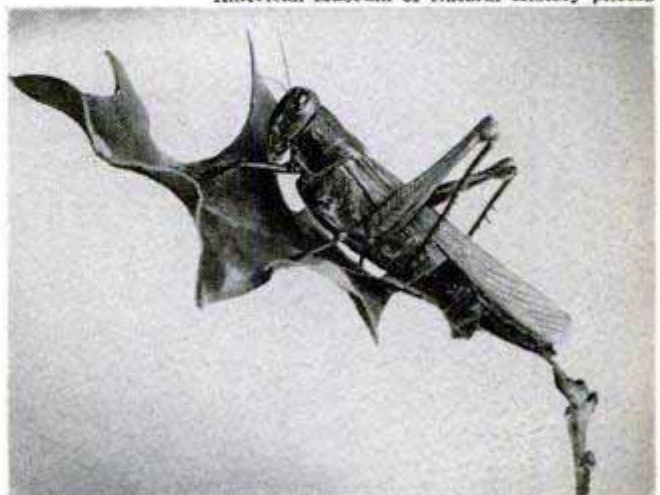

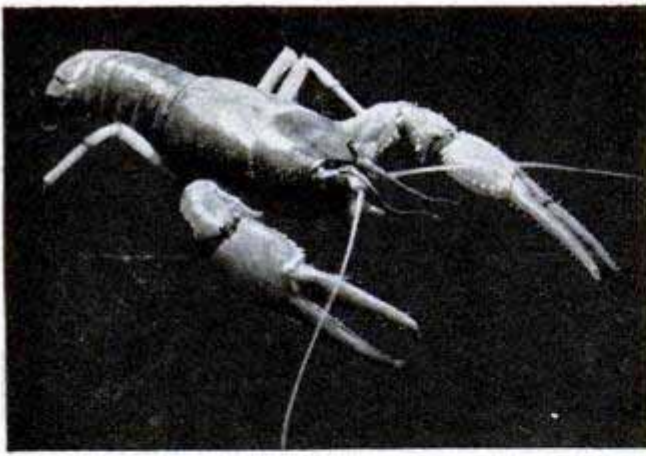

A sure-fire bait for smallmouth bass and big trout is the soft-shelled crayfish. For best results it should be lashed securely to the hook with a fine thread

HOOKING MINNOWS

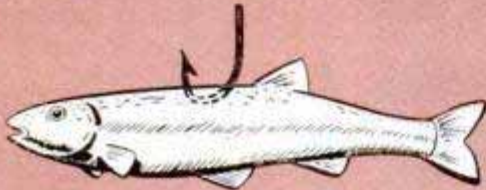
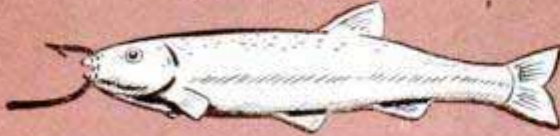

HOOKING FROG



kept for long periods of time in large containers filled with rich soil if they are supplied with foods such as corn meal or poultry mash. The soil should be kept damp, but not wet, and the food should be buried 2 to 3 in. beneath the surface.

Methods of hooking and fishing worms will depend to some extent on the fish you are after, the condition of the water and the techniques used. For trout in moving water, hook the worm under the band as in the upper left-hand detail on the preceding page. But when fishing in still water, thread the worm along the bend and shank of the hook, leaving both ends of the bait to wriggle in a lifelike manner. For panfish, loop a small worm along the bend and shank of the hook in such a way as to conceal the point and barb. For bass, catfish and bullheads, loop several worms on one hook. If you use gang hooks, hook a large worm as in the center detail on the preceding page.

Next in popularity and effectiveness among the live baits are minnows varying from 2 to 10 in. in length. They can be taken with seines or drop nets in nearly all small fresh-water streams, lakes and rivers. Various types of baited funnel traps also are used. Before trapping or netting minnows in public waters be sure to check the state laws, as most states have strict regulations governing the seining or netting of minnows. Minnows can be kept alive for a day or more in an ordinary minnow bucket, but for longer periods they must be kept in a "live" box, which is simply a wooden frame covered with galvanized wire mesh and sunk either partially or wholly below the surface in shallow water. The minnows should be fed regularly with a prepared fish food.

Details at the left show various methods of hooking minnows. For still fishing hook them through the lips or the back near the dorsal fin. For casting, drifting or trolling, minnows are lashed or "sewed" on the hook as in the two lower details. The size of the minnow used for bait depends on the fish you are after. For panfish, use minnows 1½ to 2 in. in length. For small and medium game fish use minnows 3 to 5 in. in length. For fresh-water giants such as pike, muskellunge and the big-river catfish, minnows 5 to 10 in. long are preferred. There also are many other small fish which are not true minnows but which make good live baits. These include the suckers, stonecats, lampreys and darters, and in some cases, yellow perch and bullheads.

Many fishermen prefer water and land insects as live baits. One favorite for bass is the hellgrammite which is found under rocks and logs along the stream banks. This insect, which is a larval form, is hooked under the collar, or band, for best results.

Every angler is familiar with the bass and perch bugs of early spring. These are nymphal stages of dragonflies and damselflies and are good bait for many of the smaller game fish. Most water insects are caught by using a wire or cloth screen placed in the riffles of small streams. Lifting or overturning rocks in the stream bed above the screen dislodges the insects and the swift current will sweep them into the screen. The land insects such as grasshoppers, crickets, grubs and caterpillars are good live baits for most game fish. Many fishermen find it easy to catch the livelier ones, such as grasshoppers and crickets, with a landing net into which has been fitted a lining of coarse cloth or netting. The landing net also is quite effective for catching frogs along the stream banks and in weedy inlets of small lakes and ponds.

The leopard frog is one of the best live baits for bass, pickerel and pike. One approved method of hooking frogs is shown on the opposite page, the hook passing through both lips with the barb on top. There also are special frog harnesses that hold the frog without injury, yet permit it free movement while in the water. Ranking with the various frogs in effectiveness as a live bait is the crayfish, particularly in the soft-shelled stage. Look for crayfish in shallow water along the stream bank, and under stones and among weeds at the water's edge of small lakes and ponds. Soft-shelled crayfish must be tied securely to the hook with fine thread. Hard-shelled crayfish are simply hooked through the tail with the point of the hook up.

In addition to those already pictured and described, many other live baits are used by fresh-water fishermen. These include the salamanders and newts, leeches, fresh-water clams, snails, slugs and even small snakes and mice. Fishermen also use salmon eggs when angling for steelhead trout in Western lakes and streams. However, some states have outlawed the use of sal-

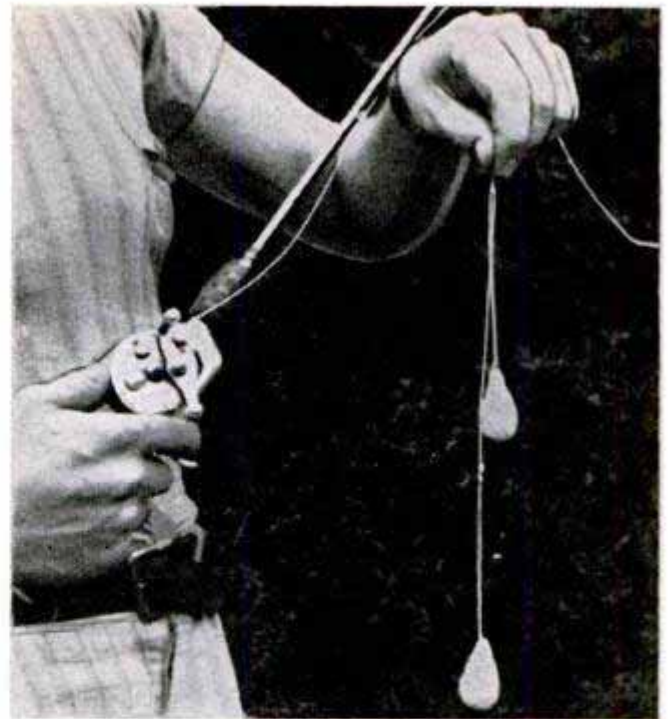

Doughball baits are familiar to big-river fishermen who go after carp, catfish and buffalo. Dough should be stiff enough to mold smoothly over the hook

mon eggs, so check the state laws carefully.

The best-known of the so-called prepared lures are the doughball baits used mainly for carp, catfish and buffalo. These consist of mixtures of flour, corn meal or bran, and a sweetening such as honey or corn syrup. A common recipe calls for equal parts of plain flour and corn meal and sufficient syrup to make a rubbery mixture when boiling water is added. It is important that the mixture be sufficiently tough to be molded onto the hook as pictured above. For catfish, fishermen sometimes add cheese, ground meat, oil of rhodium, oil of anise and asafoetida to the dough when mixing. Prepared lures of this type usually are fished deep in still water, also in rivers where sluggish current conditions permit fishing the bait on or along the stream bed. When fishing, the bait must be renewed frequently. ★ ★ ★

Pieces of Padding From Carpet Used to Repair Worn Hanger

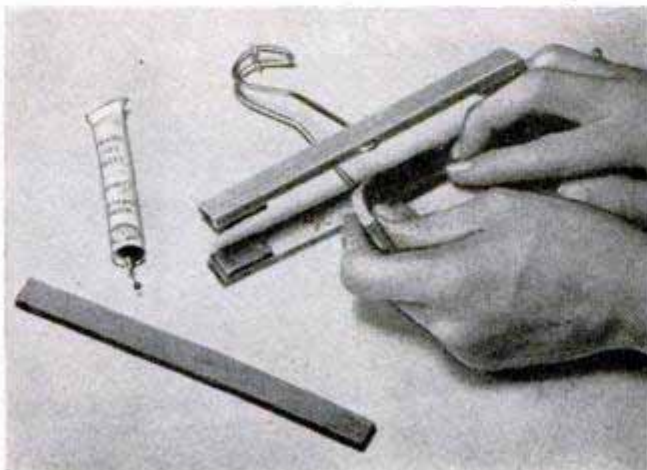

The life of worn trouser hangers can be lengthened by using pieces of rubber carpet padding to replace worn or missing pads on the hanger. Scrap pieces of the padding are cut in rectangular shapes to the size needed and affixed to the hanger with model-airplane cement. Household cement also can be used if desired.

Don Nielson, Aurora, Neb.

Small splinters of broken glass or china are easily removed from a floor by wiping it with a ball of cotton dampened slightly with water.



Sinkers Weight Minnow Net For Deep Seining

If minnows elude your seine by darting underneath the lower edge when working in fairly deep water, try weighting the lower edge with split-shot sinkers. These are easy to attach and will help keep the net on the bottom of the creek or lake bed when seining. Also, you will find that they will permit the seine to slip over small rocks much better than one or two heavy weights. Spacing of the sinkers will be determined by the amount of weight required to hold the seine on the bottom of the creek.

Cotton Removed From Bottle With Wooden Match

To remove the cotton filler from the top of a small vial, or from a cigarette lighter, simply insert the untreated end of a matchstick in the cotton and rotate it several times before removing it. The cotton will catch on the rough end of the match and enable you to remove enough to grip with the fingers. It then is a simple matter to extract the remainder of the cotton with the fingers.

E. Dzus, Prince Albert, Sask., Can.

Old Friends . . .

. . . deserve the best of care. Towering above your home may be an ancient elm or a majestic maple, an old-timer that has watched over your family for years. Such trees need care, especially when they grow old and are crippled by splitting limbs. A feature next month tells how to brace any stricken tree. It's complete with detailed drawings showing the two methods of bracing and their variations. Don't miss it.

Dulling of Cutting Edge on Chisel Prevented by Cardboard Sheath

Cutting edges of wood chisels and similar tools can be protected in storage by tight-fitting sheaths made from cardboard. To make a sheath, cut a piece of cardboard in a narrow T-shape, the narrowest width being equal to the width of the chisel blade. Fold the strip over the cutting edge and bend the flaps formed by the wider portion over the sides of the blade. Wrap with several turns of cellulose tape to hold the flaps securely in place.

R. F. Donovan, Guttenberg, N. J.

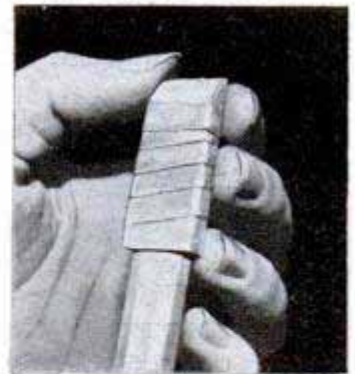

Can Opener Provides Staple Puller

The type of can opener used to punch holes in beverage cans is ideal for use in pulling staples and thumbtacks. All that is necessary is to bevel the underside edges of the pointed end of the opener to reduce its thickness and to make the point "needle sharp."

This slight alteration also will make the opener easier to use in the regular manner.—Norbert Engels, South Bend, Ind.

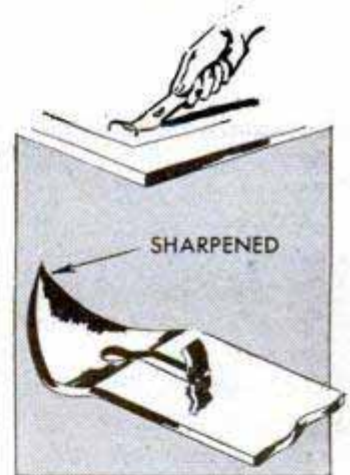

Hollow Rivet Doubles as Punch

In the absence of a regular punch, neat, round holes can be punched in leather, cardboard and similar materials by using a hollow rivet and a pair of slip-joint pliers. Just select a rivet of the size desired, place the open end on the material to be punched and apply pressure with the pliers. Another way is to place the material on a wooden block, and then punch the hole by driving the rivet with a hammer. Use a long-nose pliers to help grip the rivet with little difficulty while it is being hammered.



KNOW YOUR CAR'S NERVOUS SYSTEM

By W. K. Mitchell and Howard B. Birt



ignition

THE HIGH-VOLTAGE center of your car's electrical equipment is the ignition system, which is charged with the specialized job of producing and delivering voltage surges, or sparks, to the engine cylinders. These surges may be as high as 25,000 volts each, and they must be delivered with precision at fantastic speeds—sometimes as many as 300 per second. The units comprising the ignition system, Fig. 1, are the power source (battery or generator), ignition switch, ignition coil, distributor, condenser, spark plugs, and low and high-tension wiring.

The ignition coil: The coil is a pulse transformer that steps up the 6-volt current of the battery or generator to the 4000 to 25,000 volts necessary to jump the gaps of the spark plugs. A typical passenger-car coil consists of a primary winding which is assembled around the outside of a secondary winding, and a laminated-iron core. The latter is distributed so that one portion provides a core for the windings and the remainder forms a shell around the entire subassembly, Fig. 2.

When the contact points in the distributor close, with the ignition switch turned on, current flows from the battery through the primary winding of the coil, through the contact points and back to the battery through the ground. This current flow in the primary winding produces a magnetic field in the coil, as indicated by the dotted line, Fig. 3. However, the current flow, and thus the magnetic field, does not reach its maximum value instantly. A small fraction of a second, called build-up time, is required for this to occur. This lag is

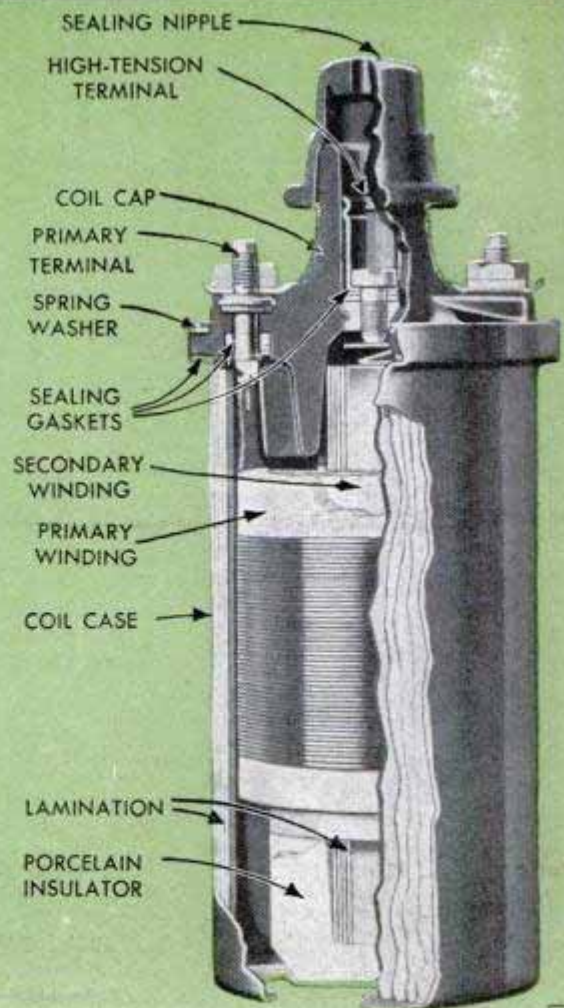
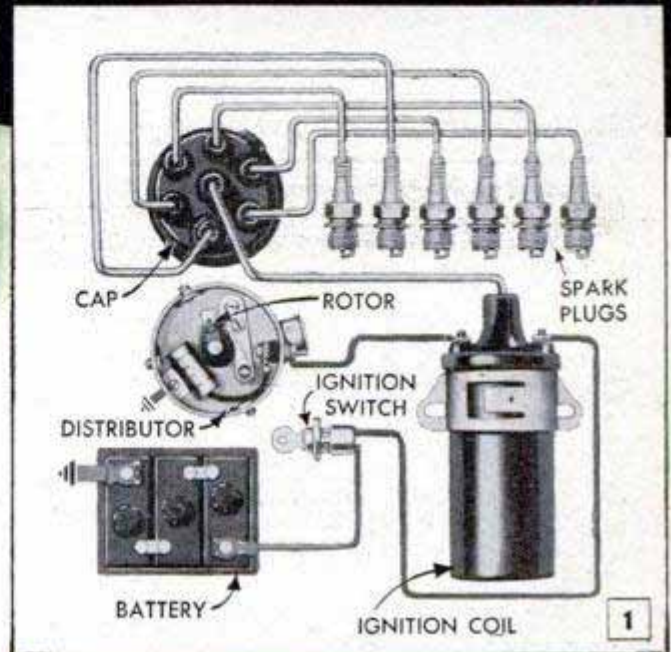

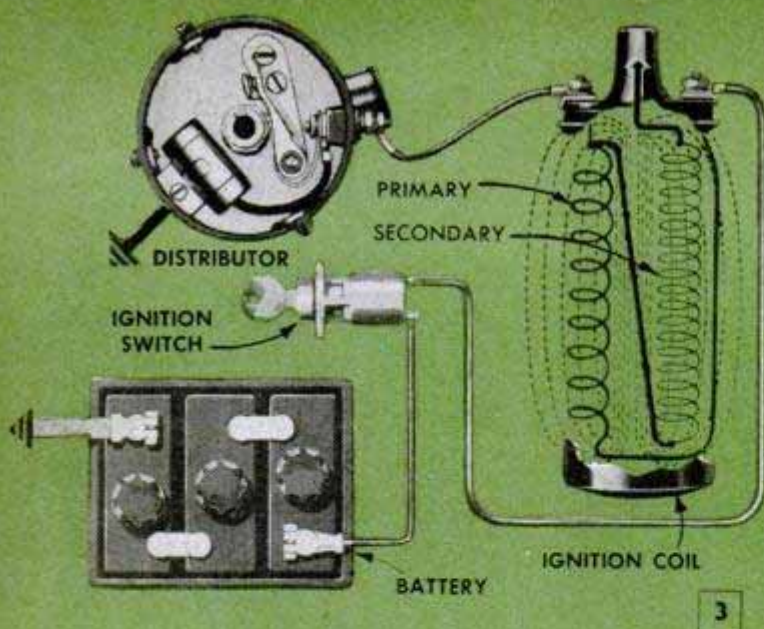

3

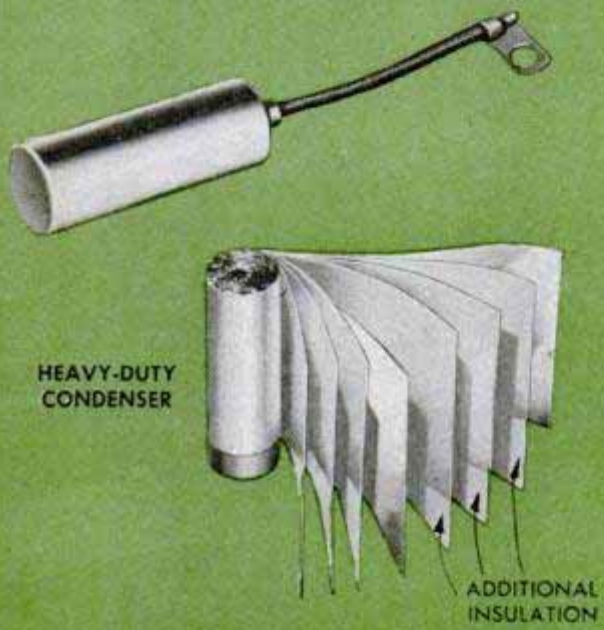

4

caused by self-induction—a momentary countervoltage, which opposes any change in the amount of current flowing through the coil. The battery voltage must overcome this countervoltage before the latter will allow the current to increase to its maximum.

During the time the contact points remain closed, energy in the form of magnetism, or magnetic flux, is being stored in the coil. But, as the points begin to open, breaking the primary circuit, self-induction in the coil again opposes any change and attempts to keep the current flowing in the primary circuit. This would cause an arc across the points as they separated—draining off the stored-up energy in the coil and burning the points—were it not for the condenser. This unit momentarily provides a place for the induced current to flow. The current flows into the condenser instead of arcing across the points. As it does so, the magnetic field, which was produced and sustained by the current flow from the power source, quickly collapses.

This collapse produces a high voltage in both the primary and secondary windings. The voltage can go as high as 250 volts in the primary winding, which would produce 25,000 volts in the secondary, as the secondary has up to 100 times as many turns of wire as the primary. Normally, the voltage does not reach this maximum, but only increases to a value sufficient to produce a spark across the spark-plug gap, usually somewhere between 4000 and 18,000 volts.

After the spark is produced, the energy built up in the coil in the form of magnetic flux drains from the coil through the secondary circuit. This sustains the spark in the spark-plug gap through several degrees of crankshaft rotation. This rapid sequence of action is repeated each time the distributor contact points close and open.

The condenser: This unit is tiny but potent. Without it the ignition system could not function and the engine could not be fired. The condenser consists of two sheets of foil separated by insulating paper and rolled into a tube, as in Fig. 4. The foil tube is encased in a metal container which, in the best and most modern condensers, is hermetical-

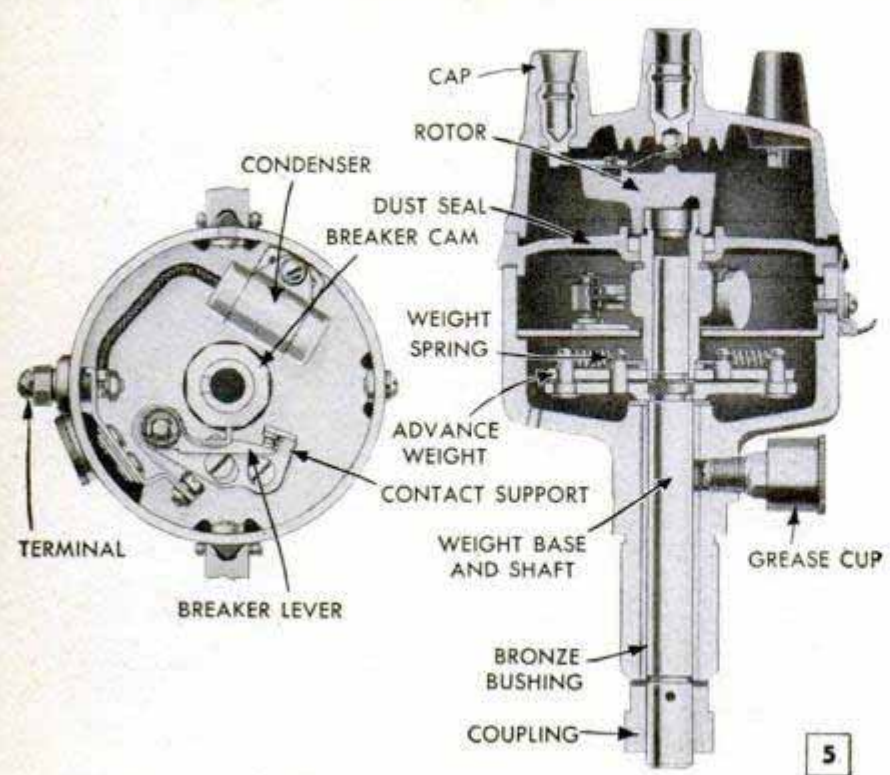

5

ly sealed against moisture. The two rolls of foil, insulated from each other, provide two separate circuits. One of these is connected to the primary circuit of the coil and the other is grounded to the distributor housing. The potential developed between the two circuits brings the electrical current to a quick stop.

The distributor: The ignition distributor, Fig. 5, accomplishes three highly technical functions. First, by means of the contact points, it opens and closes the circuit between the battery (or generator) and the ignition coil. This supplies the primary winding with intermittent surges of current which produce the high-voltage surges from the coil to fire the spark plugs. Second, the distributor times delivery of these high-voltage surges with regard to the engine requirements. Third, it directs the high-voltage surges through the rotor, distributor cap and high-tension leads to the spark plug of the cylinder at the instant it is ready to fire.

Both the primary and secondary circuits are routed through the distributor. The primary circuit extends from the coil through the contact points to ground, and includes the condenser. The secondary circuit extends from the coil high-tension outlet through the distributor cap and rotor and then through the high-tension leads en route to the spark plugs.

Fig. 5 gives a detailed look at the various parts of the distributor, their make-up and location. The distributor shaft is rotated at $\frac{1}{2}$ engine speed by its engine connection. As the shaft revolves it also rotates the breaker cam, mounted at the top of the shaft just beneath the rotor. In most passenger-car distributors the breaker cam has one lobe for each cylinder of the engine. The movable contact point is mounted on the end of the breaker-lever arm, which has a rubbing block resting against the breaker cam. The breaker-lever-arm pivot and the stationary contact support are mounted on the breaker plate, through which the shaft extends. As each lobe of the breaker cam moves past the rubbing block, the breaker-lever arm is forced away from the stationary point, separating the contact points and breaking the primary circuit. Thus, with each revolution of the breaker cam, one spark is produced for each cylinder of the engine.

The high-voltage surges produced by the coil are conducted through a high-tension lead to the center terminal of the distributor cap. From there they pass through the rotor and to various outer-cap electrodes as the rotor turns with the shaft. Each spark plug is connected to one of these electrodes by means of a high-tension lead which transmits the high-voltage surges

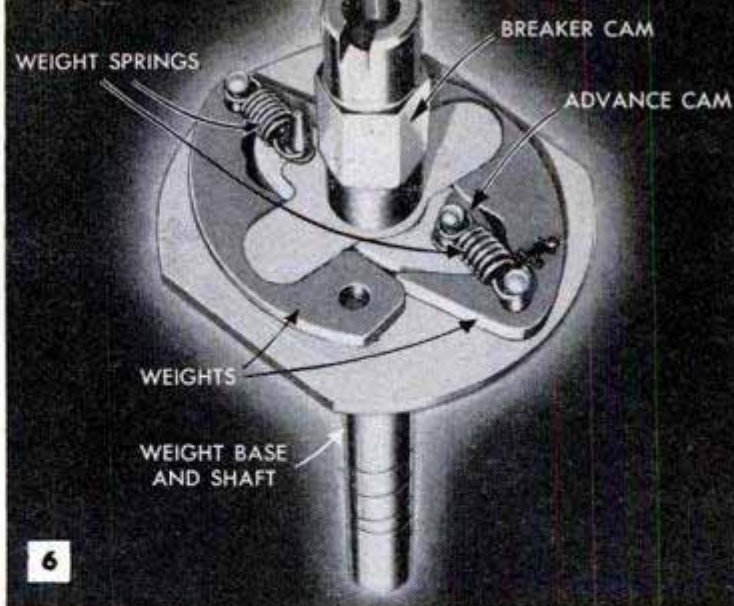

from the electrode to the spark plug.

Advance mechanisms: To obtain maximum engine performance and economy at all speeds, it is necessary for the distributor automatically to advance or retard the spark to suit the engine's varying requirements. This is accomplished by the centrifugal and vacuum advance mechanisms.

The centrifugal advance mechanism, Fig. 6, consists of an advance cam, which is integral with the breaker cam, and a pair of advance weights, springs, and a weight base which rotates with the distributor shaft. At low speeds, the tension of the weight springs holds the weights close to the shaft so that there is no spark advance. However, as speed increases, the shaft rotates

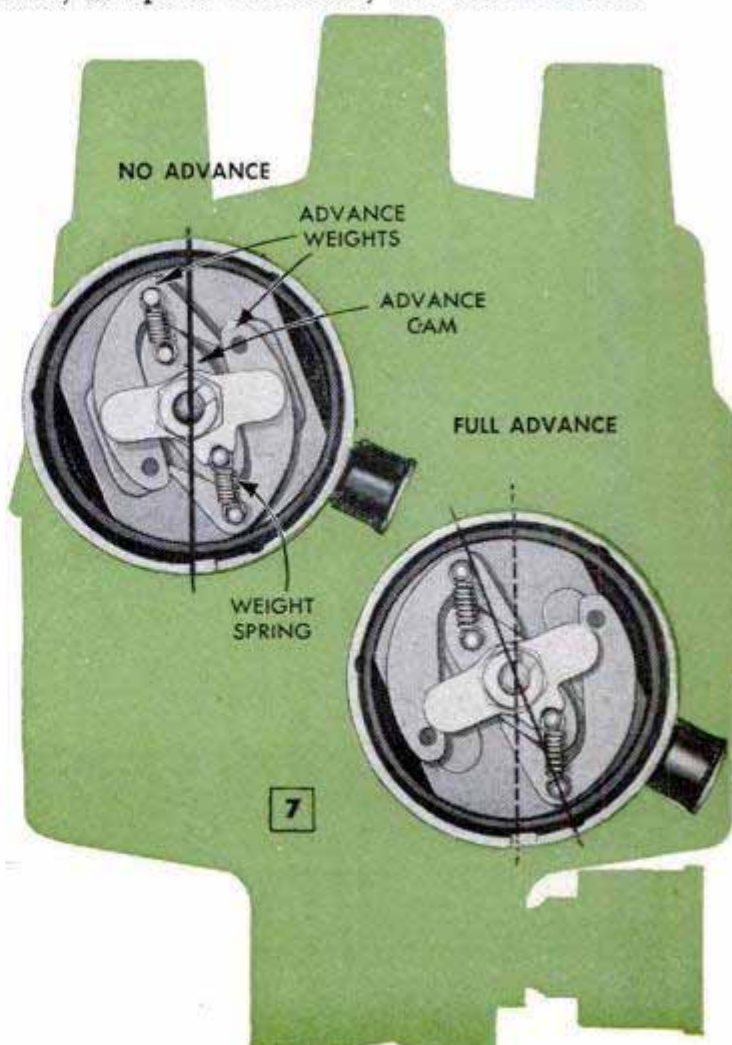

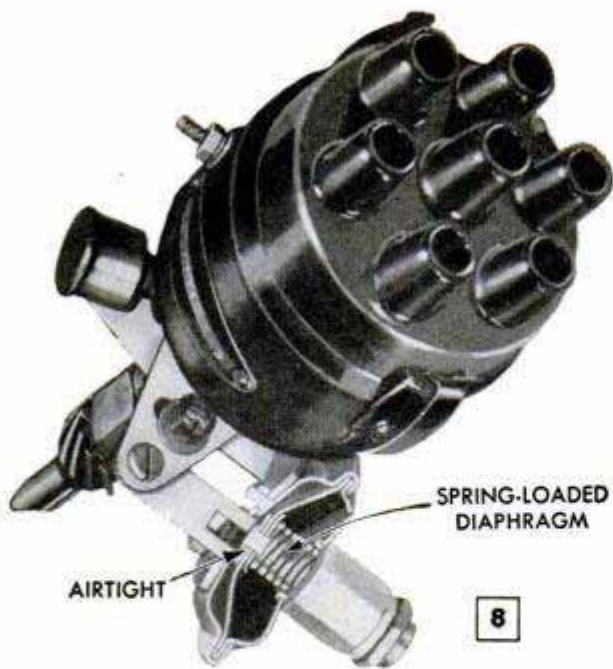

faster and centrifugal force gradually throws the weights outward. As they move, the fingers, or toggles, of the weights rotate the advance cam, and with it the breaker cam, ahead of the distributor shaft. This causes the breaker-cam lobes to open and close the contact points earlier, thus advancing the spark. Fig. 7 shows the advance weights in the "no advance" and "full advance" positions.

Under part-throttle engine operation there is a partial vacuum in the intake manifold so that the fuel-air charge taken into

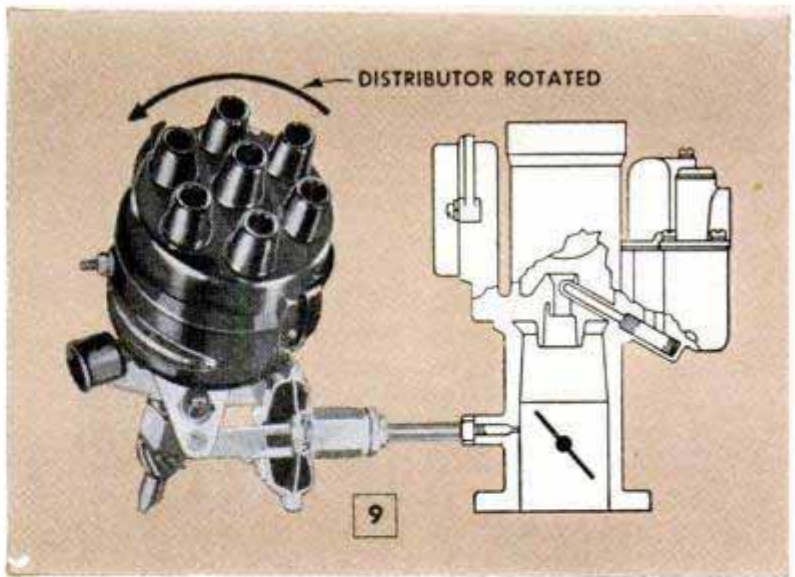
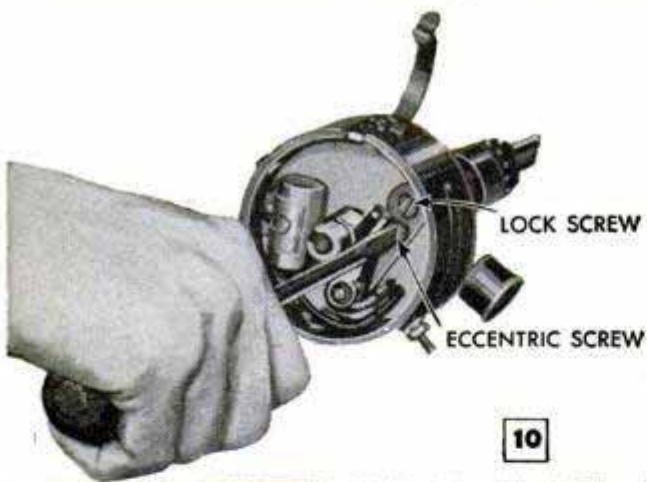

the cylinder is not so highly compressed. This lower-compression mixture burns more slowly than one more highly compressed. To get maximum power from such a fuel mixture the spark must be advanced. But, since the engine is turning over slowly under part throttle, the centrifugal advance cannot operate. To fill this gap, most modern distributors are equipped with vacuum advance mechanisms, Fig. 9.

A typical vacuum advance mechanism contains an airtight, spring-loaded diaphragm, linked to the distributor, Fig. 8. The spring-loaded, or airtight, side of the diaphragm is connected by a tube to an opening in the carburetor, Fig. 9. This opening is on the atmospheric side of the throttle valve when the throttle is in the idle position so that there is no vacuum advance. When the throttle is opened it swings past the vacuum-passage opening. The vacuum in the intake manifold then can function through the tube and it pulls the diaphragm toward the carburetor. This compresses the spring and rotates the distributor in its mounting to move the contact points ahead of the breaker cam, and thus advances the spark as required.

Quick checks: Should trouble of any type be suspected in the ignition system, the following quick checks will prove helpful in isolating it.

If the engine will not run even though the starter cranks it at normal speed, remove the lead from a spark plug and hold it about $\frac{3}{16}$ in. from the engine block while the starter is cranking the engine. *Be careful not to touch metallic connections on the lead.* If a good spark occurs, the primary and secondary circuits can be considered okay. The trouble then should be hunted in the spark plugs, timing, or the centrifugal and vacuum advance assemblies. Quite often the difficulty will be found outside the ignition system.

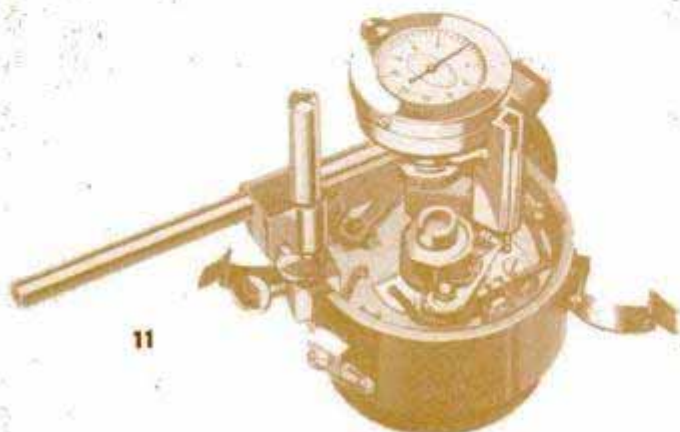

Photos and information courtesy Delco-Remy Division, General Motors Corp.

However, if a spark does not occur, observe the dashboard ammeter while operating the starter. (1) If there is a small reading which fluctuates, the primary is okay and trouble is indicated in the secondary. Check for high-tension leakage across the coil head, distributor cap, rotor, and high-tension wiring. It is also possible that the coil has shorted turns in one of the circuits, an open or grounded secondary, or that the condenser is defective. (2) If the dash ammeter registers no reading, the primary circuit is open. Check for loose connections, broken leads, defective ignition switch, contact points not making contact, or an open primary winding on the coil. (3) If there is a steady reading of several amperes, the primary circuit is not being interrupted by the contact points in the normal manner. Check the points to see if they are in adjustment. If they are, check the circuit for a ground, either in the wiring, the terminal, the condenser, or in the coil primary.

If the engine runs, but not satisfactorily, a complete engine analysis and tune-up are recommended, as so many factors may be involved. Some of the causes may be overheating, detonation, missing, or a combination of these.

Overheating may be the result of faulty timing or a variety of other engine conditions. Detonation can be brought about by improper fuel, hot spots in the cylinder, improper timing, faulty operation of the centrifugal or vacuum advance, contact points out of adjustment, worn bearings or a bent shaft in the distributor, dirty spark plugs, or plugs of the wrong heat range. Missing can be caused by a variety of ills

ranging from low battery to defective plugs.

Periodic maintenance: The best guarantee of top ignition performance is regular, periodic maintenance. Start by checking the battery cables and the low and high-tension wiring for loose connections or broken insulation. Turn the breaker cam in the direction of its rotation to check the centrifugal advance. The advance springs should return the cam to its original position freely. To check the vacuum advance mechanism, turn either the entire distributor or the movable breaker plate, depending on the type of distributor used. The spring should return these parts smoothly to the original position.

Wipe the distributor cap and rotor clean and check for carbonized tracks or traces of excess oil. Measure the space between the contact points in the open position. A feeler gauge can be used if the points are new and smooth, but will not be accurate on points which are pitted and burned, because of the roughness of the point surfaces. A dial indicator, Fig. 11, is recommended for checking used points.

If the points need cleaning, do it with a few strokes of a fine-cut contact file. Never use emery cloth or sandpaper. If new points are installed, adjust the point opening as shown in Fig. 10. Then, make sure the spring tension of the movable arm is within manufacturer's specifications, as too much tension will cause excessive rubbing-block wear and too little tension may cause contact-point "bounce," or "flutter" at high speeds. This tension is measured by hooking a spring scale to the movable arm and pulling at right angles to the arm. ★ ★ ★

Souvenir Coins and Silver Wire Used in Making Unique Bracelet

Supplied with a few souvenir coins, or coins from foreign countries, you already have the most important requirement needed in making this attractive bracelet. Approximately 18 in. of 8-ga. half-round silver wire and about 24 in. of 18-ga. round wire

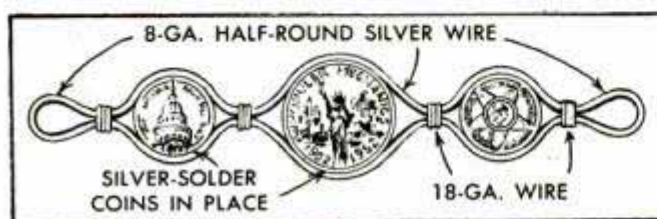

will be needed to link the coins together and provide a frame for the bracelet. Also needed are a soldering iron, silver solder, flux and polishing materials. With the flat side turned in, the half-round wire is shaped to enclose the coins as shown and held in place with several turns of the round wire cut in lengths suited for this purpose. Edges of the coins as well as the short lengths of round wire are soldered to the frame where they join. When finished, the bracelet should be buffed and polished, after which it is bent to the size required. If, when wearing the bracelet, it irritates your wrist or discolors the skin, clean the bracelet to remove all traces of perspiration and oil, and then give it a light coat of clear lacquer to seal the metal.

Roy J. Fee, Hamilton, N. D.

☞ To harden wood that has been cut or sculptured in the shape desired, boil the pieces in pure olive oil for eight to ten min.

KODACHROME
TRANSPARENCY

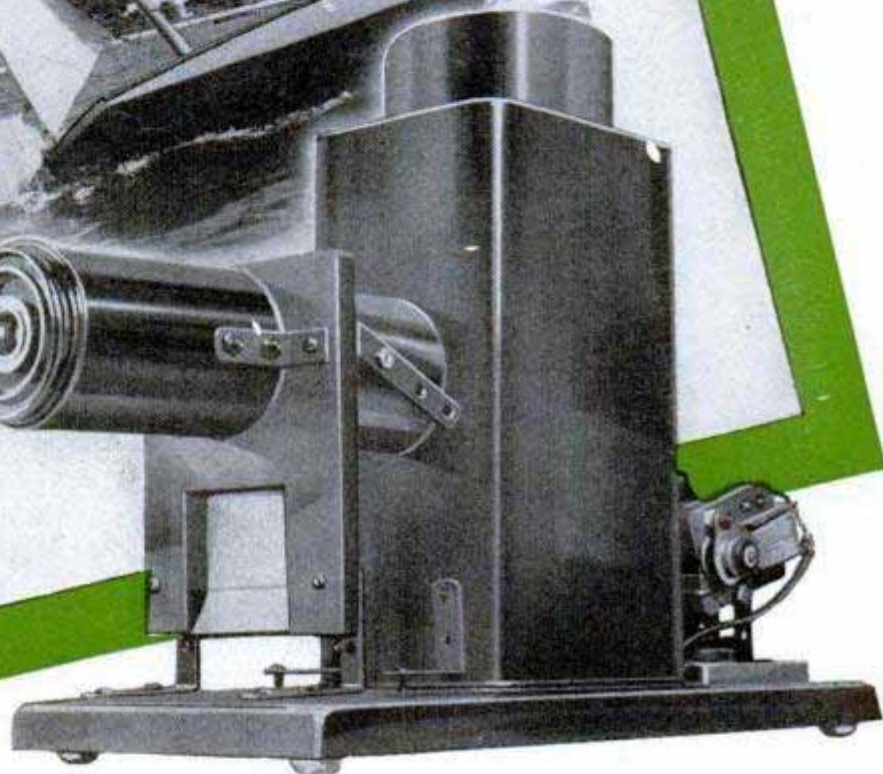
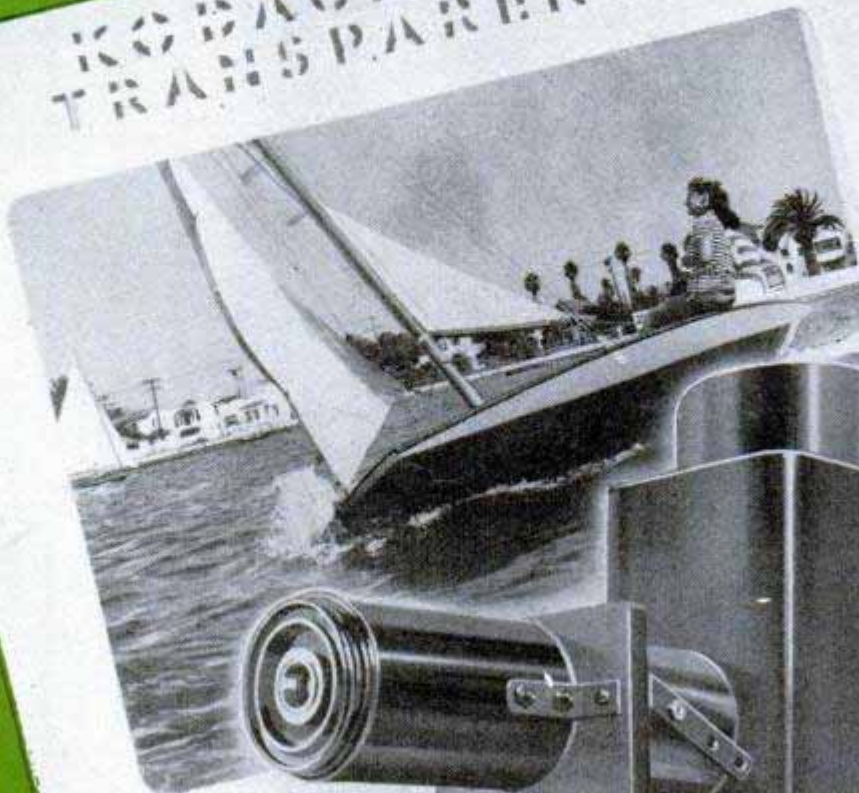

Build this 35-mm.

A disk of heat-absorbing glass supported in front of 300-watt bulb protects slides from intense heat

Tin-can baffles installed around projector bulb direct heat out through light trap on top of lamp house

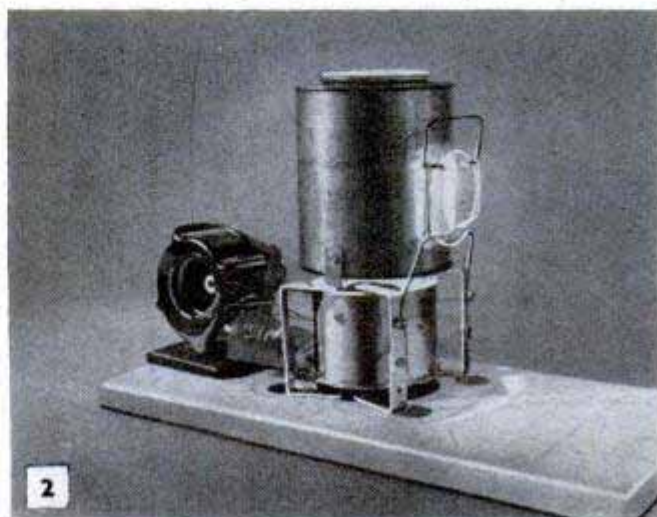
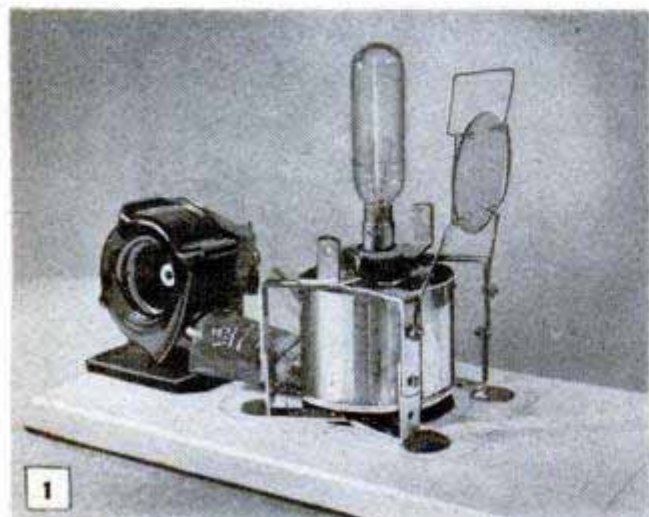

Does the high cost of a projector limit you to viewing your color slides with a direct viewer? Here's your chance to own a projector at a fraction of the cost of a commercial model. Read how Howard E. Warriner built this one from tin cans and odd parts

BEFORE YOU MAKE a down payment on an expensive slide projector, take a look around your home and workshop—you may have all the parts needed to build this excellent 300-watt, air-cooled, 35-mm. slide projector. For the most part, the projector is assembled from standard tin cans, most of which can be found in the kitchen and trash barrel. The various cans needed are as follows: One baking-powder can with either a snap or screw-on lid, $2\frac{3}{8}$ x 4 in., three fruit-juice or soup cans, $2\frac{5}{8}$ x 4 in., one deviled-ham can, $2\frac{3}{8}$ x $1\frac{3}{8}$ in., one 1-gal. vegetable-oil can, $4\frac{3}{8}$ x $5\frac{3}{4}$ x $9\frac{5}{8}$ in., one $\frac{1}{2}$ -lb. coffee can, $4\frac{1}{8}$ in. in dia., one can, $3\frac{3}{8}$ x $4\frac{5}{8}$ in., one can, $3\frac{1}{4}$ in. in dia. and one can, 3 in. in diameter. The projection and condenser lenses used in the original were taken from an enlarger, and the motor for the blower was removed from a record player. A camera lens can be used for the projection lens, and if you must buy a set of condensing lenses, specify a 3-in. focal length. You also will have to buy a 300-watt bulb and socket to fit. The blower can be had for less than a dollar from a radio-surplus store.

The first step is to lay out the wooden base according to Fig. 6 and bore the five vent holes. The stand, which supports the lamp and socket, is assembled from a 3-in. mending plate and ten metal angles of three different sizes. The $3\frac{1}{4}$ -in.-dia. can, cut

down to $2\frac{1}{2}$ in. high, forms the air chamber and fits inside the lampstand. However, a spout is fitted first to the can for connecting the blower, Fig. 5. This is formed from flat tin, bending it circular at one end and square at the other, and is soldered to a 1 x $1\frac{1}{2}$ -in. flap cut at the lower edge of the air chamber. The air chamber is attached to the lampstand at the top with two small machine screws and metal angles to raise it up from the baseboard.

The blower and motor are supported by 2-in. angle brackets and seated on sponge rubber. The exact mounting and location of the blower on the baseboard depend upon the particular type used, and it also may be necessary to add a back plate of sheet metal to the housing of the blower.

The lamp heat baffles, parts Nos. 20 and 21, Fig. 9, come next. These consist of two open-end cans, the inner one being a fruit-juice can, and both having $1\frac{3}{4}$ -in.-sq. ports cut in one side near the bottom. The exact location of these ports is governed and determined by the light axis, or horizontal line at the center of the filament. You'll note in Fig. 9 that this is $5\frac{1}{4}$ in. above the baseboard in the case of the original model. It is important that the square ports, as well as the lamp filament, heat-absorbing glass, condensing lenses, color slide and projection lenses, all be centered on the light axis. As fruit-juice cans have an inner

Tin-Can Projector

Jacks on each side of condenser-lens tube are provided for final adjustment before anchoring carrier

This view of the completed projector shows the lens mounted in snap lid of a common baking-powder can

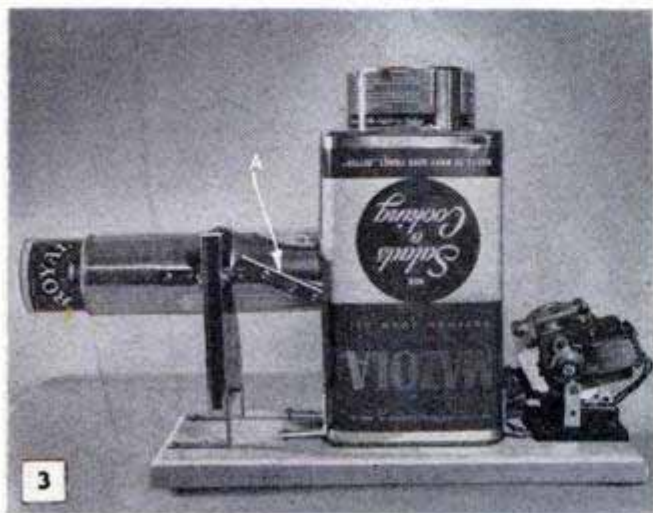

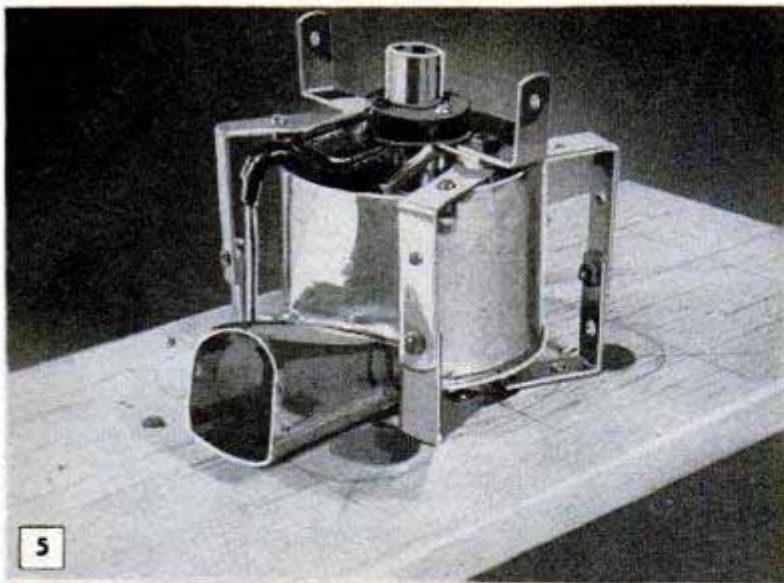

5

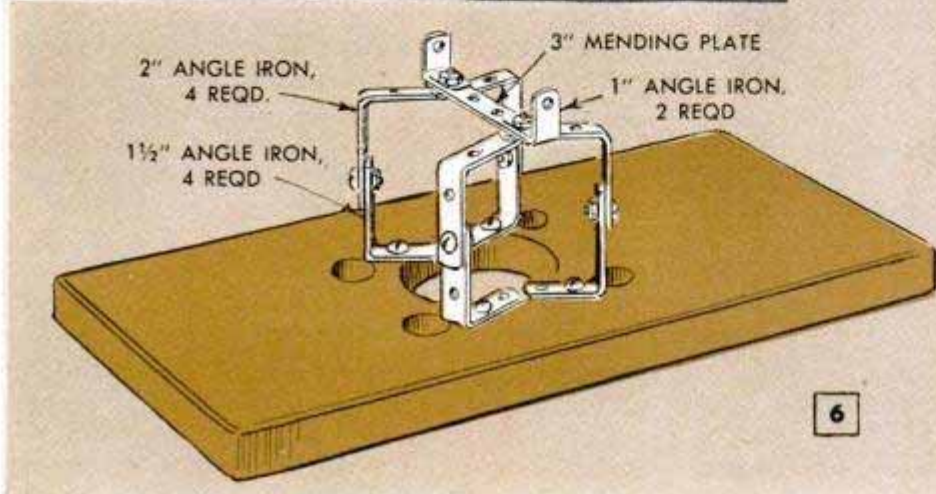
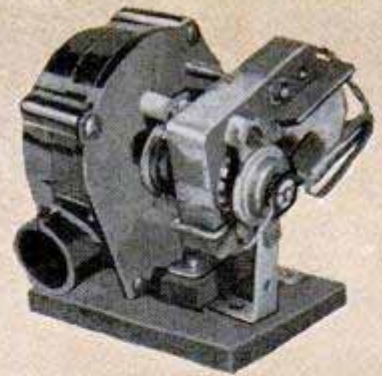

6

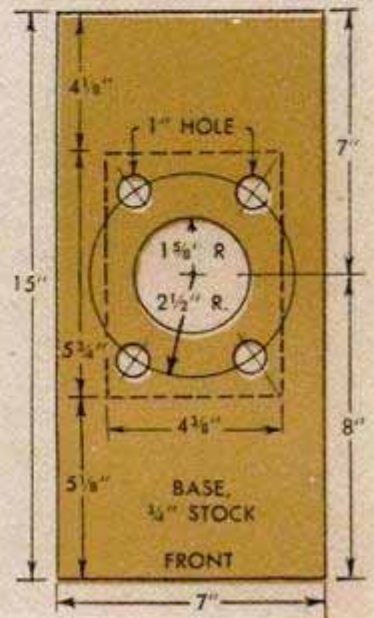

plastic coating, it will be necessary to burn it off beforehand, and as this blackens the can, a 3 x 3-in. semicircular reflector of bright tin, part No. 23, is mounted directly behind the lamp. Paper patterns pasted in position may aid you in aligning and cutting the ports. The top and bottom cuts are made with a hacksaw, a vertical cut is made with snips and the two resulting tabs are bent inward against the wall of the can. The small can is supported inside the other at the back with a 1-in. angle bracket, part No. 24, which is bent V-shape. Attach the outer can to the two angle brackets on the lampstand, two holes being made on opposite sides for machine screws.

Mounting the heat-absorbing glass, part No. 22, a necessary item installed to protect the lenses and color slide from the intense heat, completes the lampstand. This consists of a 2³/₈-in.-dia. piece of special glass centered on the light axis and mounted loosely in a wire frame. V-bends formed in the wire at four points serve to grip the glass. As you'll notice in Figs. 1 and 2, the wire frame is fastened to the lampstand so that the glass is held directly in front of the light ports in the baffles.

The vegetable-oil can forms the lamp housing. One end of the can is removed and a notch is cut down from the rim to

fit over the blower spout when the can is inverted and placed over the lamp. The circular light port in this can is centered on the light axis and is made large enough to accommodate the end of the can containing the condenser lenses, part No. 9. Three cans make up the light trap on top of the lamp house, the inner one being 1¹/₄ in. high and mounted over a 2⁷/₈-in. hole cut in the top of the housing. The outer can, a 1/2-lb. coffee can with both ends removed, is cut down to 2 in. high and soldered in place. Finally, a 3³/₈-in.-dia. can, 3/4 in. high and with one end intact, is set down over the inner can and held 1/4 in. above it with spring clips bearing on inside of can.

The condenser-lens tube, part No. 10, is a 2⁵/₈-in. can, 3 in. long and open at one end. A 1⁷/₈-in. hole is cut in the end of the can with a circle cutter and then two 2-in. angle brackets are bolted to the can, one on each side, for mounting it later to the slide carrier. Note that there must be a 1/4-in. air gap between the end of the condenser tube and the slide carrier and the bolt holes should be located accordingly. Mounting the condenser lenses is done in the following manner: First cut a piece of cardboard, 3 x 8 in., form it into a band and slide it into the far end of the can. Retainer bands for the two condenser lenses are obtained from

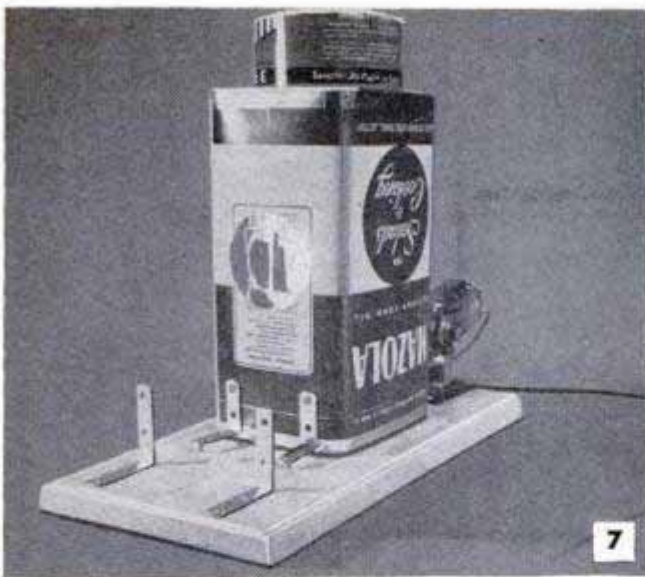

Lamp house topped with coffee-can light trap is made from 1-gal. can and anchored with angle brackets

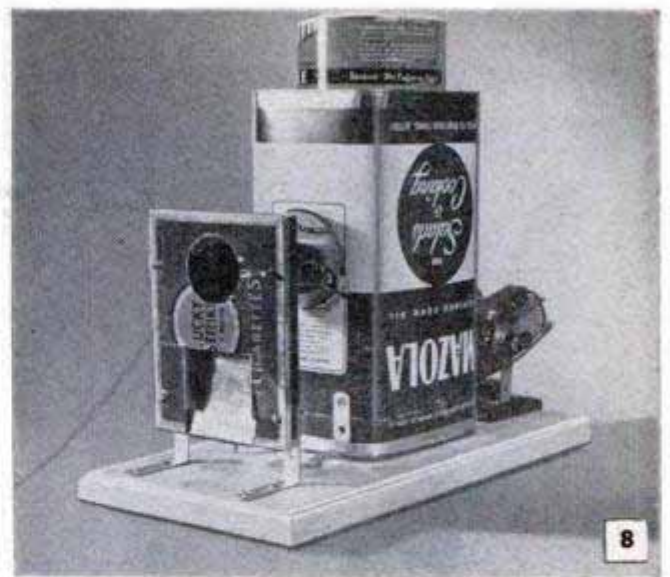

Slide carrier, featuring built-in ejection chute, is partly ready-made by using "flat fifty" cigarette box

a $2\frac{3}{8}$ -in. deviled-ham can which is opened with its key and then the ends removed from both halves. The smaller of the two bands serves as a separator and is pressed in place inside the cardboard sleeve and against the first condenser lens. The second lens is placed against the separator and held firmly in place with the metal band formed by the other half of the can.

Next comes the slide carrier, part No. 6, which is formed from a metal "flat fifty" cigarette box. To make the carrier, cut a $1\frac{3}{4}$ -in. hole in both the cover and bottom of the box, one directly over the other and centered on the light axis. A channel is formed down through the center of the box by soldering two L-shaped metal partitions to the bottom, $2\frac{1}{8}$ in. apart. The box edge at the top of the channel is cut away to admit the slide, whereas at the bottom a piece of metal, $2 \times 2\frac{1}{8}$ in., is curved slightly and soldered in place to form an ejection apron, part No. 8. A portion of the cover directly over the apron is cut out to complete the ejection chute through which each slide falls as a succeeding one is inserted in the carrier. Two flat-spring clips, parts No. 7, are finally soldered to the bottom of the box alongside the channel partitions to hold the slides in position in front of the light beam. As you'll notice in Figs. 7 and 8, the carrier is supported by two 2-in. angle brackets screwed to the base-board.

The projection lens is mounted in a hole cut in the center of the snap lid on a $2\frac{3}{8} \times 4$ -in. baking-powder can from which the bottom has been removed. The lens is held in

the lid by its threaded mounting ring. The outer can of the projection tube is centered over the hole in the slide carrier and attached with angle brackets. To obtain a snug sliding fit between the outer and inner cans, Fig. 4, the outer one is bushed with a suitable cardboard sleeve. Note that the outer can of the projection tube is the same size as the condenser can.

Provision is made for correcting the quality of light when making a screen test by installing two condenser jacks, part A, Fig. 3, one being placed on each side of the condenser tube. These are 3-in.-long flat pieces which fit over the second bolts in the angle brackets. The jacks bear against the lamp house and hold the condenser in critical adjustment when the carrier is finally anchored permanently. Interior surfaces of all the parts should be painted flat black in order to kill any interfering light reflections. ★ ★ ★

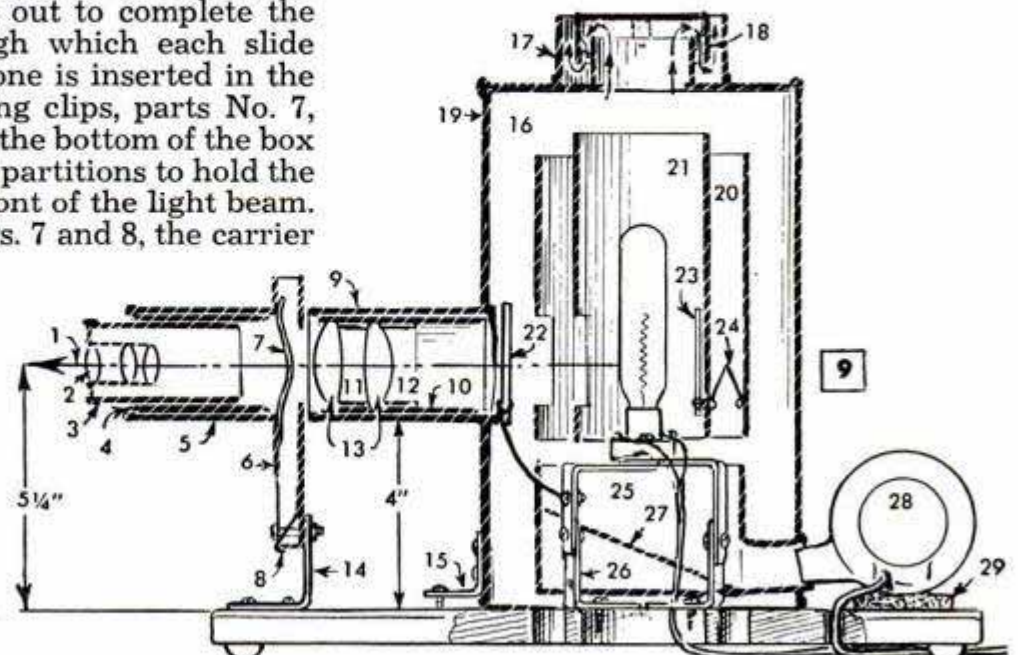

Light Mounted on Paper Cutter Simplifies Trimming Operation



Installed beneath the cutting edge of a paper cutter, a fluorescent lamp enables one photographer to trim photostats, contact prints and other translucent materials with greater speed and accuracy. The lamp

illuminates the overhanging portion of the material to be cut, indicating exactly where the blade will cut. A plastic shield may be mounted over the lamp if desired to deflect scraps into a wastebasket on the floor.

B. West, Arlington, Va.

Handy Spoon for Dry Chemicals

A glass iced-tea mixer is ideal for use in portioning dry chemicals in small amounts. These little mixers can be purchased for only a few cents at any dime store and are also useful for mixing photographic solutions in small quantities.

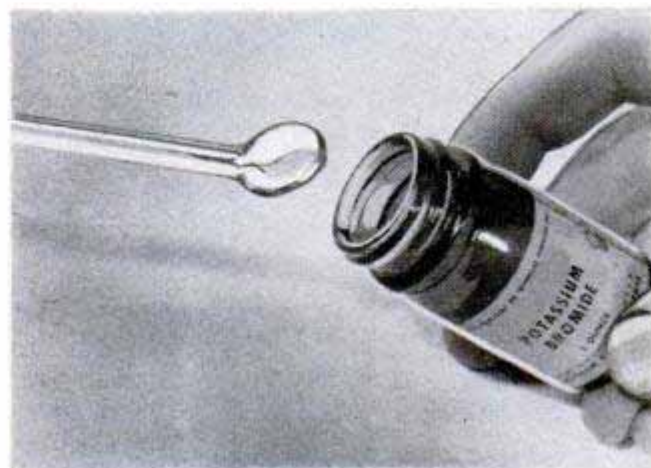

Popular Mechanics Bookshop

What Is a Hobby?

We're not sure. A glance at the big dictionary at our right hand leaves us highly confused. A hobby is a falcon, it says here. In the next paragraph it is a small horse. And all the time we thought a hobby was a pleasurable occupation, something you did for fun in your spare time.

Anyway, we're going to assume we are right. A hobby is fun, but it also can be profitable. In fact, right here we have a book called *Money-Making Hobbies* in which you'll find 132 ways to make money and have fun doing it — hobbies like modeling in plaster and ceramics, leathercraft, carving in wood, collecting and polishing gems, fashioning jewelry, glass blowing, making things from plastics, weaving, shaping metal. . . . This is a book that will introduce you to new hobbies and help you cash in on your favorite spare-time occupations. Send \$2.00 to Popular Mechanics Press, 204 East Ontario Street, Chicago 11, for *Money-Making Hobbies*.

★★★

Have you kept an account lately of your expenses for home repairs? If the bill came at the end of a year it would stagger you! In these days when plumbers and electricians

and carpenters play hard-to-get and their costs are high, it would pay you to invest \$2.50 in *Popular Mechanics Guide to Home Repairs* and do the work yourself. This 192-page book, with 646 illustrations, is packed full of answers to your home-maintenance and repair problems . . . how to install electric outlets, window and door construction, tuck pointing and roof repair, hints for remodeling and how to lay linoleum. The book will pay for itself on your first call for help around the house!

★★★

Would you pay three cents for the plans and directions for building a new chair or desk? Here is a book that brings you detailed construction plans for 100 pieces of furniture for only \$3.00. You could furnish your home completely — living room, dining room and bedroom — by following the simple how-to-do-it instructions of this beautiful book. It contains more than 500 pictures, including 30 in full color which bring out the beauty of John Bergen's styling. Many of the modern pieces were styled especially for *Popular Mechanics* by Mr. Bergen. Send \$3.00 to Popular Mechanics Press, 204 East Ontario Street, Chicago 11, for your copy of *100 Beautiful Pieces of Furniture You Can Build*.

All books available from Popular Mechanics Book Dept., 204 East Ontario Street, Chicago 11



KNURLING On Your Lathe

By E. R. Haan

KNURLING is done in most cases to provide a more positive grip on turned parts, although sometimes it is used solely for ornamentation. On occasion, a straight knurl is used to prepare a round turning for a press fit, in which case the knurls are hardened so that they cut their own grooves when pressed into a mating piece. Knurling done on a lathe as in Fig. 2 produces embossed surfaces on the periphery of turned parts, such as tool handles, thumbscrews, nuts and sleeves, some of which are pictured in Fig. 1. Most knurled surfaces consist of tiny diamond-shaped projections in a continuous pattern. On narrow edges, such as screw heads, knurling usually consists of closely spaced parallel ridges. Both of these patterns are produced in fine, medium and coarse textures as shown in Fig. 3. The range in textures gives a selection that is best suited to the particular size of the work, as well as the amount of gripping power or friction required. The medium-textured knurl is most common.

Knurling tools: A knurling tool consists of one or more hardened disks or knurls mounted in a holder, which is designed either to be held in the hand or clamped in a lathe tool post. Knurls vary in diameter from $\frac{5}{8}$ to 1 in., and in width from $\frac{3}{16}$ to $\frac{1}{2}$ in. Teeth on the edge or face of knurls leave their impression on unhardened work when brought against the surface with sufficient pressure while the work is rotated. Some of the metal is forced up between the teeth and then forms projections or ridges above

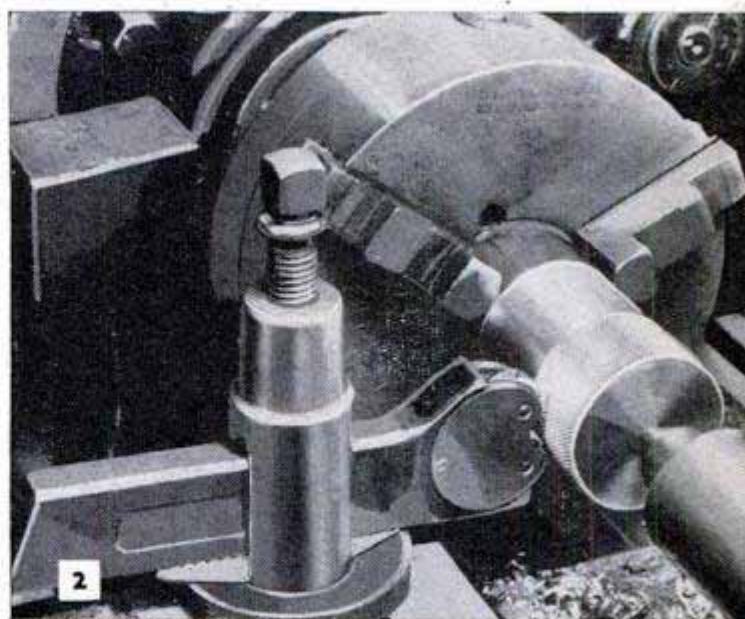

Photos courtesy Armstrong Bros. Tool Co.



Knurled surfaces shown above, each in three textures, are produced by knurls shown below

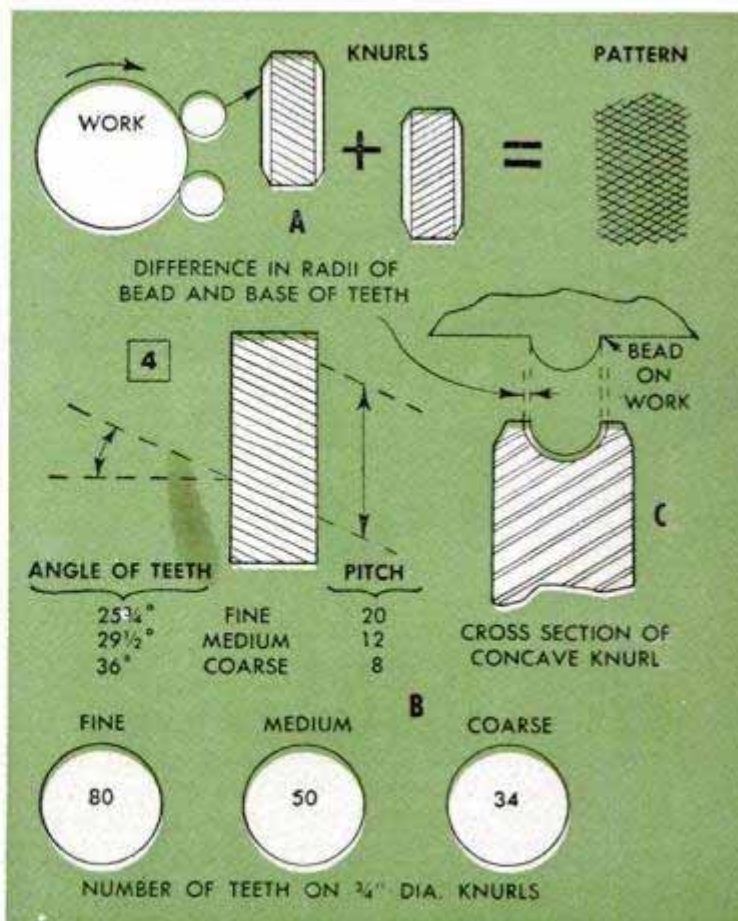



ADJUSTABLE HAND-OPERATED TOOL WITH THREE KNURLS

HAND-HELD TOOL FOR NARROW KNURLING IN LATHE

5

6

7

8

9

MOUNT WORK FOR KNURLING BETWEEN CENTERS IF POSSIBLE

LONG, LIGHT WORK NOT PROPERLY SUPPORTED

CENTER REST PREVENTS SPRINGING OF WORK

TOO FAR OUT FROM CHUCK. FREE END LACKS SUPPORT

KNURLING DONE CLOSE TO CHUCK

WORK

FULCRUM (T-REST) NEAR KNURL

knurled. If both were of the same radius, metal would be pressed on the adjacent surface or shoulder, spoiling the appearance of the work.

Hand-held knurling tools, Figs. 5 and 6, are used to knurl narrow edges of work rotated in a lathe, which do not require a traverse movement of the tool as is necessary on a surface wider than the knurl. The tool shown in Fig. 5 is adjustable to various diameters and can be used to knurl work held stationary in a vise while the tool is rotated by hand. It also can be used on flexible work. This tool has two stationary knurls and a single one on a threaded shank which is advanced on the work. The single-knurl hand tool shown in Fig. 6 must be supported on a fulcrum, such as a T-rest placed close to the knurls. In use, it is forced upward against the underside of the work with considerable leverage when the handle is moved downward. The knurls on this tool are interchangeable, one having a diamond design.

Fig. 7 shows a common type of knurling tool designed to be held in a lathe tool post. It has two knurls mounted on a semicircular holder that is self-centering. This equalizes the pressure of the knurls on the work which is necessary to assure uniform patterns. Similar distribution of pressure is obtained with the tool shown in Fig. 8, which holds three pairs of knurls. Such an arrangement is convenient when flat and concave knurls or different textures are required on one piece.

Setting up lathe for knurling: If possible, mount the work to be knurled between centers, Fig. 9, A, as this gives maximum support against the heavy pressure required for knurling. Small-diameter work may require the support of a center rest to prevent spring, details B and C. When work is mounted on a faceplate or in a chuck, the knurling is done as close to the headstock as possible, details D and E.

Set the compound rest at a 30-deg. angle to the right, as in Fig. 10, A, so that its screw handle will not interfere with turning the cross-feed screw. Slide the knurling tool into the tool post as far back as possible to obtain maximum rigidity, and set the tool post so the faces of the knurls are parallel

the surface. Using a pair of spiral-tooth knurls with the teeth slanting in opposite directions produces a diamond pattern as in Fig. 4, A. Detail B gives the angle and pitch of spiral teeth for fine, medium and coarse textures, also the number of teeth on 3/4-in.-dia. knurls. When using a concave knurl, the radius at the base of the teeth, as seen in the cross-sectional view, detail C, must be slightly larger than the radius of the bead or rounded portion to be

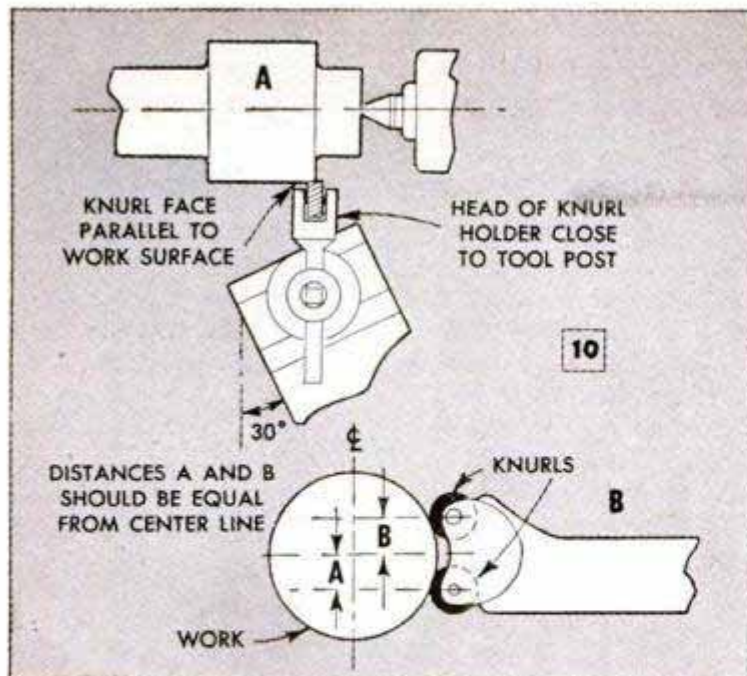

to the work surface. Adjust the tool for height to locate the knurls an equal distance above and below the center of the work, detail B. Then tighten the tool post. Knurling operations are done at slow back-gear speeds—not exceeding 50 percent of the regular cutting speeds recommended for the material being knurled.

Knurling: Adjust the lathe carriage so that the knurl face is positioned at the tailstock end of the work where knurling begins. In case it starts at the edge, as in Fig. 12, A, about $\frac{1}{3}$ to $\frac{1}{2}$ the width of the knurl should project over the edge of the work. Then with the work rotating and the knurls almost touching it, apply cutting oil liberally, Fig. 11, and feed the cross slide inward so that the knurls enter the work about $\frac{1}{64}$ in. This will produce a well-defined pattern. Steel requires application of cutting oil to avoid overheating, but cast iron and soft metals like brass and aluminum are knurled dry. Stop the lathe after a few revolutions but without backing out the tool. If the design is not correct and double impressions split the diamonds, back out the tool and start over again at another point. One way to prevent double impressions is to feed the knurl with considerable pressure at the start and then relieve it slightly. Test knurls will be rolled out automatically in the knurling process. For surfaces wider than the knurl face, use

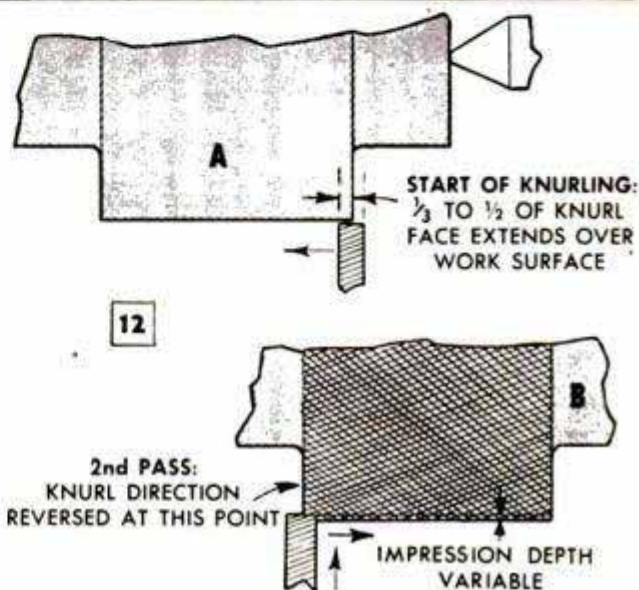

the longitudinal carriage. Fine patterns generally are finished in one pass but coarse ones often require two and sometimes three passes. When a repeat pass is necessary, knurling should be continuous without removing the knurl from the impression, although the lathe is stopped at the end of a pass. The direction of the power feed is reversed and the cross-feed slightly just after the leading edge of the knurl has passed the headstock edge of the work as in Fig. 12, detail B. But the knurl must not be permitted to run off the work. For a third pass, the process of reversal is repeated at the tailstock end. Running the tool over the work too often may ruin the pattern. In addition, any loose particles of metal that happen to get between the knurls and the work will mar it. Keep the tailstock center well-lubricated. ★ ★ ★

"Vise" Holds Washers for Filing to Required Thickness

Should you discover the need for a metal washer thinner than any of those on hand, use a 2 x 4 block to provide a simple fixture for holding the washer while it is filed to the thickness desired. Simply mount the block in a vise, place the washer on it and

drive in several brads around the edge of the hole, spacing them so they grip the washer securely. This done, proceed to file the exposed surface of the washer until the required thickness is obtained.

A. B. Royndors, St. Petersburg, Fla.

Toweling Stitched to Cloth Gloves Makes Car Polishing Easy

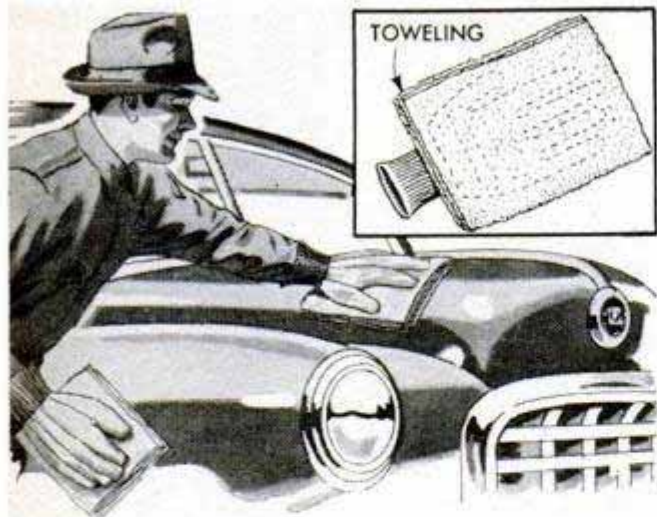

Several thicknesses of terry-cloth toweling or cheesecloth stitched to the palms of a pair of cloth work gloves will simplify and speed up the job of polishing a car. Use one glove to apply the polish or to remove the excess, and the other for the final polishing of the surface. After finishing the job, wash the mitts in hot water so they will be clean and soft for future use.

Pipe Elbow on Blowtorch Burner Directs Flame Vertically

For heating water quickly in a small container or directing the flame either right or left when it's necessary to reach hard-to-

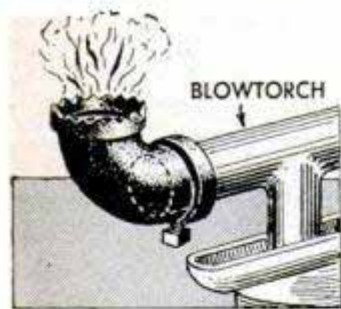

get-at places, just attach an ordinary pipe elbow to the open end of your blowtorch burner. Select an elbow that will slip easily over the burner and drill and tap it near one end for a setscrew. If a con-

tainer is to be placed on the top end of the elbow, form a "grille" by filing notches in the end of the elbow as shown.

Spading Fork With Mitten "Flag" Located Easily in Field

When a spading fork or similar hand implement is used in a field, often it is set into the ground and left momentarily. When this is done it is sometimes very difficult to locate it by sight when you return to use it again. One farmer found that he could overcome this by simply slipping a mitten over the handle. The mitten served as a flag and made the fork much easier to see at a distance. If a mitten is not available, a handkerchief or any other piece of

cloth may be tied to the handle to serve the same purpose. The time required to do this possibly may save you many minutes wasted in searching for the fork later on.

Salvaging Damaged Lathe Mandrel

If the center hole of a lathe mandrel has been damaged to the extent where it no longer can be used for precision work, you can salvage the mandrel by drilling a hole in the end and driving in a bronze plug. A new center hole is

then drilled in the plug. The hole that is to receive the plug can be drilled with the work held in the three-jaw chuck. After the plug has been driven in place, however, far greater accuracy will be required in drill-

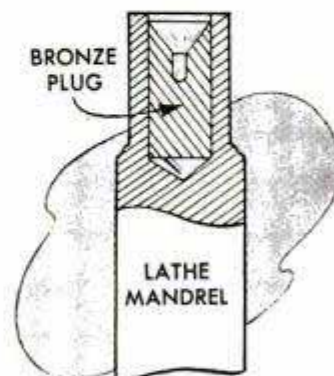

ing the tapered center hole. This can be done best by mounting one end of the mandrel on the headstock center and supporting the tailstock end in the steady rest. In this manner, the end of the mandrel can be made to run dead true and the center hole drilled with accuracy while the center drill is mounted in the tailstock chuck. The diameter of the center hole should be made the same size as the original one and should also be counterbored to protect the center from damage.—C. W. Woodson, Miami, Fla.

Folding Rule Provides "Frame" For Keeping Blueprint Flat

Keeping an unrolled blueprint flat on a bench or table for reference is easy if you use a 6-ft. folding rule as a frame or holder. Adjust the rule to a shape similar to that indicated and slip the blueprint into it. The weight of the rule also will help to prevent the sheet from being blown by the wind when used outdoors.

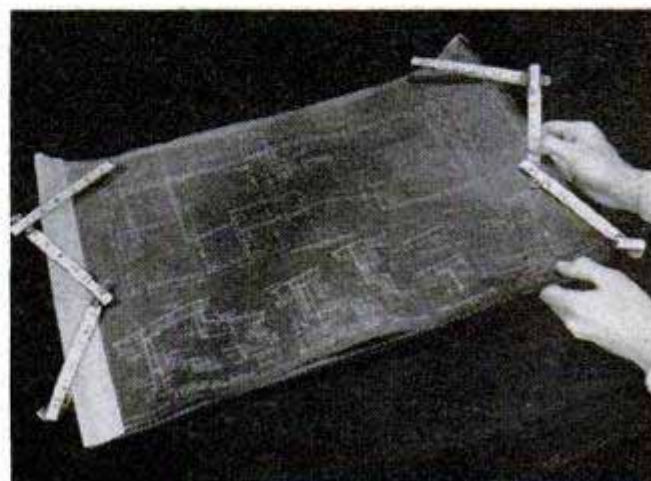

POLISHING-HEAD LATHE

By Dick Hutchinson

IF YOU have only occasional use for a wood-turning lathe in your home shop, here's a way to make a serviceable one at minimum cost. Two ordinary bench-type polishing heads form the head and tail stocks. As dimensioned below, the lathe takes 22 in. between centers and provides a 12-in. swing over the bed. The distance between centers can be increased to 29 in., the standard table-leg length, by making the angle-iron bed members $40\frac{1}{2}$ in. long. The bed members are bolted to hardwood mounting pads, the bolts passing lengthwise through the spacing blocks and through the flanges of each angle. A pipe spacer is used at the center to maintain alignment of the bed members. No changes in the polishing heads are necessary except drilling and tapping a hole in one

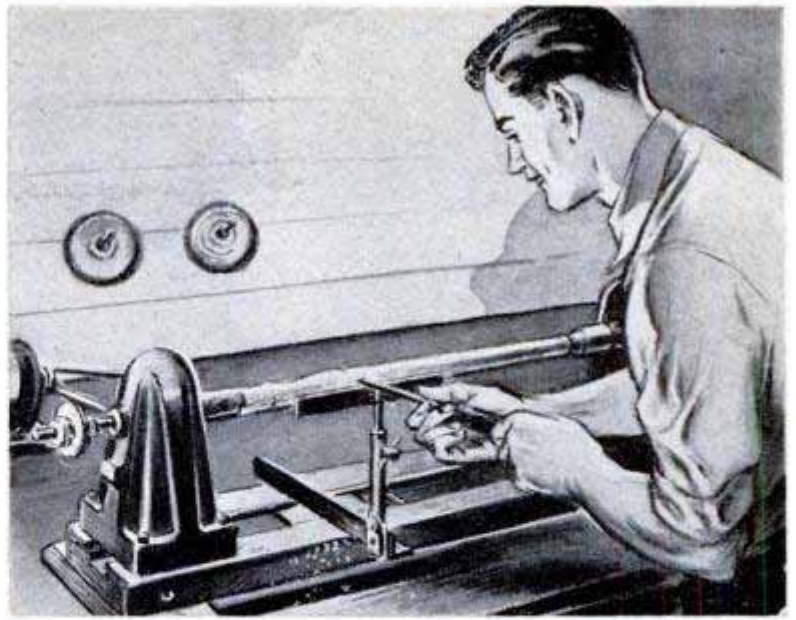

bearing of the tailstock to provide for a spindle locking screw, and filing a flat on one threaded end of the each spindle so that the setscrews in the centers do not damage the spindle threads. Both the headstock and tailstock are attached to the bed with bolts and wing nuts, the bolts passing through flat plates which bear against the angle-iron flanges. A faceplate, handwheel and tool rest are easily improvised.

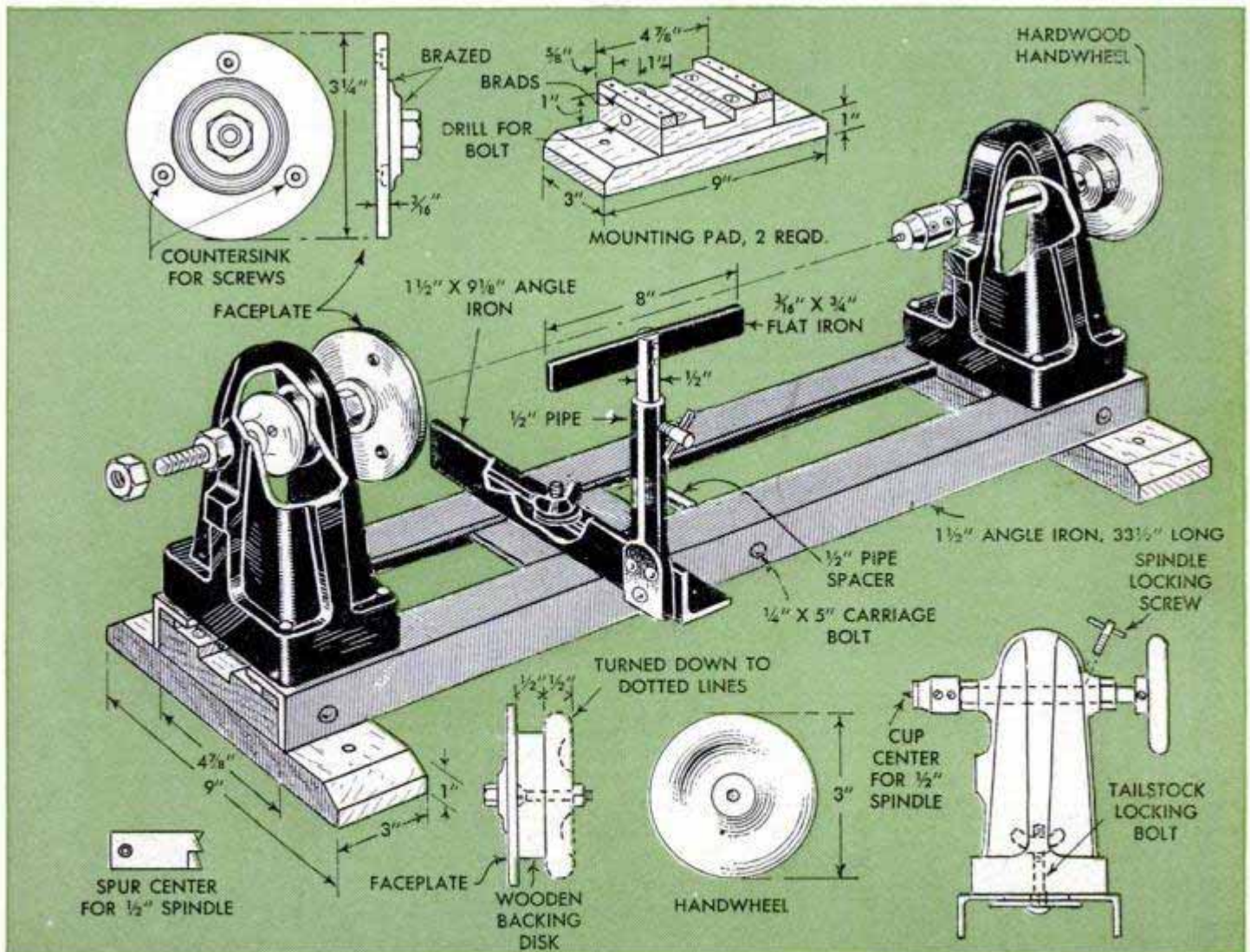

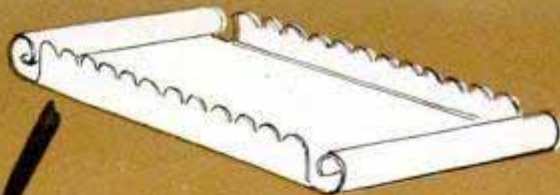
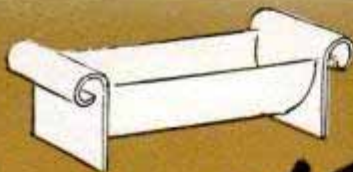

Roll 'Em Up!

with a SLIP ROLL

By Sam Brown

MANY PROJECTS in sheet metal require cylindrical and conical shapes, which often present a difficult problem to the beginner in sheet-metal work. The slip roll, Fig. 2, simplifies forming these shapes from flat sheets and, as it also will handle strap stock and wire, the project possibilities of the tool are almost unlimited. The table lamp pictured in Fig. 1 is a typical example.

A study of the drawing below and the various work pictures makes it apparent how the tool is used. There are two feed rolls which grip and feed the flat work against a single forming roll. If the forming roll is close to the feed rolls, the sheet, strap or wire work will be rolled into a cylindrical shape with a minimum diameter of about $1\frac{1}{8}$ in. Larger cylinders are formed with the forming roll positioned a greater distance from the feed rolls. In ordinary practice, the work first is rolled to a greater diameter than required and then gradually reduced by advancing the forming roll for successive passes of the work.

Figs. 3 to 9 show standard slip-roll shapes. The cone shape, Fig. 4, requires side-slipping the work to keep it square with the feed rolls. This is done most readily when the feed tension is light so as to allow the work to be pushed in a sidewise direction as the feed is made. If the work cannot be side-slipped with one hand, the feed can be



TYPICAL SLIP-ROLL PROJECTS are lamp, cigarette server and wall planters. Machine is shown at right

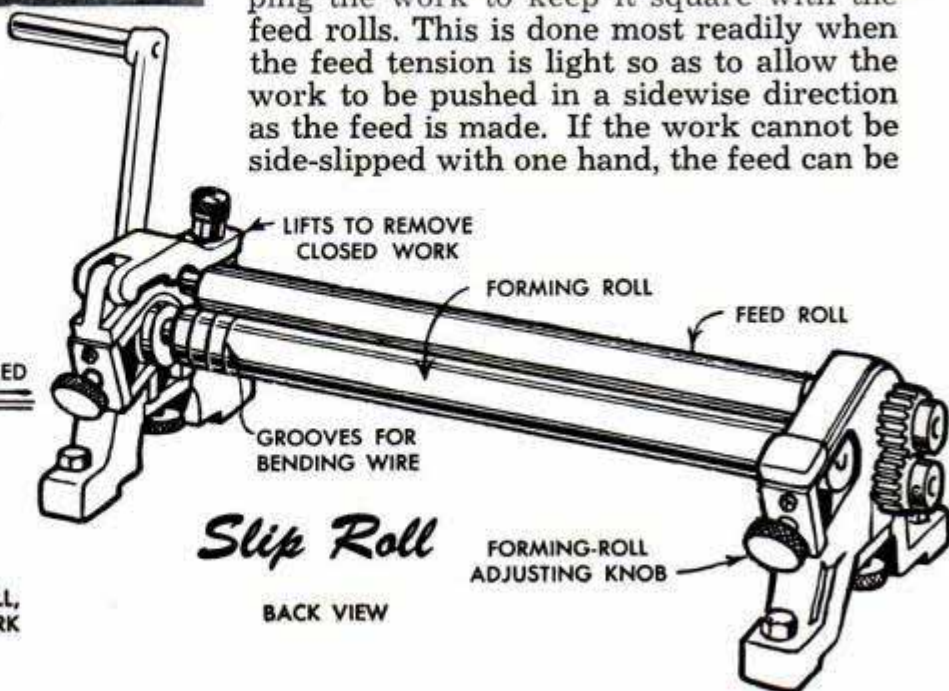
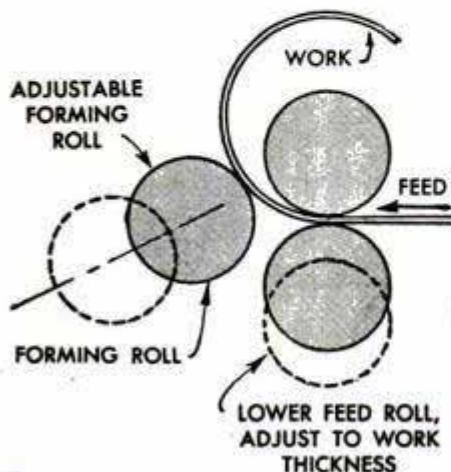

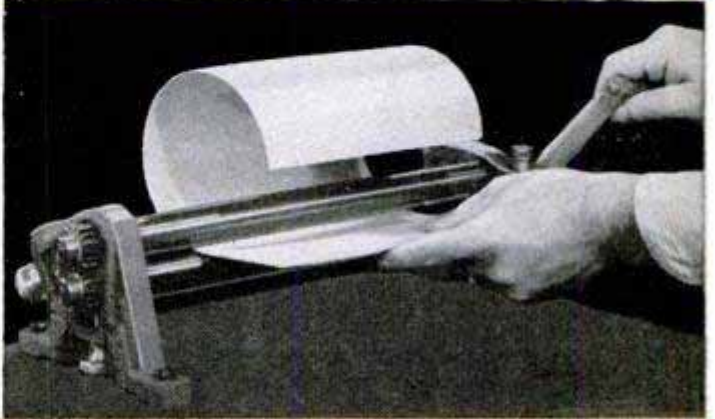
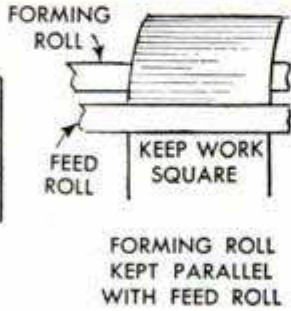
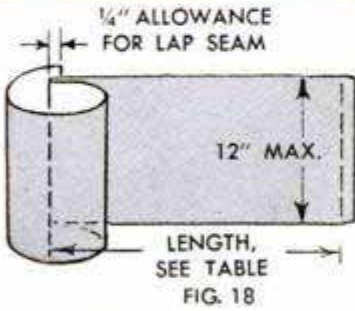
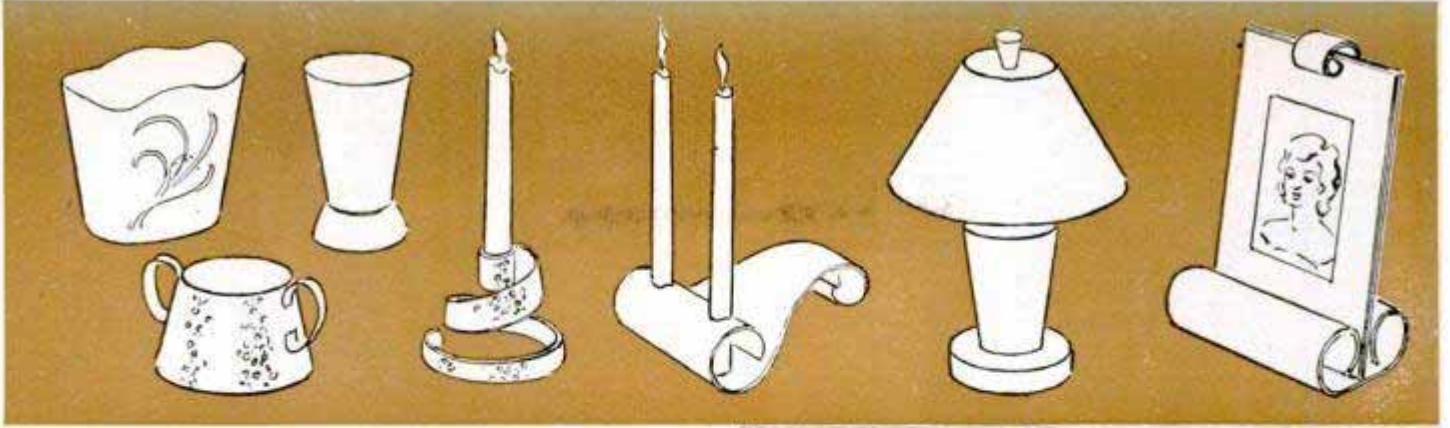

3 CYLINDER is easiest roll-up job. Minimum forming dia. is 1 1/8 in. Use table to find length

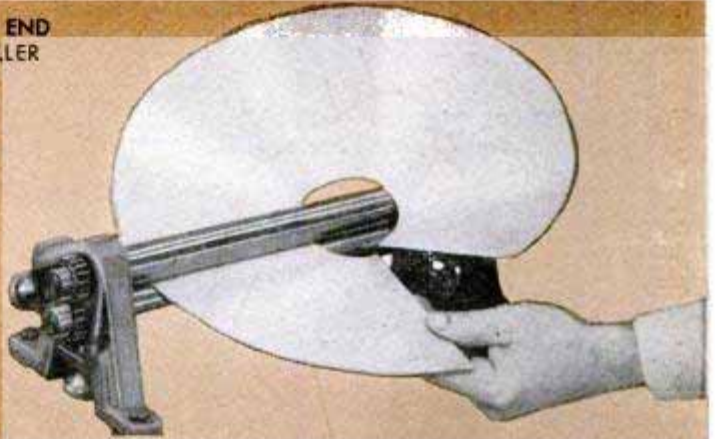
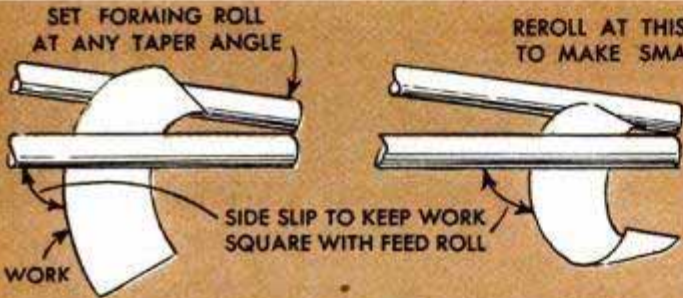

4 CONE must be side-slipped to remain parallel with the roll. Slip rolls will not form full cone as 1 1/8-in. opening is required to clear the rolls

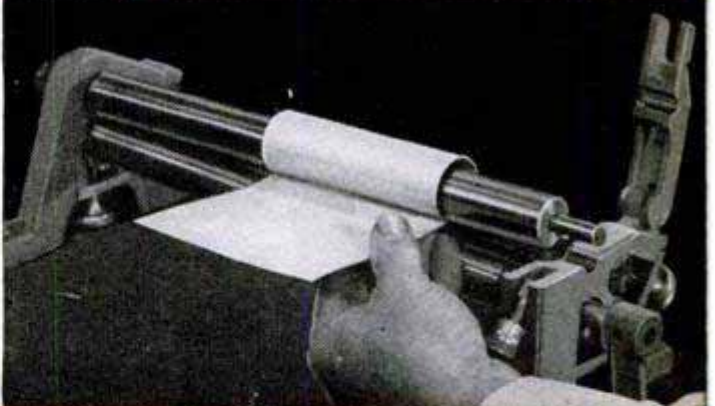
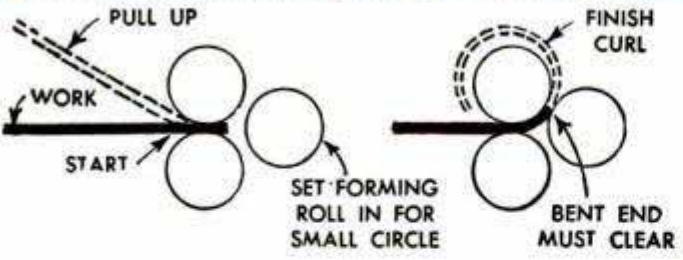

5 END CURL has numerous applications. Top feed roll is released to move work as at right. Below, double curl and reverse bends are two variations

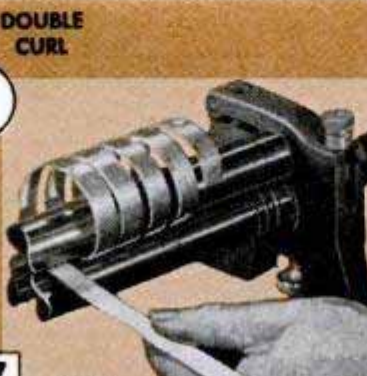
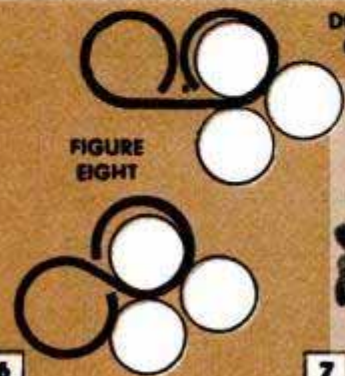

6 FIGURE EIGHT

7 SPIRAL

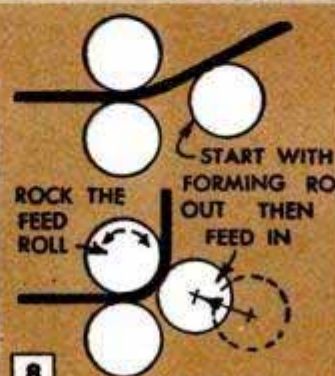

8 ROUND CORNER

9 BENDING WIRE

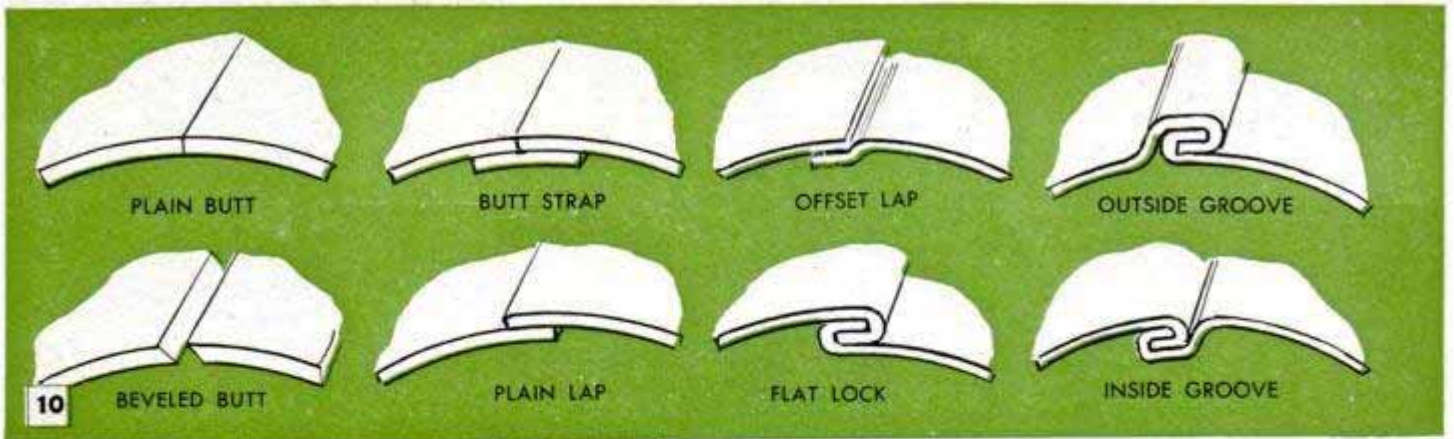

Eight Ways to Make Seams

made in short steps of about 1 in. each, squaring the work with two hands after each advance. The useful round corner, Fig. 8, is made without advancing the work. It is a plain pressure operation done by advancing the forming roll as the work is rocked backward and forward slightly.

After rolling a cylinder or cone, you have the job of securing the seam. Fig. 10 shows eight ways of doing this. The simple lap joint is most popular with beginners, using either rivets or small bolts for fastening. Holes for rivets or bolts are easy to drill if the seam is clamped with two small C-clamps and then drilled, as shown in Fig. 11. Fig. 12 is a simple, practical setup for riveting. If you have a brake and can make the necessary bends for a lock seam, you can do a neater job by "grooving" the lock to the inside, as shown in Figs. 13 and 14. For occasional work, a hardwood grooving block is satisfactory for soft metals to 22 ga.

An attractive beginning project to try on the slip roll is the teapot lamp shown in Figs. 17 and 19. The bottom alone makes a neat planter, Fig. 15. A variation of the lamp is pictured in Fig. 16, using a standard socket with clip-on shade. The planter, Fig. 15, is of 22-ga. stainless steel with ball-peen texture hammered on the sheet. ★★★

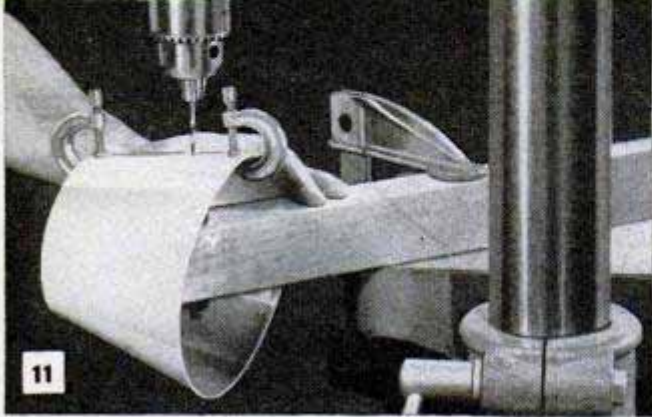

11 DRILLING holes for seams is done easily with work supported on bolt fitted in end of wooden block clamped to the drill-press table

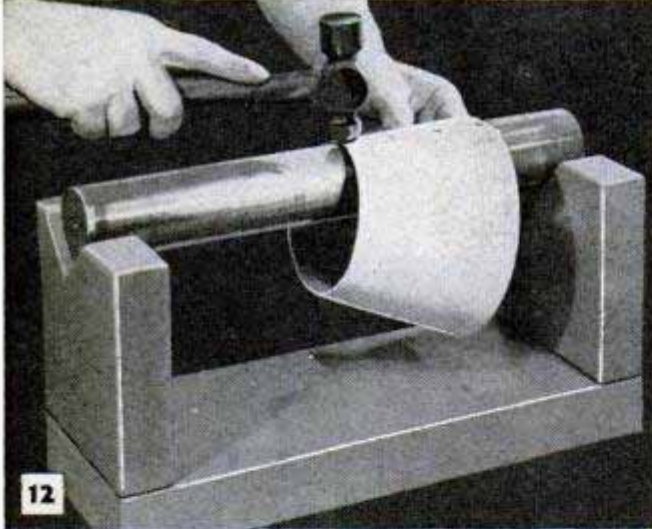

12 RIVETING IS DONE ON SIMPLE BAR ANVIL

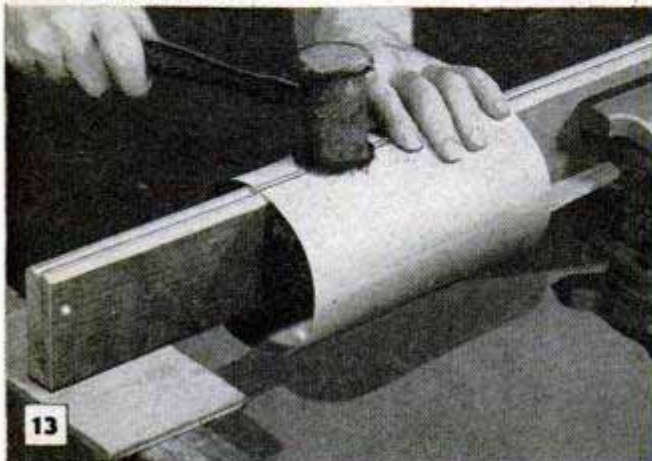

13 GROOVING MAKES A NEAT LOCKED SEAM

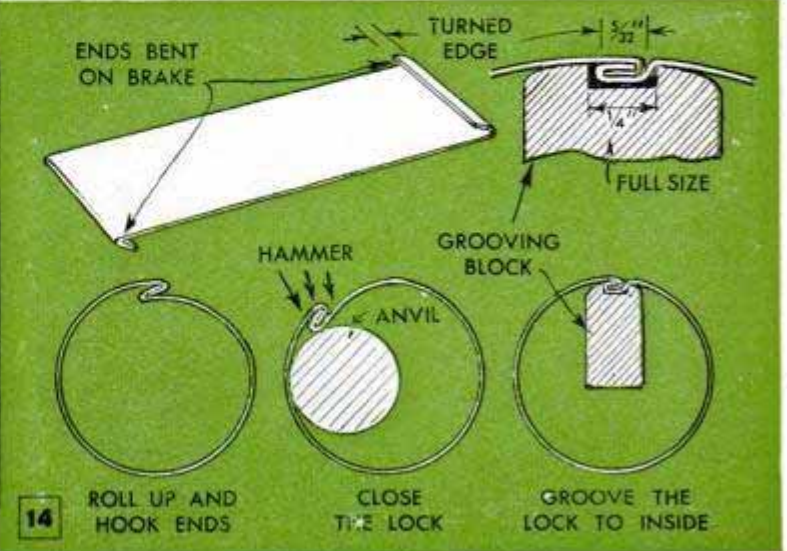

14 ROLL UP AND HOOK ENDS, CLOSE THE LOCK, GROOVE THE LOCK TO INSIDE



15



16



17

18 CIRCUMFERENCE OF CIRCLES			
Dia.	Circ.	Dia.	Circ.
1	3.14	6 1/4	19.63
1 1/2	4.71	6 1/2	20.42
1 3/4	5.50	6 3/4	21.21
2	6.28	7	22.00
2 1/4	7.07	7 1/2	23.56
2 1/2	7.85	8	25.13
2 3/4	8.64	8 1/2	26.70
3	9.42	9	28.27
3 1/4	10.21	9 1/2	29.84
3 1/2	11.00	10	31.42
3 3/4	11.78	10 1/2	32.99
4	12.57	11	34.56
4 1/4	13.35	11 1/2	36.13
4 1/2	14.14	12	37.70
4 3/4	14.92	12 1/2	39.27
5	15.71	13	40.84
5 1/4	16.49	13 1/2	42.41
5 1/2	17.28	14	43.98
5 3/4	18.06	14 1/2	45.55
6	18.85	15	47.12

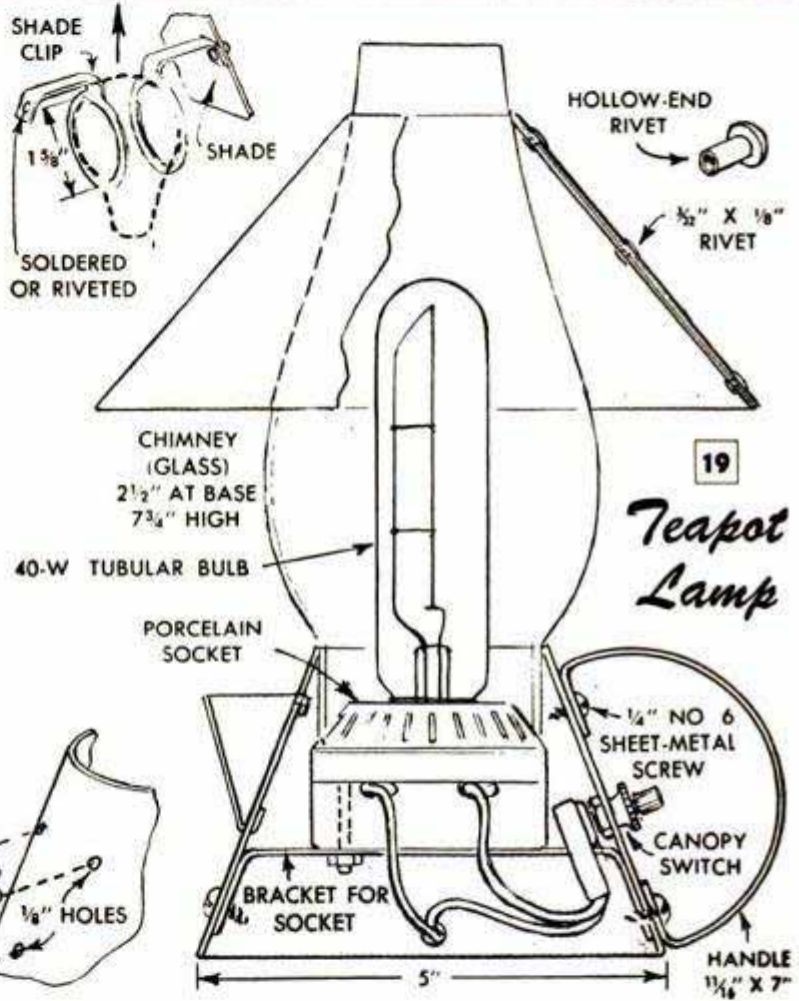

19

Teapot Lamp

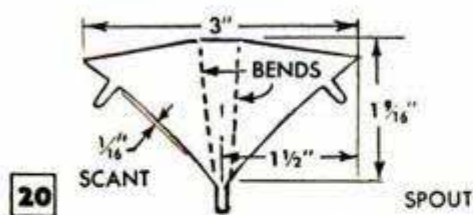

20

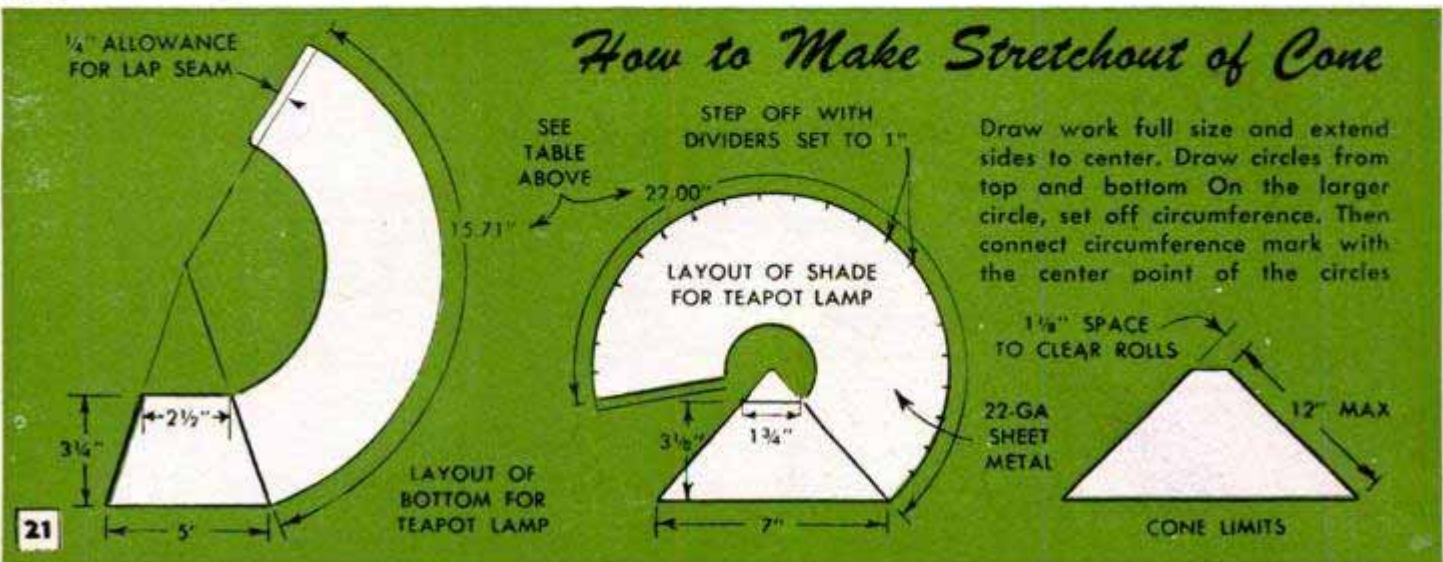
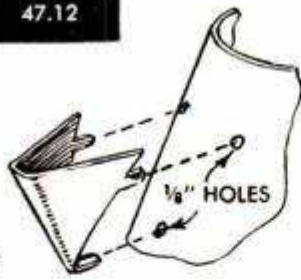

21

Wallpaper Rolls Tied Easily When Held on Handy Rack



Especially helpful when a dozen or more rolls are being wrapped, this handy rack will prove a valuable timesaver to any merchant selling considerable quantities of wallpaper. Legs, crosspieces and feet are cut from $\frac{3}{4}$ -in. stock, while the curving arms are cut from plywood. All parts are assembled with glue and screws. The rolls of wallpaper are cradled in the arms of the rack as shown and a cord passed under them and tied across the top. Extra lengths of cord may be hung over the crosspiece near the top of the rack until needed.

L. H. Houck, Jefferson City, Mo.

Registering Holes Drilled in Metal With Aid of Aligning Clamps

When it is necessary to drill or punch a series of holes through two or more thicknesses of thin sheet metal without using a jig, sheet-metal workers often use aligning clamps to aid in producing accurate work. The clamps for this purpose can be

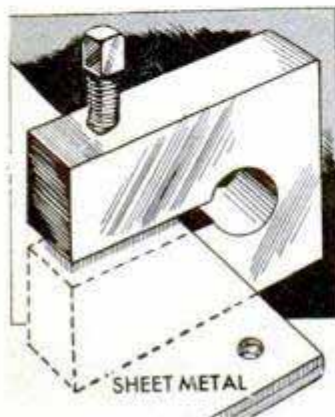

made by drilling and slotting small blocks of mild steel to form two parallel jaws, one of which is drilled and tapped for a setscrew. The threaded end of the setscrew is shouldered, after which the shouldered portion is turned to a slight

taper. The diameter of the shoulder at the larger end of the taper is equal to the diameter of the hole to be drilled. In use, the sheet-metal strips are placed in position and the first hole drilled through both thicknesses. Then the clamp is positioned and the setscrew turned down until the tapered end enters the holes in both parts. The clamp holds the parts in alignment while the remaining holes are drilled or punched. On long strips, several clamps often are used, either for aligning the holes or as conventional clamps for holding various parts together.

Barn Doors Kept From Swinging By Concrete "Blister"

Instead of using stakes or other devices to prevent sliding barn doors from being damaged by the wind, one farmer formed a channel in a concrete "blister" made in the floor. This was placed at the point where the doors meet, the lower edge of each door sliding into the channel. Holes in the blister may be provided in order to permit the use of bolt-type locks on the doors.

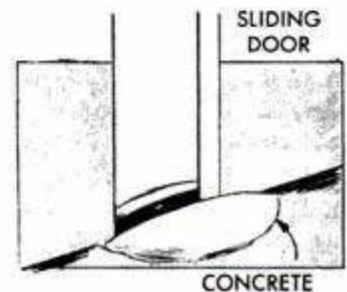

Skid Platform at Waterer Provides Dry Ramp

A common problem of hog raisers and poultrymen is preventing contamination of the range water supply when the area around the automatic waterer becomes soft and muddy due to constant trampling. Frequently the watering cups are filled with mud and debris and the valves are opened and the tank emptied. To prevent this and provide a stable ramp leading directly to the watering cups, one hog raiser simply inverted a skid platform and placed it with one end against the waterer as in the photo. The platform is held in place with small stakes driven into the ground at the sides and the outer end.

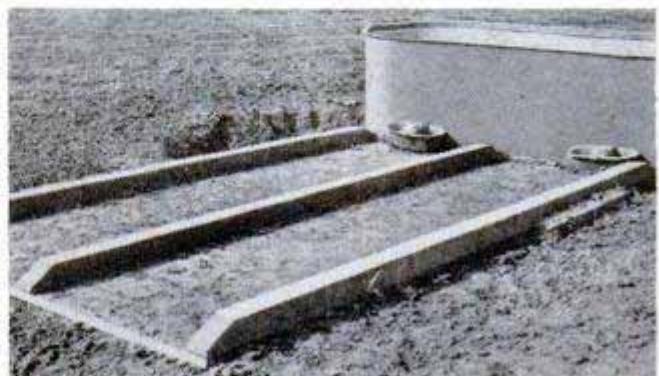

RADIUS GAUGE

By Evan Wright

TRANSFERRING an arc and determining its radius when the arc or surface will not permit measuring across the diameter is a tricky, exacting operation and involves a calculation few mechanics have time to carry out. This radius gauge makes it simple. It consists of a screw-type binding post to which are attached three lengths of drill rod as in Fig. 2. The outer ends of the rods are ground to long points and bent so that when the binding post is held on a flat surface all three points touch the surface lightly. Note that the regular screws in the binding post have been replaced with large flat-headed screws. To use the gauge, loosen the bottom screw and spread the lower arms to include as much of the arc as possible. Tighten the lower screw and loosen the top one. Adjust the upper arm so that its point touches the arc midway between the other two. Tighten the screw to hold the adjustment. The positions of the rods, or pointers, establish three points on the segment of a circumference which is a duplicate of the original. Now, transfer the location of the points to a sheet of paper by placing the gauge on the sheet and marking the position of the points, A, B and C in Fig. 3. Connect with straight lines as shown. Next, set a compass to a radius greater than half the length of the lines and using the points A, B and C as centers, strike intersecting arcs as in Fig. 4. Then draw lines through the intersecting arcs to construct perpendicular bisectors of the original lines as in Fig. 5. Extend the

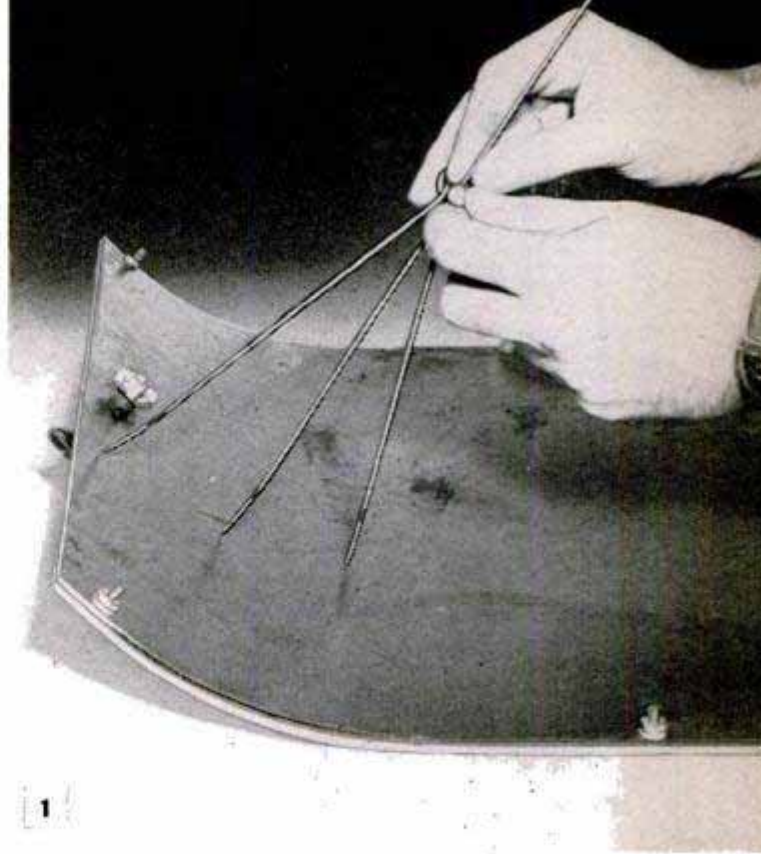

bisectors inside the arc to the point where they intersect to establish the center of the circle. The radius of the arc is the distance measured from the intersection of the bisectors to any of the three points, A, B or C. Of course, the accuracy of this procedure depends on care in transferring the three points established from the original, Fig. 1, and also on the accuracy of the layout, Figs. 3, 4 and 5. Intersecting lines should be drawn with a sharp pencil or scribe and care should be taken to place the leg of the compass precisely on the intersections and on the points transferred from the gauge. Otherwise the multiplied error may result in material waste.

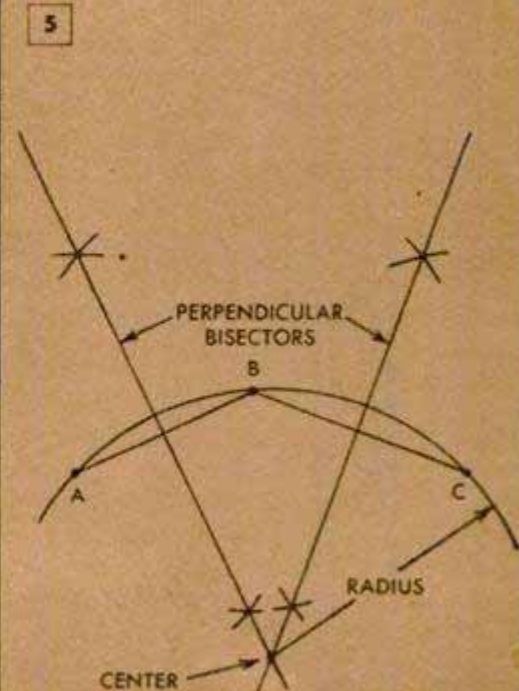
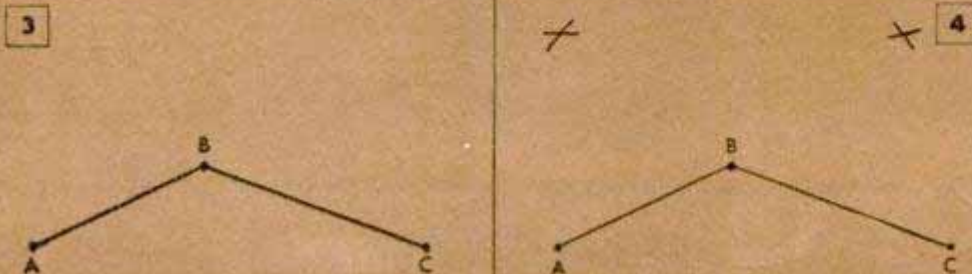
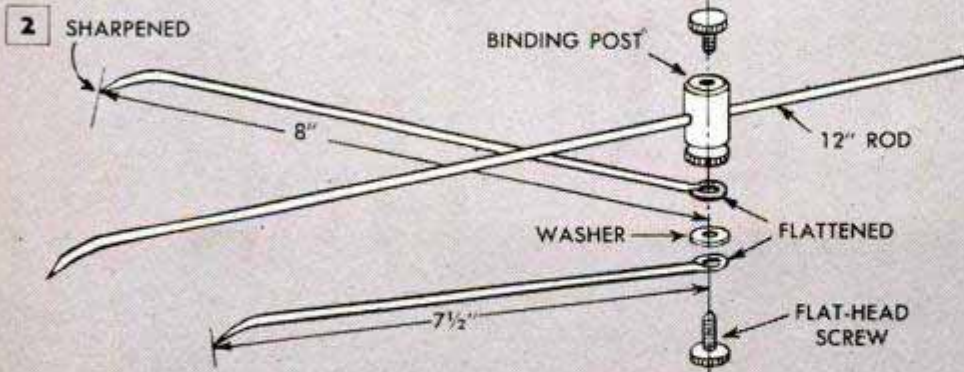

Chute Connecting Supply Barrel With Trough Permits Hog Feeding Through Fence

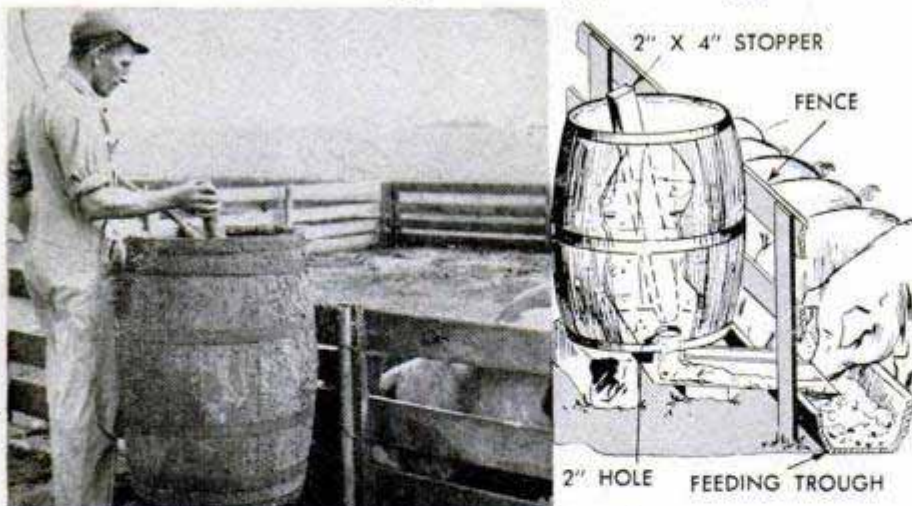

To simplify the job of slop-feeding hogs, a farmer placed a trough next to the fence and then rigged up a barrel and a chute to supply the trough from outside the pen. After cutting a 2-in. hole in the bottom of the barrel, the chute was attached directly beneath and the barrel raised on blocks to gain sufficient pitch. A 2 x 4, tapered and rounded at one end, is used both for stirring the slop and for plugging the hole.—Kenneth J. Schultz, Postville, Iowa.

Inexpensive Repairs Remedy Shop Motor Failure

One of the most frequent causes of shop motor failure—accumulations of hardened dirt and oil on the field-coil cores—can be eliminated inexpensively by anyone willing to exercise a little care and patience. Any noticeable growling and sparking, as well as any tendency of the motor to start slowly and overheat quickly, are some of the symptoms denoting this condition. In such instances, if the motor is permitted to continue running, it will eventually break down. To remedy, remove one end of the motor housing and take out the armature. With a fine file or a piece of emery cloth, smooth the end surfaces of any cores that

appear higher than the others, as well as any blackened areas. Inspect the cores for signs of the armature dragging on them. This is frequently caused by rust accumulations on the cores and wear in the armature bearings. To detect which areas will require the most smoothing, run your fingers over the core surfaces to locate any portions that feel rough or pitted. Before replacing the armature, use a brush, a cloth or, preferably, blasts of compressed air to completely remove any dust or filings that might cause a short or other damage to the motor.

Andre Von Bell, Winston-Salem, N. C.

Ground Wires Stapled to Fence Posts Protect Stock From Lightning

Cattle and hogs pushing against a stock fence during a thunderstorm sometimes are electrocuted by lightning which strikes some distance down the fence line. This danger can be minimized by stapling lengths of heavy wire vertically to the sides of some of the fence posts. Each length of wire, which should run to the bottom end of the post and extend two or three feet beyond the top, is stapled at the points where it crosses the fence wire.

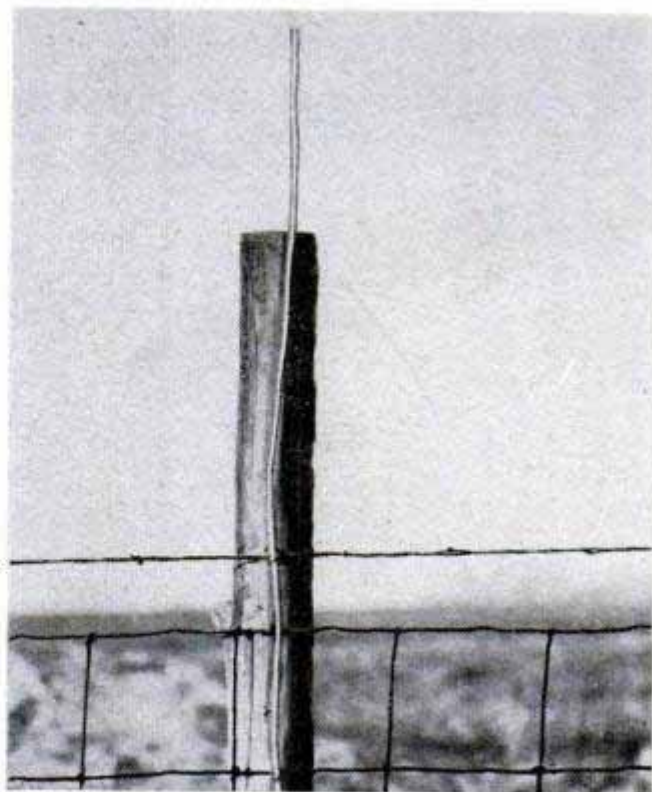

Feeler Blade Mounted on Dial Gauge Controls Travel of Contact Button

For greater speed in doing the job, one mechanic uses a .002-in. feeler blade fastened permanently to the mounting of a dial gauge to keep the contact button from dropping into oil holes and other irregularities in shafts that are being tested. The blade is placed so that it rides between the contact button and the shaft, forming a bridge over the oil holes.

Parts Cleaned in Converted Washing Machine

Designed to provide a convenient supply of a nonflammable solvent such as carbon tetrachloride for cleaning greasy parts, this portable washstand utilizes an old washing-machine chassis which serves both as a base for the unit and as a storage tank for the fluid. A car oil pump driven by a 1/4-hp. electric motor is mounted inside the tank for the purpose of drawing the fluid from the tank and discharging it into a tray set in the top of the unit. A rubber-impeller or centrifugal type of pump was found more effective than a gear pump for this purpose. The tray is made from 20-ga. steel and is provided with an opening cut in the center to be used as a drain hole. Fine-mesh screen is soldered in the opening to prevent all but the smallest particles of dirt and grease from draining into the tank below. Near the bottom of the tank, the pump in-

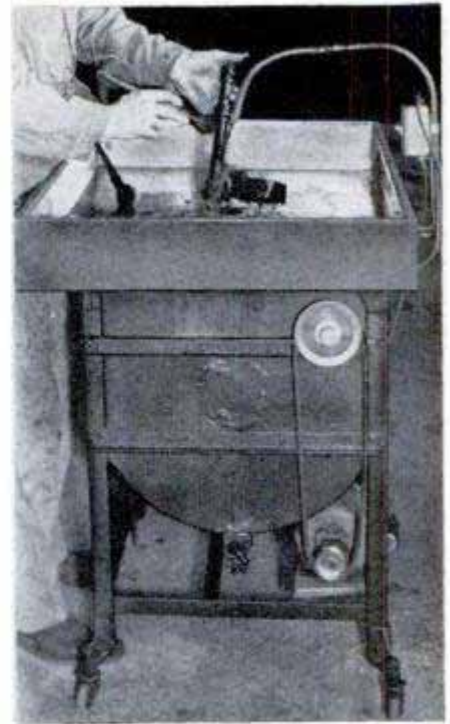
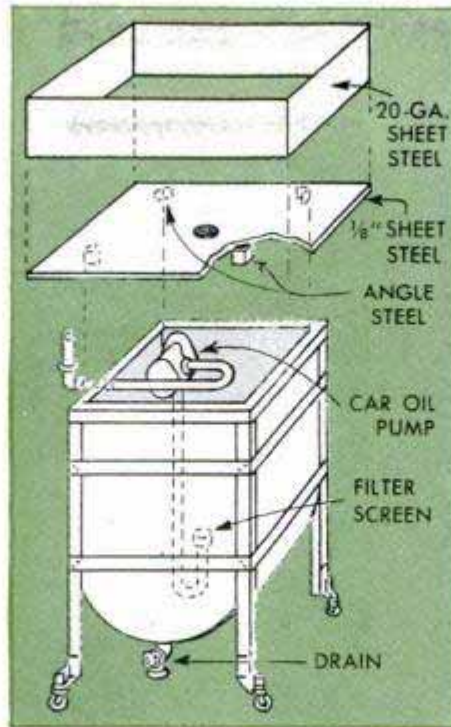

take pipe curves upward to where it draws off only fluid near the surface, thus avoiding solvent containing most of the sediment which eventually settles at the bottom of the tank. A switch located within easy reach controls the motor.—Prof. Harold L. Kugler, Manhattan, Kans.

take pipe curves upward to where it draws off only fluid near the surface, thus avoiding solvent containing most of the sediment which eventually settles at the bottom of the tank. A switch located within easy reach controls the motor.—Prof. Harold L. Kugler, Manhattan, Kans.

Push Stick Guides Turning Square Over Circular Saw to Slot End

In order to cross-slot a number of turning squares quickly for mounting on a lathe spur center, one woodworker uses a circular saw for cutting the slots and a V-notched push stick for positioning and guiding the work over the saw blade. A 90-deg. notch was cut in one end of a piece of wood to provide the push stick. In operation, the saw blade is set to cut 1/8 in. deep and the ripping fence placed

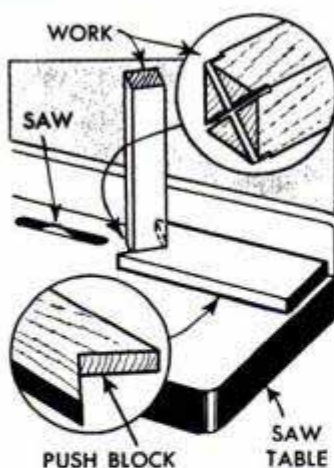

so that the blade is aligned with the center of the notch. The square is held vertically in the notch of the push stick.

so that the blade is aligned with the center of the notch. The square is held vertically in the notch of the push stick.

Ammonia Neutralizes Battery Acid

Extra precautions should be taken when adding water to storage batteries in present-day automobiles. Located as they are

under the hood at waist level, chances for spattering acid on clothing are greatly increased. To neutralize acid on clothing, apply ammonia to the affected areas immediately with a clean cloth.

Upsetting of Chemical Bottle Prevented by Wire Loop

If you have accidentally upset a bottle of soldering acid while using it around your workbench, here is a simple method of avoiding this in the future. A wire loop is twisted to fit around the neck of the bottle and has eyes formed on the ends. These slip over cup hooks driven into the wall above the bench as shown. The loop will prevent any possibility of the bottle being accidentally upset and when not in use folds against the wall out of the way.

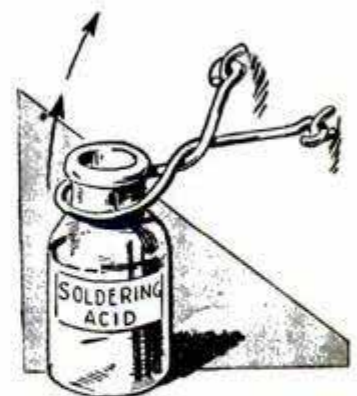

☐ To prevent static from being built up in a car with synthetic tires, use a little powdered graphite inside each inner tube.

SHOPPING FOR TOOLS

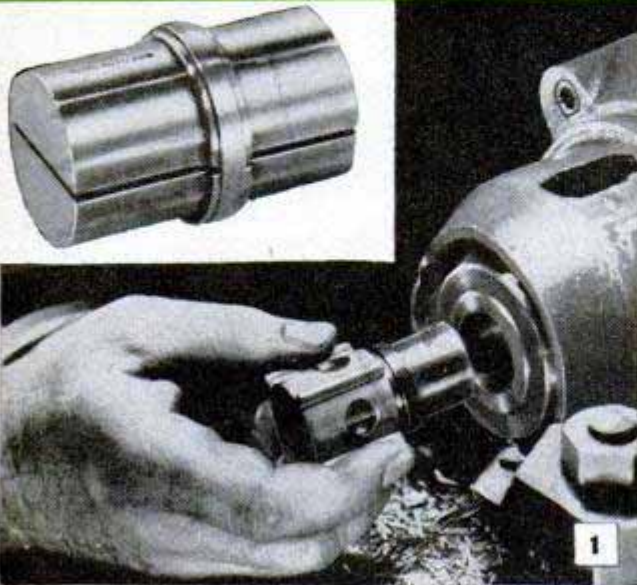

1

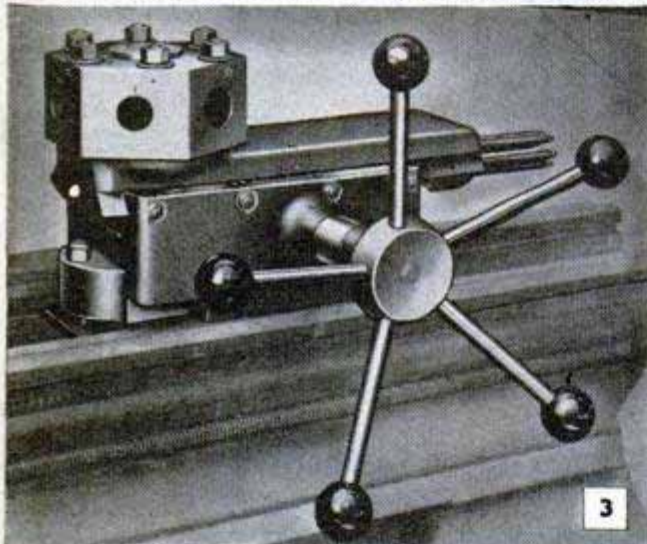

3

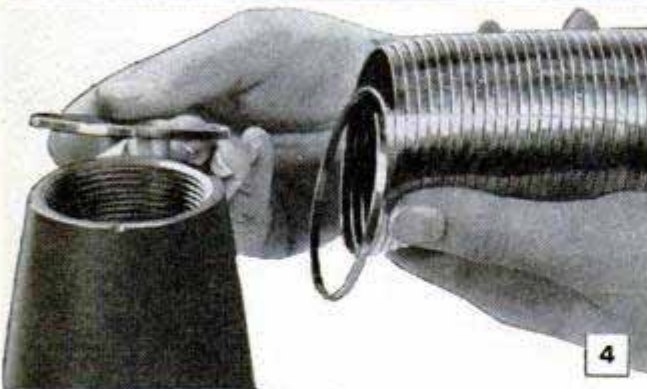

4



5

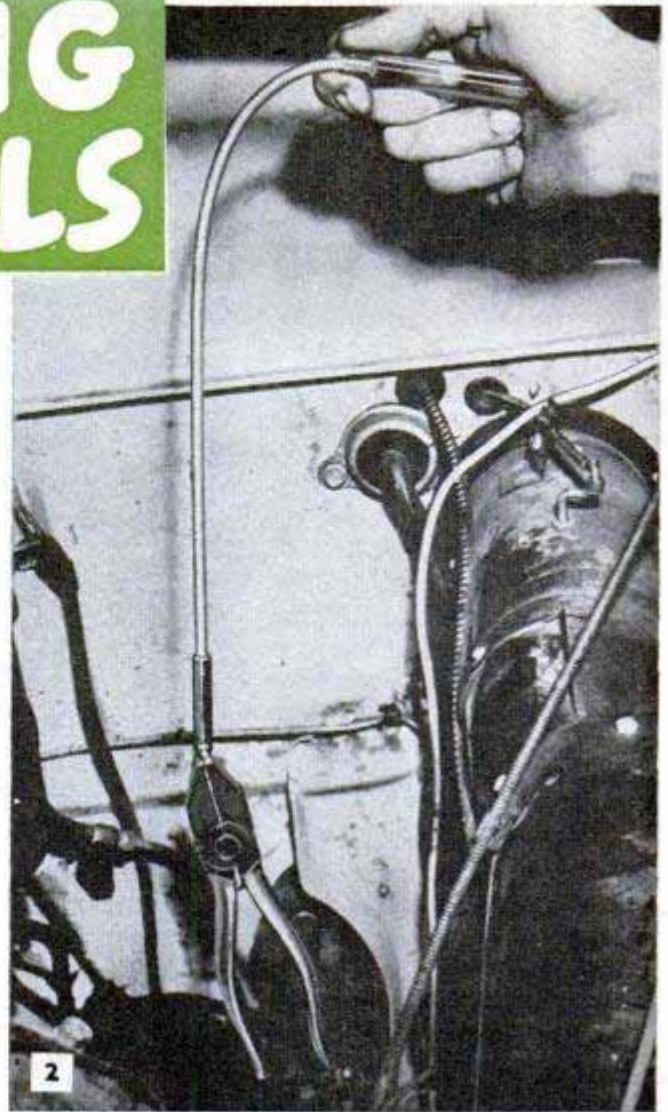

2

1. EXPANDING ARBOR is designed to permit chucking and unchucking work rapidly and accurately without stopping machine spindle. Works with standard collet on lathes, drill presses or milling machines. It holds any mechanical part, of a size within its capacity, in perfect concentricity with the collet. Available for inside diameters from $\frac{3}{8}$ to $1\frac{1}{2}$ in. by 64ths with collet and work ends no longer than $\frac{7}{8}$ in.

2. MAGNETIC PICKUP TOOL is designed to retrieve pliers, cotter pins, nuts and bolts, screws and wrenches which have been dropped accidentally into inaccessible places. Utilizes a powerful magnet of permanent type on an 18-in. length of flexible cable and is provided with a handle which makes it easy to guide magnet into small openings, around projections, and into other hard-to-reach places too small for the hand

3. SELF-INDEXING TURRET is now available for lathes from 9 to 12-in. swing. The self-indexing mechanism is linked to automatic stop rods which limit stroke length and can be preset for any requirement up to maximum working stroke of $5\frac{1}{4}$ in. All flat wear surfaces between the ram and turret are hand scraped to a perfect fit, and bearing surfaces of the ram and saddle are fitted with takeup gibs

4. PREFORMED SILVER BRAZING RINGS come in a stress-relieved notched coil which permits the rings to be detached and compressed easily into grooves and other inner-diameter applications where continuous bondings are essential, and where the nature of the work prevents use of round-wire brazing rings. The flat rings expand to the required diameter and do not distort or fall away when heat is applied

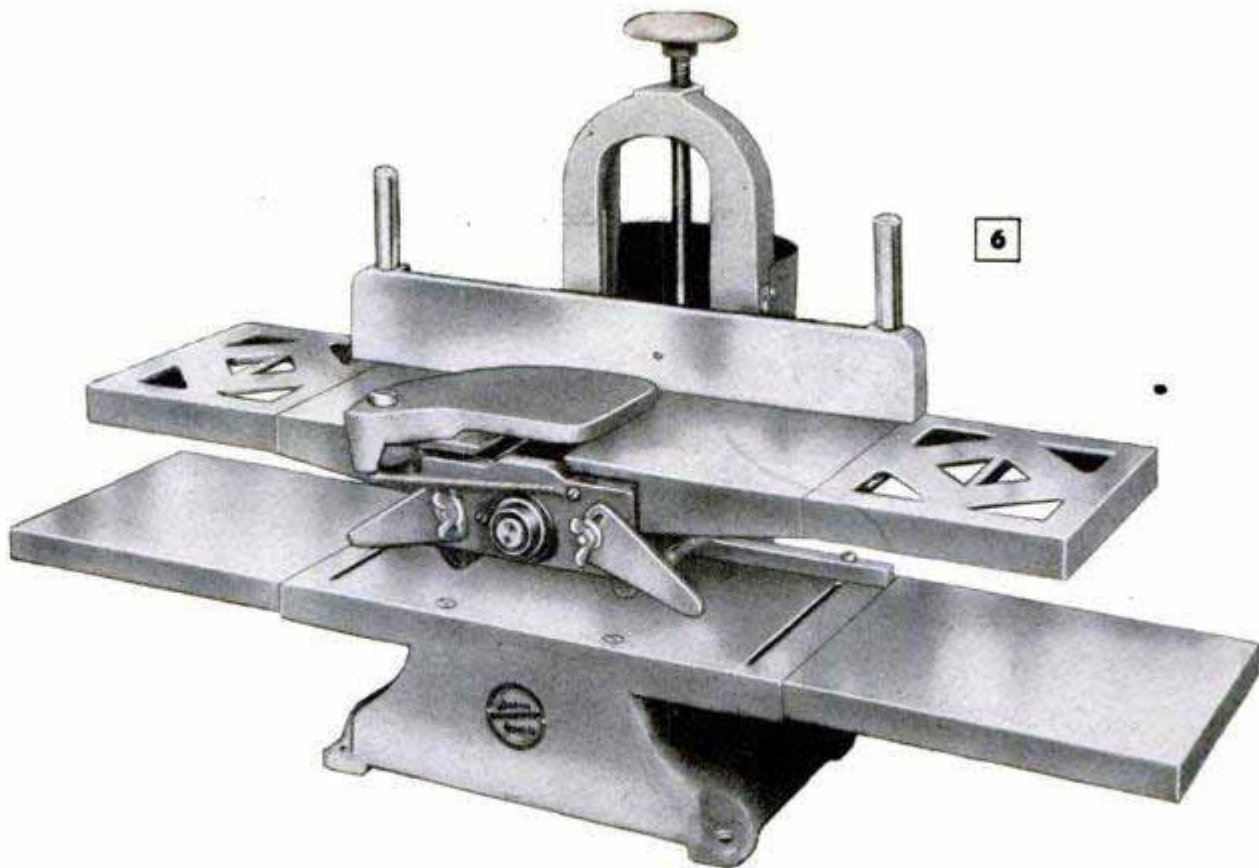

6

5. PROTRACTOR LEVEL for carpenters, plumbers and masons is made from extruded magnesium, one third lighter than aluminum. In addition to use of the unit as a conventional level, the built-in protractor provides a means of measuring existing angles such as the angle of roof rafters or truss members. Provision also is made for quick settings to determine the drop per ft. in pipe or tile runs

6. PLANER-JOINTER-MOLDER are combined in one power tool for home craftsmen and builders who make their own cabinetwork. Basically a single-head molding machine, the unit is converted to a thickness planer, or surfacer, and also to a jointer by addition of specially designed table extensions and a change from contour to straight jointer knives. Cuts moldings 4½ in. wide. Will joint or plane stock up to 6 in. in width

7. HANDY STORAGE RACK for homeowners, craftsmen and others solves problem of storage of small units such as nails, brads, screws, bolts, washers and many types of small parts. An unusual feature is the sorting funnel which makes it possible to sort all items in any one jar without removing it from the rack. Has a capacity of 15 glass jars of the 12-oz. size. The rack is sturdily made of selected white pine

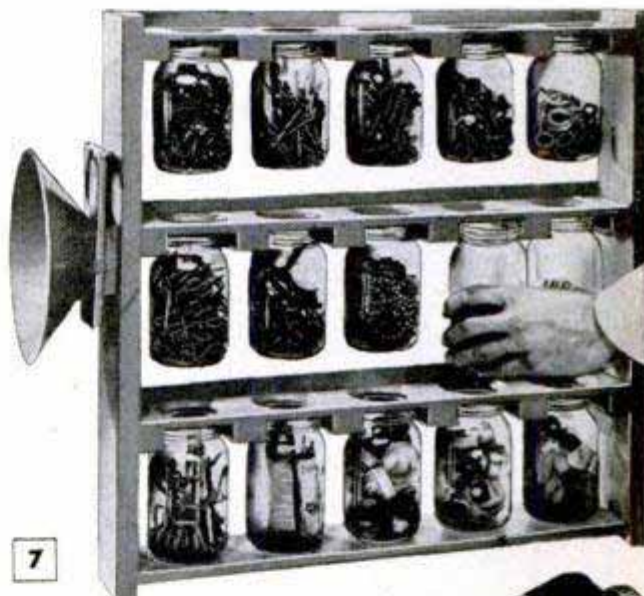

7

8. NEW CABINET SCRAPER features quick blade release and specially designed blade having a slightly curved cutting edge. Also is furnished with blades having two cutting edges. One half turn of the locking screw at the end of handle locks the blade in position or releases it. Handle is unusually large and is specially shaped to give a comfortable non-slip handhold for heavy work on flat surfaces



8

9. SELF-LOCKING ANCHOR NUT consists of flanged anchoring portion having a drawn thin-walled shell which is tapped throughout its length. This shell, or sleeve, grips the threads of the bolt without necessitating any auxiliary locking device such as a spring washer to prevent loosening under vibration or movement. Available only in the ¼-in. size at present but it will soon be supplied in No. 8 to ¾-in. sizes



9

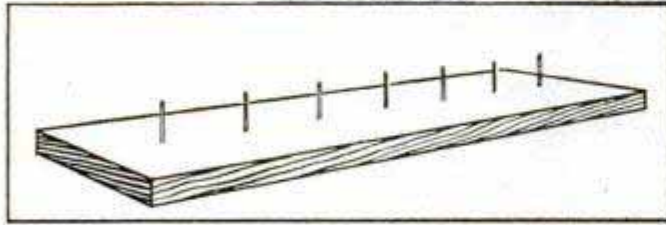
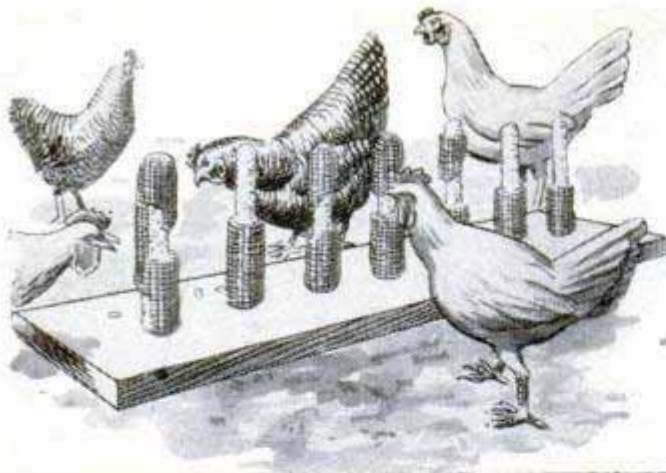

Ear Corn Impaled on Spikes Kept Clean for Poultry

To promote exercise of fowls confined to small pens, poultrymen often feed corn on the ear so that the poultry will get some exercise while picking off the kernels. When fed in this manner, the corn often becomes soiled in the litter, which is objectionable to some feeders. To avoid this, one farmer who has a relatively small flock impales the ears on spikes driven through heavy planks.

Leather-Punch Dies Protected With Can Scabbard

A cover to protect the multiple-die-head leather punch can be made from a typewriter-ribbon can or one of a similar type. Just cut notches in the sides of the can and lid to fit over the arm of the punch when the cover is placed on the head. If desired, the cover can be bolted on as indicated.

Albert Zanelli, Wyckoff, N. J.

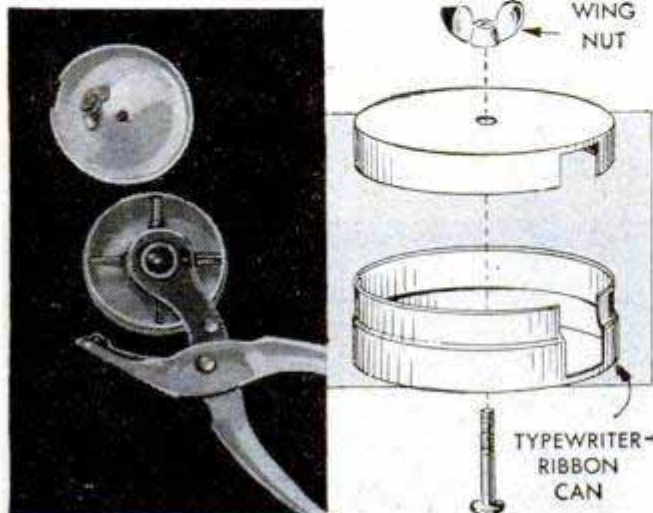

Marks Identifying Left-Hand Nuts Lessen Possibility of Damage

On machines equipped with nuts, bolts or screws having left-hand threads, the possibility of inadvertently damaging them by applying too much pressure in the wrong direction will be lessened considerably if a little white paint is daubed on to identify them. The markings will prove especially helpful to a worker who is not altogether familiar with the machine.

Henry Hanscom, Elmhurst, Ill.



Horseshoes Used as "Latches" To Hold Trough Against Fence

Nailed to each end of a trough in which feed is poured from the opposite side of the fence, a pair of horseshoes will hold the trough in position against the fence. Only one prong of each shoe is nailed to the trough, thus making it possible to work the other leg around one of the fence wires in the manner indicated.

G. E. Hendrickson, Argyle, Wis.

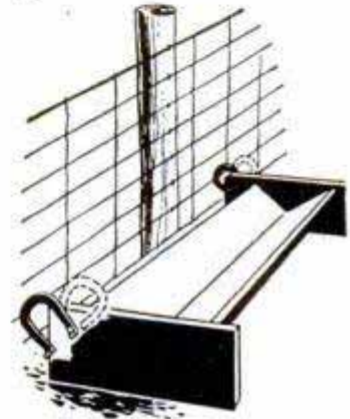

Felt Washer Oils Lathe Center

When turning work between centers—particularly long work—the tailstock center can be lubricated practically automatically by an oil-soaked felt washer. Placed over the point of the center before running it up to engage the work, the washer rides between the two as shown in the photo. As the work and center gradually become warm due to friction, the heat tends to self-feed the oil to the parts to assure adequate lubrication. One "loading" of oil usually is sufficient for the average job. Try to avoid excessive saturation of the washer, however, by applying only a few drops of oil at a time so that it will not be thrown from the work.

Richard Hanscom, Elmhurst, Ill.

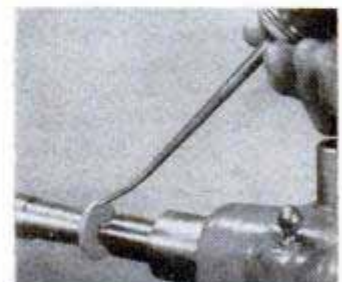

Detectors of Harmful Atomic Radiation

THE RECENT atomic-bomb test which was televised, and the publicity given to the necessary safety measures taken to guard the actual viewers from harmful radiation, have aided civil-defense authorities in their efforts to alert and inform urban populations of what to expect under more sinister circumstances.

One manufacturer has made available to the public a simple emergency device, illustrated in photo A, which can be used by anyone to detect visually the presence and direction of the source of harmful radiation resulting from an atomic-bomb explosion. It is not used for locating radioactive minerals, such as uranium, but merely is used to sweep the horizon. If harmful radiation exists, a noticeable lighting effect will be seen within the instrument. Once the source is determined, the viewer should travel in the opposite direction. Nuclear-research laboratories take elaborate precautions to guard their personnel against harmful radioactivity. Photographic radiation badges for atomic-energy workers are shown in photo B. A film emulsion measures contact with harmful rays.

Quartz fiber is used in the direct-reading survey instrument illustrated in photo C for the detection and measurement of radiation. It has been developed by scientists of the Argonne National Laboratory. A mobile laboratory for working with atomic radiation is shown in photo D. It will enable technicians to speed to the scene of the blast and determine immediately if radioactivity is present.



VERSATILE PREAMPLIFIER

By Lothar Stern

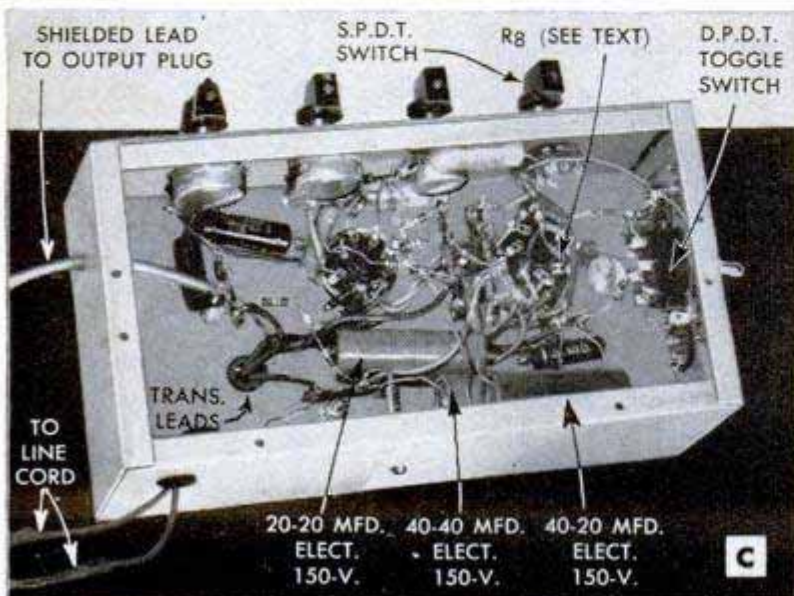
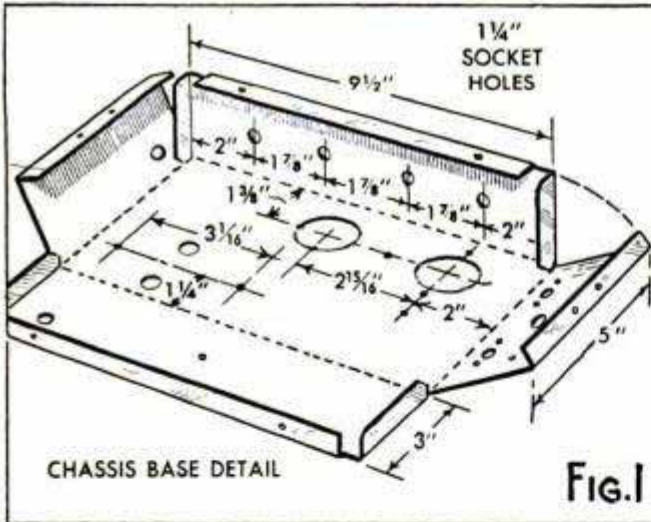
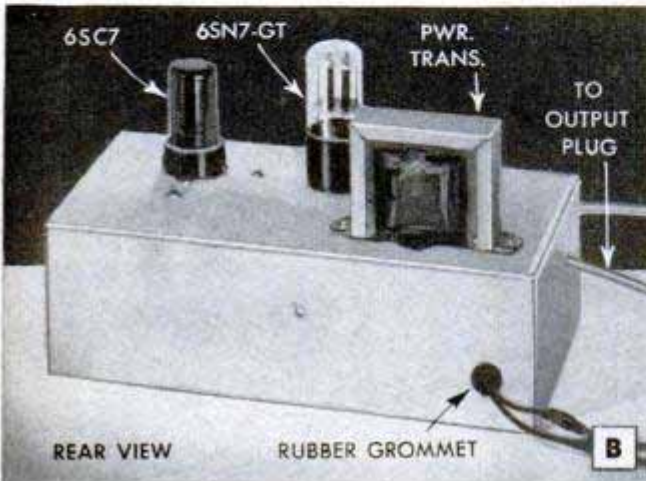
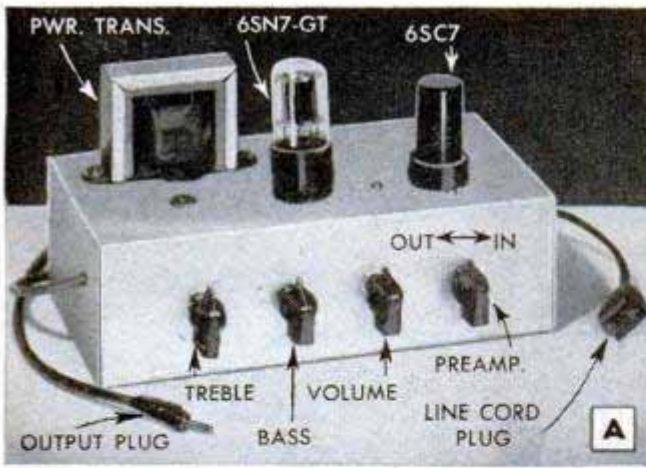

THIS preamplifier will bring your music system up to date. It is an ideal companion for any console radio or amplifier which does not include such a circuit. It can be used remotely, or it may be built into a cabinet housing the other components, such as radio tuner, record changer and speaker. You can use it to convert a phono amplifier into a public-address unit, or to improve your present record-playing system by using variable-reluctance cartridges.

It is a completely self-contained unit. It has its own power supply and includes volume and tone controls, a decided advantage if the unit is placed apart from the main amplifier. Although not designed for beginners, there is nothing difficult about its construction. In any high-gain amplifier the parts layout is rather critical. In order to prevent oscillations and hum, it is necessary that all grid and plate leads be as short as possible. Ground R8 on 6SC7 pin No. 1.

The heart of the unit is the 6SC7 tube. It serves the dual function of amplifying the voltages of a microphone or a variable-reluctance cartridge to a level suitable to drive an ordinary amplifier and providing equalization for the cartridges. This equalization, however, must be removed if a microphone is used. One portion of the d.p.d.t. switch (see photos C and D) is used for this purpose.

Drilling details of the standard-size chassis base are clearly indicated in Fig. 1. Before starting construction, carefully study photos A, B, C and D. The single-pole double-throw switch is a rotary type and is used to cut the preamplifier "in" and "out" of the circuit. You will note that there is no line switch in the circuit of the preamplifier.

RESISTORS

- 1-10,000-OHM, 1/2-WATT CARBON, R1
- 2-3.3-MEGOHM, 1/2-WATT CARBON, R2, R8
- 3-68,000-OHM, 1/2-WATT CARBON, R3, R4, R11
- 1-100,000-OHM, 1/2-WATT CARBON, R5
- 1-220,000-OHM, 1/2-WATT CARBON, R6
- 1-27,000-OHM, 1/2-WATT CARBON, R7
- 3-33,000-OHM, 1/2-WATT CARBON, R9, R10, R17
- 1-500,000-OHM, MALLORY TYPE U-48 VOL CONT., R12
- 2-2200-OHM, 1/2-WATT CARBON, R13, R22
- 2-47,000-OHM, 1/2-WATT CARBON, R14, R20
- 1-390,000-OHM, 1/2-WATT CARBON, R15
- 1-2-MEGOHM, MALLORY TYPE U-56 TONE CONT., R16
- 1-39,000-OHM, 1/2-WATT CARBON, R18
- 1-150,000-OHM, MALLORY TYPE U-42 TREBLE CONT., R19
- 1-22,000-OHM, 1/2-WATT CARBON, R21
- 1-56-OHM, 1-WATT CARBON, R23
- 1-1500-OHM, 1-WATT CARBON, R24
- 2-100-OHM, 1/2-WATT CARBON R25, R26
- 1-150,000-OHM, 1/2-WATT CARBON, R27
- 1-15,000-OHM, 1/2-WATT CARBON, R28

NOTE—R12—No. 1 TAPER; R16—No. 4 TAPER, AND R19—No. 1 TAPER

CONDENSERS

- 2-.01 MFD. DISK CERAMIC TYPE, C1, C2
- 1-20-20 MFD. 150-VOLT ELECT., C3, C4
- 3-.01 MFD. 400-V TUBULAR TYPE, C5, C10, C13
- 3-.05 MFD. 400-V TUBULAR TYPE, C6, C9, C14
- 1-40-20 MFD. 150-VOLT ELECT (C7—40, C8—20 MFD.)
- 1-40-40 MFD. 150-VOLT ELECT C11, C12

MODERNIZES PHONO-RADIO COMBINATIONS

This switch was omitted purposely as you probably will want to wire the power circuit so that the preamplifier can be turned on with the main amplifier or radio receiver. This feature is clearly indicated in the complete schematic circuit diagram, Fig 2. The output of the high-voltage winding of the preamplifier power transformer is rectified with a selenium rectifier and is well-filtered. Use rosin-core wire solder and solder all connections carefully. Shielded grid wire should be used for the input connections; the outside woven-metal braid must be grounded as indicated in Fig. 2 in order to be effective. The output of the preamplifier may be connected to the phono input of any amplifier or radio provided with a phono-input jack. A shielded cable is used for this purpose, and is terminated with the proper type of plug to fit the phono-input jack of your amplifier or set. Detailed student material list R-411 is available from Popular Mechanics Radio-TV and Electronics department upon receipt of ordinary letter postage. ★ ★ ★

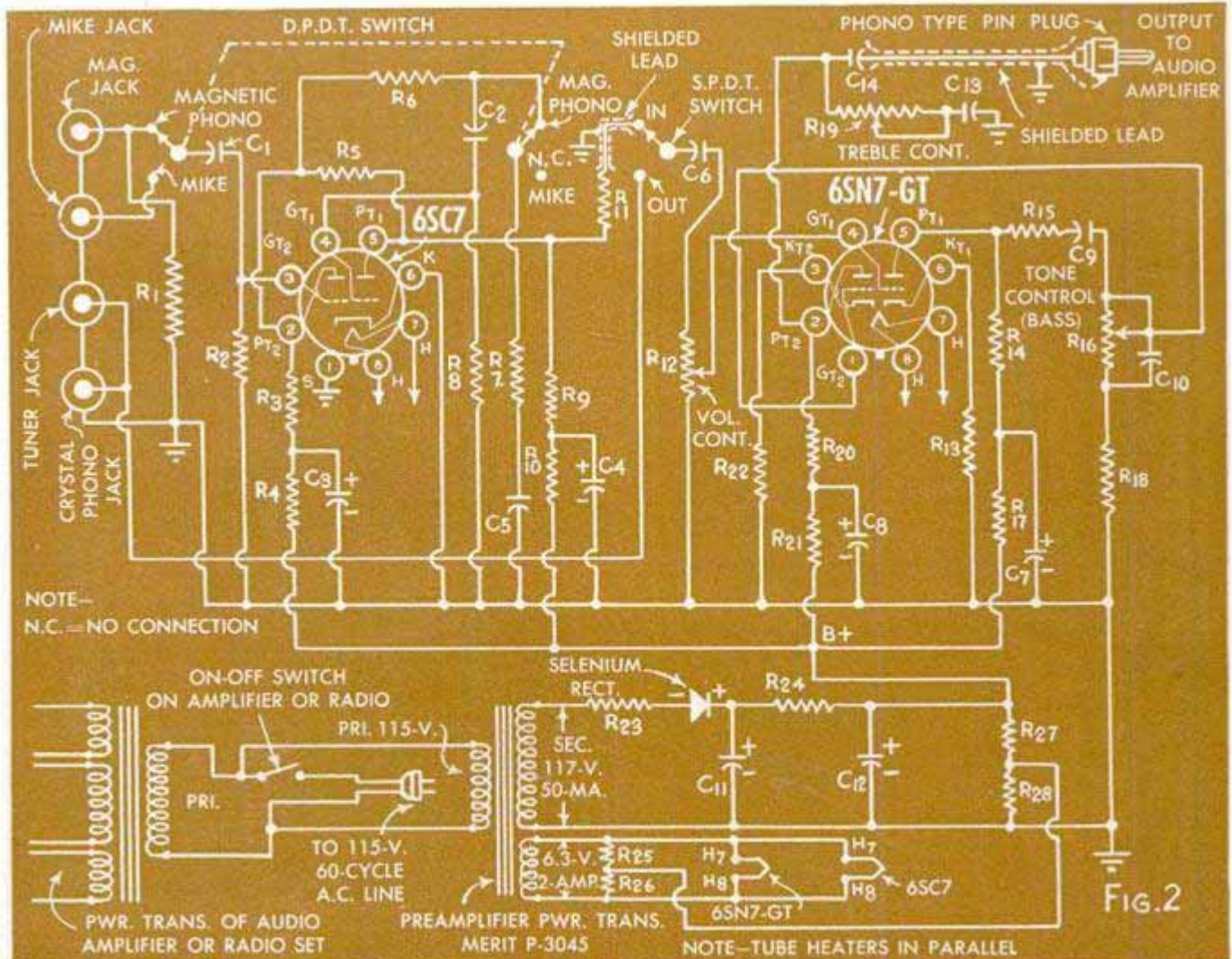
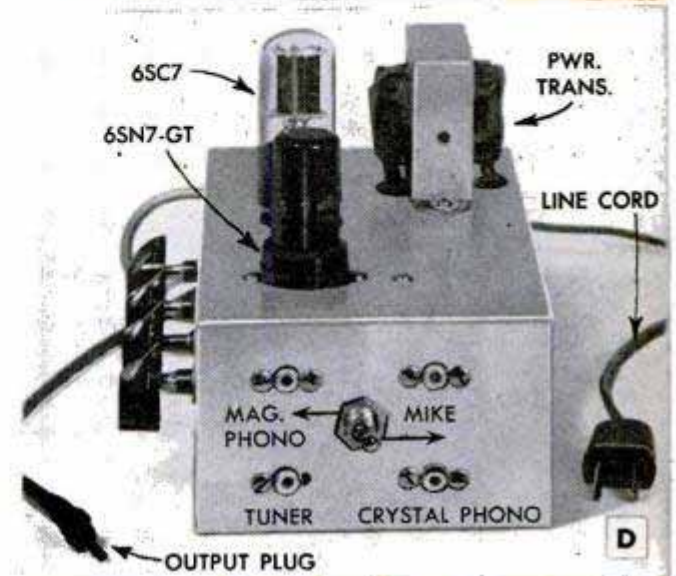

SMALL METAL DOLLIES For Radio Service Bench

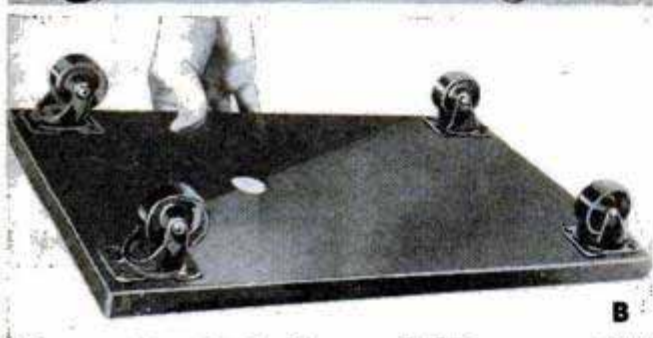
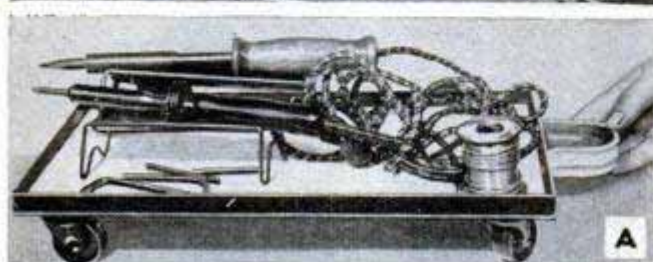
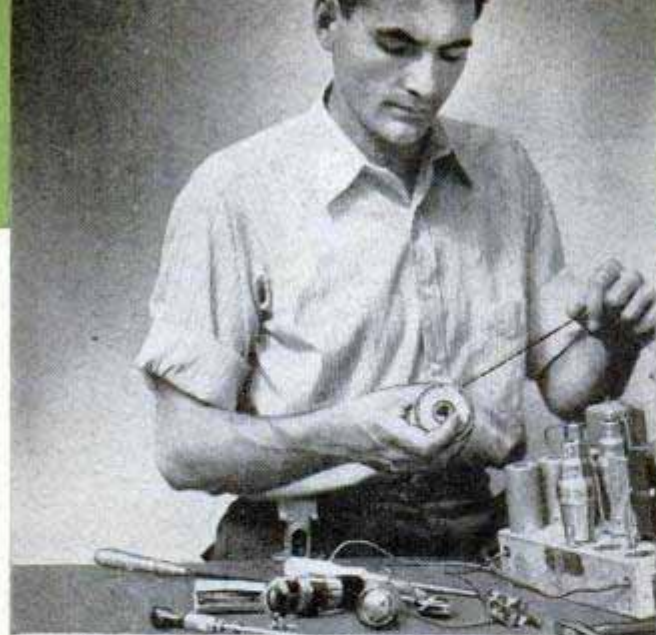

FLEXIBLE testing-instrument and tool arrangements speed up radio and television-service work at the bench. Visit any of the reliable service shops in your locality and you will find invariably that their success largely stems from the fact that they not only do good work but get it done when promised. You will not find cluttered-up workbenches in such shops. They have a well-planned arrangement for handling their testing equipment, a place for every tool and plenty of clear bench space for action.

One or more small metal dollies, sometimes called "rollaways," make handling of such test equipment easier. The bench dolly illustrated in the photos is made of heavy metal with a $\frac{3}{4}$ -in. turned-up edge all the way around. The over-all dimensions are 10 x 17 in. The one shown was purchased at a surplus store but similar dollies are available at auto-supply firms for use as under-car tool trays. As shown in photo B, this dolly has four $1\frac{1}{2}$ -in. casters and measures slightly under 3 in. from floor to its top edge.

When using the dolly for moving tools and testing equipment, as illustrated in photos A and E, the added handle shown in photo C may be found useful. The one shown was made by hand from a 2-in. pipe strap. Where dollies are to be pushed over varnished bench tops, possible scratching may be avoided by placing "moleskin" tape over the casters as illustrated in photo D.

The convenience of having associated tools such as soldering irons, extra tips and spools of wire solder together is shown clearly in photo A. Most portable testing equipment, even heavy 6-volt battery eliminators for auto-radio servicing, can be handled with these time-saving dollies.

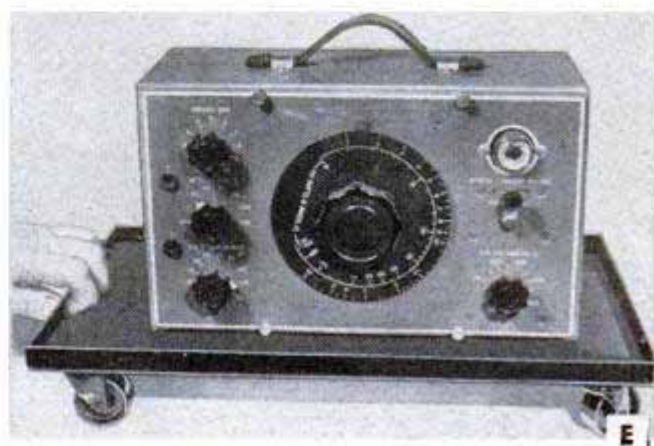

Television in the Home

JUST ABOUT the time that most of the broadcast-band radio-antenna systems were removed from the roofs of urban homes, up went the TV-antenna arrays—and we have the same old problems of how to erect the mast and bring in the lead-in. The 300-ohm, flat-ribbon twin-line TV lead-in can be any convenient length and it is supported with stand-off insulators to clear the roof, as illustrated in photo A. In many cases it can be shunted through a roof-top ventilator as shown. Continuing through the attic, it may be brought down to a suitable outlet plug in the room selected for the TV receiver.

A new TV tuner covering the 82 prospective channels is shown in photo B. Channel selection is made simply by turning the dial until the desired channel number appears in the dial window. This tuner receives both VHF and UHF signals without adjustment by repairmen. The five-element Yagi TV-antenna array illustrated in photo C is tuned for any one of the low-band (2 to 6) or high-band (7 to 13) channels. It is designed especially for weak-signal areas and employs three directors, antenna element and a reflector in each stacked assembly.

The “shorted” and “open” stubs of 300-ohm TV twin line, shown in photos D and E connected directly across the set’s antenna terminals, often reduce or eliminate interference. Try both methods—the suggested starting length for the shorted stub is about 30 in. on the higher channels to about 80 in. on the lower channels. Keep cutting off short sections until the interference is reduced as much as possible. If interference increases past a certain length, it will be best to start again with a full length. With the open stub, photo E, starting lengths may be 15 to 40 in. long, the shorter length being used for the higher channels. In either case, merely let the stubs hang behind the set. Experimental tests for length of D can be made with a knife blade through insulation.

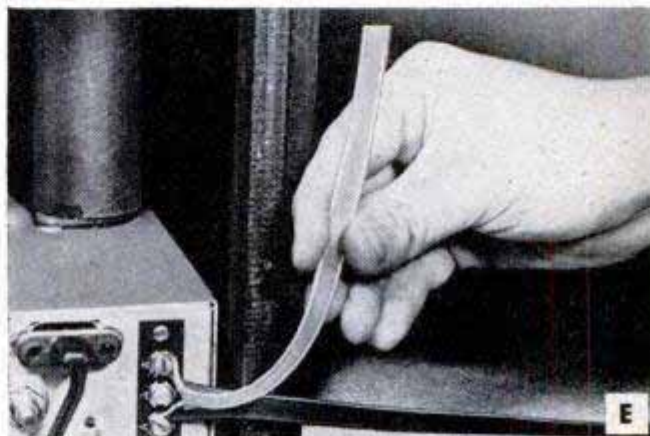
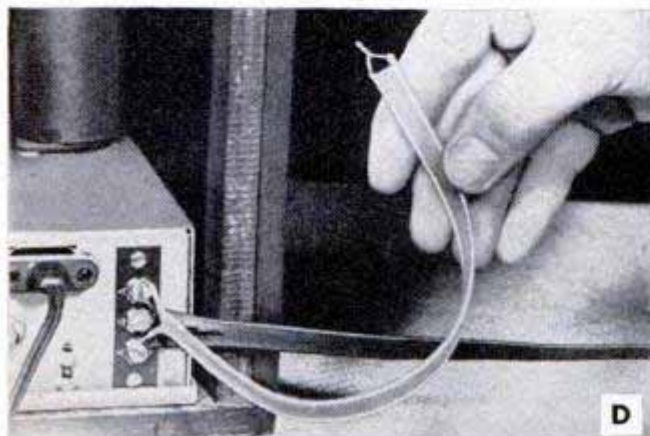
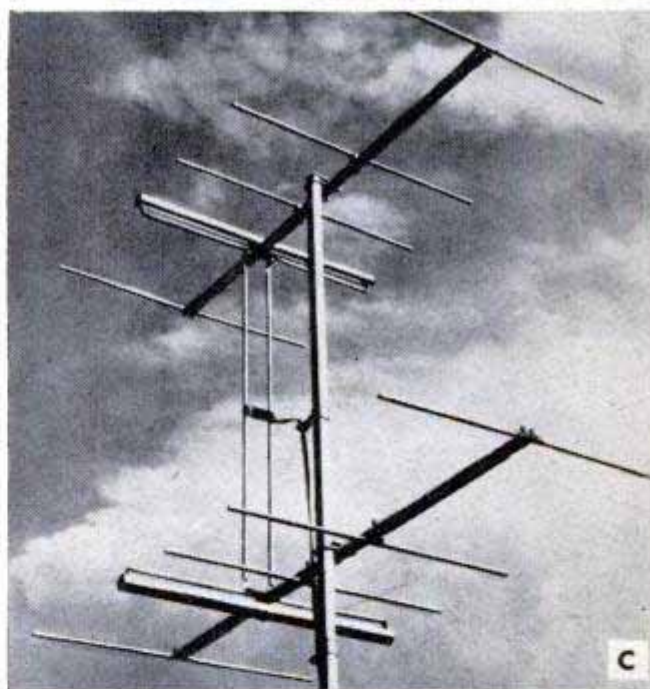
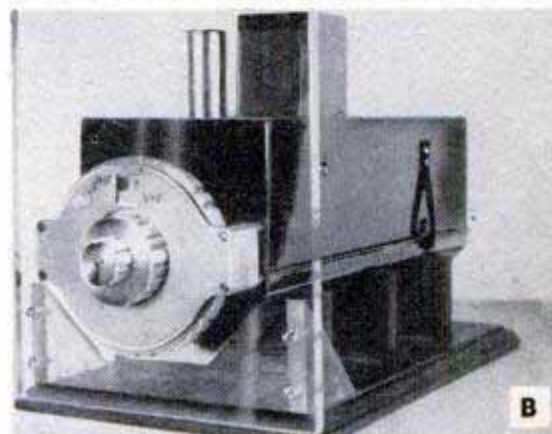

HINTS FOR RADIO WORKERS

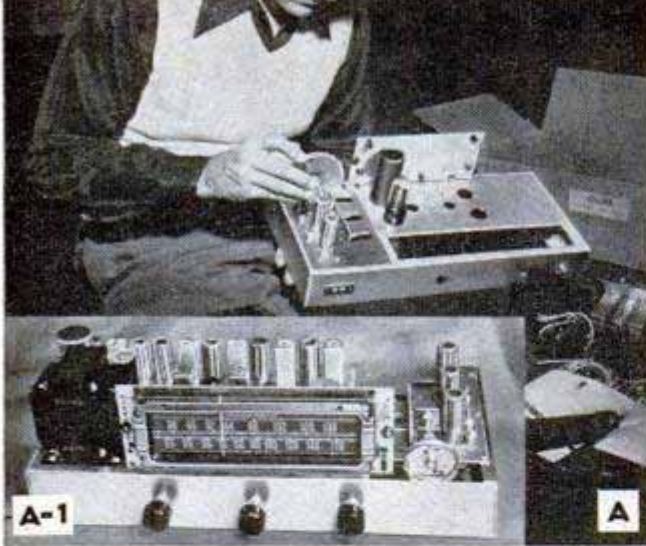

A—Special test equipment is not necessary to line up the circuits of this FM-AM tuner kit. All critical circuits are wired and aligned as subassemblies at the factory. The tuning units and I.F. components fit into the prepunched chassis, thus enabling the builder to assemble the complete tuner unit shown in A-1

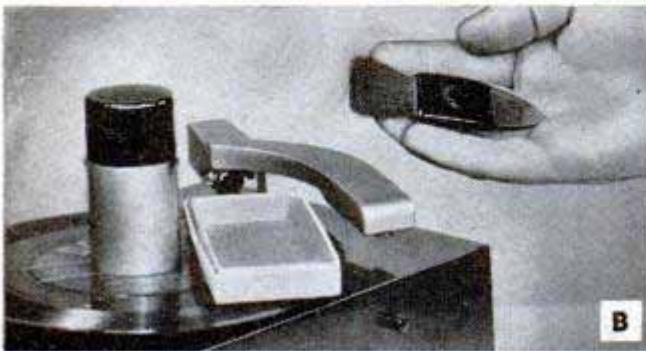

B—A camel's-hair brush of the type used by many photographers is useful for keeping the needle of your record-player pickup clean. Faithful reproduction and long record life depend upon a clean needle and careful attention to record surfaces; remove dust with soft felt or woolen cloth when necessary

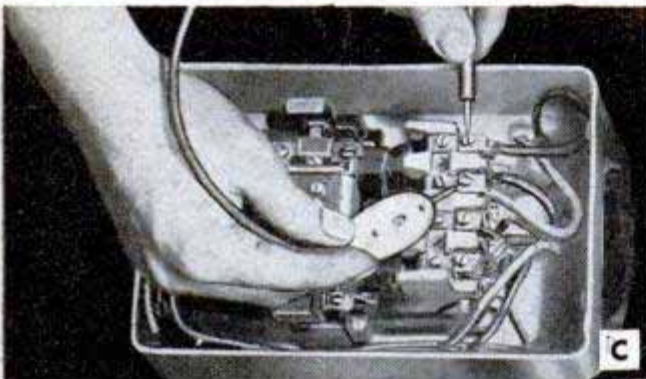

C—Pocket-size circuit tester designed to test for shorts and grounds on appliances or lines from 90 to 550 volts a.c. or d.c. operates on the neon glow-lamp principle. Checks for grounded lines or line polarity in automotive cables and circuits; also useful for checking radio and television power units

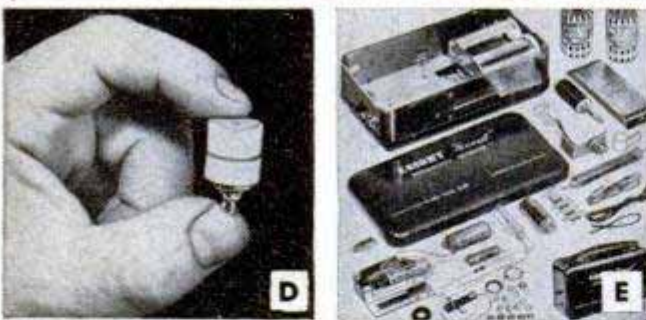

D—New high-voltage tip jack designed expressly for stability in sensitive electronic test equipment. Nylon is used for insulation; it is claimed to withstand 10,000 volts, and has negligible moisture absorption. The spring contact is made of one piece of Phosphor bronze; takes all standard tips and testing prods



E—Radioactivity-detector kit provides effective, low-cost radiation detection for schools, laboratories, civil-defense applications and prospectors seeking deposits of radioactive ores. The kit is supplied complete with all necessary tubes, parts and batteries. Any good set of 2000-ohm headphones can be employed

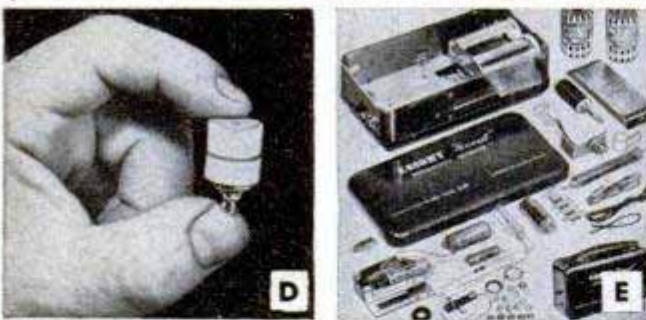

F—Lost or hidden small metal objects such as keys, weapons, property corner markers and survey pins, tools, buried silverware or treasure can be located with the single-loop metal detector illustrated. It is claimed that such metal objects can be located beneath soil, rock, concrete, brick or plastered walls



G—Test prods clip on to free radio worker's hands. The self-holding points clip to wires, socket terminals, chassis base or any leads to component parts under test. The worker is then free to make necessary adjustments in circuit controls and observe test-meter readings with the full operating power applied

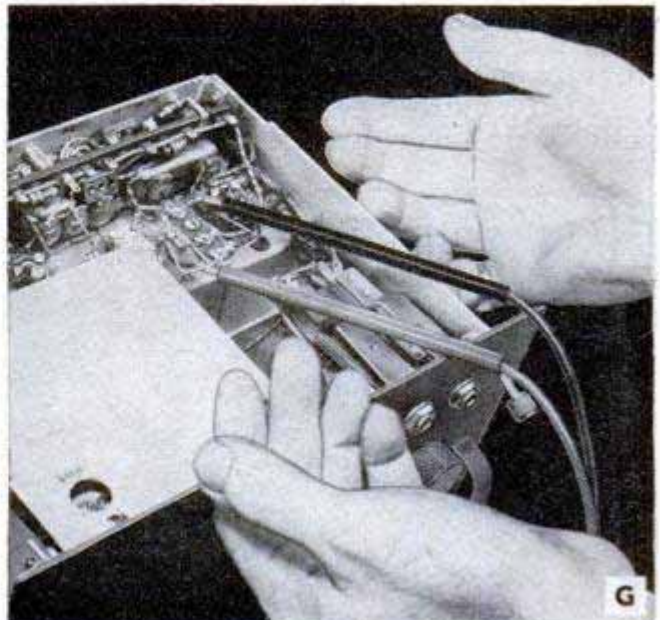

PERFECTION PERSONIFIED...



You think in terms of perfection. Your work reflects your thinking. There can be a sureness in the handling of tools that guarantees perfection. Naturally, real mechanics won't compromise on tools — only the finest are good enough.

Bonney wrenches are perfect by rigid standards. That is why mechanics call them America's finest — unmatched for lightness, strength, balance, and precision.

Bonney wrenches are the pride of the men who make them... the pride of the men who use them.



Perfection in each operation results in the amazing output of America's manufacturers of cars, trucks, buses, and military equipment. Names such as Ford, Chrysler, Hudson, Packard, Nash, Studebaker, identify millions of vehicles that measure up to the master mechanic's standards.

BONNEY FORGE & TOOL WORKS

Allentown, Pennsylvania

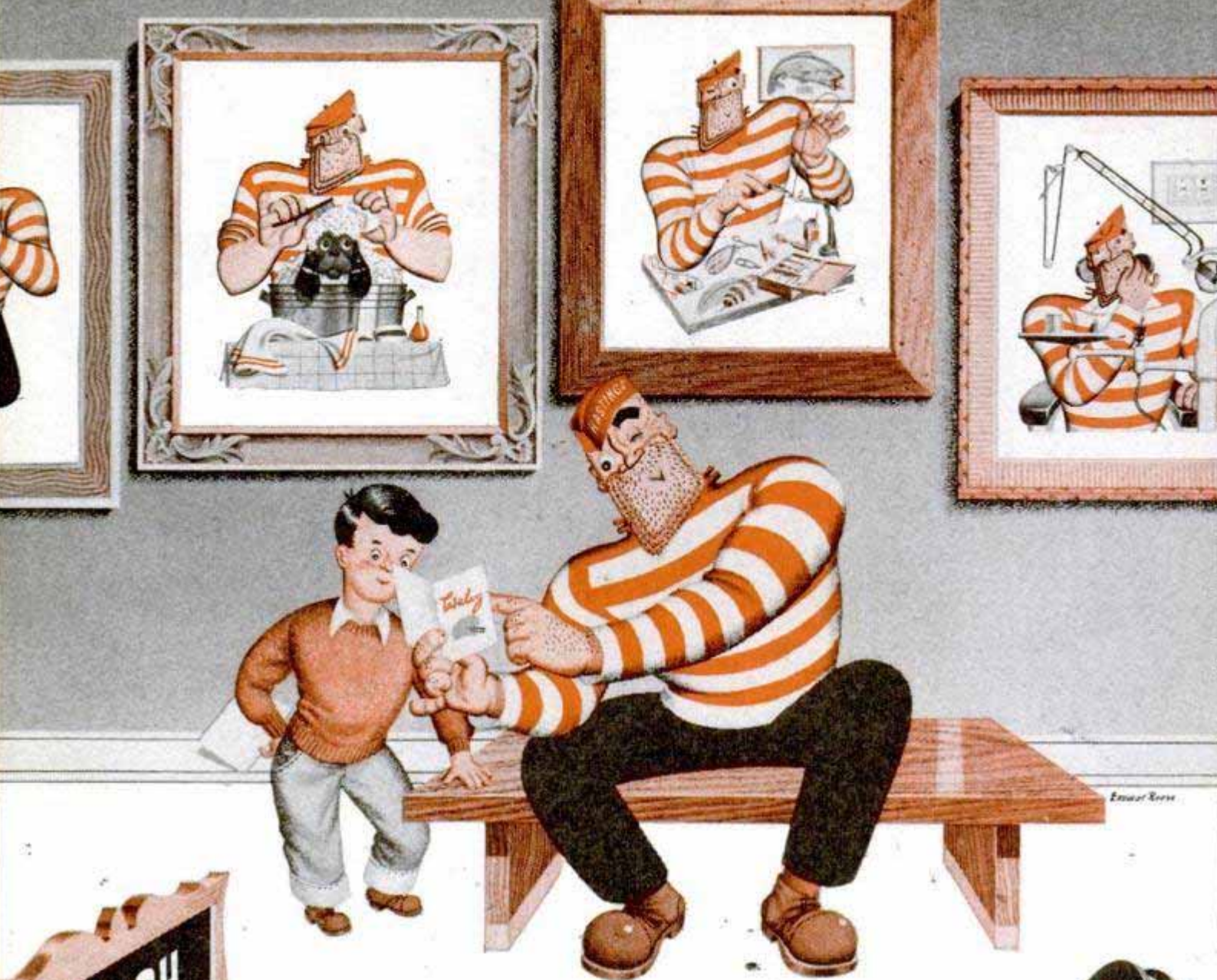

Using too much oil? You need the piston rings that are *tough* on oil-pumping.

Want to stretch your engine's life? Then get the rings that are *gentle* on cylinder walls.

There's just one thing to do about worn-out piston rings and that's replace them—and the more you delay the more you'll pay.

You'll save money if you replace them with Hastings Piston Rings. They're engineered exclusively for replacement service. They *stop* oil-pumping, *check* cylinder wear, *restore* engine performance—for thousands of extra miles. It's the best money you can spend on your car.



HASTINGS

STEEL-VENT PISTON RINGS

HASTINGS MANUFACTURING CO., Hastings, Mich. HASTINGS LTD., Toronto

PISTON RINGS • SPARK PLUGS • OIL FILTERS • CASITE • DROUT



1903

Barney Oldfield lowers track record at Indianapolis.

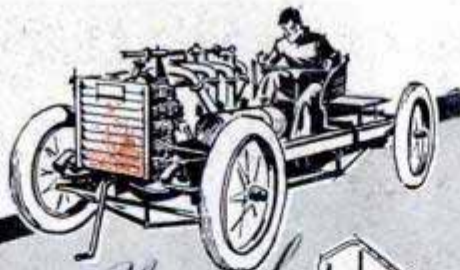

1909

Wright Brothers make new flight record.

1925

Popular Mechanics sensational Superheterodyne Eight.

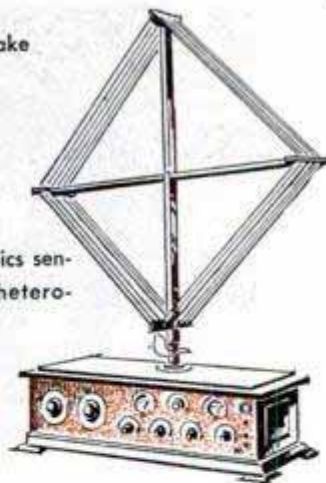

1944

The atomic powered auto.



Fifty Years of
POPULAR MECHANICS

Fifty Years of
POPULAR MECHANICS
A Book You Will Be Sure
to Want . . . to Keep
. . . to Treasure
Forever

*An album of
fascinating articles
have appeared*

The Awe-Inspiring Story of American Progress Depicted in Memorable Pages from a Half Century of Popular Mechanics

Since 1902 Popular Mechanics has faithfully recorded and accurately reported, in word and picture, the greatest 50 years of mechanical and scientific progress in human history.

More than 150,000 fascinating pages have been printed. A selection of these pages, with explanations and comments printed in an extra color in the margins, has been put into a big 320-page book by Simon and Schuster, New York publishers. The title of the book is FIFTY YEARS OF POPULAR MECHANICS.

Here is a book you will want to own — to cherish and keep forever. Your name stamped on the cloth-bound cover without extra charge. Order on coupon below.

YOUR NAME IN GOLD ON THE COVER FREE — MAIL COUPON!

POPULAR MECHANICS PRESS,

200 East Ontario Street, Chicago 11, Ill.

Send at once _____ copies of FIFTY YEARS OF POPULAR MECHANICS at \$5.00 each, postpaid, with names stamped in gold. Remittance enclosed \$_____. (Please print name below exactly as you want it to appear on book. When more than one book is ordered use margin or separate sheet for extra names.)

NAME _____

ADDRESS _____

CITY _____ STATE _____

See It Happen All Over Again!

Thrill again as the years unfold in FIFTY YEARS OF POPULAR MECHANICS. See the great inventions and scientific developments of 50 fabulous years happen all over again in articles and pictures, prepared and first printed when the events took place. Thrill to the accounts of the first channel flight and the jet-propelled airplane . . . to the pedal-propelled submarine and to the terrifying atom bomb.

History-Making Inventions • World-Shaking Events

Live again from the days of the first motorized sewing machine to the age of nylon and cellophane. See the automobile emerge; the birth of the airplane, the phonograph, motion pictures, radio and television. Follow the scientific development of two world wars. Read the fascinating articles by and about such personages as Pierre Curie, Guglielmo Marconi, Jules Verne, Winston Churchill, Lamont Dupont, Thomas Edison, the Wright Brothers and hundreds of other famous people.

The Once-in-a-Lifetime Book

FIFTY YEARS OF POPULAR MECHANICS is without a doubt one of the most fascinating, informative and entertaining books you can own or give to others. It's a big book too—Size 8½ x 11 inches with 320 pages and more than 600 illustrations. The final chapter is devoted to things to come and a glimpse into fifty years from now. Price \$5.00. Order your copy, with your name in gold on the cover, today.



For night and day shots—The Brownie Hawkeye Camera, Flash Model, has fixed-focus lens . . . just aim and shoot. New smooth-action shutter release with built-in flash gives steady exposures. $2\frac{1}{4} \times 2\frac{1}{4}$ negative size. Takes brilliant Kodacolor shots, too. Camera, \$7.20; Flashholder, \$3.39.

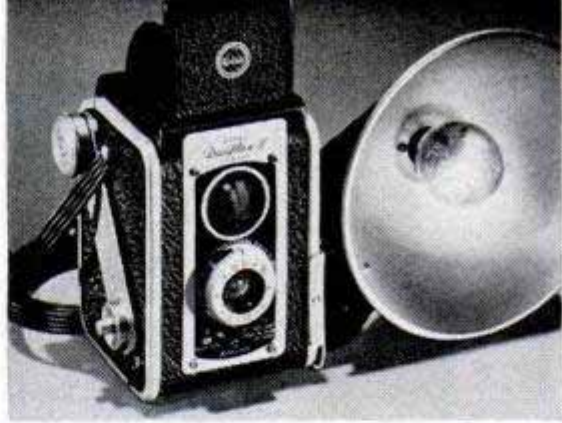

Hooded, view finder in the Kodak Duaflex II Camera previews the picture, big and clear. Two models for black-and-white and color shots: Kodet (shown) is fixed-focus, \$14.50; Kodar has $f/8$ lens, double-exposure prevention, exposure guide, \$22.30. Kodak Duaflex Flashholder, \$3.00.



The Latest . . .

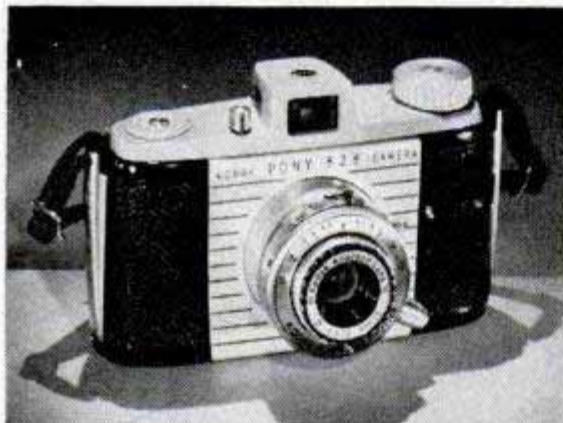

Thrifty color miniature—The Kodak Pony 828 Camera makes superb color slides on Kodachrome Film; sharp black-and-whites; beautiful full-color snapshots from Kodacolor Film. Fine $f/4.5$ lens in $1/200$ flash shutter. Average settings marked in red for box-camera simplicity when desired. \$31.15.



Kodak's new range-finder "miniature" with famous Ektar Lens ($f/3.5$)—the Kodak Signet 35 Camera. Unsurpassed for making brilliant 35mm. color slides. Key features include new-design range finder; $1/300$ flash shutter; double-exposure prevention; automatic film stop and counter. \$92.50.



Protect your camera with a Kodak carrying case like this handsome leather field case for the "Pony 828." Only \$7.00. Other cases from \$4.25 to \$11.25 (simulated leather case for Duaflex Cameras, \$2.65).



Get into that vacation picture with a Kodak Auto-Release (for any camera equipped with cable release). Set it . . . you have 10 seconds to join the group before the shutter clicks. \$3.86.

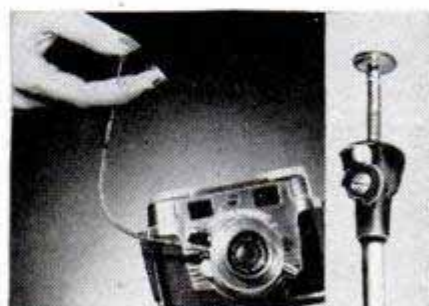

The professional touch is yours with Kodak Metal Cable Release, No. 5 (left), \$1.05, \$1.30; or T.B.I. Metal Cable Release, No. 2 (right), \$3.43. Sure way to prevent jarring of camera.

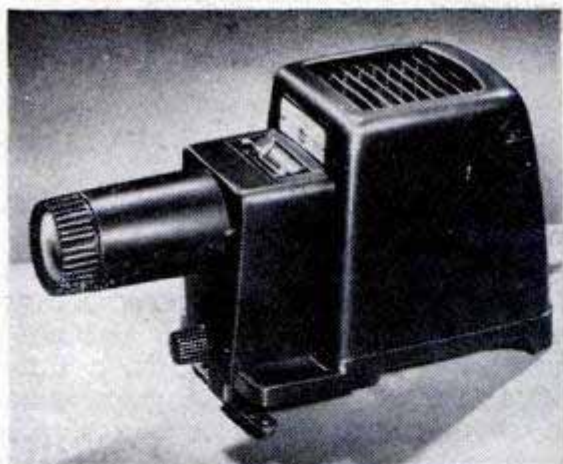

Show off your 2 x 2 slides with the Kodaslide Merit Projector. New easy-feed slide mechanism in top of projector means smooth, jar-free showings. Powerful 150-watt lamp and Kodak Projection Ektanon Lumenized Lens, 5-inch, *f*/3.5, give brilliant images on your home screen. \$26.10.

For convenient showings in daylight or lighted rooms—Kodaslide Table Viewer, 4X, combines screen and projector in one handy unit. Plug in and you're set. You'll see your vacation slides beautifully enlarged more than 4 times—bright and clear even in a fully lighted room. \$49.50.

in inexpensive photo equipment for vacation fun



Filters can do wonders for your vacation shots—The illustrations above show how the yellow Kodak Wratten Filter K2 makes clouds natural-looking. Your Kodak dealer will gladly tell you about filters . . . how you can make spectacular photos of the sky with the red A Filter; about the green X1 Filter for giving faces a natural modeling against blue sky; all about many other types of lens attachments, including Lens Hood for protecting lens from direct sunlight, Pola-Screen for darkening the sky in color pictures, Portra Lenses for close-ups. Prices of filters start at \$1.65.

Easy way to protect your filters is provided by the Kodak Combination Filter Case. Handsome leather, with reinforced compartments. Fits neatly in your pocket. One compartment holds Kodak Adapter Ring, Filter, Lens Hood; the second holds three filters. Series V, \$4.25; Series VI, \$4.95.



Store up to 240 cardboard slides in the deluxe Kodaslide Compartment File—or 96 glass slides. Has 12 handy swing-out compartments. Index inside cover. \$3.94.

Only \$1.57—keeps slides protected and organized, ready for instant use. The Kodaslide File Box is a sturdy metal box for convenient storage of 150 cardboard or 55 glass slides.



Your Kodak dealer is prepared to give you valuable help in the selection of photographic needs for your vacation. Why not take advantage of his training and experience today? He'll be pleased to see you at any time.

Prices are subject to change without notice and include Federal Tax where applicable

EASTMAN KODAK COMPANY, ROCHESTER 4, N. Y.

Kodak



Care and Feeding of Engines

BY S. P. CORP

FAN BELT FACTS

Your fan belt does a triple job. It drives fan, water pump, and generator. If too tight, it causes rapid wear of water pump and generator bearings. If too loose, it will slip, wear out too fast, permit engine to overheat, and permit battery to run down.

To replace a worn fan belt, loosen generator clamp bolts A, B, and C. Move generator toward engine, loosening belt so it can be removed. Be sure to get a new belt made for the year and model of your car. Place it on pulleys, then move generator away from engine until belt will deflect $\frac{1}{2}$ to $\frac{3}{4}$ inch under your thumb, as shown. Tighten bolt B and recheck tension. If correct tighten A and C.

Even if not worn, it's a good idea to check your present fan belt often for tension.

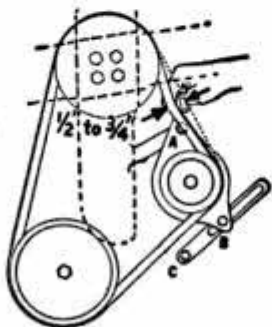

BOOSTER PUMP CAN WASTE OIL

Most cars have a vacuum booster pump as part of the fuel pump, to maintain vacuum for the windshield wiper. If the booster pump diaphragm is cracked or damaged, oil will be drawn from the crankcase, through booster pump and vacuum line into the intake manifold, where it will mix with gas and be burned.

If your exhaust shows heavy blue smoke when you accelerate, your booster pump may be the cause. It may also cause your wiper to stop when you accelerate.

Disconnect vacuum line at point indicated by arrow. Oil in the line calls for a new booster pump diaphragm. Disconnect gas line to fuel

pump. Disconnect vacuum line to windshield wiper. Remove the two cap screws holding pump to engine. Then install a replacement pump obtained from your car dealer or service station.

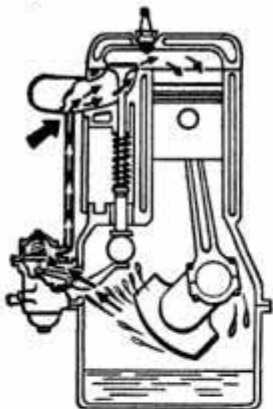

CHROME CAN TAKE PUNISHMENT

Late-model cars and trucks need Sealed Power KromeX Ring Sets, which use chrome in the right spots to fight heat, friction, corrosion, and abrasion. Top compression ring and steel rails of MD-50 Steel Oil Ring have chrome faces. Write Dept. G-7, Sealed Power Corp., Muskegon, Mich., for free illustrated booklet, "More Power, Less Oil, Less Gas."



Beachcomber's Hobby in Guam Becomes a Business in Ohio

(Continued from page 139)

coast, Long fashions interesting hurricane lamps and ash trays. Cypress knees from Florida are made into cups, planters, lamp bases and ornaments that resemble grotesque or mysterious figurines. Bamboo of various sizes and types is turned into a wide variety of items ranging from hors d'oeuvres servers, cigarette boxes, plant holders and picture frames to ash trays, lamps and steins. These projects provide enough scrap pieces of bamboo to make birdhouses, thus solving the problem of birdhouse cost.

Following the theory that something can be made out of anything, Sam Long is always alert for unusual craft materials and objects. He collects nail kegs from hardware stores, sands the staves smooth, replaces the original metal hoops with windings of unstarched cord and installs a padded plastic cushion. The resulting stools are popular for seating television guests, for recreation rooms, outdoor-dining spots, terraces and porches. Because of one particular customer, Long always keeps a stool in stock. This customer had Long make a large table and a dozen nail-keg stools, one stool for each member of his large family. Some time later he was back for another stool; and he plans to buy one every time there is a family increase.

Long keeps the interest of other craftsmen constantly in mind and often picks up a supply of materials that are difficult to get elsewhere. He sells the raw materials for any novelty in his regular line, so the customer can have the fun of putting it together. In fact, he has developed a number of kits which include all the essential ingredients for such projects as a bamboo stein, bamboo planters of various design and a cork hurricane lamp. He also stocks raffia, rattan, bamboo poles of various sizes, coolie hats which can be made into lamp shades, Oriental matting for use on floors and walls, bits of driftwood which he collects along the Muskingum River in Ohio where he has a summer cottage, various grasses, coral and tropical-plant materials that can be used for numerous decorative purposes. He sells sanded but otherwise unfinished nail kegs.

"Fact is, I give the kegs away and charge only for the sanding, which is a disagreeable job," he says. So far, his hobby business remains only a hobby; his serious work is still the covering of his sales territory. But who knows what will happen to this business, started on faraway Guam? ★ ★ ★

Hammer Test shows how--



THAT CUSHIONY FEELING LASTS LONGER WITH



Hit *Marfak* with a hammer, and this tough, stretchy lubricant won't splatter or spread—as will an ordinary lubricant. Instead, *Marfak* forms a “collar” around the hammer face. This shows how longer lasting *Marfak* chassis lubricant *stays* put, protects, clings to points of wear and friction. *Marfak* lasts for a thousand miles or more! It's specially compounded to resist jar-out and squeeze-out in spite of roughest going. Resists wash-out, too. That's why you enjoy “cushiony” driving that *lasts*. For *Marfak* lubrication, see your Texaco Dealer, *the best friend your car ever had*.

THE TEXAS COMPANY
TEXACO DEALERS IN ALL 48 STATES

Texaco Products are also distributed in Canada and in Latin America



Does it say "CLINK"



...or "CLUNK"?

One of the proofs of a file's basic soundness is its clear ring—"clink"—when you tap it lightly on an anvil or other hard piece of metal. A dull "clunk" is usually a sign of invisible "water cracks," poor hardening, or even inherently low-grade steel.

Nicholson employs a score of checks and tests in connection with steel examination, forging, blank smoothing, annealing, cutting, hardening and other operations in the manufacture of files. But it is the "ringing test" (as illustrated above) that leads to the final verdict under the Nicholson policy of *Twelve perfect files in every dozen.*

This company really "leans over backwards" to put into Nicholson and Black Diamond files longer sharpness, better performance, greater value than are combined in any other commonly known brand. That's why it will pay you to ask for them . . . and why your hardware dealer is proud to recommend them.

FREE BOOK, "File Philosophy"—48 interesting, illustrated pages on kinds, use and care of files. Indispensable to professional mechanics and home craftsmen. Write us for your copy.



NICHOLSON FILE COMPANY
22 Acorn Street, Providence 1, R. I.
(In Canada, Port Hope, Ont.)



NICHOLSON FILES FOR EVERY PURPOSE

Clinic for Homemakers

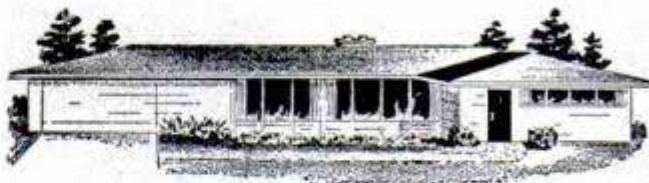

As a service to our readers in solving the hundreds of problems pertaining to a home—inside or out—the editors of *Popular Mechanics* invite you to present your problems to The Clinic Editor for help and advice. Address your questions to The Clinic Editor, *Popular Mechanics Magazine*, 200 East Ontario Street, Chicago 11, Ill.



Cold-Air Returns

Q—We have hot-air heating and last winter we had trouble heating one bedroom. We bought the house a year ago so we don't know if this condition has always existed. There are double windows on two sides of the room. A cold-air register is just outside the door in a hallway. Can you tell us, without a plan, what is the probable cause, and how to remedy it?

T.A., Minn.

A—We'll have to guess on the basis of the description you give. If by "hot-air heating" you mean you have a gravity system, then we are inclined to suspect that the cause is inadequate cold-air returns. By "inadequate" we mean that the free area of the registers, or grilles, may be less than the requirement, the sectional area of the ducts may be less than necessary for unrestricted air circulation, or the registers may not be located in the most advantageous positions in relation to the floor plan of the house. Any one, or all three, of these conditions can be causes of the trouble. In some cases, the defect may be cured by enlarging the cold-air duct and the register nearest the room affected. Usually, however, it is necessary to install an extra register and duct to assure adequate circulation. This can be installed either in the floor or in the wall at the baseboard. The wall installation usually is preferable.

Bracing Old Building

Q—I have a small barn on the back of my lot which I would like to convert to a two-car garage but the plates are bowed outward, causing the ridge to sag. The building, which is two-story, with a hay-loft, is about 2 in. out of plumb. I'd like to straighten the structure and brace it so that it can be repaired, but how do I go about it?—G.O., Ill.



A—We assume you are referring to what was generally known as a carriage barn and that it is built on a substantial foundation. We hesitate to advise that you undertake to do this job without

(Continued to page 220)

Don't get stuck with a rust-clogged radiator!



Drain it out, then clean it out. Avoid overheating!



DU PONT Cooling System CLEANSER

Summer is the season when your cooling system must work hardest to prevent engine overheating. That's why it's so important *now*, to be sure your cooling system is really clean. Du Pont Cleanser safely and easily removes all the rust that causes trouble. You can even let it work while you're driving. Neutralizer is included in the same can, and there's *no reverse flushing necessary!* Ask for Du Pont Cleanser at your auto supply store today... or ask at your service station about the complete Du Pont "Drain Out" service.

After cleaning, prevent rust all summer long with **NEW DU PONT ANTI-RUST and Water Pump Lubricant**

It's a cinch to keep new rust from forming in your radiator with Du Pont Anti-Rust. This new liquid rust inhibitor not only prevents corrosion, but neutralizes acids, lubricates the water pump and helps eliminate squeaks. It won't clog or cause sludge... is harmless to hose and metal parts.



BETTER THINGS FOR BETTER LIVING . . . THROUGH CHEMISTRY

COOL YOUR HOME THIS LOW-COST WAY

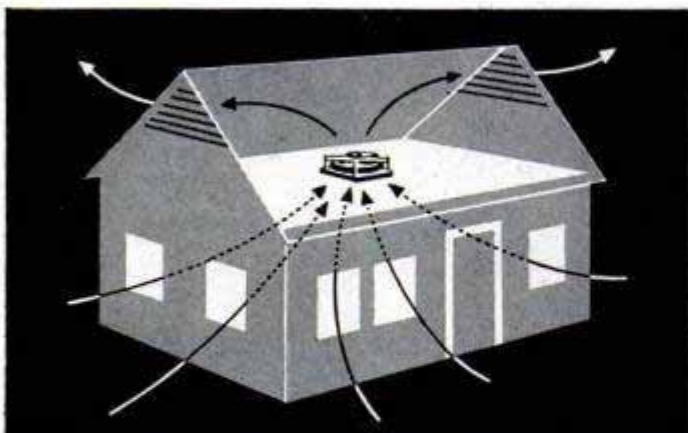

Hunter Attic Fan cools the whole house

This modern ventilating fan pulls in cool air through windows, exhausting hot stuffy air through attic louvers. In hottest summer months it circulates cooling breezes through every room in your home. The quiet, powerful Hunter Attic Fan requires little or no maintenance, costs only a few cents a night. It is backed by Hunter's 65 years of fan experience.



You can easily install a Hunter Attic Fan in your home. This compact unit is complete with automatic shutter and modern metal trim to cover the ceiling opening. No suction box to build; no accessories needed. Fan requires only 17 in. attic clearance. Look in your classified directory and phone the Hunter dealer. You can have cool comfort at low cost.

MAIL FOR FREE BOOKLET

Hunter Fan and Ventilating Company
Box 2858-S, Memphis 2, Tennessee
Send a copy of "Change Your Home
from Hot to Cool" to:

Name _____
Address _____
City & State _____

HUNTER ATTIC FANS

(Continued from page 218)

professional help. Working alone, without the equipment ordinarily used, you cannot very well proceed in an orthodox manner. Ordinarily a building in the condition you describe is plumbed at the corners first. This can be done by placing timbers, 4x4s or 4x6s, diagonally against the leaning corners and forcing the corners back with jackscrews. Leave these diagonal timbers in position. Pass a short length of chain around each plate at the center and hook a block and tackle to the chains so that you can exert inward pressure on the plates. Place two uprights, 4x4s or 4x6s, four to six ft. apart with their upper ends bearing against the ridge board at its center. Place a jackscrew under the lower end of each upright. It may be necessary to place uprights under the loft floor to carry the pressure down to a solid bearing on the first floor. Take up the slack in the tackle block and have a helper raise the jackscrews simultaneously one or two turns. Continue this procedure by stages, keeping tension on the tackle block, until the ridge has been forced back to the level position. Leave the tackle and uprights in place and under tension. Tie the structure at the plates with 2x6s or 2x8s spiked or bolted to the rafters at a point just above the plate, the other end of the brace is attached to the companion rafter about 18 in. above the midpoint. The second brace of the pair is installed in the same manner except that it runs in the opposite direction. Install a spacer block and bolt the braces together at the point where they cross. Nail diagonal braces in each corner of the building, each brace extending from the plate, or the floor joists, to the floor at the midpoint of the ends and side walls of the building. Install these braces in all four corners and on both floors. Then re nail the siding, using aluminum siding nails if available. These nails will not corrode and cause stains.

Sodding Terrace

Q — I have a steep terrace along one side of my lawn and it seems impossible to keep grass growing on it even for one whole season. The seed washes away in the spring and the grass that does catch and grow, appears to die out before the end of the summer. Are there special grasses that will grow on a terrace, or is there any preparation or procedure that will help?—B.Y., New York



A—It is difficult to maintain a vigorous sod of ordinary lawn grasses on a steep terrace especially if water runs down over it from a higher level. Soil tends to wash away slowly, exposing the plant crowns and roots. Soluble plant foods leach out of the top soil rapidly. Probably the best method on a small terrace is to prepare the soil, sow the seed, then rake and roll the surface so that it is smooth. Then spread a mat of closely woven vegetable fibers over the slope. Anchor the mat at the top of the slope with small stakes and run the roller over it to embed the fibers below the surface. Mat will hold the soil and prevent it from washing until the grass seed germinates and develops a root system. The new planting must be watered regularly throughout the season and a fairly heavy fertilizer schedule must be used the first year to assure rapid growth and full development of the individual plants. Some gardeners grade the slope into two or more separate levels to prevent rapid runoff of surface water. Where practical to work out, this plan conserves moisture and prevents washing during heavy rainstorms. Although spring seeding under such difficult conditions can be successful if made early in the season, fall seeding generally is recommended. When seeding in the fall, the work should be started sufficiently early to permit the seedlings to build a firm root system before freezing temperatures stop further growth. Do not mow a new seeding until the plants reach a height of 2 in. or more.

FOR FASTER, SCRATCH-FREE SANDING USE DREMEL *Straight-Line Action* ELECTRIC SANDERS

FOR ALL HOUSEHOLD AND WORKSHOP SANDING

You'll find Dremel Sanders indispensable around the house and workshop. Thousands of satisfied users have proved Dremel Sanders produce professional-like, scratch-free surfaces . . . are durably built to give years of service. Avoid slow, tiresome hand-sanding. Order a Dremel Electric Sander right away!

Model 2000
\$24.50

Model 2000 for HEAVY DUTY WOODWORKING PROJECTS—



MODEL 2000 PRICE INCLUDES this sturdy steel storage case, 25 asst'd. abrasives, and sheepskin polish pad.

A high speed, fast-cutting production sander for home and shop use. Its straight-line, **with-the-grain** action is ideal for redecorating jobs, furniture and cabinet making, boat building or refinishing. Great for building operations like woodwork, doors, stairways, dry-wall joints, etc. Also does a superb polishing job! Wt. 5 lbs.; 21 sq. in. sanding surface; over-all size 3 1/8" x 4 1/2" x 7". Finest sander value in the field and fully guaranteed!

BOTH MODELS FEATURE!

Only 2 moving parts;
easy one-hand operation;
10-sec. paper change;
14,400 strokes per min.;
110-120 V., 60-cycle, AC.



ONLY STRAIGHT-LINE ACTION SANDS WITH THE GRAIN

Ask any professional woodworker about sanding action. He will tell you that only straight-line, with-the-grain sanding can produce a flawless finish. Follow his advice—insist on Dremel.

BEFORE YOU BUY ANY SANDER . . . COMPARE!



14,400
SANDING STROKES
PER MIN.

MODEL "A" FOR HOBBIES, REFINISHING, REDECORATING—Dremel's lighter capacity, excellent all-purpose sander for home maintenance, unfinished furniture, hobby projects, etc. Wonderful wax polisher. A soothing massager! Only 2 1/2 lbs. with 12" sanding surface.

MODEL "A"
\$14.85

Price includes 6 sandpapers, 1 sheepskin, 1 felt pad.

WHERE TO BUY—If dealer doesn't carry, remit in full for postpaid shipment. Or send only \$2 now, pay postman balance plus postage and C.O.D. fee. *Five-day trial, money-back guarantee!*

DREMEL MFG. CO. Dept. 112-G Racine, Wis.

YOUR CAR INVESTMENT IS BIGGER THAN EVER *Protect it with Miracle Power*

Remember when a new automobile cost around \$700? Today, your big investment—and the fact that world conditions indicate it may have to last—are reasons enough for taking care of it.

That's why mechanics and racers say, "Use Miracle Power in oil and gas". They know that oil alone can't protect modern engines against friction and DRY STARTING damage—major cause of engine wear. And oil can't lubricate upper cylinder areas effectively because it

breaks down under terrific combustion chamber heat.

Miracle Power assures constant lubrication. It contains colloidal synthetic graphite in suspension. This lubricating graphite clings to metal . . . saves vital engine parts when oil is absent or ruptures . . . provides effective top cylinder lubrication because it keeps lubricating at "red hot" combustion chamber temperatures.

To save your car, use Miracle Power.



At gas stations, garages, Kaiser-Frazer, Ford and other car dealers or use this coupon for introductory offer.

Miracle Power Division
THE AP PARTS CORPORATION
759 AP BUILDING, Toledo 1, Ohio

THE AP PARTS CORPORATION
759 AP Building, Toledo 1, Ohio

Enclosed find \$_____ for which please send me *postpaid*:
_____ trial cans of Miracle Power at 75c each (1 for gas, 1 for oil)

Please send me free literature on making my car last longer.

Name _____

Address _____

City _____ Zone _____ State _____



"Don't just stand there, Bub...
Go get the 'DUCO' CEMENT!"

Fix it for keeps

WITH

**DU PONT
DUCO CEMENT**

REG. U.S. PAT. OFF.



**REPAIR CHIPPED
GLASS.** "Duco"

Cement's transparency makes the repair simple and neat—almost invisible.



SCUFFED SHOES

leather heels and insoles can be repaired in a wink with Du Pont "Duco" Cement.



**GOING TRAVEL-
ING?** Repair torn and scuffed luggage with "Duco" Cement. Leather stays firmly anchored.

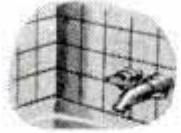

**LOOSE BATH-
ROOM TILES** can be put back to stay with tough "Duco" Cement. It's waterproof, too!

**STRONG, TRANSPARENT
FLEXIBLE, WATERPROOF**



REG. U.S. PAT. OFF.

**BETTER THINGS FOR BETTER LIVING
... THROUGH CHEMISTRY**

Trillion-Dollar Mile of Brains

(Continued from page 133)

construction of a smaller cryostat in 1946.

The large cryostat operates by compressing, regeneratively cooling and then expanding helium gas until a portion of the gas turns into a liquid just 7.6 degrees above absolute zero.

In explaining its significance, Collins notes that as temperatures approach the theoretical lower limit of absolute zero, many substances take on novel and thus far unexplained mechanical and electrical properties. In some, resistance to electric current vanishes completely, giving rise to the phenomenon known as superconductivity. The strength and brittleness of other materials change radically.

When the causes of such behavior become better known, Collins believes some of the mysteries of the structure of matter itself may be understood.

Fundamental research in the construction of better sound insulation for walls led M.I.T. to install 256 small loudspeakers in a 500,000-pound test chamber. The speakers, which have more than 12 times the power of the public-address system at Yankee Stadium, can make as much noise as a battalion of field artillery.

The loudspeakers are mounted close together in a panel of 16 rows of 16 speakers each. Driven by electronic oscillators, the speakers are brought close to the test panel, which is secured in a steel frame and set into one wall of the chamber. The walls, ceiling and floor (except for the test-panel hole) are of foot-thick solid concrete and are covered with a maze of glass fiber and wedges coming up from the floor, down from the ceiling and in from the sides. Taut wire mesh covers the wedges on the floor.

Inside the chamber a tiny microphone systematically moves across the face of the test panel and reports how much sound gets through each component of the test panel by drawing a "contour" map.

Probably the most important single scientific device conceived on Research Row is the Mark I calculating machine at Harvard—also known as Bessie, short for "Bessel Functions"—a mathematical tool analogous to logarithms.

Bessie, a long, slim, glass-sided machine with 760,000 parts, can answer riddles in nuclear physics and trigonometric functions in a flash.

Bessie, for example, can multiply a 16-digit number by another number just as long, subtract something from the product, square the result and add something to the square. During the operation it refers

(Continued to page 224)

BEFORE YOUR ENGINE GETS BALKY...

MAKE THIS ROAD TEST

with

MARVEL

*mystery
oil*

*Next time you change oil, add a quart of Marvel
... you'll marvel at the difference it makes*

- Prevents hydraulic valve troubles
- Prevents internal motor rust
- Prevents carbon formation
- Provides ring seal
- Frees sticky valves

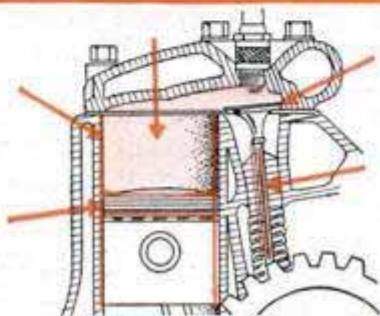

SAFER! Marvel Mystery Oil is the result of more than 30 years of lubrication research and improvement — specially developed for today's high-compression engines. Unlike many other oil additives, it contains no harmful acids or graphites — instead, it protects and adds to the life of your motor!



SMOOTHER! Marvel goes to work where regular oils stop. It combats top-cylinder dry-firing . . . reduces wear . . . keeps your engine free of gum, sludge and varnish. That means a dream of a ride, even under the most extreme conditions of pressure and heat.



SEE YOUR REGULAR GAS STATION OR DEALER
... write us for FREE information
and the name of your nearest supplier.

BE ENGINE WISE... MARVELIZE NOW!

Use Marvel Mystery Oil in the crankcase,
gas tank or any top-cylinder oiler.

EMEROL MANUFACTURING CO., INC.

Dept. 119 • 242 West 69th Street, New York 23, N. Y.

to tables of figures embedded in its memory, selects the proper figures and includes them in its calculations. It remembers intermediate figures for a fraction of a second, uses them when needed and rubs them out when through. All this is done without mistakes faster than a human being can jot down a single figure. When the calculation is completed, it pounds out the answer on an electric typewriter.

Bessie completed in 103 hours a uranium-fission problem for Princeton University that would have taken a mathematician more than 100 years. The time would not have been shortened by putting 100 mathematicians to work because each part of the problem had to be done in sequence.

Already Bessie is considered old for a computing machine. She has been at work since 1944 and, compared to her descendants Mark II and Mark III, she is actually dim-witted and slow.

Designed by Prof. Howard Aiken, head of Harvard's computation laboratory, Bessie is now expecting a great-grandson, Mark IV, being built by Harvard for the Air Force. It will remain at Harvard permanently and part of its time will be available for nonmilitary uses.

The blue-ribbon technological enterprise of Arthur D. Little, Inc.—recognized as the largest independent scientific-research or-

ganization in the world—is anchor man on the Row.

It is a consulting organization and the majority of its 180 scientists devote their time exclusively to clients' projects.

The latest addition to Research Row is the National Research Corporation, bossed by youthful, energetic Richard S. Morse, a brilliant theoretical scientist and shrewd businessman, who came to Boston in 1940 to turn his idea of a high-vacuum process into big-time operation.

N.R.C. built the first pilot plant for high-vacuum (low-pressure) production of magnesium from dolomitic limestone. From this one experiment, N.R.C. has supplied the high-vacuum research for a whole string of magnesium plants in the U. S.

One of its outstanding contributions came in 1943 when the Army Medical Corps wanted a quick way to dry penicillin. N.R.C. turned to its high-vacuum equipment and came up with the answer. With this process, dried penicillin could be stored at normal temperatures in a minimum of space with no loss of potency. By the end of the war, a large percentage of blood plasma was being dried with N.R.C. equipment. This also led to N.R.C.'s biggest profit maker—food dehydration.

Today, National Research's labs have
(Continued to page 228)

DO IT TODAY! SWITCH TO

MILD

KENTUCKY CLUB



"Look! Another man switched to Kentucky Club—the thoroughbred of pipe tobaccos."

Notice how much better your pipe tastes—how much fresher your mouth feels when you switch to Kentucky Club. Look for the blue tin with the picture of the red-coated rider. Send for free catalog showing fine pipes and how to get them at big savings. Mail Pouch Tobacco Co., Wheeling, West Va. Dept. 93



GROBAN'S BRAND NEW UNCONDITIONALLY GUARANTEED WAR SURPLUS BARGAIN SPECIALS

GENERATING PLANTS

IMMEDIATE DELIVERY • LARGE STOCK • MANY SIZES FROM 350 WATTS TO 25 KVA
 Item #347—PE-201—1000 Watts—120 Volts—60 Cycle AC—Single Phase, and .3 KVA, 14.6 Volts—20 Amps, DC for battery charging. Model A, Leland Generator, belt driven by a Briggs & Stratton 1 cylinder, air cooled, 2.7 HP gas engine at 1800 RPM. Control panel contains DC voltmeter, ammeter, rheostat, receptacle and terminals. Also AC frequency meter, rheostat, 120 volt double receptacle and terminals. Overall dimensions, 36"x19"x24". Ship. wt. 250 lbs. F.O.B. Chicago. . . . **225.00**→

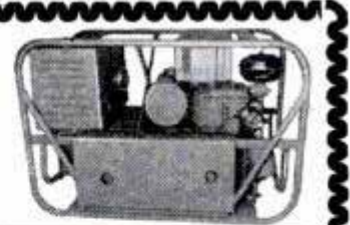

Brand New

GENERAL MOTORS — ALLISON

CENTRIFUGAL PUMP

200 GALLONS PER MINUTE

• For Draining Basements • Fire-Fighting • Irrigation • Fuel Transfer • Swimming Pools • Home Water Systems • Dewatering

This General Motors-Allison Centrifugal Pump—designed for use on U. S. Air Force Mustang Fighters, now converted for commercial, home, and industrial high volume pumping applications. Inlet, 2 1/4" standard pipe thread, twin outlets with 1 1/4" pipe thread, ball bearing supported 3/4" shaft. Easy, fast simple priming. Rotation, counterclockwise facing shaft. Shipping wt. 35 lbs. Gov't acq. cost \$145.00. F.O.B. Chicago. NOW ONLY. . . . **39.50**



(ITEM #130)

Aircraft Quality HYDRAULIC EQUIPMENT



ITEM #160—PESCO GEAR TYPE HYDRAULIC PUMP—Compact—Powerful—Reliable. Especially designed for belt drive from fan belt, power take-off, drive pulley, electric motor or small gas engine. Equally suitable for direct coupling. Pedestal type mounting with two bolt holes for 3/4" hold-down bolts. Standard 1/2" pipe thread inlet and outlet ports. Delivers 4.5 GPM at 1000 PSI at 2800 RPM with 3 HP. Hardened steel gears turn in dense oilite bronze bearings. Rotation—clockwise facing shaft. Guaranteed trouble-free service. Ship. wt. 6 lbs. F.O.B. Chicago. . . . **22.50**



(ITEM #126)

(ITEM #160)

ITEM #126—Four-way, open center control valve with built in adjustable relief valve. Factory set at 1000 P.S.I., spring loaded neutral position, for use with one double acting cylinder. In neutral position cylinder is locked and pump unloaded. Fully balanced plunger type, smooth positive, easy operation, can be used as single unit or mounted in series of any combinations desired. Has 3/4" pipe thread inlet and outlet. 1/2" pipe thread cylinder ports. Newly manufactured to our specifications. Shipping weight 8 1/4 lbs. An outstanding Buy! F.O.B. Chicago. . . . **21.50**

ITEM #42—Double action hydraulic cylinder, 4" bore, 18" stroke. Rated lift capacity with 1000 PSI line pressure is 12,500 lbs. Ship. wt. 30 lbs. F.O.B. Chicago. An Excellent Buy for. . . . **32.50**

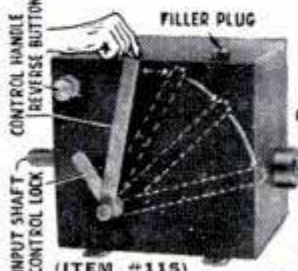

HYDRAULIC SPEED REDUCER WITH FINGERTIP CONTROL

USE FOR • Reamer Drives • Midget Cars • Feed Mills • Canning Machines • Conveyors • Lathes • Milling Machines • Motor Boats • Cream Separators • Garden Tractors • Pumps

Variable output speeds from 0 to input speed available by moving control handle. Locking handle maintains setting. Use input power of 1/4 to 1 1/2 H.P. This Westinghouse-Oil Gear Unit consists of a variable displacement hydraulic pump feeding a fixed displacement hydraulic motor. Adjustable relief valves set at factory for 100 inch pounds of torque may be reset up to 180 inch pounds. Independent reverse control allows full output power and speed selection in either direction of rotation. Shafts measure 5/8" diam., include keyway. Input rotation is counter-clockwise facing shaft. Recommended input speed not to exceed 750 R.P.M. Over-all dimensions, 7 1/2"x7 1/2"x1 1/2". Gov't acquisition cost, \$425. Ship. wt. 31 lbs. Complete with 2 qts. of oil and full instructions. F.O.B. Chicago. . . . **54.50**

(ITEM #115)

New Model 353 — Dual Range D. C. ARC WELDER

for Stationary or Portable Use. HEAVY DUTY RANGE TO 250 AMPS. NEW 'MAGIC TERMINAL' FOR LOW CURRENT 30 TO 100 AMPS. IDEAL FOR • FARM • FACTORY • GARAGE • WORKSHOP

These precision engineered D.C. Arc Welders contain the highest quality War Surplus aircraft components built to exacting government specifications. They are light in weight, have over-sized lifetime grease-sealed ball bearings, air cooled commutator, dial type rheostat for easy pin-point control, a high-low rheostat switch, reactor coil for even arc and the new 'MAGIC TERMINAL' low current welding range for welding lighter materials. Designed for many years of trouble-free service. Run welder from drive pulley or power take off of a tractor or Jeep, 7 1/2 HP electric motor or 10 HP gas engine at 2500 R.P.M. Uses two V-belts or flat belt. Continuous output rating 200 amps. Intermittent welding rating 250 amps, 30 volts. This sensational price includes double V or flat belt pulley and complete operating instructions. Shipping weight 107 lbs. \$350.00 Value. Item #65. F.O.B. Chicago Now only. . . . **119.50**



Welds Anything From Auto Fenders To Tractor Frames

ORDER DIRECT FROM AD — SEND PAYMENT OR PURCHASE ORDER TODAY—SATISFACTION GUARANTEED

FREE: 48-PAGE BARGAIN CATALOG. Write Today!

GROBAN SUPPLY CO. DEPT. PM-7
 1139 SO. WABASH AVE., CHICAGO 5, ILL.

MAGNETS LIFT 225 lbs. GENUINE ALNICO—NEVER WEAKENS

AMAZING, PERMANENT MAGNETS—WILL NOT WEAKEN! NON-ELECTRIC
 Retrieve guns, tackle, tools and other steel items from lake, river, plating tanks, drains or other hard-to-reach spots. Recover drills, taps, etc. from sweeping. Clear alley of harmful tacks, nails. Many other uses. Pays for itself quickly. GUARANTEED. Try any magnet one week. Money refunded if you are not well pleased.
 No. M-725 (Weights 54 oz.) Has pull of 225 lbs. on steel block. **\$15.00**
 No. M-675 (Weights 49 oz.) Has pull of 175 lbs. on steel block. **\$10.50**
 No. M-650 (Weights 41 oz.) Has pull of 150 lbs. on steel block. **\$ 8.50**
 No. M-30 Hobbyist assortment of six small magnets. . . . **\$ 1.50**
 Send Money Order or Check. We pay postage. No C.O.D.'s.
 MIAMI MAGNET COMPANY, 3240 N. W. 27th Ave., Miami 42, Fla.

Heads stay put ON AXES and HAMMERS
 ask your dealer for **Red Devil** grady wedges

RED DEVIL TOOLS, IRVINGTON 11, N. J., U. S. A.

NO MORE BURNED OUT ENGINES! DUE TO LACK OF OIL.

Don't run the risk of expensive motor overhaul because of lack of oil. OIL-D-CATOR tells you when you need a quart of oil without raising your hood. Insure your motor against damage. Can be installed without tools in about 5 minutes. Get yours today!



COMPLETE RELIABILITY GUARANTEED

For Fords and Chevrolets only. **PRICE COMPLETE \$4.95**
 State year, Number of Cylinders.

Send check, money-order or cash only.
 Pat. App. for Reg. Trade Mark

OIL-D-CATOR CO.
 BOX 406, WILMINGTON, DELAWARE

The inside story of Ford's

"New design makes Ford bodies the most

Balanced design!

"The ideal in correlation of structural members has been achieved in the '52 Ford. The body unit provides more usable space, unusual visibility, modern beauty . . . *plus* added strength for greater safety and longer life."

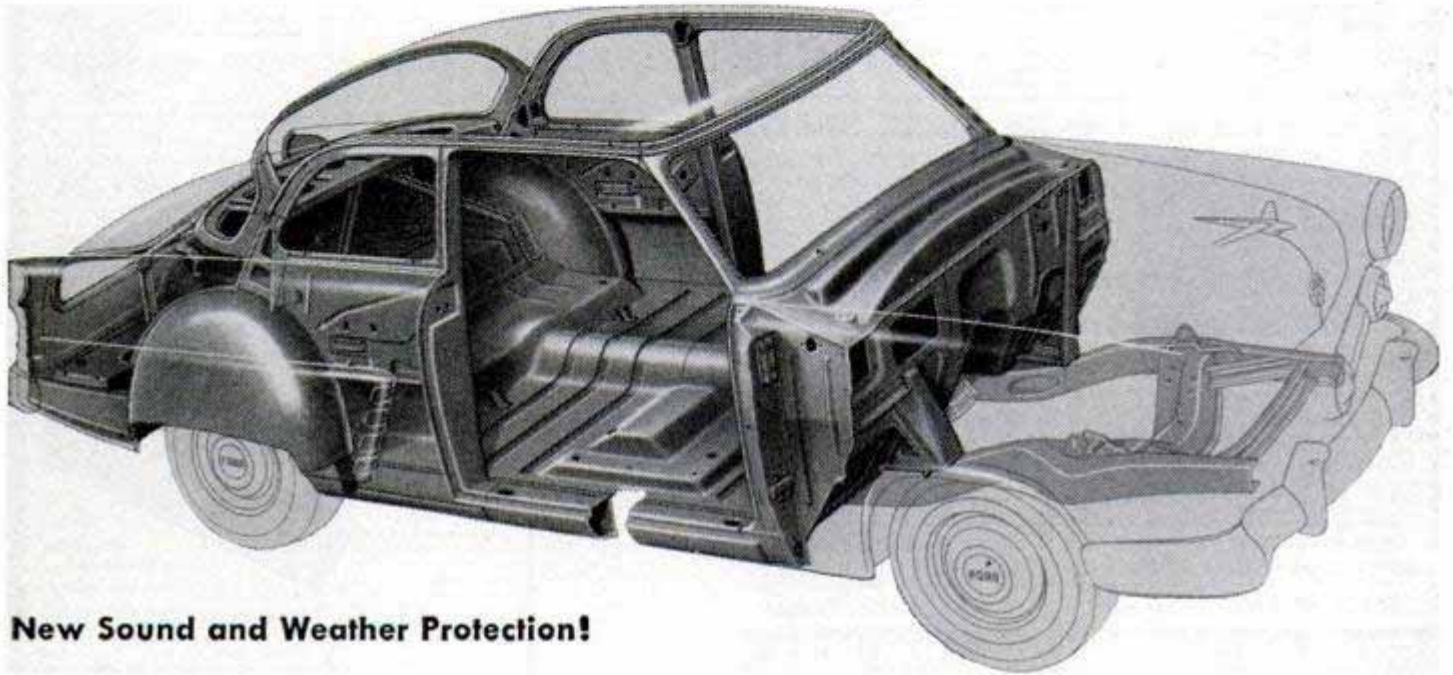

New Sound and Weather Protection!

"An important quality feature of the new Ford bodies is their superior insulation against sound and weather. Glass fibre, heavy asphalt impregnated waffled felt pads and mastic sound deadeners are used to damp out mechanically induced sounds. Even the body bolts are insulated with rubber to keep out road noises. A new design door inner panel with continuous rubber strip provides effective sealing against rain and dust."



Full Visibility plus extra strength! "3200 square inches of glass give true Full-Circle Visibility . . . 16% more than any other car in Ford's field. Windshield and rear window are completely encircled by husky box-section structures welded to roof rails and other members for greater strength."

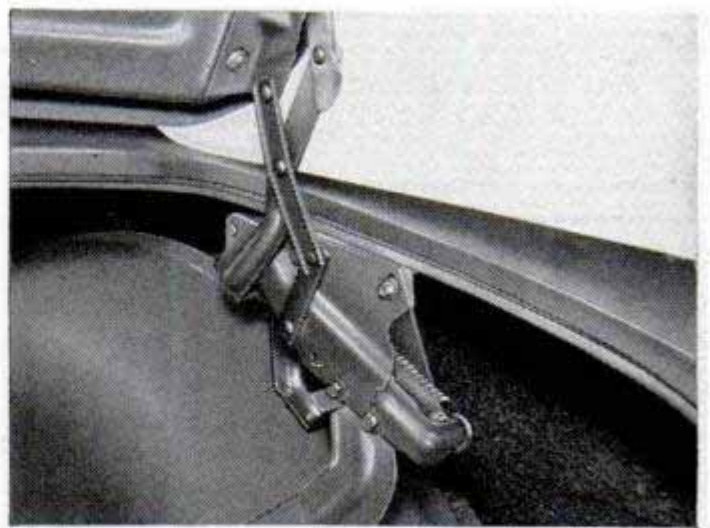

More usable room! "By taking advantage of the wider and longer body shell, Ford body engineers have achieved the maximum usable passenger and luggage space. For example, the new Space Saver Hinges and Center-Fill Fueling with its shorter fuel pipe make possible the roomiest trunk in Ford's field."

modern body construction

advanced in their field," says Dr. Roy K. Marshall.

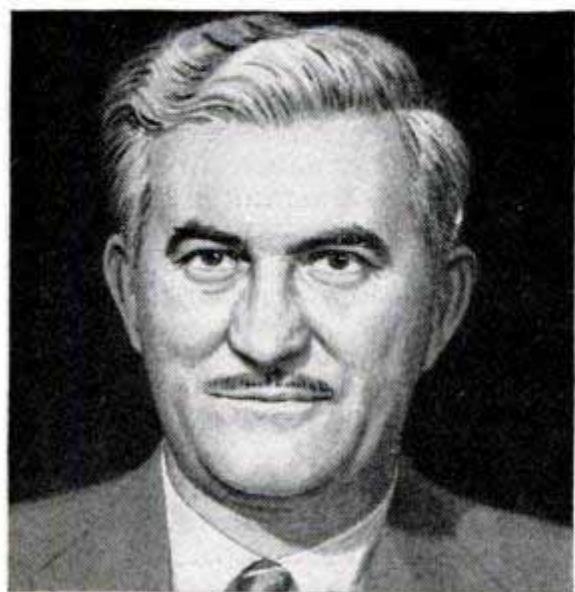

A PICTURE STORY BY DR. ROY K. MARSHALL

Dr. Marshall is a former consultant to the Atomic Energy Commission and a well-known lecturer. He is nationally famous for his simplified explanations of complicated things.

"FOR YEARS TO COME you'll see others follow the design and construction trend started by Ford body engineers.

"The completely new body is a masterpiece of balanced design, with its structural members welded into a unit of strength and beauty never before achieved in the automotive field. For very often, beauty had been sacrificed for strength, or rigidity had been sacrificed for beauty's sake. In the '52 Ford, however, you get a remarkable blending of the two in master coachwork by Ford's master craftsmen."

Over 200 combinations

"When you visit your Ford Dealer notice the careful tailoring of the rich long-wearing upholstery fabrics . . . all color-keyed to interior trim and exterior colors. From more than 200 body, color and upholstery combinations you can choose the one best suited to your taste and your needs."

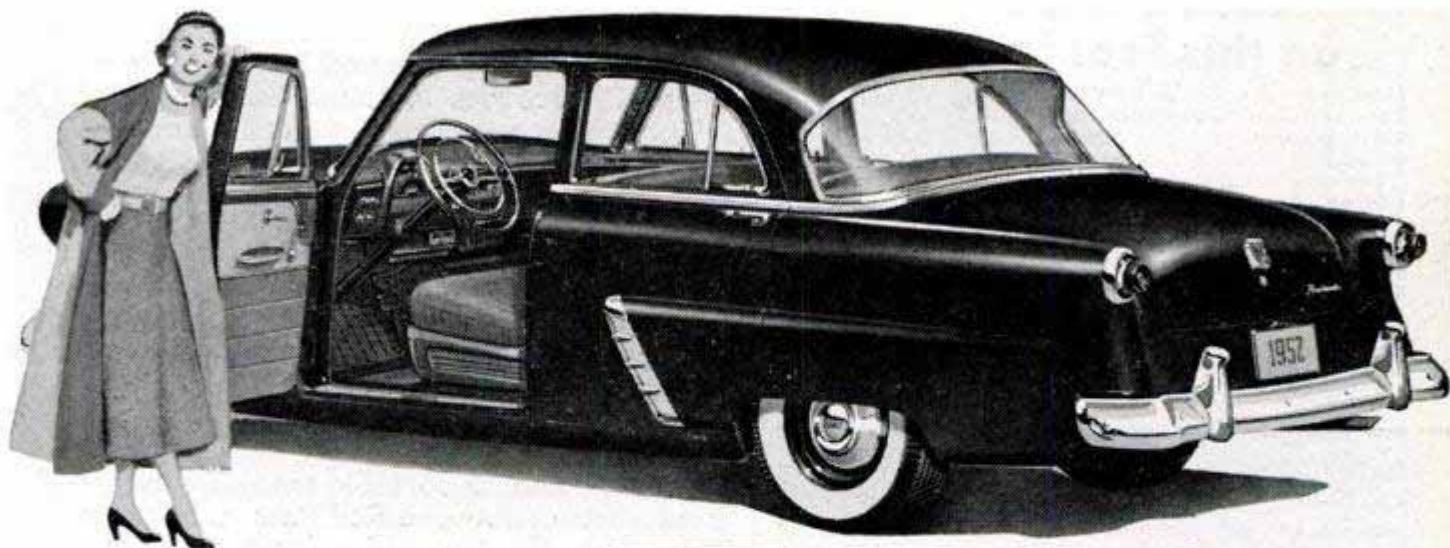

You can pay more

but you can't buy better!

White sidewall tires and heater optional at extra cost. Equipment, accessories and trim subject to change without notice.

Ford

**Make
Fancy Cuts**

**Like an
Expert!**

PORTER-CABLE
Guild

ROUTER

only \$49.50



**Do Coving • Veining • Dadoing • Fluting • Rabbeting
Inlaying • Beading • Dovetailing • Make Cut-
Outs • Raised Decorations • Molding • Relief Work**

Now—make all the fancy cuts required in furniture, cabinet, built-in and molding making. Portable Guild Router is a professional tool priced for the home craftsman. Used extensively in woodworking shops because of its sturdy construction, extraordinary speed, hairline accuracy.

All these advanced features:

Depth adjustment from $\frac{1}{64}$ " to 1" • Exclusive True-Spin chuck, $\frac{1}{4}$ " capacity • Extra heavy thrust bearings • High polish, die-cast aluminum housing and base • INTERCHANGEABLE MOTOR . . . 20,000 RPM motor also powers Guild Plane and Shaper,

**Save \$89.50
on this Tool Trio!**

Start with the Guild Router complete with base and interchangeable motor for \$49.50. Unit becomes a high speed Electric Plane by adding Plane Attachment for only \$25.00. Then an accurate Shaper by adding Shaper Table for only \$24.00. You get all 3 tools for \$98.50—eliminate the cost of 2 motors—and SAVE \$89.50 on this great combination!

Guild Plane



See your Guild Dealer — or
mail coupon for full details.

PORTER-CABLE MACHINE CO.
6167 N. Salina St., Syracuse 8, N. Y.

Please send me complete information on Guild Router, Plane and Shaper . . . also name of nearest dealer.

Name

Address

City Zone State

In Canada, write: Strangridge, Ltd., London, Ont.

acquired the look of miniature Dante's Infernos. Tiny furnaces are melting down all kinds of unusual metals. Molten fluids are being poured into strange castings in an effort to make them useful. Out of these fires may come lightweight metals that are much stronger than steel—metals that will withstand the staggering temperatures necessary in the great age of rockets and atomic power that lies ahead.

In another section of the expanding laboratories, scientists are developing new and cheaper processes for making chemicals out of natural gas and are trying to find new chemicals in the gases that nature provides. New buildings to house the multiple projects are rising in Newton, a Boston suburb.

Another famous member of the Row is the Polaroid Corporation, which has applied polarization of light in a dozen ways and gone into other fields to introduce the Land "print a minute" camera.

Two of its new developments include filters to absorb visible light and pass infrared, and a circularly polarized sheet which prevents reflections from instrument faces and radar and television screens.

It may be difficult, even for a Bostonian, to justify the nickname "Trillion Dollar Mile" but in an age where the word "billion" ceases to impress anybody, it seems as proper as Beacon Hill itself. ★ ★ ★

Boom in the Big Triangle

(Continued from page 119)

The Fraser feels the surge of industry. Along its banks and those of the Nechako have arisen world-ranking lumber mills. Prince George, the romping lumberjack city of nearly 10,000, has quintupled its population in 10 years and has the rivers' sawmill industries to thank for progress.

Thirty-five years ago, veteran lumberman Martin Caine built his first planing mill at Prince George opposite the high clay banks of the Nechako. Today, 15 large mills line that shore across the railway tracks from Prince George's bustling business section. Any day of the year, in 15 minutes you can walk past \$5,000,000 worth of dressed lumber ready or being loaded for shipment to foreign and domestic markets.

"Eleven years ago there were only 25 stationary and 50 portable sawmills in the forest district between Red Pass and Fraser Lake, a swath along 317 miles of railway," Caine pointed out recently to a group of visiting business moguls. "They had a total output of 90 million board feet.

"In 1951 the same area had 550 mills producing an all-time record of 500 million board feet. During August alone the forest

(Continued to page 230)

NEW "PAINT PEN"

PAINT STRIPING TOOL

Works like a Fountain Pen
Stripes with Paint instead of Ink!

This amazing new "PAINT PEN" is a Paint Striping Tool that makes it easy to do expert striping on furniture, bikes, model planes, autos, signs, toys, linoleum, wall board, etc. Makes plain-painted walls look like tile. Paint straight, curved, circular or evenly spaced parallel lines the same way a professional painter does. Simply fill Tubular Glass Paint Fountain with any color paint and wheel tip feeds paint evenly. Tips interchangeable — jaws split apart for easy cleaning. Tool complete with tip for 1-16 inch stripe only \$1.00 postpaid. Other complete tools with 1-64, 1-32, 3-64, 1-16, 5-64, 3-32, 1-8 inch tips, \$1.50 ea. Extra tips, 75c each. Complete KIT with 7 tips, \$5.00. C.O.D.'s postage collect. Here's the handiest tool in your whole painter's kit. Get yours today.

Paint
STRAIGHT,
CURVED OR
PARALLEL LINES

Home Craftsmen

Just the tool you've been waiting for! New Paint Striping Tool gives "professional" results every time, yet simple and easy to use as a fountain pen. Adjustable guide keeps lines straight as an arrow. Just as easy to make curves or free hand designs. Adds new beauty and finished look to everything you paint. Send \$1 now!

Only
\$1.00

WENDELL MFG. CO., Dept. 3-M,
4234 LINCOLN AVENUE, CHICAGO 18, ILL.

DEALERS
PAINT STRIPING TOOL
packed in display cartons
of 1 doz. Fast, profitable
seller. Write for illustrated circular, discounts



G E A R S

In Stock - Immediate Delivery

Gears, speed reducers, sprockets, thrust bearings, flexible couplings, pulleys, etc. A complete line is carried in our Chicago stock. Can also quote on special gears of any kind. Send us your blueprints and inquiries.

Send for Complete Catalog No. 10

CHICAGO GEAR WORKS

440-50 N. Oakley Blvd., CHICAGO 12, ILL.

Make your own Gems 29.50 F.O.B.

All necessary lapidary equipment is furnished, including a super-charged diamond blade for sawing, and all wheels for grinding, shaping and polishing; also complete instructions. The complete equipment as shown, less motor and belt, for only \$29.50, f.o.b., Burlington, Wisconsin. Write today for information and literature.

B&I MANUFACTURING CO.
Dept. S Burlington, Wis.



GERSTNER Tool Chests



A Masterpiece in construction and design for the good tools of Machinists and Toolmakers.
Free Catalog
GERSTNER TOOL CHESTS
452 COLUMBIA ST.,
DAYTON 7, OHIO

Say You Saw It in Popular Mechanics



GRAVELLY
makes tough
jobs **EASY!**

Powerful!

5-HP Gravely Tractor powers 20 tools—does every lawn, garden, and field job easier, better! All-gear drive, Reverse. New "Power vs Drudgery" Booklet FREE. Write for it today!



GRAVELLY

BOX 763 DUNBAR, W.VA.

FIELD-TESTED FOR 31 YEARS

KEEP YOUR TOOLS FREE FROM RUST!

THE FRIGIDAIRE ELECTRIC DEHUMIDIFIER

ends moisture damage in Workshops,
Basements, Darkrooms



Compact size—put it
anywhere—18¼" high—
20½" long—11¾" wide

Put a permanent end to moisture damage the instant you plug in this amazing device. Stops mold, rust, mildew. Protects equipment, luggage, furniture. Positively controls moisture in any closed area up to 8,000 cubic feet. No messy

chemicals to bother with. Operates on pennies a day. Uses refrigeration principle. Powered by world-famous Frigidaire Meter-Miser compressor with 5-Year Protection Plan. See your Frigidaire Dealer or write for special folder giving full details. Frigidaire Division, General Motors Corp., 1527 Amelia St., Dayton 1, O.

Free to mechanics DURO-CHROME TOOL CATALOG

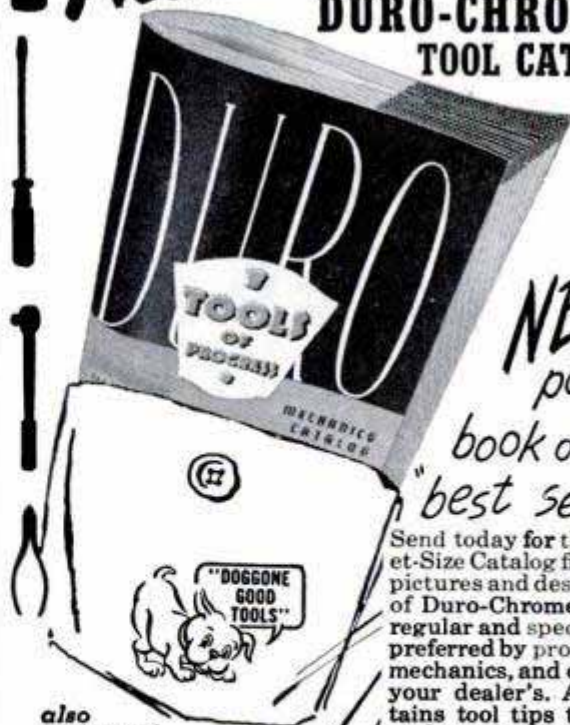

NEW
pocket-
book of tool
"best sellers"

Send today for this Pocket-Size Catalog filled with pictures and descriptions of Duro-Chrome Quality regular and special tools, preferred by professional mechanics, and on sale at your dealer's. Also contains tool tips that help make you a better mechanic. All yours without cost or obligation.

also
makers of
nationally advertised
DURO POWER TOOLS

clip this coupon now to get FREE copy
MAIL TO DURO METAL PRODUCTS COMPANY
2649 N. Kildare Ave. Chicago 39, Illinois.

Write your name and address in margin space

**FOR YOUR HOME'S SAKE
DON'T MAKE THIS MISTAKE**



Use **RUST PROOF NEVER-STAIN**

ALUMINUM NAILS

Yes, for less than \$4.00*, you can avoid costly premature repainting. When you use "Never-Stain" ALUMINUM NAILS on the siding of your home, you are insured against unsightly rust spots and streaks. No countersinking and puttying necessary—a \$60 to \$75 additional saving.

When you build or remodel, insist on lifetime "Never-Stain" ALUMINUM NAILS.

*For the wood siding on the average 5-room house.

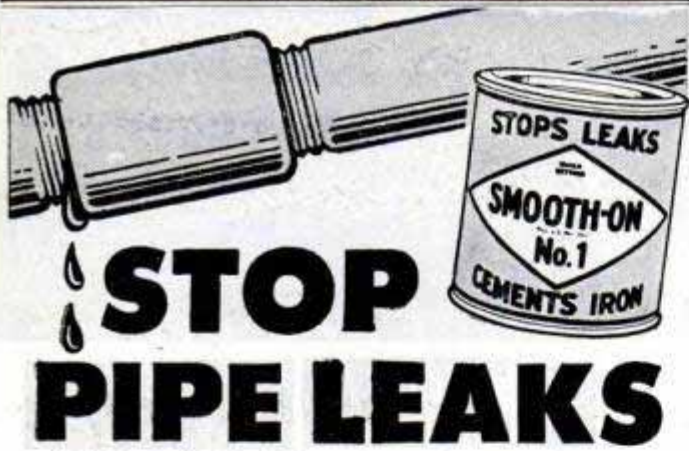

STOP PIPE LEAKS

with Smooth-On No. 1 Iron Cement. For over 50 years a home repair stand-by for stopping steam, water, oil and gas leaks in boilers, furnaces, tanks, stoves, etc. and for tightening loose parts. Get a 1 3/4 oz., 7 oz., 1 lb. or larger size at your hardware store and keep it handy.

FREE

40-PAGE REPAIR HANDBOOK

Shows many useful repairs you can easily make around the house and on the car. 170 pictures. Write NOW for free copy.

SMOOTH-ON MFG. CO., DEPT. 37G

570 Communipaw Ave., Jersey City 4, N.J.



Do it with **SMOOTH-ON**
THE IRON CEMENT OF MANY USES

industry shipped 700 carloads of forest and allied products east out of Prince George."

That's a jump of almost a half billion feet within a decade.

This tremendous increase in the sawmill industry, along with demands of Alcan, the fish trade and Cellulose, has injected new vitality into the rail traffic of the triangle. The government-owned Canadian National knows now that it has inherited a bonanza in the Jasper-Rupert leg.

Consider forest products alone. During the hungry 30s the railway carried fewer than 1000 carloads a year. Stimulated during the war, the figures jumped to 5000. In 1950, 13,000 carloads of forest products rolled to the main line of the C. N. R. at Red Pass Junction, the equivalent of a monster train 100 miles long!

The railway, responding to the increased revenues and revitalized management throughout its system, has ceased to regard the line to Rupert as an illegitimate and unwanted offspring of the Old Grand Trunk Pacific.

"This baby is going to get plenty of milk and honey from now on," said Frank Keefe, capable general manager of western lines. The passenger service has been doubled and additional freight crews spotted at divisional points. Until the railway can overcome the steel shortage and install heavier rails, the safety orders will continue to limit top speed to 35 miles an hour.

Transportation always has been the fly in the ointment of development in northern and central British Columbia. But the problems are being ironed out.

Motorists from northwestern United States this year will be able to cut off 1500 miles if they're bound for Alaska or the Yukon. That's the difference in mileage made possible by the new Hart Highway addition from Prince George to the Alaska Highway at Dawson Creek.

Extension of the Pacific Great Eastern Railway to Prince George from Quesnel, ready this summer, will encourage further settlement and investment in the Cariboo. This year, too, could see start of construction of the P.G.E. link between Vancouver and Squamish. Closing of this important 40-mile gap would eliminate the existing truck or barge hauls and consequent double handling of freight. And it would provide direct access to and from the rich interior of the triangle.

Some of the finest hunting and fishing country of the continent literally noses up to the railways of the triangle. Ever see 200 moose in a few minutes' train ride? Well, Geoff Woodall has—by actual count and with witnesses to prove it—in a winter

(Continued to page 232)



THE MOST

Versatile TOOL

ON YOUR BENCH!

CHANNELLOCK PLIERS

Made only by CHAMPION DEARMENT

In almost any job you can think of—Pliers are necessary—and Channellock pliers are the best you can buy. Whether you are working on your car, electrical repairs, plumbing work or just tightening nuts and bolts Channellock pliers do it better.

And remember, Only Champion DeArment makes Channellock—More than 3/4 of a Century of experience in producing highest quality tools. Send for Catalog D15—today.

CHAMPION DEARMENT TOOL CO.
Meadville, Pa.

Channellock pliers are listed in the Yellow Pages of most Telephone Directories

under "Tools"

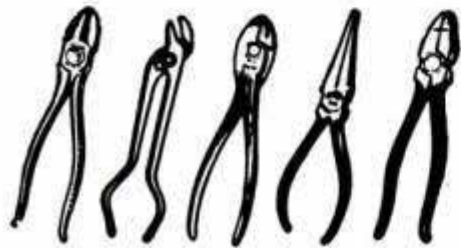

ONLY Champion DeArment makes

CHAN NEL LOCK



Preferred at Famous Fishing Spots



Dale Hollow Reservoir, Tennessee—Kentucky
A part of the vast Cumberland Valley development program, Dale Hollow Reservoir has skyrocketed to near the top of America's famous fishing spots.

In the famous fishing spots of outdoor America . . . anywhere and everywhere that fishermen fish—and catch 'em . . . you'll find H-I tackle is preferred for its quality, dependability and value.

Buy H-I—the preferred tackle line—at your dealer's. Horrocks-Ibbotson Company, Utica, N.Y. Manufacturers of the largest line of fishing tackle in the world.

The balanced action, uniform high quality and the practically indestructible dependability of H-I POWER GLASS Casting Rods are matched by their strikingly beautiful finishes and high grade mountings.



Power Glass Rods

LARGEST LINE
FINEST QUALITY
GREATEST VALUES



HIBRIDGE—precision balanced . . . all steel, "bridge" construction . . . spiral gears . . . easy 3-take-apart mechanism. Maroon anodized side plates with grey handle knobs. Price \$8.00.

SKIRR—Extra special, deluxe braided Nylon, treated by H-I's new "Heat Stretch" process. Colors—blue or green. 9—40 lb. test. Price \$1.30—\$2.60 per 50 yds.

GOLD SEAL—not affected by alkali or salt water. Hard braided, waterproof Nylon. Low cost, high quality. Colors—black and black and white. 9—40 lb. test. Price \$1.07—\$2.35 per 50 yards.



OLD HI SAYS—"As one fisherman to another, better buy H-I." Write for my free books: "Fishing for the Millions," "Salt Water Sports Fishing" or "Pacific Coastal Fishing." Horrocks-Ibbotson Co., Utica, New York. Dept. 23.



HORROCKS-IBBOTSON CO., UTICA, N. Y.

SELF-CONTROL STARTS HERE



and to restore

CAR PERFORMANCE

OIL-CONTROL STARTS HERE

To stop oil-pumping, replace worn engine connecting rod bearings

When you dig down for the cause of oil-pumping, you'll usually discover worn engine bearings.

Worn main and connecting rod bearings lose control of oil flow. They can't meter the exact amounts of oil necessary for proper engine lubrication. Excess oil reaches combustion chambers, burns to motor-fouling carbon on spark plugs, valves, pistons and rings. *Performance goes up in smoke!*

Give new piston rings a chance to do their own job — replace worn engine bearings, too! Genuine Federal-Mogul bearings are *engineered* for the job of oil control. *Ask your mechanic!*

FEDERAL-MOGUL SERVICE
(Division of Federal-Mogul Corporation)
DETROIT 13, MICHIGAN



CONTROL OIL-PUMPING

WHERE IT STARTS—REPLACE WITH

FEDERAL-MOGUL

BEARINGS

OIL CONTROL

concentration area near Burns Lake. Geoff, who went to Burns during rail-construction days in 1909 and hasn't been able to tear himself away, admits the count a bit unusual but adds that "any hunter here worth his salt can bring in his winter's meat in an afternoon."

The triangle always has garnered a sizable fistful of cash contributions left by tourists. It's only a fledging amount compared to what is expected as more Americans and Canadians discover the charm of its scenery and native lore.

Thousands, of course, are familiar with the highly publicized Triangle Tour which features the "inside passage" by boat (between Prince Rupert and Vancouver) and the two rail legs of the triangle.

There's a touch of almost every section of Canada on the trip between Jasper National Park and Prince Rupert; the highest peak in the Canadian Rockies at Mount Robson, agricultural lands almost like the Midwest, lakes and rivers reminiscent of Ontario's pre-Cambrian shield, mighty river valleys and foothills not unlike the Laurentians and verdant coastal country.

Vancouver, where you can golf or swim in the afternoon after a morning's skiing on near-by Grouse Mountain, is on the itinerary of the Triangle Tour, as is industrial New Westminster.

The coastal boat trip between Rupert and Vancouver leads through a mountain-sheltered sea lane between the mainland of British Columbia and offshore islands where, according to descriptive literature, "each mile of shore line discloses a new beauty to the eye and writes a new gay line on the pages of memory." By luxury steamer it's about a 40-hour trip and without doubt is among the most exciting of the continent's short voyages.

Scheduled ports of call include two important pulp and paper centers, Powell River and Ocean Falls, both heavy contributors to the prosperity of the triangle. When Alcan's Kitimat begins production in 1954, that new and modern city will become a major port on regular schedules of steamers plying the inland passage.

Last summer some of the tourists didn't get away. They weren't detained forcibly—they simply liked what they saw and stayed!

Quick money is the powerful lure, understandable when you learn that payrolls on Alcan projects now total \$1,500,000 per month and may go higher. For the individual, \$500 isn't too unusual and some, through overtime, are earning \$1000.

Where do all the employees hail from? Cellulose has Canadian, American, Swiss,

(Continued to page 234)

GET **BIG FISH**
IN **THE WEEDS!**

**JOHNSON'S
SILVER MINNOW**

A favorite fish-getter that casts like a bullet... retrieves through the weeds without snagging. Life-like flash and action.
5 Sizes, 4 finishes.

FREE New Booklet—

"How to Catch Fish—BIG ONES!"

LOUIS JOHNSON CO.

1547-P Deerfield Rd., Highland Park, Ill.

this **ONE**
GOVERNOR

fits ALL popular
farm & industrial
gasoline engines



PIERCE LONG RANGE
Universal Governor

ONLY
\$3950

● Instant variable speed selection and accurate engine control at any speed setting within 1200 to 2600 RPM. Higher and lower ranges obtainable by simple change of pulley. Also "constant speed" operation.

● Accurate, dependable speed control for engines operating corn shellers, drag lines, hoists, arc welders, trucks and tractors with power take-offs, etc.

Write for Complete Information

**DEALERSHIPS
AVAILABLE**

Pulley extra:
4"—\$1.70
5"—\$1.75

Send Check or
Money Order.
State Make,
Model of engine.

**THE PIERCE
GOVERNOR CO., Inc.**
1700 Ohio Avenue, Box 1000
Anderson, Indiana, U. S. A.

"World's Most
Experienced Governor
Manufacturer"

**AMAZING NEW SAFE SAW
MOST POWERFUL OF ITS KIND**

CUTS 1" Soft WOOD, thin metal, plastic! New "201" Synergro QUIET for apartment use, SAFE for kids, POWERFUL for Dad's use. Any length cuts. Stroke adjustable. Portable. COMPLETE

SYNERGRO
Electric Jig Saw

with BUILT-IN Motor, \$22.95 at dealers or postpaid. Free Circular. SYNERGRO Corporation, Dept. D-72, Oxford, Michigan.



\$22.95

**ACCENT THE GRAIN
with Cabot's Stain Wax**

It's easy to stain and wax in one application with Cabot's Stain Wax. Brings out natural beauty of grain. Wonderful for home projects. Available in new blond shades as well as traditional colors. Colors can be intermixed or tinted with colors in oil. WRITE TODAY for complete color card.

Samuel Cabot, Inc., 762 Oliver Bldg., Boston 9, Mass.

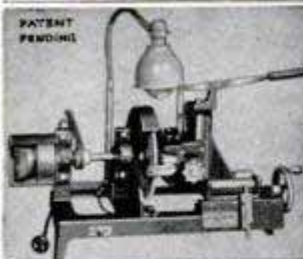

Start a NEW BUSINESS!

or Add to your present
Repair Business

SHARPEN DULL PIPE WRENCHES

PIPE TAPS & DIES
"GUM" CIRCULAR SAWS

Write for Information

J. C. MOORE INDUSTRIES
BOX M 276 FREDONIA, PA.

Earn BIG MONEY

BE YOUR OWN BOSS

EXCLUSIVE FRANCHISE in your trade area
Large, **SUCCESSFUL** tire service organization!

Hook up with this coast-to-coast network of established O.K. Rubber Welders. Finest patented tire recapping equipment. In-shop training. Mass purchasing benefits. Year 'round advertising aids. Consumer preference. Over 1100 affiliated tire shops now making top money. An opportunity to join a successful, profit-sharing outfit.

WRITE FOR DETAILS TODAY

O.K. RUBBER WELDERS; Central Division
Dept. PM7, P.O. Box 111, Littleton, Colorado



JULY 1952

Brings
'split-second'
starting
to **ANY CAR or TRUCK**

STEWART-WARNER *Electric*
fuel pump



Get yours now! Get quick, sure "split second" starts for your car or truck—every time—in any weather! This Stewart-Warner *Electric* Fuel Pump feeds a steady flow of fuel to your carburetor the *second* you turn on the ignition. Operates independently of the engine. Saves your battery. Saves you from the trouble and embarrassment of a car that dies at every stop.

Easy to Install. Takes only minutes. Do it yourself or see your local Carburetor Shop or Service Garage.

Precision Built by

STEWART-WARNER

Instrument Division, Dept. N-72

1840 Diversey Parkway • Chicago 14, Ill.

Clean hands

FAST!

but save your skin!



Boraxo "melt-away" action cleans hands faster, gentler than any other hand soap!

No harsh abrasives! Boraxo powdered hand soap contains tiny soluble crystals that clean paint, grease, stains, ground-in dirt, leaving hands and knuckles soft! A *must* for every man who has a workshop, or works on his car, in his garden, or around the house. Get hands *safely* clean in 30 seconds flat, with BORAXO! . . . for all the family!

SPECIAL OFFER

for home, workshop, garage, etc.

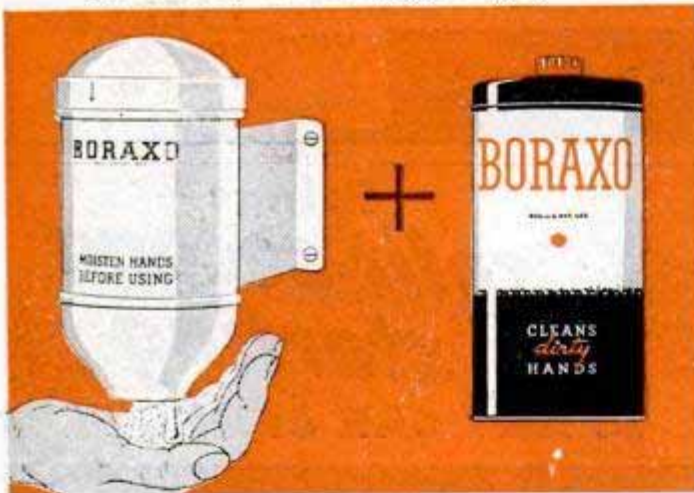

Boraxo Home Dispenser plus giant 16-oz. can Boraxo, both only \$2.95

The Home Dispenser is white, refrigerator-type baked enamel on rugged 12-ga. steel! Holds many weeks' supply of Boraxo! One-piece plunger mechanism will not clog! Built to last . . . easy to install . . . this is a real bargain you'll be glad to own and use for years to come!

MAIL THIS COUPON TODAY!

Pacific Coast Borax Co.
Dept. P-7
100 Park Ave.
New York 17, N. Y.

Please send me *postpaid* the Boraxo Home Dispenser and giant 16-oz. can Boraxo. I enclose \$2.95 (in check or money order). If not entirely satisfied I may return them for prompt refund. Offer good in U. S. only.

Name.....
Address.....
City.....Zone.....State.....

Dutch, Norwegian, Polish, German and French workers—among others. Three handsome young Spaniards were recent arrivals at the Rupert plant.

"It isn't necessary that they know English in their present jobs," volunteered a pretty stenographer in the personnel-department offices. Then, mostly to herself: "I could teach them all they need to know."

Thirty-five years ago, in 1917, a young railway porter made his first run on the Grand Trunk Pacific to Prince Rupert. Last February he retired from the service of the Canadian National after spending the useful span of his life between Jasper and the northern port.

His name, Percy Rolls, is known to hundreds of the railway's passengers, past and present.

"Seems like I'm retirin' at the wrong time," Percy joked with a smoking-car group at Christmas. "Look what's happenin' on this old line. Maybe there'd be a fortune for a good conscientious porter runnin' along here now."

"What's on your retirement blueprint?" someone asked.

"I read the papers," grinned Percy. "There's gonna be an oil line over the Yellowhead Pass and sooner or later there'll be a highway. So I got myself a good service station halfway between Jasper and Kamloops, right alongside what Boss Johnson says is gonna be the biggest thing that ever happened to B.C."

Many others who read that statement of Premier Johnson, describing the oil line as the "biggest thing that ever happened to British Columbia," stopped to wonder.

They felt the biggest thing that ever happened took place many years ago when provincial boundaries were set; when enclosed in B.C.'s borders was a vast wilderness territory now known as the triangle, robust and confident, Canada's newest land of industrial promise. ★★★

Pack Up for Camp

(Continued from page 103)

Quick-burning wood is best for baking and almost any kind will do.

In place of a cook kit gathered up in the kitchen, buy one of the better grade aluminum nesting outfits with four straight-side kettles and two skillets. Discard the aluminum cups, which are hot to the lips, and substitute enamelware.

The real secret in preparing for a trip is to make out a list of essential items, to be checked carefully later as they are assembled. If food and equipment are chosen

(Continued to page 236)

Brown WALL BREATHERS

STOP

PAINT BLISTERING, PEELING

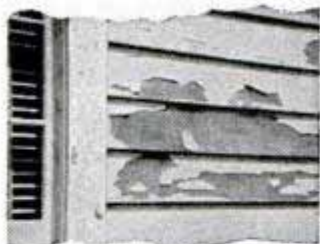

EASY TO INSTALL



3/4" Diameter—3 1/2" Long

— GIVE PAINT A CHANCE!

PROTECT YOUR HOME SAVE COSTLY REPAIRS



Between walls condensation causes paint to peel. Brown Wall Breathers permit moisture to evaporate, allow paint to adhere properly, regardless of climate.

Available at Paint & Hardware Dealers or Write for Full Information.

Brown INDUSTRIES

14222 LAKE SHORE BLVD. CLEVELAND 10, OHIO

DRAINS Cellars, Laundry Tubs; CIRCULATES Oil; IRRIGATES Gardens

Original "Type P" Pump has 2400 GPH capacity. 360 GPH 75' high, or 1500 GPH from 25' well. Use any 1/8 to 1/2 HP motor. DOES NOT CLOG. 1" intake; 3/4" outlet.

Postpaid if cash with order. (West of Miss. add 50c.) Motor coupling included.

MONEY BACK GUARANTEE

Also Gear Pumps in all sizes.

LABAWCO PUMPS, BELLE MEAD 7, N. J.

\$6.95



7" Tilting Arbor Saw

One of Shopmaster's complete line of quality-built tools at the remarkably low price of **4795** Slightly lower zone 1



SHOPMASTER, INC.

1214 Third St. S., Minneapolis, Minn.



Clark EXPANSIVE BIT

CUTS BETTER • COSTS LESS!

Accurate, fast; cuts smooth holes in hard or soft wood. Chrome vanadium steel blades, all chrome body. No. 250, 1/2"-1 1/2", \$1.89; No. 251, 3/8"-3", \$2.19. **GUARANTEED.** At your dealer or write Dept. PM7

ROBERT H. CLARK COMPANY • Beverly Hills, California

Say You Saw It in Popular Mechanics

NEW—Sensational! GEIGER COUNTER



"The SNOOPER"

LOW PRICE ONLY \$24.95

COMPLETE

Find a fortune in uranium with this new, super-sensitive Geiger Counter. Get one for atom bomb defense. So small it fits in the palm of the hand or in the hip pocket, and yet more sensitive than many large, expensive instruments. Weighs only 1 1/4 lbs. Uses flash-light battery. Low price includes earphone, radio active sample, instructions. Sold with ironclad moneyback guarantee.

ORDER YOURS TODAY—Send \$5.00 with order or payment in full to save C.O.D. Write for free catalog on treasure finders for gold, silver, etc. and larger, more elaborate Geiger Counters.

Dealer Inquiries Invited

PRECISION RADIATION INSTRUMENTS
2235 PM So. La Brea, L.A. 16, Calif.

KNOWN FOR THEIR FINER QUALITY

GENSCO

IMPORTED

SWEDISH TOOLS



WOOD CHISELS

Finest Swedish steel blades with unbreakable, machined plastic handles. Take and hold a better cutting edge. Sizes from 1/4" to 2" widths.



MORA HUNTING KNIVES

Seven models, all with leather sheaths. Hand forged, hand honed Swedish steel blades. Polished curly birch handles.

BUSHMAN BOW SAWS

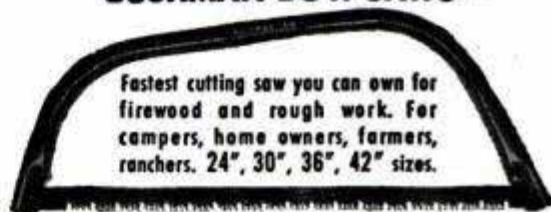

Fastest cutting saw you can own for firewood and rough work. For campers, home owners, farmers, ranchers. 24", 30", 36", 42" sizes.

AT BETTER HARDWARE STORES EVERYWHERE

GENSCO TOOL DIVISION

GENERAL STEEL WAREHOUSE CO., INC.

1832 North Kostner Ave. • Chicago 39, Ill.

A HOLLOW GROUND Hand Saw
World's First and Only Saw Blade
That Has Maximum Clearance
WHERE YOU NEED IT MOST!

The ONLY BLADE
with full clearance in the
WORKING AREA

Patent Pending



For the easiest, fastest, smoothest sawing action known, get a hollow ground saw!

FREE Valuable tips on easier sawing, and hints on saw care. New folder shows amazing advantages of hollow ground hand saws over ordinary taper-ground saws. Send for free copy today.

THEY COST NO MORE!

Sold thru dealers only

The LARSAN Mfg. Co. 23 South 11th St., Newark, Ohio

with care, there need be no concern as to over-all weight. The complete three-person outfit listed below will weigh less than three average-size passengers:

COMPLETE EQUIPMENT

	Pounds
Umbrella tent, 11 by 11 feet, pegs and poles.....	30
Three sleeping bags with air mattresses.....	60
Gasoline stove.....	20
Gasoline lamp, extra gallon of gas in safety can..	18
Folding table, 36 by 36 inches.....	12
Three folding chairs.....	30
Icebox and ice.....	35
Cook kit, dishpan and wash pans, tableware, cleaning equipment	15
Ax, shovel, extra tarp, rope, wire, nails, etc.....	12
TOTAL.....	232

ONE WEEK'S FOOD FOR THREE PERSONS

	Pounds
Flapjack, or other flour.....	3
Bacon (or ham)	3
Eggs, four dozen	8
Fruit juice and canned fruit, 12 cans.....	15
Bread, six loaves.....	10
Potatoes and onions.....	8
Rice, spaghetti, etc.....	4
Canned vegetables and soup, 12 cans.....	20
Butter	2
Fresh meat, on ice.....	8
Coffee, tea, cocoa.....	2

Sugar	3
Salt, condiments, etc.....	2
TOTAL.....	88

(NOTE: A liberal allowance of 20 pounds per person for personal items still keeps over-all weight of equipment to be carried in auto well under 400 pounds.) ★ ★ ★

Thousand-Mile Target Range

(Continued from page 112)

range. The problem of timing and coordination between the launchers and the trackers is knotty. Each clock, watch, instrument and operations order has to check out to the fraction of a second.

As dawn breaks with yellow suddenness over the Atlantic, final preparations are under way at the cape. Firemen with special apparatus stand by while fuel is "topped off" inside the bird. The Polly planes, range-clearance mission completed, return to circle lazily at a safe distance.

Three hundred feet from the launching pad is a weird domed building of pastel green. Its walls, over three feet thick, are of reinforced concrete. The windows are of three-inch glass arranged in periscope style. In this almost explosionproof cocoon are the firing-control officer and the crew actually involved in sending the missile skyward. The firing-control officer is the

(Continued to page 238)

There's two-fisted power . . . in

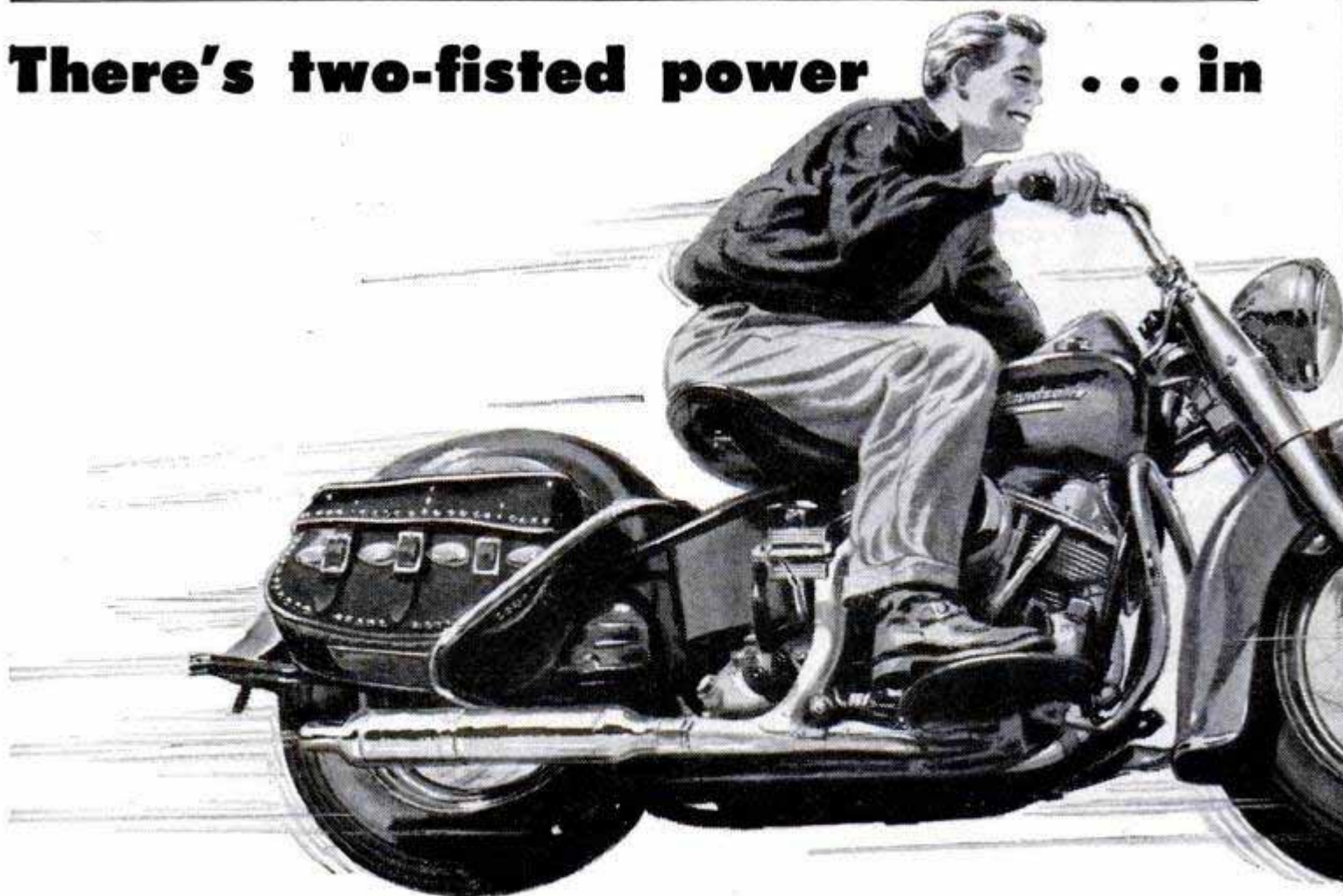

shoot
your
best...



... buy a
WINCHESTER

Make the *most* of your shooting ability... buy a WINCHESTER 22 rifle. A Winchester's extra years of trouble-free service mean *economy*, too. For every reason... pride of ownership, shooting excellence, balance, beauty... buy a genuine WINCHESTER 22.

MODEL 72—Smooth operating, ruggedly built bolt action 22 repeater. High-capacity tubular magazine; 20 Short, 16 Long, or 15 Long Rifle cartridges. Cocks on opening motion of bolt; serrated trigger. 25" barrel; 5¼ lbs.

Arms and Ammunition
Division of Olin Industries, Inc., New Haven
4, Connecticut.

MAKE YOUR SELECTION FROM THE COMPLETE LINE OF

WINCHESTER

TRADE-MARK

22 RIFLES

PRODUCTS OF



INDUSTRIES, INC.

this great motorcycle !

If you like a sky-hootin' scamper — or the thrill from barreling along on a straight stretch, throttle up on the Harley-Davidson Big Twin. You'll get a spine-tingling kick out of the zooming power, the breath-taking dig-out, the sensational performance of your mount. Treat 'em rough — pound out the miles — enjoy 'em to the hilt. No matter where you do your riding — at scrambles, club events, speed trials, field meets, or on vacation trips, the Harley-Davidson Big Twin is for *you*. See your dealer today and take your buddy along. Or send 25¢ for literature on latest models and a copy of the **ENTHUSIAST MAGAZINE** filled with exciting action pictures and stories.

HARLEY-DAVIDSON MOTOR Co., Dept. P, Milwaukee 1, Wisconsin

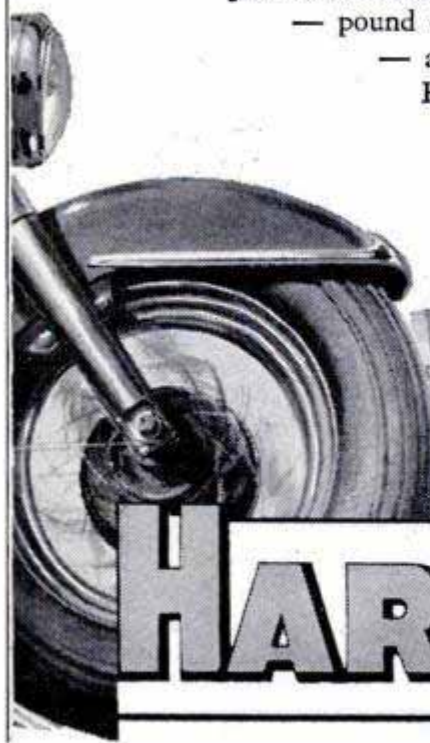

HARLEY-DAVIDSON

HYDRA-GLIDE®

SAVE TOOLS
from
RUST RUIN



with the
NEW CROWN RUST INHIBITOR
PAT. PENDING

Prevents rusting of saws, scales, micrometers, steel tapes, squares, chisels, planes, power tools, guns and other rustable tools and precision equipment!

Why let rust ruin your valuable equipment? Protect it from rust-causing dampness, humidity and moist hands with the amazing new **CROWN Rust Inhibitor**. One application protects up to a year. Not a messy, smeary oil nor a dry-hard paint, the **CROWN Inhibitor** is a high quality animal wax base fluid that is non-inflammable and harmless to metal, wood, glass or plastic. Need not be cleaned off before using tools . . . won't gum or clog under heat or friction. It has a real affinity for metal and resists rubbing off under normal handling. Can be used effectively on damp metal and will retard rust where already begun.

ONLY \$2.00
POSTPAID

No Brush—No Dip—No Greasy Rags
Handy aerosol-type spray gives neat, economical application; no waste from evaporation or spilling. Evenly covering spray reaches all nooks and crannies. Mail your order today. Shipment made same day order is received. Send name, address and \$2.00 per can to:

CROWN INDUSTRIAL PRODUCTS CO.
411 BORDEN AVE., SYCAMORE, ILL.

send for **FREE CATALOG**



America's Foremost
money-making
MECHANICS' TOOLS

It's easy to own the same "pay-off" tools used and endorsed by America's top-earning mechanics throughout the automotive, aviation and industrial fields! Snap-on tools help you handle every repair job faster, easier, better. And they **LAST** . . . pay for themselves over and over again! Start building your own tool set now with basic Snap-on units—add others any time. Genuine Snap-on tools are never sold in stores—direct to users only. Mail coupon for free catalog.



SNAP-ON TOOLS CORPORATION
8062-G 28th Ave., Kenosha, Wisconsin
Send me free catalog of Snap-on tools.

Name _____
Address _____
City _____ Zone _____ State _____

man who fingers the button for ignition.

Three miles away from the pad, joined by an intricate communications chain to the launching site, is Central Control. This modern three-story building is the post of the in-flight safety-control officer. Once the missile is airborne, it becomes his special cloud-wagon. He "flies" the missile. He can destroy it or shut off fuel if the bird goes erratic and leaves its intended course.

A spine-tingling moment approaches as the "count down" begins. "X" is the designated second for the missile launch. The missiliers begin their count from a designated minute—so it's "X minus 59 seconds," "X minus 58 seconds," and so on. Then finally down to "X minus 5 seconds." All signals are relayed down range.

The last seconds before "X" bring a tightening of the stomach muscles. Even the comparative old-timers feel it. Will the missile topple and blow? *X-time!* A puff of red and a mushroom of dust; a roar—the missile mounts slowly, picking up speed. Instruments whir and cameras grind.

Down-range stations prepare to track. The in-flight safety officer at Canaveral passes control to the Point Jupiter station as the bird leaves the cape area; then control is passed to Grand Bahama's in-flight safety officer. The procedure is continued down range until the missile has run its intended length or is destroyed en route. Transfer of responsibility to each down-range safety officer is by radio. A submarine cable will be laid to the stations.

As the missile runs the range, its radio transmits performance data—speed, fuel consumption, skin temperature, pressures and varied other information to receivers at the tracking stations. This telemetry system affords performance knowledge at any given time. With antennas mounted on Navy-type gun directors, down-range operators visually sight the missile. Transmission from the missile is transferred to tape recorders for assembling of data.

The Air Force has every conceivable type of equipment at the stations for registering the missile's flight—German-made "Askarnias" (cameras which photograph the missile, simultaneously noting elevation, direction and timing); plotting boards to record radar tracking with moving pens that trace out elevation and line of flight; optical tracking equipment; last but not least, timing equipment.

When the missile plunges into the ocean, the nearest down-range station makes an effort to recover instruments contained in the war heads, if practicable, with an 85-foot crash boat. Then comes the laborious task of sorting all data. At present, aside

(Continued to page 240)

ABSORB DAMPNESS!

In Basements, Closets, etc.
with the
**SOLVAY
AIR-DRYETTE, JR.**
and SOLVAY
CALCIUM CHLORIDE



Absorbs moisture — the cause of rust, warping, mildew in workshops, darkrooms, closets, playrooms, storage rooms, vaults. Built to last for years. Big capacity. Works fast, absorbs up to 3½ qts. per day. Compact, inexpensive, clean, safe, odorless. Thousands in use. Write for booklet and name of your nearest dealer. Not available on Pacific Coast.

Dept. 89-7, SOLVAY SALES DIVISION
Allied Chemical & Dye Corporation
40 Rector St., N. Y. 6, N. Y.

Free Course! Big Profits! Flocks & Sandblasts



Only \$24.75 Complete

Dual Purpose Spray Gun! Uses only 25 lbs. Air Pressure
• Thousands of uses in Home, Shop, Industry. Makes Auto Interiors Clean & New, Lines drawers, Marproofs lamp bases, Refinishes any object. All in colorful Flock, Etch & Frost windows, glassware, etc. Removes Paint & Rust from Autos, Tools. Guaranteed! Send \$24.75 or write for free information. Flocking supplies!
BLASTO SPRAY GUN MFG.
Dept. PM-10, 7007 Haas Avenue, Los Angeles 47, Calif.

FREE! SOUTH BEND CATALOGS

- • • 9" to 16" SWING LATHES
- • • 14" DRILL PRESSES
- • • 7" BENCH SHAPER
- • • ATTACHMENTS

Write today — check catalog wanted



SOUTH BEND LATHE WORKS
425 E. Madison St., South Bend 22, Ind.

BULL DOG HITCHES



Heavy Drop Forge Steel Construction. Strong — Safety-Engineered Reliable

Model No. 1-B
NOW ONLY \$4.95

Post Paid (when paid in advance)

Made for trailers with up to 2,500 pounds capacity.

1½" dia. shank Fits 1¼" pipe tongue

HAMMER BLOW TOOL COMPANY

Wausau 13G, Wisconsin

A BIG MONEY-MAKER

IDEAL LAWNMOWER SHARPENER



Plenty of business in your community—for a big, steady income! Cash in with the IDEAL Model 300—a rugged, precision sharpener, easy to use, backed by 50 years of experience. Sharpens all mowers. Start now, full or spare time. Write for free catalog today.

THE FATE-ROOT-HEATH COMPANY

Dept. PM-7, Plymouth, Ohio

Never be without power! FAIRBANKS-MORSE GENERATING SETS

Fairbanks-Morse
1800 Watt
A.C. Generator



Even though storms, accidents or calamities cut off your power supply, you can still have plenty of power to operate lights, utilities, tools etc., if you install a Fairbanks-Morse stand-by generating set—now!

Fairbanks-Morse Generating Sets are available in capacities from 600 to 35,000 watts, A.C. or D.C., with manual, remote or automatic starting. There are sizes for all shops, filling stations, garages, farms, homes, stores, and other businesses. For complete details, see your local Fairbanks-Morse dealer, or write Fairbanks, Morse & Co., Chicago 5, Ill.



FAIRBANKS-MORSE,

a name worth remembering

For Brilliant
Light
Anywhere
Any Time

IT'S THE NEW
Big Beam

HERMETICALLY

SEALED BEAM

only
\$750

less standard
6-volt
lantern battery

Hand Lamp

Model
166



HAS UNLIMITED
SPORTS, UTILITY,
EMERGENCY USES

See your dealer or write for folder

U-C LITE MFG. CO., 1066 W. Hubbard St., Chicago 22, Ill.

Gee I'm glad
it's a
Hydro-drive, Dad!



Hydro-drive
Champion

Independent Propeller Control Hydraulic Clutch

OUTBOARD MOTORS
FORWARD • NEUTRAL • REVERSE
without shifting gears!

CHAMPION MOTORS CO., MINNEAPOLIS, MINN.

NOW—40 different CUTS with

AMAZING, NEW

Warren

DADO SAWING WASHERS

On Your Saw Blade

Just dial widths to cut parallel grooves perfectly smooth. No warp, vibration

or trick screws. Strengthens blade, perfect balance. **GUARANTEED!** At your dealer's or order direct. Give arbor size— $\frac{1}{2}$ ", $\frac{3}{8}$ ", $\frac{3}{4}$ ", 1".

Send for free booklet

WARREN WASHERS COMPANY
Dept. 27, Box 98 North End Station, Detroit, Mich.

ONLY
\$4.95
PER SET

from priority information which promptly is relayed back to researchers at Canaveral, the balance is returned by air within 48 hours. The submarine cable will allow immediate transmission.

Grand Bahamas, largest of the stations, has set the format for the down-range facilities. More than 50 miles from the nearest community, this base is on the southeast coast of the British vacation island. Its 6000 acres envelop a landing strip and permanent buildings to house instruments, communications and personnel. About 160 missiles, both military and civilian, are at Grand Bahamas while the other stations average around 125 persons each. Comfort is provided by recreation areas, modern barracks, laundries and post exchanges.

Topographically, the planners sought to place each station in isolated areas without sacrificing the most advantageous spot for instrumentation. Elevation is desirable—the base at Eleuthera is astride Coffin Hill, a few miles north of Governor's Harbor. To explain the mission of AFMTC and dispel island fears that tests will be hazardous, the Air Force is touring villages with charts and lectures. They aim to make friends and enhance a long residence.

There's an urgency at AFMTC. It's evident at Patrick Air Force base, located 18 miles south of Canaveral, where General Richardson has his headquarters. You can see it at the down-range stations where workers are hustling heavy machinery from Navy-type landing ships. You can sense it at Canaveral where final touches are being put on a second launching pad.

In June 1951, AFMTC startled the world with the announcement of the initial long-range flight of Matador, the first pilotless bomber. Matador seared down the Atlantic test range to forecast perhaps the eventual death of piloted bombers.

As Matador exercises itself down the paradise seaway, bigger and better missiles are in various stages of development. You can bet the family silver that if and when Uncle Sam finds it necessary to send an intercontinental guided missile toward a possible enemy's territory, said bird will bear the approval stamp of AFMTC. Any of the 6000 missiliers from Canaveral to Puerto Rico will tell you that's a fact. ★ ★ ★

Underwater Windows

Glass windows placed in the bottom of the frigate *Helmsdale* are enabling British Admiralty engineers to observe ship propellers under actual working conditions. Strong lights directed through one panel illuminate the propeller area so motion pictures may be taken, too.

DO IT EASIER --- FASTER --- BETTER

with a **SHAW**
DU-ALL

Walking or Riding Tractor



Plow
Plant
Cultivate
Mow
Rake
Cut Trees
Saw Wood

1½, 2½, 3 and 5 H. P. walking tractors for all large and small gardening. 5, 8 and 12 H. P. riding models that will handle good sized farms. Quality built for 50 years. All wanted tools and attachments. See the Shaw dealer. Write for **FREE CATALOGS**, low prices on complete Shaw line. Address

SHAW MANUFACTURING CO.
4507 Front St., Galesburg, Kansas
668-G N. 4th St., Columbus, Ohio

DRIVING COMFORT at its best!
The New Electric Throttle
With Foot Control

The Electric Throttle ("Speed-selector") sets whatever speed you choose electrically — releases instantly at a touch on the toe-button, or by applying foot brake. Banish foot and back strain for good! Install it yourself. Price, \$17.50 F.O.B. Check or C.O.D. Ten day money-back guarantee. Several State franchises open. Dealer inquiries invited. Give car, make, and year.



WRITE FOR DETAILS

D & M MFG. CORP., Anderson, Ind.

Buy the Mechanic's FIRST Choice

...EMPIRE LEVELS
For Home, Farm, all Trades



See Empire Levels at your dealer, or write for free booklet "Choice and Care of your Level."

Empire No. 151 Aluminum Level: Adjustable vial cases, twin levels, plumbs, 45° vials — 24" — \$7.50.



EMPIRE LEVEL MFG. COMPANY

10930 West Potter Rd., Dept. PM., Milwaukee 13, Wis.



STARRETT "Tools and Rules" BOOK

Describes and illustrates the precision methods skilled mechanics use. Only one dime. Write Dept. AP.

THE L. S. STARRETT CO., Athol, Mass., U. S. A.



HURRICANE CUT-OUT EXHAUST

This specially engineered cut-out enables you to install special pipes and mufflers without removing the original muffler.

Now control your exhaust tone from a dash control button. Cut back into your original muffler in restricted areas at will. Fits all exhaust pipes from 1¾" to 2¼" size.

This cut-out is well constructed; actually strengthens exhaust pipe; made of heavy plate steel, designed for easy installation—no special tools required. Sent post-paid for only \$6.95 check or money order. Satisfaction guaranteed or your money back.

ST. LOUIS PRODUCTS CO., Box 24-AG, Normandy 21, Mo.

The **NEW Model 50 UTILITY TESTER**
FOR REPAIRING ALL ELECTRICAL APPLIANCES-MOTORS
an all-around electrical trouble shooter



- Measures A.C. and D.C. Voltages, A.C. and D.C. Current, Resistances, etc.
- Will measure the current consumption while the appliance under test is in operation. The appliance or utility may be plugged directly into the front panel receptacle. A special pair of insulated clip-end leads is included for motors, etc.
- Incorporates a sensitive direct-reading resistance range which will accurately measure all resistances commonly used in electrical appliances, motors, etc. This range will enable continuity checks and tests for shorts and opens.
- Will test thermostats, radio tube filaments, bulbs, fuses, fluorescents, condensers, switches, field coils, circuit breakers, lighting systems, etc.

Handsome round cornered molded bakelite case 3¼" x 5⅞" x 2¼". Complete with all test leads and instructions.

\$13.90

SHIPPED ON APPROVAL
No Money With Order — No C.O.D.

Try it for 10 days before you buy. If completely satisfied send \$3.90 and pay balance at rate of \$2.00 per month for 5 months — No Interest or Carrying Charges Added. If not completely satisfied, return to us, no explanation necessary.

SUPERIOR ELECTRONIC CO., INC.
Dept. D-20, 227 Fulton Street, New York 7, N. Y.

Please rush 1 Model 50. I agree to pay \$3.90 within 10 days after receipt and \$2.00 per month thereafter.

Name _____
Address _____
City _____ Zone _____ State _____

SAY YOU SAW IT IN POPULAR MECHANICS

Join the fun
own one!

WHIZZER

America's finest motorbike



The **SPORTSMAN** — luxury motorbike at an amazing low price!

Ride, wherever you go, on your own Whizzer! Comfortable, dependable, thrilling. Up to 100 miles on a gallon of gas, speeds up to 35 m.p.h.

EVERYTHING YOU WANT

Heavy-duty 20" wheels. Rugged frame. 5" expander brake, foot operated. Kick starter. Built-in generator. Hi-low sealed beam headlight, tail light. 3 h.p., 138 c.c., 4-cycle automotive-type motor. See your dealer now, or write for illustrated folder today!

WHIZZER MOTOR CO. 308 S. SANFORD, PONTIAC, MICH.

LUFKIN
TAPES
RULES
PRECISION TOOLS

your
standard
of accuracy
for all your
measuring
needs

BUY LUFKIN
at your hardware
or tool store

152

THE LUFKIN RULE CO., SAGINAW, MICHIGAN
132-138 LaFayette St., New York City, Barrie, Ontario

10 DAY MONEY BACK GUARANTEE

300 POWER IMPORT MICROSCOPE \$11.95
ACHROMATIC LENSES Postpaid

Precision instrument! Invaluable for study in Biology, Botany, and Zoology! Acclaimed by hobbyists, students, and professors. Achromatic eyepiece and objective lenses assure clear, sharp image, free from undesirable aberrations. Delicate focusing adjustment, full 90° body tilt adjustment, adjustable plano substage mirror, solid construction throughout. Here's the value of a lifetime, at a price anyone can afford! Complete with wood carrying case. \$11.95 Postpaid.



IMPORTED 6x15 COATED PRISM BINOCULARS

WITH LEATHER CASE \$17.95 plus 20% Shipped postpaid

Featherlight, fits palm of hand! Outperforms others many times its price by utilizing ultra precise prisms. Coated optics offer bright, clear images. Individual micrometric ocular lenses for accurate instant focusing. Dust proof, moisture proof, all metal modern construction, gleaming chrome finish. All purpose instrument for sport events, theater, traveling, nature study, etc. Linear field of view 438 ft. at 1000 yds. Complete with leather, velvet lined, zipper case. \$17.95 plus 20% tax. Shipped postpaid.

NOTE: 10 day money back guarantee on all items. Send check, cash or M.O. Illinois residents add 2% state tax. 1/2 deposit on C.O.D. orders!

Sub-Miniature CAMERA \$3.00

Takes Needle Sharp Shots Unique! Vest pocket size! Always handy for unexpected prize winning shots! Fine 20mm f/4.5 lens; shutter settings 1/25 sec. and B.; uses special daylight loading rolls, 10 exposures, 14x14mm. Built-in eye level finder, leather over metal construction, w/ 83 gr. Yours, with roll of film Free of extra cost. \$3.00 P.Pd.

Precision Engineered 20X TELESCOPE \$9.95

Would sell in stores for 3 times our price! Optically ground, coated achromatic lenses give you 400X the area magnification. All metal construction resistant to rust and salt spray. Extends to 15 1/2" telescopes to 63 1/2" pocket size. A necessity for boat owners, ideally suited for astronomical studies, hunting, observing races, sporting events. \$9.95 Postpaid.

40X POCKET MICROSCOPE

\$3.95 P.Pd. Compact, clips into pocket, always handy. Examine insects, minerals, gems, etchings, stamps, anything—anytime! Fine 4 lens compound optical system. Comes ready to use, always in focus for pin point sharpness, no adjustments necessary. \$3.95 P.Pd.

These Roving TV Men

(Continued from page 69)

will be no hitch. Sam Levin mapped out everything two weeks ahead on a telecast showing steelworkers building a new skyscraper. On show day, however, he found all his camera spots gone. The men were working three stories higher on a skeletal steel framework. So cameramen had to set up shop on wooden planks stretched between I-beams 20 floors above New York.

But the disaster assignments that pop up unannounced are the real problems.

Jim Davis and his men were covering the races at Aqueduct one day when a huge wall of black smoke rose on the western horizon. It was the Jersey City propane-explosion fire, 30 miles away. Sure enough, over the radiophone came an order for Reidel to grab part of his crew and cover it. "With a short crew, 30 miles to go and no inkling of what we'd find, we loaded two mobile vans, a portable generator and took off," he recalls. They arrived to find propane tanks blowing on all sides. The only place to set up was beside another row of tanks that might go off any minute. While fireboats played water on these, the men sprawled across the top of one truck, rigged a microwave antenna on a tripod, sighted it on the Empire State and panned in. The gasoline generator was set up near by. Truck radios couldn't reach the studio so they relayed sound via amateur radio operators in the area. Fighting smoke and heat, they dollied their big cameras in and out among smoking railroad cars to get fantastic views of the holocaust. "Tanks were blowing up all around us," says Reidel. "Finally the water spraying on those near our trucks began to sizzle. When we saw the firemen start running, we jammed our cameras in the vans, left the generator popping away and followed them."

Establishing signal contact between a remote telecast scene and home studio is a big headache in mobile TV. If the telephone company has a coaxial cable in the area there's no trouble. But often it has none. Then the men must find a spot in line of sight with the Empire State or studio antennas and rig microwave links—big dish-shaped antennas that pass the TV signal beam from one to another.

Mobile-transmitter engineers have risked their necks on several occasions. During a CBS remote from Annapolis, Sam Levin's transmitter engineer discovered the only way he could get a signal to Washington was via several links—the last from atop a skinny 200-foot radio-beacon tower. He climbed the girders, hooked his elbow

(Continued to page 244)

LEMAR SCIENTIFIC CORP.

3412 W. JACKSON BOULEVARD, CHICAGO 24, ILL.

Dept. 07

INTERNATIONAL ROTARY

1-SPEED COPE-SAW DRILL-BIT
IT DRILLS IT SAWS IT REAMS



DRILL, SAW, REAM . . . metal, pipe, wood, plastic, Transite, etc. Use with any electric drill, slow drill press, lathe or milling machine. Drills own starting hole—upper part of bit is used to cut, saw or ream circles, ovals, squares or scrolls. Easy to operate. Ideal for carpenters, mechanics, electricians, plumbers, hobbyists, many others. Abrasive resistant, high speed steel. Flutes ground from solid. Will withstand severe continuous use without breaking. Resharpener at no charge. Takes place of up to \$50 in tools. 1/2" diameter, 2" cutting sections, total length 3 1/2". Also available specially designed for wood or metal and in 2 1/2" and 1 1/2" lengths. Write for details. Specify all-purpose bit. Shipped same day. Money-back guarantee. Dealer inquiries invited.

SEND CASH, CHECK OR MONEY ORDER
Manufactured and distributed by:

INTERNATIONAL TWIST DRILL CORP.

only
\$3.95
POST PAID

624 Wyandotte, Rm. 633, Kansas City 6, Mo.

SHEET METAL BRAKES

Forms angles, flanges and Pittsburgh locks. 26 gauge steel, heavier aluminum. Cam locking. Portable, can be bolted to bench, or clamped to edge of truck. All steel, reinforced. Shipped Exp. Coll. 30" size. Wt. 54 lbs., \$26.50. 36", Wt. 66 lbs. \$31.00.

48" Wt. 100 lbs. \$45.00. Floor mountings, portable, 32" high, 30 lbs. \$7.00.
12" BRAKE. Fits in vise to form difficult compound bends, up to 20 gauge steel. Not illustrated. \$12.50 PP.
Forms hooks, angles, eyelets, etc. Capacity 1/4 x 2", or 5/16 x 1 1/2". 10 parts all steel \$10.00 PostP.

Immediate Delivery. Order direct, cash, or C.O.D. or send for folder.
VYKE BRAKE CO., P-1116 So. 27th St., Omaha 5, Nebr.

CASH IN YOUR SPARE TIME!

BIG MONEY IN OWN BUSINESS

YOU CAN MAKE UP TO \$40 a DAY sharpening and setting circular saws for factories, builders, lumber yards—with

NEW BELSAW COMPLETE CIRCULAR SAW SHOP. Low Cost, only \$15 down, sharpen 4 to 5 saws an hour. No experience needed! Instructions furnished. Send Postcard Today for FREE BOOK. **BELSAW MACHINERY CO 3704 Field Bldg. Kansas City 2, Mo.**

EVERY 1/4" ELECTRIC DRILL
A PORTABLE SAW IN ONE MINUTE!

NEW! No. 445 "ARCO-SAW" for DEPTH & BEVEL CUTS

At Better Hardware Stores Everywhere

11.50

with all GAGES & 4" "HYCARBON" Cross-cut Blade.

No. 444 "ARCO-SAW", same as above—less gages. Has accurate visual guide. **9.95**
No. 444G Depth-Bevel-Rip Gage. Easily attaches to any No. 444 "ARCO-SAW" . . . **1.95**
Extra "HYCARBON" Blades. 4" Crosscut or 4" Combination **1.60**

CAN BE USED WITH ONE HAND!
"ARCO-SAW" works like a high priced Portable Saw. RIGHT ANGLE GEAR DRIVE eliminates clumsy, dangerous direct drive with drill sideways.

CUTS 1-1/4" or 2x4 by turning over

CHECK THESE EXPENSIVE FEATURES:

Depth gage graduated from 0 to 1 1/4" depth (for grooves, dados). Bevel gage graduated from 0 to 45° angle (for dovetails, bevels). Rip gage with sideways adjustment. Visual guide with adjustment to follow lines on both straight and bevel cutting. **90-DAY FACTORY GUARANTEE.**

UNCONDITIONAL 10-DAY MONEY BACK GUARANTEE

ORDER TODAY at your dealer or send us check or M.O. (Post-paid). C.O.D.'s—postage extra.

DEALERS—Write for nearest jobber.

ARROW METAL PRODUCTS CO.

Dept. PM-7, 140 West Broadway, N. Y. 13, N. Y.

WET WALLS, BASEMENTS?

COPROX, New Patented Copperized Cement Compound, Unites Chemically with Porous Masonry to Help Seal Seepage Out

NEW YORK: A new compound that contains copper oxide and Portland Cement, called COPROX, has been perfected which helps seal out water from porous masonry walls when applied *inside* or *out*, above or below ground.

Different from all other compounds and paints, and protected by U.S. Patent, only COPROX has its exclusive copperized action, a unique three-way action that (1) *penetrates* microscopic pores of masonry surfaces, (2) *expands* to fill pores with a hard, insoluble, non-absorbent copper oxychloride plug which (3) *bonds* both chemically and mechanically with masonry, to withstand water pressures up to 500 pounds per sq. ft., in actual tests on cinder block as thin as 2 in., and yet permits breathing.

Unlike ordinary cement coating compounds, COPROX is guaranteed to contain no fats which are broken down by the lime in cement, or iron which ultimately rusts out completely.

COPROX is mixed with water, applied with a stiff fibre brush. It hardens into a stone-like surface on clean porous concrete, cement, cinder block, cement stucco, unglazed brick and porous natural stone. Recommended for foundation walls, basements, storage tanks, garages, swimming pools, fish ponds. Costs less than best oil paint. \$3.25 a gallon. Prices slightly higher west of Rockies. Five beautiful decorator's shades. Simple to apply. Available at paint, hardware and department stores. **COPROX, INC., 1270 SIXTH AVENUE, NEW YORK 20, N. Y.**

CUT BUILDING COSTS 2/3!
Make Your Own Concrete BLOCKS and BRICKS
To Use or Sell



New superior moulds make absolutely square, true, easy-to-lay blocks which will pass any building code. Production is fast . . . easy. One durable \$30 machine will make four 5"x8"x12" blocks per minute—1,000 a day. Pays for itself in one day! Sell blocks for big profit . . . or save 2/3 building cost for yourself. **POST CARD BRINGS FREE FOLDER.**

ECONOMY MFG. CO.
DEPT. P STONE MOUNTAIN, GA.

Clean your Paint Roller

this EASY way!

Just put the roller cover into handy shaker can of Imperial Roller Cleaner and shake for 30 seconds . . . Remove and wipe dry . . . Cover is perfectly clean—may be re-used immediately! Cleaning liquid can be used for as many as 6 cleanings. Safe for roller cover and your hands. At paint and hardware stores.

Write for leaflet

IMPERIAL Roller Cleaner

Wilson-Imperial Co., 119 Chestnut St., Newark 5, N. J.



STOP THAT OIL EATER!



GET NEW CAR PERFORMANCE WITH PISTON SEAL WITHOUT COSTLY OVERHAULING

Piston Seal—the amazing compound that forms a self expanding, pliable lubricating seal around pistons that compensates for wear. Eliminates oil burning, restores power and compression. Can be applied in a few minutes.

GOOD FOR 10,000 MILES



SIMPLY REMOVE SPARK PLUG AND SQUEEZE

FOR COMPLETE, FREE DETAILS WRITE TO

RICHIE DISTRIBUTING CO. 11916 Madison Ave., Dept. G, Cleveland 7, Ohio

FREE Book on Painting

Get this illustrated 24-page book absolutely free. Full of facts on how to get better results with aluminum paint—which type to use for different jobs. Absolutely no obligation—just write:



ALUMINUM COMPANY OF AMERICA
1718G GULF BLDG., PITTSBURGH 19, PA.

Your **ELECTRIC DRILL** Trims HEDGES — SHRUBS — GRASS with **ROTO-TRIM** DRILL ATTACHMENT



FITS ANY 1/4" DRILL

Today's Greatest Hedge Trimmer VALUE \$10.95
Yours, Postpaid, for only \$10.95 (Less Drill)

Keep your whole yard neatly tailored . . . trim hedges, shrubs, and hard-to-reach grass easily and smoothly with this new, inexpensive drill attachment. ROTO-TRIM quickly converts any 1/4" drill into an easy handling, keen-cutting Hedge Trimmer.

Quality Built throughout. Rigid steel and aluminum construction with smooth-running hardened steel gears and cam in one-piece case. Cutting blades are 10" long, of high-carbon steel, heat-treated, precision ground and designed for maximum safety and efficiency.

Easy to Use! Quickly attached to drill—flats simplify chucking. Light weight and precision balance make ROTO-TRIM much easier to handle than more expensive trimmers. Handle turns blade to any angle.

Order TODAY! Don't miss this chance to get your ROTO-TRIM Hedge Trimmer Attachment while still available at today's low price of \$10.95.

UNCONDITIONAL 10-DAY MONEY BACK GUARANTEE! Send check, cash or M. O. and we'll ship postpaid — direct from factory to you.

Dept. 752 **ROTEX COMPANY** 837 WEST DAVIS DALLAS 8, TEXAS

around a supporting piece of angle steel on the swaying top and started hauling up his antenna hand over hand. Suddenly he developed a violent cramp in his chest, dropped everything, writhed and squirmed in agony. With a desperate effort he finally tied himself to the tower with rope so he wouldn't fall during his spasms of pain. Navy riggers rescued him in a boatswain's chair, finished the job of hitching up the dish and the show went on.

Once the antenna is spotted, there's still the job of stringing cable between it and the van. This can be acrobatic, too. To get one line down from a 20-story roof top in a heavy snowstorm, Sam's transmitter engineer crept on hands and knees to the edge. "Couldn't see where the roof ended," says Sam, "so I held his feet while he wriggled up to it and someone else held mine. Then we fed the line down."

Remote crews hate to admit defeat and, as a result, have come up with some remarkable antennas on the spur of the moment. Sam Levin's crew was sent to cover a carnival in Garden City, Long Island, not long ago. The ground is so low that no structure in the area was high enough to make line-of-sight contact with the big tower 30 miles away. Undaunted, the transmitter engineer went to a local fire department, talked them out of their "big rig," tied his dish to the tip of its 80-foot ladder and raised the thing to full height.

Focusing these antennas on each other over short distances on a clear day is easy. But in bad weather or with 30 or 40 miles between links it's like two fencers trying to bring sword points together in a dark room. To make contact, the transmitter engineer pans his big dish back and forth vertically in the general direction of the home antenna until he gets the strongest possible signal. Then he pans in horizontally the same way and he's got it. But if his dish should slip even two degrees during the show, because of wind or poor fastening, the picture on your home set will be lost.

That's why Sam and his boys remember the hurricane of '49. They were at the Polo Grounds preparing to shoot the Fordham-N.Y.U. game using microwave when the 100-mile-per-hour winds hit New York. The phone company, up to its ears in falling telephone poles and snarled lines, backed out on the transmission job. Sam and his crew could have called off the show. Instead, two crewmen crawled against the gale up the sloping Polo Ground shelter roof some 200 feet above the street. For 100 feet they dragged their heavy microwave equipment behind them, set it up and braced it with big boards. They panned in

(Continued to page 246)

2 DRILLS in 1



\$11.95
post paid

Send check or Money Order
Satisfaction guaranteed
Order yours now

This attachment gives you two drills in one. It converts any 1/4 inch electric drill to 1/2 inch capacity. Reduction gears reduce the drill speed 5 to 1, the average speed of a 1/2 inch drill, and thereby increases the power. Absolutely indispensable for all shop work and home craftsmen.

G. M. CO. MANUFACTURING, INC.
1308 43rd AVE.
LONG ISLAND CITY 1, NEW YORK

NEW, IMPROVED CALCULATOR FOR WOODWORKERS only 25c



Instantly gives information on lumber, nails, concrete mixes, painting materials, etc. Convenient, simple to read. Just set dial for nail specifications, to convert linear to board feet, find bit sizes for screws, compare characteristics of woods. 6" diameter heavily varnished cardboard. Send 25c, no stamps, please to Greenlee Tool Co., 2107 Columbia Avenue, Rockford, Illinois.

VARIABLE SPEED HYDRAULIC POWER TRANSMISSION



It has Infinite Speeds 0 to 550, Reverse, Automatic Overload Protection; Adjustable Torque up to 180 inch pounds. 3/8" Input and Output Shafts. It will handle 1/4 to 1 1/2 H.P. Motor. Case measures 7 1/2" long, 7" high 6 1/2" wide. VALUE OVER \$300. Shipping Wt. 25#. On C.O.D. Orders we require a 10% only \$54.50 Fob. Chicago Deposit.

DIRZIUS MACHINE SHOP "D" 1423-25 So. 52nd Ave., Cicero 50, Ill.

BUY LU-MAR ALL-PURPOSE PUMP



To fill outboard motors, lawnmowers, etc. \$3.00 postpaid, less can. Strainer and shut-off, 75c. Money-back guarantee.

LUCAS METAL PRODUCTS CO.
952 Exchange St. Rochester 8, N.Y.

SET-UP - KNOCKDOWN SAWHORSE with Jiffy BRACKETS



No nails or bolts... use 2x4's for legs. 2x4 or wider for crossbar. Rugged, sturdy, easy to move, saves storage space. Sold by hardware and building material dealers, or order direct.

GRAND HAVEN STAMPED PRODUCTS CO., Grand Haven, Mich.

SEWS LEATHER AND TOUGH TEXTILES



Tough sewing jobs made easy with SPEEDY STITCHER Automatic Awl. Sews firm, even lock-stitches like machine. No skill needed to sew, repair Harness, Luggage, Boots, Sports-Gear, Overalls, Rugs, Sails, Awnings, or anything of leather, canvas, other tough materials. Specially made for heavy-duty. Handiest tool you'll ever own. Saves many times its small cost. Complete with reel of strong waxed-thread, set of diamond-pointed needles, easy-to-follow directions. Save money by sending \$1.50—we pay postage. If C.O.D., postage extra. **MONEY BACK GUARANTEE.**

SPORTSMAN'S POST 340
26 E. 46 St., New York 17, N. Y.

ONLY \$1.50
Postpaid

For **SMOOTHER MOTORING**
INSIST ON BOWES



DEPENDABLE SPARK PLUGS

Here's Why -

- ★ Every Bowes Plug is Individually Tested —tested at higher voltage than is ever encountered in your car.
- ★ Oversize Special Alloy Electrode . . . welded construction assures positive connection.
- ★ Extra Large Ground Electrode assures longer life for plug.
- ★ Husky Aluminum Oxide Type Insulator assures against porosity—sure proof against shorting.
- ★ One-Piece, Leak-Proof Construction.
- ★ Patented Engine Gasket Retainer Ring assures better contact and better heat transfer.

BOWES PLUGS are tailored to YOUR car's motor

If your favorite SERVICE STATION does not handle Bowes Spark Plugs, write us direct for further information.

BOWES "SEAL FAST" CORPORATION
INDIANAPOLIS 7, INDIANA

Bring back pictures wonderful as your vacation

Bring back perfect pictures of your trip... rather than disappointments and wasted film. With a compact, easy-to-use WESTON Exposure Meter you'll get correct exposures every shot... perfect still or movie pictures. Be sure to have one this summer. See both WESTON models at your local photo shop today.

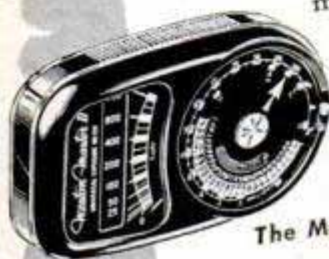

WESTON

EXPOSURE METERS

The Meters Most Photographers Use

new "STICK ON"
TOOL SILHOUETTES
KEEP TOOLS IN PLACE
SAVES TIME & DOES
AWAY WITH PAINFUL
PAINTING.
a real shopkeeper



\$3.85 (OR, POSTMAN WILL COLLECT ON DELIVERY)

You've been wanting to finish that board for your tools but never quite got to it - too hard to paint the tool outlines. At last you can cut out the tool "Tracers" you need and stick them on your tool board. Over 87 tool "Tracers" furnished including 2 saws, complete set of chisels, box end wrenches, open end wrenches, clamps, bits, pliers, drills, etc. Applied by means of an electric iron to your own tool board. New plastic adhesive is not affected by moisture. Face of "Tracers" is ready varnished for long life.

TRACERS, 1970 MARSHALL RD., KIRKWOOD 22, MO.

Send me 1 set, 3 large sheets, "TRACERS."

Name _____

Street _____

City _____

Check or M.O. Enclosed

C.O.D.

and got a signal! But in spite of bracing the dish blew flat. So the men stayed there and held it in focus for three hours while the wind ripped shingles from the roof, sent people tumbling through streets and ripped buildings from foundations. "Those boys hung on with hands, feet and teeth," says Sam. "Several times there was some question whether they were holding the dish or it was holding them but they made it."

Probably the most skittish microwave remote ever attempted was NBC's live telecast from the aircraft carrier *Leyte*, 35 miles at sea. Four cameras covered everything from pilots in the briefing room to take-offs, landings and a mock air attack on the big ship. Clinging to tiny platforms rigged on the side of the bridge and on catwalks, cameramen had to wear life jackets in case planes went wild and they were forced to jump clear.

Worse were the technical problems. Special generators for power had to be hooked up to prevent such things as the ship's elevators from clobbering the signal. Navy frequencies were cleared for audio. But there still was the incredible job of keeping a dish antenna focused within two degrees of a pin point on the horizon—on board a pitching, rolling ship that continually reversed position to take on and discharge aircraft. The *Leyte's* navigator was sure he could do it, so NBC built a special antenna. Mobile crewmen climbed the radar mast on the appointed day, hauled their transmitter after them and fastened it to the rotating Selsen antenna. The navigator plotted the Empire State building, the transmitter engineers panned in, and Navy radar operators kept that signal beamed within two degrees of a pin point for the entire half-hour show by rotating the Selsen back and forth and up and down.

Power is always a headache for the mobile crews. At best, it means hauling cable up sides of buildings, across avenues, through treetops and chimneys in order to reach a source of juice. At worst, after getting it, it may conk out. Levin's crew had a close squeak at the Statue of Liberty while shooting a show called *All Around the Town*, in which the TV cameras take the audience on sight-seeing tours every week. "Everything was set up," Levin says. "Cameras positioned, link set up on the statue's pedestal and juice connected from the island's regular line. Then we turned on the cameras for a test run with an hour to go and poof! The whole island blacked out. We'd blown the main fuse located in a deep hole under the statue."

Officials refused to let them try again on the same line so they prowled through the

(Continued to page 248)

AUTOMATIC RETOOTHER

MAKES NEW PROFITS

Cuts new teeth in 50 seconds — any size 4 to 16 points. Old teeth fall off as chips. Easy to operate. A perfect job.

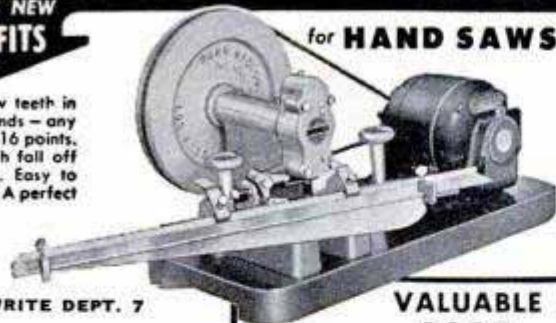

WRITE DEPT. 7

BURR MFG. CO.
8933 VENICE BLVD.
LOS ANGELES 34, CALIFORNIA

VALUABLE BOOK

25¢

Order Burr's Blue Book of Coasts to Coast prices for saw shop services.



Bedside cabinet

NEW! EARLY AMERICAN DESIGNS

Series C—15 plans 25¢

Colonial adaptations. Fun to make — easy to follow. Each project comes complete with photo and working drawing on 8½ x 11 sheet. Send 25c to: Stanley Tools, 372A Elm Street, New Britain, Connecticut. In Canada: Stanley Tool Co. of Canada Ltd., 372A Stanley Street, Roxton Pond, Quebec.



Reg. U.S. Pat. Off.

15-inch Swing

Four inches more than other heavy-duty lathes. 33" between centers. Extra features. Compare SHOPSMITH! It's a saw, sander, vertical and horizontal drill, too. Write for free catalog.

SHOPSMITH, Dept. 208-B
12819 Coit Rd., Cleveland 8, O.



NEW SMALL PARTS CABINET

Metal bound. Baked green enamel. Green plastic drawers. Removable dividers. At hardware stores. Write for free catalog—complete Waterloo line of metal boxes and cabinets.

Waterloo Valve Spring Co., Waterloo, Ia.

BUILD YOUR OWN ARC-WELDER

For Light or Heavy Work

No rewinding necessary—use coils taken from old auto generators. Works on 110 or 220 A.C. Has 20 different heats. Complete plans and BIG Catalog 35c.

LEJAY MFG. CO., INC. 3347 LeJay Bldg.



Minneapolis, Minn.



SCOOP-R-CHARGER

Smart! New! Engineered to give you the very latest! An upper hood air-scoop which directs a stream of fresh air directly to carburetor for increased horsepower. Cooler motor—better gas mileage—more efficient carburetion. Minimizes the danger of vapor lock. Eliminates need for propping hood open for extreme summer driving.

Gives your car the customized appearance of the finest in the automotive field. Replaces the original hood ornament.

Comes chrome plated ready for installation, with modern plastic ornament. Easy installation instructions included. Fits '49 thru '52 Ford, Chevrolet, Plymouth, Mercury and Oldsmobile; '47-'52 Studebaker; '46-'52 Kaiser-Frazer. State make and year of car. Price \$9.95 Post Paid. Send check or money order. Satisfaction guaranteed.

ST. LOUIS PRODUCTS CO., Box 24-MG Normandy 21, Mo.

© 1952 St. L. P. Co.

PEEL OFF PAINT with Klean-Strip



New-type remover is fast, safe, clean, and easy to use!

No wash! • Non-inflammable!
Sold at leading paint, hardware and department stores everywhere.

THE KLEAN-STRIP CO., INC.
2340 S. Lauderdale
Memphis 6, Tenn.

KLEAN-STRIP TAKES OFF ANY FINISH

AVOID REPAIR BILLS FOR SAGGING FLOORS CRACKING WALLS install TEL-O-POST yourself for only \$9.95!

Sagging floors are costly—they cause cracking plaster, sticking doors and windows, open joints. Install TEL-O-POST, the original adjustable post, now! Use in cellars, under porches, in garages, barns, etc.

Only 20 minutes to install. Then gradually adjust built-in jack to eliminate sag. If your building supply, lumber, or hardware dealer does not stock, send coupon and check for \$9.95.



Brainard

BRAINARD STEEL DIVISION, Dept. C-7
Griswold Street, Warren, Ohio

STEEL DIVISION
WARREN, OHIO

- Send illustrated booklet on TEL-O-POST installation.
- Enclosed is check for \$9.95 (\$14.95 west of Kansas City). Ship express prepaid one No. 1 TEL-O-POST, adjustable from 5' to 8' 4". MONEY-BACK GUARANTEE OF SATISFACTION.

Name _____

Address _____

City _____ State _____

GORBIN**All-Weather
PADLOCKS**

Big strong ones for general outdoor or indoor use . . . midget models for golf bags or tackle boxes . . . bike locks. They're TOPS in value! Sizes and models for every purpose —

Be sure . . . with

AT LEADING
HARDWARE
STORES
EVERYWHERE!

CORBIN CABINET LOCK DIVISION
The American Hardware Corporation
New Britain, Connecticut

vaults, opened the transformer feeding Miss Liberty's torch and tapped in on 1500 amperes. "All we needed was 25," says Sam, "but what could we do? That switch closed with a crack like a 75-mm. cannon but we got the best power we ever had—and were ready to go exactly four minutes before show time."

Tricky stunts and ingenious devices are the hallmark of the remote crews. On another *All Around the Town* show, Mike Wallace—who runs these TV expeditions—decided to show people Coney Island. He wanted to have a girl ride the 200-foot parachute drop while the camera caught her facial expressions and the mike caught her vocal ones. It wasn't practical to have an operating TV camera ride the chute beside her so Wallace took a microphone trailing a long thin wire and rode the chute beside her. Down below, the cameraman set up his rig with a 25-inch close-up lens focused on the girl's face. The microphone caught her scream of horror, the camera saw her ghastly expression and in the near-by van, video and audio engineers blended the two and sent them out to the network.

While mobile TV has plenty of hazards, some of them at least are amusing—like the sea gulls. During one cold, sleety day Sam Levin's crew was covering a waterfront news event. The cameras, of course, were nice and warm and the sea gulls found them comfortable to sit on. "Had to keep a special sea-gull-swatting detail in full swing for an hour," he recalls. "Those birds kept cluttering up the picture."

Like many other phases of TV, remote shows are trying to grow out of their swaddling clothes. And it won't be long before today's bright young engineers have an easier time of it.

Last New Year's Day, spectators at the Rose Bowl saw a weird-looking creation that resembled something between a hot-dog stand and a ricksha weaving in and out among the crowds. It was NBC-TV's "walkie pushie," a new self-contained camera without any lines or cables. The unit, mounted on a three-wheeled platform, is only four by six feet in size. It carries 20 storage batteries to supply its power. A cameraman and video engineer ride the platform and shoot the picture, which is sent out then in a half-mile radius. The signal is picked up by a near-by mobile van's all-direction antenna and relayed for telecast.

Even more fantastic is R.C.A.'s new "walkie lookie" camera, which the boys call a "creepy peepy." Like the Army's back-pack radio, this device consists of a box full of electronic gear which can be

(Continued to page 250)

Made**\$900
IN SPARE TIME**

"I did very well last year with my Foley equipment, about 950 saws, in my spare time.

About \$900 for me." — Leo H. Mix.

You can make up to \$3 or \$4 an hour in Spare Time. With a Foley Automatic Saw Filer you can file hand, band and circular saws better than the most expert hand filer. Cash business—no canvassing. No eyestrain, no experience needed.

**FREE BOOK
"MONEY MAKING FACTS"**

shows just how you can start at home in spare time, with small investment, no overhead—and develop into a full-time repair shop. Send coupon today for this practical plan. No salesman will call.

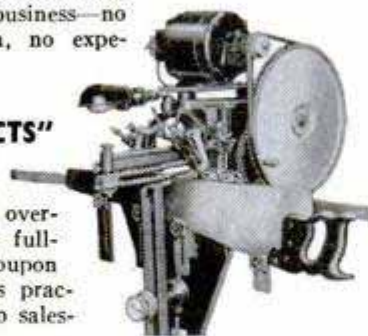
**Send Coupon for FREE BOOK****FOLEY MFG. CO.** 716-2 FOLEY BLDG.,
MINNEAPOLIS 18, MINN.Send FREE BOOK —
"Money Making Facts".

Name _____

Address _____

Ball-Bearing *SPEED WHEELS*



JUVENILE WHEELS (No bearing, solid tires)

4"	40c	6"	65c
5"	45c	7"	75c

(Semi-pneumatic tire, ball bearing)

8 x 1.25 ..	1.85	10 x 1.25 ..	2.20
8 x 1.75 ..	1.95	10 x 1.75 ..	2.30
8 x 2.00 ..	2.20	10 x 2.00 ..	2.65
12 x 1.75 ..	3.45		

INDUSTRIAL WHEELS
Lug Base, Semi-Pneumatic tire

5 x 1.75 ..	3.65	10 x 2.00 ..	6.10
6 x 2 SW ..	3.45	10 x 2.75 ..	5.15
6 x 2.00 ..	4.00	12 x 2.00 ..	6.90
8 x 2.00 ..	5.20	12 x 3.00 ..	9.20
8 x 2.50 ..	5.40	16 x 4.00 ..	15.15

Smooth Base, Pneumatic tire and tube

8 x 3.00 ..	11.00	12 x 4.00 ..	12.10
10 x 2.75 ..	6.80	4.00 x 8 ..	13.10
10 x 3.50 ..	10.55	14 x 4.50 ..	13.40

Dealers, Jobbers, and Manufacturers! Our new prices will interest you.

Available Now — CASTERS
Write for circulars on all wheels.
Prices F.O.B. our plant.

No c.o.d. orders. **JIM BROWN TOY COMPANY**
1095 HOME AVENUE AKRON 10, OHIO

MOTORISTS—Had your *Oil Filter checked recently?*

If not, chances are it's choked up... can't keep up its engine-saving, money-saving work. It's high time for a

PUROLATOR Micronic* REFILL
(Costs as little as \$1.60) *Reg. U. S. Pat. Off.



V-PLEX AUTOMATIC CLUTCHES

Get smooth pickup for your power mower, motor scooter or garden tractor... with only throttle control. Prevent stalling engine, cut belt wear, permit no-load idling. Easily installed on 1/2, 3/4, 7/8" gas engine shafts. Factory-tested. See dealer or write for folder. PM7.



V-PLEX CLUTCH DIVISION — Hagerstown, Indiana

3 ROLLS AnSCO FILM \$1
New, fresh film in factory-sealed pack! Choice of #127, 120 or 620. Pin \$1 bill, check or m.o. to ad, specify film size.
FREE DEVELOPING-ENLARGING Coupon (1 roll) with each pack.
HANDI-FOTOS Fordham P. O. Box 1-C New York City 58, N.Y.



GET DRILL PRESS ACCURACY WITH ANY ELECTRIC HAND DRILL

You can drill a straight, perpendicular hole with any electric hand drill using a Jedco Drill Aligner. Give your electric hand drill the precision of a drill press. Sent complete with precision bushing holder, 5 hardened steel drill bushings for 1/8-5/32-3/16-7/32-1/4 drills. Full price only \$2.95 postpaid. Money back guarantee.

J. E. DUNNING COMPANY
Dept. PM-2
14547 Madison Ave. Cleveland 7, Ohio

SAVE 50% ON ATTIC OR WINDOW FANS!



\$15.95 P.P.
Shipped at once! Dealers write for quantity price.

It's EASY! Build your own 30-In. Fan in 4 hours. Sleep in cool comfort. (Moves Appr. 5600 C.F.M.)

FAN KIT INCLUDES:
4 durable masonite blades • Cast spider • 2 rubber mounted bearings • 11-in. shaft and collar • Pulleys, V-Belt and necessary bolts • All you need is lumber and motor • Complete instructions. Satisfaction guaranteed. ORDER NOW!

You Get All These Parts

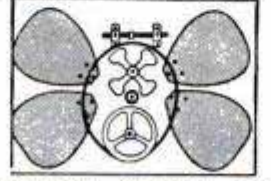

FAN KIT CO. Box 5842 Crosstown Sta., Memphis, Tenn.



PROTECT YOUR CAR

WITH

The Sensational Pneumatic Spring Booster

- For Overloads
- For Improved Roadability
- For Trailer Hauling
- For Sagging Springs

ECONOMICAL AND EASILY INSTALLED
Inflates with Air—Same as a Tire
Thousands in Use—Guaranteed

GIVE YOUR CAR A LIFT—WITH AIR LIFT

See Your Dealer or Write

AIR LIFT CO.

2330 W. MAIN STREET
LANSING, MICHIGAN



BUILD YOUR OWN POWER TOOLS—TILT/ARBOR SAW

Exclusive GIL-BILT Build-It-Yourself Features

- No machining—build easily with hand tools only
- No blueprint reading—step-by-step pictorial plans, full scale patterns, actual photographs
- Sturdy wood, aluminum, and steel construction
- Capacity and performance of commercial saws selling for \$80 and up

BANDSAW BELT SANDER SAVE \$50. OR MORE

GIL-BILT 10-INCH TILTING ARBOR SAW

- 27x28 in. table, 13 1/2 in. capacity in front of blade
- 10 in. blade cuts 3 1/4 in. deep, tilts full 45 degrees
- Floor model 34" high, table always stays level
- New Departure ball bearing arbor, 3/8" precision shaft turned down for 5/8" bore blades, alum. housing, shipped ready to run
- Jackscrew and 4 1/2 in. dia. handwheel lowers and raises blade
- Cast aluminum miter gauge and self-aligning rip fence guide

GIL-BILT Metal Parts Kit includes Plans, ball bearing arbor, miter gauge and bar, rip fence guide, dado insert, lock knobs, jack screw mechanism and handwheel, and all other metal parts (less blade).....\$20.95
Same Kit with 10" Combination Blade \$24.90
Same Kit with 8" Combination Blade \$23.90

GIL-BILT 12-INCH BAND SAW

- Cuts to center of 24 inch circle
- Handles stock up to 6 inch thick
- 18x18 inch table tilts 45 degrees
- Lower wheel and drive pulley runs on sealed New Departure Ball Bearings; Upper wheel runs on two 3/4" bore Oilite Bronze bearings.
- Upper wheel tension and tilt mechanism of cast aluminum, completely assembled.
- Upper and lower blade guides. Each has ball thrust bearing, self-lub. bronze jaws
- Rigid cast aluminum wheels fully machined ready-to-install. Heavy rubber tires
- Uses standard 78 inch blades up to 3/4 in. wide.
- Fully enclosed mechanism for utmost safety.

GIL-BILT Metal Parts Kit includes Plans, rubber tires, aluminum wheels, 1/4 in. blade, ball bearing spindle, tilt mechanism, blade guides, table tilt segments, and all other metal parts.....\$21.95
Return Kits in 10 days for refund if not satisfied.
(Prices include postage within 300 miles. Over 300 add 5%)

Also available—Plans and Parts Kit for Belt Sander and 8" Tilt/Table Saw. Order Plans at \$1.00 each—Send postpaid anywhere in the world or write for FREE descriptive catalog.

GILLIOM POWER TOOLS P. O. Box 1-PG, Lambert Field St. Louis 21, Missouri

**MAKE
OLD FURNITURE
NEW AGAIN**

**ARCHER
Pol-mer-ik**

100% PURE LINSEED OIL

FREE BOOK
Refinish, beautify, polish all woods. "101 Handy Hints." Send for today.



ARCHER • DANIELS • MIDLAND CO.
603 Roanoke Building, Minneapolis 2, Minn.

For Better Work — FASTER — EASIER

**THE
ZEPHYR
Electric Drill**

only \$18⁹⁵



Handy... Speedy... Powerful. Has many uses around the home... in the shop... on the farm. Built to Last. Full 1/4" Capacity.

DRILL STANDS Add Many Uses for Zephyr Drill

Horizontal Drill Stand— for Polishing, Buffing, Grinding, etc.



Price \$1.00

Adjustable Vertical Drill Stand— for drill press operations
Price \$10.95



De Luxe Electric Work Saver Kit



Includes above ZEPHYR Drill, plus 28 accessories for buffing, cleaning, drilling, grinding, mixing paint, polishing, sanding, sharpening, waxing, and wire brushing.
Price \$27.35

At Hardware, Implement, and Building Materials Dealers, and Department Stores—or Write Direct

PET TOOLS **PORTABLE ELECTRIC TOOLS, INC.**
324 West 83rd Street, Chicago 20, Illinois

In Canada: Portable Electric Tools, Ltd., Toronto, Ont.

slung over the shoulders. The camera itself is no bigger than a large movie camera and is connected to the back pack with standard coaxial cable. This miniature device will enable mobile cameramen to wander around relatively unburdened as long as they stay within sight of the mobile van.

And right now NBC is building a huge self-contained mobile unit for fast coverage of big disasters. It will be nearly 35 feet long. Its 12-cylinder engine will be under the floor and will kick up 210 horsepower. It will have a 22-foot roof platform for cameras and a microwave transmitter. Engineers are considering putting a hydraulic mast on the truck to support the microwave antenna. The mast would collapse like the radio aerial on your car and disappear right into the truck when not in use but would rise up to a height of some 60 feet or more at the touch of a button. It will have a 450-megacycle dual-channel transmitter; two-way radiotelephone for the program department; a compartment for refrigerated food and drinking water. It will even be air-conditioned. A gasoline engine will generate power and the van may also have portable acetylene lights for illuminating night scenes like rail or air crashes.

"Just carry a camera and cable to the roof of the truck and we're in business," says the engineer who's designing it. To cut vibration and noise of the generator, this unit will be mounted with Maxim silencers on the exhaust. Cameramen will be able to operate while the bus is in motion.

With these things on the way, your TV screen soon will be taking you almost anywhere a man can get with a movie camera.

★★★

Glass Bows for Archers

Archers can stop treating their bows like prima donnas now that a virtually unbreakable glass bow is available. The new bow is bonded of more than two million strands of glass fiber and can be subjected to all kinds of mishandling without damage. It can be left braced indefinitely without taking a set. It can be released arrowfree or shot in zero temperatures without warming up. The archer can overdraw it without fear of breakage or personal injury. In addition, the bow is said to have extraordinary accuracy and arrow thrust.

☐ Airfield runways which are harmed by jet-fuel spillage can be protected by a new coating combining plasticized synthetic rubber and tar—a blend unaffected by the heat of jet blasts which may range as high as 300 degrees F.

it's **EASY** **NOW** to make fine furniture in your spare time



With Rogers simplified project sheets, it's easy to make fine furniture for gifts or your own use. Just 15c will bring you these valuable instructions plus a full-size bottle of Rogers famous Gorilla Grip Glue — the glue with *lasting* strength. Send to Rogers Isinglass & Glue Co., Gloucester, Mass.

Ask for Rogers at your local hardware store.



*Most Wonderful Money-Making Plan I Ever Saw!**



\$15-\$20 in a few SPARE HOURS

UP TO **\$210 A WEEK** FULL TIME



Easy with Amazing D-FROST-O-MATIC

"Never defrost your refrigerator!" — 4 magic words that can pay you as much as \$15.00 to \$20.00 and more in just a few hours showing housewives how amazing D-FROST-O-MATIC ends forever the messy, sloppy, time-wasting task of defrosting by hand!!

D-FROST-O-MATIC makes any electric refrigerator AUTOMATICALLY SELF DEFROSTING! And talk about easy sales! Just plug in D-FROST-O-MATIC, tell the housewife to "try it before you buy it" and when she sees how D-FROST-O-MATIC saves time, work, food, and money—she won't let you take it out! That's why 9 out of 10 FREE TRIAL installations are almost certain sales with big cash profit for you. Many D-FROST-O-MATIC men sell 5, 7, 10, and more units IN A DAY on this sure-fire FREE TRIAL Plan!

Rush Name Today for Profit Details and FREE TRIAL PLAN!

SELLY of California started in his spare time and now sells 1500 D-Frost-O-Matics a month!

More than 29,000,000 prospects waiting! Rush your name and address today. We'll airmail exciting facts, proof and sure-profit Free Trial plan. No obligation. Write today.

D-FROST-O-MATIC, Dept. K-6
173 W. Madison Street, Chicago 2, Ill.

LOOK FOR THIS SELF-SERVICE DISPLAY



Fuller's famous unbreakable amber handles top the finest steel screw drivers and wood chisels. Fully guaranteed. At hardware stores everywhere. Wholesale Distributors! Write for Catalog Pages & Prices. **FULLER TOOL COMPANY, INC., 3522 Webster Ave., Bronx 67** World's largest makers of Amber-Handle Tools EXPORT SALES DEPT., JOHN H. GRAHAM CO., 105 Duane Street New York, U. S. A.

Print Your Own Cards, stationery, circulars, tags, labels, photo and movie titles, advertising, etc. Save money. **Print for Others, Good Profit!** easy rules sent. Raised Printing like Engraving, too. Sold direct from factory only. Write for free catalog of outfits and all details. **KELSEY PRESSES, M-37, Meriden, Conn.**

Our 503rd Advertisement

REAL DIESEL ENGINE

\$2.95 • for planes, boats, midget cars
• 7500 RPM; 1/7 HP; ht. 3 1/2"; wt. 5 oz.
• precision machined for smooth operation

You just can't beat this price for a precision diesel engine! Streamlined, compact, easy to install. Thousands of satisfied users all over the world. Fast delivery if you ORDER TODAY! Send \$2.95 plus 25c postage.

GOTHAM HOBBY CORP. Dept. P, 107 E. 126th St. New York 35, N. Y.

EASY MUFFLER REPAIR Fix holes yourself in 5 minutes. No tools needed. STOP man-killing carbon monoxide! STOP noise! STOP costly repairs! Kit fixes several mufflers and tail pipes. Money back guarantee. Rush \$2.00 with name and address to:

NoCo PRODUCTS, 3387C E. 142 St., Cleveland 20, Ohio

SAY YOU SAW IT IN POPULAR MECHANICS

Build the Best! EASY TO ASSEMBLE BOAT KITS

NEW CATALOG

OVER 40 PAGES, INCLUDES ALL YOU NEED TO BUILD YOUR OWN
1-BOAT KITS—30 MODELS
2-MARINE HARDWARE
3-MARINE ENGINES
4-MARINE CONVERSIONS
5-PAINTS & COLOR CHARTS

All For Only 35c, SEND COIN TODAY

ROWBOATS

8-10-12-14 FT.

\$39 up



OUTBOARDS

8 Models 12 to 18 FT.



INBOARDS & CABIN CRUISERS

16 TO 23 FT.

NEW 18 FT. OUTBOARD CABIN CRUISER

FAST VEE BOTTOM HULL SPEEDS UP TO 25 M.P.H. — ROOMY CABIN, WITH TOILET, SLEEPS TWO —

U-MAK-IT PRODUCTS

703 P-WHITTIER ST., Bronx 59, N. Y. City



Graduate to a GRAPHIC



for pictures
with **PUNCH!**

● It costs no more to own a Pacemaker Graphic . . . and you save many times over in better pictures and fewer shots lost. First choice of press photographers because of its rugged dependability, versatility and ease of operation . . . it's the ideal camera for you too! You'll have more fun and get better results, regardless of conditions. Two models in three sizes meet every need. Prices start at \$174.15 . . . remarkable value when you consider the prize-winning features. See the Pacemakers at your Graflex dealer's, or mail coupon for information.

Graflex Inc., Dept. 172
Rochester 8, New York

Please send me details on:
Pacemaker Graphic and Accessories

Name _____

Street _____

City _____

County or Zone _____

State _____

GRAFLEX[®]
Prize-Winning Cameras

Photography Then and Now

(Continued from page 76)

with great popularity since its introduction in 1928 is the Rolleiflex, which takes pictures 2¼ inches square. It is fitted with two lenses of identical focal lengths—one to form an image on the film, the other to form an image on ground glass so that the pictures can be previewed at full size.

The trend towards smaller cameras has reached new limits within the last few years and in such subminiatures as the Minox, a precision camera hardly as large as a fountain pen, which takes negatives barely ⅜ inch wide.

Exposure meters are now standard tools for professional and amateur alike. The photoelectric exposure meter, first brought out by the Weston Electrical Instrument Company in 1932, gives exact exposure data by converting light to measurable electric current. Indeed, electricity has produced great changes in photographic technique. Thanks to the perfection of efficient, manageable incandescent units, portraitists have moved down from their skylighted garrets and are no longer dependent on the weather. Moving-picture producers, who moved to California to get constant sunlight, now create sunlight in the studio.

The electric flash bulb has not only made combustible flash powder obsolete but it has given the photographer a flexible means of lighting scenes dramatically without cumbersome equipment. When the first flash bulbs, stuffed with magnesium foil, were brought to this country from Germany in 1929, they were used like flash powder. The camera was set on a tripod, the shutter opened, the flash fired and the shutter closed. Experimenters at once began to build electromagnets to trip the shutter at the moment the flash went off so that pictures could be taken with the camera held in the hand. Today flash is so universal that even the cheapest modern cameras boast of shutters with built-in synchronizing switches.

The expendable flash bulb is challenged now by the electronic flash, in which a high-voltage current is passed through a gas-filled tube. This type of light was invented by Dr. Harold Edgerton in 1931. The flash is so bright that photos are taken at exposures as short as 1/100,000 second. These intense, brief flashes can be repeated in quick succession and the light used as a stroboscope to "stop" rotating or oscillating motion. If, for example, a whirling wheel is illuminated once per revolution, it will appear to stand still. Edgerton used his stroboscopic light to take several exposures on

(Continued to page 254)

PARTS FOR MILITARY TRUCKS

AT A SAVINGS. NEW FREE CATALOG
 For Jeep, Dodge, Chevrolet, G.M.C., Studebaker
 Brand New — Not War Surplus — Complete
JEEP TOPS and SIDE CURTAINS
 Fits all Military Jeeps. Also adaptable to some Civilian Jeeps. Waterproof O. D. **\$59.50**

AXLES FOR TRAILERS

(Surplus) Heavy Duty axles suitable for building of many types of trailers, farm wagons, etc. Standard width straight axle, 2 inch square and is complete with Hubs, Timken bearings, 6 Hole 750x20 or 825x20 wheels, without brakes, only **\$69.50**

Dual Wheels add \$15.00 extra

Hundreds of Other Trucks & Jeep Parts and Supplies
 All prices quoted good 30 days FOB, Kansas City
 25% deposit required on COD orders. Dept. PM7

UNITED AUTO PARTS CO. INC
 1901 TROOST-GR. 1800-KANSAS CITY, MO.



BRONZE FOUNDRY

Schools and Home Workshops
 Make your own castings of aluminum, copper, bronze, silver. Foundry sets are available in three sizes including 2400 Deg. F. blast Furnaces. \$22.50; \$29.50; and \$42.00. f.o.b. Kansas City. Free Circular.

KANSAS CITY SPECIALTIES CO. P. O. BOX 6022, DEPT. P-7 KANSAS CITY, MO.



WARN HUB CAP MAKES 2 JEEPS OUT OF 1

\$20.00
 Prepaid U.S., Canada

Ends front wheel drag on 4-wheel drive Willys Station Wagons, Pick-ups and Jeeps
 Saves gas up to 5 miles per gallon, tire wear, front axles, increases speed and power. Stops shimmy—front wheels coast out of gear! 4-wheel drive handles, performs, climbs like 2-wheel. Install or remove WARN HUB CAPS in 10 minutes. Polished aluminum, guaranteed. Rush check, M.O., or C.O.D. Write for circular.

WARN MFG. CO., P. O. Box 6064A, Seattle 88, Wash.

PRINT YOUR OWN POSTCARDS with the GEM Stencil Duplicator. Save money. Hundreds of uses. FREE TRIAL—Write for Gem Outfit, complete with all supplies and Book of Ideas; sent postpaid. After 10 days pay only \$8.50 or return GEM. Guaranteed for life. BOND EQUIPMENT CO., Dept. 48, 6633 Enright, St. Louis 5, Mo.

SAVE UP TO 40% ON REPAINTING COSTS WITH DEVOE WONDER-1-COAT HOUSE PAINT



SQUAR-UP

PRECISION ANGLE PLATE AND VISE . . . that does everything!

Made of case hardened steel. Precision ground and square all over. Puts clamping pressure directly on right spot; holds any position securely, and serves many purposes better than any other squaring device. Ideal for home mechanic, or plant. Max. opening 2 1/4"; weight 5 1/4 lbs. Larger sizes available. Order now for prompt delivery. Write for free catalog.

As low as **38.50**

Kearsarge Tool & Mfg. Co.
 Sales Office: 512 Franklin Ave. Pittsburgh 21, Pa.

Watch for these
DANGER SIGNS
 of Worn-Out Shock Absorbers

A JOLTING RIDE
 WHEEL BOUNCE AND SIDE HOP
 SAGGY SPRINGS
 SLOPPY STEERING CONTROL
 SPOT-WORN TIRES

Play Safe—Replace With New
MONRO-MATIC
SHOCK ABSORBERS
 The Only Shocks with Automatic Adjustment

Don't take chances. Check your shock absorbers now and install new MONRO-MATICS if replacements are needed. They give a smoother, safer ride over any road.

EASY TO INSTALL
 It takes only a few minutes to install MONRO-MATICS on the average car. Clip this ad and send with your name and address for installation and service manual.

Guaranteed for one year or 15,000 miles

MONROE

MONROE AUTO EQUIPMENT CO., Dept. A MONROE, MICH.

PEDOMETER
 by New Haven

Clock the miles you walk at play, work, home . . . Fool-proof, practical. Great for outdoor folk, boy and girl scouts, housewives.

Check or M.O. **\$5.95** post paid ONLY

ENRIGHT, Inc.
 3074 KENSINGTON AVE. PHILA. 34, PA., DEPT. 2

MEN! WOMEN! MAKE GOOD MONEY SELLING NEW HOME DECORATIONS!

CASH IN ON MILLION DOLLAR MARKET!
 More than \$3,000,000.00 in home decoration decals sold last year! Yes, this is your opportunity to make big money full time or spare time. Beautiful decorator-designed assortments sell on sight! Dozens of fast-moving sets: kitchen, bath, nursery, novelty, baseball players, movie stars, iron-on's—and more! Be the first in your area! Mail coupon now!

WE SHOW YOU HOW! NO EXPERIENCE!
 Start with your friends, neighbors! See how they exclaim over fresh new decal designs! Up to 100% profit. No investment. One day "no risk" trial will convince you! Mail coupon today for full details, catalog and test assortment on approval.

MAIL COUPON TODAY

---SEND NO MONEY---

DECAL-ART Co., 344 N. Lorel, Chicago 44, Dept. PM-7
 Gentlemen: Rush me test assortment, catalog and full details of DECAL-ART's money making plan on approval!

Name _____
 Address _____
 City _____ State _____

a single negative, showing varying phases of action spread out or, with a single flash, to stop a single instant of time. Within the past few years, electronic flash equipment has been reduced in size so that it has become portable. The new units loosely are called "strobe" lights, even though most of the portable lamps cannot be flashed intermittently in true stroboscopic fashion.

Color photography has been perfected. Joly's screen-plate process was improved by the mosaic-screen process of Lumiere, introduced in 1908. One side of a glass plate was coated with panchromatic emulsion; the other with starch grains dyed red, green and blue. The plate was exposed in any camera and processed by a reversal technique to a positive. The resulting transparency reproduced the colors of nature by additive mixing of colors. The simplicity of Autochromes appealed particularly to amateurs. Professionals, faced with the need of supplying color prints to their clients, made direct-separation negatives through red, green and blue filters and from the negatives made prints by the carbonyl or dye-transfer process. Ingenious "one shot" cameras were designed to expose three negatives simultaneously, so that action could be recorded.

In 1935, Kodachrome film was invented. A special camera was not required, for the

three colors were recorded on a single piece of film coated with three separate emulsions, one on top of the other, each sensitive to one of the three primary colors. Special reversal development by means of substances called dye couplers turned the unexposed areas cyan, magenta and blue, thus producing a positive transparency by subtractive color mixing. Films employing this integral tripack dye-coupling principle are supplied now by several manufacturers here and abroad. Variations of the technique have been applied to making prints either by reversal or from color negatives, in which not only the lights and shades of the subject are reproduced in reverse order but the colors in their complementaries—a blonde's hair is blue, her lips, green. By means of color negatives, huge mural-size transparencies 18 by 60 feet have been produced and displayed in New York.

Rapid processing has ever been a challenge to the photographer. Five minutes seems a short time to develop and print but when the city editor is pounding at the darkroom door it is eternity. In 1949 an ingenious invention of Edwin H. Land was introduced by the Polaroid Corporation. Here film is developed within the camera and a print produced in one minute. The Land camera uses a roll of special film and

(Continued to page 256)

RETAIL PRICE \$125.00
FACTORY TO YOU \$79.95

SUPERSHOP includes precision-built 8" tilting table saw, vertical and horizontal drill press, 30" lathe, sander, grinder. 100% BALL BEARING. Write for FREE catalog, full details, trial plan. Easy Pay Plan.

POWER TOOLS, INC.

197 YATES AVENUE
BELOIT, WIS.





**THE ONLY
SPARK PLUG
WITH PATENTED
CORALOX
INSULATOR**

SURPLUS MACHINE SHOP TOOLS AT PRICES YOU CAN AFFORD

HIGH SPEED DRILLS

1/4" to 1/2" with 1/4" Shanks
1/2" to 1" with 1/2" Shanks



For the first time at these low prices! HIGH SPEED DRILL BITS UP TO 1/2" FOR YOUR 1/4" DRILL AND HIGH SPEED DRILL BITS UP TO 1-3/16" FOR YOUR 1/2" DRILL. The Tungsten steel content of these drills means they will outlast carbon and regular steel drills many, many times. New and used surplus.

DRILLS UP TO 1/2" FOR YOUR 1/4" DRILLS!			
Will Fit Any Size Chuck 1/4" and Larger	SIZE	PRICE EA.	SIZE
1/4	17/64	.45	25/64
9/32	.45	27/64	.60
19/64	.48	7/16	.65
5/16	.48	29/64	.75
21/64	.50	15/32	.75
11/32	.50	31/64	.75
23/64	.55	1/4	.80
3/8	.55	33/64	.90
		17/32	.90

DRILLS UP TO 1 3/16" FOR YOUR 1/2" DRILLS!			
Will Fit Any Size Chuck 1/2" and Larger	SIZE	PRICE EA.	SIZE
33/64	1.14	25/32	\$1.86
17/32	.91	51/64	2.05
35/64	1.14	13/16	2.05
9/16	1.14	53/64	2.15
37/64	1.24	55/64	2.25
19/32	1.24		2.25
39/64	1.30	15/16	2.43
41/64	1.43	31/32	2.50
21/32	1.43	1-1/32	2.80
43/64	1.55	1-1/16	3.05
47/64	1.80	1-5/64	3.56
3/4	1.80	1-5/32	3.98
		1-3/16	4.10

6 SLITTING SAWS WITH MANDREL

SET 6 Different Size High Speed Slitting Saws, 2 3/4" dia. x 1" arbor. Thickness from .040 to .071. Cuts wood, aluminum, brass, steel, etc. PLUS SPECIAL MANDREL which enables use of saws in 1/4" or 1/2" elec. drill. \$25 Value. PPD. Only \$4.95



7 selected, sharp H. S. Slitting Saws as above to use on your own mandrel or milling machine. New and used. PPD. \$4.95
A bargain at.....

**HIGH SPEED WOODRUFF
KEY SEAT CUTTER**

SET 5 different size cutters. Can be used as mounted milling 4C cutter or circular saw. All with 3/8" and 1/2" shank, widths up to 1/4", dia. up to 1". New and used. Ppd. \$3.95
Priced at only.....



New Carbide Tip Masonry Drill

Carbide tip goes through any masonry. Set of 5 bits containing one 7/32"; three 1/4" and one 5/16", all five, \$10 Value, only \$2.49



SET LARGE H. S. STRAIGHT SHANK 41C DRILLS: 5 Different size high speed 104 cu. in., 500 psi. Twist length up to 7". Sharp new and used surplus. Specify desired shank dia.: 1/2", 5/8", 3/4", 1", etc. PPD, only \$14.50

Air Tank—Regulator—Mask

A4 Tank — 5"x8", 104 cu. in., 500 psi. \$1.50

D2 Tank—6 1/2"x24", 500 cu. in., 500 psi. \$3.95

Demand Type Regulator. \$1.00

A14 Breathing Mask. \$1.60

Make your own diving apparatus. Mask fits regulator — regulator fits either of above tanks.



Bargain Tool & Shop Mixes!—Ppd.
NEW ROTARY FILE MIX: 7 different size H. S. files, 1/4" shanks. New cost as high as \$2.00 ea. Only \$4.49

GRINDING WHEEL MIX: 30 grinding wheels with 1/4" arbors, up to 3" in dia., plus mandrel, only \$3.29

100 MOUNTED POINTS: 1/8" and 3/32" shanks; assorted shapes and sizes. \$8.98

SURPRISE MIX: Over 50 pcs. for your 1/4" elec. drill including rotary files, drills, bits, reamers, grinding wheels and arbors for our customers who like pleasant surprises. Your money back if you aren't satisfied. \$2.98

Money Back Guarantee — All Mdse. Mixture of New and Reconditioned Unless Specified New. ALL ITEMS (EXCEPT THOSE SPECIFIED POST PAID) WILL BE SHIPPED F. O. B. TULSA — OR, ADD 10% AND WE WILL SHIP YOUR MDSE. PPD.

Write For Free Catalog Describing Thousands of Bargain Cutting Tools.

T & T TOOL 221 W. SECOND
TULSA, OKLA.

NATIONALLY KNOWN

PET 1/4" #77



Factory Guaranteed
ELECTRIC DRILL

Bright Chrome Finish. 1600 RPM. 110-120 V., A.C.-D.C. 1.6 AMP.

COMPLETE DE LUXE 38 PIECE KIT only

\$17.95
\$27.95 Value

DRILL ALONE only

\$12.95
\$17.95 Value

LABOR-SAVING FOR HANDYMAN AND HOUSEWIFE

10 day money-back guarantee

Includes above Drill, plus 37 accessories. Drills, buffs, cleans, grinds, mixes paint, polishes, sands, sharpens, waxes, wire brushes, etc. Sturdy steel case. Instructions included.

Postage 50c additional. 3% sales tax in N.Y.C. Send check or M.O. No COD's.

GOLDEN ELK PRODUCTS CO.
107-09 Northern Blvd., East Elmhurst 68, N.Y.



ELECTRIC MOTOR BARGAINS!



1/2 HP 1750 or 3450 RPM **1975** 1 HP 1750 RPM **5200**
1 1/2 HP 3450 RPM **4750** 2 HP 3450 RPM **6500**

Every Motor Fully Guaranteed

All prices F.O.B. Immediate Delivery Heavy Duty, Repulsion Induction and Capacitor Types. 110-220 Volts, 60-cycle. Single-phase. Standard Makes (G. E., Wagner, Leland, Westinghouse, etc.). Rush your order **TODAY**—large stock of motors—1 & 3 phase. 32-v. direct current bargains also.
ROBERTS ELECTRIC CO., 849 W. Grand, Dept. 13, Chicago

Quantity Purchase! Save Over Half!

16-INCH ELECTRIC FAN
WITH FULL 2-YEAR GUARANTEE



\$1975
Post paid

Buy at less than wholesale . . . and beat the heat this summer. This gleaming, modern beauty with large 16-inch blade span will air-condition homes, shops, offices, hotels, churches, stores, etc. Extremely quiet, powerful motor costs less than a penny a day to operate. Gleaming 18" guard and best grade Torrington "Varified" blade. Complete with 6 ft. cord and plug with convenient switch in the line. 110-volt 60 cycle AC. Base and column are handsomely finished in Black Crackle or Chromium. Unit stands 25" overall. Adjustable head can be tilted in any position. Shipped, knocked down to save shipping costs. Assemble in five minutes with screw driver and pliers. Weight 18 lbs. Satisfaction Guaranteed. Order NOW—this price can't be equalled.

\$1.00 additional West of Rockies

SAME DAY SHIPMENT

DEALERS WANTED . . . WRITE FOR QUANTITY DISCOUNTS
ROBERTS ELECTRIC CO., 849 W. Grand, Dept. 16, Chicago

PROCESS 33 INSTANT PAINT BRUSH CLEANER

IF ELECTRIC SHAVERS
IRRITATE YOU IN SUMMER
YOU NEED A



ONLY **\$15.95**
IN ATTRACTIVE TRAVEL CASE

THE SHAVER THAT SHAVES ANY BEARD

Whisker's clipper-type .002" thin blade shaves any length beard, even to 7 days' growth, without pulling or stalling. 110v AC model; no TV or radio interference! See your barber or dealer. If he cannot supply you, send \$15.95—we pay postage; or send \$2, you pay balance plus postage and C.O.D. 10-day money-back guarantee.

CADET ELECTRIC HAIR CLIPPER



Cuts hair, removes superfluous hair from legs and under arms. The same fine quality clipper used and sold in many beauty shops. See your shop, or dealer. If you prefer, send \$10.95—we pay postage; or \$2, you pay postman balance, postage and C.O.D.

ELECTRO TOOL CORP., Dept. W522-G, Racine, Wis.

Save Time!!! Save Money!!!
SEND FOR THIS BIG, NEW
Woodworkers Catalog No. 19



ONLY **15c** New low prices...great selection of fine domestic and imported woods...bargains in hard to get supplies--144 pages of items and ideas for woodworkers. Quick delivery on mahogany, walnut, maple, cherry, poplar, oak, red cedar, and others properly seasoned, kiln dried. Send 15c for your copy--TODAY.

Dept. A-7
CRAFTSMAN WOOD SERVICE CO.
2729 S. MARY STREET • CHICAGO 8, ILLINOIS

SAY YOU SAW IT IN POPULAR MECHANICS

HOBART "all 'round" WELDING...gets BIG PAYING jobs!



Go anywhere with trailer type gas drive welder

Don't let opportunity pass you by! Set up your own welding shop—get in on one of today's fastest growing, biggest paying businesses. Opportunities are unlimited.

Have your own **BIG PAYING business**

Hobart "simplified" welding makes learning easy, yet gives you an all 'round welder of top performance and dependability. Write for free booklet "Better Welds."

Build a **GOOD business reputation** with



Write today!

HOBART BROTHERS CO., BOX M-72, TROY, OHIO

HOBART WELDERS



It's ready!
JUST ADD WATER

SAKRETE

© SAKRETE—P. O. Box 11, St. Bernard 17, O.

PRE-MIXED
CONCRETE & MORTAR IN A BAG!

At Lumber, Building Material and Hardware Dealers . . .

\$14
POST PAID

PRECISION CALIPER

M.Z.B. Vernier Calipers guarantee highest accuracy for any kind of precision work. This chrome-steel, spring-tempered instrument measures inside, outside, thread and depth to .001" and 1/20mm (#30-64) or .001" and 1/128" (#30-61) 8" overall 6" graduation. Glass hard measuring surfaces. Either one also available in stainless steel at \$16.50 each. We also stock 12" Calipers with fine micrometer adjustment, and height gauges and 1" micrometers reading .0001".

Leather Cases \$1.00 extra.

You pay postage on C.O.D. Money Back Guarantee.

We are interested in contacting representatives for several territories.



The trade mark of highest quality

Send for descriptive literature, also on our fine imported precision calipers.

INTER-CONTINENTAL TRADING CORP.
90 WEST STREET, NEW YORK 6, N. Y.

WELD

BRAZE, SOLDER, and CUT →

ONLY \$14.75 F.O.B. complete!

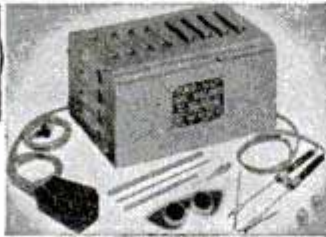

No experience needed. Follow simple instructions, weld on iron, steel, bronze, brass, aluminum, and other metals. Plugs into any properly wired 110 volt A.C. or D.C. line. Make or save time and money doing repair work for yourself and others. Repair men, farmers, tinsmiths, home and auto owners, hobbyists, etc., say FOUR-WAY pays for itself over and over. Order today or send for Free details.

Larger Equipment Available on Request
FOUR-WAY WELDER COMPANY, Dept. F2-GC
2326 S. Michigan Ave. • Chicago 16, Illinois

ORDER NOW
10 DAY TRIAL

Black & Decker Utility Tools

for HOMES • FARMS • WORKSHOPS

It's NEW, BIGGER, Better The DELTAGRAM...

• 6 GREAT ISSUES Only \$1.00 •

SEND FOR FREE "Get Acquainted" Copy

For only a dollar you get a whole year of Deltagrams—over 100 shop-tested plans, scores of fine projects and many valuable tips on home repairs and care of fine tools. Delta spent months and thousands of dollars to find out what you homecraftsmen want in a magazine—and the new Deltagram is the answer to your demand: 6 wonderful issues each year—truly a treasure house of fun and profit. Send \$1.00 today for your 1 year subscription! Or, if you prefer, first write for a free "sample" copy. Delta Power Tool Division, Rockwell Manufacturing Co., 502G N. Lexington Ave., Pittsburgh 8, Pa.

MAKE YOUR OWN POWER LAWN MOWER \$12.95

with this DRIVE CUTTER ASSEMBLY

Constructed for those who desire to build their own mower or to replace your own cutter assembly. Complete with 18" blade and double ball bearing drive...

Add 50c to cover handling & shipping. Send Check or M. O.

ATLAS KEEN MOWER

229 S.W. BLVD.

Dept. PM7

KANSAS CITY, MO

a roll of paper, to which are attached pods containing processing chemicals in jelly form. After exposure the film and paper are drawn together through rollers. The pod is broken and the chemicals spread over the film. After development, the unexposed silver slats are transferred from the film to the paper to form a unique positive image.

The scientist has come to depend upon photography as a research tool. Through the electron microscope photographs show us the structure of matter—even so fleeting a thing as smoke is seen to have a geometric structure. Long exposures through telescopes record the light of heavenly bodies so distant that the eye cannot perceive them. And now the atomic scientist uses photographic emulsions to create visible traces of the paths of cosmic rays and nuclear tracks within the almost microscopic thickness of gelatin emulsion.

The enemy fears the camera. It is said that 90 percent of intelligence during World War II was gathered from photographs. Day after day thousands of photographs, taken over the lines by fast, high-flying airplanes, were studied by specialists who were able to gather so much essential data on enemy activity that to deceive the camera became a new part of strategy. Toward the end of the war a new camera was built to take a continuous photograph on a strip of film 250 feet long moving in synchronization with the speed of the airplane.

Paralleling the growth of photographic technique has been the development of methods of printing photographs with ink. In 1902, photographs were printed in newspapers only occasionally; today the cameraman is indispensable to the editor. Picture magazines, a field in which *Popular Mechanics* pioneered, have grown in number and in size. Advertisers have turned to the color camera for illustrations.

The advent of sound changed the entire course of motion-picture photography. Sputtering arc lights gave way to silent incandescent lamps. To compensate for the consequent loss in illumination, large-aperture lenses were designed and panchromatic emulsion was adopted.

The future of photography well may lie in the field of electronics. It is not inconceivable that photography will learn from television how to intensify images of low brightness levels to reach the threshold of sensitive materials. Printing plates may be formed directly by scanning the kinescope image. The course that photography will take during the next 50 years is unpredictable. All that we can foresee is that it is destined to play an increasingly important role in our civilization. ★ ★ ★



THE BIGGEST SURPLUS BARGAIN SALE IN YEARS

BUY DIRECT FROM AD

**BUILD YOUR OWN
ARC WELDER OR
LIGHT PLANT**

**DELCO
D-C GENERATOR**

Save
\$250 to \$500

\$17.50

Instructions included. Rated 200 Amps 28 Volts 2500 R.P.M. Ship. wt. approx. 50 lbs. Stock No. 707

PRICE F.O.B.
K. C., MO.

CONVERTS TO ARC WELDER 200-250 AMP.
OR LIGHT PLANT CAP. LOAD 5000 WATTS

Stock No. 711 D. C. Generator R-1 Jack & Heintz, rated 300 Amp. 30 Volts. Gov't cost \$300.00. Instruction for converting to welder or light plant incl. Also instructions and diagram for converting the R-1 or Delco generator to Combination Welder and Light Plant included. Only **\$27.50**

Carbon Pile GENERATOR VOLTAGE REGULATOR For use with 24 or 32 Volt D.C. Generators. Also recommended for the P-1 and R-1 type generators in "build your own" Light plant. Only, postpaid **\$6.95**

R-21 HEAVY DUTY RHEOSTAT Brand New for regulating voltage on ELECTRIC WELDERS, model trains, electric blankets, lights, control photoflood lamps, etc. Rated 16-32-ohms. Size 3 1/2"x2 1/2" postpaid **\$6.95**

CUNO OIL FILTER — Brand New Aircraft type. Filters oil without cartridge replacements. Just turn handle and cartridge is clean. Standard 3/8" inlet and outlet ports to accommodate 12 gallons per minute. STOP CHANGING OIL. Instructions incl. postpaid **\$4.95**

Send check or

ELECTRIC MOTORS

Stock No. HCA24 is 1/2 H.P. 24 V. D.C. R.P.M. 2500 Gov't cost \$75.00. New **\$5.50**

Stock No. 2832 is 1/4 H.P. 28 V. D.C. R.P.M. 4000 with simple instructions to convert to 28-32 Volt A.C. Gov't cost \$82.84. New **\$3.95**

Stock No. 4949 is 1/4 H.P. 24 V. D.C. 2000 R.P.M. Mfg. by Pesco applicable for 115 V. A.C. Instructions incl. Base mounted **\$3.50**

Stock No. 66 is a 6 Volt Delco motor. Handles 6 inch blade. Ideal as windshield wiper, heater, toy applications, etc. 1/4" dia. 1 1/8" shaft, size 5"x3". 1200-2000 R.P.M. **\$2.95** post-paid

D. C. GENERATOR. Brand new, Navy Type. Delivers 430 Volts D.C. at 3450 R.P.M. Ball bearing supported. Fan cooled armature. Self lubricating bearing. #211220-A. **\$7.50** Wt. 21-lbs. Now only

PESCO CENTRIFUGAL HEAVY DUTY PUMP

Including built in motor. Applicable for 24 V. D.C./A.C. or 110 V. A.C. The motor is explosion proof constructed for gasoline fuel, oils, water, fuel booster, etc. 3/4" hose connection. Rated capacity 400 G.P.H. Instructions incl. Gov't cost \$172.00 **\$9.95** Stock #659

PESCO FOUR VANE ROTARY LARGE VOLUME UTILITY PUMP For Water, Oil, Insecticides, etc. including built in relief and by pass valve. Capacity 400 G.P.H. 1 1/2" drive spline shaft. 3/4" pipe inlet and outlets. Rotates either direction or in any position. Engineering data incl. **\$7.95** paid (Stock #600) only

INSECTICIDE PUMP SPRAYER AND FIRE EXTINGUISHER. Four Gallon size includes approx. 3 ft. of high pressure hose with fine mist nozzle. Used, good condition built to give years of heavy duty service. Wt. 15 lbs. Price **\$2.95** ea., plus postage

HYDRAULIC FLUID Mfg. by R. M. Hollinghead or Sacony Vacuum to exact Gov't spec. **\$1.75** Gal. Wt. 10 lbs. Plus postage

HYDRAULIC PRESSURE GAUGE for high pressure hyd. systems Range 0 to 2000 P.S.I. 2 1/4" dia. 1 1/4" deep. Connections are 1/8" **\$3.50** Post-paid Money Order. Prices F.O.B. K.C. except when marked "Postpaid U.S.A."

Stratopower Constant Displacement HEAVY DUTY PUMP

For operating Hydraulic cylinders, hydraulic motors on tractors, Bulldozers, Construction machinery. Lift trucks. For fuel or oil transfer. Industrial applications, etc. Delivers up to 400 G.P.H. at 3750 R.P.M. Rated 1250 to 1400 P.S.I. 3750 to 4500 R.P.M. HAS BUILT IN RELIEF AT HEAD. Rotation either direction without adjustment. \$100.00 value. Engineering data and instr. **\$17.50** incl. Stock #37. Wt. 8 lbs.

Stock No. 512 Double action hydraulic cylinder 2 1/8" Bore, 4" Stroke, Dia. 3/4" shaft including built in Hydraulic control valve which may be operated with rod or lever. Clevis mounting. Overall length shaft retracted 14". **\$75.00** f.o.b. value. Wt. 9 lbs. **\$12.95** KC. Mo.

Stock No. 472 — Double action with built in overload relief. 1" bore, Stroke 4". Shaft 7/16" dia. Length 8 3/4". A tremendous **\$4.50** post-bargain

Stock #303—Double Action 2" Bore, Stroke 11 3/4". Dia. 1 1/2". Overall length shaft retracted 23". 2000 lbs. capacity with 1000 P.S.I. gives 2500 lbs. with our **\$14.95** f.o.b. stratopower, Wt. 14 lbs..

Stock No. 12 Hydraulic Cylinder Double Action output 12560 lbs. with 1000 P.S.I. input. Gives 17584 lbs. with our STRATOPOWER PUMP 1400 P.S.I. or will produce 34168 lbs. with 3000 line pressure. Can also be operated on low pressure system. 4" Bore, 10 3/4" Stroke 1-5/16" Shaft, clevis mounting. O. Gov't. cost **\$27.50** f.o.b. \$300.00

HYDRAULIC CONTROL VALVES Adel Precision #B-10329. For controlling 2 single action or 1 double action cylinder. Including built in toggle lever. When lever is in one direction it puts pressure on one cylinder connection and opens exhaust, from opposite cylinder. When lever is released it returns to the neutral position and locks cylinder. Brand new. **\$8.95** Post-paid A tremendous bargain

HYDRAULIC ACCUMULATORS BENDIX BALL TYPE Stock #A-65 is 5 1/2" Dia. Capacity 2000 lb. P.S.I. Wt. 4 lbs. **\$8.50**

Stock #A-85. Ball type. Dia. 10" Capacity 2000 lb. P.S.I. Wt. 15 lbs. **\$17.50**

HYDRAULIC PRESSURE & RELIEF VALVE. Adj. to 3000 P.S.I. New 3/4" Ports **\$4.95** Postpaid.



GENERAL SALVAGE CO., 2922 E. 27 St., Dept. 727 Kansas City, Mo.

100 MILES to a GALLON!

with an Le 200 VELOCETTE MOTORCYCLE



This silent, clean, comfortable and SAFE machine features a water-cooled engine, shaft drive, hand starter, and excellent weather protection. Two cylinders.

Write for complete information to the Exclusive U.S.A. Distributor

BRANCH MOTORCYCLE SALES 2019 W. Pico Blvd. Dept. P6 Los Angeles 6, California



WHEELS

JUVENILE, INDUSTRIAL, AGRICULTURAL

Write for Literature and Price List.

CIRCLE METAL MFG. CO.

4266 E. Pacific Way, Los Angeles 23, Calif.

ELECTRICITY Anywhere

FOR PORTABLE, EMERGENCY OR HOME USE

ONAN Electric Plants generate 110-volt, 60-cycle current for homes, farms, cabins and resorts beyond the highline. Lightweight, portable plants cut costs, speed work for contractors. Standby plants protect units against power failure. 400 to 55,000 watts. Gasoline or Diesel-powered. Priced from \$219.00.

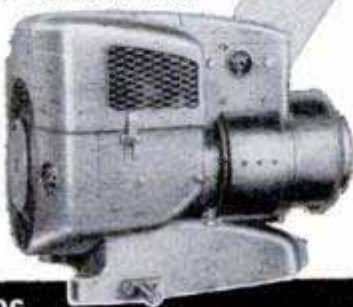

WRITE FOR CATALOG

D. W. ONAN & SONS INC.
5859 UNIVERSITY AVE., MINNEAPOLIS 14, MINN.

NEW! CHEAP! OIL BURNER SWEEPING THE COUNTRY!



SALESMEN BIG MONEY

SLIPS INTO ANY COAL RANGE, STOVE OR FURNACE

Amazing quick, intense heat. By finger-tip control. Cheaper than coal. No more shoveling coal or ashes. SENT

ON TRIAL. Prove it pays for itself quickly by what it saves. \$1 bonus for testing. We'll

let you try one in your own home for one month. Write for details today. NORTHWEST MFG. CO., 360-J Main, Mitchell, S. Dak.

PITH HELMET

Genuine British Army. Perfect ventilation for cool comfort. Most practical sun helmet made. Best possible sun protection for hunters, fishermen, prospectors, mt. climbers, beachgoers. Ideal for engineers, construction workers, farmers, gardeners, anyone out-of-doors. Proven effective by British 8th Army in Africa. Khaki covered pith cork, foil lined, leather sweatband. The perfect outdoor head-gear. Sizes: 6 7/8-7-7 1/8. Actual cost to Brl. Govt. \$12.50.



ONLY **\$3.95**



GIANT BALLOONS

Genuine govt. surplus weather target balloons. For fun or profit. Great sport in the back yard; or for parties, picnics, dances, fairs. Money-makers whenever you want to attract a crowd for lodges, civic events, school functions, conventions, exhibitions, trade shows. Special purchase makes these low prices possible.

3 Ft. Dia. **39c** - 6 Ft. Dia. **79c** - 13 Ft. Dia. **\$1.39**

Add 10% for postage & handling
Calif. residents please add Sales Tax

WAR ASSETS DIV. Volume Sales Co.
Dept. M-7-52, 3930 Sunset Blvd., Los Angeles 29, Calif.

WAR SURPLUS AND OTHER BARGAINS SAVE UP TO 90%

AIRCRAFT NAVIGATIONAL DRAFTING MACHINE



Designed for plotting navigation problems and adaptable to surveying layouts & general drafting room use. Vernier hub graduated 0° to 360° by 1's, will lock unit at any desired degree. (AN5750). Mfg. by Bruning Wallace. Non-magnetic K-Monel bands are not subject to corrosion. ALL NEW. Complete with fitted hardwood case incl. spare parts. Wt. 11 lbs. Approx. Govt. Cost \$150. **WHILE THEY LAST! ALL yours for just \$47.50.**

MICROMETERS

Chrome plated, precision engineered, carefully tooled to give long life. All new 0.1" capacity—\$2.25 ea 1.2" capacity—\$3.50.



PORTABLE WELDER

Will weld, braze, solder & cut all metals up to 3/16". No experience needed, full instructions included. Weld iron, steel, brass, aluminum and other metals. Plug into any 110 Volt A.C. or D.C. line. Save 100's of hrs. and lots of \$\$ doing repair for yourself and others. Great for any mechanic, hobbyist, etc. Not a toy. Comes complete with electrode and carbon holders and an ample supply of electrodes, carbons, flux and necessary components to do a thorough welding job of any type. This ALL NEW unit can't be duplicated for many times its modest price of \$12.00



electrodes, carbons, flux and necessary components to do a thorough welding job of any type. This ALL NEW unit can't be duplicated for many times its modest price of \$12.00

D.C. GENERATORS

Finest aircraft quality . . . heavy duty . . . lifetime grease-sealed ball bearings. Terrific for truck and marine use, for welders, plating, D. C. Appliances, lights, etc. Type P-1. Mfd. by Ford, General Electric, Westinghouse & Delco-Remy. Rated 200 Amps., 28 Volts, 2500 RPM., can be "reved" up to 300 Amps. Shpg. Wt. 53 lbs. Approx. Govt. Cost \$350 . . . New to you . . . \$21.50



Send 25c for 1952 catalog. Bargains for everyone. Check, Money Order or Cash. 25% deposit on C.O.D. orders. Prices F.O.B. Culver City, Calif., unless otherwise stated.

AIRBORNE SALES CO., INC., Dept. PM7
8501 Stellar Dr. Culver City, Calif.

HOBBYISTS! SHOPMEN! Special ONLY \$54.50

PALMGREN "HOBB-E" Rotary, Index, Milling Table
Ideal for Model Parts or Shop Work

Mill-Grind-Drill-Index-Rout curved or straight-Rabbit and Mortise on drill press or lathe. 8" Table, 4" Cross Feed, 360° Rotation, Accurately Graduated. Bolts to table. Order NOW! SAVE \$100. Only \$54.50. Less Rotary Feed \$43.75. Write for "HOBB-E" Tool Circular.

CHICAGO TOOL and ENGINEERING CO.
8365 South Chicago Ave. Chicago 17, Ill.



**CAPE COD CHAIRS
TRELLISES • ARBORS
DUTCH WINDMILLS**

Chairs style B-C-A PLANS 50c Ea., all 3 only \$1.00. 12 different trellis designs PLAN of all 12 only 50c. Authentic 40" high Dutch Windmill Detailed PLAN only 75c. Unique 40" high Lighthouse having copper lantern, ideal for garden or on lake shore of summer home. Large detailed PLAN 75c. SPECIAL all plans above \$3.00 val. Only \$2.50. Send 10c for catalog

Craftsman's Model Co. Dept. P42 DELAFIELD, WIS.

Sand WITH YOUR TABLE SAW

8" ALUMINUM DOUBLE FACED SANDING DISC FITS YOUR SAW LIKE **\$4.95** A BLADE — 1/2" to 3/4" Arbor Size



CIRCULAR SAW ACCESSORIES

SAW BLADES — DADO HEADS
MOULDING CUTTERS
SANDPAPER DISCS & CEMENT

Write for Catalog P-7

JAXON COMPANY • BOX 142 • GASPORT, N. Y.

The Owners Report on the '52 Mercury

(Continued from page 88)

any tight squeeze. It is a real improvement."

This comment came from a Lake Worth, Fla., housewife: "I have a rather tall husband, over 6 feet, and this '52 Mercury isn't comfortable for him. The front seat isn't deep enough or the roof high enough. For my own use, it's wonderful."

A good many owners agreed with an Ironton, Ohio, railroad foreman who said,

1952 MERCURY SPECIFICATIONS

ENGINE

Type 8 cyl., 90-deg. V-type, side valves
Bore and stroke 3.19 in. x 4.0 in.
Piston displacement 255.4 cu. in.
Brake horsepower 125
Compression ratio 7.2:1
Transmission: 3-speed conv., overdrive unit opt.; Mercomatic drive, torque-converter type, with planetary gears, 5 selector positions

GENERAL

(Figures on 4-dr. sedan models)

Steering ratio 18.2:1
Steering wheel, lock to lock 4 1/2 turns
Turning radius 20.05 ft.
Road clearance 6.2 in.
Tire size 7.10 x 15
Recommended tire pressure 26 lb. front, 22 lb. rear
Weight (unladen, curb weight) 3408 lb.
Wheelbase 118 in.
Tread, front 58 in.
Tread, rear 56 in.
Height, over-all 64.8 in.
Width, over-all 76.9 in.
Length, over-all 206.8 in.

INTERIOR DIMENSIONS

Front-seat width 58.9 in.
Rear-seat width 58.9 in.
Headroom, front 35.4 in.
Headroom, rear 34.2 in.
Legroom, front 42.8 in.
Legroom, rear 41.5 in.

CAPACITIES

Oil 5 qt.
Water (less heater) 22 qt.
Gasoline 19 gal.

"On the whole, my '52 Mercury certainly is a great improvement over my '51 or any other car." But a Charleston, W. Va., housewife wrote, "The 1952 is far from an improvement in appearance and still resembles the Ford."

A Glendale, Calif., owner says: "The gas-tank center-filling location is wonderful. So simple I wonder why others did not have it long ago. Watch the others copy this idea (and fast)."

In all, 69 percent of owners reported excellent or good service, 23 percent said average and only 8 percent said they received poor dealer service.

And now for my own test: I picked up a

(Continued to page 260)

WELLWORTH BARGAINS — ALL NEW EQUIPMENT

the Big 3-Wellworth COMPRESSORS

2 compression and one oil ring. aluminum alloy connecting rod. Stainless steel valves with brass seats and retainers. Cool-flo cylinder head, spray mist lubrication to every moving part. V groove fly wheel. One year guarantee.

MODEL W800. 2" bore, 1 3/4" stroke, 2 to 2.8 c.f.m. up to 150 lbs. pressure. Operates with 1/4 or 1/2 HP motor. Reg. price \$25.50... **\$20.50**
Shipping wt. 16 lbs.

MODEL W200
2 1/2"x2", 2.55 to 4.80 c.f.m. up to 150 lb. pressure. Operates with 1/2-1-1/2-3/4 HP motor. Reg. price \$36.50. Special Price... **\$27.95**
Wt. 24 lbs.

MODEL W7
2 cylinder 2 1/2"x2", 5.10 to 8.50 c.f.m. up to 150 lb. pressure. Operates with 1 1/2-2-1-1/2-1-1/2 HP motor. Reg. price \$67.50. Special price... **\$54.50**
Wt. 45 lbs.



Wellworth



Spray Gun

2-way, internal & external mix. 4 nozzles, 2 fluid tips. Requires 2 to 4 C.F.M. at 30 to 50 lbs. pressure. Qt. Cup. Wt. 6 lbs. List \$18.50. **Only... \$12.95**

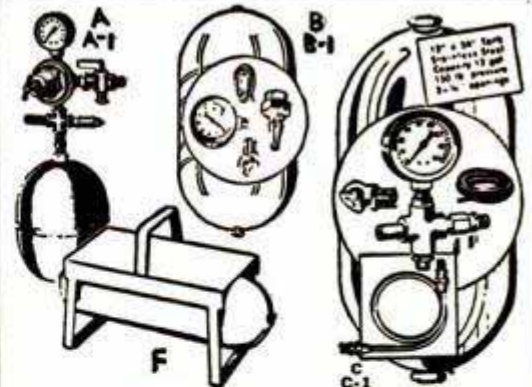

Guaranteed AIR TANKS

Models A, B, and C are rated at 500 lbs. pressure per sq. inch. F, and F-1 150 lbs. 1/4 in. standard pipe thread openings on ends as shown.

- A—8x5 1/4, wt. 2 lbs. 1.50
- A-1—8x5 1/4, with 1/4" regulator gauge, safety valve, shut-off cock, wt. 5 lbs. 11.95
- B—24"x6", wt. 7 lbs. 4.50
- B-1—24"x6", with comb. air gauge, and inflation valve for retaining pressure in tank, tire chuck, 3 ft. high test air hose, wt. 12 lbs. 7.95
- C—24 1/2"x12, stainless, wt. 20 lbs. 14.50
- C-1—24 1/2"x12, stainless with 20 ft. hose, air gauge, safety valve, copper tubing & fittings, air chuck, 4 way cross, wt. 25 lbs. 19.75
- F—7"x25", with 7 1/2"x17" plate and feet, 4 openings, 150 lb. test. 14.75
- F-1—Same as F, but 14"x32", with 18"x8" base plate, and feet, 6 openings, wt. 60 lbs. 24.50

PRICES F.O.B. CHICAGO. MONEY BACK GUARANTEE. SEND CHECK OR MONEY ORDER TODAY. PROMPT SHIPMENT.

WRITE FOR OUR FREE CATALOG.

WELLWORTH TRADING CO.

1832 S. WABASH AVE., DEPT. D-752
CHICAGO 16, ILL.

RED SEAL CONTINENTAL

Gas Engine



Rated 1 1/2 to 2 HP with 6 to 1 reduction gear. Operates at 450 R.P.M. For lawn mowers, scooters, garden tractors, pumps, compressors, generators, etc. List Price \$79.50. Shipping wt. 54 lbs. SPECIAL PRICE... **\$47.50**
Same engine at 2600 r.p.m. ... **\$47.50**

WISCONSIN GAS ENGINE

Big saving. 1952 model. A.K.N. 3 to 6 H.P. Wt. 75 lbs.

\$89.50



MERCURY CLUTCH
3" A-belt pulley. Centrifugal action for heavy loads. 5/8" bore. \$22.50 list. Special... **\$9.95**
3/4" bore. **\$10.95**

PORTABLE AUTOMATIC COMPRESSOR UNIT

1/3 h.p., 2.8 c.f.m. at 100 lbs. pressure. 20 ft. hose & tire chuck. Wt. 90 lbs. \$175 list.

Complete as shown... **\$98.50**
Regulator gauge & filter... **\$8.95**
Kidde 1/4" reg. & gauge, value, \$22.50, only... **\$12.50**

Wellworth V-BELT CLUTCH

Takes starting load off engines or motors. When speed is reached, a flip of handle shifts clutch from idling to driving position. Handles "A" belts, 2.35" pitch diameter, 5/8" bore. Ideal for use with lawn mowers, garden tractors, home workshop motors, etc. 3 1/4" long. Safe, easy to mount, sealed ball bearings, positive action. Shpg. wt. 3 lbs. **\$7.50**



BUSHING FOR 1 1/2" SHAFT 15c
SAME CLUTCH FURNISHED WITH 3/4" BORE **\$8.50**

BARGAINS IN LIGHT PLANTS, GENERATORS, AIR COND and FURNACE BLOWERS. WRITE FOR 36 PAGE FREE CATALOG

BUILD YOUR OWN FAN



One-piece cast aluminum propellers for cooling and ventilating.

Size	Polished	Unpolished	Bore
15	\$3.00	\$2.50	1/2, 5/8, 3/4
18	3.75	3.00	1/2, 5/8, 3/4
20	4.00	3.25	1/2, 5/8, 3/4
24	4.50	4.00	1/2, 5/8, 3/4

Write for pamphlet on larger fan blades, wire guards, fan bases, shutters, pillow blocks, exhaust fan frames, etc. Dealers write for discount.

KLOPPENBORG ALUMINUM FDY., Dept. PM-527, Davenport, Iowa

SHOPSMITH OWNERS

New attachment for turning metal and plastic, adaptable for tapping, milling and grinding, fully guaranteed, only \$19.50, order direct, enclose check or M.O. \$5 deposit for COD.

DIXIENG, 7301 N.W. 10th Ave., MIAMI 38, FLA.

KEEP TOOLS HANDY — AND SAFE

with this special **ALL LEATHER TOOL KIT**

only **\$2.95** postpaid

Genuine top-grain leather, sturdy stitching, reinforced with rivets for extra durability. Hammer holder and five pockets, large, medium and small. Worn on belt. Tools are always in place—safe from damage. Model No. 701—8"x11" (illustrated). Model No. 177 (Not Illustrated). Lineman's or Electrician's Seven-Pocket Kit. Made of top grain cowhide. Worn on belt. Only \$3.75. Order direct today. Money back guarantee. Send for free catalog. Salesmen's inquiries invited.

WESTERN TOOL KITS
516 Allen Ave., Glendale, Calif.



POSTPAID ANYWHERE IN U.S.A.

WE FURNISH ALL MACHINED METAL PARTS, EVERY SCREW, NUT, BOLT, WASHER, AND COMPLETE PLANS FOR THIS...

BIG 10" POWER SAW



\$10.95 FULL REFUND IF LESS GUARD NOT SATISFIED & WOOD IN 10 DAYS

COMPLETE PLANS 10c
MARCUS-POLLA
DEPT. N, ROYERSFORD, PA.

ASSEMBLE IT YOURSELF WITH SIMPLE HOUSEHOLD TOOLS!

STOPS LEAKS PERMANENTLY

Cut your fixture replacement, water and fuel bills with Economy Renewable Seats. Make economical, permanent repairs quickly and easily with the Junior Kit (illus.). Repair bathroom, kitchen and laundry fixtures. Everything you need included in steel box. This is a natural for the "Fixit" shops — get extra income from making permanent repairs on your customers' faucets.

Senior Master Kit also available—repairs faucets and valves up to 1" pipe.

Write for illustrated circular. JUNIOR KIT, only \$22.50

with 15 assorted Renewable Seats.

"Less than the cost of a set of kitchen sink fixtures."

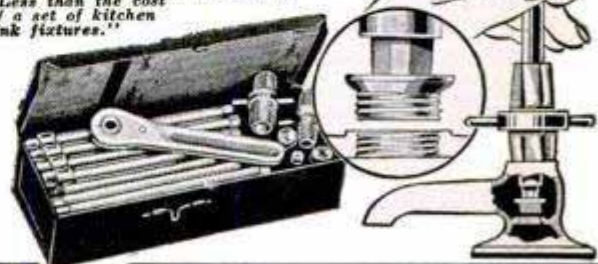

ECONOMY VALVE SEAT CO.

1430 N. Keating Ave.

Chicago, Ill.

CRYSTAL GLASS CYLINDERS

SIXTY-FIVE SIZES
CARRIED IN STOCK
FROM 1¼" TO 14"
DIAMETERS

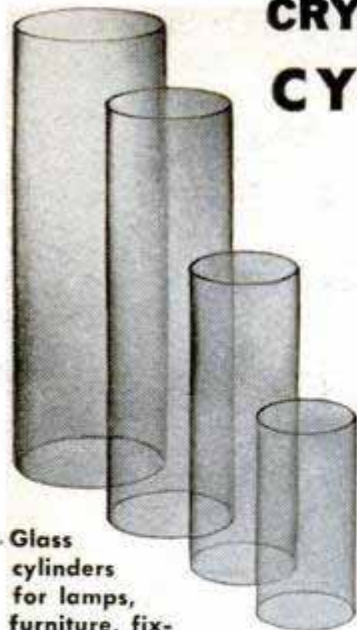

Glass cylinders for lamps, furniture, fixtures, and many other applications for hobbyists and manufacturers. Send 25c for catalogue of 65 stock sizes. In any quantity, large or small.



Dunbar Glass Corporation

DEPT. PM-2
DUNBAR, WEST VIRGINIA

DYNA-MITE POCKET RADIO

POWERFUL! PERSONAL! PORTABLE!

- Covers Full Broadcast Band 550-1600 K.C.
- Selective Dyna-Coil Tuning
- Batteries and All Parts Fit Within Case
- Hearing-Aid Battery-Powered, Long Life
- Tiny Acorn Low Drain Tube
- Loud Clear Tone
- Over 1,000 Mile Range
- No Antenna Used for Local Reception
- No Ground Connections Ever Needed
- Picture Diagram for Radio Beginners



\$5.99
Postpaid

This neatly engineered little kit was designed to give you a real personal, portable radio that you can enjoy anywhere without disturbing others. Use it on camping trips, in bed, in your office or just anywhere. Remember this is not a weak crystal set but a powerful "VACUUM TUBE" receiver that will give you good local and long distance reception. Set, with tube less batteries ONLY \$5.99 postpaid. A deposit of \$1.00 is acceptable in U.S. and possessions on COD orders. If batteries are desired we will supply at only \$1.50 per set includes TWO "A" and ONE "B". These are obtainable at local hearing aid concerns.

Order Today at This Unbelievable Low Price!

PRECISION ELECTRONICS LABORATORY
DEPT. A PLACERVILLE, CALIF.

1952 Mercury for my test in Honolulu and I drove the four-door sedan approximately 250 miles on the island of Oahu, including a trip across a winding mountain road to Kailua Bay. I did some testing on back trails, of which there are many in the island. There were not many chances for speed tests, so I finished the tests in California, Nevada and Arizona, doing an additional 840 miles in a Monterey model.

Maneuverability is excellent with little front-end "floating." A torsional stabilizer bar controls sidesway and there is little tendency to "roll" on corners. I would say it is one of the nicest cars offered by any American manufacturer to control in high-speed cornering or over the bumps.

With an over-all steering ratio of 26.4 and 4½ turns of the steering wheel from lock to lock, the Mercury has easy steering. Curb-to-curb turning diameter is 40.09.

The brakes are excellent and I especially like the tiptoe pedals suspended from the fire wall above the floor board, eliminating the need for holes in the floor board. (Of the owners reporting, 88 percent liked this feature.) Braking is more effective than in previous models. On the steepest grades or at sustained high-speed driving there was little tendency for the brakes to fade.

The Mercomatic automatic transmission is smooth in operation and is one of the best. It is a three-speed torque-converter type. Acceleration is extremely good, using drive range only, and can be increased somewhat by starting in low, holding the throttle wide open and quickly shifting to drive at about 30 miles per hour. Downshifting is smooth and at speeds below 40—regardless of the throttle opening—the shift to low range places the transmission in a lower ratio. This is advantageous for descending grades or making fast stops. Below 58 miles an hour, intermediate ratio is brought into use by flooring the accelerator.

Some tendency of the car to creep is noticeable when the lever is in either low or drive position. Mercomatic seems to have very little slippage and the car accelerates rapidly with little effort. There is a slight hum while accelerating.

Mercury offers a selection of three transmission units—conventional three-speed; three-speed transmission with overdrive (Borg-Warner); and the Mercomatic (designed by Ford and Borg-Warner engineers). It is very similar to Studebaker's Automatic drive (also Borg-Warner) with the exception that Mercomatic always drives through the torque converter while the Studebaker unit has a direct-drive feature.

New body styling is the key feature of

(Continued to page 262)

Announcing the **NEW...POPULAR MECHANICS MAGAZINE LIBRARY FILE**



*Check
these
Outstanding
Features*

1 Convenient size, measures 6 $\frac{3}{4}$ " wide, 3 $\frac{3}{8}$ " thick x 10" high. Ideal for tabletop, shelf or bookcase storage.

2 Special Reference Index Form, printed on back, records exact location of selected articles, diagrams and other information.

3 Date Label Stickers—enough to index ten years issues, furnished FREE.

NEW! NOVEL! INEXPENSIVE!

Never before so much convenience and utility at such a low price. So act now. Place your order today!

INGENIOUS CUSTOM-BUILT STORAGE FILE

*A Sensational Popular Mechanics
Value Scoop!*

Now you can preserve every issue of Popular Mechanics Magazine in orderly, chronological sequence... indexed and ready for instant reference! Made of high quality kraft fibre board, printed in rich colors and constructed to look like an attractively bound book, Popular Mechanics Magazine Library Files enhance the reference value and double the usefulness of your collection of Popular Mechanics Magazines.

Serviceable, convenient, handsome in appearance, Popular Mechanics Magazine Library Files make every volume and article instantly accessible. No more hunting for the issue or special data you want. No misplaced copies. A "must" for every reader of Popular Mechanics. Order now for immediate delivery. Use the handy coupon below.

PER SET OF 2
(Set holds 12 issues)

Only

70¢

POSTAGE PAID

5 SETS **\$3.10**
ONLY

10 SETS **\$6.00**
ONLY

POSTPAID

Best of all, production economies by the distributor service organization appointed by us to serve your needs—plus our large volume purchases—makes the phenomenally low cost of the Libraries possible.

USE THIS COUPON...Mail Today

POPULAR MECHANICS MAGAZINE, Dept. PL
200 East Ontario Street, Chicago 11, Illinois

P7-52

Please rush PREPAID _____ sets Popular Mechanics Magazine Library Files.

(QUANTITY)

Remittance for \$ _____ is enclosed.

(AMOUNT)

PRICES — 1 set (2 files) Holds 1 yr's. issues only \$.70

5 sets (10 files) Holds 5 yr's issues only \$3.10

10 sets (20 files) Holds 10 yr's issues only \$6.00

Includes Prepaid Parcel Post anywhere in U.S. and Possessions

Name _____

Address _____

City _____ Zone _____ State _____

PEEL PAINT TO BARE WOOD

6 to 10 feet per minute!

"PAINT-DOZER"

New heavy-duty electrical peeling tool for outside and inside work.

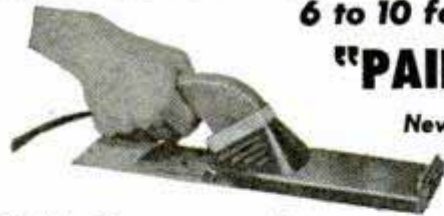

Fully Guaranteed

\$9.95

Complete

Softens and peels paint in one continuous stroke!

Eliminates hard scraping, chipping, dangerous chemicals and torches. Faster, neater, safer than a blowtorch! Quickly and easily peels house siding, sills, cabinets, floors, boats . . . any woodwork. Even curves, grooves and fancy moldings are easily peeled with "Paint-Dozer" Kurv-Kleeners. This professional tool is simple to operate. Even beginners do a smooth, clean job. Operates on ordinary household current. Constructed of heavy stamped steel; long-lasting Ni-chrome wound 1000° ceramic heating element; Marinite insulation; and hardwood pistol-grip handle. Comes complete with Kurv-Kleeners; 8-ft. neoprene cord; front and rear detachable blades and skids; attachable front guide handle for horizontal work; safety stand and instructions. Order today from your dealer, or write for fast shipment! You must be satisfied or your money back.

OTTO KONIGSLOW MFG. CO., DEPT. R
3610 PERKINS AVENUE • CLEVELAND 14, OHIO

AMAZING TOOL BARGAINS!

ALL BRAND NEW MERCHANDISE



SURPRISE VALUE
100 Pieces
FOR ELECTRIC
GRINDERS **\$1.00**
Post-paid

Grinding Wheels, Cut-off Wheels, Sanding Discs, Mounted Stones, Sharpening and Honing Stones, Rotary Cutting Burs, Abrasive Cartidges, Mandrels, and many other items.



2 DRUM SANDERS \$1.50
Post-paid

With 12 Bands in Assorted Grits, 1/2" dia. x 1" long on 1/8" arbor with 12 bands

ONE DRUM, 1" DIA. x 1" LONG ON 1/4" ARBOR WITH 6 EXTRA SLEEVES \$1.00
Post-paid

SCHUPACK SUPPLY CO., 7331 Cottage Grove, Dept. M-32
Chicago 19, Ill.
NEW 1952 Illustrated Catalog 10¢

DYNAMIC POWER TOOL COMBINATION



INCLUDES: Cummins 1/4" Electric Drill; Cummins Saw Attachment; Combination Saw Blade; Set of Drills; Lambs Wool Bonnet; 6 Sanding Disks; Steel Arbor and Attachments; Cloth Buffing Wheels; Grinding Wheel; Wire Wheel Brush; Steel Paint Mixer; Steel Bench Stand; Portable Steel Carrying Case.

Price of Dynamic Power Tool Combination complete is \$26.95

SHIPPED ON APPROVAL
NO MONEY WITH ORDER - NO C. O. D.

Try it ten days before you buy. If completely satisfied then send \$2.95 and pay balance at rate of \$4.00 per month for 6 months—No Interest or Carrying Charges Added. If not completely satisfied, return to us, no explanation necessary.

KAPNER HARDWARE INC.
Dept. A-39, 2248 Second Ave., New York 29, N. Y.
Please rush 1 Dynamic Power Tool Combination. I agree to pay \$2.95 within 10 days after receipt and \$4.00 per month thereafter.

Name _____
Address _____
City _____ Zone _____ State _____
Employed by _____

Mercury for 1952. The modern instrument panel is distinctive. All instruments and controls are grouped on a "shelf" directly in front of the driver. Control levers operate on top of the panel in toggle fashion instead of the conventional push or pull operation. I like the entire arrangement.

There is a lot of width in the seats and plentiful legroom and headroom. From the driver's seat the hood seems rather massive. I'd prefer it a little shorter, with a quicker drop in front. The headlights are unusually far forward. Attractive taillights extend far back so that the location of the lights (both front and rear) adds to the long, massive appearance of the car.

One of the Mercury innovations is the center location of the fuel-tank opening. The cap is concealed behind the license plate, which is mounted on a hinged bracket. This is an improvement, as the car can be fueled easily from either side.

There is a slot near the front of the hood which may add to appearance but has no practical value as air does not pass through it. It seems to me that Mercury engineers should have taken advantage of this design to permit air to pass through the hood on top of the engine, thus aiding in cooling by delivering fresh air above the air cleaner.

The 125-horsepower V-8 Mercury engine still retains its side-valve design, although greater power and power-to-weight ratio are offered in 1952 models. The engine is extremely smooth and the time-proven Ford V-8 design is reliable and economical to operate.

Displacement is 255.4 cubic inches and its compression ratio of 7.2 to 1 is high, yet low enough that regular gasoline can be used satisfactorily (51 percent of owners reporting use premium gas, 49 percent regular). I found regular gas entirely satisfactory for ordinary use and the Mercury's economy excellent (see economy chart). Mercury has made an enviable record by winning its class for the past three years in the Mobilgas Economy Run. The Mercury won the sweepstake award in 1950 and again in the 1952 contest when an overdrive-equipped Monterey averaged 59.71 ton-miles per gallon and 25.41 actual miles per gallon. This was almost 3 miles per gallon better than the combined average of the 26 cars competing. This mileage was made with a stock car at an average speed of 40.846 miles per hour for a distance of 1415 miles.

My own mileage test was made under different conditions, at higher speeds, with more stops and with a Mercomatic. Gasoline mileage of any car equipped with automatic transmission is one to four miles per gallon less. ★ ★ ★

BE YOUR OWN BOSS

Make Hundreds of \$ Spare or Full Time Work

NO EXPERIENCE NEEDED

Here is the ideal business with no previous experience or large investment required and no high-priced equipment to buy. A business that will return dollars for the pennies you invest.

YOU CAN CAST ANYTHING

With *Flexible Mold Making and Ornamental Casting*, an amazing fact-packed book, you learn how you can cast practically any article in concrete, plaster, imitation marble or any other casting material using a marvelous new process. You can make ash trays, novelties, garden and lawn ornaments and hundreds of other highly profitable items that cost you but a few cents and sell for as much as \$5.00 and more. Why you can even make true-to-life full-sized busts of your neighbors and friends.

NO EXPENSIVE MOLDS TO BUY

Why buy high-priced molds from others? Learn how you can make your own molds quickly, easily and inexpensively with materials that can be used over and over. You get copyrighted formulas, complete instructions and detailed how-to-do-it photographs as well as complete sources of supply for the few inexpensive materials you need. This is the only book printed in America today that contains instructions for making profitable papier-mache casts.

MONEY BACK GUARANTEE

Start on your road to extra income and independence today. Send only \$3.00 for your copy of *Flexible Mold Making and Ornamental Casting*. Complete satisfaction guaranteed or your money refunded within seven days.

POPULAR MECHANICS PRESS, Dept. 46
200 E. ONTARIO ST., CHICAGO 11, ILL.

Model 500 for Home Workshops or the Master Craftsman



From drill press to vertical miller in one minute
With vise-jaws shown — \$6.00 extra

Mastercraft ROTARY TABLE

Drills dead straight line or radius — cuts male, female slides any form — cuts flats, hex, squares, keyways, special shapes, splines, other forms. ADJUSTABLE DIALS read in thousandths — ROTARY TABLE graduated in 360 degrees; is 7" square, travels 4 1/4" either direction — QUICK ACTING Swivel Vise jaws positively lock regular or irregular shapes up to 4 3/4". ADAPTABLE TO ANY DRILL PRESS. . . . \$35.00.

Prices F.O.B. Hollywood
No Die-castings used. Write for descriptive literature for larger models.

154 CAHUENGA BOULEVARD
HOLLYWOOD 38, CALIFORNIA

YOU'LL CATCH BIGGER FISH

and have more fun catching them after you read *Popular Mechanics HOW TO TEMPT A FISH*. Here is the experience of veteran guides and fishermen brought to you for hours of enjoyable reading. Many pages of brilliant full color Kodachrome plates. Covers every phase and style of fishing — even tells where to find the big ones and what baits to use. Hundreds of kinks and tips to make every trip more enjoyable. Endorsed by leading sportsmen throughout the country. 128 pages. 525 illus.

POPULAR MECHANICS PRESS \$2.00
200 E. Ontario Street, Chicago 11



TRAILER COACHES

Here's everything you want to know about trailers, with plenty of pictures and plans and instructions for building three different types. Covers also, history of trailers, trailer parks, camps and overnight-stops information, furniture, furnishings, materials and engineering data. If you want to build a trailer, live in a trailer, or just want to know more about trailers, get this book. Only \$1.50 postpaid. Rush order to:

POPULAR MECHANICS PRESS • Dept. 350, 200 E. Ontario St., Chicago

You can make simply and cheaply



STATUARY

The Most Fascinating Book About the Automobile Ever Printed!

Popular Mechanics

AUTO ALBUM

The Motor Car in Picture and Story from 1769 to 1952

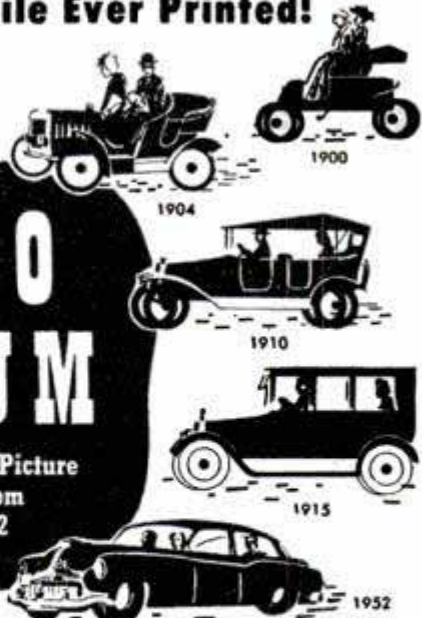

You'll Find... the Answers... the Fascinating Stories... in the AUTO ALBUM

Who built the first horseless carriage?

Who obtained the first U.S. patent on an automobile?

Where did the name "automobile" come from?

Are you familiar with the workings of the Stanley Steamer... the "electrics"... the famous Ford Model T?

Do you know when the first Indianapolis race was won... by whom... at what speed?

Do you know the story of Henry Ford, Barney Oldfield, Ransom Olds, Walter Chrysler, W. C. Durant and other automotive giants?

166 Illustrations Including 94 Old-Time Cars — 22 Auto Ads of By-Gone Days!

Here is a book you can't help enjoying and wanting, whether or not you have, or ever will own an automobile. It is the fascinating, thrilling and informative story of the horseless carriage from the first gasoline-propelled buggy to a forecast of the atomic car of the future.

Popular Mechanics AUTO ALBUM by Throm and Crenshaw presents America's first cars and the pioneering men who made them; the scrambled start and the development of the fabulous auto industry; the story of automobile racing; the growth of the Nation's highways. It is a book that just had to be published.

To Read... to Enjoy... to Remember!

More than one-half of the book is pictures, most of them action pictures, from photos of old-time cars in operation. Other pictures show race cars from 1911 to 1951; early auto advertising, picturing 32 cars priced from \$375 to \$6000; tri-cycle autos, wind wagons, auto cycles and other automotive oddities. A roll call of horseless carriages is included — the names of more than 2000 cars made in the United States.

Gift Book of the Year

Get the fascinating AUTO ALBUM for yourself today. Send it as a gift to friends and business associates. Order on coupon below. Money refunded if you are not entirely pleased.



Cloth Binding \$300

Use Coupon to Get AUTO ALBUM

POPULAR MECHANICS PRESS, Dept. AA, 200 E. Ontario, Chicago 11

Send at once postpaid — copies of Popular Mechanics AUTO ALBUM at \$3.00 each. Remittance enclosed. Send COD. I will pay postman plus charges. I understand books are returnable in 5 days for full refund if I am not pleased.

Name _____
Address _____
City _____ Zone _____ State _____

**MAKE
Big
MONEY
WITH THE**

Universal LAWN MOWER GRINDER!

Enjoy a profitable lawn mower sharpening business of your own. No previous experience needed. Place a hand or power mower on the UNIVERSAL GRINDER. With only ONE SET-UP you quickly grind the stationary blade and all the reel blades to proper clearance WITHOUT REMOVING A SINGLE BLADE from the mower.

PROOF

G. Spurlock, of Arkansas, writes: "I have my Universal Grinder two months and made a net profit of \$227.00".
C. E. Hardy of Miss. writes: "I am doing a fine business with the Universal Grinder. I spent 40¢ for a newspaper ad and have done nearly \$500.00 of business." Write today for FREE FACTS about Big Profits in Lawn Mower Sharpening.



ROGERS MFG. CO., DEPT. M-72
LINDSEY, OHIO

GET MORE POWER!

Fisher's Compression SEAL **\$3.95**
postpaid



- Stop Burning Oil!
- Restore Compression!

A small amount of Fisher's Compression SEAL in each cylinder bore will give you the economies of smooth, powerful (new car) performance and reduced oil consumption. Only takes minutes to apply . . . yet adds 10,000 more miles of economical driving pleasure to your car. A \$25,000 insurance policy is your assurance it cannot harm the finest engine.

SATISFACTION GUARANTEED

Full purchase refunded, if not completely satisfied. Why pay more when you can get Fisher's Compression SEAL . . . for less. No oil solvent baths necessary!

Send cash, check or M.O. today. Only \$3.95 postpaid. Free Folder. Dealers Inquire!

ADVANCED ENGINEERING Dept. PM-7, Box 7013
Los Angeles 37, Calif.

MODERN LAWN MOWER SHARPENER

Service departments of leading Lawn Mower manufacturers use the Modern Lawn Mower Sharpener. One lever moves lawn mower into grinding position. Gasoline and oil remain in engine while sharpening, no dismantling of wheels, roller or handle. The Modern is a precision bed knife grinder—no extra grinder to buy. Imitated but never equaled—Compare before you buy.

If it isn't a Modern it can't be Modern

(Prices subject to change without notice)

MODERN MFG. CO.

160 N. Fair Oaks - Pasadena 1, Calif.

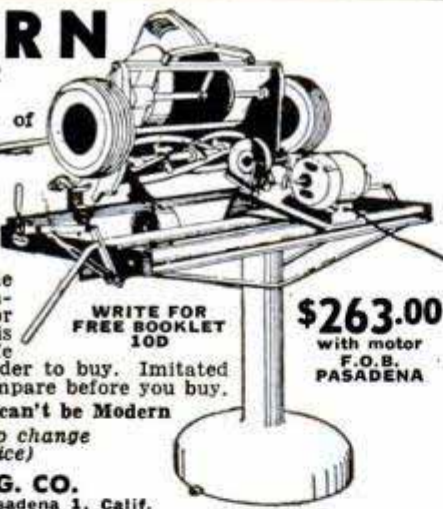

WRITE FOR
FREE BOOKLET
10¢

\$263.00
with motor
F.O.B.
PASADENA

NEW 1952 KING MIDGET AUTO

World's Lowest Priced 2 Passenger Car Drive it for 75¢ per week. Amazing performance. Surprising comfort. All steel construction. Full accessories, top and heater. Ready to run or assemble it with our bolt together parts. Send 25¢ for detailed literature or \$1 (refunded first order) for actual assembly book and service manual filled with photos, drawings, specifications, etc.



MIDGET MOTORS MFG. CO.
ATHENS, OHIO



Cap Lights Illuminate Warehouse

Office employees at a Government warehouse in Chicago look more like miners than clerks. The warehouse is used to store Government records. Instead of going to the expense of installing a new lighting system, which would have cost an estimated \$20,000, officials have provided cap lights for the clerks who search through the records. The lights are operated by rechargeable batteries and provide more than adequate illumination.



Plastic Badminton Bird

Now available for badminton players is a plastic shuttlecock that the manufacturer claims will last four times longer than a feathered bird. It is true in flight and unaffected by moisture or prolonged disuse.

BE A FROGMAN!



Join the new national FROGMAN CLUB today. All you have to do is send \$1.00—be sure to include your name and address—and here's what you get:

- 1) A miniature pair of Frog Feet. Can be worn on key chain, lapel or hung on windshield as lucky charm.
- 2) An attractive membership card.
- 3) A Frogman decal to be used on your windshield, bicycle or notebook.
- 4) A booklet on "How To Swim Underwater" and "The Supreme Sport of Spearfishing".
- 5) Periodic bulletins on the latest developments in Frogman equipment and news.
- 6) Complete catalog of Frogman equipment available for purchase.
- 7) A free coupon for \$1.00, which can be used toward the purchase of a pair of regular size Frog Feet, \$6.95 or equivalent in value. This is redeemable at your local sporting goods dealer, drug store, auto supply store or toy departments. If no such dealer available in your area, we will handle direct.

BE A FROGMAN — Send your dollar today!

National Frogman Club

1428 Maple Avenue, Dept. PM-7, Los Angeles, 15, Calif.



FILE SAWS THE RIGHT WAY

SUPER FILER No. 9

BEVEL GUIDE

USED AS JOINTER

SO EASY to joint and file saws like new. 2 hardened steel rollers keep teeth same height. All teeth cut, saw runs true and smooth... \$2.95

SUPER DRILL GRINDER

Sharpens round shank drills $\frac{3}{32}$ to $\frac{1}{2}$, 6" long
Grinds old drills like new in 4 different point angles using hand, power grinders \$2.95
At dealers or postpaid
FREE FOLDERS



GRIND all circle saws 6" to 10" with correct beveled wheel Fits your saw table \$8.95

TRU-CIRCLE Saw Set — Automatically sets teeth 10° or more \$2.95

A. D. McBURNEY, 317 E. 4th St., Los Angeles 14, Calif, Dept. A-19

SAY YOU SAW IT IN POPULAR MECHANICS

OWN A... CHEVROLET?

FIX IT YOURSELF!

Popular Mechanics Magazine has just published a new Owners Manual covering all models and years of Chevrolet Cars. So accurate mechanics use it. So simple a woman can understand it.

Save money on your Chevrolet repairs. Prevent trouble. Enjoy care-free driving. Increase trade in value. Avoid major repairs by fixing minor troubles before they get serious. Get sparkling performance at all times. Has 288 pages, more than 300 photos, diagrams, tables, charts, breakdown drawings, plus clear, non-technical directions that make all repairs simple as A B C. Written by Ed Packer with assistance of General Motors Corporation. Shows you how to diagnose Chevrolet troubles by feel, sound, sight, smell and performance. Simple trouble shooting. Permanent repairs. Emergency repairs. Plus "How to get value from garages."



MONEY BACK IF IT DOESN'T SAVE MORE THAN ITS COST!

One minor repair will save the cost ten times over. Read it. Then you decide. If you don't see that you'll save more than the cost, send it back for refund. SEND NO MONEY. Send postcard. Ask for CHEVROLET Manual. Postman will deliver C.O.D. for \$3.50 plus postage. Or, save postage by sending \$3.50 with your order. Send today. Save its cost on your next repair.

POPULAR MECHANICS PRESS

200 E. Ontario Dept. 187 Chicago 11, Illinois

NEW!



- and only 50¢

20 original projects... drawings, photos, step-by-step instructions... tips on joinery, gluing, finishing... send \$0.50 cash (no stamps) per copy, \$0.65 outside U.S.A. Limited first edition, order today.

ATLAS PRESS COMPANY

Atlas 743 North Pitcher Street, Kalamazoo, Michigan
DEPENDABLE QUALITY TOOLS SINCE 1911

Introducing

NOVA WALL UNITS



Space-savers—money-savers! Precision-built—assembled in 30 minutes! Here are wardrobes, vanity units, dressers, desks, bookshelves, storage walls—each a beautiful piece of furniture in itself; used in combination, there is no sense of sectionalizing.

10" to 26" in depth—they can even take the place of a wall, save as much as 5 feet in total house length. Wide choice of woods—unfinished, or with prime coat, paint, stain or furniture finish. Inner walls and backs are insulating, sound-deadening, mildew-proof. Write for free fully illustrated literature. Dept., 37A—NOVA SALES CO., Trenton 3, N. J.



HOLD-E-ZEE

THE ORIGINAL AUTOMATIC GRIP
SCREWDRIVERS

FIRST CHOICE OF
SKILLED CRAFTSMEN



Models for All
Types of Screws

Pat'd.

At Leading
Dealers
Everywhere

Gripper Recedes
into Handle

Upson Bros., Inc. Rochester 14, N. Y.

ADD BEAUTY and VALUE to YOUR HOME with beautiful wood-paneled walls

Install Plankweld yourself, quickly, easily — in genuine Philippine mahogany, oak, birch, knotty pine — for as little as \$60 for an average wall.

Plankweld is Weldwood® Plywood pre-cut to room height in 16¼" wide panels. Edge-grooved to provide a neat lap joint. Pre-finished — no staining or waxing required.

See Plankweld at your lumber dealer.

PLANKWELD®

Manufactured and distributed by
UNITED STATES PLYWOOD CORPORATION
55 West 44th Street, New York 36, N. Y.



Inventive Sergeant

Latest in a fast-growing list of inventions by Sgt. Paul P. Dirlik is a compressed-air water pump that fills an aircraft's tanks within minutes instead of the usual time of more than an hour. Dirlik, a Military Air Transport Service maintenance specialist at National Airport, Washington, D. C., came here from his native France after the last war. He is one of those talented people who quickly can see through problems and come up with mechanical short cuts. With a water compartment holding 77 gallons, his new invention is powered by two 180-pound pressure tanks that can be refilled from any standard air-pressure line. It has no moving parts and requires a minimum of upkeep. Among the many inventions of the 26-year-old machinist are a tool to tighten the thrustnut on an aircraft engine without removing the propeller, a tool for removing spark plugs from aircraft engines without danger of breakage and a wire cutter designed to reach into small places where the hand will not fit.

OIL FILTER REFILLS ... 10¢



Filters Oil
the full
length of
the Pack

10,000
Sq. In. of
Filtering
Surface

Plates Last
Indefinitely

Here's News! Ordinary toilet paper makes an ideal oil filter. Laboratory tests prove it cleans oil faster and better than popular makes of filter elements. All you need is a simple set of **RETLIF ADAPTER PLATES** ... and you can start using ordinary toilet paper rolls in your present oil filter. For proof and descriptive literature, send name and address to:

RETLIF CORPORATION, Dept. 102
1239 No. Highland Ave., Los Angeles 38, Calif.

Jet Power ... for your CAR with the **ECON-O-MISER**

U. S. Agriculture's Exhaustive Tests (Bulletin AIC-240) show:

Up to 30% mileage increase
More of engine's power utilized
Less Ping or Detonation

By Water Alcohol Injection in high compression engines.
ECON-O-MISER is designed to help your motor attain maximum power, speed, mileage.

Operates automatically on vacuum. Injects right amount of water and alcohol into fuel system for Efficient Motor Operation. Reduces Carbon, Ping or Detonation. Try this amazing invention on 30 day free trial. Unconditional Money Back Guarantee. Send cash, check or money order - Specify Year, Make & Model.

ONLY
\$14.95

Complete with tank, bronze injector, Carburetor Flange, hose and all fittings for easy installation.

ECON-O-MISER MFG. CO.

3019 Pico Boulevard, Santa Monica 1, California

Scientists Develop Transparent Gold Film

British technologists have devised a method of depositing a film of gold only a quarter millionth inch thick on plate glass. The layer of gold is so thin it is transparent. When heated by electric current, the film may be used to keep aircraft and automobile windshields free from ice and snow. In such applications, the film will be sandwiched between two layers of glass.

POPULAR MECHANICS

CHAMPIONS

CHOICE of the EXPERTS

for
Dependability, Performance
and Long Life

INSIST ON CHAMPIONS
FOR YOUR CAR!

CHAMPION SPARK PLUG COMPANY, TOLEDO 1, OHIO



FALSE TEETH STAY TIGHT EVEN

AFTER DRINKING HOT COFFEE!

● Mrs. J. P. writes: "I was delighted to find Staze held my teeth tight *even after hot coffee!*"

Staze is fluid-resistant . . . contains "aqua-trol," which holds back moisture penetration. Thus, it holds false teeth tighter, longer. With Staze, thousands now bite into corn and steak—enjoy all the hot coffee they want.

Even if plates are old and loose, Staze holds them tighter. Many denture wearers say that with Staze old plates seem to hold better than when new. At drugstores, or write STAZE, Box PM-6, Stamford, Conn., for free tube.



SPORTONE MUFFLERS

- Ford & Chevrolet.....\$ 4.45
- All other popular cars..... 5.45
- V-8 Dual Sets..... 15.95
- Chromed Silentsips..... 2.95

(Please state make & year of car on all orders.)

SANDEE MUFFLER CO.
5643 Carryne Place • Culver City, California

CRAFTSMAN

REG. U.S. PAT. OFF.

HAND and POWER TOOLS

Famous for fine quality . . . precision performance . . . lower price! Buy them NOW . . . at Sears convenient Retail Stores . . . located in principal cities throughout the United States.

SEARS, ROEBUCK and CO.

THE EASY WAY TO DRILL & SAW

Powerful Cummins #190 Electric DRILL & SAW KIT

Factory Guaranteed

Includes 3/4" Drill (1700 RPM, 115 V. AC-DC); 4" Saw Attachment (Adjustable); 1/4" Capacity Jacobs Chuck; 3 Steel Twist Drills; Horizontal steel drill stand, which converts drill into bench grinder, buffer, polisher, sander, etc. Attractively packaged. Instructions included.

Postage 50c additional. Send check or M.O.



Only
\$19.95

\$27.95 Value
**DANDY
FOR HOME &
SHOP USE**

10 day
money back
guarantee

3% sales tax in N.Y.C.

No COD's

GOLDEN ELK PRODUCTS CO.

107-09 Northern Blvd., East Elmhurst 68, N.Y.

for YOUR
HOME
WORKSHOP

You Can Now Order This
NEW, AMAZINGLY VERSATILE

Wade 2 WAY

HAND KNURLING

TOOL!

It's absolutely new! It can do things that no other knurling tool can do, being designed specifically for easy knurling of long or slender work that would bend under normal knurling pressure.

A sturdy, professional tool, 7" over-all. Work diameter capacity, 3/4" max., 3/32" min. Easy to operate; circular giving full instructions enclosed with each tool. Send only \$12.50 for complete unit comprising tool and set of 3 knurls. We pay postage. Specify straight or diamond pattern; also pitch desired, whether Fine (.019"), Medium Fine (.025"), Medium (.033"), or Coarse (.045"). Attractive cherry wood box to hold tool and 7 extra sets of knurls, \$3.50 additional.



**TWO-WAY
FEATURE**

Can be used in stationary position for a narrow band of knurling; and can be used to travel along the work through an "automatic feed" adjustment, for continuous knurling

ORDER AT ONCE • SUPPLY LIMITED

THE **Wade** TOOL CO., WALTHAM, MASS.

Wade

Makers of Fine Tools
for American Industry

Say You Saw It in Popular Mechanics

CAR OWNERS SHOVE \$10 BILLS IN YOUR POCKET



WHEN YOU SHOW THEM
AMERICA'S GREATEST AUTO
SEAT COVER VALUE

including

BAMBOO

NEWEST SEAT COVER SENSATION

BIG MONEY FULL OR SPARE TIME

Want extra money—plenty of it day after day? Then rush your name and address at once for Free Sample Outfit that will start you taking orders from car owners everywhere for Key expertly tailored Auto Seat Covers. EXCLUSIVE NEW PATTERNS to fit every make and model car. No one can compete with you, in wide choice, in quality—and in expert tailoring that makes covers fit like a pair of gloves—and when you quote prices that are only a fraction of what the customer expects to pay, brother! You make money hand over fist writing up the fast orders! Line includes nationally advertised sensations like BLACK EBONY Saran, beautiful BAMBOO, brilliant FIESTA, colorful BULL FIGHTER PLAIDS, plus many other exclusive patterns to choose from.

Rush Name for FREE Outfit

Give MAKE, YEAR and MODEL of YOUR CAR

No experience needed. Make all the extra money you need easily just by showing! Every car owner a "hot" prospect. YEAR AROUND STEADY PROFITS. No investment to make. Actual seat covers given to producers for OWN USE! Write for Free Selling Kit and actual samples TODAY!

KEY PRODUCTS CORP., Dept. 47

800 N. CLARK ST.,

CHICAGO 10, ILLINOIS



Asbestos Gloves for HOT Jobs

Handle hot things with safety. Wear Industrial's famous 200-14 asbestos gloves. Made of 2½ lb. Underwriters Grade cloth that resists burning. Big roomy cut, airy and comfortable. One piece construction with no seams at wrist or working edges to burn or pull out. Furnished lined or unlined. Over 40 years experience in designing safety apparel made these dependable gloves. Many styles. Write for catalog.

INDUSTRIAL GLOVES COMPANY
A Corporation
1402 Garfield St., Danville, Ill.
In Canada: Safety Supply Co., Toronto

To be Sure of the Genuine
Demand This Trade Mark

MAKE UP TO \$5 AN HOUR WITH

EASISHARP

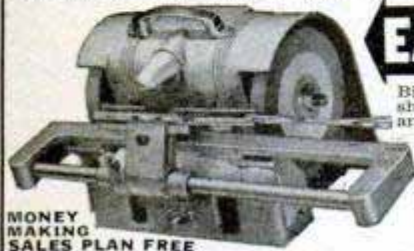

MONEY MAKING SALES PLAN FREE

Big profits in your spare time sharpening scissors, knives and other cutting edges. We show you how to start making money immediately. This is your chance now to have your own business with Easisharp. Sharpen a pair of scissors in less than two minutes! A child can operate it. Weighs only 10 lbs. Every home, barber, tailor, dressmaker — everybody uses scissors and all need sharpening two to four times a year. Don't let some one else get ahead of you. Write immediately to

SERR MACHINE CO., 9731 Lorain Ave., Cleveland, Ohio

POWER MOWERS & KITS

FREE PLANS



America's Finest Power Mowers completely assembled in 3 and 4 wheel models. Belt or direct drive. 18" and 20" sizes. Nationally known make engine. Latest improved features, sturdy construction and money back guarantee fully described in color folder. Write today.

▼ TRIANGLE MANUFACTURING CO., Box M-15, Fort Scott, Kansas

LAWN ORNAMENT-NOVELTY PATTERNS

28 Lawn Ornament Patterns, 25c. Other Patterns; 15-20" high; Dutch Girl, Dutch Boy, Pirate, Bull Terrier, Mexican Girl, Mexican Boy, Dwarf, Penguin, Flower Girl, 10c each. 25 Novelty Patterns, 30c. All 62 Full Size Patterns, \$1.00 Postpaid. Strother Pattern Service, Dept. CY-8, Box 129, Belington, W. Va.

FAMOUS RAJO HEADS Gives your '41 to '52 Chevie 25% MORE POWER



Better fuel economy, "Good Eight Power", and immediate accelerator response at both traffic and road speeds. \$169.50

SCHUCK'S

7th or Bell St. Seattle 1, Wash.

Mail this ad with check or money order
Dealers inquiries invited.

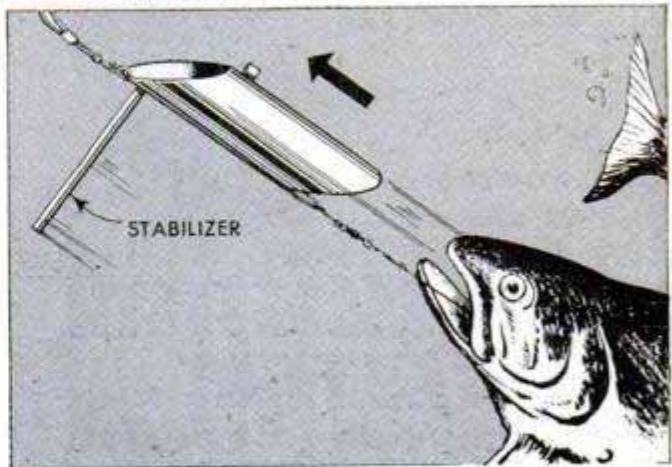
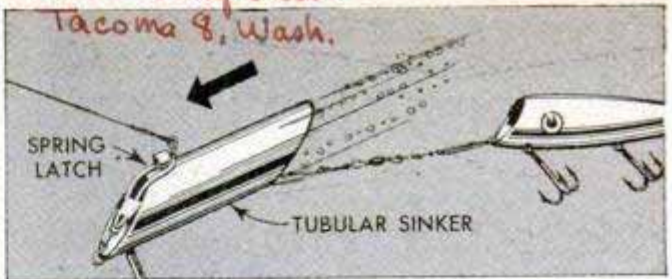

Sinker for Deepwater Trolling

With a new sinker, fishermen can do deep trolling without tiring from hauling in a heavy piece of lead. The sinker is an aluminum tube, rigged so it moves through the water at an angle to carry the line downward. When a fish is hooked or the pole given a jerk, an adjustable catch opens, altering the angle of the tube.

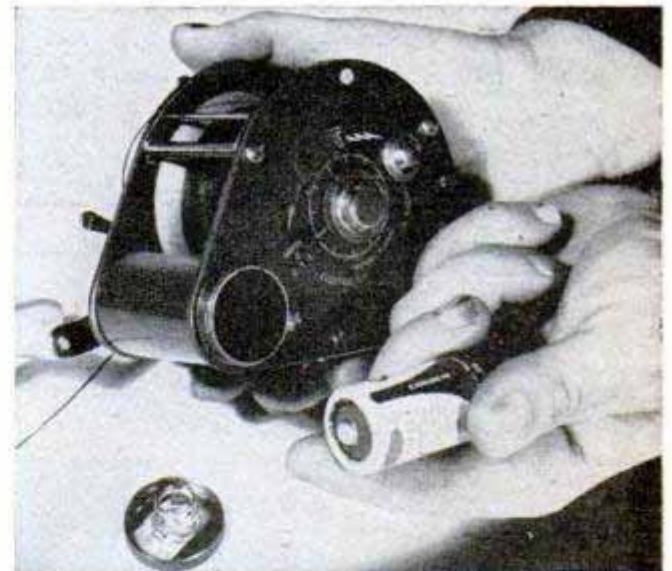

Battery-Operated Fishing Reel

Powered by a small flashlight battery, an electric brake on a new fishing reel serves as the angler's thumb to prevent backlash. The lightweight reel is made of noncorrosible aluminum alloy. The battery fits into a small cylinder at one end of the reel. The mechanism "senses" the need to prevent backlash and applies the braking action.

THIS WIRE HAS NOT BEEN OVERSEAS
This high quality two conductor communication wire offered in No. 18 and No. 22 gauge is ideal for intercoms, lead-ins, telephones, indoor and outdoor speaker extensions, doorbells, signal and burglar alarm systems, shot firing, etc., etc. **SAMPLES ON REQUEST.**

U.S. GOV'T CLOSEOUT

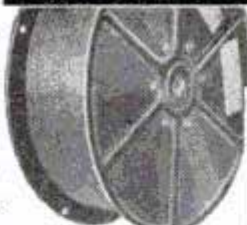

Wire

U. S. Signal Corps Communication Wire
TWISTED TWO CONDUCTOR No. 18 STRANDED per 1000 ft. \$5.00
\$7.50 per 1000 ft. TWISTED TWO CONDUCTOR No. 22 STRANDED

NEW WAR SURPLUS
Mfgd. to rigid Signal Corps specifications

Won't Last Very Long at These Prices
Stock Up Now — Subject to Prior Sale — Order Today
W-110-B — TWO CONDUCTOR #18 STRANDED (four steel and three copper strands) rubber covered plus weatherproof cotton braid and twisted. 5,280 feet per steel reel. Only \$3.50 per thousand feet on 5,280 foot reels or \$18.25 per reel.
W-130—TWO CONDUCTOR #22 STRANDED and twisted (one copper and six steel strands) in your choice of rubber or plastic insulation. 10,000 feet per steel reel. Only \$3.50 per thousand feet on 10,000 foot steel reel or \$35.00 per reel.
(Note: Steel strands are incorporated for extra tensile strength and are tinned and treated for efficient conductivity.)
All these way below market prices, our stock will not last long. Take advantage of this exceptional closeout and **STOCK UP NOW!**
Prices F.O.B. Chicago. Include approx. postage on orders paid for in advance. C.O.D. orders enclose 25%, balance sent C.O.D.

U. A. S. Corp. Dept. PM7, 5637 W. 63rd Pl. Chicago, Illinois

NOW-FIXIN' IS FUN!



SAVES REPAIR BILLS TOO!



WISE-GRIP WRENCH

LOCKS with TON-GRIP

Model 10-W \$2.60

Be your own serviceman, plumber, electrician! **WISE-GRIP** Makes You Handy! **LOCKS** to work, can't slip. Holds, pulls, turns, twists. Locking wrench, super-pliers, hand-vice — **ALL IN ONE!** 7" and 10", with or without cutter.
Only \$1.85 to \$2.60 at your dealer.

PETERSEN MFG. CO., DEPT. P-7, DEWITT, NEBR.

CHOOSE FROM PROFESSIONAL QUALITY WESTCRAFT TOOLS AT WESTERN AUTO

AMAZING BARGAINS — Save To 70%!

- Power Plants
- Hand Winches
- Chain Hoists
- Telephones
- Binoculars
- Barometers
- Air Compressors
- Water Pumps
- Electric Tools
- Contour Levels
- Flood Lights
- Air Grease Guns
- Paint Spray Outfits
- Gasoline Chain Saws
- Weed Spray Outfits
- Magnetic Recorders
- Hydraulic Units
- 100s other items

We pay all freight. Rush card for illustrated bargain sale catalog. Send today.

BURDEN SALES COMPANY
811 "O" ST., LINCOLN, NEBR.

New POWER MOWER



FREE Building Instructions Write For Them

Amazing invention makes whirl-blade mower pull and steer itself as well as cut grass and weeds. Convert your mower or build a complete mower with screw-driver & pliers. Send name and address on a Postcard.

PULLS ITSELF, STEERS ITSELF

Convert Your Mower Or Build A New One

T & H Mfg. Co., Dept. 117, 811 E. 31 St., Kansas City, Mo.



Spindle — Platform — Wheels — Fork — Handles — Driving & Steering Parts
All parts available—Kit or separately.

Double Action Hyd. Cylinder



Has a bore of 1 1/4" and shaft of 1 1/8". Stroke is 4 1/4". Overall length 10". Will take 1500 lbs. continuous duty. 3000 lbs. intermittent. Will lift or push up to approx. 1400 lbs. Never used. Wt. 5 lbs. A real buy!

ONLY . . . \$6.55

Giant Size Cotter Pin

1 1/2 lbs. Sizes 1" to 3" in length. 1/16" to 1/4" dia. New.

ONLY . . . \$1.49

PURULATOR OIL FILTERS



Permanent Type Brand New!
#G159J-40. The perfect filter to keep motor oil or hyd. fluid clean at all times. Protect your pump, engine, midget racer or boat with this unit. Just turn handle and element is clean. Inlet and outlet ports take pipe or straight threads up to 3/4". Accommodates 16 GPM at 30 PSI. Mtr. bracket. Wt. 4 lbs. \$13 value.

NOW . . . \$3.95

FREE! 2 male Reducer Connectors given with every Filter.

Pesco Positive Displ. Hydraulic Pump



Gear type. No. 1P-349. Aircraft quality. Rated 1500 PSI, .227 cu. in. per revolution. 1 GPM at 1500 RPM. Operating speed, 3750 RPM. Spined shaft. Rotation either direction with slight adjustment. 3/4" pipe ports. Has mtg. flange with 4 bolt holes. Size, 5-9/16" x 3 1/2". Used, guaranteed serviceable. Wt. 4 lbs. **ONLY . . . \$7.95**



110V 1000W AC-DC HEATING UNIT
Use for Glue Pots, Brooders, Cooking, Portable Emergency Room Heating, Basement Dryer, etc.
Brand new! U. S. Army bought them for heating shelter tents. The element is totally enclosed in die-cast metal. Does not glow when hot. Shockproof. Has 4 mtg. arms. Die-cast metal frame. 2 terminals. Make your own blower-type heater by mounting 6" fan in back. Size 7 1/2" dia. x 2 1/4". Wt. 3 3/4 lbs. A bargain! **ONLY . . . \$2.49**

AVIATOR'S OXYGEN OUTFITS

Brand new! Bail out type. Consists of all metal tank, brass release valve, 0-3000 lbs. gauge and breather hose, all enclosed in khaki colored canvas bag. Capacity, 1800 lbs. Tanks not filled. Ideal for emergency oxygen supply for airmen, mountaineers, firemen, paint shop workers, diving outfits, etc. Shipping weight, 4 lbs. **ONLY . . . \$5.95**

Refill Fitting for Oxy. Bott. \$1.95
Aviator's Oxygen Mask—Demand type. Type A-14, 24" rubber tube. Brand new! Only **\$1.95**

Vickers Hyd. Pumps & Motors
Large selection. Lowest prices. Write for special data sheet today!

ORDER FROM THIS AD! Prices F.O.B. St. Louis, Mo. Incl. post. with check or M.O.

MONEY BACK GUARANTEE! **FREE Catalog**

Edw. Aguado Trdg. Co. 689-K Arcade Bldg., St. Louis 1, Mo.

ORDER YOURS TO-DAY!



LUTHY AERO TYPE Spark Plugs With LUM-OX (Aluminum Oxide) INSULATORS

LIST PRICE \$1.00

Material developed during World War II for high speed combat aircraft. Cools rapidly, is stronger, has greater resistance to moisture and reduces breakage to a minimum. Packed in engineered sets. Correct gap setting and proper heat range. **SATISFACTION GUARANTEED.**

Airplane Type 3 point electrodes SENSATIONAL PERFORMANCE MORE R.P.M.

Distributors and Dealers—Write for Franchise
Luthy Aeronautical Sales Company
302 Cooper Street, Jackson, Michigan
Canadian address—
Box 394, Hamilton, Ontario

MAIL THIS COUPON

Send me postpaid a set of Luthy New Aero Spark Plugs. I am enclosing \$_____.
Check here if you wish us to ship C.O.D.
Year of car _____ Make and Model _____
Name _____
Street _____
City _____ Zone _____ State _____

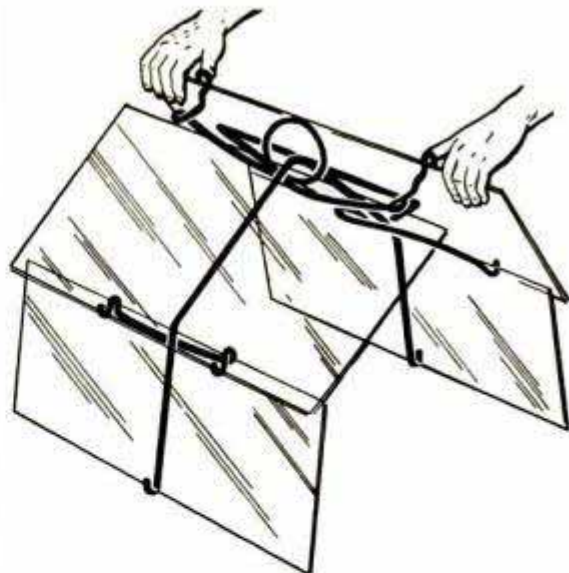

Portable Greenhouse

Gardeners can build their own greenhouses with a new kit containing sheets of glass and wire fasteners. The portable greenhouse is built in sections. A single section can be used or the sections can be combined to cover a row of any length. Each section is made from four sheets of

double-strength glass held in place by galvanized metal fittings. A handle at the top not only makes the section portable but also controls the amount of air entering along the ridge. One side of the roof can be removed to give immediate access for weeding or watering. A larger size is also available. It is constructed with a heavy tubular frame.

Sun — Not the Moon — Causes Tides on Two Pacific Islands

Most tides are produced by the moon, but two Pacific islands have sun-controlled tides, with high tide at noon and midnight and low tide at six in the morning and evening. One of these islands is Tahiti; the other, Tuesday Island—about 15 miles from the northern point of Australia. The Tahiti tide is not impressive, having a range of

only 0.8 feet, but the Tuesday tide has a range of over three feet. Scientists explain that the land boundaries or submerged ocean features which outline these tidal basins are oriented so the waters in the basins feel a minimum effect of the moon but a maximum effect of the tide-producing force of the sun.

California Farmer Builds Four-Wheel-Drive Tractor of Spare Parts



From spare parts and a new air-cooled engine, Paul Davenport of Fontana, Calif., fashioned a four-wheel-drive tractor. All the parts except the engine came from a Model-A Ford. The tractor has a 22-inch tread so it can be used for row work. The six-horsepower engine yields speeds from one to ten miles per hour, with three speeds forward and one in reverse. The tractor is powerful enough to pull a 12-inch plow 10 inches deep and moves through deep sand where two-wheel-drive tractors often lack sufficient pulling power.

DRIVE FOREVER AND NEVER CHANGE YOUR OIL!



WITH
GUARANTEED
TISSU-PAK
OIL FILTER

Absolutely New! Write for FREE Catalog.
HENDERIZE, INC. ● 5667-1M Freeport Blvd.
Sacramento, California

CARBURETOR TOO RICH MAKES MOTORIST TOO POOR



Car owners who are wasting money, getting poor gas mileage due to over-rich mixtures, will be pleased to learn how to save gasoline by **VACU-MATING OVER-RICH MIXTURES**. Vacu-Matic fits all cars, trucks and tractors, Automatic and operates on the supercharge principle. Easily installed in a few minutes.

SALESMEN WANTED! Big Profits

For FREE particulars, how you can install one on your own car for introducing, just send your name and address on a postcard to **VACU-MATIC, 7617-1917 W. State St., WAUWATOSA, WIS.**

CAR OWNERSHIP COSTS LESS WITH A HULL AUTO COMPASS



IT'S EASY to make a wrong turn without a Hull Auto Compass, drive blocks or miles before getting straightened out. Wasted miles add up amazingly... which is why a Hull Auto Compass pays for itself over and over. Write for local dealer's name, free literature.

MORE HULLS IN USE THAN ALL OTHERS COMBINED

HULL MFG. CO. P. O. BOX 246-D7
WARREN, OHIO

Beaconlite \$6.95
Illuminated
STREAMLINE \$4.95
Standard 100 ft. size

KEEP COOL THIS SUMMER WITH THESE C-BREEZE FAN BARGAINS

TWO YEAR GUARANTEED * ATTIC FANS * WINDOW FANS * AIR CIRCULATORS * EXHAUST FANS

All units complete with new 110 v 50/60 cy 1 ph. motors.

30 - 36 - 42 - 48 INCH ATTIC FANS AND MOTORS

30 in. Attic fan complete 7500 cfm 1/4 hp motor #5F02 \$62.50
36 in. Attic fan complete 9600 cfm 1/3 hp motor #5F03 73.00
42 in. Attic fan complete 12000 cfm 1/2 hp motor #5F04 97.00
48 in. Attic fan complete 16200 cfm 1/2 hp motor #5F05 135.00

12 - 16 - 20 - 24 INCH WINDOW FANS

12 inch reversible window fan—fits any 25 in. window—mesh guarded—1200 cfm—110 ac motor #1C912 — \$32.50
16 inch window fan—guarded blade—fits any 24 to 32 in. window, 110 v ac motor... #4F224 — \$29.75
20 inch Electrically switch reversible Window fan—fits any 30 to 40 in. window. Guarded 20 in. blade. 2000 cfm. Electrically reversible. 110 v ac motor #4F229 — \$43.50
24 inch Belt drive Window or Attic fan—Guarded 24 in. 4500 cfm blade—1/4 hp motor... #5F84 — \$59.00

20 inch High and Low Stand C-Breeze Air Circulators

20 in. blade Chrome low stand—wall or shelf fan. 3000 cfm—110 v ac motor... #2F76 — \$23.50
20 in. blade 8 ft. Hi stand floor fan. 3000 cfm #2F115—\$43.50

12 - 16 INCH EXHAUST FANS ON SHUTTERS

12 in. guarded blade—1000 cfm exhaust fan and shutter 110 v ac motor... #4F179 — \$24.50
16 in. guarded blade — 2000 cfm exhaust fan and shutter 110 v ac motor... #4F228 — \$37.50

Above units are complete — all accessories included — Federal Excise Taxes Paid. For prompt shipment order by number Above Special Prices are F.O.B.

Write for **FAN CIRCULAR**: Listing Blades, Guards, Motors, ALL SIZES: Attic, Window or Room Cooler

BUY from C&H

HUNDREDS of SENSATIONAL BARGAINS!
you'll save and be sure

HOT ROD SUPERCHARGER

Extra soup and go at a price you can't afford to miss! Mfr'd by Borg-Warner. Specifications: 7 1/2" deep, 7" high. Wgt. 17 lbs. Compact and sturdy. 4 base mounting holes, 3/4" outlets. 5/8" shaft with female Lovejoy coupling. Priced today at \$85. Our special SALE PRICE... \$31.00

TRACTOR SULKY for POWER MOWER

All steel, multi-purpose sulky. Soft riding tires, ball bearing wheels and adjustable bucket type seat for use with power mower. Can be used for hand-use, wheelbarrow or outdoor motor dolly—with seat off. Overall length 49" hgt. 33" wheel tread 24". Model A has 2.75x10 tires at \$22.50; Model B 4.00x16 pneumatic tires at \$34.50.

WISCONSIN GAS ENGINE

—SAVE \$50.00!! AKN model, —one of the most reliable small gas engines made. From 3.2 to 6.2 HP. 1" driveshaft. Lists at \$134. Our price rebuilt and guaranteed, Only \$75.

BRASS HAND PUMP

Double acting—pumps on forward and return strokes. Capacity 1000 gal. per hr. \$48. value, only \$18.50

ALARM HORNS

and Sirens. 110 v. AC motor driven. Heavy duty with long life and adjustable tone — high, med. and low. List \$47. NEW... \$19.95

LIGHT PLANTS

300 Watt 110-220 volt AC. Wgt. 40 lbs.—portable \$99
750-1000 Watt 110v. AC Briggs & Str'n. eng. \$169
1000-1200 Watt 110 v. AC only... \$194.00
2500-3000 Watt 110 v. AC Slow speed (1800 rpm) Leland generator for longer life. Recond'nd and fully guaranteed \$295. NEW \$345
Plants built in 1951 with tools & spare parts. \$426
5 KW Plant. 120 volts. 60 cycle AC. List today \$1910.00. Used \$675.00. NEW. Your price only \$895.00

Throw-Out Friction Disc Clutch

Twin disc, throw-out type. Ideal for power link with small gas engines and electric motors from 3/4 to 15 HP. Available with shaft bores of: 1" 7/16", 1 3/8", 1 1/4", 1" 7/8" and 3/4". (Specify size) Overall length 4", 5 1/2" plate with six mounting holes. Wgt. 4 lbs. LISTS at \$44. Used like new, Only \$12.50

RUBBER HOSE

Long wearing GOOD-RICH 2 ply 2" I. D. 25 ft. lengths worth \$25. Only \$4.95. 3 lengths for \$12.00.

SENSATIONAL WINCH VALUES

FOR — CONTRACTORS, BOATS, FARMERS, TRUCKS, LOGGERS, etc.

WINCHES, 1,000 lb. capacity. Hand operated... \$12.95
WINCHES, Hand operated ball bearing model, 1500 lb. cap. 3:1 ratio, hand brake, two speeds... \$39.50
WINCHES, 6,000 lb. double drum. Hand operated... \$49.50
WINCHES, 6,000 lb. capacity. Electric drive... \$109.50
CABLE, 1/4" preformed stainless steel aircraft; 100 ft. or less, 17c per ft.; over 100 ft., 15c per ft.

Hundreds of \$5 saving buys. These are a few of the many items at sensationally low prices!

SEND TODAY FOR FREE CATALOG

Pumps Grinders Drop Cords Generators Fire Pumps Saws Clutches Air Tanks

C&H ELECTRIC MACHINE CO. Inc.

434th W. Juneau Ave., Milwaukee 3, Wisconsin

16 to 1 SPEED REDUCERS

For Display Table—Barbecue Spits—Toy Auto Gear Box — Experimental Uses, Etc. Gears Enclosed in Aluminum Housing. Bronze Gear. Hardened Worm, Input Shaft 1/4 in. Output Shaft 3/8 in. Speed Reducer #R 161... \$3.95 Post

New Explosion Proof Motors

Underwriters approved, Class I, Group D, explosion proof motors, Westinghouse and Leland makes, heavy duty repulsion induction and capacitor types. For pumping gasoline, lacquer or use on jobs where motor is exposed to hazardous fumes or material, abrasives, dirt and dust. All 5/8" shaft, 1750 RPM.

No. EP-25, 1/4 HP, 110/220V, 60 cy., 1 ph. \$23.50
No. EP-33, 1/2 HP, 110/220V, 60 cy., 1 ph. \$28.50
No. EP-333, 1/2 HP, 220 volt, 60 cy., 3 ph. \$32.50
No. EP-32, 1/2 HP, 32V, direct current \$33.50
No. EP-115, 1/2 HP, 115V, direct current \$37.50
No. EP-230, 1/4 HP, 230V, direct current \$24.50
No. EP-233, 1/2 HP, 230 V, direct current \$27.50

All prices F.O.B. Chicago
C. MARSHALL SALES
3546 W. Fullerton Ave., Dept. P-5, Chicago 47

Volume Blowers for Heating, Ventilating, Exhausting

Blowers for forced drafts, heating boosters, exhausters, coolers, dryers and dust collectors, 110 volt A.C., 50/60 cycle motors.

*Midget Blower: 5 CFM 2 in. Wheel... \$ 5.95
*50 CFM Blower: 3 inch Wheel... \$ 9.75
*75 CFM Blower: 4 inch Wheel... \$11.25
*250 CFM Blower: 5 inch Wheel... \$22.50
*600 CFM Blower: 6 inch Wheel... \$38.50
*1000 CFM Blower: 8 inch Wheel... \$52.00
*1500 CFM Blower: 9 inch Wheel... \$72.00

*These Blowers with Motors shipped Post Paid. Larger sizes are F.O.B.

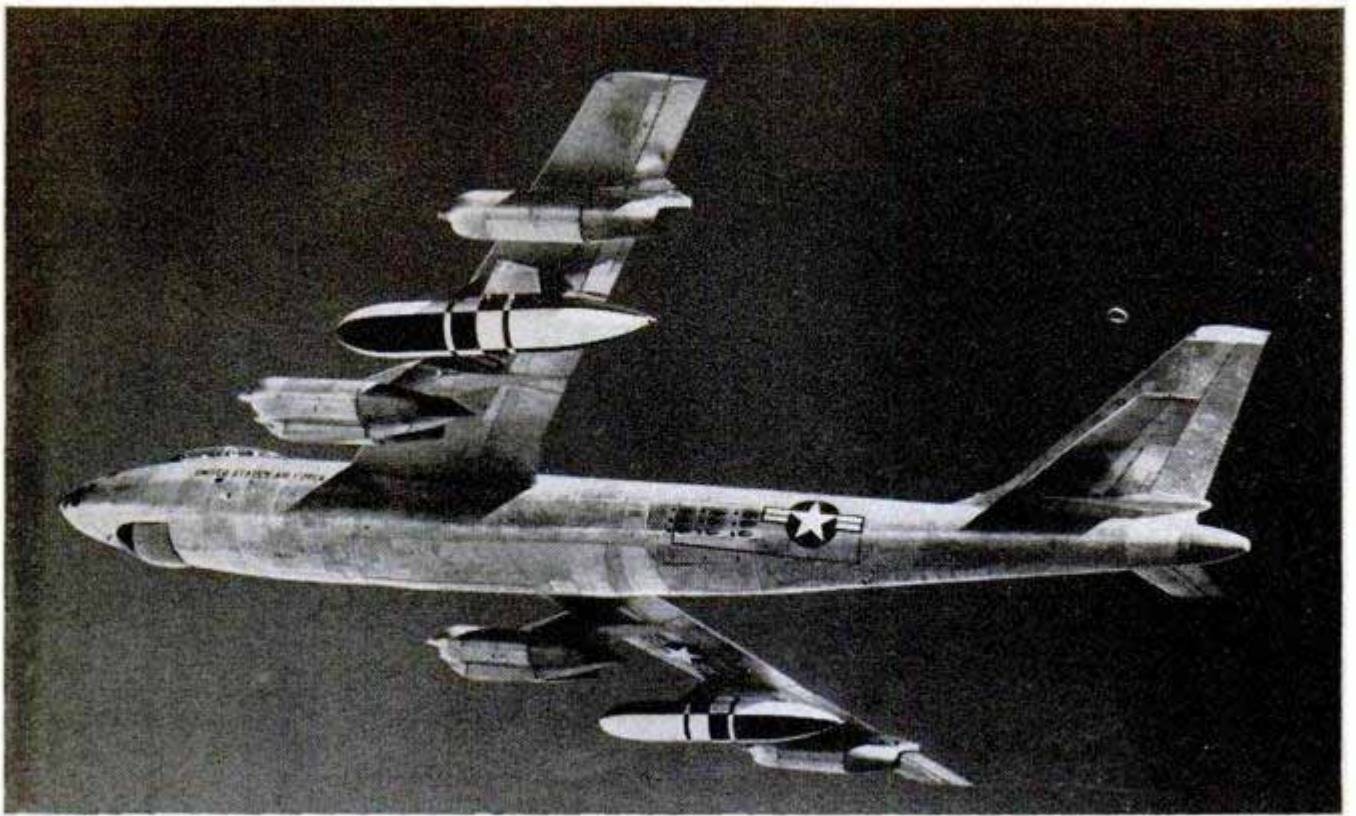

External Fuel Tanks Increase Range of Fastest Bomber

Huge streamlined fuel tanks suspended under each wing give the new B-47, "world's fastest bomber," greater range than its predecessors. The tanks, largest ever mounted on an airplane, are jettisoned when empty.

Combat potential of the sleek Stratojet is further heightened by new General Electric engines which develop a 5800-pound thrust each, 600 pounds more than that of older B-47 engines.

White House Weathermaker

Comfort of the President and his household will be assured by a new electronic control panel which regulates temperature and humidity in the White House. The complex board monitors the action of 106 thermostats in the modernized executive mansion, which is said to contain the most elaborate year-round air-temperature system ever installed in a residential building. Conditions can be checked from the panel and proper changes made.

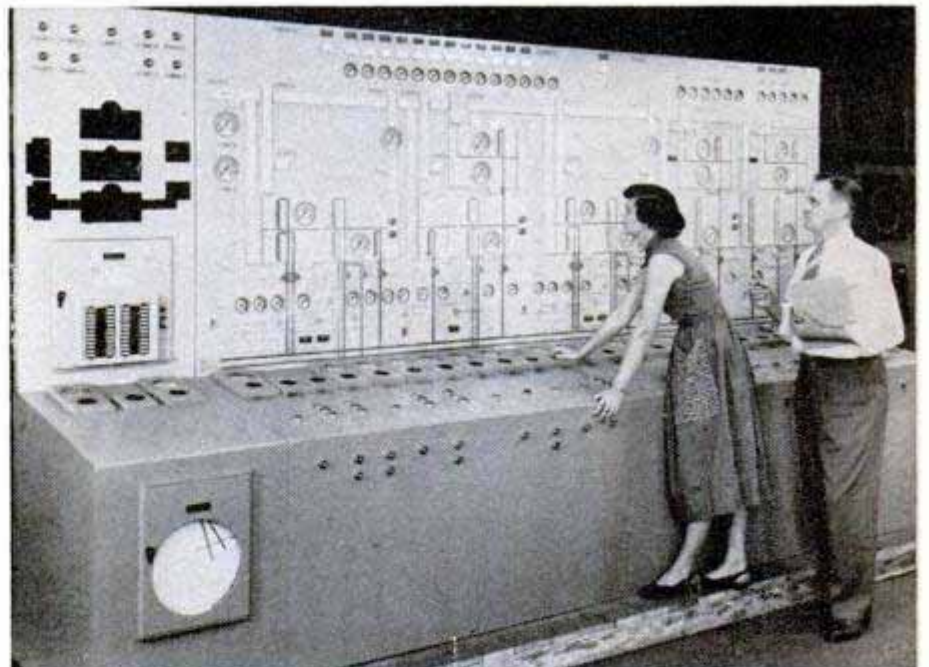

Sulphuric-Acid Treatment Quickly Aids Alkali Soil

Sulphuric acid has proved a fast and effective treatment for soils too high in alkali for plant growth. Experiments by Prof. Roy Overstreet, soil chemist at the University of California at Los Angeles, re-

vealed good yields the first season. Sulphuric acid produces water-soluble sodium compounds in alkali soil to replace the sodium salts which make the soil sticky and prevent water from percolating through.

BUY DIRECT - MASTER MECHANIC - UP TO 85% DISC.



Portable LIGHT PLANT
PUSH BUTTON START
 500-700 watts 110-120 v. — 60 cyc. A.C. Powered by a sturdy dependable easy starting, air cooled 1 3/4 hp. gas engine. No wiring necessary. Just plug in and operate. Plenty of current for any oil burner, freezer, brooder, pump, emergency lights, etc. which require up to 700 watts. Ideal for Civil Defense, Fire Depts; trailers & camps. Complete with Voltmeter and built-in winding to charge 6 v. auto batteries. Wt. 85 lbs. Fully guaranteed. Be prepared if war or storm knocks out power lines.
 Reg. \$275.00 value **\$143.50**
700-800 Watt Plant (Item 44)
 Same as above but greater output. **\$169.95**
1000-1200 Watt Plant (Item 45) same as Item 24, but larger generator & engine **\$199.50**

GIANT 2000-2500 WATT PLANT
 (Item 31) 110-120 v. 60 cyc., A.C. Absolutely the best made—exclusive dynamically balanced armature; heavy windings develop up to 5000 watt overload for motor starting. Skid-mounted — portable. Powered by easy starting Briggs or 6 hp. Wisconsin engine—complete with all accessories; engine easily disconnected for other uses. Big outlet box, voltmeter, no wiring necessary. Ample current for all purposes. Factory warranty and instructions included. Wt. 220 lbs. Reg. \$585.00. Special at... **\$299.50**
 With Electric Self Starter (Item 179) \$359.50
GENERATOR ONLY and control box **\$169.50**
 Drive it with your engine or tractor.
TRANSFORMERS (Item 197) Convert 110 v. A.C. to 220 v. Capacity 2 kva. Simple hook-up. Regularly \$55. Our price—when purchased with light plant..... **\$27.50**
 Purchased separately \$34.50.

3000-3500 WATT PLANT
 (Item 198) 110-220 v.—60 cyc. A.C. with Wis. Engine, push button start. **\$399.50**
 Wt. 370 lbs. Heavy duty **\$239.50**
 Generator only for belt drive, Wt. 115 lbs. (Item 198A).....

HI-LINE 6000 WATT PLANT
 (Item 162) Push Button Start, 115-230 v. 60 cycle A.C. A brute of a power plant with a rugged 13 hp. Wisconsin engine. Plenty of electricity for ranges, water heaters, freezers, pumps, machinery, etc. Affords both 110 and 220 volts. Ideal where heavy current is needed. Wt. 590 lbs. Easily worth \$995.00. With self starter. **\$645.00**
 Factory Spec.
 Generator and control box only, belt driven. Use your engine or tractor. **\$345.00**
 Wt. 240 lbs.
Buy Wholesale—Direct From Factory—World's Largest Direct Sellers of Light Plants.
 You can pay more — but you can't buy better

STANDBY POWER CONTROL
 (Item 207) For hospitals, radio stations, fire depts., etc. Automatically starts light plant when power fails. Available for all our plants. From \$59.50 to \$99.50.

MASTER AIR COMPRESSOR
 (Item 209) High pressure type for large volume of air for heavy duty service. For paint spraying, inflating truck and auto tires, greasing, and the hundreds of other jobs done by compressed air. Piston type. 2"x2" compressor with built-in air filter, master built with hi-strength alloys and precision bearings. Stainless steel tank, 12" x 24", 2100 cu. in. cap. Safe up to 500 lbs. Equipped with automatic switch that starts and stops motor to maintain desired pressure (up to 150 lbs.) and check valve, safety valve, gauge, shut-off valve, 20 ft. air hose and tire chuck. Beautifully balanced on ball bearing wheels and rubber tires. Note low factory prices.
 With 1 1/2 hp 110 v. A.C. motor **\$98.50**
 With 1 1/2 hp motor **\$119.50**
 (Reg. \$199.50) (Item 209A) **\$109.50**
 With 2 hp Briggs Gas Engine (Reg. \$199.50) (Item 209B) **\$20.50**
 Compressor only (2"x2") (top quality) (Item 209C) **\$24.50**
 Larger Compressor (2"x2") (none better) (Item 209D) **\$54.50**
Giant Compressor
 (twin 2 1/2"x2") (Item 209E)
 A complete line of spray guns and air tanks available at factory prices.

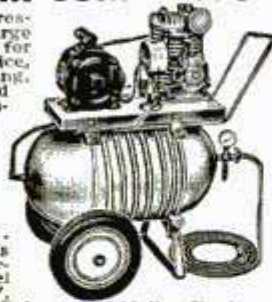

IMMEDIATE DELIVERY—ALL ITEMS HEAVY DUTY D-C ARC WELDER

Use as portable or shop welder. Up to 300 amps. Senior model. Made for years of trouble-free, continuous service. Will handle light or heavy jobs. Easily welds up to 3/4" plate using 1/4" rods. Built-in air-cooling system. Arc is easy to strike and hold, because of specially designed arc stabilizer. Hi-lo switch and dial control gives wide range of welding heats. Run welder at 2400 rpm. with tractor, jeep or 15 hp. gas engine, or 7 hp. elec. motor. Complete with instructions, guard, and double V belt or flat pulley. You can pay more, but you can't buy a better welder. Wt. 110 lbs. \$400 value at... **\$99.75**
DUAL CONTROL MODEL same as above but with built-in dual rheostat for low heat or high heat soldering, brazing, welding. Spec. **\$119.50**
WELDING KIT. Two 10 ft. leads, welding helmet, electrode holder, ground clamp. Sold only with welder at... **\$10.50**

EXTENSION CORD
 (Item 16) 40 ft. heavy duty, made of specially insulated No. 14 2-conductor wire. So tough that you can drive over it and yet flexible and easy to handle. Resists oil, grease or water. Extends electricity up to 400 ft. without voltage drop. Use indoors or out. Complete with heavy rubber plug and outlet. Wt. 2 1/2 lbs. Usually \$4.50—Special 40 ft. **\$1.99**
 Comb: 2-40 ft. and 1-20 ft. (total 100 ft.) **\$4.95**
 100 foot length (one piece)..... **\$4.85**
WIRE ONLY (Item 50) No fittings, 100 ft. **\$4.00**

HEAVY DUTY POWER CABLE
 #12-2 Cond.—stranded, very flexible, rubber covered, special outside conductor for grounding power tools, etc. Finest heavy duty power cable made. U.S. Surplus.
 50 ft. (Wt. 8 lbs.) Item 199 **\$6.95**
 100 ft. (Wt. 16 lbs.) Item 200 **\$12.95**

79 Pc. CARPENTER'S TOOL SET
 Professional quality. A complete set of Master Mechanic tools featuring the famous Stanley brand. All neatly arranged in a beautiful sturdy 32" hvy. steel tool box. Set includes: Powerful 1/4" Electric Drill (optional), 3 Stanley Wood Chisels, 2 1/2" Spring Steel Saw, Steel Bench Vice, Tin Shears, 9 Drill Bits, Sharpening Stone, 8" Plane, 24" Stanley Level, Hack-saw, Stanley Rule, 5 Double End Wrenches, 13 Ass'd. Hack-saw Blades, Stanley Hand Drill, 10" Vise Wrench, Comb. Square, Stanley Hammer, Stanley Ratchet Brace, Coping Saw, 7 Coping Saw Blades, Steel Wrecking Bar, 4 Screw Drivers, Offset Screw Driver, Nail Set, 4 Ass'd. Files, 8 Pc. Allen Wrench Set, Auger Bit Set and many other tools. Worth at least \$150.00 if purchased separately. Save cost of tools on one or two jobs. A terrific value.
 Wt. 41 lbs. Item 242 (without Electric Drill) **\$39.50**
 Wt. 45 lbs. Item 242A (incl. Electric Drill) **\$49.50**
 Wt. 15 lbs. Item 243 (Tool Box only) **\$8.95**

CARRY-IT COMPRESSOR
 A hi-pressure (up to 125 lbs.) 2x1 1/4" Air Compressor powered by a 1 1/2 hp. capacitor motor. Built-in 500 cu. in. steel tank tested to 400 lbs. Perfect portable air supply for paint spraying, insecticides, tire inflation, etc. Complete with safety valve, gauge, shut-off valve and all fittings. Definitely superior to outfits selling for \$100.00 or more.
 Item 226. Wt. 55 lbs. **\$59.50**
 Factory Special **\$45.00**
 Item 226A. Wt. 30 lbs. Same unit without Motor. **\$45.00**
 Item 241. Accessory Kit—20" Air Hose, Tire Chuck and hi-quality paint spray gun. **\$10.00**



MASTER GARDENER \$119.50

It's a lawn mower
 It's a power sickle
 It's a cultivator
 It's a plow
 It's a Snow Blow
 It's a rotary tiller
 It's a bulldozer
 Here at last is a power unit that does everything at a price that can't be matched. Built-in power takeoff to drive pumps, saws, generators, etc. Safety clutch—can't burn out. More versatile and efficient than tractors costing twice as much. Basic self propelled 2 hp tractor with Briggs or Clinton famous engine. Only. **\$119.50**
 Quickly converts your hand mower to power
 Item 208
 Lawn mower hitch (utilizes any hand mower) **\$ 4.50**
 Snow Blow **\$29.50**
 Freight prepaid to most areas. Easy payment plan available.



COMMANDO BIKE MOTOR

(Item 90)
 New, super-modern 1952 model. This job is the Cadillac of all bike motors. Sensational Auto-Clutch prevents killing motor at each stop. Also selects proper ratio on hills. Mounts behind and drives rear wheel with Dynarotor. Free Wheeling lever permits pedaling if desired. Rear Mounting eliminates fumes, heat, dirt, and hard steering. Easily installed in 15 minutes with home tools. Sturdy, trouble-free, easy starting, light weight. Airplane type engine; up to 150 miles per gallon. Fully guaranteed for fun or profit. Ideal for deliveries, paper routes, messenger service, etc. Ride to work and save. Dealer inquiries invited.
 The Commando Captain, 1 cylinder 1 1/2 hp. **\$99.75**
 The Commando General, 2 cylinder 3 hp (Item 91) **\$125.00**
 All Commandos shipped prepaid in U.S.

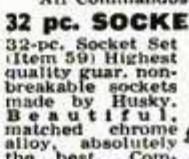

32 pc. SOCKET SET
 (Item 59) Highest quality guar. non-breakable sockets made by Husky. Beautifully matched chrome alloy absolutely the best. Complete range of 21 sockets from 1/4" thru 7/16" in 1/4" drive and 7/16" thru 1-1/16" in 1/2" drive; 2 extensions, reversible 1/2" ratchet, adaptor bit, slide head, all angle coupling, 2 end wrenches, 1/4" speeder handle and sturdy metal tool box. For prof. mechanics who want the best. Wt. 11 lbs. Easily worth \$41.50. While they last. **\$16.95**

45 pc. SOCKET SET
 (Item 205) Contains a complete set of sockets in 1/2" drive, 3/8" drive and 1/4" drive, plus all necessary extensions, handles, speeders, reversible ratchets, etc.; all uncond. guaranteed against breakage. Beautifully matched chrome thin wall alloy sockets in a sturdy handsome steel tool box. Wt. 17 lbs. List Price \$62.90. Factory Special. **\$26.95**

3/8" DRIVE 15 Pc. SOCKET SET
 (Item 201) Same top qual. as above—includes 7 sockets 3/8" thru 3/4", reversible ratchet, extension, flex. handle, cross bar, 3 punches, metal tool box. Wt. 5 lbs. List Price \$18.96. Our Spec. **\$9.95**

HYDRAULIC JACKS
 (Item 208) Heavy duty, precision built, smooth, positive acting with built-in relief valve. Hi-Lift with screw extensions. Govt. surplus at a fraction of orig. cost. (Handle included.)
 1 1/2 ton (Item 208) **\$6.45**
 Wt. 11 lbs. **\$9.45**
 3 ton (Item 208A) **\$9.45**
 Wt. 15 lbs. **\$11.45**
 5 ton (Item 208B) **\$11.45**
 Wt. 17 lbs.

HEATING & VENTILATING FAN

(Item 10) Easily installed in furnace pipes. Forces even heat to all rooms. Over range, removes kitchen smoke and odors. Powerful continuous duty motor, 110-120 v. A.C. Quiet, super efficient fan moves huge volume of air (400 to 600 c.f.m.) 8" Fan, wt. 5 lb. **\$6.35**; 9" Fan, wt. 6 lbs. **\$7.45**; 10" Fan, wt. 7 lb. **\$8.45**; 12" Fan, wt. 8 lbs. **\$9.45**
 Heavy-duty 12" fan, enclosed motor, suitable for spray booths, restaurant exhausts, poultry houses, and other difficult applications. Wt. 12 lbs. Item 10D. **\$12.95**



All items brand new. Prices f.o.b. Chicago area. 10 day Money back guarantee. Send check or M. O. **MASTER MECHANIC MFG. CO., DEPT. 75A Burlington, Wis.**

Build this Beautiful LAWN FURNITURE YOURSELF

NO EXPERIENCE NEEDED

Smart Exclusive Styles By John Bergen
... Four Big Plans Drawn to Scale ...
Complete Material List

Now with just a few spare time hours and some inexpensive materials you can build gay comfortable lawn furniture that will make your garden more attractive ... more comfortable and more fun this summer.

No need to pay a small fortune for lawn furniture when you can build your own and save over 50% of what it would cost you already built!

Popular Mechanics four big drawn-to-scale plans show every step to follow. Complete material list tells you just what sizes of wood to buy so there will be no waste.

Make your lawn and garden the finest and most attractive on your block by building this smartly styled furniture. Enjoy real comfort during those hot summer months by making your garden your outdoor living room. Send today for your plans and material list. Complete set of four plans only \$2.00. Complete satisfaction guaranteed or your money refunded.

**POPULAR MECHANICS
PRESS**
200 E. Ontario St.
Chicago 11



PORCH
CHAIR

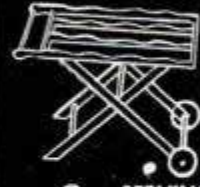

SERVING
CART



GARDEN
LOUNGE



PICNIC
TABLE



PORCH
GLIDER



ADIRONDACK
CHAIR



Four-Legged Crutch

Providing firm, stable support, a four-legged walking aid is said to speed recovery for persons with broken hips or legs and other disabling injuries. Its 18-inch handle bar is about waist high so the user can lean on it heavily without discomfort. The device adjusts to various leg spreads, making it easy to handle in cars, busses or crowded trains. Made of tubular steel, the walking aid weighs only a little more than six pounds.



Plastic Caps Are Designed To "Sterilize" Telephone

Fastened to both the earpiece and mouthpiece of a standard telephone handset, two plastic caps are said to make the instrument germfree. A felt washer, concealed inside each cap, is saturated with a germicide which destroys germs that might collect on the telephone during use. The caps come in several colors and can be quickly slipped over the telephone.

Make Money
SELLING
Eshelman
TRACTORS
and DOING
GARDEN
WORK

SNOW PLOW
PLOWS
CULTIVATES
HARROWS
HAULS
SPRAYS
SAWS
DOZER
MOWS
CUTS
ROLLS
TILLS
RAKES

ESHELMAN



FOR BETTER
LAWNS

and GARDENS
also POWER MOWERS
and RIDING TRACTORS
Women can operate it.

Also Power Re-
verse Free Catalog.
Write ESHELMAN,
Dept. 311
119 Light St.,
Baltimore 2, Md.

Say You Saw It in Popular Mechanics

300-Power Import MICROSCOPE \$14.95

LABORATORY MODEL Postpaid

Triple revolving turret has 100, 200 and 300-power lenses! No frills, just excellent optical qualities, delicate adjustment, solid construction. Its quality and price astounded biology instructors. A lifetime bargain for students, schools, labs, research, amateurs. Anyone can now own one! (Performance cannot be duplicated for \$75.00)

FEATURES: Fine micro adjustment, adjustable plano substage mirror. Dovetail hardwood case included free. If you are not amazed at its quality, send it back in 10 days. Your money refunded immediately. Send check, cash or M.O. for \$14.95 ppd. (Send \$5.00 deposit for C.O.D.'s) Free catalog. Money back guarantee.



NAVY TYPE MARK XX 20 POWER TELESCOPE

\$9.95



\$30 value. Fine optically ground achromatic lenses, fully coated. Same power as standard artillery observers spotting scope. Precision all metal construction. Extends to 15 1/4 inches. Rust and salt-spray resistant. A valuable ship and boat owner's possession now at a price everyone can afford! Shipped in fitted hardwood case. Postpaid \$9.95 Money-back 10-day guarantee on all items. Send check, cash or M.O. Free catalog on request or included with order. Calif. residents add 3% state tax.

the **AKRON** 4400 SUNSET BLVD. OPTICAL DEPT. 7-P
LOS ANGELES 27, CALIF.

SUNGLASS SPECIAL

Genuine ARMY AIR FORCES

SUNGLASSES
HERE'S THE REAL MCCOY!

ARMY AIR FORCE 6 base, Precision Polished & Ground, Glare-free color lens with leather case to be attached to belt. Gold plated adjustable frame. Pearlized sweat bar and nose pads. **NOW ONLY 475**

AIRFORCE TYPE SUNGLASS
Ground & polished processed glass lenses. Gold plated frame with Pearlized sweat bar and nose pads. Cable ear pieces, simulated leather case. **ONLY 195**

AVIATORS (AN-6530) WINDPROOF & DUSTPROOF GOGGLES
Chamois lined, rubber covered frames. Inter-changeable, GROUND LENSES in clear or green. Has non-fogging breathers in frame. Adj. nose bar. **USED 279**
Ideal for flying, cycling, etc. **NEW 395**

GO-1 GOGGLE KIT NEW! U.S. NAVY
Has soft sponge rubber frame. 4 Polaroid lenses, 2 green; 1 red; 1 clear. Perfect for racing, cycling, etc. **SPECIAL 89¢**

EYE LOUPE 99¢
An indispensable aid in fine inspection work. Available in 2 1/2, 3, 4 & 5 power. each

9 PIECE DRAWING SET
Suitable for the architect, student, draftsman, artist etc. Contains 9 separate pieces including: one 5 1/2" compass with pen & pencil ports; one 5 1/2" divider; one each 3 1/2" bow divider, bow pencil & bow pen with wheel adjustment & reversible needle point; one 4 1/2" ruling pen with extra handle; capsule of extra leads. All in a 2 flap, velvety lined pocket book case. **598**

50 POWER POCKET MICROSCOPE
A real Palley Bargain. Extremely sharp 50 power magnification. Ideal for students, geologists, mineralogist! etc. **349**

SPECIAL VALUE 20 POWER TELESCOPE
A top quality, imported instrument. Has coated lenses ... bright, clear image and wide field of view. **895**
For all 'round use.

ORDER BY MAIL TODAY
1952 CATALOG 230 PAGES
Fully illustrated 1000's of WAR SURPLUS, Factory Close-Outs and General Merchandise Values. For the mechanic, sportsman, hobbyist, home owner, etc. BIG SAVINGS on clothing, housewares, hardware, foam rubber, hand & power tools, outdoor equipment, plastics, gadgets & a huge stock of hydraulic supplies.
Send Only 50¢ (for handling & mailing)

SAVE UP TO 85% IN WAR SURPLUS

AIR CORPS RUBBER BOATS
Genuine USAAF equipment and made to Gov't specifications. An ideal boat for ocean, lake or pool. Safe, lightweight and easy to pack. Thoroughly reconditioned and ready for use.
1 MAN **1895** 5 MAN **3995** 7 MAN **5995**
PADDLES **59¢** COLLAPSIBLE OARS **295 EA.** AIR PUMP **395**

100% WOOL FILLED SLEEPING BAG
The bag with everything you desire in comfort & convenience. Square box construction. Outer covering is vat dyed, Forest Green, combed Zelon treated, poplin, Water-proof - with heavy woven lining. Insulated with weather-strip. Has detachable head flap and side closing. 100" Talon zipper. Double mattress pocket. Two bags may be zipped together. Overall size 36" x 80". **1995**
34.00 VALUE

AF FLIGHT COVERALL
Lightweight, yet warm and water repellent. Has 6 convenient pockets - (2 breast pockets & 4 leg pockets) Each leg has zipper closure to permit putting on over shoes or boots. Front has zipper closure. Back is bi-swing with 1/2 belt for snug fit adjustment. Originally designed as AAF Flying Suit. Re-issue in good condition. **895**

HUNTING KNIVES GENUINE G.I. EQUIPMENT
Has a 6 inch, polished Vanadium blade & Handle made of leather and fibre discs. Complete with tanned leather sheath. Only **198**

16 POCKET VEST
The ideal jacket for the Rifleman or Hunter. Has 14 individual, outside pockets for shells, glasses & other accessories. 2 large (11" x 8") inner pockets, a leather holder for knife, gun or tool. Sturdy, yet lightweight with tie-straps at back for adjustable fit. **349**

RADIO ANTENNA REEL
For tuning beam antenna. Powered by 1/8 HP, 24V, GE motor, engaged to gear reduction only when electrical contact is made. Operated in either direction. Ideal for auxiliary power take-off. 150 RPM at take-off. Used for opening & closing doors etc. A tremendous value. **875**

PRESSURE TANKS
G-1 - Stainless steel, shatterproof & rustless. Has reinforcing ribs & is pressure tested to 400 PSI, with high safety factor. Has 1/4" pipe ports in both ends. Ideal for use as ocean or lake buoy, underwater fishing, diving, painting, cooking or spraying. **12 1/2" x 24" ONLY 1095**
D-2 Tank- 500 cu. in. cap. **395**
A-4 Tank- 104 cu. in. cap. **195**

NEW! EMERGENCY LAMP 325
Be ready for that "emergency" or power failure. Self contained, battery operated. Has 2 bulbs in reflector - glass lens. Off-on switch - aluminum body. Completely lights average room. Ideal for camping trips, cabin, tents, garages, etc. Price complete (without batteries).

ALNICO SPEAKER
Permanent magnet type. 4" diameter. 2 wire hook-up. Ideal for small radios, inter-com systems, test equipment etc. **249**

MICROPHONE
Telephone type, highly sensitive with excellent, Clear tone. This was the Signal Corps favorite. An ideal instrument for the radio "hon" and professional recording studio, broadcasting, home recording, public address, etc. Complete with cord & plug. **329**

NAVY Sealed Beam LAMP
U.S. NAVY portable search-spot light Has pistol grip and aiming sight. Makes an ideal search, spot or emergency light for auto, boat, etc.
12V. light - 4" lens **429**
24V. light - 4" lens **479**
Set of 3 filters: red, green, amber (specify type lamp) **99¢**

EXACTOR HYDRAULIC REMOTE CONTROL MASTER & SLAVE
Consists of two units. Designed to operate controls on boats, machinery, engines, motors, etc. without need for rods, cables, pulleys, etc. When connected with 1/2" tubing & filled with oil they act as a precision, remote controller. When Master handle is moved, Slave arm responds in exact motion. Range is 0 to 90 degrees. Combination Master & Slave for **4250**

LEATHER BELT KITS
Made of bark tanned, top grain cowhide. Worn on your belt. Convenient & handy for carrying your small tools. Sturdy & durable. Re-inforced with rivets.
"A" - ELECTRICIANS KIT - 7 POCKETS. For tools, tape, pencil etc. **349**
"B" - RADIO & TV REPAIRMANS KIT - Has 1 large & 2 small pockets. for use by all mechanics, technicians etc. - **279**

SWIMMING BARGAINS

NEW SELF CONTAINED DIVING UNIT
Enjoy freedom of breathing & movement under water. Has self-operating, rust-proof regulator & outlet valve. 480 cu. in. compressed air cylinder allows 1/2 hour underwater. Has perfected mouth-piece, 2 flexible hoses to regulator & free-movement harness. Standard equip. with Navy. **9975**
DeLUXE Navy MODEL - 2 hour diving time. **24950**

"ARBALETE" SPEAR GUNS
Most efficient underwater gun made. Powerful, accurate, silent. Uses "crossbow" principle. Rubber powered. Has safety catch and will float when spear is released. Range 14 ft. **2495**
DeLUXE MODEL - Range 20 ft. 2 sets of elastics. **3495**

SNORKLE Breathing TUBES - Plastic with rubber mouthpiece. Allows breathing while eyes are underwater. Straight type \$1.95
CURVED TYPE - Has automatic seal when immersed. **\$2.95**

SWIM FLIPPERS
Top quality rubber. Has pebble tread bottom. Adjustable heel strap. Sizes: Small, Med Large **795**

DIVING MASK
Soft rubber mask fits over eyes. Heavy duty glass shield. Adj. headband. **395**

FLOATING KNIVES
Handy for use above or under water. Will float. Cannot be lost. Fine quality steel blade. Flat Blade **450** (B) Dagger **495**

NAVY WADING SUIT
Makes surf and stream fishing a pleasure! Ideal for ranchers, oil fields or any use where necessary to protect body or clothes from moisture, silt, muck etc. Made of rubberized canvas. Has vulcanized seams, built-in rubber gloves and boots. Sizes: Small, Med., Large. **795**

CONVERTED MODEL - Same as above. - Converted to waist length with bib & suspenders. **995**

NYLON FISHLINE STRONG - LIGHTWEIGHT - NYLON FISHING LINE. ROT-PROOF AND WATERPROOF . . .
1500 ft. 10 lb. Test **\$1.59**
750 ft. 45 lb. " **\$3.29**
750 ft. 50 lb. " **\$3.50**
300 ft. 72 lb. Braided **\$3.79**
300 ft. 100 lb. Test **\$3.95**

AMAZING BERNZ-O-MATIC TORCH
Makes the old "blow-torch" obsolete. Here is a self-contained fuel & burner unit that does a job where intense heat from a concentrated flame is needed. Absolutely SAFE! (ICC approved). High quality steel lightweight - replaceable fuel cyl.
PENCIL FLAME TYPE - with 10 hour cylinder & choice of one burner **ONLY 695**
EXTRA FUEL CYL-INDERS - each **195**

Palley SUPPLY CO.
NEW MAIL ADDRESS
2263 E. VERNON AVE.,
Dept PM-7
LOS ANGELES 58, CALIF.

Order From This Ad. Pay by M.O. or check. P.O.'s, accepted, from D&B firms. Deposit with C.O.D.'s. All Prices FOB Los Angeles.

SAVE 70%

SACRIFICE SALE!

**MUST RAISE CASH!
CREDITORS DEMAND PAYMENT!**



FREE

German made **KLAROVIS** 3 X 40 mm SUPER POWER with glasses of any watch. Compare to any domestic binoculars claiming 18 mile ranges and selling to \$9.95. Yours to keep even if you return watch for refund!

Frankly, we're in a tight fix! Thousands of 17 jewel precision-built watches came in too late for last Christmas and far too early for the next! Our creditors won't wait! They demand payment NOW. Our misfortune is your lucky break! Buy now! Save up to \$70.00 on one watch!

10 DAY FREE TRIAL

Examine... check... appraise any THORESEN watch for 10 days at no risk whatsoever! Full price back if not delighted. **SEND NO MONEY**—Pay price plus postage on arrival. Or send check, cash or money order for quick, prepaid delivery and **SAVE MORE!** Given: COBRA Expansion band with every watch, also instructions, Guarantee Certificate and gift shown. Rush coupon now! Prices subject to rise after present over-stock is exhausted. References: Jewelers Board of Trade, Better Business Bureau or any national bank. Buy with confidence! Thoresen's is a reliable, nationally known firm. Address:

THORESEN DIRECT SALES, Dept. 6G-100

131 WEST 33rd STREET

NEW YORK 1, N. Y.

FAMOUS RECIPRO-REGISTER CHRONOGRAPH 1995

TIMES: SPORTS • PHOTOGRAPHY • LAB WORK • SHOP WORK, ETC.

This is the **Recipro-Register Chronograph**—the BEST brand available anywhere in the world today! Thousands of proud owners paid much, much more because this is the **Prince** of modern watches—the last word in magnificent styling. Case made of Triple Chroming with lasting **Stainless Steel** back! Precision engineered in the highest traditions of Swiss craftsmanship! A smart, slim unusual timepiece of functional beauty. It's the **"CHRONOGRAPH THAT REMEMBERS!"** Freezes result while movement continues to keep time!

CHECK FEATURES WITH \$71.50 WATCHES!

- 5 Multifunction Dials
- Luminous No.'s & Hands
- Hairline Sweep Second
- Unbreakable Crystal
- 17 Jewels
- Chrome & Steel
- 5 Hands
- Incabloc
- Split Second Calibration
- 2 Clutch Operation
- Anti-Magnetic
- Shock Protected

DON'T PAY \$71.50 or more to a credit jeweler around Christmas time! Get the Genuine, Original **RECIPRO-REGISTER** at our **SACRIFICE PRICE** for cash—\$19.95 plus 10% tax, total **\$21.95** (while stocks last). **YOU SAVE OVER \$41.00.** Given: Nationally advertised \$4.95 **COBRA** expansion band, gift case, instructions and our written guarantee as well as German made **KLAROVIS** field glasses! Don't lose this bargain of a lifetime—send **TRIAL COUPON**—NOW! Check Number **233**.



17 JEWELS • EXTRA-THIN AND MODERN AUTOMATIC WATCH 14.95 plus tax

The month, date, weekday, hour, minute and this Swiss engineering triumph! An impressive, very thin timepiece of real excellence! Date Changes Automatically! Gears are precision coupled. Patented design for smooth long-life operation. Metals make for smooth long-life operation.

SPECIAL QUALITY FEATURES

- 17 Jewel Swiss movement
 - Stainless Steel Back • Unbreakable Crystal • Thin, Streamlined Design • Luminous Hands & No.'s • Rugged Construction
- Compare with other calendar watches selling for \$59.50, and if you are not thrilled with its performance and rich, modern appeal, return for full price refund! While they last, we're sacrificing them at only \$14.95, plus \$1.50 tax, a total of only \$16.45. Where, oh where can you get a value like this? Better rush that Coupon now! Order by number **243-C**.



17 Jewel Incabloc WATER & SHOCK Resist Watch 12.95 plus tax

favorite with Marines, Sailors, Soldiers, Aviators and sportsmen! Drop it, wet it, jolt it at work or play! It actually runs under water! This is no ordinary watch—it is a splendid timepiece made according to exacting standards in reputation big Swiss factories. Thousands sold at much higher prices.

COMPARE WITH WATERPROOFS AT \$59.50

- Incabloc Protected • Shock Absorbing • Water Gasket • 17 Jewels—Accurate! • Luminous Hands & No.'s • Unbreakable Crystal
- It's smaller, thinner, more accurate, better made than many competitors watches selling for much more. **DO NOT CONFUSE** with cheap models! This is a guaranteed quality timepiece with money refunded at once if not satisfied! Best of all, you save \$46.55 during our sensational Sacrifice Sale! Only \$12.95 plus \$1.30 tax, total: \$14.25. Quantity limited! Order at once by number **224**.



UNCONDITIONAL GUARANTEE

EXCLUSIVE OF PARTS!

FREE repair service ANYTIME if needed by skilled watchmakers—for the **LIFETIME** of this firm. No cost ever for "handling," adjustment or service. **FREE** annual oiling and timing service. **THORESEN** makes **LIFETIME FRIENDS!** Remember: If you are not satisfied with your purchase after 10 day trial, return for full price refund. Our written Guarantee Certificate enclosed with every watch!

SEND NO MONEY! Mail Coupon now for home trial!

THORESEN DIRECT SALES, Dept. 6G-100

131 West 33rd Street, New York 1, N. Y.

RUSH watches) checked on 10 DAY TRIAL. Send following **FREE** of extra cost with each and every watch purchased: 1. Reg. 4.95 COBRA Band. 2. KLAROVIS German Glass. 3. Guarantee Certificate. 4. Gift Box. 5. Instructions.

- Payment enclosed. Send prepaid. Send C.O.D., plus post.
- CHECK WATCH DESIRED.** (Prices shown here are tax paid.)
- No. 233 CHRONOGRAPH—\$21.95 No. 224 INCABLOC—\$14.25
- No. 243-C CALENDAR—\$16.45

You are to refund **FULL PURCHASE PRICE** if I am not delighted, keeping the "Klarovis" as your gift to me.

NAME _____
ADDRESS _____
TOWN _____ STATE _____

Which battery do you want in your car?

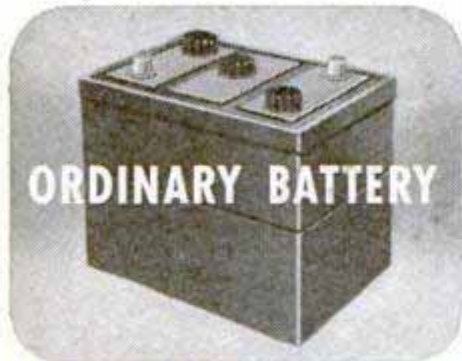

ORDINARY BATTERY

1. In ordinary batteries, small particles keep flaking off positive plates . . .

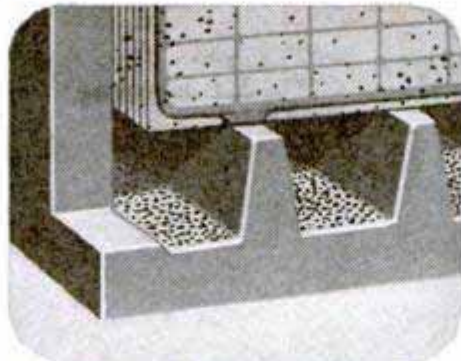

2. so ordinary design batteries must have large sediment wells at bottom of case to hold these particles.

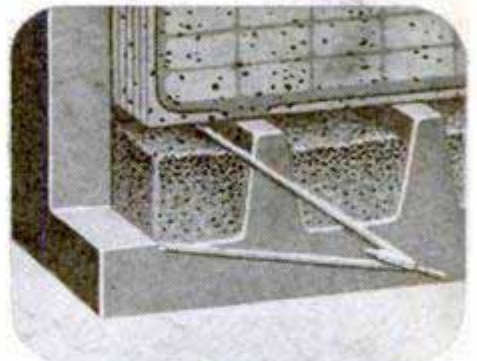

3. Even these sediment wells in ordinary batteries aren't big enough to hold flaking particles from positive plates . . .

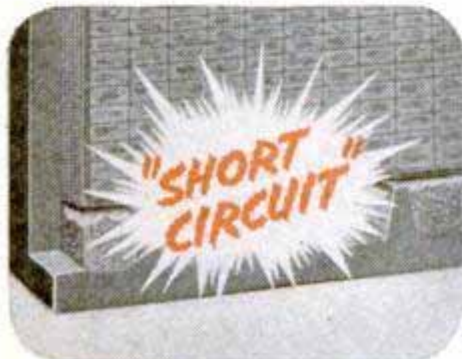

4. so particles pile up and short circuit plates, causing failure.



5. But in the Auto-Lite "Sta-ful" Battery, every positive plate has a Fibre-glass retaining mat protecting it . . .



6. to hold the active materials in place to reduce shedding and flaking.

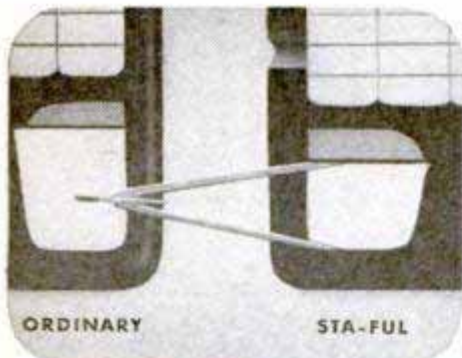

7. Side-by-side view shows that the Auto-Lite "Sta-ful" Battery doesn't need the extra space at bottom that ordinary design batteries do. So extra space . . .

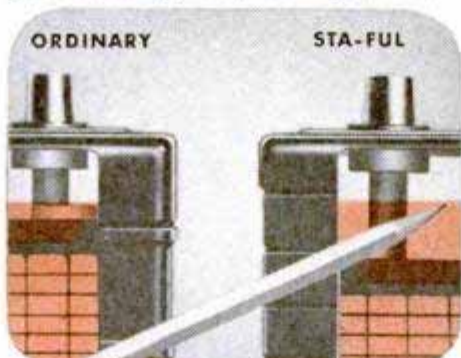

8. in "Sta-ful" Battery is moved to top where it holds more electrolyte, giving room for over 3 times the liquid reserve in the "Sta-ful" as in ordinary batteries.

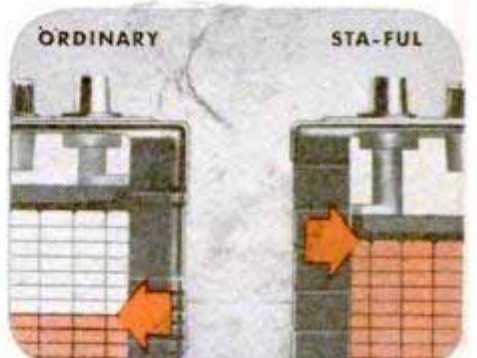

9. Here's proof of performance! Equal water evaporation shows how the Auto-Lite "Sta-ful" extra reserve keeps plates covered and active.

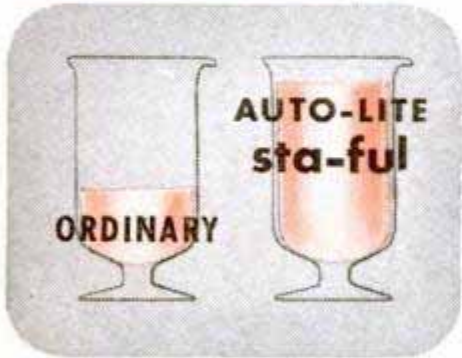

10. That's why "Sta-ful" needs water only 3 times a year in normal car use. Auto-Lite "Sta-ful" Batteries give longer life, too, in tests conducted according to minimum life cycle standards.

AUTO-LITE BATTERY CORPORATION
Toledo 1 Ohio



AUTO-LITE

sta-ful

*...needs water
only 3 times a year*

IN NORMAL CAR USE

Why did you change to Camels, ROBERT YOUNG?

*"My voice and throat
were important factors.
Camels suit my throat
and give me more
smoking pleasure
than any other
brand!"*

*Robert
Young*

SCREEN AND RADIO STAR

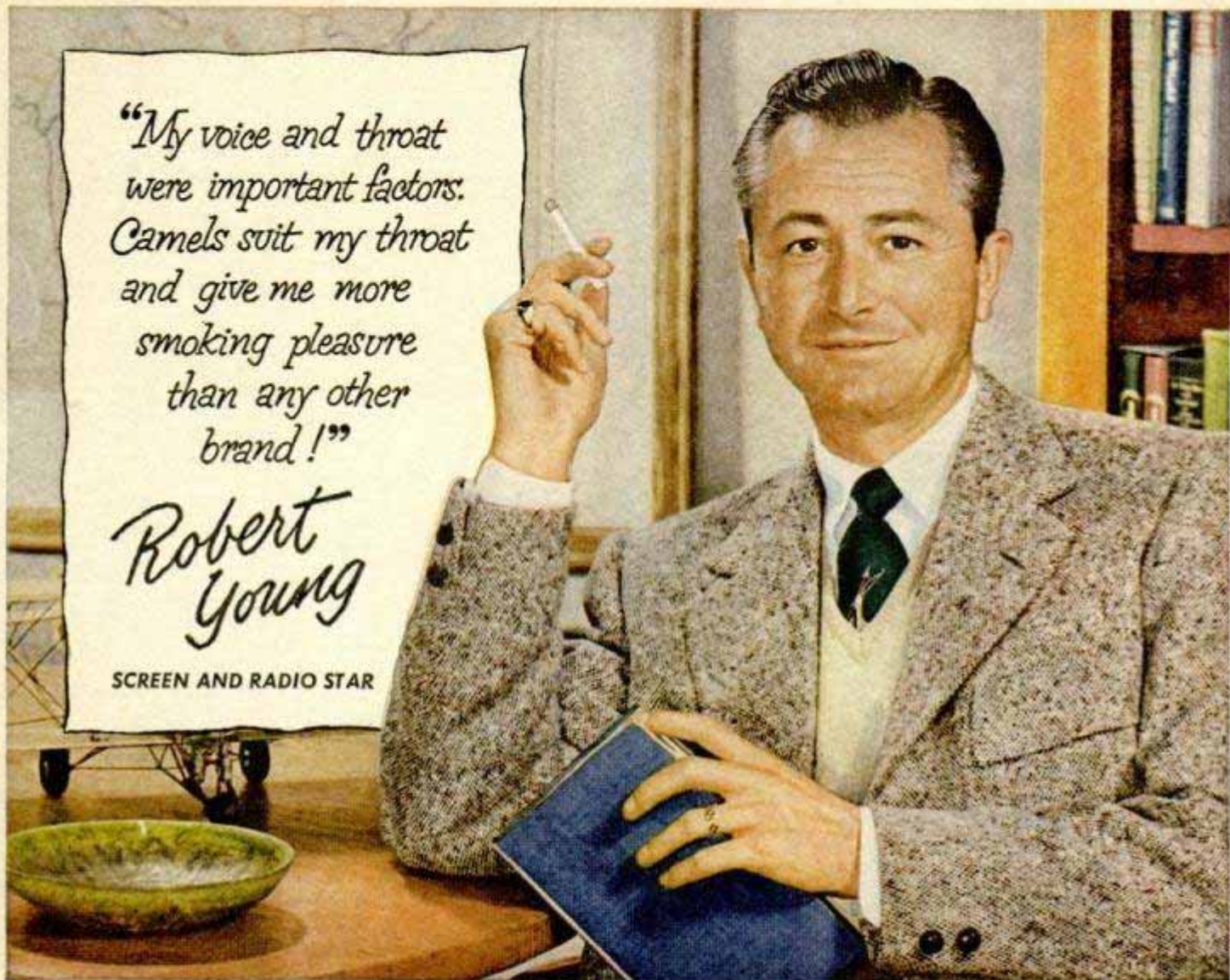

SMOKE CAMELS FOR 30 DAYS... SEE FOR YOURSELF HOW WELL

Camels agree with your throat

THE PROOF of a cigarette is in the smoking. Try Camels as your *steady* smoke for the next 30 days and see how *rich* and *flavorful* Camels are. See how *mild* Camels are... how well they *agree with your throat* — week after week!

And remember: When tens of thousands of doctors, in every branch of medicine, were asked what cigarette they smoked, the brand named most was Camel. Yes, surveys show:

**MORE DOCTORS SMOKE CAMELS
THAN ANY OTHER CIGARETTE!**



*Make your own
sensible 30-
day Camel
mildness test
in your "T-Zone"*

**— T for Throat,
T for Taste**