



POPULAR MECHANICS

MAGAZINE

YOU CAN UNDERSTAND IT

REG. U.S. PAT. OFF.



MERMAID THEATER - *page 71*

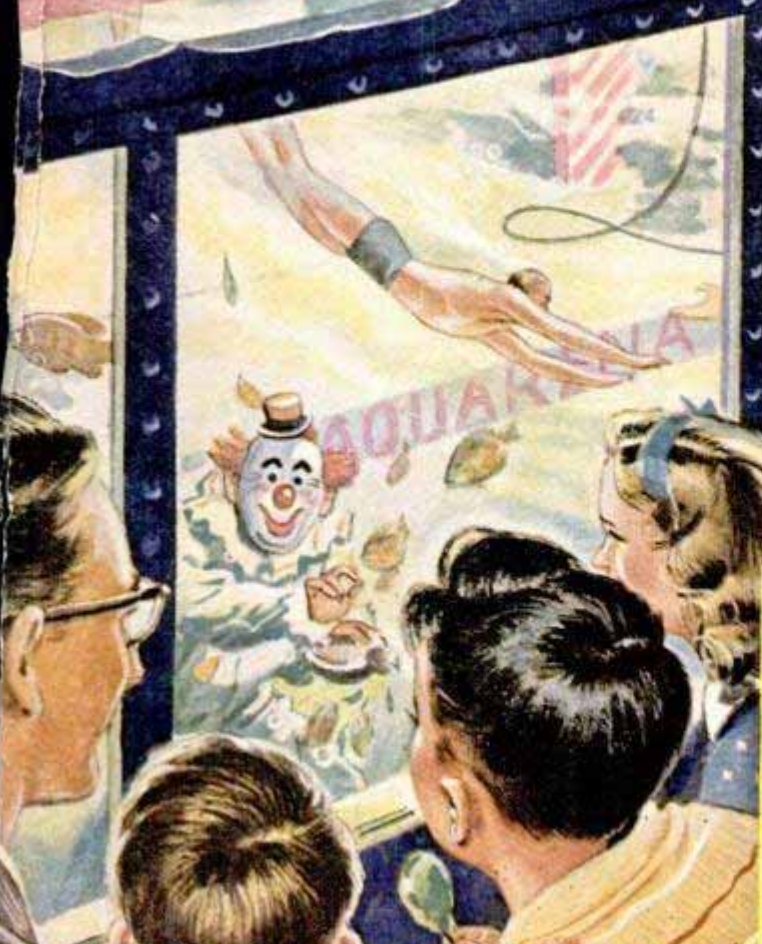

TV GOES TO THE CONVENTIONS
The Cars They Drive Are Classics
In color - America's New Superliner
For the Craftsman
How to Use Concrete at Home

EXPERTS HAVE PROVED

Auto-Lite **RESISTOR** Spark Plugs GIVE DOUBLE LIFE*

...smoother performance... quick starts... greater gas savings

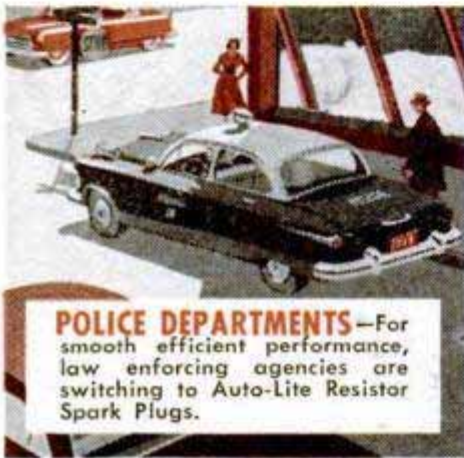

POLICE DEPARTMENTS—For smooth efficient performance, law enforcing agencies are switching to Auto-Lite Resistor Spark Plugs.



FIRE DEPARTMENTS—To get quick, sure starting, some of our nation's finest fire departments are insisting on Auto-Lite Resistor Spark Plugs.



CAB COMPANIES—Enthusiastic taxi firms report best performance in heavy city traffic after installing Auto-Lite Resistor Spark Plugs.



CAR ENGINEERS—After grueling laboratory and road tests, leading automotive engineers selected Auto-Lite Resistors as original factory equipment.



CAR OWNERS—Millions of car owners find Auto-Lite Resistor Spark Plugs give them advantages possible only in spark plugs with a built-in resistor.

EXPERTS have proved Auto-Lite Resistor Spark Plugs give smoother performance, quick starts, greater gas savings and *double life** . . . benefits important to every car owner. Discover for yourself these benefits by replacing your worn-out spark plugs with Auto-Lite Resistor Spark Plugs.

THE ELECTRIC AUTO-LITE CO.
Toledo 1, Ohio Toronto, Ont.

*Double life under equal service conditions when compared to spark plugs without a built-in resistor.



"Ignition Engineered"

AUTO-LITE

Resistor SPARK PLUGS

Auto-Lite Spark Plugs—Patented U.S.A.

The Auto-Lite Line also includes Standard, Transport, Marine, Aircraft and Model Plane Spark Plugs.

Tune in "Suspense!"...CBS Radio Mondays...CBS Television Tuesdays

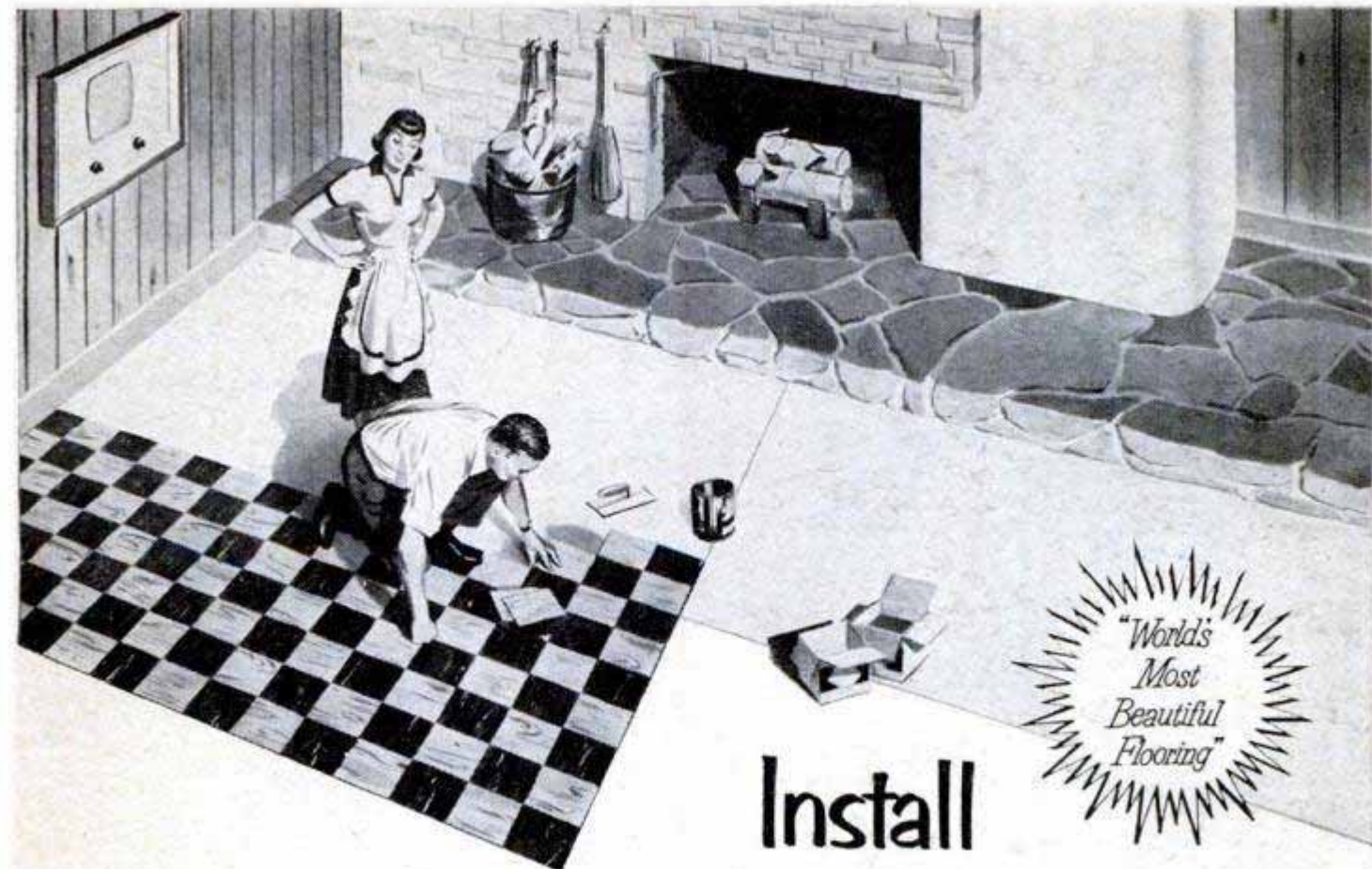

Install VINYL·TILE yourself

It's Pre-Polished! Never needs waxing!

SURPRISE! The quick, clean professional-looking job of installing VINYL·TILE that you, yourself, can do. And at such great saving, too.

You'll be delighted with the rich, warm, sunny beauty that VINYL·TILE adds to any room—*lasting* beauty because VINYL·TILE comes to you with built-in luster, resists

stains, scars, scratches, time and wear.

Best of all, VINYL·TILE comes *pre-polished*. It never needs waxing, retains its just-installed sparkle and freshness for years and years!

See VINYL·TILE — see the 24 exclusive colors—solid and marbled — at better flooring dealers', furniture and department stores.

FREE "HOW TO INSTALL"

Booklet and color samples show how easily, how economically you can install VINYL·TILE on practically any floor. Send for your copy today! Goodyear, Flooring Department 2-P, Akron 16, Ohio.

Vinyl·Tile by
GOOD YEAR

Makers of Wingfoot Rubber Flooring

Get the most for your money

INSTALL YOUR OWN KENTILE FLOOR



Only **\$19⁹⁵***
and you can have a
KENTILE FLOOR
like this!

Mrs. William A. Look Jr.
shows you how easy
it is to install
long-lasting Kentile



Here Mrs. Look is finding the center of the floor. Next, she'll spread Kentile Adhesive over half the floor before laying the tiles in place.

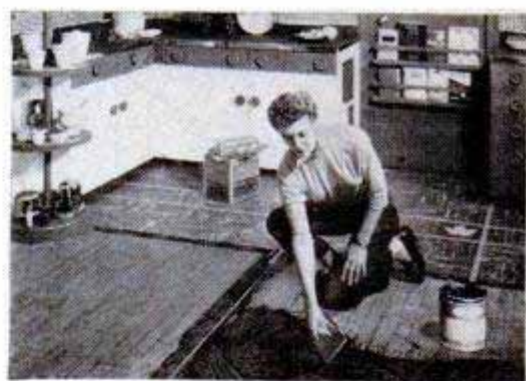

With half the floor installed, Mrs. Look spreads Kentile Adhesive to cover remaining half. Then it's simply a matter of putting tiles in place until entire floor is completed.

HERE'S America's most popular floor-covering for homeowner installation... low-cost, easy-to-lay, long-wearing. Dirt and stain-resistant... gleams like new with occasional, no-rub waxings. Don't make the mistake of buying floor-coverings with just a colored surface that wears off with use. Kentile's 26 wear-proof colors go right through each tile—its durability is assured by this written guarantee. (If you prefer, your Kentile Dealer will install your floor.)

Only Kentile Dealers offer you these low-priced Guaranteed Kentile Floors

*Price quoted is for a Kentile Floor approximately 9' x 10' installed by you. Your Kentile Floor may cost less or slightly more, depending on size of room, colors and freight rates. See your local Kentile Dealer... he's listed in the classified phone directory under FLOORS. In Canada, T. Eaton Co., Ltd.

Write for your **FREE Kentile Color Book** showing all the colors of low-cost Kentile and easy-to-follow instruction booklet

KENTILE, INC., 58 2nd Ave., Dept. G-7, B'klyn 15, N. Y.

KENTILE
GUARANTEE
FOR SELF-INSTALLED KENTILE

Kentile, Inc. will provide new tile without charge for any Kentile that wears out... and on which colors wear off... during your own occupancy of your home wherein you have installed Kentile. This guarantee does not apply to damage caused by improper handling, or failure to follow the instructions for installation and maintenance available at your Kentile dealer's.

KENTILE®

The Asphalt Tile of
Enduring Beauty



POPULAR MECHANICS

Popular Mechanics Magazine

Registered in U. S. Patent Office and Canada

H. H. WINDSOR, Founder

H. H. WINDSOR, JR., Editor and Publisher



this month's cover

DOWN TEXAS WAY, where things always seem to be first or biggest, there's a theater that dives like a submarine. When you walk into Aquarena, shown on our cover, you're standing above water level. Then water is spilled into ballast tanks and you go down, down, down until you have a fish's-eye view of the show. Mermaids and mermen cavort with fish and ducks and from the bottom of the pond you watch diving exhibitions, a ballet and even an underwater picnic—free of ants and spiders but attended by hungry schools of fish. One unique feature is an underwater stage—sort of a bubble of air suspended beneath the surface where performers can rest between acts. When the show's over, a pump forces water out of the tanks and the theater rises to the surface. The show goes on even in subfreezing weather for the pond has a year-round temperature of 70 degrees. Take in the show on page 71

Published monthly by Popular Mechanics Company, 200 E. Ontario St., Chicago 11, Ill. H. H. Windsor, Jr., president; William Harrison Pettridge, vice-president; D. F. Windsor, vice-president and secretary-treasurer; H. H. Windsor III, vice-president; Clover L. Perkins, advertising manager; Alan M. Deyoe, circulation manager. Single copy in the United States and Canada, 35 cents; subscription rates in United States and possessions, Canada, Philippines and countries of the Pan-American Postal Union, 1 year, \$3.50; 2 years, \$6.00; 3 years, \$8.00. To all other countries add \$1.00 a year over United States prices for overseas postage. If you plan to move, notify us at least 30 days in advance so you will not miss an issue. Give both your old and new addresses. Entered as Second Class Matter, September 15, 1903, at the Post Office at Chicago, Illinois, under Act of March 3, 1879. Entered as Second Class Matter at Post Office Dept., Canada, Registered as Second Class Matter at the Post Office at Mexico, D. F., Mexico, June 20, 1950. Copyright 1952 by Popular Mechanics Company. Copyright under International Copyright Union. Copyright in France. All rights reserved under Pan-American Copyright Union. Printed in the United States of America.

Volume 97

JUNE 1952

Number 6

Address all communications to:
200 East Ontario Street, Chicago 11, Illinois

Managing Editor.....Roderick M. Grant
Assistant Managing Editor.....Wayne Whittaker
Shop Notes and Crafts Editor.....James R. Ward
Radio-Television, Electronics Editor.....Frank L. Brittin
Associate Editor, Aviation.....Aubrey O. Cookman, Jr.
Associate Editor.....Clifford B. Hicks
Assistant Shop Notes and Crafts Editor.....Wayne C. Leckey
Automotive Editor.....Siler Freeman
Art Director.....Frank Beatty

Assistant Editors
W. Clyde Lamme
Carlton H. Ihde
Frank N. Stephany
Theodore A. Daum
Elliott H. McCleary
Arthur R. Railton
Elsie L. Domin

Eastern Editor.....Richard F. Dempewolf
Empire State Bldg., Room 2906, New York 1, N. Y.

Western Editor.....Thomas E. Stimson, Jr.
302 23rd St., Santa Monica, Calif.

London Manager.....Douglas W. Wedderspoon
77 Baker St., London W. 1, England

Director, Bureau of Information.....Allan Carpenter
200 E. Ontario St., Chicago 11

IN THIS ISSUE

A House to Make Life Easy	- - - - -	65
Mermaid Theater	- - - - -	71
America Bids for the Atlantic Blue Ribbon	- - - - -	81
Owners Report on the MG	- - - - -	89
TV Goes to the Conventions	- - - - -	94
Boom in the Big Triangle (Part I)	- - - - -	102
From Pills to Penicillin	- - - - -	110
What's New for Your Home	- - - - -	116
Mexico's City of Silver	- - - - -	120
The Cars They Drive Are Classics	- - - - -	136
Manning America's Radar Wall	- - - - -	144

For the Craftsman

Try Color This Vacation	- - - - -	149
Lazy Susan Picnic Table	- - - - -	154
ABC of Surf Fishing	- - - - -	159
Concrete Improvements Around the Home	- - - - -	175
Tumpline Canoe Carry	- - - - -	183
Know Your Car's Nervous System	- - - - -	186
One-Man Boat Trailer	- - - - -	194
Snips and How to Use Them	- - - - -	197
Hydraulic Lifts Do the Hard Work	- - - - -	202
Radio, TV and Electronics	- - - - -	211
Clinic for Homemakers	- - - - -	222

Other items, and manufacturers of available products described, are listed on pages 12, 14 and 16

here's why —

they're so efficient,
so economical,
so dependable!



FOR OIL HEATING

Wall-flame oil burner blankets heating plant walls with a high-efficiency flame. Burner has only one moving part (self-lubricated) and uses all residential types of oil.



FOR GAS HEATING

Wall-flame gas burner is especially constructed to direct blue-hot flame to heating surfaces. Burns natural, manufactured, mixed or LP gases. Burner is clog-proof.

TIMKEN *Silent Automatic* HEATING UNITS

*are fired by famous
Wall-Flame Burners!*

Experience-engineered to provide the finest automatic home heating money can buy! That's the big reason for the superiority of the Timken Silent Automatic oil and gas wall-flame burners! The flame is placed close to the heat absorbing surfaces—right where it does the most good! The air-fuel mixture is completely prepared before it is ignited, providing a natural-burning flame. The result: Exceptionally quiet, efficient and economical operation! Whether you need to convert an existing heating plant or install a complete furnace or boiler, you'll find your local Timken Silent Automatic Dealer is a heating expert you can depend on! See or phone him today for a no-obligation demonstration! Or, mail the coupon below for illustrated literature.

TIMKEN *Silent Automatic* HEAT

OIL • GAS • COAL

TIMKEN SILENT AUTOMATIC DIVISION

The Timken-Detroit Axle Company • Jackson, Michigan
The Timken-Detroit Axle Company of Canada, Ltd., Toronto, Ont.



MAIL THIS COUPON TODAY FOR ILLUSTRATED LITERATURE!

Timken Silent Automatic, Jackson, Michigan
Please mail illustrated literature. I am interested in:

PM-6



NAME _____ (type of equipment)

STREET ADDRESS _____

CITY and STATE _____

If you are a student, please check here () for special information.

To a motorist worried about operating costs in his car

Are you getting too little mileage from the gasoline you buy? Is your car sluggish on hills—slow on the pick-up? Are you getting too many repair bills?

Then these facts will interest you:

1. Automotive engineers tell us that at 40 miles per hour on a level road, 50% of your gasoline is used up just in overcoming engine friction. Think of that.

2. Anything that reduces that friction will make your car go faster or farther, or climb a steeper hill.

3. Hundreds and hundreds of cars like yours have been tested on a Dynamometer—the testing machine accepted by the automobile industry.

4. These tests showed that motorists get an average of 8% more power from the same amount of gasoline *after* they have changed from *whatever brand of oil they have been using* to Macmillan Ring-Free Oil.

5. At 25¢ a gallon for gasoline, that 8% means a saving of 2¢.

6. Over a normal period between oil changes, that means a \$2.00 saving.

7. That \$2.00 is enough to pay for a refill with Macmillan Oil.

8. That 8% also means 20 *extra miles* on every tankful of gas.

9. While it's reducing friction, Macmillan Ring-Free Motor Oil also reduces deposits of carbon, gum and sludge in the engine.

10. That means higher compression.

11. Better piston seal.

12. Less likelihood of ping.

13. Lower, less frequent repair bills.

14. Uses less oil.

The big red "M" is your guide to the independent service station, garage or car dealer where you will find Macmillan.

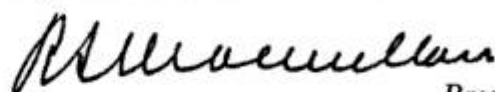

President

MACMILLAN PETROLEUM CORPORATION
530 W. 6TH STREET, LOS ANGELES
50 W. 50TH, NEW YORK • 624 S. MICHIGAN, CHICAGO



For the name of your nearest Macmillan dealer, phone Western Union, ask for "Operator 25." Give her your name, address and phone number. Your inquiry will receive our prompt attention-- no charge for this service.

This One



3EE0-GU2-R4JQ

KEEP YOUR CAR

Young

with

PYROIL

This is the time of year when car-owners really "hit the road". Lots of extra driving—extra miles—extra wear-and-tear on your car. When you have Pyroil in your motor, you can watch those miles pile up without a care. Because Pyroil contains the remarkable property of making ordinary oil cling to exposed engine parts, cylinder walls and piston rings are protected with a coating of lubrication at all times—preventing rust, the result of condensation. Pyroil cleans your motor and keeps it clean. Pyroil keeps your motor "young" and full of go. Pyroil is such low-cost insurance against costly break-downs and repairs. So before you "hit the road"—add Pyroil—add miles to your car.

Pyroil for Aircraft Engines

Use Aircraft Pyroil B for lubricating oil, Aircraft Pyroil A for gasoline.

GIVEN! An attractive Pyroil metal savings bank—takes coins up to 50¢ pieces. **MOTORISTS**, it's yours for the asking—sent postage paid.



Manufactured and Guaranteed by Pyroil Company, 136 Pyroil Bldg., La Crosse, Wisconsin.

Canadian Distributors: Central Purchasing Agencies, Ltd., Toronto, Ontario

PYROIL COMPANY

136 Pyroil Bldg., La Crosse, Wisconsin

I want my car to last and run properly. Please tell me more about Pyroil and how it can accomplish this for me.

Name _____

Address _____

City or Town _____ State _____



in this corner.....

THE EDITORS



WHEN ROBERT KORTA painted "The Old Craftsman" for our Anniversary Issue in January, he didn't know he was doing a real portrait. The sleepy old-timer in the painting came straight from Korta's imagination.



About the time the Anniversary Issue appeared on the stands, Alan Deyoe, our circulation manager, was on a business trip through Mexico. In Vera Cruz he found *Mecanica Popular*, PM's Spanish-language edition, displayed with the painting in full view. The reason? The painting is almost a photographer's portrait of Javier Avila Senties of Vera Cruz.

The flesh-and-blood "Old Craftsman" is associate distributor of *Popular Mechanics* and *Mecanica Popular* in Vera Cruz as well as a city official.

Letter to the Editor:

Enjoyed your February article, "In Battle, There's Always One More River to Cross." Thought you might like to know that the 254th Combat Engineers of the First Army, V Corps, erected a 220-foot Bailey bridge over the Thames River in England within 31 minutes from the time parts were laid out at the site. [The article stated that a bridge section 20 feet long could be erected in a half hour.] What's holding up the boys at Fort Belvoir?

James Wapner,
Highland Park, N. J.

Letter to the Editor:

When one of the local Cub Scout dens celebrated its annual dinner this year, the

(Continued to page 8)

5 reasons why ACCOUNTANCY

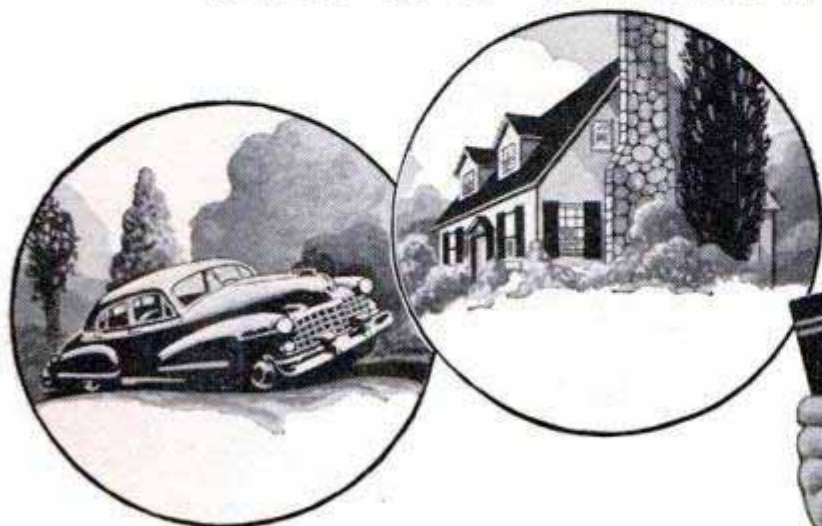

offers you MORE MONEY... and SUCCESS!

REASON #1. If you were an expert accountant right now, chances are you would find yourself among the highest-paid of all professional men and women. Even back in "depression years," surveys showed that accountants earned more on the average than men in other major professions.

REASON #2. The demand for accountants is great—everywhere. All businesses must have trained accountants to cope with ever-growing requirements. It's a profession offering wide opportunity—always—to the man who knows.

REASON #3. You can fit into any business, anywhere in the country—because accounting principles are universal. Think what this means in terms of security and independence!

REASON #4. Accountancy is open to all. Any man or woman of good intelligence, who enjoys figure work and is willing to follow LaSalle's systematic "problem method" plan, can rapidly qualify for a highly profitable, enjoyable lifetime career... and he doesn't have to finish his training before beginning to "cash in."

REASON #5. Without losing a day from your present work, you can prepare in spare hours at home, at low cost, under LaSalle's step-by-step "Problem Method" of "learning by doing." This famous plan accounts for LaSalle's remarkable record of having trained nearly 10 per cent of all Certified Public Accountants in the U. S. . . . and of having put many thousands of others into high-paying careers.

Send today for LaSalle's interesting booklets, "Accountancy, the Profession That Pays," and "Success Reports." Learn about the five great fields of opportunity . . . and LaSalle's time-tested plan for helping men and women to rapid advancement, higher income, greater prestige and professional standing. The coupon below will bring these fact-filled booklets to you—without cost or obligation—also, a free sample lesson showing LaSalle's famous "Problem Method" plan of instruction.

GET FREE SAMPLE LESSON

**WHICH . . . ?
can help you most ?**

- Accounting—Elements to C.P.A. Coaching
- Bookkeeping
- Cost Accounting
- Auditing
- Income Tax
- C.P.A. Coaching

LaSalle Extension University
— A Correspondence Institution —

Dept. 664-HR, 417 S. Dearborn St., Chicago 5, Ill.

Please send me, free of all cost or obligation, a sample lesson in Accounting . . . also, your 48-page illustrated books, "Accountancy, the Profession that Pays," and "Success Reports."

Name.....Age.....
Address.....
City, Zone, State.....

LASALLE
417 S. Dearborn St.,
CHICAGO 5, ILL.

THEY NEED YOU



A typical interview...

where Embry-Riddle students are pre-selected for essential, good-paying jobs in aviation even before their training is completed... they step right into their jobs as soon as they graduate!

...AND YOU CAN

QUALIFY IN SIX MONTHS!

EMBRY-RIDDLE OFFERS YOU COMPLETE 6-MONTHS TO 2-YEAR COURSES...NOW!

Your Career is Waiting!

The high regard of Embry-Riddle training by the leading airlines and the entire aviation industry is demonstrated time and again by the big demand for Embry-Riddle graduates.

There's an important high priority job in aviation waiting for you...however, if you do enter the services, Embry-Riddle training will definitely give you rating advantages. Thousands of Air Force men are Embry-Riddle trained.



AIRCRAFT & ENGINE MECHANICS

Vast numbers of properly trained A & E Mechanics are urgently needed. Our C. A. A. approved school with a quarter-century experience assures your quickest advancement. Embry-Riddle students learn fast with modern equipment, including jet...live aircraft, airline-size hangars.



AERONAUTICAL DESIGN AND TECHNOLOGY

Embry-Riddle's accelerated 26-mo. Aeronautical Design and Technology Course provides finest training available. Technicians with management responsibility enjoy highest salaries!



COMMERCIAL PILOT

Embry-Riddle trained pilots benefit from our years of experience with 30,000 students...the best instructors, up-to-date aircraft, superb year-round flying weather. Also Instrument and Instructor's ratings.



A & E COMBINED WITH COMMERCIAL PILOT

Airmen with dual pilot-engineering ability are needed by aviation companies and operators. Embry-Riddle combination training offers you the most in your aviation career.



CLASSES ARE BEGINNING NOW...SEND THIS COUPON TODAY!

Dean of Enrollments - Dept. 99
Embry-Riddle School of Aviation
Miami 30, Florida

Please Print

NAME _____

ADDRESS _____

CITY _____

STATE _____ AGE _____

I am interested in...

- A & E Mechanic
 Commercial Pilot
 Aeronautical Design and Technology
 A & E Combined with Commercial Pilot
 A & E Combined with Private Pilot

Check One Veteran
 Non-Veteran

TRAIN IN MIAMI - AIR CAPITAL OF THE WORLD

(Continued from page 6)

boys were overwhelmed by a huge cake topped with a campfire giving off smoke. It was the creation of Daniel Joy, a local baker and father of one of the Cubs. He fashioned a three-deck cake decorated with chocolate-icing tepees and a campfire made



Providence Journal-Bulletin photo

of pretzels, plus nine inedible Indians. A pencil flashlight was buried in the campfire to provide a glow. Through a hole in the middle of the cake passed a rubber tube, which reached to a near-by table where it was attached to a bottle of water. When Dry Ice was dropped into the water, the campfire sent up smoke signals. The boys submitted the cake to exhaustive tests and declared it a huge success.

Mrs. Ada F. Almy,
Providence, R. I.

Lady Wonder

Editor Dempewolff's article in March on Lady Wonder, the Virginia mare that taps out answers to questions on a keyboard, has aroused many comments from readers. Here are some excerpts from their letters:

"... The horse has no power; that is, of its own. It sounds to me like a duplication of Satan's power, manifested through another animal recorded in the third chapter of Genesis. Incidentally, the horse need not falter or misspell any word. That would be too obvious. It's all for one purpose—deception."—W.P., Concord, Calif.

"... I have written several articles about this amazing creature and have been interviewed by her several times. . . . The third time we went down there my husband said, 'Lady, will you give us our last name?' She did more, she spelled out 'Mary Hyde.' My husband also asked her, 'Do you remember us, Lady?' 'Sure,' she replied. . . . Many

(Continued to page 10)



Up to the top . . . together



If you've ever asked yourself "What can I do to get ahead?" you'll find the story of Ernest and Janet Jarvis interesting and inspiring

They married young. Neither had finished grammar school. Both worked—and studied.

Ernest was enrolled with the International Correspondence Schools. Janet helped him with his lessons. Together they mastered Chemistry, Metallurgy and other I. C. S. subjects.

Slowly, surely, their training bore fruit. Ernest was made plant manager of a marine pump and valve factory. Mrs. Jarvis worked as a chemist in the laboratory.

Then, with \$3500 savings, they started their own business, the Niagara Falls Smelting & Refining Co. Inside twenty years, it became the nation's largest producer of nonferrous alloys.

In 1944 they sold the company and retired as millionaires. But they couldn't stop. Before the year was out, the Jarvises were working again.

Today, Ernest Jarvis is President of the Continental Copper & Steel Industries, Inc. And Janet Jarvis, a chemist and metallurgist famed throughout the industry, is Vice-President.

Says Mr. Jarvis: "I have always felt that the training we obtained by studying I. C. S. courses at night was responsible for our success in life."

It takes courage and co-operation, hard work and sound training to do what the Jarvises did. The first three are up to you. Sound training starts with the coupon below. Mail it *today*.

INTERNATIONAL CORRESPONDENCE SCHOOLS



BOX 5528-L, SCRANTON 9, PENNA.

Without cost or obligation, please send me full particulars about the course BEFORE which I have marked X:

- | | | | |
|--|---|--|--|
| <input type="checkbox"/> Accounting and Management | <input type="checkbox"/> Air Conditioning and Plumbing Courses | <input type="checkbox"/> Structural Drafting | <input type="checkbox"/> Stationary Steam Engineering |
| <input type="checkbox"/> Architecture | <input type="checkbox"/> Air Conditioning <input type="checkbox"/> Heating | <input type="checkbox"/> Structural Engineering | <input type="checkbox"/> Tool Designing <input type="checkbox"/> Toolmaking |
| <input type="checkbox"/> Automobiles | <input type="checkbox"/> Refrigeration <input type="checkbox"/> Steam Fitting | <input type="checkbox"/> Surveying and Mapping | <input type="checkbox"/> Welding—Gas and Electric |
| <input type="checkbox"/> Chemical Engineering | Aeronautics Courses | Communications Courses | Radio Courses |
| <input type="checkbox"/> Civil Engineering | <input type="checkbox"/> Aircraft Drafting, Design | <input type="checkbox"/> Telegraphy <input type="checkbox"/> Telephony | <input type="checkbox"/> Electronics |
| <input type="checkbox"/> Commercial Art | <input type="checkbox"/> Aeronautical Engineer's, Jr. | Electrical Engineering | <input type="checkbox"/> FM and Television Servicing |
| <input type="checkbox"/> Drafting | <input type="checkbox"/> Engine Mechanic | <input type="checkbox"/> Electrical Drafting | <input type="checkbox"/> Radio, General <input type="checkbox"/> Radio Operating |
| <input type="checkbox"/> Electrical Engineering | Architecture & Building Trades Courses | <input type="checkbox"/> Electric Light and Power | <input type="checkbox"/> Radio Servicing |
| <input type="checkbox"/> High School | <input type="checkbox"/> Architecture | <input type="checkbox"/> Lighting Technician | Textile Courses |
| <input type="checkbox"/> Industrial Engineering | <input type="checkbox"/> Architectural Drafting | <input type="checkbox"/> Practical Electrician | <input type="checkbox"/> Cotton Manufacturing |
| <input type="checkbox"/> Mechanical Engineering | <input type="checkbox"/> Building Estimating | Diesel Engine Courses | <input type="checkbox"/> Loom Fixing <input type="checkbox"/> Rayon Manufacturing |
| <input type="checkbox"/> Plumbing | <input type="checkbox"/> Contractor's Building | <input type="checkbox"/> Diesel Engines | <input type="checkbox"/> Textile Eng'g <input type="checkbox"/> Woolen Manufr'g |
| <input type="checkbox"/> Radio & Television | <input type="checkbox"/> House Planning | Internal Combustion Engines | Business Courses |
| <input type="checkbox"/> Salesmanship | Art Courses | Mechanical Courses | <input type="checkbox"/> Accounting |
| <input type="checkbox"/> Shop Practice | <input type="checkbox"/> Commercial Art | <input type="checkbox"/> Forging <input type="checkbox"/> Foundry Work | <input type="checkbox"/> Advertising <input type="checkbox"/> Bookkeeping |
| <input type="checkbox"/> Steam Engineering | <input type="checkbox"/> Magazine Illustrating | <input type="checkbox"/> Heat Treatment of Metals | <input type="checkbox"/> Business Administration |
| <input type="checkbox"/> Textiles | <input type="checkbox"/> Show Card and Sign Lettering | <input type="checkbox"/> Industrial Engineering | <input type="checkbox"/> Bus. Correspondence <input type="checkbox"/> Bus. Law |
| | Chemical Courses | <input type="checkbox"/> Industrial Instrumentation | <input type="checkbox"/> Certified Public Accounting |
| | <input type="checkbox"/> Chemical Engineering | <input type="checkbox"/> Industrial Metallurgy | <input type="checkbox"/> Commercial <input type="checkbox"/> Federal Tax |
| | <input type="checkbox"/> Chemistry, Analytical & Industrial | <input type="checkbox"/> Machine Shop <input type="checkbox"/> Millwrighting | <input type="checkbox"/> Fore'ship <input type="checkbox"/> High School and College |
| | <input type="checkbox"/> Petroleum Production & Refining | <input type="checkbox"/> Mold-Loft Work | <input type="checkbox"/> Industrial Supervision |
| | <input type="checkbox"/> Plastics <input type="checkbox"/> Pulp & Paper Making | <input type="checkbox"/> Patternmaking—Wood, Metal | <input type="checkbox"/> Motor Traffic <input type="checkbox"/> Postal Civil Service |
| | Civil Engineering Courses | <input type="checkbox"/> Power Plant Engineering | <input type="checkbox"/> Personnel—Labor Relations |
| | <input type="checkbox"/> Civil Eng'ring <input type="checkbox"/> Highway Eng'ring | <input type="checkbox"/> Railroad | <input type="checkbox"/> Retailing <input type="checkbox"/> Retail Bus. Management |
| | <input type="checkbox"/> Sanitary Engineering | <input type="checkbox"/> Reading Shop Blueprints | <input type="checkbox"/> Salesmanship |
| | | <input type="checkbox"/> Sheet Metal Worker | <input type="checkbox"/> Secretarial <input type="checkbox"/> Stenography |
| | | <input type="checkbox"/> Ship Drafting <input type="checkbox"/> Ship Fitting | <input type="checkbox"/> Traffic Management |

Name _____ Age _____ Home Address _____
 City _____ State _____ Working Hours _____ A.M. to _____ P.M.
 Present Position _____ Employed by _____

Representatives in all principal cities. Canadian residents send coupon to International Correspondence Schools Canadian, Ltd., Montreal, Canada.

Will her caress test tell tales about your hair?



**Grooms hair,
never
greases it**



The proof is in
the palm of your hand!

20% more
Cream Hair Oil
for your money!

When she runs her fingers lightly through your hair, will you pass the test? Try your present hair tonic now, and see! Rub your palm across your hair, as she might do. Find a film of sticky oil? Think of her reaction and switch to Mennen Cream Hair Oil—lightly blended to keep each hair in place, yet never leave a trace. Contains lanolin. Helps remove dandruff scales and relieves dry scalp. Get a bottle today, and pass that caress test tonight!

MENNEN

Cream Hair Oil FOR MEN

(Continued from page 8)

people will begin to wonder. . . . Is intelligence all about us? Can animals know . . . more than we do? Is the bar only that of communication?"—M.J.H., Alexandria, Va.

The story of Lady Wonder had one odd consequence in Fort Wayne, Ind., which was reported by Cliff Milnor in the Fort Wayne *Journal-Gazette* of March 17.

Don A. Weber, president of the Deister Concentrator Company, had been irked by delays in the installment of a traffic light at a dangerous highway intersection. After reading the *PM* article, he dispatched a telegram requesting Mrs. Fonda, owner of the horse, to ask Lady Wonder when the State Highway Department would authorize installation of a traffic light at Glasgow Avenue and U. S. Highway 24. Although Mrs. Fonda ordinarily does not answer mail or telegraph inquiries—because, as she wrote afterwards, "I think she responds much better if her visitors come in close contact with her"—she did telegraph Mr. Weber: "About May 20."

On March 19, two days after columnist Milnor reported the prophecy of the horse, Mr. Weber reports there was "feverish activity" at the corner. The Highway Department had authorized the light and city officials rushed to install it. On March 20, instead of May 20, it was in operation. Writes Mr. Weber: "Around here everyone . . . credits Lady Wonder."

Commented highway officials in the *Journal-Gazette*: ". . . The people should know that the light became a reality through the efforts of the State Highway Department and not because of a smart horse."

Maybe Lady Wonder made a typographical error. May 20 and Mar. 20 look alike.

Letter to the Editor:

In your April issue on page 118 you show a lever-action shotgun. You state that this is the first time "lever action has been adapted to a shotgun."

I'm not so old as *Popular Mechanics* but I seem to remember a previous lever-action shotgun. I know that Winchester put out a 10 or 12-gauge lever-action shotgun early in the century. You probably have made Winchester very unhappy!

Arthur W. Krann,
Colonel, U.S.A.F.,
Washington, D. C.

Right, Colonel. Our informer did not inform us correctly. Winchester made lever-action shotguns from 1887 to 1901—mostly 10 gauge, some 12. Spencer also manufactured one. Marlin produced a lever-action shotgun for only two years, discontinuing it in 1931.—The Editor.

AUDELS Carpenters and Builders Guides 4 vols. \$6



Inside Trade Information for Carpenters, Builders, Joiners, Building Mechanics and all Woodworkers. These Guides give you the short-cut instructions that you want—including new methods, ideas, solutions, plans, systems and money saving suggestions. An easy progressive course for the apprentice and student. A practical daily helper and Quick Reference for the master worker. Carpenters everywhere are using these Guides as a Helping Hand to Easier Work, Better Work and Better Pay. To get this assistance for yourself, simply fill in and mail **FREE COUPON** below.

Inside Trade Information On:

How to use the steel square—How to file and set saws—How to build furniture—How to use a mitre box—How to use the chalk line—How to use rules and scales—How to make joints—Carpenters arithmetic—Solving mensuration problems—Estimating strength of timbers—How to set girders and sills—How to frame houses and roofs—How to estimate costs—How to build houses, barns, garages, bungalows, etc.—How to read and draw plans—Drawing up specifications—How to excavate—How to use settings 12, 13 and 17 on the steel square—How to build hoists and scaffolds—skylights—How to build stairs—How to put on interior trim—How to hang doors—How to lath—lay floors—How to paint.



AUDEL, Publishers, 49 W. 23rd St., New York 10, N. Y.

Mail Audels Carpenters and Builders Guides, 4 vols., on 7 days' free trial. If OK I will remit \$1 in 7 days and \$1 monthly until \$6 is paid. Otherwise I will return them. No obligation unless I am satisfied.

Name _____

Address _____

Occupation _____

Employed by _____ 39

REFRIGERATION AIR CONDITIONING INFORMATION IN A HANDY FORM

ASK TO SEE IT!



Every Serviceman, Mechanic & Operator can use AUDEL'S REFRIGERATION & AIR CONDITIONING GUIDE, containing Practical, Inside Trade Information on the whole subject of Refrigeration & Air Conditioning. Tells How to Service, Operate & Repair Modern Household, Commercial & Industrial Units & Air Conditioning Systems. 1280 Pages, 46 Chapters Fully Illustrated & Indexed for Quick Reference.

1001 FACTS

This big, highly indorsed book, easy to understand, gives useful basic principles on How to Repair & Install Compressors, Control Devices, How to locate Electric Motor Troubles, How to Service & Adjust Cold Storage Lockers, Quick Freezing Units, Dairy & Market Refrigerators, Ice Cream & Soda Fountains, How to Maintain Water Coolers, Marine Refrigeration, Plant Auxiliaries, Ice Making, Ammonia Plants, Brine Systems, Servicing Air Conditioning Systems, Replacement of Refrigerants including Freons, Heat Transmission & Pressure Temperature Charts, Tables, Duct Systems, Safety Codes, etc.

\$4 ANSWERS YOUR QUESTIONS

Get this Information for Yourself. Mail Coupon today. **COMPLETE • PAY ONLY \$1. A MONTH** ←

AUDEL, Publishers, 49 W. 23rd St., New York 10, N. Y. MAIL AUDEL'S REFRIGERATION GUIDE for free examination. If O. K. I will send you \$1 in 7 days; then remit \$1 monthly until price of \$4 is paid. Otherwise I will return it.

Name _____

Address _____

Occupation _____

Employed by _____ 39

WHAT ALL AUTO MECHANICS WANT TO KNOW

1800 PAGES



This Big Practical Book gives full information with working diagrams covering the principles, construction, ignition, service and repair of modern cars, trucks and buses.

Diesel Engines, Hydramatic & Fluid Drives Fully Explained.

A complete Guide of 1800 pages, with over 1500 illustrations showing inside views of working parts, with instructions for service jobs.

IT PAYS TO KNOW

How to fit pistons—How to locate engine knocks, How to fit connecting rod bearings—How to service main bearings—How to recondition valves—How to time valves—How to adjust fan belts—How to adjust carburetors and chokes, How to rebuild a clutch—How to service automatic transmissions—How to service brakes—How to adjust steering gear—How to cope with ignition troubles—How to service distributors—How to time ignition—How to "tune up" an engine.



\$4 COMPLETE • PAY \$1 A MO. TO GET THIS ASSISTANCE FOR YOURSELF SIMPLY FILL IN AND MAIL COUPON TODAY.

Step up your own skill with the facts and figures of your trade. Audels Mechanics Guides contain Practical Inside Trade Information in a Handy Form. Fully illustrated and Easy to Understand. Highly Endorsed. Check the book you want for 7 DAYS FREE EXAMINATION. Send No Money. Nothing to pay postman.

MAIL ORDER



Check NOW!

You Can Look Over Any Guide In Your Own Home — Start the Easy Payments If Satisfied

MAIL THIS TODAY



AUDEL, Publishers, 49 W. 23 St., NEW YORK 10, N. Y.

Please send me postpaid for FREE EXAMINATION books marked (x) below. If I decide to keep them I agree to mail \$1 in 7 Days on each book or set ordered and further mail \$1 monthly on each book or set until I have paid price, otherwise I will return them.

- AUTOMOBILE MECHANICS GUIDE, 1800 Pages \$ 4
- TRUCK & TRACTOR GUIDE, 1299 Pages . . . 4
- DIESEL ENGINE MANUAL, 575 Pages . . . 2
- MACHINISTS HANDY BOOK, 1650 Pages . . . 4
- WELDERS GUIDE, 400 Pages . . . 1
- BLUE PRINT READING, 416 Pages . . . 2
- MATHEMATICS & CALCULATIONS, 700 Pages. . . 2
- SHEET METAL PATTERN LAYOUTS, 1100 Pages 4
- SHEET METAL WORKERS HANDY BOOK, 388 Pgs. 1
- MECHANICAL DRAWING GUIDE, 160 Pages . . . 1
- MECHANICAL DRAWING & DESIGN, 480 Pages 2
- AIRCRAFT WORKER, 240 Pages . . . 1
- TELEVISION SERVICE MANUAL, 384 Pages . . . 2
- RADIOMANS GUIDE, 914 Pages . . . 4
- ELECTRONIC DEVICES, 216 Pages . . . 2
- ELECTRIC MOTOR GUIDE, 1000 Pages . . . 4
- ELECTRIC WIRING DIAGRAMS, 272 Pages . . . 1
- ELECTRICIANS EXAMINATIONS, 250 Pages. . . 1
- ELECTRIC POWER CALCULATIONS, 425 Pages. 2
- HANDY BOOK OF ELECTRICITY, 1440 Pages. . . 4
- ELECTRIC DICTIONARY, 9000 Terms . . . 2
- ELECTRIC LIBRARY, 7000 Pages (12 Book Set) 18
- MARINE ENGINEERS HANDY BOOK, 1258 Pgs. 4
- SHIPFITTERS HANDY BOOK, 250 Pages . . . 1
- REFRIGERATION & Air Conditioning, 1280 Pgs. 4
- MILLWRIGHTS & MECHANICS GUIDE, 1200 Pgs. 4
- POWER PLANT ENGINEERS GUIDE, 1500 Pages 4
- ENGINEERS & FIREMANS EXAMS, 525 Pages . . . 1
- PUMPS, Hydraulics & Air Compressors, 1658 Pgs. 4
- ENGINEERS LIBRARY (3 Book Set) . . . 9
- MECHANICAL DICTIONARY, 950 Pages . . . 4
- GARDENERS & GROWERS GUIDES (4 Book Set) 6
- CARPENTERS & BUILDERS GUIDES (4 Book Set) 6
- PLUMBERS & Steamfitters GUIDES (4 Book Set) 6
- MASONS AND BUILDERS GUIDES (4 Book Set) 6
- PAINTERS & DECORATORS MANUAL, 450 Pgs. 2
- HOUSE HEATING GUIDE, 1000 Pages . . . 4
- OIL BURNER GUIDE, 384 Pages . . . 1

Name _____

Address _____

Occupation _____

Employed by _____ 39

MAKES LEARNING
MUSIC SO EASY
--IT'S ALMOST
LIKE MAGIC!



I DIDN'T KNOW
A SINGLE NOTE
WHEN I STARTED!



Everyone's Talking About This

WONDERFUL, EASY WAY TO LEARN MUSIC

AND IT'S SO MUCH
FUN--YOU START
RIGHT OUT PLAYING
REAL PIECES!



THEY ARE PLAYING
-- SO CAN YOU!



Samuel Moses,
Mt. Vernon, Tenn.:
"In a short time I
could sit down and
play pieces in hymn
book. Now enter-
tain at parties --
play at church,
dances."



Howard Hopkins,
East Syracuse, N.Y.:
"Now invited to all
kinds of affairs --
auditioned for 'Barn
Dance Jamboree.'"



Lawrence Welk,
famous band lead-
er: "Got my start
in music with your
Course. How easy
it is to learn this
'teach-yourself'
way!"



Peter Kozyra,
Manitoba, Canada:
"Was able to play
many pieces in a
short time. Family
and friends cer-
tainly surprised."

No Matter WHO You Are,
or WHERE You Live, or
How LITTLE You Know About
Music Now, You Can Soon Play
Your Favorite Pieces by Note.
FREE BOOK Tells All About
This "Easy As A-B-C" Way

I'VE LEARNED TO PLAY
SO QUICKLY MY FRIENDS
ARE SIMPLY AMAZED!



NO WONDER 850,000
people have chosen
this modern way to learn music! Now
anyone can learn to play piano, accord-
ion, guitar, or any other instrument--
EVEN IF you don't know a note of mu-
sic now...

EVEN IF there is no music teacher near
your home -- or you can't afford pri-
vate lessons...

EVEN IF you can spare only a few min-
utes a day...

EVEN IF you are "tied down" to your
job or home...

EVEN IF you think you "lack talent"...
... We guarantee to show you how to
play! So quickly your friends will be
amazed. So pleasantly you'll really look
forward to each new lesson. So inex-
pensively you'll never miss the few
cents per lesson.

No tedious scales and tiresome exer-
cises. You learn by playing simple
pieces -- right from the very start! Al-
most before you realize it, you'll find
yourself playing your favorite pieces
by note.

Why not let this famous "Easy As
A-B-C" method bring the many pleas-
ures of music into YOUR life? Good
times. New friends. Extra money from
playing or teaching. Possibly a brilliant
musical career. Best of all the deep
personal satisfaction.

FREE BOOK AND FREE LESSON SAMPLE

See for yourself why our School
has been so successful for 54
years. Mail the coupon below,
and we'll gladly send you our
valuable 36-page FREE BOOK
--and also a Free Copy of our
simple "print-and-picture" Les-
son-Sample you can try out
right at home. No obligation;
no salesman will call on you.
U. S. School of Music, Studio
B306, Port Washington, N.Y.
(Special Reduced Prices on in-
struments to our students.)



U. S. School of Music, Studio B306,
Port Washington, N. Y.

Send me FREE BOOK and FREE Lesson-
Sample. No obligation--and no salesman
is to call upon me. I'm interested in play-
ing (name instrument) _____

I do I do not--have instrument now.

Name _____
(please print)

Address _____

City _____ Zone _____ State _____

WHERE-TO-BUY-IT INDEX

Source of supply appears after items commercially available

AUTOMOTIVE

C-4R-America's newest sports car.....	76
Quick release battery terminal prevents fires due to short cir- cuits (Park Sales, Box 73, Forest Park, Ill.).....	88
Chrysler experimental sports car produced in Italian shop....	98
Plastic car-body kits (Wilro Company, 1955 Lincoln Ave., Pasadena 3, Calif.).....	98
Detroit listening post.....	99
Antiskid tire tread made of tiny blocks (B. F. Goodrich Co., Akron, Ohio).....	108
Tricycle sports car.....	108
Now they're making cars of glass.....	129
Inflated rubber bumper guards absorb shocks of minor colli- sions (Hush Bumpers, Inc., 3030 Logan Blvd., Chicago 12, Ill.).....	148
Truck wheels balanced while on axle with portable machine....	148
Car-washing machine for service stations.....	148

1901 N. HERMITAGE AVE.

AVIATION

Airliner groomed for 1954 service cruises at 360 miles per hour 79	
Heavies of the U. S. and Russian air forces.....	93
Airline speeds changing from m.p.h. to knots.....	108
Falls from 50,000 feet simulated on a rack.....	119
Self-powered beaching cradle gives seaplane "land legs".....	125

FARM AND GARDEN

Mine detector scans bull.....	70
"For want of a nail".....	70
Electric "snake" scares birds.....	75
Quick-change garden tractor (Rototiller, Inc., Troy, N. Y.).....	118
Clamp deters cow from kicking (Pride Hybrid Co., Glen Haven, Wis.).....	135

HOBBIES AND NOVELTIES

Thin steel.....	75
Boat on stilts.....	109
Lobsters are like people.....	132
Coal artist.....	134
Shoe house.....	135
Canasta Lazy Susan is also an ash tray (H & H Engineering & Sales Co., 322 Virginia Ave., Indianapolis 4, Ind.).....	143

HOUSE AND HOME

Bath seat (Frohock-Stewart Co., 229 Harris Ct., Worcester, Mass.).....	116
Coffee spigot (Homemaker's Mart, Box 1376, Beverly Hills, Calif.).....	116
Tension screen (New York Wire Cloth Co., New Canaan, Conn.).....	116
Ivy support (Parker Plastic Products, 401 67th St., Houston, Tex.).....	116
Noodle nests (Maid of Scandinavia Co., Box 3035, Linden Hills, Minneapolis, Minn.).....	117
Baby walker (Walka Island Co., 8506 Sunset Blvd., Los An- geles, 46, Calif.).....	117
First-aid kit (Northwestern Products Co., 3223 Filmore St. N.E., Minneapolis, Minn.).....	117
Umbrella light (Ruth Cooper Assoc., 100 West 88th St., New York City 24).....	117
Cover holder (TidDee Products Inc., 1421 Broom Lane, Dayton 4, Ohio).....	117
Bar hanger (Hilco Engineering Co., R.R. #1, Genoa City, Wis.).....	142
Fruit juicer-squeezer attaches to grinder (Metallwarenfabrik, Bad Kissingen, Germany (American Zone).....	143

MILITARY AND NAVAL

Landing craft made of plastic.....	74
Autopilot for flatpots.....	74
Army's latest medium tank features more lethal fire power... 88	
Scientists study A-bomb burst.....	100
Submarine "speedometer".....	115
Helpful bomb.....	125

OFFICE, SHOP AND STORE

Fountain brush (Graymills Corp., 2000 Ridge Ave., Evanston, Ill.).....	115
Eye-catching sign.....	118
Desk-size facsimile machine.....	135
Circular pencil sharpener for draftsmen (Franz Patent Labo- ratories, 1023 45th Ave., Oakland 1, Calif.).....	142
Surplus army telephones are grocers' intercom.....	142

RECREATION

Portable stove burns canned gas (Pressure Products Corp., 140 N. Dearborn St., Chicago 2).....	70
Plastic bucket (Bakelite Co., 122 E. 42d St., New York City 17) 70	
Bull's-eye builder.....	126

(Continued to page 14)

You Practice COMMUNICATIONS I send you parts to build this transmitter



As part of my Communications Course you build this low power broadcasting transmitter, learn how to put a station "on the air," perform procedures demanded of Broadcast Station operators, make many tests.

This is just part of the equipment my students build. You keep all parts I send.

You Practice Radio SERVICING on this modern radio you build with parts I send

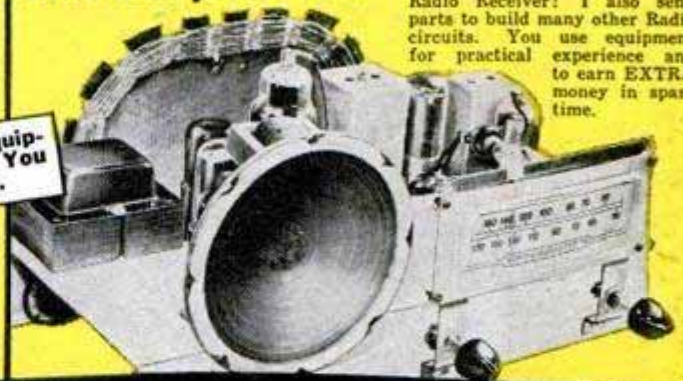

As part of my Servicing Course, I send you the speaker, tubes, chassis, transformer, loop antenna, EVERYTHING you need to build this modern, powerful Radio Receiver! I also send parts to build many other Radio circuits. You use equipment for practical experience and to earn EXTRA money in spare time.

BE A RADIO-TELEVISION TECHNICIAN

NOW! Advanced Television Practice

New, special TV kits furnished to build high-definition SCOPE . . . RF OSCILLATOR with flyback power supply . . . complete TV set . . . many other forms. Get . . . complete, saw-tooth wave forms. Get pulse, trapezoidal, saw-tooth wave forms. Mail valuable PRACTICAL EXPERIENCE locating and correcting TV troubles. Pictures and prices!

Learn Servicing or Communications Practice at Home in Spare Time



J. E. SMITH, President
National Radio Institute

Do you want good pay, a job with a bright future and security? Would you like to have a profitable shop or store of your own? If so, find out how you can realize your ambition in the fast growing, prosperous RADIO-TELEVISION industry. Even without Television, the industry is bigger than ever before. 90 million home and auto Radios, 3100 Broadcasting Stations, expanding use of Aviation and Police Radio, Micro-wave Relay, Two-way Radio for buses, taxis, etc., are making opportunities for Servicing and Communications Technicians and FCC-Licensed Operators.

Television is TODAY'S Good Job Maker

In 1950, over 5,000,000 TV sets sold. By 1954, 25,000,000 TV sets estimated. Over 100 TV Stations now operating. Authorities predict 1,000 TV Stations. This means more jobs, good pay for qualified men all over the United States and Canada.

Many Make \$10 Extra a Week in Spare Time

Keep your job while training. Hundreds of successful RADIO-TELEVISION TECHNICIANS I trained had no previous experience, some only a grammar school education. Learn Radio-Television principles from illustrated lessons. Get PRACTICAL EXPERIENCE—build valuable multimeter—experiment with circuits common to Radio and Television. Keep all equipment. Many students make \$5, \$10 extra a week fixing neighbors' Radios in spare time. SPECIAL BOOKLETS start teaching you the day you enroll.

Send Now For 2 Books FREE—Mail Coupon

Send now for my FREE DOUBLE OFFER. You get actual Servicing lesson to show you how you learn at home. Also my 64-page book, "How to Be a Success in Radio-Television." Read what my graduates are doing, earning; see equipment you practice with at home. Send coupon in envelope or paste on postal. J. E. SMITH, President, Dept. 2FA, National Radio Institute, Washington 9, D. C. Our 39th Year.

Good for Both—FREE

MR. J. E. SMITH, President, Dept. 2FA
National Radio Institute, Washington 9, D.C.

Mail me Sample Lesson and 64-page Book about How to Win Success in Radio-Television. Both FREE. (No Salesman will call. Please write plainly.)

Name.....Age.....

Address.....

City.....Zone.....State.....

Approved for training under G. I. Bill

The ABC's of
SERVICING

How to Be a
Success
in RADIO-
TELEVISION

I TRAINED THESE MEN

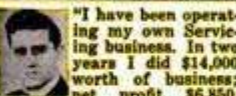

"I have been operating my own Servicing business. In two years I did \$14,000 worth of business; net profit \$6,850. Have one full time employee, an NRI student."—PHILLIP G. BROGAN, Louisville, Ky.



"Four years ago, I was a bookkeeper, with a hand-to-mouth salary. Now I am a Radio Engineer with a key station of the American Broadcasting Company network."—NORMAN H. WARD, Ridgefield Park, New Jersey.

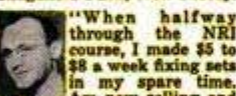

"When halfway through the NRI course, I made \$5 to \$8 a week fixing sets in my spare time. Am now selling and installing Television sets and antennas."—E. J. STREITENBERGER, New Boston, O.

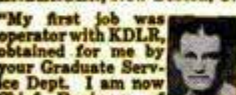

"My first job was operator with KDLR, obtained for me by your Graduate Service Dept. I am now Chief Engineer of Police Radio Station WQOX. I never hesitate to endorse NRI."—T. S. NORTON, Hamilton, Ohio.



EXTRA PAY IN ARMY, NAVY, AIR FORCE

Knowing Radio, TV, Electronics can help you get extra rank, extra prestige, more interesting duty at pay up to several times a private's base pay. You are also prepared for good Radio-TV jobs upon leaving service. Mail Coupon TODAY.

Have Your Own Business

Many N.R.I. trained men start their own Radio-Television sales and service business without capital. Let me show you how you, too, can be your own boss, have a good income from your own shop. Send coupon for FREE book now!

Tested Way to Better Pay

YOU SHAVE CLEANER IN 1/2 THE TIME

"Get it over with" fast with Schick Injector, world's only razor specially engineered to give you "Twice Over" smoothness with "Once Over" Shaving!



No movable parts that get out of adjustment, no detachable parts that can be dropped or misplaced. Specially designed to "fit" your face—under nose, around lips!

Today, get your complete razor kit:

- ★ Gold-Plated Razor
 - ★ 12 Scalpel-sharp "Gold Pack" Blades
 - ★ Handy Travel Case
- Big \$1.75 Value. Now Only

98¢

Only razor offering these 4 advantages

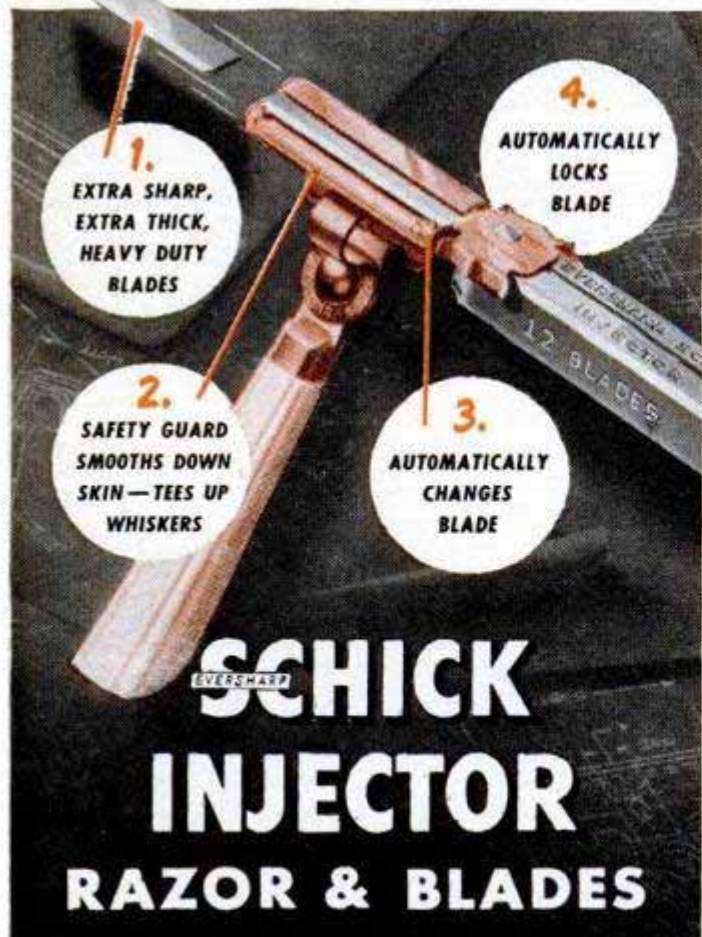

©1952, Eversharp Inc 350 Fifth Ave., N. Y. C

(Continued from page 12)

MISCELLANEOUS

X rays measure tin coating with no delay in production.....	75
Dial phone uses numbered drum.....	79
Portable piano	79
British test devices to speed home building.....	80
Highway vacuum cleaner.....	118
Quieter subways for Paris?.....	128
Chemists make rayon nonwrinkling by altering molecular structure	143
Contact lens for eye pupil.....	220

Craftsman and Shop Notes Index

AUTOMOTIVE

Pad on jack protects car bumper.....	158
Ignition provides "light" for motorist without matches.....	170
Roofing cement rustproofs car.....	200
Damaged crankcase repaired with lampwicking and board....	210

FARM

How to store fertilizer bags.....	200
Tractor weed sprayer.....	201
Protecting fruit buds from frost.....	208
Auxiliary feed supply stored in garbage can.....	208
Poultry house with center driveway has double doors at both ends	209
Easily operated corral-gate latch cannot be nudged open by horses	209
Old hot-water tank converted into automatic hog waterer....	210
Portable compressed-air unit made from oxygen container....	210

HOUSE AND HOME

Abrasive applied to ladder steps provides sure footing.....	153
Table lamps in child's room controlled by toggle switch.....	157
Repairing toilet flush tank.....	158
Solving home problems.....	164
Handy spice rack.....	167
Repairing leaky water pipes.....	170
Box mounted on cupboard door stores household articles.....	172
Hair clip holds memos.....	172
Repairing warped ironing board.....	185
Folding porch chairs stored by hanging on wall.....	185

LAWN AND GARDEN

Tile placed over tomato plant helps speed growth of stalk....	153
Waste water from drinking fountain absorbed in soil-filled sewer tile.....	158
Brick supports garden hose at correct spraying angle.....	158
Tree roots watered and fed through tile sunk in ground.....	170
Quick way to transplant small seedlings.....	172
Knockdown barbecue	173
Cutworms trapped, by fruit rinds placed among plants in garden	190
Screw eyes, string and pipe provide excellent trellis for climbing vines	193

OFFICE, SHOP AND STORE

Tubing used as rubber feet.....	163
Staples enameled before insertion to match surrounding surface	163
Posters handled easily in wind if stapled together.....	182
Thumbtack stop for box cover.....	182
Hook mounted on top of scale keeps forms close at hand.....	200
Holding sack strings for instant use.....	200
Bottom margin of typewritten page indicated by colored tab....	208
Yardsticks fastened together handled easily on blackboard....	208

PHOTOGRAPHY

Photoflood bracket	190
Improvised spotlight boom clamps to chair back.....	192
"Pin up" safelight for darkroom made from standard parts.....	192
Rubber band holding film on reel removed easily when knotted	192
Round corners protect emulsion.....	192
Tape along edge of paper trimmer speeds cutting operation....	192
Negative drier heated by bulb.....	193
Film boxes made into negative file.....	196
"Skyhooks" in basement ceiling support clamp-on photofloods.....	196
Template used for cutting prints simplifies centering of subject	196

RECREATION

Back-yard bronco gallops on auto spring to give young cowboy thrilling ride.....	157
Checkers replaced with disks sliced from broomstick.....	157

(Continued to page 16)

IMPORTANT NOTICE—It is the intention of this magazine to provide its readers with information regarding the latest developments in the mechanical arts. We take no responsibility as to whether the disclosures contained in our articles are covered by patents and advise readers to investigate this subject before making, using, or selling any of the products, machines, or processes described in order to avoid possible liability for patent infringements.



INVENTORS

Learn how to protect your invention. The U. S. Patent Laws provide that any new and useful art, machine, article of manufacture, or composition of matter, or any new and useful improvement thereof, may be patented if the act of invention is involved. Therefore, every inventor with a valuable invention should take advantage of the Patent Laws and proceed for patent protection in order to safeguard his rights.

A patent gives the inventor the exclusive right to prevent others from making, using, or selling the invention claimed in the patent for a period of seventeen years.

The Patent Laws were enacted for the benefit of the inventor to give him protection for the features of his invention which are patentable. These features must be properly and concisely set forth and claimed in a formal application for patent, in order to comply with the requirements of the Patent Laws. For that reason, unless the inventor is familiar with patent matters, he should engage a competent registered patent attorney or agent to represent him. We are registered to practice before the U. S. Patent Office and are prepared to serve you in the handling of your patent matters.

A specially prepared booklet entitled "Patent Guide for the Inventor", containing detailed information with respect to patent protection and procedure, together with a "Record of Invention" form will be promptly forwarded to you without obligation upon request.

CLARENCE A. O'BRIEN & HARVEY JACOBSON

Registered Patent Attorneys

21-F DISTRICT NATIONAL BUILDING

WASHINGTON 5, D. C.

VOTE TODAY

FOR THE FUTURE YOU WANT!

AMERICAN SCHOOL, Dept. GA45, Drexel at 58th, Chicago 37, Ill.
Without obligation, please send FREE and postpaid, full particulars about the subject checked below.

- | | | |
|--|---|---|
| <input type="checkbox"/> Accounting | <input type="checkbox"/> Drafting—Building Trades | <input type="checkbox"/> Plastic Engineering |
| <input type="checkbox"/> Air Conditioning | <input type="checkbox"/> Drafting—Machine Trades | <input type="checkbox"/> Plumbing—Practical |
| <input type="checkbox"/> Architecture & Building | <input type="checkbox"/> Electrical Engineering | <input type="checkbox"/> Private Secretary |
| <input type="checkbox"/> Automotive Technician | <input type="checkbox"/> Electricity—Practical | <input type="checkbox"/> Refrigeration |
| <input type="checkbox"/> Bus Foremanship | <input type="checkbox"/> Electronics—Industrial | <input type="checkbox"/> Retail Merchandising |
| <input type="checkbox"/> Bookkeeping | <input type="checkbox"/> High School Courses | <input type="checkbox"/> Salesmanship—Outside |
| <input type="checkbox"/> Business Management | <input type="checkbox"/> Machine Shop Operations | <input type="checkbox"/> Sheet Metal Work |
| <input type="checkbox"/> Contracting | <input type="checkbox"/> Mathematics & Slide Rule | <input type="checkbox"/> Tool Making |
| <input type="checkbox"/> Diesel Technician | <input type="checkbox"/> Mechanical Engineering | |

NAME..... OCCUPATION.....
HOME ADDRESS..... AGE.....
CITY..... STATE.....

THIS IS YOUR BALLOT

Find the subject that interests you most and then... Check, Sign and Mail Today

• Today, choose the job you want — and prepare for it in spare time at home. Or if you are already engaged in the work you like best, start training now for quicker promotion. In hours you might otherwise waste, gain the knowledge and skill that can help you to get ahead faster, make more money, and have greater security.

Training Backed by 55 Years of Experience

For over half a century American School has helped ambitious men and women toward success by providing specialized training for commercial and technical advancement. Its study program for you has been planned by experts with years of experience in the subject you select and they will give you needed guidance every step of the way.

Don't Delay Your Start

Give serious thought to the list of training courses listed above. Pick the opportunity that interests you, check it and add your name and address. (Check more than one if you are undecided as to which appeals most.) Finally clip out and mail the "ballot" and full information will be supplied, without cost or obligation.

AMERICAN SCHOOL
DEPT. GA45, DREXEL AT 58th, CHICAGO 37, ILL.

THE SOONER YOU START, THE SOONER YOUR GOAL CAN BE REACHED

(Continued from page 14)

Plan of the month—children's slide.....	168
Canvas wading pool.....	171
Small-fry bench.....	171
Portable shower.....	171
Parade routes marked temporarily with long-handled pounce bag.....	190

TOOLS

Safe holder for soldering iron.....	157
Wrench for drill-press chuck.....	163
Holder grips small drills.....	163
Stand supports outboard motor for storage or repair.....	166
Wooden pads attached to C-clamp protect finished work.....	166
Worn end mills and router bits make good punches for "tooling".....	167
Socket chain simplifies wiring of curved electrical fixtures.....	170
Foot switch added to power tool affords convenient control.....	170
Improvised small-tool rack.....	182
Length of hose plugged at ends provides saw-blade container.....	182
Hinges and screws kept together when mounted on cardboard.....	182
Shutoff valve fitted with plug for draining pipe in emergency.....	185
Marks help set index pin accurately.....	200
Special fixture aligns holes when drilling yoke.....	208
Auxiliary tool tray bolted to lathe bed serves as protective covering for ways.....	209
Portable holder for welding rods.....	210

MISCELLANEOUS

Rasp improvised from metal lath ideal for filing plasterboard.....	153
Storing leftover paint.....	158
Rig made from scrap materials simplifies cleaning of fowl.....	163
Luminous paint on umbrella adds safety at night.....	166
Flag socket from pipe elbow drains off water.....	166
Curtain stretcher dries fishline.....	170
Carrying dampened washcloth.....	172
Electric toaster serves as oven for heating sheet plastic.....	172
Rock wool and spar varnish provide chinking compound.....	185
Asbestos sleeve on soldering iron protects near-by parts.....	210

Radio-Television, Electronics

Magnetic sound on film (Bell and Howell Co., 7100 McCormick Road, Chicago 45).....	211
Oscilloscope patterns of power supply (Heath Company [Heathkit], Benton Harbor, Mich.).....	214
Tiny transistors replace certain tubes (Bell Telephone Laboratories, 463 West St., New York City 14).....	215
Printed circuit components (Centralab, Div. of Globe Union, 900 East Keefe Ave., Milwaukee 1, Wis.).....	215
Two-way mobile radio (Northeastern Development Engineers, Inc., 21 Lewis St., Pawtucket, R. I.).....	216
Two-speed push-button tape recorder (Recording Services Co., 4934 N. Claremont Ave., Chicago 25).....	216
Folding TV chairs form hassocks or table (Corson Associates, Inc., 855 Sixth Ave., New York City 1).....	216
Compact hand-type transmitter-receiver (Raytheon Mfg. Co., Waltham 54, Mass.).....	216

Storage Battery Has No Free Acid

More power and less corrosion are claimed for a new storage battery developed in England and now being produced in the United States. The secret of the improved battery is a new-type separator material that eliminates excess free acid between and around the plates. The plates are compressed tightly between layers of the superporous, highly absorbent separator so they cannot warp or buckle. The acid is held in the separators by absorption. Shedding of the plates and separators is eliminated and the usual sludge space at the bottom of the case can be omitted, providing room for longer and more powerful plates. The battery will operate even when turned upside down or placed on its side. At present it is being produced only in truck sizes and is available only within a 300-mile radius of Chicago.

Generators on a modern superbomber produce enough power to light a village of 120 homes, according to Westinghouse engineers.

INVENTORS

If you believe that you have an invention, you should find out how to protect it. The first step is to have a search made of the prior pertinent U. S. patents. If a report on this search indicates that the invention appears patentable you can apply for a patent, and the specifications and claims should be prepared.

The firm of McMorrow, Berman & Davidson, with offices in Washington, D. C., is qualified to take the necessary steps for you. We can make a preliminary search on your invention, advise you whether we think it can be patented, and prepare your application for patent.

Unless you are fully familiar with the U. S. Patent Laws, we recommend that you engage the services of a Registered Patent Attorney to protect your interests. The patent laws are *your* laws. A patent gives you the right to prevent others from making, using or selling the invention claimed in your patent for a period of 17 years.

Use these patent laws for your protection. Investigate whether your invention can be patented. If you have what you believe to be an invention, we suggest that you have this firm make a search for you.

Send for a copy of our Patent Booklet entitled "How To Protect Your Invention," containing information about patent protection and patent procedure. Along with this we will also send you an "Invention Record" form, for your use in writing down and sketching details of your invention. We will mail them promptly. No obligation. They are yours for the asking.

McMORROW, BERMAN & DAVIDSON

Registered Patent Attorneys

PATENTS • COPYRIGHTS • PATENTS

1358 VICTOR BUILDING, WASHINGTON 1, D. C.

If You Had Only 10 Days to Live..

SUPPOSE doctors said you had only ten days more to live! What would you give for another ten YEARS of gloriously healthy life? "Anything in the world," you say. But, unfortunately, it would then be too late. NOW, while you still have many years to live, is the time to fortify yourself against later troubles.

Are you "paunchy" — worried about constipation, short-wind, nervousness, tiredness? Or underweight? Here are some facts it will pay you to read:

Constipation is a Plague

Constipation is so common that many do not realize its serious results. But constipation caused by lack of proper exercise can be overcome. It is the result of letting our bodies "go to seed." First we notice "a little heaviness around the waist." Suddenly we find we are FAT! Then we may begin to get nervous. Short-winded. Pepless. Look old, feel old.

"You Have Made a NEW MAN of Me"

I have helped thousands of men (of all ages) WIN OUT over conditions like these. Men write me, saying: "You have made a New Man of me!"

My method helps to tone up your entire system — to give life to little used muscles. I do not believe in weights, springs, or other such methods. My system of Dynamic Tension is natural, and may easily be applied in the privacy of your own home!

FREE 32-PAGE BOOK

Some of those I have helped were run-down, nervous, constipated. They report that they got rid of their "bay windows"—and now feel full of vigor. They feel that they have added years to their lives.

Don't you think this is worth investigating? Just send the coupon for a free copy of my book, "EVERLASTING HEALTH AND STRENGTH." No obligation. Merely address: Charles Atlas, Dept. 8T, 115 East 23rd Street, New York 10, N. Y.



**CHARLES ATLAS, Dept. 8T,
115 East 23rd Street, New York 10, N. Y.**

I want the proof that your system of Dynamic Tension will help to make a New Man of me—give me a healthy, husky body and muscle development. Send me your free book, "Everlasting Health and Strength," and full details about your TRIAL OFFER.

Name _____ Age _____
(Please write or print plainly)
Address _____
City _____ State _____

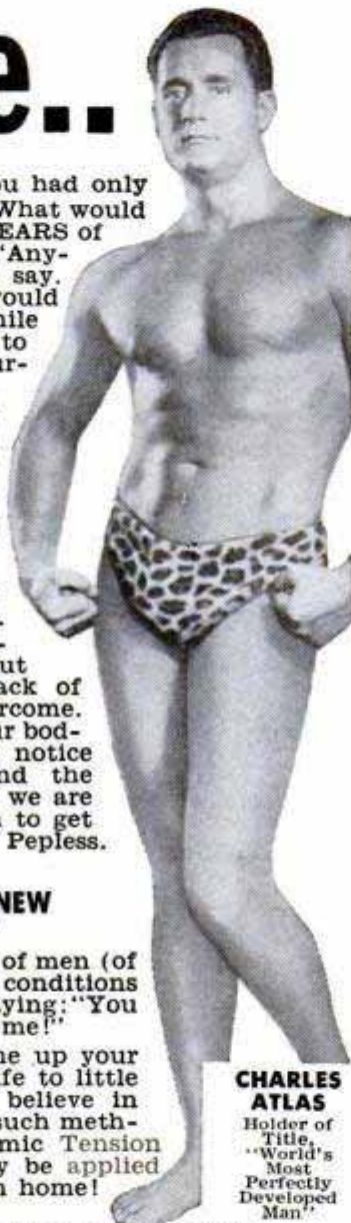

CHARLES ATLAS
Holder of Title,
"World's Most Perfectly Developed Man"

20 POWER! WHISPER WEIGHT 7½ OUNCES

2½ times stronger than binoculars

used by Armed forces! Whisper Weight — 7½ oz. for instant-on-the-spot focusing. Ideal for indoor, outdoor sports, vacationing, trips, long distance spotting. Pocket size — measures only 6¼" closed, 13½" open. NOT A CHEAPLY MADE TOY TELESCOPE! But a precision machined (threaded fittings), precision ground achromatic telescope that invites

comparison. Bears the famous UNITED "Seal of Quality" because they are UNICOATED* assuring buyers that an application of magnesium fluoride has been applied to the interior sides of the VITAL Ocular and Objective lens so users can view distant objects (even those miles away) clearer, brighter and in sharper detail than ever before. Made in American occupied Japan where skilled German optical craftsmen tutored local optical workmen in advanced techniques. It explains why the quality is so high and the prices so low. UNCONDITIONALLY GUARANTEED. Try for 30 days. If not absolutely satisfied in every way return for an immediate unquestioned refund of your money. Introductory price \$8.95 (tax free)! Cash orders postpaid. C.O.D.'s include \$2.00 deposit. UNITED BINOCULAR CO., 9043 S. Western Ave., Dept. ARF-4608, Chicago 20.



\$8.95

NO TAX

LEARN TO MOUNT BIRDS



ANIMALS, FISH, PETS

Be a Taxidermist. Save your hunting TROPHIES. Have a fine home-museum. Hunters, save and MOUNT your beautiful DUCKS, QUAIL, DEER, TAN skins, FURS. Great Fun. Spare-time PROFITS. **FREE BOOK** Tells ALL about it. 100 fine wild-game pictures, 48 pages. SEND TODAY, don't delay. Get this WONDERFUL FREE BOOK, MEN AND BOYS. Learn Taxidermy. Double your hunting pleasure. Rush letter or POSTAL today. STATE YOUR AGE. N. W. SCHOOL OF TAXIDERMISTRY, Dept. 2506, Omaha, Neb.

WRITE 3 WORDS MAKE \$6.00 PROFIT—

—on 10-Second Demonstration to merchants. Write on glass with amazing Magic Crayon—Presto!—5 color advertising message takes fire, glows like brilliant Neon. Three sales daily bring \$18 profit. Rush name for FREE Sales Kit. MAXILUME CO., 125 W. Hubbard, Dept. L-8-H, Chicago 10, Ill.



LEARN MEAT CUTTING

through actual practice. Profitable Meat Cutting and Self Service Meats taught easily, quickly. LEARN BY DOING at Toledo in just eight short weeks under actual market conditions. For beginners or men with experience. All subjects taught thoroughly and completely. Diploma. Job help. Get store of own. People must eat. School in operation over 25 years. Approved for GI training. Send today for FREE illustrated catalog. No obligation. NATIONAL SCHOOL OF MEAT CUTTING, Dept. 50-F, Toledo 4, Ohio

MAKE EXTRA MONEY PLASTICS LEARN AT HOME

LEARN HOW TO MAKE fast selling PLASTIC NOVELTIES FURNITURE JEWELRY SIGNS TOYS LAMPS

There are RICH OPPORTUNITIES for MEN and WOMEN with "know-how" in Plastics. Interstate's amazing new Plastics course tells and shows how to make hundreds of fast selling items out of Plastics. Gives complete training in fabrication, casting, lamination, molding, etc., in simple, easy, step-by-step language and pictures. **START A PLASTICS BUSINESS OF YOUR OWN.** No other industry holds such promise for the future. You can make big money manufacturing novelties, toys, signs, etc., in your own home in spare or full time. Don't wait! Learn NOW how Interstate's Plastics Training qualifies you for success in the plastics field.

Write for FREE Information Today!

INTERSTATE TRAINING SERVICE

School of Plastics, Dept. C-3F
PORTLAND 13, OREGON

Put yourself in the I.C.S. HALL OF FAME*

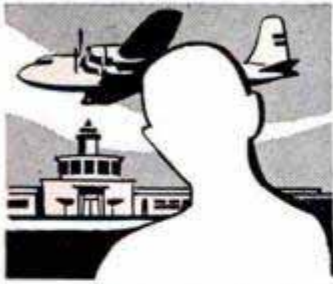

PRESIDENT of a leading airline.



CHAIRMAN of a big government agency.



INVENTOR of a well-known U. S. Army rifle.



DESIGNER of a famous aircraft engine.

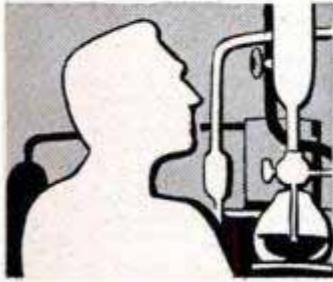

CHEMICAL director of nationally known research laboratory.

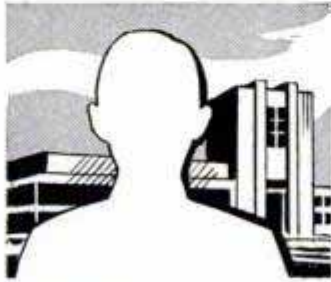

ENGINEER in charge of a famous company's engineering laboratory.

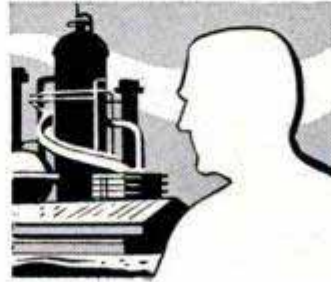

GENERAL MANAGER of one of America's largest chemical companies.



YOU

JOIN these men who have made their mark! Men who by dint of ambition, intelligence and sound, practical I. C. S. training now enjoy positions of leadership in business and industry.

The sooner you start, the better your chances of making the grade. Right now, with the criti-

cal shortage of skilled labor, trained men are becoming leaders overnight. Hundreds of I. C. S. students are reporting promotions and pay increases, earning greater security for themselves and their families. How about marking and mailing the coupon today?

*Names and positions sent on request.

INTERNATIONAL CORRESPONDENCE SCHOOLS



BOX 5529-L, SCRANTON 9, PENNA.

Without cost or obligation, please send me full particulars about the course BEFORE which I have marked X:

- | | | | |
|--|--|---|--|
| <ul style="list-style-type: none"> <input type="checkbox"/> Air Conditioning <input type="checkbox"/> Heating <input type="checkbox"/> Plumbing <input type="checkbox"/> Refrigeration, Domestic <input type="checkbox"/> Refrigeration & Air Conditioning <input type="checkbox"/> Steam Fitting <input type="checkbox"/> Aeronautics Courses <input type="checkbox"/> Aeronautical Engineer's, Jr. <input type="checkbox"/> Aircraft Drafting & Design <input type="checkbox"/> Aircraft Mechanic <input type="checkbox"/> Engine Mechanic <input type="checkbox"/> Architecture <input type="checkbox"/> Architectural Drafting <input type="checkbox"/> Building Estimating <input type="checkbox"/> Contractor's Building <input type="checkbox"/> House Planning <input type="checkbox"/> Art Courses <input type="checkbox"/> Commercial Art <input type="checkbox"/> Magazine Illustrating <input type="checkbox"/> Show Card and Sign Lettering <input type="checkbox"/> Automotive Courses <input type="checkbox"/> Automobile <input type="checkbox"/> Auto Electric Technician <input type="checkbox"/> Auto Body Rebuilding & Refinishing <input type="checkbox"/> Chemical Courses <input type="checkbox"/> Chemical Engineering | <ul style="list-style-type: none"> <input type="checkbox"/> Chemistry, Analytical <input type="checkbox"/> Chemistry, Industrial <input type="checkbox"/> Food-Plant Sanitation <input type="checkbox"/> Petroleum Production and Refining <input type="checkbox"/> Pulp and Paper Making <input type="checkbox"/> Civil Engineering <input type="checkbox"/> Bridge and Building Foreman <input type="checkbox"/> Highway Engineering <input type="checkbox"/> Reading Structural Blueprints <input type="checkbox"/> Sanitary Engineering <input type="checkbox"/> Structural Drafting <input type="checkbox"/> Structural Engineering <input type="checkbox"/> Surveying and Mapping <input type="checkbox"/> Communications Courses <input type="checkbox"/> Telegraphy <input type="checkbox"/> Electrical Courses <input type="checkbox"/> Electrical Drafting <input type="checkbox"/> Electrical Engineering <input type="checkbox"/> Electric Light and Power <input type="checkbox"/> Lighting Technician <input type="checkbox"/> Practical Electrician <input type="checkbox"/> Diesel Engines <input type="checkbox"/> Internal Combustion Engines <input type="checkbox"/> Mechanical Courses <input type="checkbox"/> Forging | <ul style="list-style-type: none"> <input type="checkbox"/> Heat Treatment of Metals <input type="checkbox"/> Industrial Engineering <input type="checkbox"/> Industrial Instrumentation <input type="checkbox"/> Industrial Metallurgy <input type="checkbox"/> Machine Shop Inspection <input type="checkbox"/> Mechanical Drafting <input type="checkbox"/> Mechanical Engineering <input type="checkbox"/> Millwrighting <input type="checkbox"/> Patternmaking—Wood, Metal <input type="checkbox"/> Reading Shop Blueprints <input type="checkbox"/> Sheet-Metal Drafting <input type="checkbox"/> Sheet-Metal Worker <input type="checkbox"/> Ship Drafting <input type="checkbox"/> Tool Designing <input type="checkbox"/> Welding—Gas and Electric <input type="checkbox"/> Radio Courses <input type="checkbox"/> Electronics <input type="checkbox"/> FM and Television Servicing <input type="checkbox"/> Radio, General <input type="checkbox"/> Radio Servicing <input type="checkbox"/> Railroad Courses <input type="checkbox"/> Car Inspector and Air Brake <input type="checkbox"/> Diesel Locomotive <input type="checkbox"/> Locomotive Engineer <input type="checkbox"/> Railroad Section Foreman | <ul style="list-style-type: none"> <input type="checkbox"/> Stationary Engineering <input type="checkbox"/> Power Plant Engineering <input type="checkbox"/> Stationary Fireman <input type="checkbox"/> Textile Courses <input type="checkbox"/> Cotton Manufacturing <input type="checkbox"/> Design Finishing <input type="checkbox"/> Rayon Mfg. <input type="checkbox"/> Woolen Manufacturing <input type="checkbox"/> Business Courses <input type="checkbox"/> Accounting <input type="checkbox"/> Advertising <input type="checkbox"/> Business Administration <input type="checkbox"/> Business Correspondence <input type="checkbox"/> Business Law <input type="checkbox"/> Certified Public Accounting <input type="checkbox"/> Commercial <input type="checkbox"/> Federal Tax <input type="checkbox"/> High School and College <input type="checkbox"/> Industrial Supervis'n <input type="checkbox"/> Personnel—Labor Relations <input type="checkbox"/> Postal Civil Service <input type="checkbox"/> Retailing <input type="checkbox"/> Retail Business Management <input type="checkbox"/> Salesmanship <input type="checkbox"/> Sales Management <input type="checkbox"/> Traffic Management |
|--|--|---|--|

Name _____ Age _____ Home Address _____
 City _____ State _____ Working Hours _____ A.M. to _____ P.M.
 Present Position _____ Employed by _____

Representatives in all principal cities. Canadian residents send coupon to International Correspondence Schools Canadian, Ltd., Montreal, Canada.

THE GREATEST
POWER ON
EARTH!

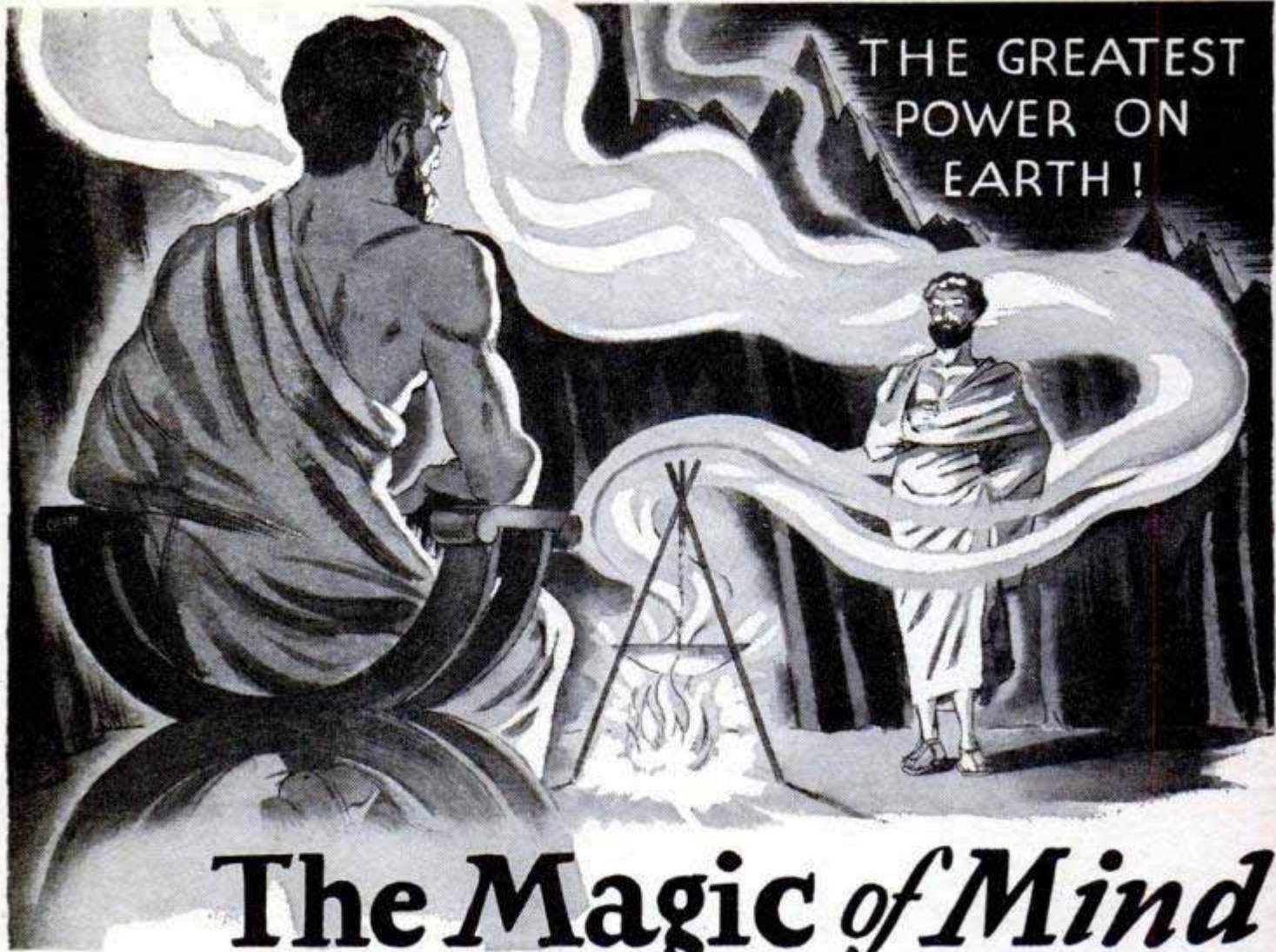

The Magic of Mind

WERE the great personages of the past victims of a stupendous hoax? Could such eminent men of the ancient world as Socrates, Pericles and Alexander the Great have been deluded and cast under the spell of witchcraft—or did the oracles whom they consulted actually possess a mysterious faculty of foresight? That the human mind can truly exert an influence over things and conditions was not a credulous belief of the ancients, but a known and demonstrable fact to them. That there exists a wealth of infinite knowledge just beyond the border of our daily thoughts, which can be aroused and commanded at will, was not a fantasy of these sages of antiquity, but a dependable aid to which they turned in time of need.

It is time you realized that the rites, rituals and practices of the ancients were not superstitions, but superfluges to conceal the marvelous workings of natural law from those who would have misused them. Telepathy, projection of thought, the materializing of ideas into helpful realities, are no longer thought by intelligent persons to be impossible practices, but instead, demonstrable sciences, by which a greater life of happiness may be had.

One of America's foremost psychologists and university instructors, says of his experiments with thought transference and the powers of mind—"The successes were much too numerous to be merely lucky hits and one can see no way for guessing to have accounted for the results." Have you that open-minded attitude of today which warrants a clear, positive revelation of the

facts of mind which intolerance and bigotry have suppressed for years? Advance with the times; learn the truth about your inherited powers.

Let this free book explain

The Rosicrucians (NOT a religious organization) have been leaders in introducing the ancient wisdom of mental phenomena. Established throughout the world for centuries, they have for ages expounded these truths to those thinking men and women who sought to make the utmost of their natural faculties. Use the coupon below—avail yourself of a pleasing book of interesting information which explains how you may acquire this most unusual and helpful knowledge.

The ROSICRUCIANS (AMORC)

USE THIS COUPON

Scribe: G. J. W.
The Rosicrucians, AMORC
San Jose, California

I am sincerely interested in knowing more about this unseen, vital power which can be used in acquiring the fullness and happiness of life. Please send me, without cost, the book, "THE MASTERY OF LIFE," which tells me how to receive this information.

Name _____

Address _____ State _____

Prepare in our
Big Training
Shops for these

GREAT OPPORTUNITY FIELDS!

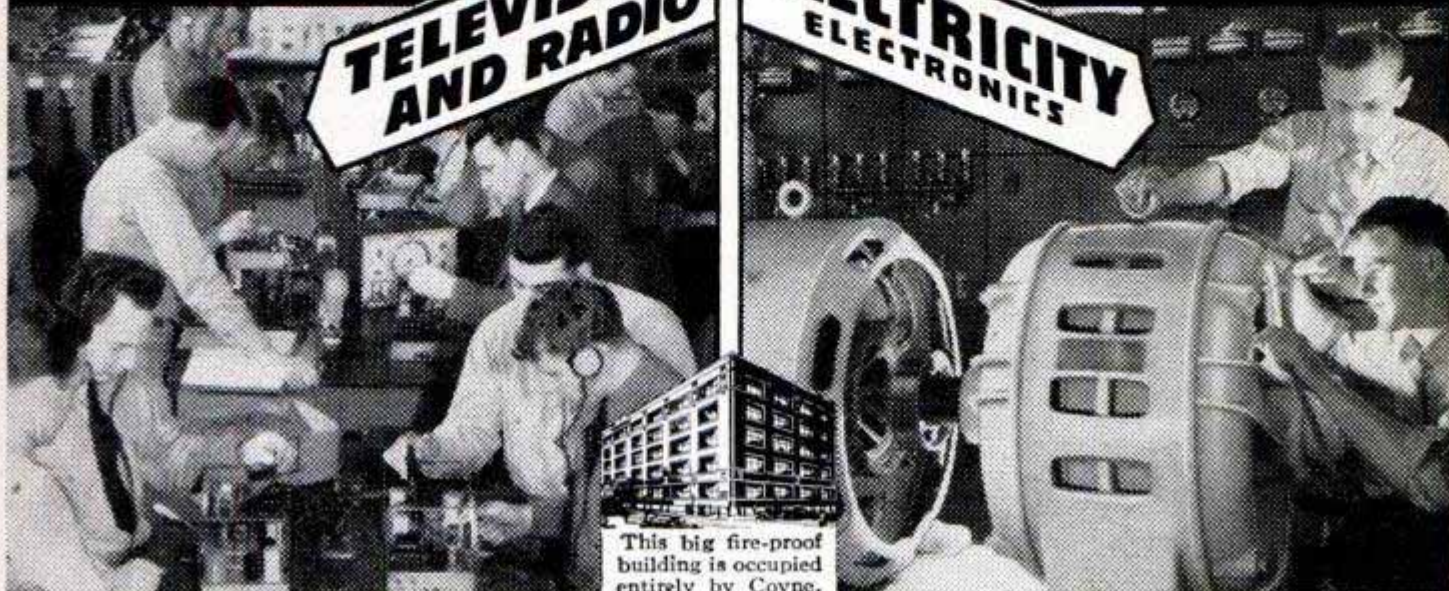

This big fire-proof building is occupied entirely by Coyne.

TRAINED YOUNG AND OLDER MEN — VITALLY NEEDED IN NATION'S DEFENSE AND MILITARY PROGRAMS

Where do you fit in today's gigantic Defense Program and Industrial expansion? Trained young and older men will play an important part in vital fields. Electricity and Television-Radio are essential to our Defense Program in both Industry and Armed Forces. Don't wait to be assigned to a dull, low pay, no future job. Get training and be ready to pick one of many job opportunities or get a better rating if drafted. Today it's not how young or how old you are that counts, but how prepared you are for jobs that demand skilled men. So, whether you are 16 or up to 50 you are needed. Qualify now for:

1. BETTER RATING, HIGHER PAY IF DRAFTED.
2. A VITAL JOB IN INDUSTRY, IF NOT IN DRAFT.

NOT "HOME-STUDY" COURSES

Our famous Television-Radio Practical-Technical method gives you practical experience on a massive outlay of equipment. Not by correspondence, but actual shop work plus necessary technical training. You are trained right here in the great Coyne shops that have been training men and young men for over 50 years.

TELEVISION-RADIO ELECTRICITY

A great opportunity field and vital to Defense. Here at COYNE you're retrained for Construction, Testing, Trouble-Shooting on Radio, Public Address, Sound Units. Training includes FM, Television Installations, Servicing, etc. Many Coyne trained men in good jobs or own well paying Television-Radio businesses of their own.

INCLUDING INDUSTRIAL ELECTRONICS

The Power behind the entire Defense Program. Big future in Power Plant Work, Motors, Armature Winding, Home and Factory Wiring, Appliances, Refrigeration, Maintenance, Illumination, etc. Lifetime job service to Coyne graduates. Send for BIG FREE BOOK.

LARGEST, OLDEST, BEST EQUIPPED SCHOOL OF ITS KIND IN THE U.S.



Mail Coupon for Big FREE Book!

Whether you prefer Television-Radio or Electricity, train on actual equipment at Coyne. We will send you a Big, fully Illustrated Book, indicate below, which course interests you most. No salesman will call. Mail coupon TODAY.



START NOW—PAY LATER

Don't let lack of money hold you back. You can finance most of your tuition and pay for it later, in easy monthly payments. Special plan for men of draft age. We'll help you get part time work, if you need it, to help pay living costs while at Coyne.

G. I. APPROVED

B. W. COOKE, President

COYNE

SCHOOL

A TECHNICAL TRADE INSTITUTE
CHARTERED NOT FOR PROFIT
Established 1899
500 S. Paulina Dept. A2-72H
Chicago 12, Illinois

ELECTRICITY ★ TELEVISION ★ RADIO ★ REFRIGERATION ★ ELECTRONICS

B. W. Cooke, President
COYNE SCHOOL, 500 S. Paulina St.
Dept. A2-72H, Chicago 12, Ill.

Send me your Big Free book, and details of your special plan for men of draft age. I am interested in field checked below. This does not obligate me.

TELEVISION-RADIO ELECTRICITY

NAME.....

ADDRESS.....

CITY..... STATE.....

I GAINED 53 LBS. OF SHAPELY POWER-PACKED MUSCLES

Roger Hirsch now



Which of these
2 ME'S is YOU?

THAT 112 LB.-6 FT.
SPINDLE-ARMED SISSY below
A FEW SHORT WEEKS AGO

NO! friend you don't have to be SKINNY any more just mail NOW the FREE coupon below as I did. Soon YOU can add

6 1/2 inches to your CHEST
3 inches to each ARM

and the rest in proportion just as I did.

You Can WIN
This 15" tall SILVER TROPHY
As I Did in 10 MINUTES of Fun a Day!



Come on, PAL, NOW YOU GIVE ME

10 PLEASANT MINUTES A DAY IN YOUR HOME ... AND I'LL GIVE

YOU a NEW HE-MAN BODY
For Your OLD SKELETON FRAME.

soys *George F. Jowett*
World's Greatest Builder of HE-MEN



GEORGE F. JOWETT
"Champion of Champions"
4 times Winner
Perfect Men Contest

NO! I don't care how skinny or flabby you are; if you're a teen-ager, in your 20's or 30's or over; if you're short or tall, or what work you do. All I want is JUST 10 EXCITING MINUTES in your home to MAKE YOU OVER by the SAME METHOD I turned myself from a wreck to a Champion of Champions.

YES! You'll see INCH upon INCH of MIGHTY MUSCLE added to YOUR ARMS. Your CHEST deepened. Your BACK AND SHOULDERS broadened. From head to heels, you'll gain SOLIDITY, SIZE, POWER, SPEED! You'll become an ALL-Around, ALL-American HE-MAN, A WINNER in everything you tackle—or my Training won't cost you one solitary cent.

Develop YOUR 520 MUSCLES
Gain Pounds, INCHES, FAST!

Friend, I've traveled the world. Made a LIFE-TIME STUDY of every way known to develop your body. Then I devised the BEST by TEST, my "5-WAY PROGRESSIVE POWER" the only method that builds you 5-ways fast. You save YEARS, DOLLARS like movie star Tom Tyler did. Like champ Roger Hirsch did. Like MANY THOUSANDS like you did. SO Mail coupon NOW!

THIS MAY BE
YOUR LAST CHANCE
TO GET FOR
ALL 5 10¢
PICTURE
PACKED COURSES
MILLIONS HAVE
BEEN SOLD FOR
\$7 AND MORE



FREE



BOTH FREE FOR QUICK ACTION!

1. Photo Book of STRONG MEN 2. MUSCLE METER

"Jowett Courses greatest in World for Building All-Around HE-MEN"
—R. F. Kelley
Physical Director

JOWETT INSTITUTE OF PHYSICAL TRAINING DEPT. PM-26
230 FIFTH AVENUE, NEW YORK 1, N. Y.
Dear George: Please mail to me FREE Jowett's Photo Book of Strong Men and a Muscle Meter, plus all 5 HE-MAN Building Courses: 1. How to Build a Mighty Chest. 2. How to Build a Mighty Arm. 3. How to Build a Mighty Grip. 4. How to Build a Mighty Back. 5. How to Build Mighty Legs—Now all in One Volume "How to become a Mighty HE-MAN." ENCLOSED FIND 10¢ FOR POSTAGE AND HANDLING (no C.O.D.'s).

NAME..... AGE.....
ADDRESS.....
CITY..... ZONE..... STATE.....

BE A FROGMAN!



Join the new national FROGMAN CLUB today. All you have to do is send \$1.00—be sure to include your name and address—and here's what you get:

- 1) A miniature pair of Frog Feet. Can be worn on key chain, lapel or hung on windshield as lucky charm.
- 2) An attractive membership card.
- 3) A Frogman decal to be used on your windshield, bicycle or notebook.
- 4) A booklet on "How To Swim Underwater" and "The Supreme Sport of Spearfishing".
- 5) Periodic bulletins on the latest developments in Frogman equipment and news.
- 6) Complete catalog of Frogman equipment available for purchase.
- 7) A free coupon for \$1.00, which can be used toward the purchase of a pair of regular size Frog Feet, \$6.95 or equivalent in value. This is redeemable at your local sporting goods dealer, drug store, auto supply store or toy departments. If no such dealer available in your area, we will handle direct.

BE A FROGMAN — Send your dollar today!

National Frogman Club

1428 Maple Avenue, Dept. PM-6, Los Angeles, 15, Calif.

TASOPE PHOTO-ENGRAVING PLANTS



Establish your own profitable PHOTO-ENGRAVING business. Make cuts for newspapers, printers, and advertisers. Make etched name plates, plaques etc. Instructions furnished, no experience necessary. Sold direct from factory since 1931. First five hundred cuts sold locally or by mail will pay for plant and pay you well for your time. Write for FREE catalog.

Material Cost Of This Cut 3/4c Selling Price \$1.00 And Up

TASOPE DEPT. PM5, AURORA, MO.

MONEY MEN ALL FREE

THE PLASTEX Industry needs manufacturers on small scale and for big production of Lamp and Clock Stands, Art Goods and Novelties in Plastex and Marble imitation. Experience unnecessary. 1/2c material makes regular 10c store sellers. Rubber moulds furnished for speed production. Small investment brings good returns. We are now placing big Chain Store Orders with manufacturers. Ambitious men have chance for real prosperity. Our Free booklet will interest and benefit you.

PLASTEX INDUSTRIES, Dept. A
3400 Third Ave. New York 56, N. Y.

CONSTRUCTION WORKERS

Crafts, Engineers, Foremen—don't slave for dollars—earn thousands year after year as qualified building SUPERINTENDENT or PROJECT MANAGER. Gain practical "know how" in spare time at home. Revolutionary new method shows you proper step-by-step procedures from elementary materials to finished construction. Includes simplified methods of handling contracts, sub-contracts, tools and equipment, estimating, planning, industrial relations, systems, etc. of both organization and management. RUSH name for full FREE facts — no obligation.

GEORGE E. DEATHERAGE & SON
5 E. PRESTON ST. Dept. 101 BALTIMORE 2, MD.

SHORTHAND IN 6

Famous Speedwriting Shorthand system. No symbols; no machines. Uses ABC's. Easiest to learn, write, transcribe. Low cost. 100,000 taught by mail. Also typing. 29th year. Write for FREE booklet to:

Speedwriting
Dept. 1506-2
55 W. 42 St., N. Y. 18, N. Y.

6
WEEKS
AT HOME

HICKORY ACRES 6-WKS. OLD CAPONS STARTED

Easy, Profitable to Raise

Wonderful, tender capon meat brings top prices — makes finest eating. Easy to raise in back yard, on farm, or with other chicks. Hickory Acres 6-Wks. Old Capons are your best buy. Cost less than day old turkeys — easier to raise. Write for prices, information.

HICKORY ACRES CAPON FARM
BOX PM, WINDSOR, MISSOURI



TRAIN AT HOME IN YOUR SPARE TIME

DON'T PUT IT OFF...MAIL TODAY!

GET THE MONEY AND SECURITY YOU'VE ALWAYS WANTED!



L. J. ROSENKRANZ, President, National Schools, the man who has trained many, many men like YOU. Men who now own successful, respected businesses of their own. Men who hold important, high-paying positions in famous companies. You CAN be a success. Mail coupon for more details.

Let Me Show You How! Mail the Coupon for My FREE Books!

Each book has page after page in color. Gives you the complete story about my proved training method...tells how quickly it can train you for a secure, high-paying job. Don't wait. Get the facts. Send today for my valuable books on Radio-Television or Automotive-Diesel. Check the coupon at right and mail it to me today. Absolutely no obligation.

NO SALESMAN WILL CALL!

I'll send you a **FREE SAMPLE LESSON TOO**, if you act fast! Shows how easy it is to learn with National Schools Home Training.

NATIONAL SCHOOLS, Dept. B-62
4000 South Figueroa Street
Los Angeles 37, California

Mail in envelope
or paste on
penny postal card

Send me *Free* the book checked below and the sample lesson. I understand no salesman will call on me.

- "MY FUTURE IN RADIO-TELEVISION & ELECTRONICS" OR
- "MY FUTURE IN DIESEL-AUTOMOTIVE & ALLIED MECHANICS."

NAME _____ AGE _____

ADDRESS _____

CITY _____ ZONE _____ STATE _____

Check here if you were released from the service less than 4 years ago.

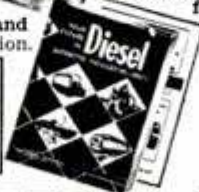

Let National Schools—a resident-training school for nearly 50 years—train you at home for today's unlimited opportunities in Radio-TV or Automotive-Diesel. National Schools is one of the largest schools of its kind in the world. It has 4 big buildings of modern shops and labs. Its faculty is considered tops. You learn fast from easy lessons—all perfected under actual shop conditions. Approved for eligible vets.



Earn Extra Money while you're learning! I'll show you how! EASY TERMS • FREE GRADUATE SERVICE
Mail coupon today—find out more!

WHICH HIGH-PAYING FIELD DO YOU WANT?

TODAY'S SHORTAGE OF TRAINED TECHNICIANS CREATES CHANCE OF A LIFETIME FOR YOU... IN EITHER FIELD!

RADIO-TELEVISION & ELECTRONICS

OR

AUTOMOTIVE-DIESEL AND ALLIED MECHANICS

JOB SECURITY! BIG MONEY! FOR YOU IN TODAY'S EXPANDING INDUSTRIES!

Think of it! With guided missiles, radar and other electronic devices so important to national defense. With big, new developments in color TV. With over 90,000,000 home and auto radios, over 12,000,000 TV sets. With more than 3100 radio stations...over 100 TV stations—and more building every day—imagine the terrific opportunity you have!

You Train at Home—In Your Spare Time

With National Schools Master Shop Home Training, you master all phases of Radio-Television-Electronics. You learn fast from hundreds of pictures and diagrams. All lessons have been developed and tested in National Schools famous shops and labs. No wonder your National Schools training is so up-to-date, practical, interesting. And so easy!

LOOK! WE SEND YOU ALL THESE PARTS! —and you keep them!



We send you lots of standard professional parts. You do lots of practical experiments. You learn step by step. Until you can build the big Superheterodyne Receiver you see above—and other important test units. Mail the coupon—today.

Only National Schools Gives You This Professional Multi-Tester



You get this factory-made new Multi-Tester...an important instrument every Radio-TV man must have.

GREATEST DEMAND FOR TRAINED MEN IN HISTORY! NOW IS YOUR CHANCE!

What an opportunity! With over 8 million older cars needing big service and repair jobs. With defense industry having more high-paying jobs than they can fill. With the Armed Forces offering quick advancement to trained mechanics. YOU ARE NEEDED as never before! Now you can get the good pay, security, the satisfaction of doing what you want to do! Don't delay—mail the coupon NOW!

Right in Your Own Home!

You learn all about Gasoline Engines, Diesel and Special-Fuel Engines, Automotive Tune Up, General Garage Mechanics, Auto Electrical Service. You get complete training for this great, growing industry.

Yet National Schools Home Training is easy! Because it's based on actual shop methods in National Schools big resident school. Mail the coupon for more details—NOW.

National Schools Gives You All These Tools

You start out owning the tools of your trade. A kit of standard, professional tools and equipment. They're all part of your course!

—And you keep them—they're yours!



I Offer You All These!

Basic Lesson Texts, Diesel Installation & Maintenance Instructions, Spare Time Lessons, Engine Service Manuals, Engine Repair Drive Systems, Diesel Electric Power Texts, Special Thermodynamic Instruction.

Attention: Men Going into the Service Soon!

With National Schools training in Radio-Television or Automotive-Diesel, you have the opportunity to get into special service classifications. That means higher pay and grade, more prestige—right away! This is important—so be sure to mail the coupon today without fail.

WHICH OF THESE HIGH-PAYING JOBS WOULD YOU LIKE?

- MOTOR TUNE UP SPECIALIST
- DIESEL ENGINE SPECIALIST
- FARM EQUIPMENT MECHANIC
- YOUR OWN GARAGE OR REPAIR SHOP
- GENERAL GARAGE MECHANIC
- PARTS DEALER
- AUTO ENGINE REBUILDING
- FUEL INJECTION SPECIALIST

You can have secure jobs like these. Just mail the coupon—and find out!

NATIONAL SCHOOLS TECHNICAL TRADE TRAINING SINCE 1905 LOS ANGELES 37, CALIFORNIA

STOP THAT OIL EATER!



GET NEW CAR PERFORMANCE WITH PISTON SEAL WITHOUT COSTLY OVERHAULING

Piston Seal—the amazing compound that forms a self expanding, pliable lubricating seal around pistons that compensates for wear. Eliminates oil burning, restores power and compression. Can be applied in a few minutes.

GOOD FOR 10,000 MILES



SIMPLY REMOVE SPARK PLUG AND SQUEEZE

FOR COMPLETE, FREE DETAILS WRITE TO

RICHE DISTRIBUTING CO. 11916 Madison Ave., Dept. F, Cleveland 7, Ohio



SEND NO MONEY • MORE THAN 4000 PAGES • 2750 PICTURES

9 BIG COMPLETE BOOKS BUILDING, ESTIMATING, CONTRACTING

Examine this Up-to-Date Edition for 10 days. See how these nine books supply easily understood training that will help you to get a better job and make more money, or start a profitable business for yourself. Think what a BIG help it will be to have them handy for use in solving all sorts of building problems.

Learn to draw plans, estimate, do all-new construction and modern remodeling to meet fast growing demand. More than 4000 pages of practical, pay-raising information with 2750 helpful illustrations, on such subjects as blueprint reading, concrete forms, masonry, carpentry, steel square, electrical wiring, plumbing, heating, painting, and hundreds more.

In our more than 50 years we have never offered more complete building information. Send the coupon TODAY.

(A year's consulting privileges with our engineers now given with these books without extra cost.)

AMERICAN TECHNICAL SOCIETY—Publishers Since 1898
Dept. GA19, Drexel Ave., at 58th St., Chicago 37, Ill.

I would like to examine your 9-Volume Set of Building, Estimating, Contracting Books. I will pay the delivery charges only, but if I choose I may return them express collect. If after 10 days' use I prefer to keep them, I will send you \$3 and pay the balance at the rate of only \$4 a month until \$34.80 has been paid. Include consulting service as offered above.

Name _____

Address _____

City _____ State _____

Please attach letter giving employer's name and address (if self-employed give business man reference). Men in service please give home address.

How to Always Have HOT WATER

Make Your Own Automatic Electric Water Heater **\$19.95** now for only

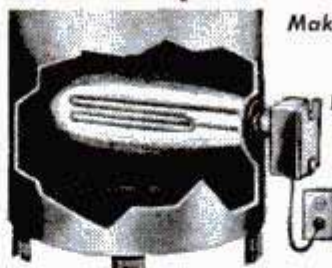

ONE YEAR GUARANTEE All Parts U. L. Approved

degrees. Replaces coal, oil, gas in home, store, summer cottage, green house, farm, barn, stock tank, poultry scalding, factory. Uses only 1/4 to 1/2¢ electricity per gallon hot water. Why burn expensive main furnace unit for hot water? Send check or M. O. NOW; save postage, shipping charges. **ORDER NOW . . . TODAY.**

COLLOID EQUIPMENT CO., INC. Dept. PM6, 50 Church Street, New York 7, N. Y.

Money back in 10 days if not delighted. **INSTALL IN 5 MIN.**

Why suffer without hot water? Enjoy lots of it to wash, bathe, shave. Heater keeps water HOT in your present tank. Turns ON when needed—shuts OFF when water is heated. No flue, dirt, fire! No disturbing or draining of tank or pipes. Ideal for 30-gal. tanks! Heater screws into any size boiler tap as shown. Plugs into outlet . . . 1320 w. 110 v. AC. (Also 2000 w. 220 v. model for BX cable \$19.95) . . . works automatically thereafter. Temperature adjustable between 120 to 180

BOOST YOUR EARNING POWER WITH

DIESEL

Train Now For This Big Pay Trade!

Are you mechanically inclined? Then you'll like DIESEL! You'll like working on these modern engines . . . pulling down the big pay of DIESEL-TRAINED men. Train at home for Diesel opportunities with simple, practical UET Training. Learn DIESEL engine operation, fuel systems, repairs, maintenance PLUS Scientific Motor Tune-up. Course includes shop training in our big, well-equipped shops, working on Diesel engines. Write now for FREE booklet!

UTILITIES ENGINEERING INSTITUTE (Founded 1927)
2521 Sheffield Avenue, Dept. DC-20, Chicago 14, Illinois



ITALIAN ACCORDIONS

Hand Made. Very Best. Buy Direct from Factory Representative at lowest wholesale prices and Save Money. Send Name and Address for FREE catalog.

ITALIAN ACCORDION MFG. CO.
7600 Cottage Grove Ave., Dept. PM-6, Chicago 19, Ill.



Bar Bells

Buy Direct From Factory **\$8.95** up

Write for free booklet and price list

INDEPENDENT IRON WORKS

2416 East 23rd Street, Dept. B
Los Angeles 58, Calif.



SILVER SOLDER TORCH & KIT \$7.50

JOINS ALL METALS PERMANENTLY

Do your own repairing. KIT includes one tube silver solder "XCEL-FLUX" paste and 10 5-in. lengths silver solder alloy. Hottest ALCOHOL TORCH known. 2700° F. flame. Operates in any position, indoors or out. Pint of special fuel included. TORCH alone with pint of special fuel \$6.50. KIT alone \$1.50. Add 35c on each order towards shipping charges.

AMERICAN PRODUCTS CORP., 422 S. Dearborn, Dept. 3-F, Chicago

OWN Your Own Business

\$5 per hour

Clean and Mothproof rugs and upholstery "in the home" or public buildings. If now employed, you can operate in spare time and build up a permanent profitable full-time business. Alert dealers can average \$5 hourly gross profit on service they render and \$3 on EACH of their servicemen at National Price Guide

charges. Easy to learn . . . quickly established.

DURACLEAN cleans by absorption! No scrubbing, soaking or shrinkage. Dirt and grease vanish . . . matted pile rises . . . colors revive. Furnishings used again same day.

DURAPROOF resists moths and carpet beetles. Your service backed by a National Money Back 4 Year Warranty.

We furnish enough material to return your total investment in War-proof Business. **EASY TERMS.** Send for **FREE** booklet TODAY.

DURACLEAN CO., 2-166 DURACLEAN BLDG., DEERFIELD, ILL.



PATENTED PORTABLE EQUIPMENT

**NOW... GET EVERYTHING YOU
NEED TO LEARN AND MASTER**

TELEVISION

**RADIO-ELECTRONICS
...AT HOME!**

Use REAL commercial-type equipment to get practical experience

Your future deserves and needs every advantage you can give it! That's why you owe it to yourself to find out about one of the most COMPLETE, practical and effective ways now available to prepare AT HOME for America's billion dollar opportunity field of TELEVISION-RADIO-ELECTRONICS. See how you may get and keep the same type of basic training equipment used in one of the nation's finest training laboratories... how you may get real STARTING HELP toward a good job or your own business in Television-Radio-Electronics. Mail the coupon today for complete facts — including 89 ways to earn money in this thrilling, newer field.

D.T.I., ALONE, INCLUDES BOTH MOVIES and HOME LABORATORY In addition to easy-to-read lessons, you get the use of HOME MOVIES — an outstanding training advantage — plus 16 big shipments of Electronic parts. Perform over 300 fascinating experiments for

practical experience. Build and keep real commercial-type test equipment shown at right

**Get BOTH of these
information packed
publications FREE!**

practical experience. Build and keep real commercial-type test equipment shown at right

MODERN LABORATORIES

If you prefer, get all your preparation in our new Chicago Training Laboratories — one of the finest of its kind. Ample instructors, modern equipment. Write for details!

MILITARY SERVICE!

If you're subject to military service, the information we have for you should prove very helpful. Mail coupon today.

**89 WAYS
TO
EARN
MONEY
IN TELEVISION
RADIO ELECTRONICS**

**You GET
ALL 6**

ACT NOW! MAIL COUPON TODAY!

DE FOREST'S TRAINING, INC. DEPT. PM-6-1
2533 N. Ashland Ave., Chicago 14, Ill.

Without obligation, I would like your Opportunity News Bulletin showing "89 Ways to Earn Money in Television-Radio-Electronics"; also, the folder showing how I may prepare to get started in this thrilling field.

Name.....Age.....
Address.....Apt.....
City.....Zone.....State.....



17 INCH TUBE

**Here's the
REAL THING!**

**SET UP YOUR OWN
HOME LABORATORY**



R-F Signal Generator



Oscilloscope

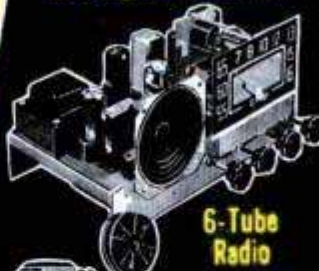

**6-Tube
Radio**



Multimeter

**Home
Movies**

**"ONE OF AMERICA'S FOREMOST
TELEVISION TRAINING CENTERS"**

DeFOREST'S TRAINING, INC.
CHICAGO 14, ILLINOIS
A DeVRY INSTITUTION

EARN MORE IN DRAFTING



More Opportunities for Employment and Promotion

"Here I am at work making good money as a draftsman. I'm glad I sent the coupon to Chicago Tech for that Free Trial Lesson and found out how easy it is to learn Drafting in spare time at home. Today I feel secure in my job because the draftsman's work comes first on any new project. And, in addition, draftsmen can't be replaced with machines. What's more, I feel I'm slated for promotion and more pay, because I see so many draftsmen advancing to high-pay jobs."

LEARN IN SPARE TIME — AT HOME!

(or at the College in Chicago)

A few hours of pleasant home study every week—that's all. No interference with your present job. All the tools you need; drawing outfit included. With Chicago Tech's help, you train yourself step by step. This tested method—developed over 48 years of C.T.C. progress—prepares men quickly for good positions in industry.



FREE INFORMATION—SEND COUPON

To prove to you how easy it is to learn Drafting at home by the Chicago Tech method, we will send you this FREE TRIAL LESSON. No charge for this lesson, now or later. Fill out and mail coupon, or send post card today.

CHICAGO TECHNICAL COLLEGE

G-250 Tech Bldg., 2000 So. Michigan Ave., Chicago 16, Illinois

Mail me FREE Lesson with information about big opportunities in DRAFTING.

Name _____ Age _____

Address _____

City _____ Zone _____ State _____

UNLIMITED OPPORTUNITIES IN ENGINEERING

DEGREE IN 27 MONTHS

Study Engineering in this world-famed school, established 1884. Demand for our graduates exceeds supply. Growing shortage of engineers. No field offers greater opportunities for responsible, lucrative positions.

Bachelor of Science Degree in Mechanical, Civil, Electrical, Chemical, Aeronautical, Radio (Television) Engineering; Business Administration and Accounting. Also 36-weeks certificate course in Surveying and Drafting.

Personalized Instruction. Accelerated courses. Non-essentials eliminated. For ambitious, earnest students. Earn your degree in the shortest possible time. Preparatory courses. Placement service.

Extensive Campus. Well equipped, new and modernized buildings; up-to-date labs. Low cost. New terms start quarterly. Enter September, January, March, June.

Write today for free catalog and special information.



TRI-STATE COLLEGE

462 College Ave. ANGOLA, INDIANA

START YOUR OWN ELECTRICAL APPLIANCE REPAIR BUSINESS



Repair electrical appliances of friends and neighbors. Service electrical equipment in factories, stores, etc. Work full or part time! New Shop Method home-training system. Rush name today for **FREE BOOK** and special form for getting Electronic Kit, Valuable Heating Element Kits, Advisory Service and Illustrated Instructions on new easy-payment plan. Pay later from **EARNINGS WHILE LEARNING.** Rush name today.

CHRISTY TRADES SCHOOL

4432 N. Kedzie, Dept. D-703, Chicago 25

AVIATION

The aircraft industry urgently needs trained personnel. Here is YOUR opportunity for a rewarding and interesting future. Study Aeronautical Engineering, Engineering Drafting, Airplane and Engine Mechanics (approved by C.A.A.). Outstanding faculty, modern equipment. Part-time employment. Free placement service. Big demand for graduates. 23rd year. Founded by Curtiss-Wright. Write for free bulletin and "Opportunities in Aviation".

AERONAUTICAL UNIVERSITY

Dept. 75, 1905 Prairie Avenue, Chicago 16, Illinois

LEARN MEAT CUTTING At Home — In Spare Time



Get into the vital meat industry. Concise, practical Home Training based on 25 years proven instruction methods used at National's famous resident school. Prepares you for bigger pay as Meat Cutter, Supervisor, market manager or more money in your own store. Go as rapidly as your spare time permits. Diploma. Start NOW to turn your spare hours into money. Send for FREE bulletin today. No obligation.

NATIONAL SCHOOL OF MEAT CUTTING, INC., Div. U-141, Toledo 4, Ohio

EASY TO LEARN CODE

Learn or increase speed with an Instructograph—the Radio-Telegraph Code Teacher that takes the place of an operator-instructor and enables anyone to master code without further assistance. Available tapes from beginners alphabet to typical messages on all subjects. Speed range 5 to 40 WPM. Always ready—no QRM. Thousands have "acquired the code" with the Instructograph System. Write today for convenient rental and purchase plans.



INSTRUCTOGRAPH COMPANY

4701-V Sheridan Road, Chicago 40, Illinois

EARN MORE MONEY

Train for an exciting career in professional photography! Study at home in your spare time. You don't need a high school diploma. Everyday common sense is all you need to understand the simple, down-to-earth, fully illustrated and diagrammed lessons in the famous NYI Home Study Course. 90 ways to Earn While You Learn! Let us show you our success-tested method. Write for your copy of our big colorful book today. Personal attendance courses in New York. 42nd Year.

N. Y. INSTITUTE OF PHOTOGRAPHY

Dept. "49" 10 W. 33rd St. CH 4-3462

Say You Saw It in Popular Mechanics

WANT TO Write Stories

FREE BOOK tells how you learn at home

Articles & Mysteries?



Would you be willing to spend a few hours a week learning to write so you may earn \$300-\$1200 a year part-time? Or many thousands full-time? FREE book, "Art of Writing Salable Stories" tells how to get started writing short stories, radio-TV scripts, articles, business items. Many students earn while learning (A.B. Aretz sold first 2 stories for \$255). Endorsed by famous authors, scores of successful graduates; approved for veterans. Send today for FREE book (no salesman will call).

PALMER INSTITUTE OF AUTHORSHIP, Founded 1917
1680 N. Sycamore Hollywood 28, Calif. Desk T-62

COLORCRETE

Lifetime beauty comes out of a gun! Colorcrete is a cementitious plastic, applied by pneumatic pressure to new or old concrete, stucco, etc. Tough, tenacious, enduring. Can be washed or scrubbed. Dirty, drab surfaces become sparkling white or tinted from a range of 30 colors.

"Building-Beautifying" - Your Big Opportunity

Colorcreting is a fascinating and profitable opportunity for men who want to build a substantial, long-term business. Colorcreting is exclusive. Rich in sales appeal to building owners. Income potentials are high; investment is low. We supply complete equipment, full instructions and liberal cooperation. Requires no previous experience or special ability. Write or wire for the Opportunity Book today. Be the first in your community.



COLORCRETE INDUSTRIES, INC.
570 Ottawa Ave., Holland, Mich.

Would You Like to Make \$1,000 A MONTH?



That's what Stanley Hyman made selling the amazing new Presto Fire Extinguisher! Many others "cleaning up" — so can you! Amazing tiny new extinguisher ends fires fast as 2 seconds. Guaranteed for 20 years! Sells for only \$3.98! Write for Free sales kit. Merlite Industries, Inc., Dept. 56, 201 E. 16th St., New York 3, N.Y. (If you want a regular Prosto to use as a demonstrator send \$2.50. Money back if you wish.)



LEARN CARTOONING Get in the Big Money

Former Landon students are really cleaning up. Creators of "Steve Canyon", "Freakies", "Out Our Way", "Winnie Winkle", "Regular Fellers", "The Neighbors", "Strange as It Seems" are just a few of them. Simplified Landon Picture Chart method makes progress quick, exciting, easy. Earn while learning. Rush 10¢ for Picture Chart (to test your ability) and full details. Please state age.



Landon School of Cartooning, 5206 CTS Bldg., Cleveland, O.

LEATHERCRAFT and many other crafts

SHELLCRAFT • easy to do • complete supplies

TEXTILE PAINTING • profitable too • everything you need

Send for FREE 1952 BIG CATALOG TODAY

KIT KRAFT • 7373 Melrose Ave. Dept. 29. Hollywood 46, Calif.

RADIO

Engineering. All phases radio & electronics theory & practice; television; FM; broadcasting; servicing; aviation, marine & police radio. Prepare for high pay: 18-month course equal in radio content to 4 yrs. college. Enter Jan., March, June, Sept. Regular campus life. Catalog.

VALPARAISO TECHNICAL INSTITUTE, Dept. D, Valparaiso, Ind.

When You Can Earn More in WATCHMAKING

LEARN By KCSW's Outstanding Method

High-paying jobs now open. Pleasant work. Or build a business for yourself right in your own home, repairing clocks and watches.

Inquire today about the opportunities in this high-paying trade, through the latest HOME STUDY TRAINING. Also Resident School.

KANSAS CITY SCHOOL OF WATCHMAKING
1218 Admiral Blvd. Kansas City 6, Missouri

HOW TO FIX ANY PART OF ANY CAR

QUICKLY--EASILY--RIGHT!



FREE 7-DAY TRIAL

Whether you're a beginner or an expert mechanic — now you can "breeze through" any "fix-it" job from simple carburetor adjustment to complete overhaul. Just look up job in index of MOTOR'S Brand-New 1952 Auto Repair Manual. Follow simple step-by-step directions, clear pictures. Presto—the job is done!

No guesswork! MOTOR'S MANUAL takes you from "scratch" — shows WHERE to start, WHAT tools to use. Covers EVERY job on EVERY car built from 1935 thru 1952!



Everything You Need to Know "Boiled Down" from 170 Official Shop Manuals

NEW, REVISED, ENLARGED, 1952 Edition contains the "meat" from over 170 OFFICIAL factory manuals—simplified for YOU. 38,000 essential repair specifications on 831 car models. Over 810 big pages. More than 2400 "this-is-how" pictures. 225,000 service and repair facts. Leads beginners every step of the way. Time-saving factory repair procedures for experts. Instructions and pictures so clear you CAN'T go wrong. Used by U. S. Army and Navy.

Try Book FREE 7 Days

SEND NO MONEY! Pay postman nothing. Make Manual show you what it's got. Unless you agree this is the greatest time and work saver you've ever seen—return book in 7 days and pay nothing. Mail coupon today to: MOTOR — Book Dept., Desk 1G, 250 W. 55th St., New York 19, N.Y.

Covers 851 Models All These Makes

- Buick La Salle
- Cadillac Lincoln
- Chevrolet Mercury
- Chrysler Nash
- Crosley Nash
- De Soto Rambler
- Dodge Oldsmobile
- Ford Packard
- Frazer Plymouth
- Henry J Pontiac
- Hudson Studebaker
- Kaiser Terraplane
- Lafayette Willys

Same FREE Offer On MOTOR'S Truck and Tractor Manual

Covers EVERY job on EVERY popular make gasoline truck, tractor made from 1936 thru 1951. FREE 7-Day Trial. Check proper box in coupon.



MAIL COUPON NOW FOR 7-DAY FREE TRIAL

MOTOR BOOK DEPT.
Desk 1G, 250 W. 55th St., New York 19, N.Y.

Rush to me at once (check box opposite book you want):

MOTOR'S New AUTO REPAIR MANUAL. If O.K., I will remit \$1 in 7 days (plus 35c delivery charges), \$2 monthly for 2 months and a final payment of 95c one month after that. Otherwise I will return the book postpaid in 7 days. (Foreign price, remit \$8 cash with order.)

MOTOR'S New TRUCK & TRACTOR REPAIR MANUAL. If O.K., I will remit \$2 in 7 days, and \$2 monthly for 3 months, plus 35c delivery charges with final payment. Otherwise I will return book postpaid in 7 days. (Foreign price, remit \$10 cash with order.)

Print Name..... Age.....

Address

City..... State.....

Check box and save 35c delivery charge by enclosing WITH coupon entire payment of \$5.95 for Auto Repair Manual (or \$8 for Truck & Tractor Repair Manual.) Same return-refund privilege.

We teach you FREE!



We put you in Business!

HERE'S THE BIG OPPORTUNITY FOR YOU! Learn a new and fascinating occupation... a wonderful hobby... and MAKE MONEY AT THE SAME TIME! OPERATE AT HOME OR IN A SMALL SHOP! AND... the complete instructions... books, lessons and personal guidance COST YOU NOTHING! We teach you FREE how to make the most beautiful jewelry you have ever seen: door-knobs imbedded with interesting objects, nite-lites, book-ends, coasters, name-plates, ash trays, paper weights, statues, figurines, souvenirs, novelties, gadgets, etc. . . . an endless variety of high-quality, highly saleable products out of LIQUID MARBLE, TRANSPARENT GEM-LIKE LIQUID PLASTIC, CERAMICS, PLASTER, COMPOSITIONS, STONE, ETC.! All without tools or machinery! The manufacture of these lovely objects is as easy as pouring water out of a glass! And—you learn how ABSOLUTELY FREE! The only limitation is your own IMAGINATION! No special talents or experience are required!

You get more than the FREE INSTRUCTIONS! We also show you methods of selling your finished work... even selling part of it to us! Start on a shoe-string! And overnight, become established in one of the most fascinating and profitable occupations in existence!

Just send 25c for our big catalog, "CASTING MATERIALS, MOLDS, ETC."—and you're on your way! Along with the catalog we will include the book, "THE ART AND BUSINESS OF CASTING" absolutely FREE! And—surprising details on an amazing, exclusive Plasticast offer guaranteeing your success! DON'T DELAY! This could be the most important step of your lifetime! WRITE TODAY!

PLASTICAST CO. (DEPT. C)

P. O. Box 6737 (WRITE TO NEAREST ADDRESS) P. O. Box 987 Chicago, Ill. Palo Alto, Calif.
CANADIAN CUSTOMERS: Send 35c for catalog to Canadian Ind. PLASTICS, 1056½ W. Pender St., Vancouver, B. C.

Learn this Profitable Profession

IN 90 DAYS AT HOME

Money-Making Career Open to Men and Women, 18 to 60

Hundreds of men and women between 18 and 60 make \$10 to \$20 in a single day giving scientific Swedish Massage and Hydro-Therapy treatments. There is big demand from doctors, hospitals, sanatoriums and clubs. Graduates earn large full time income from these or in private practice in their own offices. Others make good money from home treatments given in spare time. Learn this interesting money-making profession in your own home, through our home study course. Same instructors as in our nationally known resident school. You can win independence and prepare for future security by qualifying for your Graduation Certificate. Course can be completed in 3 to 4 months. Many earn while they learn. Begin your training at once.



NEW 32-PAGE BOOKLET FREE

Fill in the coupon below (please print name and address) and mail it for your FREE copy of 32-page Information Booklet. If you act at once we will include Anatomy Charts and Success Booklet which supply additional information you should have. All will be sent postage paid.

THE COLLEGE OF SWEDISH MASSAGE
Dept. 264G, 41 E. Pearson St., Chicago 11, Illinois

Please send me FREE and postpaid New 32-Page Illustrated Booklet, Anatomy Charts and Success Booklet at once.

Name _____ Age _____

Address _____

City _____ State _____



\$1.00
to \$2.50

The Flatfish IS SOMETHING SPECIAL

It almost passes belief how many more fish the Flatfish catches because of its offset hooking which prevents the fish from throwing the hook. When a fish strikes a Flatfish, it's in as bad a fix as a man who jumps off a skyscraper, regretting it when he is half-way down. Its number is up—and that's for sure! No wonder it's the world's largest selling plug! Get it at your tackle dealer's or write for 48-page book with fishing secrets of famous anglers.

Free CATALOG

3669 MELDRUM

HELIN TACKLE CO.

DETROIT 7, MICH.

LEARN WATCH REPAIRING



AT HOME. By our modern and original system of instruction you can learn every part of the WATCH REPAIRING TRADE AT HOME. Prepare yourself for a well-paying position or start in business after completing our course of instruction. Good watch repairers are in demand and generally earn very good salaries. For particulars apply to the

WISCONSIN SCHOOL OF WATCH REPAIRING
759 N. Milwaukee, Dept. 6, Milwaukee 2, Wis.

DAN LURIE
"America's Most Muscular Man"
—on television's "Big Top."

FAMOUS DAN LURIE

BARBELLS

with 4 courses—low factory prices
50 lb. set... \$ 8.48 | 150 lb. set... \$20.48
100 lb. set... 13.98 | 200 lb. set... 25.98

Write for Free Catalog Extra wts. 13c per lb., F.O.B. plant

DAN LURIE BARBELL CO.

1701-M6 Pitkin Ave., Dept. 259-F, Brooklyn, N. Y.



MAKE YOUR OWN!

WITH

GRIFFIN LEATHERCRAFT KITS

Best assortment of tools, materials in U.S.A. Send 25¢ for 116-page catalog. (money refunded first order)

GRIFFIN CRAFT SUPPLIES

SINCE 1924

5626-A Telegraph Ave., Oakland 9, Calif

"How to Make Money with Simple Cartoons"



A book everyone who likes to draw should have. It is free; no obligation. Simply address

FREE BOOK

CARTOONISTS' EXCHANGE

Dept. 96D Pleasant Hill, Ohio

RUPTURED?

Get Relief This Proven Way

Why try to worry along with trusses that gouge your flesh—press heavily on hips and spine—enlarge opening—fail to hold rupture? You need the Cluthe. No leg-straps or cutting belts. Automatic adjustable pad holds at real opening—follows every body movement with instant increased support in case of strain. Cannot slip whether at work or play. Light. Waterproof. Can be worn in bath. Send for amazing FREE book, "Advice To Ruptured" and details of liberal truthful 60-day trial offer. Also endorsements from grateful users in your neighborhood. Write:

CLUTHE SONS, Dept. 31, Bloomfield, New Jersey.

At Last! Science Shows You How to . . .

Stop Headlight Glare! Actually See in the Dark!

Do you drive your car after dark? Do you know that 4 out of 5 fatal smash-ups are caused at night . . . to SAFE, careful drivers who are trapped . . . blinded . . . and killed by the headlights of another man's car?

HERE is the first full story of how you can completely avoid that blinding headlight glare . . . avoid those night driving accidents . . . how you can actually drive at night with almost full daylight safety!

How many times this month have you been completely blinded by the headlights of another car? How many times have you been blinded when you were driving 30-40-50-miles an hour . . . when you were in the middle of a dangerous intersection . . . when you were turning a sharp curve or corner? Yes, how many times this month have you been forced to trust your life—and the lives of your family—to a driver who doesn't even have the sense to dim his headlights?

These Accidents Can Be Avoided

Do you know that now you can avoid all these risks? Do you know that during the last five years over 70,000 drivers have found a new way to protect themselves against this headlight blindness? That these drivers have tested and proved an optical instrument that actually makes the brightest headlights as easy to take as dims. Here is that amazing story:

Five years ago, three of the country's top optical experts decided to tackle this problem of headlight glare. They immediately discovered that all of the common remedies were either useless or actually dangerous. These experts discovered that there was only one sure way to protect yourself against this blinding night glare—a piece of optically colored glass worn by you, yourself—that filters out the glare from these headlights in exactly the same way that a pair of sunglasses filters out the glare of the sun.

These experts discovered that scientists had developed such a glass—that many of the leading automobile manufacturers, such as Buick, Cadillac, Oldsmobile, Lincoln and Chrysler—were equipping their special deluxe models with special glare-resistant windshields. However, the cost of this glass on these special cars was necessarily \$20-\$50.

To avoid these costs these experts took this special glare-resistant glass and built it into a pair of Night Driving Glasses that could be worn by any driver. Since they eliminated all rays of glare, the experts called them RAYEX Night Driving Glasses. Here are some of the amazing results they discovered when they tested them.

This Is How Night Driving Should Be

1. WITH THESE RAYEX Night Driving GLASSES, you can look directly into the brightest headlights. You will see the headlights as pale amber discs—but you will not see the glare. You could pass an entire line of fifty cars, and not even squint.
2. WITH THESE RAYEX Night Driving GLASSES your eyes will be protected against any intrusion of glare. They will not have to adjust themselves to constant flashes of light. You will actually be able to see better . . . clearer . . . and farther with them than you could see without them. You will see dark objects more quickly. You will react more quickly to the pedestrian who starts out on a side street . . . to the dark bumps in the road that ruin your tires.
3. SINCE THESE RAYEX Night Driving GLASSES PROTECT YOUR EYES AGAINST STRAIN, you will not suffer from dangerous night driving headaches. You will be able to drive as much as 400 miles in a single night without feeling the slightest strain. You will not be tired after short rides. And, above all, tired, strained eyes will not cause you to fall asleep at the wheel. You may make even the longest trips with absolute confidence. ORDER TODAY! Use coupon at right!

Proven By Over 70,000 Drivers

Before these glasses were advertised in magazines, they were distributed to over 70,000 drivers . . . volunteers who tested them under every possible sort of night driving condition. Here are the actual reactions of these drivers—their own, unsolicited experiences with these glasses. Perhaps they will help solve your night driving problems.

DO YOU EVER DRIVE ON THE OPEN HIGHWAY?

"On my trip to Denver last week, I must have passed at least 50 cars. Not one dimmed down his lights. If I hadn't had your glasses, I would have had to pull over to the shoulder, and wait till they passed by. As it was, I didn't even squint."—Mr. P. M. F., Bremerton, Wash.

DO CHILDREN RIDE IN YOUR CAR?

"I drive my little girl home from a country school during the twilight hours. I was always afraid—either of the blinding lights



GONE FOREVER! Blinding Headlight Glare—the number one cause of traffic accidents in America today! Read this amazing story of how science conquered this "one unpreventable" accident!

Mr. Car Owner Study These Pictures See If You Can Spot the HIDDEN ACCIDENT in Each of Them . . . Before It Could Happen to You!



Glaring headlights completely blind you . . . set you up for an accident.

Can you see the pedestrians stepping out of the grey shadows of this dark street?

Fog—snow—sleet—all hide oncoming cars—till they're right on top of you.

RAYEX eliminates blinding glare . . . you see lights only as pale amber discs.

RAYEX cuts out grey shadows . . . makes through fog glare with black objects stand almost perfect sharp, clearer.

With RAYEX you see light vision.

Eliminate Blinding HEADLIGHT GLARE! See What You Have to See After Dark! Do it with RAYEX Night Driving Glasses! Use Coupon to Order them today!

from the other cars at that hour—or of hitting one of the other little girls in the streets. Now, thank God, I know I can see them. I wouldn't take \$100 for these glasses."—Mrs. L. G., Forest Hills, New York.

DO YOU GET NIGHT-DRIVING SLEEPINESS?

"Drove 112 miles after midnight without the slightest strain. Never felt so relaxed and confident in my life. Thanks."—Mr. D. P., San Antonio, Texas.

DO YOU HAVE WEAK EYES?

"My husband has a cataract on his left eye and could never enjoy driving before. He thinks your glasses are wonderful—says they're also good for protection against the sun."—Mrs. L. R., Elizabeth, North Dakota.

(NOTE: We do not recommend the use of these glasses as sun glasses. They are as different as night and day. They have only one purpose—to protect you after dark.)

And here is the one fact that all of these drivers agreed upon . . . this is the way they would affect your night driving.

The very first moment you put on RAYEX Night Driving Glasses you enter into an entirely new world of night driving. There is no more blinding glare. Instead, the headlights of every car . . .

every street light . . . every window you pass, are a soft amber yellow.

You'll notice immediately, that you are more relaxed . . . more confident about your driving, because you can actually see better and farther. Test these glasses

against the first two or three cars you pass. Prove to yourself that you can see their lights . . . but there is no blinding glare. After that you will be able to totally disregard the headlights of any car coming toward you on the highway. You will be able to sit back and relax—enjoy your night driving as much as you do in the day.

Prove It Yourself! Make This Convincing "Light-Bulb" Test

When your RAYEX NIGHT GLASSES arrive, put them on. Look directly into the strongest electric light in your home. You see the light . . . the glare is gone! Then test them again in your car. Look at street lights, headlights, under every sort of difficult night driving condition. If they do not do everything we have claimed, return them to us. Your money will be returned. You are not buying these glasses—you are simply trying them at our risk!

RAYEX Night Driving Glasses have earned the Good Housekeeping Seal of Approval. Rayex lenses are not plastic. They do not distort vision. They are made of ground and polished optical plate glass, thereafter thermally curved to meet U. S. Govt. Specification No. CS-159-49. They are identical in shape, quality and appearance to the finest optically styled glasses. They come in handsome safety frames for men, beautiful harlequins for women, and clip-ons for those who already wear glasses.

Yet they cost only \$2.98 . . . less than you pay for one week's insurance on your car. Order a pair today for every driving member of your family! FREE! Handsome simulated alligator dashboard carrying case sent FREE with each order.

ACT TODAY! SEND THIS GUARANTEE COUPON NOW!

NATIONAL OPTICS CO., DEPT. M
405 EAST 74th ST., N. Y. 21

Please send me _____ pairs of RAYEX night driving glasses at \$2.98 a pair, plus C.O.D. postage, in MEN'S () WOMEN'S () CLIP-ON () WOMEN'S CLIPON () (for those who wear glasses). Also send me Absolutely FREE a handsome simulated alligator Dashboard carrying case, mine to keep FREE whether or not I keep the RAYEX Night Driving Glasses.

I understand that I am to try these glasses at your risk for one full week. I understand that these glasses must:

- 1) Eliminate blinding headlight glare.
- 2) Actually help me see better . . . farther . . . clearer after dark.
- 3) Eliminate night driving headaches and sleepiness caused by blinding glare.

If these glasses do not accomplish all three of these claims . . . if I am not thoroughly delighted then I may return them, and will receive my full purchase price.

NAME _____

ADDRESS _____

CITY _____ ZONE _____ STATE _____

SAVE MORE! Send \$3.00 cash, check or money order. We pay postage.

SAVE

TIME - MONEY

With your bookkeeping

Now You Can Keep Books Easily Without Outside Help!

TAS is an originally new weekly record of purchases, expenses, distribution, income, profit or loss, payroll, non-deductible expenditures, bank balance, depreciation, etc. Easy-to-follow instructions and facsimile page help you keep books for yourself or partnership for full year. Excellent for small business and professional men.

HOW YOU CUT COSTS WITH THIS MONEY-SAVING RECORD BOOK

TAS is workable because it is a simplified set-up for bookkeeping, a record for the entire year, that you may keep with you at all times—in your car, on the job, at home, in the shop, office or store. You will be delighted with TAS the first week you use it. Bookkeepers in many localities use TAS for all their small accounts. They praise TAS as a time, money and space saver.

Fits Auto Glove Compartment

ONLY \$7.50



10-Day Money
Back Guarantee

TAS, Dept. PM-15

1310 71st Street, Houston 11, Texas

Here is my Money Order for \$_____ Please

rush me _____ copy(s) of TAS' new money-saving yearly record book postpaid. If I am not entirely satisfied within 10 days, I will return the merchandise promptly for a full refund.

NAME _____

Please print or type

STREET _____

CITY _____

STATE _____

Spot ANY Car Trouble— in a Jiffy!

Amazing new Auto "Trouble-Shooter"
helps find what's wrong FAST!

\$1



NOW you can put your finger on just about EVERY cause of car trouble—simply by turning to indexed check-list in MOTOR'S amazing NEW "TROUBLE SHOOTER." Section on automatic transmission ALONE is worth price of book! SEND NO MONEY. TRY BOOK AT OUR RISK. Helps you track down noises, knocks, misses, breakdowns. Includes valuable cross-section pictures. Covers 2000 specific causes of car, truck troubles—engines, clutches, brakes, ignition, cooling system—all other parts. Valuable for beginner or mechanic. Write MOTOR Book Dept., Box CV, 250 West 65 Street, New York 19, N. Y. Pay postman \$1, plus C.O.D. chg., on delivery. Use 7 days. If not delighted, your \$1 back. (SAVE C.O.D. cost by sending \$1 now.)

LAW

STUDY AT HOME for Business Success and **LARGER PERSONAL EARNINGS.** 43 years expert instruction — over 114,000 students enrolled. LL.B. Degree awarded. All text material furnished. Easy payment plan. Send for **FREE BOOK.**

AMERICAN EXTENSION SCHOOL OF LAW
Dept. PMF-51 646 N. Michigan Ave. Chicago 11, Ill.

Learn UPHOLSTERING

FOR FULL OR SPARE TIME PROFIT

Easy to learn at home! Easy to start a shop, or earn spare-time profits! Complete tool set, all materials to build ottoman, included with lessons. Low terms. Write for valuable booklet today!

COMMERCIAL TRADES INSTITUTE
1400 Greenleaf Ave. • Dept. U2-6, • Chicago 26, Ill.

STUDY TO BE A DOCTOR of Psychology or Metaphysics

Obtain a Ps.D., Ms.D., D.D., or Ph.D. degree. Be a Teacher, Lecturer or Accredited Practitioner. Teach others how to achieve Health, Happiness and Contentment. Chartered by State. Write for **FREE** book telling how.

THE NEOTARIAN COLLEGE OF PHILOSOPHY
Desk 8, Pickwick Building Kansas City 6, Missouri

Watch Repairing Pays Big Money Learn at home



Watch repairers in great demand. Train step-by-step in 10 easy lessons. We furnish all tools and 15 jewel watch and practice movement. Turn spare time into cash. A licensed school. Low cost. Send for **FREE** book today.

ILLINOIS SCHOOL OF WATCH REPAIRING
2870 Elston Ave., Dept. PM-62, Chicago 16, Ill.

BIG LEATHER & CRAFT CATALOG!

1000's of items for Leathercraft, Textile Painting, Copper Tooling, Kits, Projects, Tools, Supplies, Etc. Send 25c (refunded with 1st order) to:

RUSSO HANDICRAFT SUPPLIES Dept. CD-12, 245 S. SPRING LOS ANGELES 12, CALIF.



IF I Send YOU THIS FINE SUIT—

Will You Wear It and Show It to Friends?

I need a reliable man in your town to get a fine, made-to-measure, all-wool suit without paying cash, but by taking a few orders from friends. Wear it—show it—to help you take more orders with my line of over 100 guaranteed quality fabrics. You can make up to \$12.00 in a day without experience or investment. I supply everything required **FREE**. Write today, giving age, etc., for **FREE** outfit. **John Grant, STONE-FIELD CORP., 532 S. Throop Street, Dept. G-816, Chicago 7, Ill.**

Say You Saw It in Popular Mechanics

Learn BAKING At Home

Baking is one of America's high industries in wages. Nearly depression-proof. Thorough basic home course lays sound foundation. If you have aptitude write for **FREE** BOOKLET. "Opportunities in Commercial Baking."

NATIONAL BAKING SCHOOL
835 Diversey Pkwy. Dept. 135A Chicago 14, Ill.



"A FASCINATING...MONEY-MAKING art career can be yours

America's **12** Most Famous Artists Show You How!"



says **NORMAN ROCKWELL**

We show you our successful methods and art secrets...you learn them at home, in your spare time. Write for our big, handsomely illustrated free booklet that tells how you can have a great new art career! **WRITE TODAY!**

- | | |
|--------------------|----------------|
| Norman Rockwell | Al Parker |
| Jon Whitcomb | Ben Stahl |
| Stevan Dohanos | Robert Fawcett |
| Peter Helck | Austin Briggs |
| Harold Von Schmidt | John Atherton |
| Fred Ludkens | Albert Dorne |

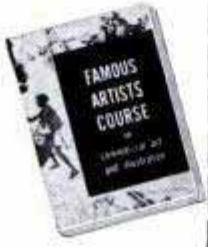

• FAMOUS ARTISTS COURSE •

Studio 6-F, Westport, Conn.

FREE Please send book about your home study art course.

Mr. Mrs. Miss Age

(Please Print)

Street

City, Zone, State

A "GOOD HAND" HELPS YOU SUCCEED!

LEARN TO WRITE WELL

Handwriting quickly improves with our easy-to-understand picture lessons! Put your spare time to good use; send today for **FREE BOOKLET**, "How to Become a Good Penman," or check volumes wanted below at \$1 each: Business Writing Artistic Writing Card Writing Bird & Design Flourishing Engraving Alphabets. **COMPLETE SET \$4.50.** Ask for price list of penman's supplies.

OUR 53rd YEAR

TAMBLYN SCHOOL of PENMANSHIP
S.A. Ziller, Pres., 442 Ridge Bldg., Kansas City, Mo., USA

Write Your Name beautifully, plus special pen-point for shaded writing. Only 10¢

TELEVISION Needs You For Top Pay Jobs!

Learn How You Can Qualify With Our 2 **FREE BOOKS**

WRITE: Radio Television Training Association
(State age) 1629 Broadway, New York 19, N.Y. Dept. R-26

SAY YOU SAW IT IN POPULAR MECHANICS

WHY BORROW MONEY? EARN EXTRA CASH This Easy Way!

Why pay high interest rates when it's so easy to earn good money in your spare time selling famous Doublewear Shoes! Smart styles—big values. Write for details.

Write to DOUBLEWEAR SHOE CO.
Dept. #1, 315 East Lake St., Minneapolis

GREER SHOP TRAINING
2230 So. Michigan Blvd. Chicago 16, Illinois

Leader in Practical Training for 50 Years

Gain success by learning a trade offering security and high pay—go into business for yourself.

Get the "Know-how" at Greer

You learn in our new, large, modern shops by working with latest tools and equipment of the trade — tear down, inspect, repair and rebuild ... under supervision of experts. Greer founded 1902. Over 51,000 successful grads. Part time, full time, day and evening. E-Z terms. Mail coupon today.

CLIP COUPON . . . MAIL TODAY
Greer Shop Training—2230 South Michigan Chicago 16, Illinois Desk 213

Please send information about trade checked:
In our Chicago Shops: Auto Mechanics
 Body, fender Repair Diesel Mechanics
 Welding—Arc, gas Tool & Die
 Refrigeration & Air-conditioning
 Machine Shop Piano tuning
G.I. app. for Vets dischgd. after 7-25-47

Or learn at home—extension courses:
 Diesel Refrigeration Plastics

Name _____
Address _____
City _____
State _____ Age _____

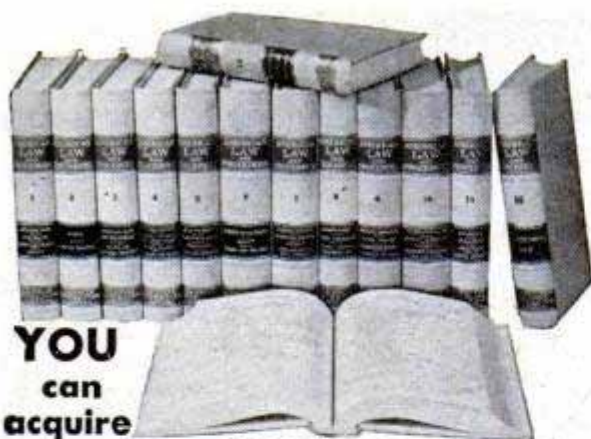

**YOU
can
acquire**

LAW NIGHTS AT HOME! L. L. B. DEGREE

LaSalle's famous Law Library—used as reference in many Law libraries and Law offices—has enabled thousands to master Law surprisingly fast, in spare hours at home, for business and professional advancement.

These 14 remarkable volumes, compiled by leading professors and lawyers, cover the whole basic field of Law in condensed, orderly, simplified manner.

You advance rapidly with this great library, plus special lectures furnished. We guide you step-by-step with personalized Problem Method of instruction . . . you learn by doing—handling legal problems—not by memorizing rules.

Send for two FREE 48-page booklets, "Law Training for Leadership," and "Evidence," answering questions about Law and its value to you, and telling how LaSalle Law graduates are winning rapid advancement in business and public life. Mail coupon below. No obligation.

LA SALLE EXTENSION UNIVERSITY A Correspondence Institution

417 S. Dearborn St. Dept. 664L Chicago 5, Ill.

Send me your two FREE booklets described above, without obligation.

Name.....Age.....

Street.....

City, Zone & State.....

BIG OPPORTUNITIES OPEN IN THE METAL TRADES



- * Drafting
 - * Tool & Die Designing
 - * Tool & Die Making
 - * Machinist Trade
- Only 60 school days - 360 Hours - of practical Shop Training or Mechanical Structural or Aircraft Drafting

Allied will train you easily and quickly for these Important Trades and place you on a Good Paying Job.

Inquire about our **PAY AFTER GRADUATION PLAN**

Write for **Free Books** a postcard will do!

INDICATE PREFERENCE - RESIDENT or HOME STUDY

ALLIED SCHOOL of MECH. TRADES
1338 S. Michigan Ave. Chicago, Ill.
406 ALLIED BLDG.

ELECTRIFY YOUR SEWING MACHINE

BE AN AGENT

\$9.00 NEW LOW PRICE!

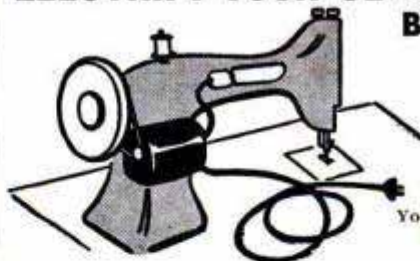

Re-sell at a PROFIT! You make as high as \$9 with each sale. Kit comes fully wired, installed in a jiffy. Fits all machines!

You get ALL NEW PARTS:

- Motor & Bracket
- AC-DC 115v 60c
- Multi-speed foot control
- Cord set & block
- Easy instructions
- Steel pulley & belt

FREE . . . reg. \$2.95 chrome SEWLITE given with every kit.

10 DAY FREE TRIAL - MONEY BACK GUARANTEE!

Send \$5 deposit, pay postman balance plus postage. Please state whether wheel on your machine turns toward you or away from you. Shipping wt. 6 lbs. Write for free sewing machine accessory catalogue. No obligation.

BEDFORD SEWING MACHINE CORP.

1039 Fulton St. Dept. PM6 Brooklyn 16, N. Y.

Be an ARTIST Get FREE BOOK and TRIAL PLAN

You Can Draw at Home in Your Spare Time

Only WSA offers this proven method. Let us prove we can teach you to draw—no risk for you because TRIAL PLAN reveals your talent. Get the facts in illustrated FREE BOOK, "Art for Pleasure & Profit." Write today. State age.

WASHINGTON SCHOOL OF ART

Studio 126F Washington 5, D.C.



"YOU ARE UNDER ARREST!"

Help Bring Crooks to Justice Through Scientific CRIME DETECTION!

We have taught thousands this exciting, profitable, pleasant profession. Let us teach you in your own home. Learn Finger Printing, Firearms Identification, Police Photography, Secret Service Methods thoroughly, quickly, at small cost. Over 800 of all American Bureaus of Identification employ I. A. S. students or graduates. We can prepare you for this fascinating work, during spare time. Write today, stating age, for "Blue Book of Crime."

INSTITUTE OF APPLIED SCIENCE, 1920 Sunnyside Ave., Dept. 135-A, Chicago 40, Ill.

Hand Guide!

POSITIVELY controls movement of hand until one's Penmanship is quickly corrected. Write,

OZMENT (INVENTOR), 34-P, ST. LOUIS, MO. (BX665)

BE A FOREMAN

TRAIN AT HOME FOR FAST PROMOTIONS
Industry needs trained leaders. Get ready now for a better job at high pay. Learn Foremanship or Factory Management thru *easy home study*. Course includes valuable text books and guide manuals. Write for free booklet.

COMMERCIAL TRADES INSTITUTE, Dept. FM2-6
1400 Greenleaf Avenue • Chicago 26, Illinois

LEOPARD COWHIDE



REVERSIBLE AUTO SEAT COVERS

Made of FLEXON
Approved by Good Housekeeping

- LEOPARD SKIN on one side
- COWHIDE on the other. Made of Heavy Gauge plastic for long wear
- WATERPROOF and STAINPROOF • Simple to attach—with REINFORCED OVERLAP side grip elastics that hold securely • PERFECT FIT COVERS are made roomy and dress up your car's interior
- PATENTED SHIRRING holds seat and back neatly. Sewn with NYLON THREAD for long wear. LONG WEARING-DOUBLE DUTY

5 DAY MONEY-BACK GUARANTEE!
CHOICE OF SPLIT OR FULL FRONT SEAT STYLES only \$2.98. Complete set for front and rear seats only \$5.00. When ordering specify make of car and style of seat. Order NOW. Enclose payment and save shipping charges. C.O.D. orders sent collect plus postage. **MARDO SALES CORP., Dept. 9182**
480 Lexington Avenue New York 17, N. Y.



FULLY GUARANTEED TIRES COST LESS!

Nationally famous FIRESTONE, GOODRICH, U. S. ROYAL, GOODYEAR, and other makes. Every tire selected and inspected for your safety.

S New Tread Tires Guar. 24 Mos. (White Walls \$2.00 Extra)

550x16	8.98	600x16(6)	10.98	650x20(8)	20.95	700x16(6)	15.48
550x17	8.98	650x15	10.98	650x15	9.98	710x15	13.98
600x15	8.98	650x16	11.48	670x15	10.98	760x15	12.48
600x16	8.98	650x16(6)	13.48	700x15	12.48	820x15	13.98

L **E** **PENNA'S LARGEST STOCK**

GOOD TIRES GUARANTEED 12 MONTHS

600x16	4.14	700x16	5.14	32x6(8)	8.84	825x20	14.24
650x16	4.54	670x15	4.74	32x6(10)	10.84	900x20	13.34
650x15	4.34	650x20	7.84	750x20(8)	8.54	1000x20	14.14
700x15	4.64	700x20(8)	8.94	750x20(10)	9.94	1100x20	16.14

AAA PREMIUM GRADE GUARANTEED 18 MONTHS

600x16	5.28	700x16(6)	7.98	600x20	9.78	825x20	18.68
600x16(6)	6.58	750x16(6)	8.98	650x20	10.88	900x20	18.98
650x15	5.78	820x15	7.48	700x20	12.88	1000x20	19.98
650x16(6)	6.98	710x15	6.09	32x6(8)	10.48	1000x22	21.98
650x15	5.98	550x18	5.98	32x6(10)	12.48	1100x20	20.98
700x15	5.58	760x15	5.48	750x20(8)	12.98	1100x22	21.98
700x16	6.78	550x17	5.58	750x20(10)	14.98	1100x24	23.98

MILITARY AA Guaranteed 12 Months—

SPECIAL	900x16	10.69	1000x20	19.98	600x16	9.98
	750x20	10.98	1100x20	21.98	600x16(6)	10.98
				700x15(6)	15.95	
				750x20(8)	25.98	

AAA GUARANTEED 18 MONTHS

900x16	14.98	750x20	16.48
--------	-------	--------	-------

Passenger Tubes—Water Tested—All Sizes... .95
Truck Tubes—Water Tested—All Sizes... .2.45

PENNA'S LARGEST STOCK
Largest stock of used tires in the East. Thousands of satisfied customers. Write for sizes not listed.
MONEY ORDER OR CHECK WITH ORDER.
NO C.O.D.'s

PYRAMID TIRE CO.
1333-35 North 5th St.
Dept. M., Phila. 22, Pa.

JUST OUT!

1952 EDITION

It's New! It's Different! Get world's largest Auto Accessory & Parts Catalog and save money. Over 50,000 items, including Hollywood Accessories, Hi-Speed Equipment, Rebuilt Engines, all parts & accessories for all cars & trucks. We have that Hard-To-Get part! Jam packed with bargains. Completely illustrated. (100 pages) Send 25c (refundable).

J. C. WHITNEY & CO., 1917-XP Archer Ave., Chicago 16, Ill.

Secrets of VENTRILOQUISM Now Revealed!

Easy to learn in 60 to 90 days with our Home Study Course. **RESULTS GUARANTEED.** Make Money! Be Popular! Have Fun! Big Opportunity! Radio, Television, Stage Appearances! For FREE Information regarding price and terms, WRITE. You must state your age. Dummy Catalog 25c.

FRED MAHER SCHOOL OF VENTRILOQUISM
Box 36, Studio F Kensington Station
Detroit 24, Michigan

Treasure and Minerals

Easily located with new Lightweight M-Scope Detector. Superior performance, lowest price, monthly payment plan.

FREE LITERATURE
FISHER RESEARCH LAB., INC.
PALO ALTO CALIF.

BUILD A \$15,000 A YEAR FUTURE!

In the exciting new business of **LAUNDERING VENETIAN BLINDS**

Send name, get pictures, profits, prices, facts—all Free—showing how to start on small investment in basement or garage. Big demand—high profits—spare or full time. Others **NOW MAKING \$15,000 a year.**

FREE! Learn all about machine and easy time-pay plan. Get names of successful men near you so you can investigate. Rush name now.

VENETIAN BLIND LAUNDRY EQUIPMENT CO., Inc.
442 North Seneca Street, Dept. 106, Wichita 12, Kansas

BECOME AN Electrical Engineer

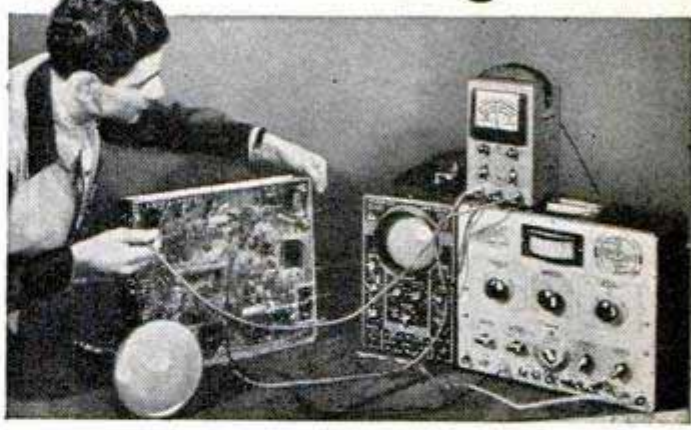

- Major in Electronics or Power
- B.S. Degree in 36 months
- Television Technician
- Certificate in 18 months

FOLLOW THIS PLAN

By 1954 there will be at least two positions for every engineering and technician graduate. Enter these opportunities early... earn your B.S. Degree in 36 months through optional year 'round study.

TELEVISION TECHNICIANS are needed throughout America's fastest growing industry.

You become a Radio Technician in 12 months. In 6 additional months become a Radio-Television Technician. These Technician Courses are complete in themselves and can be applied as one-third of the B. S. Degree program.

TERMS OPEN JULY, OCTOBER, JANUARY, APRIL

Military, Practical, or Academic training evaluated for advanced credit. Faculty of specialists. Over 48,000 former students from all states and 23 overseas countries. Nonprofit.

- Choose from these courses:
- SPECIAL! One-month Television Service Clinics on latest field problems—July & Aug.**
- SERVICE 6 months**
- Electricity
 - Welding
 - Refrigeration
 - Heating
 - Preparatory
- TECHNICIAN 12 to 18 months**
- Radio and Television
 - Electronics
 - Electrotechnics (Power)
 - Welding
 - Air Conditioning
- ENGINEERING 36 months**
- Electrical Engineering — B. S. Degree. Major in Electronics or Power.

MILWAUKEE SCHOOL OF ENGINEERING

Founded 1903. Milwaukee, Wis.

Write for free 110-page catalog, 48-page pictorial booklet "Your Career" and "Occupational Guidance Bulletins."

MILWAUKEE SCHOOL OF ENGINEERING
Dept. PM-652, 1025 N. Milwaukee,
Milwaukee, Wisconsin

Without obligation send Catalog for Electrical Engineering, B. S. Degree, major in Electronics; Power; "Your Career"; Occupational Guidance Bulletin on: Radio-TV Electrical Power Welding Heating, Refrigeration, Air Conditioning; TV Clinic.

Name..... Age.....
Address.....
City..... Zone..... State.....
If veteran, indicate date of discharge.....

BARGAINS



ALL are COATED

Brand New, top quality glasses. All have precision ground optics, durable lightweight bodies, Moisture and dust proofed. Achromatic!

Coated! Featherweight!

16x50 COATED \$69.50

The ultimate in a fine binocular. Tremendous power. Featherweight (weighs only 25 ounces!). Precision made in every detail. COATED providing sharper, brighter images. Individual focus. Objective lens is 50mm (2 inches) across!



- 6x30 16 oz. Economy \$27.95
- 7x35 All around use 42.95
- 7x50 3 1/2 oz. Sharp, bright, Bargain. 36.00
- 7x50 Center Focus, Sale priced 39.50
- 8x30 17 oz. Clear, crisp 32.50
- 8x30 Center Focus 37.50
- 8x40 Streamlined 51.50
- 10x30 18 1/2 oz. 39.50
- 10x50 35 oz. More Power 62.00
- 12x50 35 oz. Reaches out 65.00
- 12x50 Center Focus, 25 oz. 67.50

6X-10X POCKET

ALL 3 ARE COATED, precision PRISM Binoculars, Superb craftsmanship. Superior in every detail.

10x They Are News \$24.95

WEIGHS 7 1/2 OZ.! Palm sized. Full 10 Power. Color corrected. Achromatic lens. Perfect balance. Another UNITED first in revolutionary binocular developments.

6x DUO-TONE \$16.95

Illustrated. Weighs only 4 oz.! Yet has field of 375 ft. at 1000 yds.!

7x ALL CHROME \$21.95

Sturdy. Precision made. Sharp, clear vision! Sale priced.

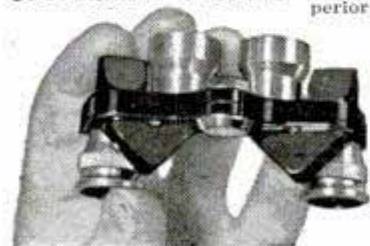

SIX TELESCOPES IN ONE!

15 to 40 POWER



\$30.75

COATED

American made Wollensak telescope. Instant focusing at 15x, at 20x, 30 and 40x, etc. Turn power tube to click—no guess work. Telescope measures 9" closed, 27" when extended. Weighs only 18 oz.! Has rust proof chrome tubes, large 40mm objective lens. All 12 optic surfaces are COATED. See .22 bullet holes clearly at 300 feet. Use also for astronomical observation. \$30.75 price includes tax and fine leather case. All binoculars bear the UNITED "Seal of Quality". Proof they are the BEST-BY-TEST and UNCONDITIONALLY GUARANTEED.



30 DAY FREE TRIAL
If not fully satisfied return for full refund! Cash orders rushed post-paid. On C.O.D.'s include \$2.00 deposit. Add Federal Tax. Prices on all of above include handsome genuine leather case and straps. DEALERS—WRITE FOR 24 PAGE WHOLESALE CATALOG. UNITED BINOCULAR CO., 9043 S. Western, United Bldg., Dept. ARF-4708, Chicago 20. Display Sales Rooms open 9:00-3:30 Mon. thru Fri.

WHY SUFFER TONGUE BITE?

Cost 3 times as much to build as the best of old-fashioned pipes. But **KILL TONGUE BITE, STOP DRINK.** FREE circular tells WHY. Write:



KLEENSMOK PIPES

P.O. No. M597,

Johnson City, Tenn.
R-Reg. U.S. Pat. Off. Pat.'s. and Pat.'s. Pend.

INVENTORS

Your first step—if you consider your invention to be something of importance—is to have a search made of pertinent, prior U. S. patents. If our search report indicates probable patentability of your invention, you may apply for a patent which gives you the right to exclude others from making, using or selling your invention as claimed for a term of 17 years.

This firm is registered to practice before the U. S. Patent Office and is available to assist in the preparation of the necessary drawings, specification and claims.

Ask for a copy of our instructive booklet "Patent Protection for Inventors" and our convenient "Evidence of Invention" form. No obligation.

VICTOR J. EVANS & Co. *Merlin M. Evans*
REGISTERED PATENT ATTORNEY
730-G MERLIN BUILDING, WASHINGTON 6, D. C.

INVENTORS

Before you make any effort to market your invention, you should take the first steps toward proceeding for patent protection.

I shall be pleased to furnish you with information relative to patent procedure, upon request from you, and this will be without any obligation on your part.

PATRICK D. BEAVERS

Registered Patent Attorney

934 Columbian Building Washington 1, D. C.

INVENTORS

Whether an invention is patentable can be substantially determined by a search of the U. S. Patent records. Without obligation, write for information explaining the steps you should take to secure a patent.

JOHN N. RANDOLPH

Registered Patent Attorney

201 Columbian Building, Washington 1, D. C.

INVENTORS

Send for **PATENT INFORMATION** REGISTERED PATENT ATTORNEY

Book and **INVENTOR'S RECORD** without obligation

GUSTAVE MILLER
62-PM WARNER BUILDING
WASHINGTON 4, D. C.

Patent Attorney & Advisor
U.S. NAVY DEPT. 1930-1947

ASSOCIATE EXAMINER
U.S. PAT. OFF. 1922-1929
PATENT LAWYER

INVENTORS

If you have working models, blue prints, or patents, covering "special use" parts or assemblies for Chevrolet, Ford, or Plymouth Cars, it will be to your advantage to get in touch with us. Write us at the factory. Dept. PM

NATIONAL MACHINE WORKS, INC.
P. O. BOX 4305 AUTOMOTIVE PARTS MANUFACTURERS OKLAHOMA CITY 9, OKLA.

PATENTS

C. A. SNOW & CO.

REGISTERED PATENT ATTORNEYS
WRITE FOR INFORMATION TO
428 SNOW BUILDING, WASHINGTON 1, D. C.

INVENTORS

IF YOU WISH TO PROTECT YOUR INVENTION, You should take steps to protect it by a U. S. Patent. Write me for "INVENTION RECORD" form

CARL MILLER
REGISTERED PATENT ATTORNEY
WOOLWORTH BLDG., 35th FLOOR, 62A
NEW YORK CITY



CRESCENT SCHOOL

"One of the largest schools of its kind"

I WILL START YOU on a HIGH PAYING CAREER in RADIO-TV SERVICING FREE!



Dr. Alexander Schure
B.S., M.A., Ph.D.

LEARN AT HOME in your spare time!



INCREASED EARNINGS



INTERESTING WORK



AN UNLIMITED FUTURE

BIG DEMAND FOR TRAINED MEN

All of the advantages of higher earnings, an interesting job with prestige and a truly unlimited future in a fast-growing field await men trained in RADIO and TV! This training can help earn extra pay and rank in the ARMY, NAVY and AIR FORCE!

"Now you can prove to yourself that you can have a profitable career in RADIO and TELEVISION—at no cost to you! The free booklet I send you is actually an illustrated, simplified CRESCENT SCHOOL lesson on how to make basic TV adjustments. With it you can start earning extra cash in your spare time—immediately! Don't wait...send for this valuable FREE offer today!"

COMPLETE TV-RADIO SERVICING COURSE

The famous CRESCENT SCHOOL course is available to you complete for home study! New simplified, illustrated lessons show you the latest techniques—no previous training needed! Carefully selected parts-kit included with the course: you learn by doing! Complete the course as quickly as you can learn; CRESCENT SCHOOL certificate—recognized by industry—awarded upon completion.

PAY AS LITTLE AS
\$5 MONTHLY

Total cost for complete course
as little as **\$100**

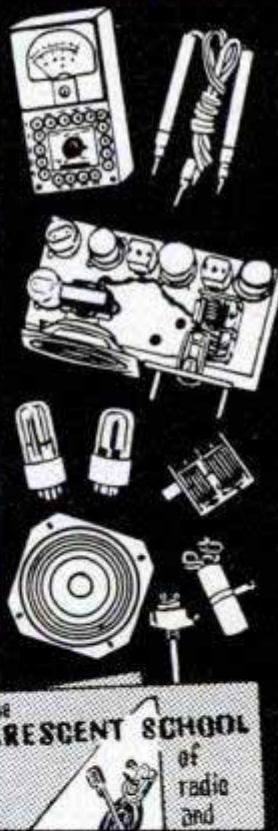
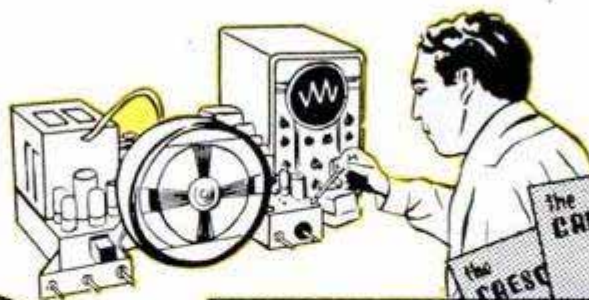

**SEND COUPON TODAY
for sensational
FREE OFFER!**

CRESCENT SCHOOL Dept. B-6
500 Pacific St., B'klyn 17, N. Y.

Dr. A. Schure: Rush FREE booklet illustrating basic TV adjustments, and full details about the CRESCENT SCHOOL Home Study Course—all at no obligation to me!

NAME

ADDRESS

CITY.....ZONE.....STATE.....

MOST PROFITABLE TOOL IN YOUR WORKSHOP

Welds • Cuts • Solders • Brazes • Heats • Even Charges Batteries

Earn Spare Money in Your Spare Time

Here's an exciting yet profitable pastime. Your "Linwelder 60" builds garden furniture, handrails, ventilators . . . hundreds of things for the house. Repairs fenders, car bodies, garden tools. Solders wires, torch heats to bend steel or harden tools. Users report earnings quickly pay for their welders.

"LINCWELDER 60"

Low in Price • Easy to Use

- Comes complete with instructions
- Operates on 115 volt grounded circuit (No. 12 wire fused for 20 amps)
- Approved by Underwriter's Laboratories
- Built by The Lincoln Electric Co. The World's Largest Manufacturer of Arc Welding Equipment.



ORDER NOW

Fill out and mail to Dept. 194, The Lincoln Electric Co., Cleveland 17, Ohio

- Ship me the "Linwelder 60" with accessories \$48.00.
(Including headshield, electrodes, carbons, electrode holder, ground clamp and cable.) Arc Torch \$6.25 extra.
 Battery Charging Attachment \$10.00 extra.
Enclosed is check money order.
 Send me free bulletin on the new "Linwelder 60".

Name _____
Address _____
City _____ State _____ 194

Send No Money— 4 BIG AUTO BOOKS On Approval!



USED BY THE THOUSANDS
IN AUTOMOTIVE TRAINING

Over 2700 Pages of
How-To-Do-It-Facts
2000 Pictures

TO HELP YOU MAKE MORE MONEY

America is again in a period when its 43 million autos and 9 million trucks and busses must be kept in good repair. That means that men with know-how are in demand for good jobs at high pay. It means that the door of Big Opportunity is wide open.

The four big, thick books of auto facts are packed full of the exact information that will help you to hold a big paying job. They will enable you to do important work better and faster. Keep them handy for convenient reference.

All pages are written in an easy-to-understand manner by expert automotive engineers with many years of successful experience. To have these great books close at hand is like having these experts beside you, ready to answer questions. Send the coupon TODAY but send no money now.

AMERICAN TECHNICAL SOCIETY—Publishers Since 1898
Dept. AA19, Drexel Ave. at 58th St., Chicago 37, Ill.

I would like to examine your Four Big Auto Books. I will pay the delivery charges only, but if I choose I may return them express collect. If after 10 days' use I prefer to keep them, I will send you \$3 plus postage and pay the balance at the rate of only \$4 a month until \$18.50 has been paid.

Name _____
Address _____
City _____ State _____
Please attach letter giving employer's name and address (if self-employed give business man reference). Men in service please give home address.

Famous 15 and 17 Jewel BULOVA WATCHES \$16.95 PLUS TAX

PRACTICALLY WHOLESALE TO YOU



UNLIMITED WRITTEN GUARANTEE

WERE UP TO
\$59.50
SAVE \$42.55

ALSO FAMOUS

- BENRUS
- GRUEN

• WALTHAM or ELGIN WATCHES

You get these unredeemed UNLIMITED GUARANTEED famous Bulova and other movements in latest style Yellow Gold Cases at this sensationally low price because we bought out SURPLUS STOCKS of leading New York and Md. Jewelers. Order now while they last. Specify make preferred and whether men's or ladies'! Only \$16.95, plus \$1.70 tax. Order right now.

FREE TRIAL OFFER! WEAR AT OUR RISK!
Money back guarantee in 10 days if not delighted.

SEND ONLY \$1 with order. Pay balance C.O.D., plus postage. Or we pay postage if you enclose \$16.95 plus \$1.70 tax.

FREE! Handsome Expansion band included with orders.

MARYLAND DISTRIBUTORS, Dept. 379
501 E. Baltimore St., Baltimore-2, Md.

WRITE FOR FREE WATCH AND DIAMOND RING CATALOG — PRACTICALLY WHOLESALE PRICES.

Unlimited Guaranteed
17 JEWEL SWISS
WRIST WATCH
Worn by Army,
Navy & Marines
Originally \$59
Now only \$14.95 Plus
\$1.50 Tax
NEW INCABLOCK,
SHOCK PROTECTED
WATER-DUST
PROOF

GROW MINIATURE TREES

FOR PROFIT & PLEASURE



Fabulous Money—Real Fun! Grow genuine live dwarf (Ming) trees. A terrific new business and hobby. Astounding details Free. Write —

DWARF TREES, Dept. 28
P. O. Box 355, Briggs Station
Los Angeles 48, Calif.

WHY DON'T YOU WRITE?

Writing short stories, articles on business, sports, hobbies, travel, shop crafts, local and club activities, etc., will enable you to earn extra money. In your own home, on your own time, the New York Copy Desk Method teaches you how to write the way newspaper men learn—by writing. Our unique "Writing Aptitude Test" tells whether you possess the fundamental qualities essential to successful writing. You'll enjoy this test. Write for it, without cost or obligation.

NEWSPAPER INSTITUTE OF AMERICA

SUITE 5592-H, ONE PARK AVENUE, NEW YORK 16, N. Y.

LAW FREE BOOK



Your FREE copy of "The Law-Trained Man" shows how to gain prestige and greater earnings through Blackstone home law study. All instruction material furnished including 16-volume Law Library written by 65 well-known law authorities. Lawyers, judges among our graduates. LL.B. degree. Low cost; easy terms. Write today.

BLACKSTONE COLLEGE OF LAW 225 N. Michigan Ave.
Dept. 50A, Chicago 1, Ill.

A Correspondence Institution Founded in 1890

REAL ESTATE BE A BROKER

PAYS BIG! SEND FOR FREE, BIG, ILLUSTRATED CATALOG NOW! Graduates report making substantial incomes. Start and run your own business quickly. Men, women of all ages, learn easily. Course covers Sales, Property Management, Appraising, Loans, Mortgages, and related subjects. STUDY AT HOME or in classrooms in leading cities. Diploma awarded. Write TODAY for free book! No obligation.



WEAVER SCHOOL OF REAL ESTATE (Est. 1936)
Suite 300 Law Bldg. Dept. PM Kansas City, Mo.

Learn PHOTOGRAPHY at Home

Prepare in spare time. Practical basic training. Long-established school. Send for free book. "Opportunities in Photography." No obligation.
AMERICAN SCHOOL OF PHOTOGRAPHY, 835 Diversoy Parkway, Dept. 135A, Chicago 14

AMAZING IMPROVED ELECTRIC SPRAYER MAKES HOME PAINTING EASY

10 DAYS FREE TRIAL
Unconditionally Guaranteed

Why wear yourself out using Expensive old-fashioned brushes? Mistifier Sprayer quickly, smoothly and evenly sprays glossy enamels, lacquers, insecticides, mothproofers and oils.

All in one self contained unit that requires no compressor, motor or accessories. All metal non-corrosive parts makes this unit a **LIFELONG** useful tool. Sturdily constructed, weighs only 2 lbs., uses standard replaceable Mason jar. Spray volume is adjustable, **80 POUNDS PRESSURE**, fingertip control, AC-110 volts. **FOR PAINTING, SPRAYING, DISINFECTING, MOTH PROOFING.** Mistifier Sprayer works wonderful when painting wicker and all other furniture, cars, metal cans, partitions, concrete, brickwork, rough wood, boats, wagons, screens, cabinets, venetian blinds. Wonderful for Mothproofing clothes, rugs, drapes, storage closets, etc.

Mistifier is Safe and Easy to use.



SPRAY FURNITURE



PAINT AUTOS

Only
\$7.95

Comes Complete — No Extras to buy. We Guarantee that Mistifier Sprayer will apply paint smoothly, quickly, easily — or return it within 10 days for full purchase price refund. Only \$7.95 Postpaid or sent C.O.D. plus postage. Full instructions. Order Now.

IMPERIAL SALES

480 Lexington Ave. Dept. B-346 New York 17, N. Y.



TIRES · TIRES · TIRES

GUARANTEED WHOLESALE VALUES
UNCONDITIONALLY GUARANTEED
plus TIRE INSURANCE FREE!



10% OFF ON TWO OR MORE USED TIRES

Here's DOUBLE proof that we bear the loss if your passenger tire wears out within the guarantee period or is damaged in any way (except willfully). Don't take risks; we send FREE insurance certificate PLUS written unconditional guarantee with your order.

LOW COST QUALITY TIRES

Unconditional Six Months' Guarantee plus Tire Insurance Free			
600-16	\$3.50	650-16	\$3.75
600-15	ea.	640-15	ea.
550-15		550-16	
		670-16	
		550-17	\$3.95
		475-19	
		710-15	
		760-15	

BETTER GRADE PASSENGER TIRES

Unconditional One-Year Guarantee plus TIRE INSURANCE FREE					
600-16	\$5.59	700-16	\$5.79	700-15	\$5.59
600-16(6)	6.50	600-15	5.59	750-16	12.25
650-16	5.79	650-15	5.59	550-15	5.59
640-15	5.95	710-15	6.50	820-15	7.50
670-15	5.95	760-15	6.75	670-16	6.95
				550-16	\$5.95
				550-17	5.75
				475-19	5.75
				760-16	7.75

MUD AND SNOW TIRES

2 Year Written Guarantee			
600-16	\$6.95	900-16	\$12.95
650-16	7.50	650-16(6)	9.50
		750-20 Reg.	\$12.50
		650-15	6.50
			Spec. \$15.95

QUALITY TRUCK TIRES

One Year Written Guarantee					
600-20	\$10.75	750-20	\$14.50	825-20	\$21.50
650-20	11.75	32x6(8)	11.75	900-20	19.50
700-20	12.50	32x6(10)	12.50	1000-20	20.00
				750-20 (10)	18.00

EXTRA MILEAGE TRUCK TIRES

Two Year Written Guarantee					
750-16-8	\$16.50	650-20	\$16.75	750-20(10)	\$23.50
700-17	16.50	700-20	17.50	825-20	25.75
750-17	19.75	32x6(8)	16.75	36x8	27.50
700-18	19.50	32x6(10)	17.50	900-20	26.50
600-20	15.50	750-20(8)	18.50	1000-20	29.75

SPECIAL — CUSTOM RECAPS — SPECIAL

Two Year Unconditional Guarantee plus Tire Insurance Free					
600-16	\$8.95	650-15	\$10.95	700-15	\$11.95
650-16	10.95	670-15	10.95	710-15	11.45
				820-15	13.50

All prices F.O.B. Richmond, Va.

SAFTYR CO., INC.,

Dept. P.M.-1 1801 E. BROAD ST., P. O. BOX 2254, RICHMOND, VA.

"FOR THAT SAFE TIRE"

MAIL ORDERS PROMPTLY FILLED.

Send check or money order with this ad.

Say You Saw It in Popular Mechanics

Make \$20 to \$30 a Day
with this new **ONE MAN**

MAIL ORDER BUSINESS

DO PLASTIC LAMINATING AT HOME!

Would you like to get orders and cash from your mailman — then in space of hours make and ship the things people ordered from you? If you have spare time and a little spare room in kitchen, garage, or basement, get the facts about the newest and most fascinating of all home operated businesses. For the first time a simplified machine brings the fabulous profit of **Plastic Sealing and Plastic Laminating** within the reach of the small operator. Any one can learn to operate the machine with a few minutes practice — then

with our **Magic Mail Plan** can get mail orders pouring in daily with cash in every envelope. No canvassing — no selling. We even supply the circulars you mail to bring back cash and orders. Don't waste a minute. Rush your name. We'll send you, **FREE** and postpaid, pictures, prices, details, all the facts you need to start. Mail coupon or send name on postcard. No charge.

WARNER ELECTRIC CO., 1512 Jarvis Av.
DEPT. L-10-H - CHICAGO 26, ILLINOIS

Make Thousands of Beautiful Art Creations

**COSTUME JEWELRY • CIGARETTE BOXES
TRAYS • CANDLESTICKS • COASTERS
LAMP BASES • BOOK ENDS...ALL IN
SPARKLING COLORED PLASTIC**



THIS MAN . . .

is taking out of the machine a Plastic Sealing Job—ordered by mail—only 11c in material cost brings back \$2.58 in cash by mail. Capacity of machine: \$25.00 profit per hour of operation.

WARNER ELECTRIC CO., 1512 Jarvis Av.

Dept. L-10-H, Chicago 26, Ill.

At no cost to me, please rush complete details postage prepaid. I am under no obligation.

Name _____

Address _____

City _____ Zone _____ State _____



\$1.00 BRINGS YOU BOTH CANS!

Yes sir — give your car the glow that rests your elbow! Use LACQUER CLEANER, the amazing pre-wax cleaner, and LACQUERWAX, the famous car finish protector. It's 5 times faster and easier to apply than ordinary paste waxes. One treatment lasts 6 months or longer.

LACQUERWAX contains no lacquer, but this hard, liquid wax is CLIMATEPROOF! Its brilliant luster shines right thru hot sun and driving rain. You can't wash it off — it won't spot! It brings out and preserves the full beauty of your car's finish. Use the LACQUER CLEANER first to remove dead paste wax and dirt, then LACQUERWAX for the beauty treatment. BOTH 10 oz. cans—ample to do your complete car—for ONLY \$1. Mail coupon NOW!

LACQUERWAX CO. (Dept. PM-6)
31 SPRUCE ST., HARTFORD 3, CONN.

Gentlemen: My dollar bill, check or money order is enclosed for the 2 ten oz. cans—LACQUERWAX & CLEANER.

Name

Address

City..... Zone.... State.....

LACQUERWAX

FOR YOUR

TECHNICAL AND VOCATIONAL TRAINING

Come to the
UNIVERSITY OF HOUSTON

One of America's large and most modern universities. Select from these fascinating fields: aeronautics air conditioning & refrigeration auto body and paint auto mechanics auto upholstery & trim diesel drafting electricity electronics machine shop photography radio stationary engineering television welding woodworking furniture upholstery.

PREPARE FOR YOUR FUTURE NOW . . . with very latest methods and equipment, at modern U. of Houston College of Technology. Entrance: high school diploma, or over 18 and ability to profit from instruction. Beautiful campus—250 wooded acres in Houston, Texas—city of tomorrow. Full college activities, sports, social life. Day or night, short or longer courses. Co-op work-study programs . . . earn part of tuition and expenses with part-time job in your own career field, while you learn. Personal vocational counselling. Diploma on completion and all credits apply towards Bachelor of Applied Science Degree. Job placement assistance. June, Sept., Feb. semesters. Mail ad now for Free fully-illustrated brochure. No obligation. Mark X before choice of subject. **Do it today!**



ADMINISTRATION BUILDING

University of Houston, College of Technology
Dept. 162 — HOUSTON 4, TEXAS

FUN FOR EVERYONE!



The Easy Way to Build Your Own OUTDOOR FIREPLACE

Food Cooked Outdoors Tastes Better . . . offers real enjoyment for the entire family . . . perfect for entertaining guests! It's easy and economical to build your own Cook Nook. Just add the masonry (any design you prefer) around the Majestic all-metal unit and start cooking! See your dealer today or send check or M. O.

Model OF-28 only
21" x 26" x 13 1/2" \$20⁹⁵

The Majestic Co.
359 Erie St., Huntington, Ind.

WHAM-O SPORTSMAN * \$1.50 35-LB. PULL!

HITS LIKE A .22 RIFLE—KILLS RABBITS, SQUIRRELS.

Powerful, silent, accurate.

For hunting, target, routing pests.

Sportsman's choice sold world over!



HUNTING SLINGSHOT

Heavy duty 7" ash stock.

40 steel balls, extra rubber, target.

GUARANTEED. At dealers, or send \$1.50 to

Wham-O Mfg. Co. Box 8T, South Pasadena, Calif.

*Professional model of Nat'l Slingshot Assn.

PLASTICS CATALOG

RETAIL & WHOLESALE PRICES

There's more information and tricks-of-the-trade and a larger variety of plastics materials listings packed into this catalog than you've ever seen before. Sheets, rods, tubes, casting, molding plastics, supplies, findings, etc. We make our own Carving Dyes, "Gem-Coat" Fiberglass and Polyester coating for wood boats. For fast, courteous, personalized service. TRY US! CATALOG 10c—or airmailed for 25c in U.S.

GEM-O'-LITE PLASTICS CO.

5350-B Riverton Ave.

North Hollywood, Calif.

Become a Doctor of PSYCHOLOGY

Win the degree of Ps.D. Teach the secret of contentment, happiness. Solve mental worries. Experience the revelation of truth. Chartered college. Individual help. Write for FREE book. COLLEGE OF UNIVERSAL TRUTH, 5153-B North Clark St., Chicago.

MUFFLER GUIDE!

Solve your muffler problems with new 1952 edition!

Includes • Dual Pipes • Headers • Heavy Duty Single Mufflers • Ext. • How Exhaust Systems Increase your Performance • Tone Adjustment

Send 50c (money refunded first order)

HUTH MUFFLER CO. 1701W. Magnolia Blvd. Burbank, Calif.

since 1938



WAR SURPLUS BARGAINS!

STARK'S

WAR SURPLUS BARGAINS

\$500,000.00 INVENTORY for QUICK LIQUIDATION

Surplus items—hundreds of them for home, shop, factory, farm and outdoor use. New items, used items, reconditioned items—all at tremendous savings—all priced for quick sale.

Page After Page of Values

This big catalog shows page after page of amazing money saving values. Write for your copy today. Send 10c to cover postage, mailing, etc. Write today!

SEND TODAY FOR YOUR COPY

STARK'S Dept. PMG 509 So. STATE STREET CHICAGO 5, ILLINOIS

10c

TRY this PRECISION-MADE
ELECTRIC RAZOR
on your own BEARD!



ONLY
\$3.95

1 Year
Guarantee

Why fuss — Why bother with old fashioned shaving? Use the TAYLOR-MADE ELECTRIC SHAVER and enjoy the most comfortable, the smoothest, cleanest shave you have ever had. Whisk through the toughest beard—slick and smooth. Best of all you need not pay high prices for an electric shaver when the precision TAYLOR-MADE is offered at an unbelievably low price of \$3.95. Compare with the most expensive razor made. You will be amazed at the value offered.

Women, too, can use this speedy, painless way to keep arms and legs hair free.

- Precision shaving heads
- Hollow ground cutting blades
- Automatic safety guide-bar
- Powerful 60-cycle motor
- Cutting blades chrome plated
- White plastic case with extension cord
- Self-starting, self-sharpening, self-lubricating
- For the incredibly low price of \$3.95

● GUARANTEED UNCONDITIONALLY FOR 1 YEAR

Use the TAYLOR-MADE ELECTRIC RAZOR for 10 days. If you are not more than pleased — return for prompt refund. Rush your name and address. Pay Postman only \$3.95 plus postal charges on delivery. (Or enclose payment and save app. 60c in postal charges.)

SUCCESS PRODUCTS

DEPT. S-925 246 ROEBLING ST. BROOKLYN, N.Y.



30 DAY FREE TRIAL

High Power BINOCULARS

Finest Precision Optics
Featherlight
Money Back Guarantee
Easy Pay Plan
Leather Case Incl'd.

Free! Catalog & Book
"How to Select Binoculars"
Dealer Inquiries Invited
Bushnell Bldg., Dept. M-46
Pasadena 1, Calif.

33 MODELS
\$14.95 up

BUSHNELL Binoculars

Easy-to-Build Old-Time Autos!

FREE!
Write for
Your Copy of
Our 4-Color
FOLDER

Authentic models—6" to 10½" in length—to assemble in your leisure hours! All our kits include shaped parts, wheels, lights, horn, radiator, etc. and instructions. Choice of 16 antique autos—\$1.95 to \$3.95 each.



1904 OLDSMOBILE. \$1.95

● IF YOU ORDER DIRECT, add 25c for postage and handling.

Hudson Miniatures' "OLD TIMERS" Antique Auto Sets
SCRANTON HOBBY CENTER, Dept. 14, Scranton 10, Pa.

GOLFERS

SAVE \$11.05

Assemble your own golf-cart. Regularly retails at \$25.00. Quickly assembled with household tools. LIGHT — STURDY — EASY ROLLING. Balloon Tires, large 10" ball bearing wheels. Beautifully finished. Completely collapsible. Makes ideal gift. Send \$10 check or money order, and pay postman \$3.95 on delivery. Or send M. O. or check for \$13.95. Postage prepaid.

SATISFACTION GUARANTEED OR MONEY BACK

CAL-CART

DEPT. P-62, SARATOGA, CALIFORNIA



LOW FACTORY PRICES

Let Us Put This NEW 1952
MIDWEST TELEVISION
or RADIO in Your Home
on 30 DAYS TRIAL

MAMMOTH
20-Inch Rectangular
PICTURE

EASY TERMS

You be the judge! See and hear Midwest Television in your home. Be 100% satisfied or return the set. Low Factory Prices.

FACTORY-TO-YOU

WE PAY TRANSPORTATION CHARGES.

Special Bonus Gift!



Illuminated TELEVISION CLOCK

Given With Every Purchase of a **MIDWEST RADIO or TELEVISION**
LIMITED TIME ONLY!

Phone For FREE 1952 MIDWEST CATALOG

IN NEW YORK Murray Hill 2-6810 IN CHICAGO State 2-5600
IN CLEVELAND PRospect 1-7450 IN PITTSBURGH Grant 1-0609
IN DETROIT WOODWARD 3-1233 IN ST. LOUIS Grand 1161
IN PHILADELPHIA LOCust 4-7035 ... or send coupon below

SEND THIS COUPON For FREE MIDWEST 1952 Catalog

MIDWEST RADIO & TELEVISION CORP.
Dept. 25-P, 909 Broadway, Cincinnati 2, Ohio

NAME _____
ADDRESS _____
CITY _____ ZONE _____ STATE _____

Learn TELEVISION-ELECTRONICS

2 Big Books
FREE

Train at Home—Get Big Kits of Radio Parts!
Prepare now in spare time. Practical instruction.
Approved for Veterans. Write for details and 2
Radio Books—ALL FREE! Rush name today!
SPRAYBERRY ACADEMY OF RADIO
Dept. 10-K 111 No. Canal Chicago 6, Illinois

RADIO

ENGINEERING DEGREE IN 27 MONTHS

Big Demand for Graduates

Aeronautical, Chemical, Civil, Electrical, Mechanical and Radio Engineering (inc. TV and Electronics)

Hundreds of young men are earning B. S. ENGINEERING DEGREES annually in this recognized institution — year around operation. New terms start quarterly. Many students earn a major part of their college expenses in this large industrial center.

Low tuition. Competent instruction. Thorough, intense, practical program. Modern, well-equipped laboratories including new physics laboratory and modern wind tunnel. Individualized instruction emphasized.

Government approved for G.I.'s. Engineering preparatory courses. Students from 48 states and 21 foreign countries. Enter June, September, December or March. Send coupon for free catalog and full information. Enroll now.

SEND COUPON TODAY

INDIANA TECHNICAL COLLEGE

562 E. Washington Boulevard
Fort Wayne 2, Indiana

Please send me free information on B.S. Engineering Degree in 27 months as checked.

- Aeronautical, Chemical, Civil, Electrical,
 Mechanical, Radio-Television

Name _____

Address _____

I have a good proposition for men or women who would like to make an extra \$125.00 a month for spare time



I won't make any fancy promises of \$50.00 a day. I'm not after your money. What I can do is show you a simple plan by which you can pick up extra money every week to help make up for higher taxes and higher living costs.

I am Sales Manager for a big company making Stainless Steel Cooking Utensils. By cutting out all other middlemen, "dinner party" giving and other big selling costs we can sell a set of Stainless Steel Cookware for home use for about what it costs some companies to make it! We add only our small profit. You add yours — and sell your friends a set equal to \$120.00 to \$180.00 sets sold by dinner party salesmen for only a small part of that cost!

To make an extra \$125.00 a month, you only have to deliver 10 sets and that's easy. Mrs. Montell of Penn. took orders for \$1400.00 worth her first month. Mrs. Wm. Henchow wrote: "Got my set Saturday—already have 17 customers."

I'll not only be glad to send Free Information. I'll also send you a complete demonstrating outfit that you can show to your friends and neighbors. I'll give exact instructions how to get your own 19-piece Demonstrator Set as a bonus, and how to get orders without making any house-to-house calls. Send your name and address today. Everything I send you is free. No obligation.

CARLTON OF CARROLLTON DEPT. 336 Carrollton, Ohio

Say You Saw It in POPULAR MECHANICS

NEW "PAINT PEN"

PAINT STRIPING TOOL
Works like a Fountain Pen
Stripes with Paint instead of Ink!

This amazing new "PAINT PEN" is a Paint Striping Tool that makes it easy to do expert striping on furniture, bikes, model planes, autos, signs, toys, linoleum, wall board, etc. Makes plain-painted walls look like tile. Paint straight, curved, circular or evenly spaced parallel lines the same way a professional painter does. Simply fill Tubular Glass Paint Fountain with any color paint and wheel tip feeds paint evenly. Tips interchangeable — jaws split apart for easy cleaning. Tool complete with tip for 1-16 inch stripe only \$1.00 postpaid. Other complete tools with 1-84, 1-32, 3-64, 1-16, 5-64, 3-32, 1-8 inch tips, \$1.50 ea. Extra tips, 75c each. Complete KIT with 7 tips, \$5.00. C.O.D.'s postage collect. Here's the handiest tool in your whole painter's kit. Get yours today.



Home Craftsmen
Just the tool you've been waiting for! New Paint Striping Tool gives "professional" results every time, yet simple and easy to use as a fountain pen. Adjustable guide keeps lines straight as an arrow. Just as easy to make curves or free hand designs. Adds new beauty and finished look to everything you paint. Send \$1 now!

DEALERS
PAINT STRIPING TOOL
packed in display cartons of 1 doz. Fast, profitable seller. Write for illustrated circular, discounts

Only \$1.00
WENDELL MFG. CO., Dept. 3-H.
4234 LINCOLN AVENUE, CHICAGO 18, ILL.



TUBE GIVEN WITH EACH PASS. & TRUCK TIRE
29 MONTHS WRITTEN GUARANTEE
Sent with Every Tire You Buy
SEND THIS AD IF YOU WANT discount on every tire.
10% SAVE TIME SAVE MONEY
GOOD USED TIRES "Not recapped."
18 YEARS AT THIS ADDRESS

A TRIAL OF ONE TIRE WILL CONVINCE YOU

600x16 \$5.45	670x15 \$5.85	710x15 \$5.45	760x16 \$7.35
650x15 5.45	700x15 5.45	750x16 10.95	820x15 7.35
650x16 5.65	700x16 7.25	760x15 6.65	670x16 6.45
640x15 5.65	550x17 5.65	475x19 5.65	550x18 5.65

600x20 \$9.95	32x6(10) \$12.25	1000x20 \$19.95
650x20 11.55	750x16(8) 12.05	1100x20 22.95
700x20 12.35	825x20 20.55	1000x22 22.95
750x20 14.25	900x20 19.35	1100x22 23.95

Thousands of tires shipped all over U. S. A. All tires shipped F.O.B. Phila. Send Check or M.O. with this ad. Dept. 2.
STANDARD 834 N. Broad St., Philadelphia 30, Pa.



WATERLOO NEW SMALL PARTS CABINET

Metal bound. Baked green enamel. Green plastic drawers. Removable dividers. At hardware stores. Write for free catalog—complete Waterloo line of metal boxes and cabinets.
Waterloo Valve Spring Co., Waterloo, Ia.

Be an ARTIST Get FREE BOOK and TRIAL PLAN

You Can Draw at Home in Your Spare Time
Only WSA offers this proven method. Let us prove we can teach you to draw—no risk for you because TRIAL PLAN reveals your talent. Get the facts in illustrated FREE BOOK, "Art for Pleasure & Profit." Write today. State age.
WASHINGTON SCHOOL OF ART
Studio 126G Washington 5, D.C.

Learn ACCOUNTING Business Administration

Bookkeeping, secretarial and allied subjects at home in your spare time or attend nationally approved resident school. Write for FREE Success Book giving complete information about courses, plans, rates and employment opportunities.

Hills BUSINESS UNIVERSITY AND EXTENSION SCHOOL
619 W. MAIN ST., OKLAHOMA CITY 2, OKLAHOMA

JITTERBUG • CATCHES MORE FISH

GREATEST BASS BAIT—DAY OR NIGHT
WRITE FOR BIG FREE COLOR CATALOG
FRED ARBOGAST & CO., INC.
2246 WEST NORTH ST., AKRON 3, OHIO

Earn BIG MONEY BE YOUR OWN BOSS

EXCLUSIVE FRANCHISE in your trade area
Large, SUCCESSFUL tire service organization!
Hook up with this coast-to-coast network of established O.K. Rubber Welders. Finest patented tire recapping equipment. In-shop training. Mass purchasing benefits. Year 'round advertising aids. Consumer preference. Over 1100 affiliated tire shops now making top money. An opportunity to join a successful, profit-sharing outfit.
WRITE FOR DETAILS TODAY
O.K. RUBBER WELDERS; Central Division
Dept. PM6, P.O. Box 111, Littleton, Colorado



**Three Authoritative
Books Every Fan Needs!**

AUTOMOBILE RACING

Famous for authoritative, detailed information on auto racing, every type race car, rules, specifications, working drawings, plans, etc. No duplication. Every book is different. Money back if not satisfied.

AUTOMOBILE RACING, 6th Ed.

★ Championship cars, big cars, midgets, roadsters, Offenhauser dirt track car. Specifications on Indianapolis cars, four-wheel drive details, front drive drawings. Plans for Ford 60 midget, roadster racer, data on engines, gear boxes, clutches, axle ratios, compression ratios, etc. Indianapolis rules and regulations. More than 100 illustrations. Only \$2.00.

AUTOMOBILE RACING, 5th Ed.

★ Tells you—Why the Fast Ones are

Fast—How to Make Them Fast—How to Build Engines—How to Build Chassis—How to Build Bodies—Who Holds What Records—What the International Formula Is—What Midget Racing Rules Are—How World's Record Cars are Built—How to Speed Up Ford V8 Cars! Only \$1.00.

AUTOMOBILE RACING, 4th Ed.

★ Gives information on midgets, including three sets of working drawings and complete building instructions. Miller-Ford V8 Front Drive Racers are illustrated and described, also other big-time data featured. Only \$1.00.

POPULAR MECHANICS PRESS, Dept. 350, 200 E. Ontario St., Chicago

FREE BOOKLET

"HOW TO KEEP YOUR HOME COOLER IN HOT WEATHER"

24-page illustrated booklet tells how to utilize trees, shrubs, awnings, venetian blinds, to keep your home cooler. Tells how to select and use electric fans, air conditioners. Many other helpful suggestions. It's free at your local Vornado dealer, or send 10¢ in coin to cover handling and mailing costs to—



Vornado®
Box 1441-PM, Wichita, Kan.

yes, I'm an engineer... but

**how can I become
an AIRCRAFT
engineer?**



Lockheed in California can train you—at full pay!

The step up to Aircraft Engineering isn't as steep as you might expect.

Aircraft experience isn't necessary. Lockheed takes your knowledge of engineering principles, your experience in other engineering fields, your aptitude, and adapts them to aircraft work. You learn to work with closer tolerances, you become more weight conscious.

What's more, Lockheed trains you at full pay. You learn by doing—in Lockheed's on-the-job training program. When necessary, you attend Lockheed classes. It depends on your background and the job you are assigned. But, always, you learn at full pay.

These opportunities for engineers in all fields have been created by Lockheed's long-range production program—building planes for defense, planes for the world's airlines.

And remember this: When you join Lockheed, your way of life improves as well as your work.

Living conditions are better in Southern California. The climate is beyond compare: Golf, fishing, motoring, patio life at home can be yours the year 'round. And your high Lockheed salary enables you to enjoy life to the full.

Send today for illustrated brochure describing life and work at Lockheed in Southern California. Use handy coupon at right.

ENGINEERING TRAINING PROGRAM

M. V. Mattson, Employment Mgr., Dept. PM-6

LOCKHEED
AIRCRAFT CORPORATION
Burbank, California

Dear Sir: Please send me your brochure describing life and work at Lockheed.

My Name _____

My Field of Engineering _____

My Street Address _____

My City and State _____

Sore Itching Feet?



for Soothing, Cooling **RELIEF**

Bactine

BRAND—Reg. U.S. Pat. Off.

Bathe sore, itching feet with BACTINE! It quickly relieves the itching! It refreshes and deodorizes tired, aching feet! BACTINE is gentle to skin, yet it kills fungus germs causing over 90% of all Athlete's foot.



AT ALL DRUG STORES 30c and 70c SIZES



BETTER LIVING

... at new low cost!

Join thousands of happy, worry-free and rent-free New Moon owners. Move to top paying jobs, enjoy travel and vacation fun — a home completely furnished and ready to live-in, including kitchen, bath and automatic heating system. Own a New Moon on our rent-like payment plan and enjoy all the comfort and advantages of genuine home ownership at once. Free! Write today for literature describing the complete line of New Moon apartment homes.

Member of

REDMAN TRAILER CO.
40 BRIDGE ST., ALMA, MICH.

AMAZING BARGAINS! VALUES UP TO \$200! IMPORTED BINOCULARS 30-DAY TRIAL



Never before such values in brand new, precision-tested, binoculars! Coated optics! Superb color-corrected lenses! Many other luxury features! Designed for ease in use, optical clarity, matchless vision.

Save 50% and More! For Your Protection and Complete Satisfaction

- Written guarantee with every pair, and full refund if not satisfied
- Every pair scientifically tested for collimation, performance, etc. by our experts • Examine and test a pair yourself without risk — 30 Day Trial Offer

WIDE CHOICE — EVERY PAIR A BARGAIN!

STOCK NO.	MODEL	POSTPAID PRICE*
1505-H	6x15 IF Coated	\$17.95
1507-H	6x30 IF Coated	39.50
1510-H	7x35 IF Coated	45.50
1523-H	7x50 IF (not coated)	36.00
1521-H	16x50 IF Coated	72.50
1522-H	16x50 CF Coated	76.00

IF—Individual Focus. For Central Focus add \$4.00 add'l. to above prices.

*All prices subject 20% Fed. Excise Tax

ORDER BY STOCK NO. • SEND CHECK OR M.O.
EDMUND SCIENTIFIC CORP., Barrington, N. J.

BECOME AN EXPERT IN TRAFFIC

Traffic men earn \$4,000 to \$10,000 and up. Thousands of firms need experts on rates, tariffs, regulations. We train you thoroughly in spare time at home for executive traffic jobs. Personal training under traffic authorities. Placement counsel and help. Write for free 48-page book "Traffic Management—the Fast Growing Profession."

LASALLE Extension University, 417 So. Dearborn St.
A Correspondence Institution Dept. 664T, Chicago 5, Ill.

BE A LOCKSMITH

Learn Locksmithing and Keymaking from Experts in Your Spare Time at Home! Locksmithing in big demand! No layoffs, no slow seasons! Age no disadvantage. Year-round, steady income in this permanent, respected field. Full or part time. Practical, illustrated lessons show how to make money even while learning! All materials, special tools supplied. FREE BOOKLET.

INSTITUTE OF LOCKSMITHING, Dept. P-31
15 PARK AVE. RUTHERFORD, N. J.
Lic. & Approved State of N.J. VA Approved

SPARE TIME PROFITS EARN MONEY AT HOME

Cash in on this pleasant and profitable business. Re-string Rackets full or spare time. No experience or skill required. Easy to learn. Full line of finest quality, guaranteed Stringing Tools, Frames, Gut and Nylon Strings. Don't Delay Act Now!



FREE CATALOG and instructions WRITE TODAY

W. A. BICKEL & CO., 803 South Blvd., Dept. PM-6, Oak Park, Ill.

Learn TATTOOING At Home

Earn extra MONEY—Tattoo blood types and designs in your community. Splendid opportunity in every town. Prepare in spare time. Practical instructions. Send 25c for details and list of Tattoo Supplies. No obligations.



NEW! SPECIAL TYPE

Eklind

EMERGENCY BRAKE SIGNAL-LITE



- Red plastic shield escutcheon. • Light warns driver when hand brake is on.
- Fits all cars including '52 models.

\$2.50 postpaid

Install this handy signal-light that glows red when ignition key is turned on, with emergency brake set. The Complete instructions for red cap also removes for handy map easy installation with reading light. each lite.

If your dealer cannot supply you, order direct (No C. O. D.'s)

EKLIND TOOL & MFG. CO. 2623 N. Western Chicago 47, Ill.

ELECTRONIC WALKIE TALKIES

• **TWO WAY.** Set consists of two (2) "transceivers" ready to hook up. No license needed! Simply attach wire coil (included in each set) to terminals and talk between any two points. Operates anywhere. Clear voice transmission guaranteed.

• **BROADCAST OVER HOME RADIO.** Either or both Walkie-Talkies can be hooked up so you can "broadcast" from your own radio speaker. Mystify your friends—plan your own radio programs and announcements.

• **RECEIVE LOCAL BROADCASTS.** Your Walkie Talkies can easily be converted to the broadcast band and thus serve as your own private radio receiver. The REMCO plug-in crystal adapter and special aerial attachment will permit reception on broadcast frequencies. Adapter and aerial attachment only \$1.98 (Optional). Sets are ruggedly constructed of high quality injection molded plastic: engineered for utility and extra long service. This is not a kit but a genuine communication system. Guaranteed—or your money refunded in full. Send check, cash or money order. For C.O.D. orders enclose \$1 deposit.

only \$3.49 postpaid 2 SETS COMPLETE!

EMPIRE MSG. CO. Dept. P-1
63 Central Avenue, Ossining, N. Y.

CARBURETOR TOO RICH MAKES MOTORIST TOO POOR



Car owners who are wasting money, getting poor gas mileage due to over-rich mixtures, will be pleased to learn how to save gasoline by **VACU-MATING OVER-RICH MIXTURES.** Vacu-Matic fits all cars, trucks and tractors. Automatic and operates on the supercharge principle. Easily installed in a few minutes.

SALESMEN WANTED! Big Profits

For FREE particulars, how you can install one on your own car for introducing, just send your name and address on a postcard to **VACU-MATIC, 7617-1908 W. State St., WAUWATOSA, WIS.**

WATCHMAKING

Learn at home • FREE sample lesson
CHICAGO SCHOOL OF WATCHMAKING
1608 N. Milwaukee Avenue Dept. 162 Chicago 47, Ill.



TEN SHAPES
FOUR COLORS

Gives any lure that extra flash and flutter that attracts big fish. A really improved rind—supple, yet tough. Colors are fast. No salt brine to corrode tackle.

FREE New Booklet
"How to Catch Fish—Big ONES!"

LOUIS JOHNSON CO.
1547-P Deerfield Rd., Highland Park, Illinois



FREE BOOK AND ACTUAL SAMPLE

Screen Print, Dept. 24
1010 So. Los Angeles St.
Los Angeles 15, California
Dear Mr. Nowak: Please rush me FREE BOOK, ACTUAL SAMPLES, and your amazing new PRINTING PLAN

Name _____
Address _____
City _____ State _____

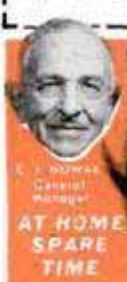

IT'S AMAZING! I'll show you how to make up to \$12.50 per hour

PRINTING WITHOUT A PRINTING PRESS

AMAZING NEW COLOR PRINTING METHOD
A fascinating new miracle-way to print—a secret method that lets you print colorful signs, posters, banners, drapes, wallpaper, flags, glass, fabrics—ANYTHING without an expensive printing press or costly equipment. This new process is revolutionizing the entire printing industry—it's one of America's fastest-growing businesses—it's your "chance of a lifetime" to make Big Money Now! Be the FIRST in your area to profit. The secret can be yours—just mail the coupon above today!

EASY TO LEARN! NO EXPERIENCE NECESSARY!
Simple fascinating method! No artistic ability needed. It's possible for anyone (young or old) to make up to \$50 PER WEEK printing in SPARE TIME alone—AT HOME!

START YOUR OWN BUSINESS—BE YOUR OWN BOSS
Wouldn't you be happy if you could take only one hour of your time and \$1.00 worth of materials—and sell your printing for \$15 or more. It's that easy! It's amazing! Your home can be your office—No selling because there's a huge demand everywhere. **GOVERNMENT CONTRACTS AVAILABLE TO BID.** Biggest opportunity in America—costs you nothing to receive all CONFIDENTIAL FACTS—Mail coupon today!

SCREEN-PRINT, Dept. 26
1010 S. Los Angeles St., Los Angeles 15, Calif.



- Print paper of all kinds
- PRINT BANNERS
- PRINT FABRICS
- PRINT INSTRUMENTS
- PRINT SIGNS
- FOR SALE



MAKE this Beautiful OTTOMAN Yourself!



Send for **FREE BROCHURE AND FREE FABRIC SAMPLES**

To save many, many \$\$\$ all you need is scissors and a hammer! No special tools required to make this big, comfortable Ottoman that adds beauty to any room.

Now available in Eastern's Exclusive Do-All Kit. Kit contains everything in pre-fabricated form, including hardwood frame, springs, rubberized hair, and choice of attractive fabrics.

Eastern's easy-to-follow Instruction Manual—over 60 photos—makes it amazingly easy to build—no special skills necessary.

Don't confuse this Ottoman with small flimsy footstools. This is a large, sturdy, well designed piece of furniture, measuring 23" x 17" x 14" high, built for years of service.

Write for free illustrated Brochure today!
EASTERN SCHOOL OF UPHOLSTERY
DEPT. M 555 BROADWAY, NEW YORK CITY

BLACK EBONY SEAT COVERS

SWEEP TO SENSATIONAL NATIONAL POPULARITY



Salesmen jamming pockets with \$1000 bills

TAKING ORDERS FOR KEY EXPERTLY TAILORED AUTO SEAT COVERS

9 STYLES

BIG SEASON NOW STARTING

You've seen the huge color advertisements in Saturday Evening Post on the new seat cover sensation—miracle SARAN in the beautiful new Black Ebony pattern. SARAN—the plastic, woven like cloth, that has the color permanently "locked" right into each thread! Car owners everywhere are demanding Black Ebony Saran Seat Covers. Now you can serve that eager demand at a fraction of the cost the customers expect to pay! No wonder salesmen are making money hand over fist with this sensational new Key line. **Make big money daily.** Take orders from car owners everywhere. Beat all competition with covers cut to accurate patterns like the finest suit of clothes...Slick, smooth, wrinkle-free fit adds an accent of elegance to any car...just like the original upholstery job!

Rush Name for FREE Outfit

Give MAKE, YEAR and MODEL of YOUR CAR

Anyone working full or spare time can realize big money in this business. No need to search for prospects. Every car owner is one. Be the first to cash in... Make year around STEADY PROFITS. Don't put it off—get your Free Selling Kit at once for some real money. *Actual seat covers given FREE to producers for OWN USE!* Write for full details!

KEY PRODUCTS CORP., Dept. 46
800 N. CLARK ST., CHICAGO 10, ILLINOIS

Say You Saw It in Popular Mechanics

\$5000.00 IN PRIZES **DRAW MY HEAD**

1st & 2nd PRIZES

COMPLETE \$130 ART COURSE
80 OTHER VALUABLE PRIZES

YOUR DRAWING JUDGED AND ANSWERED

Take this test and try for a thrilling prize. Discover if you have profitable Art talent. You may gain a lifetime of happiness and high earnings if you mail your drawing today. Amateurs only. Our present students not eligible. Copy this girl 4" to 6" high in pen or pencil, and mail to us. None returned. Winners notified. New \$5,000 Contest each month. Your drawing will be entered in Contest for month in which we receive it. Send your drawing now with your name, address, age, occupation. Enter today.

WALLER ART EXCHANGE Studio 97, 1000 N. Charles St. Baltimore-1, Maryland



NEW LIGHTNING SELLER

47 Million Prospects—up to \$4.97 on every order. Never before a sales plan like this. No "selling." Lend the Magic Defroster to any woman who has an old refrigerator. Makes it into an Automatic instantly. Then try to take it away. She'll buy everytime rather than give up the labor saving, mess saving invention. **Sent FREE.** Rush name for complete information on lending plan and offer of **SAMPLE** for DEMONSTRATING. Lend ten to twenty a day. A postcard will do, but get your name mailed today, sure—for **FREE** offer.



Amazing Attachment
Turns Old Refrigerators into Automatic Defrosters
WOMEN BUYING THOUSANDS
Write for Free Money Making Plan

MAXILUME CO., 125 Hubbard, Dept. D-8-H, Chicago 10, Illinois

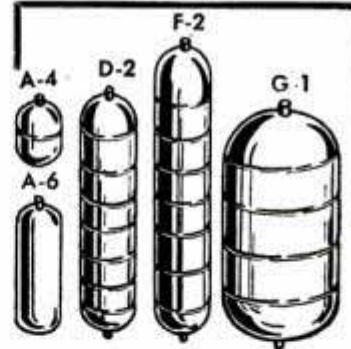

STEEL AIR TANKS

Steel pressure tanks suitable for compressors, pneumatic units, gases, hydraulics, and liquids. Rated at 500 lbs. per square inch pressure. 1/2" standard pipe thread openings on tank ends as shown.

		Size	Wt. Lbs.	Internal Volume	Price
A-4	Stainless Steel—New	7 1/2"x5 1/4"	1 1/2	104 cu. in.	\$1.50
A-6	Carbon Steel—New	14 1/2"x5 1/2"	3 1/4	280 cu. in.	3.50
D-2	Stainless Steel—New	24"x6"	5	500 cu. in.	5.50
D-2A	Carbon Steel—New	24"x6"	5	500 cu. in.	4.50
F-2	Stainless Steel—New	45"x6"	11	1000 cu. in.	9.50
F-2A	Carbon Steel—New	45"x6"	11	1000 cu. in.	5.50
G-1	Stainless Steel—New	24"x12"	18	2100 cu. in.	11.50
G-1A	Stainless Steel—Used	24"x12"	18	2100 cu. in.	9.50

Prices F.O.B. Chicago. Include approx. postage on orders paid for in advance. C.O.D. orders enclose 25%, balance sent C.O.D.

U. A. S. Corp. Dept. PM6, 5637 W. 63rd Pl. Chicago, Illinois



TALK-SING-PLAY OVER YOUR RADIO

with the real Radio Mike! Attaches in a jiffy—full instructions given! Swell for "parties"—"cut in" on or "kid" regular network programs or put on your own broadcasts! Amaze your friends—real fun. Beautiful Metallic Plastic 6 in. high!

12 RADIO BROADCAST LESSONS GIVEN with each Mike

SEND NO MONEY Just pay postman \$3.99 COD plus postage or send \$3.99 and we pay postage! Radio Mike is available only from us by mail—guaranteed.

Midway Co., Dept. MPM-6, Kearney, Nebr.



WARN HUB CAP MAKES 2 JEEPS OUT OF 1

Ends front wheel drag on 4-wheel drive Willys Station Wagons, Pick-ups and Jeeps

Saves gas up to 3 miles per gallon, tire wear, front axles, increases speed and power. Stops shimmy—front wheels coast out of gear! 4-wheel drive handles, performs, climbs like 2-wheel. Install or remove WARN HUB CAPS in 10 minutes. Polished aluminum, guaranteed. Rush check, M.O., or C.O.D. Write for circular.

WARN MFG. CO., P. O. Box 6064H, Seattle 88, Wash.



BOYS! MAKE YOUR OWN RADIO

Make your own simple, tubeless, batteryless Crystal Radio. SEND 25c for a GENUINE MELOMITE CRYSTAL with complete illustrated instructions for making your own set. Crystal sent postpaid with instructions and our own publication, "THE MAGIC CRYSTAL" which is full of news, diagrams, questions and answers of interest.

SEND 25c FOR YOUR CRYSTAL TODAY!

ALVA ALLEN RADIO Dept. PM-6 Clinton, Mo.

BURN WATER IN YOUR CAR



With The OCTA-GANE INJECTOR

This amazing all bronze, "fog type", exhaust operated PRESSURE Injector will burn water, alcohol or both. It is adjustable to burn up to one gallon of water with every 10 gallons of gasoline.

U.S. Agricultural Dept. Scientists say: "The gasoline mileage of new high compression auto engines can be increased up to 30% with alcohol-gasoline fuels."

DEALER INQUIRIES INVITED

Complete with 1 1/2 gal. tank
Only \$27.45 ppd.
(Or send \$2, balance C.O.D.)
List car make, year, # cyl.

World's Largest Firm Specializing in Hi-Performance and Hi-Mileage Equipment for All Makes of Cars.

NEWHOUSE AUTOMOTIVE INDUSTRIES
Dept. 80-6, 5805 E. Beverly Blvd., Los Angeles 22, Calif.

WRITE FOR FREE ILLUSTRATED LITERATURE



CLASSIFIED Advertisements



Advertisements in this section 85 cents per word, each insertion, minimum 10 words, payable in advance. To be inserted under proper classification, copy must be in our office the 20th of the second month preceding date of issue
F. W. Johnson, Manager, Classified Advertising
Popular Mechanics Magazine, 200 East Ontario Street, Chicago 11, Illinois

YOU'LL PROFIT

By reading and answering the classified ads in this section. Hundreds of opportunities for you to make and save money

AUTOMOBILES. MIDGET CARS

SPEED Equipment—Save up to 50%. Hollywood mufflers \$4.95, dual mufflers \$18.95, header kits \$12.95, cut outs \$6.95, dual intake manifolds \$12.95, chrome stacks \$1.25, racing cams \$29, hi-compression heads \$18.95, water injectors \$5.95, customizing kits \$1.98. Thousands of accessories! Catalog plus "Soup-Up" Handbook 25c. Almquist Engineering, Milford 64P, Penna. Dealers wanted.

SEND 50c Sample copy Floyd Clymer's Automobile Topics, America's oldest automobile magazine. A. Clymer, 1268 So. Alvarado, Los Angeles 6, Calif.

SPEED Equipment. Heads, manifolds, etc. Free catalog. Dealers wanted. Hon-saker's, Masontown, Penna.

PFOHL Hot rod cam shaft regrinding. Dual intake manifolds, 48 hour service. Box 54, Anderson, Indiana.

NON-Profit organization supplies literature—old, new and foreign automobiles, shop manuals, engineering papers, data books, glossy photos, free motor magazines. Contact auto nuts everywhere. Write today; get on free mailing list. Auto Maniacs, Stockbridge, Mich.

NASH Ramblers, Statesmen, Ambassadors by mail. Save \$50.00-\$900.00. Factory-to-you. Write Nash Sales, Box 15824M, Los Angeles 8, Calif.

POWERCAR Junior—Real children's auto! See details under "Motorcycles, Bicycles."

1952 **SUPERIGNITIONITER** Starting, pep, mileage. \$4.50. EG Mfg., Elmsford, N. Y.

SERVICYCLE \$15. Midget car \$10. Dart motorscooter \$17, less engines; two cylinder opposed 5 horsepower engine \$20, others \$7.50 up (mailorder only). Send 25c for catalogue number 47, listing these and hundreds of other bargains in midget cars, motorscooters, outboard motors, homebuilders parts, plans, etc. (35c by first class mail). Midget Motors Directory, Athens, Ohio.

"**WATER** Injection." Spark boosting. Economy methods. Neher Industries, La Verne, California.

BUY Racing heads, dual manifolds. Hot coils, etc., without money. Information free. Newhouse Automotive Industries, Los Angeles 22.

FROM Speedway to roadway! Track-proved hi-speed heads and manifolds for your passenger car! No special tools needed! Increase horsepower 30%! Astounding getaway! Free illustrated catalog. (Dealers wanted.) Speedsport, 4866-D Milwaukee, Chicago 30.

LATEST 1952 Edition! Just out—100 new pages! Get world's largest auto accessory and parts catalog and save money. Over 50,000 items, including Hollywood accessories, hi-speed equipment, rebuilt engines, all parts and accessories for all cars and trucks. We have that hard-to-get part! Jam packed with bargains. Completely illustrated. Send 25c (refundable). J. C. Whitney, 1919 Archer, Chicago 16.

SAVE—California custom accessories headquarters. Buy direct from original designers. Chrome dash panels, electric push button door-trunk conversions, fender skirts, dual mufflers, lowering kits, speed-dress up equipment. 40 page catalog, hundreds of photos—25c. Eastern Auto, 3319A South Grand, Los Angeles 7, Calif.

AUTO SUPPLIES AND EQUIPMENT

SILICONE Auto cloth cleans and polishes auto in ten minutes without use of water. Good for twenty polishings. Wonderful on chrome. Sent postpaid for \$1.00. Hall's, Dept. K, 5517 Bancroft, St. Louis 9, Mo.

AMERICAN Auto Parts Co. Inc., has for immediate shipment parts for military trucks, Jeeps, Dodge, Chevrolet, GMC, Studebaker, 4 wheel and 6 wheel drive; some "hard to get" items. Write for parts catalogue, giving name of trucks. Dept. PM, 1830 Locust, Kansas City, Mo.

BE Independent, save money. Grind crankshafts without disassembling engine. New hand operated tool \$3.75. Literature. D. McGee, 719 Cascade, Wenatchee, Wash.

CAR-Hammock, convert your car into a double bed at any time. Universal, works on 2 or 4 door sedans, club coupes and convertibles. No cutting your seats or soiling interior. Folds up when not in use for storage in trunk of car. Send \$2.00 for complete plans and illustrations to Auto Bed Company, 301 West 6th Street, Panama City, Fla.

SPEED Equipment from the world's largest firm. 25c for huge catalogue. Newhouse Automotive Industries, Los Angeles 22.

BUG And scum remover, package \$2.00. Box 952, Lake Forest, Illinois.

LIGHT Your Powerglide or Dynaflo dial. Free information. Gaiser, Box 25, Kokomo, Ind.

BURNING Oil? Loeb motor conditioner cuts gas-oil consumption, stops slap, etc. Details. Frost, 36A Cross, Leominster, Mass.

LACHAPPELLE'S Treatment, patented. Puts Babbitt bearings on the pistons. Your agent or postpaid \$3.00. Ferns Products, 8120-B Walnut Dr., Los Angeles 1, Calif. Data on request. Cuba, Luis Izaguirre, San Carlos 178, Cienfuegos.

RATTLES In car windows stopped instantly with invisible Ratal-Stop. Send 50c for complete car set. Agents wanted. 4525 Monroe, San Diego, Calif.

OVERHEAD Valve adjustment is fast, simple, easy with Feelzit-Seezit tappet tool. Postpaid \$2.85. Guaranteed satisfaction. Free circular. Atmars-Mechanico, 3561-M Lakeshore, Oakland 10, Calif.

SAFETY Belts, use for safer highway driving, all types of racing. Strong heavy 3 in. wide webbing with quick release. \$5.25 prepaid. Service Sales, P.O. Box 747, Oklahoma City, Okla.

REMANUFACTURED Engines. New car guarantee. Marvin, Box 5046, Cleveland 1, Ohio.

VACUUM Reserve system complete with tank, makes windshield wipers work like electrics. Guaranteed! \$2.95. Carco, 1229 Merle Haye, Des Moines 11, Iowa.

FREE Bargain list. Books, manuals, mechanical, electrical. Modern, Box 4704, Kansas City, Mo.

MAKE Your car last twice as long. Reduce repair costs. Save gas and oil. Use Super-Temp cooling system. Particulars 10c. Burky & Burky, 879 Villa, San Jose 26, Calif.

MOTORIST Save gasoline by Vacu-mating overrich mixtures. Fits all cars. For free particulars write Vacumatic, Dept. 1910, Wauwatosa, Wis.

TIRES: Wholesale. Major brands. Free list. Field Tire, Downingtown 3, Penna.

MAKE Repairs to cars, tractors, using re-manufactured original equipment. Carburetors, fuel pumps, distributors, generators, regulators, brakes, etc. All on exchange basis. Write for list on your makes and models. Exchange Parts Company, P.O. Box 33, Detroit 32, Michigan.

BODY And fender men: Five time saving tools you can make yourself—Plans \$1.00. Shuman, 3117 Division Street, Los Angeles 65, Calif.

FORD 1951-52 horn rings hide speedometer. Trim balls and instructions \$1. Dorn, 858—19th, Santa Monica, Calif.

CHEVROLET Owners: Stop tappet noise with Kaye Tappet Silencers. Quality product. Easy to install. Money-back guarantee. Complete set \$5.95 postpaid. Kaye Products, 1321B So. Layton Blvd., Milwaukee, Wis.

FLASHLIGHT Users. Hours more bright light from your batteries! Recharge in car free without removing from flashlight. Simply, conveniently. Guaranteed. Illustrated instructions \$1.00. Product Designers, Henniker 15, N. H.

ELECTROPLATE Metals, non-metals. Portable Tyco electroplater \$5.95. Free booklet. Tyco, Box 13231-BE, Houston 19, Texas.

FREE Trial. Gane Airflow Needles. Send car data. Neher, La Verne, Calif.

PRECISION Pressure, vacuum, ignition instrument, tunes engines to deliver dynamic performance. \$3.95 complete. Graco Engineering, Box 265, Shelton, Conn.

SIRENS. Air horns! Bermuda bells. Free accessory catalog. McCanna Company, 148-PM East 40th, New York 16.

GM71 Discarded injector parts wanted. Bares, 7120 Carnegie, Cleveland, Ohio.

AUTO Radios at wholesale. List free. Regent, 801 W. Erie, Philadelphia.

MOTORISTS Are reporting three to five more miles per gallon. Guaranteed. Gasoline vaporizer, increases power; easier starting. \$3.50. Turb-O-Vane, Stockton, California.

NEVER Change your oil! Full details free. Thousands of users. New oil filter. Dept. TI, Henderize, Inc., 5667 Freeport Blvd., Sacramento, California.

HYDRAULIC Jack repair kits. Repair your own. Send for prices. Jack Parts Company, 2000 South Claiborne, New Orleans, La.

BRUSH Plating outfits connect to a battery. No tanks or shop required. Free particulars. Gunmetal Co., Ave. J., Decatur, Ill.

AUTO Parts and accessories. Briggs Automotive Engineering of Chicago, P.O.B. 3454 Merchandise Mart, Chicago 54, Ill.

HOW To buy speed equipment without money. No selling. Information free. Newhouse Automotive Industries, Los Angeles 22.

AUTO TRAILERS

BUILD Your own trailer! Plans for all kinds. Illustrated catalog 10c. Jim Dandy, 125-M, Wausau, Wisconsin.

MOTORCYCLES, BICYCLES, MOTORSCOOTERS AND SUPPLIES

BUILD Your own motorscooter. Factory made frames, wheels, wheels parts. American Moto-Scout Co., Chicago 25, Ill.

SAVE! Nylon gabardine motorcycle jackets—Direct from factory. Rayon lined. Only \$14.95 postpaid. Blue, gray, green or maroon colors. In black horsehide—only \$24.95. Send size. American Outerwear Mfg. Co., Box 37, Garfield, New Jersey.

INTERESTED Motorcycling? America's best, popular motorcycle magazine. Annually \$2.00. Sample 20c. Address "BUZZZZ," 5424-(A) Sawyer, Chicago 25.

REBUILT Gasoline engines. \$28.00 to \$47.00. Cauffiel Motor Industries, Temperance, Michigan.

POWERCAR Junior—Real children's electric auto. Plenty of power for hills, towing wagons, etc. Catalog free. Mystic River Sales, Dept. P-6, Mystic, Conn.

WHIZZER Motor \$5; Cushman motorscooter \$15; Indian motorcycle \$30; Engines \$3 up; motorbike frame \$3. Rush 25c (35c first class mail) for catalog #951 listing many other amazing bargains in motors, midget cars, motorscooters, motorbikes, etc. Associated, Box 1764-CS, Toledo, Ohio.

RECONDITIONED Motorcycles and motors. Chromium accessories. Complete stock Indian parts. Expert rebuilding. Fast service. Indian Motorcycle Sales, Kansas City 1, Mo.

HARLEY-DAVIDSONS—All models and prices. Genuine late and old model supplies. Expert service. Send 25c for bulletin. Knuth's, 1753 Muskego, Milwaukee, Wis.

GOOD Whizzer \$20; motorscooter (twist grips) \$22.50; midget car \$15; Shaw bicycle motor \$15. Send 25c (35c first class mail) for catalog #20 jammed with sensational bargains in wheels, motors, clutches, motorscooters, midget cars, motorettes, motorbikes, etc. Gail, 538 Erie, Toledo, Ohio.

U. S. Govt. surplus "45" Harley Davidson motors, complete with carburetor and generator, in running condition—\$69.50 f.o.b. Chicago. 25% deposit with order. Parts and accessory catalog 25c. Triangle, 2157 Harrison, Chicago.

AVIATION

LEARN To fly with the Aviation Cadets. Get paid while learning. Flying Opportunities, 25c. Cramwell Books, PM-7, Adams, Mass.

GOVERNMENT Book on career opportunities in aviation, 15c. Ross Aero Publishers, Tulsa, Oklahoma.

LIGHTPLANE Circular, illustrated, 20c. Craftsmann Books, Box 1153, Milwaukee 1, Wis.

PROPELLERS: For snowsleds, boats. Literature. Standard Aerocraft, Box 387, Ft. Worth, Texas.

BATTERIES, GENERATORS

EDISON Non-acid storage batteries. Amazing long life. Any voltage. 37 to 600 ampere hour sizes. Lighting plants, generators, motors. Literature. Hawley Smith Co., Croton Falls 1, N. Y.

ELECTRICAL SUPPLIES

AMAZING—Delayed action switch continues lighting your way fully a minute after you turn it off. Guaranteed, \$2.50, 3 for \$6.00. Shor Electronics, 49 Pomfret St., Hartford 12, Conn.

ELECTRIC Pencil—Writes, engraves all metals. \$2.95. Reb Industries, 265-DAD, Elmhurst, Illinois.

LAMP Supplies, wholesale, any amounts. Prompt shipment on all parts for repairing and building lamps. Illustrated catalog 15c. Brown Lamp Co., Box 501, Wellston Sta., St. Louis 12, Missouri.

ASTONISHING! Plastic magnets. Pair 25c. 2442 Miller Road, Flint, Michigan.

FREE—War surplus catalog. Bargains galore. Welders, motors, generators, hydraulics, pumps, kits for assembling your own, other items. Save. LeJay Company, Minneapolis, Minnesota.

TELEPHONES—Telephone wire. Solve communication problems with army field telephones. Anyone can install, operate. Free folder. Loris Sales, Box 1896-B, Sacramento, Calif.

LAMPS—Had trouble finding repair parts? Your search is ended. 25c brings 64 page illustrated catalog containing wiring charts. Gyro Lamps, 5402P Clark, Chicago 40.

ELECTRIC Pencil: Engraves all metals \$1.50. Beyer Mfg., 10511-H Springfield, Chicago 43.

WELDING, SOLDERING, PLATING

A.C. Welders, four sizes, lowest prices, free literature. Holgerson's Service, Canton 1, Kans.

SPOT Welding transformers 2KVA, 60 cycle, single phase. Primary 100, 110, 120 volt—secondary 8/10 volt. Make your own workshop spot welder \$5.00 c.o.d. Heckman Co., 4528 S. Broadway, St. Louis 11, Mo.

ACETYLENE Welding outfits. New \$49.00; used \$29.00; arcwelders \$49.00. Eagle Welding, Dept. PM, 5085 Broadway, Chicago 40, Illinois.

MACHINERY, TOOLS, SUPPLIES

CHUCKS: Independent; Universal—threaded 1½"-8, 1"-8, 1"-10, 1"-12 or with adapter recess; also 6" Universal threaded 2¼"-8. The only complete line of bench lathe chucks built to heavy duty standards. Other chucks to 16" diameter. Write for free literature or quotation. No obligation. Westcott Chuck Co., 3600 Walnut, Oneida, N. Y.

BUY Good machines for your shop. 30" x24" screw-cutting engine lathe \$940.00 13"x6" quick change \$440.00; new bench lathes 10½"x38" \$250.00; 16" shaper \$280.00; 5 ft. radial drill with motor \$840.00; vertical attachment with motor \$150.00; new 9/16" wire rope 15c foot. Conversion Parts Co., 278 Adams St., Boston 22, Massachusetts.

LATHES, Shapers, millers—Build 'em yourself from unfinished castings. Send 25c for single construction drawings, \$1.00 for drawings of shaper, three millers, three lathes. Footatuck Corporation, 150 Sammis Place, Stratford, Conn.

GOVERNORS And butterflies for auto or any gasoline driven engine. Candee-Smith, P.O. Box 612, Riverside, Calif.

CONCRETE Block machines. Standard sizes. \$42.50. Average 400 daily. Free catalog. Concrete Machine Company, 5129 South Compton, St. Louis 11, Missouri.

SPEED Your metal work. Use drill and saw lubricants used by aircraft plants Convoir, Douglas, North American, etc. Different from other lubricants. For trial packages send \$2.50. Knight Company, 948 Third, San Diego, California.

AMAZING, New, inexpensive, bench grinder attachments sharpen screw-drivers, hand-plane blades and flat wood-chisels perfectly. Brush Mechanical Products, 377 N. McMillen Street, Portland 12, Oregon.

ROUND Stock or pipe jaw for your vise, ½" to 1½" pipe, \$1.00 plus 20c postage. H. A. Johnson, P-3921 La Cresta Ave., Oakland, Calif.

SIX Piece screw driver set, postpaid \$1.00. Catalog free. Robe Factory, 1716 South Michigan, Chicago 16, Illinois.

BOATS, OUTBOARD MOTORS

BUILD Beautiful Fiberglass-plastic boats without using molds. New patented method. Write Speedcraft, 2450 Emerson, Off Square Lake Road, Pontiac, Michigan.

CURE That leaking boat with Fiberglass-plastic covering. Ends caulking and painting. Nationally approved process. Easily applied, complete instructions. Industrial Plastics, 3807 Harrison Street, Oakland 11, Calif.

TWENTY Plywood boat plans \$1.00. Catalog boat building plans 25c. The Rudder, 15 Murray Street, New York 7.

BOATING Bargains—Now you can save on boat needs. Our spring value lists just off press. Assemble your own boat from a dinghy to cruiser. Power it with a Masters rebuilt inboard or outboard motor. All three lists 25c. Free boat fitting list. Act now and save dollars. W. L. Masters & Son, Inc., Dept. P, 212 W. Chicago Ave., Chicago 10, Illinois.

BOAT Owners—Build your own dock using Perma-Dock brackets. Free circular. Delmarva Marine Sales, 6069 Reinhard St., Philadelphia 42, Penna.

FIBERGLAS-Polyester permanent plastic boat coating. Catalog 10c. Gem-O'-Lite, Box 6865, North Hollywood, Calif.

FASTEST Boats in the world! Build your own Champion boat or let us build you a custom-made racer or family run-about. Send 25c today for catalogue of easy-to-follow plans for 3 point hydroplanes, runabouts and others. Dealer inquiries invited. Champion Boats, 1524 W. 15th St., Dept. 22-S, Long Beach 13, Calif.

SAVE ¾ Cost. Assemble your own boat. We furnish parts. No experience necessary. Rowboats, cruisers. Illustrated catalog 25c. Midwest Boat Company, Menomonee Falls, Wis.

NO More leaks, painting, worm or barnacle damage when your boat is covered with our Permaglas Plastic coating. Apply it yourself. Permaglas Plastics, 1536 6th Ave. W, Bradenton, Fla.

OUTBOARD Motor parts—New, used for all makes. Send stamp for price quotation, listing parts needed. Outboard Motor Mart, Inc., 229A State Street, Boston, Mass.

FULL Size, cut to shape boat patterns, blueprints, 7½"-38 feet. Illustrated "Build a Boat" catalog, 25c (coin). "How to Build Boats" book, \$1.00. PolyWog houseboat plans \$10. Marine catalog \$1.00. Cleveland Boat Blueprint Co., 3107 Detroit Ave., Cleveland 13, Ohio.

MARINE Conversions for Ford and Jeep engines. Catalog 10c. Lehman Manufacturing Company, 972D Broad Street, Newark 2, New Jersey.

"P38 Belly tanks," steel, \$9.95. Free picture. Bucks Auto Parts, Box 89, Merced, Calif.

NEW, Used, rebuilt marine motors. Marine conversions, fittings. Free catalog. Stokes Marine Supply, Dept. 24, Coldwater, Michigan.

CONVERT Fords and Jeep to 100% marine engines with Osco's world famous Convo-Kits. Deluxe catalogue 25c (coin). Oscomotors, 3627B Lawrence, Philadelphia 40, Penna.

ENGINES, MOTORS, DYNAMOS

SPECIAL Motors 24 V. D.C. ¼ inch shaft only \$3.00 cash. Aircraft parts, tools. Genex, P.O. B. 189, Burbank, Calif.

MOTORS ½ Horse \$15. ¾ \$22. 1 \$35. Compressors \$22.50. 750 Watt A.C. generators \$38.50. Butler, 1885 Milwaukee, Chicago 47.

REBUILT Gasoline engines. \$28.00 to \$47.00. Cauffiel Motor Industries, Temperance, Michigan.

ENGINES: Marine and industrial diesels and gasoline parts. Be satisfied and save money with Helwege Engine Sales, Richmond St., Freeport, N. Y.

WINDING Data, listing 225 motors, single and three phase, \$1.00. Motor Data Co., Box 7631, Kansas City 3, Mo.

ATHLETIC EQUIPMENT, BODY BUILDING COURSES

GAIN Weight! 4 exercises will increase weight. Complete \$1.00. Body Builders, 36 Nevada Street, Winthrop, Mass.

SUPER Strength building. Information, photos free. Joseph Dryer, Box 5527-A, Chicago 80.

MASSIVE Proportions; barbells wholesale; personal course. Catalog \$1.00. EG, Elmsford, N. Y.

BARBELLS. Exercise equipment. Courses. Free booklet. Good Barbell Co., Reading, Penna.

"POLICE Jiu Jitsu." Authentic, illustrated \$1 postpaid. Satisfaction or money back. Books Publishing Co., 56-C W 24th St., New York 10.

DEADLY Judo—Fiercest fighting technique. Trick knockouts. (Over 200 illustrated pictures.) Expert instructions; three volumes. Complete \$2.25. Variety House, Box 46-B Wall Station, New York 5.

SPORTING GOODS, GUNS, FISHING TACKLE, ARCHERY, TRAPPING

TENTS, Canvas; direct from manufacturer. Also war surplus. Camping equipment, sleeping bags. Tremendous selections. Free catalogue. Low prices. Morosan Sales, Dept. PM-4, 10-15R 50th Avenue, Long Island City 1, New York.

"LARGER Red Worms." 40 page, illustrated booklet, gives complete, practical plans for producing the big worms fishermen demand. Just off press. Hurry. \$1.00. Natural Baits, Rockwood 1, Tennessee.

BOWS-Arrows: Make your own. Indian-head. Box 303-PM, Lima, Ohio.

WEEDLESS Bass spoon $\frac{3}{8}$ ounce 22K gold. \$1.25 including booklet. "Carrjr" Co., Medway, Mass.

AGRAMONTE Offers tremendous selection, better values, better trades, guns galore. Antique-modern list 25c. Ed Agramonte, 201 Warburton, Yonkers 2F, N. Y.

"**FISH-Finder.**" Marvelous new invention delivers your bait to choice fishing spots across streams 300 feet beyond casting range. Only \$2 postpaid. Get free literature. Kissich Co., Cedar Rapids, Iowa.

RED Wigglers, wholesale, 1000, \$4.00 postpaid. Groves Howell, Sneads, Fla.

FRENCH Revolver \$2; 22 rifle \$5; 1824 musket \$8; double-barrel 12 gauge \$10; arrowhead collection 70c. Rush 25c (35c first class mail) for catalog #510 listing other bargains in guns (new and old), swords, relics, etc. Jefsco, Box 1682-CS, Toledo, Ohio.

CAST Iron molds—For casting fishermen's sinkers. Free illustrated booklet. Reading Instrument Co., Box 78, Reading, Penna.

120 PROFUSELY Illustrated pages antique pistols, swords, daggers, armor, etc. 50c. Robert Abels, M860 Lexington Ave., New York 21.

SHOTGUNS, Rifles, Revolvers, 500 modern, obsolete. Also cartridges. Each list 10c coin. Ed Howe, 52 Main, Coopers Mills, Maine.

5000 BARGAINS, Firearms, binoculars, war relics. Catalog 50c. Smith Firearms, Runnemeade, N. J.

MOLDS. (For fisherman's sinkers, squids, jigs and lures.) Handled and hinged. Quality fishing tackle. Free catalogue. E. L. Sweet & Son, Tonawanda, New York.

TAXIDERMY

MODERN Taxidermist Magazine, Greenfield Center 2, N. Y. Devoted entirely to taxidermy, photos, articles, methods. Trial year's subscription, \$1.00

BINOCULARS, TELESCOPES, MICROSCOPES, MAGNIFIERS

POWERFUL Terrestrial (erecting) telescope easily made. Perfect lenses and instructions for making 40, 100, 200 and 400 power telescope \$6.00. Telescopic Camera Co., Manorville, N. Y.

SAVE! Free 24-page, 3 color binocular catalog. 60 different models. United Binoculars, A-4508, 9043 S. Western, Chicago 20. Display Rooms open Mon. thru Fri. 9:00-3:30.

SAVE 50% On new binoculars! Free catalog. Free book, "How to Select Binoculars." Write today! Bushnell's, 43-M-36 Green, Pasadena 1, California.

BINOCULAR Specialists, all makes repaired. Authorized Zeiss, Hensoldt dealer. Tele-Optics, 5514 Lawrence, Chicago 30, Illinois.

TERRIFIC Values, binoculars, telescopes, microscopes, \$3.95 up. Big money saving catalog on request. Criterion Co., Hartford, Conn. Dept. P3.

WAR Surplus bargains, binoculars, telescopes, sextants, millions of lenses, prisms, reticles, eyepieces, objectives, etc. Mail 10c for big "Catalog CH." Send \$1.00 for Stock CH—10-piece lens kit and big instruction booklet. Edmund Scientific Corp., Barrington, N. J.

BUILD A 100X, 45X astronomical telescope that converts to a 45X terrestrial telescope! Inexhaustible source for thrills! 3 perfect ground and polished lenses; complete instructions for easy building. Money back guarantee. \$3.00. Lemar Scientific Corp., Dept. D63, 3412 W. Jackson Blvd., Chicago 24, Ill.

MAKE Your 6" telescope reflector. Glass, abrasives, instructions—\$8.50. F. Cameron, Box 65, Inwood 96, N. Y.

REFLECTING Telescopes, 60X, completely assembled \$29.75. Guaranteed observatory clearness. Free information. Skyscope, 475 Fifth Avenue, New York 17.

AMAZING Prices, imported precision binoculars. Free trial. Pricelist, folder "Selecting Binoculars" free. Prentiss Importers, Mercury Bldg., Los Angeles 25, Calif.

POWERFUL Astronomical telescopes easily made. Perfect lenses and instructions; 100X \$3.00; 100X and 200X \$4.00; 100X, 200X and 400X \$6.00. Full power, clear vision guaranteed. Instructions alone 10c. Suffolk Science Service, Riverhead, N. Y.

BINOCULARS, Telescopes, microscopes. Our 20th year of leadership in optical values. Bargain catalog free. Brownscope Co., 24 West 45th Street, New York.

REFLECTOR Telescope kits, refractors. Free illustrated bulletin. Esco Products, 911 Willow Ave., Hoboken, N. J.

GIANT Astronomical telescope with 6 ft. tripod \$15.00, f.o.b. factory. 100 power, (10,000 area magnification). Clear vision, full power guaranteed. Ready for use. Suffolk Science Service, Dept. BT, Riverhead, N. Y.

PETS—DOGS, BIRDS, RABBITS, HAMSTERS, ETC.

MONKEYS Are the best pets—Intelligent, easily trained, inexpensive. Send 10c for catalog. Tropical Hobbyland, 1525R N.W. 27th Avenue, Miami, Florida.

RAISE Rabbits for our markets. Free booklet tells how. Old Mill Rabbit Farm, Elmhurst, Illinois.

BEAUTIFUL Pure white pedigreed police puppies. Ansonia Kennels, Mose, N. Dak.

ST. Bernard pups! Beauties. Reg'd. Details, prices, charming pictures free. Manitou Kennels, Watrous, Sask., Canada.

BABY Skunks, raccoons. Catalog 25c. Shady Fur Farm, Springfield, Minnesota.

ANGORAS, Giant chinchillas. Finest heavy-producing, prize-winners. Catalog free. P. M. Grinsteeds, Edwardsville, Ill.

"**STOP** Mange." Keep mange away from your dog. Electro all metal collar prevents "mange." Approved by eminent veterinarian. Send neck size with two dollars and collar with lock will be sent postpaid. Send order to—Bailey, P.O. Box #26, Waltherboro, S. C.

STANDARD Rabbit Journal, B-241-M, Milton, Penna. Year \$1.00, sample dime, beginner's manual 25c.

BIG Profits—Raise Guinea pigs. Free booklet. Taylors, B426A, Hapeville, Ga.

EARN Up to \$400 monthly raising Angora or New Zealand rabbits. Plenty markets. Particulars free. White's Rabbitry, Newark, Ohio.

RAISE Rabbits. Profitable business. Free booklet. Tayco Rabbitry, Hapeville, Ga.

HAMSTERS—Golden or spotted. Cages and equipment. Free illustrated details. Lakeview Hamster Colony, Newfield, New Jersey.

BOOKLET "Treatise on Breeding and Raising Canaries"—\$1.00. Audubon Publishing Co., 3449-PM N. Western, Chicago 18, Illinois.

MAKE Big money! Raise Chinchilla rabbits. Cash markets supplied. Write today! Rockhill Ranch, Sellersville 15, Penna.

MINK Raising information free. Complete. Lake Superior Mink Farm, Superior, EE1, Wisconsin.

A Practical beginning to successful rabbit raising. 48 page illustrated booklet. Dime. American Rabbit Breeders Association. 36 AR & CBA Bldg., Pittsburgh, Penna.

FARMS, FARM LANDS, REAL ESTATE

FARM And business catalog free! Big new edition. Over 1000 bargains for \$1000 up. Maine to Florida. West's, M-6, Pittsburgh 17, Penna.

SPRING Specials. Virgin Missouri lands, 80 acres, \$6 acre, 20 acres, \$5 acre. Low monthly terms. Get big lists. Address Mr. Armstrong, Shook 34, Mo.

UNITED Farm Agency's big free summer catalog of farm and country real estate bargains can help you plan soundly for your future security in the country. Good pictures, many states, easy terms, many equipped, growing crops included. For special service, state requirements, desired location. Write for your catalog today. It's free! United Farm Agency, 220-PM South State St., Chicago 4, Ill.

STROUT'S Two catalogs. Farms, homes, businesses. 3646 bargains, 31 states. East and midwest green cover; west coast edition yellow. Either free. World's largest. Strout Realty, 7-M So. Dearborn St., Chicago 3, Ill.

FARM, Ranch, hunt, fish on your own land in beautiful Calif., Oregon and Washington. Now available, several thousand choice acres from \$10 to \$25 per acre, full price, including 100% oil and mineral rights. Low, easy terms. Send only 10c (coin) for full details, catalog, photos. Pacific Lands, Box 2350-BW, Hollywood 28, California.

FLORIDA—Hunting, fishing, fruit growing. 5 acres, \$245.00, \$10.00 down, \$10.00 month. G. B. Potterfield, Union Building, Charleston, West Virginia.

\$5.00 MONTHLY Buys 40 acres near town; price \$200.00. Free list. Box 425-P, Carthage, Missouri.

FARM-Ranch opportunities. Favorable conditions. Washington, Minnesota, Montana, Idaho, Oregon, North Dakota. Literature, farm descriptions. Specify which state. J. W. Haw, 119 Northern Pacific Ry., St. Paul 1, Minn.

HOMESITES \$300—Convenient payments. California's finest garden section. On Morro Bay's scenic shores. Wonderful fishing, boating, bathing. Fertile soil, softest water, temperate climate, congenial community. Free literature. Richard Otto, Department M, San Luis Obispo, Calif.

POULTRY, FARM SUPPLIES

EARN \$4 To \$12 hourly. Terrific profits in chick and turkey sexing, culling, caponizing. School G.I. approved. Write Pilch's School, Box SSC-10, Thompsonville, Conn.

RAISE Turkey fryers the new way. Write for free information explaining how to make up to \$300.00 weekly in your own backyard. National Turkey Institute, Dept. A-3, Columbus, Kansas.

KNOW How to raise poultry for profit. Read Poultry Industry. Every issue packed with helpful hints and practical suggestions. Latest articles on breeding, feeding and management. Subscribe now. 1 year 50c, 3 years \$1.00. U. S. funds or checks payable at a New York or Boston bank. Poultry Industry, Dept. PM, 376 Boylston St., Boston 16, Mass.

PROFITABLE OCCUPATIONS

REAL Backyard earnings. Write Kramers, 1309 South Cheyenne, Tulsa 14, Okla.

NEWSPAPER Clippings—Turn them into cash everyday in your own home. Send \$1.00 for complete, detailed instruction folio by return mail. Strickland's, Box 447, Longmont, Colorado.

\$4 TO \$10 Hour spare-time in billion-dollar adjustment field. Qualify now! Write today. Universal Schools, M-58, Box 8202, Dallas 5, Texas.

START A buying service, buy wholesale thousands nationally advertised products. Make big profits selling at sizable discounts. Send postcard for details. American Buyers Service, 631-PM Linden, Buffalo, New York.

WANTED! At once! Home producers by manufacturers in our clearing house service. Become a sub-contractor casting plastic products for these companies. Thousands of easy to make items required. Cash in at home, without previous experience. For details, write Plastic Service Guild, Dept. PM5, East Boston 28, Mass.

WANT A diesel job? New opportunities to increase income. Higher pay. More money. We can help you qualify. Tools. Shop method home training. Write today! Diesel Tractor, Heavy Equipment Division, Interstate Training Service, Dept. 3F, Portland 13, Oregon.

LEARN Figurine painting. Instructions and supplies needed. Send stamp. Box 874A, Joliet, Ill.

MEN, Women, sensational money traveling South America, Europe, Africa. Experience unnecessary. Details free. Daverport's, 1170-A Broadway, New York 1, N. Y.

FOREIGN Employment construction men, building trades, helpers, office men, others, interested in foreign projects. High wages, quarters, transportation. Send \$1 for foreign construction compendium and application forms. Foreign Service Bureau, Dept. PM6, Metuchen, New Jersey. (Not an employment agency—No fees.)

ALASKA! Just released! Over 100 gigantic new construction contracts! Names, addresses companies hiring. \$1.00 complete. Alaskan Opportunities, (PM) Box 362, Kenmore, Wash.

SEND For big, new 1952 illustrated catalog that will show you how to turn your spare time into cash—making quick-selling, highly profitable lamps. Every home a prospect. Hundreds doing it, you can, too. No experience or special tools required. Catalog No. 7 contains 56 pages filled with shades, shade frames, figurines and bases, oil lamp converters, boring compound, and dozens of similar items. Also all kinds of sockets, cords, pipes, harps, finials, bases, and hundreds of other parts—everything you need. Special 8-page section shows 6 beautiful lamps in kit form, ready to assemble. You buy wholesale, sell at retail. Make big profits. Send 25c today for new 1952 catalog and wholesale price list, you'll be glad you did. The 25c will be refunded on your first order. Gearon Co., Dept. 500-B6, 27 S. Desplaines, Chicago 6, Ill.

100 IMMEDIATE Jobs. Big money foreign and domestic openings. United States, South America, Europe. Construction workers, building trade, office and other. Large government and private contracts. Skilled and unskilled workers. Travel, living quarters paid. High wages. Men and women wanted. Act fast! Rush \$1 for complete information, application blank; Employment Service Bureau, Dept. M, 79 Cambridge Street, Boston 14, Mass.

MAIL Order—Big money—Details 25c refundable. Jackson-Adams, 1191 Station A, St. Petersburg, Florida.

PRINT Without a printing press. Big profits! See page 43.

BE Independent! \$200 weekly possible. No selling. Based on profit-tested idea. Unusual operation. Plan \$1.00, details free. Lurene Business Plans, P.O. Box 4692, San Francisco, Calif.

BE The Popular Mechanics representative in your neighborhood and earn big profits in your spare time. Write Popular Mechanics Magazine, Room 408M, 200 E. Ontario St., Chicago, Ill.

CONSTRUCTION Workers. Want to make better jobs? Longer jobs? Latest information. Jobs breaking. Jobs underway. North, south, east, west. The best. Big job list. Accurate. Up to date. Send one dollar. Dempster's Construction Scout News, Dept. 268-JF, Bridgeport, Ill.

MUSHROOMS Grown. Boxes. Barrels. Instructions 50c. Spawn \$1.00. Manureless process. \$2.00. Gordons, 328 Bannerman, Winnipeg, Manitoba.

FOREIGN Jobs. Contracts underway and soon starting in Africa, South America, Canada, England, Europe, South Pacific, Middle East, Mexico and Alaska. Send \$1.00 for foreign job news, information, application forms, etc. DCS Foreign Job News, Dept. 268-JG, Bridgeport, Ill.

MEN, Women visit foreign countries on modern ships. Big pay, adventurous living. Experience unnecessary. Details free. Davenport, 1170-K Broadway, New York City.

MAKE Flexible molds! Cast plaques, bookends, figurines! Free sample! H. Tooker, 630-M Chestnut, Hamilton, Ohio.

FOREIGN And Latin American employment. 1952 "Foreign Service Directory" gives up-to-minute facts on military and civilian construction, government jobs, major oil listings, aviation, transportation, steamship lines, mining, importers, exporters, how-when-where to apply, application forms, hot list firms hiring. \$1.00 postpaid. Global Reports, P.O. Box 883-P, Hollywood 28, Calif.

FREE Book "505 Odd, Successful Businesses." Work home. Expect something odd! Pacific, Oceanside, Calif.

"EVERYBODY Likes candy"—Learn to make professionally. (Our 40th year.) Ragsdale Candies, D6, East Orange, New Jersey.

ALASKA—Last American frontier. \$1.00 brings 1952 business directory, government map, construction projects military and civilian, homestead and highway facts, hunting-fishing-game rules, mining, aviation. List of firms hiring. How-when-where to apply. Alaska Opportunist, P.O. Box 883-P, Hollywood 28, California.

RAISE Pheasants on the \$100 week plan. Little capital and space can make you independent. Free details. Great Central Game Management System, Columbus 1, Kansas.

\$40.00 WEEKLY Made growing mushrooms, fresh, dried. Dominion patent 331583. Free spawn. North American, 169P Yonge, Toronto, Canada.

BOOKS, PERIODICALS, PICTURES, POSTCARDS

PICTURE Post cards made from your photograph. 1000 \$11.00. Raum, 4154 Fifth Street, Philadelphia 40.

BOOKS And magazines. Catalog 10c. Arnold Klein, 183 Scholes, Brooklyn 6, N. Y.

HORSES To ride—Palominos, Arabians, Morgans, Mustangs, etc. Characteristics, colors, photos. Entertaining, educational. Only \$1.50. F. Low, Reed Building, Hibbing, Minnesota.

BOOK Bargains. All subjects. Send stamp. Vallon, 63 Perry, New York 14.

FAMOUS Kentucky Derby race horses, stock farms and locations. 18 views 30c. Schneider, 1227 Woodlawn Ave., Louisville 8, Ky.

SPARETIME Profits taking subscriptions all magazines. Wholesale catalog free. Cassell Publishers, Westfield 5, N. J.

CATALOG 400 Popular books. Bargain prices, 10c. Books Publishing Co., 56-F W. 24th St., New York 10.

MAGAZINES (Back dated)—Foreign, domestic—Arts, books, booklets, subscriptions, etc. Catalog 10c (refunded). Cicero's, 86-23 Northern Blvd., Jackson Heights, N. Y.

BOOKHUNTERS! All subjects. Send wants! Jaher Book Service, 620-P East 178 Street, New York 57.

BOOK "Breeding of Parakeets" and cage-bird magazine—\$1.00. Audubon Publishing Co., 3449-PM N. Western, Chicago 18, Illinois.

BOOKHUNTERS! Scarce, unusual, miscellaneous books supplied. Atlantic Book Service, Lawrence Avenue, Charlestown 29, Massachusetts.

MAGIC TRICKS, PUZZLES, JOKER NOVELTIES

VENTRILOQUISM Selftaught—Complete book 25c. Martin Fairview, 277 Broadway, New York 7.

BECOME Millionaire overnight! Send \$1; receive parcel \$1,000,000 stage money. Muir, 521 M Street, West Palm Beach, Fla.

DAD'S Puzzle now with beautiful plastic blocks. Agents wanted. Sample and sales proposition 25c in coin. Standard Trailer Company, R.D. #1, Erie, Penna.

3 CARD Monte trick and catalog 25c. Sterling Magic, Royal Oak, Mich.

GENUINE Wooden nickels, magic catalog and trick, all for 35c. Fun 'n Magic, 511 N. St. Marys, San Antonio, Texas.

512-PAGE Catalogue of 2500 tricks, pocket, parlor, stage. World's finest magic. Send \$2.00 for catalogue (refunded first \$8.00 order). Kanter's, M-1311 Walnut, Philadelphia 7.

VENTRILOQUISM Self taught. Quick, easy instructions, 25c. "Ventriloquist," Cal Allen, Texas.

FREE Trick and large illustrated catalog 35c. Lerro Magic, 8111 Fifth Avenue, Brooklyn 9, N. Y.

WORLD'S Largest magic shop. Special: Big \$2 book of professional magic tricks, only \$1. Includes mailing lists. Holden's, M220 West 42nd St., New York.

PROFESSIONAL Catalog and free trick 35c. Terry's Magic Studio, 6606 Duryea Court, Brooklyn 19, New York.

BIG Fun kit! Tricks, jokes, novelties, books. Real clever stuff. Howls galore, \$1.00. Johnson, 414 McRae, Wilmington, N. C.

LATEST Magic for pocket, parlor, stage. Catalog 500 tricks, only 10c. Unequaled magic service for 30 years. Douglas Magicland, Dept. 1, Dallas, Texas.

PROFESSIONAL Catalog, 124 pages, 25c. Williams, 900 Plymouth, Ellwood City, Penna.

BE A magician. Large professional magic catalog of latest tricks, 35c. Ireland, C-109 North Dearborn, Chicago 2.

COINS, TOKENS, CURRENCY

OLD Money wanted. Will pay \$100 for 1894 dime, S. mint. \$50 for liberty head nickel (not buffalo). Big premiums paid for all rare coins. Send 4c for large coin folder. May mean much profit to you. Numismatic Co., Dept. 20, Fort Worth, Texas.

JAPANESE Peace medal. Scarce! Plastic covered \$1.00. Aries, 455 Utah Street, San Francisco.

BARGAINS! Rare collections. 40 different dates Indian cents \$5.00; 20 different \$1.00; 5 different types commemorative half dollars \$5.00; 50c before 1840 \$1.50; colonial coin before 1790 \$1.00; \$100 Confederate money \$1.00; 1864-L cent \$3.50; 1908-S cent \$3.00. Our complete illustrated buying-selling catalogue 25c. Worthycoin Corporation (D-424), Boston 8, Mass.

WHAT Are your coins worth? Amazing Fell's United States coin book. Everything on every single coin minted—Worth, value, how to sell, speculating, investment; other valuable facts on coins. Cloth-bound, 150 illustrations. Send no money. Pay postman only \$1.50 (plus postage) or \$1.50 postpaid (refundable). Order now! Fell Publishers, 386M3 4th Ave., New York 16, N. Y.

WE Pay \$5 to \$500 each for hundreds of old or odd U.S. and foreign coins. Keep all until posted. Send 25 cents for illustrated coin value book with bargain lists free. 45 years in business. Coin Exchange, Le Roy 10, N. Y.

100 COINS And bills \$1.50. 66 coins and bills \$1.00. Oddehon, Box 482, St. Louis, Mo.

FOREIGN Coins 10 different 25c. Foreign bills 10 different 15c. Lists. Oliver Arnold, Macon, Missouri.

SET Nine Japanese invasion notes for U. S. \$2.00. Catalogue thousands of coins, 25c. Shultz, Salt Lake 10, Utah.

FREE! Foreign coin, banknote and coin collectors illustrated catalog to approval service applicants. Send 3c postage. Tatham Coinco, Springfield 30, Mass.

FIFTY Assorted Indian cents, \$1.50. Rare 1931-S cents, \$1.00. Giant fifty-two page illustrated bargain catalog, 10c. Ben's PM Department, 31 North Clark, Chicago 2.

COIN Collector's Magazine. Largest independent, over 1000 pages per year. Sample copy 30c; \$3.00 per year. Hewitt, 5450-J Clark, Chicago 40.

FOREIGN Money, wooden nickels, and "coin collector's" big new magazine 10c. Lawrence Brothers, Anamosa, Iowa.

GET Profit and pleasure in collecting old coins. Send 10c for 56 page illustrated coin catalog. You'll be delighted with it. Send for it now. B. Max Mehl, 370 Mehl Bldg., Fort Worth Texas. Largest rare coin establishment in U. S. Established 52 years.

STAMP COLLECTING

FIVE Triangles free with approvals. Exotic Stampco, Box 2104, Miami 12, Florida.

FREE "Stamp Finder." Tells instantly country to which any stamp belongs. 32 pages profusely illustrated. Garcelon, Calais 17, Maine.

202 DIFF. Stamps 5c. Charles E. Legere, Barachois, N.B., Can.

LIBERIA! 10 Different, includes complete set, plus triangle and animal stamps, only 5c to new approval applicants. L. Moulmblow, 740 Hegney, Bronx 56, N. Y.

FREE—"German war issues," cataloging \$10.82 to approval buyers. Royal Stamp Company, Tamaqua, Penna.

1000 ITALIAN Pictorials \$1.00. Guaranteed fine. Beverini, Caselpostale Ge-Pegli, Italy.

FREE Stamp "circus" giants, pygmies, kangaroos, snakes, rhinoceros, ostriches, with approvals. Niagara Stamp Company, 17 Queensway, Niagara on the Lake, Can.

ILLUSTRATED U.S. list, 6c postage. Olson, 801 Ninth-Chester, Cleveland 14, Ohio.

OLD U.S. on approval. Low prices. MacG., 3633 Zumstein, Cincinnati 8, Ohio.

25 VARS. World airmails, 10c; 50 for 25c; 100 for \$1.00. C. Ritchie, Watertown, South Dakota.

COMMEMORATIVES, 100 Mixed U.S., 25c. Ray Worth, 321 S. Cicero, Chicago 44.

ALBUM! Holds over 1000 stamps! Only 10c! Stampmart, Hartford 1, Conn.

SEND For approvals at 1/4 catalog. Sprague, 44C Bromfield, Boston.

OPPORTUNITY—Zanzibar, Borneo, Liberia and over 100 different others. Everything 10c with approvals. Thompson, 5708 Osseo Road, Minneapolis, Minn.

STAMPS World different, 1000, \$1.00; 2000, \$2.25; 3000, \$5.00; mounted, 5000, \$13.00; 10,000, \$43.00; airmails, 100, \$1.20; 200, \$3.40; 300, \$7.20; mounted, 500, \$15.20; 1000, \$41.00. Russell, Box 2011D, Natural Bridge, St. Louis 15, Mo.

1/3 CENT Approvals. Povilauskas, 212 E. 3 St., New York 9, N. Y.

ANGOLA. Beautiful multicolor bird set plus 100 stamps, 10c to approval applicants. Sunset, Dept. 711, Box 47, South Gate, Calif.

SENSATIONAL! Set each Honduras, Martinique, Guadeloupe, Guiana, also \$2.-000,000 stamp. Brunel, over 100 different others. Everything 10c with approvals. Whitehead, 315P South 5th Ave., Canton, Illinois.

U.S. Mission mixture. 1/2 lb. 50c. Alan Atha, Moberidge, South Dakota.

1025 DIFFERENT \$1.00; 500 - 50c. Approvals. Zampino, 2337 Bath Avenue, Brooklyn 14.

A Steal. 50 different U.S. commemoratives 25c. Resch, 3739 North Wilton, Chicago, Illinois.

81 MULTI-Colored flags of the world! All different; only 10c. Kenmore, Milford F-5, New Hampshire.

PENNY Approval bargains. Write Department PM, 1267 Tutwiler, Memphis 7, Tennessee.

SAN Marino collection free—25 different, old and new issues, airmails, commemoratives, high values. Absolutely free with approvals. Viking, 130-ZZ Clinton St., Brooklyn, N. Y.

EXCHANGE Stamps universe. Particulars free. Exchangers, Bry 126, Seine, France.

LOOKING For bargains? Try our 1 & 2c approvals mounted in books of 1000. We believe in both quantity and quality. First try will satisfy. Clark, Box 544P2, Muskegon, Michigan.

ZANZIBAR Packet free—Also includes stamps from Abyssinia, Cayman Islands, Ceylon, French Colonies, Gambia, Malta, Nigeria and others. Send 5c for postage. Gray Stamp Company, Dept. PM, Toronto 5, Canada.

ARE You satisfied? If not, write us today. Ask for 1c and 2c foreign approvals. U.S. at bargain prices. References appreciated. Roseland Stamp Co., Dept. 10-B, Spring Lake, Michigan.

UNITED States stamps! Cheap! Catalogs. Sullivan, 115-F Endicott, St. Paul 1, Minnesota.

FREE Complete set of famous Americans, flags, parks and presidentials to approval buyers. Send 3c for 15 of the above stamps plus full particulars. Triboro Stamp Company, 145 Nassau Street, Dept. 106, New York 38, N. Y.

1000 MIXED United States. Guarantee 165 to 175 varieties. \$1.05 insured. Quaintance, Box 178F, Upper Sandusky, Ohio.

SPLENDID Belgium & Congo 1 lb. box. 2500 stamps, plenty good values, pictorials, semi-postals; \$2.00. 100 different Congo-Ruanda; \$2.00. 100 different semi-postals Belgium; \$3.00. All post free. Satisfaction or refund. Haché, 26 Rue Lavignerie, Brussels 4.

FREE 25 Diff. U.S. commems. Approvals. George Haberman, Osakis, Minn.

UNBELIEVABLE But true! 1000 different foreign, 100 different U.S. commemoratives. Price list all for only \$1.00. No approvals. Ideal Stampco, Box 316, Augusta, Georgia.

FIVE 10c Or two 25c sets, 10c to approval buyers. Conquistador, 15 1/2 Troy Road, Schenectady 9, N. Y.

307 ALL Different—Only 15c! Beautiful collection: commemoratives, triangles, high values, bicolored stamps, etc. Garcelon, Calais 400, Maine.

1000 UNIQUE Colorful attractive book mounted stamps 1c - 2c each. Rushed. Niagara Stamp Company, 11 Queensway, Niagara on the Lake, Canada.

100 DIFFERENT U. S. 25c. Approvals. Buckeye, Box 53, Mansfield, Ohio.

2# U. S. Mixture, old, new \$1.50. Postage extra. Weatherby, Medina, Ohio.

50% DISCOUNT Approvals. Many bargains. Gaines, 716-S Sixteenth, Mattoon, Illinois.

(SEND 10c) Informative illustrated booklet! "Easy way stamp collecting!" Offering stamps, albums, packet collections! Stamps by Mail, 2133 Lunt, Chicago 45.

77 DIFFERENT United States—25c. Approvals. Utechts, 1143-D North Keeler, Chicago 51.

NEW Issue Journal—Free—This month and every month. From Stamp Korner, 160 North 2nd St., Decatur, Indiana.

PENNY Approvals that satisfy. Neil Gronberg, Box 5441-P, Philadelphia 43, Penna.

TEN Dandy sets 10c. Approvals. Faszold, 423c Cameron, St. Louis Co. 15, Mo.

FLAG Stamp—Free with hygrade U. S. approvals. Wenigman, 1933 Patterson, Chicago 13.

OLD Scarce U. S. seconds on approval. Slightly defective. Bargain prices. Hernefield, Clintonhill Station, Newark 8, N. J.

PROFITABLE Sideline. Start your own stamp business. "Stamp Dealers' Manual" \$1.00. Brightwood, Box 6255, Pittsburgh 12, Penna.

STAMPS Wanted. Collections, duplicates, surplus stock, mint and used. Good grades only. Buy outright if bargain. What have you? Write us details. Vanroy Shirk, Lebanon, Penna.

MINT U. S. 797 SPA sheet, 10c to applicants for U. S. approvals. M. Haycock, 235M 86th St., Brooklyn 9, N. Y.

WORLDWIDE Variety packets 100 10c; 500 60c; 1,000 \$1.25; 2,000 \$3.25; 5,000 \$13.75. Philatelic House, 189 Merrick Rd., Rockville Centre, N. Y.

200 DIFFERENT Triangle, airmail, pictorials, etc.; 10c. Carlton's, Tujunga, Calif.

1/2-1-2c APPROVALS. Bargains galore! Cole, 43A Rinewalt, Buffalo 21, N. Y.

50 DIFFERENT U. S. commemoratives. \$2.00 catalog value. Good foreign. Both \$1.00. Hager, Box 10, Buffalo 11, N. Y.

40 DIFFERENT U. S. commemoratives, airmails 25c. Seidenberg, 944, Appleton, Wis.

FREE 109 Stamps to applicants for our approvals sending 3c postage. Hoyt, Lowell Road, Hudson, N. H.

FREE Sample—Interesting, informative, illustrated! National Stamp News, Anderson, South Carolina.

AMAZING Offer! 500 United States stamps—including commemoratives, airmails, high denominations to \$5.00. Only 15c to approval applicants! Illustrated bargain lists free. Mystic Stamp Co., Dept. 80, Camden, New York.

FREE U. S. and Confederate states catalogue. Stone, 45 Bromfield, Boston 8, Mass.

FREE Very large Japan Flying Geese Stamp. Approvals included. Hathaway, P.O. Box 211-P, Hempstead, New York.

POLAR Bear triangle, giant George Washington, six colored Ecuador, Arctic triangle, first American commemorative, Corsica, Devils Island, others. Everything free with approvals. Capital Stamps, Little Rock 2, Ark.

BEAUTIFUL N.Z. semipostal triangles picturing British Princesses only 10c with worthwhile approvals. George Richie, 1539 Sixth, Alameda, California.

FREE—Illustrated catalog! Kenmore, Milford, C-57, N. H.

"HOW To Recognize Rare Stamps." Free book illustrated! Kenmore, Milford, H-57, N. H.

U. S. Illustrated price list free. DeLisle, 154 S. 2nd St., San Jose, Calif.

FREE. Scott's International Album. Other big premiums. Full particulars with approvals. Raymax, 68-Z Nassau St., New York 38.

500 EXOTIC Japan stamps—10c. Kenmore, Milford, J-57, N. H.

DIFFERENT 500. 35c; 1000, \$1.00; 2000, \$2.00; 5000, \$10.00 with approvals at wholesale to clear. K. S. Holmes, London, Can.

U. S. Army and Navy heroes on stamps; 10c with United States approvals. Locust, Box 305-T, Harmon-on-Hudson, New York.

110 DIFFERENT Hitlers, Roosevelt, Liberia, Haiti, etc. with approvals 10c. Buckley, 208 Ludlow Bldg., Dayton 2, Ohio.

U. S. Price list free. P. Wetterquist, 1635-13th Avenue, Rockford, Illinois.

100 DIFFERENT Spain 25c. Penny approvals included. Reed, Box 980, Chicago 90, Ill.

50,000 STAMP Grabbags 25c each. Anderson, 630B Bingham, Reading, Penna.

FREE Collection—Over 100 different stamps of world; commemoratives, animals, natives, ships, famous men, others all to approval buyers; also Scott albums, catalogs. Bell Stamp Service, Dept. S-2, Bell, Calif.

START Your own stamp business. Send for free circular. Donald Shepard, Box 1147, Chicago.

FREE! Powerful magnifying glass. Jamestown Stamp, Jamestown 202, New York.

200 DIFFERENT Including Roosevelt triangle, 5c to approval applicants. M. Avalon Stamp Company, Springfield, Mass.

NICARAGUA Sports, Costa Rica agriculture sets 10c with approvals. Seminole Stamps, Box 1138-P, Coral Gables 34, Fla.

UNITED States approvals—Select, used, mint. Kingsbury, South Woodbury 2, Vt.

50%-75% DISCOUNTS! Approvals from 33,000 collection—1/2c up! Schur, Box 235, Buffalo 12, N. Y.

NOTHING Free. Just good stamps reasonable. Send dime for seventy-four page catalog. Ben's Stamp Shop, 31 N. Clark, Chicago 2.

WOW! 203 All different Germany 10c! Zeppelins, semipostals, airmails, high values, etc. to new customers. Jamestown Stamp, Jamestown 512, New York.

WORLD'S Largest stamp (7 1/2 x 14 inches). A real curiosity! Retail for 50c, only 3c to approval applicants. Tatham Stamp Co., Springfield 30, Mass.

500 STAMPS For only 10c! This mammoth value includes airmails, pictorials; stamps from strange countries, cataloging up to 25c each! Also approvals. Mystic Stamp Company, Camden 80, New York.

ANTIQUES, RELICS, INDIAN GOODS, CURIOS

INDIAN Beadwork, leathers, beads, feathers, moccasins, wigs, supplies; buying direct from Indians; prices reasonable. Free list. Pawnee. Bill's Indian Trading Post, Box 35-P, Pawnee, Oklahoma.

PRECIOUS STONES, MINERALS

SELECTIVE Metal and mineral detector. Revolutionary design. Distinguishes metals from black magnetic sands. Readily detects metals under salt water. Free literature. Gardiner Electronics Company, Department 12, 2018 N. Dayton, Phoenix, Arizona.

GEMSTONES. Mineral specimens. Every variety. Lowest prices. Postcard brings free booklet. Plummer's, 4720 Point Loma Ave., San Diego 7, Calif.

"GENUINE" Red Arizona rubies (garnets). Send quarter for packet. Bitner's, Box 1025B, Scottsdale, Arizona.

FIND Tungsten, mercury, uranium with Mineralight. Free brochure. Write Dept. PM8 Ultra-Violet Products, South Pasadena, California.

ROCKHOUNDS Large piece Arizona fools gold \$2.00. Sawed red jasper \$1.00. Cave-creek Agate Mines, Box 97, Cavecreek, Ariz.

JASPER, Agate, quartz, catalogue, 25c. Gemco, Elkhart Lake 1, Wisconsin. Best prices.

JADE, Agates, titanite, gems, hobbyists supplied, gem cutting machines. Free list. North West Gems, Box 305, Tacoma 1, Washington.

GEMS, Precious and semi-precious, genuine, from world-wide sources. Deal direct, no overhead, save money. Catalog 10c. Hill Co., 5450-G Portland Rd., Salem, Oregon.

GEMCUTTING. Silvercraft authority. Illustrated magazine tells how. Cut rocks, make jewelry. 150 ads illustrating equipment, offering gems for collectors, cutters. Postal brings literature. Lapidary Journal, Drawer B, Palm Desert, Calif.

HOBBIES AND COLLECTIONS

50 DIFFERENT Army embroidered patches \$1. Other bargains. Insignia Mart, 703A Broadway, New York 3, N. Y.

GET Acquainted offer. 100 different matchbook covers 50c. Free lists. Yeingst, 502 Parkway, Harrisburg, Penna.

FREE Copy "Hobby Digest" magazine. Postoffice Box 52, Detroit, Mich.

WANTED—Cigarette, tobacco cards. Write Charles Bray, East Bangor, Penna.

UNUSED Matchbook covers—100 different \$1.00 36-page catalog 25c. Charles Edelman, 1311C East 84, Cleveland 3, Ohio.

INVENTING Can be an interesting and profitable hobby. Write for complete particulars. Institute of American Inventors, Dept. 40-E 631-E St. N.W., Washington 4, D. C.

CAMERAS, PHOTO SUPPLIES

ADVANCED Amateurs and professionals, buy, sell, trade, direct with other photographers. Send for free copy of Phototrader, Box 630, Westport 1, Conn.

PHOTOMURALS. Your negative or ours. Catalogue 25c. Photomammoth Murals, Dept. M, 12048 Vanowen Street, North Hollywood, California.

BUILD Your own photo printer! Why pay high prices for contact prints? Instructions only 25c. Trio Products, Box 1576, Beverly Hills, California.

ADD "Spice" to home projection shows with colorful old-time Nickelodeon slides. 2x2. Write for free list. Nickelodeon Co., New Fieldner Bldg., Portland 5, Oregon.

BASS Says: Trading since 1910. Used but good as new buys: 8mm. B.&H. Sportster \$52.50; 16mm. Keystone A-7, F:2.5 lens \$37.50; Voigt. 35mm. Vito II, flash shutter, Skopar F:3.5, like new \$38.50; Kodak Reflex F:3.5 lens, like new \$88.50; Con. ax I, F:2 Sonnar \$87.50; 3 1/4 x 4 1/4 Speed Graphic, Skopar F:4.5, Ibsor shutter, \$52.50. Satisfaction guaranteed. Bass Camera Co., Dept. AG, 179 W. Madison St., Chicago 2.

BUY Photographic supplies wholesale. Films, cameras, projectors, enlargers, binoculars. Free catalog. Capitol Photo Supplies, 2428 Guadalupe, Austin, Texas.

PHOTOCOPIY Anything—Papers, books. No darkroom, 8 1/2" x 11" complete \$6.95. Fotoflek, 8555 Plainfield Lane, Cincinnati 36, Ohio.

FREE Photographic bargain book packed with hundreds of sensational values in still and movie cameras, lenses and latest accessories. Super savings for you in new and used equipment. Liberal trade-in allowances, too, on your equipment. Write now for your free copy to Central Camera Company, Dept. 9L, 230 S. Wabash Ave., Chicago 4. (Photographic headquarters since 1899.)

PHOTO FINISHING

8 KEEPSAKE Oversize deckledge snapshots from roll 40c, 12 exposure 55c or 2 each contact size same prices. Free mailers. Keepsake Photographic Laboratory, Box 7968-P, Kansas City 3E, Missouri.

8 CONTACTS 30c. Jumbos 40c, 12-45c, jumbos 55c, reprints 4c, jumbos 5c. Western Photo, Dept. PM62, Box 298, San Francisco 1, Calif.

8 EXPOSURE Oversize in plastic ring album 40c; 12 exp. 55c; 16 exp. 70c. Snapshots, Box 1469, York, Penna.

FILMS—Finest quality. Extra rapid service. 8 exposures enlarged, 50c. "Camera," Dept. 4, Box #280, West Chester, Pennsylvania.

TWO 8 x 10 Enlargements 50c, five for \$1.00 from your negatives. Wilart Enlargers, Box 967, Little Rock, Ark.

8 OVERSIZE Snapshots from roll, 25c with this ad. Foto's, Box 8, Aurora 1, Ill.

JUMBO Album prints—8 exp. 35c; 12, 50c. Free mailer 35mm (36), \$1.00. Flash-Foto, Box 36-M, Brooklyn 4, N. Y.

FREE Roll of film with each developing order. 75c develops and prints 8 jumbos. Sent first class mail postage paid. Oxford, 3042 Greenmount Avenue, Baltimore 18, Maryland.

SATISFACTION guaranteed! Eight jumbo size prints mounted in album, 35c—12 to 16 exposure rolls, 50c. Free mailers, quick service, finest developing, finishing. Crown Studios, Box 1223-PM, Dallas, Texas.

NOW! Get jumbo size prints for 5c, includes developing. Comes in keepsake album. 8 exposure roll, 40c; 12-60c; 16-80. Mailers free. Crown, Box 392, Augusta, Ga.

FAST—Same day service! 8 oversized prints in attractive plastic-bound book only 35c; 12-50c; 16-60c. Satisfaction guaranteed. Free exposure guide with first order. Pic-Sure, Box 899-B, Philadelphia 5, Penna.

NEW—16 Oversize contact prints, or 8 jumbos in album 25c. (Trial.) Album Studios. Weatherford, Okla.

6 OR 8 Picture roll 35c, 12 or 16 picture roll 55c. Each roll printed and developed. Handy album pack. If you fail to get pictures on your film a new roll will be sent you without extra cost. Send coin with roll. No c.o.d.'s. Mailing containers sent free. DeLux Film Service, Box 1268-A, Shreveport, Louisiana.

BEAUTIFUL Enlargement from each picture on 8 exposure roll 35c. Cut Rate Photos, Dept. B-4, Janesville, Wis.

TWO Beautiful prints from each picture on 8 exposure roll 35c. Thirty-one years of satisfied customers. Quick service. Lens Photos, Dept. J-4, Janesville, Wis.

MAIL Us your films. Prompt service. 8 exposures developed and printed 30c. Foto Art Studio, Box 406, San Francisco, Calif.

16 PRINTS Or 8 jumbos from roll, 25c with this ad. S. Skrudland, Lake Geneva, Wis.

MOTION PICTURES AND SOUND EQUIPMENT

LEARN Movie projection, management. Free catalog. Theatre Institute, Elmira, New York.

USED Sound films at bargain prices. Free lists. Seller, 1399 Eggert Road, Buffalo 21, New York.

FREE Movies. Thousands of subjects. Interesting. Entertaining. Fascinating. Latest directory—only 50c. National Cine Society, 126 Lexington Avenue, New York 16, N. Y.

WORLD'S Biggest selection of new and used 16mm. sound and silent films. Over 100,000 prints on hand! Everything at bargain prices. Savings of 50% and more are commonplace! Good used 16mm. sound projectors—Bell and Howells, Victors, Ampros, frequently available for as little as \$129.95. Reels, cans, supplies at bargain prices! Write today for your free copy of Blackhawk's big 24-page catalog. "Sixteen's super market." Blackhawk Films Inc., 1213 Putnam Building, Davenport, Iowa.

8MM. Bargains—Blackhawk's new 8mm. catalog really has them! Films, supplies—Everything at a saving! Good used 1-reel 8mm. films frequently available at \$1.98. Blackhawk Films Inc., 1214 Putnam Building, Davenport, Iowa.

I Buy, exchange 35mm silent films. 6721 Walnut, Pennsauken, N. J.

DON'T Buy a tape recorder before writing to Dressner, 624-M East 20th Street, New York 9, New York.

SNOW White movie screen paint. Free literature. 126 1/2 West Main, Danville, Ill.

"ENTIRE Life Story of Christ" 8mm., 16mm., sound and silent, purchase or rent. Hemenway Film, 33-F Melrose St., Boston 16, Mass.

BARGAINS 16MM. sound films. Also for exchange. Bedner, 5300 So. Talman, Chicago.

CLEARANCE Sale of 16mm. films. Want a real buy in 16mm. sound films? Take advantage of the I.C.S. 1952 clearance sale of 16mm. sound features, comedies, cartoons, novelties, musicals. New, used. Send for our giant list "A" today stating machine you own (make and model). Institutional Cinema Service, Inc., 1560-PM Broadway, New York 19, N. Y.

LEARN Free lance, educational, Hollywood, and television film technique at home. State licensed. Write for free catalog. Motion Picture Institute, Birmingham 4, Michigan.

5000 NEW-Used 8-16mm. silent-sound films. International, 2120 Strauss, Brooklyn 12.

8-16MM. Silent-sound films. Complete rental library. All latest subjects. Free catalogue, sample film 10c. Garden Film, 317 West 50th, New York 19.

RENT 16MM. sound films, 50c reel. Large selection; free catalog. Film Service, 128 Chestnut St., Roselle Park, N. J.

GUARANTEED Fresh 8mm. roll, magazine; 16mm. roll, magazine movie films. Color. b&w. Free catalog. ESO-S, 47th Holly, Kansas City 2, Missouri.

MOVIE Camera film: 8mm. roll \$1.50, 16mm. 100' \$3.00. Free processing. Better Films, 742 New Lots, Brooklyn, N. Y.

MUSIC AND MUSICAL INSTRUMENTS

PRE-Recorded high-fidelity tapes. 32 reel list. Leroy, Box 62, Whitewater, Kans.

GUITAR. Play first day. Easy 12 chord system. Songs included. Send \$1. Money back guarantee. Bennett, 629-J N. Saint Andrews Place, Hollywood 4, Calif.

SENSATIONAL Free booklet, "How To Write And Sell Songs." Get the facts first. Poems examined free. Reliable Music Service, Box 430-P, Hollywood 28, Calif.

ACCORDIONS—Save 50% and up. Cash or terms. New and used. All brands. Wholesale to everyone. Free catalogue. Del Principe, 31 South Cicero, Chicago 44, Ill.

YOUR Words and our music. A winning combination! Send poems. Free examination. Song Promotion Guild, 350-N Broadway, New York 13.

HOW A songwriting service operates. Inside secrets. Home-Study, 408 North High, Salem, Indiana.

1952 ACCORDIONS—Wholesale. Free catalog. American Accordion Center, 5329 Belmont, Chicago.

MUSIC Written to poems, recorded, copyrighted your name. Gregory, 1695 Broadway, New York 19.

RECORD Your song professionally. Surprising prices. Kaye Music, 103B Saint Marks Place, New York City.

SWING Piano—By mail. 30 self-teaching lessons \$3. C.O.D. (Samples.) Phil Breton Publications, P. O. Box 1402, Omaha 8, Nebr.

YOUR Voice made loud, clear and powerful with my diaphragm exerciser. Write, Inventor "Oz," 34V, Box 665, St. Louis, Mo.

POEMS Wanted for musical setting. Send poems for free examination. Five Star Music Masters, 630 Beacon Bldg., Boston, Mass.

LYRICS Set to music and recorded. Free examination. Cherrier Recording, 732 So. Norton, Los Angeles, California.

MUSIC Arranged. Songs printed. Frank Wildt, Music Publisher, Lancaster, Penna.

POPULAR Songs. How to write and sell them. Write for free booklet Successful Songwriting. Gateway Songs, Box 2470, Hollywood 28, Calif.

SONGPOEMS And lyrics wanted with new and clever ideas to be set to music. Tin Pan Alley, Inc., 1650 Broadway, New York 19, N. Y.

SONGWRITERS! Protect your ideas! Hold all songs; poems! Write for Safe Correct Procedure first! Song Service, Dept. P. 333 W. 56th St., New York 19, N. Y.

POEMS Wanted. Broadcast consideration. Sooner Song Co., 22PM North West 8th, Oklahoma City 2.

SONGWRITERS! Send poems, songs. Music Service, 243 West 72nd St., PM, New York 23.

POEMS Wanted to be set to music. Free examination. Send poems. McNeil, Master of Music, 510-PM S. Alexandria, Los Angeles, California.

WRITE Songs. Big money and reputation. Write for information. J. Gordon Pub. Co., 4700 South California Avenue, Chicago.

WANTED! Poems for musical settings. Write Songwriters' Service, Clifton, N. J.

SONGWRITERS. Amazing free offer of "wonder wheel" jiffy composer! Also, complete song service for poems and songs. Details free. J. Barnes, Box 490, Times Square Station, New York 36, N. Y.

ELECTRIC Guitars, amplifiers, wholesale. Free catalog. Carvin PM, Baldwin Park, Calif.

RADIO AND TELEVISION

FIX Your television set. Book of instructions \$1. All-America, Box 91, New York 60.

COLOR TV screen only \$2.95. Satisfaction guaranteed. Flatwoods, Leesburg, Fla.

BUILD 15 Radios—Only \$1.30 each. Experience unnecessary. Home Radio & T.V. Course. Includes trouble-shooting and servicing lessons, radio principles, code instructions, practical radio building and repairs. You build and keep receivers, transmitters, amplifiers, test equipment, code oscillator. All parts, tools, instructions supplied including radio tester and electric soldering iron. Write for full particulars and receive absolutely free your copy of "Radio & TV Repair Guide." No obligation. Progressive Electronics Co., 497 Union Ave., Dept. PM-19, Brooklyn 11, N. Y.

MINIATURE Radio with shortwave, weight, 8 oz., with batteries. Fine for servicemen. Write for prices. Ecker, 10 East Orange Grove, Pasadena, California.

ENJOY Color television now with 3 color celanese plastic filter screen. Thirty seconds to attach. Reduces glare, blur, and snow. Easy on the eyes. Only \$1 any size. Zingo Products, Johnstown, N. Y.

MAKE Simple, tubeless, batteryless, distance-getting crystal radios. Crystal and illustrated instructions 25c postpaid. Allen, 427-P, Clinton, Mo.

TV And FM antennas. Yagi, conical, bow-tie, mounts, accessories. Lowest prices. Wholesale Supply Co., Lunenburg 1, Mass.

15 TESTED One-tube circuits 25c, including "Radiobuilder," catalog. Laboratories, 1131-C Valota, Redwood City, Calif.

MAKE Distance-getting crystal radio that works. Fully illustrated booklet fifteen cents. Money back guarantee. Francis, Box 5963, Cleveland, Ohio.

BUSINESS OPPORTUNITIES

\$5 AN Hour and more possible in your home. You can paint it with suede. Fabulous new business. Spare or full time. Spray on rainbow colors. Auto dashboards and trunks, signs, radios, toys, figurines, lamps, etc. Beautified with amazing new 3rd dimensional plush-like finish with touch-appeal as well as eye-appeal. I'll send you complete, step-by-step plans and equipment, including high-velocity spray gun for no-risk examination in your own home. Send no money, just name and address. Coast, 1004-AN S. Los Angeles St., Los Angeles 15.

TRADE Magazines help you to success. Get latest copies through our easy-to-get acquainted service. Hundreds of business, professional, advertising, construction, educational, hobby, machinery, plumbing, poetry, poultry, printing, rabbit raising, radio, real estate, refrigeration, roofing, selling, specialized farming, welfare and others covering all interests. Send for list today. It's free. Commercial Engraving Publishing Company, 34C North Ritter, Indianapolis 19, Indiana.

AMAZING Genuine crushed red cedar! Cedarizes closets, trunks, drawers! Applied like paint; laboratory guaranteed. Hardware, paint, building supply dealers buy quantities. Attractively packaged; tremendous profit potential! Exclusive distributors; investment for merchandise only. Write for samples, details. Millen Mfg., 91-G Summit, Brookline, Mass.

YOU Can sell brand new adding machines for only \$14.95! Yes! You can sell 'em and make \$6.73 on every sale. They're executive model portables, precision built, fully guaranteed. For life size color photo and all details, write to Lightning Adding Machine Co., Inc., Dept. P-18, 1260 W. Second St., Los Angeles 26, Calif.

IMPORT-Export! Men—women. Instructions from established world trader shipped for no-risk examination. Opportunity profitable world-wide mail-order business from home without capital; or travel abroad. Experience unnecessary. Free details. Mellinger, 1715-BE, Los Angeles 24.

EARTHWORKS—Beginners outfits, easier methods. Stamp, please. Stoner's, Chattanooga 4, Tenn.

BOOKKEEPERS, Secretaries, clerks. Operate your own business service. Earnings to \$300 week. Eleven (11) income producing plans. For experienced, inexperienced. Details free. Commercial Business Service, 411 Fairfield Rd., High Point, N.C.

MAKE Perfumes at home. Write, "Carey Laboratories," 1914 Chouteau, PM-6, St. Louis 3, Missouri.

NEED Extra money? Mail order business can be profitable if worked right. Send 25c for booklet that shows how. Guaranteed. E. Black, Box 5, Malverne 1, New York.

MONEYMAKING Opportunities by mail. Free details. Ford, 413-R Pittsfield, Mass.

START Mailorder bookshop—Build your future. 25c brings booklet, samples, exciting ideas. General Publications, Ossining, New York.

FIGURINE Painters! Obtain supplies, instruction books. Free circular. B & B, Box 163, Portage, Wis.

FISHWORMS 200-\$1.00. Breeders 100-\$1.00. Breeders manual, \$1.00. Literature free. Haase, Kent, Ohio.

START Home mailorder business. Details. Gedgard, Box 798-J, New York 1, N. Y.

MAKE "Perfumed" stationery. Build profitable local, or mailorder business. Investigate! M. Rienzi Press, 24 North Seventh, Newark 7, New Jersey.

REAL Live Mexican jumping beans. Big profits. Mann's, 5330 N. Natoma, Chicago 31.

FIX Typewriters. Free booklet describes our modern, inexpensive home-study course. Factory methods taught. Write: Typewriter, 6915 Corbet, Tarentum, Penna.

OWN Cement painting business. Extremely profitable. Needed everywhere. Make quality paint, 5c pound. Instructions, eight formulas, \$1.00. Bryan, 3551 Edwards, Cincinnati 8.

BIG-Paying home mailorder business. Details free. Jackson, Newfoundland, Ky.

\$5.00 HOUR! At home possible! Men! Women! Simplicity piece invisible reweaving instructions. Automatic latch steel tool assembly that makes moth holes, burns, cuts, tears in clothing disappear like magic. 28 samples, 81 explanatory details. Material for life. Complete kit \$4.00. Satisfaction guaranteed. Valuable details free. Walsh, 894 Main, Buffalo 2, N. Y.

OPERATE Profitable mailorder business. Particulars free. George Lenhoff, Lincoln 8, Nebraska.

HOW And where to obtain capital; small and large loans. Free particulars. Star Service, Wapakoneta, Ohio.

HOME Mail business opportunity—Get dollar orders—Keep 90c. Everything furnished. Gemmerco, Box 142PM, Dorchester 24, Mass.

I Sold 21 of 23 prospects for average profit \$150 each. \$10,000 yearly possible part-time basis in our business. Details free. Universal, 1003 Washington Bldg., Tacoma 2, Wash.

MAKE Money at home mailing literature; offering fast-selling books and merchandise. Everything supplied at low cost. Rush name. Jasco, 2623 Columbus, New Orleans, Louisiana.

NEWSPAPERS, Old magazines. Turn them into cash. 25 methods. Instructions 50c. Turk's, 169 Behnke Ave., Paramus, N. J.

SELL Rubber stamps! Proposition 25c. Elwood, Box 163, Sunnyvale, California.

START Business without capital! Reliance, 15-A Park Row, New York 38, N. Y.

TO \$35.00 Weekly, spare time, home work. Lynn, 10420-M National, Los Angeles 34, California.

1001 OPPORTUNITIES Club. 1495-P Westchester Ave., New York 72, offers real money making ideas. Free information.

EARN Money with home print shop. Build your own press. Hamilton, 2301-PM Hill, Alexandria, Louisiana.

SELL Your products by radio! No risk! Pay commission. 400 nationwide broadcasters! Simon-P-9, 48 Fifth Ave., Pelham 65, N. Y.

LIQUID Marble—Colorful, glossy! Molded, brushed, sprayed! Cast novelties, statuary, colored tiles. Flexible molds. Composition floors. Particulars free. Marbleizing Service, Edwardsville, Illinois.

GET \$3.00 Orders. Keep money. Orders filled free. Corcoran, 2233 N. Winchell, Portland 17, Oregon.

START A buying service, buy wholesale thousands nationally advertised products. Make big profits selling at sizable discounts. Send postcard for details. American Buyers' Service, 628-PM Linden, Buffalo, New York.

LEARN Moldmaking, Plaster casting. Profitable home business. Easily mastered. Details free. Hobby Shop, 410 South Detroit, Toledo, Ohio.

EARN 400% Selling attractive low priced watches. Free salesman's sample. Result Sales, 580 Fifth Ave., New York 36A.

NEW Ideas and items. 25c brings samples to retail for \$1.00. Specialties, Box 475E, Park Ridge, Illinois.

OVER 700% Profit making finished pictures in 2 minutes on the spot in daylight with new PDQ camera, without darkroom. No experience needed. Simple directions teach you quickly. Write PDQ Camera Co., 1161 N. Cleveland Ave., Dept. XPM, Chicago 10, Illinois.

OPERATE Profitable employment agency from home or office. Unlimited possibilities. Free details. Gordon Publishers, Box 23, Pawtucket, R. I.

VENDING Machines. A post card may prove to be the opportunity you are waiting for. No experience necessary. Stamp, nut, candy, gum and others. Write Schoenbach Enterprise, Dept. 11, 1645 Bedford Ave., Brooklyn 25, N. Y.

GET Dollars in the mail. Write: Alfred Haseman, Beecher, Ill.

BECOME Contractor associated with national organization. Man experienced in roof repairs, waterproofing, coatings. Operate own business under our trade name. Franchise protection. "Luster-Kote," 19417 Derby, Detroit 3, Michigan.

RECEIVE Dimes with reliable dime puller plan. Instructions 25c. Duncan, 7906 So. Figueroa, Los Angeles 3, Calif.

LIST Your name to receive mail-order offers, samples, money-making propositions. Write Paragon, Box P-2194, Houston, Texas.

MAIL-Selling! Finkle Advertising, 8809-P West Pico, Los Angeles 35, America's recognized mailorder specialists. Investigate!

OPERATE Profitable collection agency business. Free circular. Financial, B-740-M, Chicago 90.

BOOKKEEPERS Earn \$100.00 week operating bookkeeping-tax service. Details free. Universal, Box 664-M, Springfield, Missouri.

START A Home business in spare time. Make extra money. Experience not essential. Literature free. Chas. Stevenson, St. Marys, W. Va.

SAWDUST. Turn it into cash. Twenty methods. Instructions 50c. Charles Company, 12-DAE, Norwood, Ohio.

MAKE Perfume. Profitable mailorder business. Catalogue free. International, 6347 Parnell-PM-6, Chicago 21, Illinois.

OPERATE "Escalator" mailorder system, selling our products or any products. Fastest, most revolutionary mailorder system known. Write: Selbyco, Decatur 157, Ill.

MAKE, Sell, nameplates, house numbers, flasher signs. Crabtree, Newport News 221, Va.

LITTLE As \$10 starts your business; 50 different kinds; local; mail order; workable. Natmerch, Box 1975-AF, Little Rock, Ark.

START Your own business on credit. Your own boss. 1586 of our dealers sold \$5,000 to \$27,500 in 1951. We supply stocks, equipment on credit. 200 home necessities. Sales experience unnecessary. Pleasant, profitable business backed by world-wide industry. Write Rawleigh's, Dept. F-U-PPM, Freeport, Ill.

SEWING Machines, big money! Spare time. "Hang out your shingle" at home. Learn repair, electrify, trade, sell. New machines, motors, cabinets, parts furnished. Free details. Taylor Service, Hamilton PM-6, Ohio.

BIG Money and fun growing live miniature Ming trees on your window sill. Write for free rare tree seed and plan. National Nurseries, 8620A Ruthelen, Los Angeles 47, California.

MAKE Money at home or travelling. Full particulars free. Emly Enterprises, Box 319, North Hollywood, California.

THROWN Away! Tons of ground rubber by tire recappers. Make it into plastic rubber of 1000 uses. Easy! Inexpensive! Start profitable business! Instructions with samples \$1.00. Ceeten Products, 242-U, Crozet, Virginia.

PRINT Without a printing press. Big profits! See page 43.

EASY Simplified bookkeeping system. Accurate. Amazing for small business. See page 30.

"**WORLD'S** Shortest bookkeeping system." Copyrighted; big money to bookkeepers, whole or part time; salesmen wanted; \$3 per dozen. Mixon Company, P. O. Box 2048, Los Angeles 53.

MAIL Selling opportunities galore! Free! Wehner, Box 142-A, Roxbury 19, Mass.

MAKE 400% Profit selling "Snocones." Complete information. Snocones, P.O. Box 838, Atlanta, Ga.

OPERATE Profitable mailorder business. Free details. Nelson Novelty, Box 242-A, Bangor, Maine.

MAIL Order business—Your opportunity. "How To Build Your Own Mail Order Business." Beginner's idea-book tells "how." 25c postpaid. Promptly refunded if not satisfied. Albert Zimmer, 206 Central Ave., Lockland 15, Ohio.

"**HOW** To Make Backyard Profits!" New folio 25c. Free details. Pickett's, Florence 1, Kentucky.

HOW To set up and run a mirror shop! Resilvering mirrors. Making chipped glass nameplates. Electroplating salts and rectifiers. John Sprinkle V60, Marion, Indiana.

START A Venetian blind laundry. Profit opportunity for lifetime business. New machine method. Free booklet on request. F. C. Co., 442 N. Seneca, Wichita 12, Kans.

FREE Booklet "How to Raise Worms for Bait." Tells how to propagate, package, sell. El Sobrante Earthworm Farm, 749-A Rincon, El Sobrante, California.

EARN Money at home with your typewriter! Spare time! Details free. Edwards, Publisher, 3915-PM, 12th, Des Moines 13, Iowa.

MAKE Money at home as renewal headquarters for all magazines. Liberal commissions. No experience. No capital needed. Supplies furnished. Write for free catalog. McGregor Magazine Agency, Dept. 500B, Mount Morris, Ill.

WATERLESS Hand cleaners. Highly profitable home mfg. and route business. Simply add water to concentrates, or ready-packed under your label. Dispensers at cost. Western B Aircraft, Los Angeles 19.

MAKE Money spare or full time, casting metal toys and novelties. Big wholesale and chain store demand for cast metal autos, soldiers, ashtrays, banks, etc., keeps manufacturers busy. Production molds furnished for up to 100 and more castings per hour. No experience or special place necessary. Write for information and illustrations of patterns needed. Metal Cast Products Co., Dept. A, 1696 Boston Road, New York 60, N. Y.

START Home manufacturing business. Make cleaners, soaps, polishes, cosmetics. Free literature. Kemix, Park Ridge, Ill.

LIQUID Rubber, make flexible molds. Free sample. Chaney, 1130 E. 16th St., Jacksonville 6, Fla.

MAKE Tough, durable plastic—1c pound. Makes attractive floors, walls, built-ins, roofs. Build good home, \$150.00 room. Bays Laboratory, Oklahoma City 9.

LIQUID Molding rubber, \$2.95 quart, \$9.95 gallon prepaid! Plastercraft Supply Company, 3051 St. Clair Ave., Cleveland 14, Ohio.

WHY Not make extra dollars repairing zippers? Excellent profits, uncrowded field. Details free. Texas Specialty Company, 204-B Texas, Texarkana, Texas.

SAVE. Profit—Buy thousands nationally advertised articles direct from manufacturers. Literature free. E. L. Gray, Box 456, Tombstone, Arizona.

GET Smart, buy fast selling items, wholesale. 1130 Broadway, New York.

PROFITABLE Home business. Electroplate novelties, autoparts, mirrors, baby shoes, etc. Portable Tyco electro-plater \$5.95, including plating salts, formulas, instruction manual. Free booklet. Tyco Metals, Box 13231-MP, Houston 19, Texas.

WHY Job worry? Start electroplating, metal finishing business. Free information, trade secrets. Plater M Hyde, 327 West 120th Street, Los Angeles 61, California.

MAKE Money at home doing light-easy mauling work. Everything furnished—Orders filled for you. Charles, Box 32, New York 63, N. Y.

HOME Business opportunity mailing literature to new mothers. Everything furnished. Big earnings. Orders-filled. Delray, Box 3852M, Columbus 13, Ohio.

FIGURINE Molds and many others, liquid rubber, statuary plasters, flock finishes, Glo-candle wax, etc. Illustrated catalog and "Plastercraft" manual free. Blue Rapids Supply, Blue Rapids, Kansas.

NEW Exceptionally profitable plans, ideas for home operated mail business. Rush name. Miller, 1772-P Carlyon Road, East Cleveland 12, Ohio.

MAKE Flexible molds! Cast plaques, bookends, figurines! Free sample! H. Tooker, 630-R Chestnut, Hamilton, Ohio.

21 POPCORN, Candy apple formulas, proven money-makers. Send \$1 today for formulas, catalog of money-making ideas. Concession Supply, 3916 Secor, Toledo, Ohio.

RUBBER Molds! New catalog illustrating over 100 professional molds, 10c. Castcraft Studios, 508-P Marion St., Brooklyn 33, N. Y.

RECAST Old batteries into new. Latest achievements. Battery Laboratories, Minneapolis.

READ "Advance"—The voice of mail order. Offers money-making opportunities, sources of supply, personal guidance, etc. Issued monthly. Sample copy 35c. Yearly subscription \$2.00. Advance Publishing Company, 313 East 21st Street, Suite 450, New York 10, N. Y.

MAKE Money sharpening saws and lawnmowers. Start at home. Free book, "Money Making Facts," tells how. Victor Foley Company, Columbia Heights, Minn.

COLOR Concrete with chemicals. Marble-glaze cement benches, pottery, garden ornaments. Home-shop, 10c brings sample, pictures. Hollywood Cementcraft, 8527-R Wonderland, Hollywood 46, Calif.

BOOKKEEPERS—Earn \$5000 yearly part time. Sell, operate new sensational CPA bookkeeping service. Kern, 4942 Vineland, North Hollywood, Calif.

GOOD Paving business silvering mirrors, plating autoparts, reflectors, bicycles, bathroom fixtures, etc., by late method. No tanks or shop required. Outfit furnished. Free booklet. Gunmetal Co., Ave. H, Decatur, Illinois.

137 WAYS To make money, in home or office, business of your own. Full particulars free. Elite Co., 220 Grand St., New York 13.

SELL By mail, free details; instructive booklet 25c. Manhattan House, Box 51-M, St. Albans 12, New York.

MAKE Gifts, novelties, jewelry, from sea shells, fish scales, plastics. No tools needed! Learn secret methods of bronzing, pearlizing, golding, silvering, metalizing, luminizing, dyeing. Write: Giftercrafts, Box 4550-PM, Coral Gables, Florida.

POPCORN And potato chip equipment. Long Eakins Company, 5260 High, Springfield 99, Ohio.

BUY Wholesale. Thousands articles. Supply directory, 10c. Idealso, Park Ridge, Illinois.

ESCAPE Wage slavery. Easily. Operate your own profitable lifetime business. Free literature. Corley, H285 Carlton, East Rutherford, New Jersey.

EARN Extra money! "Homeworker Magazine" tells how. Sample 25c. Sizemore, Box 7, 4917 Kostner, Chicago 30.

VENDING Machines earn big money! An investment as low as \$10.50 will start you in this fascinating, profitable business that can lead you to the road of success and independence. Routes can be established and operated in either full or spare time with no experience needed. Write for full details and our free catalog illustrating our nut, candy, gum and stamp vendors; also pin ball machines, music boxes, etc. Write immediately to Parkway Machine Corporation, Dept. 7, 715 Ensor Street, Baltimore 2, Maryland.

BE Listed to receive latest mail order offers, samples, propositions. National, Box 88-P, Dorchester 22, Mass.

BOOKKEEPERS, Keep books, small firms spare time. Manual latest technique by C.P.A., \$3.00. Modern Business, Box 406, Youngstown 1, Ohio.

FREE Book "505 Odd, Successful Businesses." Work home! Expect something odd! Pacific, Oceanside, Calif.

\$48 FROM Square foot plywood; jigsaw necessary. Write: Woodarts, Bridgewater, Mass.

EXTRA Money—No selling, operate vendors. Amazing profits, details free. Silver King, Suite 220, 622 Diversey, Chicago 14.

BUY It wholesale! Manufacturers, distributors offer 850,000 items. Literature free. Olsen, 1231-A East Third St., Duluth 5, Minn.

\$25 WEEKLY Working two hours daily. No canvassing. No manufacturing. Lycke, Box 2471-A, Cleveland 12, Ohio.

EARTHWORM Breeding? First, get unusual story. "An Earthworm Turned His Life." Free. Earthmaster, Dept. 14, El Monte, Calif.

MONEY In new greaseless doughnuts. Start in kitchen. No smoke. Sell stores. Free recipes. M. Ray Company, 3605 South 15 Ave., Minneapolis 7, Minnesota.

INCOME From local information. No selling. Write Neherco, La Verne, Calif.

UNPAINTED Bookends, plaques, statues, figurines. List. Haverty Products, 822-17th St., Altoona, Penna.

OPERATE Profitable mail order business. Write Walter Service, 4159-A East 112th, Cleveland 5, Ohio.

DOLLARS In personalized baby record books. Sell by mail. Use same literature we do. No-Co-Ro, Oakland 6, Calif.

FABULOUS Earnings—Fascinating pastime. Growing genuine, living miniature (ming) tree. New sensational business or hobby. Astounding information free. Dwarf Gardens, Box 355B, Briggs Station, Los Angeles 48, Calif.

MADE \$24,500 Using money making plans from Schemer Magazine, world's oldest mailorder publication. Box 275M, Canfield, Ohio. Year \$2.00. Sample 20c.

MINK Raising information free. Complete. Lake Superior Mink Farm, Superior, EEL, Wisconsin.

COPUBLISH Leading m.o. paper. Latest copy Mail Sale Advertiser, details, dime. Vanroy Shirk, Lebanon, Penna.

COLORGLAZED Concrete pottery made without molds. Patented method. Cemetery products, novelties, tiles. Basement leak-sealing. Money-making projects. Booklet, details free. Men only. National Potteries Company, Grand Rapids, Minnesota.

MONEYMAKING OPPORTUNITIES

SELL Snowballs. \$8.50 buys ice shaver that shaves into paper cup and enough flavor and cups for thousand snowballs. Other outfits \$2.50 up. Shavers, supplies, equipment. Illustrated circulars free. Snowball Co., 9534P Lemturner, Jacksonville 8, Florida.

BE Independent, be secure, have your own profitable business—Earn \$20.00 and more a day making beautiful, fast-selling lamps at home. No equipment needed. Illustrated course teaches you quickly. Course, parts catalog, wholesale price list—only \$2. Gearon Co., Dept. 300-B6, 27 S. Desplaines, Chicago 6, Ill.

FOUNTAIN Pen repairing. Send 50c for Penkit; includes sac, point with instructions for repairing. Penmart 96, Boulder City, Nevada.

EARN Money evenings, copying and duplicating comic cartoons for advertisers. Adservice, Argyle 1, Wisconsin.

SELL From your own catalog. Hybarger, 709 E. Baltimore, Fort Worth 4, Texas.

MAIL Order profits! Leading trade magazine (published 20 years) shows you how! Sample copy 10c. Pioneer, 4303C Highview Avenue, Baltimore 29, Maryland.

BUY Wholesale thousands nationally advertised products at big discount. Sent free "The Wholesale Plan." American Buyers' Service, 627-PM Linden, Buffalo, N. Y.

BRAND New sure fire money maker. Write Post-Rite, Box 802, Sioux Falls, S. Dak.

GROW Dwarfed trees! Pot, sell. Instructions, 25c. Levy, 4019 Dumaine, New Orleans, La.

FREE Circular on moneymaking mail order business at home. Sheldon Mail Order, Sheldon 1, Iowa.

FREE Nationwide advertising, publicity! Advertise your products to 51 million readers thru 77 national magazines, free of charge! Broadcast on 400 radio stations without risking a penny! Send 25c (refundable) for details today! Treasury, 149 Storer, New Rochelle 6-M, New York.

\$100-\$200 WEEKENDS No selling or manufacturing. Brennan, 4025-Z Lanker-shim, North Hollywood, California.

HAVE Thrilling vacation trip to South America through our easy profitable subscription plan furnished free. Sample magazine 25c. Guiding Star, Box 5944M, Los Angeles 55, Calif.

GROW Miniature dwarfed trees. Pot, sell. Instructions, 25c. Metro, Box 103PM, Berwyn, Illinois.

MAKE Money with your telephone. Profitable telephone service can be rendered by housewives, shut-ins or in an office. No solicitation. Copyrighted instructions based on actual experience of author. Instructions \$1.00. F. Shreve, Dept. J, Box 1583, Charlotte, N. C.

MAKE A fortune this summer, importing. Amazing offer, everything you need supplied, airmail \$1 (refundable). Brandt & Ditco, 910 Manning, Toronto, (Ont.).

SEVERAL Mailorder magazines, money making and homework offers. 10c. William Woodrow Jenkins, Lucasville, Ohio.

YOUNG Men earn \$200-\$400 in spare time during month of July. No investment. Box 154, Oakland City, Indiana.

WONDER Liquid—New—Not rubber or plastic. Own a profitable business making several different products. Amazing results. Details \$1.00. Mutual Service, 270 Villa St., Elgin, Ill.

WIN Contest money. General Contest Bulletin gives hundreds of tips. Lists current contests and rules. Sample 25c. General Contests, 1609½ East 5th, Duluth, Minnesota.

UP To \$25 weekly assembling costume jewelry at home. Send 10c for complete money making plan. Gemcraft, 1812C E. 13 St., Cleveland 14, Ohio.

TIE-Breakers for D.A.V. American puzzle contests exposed. Manual \$5.00. Satisfaction guaranteed. D. Wenograd, Box 1495, Philadelphia 5, Penna.

EXCITING Mail order home-work opportunities. Scneider, 1227 Woodlawn Ave., Louisville 8, Ky.

SELL Diamond gems. 10% more brilliant than expensive diamonds. New scientific discovery. Only \$9.75 carat, wholesale. Guaranteed. Make \$50.00 day. Free information. Diamond Gem Co., 1404-M Mitchell Street, Oakland 1, Calif.

MAKE Money in your back yard. Send \$1.00 for Plans to Profits. P.O. Box 633, Sheboygan, Wis.

FREE! Money-making opportunities galore including magazines. Wilbur Errickson, Englishtown, New Jersey.

50,000 ARTICLES Wholesale. Source directory, dime. Nelko, Box 3462-DR, Chicago 54.

FREE Book "505 Odd, Successful Businesses." Work home. Expect something odd! Pacific, Oceanside, Calif.

BE Appointed State Notary Public now! Details: Stationers, Helotes, Texas.

PUBLISH Your own magazine. Handsome 52 page format, well edited, illustrated. Cost low as \$1.00 month. Brings you prestige, profits. 25c brings sample, details. National, Ord, Nebr.

READ Progressive Mailtrade, the magazine that tells how to make money by mail. Dime brings sample and special offer. Progressive Mailtrade, Box 357, Sheboygan, Wisconsin.

FORMULAS, PLANS, ETC.

"EASY To make" shampoo formula \$1.00, plus generous sample. Dees, 820 Candelaria, Albuquerque, N. Mex.

10,000 FORMULAS, Processes, trade secrets, etc. 900 pages. \$3.98 postpaid. K. Paulin, Loudonville, Ohio.

REAL Manufacturing formulas. Lists free. Cummings, Chemist, Gordon Ave., Syracuse 4, N. Y.

FORMULAS; All kinds. Latest, best. Literature free. Kemixal, Park Ridge, Ill.

TESTED Formulas. Interesting descriptive booklet free. Pont, Box 635-PM, Terre Haute, Indiana.

FREE Formula catalog. Anything analyzed \$25.00. Western Chemical, Salem, Oregon.

PLASTICS

INTERNAL Carving drills, dyes, blanks, kits, supplies, findings, chain, etc. Free lists. Dept. P-2, Caraday, Box 71, Ryder Sta., Brooklyn 34, N. Y.

LEARN Plastics at home. Small cost—Spare time. Dime brings sample plastic, three experiments, full details. Plastic Projects, Box 5151, Detroit 35, Mich.

MANUFACTURERS Of a complete line of internal carvings. Special introductory offer; \$1.00, jewelry set and keychain. Crystal Floral Company, Bound Brook, New Jersey.

NEW Liquid casting plastic. Clear, colors. Embed flowers, insects, coins. Saw, drill, carve. Send 25c for wholesale catalog and new sales manual showing how to make money at home. Castolite, Dept. G-101, Woodstock, Illinois.

HOME Repair kit. Mends all plastic articles. Quick, easy, professional results. \$1.00. Free information. Plastic Industries, Box 1138, Santa Fe, New Mexico.

PLASTICS Catalog—10c. Sheets, rods, tubes, molding, casting plastics. Information, bargains galore. Sample low price: 1/16" clear Lucite, full sheets, 98c square foot. (36"x48"). Gem-O-Lite, Box 686G, North Hollywood, Calif.

LUCITE, Plexiglas. Any size sheets, masked. Square foot (12 x 12) cost, 1/16". \$1.20; 1/8". \$1.40; 3/16". \$1.75; 1/4". \$2.08. Include 10% postage. Almac Plastics, 230 Fifth Ave., New York 1, N. Y.

PLASTIC, Sheets, rods, tubes, etc. Free list. Plastic Supply Co., 2901 N. Grand Blvd., St. Louis 7, Mo.

CHEMISTRY

URANIUM Ore, weighing scale, graduate, directions 44 experiments. \$1.00. Rex Laboratories, 2849-A Birchwood, Chicago 45, Illinois.

NEW Idea chemical and apparatus outfits for home experimenting. Photo-scales, microscopes, chemicals, biological and laboratory supplies in small quantities. Catalog 25c. Established 1931. John H. Winn, 124A West 23rd Street, New York, N. Y.

CHEMICALS And apparatus for industrial, analytical, and private laboratories. Catalog 20c. Dept. M-50, Biological Supply Co., 1176 Mt. Hope Ave., Rochester 20, N. Y.

ILLUSTRATED Catalog: Chemistry, mineralogy, biology. 10c. Tracey Laboratories, Evanston, Illinois.

AGENTS WANTED

AMAZING Miracle auto polish—Plastone! New scientific discovery contains pure carnauba wax, genuine plastic plus silicones! Sensational money maker! Nationally advertised! Sold by leading firms. Used by America's largest organizations. Only \$1 retail. 100% profits. Sales experience unnecessary. Exceptionally easy sales. High repeat sales. Choice protected territories. Once in a life time opportunity for large steady earnings. Only limited number of agents accepted. Write today. Plastone Company, 2950 W. Grand, Dept. PM-6, Chicago 12, Illinois.

DISHWASHER. Portable. Fits kitchen drain board. Washes, rinses, air dries in minutes. No installation. Low priced. Guaranteed. Housewives wild about it. Great money maker. Literature free. Bes-sen Co., 522 Main, Evanston, Ill.

THREE New products, never before on the market. For details write Products, 962 Main St., Leominster, Mass.

GET Into toys! Big money. Show free toy-gift line full or spare time. Take orders, pocket juicy profits. Styleco, Dept. E259, Cincinnati 10, Ohio.

FRANCHISED Distributors, items offering 100% profit. Sample available \$1.00 (refundable). House of Holland, P.O. Box 583, Mount Vernon, New York.

AMAZING But true! We pay you daily wonderful nylon stockings at our risk. These beautiful sheer nylons cost nothing unless satisfactory! Yet, you get advance cash for giving women privilege wearing cash plus huge bonus that increases your earnings by 40%. Postcard brings you free sample stocking and complete money-making outfit. No obligation. Kendex, Babylon 93, N. Y.

MEXICAN Feather pictures. High profit! Fast sellers! Adelphi, Box 57-B, Bellerose 6, N. Y.

PRINTING—Salesbooks, envelopes, tags. Free illustrated catalog. Ersco, Dept. PM, Bronx 72, N. Y.

ASTONISHING! Plastic magnets. No metal. Good proposition. Sample 25c. Box 357, Flint 1, Michigan.

GREETING Card bargains. Personalized napkins, book matches, playing cards. Raun, 4154-g Fifth Street, Philadelphia 40.

AMAZING New seller! Chenille rugs and bath mat sets personalized with woven-in names and monograms. All colors. Low priced; big commissions. Miniature sample rugs and sales kit free. American Mills, Dept. 508, Indianapolis 7, Ind.

MAKE Extra money—For yourself, club or church. Up to 100% profit selling big value Christmas, all-occasion greeting card assortments to friends, others. 7 leading 21 card \$1.00 boxes, religious and novel cards. Gift wrappings, ribbons, stationery, napkins, animated books, sewing kits, unusual gifts. Over 150 items. Bonus plan. Experience unnecessary. Write for samples on approval, special offers. Hedenkamp, 361 Broadway, Dept. PM-21, New York.

OKURA With liquid rubber pays 200%. New miracle transparent coating protects, preserves, glamorizes floors, walls, linoleum, furniture, autos. Resists acids, soap, water, alcohol. Waterproofs wet basements. Big seller. Rubber Products, New Haven 66, Conn.

YOU Will make more money day after day, year after year selling DuPont nylons priced to sell and repeat. Details free. Write today. Arch Hosiery, 104 N. Fifth St., Philadelphia P6, Penna.

AMAZING Big profits selling exclusive Sunshine Christmas cards. Nationally famous 21 for \$1.00 assortment is unequalled, sells on sight. Other tremendous Sunshine values: merry holly-day, nature prints, Park Avenue kromekotes, scripture text, gift wraps, stationery, etc. Send for samples on approval. Earn big money now! Sunshine Art Studios, Dept. PM-6, Springfield 1, Mass.

STATE And local distributors wanted for "Blue Blaze"—Battery proven by years actual road service. Guaranteed for 30 months: non-prorated. Write Blue Blaze, 2817 Jeffries, Los Angeles 65, California.

SELL Big money maker to men and women. Easy handwork makes fast-selling useful articles. Sample free. Sunmade Company, Brockton 64, Massachusetts.

NONFLAMMABLE. Scientific. Spot remover. Send two dimes. Murphy-Yale, Meriden, Conn.

BUY Wholesale thousands nationally advertised products at big discount. Sent free "The Wholesale Plan." American Buyers' Service, 629-PM Linden, Buffalo, N. Y.

WANTED! Men-women, to sell new, different specialty to homes and business places. Big earnings full—part time! Rush name for complete offer. Brady Specialties, Dept. A, 255 West 34th Street, New York 1, N. Y.

MAKE Wedding profits. Sell invitations, napkins, matches. Samples free. Dunbar's, Middlebush 3, N. J.

100,000 ITEMS Wholesale prices. Directory 25c. Refundable. Flatwoods, Leesburg, Florida.

BUY Wholesale — 25,000 items. Catalogue 25c. Matthews, 1472-B-11 Broadway, New York City.

NEW Plastic mending tape. Just press on! Repairs clothing instantly. Lightning seller. Samples sent on trial. Kristee 148, Akron, Ohio.

BIG Daily profits—Selling embroidered wool and cotton uniforms, initialed buckles, belts, badges, choice 3000 emblems. Free sales kit. Hook-Fast, Box 480PM, Roanoke, Virginia.

FREE Samples, and amazing plan, giving you gorgeous dress without penny cost. Rush name today with dress size. Harford, Dept. G735, Cincinnati 25, Ohio.

MEXICAN Feather pictures. Sell on sight; 200% profit! Free details. Sample 20c stamps. (No coins). Sylviap, Apartado 9036, Mexico City.

WHOLESALE Catalog appliances, toys, watches, etc. 25c (refund first order). Cam Company, 1717 58th, Brooklyn 4, N. Y.

BE A money maker. Use your home as magazine headquarters. Liberal commissions. No experience. No capital needed. Everything furnished. Write for free catalog. McGregor Magazine Agency, Dept. 500A, Mount Morris, Ill.

BIG Profits selling ties (\$2.00 values.), \$6.50 dozen. Free catalog. Empire Cravats, 648 Broadway, New York 12.

GOLD Lacquered and silver sign letters. Windows, doors, trucks. Standard sizes. Penny and up samples. Atlas-P, 544 West 79th, Chicago 20.

YOUR Own business—Used suits \$1.50; topcoats 50c; shoes 12½c; ladies' coats 30c; dresses 10c. Enormous profits. Catalog free. Moro, 558-AA Roosevelt, Chicago 7.

MAKE Tremendous profits with fast-selling costume jewelry! Buy direct! Sell your friends, neighbors and customers at big savings to them! Write for our free catalog! Penn Jewelry, Dept. P, 826 W. Lacka., Scranton, Penna.

CALIFORNIA Sweet smelling beads. Sensational sellers. Free particulars. Mission, 2328PM West Pico, Los Angeles 6, Calif.

\$50 WEEKLY Selling finest razor blades, other items. Free details. Edisans, Box 274, Far Rockaway, N. Y.

GUARANTEED 200,000 Mile ring, valve job! Restores compression! Stops oil pumping! Send \$3.00 for \$6.00 package and sales offer! Nerlino, Box 7, Inglewood 5, Calif.

NEED Extra cash? Take orders for personal initialed belts and buckles, cap badges, tie holders, etc. Choice of 3000 emblems. Free sales kit. Hook-Fast, Box 1425PM, Providence, R. I.

EXCELLENT Sideline for printing and advertising salesmen. Decalcomania name plates in small quantities. Great demand. Also, make money with our line of automobile initials and sign letters. Free samples. "Ralco" XL-Roxbury, Boston 19, Mass.

AGENTS: Stamping names on key protectors. Sample 25c. Stamping outfits, checks, social security and name plates. Hart Mfg. Co., 303 Degraw St., Brooklyn, N. Y.

BE The Popular Mechanics representative in your neighborhood and earn big profits in your spare time. Write Popular Mechanics Magazine, Room 408M, 200 E. Ontario St., Chicago, Ill.

AGENTS — 300% Profit selling genuine gold window letters; stores and offices. Free samples. Metallic Letter Co., 438-B North Clark, Chicago.

SALESMEN, Distributors, fast selling costume jewelry direct from factory. Big picture catalog, free. Pickcraft, M19 Bank, Attleboro, Massachusetts.

HIGH-GRADE SALESMEN

WANT To make real money? You can positively make \$50.00 a day and up selling a brand new item going to every type of food and beverage store, factories, laboratories, hospitals, etc. First time advertised. Samples furnished. Utility Dura-wear, 53 West Jackson Blvd., Dept. PM-6, Chicago, Illinois.

GET Into million dollar work clothes business! Earn big money now, unlimited future! Sell finest-quality embroidered uniforms and work clothes to factories, garages, service stations, lumber yards, everybody! Huge profits possible. No experience needed. Gorgeous selling kit, actual fabric samples, everything free! Write Topps, Dept. 536, Rochester, Indiana.

SIDELINE For energetic salesmen—Sell advertising specialties, calendars. Earn \$500 monthly easy. Big commissions advanced, bonuses. Samples furnished. Continental Calendar, 542-L So. Dearborn, Chicago.

IS \$210 A week worth a postcard to you? Then rush card with name and address for special free trial plan that sells amazing new automatic refrigerator defroster "like hot cakes!" Write to Mr. Lewis, D-Frost-O-Matic Corp., Dept. J-102, 173 W. Madison, Chicago 2, Ill.

WRITE 3 Words—Collect \$7.65 on 10-second demonstration to merchants. Write on glass with amazing magic crayon—presto! 5 color advertising message takes fire. Glows like brilliant neon. Three sales daily bring \$22.95 profit. Rush postcard for details. Complete sales kit, free! Maxilume Co., 125 W. Hubbard, Dept. CL-8-H, Chicago 10, Illinois.

DISTRICT Mgr. calendars, specialties. Klingstedt's, 425-509 Schroyer, Canton, O.

COMPLETE Line calendars and advertising specialties. Excellent commissions. Bonus. Full time, sideline. Write fully. Midwestern, Dept. 7, Box 129, Normandy Station, St. Louis 21, Missouri.

SELL Sensational bass lure and catfish bait guaranteed stay on hook. Box 927, Coleman, Texas.

COUNTY Agency. Power mowers, \$41.90. Delivered. Appointment dealers-agents. Rotacut-51, Excelsior Springs, Mo.

MAKE \$3000 Next 60 days selling 1953 calendars, advertising specialties and executive gift line. Season on. Big commissions advanced. Outfit free. Meyerson Calendar, 605-PM Washington, Chicago 6.

ADVERTISING Book matches—Cash in on big demand; sell union label matches. Cuts for all businesses and political parties. Free powerhouse selling kit, low prices, protection guaranteed on repeat orders. Cash commissions. Superior Match Co., Dept. M-652, 7530 Greenwood, Chicago.

I Need 500 men to wear made-to-measure suits and earn up to \$15.00 in a day showing friends and taking orders. Write for free outfit. Progress Tailoring Co., 500 S. Throop St., Dept. G-217, Chicago 7, Ill.

\$12,000 EARNINGS Or more each year. Sell for a company successfully manufacturing a molybdenum disulfide grease and other top quality "specialized lubricants." Call on owners and users of heavy duty equipment in industry and in the field. An advance on earnings with no collection or delivery worries. Write experience and qualifications to E. J. Baker, P.O. Box 676, Dayton, Ohio.

AD Matches! Sell amazing designs—20, 30, 40 and 240-light book matches. Bigger spot cash commissions; every business a prospect. Low prices for high quality. Repeats. Start without experience; men, women; full, part time. Buy nothing! Sales kit furnished. Match Corp., Dept. PM-30, Chicago 22, Illinois.

ANYONE Can sell Hoover DuPont nylon uniforms for beauty shops, waitresses, doctors, nurses, others. In white and colors. Exclusive styles. Top quality. Low priced. Exceptional income. Real future. Equipment free. Write fully. Hoover, Dept. F-100, New York 11, N. Y.

MIRACLE Glaze—Amazing car luster. Free sample. Big commissions. Miracle Glaze Company, 9714 Austin, Oaklawn, Illinois.

SALESMEN: \$100.00 More weekly on present job using "amazing secret." Postcard brings startling information. Brennan, 4025-C Lankershim, North Hollywood, Calif.

SALESMEN—Get happy! Hundreds different things to sell; all details free! Write what you sell now; what you'd like to sell. Your mail box will run over! Salesmen's Service, Drawer 8711, Fort Worth 12, Tex.

NEW Jobs open in selling! Send name, address for five free issues of Opportunity Magazine's money-making guide, listing hundreds of companies who'll pay you well, full or part-time. No experience needed. Opportunity, 28 E. Jackson, Dept. 17, Chicago 4, Ill.

EDUCATIONAL AND INSTRUCTION

CAN A man my age become a hotel executive even though he has no previous hotel experience? Would you like to step into a well-paid position as hotel or club manager, purchasing agent, social director or assistant manager, etc.? The success of Lewis graduates from 18 to 50 proves you can—though you have no experience in hotel work. Harry E. Roorbach says: "While in the hospital I enrolled for Lewis Training. Shortly after completing the course, the Lewis Placement Service informed me of an opening. At present, I am night manager in the largest hotel in Rochester. I owe my success to the Lewis Course." Our free book explains how you can qualify for a well-paid position in leisure time, how you are registered free of extra cost in Lewis National Placement Service. Write today. Course approved for veterans' training. Lewis Hotel Training School, Desk VH-324, Washington 7, D. C.

BECOME An accountant. No previous bookkeeping experience required. We train you at home spare time, low cost. Ask for free booklet, "Accounting, the Profession That Pays." LaSalle Extension University, a correspondence institution, 417 South Dearborn Street, Department H 911, Chicago 5, Ill.

LISTEN—Learn a language by Linguaphone. At home, quickly, easily, correctly master Spanish, French, German, Russian, Chinese—any of 29 languages through Linguaphone Conversational Method. Add to service, job, travel opportunities. Send for free book. Approved for Veterans' Training. Linguaphone Institute, 8306 Radio City, New York City.

WANT A diesel job? New opportunities to increase income. Higher pay. More money. We can help you qualify. Tools. Shop method home training. Write today! Diesel, Tractor, Heavy Equipment Division, Interstate Training Service, Dept. 3F, Portland 13, Oregon.

INVESTIGATORS Trained, men-women, learn fascinating profession. Spare time study. Big pay. Folders free. Investigator, Box 490, Times Square Station, New York 18, N. Y.

LEARN Watchmaking. One year forty hour week course. Gruen Watchmaking Institute, Cincinnati 12, Ohio.

USED Correspondence courses and educational books bought, sold, rented, catalog free. Educational Exchange, Summerville, Ga.

U. S. Civil Service jobs! Start high as \$73.00 week. Men-women. 95,000 jobs open! Qualify now! Experience usually unnecessary. Get free 32-page book showing jobs, salaries, requirements, sample tests. Write today: Franklin Institute, Dept. K-24, Rochester, N. Y.

MAKE Up to \$45-\$55 week as a trained practical nurse! Learn quickly at home. Booklet free. Chicago School of Nursing, Dept. M-6, Chicago.

GERMAN Slide rules, scales. Student's, engineer's. Free catalog. 11C East Peoria, Pasadena, Calif.

HIGH School—No classes. Study at home. Spare time. Diploma awarded. Write for free catalog HF-21, Wayne School, 2527 N. Sheffield, Chicago 14, Ill.

LEARN Priceless secrets of technical metaphysics. Easy. Simple. Write Canada School of Technical Metaphysics, 2532 McKenzie St., Vancouver, B. C., Canada, for amazing information.

"HOW To Break and Train Horses"—A book every farmer and horseman should have. It is free; no obligation. Simply address Beery School of Horsemanship, Dept. 1106, Pleasant Hill, Ohio.

THE Collection agency business is one of finest opportunities today. Write G. H. Cole, Syracuse 2, N. Y., for free folder.

WELDING Training pays at Hobart Welding School, Box M-622, Troy, Ohio. VA contract. Best equipment. Catalog free.

STUDY For game warden, park, forestry and patrol service. Write Delmar Institute, D11, Whittier, Calif.

BOOKKEEPERS! Increase your earnings! Operate your own simplified "Dollar-A-Week" bookkeeping and tax service. Full or spare time. Details free. No obligation. Ellis, Box 200-F, Cedar Grove, North Carolina.

READ Your Bible at home during the summer months, using the new "Faith" Bible correspondence course offered by world-wide radio broadcasters. Write: Voice of Prophecy, Box 55, Los Angeles 53, California.

BE A real estate broker. Study at home or in classrooms in leading cities. Write for big illustrated free book today. Weaver School of Real Estate, Suite 304 Law Bldg., Kansas City, Mo.

3800 USED Correspondence courses. Catalog \$1.00. Art work. EG, Elmsford, N. Y.

EASY Simplified bookkeeping system. Accurate. Amazing for small business. See page 30.

SAVE Algebra worry. New, analytic method teaches quadratics instantly. Rush \$1. Guaranteed. Ziembak, 6123 Orchard, Dearborn, Mich.

CORRECT Your speech defects at home. Complete instructions \$1.00. John E. Thompson, Gastonville, Penna.

MIDLAND Linotype School, Charles City, Iowa. Civilian and Veteran Courses. Free placement. Established 1909.

PROFIT From secrets of Eastern Wisdom. Learn Yoga at home. Become physically fit, mentally dominant, financially independent. Send 25c for first lesson. Insight School, Dept. PM, 1144 Ashland, Evanston, Illinois.

HOME Study course, drugless therapy. Free literature. Institute of Drugless Therapy, Tama, Iowa.

OWN A collection agency. Big money. Franklin Credit, Roanoke 7, Virginia.

HAPPINESS, Success, money. All these can be yours. Know thyself. Send for free analysis chart. Sullivan Institute, 541 North 89th St., Milwaukee 13, Wisconsin.

\$8-15,000 YEARLY Not unusual for Acme-trained tool and die designers! Industry desperately needs competent men. You can learn quickly by easy home study. No art ability required. Acme graduates go farther faster in tool and die designing. Famous "Cope" system includes same methods and texts used by our resident schools to train tool and die designers. Write today for free literature. Acme School of Die Design, 8 N. Jefferson Street, Dayton 2, Ohio.

MEDICAL Laboratory technicians in great demand. We train you in your own home. Catalogue free. Imperial Technical Institute, Box 973-J, Austin, Texas.

USED Correspondence courses and books sold and rented. Money back guarantee. Catalog free. Courses bought. Lee Mountain, Pisgah, Alabama.

PIANO Tuning pays. Learn this profitable profession at home. Our Tonometer and mechanical aids make learning easy. No knowledge music necessary. Diploma granted. Largest and oldest school—53rd year. G.I. approved. Write for booklet. Niles Bryant School, 78 Bryant Bldg., Washington 16, D. C.

SECRET Investigation. Experience unnecessary. Investigators particulars free. George Wagner, M125 West 86th, New York 24.

INVESTIGATOR Training. Phillips Secret Service System, 1917-B North Keneth, Chicago 39.

PLAYS, STORIES, MANUSCRIPTS

BEGINNING Writers: Let us show you how to get \$1 to \$20 checks in your daily mail doing simple spare time writing. Experience unnecessary. Details free. W. Herwell, 7016 Euclid, Cleveland 3, Ohio.

MUSICAL Comedy plays. Dorby Publications, P.O. Box 131, Brier Hill, New York.

I Want new writers to cash checks of \$1 to \$100 offered daily. The easiest way to write for pay. No previous experience necessary. Free details. Saunders M. Cummings, 468-11 Independence Bldg., Colorado Springs, Colo.

BUSINESS SERVICE

REMAIL. Forwarding service from New Orleans. Commercial, private, 25c each, \$4.00 monthly. Sinclair, Box 762, New Orleans 2, Louisiana.

SPECIAL SERVICES

PRETEND Visiting Michigan's vacationland. Detroit remails 25c, help wanted section 50c. Edwards, Box 1067, Allen Park, Michigan.

STAMPED Letters remailed 10c each. Replies forwarded, dollar per month. California House, Box 1131, Long Beach, Calif., Dept. A.

LETTERS Rемаiled Atlantic City 25c each. 2 scenic postcards 25c. Lucas, Box 1115, Atlantic City, N. J.

TEXAS Letters remailed 25c. Houston help wanted columns and business opportunities mailed \$1.00. Huebner, 1112 Danube, Houston, Texas.

REMAIL 25c; Canada; Hamilton, Toronto, Vancouver; also Niagara Falls, Buffalo, Frank Richardson, Mt. Hope, Ontario.

NEW Orleans! Letters remailed 25c each. Levy, 4019 Dumaine, New Orleans, La.

RENO, Nevada; Sacramento, San Francisco, California. Dependable remailing service. Letters, cards 25c each. M. Custer, P.O. Box 1404, Sacramento, California.

REMAILS: Los Angeles! Hollywood! 25c each, 5—\$1.00. Roope, Box 561, Inglewood, California.

LETTERS Rемаiled New York City 25c each. 2 scenic postcards 25c. Bereson, 380 92d St., Brooklyn, N. Y.

CALIFORNIA Or Mexico remail service 25c per letter. Knight Company, 948 Third, San Diego, California.

ENGLAND, London, remails \$1. Air both ways \$2. Franchel, Palmyra, N. Y.

PALM Beach. Letters remailed. Forwarding service 25c ea.; picture cards \$1 doz. Help wanted, business opportunities column. Miami, Palm Beach, Jacksonville, \$1 ea. air mail. P.O. Box 1645, West Palm Beach, Fla.

HOLLYWOOD Postmark! Letters, cards remailed 25c each. 8 scenic postcards \$1.00. Mailing address \$3.00 monthly. Stadler, Box 2335, Hollywood 28, California.

MANUFACTURERS Names any item \$2.00. H. M. G. Company, Mecca, Ind.

CARTOONING, COMMERCIAL ART, SHOWCARD WRITING, SIGN PAINTING

EARN Money evenings, copying and duplicating comic cartoons for advertisers. Adservice, Argyle 1-A, Wisconsin.

CARTOON charts make cartooning easy. 400 comic illustrations 25c coin. Randall, 312 First, Peoria, Illinois.

LEARN Cartooning, commercial art, portrait drawing, lettering, showcard writing, etc., quickly with our new, easy methods. Literature free. National Artists, 801-A North Marsalis, Dallas 3, Texas.

HANDPAINT Neckties for fun and profit. 25 sport and novelty patterns, plus "How to Paint." \$1.00. Walker Studio, Dept. M6N, 4343 Lindell, St. Louis 8, Mo.

ARTISTIC Back dated art magazines, eight \$1.00 postpaid. Wonderful courses, drawing, painting, cartooning. Free catalog. Art Book Shop, Arnold 8, Missouri.

"HOW To Make Money With Simple Cartoons"—A book everyone who likes to draw should have. It is free; no obligation. Simply address Cartoonists' Exchange, Dept. 96-C, Pleasant Hill, Ohio.

BE Smart. Get in art. Let me start you free. 25 years experience. Nick Nichols Arts, 39 W. Adams, Chicago 3, Ill.

LEARN Sign painting at home. Test lesson free. Ben Kerns, Box 812-P.M., Greenville, S. C.

CHALK Talks. Laugh producing program, \$1.00. Catalog 10c. Balda, The Cartoonist, Oshkosh, Wisconsin.

ADVERTISING AGENCIES, LETTER WRITERS, FOR ADVERTISERS

"ADVERTISING Doesn't cost—It pays" in our various magazines. Samples, 25c. Mention product, services. Wright Publications, 2270 Hubbard, Memphis 8, Tenn.

LETTERS By Ace pull sales. Two dollars. Ace, 208 Broad, Elizabeth 3, N. J.

NAMES Cash customers. 1000, \$3.50. Bolaine Sales, Box 5004, St. Paul.

MAILING Lists—New Orleans area. Thousand \$4.00, others \$3.00, \$1.00. Sinclair, Box 762, New Orleans 2, Louisiana.

FREE Copy, layout service. Mailorder ad, 1,700,000 nationwide circulation, \$27.30 inch. 24-word classified, 20 big Sunday newspapers, \$30.00. Advertising ratebook free. Chicago Advertising Agency (established 1900), Chicago 4.

ADVERTISE: 24 Words, 100 Canadian newspapers \$5.50. Lists free. Advertising Bureau, 10511-C Springfield, Chicago 43.

ADS Placed in out of town newspapers and magazines. Low rates. Catalogue free. Ideas that pay. Baker Advertising Agency, Successors Ankrum Agency, 189 W. Madison, Chicago 2.

ADVERTISERS! Reach nearly 18,000,000 readers. 25 Sunday national key newspapers. 18 words, \$59.00. "Terrific pullers." 20 popular newspapers, \$11.50. Free booklet. Special—One inch display 2.-821.198 circulation, \$51.10. Newmark's Advertising Agency, (Established 1893), 217-7th Ave., New York 11.

MAILING Lists: \$5.00-1000 up. Write Dixie Service, King, N. C.

RUBBER STAMPS AND OFFICE SUPPLIES

3 LINE; Self-inking pocket stamp. \$1. Bauer-Lee, Sierra Madre 5, California.

3 LINES 50c; Pads 35c; signature \$2.35. Stamp-Right, Wauwatosa, Wis.

TYPEWRITERS, DUPLICATORS, OFFICE DEVICES

RECONDITIONED Typewriters, printing devices, office machines, equipment. DixieGraph, King, N. Car.

PRINTING, MULTIGRAPHING, MIMEOGRAPHING GUMMED LABELS

1000 BUSINESS Cards \$2.50 prepaid. Samples free. Reliable Print Shop, 905 E. Jefferson, Louisville 6, Ky.

QUALITY Printing, postpaid. Free samples, prices. Sutton Printing, Box 853-M, Waycross, Georgia.

JOB Printing. Free samples, prices. McDonald, 545 N. Oakland, Pasadena 4, Calif.

GUMMED Labels, stationery. Free list. Reed, Box PM-135, Spiro, Okla.

100 LETTERS Mimeographed. Postpaid \$2.25. Send for lowest prices. Tom Ross, Big Spring, Texas.

SLASH Printing costs. Samples, huge value packed catalog free. Customprint, 4506 Bedford, Omaha, Nebraska.

LETTERHEADS, Envelopes. Free catalog. Crowley, 241 Flat Shoals Avenue, Atlanta, Georgia.

MIMEOGRAPHING, 250 8 1/2 x 11 \$2. samples. Mimeographing, 1105 Putnam, Richland, Wash.

200 BUSINESS Cards \$1.00. Lipke, 1127 Hoffman, Long Beach, California.

BOOKLETS, Circulars, letterheads, envelopes. Estimates free. Lonelm Printers, Paulding, Ohio.

MIMEOGRAPHING—Reasonable. Any copy. Mailers Service, Box 606-A, Chicago 90, Ill.

CALENDAR Cards, printed word, send stamp. Cassel, Kirbytown Road, Middletown, N. Y.

1000 #6 3/4 ENVELOPES \$5.00 C.O.D. Send for selling details. M & O, 6060 Buffalo Rd., Churchville, N. Y.

LETTERHEADS, Envelopes, statements, circulars, etc. Prices, samples. Mercury Press, Box 69, Marengo, Iowa.

MIMEOGRAPHING, Screen printing, posters (any copy), mailing. Lowest prices. Sinclair, Box 762, New Orleans 2, Louisiana.

8 1/2 x 11 LETTERHEADS. 500, \$2.50; 1000, \$4.00. Samples. D'Yarmett Printing, Newark 2, Ohio.

BILLHEADS, Statements, letterheads, 5 1/2 x 8 1/2, 2000—\$8.95, 4000—\$15.25, postpaid. Free samples. Community Press, East Aurora, N. Y.

QUALITY Printing, Stationery, circulars, booklets, publications. Free catalog. Adams, 30 West Washington, Chicago 2, Illinois.

MIMEOGRAPHING—Letters, pricelists, formulas, instructions. Lowest prices. Lem's Letter Shop, 5710 Stanton, Detroit 8.

125 8 1/2 x 11 LETTERHEADS And 125 6 3/4 envelopes \$2.00, postpaid. 250 of each \$3.50. Going Print Shop, Box 1544A, Muskogee, Oklahoma.

500 3/4 x 2 1/4 FOUR Line gummed stickers 50c. Red border \$1.00. Moritz Printery, Saginaw, Mich.

PRINTING OUTFITS AND SUPPLIES

MAKE Your own self-molding rubber printing cuts. Plexirubber, Argyle 1, Wis.

PRESSES, Type, cabinets, supplies. List for stamp. Lincoln Press Company, 220-H Hartwell, Fall River, Mass.

BLANK Envelopes. Bargain price list free. Mercury, 9800 Oglesby, Chicago, Ill.

DO Your own printing. Save money. Simple rules. We supply everything. Print for others; good profit. Raised printing like engraving too. Have home shop. Details free. Kelsey Presses, V-11, Meriden, Conn.

PRESSES, Supplies, paper. Catalog 10c. Custom, Box 211-P, Springfield, Missouri.

PRINTING Presses, type, supplies. Lists 3c. Turnbaugh Service, Loysville, Penna.

PATENT ATTORNEYS

INVENTORS—If you consider your invention to be something of importance, take steps to protect it with a United States Patent which gives you the right to exclude others from making, using and selling your invention as claimed. "Patent Protection for Inventors" outlines steps to take to secure patent protection. Mailed promptly without obligation. Victor J. Evans & Co., Merlin M. Evans, Registered Patent Attorney, 731-G Meriin Building, Washington 6, D. C.

INVENTORS—If you believe you have an invention, we can make a preliminary search on your invention and advise you whether we think it can be patented. Send for copy of our Patent Booklet "How to Protect Your Invention" and "Invention Record" form. No obligation. McMorro, Berman & Davidson, Registered Patent Attorneys, 134-S Victor Building, Washington 1, D. C.

INVENTORS: Learn how to protect your invention. Special booklet "Patent Guide for the Inventor" containing detailed information concerning patent protection and procedure together with "Record of Invention" form will be promptly forwarded to you upon request—without obligation. We are registered to practice before the U. S. Patent Office and prepared to serve you in the handling of your patent matters. Clarence A. O'Brien & Harvey Jacobson, Registered Patent Attorneys, 21B-D District National Building, Washington, D. C.

"INVENTOR'S Guide" free. Frank P. Ledermann, Registered Patent Attorney, 154 Nassau Street, New York.

REGISTERED Patent attorney offers services. Sanders, 6430 Evans, Chicago 37, Ill.

PATENTS. "Proof of Invention" free. E. E. Vrooman, Registered Patent Attorney, 507 McKim Building, Washington 5, D. C.

INVENTORS—For "Invention Record" form, contact Carl Miller, Registered Patent Attorney, Woolworth Building, New York.

INVENTORS: When you are satisfied that you have invented something of value write me, without obligation, for information as to what steps you should take to secure a patent. Write Patrick D. Beavers, Registered Patent Atty., 935 Columbian Bldg., Washington 1, D. C.

C. A. Snow & Co.—M-427, Snow Building, Washington 1, D. C. Registered Patent Attorneys. Write for information.

INVENTORS: Without obligation, write for information explaining the steps you should take to secure a patent. John N. Randolph, Registered Patent Attorney, 203 Columbian Bldg., Washington 1, D. C.

CANADA—Ramsay Company Registered, 273 Bank Street, Ottawa, Canada.

FOR INVENTORS

PATENT Searches, \$5.00, including patent copies. Same reliable search as conducted for patent attorneys. Free protection forms, 48 hour services. Patent Service Institute, 945-A Pennsylvania Avenue, Washington 4, D. C.

INVENTORS—If you believe you have an invention, we can make a preliminary search on your invention and advise you whether we think it can be patented. Send for copy of our Patent Booklet "How to Protect Your Invention" and "Invention Record" form. No obligation. McMorrow, Berman & Davidson, Registered Patent Attorneys, 134-R Victor Building, Washington 1, D. C.

INVENTORS: We can handle manufacturing and sales of good inventions. Cash your ideas. Write, Iroquois Farm Supply, Cissna Park, Illinois.

INVENTORS—If you have a valuable invention, you are advised to authorize a preliminary search through appropriate classes of United States patents. This firm is registered to practice before the Patent Office and is available to make such search and report to you concerning the probable patentability of your invention. Instructive booklet with "Evidence of Invention" form sent upon request. Victor J. Evans & Co., 732-G Merlino Building, Washington 6, D. C.

OFFICIAL Patent drawing Bristol board, 25c sheet, postpaid. Minimum order, \$1.00. Patent Drawings, Dandridge, Tenn.

INVENTORS! Let me help you develop ideas in medicine, chemistry, electronics. Confidential, ethical consultation service. Write Dr. Arthur L. Dunn, Box 24, Elmwood Station, Omaha 6, Nebraska.

INVENTORS: Let us help you sell your idea. Send 25c for our successful sales plan. Write Visioning Inc., Wells Bldg., Milwaukee, Wisconsin, Department M.

INVENTORS! For "Copyright, Design and Patent Guide" contact Mr. Metzler, 11 West 42nd, New York 18.

INVENTORS: Learn how to protect your invention. Special booklet "Patent Guide for the Inventor" containing detailed information concerning patent protection and procedure together with "Record of Invention" form will be promptly forwarded to you upon request—without obligation. We are registered to practice before the U. S. Patent Office and prepared to serve you in the handling of your patent matters. Clarence A. O'Brien & Harvey Jacobson, Registered Patent Attorneys, 21A-D District National Building, Washington, D. C.

PATENT Searches \$5.00. Record of invention forms free. 48-hour service. Write Miss Ann Hastings, P. O. Box 176, Washington 4, D. C.

INVENTORS: Without obligation, write for information explaining the steps you should take to secure a patent on your invention. John N. Randolph, Registered Patent Attorney, 202 Columbian Bldg., Washington 1, D. C.

SEARCHES—Put your patent searches in the hands of a registered patent attorney or agent, as he qualifies to give a worthwhile patentability report. Record of invention form upon request and information on patent protection. Patrick D. Beavers, Registered Patent Attorney, 936 Columbian Bldg., Washington 1, D. C.

PATENT Searches \$5.00. 48-hour service. Protection forms free. Write Raymond L. Smith, Patent Searcher, 410 Bond Building, Washington 5, D. C.

INVENTORS — For "Invention Record" form, contact Carl Miller, Registered Patent Attorney, Woolworth Building, New York.

CASH For your idea, 280 manufacturers need inventions, patented or unpatented. List free. Invention Bureau, 208M Clinton, Oak Park, Ill.

PATENT Searches \$5.00. Protection forms free. Patent drawings prepared. Write Patent Engineering Service, 1404 New York Avenue, Washington 5, D. C.

INVENTORS: If you have an invention for sale, patented or unpatented, write Institute of American Inventors, Dept. 40A, 631-E St. N.W., Washington 4, D. C.

INVENTIONS WANTED

ENGINEERS, Registered professional, independent, will assist commercialization your invention. Write or consult A. B. Court, 690 Market, San Francisco 4.

PRODUCTS, Mechanical, chemical; financed, marketed. No fees. Details free. Paisley, 2030 Chestnut, St. Louis, Mo.

INVENTIONS Wanted. Patented or unpatented. Write for details. Global Marketing Service, 1404 Mitchell Street, Oakland 1, Calif.

HIGHEST Cash and royalties. Inventors having unpatented, patents for sale request free booklet. Inventors Creative Service, 354 South Spring Street, Los Angeles 13, Calif.

INVENTIONS Wanted. Patented or patent pending. 21 years experience promoting inventions. National Service Bureau, 3120 Meramec, St. Louis 18, Mo.

INVENTORS — Good patented, patent pending inventions wanted by manufacturers. Booklet free. Market Contacts, 719-A2 Magnolia, Tupelo, Miss.

INVENTIONS Wanted by manufacturers. Patented-pending only. Free details. Inventors Exchange, Dept. B, Hartford 1, Conn.

INVENTIONS Promoted. Patented or unpatented. Established 1911. Write Adam Fisher Company, 61 Enright, St. Louis, Mo.

INVENTORS: Hundreds of manufacturers have requested our assistance in locating marketable new products. Complete information free. Institute of American Inventors, Dept. 40-D, 631-E St. N.W., Washington 4, D. C.

CASH In on your ideas! Learn which inventions are profitable: how to sell or finance and market your invention. Send only \$2.50 for the big 144-page book "Money From Ideas," a primer on inventions and patents by a real, successful inventor. Popular Mechanics Press, Dept. 104, 200 E. Ontario St., Chicago 11, Ill.

PATENTS FOR SALE

SELF-Feeding skate sharpener. Patented in United States and Canada. Omer Devau, Derby Line, Vt.

INVENTORS: Test the commercial value of your patented or unpatented inventions, quickly and inexpensively. Write for free information. Institute of American Inventors, Dept. 40-B, 631-E St. N.W., Washington 4, D. C.

MANUFACTURING

ENGRAVING, Models, small lot manufacturing. Designing. Specialty Machine, 1600 Junction, Racine, Wis.

MODELS — Small lot manufacturing. Metals, plastics, etc. Milburn, Burlington, Kentucky.

MODELS, MODEL SUPPLIES

MODEL Turbines and boilers. Folder describing ready-built steam plants, reduction gears, etc., 5c. Russell L. Hutchens, Box 14, Peak Island, Maine.

POWER Models. Unusual steam, gasoline and traction engines. Metals, tools, accessories. Catalog 50c. Chas. Cole, Ventura, Calif.

STEAM Engines, boilers, castings. Catalog 25c. Anton Bohaboy, 2297 Price, Rahway 7, N. J.

RAILROAD Photo albums. Model making tools. List for dime. Refunded. Frederick Woods, Livingstone, Beverly, Mass.

STAGECOACH, Surrey, horses, 20 kits. Folders 10c. Sample buckboard \$1.00. Tontz' Country Store, Elsinore 10, Calif.

FREE. Examine without cost leading model railroad reference book—"Manual and Catalog of All Gauges." 144 big pages—valuable data. Beautifully printed. Lots of pix. How-to-do-it articles. After ten days either remit \$2.00 or return book. Model Railroad Equipment Corp., Dept. M, 23 W. 45th St., New York 19, N. Y.

BUILD Historic ships, vehicles. 50c to \$9.00 kits. Illustrated catalog 10c. Ideal Models, 19 West 18th Street, New York 11.

SHIP And yacht model fittings; blueprints. Send 25c for illustrated catalog No. 27—listing hundreds of items. A. J. Fisher, 1002-1 Etowah Ave., Royal Oak, Mich.

LIONEL American Flyer, illustrated catalog free. Ben's PM Department, 134 North Dearborn, Chicago 2.

SHIP Models and yacht supplies complete. Large 64 page catalogue 30c. Bill Wild's, 510 East 11 St., New York City 9.

STEAM Locomotives, 1½", 1", ¾", ½" ¼" scales. Castings, rail, steam fittings! Thorough drawings with instructions. Catalog 50c. Little Engines, Wilmington, California.

HOME CRAFTSMEN

COLONIAL Reproductions—Full size jig saw patterns (32) early American shelves, trays, stands, cupboards, etc. Easily built. Useful. Saleable. Only \$1.00. Vosbury Patterns, M.R. 95, Binghamton, N. Y.

FIRST Time offered—Big savings in top grain cowhide leather at special "tannery to you" prices. Full sides, (a half of a hide) for decorating home furnishings, for making useful household articles, and for leathercraft hobbyists making billfolds, purses, belts, handbags, brief cases, gun cases, moccasins, holsters, etc. Take advantage of these amazingly low "tannery to you" prices being offered for the first time by one of America's oldest, largest tanneries. Write today for complete information. Address Department 2, W. D. Byron & Sons of Maryland, Inc., Williamsport, Maryland.

RARE Wood. Featuring this month these beauties from the far corners of the earth: English Grey Harewood, Brazil Rosewood, East India Satinwood, African Mahogany, Balsawood. All kiln dried, best grade obtainable. 1" thick or resawed. Also 4 x 6 x 18 or longer African Mahogany carving blocks. Write for prices. T. W. Caudill & Co., 245 State St., Auburn, N. Y.

16 NEW Lawn chairs, 22 picnic tables, benches, trellises, etc. All 38 plans with necessary full size patterns, \$1.00. Mastercraft, 63M, 7041 Olcott, Chicago 31, Ill.

WOODCRAFT Patterns — Assortment large whatnot, lawn ornament, windmill, toy, novelty patterns. Only \$1.00. Joanes, Box 141-N, Omaha 7, Neb.

FULL Size patterns, furniture, toys, whatnots. Picture catalog 10c. J. M. Willard's, Canoga Park, California.

89 FULL Size jig saw patterns of beautiful shelves, ornaments, toys, novelties. Plus "How, Where to Sell." Only \$1.00. Mastercraft, 64M, 7041 Olcott, Chicago 31, Illinois.

FULL Size patterns for book ends, pet feeder, shoe rack, shopping cart, \$1.00. Willard's, Canoga Park, California.

EASY. Build authentic colonial 16" x 18" wall magazine rack. Shaped mortised pine parts, supplies, instructions for \$3.75 ppd. Literature free. Rak Makers, 200 Union, New London, Conn.

OUR Biggest leather and craft catalog yet! 1000's of items. Send 25c (refunded with first order). Russo Handicraft Supplies, Dept. 6-C, 245 S. Spring, Los Angeles, California.

JIGSAW Owners attention! Start earning money at home cutting out wooden novelties and souvenirs. Write H. Cook, Dept. A, 4407 S. Normal Ave., Chicago 9, Illinois.

EARRING Screwbacks 30c dozen, \$2.25 gross. Large, medium, small. Postpaid. Quality guaranteed. Folsoms Jewelry, 11 Oakland St., Medford, Mass.

90 ALL New, full size lawn ornament and novelty patterns, up to 20" high. Only \$1.00. Mastercraft, 62M, 7041 Olcott, Chicago 31, Illinois.

LEATHERCRAFT For pleasure or profit. Make easy-to-assemble purses, belts, gloves, woolskin toys, 100 other items for gifts or to sell. Send 10c today for big catalog. Largest leathercraft stock in U.S. J. C. Larson Co., 820 S. Tripp, Dept. 2150, Chicago 24.

SWISS Musicbox movements, 22 note \$3.75; clock movements, cuckoo clock parts. Price list 10c. Pierlot, 1010 S. Fir, Inglewood 1, Calif.

MOLD Making simplified for concrete flamingos and duck sets. Instructions and illustrations \$2.00. Stanley Both, Bay-View Rd. 5, Hamburg, N. Y.

SHELLCRAFT Catalogue and eighteen late designs 25c, refunded first order. Rice's Shellcraft, Dept. B, 1711 N. Mills St., Orlando, Florida.

CYPRESS Knee. Lamp size \$1.00. Cy Products, Ella Street, Lafayette, La.

30 LAWN Ornament patterns. Ready cut. Full size. Color indicated. \$1.00 postpaid. Lincoln Craft Studio, Columbia, Conn.

LEATHERCRAFTERS: Beautiful tanned snake skins, kits, finished products. Tex Harris Snake Farm, Box 424, Warsaw, Indiana.

FREE Shellcraft catalog, Shell instruction book 35c. "Secors," Bradenton Beach, Florida.

WOODWORKING Patterns, full size. Large assortment \$1.00. Sample 25c. Duty free. Mosbro Patterns, 44-M, Victor, Mimico, Ontario.

LEATHERCRAFT, Textile painting, beadcraft, shellcraft, many other crafts. Big free catalog shows everything you need. Kit Kraft, 7377 Melrose, Hollywood 46, Calif.

LEATHERCRAFT. Tremendous stock of leather, tools, supplies, and kits. In leather business over forty years. Send 10c for big catalog. Sax Bros., 1111 No. 3rd, Dept. PM, Milwaukee 3, Wisconsin.

MINIATURE Furniture kits. Solid cherry. Easily assembled. Large selection. Catalog 20c. Culver Miniatures, 194 Sixty First St., Dept. A, Niagara Falls, N. Y.

LEATHERCRAFT Bargains! Lacing. Francis Byrd, 3406 Montrose Ave., Richmond, Va.

VIOLINMAKERS. Amateurs, professionals. Fine tone European wood, materials, supplies, instructions, patterns. Illustrated catalogue 10c, refunded. Premier Violin Supplies, Dept. VZ, 430 South Broadway, Los Angeles 13, California.

"TOPS" In everything for leathercraft. Low priced kits, leathers, tools, lacing. Catalog 10c. Crown Leathers, 22 Spruce Street, New York 38.

FREE Information. How to make money with jig saw. Write Jigsaws, 117-M Worth, New York 13.

WHOLESALE Shellcraft book 15c. Large shellcraft kit \$1.85 postpaid. Shell-Art Novelty, 5th and Moore, Philadelphia 48, Penna.

\$46 FROM Square foot plywood; jig saw necessary. Write: Woodarts, Bridgewater, Mass.

KNOCKDOWN Cedar chests. Lumber and veneers. Free price list. Giles & Kendall Company, Huntsville, Ala.

LEATHERCRAFT Supplies catalog. Pleasure and profit. New style handbag patterns, belts. Leathercraft school G.I. approved. 25c for catalog (refund 1st order). Dept. PM, Apache Leather Co., 2004 E. Washington St., Phoenix, Arizona.

LEATHER. Tools, lacings, supplies. Free catalog. National Handicraft, 199 William St., New York 7.

FREE Giant Popular Mechanics 40 page Golden Anniversary Book Catalog! Over 400 books on workshop planning, home building, household repairs, projects, motor, sports, photography, money making opportunities, machinery, inventions, crafts, hundreds more. Many not available in stores. Send postcard today to Popular Mechanics Press, Dept. 110, 200 E. Ontario, Chicago 11, Ill.

MAKE IT YOURSELF

COMPLETE Plans, California style home. \$5.00. Joseph Kiktavi, Box 381, Palm Springs, California.

BUILD Inexpensive concrete blockmaker. Motor, hand. Write: C. Lee, Mountain View, Oklahoma.

BUILD Real refrigerated room air conditioner from refrigerator parts. Plans \$1.00. T. B. Fairey, 1-C Charles Street, Woodside, Greenville, S. C.

THIRTY Individual pipe patterns 2" to 10"; suitable for tracing. \$2.50. 613 E. Jefferson, Ville Platte, La.

HAND Protecting cream from grocery store items. Keeps out dirt. Working hands wash clean. Free "Blendol" with formula. \$1.00. BonArt, Lake Orion 3, Michigan.

ATTIC Fan kits, write for free list. McLean Engineering, Princeton, New Jersey.

SEE "Kimo Handbook" before building machinery. Satisfaction guaranteed. 25c (refundable). Box 307-P, New York 19.

GRANDFATHER Clock easily built. Big savings. See ad on page 253.

NEW Admiral streamline refrigerator cabinets \$39.50. Metro, 44 North Albany, Chicago.

MECHANICS Handbook plans, tips, formulas 25c. JSSCO, 2623 Columbus, New Orleans, La.

FREE Handbook. Build sawmills, block machines, freezers, tractors, scooters. Nichols Company, Purvis 2, Miss.

"CONCRETE Block Homes." 32-page booklet, on how to build. \$1.00. H. C. Lightfoot, Civil Engineer, Richboro 1, Penna.

HOW To build most maneuverable small riding tractor in use. Low cost. Easy to build. Turns around inside three foot circle. \$1.00 on how to build with manufacturer's patent plans. Turn-O-Bout, 1668 Willamette, Eugene, Oregon.

MAKE Your own "Stone-Veneer." Economical. Easily made, quickly applied. Looks like genuine stone. Transforms any home into one of excellent beauty. Formulas, illustrations, patterns. Alburg, Box 17, Carrollton, Mich.

\$750 BUILDS Cozy 4 rooms and bath; concrete block, stuccoed. Instructions and blueprint \$1.00. Farrow, G83, Box 645, Columbus 16, Ohio.

SEND 25c Today for new large catalogue of supplies for 21 popular crafts. Dept. D-11, Dearborn Leather Company, 8625 Linwood Avenue, Detroit 6, Michigan.

BUILD Your own "tractor." Free information. Eltraco, D-1, Camptonville, California.

HOMES You can build for \$4500 to \$7046. Books that take you through every step. Popular Mechanics Famous Concrete Block House, \$2.00. Your Home and How to Build It Yourself, \$3.00. Also full-sized builder's plans for each home at nominal price. Popular Mechanics Press, Dept. 102, 200 E. Ontario St., Chicago 11, Ill.

WATCHES, OLD GOLD, JEWELRY

WATCHES Completely repaired \$4.50. Guaranteed. Berkowitz, 1150 Castlehill, Bronx 61, N. Y.

UNREDEEMED Diamond, 1-carat, \$295. 30-day refund. Free catalog. Broff's Diamond Loan Association, 411 Smithfield, Pittsburgh, Penna.

RHINESTONES. Jewelry settings, cameos, sequins, beads. Send 10c for illustrated catalog. J & M Novelties, Dept. CG-3, Griffith, Ind.

PEDOMETER For scouts, hikers, athletes. Registers the miles you walk up to 100. Adjusts to length of stride. Constructed like a watch. Nickel finish, handy clip hooks to pocket or belt. \$7.00 complete postpaid. Enright, 3074 Kensington Ave., Philadelphia, Penna.

EARN \$7.00 Chronograph wrist watch! Easy. Box 267, New York 5, N. Y.

WATCHMAKERS', Hobbyists' complete informative catalog 20c. Bengal Company, Culver City, Calif.

5000 JEWELRY Styles, you can easily make yourself—Pins, earrings, bracelets, rings, matched ensembles. Instructions and catalog 10c. Barrys, 101 Ardsley Court, Newark, N. J.

HIGHEST Cash paid for old, broken jewelry, gold teeth, watches, silverware, diamonds, spectacles, platinum. Free information. Satisfaction guaranteed. Rose Smelting Company, 29-A East Madison, Chicago.

TOBACCO, SMOKERS' SUPPLIES

50 CIGARS, \$2.25. Irregulars of a popular brand. Others. Public Cigar Co., East Orange 1, N. J.

CIGARETTES—Roll 200 mild-satisfying for 75c. Particulars free. Pete Moberly, Box 850, Owensboro, Kentucky.

FOR SALE—MISCELLANEOUS

NOISE. New ear sound filter. Hear conversation but stop loud noises. No wires, batteries, lasts indefinitely. Protect your health, increase your efficiency, comfort. Free details. Anza Company, 3560A 20th Street, San Francisco 10, California.

FULL Automatic tractor hitch combination. Patent pending. Ernest Sharr, Braddyville, Iowa.

CHROME Cabinet hardware. Bathroom accessories. Push button spraying enamel. Write Box 89, Troy 2, Ohio.

MEN'S Supplies of soap, blades, lotions and many other useful masculine needs may be had at large saving. Post card for our list. Sullivan Sales, Box 5655, Chicago Ill.

THE World's most amazing catalog. 230 fantastic pages of sensational bargains at savings up to 85% in war surplus and factory close-outs. Values in general merchandise such as clothing, housewares, hand and power tools, foam rubber, outdoor and camping equipment, photo supplies, plastics, metals, hydraulic cylinders, valves, pumps and many hundreds more. Send only 50c to cover handling and mailing. Palley Supply Co., Rm. 14, 2263 E. Vernon Ave., Los Angeles 58, Calif.

SAVE Money on army, navy and factory surplus. Write today for new 48-page illustrated catalog. Tennusa Sales Co., Dept. AN, 1451 Market, Chattanooga, Tenn.

WANTED—MISCELLANEOUS

SCRAP Mercury (quicksilver) tantalum, bismuth, tungsten. Metallurgical Products Company, Established 1909. 35th & Moore Sts., Philadelphia 45, Penna.

PERSONAL

LETTERS Remailed or replies forwarded 25c each. Monthly rates \$2.00. McLaughlin, 369 Welch, Columbus 7, Ohio.

BORROW By mail. Loans \$50 to \$600 to employed men and women. Easy, quick. Completely confidential. No endorsers. Reply in convenient monthly payments. Details free in plain envelope. Give occupation. State Finance Co., 323 Securities Bldg., Dept. M-14, Omaha 2, Nebr.

CUT Your own hair. Price \$2.50. Nothing else to buy. Lasts forever. EOK-Hair-cutter, Box 2902, Los Angeles 54, Calif.

ASTONISHING four-eyed portrait of yourself. Laugh provoking optical illusion (8x10) to startle your friends who see double. Send photo (returned) and \$1.00 to Hiawatha Studios, Dept. D1, Red Wing, Minnesota.

MEXICAN Law. General Practice Attorney, 1203 Arizona St., El Paso, Texas.

PERFUME — Wholesale only. World's finest French-type perfumes. Distributors wanted. Catalogue, details, generous sample 25c. Elliott-Stuart Limited, 4616 Hollywood Blvd., Hollywood 27, California.

PRINT Without a printing press. Big profits! See page 43.

LETTERS Remailed 25c each. Mail received and forwarded \$3.00 month. Vandal Williams, Big Bend National Park, Texas.

PARIS Remail, 3 letters \$1.00. D. Sloan, 14 Rue D'Abbeville, Paris X, France.

"HOW Can I find out?" You can! Information discreetly developed. Any matter, person, problem, anywhere. Worldwide. Officially licensed, bonded service. Established 1922. Reasonable. Confidential. William Herman, 170 Broadway, New York.

HERE'S How and where to borrow \$50.00 to \$300.00 by mail. Confidential. Free particulars. Postal Finance Company, Dept. 45, Sioux City, Iowa.

MEXICAN Law practice reliably conducted. Box 1736, El Paso, Texas.

MISCELLANEOUS

INDISPENSABLE Kits. Tool, Fishing, Hobby, Outdoor. Free catalog. Trader Lewis, 105G East Delaguerra, Santa Barbara, Calif.

CESSPOOL Trouble? Start leaching and weeping process by instilling Sursolvent, the miracle cesspool and septic tank reconditioner. Saves pumping. Reduces odors. Opens clogged pipes. Reclaims old systems to a condition approaching newness. Simple to use. Mix with water and pour down sink. Write for descriptive literature. Electric Sewer Cleaning Co., Boston 34, Mass.

INCREDIBLE! Unprecedented! Become a mental superman overnight! Floor everybody! No studying! "Memoprop" does all your thinking! It's uncanny! Revolutionary! Write: Bijou, Box 1727-MS, Hollywood 28, California.

LABELS. Small corrugated cartons. Smith's, 1040 South Westlake, Los Angeles, California.

YOUR Leather jacket renovated expertly. Free circular. Berlew Mfg. Co., Dept. 8, Freeport, N. Y.

RECEIVE Mails, magazines, samples. Your name in numerous mailing lists 20c. Wallace Greenwood, 273 Broadway, New York 7.

SQUARE Dance instructions, thirty dances, \$1.00. Wesley Rader, 3926 Alcott, Denver 11, Colorado.

GET Plenty power from new kind, low, homemade windmill. No mortising, riveting, welding. Write: Ziembak, 6123 Orchard, Dearborn, Mich.

PARDNER. How'd you like a California trip for a dollar? Browse through colorful 4-in-one gift packet. Pictorial map of 66 outstanding southern attractions. Ghost Town annual magazine, rare pictures, maps, true tales. Authentic. Four souvenirs. All postpaid \$1. N. F. Wilson, Box 115, Ghost Town, Buena Park, Calif.

"SUN & Fun Magazine" (paying hobbies) 15c. M. Pennebaker, Kerrville, Texas.

LEATHERCRAFT. Everything needed by beginners, advanced hobbyists and professional leatherworkers. Largest stock of supplies in U.S. Moderate-priced tooling leathers, top quality calfskins, tools, supplies, kits. Send 10c for big catalog. J. C. Larson Co., 820 S. Tripp, Dept. 2151, Chicago 24.

EASY Simplified bookkeeping system. Accurate. Amazing for small business. See page 30.

CUT Your husband's and children's hair, save on barber bills, new 7½ inch comb device. Barbour, 134 South Jefferson Avenue, Peoria 2, Illinois.

BIG Mails, mail order magazine opportunities 25c. Harvey Teeple, Decatur, Indiana.

LEARN Sharpening and adjusting hand and power lawn mowers yourself. \$1.00. Wirt's, 2419 Gnahn, Burlington, Iowa.

SELECTIVE Metal and mineral detector. Revolutionary design. Distinguishes metals from black magnetic sands. Readily detects metals under salt water. Free literature. Gardiner Electronics Company, Department 12, 2018 N. Dayton, Phoenix, Arizona.

QUALITY Ties, 3 exchanged for 3. \$1.00. Elliott, Rockton, Ill.

FREE Catalog! War surplus clothing. Amazing bargains. N. Y. Clothing Co., New York 29A.

CESSPOOL Trouble? Use Peps-It. Saves pumping costs, deodorizes, reduces masses. rejuvenates fermentation action. Safe. Sanitary. Free descriptive literature. Costs only \$2.50. Chemical Cesspool Cleaning Co., Boston 34, Mass.

VERMONT Maple syrup, pints \$1.35 postpaid. Sugar and cream. 100% pure. Butternuts, hickorynuts. List. Marshall Maples, Poulitney 5, Vt.

RECEIVE Giant mails, magazines, catalogs! Three months 25c, year 50c. Waddell's Directory, 341B East 76th, New York 21.

GOLD. Silver, metal detectors. Geiger counters for uranium. Mineralights. Sensational new fully guaranteed models. None finer. Information free. Detectron Co., 5631 Cahuenga Blvd., North Hollywood, California.

LEATHER Jackets repaired. New knit, zippers or relined. Work fully guaranteed. Jackets made to order. Free circular. Taubers, 689 Mission, San Francisco 5, Calif.

OUTDOOR Toilets, cesspools, septic tanks cleaned, deodorized with amazing new product. Just mix dry powder with water; pour into toilet. Safe, no poisons. Save digging, pumping costs. Postcard brings free details. Burson Laboratories, Dept. C-36, Chicago 22, Illinois.

TREASURE Finders for gold, silver and minerals. Money back guarantee, best available. Also Geiger counters for uranium prospectors, free information. Write Goldak Company, 1541 West Glenoaks, Glendale 1, Calif.

PANNING Gold lesson and catalogue. Beginners supplies, books, "maps where to go" free. Old Prospector, Box 729D1, Lodi, Calif.

TREASURE—M-Scope Geiger counters, mineral locators. Why buy something inferior when you can buy the best at a lower price? Backed by years of experience. Fully guaranteed by factory. Detects minerals, metals, gold, silver, coins. Payment plan available. Proven superior performance. Free 16 page illustrated booklet. Fisher Research Lab., Inc., Palo Alto, California.

WALKIE TALKIES! — \$4.99 COMPLETE SET OF 2
POCKET SIZE — ELECTRONIC VOICE POWERED

No tubes, batteries, adjustments. Guaranteed to work anywhere up to 1/4 mile with extra wire. Swell for room to room—garage to house, etc. Your own private, talk-listen phone. Not war surplus. Brand new. Guaranteed. Two complete units with interconnecting wire — **READY TO USE!**

SEND \$1.00 deposit and pay postman \$3.99 plus postage charges or send \$4.99 for postpaid delivery. Available only by mail from **MIDWAY COMPANY, Dept. WPM-6, Kearney, Nebraska**



I'LL PAY YOU TO "GIVE AWAY" NYLONS AT 49c!



REPLACEMENT OR REFUND OF MONEY
Guaranteed by Good Housekeeping
IF NOT AS ADVERTISED THEREIN

Did you ever hear of first quality full fashioned nylon stockings at 49c a pair? Yet, that's all they cost if they run or snag within guarantee period up to **THREE WHOLE MONTHS!** I'll pay you advance cash plus 40% bonus just for writing orders in spare time! We deliver and collect.

FREE SAMPLE STOCKING!

I'll give you sample stocking and everything else necessary absolutely **FREE!** I'll even pay the postage. What's more, you need promise nothing. The whole outfit is yours, no obligation. If you don't make enough money, just throw it away!

I don't care if you are 18 or 80 — if you can spare one hour or 50 hours a week. Man or woman — spare or full time — **YOU** can make a steady cash income that can solve all your money problems. Just mail postcard with name and address to:

Michael H. Kent, President
KENDEX CORP. BABYLON 546, N. Y.

It's New!
Tells Direction
Tells Time

Guaranteed WRIST WATCH With Jeweled COMPASS

The most practical watch ever devised for **OUTDOOR MEN!** Guaranteed accurate timekeeper with a dependable compass right on the dial. Check your direction at a glance. Features gleaming chrome-plated case, non-shatter crystal and embossed genuine leather strap. Ruggedly built for rough, outdoor treatment! Order today.

SEND NO MONEY
Just send name, address. We ship immediately. Pay postman plus postage. Or send cash, check or MO, **WE PAY POSTAGE.** Try 10 days **AT OUR RISK.** Return for prompt refund if not 100% satisfied.

Introductory Offer \$7.95 Plus 80c Fed. Tax

YOUNG PRODUCTS Dept. 445, 2605 Elmhurst, Detroit 6, Mich.



New SPARK PLUG TESTER

TEST your own PLUGS!
• Save time—money
• Convenient—easy to carry, only 5" long
• Mechanical pencil on one end

ONLY \$1.50 P.P.
Made on New Ultra-High Frequency principle. Forms miniature radio receiver. A reliable indicating device, will only respond to performance of Spark Plug inside Motor. Reveals whether Plug is sooted—greasy or short-circuited. Easily, Quickly and Safely. Check before replacing plugs.

WESCO SALES 5864 Hollywood Boulevard Dept. PM-6 Hollywood 28, Calif.



STOP BURNING OIL
With Fisher's Compression SEAL

Why pay more when you can get Fisher's Compression SEAL—for less!
SATISFACTION GUARANTEE
Accept no substitutes! Only Fisher's Compression SEAL gives you their exclusive Satisfaction Guarantee.

A small amount of Fisher's Compression SEAL in each cylinder bore will give you the economies of smooth, powerful (new car) performance and reduced oil consumption. \$25,000 indemnity insurance policy is your assurance it cannot harm the finest engine. Simple to apply.

Only \$3.95 postpaid. Order today. Send cash, check or M.O. Free Folder. **Dealers Inquire.**

\$3.95 post-paid

ADVANCED ENGINEERING Dept. PM-6, Box 7013 Los Angeles 37, Calif.



SAVE 70%

SACRIFICE SALE!

**MUST RAISE CASH!
CREDITORS DEMAND PAYMENT!**

Frankly, we're in a tight fix! Thousands of 17 jewel precision-built watches came in too late for last Christmas and far too early for the next! Our creditors won't wait! They demand payment NOW. Our misfortune is your lucky break! Buy now! Save up to \$70.00 on one watch!

10 DAY FREE TRIAL

Examine . . . check . . . appraise any THORESEN watch for 10 days at no risk whatsoever! Full price back if not delighted. **SEND NO MONEY**—Pay price plus postage on arrival. Or send check, cash or money order for quick, prepaid delivery and **SAVE MORE!** Given: **COBRA** Expansion band with every watch, also instructions, Guarantee Certificate and gift shown. Rush coupon now! Prices subject to rise after present over-stock is exhausted. References: Jewelers Board of Trade, Better Business Bureau or any national bank. Buy with confidence! Thoresen's is a reliable, nationally known firm. Address:

THORESEN DIRECT SALES, Dept. 6-FB

131 WEST 33rd STREET

NEW YORK 1, N. Y.

IMPERIAL DELUXE MODEL 18 kt. Rolled GOLD PLATE

CHRONOGRAPH 27²⁵

TIMES: SPORTS • PHOTOGRAPHY • LAB WORK • SHOP WORK, ETC.

This is the **IMPERIAL** model of the **Recipro-Register Chronograph**—the **BEST** brand available anywhere in the world today! Thousands of proud owners paid much, much more because this is the **Prince** of modern watches—the last word in magnificent styling. Case made of **18 Karat rolled GOLD PLATE** with lasting **Stainless Steel** back! Precision engineered in the highest traditions of Swiss craftsmanship! A smart, slim unusual timepiece of functional beauty. It's the **"CHRONOGRAPH THAT REMEMBERS!"** Freezes result while movement continues to keep time!

CHECK FEATURES WITH \$100.00 WATCHES!

- 5 Multifunction Dials
- Luminous No.'s & Hands
- Hairline Sweep Second
- Unbreakable Crystal
- 17 Jewels
- 18 Kt. RGP
- 5 Hands
- Incabloc
- Split Second Calibration
- 2 Clutch Operation
- Anti-Magnetic
- Shock Protected

DON'T PAY \$100.00 or more to a credit jeweler around Christmas time! Get the Genuine, Original **RECIPRO-REGISTER** at our **SACRIFICE PRICE** for cash—\$27.25 plus 10% tax, total: **\$29.98** (while stocks last). **YOU SAVE OVER \$70.00.** Given: Nationally advertised \$4.95 **COBRA** expansion band, gift case, instructions and our written guarantee as well as German made **KLARO-VIS** field glasses! Don't lose this bargain of a lifetime—send **TRIAL COUPON—NOW!** Check Number **233-18 K.**



17 JEWELS • EXTRA-THIN AND MODERN AUTOMATIC CALENDAR WATCH 14⁹⁵ plus tax

The month, date, weekday, hour, minute and second are yours at a glance with this Swiss engineering triumph! An impressive, very thin timepiece of real excellence!

Date Changes Automatically! Gears are precision coupled. Patented design for smooth long-life operation.

SPECIAL QUALITY FEATURES

- 17 Jewel Swiss movement
- Stainless Steel Back • Unbreakable Crystal • Thin, Streamlined Design • Luminous Hands & No's • Rugged Construction

Compare with other calendar watches selling for \$59.50, and if you are not thrilled with its performance and rich, modern appearance, return for full price refund! While they last, we're sacrificing them at only **\$16.45**, plus \$1.30 tax, a total of only **\$17.75**. Where, oh where can you get a value like this? Better rush that Coupon now! Order by number **243-C.**

17 Jewel Incabloc WATER & SHOCK Resist Watch 12⁹⁵ plus tax

A favorite with Marines, Sailors, Soldiers, Aviators and sportsmen! Drop it, wet it, jolt it at work or play! It actually runs under water! This is no ordinary watch—it is a splendid timepiece made according to exacting standards in reputable Swiss factories. Thousands sold at much higher prices.

COMPARE WITH WATERPROOFS AT \$59.50

- Incabloc Protected
- Shock Absorbing
- Water Gasket
- Shock Absorbing
- Accurate
- No's.
- Luminous Hands
- Unbreakable Crystal

rate, better made than many competitors' watches selling for much more. **DO NOT CONFUSE** with cheap quality timepiece — Your money refunded at once — if not satisfied! Best of all, you save \$46.55 during our sensational Sacrifice Sale! Only **\$12.95** plus \$1.30 tax, total: **\$14.25**. Quantity limited! Order at once by number **224.**



SEND NO MONEY! Mail Coupon now for home trial!

THORESEN DIRECT SALES, Dept. 6-FB
131 West 33rd Street, New York 1, N. Y.

RUSH watches checked on 10 DAY TRIAL. Send following **FREE** of extra cost with each and every watch purchased: 1. Reg. 4.95 **COBRA** Band. 2. **KLAROVIS** German Glass. 3. Guarantee Certificate. 4. Gift Box. 5. Instructions.

- Payment enclosed. Send prepaid. Send C.O.D., plus post.
- No. 233-18K **CHRONOGRAPH**—\$29.98 No. 224 **INCABLOC**—\$14.25
- No. 243-C **CALENDAR**—\$16.45

You are to refund **FULL PURCHASE PRICE** if I am not delighted, keeping the "Klarovis" as your gift to me.

NAME _____

ADDRESS _____

TOWN _____ STATE _____

UNCONDITIONAL GUARANTEE

EXCLUSIVE OF PARTS!

FREE repair service ANYTIME if needed by skilled watchmakers—for the **LIFETIME** of this firm. No cost ever for "handing," adjustment or service. **FREE** annual oiling and timing service. **THORESEN** makes **LIFETIME FRIENDS!** Remember: If you are not satisfied with your purchase after 10 day trial, return for full price refund. Our written Guarantee Certificate enclosed with every watch!

*Most Wonderful
Money-Making
Plan I Ever Saw!*



\$15-\$20 in a few SPARE HOURS

UP TO \$210 A WEEK FULL TIME



**Easy with Amazing
D-FROST-O-MATIC**

"Never defrost your refrigerator!"
—4 magic words that can pay you as much as \$15.00 to \$20.00 and more in just a few hours showing housewives how amazing D-FROST-O-MATIC ends forever the messy, sloppy, time-wasting task of defrosting by hand!!

D-FROST-O-MATIC makes any electric refrigerator AUTOMATICALLY SELF DEFROSTING! And talk about easy sales! Just plug in D-FROST-O-MATIC, tell the housewife to "try it before you buy it" and when she sees how D-FROST-O-MATIC saves time, work, food, and money—she won't let you take it out! That's why 9 out of 10 FREE TRIAL installations are almost certain sales with big cash profit for you. Many D-FROST-O-MATIC men sell 5, 7, 10, and more units IN A DAY on this sure-fire FREE TRIAL Plan!

Rush Name Today for Profit Details and FREE TRIAL PLAN!

More than 29,000,000 prospects waiting! Rush your name and address today. We'll airmail exciting facts, proof and sure-profit Free Trial plan. No obligation. Write today.

**D-FROST-O-MATIC, Dept. J-6
173 W. Madison Street, Chicago 2, Ill.**

SELLY of California started in his spare time and now sells 1500 D-Frost-O-Matics a month!

GIANT BALLOONS

Genuine government surplus weather and target balloons. For fun or profit. Great sport in the back-yard; or for parties, dances, fairs, picnics. Money-makers whenever you want to attract a crowd, for lodges, civic events, school functions, conventions, exhibitions, trade shows. Special purchase makes these prices possible. Add 10% for postage & handling.

3 Ft. Dia. **39c** - 6 Ft. Dia. **79c** - 13 Ft. Dia. **\$1.39**

AQUA GOGGLES

Be a frog-man, double your swimming fun. See the many miracles of the deep. With under-water "clear vision" you can play tricks on your friends. These same goggles used by pearl divers, marine observers, distance swimmers. Large glass lens, vacuum fit, adjustable for comfort. Protection against chlorine & salt water. Natural sea-green rubber, only **\$1.25**



Genuine U. S. Air Force 6 base Rose smoke sun glasses, a \$12.50 value for **\$3.95**
USAF blue lens sun glasses same style as above **\$2.79**
Nite driving glasses, USAF frame **\$1.95**

Add 10% for postage & handling —
Calif. residents please add Sales Tax

WAR ASSETS DIV. Volume Sales Co.
Dept. M-6-52, 3930 Sunset Blvd., Los Angeles 29, Calif.



PARAKEETS
(Rare Little Talking Birds)

Yes, genuine Australian Shell Parakeets ("Budgies") in your choice of yellow, green, blue! These amazing birds sing, whistle, talk, do tricks. Ideal pet and companion, wonderful gift — especially nice for children and shut-ins. They're small (about 7" long), hardy, clean, long-lived. Easy, inexpensive to raise—less than a penny a day! Talk better than parrots, often learn 400 words or more. These are all young birds, just the right age to start learning words and real characters!

tricks. Teaching is easy, too—parakeets are natural mimics, learn fast, just love to "show off". They're amusing . . . entertaining . . .

ORDER YOUR PARAKEET BY MAIL TODAY!
Only \$9.95 each, complete with training book ("The Talking Budgie") and month's supply of feed. Check, money order or C.O.D. Prompt Express delivery (charges collect). Book alone, \$1.00. **GUARANTEE:** your bird must please you completely, or return within 10 days for immediate refund.

HOUSE OF PARAKEETS
304 KANSAS AVE DEPT. B-29 TOPEKA, KANSAS



AMAZING NEW RADIO
POCKET SIZE

COMPLETE AS SHOWN—NO TUBES—BATTERIES OR ELECTRIC "PLUG-INS" NEEDED
—Has new Crystal Diode and speaker-phone! Selective Clear tone. Gets local stations most anywhere you go. Should last for years. Send \$1.00 and pay postman \$3.99 C.O.D. postage or send \$4.99 for p.p. delivery. **GUARANTEED.** Rush order now!

MIDWAY CO.
DEPT. PPM-6 KEARNEY, NEBR.



DO OWN MODERNIZING *save 50%*

Do your own home repainting, modernizing. Don't be robbed by sky-high labor costs. Giant new book shows how to save hundreds of dollars. Make space-saving cabinets, install picture windows, add new porch, convert attic into modern rooms, put on new roof, siding, insulate and save on fuel. How to do concrete work, build own garage, even complete new home. Reduces jobs to simple, easy steps. Over 1100 illustrations. **SEND NO MONEY.** Simply clip this ad and mail with name, address (U.S. Only). If not pleased return in 5 days, pay nothing. If you keep book send only \$5 plus 35c for shipping.

NOTE: Save 30c by sending remittance with order. Same return privilege!
GOODHEART-WILLCOX CO., Dept. 182, 1321 S. Michigan Ave., Chicago 5

PRINT YOUR OWN POSTCARDS with the GEM Stencil Duplicator. Save money. Hundreds of uses. **FREE TRIAL**—Write for Gem Outfit, complete with all supplies and Book of Ideas; sent postpaid. After 10 days pay only **\$8.50** or return GEM. Guaranteed for life. **BOND EQUIPMENT CO., Dept. 48, 6633 Enright, St. Louis 5, Mo.**



DON'T RISK INJURY... SAVE TIME
NEW SAFETY LADDER LEVELLER

Home owners, painters, carpenters—sturdy safety ladder levelers are easy, simple to adjust. Insures safety on sloped surfaces . . . saves effort, time.
SATISFACTION GUARANTEED OR MONEY BACK!
Send check or money order. **\$4.95**
Shipped post paid.
ORDER YOURS TODAY!
SAFETY LADDER LEVELLER CO.
P. O. Box 122, Sta. A, Atlanta, Ga.



HURRICANE BI-PASS UNIT

Now! By popular demand—a complete muffler Bi-Pass Unit, to give your car the power and zip of straight pipe performance, in non-restricted areas.
Maintain your original exhaust system. Hurricane is equipped with dash control, enabling you to cut in or out at will. Fits all cars and trucks with 1 3/4" to 2 1/4" dia. engine pipes.
Unit complete as pictured, includes dash control, cut-out and cut-in; 48"—1 3/4" flexible tubing, clamps, and all necessary fastenings and packing. Price complete \$9.95 post paid. Satisfaction guaranteed. (Flexible tubing over 48" available at 46c per additional foot.) Send check or P. O. money order to

ST. LOUIS PRODUCTS CO., Box 24-VF, Normandy 21, Mo.

© 1952 St. L. P. Co.

SO BADLY NEEDED

Our men now make \$40.00 to \$60.00 a DAY!



Coilette is the wonderful invention that does away with tangled, twisted, dangerous wires. Slips on phone, toaster, vacuum, adding machine, or power tool extensions in a jiffy. Then keeps cords in neat coil that stretches out as it's used—RE-coils when use is over. Riggs made \$187.26 in one afternoon in just five calls. Naylor sold 432 on one demonstration. An office girl, in spare time sold 97 in two calls. Retail for 95c—so cheap anyone can buy from 3 to 7. Millions to be sold this year. Tremendous new opportunity for salesmen, crew managers, or spare time workers. Read sample offer at right. Then rush name for samples today.

EVERY HOUSEWIFE needs 3 to 7
EVERY OFFICE needs 5 to 100
EVERY FACTORY needs 10 to 200

MONEY BACK

Send \$1.00 bill for two 95c samples—one of each model. Money back if you return them in ten days. You'll understand why Coilette is such a sensational money maker until you see it in action. Send for samples today and complete sales kit.

MAXILUME CO.,
125 W. Hubbard St., Dept. T-8-H Chicago 10, Illinois

Become an Industrial Designer...

Learn to design Automobiles, Products, Furniture, Stores and Offices, Packages, Displays and Exhibits. Your future begins now, studying with experienced, professional designers. B.P.A. Degree granted. Request Catalog I.

THE ART CENTER SCHOOL

5353 WEST THIRD STREET • LOS ANGELES

HE-MAN VOICE!

STRENGTHEN your voice this tested scientific way. Yes—you may now be able to improve the POWER of your speaking and singing voice . . . in the privacy of your own room! Self-training lessons, mostly silent. No music required.

FREE BOOK Write TODAY for Eugene Feuchtinger's great booklet "How to Develop a Successful Voice." It's absolutely FREE! You must state your age. Booklet mailed postpaid in plain wrapper. No salesman will call. Send your name and age RIGHT NOW! Perfect Voice Institute, 210 S. Clinton St., Studio FY-2, Chicago 6, Ill.



60 POWER TELESCOPE \$3.95

VARIABLE EYEPIECE 20 x 40 x 60 — BRASS BOUND

NEW! Three telescopes in one. 3 different magnifications. 20 power for ultra-bright images with 40 and 60 power for extra range. Guaranteed to bring distant objects, people, sports events, ships, moon, stars, etc. 60 times as close.



Most powerful for any-where near the moon. Contains 4 ground and polished lenses. Also used as a powerful compound microscope. Directions included. Mass production enables us to offer this high-powered instrument at the amazing price of only \$3.95. We pay the postage. Get yours immediately. **CRITERION CO., 438 Asylum St., Hartford 3, Conn., Dept. PMB 3**

SAVE GAS

WITH A FUEL PRESSURE REGULATOR!

THIS REVOLUTIONARY NEW ACCESSORY STOPS GAS WASTE CAUSED BY FUEL PUMP PULSATION. ELIMINATES CARBURETOR FLOODING AND FUEL "SURGE." STOPS THE ANNOYANCE AND POWER LOSS CAUSED BY "MOTOR CUT-OUT." Many users claim up to 25% gas saved. Regulator stops gas flow prevents vapor lock and percolating.

It pays for itself in a few weeks with gas saved, by eliminating frequent carburetor tuning and by reducing engine and carburetor wear. Fits all cars and trucks.



BEFORE AFTER
Only \$5.95 post-paid (or send \$1. balance COD)



3 BOOKS FREE With each order: Big Speed Equipment Catalog plus "Economy Driving Manual" plus famous "150 Miles Per Gallon Book"—a regular \$1.75 value free with order.

NEWHOUSE AUTOMOTIVE INDUSTRIES
Dept. BR-6, 5905 E. BEVERLY BLVD., LOS ANGELES 22, CALIF.

GROW Living MIDGET TREES!

EARN \$100 PER HOUR!

- AT HOME
- IN SPARE TIME
- NO EXPERIENCE NEEDED



It's new! Amazing! At last, the secret of growing miniature (MING) trees can be yours. FULL GROWN, dwarf trees—only a few inches high. Beautiful miniature fir, orange, oak, Chinese elm, peach, pine, cypress—any kind! ALL BLOOM and even BEAR FRUIT. All perfect healthy specimens—but miniature in size! Make costly home decorations and expensive centerpieces. (SOLD FOR OVER \$1,500 EACH) Big demand. Costs only pennies—takes only minutes per week. IT'S EASY! Fun! A new fascinating hobby—a new fabulous \$\$\$\$ business. Send for free secret plan details and real seed.

HELP US FILL HUGE DEMAND!

These trees are being demanded by STORES CLUBS • HOTELS • FLORISTS • HOUSEWIVES • INTERIOR DECORATORS • COLLECTORS • HOBBYISTS—A Big Money Opportunity FOR YOU.

FREE! GENUINE SEED AND PLAN!



NATIONAL NURSERY GARDENS, Dept. M6
8463 South Van Ness
Inglewood 4, Calif.
Rush me FREE plan and seed IMMEDIATELY!

Name _____
Address _____ Zone _____
City _____ State _____

High School at Home

Many Finish in 2 Years

No classes. No time wasted going to and from school. Progress as fast as your time and abilities permit. Standard H. S. texts supplied. Thousands enroll each year in this 55-year-old school. Send for FREE descriptive booklet.

AMERICAN SCHOOL, Dept. HA45
Drexel at 58th St., Chicago 37, Ill.

Without obligation, please send FREE descriptive booklet.

Name _____
Address _____

WORK FOR THE



GOVERNMENT

START AS HIGH AS \$3,795.00 YEAR
Many Appointments To Be Made Experience Usually Not Required **MEN—WOMEN** Mail Coupon Today—Sure

FRANKLIN INSTITUTE, Dept. J-83,
Rochester 4, N.Y. (Not Govt. Controlled)
Sirs: Rush with charge, (1) 32-page book with list of U.S. Government Jobs, (2) Tell me how to get one of these jobs.

Name _____
Address _____ Age? _____

MAIL COUPON
FOR A...

FREE BOOK & LESSON BUILD AND KEEP A POWERFUL GIANT SCREEN TV SET!

THIS YOURS TO BUILD AT HOME
ENJOY FOR YEARS



PERHAPS NEVER AGAIN AN OFFER LIKE THIS!

NOW! The greatest history-making offer in our 15 years! Your chance to get into high-paying Radio, Television field by actual practice on kits so valuable you simply can't afford to pass this up! Just imagine! You build and KEEP beautiful giant screen TV Set—build and KEEP 6 tube superheterodyne RADIO. We give you professional MULTITESTER you can use in your own service shop PLUS more than 12 other valuable kits! Also, you get amazing shop-type "learn by doing" training developed by world famed electronic experts—a great new method that has been universally acclaimed as a MARVEL of SIMPLICITY in over 40 DIFFERENT COUNTRIES! At least INVESTIGATE this marvelous training that has already placed THOUSANDS OF MEN in high-paying RADIO and TV jobs or in business! Graduates in U.S. and Foreign countries state CETI easy-to-learn lessons are FAR SUPERIOR TO ALL OTHERS! For your own future you MUST INVESTIGATE TODAY! Mail coupon above for fascinating free book and free lesson thousands have used as stepping stones to big jobs in RADIO-TV! ACT NOW!

CALIFORNIA ELECTRONICS & TELEVISION INSTITUTE
DEPT. PM 1121 W. PICO BLVD., LOS ANGELES 15, CALIF.

Send, without obligation, your Big Book containing hundreds of TV-RADIO Facts and Ideas plus Free Lesson. (No salesman will call.)

Name _____
Address _____
City _____ State _____



STUDY IN
SPARE TIME
AT HOME



MAIL
COUPON TODAY!
GET FREE
TV FACTS-TV IDEAS

BONUS
12 BIG KITS
OF RADIO
PARTS



CALIFORNIA ELECTRONICS & TELEVISION INSTITUTE
DEPT. PM 1121 W. PICO BLVD., LOS ANGELES 15, CALIF.

NO MORE BURNED OUT ENGINES! DUE TO LACK OF OIL.

Don't run the risk of expensive motor overhaul because of lack of oil. OIL-D-CATOR tells you when you need a quart of oil without raising your hood. Insure your motor against damage. Can be installed without tools in about 5 minutes. Get yours today!



For Fords and Chevrolets only.
State year.

PRICE COMPLETE \$4.95

Send check, money-order or cash only.

Pat. App. for

Reg. Trade Mark

OIL-D-CATOR CO.
BOX 406, WILMINGTON, DELAWARE

100 POWER... Telescope Lens Kit COMPLETE ONLY \$3.00

NEW 3 IN 1 VALUE! Build a 45X and 100X Astronomical telescope! Converts to 45X Terrestrial telescope! Explore the wonders of the sky. View distant objects on earth. Kit consists of 47mm dia. 50 1/2" focal length ground and polished objective lens, 100X eyepiece lens, 45X eyepiece lens, easy building instructions. Mounting and tripod not included, easily made. Money Back Guarantee.

LEMAR SCIENTIFIC CORP., Dept. D66, 3412 W. Jackson Blvd., Chicago 24

GREAT PROFITS
MAKE YOUR OWN RUBBER MOLDS

X.L. RUBBER MOLDS

will realize your great profits quickly!
WRITE FOR NEW FREE CATALOG
YOU can EASILY learn to cast thousands of perfect plaques, book ends, figurines, ash trays, etc. IT'S EASY, FUN, PROFITABLE!
X.L. Rubber, Pts. \$2.50; Qts. \$4.00 (postage extra). Models and enough for 3 molds \$1.50 prepaid.



SEND FOR FREE FACTS

PLASTIC ARTS STUDIO

Address Dept. 2
3403 S. Madison St.

Muncie, Ind.

ENGINEERING DEGREE IN 27 MONTHS

INDIANA
TECHNICAL
COLLEGE

B. S. DEGREE, Aeronautical, Chemical, Civil, Electrical, Mechanical and Radio Engineering (inc. TV and Electronics). Drafting, 1-yr. G.I. Gov't approved. Low rate. Earn board. Large industrial center. Students from 48 states, 21 countries. Demand for graduates. Enter June, September, December, March. Write for catalog, 1662 E. Washington Boulevard, Fort Wayne 2, Indiana.



Anybody Handy With Tools Can Build

LEATHER LOUNGES
FOR KITCHENS AND
RESTAURANTS

Frames, springs, filling, construction simplified.

Send \$5.00 for complete plans and instructions, or 10¢ for brochure.

STEFAN GALENSKI
Designer & Manufacturer

2221 BROADWAY

BUFFALO 12, NEW YORK

STEADY PROFITS!

Your Own Business With
CORADIO

Coin Operated Radio



Place these specially built radios that play 1 or 2 hours for 25¢ in the thousands of available hotel rooms, tourist courts, etc. They yield immediate profits and steady income. Minimum capital required \$750 for equipment. Expansion unlimited. For further information write:

CORADIO Coin Operated Radio

DEPT. No. 6PM

Phone: BEekman 3-0038-9

212 BROADWAY
NEW YORK 38, N.Y.



Save Money on
HOW-TO-DO-IT BOOKS

The latest, most practical information at lowest cost. Big 100-page, fully illustrated books, both for only \$1. Equal in contents and usable information to books selling for \$2.00 and more. Plain, durable covers instead of expensive fancy bindings save you money—give you bigger value. Now ready—HOUSE WIRING MADE EASY—PLUMBING SIMPLIFIED. Show you how to do professional-like jobs with no previous experience. Clip this ad and mail with name and address and a dollar bill for both books. Money back if not satisfied.

Two for \$1

FREDERICK J. DRAKE & CO., Dept. 1-A, 117 Green Bay Rd., Wilmette, Ill.

MONTH AFTER MONTH, YEAR AFTER YEAR, YOU SEE OUR AD.

REMEMBER IT'S DANGEROUS to pay less if you want the finest (nonskid) USED tires.

GOOD YEAR Firestone

GOODRICH, UNITED STATES, GENERAL & OTHERS, NOT RECAPS

Our policy is to select your tires so carefully, as if our very future depended on the service given by that particular tire.
FREE TUBE - WITH ANY GRADE TRUCK OR PASS. TIRE (EXCEPT MILITARY TREAD TIRES)

GOOD GRADE TIRES — 16 MONTHS GOLDEN RULE GUARANTEE	
600-16 \$4.13	820-15 \$5.43
650-16 5.43	700-15 4.53
700-16 5.03	670-15 4.73
650-15 4.43	710-15 4.93
760-15 5.03	550-17 4.63

FINEST GRADE, 29 MONTHS GOLDEN RULE GUARANTEE BOND THIS GRADE MADE THE BLATT NAME "WORLD FAMOUS"	
600-16 \$5.43	LO-PRESSURE TRUCK TIRES
600-16 (6) 7.03	550-15 \$6.13
650-16 6.43	640-15 6.23
650-16 (6) 7.73	670-15 6.23
700-16 6.93	710-15 6.33
750-16 7.43	760-15 6.53
525-18 5.93	800-15 6.83
550-17 5.93	820-15 6.83
650-16 5.93	670-16 6.43
700-15 6.53	760-16 6.93
WHITEWALLS 52 ea. EXTRA	32x6(8) 11.93
	32x6(10) 13.93

Buy the "Right" **TRUCK TIRES** for "Your" Job Depend On Us

Std. Guar. 16 Mos. Rugged Guar. 30 Mos.	MILITARY MUD-SNO TREAD
750-20 \$10.03	750-20Rg. \$16.63
600-16 Std. 6.73	600-16 Rg. 9.93
900-16 Std. 10.03	900-16 Rg. 16.03

BLATT BLATT BLDG., GIRARD & LANCASTER AVES., DEPT. PM, PHILADELPHIA 31, PA.
Send check or money order. Send this ad with order. We won't ship a tire we wouldn't use. The name to trust in rubber.
Shipments RUSHED Down South, Up North and Far West

LOCKSMITHING & Key Making

PRACTICAL UP-TO-DATE COURSE—ONLY \$4.95
Easy-to-learn modern information for self-instruction. How to work on locks, de-code, make master-keys, repair, install, service, etc. For every handyman, home owner, carpenter, mechanic, service station operator, fix-it shop, hardware dealer, gunsmith, 53 plain illustrated lessons. **FULL PRICE ONLY \$4.95. SEND NO MONEY.** Just pay postman plus G.O.D. postage. Or send \$4.95 with order, we'll ship postpaid. Satisfaction guaranteed or refund.
NELSON-HALL CO., 210 S. Clinton St., Dept. FY-2, Chicago 6, Ill.

Specialized Magazines

Will help YOU to Success
Get latest copies covering YOUR interests through our Easy-to-Get-Acquainted Service. Hundreds of business, trade, professional, advertising, agricultural, chemical, confectionery, construction, diesel, dog, fashion, florist, food, furniture, gift, grocery, health, historical, hobby, home craft, horticulture, industrial, insurance, jewelry, metal, motor, music, optical, paint, patent, petroleum, pets, photographic, plastic, plumbing, poultry, printing, radio, real estate, refrigeration, selling, spo. ts, store display, signs, television, textile, tobacco, writer and others covering ALL interests. Send for LIST today. It's FREE.

COMMERCIAL ENGRAVING PUBL. CO.
34AB NORTH RITTER INDIANAPOLIS 19, IND.

Our 493rd Advertisement
REAL DIESEL ENGINE
\$2.95 • for planes, boats, midget cars
• 7500 RPM; 1/7 HP; ht. 3 1/2"; wt. 5 oz.
• precision machined for smooth operation
You just can't beat this price for a precision diesel engine! Streamlined, compact, easy to install. Thousands of satisfied users all over the world. Fast delivery if you ORDER TODAY! Send \$2.95 plus 25c postage.
GOTHAM HOBBY CORP., Dept. P, 107 E. 126th St. New York 35, N. Y.



WORK IN COOL SAN DIEGO

Illustrated book sent FREE

San Diego offers you California living at its best — and Convair gives you the top working conditions. Employee Retirement Plan. Group Insurance. Two weeks vacation. Eight holidays annually. Free Housing Office and much more — plus that wonderful San Diego climate. These classifications now open for you:

1. TOOL DESIGNERS
2. TOOL PLANNERS
3. PATTERN MAKERS
4. TOOL & DIE MAKERS
5. JIG AND FIXTURE BUILDERS
6. MACHINISTS
7. LOFTSMEN
8. FIELD & SERVICE MECHANICS
9. AIRCRAFT MECHANICS
10. AIRCRAFT ELECTRICIANS
11. IBM TAB MACHINE OPERATORS
12. INSPECTORS

CONVAIR

Send this coupon for FREE book and details:
Employment Office 700
Consolidated Vultee Aircraft Corporation
3302 Pacific Hiway
San Diego, California

NAME _____
OCCUPATION _____
ADDRESS _____
CITY _____ STATE _____

Learn CARTOONING
HAVE FUN! MAKE MONEY! Cash in on your sense of humor at HOME — BY MAIL. No experience needed to start. Write today for FREE TRIAL LESSON and full particulars.
MOON Gag Cartoon School, Dept. A, Fall Creek, Wis.

Build the Best! EASY TO ASSEMBLE BOAT KITS

NEW CATALOG
OVER 40 PAGES, INCLUDES ALL YOU NEED TO BUILD YOUR OWN
1-BOAT KITS—30 MODELS
2-MARINE HARDWARE
3-MARINE ENGINES
4-MARINE CONVERSIONS
5-PAINTS & COLOR CHARTS

ROWBOATS 8-10-12-14 FT. \$39 up

OUTBOARDS 8 Models 12 to 18 FT.

INBOARDS & CABIN CRUISERS 16 TO 23 FT.

NEW 18 FT. OUTBOARD CABIN CRUISER
FAST VEE BOTTOM HULL SPEEDS UP TO 25 M.P.H. — ROOMY CABIN, WITH TOILET, SLEEPS TWO —
U-MAK-IT PRODUCTS
703 P-WHITTIER ST., Bronx 59, N. Y. City

✓ a bit about
"Bite"



SOME FOODS taste better when the "bite" of mustard, horse-radish or sauce is added!



SMOKING TOBACCO tastes better when the "bite" is out! Prince Albert is specially treated to insure against tongue bite!

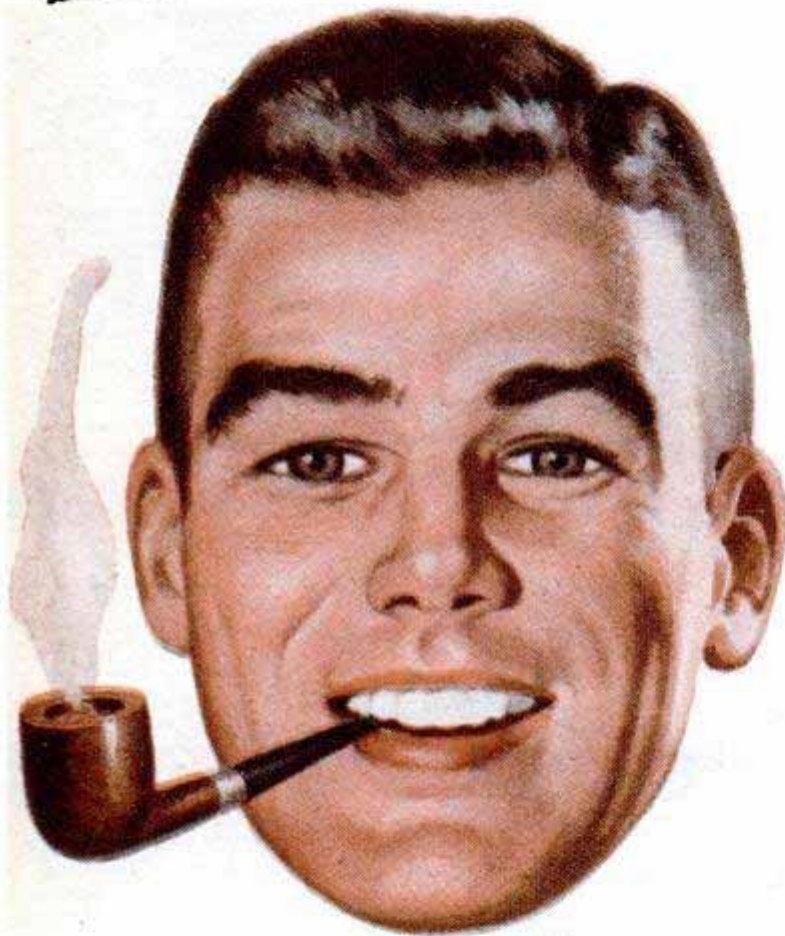

BITES OUT PLEASURES IN

*there's more tobacco
in every tin!*

● Get P.A. and you'll get *more* real smoking comfort. Prince Albert is treated with the patented "No-Bite" process that guards against tongue bite! Cool and mild—P.A. is the favorite of pipe smokers and roll-your-owners alike!

*Process patented July 30, 1907.

More Men Smoke

PRINCE ALBERT

than any other tobacco

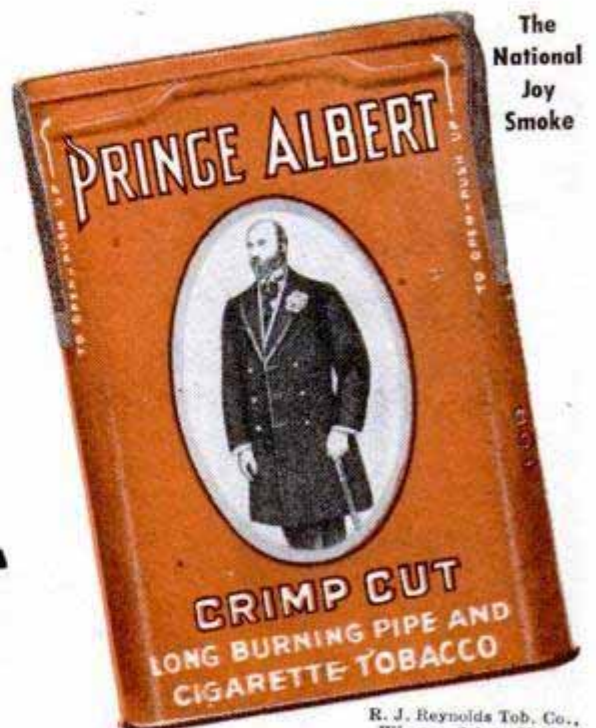

The
National
Joy
Smoke

R. J. Reynolds Tob. Co.,
Winston-Salem, N. C.

A HOUSE TO MAKE LIFE EASY

WRITTEN SO YOU CAN UNDERSTAND IT
VOL. 97 NO. 6

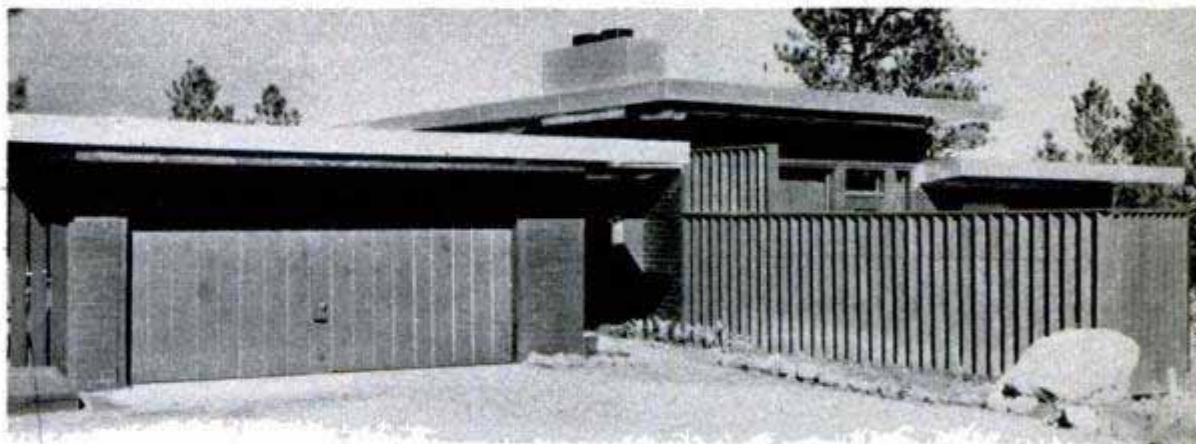

House of the future? Home was designed by a writer of stories about a future world

By Thomas E. Stimson, Jr.

IN WHAT KIND of house will the captain of a space ship live during his stopovers on earth?

It's too early to say yet, though probably it will contain some of the features of a residence just built by Robert A. Heinlein in Colorado Springs, Colo.

Heinlein is author of the movie *Destination Moon* and creator of the *Tom Cor-*

bett, Space Cadet program on television. As a writer of science fiction his books *The Green Hills of Earth*, *The Puppet Masters* and others are on current book lists.

The engineering training that gives him a solid background for writing about the mechanics of space travel also has helped him in designing a house that's called extreme today but may become conventional

Author Heinlein relaxes on built-in divan beside raised fireplace. Note convenient cupboard at end of divan

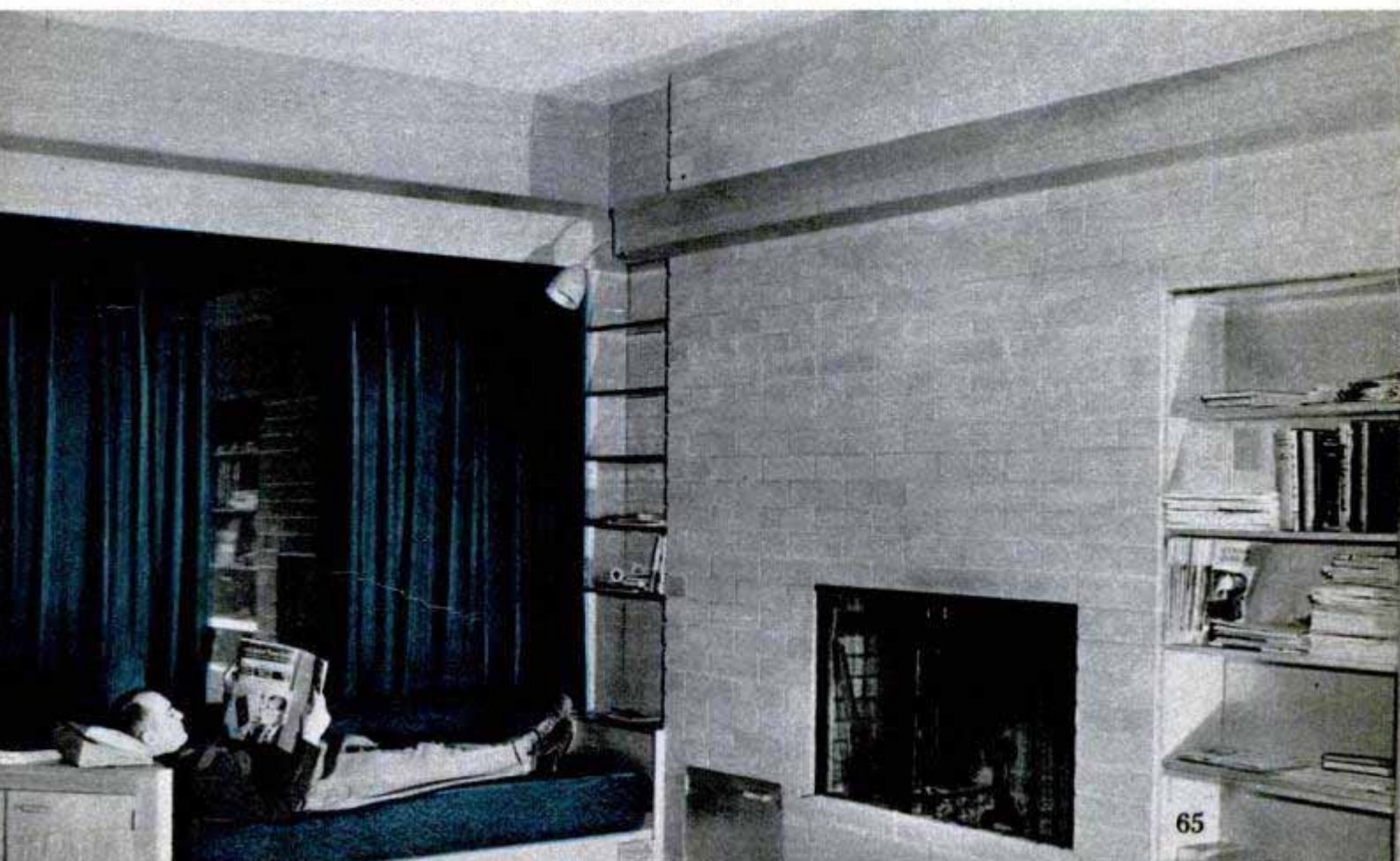



There's everything to please a housewife in the kitchen, including an "office" with phone and typewriter

Below, "commuting" table is set with china in kitchen, then rolled through a wall to the dining area





Skylight panels have mirrors which reflect sunlight into house. Behind panels are tubes for night lighting

before the 20th century has run its course.

Heinlein's house runs itself with a minimum of maintenance and housework. It has an indoor climate that's unrelated to varying outdoor temperatures. Within reason it is fireproof, termiteproof and earthquakeproof. The house is expensive compared to minimum standards and yet the owner saved money when he moved in.

What Mr. and Mrs. Heinlein wanted was a comfortable, pleasing residence that would just about take care of itself. The result is a single-story flat-roofed house containing entry hall, combination living-dining room, kitchen, bedroom and nursery with a sliding wall between, study, two baths and attached garage with space for a home workshop.

It's a small house, 1150 square feet of floor space in the living area, designed for two adults and a child, yet by means of built-in furniture it could sleep seven without crowding. Built-ins are a major feature. Aside from a few chairs, a piano, and a dining-room table that commutes on wheels, there is no movable furniture in the house.

"The built-in bed with storage drawers beneath it, the built-in divans that can be converted to extra beds and all the other furniture are built right down to the floors," Heinlein says. "There is nothing to clean under.

"There are no rugs or any need for them. All floors are surfaced with cork tile that provides a warm, comfortable and clean footing. Nor are there any floor lamps or table lamps. The illumination is built into the house. General lighting for the living room comes from cold-cathode tubes concealed behind a box molding. These illuminate the ceiling. Adjustable wall spotlights are located at all work and relaxation areas in the house. All electric convenience outlets are at comfortable hip height. I'm through stooping over to the baseboard

The Heinleins, after careful study, made personal recommendations for every built-in item in their home

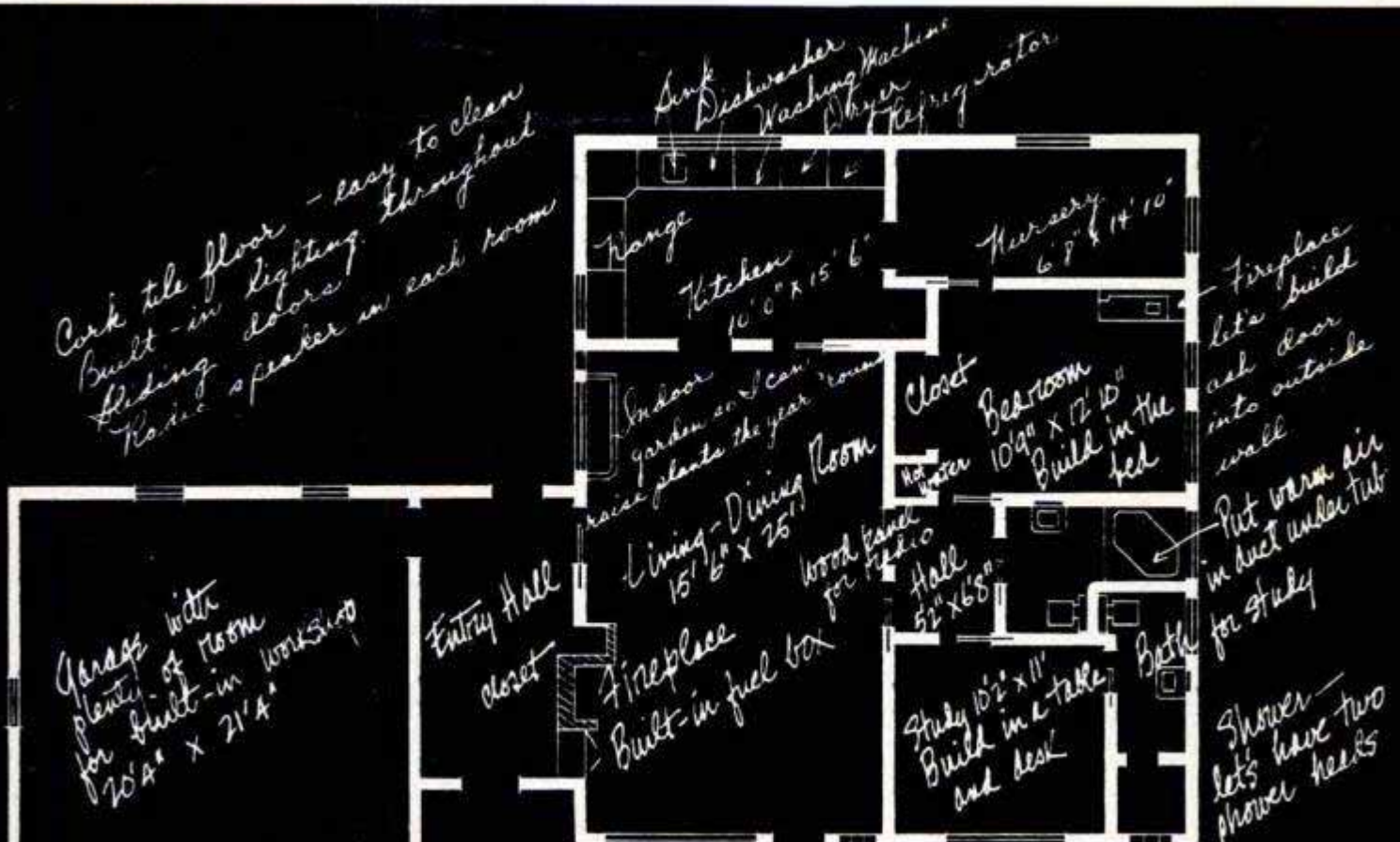

Divans in home can be converted into double beds simply by swinging top half out onto floor and covering with pads

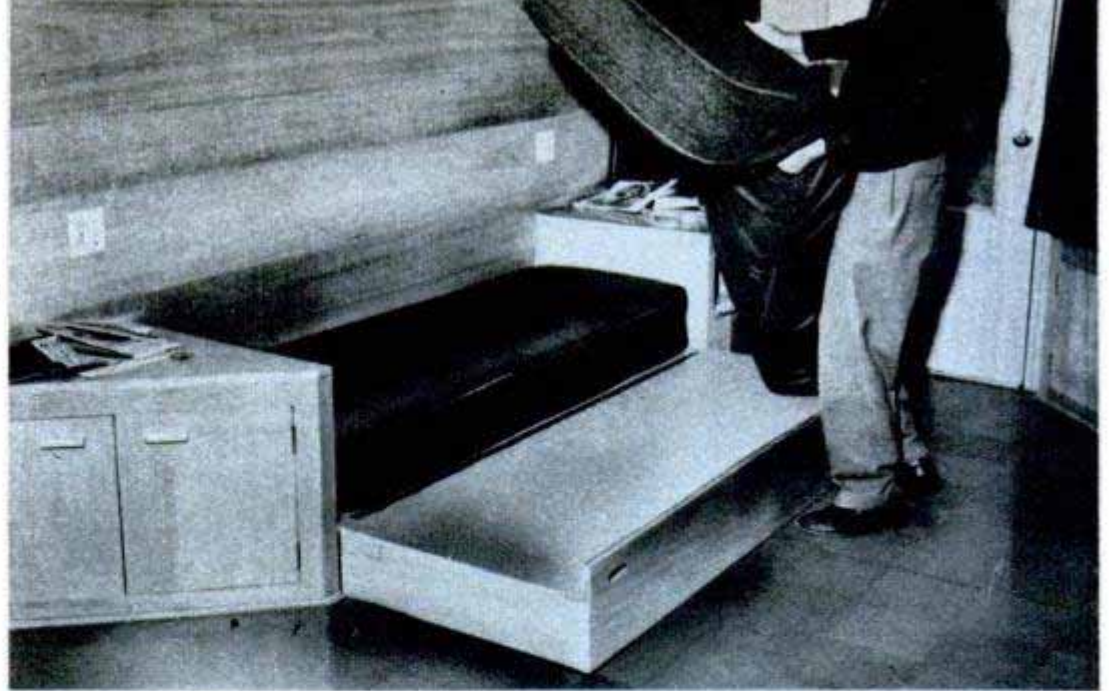

whenever I want to plug in an appliance."

With no rugs or movable lamps or furniture, the whole house can be given a general cleaning in about an hour.

The house is built of steel-reinforced concrete blocks and masonry and is painted dark green on the exterior, offset by broad panels of gleaming aluminum roof trim. Interiors of the concrete-block walls are exposed and painted light green. Interior partitions are of bleached mahogany backed with rock wool. The same wood is used for all cabinetry and built-in furniture. All interior doors are sliding doors. Walls of the study and the water-heater compartment are soundproofed. The roof is insulated.

A flat roof is no disadvantage in snow country, Heinlein finds, if it is properly reinforced against heavy loads. The extra

strength permits it to be decked over and used as a porch for sun bathing. The roof surface consists of several layers of hot-mopped roofing paper topped by a layer of gravel and sprayed with aluminum paint to reflect solar heat. The roof projects far enough beyond the south side of the house to shade the south windows from the summer sun, yet it admits light to the windows in winter when the sun is lower in the sky.

Two small skylights that work night and day help illuminate the study and a small center hall. Each skylight contains a pair of fluorescent tubes that provide indirect lighting in the evening for the area below. Top and bottom of each skylight are translucent glass, with the bottom frame hinged for access to the lighting tubes. The skylight interiors are painted aluminum for

Oversize bed (seven by six feet) has storage drawers on each side, a table on both sides of the headboard

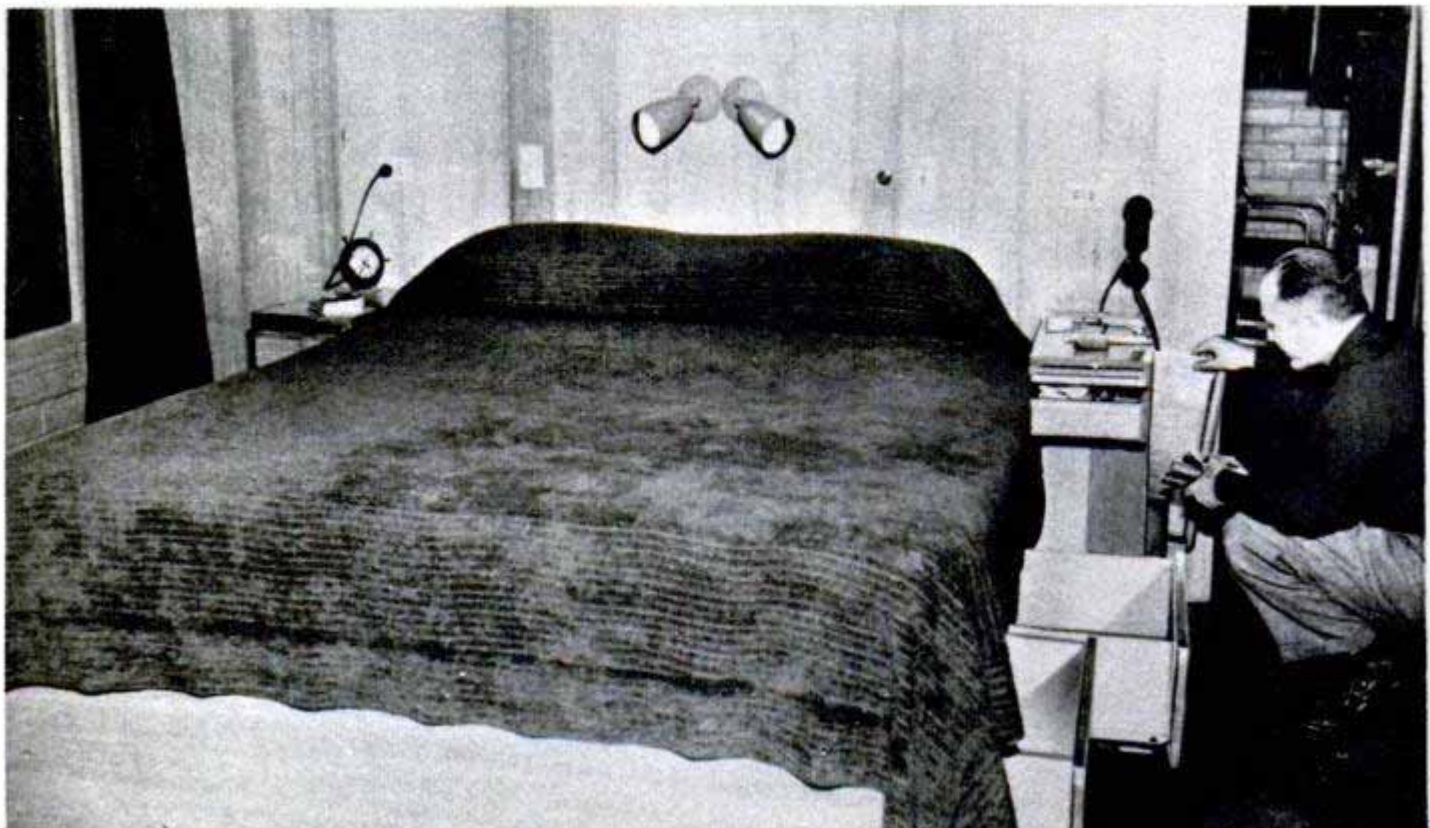



Trash goes through a hinged partition in kitchen wall, falls into a storage bin outside the house



Music center in hall off the study contains radio and record player wired to speakers in each room

greater efficiency and contain mirror panels slanted to reflect sunlight below even when the sun is not at its zenith.

Most houses are too hot or too cold at times, or too drafty or dusty. Heinlein gets just the indoor climate he wants by an ingenious arrangement of air conditioning and ducts. First of all, the house is sealed. None of the windows can be opened. They are double-glazed, in fact, with 1/4-inch air space between the panes.

The air-conditioning unit, off the kitchen, consists of a gas-fired furnace and electric blower equipped with dust filter, humidifier and glycolator air purifier. Tempera-

Heated air enters the bathroom through a duct beneath the tub, warming the bathtub and the floor



ture is controlled by a thermostat in the living room. The blower operates at all times. The furnace draws 20 percent of its air from outside the house, creating a positive pressure indoors that is exhausted through concealed vents in the kitchen and each bath. Heinlein estimates that the blower uses no more power in constant operation than it would in intermittent use. He plans to add an electrostatic precipitator to the system to augment the present dust filter.

Air from the conditioner is ducted at floor height along the exterior walls of the house to the room outlet grilles. This perimeter ducting creates a band of warmth that insures comfortable floors even in freezing weather. In one bath the warm air is ducted under the bathtub, in the other the warm-air supply flows under the floor of the shower. Thus the tub and shower floor are pleasantly warm at all times.

The shower, incidentally, has an extra shower head on the wall opposite the standard fixture. It's operated by an overhead valve and a bather may be sprayed from two sides if he desires. A shampoo dispenser is attached to the shower wall just below the soap dish.

The built-in furniture includes a seven by six-foot bed with drawers beneath, a storage-wall-type wardrobe closet containing a set of drawers, a combination worktable and typewriter desk for Heinlein in his study, and its counterpart, an "office" in a corner of the kitchen for his wife. Here she has a desk with drawers, bookshelves and a flat top that folds back to reveal a typewriter and paper compartments.

In a compact line around the kitchen

(Continued to page 228)



"For Want of a Nail"

Shoeing horses is not exactly an expanding occupation, yet, if Harry Howe, horseshoe expert, is right, it is in for even worse times now that every horseman can shoe his own animals. Nails are no longer necessary, he claims, if the shoes are held in place by plastic glue. Howe has invented an electric-powered hoof trimmer that cleans out the hoof and makes it possible to use the powerful glue to attach the shoes. Most of today's horse-shoeing activity is centered around the nation's race tracks, where Howe has been demonstrating his invention and the plastic glue to horse trainers.

Mine Detector Scans Bull

When a rancher near Central Ferry, Wash., noticed that his prize \$5000 Hereford bull was ailing, he took the animal to the veterinary school at Washington State College. The vets suspected that a chunk of metal was lodged somewhere in the bull's body but couldn't determine the exact location. A call to the college ROTC staff produced Lt. Col. Frank G. Hubbard, armed with a mine detector. After sweeping the instrument over the bull's hide for a few minutes, the Army officer pointed to the

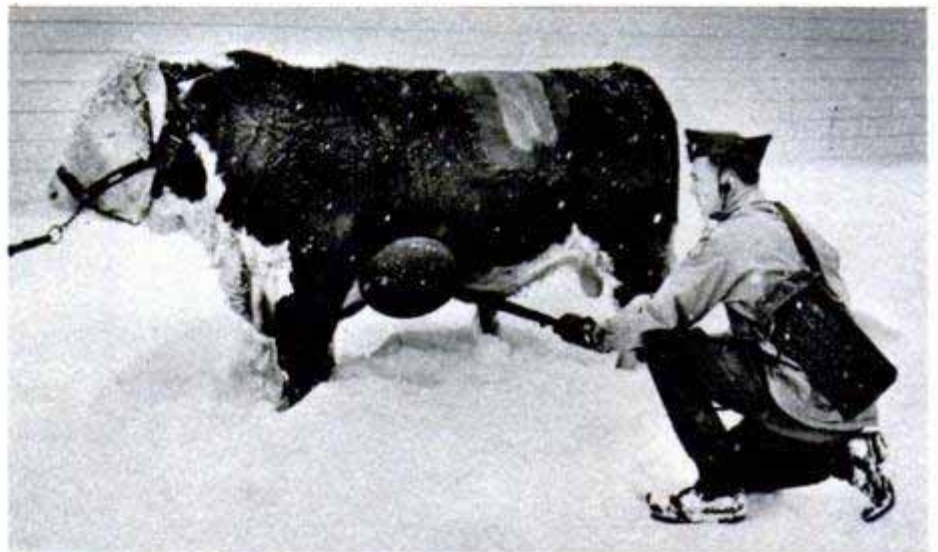

exact spot where the piece of metal was lodged. Now the school is considering a mine detector as standard equipment.



Plastic Bucket

Easy-to-pack equipment for campers and picnickers now includes water buckets, basins, drinking cups and dishpans made of plastic sheeting. The material is resistant to moisture, food, mildew, tearing and scuffing. The drinking cups, which hold six fluid ounces and can be used for hot coffee, fold flat and will fit in a shirt pocket.

☐ Tires are now being made on which airplanes can land at 240 miles per hour without danger of blowouts.



MERMAID THEATER

By Norris Jackson

AT SAN MARCOS, Texas now boasts a venture unique to both the entertainment and educational worlds—a theater which allows an amazed audience to witness an hourlong program beneath the surface of a crystal-clear lake. It is a submarine theater which, when a special ballast tank is flooded, takes its cargo of people below the surface.

Aquarena is situated at the head of the San Marcos River, a spring-fed stream that maintains a 70-degree temperature every day of the year.

The arena holds three million gallons of water and is 30 feet deep. Between shows, a pump spills 10,000 gallons of fresh water into the arena per minute for a constant supply of clear water. The water is taken directly from an encased spring.

Submerging 42 inches in 11 minutes, the theater will accommodate 100 spectators,

Left, "aquamaid" holding an air hose for breathing comfortably feeds fish during the hourlong show. Above, spectators are seated comfortably beneath the surface and watch the show through plate glass

who witness the underwater routines through plate-glass windows. The submarine's entrance, which is above water even when the theater is submerged, remains open at all times.

Some 50 tons of steel and 20 tons of concrete went into the submarine theater's structure. It requires 15,500 gallons of water for submersion.

Opposite the theater at a distance of 30 feet are the surface and underwater stages. These two stages are built of steel, glass and wood, supported by concealed pontoons.

Serving as an underwater breathing station for the performers, the underwater stage is suspended from and hangs below the surface stage. Air pressure supplied by two compressors forces the water level downward within a special compartment

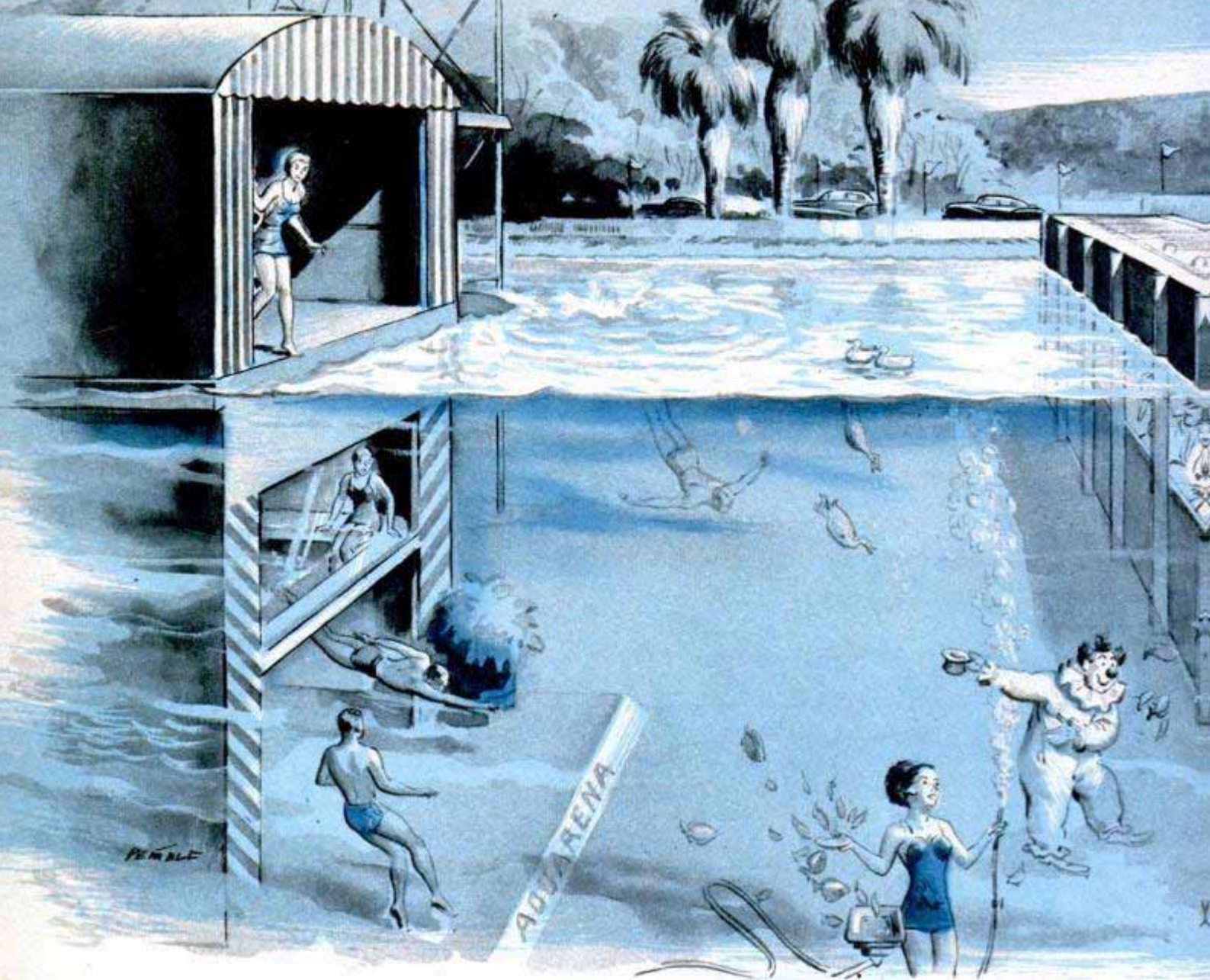

Artist's drawing shows how the theater submerges to give spectators underwater view of the show. Water ballast flows into tanks under the seats to move the gallery 42 inches downward. At left are the two stages, one above the surface and the other underwater. Compressed air forces water out of the lower stage, which is used as a breathing platform by the entertainers. Pumps force out the ballast to return theater to the surface



where performers may wait between acts.

The sequence of events during the show begins as the captain of the theater-going submarine opens a valve to take in water for submersion. Seated comfortably behind the large windows, the visitors see a strange and unusual sight as ducks dive beneath the surface to fetch food thrown to them from above. This act has become one of the high lights of the show.

Routines that follow feature an underwater ballet and a demonstration of diving while breathing through a hose, a new and revolutionary method. A genuine picnic—free of ants and bugs but full of small perch—is conducted underwater. A fish-feeding routine, in which fish take food from the girls' hands, also entertains the

In new diving method exhibited at show, air intake is regulated to permit deep diving without weights

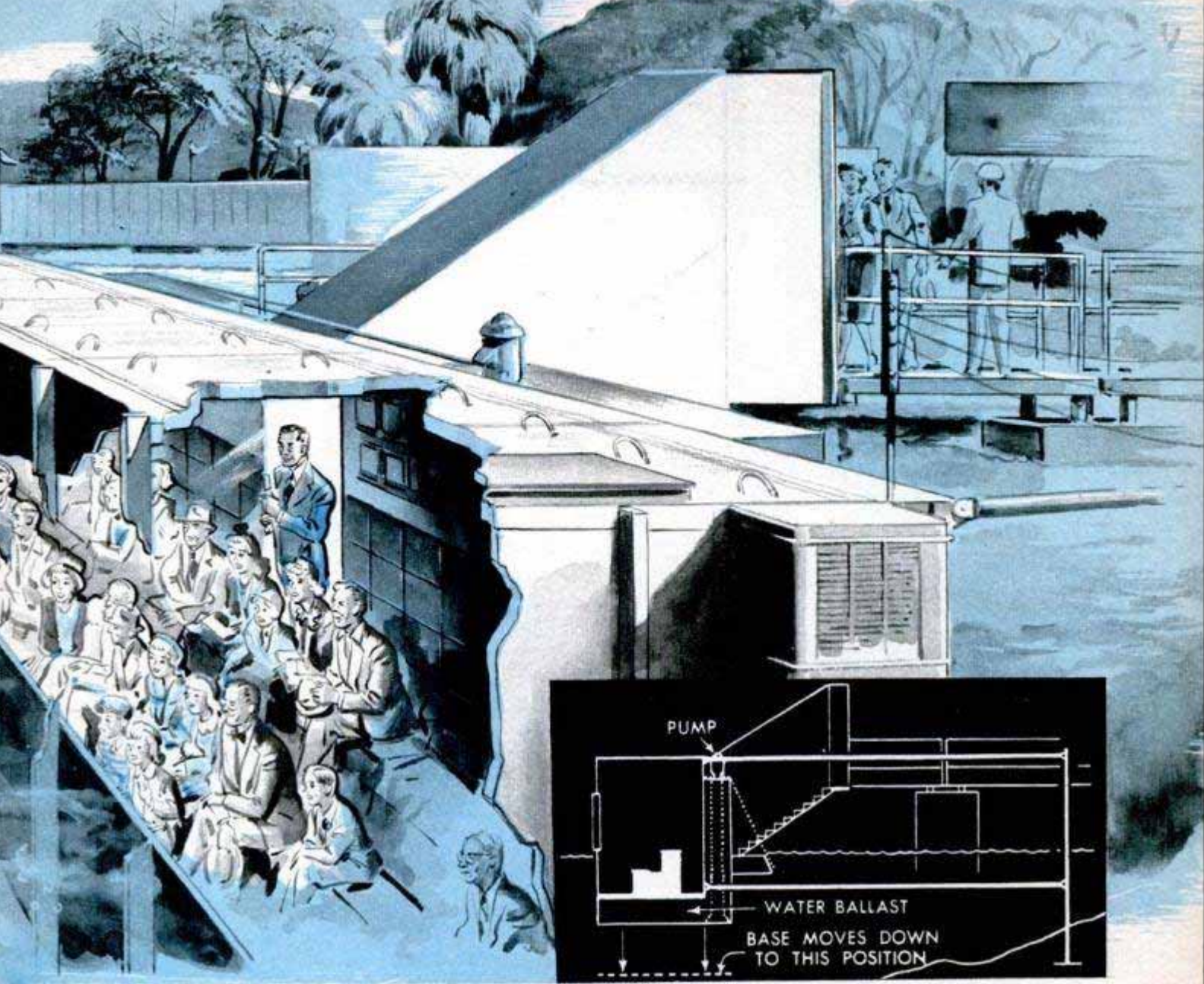

Diagram above shows how the theater gradually settles as water flows into the ballast tanks. Pump forces out water as the show enters the finale. Below, gangplank entrance remains above surface

visitors. "Glurpette," the underwater clown, provides the comedy.

Throughout the hourlong program, the performers talk to the audience via an intercommunication system from the breathing station.

The show enters its final scene when the captain throws an electric switch, starting the pumps which empty the ballast tank. During the eight minutes required for surfacing, the "aquamaids" enact a grand finale of underwater and surface ballet routines.

Even in subfreezing weather, four shows are produced every day at the submarine theater. The secret — of course — is the pleasant, year-round 70-degree temperature of the water pumped into the Aquarena pool from near-by springs. ★ ★ ★

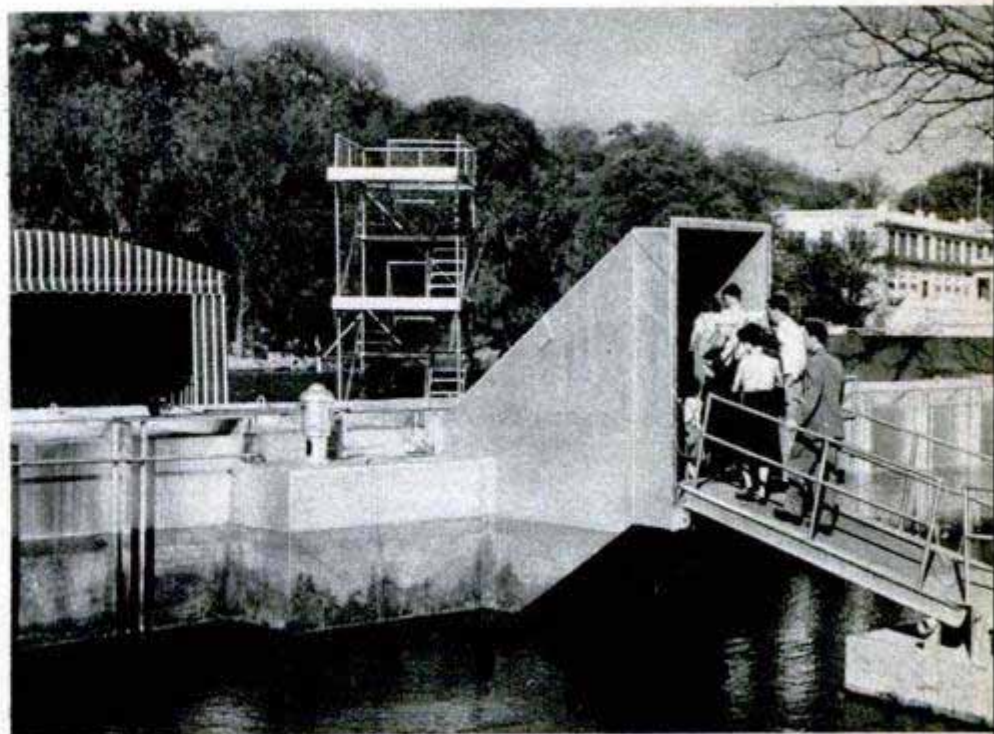

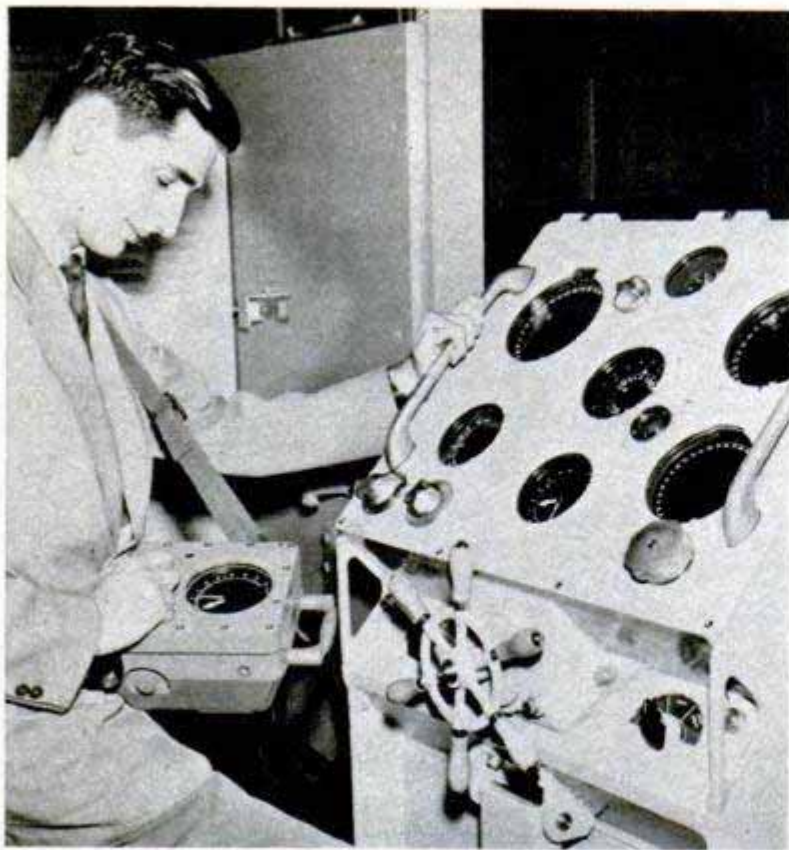

Autopilot for Flattops

Without human aid a new automatic pilot for aircraft carriers will steer prescribed zigzags and follow computed course schedules despite the disturbing forces of wind and sea. The robot helmsman, developed by the Sperry Gyroscope Company, is being installed aboard the USS *Oriskany*. A magnetic "brain" which anticipates steering motions replaces conventional electron tubes used to control earlier pilots. One use of the robot will be to steer the carrier into the wind—within close tolerances—during the launching and landing of aircraft. This requires keeping the wind a precise number of degrees off the port bow to neutralize the turbulent stream of air which flows around the ship's island. The ship's course may also be guided from remote stations by means of a portable controller.

Small Portable Gas Stove Fueled From Pressure Can

You could cook in the living room with a portable gas stove that gets its fuel from a pressure can of the same size as those used to package bug spray. You merely push the can into an opening on one side of the two-burner stove and it is automatically punctured and it is automatically punctured. The burners, just like those on a standard kitchen range, are recessed to permit use of the stove outdoors in the wind. One burner operates for 2½ hours on a can of fuel which, when exhausted, is thrown away and replaced by a full one.

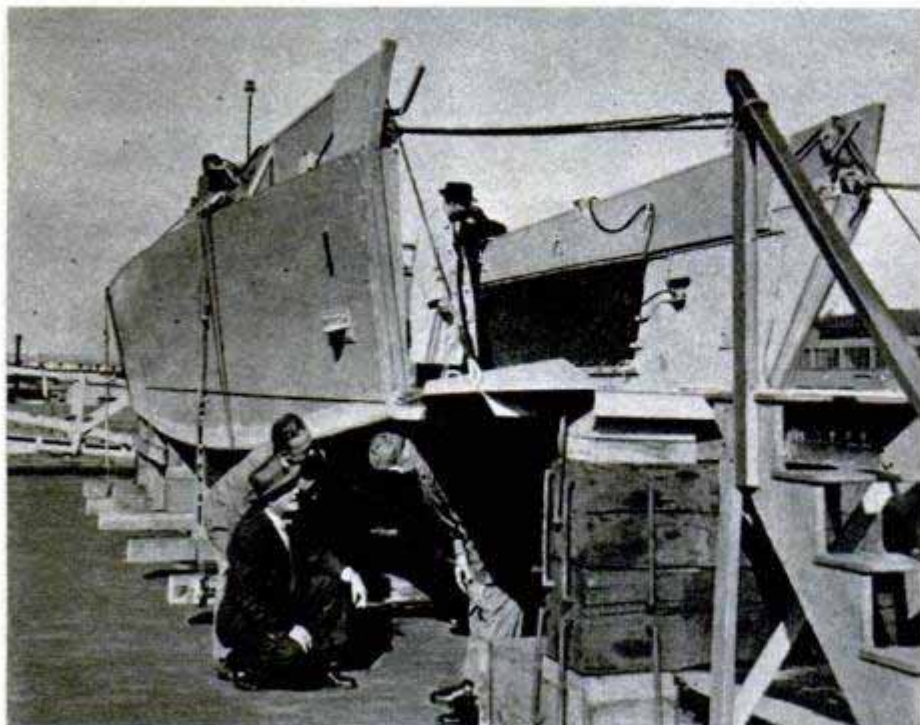

Landing Craft Made of Plastic

Virtually the entire hull of an experimental landing craft built for the Navy is made of plastic. The craft is identical in design and size to the conventional landing craft used during World War II but very little metal was used in its construction. Its hull was built up of glass fiber reinforced with cloth and impregnated with a resin.

Ⓢ Natural-gas pipe lines in the United States today total more than 314,500 miles.

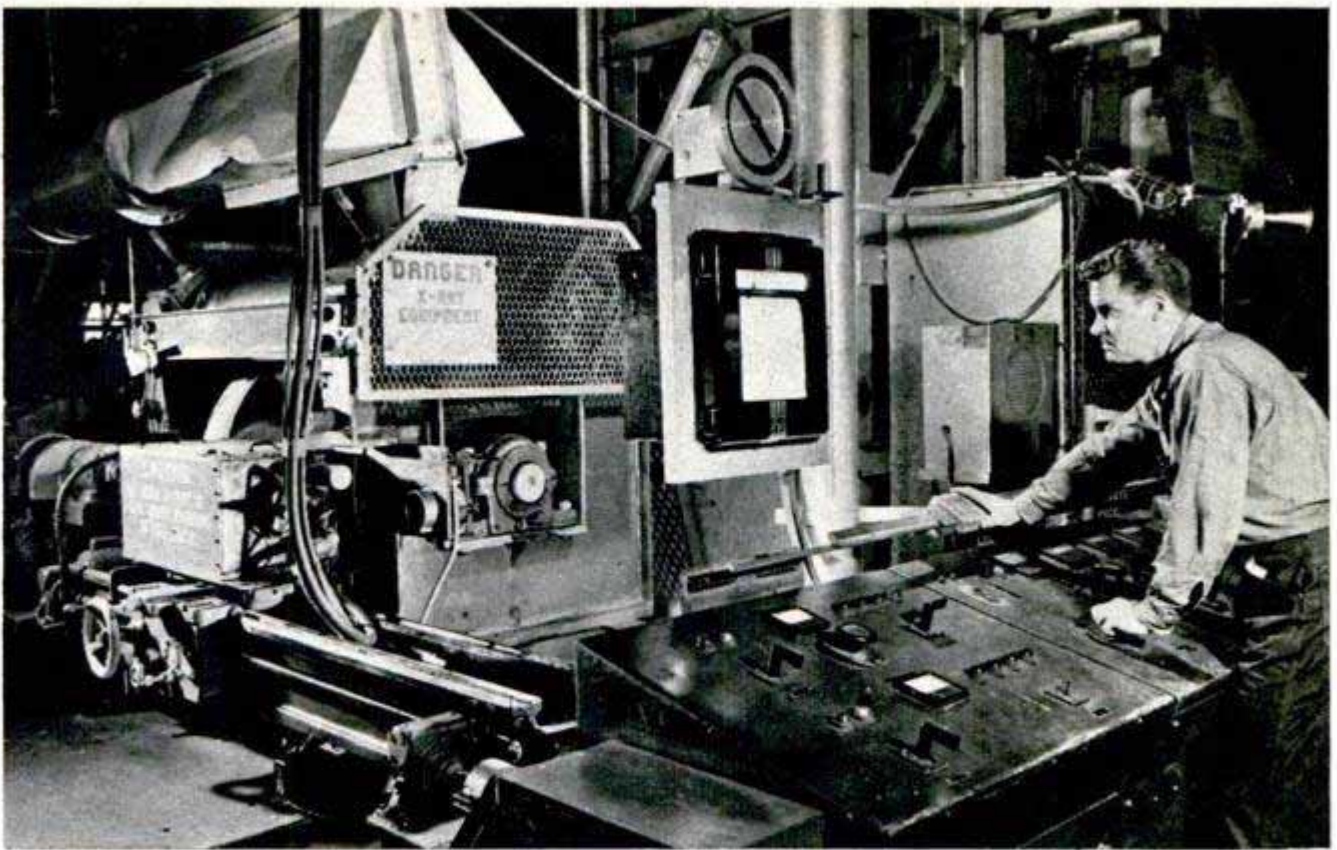

X Rays Measure Tin Coating With No Delay in Production

Using X rays, a new instrument provides a continuous visual record of the tin coating on tinplate as it moves along the production line. Measuring in millionths of an inch, it operates on the principle that rays of a certain length will cause fluorescence in sheet steel, but not in the coating.

With an X-ray tube and a scintillation counter mounted in front of the puller roll, rays are shot at the tinplate and the resulting fluorescence measured as the plate speeds past. The present method is to halt the line and cut out a sample for tests, which results in a 15-minute delay.



Electric "Snake" Scares Birds

Marauding birds which are damaging the garden of Halsey W. Kline, a General Electric engineer, now are frightened away by an electric "snake" fashioned from a bamboo fish pole and a piece of aluminum. A clock motor makes the snake revolve.

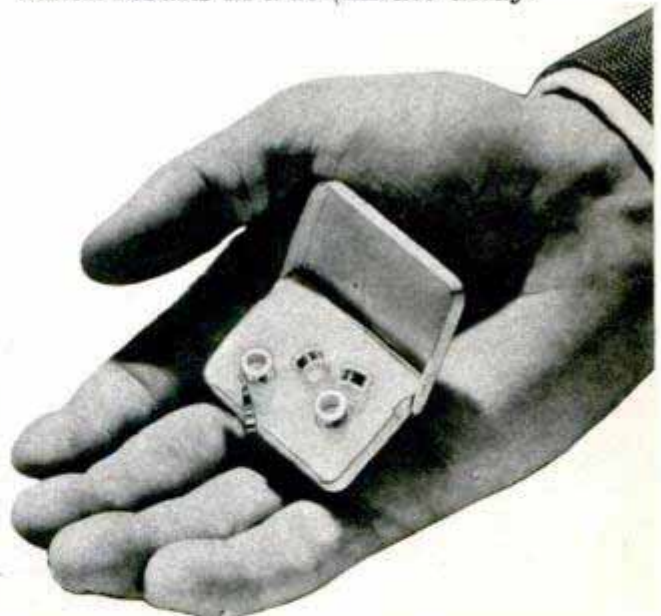

Thin Steel

Shipping an order of steel in an aspirin-tablet box may sound ridiculous, but that is the way a special superthin steel ribbon is packed. So thin that it would require 10 pieces to equal a human hair in thickness, the Armco electrical steel ribbon is wrapped on tiny coils. It was developed for use in a secret electronic device for the Navy.

THE C-4R—



Briggs Cunningham sits in the cockpit of his new masterpiece, the C-4R. The safety steering wheel collapses in the event of a collision. Below, racing driver Phil Walters points to the cooling fins which force a stream of air over the brake drum

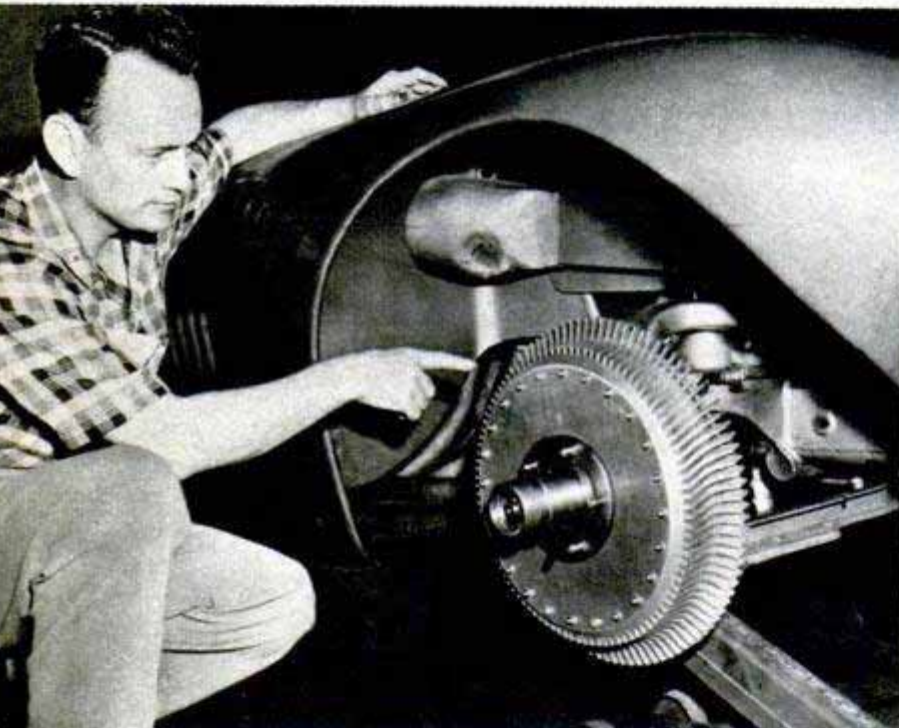

Powerhouse of the C-4R is a modified Chrysler V-8 engine that develops 300 horsepower. It has a compression ratio of $7\frac{1}{2}$ to 1

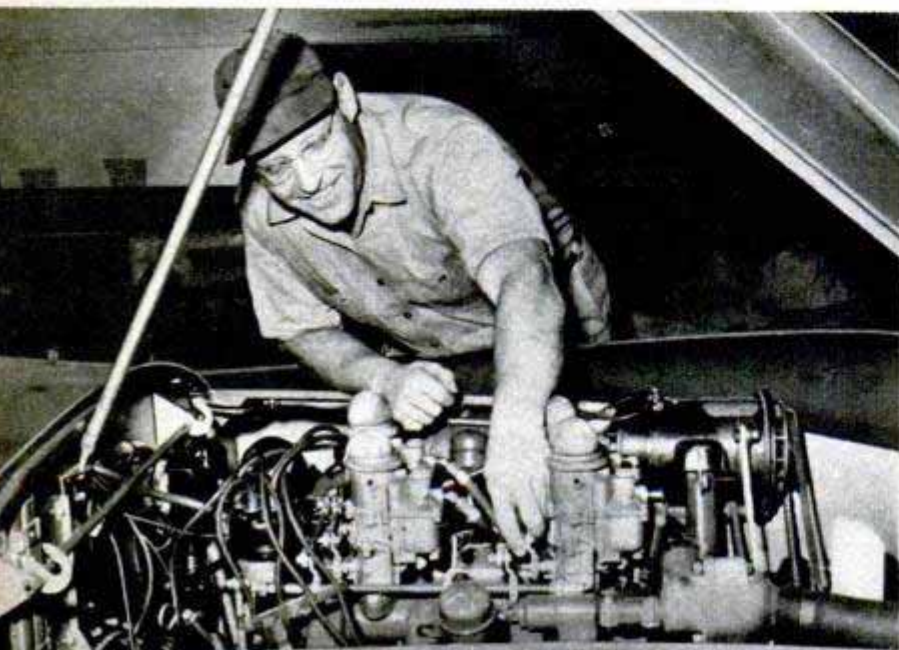

POUNDING HAMMERS and hissing torches in the hands of expert mechanics in Briggs Cunningham's autoshop at West Palm Beach, Fla., are producing a car that promises to put an American trademark among the world's best-known sports cars.

A streamlined, low-slung powerhouse on wheels with a grille that gives it the look of a squatting beetle, the new Cunningham C-4R embodies a host of innovations worked out on three earlier models. It is 800 pounds lighter than the 3200-pound Cunningham in which racing driver Phil Walters roared through the Austin-Martin trap at 152 miles per hour at Le Mans, France, last year. How fast will the new one go? "Better than 150," Walters says, smiling. Most sports-car fans figure it will hit close to 175 miles per hour as its big 7.50 x 15 racing tires wail like sirens on the straightaways.

Under the sloping hood of the Cunningham, a Chrysler V-8 Fire-Power engine modified with special carburetors and Cunningham tricks will send the little car rocketing under the mighty push of 300 horsepower.

This will give the new American sports car twice the horsepower of the average automobile engine harnessed in a lightweight, one-piece frame of welded tubular steel for maximum rigidity and strength. With all those horses and so little weight, acceleration of the Cunningham gives a driver the feeling that he's about to shoot out the back end and wind up sliding along the road on the seat of his pants. To hop up acceleration even more, the three-speed Cadillac transmission used in former models has been abandoned in favor of a new five-speed gearbox of Cunningham's own design and construction. "It covers the same gear-ratio span," says Phil Walters, "but will permit the use of even more horsepower during acceleration since a driver can keep the engine speed higher."

Biggest eyebrow raiser of the new C-4R is the fact that Cunningham has thrown out the famous de

AMERICA'S NEWEST SPORTS CAR

Dion rear end. Invented in 1904 by a Frenchman of the same name, this suspension was almost ignored after World War I until Mercedes picked it up in the late 30s. But the C-4R's rear end is a brand-new Cunningham-designed affair about which the builder and his engineers are extremely secretive. "It's the first revolutionary rear-end improvement since the de Dion," Walters says. "Its principal feature is 25 percent less weight but it is also tougher."

A low center of gravity and careful weight distribution make the new Cunningham hug the road with rugged tenacity and give it the feel of a much heavier car. "Like the Jaguar XK-120, it always seems to be going about 40 miles an hour slower

than it actually is," one test driver reveals.

Driver comfort and safety are heavily emphasized features of the Cunningham. It has the roomiest cockpit of any sports car, allowing the driver to stretch his legs, wave his arms around or sprawl every which way if he wishes. Foam-rubber bucket seats are covered with a special, rough fabric to keep the driver from slipping on fast turns or stops.

Brakes on the new Cunningham are unbelievably powerful. Even on the earlier models tested over a pebbly, rough asphalt surface, the cars screeched to a dead stop from 60 miles per hour in 134 feet. What's more, Cunninghams have finished races with as much "pedal" as they had when

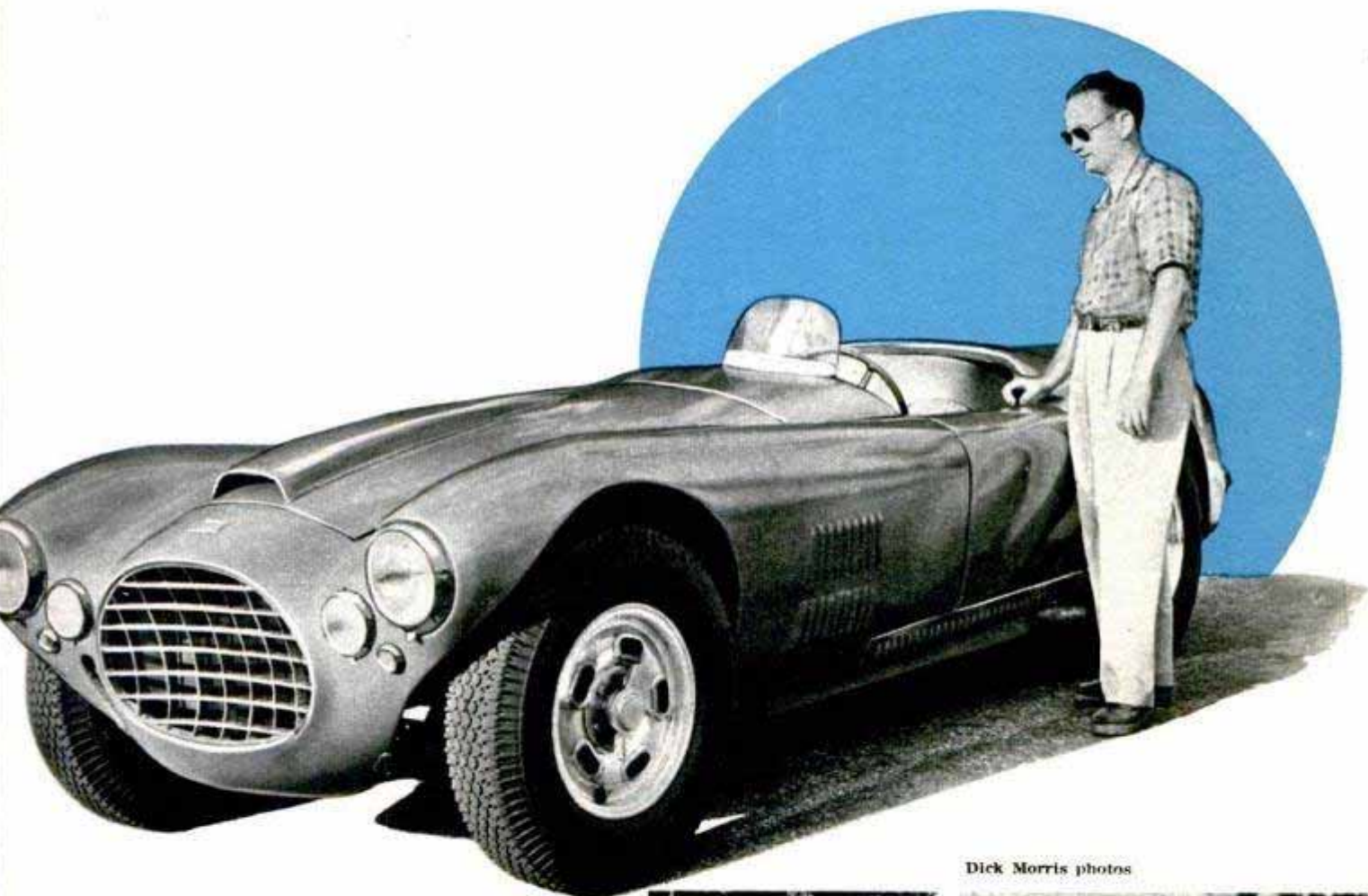

Dick Morris photos

Over-all view of the Cunningham sports car shows off its low lines and complete streamlining. This model, designed for racing, is priced at \$16,000

Right, air scoops on top of hood and at the left of the grille carry cooling air directly to engine. Just visible on inside of wheels are brake-cooling scoops

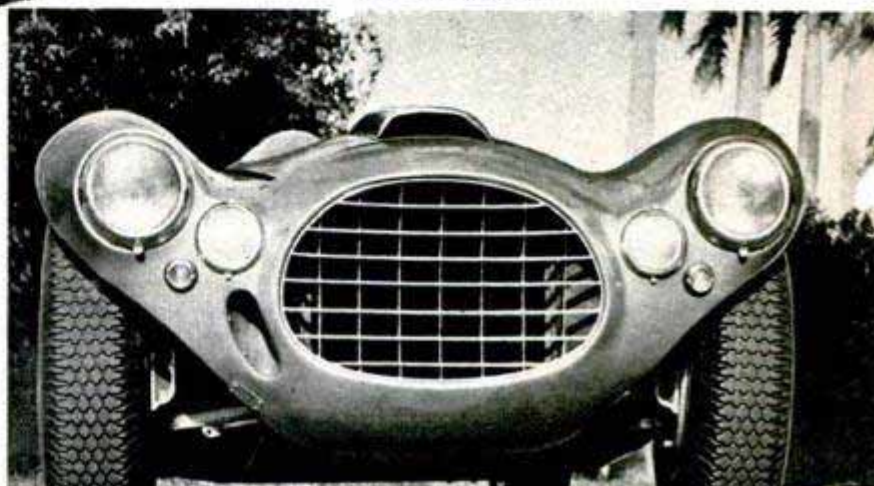



Here's a full side view of the sleek American sportster that is expected to hit close to 175 miles an hour

they started and with no sign of brake fading—a common complaint with high-performance sports cars after repeated stops.

On the C-4R the brakes are even more powerful than on former models. "You can increase braking performance in three ways," Walters explains. "You can reduce the car's weight, increase the brake size or improve brake cooling. We did all three. Brakes on the C-4R are 20 percent larger than last year's Cunningham Model C-2."

Secret of the nonfading feature is a unique cooling system for the brakes. Metal fins on the rims of the brake drums act as centrifugal blowers and whip cool air from scoops under the car, across the brake drums and out through exhaust holes in the hubs.

Cunningham is experimenting with a hardtop model which has low, swooping lines that slim into a V-shape in the rear.

It will be run through wind-tunnel tests in Germany, probably in the same lab used to test Mercedes bodies. Right now the long, chest-high automobile is a three-foot clay model in the Cunningham shops at West Palm Beach. There it is undergoing continual changes in conformation as engineers experiment with air-flow curves over its surfaces.

Since the Cunningham is unique in many ways, it doesn't lend itself to assembly lines. Most of it must be put together by hand. In spite of this, production slowly is creeping upward. Fifty C-3 Continental coupes will be delivered this year as their handmade bodies arrive from Italy. Cunningham expects to produce about 25 of his sports cars this year and 50 in 1953.

You can have one of the C-4Rs for about \$16,000. The Continental coupe is all yours for \$9000. ★ ★ ★

Everything from the chassis of tubular steel to the upholstered seats is handmade on the Cunningham. Chassis is welded into a unit for maximum strength

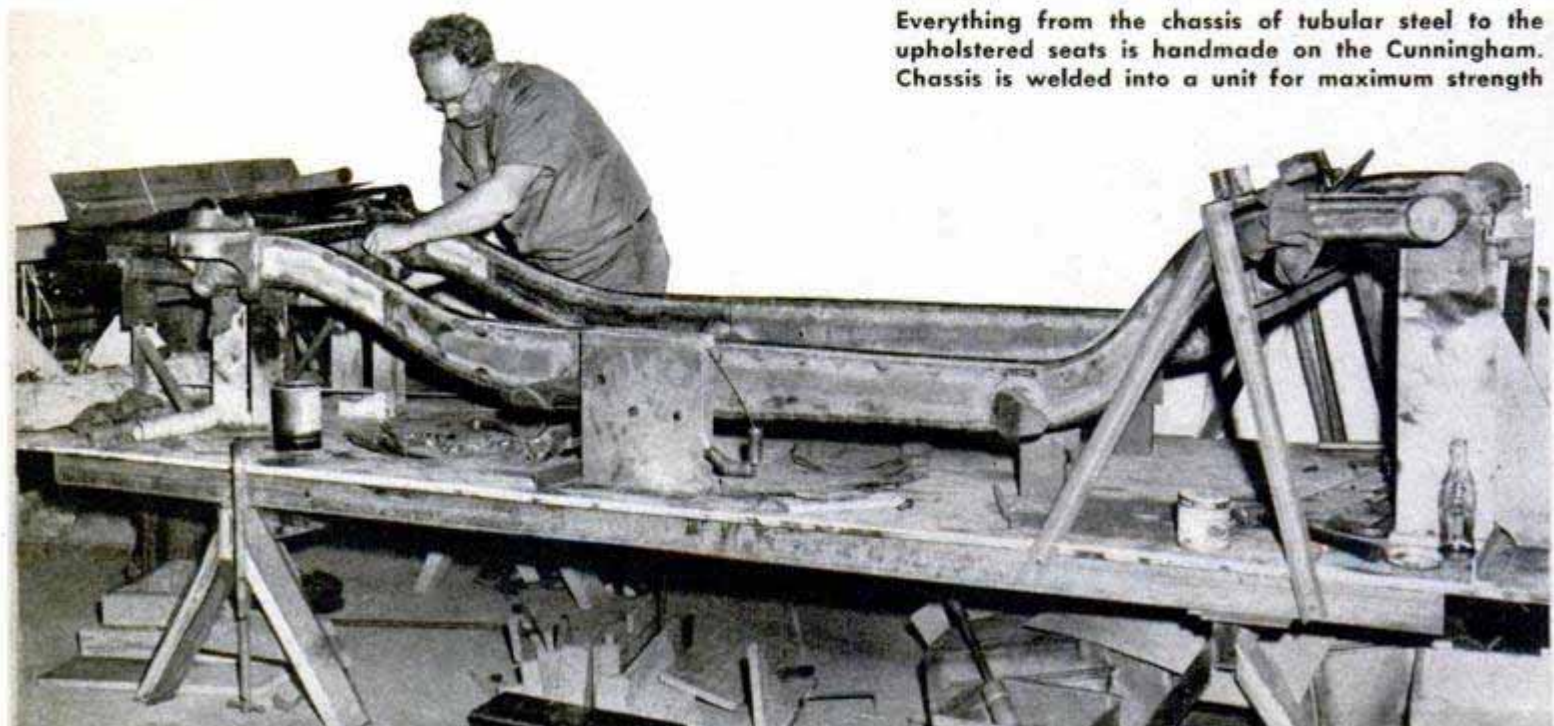



Douglas Aircraft Co. photo

Airliner Groomed for 1954 Service Cruises at 360 Miles per Hour

One hour will be lopped from coast-to-coast air-travel time when the new Douglas DC-7 goes into service for American Air Lines late next year or in early 1954. The 60-passenger airliner is a little more than three feet longer than its widely used pred-

ecessor, the DC-6, and 50 miles per hour faster. It has a cruising speed of more than 360 miles per hour. Both have a wingspan of 117½ feet. Four Wright compound engines turn out 13,000 horsepower at take-off, compared with 8400 for the DC-6.



Portable Piano

Small and light enough to be carried in a suitcase, a portable piano developed by a Berlin radio engineer plays up to five octaves. Karl Baessler calls his 25-pound instrument a "pianophon." In place of strings it has metal bars similar to reeds in a mouth organ. The vibrations from them are picked up and transformed into tunes in a magnetic system and amplified.



Dial Phone Uses Numbered Drum

Faster dialing and fewer wrong numbers are the advantages of a new German telephone. Instead of a clockface dial, the new instrument has a cylinder with odd numbers listed on one side and even numbers on the other for rapid location. There is also a sound-modulator control mounted on the telephone so you can adjust the sound to suit your ear.

British Test Devices To Speed Home Building

BRITAIN, even more than the United States, has faced a widespread housing shortage since the end of World War II. Bombing raids plus the dearth of building during war years made the shortage a national problem. Today building materials are second only to armaments on the priority lists of the British government.

To get more houses per man-hour of labor, the government set up a laboratory near London that develops and tests mechanical methods of speeding output. The lab even designs and builds complete housing units. In fact, one of its buildings is a test structure known as the "Ctesiphon." Mound-like, it is made of reinforced concrete in corrugated form. Fire-proof, verminproof and resistant to earthquakes and shocks such as bombings, the building is being tested for possible use as a home.

Other research projects are eliminating bottlenecks in brick-home construction. New material-handling methods, both British and foreign, are tested. Those found practical are then made available to the nation's contractors and builders.

Above, a mechanical "hod carrier" is able to haul 10 buckets of mortar on each trip

Below, a large number of British houses are of brick. A brick grab, also crane-powered, picks up 98 bricks in one bite

Another brick-handling device is a fork with a capacity of 160 bricks. The crane is designed for small construction jobs

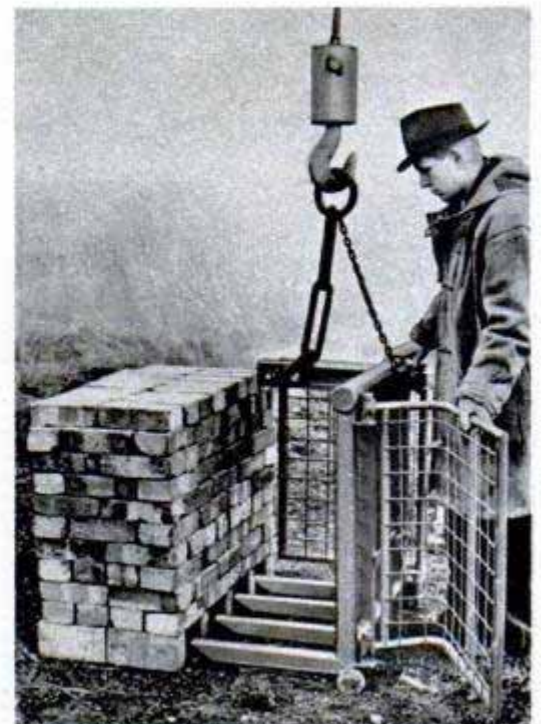

AMERICA BIDS for the ATLANTIC BLUE RIBBON

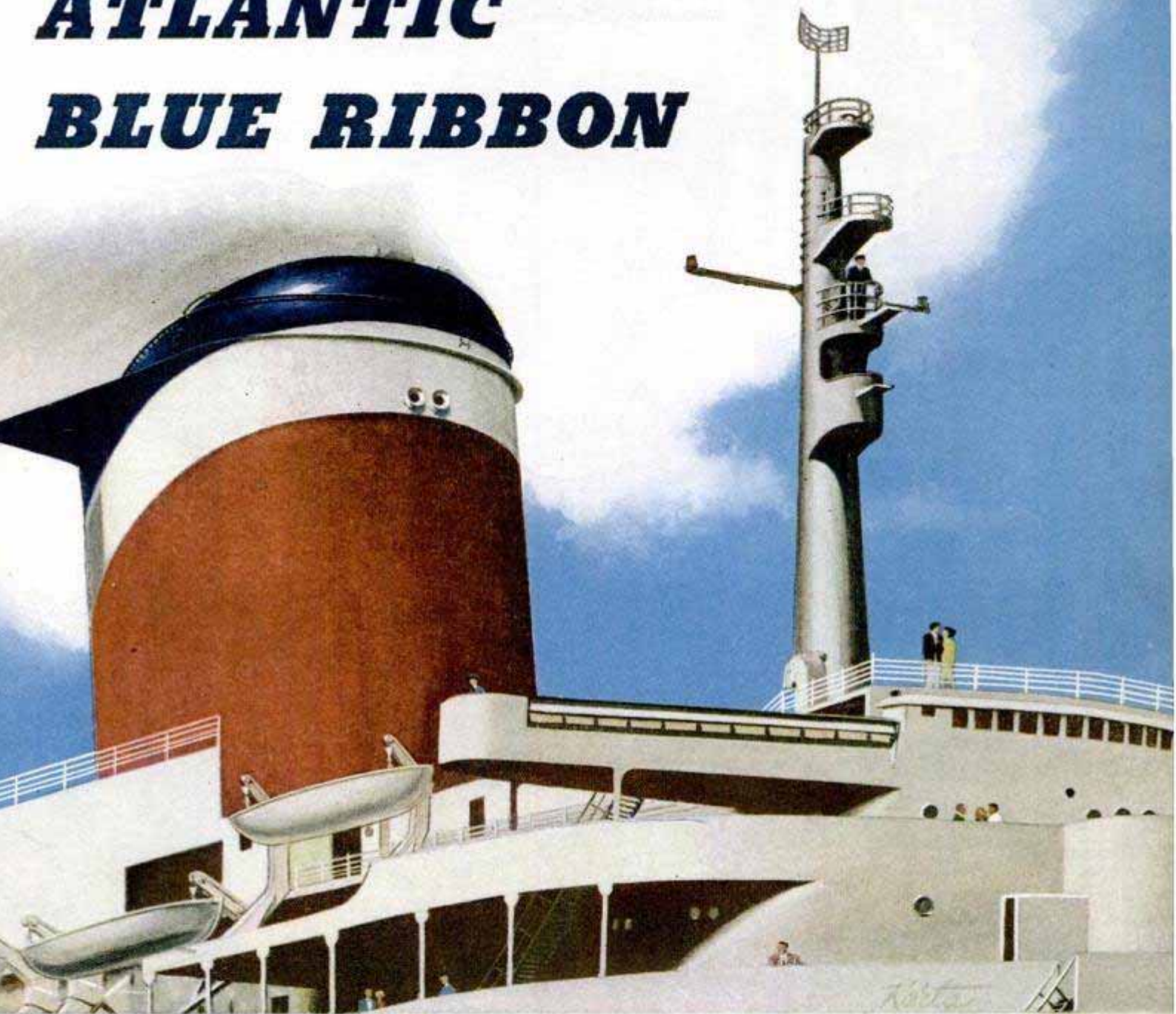

Towering above the *United States* is its forward stack—biggest ever built—and the communications mast

By Richard F. Dempewolff

ON THE COAST of southern Virginia, there's a world of supergiants. Rumbling monster cranes towering 14 stories into the sky stud the horizon, swinging 40-ton chunks of fabricated steel into place like so many matchsticks. Single rooms in some of the vast buildings cover about the same floor space as six football fields. Inside these caverns, men crawl like flies among three-story steel behemoths that, for the past 2½ years, have been thundering and whining as they fashioned or finished off even more monstrous goliaths: King-sized

turbines; incredible shafts of gleaming steel, as big around as a barrel, that stretched away in the gloom as far as you could see; unbelievable bronze propellers that, from blade tip to blade tip, stood higher than the roof of a two-story house; great steel plates, twice the size of your garage floor, thumped and twisted into curved shapes like bits of foil. All bore the simple mark, "Hull 488."

On the waterfront of the sprawling Newport News Shipbuilding and Drydock Company where all this transpired, Hull 488 was a mountain of steel gradually rising



Forward stack measures a mighty 60 feet fore and aft, 55 feet high. Finlike projections prevent the smoke from swirling down to the deck. Cutaway at left shows how smoke ducts branch off into four huge dust-collecting drums

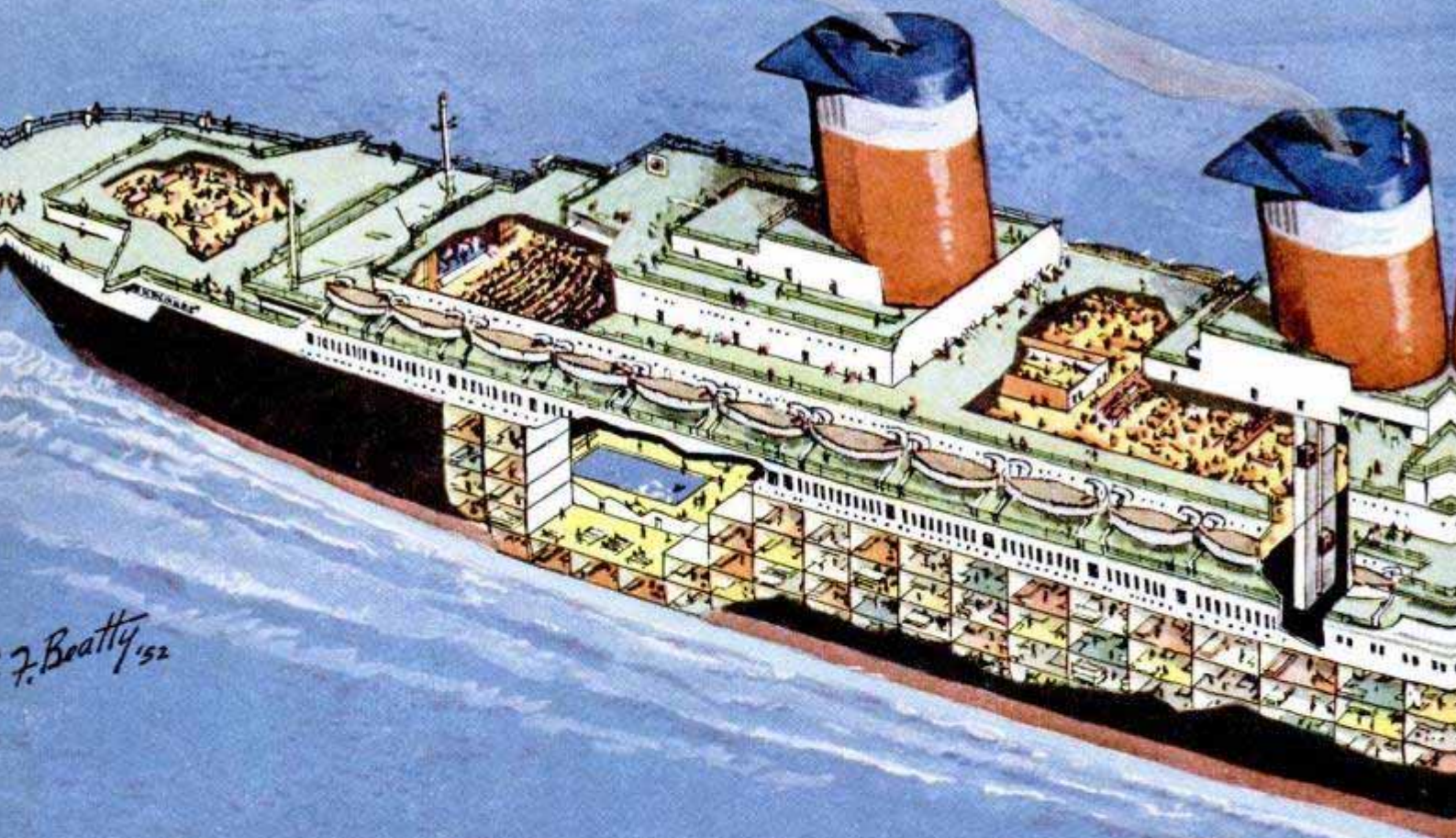
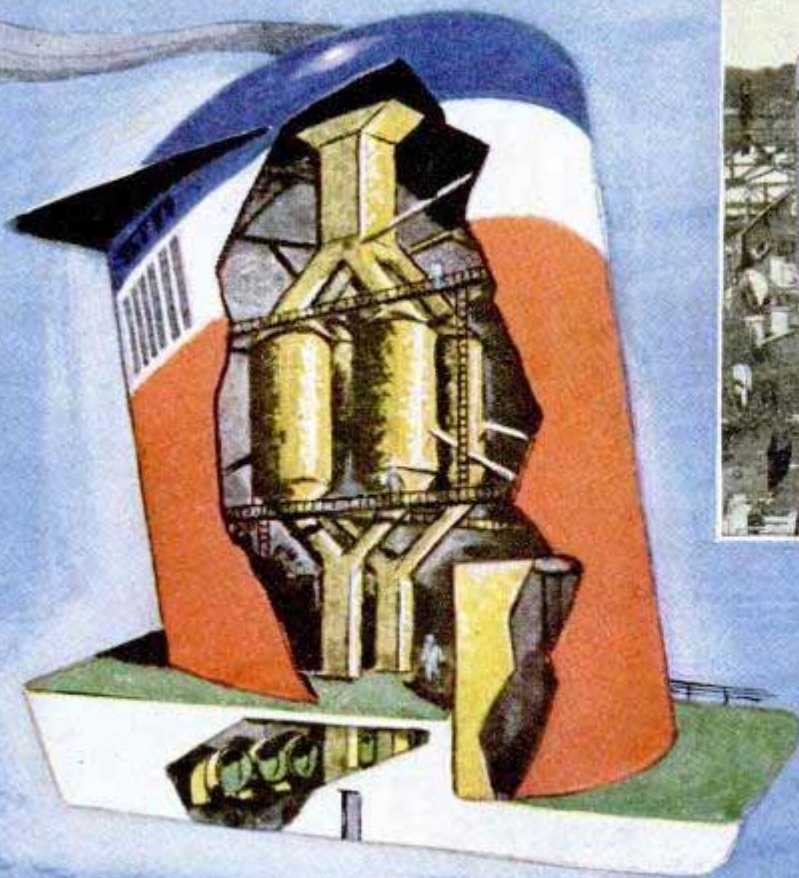

F. Beatty '52

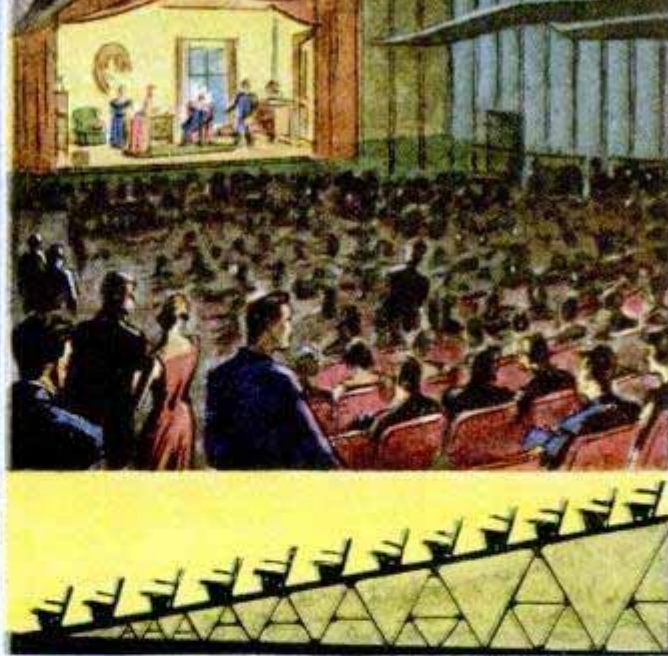
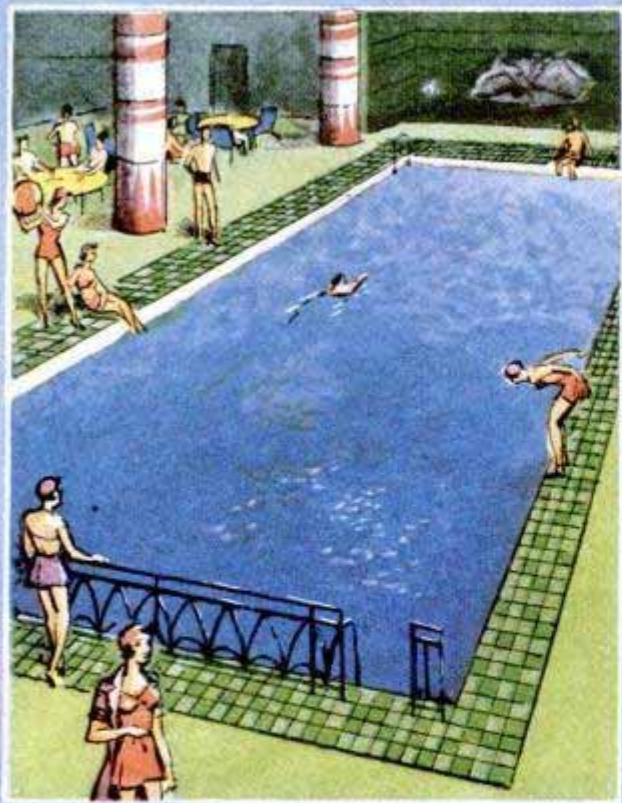

There are two theaters aboard, each seating more than 500 persons. They are the first theaters aboard ship to have sloping floors for visibility. During the day passengers can swim in the big interior pool surrounded by a luxurious terrace for lounging and games

AMERICA'S BIGGEST LINER

Cost — \$75,000,000	Weight — 51,500 tons
Crew — 1000 men	Decks — 12
Length — 990 feet	Beam — 101 feet
Height from keelson to stack top — 175 feet	
Passenger accommodations — 2000	
Troop accommodations in wartime — 14,000	
Horsepower — At least 118,500	
Propellers — Four with nine-foot blades	
Speed — At least 30 knots (about 35 miles per hour)	

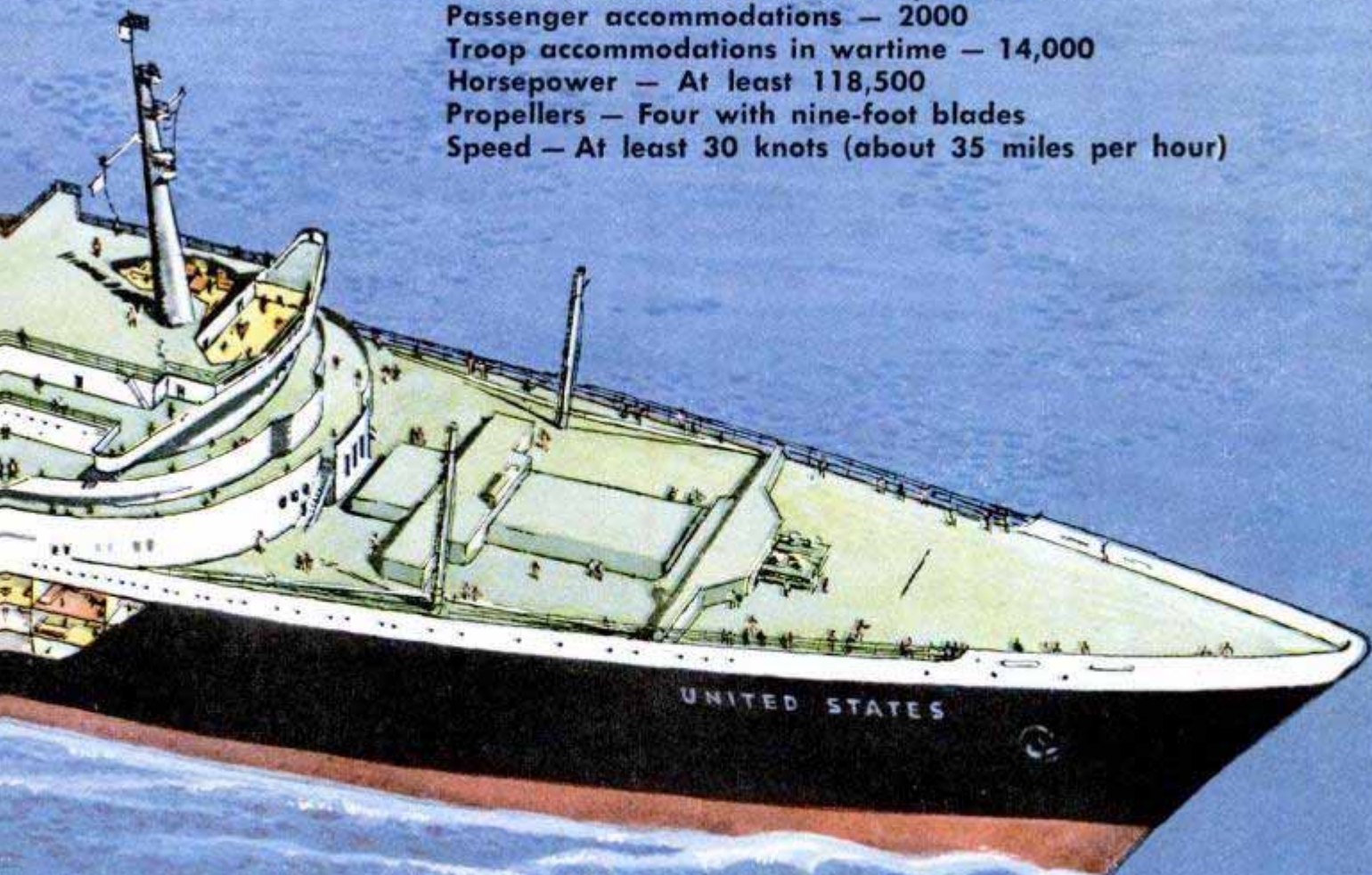

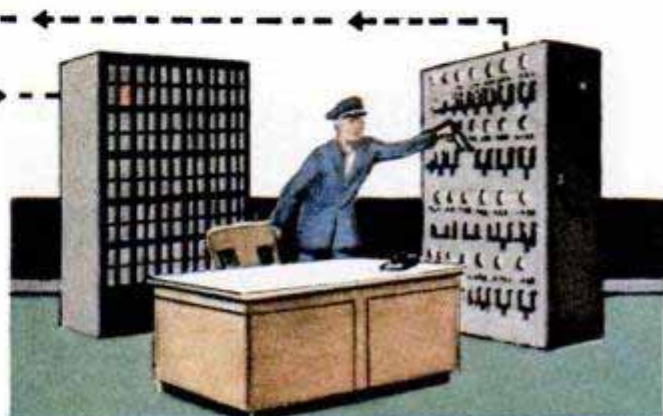
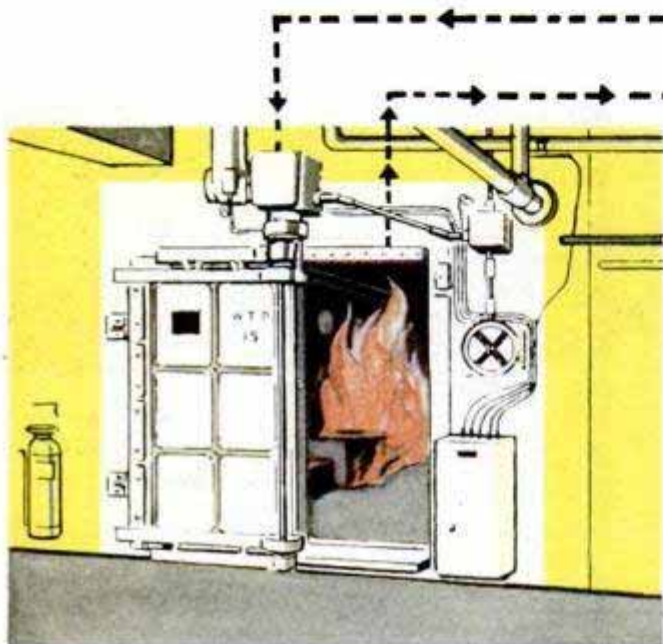

Top, hull is compartmented like a battlewagon with waterproof, fireproof bulkheads. In case of fire or collision, damaged compartment can be sealed off

Above and left, if a fire should break out in a stateroom, smoke detector triggers signal on bridge. Officer can sound alarm, then close door to stateroom

in a step-sided concrete graving dock. No ordinary incline shipway on the whole coast was big enough to take the great keel. Here, in the birthplace of such sea mammoths as the giant aircraft carriers *Midway* and *Coral Sea*, she slowly grew.

One scorching day last summer, under a splatter of champagne and the roar of a crowd, Hull 488 took on a new name. She became the SS *United States*—the most revolutionary modern superliner in the world and the mightiest ever built in this country. Bigger than her aircraft-carrier predecessors, her 990-foot length overhung the rim of the huge graving dock by 30 feet at bow and stern. If upended, she would top the 70-story R.C.A. Building at Radio City by 140 feet. Her 101-foot beam can skim through the Panama Canal locks with only four feet to spare on each side. From keelson to the top of the forward stack, she towers 175 feet in the sky, or about as high as a 14-story building.

No greased skids or dramatic splash marked the launching of this supership. Instead, her builders opened the floodgates of the big graving dock. Water from the James River swirled around her vast hull and

lifted her from a forest of chocks. A small fleet of tugs nosed her a mile downstream alongside the pier where 3000 men working in three shifts are putting the finishing touches on her thickly carpeted staterooms and lavish public lounges. Next month—half a year ahead of schedule—under the banner of United States Lines, the \$75,000,000 behemoth will make her maiden voyage on the run between New York, Southampton and LeHavre.

Tip-off to the drastic innovations in the SS *United States* is her mysterious gross weight. Though she's nearly as big as the *Queen Mary* and *Queen Elizabeth* (1021 and 1031 feet respectively), she is listed at only 51,500 gross tons—about the same as the old *Bremen*. Gross tonnage of the *Mary* is 81,235; the *Elizabeth*, 83,673. But the capacity and accommodations on the *United States* are almost identical with the big *Queens*.

It will take 1000 crew members to send her plowing through the North Atlantic. Some 2000 passengers will be luxuriously accommodated in the 12 completely air-conditioned decks that honeycomb her cavernous hull. They will be lifted and dropped to

various levels in a dozen different elevators. Their evenings at sea will be brightened by entertainment in two theaters with sloping floors and seating capacities upward of 500. They will have the run of three spacious lounges and exercise on a broad sports deck. Two and a half turns around the "prom" deck will provide a one-mile stroll. They'll eat in one of three dining rooms and swim, if they wish, in an interior pool framed with a colonnaded beach terrace. Every passenger space is equipped with ship-to-shore telephone that will connect with any part of the world. No other ship is as well-equipped.

But there's a lot more. The SS *United States* is no ordinary ship. Dark secrecy has cloaked her ever since 1946 when she was a gleam in the eye of her designer—a retiring, bespectacled naval architect named William Francis Gibbs. She is considered strictly a naval vessel. That's why the Navy is paying the bill for features that will adapt her for war. The Maritime Commission will pay the balance and turn her over to the United States Lines for only \$28,000,000. In return, she is subject to call at any time as a transport. And what a transport! Enveloped within her sleek lines are all the tricks of ship design learned during World War II. She's a "convertible." In a matter of days (instead of months and years as was the case with ships like the *America*), her luxurious fittings can be stripped out. Roomy accommodations for 14,000 troops—a full division—can be fitted into the same space. And she will be able to carry them 10,000 miles, if necessary, without stopping to refuel or reprovision.

Four propellers with nine-foot blades will slam the floating hotel through the seas, driven by a series of four roaring high-temperature steam turbines. According to the

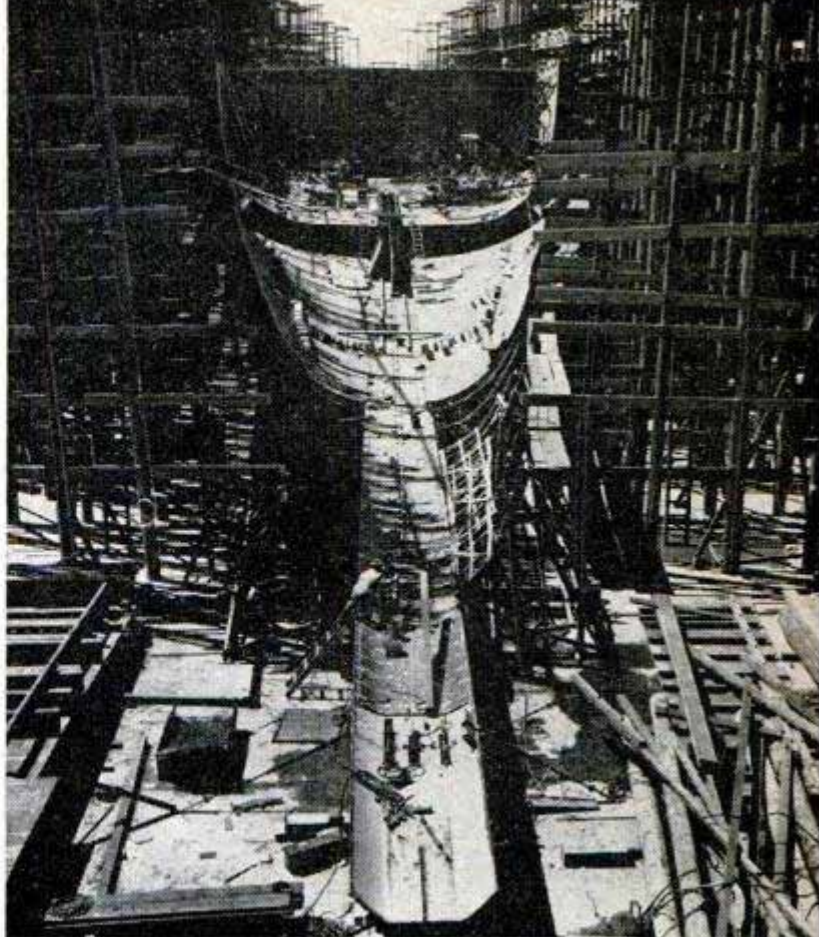

Tiny dots inside the hull are workmen, dwarfed by just one section of big ship during construction. Far "wall" is one of the many watertight bulkheads

Merchants Vessel Register, they'll kick up 118,500 horses. (According to other authorities, lots more.)

Just how fast she'll go no one is telling. The officially announced speed is 30 knots—about 35 miles per hour. That's the same as the *Queen Elizabeth*. Mention this to anyone who knows and he'll just smile. It's a widely circulated "secret" that she may attain nearly 40 miles per hour—fast enough to make the run to Southampton in

Designers check stack shape inside a wind tunnel. These stacks were abandoned when they failed the tests

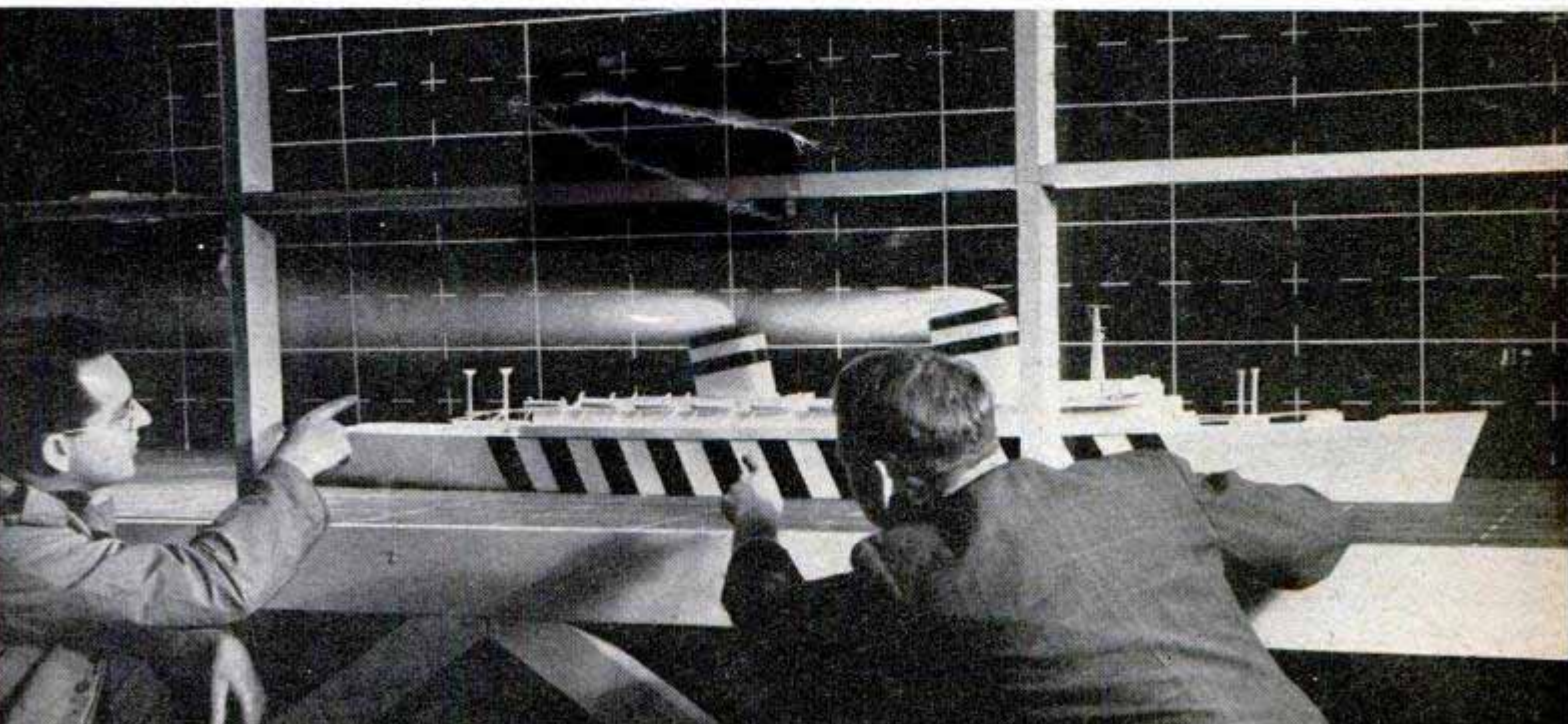

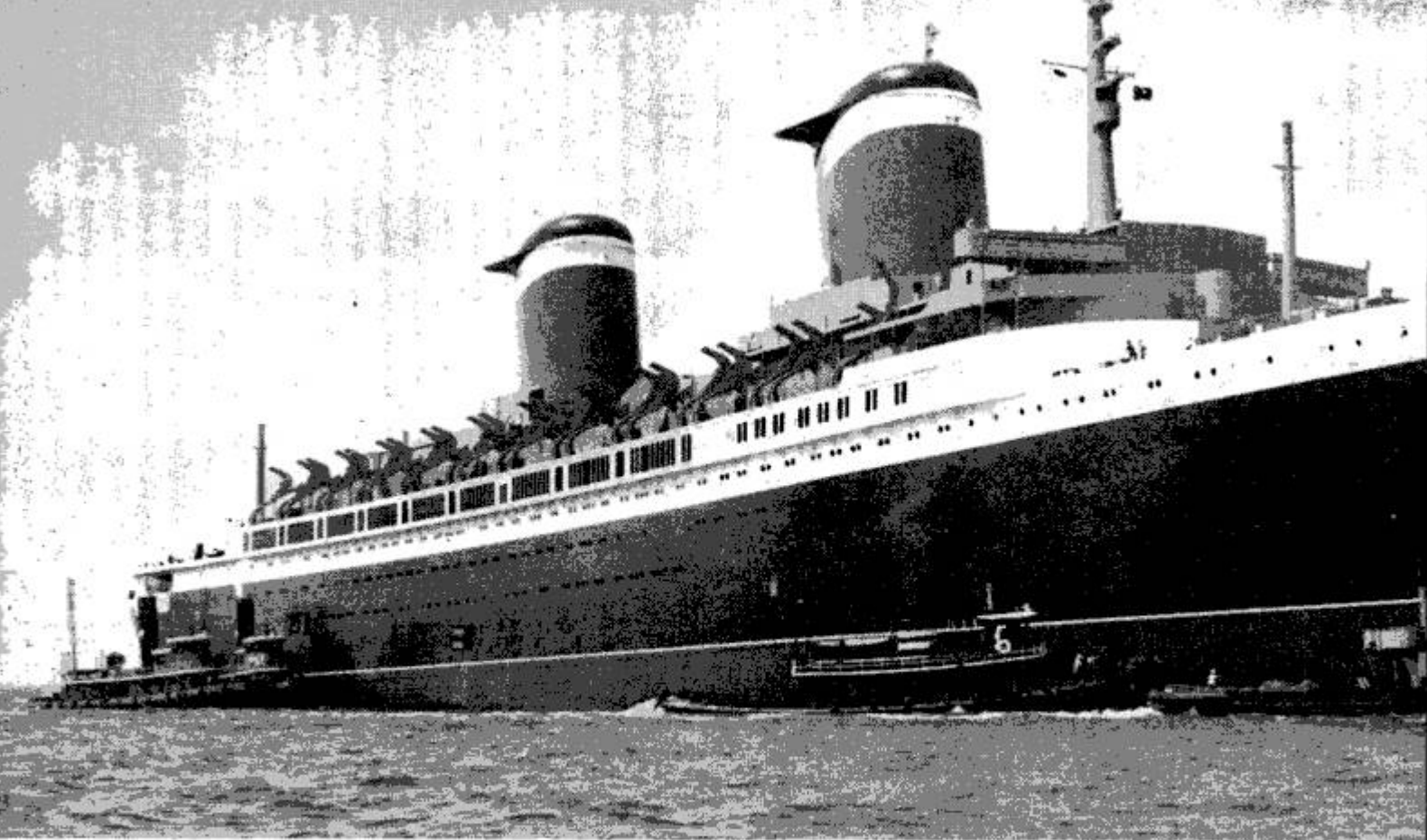

Whopping 990-foot superliner, ready for finishing touches, is shoved toward fitting berth by a fleet of tugs

a record-breaking time of only 70 hours!

How is it possible to pack all that punch into a supership which, big as she is, seems slightly outclassed by the British *Queens*?

Stand on her rakish forepeak, look around at the towering superstructure and you soon see one reason. Virtually everything from the promenade deck up is made of aluminum. Even lifeboats, davits, ladders, rails and stacks are made of the light metal. Below decks, you find it in many partition bulkheads, shower stalls, crews' berths and elevator doors. Some 2000 to 3000 tons of the featherweight metal account for the mighty ship's unbelievably small dead weight of a mere 12,810 tons—half that of the *Queens*. It also accounts for years of headaches and engineering miracles turned by the Newport News builders.

Aluminum must be worked "cold" (under 400 degrees F.) or it loses strength and corrosion resistance. Big die presses are fine for punching out odd-shaped forms for mass production. But when you're making only one each of a few hundred different forms, die presses become uneconomical. Hence, aluminum plates for the *United States* had to be formed individually by hand. To shape plates, men had to pound them in steel forms with machine hammers—somewhat the way you'd hammer out a copper bowl in a wooden form.

The fantastic job of forming and riveting the metal fell largely to Gordon Donnan and Charles Boykin, young engineers in

the planning section of the shipyard's steel-hull division.

"All our folks are principally steel men," Boykin explains. "The properties of steel are vastly different from those of aluminum. So we had to experiment for months to acquire the 'know how' of aluminum."

Aluminum has more "spring back" than steel, for instance. If the huge ½-inch plates for the stacks had been hammered to the exact swooping curves called for by ship designers, they would have "unbent" themselves enough to throw everything out of kilter. "So our fabricating men," says Boykin, "had to 'overform' all rolls and bends in making the design shapes."

If bent at too abrupt an angle, aluminum will fracture, so the fabricators soon learned to turn sharp corners in the metal with a more generous radius. Expansion and contraction of aluminum are twice that of steel. During early experiments, the men riveted some aluminum plates together. Overnight, the temperature dropped, the plates contracted and morning found the riveted seams ripped apart. Aluminum partitions on the big ship now fit in slotted columns. They can expand and contract every which way without popping loose.

Aluminum rivets lose some strength if driven hot, but not if you freeze them. So while aluminum riveting was in progress on the *United States*, her passageways were dotted with Dry Ice cabinets loaded with deep-frozen rivets that could be lifted out,



steaming, in wire-mesh baskets all ready to hammer in place.

Most of the monster ship was built in chunks in the shops on steel platens or skids. The hull alone consists of 183,000 separately fabricated pieces. Some, like the bow section, weighed up to 200,000 pounds!

The real "skull busters" were the ship's mighty funnels with their streamlined, finned "umbrellas." They are the biggest smokestacks of any ship in the world. Largest of the two is the forward one, stretching away for 60 feet fore and aft and 55 feet skyward. More than 80 tons of aluminum and steel and 65,000 rivets make up its shell, which is big enough to accommodate four six-room houses and a few front lawns.

(Continued to page 252)

Instead of oars, lifeboats have pump handles which are worked back and forth in unison. Shafts operate gears, which turn a propeller to move the craft

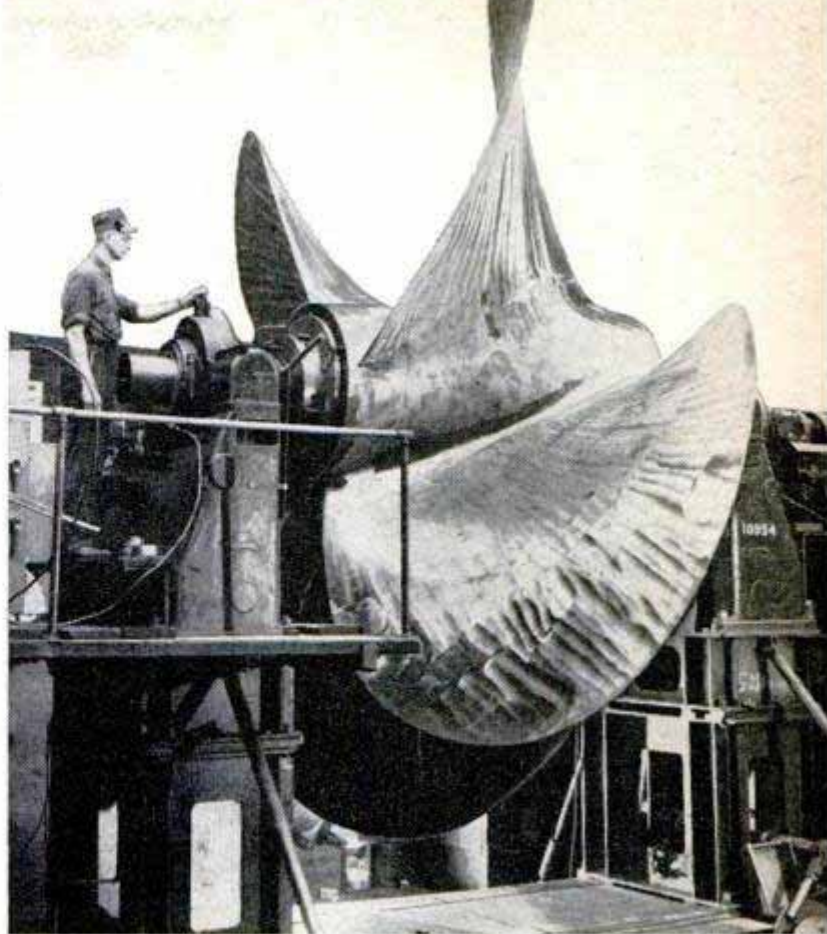

Four massive propellers with nine-foot blades will drive ship at speed of at least 35 miles per hour



Aluminum rivets, made malleable by keeping them cold, are delivered to workmen from freeze chests. Below, 40-foot aluminum lifeboat carries 140 persons

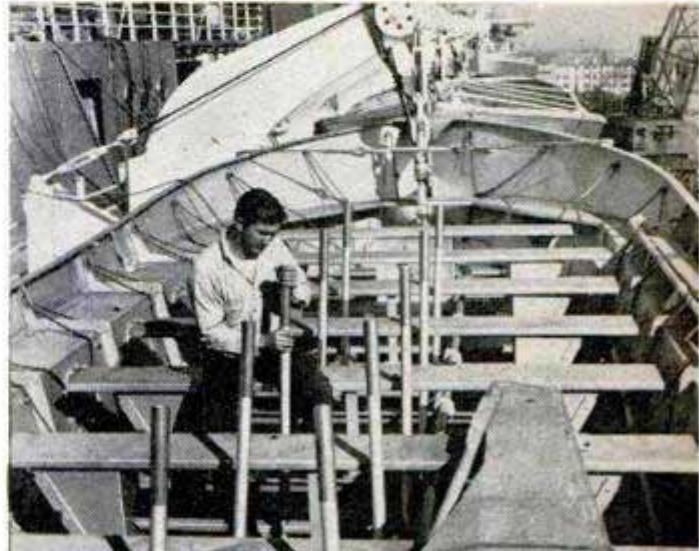
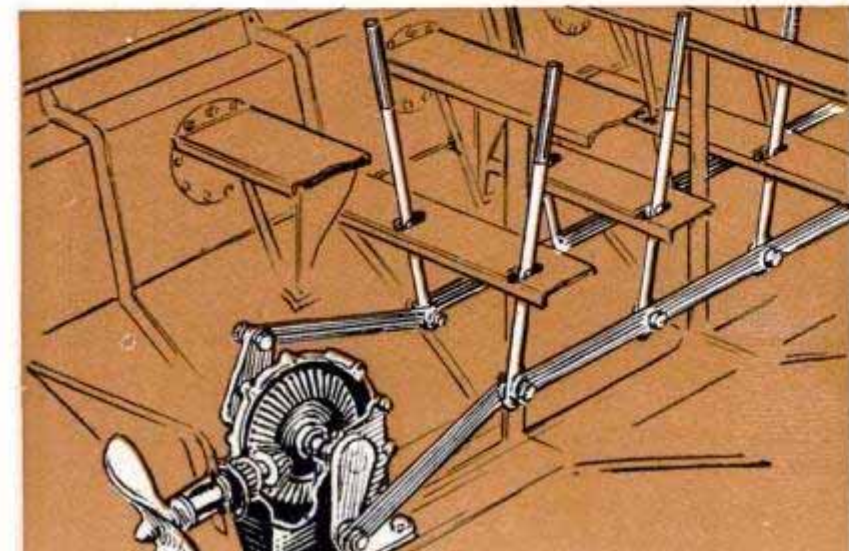

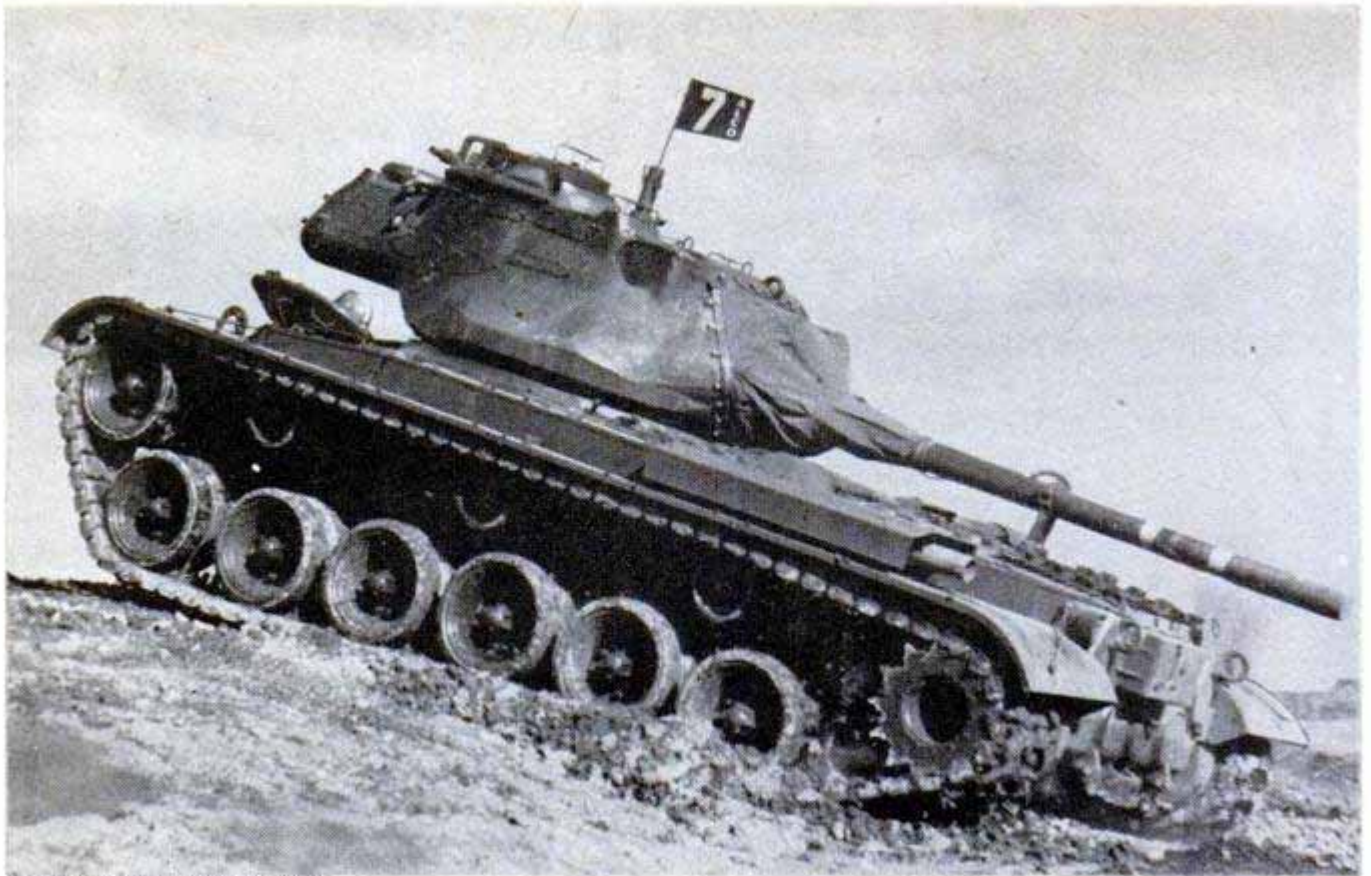

American Locomotive Co. photo

Army's Latest Medium Tank Features More Lethal Fire Power

Hundreds of fighting models of what an Army arsenal commander describes as the "finest medium tank in existence" are off the production lines already. The 48-ton metal monster—the M-47—has an 810-horsepower air-cooled engine that drives it over rough terrain at faster than 35 miles

per hour. The 28-foot-long, 11½-foot-wide tank has a five-man crew. Its most superior feature is increased fire power. An improved high-velocity gun steps up probability of first-round hits and has a compensator that automatically restores the aim of the gun after each shot.

Quick-Release Battery Terminal Prevents Fires Due to Short Circuits

Short circuits in a car's electrical system can cause fires unless the current is shut off quickly by disconnecting a battery cable. A fast-acting terminal clamp enables the motorist to disconnect the ground terminal in seconds without any tools, thus eliminating the cause of the fire before serious damage can be done. The safety device, a handle-like rod threaded on one end, replaces the clamp bolt in the conventional terminal. When the handle is pushed flat against the top of the battery, the clamping nut can be drawn up tight to make a good connection. In an emergency, you merely swing up the handle to a vertical position and, by means of a washer arrange-



ment, the tension on the battery post is released, allowing you to pull off the terminal easily.

The OWNERS' REPORT on the MG

7651

I am the owner of MG. I have owned it approximately 23 years. Having tried both kinds, I find that my MG operates on regular gasoline premium (high test) gasoline. My average gasoline mileage is 23 m.p.g. for city driving, and 28 m.p.g. for country driving.

I CHANGE OIL every 2000 miles, but also ADD OIL every 1000 miles.

Roadability and handling qualities are: Excellent Good Unsatisfactory Better than excellent

Maneuverability in traffic seems to be: Excellent Good Unsatisfactory

Acceleration is: Exceptional Very Good Average Poor (Very good for 1250 cc.)

Curb and road clearance is: Satisfactory Too High Too Low

My MG is the only car I own ; I own another car (or cars), beside the MG . Here are my main reasons for purchasing an MG: Wanted sports car at a low price with reasonable cost of operation, also a high degree of reliability for everyday use.

Particular features I like are: Low center of gravity, low body lines ; Compact interior, seating arrangement ; Size and weight of car ; Length of wheelbase ; Four-speed transmission ; Four-cylinder, overhead-valve engine ; Others I like.

I use my MG: for general pleasure driving ; in competition exclusively ; for both foregoing purposes .

Specifically, what do you dislike about the car? Poor instrument lighting - poor quality material in top & side curtains. Numerous oil leaks when raked-up & near maximum for long periods.

Have you ever owned an MG before? Yes No How many? Two

Would you buy another MG? Yes Possibly No

M.G. is the finest all-around sports & passenger car available. No, definitely.

Do you find MG parts and repair service readily available? Yes, definitely.

How do you find your dealer service? Excellent Good Average Poor

The dealer I bought my car from is a moon about mechanical work and a small time swindler to boot!

How do you rate your MG, generally? Excellent Good Average Poor

GENERAL INFORMATION

What type of car would you prefer in your next sports car? In-line V-type

Valves: Side Overhead

More?

2 cc. D.O. H.C. V-6 (to make at cost I can afford)

Do you think the MG have a real future in America? Yes - we have experienced a tremendous future in this area.

My question listed. Thank you.



Aside from questionnaire survey (sample above), Clymer interviewed many enthusiastic MG owners in person

By Floyd Clymer

OUR SURVEY of MG owners hit a new high in the percentage of questionnaires that came back. They not only answered all questions with alacrity but nearly all added personal comments, mostly

in praise of the popular British sports car. Although production capacity and other factors make it improbable that sports cars ever will give Detroit manufacturers serious competition, it is obvious that there is

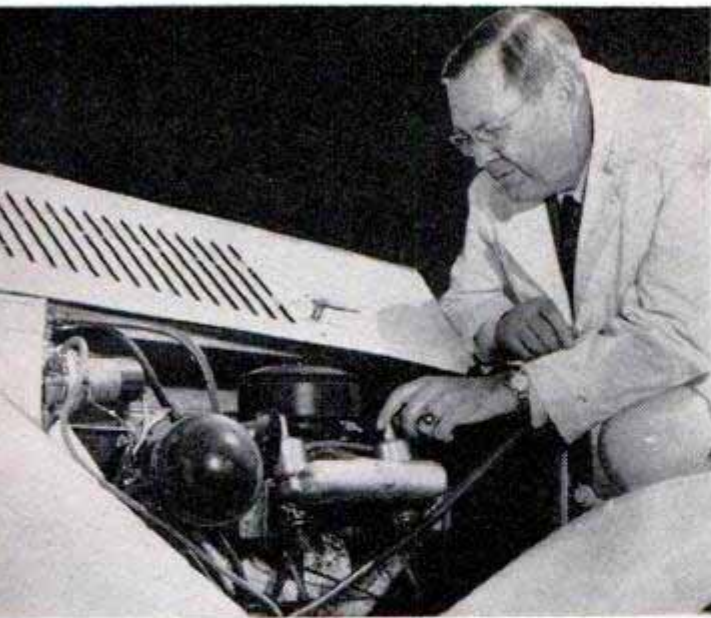

The MG's tiny four-cylinder OHV engine has only a 76.6-cubic-inch displacement; has dual carburetors

"I think they're here to stay but they'll never offer any competition to passenger cars."—Albany, Ore., physicist.

"It puts the pleasure back in pleasure driving."—Milwaukee, Wis., bus driver.

"It seems to be an amazing piece of machinery—fast, safe and fairly comfortable."—Chicago dentist.

"If the general public in some way could be shown (through demonstrations) what it is missing, the light-car manufacturers of the U. S. either would have to go out of business or get on the ball."—Hollywood, Calif., movie sound technician.

"My MG is an attraction wherever I park

Acceleration Test

MG Midget, Series TD

¼ mile from zero	(Through 1-2-3 gears) — 20.1 seconds
½ mile from zero	(1-2-3 gears) — 33.8 seconds
0 to 30 m.p.h.	(Low and second) — 6.1 seconds
0 to 60 m.p.h.	(1-2-3 gears) — 22.7 seconds
0 to 70 m.p.h.	(1-2-3-4 gears) — 44.8 seconds

SPEED IN GEARS	M.P.H. (Normal & maximum)
1st	18-23 m.p.h.
2nd	32-39 m.p.h.
3rd	50-60 m.p.h.
4th	81-83 m.p.h.

Actual speed 79-80 m.p.h.; Speedometer variation 2 or 3% (quite accurate)

Best cruising speeds — 60 to 65 m.p.h.

it. I find myself wanting to do all the polishing and simple maintenance work myself in my spare time. The little car has zip, dash, character and a good personality."—Wrentham, Mass., lawyer.

"I hope Detroit wakes up some day and gets something just half as good on an assembly line."—Crestline, Calif., Air Force officer.

"I enjoy driving it as I have a sense of being part of the car rather than having just a means of transportation. This is partly because of the need for constant shifting, the sound of the high-r.p.m. motor and the responsive steering."—Thiensville, Wis., industrial engineer.

"The car should have a 6-volt electrical

Short turning radius of the MG (complete circle in less than 16 feet) makes it a pleasure on quick turns

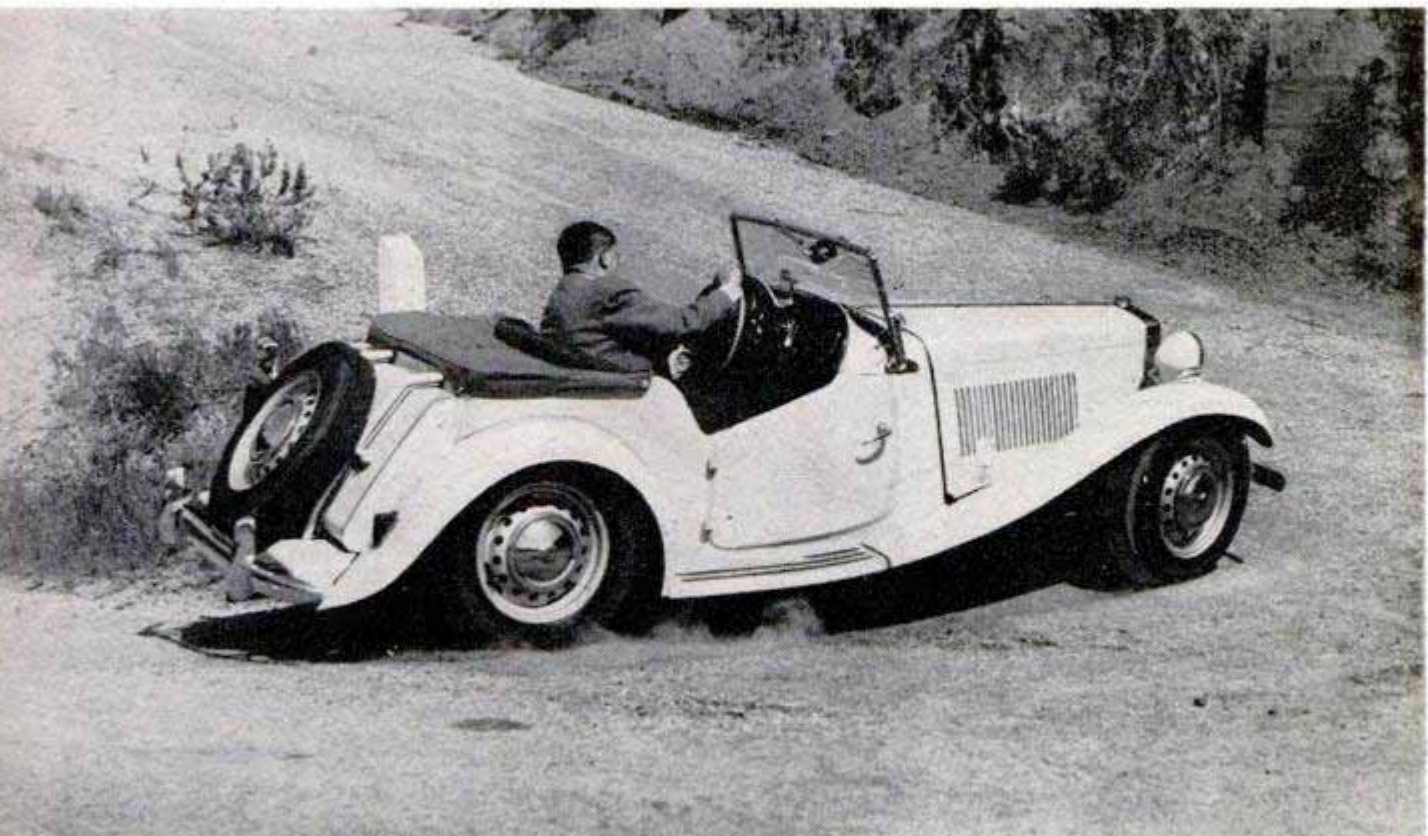

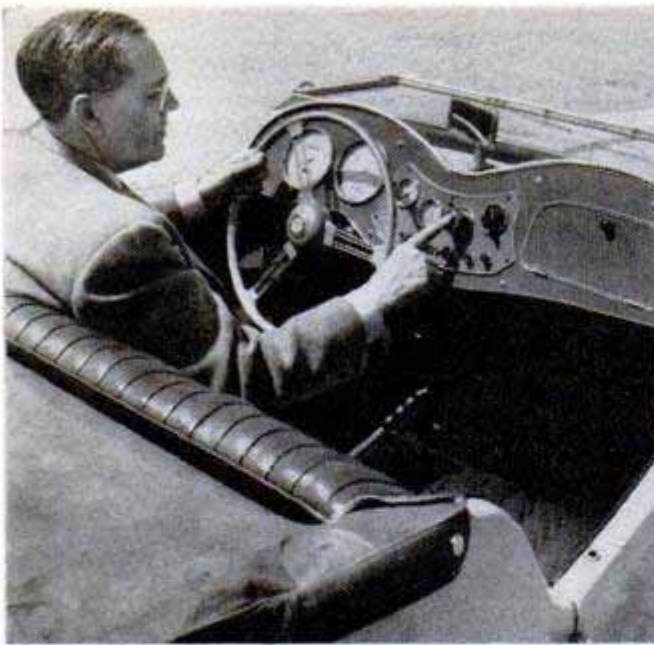

Clymer touches horn button on the MG, oddly placed in center of dash in a unit with the dimmer switch

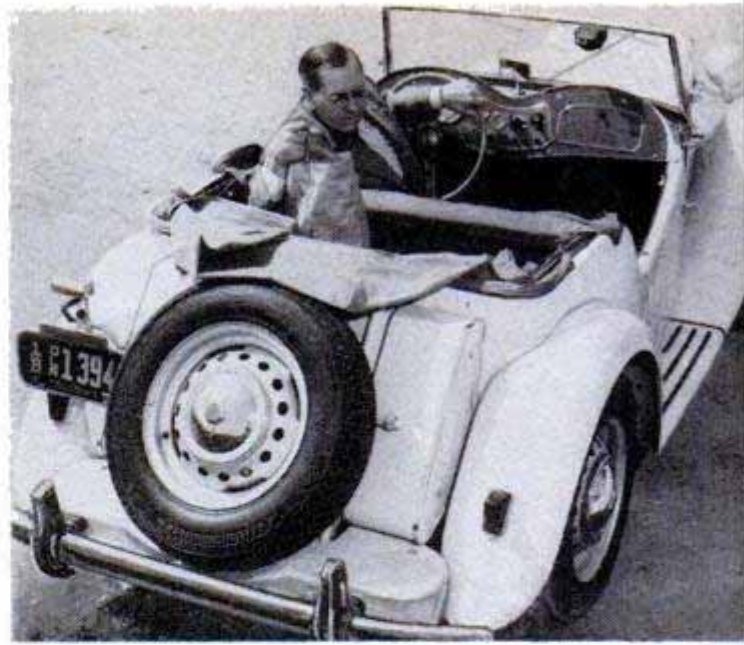

Luggage space back of seat may be large for a midget car, says Clymer, but small by U. S. standards

system as the 12-volt system is harder to service in the U. S. Otherwise it's a fine car."—Los Angeles, Calif., broker.

A La Grange, Ill., manufacturer's agent and a Dumont, N. J., engineer agreed on one thing. The first said, "Definitely they are cars for men. Married women are a detriment to their sale. They want a utility car." The second said that MG has a real future in America "only if women allow the men in the family to choose the car to be purchased."

At least two woman owners contradicted this masculine opinion. A Milwaukee, Wis., fashion designer wrote, "Every girl should have one." A Portland, Ore., secretary said, "For me it's the ideal car. . . . Practical, easy to keep up and service myself. Also, there's the woman's angle. The MG has a certain style of its own."

"My MG costs little to run, has very good roadability, it's an awful lot in a small package and, above all, it's the cutest car."—Brooklyn, N. Y., nurse.

"From the woman's point of view, the MG has a lot to offer. . . . Why would anyone want an American car?"—New Orleans, La., secretary.

As always, some objections arose. These included:

"Too small, hard to get in and out of, poor resale value."—Montclair, N. J., physician. (Conversely, a Beaver Falls, Pa., insurance agent remarked: "I weigh 230 pounds and am 6 feet tall but can slide in and out of my MG without difficulty.")

"I have been backed into three times to date by people who seemingly did not see the car. There appears to be no solution unless the American public is educated to watch more closely."—Piedmont, Calif., draftsman.

"Repair work on my MG runs higher than I figured it would when I bought it. Too many repair men figure any man with a foreign car has plenty of cash in the bank."—Milwaukee custodial worker.

"Sports cars are slow to sell as used cars."—Flint, Mich., jeweler.

"The worst part about owning an MG is the price of a heater, radio, luggage rack, etc. They are way too high and since the MG has a 12-volt system you can't buy electrical accessories from other local dealers."—Union, N. J., factory foreman.

Some more miscellaneous reactions of the survey included:

"Rings and bearings on the MG show much more wear than those on American cars, because of the constant high engine speed."—Winnetka, Ill., research engineer.

"Not enough 'guts,' poor workmanship, poor engineering, won't stand rough treatment."—Longview, Wash., machinist. (This complaint was the only one of its kind in the entire survey.)

"Can't read the instruments at night. . . . The MG could use an additional 15 to 20 horsepower."—Burbank, Calif., advertising artist.

"Should be more powerful with the great highways we have."—Los Angeles investment broker.

"In extremely cold weather, visibility is poor. Windshield continually fogs and freezes."—Chicago salesman.

"People always are touching and playing with the car when I park it."—Oakland, Calif., airline inspector. (This complaint was noted several times.)

The most common complaint about MG's Midget TD model was a minor one—many don't like the canvas top and side windows.

(Continued to page 240)

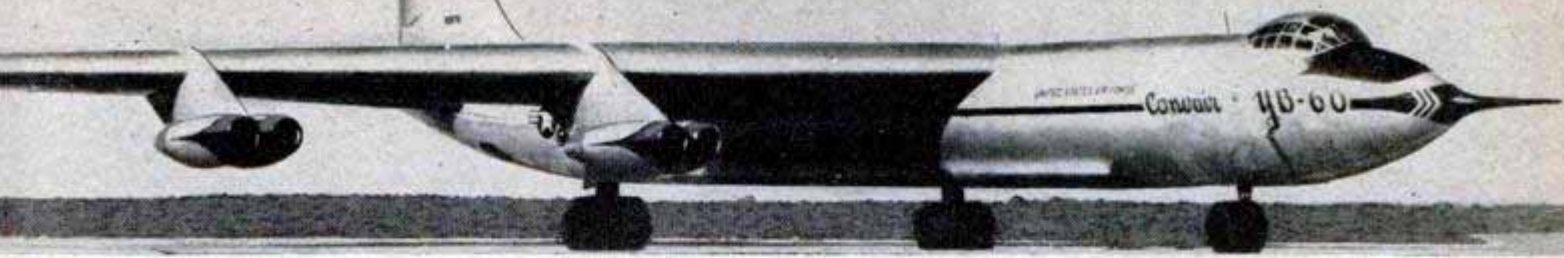

First flown in April, the YB-60, above, was built for the Air Force by the Consolidated-Vultee Aircraft Corporation. Slung beneath its wings are four pairs of J-57 turbojet engines whose total thrust equals nearly 80,000 horsepower, about four times as much as the giant B-36's six piston engines now produce

Weighing approximately 175 tons, the YB-52, below, is capable of speeds as high as 550 miles an hour. Its eight jet engines are the same as those powering the YB-60. In the nose of the Boeing-built bomber is a new sight designed for precision bombing at altitudes above 10 miles with visibility at zero

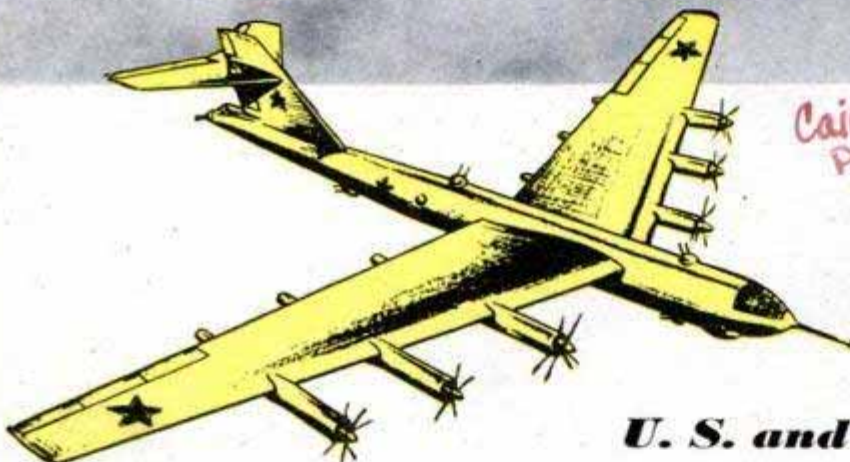

Cain + VORDEN - "MILITARY AIRCRAFT"
 PUBLISHER: HERBERT JENKINS
 3 DUKE OF YORK ST.
 LONDON S.W.1

HEAVIES

U.S. REP: LAWRENCE V. FAIRMALL
 231 So. LA SALLE ST.

U. S. and Russian Air Forces

CHGO 4, ILL.
 AN 3-2061

Boeing Magazine

Drawn by British artist James Hay Stevens, using data brought from behind the Iron Curtain, the Russian intercontinental bomber, above, is about the same size as the B-36. Reportedly it is powered by six turbojet engines and is believed to have a range near 10,000 miles. Its 22-man crew functions in shifts

Two MIG-15 fighters can be carried on hooks under the wings of a Soviet TU-4, below, economizing on fuel consumption for the small craft. Based on the American B-29, the Red bomber has turbojet engines copied from the Rolls-Royce "Nene" design. There is also a Russian transport version of the same plane

From *Military Aircraft* by Cain and Vorden

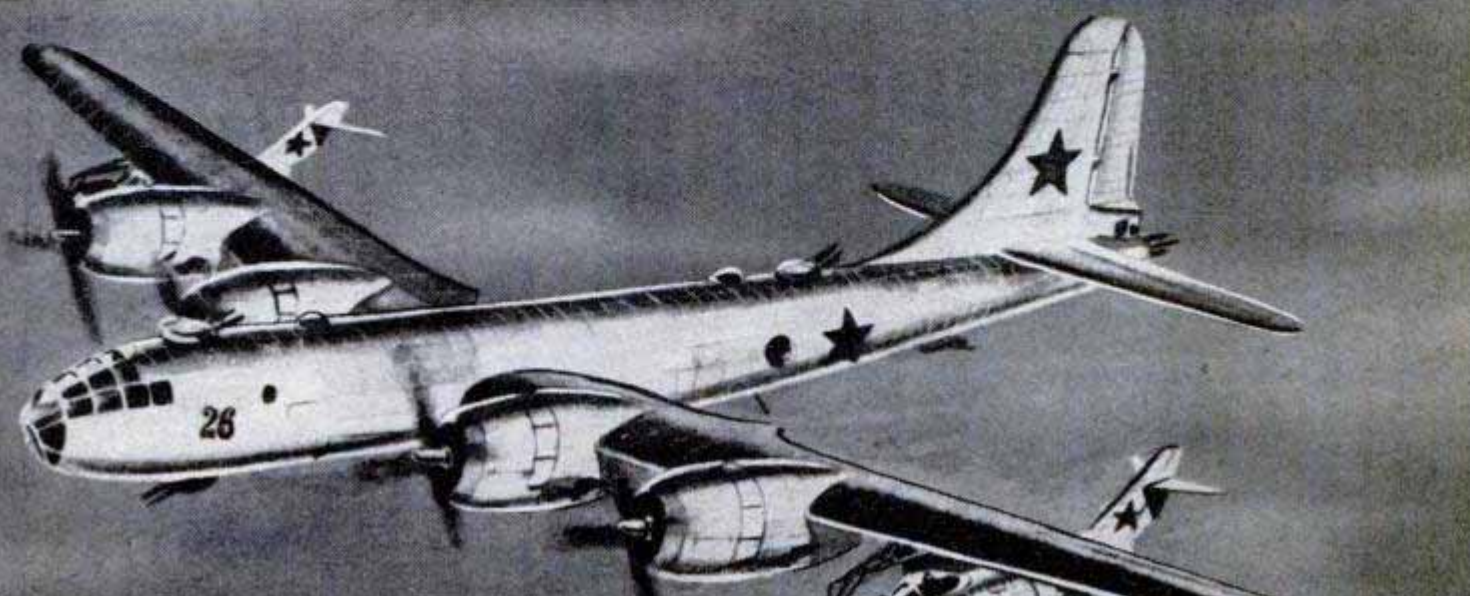

TV Goes to the CONVENTIONS

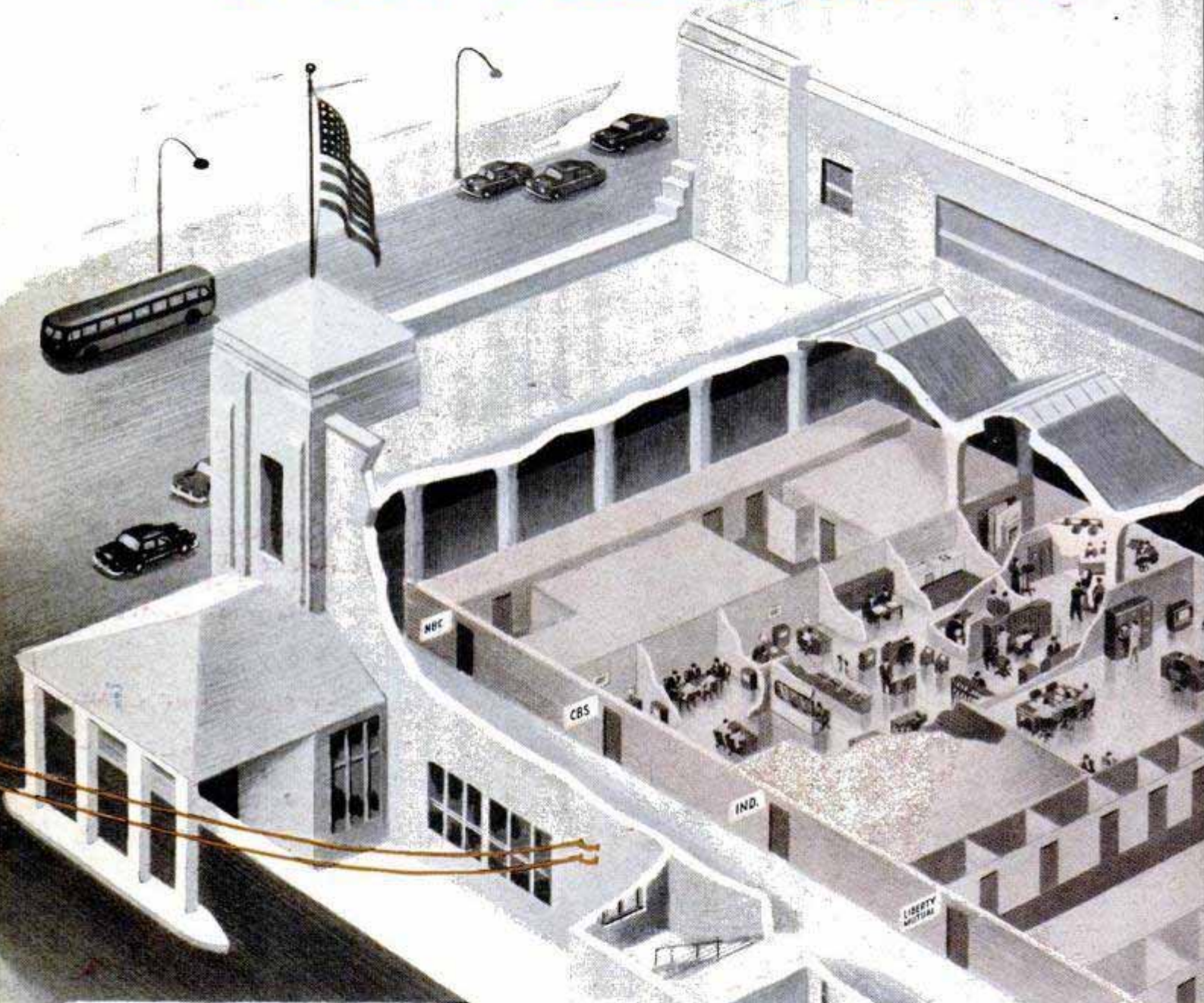

ACCORDING to estimates, about 60 million people, or 40 percent of the nation's population, will watch the political conventions this summer on more than 16 million TV sets. The largest concentration of television equipment ever assembled will beam the convention to the nation. These four pages of drawings show how it will be done. One entire wing of Chicago's Amphitheatre will be given over to television and radio studios and equipment. Cable is being laid to every vantage point in the building and live pickups will be made at the entrances. An antenna on the roof will pick up remote broadcasts from hotels and rail terminals. Cameras on special pedestals will televise the convention proceedings from several points inside the vast main hall of the Amphitheatre



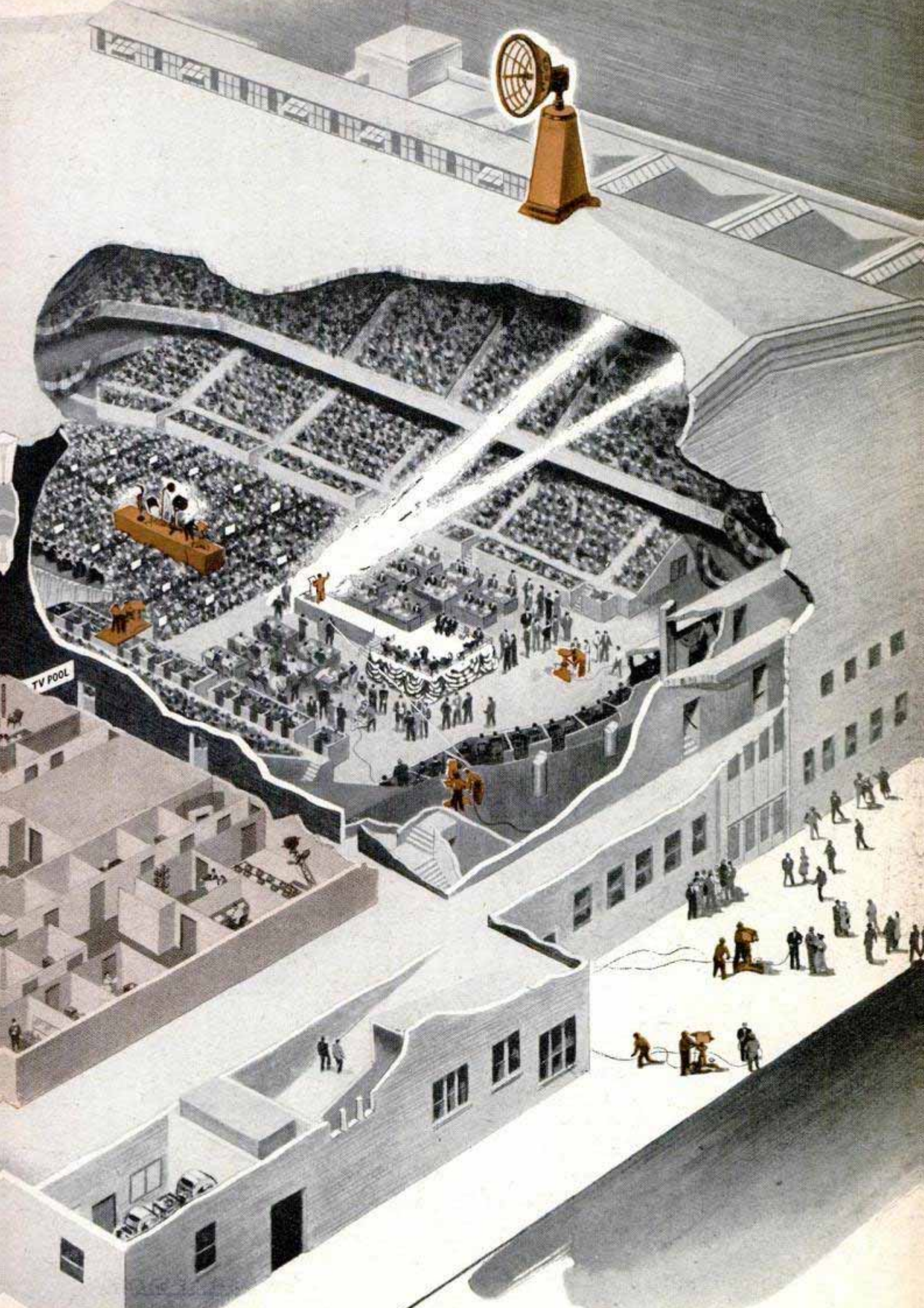

TV POOL

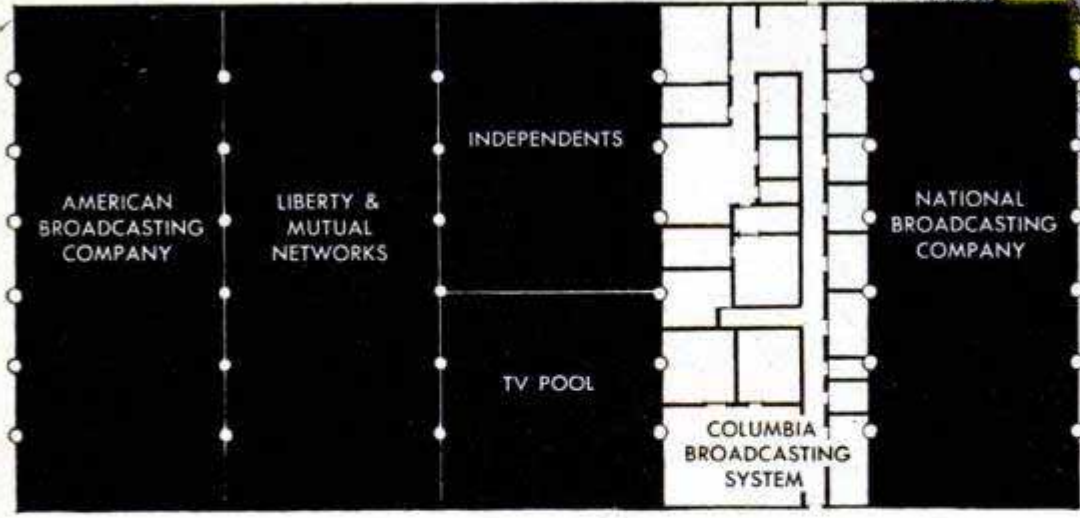
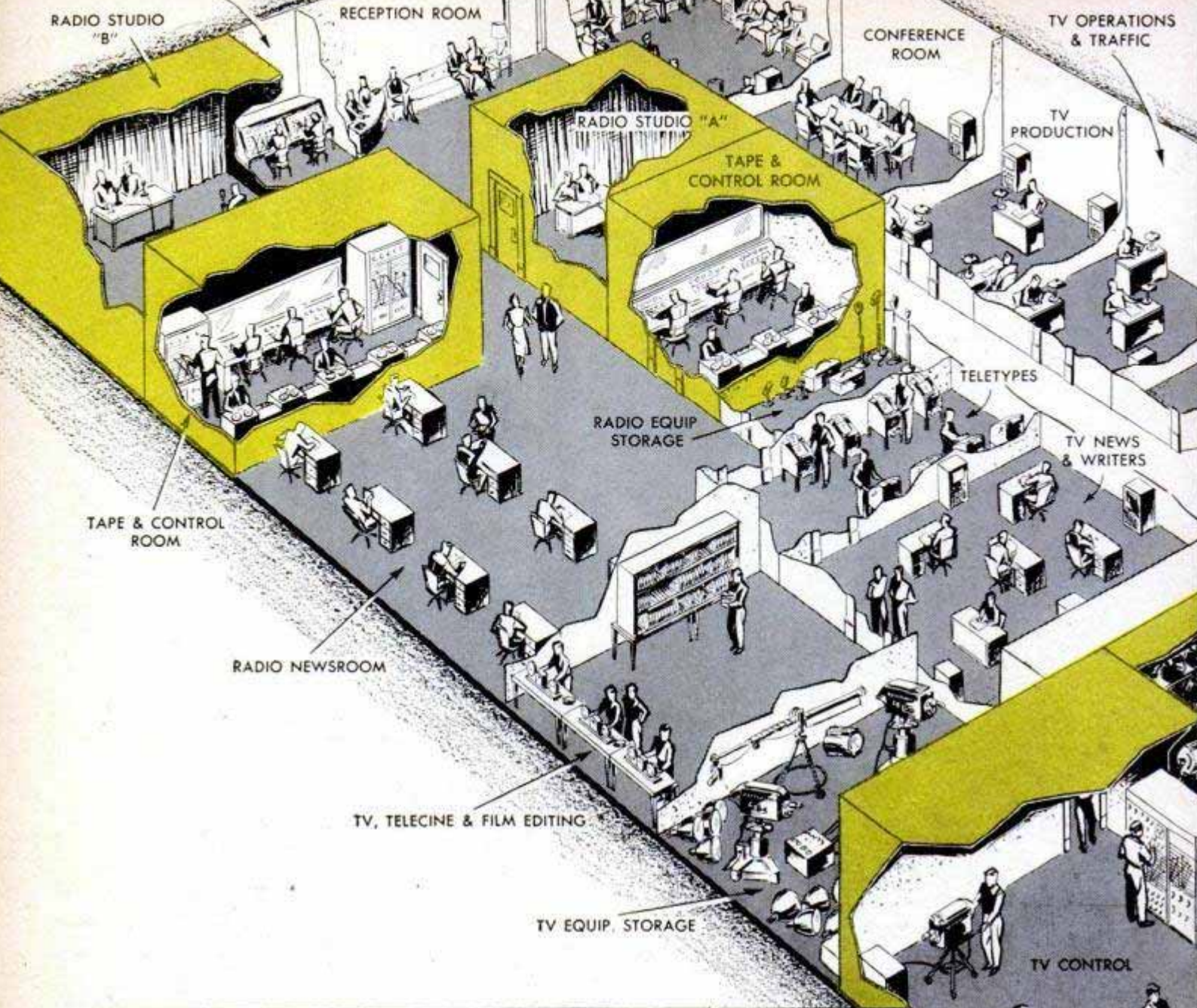

Big wing of the building is split into five similar sections—four for the major television networks and one to be used jointly as a TV pool which also will serve the independents. The area in white shows the floor plan for one network. The cutaway drawing shows how this section will be split into studios and control rooms. Each of the rooms with colored walls and ceilings will be soundproofed. The remaining

rooms will be built with temporary partitions. Studios permit interviews and comments whenever there is a lull in the convention proceedings. Telecasts from various parts of the building and from several strategic spots in Chicago's Loop will be funneled into the control room. There technicians will be able to choose the most interesting picture to transmit to viewers watching video screens across the nation

In addition to the studios, other rooms in the layout will be used for film editing and storage, headquarters for TV and radio newsmen, lounges, conference rooms, a scenery room and a complete kitchen. Teletypes will bring in the latest news and reactions from other parts of the country. Although this drawing shows only one of the four network areas, the others will have similar layouts. For the first time a large segment of the American voters actually will be able to see their candidate as he is chosen in the convention

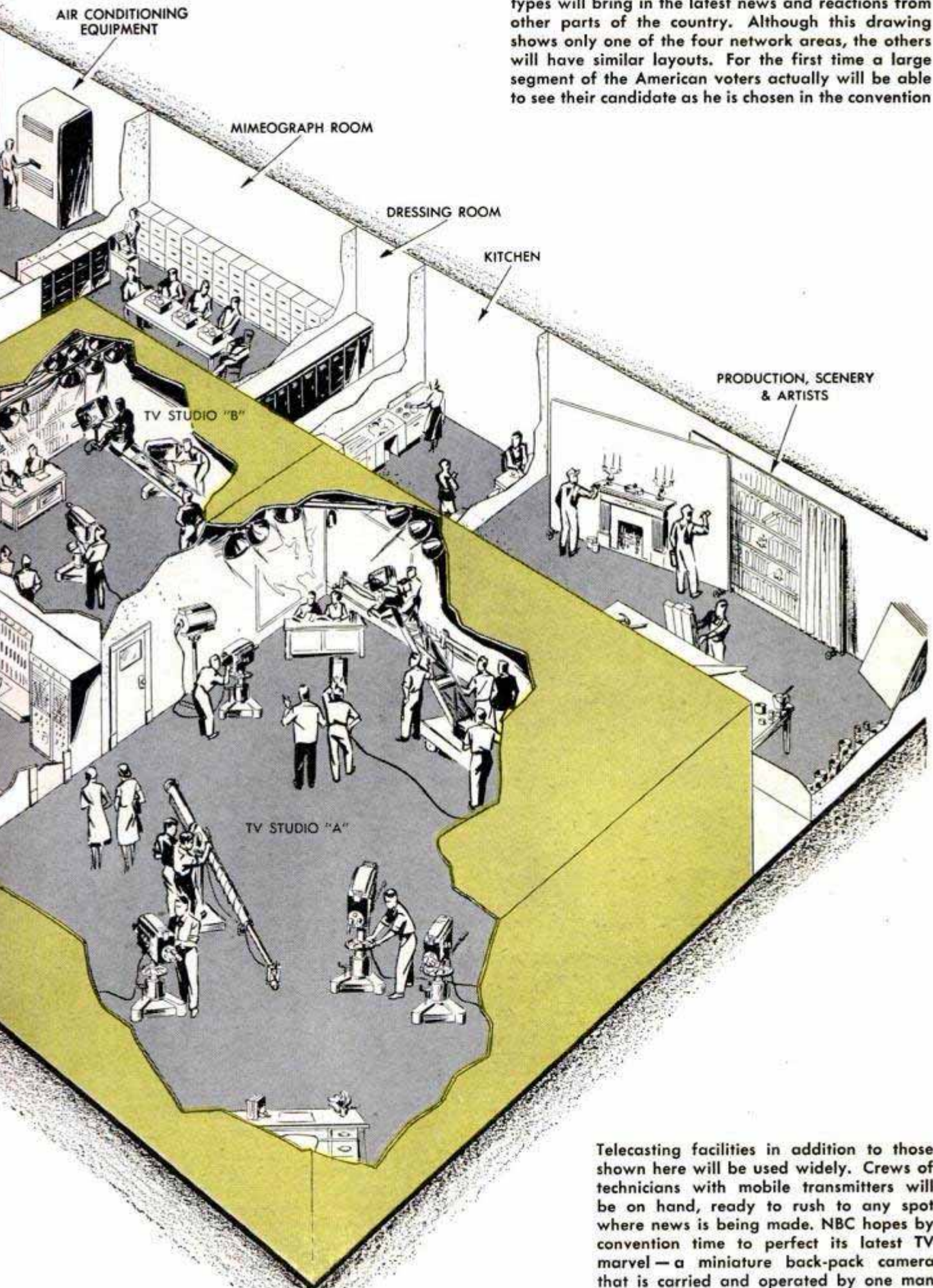

Telecasting facilities in addition to those shown here will be used widely. Crews of technicians with mobile transmitters will be on hand, ready to rush to any spot where news is being made. NBC hopes by convention time to perfect its latest TV marvel — a miniature back-pack camera that is carried and operated by one man



Plastic Car-Body Kit

You can build your own high-performance sports car for less than \$1000 by reshaping the frame of a secondhand Crosley and installing a new lightweight, low-slung plastic body. The original engine of 26 horsepower can be rebuilt to produce 46 horsepower and give a road speed of 95 miles per hour and more. Other small engines up to the V-8 60 may be used, or a motorcycle engine of the 500-c.c. class may be mounted over the rear wheels for a rear-engine installation. The plastic body weighs 100 pounds exclusive of glass and hardware and sells in kit form for \$445. The kit consists of the body itself, deck lid, hood and rear bumper plus instruction sheets and draw-



ings. Windshield assembly, hydraulic brakes and an all-weather top are available also. The average mechanically inclined owner can make the complete conversion in 100 to 125 hours.

Chrysler Experimental Sports Car Produced in Italian Shop

Trying to combine features of sports-car styling with some elements of practical automobile design, Chrysler has come up with its C-200 convertible. All plans for the experimental model were completed in Detroit but actual body construction and as-

sembly were done in Turin, Italy, by Ghia, custom-body builder. The car stands less than five feet high at the top of its windshield. A long hood line and large, fully exposed wire wheels show the European sports-car influence as do the straightfor-



ward grille and closely set headlights. Front and rear fenders blend smoothly into the body structure although the front fenders are outlined sharply forward. The engine is a standard Chrysler Fire-Power V-8 and the frame also a standard 125½-inch production job. Instrument panel is typical of the sports car with individual instruments, including a tachometer, rather than the cluster of the modern American car.



Detroit Listening Post

By Siler Freeman

IT IS PROBABLY a good thing for the old-line automobile manufacturers that many of their customers do not get to see sports-car displays. One such as was held this spring in New York's Grand Central Palace might cause some dissatisfaction with the efforts of the car designers to please the mass market.

Many of the cars at the sports show were ordinary makes like Chevrolet, Buick and Cadillac. But by paring off some of the chrome, hammering out a different-styled hood and making a few other deft changes, a stockcar took on a custom air.

The epidemic of "dream cars" brought out this year by the industry indicates some thought is being given to different-looking cars. The latest dream car may be one of the few to find its way into the market. This is Packard's sports roadster, a three-seater called the Pan American. It has the same Packard chassis and 175-horsepower power plant under a specially built body. The drawback? Its price can't even be held within four figures. In mass production, however, it could be brought down considerably.

Both Packard and Chrysler have revealed a trend in their dream cars that may be a welcome revival. Both have shown wire wheels on their custom jobs. The wire wheels serve a dual purpose as well as look attractive—they help keep the brakes cooler and they give a "softer" ride.

Wire wheels were once the rage but went out before the heavy-looking disks of steel. They may make a comeback, as has the spare wheel hooked onto the rear deck. It remains only for running boards to reappear and the spare wheel will again be set into them.

Despite the apparent stodginess of the industry in regard to new body designs, its mechanical improvements continue to advance. Power brakes, power steering, more powerful yet more efficient engines and the automatic headlight dimmers—to say nothing of further advances in transmissions—are some examples of what is keeping engineers on their toes.

The hottest item since the automatic

transmission is power steering. And it seems to be receiving parallel acceptance. Like Hydra-Matic, it will grow faster when increased volume reduces cost.

Don't think automatic transmissions have reached their end of improvements. All types are undergoing constant study to make them more efficient.

Chrysler is expected to be the next to come out with a new type of automatic transmission. It has one now that is semi-automatic but the next one will be fully automatic.

And that brings up the question of what it will do for Plymouth. The first step recently was taken when the company announced an automatic overdrive at extra cost. But that does not meet the competition of Powerglide or Fordomatic. Tool ordering is being watched for a clue as to what Plymouth will have for 1953. It's almost certain the car will have an automatic transmission.

Tooling orders already placed by the car manufacturers indicate 1953 will be a better-than-average new-model year. Power-plant changes are certain and so are new body designs for companies which did not introduce them for 1952.

This could include most of the Chrysler divisions, Buick, Pontiac, Chevrolet, Hudson and Kaiser-Frazer. Ford and Nash will stand by their present models.

The change this year may be the earliest in some time. It has been whispered that Chevrolet will be ready early in the fall with its challenge to the restyled Ford.

The horsepower race may make 1953 the year when the first 200-horsepower engine is seen in a stockcar. But it is not through any desire of the competing companies. In fact, the leaders are a little sorry they ever started the whole thing.

The engineers themselves disclaim any part in this race or even that it is a race. They intimate it was the sales departments that emphasized the tremendous power. All the engineers sought was more efficiency.

But there seems to be no way for the competition to stop now. That is, short of a 200-horsepower engine.

Scientists Study A-BOMB BURST

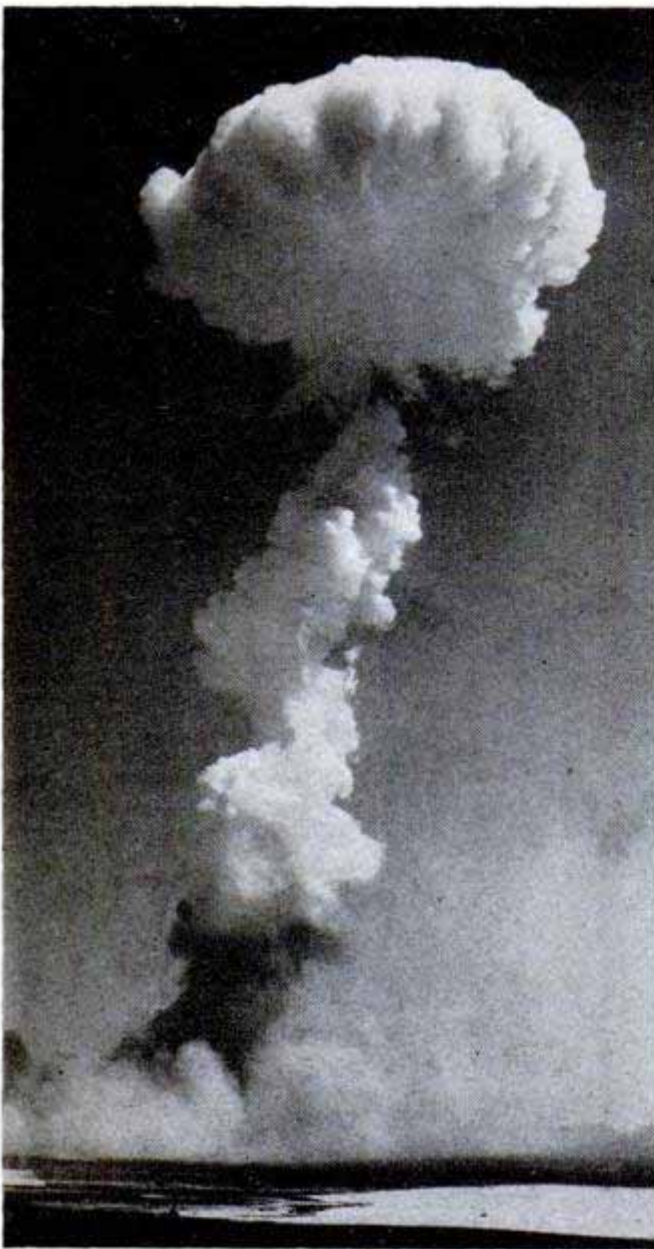

WHAT the awed spectators saw 11 miles across the Nevada desert last April was the biggest ball of atomic fire ever unleashed. What the eyes and ears of the Army and the nuclear scientists recorded was a gigantic secret on strips of film from cameras and sensitive instruments focused on Operation Big Shot from circling reconnaissance planes and distant mountaintops and bunkers ranged from the fringe of the blast area to ground zero.

The test proved that ground troops can move safely into the explosion area one hour after the bomb goes off. Monitors, checking for dangerous radioactivity, moved in almost immediately. The bomb was detonated at a height of 3000 to 3500 feet to prevent radioactive contamination of the ground. Military experts are weighing the advantages of this against an explosion closer to the earth that would have been more destructive to defenses. In the April test, some 2100 soldiers, including paratroops, were dug in four miles from ground zero. After the explosion, the paratroops were flown over the area and parachuted to earth.

A study of the radioactive clouds that formed after the explosion was made from numerous aircraft, including jets. These planes took samples of the air at various

Within a minute after the initial atom-bomb explosion, a doughnut-shaped cloud replaces ball of fire. The cloud is 30,000 feet high. Below, 10 cameras project from side of plane to record the explosion



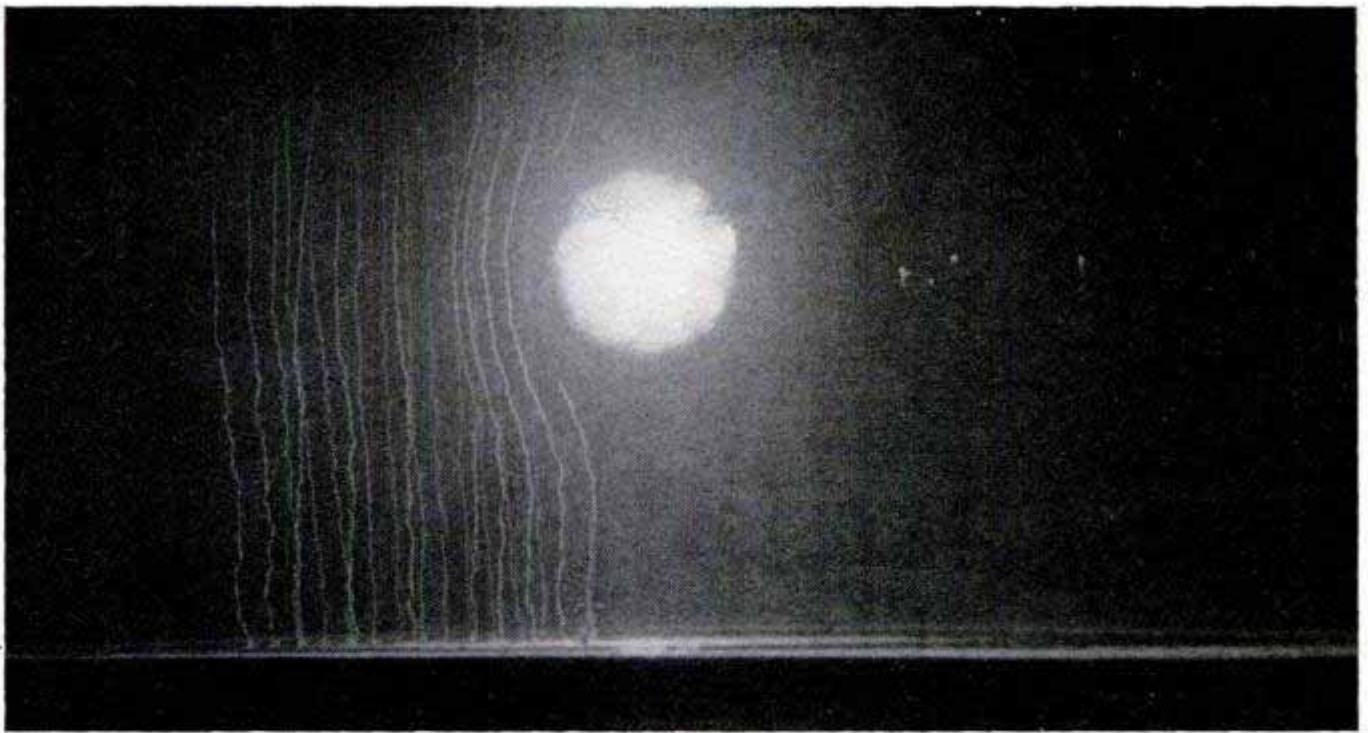

Bomb explodes in dazzling ball of fire. At left, the smoke trails from rockets measure motion of air

levels to measure radioactivity. All the planes that went up after the explosion were carefully checked when they landed for deposits of radioactivity.

Of vital interest, also, was the problem of delivering the bomb to its detonation point. As the bomb was exploded in a troop maneuver, the direction and velocity of the wind were of extreme importance. Last-minute measurements were made with captive balloons. The bomb, dropped from a Boeing B-50 at 30,000 feet, exploded only 200 feet in a lateral distance from the planned position.

The April maneuvers were a continuation of the studies described in the March issue of *Popular Mechanics* under the title "The Army Meets the Big 'A.'" ★ ★ ★



Helicopter, above, carries TV antenna to mountaintop relay point, below. Wing tank of jet plane, lower left, was adapted to sample air for radioactivity



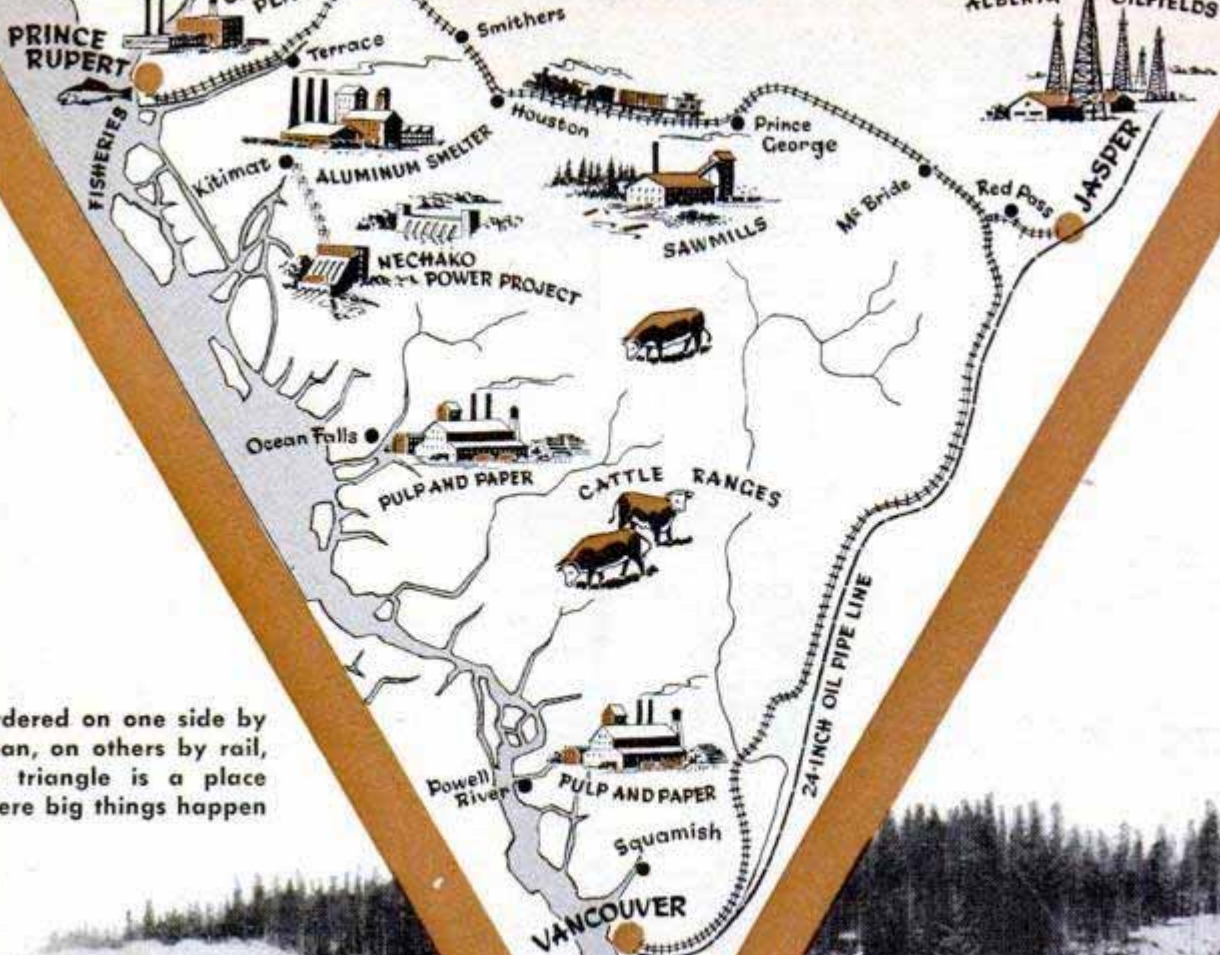

Bordered on one side by ocean, on others by rail, the triangle is a place where big things happen

BOOM

IN THE

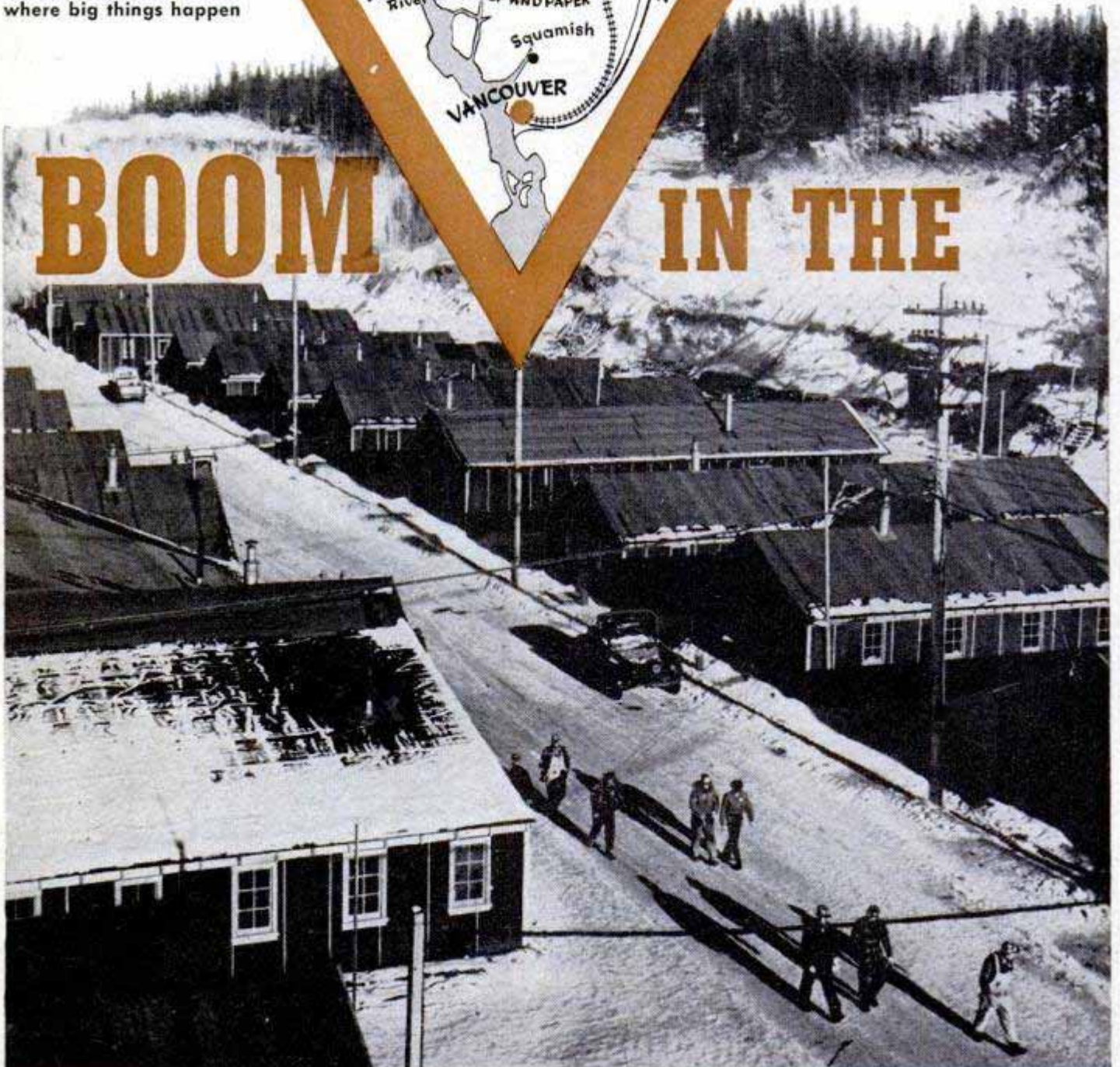

Part I

WHEN PREMIER Byron Johnson, bossman of Canada's most westerly province, described the building of a 700-mile oil pipe line as "the biggest thing that ever happened to British Columbia," he was taking in a lot of territory.

So many "biggest things" have been unloading on B.C.'s industrial doorstep that the terrific impact on its economy is difficult to grasp. Gigantic projects, sprung in overnight announcements, have involved investments of millions of dollars toward developing tremendous natural resources of the Pacific province.

The oil pipe line, while not utilizing a British Columbia resource but of distinct benefit to coastal enterprise, is the latest of developments marking two years of astronomical industrial growth.

Trans-Mountain Oil Pipe Line, backed by six major oil companies, ran its survey last

summer and estimates the cost at \$82,000,000. Late 1953 is the target for completion—when the 24-inch line will be primed to carry 75,000 barrels of Alberta crude oil a day; ultimately, 200,000 barrels.

For 500 of its 700 miles the oil line will snake through mountain valleys, climbing from Jasper, Alta., over Yellowhead Pass and skirting the base of Mount Robson, highest summit in the Canadian Rockies. Pumping stations will lift the oil over the coast range and down to Vancouver.

The route from Jasper to Vancouver follows one leg of a booming industrial triangle. This triangle—with its corners at Red Pass, Vancouver and Prince Rupert—fences a vast area of almost 150,000 square miles, a region of great waterways like the Fraser and Skeena rivers, forest and mineral riches, enormous power potential and resources in fisheries and agriculture.

Flanked on two sides by rail lines forking out from Red Pass Junction and on a

By Harry Rowed

BIG TRIANGLE

Cities in triangle range from sprawling, modern Prince Rupert, below, to a work camp at Nechako Dam, opposite page. Insert, engineer rides cable over river on a power survey

Wrathall photo

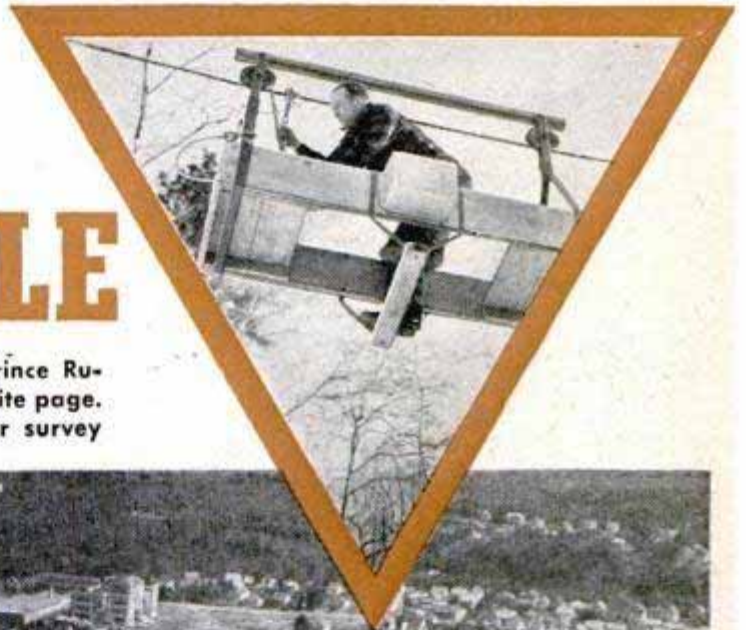



Above, salt-water lumberjacks take up slack on the thick cables around a giant raft of logs at Queen Charlotte Islands. Raft will be towed over coastal route to Powell River pulp mills. Secure lashings are essential because of the possibility of rough water

Below, the vast size of the Nechako-Kitimat project is shown here. The Nechako Dam is at extreme right. It will raise water level as much as 170 feet and reverse flow from east to west toward underground powerhouse. Power will go to smelter at Kitimat

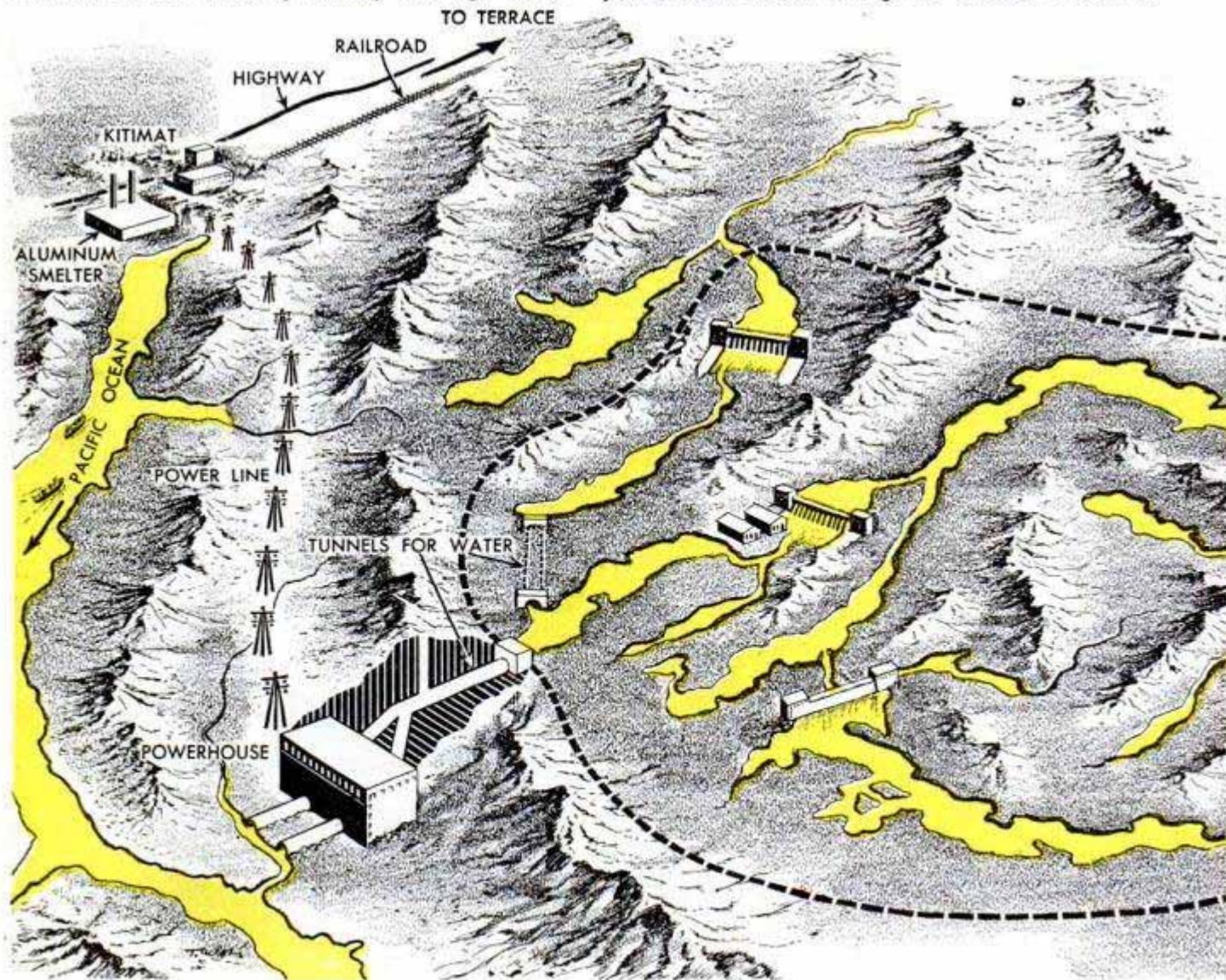

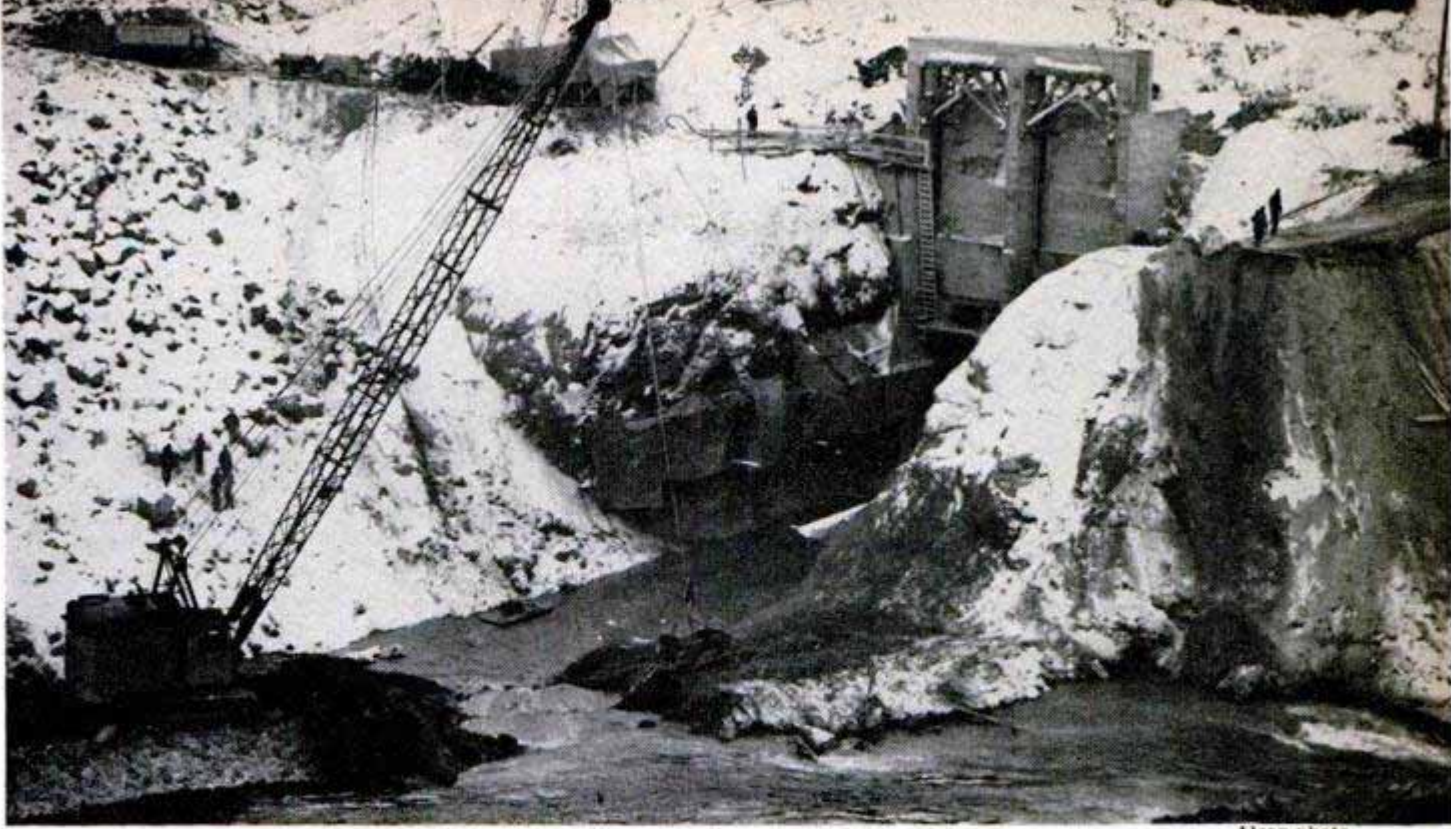

Alcan photo

Diversion of water through tunnel at site of Canyon Dam on Nechako River was accomplished October 1951

third by the ocean span from Vancouver to Prince Rupert, the triangle is nurturing a healthy flock of young enterprises.

Here's the lineup:

The \$600,000,000 aluminum smelter and power project of the Aluminum Company of Canada is surging into its second year of development. Possible offshoots include a huge pulp mill and a fertilizer plant.

At Prince Rupert, Columbia Cellulose has announced a step up in production and plant expansion.

At Prince George, hub of the sawmill in-

dustry, a large tract of land has been purchased, probably for a pulp-mill site.

At Terrace, Canadian National Railways likely will step into first stages of construction of a rail line joining Alcan's Kitimat with the northern transcontinental route. A highway may parallel the railroad.

Oil and gas exploration, spurred by new discoveries in the Peace River region, blankets millions of acres. Seismic and geological crews have pushed by aircraft, tractors and pack trains from Alberta's northern muskeg far into the mountains of B.C.

Alberta's legislature authorized export of natural gas from Peace River to British Columbia and the United States. This means another big triangle pipe-line project.

A Dominion-Provincial Board study of economic and settlement possibilities of the Fraser River could result in a seaway project at an estimated cost of \$100,000,000.

Demand for base metals has created intensive search and renewal of activity in the triangle's mining industry, particularly at Smithers, Hazelton and other north-line points. Important asbestos finds have been staked near Alaska Highway to the north.

British Columbia Power Commission surveys indicated new power development along Quesnel River inside the triangle.

The new oil line from Edmonton to Vancouver could mean immediate start on construction of a good highway following explorers' trails west beyond Yellowhead Pass along southern border of the triangle.

For sheer prodigy and as a colossal feat in engineering, few construction projects match Alcan's power development 400

DOTTED LINE SHOWS DRAINAGE AREA OF PROJECT

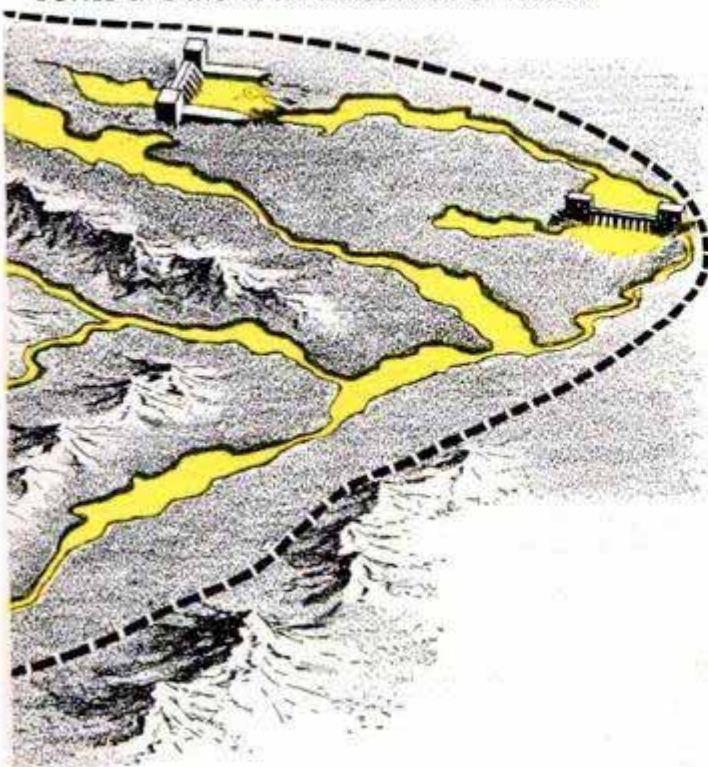

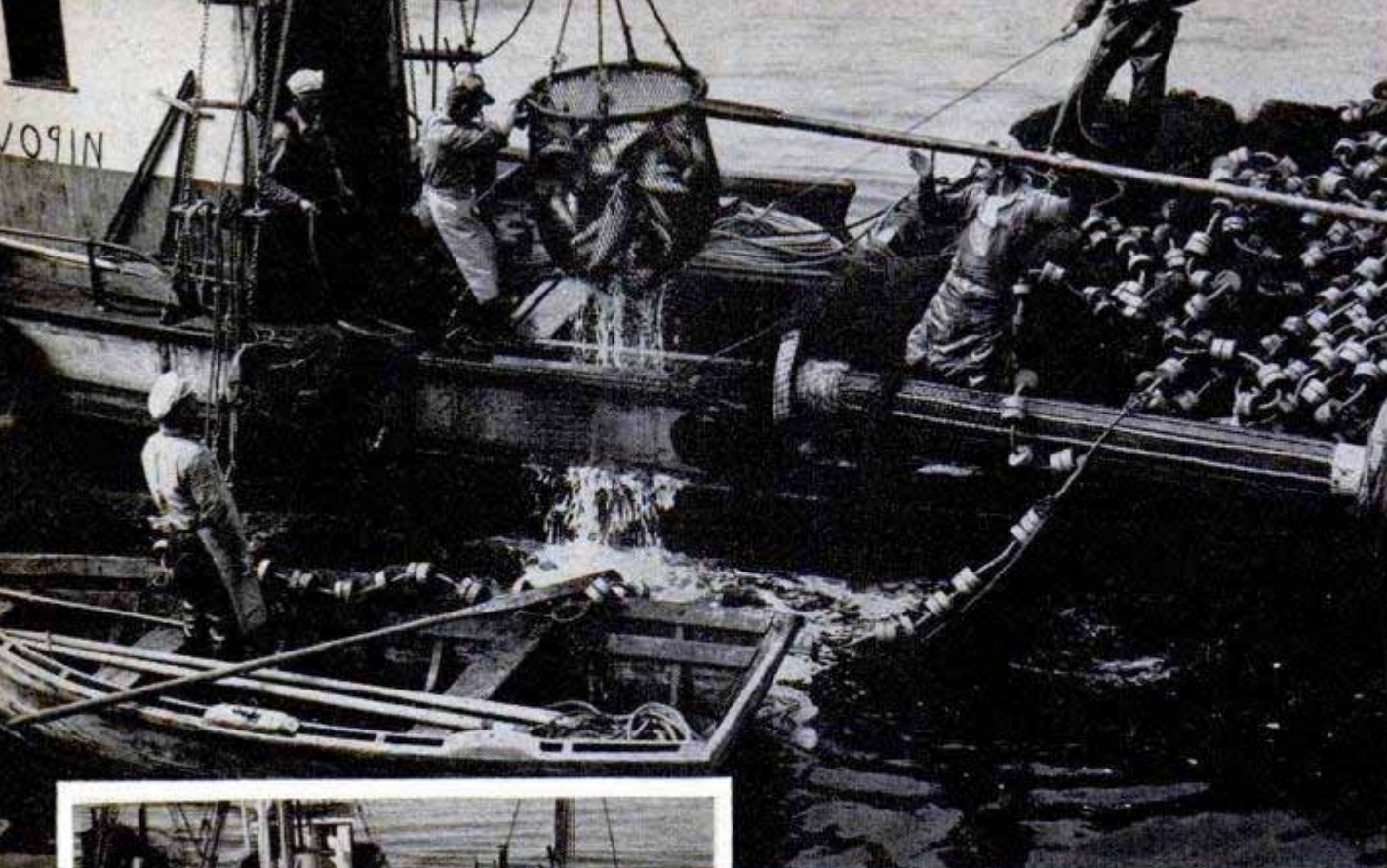

National Film Board photo

Above, basic industry in Prince Rupert is fishing. Talk of the province's big expansion doesn't excite fishermen, who have average annual income of \$6600

miles north of Vancouver. This gargantuan plan spreads over 5400 square miles of rugged mountains, forests and streams.

When finished, it will provide British Columbia with two more superlatives—the biggest power-generating plant ever built and the world's biggest aluminum smelter.

The Alcan Story, first of all, entails construction of a great rock-fill dam in the Grand Canyon of the Nechako River. Four million cubic yards of fill will be dumped into this precipitous gorge to create a dam 1500 feet across and 325 feet deep.

Slowly, over a period of four years, this manmade plug in the Nechako will back up waters which normally flow in the opposite direction. The balked river will retreat into a dozen lakes to form a reservoir with a surface area of 335 square miles.

Meanwhile, to the west, veteran hard-rock miners are sinking drills into the face of a granite mountain. From Kemano's compact camp of 2000 men on the opposite side of the peak, more drillers are biting into the rock. When the crews meet, a tunnel—a second tunnel is tentative—25 feet in diameter and 10 miles long will have been driven through the mountain. Then mountain-locked waters will thunder into the tunnel and tumble downward 2600 feet to Alcan's immense powerhouse. The powerhouse, to be completed by 1954, will be inside the mountain. A huge excavation to house three massive generators is being



Above, fishing boats at Prince Rupert. Below, these are frozen salmon in quick-freezing plant at Rupert. Temperature is 26 degrees below zero. Salmon is the most valuable catch of the fleet, with halibut next



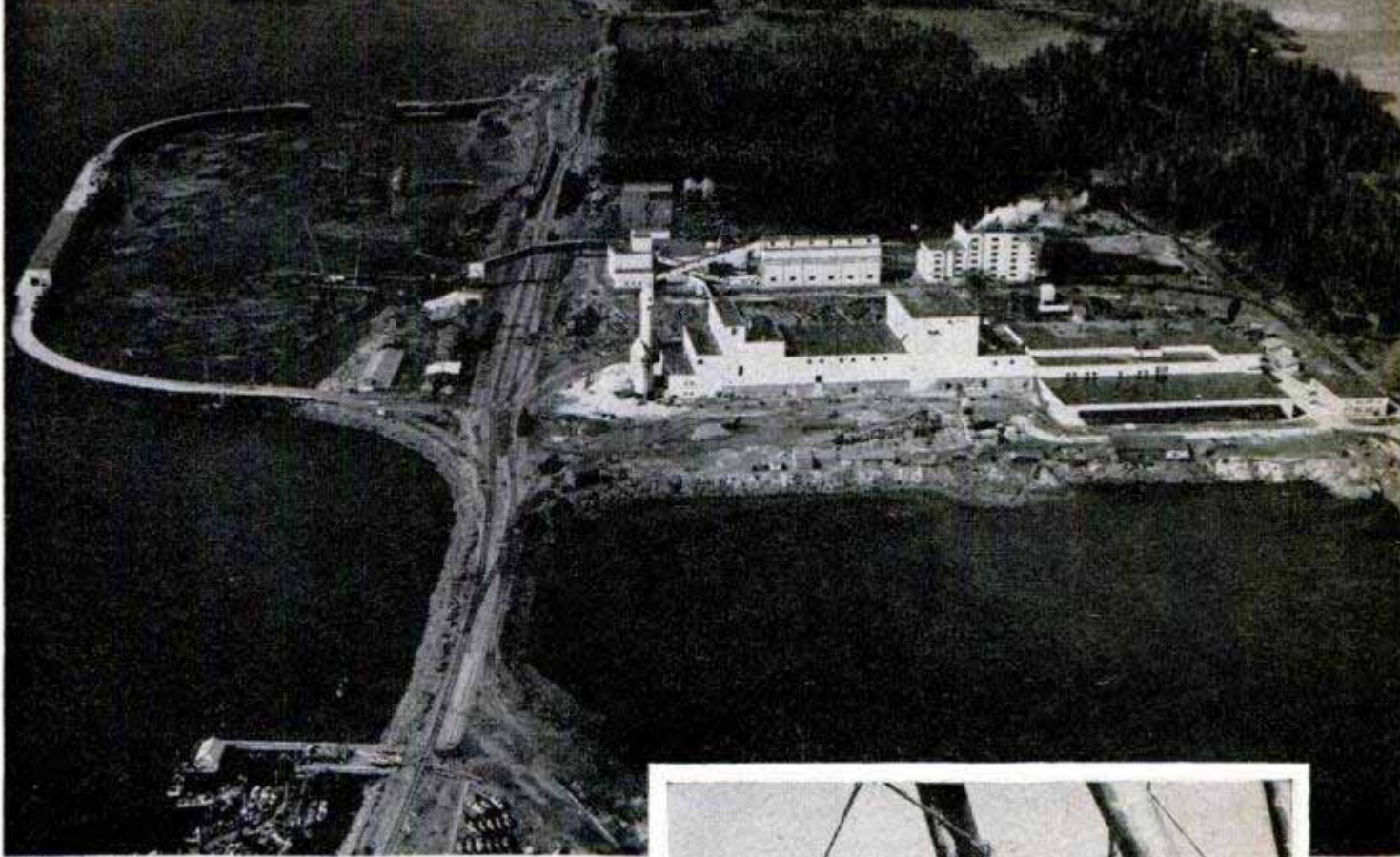

Wrathall photo

Air view of the Columbia Cellulose plant at Prince Rupert. It produces more than 200 tons of pulp each day for shipment to producers of yarns and plastics

blasted and drilled $\frac{1}{4}$ mile into the granite.

Alcan engineers list three good reasons for building their powerhouse in a subterranean cavern. While cost of further tunneling from penstock to powerhouse will be high, steel pipe also is expensive—and scarce. An underground plant also will afford greater security in time of war. But principally they figure that the 6000-foot mountain holding down the powerhouse will serve as a useful overburden when Nechako's waters hit the turbines with a smashing pressure of almost 150,000 pounds per square inch.

Power output in the initial stage will be 420,000 horsepower with the ultimate goal a staggering 1,657,000-horsepower output.

Why all the power? Simply that smelting of aluminum, an electrolytic process, consumes a colossal amount of electricity. If your home is average, you could provide yourself with 16 years of power with the amount required to melt enough ore to produce one ton of aluminum.

What will happen to the power from Kemano? Crews are building transmission lines to Kitimat, 50 miles over a serrated mountain summit from Kemano. They are following a survey made by helicopter-hopping engineers.

Kitimat (in Indian, "Place of the Melting Snows") is destined to be the king post in Alcan's B.C. structure. It is the site for the

(Continued to page 246)

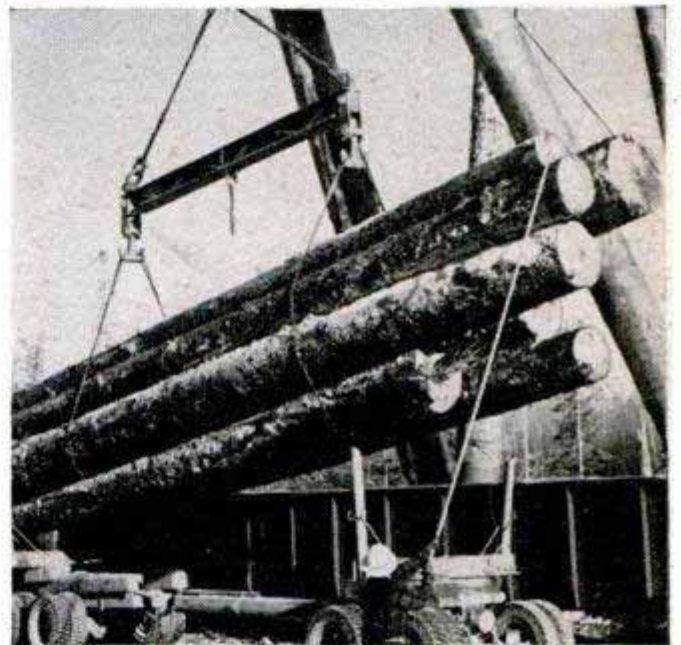

Above, at Terrace logs fresh from woods are loaded on a train by crane for shipment to plant at Rupert. Below, long lengths of the timber are hauled up the jack ladder at Cellulose. Most of wood is hemlock



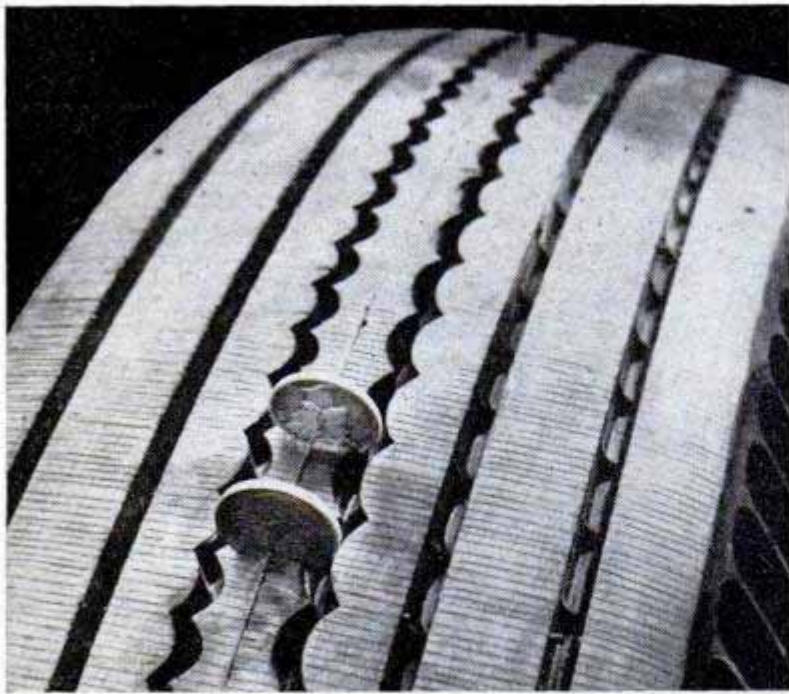

Antiskid Tire Tread Made of Tiny Blocks

More than 10,000 tiny blocks of rubber make up the tread of a new antiskid tire, acting as fingers to grip a wet or icy surface. The tire is the puncture-sealing tubeless type. The little rubber blocks are $\frac{1}{4}$ inch deep. As the brakes are applied the blocks separate into individual gripping surfaces. Tests indicate that the tire shortens stopping distance on ice up to 30 percent and on wet pavement up to 20 percent. When the tire is rolling, each block exerts a "walking" motion instead of the scuffing action of a regular tire. This tends to increase mileage.

"Tricycle" Sports Car

Capable of speeds up to 120 miles an hour, a three-wheeled sports car looks like a wingless jet plane. Built by Richard Harp of Boonsboro, Md., the 1800-pound car is powered by a 75-horsepower aircraft engine. It took Harp two years to construct the car, which he values at \$5000.



Airline Speeds Changing From M.P.H. to Knots

Beginning July 1, airline pilots in the United States will express air speed in terms of knots and distances as nautical miles. Air Force and Navy pilots already are using them as units of measurement and the standardization is expected to simplify things for both flyers and ground personnel. A plastic ring designed to fit around present air-speed indicators is being developed to facilitate the switchover to knots. It is calibrated so that the pilot can read his speed directly in knots without having to use conversion tables. New maps will have nautical as well as statute-mile scales. A nautical mile is 6080 feet (compared to 5280 feet in a land mile) and a knot is used to measure nautical miles per hour.

¶If you're discouraged because you feel there's nothing left to discover, take comfort from the fact that each year scientists find 5000 new kinds of insects, 2000 new kinds of plants, 500 new mollusks and 20 or 30 new mammals—but only two or three new birds.

Thousand-Mile Target Range

Stretching away from a knob of Florida coastland to the western tip of Puerto Rico is a 1000-mile swath of Caribbean water, a beautiful strip where the Air Force is playing hide-and-seek with some of the deadliest weapons ever developed. This is the target range for guided missiles, a proving ground for push-button warfare. On seven scattered islands men hunch over instruments, tracking the missiles that roar overhead. For the exciting story of these trail-blazing flights, read "Thousand-Mile Target Range" in the July issue.



BOAT ON STILTS

EVER SEE a speedboat buzz along on stilts? Allyn B. "Hap" Hazard of Los Angeles, Calif., flies above the water instead of plowing through it. Hazard attached a pair of stilts to the sides of his craft. Each stilt ends in a hinged hydrofoil surface and another hydrofoil is mounted on the long shaft of the 16-horsepower motor. At 15 miles per hour, Hazard pulls back on a control stick which changes the pitch of the front hydrofoils and the boat rises out of the water.

Small finlike surface at the bottom of each stilt can be tilted up or down with control stick. Below right, another fin fits on the extra-long motor shaft

In stunt for camera, fins ride on top of water. Below, normally hydrofoils slip along just beneath surface. It's a smooth fast ride even in rough water

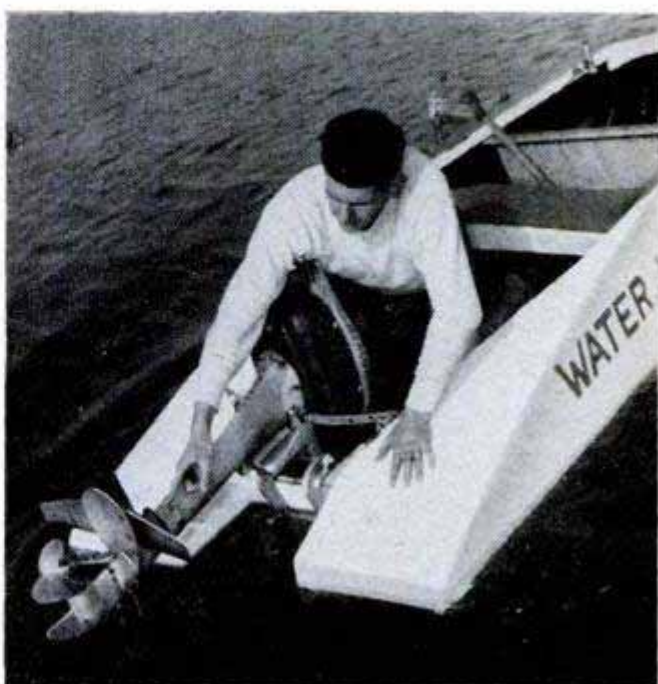
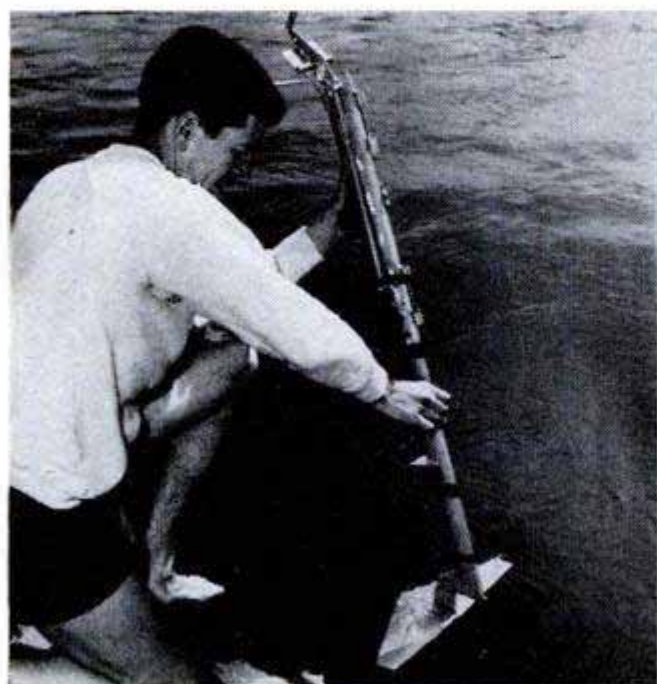
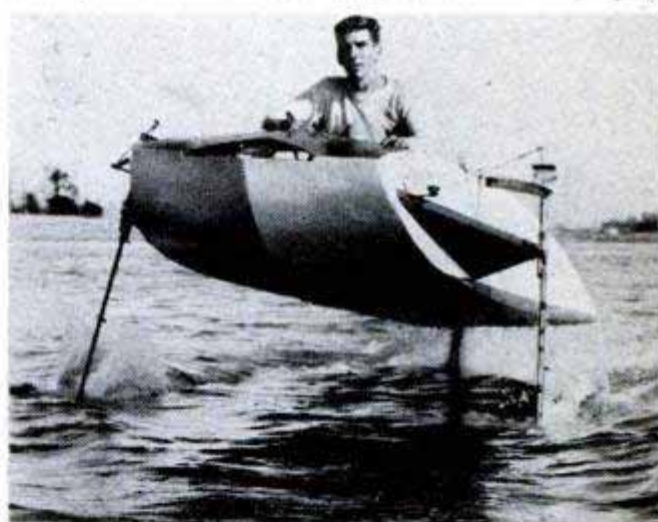

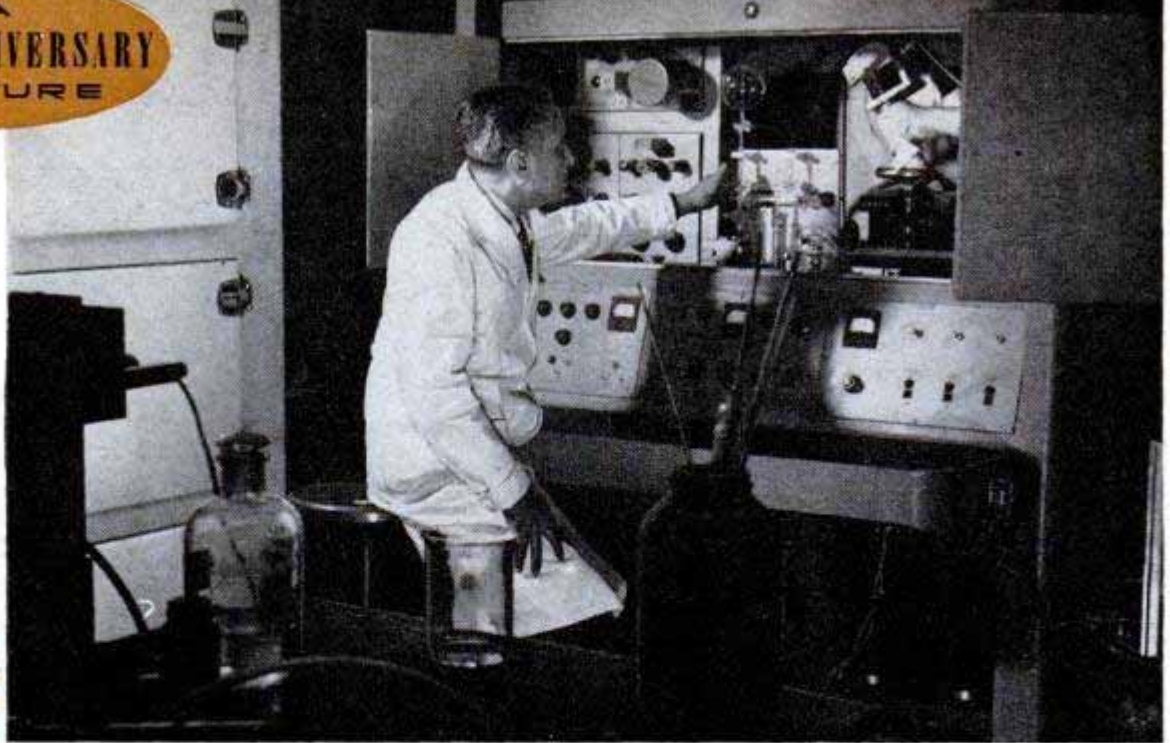

Research in pure science has spurred medicine's greatest gains



1902

FROM PILLS

By Herb Bailey

DON'T EVER MAKE the mistake of longing for the good old days—at least not in medicine. If you were born 50 years ago, the chances are you're alive today because you were born naturally strong and lucky. It isn't likely that the medicine of

that period did much to save you for medicine was just learning to be scientific, which is another way of saying effective.

If medical progress hadn't advanced your life expectancy, last year you'd have been slated to die at the age of 49! In 1902 there

Instead of being trundled about in tanks, life-sustaining oxygen is now piped into some hospital rooms

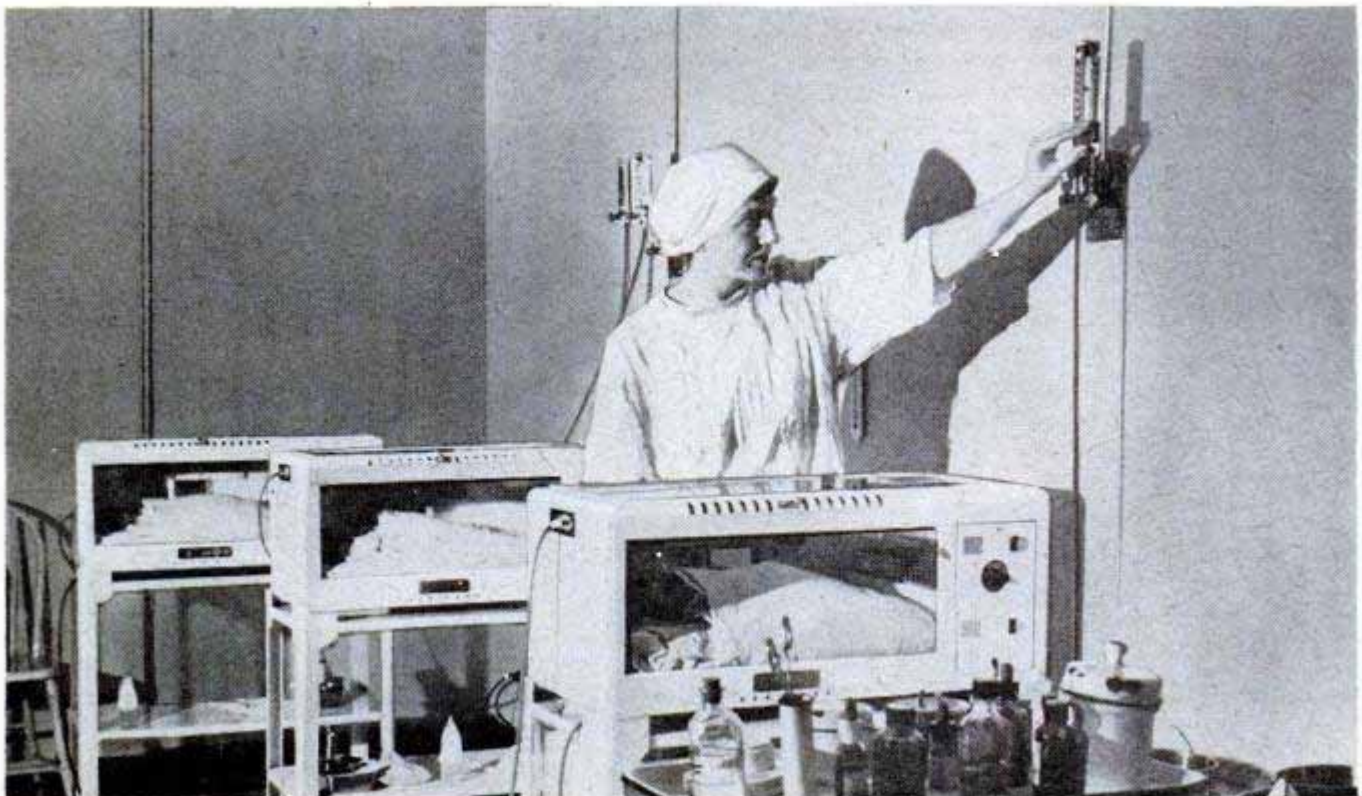

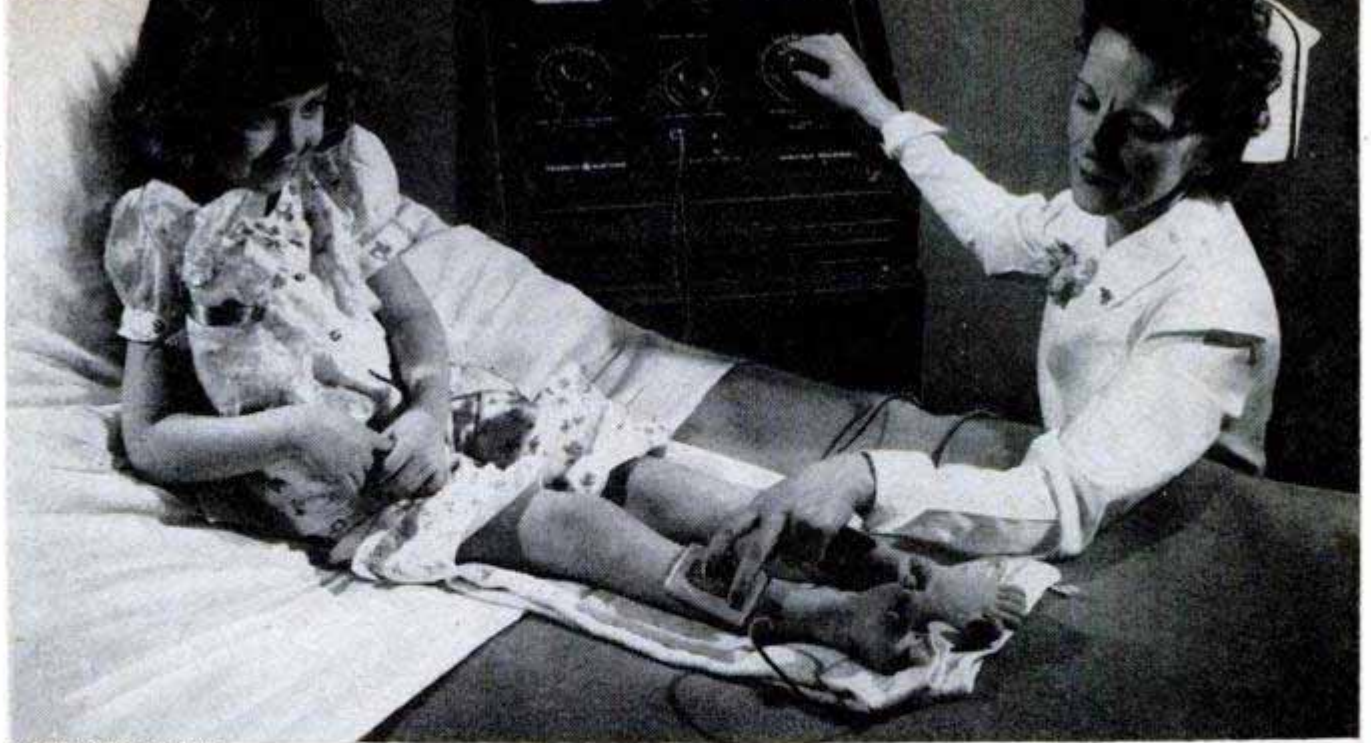

General Electric photo

Electric current stimulates paralyzed muscles, preventing them from wasting away

to PENICILLIN

were few diseases that could be cured; today there are few diseases that cannot be cured if treated in time.

Fifty years ago childhood diseases—diphtheria, scarlet fever, measles and whooping cough—were exacting terrible tolls. The doctors were nearly powerless. They had to let the diseases run their courses, keeping the patients as comfortable as possible. If children escaped these dread diseases, there was practically everything else in the book ready to ambush them before they grew up. The average age of adults dying in 1902 was only 30. Today this has been advanced to nearly 70!

Tuberculosis, malaria, pneumonia, syphilis, typhoid fever, typhus fever, diabetes, pernicious anemia, meningitis and cancer yearly claimed millions of victims even in "civilized" countries. Methods of antisepsis were not practiced as they are today; many patients died from infections contracted at the operating table; many died from shock.

Blood transfusion was almost unknown until 1912 and it was much later before it was generally practiced. Of course, such refinements as the matching of blood were little known; likewise, making counts of red and white corpuscles to diagnose disease, a practice now routine.

Vitamins were unheard of, the first being isolated around 1918. The first hormones—vital secretions of the ductless glands—had been used in treating thyroid deficiencies in 1891 but little else was done for years.



ARTIFICIAL HEART AND LUNG MACHINE

BLOOD DRIPS THROUGH MESH PACKING, ABSORBING OXYGEN AND GIVING OFF CARBON DIOXIDE

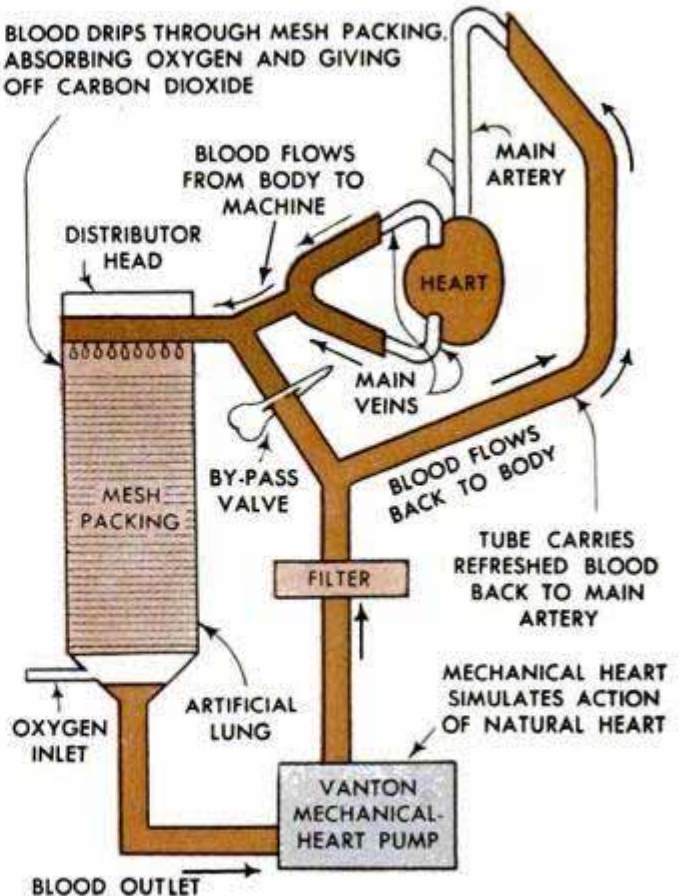

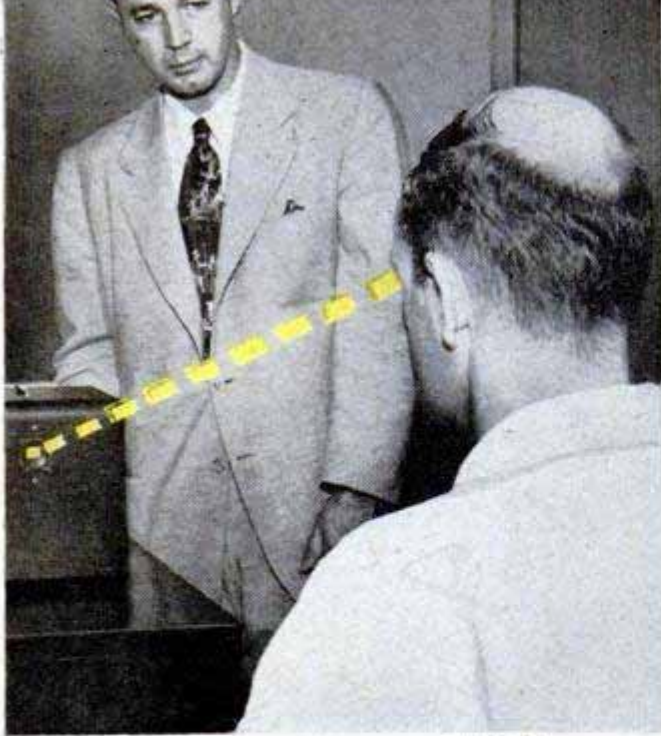

From patient's reactions to flickering light of a photometer, above left, a doctor can detect even the likelihood of cardiovascular troubles. The tiny capillaries in the eyes reflect impending diseases. Above, an electroencephalograph, a device that can distinguish normal from abnormal brain patterns, is helpful in diagnosing epilepsy and schizophrenia

Guided by a counter which picks up gamma radiation from radioactive iodine that collects in thyroid glands, device below traces glands' size and shape. A normal gland is "pictured" on the opposite page



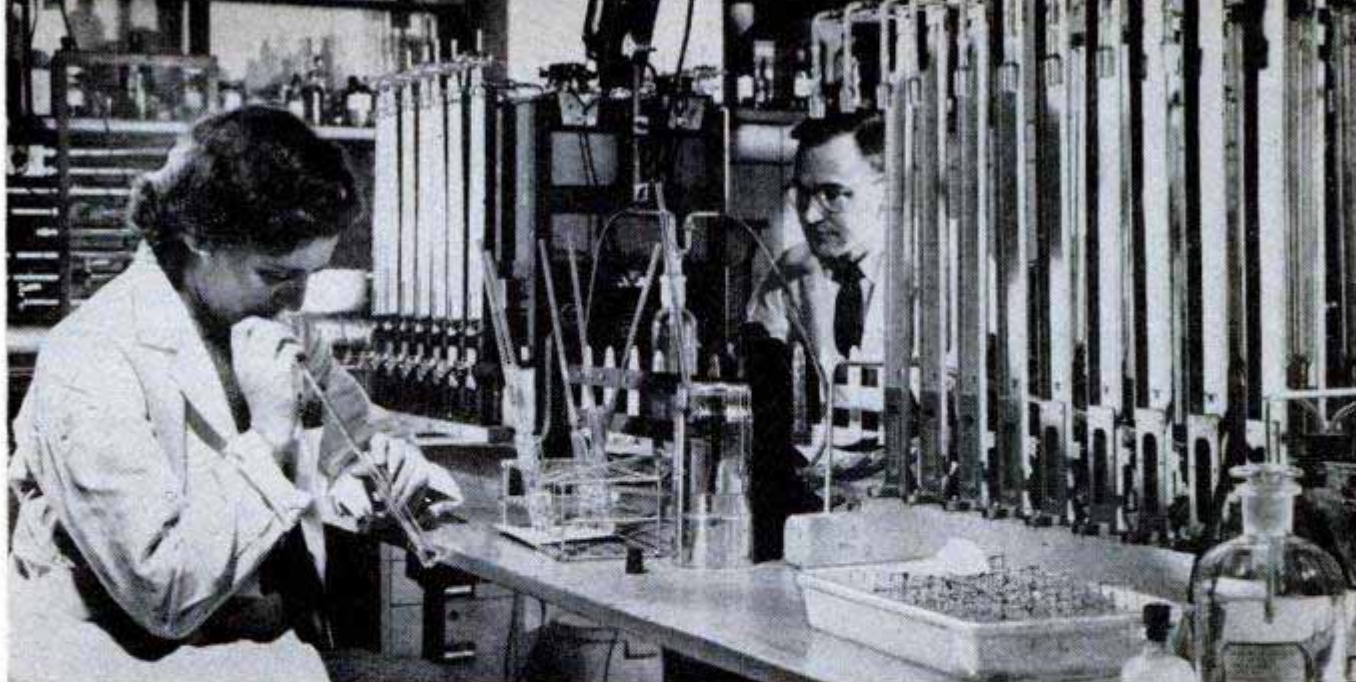

University of Illinois photo

Building up more knowledge of the human brain, this equipment studies physiological aspects of its cells

The control of disease by a specific medicine (chemotherapy) was in its infancy. In fact, a person couldn't even cure a headache safely and effectively for acetylsalicylic acid, commonly known as aspirin, wasn't yet in wide use. You say there were fewer headaches in 1902? Well, maybe.

Though medicine was beginning to learn how to immunize humans against diseases by preparing serums made of weak or dead germs cultured in the bodies of animals, it was many years before such diseases as diphtheria were brought to bay. Yet today there are doctors who have never seen a case of diphtheria or typhoid fever!

While the mysterious X rays had been named in 1895 by Roentgen and first used in the treatment of cancer by Emil Grubbe shortly afterwards, they were still looked upon with much suspicion by conservative

doctors in 1902. Later the infinitesimal rays were to save millions suffering from countless diseases and eventually they were used to treat diseases such as cancer, brain tumor, hyperthyroidism and leukemia.

A person suffering from a mental illness, or even a physical disease of mental origin (now called psychosomatic), was totally out of luck. He didn't even have the meager comfort of understanding. Psychiatry still was engaged in classifying the types of mental illnesses. The first work of Sigmund Freud, pathfinder of the intricate mental processes which govern us in both sickness and health barely had been published. None of the controversial storms concerning the relationship of sickness to the mind yet had shaken the medical profession. And, of course, none of the physical treatments for mental illnesses, such as electric

Sketch of the "brain" of device, left, that outlines size and shape of thyroid glands

Heavy concentration of pen strokes, caused by greater gamma radiation from iodine, forms picture of the thyroid glands

SCINTILLATION TUBE
GAMMA-RAY TYPE

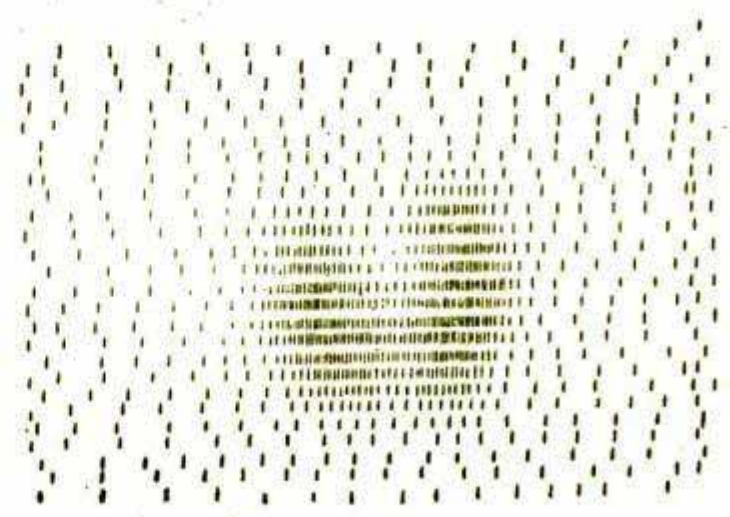
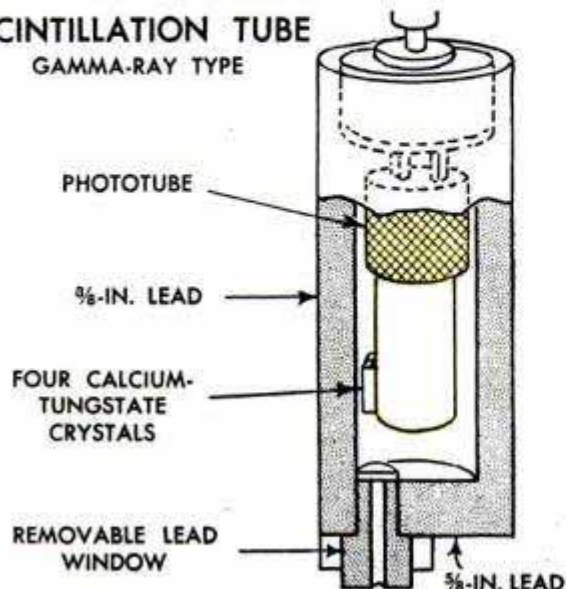



Deep-therapy X ray, 25 million volts of it, is delivered by the University of Illinois betatron for treating cancer victims. Below, another cancer fighter is this General Electric device using radioactive cobalt to combat deep cases of the dreaded disease

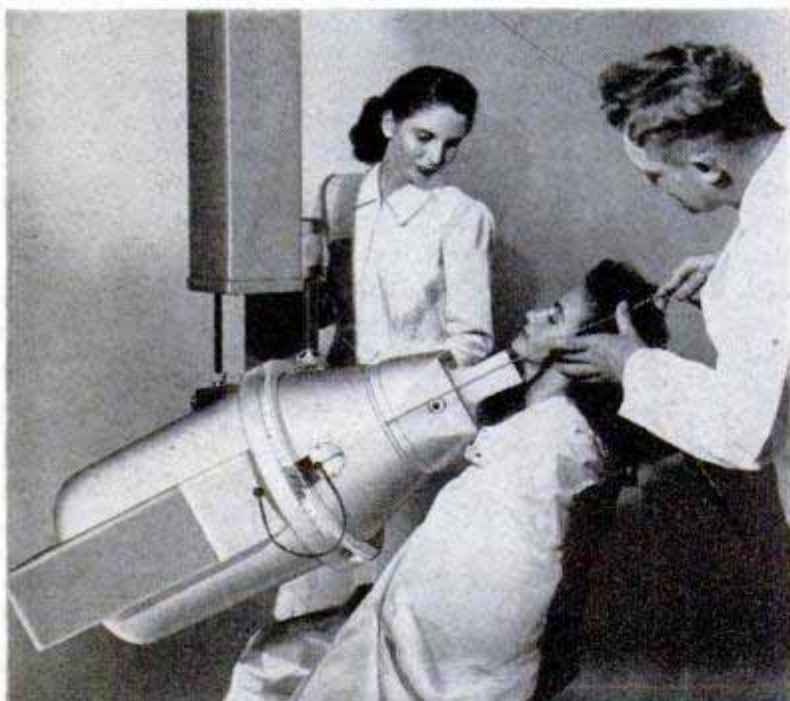

General Electric photo
Widespread detection of diabetes, eighth-greatest killer, is made possible by the "clinatron," which speeds up blood analysis



shock, even had been dreamed of.

If you were crazy, you were crazy. That's all, brother, and you were put away in an institution which did nothing for you except provide guards to watch you closely. Or, if you kept complaining about symptoms for which doctors couldn't find any physical basis, most likely you'd be shrugged off as a malingerer or a neurotic. Today it's acknowledged that many organic diseases can be traced to emotional causes.

Before 1900 and for some time after, medicine was practiced as an art, not a science. Doctors based their treatments on what they learned from older doctors, whose greatest education was obtained in the school of experience.

In contrast to the 19th century, modern medicine doesn't guess. Medical laboratories test drugs sometimes for years before releasing them for use. But a good scientific reason has to be advanced before any testing occurs. This doesn't mean that today's findings are not the result of insight. Many great discoveries have occurred because of successful "hunches."

The laboratory methods of the "pure" scientists began to come into their own early in the 20th century. The result was that the first 51 years of this century—particularly the last 25—zoomed into a revolution which affected you, me and our children more than any series of revolutions, wars or discoveries ever has affected the human race.

Probably the most dramatic of the new methods of science to fight disease with chemicals came in

1909 when Paul Ehrlich in Germany announced his magic bullet 606, or Salvarsan, would destroy the deadly spirochetes that caused syphilis. This was indeed a monumental discovery. As revolutionary as the new magic bullet was, the treatment generally was long and costly, and it wasn't until the widespread use of penicillin in the 1940s that the treatment of syphilis was simplified.

By that time, however, syphilis—like many other diseases such as tuberculosis—had ceased to be a great public menace because of widespread public-health education in prevention and prompt treatment.

Equally famous in medical history was the discovery by Doctors Banting and Best in 1921 that insulin, a hormone secreted by the pancreas, could control diabetes. Until then there had been no treatment for the disease. Millions had died because of their bodies' mysterious inability to absorb, or "burn," sugar. According to estimates, nearly 500,000 persons in the U. S. alone are diabetic—without knowing it. About the same number do know it. Today diabetics can live normal lives, thanks to the miracle of insulin.

In 1926 Doctors Minot and Murphy discovered a half pound of liver daily would control most cases of pernicious anemia, a dread blood and nerve disease which had been fatal until then. Today we know the substance in the liver which set the red blood and nerve cells right was vitamin B₁₂. Only a few micrograms of this vitamin will supplant the raw liver needed for control of pernicious anemia.

Use of the first "wonder" drugs in the early 1930s touched off a cycle of amazing cures. Beginning with sulfanilamide and continuing with the antibiotics, penicillin and the newer aureomycin and terramycin, these drugs did more to provide medicine with effective tools of treatment than any other methods in the preceding 500 years.

Sir Alexander Fleming discovered penicillin in 1929. Not until 10 years later were its curative qualities demonstrated on human beings. Since most readers of *Popular Mechanics* want to know how and why anything works, here is the best explanation the physiologists give as to how the antibiotics work: Germs have to combine with red blood cells or other cells of the body in order to produce their deadly reaction. The molecules of the sulfa or the earth drugs such as penicillin imitate our body cells to such an extent they trap the germ cells into combining with them instead of our cells.

The discovery of chlorophyll as a wound healer (it's 2½ times faster in this respect than penicillin) and deodorant deserves

(Continued to page 234)



Fountain Brush

Using the same solution over and over again, a fountain brush cleans oily, greasy or dirty parts. With the solution flowing through its nylon bristles, the brush dislodges particles while the solution floats them away. The solvent, clean at all times, is filtered twice before it is pumped through the brush. Only three gallons of solution are needed for a steady flow. Another tank holding 2½ gallons of solution can be used for soaking parts. The unit generally is placed on the workbench and plugged into any 115-volt electric outlet.

Submarine "Speedometer"

Although the details are still secret, the Navy has revealed a new instrument that accurately measures a submarine's speed and distance traveled. These factors are now recorded by dead-reckoning analyzers that indicate latitude and longitude, from which position and speed are figured. The device was developed at the University of Cincinnati's Science Research Laboratory.

Do You Remember . . .

. . . When photographers made flash shots with a tray of powder held high above their heads? When flash photography was so dangerous every camera case included a first-aid kit for burns? When exposures were judged by eye and a photographer might mention he used a lens opening "about the size of a dime?" Two of America's foremost authorities on photography take a long and fascinating look at its development in an Anniversary Feature in July. The illustrations include some of the finest photographs ever made.

WHAT'S NEW FOR Your Home

1. BATH SEAT fits any tub by wedging against the sides. It will support the heaviest person safely. Rubber padding on ends prevents damage to the bathtub

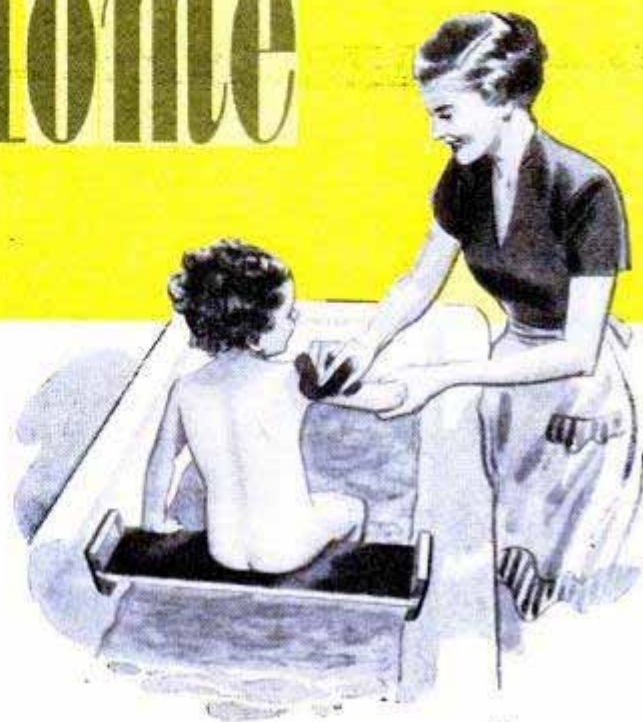

1



2

2. COFFEE SPIGOT not only opens the can but makes a tight seal that keeps flavor in. Cuplike cap is a tablespoon measure

3. TENSION SCREEN with improved brackets can be put up from the inside in seven seconds. There's no hardware on the sill

4. IVY SUPPORT is a plastic tube filled with sphagnum moss to which plant clings. It stores up moisture for the ivy, too

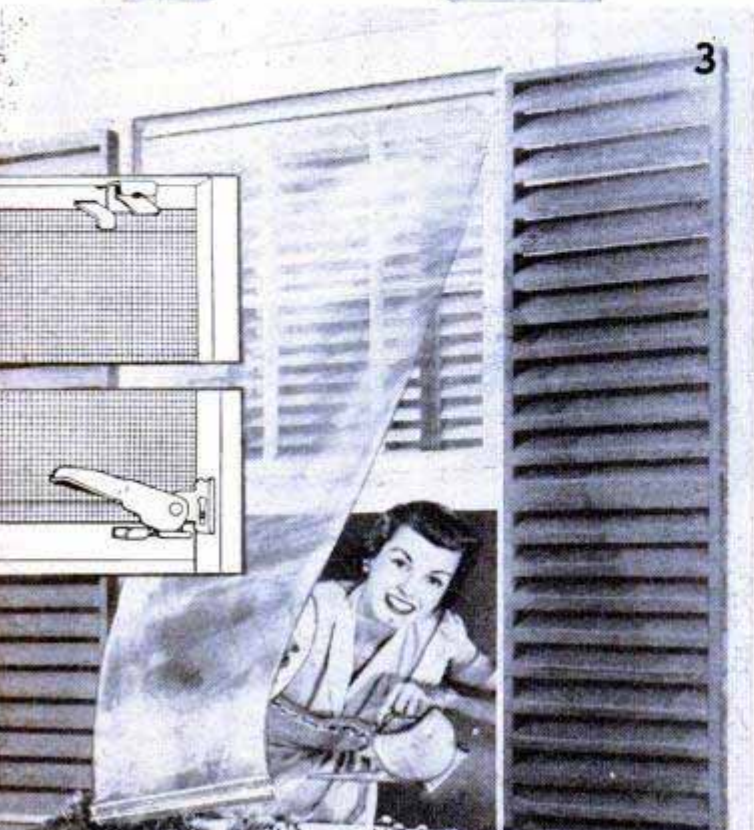

3

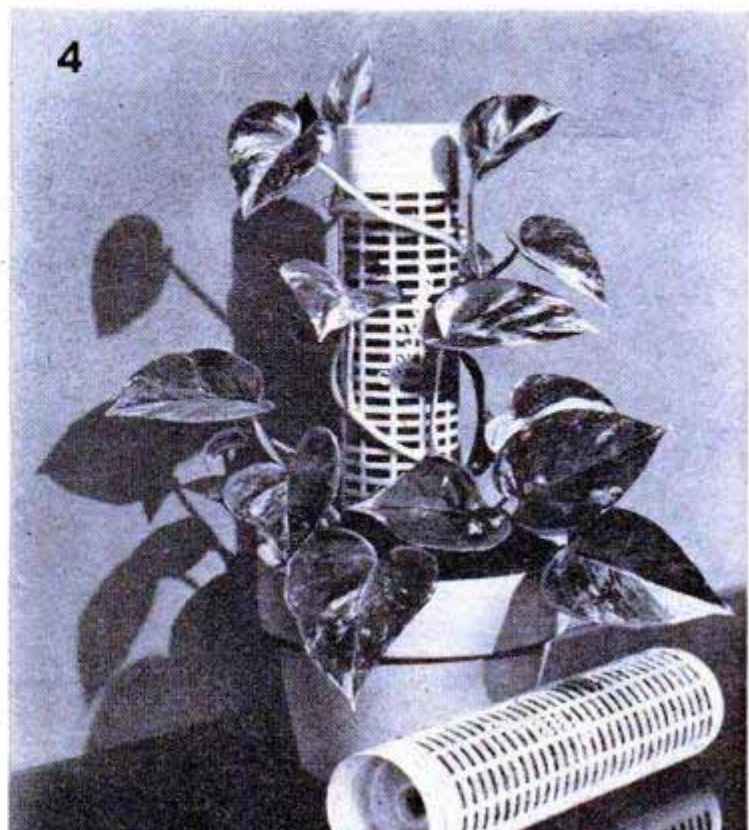

4

a fryer consisting of two wire baskets that hold the noodles or shredded potatoes in a nest shape while you fry them. Simply stuff them and luncheon is ready

6. **BABY WALKER** lets the child learn to walk but keeps him out of dangerous spots. A 20-pound sandbag serves as a pivot around which the caster-mounted walker revolves. The canvas seat can be removed for laundering and is adjustable

7. **FIRST-AID KIT** for furniture has materials and equipment to eliminate the scratches in furniture of all kinds from the dining table to the kitchen sink or range. Included in the kit are a spirit lamp, spatula, brush and filler material

8. **UMBRELLA LIGHT** is concealed in the handle on which its plastic lens is a decorative tip. Battery-operated, it can be removed and used separately, also

9. **COVER HOLDER** ends the problem of keeping the lid on the garbage can. Held to the handles by a coil spring, the lid is easily removed yet stays on securely

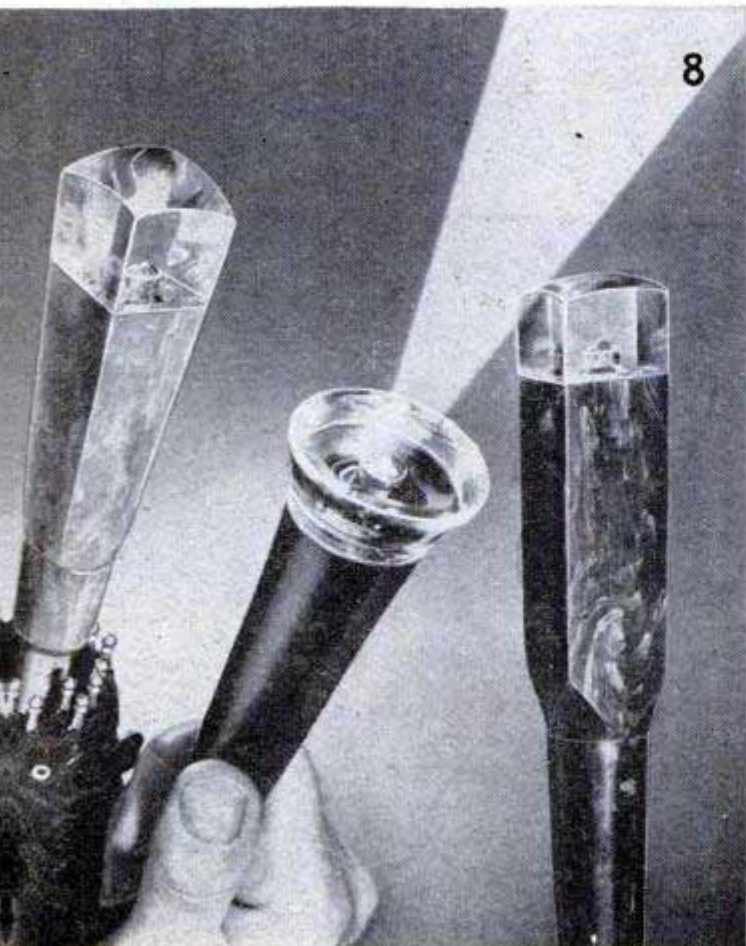
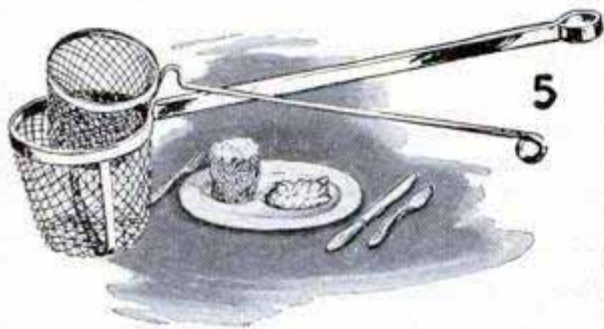



Highway Vacuum Cleaner

California is keeping its highways clean with a giant vacuum cleaner strong enough to suck up gallon-size glass jugs. Developed by the Division of Highways, the highway cleaner started out as a leaf picker. Mechanics converted it into a powerful vac-

uum cleaner that is mounted on a trailer chassis and towed behind a truck. Workmen move ahead of the cleaner, raking the trash into a row. The operator, riding on the side of the trailer, guides the flexible nozzle over the row of trash to suck it through the machine and into the body of the towing truck.

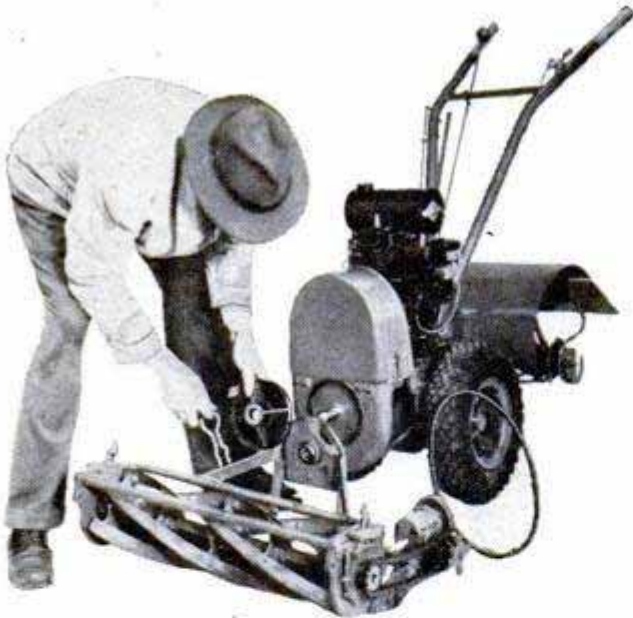

Quick-Change Garden Tractor

Attachments can be installed on a small garden tractor within seconds through a disk converter appearing on new models of the machine. The owner can change the tractor from a tilling machine to a pump or mower in less than a minute. A pin is pulled out of the flanged disk, which then is removed. This exposes a stud to which the attachment is connected.



Eye-Catching Sign

Electricians at the Hawaiian Pineapple Co. have rigged a novel sign to prevent eye injury. When a workman picks up his goggles, the grinder starts automatically. But the real safety device is a sign which flashes the message, "Wear Your Goggles."

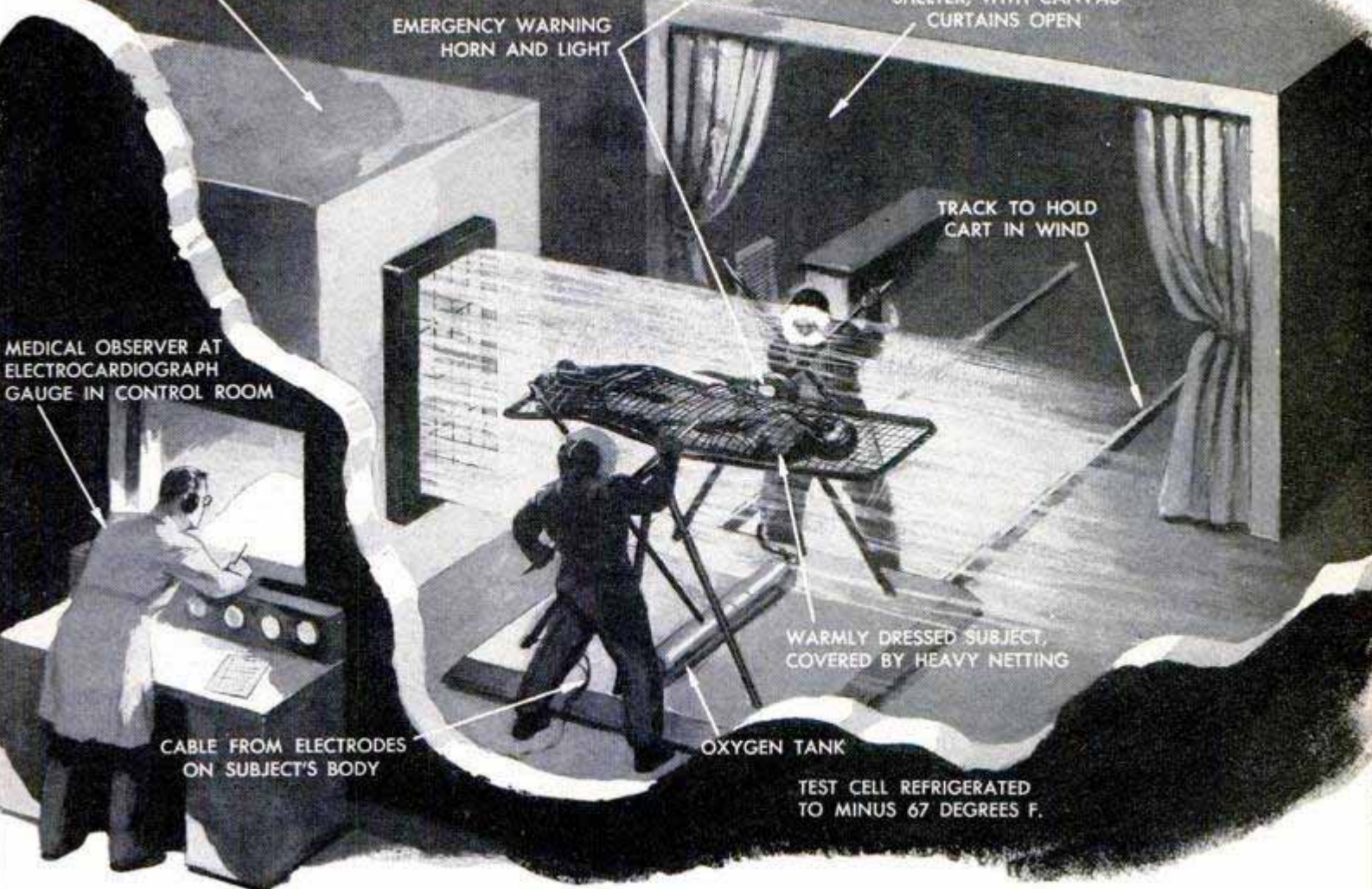

Observers, standing out of the direct path of wind blast, turn rack to simulate various falling positions

Falls From 50,000 Feet Simulated on a Rack

USING a machine to stir up 125-mile-an-hour winds in a hangar refrigerated to 65 degrees below zero, Air Force researchers found that flyers can make free falls safely from 50,000 feet. Complete body covering, even though light, is necessary, particularly for the head, hands and feet. Seventy-nine volunteers were tested three minutes at a time. Dressed in flight clothes of various weights, they were fastened to a rack directly in the path of the wind blast and held in positions a falling body might assume. Some were turned over and over on the rack to simulate tumbling through the air. Instruments attached to the subjects measured their skin temperatures, blood pressure, heartbeat and respiration. Only three very mild cases of frostbite were reported during the mock falls.

Coarse hammock netting strung over a steel frame completely envelops subjects, who draw oxygen from cylinder below the rack

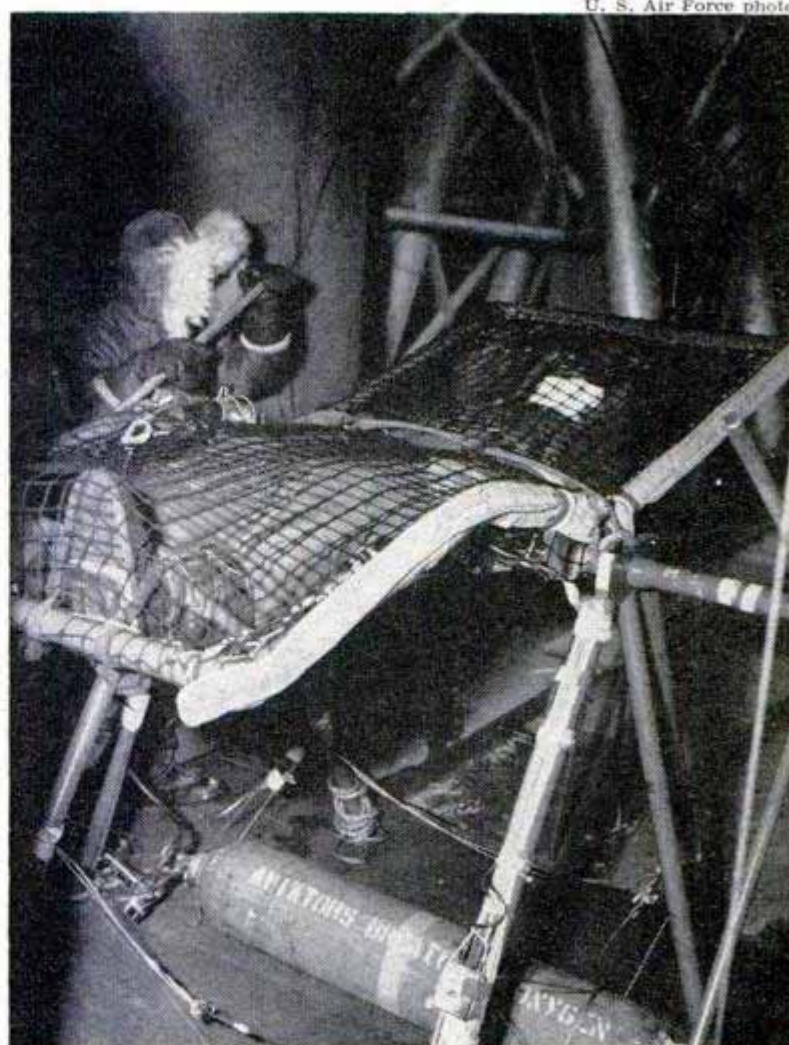

U. S. Air Force photo

MEXICO'S

◆ Intricate necklace has a true Mayan design that dates back for centuries. Right, area also abounds in tin, which is made into gleaming lamps for patios

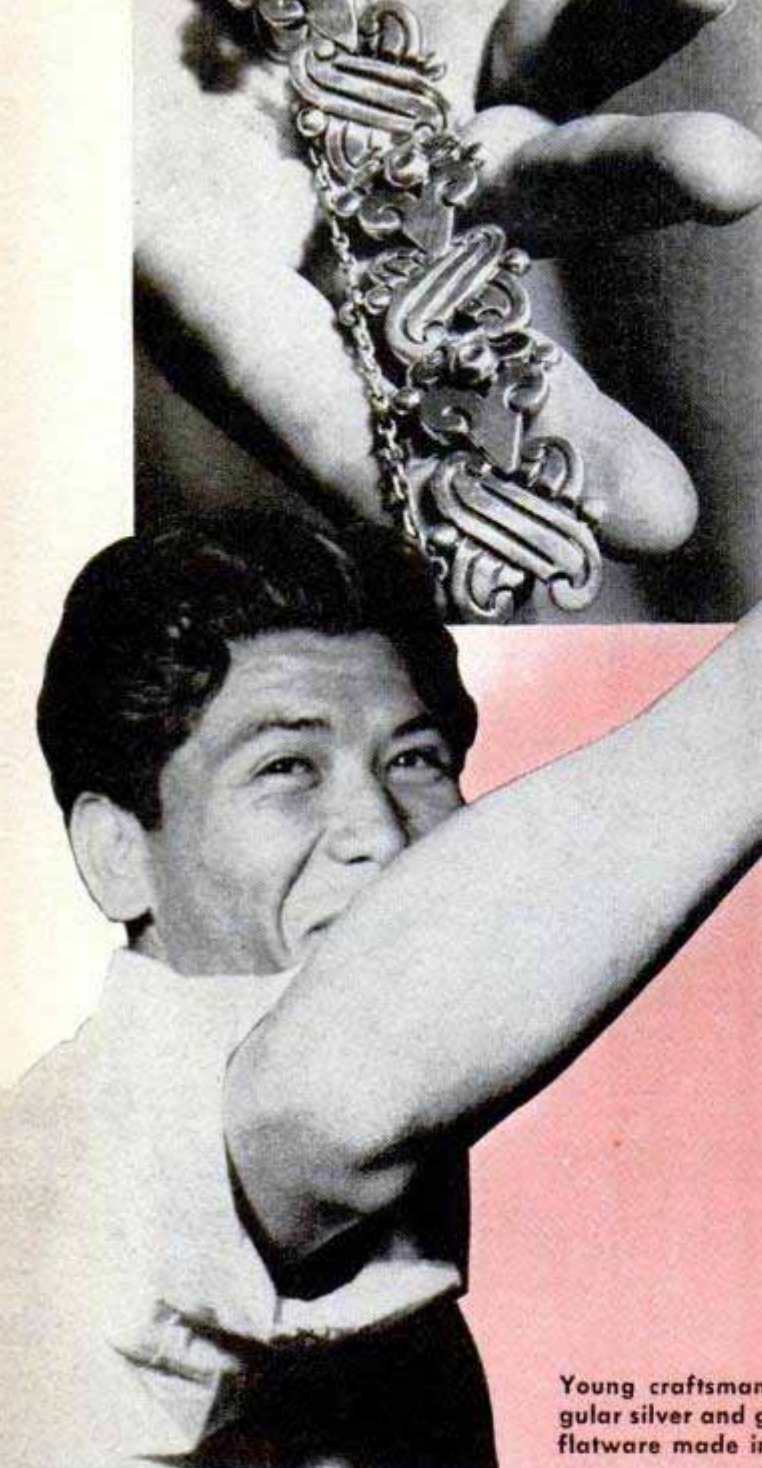

Young craftsman shows off an angular silver and glass lamp. Below is flatware made in old Aztec pattern



CITY OF SILVER

By Michael Day

WE CALL IT *metales casados*, which in English means 'married metals,' said the young craftsman, whose dark complexion, high cheekbones and square body betrayed his Aztec forebears. Standing in his little adobe shop in Taxco, a picture-post-card village clinging to a mountainside high above Mexico's central plateau, he twirled a beautifully wrought tray of pure silver, so cleverly inlaid with patterns and figures of copper, bronze and black silver that a magnifying glass would not show a line of separation between the metals.

On the felt-covered tables around him lay a fortune in precious silver artistry—heavy necklaces and bracelets inlaid with turquoise and mother-of-pearl, delicately wrought chains with glittering black-onyx pendants hand-carved like the grotesque faces on idols around the Mayan pyramids. Silver forks and spoons, sweated tightly to red-mahogany handles, gleamed in the dim light of the ancient Spanish colonial building. Every item on display revealed evidences of an art which, until a few years

ago, was lost in the moldering ruins of Montezuma's Aztec empire. And if it hadn't been for a Tulane University professor named Bill Spratling, it might still be lost and moldering.

Some 20 years ago, Spratling visited Taxco and fell in love with the ancient colonial village, its steep, narrow, cobblestone streets, burro traffic and its shaded square. He learned that abandoned silver mines tunneled the mountains beneath those streets; that Cortes, thinking the metal was tin, had mined it to make guns; that long before the conquistadors, Aztecs had mined it for ornaments and pottery, and that Jose de la Borda, a French mining engineer who gave the town its great twin-spired church with golden altars, was riding a mule when he stumbled on a new vein of ore that kept the town rich for nearly 50 years, some two centuries ago. Since Borda, however, Taxco's time seemed to have run out. Its rich ore veins were bled dry and the listless villagers were glad to subsist on the few tourists who might

Copper or silver strips are shaped to hold tiny mirrors, which in turn are formed into an elaborate frame

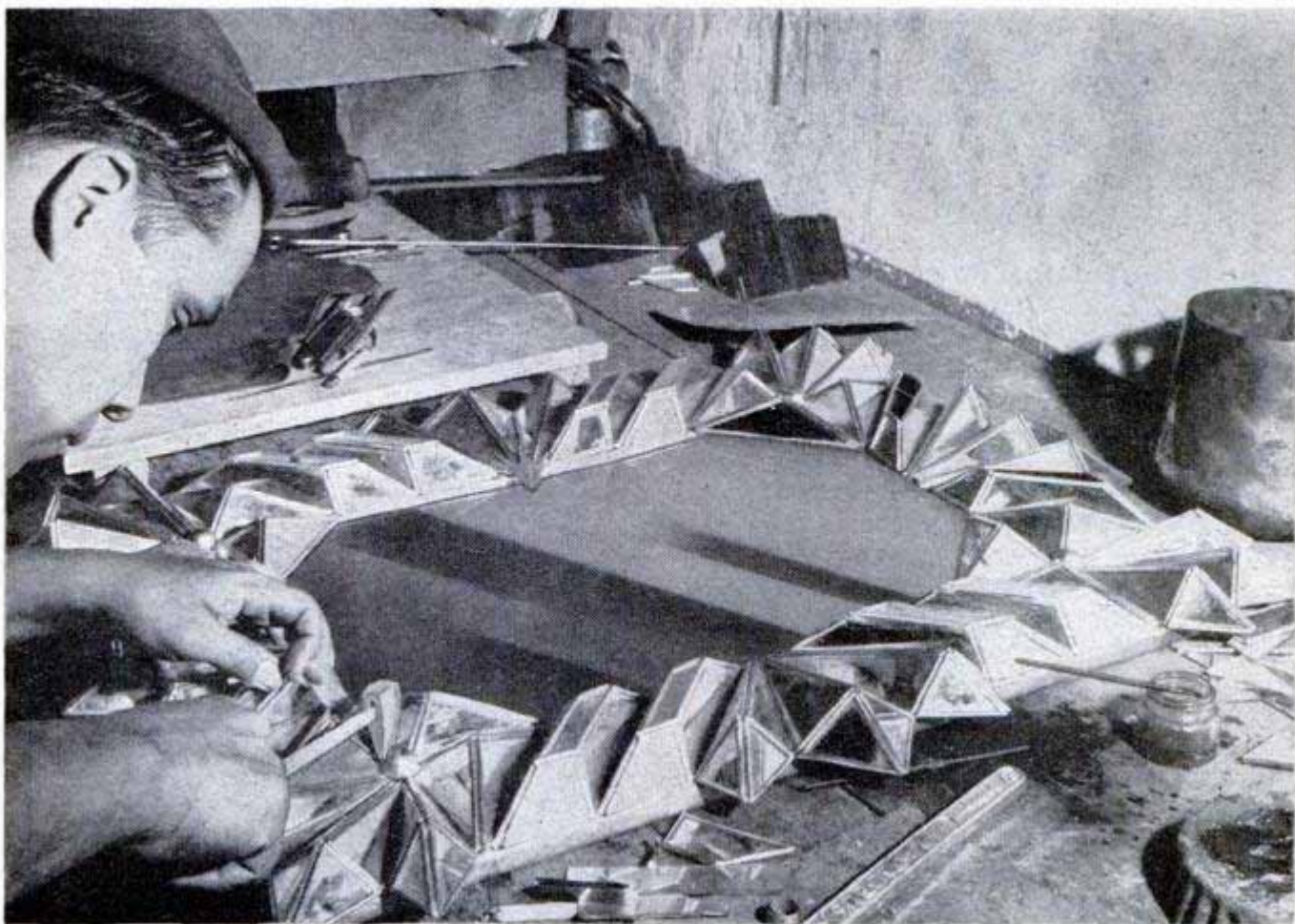

PINS PROJECTING FROM TOP
AND BOTTOM BALLS FIT
SOCKETS IN CENTER BALL

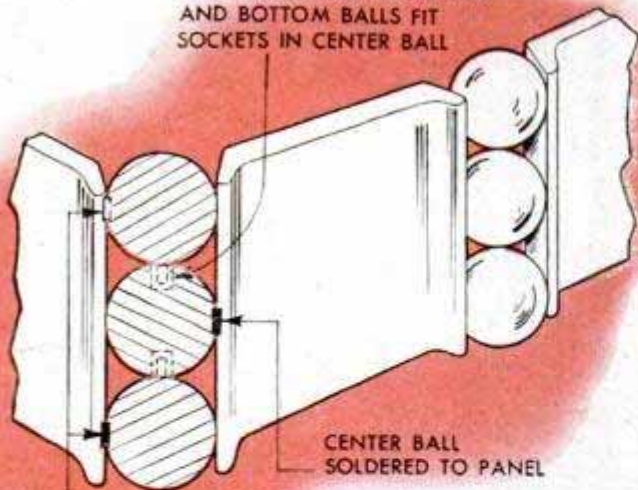

CENTER BALL
SOLDERED TO PANEL

TOP AND BOTTOM BALLS
SOLDERED TO SILVER PANEL



Hidden hinge developed by a Taxco craftsman has a swivel joint concealed in three gleaming balls

Completed bracelet, made of alternate panels and balls, is flexible, yet hinges can't be seen anywhere

journey the 75 roller-coaster miles southwest from Mexico City to see their quaint town.

Spratling investigated the mines and found there still was silver to be had for the digging and refining. "But I searched Taxco in vain for a silversmith," he says.

After months of scouting the rugged mountains for hundreds of miles around, he finally located an aged silverworker in an Indian village. Spratling designed jewelry from old Aztec archeological pieces which he scoured Mexico to find—pre-Cortes vases, ornaments and hand-carved stone utensils. The Indian transformed these patterns into native silver masterpieces as his forebears had done. That was the beginning, 15 years ago. The old man taught some younger men his tricks and techniques. They, in turn, taught others.

Today, Taxco is once again Mexico's city of silver—abuzz with activity. Fires roar in a hundred smelting furnaces under the red-tiled roofs and in the picturesque patios of its jumbled, white-adobe houses that literally stand on top of each other as they climb the steep slopes above the stone spires of the church in the plaza and spill into the deep *barrancas*, or eroded ravines. Little burros once more tote basket cargoes of silver treasure up and down the precipitous streets, zigzagging so they won't plunge headlong if they stumble. Craftsmen in a hundred shops are plying the ancient trade of the Aztecs—soldering, sweating, molding and carving the precious metal.

Just outside Taxco, in what was once a huge old ruin, about 500 of Spratling's own artisans melt, pour, hammer and polish at

a huge collection of forges and shops that scramble up the side of a mountain in three vast levels. Spratling still designs his fabulous pieces from old Aztec patterns, and his craftsmen use the ancient techniques to make them. Up and down the steps they go, their arms laden with jade, turquoise and silver treasure. Out of this fabulous studio, or *taller*, pours more than \$2,000,000 worth of hand-wrought jewelry, tea services, bowls and water pitchers each year.

One of the most intricate of all the jewel-making techniques you can see in Mexico's newly revived silver industry today is the Aztec mosaic and married-metal work orig-

Silver taken from the honeycomb of ancient mines beneath village is melted and poured into a mold

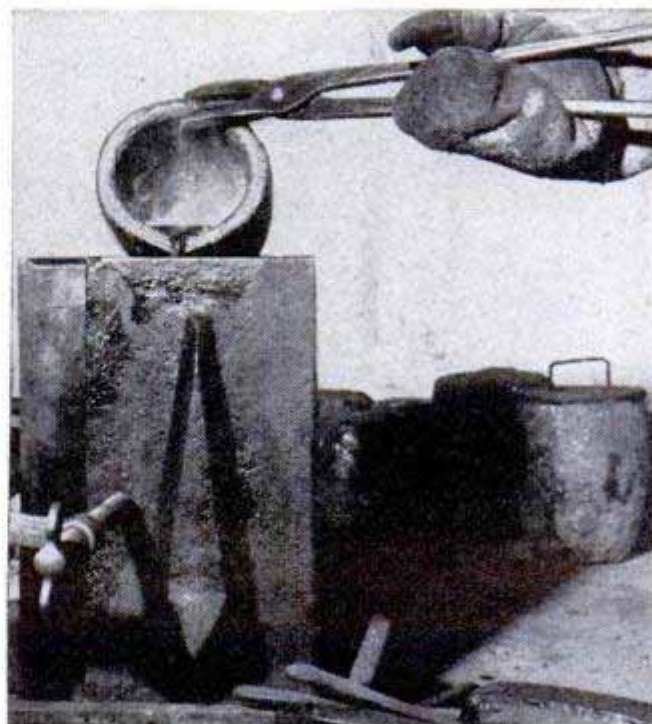

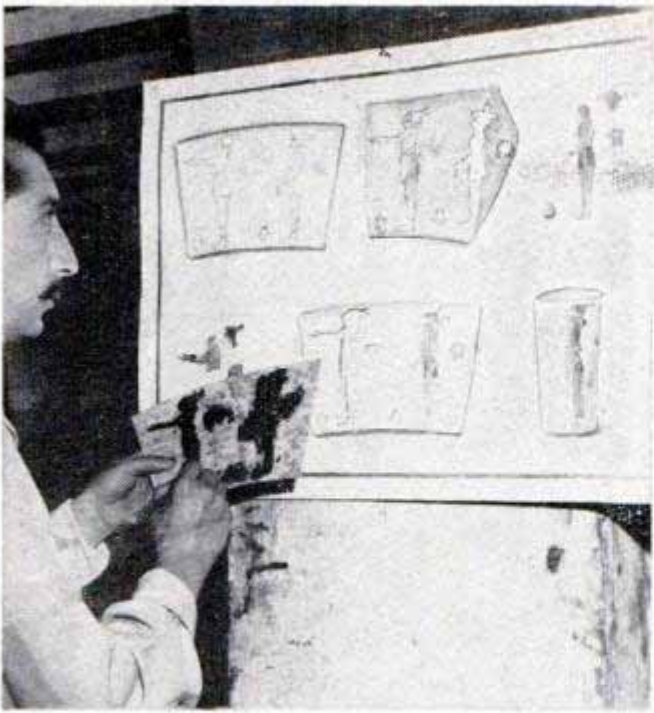

Silversmith makes a pattern by tracing the design of ancient artwork taken from ruins of the Aztecs

inated by Los Castillo a year ago. The first step is identical with what you may see in any of the silver shops of Taxco. The craftsman melts down the raw silver over a charcoal blaze. His big iron ladle dips into the white metal, which he pours into an ingot or bar mold. Into a cool bath goes the cherry-red bar, sizzling and steaming as it falls from the mold. While it's still hot, the artisan squeezes it, like dough under a rolling pin, between the steel cylinders of a roller press until it becomes a sheet of metal just the right thickness for what he wants.

From this sheet are cut blanks for neck-

Silver ingot is forced between rollers which squeeze it out into a sheet of exactly the right thickness



"Married metals" are made by routing a silver base, filling it with copper or bronze and hammering it

lace pieces, bracelets and ash trays. Now he hammers, etches, saws and files each tiny piece with a vast assortment of tools. A long, slender, soldering iron that looks like a pencil ties the links to his necklace pieces. Tiny files smooth rough edges. With a miniature saw he cuts a slice of jade onyx, lapis lazuli or mother-of-pearl to the exact dimensions of the well into which it must fit. Then, with a dozen different-sized hammers and punches, he beats and taps until his entire mosaic of gems and silver has become one piece. Turquoise is easier, since it is crushed, melted into the piece and burnished flush on a wheel.

Wire is made by cutting a narrow strip from the sheet, then pulling it through successive holes in steel plate

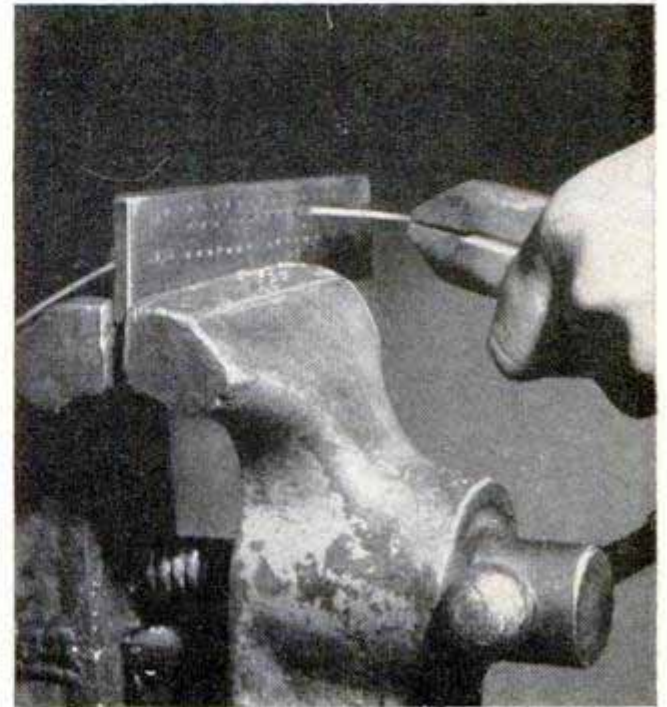

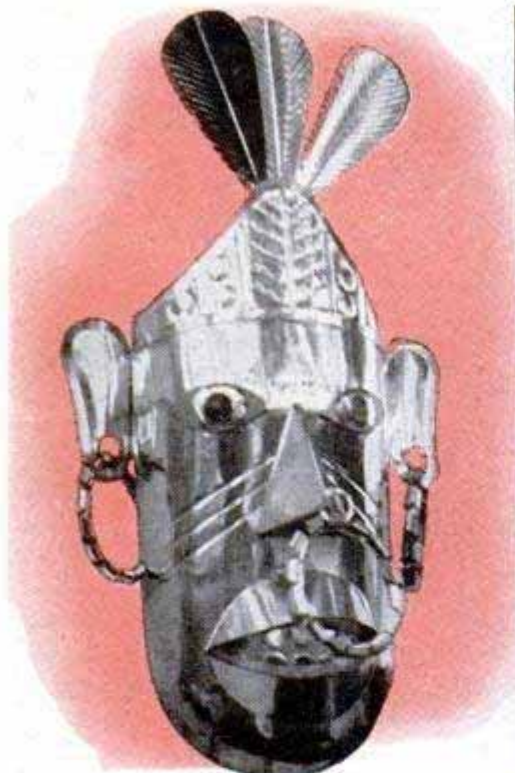

Aztec ceremonial masks, made of tin, adorn Taxco and the surrounding towns

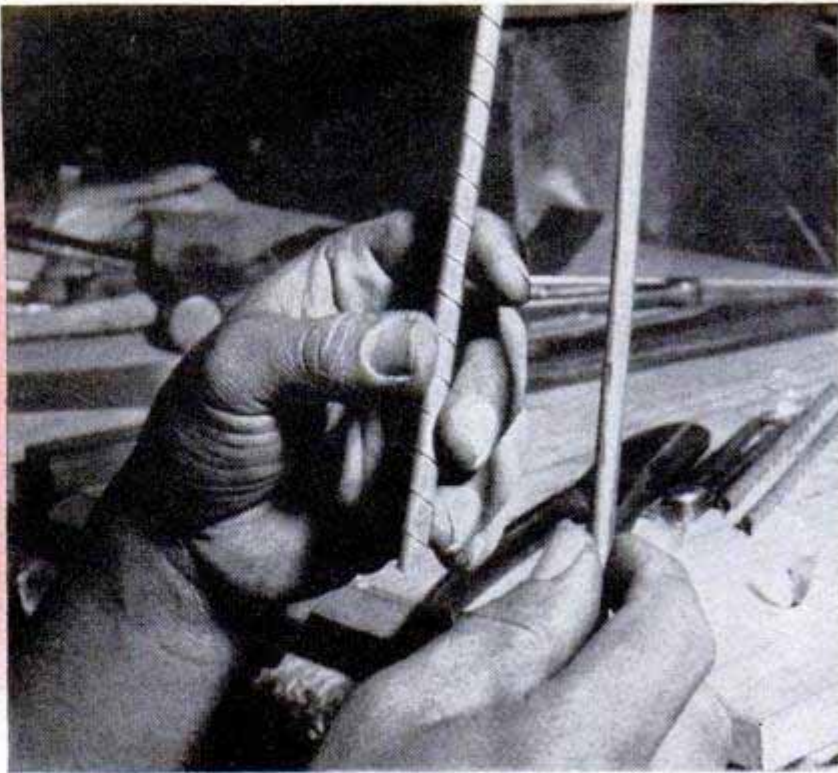

To make rings for ears and nose of a mask, a craftsman wraps a metal strip around a rod, then strips it off and bends it to shape

Toughest are the inlaid, or married, metals which must fit without a hairline of space between them and then be cold-hammered into the silver piece so they are in a single plane.

"This sounds easy," one of Los Castillo's best artisans says, "but when you are inlaying many types of metal in a tray with large surface, it is the devil. It takes me three days to turn out even a small ash tray of *metales casados*."

This craftsman spent months creating a huge silver tray with 14 Aztec figures in bronze, copper, silver and black silver—all inlaid at the surface of the tray so perfectly that no wave appears anywhere on it. You can run a needle tip across it without feel-

ing a click as the point rides across the different inlays. The piece today is on exhibit at the Museum of Fine Arts in Mexico City.

In the same way, working so closely that he must rest his eyes every few minutes, this man inlays his fantastic mosaics of metal and gems in black onyx. No cement anchors the pieces. Using tweezers and tiny punches, he hammers and sweats the inlays until they fit as snugly as though they were a part of the original stone.

Most craftsmen in Taxco started out at Spratling's *taller*, where they learned to hew closely to the Aztec line and to maintain a sharp integrity in the quality of their workmanship. When they branched out to start their own little shops, they developed new techniques and individuality, but the results are as fine—and often unique.

At the forges of Antonio Pineda's place on the village plaza, Indian artisans build their curious primitive designs into three-dimensional hollow jewelry with a distinctly modern flavor. Silver sheets are cut and soldered into swirling pyramids for incredibly beautiful necklace pendants. Heavy-looking concave bracelets, ringed with beads of turquoise, look like museum pieces. Fantastic angular mirror frames are held together by beading, made by coiling a thin strip of metal around a rod, slipping it off and soldering it to the joint between the flat sections of the frame.

(Continued to page 220)

Jack Atkin photo



Intricate inlay design is filed smooth so it will fit exactly into recess routed from the silver base

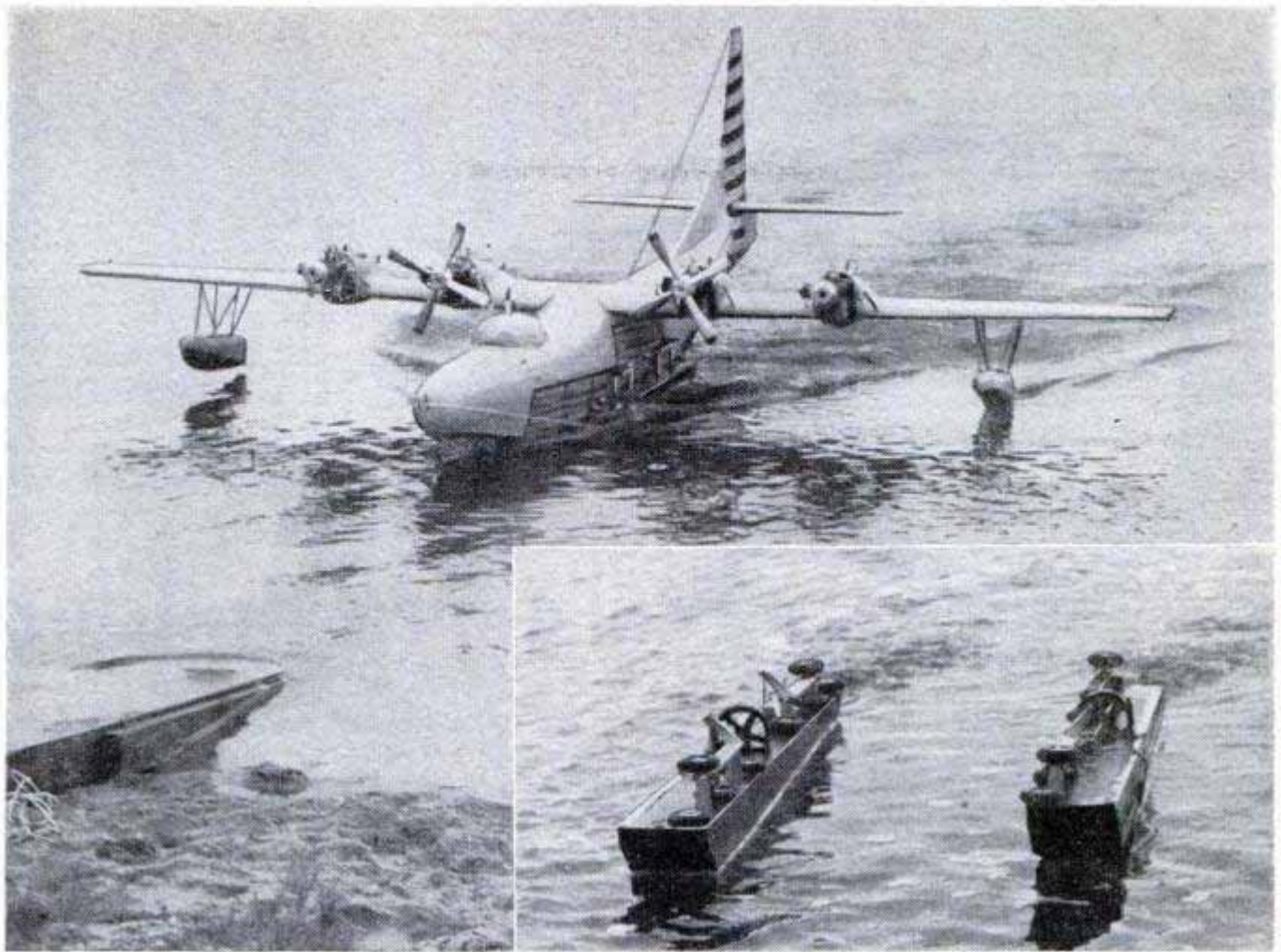

Self-Powered Beaching Cradle Gives Seaplane "Land Legs"

Today's largest U. S. seaplane can be picked up and brought ashore by a new self-powered beaching cradle. Designed by the Consolidated-Vultee Aircraft Corp., the 20,000-pound cradle has four outboard motors totaling 100 horsepower and travels at about six knots. An operator, seated at controls under a Plexiglas canopy in one of two aluminum-alloy pontoons, guides the amphibious craft alongside the aircraft's hull. Cradle-to-pilot communication is established and steel cables are attached from

cradle to plane. Pneumatic pistons elevate the cradle's substructure so the cushioning pads make firm contact with the seaplane hull. A glass-bottom window at the operator's station permits direct view of the pads, the step-positioning block and the hull bottom. A diver's lamp improves visibility in murky water. His "land legs" attached, the pilot is able to taxi up the ramp and park the plane. On land the steering is done by the cradle operator under guidance of a signalman.

Helpful Bomb

Assistance instead of destruction is the purpose of a "mercy bomb" planned and built by two Air Force men in Korea. An obsolete napalm tank is loaded with heavy clothing, carbine, water-purifying tablets, first-aid kit, three days' food supply, portable stove, sleeping bag, radio and other survival aids. Fastened beneath a rescue plane, the tank is dropped from low altitudes.





Marsh grass, twisted into a loose rope, is wrapped around a core to make the target by a machine that works in the field

Bull's-Eye Builder

MAKING A LIVING by stopping arrows may sound like a dangerous occupation, but for Charles Saunders it isn't. He produces archery targets—those overgrown bull's-eyes that look like bundles of straw to the uninformed.

Target making is not as simple as you might think. It takes a well-made, resilient target to stop fast-flying arrows repeatedly without breaking down. The material best suited for the job is a tough marsh grass known as *Spartina*.

Up to 1939, targets for the modern Robin Hood were made completely by hand. After

many unsuccessful attempts, Saunders, who now operates his target business in Manilla, Iowa, developed machinery to speed the job.

Saunders' machinery cuts the grass and feeds it into a spiral winding drum that wraps it tightly around the core, the actual bull's-eye. This operation takes place right in the marsh where the grass grows. A special lightweight tractor had to be built to power this machinery. After curing in the field, the targets are stitched tightly by hand so they will stand up under the repeated bombardment of arrows. ★ ★ ★

Archery appeals to all ages, and the targets are made in different sizes to challenge the aim of the bowmen

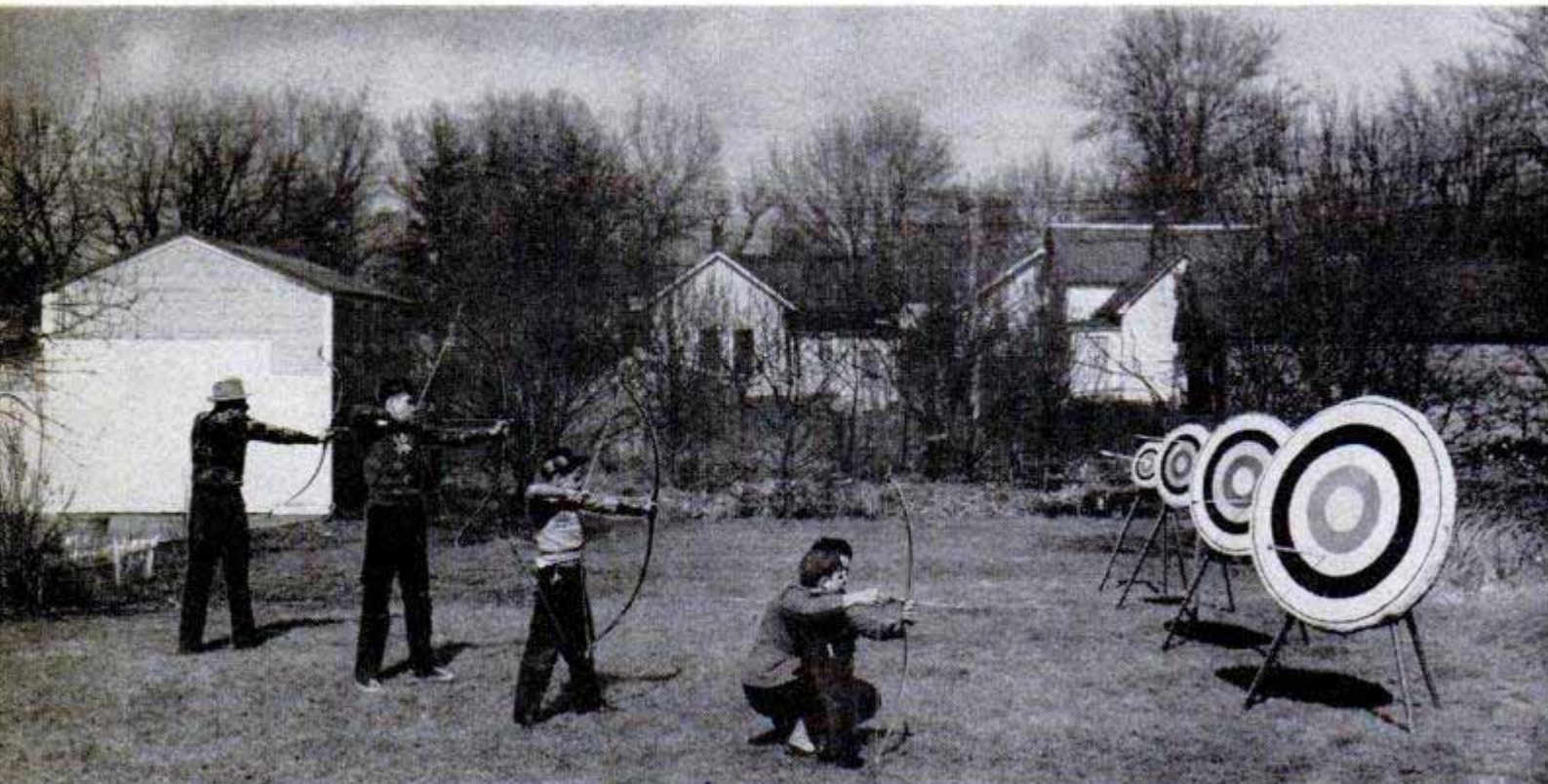

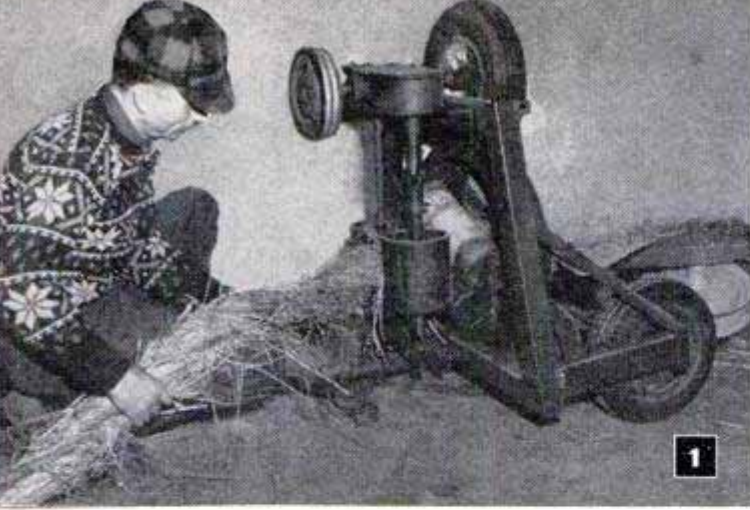

1

1. After the marsh grass has been mowed, a machine twists the long strand into a loose rope which is then left in the field for a week or more to cure. Saunders developed the rope-twisting machine. Before he entered the business, targets were all handmade



2

2. The bulky target-winding machine, opposite page, wraps the grass rope around the target core, forming mats such as these which are stacked in the field to permit air circulation during a second curing period. The core, or bull's-eye, is plainly seen in this photo

3. Testing the targets is an important part of the process because they must be firm enough to stop a speeding arrow. This device exerts the same force as an arrow from an 80-pound bow. Any soft spots that are found are corrected by tightening the stitching

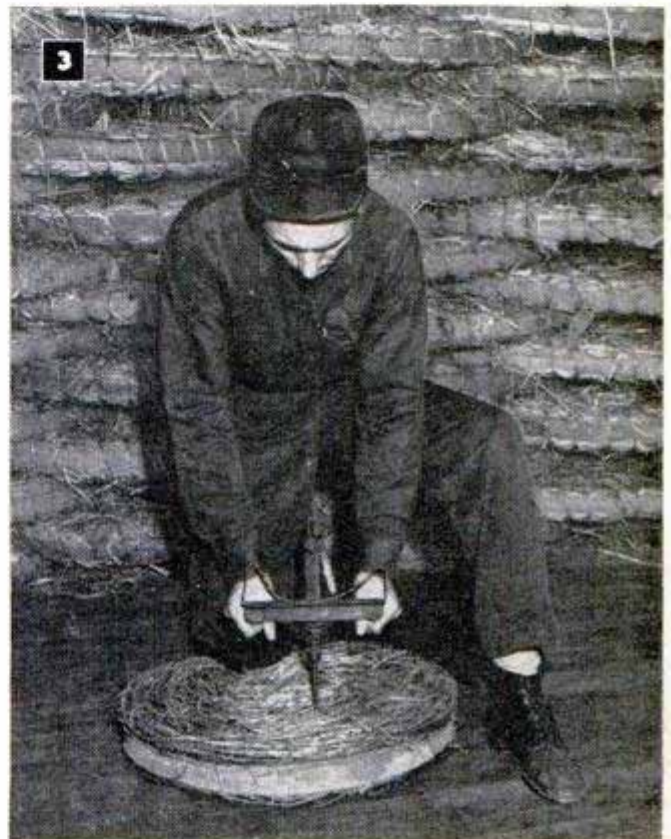

3

4. Despite the Saunders inventions, there are still hand operations in target manufacturing. Sewing the grass mat to make it strong is one of these. Walter Crouch, veteran target maker, stitches a mat, using 48 hooked needles to pull the cord through the grass

5. Targets, tightly sewed and ready to stop arrows, are covered with burlap on the stretching machine. The burlap protects the target mat and it provides a surface on which the scoring rings can be painted



4

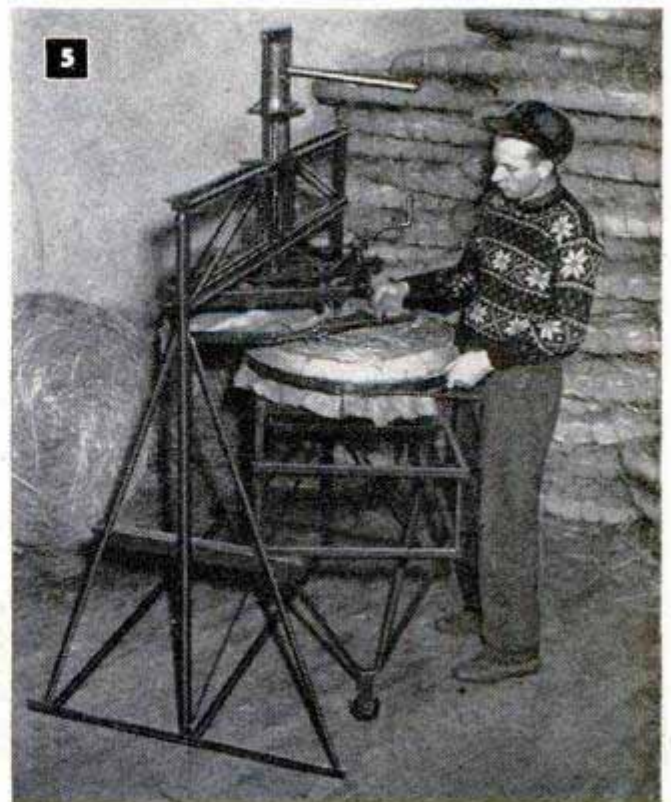

5

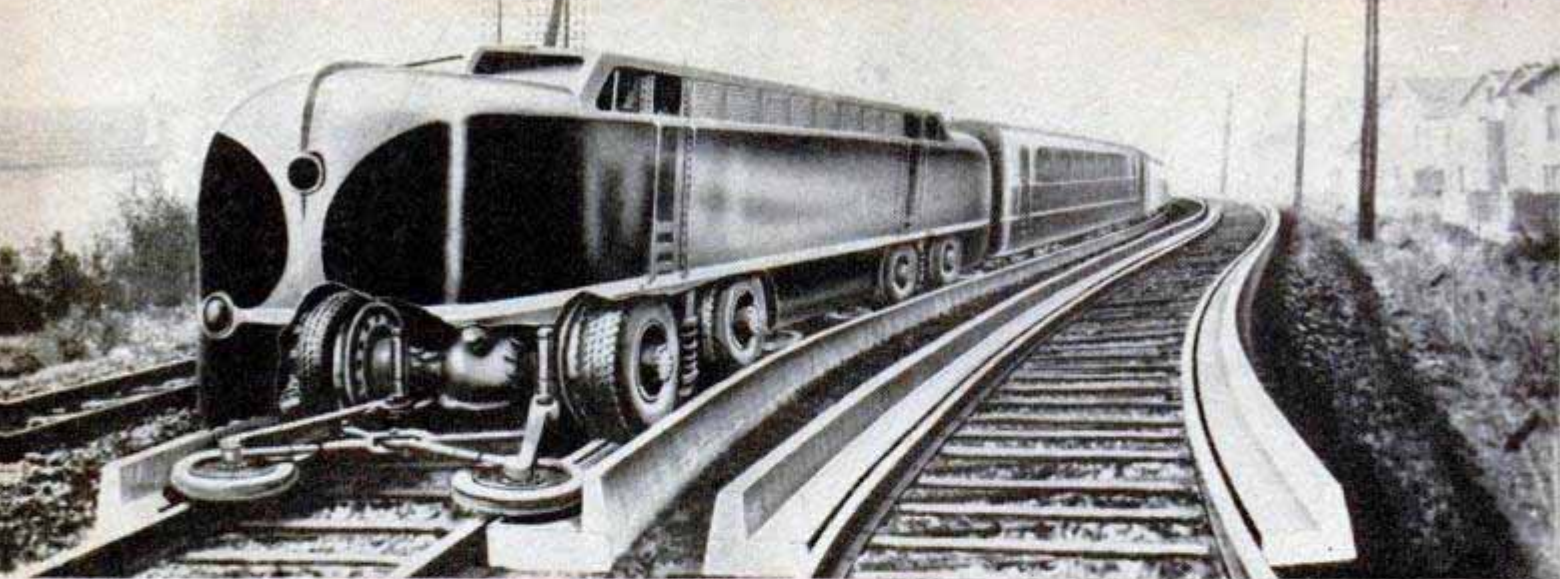

Artist's drawing shows how Parisian train of the near future will look if tests with tires are successful

QUIETER SUBWAYS FOR PARIS?

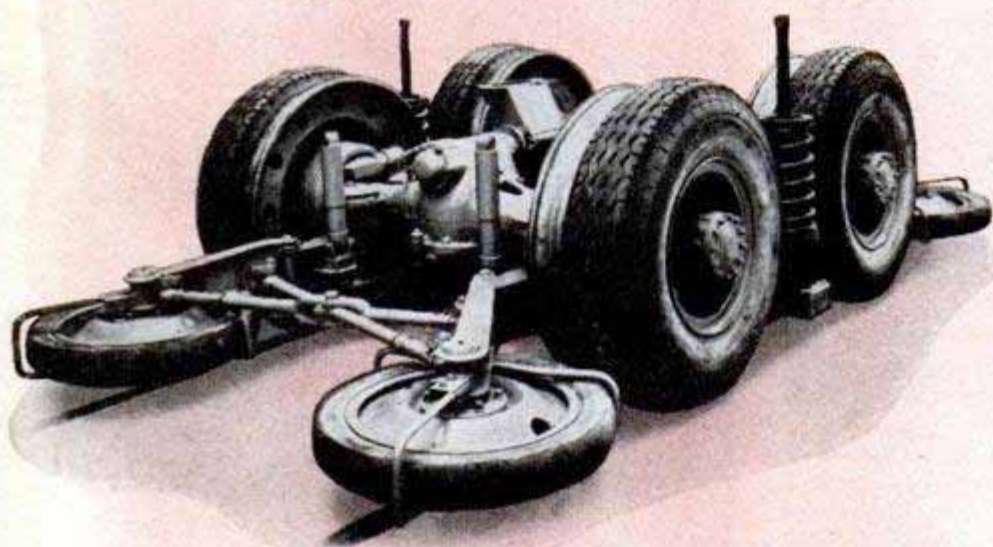

Horizontal wheels in front of train guide truck along rails. Below, test train runs along wooden tracks, to be replaced later with concrete

IN PARIS, a train equipped with rubber tires is traveling the subway system. Conventional truck tires have been fastened outside the regular flanged wheels in an attempt to reduce noise and increase comfort. The train travels along a wooden runway, to be replaced later with concrete tracks. Two smaller tires mounted horizontally in front of the train press against the sides of the track to guide the main wheels. In case of puncture, the train can proceed without delay on its old flanged wheels.

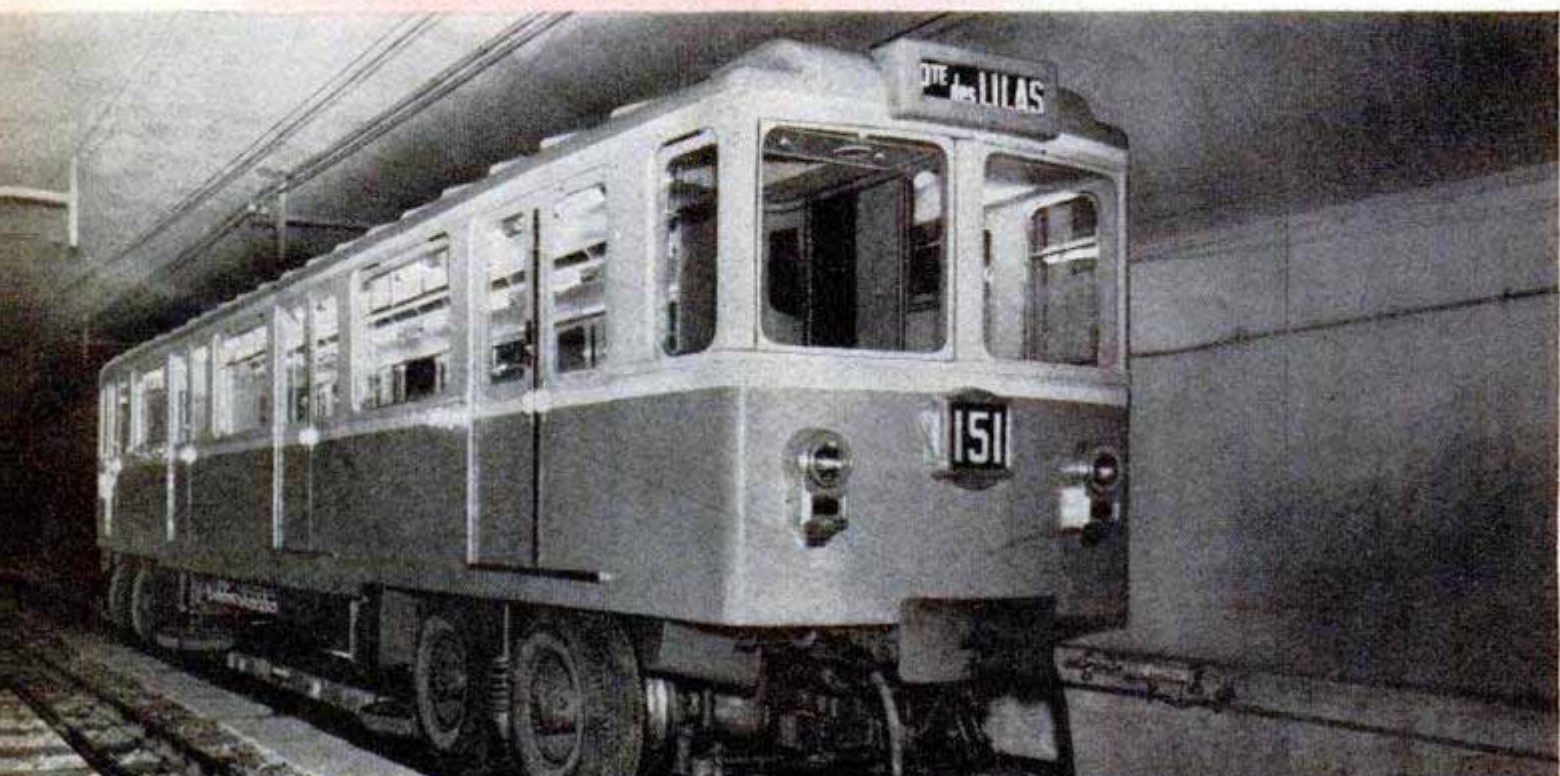

NOW THEY'RE MAKING CARS OF GLASS



In demonstrating the ruggedness of laminated glass fiber, worker repeatedly clubs a removable top with all his force but it fails to show the slightest sign of a dent

By Paul W. Travis

WITH STEEL so short, why not make car bodies of glass fiber?

A California company answered that question by turning out one weighing only 140 pounds, one third the weight of a conventional steel model but equally strong. In addition, it is dent and corrosion-resistant.

Before the hood was attached, the laminated-glass-fiber body was laid on a concrete floor. Husky men with boots jumped on it, drove automobiles over it and beat it with a sledge hammer — without damage.

The car was built by the Glasspar Company of Costa Mesa, Calif., for Maj. and Mrs. Kenneth Brooks of near-by Lido Island. It was designed by William Tritt of Glasspar. A 1940 Willys chassis was used and the forms for the glass fiber were made from a wooden body model built over it. Then the $\frac{1}{8}$ -inch-thick body was made from layers of fiber held together by plastic polyester glue.

Makers of laminated boats for years, the company is also building removable tops of

Layers of glass held together by plastic polyester glue form the $\frac{1}{8}$ -inch-thick body built for Major Brooks

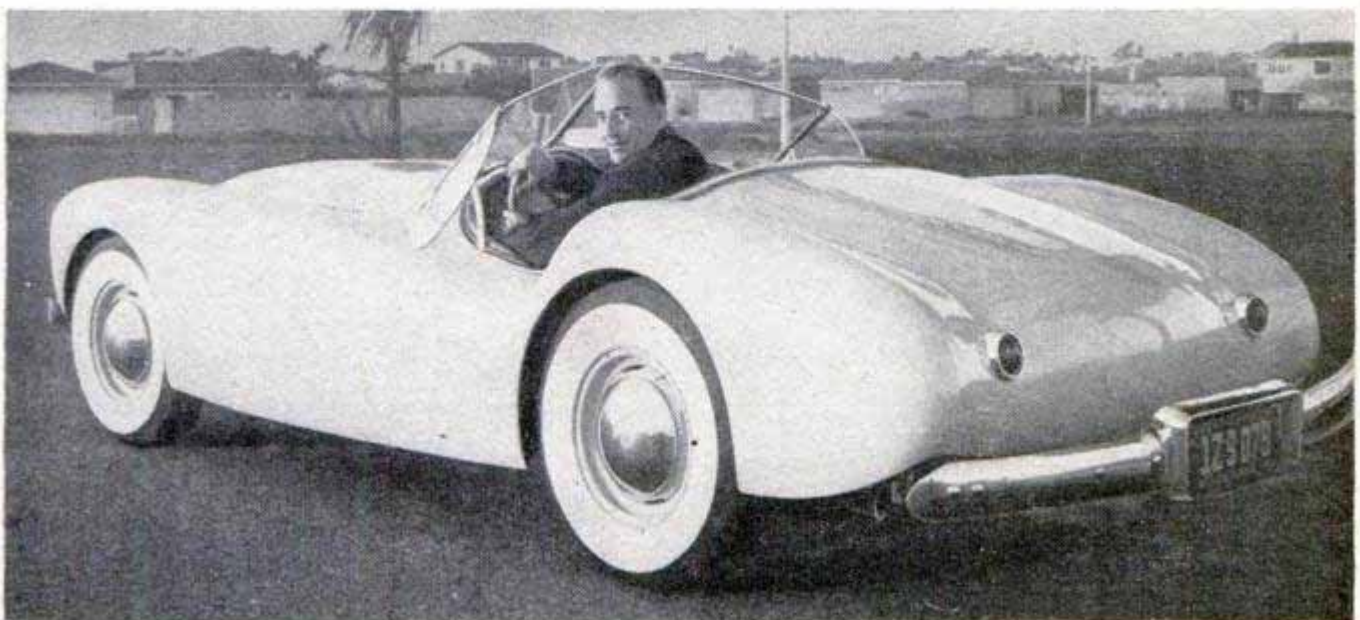

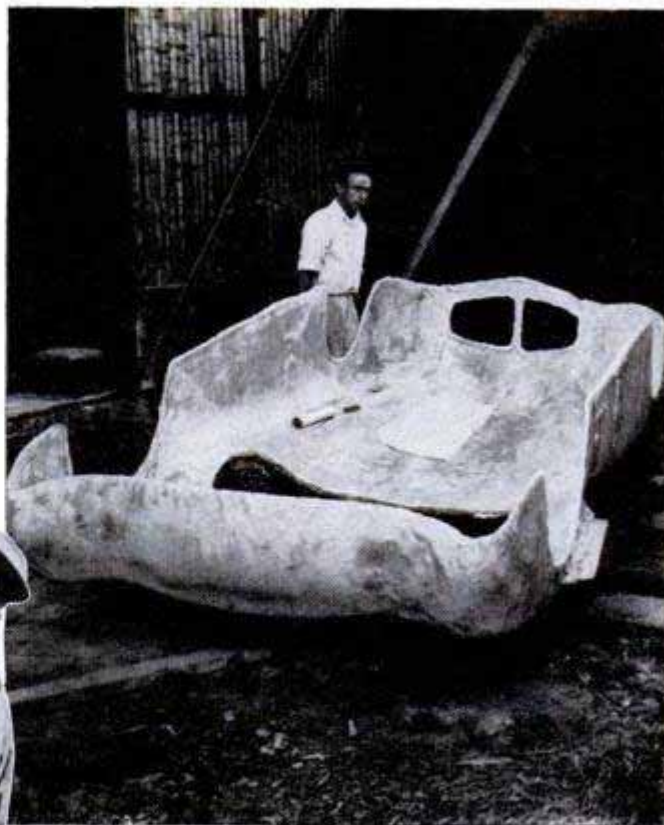

Mold, above, in which the glass-fiber car was formed. A special releasing agent is painted over the inside. The first body stuck and had to be chiseled out in pieces

Strong and tough-skinned, fiber top for Jaguar easily bears the weight of two men as they jump up and down. A special repair kit simplifies the smooth patching of large holes

William Tritt, the top's designer, holds it over his head to demonstrate the material's lightness. Two average-size men could lift an entire car body built of glass fiber



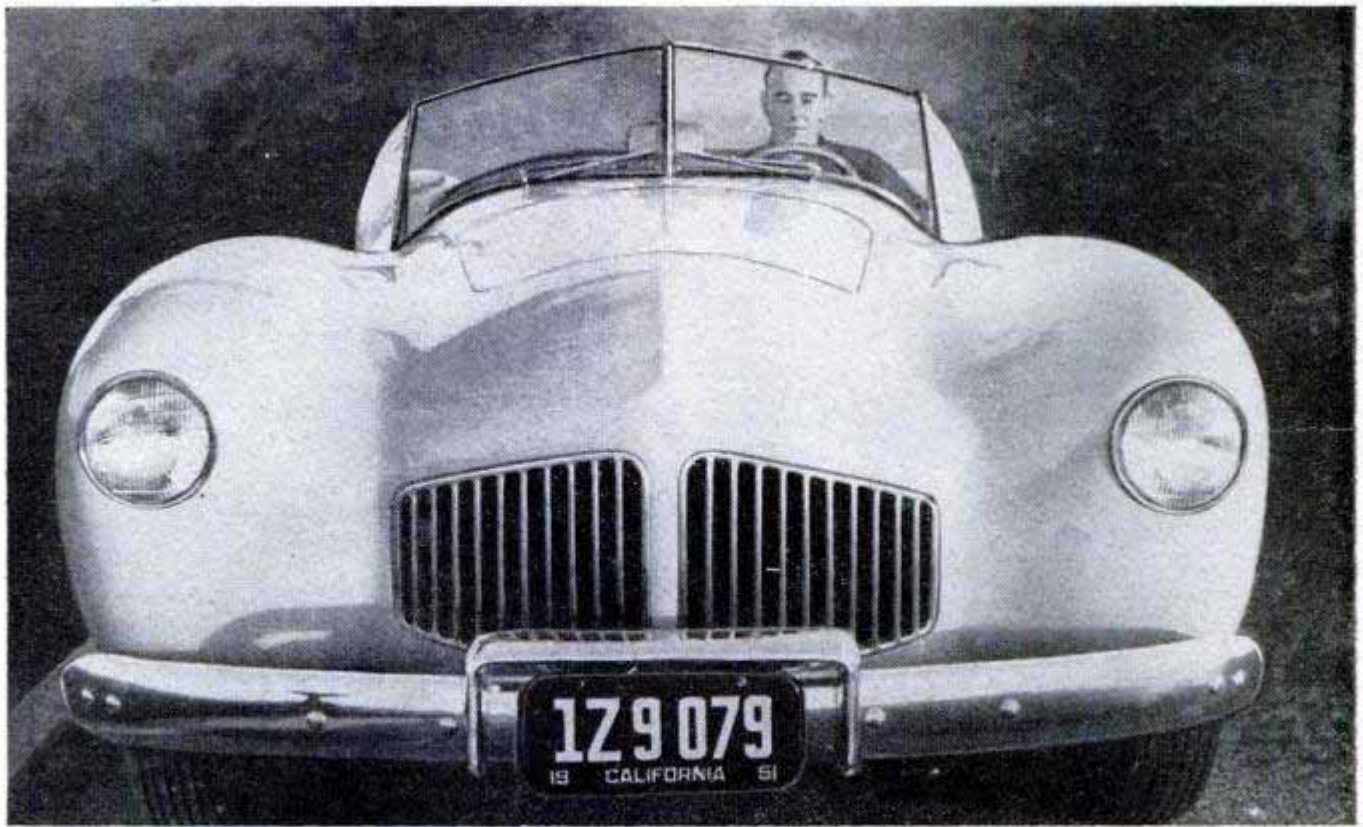

Sanding, a prime coat and 12 heavy coats of lacquer gave the Brooks' car body its exceedingly glossy finish

glass fiber for the British Jaguar Sportster. These weigh 22 pounds and can be attached in 15 minutes by three screws in the windshield frame and a bolt on each side. With a repair kit soon to be made available, a layman could patch a two-inch hole in the top so expertly, the manufacturer claims, that the repaired spot couldn't be detected under close observation.

In appearance, the car most closely resembles a Jaguar. The wheelbase is 102

inches and the tread is a standard 56 inches. Its exceedingly glossy, fine-grained paint job was done in the conventional manner with sanding, a prime coat and 12 heavy coats of lacquer topped off with a polishing.

The Brooks' car is so low-slung and lightweight that sharp corners can be turned at 50 miles an hour. The passengers' heels are only nine inches from the ground. The pedals are adjustable to the driver's size.

★ ★ ★

It takes only 15 minutes to adjust three screws and two bolts that attach 22-pound top to a Jaguar Sportster

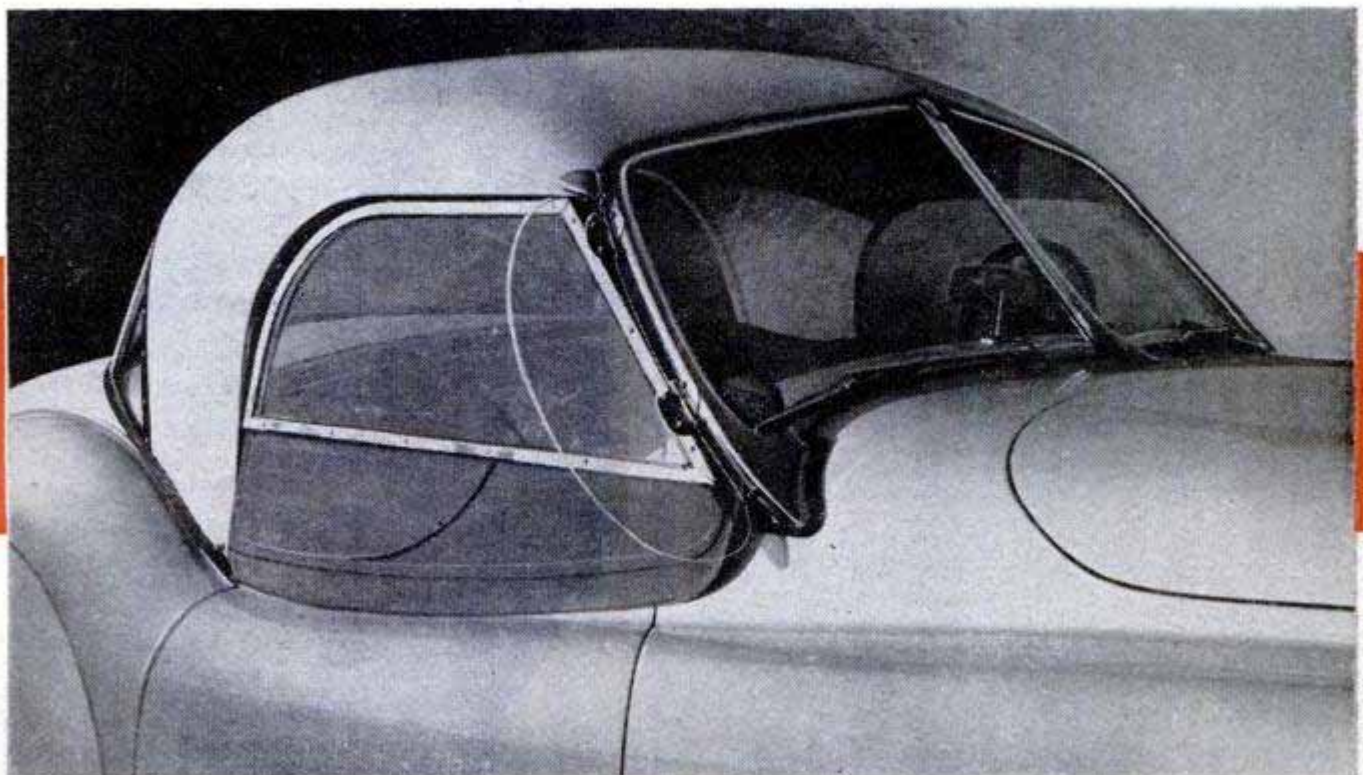

LOBSTERS ARE LIKE PEOPLE

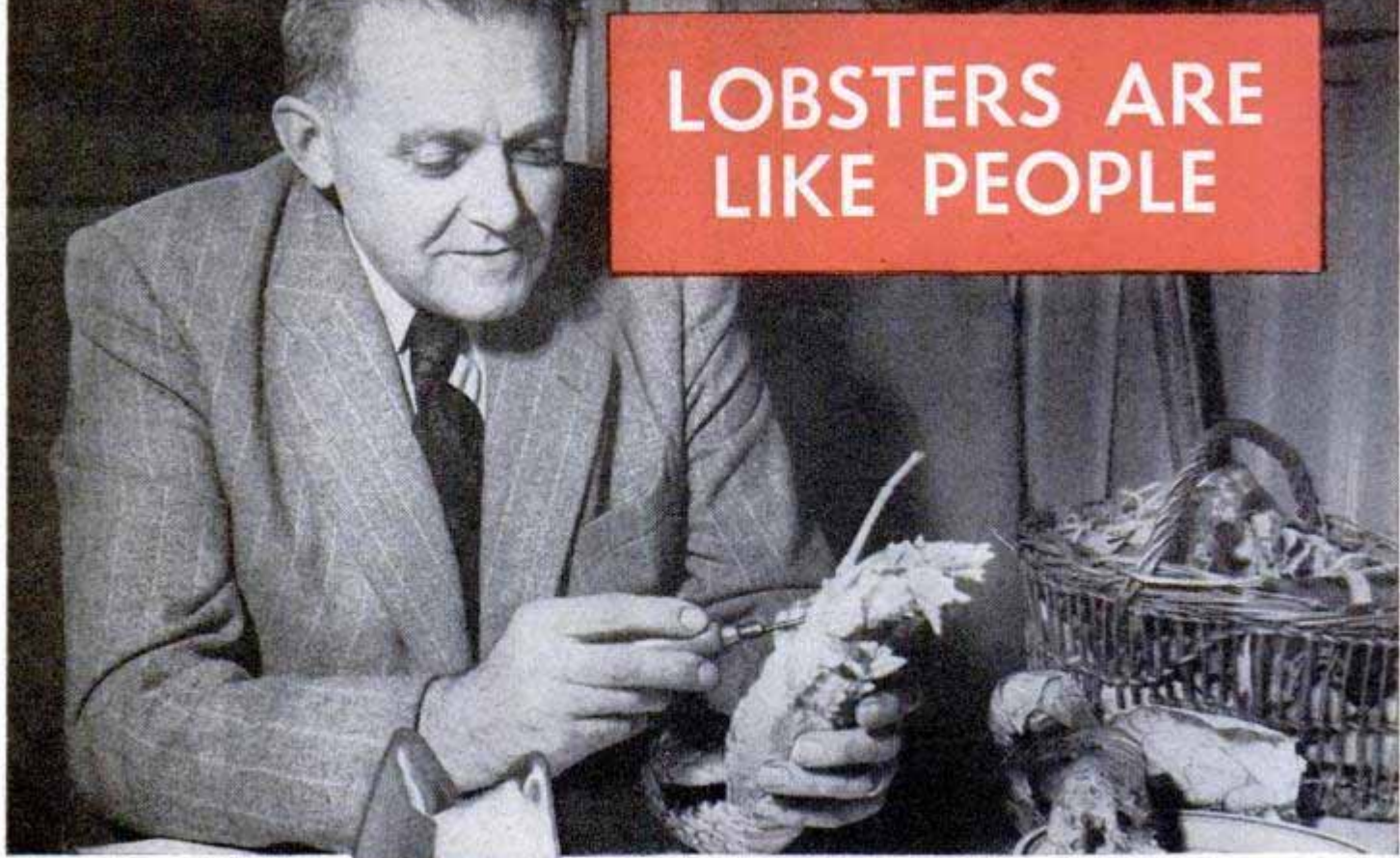

Jean Sulpice, Parisian restaurateur, believes that lobsters and people have similar features. These "portraits" seem to prove the artist's contention

With a few props (a cigar, glasses and hats) and his lobster shells, the Frenchman created these caricatures of two famous international figures





Fine wire holds the various parts of the figures together in their lifelike poses

ANYONE WHO HAS seen Paris knows about Place Pigalle—and knows that almost anything can be found there. That is why it is no surprise to learn that in the city of artists, one Pigalle restaurateur is an artist who hangs his work from the ceiling. More surprising is his medium—lobster shells! ★ ★ ★

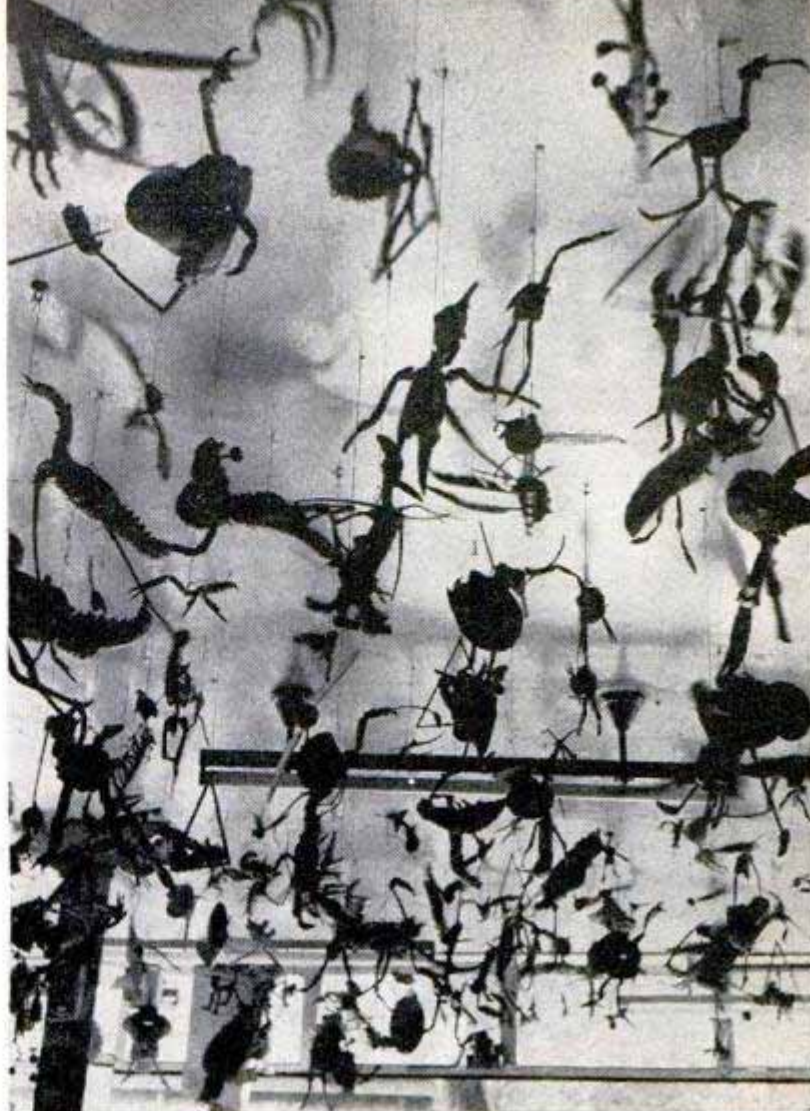

Hanging from the ceiling in a somewhat frightening array are scores of examples of the artist's work in a variety of subjects



Left, no label is needed to identify De Gaulle. Right, not so easy to recognize is the figure of the French president, Vincent Auriol



COAL ARTIST

COAL IS MIGHTY common in Pennsylvania—common, that is, until Charles Cunningham, a former miner, starts working on it. When he gets through with it, a chunk of common Pennsylvania anthracite looks like a precious stone. He carves it into many beautiful shapes and gives it a mirrorlike shine by a process that is his personal secret, learned from his father who began carving coal 70 years ago.

Animals are favorite subjects for the coal sculptor, who learned the art when a child

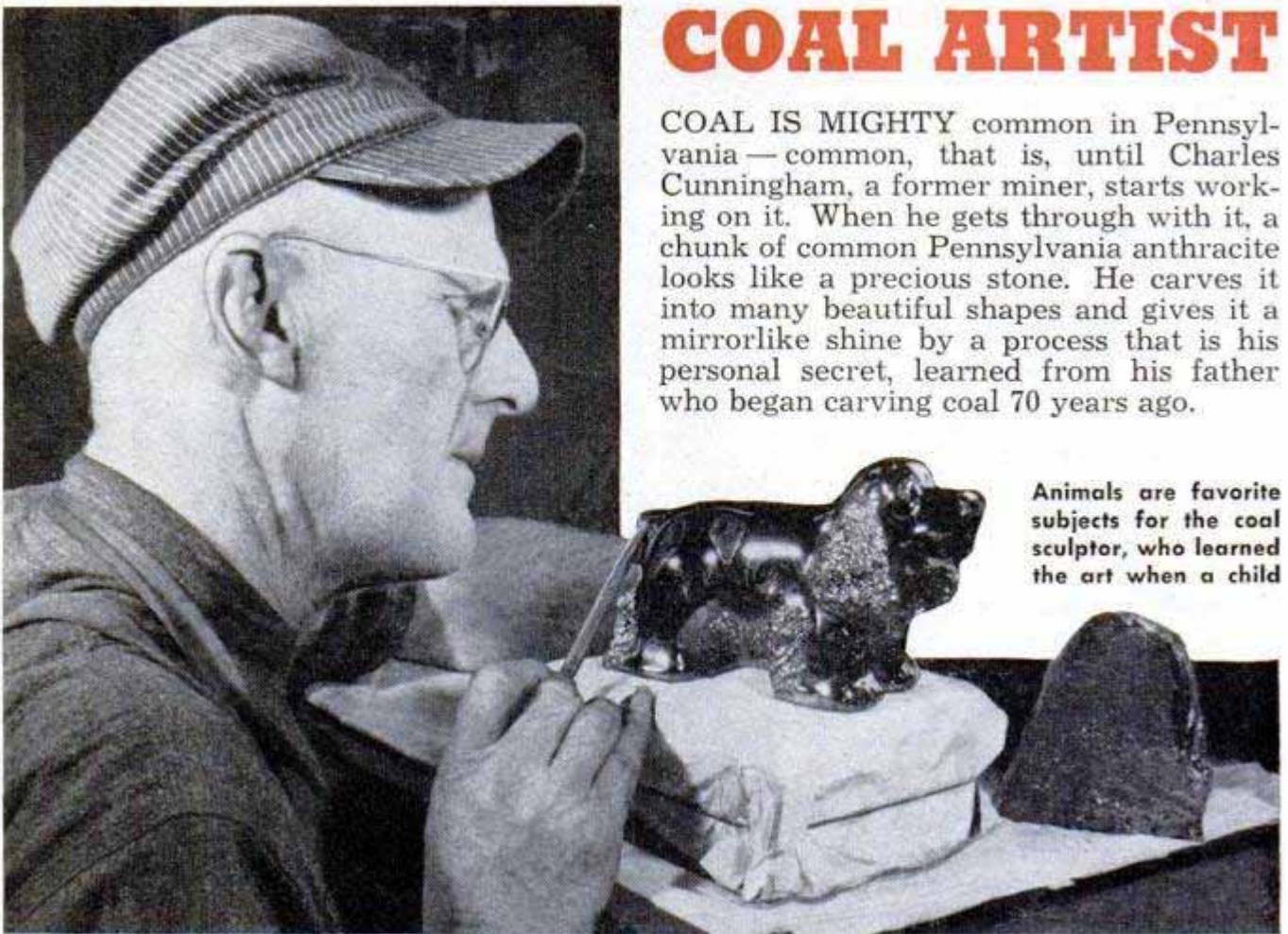

Below left, some of his work. Right, he selects coal in the mine himself, splits it carefully in his shop

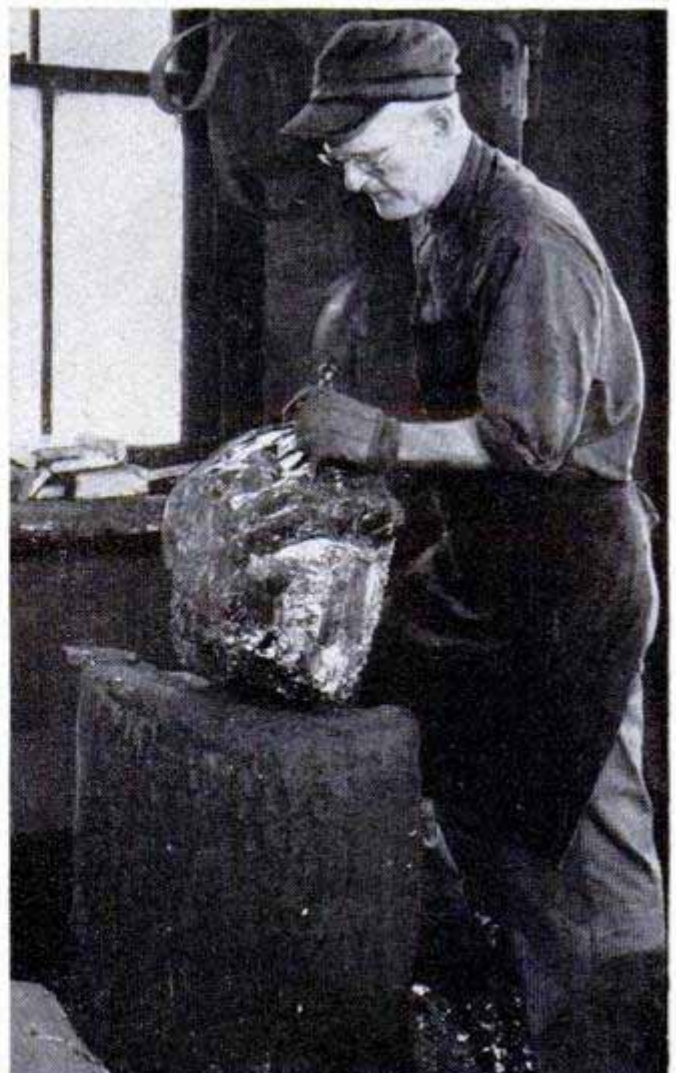

Clamp Deters Cow From Kicking

Cows in stanchions are discouraged from kicking by a U-shaped clamp that exerts light pressure on certain muscles. The clamp grips the animal at a point below and slightly behind the hipbone projection. Pressure in this area inhibits the use of muscles involved in kicking. The instrument also affects certain nerves, according to the manufacturer. The gentling device is made in a standard size to fit most cattle and a smaller size for cattle of smaller breeds.

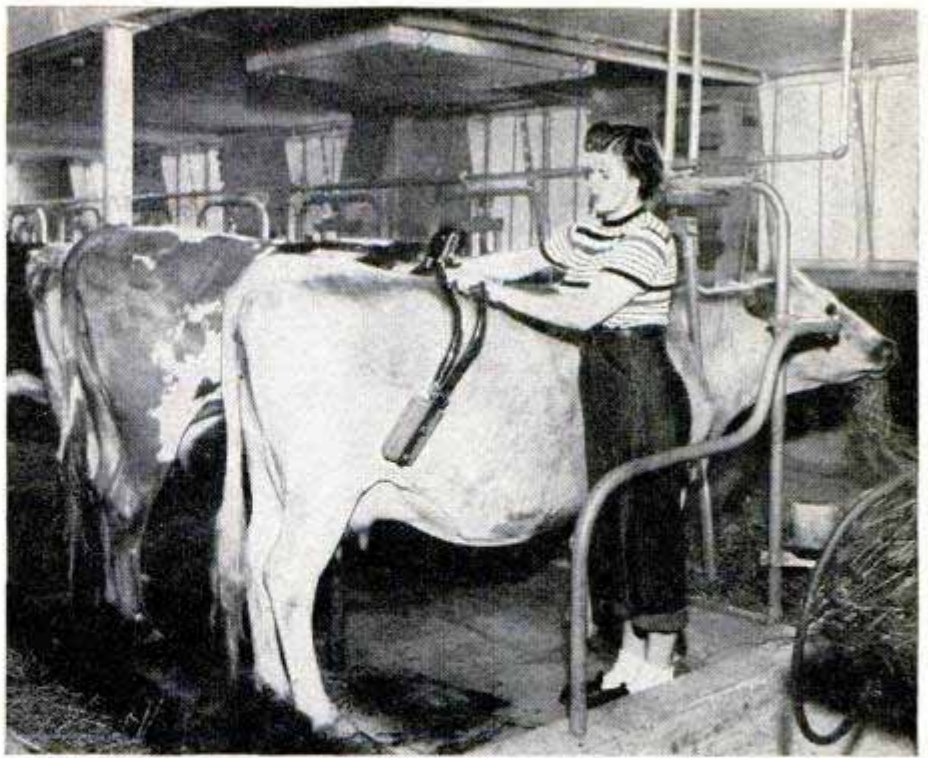

Desk-Size Facsimile Machine

Smaller than a typewriter, a miniature self-contained telegraph "office" provides the executive with 24-hour telegram service. Telegrams are sent and received simply by pushing a button. They don't even have to be typewritten. You simply write out the message on a blank, wrap the blank around the drum of the machine and turn it on. A scanner views the message and sends it to the addressee where an exact copy is reproduced by an identical machine. Transmission time of about 2½ minutes is required to handle a full message. The call is routed through the main office of Western Union, which directs the message to its destination and bills the sender.

Shoe House

"There was an old woman who lived in a shoe"—at Hickam Air Force Base in Hawaii. A few years ago S/Sgt. George E. Sylvain built a playhouse—a replica of a modern bungalow—for his three daughters. Eventually they lost interest in the house and he sold it to a civilian. But later they wanted another miniature home, so Sylvain went to work again. This time he built them a home in the form of a huge shoe. The playhouse is complete with a miniature door, windows, painted-on laces and a crooked chimney.



THE CARS



By Ewart Thomas

ABOUT EVERY five miles in traffic someone pulls alongside Bob Gottlieb with the question, "What's that you're driving, one of the new foreign cars?"

Gottlieb leans over the side of his long, low, sporty automobile and grins. "Nope," he replies, "It's a 20-year-old Chrysler."

In this lineup, the old-time Packard, Pierce-Arrow and Rolls-Royce are classics, restored in every detail and now used daily by their owners



And it is, though the gleaming maroon custom body doesn't look a month old and the engine is so quiet you hardly can hear it.

The car was a rusty wreck when Gottlieb paid a couple of hundred dollars for it several years ago. The water jacket had rusted out, cam followers were broken, three springs had snapped, the brakes were shot, universal joints ruined and many parts missing. The new owner spent six months of spare time restoring the car to original condition and today he drives it to work.

Last year he put 22,000 miles on it. The whole car is strictly original except for a 1950 carburetor that was installed for better mileage.

Gottlieb can afford a new car but there probably isn't a 1952 model on the market he'd accept as an even trade. He's one of the "classic car" fans, one of the growing number of enthusiasts who delight in restoring and driving some of the great cars that were built in the past.

The classics include most of the expensive, limited-production automobiles that were built for looks, performance and durability. Many of them cost fabulous amounts when new. A

THEY DRIVE ARE CLASSICS

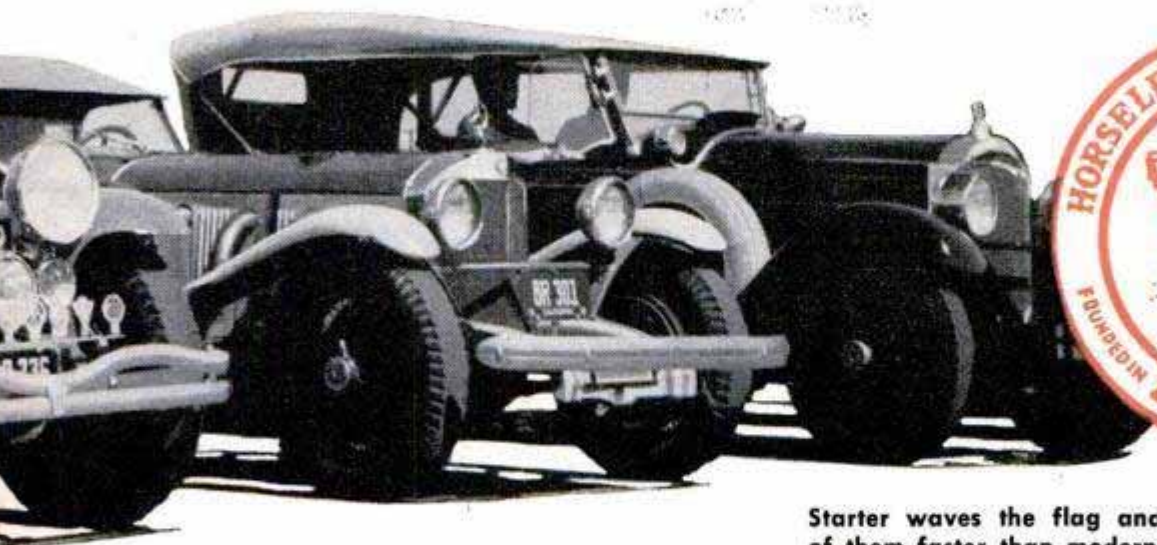

Starter waves the flag and the classic cars—many of them faster than modern cars—are off on a race

1928 Rolls-Royce town car with special body that sold originally for \$25,000 is a classic even though you can pick one up today, unrestored, for around \$500.

Beauty of lines, performance, rarity and present usefulness all contribute to the definition of a classic car. Such cars have also been called romantic cars, or cars of special interest. Age makes no difference. The 1920 series 5 Mercer runabout with bucket seats and the 1941 Lincoln Continental are both classics.

Among the classic cars are the Marmon and Cadillac V-16s, the 12-cylinder Packards, Pierce-Arrows, Auburns and Lincolns. The supercharged Cords of the 30s

are classics, as are the 100-mile-per-hour Stutz Bearcats and Super Bearcats. Many of the best foreign cars are in the classic category in spite of age. The greater beauty of a custom-built body always contributes to the value of a classic.

The early Stars, Overlands, Chevrolets and Durants are not classic cars although some may be prized for other reasons.

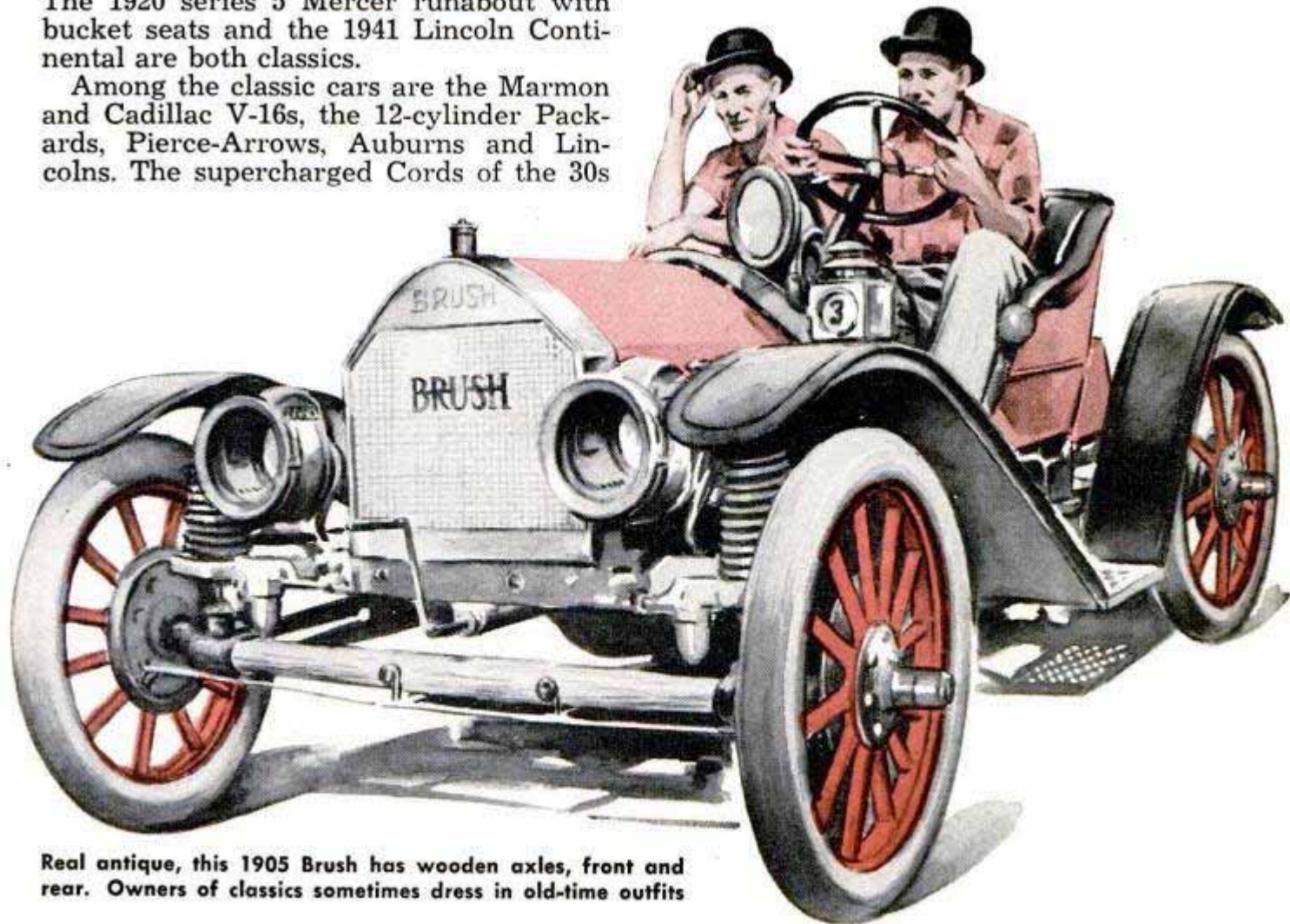

Real antique, this 1905 Brush has wooden axles, front and rear. Owners of classics sometimes dress in old-time outfits

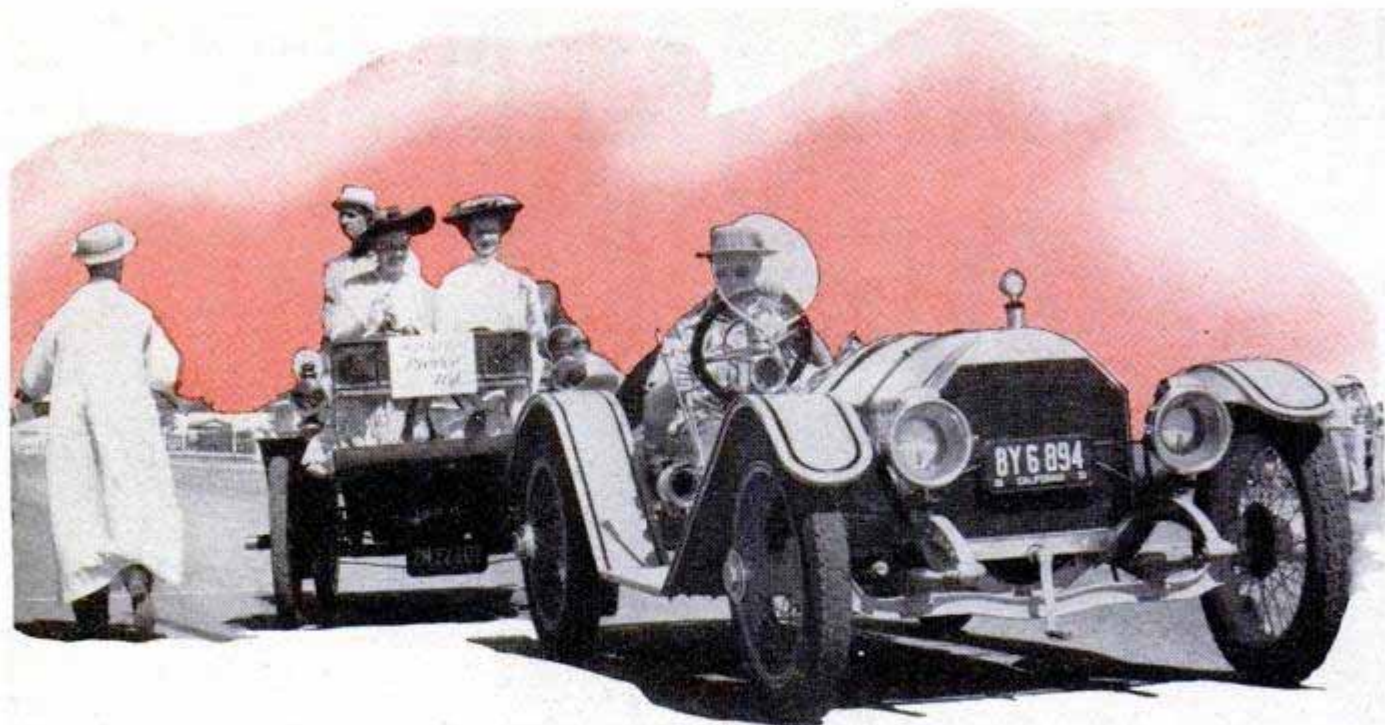

Early Mercer with a "monocle" windshield and acetylene lamps leads a one-cylinder 1902 Pierce in field meet

Unlike a collector of antique cars who hesitates to take his early creation out on the highway except on special occasions, the enthusiast who has restored an old Stutz or a custom Chrysler is apt to drive it almost daily. The springs aren't as soft as on a newer model, to be sure, and the acceleration of the long-stroke engine is slower, but the chances are good that his restored vehicle can go faster than any modern stockcar he'll meet. There's no doubt at all about its superiority on a twisting mountain road. Virtually all the old cars corner like jack rabbits. They breeze around turns that a modern car with

its soft springs and heavy front end can't take without slowing down.

The rage to restore the old cars started several years ago and has been growing rapidly. Luxurious but time-worn automobiles that had no takers at \$50 a couple of years ago now command prices of several hundred dollars. Not all of them are bargains and it never pays to try to restore a car that is ready for the junk heap. If the car is completely worn out or wrecked it's best not to buy it.

The Horseless Carriage Club and other organizations of antique-car enthusiasts have opened their memberships to the own-

Right-hand-drive Mercer had cumbersome gearshift. It was really open-air driving with circular windshield

Steering wheel of Kissel pushed up out of the way when driver entered, then snapped in place again





At a Western field meet, passengers in antique cars compete in trying to "lance the ring" with wooden poles

ers of classic automobiles, and in the Horseless Carriage Club alone classic owners are joining at up to 200 new members per month. The field meets that are held annually by these organizations are now beginning to take on a semimodern look. Sprinkled in among the early horseless vehicles, steamers and electrics, there are now plenty of classic automobiles that add a touch of the 30s to the earlier equipment.

Both the classics and the antique cars compete in field events at these meets. Races are for short distances only, to hold down speeds, and a powerful classic car

doesn't always beat an earlier automobile of little horsepower. In a typical race the cars may sprint for several hundred yards, come to a dead stop, stand there while the drivers leave their seats and run all the way around their cars, then start up again to sprint to a finish line.

Most classic-car owners are content with one old automobile but some owners enjoy their cars so much that they may wind up with half a dozen. One such enthusiast is Elliott Wiener of Pacific Palisades, Calif., who acquired a 1909 Buick in 1945 and spent the next year restoring it. The Buick

Elliott Wiener, bitten by the bug to restore the classics, soon discovered he needed a modern machine shop to rebuild parts. Here's the result. There's even a pit built into floor for servicing the antiques

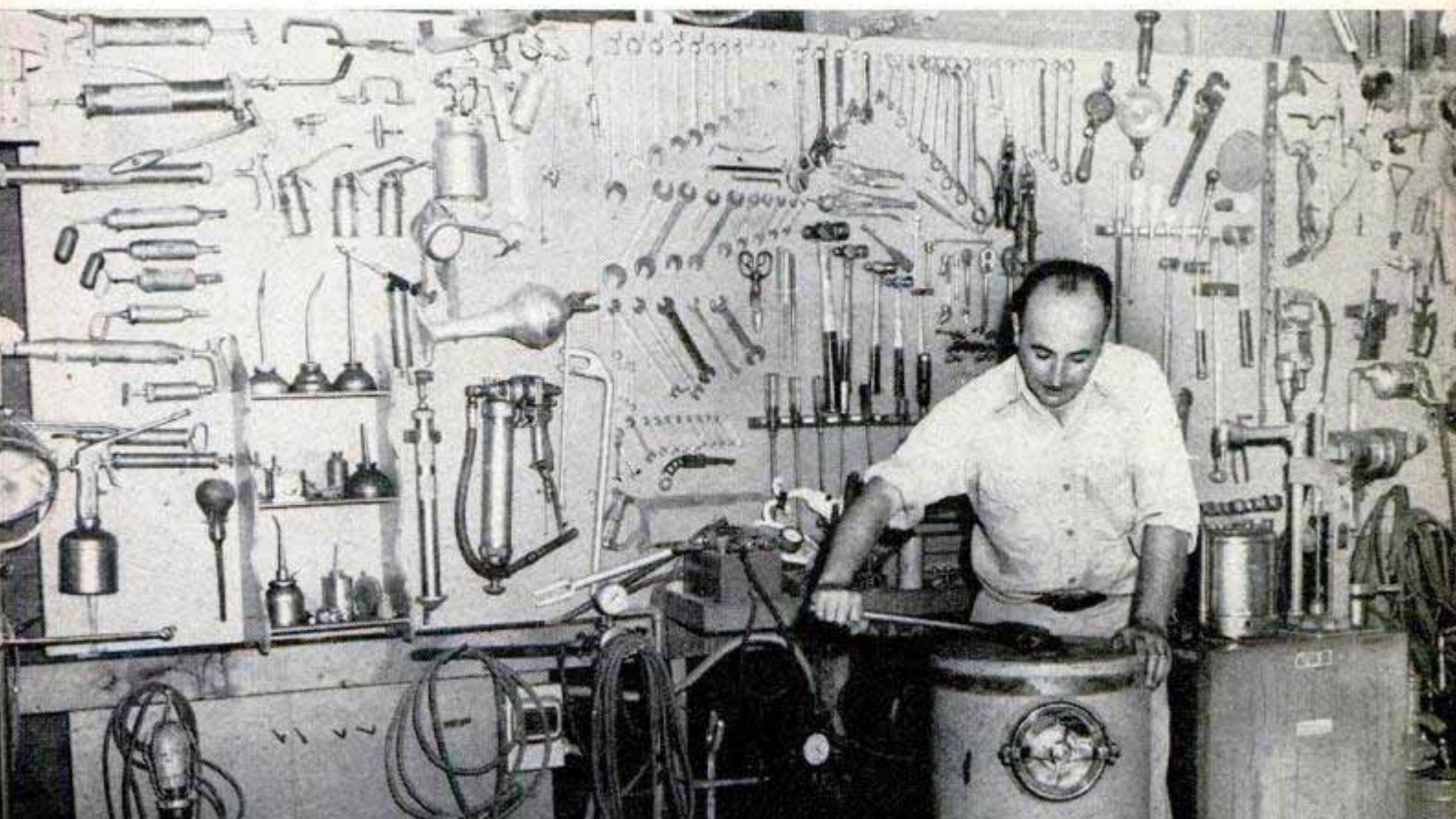

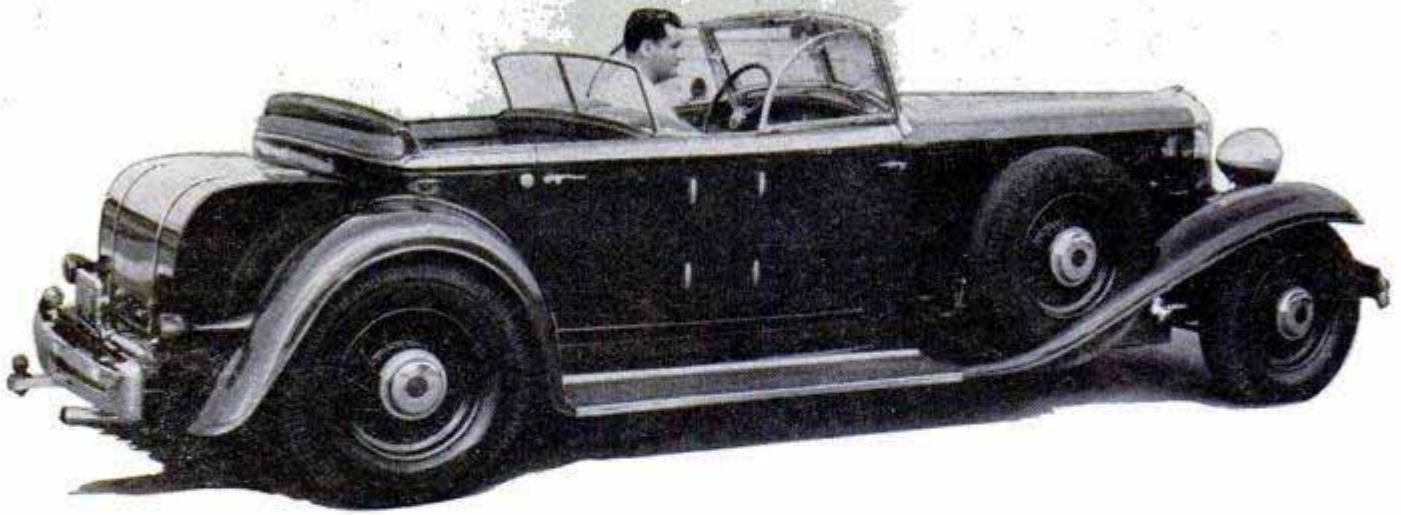

Owner drove 20-year-old Chrysler 22,000 miles last year. It has custom body resembling modern foreign cars

is a true antique, and Wiener next bought a classic, paying \$350 for a 1927 Stutz four-passenger speedster in excellent condition. A year's spare time was devoted to restoring the car completely. Today the Stutz undoubtedly could be clocked in excess of 100 miles per hour, the speed it was guaranteed to do when new. Its present value is more than \$3000.

His next restoration was a 1915 Pierce-Arrow, a ponderous antique that he occasionally drives to field meets. The car is powered with a six-cylinder T-head engine.

Today Wiener is restoring two classic cars, a Phantom I Rolls-Royce town car that was a mechanical ruin when he started work on it, and a 1920 Mercer runabout that had been used for a time as a race car.

Wiener enlarged his private garage several years ago to house his collection, then added a new garage complete with shop and pit when his collection continued to grow. Stored away against the time when

he can get to work on them are a 1920 HCS with a sport touring body and a four-cylinder overhead-valve engine and a 1909 Overland coupe that has the appearance of an early electric.

King of all the classics is the Duesenberg J, a juggernaut of an automobile that has become a legend in automotive circles. The Duesenberg was the mightiest stock-car ever produced in America and its eight-cylinder engine, equipped with 32 valves and dual overhead cams, developed 265 horsepower. The Duesenbergs were reputed to have a top speed of 120 miles per hour, to do 105 miles per hour in second gear and to go from 0 to 100 miles per hour in 20 seconds. Some 470 of these cars were built between 1929 and 1937.

The Duesenberg had a wheelbase of 153 inches, weighed 6800 pounds and cost \$16,500 with a custom body. By modern standards it handles like a fire engine and is too big and long for comfortable driving

Wiener usually drives sports car in center, but often rolls along streets in 1909 Buick, left, or early Kissel



in traffic. But some of the Duesenbergs that still exist have gone 600,000 miles and seem good for many hundreds of thousands of miles more.

Among the Duesenbergs that have been restored to tiptop condition is a 1930 convertible Berline owned by James Talmadge, also of Pacific Palisades. The car was being used as a chicken roost when Talmadge paid \$400 for it in 1949. Recently he refused \$2500 for it.

The Duesenbergs all had four-wheel brakes and a lubricating system that automatically lubricated all spring and steering points every 85 miles. In addition to the standard instruments there were also an intake-vacuum gauge, tachometer, chronograph, brake-pressure indicator and altimeter.

The goal in restoring a classic car is to return it to its pristine factory condition and appearance. You wouldn't use modern sealed-beam headlights on a 1932 Pierce-Arrow, nor would it be right to install an automatic transmission in an early Hupmobile. But in the case of his Duesenberg, Talmadge made several changes for the sake of efficiency and safety. The original car was equipped with 6:50 x 19 tires, not now available, and so Talmadge uses eight-ply truck tires on 20-inch wheels. The original carburetor and ignition system were poor by modern standards, so he replaced those parts with better equipment. To cut down the thundering exhaust he uses part of a diesel-truck exhaust system plus a special tip. Aside from those changes the car is completely stock.

If you hanker to drive a Rolls-Royce, say, or a Cadillac 16, here's some composite advice put together by scores of owners who have restored some of the old classics.

There's no telling where you'll find one of the old cars. Occasionally one is seen

(Continued to page 230)



Antique-auto collector works on 1911 Stearns, which has sleeve-valve engine, spring-operated starter and body springs heavy enough for truck



Wiener checks the wheel hubs of a 1929 Rolls-Royce which he has almost completely restored. "Royalty" of the classic cars is a Duesenberg. Photo below shows an eight-cylinder Duesenberg engine of 265 horsepower

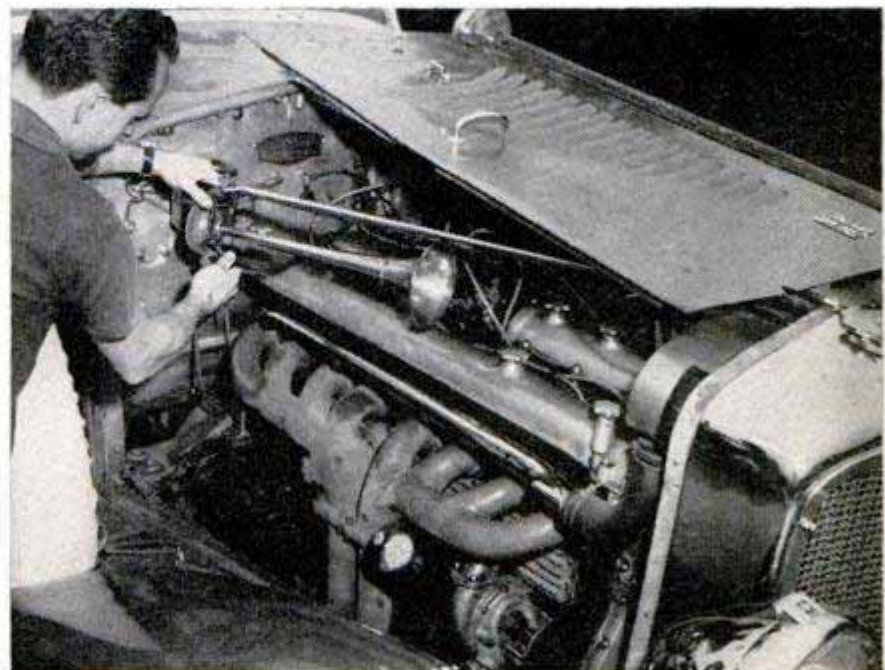



Surplus Army Telephones Are Grocers' Intercom

Several war-surplus field telephones make the job of replenishing shelf stock in a self-service grocery store much faster. Two Moscow, Idaho, grocers use these battery-operated phones to cut shelf-filling time from 2 hours to 20 minutes a day. The store is wired with outlets, all con-

nected to the stock room. The checker in the store simply moves along the rows and, by plugging his phone into various outlets, can relay shortage data to the stock room. Because the items are loaded on carts in order of their display positions, unloading is fast and efficient.

Bar Hanger

Fixture installation on both new and old work is speeded by an adjustable hanger that telescopes to fit any joist or stud spacing from 10 to 24 inches. The outlet box is held in place with a sliding stud that locks by means of a pivoting lever. Sharp prongs at each end hold the bar in position until nailed.

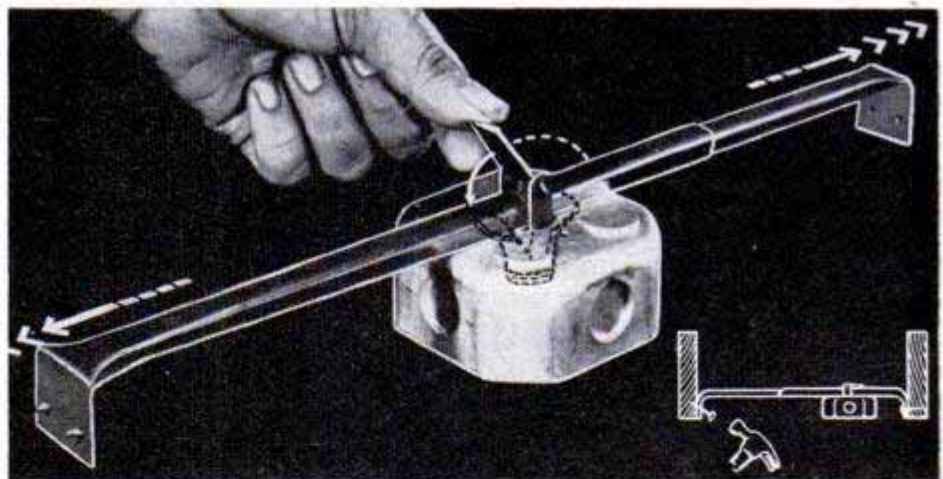

Circular Pencil Sharpener For Draftsmen

Pencils used by artists and draftsmen can be sharpened to extremely fine points with the aid of a cuplike tool. The pencil point simply is revolved around the inside wall of the cup. This wall is covered with silicon carbide, an abrasive almost as hard as diamond. A felt strip guides the draftsman in sharpening the pencil and also removes excess graphite.

Fruit Juicer-Squeezer Attaches to Grinder

Berries and other fruit are squeezed and juiced by a conical-shaped attachment that fastens to the mouth of a German meat grinder. The usual knife blade is removed and the attachment substituted for it. As the handle is turned, the fruit is fed into the tapering squeezer which forces the juice and fine pulp out through a sieve on the underside. Seeds and pulpy material like the cores are ejected through the nozzle. A knob on the nozzle controls the amount of juice extracted.



Chemists Make Rayon Nonwrinkling by Altering Molecular Structure



Iron stains on rayon at left resulted from chlorine retention. Treated rayon did not yellow. Right, the four strands of rayon were moistened with water. Two straight strands were X-2 treated; other two were not

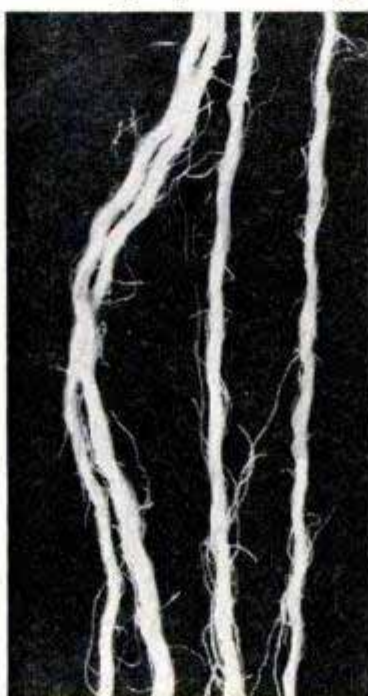

Chemists have found a way to change the molecular structure of rayon fiber to stop wrinkling, yellowing and other undesirable characteristics of the man-made textile. The process by which the structure is changed is known by the laboratory name of X-2. It promises to double the wear life of rayon clothing and makes all-white rayon clothing practical for the first time. It assures shrinkage control and makes the textile completely washable. The rayon will not retain chlorine used in laundry bleaches. Regular resin-treated rayon did absorb this chemical and breakdown often resulted.

Canasta Lazy Susan Is Also an Ash Tray

Canasta players have a new device for simplifying the game — a merry-go-round tray. The base of the device is a large metal ash tray. The card tray is supported by a metal rod that pivots so it can be swung around in each player's turn. A compartment below the card shelf holds the score card and pencil to provide more space for melding.



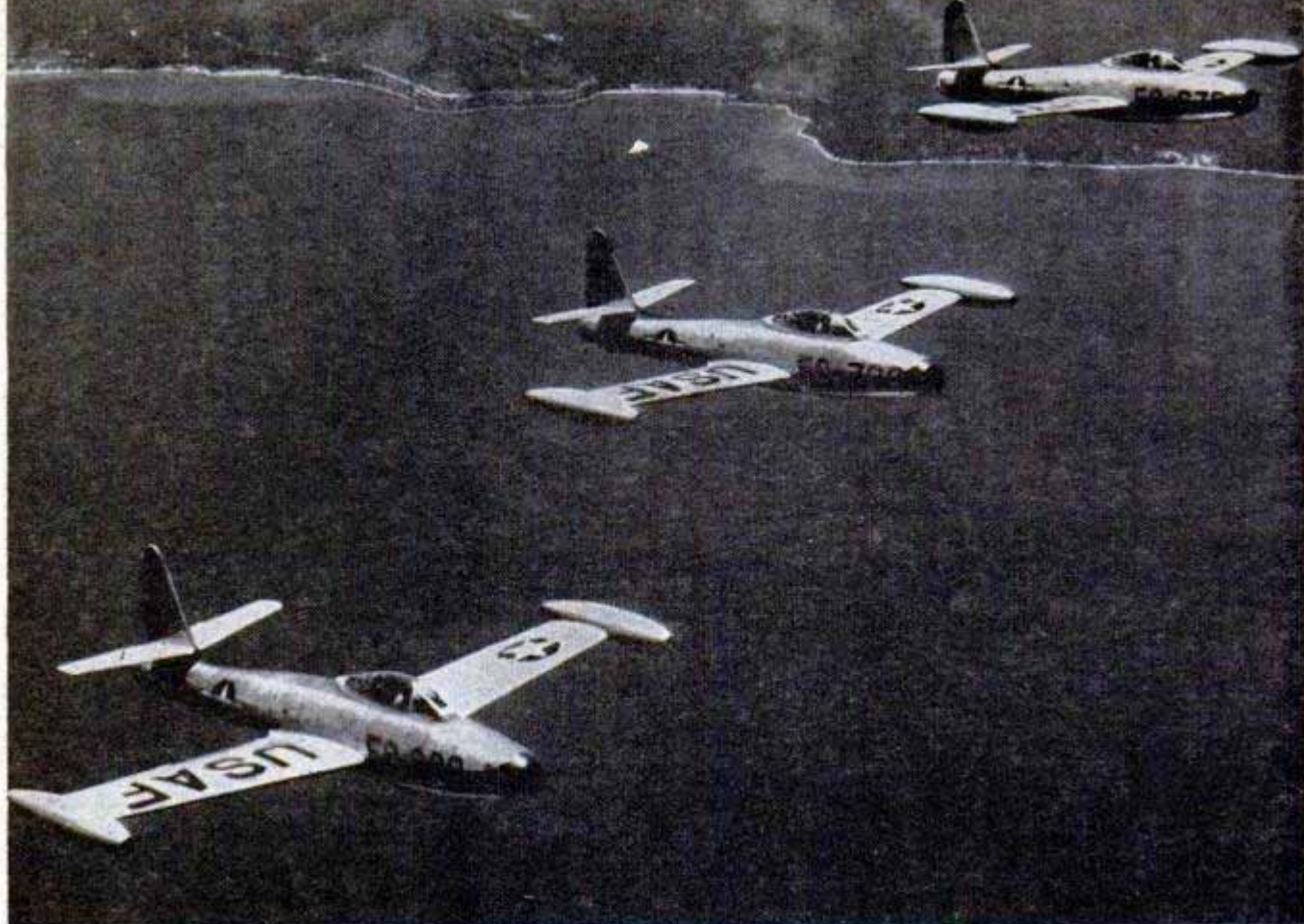

When radar outposts pick up a suspicious "blip," fighter planes are "scrambled" to intercept unknown craft

MANNING AMERICA'S RADAR WALL

By Dick Frederic



SQUATTING ATOP desolate bluffs or standing amid the snows of North America's frigid arctic perimeter, the eyes of the world's greatest radar system constantly are on watch these days. Few people have seen the steel towers with their great antennas slowly revolving day and night. The antennas are the secret outposts of our early warning radar net. Their lonely locations were picked for two reasons: Secrecy and clear line of sight.

Spaced several hundred miles apart from southern California's shores clear up along the Alaskan peninsulas, around the arctic rim and down the East Coast to Florida, these lonely stations—each manned by 200 to 400 Air Force technicians—form an overlapping network of radar. They maintain a constant vigil of the skies. Their job is to spot any suspicious aircraft headed our way with unknown cargo and flash a warning.

Actually, these outposts are only the forward scouts of a big team that makes up

Big "acquisition" antenna scans skies, picks up target for smaller radar which automatically points AA guns

At an arctic outpost, snow can drift roof-high overnight and men must burrow tunnels between buildings

our air-defense setup. Some 400,000 volunteer aircraft spotters, or ground observers, also are watching the skies (see *Popular Mechanics*, July 1950). Reports from their lookout posts are flashed to filter centers where the information is pieced together.

Data on hostile planes flows from both early warning radar outposts and from the filter centers to a third outfit—a ground-control intercept (GCI) station. Here reports from both sources are studied and orders to “scramble” interceptor planes are flashed to near-by air bases. Simultaneously, GCI shoots all the hostile-plane information along to another post still farther back. This is the air-defense control center, or ADCC. ADCC gets reports from many GCI stations. From the picture these reports make on the big plotting board, officers can soon tell if an enemy is sending in one or several waves of planes along a wide stretch of coastline. It can see which wave is the feint and which the real strike. ADCC may order the fighter interceptors rerouted in flight so they’ll converge where they’ll do the most good. This chain reaction, as warnings flash back to station after station, is known as “depth defense.” GCI and ADCC also scan the skies with radar.

The real eyes of this intricate system, however, are the early warning radar outposts. Their invisible pulses can scan more than 200 miles, pinpoint planes flying 1000 miles per hour at 80,000 feet.

One of the outposts recently opened its gates to *Popular Mechanics*. It was a bleak winter day when the Air Force lieutenant



Diagram below shows how the radar network picks up and sifts information: An early warning radar spots small flight of planes (1); (2) information is flashed to ground-control intercept; (3) ground observers also spot the planes and send information to filter center, which transmits it to GCI; (4) GCI scrambles interceptors from near-by base and sends data back (5) to air-defense control center; (6) GCI vectors aircraft toward the target by radio; (7) meanwhile, another radar down-coast spots a larger flight of aircraft and (8) flashes data to its GCI; (9) ground observers fill in further information and this GCI scrambles interceptors (10) from another base; (11) all information goes to air-defense control center where controllers soon realize second alert is the big one; (12) ADCC reroutes most of the interceptors from the first base toward the major enemy flight. One plane proceeds toward the diversionsary attack

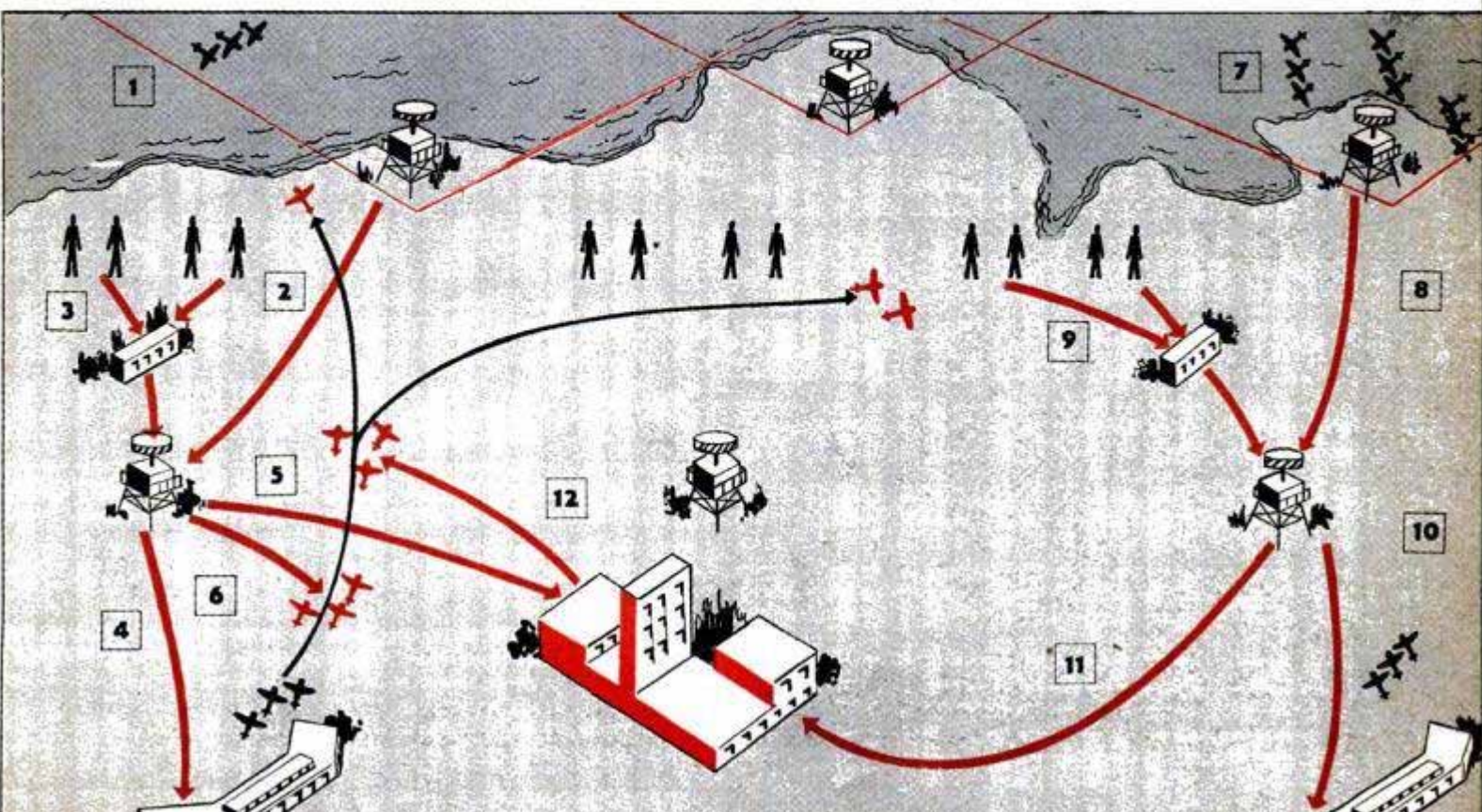

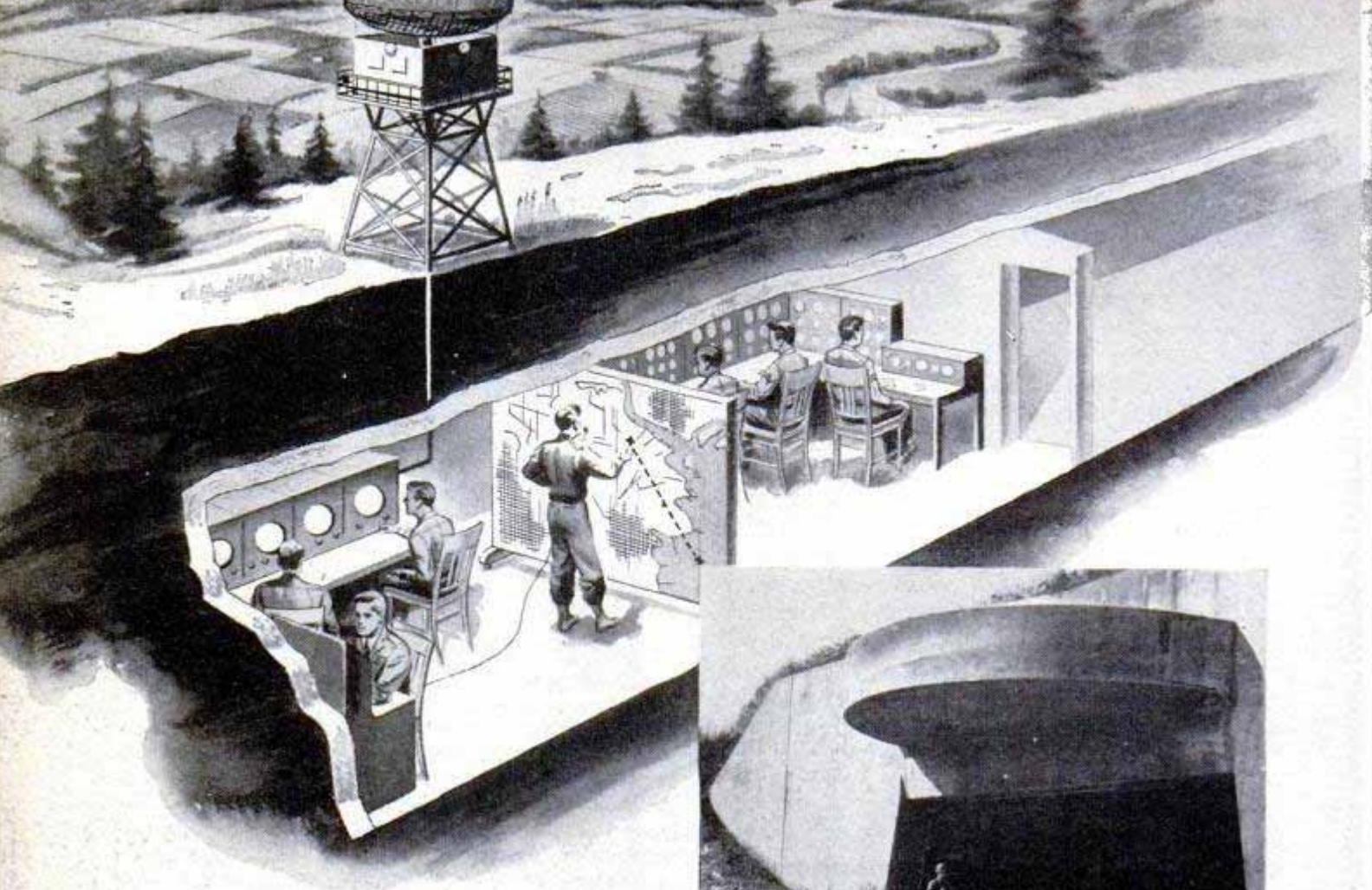

In one typical early warning outpost, big radar squats atop an underground bunker. "Scope dopers" interpret the radar signals, feed information to officer who plots flight on map. Men in other room are ready to send up interceptors. Right, armed guard patrols entrance to underground installations. Below, big snow compacter builds air strip in Arctic so another early warning outpost can be flown in and supplied



accompanying me wheeled his car across miles of desolate land. We turned off on a road hemmed in by high scrub, underwent 15 minutes of identification and were led into the base by an armed guard.

A lonelier spot would be tough to find. A barren vertical bluff dropped away so far and abruptly that no sound from the pounding Atlantic combers below reached our ears. Above us, on a high mound, towered the black skeleton of the "set," its massive "fan" turning ponderously. Huge bunkers overgrown with scrubby bushes hide a maze of rooms. The crew houses a lot of its gear in underground hideaways. Even the motor-pool vehicles have a gloomy, subterranean garage.

The cable from the big set feeds its radar impulses into one of these underground chambers. Here a controller is always on duty. Under him, a crew chief and 8 to 16 technicians run the set. Four separate crews maintain watches around the clock.

In one section of the underground chamber, heads are bent over an array of scopes on which the white and green light from the cathode rays paints ever-changing patterns of what the big fan "sees" as it revolves overhead. The men call these fellows "scope dopers." Their trained eyes are

One of the loneliest spots in the world is this radar outpost, circled in red, perched on Aleutian mountain

constantly alert for the tiny "blip" of light that will indicate something in the sky.

Near by, at a huge luminous board, plotters are sketching the tracks of all aircraft in the area. They get their information via telephone from the row of scope dopers, each of whom is following the progress of the tiny blips on his scope. If several flights of aircraft are moving across the sky at once, the scope dopers divide them, each keeping tabs on a single flight or group of flights. On the plotting board the controller can see from which direction a possible attack may come. If the aircraft are not identified, he'll instantly contact fighter operations at an air base, calling them by a code name. His patter will go something like this:

"Hello, Red Dog. Scramble 20 to 15,000 feet. Rendezvous at Top King 8521. Contact Gingerbread."

In plain English this means the air base is to send 20 jet interceptors to 15,000 feet to rendezvous at a given location (Top King 8521) and contact via their VHF radios a certain GCI station called "Gingerbread." Down in the operations room of Gingerbread, radio operators guided by the scope dopers' information will continue to vector the jets toward moving targets.

Meanwhile, a GCI teller flashes all information concerning target locations and scrambled fighters to an air-defense control center, where the track of enemy aircraft is plotted on another big board along with the tracks called in by all other GCI stations in the area. If they all agree, the early warning job is done and the rest is up to the fighter pilots. Plotters and radiomen are crisp and precise as they call their coded data back and forth. But among themselves, the men have a special language.

"I'm painting something," a scope doper may mutter.

"What you got?" asks the plotter.

"Boxcar at four angels going buster." Translated, this gibberish means the scope doper has a blip on his scope. He pegs it as a C-47 or C-54 cargo plane (boxcar), flying at 4000 feet (one angel per thousand) and going full speed (buster).

Of all the jobs at the set, scope doping is most grueling. Sgt. Henry Vallee, crew chief who's been reading scopes at this post for three years, explains it this way: "When a man stares at a busy scope more than two hours he gets 'blip eyed.' One man asleep or woolly-eyed at his scope and the whole chain is broken—because it might be his scope that would pick up the crucial plane."

Radar sends out short, rapid energy bursts called pulses—about one millionth

(Continued to page 258)





Car-Washing Machine For Service Stations

It takes only 15 minutes for one man to wash a car with a machine that sprays powerful jets of detergent solution as it passes over the car. Tanks or special pipes are not needed as the washer attaches to existing water lines. It can be installed in the same bay as a lift without interfering with the use of the lift. It is especially economical on water and detergent, using only two or three cents' worth of detergent per car and 30 gallons of water, a large saving over the 300 or 400 gallons ordinarily used.

Truck Wheels Balanced While on Axle With Portable Machine

Truck and bus wheels are balanced without removal from the axle by a compact outfit that can be rolled around the garage. Containing a three-horsepower motor, the portable balancer drives the vehicle wheel at any desired speed by means of a spinning disk which is held against the sidewall of the tire. A pickup arm, placed directly beneath the vehicle axle, transmits data on static and dynamic balance to a neon light on the balancer housing. The stroboscopic light "stops" the movement of an indicator marker fastened on the wheel. From the position of this indicator, the operator determines the location of the weights for correction of both static and dynamic balances.



Inflated Rubber Bumper Guards Absorb Shocks of Minor Collisions



Extending beyond the thickness of conventional auto bumper guards, a set of inflated rubber guards takes the sharp jolt out of two cars colliding. The molded guards also eliminate dented and scratched chrome bumpers. They are attached by drilling a new set of holes to accommodate regular-size bolts.

Sources of available products described in this issue are indexed on pages 12, 14 and 16. Sources of further information on other articles are listed in the WHERE-TO-FIND-IT LIST, available from the Bureau of Information, 200 East Ontario St., Chicago 11

the

POPULAR
MECHANICS

CRAFTSMAN

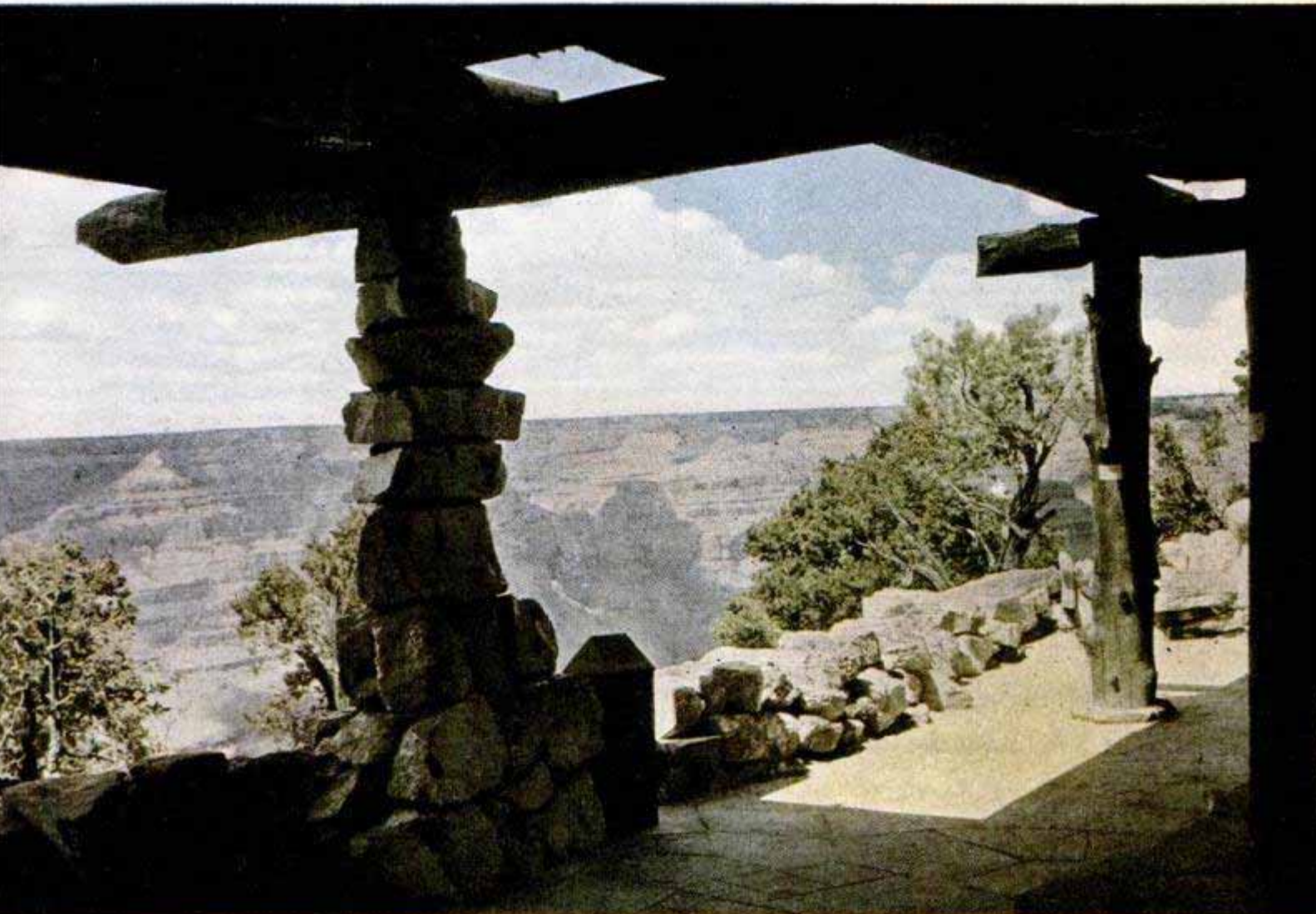

TRY COLOR THIS VACATION

By Paul T. Hutchinson

ARE YOU PLANNING a vacation trip this summer? By all means, take your camera loaded with color film. The pictures you take will provide a record whereby you may relive a glorious vacation at any time. Vacation trips offer countless opportunities for interesting and unusual shots of scenery, buildings, historic sites, boats, beach scenes and people. Actually, the making of color photos outdoors isn't much different from taking black-and-white snapshots if you remember a few rules.

Any 35-mm. camera on the market today is suitable for color film and capable of reproducing faithfully any subject you

This excellent shot of the Grand Canyon is a good example of how your pictures will take on a third-dimensional quality when framed by the foreground. Animals, horses especially, are good color subjects





Group shots are more interesting when subjects are engaged in some activity, such as kids climbing fence



In most cases front lighting is recommended for color film although these two examples show interesting effects obtained by side and back lighting

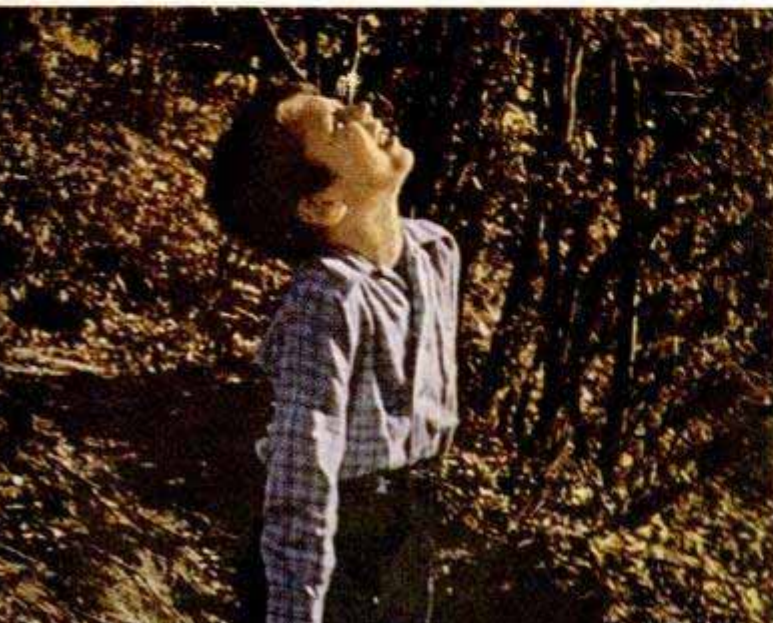

might choose. A lens of $f:4.5$ is desirable because even outdoor color film, depending on the kind you use, is from 3 to 10 times slower in inherent speed than black-and-white film, and the widest diaphragm opening might be needed under weak lighting conditions. High shutter speeds are not a requirement because most shots will be taken at $\frac{1}{25}$ or $\frac{1}{50}$ second. Possibly you might use $\frac{1}{100}$ second but only on rare occasions when necessary to shoot action.

Color films are different from black-and-white in that they have a narrow exposure latitude. The ability of a film to record a range of brightness values is called latitude. Emulsions that are able to reproduce a long range of brightness values are said to have a wide latitude, while emulsions that reproduce a short range of brightness values are said to have a narrow latitude. The average black-and-white film has a latitude of about 1 to 130. This means that a high-light area in a subject can be 130 times as bright as the shadow area and the film will produce a negative that has a normal range of tones. The brightness range of the average scene under average lighting conditions is 1 to 32. Therefore, there can be considerable variation of exposure above and below normal which will still produce a normal negative. This does not hold true with color film because it has a brightness range, or latitude, of only 1 to 4, as compared with 1 to 130 in black-and-white, which indicates that correct exposure is the first important factor in producing good color photos.

There are two methods of computing correct exposure: One is by using a photoelectric exposure meter and the other is an exposure guide. The reflected-light-type exposure meter is the more accurate way to calculate exposure outdoors and also eliminates the guesswork usually involved in taking pictures. The meter is not infallible but if used correctly will become a valuable asset to you. Be selective in taking your exposure reading. When people are the important part of your picture and are within 20 feet of the camera, take the reading on them. If they are beyond that, take a general-scene reading from the camera position. By taking readings close up, you avoid getting incorrect information from the more intense light surrounding your subject. If you were photographing people and took a reading from the camera position the result would be underexposure because of the high reading from the background light. Thus, the important part of the picture, the people, would be sacrificed in using a general reading. When people in the scene are beyond 20 ft. they become only a small part of the entire picture. The exposure of the background and the exposure of

Correct exposure is found with either a photoelectric meter, shown at right, or an inexpensive exposure guide pictured below meter. Meter is the more accurate

the people is of equal importance and an average reading is used.

In taking landscapes the meter should be tilted downward to avoid the intense light from the sky. When taking pictures of people on the beach a close-up reading is best. When making general shots of a beach or seascape, cutting the meter reading in half is advisable to avoid underexposure caused by the intensity of reflected light from haze, water and sand. If you are in doubt whether to expose for the bright or dark colors in your subject, and if the dark colors are not too important, the most pleasing results to the eye will be had by exposing for the bright colors.

An exposure guide is a good inexpensive substitute for a meter and with practice will enable you to get good results under average light conditions. Manufacturers of color film always enclose a data sheet in the film package which gives information concerning the film speed and exposure tables. The exposure tables include the lens openings and while these tables are of some value, you can have more complete information in a compact and convenient form by buying an exposure guide. By rotating a disk which is attached to the face of the guide you can match lighting conditions with subject contrast and obtain the correct aperture and shutter speed for the type of film you are using. While the success and accuracy of your exposure depend, to a certain extent, on your judgment in using a guide of this type, it nevertheless is far better than just guessing at exposure.

Choice of subject, lighting, composition,

Photos below and at right show how foreground objects lend depth in both cases to improve composition

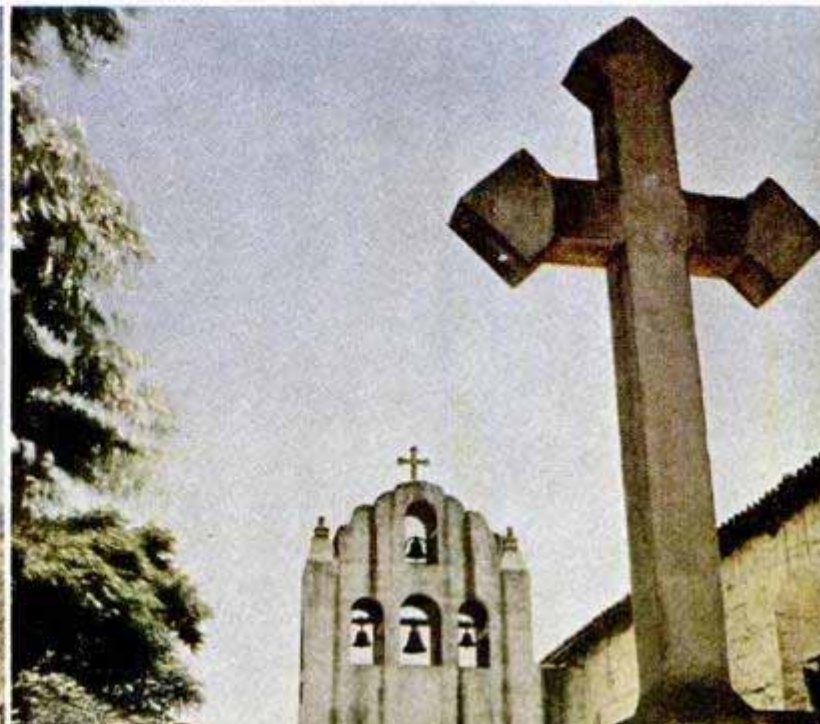
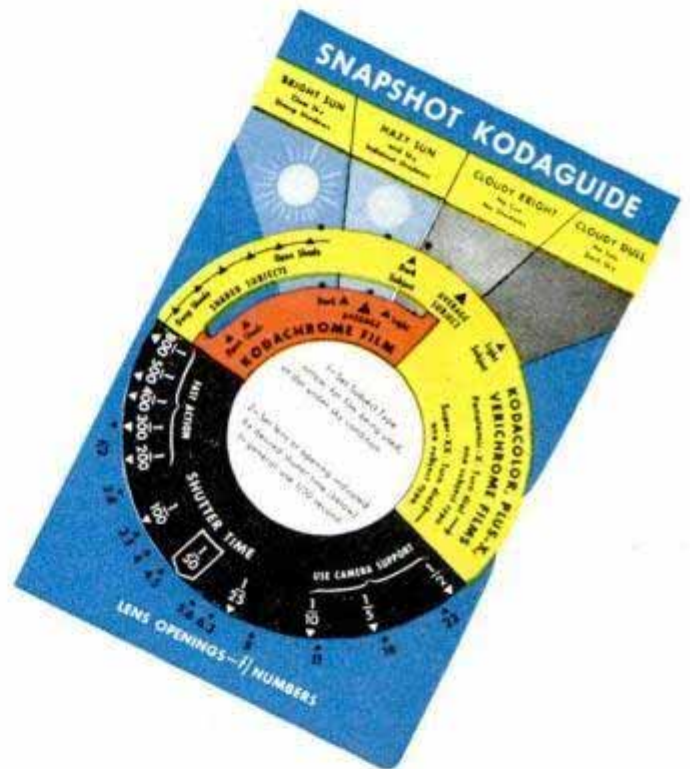



Above, rocks in foreground provide a base for this typical seashore vacation shot and add strong focal point to an otherwise average photo. Below, left, posing family and car with cactus makes picture personal

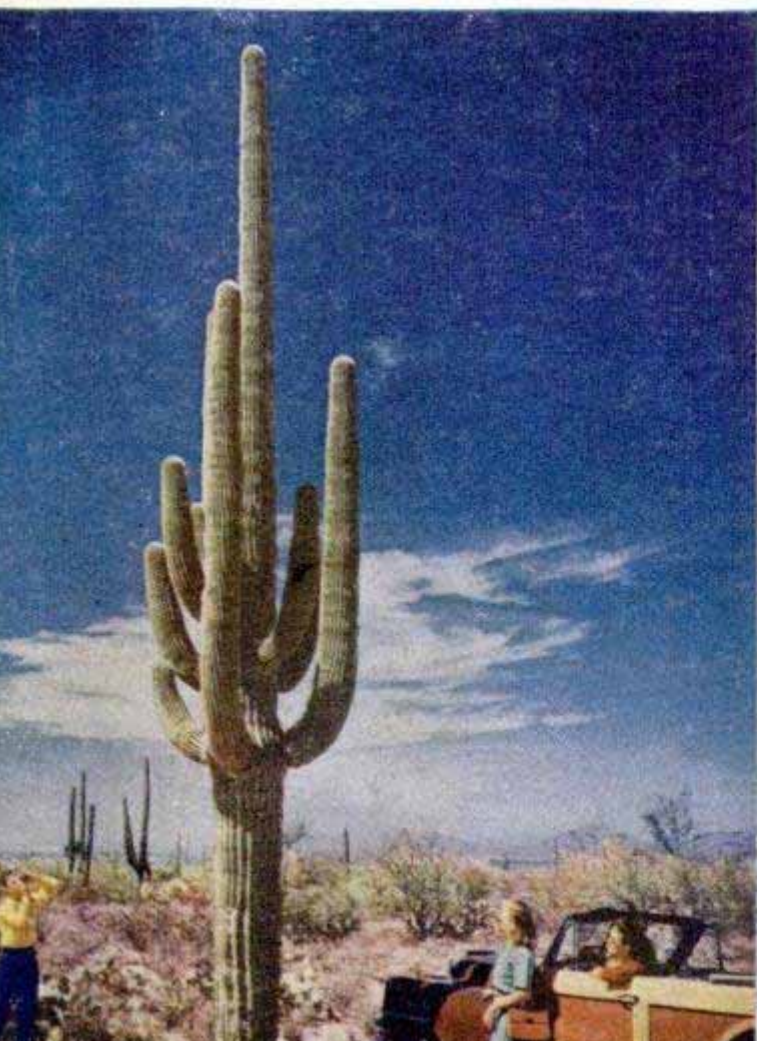

and time of day are as important as exposure and make the difference between an interesting transparency or just another picture. When photographing landscapes, try to include some near foreground objects in the picture, such as rocks, trees, walks, railings or shadows. Shots through arches, doorways or pillars give a picture a third-dimensional quality that is not there if you shoot in the open. The photos of the mission churchyard, the Grand Canyon, and the seashore illustrate the effect of proper framing and camera angle. Repetition of a particular subject also creates a pleasing effect. Pictures of people are most interesting if they are engaged in some activity rather than just standing and staring at the camera. Children with their endless activities are perfect subjects for the candid color camera. If people are your subject, fill the view finder with them unless the background is necessary to create the effect you desire. Pictures of people 15 or 20 feet from your camera in uninteresting surroundings are of no value.

During the summer it is best to make color photos in midmorning and midafternoon and to avoid taking pictures at noon-time because the lighting is too flat. However, in the winter when the sun is always at a low angle, the most successful pictures are taken during the midday hours. Front lighting usually is recommended with color film, but side and back lighting may be used to give special effects as shown in the photos of the girl on the beach and the boy in the woods. You also can make shots in open shade, but your picture will have a bluish cast. Photos made of snow scenes also have a slight blue cast because of the reflected blue color of the sky.

Sunrises and sunsets can be taken with very striking results. Because of the extreme brightness range, a sunrise or sunset exposure is made for the sky area. So make your exposure when the sun is concealed by the horizon or clouds, or use the shadow of some foreground object to shield the lens and avoid flare caused by light reflections.

A certain amount of haze is present in all landscape and seascape photos and can be partly eliminated with the Skylight Filter, number 1A. This filter absorbs the ultraviolet, blue and some green light from the haze. It requires no increase in exposure and can be used for all outdoor pictures with no effect other than giving a slightly warmer tone to your pictures. ★ ★ ★

Rasp Improved From Metal Lath Ideal for Filing Plasterboard

Desiring a fast method of smoothing overlapping edges of plasterboard on an outside corner before applying corner beading, one workman made a coarse rasp by wrapping a piece of metal lath around a block of wood and locking it in place with a second block nailed to the back. By overlapping the edges of the lath a little, a ridge is formed to embed in the wood and hold the lath more securely. Should the lath gradually become clogged with plaster, a sharp rap will clean it.

O. W. Johnson, Spokane, Wash.



Abrasive Applied to Ladder Steps Provides Sure Footing

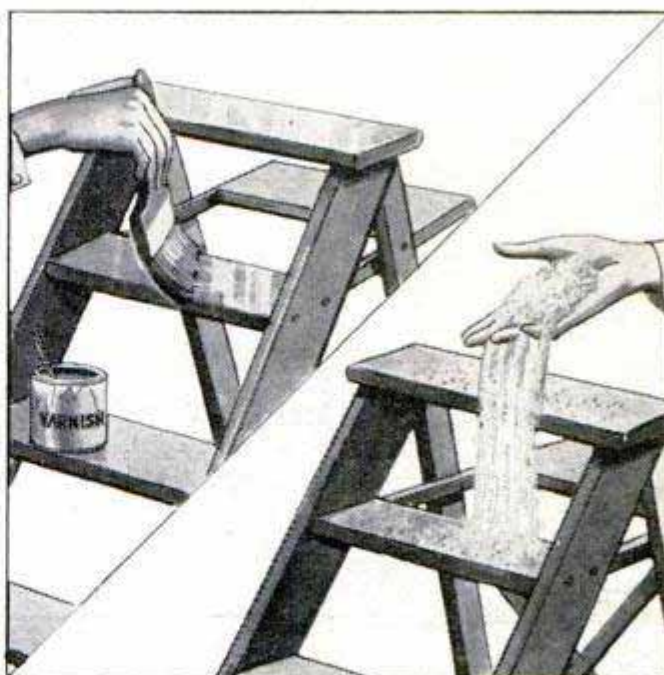

Here is one way to safeguard against the possibility of slipping and falling from a stepladder the next time you redecorate or wash windows. First, apply a coat of varnish to the treads and then, while it is still tacky, sprinkle it with either sawdust or sand. The particles will adhere to the varnish and create a surface sufficiently rough to provide a safe, nonslip footing.

Bess Ritter, New York City.

Tile Placed Over Tomato Plant Helps Speed Growth of Stalk

To speed plant growth and increase the abundance of tomatoes, one gardener places a tile, or a tin can with the bottom removed, over each tomato plant as it is set in the ground. This not only forces the

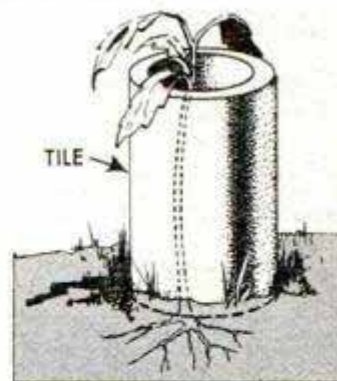

plant to grow more rapidly in order to reach the sunlight but also produces a stalk that is pale and tender. The tile is removed as soon as the leaves of the plant appear above the top of it. The plant is then laid upon the ground and all but the leaves is covered with soil. Additional roots soon sprout from the buried stalk, resulting in a larger, hardier shrub and more abundant crop.—G. E. Hendrickson, Argyle, Wis.

☛ A cone-shaped paper cup having the pointed end torn off provides a handy funnel when pouring liquids.

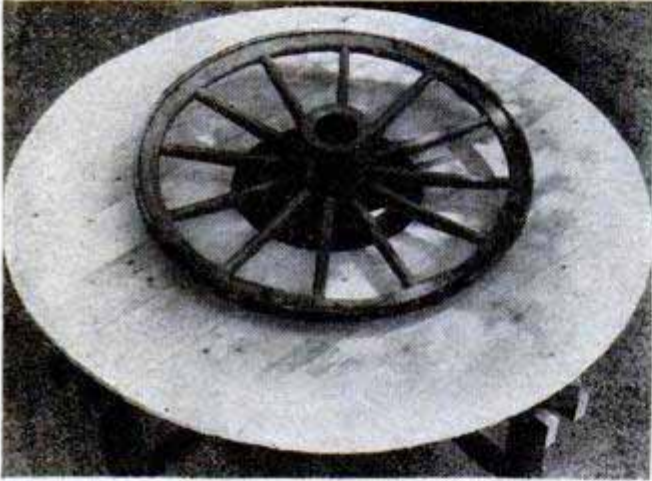
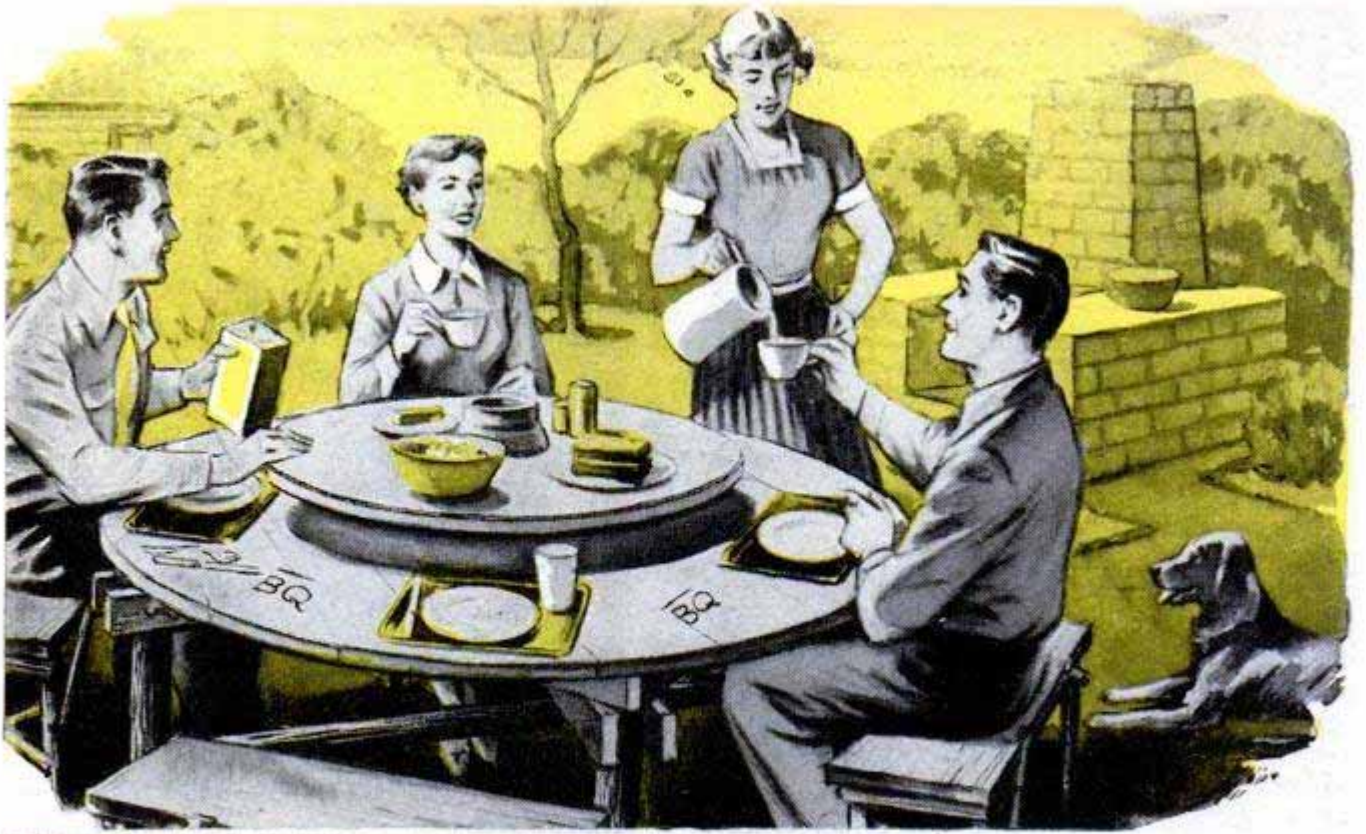

This view shows the table proper completed and the wagon wheel in place ready to be covered with a disk of 1/2-in. outdoor plywood which later is varnished

The strips to which the table boards are screwed should be a loose fit in the notches so that the entire top can be lifted off easily for winter storage

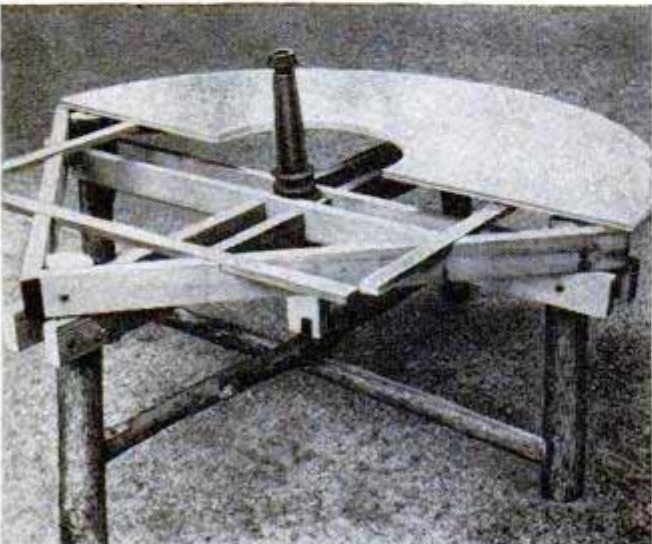

LAZY SUSAN PICNIC TABLE

By Elma Waltner

ADD TO THE enjoyment and convenience of your back-yard picnics by building this rustic Lazy Susan lawn table. The feature of the table is a large rotating tray made from an old wagon wheel which is covered with a plywood disk. Legs and cross braces of both the table and matching benches are sections cut from tree limbs. The framework for the upper portion of the table is made from common 2 x 4 and 1 x 2 stock.

Note in the detail at the right how the tree-limb sections and the framework are assembled with bolts and metal angles. Sides of the four legs are notched to provide flat surfaces for the two pairs of diagonal stringers as well as for the apron. The stringers are half-lapped at the center of the table to form a holder for the axle on which the wagon wheel is mounted. The lower end of the axle is cut off so the skein projects the desired height above the top of the table and then is fastened to one of the cross braces with two metal angles. The aprons are notched, as shown, to take four 1 x 2 cleats to which the table top is fastened with wood screws. The notches hold the top in place and allow it to be lifted from the framework for winter storage.

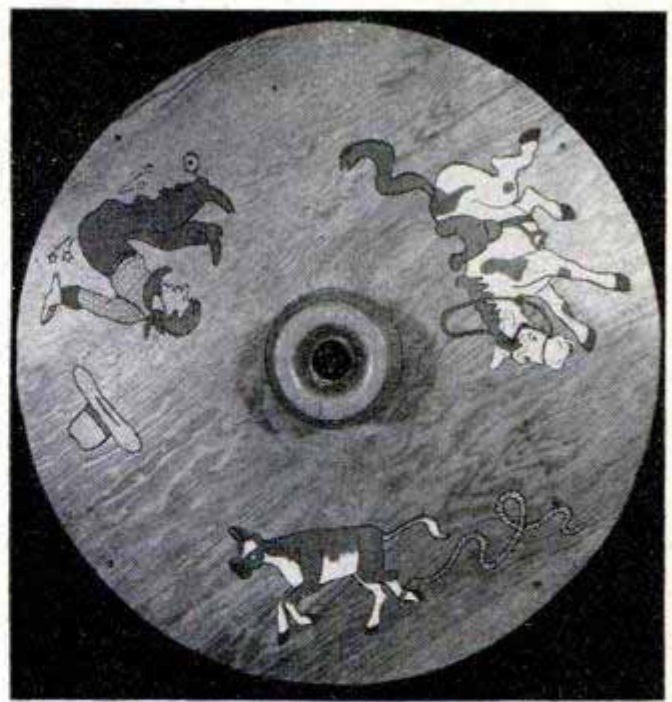
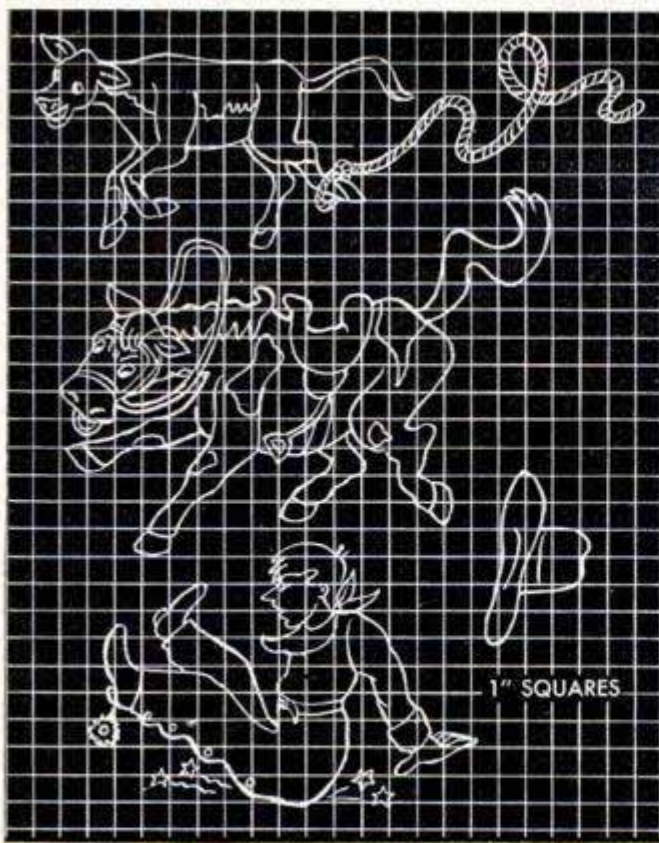

In keeping with the "chuck wagon" theme of the table, the Lazy Susan is decorated with colorful Western figures and the table top with branding-iron motifs

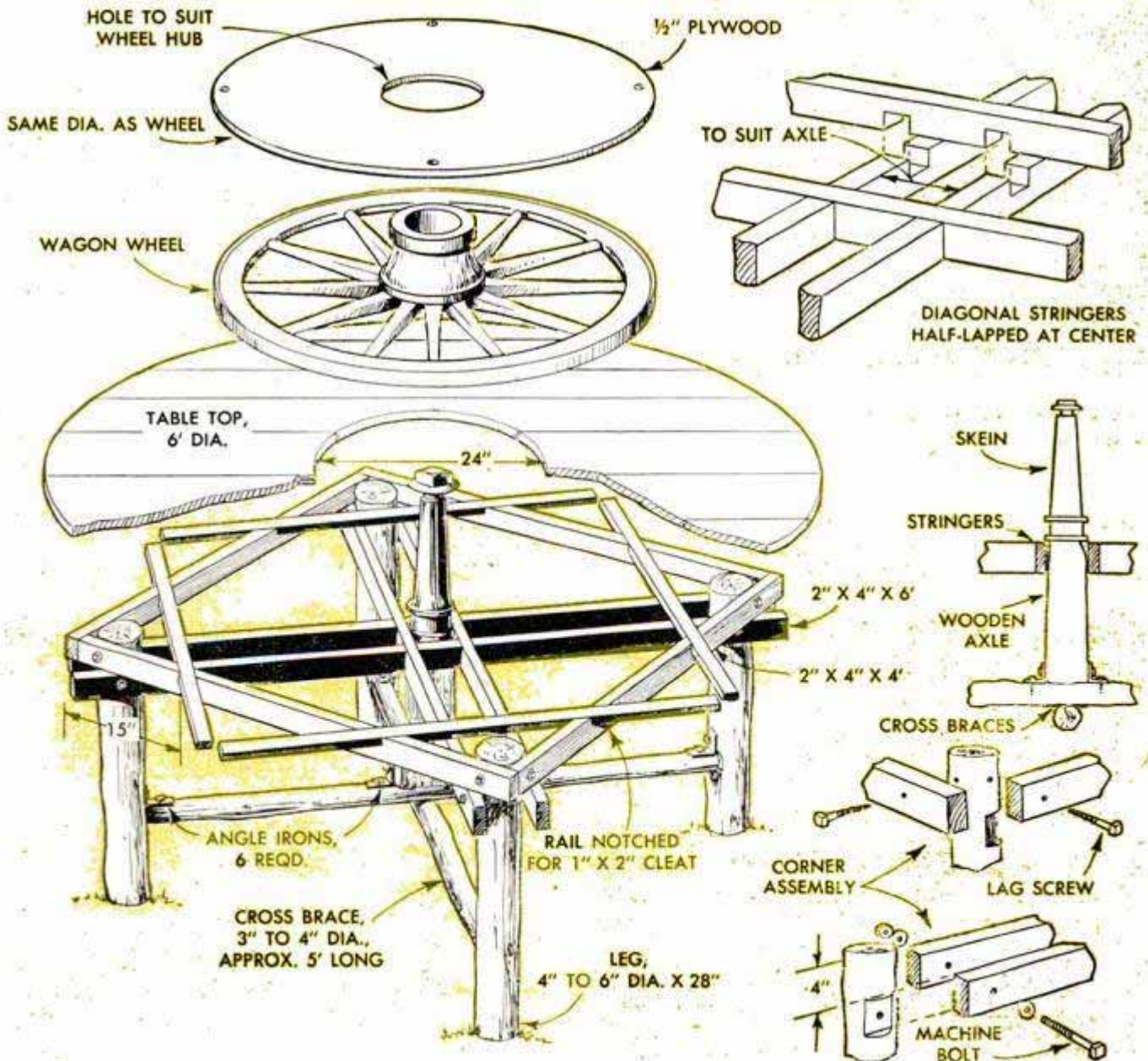

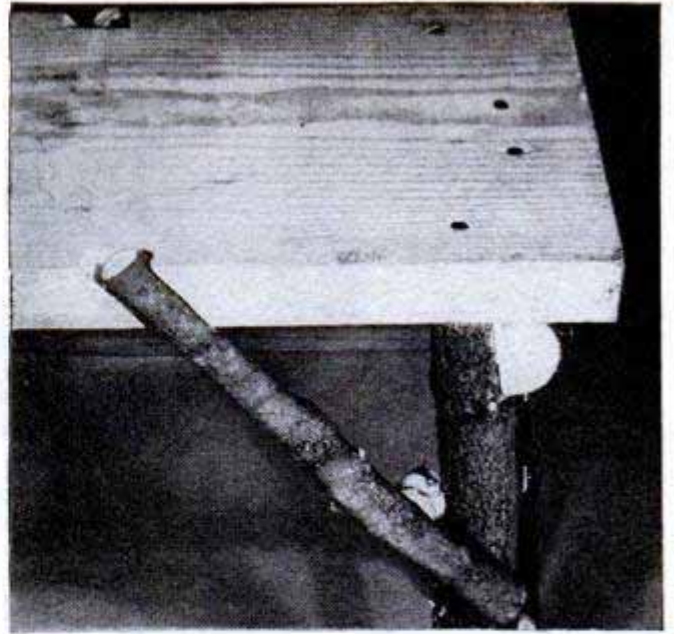
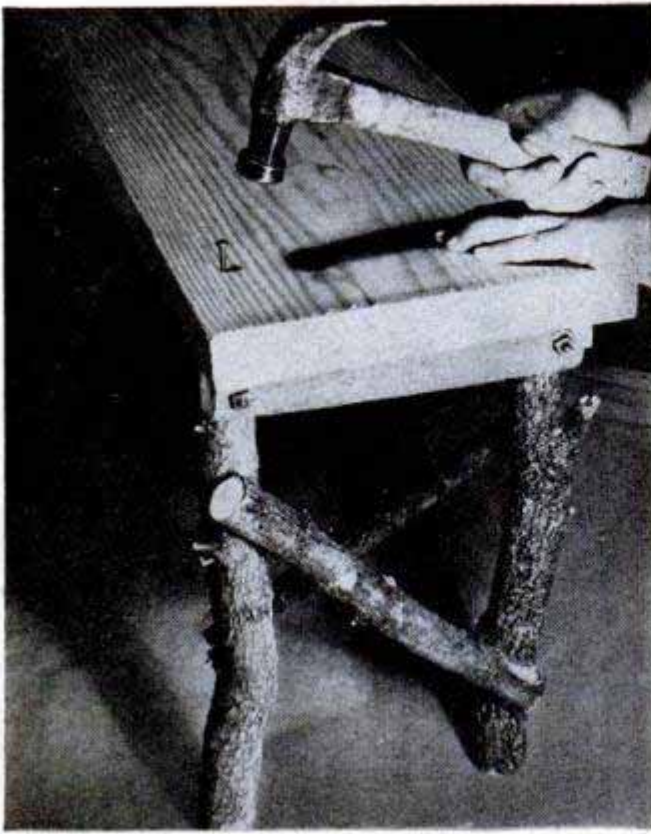

Above, note how the side braces for the bench legs are nailed in slanting notches cut in the edges of the plank seats and sawed off flush with the top. Left, the 2 x 12 bench tops are nailed to the leg assemblies. The cross members of the leg assemblies are half-lapped and bolted as shown in the detail

The top is built up of wide tongue-and-groove flooring, the boards being temporarily assembled to form a 6-ft. square. Two concentric circles are laid out on the assembly, one 2 ft. in dia. and the other 6 ft. in dia., and then the boards are numbered in sequence, disassembled and cut along the layout lines. The boards are reassembled by screwing them to the cleats, the latter being set in the apron notches during assembly.

The benches are made of tree-limb sections and 2-in. stock as detailed below. Both seat and legs of the benches are given two coats of marine varnish.

The table is finished by giving the entire unit a coat of marine varnish. Then, if desired, the cartoons and brand designs are added with enamel or oil colors. After drying, the table top and Lazy Susan are given two more coats of varnish, rubbed lightly with steel wool and waxed. ★ ★ ★

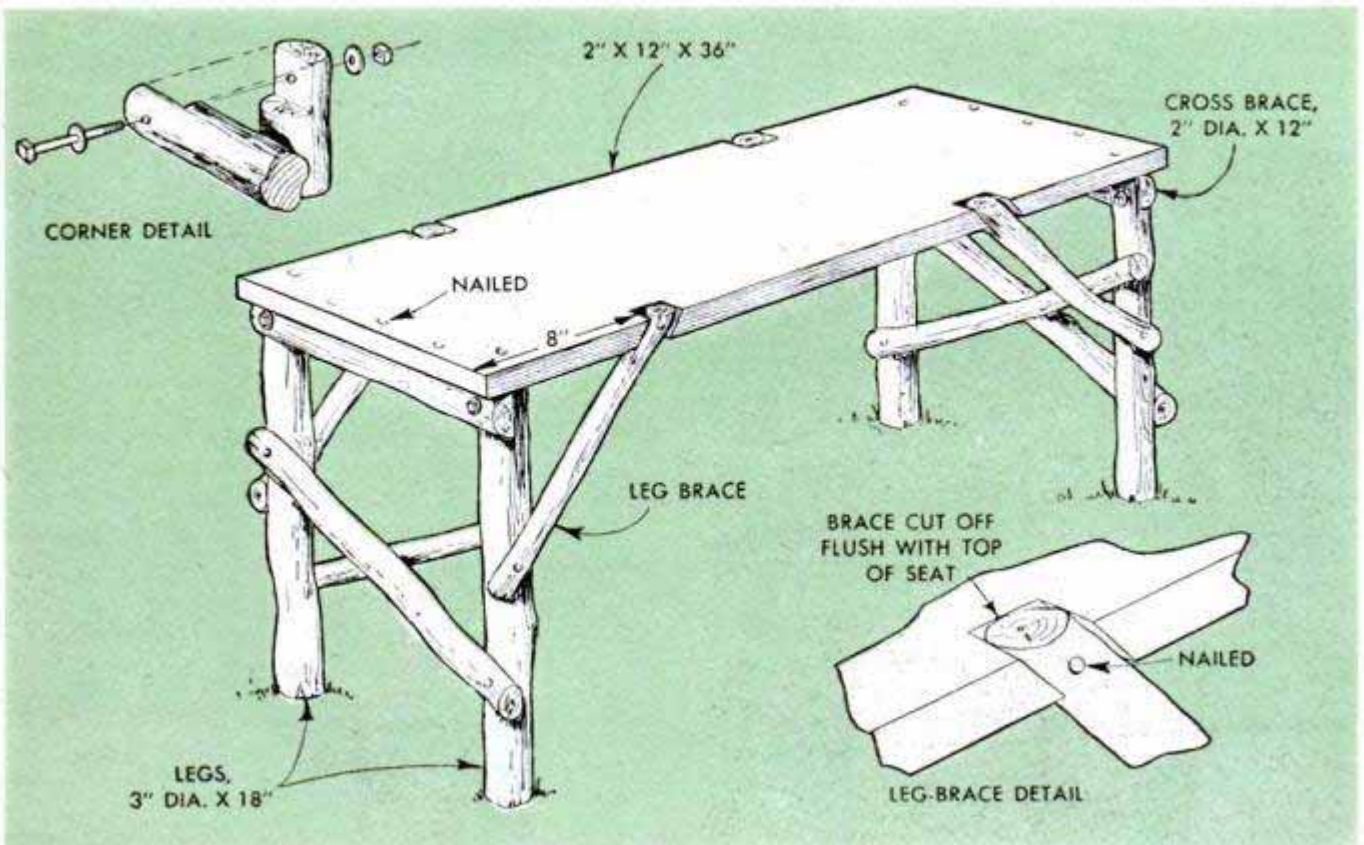

Johnny will turn his hobbyhorse out to pasture when he lays eyes on this real hard-riding pony. The horse, which is about 36 in. long, is cut from a 2 x 12 and fitted with an old tricycle seat to form a comfortable saddle. The "ride" is obtained by mounting the horse on an auto spring as shown in the drawing. Note that the short leaves are removed from the spring. One end of the spring is inserted in a mortise or notch cut in a post and held in place with a bolt passed through the eye. The spring is then clamped to the top of a second post, U-shaped clamps bent from flat steel being used to fasten the spring to the post and the horse. — Ben Hoffman, Troy Center, Wis.

Back-Yard Bronco Gallops on Auto Spring To Give Young Cowboy Thrilling Ride



Table Lamps in Child's Room Controlled by Toggle Switch

Parents will save many steps if out-of-reach table lamps or floor lamps in a child's room are equipped with a switch that the youngster can operate. This can be done easily by wiring a toggle switch in the lamp cord, as pictured, and mounting the switch on a wooden bracket. The latter is screwed to the back of a chest to hold the switch within easy reach of the child.

Earl H. Hills, Byron, Ont., Can.

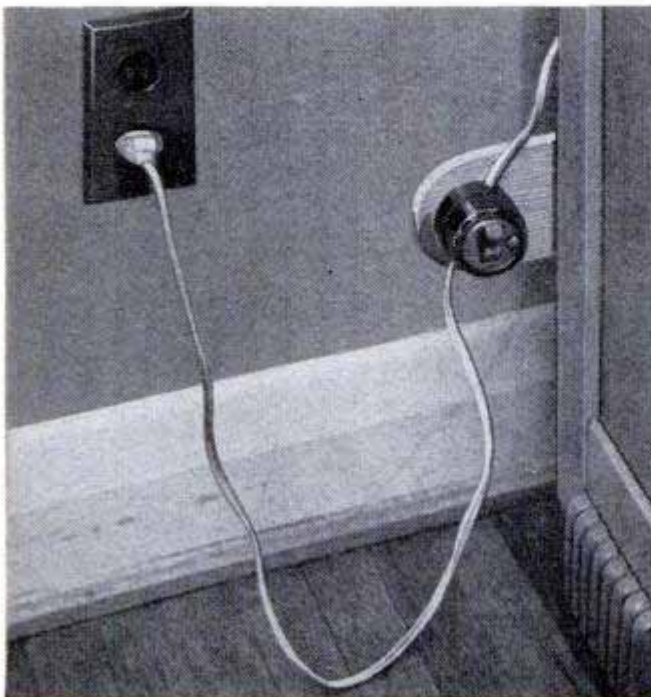

Safe Holder for Soldering Iron

To avoid accidental burns from a soldering iron resting in an exposed holder, place the hot iron in a sheath of pipe or tubing set vertically in the bench top. The tubing is flared at the top for easy insertion of the iron.

If the handle of the iron is small enough to slip through the pipe, fit the iron with a large washer or sheet-metal collar just below the handle to support it as shown.—William B. Egan, Louisville, Ky.

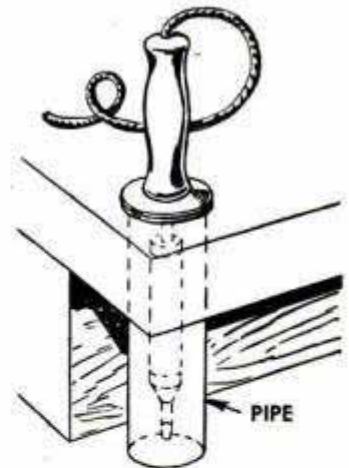

Checkers Replaced With Disks Sliced From Broomstick

Checkers which are frequently lost by children are replaced inexpensively by cutting disks, 1/4 in. thick, from a section of broomstick. Enough makeshift checkers to fill out the set usually can be cut in a few minutes, using a handsaw and holding the work in a miter box. After the disks have been sanded smooth, they are painted to match missing checkers.

Blanche Campbell, Las Vegas, Nev.

Waste Water From Drinking Fountain Absorbed in Soil-Filled Sewer Tile



To prevent puddles from forming around a hydrant being used for a drinking fountain, one gardener slipped a large sewer tile over it as shown. The tile was filled with soil in which mint was planted to catch and absorb waste water from the fountain. Not only did this keep the ground dry but the plant was assured adequate watering.
Hi Sibley, Nuevo, Calif.

Brick Supports Garden Hose At Correct Spraying Angle

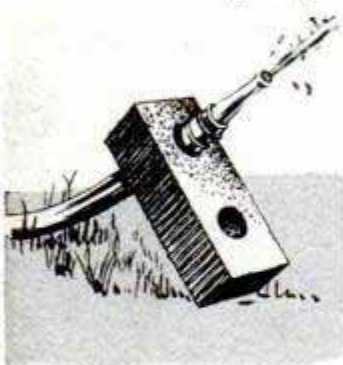

Using a brick of the type shown, a garden hose can be held in a stationary position so that it will spray a certain area. Simply insert the nozzle through one of the holes, adjusting the angle of the spray by tilting the

brick, or by moving the hose forward or backward a few inches in the hole.
Thomas P. Ramirez, Fond du Lac, Wis.

Repairing Toilet Flush Tank

Small annoying leaks in toilet flush tanks, caused by fine hairline cracks which radiate from mounting-bolt holes, can be repaired

by applying several coats of model-airplane dope to the inside of the tank where the cracks appear. To do this, first shut off the water and drain the tank, using a cloth or siphon to remove any water that does not drain out when the tank is flushed. Wipe dry the surface to be covered, and then apply several coats of dope to the damaged areas around the mounting holes of the tank.

Hugh L. Bryan, Chino, Calif.

Pad on Jack Protects Car Bumper

Fastened to the faces of the lifting hook on a bumper jack, a heavy rubber, canvas or leather pad will prevent damage to the chromium on the bumper. A piece of tire or shoe-sole leather is ideal for this purpose and can be cut to size and attached to the hook of the jack with household cement or thick shellac.

Henry Hanscom, Elmhurst, Ill.



Storing Leftover Paint

A small amount of varnish, enamel or lacquer remaining in a can may be salvaged by pouring it into an empty nail-polish bottle which has been thoroughly cleaned with lacquer thinner. This will enable you to keep it handy for future touch-up work as well as for decorating small pieces of craftwork. A wire held across the can as shown forms a "spout" to guide the liquid into the small neck of the bottle.



ABC OF SURE FISHING

X287

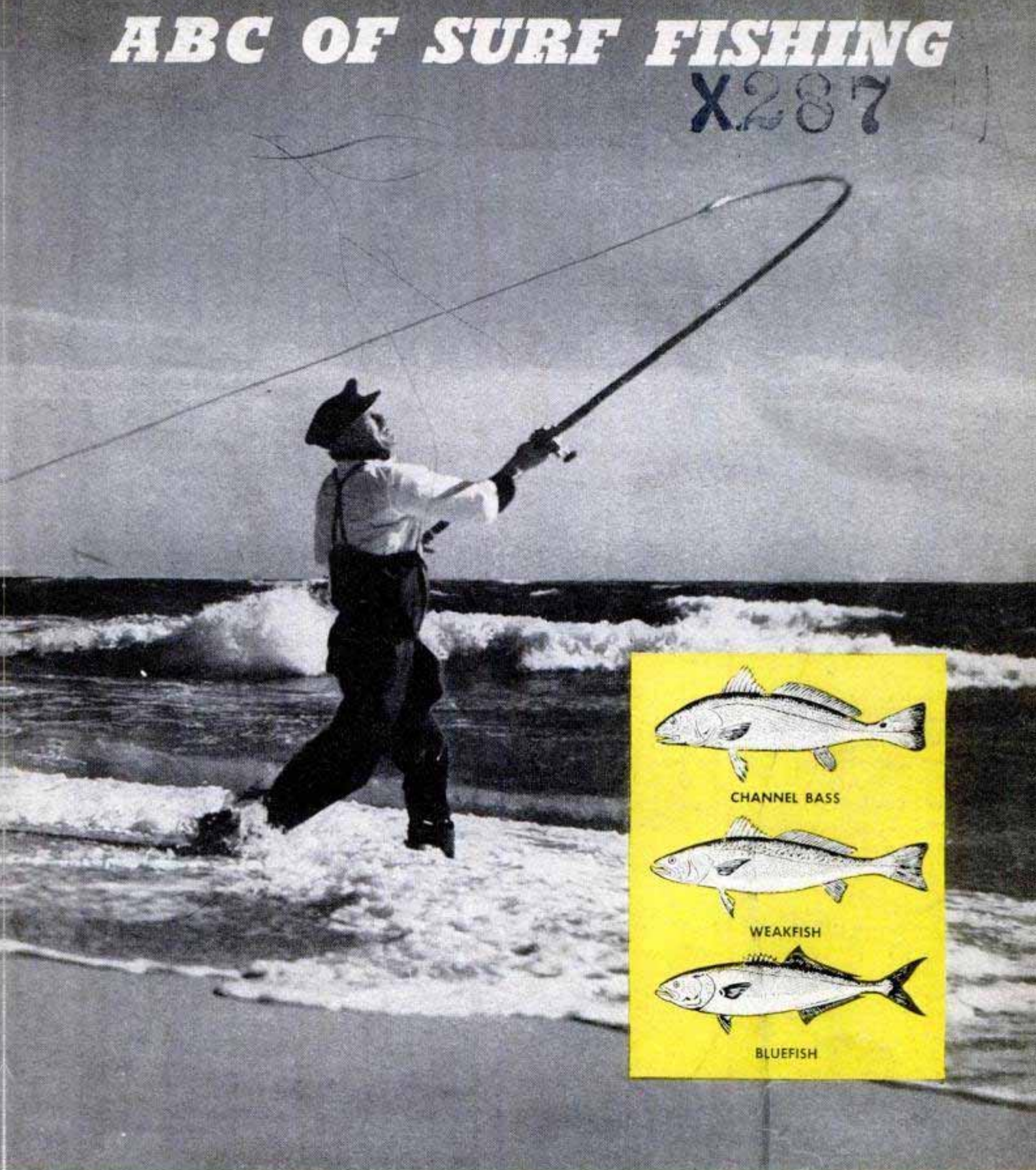

CHANNEL BASS

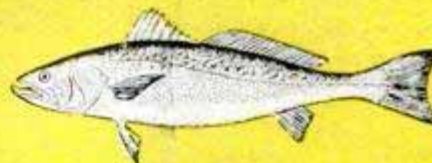

WEAKFISH



BLUEFISH

By Vlad Evanoff

WHEN THE SURF fisherman sends his bait far out over salt water in a long-distance cast he must be ready for almost anything within an angler's experience, for his catch can range from a 2-lb. weakfish to a 100-lb. shark. Compared with the average rod-and-reel game fish familiar to inland fishermen, ocean game fish taken in the surf come big and tough. Two of the

favorites among many are the striped sea bass and the bluefish. The striped bass, or striper, averages 5 to 8 lb. and is fairly common up to 20 lb. Individuals are caught each year running as high as 50 lb. in weight. Although smaller than the striper, many experienced fishermen rate the bluefish as the greatest rough-and-tumble fighter taken by surf anglers.

Surf fishing calls for the use of heavy tackle and the development of special skills.

1 Surf-Fishing Equipment



Old hands with the bait rod in fresh water will have little difficulty mastering the technique of the surf caster, but newcomers to the sport will require a period of practice in order to become proficient in handling a surf rod. The standard rod used by surf fishermen comes in two sections, known as the tip and the butt. The tips run from 5½ to 8 ft. in length and the butts from 22 to 30 in., depending on the choice of the angler. Surf rods are made from split bamboo, tubular steel, glass fiber and whole cane. Although many expert surf fishermen still prefer the split-bamboo rod, the glass-fiber rods are widely used. A surf angler picks his rod according to the kind of fishing he expects to do. For casting artificial baits, "squidding" as it is called, the fisherman selects a lighter rod than he would use for fishing live baits deep in the water or on the bottom. For average all-around work he picks a medium-weight rod having a tip from 6 to 7 ft. long, a butt section 24 to 28 in. in length and a weight, in split bamboo, of 9 to 12 oz. A man of average or below-average stature will find the 6-ft. tip more to his liking.

Surf casters pick the reel with care, as proficiency in making long casts over the surf depends to a great extent on smooth and reliable operation of the reel. It must have a lightweight spool, star drag and free-spool, and a gear ratio of at least 3:1. For casting artificial baits, the spool should hold at least 200 yd. of 9-thread linen line or the equivalent in a line laid with synthetic fibers (nylon). For bait fishing, the spool should hold about 200 yd. of 12-thread linen line or its equivalent in nylon. Many surf reels are available with various types of automatic brakes, operated either mechanically or magnetically, which are designed to prevent overrunning of the line on a long cast. These are useful to the novice, as they help to prevent backlash due to inexperienced thumbing of the running line. However, automatic braking tends to cut down distance. Expert surf casters sometimes overcome this tendency by using a heavier rig, but generally they prefer to use a standard reel with regular fittings, especially when conditions require maximum long-distance casting.

Preferences also vary among experienced surf fishermen as to the type of line used. Nylon lines are gaining favor because they are waterproof and exceptionally free-running. Other anglers, equally experienced in casting under varying conditions, object to the excessive elasticity of the synthetic line, its tendency to burn the thumb while maintaining control on a long cast, and also its inability to resist snagging on rocks and other underwater obstructions. Although the linen line lacks both the waterproof

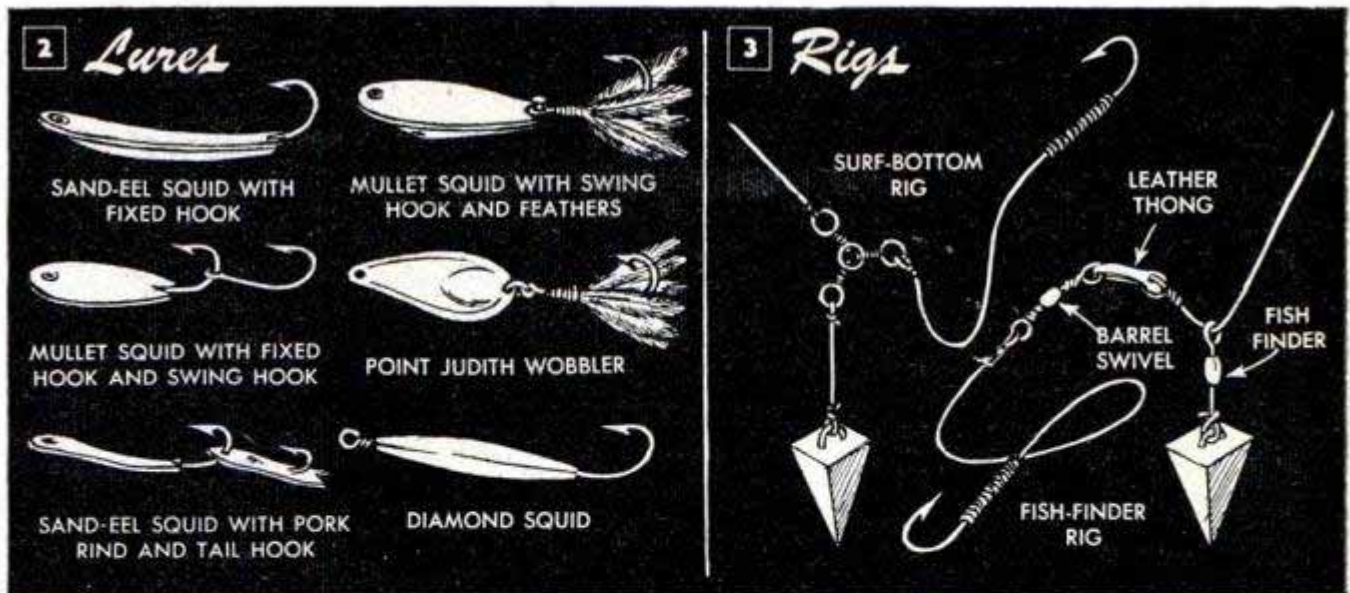

One of the oldest and most popular artificial lures for surf fishing is the metal squid available in many forms. Several types of rigs are made up by surf fishermen but only the two most commonly used are detailed

and exceptional free-running qualities of the synthetic line, it is extremely durable and also has what fishermen call "spring," a characteristic peculiar to lines laid with natural fibers. This quality of the linen line enables it to resist kinking and coiling in the air, thus holding air resistance and wind deflection to the minimum. Under average conditions such a line requires less thumbing to maintain control throughout the full length of the cast, and it flies true even in a quartering wind or a stiff inshore breeze. For long casts under difficult conditions surf fishermen generally prefer a linen line. The popular sizes in linen lines are 6, 9, and 12-thread lines, while in nylon 25, 36 and 45-lb. test lines are a common choice. In addition to the basic rod, reel and line, the essential accessories carried by surf fishermen are shown in Fig. 1. The common artificial lures and the surf-bottom and fish-finder rigs are shown in Figs. 2 and 3. These rigs are worked with pyramid sinkers weighing from 2 to 6 oz., depending on weather conditions and the surf and current.

One of the oldest and most popular of the

artificial baits is the metal squid, several types of which are shown in Fig. 2. These lures are remarkably realistic imitations of the common sand eel and mullet, both of which are favorite foods of surf fish. They come in weights ranging from 1 to 4 oz., the heavier sizes being recommended for long-distance casting. Wooden and plastic plugs similar to fresh-water lures also are used. These range from 1 to 4 oz. in weight and are furnished for both surface and underwater fishing. Most plugs are supplied with heavy double or treble gang hooks and are from 3 to 9 in. long. Common color combinations include red and white, shiner, mullet and herring. When fish are feeding on live squid, red and amber-colored plugs are most effective. For striped sea bass, eels rigged as in Fig. 4 are considered best among the various live baits, but in common with most live baits are difficult to cast with the accuracy and distance usually required in surf fishing. To overcome this drawback, anglers sometimes remove the head of the eel and insert a lead weight in the body, making what is known as an eel-bob, which is much easier to cast. Besides

When the fish won't take artificial lures surf anglers resort to live baits, eels being among those most productive of good results. Details below show two approved methods of rigging eels for surf casting

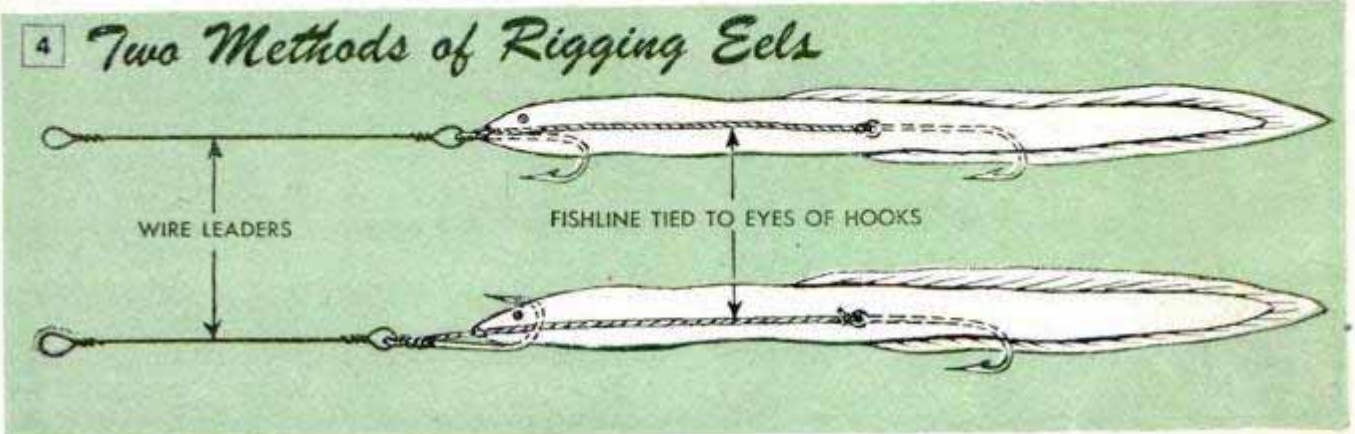

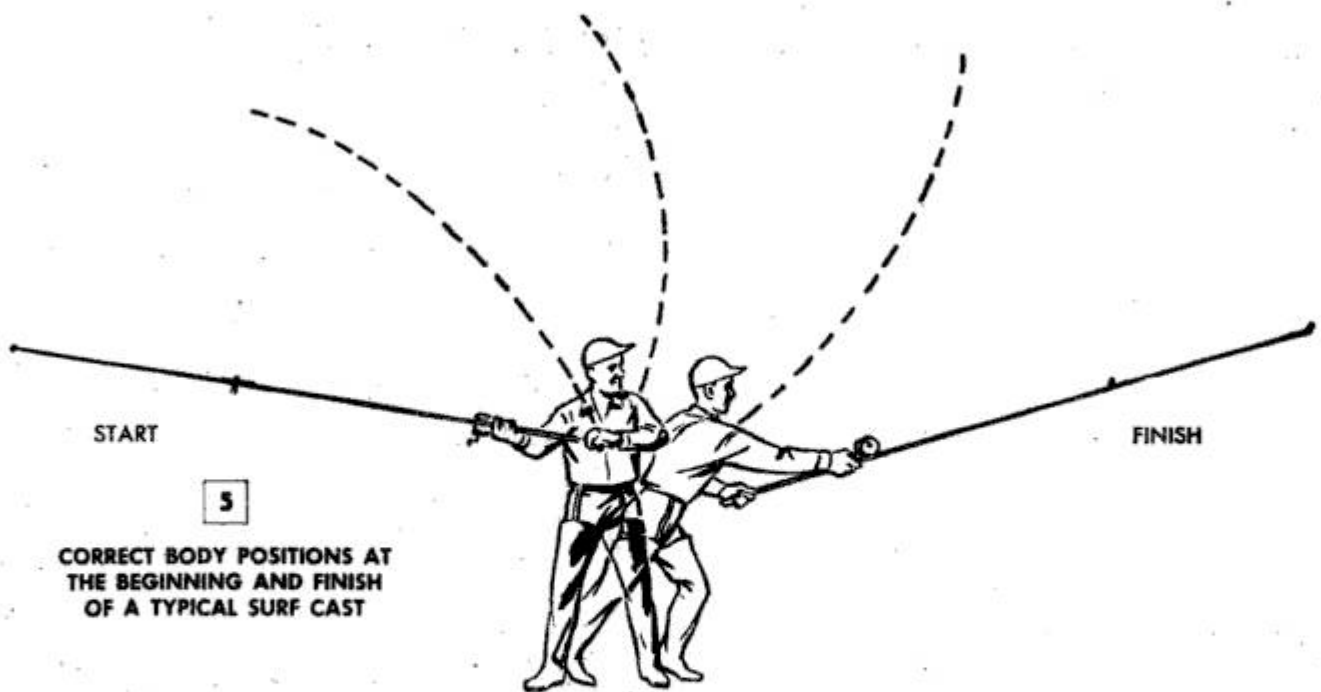

5
CORRECT BODY POSITIONS AT
THE BEGINNING AND FINISH
OF A TYPICAL SURF CAST

eels, which are favorite live lures, fishermen use other live baits such as crabs, clams, sea worms of certain kinds and whatever bait fish are commonly available in the locality. Live baits are used on hooks ranging in size from No. 1 to 9/0, depending on the size of the fish sought and the structure of its mouth.

At the beach surf fishermen keep a constant watch for certain signs that indicate the presence of fish. The gamiest surf fish are wanderers, usually traveling in schools that come and go with the tides. Old hands keep an eye on the gulls, terns and other sea birds that feed on the bait fish which are driven to the surface by feeding game fish. When gulls wheel and dive at the edge of the breakers it usually indicates to the fisherman that the bait fish are breaking water. Occasionally game fish break water when feeding actively. It is then that the surf caster unlimbers his tackle and lets go with plugs or metal squids, selecting his lures to imitate as closely as possible the bait fish present at the time.

When there are no signs which indicate the presence of fish, the angler studies beach formations and the water to determine the most likely spots to fish his bait. Jutting rock bars and sand spits where the waves curl and break into swirling white water are always worth a try for striped sea bass. Other sea fish that live close inshore often prefer the deeper water off rocky coves and also the holes and inlets near a river mouth. Entrances to ocean inlets and salt flats usually are good spots to hook the fighting bluefish, especially when the tide is going out. Of course, there is no hard-and-fast rule for locating productive fishing spots. Surf fishermen say that the fish are where you find them.

The technique of surf casting is well pictured in the photo on page 159 and also in the detail, Fig. 5. Stand with the legs braced well apart and face down the beach at right angles to the ocean. Set the reel in free-spool, place the right thumb on the spool and grip the rod butt firmly with both hands as shown. Start the cast with the rod tip pointing back, as in Fig. 5, and bring the rod forward, somewhat above the horizontal, in a hard, fast swing as pictured. This movement is important as it is the only way you can utilize the full driving power of a good surf rod. Just before the rod straightens near the end of the swing, lift the thumb from the reel spool. As the line starts to run out bring your thumb back on the spool lightly to take the slack out of the running line and prevent a backlash. As the cast loses its initial drive and the bait lowers in the air, thumb the reel spool hard to stop the cast and drop the bait lightly into the water. Of course, a description of the procedure can give only a general idea of the various steps in surf casting. Beginners should confine their efforts to making short casts until they get the feel of the rod and lure under the tension of the initial swing. Timing the thumbing of the reel is the trick in making long casts over the surf. If the spool is thumbed either too early or too late, the cast will fail. If thumbed too early, the initial drive will be lost; if too late, the spool may overrun the line. Good surf casters regularly put out 200 to 250 ft. of line when it is necessary to reach fish feeding a considerable distance off shore. Of course, this is regarded as maximum long-distance casting, reserved for the experts, but generally there is good fishing closer inshore for those who learn the signs indicating presence of fish. ★ ★ ★

Staples Enamelled Before Insertion To Match Surrounding Surface



When stapling material where it is desirable to have the staples as inconspicuous as possible, apply enamel to the top of the strip of staples before putting them in the machine. Use a color

that will match or at least harmonize with the color of the surface on which the staples are to be used. Lacquer for this purpose can be purchased in small bottles at department stores or automobile-accessory shops.

Ken Murray, Colon, Mich.

Wrench for Drill-Press Chuck



If your drill press is fitted with a keyless chuck which is difficult to open, make a wrench for it from a piece of $\frac{3}{4}$ -in. plywood. Cut the wrench to resemble a paddle with a handle

about 8 in. long and a diamond-shaped hole in the center of the wide portion that will just slip over the chuck. In use, the wrench is slipped over the chuck and the latter gripped by pressing down on the handle.

Tubing Used as Rubber Feet

Rubber feet for use on the underside of small boxes or novelties may be made easily by fitting thumbtacks inside short lengths of rubber hose and attaching them.

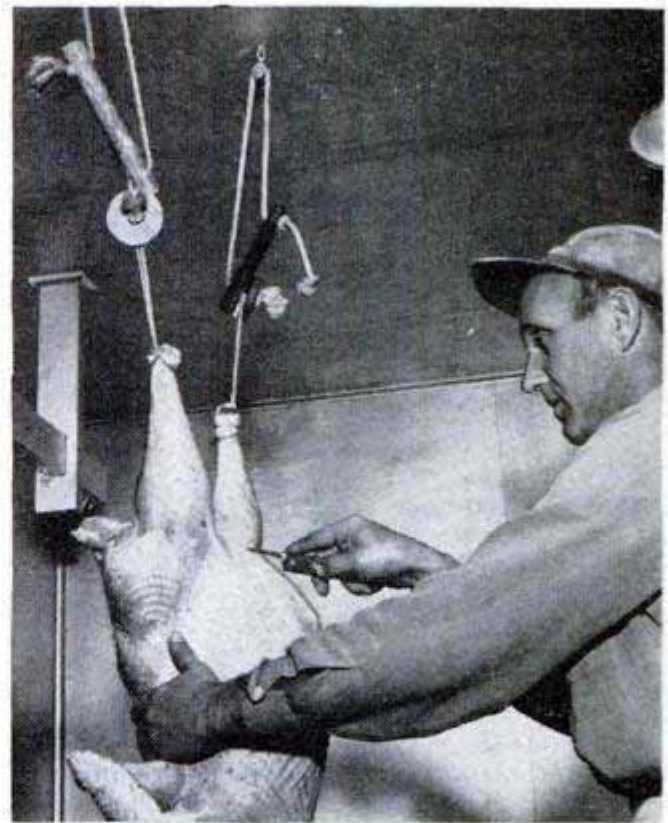
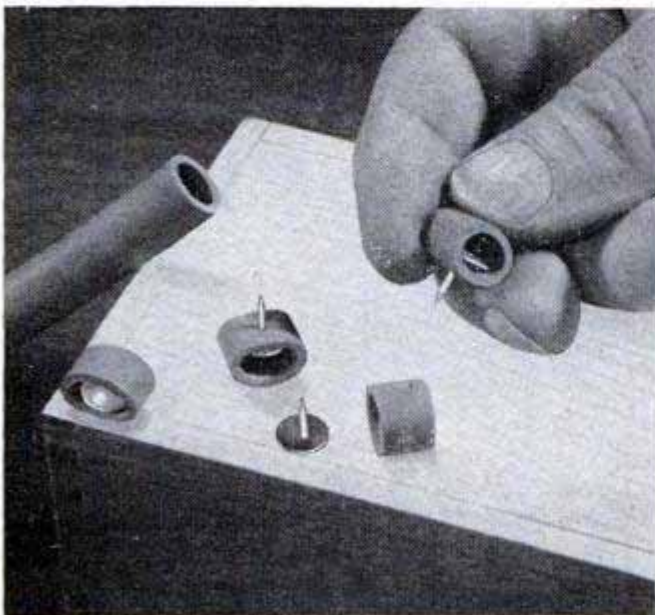

Rig Made From Scrap Materials Simplifies Cleaning of Fowl

Requiring only scrap materials that can be found in almost any household, this device will enable you to clean and dress poultry singlehandedly, working at a comfortable height with only a minimum handling of the fowl necessary. A loop of heavy twine is slip-knotted around each leg of the fowl, after which opposite ends of the loops are slipped over small wooden disks that are suspended from the ceiling by short lengths of clothesline. This clothesline, through the utilization of pulleys and pieces of broomstick arranged as shown, permits hanging the fowl at a convenient height.

A. Neimann, West Chicago, Ill.

Holder Grips Small Drills

A rectangular piece of rubber cut from an old inner tube can be made into an excellent holder for small drills and grinding attachments. Just punch two parallel rows of holes in the piece with

each hole in one row being directly across from one in the other. Now simply insert the drills by forcing them through the holes as illustrated. The resiliency of the rubber will hold the drills in place even in instances where the holder is rolled or folded.

Richard Hanscom, Elmhurst, Ill.

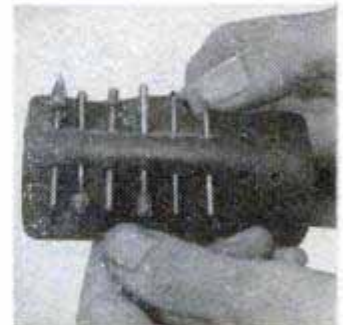



COOKBOOK EASEL hinged to underside of wall cabinet holds recipes at eye level where they are easy to follow. Chain supports the plywood easel in the open position and a cupboard catch holds it closed



BOTTLE LABELS CAN BE REMOVED quickly even though soaking does not soften adhesive by rubbing them briskly with medium or coarse steel wool

Solving HOME

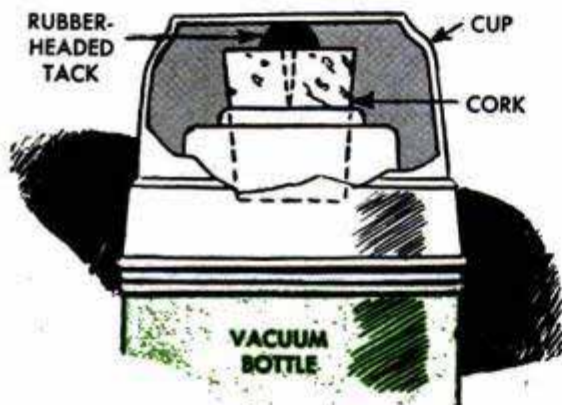

VACUUM-BOTTLE CORK won't loosen and permit leakage if held tightly in place by screw cap of bottle. To extend the top of the cork so the cap will bear against it, press a rubber-headed tack in the cork

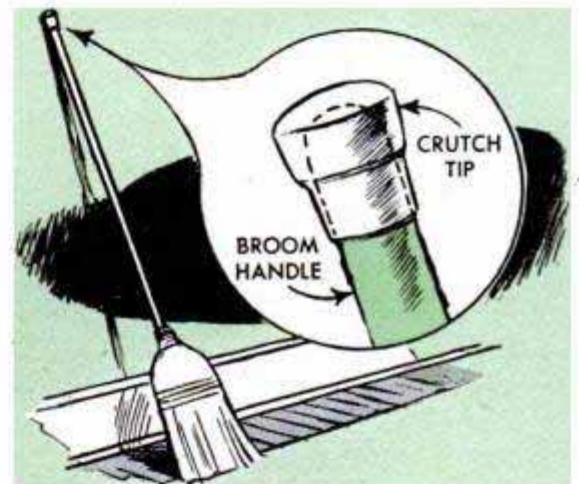

RUBBER CRUTCH TIP pressed over end of handle will keep mop or broom from slipping when it is leaned against a wall. Also improves grip on mop handle when dusting under beds and low furniture

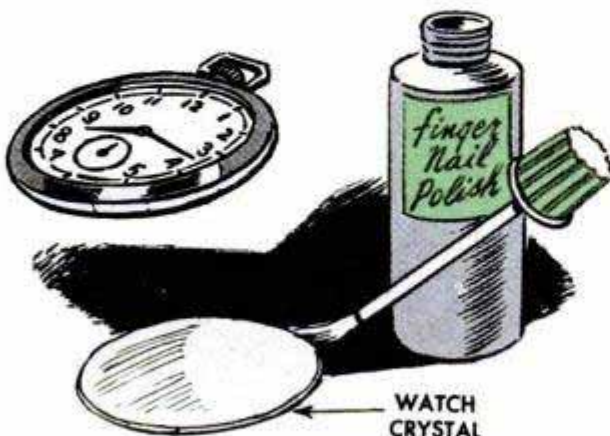

IF THE CRYSTAL on your wrist watch or pocket watch allows dust to seep through, remove it and coat the edges with a thin layer of clear finger-nail polish before replacing crystal in the bezel

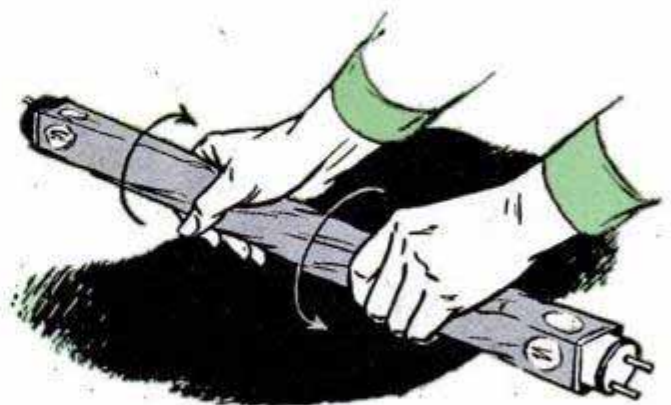

DON'T CHANCE BREAKING a newly purchased fluorescent lamp by having the tube slide from the carton on the way home. To hold it in place, gently twist the carton around the bulb, as shown above

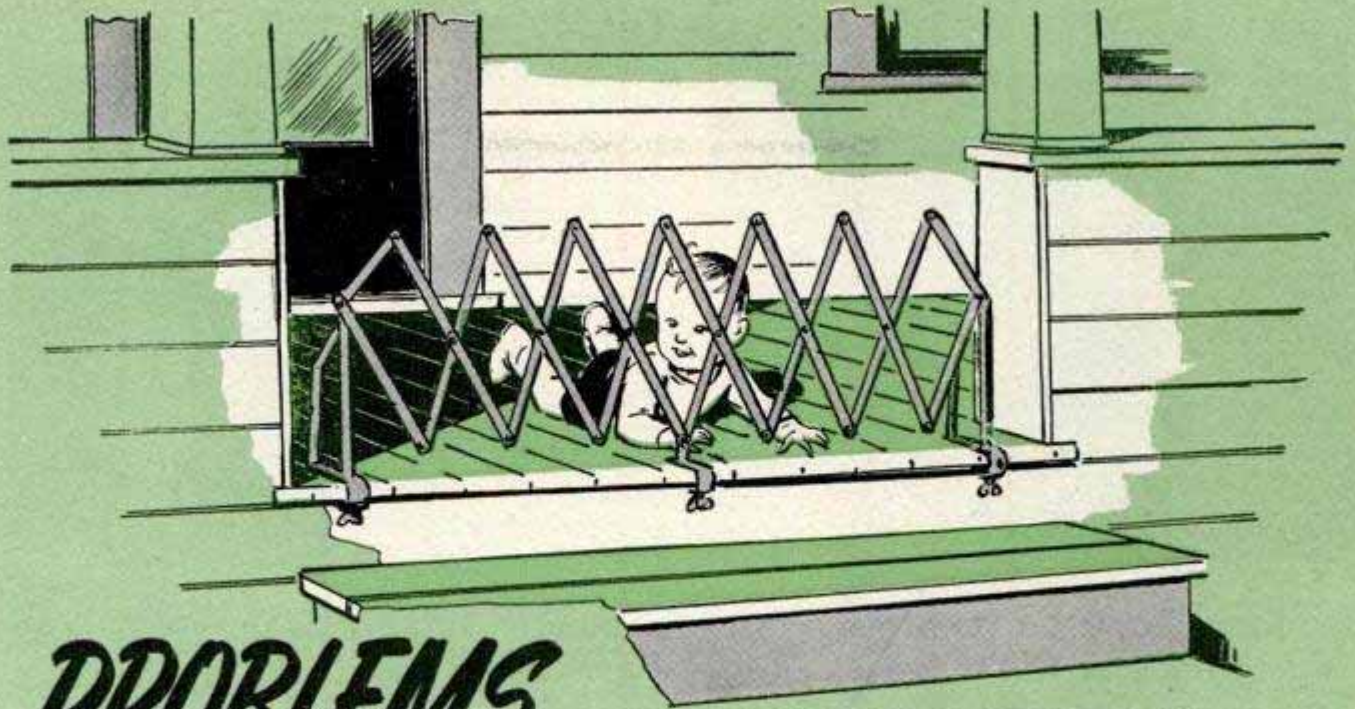

PROBLEMS

RUNNING-BOARD LUGGAGE RACK of the type used on old cars makes a good substitute for a folding gate to keep an infant safely penned on an open porch



TO PREVENT STAINING HANDS with hard-to-remove shoe polish, protect your fingers with an old rubber glove when polishing shoes. Polish can be applied directly with the glove or with a cloth, as usual

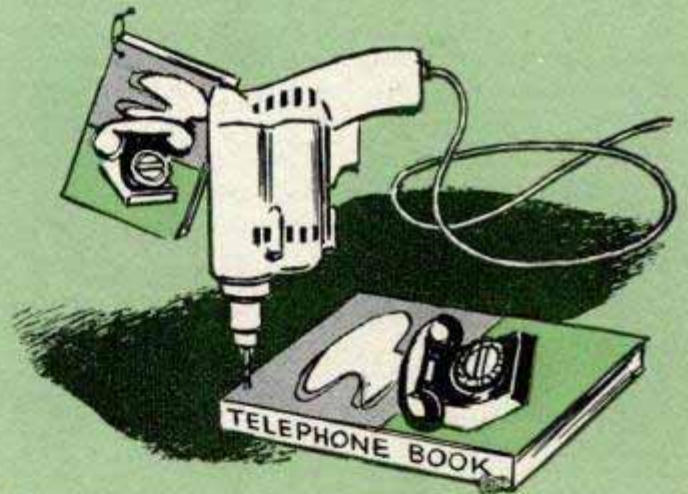

HEAVY TELEPHONE DIRECTORIES can be perforated for hanging from a wall hook by drilling at upper left-hand corner. Portable electric drill with a 3/16-in. bit quickly bores neat hole through the thick book



DRAINING MILK FROM COCONUT is done easily by punching two holes in "eyes" of fruit. Holding coconut so one opening will drain into a cup or tumbler, blow into the second opening through drinking straw



FLOOR-WAX APPLICATOR speeds job of applying paint to large floor areas such as kitchen linoleum or concrete basement floor. Pour paint into shallow container large enough to permit dipping the applicator



Luminous Paint on Umbrella Adds Safety at Night

If you are in the habit of using an umbrella on stormy nights, apply luminous paint to the rib tips. This will enable motorists to see you more readily when crossing a street and will be of aid in heavy pedestrian traffic. It's a good idea to prepare one umbrella in this fashion and keep it for night use only as this paint rubs off easily. If available, reflective tape may be used instead of paint. This comes with an adhesive backing for easy application.

Flag Socket From Pipe Elbow Drains off Water

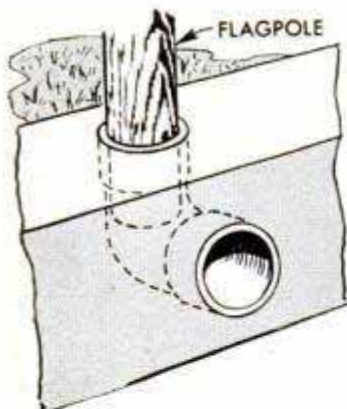

Flag sockets installed in curbs often become packed with mud and litter and sometimes are broken when water freezes inside them. The socket will stay clean and will not hold water if it is made from a pipe elbow. The

elbow is embedded in the concrete at the time the curbing is poured so that both ends are open—the upper opening holding the flagstaff and the lower one providing a drain. Rain will wash away any accumulation in the elbow and if ice should collect during the winter it can be removed quickly with a little hot water.

☞ When you find that insects are difficult to remove from a car windshield, use a small amount of baking soda on a damp cloth. Follow this by wiping with a clean dry cloth.

Stand Supports Outboard Motor For Storage or Repair

To support an outboard motor in a convenient position while repairing it, or for storing it safely, use a stand like the one shown. It is made of 2 x 8-in. material assembled as indicated. The vertical member is bolted at right angles to a 4 x 4-in. piece which, in turn, is bolted at right angles to a piece of 2 x 8, thus producing a base



that will not tip. It will be necessary to add blocks to the underside of the 4 x 4 at the ends in order to make the stand set level. Dimensions of the stand will be determined by your particular motor and also by the height at which you want it supported.

Ivan Grosvenor, Richmond, Ind.

Wooden Pads Attached to C-Clamp Protect Finished Work

To save time and also to simplify the use of C-clamps on finished work, one craftsman attached wooden blocks to the pads of the clamps. These were blind-bored to fit the clamp pads so they would not drop off with normal handling yet would be easy to remove when necessary. If desired, faces of the blocks may be cushioned by adding felt or rubber pads. These can be cemented in place to protect a varnished surface.

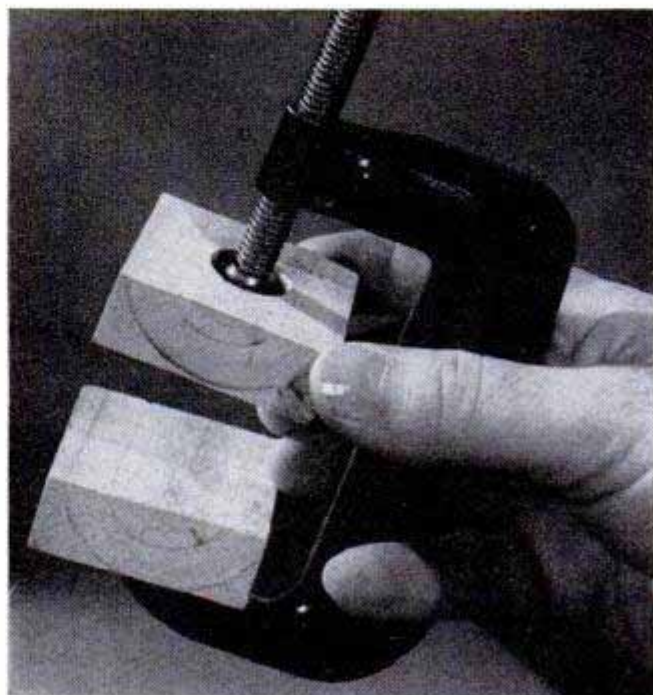



Handy SPICE RACK

Ideal as a one-evening project in metal-work, this little spice rack is dimensioned to hold four standard spice cans. It may be made larger, however, to accommodate more or different-sized cans. Usually, enough sheet metal to make the rack can be salvaged from a large can or other object. If the metal happens to be slightly rusted, it can be cleaned up satisfactorily with sandpaper or steel wool as you will be painting it to match the kitchen color scheme. The $\frac{3}{8}$ -in.-wide retaining band is attached to the rack by sweat-soldering.

I. M. Fenn, Chicago.

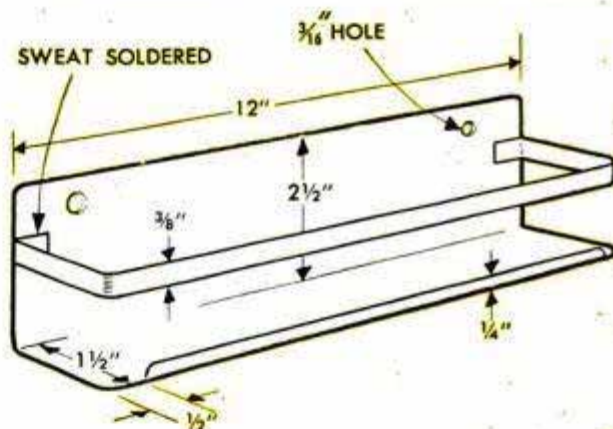

Worn End Mills and Router Bits Make Good Punches for "Tooling"

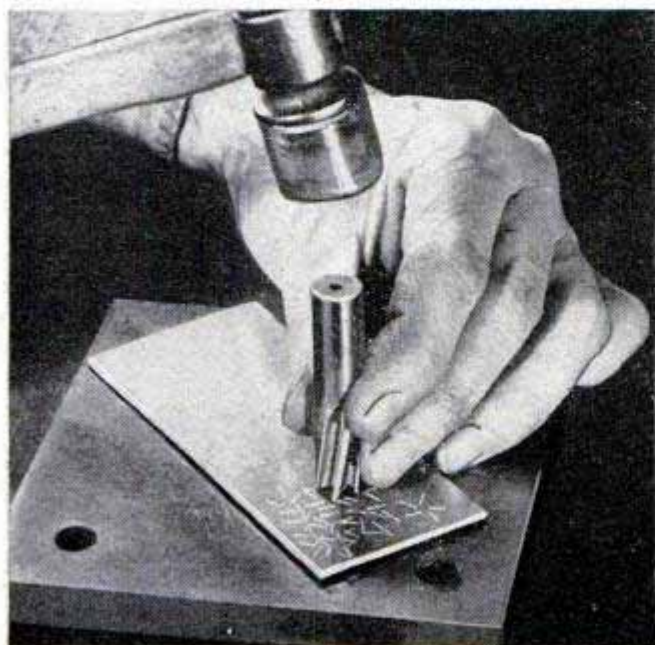

End mills and router bits, usually discarded when worn, may be put to good use by the home crafter as punches or background tools for stamping decorative designs on various craft materials such as metal, wood and leather. Soft aluminum and copper are ideal metals for stamping and they are soft enough not to damage even a new tool if one is used. By using four, six or eight-lip end mills, interesting star-shaped designs may be worked out with a tap of a hammer. Wooden moldings may be embossed in bas-relief by stamping a series of repeat designs in a continuous pattern. In tooling metal with an end mill or router bit, it is advisable to do the work with the metal placed on a flat steel surface to obtain good clear impressions. If a new tool is used for this purpose, use a plastic-headed hammer or wooden mallet to avoid damaging the end of the shank.

PLAN of the MONTH...

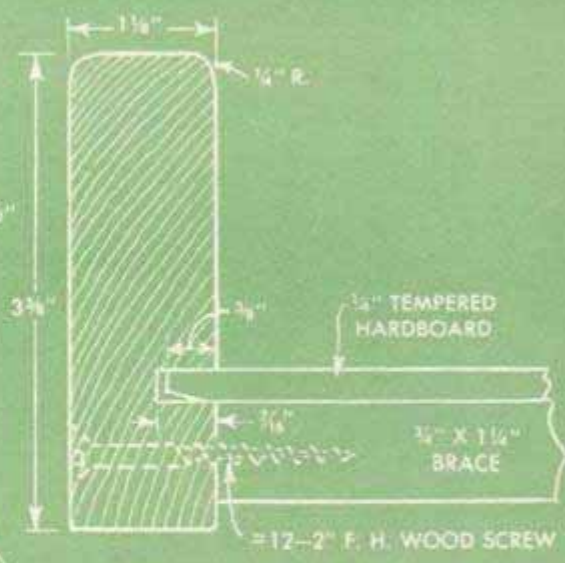
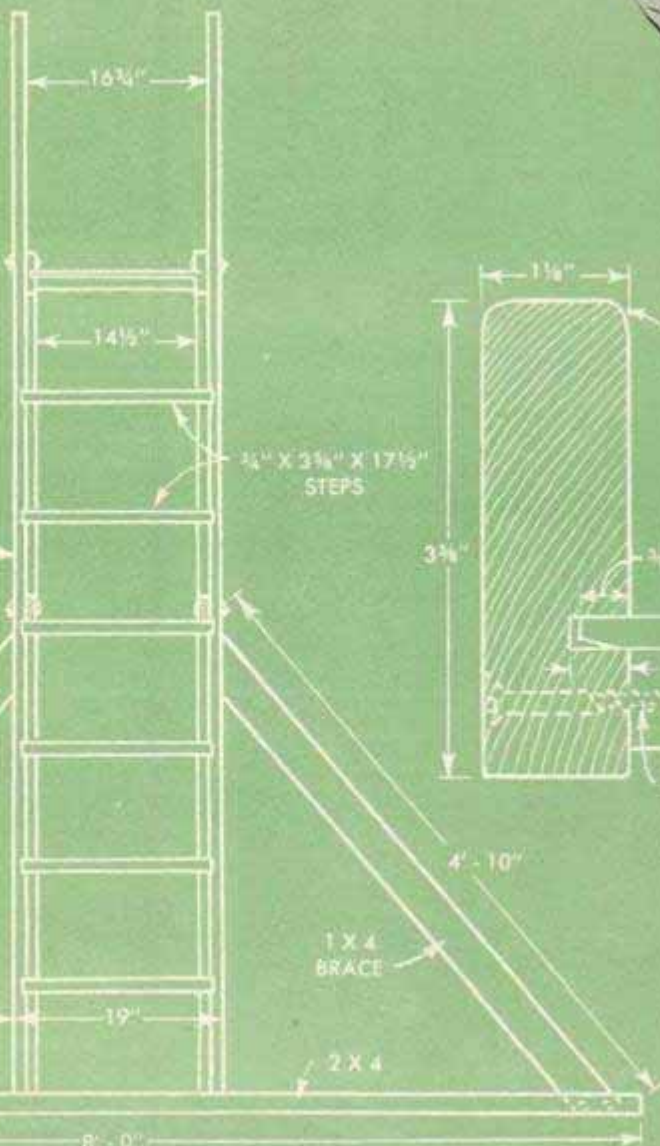
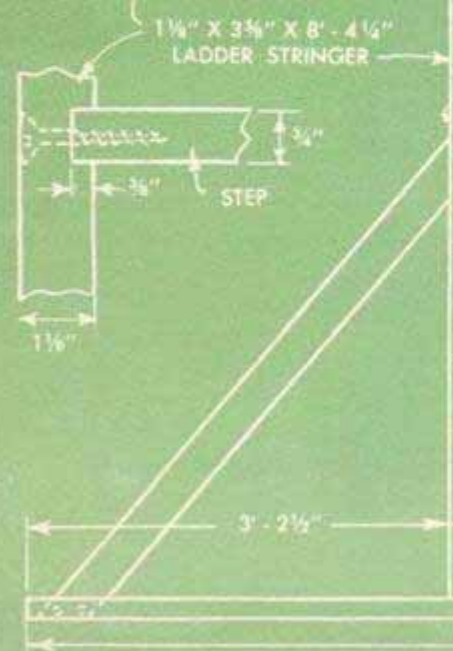
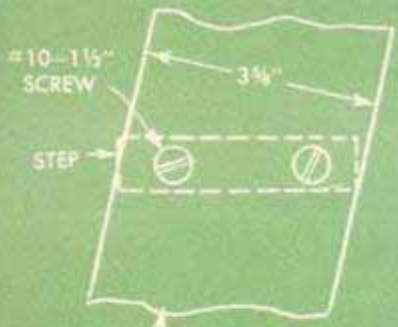
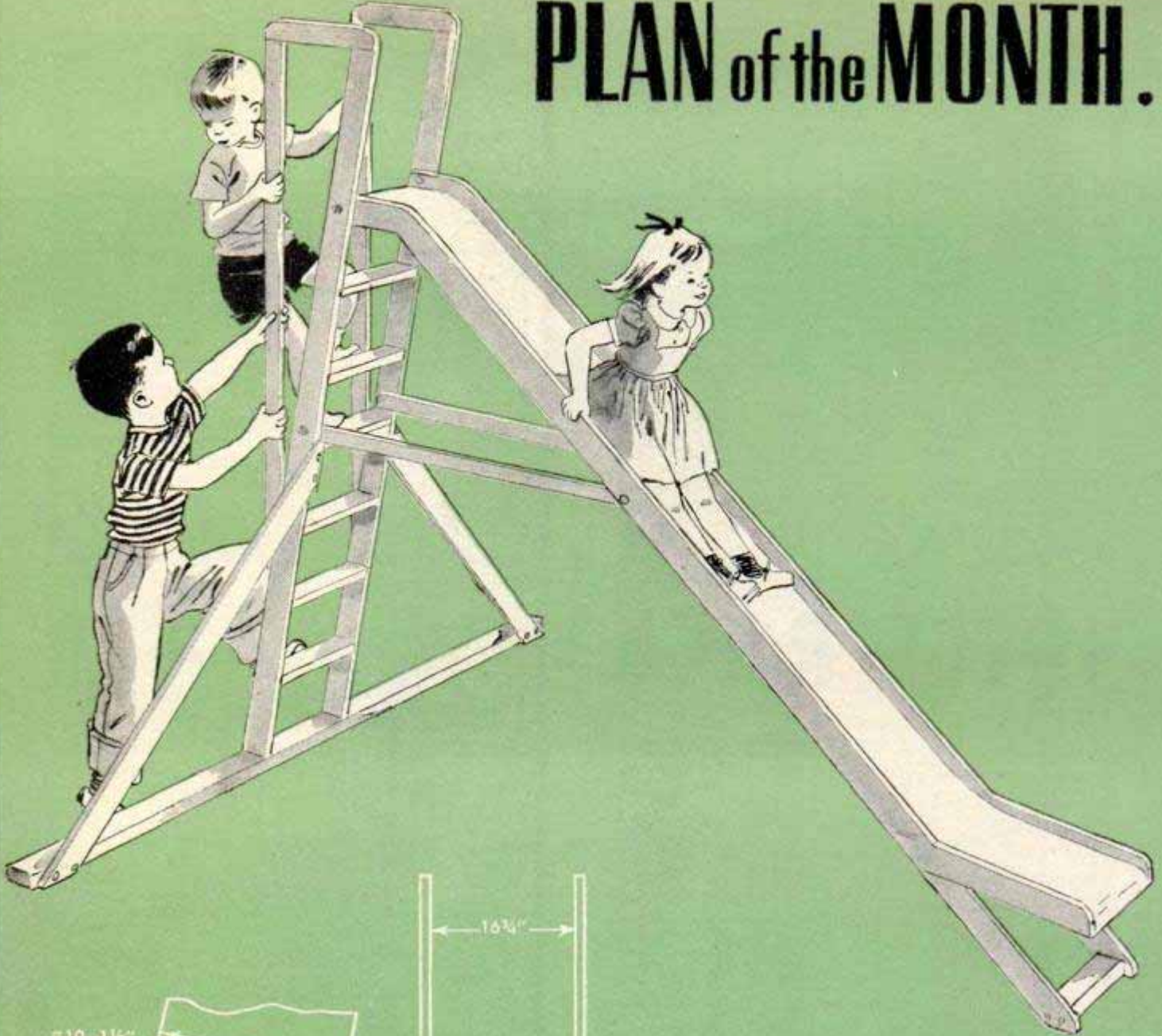

SECTION THROUGH SLIDE RAIL

Foot Switch Added to Power Tool Affords Convenient Control

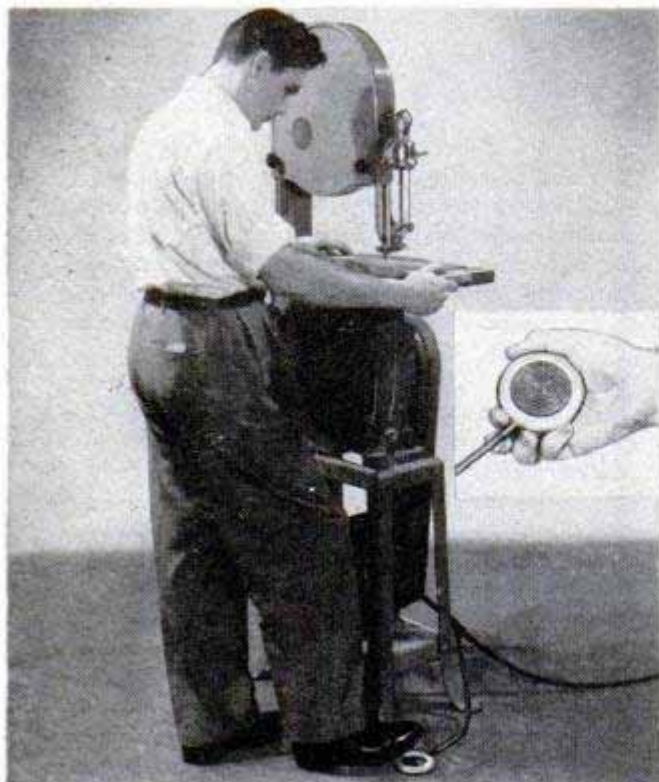

A foot switch of the type used with photo enlargers can be adapted easily for use with a jigsaw, bandsaw or other power tool. The switch, which is wired in series with the power tool, conveniently permits instant starting and stopping without need for taking the hands from the work.

Tree Roots Watered and Fed Through Tile Sunk in Ground

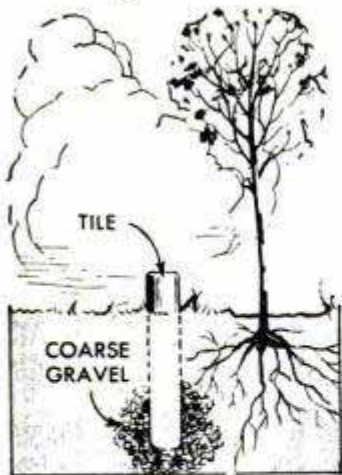

To save a young tree during extremely dry summer months, one nurseryman set an open-end tile in the ground near the tree to serve as a reservoir for supplying it with water and soluble plant foods. Placed in a hole dug near the outer spread of the roots, the lower end of the tile was embedded in coarse gravel and the upper end capped.

Ervin L. Strayhorn, Beebe, Ark.

Ignition System Provides "Light" For Motorist Without Matches

On occasion when finding himself without matches, one motorist uses this unique method of obtaining a light for a cigarette

or for starting a fire. With the car engine running, an ignition wire is removed from a spark plug and held just far enough above it to cause sparks to jump the gap. A gasoline-soaked stick or weed is then held in line with the spark to quickly ignite it.

Repairing Leaky Water Pipes

When an otherwise good section of water pipe in his basement sprang a leak, one homeowner not only saved himself the expense of replacing the pipe but also that of removing one end of it from a wall in

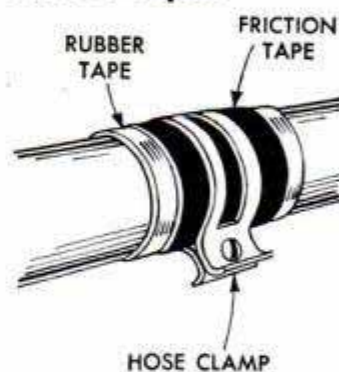

which it was embedded. The defective portion of the pipe was wrapped with several turns of electrician's rubber tape, followed by several turns of friction tape. Following this, a hose clamp was applied as shown.

Socket Chain Simplifies Wiring Of Curved Electrical Fixtures

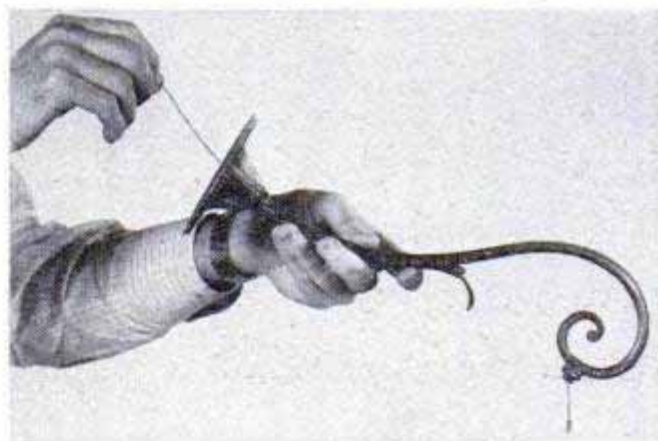

A length of socket pull chain may be used effectively in place of an electrician's fish wire, which generally is used for pulling wires through curved electrical fixtures. Fed into one end of a lamp, the chain—because of its weight and flexibility—can be shaken easily past curved portions of the fixture and out the opposite end. The electric wire is then attached to one end of the chain, after which it may be drawn through with little, if any, difficulty.

Otto Merker, Chicago.

Curtain Stretcher Dries Fishline

One fishing enthusiast hit upon the idea of drying fishing lines by stringing them between the top and bottom rows of nails on a curtain stretcher. Several lines can be accommodated at one time.

George Kapitan, New York City.

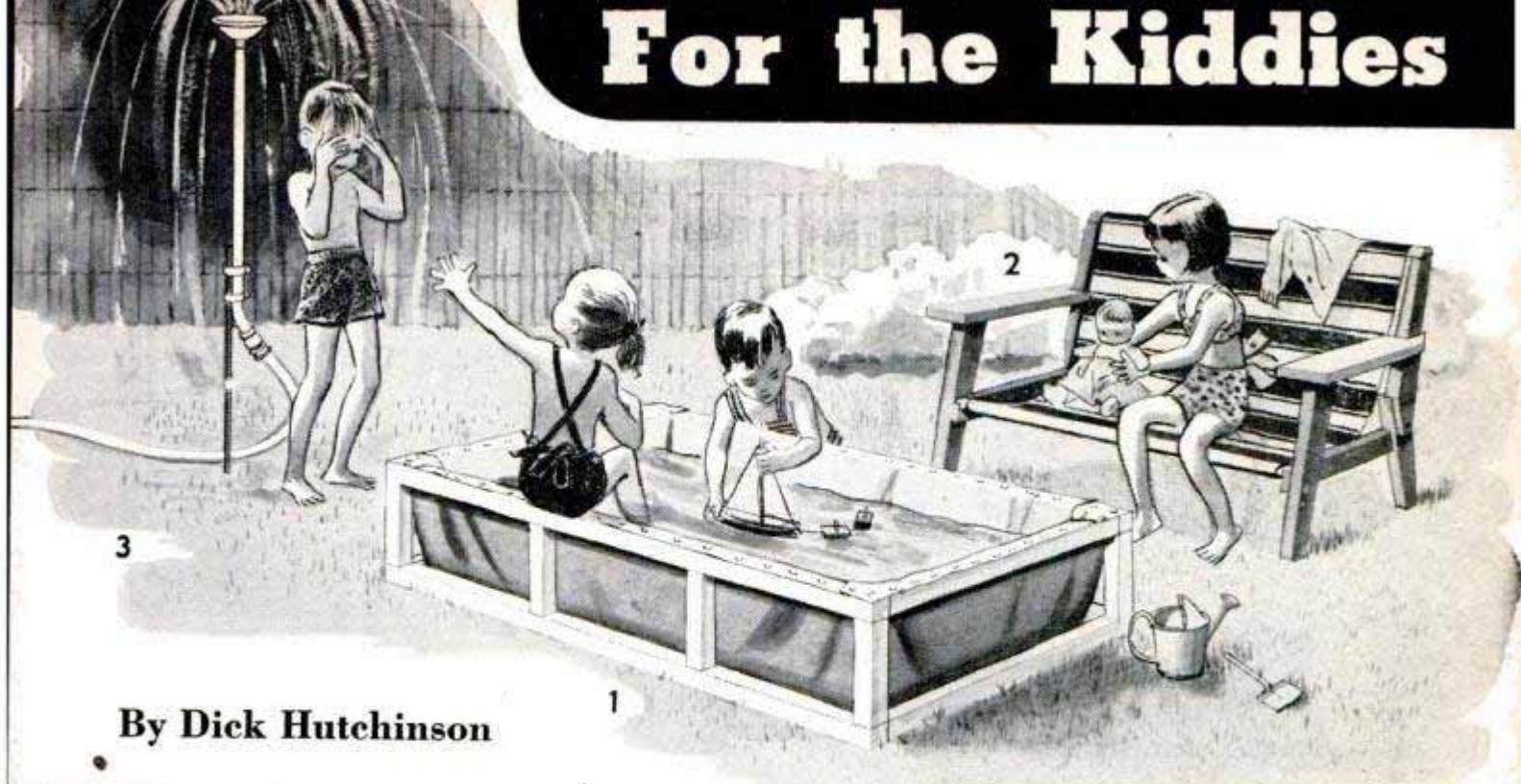

By Dick Hutchinson

1-Canvas Wading Pool

Made as detailed, the wading pool is large enough for sailing toy boats and splashing, but not too cumbersome to permit storage in the basement or garage. Waterproof canvas simply is brought around edges of a wooden frame and tacked securely. Water can be siphoned out with aid of a garden hose

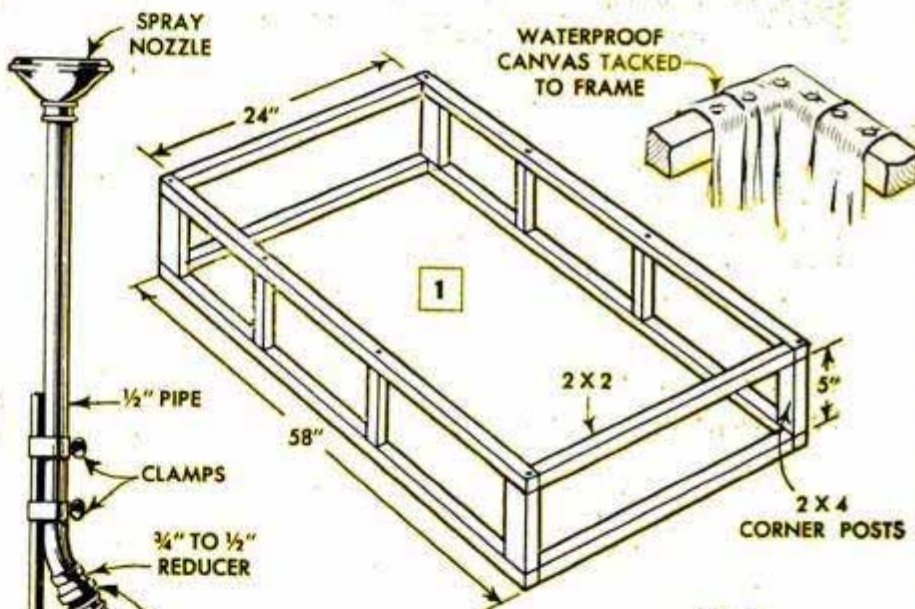

2-Small-Fry Bench

This little bench provides an ideal spot for the tots to dry out after a romp under the shower or a dip in the pool. A yard of awning canvas, 36 in. wide, is tacked to the front and back rails of the bench to form a comfortable seat. Stock sizes given in the detail may be varied to utilize lumber already on hand

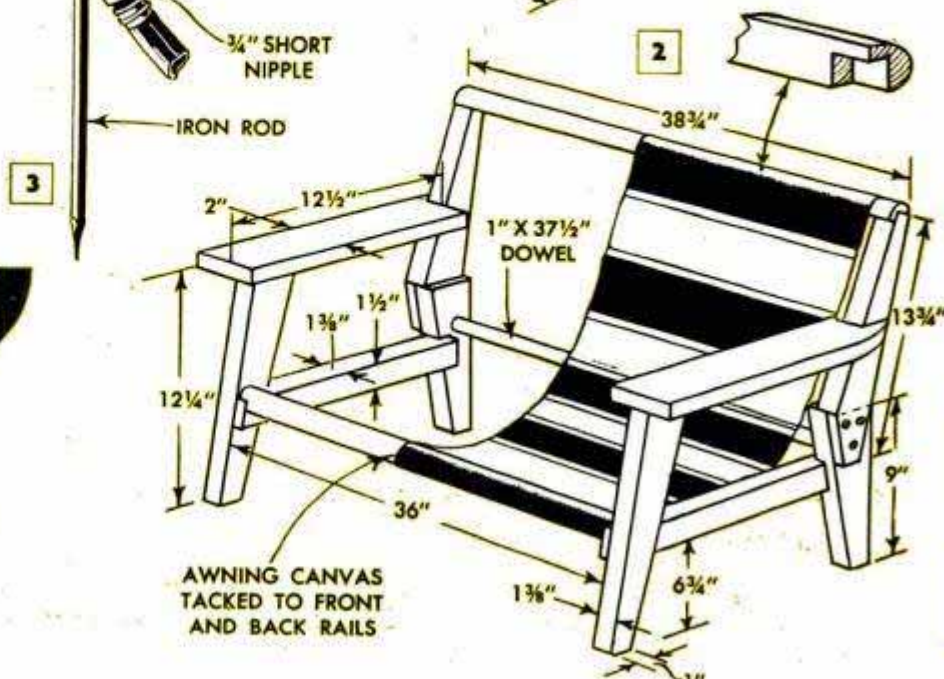

3-Portable Shower

Connected to the garden hose, the portable shower can be set up anywhere in the yard. Radiator-hose clamps hold the pipe extension to a pointed length of rod which is pressed into the ground. If spray nozzle won't fit 1/2-in. pipe, use reducer and nipple at the top of the pipe in same way as for hose connection

Box Mounted on Cupboard Door Stores Household Articles



Should you need a container in the kitchen for storing string, paper bags and other useful items, make one from a discarded cheese box and attach it to the inside of a cupboard door. Fit a partition cut from the cover in one end of the box to form a compartment large enough to hold a ball of string and drill a small hole in the end of the box through which the twine can be withdrawn as needed. Paper bags and other articles can be stored in the larger compartment.

Hair Clip Holds Memos



Taped to the wall near the telephone, an ordinary spring-type hair clip provides a convenient memo holder. Using cellulose or adhesive tape, fasten one arm of the clip to a wall or the side of a cabinet so that the jaws of the clip point downward. To use, simply press against the top of the clip and insert note paper between the outer jaw and the tape.

Joseph Jay Gold, Brooklyn, N. Y.

Carrying Dampened Washcloth

When traveling with children or taking them on a picnic, a damp washcloth is a must for cleaning soiled hands and faces. In case water may not be available, dampen

the cloth before leaving the house and carry it in a plastic container of the kind ordinarily used for sandwiches.

A. R. Tanner, Cold Spring, N. Y.

Electric Toaster Serves as Oven For Heating Sheet Plastic

Small pieces of plastic not more than $\frac{3}{8}$ in. thick can be heated for bending in the bread slots of an electric toaster. A toaster with manual controls is most suitable for the job. However, a completely automatic toaster may be used, provided the plastic is pressed down again each time it pops up until heated sufficiently. It is advisable to use a scrap piece of plastic first to determine how much time will be required to soften the material.

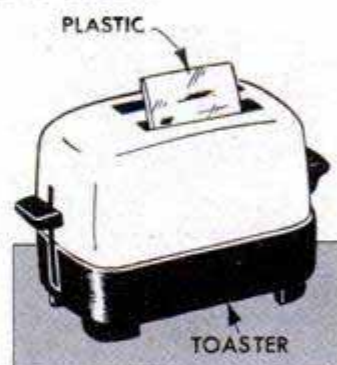

Quick Way to Transplant Small Seedlings

If you have a number of seedlings to transplant, the job can be done quickly by using a spade as indicated. First, sink it into the soil to the desired depth and then move it back and forth to form a trench equal to the width of the spade. Now, insert the plant and spread the roots in the trench. This done, sink the spade into the soil a few inches back of the trench and push the soil forward to close the trench around the roots. The small opening made in doing this allows the roots to get plenty of ventilation and also serves as a water reservoir for providing moisture which the seedlings will need to get a new start.

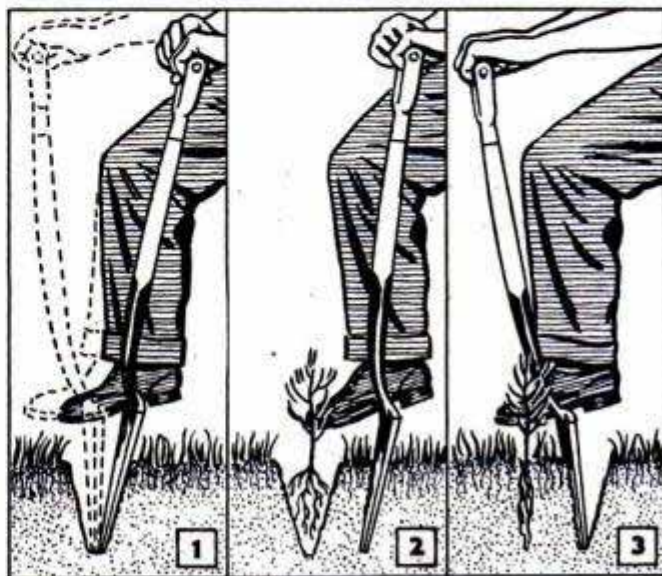

KNOCKDOWN BARBECUE



IF YOU LIKE to cook an occasional dinner in the back yard but have no particular desire for a permanent outdoor fireplace, this knockdown barbecue will handle the cooking and can be tucked away in the basement or garage when not needed. It is set up in a minute or two and, being compact, is ideal for carrying on picnics. Steel scrap, pipe and an 18-in. harrow disk are used to make the unit, as detailed at the right. The 4-in.-deep firebox was designed for charcoal, but it can be adapted for burning wood by adding another 4 in. or so to its depth. The firebox is assembled by welding or riveting sheet iron to two flat-steel rings, and covering the top with a grid of heavy steel mesh. Three pipe caps are welded to the underside of the harrow-disk fire pan to take legs of $\frac{1}{2}$ -in. pipe. A steel-mesh grate, about 12 in. in dia., is placed in the bottom of the fire pan. A simple holder for roasting forks can be bent from rod and welded to the edge of the disk, and a hot plate may be cut from sheet iron. The barbecue is stored compactly by removing the legs, turning the firebox upside down in the fire pan and placing the grate and hot plate inside the firebox. The hole, which is located at the center of the harrow disk, is left open to provide additional draft for the fire.

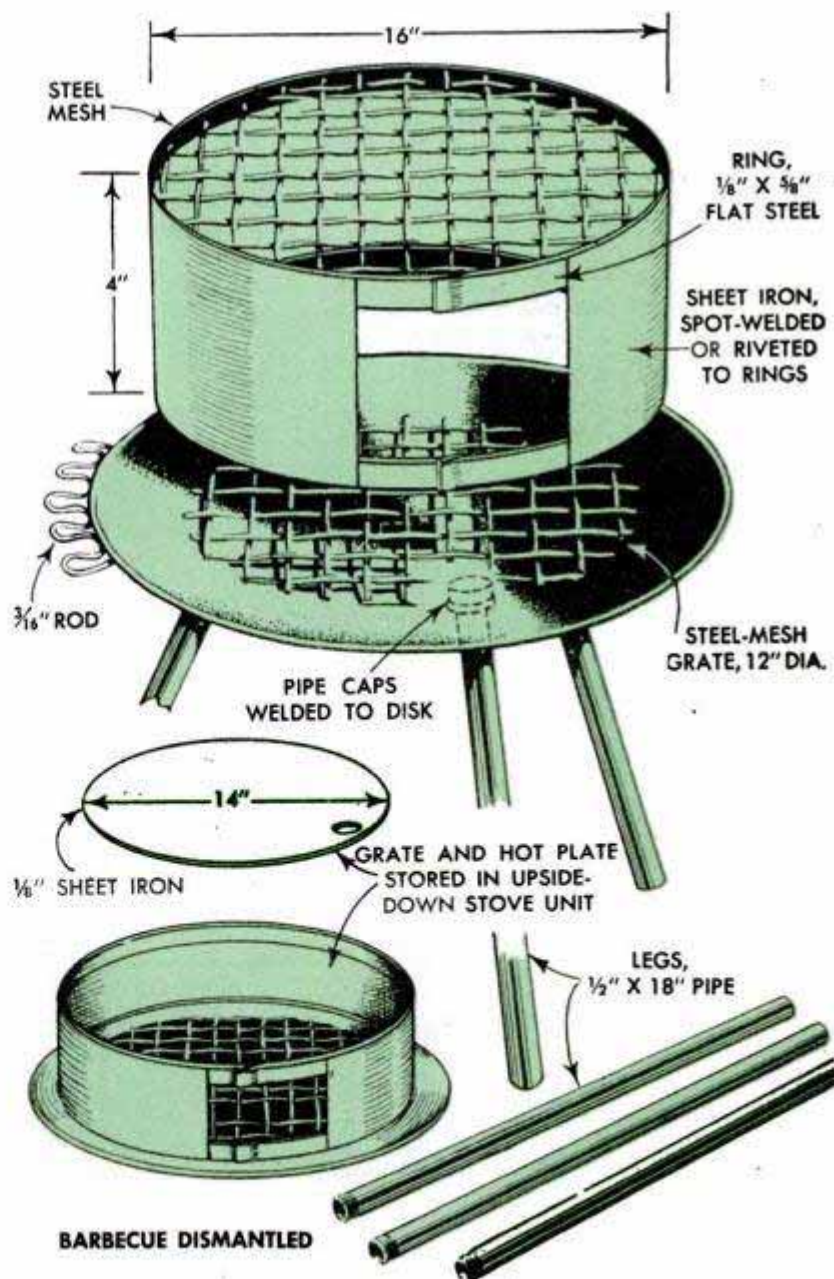

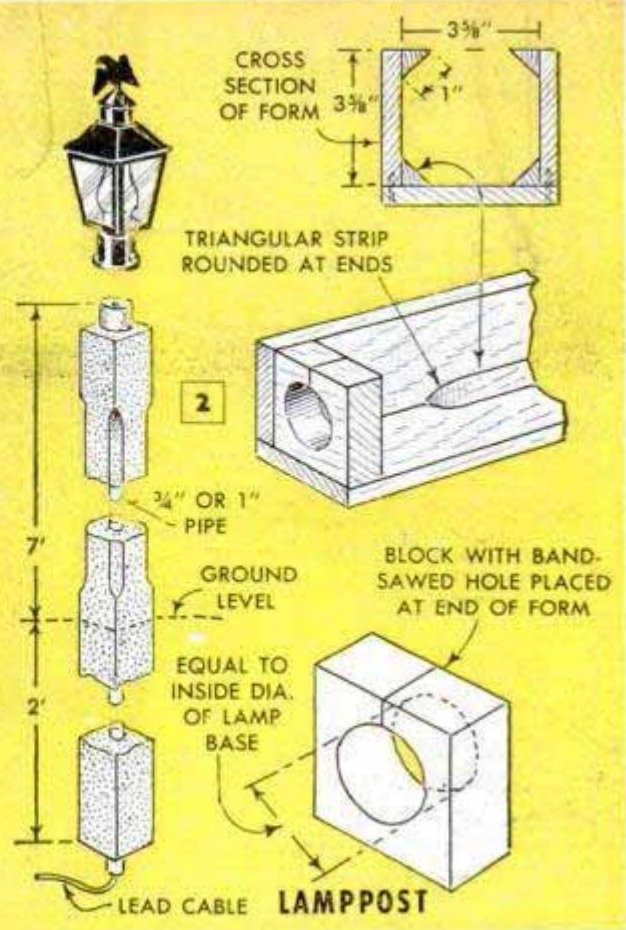
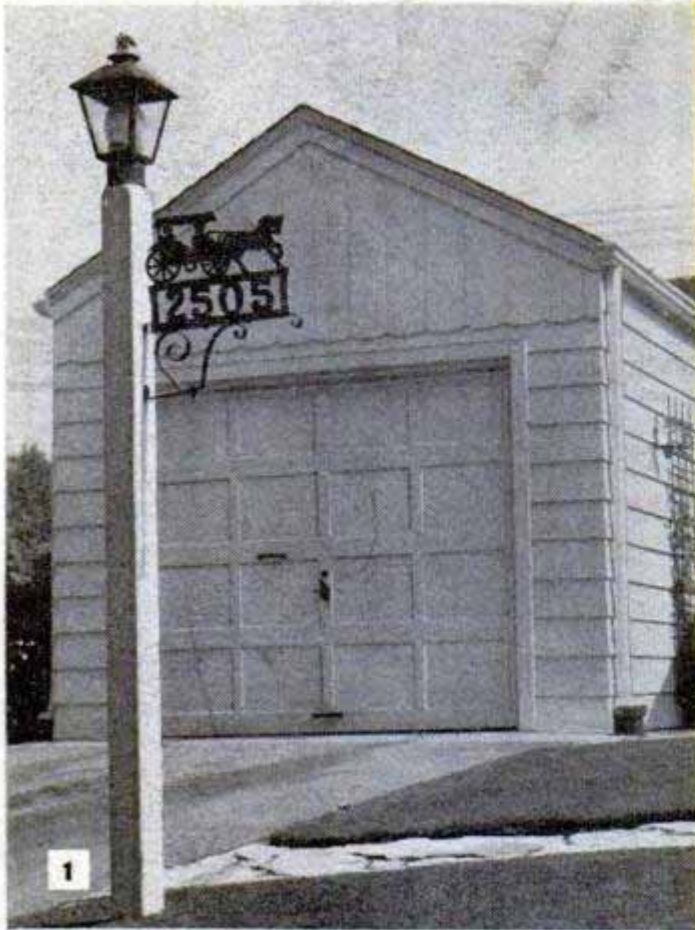

CONCRETE IMPROVEMENTS

By E. R. Haan

WHEN PERMANENCE is the main requirement in exterior home improvements such as lampposts, steps and fireplaces, it's generally more practical to use concrete. This common building material can be mixed in attractive permanent colors, is rot, fire and termite-proof and, when properly mixed and poured according to approved specifications, will withstand weathering and extremes of temperature over long periods of time without damage. It also has a decided advantage in economy and ease of handling. Homeowners without any previous experience in working with concrete can tackle many jobs single-handed with assurance of good results right from the start.

Lamppost: A concrete lamppost of the kind shown in Figs. 1 and 2 is cast in a three-sided form. If you use lumber with a pronounced grain for the form, the wood grain will be imprinted attractively in the concrete post. Chamfered corners are formed on the post by triangular strips rounded at the ends and nailed to the inside corners of the form as in Fig. 2. The post should extend into the ground below the normal frost level. If the lamp has a round, hollow base, the upper end of the post is cast round to fit it by nailing a wood-

en block in the end of the form. A hole is bandsawed in the block, its diameter being slightly less than the inside diameter of the lamp base. The hole forms a boss on the top end of the post. A length of pipe supported at each end of the form serves the double purpose of reinforcing the concrete and providing an opening for the wiring. White cement often is used for this job so it will not be necessary to paint the post. Use a mix of 1 part cement, $2\frac{1}{4}$ parts sharp sand and $2\frac{1}{2}$ parts of gravel screened to $\frac{1}{2}$ in. in dia. Add sufficient clear water to make a smooth mixture. Work the concrete into contact with every part of the form, especially at corners, to avoid air pockets.

Concrete flagstones: Precast concrete flagstones, Figs. 3 and 4, need be made only $1\frac{5}{8}$ in. thick if they are reinforced with welded fence wire as in Fig. 4, B. Build the form as in detail A. Note that the sides and ends are hinged so they can be swung outward to remove the slabs easily after they have hardened for two or three days. The form shown produces enough flagstones to lay a $4\frac{1}{2}$ -ft. section of walk about 30 in. wide, arranged as in detail C, each alternate section being reversed. Such irregular patterns as the one in detail D also are possible. The form shown in Fig. 4, A, requires nearly $1\frac{1}{2}$ cu. ft. of concrete to fill it. A



Around the HOME

1: $2\frac{1}{4}$: $2\frac{1}{2}$ mix is recommended, with the gravel screened to $\frac{1}{2}$ in. in dia. Flagstones can be cast with colored concrete if desired. Brush the forms liberally with oil, clean them after each casting is removed, and re-oil before using again. Cut the reinforcing wire with a heavy-duty cutter so that each piece is slightly smaller than the slab. After filling the form half full, press the wire in place, then fill to the top and strike off level.

Concrete steps: For permanence, build steps on a 6-in. foundation wall extending below the local frost level, Figs. 5 and 6. In sandy soil a double form is needed, but where soil is stiff enough to resist caving, an inner form usually is sufficient. After the foundation has hardened, fill the hole, tamp the gravel fill and build the form for the steps. Note that tie strips are located well above the edges of the form boards to allow room for finishing the concrete with trowel and edger. Treads should be 10 to 11 in. wide and the step height 7 to 8 in. Slanting the risers inward 1 in. at the bottom provides added toe space. In this case the edges of the riser forms should be planed at an angle to fit flush with the tread surfaces. If one riser must be of slightly less height than the others, it should always be located at the bottom for maximum safety. If you notice that the first tread bulges up when concrete is poured to the second

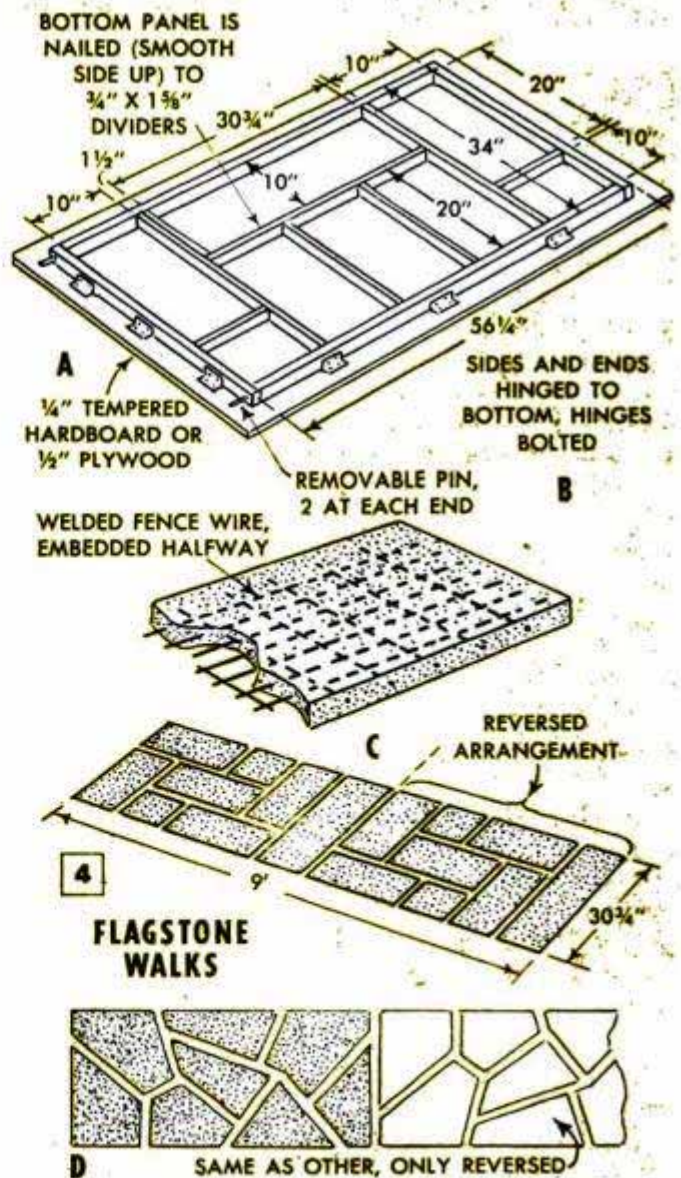

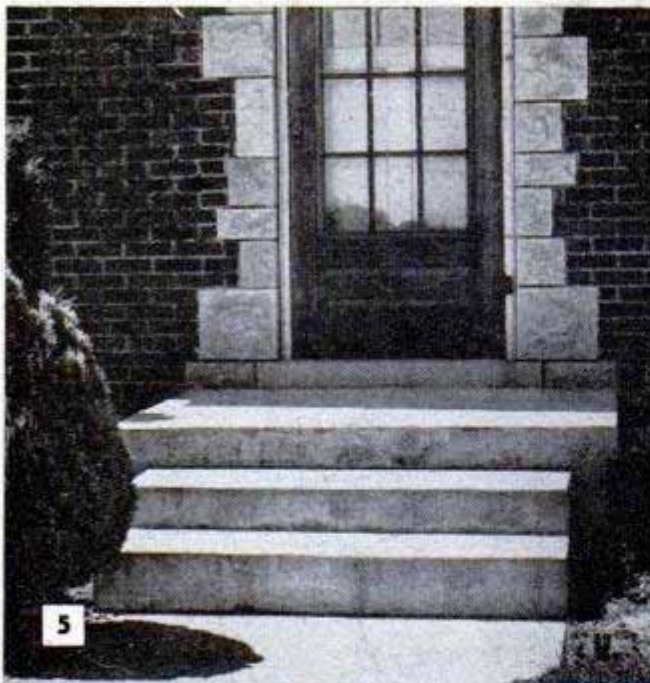

5

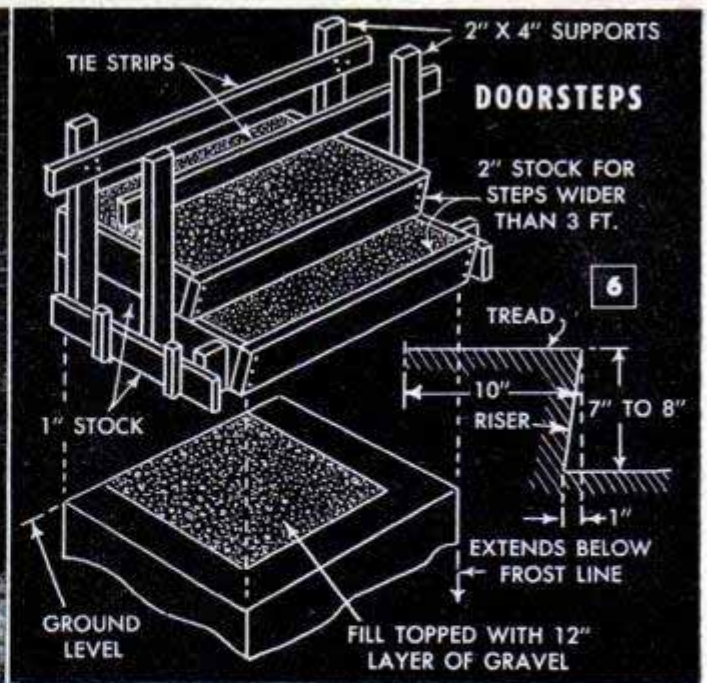

6

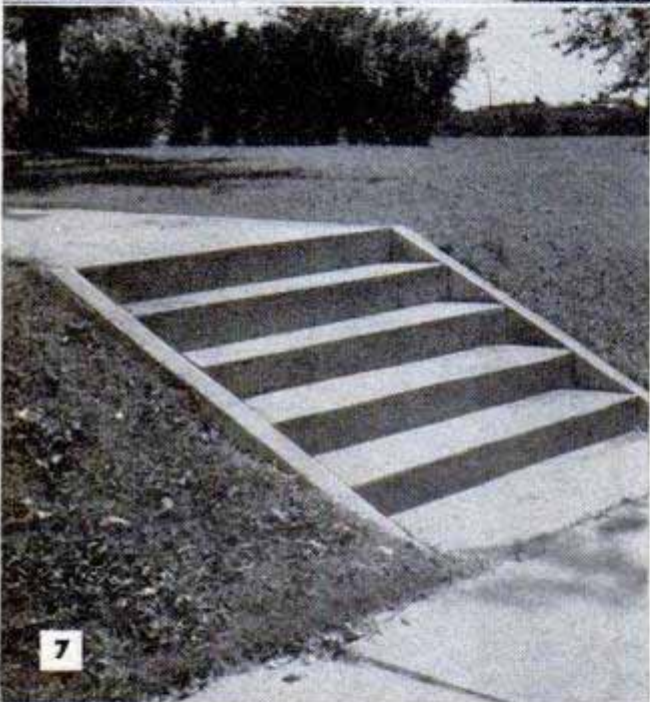

7

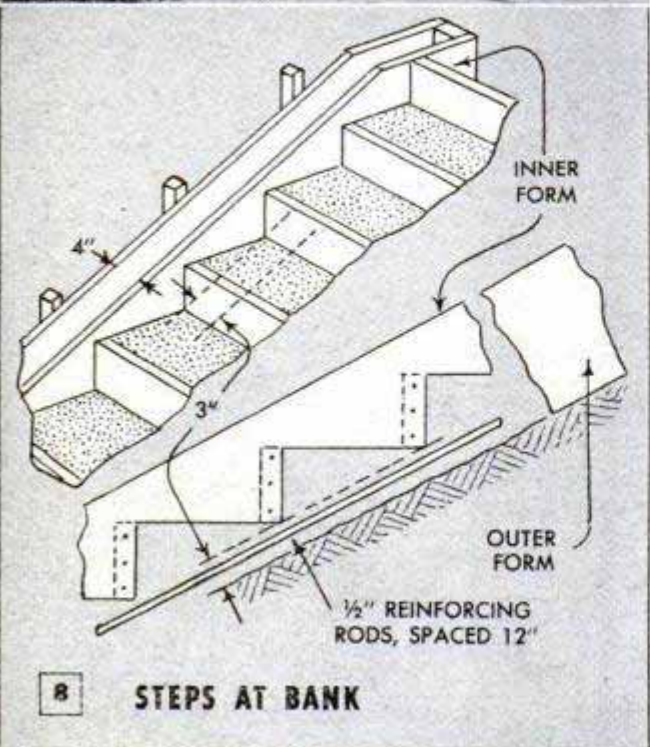

8

STEPS AT BANK

tread level, the mix is not stiff enough. To avoid trouble let the concrete of each tread level set several hours; mix a new batch for each step. Round the edges of the treads with an edger after finishing with a trowel or float. Steps on a bank, Figs. 7 and 8, should have side walls made by using a double form. The earth should be excavated below the treads to produce a continuous slab 3 or 4 in. thick, which is reinforced with $\frac{1}{2}$ -in. rods. A mix of 1: $2\frac{1}{4}$: 3 is recommended for steps, the gravel being screened to $\frac{1}{2}$ in. in size.

Garden seats: Garden seats of the type shown in Figs. 9 and 10 consist of a reinforced concrete seat slab laid on two supports. Reinforce the seat with iron rods or welded fence wire. Cast the seat in the inverted position so that you can embed bolts by holding them in place with crosspieces nailed to the sides of the form about 6 in. from the ends. To form neat edges on the seat, nail $\frac{3}{4}$ -in. quarter-round and cove molding to the inside of the form as in Fig. 10. A piece of tar paper laid on the bottom of the form made up of boards will provide a smooth surface and prevent imprinting of the wood grain. Brush oil on the forms before pouring concrete. Note how the sides of the form are held from spreading at the ends by cleats on the end forms, and how blocks and wedges are used to hold the form in position. The embedded bolts in the seat fit correspondingly spaced holes cast in the supports by means of greased dowels driven through holes in the form. The bolts are screwed into expansion sleeves. The form for the supports is made in the same way as the seat form except that sheet metal is used to form the curved edges. Use a 1: $2\frac{1}{4}$: $2\frac{1}{2}$ mix with gravel screened to $\frac{1}{2}$ in. in dia. Trowel the concrete against the edges and into the cor-

ners of the form before it has been completely filled. Although the castings can be removed from the forms in two or three days, keep them covered with wet grass clippings or straw for a week to ten days before assembling. In the meantime pour the footings for the seat supports in the desired location in the garden. If you prefer a bench having a wooden seat and backrest on concrete supports, or endpieces, follow the design shown in Fig. 11.

Porch floors: Perhaps you have been planning a screened porch with a concrete floor, such as the one in Fig. 12. Concrete porch floors laid on newly graded soil or raised slightly above grade should be supported on concrete piers extending to well-compacted soil below the frost level as in Fig. 13. If the soil is heavy, the holes for the piers can be dug with a posthole auger, but if sandy, use sheet-metal furnace pipe for forms. Build the edge forms so the floor will slope $\frac{1}{4}$ in. per foot for drainage. Then fill the space below the floor with tamped gravel and pour the concrete, using a 1: 2 $\frac{1}{4}$: 3 mix. Reinforce in two directions with iron rods. Reinforcing is necessary since most of the floor weight will be carried on the piers. A mastic joint between the porch floor and the house wall allows for slight expansion and contraction without breaking the seal. You can use mastic strips or you can insert a wedge-shaped form board between the wall and the slab to leave a space to be filled later with oakum and roofing cement or hot asphalt.

Birdbath: Figs. 14 and 15 show a concrete birdbath having an attractive fluted

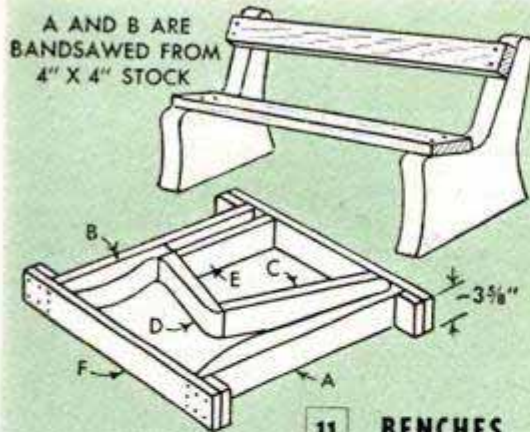
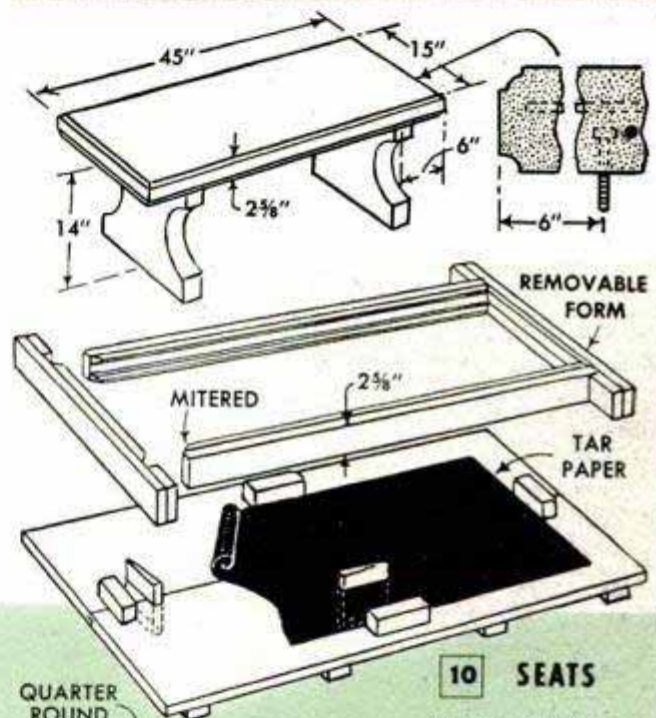

11 BENCHES

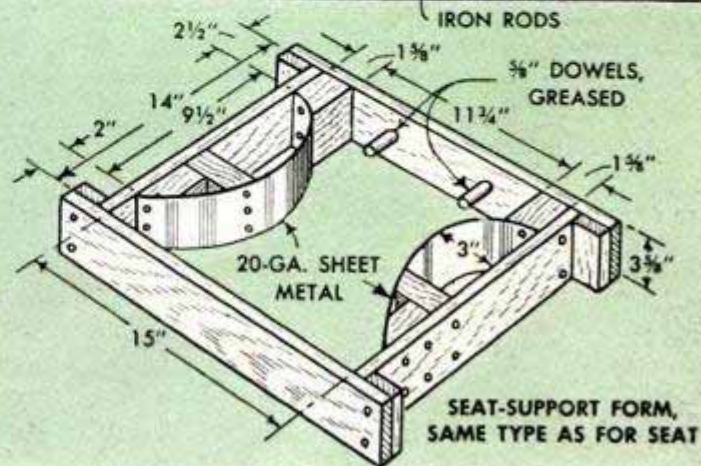
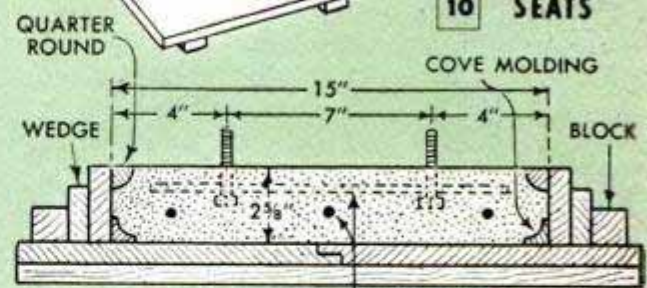
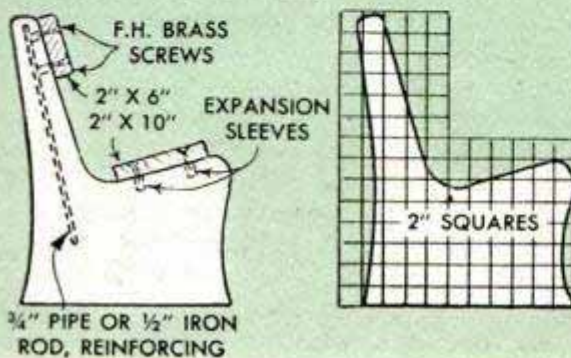

SEAT-SUPPORT FORM, SAME TYPE AS FOR SEAT

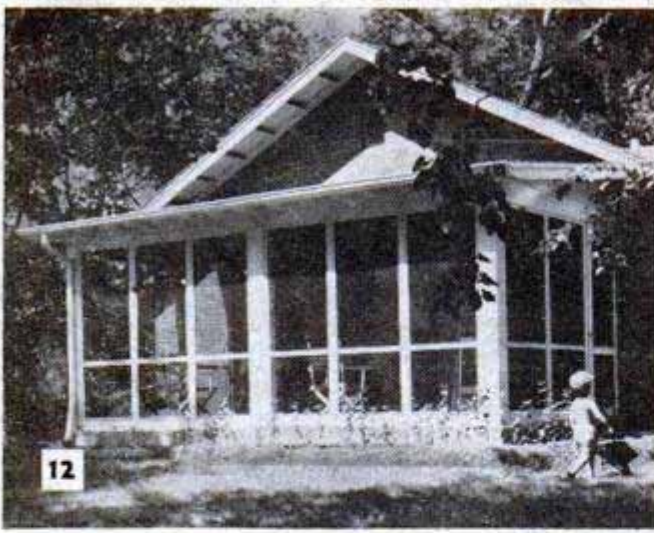

Concrete porch floors laid over new earth fill are supported on concrete piers extending below frost level. Holes for piers are dug with posthole auger

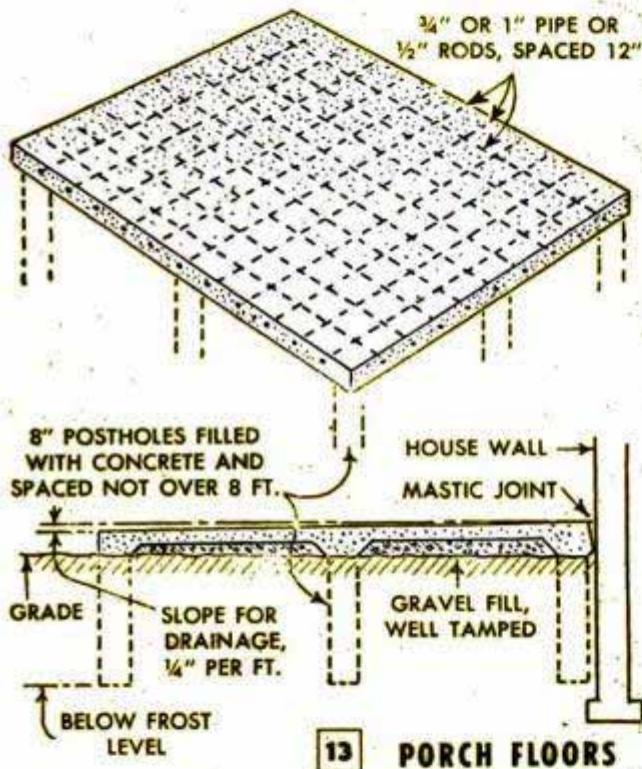

13 PORCH FLOORS

pedestal and a molded base. This design is intended for permanent location as the pedestal extends below the frost level. The bowl is cast with a tapered boss, or lug, which fits into a tapered hole in the top of the pedestal. The inside contour of the bowl is formed with a clay or mortar core, made as in the upper detail in Fig. 15, using a pivoted sweep bandsawed to the proper curvature. A sheet-metal strap nailed to the end of the sweep slips over a rod projecting through the platform and into the ground. The bottom of the bowl is formed with a sweep in the same manner. The clay core should be thoroughly dry and must be coated with heavy oil before forming the bowl over it. The end blocks of the pedestal form are split turnings and the flutes are formed

by alternate straight and half-round strips nailed to square blocks, which are first cut in half and a semicircular cut handsawed in one edge of each piece on a 6-in. radius to form a round opening when the two halves are assembled. Level the form over a posthole dug in the desired location. For sandy soil use a length of 8-in. furnace pipe for the form below grade. This section of the pedestal should extend below local frost levels. For reinforcing the pedestal, center a length of 1-in. pipe in the hole. Four $\frac{1}{4}$ -in. iron rods placed near the edges of the form also can be used. Use a 1: $2\frac{1}{4}$: $2\frac{1}{2}$ mix, with gravel not over $\frac{1}{2}$ in. in dia. for that part of the pedestal below grade. Use only cement mortar (1 part cement to 3 parts sand) to form the molded section, tamping it to assure contact with the form. Then continue with the concrete mix, but resort to cement mortar again at the top turning. The hole at the top of the pedestal is formed by a greased wooden turning which is slightly tapered. Embed a 6-in.-wide band of welded fence wire in the mortar around the hole.

Vases and urns: You can make attractive vases and urns, Figs. 16 and 17, from cement mortar without using molds by applying the mortar in successive layers to expanded metal lath held on a removable form. After determining the size and design of the vase, Fig. 17, make a full-size pattern of it on heavy paper. Allow $1\frac{1}{8}$ in. for wall thickness and mark this off on the pattern so that you can determine the width of the stock for the ribs. Bandsaw the ribs to identical curvature and also bandsaw three disks, two for the top and one for the bottom. After assembling the form, drill center holes for $\frac{1}{2}$ -in. pipe. Then cover the form, including the bottom, with metal lath. Don't attach the lath to the form with nails or staples as it must be removed. Next, make the platform on which the inverted form is rotated while applying the mortar. A sturdy template, or sweep, is firmly mounted on the platform to serve as a guide for applying mortar and also as a support for the $\frac{1}{2}$ -in. pipe. A suitable mortar is made by dry-mixing (by volume) 1 part portland cement, 3 parts sharp sand and $\frac{1}{10}$ part hydrated lime. Add water to make a rather stiff mixture and let it stand for an hour or so before using. Apply the mortar in three successive $\frac{3}{8}$ -in. coats, one full day apart. The first coat should anchor securely to the lath and just cover it. Don't trowel the surface smooth as the next coat will key better to a rough surface. To check on the thickness of the first coat, hold a small $\frac{3}{4}$ -in. block between the template and the mortar while rotating the form. Application of the second and third coats is similar. Before applying these, wet the

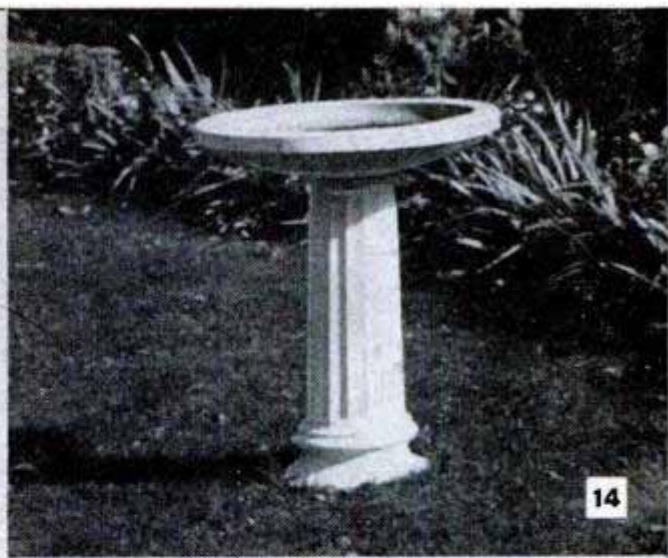
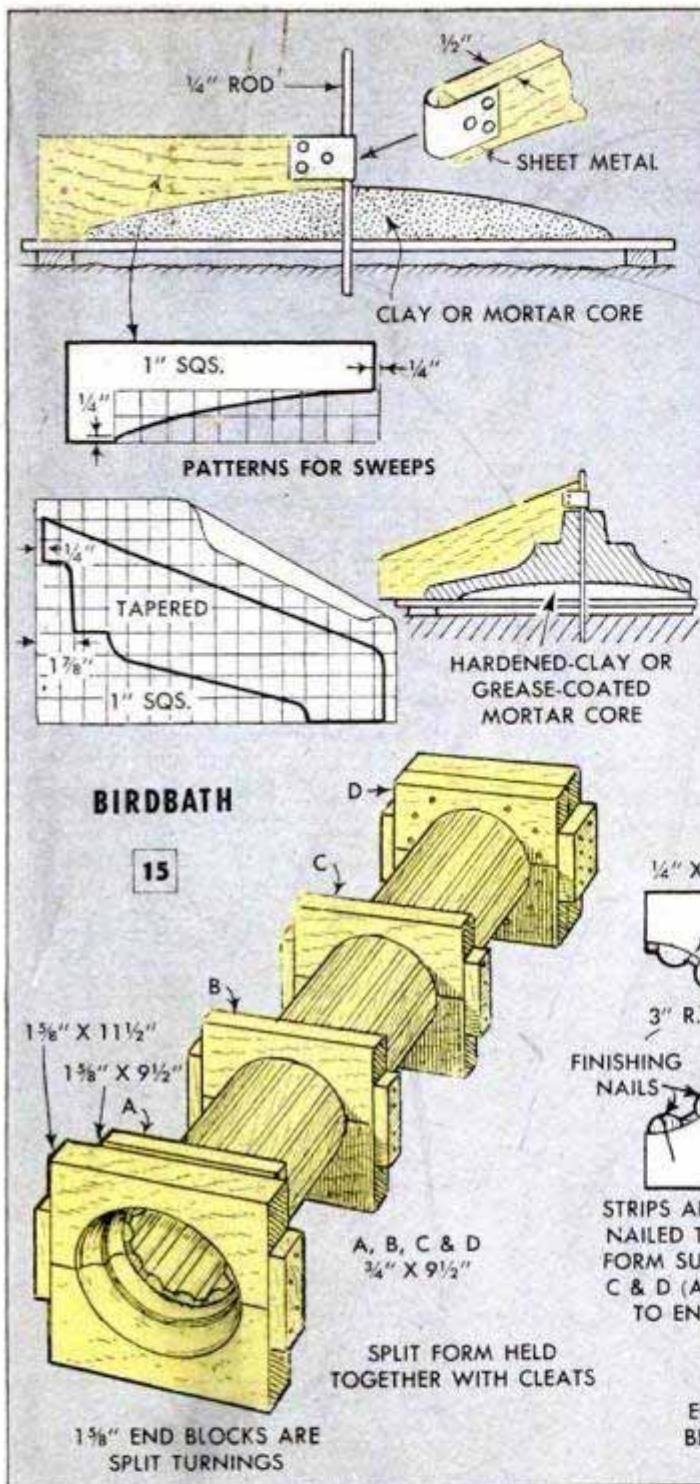

14

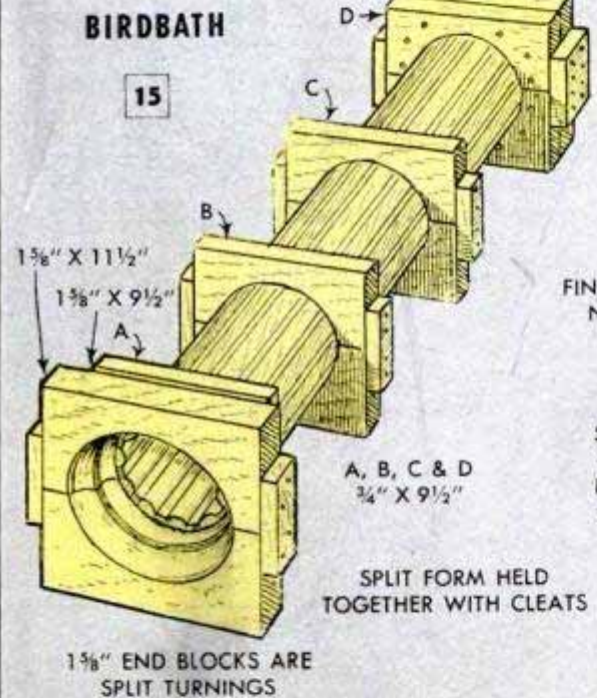
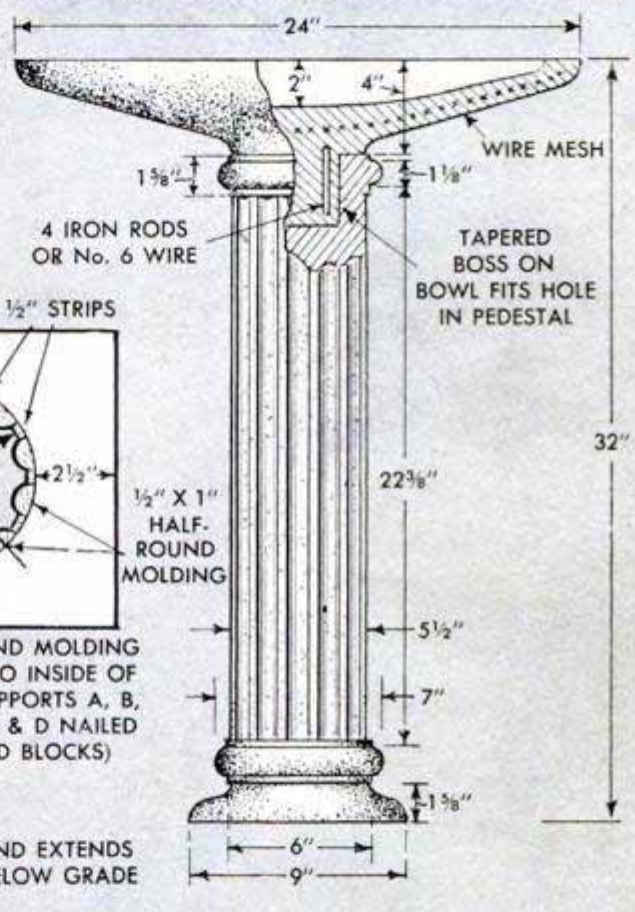

15

previous coats thoroughly. The last coat is trued by rotating the form against the stationary sweep which has a beveled edge to produce a smooth finish. After the mortar has hardened so it resists marking, wrap the vase in several layers of burlap and keep this wet for a week. Slow curing of the mortar gives it maximum strength. Then remove the base from the platform and unscrew the two disks at the top, after which the ribs can be pulled out easily. If the bottom disk is swollen from moisture, wait until it dries and shrinks before attempting to dislodge each half with a punch inserted through the hole in the bottom of the vase. This hole is filled with mortar when finishing the inside of the neck.

Trash burner and fireplace: To eliminate

an unsightly wire trash burner, substitute one of concrete, Fig. 19, A. First pour a 6-in. concrete slab, reinforcing it with 1/4-in. iron rods or pipe. The form for the slab is shown in detail B. It should be about 4 in. larger each way than the burner and should be flush with the grade so that the grass edging can be cut with a lawn mower. The burner forms, detail C, are built with sheathing board or plywood and are cleated with 1 x 2 and 2 x 4-in. stock. A rectangular box-type form is fitted between the inner and outer forms to produce the draft opening. It also serves to hold the inner form in position while the concrete is being poured. The inside form is cleated on the inside corners, and similar cleats are nailed on the outside of the outer forms, with adjacent sides

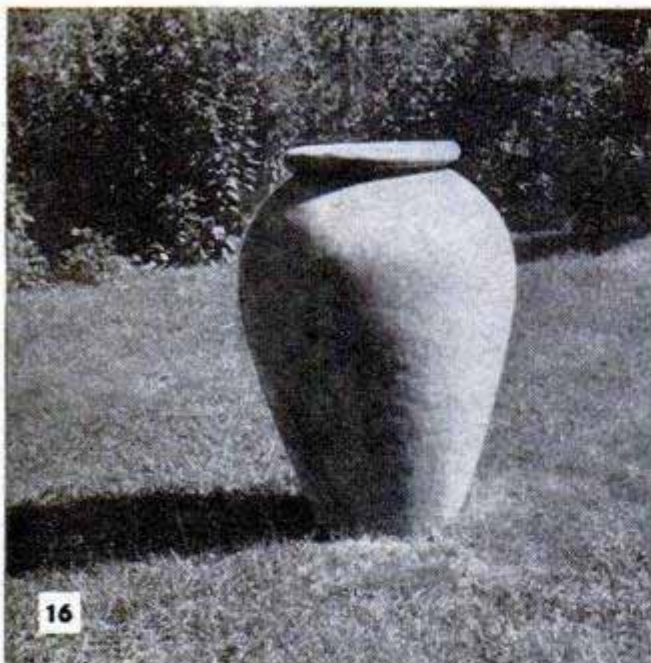

nailed to them, one from the inside and the other from the outside. Only a single support placed edgewise is needed on each side of the outer form. These supports are held by tie strips at the top, and braces and stakes at the bottom. A similar procedure is followed in making a charcoal-burning fireplace, Figs. 18 and 19, D. If desired, this can be used as a trash burner. Four bolts or 6-in. lengths of $\frac{1}{2}$ -in. iron rod are embedded in the walls to support the top grate. Only two are needed for the lower grate as it rests on concrete at the front. The bolts or rods are inserted through holes bored in the form. Be sure to get them level, particularly those for the top grate. Don't use iron rods extending across the opening as expansion of the rods when heated may crack the walls. For grates you can use discarded refrigerator or stove shelves of welded construction. Or, you can make grates as in detail E. Trash burners and fireplaces should be reinforced by using welded fence wire. Use a 1: $2\frac{1}{4}$: 3 mix, with gravel not over $\frac{3}{4}$ in. in dia. Where heaving frosts are likely to tilt the slab, the foundation walls should extend below the local frost level. Don't light a fire until after the concrete has cured for two weeks, during which time it should be kept moist by covering with burlap sacks and soaking them thoroughly every day.

Making good concrete: One sack of portland cement contains 1 cu. ft. by volume. Proportions for dry mixes are measured by volume also, and this should be done accurately. Use only clean sharp sand. Both sand and gravel should be free from vegetable matter, clay, loam and dirt. Cement and sand are mixed first, then the gravel is

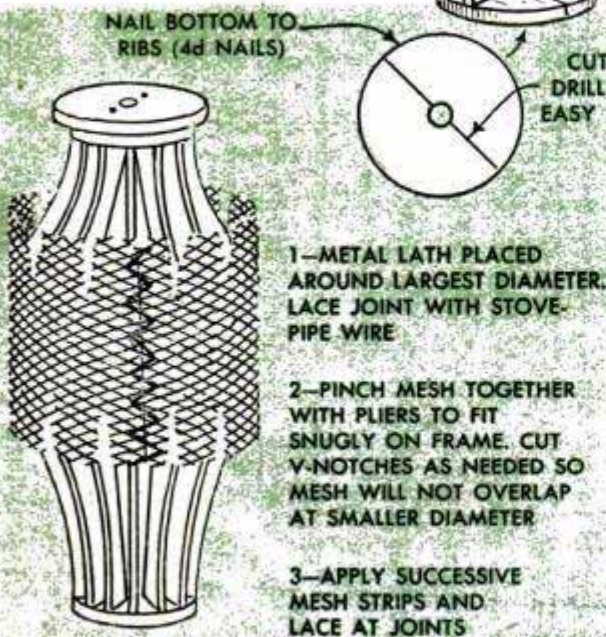
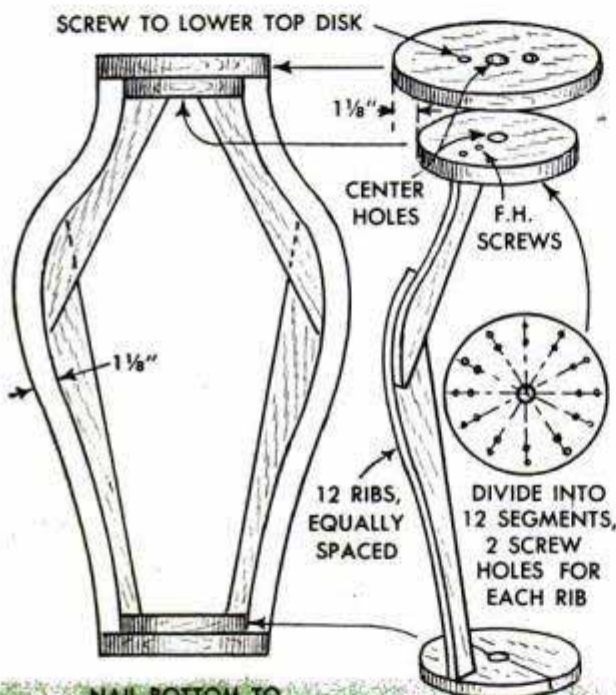

17 CONCRETE POTTERY

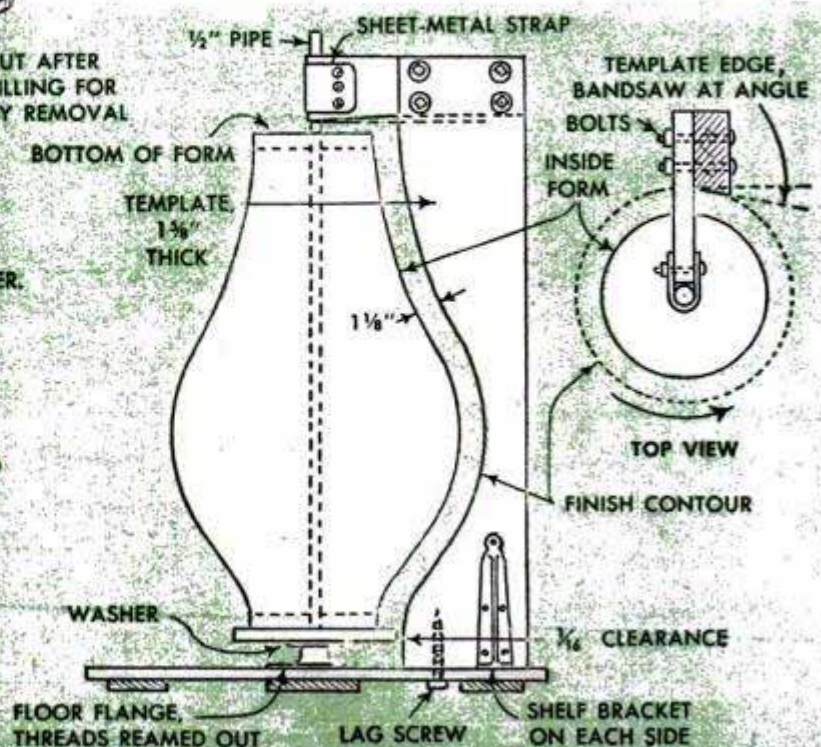

added and mixed. Proportions of mixes are given in the same order. For example, a 1: 2: 3 mix is composed of 1 part cement, 2 parts sand and 3 parts gravel. The water used for mixing concrete should be clean and the amount added after the dry aggregate has been thoroughly mixed should be just enough to produce a workable mixture. From $3\frac{3}{4}$ to $6\frac{1}{4}$ gal. of water are used for each sack of cement, or proportionally smaller quantities for less cement. The minimum amount of water will produce a mix varying from a pouring plasticity to a stiff consistency depending on the degree of moisture present in the sand and gravel. When a mix is too stiff, it will not make uniform contact in the form, resulting in air pockets and stony spots that detract from good appearance. Working the mix into contact with the forms is possible only if it is plastic enough to work easily. Concrete and mortar should be placed in forms not later than 45 minutes after mixing. Never let newly poured concrete dry out; keep it moist for a week to ten days. Large surfaces, such as porch or patio floors, can be covered with straw and loose earth. This must be kept moist by frequent sprinkling. Remember to cover not only the surface but, if the forms are removed, the edges of the slab as well. Shovel earth against the edges as soon as forms are removed.

Coloring concrete: Mineral-oxide pigment, available in several colors, is best for coloring concrete or cement mortar. It is mixed with the sand and can be used in quantities up to 10 percent of the amount of cement used in a batch to give deep shades of color. Thorough mixing after adding water also is essential. ★ ★ ★

Certain photos courtesy Portland Cement Association

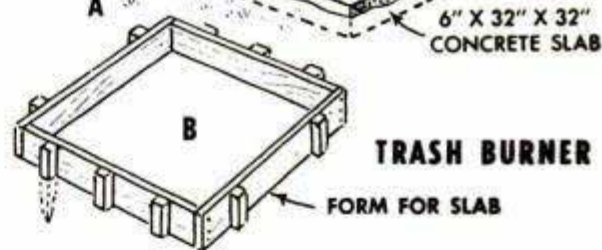
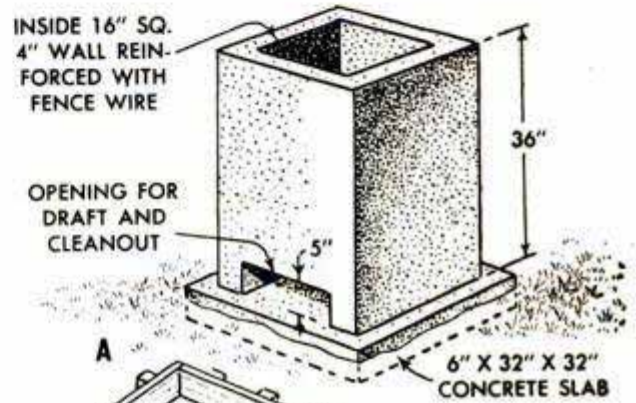
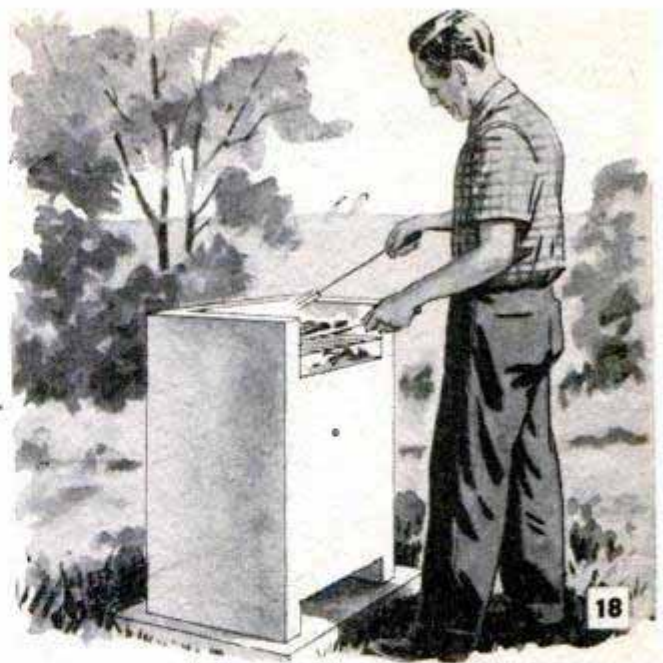

TRASH BURNER

FORM FOR SLAB

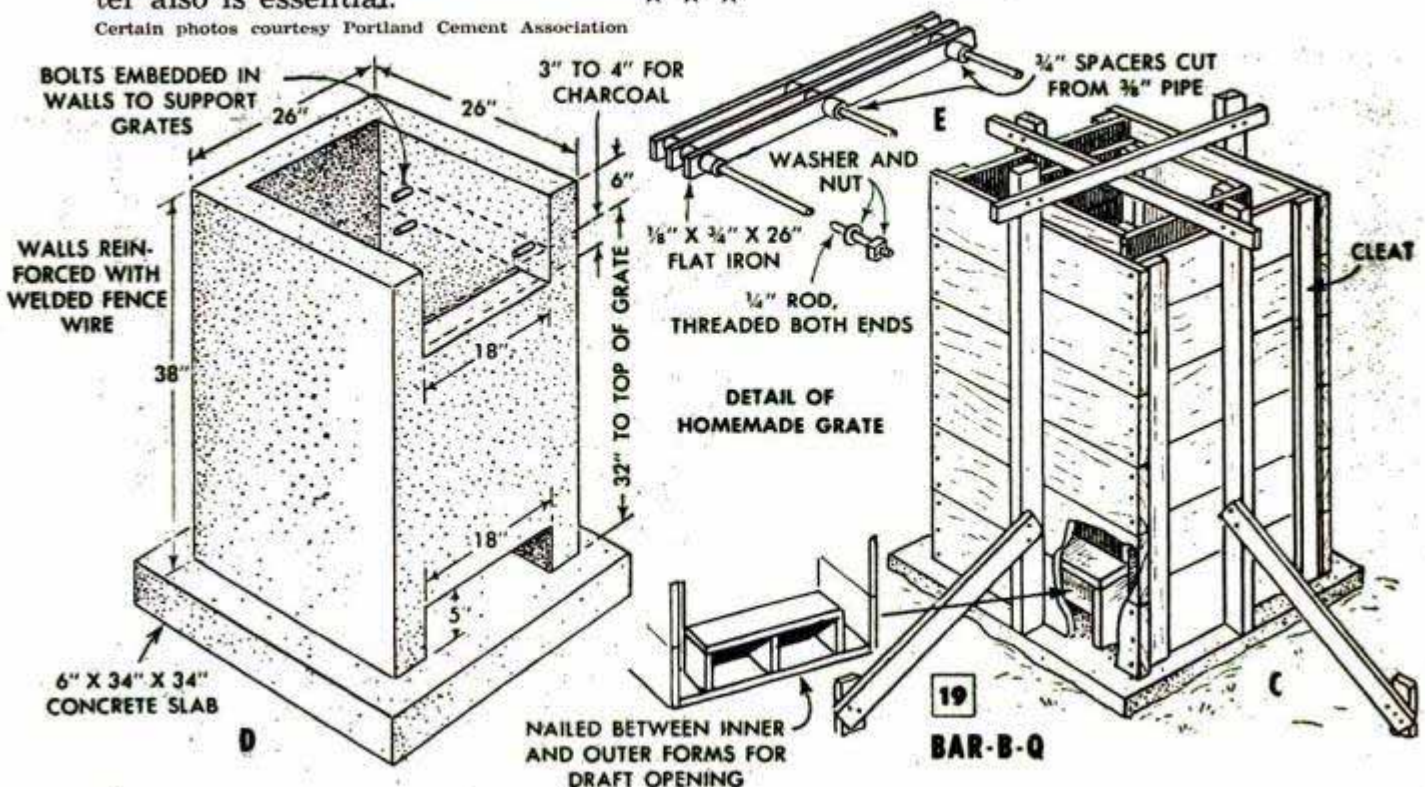

DETAIL OF HOMEMADE GRATE

19
BAR-B-Q

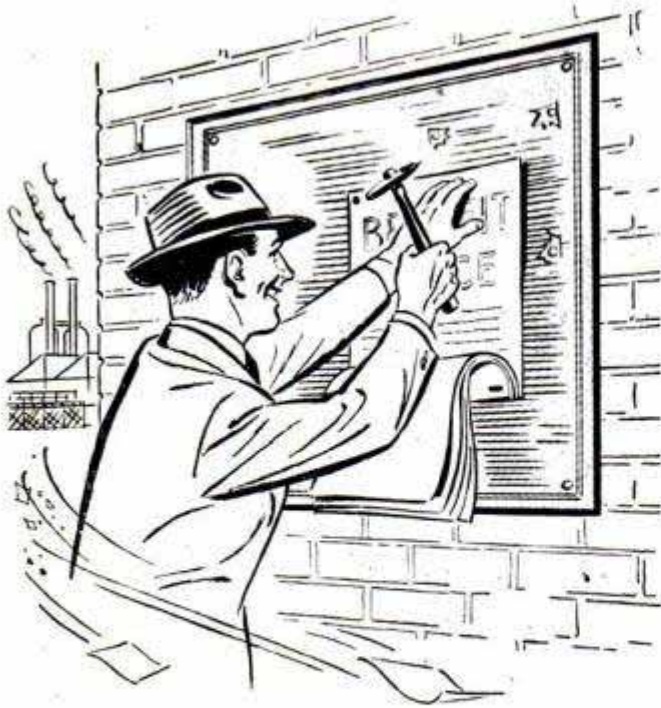

Posters Handled Easily in Wind If Stapled Together

The difficulty of tacking posters to outdoor bulletin boards on a windy day can be overcome easily by stapling them together along the bottom edges to form a pad. In this way, the hands are left free to tack the bottom poster at the upper corners while the remaining ones hang from the staples. After the bottom poster has been tacked near the lower corners, the remainder of the pad is pulled free.

Length of Hose Plugged at Ends Provides Saw-Blade Container

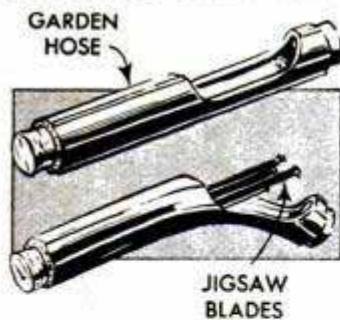

Plugged at the ends with corks, a short length of garden hose cut as shown will provide a useful holder for jigsaw blades. The cut-away portion of the hose simplifies selection of the

blade desired and also provides the opening from which the blade is removed when the hose is bent.

Come and Get It!

Next month we present a feature dear to the heart of the amateur chef—an array of fireplaces and back-yard kitchens that carries visions of tasty frankfurters and broiling 'burgers. The article includes complete plans for building two outdoor ranges and a barbecue cart you can wheel about the back yard. In addition, there'll be a good many photos of complete outdoor kitchens. Don't miss this feature in the July Craftsman Section.

Improved Small-Tool Rack

A simple rack for screwdrivers, files and other small tools is improvised quickly by using a "girder" from a toy construction set. The metal strip, which is ready-punched to take the tools, is fastened to the wall with an angle bracket. Several girders can be joined together to form a long rack.



Thumbtack Stop for Box Cover

On small boxes with sliding covers, a thumbtack pressed through the top of the cover will act as a stop to keep the box from sliding out all the way. The tack is placed near the end of the cover so that its point will catch one end of the box when opened.



Hinges and Screws Kept Together When Mounted on Cardboard

If you have removed a hinge that will not be used again for some time, "screw" it to a piece of cardboard as shown for handy filing in a cabinet or drawer. This will eliminate the possibility of the screws being misplaced, as frequently happens when screws are stored separately for a prolonged period of time.

Benjamin Nielsen, Aurora, Neb.

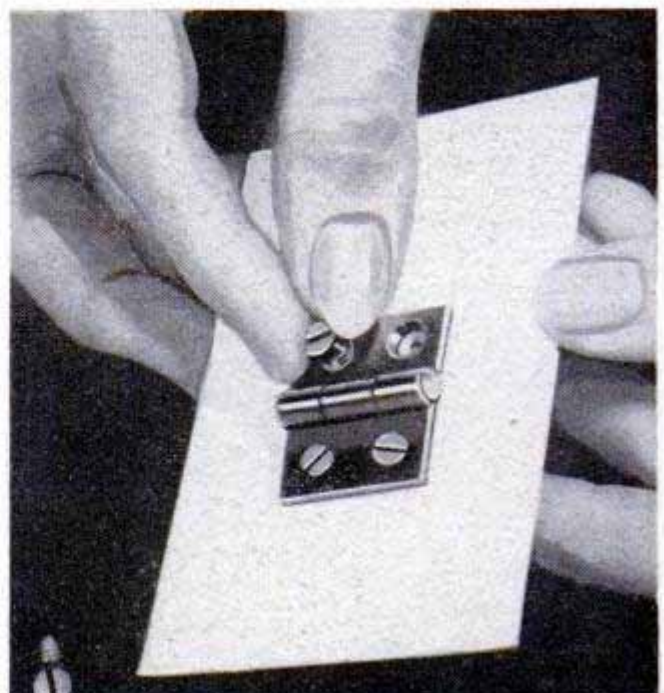

Tumpline CANOE CARRY

By Cal Craig

GOOD FISHING water is never beyond the reach of the experienced canoeman who uses a tumpline to carry his canoe comfortably under difficult conditions. A tumpline, correctly rigged, permits shifting the load alternately from the head to the shoulders without stopping. The tump rig also makes it easier to control the craft when portaging in open country on a windy day. The headband is cut from heavy oil-tanned leather. Although the dimensions in the detail give the width as 2 in., some outdoorsmen may prefer to cut the band 2½ in. wide at the center portion. Soft-leather thongs, or straps, about ½ in. wide are double-stitched to each end of the headband. The thongs should be about 30 in. long, and preferably of rawhide. Drill four small holes through the center thwart, spacing the holes as indicated in the upper detail at the right. Then insert the ends of two short lengths of copper wire through the holes. Place the paddle blades in the position shown by the dotted lines, then twist the ends of the wires together loosely so that the paddle blades are easily inserted and withdrawn from the wire loops. Now wrap and tie the thongs to the thwart, adjusting the tie on each thong so that the headband hangs just above the bottom of the canoe

Photos by Chuck Kinter

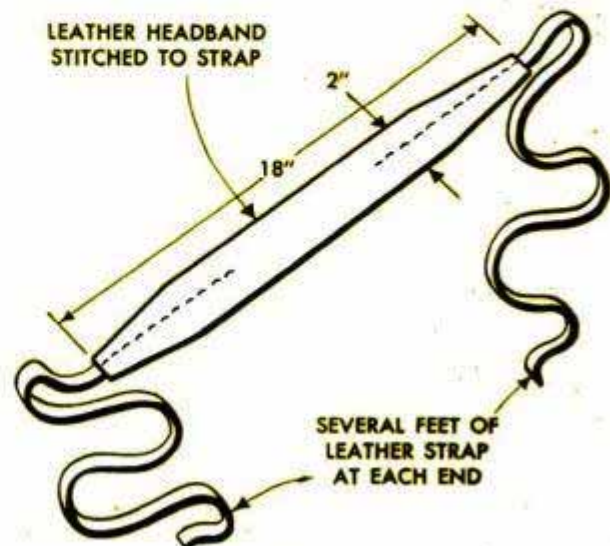
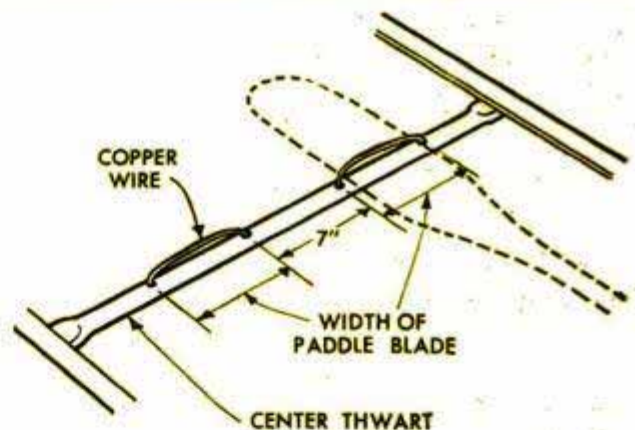
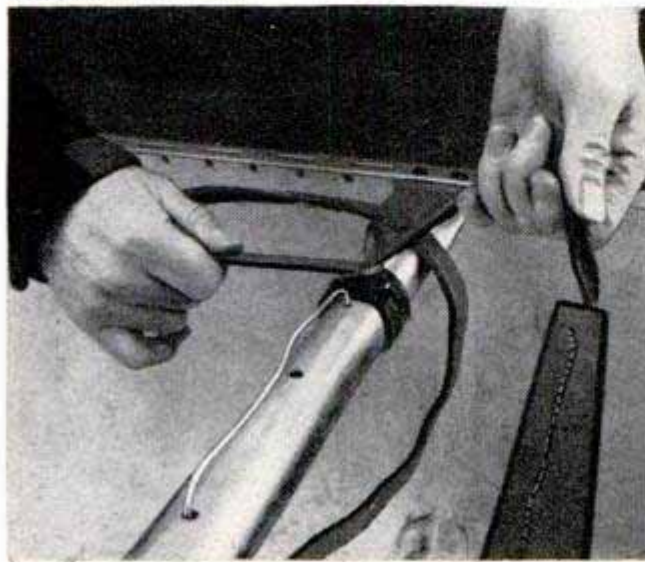

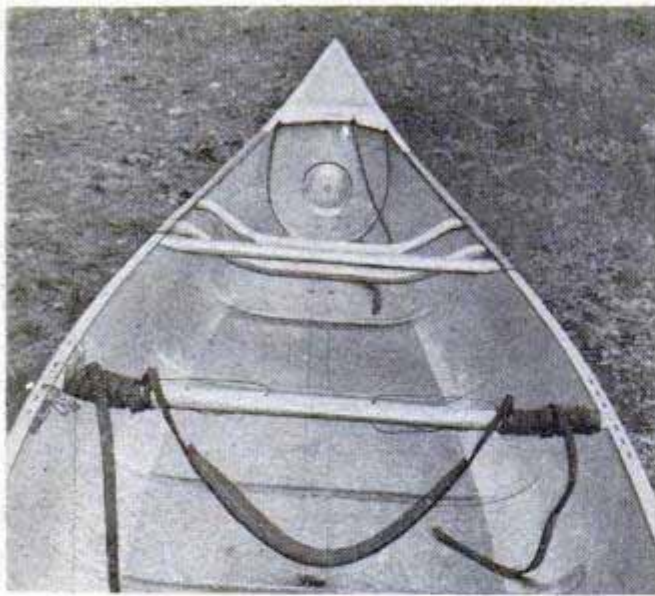

Leather thongs attached to the ends of the tump-line are wrapped around the center thwart and tied so that the line just clears the bottom of the canoe when hanging free. Some experimenting may be necessary to determine the correct position



The oar blades are inserted under the tump-line and through copper-wire loops attached to the thwart. Shanks of the oars are lashed to the forward center thwart. In this position oars can be made to support all or part of the weight on the shoulders

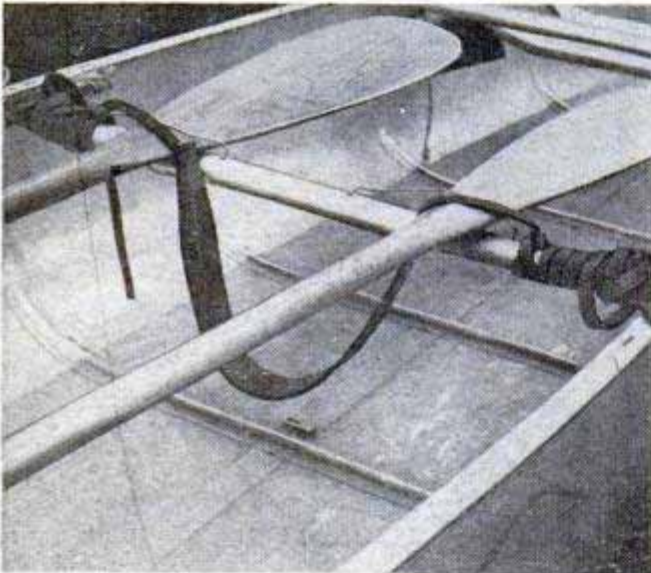

Above, once it has been tied in the correct position the tump-line need not be removed, as it does not interfere with placement of duffel or fishing gear in the mid-ship section of the canoe. Below, the first step in lifting an all-metal canoe into the carrying position

as in the upper left-hand photo. Then raise the thongs and insert the paddle blades as shown in the upper right-hand photo and also in the center photo at the left. Lash the paddle handles to the forward thwart. To raise the canoe into carrying position grasp the center thwart and lift the canoe onto the knees. Then place the right hand below the gunwale so that the latter will slide into the crook of the elbow. Raise the canoe, turning it simultaneously and lowering the head as in the lower right-hand photo. If the second half of the procedure is carried out as one continuous movement, the headband will fall into position, the paddles resting lightly on the shoulders. By shifting the paddles slightly the weight can be transferred to the shoulders. ★ ★ ★

Next step in the pickup, or lift, is to place the right hand on the side of the canoe below the gunwale so that the latter will slide into the crook of the elbow as the canoe is raised. Then swing the canoe up and over until paddles rest on the shoulders



Folding Porch Chairs Stored by Hanging on Wall

There's a seat for everyone at those friendly summertime gatherings on the front porch if you have a number of folding chairs handy—and with the chairs hung from the porch wall you won't have to get them from the house. In addition, the unused chairs require no porch space and cannot be blown over by the wind. To hang the chairs, drive two screw eyes into the back of each chair and merely slip them over pairs of cup hooks turned into the siding. The hooks are spaced the same as the screw eyes.—R. M. Woodbury, Natick, Mass.

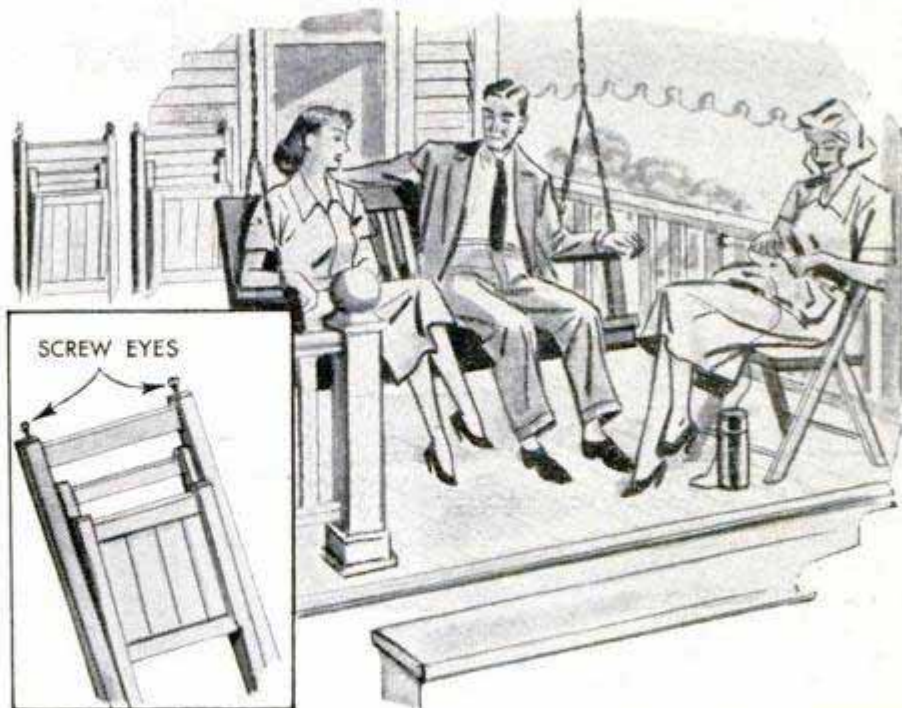

Rock Wool and Spar Varnish Provide Chinking Compound

The three major requirements of chinking compound used on a log cabin are that it adhere firmly to the logs, be resilient enough to compensate for shrinkage and

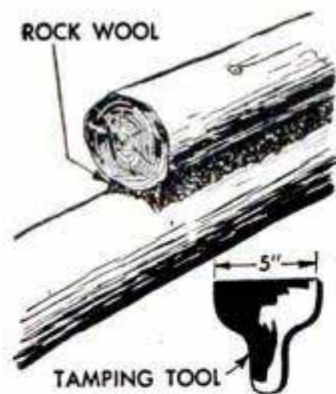

provide effective insulation. These requirements can be met at minimum expense by using rock wool, either the pellet or bat type, and applying it with spar varnish. To chink the logs, first apply varnish in between them, covering only a short section at a time, and pack the wool in place with a tamping tool while the varnish is wet. A tamping tool can be made from $\frac{3}{8}$ -in. wood as detailed. After packing the wool in place, give it a light coat of varnish, using quick strokes to limit penetration.—H. G. Thuesen, Stillwater, Okla.

use. Repeated wetting and drying of the board often will hasten the straightening. Wetting swells the wood fibers on the curved side and tends to force it back into its original shape. Let the board dry in open air since any hastening of the drying with artificial heat may split the wood.

Peter G. Gordon, Lansing, Ont., Can.

Shutoff Valve Fitted With Plug For Draining Pipe in Emergency

It is frequently desirable to convert an ordinary shutoff valve into a drain-type valve to permit draining of a pipe line for repairs and to prevent freezing during cold weather. The operation is comparatively easy, even with the valve connected in the line. First, a small hole is drilled and tapped in the valve chamber on the outlet side of the valve. A short bolt fitted with a rubber or leather washer is then inserted in the opening. With the valve turned off, removal of the bolt will allow the line beyond the valve to drain.

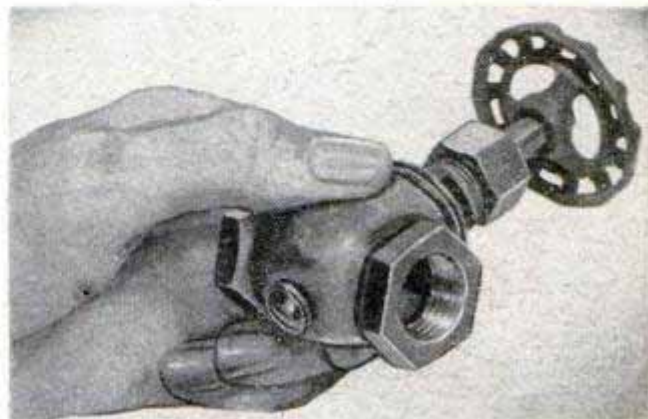

Repairing Warped Ironing Board

A warped ironing board top often can be flattened by turning it over so that the underside is on top. On most boards this can be done by unscrewing two cleats that hold the leg assembly to the board and then screwing them to the opposite side. Ordinarily, the board will flatten after some

By **W. K. Mitchell**
and **Howard B. Birt**

The Electric Starter— Operation, Care and Repair

PROBABLY ONE of the units of the automotive electrical system most taken for granted is the cranking motor, or starter. Although it operates only for short periods of time compared with other parts of the car, its successful performance definitely depends on regular checking and maintenance procedures. The armature in this highly specialized unit rotates at about 1500 r.p.m. in order to crank the car engine at 100 r.p.m.

It operates on the principle that opposing magnetic fields tend to attract each other while similar magnetic fields repel each other. Fig. 1 is a simple sketch of a magnetic field from a permanent magnet in which a single conductor has been placed. Current flowing through the conductor in the direction indicated by the heavy arrow causes a magnetic field to circle the conductor as shown by the circular arrows. As a result a force is exerted on the conductor which tends to move it to the right.

Fig. 2 explains this force. The circular magnetic field around the conductor (indicated by the circular arrow) opposes the permanent magnetic field on the right side of the conductor while it aids the magnetic field to the left of the conductor. Opposition to the magnetic field on the right tends to cancel it, so there is less magnetism to the right of the conductor than there is to the left. The magnetic lines of force are thus distorted around the conductor and exert a thrust on it.

Fig. 3 is a drawing of a simple electric motor with a one-turn armature which indicates how the sidewise thrust on the conductor causes it to rotate and crank an engine. The armature is a single loop of wire suspended between two magnetic poles. The magnetic field of each pole is reinforced by the field coil wound around it. When the circuit between the battery and the motor is closed, current flows from battery through the armature loop, then through the field-coil windings and back to the battery as shown by arrows. On the left-hand side of the armature loop current is flowing in the direction of the loop arrows, which causes an upward thrust on that half of the armature. Since the current is flowing in the opposite direction through the other half of the armature, the thrust on it is downward. These opposing thrusts

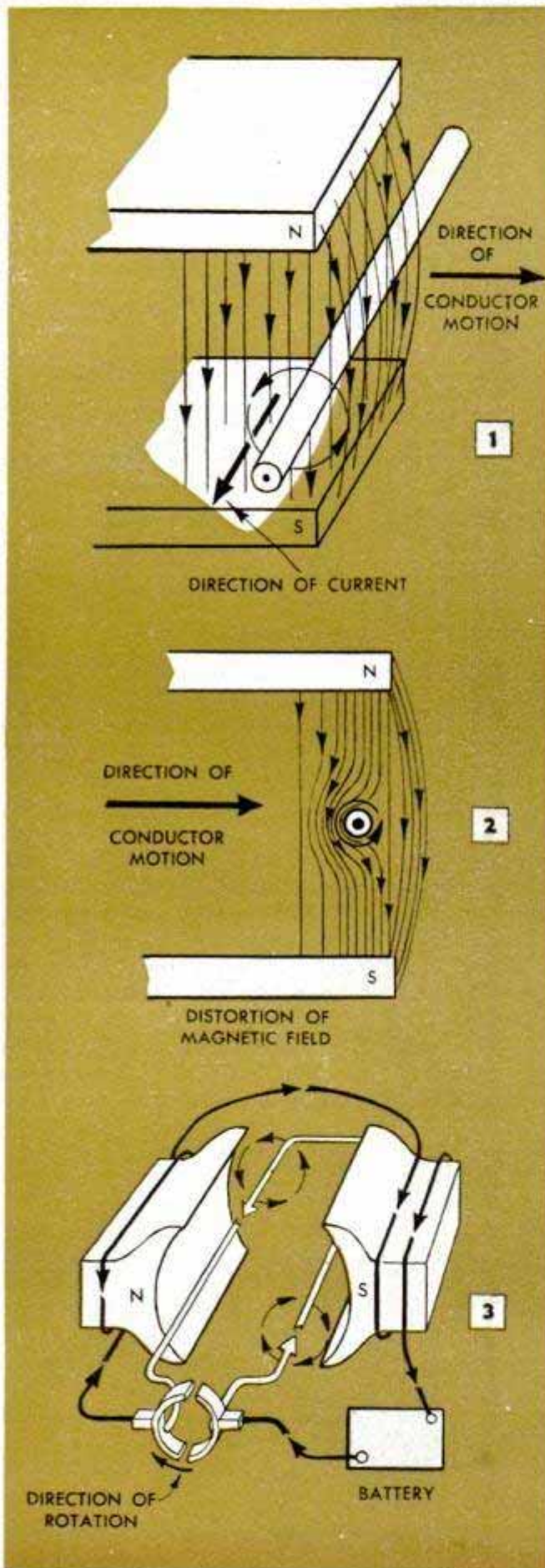

The Starter

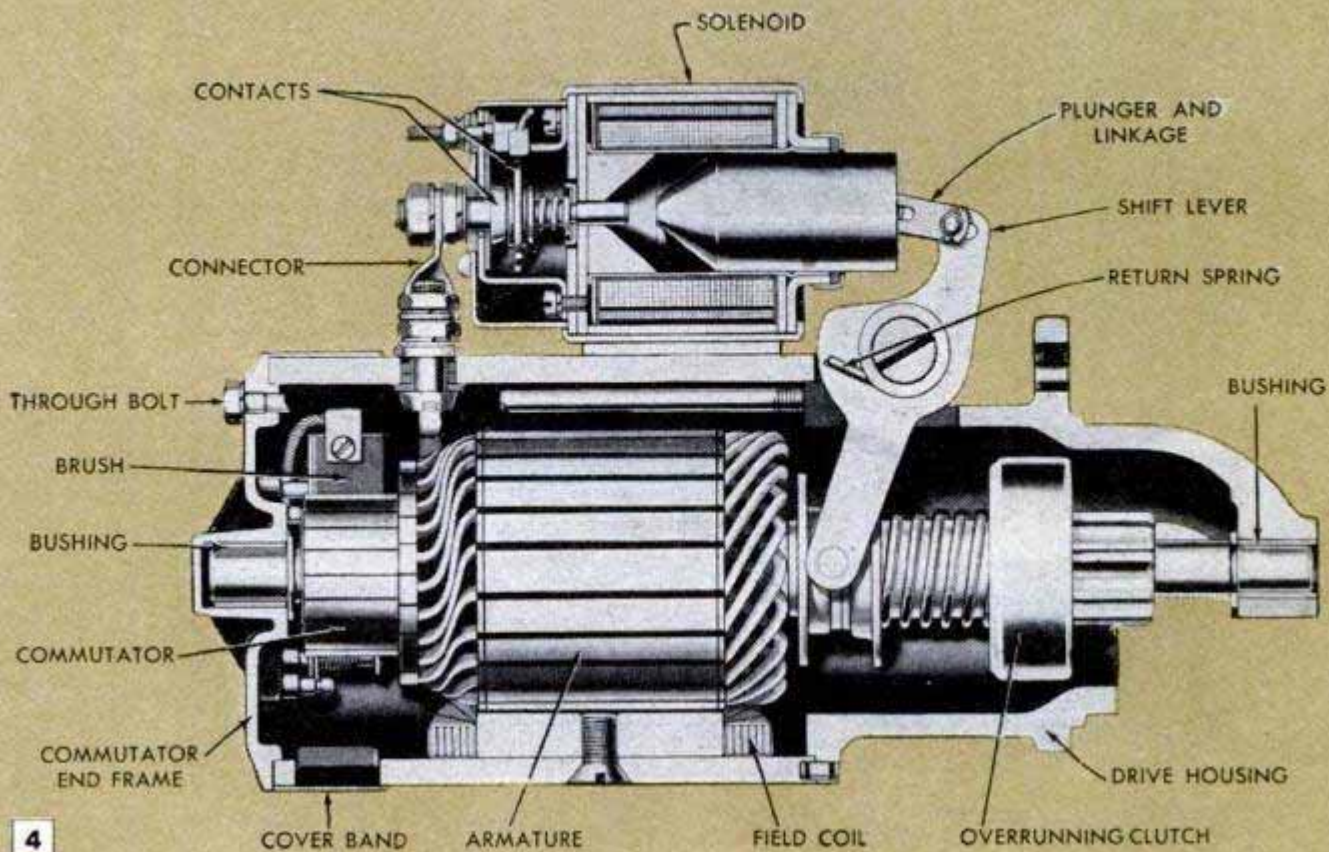

4

cause the armature to rotate in a clockwise direction.

A powerful cranking torque is produced by using many windings in the armature, instead of the single loop of wire, thus multiplying the thrusts on the armature. Fig. 4 is a sectional view of a typical modern passenger-car starter.

All passenger-car starters are much the same in general design and operation, differing mainly in the type of drive used. The drive mechanism has two functions—to transmit the cranking torque to the engine flywheel and to disconnect the starter from the flywheel after the engine has started. Most passenger cars use either the Bendix or the overrunning-clutch type of drive.

A typical Bendix-drive starter is shown in Fig. 5. This drive depends upon inertia to mesh and unmesh the starter drive pinion from the engine-flywheel ring gear. When this type of starter is not operating, the pinion is out of mesh with the flywheel ring gear. As soon as the starter switch is closed, the starter armature begins to rotate and moves the pinion into mesh with the flywheel.

The overrunning-clutch type of drive, Fig. 4, is shifted

mechanically into mesh with the flywheel. This may be done directly by foot pressure on a pedal or by a solenoid switch controlled from the dashboard. Completion of the shift in either case closes the circuit between the starter and the battery. The pinion maintains contact with the flywheel ring gear until the pedal or switch is released.

Briefly, the overrunning clutch consists of a shell-and-sleeve assembly—in which is fitted a pinion-and-collar assembly, Fig. 7—that rotates with the armature. Four tapered slots in the face of the shell take spring-loaded steel rollers. When the shell is rotated by the starter motor, the rollers move into contact with the collar, jamming tightly against it and forcing it to rotate

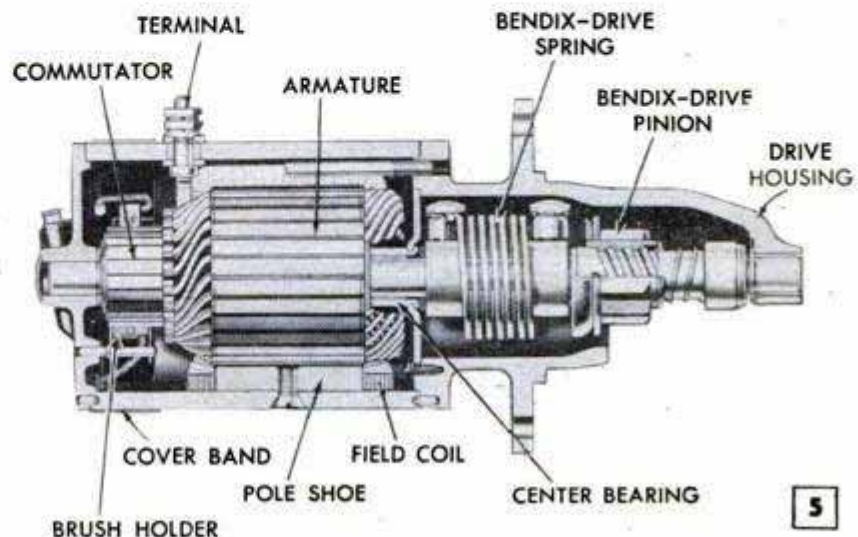

5

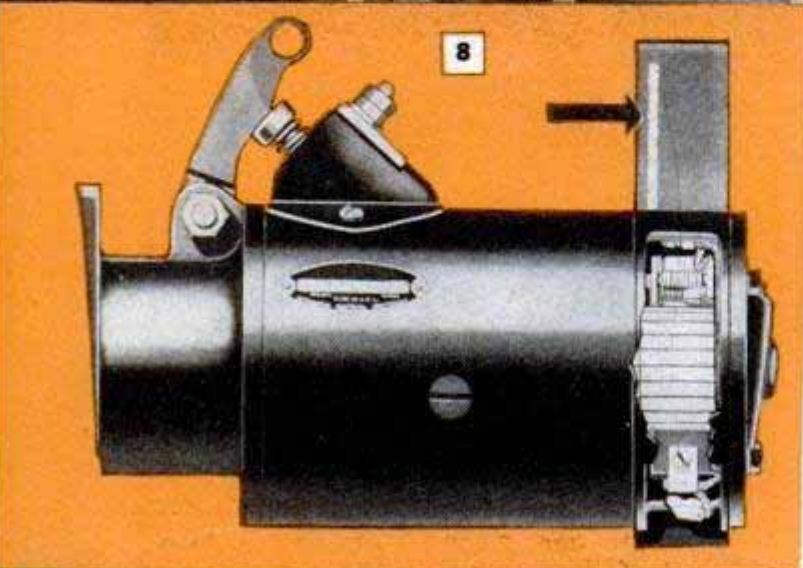
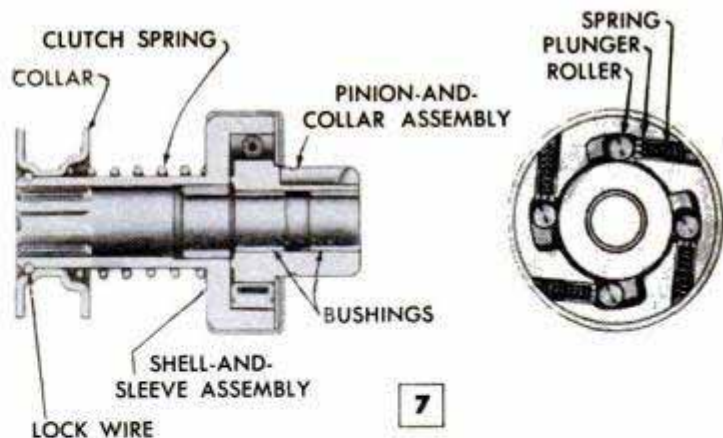

with the shell, thus cranking the engine. When the engine flywheel rotates faster than the shell, the rollers move back in the slots, disengaging the collar and shell so the shell overrides the collar and disengages the starter from the engine.

Obviously, as soon as the engine begins to operate, the starter switch or pedal should be released. Otherwise the drive pinion remains in mesh and continues to overrun the armature, which will cause overheating.

Quick checks and maintenance procedures: Armed with a working knowledge of the operation of his car's starter, a motorist can do much to assure a long and dependable life for the starter. The following trouble shooting, inspection and maintenance procedures can be followed easily without specialized equipment or tools.

To make a quick check of the starter system, turn on the headlights. If they do not burn with normal brilliance, the battery should be checked. If the battery is in a charged condition and the lights burn brightly, operate the starter. One of these things will happen to the lights: They will go out, dim considerably or stay bright with no cranking action taking place.

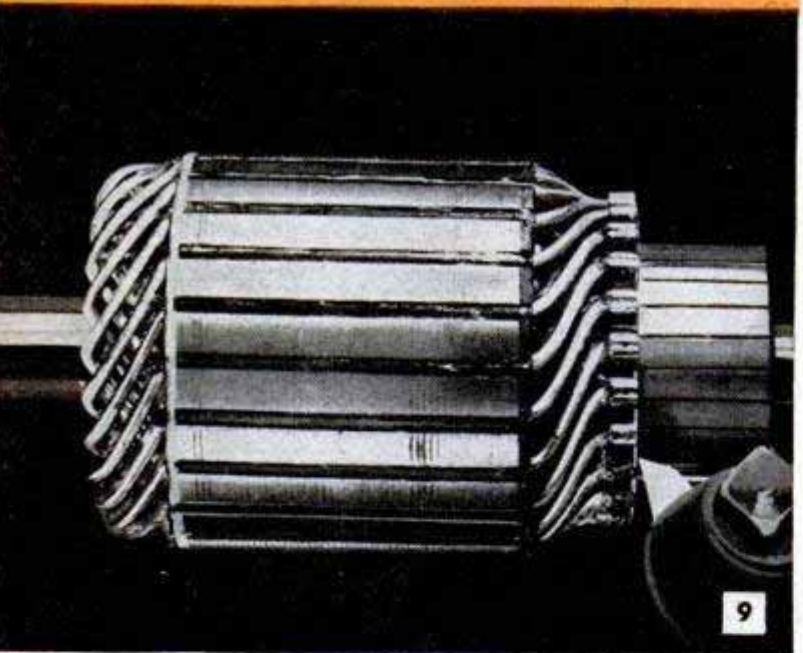

1. If the lights go out, there is a poor connection, which usually will be found at the battery terminals, between the battery and the starter. Correction is made by removing the cable clamps and cleaning both the clamps and terminals. After reconnecting and tightening the clamps, a corrosion inhibitor such as petroleum jelly should be applied.

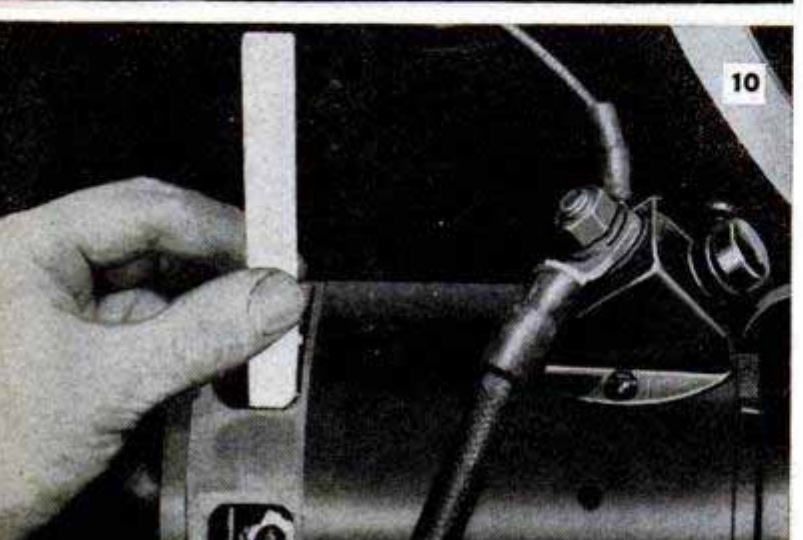

2. If the lights dim considerably, the battery may be discharged or there may be some mechanical fault in the engine or starter which is throwing a heavy burden on the starter. Check the battery first. If it is in good condition, the trouble is in either the engine or the starter. In the engine, tight bearings or pistons or extra-heavy oil may be causing the added strain on the starter. Low temperatures cause engine oil to thicken and make the engine more difficult to start. Low temperatures

also lessen the effectiveness of the battery. In the starter, look for a bent armature shaft, loose pole-shoe screws or worn bearings. Any of these will cause the armature to drag and reduce starting performance.

Occasionally, more serious internal damage may be found. Thrown armature windings or commutator bars, which sometimes occur on overrunning-clutch-type starters, usually are caused by excessive overrunning after starting.

On Bendix-drive starters, broken Bendix housings and "wrapped up" Bendix springs may result if the driver closes the starter switch during engine "rock back," which occurs when the engine starts automatically, then stops again. Another cause may be engine backfire resulting from ignition timing being too far advanced. To avoid such failures, the driver should pause a few seconds after a false start to make sure the engine has come to rest completely.

Frequently, a worn pinion gear in a Bendix drive will jam into mesh with the flywheel ring gear and refuse to unmesh. If this happens, put the car in gear and manually rock it forward and backward.

3. If the lights stay bright and no starting action takes place, an open circuit at some point is indicated. This may be in the starter, in the starter switch or in the control circuit. Where the starter is operated by a solenoid switch, temporarily eliminate the solenoid circuit by placing a heavy jumper lead across the solenoid's main terminals to see if the starter will operate. This connects the starter directly to the battery. If the starter operates, the control circuit is not functioning normally. If the starter does not operate, the trouble most likely will be found in it.

Every 5000 miles, under normal operating conditions, inspect the mounting, wiring and connections to make sure they are in good condition. The magnetic switch or solenoid should be mounted firmly and should operate freely, without binding.

Next, remove the cover band so the commutator, brushes and internal connections can be checked, Fig. 6. Examine the cover band for thrown solder, Fig. 8 (arrow), which results if the starter is subjected to such excessively long cranking periods.

Check the brushes to see that they are not binding and that they are resting on the commutator with sufficient tension to give good, firm contact. Make sure brush leads and screws are tight. If the brushes are worn down to half their original length, they should be replaced.

Note the condition of the commutator. If it is glazed or dirty, it can be cleaned quickly by holding a strip of No. 00 sandpaper against it with a piece of wood, Fig. 10, while the starter is operated. A brush-

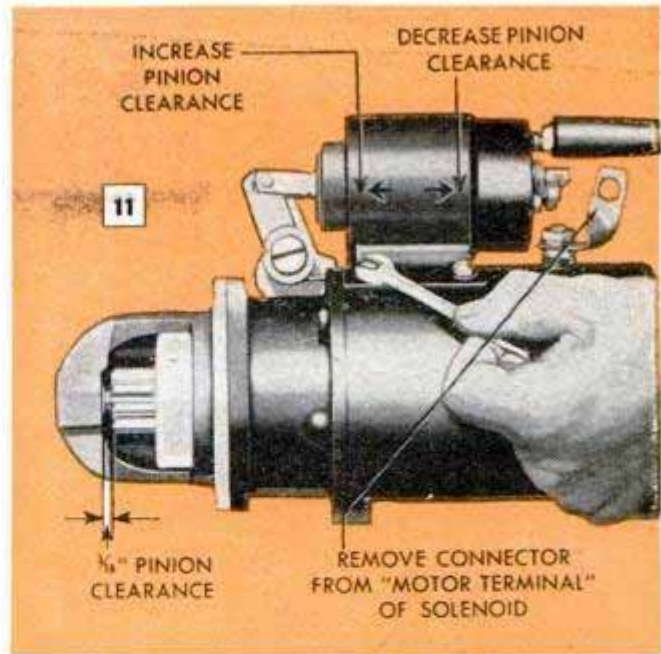

seating stone may be used for the same purpose. Move the sandpaper or stone across the face of the commutator as it spins. Blow out all dust after the commutator is cleaned. Always remember never to operate any starter for more than 30 seconds to maintain an accurate adjustment of the pinion clearance. Fig. 11 shows the proper method of making this adjustment. Remove the connector from the "motor" terminal of the solenoid. Place a piece of $\frac{3}{16}$ -in. bar stock or a $\frac{3}{16}$ -in. gauge between the pinion and the housing. Connect a six-volt battery across the "switch" terminal of the solenoid and the solenoid base (ground) and push the solenoid plunger in by hand. Battery current will hold the plunger in the "bottomed" position while the pinion clearance is adjusted. Loosen the solenoid-switch mounting and pull the switch away from the shift lever until play is taken out of the lever and the clutch mechanism. *Be careful not to compress the overrunning-clutch spring.* Moving switch toward the lever increases clearance; moving switch away from the lever decreases pinion clearance. Then tighten the switch-mounting screws and replace connector at "motor" terminal of the solenoid.

This adjustment must be made each time after the armature is removed from the starter for any reason. Unless it is correctly adjusted, the solenoid cannot operate properly. Starters equipped with hinge-cap oilers should have 8 to 10 drops of light oil each 5000 miles.

Some models are equipped either with oil wicks to lubricate the center and drive-end bushings or with oilless bushings. Oilless bushings should be supplied with a few drops of light engine oil whenever the starter is disassembled for repair or service.

★ ★ ★

Photos and information courtesy Delco-Remy Division, General Motors Corp.

PHOTOFLOOD

By Hugh Smiley, Jr.



Parade Routes Marked Temporarily With Long-Handled Pounce Bag

Frequently asked to mark parade routes through city streets, one person does the job quickly with a marking device which is nothing more than a pounce bag having a long handle of pipe. A piece of $\frac{1}{2}$ -in. pipe about 4 ft. long is fitted at one end with a tee which, in turn, is fitted with two short lengths to form handles as shown. After tying a small burlap bag over the lower end of the pipe, the device is made ready for use by pouring whiting in the upper end. In use, the whiting contained in the bag sifts through making a white mark each time the bag is tamped against the pavement. The marker may be carried and manipulated while walking or while riding in the back of a truck along the parade route.

Cutworms Trapped by Fruit Rinds Placed Among Plants in Garden

Placed upside down, discarded halves of oranges and grapefruit will trap cutworms and snails preying upon plants in a garden. An inspection of the rinds each morning will reveal a number of worms and snails feeding upon the spoiling fruit which they generally will prefer to growing plants.

John Krill, North Lima, Ohio.

☐ When cleaning a small quantity of tiny screws, nuts or bearings, put them in a metal teaball. You can douse them up and down in kerosene or other cleaning fluid or let them soak without danger of losing them.

YOUR TRIPOD doubles as a fine lamp-stand when fitted with this handy photoflood bracket. Designed to hold two reflector-type bulbs, the unit frames the camera and has a high-low lighting feature which permits the lamps to be dimmed for focusing, thereby increasing the life of the lamps for a greater number of shots.

Made of aluminum or any other sheet metal at hand, the hexagon band of the unit is bent from a strip measuring $\frac{1}{8} \times 2 \times 30\frac{1}{2}$ in. Note in the drawing that the ends of the band are lapped and joined with 6-32 machine screws turned into tapped holes. Note also that the band is drilled at five points for locating the lamps at various positions around the band. Two $\frac{1}{4}$ -in. holes, one to be tapped, are made at the lap, the tapped one being used to mount the band directly to the tripod and the other to attach a camera mounting plate.

Split, screw-type porcelain sockets are installed in the rounded ends of the two lamp brackets, the latter being fastened to the band with small stove bolts and wing nuts. The camera is centered in the band on a separate mounting plate which is drilled at each end and fastened to the band with a $\frac{1}{4}$ -in. flat-headed stove bolt, the head being set flush on the underside. A $\frac{1}{4}$ -in. thumbscrew, made by soldering a short section of bolt to a wing nut, is used to mount the camera.

Two three-tap baseboard receptacles are fastened back-to-back with two 6-32 machine screws. Only the two end outlets of each receptacle are used. If you study

Two three-tap baseboard outlets fastened back-to-back and wired according to the diagram at the right serve to form the dimmer unit used when focusing

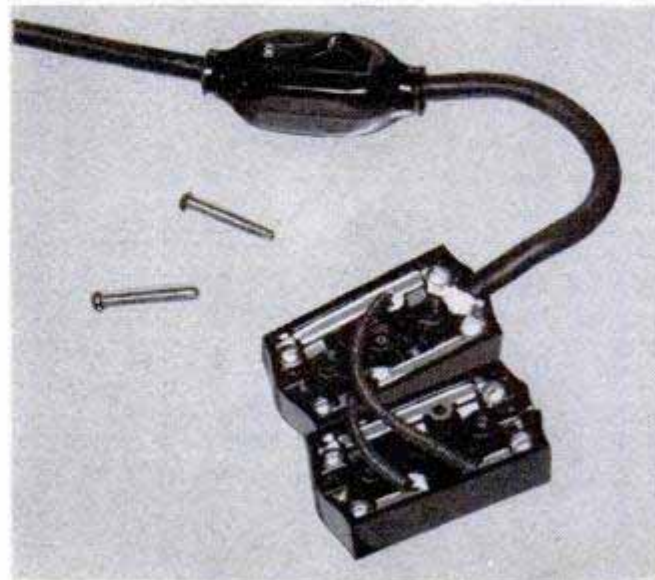

BRACKET ★

closely the photo on the opposite page, you'll note the outlets are joined together with metal strips held at each end with a screw or rivet. One of the strips is cut to form an open circuit, which is done by removing a 1/4-in. piece from the center. Wire the outlets as shown in the diagram, soldering short insulated wires between the outlets of each unit. Note, particularly, that the unbroken connector on one side of the low tap is not wired to the 110-volt line. Instead, it serves as a jumper when both plugs on the lamp cords are inserted and connects the filaments in series. Mark the outlet to identify the low tap at a glance. The heavy extension cord to which the high-low tap is attached should be at least 15 ft. long and rubber-covered. Individual lamp cords are about 3 ft. long. ★ ★ ★



As the camera actually is behind the photofloods, it is best to shade the lens with a regular hood

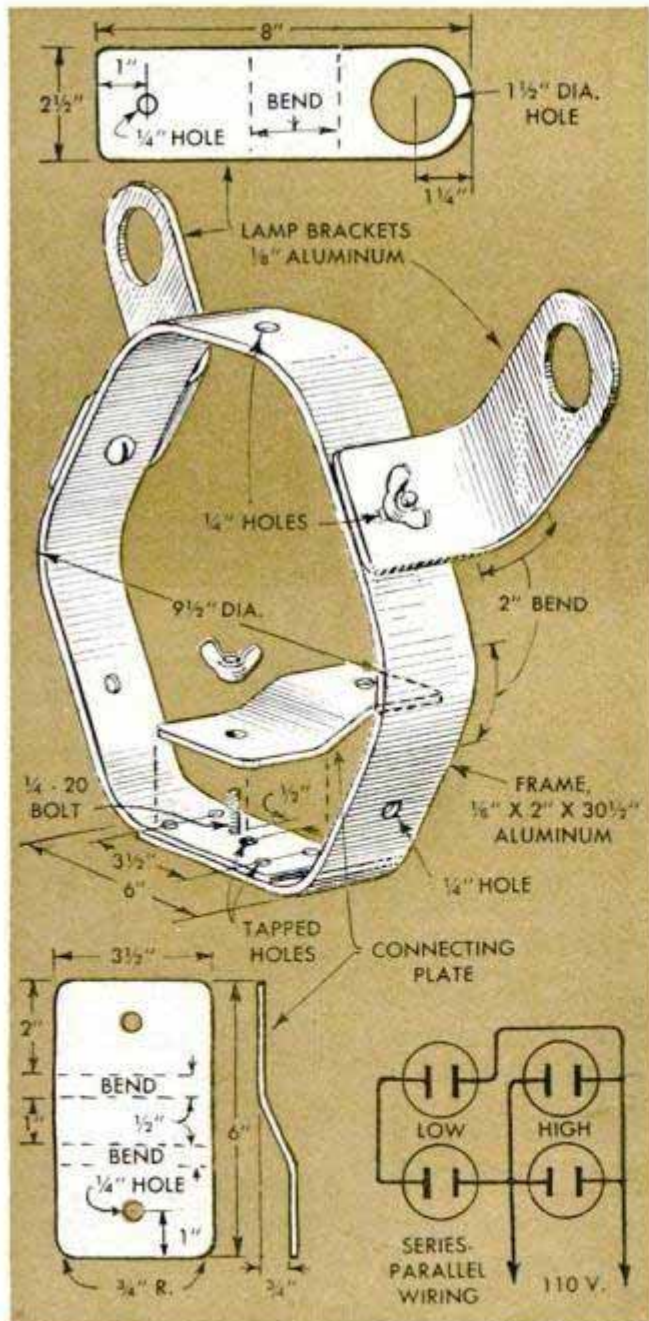

Above, the band is bent hexagonally by gripping with C-clamps and wooden pads. Below, holes for bulb sockets are cut in brackets with a coping saw

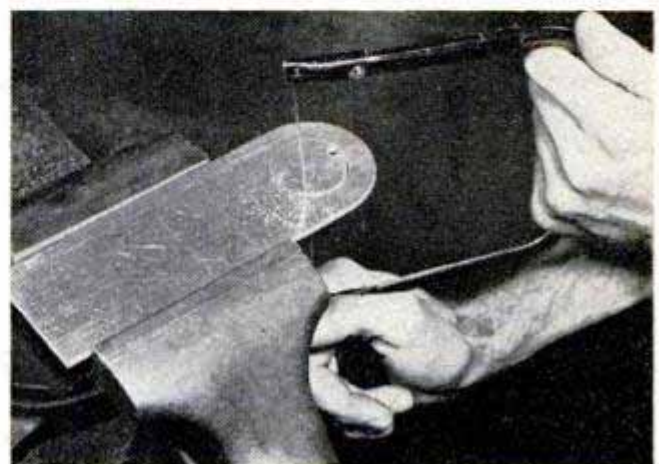

Improved Spotlight Boom Clamps to Chair Back



Handy for overhead lighting in either portrait or still photography, this adjustable spotlight boom is made from a metal fishing-rod holder and a broomstick or length of 1/2-in. pipe. The holder is clamped to the back of a chair and the pole, with a spotlight attached, is mounted in the holder as shown. A thumbscrew permits adjustment of the boom to the desired angle.

"Pin Up" Safelight for Darkroom Made From Standard Parts

Amateur photographers who utilize the kitchen or bathroom as a temporary darkroom, will appreciate a compact safelight such as this. Assembled from common electrical fittings it takes up little space and can be quickly mounted on a wall in any desired position. Two small socket units of

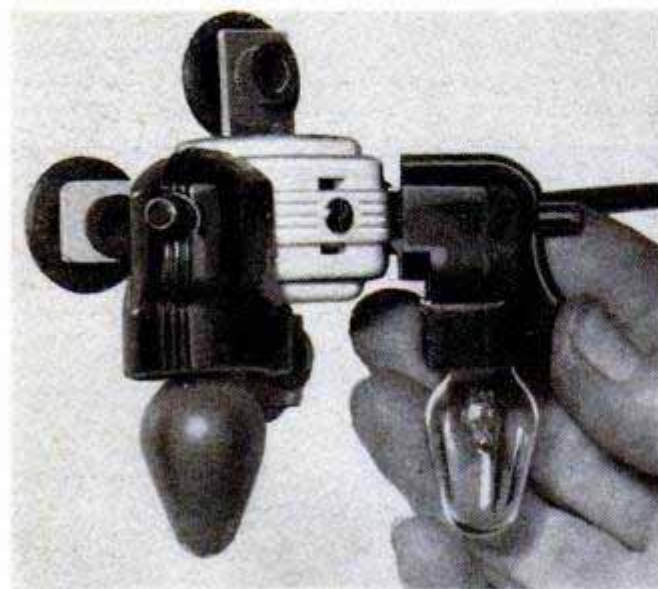

the type that are equipped with individual switches and made to plug into standard receptacles provide a red and a white light. These units are plugged into a dual-plug surface receptacle that is attached to an extension cord. An L-bracket is fitted with rubber suction cups and attached to the receptacle to permit mounting the entire assembly to any smooth surface. Moistening the inside of the cups will help make them adhere more readily.

Ivan Grosvenor, Richmond, Ind.

Rubber Band Holding Film on Reel Removed Easily When Knotted

If you use a rubber band to hold movie film on a reel, tie a short loop in the band before stretching it over the film. This will provide a convenient handle with which to remove the band, thus eliminating the difficulty of getting hold of it with your fingers. Be sure the band is large enough so that it will not damage the film.



Round Corners Protect Emulsion

In order to prevent the emulsion on sheet film from being damaged while being washed in a tray, simply round the corners of each sheet to eliminate the possibility of their gouging one another. One of the simplest ways to do this is by using fingernail clippers.—Virginia Hanson, Los Angeles, Calif.



Tape Along Edge of Paper Trimmer Speeds Cutting Operation

A strip of masking tape will furnish the amount of friction needed to help prevent photographs from shifting while they are being cropped on a print trimmer. The increased friction also will prove helpful when a print is being manipulated into position for cutting. The tape is applied in the normal manner near the cutting edge.

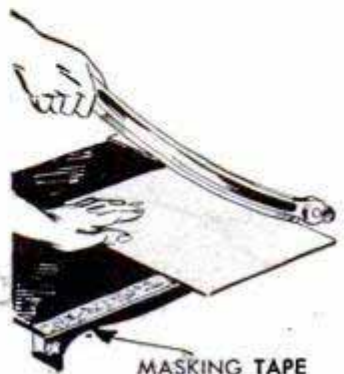

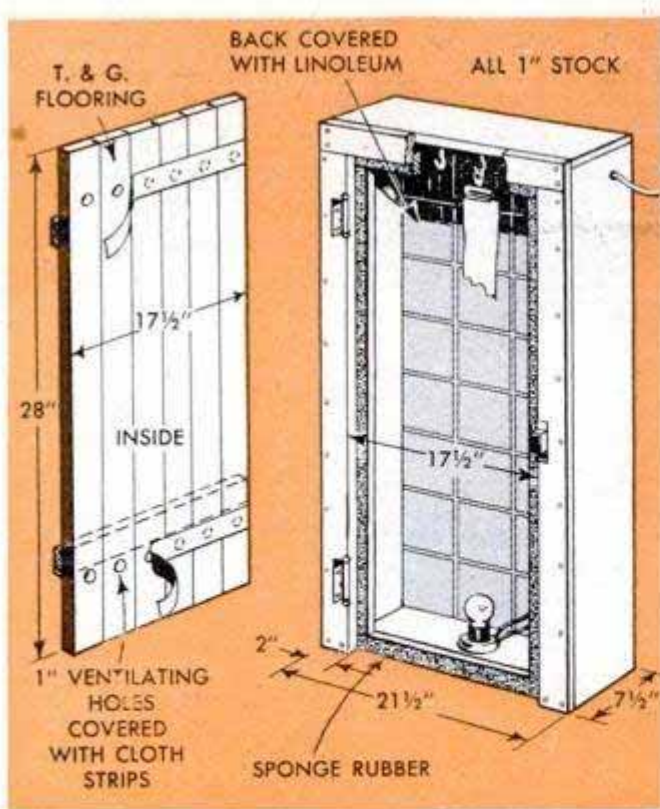

Negative Drier Heated by Bulb

By A. L. Armstrong

DUST IS ever present in the average basement darkroom yet it is common practice for the man who processes his negatives at home to hang the film in the open to dry. Wet film is susceptible to dust floating in the air and, while it may not be noticeable through casual observation of the film, dust may make a difference in the quality of the finished print. This dust-tight drier solves the problem perfectly. Consisting of little more than a box fitted with a hinged door which is sealed with sponge-rubber weather stripping, the drier is heated by a 75-watt

bulb installed in the bottom of the cabinet. The drawing gives the size of the original drier, which primarily was designed to hold cut film. Note how the drier is ventilated through a series of holes at the top and bottom of the door which are covered on the inside with muslin to exclude dust. The back of the original drier was covered with a scrap of tileboard, although a sheet of plywood may be used. Likewise, the door can be of plywood. If the drier is fastened permanently to a wall, a backing will not be required. Several screw hooks are provided for film clips. Before painting the cabinet seal any cracks with wood putty.

Screw Eyes, String and Pipe Provide Excellent Trellis for Climbing Vines

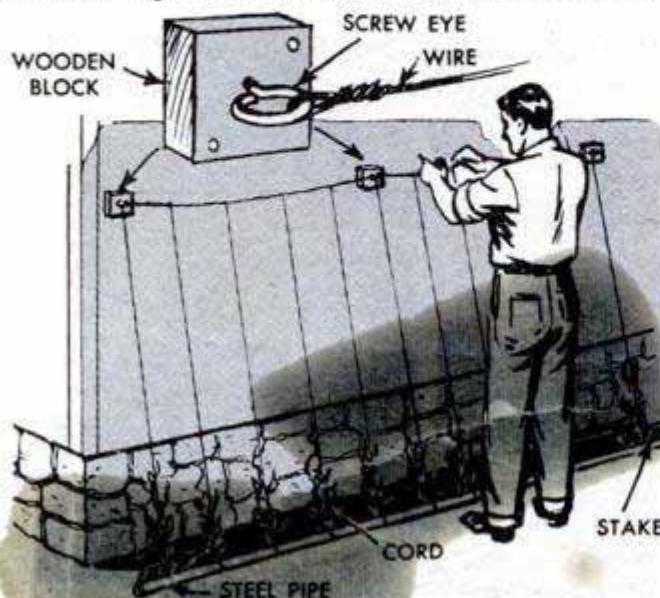

Sweet peas, moonflowers grown as annuals and other one-season climbers do best on a simple string trellis which does not absorb heat from the hot midsummer sun and is disposed of easily along with the dead vines in the fall. This trellis also keeps strings taut throughout the growing season. Cut the strings to equal lengths of 4 to 8 ft. as required and tie them to a length of pipe of approximately the same length as the seedbed. Then attach a length of wire to the side of the house by means of small wooden blocks and screw eyes. Tie the individual strings to the wire as shown, spacing them 6 to 12 in. apart. Plant the seeds in a trench between the pipe and the wall. As the strings gradually stretch, the pipe is moved out to keep them taut.

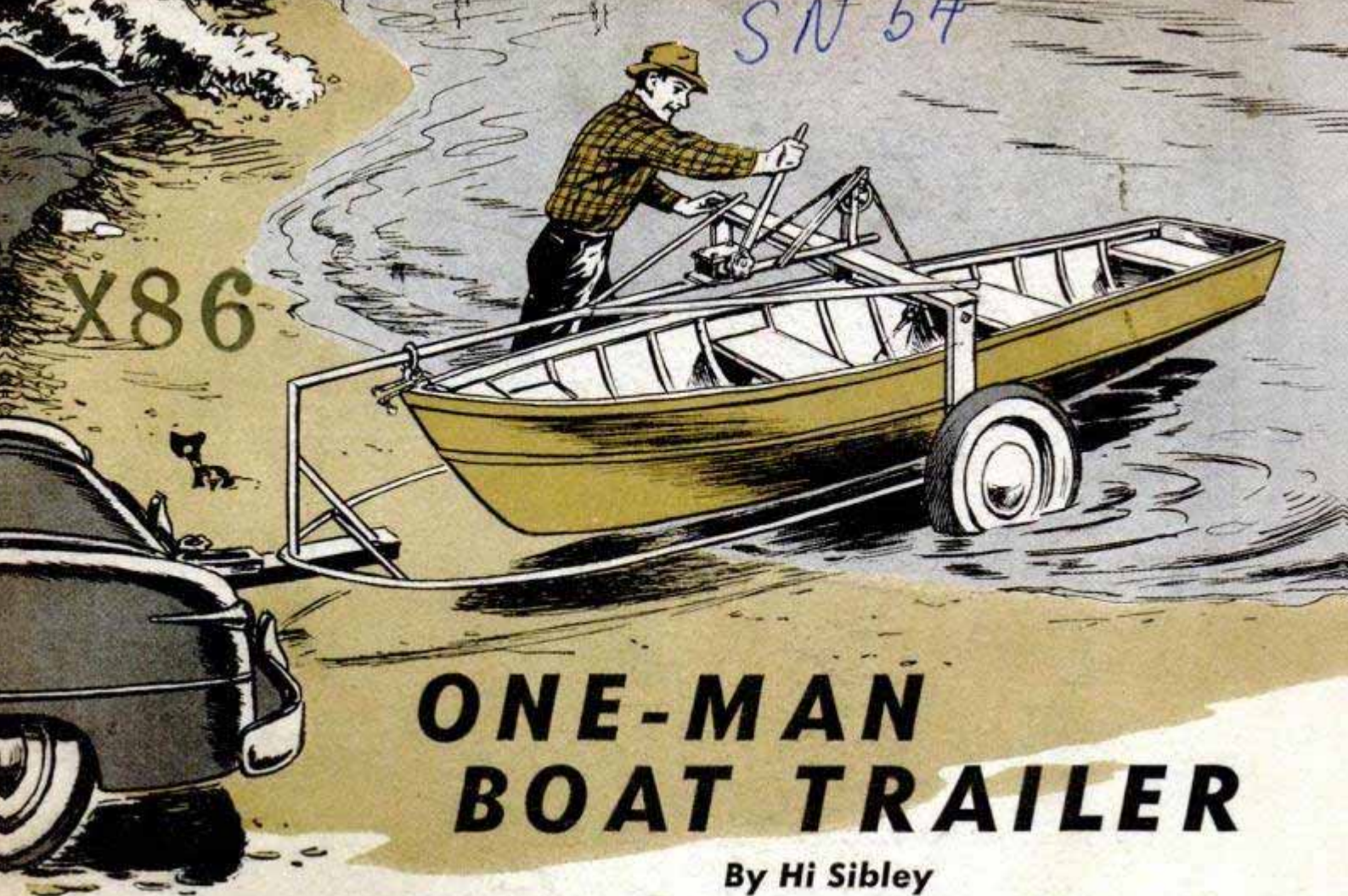

ONE-MAN BOAT TRAILER

By Hi Sibley

LAUNCHING a rowboat or lifting it from the water is no longer a back-breaking job if you use this underslung boat trailer equipped with a powerful hoist. The trailer will be especially appreciated if you go fishing alone, as the trailer permits handling the boat singlehandedly. The trailer frame is welded from pipe and steel channel and fitted with a lever-type hoist, as in detail A. Note in detail B how a length of

chain is bolted to one of the center frames of the boat. A coil spring attached to the chain is slipped over the hoist-chain hook, the heavy spring providing a shock absorber when the boat is in riding position. A hook and eyebolt are fitted to the bow of the boat, detail C, the eyebolt being fastened to the movable clevis before the boat is raised. An angle-steel cross brace is bolted to frame after boat is in position.

Pumping lever-type hoist easily raises boat into position on trailer. Note how sheave is mounted

Movable clevis guides bow of boat to angle-steel rest at front of trailer. Hook secures bow to frame

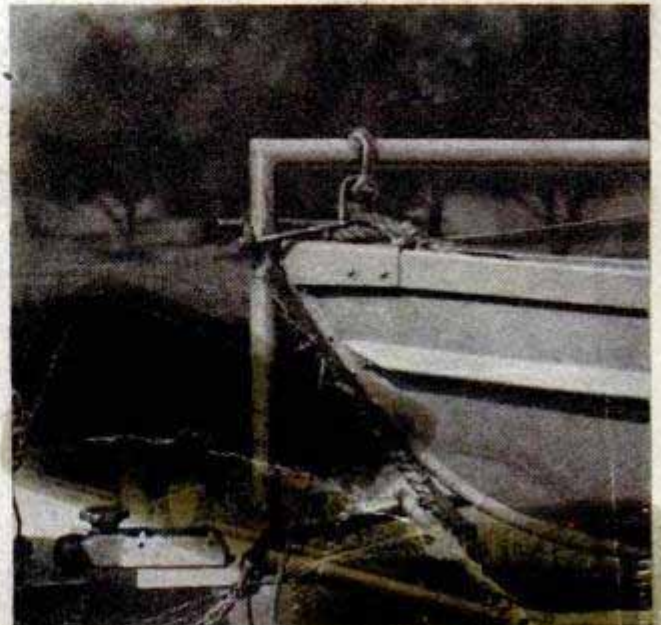
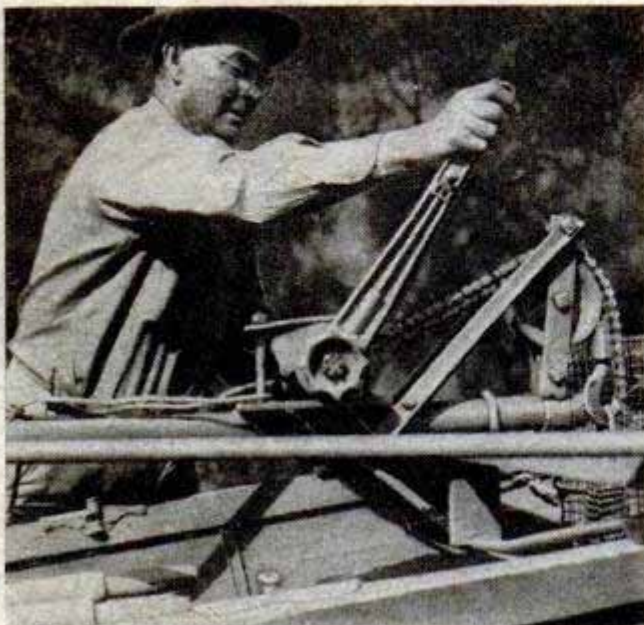

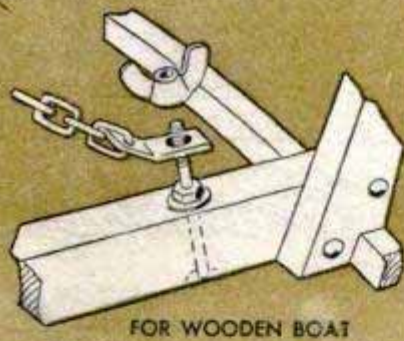
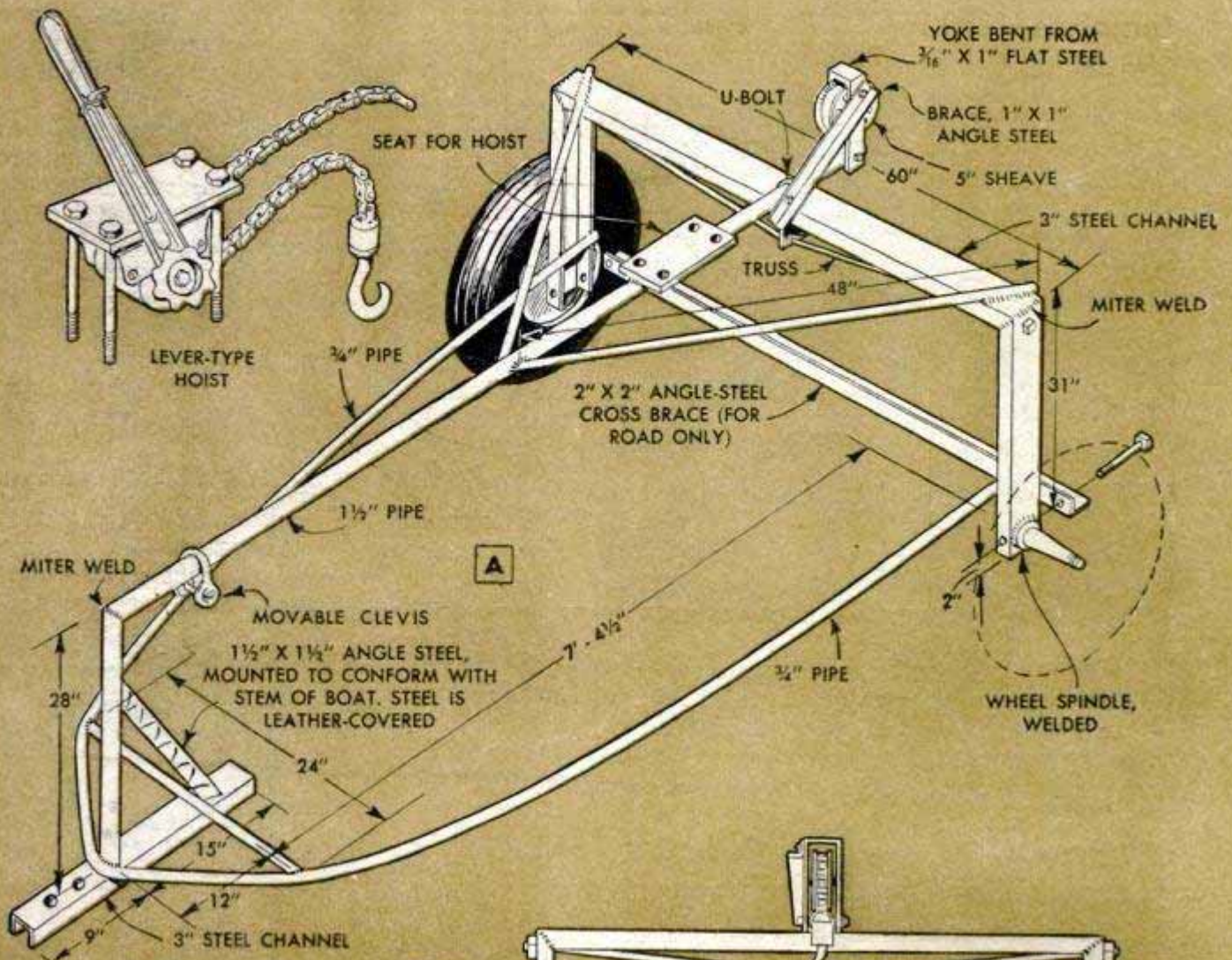

B

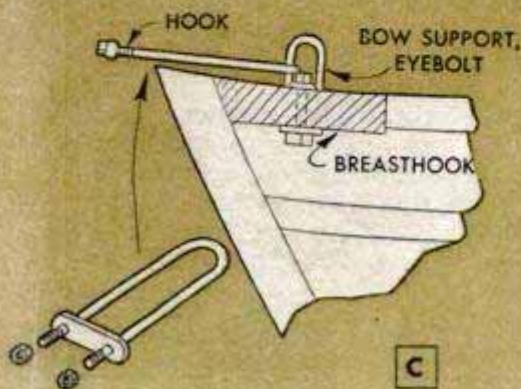
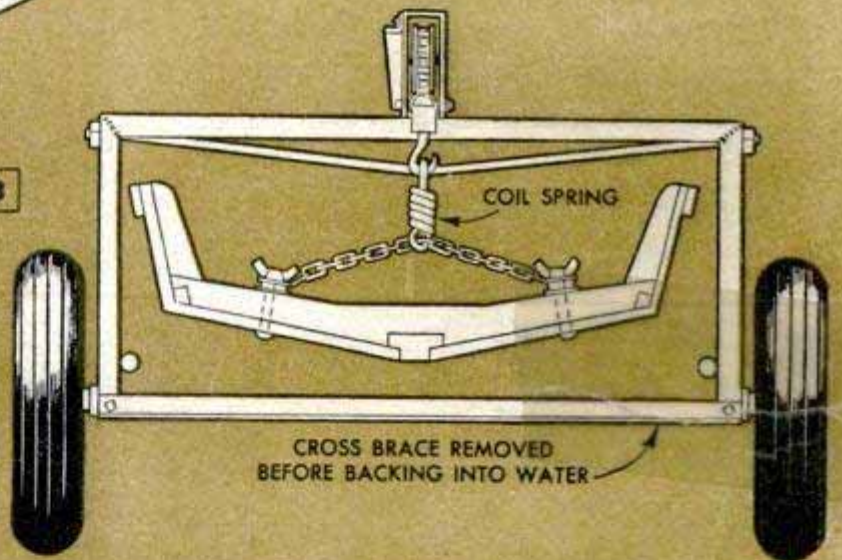

Template Used for Cutting Prints Simplifies Centering of Subject



By using a transparent template for cutting photos to an irregular shape, it is easy to see when the desired portion of the picture is centered. Such templates can be made from clear plastic or celluloid.

"Skyhooks" in Basement Ceiling Support Clamp-On Photofloods

Having occasion to take photos of shop projects in my basement, but not frequently enough to warrant buying lamp stands, I provided "skyhooks" in the ceiling so that I could clamp the reflectors overhead and

out of the way. Two screw eyes, spaced about 1½ in. apart, were placed at key positions in the paneled ceiling for each lamp, screw eyes being driven in line edgewise. The screw eyes provided an excellent clamping surface and when not in use were practically unnoticeable. To keep the lamp cords well out of the way I installed several screw hooks to support the wire across the ceiling. I found that supporting the lights in this manner was even better than with regular stands as the photofloods were always out of the picture and could still be adjusted to direct the light just where needed.—Walter E. Burton, Akron, Ohio.

Film Boxes Made Into Negative File

To simplify the problem of keeping used and unused negatives separated while making enlargements or contact prints, one amateur photographer glued together several discarded cut-film cartons in order to make a handy, portable file for this purpose. Two outer covers are joined together to form each "leg" of the container, while inner-box sections are cut and assembled as shown to form additional compartments.

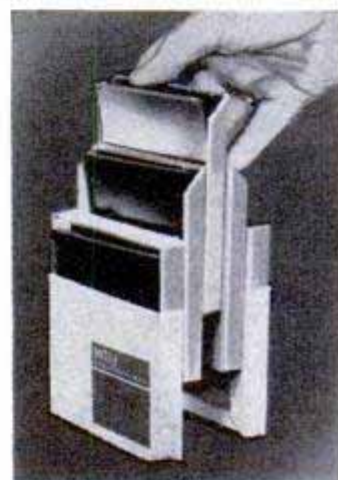

Popular Mechanics Bookshop

What'll I Do Next, Dad?

It's the too-familiar cry of the youngster just out of school, a long vacation ahead and not a thing to do!

The Young Craftsman is a good book to start off a young fellow's summer holidays. An old and famous *Popular Mechanics* title, this book, always brought up to date, is full of projects for youngsters of school age. It helps to train their minds and their hands, tells them what to make and how to make it—more than 450 easy building projects requiring only the simplest of tools. And there are things to do even if you're a youngster of 60 years! Order *The Young Craftsman* (\$2.00) from Popular Mechanics Press, 204 East Ontario Street, Chicago 11.

★ ★ ★

Stop a minute and take inventory. Sidewalks cracked? Concrete steps crumbling? Need a new flagstone walk in the garden? What about that tennis court you were going

to build, that driveway or swimming pool? Concrete work is easy if you follow the suggestions in *What to Make With Concrete*, a profusely illustrated, authoritative book with formulas for mixing and directions for laying concrete for dozens of projects around the home. The book will save you many times its price. Only \$2.00 by mail from Popular Mechanics Press, 204 East Ontario Street, Chicago 11.

★ ★ ★

Camping and hunting, fishing and sailing—any outdoor sport is more enjoyable if you start out as an expert, with equipment you have planned and made yourself. Here is a book that tells you how to make your own gear for hunting, sailing and trapping, how to pick the right gun and how to handle a boat. Get the most out of outdoor sports and hobbies by reading this 160-page book, *Outdoor Sports Manual*, \$2.00 by mail from Popular Mechanics Press, 204 East Ontario Street, Chicago 11.

All books available from Popular Mechanics Book Dept., 204 East Ontario Street, Chicago 11



SHOP NOTES

SNIPS

and how to use them

By E. R. Haan

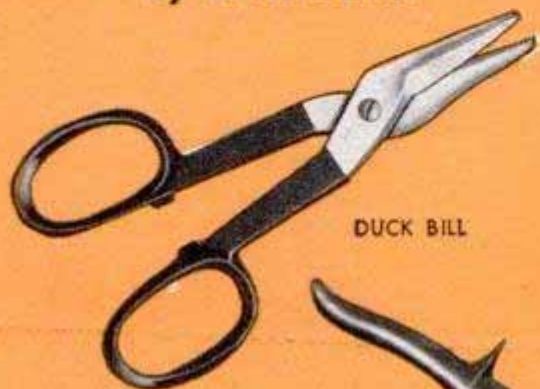

DUCK BILL

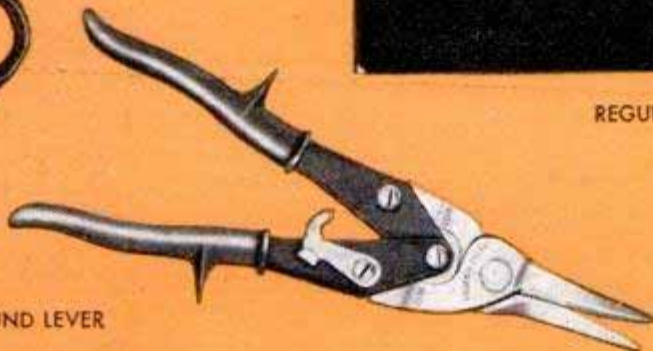

COMPOUND LEVER

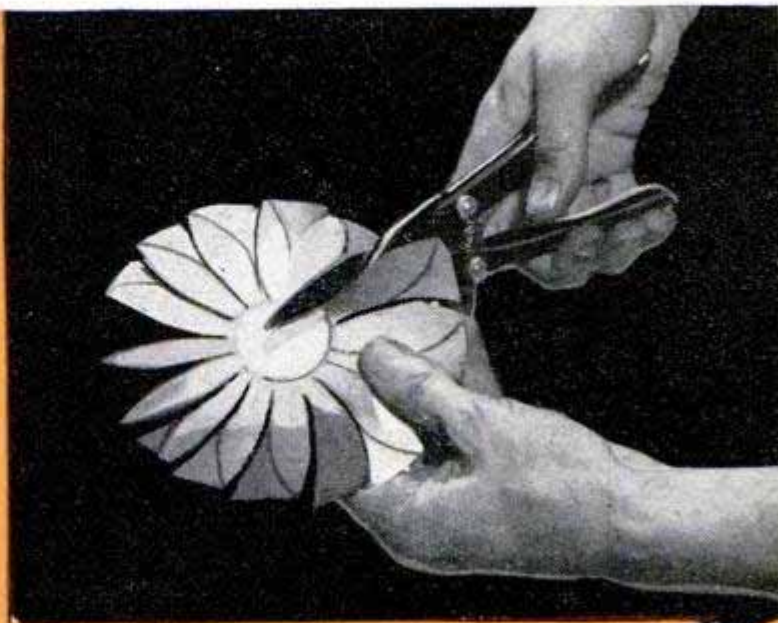

REGULAR PATTERN



COMBINATION TYPE

1

Photos courtesy J. Wren & Sons Co.

WITH HAND SNIPS of the proper size, you can cut sheet metal having a thickness up to 18 gauge. Snips vary in size from 6 to 17 in. in over-all length, with cutting edges ranging from $1\frac{3}{4}$ to $3\frac{1}{2}$ in. Both right and left-hand models are available in many types. Some snips are designed for specific purposes, such as the double-cut type and those having curved blades.

Common types: Duck-bill snips, Fig. 1, have narrow, beveled blades with somewhat slender tips that have an outward curve and are designed for making both straight and curved cuts. Compound-lever, or aviation-type, snips also are used for straight and curved cuts. Their special feature is a powerful cutting action that requires minimum effort to operate. By test, one make required about half the cutting effort needed to operate standard 13-in. snips. Most of these have a spring that opens the blades. The blade bevel permits easy handling on curves and the finely ser-

rated cutting edges keep metal from slipping while being cut. The snips come in different patterns, one primarily for straight and limited-curve cuts, one for left-hand and one for right-hand cuts. The 10-in. size is most common. Regular-pattern, straight-blade snips are intended mostly for straight cuts but can be used for large-radius external curves also. The flat inner surfaces of the blades slide along the edges of the stock on straight cuts and should be kept at right angles to the stock surface. Heavy-duty, or "bulldog," straight snips, not shown, have shorter blades and longer handles. Straight, beveled-blade snips, also called combination snips, permit greater side movement than the regular-pattern straight snips when cutting curves.

Special types: Curved-blade snips are especially designed for cutting circles and arcs, Fig. 2. Note the blade arrangement of snips for cutting either toward the left or right. The hawk-bill snips have offset

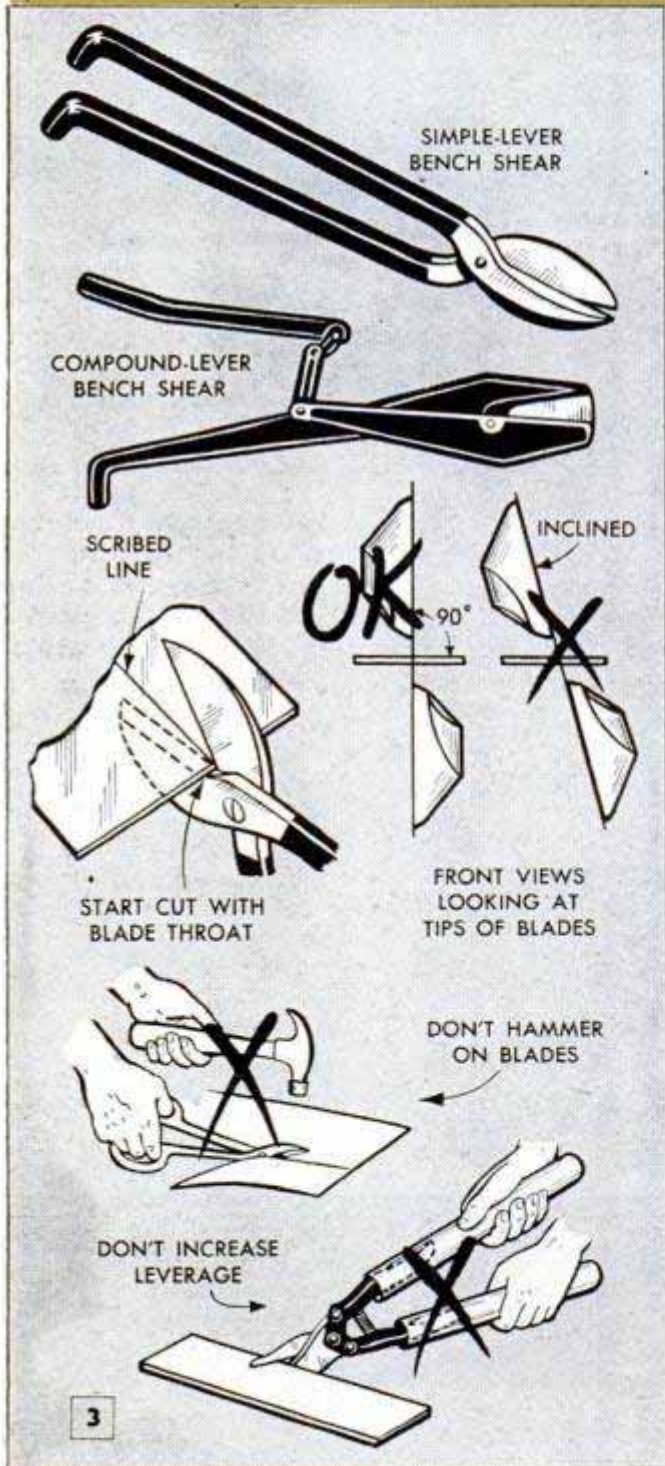
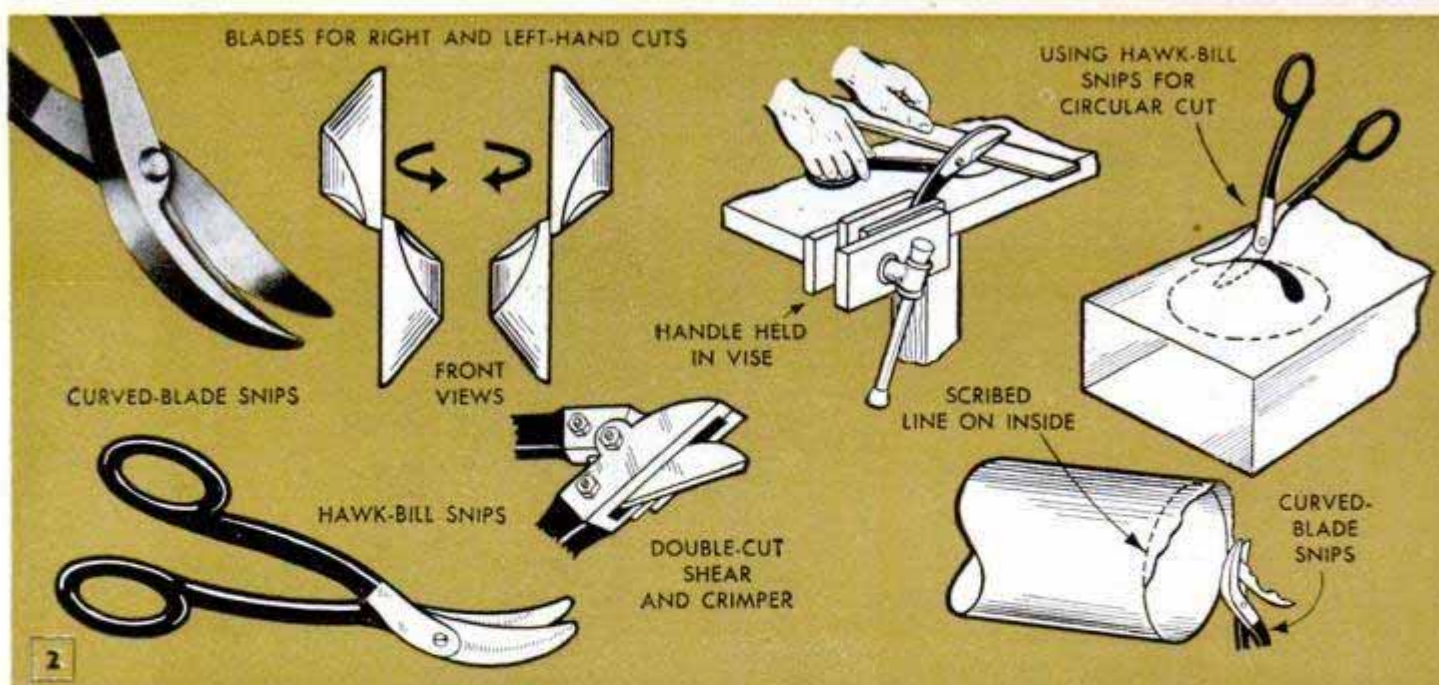

handles and narrow, curved blades for straight or curved cuts in cramped quarters and for cutting openings in ducts. Some compound-lever snips are of similar design. Double-cut shears, which are used to cut off sections of sheet-metal pipe without distorting the metal, are sometimes combined with a crimper. The blade shears on both sides, thus removing a narrow strip of metal. Hand-operated bench shears may be of the simple-lever or the compound-lever type, Fig. 3. The latter cuts sheet iron up to 12-ga. thickness. Both types have bent handles, the lower one to fit a hole in the bench and the upper one to serve as a stop.

How to use snips: When handling sheet metal, it's always best practice to wear gloves for protection against sharp edges. Insert the work about as far as it will go between the blades. Cutting near the throat of the blades is easier and gives better control than cutting near the tips because leverage is increased. Sometimes there's appreciable side spread near the tips, resulting in less-accurate cutting. Hold the snips squarely and start right on the scribed line, as in Fig. 3. Inclining the snips toward one side is apt to pinch the metal between the blades and cause burring. Don't close the blades so tightly that the tips come together in the work, as this bends the metal and is apt to tear it sideways where the tips meet. This also causes sharp edges and slivers. Stop each stroke a safe distance from the tips and start a new one. When you approach the end of a cut that stops in the stock, use the throat end of the blades and cut slowly for best control to stop accurately. Passing the stopping point in metal is a common error.

If the cutting edges of the snips drift from the scribed line on the work, hold the snips slightly inclined in the same direction as the drift in order to return to the

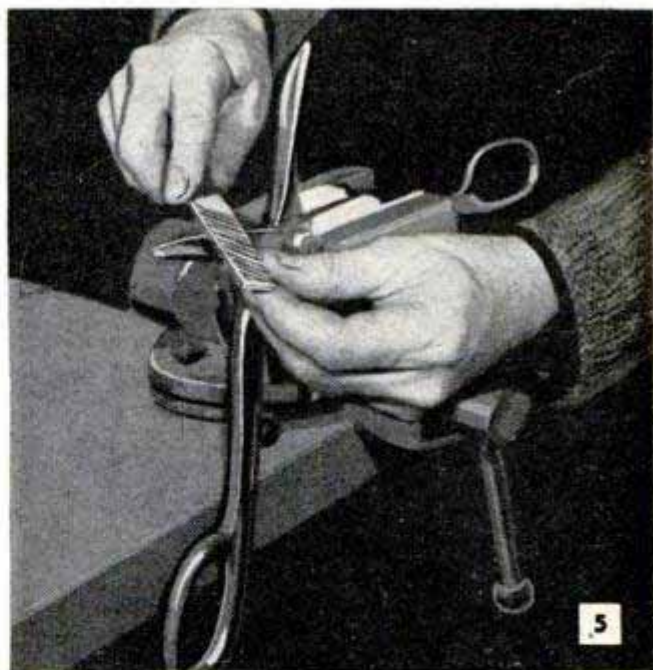
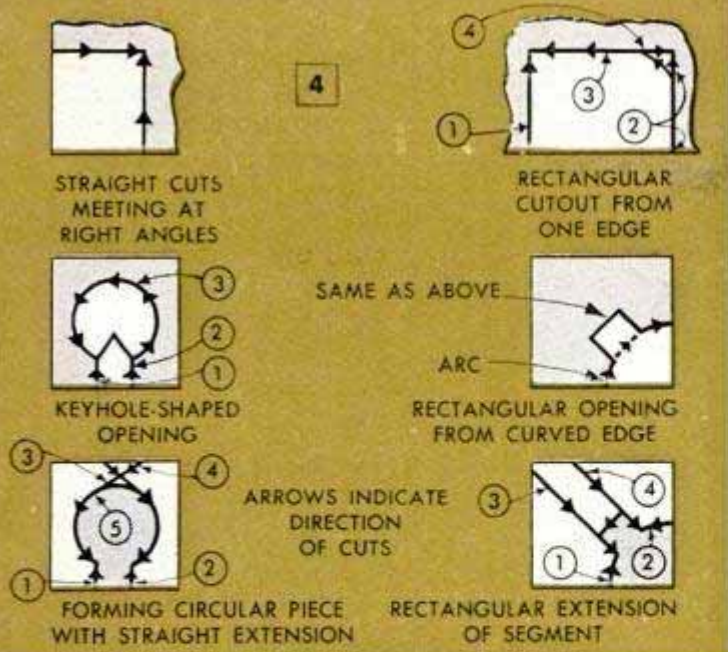

line. When cuts in heavy stock become burred, use the throat end of the blades. If this does not stop the burring, cut the stock on the side of the scribed line toward the waste to allow for filing off the burr. When cutting requires excessive effort, the snips may be dull, the blades may be loose or the work may be heavy enough to require the use of larger snips. Don't increase the leverage of snips by slipping pipes over the handles. When cutting large sheets, you can rest the lower handle of the snips on the bench and grip the upper one; this lessens finger strain and allows you to use your weight to advantage. For short cuts in heavy stock you can use snips as in Fig. 2, one handle being held in a vise between pads.

For internal cuts, punch or drill a starting hole in the waste portion near the cutting line. Support the metal on the smooth end grain of a hardwood block when punching. Then use a hawk-bill snips or a similar-shaped compound-lever snips. You also may be able to use a double-cut shears. Handle a hawk-bill snips carefully to prevent springing the slender blades. To trim a straight edge on cylindrical or conical work, scribe a line on the inside surface and cut the edge farthest away from you; for greatest accuracy, use a curved-blade snips as in Fig. 2. You'll avoid considerable trouble if you keep in mind direction and sequence of cuts. Note the examples in Fig. 4. Don't try to make sharp turns in the metal but form inside corners with two meeting cuts. Greater accuracy results from following a thin mark scratched with a sharp scribe rather than a heavy pencil line.

Care of snips: The blades must be kept in firm, sliding contact with each other. If there's space between them they will not cut thin stock, especially near edges, and will burr thicker stock. Also, if blades are

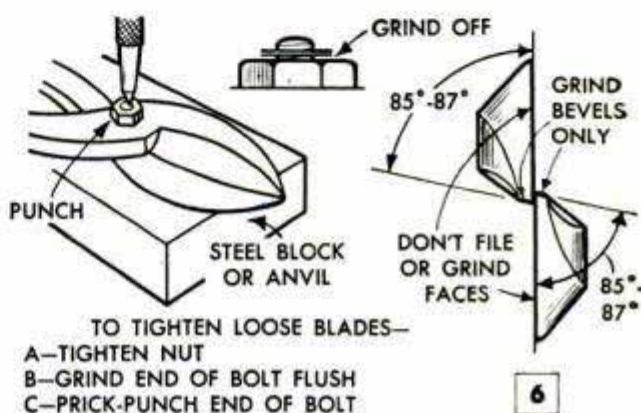

loose, it's hard to follow a line accurately. To tighten blades, turn up the nut on the pivot bolt, file off the projecting end of the bolt and then lock the nut and bolt by prick-punching carefully, Fig. 6. Keep the pivot and blades oiled. When snips are not in daily use, particularly in humid places, protect them from rust by wiping frequently with an oily rag. Keep the blades closed when not in use and hang snips out of the way of other tools. Never nick blades by using snips to cut wire, nails, pins or rivets—use cutting pliers or a bolt cutter suitable for the particular job at hand.

Sharpening: Resharpen dull blades at an angle of 85 to 87 deg., Fig. 6. Use a fine file such as a No. 2 half-round diemaker's file, holding snips in a vise, as pictured in Fig. 5. If you prefer grinding the blades, take them apart. Hold them to the wheel lightly for short durations, and each time the blades are removed from the wheel, dip them in water to prevent drawing the temper. Don't remove metal from the flat face of the blades—only the burr at the edges, using a slipstone or very fine emery stone. ★ ★ ★

☛ Cork fishing-rod handles will look like new if cleaned with fine emery paper and coated with liquid floor or car wax.

Hook Mounted on Top of Scale Keeps Forms Close at Hand



In order to hold weigh slips, invoices and other papers on a produce scale where they would be handy and would not be blown away, a merchant installed a hook of heavy steel wire in a hole drilled in the top board of the scale as shown. With its point resting on the papers, the weight of the hook is sufficient to hold them securely and yet light enough to be raised with a single finger for releasing the slips.

Holding Sack Strings For Instant Use



the others by selecting an end and pulling it out with a quick jerk.

Roofing Cement Rustproofs Car

In the absence of a professional job of undercoating, a car can be protected from rust by the use of roofing cement for coat-

ing various joints and surfaces where rust is most likely to develop. Naturally, this cement cannot be expected to give thorough protection for as long a period of time as the regular undercoating material. Remove one wheel at a time and use an old brush to apply the cement, working it well into the joints between fenders and body. It is a good idea to coat all exposed metal parts that are accessible on the underside of the car. Application of the cement will be easier if it first is thinned by heating.
Ed Packer, Chicago.

How to Store Fertilizer Bags

To prevent empty fertilizer sacks being blown about the fields, one farmer made several holders, each consisting of a 36-in. length of $\frac{3}{8}$ -in. steel rod pointed at both ends and



having a small lug welded at the midpoint to form a footrest. Each holder is forced into the ground near the point where the sacked fertilizer is stacked. As the paper sacks are emptied they are pressed down over the sharp point of the rod where they are held in place in the same manner as are papers on an office spindle file.

Marks Help Set Index Pin Accurately

As an aid in setting an indexing pin on a wood or metal-turning lathe, paint white marks on the head as indicated to divide the holes into pairs. In this way, the marks act as a guide when turning the index head, thus making it possible to keep an accurate count of the holes.

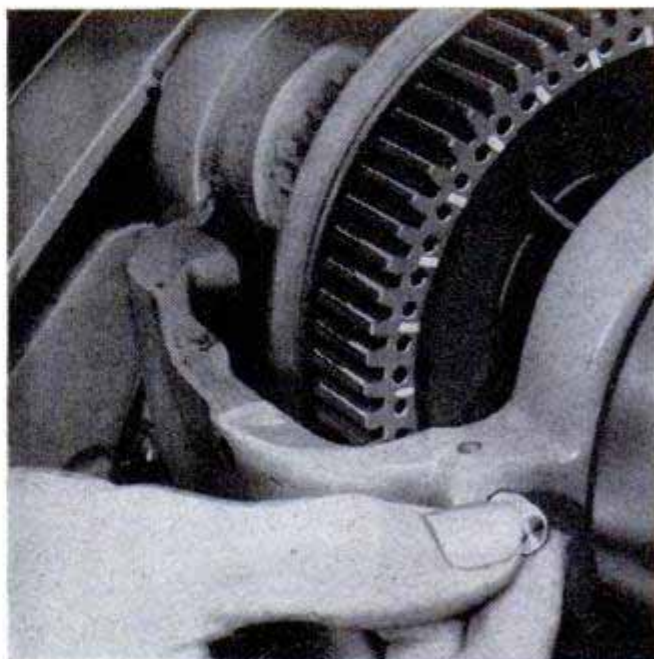



TRACTOR WEED SPRAYER

By Richard C. Bell

SINCE C. E. van Winkle of Sunnyside, Wash., equipped his tractor with this handy sprayer, killing weeds in row and field crops is as easy as falling off a log. With the sprayer, which cost less than \$100, he can apply 9½ gal. of weed killer per acre at the fast clip of 3 m.p.h. He used a 50-gal. oil drum for a tank and mounted it on the rear of the tractor. The oil drum is connected to a small compressor driven by the accessory belt-drive unit attached to the tractor's power-take-off shaft. Air is pumped into the bottom of the tank to force the spray material through a hose running to the spray boom at the front of the tractor. A shutoff valve located within reach of the operator makes it convenient to control and regulate the supply, and a safety valve and pressure gauge provide a means of checking the 40-lb. air pressure required to assure efficient operation.

The boom of the sprayer is made from three lengths of ¾-in. galvanized pipe, two 5-ft. lengths being connected to a short center section with regular spray-boom fittings which permit raising the outboard ends of the boom to a vertical position for traveling from one field to another. The boom is fitted with nine fan-type nozzles and each end of the boom, of course, is capped. By studying the photo at the top of the page you can get an idea of how the original sprayer assembly was rigged and mounted to the tractor.

Above, the hose from the tank is connected to the sprayer by a pipe tee fitted in the short pipe section to which the outboard ends of the boom are attached. Below, this view shows how the compressor is connected to the tank and the convenient location of the shutoff valve and the air-pressure gauge





HYDRAULIC LIFTS

do the hard work

By S. H. A. Young

BOTH IN INDUSTRY and on the farm hydraulically operated lift and control mechanisms are doing more and more of the hard work in handling heavy loads and in raising, lowering and depth control of heavy farm implements. Hydraulic controls also are used on various types of units designed to move earth and snow, scrape and level fields and roads, and scoop loose materials.

Using such component parts as hand and power-driven pumps, lift cylinders, control valves and flexible pressure lines, it is easy to build a hydraulic unit to do almost any kind of work desired. Although an assembled, hydraulically operated unit may appear quite complicated, the principle on which it operates is simple. The pressure applied to the fluid, usually oil, is transmitted through the various parts to every point the fluid reaches in the system. The simple system employs an assembly of hydraulic elements for accomplishing the required routing of the oil under pressure to the lift cylinders or other devices for obtaining the desired movement. There must be a pump, either hand or power-operated, for generating pressure, and flexible pressure lines for carrying the oil under pressure to the desired points. Cylinders and other units, such as fluid motors, are used to convert the energy into useful work. Valves are in-

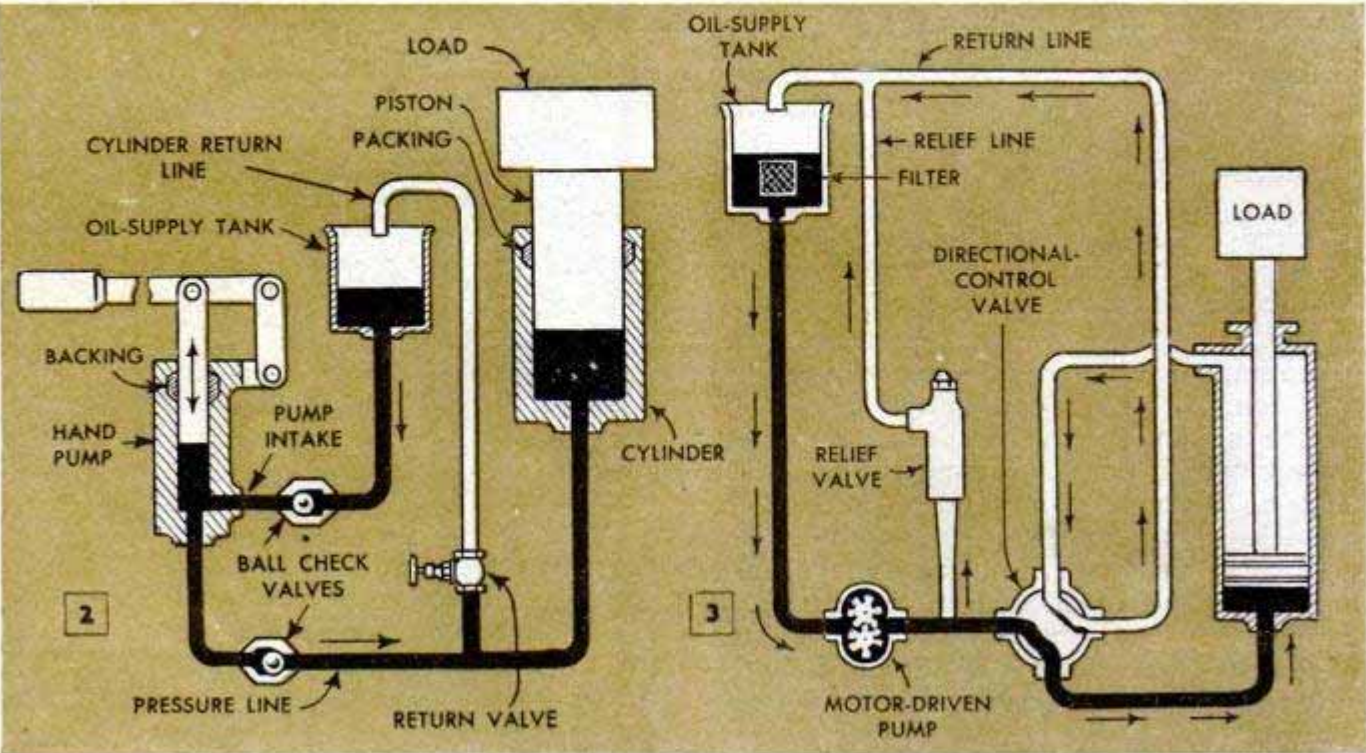
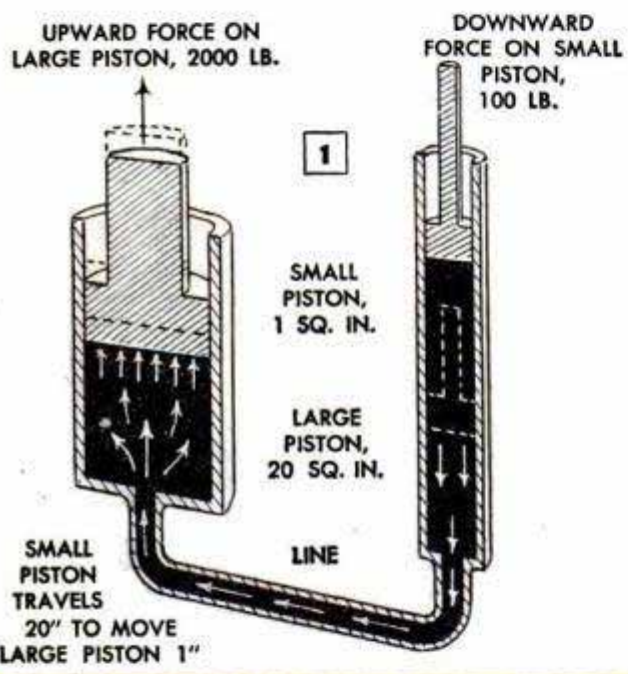



A Jeep or light truck fitted with this combination bulldozer-snowplow speeds up the job of clearing snow from driveways, feeding floors and farmyards. It also makes a fast, handy 'dozer for moving earth

stalled in the lines to control the direction of fluid flow and to limit the pressure where required.

Figs. 2 and 3 show basic types of hydraulic systems, that in Fig. 2 being hand-operated with a manually operated return valve while the more elaborate system shown in Fig. 3 employs an automatic relief valve, a directional control valve and a motor-driven pump. The basic principle on which these systems operate is shown in Fig. 1. Using this detail as an example, the application of a force of 20 lb. to the small piston, having an area of 1 sq. in., will exert a pressure on the oil below the piston of 20 lb. per sq. in. As the small cylinder is connected to the large cylinder by a pressure line, the force exerted against the bottom

of the piston in the larger cylinder by the column of oil will be 20 times 10, or 200 lb., assuming that the larger piston has an area of 10 sq. in. By raising the pressures the values will be raised proportionally. If, for example, the force applied to the small piston is raised to 100 lb., then the lifting power (upward force) of the large piston will be 2000 lb. However, the important thing to keep in mind is that if the application of force to the larger piston causes it to travel 1 in., the smaller piston must travel 10 times that distance, or 10 in.

In the practical working unit in Fig. 2 the small piston is a pump fitted with a handle permitting repeated strokes. This reduces the size of the pump (smaller piston) to a point within usable limits. Check valves

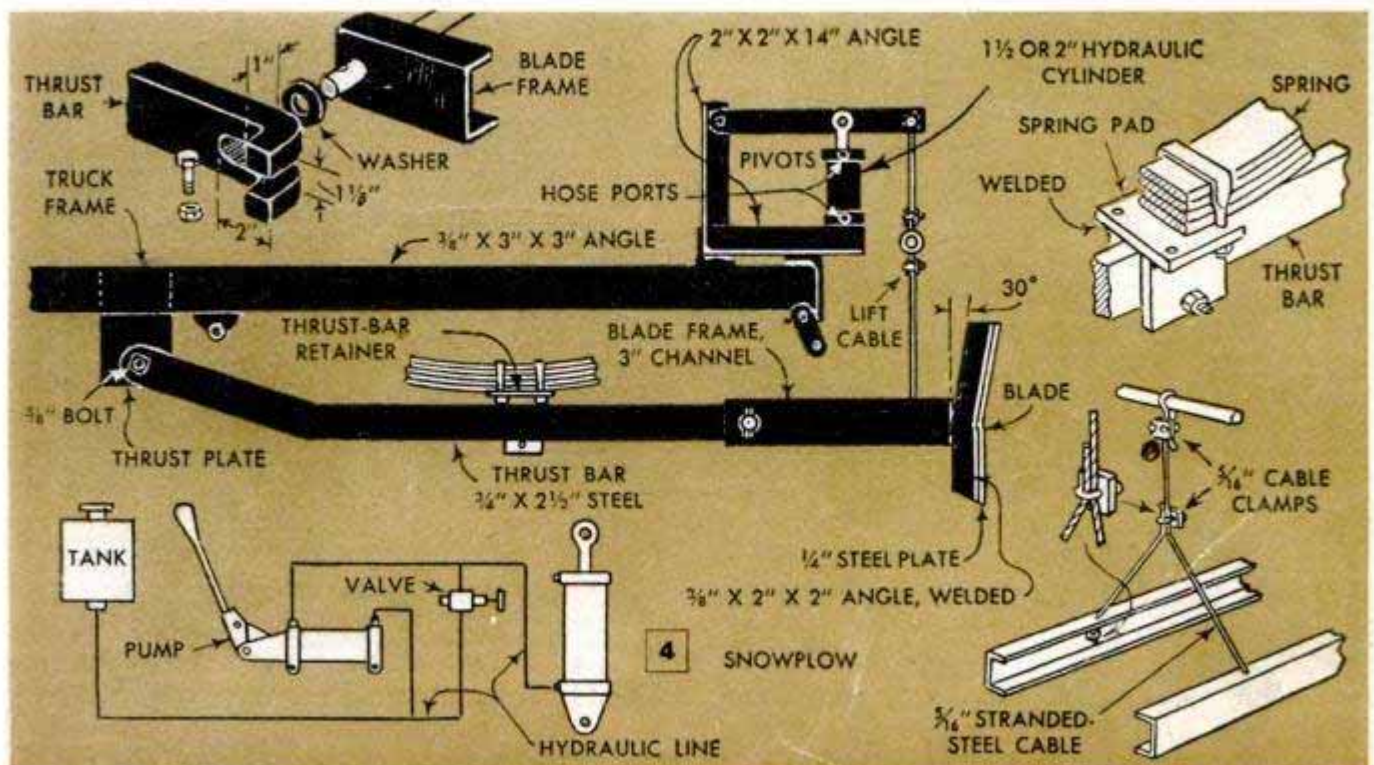

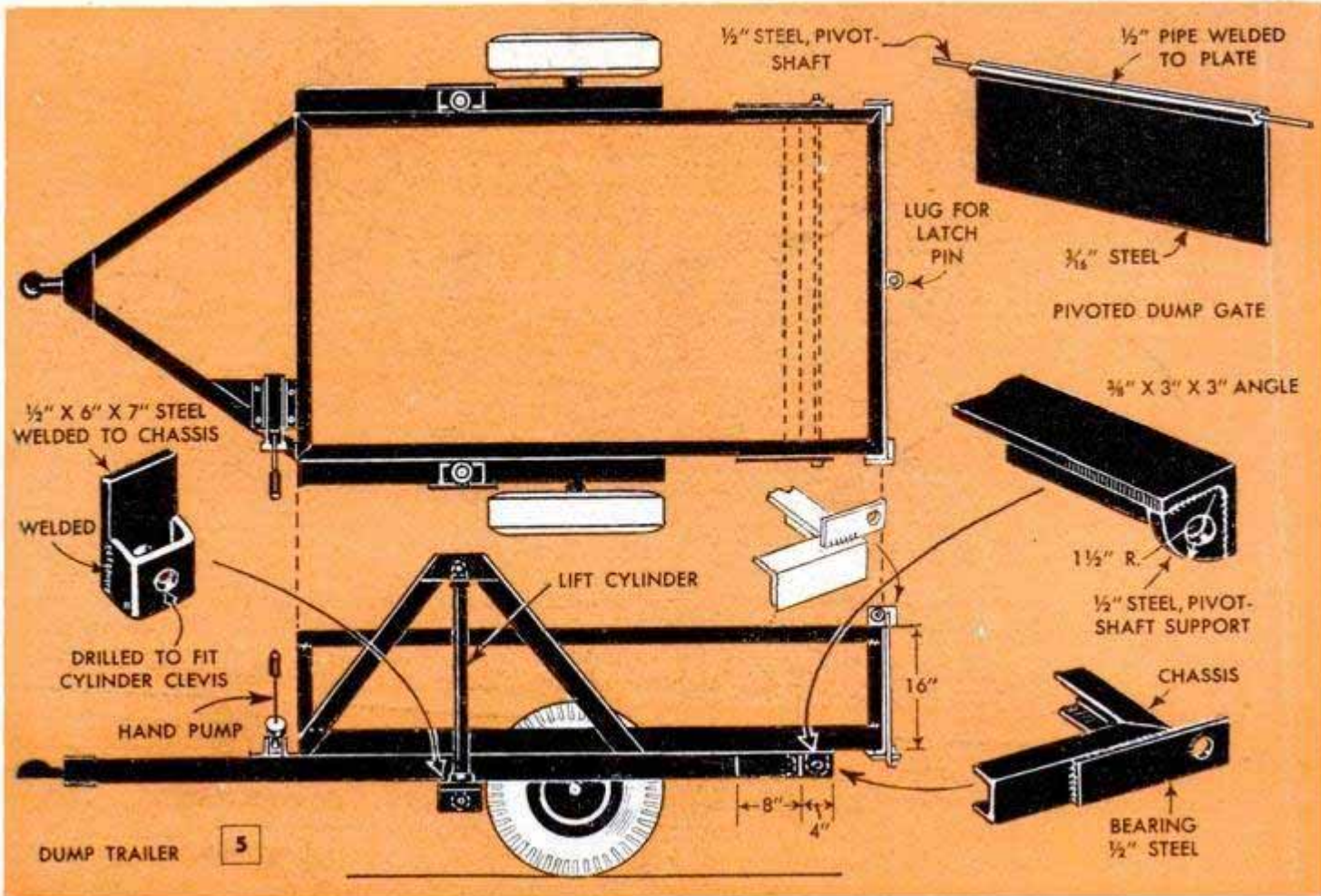

Hydraulic dumping mechanism is easily installed on trailer while it is being built. Only two lift cylinders and a hand pump are required. Body and chassis of the trailer are built by welding steel angles and channels

have been installed in the system to prevent the oil in the larger cylinder from returning to the smaller cylinder when the pump handle is released. The second check valve prevents the oil under pressure in the smaller cylinder from returning to the supply tank. Also, in order to make the unit workable, it is necessary to install a return valve so that oil in the larger cylinder can be returned to the supply tank when the work stroke of the larger piston has been completed.

Now note the variations in the system detailed in Fig. 3. By using a continuously rotating pump the ball check valves can be eliminated. The directional control valve is used to route oil under pressure to both ends of the lift cylinder, providing a means of exerting force in opposite directions. To protect the pump from damage by excessive pressures a relief valve releases oil from the pump outlet when pressure in the lines exceeds a given level. To protect the pump and cylinders from excessive wear a filter is installed in the supply tank to remove any abrasive material which may be present in the oil.

Note that by rotating the directional valve through 90 deg., Fig. 3, the oil under pressure will be directed to the upper end of the cylinder, forcing the piston down-

ward. Oil below the piston remaining from a previous upward power stroke will be bypassed by the directional valve back to the supply tank. There are, of course, many variations of the valves, lines, pumps, cylinders and fluid motors used in hydraulic systems and for this reason none of these components has been shown in complete detail in the illustrations. Operating conditions generally serve as a basis for determining the types and sizes of the parts used in building and installing the system.

Typical examples of the application of the simple hydraulic system are the combination snowplow and bulldozer shown in Fig. 4 and the dump trailer, Fig. 5. Both of these units utilize the hand-operated hydraulic system detailed in Fig. 2, as the only function of the hydraulic unit is to raise the trailer body and the snowplow blade. There is sufficient weight in both the body and blade to lower the parts by gravity alone. Both hydraulic systems will be used only intermittently and, as there is no requirement for oil under continuous pressure, a hand pump will serve the purpose in both installations.

Installation of the bulldozer requires no major structural changes in a truck or Jeep. Flat-steel thrust plates are bolted or welded to the chassis frame just back of the rear-

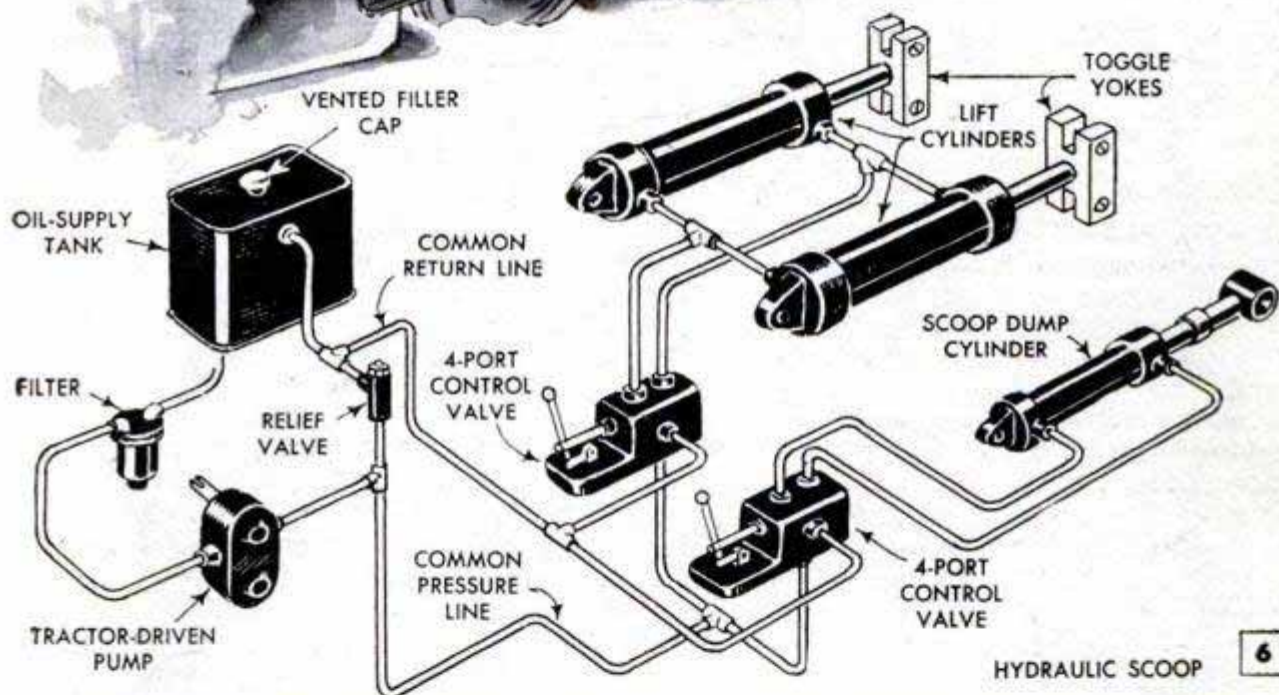
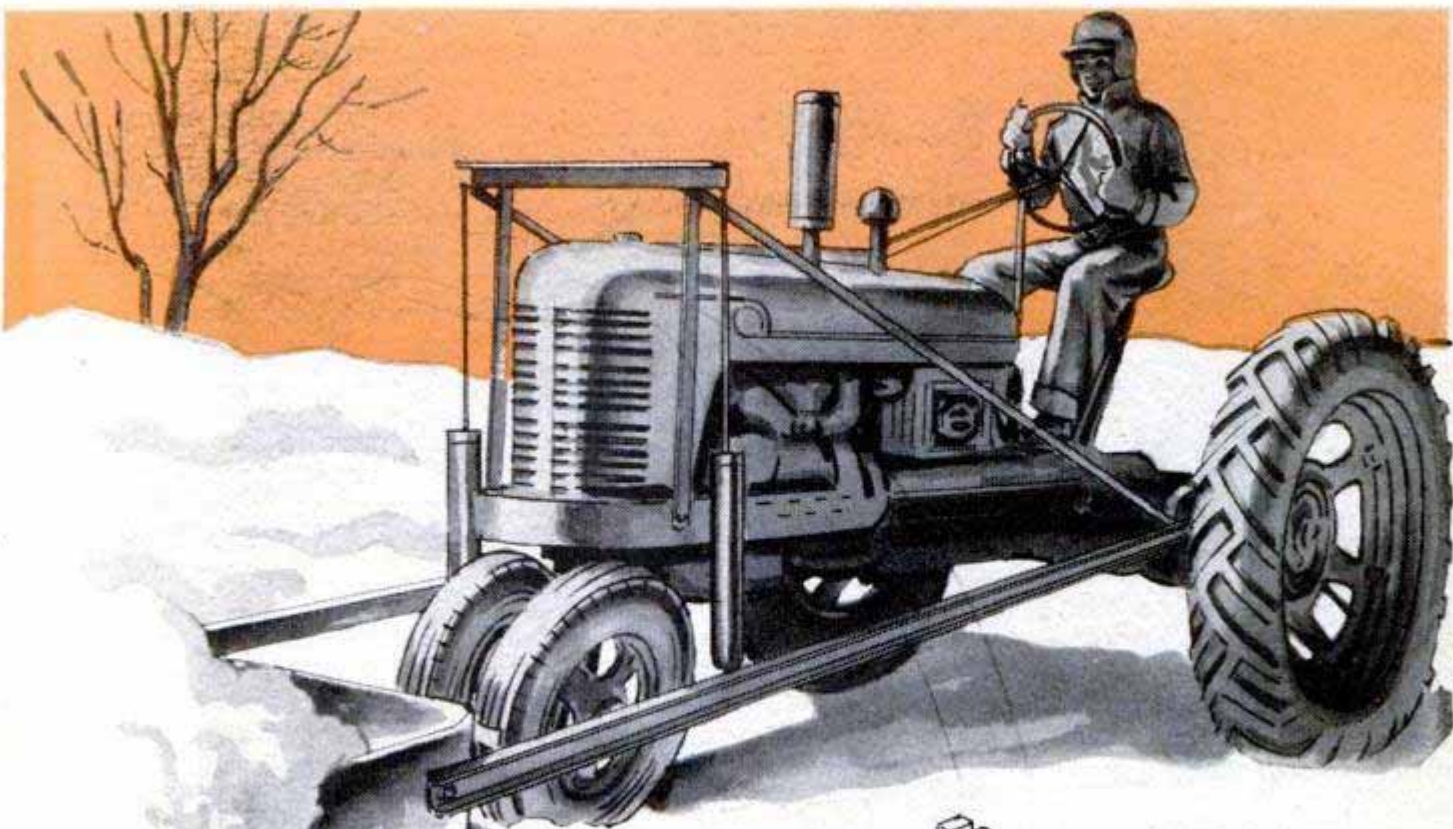

spring shackles and the thrust bars are attached to the plates with $\frac{5}{8}$ -in. bolts fitted with castle nuts. The forward ends of the thrust bars are slotted and the projections bent at right angles so that the members of the blade frame can be fastened with bolts to permit easy removal. The method of attaching these parts is shown in the upper left-hand detail in Fig. 4. The upper right-hand detail shows how the thrust bars may be attached to the spring pads. The hand pump should be bolted to the floor of the driver's compartment, or cab, in such a position that the handle is reached easily with the right hand. Also, the return valve should be located so it is within easy reach when it is desired to lower the blade. The supply tank should be mounted on a bracket at a level higher than the pump for best results.

When the unit is used as a snowplow the hydraulic system should be filled with No. 10W motor oil for easy operation in low temperatures.

Although there are various types of hydraulic dump trailers, the type shown in Fig. 5 has a hydraulic system which is especially adapted to a small two-wheel trailer chassis. The drawings are intended merely as suggestions for constructing a trailer adapted to the needs of the individual, hence complete construction details are not given. As shown the trailer body is fitted with side-mounted lift cylinders and a pivoted dumping endgate. The body frame, chassis frame and drawbar are welded steel angles and channels, and the bed, sides and ends can be made of steel plates or hardwood boards bolted to the steel frame

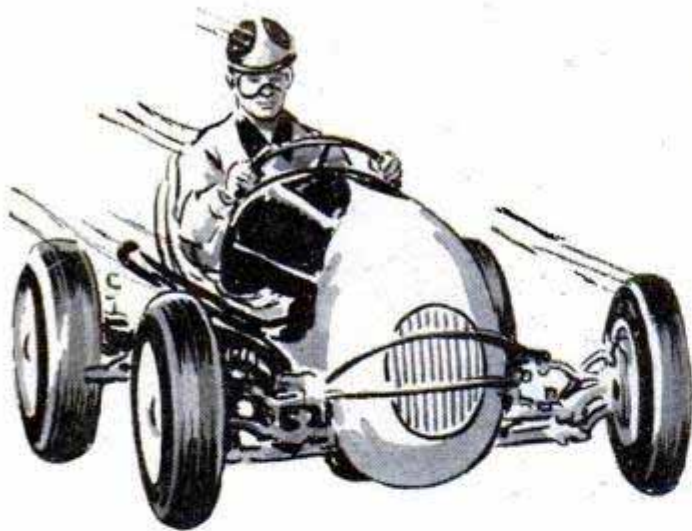

is advantageous to build a hydraulic unit for special jobs, or for use on an older tractor not equipped with a hydraulic pump. A typical hydraulic-lift unit for operation of a tractor scoop is shown in Fig. 6. This unit features hydraulic-lift and scoop-control cylinders and dual control valves. The usefulness of this assembly is not confined to the operation of a farm-tractor scoop. It is suitable for other purposes as well, as all cylinders permit force to be applied in two directions.

In any hydraulic-lift installation where movement of the parts requires provision for flexibility in the pressure lines, always use a synthetic-rubber braided line especially designed for hydraulic systems. Avoid the use of rigid pipe wherever possible. In some cases it is necessary to install T-fittings with one opening plugged to provide a means of bleeding air from the system. Usually these fittings should be installed at the top ends of the cylinders.

Many builders of midget cars utilize hydraulic transmissions. These are available in several types and sizes. Most of the units are self-contained and will handle readily the power output of 1 to 5-hp. engines. The units also are available with input and output speeds in varying ratios. For example, one unit is available in which the maximum speed of the output shaft is only about $\frac{1}{2}$ the speed of the input shaft. Another delivers the same speed at the output shaft as that of the input shaft when the control

of the body to give the depth required.

The hand pump is shown mounted on a steel plate on the left side of the chassis frame. This plate is welded to the frame members and serves both as a base for the pump and as a frame-reinforcing gusset. The hydraulic cylinders are bolted to A-frames at the top, and the piston eyes, or clevises, pivot in special brackets welded to the chassis frame. Two cylinders are required, one on each side of the bed, and they should be of sufficient length to lift the pivoted bed to the required height for dumping loose material.

Nearly all late-model farm tractors come equipped with hydraulic pumps and accessory hydraulic fittings are supplied for various purposes. However, it occasionally

Builders of midget cars of nonprofessional types often utilize flexibility of self-contained hydraulic transmission which is available in several types and sizes with input and output-shaft speeds in varying ratios

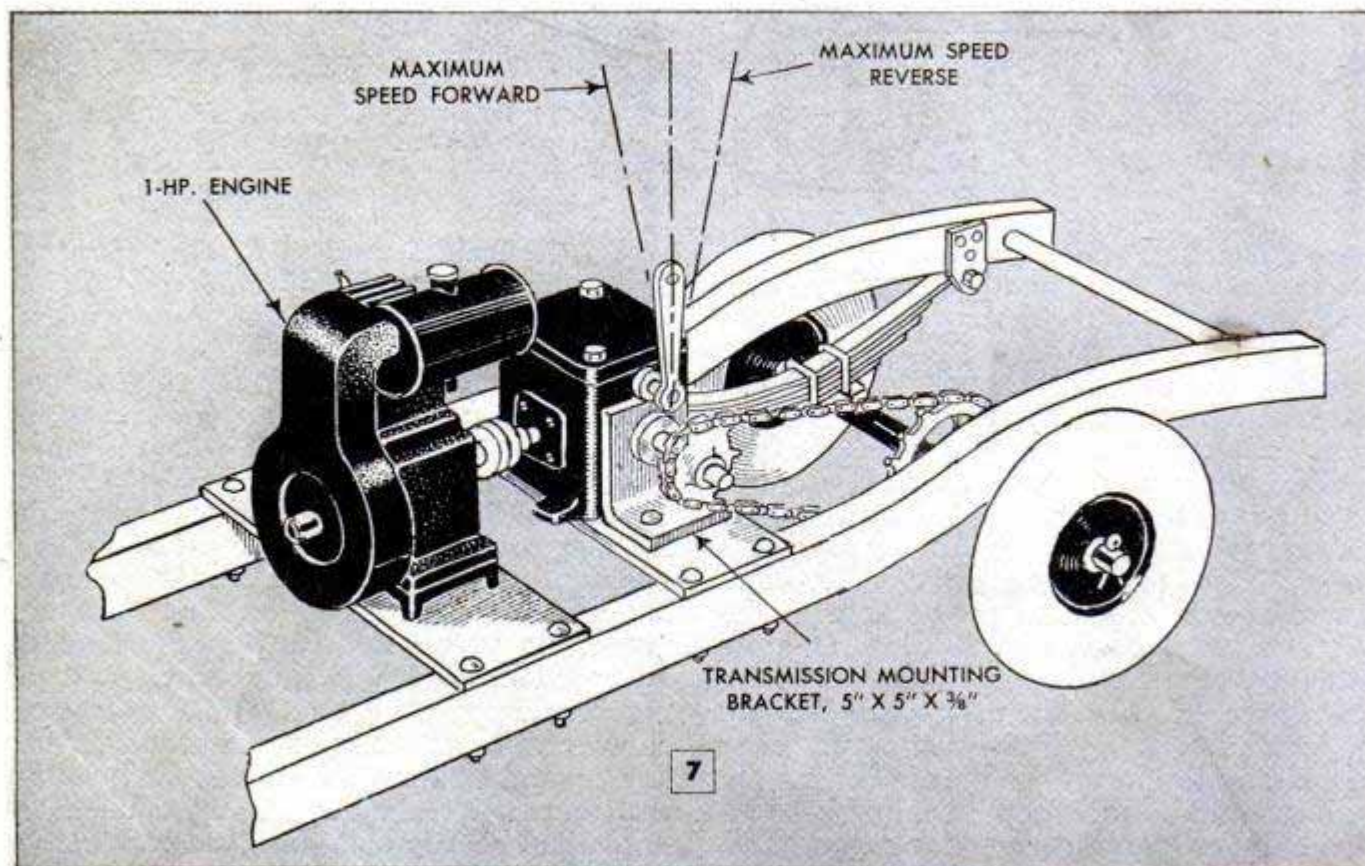

lever is set to the maximum forward speed. In nearly all units the speed can be varied from zero to maximum simply by moving the control lever forward or back. On several of these units no clutch is necessary. Fig. 7 shows a typical installation. Although this unit is shown in direct drive with the engine connected to the transmission through a flexible coupling, some types of hydraulic transmission will require a belt reduction from the engine to the input shaft in order to take full advantage of the speed range. Speed reductions to the rear axle of the car are accomplished by means of roller-chain or V-belt drives.

Another hydraulically operated labor saver for farmers and truckers is the automatic truck-gate lift shown in Fig. 8. It can be installed with only minor variations on trucks of nearly all makes having pickup bodies. The hydraulic system required is similar to that used on the tractor-scoop lift, Fig. 6, except that only one control valve is required. Of course, a hand-pump lift could be used, but the slow lifting speed would reduce its efficiency and usefulness in this application.

On trucks fitted with power take-offs, installation of the hydraulic pump is quite simple as the pump usually can be bolted to a bracket attached to the transmission or the truck frame. For intermittent use, the

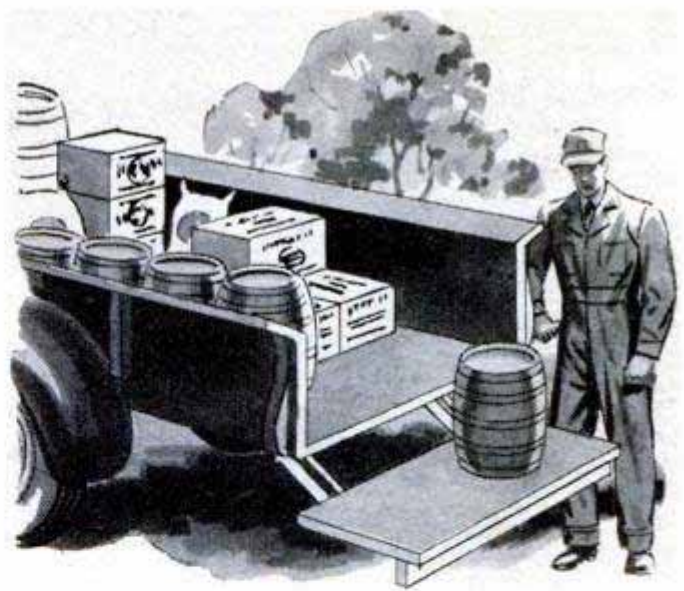

pump can be powered with a starter motor. The battery drain is nominal as the pump is operated only during the lifting stroke of the hydraulic cylinders which normally requires but a few seconds. Only the general assembly of a typical lift is shown in Fig. 8 and the dimensions of the parts are not given as these must be worked out to suit the truck on which the unit is mounted. In most cases the original endgate can be adapted as a combination lift platform and gate. It may be necessary to reinforce it by welding in vertical stiffeners. Light steel channels will serve this purpose. ★ ★ ★

Another hydraulically operated labor saver for farmers and truckers is the automatic truck-gate lift which will lift heavy crates, boxes and barrels from the ground to the truck-bed level in a few seconds' time

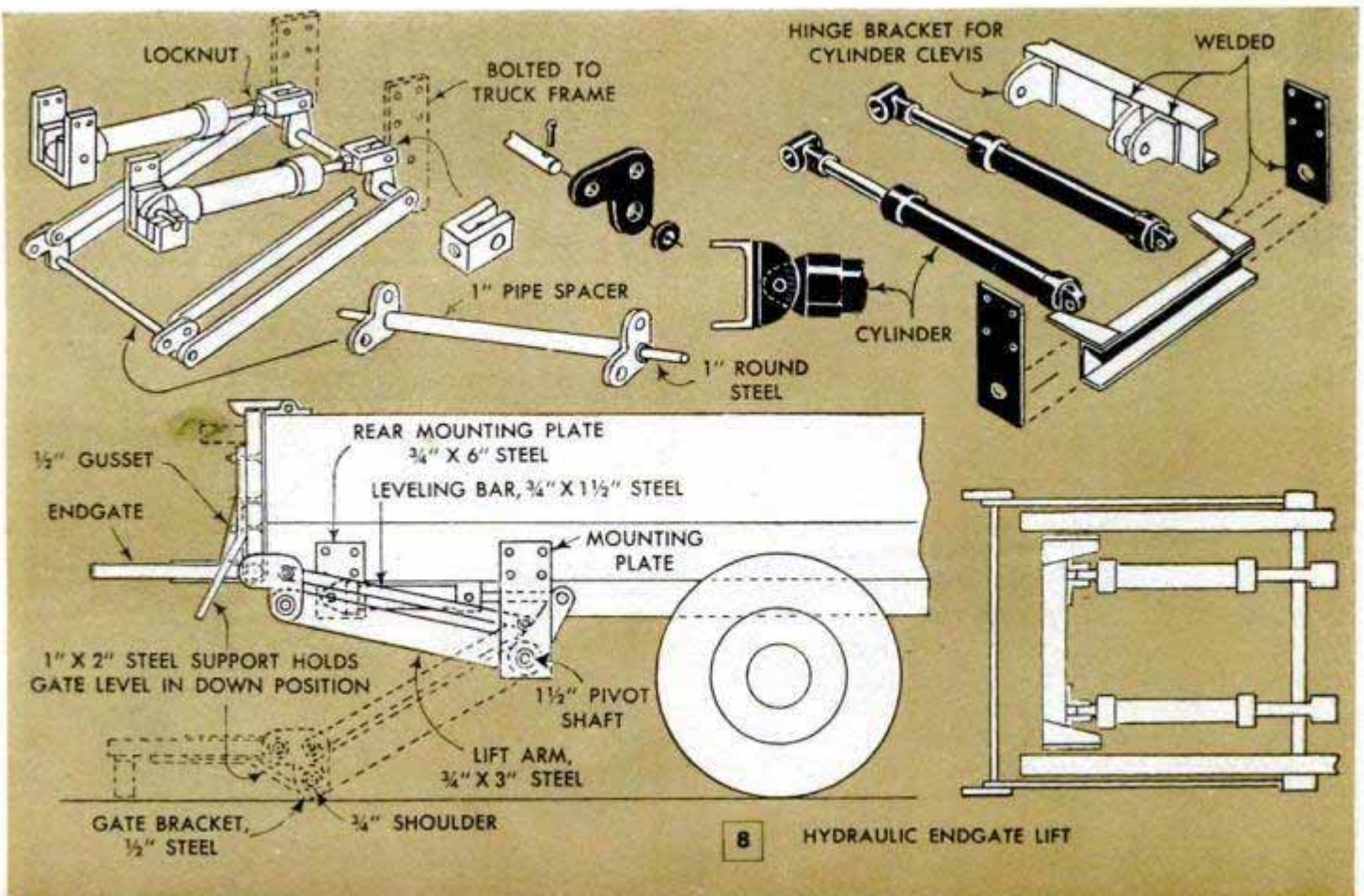

Yardsticks Fastened Together Handled Easily on Blackboard



The difficulty of holding a yardstick flat against a blackboard when it is used as a straightedge may be overcome to a great extent by tacking or gluing two sticks together as shown. The additional stick prevents the original one from bending or bowing out of position and also provides a convenient grip for moving it about.

Special Fixture Aligns Holes When Drilling Yoke

Drilling aligning holes through both arms of a yoke or any U-shaped part often poses a problem in the job machine shop. One

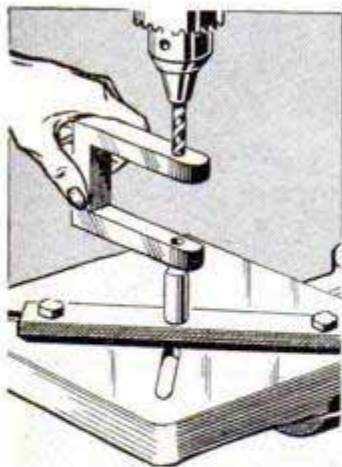

machinist does this ticklish job with a simple aligning fixture which is bolted to the drill-press table and positioned with an indicator on the center line of the drill-press spindle. The fixture consists of a flat steel bar supporting a vertical 60-deg. center which is machined to a

press fit in a hole drilled through at the center of the bar. To use the fixture locate and center-punch the holes to be drilled through the yoke. Then run in on the punch marks with a 60-deg. centering reamer. Hold the work as shown with the vertical point of the jig entering one of the center holes. Drill the first hole, using the center

hole in the upper arm of the yoke as a pilot for the drill. Then turn the piece over, center as before and drill the second hole.

Henry Sevcik, Los Angeles, Calif.

Protecting Fruit Buds From Frost

Spraying fruit trees with water in late evenings of spring nights that threaten to bring frost will often protect the buds from frostbite. Ice coats form over the buds and act as insulators to protect them from the damaging weather.

William Allen Ward, Dallas, Tex.

Auxiliary Feed Supply Stored in Garbage Can

To save time and labor hauling feed to range feeders, one poultryman keeps an auxiliary supply of ground feed stored in a garbage can placed near each feeder. The

can holds an extra filling or two and the tight-fitting cover prevents damage and minimizes waste of the stored feed by keeping out rain and rodents. — A M. Wettach, Mt. Pleasant, Iowa.



Bottom Margin of Typewritten Page Indicated by Colored Tab

A margin indicator for the bottom of a typewritten page can be made by cementing a colored tab in the lower right-hand corner of a blank sheet and inserting it in a typewriter under the copy sheet. As the writing nears the bottom of the page, the tab will appear to warn the typist.



When a lathe is used primarily for short work, it often is practical to clamp a simple wooden tray to the bed beyond the tailstock. The tray, made of scrap lumber, plywood or hardboard, not only holds tools and small parts within easy reach but forms a protective covering over the unused portion of the ways. To clamp the tray in place, a wooden cleat or length of flat steel is drawn against the underside of the bed with a bolt which is passed through the table, the latter being counter-bored for the bolt head. —Erwin S. Koval, Homestead Park, Pa.

Auxiliary Tool Tray Bolted to Lathe Bed Serves as Protective Covering for Ways

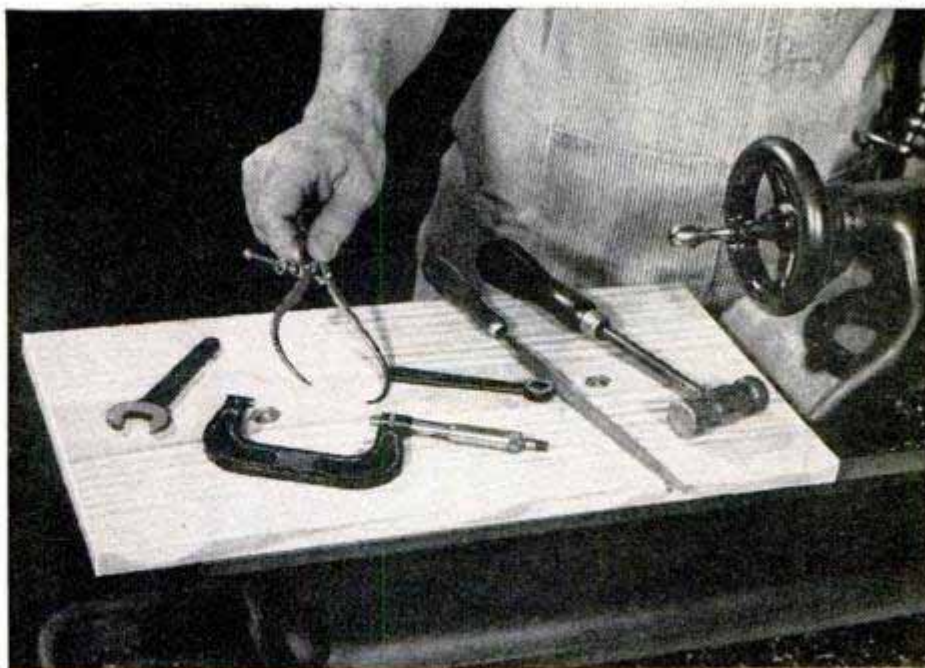

Easily Operated Corral-Gate Latch Cannot Be Nudged Open by Horses

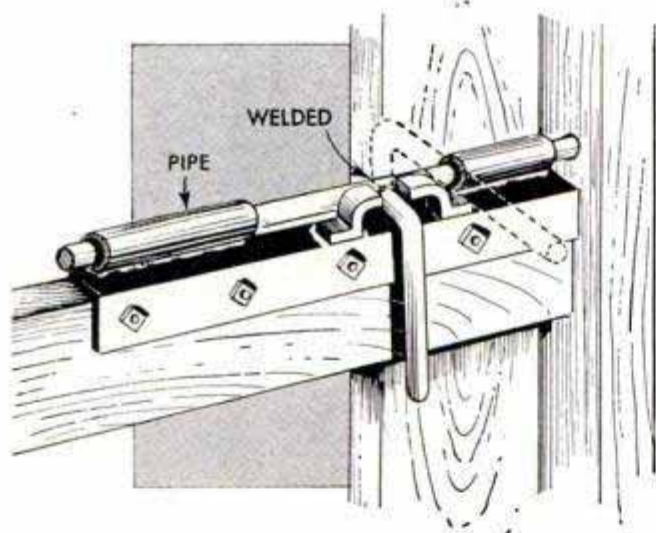

Horses that frequently are able to nudge open various locks and latches used to secure corral gates, will be unable to operate this simple but effective sliding bolt. In operation, a steel rod is slid back and forth inside two lengths of pipe welded to one side of a piece of angle steel. Another length of rod, bent at right angles, is welded to the bolt to form a handle which must be raised before the bar can be moved into the unlocked position. Small pieces of flat steel are bent and welded to the angle in the positions shown to provide stops for the bolt. The angle is then bolted to a cross member of the gate and a hole is drilled in the gatepost to receive the bolt.

Hi Sibley, Nuevo, Calif.

Poultry House With Center Driveway Has Double Doors at Both Ends

With a year-round capacity of 400 to 500 laying hens, this extra-large poultry house features a center driveway which allows the manure spreader to be brought inside the building when the latter is being cleaned. The driveway is 10 ft. wide and fitted with two pairs of doors at each end. The inner doors are simple frames covered with poultry wire and are hinged to swing inward. The solid outer doors may be kept closed during the winter months, the house being entered through a small access door in one of the larger doors. The combination of screened and solid doors permits ventilation in all kinds of weather. Extra-strong headers should be used over the doorways and studs on the sides of each door reinforced with diagonal braces.



Asbestos Sleeve on Soldering Iron Protects Near-By Parts



Wrapped around a soldering iron as shown, an asbestos sleeve will be found useful when soldering radio and electrical parts where there is the possibility of near-by wires and parts coming in contact with the iron and being damaged. Wired in place, the asbestos can be slipped back while the iron is being heated. The sleeve will also help to conserve the iron's heat.

Portable Compressed-Air Unit Made From Oxygen Container

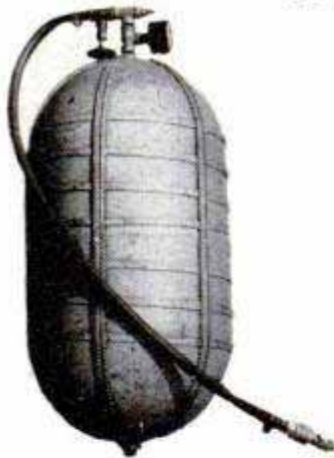

A war-surplus oxygen tank fitted with a pressure gauge, shutoff valve, and a hose and air chuck has been utilized by one farmer as a portable compressed-air unit for filling tires, paint spraying and cleaning dust from motors and other shop equipment.

The tank is kept filled with air from the compressor in the farm workshop so that it is always ready for use.

Kenneth R. Imig, Watseka, Ill.

Damaged Crankcase Repaired With Lampwicking and Board

If the crankcase of your car is damaged miles from the nearest garage facilities, you may find it practicable to improvise whatever repairs are needed to continue under your own power to the nearest city for help. One motorist, from whose car the crankcase drain plug had been torn by an unseen obstruction, used lampwicking and a small board to seal the jagged opening until permanent repairs could be made.

The wicking was coated with rubber cement and formed into the shape of a ring large enough to encompass the hole. Placed over the hole like a large gasket, the wicking was held in place by a board which was secured with wire to convenient projections on the engine block. The board, had it been fastened to the car frame, would have worked loose eventually, due to the play between the frame and the engine, which is rubber-mounted. A jack was used to support the board until it was securely fastened. The arrangement enabled the motorist, after replacing the oil, to travel 200 miles before stopping for repairs.

Joseph Singerman, New York City.

Portable Holder for Welding Rods

Welders, especially those who work on farm machinery, like this portable holder for welding rods as it is easily carried about and will stand upright almost anywhere. The holder is made by welding a square of $\frac{1}{8}$ -in. flat steel to one end of an 8-in. length of 2-in. pipe. A handle bent from $\frac{3}{8}$ -in. steel rod to form a hook is welded to the open end of the holder. If desired, a suitable divider to separate two sizes of welding rod can be made by simply drilling through the pipe near the open end and inserting a small bolt.



Old Hot-Water Tank Converted Into Automatic Hog Waterer

An efficient long-lasting hog waterer can be made from an old hot-water tank, the larger the better. One side of the tank is partially cut away with a torch, leaving



one end uncut to shield the float valve. Pieces of flat steel welded across the cut portion of the tank divide it into compartments which prevent the hogs from getting into the water and also aid in preventing them from crowding each other.

Magnetic Sound on Film

AMATEUR movie makers now can make their own sound films with a new 16-mm. combination optical magnetic-recording projector, recently demonstrated by the Bell and Howell Company. It was announced that the company has developed a process called Soundstripe to coat movie film permanently for magnetic sound. The new projector is an all-purpose unit. It records and plays back magnetic sound at either 16 or 24 frames per second by means of a stripe of magnetic material on the film edge. As the film is projected, sound is recorded and stored on the magnetic stripe, ready for instant playback. Commentary can be erased and re-recorded an unlimited number of times.

The unit projects conventional optical sound films as well as silent films. It can also be used as a public-address system and a regular magnetic recorder. The unit, including the speaker, is entirely self-contained in a single case. A separately cased 12-in. speaker also is available. To record a magnetic sound track you merely plug in the microphone, start the projector and describe what you see on the screen. Photo A shows dad threading the new projector, a close-up of which appears in photo B, preparatory to recording a sound track. Photo C shows the principal operating controls.

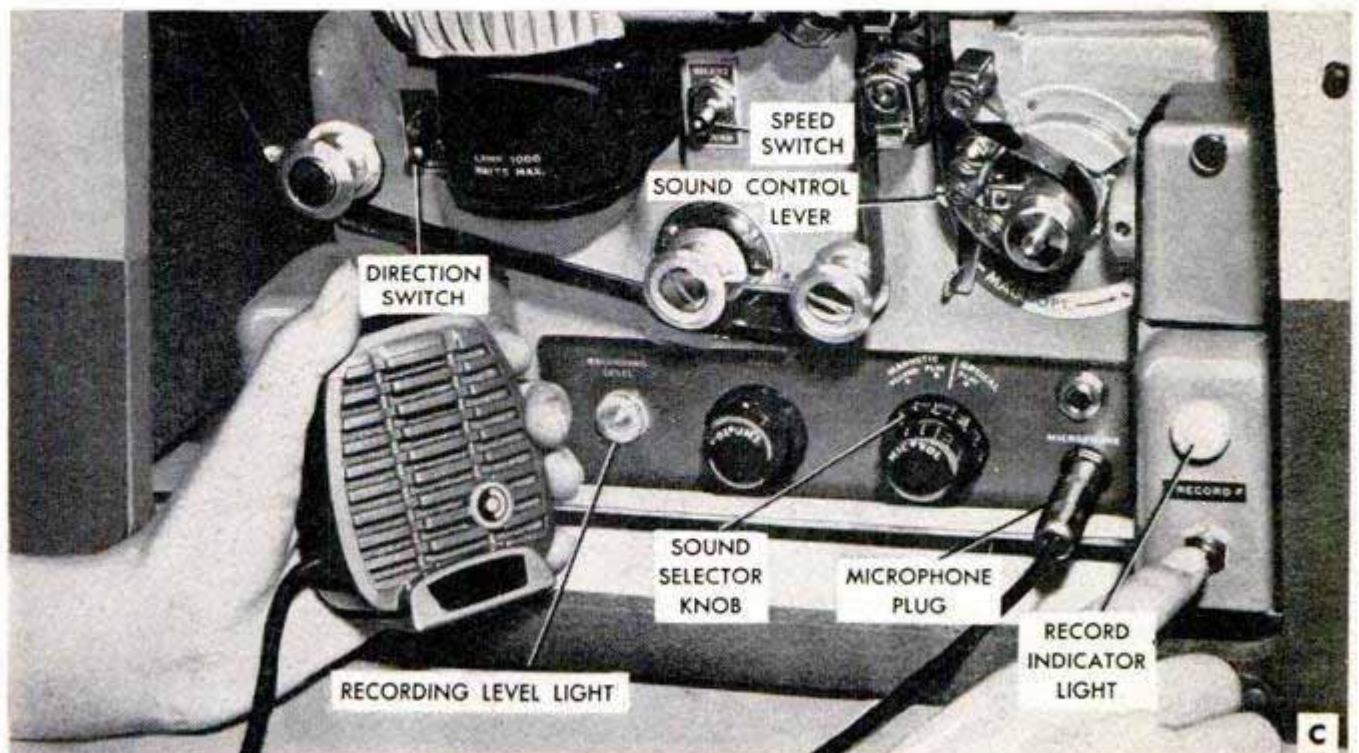
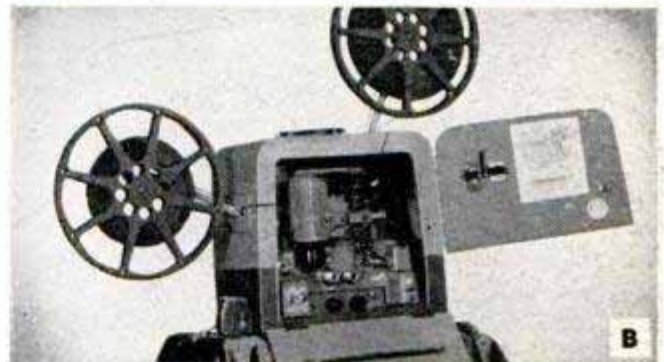

ELECTRON-COUPLED CODE-PRACTICE

By Lothar Stern

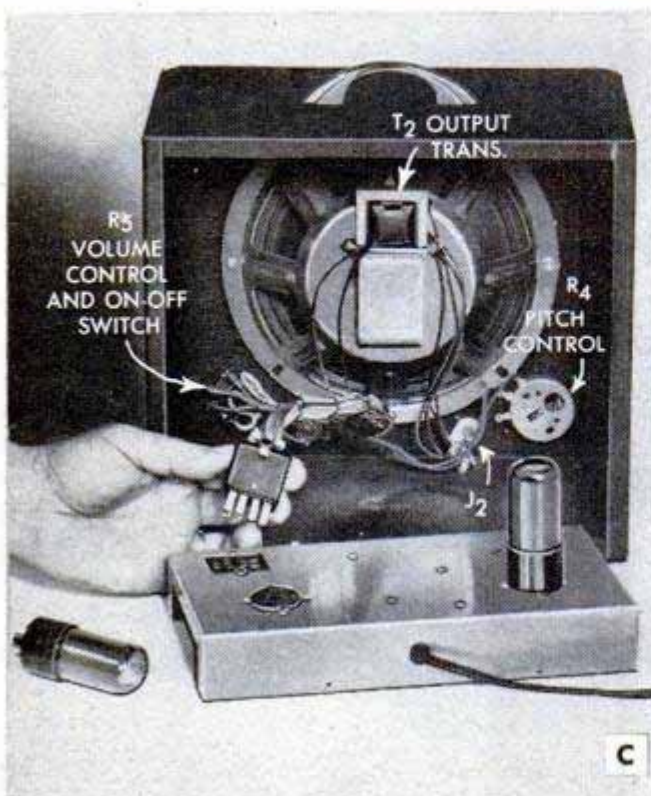
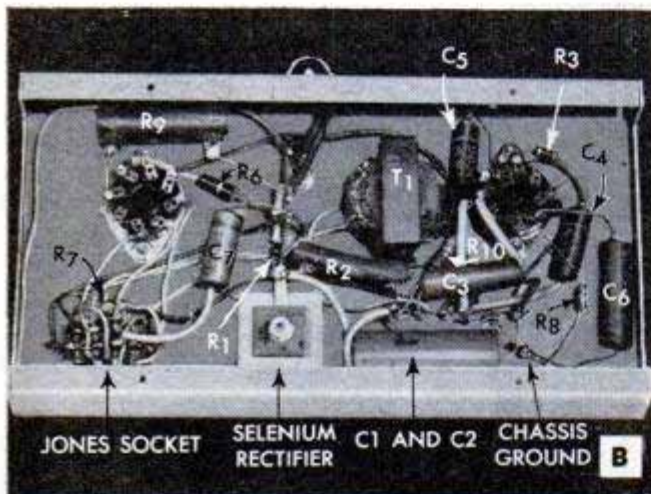
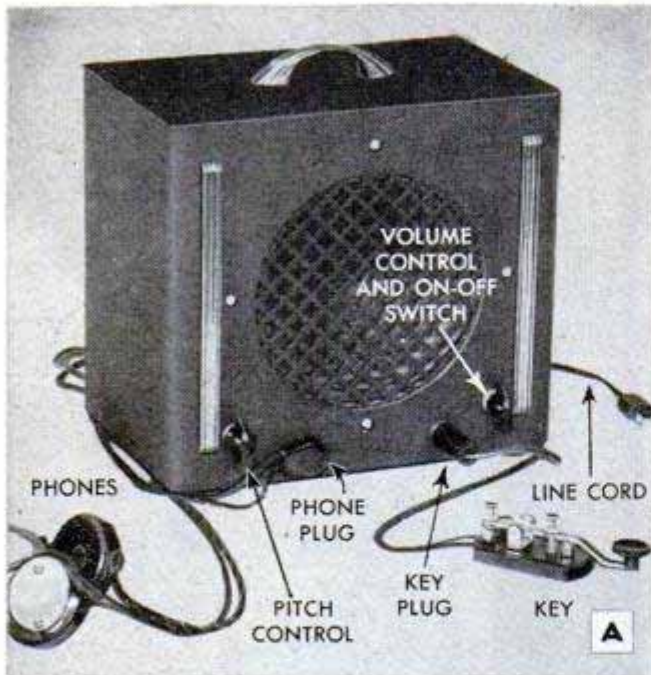

MANY PERSONS interested in amateur radio are forming code-practice groups to qualify for the new novice-band license. Previous to the opening of this band in July 1951, the Federal Communications Commission required a proficiency in sending and receiving continental Morse code at a rate of 13 or more words per minute to qualify for a ham license. When the new band opened, anyone could obtain a beginner's novice license by being able to copy only five words per minute and pass a comparatively simple examination. This training-on-the-air program has become very popular as some beginners had been reluctant to undertake the more difficult tests. The new license enables them to get on the air with simple equipment for one year, after which they are required to qualify for a higher-class license. The experience and confidence gained in actual operation on the air make this comparatively easy. Complete information is available to the beginner from any FCC office.

Groups interested in forming classes all over the country have created a demand for a code-practice oscillator with sufficient power output to drive a large speaker as well as a number of headphone sets. The unit illustrated has several features usu-

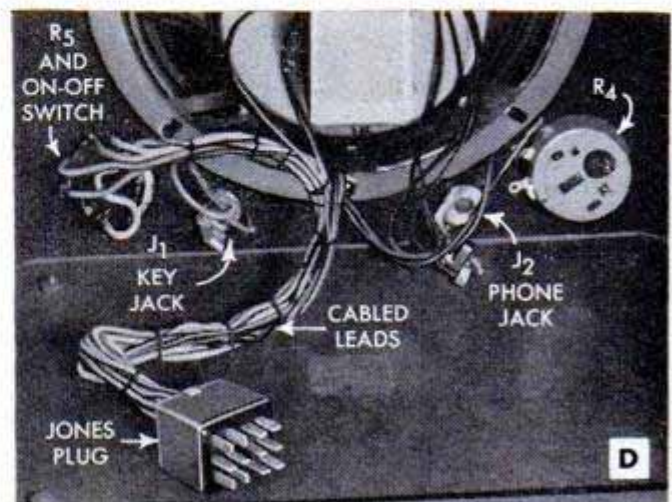
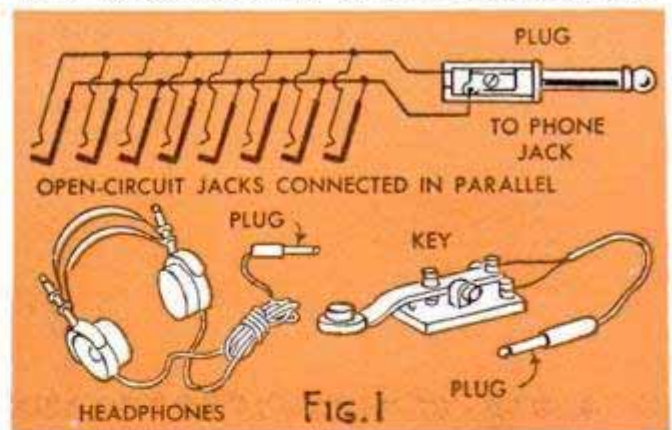

OSCILLATOR FOR GROUP INSTRUCTION

ally not found in code-practice oscillators.

Photo A shows the completed instrument housed in a metal speaker cabinet; a wooden cabinet may be substituted if desired. The speaker cabinet is 7 x 11 x 9 $\frac{3}{4}$ in. The operating controls are all mounted on the front of the cabinet as indicated in photos A, C and D. All other parts are mounted on a standard aluminum chassis base 1 $\frac{1}{2}$ in. high, 9 $\frac{1}{2}$ in. long and 5 $\frac{1}{2}$ in. wide. The controls and jacks on the front of the cabinet are connected in the circuit by means of cabled leads. A Jones No. S-312-AB socket is mounted on the chassis base and the cabled connections are made with a Jones No. P-312-CCT plug. These plug and socket connections are clearly indicated in the circuit diagram Fig. 2 by means of arrows and dotted lines. These correspond to the numbered plug and socket terminals shown at lower right. A bottom view of the chassis base appears in photo B. The chassis base is isolated to eliminate any possible chance of shock.

The output transformer T2 is mounted directly on the speaker and all connections to the transformer are included in the cable. This transformer is a 2000-ohm primary,

(Continued to page 244)

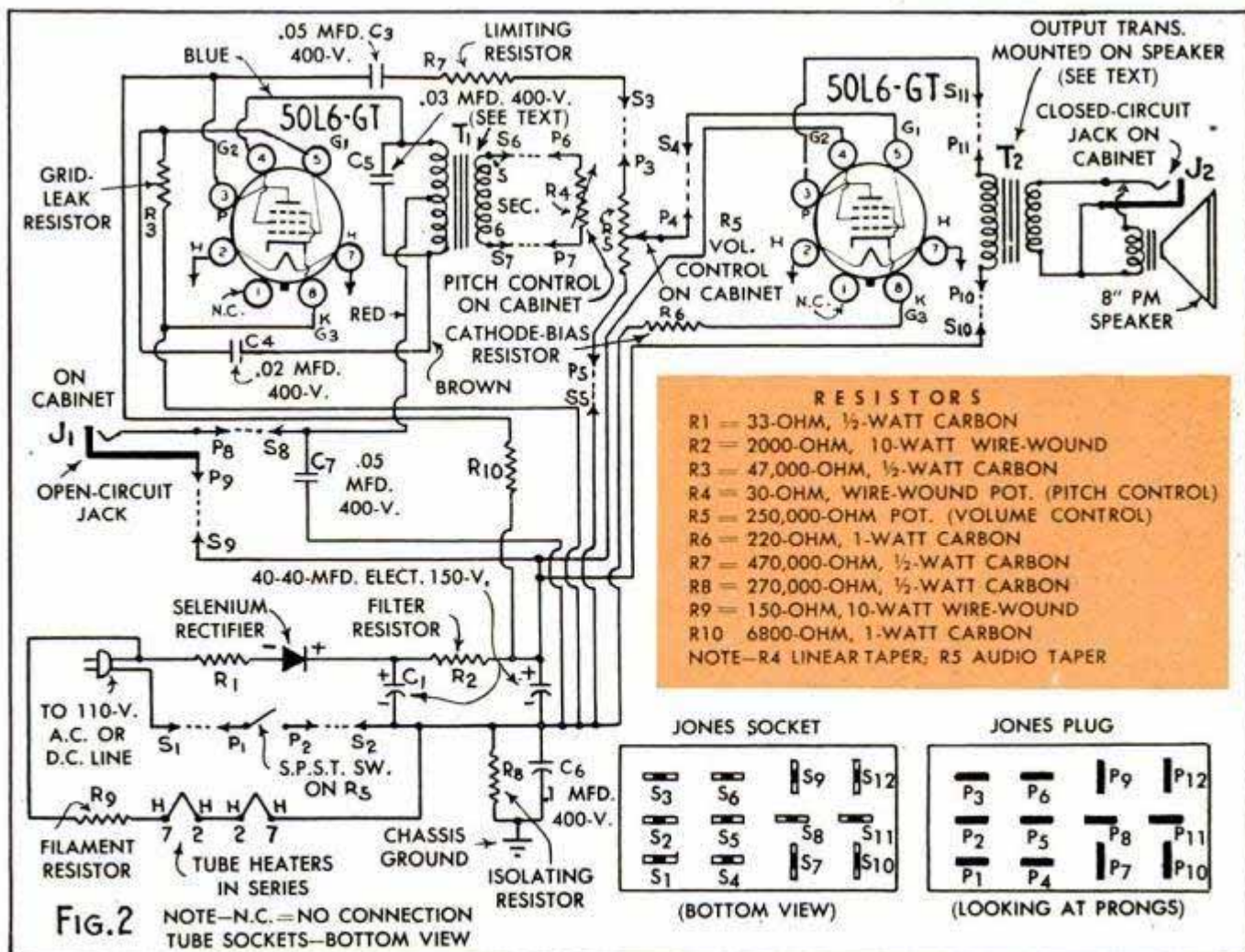
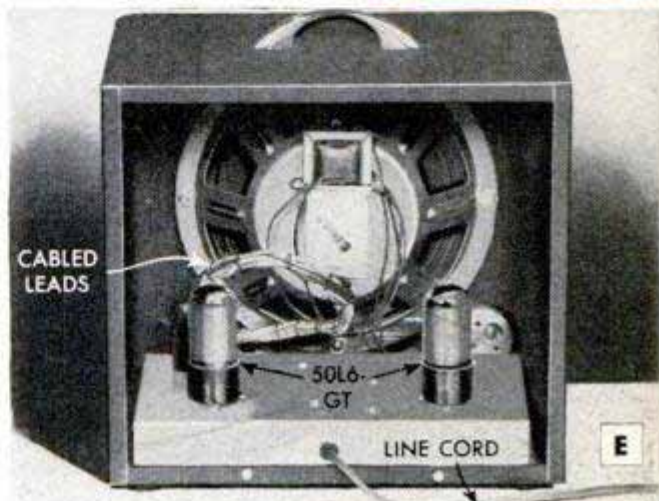

Oscilloscope Patterns Of Radio Power Supplies



AN OSCILLOSCOPE no longer is a mysterious gadget to the student and experimenter. It is a useful electronic tool used by most radio servicemen in repairing radio and television receivers. Proper use of this instrument makes it easy to trace defective circuits and breakdowns in component parts. One useful application is in checking power supplies. The student learns a great deal by viewing the power-system voltages with a cathode-ray oscilloscope, as illustrated in photo A. The oscilloscope shown was assembled at home from a Heathkit. Diagram B illustrates the proper connection to a power-supply transformer for viewing an ordinary 60-cycle sine wave. The ground terminal from the oscilloscope is connected to the grounded side of the 6.3-volt winding and the "hot" side of the winding is connected to the vertical-input terminal of the oscilloscope.

Trace pattern No. 1 shows the internal horizontal sweep adjusted, ready for the voltages which are to be observed. Trace No. 2 shows the 60-cycle sine-wave pattern. The controls of the scope may be adjusted and centered to show one cycle of the 60-cycle pattern as illustrated in trace No. 3. By connecting the vertical plates of the scope from the filament of the type-80 rectifier tube to the chassis, the ripple voltage across the input of the filter system may be seen, as in trace No. 4. Using the same connections, one plate lead to the type-80 tube was disconnected to form a half-wave rectifier instead of full-wave. In trace No. 5 note that there are fewer cycles for the same scope adjustment. To check output, or filtered voltage, the vertical scope terminals are connected from the plate of the radio output tube (B plus) to chassis for observation, and the volume control is turned down so that no signal is heard. The resulting ripple, trace No. 6, is low, and the vertical gain was increased to produce an exaggerated pattern. Trace No. 7 shows the result of a very loud hum, resulting when a filter condenser is disconnected.

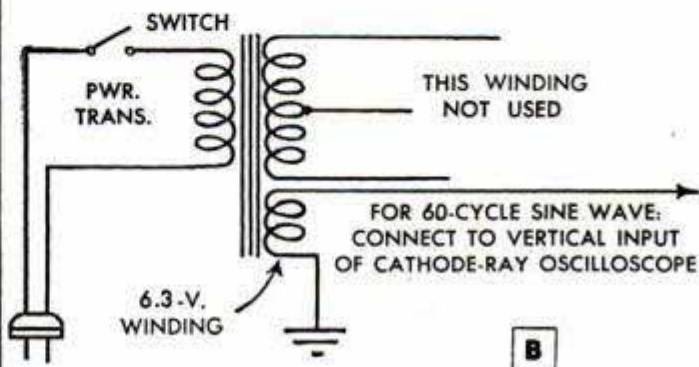
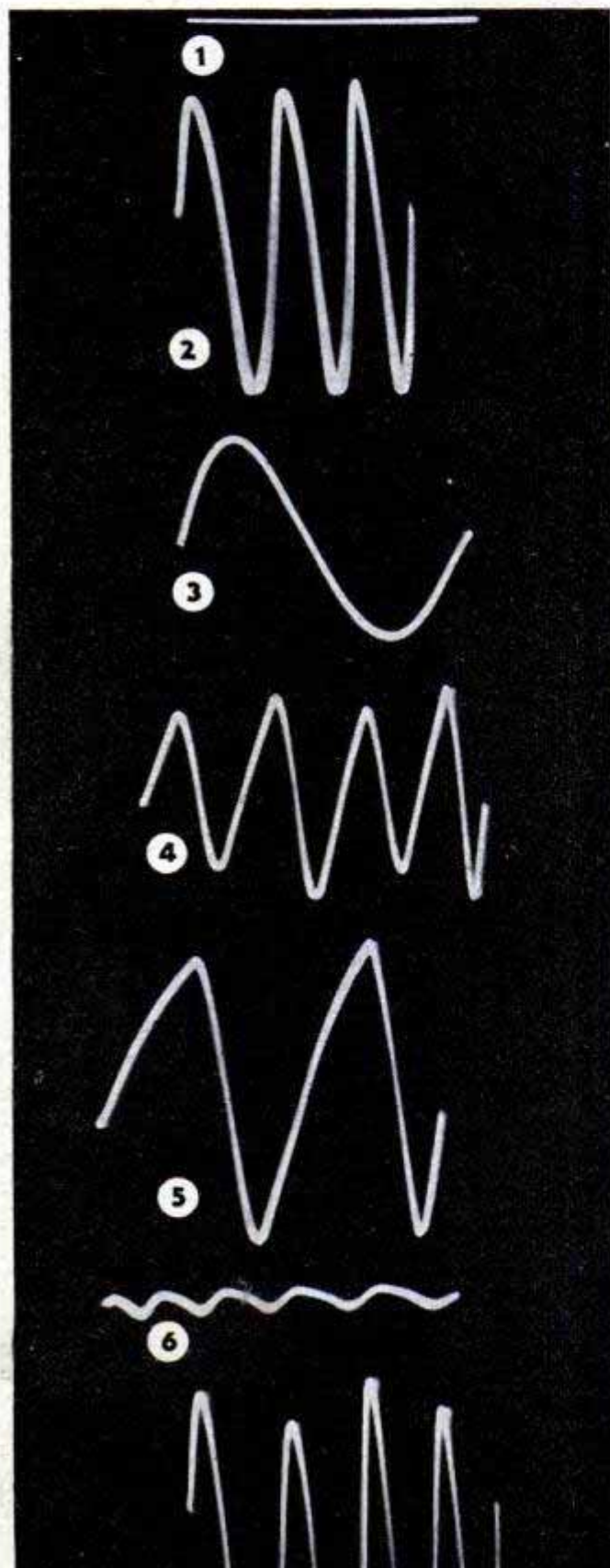

Tiny Transistors and Printed Circuits Are Important Developments in Electronics

TRANSISTORS, subminiature tubes and printed circuits are now being brought to the attention of the general reader, who may be amazed at their tiny size and remarkable possibilities. Most radio students and experimenters are familiar with subminiature tubes and the unbelievably small components used in printed circuits, especially in the manner in which they are used in hearing aids.

One of the recent subminiature-tube units is the three-tube audio amplifier illustrated in photo A. It is a complete three-stage speech amplifier built on a lightweight plate of thin ceramic. Designed for commercial and military applications where dependable amplification is required in extremely small or portable equipment, all resistors, condensers and tube sockets are included in the tiny amplifier unit, which is not much larger than a postage stamp. The actual dimensions are $1\frac{1}{2} \times 1\frac{5}{16} \times 1\frac{1}{32}$ in. One of the small components used with miniature portable equipment of this description is the volume control with built-in switch shown in photo B. This is actually smaller than a dime.

The transistor is a comparatively new germanium-crystal device, more properly called a germanium triode. The germanium-diode crystal was developed during World War II and used in radar equipment. The transistor is closely related to it. The main difference between the two is that the transistor has two "whiskers" instead of one making point contact with a tiny germanium wafer. Thus it becomes a useful tube substitute in certain radio and TV-circuit applications.

This new triode unit, photo C, is an amplifier developed by the Bell Telephone laboratories and is about the size of a pea. The basic circuit is shown in Fig. 1. One of the whiskers is biased with a small positive voltage. It acts very much like the control grid of a triode tube and is called the emitter. A much higher negative voltage is applied to the second whisker which is called the collector. It is similar to the plate of an ordinary tube. The germanium crystal is the common electrode and it is comparable to the cathode of a tube. In one type, the points of the two whiskers rest upon the germanium "base" surface only .002 in. apart. A signal is applied to the input circuit in series with the low emitter bias voltage and the amplified signal is taken from the output circuit.

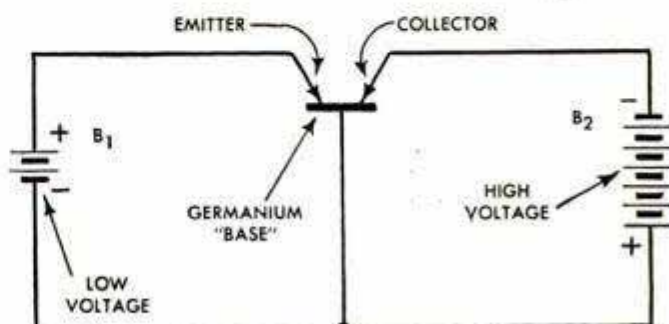
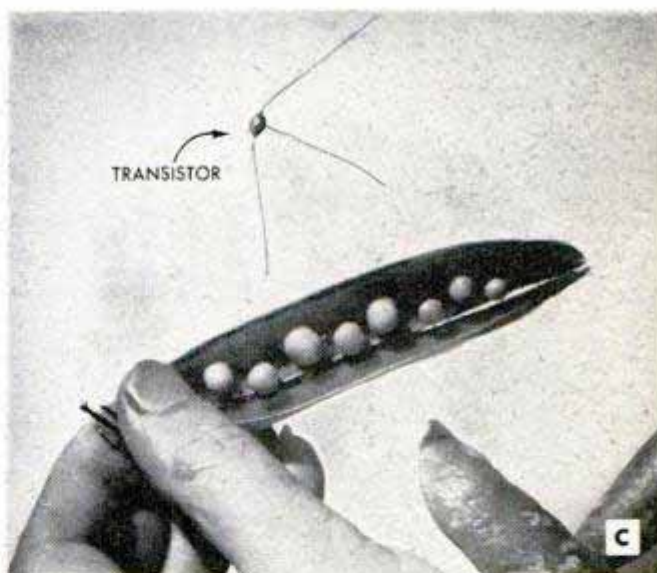
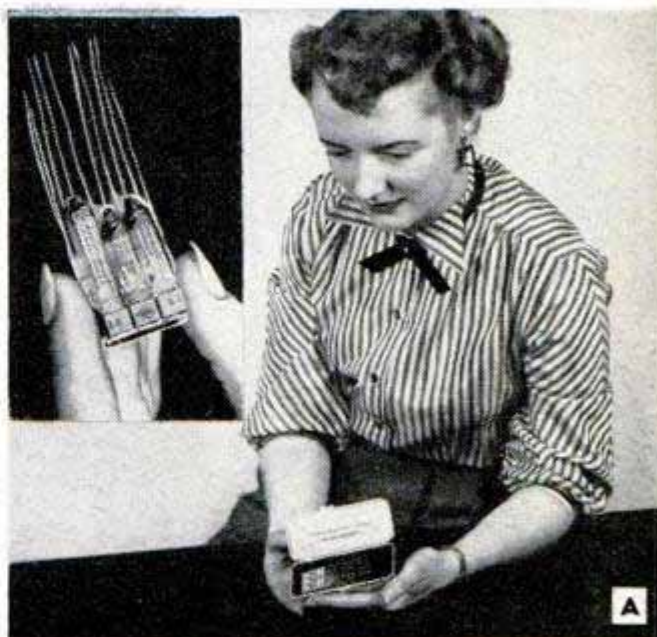

FIG. 1 BASIC TRANSISTOR CIRCUIT

Radio and Electronics Today



A

A—Designed to send and receive radio messages in trucks, taxis, fire trucks, police cars and civil-defense passenger cars, this lightweight unit can be installed quickly by plugging it into a cigarette-lighter outlet to obtain the necessary six volts for operation. It is available in either a variable or fixed-frequency model and may be operated on various wavelengths. It has a power output of about four watts and a range of approximately 20 miles. It also may be used on a standard 115-volt 60-cycle a.c. line



B

B—A truly automatic tape recorder is now available in a compact portable carrying case. The one shown is 12 x 14 x 7 in. and weighs less than 20 pounds. It uses five or seven-inch reels and is available in two speeds. Push-button operated, there are no clutches to cause trouble. Records from microphone, external radio or other external source. The tape may be erased and re-used indefinitely. There is a neon recording-volume indicator and a jack for an external speaker. High-fidelity reproduction is claimed



C

C—The three folding chairs used by these television viewers are designed primarily for this purpose. They are highly versatile, however, and very useful in small apartments where space is at a premium. They fold together into a 12-in. hassock or they may be used to form a cocktail table. The folding units have iron-braced legs and stand 17½ in. high when opened. The top of each unit measures 14 x 19 in. They are upholstered in attractive vinyl-coated plastic that is water and sun-resistant

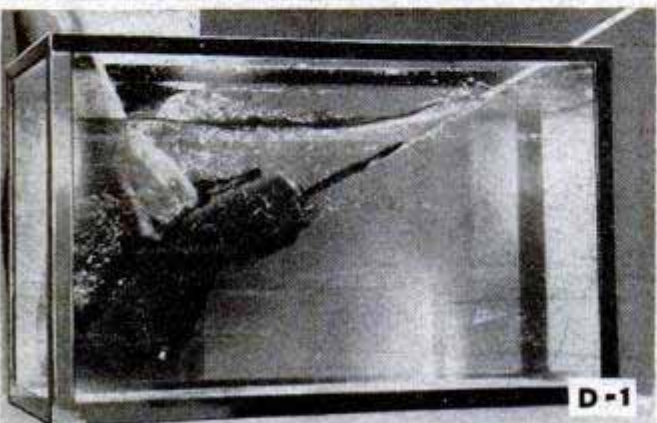

D-1

D—One of the lightest and most compact hand radio transmitter-receivers ever made recently has been developed by the Raytheon laboratories. It employs tiny subminiature tubes and has a complete transmitter, receiver, battery-power source and antenna in one package. Photo D-1 shows it immersed in a tank of water in a submersion test. D-2 illustrates its method of operation. Designed to link front-line troops with other units, it weighs only 6½ pounds



D-2

Isn't it time to paint your house ?

WITH THIS



Take a good look at your house! Doesn't it really need paint? Doesn't it deserve the best paint? Don't gamble with ordinary paint when the best costs so little. Enough SWP House Paint for the average six-room home costs less than \$45.

SWP has been the standard of quality in house paint for 70 years. This is the paint that is *Weatherated* to stand up against everything the weather can think of . . . to make your house look better *longer*. Insist on SWP for the most paint value.

Ask your Sherwin-Williams dealer to show you how SWP House Paint is *Weatherated* to clean itself and wear longer.

IT'S WEATHERATED

That means SWP is tested rigorously for its ability to resist chalking, checking, cracking, fading and dirt collection.

*Go outside and look at your house...
isn't it time for SWP?*

FREE . . . For Decorating Ideas let your Sherwin-Williams dealer show you or lend you the big Paint and Color Style Guide. Scores of large color photographs of beautiful rooms and homes. Hundreds of authentic color styling suggestions.

If you wish, we will recommend a reliable painting contractor.



IT PAYS TO SEE THE
DEALER WHO SELLS

SHERWIN-WILLIAMS PAINTS

©1952, The Sherwin-Williams Co.

SHERWIN-WILLIAMS AND ITS ALLIED COMPANIES LEAD THE WORLD IN PAINT RESEARCH



For more fun at Camp-

Take pictures on sunny days... develop and print 'em on rainy days

The Boy Scouts' motto is: "Be Prepared." That's a good motto for you, too, on your next camping trip—and for your children when they pack off for summer camp.

Be prepared to add to all the fun with some of the picture-taking "gear" you see

on these two pages. The cost is really little when you consider how rewarding snapshots can be. There's no better way to bring back memories of happy days. Your Kodak dealer will be glad to help you choose the right equipment.

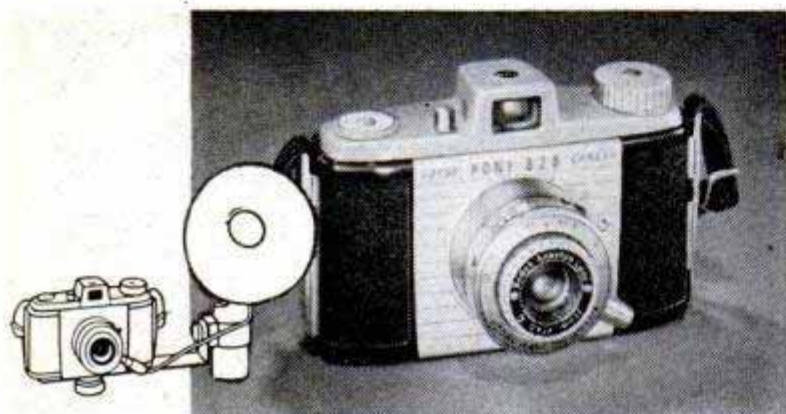

Modestly priced small cameras—superb for color—The famous Kodak Pony 828 Camera is a lightweight, thrifty "miniature." Makes superb color slides on Kodachrome Film, sharp black-and-white negatives that enlarge beautifully . . . Kodacolor snapshots, too. Kodak Anaston *f/4.5 Lumenized Lens*; Kodak Flash 200 Shutter with built-in "synch"; simplified settings marked in red. Takes 8-exposure rolls. Only \$31.15. "Pony 135" for 20- or 36-exposure 35mm. films has automatic film-stop and exposure counter—\$35.75. For flash shots any time, anywhere—Kodak Flashholder fits both cameras. \$10.55.

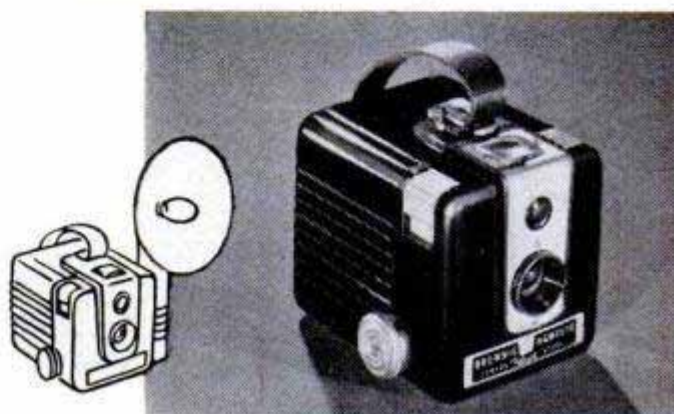

Rough-and-ready camera for youngsters—The inexpensive Brownie Hawkeye Camera, Flash Model, has up-to-the-minute styling. Simple to operate; no adjustments, just aim and shoot. Oversize view finder shows picture subject big and clear. Takes 12 snapshots on a roll of black-and-white or Kodacolor Film. \$7.20. The Kodalite Flashholder attaches easily for flash pictures night or day, indoors or out. \$3.39.

For protecting your camera—a Kodak carrying case is a smart idea. The handsome, top-grain leather Kodak Field Case for Kodak Pony 828 Camera (right) opens in an instant. \$7. Your Kodak dealer has a protective case for practically any camera.

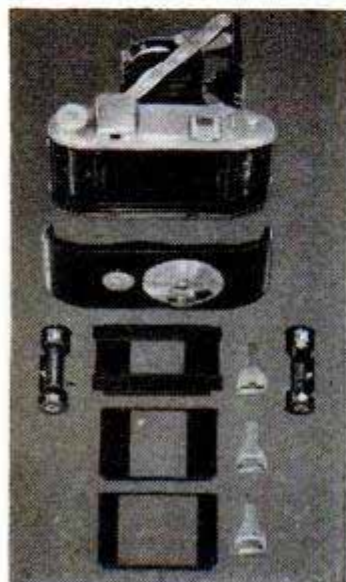

Adapter kits permit Kodak Tourist and Reflex Cameras to use Kodachrome Film—The Kodak Tourist Adapter Kit (left) for deluxe model Kodak Tourist Cameras permits color shots on Kodachrome 828 Film (for 2x2-inch slides), also economical half and square pictures on all Kodak 620 films. \$13.25. The 828 Adapter for Kodak Reflex Cameras (right) permits use of Bantam-size films—both color and black-and-white. \$4.59. Both kits include back-frame and view-finder masks, and special spool baskets.





Perfect for the beginner—The Kodacraft Printing Kit contains easy-to-use materials for printing your own pictures. Includes trays, printing frame, graduate, thermometer, stirring rod, Kodak Velite Paper for printing in daylight. \$4.30.



Everything you need to develop and print pictures—The Kodacraft Photo-Lab Outfit includes new Kodacraft Roll-Film Tank; Kodacraft Printing Frame; trays; Kodak Velite Paper; chemicals; graduate; thermometer; and film clips. \$7.45.



This advanced outfit includes a metal printer—The Kodacraft Advanced Photo-Lab packs neatly into the Kodacraft Metal Printer. Contains all materials for developing, printing pictures, including a Brownie Darkroom Lamp, Model B. \$12.10.



To put snap in your snapshots—Medium yellow Kodak Wratten Filter K2 darkens blue skies and emphasizes clouds. From \$1.65. And with inexpensive cameras, a Kodak Cloud Filter brings out clouds in true contrast. \$1.72.

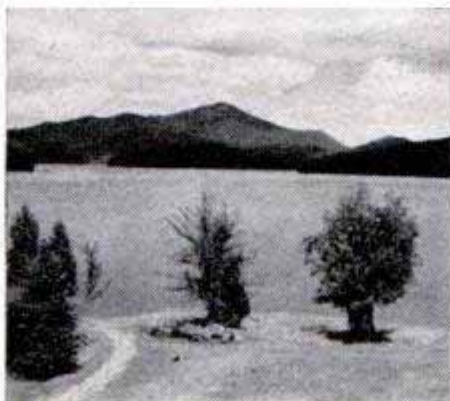

To warm up your distant color shots, Kodak Skylight Filter—Reduces bluish cast in distant scenes. Use it to get warmer-tone pictures of mountains, seascapes . . . pictures in open shade under clear sky and on overcast days. From \$1.65.



For nature study shots—A Kodak Close-up Attachment enables you to "shoot" at closer range than is normally possible with a simple camera. Gets big, sharp images of flowers and small still-life subjects. Any size, \$1.63.



Get in the picture yourself—Attach the Kodak Auto-Release to any camera which has a cable release . . . set it . . . you have 10 seconds before the shutter clicks. \$3.86 (cable release not included).



Shade the eye of your camera—A Kodak Lens Hood helps to guard against direct sunlight striking your lens. Also reduces sky "flare" when pictures are side-lighted by sun or photo lamps. From \$1.65.

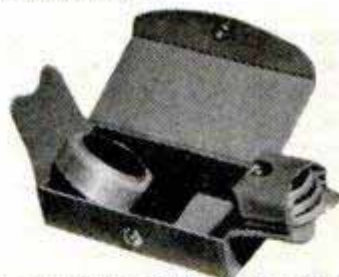

Keep your filters protected and ready for action—Kodak Combination Filter Cases are made of durable leather. Hold a Kodak Adapter Ring, Lens Hood, and four filters. Series V, \$4.25; Series VI, \$4.95.



And when you get home—you'll surely want to make enlargements from your choice negatives. The Kodak Hobbyist Enlarger (left) is only \$44 complete with lens. "Cold" light protects negatives . . . new negative carrier simplifies loading, takes negative sizes through 2 1/4" x 3 1/4". The Kodak Fluorolite Enlarger (right) has "cold" light illumination . . . rotary negative carrier for easy loading . . . lighttight cabinet in base for paper storage. \$99.50 (without lens).

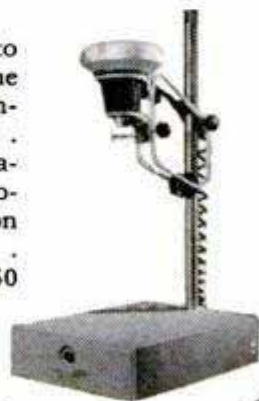

Prices subject to change without notice and include Federal Tax where applicable

Your Kodak dealer will be glad to demonstrate this equipment for you—see him for all your photo needs.

EASTMAN KODAK COMPANY, ROCHESTER 4, N. Y.

Kodak
TRADE-MARK

(Continued from page 124)

The men, whose craft has lain dormant for so many centuries, continually show their cleverness by devising new and intricate ideas. Recently one of the men at Antonio's came up with a beautiful, heavy-linked bracelet in which the hinges were completely hidden. Concave panels of the jewel were alternated with decorative rows of three silver balls, about 1/4 inch in diameter. Top and bottom balls were soldered to one panel, the center ball to the adjoining panel. Tiny silver pins in the top and bottom balls fitted into sockets in the center ball. Hence, each row of balls was actually a hinge, so closely fitted that it would take an X-ray eye to spot the trick.

To keep up the high standard of workmanship in his rejuvenated Taxco, Spratling runs a school for apprentice silversmiths where young Mexicans of the town and from near-by villages and farms may learn the trade of their ancestors from the older, skilled artisans.

And so that Taxco's new-found wealth—from Spratling silver and tourist gold—would not result in neon signs, chrome bars and Cape Cod cottages, Bill Spratling organized a citizens' committee which persuaded the government to proclaim the town a national monument. A rigid zoning code outlaws anything but true colonial architecture. No billboards will ever deface Mexico's city of silver. There will never be concrete sidewalks or tin roofs. Everything will conform with the quaint flavor of this ancient town whose river of precious metal still pours out its bounty more than five centuries after conquistador Cortes first saw the original shaft (still in existence) and described its opening as "large enough for a mounted knight to ride through." ★ ★ ★



Care and Feeding of Engines

BY S. P. CORP

VACATION FUN INSURANCE

To insure *maximum* fun on your vacation motor trip, take time out to insure *minimum* car trouble. Have your engine tuned up. Get a thorough chassis lubrication job. Don't forget front and rear wheel bearings—they are not part of a regular chassis lube job, and can easily be overlooked too long. Change engine oil and be sure your oil filter is clean.

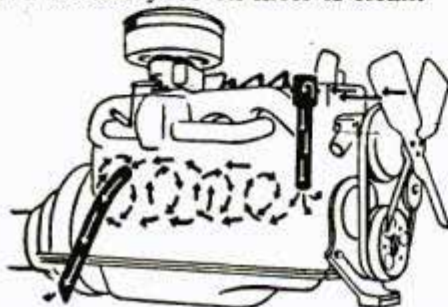

Clean the gauze filter element in the top of your oil filler cap by washing it in kerosene, so the crankcase can breathe. Choked-up breathing

here can cause crankcase dilution and poor oil mileage.

At the right rear of your engine, sometimes connected to the valve cover plate, you will find a one-inch air-outlet pipe. Check tapered lower end, which should open to the rear, to make sure it is not bent or damaged. If bent, straighten it, as the vacuum created by this taper is an important factor in proper crankcase breathing. If this pipe has a gauze filter at the top, clean it with kerosene.

UNIVERSAL JOINT

Every 20,000 to 30,000 miles, universal joints require lubrication. This calls for disassembling of the unit and thorough cleaning, after which high-melting-point wheel-bearing lubricant is added. It is a puttery, detailed job, but means saving a lot of money on costly repairs later. If you don't *know* it has been done recently, be sure to do it before starting that vacation trip!

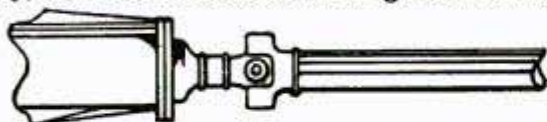

LATE-MODEL CARS AND TRUCKS ...

...operate at higher engine speeds, higher compressions, higher combustion temperatures. That's plenty of punishment for piston rings, and new Sealed Power KromeX Ring Sets can take it! Top compression ring and steel rails of MD-50 Steel Oil Ring have chrome faces to fight heat, friction, abrasion and corrosion. Write Dept. G-6, Sealed Power Corp., Muskegon, Mich. for your free copy of new illustrated booklet, "More Power, Less Oil, Less Gas."



Contact Lens for Eye Pupil

Weighing less than a drop of water, a new plastic contact lens fits only over the eye pupil and is held securely in place by a natural layer of tears. Earlier types of contact lenses fitted over the whites of the eyes as well as the pupils and were put on and taken off with suction cups. The lens is 1/2 inch in diameter and can be flicked on and off with a finger. Doctors estimate that about 60 percent of the persons now wearing eyeglasses could wear contact lenses successfully.

*univ. of Technology
Stockholm, Sweden*

Through a new Swedish process, rubber can be made from wood by utilizing the alcohol obtained in paper mills.

*Feinbloom Contact Lenses, Inc.
130 E. 74th St., N.Y.C.*

TOMORROW'S
AUTOMOBILE



Made for Each Other

**Modern Cars, Modern Heavy-Duty Motor Oil
and Modern WIX Oil Filter Cartridges**

Today's closer fitting parts and hydraulic valve lifters in your modern, high compression car engine demand exceptional filtration that also can handle the new heavy-duty, detergent type oils. Today's WIX Oil Filter Cartridges give it to you, because they contain the modern, heavy-duty filtrant —

WIXITE

Heavy-duty WIXITE gives you this essential depth filtration in its resilient density and electronically controlled construction. This sludge-thirsty depth removes more harmful dirt, grit and dust *but does not remove* detergent additives from the new oils. For trouble-free driving and modern engine protection, look for the famous WIX trademark on the Oil Filter Cartridges you buy. Care will save your car and here's the place to start saving.

wix

TRADEMARK REG.

OIL FILTERS CARTRIDGES

**WIX ACCESSORIES CORPORATION • GASTONIA, N. C.
IN CANADA: WIX ACCESSORIES CORP., LTD., TORONTO, ONTARIO**



**SEE
FOR YOURSELF!**

Only dealers who sell WIX Filters and Cartridges have the patented WIX Dirtector to show you the TRUE condition of your motor oil. A few drops from your crankcase will expose the presence of damaging grit and sludge. SEE and KNOW what goes on in your engine . . . patronize dealers who sell WIX ENGINEERED FILTRATION and be SURE!



FOR DIESEL & GASOLINE ENGINES

WIX Engineered Filtration includes sizes and types of Filters and Filter Cartridges for Railroad Diesels, Farm Equipment, Marine, Stationary Engines and Compressors as well as for cars, trucks, tractors and buses. Whatever your lubricating oil or fuel filtration problem, write for particulars. CLEAN IT UP WITH WIX.

Here's how for home painters



Get rid of fresh paint smells—overnight! Pour a teaspoonful of ammonia into a bowl of water in center of fresh-painted room. Relax and go to bed. Next morning the smell is gone. Of course, you can save yourself *all* this trouble by using Devoe Wonder Tones—*leave no*

painty smell, dry in 20 minutes.

Clean-up trick for roller coater containers! Before you start, line bottom of paint tray with two layers of newspaper. Then bend over edges and tape them down. When painting's done, just throw papers away. Containers are as clean as when you started.



Preventing paint skin—a two-edged trick! To prevent skin from forming in partly used can, float a little turpentine on top of the paint. Pour just enough to cover surface. Because paint thickens when it stands for long, surface turpentine can be stirred in as thinner when you're ready to paint again.

A tip for painting drawer knobs! Here's a handy tip: before you start painting, screw the knobs part way into a piece of cardboard—like the top of a shoe box. You can hold the knob steady while painting—and it will sit still while drying. The perfect enamel for that knob, by the way, is Devoe Mirrolac—comes in many bright colors.



You can get all the painting accessories that you need—and many more helpful tips at the sign of the Devoe Diamond. Why not stop in and see your Devoe Dealer very soon? You'll find his name listed in the *Classified Phone Book*.



Clinic for Homemakers

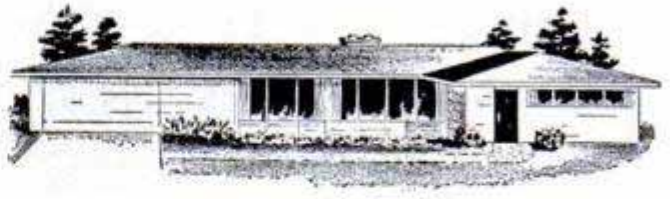

As a service to our readers in solving the hundreds of problems pertaining to a home—inside or out—the editors of *Popular Mechanics* invite you to present your problems to The Clinic Editor for help and advice. Address your questions to The Clinic Editor, *Popular Mechanics Magazine*, 200 East Ontario Street, Chicago 11, Ill.



Finishing Cherry

Q—I want to finish cherry wood in the natural color, but the pieces I have are very light colored, almost as light as poplar or basswood, except that the grain is more pronounced. I was doubtful if this is genuine cherry, but my dealer insists that it is. How should I finish it without using a dark stain?—U.T., Ark.

A—First of all, you should keep in mind that cherry wood, in both the northern and southern types, tends to darken with age. We are not sure that we understand your question, as your mention of "natural color" would imply that you wish to finish the wood in such a way as to preserve its present color. Any transparent finishing material you apply to the wood will darken it somewhat. Paste wax applied directly to the wood probably will color it least of all. However, cherry stock not selected for grain and uniformity of color is not especially attractive in a natural finish. We would suggest that you cut a small sample piece, sand the surface thoroughly with several grades of sandpaper, beginning with No. 2/0 and finishing with No. 8/0. Then apply a coat of raw linseed oil, wiping it on with a cloth and wiping off the excess oil after a few minutes. Allow to dry for 36 to 48 hours, sand lightly with No. 8/0 sandpaper, or rub with fine steel wool, and finish with two or three coats of paste wax, polishing the last coat to a soft sheen. Many finishers use light-colored wiping stains instead of linseed oil. If stain is used, it will be necessary to apply a sealer before applying finishing coats of wax, varnish or lacquer. We suggest that you experiment with both the oil and wiping-stain treatment to find color desired.

Pruning Brambles

Q—I have a small patch of red raspberries on my newly acquired property which has been neglected. I would like to re-establish it by pruning and doing whatever else is necessary to bring the plants back into full productivity. I understand this can be done, but how? How does one prune red raspberries?

D.A., Iowa.



(Continued to page 224)

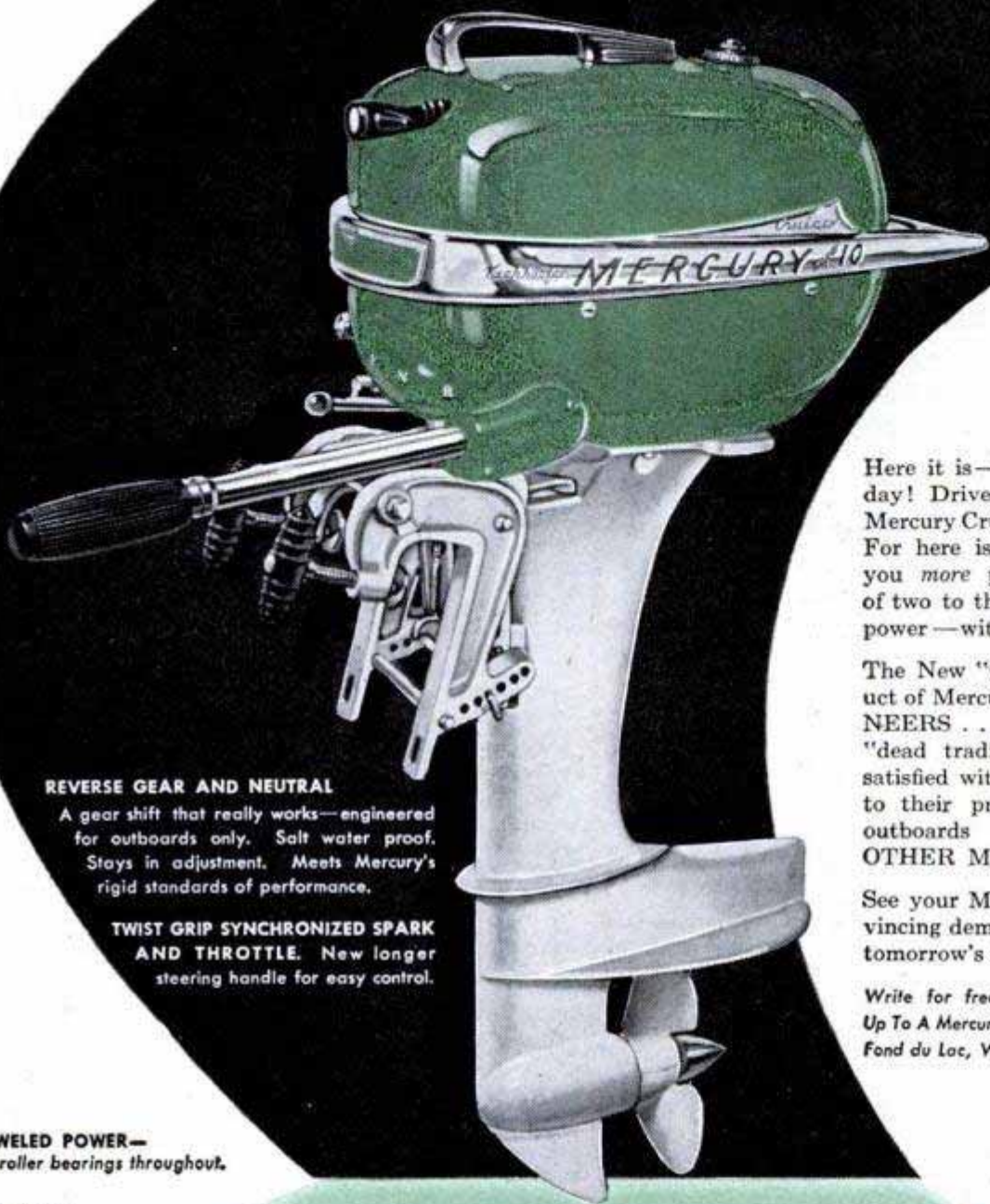

REVERSE GEAR AND NEUTRAL

A gear shift that really works—engineered for outboards only. Salt water proof. Stays in adjustment. Meets Mercury's rigid standards of performance.

TWIST GRIP SYNCHRONIZED SPARK AND THROTTLE. New longer steering handle for easy control.

FULL JEWELLED POWER—
ball and roller bearings throughout.

Features of Mercury Motors are protected by issued or pending patents.

Here it is—tomorrow's outboard today! Drive it and see why the new Mercury Cruiser is bound to be copied. For here is an outboard that gives you *more* performance than others of two to three times its rated horsepower—with up to 30% *less weight!*

The New "Cruiser" is another product of Mercury's CREATIVE ENGINEERS . . . men who steer clear of "dead tradition" . . . who are never satisfied with "good enough". Thanks to their progressive spirit Mercury outboards **OUTPERFORM ALL OTHER MAKES!**

See your Mercury dealer for *one* convincing demonstration and you'll *own* tomorrow's outboard today!

Write for free illustrated catalogue—"Move Up To A Mercury" KIEKHAEFER CORPORATION, Fond du Lac, Wisconsin.



Move up to a

KIEKHAEFER
MERCURY CRUISER

The outboard that will still be copied years from now!



 she'll love 
 kitchen cupboards
 of sunny
 WESTERN PINES*

HERE'S a remodeling job you can do yourself with the help of the Western Pines*. Lovely-to-look-at, easy-to-handle with machine or hand tools, these soft-textured, fine-grained woods are popular with home craftsmen everywhere. There's a mellow, friendly charm about them that adds lasting beauty to any room or workshop project. It's no trick at all to build cabinets, storage walls, garden furniture, bookshelves . . . to reclaim idle space in attic or basement for bunk bedrooms, playrooms, or TV "theaters" . . . when you use versatile Western Pines*. They take paint, stain and enamel beautifully, are particularly handsome left natural, then waxed and rubbed to a gleaming finish.

FREE—IDEA PACKET NO. 535

includes how-to-do-it folders and booklets, also a copy of the new 1952 edition of 68-picture booklet, "ENCHANTING HOMES OF WESTERN PINES," that will help you get started. Send for yours today to WESTERN PINE ASSOCIATION, DEPT. 535-N, YEON BLDG., PORTLAND 4, OREGON.

These are the Western Pines

- * IDAHO WHITE PINE
- * PONDEROSA PINE
- * SUGAR PINE

(Continued from page 222)

A—The first thing to do is cut out all dead canes, weed stalks and other debris that may have accumulated. Remove all short, underdeveloped shoots from each plant crown. Ordinarily this is done in the late winter or early spring before growth starts. At this stage it will do no harm to cut off dead tips of last year's canes. Some of these will die during the season without fruiting, but a large percentage will bear. This is about all you can do the first year, except to keep down weeds. Many gardeners mulch small patches of brambles with straw to a depth of 4 to 6 in. The straw mulch prevents weed growth and conserves moisture. In the late winter or early spring of the second bearing year, again remove all dead canes and thin the live canes, leaving 4 to 6 to each crown. Later in the season, after growth is well developed, pinch off the tip of each new cane. This tends to force development of new branches, or laterals, lower down on the cane. Early in the third season, preferably before growth starts, the tips of these laterals are shortened to force a more compact blossom set and production of finer fruit. Thereafter the procedure is carried out as in the second year.

Flue Size

Q—I am remodeling my home and the plans call for the construction of a new chimney. I'm told that a round flue is much more efficient than a square or rectangular flue. Why? Also, I'm told that it is necessary to install a tile lining. Is this correct? How does one calculate the required flue area?—T.A., Ind.



A—Answering your questions in order, a round flue is, of course, the most efficient, the principal reason being that smoke and gases always ascend in a spiral motion and therefore there is no circulation in the corners of a square or rectangular flue. Although tile linings generally are recommended, they are not essential if the inside of the flue is plastered and troweled smooth as the chimney is built. Of course, the plaster (mortar) cannot be expected to last as long as vitreous tile. When solid fuels are burned, this is a factor to be considered. It is not possible for us to give you a definite answer to your last question, as you did not say what type of heating equipment you are using or plan to install. In general, when solid fuels are used, the flue area should be at least 1/2 the area of the grate in the boiler or furnace. Manufacturer's specifications of flue sizes for oil and gas-burning heating units vary with the size and rating of the equipment.

Masonry Measurement

Q—What is meant by the term "perch" in connection with masonry measurement? Does it refer to the number of bricks or stones in a wall of a given size or thickness?—P.T., Nev.

A—This is an older builder's term, but still is quite commonly used. It will be found in tables of cubic measure (measures of volume). As generally stated in these tables one perch of masonry equals 24 3/4 cu. ft., or that part of a wall or structure measuring 16 1/2 x 1 1/2 x 1 ft.

Eradicating Ants

Q—How does one get rid of ants in lawn and garden? I've tried several eradicators with no success. The pests remain in the same location from year to year and damage both my lawn and growing flowers and vegetables.—R.B., Neb.

A—There are a number of preparations which should give good results if the manufacturer's instructions are followed in all details. Old-time gardeners simply fed the ants boiling water. A gallon in each anthill should do it. Of course, boiling water will damage the grass to some extent but it will eliminate the ants quite effectively. It is comparatively easy to reseed the damaged area.

Builder of the sensational **CUNNINGHAM** selects **CHAMPION** spark plugs for America's

TOP SPORTS CAR!

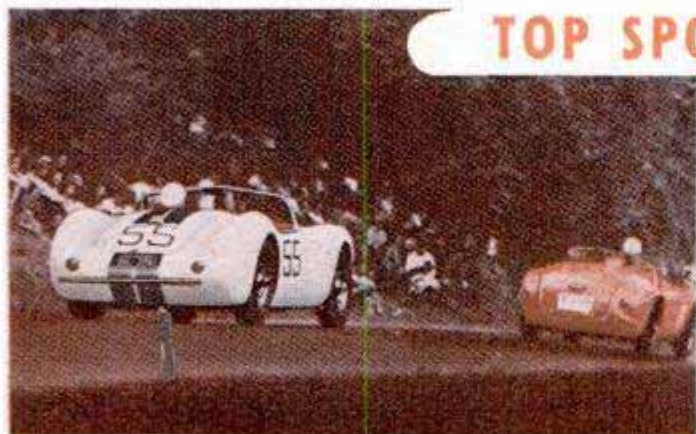

Phil Walters driving one of the Cunningham cars in the Watkins Glen, N. Y. Grand Prix. Walters went on to win, setting new lap and average speed records for this event.



Briggs Cunningham at the Bridge in the Watkins Glen race. These cars driven by Walters, Fitch and Cunningham, placed first, second and fourth, in this Sports Car classic.

BRIGGS S. CUNNINGHAM

(shown here with a 300 HP, 150 MPH Cunningham open tourer) has made a great contribution to the re-birth of American road racing for sports cars—competition cars suitable for everyday driving. In his Florida plant, Mr. Cunningham is manufacturing American sports cars to compete successfully with the best that Europe has to offer.



"Sports car racing in the United States and Europe imposes extreme demands on engine performance. While this form of racing has its share of sustained top speed driving, it places a much greater premium on flexibility. Phenomenal cornering at unbanked turns, terrific bursts of speed coming into the straightaways, shifting down through gears for maximum power, control and braking at steep grades and corners, then up through gears again for top overtaking speeds—all call

for fantastic engine acceleration and equally severe deceleration. Only the most rugged spark plugs can take this grueling punishment and still deliver competition quality performance.

We've found that Champion Spark Plugs more than live up to their great reputation for long life and dependability under these conditions. We use Champions exclusively in the Cunningham cars."

—BRIGGS S. CUNNINGHAM

FOLLOW THE EXPERTS

DEMAND DEPENDABLE CHAMPIONS FOR YOUR CAR

CHAMPION SPARK PLUG COMPANY, TOLEDO 1, OHIO



The Sign of Dependable Service!



SOUND TEST FOR SOUNDER CARS. Even a noise which might escape the human ear could be a signal that something is not quite right in a car's construction. That's why Chrysler Corporation engineers use sensitive recording instruments to inspect each new model as it is developed. Cars are

WHAT MAKES A CAR WORTH MORE TO YOU?

You measure the value of a car very simply: a car that performs better when you drive it, then brings a higher return when you trade it in, is *worth more* to you.

The value you get in a Chrysler-built car is the result of a lot of little things, as well as big ones. Engineering, testing, developing new processes—all add up to cars and trucks

PROOF OF VALUE. Newark, N. J., cab driver Albert Cornell operates his Plymouth taxi day and night in rain, shine, snow, sleet and heavy city traffic. The same engineering skill that built faithful performance into Albert Cornell's cab puts hard-working value into *every* Plymouth, Dodge, De Soto and Chrysler car.



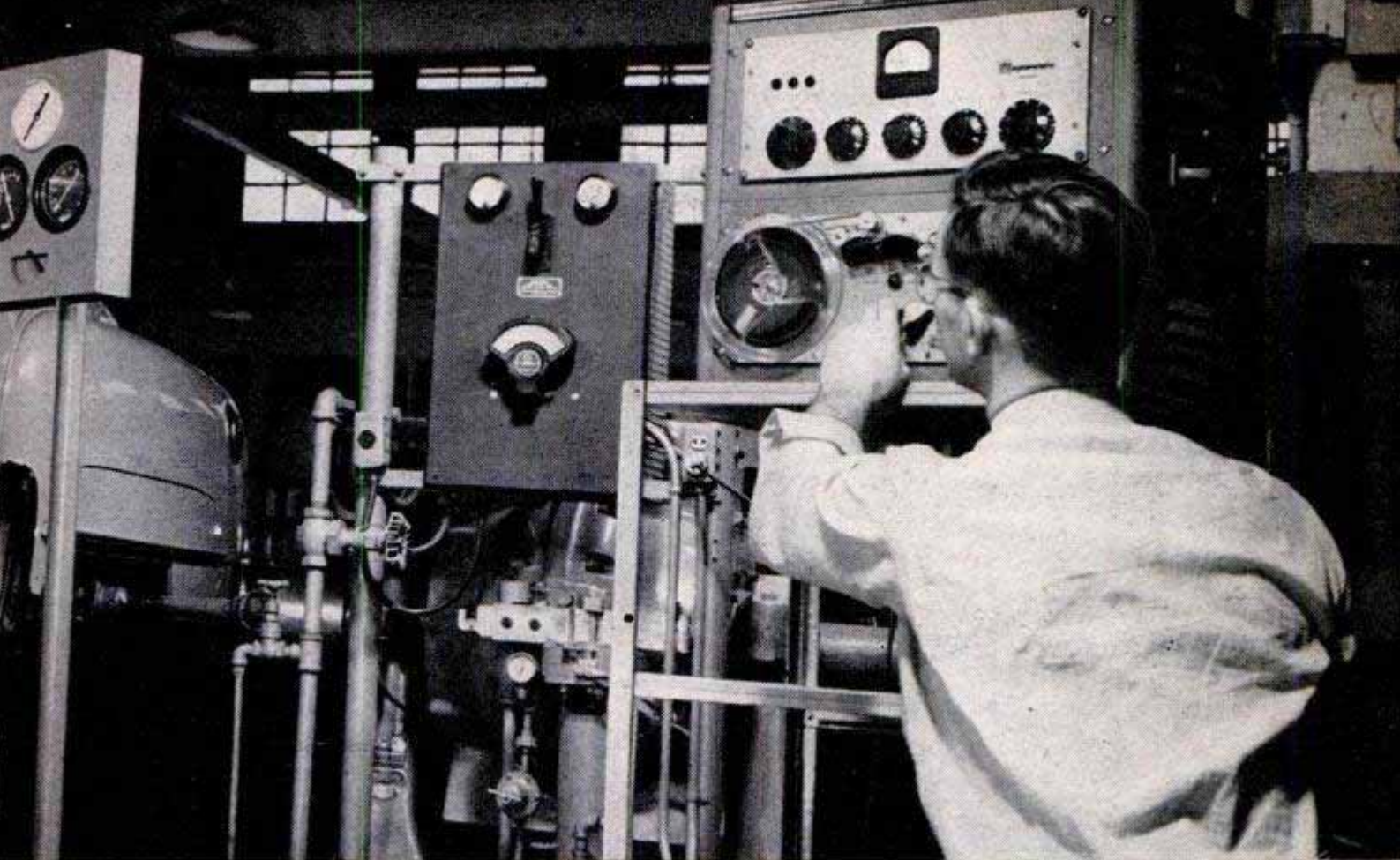

test-driven at varying speeds in the laboratory, as you see here, and other tests are made on the road. These tests help engineers eliminate potential trouble spots *in advance*, giving you more value in Plymouth, Dodge, De Soto and Chrysler cars, and Dodge trucks.

that operate better and longer. This kind of value is important now, when so much of American life depends on motor vehicles.

The same skills that give you Chrysler Corporation cars and trucks are filling defense assignments to help protect the way we live.

CHRYSLER CORPORATION engineers and builds
PLYMOUTH; DODGE, DE SOTO, CHRYSLER CARS & DODGE TRUCKS

Chrysler Marine & Industrial Engines • Oilite Powdered Metal Products • Mopar Parts & Accessories
 Airtemp Heating, Air Conditioning, Refrigeration • Cycleweld Cement Products

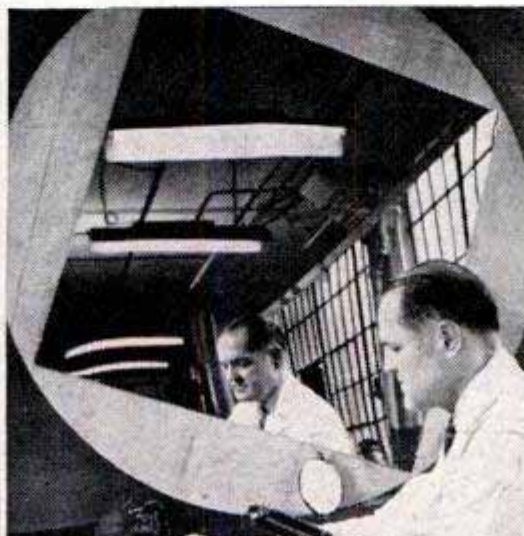

SECRETS OF LONGER LIFE.

That metal bearing (*left*) actually contains tiny pores, each holding a supply of oil. This metal, *Oilite*, is used for bearings in hard-to-reach spots and other places in your car. *At right* is a "mirror" of tough metal, *Superfinished* by a special process which keeps wear of moving parts to a minimum. *Oilite* and *Superfinish* add greatly to the long life of Chrysler-built cars.

*Do it Yourself
and Save!*

Assemble Your Own

BILT-WELL

Nu-Style Wood Cabinets



Your local Lumber Dealer will assist you in the purchase of Bilt-Well Cabinets.



Anyone can assemble Bilt-Well Cabinets as all parts are prefitted. Cabinets fit directly to wall surface.



You can decorate Nu-Style Cabinets any color. Re-decorate them anytime.

Why wait to buy what you can have now by doing the assembling, the installing and the decorating yourself? Bilt-Well Nu-Style Cabinets are completely machined, pre-fitted, and ready to put together. Don't wait until you "save up" for a new kitchen, do it yourself and save. Sold by leading Lumber Dealers.

CARR, ADAMS & COLLIER CO.
Dubuque, Iowa

CARR, ADAMS & COLLIER CO. Dept. M/2
Dubuque, Iowa

Please send me BILT-WELL cabinet booklet. Enclosed 25c to cover cost of mailing.

Name.....
Address..... State.....
City.....
My Lumber Dealer is..... State.....
City..... State.....

Build Well
with **BILT-WELL**
WOOD WORK

A House to Make Life Easy

(Continued from page 69)

walls are the stove, sink and electric-dishwasher combination, automatic clothes washer, drier and refrigerator. Storage walls are used in place of closets for canned goods and other supplies. Such a storage wall contains sets of shallow shelves recessed into the wall. The cans stand in single rows, take up no space and every item is in sight for instant selection.

A time-consuming domestic chore is that of carrying dishes to the dining table before a meal and then carrying them back to the kitchen after a meal is finished. In the Heinlein house the dining table rolls right into the kitchen where all silver, china and food dishes are laid out. Then the table is pushed through the wall into the dining area. It goes back into the kitchen again after a meal and Mrs. Heinlein transfers the dishes directly to the dishwasher.

The table travels through an opening in the wall and normally stands with one end in the dining area and the other end in the kitchen. A sliding partition above the table top may be raised to provide clearance for articles on the table, and a door below may be swung out of the way when the entire table is to be moved into the dining area.

Other features of the house include a radio and phonograph-control center in the hall wired to speakers in each room. The speakers may be controlled at convenient locations.

There is an indoor-garden area in the living room with soil going right down to natural earth. The perimeter heating system keeps the soil warm all through the winter, so delicate plants can be transferred to the indoor garden for the cold season.

Translucent blocks are used to outline the front-entrance door. One block at eye level is of clear glass and has a mirror attached diagonally to its exterior so that Mrs. Heinlein can inspect a caller before she opens the door.

A writer is apt to work late into the night and then sleep late the next morning, so the blinds of the Heinlein bedroom are of lightproof material. Their sides are fitted into sheet-metal slots as a double precaution for keeping out sunlight.

There are wastebaskets in every room but not one of them is visible. They are built in with other furniture and all you see is a spring-hinged trap door.

Heinlein's house has lots of windows, yet a stranger approaching the house can see only the outer garden and the entrance.

(Continued to page 230)

This automobile lighter could save your life!



TAKE your eyes off the road for a split second and *anything* can happen!

Yes, tragedy can take the wheel in *the four seconds it requires to light a cigarette*. Play it safe with the new Wico Safety Cigarette Lighter!

No need to take your eyes off the road ever! It lights your cigarette and takes the first few puffs.

The Wico fits into the present lighter receptacle of your car. No installation or new wiring needed.

ONLY
\$2.95

at auto dealers, accessory stores, gift shops, department stores, and gas stations. Or you can use the coupon to order direct from the factory. Get yours *today!*



WICO ELECTRIC CO.
WEST SPRINGFIELD, MASS.
Producers of specialized fine ignition equipment for more than 50 years.

IT'S THIS SIMPLE... THIS SAFE!



Remove old lighter from receptacle.



Slip Wico Safety Cigarette Lighter in its place. It's now ready for use.



Place cigarette firmly in the lighter.



Push plunger in for a moment... pump once or twice.



Remove lighted cigarette and enjoy your smoke in safety!

WICO ELECTRIC COMPANY
WEST SPRINGFIELD, MASS.

PM401B

Enclosed is my check (or money order) for \$2.95. Please ship immediately Wico Automobile Safety Lighter for car _____

(Year) _____ (Make) _____

Name _____

Address _____

City _____ Zone _____ State _____

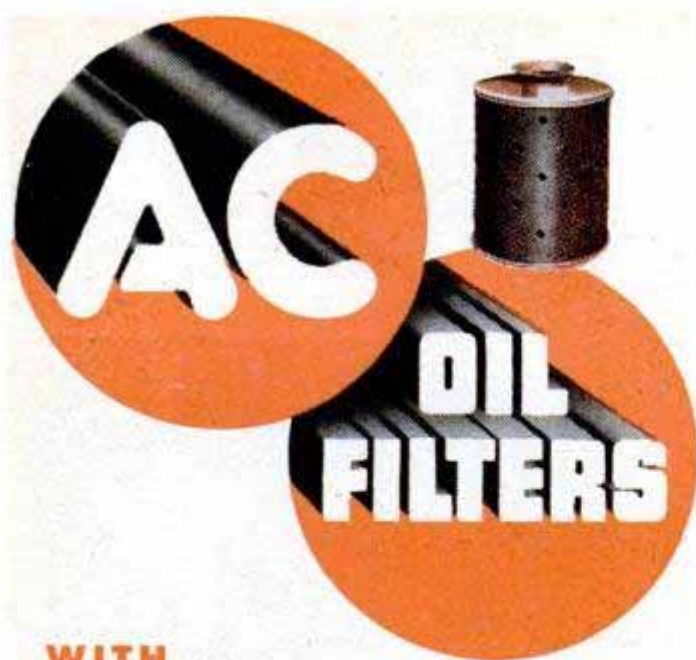

WITH

ALUVAC
ELEMENTS

*are protecting
more new car
engines than
any other
brand!*



AC ALUVAC ELEMENTS

the finest engine protection money can buy—
are available for nearly every make of filter.

AC SPARK PLUG DIVISION  GENERAL MOTORS CORPORATION

Shadow trellises at each side screen the view from the street.

The house cost a little more than \$20 per square foot. That sounds expensive but it really isn't. For one thing, cost per square foot would have been less had Heinlein built a larger house; he packed all the expensive kitchen and bathroom fixtures into a small residence. For another thing, much of the house was custom-built on the site because some materials weren't available in the shapes and sizes he required. Most important of all, he had no furnishings to buy when he moved in.

Instead of hiring a moving van, he simply made a couple of trips with his automobile to transfer clothes, food, utensils, linens and personal belongings to his new house. When these items had been put in place, moving day was over. ★★★

The Cars They Drive Are Classics

(Continued from page 141)

sitting at the rear of a secondhand-car lot. Sometimes a classic can be found in a private garage where it has been stored, almost forgotten, for years. Now and then such a car is literally rusting away behind the barn of some farm.

There are two things to do before you buy the car: Make sure that it can be restored and be certain the price is right. If the body has been wrecked or the motor ruined it's a bad buy at any price, though some enthusiasts have bought two junk cars and assembled one good car from the pieces. Spare parts and replacements usually don't exist. In fact you may have to have some engine parts manufactured to the old specifications in a machine shop.

If you are a true classic fan, you won't drive the car a mile until after you've completely restored it. That means a complete mechanical overhaul. Usually all the upholstery must be replaced. All the paint is removed from the body, every bump ironed out and a new paint job applied. For the sake of economy you can replace the original carburetor with one of modern design and for safety you can install four-wheel brakes if the car didn't have these as original equipment. Aside from those items you'll want to rebuild the car exactly to original specifications.

It may take six months or even a year of spare-time labor to put your old car in new condition. But on the happy day you finally wheel it out into traffic you'll have the satisfaction of knowing that your vehicle is right in style again and that, car for car, it need bow to no modern automobile on the road. ★★★

Tighten Loose Handles

TO STAY



Use the "repairman's standby" — Smooth-On No. 1 Iron Cement—to anchor loose tool and cutlery handles, knobs, pulls, casters, clothes-hooks, bolts, screws, etc. You apply it like putty — no heat required. It hardens like metal. And because Smooth-On expands slightly as it sets, your repairs *stay tight*. Buy Smooth-On No. 1 in 1¾-oz., 7-oz. or 1-lb. size at your hardware store. If they haven't it, write us.

FREE Repair Ideas

40 pages of time-saving, money-saving ways to stop leaks, seal cracks, tighten loose parts. 170 illustrations. Clear, simple directions. Send now.

SMOOTH-ON MFG. CO., Dept. 37F
570 Communipaw Ave., Jersey City 4, N. J.

Do it with

SMOOTH-ON

THE IRON REPAIR CEMENT OF MANY USES



It's a cinch to Install!



Combustioneer[®] AUTOMATIC HUMIDIFIER

A few dollars, your own tools, a couple of hours will give your home all the benefits of healthful, protective *automatically humidified air*! Yes, in your *present* warm-air furnace—coal, gas or oil! No plumbing necessary!

Exclusive Combustioneer features... Twin-Valves of stainless steel, can't rust, corrode or leak... "Noverflow", prevents water dripping *inside* furnace... big "Thirsty-Thick" ceramic plates for larger water evaporation area... Selector Dial for positive humidity control... Water pan of heavy non-corroding metal.

Low Prices! Model CH-300, 4 plates for 13" to 20" plenum (width or length), \$20. CH-200, 6 plates for 22" to 25" plenum, \$22, F.O.B. Springfield, Ohio. Prices include 10 feet of tubing, saddle valve and adjustable hinge face plate. Immediate shipment. Check or Money Order. **Combustioneer DIV. THE STEEL PRODUCTS ENGINEERING CO. 1224 W. COLUMBIA STREET, SPRINGFIELD, OHIO**

Get the **PLIERS** with the

Bull Dog Grip!



SARGENT Parallel-Action Pliers

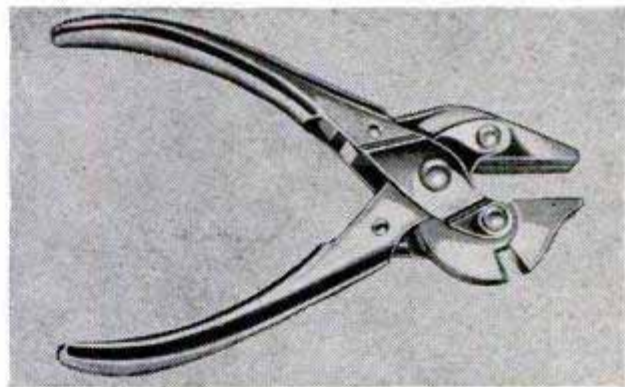

Extreme Gripping Power is developed by compound leverage... parallel jaws take hold like the jaws of a vise.

Outside Cutters cut wire even when it lies tight against a flat surface.

Open Throat permits wire pulling and many other operations that are impossible to do with other types of pliers.

Riveted Assembly assures permanent adjustment of cutting blades and jaws.

See them in 4½", 5½", 6½" and 8" lengths at your hardware dealer or write for details. Dept. 20F.



**SARGENT
and COMPANY**

New York • New Haven, Conn. • Chicago

The Tops in Tools... The Latest in Locks

ANNOUNCING ... America's

THE NEW HARLEY-

designed to outperform, outride, outlook,

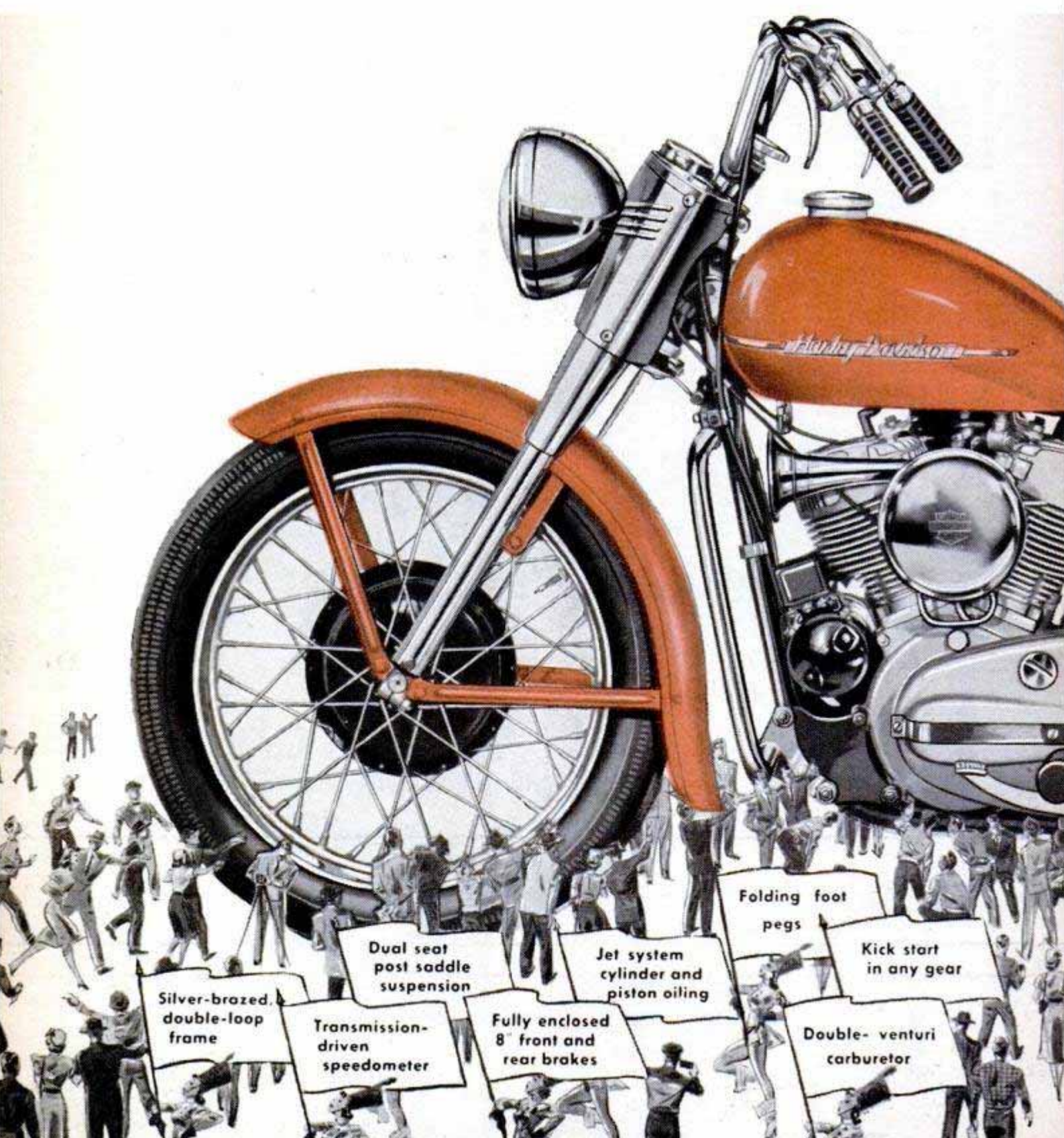

Silver-braced,
double-loop
frame

Dual seat
post saddle
suspension

Transmission-
driven
speedometer

Fully enclosed
8" front and
rear brakes

Jet system
cylinder and
piston oiling

Folding foot
pegs

Kick start
in any gear

Double-venturi
carburetor

DAVIDSON Model K

outvalue ... any motorcycle in its class !

Here's the latest addition to the world-famous family of Harley-Davidson Motorcycles — the sparkling, *all-new* Model K. It's the motorcycle you've dreamed about — has everything you've always wanted! You'll get the thrill of your life when you swing into the saddle of this thoroughbred. Its surging power will dazzle you. Its comfort will amaze you. Its handling ease will astound you. You'll want to ride, ride, ride — and in competition you'll lead the pack. Come see this mighty new Harley-Davidson Model K at your dealer, and be prepared to enjoy a new sensation in motorcycling. Bring your buddy along.

HARLEY-DAVIDSON MOTOR CO.

Dept. P, Milwaukee 1, Wisconsin

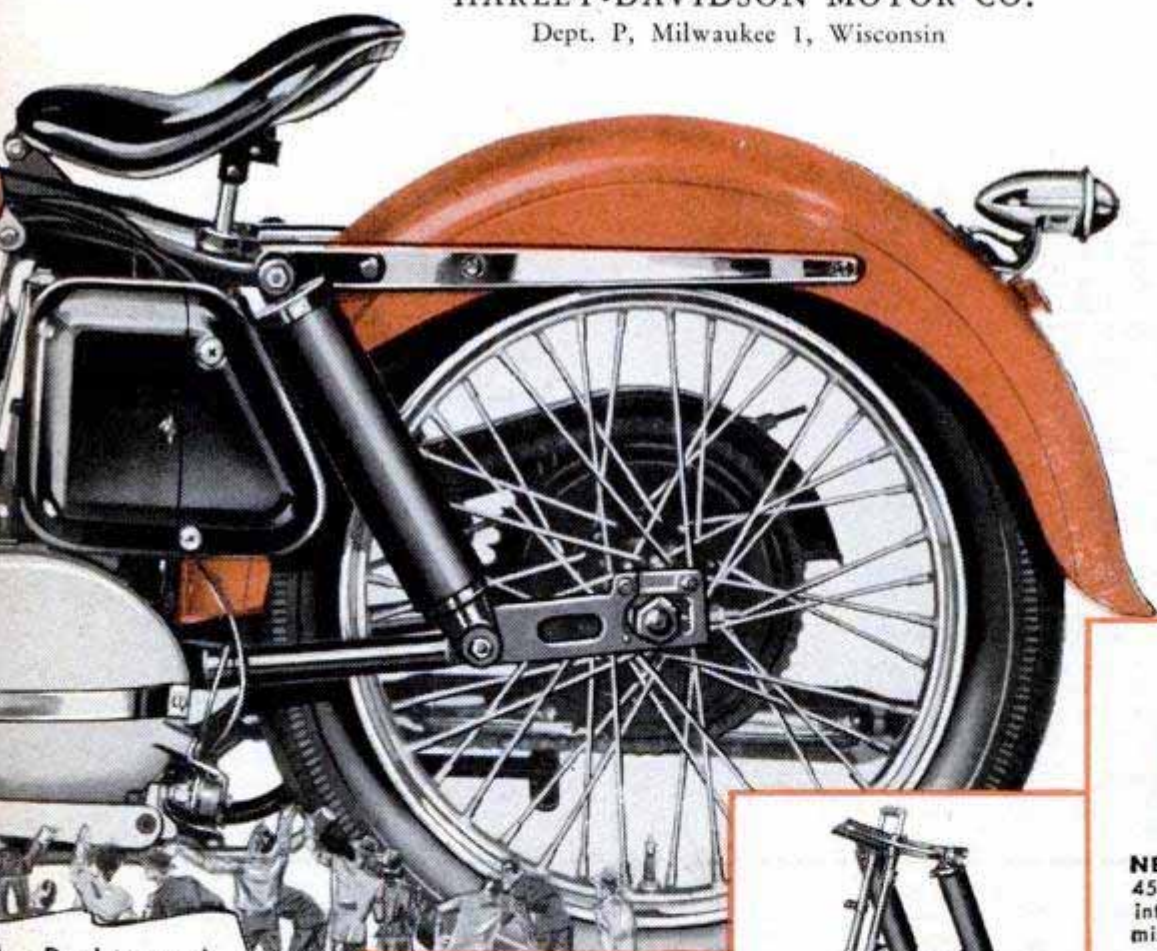

Dual tapered
Timken main
bearings

Shunt generator
with voltage
control



NEW FOOT SHIFT, HAND CLUTCH Built-in to give maximum ease of operation.



NEW REAR SUSPENSION
Swinging arm, coil spring,
hydraulic shock absorbers.

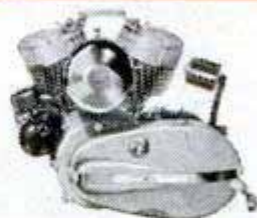

NEW POWERFUL MOTOR
45 cu. in. side valve with
integral unit, four-speed trans-
mission.



SLEEK NEW LINES
Motorcycling's newest look;
plus the last word in han-
dling ease and comfort.

**AMERICA'S CHOICE
IS AMERICAN MADE**

Practical Gifts for Every DAD!

FATHER'S DAY
JUNE 15TH

**STANLEY
TOOLS**

Tickled pink! That's Dad if he's surprised with Stanley Tools on Father's Day or his next birthday. Tools are the original gift idea—certain to surprise and sure to please. And, if they are Stanley Tools, they are sure to go right on pleasing Dad all year long. To make your shopping for Dad more fun, visit your local hardware dealer. Look for the famous trade mark **STANLEY** when you buy.

Western Prices Slightly Higher



NEW EDITION! — only 25¢ postpaid

Gives the care and use of common woodworking and several metal-working tools. 40 pages — 38 charts — over 200 illustrations. Invaluable for beginners, helpful for skilled craftsmen. Use coupon below.



STANLEY
Reg. U.S. Pat. Off.

Stanley Tools
New Britain, Connecticut
THE TOOL BOX OF THE WORLD

Hardware • Tools • Electric Tools • Steel Strapping • Steel

SEND STANLEY TOOL GUIDE

STANLEY TOOLS, 362 Elm St., New Britain, Conn.

(In Canada: Stanley Tool Co. of Canada, Ltd.,
362 Stanley St., Roxton Pond, Quebec)

Send me.....copies of Stanley Tool Guide. I enclose.....

Name.....

Street.....

City..... State.....

From Pills to Penicillin

(Continued from page 115)

mention. In late 1951 proof by Dr. Gustav Rapp at Loyola University of Chicago that regular use of chlorophyll in a dentifrice would prevent or curb most simple gum troubles threatens to deal a staggering blow to the diseases which are responsible for many false teeth. Chlorophyll operates on gums as on wounds; it prevents the bacteria and enzymes which cause decay from uniting with the tissues.

Modern dentistry has followed medicine in scientific research. A good example of how science paid off in dentistry is discovery of the value of sodium fluoride. Added to drinking water or applied by a dentist, this hardens the teeth and cuts children's cavities about half.

The modern medical practitioner relies more and more on machines to diagnose and treat diseases. These machines range from the gigantic 450-million-volt synchrocyclotron at the University of Chicago to the common blood-pressure machine used by your family doctor. The synchrocyclotron is being used for basic research and is expected to answer many questions concerning the biochemistry of our cells.

The "isotron" at Northwestern University, a marvel of electronic science with its rows of intricate tubes and circuits, is being used to pin-point brain tumors. It is the first clinical machine to utilize atomic energy in medicine.

The suspected brain-tumor victim is first injected with radioactive material which has a special affinity for tumor tissue. When the hot atoms reach the site they emanate atomic discharges which, checked and recorded by the isotron, reveal the site of the tumor.

I was the only writer to see this first successful use of the atom to fight disease. I felt the occasion was more significant to mankind than the atom-bomb explosion which wiped out 100,000 human lives.

The development of the "clinitron," a machine which vastly speeds up blood analysis, makes possible easy testing for diabetes, our eighth-greatest killer.

A machine using terrific supersonic vibrations has disintegrated gallstones in animals and may prove effective in human beings. This machine, as a therapeutic measure, is also in wide use in Europe.

Artificial hearts and kidneys have been developed which already are responsible for saving many lives.

A more familiar example of machines in medicine is the electrocardiograph. This records the electrical impulses from the

(Continued to page 236)

ONLY SEARS SELLS THIS

DUNLAP Tilting Arbor 8-inch Bench Saw with precision ball bearings



\$46⁹⁵ Cash

Complete with blade, miter gauge, rip fence, machine pulley
ONLY \$5.00 DOWN

Complete Bench Saw

\$110⁰⁰ with motor, motor pulley, V-Cash belt, two side table extensions, power tool bench, tool light and Powr-Panl.
ONLY \$11.00 DOWN ON EASY TERMS



Choose this great DUNLAP saw value NOW!
Available only at your nearest Sears retail store.

Table stays level, work lies flat at any angle of cut. Blade and arbor raise and lower; also tilt up to 45 degrees.

Double-row sealed precision ball bearings form unit with arbor, prevent misalignment; never need lubrication.

Floating motor mount smother's vibration... makes tilting easier... keeps proper belt tension... motor portable.

Improved fence design squares fence directly against front of table. Use on either side of blade. Removable.

17x14-in. cast semi-steel table; top, sides machined. Grooved on both sides of blade for miter gauge.

Comes with 8-in. combination blade (1/2-in. bore); gives up to 2 1/4-in. depth of cut. (Use at least 1/2-H.P. motor; 3450 R.P.M., 2 1/2-in. pulley, 40-in. belt; or 1750 R.P.M., 5-in. pulley, 44-in. belt.)

Complete outfit (as shown) includes CRAFTSMAN 1/2-H.P. 3450 R.P.M. ball-bearing capacitor motor (110-120 volt, 60-cycle AC), 2 1/2-in. motor pulley, 2 side table extensions, 40-in. belt, adjustable steel power tool bench, tool light, and Powr Panl (remote control for light, motor, etc.).

The Sears Retail Store nearest you will furnish you with exact selling prices which will not exceed O.P.S. ceiling prices.

These Accessories make your saw much more useful



A

A CRAFTSMAN 6-in. Dado Set. Dadoes, rabbets, grooves, etc. with 1/2 or 5/8-inch-arbor bench saws. \$9.50 per set.



B CRAFTSMAN Molding Cutter Head. Fits most bench saws with 1/2 or 5/8-inch arbors. 4-inch diameter. With Allen wrench included \$4.50

Cutter bits for above head. 1-inch wide bits cut styles as shown. Made of tool steel. Styles \$2.95 per set, and up.

C CRAFTSMAN 8-tooth Carbide-tipped Saw Blade. Lasts 20 times longer than ordinary blades. Safer—8-tooth design eliminates kickback. Cuts all types of wood, plastic, plywood, formica, Masonite Presdwood, wallboard, abrasive building materials, transite, asbestos, aluminum and asphalt roofing and siding. Teeth project only .020 in. above non-cutting edges. Rips, crosscuts, miters. 5 7/8 to 10-in. diam., all arbor sizes. \$10.85 and up.



C

CRAFTSMAN and **DUNLAP** Tools by **SEARS, ROEBUCK and CO.**

Famous for fine quality . . . precision performance . . . low price!

COOL YOUR HOME THIS LOW-COST WAY

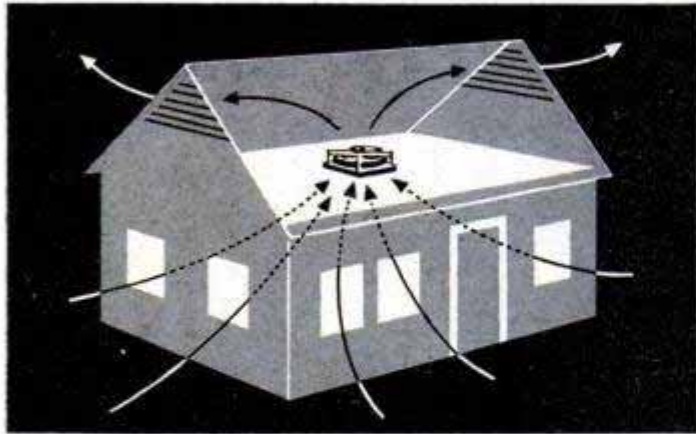

Hunter Attic Fan cools the whole house

This modern ventilating fan pulls in cool air through windows, exhausting hot stuffy air through attic louvers. In hottest summer months it circulates cooling breezes through every room in your home. The quiet, powerful Hunter Attic Fan requires little or no maintenance, costs only a few cents a night. It is backed by Hunter's 65 years of fan experience.



You can easily install a Hunter Attic Fan in your home. This compact unit is complete with automatic shutter and modern metal trim to cover the ceiling opening. No suction box to build; no accessories needed. Fan requires only 17 in. attic clearance. Look in your classified directory and phone the Hunter dealer. You can have cool comfort at low cost.

MAIL FOR FREE BOOKLET

Hunter Fan and Ventilating Company
Box 2858-R, Memphis 2, Tennessee
Send a copy of "Change Your Home
from Hot to Cool" to:

Name _____
Address _____
City & State _____



HUNTER ATTIC FANS

heart, telling the specialist how the heart is behaving. Similarly, the electroencephalograph takes the electrical pulse of the brain. These findings are invaluable in diseases like epilepsy or schizophrenia since the brain-wave machine can distinguish normal brain patterns from abnormal.

What of the future? What can we expect of medicine within our lifetimes?

Today, infectious diseases nearly are conquered. Even tuberculosis, the leading cause of death as late as 1910, is no longer a great menace. Medical men predict the white plague will be a rarity in 20 years. Now our worst foes are the old-age diseases: Heart and blood-vessel disorders, cancer and the neuroses produced by the strain of living in our exciting, exacting era.

Here's the newest in what probably concerns you the most—your heart. First of all, heart surgery has advanced to a point where operations can be performed while an artificial heart pumps blood. The most difficult of heart operations can be done with a minimum of risk.

Furthermore, Dr. Richard Krasno at the University of Illinois has developed an instrument, the "flicker photometer," which will not only call the shots on various types of heart disease but actually will predict whether you are likely to suffer from cardiovascular troubles. The instrument is based on a patient's response to the flickering of light. The tiny capillaries in one's eyes apparently reflect impending heart and blood-vessel diseases.

In the same field, Dr. John Gofman and others at the University of California have theorized that the substance cholesterol may be the villain in cases of hardening or aging of the arteries. Cholesterol deposits on the walls of the arteries force the heart to pump harder to keep blood circulating. Gofman found that by reducing the cholesterol intake (fatty foods, primarily) the stuff could be kept from laying its deadly deposit on the arterial walls.

The answer to the country's No. 2 destroyer, cancer, may come more quickly than most doctors thought possible even a year ago. Today, early recognition and prompt treatment with X rays, radium and surgery are saving millions. Yet 200,000 continue to die yearly from cancer in the U. S. Other treatments offering promise of control for certain types of cancer are injections of hormones and immunization.

Discovery that ACTH and cortisone give amazing relief in some types of arthritis, a disease affecting 7.5 million persons in the U. S., opened an exciting field. ACTH, derived from the pituitary gland, is a substance which stimulates the adrenal glands

(Continued to page 238)

on every *Pontiac*

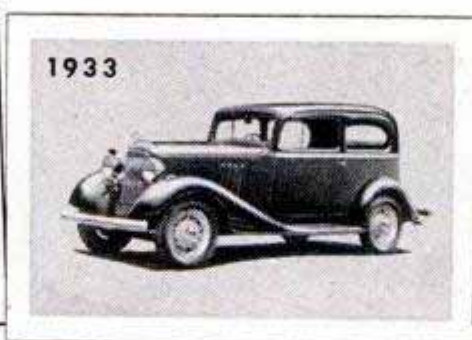
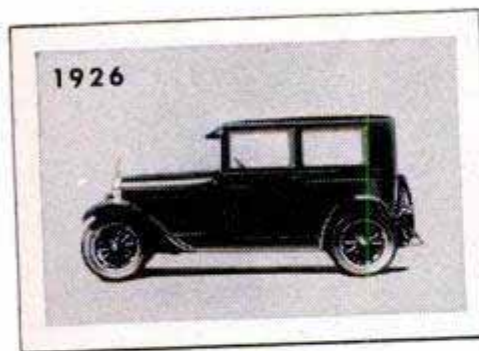

...Since the First *Pontiac* Was Introduced in 1926

This Pontiac-AC partnership has been in existence for 26 years -- with Pontiac supplying the power -- and AC providing the spark that helps convert this power into mile after mile of motoring pleasure.

Pontiac relies on AC for split-second starting -- for smooth-sailing performance -- for day-in and day-out reliability. And AC, only Spark Plug with patented CORALOX Insulator, brings about these desired results -- not only for Pontiac, but for all other makes of cars as well.

Are you getting top performance out of your engine? To be sure, specify ACs the next time your car needs spark plugs.

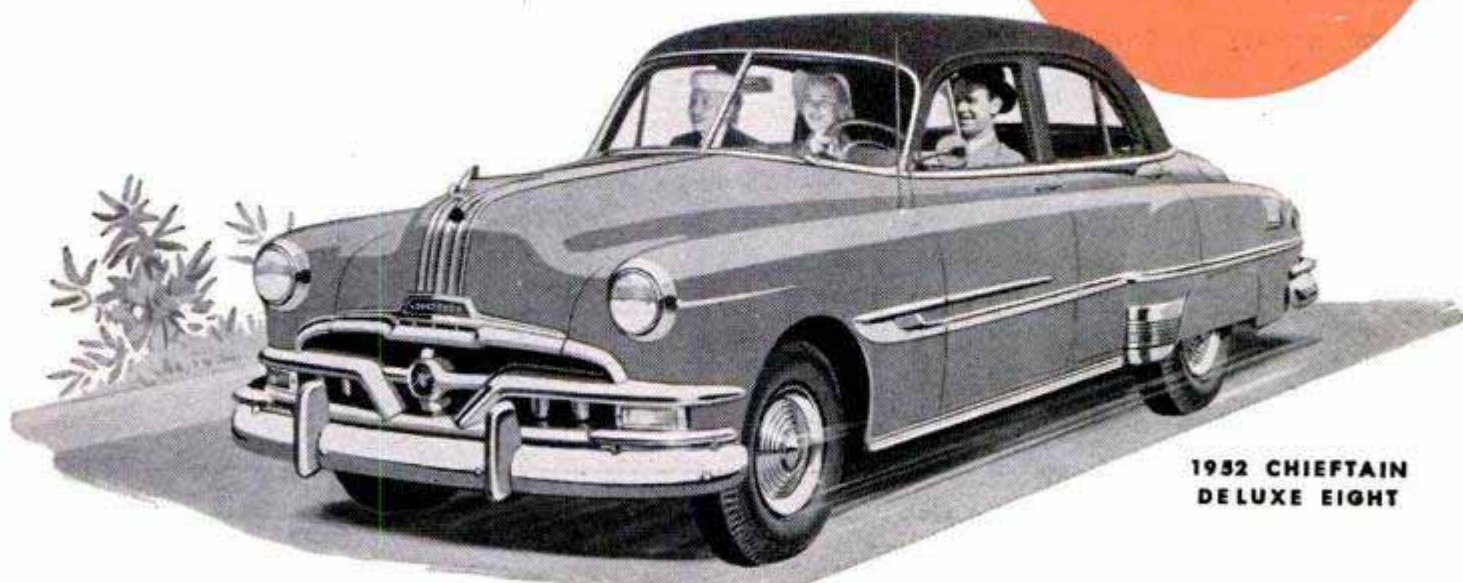
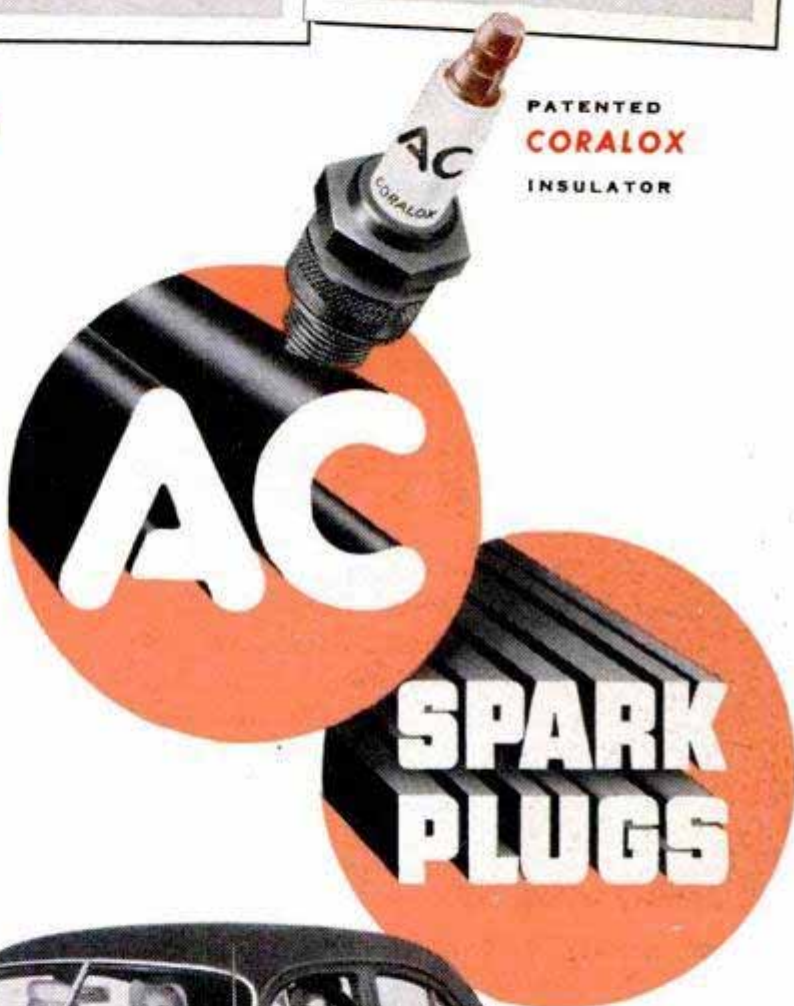

AC SPARK PLUG DIVISION



GENERAL MOTORS CORPORATION

Black & Decker
1/4" Drill
 only
\$22.95



IT DRILLS!



IT POLISHES!



IT SANDS!



IT GRINDS!



IT BUFFS!



IT WIRE BRUSHES!

Speeds Up Drilling—and plenty more!

THIS HANDY Black & Decker 1/4" Electric Drill is so versatile it drives many accessories to handle job after job. So speedy and easy-to-handle it helps you do more work in your spare time. So well-built it gives you trouble-free performance year after year. So down to earth in price you can't afford to be without it. No wonder well over a million have been sold!

Try a B&D 1/4" Drill and accessories today at your hardware, appliance or department store. It's its own best salesman! **THE BLACK & DECKER MFG. Co., Dept. H6M, Towson 4, Maryland.**

Black & Decker



**PORTABLE
 ELECTRIC
 TOOLS**

DRILLS • SANDER-POLISHERS • SAWS • KITS

to produce cortisone. Recently, it has been found that hydrocortisone, rather than cortisone, is a true hormone and even more spectacular results have been achieved.

Cortisone dramatically reduces the symptoms of many diseases in addition to arthritis. In pneumonia, for instance, when given cortisone, sufferers are relieved of almost all symptoms including fever, coughing and others produced by the body's reactions to the pneumonia germs. The patient may feel well though the germs are still in there pitching for all they're worth. This teaches an important lesson to scientists. In many diseases, it's the body's allergic reaction to germs that kills the patient, not the germs themselves!

What about our century's particular sickness—neurosis? Almost everybody has that in varying degrees and manifestations. To most, it's evidenced by despondency, anxiety or feeling of insecurity. Happiness or peace of mind is as important to our bodies as penicillin is for specific diseases. Yet it's obvious that we can't all go to expensive psychiatrists.

The outlook for a quick, easy cure is hopeful, at least for 70 percent of us neurotics. The man who introduced shock therapy for the insane, Dr. L. J. Meduna, has come up with another device for curing psychoneuroses. It's carbon-dioxide gas. Breathed twice a week for several weeks, it's been amazingly effective in producing permanent cures, Doctor Meduna reports. I personally can report that his patients are extremely enthusiastic about CO₂ therapy and the doctor's findings have been supported by studies at the Veterans Administration in Chicago.

How can the common soda-water gas, carbon dioxide, achieve the fantastic result of curing your neurosis? It does it by suppressing the harmful, neurotic stimulations which infiltrate our brain cells. CO₂ raises the brain cells' ability to resist these abnormal stimulations.

Almost equally miraculous is the treatment of the truly insane with histamine injections. Based on the theory that insane people suffer from too little oxygen in the brain cells, the new histamine treatment which opens up the arteries is producing cures in schizophrenic and other mental disorders. Sometimes, in stubborn cases, histamine is used along with the electroshock treatment.

So we see that medicine—now the science dedicated to the prolongation of human life as well as treatment of its afflictions—swept like a 50-year typhoon across the records of mankind. Disease, which frequently has struck down man in his prime of life, is being conquered. ★ ★ ★

EVERY 1/4" ELECTRIC DRILL
A PORTABLE SAW IN ONE MINUTE!

NEW! No. 445 "ARCO-SAW" for
DEPTH & BEVEL CUTS

At
Better
Hardware
Stores
Every-
where

11.50

with
all GAGES &
4" "HYCAR-
BON" Cross-
cut Blade.

No. 444 "ARCO-SAW", same as
above—less gages. Has
accurate visual guide. **9.95**
No. 444G Depth-Bevel-Rip Gage.
Easily attaches to any No. 444
"ARCO-SAW" **1.95**
Extra "HYCARBON" Blades. 4"
Crosscut or 4" Combination **1.60**

OVER 100,000 SOLD
**ARCO
SAW**

CAN BE USED WITH ONE HAND!

"ARCO-SAW" works like a
high priced Portable Saw.
RIGHT ANGLE GEAR
DRIVE eliminates clumsy,
dangerous direct drive with
drill sideways.

CUTS 1-1/4" or 2x4 by
turning over

CHECK THESE EXPENSIVE FEATURES:

Depth gage graduated from 0
to 1 1/4" depth (for grooves,
dados). Bevel gage graduated
from 0 to 45° angle (for dove-
tails, bevels). Rip gage with
sideways adjustment. Visual
guide with adjustment to follow
lines on both straight and bevel
cutting. **90-DAY FACTORY
GUARANTEE.**

**UNCONDITIONAL 10-DAY
MONEY BACK GUARANTEE**

ORDER TODAY at your dealer
or send us check or M.O. (Post-
paid), C.O.D.'s—postage extra.

DEALERS—Write
for nearest jobber.

ARROW METAL PRODUCTS CO

Dept. PM-6, 140 West Broadway, N. Y. 13, N. Y.

Extra big disc sander

COMPARE size, quality, fea-
tures! 5-in-1 SHOPSMITH has
12" disc, large tilting table,
miter gauge, rip fence. Con-
verts to saw, lathe, ver-
tical and horizontal drill.
Write for FREE catalog.

SHOPSMITH, Dept. 183-B
12819 Coit Rd., Cleveland 8, O.



EVINRUDE Catalog Free

Write today for big full-color catalog of complete
Evinrude line—the right motor for every boat!
4 models, 3 to 25 certified H.P. 2 models with
Gearshift and Cruis-a-Day Tank. Thrilling new
Big Twin—a 30 miler that trolls, handles like a
small motor! Write for your copy today—address

EVINRUDE MOTORS
4848 N. 27th St., Milwaukee 16, Wis.

DRAINS Cellars, Laundry Tubs; CIRCULATES Oil; IRRIGATES Gardens

Original "Type P" Pump has 2400 GPH capacity.
360 GPH 75' high, or 1500 GPH from 25' well.
Use any 1/8 to 1/2 HP motor. DOES NOT CLOG.
1" intake; 3/4" outlet.

Only \$8.95 postpaid if cash with order.
(West of Mississippi, add 50c.)

Motor coupling included.
MONEY BACK GUARANTEE!

LABAWCO PUMPS, BELLE MEAD 7, N. J.

\$6.95



CRESCENT TOOLS

Give Wings to Work

ASK YOUR
HARDWARE
DEALER

POWER MOWERS & KITS

**FREE
PLANS**

LOW FACTORY
PRICES DIRECT
TO YOU

Build your own quality
mower with our LOW
COST KITS, Parts, Engines. Free
Plans guide you. 3 and 4 Wheel Kits,
complete. Parts precision finished,
ready to use. Write TODAY
for Free Plans, Low Prices,
Parts List and Guarantee.

3 & 4
Wheel
Model



4
Wheel
Direct
Drive



America's Finest Power Mowers complete-
ly assembled in 3 and 4 wheel models.
Belt or direct drive. 18" and 20" sizes.
Nationally known make engine. Latest
improved features, sturdy construction
and money back guarantee fully described
in color folder. Write today.

3-WHEEL KIT NO. T-800



▼ **TRIANGLE MANUFACTURING CO., Box M-14, Fort Scott, Kansas**

**DON'T LET
A FIRE
HAZARD
HITCH
A RIDE
IN YOUR
CAR!**



You have a fire-
bug for a pas-
senger when you
drive a car with
defective wiring.
Neglected wires
do cause automo-

mobile fires. Millions of dollars worth of cars,
trucks and buses go up in smoke every
year. National Safety Council figures tell
the same story all over the country—with
"caused by defective wiring" fires running
as high as 92%.

Don't play with fire. See that *your* wires
and cable are checked *today*. Not only to
prevent fire, but to prevent hard starting,
poor engine performance, battery failure.
When wiring is bad, install new genuine
Wiry Joe Wires and Cables.

Write now for this valuable free booklet!

THE CRESCENT COMPANY, Inc.
Pawtucket, Rhode Island

Please send me my free copy
of "The Effect of Defective
Wiring on Car Performance."



NAME _____

ADDRESS _____

CITY _____ ZONE _____ STATE _____

BIG MONEY

in your hands!



BE YOUR OWN BOSS! Men who are determined to get ahead in something for themselves will find this opportunity hard to beat! Where else can a man turn his own labor so quickly and easily into **BIG MONEY!** Earn as high as \$50 and more a day sanding floors with an easy-to-run American Machine—and **YOU ARE BOSS.** Prospects everywhere—old and new homes and remodeling. Pleasant indoor work—steady the year round. No schooling—no experience needed. Age makes no difference—men 18 to 80 are active and successful. Send coupon for "money-making" booklet entitled "Opportunities in Floor Surfacing"—enclose 25c in coin or stamps to cover handling.



AMERICAN FLOOR MACHINES

SEND

The American Floor Surfacing Machine Co.
535 So. St. Clair St.
Toledo 3, Ohio

Enclosed find 25c in stamps or coin for booklet "Opportunities in Floor Surfacing", telling me how I can start my own floor sanding business.

Name _____
Street _____
City _____ State _____

The Owners Report on the MG

(Continued from page 92)

Quite a few owners regretted that the factory had switched from wire wheels to disk wheels for this model and others didn't like the absence of gasoline and water gauges. But the over-all number of unfavorable complaints on the MG in this survey was remarkably low.

My Own Road Test and Report: I drove the test car over good highways, back roads and some miles in the desert and mountains.

It really is a thrill to drive an MG because the driver seems to become a part of

CLYMER'S ECONOMY TEST

MG MIDGET TWO-SEATER

(Using premium gasoline of popular brand)

Miles per Gallon	
At constant 30 m.p.h.....	34.8 m.p.g.
At constant 50 m.p.h.....	30.1 m.p.g.
At constant 60 m.p.h.....	26.3 m.p.g.
At constant 70 m.p.h.....	23.2 m.p.g.
Average Miles per Gallon	
Los Angeles to Bakersfield and return (241 miles). Open stretches and some mountain grades.....	28.7 m.p.g.
50 miles in city traffic obeying all speed laws and traffic stops.....	24.7 m.p.g.

the car. The ride is not comparable to that in a large American car insofar as comfort or suspension is concerned. But the MG exceeds any American car in ability to corner at high speeds and to maneuver quickly around sharp turns because of its low center of gravity, stiff suspension, steering-gear ratio and general design. Traction is excellent: 51 percent of the weight is on the rear wheels. The hood is quite long and the driver soon forgets that he actually is in a small car.

The four-cylinder overhead-valve engine has a displacement of 76.6 cubic inches with 54.4 horsepower at 5200 revolutions per minute. The engine size is less than half that of the Henry J, Willys or Nash Rambler—and less than one third the size of a Ford, Chevrolet or Plymouth engine—yet the car will do an honest 80 miles an hour and can cruise all day long at 60 to 65 miles per hour. Most sports-car drivers are "r.p.m. conscious" and drive by tachometer, a gauge which shows engine revolutions per minute. While the MG will turn over at 6000 revolutions per minute, about 5000 is considered safe engine speed for the average driver. For the size of the engine (it has approximately the same cubic displacement as the engine in a large American motorcycle), performance of the MG

(Continued to page 256)

GROBAN'S WAR SURPLUS BARGAINS

ALL BRAND NEW-UNCONDITIONALLY GUARANTEED

General Motors — Allison CENTRIFUGAL PUMP

BRAND NEW

200 GALLONS PER MINUTE



- For Draining Basements • Fire-Fighting
- Irrigation • Fuel Transfer • Swimming Pools • Home Water Systems • Dewatering

This General Motors—Allison Centrifugal Pump — designed for use on U.S. Air Force Mustang Fighters, now converted for commercial, home, and industrial high volume pumping applications. Inlet, 2 1/2" standard pipe thread, twin outlets with 1 1/4" pipe thread, ball bearing supported 3/4" shaft. Easy, fast simple priming. Rotation, counterclockwise facing shaft. Shipping wt. 35 lbs. Gov't acq. cost \$145.00. F.O.B. Chicago.

39.50

HYDRAULIC SPEED REDUCER

ITEM #115 WITH FINGERTIP CONTROL

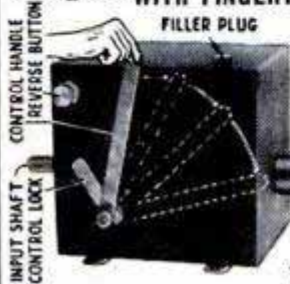

- USE FOR:
- Reamer
 - Drives • Midget Cars • Feed Mills • Output Can - Shafting • Machines • Conveyors • Lathes • Milling Machines • Motor Boats • Cream Separators • Garden Tractors • Pumps

Variable output speeds from 0 to input speed available by moving control handle. Locking handle maintains setting. Use input power of 1/4 to 1 1/2 H.P. This Westinghouse-Oil Gear Unit consists of a variable displacement hydraulic pump feeding a fixed displacement hydraulic motor. Adjustable relief valves set at factory for 100 inch pounds of torque may be reset up to 180 inch pounds. Independent reverse control allows full output power and speed selection in either direction of rotation. Shafts measure 5/8" diam., include keyway. Input rotation is counter-clockwise facing shaft. Recommended input speed not to exceed 750 R.P.M. Over-all dimensions, 7 1/2"x8 7/8"x11 1/2". Gov't acquisition cost, \$428.00. Ship. wt. 31 lbs. Complete with 2 qts. of oil and full instructions. F.O.B. Chicago

54.50

1/4" ELECTRIC DRILL KIT STANDARD DUTY MODEL 77-5



Item #348—contains 1/4" Electric Drill with 3-jaw knurled chuck, double pole automatic electric switch, 10' rubber covered—oil and gasoline resistant cord and pistol grip handle. Drill has universal 115 volt AC-DC motor, precision heat-treated alloy steel gears enclosed in grease tight housing. Accessories include drill bits in graduated sizes, sanding discs, lamp's wool buffer, wire buffer wheel, mounted grinders, etc. All enclosed in sturdy metal box. Shipping weight 8 lbs. A terrific buy! F.O.B. Chgo. Only

20.95

NEW MODEL 353 — DUAL RANGE D. C. ARC WELDER

For Stationary or Portable Use. HEAVY DUTY RANGE TO 250 AMPS. NEW 'MAGIC TERMINAL' FOR LOW CURRENT 30 TO 100 AMPS. IDEAL FOR FARM • FACTORY • GARAGE • WORKSHOP

These precision engineered D.C. Arc Welders contain the highest quality War Surplus aircraft components built to exacting government specifications. They are light in weight, have over-sized lifetime grease-sealed ball bearings, air cooled commutator, dial type rheostat for easy pin-point control, a high-low rheostat switch, reactor coil for even arc and the new 'MAGIC TERMINAL', low current welding range for welding lighter materials. Designed for many years of trouble-free service. Run welder from drive pulley or power take off of a tractor or Jeep, 7 1/2 HP electric motor or 10 HP gas engine at 2500 R.P.M. Uses two V-belts or flat belt. Continuous output rating 200 amps. Intermittent welding rating 250 amps, 30 volts. This sensational price includes double V or flat belt pulley and complete operating instructions. Shipping weight 107 lbs. \$350.00 Value. Item #65. F.O.B. Chicago Now only

119.50

FREE: NEW 48-PAGE CATALOG

CHUCK-FULL OF UNSURPASSED WAR SURPLUS BARGAINS FOR THE FARM, HOME, FACTORY, WORKSHOP. WRITE TODAY.

GENERATING PLANTS

FOR YOUR SUMMER POWER SUPPLY

IMMEDIATE DELIVERY • LARGE STOCK

MANY SIZES

FOR COTTAGES • CAMPS • HOUSE TRAILERS • CONSTRUCTION • ROAD BUILDING, etc.

Plenty of emergency stand-by or general utility power from 350 watts to 25 KVA.

Item #183—3000 to 4000 WATT GENERATOR SET

— FEATURES — Power for your home or business. Simply connect to power panel or house circuit. • Constant voltage regardless of load. • Push button start or stop. • Easily made full automatic start or stop. SPECIFICATIONS—Size 19"x30"x48". Steel skids, weatherproof housing, requires no building. Wt. 725 lbs. Hercules 4-cyl. 10 HP gasoline engine. Load governor. Oil filter.

ITEM #183

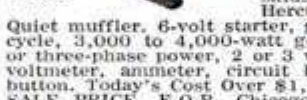

Quiet muffler, 6-volt starter, generator. • Hobart 115 volt, 60 cycle, 3,000 to 4,000-watt generator. • Furnishes either single or three-phase power, 2 or 3 wire. • Panel contains oil gauge, voltmeter, ammeter, circuit breaker, voltage regulator, start button. Today's Cost Over \$1,200.00.

SALE PRICE, F.O.B. Chicago

Item #178—350 watt—110 volt—60 cycle A.C. direct coupled to 1 cylinder Midco engine. Shpg. Wt. 116 lbs. F.O.B. Chicago

Item #182—Onan Generator—5KW—120 volt—60 cycle A.C. single phase, direct coupled to Ford 4 cylinder, water cooled engine with push button start, battery ignition. (Battery not included.) Shpg. wt. 1200 lbs. F.O.B. Chicago

Item #199—Power Unit PE-99—7.5 KW—120 Volt—Single and 3-phase—60 Cycle A.C. Master generator driven by a 4 cylinder, V-type, air cooled, Wisconsin engine with magneto ignition, push button start. The self-excited, drip-proof generator is driven from 5 parallel V-belts. Control panel contains engine and generator instruments, including circuit breaker, emergency start-stop buttons, volt meter, ammeters. Complete semi-enclosed unit mounted on steel skid. Weight 1885 lbs. F.O.B. Chicago

Item #201—PE 95-G—10 KW—110/220 Volt 60 Cycle A.C.—Single Phase. Totally enclosed. Onan generator direct coupled to Willys Jeep, 4 cylinder, water cooled engine, push button start. Instrument panel with engine and generator instruments, circuit breaker, controls, etc. Uses 6 volt car battery. (Battery not incl.) Skid mounted. Ship. wt. 1500 lbs. F.O.B. Chicago

Item #347—PE-201—1000 Watts—120 Volts—20 Cycle AC—Single Phase, and .3 KVA, 14.6 Volts—20 Amps. DC for battery charging. Model A. Leland Generator, belt driven by a Briggs & Stratton 1 cylinder, air cooled, 2.7 HP gas engine at 1800 RPM. Control panel contains DC voltmeter, ammeter, rheostat, receptacle and terminals. Also AC frequency meter, rheostat, 120 volt double receptacle and terminals. Overall dimensions, 34"x19"x24". Ship. wt. 250 lbs. F.O.B. Chicago

Item #199

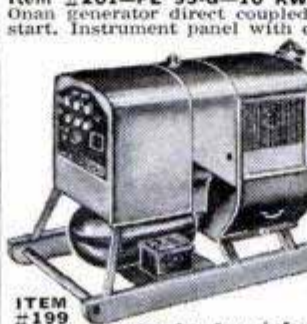

Write for free information on other generators — 350 Watts to 25 KVA

ITEM #178



ITEM #182



ITEM #126



BRAND NEW HEAVY DUTY HYDRAULIC EQUIPMENT

Large supply of new labor-saving, economical hydraulic equipment in many types and sizes. Use these positive, highly efficient smooth pressure hydraulics on presses, arborers, lifts, loaders, power control, positioning, brakes, plastic dies, auto frame alignment, etc., etc.



ITEM #160

ITEM #160—PESCO GEAR TYPE HYDRAULIC PUMP—Compact—Powerful—Reliable. Especially designed for belt drive from fan belt, power take-off, drive pulley, electric or small gas engine. Equally suitable for direct coupling. Pedestal type mounting with two bolt holes for 3/4" hold-down bolts. Standard 1/2" pipe thread inlet and outlet ports. Delivers 4.5 GPM at 1000 PSI at 2800 RPM with 3 HP. Will actuate one Item #6, 3" bore, 24" stroke cylinder in 10 seconds. Hardened steel gears turn in dense oilite bronze bearings. Rotation—clockwise facing shaft. Guaranteed trouble-free service. Ship. wt. 6 lbs. F.O.B. Chicago

22.50

ITEM #126—Four-way, open center control valve with built-in adjustable relief valve. Factory set at 1000 P.S.I., spring loaded neutral position, for use with one double acting cylinder. In neutral position cylinder is locked and pump unloaded. Fully balanced plunger type smooth, positive, easy operation, can be used as single unit or mounted in series of any combinations desired. Has 3/4" pipe thread inlet and outlet, 1/2" pipe thread cylinder ports. Newly manufactured to our specifications. Shipping weight 8 1/4 lbs. An outstanding Buy! F.O.B. Chicago

21.50

ITEM #127—Double acting hydraulic cylinder, 1" bore, 1" stroke, 1/2" diam. shaft, 1/4" tubing thread ports. Over-all length closed — 6 1/2". Clevis mounting at both ends. Perfect for clamping and feeding. Postpaid

5.95

ITEM #16C—Double acting hydraulic cylinder, 1 1/2" bore, 26" stroke. Will lift 1700 lbs. with 1000 PSI line pressure. Weight 8 lbs. A \$55.00 value. Now only. Postpaid

16.95

ITEM #42—Double action hydraulic cylinder, 4" bore, 18" stroke. Rated lift capacity with 1000 PSI line pressure is 12,500 lbs. Ship. wt. 30 lbs. F.O.B. Chicago. An Excellent Buy for

32.50

ITEM #103—Double acting hydraulic cylinder, 2 1/2" bore, 17" stroke. Clevis mounting. Will lift 4900 lbs. with 1000 PSI line pressure. 1 1/4" diam. shaft, 3/8" tubing thread ports. Overall length closed 28". Ship. wt. 11 lbs. F.O.B. Chicago

21.50

ITEM #6—Double action hydraulic cylinder, 3" bore, 24" stroke, will lift 7070 lbs. with 1000 PSI line pressure. Steel barrel, 1 1/8" stainless steel shaft. Gov't acq. cost \$176. Ship. wt. 26 lbs. F.O.B. Chicago

28.00

ITEM #29KJ—Gear Type Hydraulic Pump. Ideal in industrial applications and for operating all hydraulically powered farm implements including loaders, stackers, swathers, plows, etc. Delivers 1000 PSI (may be set at lower PSI if desired), 12 GPM at 400 RPM. Maximum operating speed 800 RPM—rotation counter clockwise. Has built-in relief valve, permanent or torque bar mounting, 1" diameter shaft, 3/4" pipe tap inlet, 1/2" pipe tap outlet. Ship. wt. 22 lbs. F.O.B. Chicago

45.50



ITEM #29KJ

ORDER DIRECT FROM AD — SEND PAYMENT OR PURCHASE ORDER TODAY — SATISFACTION GUARANTEED

GROBAN SUPPLY CO. 1139 SO. WABASH AVE., CHICAGO 5, ILL. DEPT. PM-6

Here's how Ford controls

A picture story by Dr. Roy K. Marshall

Dr. Marshall is a former consultant to the Atomic Energy Commission and a well-known lecturer. He is nationally famous for his simplified explanations of complicated things.

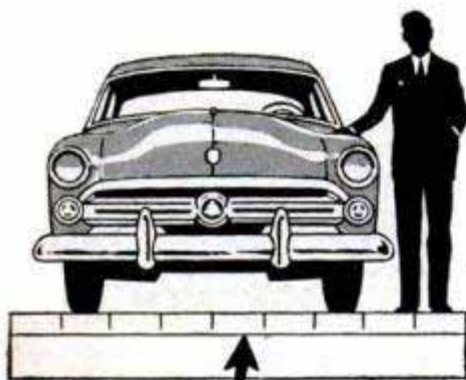
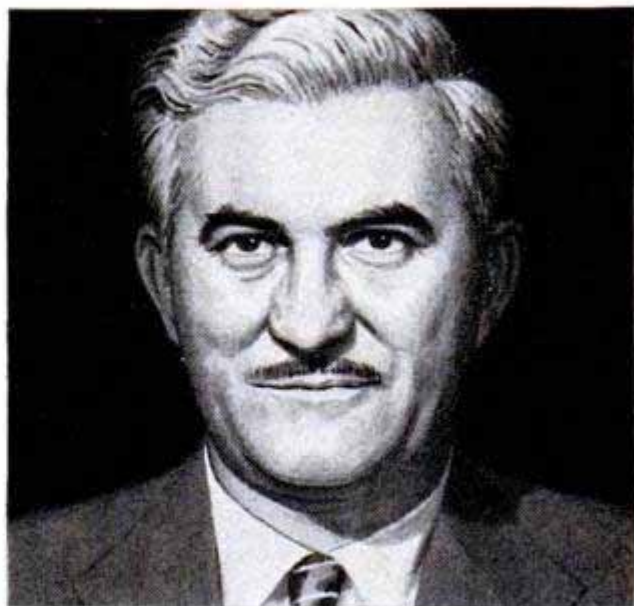

1 New wider front tread.

"Ford's wider front tread plus a longer, heavier anti-sway stabilizer bar combat the normal tendency of a car to lean over on curves."

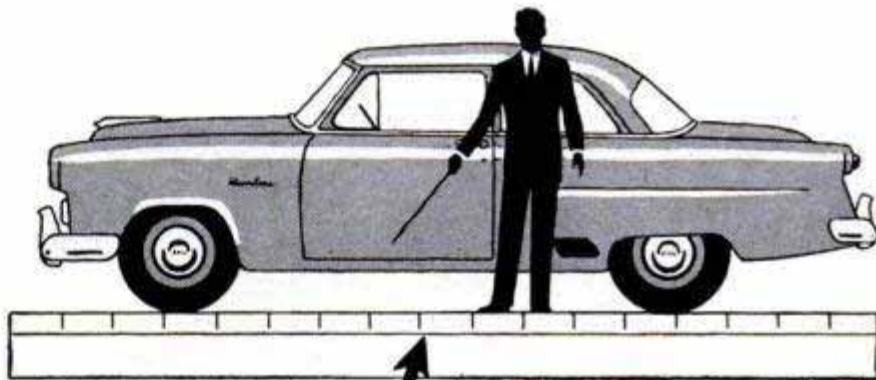

2 New longer wheelbase.

"Ford's longer wheelbase plus lower center of gravity help give you a road-hugging ride with practically no road vibration . . . even in rough going."

You can pay more but you

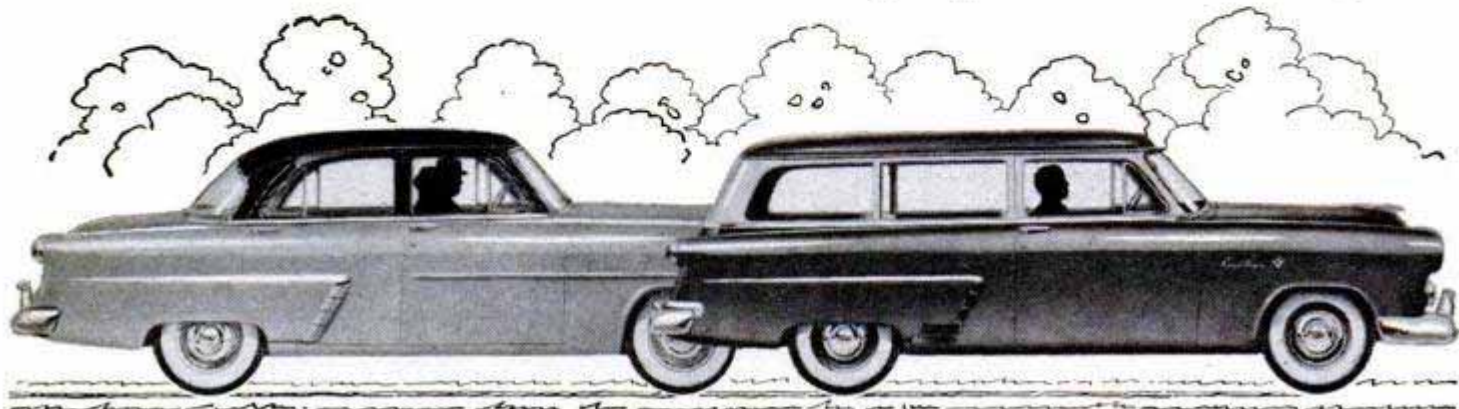

your ride automatically

"Ford's New Automatic Ride Control effectively eliminates objectionable sidesway and absorbs bumps."

"Folks who have driven the 1952 Ford ask me to explain what's behind its obviously smoother ride, behind the way it seems to level out the curves. The answer is many things . . . and they all add up to Ford's

Automatic Ride Control, a unique system of balance and suspension. Below, I explain the major elements of this system which automatically adjusts the car's ride to meet every change in the road."

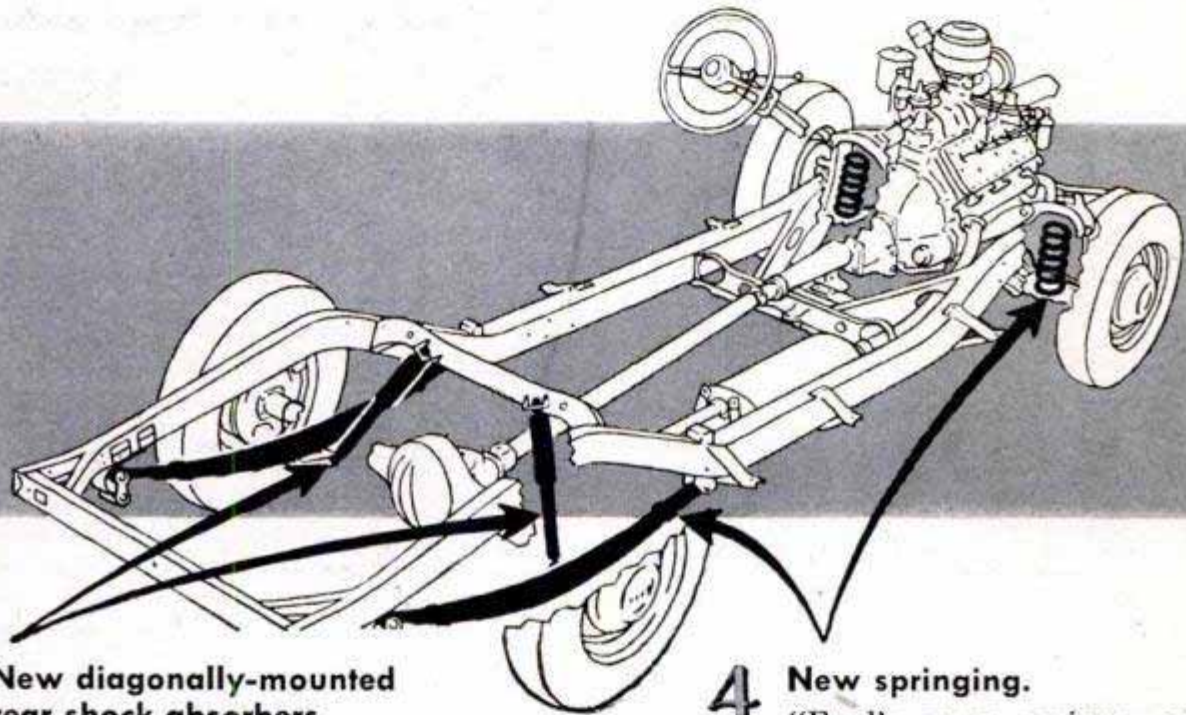

3 New diagonally-mounted rear shock absorbers.

"They 'lean in' to help hold the car level on curves, adjust their 'give' as road conditions change."

4 New springing.

"Ford's rear springs are three inches longer for easier action. Front springs are tailored to each model's weight for more precise ride control."

can't buy better!

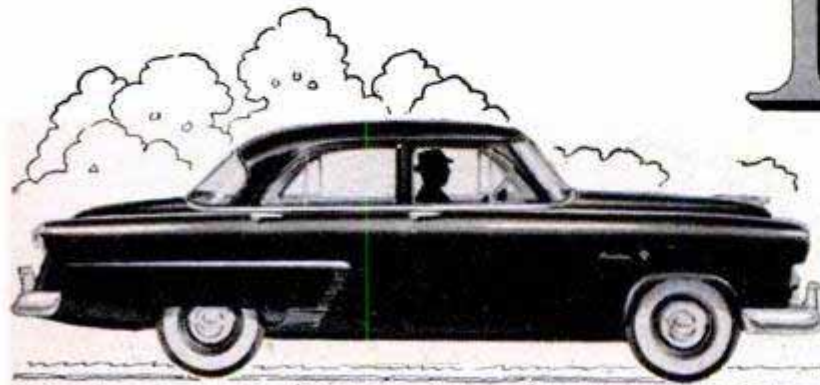

Ford

White sidewall tires and two-tone combinations illustrated, optional at extra cost. Equipment, accessories and trim subject to change without notice.

Clean hands

FAST!

but save your skin!



Boraxo "melt-away" action cleans hands faster, gentler than any other hand soap!

No harsh abrasives! Boraxo powdered hand soap contains tiny soluble crystals that clean paint, grease, stains, ground-in dirt, leaving hands and knuckles soft! A *must* for every man who has a workshop, or works on his car, in his garden, or around the house. Get hands *safely* clean in 30 seconds flat, with BORAXO! . . . for all the family!

SPECIAL OFFER

for home, workshop, garage, etc.



Boraxo Home Dispenser plus giant 16-oz. can Boraxo, both only

\$2.95

The Home Dispenser is white, refrigerator-type baked enamel on rugged 12-ga. steel! Holds many weeks' supply of Boraxo! One-piece plunger mechanism will not clog! Built to last . . . easy to install . . . this is a real bargain you'll be glad to own and use for years to come!

MAIL THIS COUPON TODAY!

Pacific Coast Borax Co.
Dept. P-6
100 Park Ave.
New York 17, N. Y.

Please send me *postpaid* the Boraxo Home Dispenser and giant 16-oz. can Boraxo. I enclose \$2.95 (in check or money order). If not entirely satisfied I may return them for prompt refund. Offer good in U. S. only.

Name

Address

City.....Zone.....State.....

Electron-Coupled Code-Practice Oscillator for Group Instruction

(Continued from page 213)

50-ma., five-watt type. The cabled leads should all be long enough so that the chassis can be removed from the speaker case without removing the plug from the socket. When mounting the jacks on the metal cabinet, be sure to use fiber washers so the jacks are insulated from the speaker case. The volume control enables the operator or instructor to adjust the volume to any suitable level. The variable pitch control can be adjusted to sound like actual "on the air" transmissions. The unit is easily portable, and jacks provide for the insertion of either telegraph keys or headphones at the student operating positions indicated in the student-group sketch. These jacks, connected in parallel as shown in Fig. 1, may be mounted on small Bakelite panels at each operating position. The terminating plug can be inserted by the instructor in either the phone or key jack on the cabinet for copying or keying practice. Any number of keys or phones can be plugged in for student participation.

The heart of the instrument is a stable electron-coupled oscillator circuit employing a 50L6-GT tube as an oscillator, and a 50L6-GT amplifier stage. There will be no appreciable change in the pitch with line-voltage variations. The oscillator coil T1 is the center-tapped primary winding of an ordinary universal-type output transformer. The one used was a four-watt type, with a primary impedance of 4000-14,000 ohms. The builder should experiment with the various taps on the secondary winding in order to locate those which will provide the greatest tone variations without stopping the oscillations as the secondary winding is short-circuited. The oscillator signal is resistance-capacitance coupled to the power-amplifier stage. This stage furnishes the necessary power to drive the speaker or several sets of headphones. The secondary of the speaker output transformer is connected to a closed-circuit, make-break jack which determines whether the output is to go to the speaker or to the headphones. As headphones are plugged in, the speaker is automatically disconnected.

An a.c.-d.c. power supply is employed; a 150-ma. selenium rectifier is used to rectify a.c. line voltage. If the unit is used on a 110-volt d.c. line, it may be necessary to reverse the line plug in the wall socket if the unit does not operate when first plugged in. Detailed student material list R-410 is available from Popular Mechanics Radio and Electronics department upon receipt of ordinary letter postage. ★ ★ ★

BUILD YOUR OWN ARC WELDER OR LIGHT PLANT

DELCO D-C GENERATOR

Save \$250 to \$500

\$17.50



Instructions included. Rated 200 Amps, 28 Volts, 2500 R.P.M. Ship. wt. approx. 50 lbs. Stock No. 707

PRICE F.O.B. K.C. MO.

CONVERTS TO ARC WELDER 200-250 AMP. OR LIGHT PLANT CAP. LOAD 5000 WATTS

Stock No. 711 D. C. Generator R-1 Jack & McIntz, rated 300 Amp. 30 Volts. Gov't cost \$300.00. Instruction for converting to welder or light plant incl. Also instructions and diagram for converting the R-1 or Delco generator to Combination Welder and Light Plant Included. Only... **\$27.50**

CARBON FILE GENERATOR VOLTAGE REGULATOR
For use with 24 or 32 Volt D. C. Generators. Also recommended for the P-1 and R-1 type generators in "build your own" Light plant. Only... **\$6.95**



R-21 HEAVY DUTY RHEOSTAT
Brand New for regulating voltage on ELECTRIC WELDERS, model trains, electric blankets, lights, control photoflood lamps, etc. Rated 16-32-ohms. Size 3 1/2" x 2 1/2" postpaid... **\$6.95**

WEAVERS HYDRAULIC HAND PUMP
BRAND NEW INCL. BUILT IN CHECK & RELIEF VALVE. For hydraulic jacks, presses, hoist, etc. For operating hydraulic cylinders to pump oil or hydraulic fluid under pressure, and is capable of delivering 1000 lbs. pressure. Wt. 10 1/2 lbs. A \$50.00 post-value. Instr. incl. Price... **\$12.95**

Valuable Gears — Bargains — Speed Reducers
10-1 or 5-1 ratio, 90 degree angle. Shaft driven 1/2" spline shaft with 3 mounting holes 5/16". Gears held in forged and machined aluminum housing with two needle bearings, one bronze bearing, and three high speed shielded bearings. Rated **\$5.95** postpaid

New Ampidyne MOTOR GENERATOR
Use as 24/32 D.C. motor, pulls 1/2 HP. Applicable for 110 V. A.C. by simple change in connection. Applicable to independent and rural lighting. Instructions incl. Cost over \$140.00... **\$7.50**

SENSATIONAL SELSYNS
Two or more connected together, work perfectly on 110 V. A.C. For weather vanes, rotating directional antennas or controlling distance operations. Complete with diagram and instructions. Wt. 3 1/2 lbs. PER PAIR... **\$7.95** Postage paid

Hydraulic Solenoid Control Valve
BENDIX. No. 81560 24V. D.C. For remote control operation and to operate one single action or double action hydraulic cylinders with 24 V. D.C. Recommended pressure 800 to 1500 P.S.I. connections are 3/50"-18thd. Also applicable for 115 V.A.C. Instructions, Diagrams & Data incl. \$35.00 ea. **\$3.50** pair

RIGHT ANGLE DRIVE with 1 to 1 ratio through 90 degree bevel gears. Drive and take off shaft are 3/8" dia. Self lubricating. Size 3 1/2" x 2 1/2" x 1 1/4". Rated 1/2 HP. at 1750 R.P.M. Ideal for use with power tools, etc. Has three 3/16" mounting holes on 1-5/16" post-center. Price... **\$3.50** post-paid

CUNO OIL FILTER — Brand New
Aircraft type. Filters oil without cartridge replacements. Just turn handle and cartridge is clean. Standard 3/4" inlet and outlet ports to accommodate 12 gallons per minute. STOP CHANGING OIL. Instructions **\$4.95** post-incl.

Send check or money order — all prices FOB Kansas City, Mo. except

ELECTRIC MOTOR 1/2 H.P. 24 Volt D.C. R.P.M. 2500. Amp. 22 #HCA24. Gov't cost \$75.00. Brand New... \$5.50

ELECTRIC MOTOR 1/4 H.P. 28 Volt D.C. R.P.M. 4000 #2832 with simple instructions to convert to 28-32 Volt A.C. Gov't cost \$82.84. Brand New... \$4.50

ELECTRIC MOTOR 1/4 H.P. 24V. D.C. 2000 R.P.M. Applicable for 115V. A.C. Instructions incl. Stock #4949... \$3.50

ELECTRIC MOTOR 6 Volt D.C. Delco. Handles 6" blade, ideal as windshield wiper, car heater motor, toy application, etc. 1/4" dia., 1 1/2" long shaft, size 5"x3", 1200-2000 RPM, incl. 2 mounting studs... \$2.95 post-studs.

AIR FILTERS

Framed air filter for air conditioner, heater, or windows, made of metallic with metal frame to give years of service. Can be easily cleaned to be as good as new again. 4 1/2" x 5 1/2" x 2". Wt. 8#. \$25.00 Value. **\$2.50** each. FOB K.C., Mo.

HY-PRESSURE CYLINDER

Valve and safety locking pin. Applicable as tire inflator, fire extinguisher, spray painter, life raft, etc. Shatterproof. **\$2.95** plus 35c Size 12"x2 3/4". Price...

ECLIPSE MOTOR GEAR UNIT

Brand New including 24V. D.C. Motor Gear ratio 4:1, can be adapted for 2:1, 40:1 & 20:1. Gear unit with separate A.C. motor makes ideal GARAGE DOOR OPENER, HOIST, PUMP JACK, HAYLIFT, LAWN MOWER DRIVE, DRIVE FOR POST DRILL, etc. diagrams & instructions incl. Gov't cost \$221.00. **\$12.95**

D. C. GENERATOR. Brand New. Delivers 430 Volts at 3450 RPM. Ball bearing supported, air cooled, armature base mounted. Wt. 23 lbs. #211220-A... \$7.50

UTILITY PUMP ROTARY VANE TYPE
FOR WATER, OIL, INSECTICIDES. Also applicable as Automobile Crankcase Drain Pump. Pressures 70 lbs. 12 gal. per minute at 200 R.P.M. Vacuum pump for milking machines, compressors, lab., etc. 1/2" pipe thread ports. Data & instructions incl. Stock #27... **\$12.95** post-paid
Utility pump stock #75 is the same as #27. Has about once and half time the volume. Wt. 12 lbs. **\$15.50**

ROTARY PUMP For pumping WATER FROM LILY POOLS, OR BASEMENT'S SUMP, pumping lubricants. Applicable for Garden & lawn sprayers. For use with hydraulic cylinders, vacuum, in dental lab, etc. Capacity 180 G.P.H., 200 lb. pressure. 29 in. vacuum. 500 to 3000 R.P.M. Steel shaft Std. 1/2 in. Stock #101. Instructions incl... **\$6.95**

Thompson Motor Driven PUMP
Including Built in Motor. Applicable for 24 V. D.C./A.C. or 110 V. A.C. The motor is explosion proof constructed. Pumping GASOLINE, FUEL TRANSFER, HOT WATER HEATING CIRCULATOR, USE IT AS COOLANT PUMP, FUEL BOOSTER, OIL PUMP, etc. Discharge connection is for 1" hose. Rated Capacity 300 G.P.H. Direction & data incl. A tremendous bargain! Stock No. 1200—Only... **\$9.95**

PESCO FOUR VANE ROTARY LARGE VOLUME UTILITY PUMP
For Water, Oil, Insecticides, etc. including built in relief and bypass valve. Capacity 400 G.P.H. 1/2" drive spline shaft. 3/4" pipe inlet and outlets. Rotates either direction or in any position. Engineering data incl. (Stock #600) **\$7.95** post-only

Adel Self-Priming ELECTRIC PUMP
For pumping light oils, oil burners, fluid metering, fuel pump, cool post grinder, coolant, pressure lubricating pump, etc. 1/30 H.P. rated 12000 R.P.M. Applicable for 24 V. D.C./A.C. or use on 110 Volt A.C. Size 6 3/4" x 3 1/4" x 3 1/4". rated 3 G.P.H. Diagram and instr. incl. \$50.00 val... **\$9.95** post-instr. incl.

FIRE EXTINGUISHER or INSECTICIDE PUMP SPRAYER. Four Gallon size includes approx. 3 ft. of high pressure hose with fine mist nozzle. Ship. wt. 15 lbs. via Express or Freight. Used, good condition. f.o.b. **\$2.50** each. K.C., Mo.

HYDRAULIC FLUID Mfg. by R. M. Hollinghead or Sacony Vacuum to exact Gov't spec. \$1.75 Gal. Wt. 10 lbs. Plus postage.

Stratopower Constant Displacement HEAVY DUTY PUMP



For operating Hydraulic cylinders, bulldozers, construction machinery, lift trucks. For fuel or oil transfer, Industrial applications, etc. Delivers up to 400 G.P.H. at 3750 R.P.M. Rated 1250 to 1400 P.S.I. 3750 to 4500 R.P.M. HAS BUILT IN RELIEF AT HEAD. Rotation either direction without adjustment. \$100.00 value. Engineering data and instr. incl. Stock #37. Wt. 8 lbs. **\$17.50**

AIR OR OIL HYDRAULIC CYLINDERS
Stock No. 512
Double action hydraulic cylinder 2 1/4" Bore, 4" Stroke, Dia. 3/4" shaft including built in hydraulic control valve which may be operated with rod or lever. Clevis mounting. Overall length shaft retracted 14" \$75.00 value. f.o.b. KC, Mo. value. Wt. 9 lbs. **\$12.95**

Double Action 1 1/2" Bore, 6" Stroke, 5/8" Dia. Shaft. Clevis mounting base and shaft end. Capacity 1160 lbs. with 1000 P.S.I. input. Has a capacity of 1625 lbs. with our STRATOPOWER 1400 P.S.I. A \$50.00 value. **\$8.95** Postpaid Only

Stock #303—Double Action 2" Bore, Stroke 1 1/4", Dia. 1 1/2" Overall length shaft retracted 23". 2000 lbs. capacity with 1000 PSI gives 2800 lbs. with our f.o.b. stratopower. Wt. 14 lbs. **\$14.95** KC, Mo.

Stock No. 12 Hydraulic Cylinder Double Action output 12560 lbs. with 1000 P.S.I. input. Gives 17584 lbs. with our STRATOPOWER PUMP 1400 P.S.I. or will produce 34168 lbs. with 3000 line pressure. Can also be operated on low pressure system. 4" Bore, 10 3/4" Stroke 1-5/16" Shaft, clevis mounting. O. Gov't cost **\$27.50** f.o.b. \$300.00 KC, Mo.

Pesco Hydraulic Flow Equalizer & Pressure Balancer Valve.
Brand New. Guarantees equal flow, and equal pressure for two cylinders or two systems. Capacity 360 G.P.H. 1500 P.S.I. Data & instructions incl. A \$75.00 value. **\$14.50** postpaid Stock 1-D-397 only

HYDRAULIC CONTROL VALVES
Adel Precision #B-10329. For controlling 2 single action or 1 double action cylinder. Including toggle lever. When lever is in one direction it puts pressure on one cylinder connection and opens exhaust, from opposite cylinder. When lever is released it returns to the neutral position and locks **\$8.95** post-cylinder. Brand new

VICKERS Four Way Hyd. Control Valve #137
For two double action cylinders allowing operator to raise or lower the both cylinders simultaneously or raise one and lower the other at predetermined rate **\$14.50** post-and speed

Pesco Pressure and Relief Control Valve
Brand new, with 3 ports and external pressure adjustment. Has two ports for normal flow, one for relief line to fluid supply or to pump inlet. Eng. data incl. A terrific bargain! Stock #575. Only... **\$4.95** post-bargain! Stock #575. Only... **\$4.95** paid

Large Volume hydraulic pressure relief valve. 3/4" ports, spring loaded. Range 1250 P.S.I. adjustable up to 3000 P. S. I. **\$4.95** postpaid Brand New

FOUR WAY VALVE
Solenoid operated on 24 Volt D.C. Applicable for 115 V. AC. Off in neutral position. For operating double action hyd. cylinders, remote control, etc. Has 1/4" tube ports. Instructions incl. Brand New **\$8.95** post-#324

HYDRAULIC PRESSURE GAUGE. New for High pressure hyd. systems. Range 0 to 2000 P.S.I. 2 1/4" dia. 1 1/4" deep. Black instrument face with white pointer and numerals. Uses 1/4" MPT fittings. **\$3.50** post-paid

Hydraulic Accumulators — Bendix Ball Type. Dia. 5 1/2". Built to stand 2000 P.S.I. Stock #A-65. Wt. 4 lbs. only **\$8.95**
BENDIX ACCUMULATOR. Ball Type. Dia. 10". Built to stand 2000 P.S.I. Wt. 15 lbs. Stock #A-85. Only... **\$17.50**

VICKERS CONSTANT DISPLACEMENT HYDRAULIC PUMPS. Brand New Stock No. PF-713-20. For any type liquid pumping job. 375 gal. per hr. at 3750 R.P.M. 1000 P.S.I. 410 cu. in. per rev. Gov. **\$17.50** post-cost \$100.00

ALTERNATING SHUT-OFF VALVE
Brand New. High pressure. Operates by worm-gear cam operating poppets to alternately close & open either pair of four ports. Standard 3/4" pipe **\$5.50** post-ports. \$50.00 value only... **\$5.50** paid when marked postpaid U.S.A.



ORDER YOURS TO-DAY!

LUTHY AERO TYPE Spark Plugs

With LUM-OX (Aluminum Oxide) INSULATORS



Material developed during World War II for high speed combat aircraft. Aluminum Oxide Insulator cools very rapidly, is stronger, has greater resistance to moisture and reduces breakage to a minimum. Packed in engineered sets of Six and Eight spark plugs. Correct Gap setting and proper heat range for your automobile, truck, tractor, hot-rod and stock car.

TOMMY THOMPSON, famous racing driver, says — "In Daytona 100 mile stock car race engine turned 200 more R.P.M. with Luthy plugs than I could get with any other plug."

LIST PRICE
\$1.00

This revolutionary designed 3 Point Electrode Aero Type Aluminum Oxide Insulator Spark Plug is the product of fifteen years of spark plug manufacturing and development. **GUARANTEED SATISFACTION OR YOUR MONEY BACK.**

Airplane Type
3 point electrodes
SENSATIONAL PERFORMANCE
MORE R.P.M.

LUTHY MOTOR REBUILDING COMPLETE KITS

Consists of Aeronautical Type pistons and pins—engineered rings—special racing type spark plugs. Specially designed round pistons of aircraft quality for high speed performance and quality. Write for descriptive literature and prices.



SERVICE MANUAL—JUST OFF THE PRESS

Over 100 pages with 116 illustrations dealing with such subjects as Dismantling and Inspection of Valves, Pistons and Rings, Cylinder Bores and Bearings; Assembly Recommendations; The Cooling System; Care of a Reconditioned Engine; Cause of Unsatisfactory Overhauls and an abundance of other material of genuine interest to the mechanic. Both educational and informative. A wealth of authentic data worth many times the price asked. **ONLY \$1.00** Order your copy today.



SPECIAL OFFER We will include one of the manuals without charge with every order for spark plugs received while the supply of manuals lasts.

SEE YOUR DEALER OR ORDER DIRECT
Distributors and Dealers — Write for Franchise

LUTHY AERONAUTICAL SALES COMPANY
302 COOPER STREET JACKSON, MICHIGAN
Canadian Address — Box 394, Hamilton, Ontario

MAIL THIS COUPON

Please send me postpaid a set of Luthy New Aero type plugs.

I am enclosing \$_____.

Year of car _____ Make and Model _____

Check here if you wish us to ship C.O.D. Pay Postman price of plugs only. We pay the C.O.D. and postage fees.

Check here if you are just ordering the manual.

Name _____

Street _____

City _____ Zone _____ State _____



Alcan photo

There are snow and ice in the triangle, too! This is a survey crew plotting route of proposed power line

Boom in the Big Triangle

(Continued from page 107)

giant aluminum-reduction plant which will utilize Kemano's power, eventually will be a major seaport with 50,000 residents.

Less than a year ago, six carpenters pulled into the lonely, uninviting shore line up-fiord from an ancient Indian settlement and clambered ashore to build a work cabin. Now trees have been cleared, docks line the waterfront and permanent camps have sprung up. Before long, first shipments of aluminum's basic raw materials, bauxite and cryolite, are to be unloaded at Kitimat; by 1954, first ingots will be produced. Plans call for an annual output of 1.1 million pounds of aluminum by 1956.

While Alcan's initial surveys were piercing into the watersheds of the Nechako and Fraser three years ago, Columbia Cellulose Company was drafting final blueprints for a purified pulp mill at Prince Rupert. The \$27,000,000 plant went into production in the summer of 1951. Reaching far beyond the 35-acre site of the mill, Columbia's venture embraces 600,000 acres of forest ranged along the Skeena and the Naas, all within a 150-mile radius of Prince Rupert.

To guarantee a perpetual supply of first-quality pulpwood, Columbia's foresters have adopted a cutting schedule based on 100 years' rotation. This entails patch logging, a common-sense approach to the problem of reseeding logged-over limits. Boiled

(Continued to page 248)

You'll find hundreds of time and money-saving uses for this

NEW 2 SPEED 100° ANGLE

BUFFING AND SANDING ATTACHMENT

A complete kit with 2-speed, 100° angle drive unit, 5" rubber pad, 2 5" sanding discs and 5" lamb's wool bonnet. **\$845***

*Price slightly higher in West and Canada



The Mark of Superiority



FITS ANY 1/4-INCH ELECTRIC DRILL and makes it an efficient rotary polisher and sander. Operates at 1/2 or twice drill speed. Exclusive 100° angle feature keeps drill and cord clear of work. A sturdy, smooth-running tool that makes countless jobs quick and easy. Grease sealed lubrication. Machine-cut steel gears. Ask for it at your hardware dealer's.

MILLERS FALLS COMPANY • GREENFIELD, MASSACHUSETTS

A REVOLUTIONARY CATCH FOR CUPBOARD DOORS!

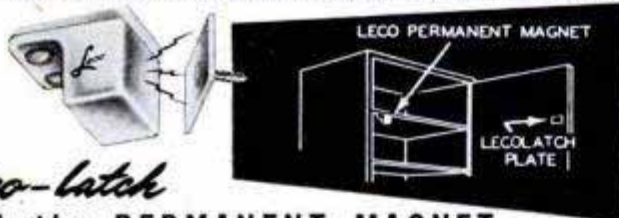

Leco-latch

with the **PERMANENT MAGNET**

No Moving Parts • No Springs • Absolutely Trouble Free

Utilize the continuous energy of the Permanent Magnet. It will work for you silently and efficiently for the rest of your life! Lasts forever — nothing to get out of order... Works perfectly — even if doors sag or warp... Doors open easily — without snap, noise or jerk... Holds doors in place firmly, yet gently... Easily installed... Improves appearance.

See your local lumber or hardware dealer, or write to

LABORATORY EQUIPMENT CORPORATION ST. JOSEPH 12, MICHIGAN

!!! SAVE \$25.00 !!!

16" ELECTRIC, made by a leading rotary mower builder to sell at \$64.50, only **\$39.50**

FOB K.C., MO.

(Use #16 or heavier cord)

- 1/3 H.P. Delco motor with over-load switch.
 - Trimmer type aluminum alloy base.
 - Adjustable floating handle.
 - 1-2-3" cutting heights.
 - 3 replaceable knives.
- Shpg. wt. 46 lbs. Send check or M.O. for 39.50. Shipping charges collect.



LIMITED SUPPLY!

Write for literature

WESTPORT INDUSTRIES
Box 5870, WESTPORT STATION, KANSAS CITY, MISSOURI

Greatest tool values CATALOG FREE

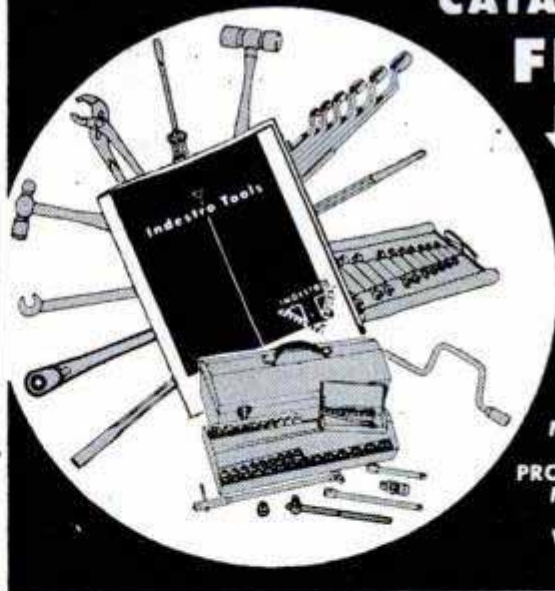

AUTO SERVICE MEN

FARM MECHANICS

PROFESSIONAL MECHANICS

WORKSHOP HOBBYISTS

This brand-new book gives you full information on High-Quality, Low-Price Indestro Tools your dealer can supply. The very newest designs in regular or special hand tools, tool sets and complete tool chests; every tool finely made, properly heat-treated, ground and polished for years of satisfying service. Insist on Indestro, the choice of professional shop men.

send coupon for INDESTRO catalog

FILL OUT AND MAIL NOW FOR FREE COPY

Send to INDESTRO MANUFACTURING CORP.
N. Kildare at Schubert, Chicago 39, Ill.

write your name and address in margin space

How to get more mileage out of your motoring dollar



REDUCE TIRE WEAR

car may become hard to control...tires wear excessively and unevenly.

Align wheels at least twice a year. Rough roads, shocking jolts and stops throw your car's wheels out of alignment. The result:

Keep up your car's looks. Frequent washing... regular application of finish preservatives not only improve your car's appearance; they lengthen the life of the finish, increase your car's turn-in value. A few do's and don'ts: Keep car under cover whenever possible; never dust with dry cloth; park in the shade.



MAINTAIN CAR FINISH



FINEST OIL FILTER

Keep a fresh Purolator* Oil Filter Refill on the job. Unique accordion-pleated, plastic-impregnated element (see cut-away at left) provides up to 10 times more filtering area... traps abrasive particles of dirt and hard carbon as tiny as .000039" in

diameter out of engine's oil stream. To keep filter functioning efficiently, replace element before it becomes clogged (a good filter may collect over 2 pounds of sludge and abrasives in 5,000 miles of normal driving). A fresh Purolator Micronic* Refill costs as little as \$1.60. Takes just a few minutes to install.

*Reg. U.S. Pat. Off.

Check your oil filter every time you change your oil



PurOlator
(ENGINEERED FOR EVERY MAKE OF CAR)
Micronic OIL FILTER

down, it simply means cutting timber in checkerboard plots, leaving a block of mature trees to reseed the section which has been logged. Where nature's seeding fails, actual reforestation is practiced. R. L. Johnson, woods division chief, claims that patches logged out this summer will bear a top-grade crop 100 years from now.

Based at Terrace, 100 miles east of Rupert, Cellulose woodsmen with portable power saws are downing great hemlock, balsam and spruce. These giants of the coastal forests are trucked to the rail spurs where trains take over. To control the heavy truck traffic cruising its woodland roads, Cellulose is planning an over-all radio-dispatch system.

At Rupert, Cellulose already is producing finished pulp over its rated capacity of 200 tons a day. A new and carefully guarded process introduced in part by researchers of the parent Celanese Corporation has proved so successful that increased output of 100 tons a day is imminent. This pulp is shipped to plants of Celanese for manufacture of chemical yarns and plastics.

Prince Rupert, the northwestern tip of the triangle, now stands on the threshold of a long-overdue development. Rupert is not a boisterous boom city. Her people are cautious; they've seen previous economic surges come and go, leaving little in their wake but disillusionment. Again, Rupert for years has enjoyed an earned reputation as "the fishing capital of the world" and fishermen still make up the basic population. While concerned about factors controlling their own welfare, they're mostly apathetic when gunwale confabs get round to Kitimat and Cellulose. The Aluminum Company's water juggling in the Tweedsmuir Park lakes has worried the industry but fluctuation of the Skeena's salmon run is not a likely aftermath of Alcan floodings.

Rupert's natural caution dates back to early in the century. In 1906 Charles Melville Hays, a vigorous railroad planner from the United States, pounded a desk in Ottawa and told a doubting government that Rupert would become the principal port on the North Pacific, the shortest route to Asia. He backed his beliefs by organizing the Grand Trunk Pacific Railway and immediately shoved survey crews along the Fraser, Bulkley and Skeena rivers.

A hog-wild real-estate splurge hit Rupert in 1909 and lasted until 1912, the year of the Titanic disaster in mid-Atlantic. Charles Melville Hays went down with the pride of the White Star Line. Without its guiding spirit, the railway limped to completion at Rupert, "a ghost train without Hays at the throttle." Steeped in politics, the line

(Continued to page 250)

SAVE 50% - THOUSANDS HAVE ASSEMBLED

\$42^{UP} PACKAGED BOAT KITS

27 MODELS

Dinghies, skiffs, racers, inboards, outboards and cruisers. Assemble your own boat, it's easy, it's fun!

All parts pre-cut or pre-fabricated from finest materials. Get all the facts from our big 24 page catalog. See how Packaged Boats are built, how they perform, how exclusive construction features make assembly easy. Includes specifications, performance data plus hardware and paints.

SEND 25¢ for NEW 24 PAGE CATALOG
CUSTOM-CRAFT - DEPT. 7 - BUFFALO 7, N. Y.

BOAT PLANS Over 50 modern plans and full size patterns. Racing classes, cruisers, inboards, outboards, sail boats. By famous designers. 6' to 30'. DESIGN CATALOG 35¢. Design Catalog and boat building handbook, \$1.00

PATTERNS

MARINE MART - DEPT 7 - BUFFALO 7, N. Y.



MAGNETS

GENUINE ALNICO - NEVER WEAKENS

LIFT 225 lb.

AMAZING, PERMANENT MAGNETS—WILL NOT WEAKEN! NON-ELECTRIC
Retrieve guns, tackle, tools and other steel items from lake, river, plating tanks, drains or other hard-to-reach spots. Recover drills, taps, etc. from sweeping. Clear alley of harmful tacks, nails. Many other uses. Pays for itself quickly. **GUARANTEED.** Try any magnet one week. Money refunded if you are not well pleased.
No. M-725 (Weights 54 oz.) Has pull of 225 lbs. on steel block. \$15.00
No. M-675 (Weights 49 oz.) Has pull of 175 lbs. on steel block. \$10.50
No. M-650 (Weights 41 oz.) Has pull of 150 lbs. on steel block. \$ 8.50
No. M-30 Hobbyist assortment of six small magnets. \$ 1.50
Send Money Order or Check. We pay postage. No C.O.D.'s.

MADE RITE CORPORATION
Trailer Running Gear



58" 2 TON AXLE \$8.00 RETAIL SPECIAL PRICE TO DEALERS PAT PENDING.
F. O. B. 6454 EPWORTH BLVD. DETROIT 10, MICHIGAN

Build your own JET ENGINE!



SEND NO MONEY

Order these plans today

1. JET PROPELLED BICYCLE. Assemble your own. Photo and instructions, \$1.00.
2. HOW TO MAKE EXPERIMENTAL JET ENGINES. Seven sheets drawings with information and instructions \$2.95.
3. BOTH OF ABOVE in one order \$3.75. SEND NO MONEY. Order both at once \$3.75 C.O.D. in USA plus e.o.d. postage. Send check or Money Order and we pay postage. Get other information too. Rush Order.

J. HOUSTON MAUPIN, Dept. 55, Tipp City, Ohio

NEW—Sensational! GEIGER COUNTER



"The SNOOPER"
LOW PRICE ONLY **\$24.95** COMPLETE

Find a fortune in uranium with this new, super-sensitive Geiger Counter. Get one for atom bomb defense. So small it fits in the palm of the hand or in the hip pocket, and yet more sensitive than many large, expensive instruments. Weighs only 1 1/4 lbs. Uses flash-light battery. Low price includes earphone, radio active sample, instructions. Sold with ironclad moneyback guarantee.

ORDER YOURS TODAY—Send \$5.00 with order or payment in full to save C.O.D. Write for free catalog on treasure finders for gold, silver, etc. and larger, more elaborate Geiger Counters.

Dealer Inquiries Invited **PRECISION RADIATION INSTRUMENTS**
2235 PM So. La Brea, L.A. 16, Calif.

Do 1001 Homecraft Jobs EASIER—FASTER

with



HI-POWER COMPLETE ALL-PURPOSE POWER TOOL KIT

Features Hi-Power 1/4" Electric Drill for use as a portable tool, and the easy handling PET Drill-Saw with 4" blade that takes the work out of cross-cutting and ripping boards up to 1" Also includes Horizontal Stand and bits, plus accessories for sanding, polishing, and mixing. This 22-piece Hi-Power Kit, Model 77-16, is a real thrill for anyone who likes to build or repair things around home, farm, shop. Complete with sturdy metal carrying case—only **\$26.60**



Model 510
1/2" drill—**\$38.75**

ZEPHYR ELECTRIC DRILLS—lightweight, modern streamline designs. Precision dynamically balanced, smooth running, AC-DC motors.



Model 1950-H
1/4" drill—**\$18.95**

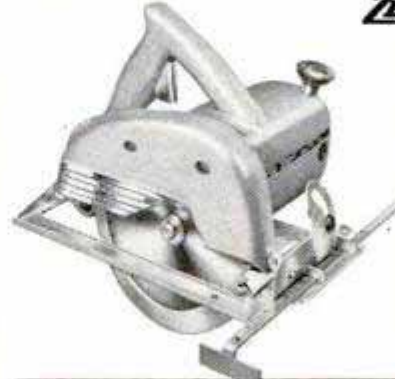

ZEPHYR 625-L ELECTRIC

HAND SAW—Balanced, lightweight design for easy handling in any position. 6 1/4" blade. Depth of cut 2 1/2". Adjustable for depth and angle. Includes graduated ripping guide. AC-DC motor. Price **\$47.50**

Write for name of nearest dealer and new catalog on complete line of PET Hi-Power and Zephyr Tools.

PORTABLE ELECTRIC TOOLS, INC.

324 West 83rd Street, Chicago 20, Illinois
In Canada: Portable Electric Tools, Ltd.
369 Danforth Rd., Toronto 13, Ontario

BIG VALUES IN ALLIED'S NEW TV-RADIO SUPPLEMENT

FREE SEND FOR IT



"SKY-ROVER" PORTABLE KIT Complete with Carrying Case

Build this powerful 3-way super-het portable for AC, DC, or battery operation. Covers 535-1650 kc AM broadcast band; has built-in antenna, PM speaker, automatic volume control, beautiful carrying case. Easy to assemble from 8-page illustrated manual. High-quality kit includes all parts, tubes and case (less batteries). Shpg. wt., 6 lbs. **83-276. Only.....\$17.95**
80-596. Battery Kit..... \$ 2.11



WELLER SOLDERING GUN

Squeeze the trigger—you're ready to solder in 5 seconds! Double-tube electrode and long tip; with spotlight that lights up working area. Air-cooled transformer. Balanced rugged plastic housing. 100-135 watt dual-heat. Shpg. wt., 3 lbs. **46-589. Only . \$11.71**



MICRO-VOX WIRELESS MICROPHONE

Mike with built-in midget radio transmitter plays magically (without wires) through any radio within 50 feet. Easy to use for home entertainment or as small P.A. System. Provides endless amusement. Complete with built-in batteries and instructions. Shpg. wt., 3 lbs. **99-485. Only..... \$5.85**

E-Z-I TELEVISION LIGHT & CLOCK

Combination TV light and electric numeral-type clock. When placed on top of TV cabinet, helps reduce viewing eye-strain. Keeps accurate time. Walnut plastic case, 5 x 5½ x 7½". For 110 v., 60 cy. AC. Shpg. wt., 2½ lbs. **78-328. Only.... \$7.66**



CHAMPION ELECTRIC SPRAY GUN

Sprays lacquer, paint, varnish, chemicals, insecticides, etc. No compressor needed—has motor right in handle—develops over 90 lb. pressure. Pistol trigger. With 25-oz. glass jar and 8-ft. cord. For 110-120 v., 60 cy. A.C. Shpg. wt., 5 lbs. **46-139. Only..... \$9.57**

(All prices F.O.B. Chicago)

HUNDREDS OF OTHER GREAT VALUES

ALLIED RADIO

FREE Supplement

ALLIED RADIO CORP. Dept. 5-F-2
833 W. Jackson Blvd., Chicago 7, Ill.

- Send FREE ALLIED Supplement No. 130.
 Enter order for _____ \$ _____ enclosed.

Name _____

Address _____

City _____ Zone _____ State _____

barely survived the next two years. Rupert's bubble was punctured. The railway struggled through World War I, collapsed in 1922 and became the mate of the also-shaky Canadian Northern under the married name of Canadian National Railways.

World War II brought another glimmer of light to Rupert's commercial horizon. Hoisted into importance as a shipbuilding center, a strategic port and an active military location combining both U. S. and Canadian personnel, Rupert's population zoomed from 6500 in 1940 to 27,000 in 1945. But in one year, at war's end, she lost most of her gains and settled down at 7500. Fishing again became the No. 1 industry.

As No. 1 industry it hasn't been so bad. Millions of dollars are netted each year by Rupert fishermen. In 1950, 2500 of them averaged \$6600 each.

Last summer, a philanthropic member of the Royal Canadian Mounted Police was about to loan a few dollars to a seedy-looking character roaming the streets of Rupert until he learned that the object of his sympathy had earned \$16,000 as a fisherman. A young druggist moved up the coast to open a pharmacy, became a summer fisherman instead, saved \$4000 in his first season.

Salmon is the most valuable catch, with halibut second. Ten canneries operating in the Rupert area last year canned close to one million cases of salmon, a catch which boosted fishermen's incomes by \$10,000,000. Herring, sole and skate are now profitable, while cod fishing has developed into a source of revenue during winter months. But canning of the sockeye salmon still provides the most jobs and incomes.

A successful fish cooperative is established at Rupert along with several quick-freeze filleting plants and two independent cold-storage establishments. B. C. Packers' giant plant has a daily freezing capacity of 130,000 pounds of fish and storage vaults for 12 million pounds. Co-op and Atlin combine to add another 10 million pounds of storage.

As science has perfected methods of filleting, canning and curing fish and aided materially in the techniques of storage and marketing, it also has brought improved methods of great value to the fisherman out on the waters. While more capital now is needed to break into the industry, the fisherman stands a far better chance of chugging home with a pay load than did his predecessors of Rupert's early days.

Today, all of the fishing fleet is power-driven. But more interesting are the devices with which the vessels are equipped. The up-to-the-minute fishing craft has a ship-to-shore telephone, a radio direction

(Continued to page 252)

The Biggest Money Saving Idea in Car Maintenance in 20 Years

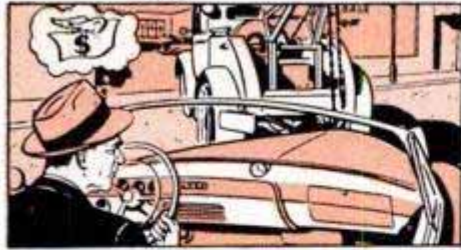

STOP those endless repairs that keep pulling \$10 bills out of your pocket.



STOP expensive overhauls that still leave things undone to break down later.



STOP paying high gas, oil and maintenance bills on an unsafe, worn-out engine.

New Kind Of Replacement Engines ...Successor To Costly Overhauls!

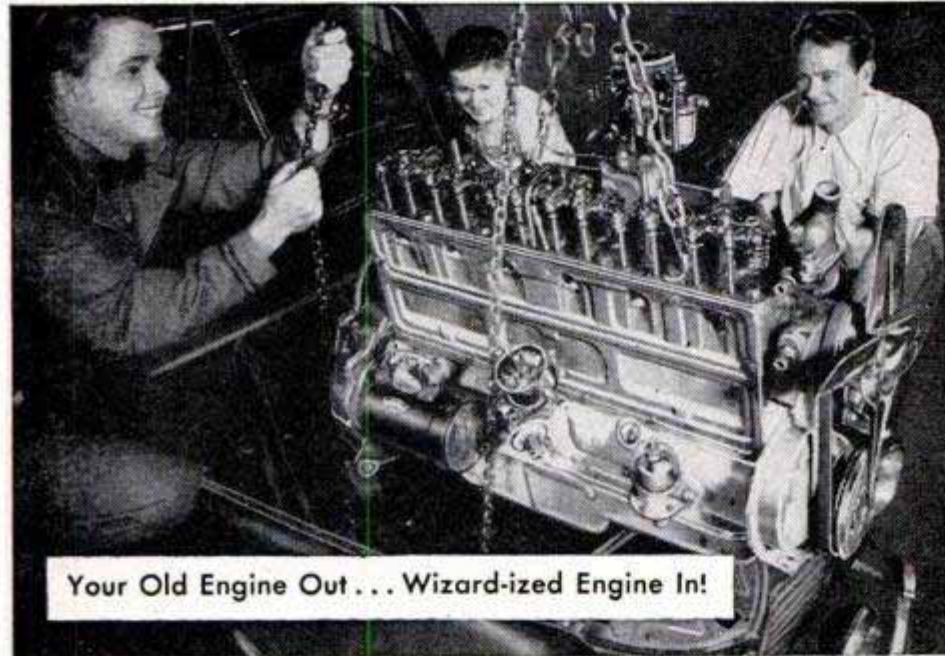

Your Old Engine Out . . . Wizard-ized Engine In!

Enjoy again the new-car thrill of an engine that's packed with surging power . . . power to level any hill . . . power to pull out of tight spots in traffic . . . power that means years of care-free driving and day after day dependability. You

can have it now in one complete, guaranteed package in a Wizard-ized Engine. (Attached engine accessories are used from old engine, or may be replaced new.) Yours on easy Western Auto terms!

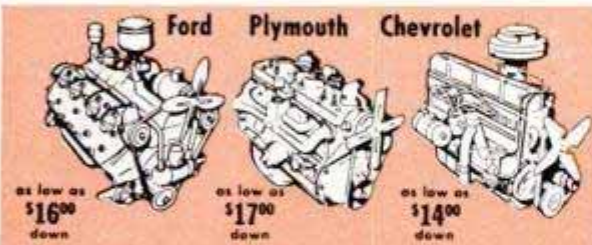

(Terms vary by area, make and model of car)



No Regular Overhaul At Any Price
Can Match Your New
Factory Remanufactured*

Wizard-ized Engine!

HERE, AT LAST, is a new kind of replacement engine for your car! . . . so much better than partially rebuilt engines or ordinary overhaul jobs that thousands call it the successor to costly overhauls!

*NOT A SO-CALLED "REBUILT" but completely remanufactured in 5 large factories, this Wizard-ized engine gives you an easy, low-cost way to end costly repair bills. And you can . . .

GET ANOTHER 50,000 OR MORE MILES from your present car! That's because . . .

EVERY MOVING PART IS BRAND NEW top quality or fully remanufactured to function like new. Over 150 new parts. That's why you can buy with new car confidence. In fact, Western Auto gives you . . .

THE SAME GUARANTEE THAT COMES WITH A NEW CAR ENGINE—plus a free 500-mile service inspection of our installation. Still this Wizard-ized Engine is . . .

PRICED FAR BELOW THE COST OF A NEW ENGINE . . . or about the cost of a bearing, ring and rebore overhaul! Our . . .

INSTALLATIONS ARE MADE BY trained mechanics in fully equipped garages. So . . .

SEE YOUR WESTERN AUTO MAN TOMORROW . . . ask about his trade-in allowance for your old engine!

Wizard-ized Engines

FACTORY REMANUFACTURED

The Engine You Can Buy with New Car Confidence



© 1952 Western Auto Supply Co., K. C., Mo.
NOTE: Western Auto Associate Dealers own their own stores and set their own prices. Terms quoted are recommended terms, subject to variance.

PM-62

WELD
BRAZE, SOLDER,
and CUT →

ONLY \$1475
F.O.B.
complete!



No experience needed. Follow simple instructions, weld on iron, steel, bronze, brass, aluminum, and other metals. Plugs into any properly wired 110 volt A.C. or D.C. line. Make or save time and money doing repair work for yourself and others. Repair men, farmers, tinsmiths, home and auto owners, hobbyists, etc., say FOUR-WAY pays for itself over and over. Order today or send for Free details.

Larger Equipment Available on Request
FOUR-WAY WELDER COMPANY, Dept. F2-FC
2326 S. Michigan Ave. • Chicago 16, Illinois

ORDER NOW
10 DAY TRIAL

EXPAND YOUR HOME!

USE YOUR ATTIC

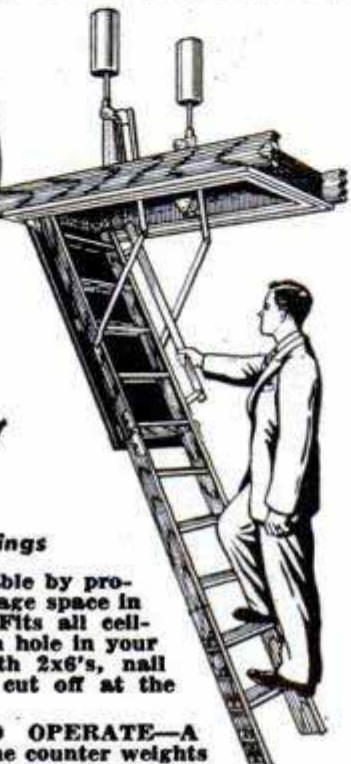

Install the **PRECISION Folding Stairway** at a cost of **\$60 to \$75**

Equipped with Roller Bearings

Makes your home more livable by providing extra rooms and storage space in the most economical way. Fits all ceilings—Just saw a 26x54 inch hole in your ceiling, frame the hole with 2x6's, nail the stairway in place and cut off at the calibrated ceiling height.

SIMPLE AND EASY TO OPERATE—A slight pull of the cord and the counter weights that operate on factory packed roller bearings silently ease the stairway into down position. The same counter weights return the stairway to its up position with equal ease. **RUGGED AND STRONG**—Construction of No. 1 kiln dried poplar. Brackets, rocker arms and hinges of heavy cast aluminum alloy. All parts numbered and interchangeable. Panel insulated and protected with tough chip board. Steps covered with safety treads. **FITS ANY CEILING**—from 7 feet to 10 feet 3 inches high. Runners graduated to facilitate cutting off for different ceiling heights. **REQUIRES NO ATTIC SPACE**—Full height above attic floor only 36". Folds completely into opening in ceiling. **SHIPPED IN ONE PACKAGE**—Each stairway thoroughly inspected, assembled and ready to install. Shipping weight 130 pounds. Sold by more than 12,000 dealers in U.S.A. and Canada. **APPROVED BY F.H.A. EVERYWHERE.** Mail coupon TODAY for descriptive folder and complete information concerning delivery, prices and installation.

TO MAKE YOUR HOME MORE LIVABLE, Mail This Coupon today!



PRECISION PARTS CORPORATION
402 North First Street, Nashville 7, Tenn. PM

Please send me FREE folder and complete information on PRECISION folding stairways.

Name _____

Address _____

finder and a depth sounder whose oscillators beam a pulse to the ocean floor. This super-sonic beam travels down until it strikes anything with a density different from water, then bounces back to recording instruments in the pilothouse. The receiver marks every depth measurement with a stylus on a roll of paper. It provides a moving chart which graphically describes the hills and valleys of the bottom and picks out fish schools. And in fog or at night, the chart is always operating so that the pilot is warned of reefs and other underwater hazards.

(To be continued next month)

America Bids for the Atlantic Blue Ribbon

(Continued from page 87)

The problem was how to get these pre-fabricated monsters into place. Donnan's lips still tighten when he remembers the job. "As designed," he says, "those stacks reached 175 feet above the keel. The cranes could reach about 180 feet and carry 75 tons on the lower hooks. But the top auxiliary hooks we'd have to use couldn't begin to handle 80 tons. So we split the funnels in two, hoisted the bottom half to the foredeck first, got two traveling cranes on each side and lifted the thing in place. Then we picked up the top half the same way and set it in place—like putting a 40-ton lid on a 40-ton pot."

The big rakish stacks with their winglike vanes are not just for looks. Their vast interior is a maze of catwalk-entwined smoke ducts that branch off into four huge dust-collector drums—each about the size of a railroad tank car—and narrow down again to the single small vent in each hood. Each stack handles ducts from two engine rooms as well as a battery of huge air-conditioning fans.

The stack hood vanes help cut the down-draft behind the funnel when the ship is under way and so aid in keeping people on the sports deck from having to play shuffleboard under a smoke screen.

Since naval features account for some \$30,000,000 of the ship's total cost, many of the secrets beneath her hull plates will never be revealed. But without doubt, she's the safest ship in the world. The *United States* has innovations that will enable her to withstand collision damage more than twice that required by international standards. Her entire hull is compartmented like a battlewagon, with watertight, fireproof bulkheads that span her girth.

Imagine that a fire breaks out on B deck

(Continued to page 254)

DRY OUT DAMP WORKSHOPS!

Amazing little Fedders Electric Dehumidifier dries damp rooms without messy chemicals! Plugs in like a radio, removes up to 3 gals. of moisture from the air every 24 hours. Stops damage from rust, mildew, rot, warp. Protects tools, wood, guns, luggage, furniture, linens. Compact and portable. 15" wide, 22½" high, 13½" deep. No service worries. Runs for a few pennies a day. Write today for FREE illustrated booklet. Fedders-Quigan Corp., Dept., PM-4, Buffalo 7, N. Y.

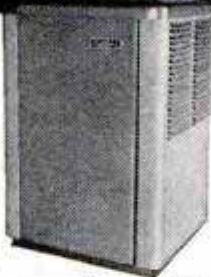

fedders

A GREAT NAME
IN COMFORT

LAWN ORNAMENT-NOVELTY PATTERNS

28 Lawn Ornament Patterns, 25c. Other Patterns: 15-20" high: Dutch Girl, Dutch Boy, Pirate, Bull Terrier, Mexican Girl, Mexican Boy, Dwarf, Penguin, Flower Girl, 10c each. 25 Novelty Patterns, 30c. All 62 Full Size Patterns, \$1.00 Postpaid. Strother Pattern Service, Dept. CY-8, Box 129, Belington, W. Va.

New POWER MOWER

FREE Building Instructions
Write For Them

Amazing invention makes whirl-blade mower pull and steer itself as well as cut grass and weeds. Convert your mower or build a complete mower with screw-driver & pliers. Send name and address on Postcard.

Convert Your Mower
Or Build A New One

T & H Mfg. Co., Dept. 116, 811 E. 31 St., Kansas City, Mo.



Spindle—Platform—Wheels—Fork—Handles—Driving & Steering Parts
All parts available—Kit or separately.

BUILD FINE GRANDFATHER CLOCK NOW

The simple sensible Red-i-Kut way as thousands have—SAVE HALF. SHOP TESTED PLANS "SPIRIT OF THE CENTURY" Narrow waist 83" tall or stately straight side "SPIRIT OF AMERICA." EASY-to-FOLLOW photomockt PLANS tell all—plus BROCHURE of heavy brass weight Westminster, tube chime, movements, gorgeous dials, ¾" solid mahogany case kits. Send \$1.00 today—Both plans \$1.50 NOW. KUEMPEL CHIME CLOCK CO., #4 Kuempel Bldg., Minneapolis 16, Minn.



HURRICANE CUT-OUT EXHAUST

This specially engineered cut-out enables you to install special pipes and mufflers without removing the original muffler.

Now control your exhaust tone from a dash control button. Cut back into your original muffler in restricted areas at will. Fits all exhaust pipes from 1¾" to 2¼" size.

This cut-out is well constructed; actually strengthens exhaust pipe; made of heavy plate steel, designed for easy installation—no special tools required. Sent post-paid for only \$6.95 check or money order. Satisfaction guaranteed or your money back.

ST. LOUIS PRODUCTS CO., Box 24-A6, Normandy 21, Mo.

SEE BETTER

SHOOT BETTER

WITH NAKED EYE



WITH A
MOSSBERG
SCOPE



Only
\$995

Patented
INTERNAL
ADJUSTMENTS

All lens surfaces
hard coated, to
assure sharp image.

Mossberg scopes fit almost all makes
of rifles up to 25-20 cal.

YOUR MOSSBERG DEALER
WANTS TO SHOW YOU THESE

MODEL #2M4 with improved CAST mount.
For high or low position.

MODEL #4M4 with dovetail mount specially
designed for certain Mossberg
rifle models.

O.E. Mossberg
® & SONS, INC.

Send for
FREE catalog
No sales at factory

29706 St. John St., New Haven 5, Conn.

YOU'LL HAVE MORE FUN WHEN YOU OWN A Whizzer



- 5 TO 35 M.P.H.
- UP TO 100 MILES PER GALLON
- 3 H.P., 4-CYCLE MOTOR

Finest low-cost transportation anywhere. Takes you wherever you want to go—on streets, highways or trails. Whizzer gives you comfort, dependability, beauty and safety, yet costs only a fraction of a cent a mile. Get a Whizzer now!

FREE! Illustrated booklet with photographs, descriptions of all Whizzer models. See your dealer, or write.

WHIZZER MOTOR CO. 306 S. Sanford, Pontiac, Mich.

**'Tain't no trouble
to give your car long-lasting wax protection!**

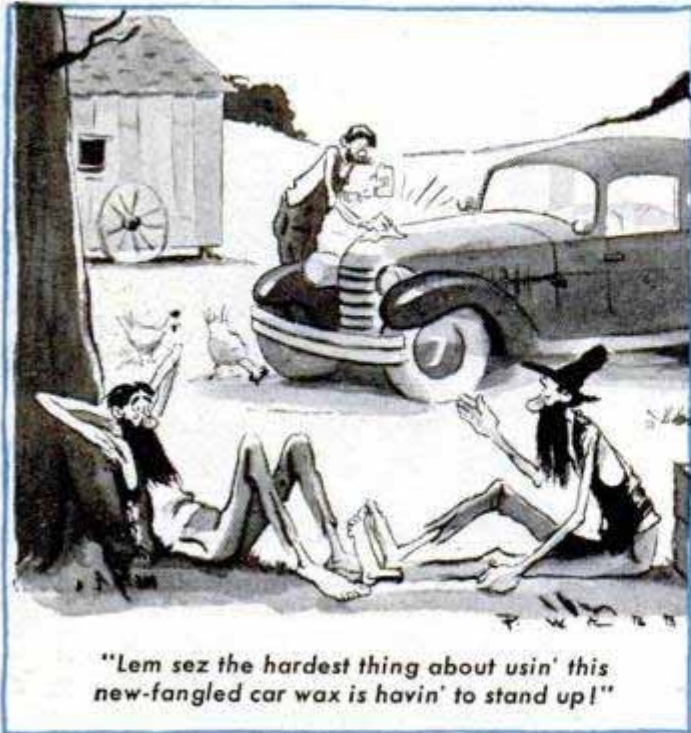

"Lem sez the hardest thing about usin' this new-fangled car wax is havin' to stand up!"

**Johnson's Car-Plate
Waxes any car in 20 minutes!**



**Spread it on—no rubbing—let it dry!
Wipe it off—no rubbing—that's all!**

Johnson's Car-Plate is the no-rubbing auto wax described in Reader's Digest. Its shine is as bright and long-lasting as a hard-rub professional wax job costing \$15 or more! Don't delay. Wax your car the easy way. Pick up a can of Johnson's Car-Plate today.



**Car-Plate CLEANER...
New, better, faster!**

Developed especially to clean and condition the finish of your car for a perfect Car-Plate wax job. New Car-Plate Cleaner safely removes all greasy road grime—goes on and off with minimum of effort!

Protect your car's chrome trim. Clean with Johnson's Chrome Cleaner—protect with Johnson's Car-Plate.

© S. C. Johnson & Son, Inc., Racine, Wis., 1952
"Johnson's" and "Car-Plate" are trademarks.

in a stateroom. Immediately, a smoke detector will trigger a signal to the damage-control room on the bridge, where almost any kind of malfunction registers on a big electronic panel by means of colored lights. Instantly the damage-control officer knows there's a fire and its location. On a switchboard beside his desk, he flips a series of finger switches. One rings an alarm in that "piece" of the ship. Passengers are immediately evacuated. Other switches control all the automatic watertight fire doors in the special gunwale-to-gunwale bulkheads on each side of the fire area. The blaze is trapped and fire fighters can move in on it.

It's extremely unlikely that fire could ever start in the superliner anyway. There is no wood to be found anywhere aboard, except in such items as the grand piano and the butchers' chopping blocks. All of the decorative fabrics, bedding and upholsteries are treated with a resin compound to make them highly fire-resistant.

If passengers should ever be forced to abandon ship, they will climb into some of the biggest lifeboats ever installed on any ship. Twenty-four of the gleaming, deep-draft boats skirt the long promenade deck. Each is about 40 feet long and will accommodate 140 persons with ease. Actually, 400 persons could pile into one of them without sinking it. Instead of oars, the boats are equipped with five pairs of push-pull handles that jut from the centerline. A propulsion crew will pump these handles back and forth in unison, thus spinning a propeller that will send the boat forward.

When she steams into New York Harbor to become flagship of the United States Lines fleet, America's first superliner will already have hung up a host of records. Her hull plates, if laid end to end, would stretch for nearly five miles. The welds that tie her together would reach 1500 miles. Her 1,200,000 blueprints required 145,000 pounds of paper—two freight-car loads!

The SS *United States* today stands as a tribute to American production speed. For, from keel-laying to the last daub of paint on her superstructure, it took only 1031 days—just about half the time required to build each *Queen*, with whom she will compete on the high seas. And if Mr. Gibbs, the Newport News Shipbuilding and Drydock Company and the United States Lines are right about their "baby," she'll be hanging up a few more unprecedented records in the next few months. ★ ★ ★

Developed by the Quartermaster Corps, a combination sleeping bag and comforter is filled with chicken feathers, making it twice as warm as a wool sleeping bag and saving large quantities of wool.

TAKE LESS THAN 1 MINUTE TO

Keep Paint Brushes
Like **NEW!**

Store Them Dry.
They Stay Soft
and Flexible
**READY FOR
INSTANT USE!**

PROCESS 33

INSTANT PAINT BRUSH CLEANER

- Quickly cleans fresh paint from a paint brush or roller.
- You can paint instantly with another color—or store brush dry—it will stay soft.
- Economical—can be used again and again.
- Safe for all brushes and rollers.

Pint 59¢ Quart 98¢ Gallon \$3.25

Wherever Paint is Sold

A FLUSHING TOILET and SEWAGE DISPOSAL UNIT *Easily Installed*

IN RURAL HOMES, TRAILERS
AND SUMMER COTTAGES

This modern McPherson flush-type toilet with its sewage processing feature grinds, liquifies and aerates fully all sewage for quick absorption into the soil thru an inexpensive sub-surface irrigation system. Real expensive plumbing installations are no longer necessary with this entirely new water-driven sewage disposer.

Install in
a few hours.

No Freezing
Drains Dry

No Chemicals
or
Septic Tanks

Write Today
for
Free Catalog



Complete
Only
\$155.00

McPHERSON, INC.
7450 N. Milwaukee Chicago 31, Ill.

Big Deal!



Yessir!...Your Hardware
Dealer Has It for You NOW...

SIMONDS *SI-CLONE* SAWS

That's right — Simonds quality at pop prices! First time you've seen a line like this ... 13 saw-types up to 12" diam. (including dado heads and carbide-tipped saws). Round or special-shape center holes. Best saws made at these prices (look below) for home workshops, schools, contractors, and light industrial work. See your hardware dealer now.

RIP • CUT-OFF • EASY-CUT & COMBINATION

6" - \$1.75	8" - \$2.15	10" - \$3.15
7" - 2.00	9" - 2.65	12" - 4.35

GUARANTEE
Made of SIMONDS STEEL
fully guaranteed
against any defect in
material or workmanship.



SIMONDS
SAW AND STEEL CO.

FITCHBURG, MASS.

Factory Branches in Boston, Chicago, San Francisco, and
Portland, Ore. Canadian Factory in Montreal, Que.

**"I DRIVE BY
MILE-O-METER"**

Reg. U.S. Pat. Off.

LEE WALLARD

winner of the 1951
Indianapolis 500-Mile
Speedway



**GUARANTEED FOR
100,000 MILES**

"The Mile-O-Meter is great! It's one of the most important instruments that you can install in your car. It's the only gauge on your dashboard that can tell you how your engine is performing, and whether or not you're getting maximum mileage out of every gallon. I endorse and recommend the Mile-O-Meter to every motorist."

Lee Wallard

Install Mile-O-Meter on the dashboard of your car in a few minutes . . . no holes to drill, no experience needed. Mile-O-Meter will faithfully register miles per gallon at every speed and driving condition. You actually save gallons of gas because Mile-O-Meter accurately and continuously indicates the rate of fuel consumption. Mile-O-Meter also serves as a constant check on motor conditions, and warns you when adjustments are needed. Mile-O-Meter is the only instrument on your dashboard that can give you all this information. It's the most important investment you can make for overall driving economy and safety . . . pays for itself over and over again.

CHECKS
PERFORMANCE



CHECKS
CARBURETOR



CHECKS
TIMING



CHECKS
RINGS



CHECKS
DISTRIBUTOR



FREE with your order:
24 Page Motorist's Manual,
Instruction booklet, and handy Mileage
Calculator.

MAIL YOUR ORDER TODAY!

Dealer Inquiries Invited

money-back
guarantee.

\$14⁹⁵

Deluxe
Illuminated
Model
3 1/4" dia.
Pd. Fed.
Tax incl.

\$9⁷⁵

Standard
Model
2 3/4" dia.
Pd. Fed.
Tax incl.

Order from **GALE HALL ENGINEERING** Dept. 184
107 Northampton St., Boston 18, Mass.

Please send.... Deluxe Standard Mile-O-Meters at \$

Name

Address

City

Check enclosed C.O.D. Gift Wrapped (free)

is unbelievable and the servicing is easy. The transmission is four-speed synchromesh—four speeds forward and reverse—and is quite noisy. Sports-car enthusiasts enjoy the thrill of shifting.

The clutch and brake pedals are small and I'd like more space between them. The Lockheed hydraulic brakes are very effective and show no tendency to fade even when abused. The emergency brake, located between the seats, operates when

MG Midget Specifications (Series TD)

ENGINE

Type.....Four cylinders, in-line, OHV
Bore and stroke.....2.56 in. x 3.54 in.
Piston displacement.....76.6 cu. in.
Brake horsepower.....54.4 at 5200 r.p.m.
Compression ratio.....7.25 : 1
Carburetors.....Two inclined downdraft
Piston speed at 5200 r.p.m.....3070 ft. per min.
Ignition.....12 volt, coil
Transmission.....Four-speed synchromesh
Rear-axle ratio.....5.125 : 1

GENERAL

Steering wheel, lock to lock.....2 3/4 turns
Turning radius.....15 3/4 ft.
Road clearance.....6 in.
Tire size.....5.50 x 15
Recommended tire pressure.....18 lb.
Weight (unladen).....2016 lb.
Wheelbase.....94 in.
Tread, front.....47 3/8 in.
Tread, rear.....50 in.
Brakes.....Lockheed hydraulic
Height over-all.....53 in.
Width over-all.....58 5/8 in.
Length over-all.....145 in.

INTERIOR DIMENSIONS

Seat width (two bucket-type seats).....45 in.
Headroom.....35 in.
Legroom (measured from front of seat to
foot pedals, seat fully back).....23 1/2 in.

CAPACITIES

Oil.....5.3 qt.
Water.....7.2 qt.
Gasoline.....14.9 gal.

pulled upward and is of a design commonly used in racing cars. To lock the brake the lever must be pulled up and a thumb button pressed.

Driving position is comfortable in the MG as the doors are cut low and afford excellent armrests. Legroom is more than adequate.

MG believes in furnishing the purchaser with proper tools. (Too bad that American manufacturers completely have forgotten that good tools are necessary and should be furnished with a car.) The MG actually is equipped with 22 separate tools.

I gave the car a thorough working over and was impressed with its many fine features. It simply is a different type of motor-car from that to which the American driver is accustomed. It does not fit the requirements of millions of Americans but it does offer the unusual in a unique sports car.

★ ★ ★

"HELIOS" ORIGINAL TOOLMAKERS VERNIER CALIPERS



ULTRA PRECISION — Imported for the really critical mechanic who must have the best. Recommended & used by experimental & research machinists at Lockheed, Douglas, Bendix, GM, RCA, GE, ALL NEW. All with 1/1000" and 1/128" verniers... decimal equivalents in 8th, 32nd and 64th... graduation divisions engraved... extra heavy rule, hand-fitted sliding head, no side play... Rockwell C. 60 lapped measuring surfaces... Plofilm carrying case.

No. 50E—inside, outside & depth measurements, length of graduation 6", handy thumb-operated slide lock, a \$37.50 value—**SAVE 66%—only \$12.95.**

No. 65—inside & outside measurements, with points, measuring range 8", a \$47.50 value for just **\$14.95.**

No. 65B—with 12" measuring range for **\$16.95.**

German-made Mauser Design Caliper for the production machinist, 0-6" in thousandths, just **\$10.95** incl. leather case. Unbelievably low prices due to lower import duty. Money back guarantee!

PORTABLE WELDER



Will weld, braze, solder & cut all metals up to 3/16". No experience needed, full instructions included. Weld iron, steel, brass, aluminum and other metals. Plug into any 110 Volt A.C. or D.C. line. Save 100's of hrs. and lots of \$\$ doing repair for yourself and others. Great for any mechanic, hobbyist, etc. Not a toy. Comes complete with electrode and carbon holders and an ample supply of electrodes, carbons, flux and necessary components to do a thorough welding job of any type. This ALL NEW unit can't be duplicated for many times its modest price of **\$12.00.**

MAGNETIC BASE INDICATOR HOLDER

For all types of dial indicators with guaranteed lifetime ALNICO magnets. V-slotted base has a 45 to 50 lbs. pull, permits immediate application without clamps or special attachments and mountings can be made on cylindrical surfaces. For machinists, tool-makers and inspectors. Base 3 1/2" long by 1 1/8" wide. NEW. --- **\$3.50 ea.**



BRAND NEW PUMP AND MOTOR

Pump has 1" connections, built-in relief valve, adjustable up to 1500 lbs. Max. capacity 6 GPM. 1 1/2 H.P., 24-volt motor... 4000 RPM. Can be used on 12 or 36 volts. Govt. cost approx. \$350—our price—NEW—**\$9.75.**



LOW VOLTAGE CIRCUIT TESTER

Made for U. S. Ordnance Dept. to rigid specification. Portable steel hand-carrying unit is a self-contained trouble shooting device for making a complete & rapid check of the generator battery circuit, incl. any circuit & voltage regulators. Battery voltage, regulators, cut-out settings and generator performance easily determined. Terrific testing unit for garages, mechanics, truck fleet owners, boat and marine mechanics. Can be used on any 6 or 12 volt system. Approx. Govt. cost \$175. NEW, complete with instruction book, only **\$32.50.** Shpg. wt. 20 lbs.



ALL NEW HIGH SPEED DRILLS

Fractional & numbered. Nationally known brand. Set of 30, assorted sizes, an \$18 value for only **\$3.50** complete.

STRAIGHT SHANK DRILLS — 10 different sizes High Speed Straight Shank Jobber length drills, 1/4" to 1/2" (shank same diameter as drill). Here's a \$25 value you can have for **\$3.50.**

WIRE GAUGE DRILLS — Between 45 and 60. Highest quality steel. You'll recognize the brand. Hard to get sizes valued at \$7.50. Airborne gives you a set of 12 for just **\$1.50**

Set from 1/4" to 33/64". Five sizes with 1/4" shanks. You'll surely want this set for the low, low price of **\$3.00.**

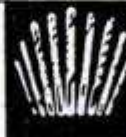

4 BRIAR PIPES, \$1 Sharp looking, brand new, genuine briar pipes. These beauties Approx. Govt. price \$2.50 to \$3 apiece. Complete set of 4 only **\$1**... **WHILE THEY LAST!**



MICROMETERS

Chrome plated, precision, engineered, carefully tooled to give long life. All new 0.1" capacity—**\$2.25 ea** 1.2" capacity—**\$3.50.**



Send 25c for 1952 catalog. Bargains for everyone. Check, Money Order or Cash, 25% deposit on C.O.D. orders. Prices F.O.B. Culver City, Calif., unless otherwise stated.

AIRBORNE SALES CO., INC., DEPT. PM 652
8501 STELLAR DR., CULVER CITY, CALIF.

2 DRILLS in 1

This attachment gives you two drills in one. It converts any 1/4 inch electric drill to 1/2 inch capacity. Reduction gears reduce the drill speed 5 to 1, the average speed of a 1/2 inch drill, and thereby increases the power. Absolutely indispensable for all shop work and home craftsmen.

\$11.95 post paid

Send check or Money Order • Satisfaction guaranteed • Order yours now

G. M. CO. MANUFACTURING, INC.
1308 43rd AVE.
LONG ISLAND CITY 1, NEW YORK

Make \$20 to \$30 a Week EXTRA MONEY!

With the high prices of food, clothing and everything else, just think what you could do with extra money every week! Turn your spare time into CASH—sharpening saws with a Foley Automatic Saw Filer pays up to \$3 or \$4 an hour. Start in your basement or garage — no experience necessary. "The first saw I sharpened with my Foley Filer came out 100%"—writes Clarence E. Parsons. No canvassing—"I advertised in our local paper and got in 93 saws"—says M. L. Thompson. With a Foley you can file all hand saws, also band and cross-cut circular saws.

FREE BOOK Shows How to Start

It explains how you can get business from home owners, farmers, carpenters, schools, factories, etc. "I get work from 20 to 30 miles away"—says Charles H. Smith. Free Book, "Money Making Facts," tells how to start. Send coupon today—no salesman will call.



Send Coupon for **FREE BOOK**

FOLEY MFG. CO. 616-2 FOLEY BLDG. MINNEAPOLIS 18, MINN.

Send me free book "MONEY MAKING FACTS"

Name _____
Address _____

Regular Price of a Slide Rule \$4 and up

Slide Rule 92c

and this coupon Add 8c Postage

If you know how to use a pencil you can use a slide rule. For bookkeepers, accountants, salesmen (figuring commissions, cost, etc.), farmers, housewives, etc. For Armed Forces highly important. Men's most useful tool. Easy to calculate instantly. Multiplying, proportions, division, extracting roots, etc. "High Vision" Clear View Slide. Full 10" Rule. A, B, C, D, C1 and K scales. FREE 28-page instruction book on how to get correct answers instantly without pencil or paper.

Gene Loewy, 545 5th Ave., Dept. 143-D, N.Y. 17
Limit three rules to each coupon

best
white tape
made

ONLY
98¢*



The new "Evans White-Tape" has everything you'll find in tapes costing over \$1.50—plus.

- snow-white blade with bold, legible, jet-black numerals and graduations. Graduated in 32nds for first 6 inches.
- sturdy die-cast case heavily chrome-plated, calibrated for quick reading inside and outside measurements.
- blade 1/2" wide made of finest high carbon steel—tempered—Bonderized—enamelled—baked.
- blade replaceable in seconds—without tools—without even opening case. And Evans replacement blades cost far less.
- every "Evans White-Tape" is unconditionally guaranteed.
- exclusive Evans automatic brake gives smoother push-pull action with absolutely no "creeping" of tape into case.
- underside is white, too. Mark with ordinary pencil, remove mark with flick of thumb.
- unheard-of low price*: 10-ft. \$1.49; 8-ft. \$1.19; 6-ft. 98¢. Prices higher in far west and Canada.

Evans & CO. • Elizabeth, N.J. • Montreal, Que. © 7429
Makers of Evans 6-ft. Folding Rule and "Folding Yardstick"

Sold only through retailers.

The easy way to paint!

Speedy Sprayer

Favorite of home owners and craftsmen for 20 years! SPEEDY SPRAYER gives your work that professional paint finish everyone admires. Sprays paint, enamel, varnish, lacquer, etc. . . . 4 to 7 times faster than hand brushing! Lightweight, portable, uses any 1/4 H.P. motor. Improved diaphragm principle assures clean, oil-free air. You'll find dozens of time and money saving uses for SPEEDY SPRAYER, including spraying insecticides 2-4-D and DDT. Complete outfit, without motor, only \$32.50.

At leading hardware, lumber, and auto supply dealers.
FREE—write for handy booklet "How to Spray."

W. R. BROWN CORPORATION
2635 N. Normandy • Chicago 35, Ill.

ONLY
\$32.50
LESS
MOTOR

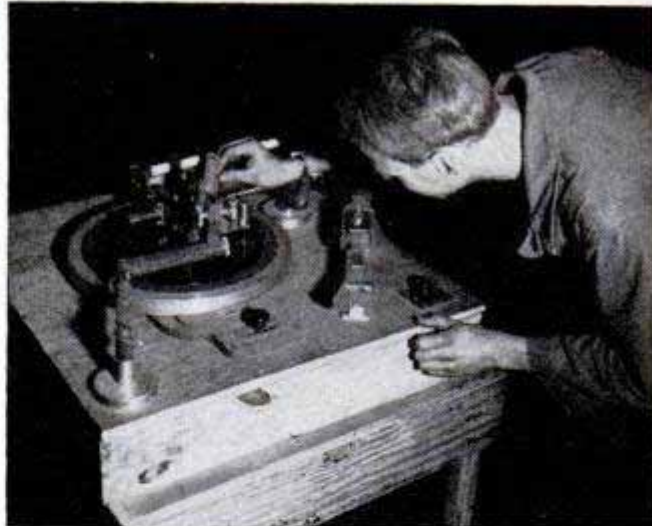

Hobbies are important at lonely radar outposts. This man built his own high-fidelity recorder from scrap

Manning America's Radar Wall

(Continued from page 147)

of a second long and one thousandth of a second apart. Each time the big fan revolves the echo pulses make a blip of light on the scope doper's radar screen at the moment the antenna is pointed toward a plane or other object in the sky. So the bearing of the antenna is also the bearing of the target and can be used to vector the fighter planes or point AA guns.

No matter how many targets surround the big set, each is translated into a blip on the radar scopes. While these blips do not resemble actual images of airplanes, a good scope doper can interpret them. But occasionally even the veterans are fooled.

"Once," says Sergeant Vallee, "the boys painted something moving in. Suddenly it split into five blips, with all the earmarks of a flight of unidentified aircraft. GCI scrambled everything in the area. We were still painting them when pilots reported that the sky in the target area was empty. Finally, after 10 minutes' hunt, one pilot spotted them. It was a flight of five ducks."

Radar echoes bounce back from many odd things at sea. Several times planes have been scrambled only to find that the scope dopers were getting a return from ocean spray whipping off of breakers.

When long-range radar picks up a potential enemy and planes are scrambled, anti-aircraft artillery at strategic spots also is alerted. The day we were at the outpost, a battery was busy rehearsing with the radar unit. Its 90-mm. guns sat on the bluff with a clear view of sea and sky. Here's how these new, fully automatic guns work:

The battery is alerted by GCI. Out on location, it has its "acquisition" antenna. Like the big outpost's radar fan, it searches

(Continued to page 260)

SURPLUS MACHINE SHOP TOOLS AT PRICES YOU CAN AFFORD

SET 12 Different Size H. S. Straight Shank Drills, 1/4" to 1/2", extra long. 7B lengths up to 7" PPD. Only. **\$3.98**

SET 10 Different size H. S. Straight Shank Drills, 1/4" to 1", extra long. 8B \$40 value. New and slightly used surplus. PPD. **\$6.95**

HIGH SPEED DRILLS 1/2" to 1" with 1/2" Shanks



SET 5 different size H. S. Drills, 1/2" to 1" with 1/2" shanks. PPD. **\$6.95**

SET 10 different size H.S. Drills, 1/2" to 1" with 1/2" shanks. PPD. **\$12.95**

A wonderful bargain . . . 5 H.S. Drills for the price of one new 1"! These drills can be used in 1/2" electric drill or a 1/2" capacity lathe or drill press.

HIGH SPEED WOODRUFF KEY SEAT CUTTER

SET 5 different size cutters. Can be used as mounted milling 4B cutter or circular saw. All with 3/8" and 1/2" shanks, widths up to 1/4", dia. up to 1". New and used. Ppd. **\$3.95**
Priced at only . . . **\$3.95**



6 SLITTING SAWS WITH MANDREL

SET 6 Different Size High Speed Slitting Saws, 2 3/4" dia. x 1" arbor. Thickness from .040 to .071. Cuts wood, aluminum, brass, steel, etc. PLUS SPECIAL MANDREL which enables use of saws in 1/4" or 1/2" elec. Drill. \$25 Value. PPD. Only. **\$4.95**



7 selected, sharp H. S. Slitting Saws as above to use on your own mandrel or milling machine. New and used. PPD. **\$4.95**
A bargain at

HIGH SPEED STRAIGHT SHANK CHUCKING REAMERS

SET 20 Different Size High Speed Straight Shank 16B Chucking Reamers up to 1/2". New and used. Priced at only **\$7.95**



SET 15 Different Size High Speed Straight Shank 18B Chucking Reamers from 1/4" to 1". New and used. Priced at only **\$6.95**

H. S. TAPS: Slightly used surplus. Your choice of the following sizes: 5/16"-3/8"-7/16" NC or NF, PPD. ea. only. **26c**

PUMP AND MOTOR

Pump has 1" connections, built-in relief valve, adjustable up to 1500 lbs. Max. capacity 6 GPM. 1 1/2 H.P., 24-volt motor, 4000 RPM. Can be used on 12 or 36 volts. 500 units available at quantity discounts. Wt. 20 lbs. Close out at. . . **\$9.98**



Bargain Tool & Shop Mixes!—PPD.

MILLING CUTTER MIX: Assortment of 4 various size H. S. milling cutters, all with 1" arbors; up to 3" dia. only **\$3.98**

NEW ROTARY FILE MIX: 7 different size H. S. files, 1/4" shanks. New cost as high as \$2.00 ea. Only. **\$4.49**

FILE MIX — BRAND NEW: Set of 12 different files, lengths 6, 8, 10, 12 in. Half rounds, bastards, knife, mills, etc. First line Nichols, Heller and other brands. **\$3.49**

GRINDING WHEEL MIX: 30 grinding wheels with 1/4" arbors, up to 3" in dia., plus mandrel, only. **\$3.29**

SURPRISE MIX: Over 50 pcs. for your 1/4" elec. drill including rotary files, drills, bits, reamers, grinding wheels and arbors for our customers who like pleasant surprises. Your money back if you aren't satisfied. **\$2.98**

1/4" to 1/2" H. S. DRILL MIX WITH 1/4" SHANKS: 10 different size new and used bits, only. **\$4.95**

1/4" SHANK MOUNTED STONES: mixture of 12 **\$2.95**

Money Back Guarantee — All Mdse. Mixture of New and Reconditioned Unless Specified New. All items (Except Those Specified Post Paid) Will Be Shipped F. O. B. Tulsa — Or, Add 10% and We Will Ship Your Mdse. PPD. Write For Free Catalog Describing Thousands Of Bargain Cutting Tools.

T & T TOOL 221 W. SECOND TULSA, OKLA.

Say You Saw It in Popular Mechanics

MODERN LAWN MOWER SHARPENER

Service departments of leading Lawn Mower manufacturers use the Modern Lawn Mower Sharpener. One lever moves lawn mower into grinding position. Gasoline and oil remain in engine while sharpening, no dismantling of wheels, roller or handle. The Modern is a precision bed knife grinder—no extra grinder to buy. Imitated but never equaled—Compare before you buy. If it isn't a Modern it can't be Modern (Prices subject to change without notice)

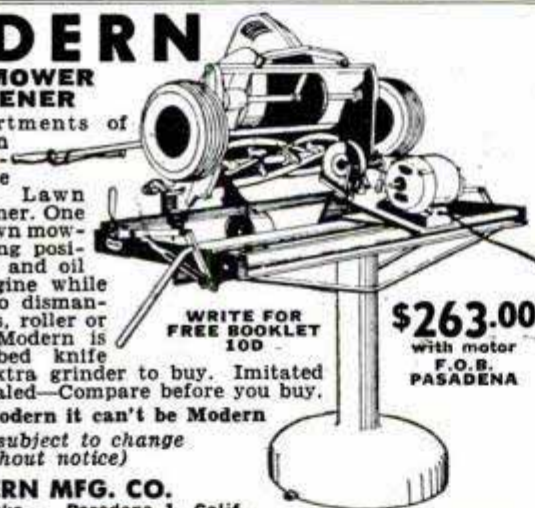

WRITE FOR FREE BOOKLET 10D

\$263.00
with motor
F.O.B.
PASADENA

MODERN MFG. CO.

160 N. Fair Oaks - Pasadena 1, Calif.

Brown WALL BREATHERS STOP PAINT BLISTERING, PEELING



EASY TO INSTALL

3/4" Diameter—3 1/2" Long
— GIVE PAINT A CHANCE!

PROTECT YOUR HOME SAVE COSTLY REPAIRS



Between walls condensation causes paint to peel. Brown Wall Breathers permit moisture to evaporate, allow paint to adhere properly, regardless of climate.

Available at Paint & Hardware Dealers or Write for Full Information.

Brown INDUSTRIES

14222 LAKE SHORE BLVD. CLEVELAND 10, OHIO

THE AMATEUR'S LATHE by L. H. Spary 232 pages—18 Chapters. Over 200 photos of tools, equipment, set ups. Line Drawings of lathe produced workshop accessories. Cloth Bound, gloss pages, now in its 20,000 copy. 10 days money back guarantee \$3.98 P.P. or C.O.D. accepted. Dozens other books available catalogue 25c to TECHNICAL BOOKS, 10 E. Overlea Ave., Baltimore 6, Maryland

send for **FREE CATALOG**

America's Foremost
money-making
MECHANICS' TOOLS



It's easy to own the same "pay-off" tools used and endorsed by America's top-earning mechanics throughout the automotive, aviation and industrial fields! Snap-on tools help you handle every repair job faster, easier, better. And they LAST . . . pay for themselves over and over again! Start building your own tool set now with basic Snap-on units—add others any time. Genuine Snap-on tools are never sold in stores—direct to users only. Mail coupon for free catalog.



SNAP-ON TOOLS CORPORATION
8062-F 28th Ave., Kenosha, Wisconsin
Send me free catalog of Snap-on tools.

Name _____
Address _____
City _____ Zone _____ State _____

Get perfect pictures
with your camera...



... just make sure every exposure is correct and you'll have sharp, life-like pictures every time. It's easy with a WESTON Exposure Meter. This easy-to-use device instantly gives the correct camera settings for any scene, in or out-of-doors, and for any camera or film, including color. See one at your local dealer's today.

WESTON EXPOSURE METERS

The Meters
Most Photographers Use



Send for this
BIG NEW
Hunt's
WOODWORKERS
CATALOG NO. 19

NEW LOW PRICES **ONLY 15c**

Offers greatest selection of fine domestic and imported woods--and hundreds of woodworkers items at bargain prices!

You'll save time and money with this big, new catalog. Contains everything wood craftsman needs. Shows 32 rare and fancy woods in color...43 veneer designs...275 scroll patterns...multicolor inlays, overlays, bandings...all kinds of tools, machinery, cabinet hardware, ornaments, mouldings...and pages of valuable tips, ideas, information, instruction. Send for your copy NOW. Only 15c--refundable on your first order.

- 144 PAGES
- QUICK DELIVERY
- on maple, poplar, oak, mahogany, red cedar, cherry, walnut, and many others--
- all properly seasoned and kiln dried.

MAIL THIS COUPON--TODAY!

CRAFTSMAN WOOD SERVICE CO.
2729 S. Mary St., Dept. A6
Chicago 8, Illinois

Send me the big, new, money-saving Catalog No. 19. Enclosed is 15c--refundable on my first order.

Name _____
Address _____
City _____ Zone _____ State _____

the sky in the area indicated by early warning. What it sees appears on radar screens inside a mobile radar van, an electronic brain on wheels. Inside, silence is broken only by the hum of tubes and code talk as operators check GCI on locations of aircraft, check with their own scope dopers and plot correct tracks.

Atop each truck is the tracking antenna—a small, circular grid. This is focused on the target and follows it automatically. Down on the bluff the guns electronically are tied in with the movement of this tracking antenna and their long muzzles follow its every waver. In the truck, men feed data on wind, range and azimuth deviations into an electronic brain. As the guiding impulses from the tracking antenna go to the guns, these deviations also are fed into the cables and the guns automatically assume proper lead.

Life at an isolated early warning post is not so dull as you might suppose. The men are kept busy monitoring the skies and guarding their set from prying eyes. Guards all wear loaded weapons and no one gets on the post without a thorough going-over.

Life is a little tougher on some of the remoter arctic outposts. Corp. Bill Carothers spent 15 months at an early warning set on an Alaskan peninsula. "We were 300 miles from civilization of any kind," he says. "All our buildings were connected by corridors so when the snow drifted over them we could get from one to another. Temperatures dropped to 30 degrees below zero for weeks on end and no one went out but the security patrol and the path-shoveling details." To build these arctic outposts, engineers faced grueling problems. Huge cargo planes flew in and dropped heavy machinery, prefab huts and supplies by parachute. Helicopters brought in work crews. Meals served in mobile kitchens would freeze by the time the men reached their bunks with the food. Metal parts snapped in the icy air. Snow-compacting tractors used to tamp temporary air strips cracked their frames. But little by little these rugged crews carved tiny outposts across the frozen north.

Despite the vast improvement in our radar net, General Vandenberg and other Air Force leaders still think that a clever enemy might send in waves of planes with a good chance of 70 percent of them getting through. But improvements are being devised constantly to stop the gaps.

Right now though, we can count on thousands of ground observers and an army of scope dopers under the revolving fans at hundreds of early warning sites to keep us posted on suspicious-looking skyborne craft headed our way. ★ ★ ★

INTERNATIONAL ROTARY H-SPEED COPE-SAW DRILL-BIT IT DRILLS IT SAWS IT REAMS



DRILL, SAW, REAM . . . metal, pipe, wood, plastic, Transite, etc. Use with any electric drill, slow drill press, lathe or milling machine. Drills own starting hole—upper part of bit is used to cut, saw or ream circles, ovals, squares or scrolls. Easy to operate. Ideal for carpenters, mechanics, electricians, plumbers, hobbyists, many others. Abrasive resistant, high speed steel. Flutes ground from solid. Will withstand severe continuous use without breaking. Resharpener at no charge. Takes place of up to \$50 in tools. 3/4" diameter, 2" cutting sections, total length 3 1/2". Also available specially designed for wood or metal and in 2 1/2" and 1 3/4" lengths. Write for details. Specify all-purpose bit. Shipped same day. Money-back guarantee. Dealer inquiries invited.

SEND CASH, CHECK OR MONEY ORDER
Manufactured and distributed by:
INTERNATIONAL TWIST DRILL CORP.

only
\$3.95
POST PAID

624 Wyandotte, Rm. 632, Kansas City 6, Mo.



10% MORE BUILT-IN POWER!

U. S. Testing Laboratory report proves Burgess Flashlight Batteries contain more active ingredients than two other leading brands. Selected best quality materials guarantee longer-lasting bright light. Buy BURGESS at better dealers everywhere. Burgess Battery Company, Freeport, Illinois—Niagara Falls, Canada.

BURGESS FLASHLIGHT BATTERIES

● BIG BARGAIN BOX OF SPRINGS

● for home mechanics. Over 40 springs asst'd sizes, expansion & compression, steel & brass. Less than 3¢ ea. Handiest buy ever, order today. Postpaid **\$1.25**

Eagle Products Box 84A, MERIDEN, CONN.

5 BIG POWER TOOLS in ONE

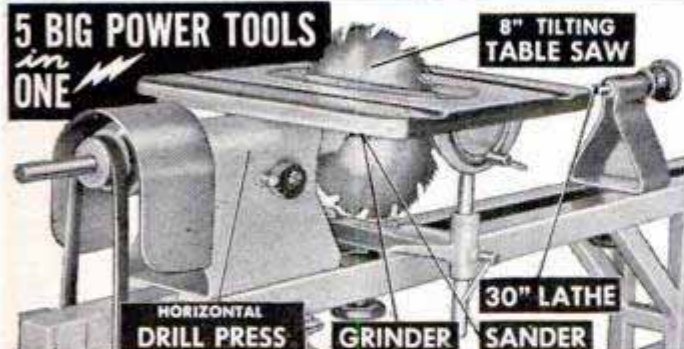

RETAIL PRICE \$125.00
FACTORY TO YOU \$79.95

SUPERSHOP is a PRECISION-BUILT WORKSHOP, 100% ball bearing. All running parts precision ground. Big capacity. Extra rugged. Amazing value. Write for FREE catalog.

BUY ON EASY PAYMENTS

POWER TOOLS, INC. 136 YATES AVENUE
BELOIT, WISCONSIN



RELIEVES PAIN OF HEADACHE • NEURALGIA NEURITIS

FAST

The way
thousands of
physicians
and dentists
recommend



Anacin® relieves headache, neuralgia, neuritis pain fast because Anacin is like a doctor's prescription—that is, Anacin contains not just one, but a combination of medically proven, active ingredients in easy-to-take tablet form. Thousands have been introduced to Anacin through their own dentist or physicians. If you have never used Anacin, try these tablets yourself for incredibly fast, long-lasting relief from pain. Don't wait. Buy Anacin today.



When Screws Won't Stay TIGHT, Use SMOOTH-ON

Apply Smooth-On No. 1 Iron Cement to screw threads and into the screw hole. Insert and tighten up the screw. It will take hold and, when set, will STAY TIGHT, for Smooth-On expands slightly as it hardens, wedging the screw in place. This is only one small use for this general-purpose iron cement. With it you can stop leaks and seal cracks in cast metal parts, tighten loose knobs, casters, tool and utensil handles, make many auto repairs. Buy it in 1 1/4-oz., 7-oz., 1-lb. or larger size at your hardware store. If they haven't Smooth-On, write us.

FREE 40-page Repair Handbook

Many original uses for Smooth-On around the house, on the car, etc. Simple directions. 170 illustrations. Send for YOUR free copy. SO 377

SMOOTH-ON

SMOOTH-ON MFG. CO., DEPT. 37F
570 Communipaw Ave., Jersey City 4, N.J.

Please send me FREE Repair Handbook

Name.....
Address.....
City..... State.....



WET WALLS, BASEMENTS?

COPROX, New Patented Copperized Cement Compound, Unites Chemically with Porous Masonry to Help Seal Seepage Out

NEW YORK: A new compound that contains copper oxide and Portland Cement, called COPROX, has been perfected which helps seal out water from porous masonry walls when applied *inside* or *out*, above or below ground. Different from all other compounds and paints, and protected by U.S. Patent, only COPROX has its exclusive copperized action, a unique three-way action that (1) *penetrates* microscopic pores of masonry surfaces, (2) *expands* to fill pores with a hard, insoluble, non-absorbent copper oxychloride plug which (3) *bonds* both chemically and mechanically with masonry, to withstand water pressures up to 500 pounds per sq. ft., in actual tests on cinder block as thin as 2 in., and yet permits breathing.

Unlike ordinary cement coating compounds, COPROX is guaranteed to contain no fats which are broken down by the lime in cement, or iron which ultimately rusts out completely.

COPROX is mixed with water, applied with a stiff fibre brush. It hardens into a stone-like surface on clean porous concrete, cement, cinder block, cement stucco, unglazed brick and porous natural stone. Recommended for foundation walls, basements, storage tanks, garages, swimming pools, fish ponds. Costs less than best oil paint. \$3.25 a gallon. Prices slightly higher west of Rockies. Five beautiful decorator's shades. Simple to apply. Available at paint, hardware and department stores. COPROX, Inc., 1270 SIXTH AVENUE, NEW YORK 20, N. Y.

ADD BEAUTY and VALUE to YOUR HOME
with beautiful wood-paneled walls

Install Plankweld yourself, quickly, easily — in genuine Philippine mahogany, oak, birch, knotty pine — for as little as \$60 for an average wall.

Plankweld is Weldwood® Plywood pre-cut to room height in 16 1/4" wide panels. Edge-grooved to provide a neat lap joint. Pre-finished — no staining or waxing required.

See Plankweld at your lumber dealer.

PLANKWELD®

Manufactured and distributed by
UNITED STATES PLYWOOD CORPORATION
55 West 44th Street, New York 36, N. Y.



LAW **STUDY AT HOME** for Business Success and **LARGER PERSONAL EARNINGS.** 43 years expert instruction — over 114,000 students enrolled. LL.B. Degree awarded. All text material furnished. Easy payment plan. Send for **FREE BOOK.**

AMERICAN EXTENSION SCHOOL OF LAW
Dept. PMB-51 646 N. Michigan Ave. Chicago 11, Ill.

POSTPAID ANYWHERE IN U.S.A.

WE FURNISH ALL MACHINED METAL PARTS, EVERY SCREW, NUT, BOLT, WASHER, AND COMPLETE PLANS FOR THIS...



BIG 10" POWER SAW

\$10⁹⁵ FULL REFUND IF LESS GUARD & WOOD NOT SATISFIED IN 10 DAYS

COMPLETE PLANS 10c
MARCUS-POLLAK
DEPT. N, ROYERSFORD, PA.

ASSEMBLE IT YOURSELF WITH SIMPLE HOUSEHOLD TOOLS!

G E A R S



In Stock - Immediate Delivery

Gears, speed reducers, sprockets, thrust bearings, flexible couplings, pulleys, etc. A complete line is carried in our Chicago stock. Can also quote on special gears of any kind. Send us your blueprints and inquiries.

Send for Complete Catalog No. 10
CHICAGO GEAR WORKS
440-50 N. Oakley Blvd., CHICAGO 12, ILL.

BUILD BACKYARD BARBECUE

No bricks or mortar necessary. Attractive, compact, blends with landscaping. Wonderful for small city yard. Amaze your friends with true barbecue roast. For easy to read plans and cooking instructions send \$1.00 to Ye Olde Smoke House, Box 472, Waukesha, Wis.

NEW, IMPROVED CALCULATOR FOR WOODWORKERS only 25c

Instantly gives information on lumber, nails, concrete mixes, painting materials, etc. Convenient, simple to read. Just set dial for nail specifications, to convert linear to board feet, find bit sizes for screws, compare characteristics of woods. 6" diameter heavily varnished cardboard. Send 25c, no stamps, please to Greenlee Tool Co., 2106 Columbia Avenue, Rockford, Illinois.

PUMP WATER FAST!

DRAIN WASH TUBS, CELLARS, CISTERNS IRRIGATE—FILL TANKS—DRAW WELL WATER

Pumps 2800 GPH. 420 GPH at 75' High or 1600 GPH from 25' well. Sturdy, Rustproof Alloy Metal. Six Blade Impeller. Uses any 1/8 to 1/2 H.P. Motor. Will not leak or clog. Fits any garden hose. Immediate Money Back Guarantee. Send Check, M.O., or C.O.D. **895** IN U.S.

MOORE MANUFACTURING CO.
SWEDESBORO 1 NEW JERSEY

WHEELS JUVENILE, INDUSTRIAL, AGRICULTURAL
Write for Literature and Price List.
CIRCLE METAL MFG. CO.
4266 E. Pacific Way, Los Angeles 23, Calif.

NEW DREMEL Electric RAZOR BLADE SHARPENER

READ WHAT! USERS SAY!

- "Congratulations on first really top-notch sharpener in my 35 year shaving experience!"—Conn. User
- "Got 87 good, clean shaves from only one blade."—Texas User
- "Sharpening ability wonderful—getting real shaving comfort."—Mich. User
- "Getting the best shaves of my life."—New York User
- "Used only 2 blades in 9 months and every shave a pleasure."—Calif. User

(USERS' NAMES ON REQUEST)

These are typical results from the Dremel Sharpener. Thousands of double-edge blade users get smoothest shaves of their life... months of perfect shaving from only one blade! All possible because it hollow-hones and strops to sharpest edges ever in one 15-20 second operation. Do like others—prove it to yourself on a money-back guarantee!

UNIQUE FATHER'S DAY GIFT

Any man will be thrilled with the years of shaving comfort. It's a precision instrument tested to the equivalent of 20 years' daily use by one man. All-plastic housing 2 1/2" x 3 1/4" x 3 1/4"; 110-120 V., AC-DC. Sharpening rollers will last many years—replaceable when necessary at nominal cost. Double-edge blades only.

MONEY-BACK GUARANTEE OFFER—Send check or money-order for \$9.85 postpaid. If not satisfied return Sharpener in good condition within 10 days for prompt refund. Order yours today!

DREMEL MANUFACTURING COMPANY, Dept. 112-F, RACINE, WIS.

TRY MONTA MOWER

on Your Own Lawn

on *Approval*

8 1/4 LBS.



**TRIMS
AS IT MOWS
IN ONE
EASY OPERATION**

Save time and labor! So sure are we that you will find the versatile MontaMower an amazing work and time saver that we offer it on approval for an extended trial period. Its live, precision mechanism first gathers then smoothly cuts a clean 16" swath through grass, dandelions, spike grass and tall lawn weeds. Almost noiseless. As modern and efficient as your electric razor. Cuts right up to walls, fences, trees and under overhanging shrubs . . . practically eliminates hand trimming! Cutting height adjustable. Cuts steep banks easily! Cutters are self-sharpening. Drive shaft mounted on free rolling, permanently lubricated and factory sealed bearings. Hundreds of thousands in use. Buy direct from factory and save. Write today for full details on limited "Special Price . . . Extended Trial Offer".

MONTAMOWER DISTRIBUTING CO.

P.M.26 KEELER BLDG. • GRAND RAPIDS 2, MICH.

SELL GOLD & SILVER WINDOW LETTERS

300% PROFIT! Fast, easy sales to stores, offices, doctors, lawyers, etc. Individual orders for merchants interested in saving \$\$\$\$ doing their own window lettering. Letters easily applied on glass, wood, metal with varnish-glue (not water). Won't wash off; withstands frost. Write for samples. **METALLIC SIGN CO., 430 N. Clark St., Chicago 10, Ill.**



MY FALSE TEETH STAY TIGHT EVEN

AFTER DRINKING HOT COFFEE!

● Mrs. J. P. writes: "I was delighted to find Staze held my teeth tight *even after hot coffee!*"

Staze is fluid-resistant . . . contains "aquatrol," which *holds back moisture penetration.* Thus, it holds false teeth *tighter, longer.* With Staze, thousands now bite into corn and steak — enjoy all the hot coffee they want.

Even if plates are old and loose, Staze holds them tighter. Many denture wearers say that with Staze old plates seem to hold better than when new. *At drugstores, or write STAZE, Box PM-5, Stamford, Conn., for free tube.*

SAY YOU SAW IT IN
POPULAR MECHANICS

MAKE Big MONEY WITH THE Universal LAWN MOWER GRINDER!

Enjoy a profitable lawn mower sharpening business of your own. No previous experience needed. Place a hand or power mower on the UNIVERSAL GRINDER. With only ONE SET-UP you quickly grind the stationary blade and all the reel blades to proper clearance WITHOUT REMOVING A SINGLE BLADE from the mower.

PROOF
G. Spurlock, of Arkansas, writes: "I have my Universal Grinder two months and made a net profit of \$227.00".
C. E. Hardy of Miss. writes: "I am doing a fine business with the Universal Grinder. I spent 40c for a newspaper ad and have done nearly \$500.00 of business." Write today for FREE FACTS about Big Profits in Lawn Mower Sharpening.

**ROGERS MFG. CO., DEPT. M-62
LINDSEY, OHIO**



A DIFFERENT GIFT FOR FATHER'S DAY!

GRINDS • CARVES • ENGRAVES
DRILLS • ROUTS • SHARPENS

DREMEL Electric MOTO-TOOL

FASTEST MOST POWERFUL TOOL in its class—Approx. 27,000 r.p.m.

Most practical tool a man can own—more powerful than any similar tool you can buy. Works well in wood, plastics, and metal. For home maintenance jobs you'll wonder how you got along without it. For model making it's a must. And for general shop operations it saves time and money. Compare it, try it, buy it. You be the judge!

Check These Important Features

—Oilless sealed bearings • Dynamically balanced armature • Shockproof, Bakelite housing • Dust-filtered air cooling system • Sturdy 110-120 V., A.C.-D.C. motor • Wt. only 13 oz. • A precision tool widely used in industry for many years.



MOTO-TOOL No. 2
(with 1 emery wheel point)
\$16.50

MOTO-TOOL KIT No. 2
With 23 Accessories
(High-Speed Steel Cutters, Grinding Wheels, Polishers)
\$23.50



WHERE TO BUY MOTO-TOOL: If your dealer cannot supply you, send remittance in full for postpaid shipment. Or, send only \$2; pay postman balance plus postage and COD fee. Money back if not delighted after 5 days' trial.

DREMEL MFG. CO., Dept. 112-F, RACINE, WIS.



On TILE
PLASTER
WOOD
GLASS

Stick 'Em Up!
NO NAILS!
NO SCREWS!
NO TOOLS Needed!

Selfix
SELF-ADHERING PRODUCTS



SELFIX HOOKS 2 for 25c
Hold 15 lbs.

SOAP DISH . . . 39c

TOOTHBRUSH HOLDER . . . 29c

3-PRONG HOOK 29c

Just moisten with water — press — they're up! Firm as a rock — fully tested — only Selfix patented wood insert insures strong and lasting adhesion . . . Reject substitutes! White, Red, Yellow, Black, Green. At 5 and 10, hardware stores — or write for address of nearest store. **SELFIX Products Co., Dept. D6, 30 E. Adams St., Chicago 3.**

300-Power Import MICROSCOPE \$14.95

LABORATORY MODEL Postpaid

Triple revolving turret has 100, 200 and 300-power lenses! No frills, just excellent optical qualities, delicate adjustment, solid construction, its quality and price astounded biology instructors. A lifetime bargain for students, schools, labs, research, amateurs. Anyone can now own one! (Performance cannot be duplicated for \$75.00)
FEATURES: Fine micro adjustment, adjustable plano substage mirror. Dovetail hardwood case included free. If you are not amazed at its quality, send it back in 10 days. Your money refunded immediately. Send check, cash or M.O. for \$14.95 ppd. (Send \$5.00 deposit for C.O.D.'s) Free catalog. Money back guarantee.



NAVY TYPE MARK XX 20 POWER TELESCOPE

\$9.95

\$30 value. Fine optically ground achromatic lenses, fully coated. Same power as standard artillery observers spotting scope. Precision all metal construction. Extends to 15 1/4 inches. Rust and salt-spray resistant. A valuable ship and boat owner's possession now at a price everyone can afford! Shipped in fitted hardwood case. Postpaid \$9.95



PROFESSIONAL
DISSECTING
KIT
\$4.95

FOR MICRO-
SCOPIC
SLIDE
WORK IN
BIOLO-
GY, BOT-
ANY, ZO-
OLOGY

Equipment in this kit worth \$15. Ten pieces in fitted hardwood case. Professional instruments of surgical steel. For universities, doctors, students. Postpaid \$4.95

20, 40, 60 Power Pocket MICROSCOPE



Select whichever power you want, then focus to pinpoint sharpness with spiral ring. Finest optics, amazing versatility. A compact new precision instrument for field study. Postpaid \$4.95

Money-back 10-day guarantee on all items. Send check, cash or M.O. Free catalog on request or included with order. Calif. residents add 3% state tax.

AKRON 4400 SUNSET BLVD. OPTICAL DEPT. 6-P
LOS ANGELES 27, CALIF.

STOPS TAPPING NOISE

on
CHEVROLET
and
BUICK CARS



EASY TO
INSTALL

The installation of a VAL-VIN-HED Silencer does these important jobs: Stops valve tapping noise . . . provides constant overhead lubrication . . . reduces friction, lessens moisture condensation and assures you of quieter, more efficient operation. A Silencer for Chevrolet cost only \$2.95, Buick \$3.50. Get one at your garage or from factory direct. JOE L. ESTES CO., Dept. PM-5, Winder, Ga.



VAL-VIN-HED
Silencer

It Really Works
LURES, TRAPS, KILLS FLIES

BIG STINKY OUTDOOR FLY TRAP!

Big Stinky's control fluid aids in producing potent scent attractive to pesty flies — lures those in immediate vicinity — traps, then kills them! It's self-regenerative — feeding on the flies it kills. It really works!

Get Big Stinky now
At Leading Dealers Everywhere!

THE DIOPTRON CO. MILWAUKEE 1, WISCONSIN



Scrape paint quickly
ask your dealer for
Red Devil
Wood Scrapers



RED DEVIL TOOLS, IRVINGTON 11, N. J., U. S. A.

BUILD YOUR OWN FAN



One-piece cast aluminum propellers for cooling and ventilating.

Size Inches	Polished 2 Blade	Polished 3 Blade	Unpolished 2 Blade	Unpolished 3 Blade	Bore Inches
15	\$3.00	\$4.00	\$2.50	\$3.00	1/2, 3/8, 3/4
18	3.75	5.00	3.00	4.00	1/2, 3/8, 3/4
20	4.00	5.50	3.25	4.50	1/2, 3/8, 3/4
24	4.50	6.50	4.00	5.50	1/2, 3/8, 3/4

Write for pamphlet on larger fan blades, wire guards, fan bases, shutters, pillow blocks, exhaust fan frames, etc. Dealers write for discount.
KLOPPENBORG ALUMINUM FDY., Dept. PM-526, Davenport, Iowa

7" Tilting Arbor Saw



One of Shopmaster's complete line of quality-built tools at the remarkably low price of **4795**
Slightly lower zone 1



SHOPMASTER, INC.
1214 Third St. S., Minneapolis, Minn.

Print Your Own

Cards, stationery, advertising, etc. Save money. **Print for others, good profit!** easy rules sent. Raised printing like engraving, too. Sold direct only. Write for free details. **Kelsey Presses, F-37 Meriden, Conn.**

Say You Saw It in Popular Mechanics

SHEET METAL BRAKES

Forms angles, flanges and Pittsburgh locks. 26 gauge steel, heavier aluminum. Cam locking. Portable, can be bolted to bench, or clamped to edge of truck. All steel, reinforced. Shipped Exp. Coll. 30" size. Wt. 54 lbs., \$26.50. 36" Wt. 66 lbs. \$31.00. 48", Wt. 100 lbs. \$45.00. Floor



30"-36"-48" mountings, portable, 32" high, 30 lbs. \$7.00.
12" BRAKE. Fits in vise to form difficult compound bends, up to 20 gauge steel. Not illustrated . . . \$12.50 PP.
IRON BENDER. Forms hooks, angles, eyelets, etc. Capacity 1/4 x 2", or 5/16 x 1 1/4". 10 parts all steel . . . \$10.00 PostP.

Immediate Delivery. Order direct, cash, or C.O.D. or send for folder.
VYKE BRAKE CO., P-1116 So. 27th St., Omaha 5, Nebr.

ROTARY CUTTERS

and ABRASIVE KIT SPECIALS!



COMPLETE
Over 400 Pieces

4.95

ALL BRAND NEW and FULLY GUARANTEED Cutters fit all standard rotary electric hand tools. Ideal for tooling leather, wood, plastic, hard rubber, etc.

Kit consists of High Grade Tungsten Steel, 1/8" Polished Shafts Assortment of 10 Cutters; also wire wheel, bristle brush, 400 sandpaper discs 5/8" and 7/8" diam., 7/8" x 1/8" grinding wheel and mandrel, dressing stone, etc.

\$1.25 SPECIAL — 2 Circular Saws 3/4" and 13/16" plus 2 Mandrels 1 3/4" x 1/8" — all high grade tungsten steel, 400 sandpaper discs 5/8" and 7/8" diam., and dressing stone.

\$2.25 PER ROLL SPECIAL — Abrasive cloth shop roll 3/4" wide x 50 yards long in 60 grit or 240 grit — specify grit desired when ordering.

Send check or Money Order—postpaid in U.S.A. →
MERCANTILE ABRASIVE CO., 644 S. Clark St., Chicago 5, Ill.



Now-32 DRAWERS PRICED \$200 LESS

Famous All-Metal PARTS CHEST



keeps all small things handy
Heavy, welded steel case, 6" x 15 1/4" x 12 5/8", gray enamel finish. No-rust aluminum drawers 1 1/4" deep, 2 3/4" wide. 5 3/4" long with pulls and index cards. 64 slide-in dividers make 96 compartments.

Bargain buy **Only \$10.95**
16 Drawers **\$6.95**
6x8 3/8 x 12 5/8" NO C.O.D. — POSTPAID

CANTON CABINET CO.
1014 Tusc. W. CANTON, OHIO

UNMATCHED SPEED FOR OUTBOARDS



of all makes from 7 1/2 to 50 HP on racing boats and fast runabouts is provided with the famous Michigan AQUA-JET propellers. No rebuilding of lower unit is necessary. Each propeller is specifically engineered for the motor on which it is to be used. Other propellers for superior performance for practically every motor ever built, and a complete line of fine boat fittings are described in our 1952 catalog — the Outboarder's Bible. Its FREE. Write Michigan Wheel Company, Dept. PM-46 Grand Rapids, Mich.

take it easy! LAWN & GARDEN LABOR SAVER 10 IMPLEMENTS IN ONE!

\$119.50
TRACTOR WITH
2 H.P. ENGINE
TOOLS
\$4.50 to \$42.50
F.O.B. Sullivan

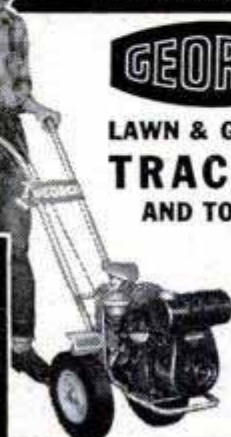

GEORGE
LAWN & GARDEN
TRACTOR
AND TOOLS

- Plows - Tills
- Hoed - Harrows
- Cultivates
- Mows lawns
- Cuts weeds
- Dozes dirt
- Blows snow
- Portable power unit

Rugged! Easy to handle! Quality engineered, fully guaranteed! Compare with others at \$50 to \$75 more. See your dealer or write for Folder 24.

GEORGE GARDEN TOOL DIV.
Community Industries Assn.
Sullivan—Illinois

ARCADIA ELECTRIC POCKET Viewers

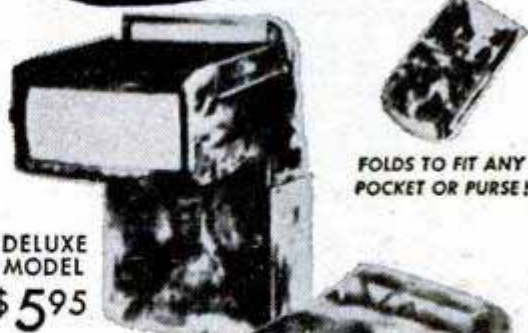

FOLDS TO FIT ANY
POCKET OR PURSE!

DELUXE
MODEL
\$5.95

Powered On
Standard
Flashlight
Batteries!

STANDARD
MODEL
\$4.95

FOR 2x2 SLIDES —
BANTAM AND STRIP FILM

BRINGS OUT BRILLIANCE IN
YOUR COLOR SHOTS!

AT BETTER CAMERA SHOPS AND
DEPARTMENT STORES EVERYWHERE

IF YOUR DEALER CAN'T SUPPLY YOU,
WRITE DIRECT

ARCADIA MANUFACTURING CO.

2640 WEST NORTH AVENUE
CHICAGO, ILLINOIS



Your ELECTRIC DRILL Trims
HEDGES — SHRUBS — GRASS
with **ROTO-TRIM**
DRILL ATTACHMENT

FITS ANY
1/4" DRILL

Today's Greatest
Hedge Trimmer VALUE **\$10.95**
Yours, Postpaid, for only **\$10.95** (Less Drill)

Keep your whole yard neatly tailored... trim hedges, shrubs, and hard-to-reach grass easily and smoothly with this new, inexpensive drill attachment. ROTO-TRIM quickly converts any 1/4" drill into an easy handling, keen-cutting Hedge Trimmer.

Quality Built throughout. Rigid steel and aluminum construction with smooth-running hardened steel gears and cam in one-piece case. Cutting blades are 10" long, of high-carbon steel, heat-treated, precision ground and designed for maximum safety and efficiency.

Easy to Use! Quickly attached to drill—flats simplify chucking. Light weight and precision balance make ROTO-TRIM much easier to handle than more expensive trimmers. Handle turns blade to any angle.

Order TODAY! Don't miss this chance to get your ROTO-TRIM Hedge Trimmer Attachment while still available at today's low price of \$10.95.

UNCONDITIONAL 10-DAY MONEY BACK GUARANTEE!
Send check, cash or M. O. and we'll ship postpaid — direct from factory to you.

Dept. 652 **ROTEX COMPANY** 837 WEST DAVIS DALLAS 8, TEXAS

WYTEFACE

TRADE MARK

STEEL TAPES

No squinting, no guessing when you use WYTEFACE Steel Tapes. Jet black markings (foot numbers in red) on a white background. Easier to read in any light. Faster, more accurate measurements. Rust-resisting, hard to kink, simple to clean.

Protected by U. S. Patent 2,089,209



"I'll take the WHITE one every time!"

KEUFFEL & ESSER CO.

NOW— Fixin' is Fun!



MAKES ME AN
EXPERT FIXER



Model
No. 10-W
\$2.60

WISE-GRIP
WRENCH

**LOCKS to the work
with TON-GRIP**

Remains locked with hand removed

All those fixin' jobs can be FUN — easily, quickly done with a Vise-Grip, the tool that Makes You Handy! Locks to the work. Can't slip. Clamps, turns, twists, pulls, cuts. Actually pipe-wrench, super-pliers, end-wrench, locking-wrench, toggle-press, vise — all in one! The one tool you'll use . . . Use . . . USE!
Favorite of mechanics, everywhere! 7" and 10", with or without cutter. Get yours today, plus an extra for your car tool-kit.

Only \$1.85 to \$2.60 at your dealer.

PETERSEN MFG. CO., Dept. P-6, DeWitt, Nebr.

65 KW. 225 Volt D. C. DIESEL ELECTRIC GENERATING UNIT

RECONDITIONED



Equipped with 6 cyl. DIXIE Hercules DIESEL engine, 4 3/8" bore, 5 1/4" stroke, 120 H.P. at 2000 R.P.M. Complete with injector pump, nozzles and electrical equipment. Generator attached to engine. Complete as shown.

RADIATOR for above unit \$89.50

Each \$1375.00
Lots of 2 \$1295.00
each

Write for price on DIESEL ENGINE only.



1952
EDITION

It's NEW! Get the world's largest Auto Accessory & Parts Catalog & Save money. Over 50,000 items, including Hollywood Accessories.

Hi-Speed Equipment, Rebuilt Engines, all parts & accessories for all cars & trucks. We have that Hard-to-Get part. Completely illustrated. 100 pages. Send 25c (refundable)



FOR GAS, OIL, WATER. NEW
5 GAL. CANS

- Self locking cap.
 - Compact in size.
 - Sturdily made.
 - Floats when full.
 - 3 bar strong handle.
 - 18" High, 6 1/4" thick, 13" wide.
- Ea. \$2.95 \$2.49
Lots 5, or more ea.

SEND 25% CASH WITH
ORDER, BALANCE C.O.D.

J. C. WHITNEY & CO.
1917SP ARCHER AVE. CHICAGO 16, ILL.

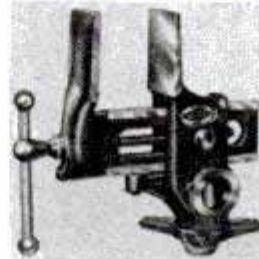

DESIGNED FOR THE HOME WORKSHOP

Here's the ideal vise for those hard-to-do jobs. Use upright (as shown), flat on its side, turned to any angle. Order now — only \$9.95 f.o.b. factory, or send for folder. Money-back guarantee.

THE WILL-BURT CO.
Dept. PM Orrville, Ohio



ELECTRIC WELDER

AC or DC 110 Volts

"The Little Marvel" All-Metal welder. 5-year written guarantee. Welds 1/8" thick metal or money back. Repairs tanks, tools, fenders, machine parts, etc. Comes complete with everything — rods, unit, eye shield, and directions. We also make a welder for 16 to 22 gauge metal . . . \$3.95 complete.

Transformer welder \$18.95. On C.O.D.,
plate. Transformer postage extra.

\$645
Complete

ESSAY MFG. CO., Inc., Dept. 51, Quincy 69, Mass.

SS WANT TO SAVE GAS? SS

USERS REPORT UP TO 30% MORE MILEAGE WITH

THE ECONO-MISER SYSTEM

EASILY INSTALLED, ONLY \$14.95 POST PAID WITH COMPLETE INSTRUCTIONS
SEND FOR YOURS TODAY • MONEY BACK GUARANTEE • GIVE MAKE AND YEAR OF CAR
MIJON INDUSTRIES DEPT. M2 6414 RADFORD ST., N. HOLLYWOOD, CAL.

SAY YOU SAW IT IN POPULAR MECHANICS

NOW—40 different CUTS with AMAZING, NEW

Warren

**DADO SAWING WASHERS
On Your Saw Blade**

Just dial widths to cut parallel grooves perfectly smooth. No warp, vibration

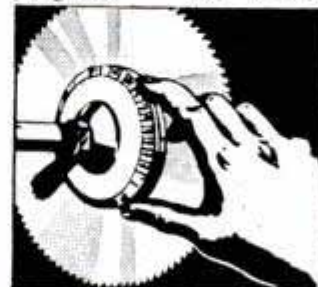

or trick screws. Strengthens blade, perfect balance. GUARANTEED! At your dealer's or order direct. Give arbor size—1/2", 3/8", 3/4", 1".

Send for free booklet

WARREN WASHERS COMPANY
Dept. 26, Box 98 North End Station, Detroit, Mich.

ONLY \$4.95 PER SET

AMAZING TOOL BARGAINS!

ALL BRAND NEW MERCHANDISE

12 MINIATURE CUTTERS \$1.00



FOR CUTTING WOOD, PLASTIC, or METAL. Actual size, Assorted shapes on 3/32" shank. For die makers, home workshop, etc.

\$1.00 Post-paid

SURPRISE VALUE 100 Pieces FOR ELECTRIC GRINDERS \$1.00



Grinding Wheels, Cut-off Wheels, Sanding Discs, Mounted Stones, Sharpening and Honing Stones, Rotary Cutting Burs, Abrasive Cartridges, Mandrels, and many other items.

\$1.00 Post-paid

12 MOUNTED WHEELS and points on 1/4" Mandrel \$2.95



For grinding on plastic, wood soft and hard metals. Regular \$8.40 List Val. 12 wheels on 1/4" Mandrel \$3.60

\$2.95 Post-paid

18 MOUNTED POINTS ON 3/32" MANDREL \$2.50

SCHUPACK SUPPLY CO., 7331 Cottage Grove, Dept. M-31 Chicago 19, Ill.

NEW 1952 Illustrated Catalog 10c

NEW 1952 KING MIDGET AUTO

World's Lowest Priced 2 Passenger Car Drive it for 75c per week. Amazing performance. Superior comfort. All steel construction. Full accessories, top and heater. Ready to run or assemble it with our bolt together parts. Rider agents wanted, earn your car free. Send 25c for detailed literature or \$1 (refunded first order) for actual assembly book and service manual filled with photos, drawings, specifications, etc.



MIDGET MOTORS MFG. CO. ATHENS, OHIO

New & Used PARTS FOR ALL CARS AND TRUCKS!

ORDER FROM Largest Stock in America of new, rebuilt and used parts for late and old models. America's largest stock of parts for Army Trucks & Jeeps. All items Guaranteed. Fast Service. No Catalog, inquiries promptly answered, prices quoted.

PIONEER AUTO & TRUCK PARTS CO.
732 W. 13th Ave. • Denver 17, Colo.

DO IT EASIER --- FASTER --- BETTER

with a **SHAW** "DU-ALL"

Walking or Riding Tractor

Plow
Plant
Cultivate
Mow
Rake
Cut Trees
Saw Wood

1½, 2½, 3 and 5 H. P. walking tractors for all large and small gardening. 5, 8 and 12 H. P. riding models that will handle good sized farms. Quality built for 50 years. All wanted tools and attachments. See the Shaw dealer. Write for **FREE CATALOGS**, low prices on complete Shaw line. Address

SHAW MANUFACTURING CO.
4506 Front St., Galesburg, Kansas
668-G N. 4th St., Columbus, Ohio

IT TAKES **2** HOLES TO MAKE A PUNCTURE



● Anything that punctures your tube must go *through* your casing. You have the tube repaired, but what do you do about the **FIRST** hole . . . the one in the casing? Never neglect it!

Punctures in casings—even small ones—suck up dirt and moisture, cause rot, result in blowouts, waste thousands of tire miles. To make tire mileage stretch, it's important to get all the tire service you can. It takes **TWO** holes to make a puncture . . . always have **BOTH** repaired.



Your Bowes "Seal Fast" dealer has the finest tire repair materials . . . equipment . . . and "know how." Take your tire troubles to him. He will inspect your tires thoroughly *inside and out*. When he finds trouble he will fix it and give you many added tire miles . . . and **SAFETY**. For safe tire service, look for the Bowes Emblem.

BOWES "SEAL FAST" CORP. • INDIANAPOLIS 7, IND.

P & C Hot Forged Tools

Do the job **FASTER!**

You get down to business *fast* with P & C Tools. They're master craftsman designed to fit openings quickly... turn nuts and screws smoothly... get into tight places easily. And tough, too, with special analysis alloy steels scientifically heat treated. Look for the P & C rotary tool display unit at your favorite tool dealer's. He'll show you—"the best tools money can buy."

Write for handy pocket catalog. Complete data on some 300 P & C Tools.



P & C Hand Forged Tool Co.
Box 5926 H
Portland 22, Ore.



Fast, EASY Way to REMOVE Paint



Just apply WONDER-PASTE Remover with a regular brush over paint, enamel or varnish... Then let it penetrate... The old finish quickly becomes a soft mass that comes off cleanly with every stroke of your putty knife. No hard scraping or sanding! Harmless to any type surface or your hands. Use Wonder-Paste outdoors or indoors. At paint and hardware stores.

WONDER-PASTE

Over 3,000,000 cans sold—it must be good!

Write for free leaflet and advice on your removing problems
Wilson-Imperial Company, 119 Chestnut Street, Newark 5, N. J.

100 MILES to a GALLON!



with an Le 200 VELOCETTE MOTORCYCLE

This silent, clean, comfortable and SAFE machine features a water-cooled engine, shaft drive, hand starter, and excellent weather protection. Two cylinders.

Write for complete information to the Exclusive U.S.A. Distributor

BRANCH MOTORCYCLE SALES 2019 W. Pico Blvd. Dept. P6
Los Angeles 6, California

"BEST SANDER I'VE USED IN 40 YEARS OF DECORATING"



Follow Master Decorator Jokela's advice—get the amazing new "504" SYNCRO—only sander with Double Arc Motion DOUBLING sanding action! Low cost. At dealers or Circular Free: SYNCRO Corp., Dept. D-62, Oxford, Michigan, U.S.A.



NEW!



- and only **50¢**

20 original projects... drawings, photos, step-by-step instructions... tips on joinery, gluing, finishing... send \$5.00 cash (no stamps) per copy, \$6.65 outside U.S.A. Limited first edition, order today.

ATLAS PRESS COMPANY

643 North Pitcher Street, Kalamazoo, Michigan
DEPENDABLE QUALITY TOOLS SINCE 1911

TAKE THIS TIP FOR THAT MOTORING TRIP



A DEPENDABLE auto compass leads you right, always. That's why it's important to insist on a HULL—the only auto compass produced in commercial volume for 19 years, and proved for longtime dependability by the hundreds of thousands. Write for local dealer's name, free literature.

EASIER TO INSTALL IN ANY CAR

HULL MFG. CO. P. O. Box 246-06
WARREN, OHIO



Beaumont \$6.95
Streamline \$4.95

Home Owners Oil Burner Service

You can make your oil burner operate properly yourself. We can help you. Manual available now at \$2.00 for Space Heaters, Water Heaters, Furnaces, using pot-type burners. Corrections for all makes by correspondence at nominal charge. Money back guarantee. Parts for all makes for sale. Catalogue on request. Give make, model, serial number when writing.

HOME OIL BURNER SERVICE, Box 355 - Milford, Michigan

A BIG MONEY-MAKER

IDEAL LAWNMOWER SHARPENER



Plenty of business in your community—for a big, steady income! Cash in with the IDEAL Model 300—a rugged, precision sharpener, easy to use, backed by 50 years of experience. Sharpens all mowers. Start now, full or spare time. Write for free catalog today:

THE FATE-ROOT-HEATH COMPANY
Dept. R-3, Plymouth, Ohio

ABSORB DAMPNESS!

In Basements, Closets, etc.
with the
**SOLVAY
AIR-DRYETTE, JR.**
and SOLVAY
CALCIUM CHLORIDE

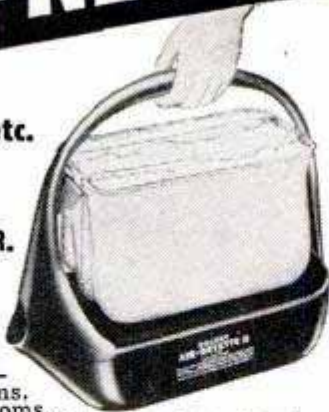

Absorbs moisture — the cause of rust, warping, mildew in workshops, darkrooms, closets, playrooms, storage rooms, vaults. Built to last for years. Big capacity. Works fast, absorbs up to 3½ qts. per day. Compact, inexpensive, clean, safe, odorless. Thousands in use. Write for booklet and name of your nearest dealer. Not available on Pacific Coast.

Dept. 89-6, SOLVAY SALES DIVISION
Allied Chemical & Dye Corporation
40 Rector St., N. Y. 6, N. Y.

WANT TO SAVE GAS? ½ MILLION NOW USE GANES

AMAZING GANE NEEDLE TRY ONE FREE IN YOUR CAR!

TRY BEFORE YOU BUY!

MANY GANE NEEDLE USERS REPORT UP TO 25% more mileage, faster pickup, easier starting and smoother idling.

NOW TEST A GANE NEEDLE IN YOUR CAR for ten days, then compare your mileage and performance. If satisfied, send \$1.50 per needle (5 cyl. cars take 2). If not satisfied, just return it—fair enough? Since authorities differ on its merits and some users report no improvement, **TRY BEFORE YOU BUY!** (Gane Needle replaces idling adjustment screw in carburetors—easily installed in a few minutes.)

WRITE TODAY. ENCLOSE NO MONEY. PAY POSTMAN NOTHING. Just send us your name, address, and make and year of car.
NATIONAL AUTOMOTIVE RETAIL CORP., Dept. J-6
350 W. Washington Blvd. Venice, California

FREE Auto Economy Manual
Tells how to save gas, tires, brakes, etc. Also introduces many new economy products. (Sent absolutely free to all who try Gane Needles.)

A Sensational New Machine

*9 Handy Tools in 1
The New PORTO-WELD Machine

- *• WELDS
 - BRAZES
 - GRINDS
 - SANDS
 - POLISHES
 - BUFFS
- BRUSHES
 - MOTOR DRIVE
 - QUICK BATTERY CHARGER



PORTO-WELD MODEL 2A
Comes as illustrated above. Has 7 speeds and welds to 1/2" steel. Uses up to 5/32" rod (150 Amps.) Shipping Wt. 80 lbs.
F.O.B. Chicago, Illinois **\$9850**
PRICE
Quick Battery Charger Attachment \$5.00 Extra.

Here is an Economy Combination Tool that is of vital importance to any Shop—Garage—Service Station—Plumber—Boiler Man—Farmer or Home Workshop. PORTO-WELD has a SELF-CONTAINED MOTOR GENERATOR just like the large industrial units. Just plug it into any two 110 Volt AC or DC (any cycle) or 220 Volt single or dbl. phase lines and it's ready for use. Easy to take to the job. Its portable power unit can be used to operate saws, planers, sanders, etc. Can be used straight or reverse polarity. Other models available (80 Amp.—225 Amp.—Cart Model, Etc.). Send for FREE Literature.

Fully Guaranteed in Writing
Write For Dealer Territories

GENERATOR SALES CO.

1625 N. DAMEN AVE.

CHICAGO 47, ILLINOIS

The NEW Model 50 UTILITY TESTER FOR REPAIRING ALL ELECTRICAL APPLIANCES-MOTORS

an all-around electrical trouble shooter



• Measures A.C. and D.C. Voltages, A.C. and D.C. Current, Resistances, etc.

• Will measure the current consumption while the appliance under test is in operation. The appliance or utility may be plugged directly into the front panel receptacle. A special pair of insulated clip-end leads is included for motors, etc.

• Incorporates a sensitive direct-reading resistance range which will accurately measure all resistances commonly used in electrical appliances, motors, etc. This range will enable continuity checks and tests for shorts and opens.

• Will test thermostats, radio tube filaments, bulbs, fuses, fluorescents, condensers, switches, field coils, circuit breakers, lighting systems, etc.

Handsome round cornered molded bakelite case 3 1/8" x 5 1/8" x 2 1/4". Complete with all test leads and instructions.

\$13⁹⁰

SHIPPED ON APPROVAL
No Money With Order — No C.O.D.

Try it for 10 days before you buy. If completely satisfied send \$3.00 and pay balance at rate of \$2.00 per month for 5 months —No Interest or Carrying Charges Added. If not completely satisfied, return to us, no explanation necessary.

SUPERIOR ELECTRONIC CO., INC.
Dept. D-17 • 227 FULTON STREET • NEW YORK 7, N.Y.



The **COASTER BRAKE**
with
SELF-ALIGNING BRAKE SHOES



Ride a Bike it's Fun!

Self-aligning brake shoes give quicker stops, longer life, easier pedaling. It's another Bendix feature that makes the Bendix* Coaster Brake the outstanding performer in its field. Your dealer will put on the brake you want—so just say "Bendix Coaster Brake."
*REG. U.S. PAT. OFF.

DOUBLE THE FUN

WITH A **Bendix** COASTER BRAKE

ECLIPSE MACHINE DIVISION of
Elmira, New York



10 DAY MONEY BACK GUARANTEE

300 POWER IMPORT MICROSCOPE

\$11.95

ACHROMATIC LENSES

Precision instrument! Invaluable for study in Biology, Botany, and Zoology! Acclaimed by hobbyists, students, and professors. Achromatic eyepiece and objective lenses assure clear, sharp image, free from undesirable aberrations. Delicate focusing adjustment, full 90° body tilt adjustment, adjustable plano substage mirror, solid construction throughout. Here's the value of a lifetime, at a price anyone can afford! Complete with wood carrying case. \$11.95 Postpaid.



IMPORTED 6x15 COATED PRISM BINOCULARS

WITH LEATHER CASE **\$17.95** plus 20% tax. Shipped post-paid.

Featherlight, fits palm of hand! Outperforms others many times its price by utilizing ultra precise prisms. Coated optics offer bright, clear images. Individual micrometric ocular lenses for accurate instant focusing. Dust proof, moisture proof, all metal modern construction, gleaming chrome finish. All purpose instrument for sport events, theater, traveling, nature study, etc. Linear field of view 438 ft. at 1000 yds. Complete with leather, velvet lined, zipper case. \$17.95 plus 20% tax. Shipped postpaid.

NOTE: 10 day money back guarantee on all items. Send check, cash or M.O. Illinois residents add 2% state tax. 1/3 deposit on C.O.D. orders!

Sub-Miniature CAMERA \$3.00

Takes Needle Sharp Shots Unique! Vest pocket size! Always handy for unexpected prize winning shots! Fine 20mm f/4.5 lens; shutter settings 1/25 sec. and B.; uses special daylight loading rolls, 10 exposures, 14x14mm. Built-in eye level finder, leather over metal construction, wt. 83 gr. Yours, with roll of film Free of extra cost. \$3.00 P.Pd.

Precision Engineered 20X TELESCOPE \$9.95

Would sell in stores for 3 times our price! Optically ground, coated achromatic lenses give you 400X the area magnification. All metal construction resistant to rust and salt spray. Extends to 15 1/2", telescopes to 6 3/4" pocket size. A necessity for boat owners, ideally suited for astronomical studies, hunting, observing races, sporting events. \$9.95 Postpaid.

40X POCKET MICROSCOPE \$3.95

Compact, clips into pocket, always handy. Examine insects, minerals, gems, etchings, stamps, anything—anytime! Fine 4 lens compound optical system. Comes ready to use, always in focus for pin point sharpness, no adjustments necessary. \$3.95 P.Pd.

LEMAR SCIENTIFIC CORP.

Dept. D6

3412 W. JACKSON BOULEVARD, CHICAGO 24, ILL.

BUILD YOUR OWN GARAGE DOOR...

SAVE MONEY!

WORK FROM A PAPER PATTERN — STEP-BY-STEP DIRECTIONS

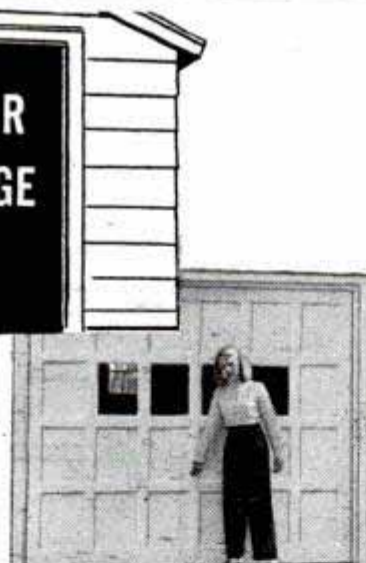

With Easi-Bild® Build It Yourself Pattern No. 86 you can have a garage door with Stanley Swing-Up Hardware — for less than 1/2 present costs! Pattern tells what materials to buy, where and when each is used. No special tools or skill required. Install the Stanley Garage Door Set with hand tools.

You'll be amazed at how easily and economically you can build a professional looking door by following the step-by-step procedure outlined in this pattern. Ask your dealer for Simplified Directions for installing Stanley Garage Door Hardware, and Easi-Bild Pattern — or send coupon below.

*Trade Mark Reg. U. S. Pat. Off — Easi-Bild Pattern Co.

EASI-BILD PATTERN CO., Dept. S-4, Pleasantville, N. Y.

Enclosed is 50c in Coin, Money Order, Check for Single and Double Garage Door Pattern No. 86.

Please send Simplified Directions for installing Single Double Garage Door Hardware

Name.....
Address.....
City..... State.....

ATLAS Rotary Type POWER KEEN-MOWER

A COMPLETE POWER MOWER

(less elec. motor or engine)

Model 50M as illustrated

\$44.95



This is one of America's finest Power Lawn Mowers... offered at the sensational low price of \$44.95. When you receive mower all you need do is add your gas engine or electric motor. Mower has concealed blade for safety, 3 cutting heights, 1 1/2" to 3 1/2". Ball bearing rubber tired wheels. 18" cut and cuts to within 1/2" of sidewalk. Weighs only 48 lbs. Shipped FOB, Kansas City. Send check or money order.

\$44.95 ONLY.....

ATLAS KEEN MOWER
KANSAS CITY, MO

229 S. W. BLVD.

Dept. PMG

SAWHORSE made Quicker... Easier... Better

with NEW **Spee-Dee BRACKETS**



Only sawhorse brackets having flanged nail holes for easy disassembling! Takes dressed or common 2x4 lumber. Employs nails to secure assembly. No complicated instructions. Produce sturdy sawhorse that won't fall apart when lifted by the rail! Use for ping-pong, picnic tables; platforms; carpenter's horse, etc. \$2 pr. At Hdwe., Bldg. Supply stores. If not stocked, write Dalton Mfg. Co., 20 S. Central, St. Louis 5, Mo.

BRONZE FOUNDRY

Schools and Home Workshops

Make your own castings of aluminum, copper, bronze, silver. Foundry sets are available in three sizes including 2400 Deg. F. blast Furnaces. \$22.50; \$29.50; and \$42.00. f.o.b. Kansas City. Free Circular.

KANSAS CITY SPECIALTIES CO. P. O. BOX 6022, DEPT. P-G KANSAS CITY, MO.

BUY LU-MAR ALL-PURPOSE PUMP

To fill outboard motors, lawnmowers, etc. \$3.00 postpaid, less can. Strainer and shut-off, 75c. Money-back guarantee.

LUCAS METAL PRODUCTS CO.
952 Exchange St. Rochester 8, N.Y.



BeMaCo Dependable

AUTOMATIC SAW SET

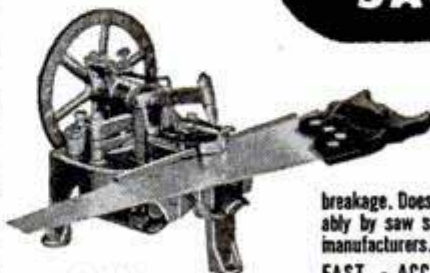

Sets 400 teeth per minute on hand or band saws 4 to 16 point. Hammer and anvil action sets teeth accurately and uniformly... No tooth breakage. Does a perfect job. Used profitably by saw shops everywhere and saw manufacturers. Every machine guaranteed!

FAST - ACCURATE - DEPENDABLE

★ INCREASES PROFITS

BEAVER MFG. CO.

Saw Machine Div. #12M
800 SO. ISIS AVE. • INGLEWOOD, CALIF.

POPULAR MECHANICS

New MOTOR BARGAINS for Home, Farm & Industry



ALL NEW MOTORS WITH ONE YEAR FACTORY GUARANTEE

All are 110 V. or 110/220 V. 60 cy. 1 ph. A.C. Motors.
Write for **FAN CIRCULAR: Listing Blades, Guards, Motors, ALL SIZES: Attic, Window or Room Cooler**

1/3 H.P.	Delco: 1750 RPM—	
	Ind. Type	\$14.75
1/2 H.P.	Dayton: 1750 RPM—	\$18.75
	Double Shaft	\$22.50
3/4 H.P.	Dayton: 1750 RPM—	\$22.50
	Capacitor	\$22.50
1 H.P.	Westinghouse—1750 RPM—	\$22.50
	Dayton—3450 RPM—	\$23.50
1 1/2 H.P.	Dayton: 3450 RPM—	\$23.50
	Induction Type	\$18.50
1 H.P.	Dayton: 1750 RPM—	\$32.50
	Capacitor	\$32.50
1 H.P.	Gen. Elec.: 1750 RPM—	\$34.50
	Double Shaft	\$34.50
1 H.P.	Dayton: 3450 RPM—	\$34.50
	Capacitor	\$34.50
1 H.P.	Dayton: 1750 RPM—	\$52.00
	Capacitor	\$52.00
1 1/2 H.P.	Dayton: 3450 RPM—	\$52.00
	Capacitor	\$52.00
1 1/2 H.P.	Dayton: 3450 RPM—	\$59.00
	Double Shaft	\$59.00
1 1/2 H.P.	Dayton: 1750 RPM—	\$67.50
	Capacitor	\$67.50
1 1/2 H.P.	Dayton: 3450 RPM—	\$62.00
	Capacitor	\$62.00
1 1/2 H.P.	Dayton: 3450 RPM—	\$67.50
	Double Shaft	\$67.50

Above Special Prices are F.O.B.

C. MARSHALL SALES,

3546 W. Fullerton Ave., Dept. P-5, Chicago 47



16 to 1 SPEED REDUCERS

For Display Table — Barbecue Spits — Toy Auto Gear Box — Experimental Uses, Etc. Gears Enclosed in Aluminum Housing. Bronze Gear, Hardened Worm, Input Shaft 1/4 in. Output Shaft 3/8 in. Speed Reducer \approx R 161. **\$3.95** Post Paid

• New Explosion Proof Motors •

Underwriters approved, Class I, Group D, explosion proof motors. Westinghouse and Leland makes, heavy duty repulsion induction and capacitor types. For pumping gasoline, lacquer or use on jobs where motor is exposed to hazardous fumes or material, abrasives, dirt and dust. All 5/8" shaft, 1750 RPM.

No. EP-25, 1/4 HP, 110/220V, 60 cy., 1 ph.	\$23.50
No. EP-33, 1/3 HP, 110/220V, 60 cy., 1 ph.	\$28.50
No. EP-333, 1/3 HP, 220 volt, 60 cy., 3 ph.	\$32.50
No. EP-32, 1/3 HP, 32V, direct current . . .	\$33.50
No. EP-115, 1/3 HP, 115V, direct current . . .	\$37.50
No. EP-230, 1/4 HP, 230V, direct current . . .	\$24.50
No. EP-233, 1/3 HP, 230V, direct current . . .	\$27.50

All prices F.O.B. Chicago

Volume Blowers for Heating, Ventilating, Exhausting

Blowers for forced drafts, heating boosters, exhausters, coolers, dryers and dust collectors. 110 volt A.C., 50/60 cycle motors.

*Midget Blower: 5 CFM 2 inch Wheel	\$ 5.95
*50 CFM Blower: 3 inch Wheel	\$ 9.75
*75 CFM Blower: 4 inch Wheel	\$11.25
*250 CFM Blower: 5 inch Wheel	\$22.50
600 CFM Blower: 6 inch Wheel	\$38.50
1000 CFM Blower: 8 inch Wheel	\$52.00
1500 CFM Blower: 9 inch Wheel	\$72.00

*These Blowers with Motors shipped Post Paid. Larger sizes are F.O.B.

\$\$\$ PROFITS with "all 'round" HOBART WELDING

Goes anywhere!
Trailer type gas drive welder.

HOBART welders

The demand for welding has never been so great—and is only just beginning. Profit opportunities are unlimited. You, too, can cash in on it! Set up your own welding shop—the smart way—with a

Hobart welder. Only a performance-proven, long lived, all round welder can assure maximum jobs, bigger profits. Write for FREE booklet "How to Get Better Welds"

HOBART BROS. CO., Box M-62, TROY, O.

AIR CONDITION Any CAR

PLANS SHOW YOU HOW . . . \$1.00 • HOT OUTSIDE . . . COLD INSIDE

Enjoy pleasure driving in cool comfort in scorching outside temperatures, with real mechanical refrigeration. (Not a dry ice or window unit.) Easily installed by anyone handy with tools. No experience necessary. Powered direct from your engine. Completely automatic. PATENT FEATURE controls temperature from idle to 100 mph. Build and install it yourself! Keeps your automobile comfortable—Tractor Cab cool—Truck cooled for hauling perishables. Send \$1 for your set of PLANS now. Do it today!

LEJAY MFG. CO., 547 LeJay Bldg., Minneapolis 8, Minn.

SHOPSMITH OWNERS

New attachment for turning metal and plastic, adaptable for tapping, milling and grinding, fully guaranteed, only \$19.50, order direct, enclose check or M.O. \$5 deposit for COD.

DIXIENG, 7301 N.W. 10th Ave., MIAMI 38, FLA.

PEEL PAINT TO BARE WOOD

6 to 10 feet per minute!

"PAINT-DOZER"

New heavy-duty electrical peeling tool for outside and inside work.

Fully Guaranteed **\$995** Complete

Softens and peels paint in one continuous stroke!

Eliminates hard scraping, chipping, dangerous chemicals and torches. Faster, neater, safer than a blowtorch! Quickly and easily peels house siding, sills, cabinets, floors, boats . . . any woodwork. Even curves, grooves and fancy moldings are easily peeled with "Paint-Dozer" Kurv-Kleeners. This professional tool is simple to operate. Even beginners do a smooth, clean job. Operates on ordinary household current. Constructed of heavy stamped steel; long-lasting Ni-chrome wound 1000° ceramic heating element; Marinite insulation; and hardwood pistol-grip handle. Comes complete with Kurv-Kleeners; 8-ft. neoprene cord; front and rear detachable blades and skids; attachable front guide handle for horizontal work; safety stand and instructions. Order today from your dealer, or write for fast shipment! *You must be satisfied or your money back.*

OTTO KONIGSLOW MFG. CO., DEPT. Q
3610 PERKINS AVENUE • CLEVELAND 14, OHIO

Say You Saw It in Popular Mechanics

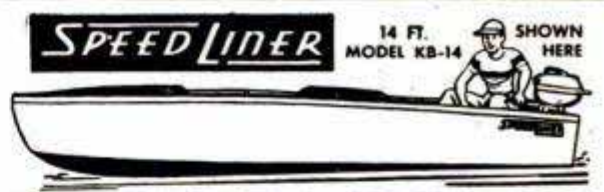

BOAT KITS

Assemble Yourself . . . Have Fun . . . Save 1/2

Get a kit designed by builders of famous Speedliners and save about 1/2. Easy-to-follow illustrated instructions. No special tools needed. Boat building experience not necessary. Transom and frames furnished completely assembled, other parts carefully cut to size. Screws and glue furnished. Only finest materials—Philippine mahogany lumber and finest boat grade fir plywood furnished. Speedliners are designed for safety, strength, comfort and ruggedness. See your local Speedliner dealer for ready-built boats (26 models available) and boat kits. **OR SEND COUPON TODAY!**

General Marine Co. 6th and Oak Street	Dept. 555 St. Joseph, Mo.
Please send me FREE your complete catalog on Speedliner Boats and information and prices on your full line of Speedliner Boat Kits.	
Name _____	
Address _____	
City _____ State _____	

HOW...and WHY...THE WHEATLEY TURBO ATOMIZER can save you \$\$\$\$\$\$\$ IN FUEL OIL BILLS!

Do you know that your oil burner, whether conversion or complete unit, actually wastes from up to 50% of the oil you pay for every year? That of the 140,000 BTU's (Heat Units) in every gallon of #2 Fuel Oil, your oil burner utilizes only a fraction?

And do you know that your oil burner is actually capable of producing more heat from less oil... in fewer and shorter "ON" periods... by using the new, scientifically designed WHEATLEY TURBO ATOMIZER?

THE WHEATLEY TURBO ATOMIZER ACTS LIKE A SUPER CHARGER... It stops oil waste by supplementary atomization of the fuel oil, creating primary and secondary mixtures, and then precision channeling the finer spray so that the burner flame is cleaner and hotter and producing more efficient combustion. MANY USERS OF THE WHEATLEY TURBO ATOMIZER REPORT THAT THEY WERE ABLE TO SWITCH TO SMALLER SIZE NOZZLES, EFFECTING ADDITIONAL SAVING IN OIL CONSUMPTION!

INSTALLATION IS QUICK AND EASY... You can install it in a few minutes or, if you prefer, your service man will do it at small cost of service call. (Due to material shortages necessitating limited production, the WHEATLEY TURBO ATOMIZER is not available to the trade.)

Right now, start timing the "ON" periods of your burner. Then when you install the WHEATLEY TURBO ATOMIZER, time the "ON" periods again. YOU'LL FIND YOUR BURNER OPERATING FOR SHORTER PERIODS... you are using less oil than before, and saving wear and tear of your burner besides! NO MOVING PARTS, NO ADJUSTMENTS NECESSARY ONCE INSTALLED.

UNCONDITIONAL GUARANTEE!... Send us your check or money order for \$5.95, with your name and address. By return mail, you will receive the amazing WHEATLEY TURBO ATOMIZER with easy to follow instructions. IF AFTER INSTALLATION YOU DO NOT GET MORE HEAT WITH LESS OIL, RETURN THE UNIT WITHIN 10 DAYS FOR FULL REFUND. (Suitable for use only on high pressure gun type burners.)

WHEATLEY HEATING & ENGINEERING CO., Dept. H
2 East 45th St., New York 17, N. Y.



OVER 700% PROFIT!
WITH THE
PDQ CHAMPION PHOTOMASTER

Makes finished pictures in 2 minutes.
Takes and finishes 30 to 40 everlasting, black and white or sepia photos an hour. No dark room. Guaranteed not to fade. Photos taken on "SUPER SPEED" direct positive paper. Picture size 2 1/2 x 3 1/2 in. Complete, easy-to-operate portable photo studio. Size 4 1/2 x 5 x 10. Wt. 6 lbs. 700% PROFIT. Write quick, get details about the great PDQ CHAMPION PHOTOMASTER.

P D Q CAMERA CO.
1161 N. CLEVELAND AVE. Dept. PM-6 CHICAGO 16, ILL.

ELECTRICITY Anywhere

FOR PORTABLE, EMERGENCY OR HOME USE

ONAN Electric Plants generate 110-volt, 60-cycle current for homes, farms, cabins and resorts beyond the highline. Lightweight, portable plants cut costs, speed work for contractors. Standby plants protect units against power failure. 400 to 55,000 watts. Gasoline or Diesel-powered. Priced from \$219.00.

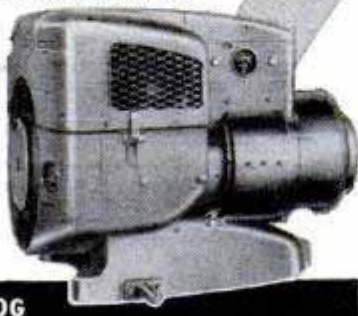

WRITE FOR CATALOG

D. W. ONAN & SONS INC.
5858 UNIVERSITY AVE., MINNEAPOLIS 14, MINN.

ELECTRIC MOTOR BARGAINS!

1/2 HP 1750 or 3450 RPM	1975	1 HP 3450 RPM	3900
1 1/2 HP 3450 RPM	4750	2 HP 3450 RPM	6500

All prices F.O.B. Heavy Duty, Repulsion Induction and Capacitor Types, 110-220 Volts, 60-cycle. Single-phase. Standard Makes (G. E., Wagner, LeLand, Westinghouse, etc.). Rush your order TODAY—large stock of motors—1 & 3 phase. 32-v. direct current bargains also.

ROBERTS ELECTRIC CO., 849 W. Grand, Dept. 8, Chicago

Quantity Purchase! Save Over Half!

16-INCH ELECTRIC FAN

WITH FULL 2-YEAR GUARANTEE

Buy at less than wholesale... and beat the heat this summer. This gleaming, modern beauty with large 16-inch blade span will air-condition homes, shops, offices, hotels, churches, stores, etc. Extremely quiet, powerful motor costs less than a penny a day to operate. Gleaming 18" guard and best grade Torrington "Varified" blade. Complete with 6 ft. cord and plug with convenient switch in the line. 110-volt 60 cycle AC. Base and column are handomely finished in Black Crackle or Chromium. Unit stands 25" overall. Adjustable head can be tilted in any position. Shipped, knocked down to save shipping costs. Assemble in five minutes with screw driver and pliers. Weight 18 lbs. Satisfaction Guaranteed. Order NOW—this price can't be equalled.

\$1975 Post paid
\$1.00 additional West of Rockies

DEALERS WANTED... WRITE FOR QUANTITY DISCOUNTS

ROBERTS ELECTRIC CO., 849 W. Grand, Dept. 10, Chicago

FREE!

New Johnson Sea-Horse Handy Chart. Describes, in detail, the four great Johnson outboard motors for 1952—from 3 hp to 25 hp. A size for every outboard need—from canoe to cruiser. Write!

JOHNSON MOTORS, 400 Pershing Rd., Waukegan, Ill.

Catalog of 3000 Novelties 10c

Send 10c for amazing catalog of novelties, live animals, scientific supplies, hobbies, funmakers, planes & boats, looms, magic tricks, joke articles, unusual seeds, gadget timersavers, cameras, optical goods, projectors, movies, lucky jewelry, religious novelties, disguises, musical instruments, stamps, coins, puzzles, fortune tellers, radios, auto & bike accessories, telescopes, magnifiers, compasses, banks, smokers' gadgets, artists' supplies, printing sets, engines, motors, shockers, knives, billfolds, fireworks, guns, rifles, sports, books, games, plants, etc. Send name, address & 10c to:

JOHNSON SMITH & CO., Dept. 493, Detroit 7, Michigan

Gerstner TOOL CHESTS

Highest Quality Chests provide maximum care for the good tools of Machinists and Toolmakers.

Free Catalog

GERSTNER TOOL CHESTS

452 Columbia St. Dayton 7, Ohio

NONE BETTER! SUPER DRILL GRINDER



Sharpens round shank drills from 3/32" to 1/2" in diameter, up to 6" long. Grinds old drills like new in 4 different point angles, using hand or power grinding wheels. Money-back guarantee.

Price only \$2.95
At Dealers or Postpaid

CRANDALL MFG. CO. 1512 W. Slauson, Dept. P-6 Los Angeles 44, Calif.

REVIVE OLD STIFFS



Soak them in CABOT'S BRUSH CLEANER. Smacks out hardened paint, varnish, right down to the heel... leaves bristles soft and pliable, just like new. Economical—can be used over and over. Non-inflammable. Buy Cabot's Brush Cleaner from your dealer or send \$1.35 for a pint or \$1.30 for a quart to Samuel Cabot, Inc., 664 Oliver Bldg., Boston 9, Mass.

\$14

POST PAID

PRECISION CALIPER

M.Z.B. Vernier Calipers guarantee highest accuracy for any kind of precision work. This chrome-steel, spring-tempered instrument measures inside, outside, thread and depth to .001" and 1/20mm (#30-64) or .001" and 1/128" (#30-61) 8" overall 6" graduation. Glass hard measuring surfaces. Either one also available in stainless steel at \$16.50 each. We also stock 12" Calipers with fine micrometer adjustment, and height gauges and 1" micrometers reading .0001".

Leather Cases \$1.00 extra. You pay postage on C.O.D. Money Back Guarantee. We are interested in contacting representatives for several territories.



The trade mark of highest quality

Send for descriptive literature, also on our fine imported precision pliers.

INTER-CONTINENTAL TRADING CORP.
90 WEST STREET, NEW YORK 6, N. Y.



Install in 60 Seconds
SCREWS IN LIKE A LIGHT BULB!

So easy! Just unscrew present light bulb from socket and replace with this fixture. U.L. Approved.

\$7.95
Post-paid

IT'S NEW! Circline 22 Watt Fluorescent Light Fixture

Circline lamp included. White enamel finish. Ideal for kitchen, bathroom, hall, playroom, workshop, etc. Diameter 9 7/8 inches. Gives lots more light than incandescent for less current. Satisfaction guaranteed. Order today. Send check or M.O. to dept. A.
Pleasant Valley Dist. Co., P.O. Box 383, Park Ridge, Ill.

DO MORE PLANING JOBS WITH LOW-COST BELSAW **\$215.00**

AMAZING 12 1/4-IN. PLANER Does All Ordinary Planing Mill Jobs. Provides attachments for Jointing, Rabbling, Tongue, Groove, Matching. 12 1/4 x 6-in. capacity, 3-knife solid round all-steel cutterhead. Power feeds at 24 feet per minute, 42 cuts per inch. Provides for full line of accessory attachments—Grind and Joint knives IN THE CUTTERHEAD WITHOUT REMOVING.
BELSAW MACHINERY CO
1019 Field Bldg., 315 Westport Rd., Kansas City 2, Mo.

VARIABLE SPEED HYDRAULIC POWER TRANSMISSION

It has Infinite Speeds 0 to 550. Reverse. Automatic Overload Protection; Adjustable Torque up to 180 inch pounds. 5/8" Input and Output Shafts. It will handle 3/4 to 1 1/2 H.P. Motor. Case measures 7 1/2" long, 7" high 6 1/2" wide. **VALUE OVER \$300.** Shipping Wt. 25#. On C.O.D. Orders we require a 10% only **\$54.50** deposit. **Feb. Chicago**

DIRZIUS MACHINE SHOP "C" 1423-25 So. 52nd Ave., Cicero 50, Ill.

SAY YOU SAW IT IN POPULAR MECHANICS

FILE SAWS the RIGHT WAY



SO EASY with this new filing jig and jointer anyone can now sharpen any hand saw like new! When file hits hardened steel rollers teeth are finished and EXACTLY THE SAME HEIGHT. All teeth cut and saw runs true and smooth. Jig and instructions \$2.95 postpaid. FREE FOLDER.

SHARPEN YOUR CIRCULAR SAWS

The RIGHT WAY on your own saw table. Sharpens rip, cutoff, hollow ground and combination blades—6" to 10". Saws stay round with correct bevel. Easy to use. **GUARANTEED. TRU-CIRCLE JIG #7 \$8.95.** Includes \$3.00 Grinding wheel.

"TRU-CIRCLE" saw set automatically sets teeth at 10° or more. **\$2.95**

AT DEALERS OR POSTPAID

A. D. McBurney, 317 E. 4th St., Los Angeles 14, Cal., Dept. A-18

LESS FOULING! BETTER SERVICE!
LESS GAP-GROWTH! LONGER LIFE!

... because the electrodes are shrouded!

Here's the new spark plug that improves performance in any engine! Hastings Aero-type Shrouded has two electrodes —and they are completely protected from the path of the flame.

Find out how Hastings Spark Plugs can save you money. If your dealer can't supply you, send order giving make and model.



\$1.00 EACH

For complete information write for illustrated folder, Dept. PM Hastings Mfg. Co., Hastings, Mich.

HASTINGS Aero-type SHROUDED SPARK PLUGS

Start a Business in Your Backyard



General Concrete Vibrator **BLOCK MACHINE**
CAPACITY 1000 BLOCKS A DAY

only **\$218** LESS MOTOR F.O.B. PLANT

SHIPPING WEIGHT 400 LBS.



Here is a business you can start on small capital—in your own backyard—that earns 100 to 150% profit, with unlimited opportunities. Make concrete or cinder blocks. Millions used for homes, factories, public buildings, garages. Sell all you make to building trade. Do it with a General—and you're headed for success.

1000 BLOCKS A DAY

The General is a high speed, power-driven block machine at amazingly low cost. Rugged all-steel construction. Simple to operate indoors or outdoors. Makes superior 3 core type block meeting all code requirements. Produces up to 1000 blocks per day. Full operating instructions and mixing formulas supplied. Write for FREE details.

Wonderful Book Written & Illustrated by Experts



GENERAL ENGINES CO.

DEPT. M-62 • 307 HUNTER ST. • GLOUCESTER, N. J.

Includes floor plans for 6 beautiful, easy to build concrete block bungalows. Shows ways to save money. How to lay blocks, lay out building lines, mix concrete, build steps, porches and concrete floors. Mail coupon at once with \$1.

Name.....
Address.....
City..... Zone..... State.....

BUILD YOUR OWN POWER TOOLS - TILT/ARBOR SAW

Exclusive GIL-BILT Build-It-Yourself Features

- No machining—build easily with hand tools only
- No blueprint reading—step-by-step pictorial plans, full scale patterns, actual photographs
- Sturdy wood, aluminum, and steel construction
- Capacity and performance of commercial saws selling for \$60 and up

BANDSAW
BELT SANDER
SAVE \$50.
OR MORE

GIL-BILT 10-INCH TILTING ARBOR SAW



- 27x28 in. table, 13 1/2 in. capacity in front of blade
- 10 in. blade cuts 3 1/4 in. deep, tilts full 45 degrees
- Floor model 34" high, table always stays level
- New Departure ball bearing arbor, 3/4" precision shaft turned down for 5/8" bore blades, alum. housing, shipped ready to run
- Jackscrew and 4 1/2 in. dia. handwheel lowers and raises blade
- Cast aluminum miter gauge and self-aligning rip fence guide

GIL-BILT Metal Parts Kit includes Plans, ball bearing arbor, miter gauge and bar, rip fence guide, dado insert, lock knobs, jack screw mechanism and handwheel, and all other metal parts (less blade).....\$20.95
Same Kit with 10" Combination Blade \$24.90
Same Kit with 8" Combination Blade \$23.90

GIL-BILT 12-INCH BAND SAW



- Cuts to center of 24 inch circle
- Handles stock up to 6 inch thick
- 18x18 inch table tilts 45 degrees
- Lower wheel and drive pulley runs on sealed New Departure Ball Bearings; Upper wheel runs on two 5/8" bore Oilite Bronze bearings.
- Upper wheel tension and tilt mechanism of cast aluminum, completely assembled.
- Upper and lower blade guides. Each has ball thrust bearing, self-lub bronze jaws
- Rigid cast aluminum wheels fully machined ready-to-install. Heavy rubber tires.
- Uses standard 78 inch blades up to 3/4 in. wide.
- Fully enclosed mechanism for utmost safety.

GIL-BILT Metal Parts Kit includes Plans, rubber tires, aluminum wheels, 1/4 in. dia. ball bearing spindle, tilt mechanism, blade guides, table tilt segments, and all other metal parts.....\$21.95

Return Kits in 10 days for refund if not satisfied.
(Prices include postage within 300 miles. Over 300 add 5%)
Also available—Plans and Parts Kit for Belt Sander and 8" Tilt/Arbor Saw. Order Plans at \$1.00 each—Send postpaid anywhere in the world or write for FREE descriptive catalog.

GILLIOM POWER TOOLS P. O. Box 1-PF, Lambert Field St. Louis 21, Missouri

Build World's Finest Crystal Radio



EASY to make. Assembled in minutes. Gets distant stations clearly. Uses Germanium Crystal Diode in special constructed circuit. Very selective. All parts laboratory quality engineered for best performance. Head phones included. Nothing extra to buy. Sold on money back guarantee. Complete kit \$8.95 prepaid. (C.O.D. on \$1.00 deposit.)

R. A. JAEGER & CO.
8044 HAMLIN AVE.,
SKOKIE, ILL.

WAR SURPLUS BARGAINS

HOT ROD SUPERCHARGER



Extra soup and go at a price you can't afford to miss! Mfr'd by Borg-Warner. Specifications: 7 1/2" deep, 7" high, Wgt. 17 lbs. Compact and sturdy, 4 base mounting holes, 3/4" outlet, 3/8" shaft with female Lovejoy coupling. Priced today at \$85. Our special SALE PRICE \$31.00

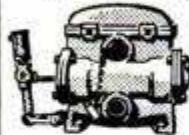

ALARM HORNS

and Sirens. 110 v. AC motor driven. Heavy duty with long life and adjustable tone high, med. and low. List \$47. NEW \$19.95



BRASS HAND PUMP. Double acting pumps on forward and return strokes. Capacity 1000 gal. per hr. \$48 value, only \$18.50

LIGHT PLANTS

300 Watt 110-220 volt AC, Wgt. 40 lbs.—portable \$99.
750-1000 Watt, 110 v. AC, Briggs & Str'n eng. \$169.
1000-1200 Watt 110 v. AC, only \$194
2500-3000 Watt 110 v. AC, Slow speed (1800 r.p.m.) Leland generator for longer life. Recond'nd and fully guaranteed \$295. NEW \$345.
Plants built in 1951 with tools and spare parts, \$426.
5000 Watt 120 v. AC, 4 cyl. gas engine, Hobart generator. List today \$1910.00. Used \$675.00. NEW, only \$895.00.

Write today for free catalog. Thousands of \$\$ saving buys.

WINCHES

1000 lb. cap. Hand oper. \$12.95
Hand operated ball-bearing model.
1500 lb. cap. 3-1 ratio, hand brake, 2 speeds.....\$39.50
6000 lb. double drum. Hand operated.....\$49.50
1500 lb. electric drive.....\$109.50
6000 lb. electric drive.....\$188.50
Single drum, 3/4 HP motor 110 or 220 AC. Start-stop-reverse switch, belt pulleys & loose steel cable. Ratio 12-1. NEW.....\$125.00
Double drum model.....\$135.00

RUBBER HOSE

GOODRICH 2 ply 2" I.D. 25 ft. lengths worth \$25. Only \$4.95.
3 lengths for \$12.00.

C&H ELECTRIC MACHINE Co. Inc.

434G W. Juneau Ave.,
Milwaukee 3, Wisconsin

FANS! FANS!

ALL TYPES — ALL SIZES

MAKE YOUR OWN ATTIC FAN
with patented Torrington belt drive factory balanced blades, the finest money can buy. Shipped knocked down. Assemble in 10 minutes.

BLADE DIA.	C.F.M.	R.P.M.	H.P. REQ.	PRICE
24	5560	625	1/4	\$12.75
30	7125	425	1/4	14.75
36	10100	370	1/2	16.95
42	12500	295	1/2	19.95
48	16300	260	1/2	21.95

Reconditioned G. E. 1/4 H.P. Rubber Mount Motor.....\$9.75
Kitchen Ventilators, Exhaust Fans, Attic Fans, Blowers, Heat Boosters, Desk Fans, Window Fans, Blades, Guards, Shutters, Motors, etc.
Free illustrated catalogue, dealers inquiries invited
EDWARDS BROS. ESTAB. 20 YEARS
WESTERN APPLIANCE CO., INC.
5650 Grand River Ave., Dept. F, Detroit 8, Mich.



MARVEL

Mystery Oil

- Frees Sticky Valves
- Stops Hydraulic Valve Clatter

Buy it at your favorite gas station



GIGANTIC SURPLUS EQUIPMENT SALE

Amazing bargains. Savings to 70%. Gas engines, A-C generators, boat winches, telephones, air compressors, paint spray outfits, water pumps, electric saws-drills, welders, chain saws, battery chargers, binoculars, contour levels, electronic components, many other items. Freight prepaid. Rush card illustrated sale catalog.

BURDEN SALES COMPANY

810 "O" ST.,

LINCOLN, NEBRASKA

ONE-MAN SAWMILL LOW \$50.00 DOWN AS...



Take BELSAW Portable Sawmill right to the trees—turn out valuable lumber for local yards—do "custom sawing" for neighbors. BELSAW lasts a lifetime. No crew needed. Power with old auto engine. Beginners get excellent results. Send postcard for FREE BOOK, "How To Make Lumber."

BELSAW MACHINERY CO
8117 Field Bldg. 315 Westport Rd, Kansas City 2, Mo.

WORLD'S FASTEST BOATS!



Send 25c today for Illustrated Catalog of Champion Racing Hydroplanes, Utilities, 3 Points, 7 to 17 ft. lengths. Easy to follow Plans \$8.75 up; complete Kits, \$120 up, custom built Speedboats from \$210. **CHAMPION BOATS**, 1524 W. 15th St., Long Beach 13, Calif. Dept. 15-S.



STARRETT "Tools and Rules" BOOK

Describes and illustrates the precision methods skilled mechanics use. Only one dime. Write Dept. AP.

THE L. S. STARRETT CO., Athol, Mass., U. S. A.

POWER HACKSAW \$52.75

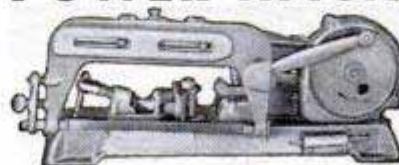

LESS MOTOR
F. O. B. Benton Harbor

• Rugged cast iron construction. Wt. 56 lbs. bronze bearings. Draw cut. Auto. return lift. Auto. shut-off. Vise swivels 45°. Cap. 4"x4".

Send for full details and name of nearest dealer.

EXCEL MACHINE TOOLS BENTON HARBOR, MICHIGAN

WESTINGHOUSE HYDRAULIC TRANSMISSION

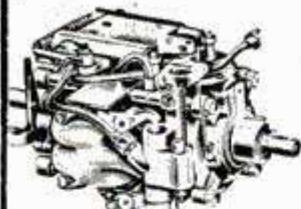

ALTIMETERS

Ideal for lathes, drills, chain saws, power machinery, chucking machines, farm machinery, tractors, trucks, or hydraulic torque converters, etc. Contains hydraulic pump and hydraulic mtr.; reversible controls. Designed for 2-ton 40 mm AA guns; high quality precision workmanship. Overall size: 12" long x 5 1/2" wide x 6 1/2" high. Shipping wt. 20 lbs. Govt. cost more than \$300.00
BRAND NEW... \$29.95



Pioneer sensitive altimeters. Range 0-35,000 ft., calibrated in 100's of feet. Barometric setting adjustment. No hook-up required... for auto or aircraft installation.

Used, Good \$12.95



U. S. Navy surplus altimeters. Range 0-10,000 ft. Adjusts to sea level setting of terrain. Requires no hook-up for auto or aircraft installation.

NEW \$7.95

All Equipment F.O.B. Pasadena • Enclose Full Amount With Order

C and H Sales Company

Box 356-MJ • East Pasadena Sta. • Pasadena 8, California



CAPE COD CHAIRS TRELLISES • ARBORS DUTCH WINDMILLS

Chairs style B-C-A PLANS 50c Ea., all 3 only \$1.00. 12 different Dutch Windmill Detailed PLAN only 75c. Unique 40" high Light-house having copper lantern, ideal for garden or on lake shore of summer home. Large detailed PLAN 75c.

SPECIAL ALL PLANS ABOVE \$3.00 VALUE ONLY \$2.50

SEND 10c for catalogue of many fine projects.

Dept. P41
CRAFTSMAN'S MODEL CO. DELAFIELD, WISCONSIN

Expert's Painting Tips - FREE

Lifetime of experience with aluminum paint, yours free — write for free 24-page illustrated book. Tells how to buy and apply right kinds of aluminum paint. We don't make paint but have prepared this to help you get best results. Just write for "Paint it Bright."

ALUMINUM COMPANY OF AMERICA,
1718F GULF BLDG., PITTSBURGH 19, PA.



MAGNETS OF ALL TYPES — 10c UP

AMAZINGLY POWERFUL!!
1/2 lb. magnet lifts 25 lbs. \$1.95.
Our Leader, 1 lb. magnet lifts 40 lbs. \$2.95. New alloy—will not weaken!
Useful for lifting valuables from tanks, lakes, or rivers easily! 7 small magnets \$1.25 with list of many shop and home uses. Satisfaction guaranteed.
R. EYRICH, 1219 W. MEINECKE AVE., MILWAUKEE, WIS.

NEW! NON-FOULING SPARK PLUG for

AUTOMOBILES • TRACTORS • TRUCKS
LIGHTING PLANTS • POWER MOWERS
MARINE ENGINES • OUTBOARDS

Amazing New CIRC-O-FIRE "360"

Lasts Longer! Fires in a Circle!
Permanent Gap! Self-Cleaning!
Improves in Use!

SEND FOR YOUR SET NOW!
Include Make-Model-Year-
Number Cylinders

SEND NO MONEY-PAY C.O.D.



95¢

each in
sets of
6 to 8!

Write for
FREE
Literature!

2413 DENTON AVE.

CIRC-O-FIRE SPARK PLUG CO. DETROIT 12, MICH.

OVERHAUL YOUR MOTOR in 10 minutes



THE AMAZING MOTOR "RENEW" KIT

- INCREASES COMPRESSION
- STOPS PISTON SLAP
- STOPS OIL BURNING
- FREES VALVES, RINGS AND PISTONS

PREPARE NOW FOR SUMMER DRIVING!

RENEW WITH "COMPRESSION SEAL!"

This proven motor treatment gives up to 15,000 miles of powerful, knock free performance to any car. Squeezed into cylinders, it forms a long wearing, lubricating seal by filling in worn places between cylinder walls and pistons. This increases engine compression, cuts oil and gas waste and eliminates the need of costly overhaul and ring jobs.

CLEANSE WITH MOTOR "PURGE" FORMULA!

Your engine will run smoother, cooler and more efficiently once flushed with Motor "Purge". When poured into cylinders it cleans, quiets and frees rings, valves and pistons from gums, carbons and varnish.

A MOTOR "RENEW" KIT TREATMENT... REVITALIZES AND INCREASES THE LIFE OF ANY ENGINE!

FREE AUTO MANUAL WITH EACH ORDER!

Manual tells how to save gas, oil, brakes and tires through simple economy secrets... introduces many new products.

FULL 10 DAY "MONEY BACK" GUARANTEE! **\$6.95** (Post-paid \$1 C.O.D. deposit)

DEALER INQUIRIES INVITED! Kit treats all 4, 6, 8, cylinder cars up to 1947.

8 cyl. cars from '48 to '52 require a DUAL KIT, \$11.90 ppd.
CONSOLIDATED ENGINEERING, Dept. PMK-6
10407 W. Washington Blvd., Culver City, Calif.

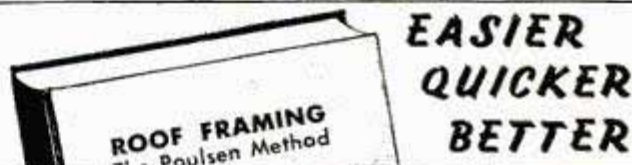

EASIER
QUICKER
BETTER

ROOF FRAMING

Rafter Length and Cuts Without Use of Square!

Lay out any type of roof more accurately and in only one-fifth of the time required by other methods. Get the **POULSEN METHOD OF ROOF FRAMING**. It will save your time and make money for you. Valuable tables — 54 of them — starting with one-quarter inch rise per foot of run — simplify all roof framing problems. Tables give common, hip, valley and jack rafter length and necessary cuts in a jiffy without calculation. Learn also how to measure rafters from top and edge — definitely and accurately. No need to bother with centers and making adjustments for cuts.

Money Back Guarantee

Clip this ad and send with your name and address and \$3.00 for your copy postpaid today. Money back if not fully satisfied.

For Amateur and Professional

Every handyman, repairman, amateur carpenter and professional builder needs this **POULSEN METHOD** book. It saves four-fifths of all roof layout time and labor. Everything is already worked out for you in simple, easy-to-use tables. Cloth bound. Book has 90 pages and many illustrations. Besides the tables it contains every other bit of roof information a carpenter, whether amateur or journeyman, should have.

POPULAR MECHANICS PRESS

DEPT. RF

200 E. ONTARIO ST.

CHICAGO

SOUTH BEND LATHES • SHAPERS DRILL PRESSES



Send for catalog on Lathes (9" to 16-24"), Shapers or Drill Presses. **SOUTH BEND LATHE** South Bend, Ind.

DUST-O-VAC

FOR HOME WORKSHOP & INDUSTRY

FOR ALL MACHINES — Collects & Bags Wood & Plastic Chips, Wood & Metal Dust, Wood Shavings. 110 AC, DC. SEND FOR FREE LITERATURE. **\$1995**

HEAVY CAST ALUMINUM BLOWER — ONLY \$11.25 For workshop, lab., kitchen, cellar, app. 100 CFM. Send for circular. **UNIVERSAL YONKERS CORP.,** 137 ALEXANDER ST., M-6, YONKERS 2, N. Y.

Make Money SELLING Eshelman Tractors and DOING GARDEN WORK

ESHELMAN FOR BETTER LAWNS and GARDENS also POWER MOWERS and RIDING TRACTORS Women can operate it.

Low as \$95 PLUS TOOLS

Also Power Reverse 1 1/2-3-6 H.P. Free Catalog. Write **ESHELMAN CO.,** Dept. 310, 119 Light St., Balto., 2, Md.

PLOWS CULTIVATES HARROWS HAULS SPRAYS SAWS DOZER MOWS CUTS ROLLS RAKES

SANDEE SPORTONE MUFFLERS

Ford & Chevrolet.....	\$ 4.45
All other popular cars.....	5.45
V-8 Dual Sets.....	15.95
Chromed Silents.....	2.95

(Please state make & year of car on all orders.)

SANDEE MUFFLER CO., 5643 Corryne Place • Culver City, California

YES! SEND

directly to my door every month

I am enclosing

\$3.50 for 1 year

\$8.00 for 3 years

name _____

address _____

city _____ zone _____ state _____ A-62

Hand this order to your newsdealer or send it to

POPULAR MECHANICS
200 East Ontario St. Chicago 11, Ill.

ARE YOU The "Take a Chance Type?"

If so don't read any further. This AD is only intended for car owners too smart to be caught short, on a LONELY road, after dark, miles from nowhere, with IGNITION TROUBLE. This COULD happen to YOU. Would you spend \$1.69 to get out of such a JAM? Why not prevent it by carrying a "ROAD DOCTOR" in the glove compartment — requires less than 1 minute to install. Be safe, not sorry—ORDER ONE TODAY. Satisfaction guaranteed or money refunded.

THE ROAD DOCTOR, Phila. 5, Penna.
Branch #4, P. O. Box #447

FIRST AID... for CLOGGED OR SLUGGISH SEPTIC TANKS

15,000 Dealers Coast-to-Coast
Write for Free Bulletin "Care & Treatment of Septic Tanks"

CAMP Chemical Co., Inc. BROOKLYN 15, N. Y.
World's Largest Mfrs. of Sewage Chemicals

DEPENDABLE CRAFT SUPPLIES

LEATHER CRAFT • PLASTICS • POTTERY CRAFT • BLOCK PRINTING • BELT CRAFT • TEXTILE COLORS • POWER TOOLS • WOOD BURNING • INSTRUCTION BOOKS • ETC.

DWINNELL CRAFT SHOP
Dept. PM-652—Wheeling, W. Va.

WRITE FOR CATALOG SINCE 1928

NEW SAW SHARPENER

Improved #64 Hand Gummer sharpens all types circular saws 4" to 20" diam. Ideal for saw shops. Self-Centering adjustment for quick, easy set-ups. Complete with 1/4 HP motor, 1 grinding wheel & cord, \$79.50 FOB Portland. Wt. 70#* SEND FOR FREE LITERATURE.

P. T. HOBBS MACHINERY
8375 N. INTERSTATE AVE.
Dept. P.M.-61, PORTLAND 17, OREGON

AXLE ASSEMBLIES

MODEL 1UCO

Ideal axles for farm implements, carts and trailers of all kinds

Solid steel construction with springs and saddles—U-bolts and shackles—spring bolts and brackets—hubs and bearings and 15" or 16" Wheels—shipped complete, ready for use

\$65.29 Less Tires F.O.B. Factory

HAMMER BLOW TOOL COMPANY Wausau 13F, Wisconsin

DRILL STRAIGHT HOLES INTO WOOD WITH NEW ELECTRIC DRILL ALIGNER

You can drill a straight, perpendicular hole with any electric hand drill using a Jedco Drill Aligner. Give your electric hand drill the precision of a drill press. Sent complete with precision bushing holder, 5 hardened steel drill bushings for 1/4-5/32-3/16-7/32-1/4 drills. Full price only \$2.95 postpaid. Money back guarantee.

J. E. DUNNING COMPANY
Dept. PM,
14547 S. Madison Ave., Cleveland 7, Ohio

"PERSONALIZED"

CLOTHES MARKER

For Campers . . . Travelers
ORDER NOW FOR CAMP SEASON!

Prevents mix-ups, easy to use, stamps on clothes or make your own name tags. Useful for campers, students, servicemen, travelers. Reg. \$2.00 value . . . complete kit includes name and stamp, ink pad, streamlined plastic holder and 5 yr. ink supply. **\$1.00**

MONEY BACK GUARANTEE
CHESSMAN COMPANY, Box 965, Dayton 1, Ohio

BUY DIRECT

MASTER MECHANIC

UP TO 85% DISC.



Portable LIGHT PLANT

PUSH BUTTON START
500-700 watts 110-120 v. — 60 cyc. A.C. Powered by a sturdy dependable, easy starting, air cooled 1 3/4 hp. gas engine. No wiring necessary, just plug in and operate. Plenty of current for any oil burner, freezer, brooder, pump, emergency lights, etc. which require up to 700 watts. Ideal for Civil Defense, Fire Depts; trailers & camps. Complete with Voltmeter and built-in winding to charge 6 v. auto batteries. Wt. 85 lbs. Fully guaranteed. Be prepared if war or storm knocks out power lines.

(Item 24) Reg. \$275.00 value. **\$143.50**
700-800 Watt Plant (Item 44) Same as above but greater output. **\$169.95**
1000-1200 Watt Plant (Item 45) same as Item 24, but larger generator & engine. **\$199.50**

GIANT 2000-2500 WATT PLANT

(Item 31) 110-120 V. 60 cyc. A.C. Absolutely the best made—exclusive dynamically balanced armature; heavy windings develop up to 5000 watt overload for motor starting. Skid-mounted — portable. Powered by easy starting Briggs or 6 hp. Wisconsin engine — complete with all accessories: engine easily disconnected for other uses. Big outlet box, voltmeter, no wiring necessary. Ample current for all purposes. Factory warranty and instructions included. Wt. 220 lbs. Reg. \$885.00. Special at. **\$299.50**
With Electric Self Starter (Item 179) **\$359.50**
GENERATOR ONLY and control box. Drive it with your engine or tractor. **\$169.50**
TRANSFORMERS—(Item 197) Convert 110 v. A.C. to 220 v. Capacity 2 kva. Simple hook-up. Regularly \$55. Our price—when purchased with light plant. **\$27.50**
Purchased separately \$34.50.

3000-3500 WATT PLANT

(Item 198) 110-220 v.—60 cyc. A.C. with Wis. Engine, push button start. Wt. 370 lbs. Heavy duty. **\$399.50**
Generator only for belt drive, Wt. 115 lbs. (Item 198A). **\$239.50**

HI-LINE 6000 WATT PLANT

(Item 162) Push Button Start, 115-230 v. 60 cycle A.C. A brute of a power plant with a rugged 13 hp. Wisconsin engine. Plenty of electricity for fans, water heaters, freezers, pumps, machinery, etc. Affords both 110 and 220 volts. Ideal where heavy current is needed. Wt. 590 lbs. Easily worth \$995.00. With self starter. **\$645.00**
Factory Spec. **\$345.00**
Generator and control box only, belt driven. Use your engine or tractor. Wt. 240 lbs. **\$345.00**

Buy Wholesale—Direct From Factory—World's Largest Direct Sellers of Light Plants.

You can pay more — but you can't buy better
STANDBY POWER CONTROL
(Item 207) For hospitals, radio stations, fire depts., etc. Automatically starts light plant when power fails. Available for all our plants. From \$59.50 to \$99.50.

MASTER AIR COMPRESSOR

(Item 209) High pressure type for large volume of air for heavy duty service. For paint spraying, inflating truck and auto tires, greasing, and the hundreds of other jobs done by compressed air. Piston type. 2"x2" compressor with built-in air filter, master built with hi-strength alloys and precision bearings. Stainless steel tank, 12" x 24", 2100 cu. in. cap. Safe up to 500 lbs. Equipped with automatic switch that starts and stops motor to maintain desired pressure (up to 150 lbs.) and check valve, safety valve, gauge, shut-off valve, 20 ft. air hose and tire chuck. Beautifully balanced on ball bearing wheels and rubber tires. Note low factory prices. With 1 1/2 hp 110 v. A.C. motor. Reg. \$175.00 (Item 209). **\$98.50**
With 1/2 hp motor (Reg. \$199.50) (Item 209A). **\$119.50**
With 2 hp Briggs Gas Engine (Reg. \$199.50) (Item 209B). **\$109.50**
Compressor only (2"x1 3/4") (top quality) (Item 209C). **\$20.50**
Larger Compressor (2"x2") (none better) (Item 209D). **\$24.50**
Giant Compressor (twin 2 1/2"x2 1/2") (Item 209E). **\$54.50**
A complete line of spray guns and air tanks available at factory prices.



IMMEDIATE DELIVERY—ALL ITEMS

HEAVY DUTY D-C ARC WELDER



Use as portable or shop welder. Up to 300 amps. Senior model. Made for years of trouble-free, continuous service. Will handle light or heavy jobs. Easily welds up to 1/4" plate using 1/4" rods. Built-in air-cooling system and hold, because of specially designed arc stabilizer. Hi-lo switch and dial control gives wide range of welding heats. Run welder at 2600 rpm. with tractor, jeep or 15 hp. gas engine, or 7 hp. elec. motor. Complete with instructions, gear, and double V belt or flat pulley. You can pay more, but you can't buy a better welder. Wt. 110 lbs. \$400 value at. **\$99.75**
DUAL CONTROL MODEL same as above but with built-in dual rheostat for low heat soldering, brazing, welding. Spec. **\$119.50**
WELDING KIT. Two 10 ft. leads, welding helmet, electrode holder, ground clamp. Sold only with welder at. **\$10.50**

EXTENSION CORD

(Item 16) 40 ft. heavy duty, made of specially insulated No. 14 2-conductor wire. So tough that you can drive over it and yet flexible and easy to handle. Resists oil, grease or water. Extends electricity up to 400 ft. without voltage drop. Use indoors or out. Complete with heavy rubber plug and outlet. Wt. 2 1/2 lbs. Usually \$4.50—Special 40 ft. **\$1.99**
Combs: 2-40 ft. and 1-20 ft. (total 100 ft.) **\$4.95**
100 foot length (one piece) **\$4.85**
WIRE ONLY (Item 50) No fittings, 100 ft. **\$4.00**

HEAVY DUTY POWER CABLE

#12-2 Cond.—stranded, very flexible, rubber covered, special outside conductor for grounding power tools, etc. Finest heavy duty power cable made, U.S. Surplus. 50 ft. (Wt. 8 lbs.) Item 199. **\$6.95**
100 ft. (Wt. 16 lbs.) Item 200. **\$12.95**

Variable Speed Selector

Heavy duty, made by B. F. GOODRICH for industrial use. Provides instant speed changes for any drive. For machine tools, dryers, printing, conveyors, production lines, hoists—any operation requiring variable speed. Ideal for midgeet autos. Employs reliable "trouble free" planetary system. No hydraulic power losses or creeping. Infinite range, smooth operation, easy installation. 3 sizes: 1/2-1 hp. wt. 36 lbs.; 1-2 hp. wt. 55 lbs.; 2-3 hp. wt. 105 lbs. Reg. list \$228, \$252 and \$352. Brand new, in Goodrich boxes and guaranteed. Complete installation data included. Unprecedented surplus sacrifice **\$79.50, \$89.50 and \$114.50.**

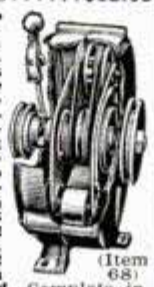

POTTERS WHEEL

(Item 47) Complete prof. equip. for making finest ceramics and pottery. New design, large, non-breakable, Alemite bearings. Large dynamically balanced cast-aluminum reversible turntable with variable speed drive (38 to 140 rpm) controlled by foot-pedal. Built-in adjustable arm rests, water cup and welding wire. 18"x18" enclosed throwing table—ample area for largest pieces. Reg. 1/4 hp. motor (not incl.). Complete with pulleys, belts and instructions. Wt. 26 lbs. \$145 value at. **\$59.95**
Westinghouse 1/2 h.p. motor for above. Wt. 27 lbs.—Item 47A. **\$19.50**



able turntable with variable speed drive (38 to 140 rpm) controlled by foot-pedal. Built-in adjustable arm rests, water cup and welding wire. 18"x18" enclosed throwing table—ample area for largest pieces. Reg. 1/4 hp. motor (not incl.). Complete with pulleys, belts and instructions. Wt. 26 lbs. \$145 value at. **\$59.95**
Westinghouse 1/2 h.p. motor for above. Wt. 27 lbs.—Item 47A. **\$19.50**

DUAL TUBE LIFE SAVERS

(Item 54) NEW APPROVED TYPE made by Genl. Tire for Navy. Each has 2 rubber tubes for double protection. Easily inflated by mouth \$145 value at. **\$5**
to 55 in. Wear one around waist as comfortable life saver. Adjustable safety buckles fit adults or children. Tie several together for raft or big luxurious mattress. Invaluable on boats or beach. Wt. 2 lbs. each. Our spec. (a fraction of cost) 99¢ each, 6 for. **\$5**

MALL ELECTRIC CHAIN SAWS

Amazing labor saver. Fells and cuts up 36" trees in minutes. Wonderful for pruning and trimming. Use portable light plant for power. Item 202, 12" Saw Wt. 12 lbs. **\$15.00**
Item 203, 18" Saw Wt. 20 lbs. **\$130.00**

SAVE ON CATALOG ITEMS

We have hundreds of bargains. Send 10¢ for catalog for information on following items: Trouble Lights, Air Tanks, Fire Extinguishers, Electric Hot Water Htrs., Rubber Hose, Electric Tools, A.C. Arc Welders, Sleeping Bags and many, many other useful articles.

MASTER GARDENER \$119.50

It's a lawn mower It's a plow
It's a power sickle It's a Snow Blow
It's a cultivator It's a rotary tiller
It's a bulldozer



Here at last is a power unit that does everything at a price that can't be matched. Built-in power takeoff to drive pumps, saws, generators, etc. Safety clutch—can't burn out. More versatile and efficient than tractors costing twice as much. Basic self propelled 2 hp tractor with Briggs or Clinton famous engine. Only **\$119.50**

Item 208
Rotary tiller. **\$42.50**
Plow. **\$15.00**
Sickle Bar-Mower. **\$42.50**
Cultivator. **\$ 8.75**
Bulldozer. **\$11.25**
Weeder (2-shovel). **\$15.00**
Lawn mower hitch (Utilizes any hand mower). **\$ 4.50**
Snow Blow. **\$71.50**
Freight prepaid to most areas. Easy payment plan available.

COMMANDO BIKE MOTOR

(Item 90) New, super-modern 1952 model. This job is the Cadillac of all bike motors. Sensational Auto-Clutch prevents killing motor at each stop. Also selects proper ratio on hills. Mounts behind and drives rear wheel with Dynastor. Free Wheel Mounting eliminates fumes, heat, dirt, and hard steering. Easily installed in 15 minutes with home tools. Sturdy, trouble-free, easy starting, light weight. Airplane type engine; up to 150 miles per gallon. Fully gaur. Ride for fun or profit. Ideal for deliveries, paper routes, messenger service, etc. Ride to work and save. Dealer inquiries invited. The Commando Captain. **\$99.75**
1 cylinder 1 1/2 hp. **\$125.00**
The Commando General, 2 cylinder 3 hp. (Item 91). **\$125.00**
All Commandos shipped prepaid in U.S.

32 pc. SOCKET SET

32-pc. Socket Set (Item 59) Highest quality guar. non-breakable sockets made by Husky. Best of U.S. matched chrome alloy, absolutely the best. Complete range of 21 sockets from 1/4" thru 7/16" in 1/4" drive and 7/16" thru 1-1/16" in 1/2" drive; 2 extensions, reversible 1 1/2" ratchet, adaptor bit, slide head, all angle coupling, 2 end wrenches, 1/2" speeder handle and sturdy metal tool box. For prof. mechanics who want the best. Wt. 11 lbs. Easily worth \$41.50. While they last. **\$16.95**



45 pc. SOCKET SET

(Item 205) Contains a complete set of sockets in 1/2" drive, 3/8" drive and 1/4" drive, plus all necessary extensions, handles, speeders, reversible ratchets, etc.; all uncond. guaranteed against breakage. Beautiful matched chrome thin wall alloy sockets in a sturdy handsome steel tool box. Wt. 17 lbs. List Price \$62.90. Factory Special. **\$26.95**

3/8" DRIVE 15 Pc. SOCKET SET

(Item 201) Same top qual. as above—includes 7 sockets 3/8" thru 3/4", reversible ratchet, extension, flex. handle, cross bar, 3 punches, metal tool box. Wt. 5 lbs. List Price \$18.95. Our Spec. **\$9.95**

HYDRAULIC JACKS

(Item 208) Heavy duty, precision built, smooth, positive acting with built-in relief valve. Hi-Lift with screw extensions. Govt. surplus at a fraction of orig. cost. (Handle included.)
1 1/2 ton (Item 208) **\$6.45**
Wt. 11 lbs. **\$9.45**
3 ton (Item 208A) **\$11.45**
Wt. 15 lbs. **\$11.45**
5 ton (Item 208B) **\$11.45**
Wt. 17 lbs. **\$11.45**

HEATING & VENTILATING FAN

(Item 10) Easily installed in furnace pipes. Forces even heat to all rooms. Over range, removes kitchen smoke and odors. Powerful continuous duty motor, 110-120 v. A.C. Quiet, super efficient fan moves huge volume of air (400 to 600 c.f.m.) 8" Fan, wt. 5 lb. **\$6.35**; 9" Fan, wt. 6 lbs. **\$7.45**; 10" Fan, wt. 7 lb. **\$8.45**; 12" Fan, wt. 8 lbs. **\$9.45**. Heavy-duty 12" fan, enclosed motor, suitable for spray booths, restaurant exhausts, poultry houses, and other difficult applications. Wt. 12 lbs. Item 10D. **\$12.65**



All items brand new. Prices f.o.b. Chicago area. 10 day Money back guarantee. Send check or M. O. **MASTER MECHANIC MFG. CO., DEPT. 73A Burlington, Wis.**

TERRIFIC HYDRAULIC BARGAINS!

Hyd. Cylinders



Brand new! Double acting, 3" bore, 8 1/2" stroke. Overall length 21 1/2" closed. Has adjustable dampener check valves built in at both ends, eye bolt mounting at base of cylinder. Will lift approx. 7000 lb. using 1000 PSI. Threaded for std. pipe. \$88 value. Wt. 10 lb. ONLY... **\$17.95**



Pesco Positive Displ. Hydraulic Pump

Gear type, No. 1P-349. Aircraft quality. Rated 1500 PSI, .227 cu. in. per revolution, 1 GPM at 1500 RPM. Operating speed, 3750 RPM, intermittent max. 4500 RPM. .65" dia. spline shaft. Rotation either direction with slight adjustment. 3/4" pipe ports. Has mtg. flange with 4 bolt holes. Size, 5-9/16" x 3 1/2". Used, guaranteed serviceable. **WT. 4 lb. ONLY... \$7.95**

Stratopower Constant Displ. Heavy Duty Pump

For operating hyd. cylinders, hyd. motors on tractors, bulldozers, construction machinery, lift trucks.



\$9.95

For fuel or oil transfer, industrial applications, etc. Delivers up to 120 GPM at 1500 RPM. Rated 1400 PSI at max. 4500 RPM. Has built in relief at head. Rotation either direction without adjustment. \$100 value. Used, but tested, guaranteed serviceable. Wt. 7 lb. ONLY...

Brand New Differential Hoists



Ideal for warehouses, shops, farm, garage. Handy, portable. Holds load at any point, will not self-lower. Have high tensile metal frames, finest elec. welded chains, heavy sheaves, drop-forged H.T. hooks. Lower sheave and hook equipped with bearings. 1/2 ton, **\$20.60**
1 ton, **\$31.00**

Spur Gear Hoists

Features: Elec. welded, H. T. chain, drop-forged, H. T. hooks, detachable shackles, load chain guard. Adjustable hand chain guide, forged steel crossheads, heavy steel gear cover. Rebuilt, guaranteed.

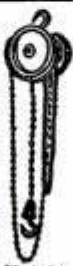

1 ton, wt. 110 lb. **\$59.95** up
2 tons, wt. 235 lb. **\$89.95** up
3 tons, wt. 230 lb. **\$99.95** up

In stock, Differential Hoists, 1/2 to 2 tons. Spur Gear Hoists, 1/2 to 20 tons. We Repair, Rent, Exchange hoists, also buy spare parts. Send us your hoist problems. No obligation.

PUROLATOR OIL FILTERS



Permanent Type

Brand New! # G 159J-40. The perfect filter to keep motor oil or hyd. fluid clean at all times. Protect your pump, engine, midge- et racer or boat with this unit. Just turn handle and element is clean. Inlet and outlet ports take pipe or straight threads up to 3/4". Accommodates 16 GPM at 30 PSI. Mtr. bracket. Shpg. wt. 4 lb. \$13 val. **\$3.95** use. NOW... FREE! 2 male Reducer Connectors given with every Filter.

WHIZ brand Liquid Metal Polish. Pt. can, 25c. 5 cans, 99c. Quantity buyers, write for discounts.



AVIATOR'S OXYGEN OUTFITS

Brand New! Bail out type. Consists of all metal tank, brass release valve, 0-3000 lb. gauge and breather hose, all enclosed in khaki colored canvas bag. Tanks are charged with breathing oxygen at 1800 lbs. pressure. Ideal emergency oxygen supply for airmen, mountaineers, firemen, paint shop workers, diving outfits, etc. Shipping weight, 4 lbs. **NOW ONLY... \$5.95**

Aviator's Oxygen Mask—Demand type. Type A-14. 24" rubber tube. Brand New! Only... **\$1.95**

6 VOLT WILLARD WET CELL BATTERY

Brand New! Made by Willard. Extra long life. Rechargeable. Ideal for radios, boats, autos, etc. 3 cells of 2 volts each. 1 1/2" high ball float hydrometers built-in each Lucite case. Shipped dry.. Size, 7 1/2" x 2 1/2" x 6". Shpg. wt., 6 1/2 lb. **ONLY... \$6.75**



ORDER FROM THIS AD! Prices F.O.B. St. Louis, Mo. Include postage with check or Money Order. **MONEY BACK GUARANTEE!**

Edw. Aguado Trdg. Co.

689-J Arcade Bldg., St. Louis 1, Mo.

SAY YOU SAW IT IN POPULAR MECHANICS

It's NEW, BIGGER, Better The DELTAGRAM...

• 6 GREAT ISSUES Only \$1.00 •

Priceless information at a wonderful bargain price—The New, Bigger, Better Deltagram!—With more than 100 shop-tested projects, complete plans, "how to do it" instructions—6 times yearly all for only \$1. Nothing like it at any price!



Subscribe now... write to **DELTA POWER TOOL DIVISION** Rockwell Manufacturing Company 502F N. Lexington Avenue Pittsburgh 8, Pennsylvania

DYNAMIC POWER TOOL COMBINATION



INCLUDES: Cummins 1/4" Electric Drill; Cummins Saw Attachment; Combination Saw Blade; Set of Drills; Lambs Wool Bannet; 6 Sanding Disks; Steel Arbor and Attachments; Cloth Buffing Wheels; Grinding Wheel; Wire Wheel Brush; Steel Paint Mixer; Steel Bench Stand; Portable Steel Carrying Case.

Price of Dynamic Power Tool Combination complete is \$26.95

SHIPPED ON APPROVAL NO MONEY WITH ORDER - NO C.O.D.

Try it ten days before you buy. If completely satisfied then send \$2.95 and pay balance at rate of \$4.00 per month for 6 months—No Interest or Carrying Charges Added, if not completely satisfied, return to us, no explanation necessary.

KAPNER HARDWARE, INC.

Dept. A-35, 2248 Second Ave., N. Y. 29, N. Y.

CASH IN YOUR SPARE TIME!

BIG MONEY IN OWN BUSINESS



YOU CAN MAKE UP TO \$40 A DAY sharpening and setting circular saws for factories, builders, lumber yards—with

NEW BELSAW COMPLETE CIRCULAR SAW SHOP. Low Cost, only \$15 down, sharpens 4 to 5 saws an hour. No experience needed! Instructions Furnished. Send Postcard Today for FREE BOOK. BELSAW MACHINERY CO 3704 Field Bldg. Kansas City 2, Mo.



Clark EXPANSIVE BIT

CUTS BETTER • COSTS LESS!

Accurate, fast; cuts smooth holes in hard or soft wood. Chrome vanadium steel blades, all chrome body. No. 250, 1/2"-1 1/2", \$1.89; No. 251, 7/8"-3", \$2.19. **GUARANTEED.** At your dealer or write Dept. PM6

ROBERT H. CLARK COMPANY • Beverly Hills, California



make your own Gems 29.50 F.O.B.

All necessary lapidary equipment is furnished, including a super-charged diamond blade for sawing, and all wheels for grinding, shaping and polishing; also complete instructions. The complete equipment as shown, less motor and belt, for only \$29.50, f.o.b., Burlington, Wisconsin. Write today for information and literature.

B & I MANUFACTURING CO.

Dept. S Burlington, Wis.



Find HIDDEN TREASURES

GEIGER COUNTERS for Uranium Detection. (see at left). **TREASURE DETECTORS** for gold, silver, etc. Lightweight, ultra sensitive. None finer at ANY PRICE.

Information FREE.

Detection Co.

5631 Cahvenga, No. Hollywood, Calif.

HELPFUL BOOKS

Send post card asking for FREE catalog

Popular Mechanics Press, 200 E. Ontario, Dept. 601, Chicago 11

HOBBYISTS! SHOPMEN! Special ONLY \$54.50

PALMGREN "HOBB-E" Rotary, Index, Milling Table Ideal for Model Parts or Shop Work

Mill-Grind-Drill-Index-Rout curved or straight-Rabbit and Mortise on drill press or lathe. 8" Table, 4" Cross Feed, 360° Rotation, Accurately Graduated. Bolts to table. Order NOW! SAVE \$100. Only \$54.50. Less Rotary Feed \$43.75. Write for "HOBB-E" Tool Circular.

CHICAGO TOOL AND ENGINEERING CO. 8365 South Chicago Ave. Chicago 17, Ill.



WELLWORTH BARGAINS — ALL NEW EQUIPMENT

the Big 3-Wellworth COMPRESSORS

2 compression and one oil ring. aluminum alloy connecting rod. Stainless steel valves with brass seats and retainers. Cool-flo cylinder head, spray mist lubrication to every moving part. V groove fly wheel. One year guarantee.

MODEL W200
2 1/2"x2", 2.55 to 4.80 c.f.m. up to 150 lb. pressure. Operates with 1/8 - 1/2 - 3/4 HP motor. Special Price... **\$27.95**

Wt. 24 lbs.

MODEL W7
2 cylinder 2 1/2"x2", 5.16 to 8.50 c.f.m. up to 150 lb. pressure. Operates with 1/2-3/4-1-1 1/2 HP motor. Special Price... **\$54.50**

Wt. 45 lbs.



MODEL W800, 2" bore, 1 3/4" stroke, 2 to 2.8 c.f.m. up to 150 lbs. pressure. Operates with 1/4 or 1/2 HP motor... **\$20.50**
Shipping wt. 16 lbs.

SPRAY GUN VALUES



W103
External atomizing. Flat and round spray. Qt. cup. Maintains 35 to 40 lbs. at 2 to 4 c.f.m. working pressure. Filter built in handle. Wt. 6 lbs.... **\$9.95**



W28
2-way, internal & external mix. 4 nozzles, 2 fluid tips. Requires 2 to 4 C.F.M. at 30 to 50 lbs. pressure. Qt. Cup. Wt. 6 lbs. List \$18.50. **\$12.95** —Only..



PORTABLE AUTOMATIC COMPRESSOR UNIT
1/2 h.p., 2.8 c.f.m. at 100 lbs. pressure. 20 ft. hose & tire chuck. Wt. 90 lbs. \$175. List Complete as shown... **\$98.50**
Regulator gauge & filter... **\$8.95**

RED SEAL CONTINENTAL GAS ENGINE



1 1/2 HP with 6 to 1 reduction gear. Operates at 450 R. P. M.

For lawn mowers, scooters, garden tractors, pumps, compressors, generators, etc. List Price \$79.50. Shipping wt. 54 lbs. **SPECIAL PRICE \$47.50**

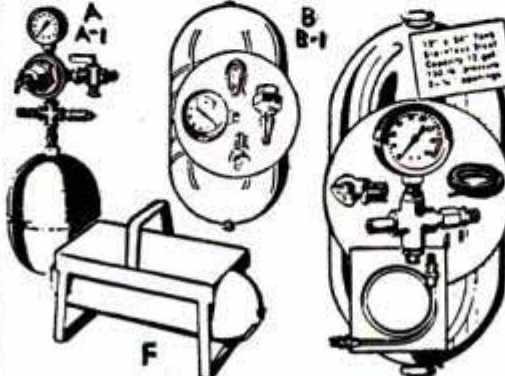

- A-8x5 1/4, wt. 2 lbs. 1.50
- A-1-8x5 1/4, with 1/4" regulator gauge, safety valve, shut-off cock, wt. 5 lbs. 11.95
- B-24"x6", wt. 7 lbs. 4.50
- B-1-24"x6", with comb. air gauge, and inflation valve for retaining pressure in tank, tire chuck, 3 ft. high test air hose, wt. 12 lbs. 7.95
- C-24 1/2"x12, stainless, wt. 20 lbs. 14.50

AIR TANKS

All New — Guaranteed
Models A, B, and C are rated at 500 lbs. pressure per sq. inch. Models D, E and F, 150 lbs. 1/4 in. standard pipe thread openings on ends as shown.

- C-1-24 1/2"x12, stainless with 20 ft. hose, air gauge, safety valve, copper tubing & fittings, air chuck, 4 way cross, wt. 25 lbs. **19.75**
- D-7"x25, welded tank, 4 openings, wt. 17 lbs. **9.75**
- E-14"x32", with 18"x8" base plate, and feet, 6 openings, wt. 60 lbs. **24.50**
- E-1-20"x48" A.S.M.E., 200 lb. working pressure, four 1/2" openings, wt. 225 lbs. **89.50**
- F-7"x25", with 7 1/4"x17" plate and feet, 4 openings **14.75**

WELLWORTH V-BELT CLUTCH

Takes starting load off engines or motors. When speed is reached, a flip of handle shifts clutch from idling to driving position. Handles "A" belts, 2.35" pitch diameter, 5/8" bore. Ideal for use with lawn mowers, garden tractors, home workshop motors, etc. 3 1/4" long. Safe, easy to mount, sealed bronze bearings, positive action. Shpg. wt. 3 lbs.



\$7.50

BUSHING FOR 1/2" SHAFT 15c
SAME CLUTCH FURNISHED **\$8.50** WITH 3/4" BORE

LIGHT PLANTS & GENERATORS

- \$375 Leland 2 1/2 to 3 KW generator, 135 lbs. **\$225.00**
- 2 to 2 1/2 KW light plant, wt. 180 lbs. **\$299.50**
- \$365 list. Special... **\$169.50**
- Generator only, wt. 75 lbs. **\$169.50**
- 500 WATT GENERATOR, wt. 55 lbs. **\$99.50**
- 5000 to 6000 W. GENERATOR, 110/220V. Wt. 225 lbs. **\$325.00**
- 5000 W. LIGHT PLANT, 110/220V. 60 cy. Wt. 575 lbs. **\$645.00**
- \$2000 Hobart light plant, 5 K.W. **\$895.00**

AIR COND. BLOWER BARGAIN

10" double wheel inlet, 1600 c.f.m. quiet operating, with belt and variable speed drive. Wt. 45 lbs. A real buy. Only... **\$30.00**
PRICES F.O.B. CHICAGO. MONEY BACK GUARANTEE. SEND CHECK OR MONEY ORDER TO DAY. PROMPT SHIPMENT. WRITE FOR OUR CATALOG. SEND 10c FOR POSTAGE

WELLWORTH TRADING CO. 1832 S. Wabash Ave., Dept. D-652, Chicago 16, Ill.



It's ready!
JUST ADD WATER

SAKRETE

PRE-MIXED CONCRETE & MORTAR IN A BAG!

© SAKRETE—P. O. Box 11, St. Bernard 17, O.

At Lumber, Building Material and Hardware Dealers . . .

BACK AGAIN BECAUSE OF POPULAR DEMAND!

INTERNATIONALLY FAMED SINCE 1925
PRECISION ENGINEERED NO MOVING PARTS



H. P. Jespersen
Automotive Engineer

THOUSANDS OF UNITS SOLD — FITS ALL CARS

GAS MISER

GUARANTEED

UP TO 300 GAS FREE MILES

OUT OF EVERY 1,000 DRIVING MILES



PLUS MORE POWER ✓ QUICKER STARTING ✓ KEEPS SPARK PLUGS CLEAN

MOTOR RUNS SMOOTHER ✓ LESS OIL CHANGE ✓

INVENTED BY H. P. JESPERSEN, FAMOUS AUTOMOTIVE ENGINEER. PROVED ITSELF TO SAVE CAR OWNERS HUNDREDS AND HUNDREDS OF DOLLARS ON GAS, AND GIVES THEM GREATER PERFORMANCE. JUST SLIPS INTO YOUR MANIFOLD INTAKE—WORKS LIKE A TORNADO ON GAS. BREAKING IT DOWN INTO A FINER MIXTURE.

AGENTS WANTED

ONLY **\$10.00**

Increases your mileage 10 to 30%

MAIL TODAY TO **P6**
AUTOMOTIVE SALES CLINIC
P. O. Box 448, Council Bluffs, Iowa

NAME _____
ADDRESS _____
CITY _____ STATE _____
Make of Auto _____ Truck _____

or Tractor _____ Model _____ Year _____

ENCLOSE CHECK SEND OR MONEY ORDER **C.O.D.**

HYDRAULIC Special

COMPLETE HYDRAULIC POWER UNIT!!



Complete hydraulic pumping unit. All necessary parts assembled & ready to work at a great saving in time and cost to you. Delivers 3 1/2 GPM at 1500 PSI at 1800 RPM. (other volumes and pressures can be obtained by simple adaptations) Unit consists of a gear pump driven by a 2 1/2 HP, DC motor (4000 rpm max.), relief valve, pressure-unloading switch, filter, accumulator, reservoir with sight gauge & complete plumbing. Mounted on 19" x 25" aluminum panel. Complete with 24V-DC motor (Other motors of any current rating can be adapted) **4995**

HYDRAULIC CYLINDER SPECIAL

Gives 20,000 lb. thrust (push-pull) using 1500 PSI line pressure as obtained from our hyd. pumps. Or will produce 40,000 lb. thrust with 3000 lb. line pressure. Can ALSO BE OPERATED ON LOW PRESSURE AIR SYSTEMS. 4" bore, 1 1/2" dia. piston shaft, 18" stroke, length: 30 1/2". Equipped with ball bearing loaded clevis type mounting and swivel type high pressure steel pipe bracket for easy use. Ideal for road, farm & shop machinery, presses etc. Cost gov't \$390.00 **2995**



No. 3 DOUBLE ACTION CYLINDER - Bore is 1" - Shaft is 1/2". Has a stroke of 2 1/2" to 4". Stroke can be adjusted with internal sleeve stops. Overall length is 8 1/2". Will take 1500 lbs. continuous duty. 3000 lbs. intermittent. Will lift or push up to 1100 lbs. **575**

We carry the World's largest supply of Special Hydraulic Equipment featuring over 20,000 cylinders in 61 sizes and types. Can also supply all accessories such as Pumps, Valves, Tanks, Hoses and Fittings. Write for information.



BENDIX HYDRAULIC PUMP AND MOTOR **1950**
Has 3 1/2 GPM capacity at 600 PSI. Motor is 1 1/2 HP, 24V, DC. Operates on either 12 or 32V, DC current. Has built-in relief valve adj. to 1500 PSI. This unit ideal for bait tanks, hyd. lifts, portable loaders etc. Cost gov't. approximately \$350.00.



VICKERS HYDRAULIC VARIABLE DISPLACEMENT PUMP GENERATOR
May be used as an elec. motor driven type pressure generator in an hyd. system where a varying volume is desired with a non-pulsating flow. Will give max. volume at pressure settings between 600 & 900 PSI by simple adjustment screw. Pump housing serves as reservoir for system. Has built in compressed air supercharger to make system independent of outside atmospheric pressure. Rotation, left hand only. Max. speed for continuous duty 3750 RPM. Displacement .484 cu. in. per revolution or approx. **3250**
4 GPM at 1750 RPM.

SAVE UP TO 85% ON WAR SURPLUS

ELECTRIC GYRO
Turns up to 50,000 RPM. Electric drive motor is integral part of balance wheel. Has double end shaft to drive precision tools or machinery at precise, controlled speeds. Ball bearing mounted. Runs on high or low voltage. Ideal for experimental work, labs, hobbyists, technicians, etc. **495**

3 SPEED TRANSMISSION
Converts a high RPM, low power input into low, RPM, high torque output. Has 2 take-off shafts at 4 to 1 & 16 to 1 ratio. Gear box has worm drive bronze gears & throw-out clutch. Will operate forward or reverse directions. Adaptable to many uses on power machinery. **1995**

90° TRANSMISSION
Has 1 1/2 to 1 gear reduction through bevel gears. Pre-lubricated bearings in dust proof housing. A positive lever controlled clutch. Size 7" x 6", 3/4" take-off shaft. **NOW ONLY 395**

180° OFFSET GEAR DRIVE
For use where high power at low take-off RPM is desired. Ideal for revolving radio or TV antenna etc. Has 85 to 1 gear ratio. Used New **675 1295**

HYDRAULIC HAND PUMP
Hand operated. Operating pressure 1000 PSI. Capacity 1.6 cu. inch per cycle. \$55.00 Value - **Only 1075**

AGASTAT TIME DELAY RELAY
Has 24v DC, energizing coil which operates a double pole, single throw relay switch. Holds circuit closed from fraction of second to 15 seconds by means of adj. set screw. Ideal for animated signs, displays, electric locks etc. **225**

MAKE YOUR OWN ARC WELDER
Use this top quality, precision built R-1 generator. An aircraft generator that originally cost the government approximately \$400. Gives 300 to 400 amps at 27 volts. Ideal to convert for all welding, light or heavy up to 5/8" thickness. Free conversion instructions with each unit. **2795**

OTHER AIRCRAFT GENERATORS
X-10 - 12 to 15 Volts 50 Amps \$12.95
X-11 - 27 VOLTS . . . 200 AMPS \$15.95
X-12 - 27 VOLTS. . . 100 AMPS \$25.00
X-13 . . . 27 VOLT. 140 AMP. **1695**
X-14 . . . 27 VOLT. . . 75 AMP. **1595**
Also available - complete DC Arc Welder. 300 amps continuous. 350-400 amps intermittent. Write today for details.

NEW ILLUSTRATED 230 PAGE - 1952 CATALOG

1000's of WAR SURPLUS, Factory Close-Outs and General Merchandise Values. For the mechanic, sportsman, hobbyist, home owner etc. BIG SAVINGS on clothing, housewares, hardware, foam rubber, hand & power tools, outdoor equipment, plastics, gadgets & a huge stock of hydraulic supplies.

Send Only 50¢ (for handling & mailing)

SAVE 85% ON WAR SURPLUS
PALLEY SUPPLY NEW MAIL ADDRESS 2263 E. VERNON AVE. Dept. PM-6 CO LOS ANGELES 58, CALIF.

GADGET MIXES
GADGET MIX - Rivets, Spacers, Bolts, Screws, Gears, Wheel bearings, Springs and Clamps. No. 106, 5 lbs. **1.19**

BEARING MIX. No. 170A. Approx. 20 needle, Ball & Roller Bearings, New & Used. Sizes: 1/2" to 4". Some of these cost Gov't \$100 a piece. Never such a value! 5 lbs. ONLY **1.59**

FILE MIX - Ten assorted Files - 4" to 12". Includes Vixens, half rounds, mills, bastards, etc. - in seconds and used but good condition. 1 Vixen alone is worth our price for entire mix. . . **99¢**

IMMERSION HEATER
Designed for installation in water base fluids, as in coffee urns, sterilizers, humidifiers etc. Has two copper-sheathed, tubular heat elements, silver soldered into head. A 3-heat type. 3000 watt. 230v, 2" pipe thread collar. **A PALLEY Value 1200**

WESTINGHOUSE AIR COMPRESSOR
1000's now in use for spraying, inflating, air tools, in garages, laboratories, shops & on trucks, tractors, jeeps, etc. Lightweight but powerful. Operates on 1/2 HP gas or electric motor. Runs either direction. Delivers approx 3.27 CFM at 600 RPM or 6.54 CFM at 1200 Rpm. Has 2" bore, 1 1/2" stroke. **2395**
We have motors, tanks and fittings to adapt this unit.

AIRCRAFT CABLE
Rust resistant, alloyed steel. Extra flexible. Pre-formed, 7 x 19 strand. On reels.
1/16" - 4 1/2 ft. (7x7) 7/32" - 10 1/2 ft.
5/64" - 5 ft. (6x7) 1/4" - 12 1/2 ft.
3/32" - 5 1/2 ft. 9/32" - 15 ft.
1/8" - 7 ft. 5/16" - 16 1/2 ft.
5/32" - 7 1/2 ft. 3/8" - 18 ft.
3/16" - 9 1/2 ft. 1/2" - 20 ft.
SPECIAL 3/16" cable, 18 feet long, with turnbuckle ends. . . **99¢**
Stainless Steel Cable - Pre-Formed
1/16" - 6 ft. 5/32" - 20 ft.
3/16" - 23 ft.
Bronze Cable - Not Pre-Formed
1/4" - 17 ft. 5/16" - 23 ft.
1/2" - 38 ft.

ELECTRIC MOTORS

606 - DELCO MOTOR
1/50 HP, 24v DC, 1.6 amp. turns 3000 RPM. Has adj. overspeed contactor to stabilize and control speed. Length 5 1/2". Diam. 3". **ONLY 495**

SAMSELL MOTOR.
27 volts, 16 amps, 1 1/2 H.P. reversible, series wound on motor. 3800 RPM, shaft 9/32" diameter. 12-spline. 4-3/8" x 2-3/8". **ONLY 395**

SURPLUS MOTORS
No. 500 - New 1/2 HP - 27 volt, DC-AC. This motor can be readily adapted to deliver up to 1/2 HP on 110 volts AC by the simple method of rearranging armature brush-leads. Free Diagram with each order. A SENSATIONAL VALUE. **595**

No. 500-A - Converted to 110 Volts, A.C. Equipped with plug and 1 1/2 ft. heavy duty cord. . . **849**

GEAR HEAD MOTORS
Heavy duty G.E. Gear Head Motor. 1 1/2 H.P., 24 volt D.C., 125 Amp. reversible motor will drive reduction gear box unit 40 to 1, resulting in 108 RPM at 5/8" diameter take-off shaft. Motor contains electro magnetic brake! **1095 MOTOR 495**

UNIT COMPLETE 1095 MOTOR 495
GEAR BOX ALONE 795

LEAR GEAR HEAD MOTOR - Lear 24 volt DC, 7.6 amp, series wound reversible motor with overload clutch. Motor turns 11,000 RPM driving thru a 10 to 1 gear reduction box which turns the final take-off shaft 1100 RPM. Adjustable limit switches control limit of travel. Take-off shaft adapts to flex or rigid drives. **1750**

ELECTRIC ACTUATOR
Hundreds of uses for any mechanical device needing controlled 2 way action. Opens, closes, raises or lowers doors... windows, gates, valves.
CTU-2 Foote Linear Actuator. 24V AC or DC, 8500 RPM, 1/8 HP - series wound motor. 4-1/2" stroke in 13-1/2 seconds. Compression & tension loads up to 750 lbs. Adjustable micro switch for limits of travel. Overall lgh. retracted 795 11 inches.

EA-E1 - EASTMAN ACTUATOR - Has a 1/8 HP, 24 volt DC, 10,200 RPM motor and push-pull actuator. Actuator has 4" travel through a reduction gear box. Has adjustable limit switches & forward & reversing relays. Overall lgh. extd. 20", retracted 15 1/2". **1295**

FIRE EXTINGUISHER
Kiddie Lux - CO₂ Type. Built to Gov't specifications. Heavy, shatter-proof case. Recent hydrostatic test. Reconditioned and fully charged. LIKE NEW! READY FOR INSTANT USE!!
2 lb. size with Swing Nozzle . . . 13.75
3 1/2 lb. size with Swing Nozzle . . . 17.95
7 1/2 lb. size with Horn 23.75
10 lb. size with New Squeeze Grip Handle & 3/2 ft flex hose with Horn. **29.75**
15 lb. size with Squeeze Grip hdl, 4ft. flex hose, plastic hom. . . **\$42.50**
15 lb. size with Wheel Control . . . **37.95**

Order From This Ad. Pay by M.O. or check. P.O.'s, except from D&B firms. Deposit with C.O.D.'s. All Prices FOB Los Angeles.

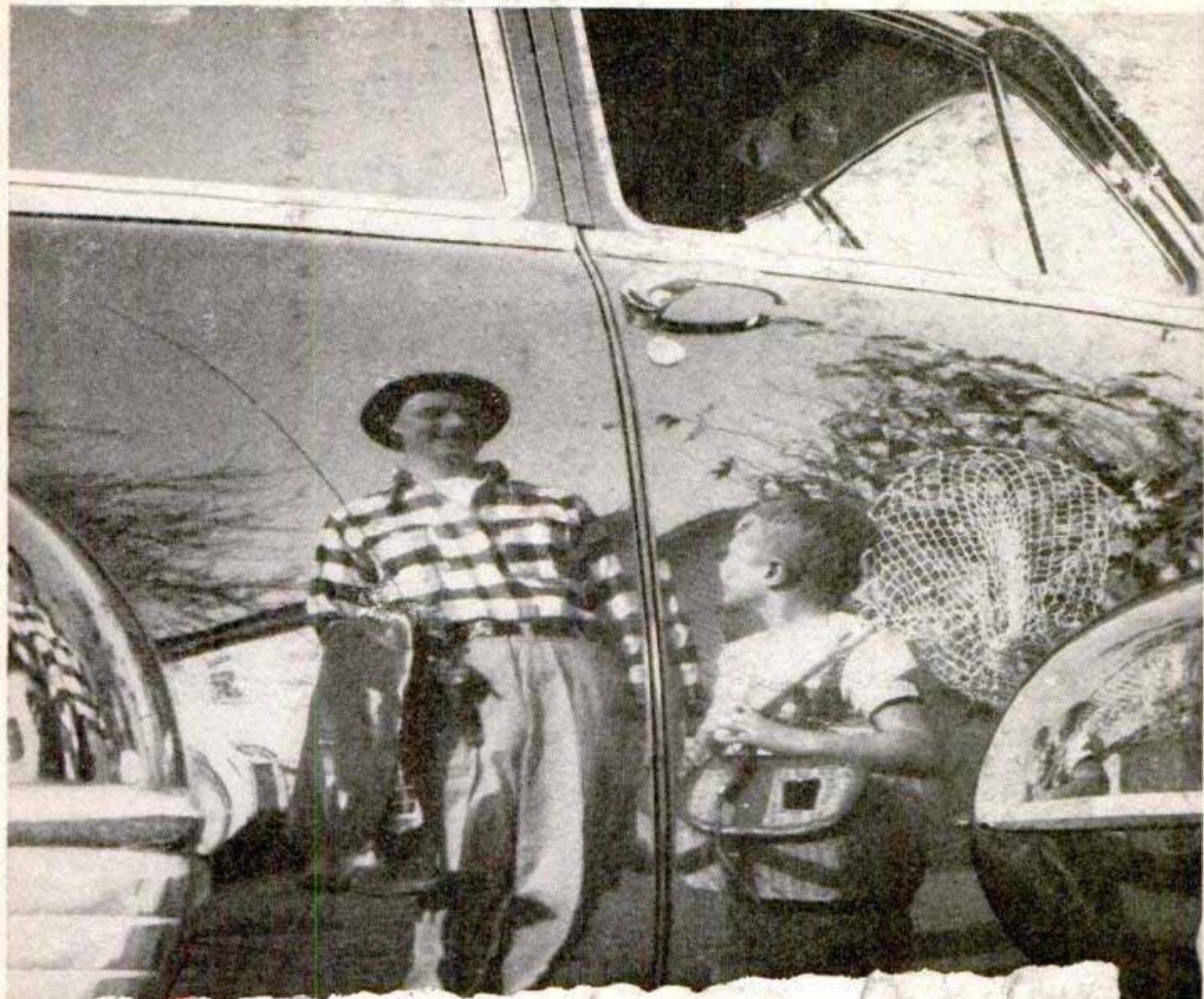

**Shine your car the easy way
...have more leisure time for play!**

SAVE TIME—CLEAN AND POLISH YOUR CAR IN ONE EASY OPERATION WITH ECONOMICAL DU PONT NO. "7" POLISH

Watch dirt film disappear... watch the brilliant shine come out on your car when you use Du Pont No. "7" Polish.

No. "7" Polish does both jobs at once—cleans and polishes—with *much less rubbing!* That's because it contains "methyl cellulose," the exclusive "stroke-saving" ingredient found only in Du Pont's patented formula.

You'll find No. "7" Polish makes polishing so much faster and easier, you'll have more time and energy left to enjoy your car.

*REG. U. S. PAT. OFF.

Patented Du Pont formula contains methyl cellulose—polishes faster with less rubbing



DU PONT NO. "7" POLISH

BETTER THINGS FOR BETTER LIVING... THROUGH CHEMISTRY

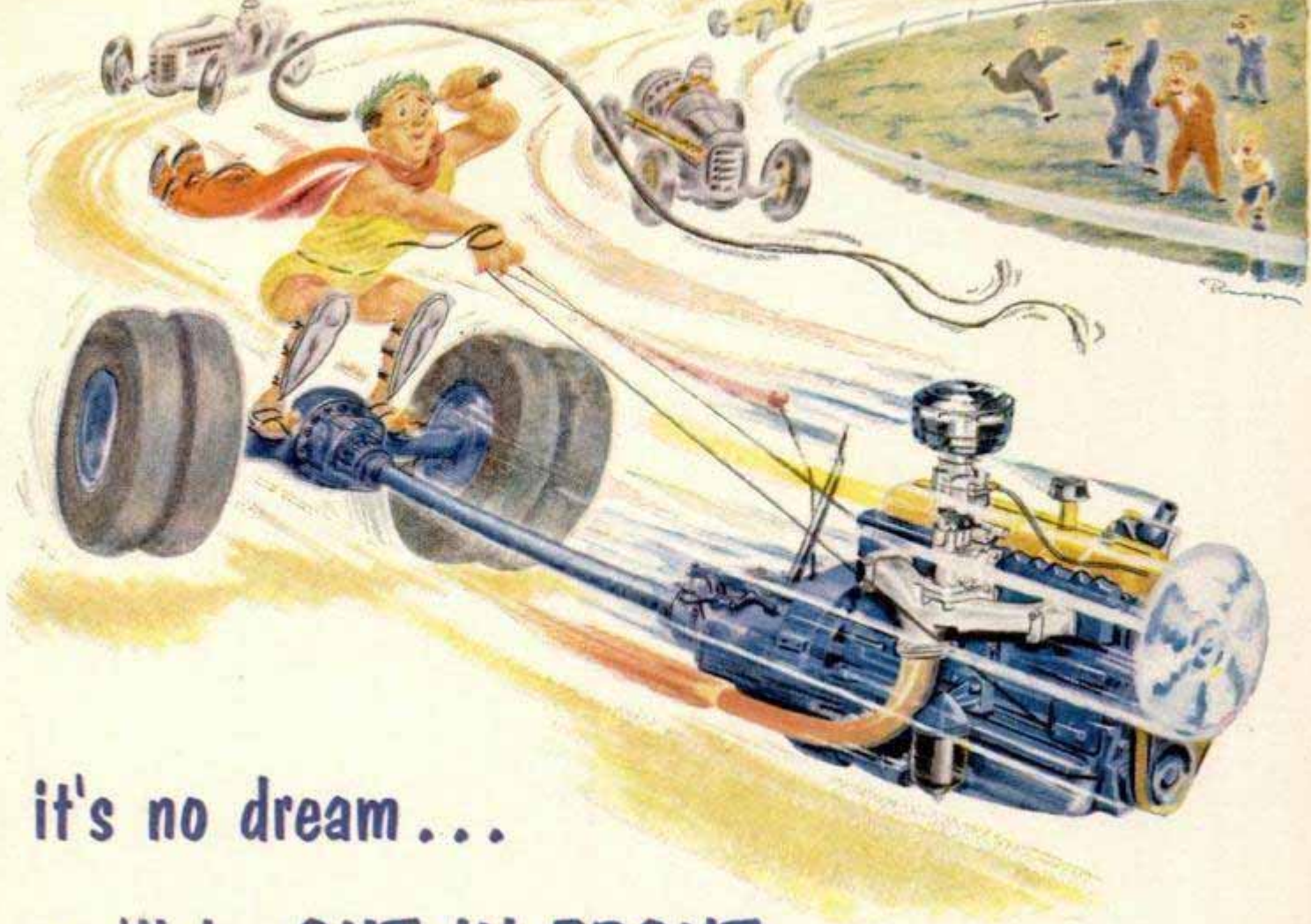

it's no dream . . .

you'll be **OUT IN FRONT,**

with a

REO

Gold Comet . . .

Tell the boss you want to try one. (All he has to do is phone his nearby Reo Dealer) . . . Then you'll both be out in front.

What an engine! Ask the next Reo driver you meet how he likes that steady, dependable *Gold Comet* power. He'll tell you Reo irons out the toughest hills, gives you more even weight distribution, better braking power and handles like a dream in the city or on the highway.

REO MOTORS, INC., LANSING 20, MICHIGAN

REO

Builds The
Amazing

EAGER BEAVER

Truck For The
U.S. Army.