



POPULAR MECHANICS

MAGAZINE

WRITTEN SO YOU CAN UNDERSTAND IT

REG'D. TRADE MARK, GREAT BRITAIN, No. 410426

See page 97



In This Issue

REVOLUTION ON THE FARM

an anniversary feature by Wheeler McMillen

For the Craftsman

HOW TO BUILD A MIDGET



Starliner "hard-top" convertible. Chrome wheel discs optional at extra cost—decorative and other specifications subject to change without notice.

Announcing
the newest of the new for '52

NEW 1952 STUDEBAKER

A NEW 120-HORSEPOWER COMMANDER V-8



A NEW CHAMPION IN THE LOW PRICE FIELD

NOW READY for you in refreshingly distinctive new beauty—the brilliant-performing Studebaker Commander V-8—the sprightly Studebaker Champion.

Vigorously sleek in every line—and impressively proportioned—these sparkling 1952 creations conform faith-

fully to the long established and unchanging Studebaker standards of designing for easy handling, easy maneuvering, easy parking and exceptional gasoline economy.

Stop in and see these wonder cars—newest of the new for '52—now on view at a nearby Studebaker showroom.

"It's Sensational!" SAYS GARY COOPER



SEA-HORSE
25

On location in Florida, Gary Cooper makes the 8-mile trip into the Everglades with a Sea-Horse 25—the outboard motor that modernizes water travel everywhere.

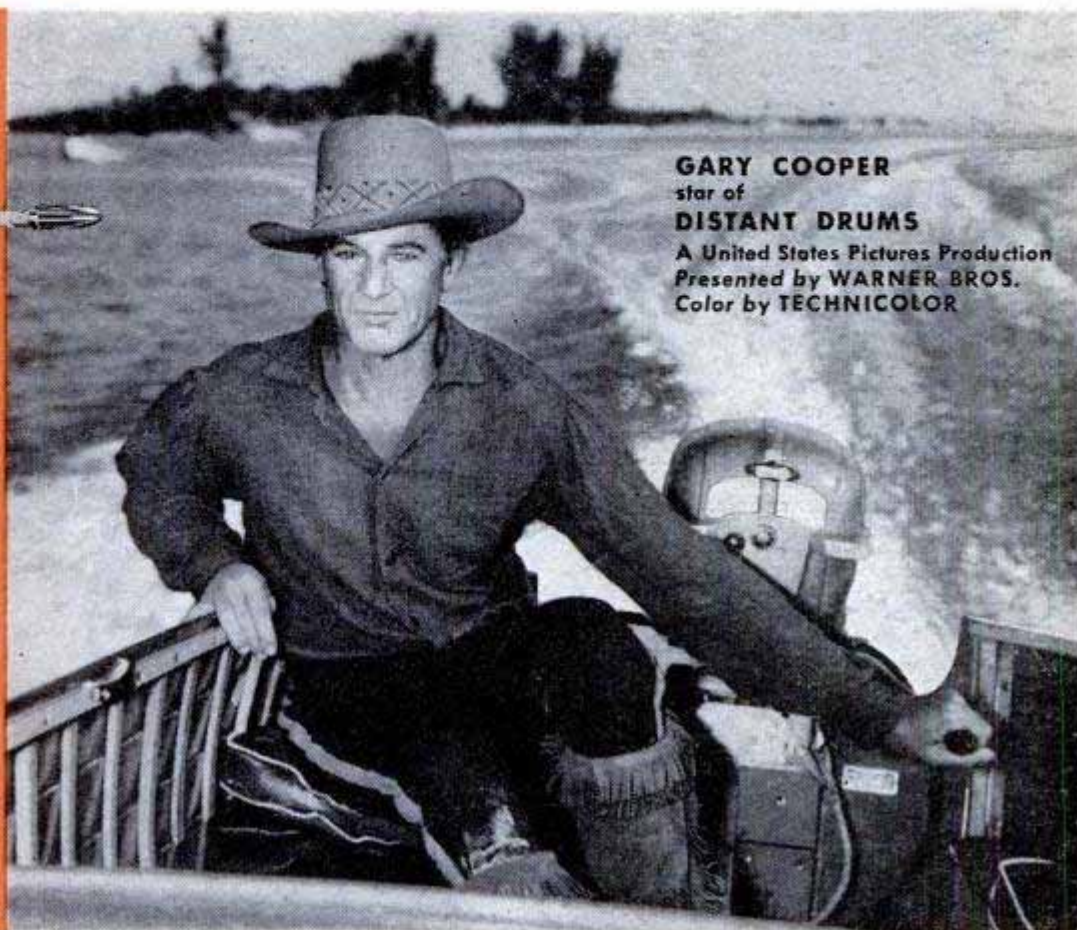

GARY COOPER
star of
DISTANT DRUMS
A United States Pictures Production
Presented by WARNER BROS.
Color by TECHNICOLOR



Here is **DEPENDable**, low-cost power for modern water transportation. Speeds over 30 mph—in a motor so beautifully engineered it *trolls!* Less than 4 lbs. per hp.! A brute for rough going and heavy loads, yet as easy to handle as a "5"! Features? The latest and the best: Gear Shift, Synchro Twist-Grip Speed Control, Mile-Master Fuel Tank with Ful-Vue Fuel Gauge. Adaptable to full remote control. Best of all, Johnson's big production makes this great motor available at only \$390*. See your Johnson Dealer. Look for his name under "Outboard Motors" in your classified phone book.

FREE! New Handy Chart. Describes the 4 great '52 models, including the *all-new* Sea-Horse 3. Write!
JOHNSON MOTORS, 400 Pershing Road, Waukegan, Illinois
Johnson Motors of Canada, Peterborough

- SEA-HORSE 3 — 3 H.P. Less than 30 lbs.! Amazing new Johnson Angle-matic Drive \$145.00*
- SEA-HORSE 5 — 5 H.P. Neutral Clutch.... \$187.50*
- SEA-HORSE 10 — 10 H.P. Gear Shift. Mile-Master Fuel Tank..... \$295.00*
- SEA-HORSE 25 — 25 H.P. Gear Shift. Mile-Master Fuel Tank. Synchro Twist-Grip Speed Control \$390.00*

All hp ratings OBC Certified brake hp at 4000 rpm. *All prices f.o.b. factory. Subject to change without notice.

Johnson
SEA-HORSES
FOR **DEPENDABILITY**

This One



1903 Barney Oldfield lowers track record at Indianapolis.



1909 Wright Brothers make new flight record.

1925

Popular Mechanics sensational Superheterodyne Eight.

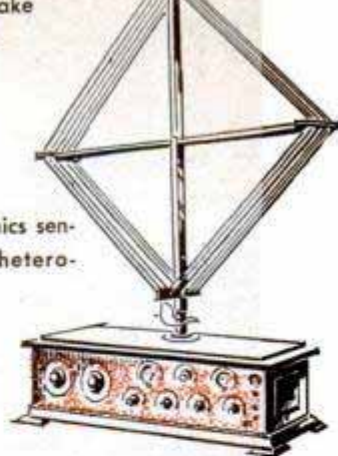

1944

The atomic powered auto.



Fifty Years of
POPULAR MECHANICS

19

An album of fascinating articles have appeared

Fifty Years of
POPULAR MECHANICS

A Book You Will Be Sure to Want . . . to Keep . . . to Treasure Forever

See It Happen All Over Again!

Thrill again as the years unfold in FIFTY YEARS OF POPULAR MECHANICS. See the great inventions and scientific developments of 50 fabulous years happen all over again in articles and pictures, prepared and first printed when the events took place. Thrill to the accounts of the first channel flight and the jet-propelled airplane . . . to the pedal-propelled submarine and to the terrifying atom bomb.

History-Making Inventions • World-Shaking Events

Live again from the days of the first motorized sewing machine to the age of nylon and cellophane. See the automobile emerge; the birth of the airplane, the phonograph, motion pictures, radio and television. Follow the scientific development of two world wars. Read the fascinating articles by and about such personages as Pierre Curie, Guglielmo Marconi, Jules Verne, Winston Churchill, Lammot Dupont, Thomas Edison, the Wright Brothers and hundreds of other famous people.

The Once-in-a-Lifetime Book

FIFTY YEARS OF POPULAR MECHANICS is without a doubt one of the most fascinating, informative and entertaining books you can own or give to others. It's a big book too—Size 8½ x 11 inches with 320 pages and more than 600 illustrations. The final chapter is devoted to things to come and a glimpse into fifty years from now. Price \$5.00. Order your copy, with your name in gold on the cover, today.

The Awe-Inspiring Story of American Progress Depicted in Memorable Pages from a Half Century of Popular Mechanics

Since 1902 Popular Mechanics has faithfully recorded and accurately reported, in word and picture, the greatest 50 years of mechanical and scientific progress in human history.

More than 150,000 fascinating pages have been printed. A selection of these pages, with explanations and comments printed in an extra color in the margins, has been put into a big 320-page book by Simon and Schuster, New York publishers. The title of the book is FIFTY YEARS OF POPULAR MECHANICS.

Here is a book you will want to own — to cherish and keep forever. Your name stamped on the cloth-bound cover without extra charge. Order on coupon below.

YOUR NAME IN GOLD ON THE COVER FREE — MAIL COUPON!

**POPULAR MECHANICS PRESS,
200 East Ontario Street, Chicago 11, Ill.**

Send at once ___ copies of FIFTY YEARS OF POPULAR MECHANICS at \$5.00 each, postpaid, with names stamped in gold. Remittance enclosed \$_____. (Please print name below exactly as you want it to appear on book. When more than one book is ordered use margin or separate sheet for extra names.)

NAME _____

ADDRESS _____

CITY _____ STATE _____

Popular Mechanics Magazine

Registered in U. S. Patent Office and Canada

H. H. WINDSOR, *Founder*

H. H. WINDSOR, JR., *Editor and Publisher*



this month's cover

WITH HER TUBBY BOW and squared-off stern she's far from the sleekest vessel in the Navy, but despite her weird lines she's a bravely determined craft. She's sort of a floating hotel-garage for miniature minesweepers. In the yawning cavity of her hull she carries up to 27 little boats, each fitted with minesweeping gear. On the edge of a mine field she slowly squats down in the water until she's half submerged, and the flotilla of babies comes sputtering out. These smaller craft form into echelons and sweep through the field, clearing paths for larger vessels to follow. Job done, they head back to the mother ship, swoop into the open stern and are tucked away in the huge room. As water flows out, the big vessel rises until the squadron in her belly rides high and dry. Then she steams away toward her next job. The story of this new seagoing "garage" and how she has helped the war in Korea begins on page 97

Published monthly by Popular Mechanics Company, 200 E. Ontario St., Chicago 11, Ill. H. H. Windsor, Jr., president; William Harrison Petridge, vice president; D. F. Windsor, vice president and secretary-treasurer; H. H. Windsor III, vice president; Clover L. Perkins, advertising manager; Alan M. Deyoe, circulation manager. Single copy in the United States and Canada, 35 cents; subscription rates in United States and possessions, Canada, Philippines and countries of the Pan-American Postal Union, 1 year \$3.50; 2 years, \$6.00; 3 years \$8.00. To all other countries add \$1.00 a year over United States prices for overseas postage. If you plan to move, notify us at least 30 days in advance so you will not miss an issue. Give both your old and new addresses. Entered as Second Class Matter, September 15, 1907, at the Post Office at Chicago, Illinois, under Act of March 3, 1879. Entered as Second Class Matter at Post Office Dept., Canada. Registered as Second Class Matter at the Post Office at Mexico, D. F., Mexico, June 20, 1950. Copyright 1952 by Popular Mechanics Company. Copyright under International Copyright Union. Copyright in France. All rights reserved under Pan-American Copyright Union. Printed in the United States of America.

FEBRUARY 1952

Volume 97 FEBRUARY 1952 Number 2

| | |
|---|------------------------|
| Managing Editor..... | Roderick M. Grant |
| Assistant Managing Editor..... | Wayne Whittaker |
| Shop Notes and Crafts Editor..... | James R. Ward |
| Radio-Television, Electronics Editor..... | Frank L. Brittin |
| Associate Editor, Aviation..... | Aubrey O. Cookman, Jr. |
| Associate Editor..... | Clifford B. Hicks |
| Associate Editor..... | Donald R. Brooks |
| Assistant Shop Notes and Crafts Editor..... | Wayne C. Leckey |
| Automotive Editor..... | Siler Freeman |
| Art Director..... | Frank Beatty |

| | | |
|--------------------------------------|--|-------------------|
| Assistant Editors | | |
| W. Clyde Lammy | Theodore A. Daum | Frank N. Stephany |
| Arthur R. Railton | Dorothy E. Hoffmann | Carlton H. Ihde |
| Eastern Editor..... | Richard F. Dempewolff | |
| | Empire State Bldg., Room 2906, New York 1, N. Y. | |
| Western Editor..... | Thomas E. Stimson, Jr. | |
| | 302 23rd St., Santa Monica, Calif. | |
| London Manager..... | Douglas W. Wedderspoon | |
| | 77 Baker St., London W. 1, England | |
| Director, Bureau of Information..... | Allan Carpenter | |
| | 200 E. Ontario St., Chicago 11 | |

IN THIS ISSUE

| | | |
|--|-----------|-----|
| Rust Meets Its Worst Enemy | - - - - - | 81 |
| American Way of Life Photo Contest | - - - - - | 88 |
| Mother of the Minesweepers | - - - - - | 97 |
| Miniature Revolution | - - - - - | 110 |
| So That the Blind Can Work and Play | - - - - - | 117 |
| Career School for Jet Mechanics | - - - - - | 122 |
| What's New for Your Home | - - - - - | 130 |
| There's Always One More River to Cross | - - - - - | 134 |
| Revolution on the Farm | - - - - - | 143 |
| Library of Plants | - - - - - | 150 |
| Daniel Boone Keeps up a Tradition | - - - - - | 154 |
| The Private Life of a Snowflake | - - - - - | 158 |

For the Craftsman

| | | |
|---|-----------|-----|
| Fused-Enamel Finishes | - - - - - | 165 |
| "Tooled Leather" Tops for Your Furniture | - - - - - | 168 |
| Sidewalk Play Car Has Electric Drive | - - - - - | 174 |
| Care and Repair of Mortised Door Locks | - - - - - | 188 |
| Restrung That Old Tennis Racket | - - - - - | 196 |
| Know Your Car's "Nervous System" | - - - - - | 201 |
| Easy-to-Store Horses and Scaffolds | - - - - - | 211 |
| Extra Uses for Your Drill Press — Part II | - - - - - | 216 |
| Shopping for Tools | - - - - - | 224 |
| Radio, Television and Electronics | - - - - - | 227 |
| Clinic for Homemakers | - - - - - | 238 |

Other items, and manufacturers of available products described, are listed on pages 10, 14 and 16

THE GREATEST
POWER ON
EARTH!

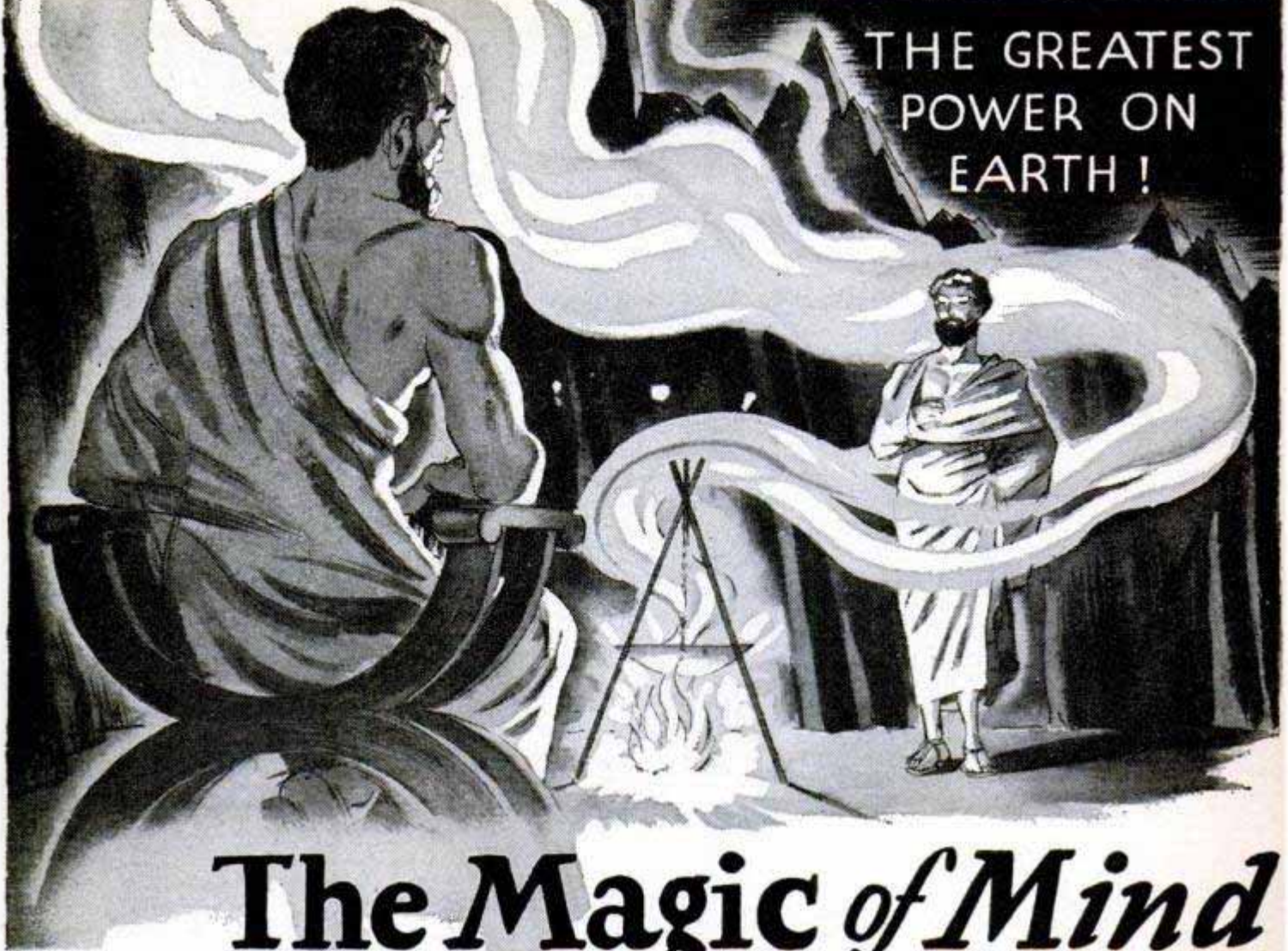

The Magic of Mind

WERE the great personages of the past victims of a stupendous hoax? Could such eminent men of the ancient world as Socrates, Pericles and Alexander the Great have been deluded and cast under the spell of witchcraft — or did the oracles whom they consulted actually possess a mysterious faculty of foresight? That the human mind can truly exert an influence over things and conditions was not a credulous belief of the ancients, but a known and demonstrable fact to them. That there exists a wealth of infinite knowledge just beyond the border of our daily thoughts, which can be aroused and commanded at will, was not a fantasy of these sages of antiquity, but a dependable aid to which they turned in time of need.

It is time you realized that the rites, rituals and practices of the ancients were not superstitions, but superfluges to conceal the marvelous workings of natural law from those who would have misused them. Telepathy, projection of thought, the materializing of ideas into helpful realities, are no longer thought by intelligent persons to be impossible practices, but instead, demonstrable sciences, by which a greater life of happiness may be had.

One of America's foremost psychologists and university instructors, says of his experiments with thought transference and the powers of mind — "The successes were much too numerous to be merely lucky hits and one can see no way for guessing to have accounted for the results." Have you that open-minded attitude of today which warrants a clear, positive revelation of the

facts of mind which intolerance and bigotry have suppressed for years? Advance with the times; learn the truth about your inherited powers.

Let this free book explain

The Rosicrucians (NOT a religious organization) have been leaders in introducing the ancient wisdom of mental phenomena. Established throughout the world for centuries, they have for ages expounded these truths to those thinking men and women who sought to make the utmost of their natural faculties. Use the coupon below — avail yourself of a pleasing book of interesting information which explains how you may acquire this most unusual and helpful knowledge.

• *The ROSICRUCIANS*
(A M O R C)

USE THIS COUPON

Scribe: D.M.K.
The Rosicrucians, AMORC
San Jose, California

I am sincerely interested in knowing more about this unseen, vital power which can be used in acquiring the fullness and happiness of life. Please send me, without cost, the book, "THE MASTERY OF LIFE," which tells me how to receive this information.

Name _____

Address _____

State _____

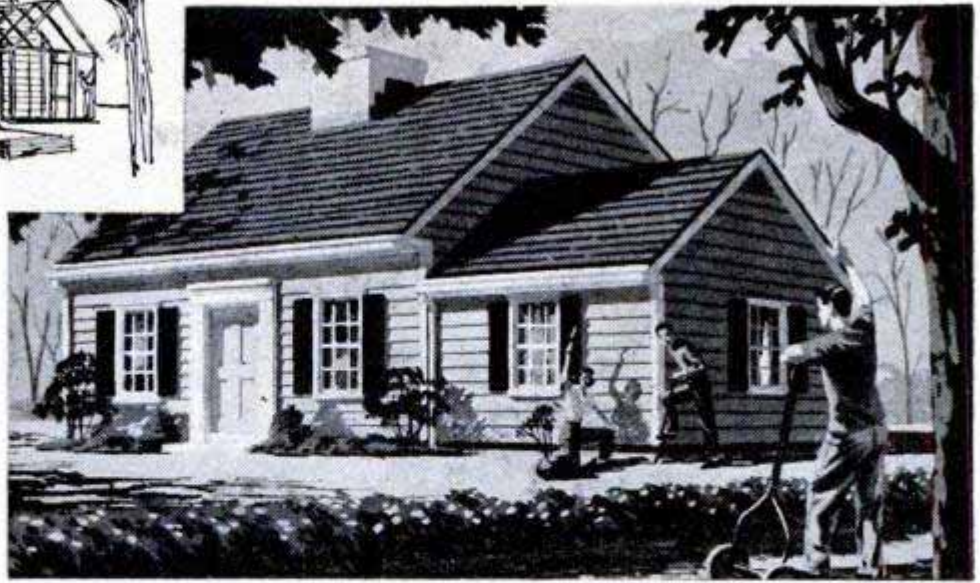

One dollar brings Easi-Bild Patterns for a new wing on your home!

... Build it Yourself! You'll save up to 50%!

Want a new 12' x 16' wing on your house?

With Weldwood Plywood, you can build it yourself! Easily . . . economically!

You can get all the information you need for building it just by sending *one dollar* for Easi-Bild* Pattern #760.

This new wing is designed to give you *three* important benefits:

. . . it gives you more *living* space—more *working* or *playing* space.

. . . it improves the appearance of your home—offers you a choice of designs to match your present style of architecture.

. . . and it adds *resale value*—even though the cost of building the wing with Easi-Bild patterns may be comparatively slight.

The directions of these Add-a-Room Easi-Bild patterns are easy to follow.

Weldwood® Plywood

Interior grade Weldwood Plywood is guaranteed for the life of the building in which it is used.

*T. M. Easi-Bild Pattern Co.

They supply step-by-step instructions covering foundations, framing, flooring and general interior work.

They show you how to save time, money and effort by using large, durable, quickly-installed Weldwood Plywood panels.

Inexpensive fir Weldwood for sub-flooring, side and roof sheathing keeps costs down—beautiful walnut, birch, mahogany or oak Weldwood to add lasting charm to interior walls and built-in units.



Send the coupon today.



UNITED STATES PLYWOOD CORPORATION
Box 61, New York 46, N. Y. **PM-2-52**

Enclosed is \$1. Please send Easi-Bild Pattern #760, containing step-by-step directions, rafter patterns and complete list of materials.

Enclosed is 10c. Please send illustrated booklet, "Beautiful Wood for Beautiful Homes."

Name _____

Address _____

City _____ Zone _____ State _____

Whatever the weather— the GOING is better with **Pyroil**

● Rain or snow, to make sure your car will “go”, add Pyroil every 250 miles. Low viscosity oils rob your motor of important lubrication protection. That’s where Pyroil goes to work. Silently and magically, Pyroil goes to work inside the motor, covering all exposed engine parts with a clinging film of oil. Pyroil helps you to “quick starts”. It prevents friction — Pyroil protects piston rings and cylinder surfaces from condensation and rust.

Next time you add gas or oil—add Pyroil—add miles to your car.

Pyroil for Aircraft Engines

Use Aircraft Pyroil B for lubricating oil, Aircraft Pyroil A for gasoline.

GIVEN! An attractive Pyroil metal savings bank—takes coins up to 50¢ pieces. **MOTORISTS**, it's yours for the asking — sent postage paid.



Manufactured and Guaranteed by
Pyroil Company, 124 Pyroil
Bldg., La Crosse, Wisconsin

Canadian Distributors:
Central Purchasing Agencies, Ltd.,
Toronto, Ontario

PYROIL COMPANY

124 Pyroil Bldg., La Crosse, Wisconsin

I want my car to last and run properly. Please tell me more about Pyroil and how it can accomplish this for me.

Name _____

Address _____

City or Town _____ State _____



in this corner.....

THE EDITORS

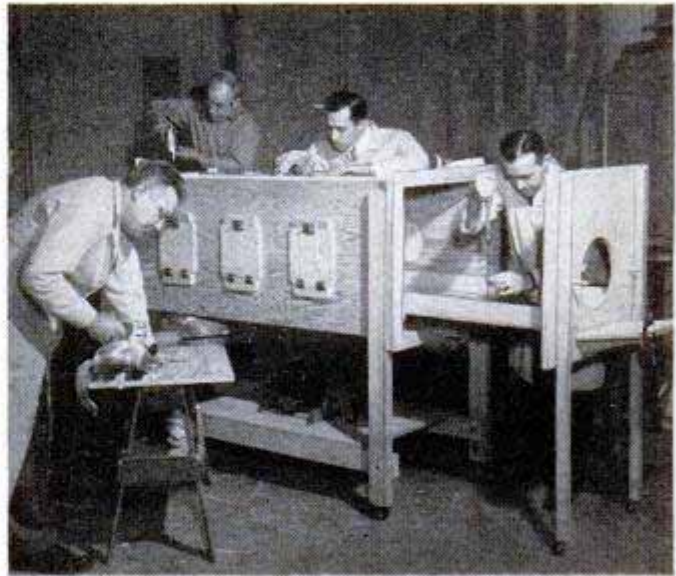

FROM PLANS and construction details in the January craft section, *Popular Mechanics* employees took time out to build one of their own projects—a “wooden lung” respirator. Made almost entirely of stock plywood, the lung was assembled in *PM*'s workshop and has been made available to the U. S. Junior Chamber of Commerce, which has adopted the emergency unit as a national project. The respirator will be turned over to a local hospital needing such equipment prior to the time they can be furnished one through local Jaycees.

Because of unusual interest shown by service clubs and civic-minded groups, *Popular Mechanics* has made enlarged, detailed plans available free to any group wishing to build this respirator.

Letter From Our Eastern Editor

Dear Boss:

Today, down at Richmond, Va., I had my first interview with a horse. I'm being very careful whom I tell it to around here, since the temperature has been hovering between 95 and 100 for two days, and anyone in his right mind might figure I was troubled with the heat. However, between us, the horse said some interesting things. For instance, she says we'll have a big war in 1952. Do not snicker too loud. In 1940 she said Roosevelt would run for a third term, that Germany would lose the war.

Her name is Lady Wonder, and she's sort of a sly old gal going on 27. Has a nice, gentle expression, with dreamy eyes, a soft, soft nose with which she nuzzles her

(Continued to page 8)

Let Us Send You FREE PROOF that you can become an expert **ACCOUNTANT... BOOKKEEPER** **OR C.P.A.**

FREE SAMPLE LESSON

We offer you this free sample lesson so that you can *prove to yourself* that you **CAN** master Accountancy—quickly, thoroughly—in spare time at home.

You will see exactly how LaSalle's famous "Problem Method" works . . . how you are led step-by-step through actual accounting work—*learning by doing* and not by study of theory alone. First you tackle easy problems, then more difficult ones—until soon you master them all. And at every step you have the close personal guidance of LaSalle's large staff of C.P.A. instructors.

**Nearly 10%
of all C.P.A.'s
in the U.S. have
been trained by the
LaSalle Problem
Method**

GOOD-PAY JOBS IN 5 BIG FIELDS

If you were an expert accountant right now, chances are you would find yourself among the highest-paid of all professional men and women. Surveys show that accountants earn more than those in other major professions.

There are five big fields of opportunity open to Accountancy-trained men and women . . . opportunities that are wide open and highly inviting, offering maximum income and job security in good times or bad. And under LaSalle's "Problem Method" you can start earning while still learning—either in spare-time or full-time employment . . . or in business for yourself with no capital required.

Get the latest information by sending for our 48-page book, "Accountancy, the Profession That Pays" . . . plus free sample lesson. The coupon at right will bring both to you without cost or obligation. LaSalle Extension, 417 S. Dearborn St., Chicago 5, Ill.

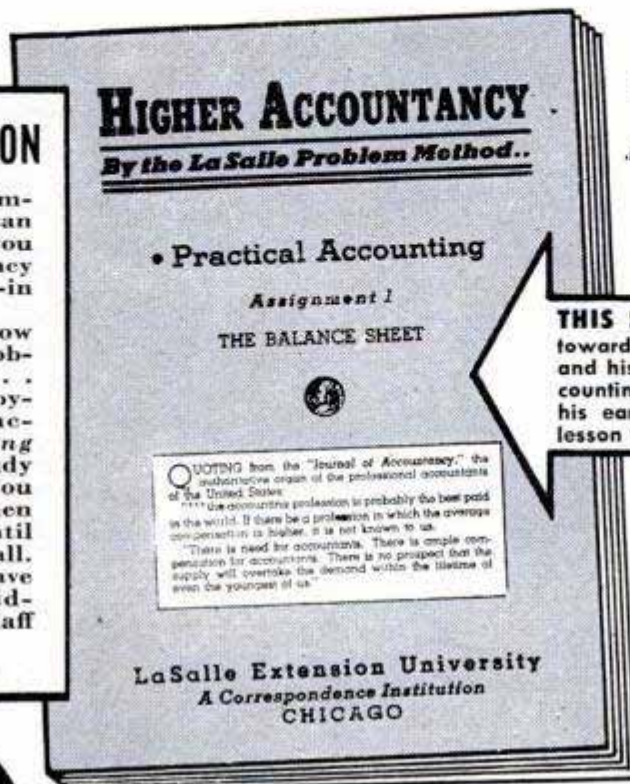

LOWELL C. DOAK
C. P. A., M. B. A.
Director of
LaSalle Accountancy
Instruction



THIS SAME LESSON STARTED MR. DOAK toward a well-paid public accounting career—and his C.P.A. degree. He knew nothing of accounting before—yet his progress was rapid—his earning power climbed fast. This sample lesson will show you why.

If you have been envying the high incomes and good jobs enjoyed by thousands of men and women Accountants today . . . incomes ranging from \$4,000 to \$10,000 and more per year . . . why not launch such a career for yourself?

Do you doubt that you can?

Then let us send you—without cost or obligation—the same Lesson Number One with which LaSalle has started several hundred thou-

sand men and women toward successful accounting careers. We want you to see for yourself how this remarkable method, originated by LaSalle, makes Accountancy simple, interesting, practical, and certain . . . how it leads you step-by-step to a complete mastery of Accounting—and on up to the coveted degree of Certified Public Accountant if you so aspire.

It doesn't matter whether you've had previous bookkeeping experience, or whether you don't know a debit from a credit. Whether you wish to qualify as an expert bookkeeper, advanced accountant, cost accountant, auditor, government accountant, income tax specialist, or public accountant . . . you'll find in LaSalle's Problem Method the exact plan to prepare you rapidly and inexpensively—in spare hours at home—without losing a day from your present job.

So right now, today . . . if you are an adult, employed, and earnestly ambitious for rapid advancement in this highest-paying of all professions . . . send your name and address on the coupon below. We'll send the free sample lesson—plus our 48-page book outlining today's career opportunities and how you can qualify for them. A coupon like this has started many thousands toward greater success. It can do the same for you. Mail it today!

Clip Coupon . . . Mail TODAY!

LaSalle Extension University . . . A Correspondence Institution
Dept. 264H, 417 S. Dearborn Street, Chicago 5, Illinois

YES, I want to see how LaSalle's "Problem Method" works . . . how I can qualify for high-pay Accountancy positions. Also, send your 48-page book, "Accountancy, the Profession That Pays" . . . all without cost or obligation.

Name Age
Street Address
City, Zone & State
Present Position



Right Now!

Handsome Hair! 3 Ways



1
Fights
Dandruff!

2
Relieves Dryness
and Itching!



3
Grooms Hair
Perfectly!



Lucky Tiger grooms your hair perfectly. But it does a lot more besides. Lucky Tiger kills on contact the dandruff germ, *pityrosporum ovale*, removes loose dandruff and gives your scalp a clean, wide-awake tingle. Treat your hair to all this, plus natural, greaseless grooming. Ask your barber, he knows.

LUCKY TIGER 3-PURPOSE Hair Tonic



Sold at all toilet goods counters.

spelling gadgets as well as her patrons. The customer is led into an old nondescript barn and stands before a rail made of pipe iron. In front of Lady is a keyboard of steel keys tipped with sponge rubber. Ask her a question and she starts nuzzling the keys, carefully choosing the ones she wants. Every time her nose depresses a key, a letter or number tag is released and pops up in front of the questioner. I'm convinced the old nag can at least *read*, or recognize letters of the alphabet and numbers.

Anyway, I asked her the name of my boss in Chicago. She fumbled around a while, tripped a couple of wrong letters, and finally tapped off G-R-A-N—T. (It took her a little longer to get the T.) She has also spelled D-E-M-P-E-W-O-L-F-F.

A real cute horse. Almost like people. And a good deal more frightening, if true. I kept wondering just how much that horse *did* know about me.

Dick Dempewolff.

★ ★ ★

Mr. Dempewolff's article on this mind-reading horse, and a report on the latest developments in the study of extrasensory perception by Duke University scientists—who know Lady Wonder well—will appear in the March issue. Don't miss it!

Clymer Reports on Foreign Cars



Floyd Clymer, who conducts our automobile-owners' reports and tests, has just returned from Europe where he made a survey on foreign cars for *PM* readers. He attended the Paris and London automobile shows, and then made an extensive tour of auto plants in France, England, Germany, Sweden, Italy and Spain. In Vienna he managed to inspect a couple of Russian cars. Clymer is shown above in conference with Dr. Ferdinand Porsche, Jr., builder of the swank Porsche sports car in Stuttgart.

(Continued to page 10)

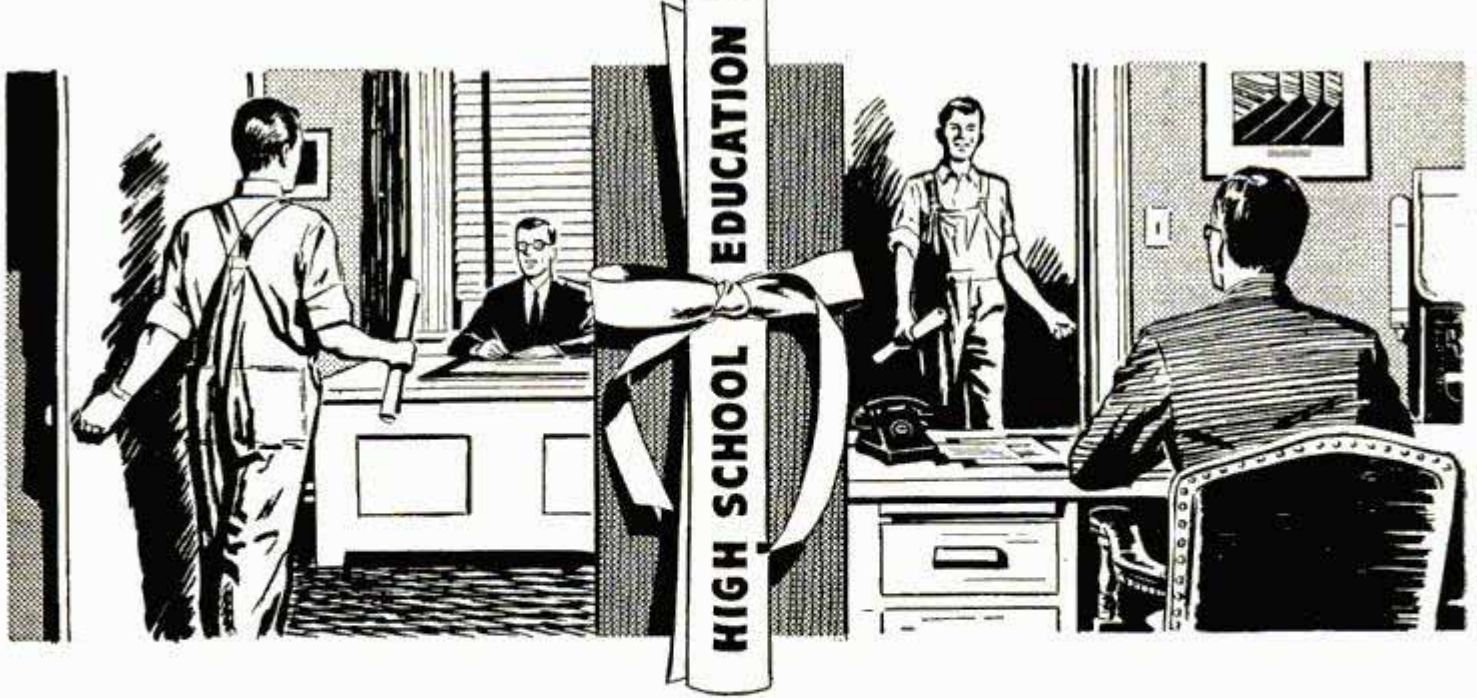

Is THIS all that separates you from a better job?

When the boss looks around for a man to promote, the chances are mighty good that he'll pick a high school graduate over one who quit school in the 8th grade.

U. S. Census figures prove it. The average pay of high school trained men is far greater than that of men who did not graduate. Their chances for employment are better.

If it's lack of education that's holding you back, do something about it right now! Send the coupon today! Find out how International Correspondence Schools courses enable you to go to high school at home, in spare time. You need study only the subjects you've missed, to qualify you for a State Equivalency Certificate.

Don't wait! Mail this coupon now!

INTERNATIONAL CORRESPONDENCE SCHOOLS



BOX 5520-L, SCRANTON 9, PENNA.

HIGH SCHOOL

Aeronautics Courses

- Aeronautical Engineer's, Jr.
- Aircraft & Engine Mechanic
- Aircraft Drafting & Design

Air Conditioning and Plumbing Courses

- Air Conditioning
- Heating
- Refrigeration
- Plumbing
- Steam Fitting

Automobile Courses

- Automobile
- Automobile Body Rebuilding
- Automobile Electrical Technician
- Automobile Technician

Chemical Courses

- Chemical Engineering
- Chemistry, Analytical
- Chemistry, Industrial
- Food-Plant Sanitation
- Petroleum Production & Refining
- Plastics
- Pulp and Paper Making

Civil Engineering and Architectural Courses

- Architecture

Please send me full particulars about the course marked X:

Architectural Drafting

- Bridge and Building Foreman
- Building Estimating
- Civil Engineering
- Contracting and Building
- Highway Engineering
- Reading Structural Blueprints
- Sanitary Engineering
- Structural Drafting
- Structural Engineering
- Surveying and Mapping

Communications Courses

- Electronics
- Practical Telephony
- Radio, General
- Radio Servicing
- Telegraph Engineering
- Television

Electrical Courses

- Electrical Drafting
- Electrical Engineering
- Electric Light and Power
- Lighting Technician
- Practical Electrician

Diesel Engines Courses

- Diesel Engines
- Internal Combustion Engines

Mechanical Courses

- Forging
- Heat Treatment of Metals
- Industrial Engineering
- Industrial Instrumentation
- Industrial Metallurgy
- Machine Shop
- Mechanical Engineering
- Mold-Loft Work
- Patternmaking—Wood, Metal
- Reading Shop Blueprints
- Sheet-Metal Drafting
- Sheet-Metal Worker
- Ship Drafting
- Tool Designing
- Welding—Gas and Electric

Railroad Courses

- Air Brake
- Diesel Locomotive
- Locomotive Engineer
- Locomotive Fireman
- Locomotive Machinist
- Railroad Section Foreman
- Steam-Diesel Loco. Eng.

Stationary Eng'g Courses

- Power Plant Engineer

- Stationary Fireman
- Stationary Steam Engineer

Textile Courses

- Cotton Manufacturing
- Loom Fixing
- Textile Engineering
- Woolen Manufacturing

Business and Academic Courses

- Accounting
- Advertising
- Business Administration
- Bus. Correspondence
- Cartooning
- Cost Accounting
- First Year College
- Good English
- Higher Mathematics
- Industrial Supervision
- Motor Traffic
- Personnel-Labor Relations
- Retailing
- Salesmanship
- Sign Lettering
- Traffic Management
- Bookkeeping
- Bus. Law
- Cert. Public Acct.
- Commercial
- Commercial Art
- Federal Tax
- Foremanship
- Illustration
- Postal Civil Service
- Secretarial
- Stenography

Name _____ Age _____ Home Address _____

City _____ State _____ Working Hours _____ A.M. to _____ P.M.

Present Position _____ Employed by _____

Special tuition rates to members of the Armed Forces. Canadian residents send coupon to International Correspondence Schools Canadian, Ltd., Montreal, Canada.

BECOME AN Electrical Engineer

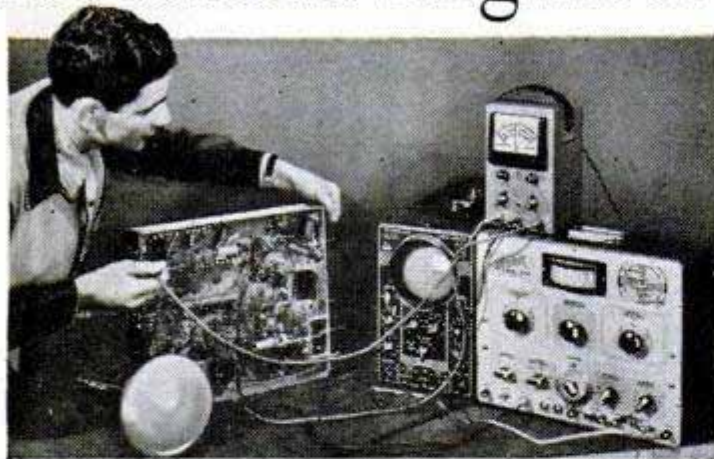

- Major in Electronics or Power
- B.S. Degree in 36 months
- Technician Certificates in 12 to 18 months

FOLLOW THIS PLAN

By 1954 there will be at least two positions for every engineering and technician graduate. Enter these opportunities early . . . earn your B.S. Degree in 36 months through optional year 'round study.

RADIO-TELEVISION TECHNICIANS are needed throughout America's fastest growing industry.

You become a Radio Technician in 12 months. In 6 additional months become a Radio-Television Technician. These Technician Courses are complete in themselves but can be applied as one-third of the B. S. Degree program.

Choose from these courses:

SERVICE 6 months

- Electricity
- Welding
- Refrigeration
- Heating
- Preparatory

TECHNICIAN 12 to 18 months

- Radio and Television
- Electronics
- Electrotechnics (Power)
- Welding
- Air Conditioning

ENGINEERING 36 months

- Electrical Engineering — B. S. Degree. Major in Electronics or Power.

Military, Practical, or Academic training evaluated for advanced credit. Faculty of specialists. Over 48,000 former students from all states and 23 overseas countries. Nonprofit school in its 49th year.

MILWAUKEE

SCHOOL OF ENGINEERING

TERMS OPEN APRIL, JULY, OCTOBER, JANUARY
Founded 1903. Milwaukee, Wis.

Write for free 110-page catalog, 48-page pictorial booklet "Your Career" and "Occupational Guidance Bulletins."

MILWAUKEE SCHOOL OF ENGINEERING
Dept. PM252, 1025 N. Milwaukee,
Milwaukee, Wisconsin

Without obligation send Catalog for Electrical Engineering, B. S. Degree, major in Electronics; Power; "Your Career"; Occupational Guidance Bulletin on: Radio-TV Electrical Power Welding Heating, Refrigeration, Air Conditioning.

Name.....Age.....

Address.....

City.....Zone.....State.....

If veteran, indicate date of discharge.....



Porsche is the son of the noted German engineer who designed the Volkswagen. Clymer's authoritative two-part article with some exciting illustrations begins in the March issue.

Letter to the Editor

Looks like you can't stop a GI.

J. M. McMurtry of Hattiesburg, Miss., got a house-moving contract that was too big for his truck. But it wasn't too big for his imagination. As the photo shows, he cut



the house in two. And I have his word for it that this was done with nothing more than a handsaw.

Then, by excavating enough under each section to get timbers in place, the house was jacked up so it could be rolled away.

Seen in the picture is McMurtry checking the connection between the timbers and his G.M.C. 6 x 6 truck. In this way he took the two sections for a four-mile ride. They were nailed together at their new location.

Ed Packer, Chicago.

Letter to the Editor

Your article "Air Support Is the GI's 'Sunday Punch'" in the October 1951 issue came as a very pleasant surprise. I wish to commend you on a splendid article.

I am a member of one of the three major elements that make up a close-support team, being a radio operator with a forward air-control team. . . . Many men [of our outfit] have been decorated and many have been wounded, and some have been killed while on duty with the infantry. We are known as the "Ground Pounding Flyboys," and all of us are proud of our outfit.

Thanks again for the article. . . . It will bring to the American public the wonderful job our Air Force is doing, in helping bring peace to a war-torn country, as its role in the United Nations team.

Cpl. R. B. Gates,
6150th Tactical Control Squadron.

AUDELS Carpenters and Builders Guides



4 vols. \$6

Inside Trade Information for Carpenters, Builders, Joiners, Building Mechanics and all Woodworkers. These Guides give you the short-cut instructions that you want—including new methods, ideas, solutions, plans, systems and money saving suggestions. An easy progressive course for the apprentice and student. A practical daily helper and Quick Reference for the master worker. Carpenters everywhere are using these Guides as a Helping Hand to Easier Work, Better Work and Better Pay. To get this assistance for yourself, simply fill in and mail the FREE COUPON below.

Inside Trade Information On:

How to use the steel square—How to file and set saws—How to build furniture—How to use a mitre box—How to use the chalk line—How to use rules and scales—How to make joints—Carpenters arithmetic—Solving mensuration problems—Estimating strength of timbers—How to set girders and sills—How to frame houses and roofs—How to estimate costs—How to build houses, barns, garages, bungalows, etc.—How to read and draw plans—Drawing up specifications—How to excavate—How to use settings 12, 13 and 17 on the steel square—How to build hoists and scaffolds—skylights—How to build stairs—How to put on interior trim—How to hang doors—How to lay floors—How to paint



AUDEL, Publishers, 49 W. 23rd St., New York 10, N. Y. Mail Audel's Carpenters and Builders Guides, 4 vols., on 7 days free trial. If O.K. I will remit \$1 in 7 days and \$1 monthly until \$6 is paid. Otherwise I will return them. No obligation unless I am satisfied.

Name _____
 Address _____
 Occupation _____
 Employed by _____ PM

Audel's PRACTICAL ELECTRIC LIBRARY

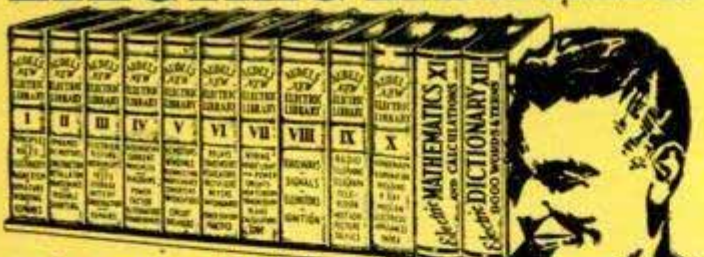

Answers YOUR QUESTIONS!

WHAT EVERY ELECTRICIAN WANTS TO KNOW

Is easily found in AUDEL'S ELECTRIC LIBRARY. Electricity made simple as ABC. Practical inside trade information for the expert and ALL electrical workers.

Questions, answers, diagrams, calculations, underwriter's code; design, construction, operation and maintenance of modern electrical machines and appliances FULLY COVERED.

All available at small cost, easy terms. BOOK-A-MONTH service puts this Important information in your hands for 6¢ a day. You can start your subscription with any volume.

Write TODAY for Electric Folder and FREE TRIAL offer.

AUDEL, Publishers, 49 W. 23rd St., New York 10, N. Y.

Mail Vol. I, Electric Library on 7 days' free trial. If O.K. I will remit \$1.50, otherwise I will return it. I also request you to mail one book each month on same terms. No obligation unless I am satisfied.

Name _____
 Address _____
 Employed by _____

WHAT EVERY AUTO MECHANIC WANTS TO KNOW



This Big Practical Book gives full information with working diagrams covering the principles, construction, ignition, service and repair of modern cars, trucks and buses. Diesel Engines, Hydramatic and Fluid Drives Fully Explained. A complete Guide of 1800 pages, with over 1500 illustrations showing inside views of the working parts, with instructions for service jobs.

IT PAYS TO KNOW

How to fit pistons—How to locate engine knocks—How to fit connecting rod bearings—How to service main bearings—How to recondition valves—How to time valves—How to adjust fan belts—How to adjust carburetors and

chokes—How to rebuild a clutch—How to service automatic transmissions—How to service brakes—How to adjust steering gear—How to cope with ignition troubles—How to service distributors—How to time ignition—How to "tune up" an engine.

\$4 COMPLETE • PAY \$1 A MO. TO GET THIS ASSISTANCE FOR YOURSELF SIMPLY FILL IN AND MAIL COUPON TODAY.



Step up your own skill with the facts and figures of your trade. Audel's Mechanics Guides contain Practical Inside Trade Information in a handy form. Fully illustrated and Easy to Understand. Highly Endorsed. Check the book you want for 7 DAYS FREE EXAMINATION. Send No Money, Nothing to pay Postman.

CUT HERE MAIL ORDER

AUDEL, Publishers, 49 W. 23 St., NEW YORK 10, N. Y.

Please send me postpaid for FREE EXAMINATION books marked (X) below. If I decide to keep them I agree to mail \$1 in 7 Days on each book or set ordered and further mail \$1 monthly on each book or set until I have paid price, otherwise I will return them.

- TRUCK & TRACTOR GUIDE, 1299 Pages . . . \$ 4
- AUTOMOBILE MECHANICS GUIDE, 1800 Pages . . . 4
- DIESEL ENGINE MANUAL, 575 Pages . . . 2
- MACHINISTS HANDY BOOK, 1650 Pages . . . 4
- WELDERS GUIDE, 400 Pages . . . 1
- BLUE PRINT READING, 416 Pages . . . 2
- MATHEMATICS & CALCULATIONS, 700 Pages . . . 2
- SHEET METAL PATTERN LAYOUTS, 1100 Pages . . . 4
- SHEET METAL WORKERS HANDY BOOK, 388 Pgs. . . 1
- MECHANICAL DRAWING GUIDE, 160 Pages . . . 1
- MECHANICAL DRAWING & DESIGN, 480 Pages . . . 2
- AIRCRAFT WORKER, 240 Pages . . . 1
- TELEVISION SERVICE MANUAL, 384 Pages . . . 2
- RADIOMANS GUIDE, 914 Pages . . . 4
- ELECTRONIC DEVICES, 216 Pages . . . 2
- ELECTRIC MOTOR GUIDE, 1000 Pages . . . 4
- ELECTRIC WIRING DIAGRAMS, 272 Pages . . . 1
- ELECTRICIANS EXAMINATIONS, 250 Pages . . . 1
- ELECTRIC POWER CALCULATIONS, 425 Pages . . . 2
- HANDY BOOK OF ELECTRICITY, 1440 Pages . . . 4
- ELECTRIC DICTIONARY, 9000 Terms . . . 2
- ELECTRIC LIBRARY, 7000 Pages (12 Book Set) . . . 18
- MARINE ENGINEERS HANDY BOOK, 1258 Pgs. . . 4
- SHIPFITTERS HANDY BOOK, 250 Pages . . . 1
- REFRIGERATION & Air Conditioning, 1280 Pgs. . . 4
- MILLWRIGHTS & MECHANICS GUIDE, 1200 Pgs. . . 4
- POWER PLANT ENGINEERS GUIDE, 1500 Pages . . . 4
- ENGINEERS & FIREMANS EXAMS, 525 Pages . . . 1
- PUMPS, Hydraulics & Air Compressors, 1658 Pgs. . . 4
- ENGINEERS LIBRARY (3 Book Set) . . . 9
- MECHANICAL DICTIONARY, 950 Pages . . . 4
- GARDENERS & GROWERS GUIDES (4 Book Set) . . . 6
- CARPENTERS & BUILDERS GUIDES (4 Book Set) . . . 6
- PLUMBERS & Steamfitters Guides (4 Book Set) . . . 6
- MASONS AND BUILDERS GUIDES (4 Book Set) . . . 6
- PAINTERS & DECORATORS MANUAL, 450 Pgs. . . 2
- HOUSE HEATING GUIDE, 1000 Pages . . . 4
- OIL BURNER GUIDE, 384 Pages . . . 1

Check NOW!

You Can Look Over Any Guide In Your Own Home

Start the Easy Payments If Satisfied

MAIL THIS TODAY

Name _____
 Address _____
 Occupation _____
 Employed by _____

Best Engine Protection Money Can Buy

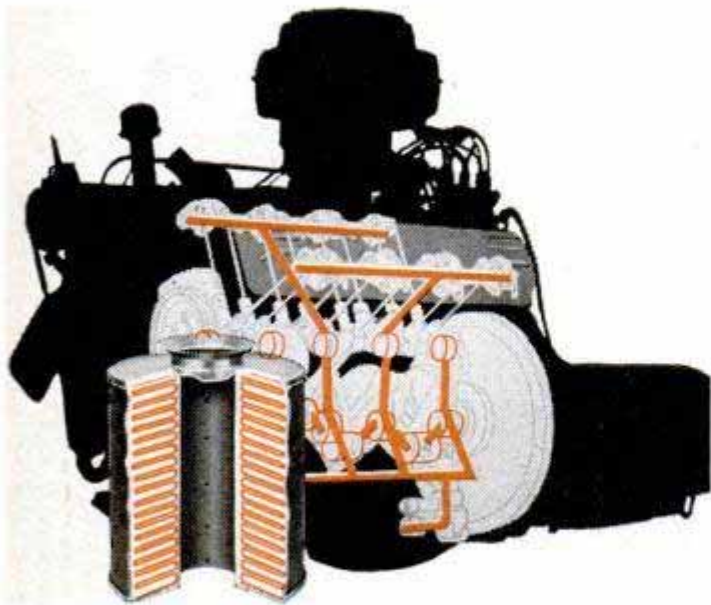

AC ALUVAC Oil Filter Elements

Here's the newest and finest development in engine oil filtration—AC Aluvac. It removes dirt particles finer than the thickness of your engine oil-film—as fine as 1/100,000 of an inch. Removes sludge as fast as it forms. Keeps piston rings and valves free—retards wear on moving parts. For the best engine protection money can buy, use an AC Aluvac Element in your oil filter.

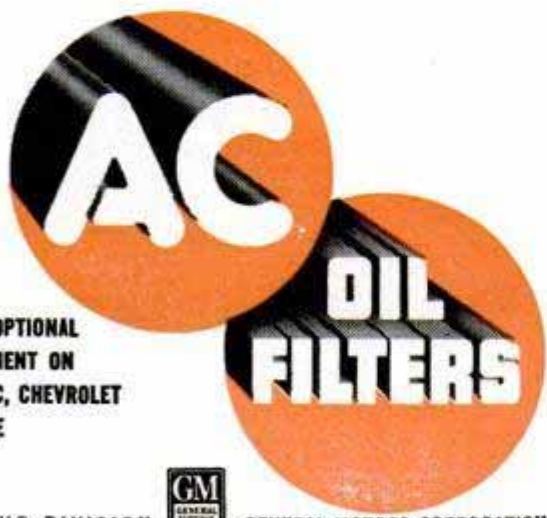

STANDARD OR OPTIONAL
FACTORY EQUIPMENT ON
BUICK, CADILLAC, CHEVROLET
AND OLDSMOBILE

AC SPARK PLUG DIVISION GENERAL MOTORS CORPORATION

WHERE-TO-BUY-IT INDEX
Source of supply appears after items commercially available

AUTOMOTIVE

| | |
|---|-----|
| Detroit listening post..... | 106 |
| 1952 Oldsmobile | 107 |
| 1952 Lincoln and Mercury..... | 108 |
| 1952 Chevrolet | 109 |
| 1952 Buick | 109 |
| Fuel preheater (Global Electric Mfg. Co., 36 N. Commerce St., Stockton 2, Calif.)..... | 113 |
| Poor man's "hot rod"..... | 127 |
| All-night heater burns bottled gas to keep truck engines warm | 128 |
| Winter parking shield for car windshields (Brittain Products Co., 380 E. Exchange St., Akron 4, Ohio)..... | 129 |
| Metal traction aid (Jetron Corp., Butler, Wis.)..... | 129 |
| Air controller synchronizes truck-tractor brakes with trailer..... | 132 |
| Wheel balancer (Hunter Engineering Co., 8844 Ladue Road and Gay Avenue, St. Louis 24, Mo.)..... | 139 |
| Heel mat (Brittain Products Co., 380 E. Exchange St., Akron 4, Ohio)..... | 139 |
| Gas-tank "watchdog" (FM Industries, Inc., Box 1313, New York City 17)..... | 139 |
| Easy-on chains (Horner & Robertson, Inc., Idaho Springs, Colo.)..... | 139 |
| Car-door pocket (Peachtree Co., 933 W. Peachtree St., N.E., Atlanta, Ga.)..... | 157 |
| Magnetic arm (Abercrombie & Fitch Company, 45th St. & Madison Ave., New York City 17)..... | 157 |
| Shoescraper for automobiles without running boards (C. H. Schetzer, Schetzer Mfg. Co., Goodland, Kans.)..... | 157 |
| Remote-control drain plug simplifies oil changing (Filtaire Products, Inc., 1705 Peoria Road, Springfield, Ill.)..... | 157 |
| "Tug" for maneuvering semitruck trailers pivots on one wheel | 164 |

AVIATION

| | |
|--|-----|
| Windless "wind tunnel" for high-altitude tests..... | 105 |
| Metal amphibian has plastic-bonded plywood hull..... | 105 |
| Sea-water still (Bakelite Plastic, Division of Union Carbide & Carbon Corp., 122 East 42nd St., New York City 17)..... | 113 |
| Rocket motor doubles power of jet fighters..... | 116 |
| Glider trainee gets over-the-shoulder instruction..... | 127 |
| British carrier-based jet features "butterfly" tail..... | 133 |
| "Traffic lights" for planes..... | 153 |
| "Clamshell" hangar | 156 |

HOBBIES AND NOVELTIES

| | |
|-----------------------------|-----|
| Fisherman and his pets..... | 87 |
| Leaping Model T..... | 133 |
| Table-top workshop | 164 |

HOUSE AND HOME

| | |
|--|-----|
| Dustless house | 86 |
| Compact air drier (Appliance Mfg. Co., Alliance, Ohio)..... | 130 |
| Thread holder (O. L. Phillips Co., 1316 National Ave., Rockford, Ill.)..... | 130 |
| Dull silver (Merchants Chemical Co., Elm Court, Stamford, Conn.)..... | 130 |
| Clothes drier (National Engineering & Mfg. Co., 519 Wyandotte St., Kansas City 6, Mo.)..... | 131 |
| Portable breezes (W. W. Welch Co., Glenn Bldg., Cincinnati, Ohio)..... | 131 |
| Knife sharpener (Herberts Inc., Pine at Westlake, Seattle 1, Wash.)..... | 131 |
| Aquarium-planter (Rene-Craft Products, 21 Owen's Bldg., Wilmette, Ill.)..... | 131 |
| Clothesline hideaway (Bertram Engineering & Supply Co., 3125 Harrison St., Kansas City, Mo.)..... | 131 |
| Oven barbecue (Albin of California, 1401 West 19th St., Los Angeles 17, Calif.)..... | 131 |
| Switch-box brackets (Hilco Engineering Co., Genoa City, Wis.)..... | 153 |
| Hook attaches paintbrush to old broom handle (Baker, Carver & Morrell, 35 Water St., New York City)..... | 268 |

INDUSTRY

| | |
|---|-----|
| Crash canopy on "cat" shields loggers from falling trees..... | 121 |
| Bridge floated downstream into position on piers..... | 121 |
| Silicone-rubber glass cloth..... | 128 |
| Atomic "furnace" for use in industrial research..... | 129 |
| Magnesium protects metals buried underground..... | 264 |

MARITIME

| | |
|---|-----|
| Electric fishing | 96 |
| "Superpier" almost floats..... | 114 |
| Curved locks open by rotating on pivot..... | 142 |
| Tool winds rope around cable..... | 149 |
| Long haul for Australian ore..... | 246 |

MILITARY

| | |
|---------------------------------------|-----|
| Seven-foot arm on Jeep lays wire..... | 87 |
| Versatile tractor has many jobs..... | 113 |
| GI showers | 132 |
| Lightweight diver's suit..... | 149 |

SPORTS

| | |
|---|-----|
| Battery-powered baseball scoreboard (Sporco Co., Room 518, 710 Plankinton Ave., Milwaukee, Wis.)..... | 87 |
| British use indoor wind to test their skiing form..... | 128 |
| Folding fairway (A. E. Peterson Mfg. Co., 700 E. Allen Ave., Glendale 1, Calif.)..... | 132 |

(Continued to page 14)

INVENTORS

Learn how to protect your invention. The U. S. Patent Laws provide that any new and useful art, machine, article of manufacture, or composition of matter, or any new and useful improvement thereof, may be patented if the act of invention is involved. Therefore, every inventor with a valuable invention should take advantage of the Patent Laws and proceed for patent protection in order to safeguard his rights.

A patent gives the inventor the exclusive right to prevent others from making, using, or selling the invention claimed in the patent for a period of seventeen years.

The Patent Laws were enacted for the benefit of the inventor to give him protection for the features of his invention which are patentable. These features must be properly and concisely set forth and claimed in a formal application for patent, in order to comply with the requirements of the Patent Laws. For that reason, unless the inventor is familiar with patent matters, he should engage a competent registered patent attorney or agent to represent him. We are registered to practice before the U. S. Patent Office and are prepared to serve you in the handling of your patent matters.

A specially prepared booklet entitled "Patent Guide for the Inventor", containing detailed information with respect to patent protection and procedure, together with a "Record of Invention" form will be promptly forwarded to you without obligation upon request.

CLARENCE A. O'BRIEN & HARVEY JACOBSON

Registered Patent Attorneys

21-B DISTRICT NATIONAL BUILDING

WASHINGTON 5, D. C.

Chances Are 1 in 9 You'll Be Hospitalized This Year



BE SURE YOUR HOSPITAL INSURANCE WILL MEET TODAY'S HIGHER COSTS

Like other costs, hospital charges have gone up. As a result, many hospital plans . . . probably YOURS among them . . . are hopelessly out of date.

Your family's hospital insurance must be planned for TODAY'S costs. See what Mutual of Omaha's new Hospital Insurance plan offers you or your entire family. This liberal low-cost protection pays:

UP TO \$10 A DAY for hospital board and room for as long as 200 DAYS hospitalization for any one sickness or accident.

UP TO \$25 EACH for such additional expenses as operating room, hypodermics, surgical dressings and casts, medicines, transfusions, and ambulance.

MATERNITY BENEFITS on family plans . . . up to 10 times your daily room benefit, whether confinement is at home or in the hospital.

ADDITIONAL SURGICAL and medical benefits may be included, if desired.

Your health is your wealth . . . insure it with Mutual of Omaha, world's largest exclusive health and accident company. More than \$400,000,000 paid in benefits! Licensed in all 48 states, District of Columbia, Canada, Alaska and Hawaii.

SEND COUPON TODAY FOR FULL INFORMATION NO COST . . . NO OBLIGATION

JUST PASTE ON POSTCARD IF YOU LIKE

Gentlemen:
I would like full information, without cost or obligation, on Mutual of Omaha's Hospital Insurance plan.

Name _____ Age _____

Address _____

City _____ State _____

PM252



**MUTUAL BENEFIT HEALTH & ACCIDENT ASSOCIATION
OMAHA, NEBRASKA**

Dr. C. C. Criss, Chairman of the Board
V. J. Skutt, President

Canadian Head Office: Toronto

MISCELLANEOUS

| | |
|--|-----|
| Antidote for beryllium poisoning | 16 |
| Cement for fabric (Immerman & Sons, 1812 East 13th St., Cleveland 14, Ohio) | 86 |
| Wheel rakes (Pollard Mfg. Co., Inc., Foshay Tower, Minneapolis, Minn.) | 86 |
| Blood fractionator | 116 |
| "Venetian" awnings (Japanese-American Metal Home Co., Ltd., 17, 1-Chome Nagata-Cho, Chiyoda-Ku, Tokyo, Japan) | 120 |
| Writing materials carried inside portable desk with sliding top (Fred C. Williams, 521 Dunning St., Madison, Wis.) | 120 |
| Japan transmits by facsimile | 120 |
| Electric "hot foot" (Goodyear Tire & Rubber Co., Akron, Ohio) | 127 |
| Chemical sterilizer for fruit trees (Thompson Horticultural Chemicals Corp., 3028 Locust St., St. Louis 3, Mo.) | 127 |
| Overhead heater (Norman Products Co., 1150 Chesapeake Ave., Columbus 12, Ohio) | 128 |
| Sun-gazer's telescope | 140 |
| Self-administered anesthetic | 149 |
| Radiation "lamp shade" | 153 |
| Flash-gun has pistol grip | 156 |
| Nine-mile tunnel through mountain solves Mexico City's water problem | 236 |
| Atomic energy heats building | 262 |
| Star-shaped Tenite plug anchors screw in concrete | 264 |

Craftsman and Shop Notes Index

AUTOMOTIVE

| | |
|--|-----|
| Reversing handles on car doors prevents accidental opening | 173 |
| Mirror reflects headlight beams to warn oncoming motorists | 182 |
| Thin chrome plating on new cars requires special care | 183 |
| Safety reflectors on car doors | 186 |
| Temporary brake-hose repair | 194 |
| Antimoisture products are safe for mixing with auto fuels | 194 |
| Improperly mounted air cleaner will lower gasoline mileage | 200 |
| Rack screwed to car floor holds vacuum bottles | 206 |
| Simple rules for installation of new or used spark plugs | 215 |
| Engine data taped to fire wall | 215 |

FARM

| | |
|---|-----|
| Egg candler quickly improvised | 206 |
| Hog wire protects grass seed in fight against soil erosion | 221 |
| Portable livestock-loading chute is fitted with retractable dolly | 223 |
| Portable electric-power unit drives farm machinery | 226 |

HOUSE AND HOME

| | |
|--|-----|
| Tin cans hold insulating material around water pipes | 178 |
| Solving home problems | 180 |
| Plastic or hardboard reel eliminates danger of tripping over lamp cord | 183 |
| Small-drawer partitions | 204 |

NOVELTIES AND TOYS

| | |
|---|-----|
| Tinkling centerpiece | 179 |
| Bulb syringe fires dowel ammunition from unique toy-cannon barrel | 183 |
| Tire provides rubber "horseshoes" when game is played indoors | 186 |
| Kiddie combination padlock | 187 |
| Make a paper menagerie | 192 |
| Glazed bird shelter on window sill provides unique entertainment for the family | 200 |
| Rustic candlestick for a cabin | 204 |

OFFICE, SHOP AND STORE

| | |
|---|-----|
| Lighter fluid cleans typewriter | 173 |
| Paper-clip note file | 191 |
| Portable mop "bucket" and wringer for cleaning large floors | 222 |
| Drawing board has small drawers made from matchboxes | 222 |
| False bottom placed in desk tray speeds removal of paper | 226 |

PAINT AND PAINTING

| | |
|---|-----|
| Estimating paint coverage | 173 |
| How to apply lacquer without brush marks | 194 |
| Renovating varnished floor | 206 |
| Squeegee used as a shield when painting windows | 206 |

PHOTOGRAPHY

| | |
|---|-----|
| Correcting flash-gun parallax | 207 |
| Water controls print reduction | 207 |
| 35-mm. slide projector | 208 |
| Ball-point pen used as stylus to emboss photographs | 210 |
| Pouring spout for chemical can | 210 |
| Bowl cover and cake pan improvise photo tray | 210 |
| Cleaning rubber-cement brushes | 210 |

(Continued to page 16)

IMPORTANT NOTICE—It is the intention of this magazine to provide its readers with information regarding the latest developments in the mechanical arts. We take no responsibility as to whether the disclosures contained in our articles are covered by patents and advise readers to investigate this subject before making, using, or selling any of the products, machines, or processes described in order to avoid possible liability for patent infringements.

INVENTORS

If you believe that you have an invention, you should find out how to protect it. The first step is to have a search made of the prior pertinent U. S. patents. If a report on this search indicates that the invention appears patentable you can apply for a patent, and the specifications and claims should be prepared.

The firm of McMorrow, Berman & Davidson, with offices in Washington, D. C., is qualified to take the necessary steps for you. We can make a preliminary search on your invention, advise you whether we think it can be patented, and prepare your application for patent.

Unless you are fully familiar with the U. S. Patent Laws, we recommend that you engage the services of a Registered Patent Attorney to protect your interests. The patent laws are *your* laws. A patent gives you the right to prevent others from making, using or selling the invention claimed in your patent for a period of 17 years.

Use these patent laws for your protection. Investigate whether your invention can be patented. If you have what you believe to be an invention, we suggest that you have this firm make a search for you.

Send for a copy of our Patent Booklet entitled "How To Protect Your Invention," containing information about patent protection and patent procedure. Along with this we will also send you an "Invention Record" form, for your use in writing down and sketching details of your invention. We will mail them promptly. No obligation. They are yours for the asking.

McMORROW, BERMAN & DAVIDSON

Registered Patent Attorneys

PATENTS • COPYRIGHTS • PATENTS

1354 VICTOR BUILDING, WASHINGTON 1, D. C.

OWN a GROWING Lifetime Business

Built on Voluntary and Repeat Orders

If you are capable . . . co-operative . . . willing to work to enjoy success, we'll establish you in YOUR OWN business. The international chain of Duraclean dealerships is now expanding. The business is *easy to learn* . . . and *quickly established*. You use the proven methods of successful dealers. Your service is recommended nationally by America's foremost furniture and department stores.



Shop Optional

No overhead expense. Service is rendered in homes, offices, hotels, institutions, etc., by service men. You can operate from a shop, office, or your home. If now employed, you can operate in spare time and build a permanent profitable full-time business. Alert dealers can average \$4.50 hourly gross profit on service they render and \$3 on EACH of their servicemen at National Price Guide charges.

Patented Machine Becomes Carrying Case

Carpets and Upholstery Safely Duracleaned . . . Use Again Same Day

Duracleaning ends need for harsh machine scrubbing and soaking. It does away with harmful solvents and strong soaps. Instead of floating surface soil into upholstery or rug pile, this improved process REMOVES it.

Cleans by ABSORPTION . . . No Scrubbing

Aerated foam is created by the patented electric Foamovator. Dirt, grease and many unsightly spots vanish. Rugs and upholstery are cleaned with a new consideration for their life and beauty.

Fiber Life Restored

The fiber lubrication of wool and other animal fabrics is restored. Resiliency returns to the pile. It rises again. Its life is prolonged. Brilliant colors revive. Results are often almost unbelievable.

Duraproof Protects Against Moths & Carpet-Beetles

You give your customers a 4-year money-back warranty. This year-round service is rendered without removing furnishings.

A Moderate Payment

establishes your own business. We furnish electric machines, folders, store-cards, introduction slips, sales book, demonstrators and enough materials to return your TOTAL investment. If you are dependable, we want to hear from you. Free 16 page illustrated booklet explains everything. Write today while dealerships are available. No obligation.

Duraclean Co., 2-162 Duraclean Bldg., Deerfield, Ill.

Say You Saw It in Popular Mechanics

World's Greatest Hobby For Men and Boys! Get This Free Book. It Tells How You Can Learn to



Learn At Home Men, Boys, Hunters, Fishermen, mount and save your lovely wild-game trophies. Be a Taxidermist. Mount Birds, Animals, Heads, Fish, Tan skins. YOU learn easily, quickly in spare time. Have a grand home-museum. The finest and the greatest hobby known, for sportsmen. Fun, real profits.

Yes, FREE, beautiful strange, valuable Book, telling all about Taxidermy. Contains over 100 beautiful game-pictures. And it's yours FREE, if you rush your request. You can mount all kinds of wild-game, and common specimens too. We can positively TEACH YOU. So GRASP this opportunity. RUSH letter or postal for this amazing FREE BOOK. Don't delay. State your AGE. N. W. SCHOOL OF TAXIDERMY, 2502 Elwood Bldg., Omaha 2, Neb.

GET THIS FREE BOOK

RECREATION

- Muffin tin provides multiple target for tiddlywinks game... 177
- Skater's portable bonfire is towed across ice... 178
- Portable rack supports guns safely when shooting on open range... 182
- Storing game Carroms on cue stick keeps them at hand... 191

TOOLS

- Fitting oversize chuck to spindle increases capacity of drill... 173
- Handy tool for salvaging lumber made from auto-spring leaf... 215
- Guide lines on lathe steady rest help when centering work... 219
- Nonskid miter-box feet prevent sliding on bench... 222
- Lathe gears spaced easily... 222
- Boring-tool holder adjusts to close tolerances... 223
- Hold-down attachment (Duro Metal Products Co., 2654 N. Kildare Ave., Chicago 39)... 224
- Valve lifter (Kent-Moore Organization, Inc., General Motors Bldg., Detroit 2, Mich.)... 224
- Paint heater (Spec-Flo Co., 3615 Harrisburg Blvd., Houston 3, Tex.)... 224
- Wire-measuring gauge (Federal Products Corp., 1144 Eddy St., Providence, R. I.)... 224
- Internal pipe wrench (Clark Bros. Mfg. Co., Hillsboro, Ore.)... 225
- Treetop hoist (LeRoy Machine Co., LeRoy, N. Y.)... 225
- Push-pull steel rule (Master Rule Mfg. Co., 40 Mulberry St., Middletown, N. Y.)... 225
- Paint-pail holder (Brittain Products Co., 380 E. Exchange St., Akron 4, Ohio)... 225

WOODWORKING

- Plan of the month — dining chairs... 184
- Regluing furniture joints... 186
- Versatile knitting table... 195
- Chair-ladder... 205

MISCELLANEOUS

- Worn spade used as shoescraper... 173
- Screw taped to screwdriver is started easily... 177
- Legibility of labels may be preserved when liquids are poured from bottles... 177
- Drying outboard motor... 178
- Trim boards removed undamaged by sawing off nails... 182
- Sheet metal clamped in vise cut out neatly with hammer and cold chisel... 182
- Pulley hung for easy removal locked with wooden block... 186
- Tape kept from sticking to coins... 186
- Tent-rope "shrink absorbers" prevent pulling of stakes... 191
- Towel rack holds boat oars... 191
- Tobacco-can tray holds small parts... 194
- Wax protects scale on rule and lubricates the joints... 194
- Ring-fitted pocketknife is carried in key wallet by clipping to fastener... 200
- Glue anchors switch-plate screws... 200
- Rubber pads from pencil eraser... 204
- Tobacco tin holds steel wool to protect hands... 204
- Solder locks nut on bolt... 204
- Cylinder from truck jack operates hydraulic press... 215
- Damage to welded castings reduced by baking process... 222
- Iodine loosens frozen nuts... 223
- How to transfer blind holes... 226
- Formula for machine-screw sizes... 226

Radio-Television, Electronics

- Color TV for theaters... 227
- Versatile amplifier serves practically any audio purpose... 228
- TV-booster hints... 231
- Modernize your old radio-phonograph combination... 232

Antidote for Beryllium Poisoning

"The first successful antidote" for beryllium poisoning has been discovered at Argonne National Laboratory. Beryllium poisoning might be called an atomic-age disease, as the lightweight durable metal, which causes widespread damage to the body, is under investigation as a possible construction material for atomic piles. The new antidote is a chemical called aurin tricarboxylic acid. It reacts with beryllium salts to convert the beryllium into an inactive, nonpoisonous compound.

Outlasting present dry batteries two to one, a new battery developed by the Army Signal Corps substitutes plentiful domestic manganese dioxide for the higher grade product imported from the African Gold Coast.

NOW!



Industry needs *trained* men—needs them NOW!

Can you qualify for the premium jobs that are open to trained draftsmen, machinists, technicians?

You can, if you start preparing yourself immediately. And the International Correspondence Schools can help you.

Just mark and mail the coupon below. We'll rush you full information about practical, easy-to-understand I. C. S. Courses—courses being used by many defense industries to train their own workers.

The time for action is NOW!

INTERNATIONAL CORRESPONDENCE SCHOOLS



BOX 5521-L, SCRANTON 9, PENNA.

Without cost or obligation, please send me full particulars about the course BEFORE which I have marked X:

- | | | | |
|--|---|--|--|
| <p>Air Conditioning and Plumbing Courses</p> <p><input type="checkbox"/> Air Conditioning <input type="checkbox"/> Heating</p> <p><input type="checkbox"/> Plumbing <input type="checkbox"/> Refrigeration</p> <p><input type="checkbox"/> Refrigeration, Domestic</p> <p><input type="checkbox"/> Refrigeration & Air Conditioning</p> <p><input type="checkbox"/> Steam Fitting</p> <p>Aeronautics Courses</p> <p><input type="checkbox"/> Aeronautical Engineer's, Jr.</p> <p><input type="checkbox"/> Aircraft Drafting & Design</p> <p><input type="checkbox"/> Aircraft Mechanic</p> <p><input type="checkbox"/> Engine Mechanic</p> <p>Automotive Courses</p> <p><input type="checkbox"/> Automobile <input type="checkbox"/> Auto Technician</p> <p><input type="checkbox"/> Auto Electric Technician</p> <p><input type="checkbox"/> Auto Body Rebuilding & Refinishing</p> <p>Chemical Courses</p> <p><input type="checkbox"/> Chemical Engineering</p> <p><input type="checkbox"/> Chemistry, Analytical</p> <p><input type="checkbox"/> Chemistry, Industrial</p> <p><input type="checkbox"/> Food-Plant Sanitation</p> <p><input type="checkbox"/> Petroleum Refining <input type="checkbox"/> Plastics</p> <p><input type="checkbox"/> Pulp and Paper Making</p> <p>Civil Engineering and Architectural Courses</p> <p><input type="checkbox"/> Architecture <input type="checkbox"/> Architectural Drafting</p> <p><input type="checkbox"/> Bridge and Building Foreman</p> | <p><input type="checkbox"/> Building Estimating</p> <p><input type="checkbox"/> Civil Engineering</p> <p><input type="checkbox"/> Contracting and Building</p> <p><input type="checkbox"/> Highway Engineering</p> <p><input type="checkbox"/> Reading Structural Blueprints</p> <p><input type="checkbox"/> Sanitary Engineering</p> <p><input type="checkbox"/> Structural Drafting</p> <p><input type="checkbox"/> Structural Engineering</p> <p><input type="checkbox"/> Surveying and Mapping</p> <p>Communications Courses</p> <p><input type="checkbox"/> Electronics</p> <p><input type="checkbox"/> Practical Telephony</p> <p><input type="checkbox"/> Radio, General <input type="checkbox"/> Radio Operating</p> <p><input type="checkbox"/> Radio Servicing <input type="checkbox"/> Television</p> <p><input type="checkbox"/> Telegraph Engineering</p> <p>Electrical Courses</p> <p><input type="checkbox"/> Electrical Drafting</p> <p><input type="checkbox"/> Electrical Engineering</p> <p><input type="checkbox"/> Electric Light and Power</p> <p><input type="checkbox"/> Lighting Technician</p> <p><input type="checkbox"/> Practical Electrician</p> <p>Diesel Engines Courses</p> <p><input type="checkbox"/> Diesel Engines</p> <p><input type="checkbox"/> Internal Combustion Engines</p> <p>Mechanical Courses</p> <p><input type="checkbox"/> Forging <input type="checkbox"/> Foundry Work</p> <p><input type="checkbox"/> Heat Treatment of Metals</p> | <p><input type="checkbox"/> Industrial Engineering</p> <p><input type="checkbox"/> Industrial Instrumentation</p> <p><input type="checkbox"/> Industrial Metallurgy</p> <p><input type="checkbox"/> Machine Shop</p> <p><input type="checkbox"/> Mechanical Drafting</p> <p><input type="checkbox"/> Mechanical Engineering</p> <p><input type="checkbox"/> Mold-Loft Work</p> <p><input type="checkbox"/> Patternmaking—Wood, Metal</p> <p><input type="checkbox"/> Reading Shop Blueprints</p> <p><input type="checkbox"/> Sheet-Metal Drafting</p> <p><input type="checkbox"/> Sheet-Metal Worker</p> <p><input type="checkbox"/> Ship Drafting <input type="checkbox"/> Ship Fitting</p> <p><input type="checkbox"/> Tool Designing <input type="checkbox"/> Toolmaking</p> <p><input type="checkbox"/> Welding—Gas and Electric</p> <p>Railroad Courses</p> <p><input type="checkbox"/> Air Brake <input type="checkbox"/> Car Inspector</p> <p><input type="checkbox"/> Diesel Locomotive</p> <p><input type="checkbox"/> Locomotive Engineer</p> <p><input type="checkbox"/> Locomotive Fireman</p> <p><input type="checkbox"/> Locomotive Machinist</p> <p><input type="checkbox"/> Railroad Section Foreman</p> <p><input type="checkbox"/> Steam-Diesel Locomotive Eng.</p> <p>Stationary Engineering Courses</p> <p><input type="checkbox"/> Power Plant Engineering</p> <p><input type="checkbox"/> Stationary Fireman</p> <p><input type="checkbox"/> Stationary Steam Engineering</p> | <p>Textile Courses</p> <p><input type="checkbox"/> Cotton Manufacturing</p> <p><input type="checkbox"/> Loom Fixing <input type="checkbox"/> Rayon Mfg.</p> <p><input type="checkbox"/> Textile Engineering</p> <p><input type="checkbox"/> Woolen Manufacturing</p> <p>Business and Academic Courses</p> <p><input type="checkbox"/> Accounting <input type="checkbox"/> Advertising</p> <p><input type="checkbox"/> Bookkeeping</p> <p><input type="checkbox"/> Business Administration</p> <p><input type="checkbox"/> Business Correspondence</p> <p><input type="checkbox"/> Business Law <input type="checkbox"/> Cartooning</p> <p><input type="checkbox"/> Certified Public Accounting</p> <p><input type="checkbox"/> Commercial <input type="checkbox"/> Commercial Art</p> <p><input type="checkbox"/> Cost Accounting</p> <p><input type="checkbox"/> Fashion & Book Illustration</p> <p><input type="checkbox"/> Federal Tax <input type="checkbox"/> First Year College</p> <p><input type="checkbox"/> Foremanship</p> <p><input type="checkbox"/> Good English <input type="checkbox"/> High School</p> <p><input type="checkbox"/> Higher Mathematics</p> <p><input type="checkbox"/> Industrial Supervision</p> <p><input type="checkbox"/> Motor Traffic</p> <p><input type="checkbox"/> Personnel—Labor Relations</p> <p><input type="checkbox"/> Postal Civil Service <input type="checkbox"/> Retailing</p> <p><input type="checkbox"/> Retail Business Management</p> <p><input type="checkbox"/> Salesmanship <input type="checkbox"/> Secretarial</p> <p><input type="checkbox"/> Sign Lettering <input type="checkbox"/> Stenography</p> <p><input type="checkbox"/> Traffic Management</p> |
|--|---|--|--|

Name _____ Age _____ Home Address _____

City _____ State _____ Working Hours _____ A.M. to _____ P.M.

Present Position _____ Employed by _____

Special tuition rates to members of the Armed Forces. Canadian residents send coupon to International Correspondence Schools Canadian, Ltd., Montreal, Canada.

Best Value - Bar None!

DU-FAST*

Oscillating Motion SANDER & POLISHER

Think of it! — The Du-Fast* Sander and Polisher gives a FULL 1/2" OSCILLATING MOTION... BIG 3 1/2" x 7" FAST-WORKING SURFACE... USES INEXPENSIVE STANDARD CUT PAPERS!

IT'S THE WORLD'S FASTEST CUTTING OSCILLATING SANDER!

Yes! — And it attaches in 10 seconds to any Home Utility Black & Decker 1/4" Electric-Drill... Light weight for smooth, easy, continuous use without tiring... powerful for the toughest Sanding and Polishing job!

DU-FAST* is the perfect Sander and Polisher for every home use!

Over 100,000 Satisfied Users!

only **\$14.95**

(For Du-Fast* Attachment)

DU-FAST* Oscillating SANDER & POLISHER, powered by Black & Decker Home Utility 1/4" Electric Drill.

PAT. APP. FOR



MANUFACTURED BY

DU-FAST, INC. 32 East 4th Street New York 3, N. Y.

THE AMAZING NEW POLARVISION SAFETY LIGHT

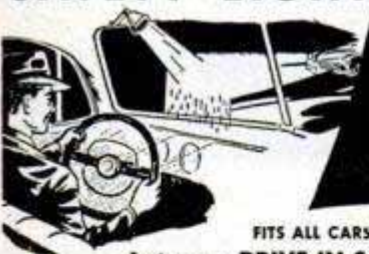

STOP HEADLIGHT GLARE!
STOP FOGGING & ICING!
(ON WINDSHIELD)

FITS ALL CARS & TRUCKS

Lets you DRIVE IN SAFETY & COMFORT

NEW revolutionary discovery—Now available! Famous "Ergon Lens" and other elements produce a BLACK RAY—(almost invisible to the eye) that shines down on your windshield. This ray COUNTERACTS THE GLARE from oncoming headlight street lights, etc. PREVENTS FOGGING AND ICING on your windshield during cold weather! WORKS LIKE MAGIC!

BEAUTIFUL RICH-LOOKING ACCESSORY

All vital elements encased in precision "air-tight," heavy duty, chrome case — sealed and guaranteed a lifetime. All installation equipment and copper cable included. Easy to install—no holes to drill.

FULL MONEY BACK GUARANTEE

This new product resulting from years of research and testing secret light formulas—is ALREADY America's most wanted automobile accessory! Send only \$1.00 for C.O.D. delivery.

COMPLETE PRICE **\$6.95** POST PAID
Dust kit (inc. passenger side mounting) \$11.99



ORDER BY MAIL for immediate delivery.

ELECTRONIC DEVELOPMENTS, Dept. B2
Box 775, Portland 7, Oregon
Enclosed find \$
Please Rush Polarvision Light:
 Post Paid C.O.D.

Name _____
Address _____
City _____ State _____

NEW "PAINT PEN"

PAINT STRIPING TOOL
Works like a Fountain Pen
Stripes with Paint instead of Ink!

This amazing new "PAINT PEN" is a Paint Striping Tool that makes it easy to do expert striping on furniture, bikes, model planes, autos, signs, toys, linoleum, wall board, etc. Makes plain-painted walls look like tile. Paint straight, curved, circular or evenly spaced parallel lines the same way a professional painter does. Simply fill Tubular Glass Paint Fountain with any color paint and wheel tip feeds paint evenly. Tips interchangeable — jaws split apart for easy cleaning. Tool complete with tip for 1-16 inch strip only \$1.00 postpaid. Other complete tools with 1-64, 1-32, 3-64, 1-16, 5-64, 3-32, 1-8 inch tips, \$1.50 ea. Extra tips, 75c each. Complete KIT with 7 tips, \$5.00. C.O.D.'s postage collect. Here's the handiest tool in your whole painter's kit. Get yours today.



Paint STRAIGHT, CURVED OR PARALLEL LINES

Home Craftsmen

Just the tool you've been waiting for! New Paint Striping Tool gives "professional" results every time, yet simple and easy to use as a fountain pen. Adjustable guide keeps lines straight as an arrow. Just as easy to make curves or free hand designs. Adds new beauty and finished look to everything you paint. Send \$1 now!

DEALERS
PAINT STRIPING TOOL packed in display cartons of 1 doz. Fast, profitable seller. Write for illustrated circular, discounts

WENDELL MFG. CO., Dept. 3-B,
4234 LINCOLN AVENUE, CHICAGO 18, ILL.

When You Can Earn More in WATCHMAKING

LEARN By KCSW's Outstanding Method

WRITE TO

High-paying jobs now open. Pleasant work. Or build a business for yourself right in your own home, repairing clocks and watches.

Inquire today about the opportunities in this high-paying trade, through the latest HOME STUDY TRAINING. Also Resident School.

KANSAS CITY SCHOOL OF WATCHMAKING
1218 Admiral Blvd. Kansas City 6, Missouri

A "GOOD HAND" HELPS YOU SUCCEED!

LEARN TO WRITE WELL

Handwriting quickly improves with our easy-to-understand picture lessons! Put your spare time to good use; send today for FREE BOOKLET, "How to Become a Good Penman," or check volumes wanted below at \$1 each: Business Writing Artistic Writing Card Writing Bird & Design Flourishing Engraving Alphabets. COMPLETE SET \$4.50. Ask for price list of penman's supplies.

TAMBLYN SCHOOL of PENMANSHIP
S.A. Ziller, Pres., 442 Ridge Bldg., Kansas City, Mo., USA



AUTO WASHER

Your car sparkling clean—in a jiffy—magic "sponge" cleaning-cloth. Simply glide over car. PRESTO! Dust, grease, dirt, grime disappear like magic. Your car gleams like a mirror. Take orders! Make money!

SAMPLES for TRIAL
Sample offer sent immediately to all who send name at once. Hurry, postal will do. **SEND NO MONEY**—just your name.
KRISTEE CO., Dept. 690, Akron 8, Ohio

Have an OFFICE of YOUR OWN!

LEARN NEW PROFITABLE PROFESSION
At Home in 60 Days, Men & Women, 18 to 70!

Earnings of men and women in this profession run as high as \$5,000-\$15,000 yearly. Others make good money in spare time. Little money needed to start. A business where your earnings begin sooner. Easy to learn. No selling or goods to buy. No experience necessary. A depression-proof business. A course of action to guide you step by step as you earn. All 53 lessons sent at once to use as operating manuals. Easy terms. Diploma. Money-back agreement. Write for **FREE BULLETIN**.

Be Your Own Boss and the Boss of Others. Be Respected. Meet Interesting People.



FRANKLIN CREDIT SCHOOL
Dept. 71-M ROANOKE 7, VIRGINIA

BY MAIL in Easy Lessons

THESE MEN ARE GETTING PRACTICAL TRAINING IN **ELECTRICITY**



On Real:

**A.C. and D.C. MOTORS
GENERATORS
SWITCHBOARDS
CONTROLLERS
WIRING JOBS
APPLIANCES
ELECTRONIC UNITS**

(Shown at left—Instructor explaining operation and testing of a large Motor Generator in our A.C. Department.)

AND **TELEVISION-RADIO**

On Real:

**TELEVISION SETS
RADIO RECEIVERS
F.M.**

**(Frequency Modulation)
RECORD CHANGERS
AUTO RADIOS**

PUBLIC ADDRESS Systems

(Right—Instructor helping students check the wiring and trace circuits of television receivers.)



TRAIN QUICKLY in the Great Shops of COYNE for VITAL FIELDS

ELECTRICITY—RADIO—TELEVISION—ELECTRONICS—VITAL in defense program. Trained men whether 16 or up to 50 needed. **TRAIN QUICKLY** for better rating if drafted—Vital job in industry if not.

FINANCE PLAN for non-veterans. G. I. Approved. Special plan for men of draft age.

NOT "HOME-STUDY" COURSES! At Coyne you learn on real, full-size equipment. Trained instructors show you how, then you do typical jobs yourself. We don't teach by mail.

CLIP COUPON NOW for big new illustrated Coyne book. Check whether interested in **ELECTRICITY** or **TELEVISION-RADIO** or both. No obligation; no salesman will call. Get vital facts now!

B. W. COOKE, President



**Mail Coupon for
BIG FREE BOOK!**



B. W. COOKE, President
COYNE SCHOOL

500 S. Paulina St., Chicago 12, Ill. Dept. 22-72H

Send **BIG FREE** book and details of your training offer. This does not obligate me and no salesman will call. I am interested in:

ELECTRICITY **TELEVISION-RADIO**

NAME

ADDRESS.....

CITY.....STATE.....

COYNE [SCHOOL]

**A TECHNICAL TRADE INSTITUTE
CHARTERED NOT FOR PROFIT
Established 1899**

**500 S. Paulina Dept. 22-72H
Chicago 12, Illinois**

ELECTRICITY ★ TELEVISION ★ RADIO ★ REFRIGERATION ★ ELECTRONICS

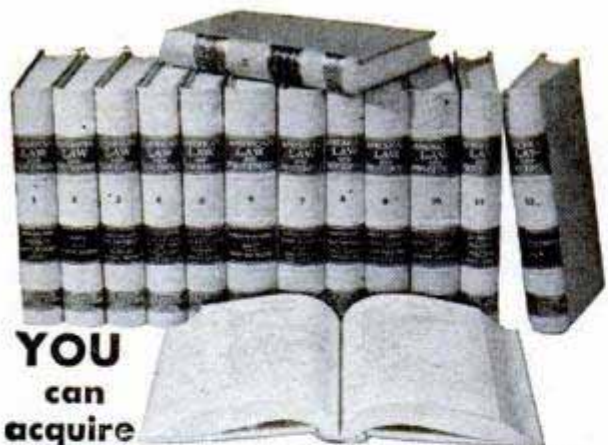

**YOU
can
acquire**

LAW NIGHTS AT HOME! L. L. B. DEGREE

LaSalle's famous Law Library—used as reference in many Law libraries and Law offices—has enabled thousands to master Law surprisingly fast, in spare hours at home, for business and professional advancement.

These 14 remarkable volumes, compiled by leading professors and lawyers, cover the whole basic field of Law in condensed, orderly, simplified manner.

You advance rapidly with this great library, plus special lectures furnished. We guide you step-by-step with personalized Problem Method of instruction . . . you learn by doing—handling legal problems—not by memorizing rules.

Send for two FREE 48-page booklets, "Law Training for Leadership," and "Evidence," answering questions about Law and its value to you, and telling how LaSalle Law graduates are winning rapid advancement in business and public life. Mail coupon below. No obligation.

LA SALLE EXTENSION UNIVERSITY A Correspondence Institution

417 S. Dearborn St., Dept. 264L, Chicago 5, Ill.

Send me your two FREE booklets described above, without obligation.

Name.....Age.....

Street.....

City, Zone & State.....

ENGINEERING DEGREE IN 27 MONTHS

Big Demand for Graduates

Aeronautical, Chemical, Civil, Electrical, Mechanical and Radio Engineering (including Television)

Hundreds of young men are earning engineering degrees in this recognized institution each year—continuous operation. New terms start quarterly. Many students earn a major part of their college expenses in this large industrial center.

Low tuition. Competent instruction. Thorough, intense, practical program. Modern laboratory facilities including new physics lab. and modernized wind tunnel. Individualized instruction emphasized.

Approved for Veterans. Engineering preparatory courses. Students from 48 states and 21 foreign countries. Enter March, June, September or December. Send coupon for free catalog and full information. Enroll now.

SEND COUPON TODAY

INDIANA TECHNICAL COLLEGE

522 E. Washington Boulevard
Fort Wayne 2, Indiana

Please send me free information on B.S. Engineering Degree in 27 months as checked.

Aeronautical, Chemical, Civil, Electrical,
 Mechanical, Radio-Television

Name.....

Address.....

No Experience Needed To PRINT YOUR OWN POST CARDS

The GEM STENCIL DUPLICATOR saves money... gets results quickly! Hundreds of uses for every type of business and organization. We ship the GEM complete with all supplies, Guide Board for accurate printing and 60-page Book of Ideas at the special low price of only \$8.50 (a \$15 value).

FREE TRIAL OFFER

Use the GEM FREE at our expense! SEND NO MONEY. Write and complete GEM outfit will be sent you postpaid. After ten days, send us only \$8.50 or return the GEM. You must be satisfied!

BOND EQUIPMENT CO. Dept. 48
6633 Enright • St. Louis 5, Mo.



GET INTO REAL ESTATE Business

FREE BOOK TELLS NOW

Start your own business—very little capital needed. Good pay jobs available. Taught by easy method in Home Study Course. G.I. Approved. Can earn up to \$1,000 monthly. PREPARE FOR LIFETIME CAREER AND BIGGER MONEY. Write for Free Book TODAY. No obligation.

WEAVER SCHOOL OF REAL ESTATE, Dept. NC-2
Suite 300 Law Bldg. Kansas City, Missouri

TOOTHACHE? Ask your Druggist for DENT'S

TOOTH GUM
TOOTH DROPS
POULTICE

GROW MINIATURE TREES FOR PROFIT & PLEASURE



Fabulous Money—Real Fun! Grow genuine live dwarf (Ming) trees. A terrific new business and hobby. Astounding details Free. Write —
DWARF TREES, Dept. 28
P. O. Box 355, Briggs Station
Los Angeles 48, Calif.

PORTABLE GARAGE

\$1095

(Extra Heavy Gauge)

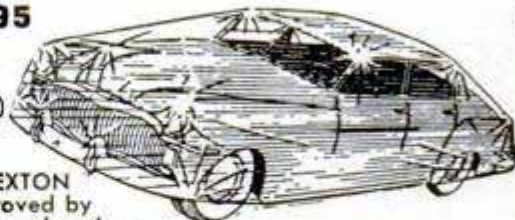

\$895

(Heavy Gauge)

FLEXTON
Approved by Good Housekeeping

USE IT ANYWHERE!

- Goes wherever your car goes ● Folds compactly ● Keeps rain, snow, dust, salt air, sun or sleet away ● Will withstand Extreme cold without cracking and protects your car's finish ● Perfect for storage of Cars, Furniture, Machinery Equipment ● Durably constructed of clear transparent—heavy gauge vinyl plastic that is long wearing and tough ● Nylon threads and grommets for extra security and wear ● Spring-tite elasticized bottom, holds securely in all kinds of weather ● Fits all makes and models ● Direct from manufacturer ● FREE: Carrying case! Enclose check or money order, or sent C.O.D.

MARDO SALES CORP., Dept. A-567

480 Lexington Ave.

New York 17, N. Y.

GET THE MONEY AND SECURITY YOU'VE ALWAYS WANTED!



L. J. ROSENKRANZ, President, National Schools, the man who has trained many, many men like YOU. Men who now own successful, respected businesses of their own. Men who hold important, high-paying positions in famous companies. You CAN be a success. Mail coupon for more details.

Let Me Show You How! Mail the Coupon for My FREE Books!

Each book has page after page in color. Gives you the complete story about my proved training method...tells how quickly it can train you for a secure, high-paying job. Don't wait. Get the facts. Send today for my valuable books on Radio-Television or Automotive-Diesel. Check the coupon at right and mail it to me today. Absolutely no obligation.

NO SALESMAN WILL CALL!
I'll send you a FREE SAMPLE LESSON TOO, if you act fast! Shows how easy it is to learn with National Schools Home Training.

NATIONAL SCHOOLS, Dept. B-22
4000 South Figueroa Street
Los Angeles 37, California

Mail in envelope or paste on penny postal card

Send me Free the book checked below and the sample lesson. I understand no salesman will call on me.

- "MY FUTURE IN RADIO-TELEVISION & ELECTRONICS" OR
 "MY FUTURE IN DIESEL-AUTOMOTIVE & ALLIED MECHANICS."

NAME _____ AGE _____

ADDRESS _____

CITY _____ ZONE _____ STATE _____

Check here if you were released from the service less than 4 years ago.



Let National Schools - a resident-training school for nearly 50 years - train you at home for today's unlimited opportunities in Radio-TV or Automotive-Diesel. National Schools is one of the largest schools of its kind in the world. It has 4 big buildings of modern shops and labs. Its faculty is considered tops. You learn fast from easy lessons - all perfected under actual shop conditions. Approved for eligible vets.



Earn Extra Money while you're learning! I'll show you how!
EASY TERMS • FREE GRADUATE SERVICE
Mail coupon today - find out more!

WHICH HIGH-PAYING FIELD DO YOU WANT?

TODAY'S SHORTAGE OF TRAINED TECHNICIANS CREATES CHANCE OF A LIFETIME FOR YOU... IN EITHER FIELD!

RADIO-TELEVISION & ELECTRONICS

OR

AUTOMOTIVE-DIESEL AND ALLIED MECHANICS

JOB SECURITY! BIG MONEY! FOR YOU IN TODAY'S EXPANDING INDUSTRIES!

Think of it! With guided missiles, radar and other electronic devices so important to national defense. With big, new developments in color TV. With over 90,000,000 home and auto radios, over 12,000,000 TV sets. With more than 3100 radio stations...over 100 TV stations - and more building every day - imagine the terrific opportunity you have!

You Train at Home - In Your Spare Time

With National Schools Master Shop Home Training, you master all phases of Radio-Television-Electronics. You learn fast from hundreds of pictures and diagrams. All lessons have been developed and tested in National Schools famous shops and labs. No wonder your National Schools training is so up-to-date, practical, interesting. And so easy!

LOOK! WE SEND YOU ALL THESE PARTS! -and you keep them!



We send you lots of standard professional parts. You do lots of practical experiments. You learn step by step. Until you can build the big Superheterodyne Receiver you see above - and other important test units. Mail the coupon - today.

I TRAIN YOU FOR GOOD-PAYING JOBS LIKE THESE

Radio Station Engineer; District Service Manager; Aircraft Radio Inspector; Inspector Technician; Own your own repair shop; Service Specialist; Special Civil Service Positions; Sound Truck Operator; Complete Television Service and many others. Thousands of National Schools graduates have jobs like these. Why not you? Start your career - be sure to mail the coupon today.

Only National Schools Gives You This Professional Multi-Tester



You get this factory-made new Multi-Tester...an important instrument every Radio-TV man must have.

GREATEST DEMAND FOR TRAINED MEN IN HISTORY! NOW IS YOUR CHANCE!

What an opportunity! With over 8 million older cars needing big service and repair jobs. With defense industry having more high-paying jobs than they can fill. With the Armed Forces offering quick advancement to trained mechanics. YOU ARE NEEDED as never before! Now you can get the good pay, security, the satisfaction of doing what you want to do! Don't delay - mail the coupon NOW!

Right in Your Own Home!

You learn all about Gasoline Engines, Diesel and Special-Fuel Engines, Automotive Tune Up, General Garage Mechanics, Auto Electrical Service. You get complete training for this great, growing industry.

Yet National Schools Home Training is easy! Because it's based on actual shop methods in National Schools big resident school. Mail the coupon for more details - NOW.

National Schools Gives You All These Tools

You start out owning the tools of your trade. A kit of standard, professional tools and equipment. They're all part of your course! -And you keep them - they're yours!



I Offer You All These!

Basic Lesson Texts. Diesel Installation & Maintenance Instructions. Spare Time Lessons. Engine Service Manuals. Engine Repair Drive Systems. Diesel Electric Power Texts. Special Thermodynamic Instruction.

Attention: Men Going into the Service Soon!

With National Schools training in Radio-Television or Automotive-Diesel, you have the opportunity to get into special service classifications. That means higher pay and grade, more prestige - right away! This is important - so be sure to mail the coupon today without fail.

WHICH OF THESE HIGH-PAYING JOBS WOULD YOU LIKE?

- MOTOR TUNE UP SPECIALIST
- DIESEL ENGINE SPECIALIST
- FARM EQUIPMENT MECHANIC
- YOUR OWN GARAGE OR REPAIR SHOP
- GENERAL GARAGE MECHANIC
- PARTS DEALER
- AUTO ENGINE REBUILDING
- FUEL INJECTION SPECIALIST

You can have secure jobs like these. Just mail the coupon - and find out!

NATIONAL SCHOOLS TECHNICAL TRADE TRAINING SINCE 1905
LOS ANGELES 37, CALIFORNIA



SEND NO MONEY
 • MORE THAN 4000 PAGES
 • 2750 PICTURES

On Approval

9 BIG COMPLETE BOOKS BUILDING, ESTIMATING, CONTRACTING

Examine this Up-to-Date Edition for 10 days. See how these nine books supply easily understood training that will help you to get a better job and make more money, or start a profitable business for yourself. Think what a BIG help it will be to have them handy for use in solving all sorts of building problems. Learn to draw plans, estimate, do all-new construction and modern remodeling to meet fast growing demand. More than 4000 pages of practical, pay-raising information with 2750 helpful illustrations, on such subjects as blueprint reading, concrete forms, masonry, carpentry, steel square, electrical wiring, plumbing, heating, painting, and hundreds more. In our more than 50 years we have never offered more complete building information. Send the coupon TODAY. (A year's consulting privileges with our engineers now given with these books without extra cost.)

AMERICAN TECHNICAL SOCIETY—Publishers Since 1898
 Dept. G219, Drexel Ave. at 58th St., Chicago 37, Ill.

I would like to examine your 9-Volume Set of Building, Estimating, Contracting Books. I will pay the delivery charges only, but if I choose I may return them express collect. If after 10 days' use I prefer to keep them, I will send you \$3 and pay the balance at the rate of only \$4 a month until \$34.80 has been paid. Include consulting service as offered above.

Name _____
 Address _____
 City _____ State _____
 Please attach letter giving employer's name and address (if self-employed give business man reference). Men in service please give home address.

GO FOR THE BIG ONES THE INDIAN WAY



STEAL up softly on the wise old battlers in your Old Town Canoe. Responsive and buoyant. Easy to paddle and portage. Sturdily built by makers with fifty years' experience.

FREE CATALOG shows all kinds of canoes for paddling, for sailing, for outboards. Also sailboats, outboard boats, dinghies, rowboats.

OLD TOWN CANOES

Old Town Canoe Co., 842 Elm St., Old Town, Maine
 PLEASE SEND ME FREE CATALOG

Name _____
 Address _____
 City _____ State _____

WEATHER DAMP—Car Won't Start?



SHORTSTOP

starts damp motors quick
 Just press button on handy aerosol can and spray plugs and wires. New, improved formula contains silicone. One treatment protects for months.

Get Shortstop at your service station, garage or auto supplies store.

ZACO LABS • 1360 W. 9th, Cleveland, O.

MONEY for MEN ALL DATA FREE

THE PLASTEX Industry needs manufacturers on small scale and for big production of Lamp and Clock Stands, Art Goods and Novelties in Plastex and Marble imitation. Experience unnecessary. 1/2¢ material makes regular 10¢ store sellers. Rubber moulds furnished for speed production. Small investment brings good returns. We are now placing big Chain Store Orders with manufacturers. Ambitious men have chance for real prosperity. Our Free booklet will interest and benefit you.

PLASTEX INDUSTRIES, Dept. A
 3400 Third Ave. New York 56, N. Y.

FOR BIG MEN ONLY!



SIZES 10 to 16 WIDTHS AAA to EEE

We SPECIALIZE in large sizes only — sizes 10 to 16; widths AAA to EEE. Loungers, Nylon Mesh; Dress Oxfords; Moccasins; High and Low Work Shoes; Slippers; Rubbers; Overshoes; Sox. Enjoy the finest in fit, comfort, style at amazingly low cost. Sold by mail only. Write for FREE Style Book TODAY!

SEND FOR FREE CATALOG

KING-SIZE, Inc., 830, Brockton, Mass.

Special FISHING LINES YOUR CHOICE FOR

| | |
|------------------------------|----------------------------|
| 500' 2-PLY NYLON 25 lb. T | 125' 3-PLY NYLON 110 lb. T |
| 250' 3-PLY NYLON 45 lb. T | |
| BRAIDED NYLON LINE | |
| 200 ft. 15 or 20 lb. Test | |
| 175 ft. 35 lb. Test | |
| 150 ft. 50 lb. Test | |
| 125 ft. 75 lb. Test | |
| 100 ft. 100 lb. Test | |
| 50 ft. 100 lb. Test | |

Imported
FLIES, Assorted 10 for \$1.00
 Level Fly Line, size E or D, 75 ft. \$1.00
 All lines available in longer lengths. Send Check or Money Order. We pay Postage.
MAC-MILLS, Dept. K-2, Pleasant Valley, New York

Saves Digging, Pumping, Moving!

OUTDOOR TOILETS CESS POOLS • SEPTIC TANKS Cleaned — Deodorized

Banish offensive odor of disposal units with amazing new product! Just mix dry powder with water and pour into outdoor toilet, cess pool or septic tank. That's all! Absolutely safe—nontoxic, no poisons. Works like magic to reduce mass, to unclog walls and pipes . . . to facilitate free and easy drainage. One treatment lasts months and months.



FREE! Just send your name and address on a postcard and get exciting details BY RETURN MAIL. Discover how you can clean, deodorize and sanitize your disposal unit QUICKLY and EASILY . . . at amazing low cost. LEARN HOW YOU CAN AVOID DIGGING, PUMPING AND MOVING. Write TODAY for complete details sent FREE!
BURSON LABORATORIES, 951 Willard Ct., Dept. 801, Chicago 22, Ill.

**NOW... GET EVERYTHING YOU
NEED TO LEARN AND MASTER**

TELEVISION

**RADIO-ELECTRONICS
...AT HOME!**

Use **REAL** commercial-type equip-
ment to get practical experience

Your future deserves and needs every advantage you can give it! That's why you owe it to yourself to find out about one of the most **COMPLETE**, practical and effective ways now available to prepare **AT HOME** for America's billion dollar opportunity field of **TELEVISION-RADIO-ELECTRONICS**. See how you may get and keep the same type of basic training equipment used in one of the nation's finest training laboratories — how you may get real **STARTING HELP** toward a good job or your own business in Television-Radio-Electronics. Mail the coupon today for complete facts — including 89 ways to earn money in this thrilling, newer field.

D.T.I., ALONE, INCLUDES BOTH MOVIES and HOME LABORATORY — in addition to easy-to-read lessons, you get the use of **HOME MOVIES** — an outstanding training advantage — plus 16 big shipments of Electronic parts. Perform over 300 fascinating experiments for

Get **BOTH** of these information packed publications **FREE!**

89 WAYS TO EARN MONEY IN TELEVISION RADIO ELECTRONICS

YOU GET ALL 6

practical experience. Build and keep real commercial-type test equipment shown at right

MODERN LABORATORIES

If you prefer, get all your preparation in our new Chicago Training Laboratories — one of the finest of its kind. Ample instructors, modern equipment. Write for details!

MILITARY SERVICE!

If you're subject to military service, the information we have for you should prove very helpful. Mail coupon today.

ACT NOW! MAIL COUPON TODAY!

DE FOREST'S TRAINING, INC. Dept. PM-2-1
2533 N. Ashland Ave., Chicago 14, Ill.

Without obligation, I would like your Opportunity News Bulletin showing "89 Ways to Earn Money in Television-Radio-Electronics"; also, the folder showing how I may prepare to get started in this thrilling field.

Name..... Age.....
Address..... Apt.....
City..... Zone..... State.....



ABOVE: Build and keep a real 17 INCH commercial TV receiver. Optional after-completing regular training at moderate added cost.

Here's the REAL THING!

SET UP YOUR OWN HOME LABORATORY



R-F Signal Generator



Oscilloscope



6-Tube Radio



Multimeter



Home Movies

One of America's Foremost Television Training Centers

De FOREST'S TRAINING, INC.
CHICAGO 14, ILLINOIS
A De VRY INSTITUTION

"I'M MAKING MORE THAN \$1000 a Month Haven't Touched Bottom Yet!"



C. KAMA

—reports Charles Kama, Texas, one of many who are "cleaning up" with orders for PRESTO, Science's New Midget Miracle Fire Extinguisher. So can YOU!



A MAZING new kind of fire extinguisher. Tiny "Presto" (about size of a flashlight!) does job of bulky extinguishers that cost 4 times as much, are 8 times as heavy. Ends fires fast as 2 seconds. Fits in palm of hand. Never corrodes. **Guaranteed for 20 years!**

Show it to civil defense workers, owners of homes, cars, boats, farms, etc. and to stores for re-sale—make good income. H. J. Kerr reports \$20 a day. Wm. Wydallis, \$15.20 an hour. Write for FREE Sales Kit. No obligation. MERLITE INDUSTRIES, Inc., Dept. 52, 201 East 16th St., New York 3, N.Y. *IN CANADA: Mopa Co., Ltd., 371 Dowd St., Montreal 1, P.Q.*

Science's New Midget Miracle "PRESTO"

(If you want a regular Presto to use as a demonstrator, send \$2.50. Money back if you wish.)



"GET ON" Uncle Sam's PAYROLL

START as high as \$3,795.00 a Year

REARMAMENT PROGRAM CREATING THOUSANDS OF ADDITIONAL JOBS!

VETERANS GET SPECIAL PREFERENCE

Railway Postal Clerks
City Mail Carriers
City Postoffice Clerks
Stenographers-Typists
Customs Inspectors
Messengers, Etc.

32-Page Book on Civil Service FREE.

Mail Coupon today—**SURE**

COUPON

FRANKLIN INSTITUTE

(Not Government Controlled)

Dept. E-83
Rochester 4, N. Y.

Rush to me, entirely free of charge, 32-page book with: (1) A full description of U. S. Government jobs; (2) A list of U. S. Government jobs; (3) Tell me how to qualify for a job.

Name _____

Street _____

City _____ Age _____

TAKE THE STEPS NOW THAT WILL GIVE YOU LIFETIME SECURITY IN AVIATION!

NOW IS THE TIME

Booming aviation industry urgently needs properly trained young men! Big paying jobs are open right now, with more to come! Embry-Riddle offers maximum training in minimum time. Fully accredited 8-mo. to 26-mo. courses in all aeronautical phases. Job-fitting instruction backed by 25 yrs. experience training today's aviation leaders. Be prepared. Enroll now! Illustrated catalog, address: REGISTRAR, EMBRY-RIDDLE, DEPT. 99, MIAMI 30, FLA.

MANAGEMENT PRODUCTION

Production experts earn big money. Thousands of firms need them. We train you thoroughly at home in spare time for management positions. Previous experience unnecessary. Personal training under supervision of production management authorities. Placement counsel and help. Write for FREE book "Industrial Management."

LASALLE Extension University, 417 So. Dearborn St. A Correspondence Institution, Dept. 264-IM, Chicago 5, Ill.

SHORTHAND in 6 Weeks at Home

Famous Speedwriting system. No signs; no symbols; no machines; uses ABC's. Easy to learn; easy to write and transcribe. Low cost. 100,000 taught by mail. For business and Civil Service. Also typing. 20th year. Write for FREE booklet to:

Speedwriting

Dept. 1502-2, 55 W. 42 St., New York 18

LAW FREE BOOK

Your FREE copy of "The Law-Trained Man" shows how to gain prestige and greater earnings through Blackstone home law study. All instruction material furnished including 17-volume Law Library written by 65 well-known law authorities. Lawyers, judges among our graduates. LL.B. degree. Low cost; easy terms. Write today.

BLACKSTONE COLLEGE OF LAW 225 N. Michigan Ave. Dept. 52, Chicago 1, Ill.
A Correspondence Institution Founded in 1890

ITALIAN ACCORDIONS

Hand Made. Very Best. Buy Direct from Factory Representative at lowest wholesale prices and Save Money. Send Name and Address for FREE catalog.

ITALIAN ACCORDION MFG. CO.
7600 Cottage Grove Ave., Dept. PM-2, Chicago 19, Ill.

LEARN AT HOME TO MOUNT BIRDS

Animals, Heads, Fishes, Pets; to TAN. Be a Taxidermist. Profit and FUN. Hunters, save your valuable TROPHIES. Mount ducks, squirrels, everything. Learn to TAN for leather and furs. Wonderful HOBBY. Have a HOME MUSEUM. BIG PROFITS mounting for others. INVESTIGATE NOW.

FREE BOOK With 100 fine game pictures. NOW absolutely FREE. Write TODAY.

Send Postal TODAY for FREE BOOK. State AGE. **N. W. SCHOOL OF TAXIDERMY, Dept. 2562, Omaha, Neb.**

NOW YOU CAN FIX ANY PART OF ANY CAR

in 3 easy steps!

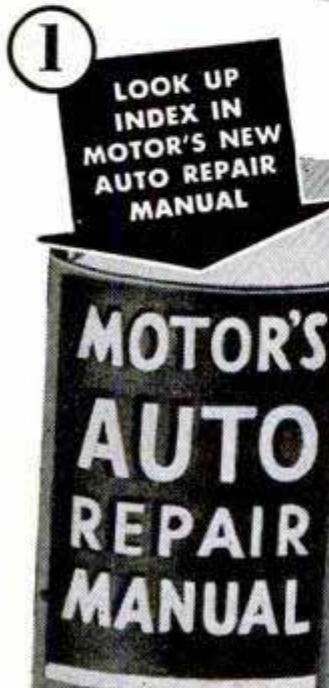

Now ANY Auto Repair Job is a "Push-Over" for You — Whether You're a Beginner or Expert Mechanic! Giant New Manual Shows How to Repair ANY Car — ANY Model from 1935 thru 1951

YES, now you can "breeze through" ANY "fix-it" job on ANY car—from a simple carburetor adjustment to a complete overhaul! It's easy when you have MOTOR'S BRAND-NEW AUTO REPAIR MANUAL. Step-by-step instructions and crystal-clear pictures show you HOW.

No guesswork! This giant guide tells you where to start. What tools to use. Leads you easily and quickly right through entire operation.

Over TWO THOUSAND Pictures

NEW REVISED Edition covers everything you need to know to repair 800 car models. 769 giant pages, 2300 "This-Is-How" pictures.

Over 200 "Quick-Check" charts—more than 38,000 essential dimensions and specifications. Instructions and pictures are so clear you can't go wrong!

Even a green beginner mechanic can do a good job with this giant manual before him. If you're a top-notch mechanic, you'll find efficient car factory recommended repair procedures that will amaze you. No wonder

this guide is used by the U. S. Army, Navy, and hundreds of thousands of repair men!

Meat of Over 150 Official Shop Manuals

Engineers from every auto plant in America worked out these time-saving procedures for their own car line. Now MOTOR brings you this wealth of "know-how" from over 150 Official Shop Manuals, "boiled down" into crystal-clear terms, profusely illustrated, in one handy indexed book!

SEND NO MONEY

When postman brings book keep pay him nothing. First, make it show you what it's got! Unless you agree this is the greatest time-saver and work-saver you've ever seen—return book in 7 days and pay nothing. Mail coupon NOW! MOTOR Book Dept., Desk 1B, 250 W. 55th St., New York 19, N. Y.

BRAND-NEW EDITION! USED BY U. S. ARMY AND NAVY

Free
7-DAY TRIAL
Return and Pay Nothing
If Not Satisfied!

Just a Few of the Many Letters of Praise



"Fixed motor another mechanic had worked on half a day. With your Manual I did it in 30 minutes."
—C. AUBERRY, Tenn.

"MOTOR'S Manual paid for itself on first 2 jobs, and saved me valuable time by eliminating guesswork."
—W. SCHROP, Ohio.



Covers 800 Models—All These Makes

| | | |
|-----------|-----------|------------|
| Buick | Henry J | Nash |
| Cadillac | Hudson | Rambler |
| Chevrolet | Kaiser | Oldsmobile |
| Chrysler | Lafayette | Packard |
| Crosley | La Salle | Plymouth |
| De Soto | Lincoln | Pontiac |
| Dodge | Mercury | Studebaker |
| Ford | Nash | Terraplane |
| Frazer | | Willys |

ALSO tune-up adjustments for others

Same FREE Offer On MOTOR'S

New Truck and Tractor Manual
BRAND-NEW Edition! Covers EVERY job on EVERY popular make gasoline-powered truck and farm tractor made from 1936 thru 1951. FREE 7-Day Trial. Check proper box in coupon.



MAIL COUPON NOW FOR 7-DAY FREE TRIAL

MOTOR Book Dept., Desk 1B,
250 West 55th Street, New York 19, N. Y.

Rush to me at once: (Check box opposite book you want)

MOTOR'S New AUTO REPAIR MANUAL. If O.K. I will remit \$1 in 7 days, (plus 35c delivery charge—then \$2 monthly for 2 months, and a final payment of 95c a month later. Otherwise I will return book postpaid in 7 days. (Foreign price, remit \$8 cash with order.)

MOTOR'S New TRUCK & TRACTOR REPAIR MANUAL. (Described at left.) If O.K. I will remit \$2 in 7 days, and \$2 monthly for 3 months, plus 35c delivery charge with final payment. Otherwise I will return book promptly. (Foreign price, remit \$10 cash with order.)

Print Name.....Age.....

Print Address.....

City & Zone No.....State.....

SAVE 35c delivery charges by enclosing WITH COUPON check or money order for full payment of \$5.95 for Auto Manual (or \$8.00 for Truck Manual). Same 7-day return-refund privilege applies.

MORE PAY through HOME STUDY TRAINING in SPARE TIME

Do you want a better position—a larger salary? They are within your reach—now. LaSalle experts will guide you step by step in gaining business training which leads to greater earnings.

The time-saving, interesting LaSalle Problem Method helps you prepare at home, without interference with your present duties.

Simply mark on the coupon the field in which you desire success, and we will mail you a valuable book describing the opportunities in that field—plus "Ten Years' Promotion in One"—a book which has helped many men. Let us tell you how we have started thousands of average men and women on the high road to success and more money. Check and mail the coupon now.

LASALLE EXTENSION UNIVERSITY

A Correspondence Institution

417 S. Dearborn St., Dept. 264R, Chicago 5, Ill.

Send me full information regarding the course I have marked—without obligation—plus "Ten Years' Promotion in One."

- | | |
|--|---|
| <input type="checkbox"/> Higher Accountancy | <input type="checkbox"/> Salesmanship |
| <input type="checkbox"/> C.P.A. Coaching | <input type="checkbox"/> Traffic Management |
| <input type="checkbox"/> Bookkeeping | <input type="checkbox"/> Foremanship |
| <input type="checkbox"/> Law: LL.B. Degree | <input type="checkbox"/> Industr'l Management |
| <input type="checkbox"/> Business Management | <input type="checkbox"/> Stenotypy (Machine Shorthand) |

Name.....Age.....

Address.....

City.....Zone.....State.....

PRESTO! ANYONE CAN MASTER GLAZE

LEAVES HARD GLASS-LIKE FINISH
EASY TO APPLY
PROTECTS THE SURFACE
NO SMEAR OR STREAKS AS WITH WAX
LASTS SIX MONTHS TO A YEAR

SEALS THE PORES OF THE SURFACE
WILL NOT FINGER-MARK
NO OILY FILM AS WITH POLISH
SAVES YOU MONEY

Car Owners! Meet Master Glaze—the sensationally different luster for new and used cars! Not a wax—not an oil polish—not a paint!—nothing that "smears" over the surface.

MASTER GLAZE is a unique discovery—a creamy liquid—quick and easy to apply! Gives a hard, glass-like surface. Even gasoline cannot dull it! Lasts six months to a year! Amazing luster—beautiful, sparkling clean and brilliant! Doesn't finger-mark—doesn't smear! A match box full glazes an entire car. Seals the pores—protects! **NOTHING LIKE IT!**

FREE SAMPLE

Just send your name and address to

MASTER GLAZE CO., 7720-727 W. Harwood Ave., Milwaukee, Wis.

AGENTS
An unusual opportunity!
Quick, flashy demonstrator.
Big profits.
Good territory.
Write today!

How to Always Have HOT WATER

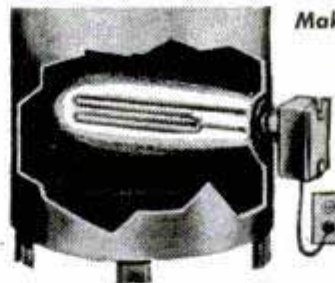

Make Your Own Automatic Electric Water Heater **\$19.95** now for only

INSTALL IN 5 MIN.

No disturbing or draining of tank or pipes

Why suffer without hot water? Enjoy lots of it to wash, bathe, shave. Heater keeps water HOT in your present tank. Turns ON when needed—shuts OFF when water is heated. No flue, dirt, fire!

ONE YEAR GUARANTEE
U. L. Approved Heater

Ideal for 30-gal. tanks! Heater screws into any size boiler tap as shown. Plugs into outlet . . . 1320 w. 110 v. AC. (Also 2000 w. 220 v. model for BX cable \$19.95) . . . works automatically thereafter. Temperature adjustable between 120 to 180 degrees. Replaces coal, oil, gas in home, store, summer cottage, green house, farm, barn, stock tank, poultry scalding, factory. Uses only 1/4 to 1/2c electricity per gallon hot water. Why burn expensive main furnace unit for hot water? Send check or M. O. NOW; save postage, shipping charges. ORDER NOW . . . TODAY. Money back in 10 days if not delighted.

COLLOID EQUIPMENT CO., INC. Dept. PM2, 50 Church Street, New York 7, N. Y.

MEN - WOMEN, LEARN

Skil-Weaving

MAKE GOOD MONEY AT HOME

SECRETS OF FRENCH INVISIBLE REWEAVING
Now, learn invisible reweaving at home. Repair burns, tears and moth holes in suits, dresses, coats, etc., like new, at big profit. No previous experience needed. Big profit orders come from Homes, Cleaners, Dept. Stores—also mail orders. Up to \$5 an hour possible, spare or full time without overhead or expense for materials. Complete Skil-weave Instructions yours to examine at home, without risk. FREE details—write NOW. Airmail reaches us overnight.
SKIL-WEAVE, 1715-JA Westwood, Los Angeles 24, California.

World's Fastest Boats!



Build your own high speed racing boat from a Champion plan! Send 25c for catalogue containing pictures and description of 18 models. Hydroplanes, Utilities and 3 Points. 6 to 20 ft. lengths. **CHAMPION BOATS, 1524 W. 15th St., Long Beach 13, Calif. Dept. 15 N.**

MAKE EXTRA MONEY!



SELL QUICK-BEARING NEW FRUIT TREES
GORGEOUS FLOWERING SHRUBS, ORNAMENTALS, ROSES
Get FREE Sales Kit—make money fast demonstrating world-famous Stark Patented Apple, Pear, Peach and other fruit trees, Grapes and Berries. Gorgeous flowering shrubs, roses, ornamentals sell fast to home owners. Sensational hardy, Quick Bearing new varieties. Enormous demand for small farms, home yards, etc. No experience needed. Rush your name for Giant Kit and Color Plate Book—FREE.
STARK BRO'S, DEPT. 5522, LOUISIANA, MISSOURI



Make BIG MONEY!
RAISE CHINCHILLA RABBITS!
Cash Markets Supplied for Your Production
FREE - Illustrated Booklet - **WRITE TODAY!**
ROCK HILL RANCH, SELLERSVILLE 36, PA.
World's Largest Breeder of Chinchilla Rabbits

RUPTURED?

Get Relief This Proven Way

Why try to worry along with trusses that gouge your flesh—press heavily on hips and spine—enlarge opening—fall to hold rupture? You need the Cluthe. No leg-straps or cutting belts. Automatic adjustable pad holds at real opening—follows every body movement with instant increased support in case of strain. Cannot slip whether at work or play. Light. Waterproof. Can be worn in bath. Send for amazing **FREE** book, "Advice To Ruptured" and details of liberal truthful 60-day trial offer. Also endorsements from grateful users in your neighborhood. Write:

CLUTHE SONS, Dept. 31, Bloomfield, New Jersey.

Don't Renew Your TV Service Contract! ... Don't Buy A TV Set!

UNTIL YOU READ THIS!

SAVE up to \$100 a Year on Your TV REPAIRS!

SAVE UP TO \$150 ON A NEW TV SET!

NOW! You Can Fix Your Own TV Set
Easily • Safely • Quickly with
Sensational NEW TV OWNER'S Guide
... Just Published!

Fix Any Set—Any Make

The Biggest, Most Complete TV Owner's Handbook Ever Published!
All The Money Saving Information You Want—Easy To Follow—
No Experience Needed—Easy as A-B-C Picture Instructions
Show You How To Improve Reception, Make 90% Of Your TV
Repairs In 1 to 5 Minutes—Only Tool Needed Is Screwdriver!

AT LAST, James Contos, Chief Engineer of a leading electronics corporation, for years in charge of servicing N. Y. department store TV sets, has just published his BRAND NEW TV OWNER'S GUIDE—the book that saves you money every time you open it!

YES! We Will Send You This Amazing New Money-Saving Book For A Full Year! We Guarantee Whether You Now Own A TV Set, Or Plan To Buy One, You Will Save \$65 to \$200 This Year!—or it won't cost you a penny!

IF YOU NOW OWN A TV SET

This Book Shows You How To:
... Fix Your Own Television Set—In 1 to 5 Minutes!
... Build Your Own Color Converter—In 1 Weekend!
... Install Your Own Special Antennas—Filters—Boosters!
... Double and Triple Reception In Bad Or Fringe Areas!

IF YOU PLAN TO BUY A TV SET

This Book Shows You How To:
... Save Up To Half The Price When You Buy!
... Get The Best Possible Set For Your Area!
... What To Watch For When Buying!—Don't Be Cheated!
... Get The Top Trade-In Value On Your Old Set!

Tells You Everything You Have To Know

Are you one of the thousands needlessly plagued by troubles and distortions on your set? Are you still throwing out \$5—\$10—\$20 every time a service man twists a knob on your set, or turns the same screw you can turn with your thumbnail? Isn't it foolish to spend \$65 or \$100 for a service contract, and then wait 3 or 4 days for repairs? ... when it's so easy to fix your set yourself, AND SAVE! Save up to \$75 on special antennas, color converters, filters—SAVE \$65 to \$200 IN 1 YEAR!

Clear—Simple—You Can't Go Wrong!
No Technical Diagrams—Easy as A-B-C,
with Hundreds of "Show-How" Pictures

This new TELEVISION OWNER'S GUIDE is so complete, so easy to follow, so FOOL-PROOF, it's like having a top-notch television engineer right at your elbow! Regardless of the make or year of your set, HUNDREDS OF

BEDFORD COMPANY
Dept. PM2, 699 Madison Ave., New York 21, N.Y.

GUARANTEE
Save \$65 to \$200 This Year Alone
OR YOUR MONEY BACK!

Send No Money

"HOW-TO" PICTURE INSTRUCTIONS track any trouble right to its source, show you exactly what to do, and then lead you step-by-step through the entire repair! It's so easy, and there's absolutely no danger when you do it our way. In less than 5 minutes you'll be fixing those jumpy or distorted pictures, cutting out static, ghosts, snow, herringbone effects, lines,—making major repairs such as burnt out tubes, blurred pictures, shorted picture tubes, even if you've never seen the inside of a set before! ... and without spending one cent for special equipment!

1001 Money-Saving Tricks

Learn the 1001 money-saving shortcuts and professional tricks that take all the expensive "hocus-pocus" out of television. Learn how to save up to 50% when buying your set, installing your set, adding accessories. Know when you need a serviceman, and when you don't; what has to be done, how much it should cost, how to adjust rear set controls — or best reception. Even includes a chapter on Radio Repairs! It's the most complete, authoritative, up-to-the-minute volume on television ever published, and it's yours to use for an entire year at our risk if you send today!

Amazing Full Year's GUARANTEE

Read this during introductory guarantee! TV OWNER'S GUIDE must save you \$65 to \$200 this year alone, whether you now own a TV set or plan to buy one in the future, or you may return the book even a year from today for full money back.

Signed
BEDFORD COMPANY

ACT NOW!

Special Offer Gives You
Magic Trouble
Spotter FREE!

Send TODAY and get Magic Trouble Spotter FREE, with your TV OWNER'S GUIDE. Examine up to a full year. If not convinced book will pay for itself in 1 day—if it doesn't save you \$65 to \$200 in 1 year, return for money back, keep Magic Trouble Spotter as FREE Gift!

SEND NO MONEY! Mail Free Gift Coupon NOW!

Bedford Co., Dept PM2, 699 Madison Ave., N. Y. 21

Gentlemen: Without obligation, please rush me the new TV OWNER'S GUIDE for no risk examination and trial. I agree to pay postman on arrival \$1.98 plus postage. If I am not satisfied I may return at any time within a year for full money back.

Also send me ABSOLUTELY FREE, the Magic Trouble Spotter chart, mine to keep as a FREE GIFT whether or not I keep the TV OWNER'S GUIDE.

NAME
ADDRESS
CITY ZONE STATE

SAVE MORE! If you send \$1.98 with coupon, we pay all postage charges. Same money back guarantee.

FREE!

(Yours to keep even if you return book!)

MAGIC "TROUBLE SPOTTER"

Now! Spot Your TV Trouble at a Glance... and see how to fix it, fast.

Big 11 by 44 inch chart pictures 90% of TV troubles! You instantly spot your problem, and see exactly what to do to fix it! Here are just a few samples of the many repairs you'll be making yourself, in 1 to 5 minutes, and saving \$5 to \$20 every time!

If Set Suddenly Goes Black
No waiting 3 or 4 days for service or getting "soaked" by independent repair man. Magic Trouble Spotter tells what's wrong, and shows what to do!

If Picture Tube Shuts Out
Why throw away \$25 for repair? Magic Trouble Spotter and screwdriver give you miracle repair in 4 minutes!

No Picture, No Sound
No need to run to neighbor's house for favorite program! Magic Trouble Spotter has set operating again before commercial is over!

Picture Blurred? Stretched?
Magic Trouble Spotter gives you movie-clear picture in 30 seconds, easy as A-B-C!

SAVES You MONEY 24 Ways!

This Book Shows You:

- How To save up to \$150 when buying your set.
- How To get the best set for your viewing area.
- How To buy a "top brand" set for up to 50% less.
- How To avoid hidden installment payments.
- How To get the top trade in on your old set.
- How To avoid being gyped.
- What to watch for when buying your new set.
- What you must know about your warranty, and service contract.
- How To double and triple fringe or bad area reception without a special antenna.
- How To bring in weak channels clearly with only 5 minutes work.
- How To install your set.
- How To install your own antenna—built in, indoor, or outdoor.
- How To be sure you're getting an honest repairman.
- How To repair your own set, on the spot, with no special equipment, no experience.
- How To avoid repair rackets.
- How To know what the repair should cost, and avoid overcharges.
- How To avoid long waits when you give your set to a repairman.
- How To light your room correctly to avoid television eyestrain.
- How To correct minor defects and avoid major breakdowns.
- How To buy at auction sales—discount houses—second hand shops.
- How To know your legal rights with your landlord, repair man, service contract.
- How television can benefit your child.
- How To get more enjoyment from your TV set.
- How Your television set really works.

... and so much more!

NOW—BE A FULLY RADIO-TELEVISION 10 MO



**I Send You
18 BIG
KITS
OF RADIO-
TELEVISION
EQUIPMENT**

EXTRA MONEY

**Earn While You Learn
In Your Spare Hours!**

You do all your training with me AT HOME in spare hours. Keep right on with your present job and income while learning—and earn extra cash besides! The day you enroll I begin sending you plans and ideas for doing profitable spare time Radio-TV work. Many of my Sprayberry students pay for their entire Radio-TV training this way!



YOU KEEP THIS VALUABLE EQUIPMENT

The many big kits of Radio-Television parts and equipment are sent to my students "for keeps." Nothing need be returned—it is YOURS! There is absolutely nothing else to buy!

TRAINED, QUALIFIED TECHNICIAN IN JUST MONTHS OR LESS!

New "Package" Unit Training Plan—PAY AS YOU LEARN—YOU SET THE PACE! TRAIN AT HOME IN SPARE HOURS!—No Monthly Payment Contract to Sign!

Now . . . be ready for Radio-Television's big pay opportunities in a few short MONTHS! Frank L. Sprayberry's completely new "Package" training unit plan prepares you in just 10 MONTHS . . . or even less! Equally important, there is NO monthly payment contract to sign . . . thus NO RISK to you! This is America's finest, more complete, practical training—gets you ready to handle any practical job in the booming Radio-Television industry. In just 10 months you may start your own profitable Radio-Television shop . . . or accept a good paying job in this fascinating expanding field in work you've always wanted to do. Mr. Sprayberry has trained hundreds of successful Radio-Television technicians—and stands ready to train you in less than one year, even if you have no previous experience. You learn by DOING . . . actually working with your hands with equipment of special design to illustrate basic theory instead of relying on books alone. Your training is very interesting because it's really practical.

The Sprayberry 10 MONTH TRAINING PLAN includes, Radio, Television, FM (Frequency Modulation), Public Address Systems . . . everything you need to make big money in this fast moving industry. This new Sprayberry "package" plan includes many kits of genuine, professional Radio-Television equipment. While training at home in spare hours you actually perform over 300 demonstrations, experiments and construction projects. In addition, you build a powerful 6-tube standard and short wave radio set, a multi-range test meter, a signal generator, signal tracer and many other projects. All equipment is yours to keep . . . you have practically everything you need to set up your own service shop. The interesting book-bound lessons, manuals, bulletins . . . all are yours to keep. If you expect to be in the armed forces later, there is no better preparation than good Radio-Television training. These are sound, logical, money-in-the-bank reasons why this training is the best training of all for you.

MEET A FEW OF MY GRADUATES



Training Leads to Good Radio Job

"Got a job in local radio shop soon after enrolling. Very satisfied with training."
— Stanley Clemmons, Kansas.



Radio Profits Pay Cost of Training

"I have more than taken in the cost of your training doing spare time radio repair work. See bright future ahead."
— Thomas Shearer, N.Y.



Earns Easy Spare Time Cash

"While training, I made about \$180.00 in spare time. Thank you for wonderful Radio-TV training."
— Herbert Burroughs, W. Virginia.

No Previous Experience Needed to Succeed

My Training in Radio-Television is so complete, so down-to-earth that previous experience is not necessary. I start you with basic fundamentals and carry you in easy, practical steps through one Radio-Television subject after another. You will be amazed at your rapid progress and your knowledge of Radio-Television. Best of all, you put this knowledge to work making spare time cash soon after you enroll! You may train as fast or as slowly as suits your convenience. Each of my students receives individual training!

IF YOU ARE EXPERIENCED IN RADIO

Men already in Radio who seek a short intensive 100% TELEVISION Training with FULL EQUIPMENT INCLUDED are invited to check and mail the coupon at the right.

Sprayberry Academy of Radio, Dept. 10-F
111 North Canal St., Chicago 6, Ill.

Be Ready for Top Paying Radio-Television Jobs!

Radio-Television is growing with amazing speed. More than 2000 broadcasting stations PLUS an additional 102 Television stations are now on the air. Radio sets and TV receivers are being made and sold in record breaking numbers. If you enjoy working with your hands . . . if you like interesting and varied work . . . YOU BELONG IN RADIO-TELEVISION. But you MUST have good Training to "cash in" . . . the training that starts with basic fundamentals and carries through every circuit and problem of Radio-TV.

FREE 3 Big Radio and Television Books



I want you to have ALL the facts about my complete system of Radio-Television Training! Act now! Rush the coupon for my three big Radio-Television books: "How To Make Money in Radio-Television," PLUS my new illustrated Television bulletin PLUS an actual sample Sprayberry Lesson—all FREE with my compliments. No obligation and no salesman will call on you. Send the coupon in an envelope or paste on back of post card. I will rush all three books at once!

Mail Coupon Today!

**NO OBLIGATION
No Salesman
Will Call**

SPRAYBERRY ACADEMY OF RADIO, Dept. 10-F
111 North Canal St., Chicago 6, Ill.

Please rush to me all information on your Radio-Television Training plan. I understand this does not obligate me and that no salesman will call upon me.

Name..... Age.....

Address.....

City..... State.....

Please Check Below About Your Experience

Are You Experienced?

No Experience

Send No Money— 4 BIG AUTO BOOKS



On Approval!

Over 2700 Pages of
How-To-Do-It-Facts
2000 Pictures

TO HELP YOU MAKE MORE MONEY

America is again in a period when its 43 million autos and 9 million trucks and busses *must* be kept in good repair. That means that men with know-how are in demand for good jobs at high pay. It means that the door of Big Opportunity is wide open.

The four big, thick volumes in this 20th Edition of auto fact books are packed full of the exact information that will help you to hold a big paying job. They will enable you to do important work better and faster. Keep the set handy for convenient reference.

All pages are written in an easy-to-understand manner by expert automotive engineers with many years of successful experience. To have this 4-volume set close at hand is like having these experts beside you, ready to answer questions. Send the coupon TODAY but send no money now.

(A year's consulting privileges with our engineers now given with these books without extra cost.)

AMERICAN TECHNICAL SOCIETY—Publishers Since 1898
Dept. A219, Drexel Ave. at 58th St., Chicago 37, Ill.

I would like to examine your 4-Volume Set of Auto Books. I will pay the delivery charges only, but if I choose I may return them express collect. If after 10 days' use I prefer to keep them, I will send you \$3 and pay the balance at the rate of only \$4 a month until \$24.80 has been paid. Include consulting service as offered above.

Name _____

Address _____

City _____ State _____

Please attach letter giving employer's name and address (if self-employed give business man reference). Men in service please give home address.

Can A Man My Age Become A Hotel Executive Even Though He Has No Previous Hotel Experience?

Would you like to step into a well-paid position in a Hotel, Club, Restaurant, essential Defense Cafeteria or Housing Project? Would you like to look forward happily to the future? The success of Lewis graduates from 18 to 50 PROVES you can—though you have no experience in hotel work.

**Don E. Ulmer Becomes Hotel Manager
With Substantial Increase in Salary,
Although He Knew Nothing about
Hotel Work**

"After I received my Lewis diploma, I gave up an office job and accepted a position obtained by the Lewis Placement Service at a resort hotel. At the end of the season I was appointed Manager of another hotel. Later I came to this hotel. Each change meant an increase in salary. I give credit to the Lewis Course."

Step Into a Well-Paid Hotel Position FREE Book Gives Fascinating Facts

Our FREE Book, "Your Big Opportunity," explains how you can qualify for a well-paid position at home, in leisure time; tells how you are registered FREE of extra cost in the Lewis National Placement Service. Most important, it shows how you can be a Lewis Certified Employee—certified to "make good" when placed in a position. Mail the coupon NOW!

Course Approved for Veterans' Training

LEWIS HOTEL TRAINING SCHOOL
Room VB-324, Washington 7, D. C.

36th SUCCESSFUL
YEAR

Send me the Free Book, "Your Big Opportunity," without obligation. I wish to know how to qualify for a well-paid position at home, in my leisure time.

Name _____

(Please Print Name & Address)

Address _____

City _____ Zone _____ State _____

DYNAMIC POWER TOOL COMBINATION



INCLUDES: Cummins 1/4" Electric Drill; Cummins Saw Attachment; Combination Saw Blade; Set of Drills; Lambs Wool Bonnet; 6 Sanding Disks; Steel Arbor and Attachments; Cloth Buffing Wheels; Grinding Wheel; Wire Wheel Brush; Steel Point Mixer; Steel Bench Stand; Portable Steel Carrying Case.

Price of Dynamic Power Tool
Combination complete is \$26.95

**SHIPPED ON APPROVAL
NO MONEY WITH ORDER—NO C. O. D.**

Try it ten days before you buy. If completely satisfied then send \$2.95 and pay balance at rate of \$4.00 per month for 6 months—No Interest or Carrying Charges Added, if not completely satisfied, return to us, no explanation necessary.

KAPNER HARDWARE, INC.

Dept. A-26, 2248 Second Ave., N. Y. 29, N. Y.



Free
Book

Money In Hamsters

The new wonder animals from Syria. Often called Toy Bears. Delightful pets. Everyone wants them. Laboratories use thousands. Clean, odorless. Raise anywhere. NOW, spotted and golden breeds. We furnish breeders, equipment and manual of instruction. Write today for free illustrated literature.

GULF HAMSTERY 1536 BASIL ST.,
MOBILE 17, ALA.



LEARN MEAT CUTTING At Home—In Spare Time

Get into the vital meat industry. Concise, practical Home Training based on 25 years proven instruction methods used at National's famous resident school. Prepares you for bigger pay as Meat Cutter, Supervisor, market manager or more money in your own store. Go as rapidly as your spare time permits. Diploma. Start NOW to turn your spare hours into money. Send for FREE bulletin today. No obligation.

NATIONAL SCHOOL OF MEAT CUTTING, INC., Div. U-137, Toledo 4, Ohio

RUPTURE!

An amazing Air-Cushion
Invention allows body
freedom at work or play.
Light, neat, cool, sanitary.

Durable, cheap. Day and night protection helps Nature support weakened muscles gently but surely. No risk. **Send on Trial!** Write NOW for free Booklet and **Proof of Results.** All correspondence confidential.

Brooks Company, 373 State St., Marshall, Mich.



LEARN WATCH REPAIRING



AT HOME. By our modern and original system of instruction you can learn every part of the **WATCH REPAIRING TRADE AT HOME.** Prepare yourself for a well-paying position or start in business after completing our course of instruction. Good watch repairers are in demand and generally earn very good salaries. For particulars apply to the **WISCONSIN SCHOOL OF WATCH REPAIRING**, 759 N. Milwaukee, Dept. 2, Milwaukee 2, Wis.



**CLEANS WINDOWS
WITHOUT WATER**

NEW CHEMICAL MITT

Sensational! DRY Window Cleaner! Uses no water, no messy liquids. Chemically Treated. Simply glide over windows; leaves glass sparkling clear. No heating water, no heavy buckets to carry. No rags, powders, sponges, chemicals. No mess or muss. No red chapped hands. Dust, dirt, grime, fog disappear like magic. *Take orders from friends! Extra money!*

SAMPLES FOR TRIAL immediately to all who send name at once. Hurry. Postcard will do. **SEND NO MONEY—just your name.** KRISTEE CO., Dept. 691, AKRON 8, OHIO

THOUSANDS NOW PLAY

who never thought they could!



"Opened Door to Popularity"

"I was able to play many pieces in a short time. Family and friends certainly surprised. Course opened door to popularity, wider circle of friends. Recently I entered amateur contest—won First Prize."—*Peter H. Kozyra, Manitoba, Canada.*



Course Inspires Music Circle

Shown above is Miss Mildred Cade, of Houston, Texas. She and a number of her friends are so enthusiastic about the U. S. School of Music's quick easy way of learning that they've ALL taken it up.



Plays Banjo In A Short Time

"Enjoy your lessons for the Tenor Banjo; am progressing rapidly. Lessons are so simple, anyone can understand; yet so thorough I have learned to play by note in little more than a month!"—*Andrew Schneider, Hanna, Wyoming.*



"Can't Thank Your School Enough"

"Never studied music before. Your method is easy; being your own teacher is best. After 4 lessons, I could play a few pieces. Now play any piece I like. Can't thank you enough."—*Rose Boyer, Blackwell, Mo.*



Learns Faster Without Teacher

"I have no special talent — but thanks to you I play my guitar better than many who have taken lessons from teachers longer, and naturally at higher cost." — *Myrella-Muquette Saint Andre, Montreal, Canada.*



Now a Famous Orchestra Leader

"I got my start in music with a U. S. School Course. How easy it is to learn to read notes, play an instrument, this 'teach-yourself' way! I've enrolled my two daughters." — *Lawrence Welk.*

You, too, can play any instrument— By this EASY A-B-C Method

You think it's difficult to learn music? That's what thousands of others have thought! Just like you, they long to play some instrument — the piano, accordion, violin, guitar, saxophone or some other favorite. But they denied themselves the pleasure — because they *thought* it took months and years of tedious study to learn!

Learn in Spare Time at Home

And then they made an amazing discovery! They learned about a wonderful way to learn music at home — without a private teacher — without tedious study — and in a surprisingly short time. They wrote to the U. S. School of Music for the facts about this remarkable short-cut method. And the facts opened their eyes! They were amazed to find how easy it was to learn!

850,000 Students!

The result? Over 850,000 men and women have taken up music at home this simple, A-B-C way. Now, all over the world, enthusiastic music-lovers are enjoying the thrilling satisfaction of creating their own music. They have found the key to good times, and popularity.

NOTICE

Please don't confuse our method with any systems claiming to teach "without music" or "by ear". We teach you easily and quickly to play *real music*, any music by standard notes—not by any trick or number system.

Costs Only Few Cents a Lesson

And that's what you can do, right now. **NO TEDIOUS PRACTICING OF BORING SCALES AND EXERCISES!** Even if you don't know a single note now, you'll "start right in on pieces." This builds up your skill and confidence so rapidly that soon you'll be able to play **ALL** your favorite songs and compositions **by note**. It's all so clearly explained—so **EASY** to understand—that even children "catch on" at once.

Get the proof that you, too, can learn to play your favorite instrument — quickly, easily, in spare time at home for only a few cents a lesson!

FREE BOOK AND FREE INSTRUCTION SAMPLE

Never mind if you have no musical knowledge, training or talent. Just read the fascinating **FREE BOOK** and **Print and Picture Sample** that fully explain all about the famous U. S. School method. (Instruments supplied when needed, cash or credit.) If interested tear out the coupon now, before you turn the page. U. S. School of Music, Studio B302, Port Washington, N.Y.



U. S. School of Music, Studio B302, Port Washington, N. Y.

Send me **FREE BOOK** and **FREE Instruction-Sample**. No obligation—and no salesman is to call upon me. I'm interested in playing

(name instrument).....

I do I do not — have instrument now.

Name.....
(please print)

Address.....

Learn this Profitable Profession



IN 90 DAYS AT HOME

Money-Making Career Open to Men and Women, 18 to 60

Hundreds of men and women between 18 and 60 make \$10 to \$20 in a single day giving scientific Swedish Massage and Hydro-Therapy treatments. There is big demand from doctors, hospitals, sanatoriums and clubs. Graduates earn large full time income from these or in private practice in their own offices. Others make good money from home treatments given in spare time. Learn this interesting money-making profession in your own home, through our home study course. Same instructors as in our nationally known resident school. You can win independence and prepare for future security by qualifying for your Certificate. Course can be completed in 3 to 4 months. Many earn while they learn. Begin your training at once.



NEW 32-PAGE BOOKLET FREE

Fill in the coupon below (please print name and address) and mail it for your FREE copy of 32-page Information Booklet. If you act at once we will include Anatomy Charts and Success Booklet which supply additional information you should have. All will be sent postage paid.

THE COLLEGE OF SWEDISH MASSAGE
Dept. 264B, 41 E. Pearson St., Chicago 11, Illinois

Please send me FREE and postpaid New 32-Page Illustrated Booklet, Anatomy Charts and Success Booklet at once.

Name _____ Age _____
Address _____
City _____ State _____



START AS HIGH AS \$3,975.00 YEAR

Many Early Examinations Expected. Prepare NOW! Veterans Get Special Preference! 32-Page Civil Service Book FREE Mail Coupon Today SURE ★

Franklin Institute
Dept. E-84
Rochester 4, N. Y.
(Not Government Controlled)

Gentlemen: Rush to me, FREE of charge, list of U.S. government big pay jobs. Send FREE 32-page book describing salaries, vacations, hours, work, etc. Tell me how to qualify for one of these jobs.

COUPON
Name.....
Street.....
City..... Age?.....

NOW YOU TOO CAN BUILD 15 RADIOS COMPLETE AND \$19.95

The Progressive Radio "Edu-Kit" is a Home Radio Course in kit form. No previous knowledge of radio is required. No additional parts necessary. Tools included. Easy-to-follow instructions. Theory, Practical Work, Trouble-shooting are taught. Used in many radio schools. Excellent background for television.

Kit includes all parts, instructions, radio tester, electric soldering iron, trouble-shooting guide, quizzes, television book, consultation service. \$19.95 is complete price. Nothing else to buy. Everything you build is yours to keep. All parts and equipment guaranteed.

Order your kit today, or send for further information. You risk nothing. 10 Day Money-Back Guarantee.

Postage prepaid on cash orders. C.O.D. orders accepted in U.S.A.

PROGRESSIVE ELECTRONICS CO.
497 Union Ave., Dept. P.M.-3 Brooklyn 11, N. Y.

NEW! NEW "WIGGLE" GETS BIG FISH HULA DIVER

POSITIVE CONTROL OF DEPTH AND ACTION

New big lip and rear paddle for amazing results. Ideal open-water 5/8 oz. lure for deep-feeding game fish. \$1.25 at your dealer.

FRED ARBOGAST & Co., Inc., 2262 W. North St., Akron 3, Ohio

FREE WRITE TODAY FOR YOUR BIG FREE ARBOGAST COLOR CATALOG - FULL OF PICTURES OF CATCHES

PLASTICS CATALOG

Small Quantities — SPECIAL PRICES — Large Quantities

There's more information and tricks-of-the-trade and a larger variety of plastics materials listings packed into this catalog than you've ever seen before. Sheets, rods, tubes, casting, draping, molding plastics, supplies, findings, etc. We make our own Carving Dyes. "Gem-Coat" Fiberglass and Polyester coating. For fast, courteous, personalized service. TRY US. CATALOG 10¢, —or Airmailed for 25¢ in U.S.

GEM-O-LITE PLASTICS CO.
5350B Riverton Ave., North Hollywood, Calif.

ENGINEERING DEGREE IN 27 MONTHS

INDIANA TECHNICAL COLLEGE

B. S. DEGREE, Aeronautical, Chemical, Civil, Electrical, Mechanical and Radio Engineering (inc. television), Drafting, 1-yr. Government approved for G.I.'s. Low rate. Earn board Large industrial center. Students from 48 states, 21 countries. Demand for graduates. Enter March, June, September, December. Write for catalog, 1622 E. Washington Boulevard, Fort Wayne 2, Indiana.

Learn ACCOUNTING BOOKKEEPING

This nationally renowned school has demand for graduates in good salary positions thru Nationwide recognition and placement service. Write Department PMG today for Big 32 page Success Book to be sent to you **FREE**

Hills BUSINESS UNIVERSITY AND EXTENSION SCHOOL
619 W. MAIN ST. OKLAHOMA CITY 2, OKLAHOMA

EASY TO LEARN CODE

Learn or increase speed with an Instructograph — the Radio-Telegraph Code Teacher that takes the place of an operator-instructor and enables anyone to master code without further assistance. Available tapes from beginners alphabet to typical messages on all subjects. Speed range 5 to 40 WPM. Always ready — no QRM. Thousands have "acquired the code" with the Instructograph System. Write today for convenient rental and purchase plans.

INSTRUCTOGRAPH COMPANY
4701-V Sheridan Road, Chicago 40, Illinois

Learn PHOTOGRAPHY at Home

Splendid opportunities. Prepare in spare time. Practical basic training. Long-established school. Send for free book, "Opportunities in Photography." No obligation.

American School of Photography, 835 Diversey Parkway, Dept. 1352, Chicago 14, Ill.

Tired of Being Ashamed of Your Build?

LET ME GIVE YOU A NEW HE-MAN BODY!

Charles Atlas

Awarded the title of "The World's Most Perfectly Developed Man" in an international contest.

My Secret Method Has Worked for Thousands No Matter How Skinny or Flabby They Were — Now, Why Not Let It Work For You?

**HERE'S WHAT I'LL PROVE
15 MINUTES A DAY CAN DO FOR YOU**

I don't care how old or young you are, or how ashamed of your present physical condition you may be. If you can simply raise your arm and flex it I can add **SOLID MUSCLE** to your biceps—yes, on each arm—in double-quick time! *Only 15 minutes a day*—right in your own home—is all the time I ask of you! And there's no cost if I fail.

I can broaden your shoulders, strengthen your back, develop your whole muscular system **INSIDE and OUTSIDE!** I can add inches to your chest, give you a vise-like grip, make those legs of yours lithe and powerful. I can shoot new strength into your old backbone, exercise those inner organs, help you cram your body so full of pep, vigor and red-blooded vitality that you won't feel there's even "standing room" left for weakness and that lazy feeling! Before I get through with you I'll have your whole frame "measured" to a nice, new beautiful suit of muscles!

WHAT'S MY SECRET?

"**DYNAMIC TENSION!**" That's the ticket! The identical natural method that I myself developed to change my body from the scrawny skinny chested weakling I was at 17 to my present superman physique! Thousands of other fellows are becoming marvelous physical specimens—my way. I give you no gadgets or contraptions to fool with. When you have learned to develop your strength through "*Dynamic Tension*" you can laugh at artificial muscle-makers. You simply utilize the **DORMANT** muscle-power in your own God-given body—watch it increase and multiply double-quick into real solid **LIVE MUSCLE**.



ARE YOU Skinny, weak, and run down? Always tired? Nervous? Lacking in confidence? Constipated? Suffering from bad breath? Fat and flabby? Do you want to lose or gain weight? **WHAT TO DO ABOUT IT** is told in my **FREE BOOK**.

FREE Illustrated 32-page Book. Just Mail the Coupon.

SEND NOW for my famous book, "Everlasting Health and Strength." Packed with actual photographs. Page by page, it shows what "*Dynamic Tension*" can do for YOU.

This book is a real prize for any fellow who wants a better build. Yet I'll send you a copy absolutely **FREE**. Rush coupon to me personally: Charles Atlas, Dept. 8P, 115 East 23rd St., New York 10, N. Y.



"I gained 11 lbs. and 4 1/4 inches on my chest, 3 inches on my arms. I am never constipated."
—Henry Neven, Canada

"I gained 34 lbs. and increased my chest 6 inches!"
—Stanley Lynn, Calif.

"What a difference! Have put 3 1/2 inches on my chest (normal) and 2 1/2 inches expanded."
—F. S., New York

"Gained 29 pounds. When I started your course I weighed only 141. Now I weigh 170."
—T. K., New York

SILVER CUP GIVEN AWAY
This handsome cup, over a foot high, will be given to the pupil who makes the greatest physical improvement in the next 3 months.

**CHARLES ATLAS, Dept. 8P,
115 East 23rd St., New York 10, N. Y.**

Send me—absolutely **FREE**—a copy of your famous book, "Everlasting Health and Strength"—32 pages, crammed with photographs, answers to vital health questions, and valuable advice. I understand this book is mine to keep and sending for it does not obligate me in any way.

Name.....Age.....
(Please print or write plainly)

Address.....

City.....State.....

SCRAM! You SKINNY SCARECROW!

The boys Shouted at me—
ONLY A FEW WEEKS AGO!

"I was a SKINNY, scared, girl-shy skeleton. Now I feel and look great. Pal, do as I did, right NOW! Mail the Coupon below.

I gained 53 lbs. of MIGHTY MUSCLE

6 1/2 inches on my CHEST;
3 inches on each ARM

You can do it in 10 minutes a day and WIN This 15" Tall SILVER TROPHY"



ROGER HIRSCH was an 112 lb. 6 ft. weakling LOOK AT HIM NOW!

Roger D. Hirsch
New York

MAN! aren't YOU as SICK and TIRED as I and thousands of MIGHTY JOWETT HE-MEN were of being SKINNY?

Come on, Pal, Give me 10 pleasant minutes of fun a day and I'll give YOU a NEW HE-MAN BODY for your Old Skeleton Frame.

NO! I don't care how skinny or flabby or how young or old you are I want to MAKE YOU OVER by the SAME METHOD I turned myself from a wreck to a Champion of Champions.

YES! You'll see INCH upon INCH of MIGHTY MUSCLE added to YOUR ARMS. Your CHEST deepened. Your BACK AND SHOULDERS broadened. You'll gain SOLIDITY, SIZE, POWER, SPEED! You'll become an ALL-American HE-MAN, a WINNER in everything you tackle—or my Training won't cost you one cent!

Develop YOUR 520 MUSCLES! Gain Lbs., INCHES, FAST!

Friend, I've made a LIFETIME STUDY of every way known to develop your body. Then I devised my "5-WAY PROGRESSIVE POWER" the only method that builds you 5-ways fast. You save YEARS and DOLLARS by Mailing Coupon NOW.



GEORGE F. JOWETT
Champion of Champions



"IN 90 DAYS You changed me from a SKINNY wreck to a MIGHTY HE-MAN. With ONE hand I can NOW lift overhead a boy weighing 115 lbs."

John Jackson Jr. ARK.

"10 Minutes a day and I am a NEW STRONG MAN! I have a big 49 in. CHEST, powerful 17 inch ARMS a 32 inch WAIST."



Felipe Mendigo - Cal.

FREE if you mail COUPON NOW
1. MUSCLE METER
2. JOWETT'S Photo Book of Famous Strong Men—
"Nerves of Steel, Muscles of Iron," packed with photos of miracle he-men whom Jowett guided from weaklings to muscular power. Read thrilling adventures of Jowett, himself. Mail Coupon NOW!



AMAZING ALL 5
Picture-packed courses while the supply lasts—only **10c**
MILLIONS SOLD at 51 and more

FREE PHOTO BOOK of Famous Strong Men and a MUSCLE METER

Dept. PM-22

"Jowett Courses greatest in World for Building All-Around HE-MEN."
—R. F. Kelley
Physical Director

JOWETT INSTITUTE OF PHYSICAL TRAINING
230 FIFTH AVENUE, NEW YORK 1, N. Y.
George: Send me FREE Photo Book of Strong Men, a Muscle Meter, plus all 5 HE-MAN Building Courses: 1. How to Build a Mighty Chest; 2. Mighty Arm; 3. Mighty Grip; 4. Mighty Back; 5. Mighty Legs—all in One Volume "How to Become a Mighty He-Man." I enclose 10c. (No C.O.D.'s)

Name Age

Address

City Zone State

CASH FOR YOU WRITING ORDERS!

KENDEX NYLONS ARE FREE UNLESS SATISFACTORY!

Amazing, but true! The most sensational offer ever made! Earn big money spare or full time writing orders. We deliver and collect. Leading Kendex full fashioned, first quality sheer all DuPont nylon stocking, guaranteed against everything, is now reduced to 98c a pair (including your commission, bonus and postage). If these wonderful stockings run or snag within 1 1/2 months, the full 98c is refunded, so they actually cost nothing unless satisfactory! Write for free sample stocking and money making outfits free and prepaid. No obligation.

KENDEX CORP. BABYLON 146, N.Y.

Now MIRACLE WALL CLEANER

QUICK EASY Saves Costly Redecorating
AMAZING INVENTION. Banishes old-style housecleaning mess and muss. No rags—no sticky "dough"—no red, swollen hands. No more dangerous stepladders. Literally erases dirt like magic from Wallpaper, Painted Walls, Ceilings, Window Shades. Take orders from friends! Earn money! Act now!

SAMPLES FOR TRIAL Sample offer sent immediately to all who send name at once. Hurry. Postcard will do. **SEND NO MONEY—just your name.** KRISTEE CO., Dept. 692, AKRON 8, OHIO

HICKORY ACRES 6-WKS. OLD CAPONS STARTED

Easy, Profitable to Raise
Wonderful, tender capon meat brings top prices — makes finest eating. Easy to raise in back yard, on farm, or with other chicks. Hickory Acres 6-Wks. Old Capons are your best buy. Cost less than day old turkeys — easier to raise. Write for prices, information.

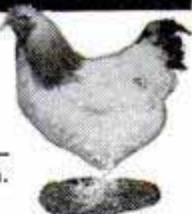

HICKORY ACRES CAPON FARM
BOX PM, WINDSOR, MISSOURI

GREAT PROFITS X.L. RUBBER MOLDS

will realize you great profits quickly!
WRITE FOR NEW FREE CATALOG

YOU can EASILY learn to cast thousands of perfect plaques, book ends, figurines, ash trays, etc. IT'S EASY, FUN, PROFITABLE!
X.L. Rubber, Pts. \$2.50; Qts. \$4.00 (postage extra). Models and enough for 3 molds \$1.50 prepaid.

SEND FOR FREE FACTS

PLASTIC ARTS STUDIO Address Dept. 2
3403 S. Madison St. Muncie, Ind.

WANT TO Write Stories Articles Mysteries?

FREE BOOK tells how you learn at home

Would you be willing to spend a few hours a week learning to write so you may earn \$300-\$1200 a year part-time? Or many thousands full-time? **FREE** book, "Art of Writing Salable Stories" tells how to get started writing short stories, radio-TV scripts, articles, business items. Many students earn while learning (A.B. Aretz sold first 2 stories for \$255). Endorsed by famous authors. scores of successful graduates; approved for veterans. Send today for **FREE** book (no salesman will call).

PALMER INSTITUTE OF AUTHORSHIP, Founded 1917
1680 N. Sycamore Hollywood 28, Calif. Desk T-22

VOTE TODAY

FOR THE FUTURE YOU WANT!

AMERICAN SCHOOL, Dept. G245, Drexel at 58th, Chicago 37, Ill.
Without obligation, please send FREE and postpaid, full particulars about the subject checked below.

- Accounting
- Air Conditioning
- Architecture & Building
- Automotive Technician
- Better Foremanship
- Bookkeeping
- Business Management
- Contracting
- Diesel Technician

- Drafting—Building Trades
- Drafting—Machine Trades
- Electrical Engineering
- Electricity—Practical
- Electronic—Industrial
- High School Courses
- Machine Shop Operations
- Mathematics & Slide Rule
- Mechanical Engineering

- Plastics Engineering
- Plumbing—Practical
- Private Secretary
- Refrigeration
- Retail Merchandising
- Salesmanship—Outside
- Sheet Metal Work
- Tool Making

NAME.....

HOME ADDRESS.....

CITY.....

OCCUPATION.....

AGE.....

STATE.....

— THIS IS YOUR BALLOT

Check the career that interests you most, Fill in spaces and mail at once—no obligation

● Today, choose the job you want — and prepare for it in spare time at home. If you are already engaged in the work you like best, start training now for quicker promotion. In hours you might otherwise waste, gain the knowledge and skill that can help you to get ahead faster, make more money, and have greater security.

Thousands before you have followed this plan and were able to step out ahead of others who didn't fit themselves for advancement or who seemed willing to trust to luck.

Training Backed by 55 Years of Experience

For over half a century American School has helped ambitious men and women

toward success by providing specialized training for commercial and technical advancement. At a cost you can afford you can prepare at home to climb in the kind of work you prefer. American School's study program for you has been planned by experts with years of experience in the subject you select and they will give you needed guidance every step of the way.

Don't Delay Your Start

Give serious thought to the list of training courses listed above. Pick the opportunity that interests you, check it and add your name and address. (Check more than one if you are undecided as to which appeals most.) Finally clip out and mail the "ballot" and full information will be supplied, without cost or obligation.

PRACTICAL, EFFECTIVE HOME STUDY TRAINING SINCE 1897

AMERICAN SCHOOL, Dept. G245, Drexel at 58th, Chicago 37, Ill.

THE SOONER YOU START, THE SOONER YOUR GOAL CAN BE REACHED

EARN MORE IN DRAFTING



More Opportunities for Employment and Promotion

"Here I am at work making good money as a draftsman. I'm glad I sent the coupon to Chicago Tech for that Free Trial Lesson and found out how easy it is to learn Drafting in spare time at home. Today I feel secure in my job because the draftsman's work comes first on any new project. And, in addition, draftsmen can't be replaced with machines. What's more, I feel I'm slated for promotion and more pay, because I see so many draftsmen advancing to high-pay jobs."

LEARN IN SPARE TIME — AT HOME!

(or at the College in Chicago)

A few hours of pleasant home study every week—that's all. No interference with your present job. All the tools you need; drawing outfit included. With Chicago Tech's help, you train yourself step by step. This tested method—developed over 47 years of C.T.C. progress—prepares men quickly for good positions in industry.



FREE INFORMATION—SEND COUPON

To prove to you how easy it is to learn Drafting at home by the Chicago Tech method, we will send you this FREE TRIAL LESSON. No charge for this lesson, now or later. Fill out and mail coupon, or send post card today.

CHICAGO TECHNICAL COLLEGE

B-250 Tech Bldg., 2000 So. Michigan Ave., Chicago 16, Illinois

Mail me FREE Lesson with information about big opportunities in DRAFTING.

Name _____ Age _____

Address _____

City _____ Zone _____ State _____

INVENTORS

Send for PATENT INFORMATION Book and INVENTOR'S RECORD without obligation
GUSTAVE MILLER
12-PM WARNER BUILDING
WASHINGTON 4, D.C.

REGISTERED PATENT ATTORNEY
Patent Attorney & Advisor
U.S. NAVY DEPT. 1930-'47
ASSOCIATE EXAMINER
U.S. PAT. OFF. 1922-1929
PATENT LAWYER

SAY YOU SAW IT IN POPULAR MECHANICS

MAKE MONEY with Exclusive Cushion Shoes

Extra Cash for Spare Time—
Up to \$5.00 Pair

Advance Commissions and Bonus

Sensational new exclusive Paratroop Boot—ONLY one with heel-toe cushion—finest in the country. Dress, sport, work shoes with cushion. Leather-lined Cordovans, Bolo, Swank in smart new styles. Fast sales daily. No experience or investment necessary. Samples to producers. WRITE TODAY for FREE outfit.

PARAGON SHOE CO.

718 Columbus Ave., Boston 20, Mass.



FREE OUTFIT

Like MAGIC

INVENTORS

Before you make any effort to market your invention, you should take the first steps toward proceeding for patent protection.

I shall be pleased to furnish you with information relative to patent procedure, upon request from you, and this will be without any obligation on your part.

PATRICK D. BEAVERS

Registered Patent Attorney

934 Columbian Building Washington 1, D. C.

PATENTS

C. A. SNOW & CO.

REGISTERED PATENT ATTORNEYS
WRITE FOR INFORMATION TO
428 SNOW BUILDING, WASHINGTON 1, D. C.

INVENTORS

If you have working models, blue prints, or patents, covering "special use" parts or assemblies for Chevrolet, Ford, or Plymouth Cars, it will be to your advantage to get in touch with us. Write us at the factory. Dept. PM



NATIONAL MACHINE WORKS, INC.
P. O. BOX 4305 AUTOMOTIVE PARTS MANUFACTURERS OKLAHOMA CITY 9, OKLA.

INVENTORS

Whether an invention is patentable can be substantially determined by a search of the U. S. Patent records. Without obligation, write for information explaining the steps you should take to secure a patent.

JOHN N. RANDOLPH
Registered Patent Attorney
201 Columbian Building, Washington 1, D. C.

INVENTORS

Send today for "Patent Protection for Inventors" outlining preliminary steps to take toward patent protection, also convenient "Evidence of Invention" Form.

VICTOR J. EVANS & CO.
730-B Merlin Building • Washington 6, D. C.

INVENTORS

IF YOU WISH TO PROTECT YOUR INVENTION, You should take steps to protect it by a U. S. Patent. Write me for "INVENTION RECORD" form

CARL MILLER
REGISTERED PATENT ATTORNEY
WOOLWORTH BLDG., 35th FLOOR, 22A
NEW YORK CITY

START YOUR OWN BUSINESS!

ELECTRICAL APPLIANCE REPAIRING

**SECURITY — INDEPENDENCE
WORK SHORT HOURS**

IN YOUR OWN KITCHEN, BASEMENT, OR GARAGE



There are millions of electrical equipment units in daily use . . . in factories, homes, office buildings and on farms. Skilled electrical technicians are needed to keep this equipment in good running condition. Learn at home in spare time.

You don't need elaborate fixtures or expensive equipment to be a successful repairman. Work as many hours as you wish. The Electrical Appliance Technician is his own boss!

EARN WHILE YOU LEARN!

You can now **BE TRAINED** to fill this **BIG NEED** . . . a need that grows day by day because of new electrical inventions for home and factory.

If you are mechanically inclined, can hold and use tools, we can give you the training and time-saving kits that will enable you to . . . **Command More Money at Work . . . A Better Paying Job Elsewhere . . . Or A Business Of Your Own!**

\$5.00 - \$6.00 HOUR

often charged for making ordinary repairs. We show you how to repair refrigerators, vacuum cleaners, washing machines, motors, etc., etc.

Only had your course a few short weeks and have already made \$800.00. Going to quit my job paying \$250.00 straight salary to operate my own business.—J. D. S., St. Louis, Mo.

I work day times at the shipyard and after 4:00 P. M. I operate from my cellar and garage. I average \$10.00 to \$15.00 clear every day.—Walter Hanhy, Brockton, Mass.

The **ELECTRONIC KIT**, a multi-purpose trouble detector, and other valuable Shop Method Training is sent to you! All instruction material is written in simple, easy-to-understand language, chock full of hundreds of detailed photos and drawings. Used by servicemen the country over.

We show you how to quickly locate the trouble, how to fix it and what to charge. **ALSO**, how to solicit business and keep business coming to you.

AGE IS NO BARRIER

Nor is a minor physical handicap. Work is light, pleasant and **PROFITABLE**.

Get Full Facts on how you can get this training at home in your spare time and pay for it out of your earnings while learning!

FREE BOOK

On America's fastest growing industry



**CHRISTY TRADES SCHOOL, Dept. D-303
4432 N. Kedzie Ave., Chicago 25, Ill.**

Gentlemen:
Please rush me your **FREE ILLUSTRATED BOOK** about Electrical Appliance Servicing, facts on your Electronic Kit and Special form for paying later from earnings while learning.

NAME _____ Age _____

ADDRESS _____

CITY _____ Zone _____ State _____

FREE



1952

ALLIED RADIO & TV CATALOG

EVERYTHING IN RADIO
AND TV AT LOWEST PRICES!

SEND FOR IT

212 PAGES
Value - Packed

**Everything for
Experimenters, Builders, Amateurs,
Servicemen, Engineers, Soundmen...**

Save money on every Radio and TV need! Get the big 212-page 1952 ALLIED Catalog featuring the world's largest selections of top-quality electronic equipment at lowest, money-saving prices. See the latest in TV, home radios, Amateur equipment, P.A. systems and Hi-Fidelity custom sound, recorders, test instruments, builders' kits—plus thousands of parts, tools, books and diagrams. Get more for your money from the World's Largest Radio Supply House. Send today for your FREE 1952 ALLIED Catalog!



Save on
Everything
in Radio & TV

**FREE
CATALOG**

SEND FOR IT TODAY

ALLIED RADIO

ALLIED RADIO CORP., Dept. 5-BB-2
833 W. Jackson Blvd., Chicago 7, Ill.

Rush FREE 1952 ALLIED 212-Page Catalog

Name _____

Address _____

City _____ Zone _____ State _____

New
**Advertising
Machine**



Prints & Illustrates Gov't Post Cards

FREE Learn how thousands of business men, in every line, are boosting sales in spite of conditions—with ad messages—printed and illustrated in a few minutes on gov't post cards—with amazing new patented **CARDMASTER**. Your "today's" ideas, read by your prospects next morning. Not a toy, but a sturdy advertising machine, built to last for years. Low price, sold direct. Guaranteed for five years. Send name today.
SEND NAME We'll send **FREE** illustrated book of money-making **IDEAS** for your business and complete, unique advertising plans. **RUSH YOUR NAME TODAY.**
CARDMASTER COMPANY
1920 SUNNYSIDE, Dept. 132, CHICAGO 40, ILL.

HAWAIIAN WIGGLER #1

**WORLD-FAMOUS
FISH-GETTER**



Deep runner. No snag-up in pads and brush. Easy to cast. Rubber Hula Skirt acts alive. At your dealer 5/8 oz. or 1/4 oz.. \$1.15 each.

FRED ARBOGAST & Co., Inc.
2212 W. North St., Akron 3, Ohio

FREE WRITE TODAY FOR YOUR BIG FREE ARBOGAST COLOR CATALOG—FULL OF PICTURES OF CATCHES

WHY DON'T YOU WRITE?

Writing short stories, articles on business, sports, hobbies, travel, shop crafts, local and club activities, etc., will enable you to earn extra money. In your own home, on your own time, the New York Copy Desk Method teaches you how to write the way newspaper men learn—by writing. Our unique "Writing Aptitude Test" tells whether you possess the fundamental qualities essential to successful writing. You'll enjoy this test. Write for it, without cost or obligation.
Veterans: Course approved for Veterans' Training.
NEWSPAPER INSTITUTE OF AMERICA
SUITE 5592-B, ONE PARK AVENUE, NEW YORK 16, N. Y.

FOR SPARE TIME PROFITS OR A FULL TIME CAREER

LEARN UPHOLSTERING

Learn at home in months! Earn spare time money—or start a shop! Easy lessons show how. Tools and materials to build ottoman included. Low terms. Write for valuable booklet today!
COMMERCIAL TRADES INSTITUTE, Dept. U 2-2
1400 Greenleaf Avenue • Chicago 26, Illinois



SEND FOR THIS **FREE!**

Make money. Know how to break and train horses. Write today for this book **FREE**, together with special offer of a course in Animal Breeding. If you are interested in Galting and Riding the saddle horse, check here () Do it today—now.

BEERY SCHOOL OF HORSEMANSHIP
Dept. 1102D Pleasant Hill, Ohio



Thrilling Work COLORING PHOTOS

Fascinating vocation learned at home by those with aptitude. Thrilling pastime. National method brings out life-like colors. Free booklet.
NATIONAL PHOTO COLORING SCHOOL
835 Diversey Pkwy., Dept. 1352, Chicago 14

DRAW FOR MONEY — BECOME YOUR OWN BOSS!

BE AN ARTIST

Amazing WSA Way Teaches You to Draw Step-by-Step — At Home in Spare Time

TWO BIG ART OUTFITS INCLUDED

First set of art materials comes with first set of lessons. Advanced outfit comes when you need it later in course — all at no extra cost.

—for one illustration.

"WSA has given me the know-how to earn while learning"—Floyd M. Green, Seattle, Wash.

—"Art stores buy all my work. I earn around \$50 a week in just my spare time. I highly recommend 'WSA' ". — Mrs. T. Teichman, Northfield, N.J.

Now you can prove to yourself that you have art talent! Our famous 38-year-old home study method makes it easy to get started. Get the facts about how you can prepare for a profitable career or fascinating hobby. Qualify for a good position in the exciting world of art — and earn \$75, \$100 and more weekly. Learn Commercial Art, Designing, Cartooning — all in one complete home study course. *You don't need previous experience* — WSA teaches you from the beginning. Low cost — easy monthly terms.

NEW TRIAL PLAN Reveals Your Talent!

FREE BOOK gives details

WASHINGTON SCHOOL OF ART
Studio 122 F, Washington 5, D. C.

Send me without obligation, Free Book, "Art for Pleasure and Profit." No salesmen. (Please Print)

Name.....

Address..... Age.....

City..... Zone... State.....

I am interested in your new Trial Plan



Tells about our course and opportunities for you in Art. See reproductions of student and graduates' artwork and read about results enjoyed by WSA trained artists.

OUR 38th YEAR!

WASHINGTON SCHOOL OF ART

POWERFUL MOTOR

ONLY \$2⁹⁸

DRIVES MODEL PLANES, BOATS, CONSTRUCTION SETS, Etc. WITH AMAZING SPEED! RUNS ON FLASHLIGHT BATTERIES!

BOYS! MODEL-MAKERS! Get this new MIGHTY MIDGET D. C. Electric motor. It's a honey! Looks and runs just like a big one. Motor is powerful yet measures only 1 x 1 x 1 1/4 inches; weighs one ounce! Turns up 6,800 r.p.m.'s. REVERSES instantly. Motor is in durable black plastic housing. Comes complete with two 1 1/2 volt batteries in clip holder, transparent plastic gear-box—PLUS ten extra gears and pulleys for working out your own ratios. No shocks, sparks or shorts. Endless hours of fun. Educational, too! 10 Day Money back guarantee! Send no money. Order today. Pay postman only \$2.98 plus postage when delivered. Or send \$2.98 with order and we will pay postage.

NO TRANSFORMER NEEDED

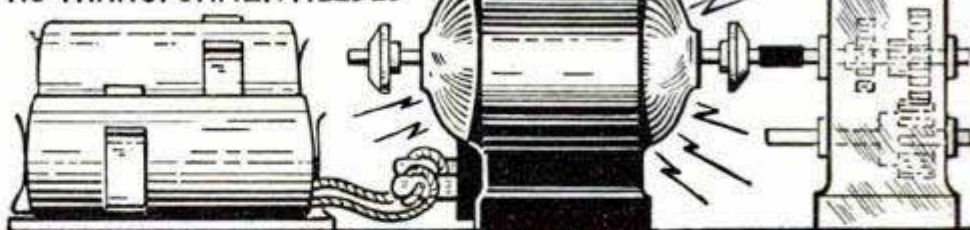

IMPERIAL SALES CO., Dept. 465
114 East 47 St., New York 17, N. Y.

Amazing Attachment MAKES OLD REFRIGERATORS INTO MODERN Automatic Defrosters!

Thirty Million Prospects. Sell without "selling pressure" on sensational Free Trial Plan. Just plug it in and leave it. Frees women from drudgery and mess of defrosting. Saves electricity. Keeps food longer, better. Gives longer life to refrigerator. Secret "follow-up" Plan often brings five additional sales by making every user your agent. Big season now on! **SENT FREE... JUST SEND NAME!**

Don't send a cent—just your name on penny postcard. We'll send you the biggest money-maker you ever got your hands on and guarantee your sales at profits as high as \$5.00 on each sale. Rush your name!

MAXILUME COMPANY, 125 West Hubbard Street, Dept. D-8-B, Chicago 10, Illinois

Women buying by the thousands!

Salesmen Cleaning up on "Free Trial" Sales Plan Sent Free with Instructions.

Make as high as \$5 on Every Sale!



CORTINAPHONE
makes it **FUN** to



SPEAK FRENCH-SPANISH

RUSSIAN - GERMAN
ITALIAN - BRAZILIAN - JAPANESE
"Learn by Listening" to **CORTINA RECORDS**, at home.
the **NATURAL** way — quickly, easily, cheaply.

Only 15 Minutes a Day!

The Cortina method, famous for 70 years, teaches you to speak like a native. **THOUSANDS** have found it the most fascinating, most effective way to learn languages for **Pleasure, Business, Travel, Culture. INVESTIGATE!**

Send For FREE BOOK!

Illustrated 32-page book, "The Cortinaphone Short-Cut" sent **FREE**. No obligation. Tells just what you want to know. Interesting. Get it!

ALL NEW RECORDINGS ON UNBREAKABLE RECORDS **WRITE TODAY**

CORTINA ACADEMY (Est. 1882)
Suite 642, 105 W. 40 St., N. Y. 18, N. Y.
Please send me—without obligation—your free book. I am interested in (check):
 French Spanish German Italian Brazilian
 Russian Japanese

Name _____
Address _____
City _____ State _____
 VETS! Check if **NOW** eligible under G. I. Bill. _____

THIS HANDBOOK FOR AMBITIOUS MEN FREE!

Have you had your copy?

150 pages of guidance to best-paid positions. Up-to-the-minute information for men who want to climb to the top. Tells how to get promotion, security and better pay through home study courses. This handbook "Engineering Opportunities" is free and entirely without obligation. Send the coupon. Make this your big year! Describes over ninety courses including:

- | | | |
|-----------------|---------------|-------------|
| Mechanical Eng. | Electrical | A.F.R.Ae.S. |
| Aeronautical | Radio | A.M.I.C.E. |
| Television | Automobile | B.S. (Pure |
| Building | A.M.I.Mech.E. | Science) |

--- SEND COUPON TODAY ---

Canadian Institute of Science & Technology Limited, 534 Century Building, 412, 5th Street, N.W., Washington, D.C.

Please forward free of cost or obligation your handbook, "ENGINEERING OPPORTUNITIES".

Name.....
Address.....

Course interested in..... Age.....

Canadian enquiries: 263 Adelaide St. W., Toronto 1

UNLIMITED OPPORTUNITIES IN ENGINEERING DEGREE IN 27 MONTHS

Study Engineering in this world-famed school, established 1884. Demand for our graduates exceeds supply. Growing shortage of engineers. No field offers greater opportunities for responsible, lucrative positions.

Bachelor of Science Degree in Mechanical, Civil, Electrical, Chemical, Aeronautical, Radio (Television) Engineering; Business Administration and Accounting. Also 36-weeks certificate course in Surveying and Drafting.

Personalized Instruction. Accelerated courses. Non-essentials eliminated. For ambitious, earnest students. Earn your degree in the shortest possible time. Preparatory courses. Placement service.

Extensive Campus. Well equipped, new and modernized buildings; up-to-date labs. Low cost. New terms start quarterly. Enter September, January, March, June.

Write today for free catalog and special information.

TRI-STATE COLLEGE
422 College Ave. ANGOLA, INDIANA



GOLD-SILVER-COINS

Easily located with new Lightweight M-Scope Detector. Superior performance, lowest price, monthly payment plan.

FREE LITERATURE
FISHER RESEARCH LAB., INC.
PALO ALTO CALIF.

WHY SUFFER TONGUE BITE?
Cost 3 times as much to build as the best of old-fashioned pipes. But **KILL TONGUE BITE, STOP DRINK.** FREE circular tells WHY. Write:
KLEENSMOK PIPES
P.O. No. M597,
Johnson City, Tenn.
R-Reg. U.S. Pat. Off. Pat's. and Pat's. Pend.

Watch Repairing Pays Big Money Learn at home



Watch repairers in great demand. Train step-by-step in 10 easy lessons. We furnish all tools and 15 jewel watch and practice movement. Turn spare time into cash. A licensed school. Low cost. Send for **FREE** book today.

ILLINOIS SCHOOL OF WATCH REPAIRING
2870 Elston Ave., De:t. PM-2, Chicago 18, Ill.

Say You Saw It in Popular Mechanics

MAKE EXTRA MONEY **PLASTICS** LEARN AT HOME

LEARN HOW TO MAKE fast selling **PLASTIC NOVELTIES FURNITURE JEWELRY SIGNS TOYS LAMPS**

There are **RICH OPPORTUNITIES** for **MEN** and **WOMEN** with "know-how" in **Plastics**. Interstate's amazing new **Plastics** course tells and shows how to make hundreds of fast selling items out of **Plastics**. Gives complete training in fabrication, casting, lamination, molding, etc., in simple, easy, step-by-step language and pictures.

START A PLASTICS BUSINESS OF YOUR OWN. No other industry holds such promise for the future. You can make big money manufacturing novelties, toys, signs, etc., in your own home in spare or full time. Don't wait! Learn **NOW** how Interstate's **Plastics** Training qualifies you for success in the plastics field.

Write for **FREE** Information Today!

INTERSTATE TRAINING SERVICE

School of Plastics, Dept. C-3B
PORTLAND 13, OREGON

POPULAR MECHANICS



Leonard C. Lane
 B.S., M.A., Exec. Dir. of Pierce
 School of Radio and Television.
 Licensed by the State of N. Y.
 President of Radio-Television Training
 Association. Approved as a Correspondence
 School under the Laws of the State of N. Y.

TELEVISION NEEDS YOU

FOR TOP PAY JOBS

I GIVE YOU COMPLETE TRAINING AT HOME
 IN YOUR SPARE TIME — IN A SHORT TIME!

I GIVE YOU **15** BIG TV-RADIO KITS
 Build & **KEEP** this Giant-Screen TV Set &
 other units shown **YOURS TO MAKE AND KEEP**
 PLUS a C-W Telephone Receiver,
 AC-DC Power Supply unit (not shown here)



I GIVE YOU A ROUND TRIP TO NEW YORK CITY

from wherever you live in the U.S. or Canada. Yes, I pay your way. After you finish your home-study course, you can study with me, here, in the heart of the radio and television world. Two weeks, 50 hours, advanced instruction using the most modern electronic equipment at world-famous Pierce School of Radio & Television, PLUS operating Pierce Radio Station and Pierce TV Station (both operated by students), PLUS Code Machine Set Up. I take you behind the scenes of New York's Radio-TV stations—to study first hand! You learn BEST with the BEST!

Men! Television is a billion dollar industry growing amazingly day by day, right before our eyes. See how big it is already—and yet see how many sections of the country are still waiting eagerly for Television. *Get in on the ground floor of AMERICA'S FASTEST GROWING BIG INDUSTRY... NOW!* Don't let this chance pass you by. Demand for trained radio-TV men will far outstrip supply for years and years.

EARN EXTRA MONEY IN YOUR SPARE TIME
 Keep your job. Make as much as \$5 an hour extra, while learning. Fix neighbors' and friends' radios and TV sets. I show you how! Many students pay for entire training out of spare time earnings!

BECOME A CERTIFIED TV TECHNICIAN
 RTTA Shop-Methods are widely acclaimed because they're so practical. Step by step you learn *how* by doing. RTTA is tops for recognition by leading companies.

GOING INTO UNIFORM? Learn how RTTA's home study can qualify you for military specialist ratings, increase your pay!

Only RTTA is at Times Square—Radio City—"Heart of the Radio-TV World". Latest "on the spot" technical information comes to you from RTTA.

I TRAIN MEN FOR SUCCESS!

9/14/51 "My FCC License plus your practical Shop-Training Methods upped my earnings. Highly recommend your school."—Jim Stapleton

12/20/51 "Your training prepared me for this TV Technician job with security. I'll always be glad I chose your school."—Gil Grossinger

6/15/51 "I can look forward to a profitable future, as a TV Ser. Techn., thanks to your training."—I. Samuels

8/10/51 "It takes your type of training to get good jobs. As a TV Tech. I make good money."—Bill Atkinson

PLUS THESE BIG "EXTRAS"
 • Only RTTA gives you a home study course in RADAR at no extra cost!
 • RTTA helps you prepare for your FCC license with FCC STUDY AIDS, which are provided as part of this course... at no extra cost.

EARN GOOD PAY — OR START YOUR OWN BUSINESS
 My trained graduates are holding good jobs at NBC-TV, CBS-TV, RCA, DUMONT, EMERSON, PHILCO, ADMIRAL, HUGHES AIRCRAFT — and many more radio and TV stations, electronic firms, and telephone systems. If you prefer, get a good job installing and servicing radio-TV sets—or start your own business. You can write your own ticket in this big industry. Be independent. Well-trained technicians earn respect.

NO PREVIOUS TRAINING NEEDED
 Even with a grammar school background you can master RTTA methods which are based on practical "learn by doing." You work out the problems. You set up and use the apparatus as per RTTA simple directions. It's easy, you learn fast, and before you know it, you're an expert technician.

RADIO-TELEVISION TRAINING ASSOCIATION
 1629 BROADWAY — RADIO CITY STATION
 NEW YORK CITY 19, NEW YORK

BOTH FREE THIS COUPON GOOD FOR BOTH. MAIL TODAY!

Mr. Leonard C. Lane, President Dept. 21
 RADIO-TELEVISION TRAINING ASSOCIATION
 1629 Broadway, Radio City Station
 New York 19, N. Y.

Dear Mr. Lane:
 Show me how I can make BIG MONEY IN TELEVISION within MONTHS! Rush by return mail my FREE Sample Lesson and BIG FREE Manual.

Name

Address

City Zone State

Age (PLEASE PRINT PLAINLY)

FREE SAMPLE LESSON, BIG FREE MANUAL

make your WORKSHOP PAY

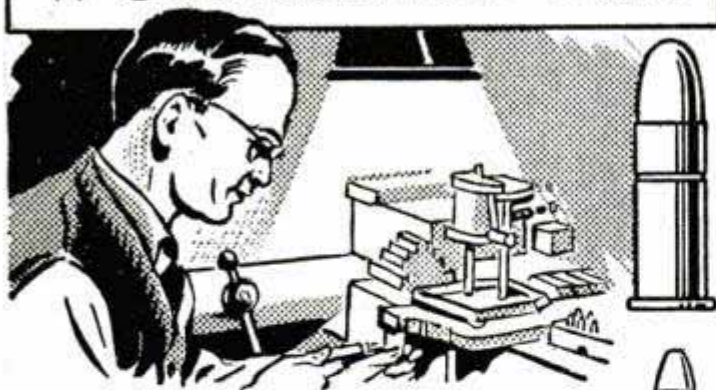

make your **AMMUNITION**,
safely and easily.

Savings per 100 rounds: (examples)
30/06 cal. \$13.80; .22 Hornet \$6.40
45 Automatic \$6.23;
Shotgun Shells \$4.48

Full details and instructions in
the illustrated Ideal Reloading
Hand Book, 184 pages . . . 75¢

The Lyman Gun Sight Corp.
MIDDLEFIELD, CONN.



Men!

Reading This
Message Could Be
the Most Important
40 Seconds In Your Life

From every indication Auto Body and Fender Repair work will continue to be one of America's Big Income fields. Here at U.E.I. we're training men for it—a proven plan that combines spare-time, home study and actual shop practice. Men from coast to coast have successfully completed the U.E.I. course in Auto Body and Fender Repair—many earned money while learning—many now have their own shops. What about you? Isn't this the time for you to see what this big-pay field offers you? Do this: Mail the coupon below and we'll send you our big, descriptive book, "Opportunities." It's Free — Mail the Coupon.

UTILITIES ENGINEERING INSTITUTE, Chicago 14, Illinois
Founded 1927

UTILITIES ENGINEERING INSTITUTE,
2523 Sheffield Ave., Dept. XC-12, Chicago 14, Illinois
Please send, Free, Your Book "Opportunities".
NAME (print) AGE.....
ADDRESS
CITY..... (Zone).... STATE.....
 Check here for information if you are under 17.



THE MOST AMAZING OFFER IN USED
TIRE HISTORY. EVERY PASSENGER TIRE
**UNCONDITIONALLY
GUARANTEED**
plus TIRE INSURANCE FREE

10% OFF on ORDERS FOR TWO OR MORE TIRES.
Here's DOUBLE proof that we bear the loss if
your tire wears out within the guarantee period or
is damaged in any way (except willfully). Don't take
risks; we send FREE insurance certificate PLUS
written unconditional guarantee with your order.

TRIPLE INSPECTED PASSENGER TIRES

| | | | | | |
|---|--------|--------|--------|--------|--------|
| Unconditional One Year Guarantee plus Tire Insurance Free | | | | | |
| 600-16 | \$5.59 | 700-16 | \$7.59 | 703-15 | \$5.59 |
| 600-16(6) | 6.50 | 600-15 | 5.59 | 750-16 | 12.25 |
| 650-16 | 5.79 | 650-15 | 5.59 | 550-15 | 5.59 |
| | | | | 550-17 | 5.75 |
| | | | | 475-19 | 5.75 |

LO-PRESSURE TIRES FOR EASY RIDING

| | | | | | |
|---|--------|--------|--------|--------|--------|
| Unconditional One Year Guarantee plus Tire Insurance Free | | | | | |
| 640-15 | \$5.75 | 710-15 | \$6.50 | 820-15 | \$7.50 |
| 670-15 | 5.95 | 760-15 | 6.75 | 670-16 | 6.95 |
| | | | | 760-16 | \$7.50 |

MUD AND SNOW TIRES

| | | | | | |
|--------------------------|--------|--------|---------|----------------|---------|
| 2 YEAR WRITTEN GUARANTEE | | | | | |
| 600-16 | \$6.95 | 900-16 | \$12.95 | 750-20 Regular | \$12.50 |
| | | | | Special | \$15.95 |

EXTRA VALUE TRUCK TIRES

| | | | | | |
|----------------------------|---------|----------|---------|------------|---------|
| ONE YEAR WRITTEN GUARANTEE | | | | | |
| 600-20 | \$10.75 | 750-20 | \$14.50 | 825-20 | \$21.50 |
| 650-20 | 11.75 | 32x6(8) | 11.75 | 900-20 | 19.50 |
| 700-20 | 12.50 | 32x6(10) | 12.50 | 1000-20 | 20.00 |
| | | | | 750-20(10) | 18.00 |

TRACTOR TIRES available in all sizes. Complete line of High Mileage
Tires in stock. Write for price list for sizes not listed. Take off 10%
on orders for two or more tires. Prices subject to change.

MAIL ORDERS PROMPTLY
FILLED. Send check or
money order with this ad. **THE SAFTYRE CO.**
"FOR THAT SAFE TIRE"
Dept. PM, 920 W. CARY ST., PO BOX 2254, RICHMOND, VA.

**"How to Make Money with
Simple Cartoons"**

A book everyone who likes to draw
should have. It is free; no
obligation. Simply address **FREE
BOOK**

CARTOONISTS' EXCHANGE
Dept. 92D Pleasant Hill, Ohio

RADIO ENGINEERING, Broadcasting,
Television, FM, Servicing, Elec-
tronics, Aviation, Marine & Po-
lice Radio taught thoroughly.
Engineering course equivalent to 3 years' college radio
work. Approved Veteran Training. Catalog free.
VALPARAISO TECHNICAL INSTITUTE, Dept. D, Valparaiso, Ind.

Play GUITAR in 7 DAYS

OR GET YOUR MONEY BACK!
Let Ed Sale teach you to play with his
famous diagram photo system. Book contains
53 photos, 43 diagrams, showing exactly how
to place your fingers. Gives you 110 popular
songs, words and music—along with complete, easy
to learn instructions. Imagine your joy when you
find after 7 days you are playing beautiful music! Amaze
your friends! Be the life of the party! **SEND NO MONEY** Pay Post-
man \$1.98 Plus Postage. **ED SALE, Dept. PM-2, Point Pleasant, N. J.**

SAY YOU SAW IT IN POPULAR MECHANICS

Develop Hidden Earning Power
STUDY LAW
at home! LL.B. Degree

Qualify yourself in spare time for advancement, great-
er earnings, business success. Now, more than ever,
legal ability is in demand! Easy-to-understand step-
by-step lessons and text material furnished — inval-
uable for permanent reference. 43 years expert teach-
ing. 114,000 students enrolled. Easy payments. Find
out now, at no cost, how study of law can help you.
Write today for FREE Book "Law and Executive
Guidance."

AMERICAN EXTENSION SCHOOL OF LAW
Dept. PM-47, 646 N. Michigan Ave., Chicago, Ill.

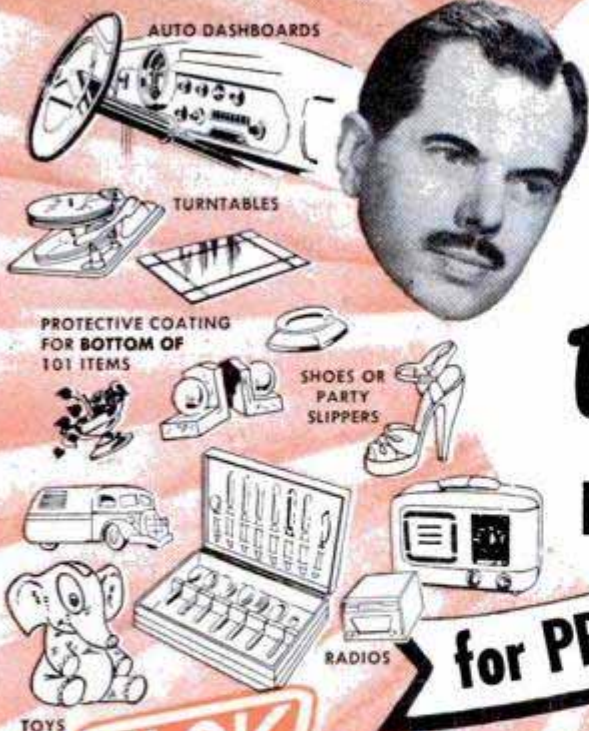

MEN - WOMEN!

Paint it with Suede!

SPRAY ON RAINBOW COLORS

for PROFIT and Pleasure...



A SENSATIONAL NEW HOME BUSINESS!!
A NEW INDUSTRY... A NEW MIRACLE FINISH!!
MAKE \$500 to \$1000 PER HOUR and more!

Flok-Kraft Covers:
 Fabric, Metal, Glass, Plaster,
 Wood, Plastic or -any surface!

PROFESSIONAL SECRETS CAN BE YOURS

At last the carefully guarded secrets of this amazing miracle finish can be yours. Huge profits are waiting to be tapped in this tremendous new field. Flok-Kraft gives a velvety, luxurious surface to radios, lamps, toys, signs, store displays, figurines, auto dash boards—actually a thousand and one items to be seen on every hand can easily and quickly be beautified, enriched, increased in value with Flok-Kraft. Make old objects beautiful and saleable. Make new things worth more with this soft, rich covering that can be applied to any surface, even if old and worn.

YOU CAN LEARN IN A FEW DAYS

Yes, you can learn in a few days to start making money—big money! Make to \$5.00—yes! even \$10.00 and more per hour. Everything you need is furnished, including fully detailed instructions that are complete and easy to understand. Every point is explained to show you how to start on the road to big money, full or spare time.

WE FURNISH EVERYTHING YOU NEED TO START

In addition to the full step-by-step instructions you get a complete set of materials and equipment that enables you to start at once. A few cents worth of materials can mean many dollars in returns to you. You can make big profits, spare or full time—add to your income from your regular job or begin to build your own successful future with a full time business of your own and do it all right in your own home! A corner of your basement, garage, service porch, kitchen or living-room is all the space you need to start.

GRASP THIS LIFETIME OPPORTUNITY TODAY

This is one too good to miss. Fill out the coupon below and mail it today for full free details. I'll arrange to send you the complete outfit—everything you need to start—for leisurely, no-risk examination right in your own home. You owe it to yourself to investigate. Write now for full, free details, samples, etc. Fill out and mail the coupon below Do it today! Everything I send you is FREE.

SEND NO MONEY—MAIL COUPON NOW!

COAST INDUSTRIES, Dept. 22
 1004 S. Los Angeles St., Los Angeles 15, California
 Gentlemen.
 Please rush me FREE details, sample, etc., I understand that everything you send is free and that I'll be under no obligation now or ever

NAME _____
 STREET _____
 CITY _____ STATE _____

Read What Others Say About Flok-Kraft

"Received the flok-kraft outfit and everyone that saw it is very enthused. I only had it about thirty minutes and got an order for a hundred dollar job." Mr. C. H. Maryland.



"... I have received my order of Flok and Adhesives and believe me, I'm very pleased and happy as I've made myself MORE than the cost of my supplies already, and I've still got more jobs to do." Cpl. G. W., S. Carolina



"Got \$52.50 for those 7 trunk interiors for about 4 hours work. \$7.50 per trunk." J. O., Mo.



"... pleased with your course and I'm being swamped with work to do." W. F.,

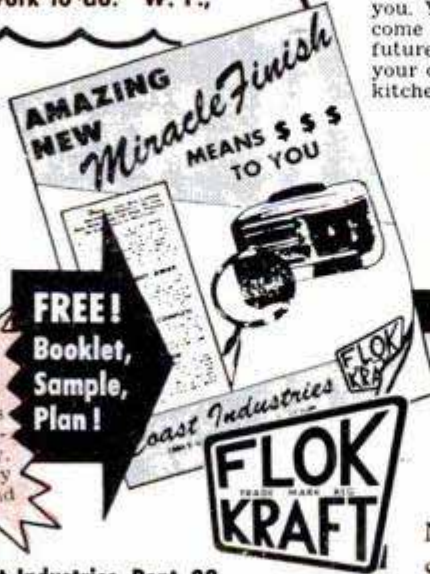

FREE!
 Booklet,
 Sample,
 Plan!

YOURS TO EXAMINE WITHOUT RISK!!

Examine in your own home—then decide. The complete instructions, the full starting kit of materials and equipment and full details on how you can open your own business, spare or full time—EVERYTHING will be sent you to EXAMINE AT OUR RISK!

FLOK-KRAFT and DEFENSE

This amazing miracle finish is of inestimable value for use on hundreds of defense products. Flok-Kraft offers you a way to big, extra money, assisting manufacturers in many lines as well as filling a big demand on the home front.

Coast Industries, Dept. 22
 1004 Los Angeles St., Los Angeles 15, Calif.

NOW! Spotting Any Car Trouble

is a "Snap!"

Brand-New Guide Helps Find "What's Wrong" FAST!

Save time and work! Brand-new, revised **TROUBLE-SHOOTER** helps spot any car trouble in a jiffy. Suppose Fan Belt is noisy—index leads you *instantly* to 7 things that can be wrong. In same way, it covers engines, automatic transmissions, overdrives, clutches, brakes, ignitions, springs, rear axles, tires, wheels, etc.—over 2,000 causes of trouble in all. Also explains clearly how electrical, fuel, ignition, brake & clutch systems actually work; plus helpful information on performance, fuel economy, speed, chokes, valves, cooling systems, why engines won't start, etc. Cross-section **PIC-TURES**. Spiral-bound; pocket-size. Big help for beginners or experienced repair men. Prepared by editors of famous **MOTOR** manuals.

SEND NO MONEY

Just send your name, address. Pay postman only \$1 for each copy ordered, plus postage and C.O.D. charges. (Or pin \$1 to this ad and **SAVE ALL SHIPPING CHARGES!**) If not delighted, return book(s) in 7 days for prompt refund. **MOTOR** Book Dept., Box 250 W. 55th St., New York 19, N. Y.



Tells how to Spot 108 Automatic Transmission Troubles • 7 Causes of Fan Belt Noise • 46 Causes for Engine "Misses" • 62 Causes of Excessive Oil Consumption • 8 Common Causes of Engine Vibration • 77 Causes for Clutch Troubles • 43 Causes of Rear-Axle Trouble • 140 Causes of Brake Trouble • 58 Checks for Faulty Springs and Shock Absorbers • 24 Different Causes of Wheel Noise • Also explains how electrical, fuel, ignition, clutch, brake & cooling systems work... **PLUS LOTS MORE!**

STOP THAT OIL EATER!



GET NEW CAR PERFORMANCE WITH **PISTON SEAL** WITHOUT COSTLY OVERHAULING

Piston Seal—the amazing compound that forms a self expanding, pliable lubricating seal around pistons that compensates for wear. Eliminates oil burning, restores power and compression. Can be applied in a few minutes.

GOOD FOR 10,000 MILES



SIMPLY REMOVE SPARK PLUG AND SQUEEZE
FOR COMPLETE, FREE DETAILS WRITE TO

Richie Distributing Co. 11916 MADISON AVE., Dept. B LAKEWOOD 7, OHIO

NEW! STUDENT DRUMS FOR PARADE.. FOR CONCERT



A complete line, including snare drums, parade drums, Scotch bass drums and concert bass drum—all separate tension—provides professional performance for the student or school musician. Fully guaranteed and registered by the Pan-American factory. See your dealer, or write for free drum picture. Address Department 203.



PROFESSIONAL PERFORMANCE

SEND FOR **FREE INSTRUMENT PICTURE**

PAN-AMERICAN BAND INSTRUMENTS

Division of C. G. Conn Ltd., Elkhart, Indiana

ROLL-O-KITE

Thrill to this revolutionary spool-type kite and its amazing spinning action.



\$1.00 **POSTPAID**

Kit contains durable ready-cut balsa, brightly colored discs, easy-to-follow assembly and flying instructions. Measures 15x6 in.

ROLL-O-KITE, Box 182B, Lomita, Calif.

NEW, IMPROVED CALCULATOR FOR WOODWORKERS only 25c



Instantly gives information on lumber, nails, concrete mixes, painting materials, etc. Convenient, simple to read. Just set dial for nail specifications, to convert linear to board feet, find bit sizes for screws, compare characteristics of woods. 6" diameter heavily varnished cardboard. Send 25c, no stamps, please to Greenlee Tool Co., 2102 Columbia Avenue, Rockford, Illinois.

JUST OUT!



1952 EDITION

It's New! It's Different! Get world's largest Auto Accessory & Parts Catalog and save money. Over 50,000 items, including Hollywood Accessories, Hi-Speed Equipment, Rebuilt Engines, all parts & accessories for all cars & trucks. We have that Hard-To-Get part! Jam packed with bargains. Completely illustrated. (100 pages) Send 25c (refundable).

J. C. WHITNEY & CO., 1917-XP Archer Ave., Chicago 16, Ill.

MY FALSE TEETH STAY TIGHT EVEN AFTER DRINKING HOT COFFEE!

● Mrs. J. P. writes: "I was delighted to find Staze held my teeth tight even after hot coffee!"

Staze is fluid-resistant... contains "aqua-trol," which holds back moisture penetration. Thus, it holds false teeth tighter, longer. With Staze, thousands now bite into corn and steak—enjoy all the hot coffee they want.

Even if plates are old and loose, Staze holds them tighter. Many denture wearers say that with Staze old plates seem to hold better than when new. At drugstores, or write **STAZE, Box PM-1, Stamford, Conn., for free tube.**

Not everyone does as well,
but E. O. Lockin, who started
a business of his own, reports . . .

for 12 months I've averaged

\$800

PER MONTH
INCOME

—most of it clear profit for me!

● Mr. Lockin expresses his grateful thanks for the opportunity to make a decent living on his own. Many men have discovered how to be independent, to be freed of bosses and layoffs—to build their own future on a steady, dependable foundation. L. A. Eagles grossed more than \$200 his first week. R. E. Traynor says, "I made \$62 gross in one day." Others report gross from \$100 per week to \$12,000 per year.

How much you make depends largely on you. You need no special skill, no large investment to start.

No shop necessary. Our ELECTRIC RUG WASHER cleans rugs and carpets like new right on the floor . . . removes dirt and grime and helps to show their natural color and beauty. So efficient and safe for carpets, it is used by largest hotels and railroads.

You take no risk. Machines fully guaranteed. Don't delay! Mail coupon today for complete information including how to start making big profits quickly in YOUR OWN business. BIG opportunity.

Send Coupon Now!

VON SCHRADER MFG. CO. 1230 "R" Pl. Racine, Wis.

You, too, can start your own business. No special skill, no large investment required. Costs nothing to find out—no obligation. Mail coupon today for interesting

FREE BOOK

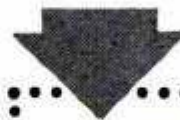

VON SCHRADER MFG. CO.,
1230 "R" Pl., Racine, Wisconsin

Send at once (no obligation) your **FREE** booklet containing information about your ELECTRIC RUG WASHER and how I can start my own permanent, profitable business.

Name _____

Address _____

City _____ Zone _____ State _____



"YOU ARE UNDER ARREST!"



**There's a Thrill
in Bringing a
Crook to Justice
Through Scientific
CRIME
DETECTION**

We have taught thousands of men and women this exciting, profitable, pleasant profession. Let us teach you, too, in your own home. Prepare yourself in your leisure time to fill a responsible, steady, well-paid position in a very short time and at very small cost. What others have done, you too, can do.

**Over 800 of All American
Identification Bureaus**

employ students or graduates of I.A.S. This fascinating work is easy to learn and the training is inexpensive. You, too, can fit yourself to fill a responsible crime detection job with good pay and steady employment. But don't delay—get the details now. Let us show you how easily and completely we can prepare you for this fascinating work, during spare time in your own home. You may pay as you learn. Write today for free Crime Book.

**Be A
FINGER
PRINT
Expert**

FREE! "THE BLUE BOOK OF CRIME"
It's a thriller. Tells about some of the most interesting crimes ever perpetrated and how they were solved through the very methods taught by I.A.S. Send now—be sure to state age.

INSTITUTE OF APPLIED SCIENCE
Dept. 1352 1920 Sunnyside Ave. Chicago, Illinois

**Use Your Spare Time
Learn ENGRAVING
As a Career or a Hobby**

**WRITE
TO**

Build a business for yourself; Engrave Silver—Jewelry—Trophies right in your own home. Learn this fascinating craft by the NEW "SILENT TEACHER" HOME STUDY METHOD. Inquire today — or at our resident school.

KANSAS CITY SCHOOL OF WATCHMAKING
1218 Admiral Blvd. Kansas City 6, Missouri

SAY YOU SAW IT IN POPULAR MECHANICS

**High School
at Home**

Many Finish in 2 Years

No classes. No time wasted going to and from school. Progress as fast as your time and abilities permit. Standard H. S. texts supplied. Thousands enroll each year in this 55-year-old school. Send for FREE descriptive booklet.

AMERICAN SCHOOL, Dept. H245
Drexel at 58th St., Chicago 37, Ill.

Without obligation, please send FREE descriptive booklet.

Name _____

Address _____

FREE CATALOG!

BUY GENUINE

Diamonds

from New York's leading
PAWNBROKER

**SAVE 50% and
more**

Diamonds from un-redeemed loans and estates being liquidated; re-set in smart modern mountings; 10 DAY UNCONDITIONAL MONEY-BACK GUARANTEE. Write for free catalog. Est. 1882, famous for unbeatable diamond bargains. References, your own bank or any mercantile agency.

KASKEL'S • Kaskel Bldg., 9 Columbus Ave.
New York 23, N. Y. Dept. PM-2

**BECOME AN EXPERT IN
ELECTRICAL CONTROL**

Earn up to \$700/mo. Only basic knowledge of electricity needed. Home course.

ELECTRICAL INSTRUCTIONS, DEPT. PM-2
AUDUBON STA., BATON ROUGE, LA.

**BECOME AN EXPERT IN
TRAFFIC**

Traffic men earn \$4,000 to \$10,000 and up. Thousands of firms need experts on rates, tariffs, regulations. We train you thoroughly in spare time at home for executive traffic jobs. Personal training under traffic authorities. Placement counsel and help. Write for free 48-page book "Traffic Management—the Fast Growing Profession."

LASALLE Extension University, 417 So. Dearborn St.
A Correspondence Institution Dept. 264T Chicago 5, Ill.

**REAL ESTATE
BE A BROKER**

PAYS BIG! SEND FOR FREE, BIG, ILLUSTRATED CATALOG NOW! No obligation. Graduates report making substantial incomes. Start and run your own business quickly. Men, women of all ages, learn easily. Course covers Sales, Property Management, Appraising, Loans, Mortgages, and related subjects. **STUDY AT HOME** or in our classrooms in big cities. Diploma awarded. G.I. approved. Nationally known.

WEAVER SCHOOL OF REAL ESTATE (Est. 1936)
Suite 300 Law Bldg., Dept. PM, Kansas City, Mo.

**FREE
BOOK
TELLS
HOW**

**BE A HIGH-PAID MAN IN YOUR
COMMUNITY WITH THIS
LONG NEEDED INVENTION**

Earn up to \$10,000 or more per year!
Nothing to invest! Be your own boss!

U.S. Pat.
D 153853-
D 153854

A worldwide product needed by every home, business and farm... priced to sell quickly! Automatic Red Comet goes into action as soon as fire starts... smothers fire without human aid. It's a sales "natural"!

FREE SALES KIT

Demonstrator units, sales literature, etc., furnished you FREE. Handsome leather-type kit. Tried and proved, it will make you an independent businessman. ACT NOW! Someone in your community will be appointed soon. Write for details, today!



RED COMET, INC.
Dept. 25-B, R.C. Bldg., Littleton, Colo.



I'll show you how to EARN BIG MONEY IN PLASTICS without tools or machinery!

A NEW HOME INDUSTRY

NEVER BEFORE has such a GREAT OPPORTUNITY like this been offered! The CHANCE OF A LIFETIME! The chance to learn and START a new, fascinating and HIGHLY PROFITABLE business of your own! We have started THOUSANDS of ambitious people in this wonderful and thrilling new business because the work is so easy and pleasant (many turn it into a profitable hobby); requires only a FEW dollars investment, can be started ANYWHERE by ANYONE . . . at home, garage, basement, den, shop, etc. and most important, WITHOUT TOOLS OR MACHINERY you can produce in QUANTITY exceptionally attractive and desirable plastic things of such great variety and usefulness beyond your imagination! All this valuable knowledge and instruction is yours FREE . . . we teach you, help you get started and buy part of your production! We also help you obtain DEFENSE WORK!

MAKE ANYTHING

This new method of creating unlimited quantities of useful things without machinery is CASTING . . . the extremely simple process of pouring liquid plastics into molds; *the entire method is as easy as pouring water out of a glass!* No machinery or tools required! In a few minutes the liquid turns into a beautiful solid, hard, durable, colorful or transparent plastic in the form of Jewelry, Novelties, Gadgets of every shape and form, Machine Parts, Fishing Lures, Bookends, Cig. Lighters, Tools, Dies, Handles, Knobs, Pensets, Figurines, Souvenirs, Toys, Dolls, Baby Shoes . . . A THOUSAND USEFUL THINGS! Some of our plastics are transparent and sparkling clear, ideal for imbedding flowers, photos, curios, etc. Others are like beautiful Ivory, Ebony, Marble, Ce-

ramics, Etc. The field is really UNLIMITED. Practically anything your imagination can create can be CAST with our plastics, one or a thousand!

BILLIONS FOR DEFENSE

The government has started the greatest defense program in history! BILLIONS are being spent. Our Liquid plastics can be used in THOUSANDS of vital defense applications. With our catalog we will include instructions how YOU can obtain defense work, how YOU can take part in this tremendous program to insure the future of America! A grand opportunity to combine patriotism and profit! A grand opportunity of obtaining THOUSANDS OF DOLLARS of defense work!

1000 OPPORTUNITIES

Regardless what you are doing now you can get into the CASTING BUSINESS in your spare time or evenings; we assure you, once you do, you will be eagerly devoting all of your time to this very easy, fascinating and HIGHLY PROFITABLE business. Countless letters from enthusiastic busy PLASTICAST users testify to successful businesses developed as a result of answering this ad! BUT LET US PROVE IT: send only 25¢ for our big 48 page catalog of Casting Materials, Molds, etc. We will also send you, absolutely FREE, an attractive CASTING to show you what can be done with our plastics in a few minutes! IN ADDITION, we will also send you a valuable instruction book giving details on the ART & BUSINESS OF CASTING! Yes, all this for only 25¢, but write for it today . . . this may be the lucky coin that will start the most fascinating and profitable phase of your life! Don't delay anything that can mean so much to your future—write today.

PLASTICAST CO. (Dept. "C")

P. O. BOX 6737 (Write to P. O. BOX 987
CHICAGO 80, ILL. nearest address) PALO ALTO, CALIF.
CANADIAN CUSTOMERS: Send 30¢ for catalog to Canadian Ind. Plastics, 1056½ W. Pender St., Vancouver, B.C.



LEARN MEAT CUTTING AT NATIONAL Pay After Graduation

NOW—train in JUST 8 WEEKS at famous National School for a big-pay job with a SECURE future in the dependable trade of Meat Cutting, Meat Merchandising and Self Service Meats.

Be an expert Meat Cutter, Market Manager, Supervisor and make an expert's pay. Get a profitable market OF YOUR OWN. Unlimited opportunities in this vital, nationwide field.

You learn easily, quickly the National Way. You have your own tools and meat to work with. Expert instructors show you how. You get actual, practical experience right here in our big, modern school where we have been training top meat men for nearly 30 years.

Cutting, percentage, pricing, advertising, selling, buying, A COMPLETE RETAIL MEAT EDUCATION. Diploma. FREE employment help. Thousands of successful graduates.

TRAIN NOW — PAY LATER

Get your training NOW. Pay tuition in easy installments after you graduate. We'll get you a job, if you need it, to PAY ALL YOUR EXPENSES while at school.

If you want to BE A SUCCESS—have a secure future—send coupon AT ONCE for our big 52-page school catalog showing students in training and telling about our LEARN BY DOING method. Read letters from graduates. GET ALL THE FACTS. No obligation. You have



everything to gain. Paste coupon on postcard or mail in envelope TODAY.

National School of Meat Cutting, Inc., Dept. 50-B, Toledo 4, Ohio

Send me your FREE school catalog on National Training at Toledo in Meat Cutting, Meat Merchandising and Self Service Meats. No obligation. No salesman will call.

Name _____

Address _____

City _____ Zone _____ State _____

What Every ELECTRICIAN Must Know

ABBOTT'S JUST OFF THE PRESS • UP TO THE MINUTE
7th EDITION • REVISED and ENLARGED

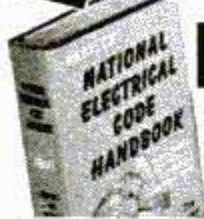

National Electrical Code Handbook

Covers Every Wiring and Installation Job

Approved Types of Wiring • Installation Requirements for All Types of Wiring • Cable Assemblies • Outlet, Switch, and Junction Boxes • Electrical Appliances • Generators • Transformers • Grounding • Outside Wiring • Communication Systems • Elevators • Machine Tools — and MUCH MORE.

AT LAST! The brand-new, revised and enlarged book that makes it easy to do all wiring and installation jobs in accordance with the latest National Electrical Codes. Protects you against legal violations. Answers questions on materials, plans, wiring, installations.

652 big pages — crammed with 441 diagrams, sketches, drawings — which simplify, explain, and tell how to apply every rule. Includes special requirements for hazardous locations. Complete tables give full-load current, wire size, conduit size, and branch fuse rating of all motors. Covers motor wiring, switches, generators, appliances, cable assemblies, transformers, etc.

FREE 10-DAY EXAMINATION. Mail coupon NOW!

McGraw-Hill Book Co., Inc., Dept. PM-2-52

327 West 41st St., New York 18, N. Y.

Send the Abbott's National Electrical Code Handbook for 10-DAY FREE EXAMINATION. If not satisfied I will return it — pay nothing. Otherwise, I will keep it and send only \$2 (plus small delivery charge) then — and \$2 monthly for 2 months.

Name.....

Address.....

Employed By..... PM-2-52

City.....Zone.....State.....

SAVE DELIVERY COST — Check here if enclosing \$6 WITH coupon. Then WE prepay all handling charges. Money back if you return book.

FIRST AID FOR TV SET OWNERS!

H. G. CISIN'S "TV DOCTOR"
Shows you how to fix your own set rapidly and SAFELY!



YOURS TO TRY 5-DAYS FREE!

Save money, throw away service contracts. Here's a real "fix-it-yourself" book — an amazing, quick, copyrighted method of locating & fixing TV troubles. Written by a noted inventor & educator, H. G. Cisin, in language you can understand.

TUBES CAUSE 80% OF TV TROUBLES!

"TV DOCTOR" shows you how to quickly locate and change all defective tubes with complete safety.

WITHOUT EXPERIENCE!—PICTURES & TEXT MAKE FIXING IT YOURSELF EASY

Reveals many closely guarded TRADE SECRETS. Lists over 123 trouble conditions. Method applies to all TV sets, even newest RCA's, Philco's or any 2,000 models, old & new. Copyrighted TROUBLE SHOOTING GUIDE pin-points hundreds of troubles which can be fixed without tools.

11 money-saving, fact crammed, detailed, illustrated chapters include: practical ways to combat interference & ghosts, how to appraise & buy a TV set, valuable information on antennas, lead-ins, color, explains TV terms, lists names & addresses of TV mfgs.—a veritable encyclopedia.

Continual Entertainment—No Service Charges!
Only \$1. — you'll say it's worth hundreds.

FREE SPECIAL OFFER: Act at once & get a new full size profusely illustrated \$1. book—"TV TROUBLE PICTURE GUIDE INCLUDING TV TERMS SIMPLY EXPLAINED" as a FREE GIFT by ordering the "TV DOCTOR" & H. G. Cisin's famous "TV TROUBLE SHOOTING METHOD," which trains you to be a TV diagnostician & serviceman... sells for \$1. Think of it! All 3 TV Books postpaid for only \$2... you save \$1.

H. G. CISIN, Consulting Engineer,
200 Clinton St., Bklyn. 2, N. Y. (Dept. PM-3)

Enclosed find \$2. full payment for "TV DOCTOR," "TV TROUBLE SHOOTING METHOD" & "TV TROUBLE PICTURE GUIDE"—rush copies postpaid.

Enclosed find \$1. in full payment for "TV DOCTOR," rush copy postpaid.

Name.....

Address.....

City.....Zone.....State.....

RUSH COUPON with your name & address. Enclose \$1.50-days to read without risk or return for refund.

ORDER NOW POSTPAID

UNLIMITED WRITTEN GUARANTEE! 17 JEWEL WRIST WATCH 14 95 Plus 1.50 Tax

WAR ON PRICES! FORMERLY SOLD FOR \$59.00
INCABLOC SHOCK PROTECTED WATER & DUST PROOF

Worn by ARMY, NAVY & MARINES
Luminous dial... sweep second hand... Super Accurate. Imported Swiss precision movement and case. You get these brand new FULLY GUARANTEED watches now for a small fraction of the original price. You save \$44, because we bought-out surplus stock! Don't delay.



10 DAY FREE TRIAL!

WEAR AT OUR RISK! MONEY BACK IF NOT DELIGHTED. SEND ONLY \$1 DOWN PAYMENT with order. Pay balance to postman on arrival plus postage. Send check or M.O. for full amount and we pay postage. Men's Style \$14.95 plus \$1.50 tax, total \$16.45. Ladies' and nurses' style \$16.95 plus \$1.70 tax, total \$18.65. Order now at this low price.

FREE! Handsome Expansion Band with Order

MARYLAND DISTRIBUTORS, Dept. 345
501 E. Baltimore St., Baltimore-2, Maryland
Write for Free Watch and Jewelry Catalog at Almost Wholesale Prices

NURSES MODEL \$16.95 Plus Tax

TASOPE PHOTO-ENGRAVING PLANTS



Establish your own profitable PHOTO-ENGRAVING business. Make cuts for newspapers, printers, and advertisers. Make etched name plates, plaques etc. Instructions furnished, no experience necessary. Sold direct from factory since 1931. First five hundred cuts sold locally or by mail will pay for plant and pay you well for your time. Write for FREE catalog.

Material Cost Of This Cut 3/4c Selling Price \$1.00 And Up

TASOPE DEPT. PM10, AURORA, MO.

BE A LOCKSMITH



Learn Locksmithing and Keymaking from Experts in Your Spare Time at Home! Locksmiths in big demand! No layoffs, no slow seasons! Age no disadvantage. Year-round, steady income in this permanent, respected field. Full or part time. Practical, illustrated lessons show how to make money even while learning! All materials, special tools supplied. FREE BOOKLET.

INSTITUTE OF LOCKSMITHING, Dept. P-27, 15 PARK AVE. RUTHERFORD, N. J.
Lic. & Approved State of N.J. VA Approved

BIG MUSCLES don't just happen

Build Them the York Barbell Way!
Don't be fooled! There's no easy way to strength, health, and a beautiful body. But it's fun the York Barbell way. Let Bob Hoffman, famous Olympic weight-lifting coach, show you how! Send postcard, ALL THIS FREE: Copy of Strength & Health, York Barbell Catalog, Bob Hoffman's Tips.

YORK BARBELL CO. York 22, Pa.

FREE BERRY'S NEW POULTRY BOOK

Gorgeously illustrated, describing DAY-OLD and 4-WEEK CHICKS, 50 varieties, veiled or unsexed, AMERICA'S FINEST; also Ducks, Geese, Guinea, ORIGINAL BERRY'S FARM, for over 50 years. Beautiful book and LOW PRICE LIST FREE, stamps appreciated. BERRY'S POULTRY FARM, Box 29, Clarinda, Iowa

COULD YOU USE EXTRA MONEY?

Get \$60.00 a Week for Only 3 Pair a Day!
It costs you nothing to wear your own shoe business! Actual shoe samples supplied. Up to \$4.00 cash for you per pair. Also cash bonus. Paid vacation. Tremendous variety styles, sizes for men, women, children. Exclusive magic comfort heel-toe cushion is selling dynamite. No experience or investment needed. Write TODAY for FREE 64 page Catalog and full information.



THE BIGGEST SELLER IN 31 YEARS

TANNERS SHOE CO., 923 Boston 10, Mass.

**WORLD'S
BEST
WANT AD
MEDIUM**

CLASSIFIED Advertisements



Advertisements in this section 85 cents per word, each insertion, minimum 10 words, payable in advance. To be inserted under proper classification, copy must be in our office the 20th of the second month preceding date of issue
F. W. Johnson, Manager, Classified Advertising
Popular Mechanics Magazine, 200 East Ontario Street, Chicago 11, Illinois

YOU'LL PROFIT

By reading and answering the classified ads in this section. Hundreds of opportunities for you to make and save money

AUTOMOBILES, MIDGET CARS

BIGGEST "Speed equipment catalog" in world! Save, order direct—Hollywood mufflers \$4.95, dual mufflers \$18.95, cut outs \$6.95, dual intake manifolds \$12.95, racing cams \$29, hi-compression heads \$26.95, water injectors \$6.95, customizing kits \$1.98, chrome accessories at discounts! Catalog plus "Hot Rod Handbook"—25c. Almqvist Engineering, Milford 24P, Pennsylvania. (Dealers wanted.)

ATTENTION! Ford parts "A," "T," Model A Motors, Unionville, Conn.

FREE Motor magazines; also old, new and foreign automobile literature; shop manuals, engineering papers, data books, glossy photos. Contact auto nuts everywhere. Write today; get name on free mailing list. Auto Maniacs, Stockbridge, Mich.

BUILD Midget auto. Complete drawings. Pictures and list of parts \$1.00. Lee's Midget Autos, 3361 Dupont Ave. S, Minneapolis, Minnesota.

CATERPILLAR Kid-size crawler tractor—Electric motor driven! Rugged full-track pulls loads easily over lawns, fields, pavements. Most sensational child's vehicle made! Catalog free. Mystic River Sales Co., Box 312-P, Mystic, Conn.

MOTORISTS—Save gas with proven automatic alcohol-water injector. Only \$5.95! Free literature. Vaporizer Company, Box 7033Z, Los Angeles 37, Calif.

SURPRISE Package "on approval." Send only name and address. Pay \$1.00 later (without money) if delighted. Octa-Gane, San Gabriel 5, California.

GENUINE Crosley parts, tires, accessories. Factory rebuilt engines. Walraven Motors, Marion, Ohio, Phone 2-4135.

LATEST 1952 Edition! Just out—100 new pages! Get world's largest auto accessory and parts catalog and save money. Over 50,000 items, including Hollywood accessories, hi-speed equipment, rebuilt engines, all parts and accessories for all cars and trucks. We have that hard-to-get part! Jam packed with bargains. Completely illustrated. Send 25c (refundable). J. C. Whitney, 1919 Archer, Chicago 16.

MAKE Ford use diesel fuel. \$1.00 for plans. Refiner, Box 292, Columbus, Nebr.

SAVE—California custom accessories headquarters. Buy direct from original designers. Chrome dash panels, electric push button door-trunk conversions, fender skirts, dual mufflers, lowering kits, speed-dress up equipment. 40 page catalog, hundreds of photos—25c. Eastern Auto, 3319A South Grand, Los Angeles 7, Calif.

GENUINE Crosley parts, tires, accessories, rebuilt engines. Walraven Motors, Marion, Ohio, Phone 2-4135.

FROM Speedway to roadway! Track-proved hi-speed heads and manifolds for your passenger car! No special tools needed! Increase horsepower 30%! Astounding getaway! Free illustrated catalog. (Dealers wanted.) Speedsport, 4866-D Milwaukee, Chicago 30.

BUY Racing heads, dual manifolds. Hot coils, etc., without money. Information free. Newhouse Automotive Industries, Los Angeles 22.

WATER Injection. Also economy, power, methods. Free illustrated information. Neher Industries, La Verne, California.

WIGLESWORTH-Chasteen's Automobile History Scrapbook. 160 pages. Old time pictures and advertisements of automobiles from 1899 to 1934. \$1.50. Deluxe binding \$3.50. Wiglesworth-Chasteen, 7134 PM Alhambra, Mission, Kansas.

AUTO SUPPLIES AND EQUIPMENT

NEVER Change your oil! Full details free. Thousands of users. You'll be amazed! Dept. TI, Henderize, Inc., 5667 Freeport Blvd., Sacramento, California.

FREE Illustrated auto parts catalogue. New and used. Elgin Salvage Auto Wreckers, 751 No. State Street, Elgin, Ill.

AIR Horns! Bermuda bells, etc. Free catalog. John McCanna, 148½ East 40th, New York 16.

YES, Lachapelle's treatment puts babbit type bearings on the pistons. \$3.00 from your agent or postpaid. Ferns, 8120-B Walnut Dr., Los Angeles 1, Calif. (Data on request.)

"HOW To Soup-Up Your Car." Hot rod handbook plus equipment catalog—25c postpaid. Almqvist Engineering, Milford 26P, Pennsylvania.

MOTORIST Save gasoline by Vacuumating overrich mixtures. Fits all cars. For free particulars write Vacuumatic, Dept. 1859, Wauwatosa, Wis.

AUTO Owners! This is it! Increase performance and life of your car. Send \$1.00 for your Carr-Saver. Carr-Saver Co., Box 735, Federal Bldg., Detroit 31, Mich.

CHEVROLET Owners—Save money; make your Chevy run better, last longer! Get Popular Mechanics big Manual for Chevrolet Owners by Ed Packer today. 304 pages; hundreds of illustrations. Find out how to make your own repairs; keep your Chevy in tip-top shape. First minor adjustment or repair saves you many times cost of book. Send \$3.50 today to Popular Mechanics Press, Dept. 108, 200 E. Ontario, Chicago 11, Ill.

STOP Worrying about fires. Install a Zak Auto Fireman in your car. This safety gadget quickly releases battery cable from battery terminal, stopping electrical fires. Replaces terminal clamp bolt. \$1.00 postpaid. Park Sales, P.O. Box 73, Forest Park, Illinois.

WATERPROOF Your car ignition, latex rubber insulation. Guaranteed starting with motor wet. Big supply \$1.00. Sure Start, Box 94, Union City, N. J.

CHEVROLET Owners—Let the hydraulic spring in oil adjusting screw stop your tappet noise. Will last the life of your motor. Simple and easy to install. Complete set \$5.95. Kaye Products, P.O. Box 1423-PM, Milwaukee, Wisconsin.

WELDING Hose two line 15c foot. Air and spray paint hose 10c foot. Fittings extra 50c each. Heater hose 10c foot, new. C. J. Bate's Rubber, Box 501, Wildwood, N. J.

WATER Injector. Build your own economically. Illustrated instructions \$1.00. Box 3066, Glendale 1, California.

CHAMOIS, (24" x 30" Full skin)—\$2.95; revolutionary hand cleaner, \$1.25 quart; genuine Mediterranean 10" sponges, \$2.80. All three, \$6.00 postpaid. \$10.00 value! Send check or money order. Guaranteed! Modern Products, 2738 Lyndale South, Minneapolis.

WINDSHIELD Washer for your car at amazing bargain price. See page 276. Young Products.

INCREASE Gas mileage 25/60% with Mabros new gasoline additive. Smoother performance, additional horsepower, anti-knock, efficiency proven. \$2.00 for 30 tanksful ppd. or c.o.d. Phillips Scientific Laboratories, Arlington, N. J.

ELECTROPLATE Auto-parts, accessories, novelties. \$5.95 includes portable electroplater, plating salts, formulas, electroplating manual. Tyco Metals, Box 13231-BC, Houston 19, Texas.

OVERHAUL? Rebuilt? New engine? Our free information saves you plenty of money on your auto, truck, tractor engine repair. Skaggs Brothers Garage, Dept. C, 5425 South Vermont Avenue, Los Angeles, California.

LIGHT Your Powerglide dial. Free information. Gaiser, Box 25, Kokomo, Ind.

FOR Economical operation of cars, trucks, tractors install Octa-Gane Alcohol-Water injector. Write Shade, Webster 1, N. Y.

AUTO Parts and accessories. Briggs Automotive Engineering of Chicago, P.O.B. 3454 Merchandise Mart, Chicago 54, Ill.

HOW To buy speed equipment without money. No selling. Information free. Newhouse Automotive Industries, Los Angeles 22.

NEW And used guaranteed parts for civilian and army cars and trucks. Largest stock in America. Mail orders. Pioneer Auto Wrecking Co., 734 W. 13th Ave., Denver, Colorado.

NEW Government surplus. Low voltage circuit tester in steel box cost \$202. Our price \$27.50. Will test batteries, starters, generators, voltage regulators, grounds, short circuits. Wilt Electrical Company, 7829 S. Racine Ave., Chicago 20, Ill.

SEND For free life membership card. "Water Burners" of America, La Verne, California.

GET Your colorful copy of the largest, most modern automotive catalog ever presented. Over 1000 items, completely illustrated, priced and indexed. Custom, speed and power equipment. Mail 50c today to Auto Accessories, 127-P W. Washington Blvd., Los Angeles 15, California.

AUTO TRAILERS

BUILD Streamlined house trailer, telescopes small for towing. Not canvas. Complete blueprints, pictures and instructions \$2.00. T. Comstock, 820 No. 17th, Parsons, Kansas.

BUILD Your own trailer! Plans for all kinds. Illustrated catalog 10c. Jim Dandy, 125-M, Wausau, Wisconsin.

MOTORCYCLES, BICYCLES, MOTORSCOOTERS AND SUPPLIES

RECONDITIONED Motorcycles and motors. Chromium accessories. Complete stock Indian parts. Expert rebuilding. Fast service. Indian Motorcycle Sales, Kansas City 1, Mo.

HARLEY-Davidsons—All models and prices. Genuine late and old model supplies. Expert service. Send 25c for bulletin. Knuth's, 1753 Muskego, Milwaukee, Wis.

WHIZZER Motor \$5; motor-scooter \$15; Indian motorcycle \$30; Engines \$3 up; motorbike frame \$3. Rush 25c (35c first class mail) for catalog #950 listing many other amazing bargains in motors, midget cars, motorscooters, motorbikes, etc. Associated, Box 1764-CS, Toledo, Ohio.

GOOD Whizzer \$20; motorscooter (twist grips) \$22.50; midget car \$15; Shaw bicycle motor \$15. Send 25c (35c first class mail) for catalog #20 jammed with sensational bargains in wheels, motors, clutches, motorscooters, midget cars, motorettes, motorbikes, etc. Gail, 538 Erie, Toledo, Ohio.

WHIZZER Motor \$10; 1946 Servicycle \$15; homemade motorbike \$10; Crosley convertible \$50; Electric Motorette \$55; midget car less motor \$10. Four airplane tires \$3 (mailorder only). Send 25c for new catalogue Number 45, just out listing these and hundreds of other bargains in new and used midget cars, motorscooters, homebuilders parts, plans, engines, transmissions, war surplus, etc. (35c by first class mail). Midget Motors Directory, Athens, Ohio.

U. S. Govt. surplus "45" Harley Davidson motors, complete with carburetor and generator, in running condition — \$69.50 f.o.b. Chicago. 25% deposit with order. Parts and accessory catalog 25c. Triangle, 2157 Harrison, Chicago.

MOTORCYCLE Magazine — Worldwide coverage. Yearly subscription \$2.00. Sample 20c. Motorcycle News, 5424-A Sawyer, Chicago 25.

REBUILT Gasoline engines \$17.00 to \$37.00. Cauffiel Motor Industries, Temperance, Michigan.

AVIATION

JET Engine plans \$1.00. Very simple—make own. J. Symonds, 500 N. Tamarind, Fontana, Calif.

PROPELLERS: For snowsleds, boats. Literature. Standard Aircraft, Box 387, Ft. Worth, Texas.

BATTERIES, GENERATORS

EDISON Non-acid storage batteries. Amazing long life. Any voltage. 37 to 600 ampere hour sizes. Lighting plants, generators, motors. Literature. Hawley Smith Co., Croton Falls 1, N. Y.

ELECTRICAL SUPPLIES

TELEPHONES — Telephone wire. Low-cost army field telephones will solve your communication problems. Simply string wire, connect phones, ring and talk any distance. Free illustrated folder. Loris Sales, Dept. B, 907 2nd St., Sacramento, Calif.

BE Independent, be secure, have your own profitable business—Earn \$20.00 and more a day making beautiful, fast-selling lamps at home. No equipment needed. Illustrated course teaches you quickly. Course, parts catalog, wholesale price list—only \$2. Gearon Co., Dept. 200-B2, 27 S. Desplaines, Chicago 6, Ill.

ELECTRIC Pencil—Writes, engraves all metals. \$2.95. Reb Industries, 265-DK, Elmhurst, Illinois.

BIG Profits rebuilding automobile generators. Introductory manual \$1. Modern, Box 4704, Kansas City, Mo.

WATTHOUR Meters \$5.00. Excellent condition. Miller, 1011 West 16th St., Davenport, Iowa.

LAMP Supplies — Wholesale. Any amounts. Prompt shipment on all parts for repairing and building lamps. Illustrated catalog 15c. Brown Lamp Co., Box 501, Wellston Sta., St. Louis 12, Missouri.

ELECTRIC Pencil: Engraves all metals \$1.50. Beyer Mfg., 10511-H Springfield, Chicago 43.

LAMPS — Had trouble finding repair parts? Your search is ended. 25c brings 64 page illustrated catalog also containing wiring charts. Gyro Lamps, 5402P Clark, Chicago 40.

WELDING, SOLDERING, PLATING

ELECTRO Plating equipment—new and used. Complete assemblies. All sizes for all types of plating. Baby shoe metalizing sets. Mounts, supplies. Free catalog. Hollywood Bronze Supply, Dept. 2, 1624 E. First Street, Los Angeles 33, California.

ACETYLENE Welding outfits new \$49.00; used \$29.00. Arcwelders \$49.00. Eagle Welding, Dept. PM, 5085 Broadway, Chicago 40, Illinois.

RADIATOR Repairing, cleaning, recoring. How to equip small shop at low cost. Supply sources, trade secrets. Instructions \$3.50 postpaid. Radiator Service, McBain, Mich.

200 AMP. Welding generators. Brand new. \$25.00. Free literature. Thorndyke Mfg. Co., Pipestone, Minn.

A.C. Welders. 4 sizes, lowest prices. Free literature. Holgerson's Service, Canton 1, Kans.

MACHINERY, TOOLS, SUPPLIES

TUBULAR Rivets, tools, washers. Best fasteners. Catalog. Craftlines, 921-CM Cedar, Burbank, Calif.

CONCRETE Block machine. Standard sizes. \$39.50. Average 400 daily. Free catalog. Concrete Machine Company, 5129 South Compton, St. Louis 11, Mo.

DRILL Grinder for twist drills, \$2.95. See ad on page 276.

FLEXIBLE Shaft tool by Fairchild for grinding, polishing, sanding, buffing, carving. Original price \$19.95. While they last! Special price \$12.95. Public Sport Shops, 11 S. 16th Street, Philadelphia 2, Penna.

WATCHMAKERS' Staking set, 50 punches, 6 stamps, \$39.50. Larger set 100 punches, 20 stamps, \$49.50. Public Sport Shops, 11 S. 16th Street, Philadelphia 2, Penna.

SAVE 90% On power tools. Handbook 25c. Robert Fellows, Caledonia 4, N. Y.

BOATS, OUTBOARD MOTORS

BAR-HOO! Newest scientific discovery. Waterproofing compound. Boats and such. Hygroscopic. Expansive. Permanent. Bulletin available. Send \$3.20 for 1.102 pounds postpaid. Bar-Hoo Co., 106 First Ave., Flint, Mich.

FASTEST Boats in the world—Build now. Complete plans available for sleek three point racing hydroplanes, runabout and others. Send 25c immediately for illustrated catalogue. Champion Boats, 1524 W. 15th St., Dept. 22-N, Long Beach 13, Calif.

SAVE Money, have fun—Build your own boat. Popular Mechanics "23 Boats You Can Build" tells and shows you how. 192 pages, 500 illus., detailed diagrams and material lists. Everything from 10 ft. dinghy to 25 ft. cabin cruiser. Only \$2.00. Order today from Popular Mechanics Press, Dept. 107, 200 E. Ontario, Chicago 11, Ill.

GET Our big 228-page 1952 marine hardware, boat and equipment catalog. Send \$1.00 for packing and mailing, refunded with first order. Garland Frasher Marine Sales, 540-J 31st Street, Huntington, W. Va.

CURE That leaking boat with Fiberglass-Plastic covering. Ends caulking and painting. Nationally approved process. Easily applied. Complete instructions. Industrial Plastics, 3807 Harrison Street, Oakland 11, Calif.

OUTBOARD Motor parts—New, used for all makes. Send stamp for price quotation. Outboard Motor Mart, Inc., 309-A Atlantic Avenue, Boston 10, Massachusetts.

MARINE Conversions for Ford and Jeep engines. Catalog 10c. Lehman Manufacturing Company, 972D Broad Street, Newark 2, New Jersey.

"P38 Belly tanks," steel, \$9.95. Free picture. Bucks Auto Parts, Box 89, Merced, Calif.

FULL Size, cut to shape boat patterns, blueprints, 7½-38 feet. Illustrated "Build a Boat" catalog, 25c (coin). "How to Build Boats" book, \$1.00. PolyWog houseboat plans \$10. Marine catalog \$1.00. Marine Specialty Mfg. Co., 3107 Detroit Ave., Cleveland 13, Ohio.

NEW, Used, rebuilt marine motors. Marine conversions, fittings. Free catalog. Stokes Marine Supply, Dept. 24, Coldwater, Michigan.

CONVERT Fords and Jeep to 100% marine engines with Osco's world famous Convo-Kits. Deluxe catalogue 25c (coin). Oscomotors, 3627B Lawrence, Philadelphia 40, Penna.

SAVE ¾ Cost. Assemble your own boat. We furnish parts. No experience necessary. Rowboats, cruisers. Illustrated catalog 25c. Midwest Boat Company, Menomonee Falls, Wisconsin.

ARE You interested in boats? Write for free copy The Rudder, a magazine on boats and boating. 15 Murray St., New York 7.

INBOARD Speed boat hulls, \$365 up. Lit-rature 10c. Huebl Boats, LeSueur, Minn.

ENGINES, MOTORS, DYNAMOS

REBUILT Gasoline engines \$17.00 to \$37.00. Cauffiel Motor Industries, Temperance, Michigan.

WINDING Data, listing 225 motors, single and three phase, \$1.00. Motor Data Co., Box 7631, Kansas City 3, Mo.

ATHLETIC EQUIPMENT, BODY BUILDING COURSES

"POLICE Jiu Jitsu." Authentic, illustrated \$1 postpaid. Satisfaction or money back. Books Publishing Co., 56-C W 24th St., New York 10.

DEADLY Judo—Fiercest fighting technique. Trick knockouts. (Over 200 illustrated pictures.) Expert instructions; three volumes. Complete \$2.25. Variety House, Box 46-B Wall Station, New York 5.

GAIN Weight! 4 exercises will increase weight. Complete \$1.00. Body Builders, 36 Nevada Street, Winthrop, Mass.

SPORTING GOODS, GUNS, FISHING TACKLE, ARCHERY, TRAPPING

TENNIS Supplies. Trade prices. Free list. Southern Tennis Company, 622 Preston Place, Charlottesville, Virginia.

FISHWORMS At wholesale. Send 3c stamp. Alton Tozier, Macon, Georgia.

H&R .22 With holster \$20; .22 rifle \$10; 1828 musket \$13; arrowhead collection 70c; German officer's swords \$5; pistols \$2 up. Rush 25c (35c first class mail) for catalog #509 listing many other bargains in guns (new and old), swords, relics, etc. Jefscs, Box 1682-CS, Toledo, Ohio.

MAKE Every shot count! Our free booklet, "Straight from the Shoulder" tells how to improve your shooting and save ammunition. Write the Poly-Choke Co., 811 Tunxis St., Hartford, Conn.

"CROW Hunting," complete book and "Toad's" guaranteed multi-tone crow call, \$1.00. Toad Co., Lamar, Missouri.

LEARN Gunsmithing! Free information. Gunsmith, 3118 Montrose, Chicago, Illinois. We buy, sell, trade.

SHOTGUNS, Rifles, Revolvers, 500 modern, obsolete. Also cartridges. Each list 10c coin. Ed Howe, 52 Main, Coopers Mills, Maine.

CAST Iron molds—For casting your own sinkers. Free booklet. Reading Instrument Co., Box 78, Reading, Penna.

5000 BARGAINS, Firearms, binoculars, war relics. Catalog 50c. Smith Firearms, Runnede, N. J.

MOLDS. (For fisherman's sinkers, squids, jigs and lures.) Handled and hinged. Quality fishing tackle. Free catalogue. E. L. Sweet & Son, Tonawanda, New York.

TAXIDERMISTRY

MODERN Taxidermist Magazine. Greenfield Center 2, N. Y. Devoted entirely to taxidermy, photos, articles, methods. Trial year's subscription, \$1.00.

BINOCULARS, TELESCOPES, MICROSCOPES, MAGNIFIERS

SAVE! Free 20-page, 3 color binocular catalog. 60 different models. United Binoculars, A-3708, 9043 S. Western, Chicago 20.

SAVE 50% On new binoculars! Free catalog. Free book, "How to Select Binoculars." Write today! "Bushnell's, 43-M-32 Green, Pasadena 1, California.

TELESCOPIC Cameras easily made. Trifling cost. Carl Jamer, Manorville, N. Y.

REFLECTING Telescopes, 60X, completely assembled \$29.75. Guaranteed observatory clearness. Free information. Skyscope, 475 Fifth Avenue, New York 17.

AMAZING Prices, imported precision binoculars. Free trial. Pricelist, folder "Selecting Binoculars" free. Prentiss Importers, Mercury Bldg., Los Angeles 25, Calif.

BINOCULARS, Telescopes, microscopes. Our 20th year of leadership in optical values. Bargain catalog free. Brown-scope Co., 24 West 45th Street, New York.

WAR SURPLUS bargains, binoculars, telescopes, sextants, millions of lenses, prisms, reticles, eyepieces, objectives, etc. Mail 10c for Big "Catalog CH." Send \$1.00 for Stock CH-10-piece lens kit and big instruction booklet. Edmund Scientific Corp., Barrington, N. J.

ASTRONOMICAL Telescopes, binoculars, microscopes, bought, sold, repaired. Books. Lists 10c. Rasmussen-Reece, Amsterdam, N. Y.

POWERFUL Astronomical telescopes easily made. Perfect lenses and instructions; 100X \$3.00; 100X and 200X \$4.00; 100X, 200X and 400X \$6.00. Full power, clear vision guaranteed. Instructions alone 10c. Suffolk Science Service, Riverhead, N. Y.

MAKE Your 6" telescope reflector. Glass, abrasives, instructions—\$8.50. F. Cameron, Box 65, Inwood, N. Y.

REFLECTOR Telescope kits, refractors. Free illustrated bulletin. Esco Products, 911 Willow Ave., Hoboken, N. J.

GIANT Astronomical telescope with 6 ft. tripod \$15.00, f.o.b. factory. 100 power. (10,000 area magnification). Clear vision, full power guaranteed. Ready for use. Suffolk Science Service, Dept. BT, Riverhead, N. Y.

PETS—DOGS, BIRDS RABBITS, HAMSTERS, ETC.

HOBBY Or profit. Australian Shell Parakeets. Any age or color. Valley Aviarics, Box 598, Edinburg, Texas.

BIG Profits. Raise guinea pigs. Free booklet. Taylors, B426A, Hapeville, Ga.

BARE Rabbit swindles. Get book, "Inside secrets of Rabbit Raising." Ultra modern hutches, diseases, cures, etc. Send \$2.00. Thomas Drake, Box 302, Pass Christian, Miss.

RAISE Rabbits. Profitable business. Booklet dime. Tayco Rabbitry, Hapeville, Georgia.

500 BRED Mink. Booklet, pen plans 20c. Lake Ontario Mink Ranch, Gravel Road, Webster, N. Y.

BEAUTIFUL Pure white pedigreed police puppies. Ansonia Kennels, Mose, N. Dak.

EXCELLENT Opportunity raising Angora rabbits. Big money. Free illustrated information. Ohloland Rabbitry, Box 4756, Cleveland 26, Ohio.

DAIRYMEN: Why pay more? Buy direct. Quality dairy calves—heifers—cows. T.B. and Bangs free. Cattle shipped on order. R. H. Walter, Lannon, Wis. Phone: 26M13 or 28M5.

NATURALIST'S Catalog 10c. Chameleon 50c. Salamander 50c. 200 Mealworms \$1.00. Quivira Specialties, Topeka 51, Kansas.

HAMSTERS—Golden or spotted. Cages and equipment. Free illustrated details. Lakeview Hamster Colony, Newfield, New Jersey.

RACCOONS—Minks, bred females. Baby skunks. Catalog, 25c. Shady Fur Farm, Springfield, Minnesota.

BOOKLET "Treatise on Breeding and Raising Canaries"—\$1.00. Audubon Publishing Co., 3449-PM N. Western, Chicago 18, Illinois.

RAISE Mink: Free booklet, pen plans, inside "secrets", feed, care. Mink are money makers. Investigate today. Lawrence Molgard, Brigham City 12, Utah.

SPORTSMEN: 200 Pointers, Setters, straight Cooners, combination hunters, rabbit and fox hounds. Reasonable. List free. Ramsey Creek Kennels, Ramsey, Ill.

MAKE Big money! Raise Chinchilla rabbits. Cash markets supplied. Write today! Rockhill Ranch, Sellersville 15, Penna.

EARN Up to \$400 monthly raising Angora or New Zealand rabbits. Plenty markets. Particulars free. White's Rabbitry, Newark 38, Ohio.

MINK Raising information free. Complete. Lake Superior Mink Farm, Superior, E11, Wisconsin.

A Practical beginning to successful rabbit raising. 48 page illustrated booklet. Dime. American Rabbit Breeders Association. 36 AR & CBA Bldg., Pittsburgh, Penna.

PLANTS, SEEDS, NURSERY AND GARDEN SUPPLIES

TREES And shrubs. Raise your own from seed for ornament, windbreak, snow fence, erosion control. Christmas trees, spruce, firs, pines, others. Free planting guide, price list. Woodlot Seed Company, Norway 4, Michigan.

GLADIOLUS—1000 Mixed blooming size \$1.59, bulbets \$1.29. Blue Amaryllis seed 3 for \$1. Glad Haven Sebastopol, Calif.

RAYNER'S Special berry garden. Luscious, fresh fruit grown in your own garden. Strawberries: 100 early, 100 mid-season. 100 late top quality plants for \$6.99. Blueberries: 4 early, 4 midseason, 4 late giant cultivated bearing age plants \$7.69. Nationwide shipments. Also fruit trees, ornamentals. Catalog free. Rayner Brothers, Salisbury 99, Maryland.

FARMS, FARM LANDS, REAL ESTATE

CANADIAN Tax sale lands for two dollars an acre and up. Small monthly payments. Farms, timber, hunting and fishing camps, minerals. Limited number of properties. Write at once for free catalogue. Tax Sale Service, Room 105, 120 Bloor St., W., Toronto 5, Canada.

FLORIDA—Hunting, fishing, fruit growing, 5 acres, \$245.00, \$10.00 down, \$10.00 month. G. B. Potterfield, Union Building, Charleston, W. Va.

FREE Farm catalog. United Farm Agency's new free spring catalog of farm and country real estate bargains. Just off press. Can help you plan soundly for your future security in the country. Good pictures, many states, easy terms, many equipped, growing crops included. For special service, state requirements, desired location. Write for your catalog today. It's free! United Farm Agency, 220-PM South State St., Chicago 4, Ill.

OZARK Retirement farm \$200. \$5 month. Get complete information. Address, Armstrong, Shook 34, Mo.

5-ACRE Florida garden farm, high and dry, beautifully wooded, only \$375, payable \$10 monthly. Near famous Panama City pleasure resort. World's finest beaches. Wonderful fishing, hunting. Grow fruits, berries, vegetables, poultry. Glorious climate. Desirable community. Ideal for vacation or retirement home. Booklet free. Wendell Wood, Box 873, Houston, Texas.

TWO Strout catalogs. East and mid-west red cover; west coast edition blue. Farms, homes, businesses, bargains galore. Either mailed free. Strout Realty, 7 So. Dearborn St., Chicago 3, Ill.

\$5.00 MONTHLY Buys 40 acres near town; price \$200.00. Free list. Box 425-P, Carthage, Missouri.

FARM-Ranch opportunities. Favorable conditions. Washington, Minnesota, Montana, Idaho, Oregon, North Dakota. Literature, farm descriptions. Specify which state. J. W. Haw, 119 Northern Pacific Ry., St. Paul 1, Minn.

HOMESITES \$300—Convenient payments. California's finest garden section. On Morro Bay's scenic shores. Wonderful fishing, boating, bathing. Fertile soil, softest water, temperate climate, congenial community. Free literature. Richard Otto, Department M, San Luis Obispo, Calif.

WESTERN Ranch lands. Virgin timber. Hunting, fishing, river and highway frontage tracts. \$5 to \$10 acre full price. Easy terms. 10c (coin) brings Land Catalog, pictures. Pacific Lands, Box 2350BW, Hollywood 28, California.

POULTRY, FARM SUPPLIES

ARBOR Acres Strain White Rocks. Pilch Official COT 1951 winner. 5 lbs., 5 oz. at 12 weeks. Try a strain brood. See for yourself why this strain is sweeping the country. Pullorum clean. Pilch's Chicks, PM, Hazardville, Conn.

POULTRY Farmers, broiler growers, turkey raisers read the new American Poultry Journal for latest ideas and greater profits. 12 months, 50c. Special offer, 4 years, \$1.00. American Poultry Journal, 532 South Clark, Chicago.

BABY Chicks, America's finest, 50 varieties, 8 crossbreeds, bloodtested, sexed or unsexed, low prices. Gorgeous poultry book free. Berry's Farm, Route 12, Clarinda, Iowa.

KNOW How to raise poultry for profit. Read Poultry Industry. Every issue packed with helpful hints and practical suggestions. Latest articles on breeding, feeding and management. Subscribe now. 1 year 65c. 2 years one dollar, foreign subscriptions \$1.00 a year. Poultry Industry, Dept. P.M., 376 Boylston St., Boston 16, Mass.

RAISE Turkeys the new way. Write for free information explaining how to make up to \$3000 in your own backyard. Address National Turkey Institute, Dept. 3, Columbus, Kansas.

PROFITABLE OCCUPATIONS

START Profitable business at home making quick selling transparent plastic, opaque plastic, plaster articles, etc. Learn mold making, carving, fabrication, mass product production, etc. Free Plasti-Art book. Advance Trades School, Dept. 105, Chicago 31.

WANT A diesel job? Our approved, up-to-the-minute diesel training program can help you qualify for steady, big pay jobs or specialized military training. Covers diesel, tractor, heavy equipment repair, service, operation. Easy to master. High grade mechanics tools, worth \$50 come with course. No loss of present income. Job placement advisory service. Investigate! We invite comparison of material and service. Write for information today. Interstate Training Service, Dept. 3B, Portland 13, Oregon.

TURN Your spare time into cash. Make quick-selling, highly profitable lamps—every home a prospect. No experience or special tools required. New 1952 56-page illustrated catalog shows shades, shade frames, figurines and bases, oil lamp converters, boring compounds, and dozens of similar items. Also all kinds of sockets, cords, pipes, harps, finials, bases, and hundreds of other parts—everything you need. Special 8-page section shows 6 beautiful lamps in kit form ready to assemble. You buy wholesale, sell at retail—make big profits. Hundreds doing it. You can, too! Send 25c today for catalog and wholesale price list. Refundable first order. Gearon Co., Dept. 500-B2, 27 S. Desplaines, Chicago 6, Ill.

MAKE Money at home with Larson leathercraft. No experience needed. Easy-to-assemble belts, purses, gloves, etc. Send 10c for big catalog of 100 ideas. Largest stock in U. S. J. C. Larson Co., 820 S. Tripp Ave., Dept. B75, Chicago 24.

"HOW To Make Money With Simple Cartoons"—A book everyone who likes to draw should have. It is free; no obligation. Simply address Cartoonists' Exchange, Dept. 92-CP, Pleasant Hill, Ohio.

FOREIGN Employment construction men, building trades, helpers, office men, others, interested in foreign projects. High wages, quarters, trans. Listings of firms actively working on U.S. foreign, intercontinental projects. Send \$1 for foreign construction compendium and application forms. Foreign Service Bureau, Dept. PM-2, Box 295, Metuchen, New Jersey. (Not an employment agency—No fees.)

\$4 TO \$10 Hour spare time, billion-dollar adjustment field. Free book—Now! Universal Schools, M-54, Box 8262, Dallas 5, Texas.

MUSHROOMS Grown. Boxes. Barrels. Instructions 50c. Spawn \$1.00. Manureless process. \$2.00. Gordons, 328 Bannerman, Winnipeg, Manitoba.

\$100-\$200 WEEKENDS. No selling or manufacturing. Mahaffey, 3032-W Weldon, Los Angeles 65.

PRINT Without a printing press. Big profits! See page 43.

START A buying service, buy wholesale thousands nationally advertised products. Make big profits selling at sizable discounts. Send postcard for details. American Buyers' Service, 627-R Linden, Buffalo, New York.

WEATHERSTRIPS. Sell and install. Big profits. Morgan Co., 6113 3rd Ave., Minneapolis, Minn.

HONEST Information! Pictures. Leading rabbit farming magazine. Not hobby. Sample dime. Box 5142, Miami 29, Florida.

ALASKA! Just released! Over 50 gigantic new construction contracts! Names, addresses, companies hiring. \$1.00 complete. Alaskan Opportunities, (PM) Box 362, Kenmore, Wash.

BE Your own boss. Free book "163 Unique, Successful Businesses" tells how. Start sparetime, small capital, work home. Deumant Publications, 81-P Deumant, Kenmore 23, New York.

HOME Electroplating kits. \$14.95. Free details. Reed Engineering, 620 S. Inglewood, Inglewood, Calif.

ALASKA—Last American frontier. \$1.00 brings 1952 business directory, government map, construction projects military and civilian, homestead and highway facts, hunting-fishing-game rules, mining, aviation. List of firms hiring. How-when-where to apply. Alaska Opportunist, P.O. Box 883-P, Hollywood 28, California.

FOREIGN AND Latin American employment. 1952 "Foreign Service Directory" gives up-to-minute facts on military and civilian construction, government jobs, major oil listings, aviation, transportation, steamship lines, mining, importers, exporters, now-when-where to apply, application forms, hot list firms hiring. \$1.00 postpaid. Global Reports, P.O. Box 883-P, Hollywood 28, Calif.

CONSTRUCTION Job list. Published monthly. \$1.00. Dempster's Construction Scout News, Dept. 268-JC, Bridgeport, Ill.

READ Tip Top Salesman. Three months 25c. Kohler, Box 5910, Philadelphia 37, Penna.

FREE Book "505 Odd, Successful Businesses." Work home. Expect something odd! Pacific, Oceanside, Calif.

OWN A printing business. Good profits printing cards, stationery, etc., in spare time. Easy rules furnished. Have home shop. Send dime for illustrated printer's supply book and samples. Kelsey, Inc., T-24, Meriden, Conn.

"EVERYBODY Likes candy"—Learn to make professionally. (Our 40th year.) Ragsdale Candies, D6, East Orange, New Jersey.

EARN Up to \$400 monthly raising Angora or New Zealand rabbits. Plenty markets. Particulars free. White's Rabbitry, Newark 61, Ohio.

MAKE Flexible molds! Cast plaques, bookends, figurines! Free sample! H. Tooker, 630-M Chestnut, Hamilton, Ohio.

RAISE Pheasants on the \$100 week plan. Little capital and space can make you independent. Free details. Great Central Game Management System, Columbus 1, Kansas.

\$40.00 WEEKLY Made growing mushrooms, fresh, dried. Dominion patent 331583. Free spawn. North American, 169P Yonge, Toronto, Canada.

BE The Popular Mechanics representative in your neighborhood and earn big profits in your spare time. Write Popular Mechanics Magazine, Room 408M, 200 E. Ontario St., Chicago, Ill.

BOOKS, PERIODICALS, PICTURES POSTCARDS

LATEST Books rented, purchased, sold. Catalogues free. Advanced, 56 South 25th, Pittsburgh, Penna.

MORE Amazing and startling than Science-fiction. "The Complete Prophecies of Nostradamus." Contains over 1000 astounding prophecies from 1555 to the present, which have proven themselves with uncanny accuracy—and beyond until 3797. Contains old French text and exact English translation, in plain language easy to understand. Translated, edited and interpreted by Henry C. Roberts. 350 pages, handsomely bound 6"x8". \$3 postpaid. Nostradamus, PM, 380 Canal St., New York City 13.

MACHINISTS Tricks of trade \$1.00. Edward Glen, 175 Division Avenue, Garfield, New Jersey.

HOW To Retire Magazine, Winchester, Ohio. Copy 25c. Year \$2.00.

MAGAZINE Subscriptions wholesale! Bedard Publications, Dept. PM, Box 637, Detroit 31, Michigan.

CATALOG 400 Popular books. Bargain prices, 10c. Books Publishing Co., 56-F W. 24th St., New York 10.

SHIP Photographs, lists 10c. Scozafava, 1648 59th Street, Brooklyn 4, N. Y.

ILLUSTRATED Humor library—Jokes, gags, after dinner stories, and more—24 pocket size booklets. \$1.00 with free fascinating catalog. Aladdin Book Co., 210-P Fifth Avenue, New York 10.

FASCINATING, Entertaining once-in-a-lifetime book! "Fifty Years of Popular Mechanics." Tremendously exciting story of most fabulous years in American history. Describes birth of auto, radio, airplane, television; hundreds of other inventions and world shaking events. Nostalgic old time ads and prediction of fabulous inventions to come next fifty years. Giant size—500 pages; 8½"x11". Order now while stock still available. Send \$3.00 to Popular Mechanics Press, Dept. 109, 200 E. Ontario, Chicago 11, Ill.

MAGAZINES (Back dated)—Foreign, domestic—Arts, books, booklets, subscriptions, etc. Catalog 10c (refunded). Cicerone's, 86-22 Northern Blvd., Jackson Heights, N. Y.

USED And out-of-print books. Catalogue free. Balliol, Box 85, Station K, Toronto, Canada.

BOOKHUNTERS! All subjects. Send wants! Jaher Book Service, 620-P East 178 Street, New York 57.

BOOK "Breeding of Parakeets" and cage-bird magazine—\$1.00. Audubon Publishing Co., 3449-PM N. Western, Chicago 18, Illinois.

BOOKHUNTERS! Scarce, unusual, miscellaneous books supplied. Atlantic Book Service, Lawrence Avenue, Charlestown 29, Massachusetts.

GAMES AND ENTERTAINMENT

Q-BICLES—Tantalating, titillizing game. 25c each. Haynes, 2500 Wisconsin Ave., Washington 7, D.C.

FREE Giant Popular Mechanics 40 page Golden Anniversary Book Catalog! Over 400 books on workshop planning, home building, household repairs, projects, motoring, sports, photography, money making opportunities, machinery, inventions, crafts, hundreds more. Many not available in stores. Send postcard today to Popular Mechanics Press, Dept. 110, 200 E. Ontario, Chicago 11, Ill.

MAGIC TRICKS, PUZZLES, JOKER NOVELTIES

LEARN Magic from Sachs's "Sleight-of-Hand," greatest magic textbook, cloth, 416 large pages, \$5.00. Others, \$1.00 up. List free. Fleming Book Company (world's largest magic book dealers), 728 Madison, York, Penna.

PROFESSIONAL Catalog and free trick 35c. Terry's Magic Studio, 6606 Duryea Court, Brooklyn 19, New York.

FREE Trick with 1952 illustrated catalogue 10c. MAJ Magic Products, 23-P Friends Lane, Westbury, N. Y.

JOKER'S Novelties, 28 different, 35c. Sebastian, 5138-B Cahuenga, North Hollywood, Calif.

8 AMAZING Mystifying tricks, no gadgets \$1. Edwards, 16751 Ashton Road, Detroit 19.

WORLD'S Largest professional magic shop, keeps you in touch with latest tricks. To receive mailings, send \$1.00 for new catalog. Holden's, M220 West 42nd St., New York.

BIG Fun kit! Tricks, jokes, novelties, books. Real clever stuff. Howls galore, \$1.00. Johnson, 414 McRae, Wilmington, N. C.

16 CARD Tricks and catalog 25c. Sterling Magic, Royal Oak, Mich.

FREE Trick and large illustrated catalog, 35c. Lerro Magic, 509 80th Street, Brooklyn 9, N. Y.

LATEST Magic for pocket, parlor, stage. Catalog 500 tricks, only 10c. Unequaled magic service for 30 years. Douglas Magicland, Dept. 1, Dallas, Texas.

512-PAGE Catalogue of 2500 tricks, pocket, parlor, stage. World's finest magic. Send \$1.50 for catalogue (refunded first \$6.00 order). Kanter's, M-1311 Walnut, Philadelphia 7.

PROFESSIONAL Catalog, 124 pages, 25c. Williams, 900 Plymouth, Eliwood City, Penna.

BE A magician. Large professional magic catalog of latest tricks, 35c. Ireland, C-109 North Dearborn, Chicago 2.

200 ELECTRIC Stunts, 110 volts, \$1. Kutting Sons, Los Altos, Calif.

COINS, TOKENS, CURRENCY

OLD Money wanted. Do you know that coin collectors pay up to \$100.00 for certain U. S. cents? And high premiums for all rare coins? We buy all kinds. Send 4c for large coin folder. May mean much profit to you. Numismatic Co., Dept. 20, Fort Worth, Texas.

1951 U. S. Proof set in holder \$3.50. Uncirculated nickels 1950-D, six for \$1.00; 1950-P, ten for \$1.00. Lists. Bolus, 1139 11th N.W., Canton 3, Ohio.

PONY Express medal 60c. Free coin lists. Perkins, Hamilton Square, New Jersey.

10c 1916-D, \$4.50, 21-21D, 75c; All V.G. 1c, 1909-S, VDB, \$8.00, V.G. 1909-S, \$1.20, 1931-S, 80c, P-UP, 1914-D, \$4.50, V.G.F.; U.S. rare coin value guide, 50c. Russell, P.O. Box 2011-D, Natural Bridge, St. Louis 15, Mo.

FREE! Foreign coin, banknote and coin collectors illustrated catalog to approval service applicants. Send 3c postage. Tatham Coinco, Springfield 30, Mass.

WANTED—1894-S Dime, pay \$500. Certain 1913 nickel \$1,000. 1901-S quarter \$20 to \$150. Hundreds of others. Know their true value. Complete illustrated catalogue 25c. Worthycoin Corporation (D-325), Boston 8, Massachusetts.

40 DIFFERENT Coins, \$1.00. 100 different bills, \$1.00. Oddehon, Box 482, St. Louis, Mo.

FIFTY Assorted Indian cents, \$1.50. Rare 1931-S cents, \$1.00. Giant fifty-two page illustrated bargain catalog, 10c. Ben's PM Department, 31 North Clark, Chicago 2.

COIN Collector's Magazine. Largest independent, over 1000 pages per year. Sample copy 30c; \$3.00 per year. Hewitt, 5450-J Clark, Chicago 40.

JAPANESE Invasion notes for United States 1c to \$1,000.00; set \$2.00. Illustrated coin catalogue 25c. Shultz, Salt Lake 10, Utah.

GENERAL MacArthur set (2) \$3.75; Vatican Holy Year set (4) \$1.00; 256 page retail guidebook \$1.50; premium handbook \$1.00; giant bargain catalogue 25c. Bebee's, 1180 East 63rd, Chicago 37, Illinois.

GET Profit and pleasure in collecting old coins. Send 10c for 56 page illustrated coin catalog. You'll be delighted with it. Send for it now. B. Max Mehl, 370 Mehl Bldg., Fort Worth Texas. Largest rare coin establishment in U. S. Established 52 years.

FOREIGN Money, wooden nickels, and "coin collectors" big new magazine 10c. Lawrence Brothers, Anamosa, Iowa.

OLD STAMPS WANTED

I Will pay \$100.00 each for 1924 1c green Franklin stamps, rotary perforated eleven (up to \$1,000 each unused). Send 10c for large illustrated folders showing amazing prices paid for old stamps, coins and collections. Vernon Baker, PM-22, Elyria, Ohio.

STAMP COLLECTING

FREE! First stamps issued by 11 countries. Here's your chance to get these hard-to-get stamps with approvals. Moulblow, 740C Hegney, Bronx 56, N. Y.

BEAUTIFUL N.Z. semipostal triangles picturing British Princesses only 10c with worthwhile approvals. George Richie, 1539 Sixth, Alameda, California.

1000 FINE Mixed U. S. stamps, 25c. Wright, 201 Mealey, Hagerstown, Md.

MINT U. S. 797 SPA sheet, 10c to applicants for U. S. approvals. M. Haycock, 235M 86th St., Brooklyn 9, N. Y.

FREE—Illustrated catalog! Kenmore, Milford, C-57, N. H.

20 CONGO, French Colonies, Vaticans, etc., all mints, 10c. Approvals. Haworth, 4966 Victoria Drive, Vancouver, Canada.

ANGOLA! Beautiful multicolor bird set plus 100 stamps, 10c to approval applicants. Sunset, Dept. 333, Box 47, South Gate, Calif.

GIVEN Free U. S. \$5 Presidential plus valuable foreign stamps to customers. Bala Stamps, Bala, Penna.

LOOKING For better U. S. on approval? Write New-Way Stamp, Lawrence, Mass.

SCARCE Philippines 405-407a, \$1; Curacao royal family 50c; list free. Peterson, 284, Ponca, Neb.

U. S. Illustrated price list free. Lush, 9627 Martindale, Detroit 4, Michigan.

FINE Approvals. Fast, personal service. What countries do you prefer? I'll send their stamps. Skinner, 438 Locust Ave., Long Beach 12, California.

GET This! Airmail book, plus over 100 airmail stamps—only 15c. Thrilling stories, valuable information on beautiful airmails from the world over including \$10,000 airmail—all for 15c! Big bargain lists and approvals. Jamestown Stamp Co., Jamestown 708, N. Y.

FREE Belgium complete set of 17 stamps to approval applicants. (We pay return postage.) Frank Newman, 3539 Hartford St., St. Louis 18, Mo.

UNITED States stamps! Cheap! Catalogs. Sullivan, 115-F Endicott, St. Paul 1, Minnesota

FREE Complete set of famous Americans, flags, parks and presidentials to approval buyers. Send 3c for 15 of the above stamps plus full particulars. Triboro Stamp Company, 145 Nassau Street, Dept. 102, New York 38, N. Y.

50 DIFFERENT Latin American airmail stamps 30c. Approvals. Johnson, Box 367, Morgan Hill, Calif.

YOU stretch your dollar by buying our mounted 1c and 2c foreign approvals. Also U. S. at bargain prices. Don't delay. Write today. Roseland Stamp Co., Dept. 10-C, Spring Lake, Michigan.

LOOKING For bargains? Try our 1 & 2c approvals mounted in books of 1000. We believe in both quantity and quality. First try will satisfy. Clark, Box 544P2, Muskegon, Michigan.

GENERAL Approval service by country. Miracle Stamps, Miracle Hot Springs 2, Calif.

PENNY Approvals by country. M. H. Hoerning, 15, Farmington, Ark.

SAN Marino collection free—25 different, old and new issues, airmails, commemoratives, high values. Absolutely free with approvals. Viking, 130-ZZ Clinton St., Brooklyn, N. Y.

"HOW To Recognize Rare Stamps." Free book illustrated! Kenmore, Milford, H-57, N. H.

U. S. Illustrated price list free. DeLisle, 154 S. 2nd St., San Jose, Calif.

FREE! Spanish Guinea #305-7 with foreign approvals. Sharp, Temple 1, Penna.

EXTRA Special 1/2 cent approvals. Emile Auer, Buffalo 10, N. Y.

FIFTY Different United States; commemoratives, dues, etc. All for 10c. Ed. Keller, Library 1, Penna.

100 DIFFERENT Stamps free with approvals at 60% discount. Martinsen, Box 115, New York 33, N. Y.

FREE Bahrain with bonus approvals! Stampart, Box 28A, Rutherford, N. J.

RUSSIAN 250,000 Ruble stamp plus 311 others 10c. Goliath, Bethlehem 2, N. H.

PENNY Approvals and specialties. Lush, 9527 N. Martindale, Detroit 4, Mich.

FREE. Scott's International Album. Other big premiums. Full particulars with approvals. Raymax, 68-Z Nassau St., New York 38.

500 EXOTIC Japan stamps—10c. Kenmore, Milford, J-57, N. H.

FREE! Big "3." 3 Abyssinia, 3 triangles, 3 midgets, to new approval applicants. N. Moulblow, 740 Hegney, Bronx 56, N. Y.

ZANZIBAR Packet free—Also includes stamps from Abyssinia, Cayman Islands, Ceylon, French Colonies, Gambia, Malta, Nigeria and others. Send 5c for postage. Gray Stamp Company, Dept. PM, Toronto 5, Canada.

LAUGH At inflation! Thousands of fine stamps, just 1c—2c! Send references for book of 1000. Niagara Stamp Company, 11 Queensway, Niagara-on-the-Lake, Canada.

1,214 DIFFERENT Stamps \$1.00! Goya Nude set, Seville Exposition, Montserrat, Madrid airmails, Morocco UPU, etc., including Spanish collection (213), plus 1,001 different stamps; everything \$1.00! Approvals included. Stampex, 116-SC Nassau, New York City.

FREE! Your choice! 25 different from first "Penny Approvals" booklet. Hanlon, Box 407-M, Upper Darby, Penna.

ILLUSTRATED, Complete U.S. list—6c postage. Hantak, 1030 Euclid, Cleveland 15, Ohio.

OLD U.S. on approval. Low prices. MacG, 3633 Zumstein, Cincinnati 8, Ohio.

NUDES Set and colorful approvals—10c! Atlas, 2830-a Eisenhower, Racine, Wis.

CANADA Scarce 1950 set 10c with attractive approvals. Rheamus, 6591 11th Ave., Montreal 36, Canada.

ALBUM! Holds over 1000 stamps! Only 10c! Stampmart, Hartford 1, Conn.

"HOW To become stamp dealer." \$1.00. Nelson Exchange, Rye, N. Y.

FREE! Rare, colorful, complete set German Zeppelins! With temptingly-priced approvals. "PG," 195 Park, Lewiston, Maine.

WONDERFUL Offer. 7 complete mint sets Manchukuo, Bohemia, etc., only 10c with approvals. Reich Stamp Co., 4647 Kenmore, Chicago 40, Dept. M23.

SAN Marino—25 different, only 10c! Erie, Box 2642, Lakewood, Ohio.

FREE! Triangle, diamond, midget. Giant Roosevelt, Hitler, Stalin with approvals. Send 3c postage. Thrifty Stamps, Silver Spring, Maryland.

FREE Sample—Interesting, informative, illustrated! National Stamp News, Anderson, South Carolina.

FREE—Illustrated U. S. list! Postage 3c. Brock, 10516 Clifton, Cleveland 2, Ohio.

233 DIFFERENT, including 19th Century; diamonds, jubilees, souvenir sheet—10c. Approvals. Brooks, 2352D East 23rd Street, Brooklyn 29, New York.

SCANDINAVIA!—100 Different, 18c. 50 Norway, 10c. 50 Finland, 10c. Free lists. Hantak, 1030 Euclid, Cleveland 15, Ohio.

310 BRITISH North America early issues, airmails, commemoratives, all off paper, catalog value over \$7.00 with Canadian price list and Emco Journal included. Send only 25c. Marks Stamp Company, Dept. PM, 92 Adelaide St. W., Toronto, Canada.

100,000 STAMPSATIONAL Grabbags, 25c each! Niagara Stamp Company, 15 Queensway, Niagara-on-the-Lake, Canada.

TALKING Drums (Gold Coast); 2 Nicaragua triangles, 55 other beauties, total catalogue \$2, all only 2 dimes. Approvals. Reuter, 611 W. 40th Pl., Los Angeles 37.

U. S. And Confederate catalogue free. Stone, 45 Bromfield, Boston 8, Mass.

VATICAN—20 Different mint, 10c; approval applicants. Broadmoor Stamp Company, Pittsburgh 34, Penna.

DIFFERENT 500, 35c; 1000, \$1.00; 2000, \$2.00; 5000, \$10.00 with approvals at wholesale to clear. K. S. Holmes, London, Can.

1000 MIXED U. S. and foreign 25c. Monjar, Fairmount, Cincinnati 14, Ohio.

FREE—"Goya Nude" with approvals. References. Royal Stamp Company, Tamaqua, Penna.

U. S. Army and Navy heroes on stamps; 10c with United States approvals. Locust, Box 305-T, Harmon-on-Hudson, New York.

500 MIXED Stamps and surprise packet for 10c, with approvals. Fahsing, Dept. PM, Atascadero, California.

COMPLETE New issue free to new approval applicants. Paul Seaman, Box 176, Langhorne, Penna.

POUND Mixtures. U. S. or foreign, \$1.00. Book Nook, Willmar 61, Minnesota.

FREE! Big United States catalog! Invaluable guide and check list. Hundreds of illustrations. Harris & Co., Boston 17, W—Mass.

SCARCE Nicaragua Roosevelt, Madagascar, Turkey, Martinique, Ecuador, Somali Coast, Cuba, Mints. Send \$3. Silas Stamps, Box 55-X, Triborough, New York 35, N. Y.

110 DIFFERENT Hitlers, Roosevelt, Liberia, Haiti, etc. with approvals 10c. Buckey, 208 Ludlow Bldg., Dayton 2, Ohio.

U. S. Specialists! Stamps, coins. Write 210 South Sixth Street, Minneapolis.

FREE Packet with introductory approvals. Luther Chick, 436 No. Main, Brewer, Maine.

U. S. Price list free. P. Wetterquist, 1635—13th Avenue, Rockford, Illinois.

100 DIFFERENT Spain 25c. Penny approvals included. Reed, Box 980, Chicago 90, Ill.

FREE! Big illustrated catalog! "Everything for the stamp collector." Harrisco, 202 Transit Bldg., Boston 17, Mass.

50,000 STAMP Grabbags 25c each. Anderson, 630B Bingham, Reading, Penna.

FREE. 750 Mixed U. S. for dime postage. Weatherby, Medina, Ohio.

FREE 109 Stamps to applicants for our approvals sending 3c postage. Hoyt, Lowell Road, Hudson, N. H.

10,000 PENNY Approvals waiting for you. Many from exotic countries, pictorials, airmails, new issues. Tilbury, Box 862, Newark 1, N. J.

FREE, 25 Different U.S. approvals a-company. Village Stamps, 90-39P 214 St., Queens Village 28, N. Y.

FLAG Stamp—Free with hydrate U.S. approvals. Wenigman, 1933 Patterson, Chicago 13.

FREE Collection — Over 100 different stamps of world; commemoratives, animals, natives, ships, famous men, others all to approval buyers; also Scott albums, catalogs. Bell Stamp Service, Dept. S-2, Bell, Calif.

START Your own stamp business. Send for free circular. Donald Shepard, Box 1147, Chicago.

ZOUNDS! Amazing "queer countries," savage and exotic lands packet. Absolutely free with approvals! Saxon, Vista, Calif.

205 AUSTRIA—All different only 10c. Beautiful commemoratives, pictorials, airmails, high values. Catalog price nearly \$6! Approvals. Garcelon, Calais 111, Maine.

NICARAGUA Sports, Costa Rica agriculture sets 10c with approvals. Seminole Stamps, Box 1138-P, Coral Gables 34, Fla.

4 GERMAN Pair sets. Free to approval buyers. Pleasure Stamps, 1865P 52nd, Brooklyn 4, N. Y.

UNITED States approvals—Select, used, mint. Kingsbury, South Woodbury 2, Vt.

GIANT Selection, penny stamp. Wahl's Stamp Exchange, 7008P Farragut, Chicago 31.

10,000 DIFFERENT 1c Each! Gordon Davison, Box 1019S, Manchester, N. H.

312 MIXED U.S. only 10c to "gold nugget" approval applicants! Nothing like them. Kessel's, Folsom, California.

OLD Scarce U. S. seconds on approval. Slightly defective. Bargain prices. Hernefield, Clintonhill Station, Newark 8, N. J.

50%-75% DISCOUNTS! Approvals from 33,000 collection—1/2c up! Schur, Box 235, Buffalo 12, N. Y.

GERMANY — Colonies, offices, states. Mostly 1/2-1/5 catalogue. Approvals—lists 3c. Myers, VanZandt Ave., Little Neck, N. Y.

750 FRANCE And colonies stamps 10c. Littleton Stamp Co., Littleton 25, N. H.

300 DIFFERENT Given free with approvals. Postage 3c. Windsor Stamps, 1435 East 67th Place, Chicago 37.

50 DIFFERENT U. S. 10c. No approvals. Seidenberg, 944, Appleton, Wis.

STAMPS Wanted. Collections, duplicates, surplus stock, mint and used. Buy outright if bargain. What have you? Vanroy Shirk, Lebanon, Penna.

77 DIFFERENT United States—25c. Approvals. Utechs, 1143-D North Keeler, Chicago 51.

307 ALL Different—Only 15c! Beautiful collection: commemoratives, triangles, high values, bicolored stamps, etc. Garcelon, Calais 400, Maine.

NOTHING Free. Just good stamps reasonable. Send dime for seventy-four page catalog. Ben's Stamp Shop, 31 N. Clark, Chicago 2.

FREE U. S. price list, postage 3c. Mark Hanna, 335 5th Ave., Pittsburgh 22, Penna.

AMAZING Offer! 500 United States stamps—including commemoratives, airmails, high values to \$5.00. Only 10c to approval applicants! Illustrated bargain lists free. Mystic Stamp Co., Dept. 80, Camden, New York.

FIRST U. S. (1847) government reissues 5c, 10c, plus giant bargain U. S. collection—only 5c to applicants U. S. approvals. Metropolitan, Box 312G, Jackson Heights, N. Y.

FREE "Stamp Finder." Tells instantly country to which any stamp belongs. 32 pages profusely illustrated. Garcelon, Calais 17, Maine.

WOW! 203 All different Germany 10c! Zeppelins, semipostals, airmails, high values, etc. to new customers. Jamestown Stamp, Jamestown 512, New York.

WORLD'S Largest stamp (7 1/2 x 14 inches). A real curiosity! Retail for 50c, only 3c to approval applicants. Tatham Stamp Co., Springfield 30, Mass.

UNITED States stamps nearly 100 years old. Roosevelt set, others, 40c value—only 5c to applicants United States approvals. Wakonda, Box 272K, Jackson Heights, N.Y.

500 STAMPS For only 10c! This mammoth value includes airmails, pictorials; stamps from strange countries, cataloging up to 25c each! Also approvals. Mystic Stamp Company, Camden 80, New York.

COLUMBIANS, Trans-Mississippi, Pan Americans, Pan Pacific, ten other different commemoratives. All 10c with your request for U.S. approvals. Moda Stamps, Box 251-X, C.S.A., New York 8.

FREE! Powerful magnifying glass. Jamestown Stamp, Jamestown 202, New York.

200 DIFFERENT Including Roosevelt triangle, 5c to approval applicants. M. Avalon Stamp Company, Springfield, Mass.

OVER 1,000,000 Sold; 200 different stamps 10c with approvals. Carlton's, Tujunga, Calif.

GET \$3.00 Orders. Keep money. Orders filled free. Free details. Corcoran, 2233 N. Winchell, Portland 17, Oregon.

U. S. Collectors—Write today for free material. Eagle Stamp Co., 2221-A Romine, Pittsburgh 26, Penna.

FREE! Big illustrated catalog! Send today! "Stamps by Mail," 2133 Lunt, Chicago 45.

ANTIQUES, RELICS, INDIAN GOODS, CURIOS

4 PERFECT Ancient arrowheads \$1.00. Fine grooved tomahawk \$3.00. Perfect peace pipe \$5.00. 4 tiny bird arrowheads \$1.00. List free. Lear's, Glenwood, Ark.

PRECIOUS STONES, MINERALS

MINERALS. Twelve fine desert specimens carefully selected for your collection. Labeled. One dollar. Latners, Box 4343, University Station, Tucson, Arizona.

COPPER. Sulphur, gold, lead, uranium. Learn to recognize these items and turn rocks into cash. Large labeled specimens \$2.00 per dozen. Federal, Box 57, Argentina, Kansas City 6, Kansas.

FIVE Assorted agate slabs \$3.00. N. Mexico minerals, mineral books. Free lists. Vansant's, Truth or Consequence, N. Mex.

"GENUINE" Red Arizona rubies (garnets). Send quarter for packet. Bitner's, Box 1025-B, Scottsdale, Arizona.

PEARLS—Lustrous cultured, \$5 pair. Box 457, Franklin Park, Illinois.

WHITE Mountains specimens of valuable minerals \$1. Ramblin' Ranch, Campion, New Hampshire.

GEMS. Precious and semi-precious, genuine, from world-wide sources. Deal direct, no overhead, save money. Catalog 10c. Hill Co., 5450-G Portland Rd., Salem, Oregon.

FIND Tungsten, mercury, uranium with mineral light. Free brochure. Write Dept. PM8 Ultra-Violet Products, South Pasadena, California.

SAMPLE Uranium ore postpaid for dollar bill. Prospector, Box 592, Truth or Consequences, N. M.

JADE. Agates, titanite. Free list. North West Gems, Box 305, Tacoma 1, Wash.

GEMCUTTING. Silvercraft authority. Illustrated magazine tells how. Cut rocks, make jewelry. 150 ads illustrating equipment, offering gems for collectors, cutters. Postal brings literature. Lapidary Journal, Drawer B, Palm Desert, Calif.

GEMSTONES. Mineral specimens. Every variety. Lowest prices. Postcard brings free booklet. Plummer's, 2183C Bacon, San Diego 7, California.

HOBBIES AND COLLECTIONS

50 DIFFERENT Army embroidered patches \$1. Other bargains. Insignia Mart, 703A Broadway, New York 3, N. Y.

NEW—15 Different match covers 10c. Box 202, Rochester 1, N. Y.

MATCHBOOK Covers—100 different unused \$1.00. Free lists. Yeingst, 502 Parkway, Harrisburg, Penna.

UNUSED Matchbook covers—100 different \$1.00 36-page catalog 25c. Charles Edelman, 1311C East 84, Cleveland 3, Ohio.

INVENTING Can be an interesting and profitable hobby. Write for complete particulars. Institute of American Inventors, Dept. 40-E 631-E St. N.W., Washington 4, D. C.

CAMERAS, PHOTO SUPPLIES

PLASTI-Tak, the revolutionary re-useable adhesive for making borderless enlargements, mounting snapshots, etc. 25c postpaid. Chelsie Company, Box 35-B, Cincinnati 24, Ohio.

BUY Photographic supplies wholesale. Free catalog. Expert camera repairing. Capital Photo Supplies, 2428 Guadalupe, Austin, Texas.

TELEPHOTO Cameras easily made. Trifling cost. Telescopic Company, Man-orville, N. Y.

MAKE Half-tone and line negatives for offset or photoengraving with your photo enlarger. 32-page manual tells you how. Price \$3.50. Cliff Edom, 117-M Stewart Road, Columbia, Missouri.

ATTENTION Photographers—Send for our 72 page catalogue of mounts, albums, frames, mailers. International Sales, 414 E. Baltimore, Baltimore 2, Md.

BASS Says: Trading cameras a national habit since 1910. Write to Bass the old "horse trader." A postcard will do. Simply say: "Bass, I have and I want. How much will you allow me?" It's fun to trade with Bass. Satisfaction guaranteed. Bass buys, sells, and trades. Bass Camera Company, Dept. AG., 179 W. Madison St., Chicago 2.

FREE Photo catalogs, cameras, supplies. Rock bottom prices. Trades welcomed. Mogull's, (Dept. P.M.), 112 West 48th, New York 19, N. Y.

FREE Photographic bargain book packed with hundreds of sensational values in still and movie cameras, lenses and latest accessories. Super savings for you in new and used equipment. Liberal trade-in allowances, too, on your equipment. Write now for your free copy to Central Camera Company, Dept. 9L, 230 S. Wabash Ave., Chicago 4. (Photographic headquarters since 1899.)

ADD "Spice" to home projection shows with colorful old-time Nickelodeon slides. 2x2. Write for free list. Nickelodeon Co., New Fleidner Bldg., Portland 5, Oregon.

PHOTOMURALS. Your negative or ours. Catalogue 25c. Photomammoth Murals, Dept. M, 12048 Vanowen Street, North Hollywood, California.

PHOTO FINISHING

TWO 8x10 Enlargements 50c. Five for \$1.00. Send negatives and coins to Wilart Enlargers, Box 967, Little Rock, Ark.

SEND Now for free Snapshot Magazine. Mailers, offers. Houghton's, Athol, Mass.

FREE Coupon, price list portraits, enlargements, etc. Dornfeld, Iron Ridge 9, Wisconsin.

CASH For photos. Addresses 100 best markets \$1.00. Gorman Co., 2452 Lincoln Blvd., Dept. P, Santa Monica, Calif.

ENLARGEMENTS—5x7, 25c; 8x10, 40c; New negative 45c; minimum \$1.00. Lawson, 1505 Southern Blvd., Bronx 60, N. Y.

8 CONTACTS 30c. Jumbos 40c, 12-45c. Jumbos 55c, reprints 4c. Jumbos 5c. Western Photo, Dept. PM252, Box 298, San Francisco 1, Calif.

MAIL Us your films. Prompt service. 8 exposures developed and printed 30c. Foto Art Studio, Box 406, San Francisco, Calif.

16 PRINTS Or 8 jumbos from roll, 25c with this ad. S. Skrudland, Lake Geneva, Wis.

6 OR 8 Picture roll 35c, 12 or 16 picture roll 55c. Each roll printed and developed. Handy album pack. If you fail to get pictures on your film a new roll will be sent you without extra cost. Send coin with roll. No c.o.d.'s. Mailing containers sent free. DeLuxe Film Service, Box 1268-A, Shreveport, Louisiana.

YOUR Film developed and custom printed, contact. "Pure as Snow" process, 50c. Photo Park, Canton, New York.

MOTION PICTURES AND SOUND EQUIPMENT

CLEARANCE Sale of 16mm. films. Want a real buy in 16mm. sound films? Take advantage of the I.C.S. 1952 clearance sale of 16mm. sound features, comedies, cartoons, novelties, musicals. New, used. Send for our giant list "A" today stating machine you own (make and model). Institutional Cinema Service, Inc., 1560-PM Broadway, New York 19, N. Y.

WORLD'S Biggest selection of new and used 16mm. sound, 16mm. silent and 8mm. films—over 100,000 prints on hand! Everything at bargain prices. Savings of 50% and more are commonplace! Good used 16mm. sound projectors—Ampros, Bell and Howells, Victors are often available for as little as \$129.95. Reels, cans, supplies at bargain prices! Write today for your free copy of Blackhawk's big current catalog. "Sixteen's Super Market." Blackhawk Films Inc., 1207 Putnam Building, Davenport, Iowa.

BARGAINS 16MM. sound film, misc-laneous, "as is." Cent foot. Features \$42.50, shorts \$2.50. 1600' reels \$1.00, cans take two 1600' reels 95c. Belts 49c. Films, equipment, bought, sold, exchanged. Sound projectors, 16mm., 35mm. from \$127.50. Screens, microphones, splicers, processing equipment, lenses, cameras. Lists free. Mogull's, 112 W. 48th St., New York.

"JOIN Our club and exchange your movie films for others; free. Send for details. Genduso, 154 7th Ave., New York 11, N. Y.

THE World's greatest story. "Entire Life of Christ;" 8 mm., 16mm. Sound and silent. Rent or purchase. Hemenway Film, 33 F Melrose Street, Boston 16, Mass.

16MM Kodachrome Sound films of Hawaii. Cinepic, 1847 Fort Street, Honolulu, Hawaii.

5000 NEW-Used 8-16mm. silent-sound films. International, 2120 Strauss, Brooklyn 12.

NEW And used sound film for sale at less than cost. Soundies, shorts, features. Write for listing. Lawrence Camera Shop, Box 1597, Wichita, Kansas.

LEARN Free lance, educational, Hollywood, and television film technique at home. State licensed. Write for free catalog. Motion Picture Institute, Birmingham 4, Michigan.

UNUSUAL 8-16MM. movies. Full-color projection length sample, \$1.00. Color Tru-Art slides, three samples \$1.00. Big catalog, 25c (refundable). National Film Supply, Toledo 9-H, Ohio.

8-16MM. Silent-sound films. Complete rental library. All latest subjects. Free catalogue, sample film 10c. Garden Film, 317 West 50th, New York 19.

BASS Says: Leadership since 1910 guarantees satisfaction. Finest Cine equipment: 8mm., 16mm., and 35mm., silent and sound. Write the old "horse trader." Satisfaction or your money back always! Bass Camera Company, Dept. A, 179 W. Madison St., Chicago 2.

RENT 16MM. sound films, 50c reel. Large selection; free catalog. Film Service, 128 Chestnut St., Roselle Park, N. J.

GUARANTEED Fresh 8mm. roll, magazine; 16mm. roll, magazine movie films. Color, b&w. Free catalog. ESO-S, 47th Holly, Kansas City 2, Missouri.

MOVIE Camera film: 8mm. roll \$1.50, 16mm. 100' \$3.00. Free processing. Better Films, 742 New Lots, Brooklyn, N. Y.

MUSIC AND MUSICAL INSTRUMENTS

YOUR Voice made loud, clear and powerful with my diaphragm exerciser. Write. Inventor "Oz," 34V, Box 665, St. Louis, Mo.

POEMS Wanted for musical setting. Send poems for free examination. Five Star Music Masters, 630 Beacon Bldg., Boston, Mass.

MUSIC Arranged. Songs printed. Frank Wildt, Music Publisher, Lancaster, Penna.

PLAY Piano! Beginners self-instruction book. Advanced book. Chords-swing bass. Only \$2; both \$3. Moreau Studios, 139 Mathewson St., Providence 3, R. I.

PLAY Piano by ear in 1 week. Details free. C. Seibold, 6621 S. Bishop, Chicago 36, Ill.

SONGWRITERS! This is the thing! Free information. Trans-World Music Co., 6356 Hollywood Boulevard, Suite 230C, Hollywood 28, Calif.

GUITAR. Master only 12 chords, play hundreds of songs. \$1. Money back guarantee. Bennett, 629 N. St. Andrews Place, Hollywood 4, Calif.

1952 ACCORDIONS — Wholesale. Free catalog. American Accordion Center, 5329 Belmont, Chicago.

RECORDS. Guaranteed new latest Hill-billy, Pops, Blues, Spirituals, low as 4 for \$1.00. Free catalog. CI Mailor, 570 N. Gay Street, Baltimore, Maryland.

SONGWRITERS! Outstanding, ethical offer. Hibbeler, C-5, 2157 N. Avers, Chicago 47.

ELECTRIC Guitars, amplifiers, wholesale. Free catalog. Carvin PM, Baldwin Park, Calif.

SEND For free booklet, How To Write and Sell Songs. Get the facts first. Poems examined free. Reliable Music Service, Box 430-P, Hollywood 28, California.

SONGWRITERS! Protect your ideas! Hold all songs; poems! Write for Safe Correct Procedure first! Song Service, Dept. P, 333 W. 56th St., New York 19, N. Y.

POEMS Wanted. Broadcast consideration. Sooner Song Co., 22PM North West 8th, Oklahoma City 2.

SONGWRITERS! Send poems, songs. Music Service, 243 West 72nd St., PM, New York 23.

SWING Piano—By mail, 30 self-teaching lessons \$3. (Samples.) Phil Breton Publications, P.O. Box 1402, Omaha 8, Nebr.

POEMS Wanted to be set to music. Free examination. Send poems. McNeil, Master of Music, 510-PM S. Alexandria, Los Angeles, California.

WRITE Songs. Big money and reputation. Write for information. J. Gordon Pub. Co., 4700 South California Avenue, Chicago.

WANTED! Poems for musical settings. Write Songwriters' Service, Clifton, N. J.

ACCORDIONS—Save 50% and up. Cash or terms. New and used. All brands. Wholesale to every one. Free catalogue. Del Principe, 307 South Wabash, Chicago, Ill.

24 PAGE Plans 18 long distance crystal sets, 25c; including "Radiobuilder," catalog. Laboratories, 1131-C Valota, Redwood City, California.

REPAIR Your own radio. Tells how to repair radios in a few minutes, without extensive study or expensive equipment. \$1.00 postpaid. Slaters Radio Service, Corsicana, Texas.

FREE! 212 Page Radio-Television-Electronic Catalog! World's largest stocks, lowest prices. Complete supplies for builders, experimenters, amateurs, servicemen. Latest radios, phonos, television, recorders, sound equipment. Thousands of parts, tubes, test instruments, books, diagrams. Top quality money saving values. Get yours now! Allied Radio Corp., 833 W. Jackson Blvd., Dept. 45, Chicago 7, Ill.

TV And FM antennas. Yagi, conical, bow-tie, mounts, accessories. Lowest prices. Wholesale Supply Co., Lunenburg 1, Mass.

AMATEURS — Radio engineering questions answered \$1.00. With schematics \$2.50. Henry Twillmann, R.R. #1, Chesterfield, Missouri.

MAKE Simple, tubeless, batteryless, distance-getting crystal radios. Crystal and illustrated instructions 25c postpaid. Allen, 427-P, Clinton, Mo.

BUSINESS OPPORTUNITIES

START Big-paying business. Operate from your home. Full or sparetime. Amazing new service for homes, offices, hotels, apartments, public buildings. Free details. American Co., Inc., Dept. G-30, 211 North 7th St., St. Louis, Missouri.

INVISIBLE Reweaving. Men-women. Instructions shipped for no-risk examination. \$5.00 hour possible spare-full time. Reweave burns, tears, moth-holes like new at home. Free details. Skilweave, 1717-BA Westwood, Los Angeles 24.

BIG Money! Spare or full time in your home. No selling! Spray new miracle finishes, plush and suede, on signs, radios, automobiles, figurines, lamps, toys, etc. Our business is booming. Help us fill huge demand. New easy Flok-Kraft methods. Material costs few pennies. You get dollars. Free samples, complete powerful money-making plan free. Write now! Coast, 1002B S. Los Angeles St., Los Angeles 15, Calif.

START Your own business on credit. Always your own boss. 1437 dealers sold \$5,000 to \$28,500 in 1950; their average \$6,704. We supply stocks, equipment on credit. 200 home necessities. Selling experience unnecessary to start. Wonderful opportunity to own pleasant, profitable business backed by world-wide industry. Write Rawleigh's, Dept. B-U-PPM, Freeport, Ill.

START Your own mail order business with hundreds of live repeat hobbycraft items. No stock to carry. We pack and ship for you. Free details. Write Dept. A2, Mail Order Service, 845 S. Wabash, Chicago 5.

LEARN Sewing machine repair. Electrify, rent, trade, sell. Make "big money" at home, spare time. New motors, machines, etc. wholesale. Details free. Taylor Service Co., Hamilton PM-2, Ohio.

MAKE Money sharpening saws and lawnmowers. Start at home. Free book, "Money Making Facts," tells how. Victor Foley Company, Columbia Heights, Minn.

PROFITABLE Mail address for individuals and manufacturers. Details. Mail Center of Chicago, 216 W. Jackson, Chicago 6.

COLOR Concrete with chemicals. Marble-glaze cement benches, pottery, garden ornaments. Home-shop. 10c brings sample, pictures. Hollywood Cementcraft, 8527-R Wonderland, Hollywood 46, Calif.

MAKE Money with Merritt. Sell Davis air-cushioned men's shoes, dress, work, heavy duty. Popular priced. Advance commissions. Cash bonuses. Experience unnecessary. Write to Geo. Merritt Shoe Co., C-102, Brockton, Mass.

FISHWORM Business. Raise and sell fishworms. Big demand, large profit. This booklet, "Raising Worms for Pleasure or Profit," gives complete details. \$1.00 postpaid. Tennessee Worm Hatchery, Box 265-B4, Nashville 2, Tennessee.

GET Money every day by mail. Pleasant home-operated business. New booklet tells how. Only 25c. Esco Prints, PM. 8 Holt St., Dayton 7, Ohio.

EARTHWORMS—Biggest money makers for fishing in all climates. New method. William Barnard, 2121 Vanderbilt, Redondo Beach, Calif.

MAKE Perfumage at home. Write. "Carey Laboratories," 1914 Chouteau PM-2, St. Louis 3, Missouri.

OPPORTUNITIES In small-town and rural radio broadcasting. Good profits from nominal investment in construction and operation of your own FCC licensed station. For full information write Broadcast Service Associates, Box 432, Detroit 31, Michigan.

START Home mailorder business. Details. Gedgard, Box 798-B, New York 1, N. Y.

MAKE Big mailorder profits. Details. Ferguson, 521 Midland, Little Rock, Ark.

DEALERS, Agents, distributors, wanted. High grade plastic wall tile. Large profits. Write manufacturers. Artistic Tile, 3010 W. Irving Park, Chicago 18, Illinois.

TRADE Magazines help you to success. Get latest copies through our easy-to-get-acquainted service. Hundreds of business, professional, craft, cooperatives, agricultural, dairying, dental, diesel, dog, dramatic, drug, educational, electrical engineering, farm bureau, farm implement, farm livestock, farm newspapers—and others covering all interests. Send for list today. It's free. Commercial Engraving Publishing Company, 34C North Ritter, Indianapolis 19, Indiana.

"HOW To Sell by Mail." Informative, fact packed, interesting, 25c. Ransie, Box 1719, Richmond, Virginia.

YOUR Name and address on postal will bring many local and mail business opportunities. Apex Supply, Box 165, New York 18, N. Y.

MAKE Tough, durable plastic—1c pound. Makes attractive floors, walls, built-ins, roofs. Build good home, \$150.00 room. Bays Laboratory, Oklahoma City 9.

THERE'S Big money servicing a route of waterless hand cleaner dispensers, full or spare time! No other like ours! Western B Aircraft, Los Angeles 19.

WANTED! At once! Home producers by manufacturers in our clearing house service. Become a sub-contractor casting plastic and plaster products for these companies. Thousands of easy to make items required. Cash in at home, without previous experience. For details write Plastic Service Guild, Dept. PM, East Boston 28, Mass.

GET \$3.00 Orders. Keep money. Orders filled free. Free details. Corcoran, 2233 N. Winchell, Portland 17, Oregon.

CASH Income from your backyard! Unusual businesses! Pickett's, Florence, Kentucky.

BIG Mail, Free. Send name. Publisher 32, 4121 Wyoming, St. Louis 16.

FEBRUARY Only! Complete instructions \$1.00! Sell books by mail! March price \$2.00. Paramount Book Service, 39 Hopedale Street, Allston 34, Mass.

URANIUM Enterprise possessing unlimited potentialities requires several associates to participate in development of this "world's most sought for" material. Write Johnston, Box 142D, North Battleford, Saskatchewan, Canada.

TO \$35.00 Weekly. Spare time, home operated mail order business. Successful small "beginner's" plan. Everything supplied. Lynn, 10420-M National, Los Angeles 34, California.

INVISIBLE Reweaving — Big profit, big demand, easy-to-learn with low-cost complete course—nothing else to buy, ever. Details free, write today: Fabricon, Dept. N-1, 8342 S. Prairie Ave., Chicago 19, Ill.

BOOKKEEPERS—Earn \$5000 yearly part time. Sell, operate new sensational CPA bookkeeping service. Kern, 4942 Vineland, North Hollywood, Calif.

BUTTERFLIES! Profits, pleasure, 20 assorted tropical \$2.00. Ideal home business. Make pictures, paper weights, plastic embedding, etc. Free booklet. American Butterfly Co., 3706 Rosedale Road, Baltimore 15, Maryland.

TIN-Cans. Turn them into cash. Nine methods. Instructions 50c. Charles Company, 12-CTE, Norwood, Ohio.

SELF Haircut—Men. Simple easy instructions; \$100 weekly income. Folio, quarter each. Foundation, 61 N. Venice Blvd., Venice, Calif.

EARN Extra money operating mailing-addressing service. Also type manuscripts for authors. Particulars free! Vernon Torrey, Melrose 76, Mass.

SAWDUST. Turn it into cash. Twenty methods. Instructions 50c. Charles Company, 12-CTD, Norwood, Ohio.

\$200 WEEKLY Reported! No selling. Free booklet. T. J. Surface, Roanoke 4, Virginia.

GROW Laboratory animals for fun and profit. Teach children food values. See food promote growth and health, or stunt growth, destroy health. Wonderful hobby, educational, entertaining. Sell animals for profit. Use in schools, clubs, demonstrations. We furnish animals, instructions, cages, supplies. Information free. Cage Supply, 121 East Fifth Street, Bonham, Texas.

AMAZING New Cedarwall! Cedarizes closets, trunks, drawers, permanently. Laboratory approved; guaranteed. Easily and quickly applied like paint. Building supply dealers, paint and wallpaper, hardware stores, lumberyards, contractors buy quantities. Attractively packaged, and displayed. Exclusive distributors, protected territory. Wire, write now for samples, literature, full details. Millen Mfg., 90-AA Summit Ave., Brookline, Mass.

50 WAYS Make money; spare time. Anybody in meadows, forests, woodlots. 50c instructions. Guide, Box 692, Escondido, Calif.

SENSATIONAL Imported snapping alligator 15c novelty, enormous demand. Two samples, mail two dimes. Unger, 655 South Wells, Chicago 7.

MINIATURE Golf plans, free literature. Dixieand, 2924 Douglass, Memphis, Tenn.

WHERE To buy at wholesale 100,000 articles. Free list. Also extra-income information. Maywoode, 1133 Broadway, New York.

MAKE Big money at home with magic pearl finish. Free plan. Pearl-Art, 7216 Bear, Bell, Calif.

MAKE Perfume. Profitable mailorder business. Catalogue free. International, 6347 Parnell-PM-2, Chicago 21, Illinois.

PRINT Without a printing press. Big profits! See page 43.

EARN Extra money, spare time. Write. Chamberlain, Box 894, Manchester, New Hampshire.

CHINCHILLAS (No rabbit). Raise anywhere. Pleasant, profitable. Information. Chinchillas, Ithaca, Michigan.

BUY-Sell using coupons both ways. Build big business. How 25c. Artcraft, B814, Ft. Worth 1, Texas.

TYPE For pay (20-ways). Free literature. McAllister, 1513-PM Charlotte, Bronx 60.

NEW Easy watchmaking — Home study manual! Complete course \$10.00. "Money back if not satisfied." Simco, 515 Columbia, Lafayette, Indiana.

YOU Need a Chicago mail address. Business or personal use. Receiving and forwarding. Confidential, P-677 Milwaukee Ave., Chicago 22.

\$100 WEEKLY! Mail selling! Free! Wehner, Box 142-A, Roxbury 19, Mass.

GET Money every day by mail. Pleasant home-operated business. New booklet tells how only 25c. L. Behnke, Guttenberg, Iowa.

TWENTY Moneymaking opportunities. Literature 10c (refundable). Cashbox Ideas, Mar Vista 7, California.

START Profitable home business. "101 Ideas" tells how. Free with year's subscription. Progressive mail trade. Mated Book Agency, Western Springs 4, Illinois.

\$10 HOUR Possible! At home! Invisible reweave cuts, tears, moth holes, snags, burns in clothing. Instructions, 17 samples, automatic latch steel tool, material for life \$3.00 complete. Guaranteed details free. Walsh, 894 Main, Buffalo 2, N. Y.

FLOCKING And upholstery cleaning. Latest 7000 word book. Complete information. \$1.00 postpaid. Modern Products, 2738 Lyndale Avenue South, Minneapolis.

EARN \$12,500 Annual minimum or money back. Protected by franchise. Live at home. No merchandise to buy. One of most exclusive and noncompetitive business in United States. Mail 50c to help cover cost of handling and printing of explanatory book. Harrell and Company, Box 547, Louisville, Illinois.

ELECTROPLATE Giftwares, novelties, baby-shoes, jewelry, auto parts, mirrors. \$5.95 includes portable electroplater, plating salts, formulas, electroplating manual. Tyco Metals, Box 13231-MD, Houston 19, Texas.

UP To \$200 weekly. Work home, start sparetime, small capital. Free book "163 Unique Successful Businesses" tells how. Deumant Publications, 81-M Deumant, Kenmore 23, N. Y.

SELL By mail. Details free. **Samples 25c.** Chatco, 1284 Cranston, Cranston 9, R. I.

GOOD Paying business silvering mirrors, plating autoparts, reflectors, bicycles, bathroom fixtures, etc., by late method. No tanks or shop required. Outfit furnished. Free booklet. Gunmetal Co., Ave. H, Decatur, Illinois.

137 WAYS To make money, in home or office, business of your own. Full particulars free. Elite Co., 220 Grand St., New York 13.

START A venetian blind laundry. Profit opportunity for lifetime business. New machine method. Free booklet on request. F. C. Co., 442 N. Seneca, Wichita 12, Kans.

MAKE Money at home as renewal headquarters for all magazines. Liberal commissions. No experience, no capital needed. Supplies furnished. Write for free catalog. McGregor Magazine Agency, Dept. 500B, Mount Morris, Ill.

EXPORT-Import! Represent manufacturers! Conduct barter exchange. War-peace time big profit business. Buy-sell by mail operating at home. Let experts show you how. No previous experience needed. Get free facts now. International Trades, 246-P, Fifth Ave., New York 1.

SELL By mail, free details; instructive booklet 25c. Manhattan House, Box 51-M, St. Albans 12, New York.

1001 OPPORTUNITIES Club, 1495 Westchester Ave., New York 72, offers real money making ideas. Free information.

RADIO Advertising without risk! Pay "per order." Further details, 10c. (Refundable.) Simon-P5, 59 Park Avenue, New York City 16.

FREE Illustrated instructions, casting novelties. Genuine latex for molds. Major Chemical & Latex Co., 25 Allerton St., Boston 19, Mass.

MAKE GIFTS, novelties, jewelry, from sea shells, fish scales, plastics. No tools needed! Learn secret methods of bronzing, pearlizing, gilding, silvering, metalizing, luminizing, dyeing. Write: Giftcrafts, Box 4550-PM, Coral Gables, Florida.

EARN Money at home with your typewriter! Spare time! Details free. Edwards, Publisher, 3915-PM 12th, Des Moines 13, Iowa.

POPCORN And potato chip equipment. Long Eakins Company, 5260 High, Springfield 99, Ohio.

FREE Particulars "Profitable Home Business Projects" plus wholesale sources 740,000 items. Cottage Industries, Omaha 12, Nebr.

BUY Wholesale. Thousands articles. Supply directory, 10c. Idealco, Park Ridge, Illinois.

ESCAPE Wage slavery. Easily. Operate your own profitable lifetime business. Free literature. Corley, H285 Carlton, East Rutherford, New Jersey.

LEARN Silk screen printing; invisible reweaving; repair dolls; make rubber stamps; repair sewing machines. Natural Rubber for molds. Free sample. Universal, Box 1076-a, Peoria, Ill.

SAVE. Profit — Buy thousands nationally advertised articles direct from manufacturers. Literature free. E. L. Gray, Box 456, Tombstone, Arizona.

MAKE \$50-\$300 Weekly at home—Dozens of ideas to choose from. Start now. Write: Graybill, R. 4-S, Lancaster, Penna.

EARN Extra Money! "Homeworker Magazine" tells how. Sample 25c. Sizemore, Box 7, 4917 Kostner, Chicago 30.

VENDING Machines earn big money! An investment as low as \$10.50 will start you in this fascinating, profitable business that can lead you to the road of success and independence. Routes can be established and operated in either full or spare time with no experience needed. Write for full details and our free catalog illustrating our nut, candy, gum and stamp vendors; also pin ball machines, music boxes, etc. Write immediately to Parkway Machine Corporation, Dept. 7, 715 Ensor Street, Baltimore 2, Maryland.

DISTRIBUTORS Wanted. Aluminum awnings. Big profits. Big demand. Make your own. Everything supplied. Details free. Kramer Industries, 321 S. Anita, Los Angeles, Cal.

EARN Money mailing dollar-pulling circulars—Keep 90c. Everything furnished. Genmerco, Box 142-P, Dorchester 24, Mass.

BE Listed to receive latest mail order offers, samples, propositions. National, Box 88-P, Dorchester 22, Mass.

NEW Exceptionally profitable plans, ideas for home operated mail business. Rush name. Miller, 1772-P Carlyon Road, East Cleveland 12, Ohio.

WHY Job worry? Start electroplating, metal finishing business. Free information, trade secrets. Plater M Hyde, 327 West 120th Street, Los Angeles 61, California.

BOOKKEEPERS. Keep books, small firms spare time. Manual latest technique by C.P.A., \$3.00. Modern Business, Box 406, Youngstown 1, Ohio.

FIX Typewriters. Free booklet describes our modern, inexpensive home-study course. Factory methods taught. Write: Typewriter, 1215 Corbet, Tarentum, Penna.

FREE Book "505 Odd, Successful Businesses." Work home! Expect something odd! Pacific, Oceanside, Calif.

NATURAL Molding Latex. Extra thick. Free sample. W. Wooley, 115-A Donald, Peoria, Ill.

\$46 FROM Square foot plywood; jigsaw necessary. Write: Woodarts, Bridgewater, Mass.

MAKE Money spare or full time, casting metal toys and novelties. Big 1952 wholesale and chain store orders for cast metal autos, soldiers, ashtrays, banks, etc., keep manufacturers busy. Production molds furnished for up to 100 and more castings per hour. No experience or special place necessary. Write for information and illustrations of patterns needed. Metal Cast Products Co., Dept. A, 1696 Boston Road, New York 60, N. Y.

QUICK Money! Repairing car batteries! At home! Easy too! Batteryman, Grand Junction, Colorado.

EXTRA Money—No selling, operate vendors. Amazing profits, details free. Silver King, Suite 220, 622 Diversey, Chicago 14.

BIG Money and fun growing live miniature Ming trees on your window sill. Write for free rare tree seed and plan. National Nurseries, 8620A Ruthelen, Los Angeles 47, California.

BUY It wholesale! Manufacturers, distributors offer 850,000 items. Literature free. Olsen, 1231-A East Third St., Duluth 5, Minn.

FIGURINE Molds and many others, liquid rubber, statuary plasters, flock finishes, etc. Illustrated catalog and "Plastercraft" manual free. Blue Rapids Supply, Blue Rapids, Kansas.

\$25 WEEKLY Working two hours daily. No canvassing. No manufacturing. Lycke, Box 2471-A, Cleveland 12, Ohio.

MOLDING Rubber \$2.95 quart, \$9.95 gallon prepaid! Plastercraft Supply Company, 3051 St. Clair Avenue, Cleveland 14, Ohio.

HOW And where to obtain capital, details free. Star Service, Wapakoneta, Ohio.

EARTHWORM Breeding? First, get unusual story. "An Earthworm Turned His Life." Free. Earthmaster, Dept. 14, El Monte, Calif.

MONEY In new greaseless doughnuts. Start in kitchen. No smoke. Sell stores. Free recipes. M. Ray Company, 3605 South 15 Ave., Minneapolis 7, Minnesota.

INCOME From local information. No selling. Write Neherco, La Verne, Calif.

MAKE Flexible molds! Cast plaques, bookends, figurines! Free sample! H. Tooker, 630-R Chestnut, Hamilton, Ohio.

NEW Profitable home business repairing zippers. Thousands of customers waiting. No experience required. We furnish everything. Write Texas Specialty Company, 204-B Texas, Texarkana, Texas.

UNPAINTED Bookends, plaques, statues, figurines. List. Haverty Products, 822-17th St., Altoona, Penna.

START Mailorder bookshop — Everything furnished. 25c brings booklet, samples, exciting ideas. General Publications, Ossining, N. Y.

OPERATE Profitable mail order business. Write Walter Service, 4159-A East 112th, Cleveland 5, Ohio.

DOLLARS In personalized baby record books. Sell by mail. Use same literature we do. No-Co-Ro, Oakland 6, Calif.

FABULOUS Earnings—Fascinating pastime. Growing genuine, living miniature (ming) tree. New sensational business or hobby. Astounding information free. Dwarf Gardens, Box 355B, Briggs Station, Los Angeles 48, Calif.

MADE \$24,500 Using money making plans from Schemer Magazine, world's oldest mailorder publication. Box 275M, Canfield, Ohio. Year \$2.00. Sample 20c.

MINK Raising information free. Complete. Lake Superior Mink Farm. Superior, EEL, Wisconsin.

COMMERCIAL Deep frying course. Mock chicken legs, potatoes. New and proven methods. Learn about this money-making field. \$2.50 p.p. Concession, Toledo 13, Ohio.

COPUBLISH Leading m.o. paper. Latest copy Mail Sale Advertiser, details, dime. Vanroy Shirk, Lebanon, Penna.

COLORGLAZED Concrete pottery made without molds. Patented method. Cemetery products, novelties, tiles. Basement leak-sealing. Money-making projects. Booklet, details free. Men only. National Potteries Company, Grand Rapids, Minnesota.

READ "Advance"—The voice of mail order. Offers money-making opportunities, sources of supply, personal guidance, etc. Issued monthly. Sample copy 25c. Yearly subscription \$2.00. Advance Publishing Company, 313 East 21st Street, Suite 450, New York 10, N. Y.

LIQUID Rubber. Make flexible molds. Free sample. Chaney, 1130 E. 16th St., Jacksonville 6, Fla.

MAILING Postcards selling repeat merchandise is profitable. Everything supplied. Details free. Gordan Publishers, Box 23, Pawtucket, R. I.

MEN—Women. Everybody likes candy. Learn to make professionally. Our 40th year. Ragsdale Candies, D5, East Orange, New Jersey.

VITAMIN Sales business complete, \$50! Includes packaged vitamins worth \$126.00, labels printed with buyers name, prepared literature, automatic selling plan. Terrific local, national, foreign sales. Immense profits. Man or woman can operate anywhere. \$3.00 full size, sample \$1.50. Durkin, 410-R West 9th St., Los Angeles 15, Calif.

MONEYMAKING OPPORTUNITIES

MAKE And sell your own plastic foam favors and novelties. Complete introductory kit \$1.00, contains styrofoam, instructions, and patterns. Foam Fantasy Company, 1101 Janes, Saginaw 19, Michigan.

WIN Cash, cars in prize contests! Write for copy filled with current contests, winning hints and tips. Send only 30c. Wright Contest Digest, Dept. 17-B, P.O. Box 2266, St. Louis 9, Mo.

"HOW To Make Money With Simple Cartoons"—A book everyone who likes to draw should have. It is free; no obligation. Simply address Cartoonists' Exchange, Dept. 92-CM, Pleasant Hill, Ohio.

WIN Contest money. General Contest Bulletin gives hundreds of tips. List current contests and rules. Sample 25c. General Contests, 1609½ East 5th, Duluth, Minnesota.

EARN Money evenings, copying and duplicating comic cartoons for advertisers. Adservice, Argyle 1, Wisconsin.

STOP! Write here. Cash opportunities. Green, 13 Earl, Red Bank, N. J.

TREMENDOUS Profits! Sell name-lists by mail. Complete instructions including sample list of 1000 names. 25c. Wilbur Erickson, Englishtown, New Jersey.

SPARETIME Homework opportunities. Free details. Pallo, Box 504, Yonkers, N. Y.

BE Independent. Grow herbs for profit. Detailed booklet, seed source 50c. Domesticated earthworms make fertilizer from garbage. Valuable booklet 10c. Avarm, 112-M Elizabeth, Wichita 12, Kansas.

\$100-\$200 WEEKENDS. No selling or manufacturing. Mahaffey, 3032-B Weldon, Los Angeles 65.

MAILORDER Magazine, homework offers 10c. William Woodrow Jenkins, Lucasville, Ohio.

580 MONEY Making secrets. Send stamp for particulars. Book Service, P.O. Box 453, Port Chester, New York.

\$35 WEEKLY Possible! Home! Two hours daily! 27 unusual projects. Walsh, 894 Main, Buffalo 2, N. Y.

GOOD Indoor income, growing chop suey bean sprouts. Instructions, seed, 30 sprout recipes, \$5.00. Texas Health Products, Box 23, Beeville, Texas.

\$15,000 YEARLY Possible with surplus comic books. New, fascinating. Particulars and sample 25c. Kenneth C. Fleck, Columbia City, Indiana.

FREE Folder "Your Happiness;" extra income, health, success! Adolph Menzel, Oshkosh 13, Wis.

AD Matches! Sell amazing designs—20, 30, 40 and 240-light book matches. Bigger spot cash commissions; every business a prospect. Low prices for high quality. Repeats. Start without experience; men, women; full, part time. Buy nothing! Sales kit furnished. Match Corp., Dept. PM-26, Chicago 32, Illinois.

UNPAID Plaques, booklets, novelties. Stamp brings list. Jmiauf, 239 S. Luther, Detroit 25, Michigan.

GET Several plans for home business, 25 cents. Box 165, Brooklyn 17, N. Y.

MONEYMAKING Opportunities. Free literature. National Hobbies, Box 524, Rochester, Minnesota.

BIG Money jobs in foreign employment for construction men, building trades, helpers, office men, others, interested in foreign projects. High wages, quarters, transportation. Listings of firms actively working on U.S., foreign, intercontinental projects. Send \$1 for foreign construction compendium and application forms. Foreign Service Bureau, Dept. M, Box 295, Metuchen, N. J.

FREE Nationwide advertising, publicity! Advertise your products to 51 million readers thru 77 national magazines, free of charge! Broadcast on 400 radio stations without risking a penny! Send 25c (refundable) for details today! Treasury, 149 Storer, New Rochelle 3-L, New York.

QUICK Profits taking magazine subscriptions, handling greeting cards. Cassell Publishers Service, Westfield, N. J.

LEARN Mailorder selling. Free details. Greenlawn Enterprises, 15378-X Greenlawn, Detroit 21, Michigan.

50,000 ARTICLES Wholesale. Source directory, dime. Nelko, Box 3462-DR, Chicago 54.

START A profitable subscription business in spare time! We need men and women (young or old) as representatives for all leading national magazines. Liberal commissions paid for new and renewal subscriptions. Start earning money in this pleasant work at once! Clip this ad and send with your name and address to: International Circulation Division, Dept. PM, Hearst Magazines Inc., 250 W. 55th St., New York 19, N. Y.

TIE-Breaker picture puzzles exposed, \$1.00. Wenograd, Box 1495, Philadelphia 5, Penna.

FREE Book "505 Odd, Successful Businesses." Work home. Expect something odd! Pacific, Oceanside, Calif.

BE Appointed State Notary Public now! Details: Stationers, Helotes, Texas.

PUBLISH Your own magazine. Handsome 52 page format, well edited, illustrated. Cost low as \$1.00 month. Brings you prestige, profits. 25c brings sample, details. National, Ord, Nebr.

READ Progressive Mailtrade, the magazine that tells how to make money by mail. Dime brings sample and special offer. Progressive Mailtrade, Box 357, Sheboygan, Wisconsin.

FORMULAS, PLANS, ETC.

YOURS. Free catalog profitable formulas. Chemsul, Box 201, Cincinnati 14, Ohio.

ANY Formula \$2.00. Satisfaction guaranteed. Jack, Chemist, 4292 Parkside, Philadelphia 4.

REAL Manufacturing formulas. Lists free. Cummings, Chemist, Gordon Ave., Syracuse 4, N. Y.

ANY Formula \$1.00 or refund. Write Doctor Paul, 11559 Kling, North Hollywood, California.

FORMULAS: All kinds. Latest, best. Literature free. Kemixal, Park Ridge, Ill.

LATEST Manufacturing formulas, for profitable, easy to make chemical specialties. Lists free. Automotive Chemical Laboratories, Box 393-A, Hicksville, N. Y.

FORMULAS. Trade secrets, for nearly everything. Catalog free. Creative Publishers, Winnetka 6, Illinois.

TESTED Formulas. Interesting descriptive booklet free. Pont, Box 635-PM, Terre Haute, Indiana.

PLASTICS

PLEXIGLAS. Square foot, 1/16 72c, 1/4 94c, 3/16 \$1.14, 1/2 \$1.35. Free inventory. Hub, 355 Congress, Boston, Mass.

LEARN Plastics at home. Small cost—Spare time. Dime brings sample plastic, three experiments, full details. Plastic Projects, Box 5151, Detroit 35, Mich.

NEW Liquid casting plastic. Clear, colors. Embed flowers, insects, coins. Saw, drill, carve. Send 25c for wholesale catalog and new sales manual showing how to make money at home. Castolite, Dept. B-101, Woodstock, Illinois.

PLASTIC-Crafters supplies wholesale. Literature 20c. Cosmopolitan, Box 176-PM, New York 8, N. Y.

ACETATE, Cellophane, Plexiglas. Masked. Square foot (12 x 12) cost, 1/16", \$1.20; 1/8", \$1.40; 3/16", \$1.75; 1/4", \$2.08. Include 10% postage. Almac Plastics, 230 Fifth Ave., New York 1, N. Y.

PLASTIC. Sheets, rods, tubes, etc. Free list. Plastic Supply Co., 2901 N. Grand Blvd., St. Louis 7, Mo.

CHEMISTRY

SAVE Money! Supplies catalog 15c, refundable. Laboratory Sales, Box 161-A, Brighton, Mass.

CHEMICALS And apparatus for industrial, analytical, and private laboratories. Catalog 20c. Dept. M-50, Biological Supply Co., 1176 Mt. Hope Ave., Rochester 20, N. Y.

LABORATORY Apparatus, chemicals, microscopes, complete chemistry sets, minerals, uranium ore. 10c brings catalog. Porter Chemical Company, Hagerstown 1, Maryland.

SPECTROSCOPE For quick chemical analysis \$3. Kutting Sons, Los Altos, Calif.

NEW Idea chemicals and apparatus outfits for home experimenting. Photo-scales, microscopes, chemicals, biological and laboratory supplies in small quantities. Catalog 25c. Established 1931. John H. Winn, 124A West 23rd Street, New York, N. Y.

ILLUSTRATED Catalog: Chemistry, mineralogy, biology. 10c. Tracey Laboratories, Evanston, Illinois.

HELP WANTED

TIRED Of no money, second rate jobs? Like to start a real career with a lifetime of high salaries? Write me about two growing fields that really need men. Ed. Howes, Chief, 456 W. Santa Barbara Avenue, Los Angeles 37.

AGENTS WANTED

AMAZING Miracle auto polish—Plastone! New scientific discovery contains pure carnauba wax, genuine plastic plus silicones! Sensational money maker! Nationally advertised! Sold by leading firms. Used by America's largest organizations. Only \$1 retail, 100% profits. Sales experience unnecessary. Exceptionally easy sales. High repeat sales. Choice protected territories. Once in a life time opportunity for large steady earnings. Only limited number of agents accepted. Write today. Plastone Company, 2950 W. Grand, Dept. PM-2, Chicago 12, Illinois.

DO You need money? \$40 is yours for selling only 50 boxes of our 300 greeting card line. And this can be done in a single day. Free samples. Other leading boxes on approval. Many surprise items. Experience unnecessary. Free samples personalized stationery, napkins. Write today. It costs you nothing to try. Cheerful Card Co., 464 White Plains, New York.

PART Time salespeople—Men and women. Daily cash returns showing Artmoore Products, three "in demand" items. No investment in stock. Liberal no risk starting offer. Write Dept. P-2, Artmoore, 1319 North Third, Milwaukee, Wisconsin.

MAKE Money fast—Sell big value greeting cards. Four new 21 card \$1.00 all-occasion assortments. Birthday, Easter, novelty cards. Gift wrappings, stationery, notes. Unusual gift items. Over 100 fast-sellers. Amazing profits. Write for samples on approval and "get-started" plan. Hedenkamp, 361 Broadway, Dept. PM-18, New York.

A Penny postcard can put you in business. Complete line. Leather jackets, 151 shoe styles. Big commissions. No experience, no investment. Send penny post card for free outfit. Consolidated Shoe System, Dept. CI-99, Chippewa Falls, Wisconsin.

NEED Extra money? Show your friends wonderful Regal line of all-occasion greeting cards. Over 100 beautiful assortments to choose from. Also exclusive stationery unobtainable elsewhere. No experience necessary. Your profit up to 100% plus bonus. Write for free samples. Sales kit on approval. Regal Greeting Card Co., Dept. 83, Ferndale, Michigan.

STRANGE "Dry" window cleaner. Sells like wild. Replaces messy rags, liquids. Simply glide over glass. Samples sent on trial. Kristee, 143, Akron, Ohio.

FREE Samples, and amazing plan, giving you gorgeous dress without penny cost. Rush name today with dress size. Harford, Dept. G-335, Cincinnati 25, Ohio.

NEED Money? \$50-\$100 and more is yours—easily, pleasantly, quickly. In spare time just show friends irresistible Elmira assortments of all-occasion greeting cards, wrappings, personalized stationery, napkins, matches, many other exclusive, profitable specialties. No investment. No experience. Success assured. Bonus. Special prizes. Promptest service. Write today. Free samples, assortments on approval. Elmira Greeting Card Co., Elmira 110, N. Y.

ABSOLUTELY Free! Big package actual sample fabrics and style presentation of dresses, lingerie, hosiery, etc. Take orders. Commissions big. Send no money. Melville Co., Dept. 6704, Cincinnati 25, Ohio.

SELL Sunshine exclusive everyday cards and make big money the easy friendly Sunshine way. Complete selection greeting cards, stationery, gift wraps, novelties, etc. 21 deluxe miniature everyday cards—75c. Many others. Send postcard today for your Sunshine sample kit on approval to: Sunshine Art Studios, Dept. PM-2, 115 Fulton St., New York 38, New York.

JUST Out! New thrilling sensation in everyday cards. Rich foils, satins, velours sell on sight, 21 for \$1. Make up to 100% profit. 50 assortments, imprint stationery and book matches, gift items. Two \$1 assortments on approval. Imprints free! Joy Greetings, 507 N. Cardinal, Dept. R-60, St. Louis, Mo.

MAKE Money calling on friends. Show nationally advertised greeting cards—New all-occasion assortment and laugh-packed barrel-of-fun. Also sensational pinafors and parasols personal notes. All three dollar sellers. Up to 50c profit for you. Big line, includes gift wrappings, stationery, gift items, etc. Get three assortments on approval. Write Wallace Brown, 225 Fifth Ave., Dept. H-4, New York 10.

MAKE Wedding profits. Sell invitations, napkins, matches. Samples free. Dunbar's, Middlebush 3, N. J.

BIG Daily profits—Selling embroidered wool and cotton uniforms, initialed buckles, belts, badges, choice 3000 emblems. Free sales kit. Hook-Fast, Box 480PM, Roanoke, Virginia.

100% PROFIT. Experience. Pas-Cal vitamin. Mineral Products, Box 203, Altadena, Calif.

BARGAINS—Terrific savings, job lots, close-outs! Also save up to 50% on complete lines of drygoods, clothing, hosiery, notions, drug sundries, toiletries, novelties, gifts, jewelry, television, etc. 2000 items. Send 25c for illustrated wholesale bargain catalog, closeout flyers, and special "get acquainted" offer. Valuable merchandise certificate (worth many times 25c) included free. Reliable Jobbers, 311-B N. Desplaines, Chicago 6.

MAKE Money selling ties. Free catalog. Write to Philip's Neckwear, Dept. 906, 20 West 22 St., New York.

AT Last! Something new and sensational in everyday cards, 21 for \$1. Make extra money fast! Show satin, velour, metallic cards. Get orders easy. Big line \$1 assortments, scented stationery, personal matches, kiddie books. Imprints free. Two \$1 boxes on approval. Puro Co., 2801 Locust, Dept. 240-B, St. Louis 3, Mo.

LOOK! Extra money for vacations, unpaid bills, savings, charities. Sell friends greeting cards, gift wrappings, gifts. Experience unnecessary. Big profits. Bonus. Surprise gift offers. Request feature all-occasion assortments on approval. Free samples name imprinted stationery, napkins, towels and free catalog. New England Art Publishers, North Abington 605-B, Mass.

BUY Wholesale — 25,000 items. Catalogue 25c. Matthews, 1472-B7 Broadway, New York City.

3 BILLION Greeting cards bought yearly. You can cash in on this million dollar market. Make 100% profit easily with Fanmour greeting, imprint stationery, napkins, gifts. Complete selling outfit on approval. Fanmour Corp., 200 Fifth Avenue, Dept. PM-2, New York 10.

TROPICAL Flower corsage. Take servicemen orders. Olen Metz, 520 Hess, Evansville 12, Ind.

MEXICAN Feather pictures. Sell on sight; 200% profit! Free details; sample 10c stamps. Sylvia PU, Apartado 9036, Mexico City.

NEW "Sponge" wall cleaner. Erases dirt like magic. Wallpaper, painted walls, ceilings. Saves redecorating. Lightning seller. Samples sent on trial. Kristee, 142, Akron, Ohio.

Kendex nylons are free unless satisfactory." New style 300 only 98c including your commission, bonus and postage. If these wonderful sheer DuPont nylon stockings run, snag or are not satisfactory within 1½ months of receipt, we refund the full 98c so they will cost nothing! What woman will hesitate to wear fine nylons at our risk? Just write orders. We deliver and collect. Advance cash plus huge bonus. Spare or full time. No experience necessary. Postcard brings you sample stocking and money-making outfit free and prepaid. No obligation. Kendex Corporation, Babylon 43, N. Y.

NEW, Clever birth announcements. Profit \$1.00 box. Free samples. Birth-O-Gramm, Coral Gables 34, Florida.

GUARANTEED 200,000 Mile ring, valve job! Restores compression! Stops oil pumping! Send \$3.00 for \$6.00 package and sales offer! Nerlino, Box 7, Inglewood 5, Calif.

BIG Money career selling exclusive guaranteed, sanforized, fast color uniforms \$3.98 up. Nylons, cottons. Sell beauticians, nurses, waitresses, etc. Full, part time—constant demand. Experience unnecessary. Free outfit. Upland Uniforms, 208 East 23rd, Dept. G-5, New York.

SPILL-Proof baby feeding cups and dishes—Ideal for training baby to feed itself. Sell fast to every young mother. Excellent gifts. Good profits—full or spare time. Details free. Write Keeler Products, 1703-T North Albany, Chicago 47.

BIG Profits in spare time! I'll send free assortment full-size samples fine foods, household necessities to ambitious men-women who need money. Friends, neighbors buy eagerly. Send no money. Just write Blair, Dept. 31HB, Lynchburg, Va.

AGENTS—Every woman needs nylon dip; makes nylons last up to five times longer. Big demand. Robert Smith manufacturing Company, Inc., 4731 East 52 Drive, Los Angeles 22.

IT'S Hot; retails 39c. Big profit. National Sales and Service, Box 32, Greenville, Penna.

MEXICAN Feather pictures. High profit! Fast sellers! Adelphi, Box 57-B, Belrose 6, N. Y.

JOBBER-Dealer. Power mowers. Prepaid. Extra profit. City-county. Rotacut, PM, Excelsior Springs, Mo.

BIG Profits selling ties. (\$2.00 values) \$6.50 dozen. Free catalog. Empire Cravats, 648 Broadway, New York 12.

COUNTERFEIT Detector. No competition! Every storekeeper your prospect. Tensecond demonstration sells on sight. Thousands of banks all 48 states using this revolutionary invention. Sample \$2.50 (retails \$5.00). Ruth Devices Corp., New York 4.

BUY Wholesale thousands nationally advertised products at big discount. Sent free "The Wholesale Plan." American Buyers' Service, 629-R Linden, Buffalo, N. Y.

AGENTS—Salesmen! Import your own merchandise, make 500% profit. Represent manufacturers, make huge commissions. 1952 copyright illustrated trade bulletin \$1. Refunded if dissatisfied. Benko, 246-P Fifth Ave., New York 1.

BIG Profits selling "Scotchlite" signs. Full or part time. Write John D. Co., 249 West Seventh, St. Paul 2, Minn.

MEN! You can make a fortune if you join us now. We are introducing Kantlash. Greatest fishing equipment accessory ever manufactured. Sales already pouring in. We want distributors immediately! Retails \$2.95. Big, easy profits. Write today! Kantlash, Evanston 7, Illinois.

BE A money maker. Use your home as magazine headquarters. Liberal commissions. No experience—No capital needed. Everything furnished. Write for free catalog. McGregor Magazine Agency, Dept. 500A, Mount Morris, Ill.

\$50 WEEKLY Selling finest razor blades, other items. Free details. Edisons, Box 274, Far Rockaway, N. Y.

MEXICAN Feather pictures, unusual novelty. \$1.00 (stamps) brings \$2 worth samples. Refunded if unsatisfied. Aztec Art, Apartado 762, Mexico City.

BIG Profits selling ties. (\$2.00 values) \$6.50 dozen. Free catalog. Empire Cravats, P648 Broadway, New York 12.

YOUR Own business—Used overcoats 50c; mackinaws 34c; shoes 12½c; ladies' coats 30c; dresses 10c. Enormous profits. Catalog free. Moro, 558-AA Roosevelt, Chicago 7.

SCHOOL Seniors— Earn sensational profits selling classmates America's most beautiful graduation name cards. Largest selection. Outsell all others. Free sample kit. Printcraft, Dept. M, 1425 E. Elm St., Scranton 5, Penna.

NEED Extra cash? Take orders for personal initialed belts and buckles, cap badges, tie holders, etc. Choice of 3000 emblems. Free sales kit. Hook-Fast, Box 1425PM, Providence, R. I.

SCHOOL Seniors— Earn sensational profits selling classmates America's most beautiful graduation name cards. Largest selection. Outsell all others. Free sample kit. Printcraft, Dept. M, 1425 E. Elm St., Scranton 5, Penna.

EXCELLENT Sideline for printing and advertising salesmen. Decalomania name plates in small quantities. Great demand. Also, make money with our line of automobile initials and sign letters. Free samples. "Ralco" XL-Roxbury, Boston 19, Mass.

AGENTS: Stamping names on key protectors. Sample 25c. Stamping outfits, checks, social security and name plates. Hart Mfg. Co., 303 Degraw St., Brooklyn, N. Y.

AGENTS—300% Profit selling genuine gold window letters; stores and offices. Free samples. Metallic Letter Co., 438-B North Clark, Chicago.

WANTED—Purchasing agents. No money or experience required. Write Dept. C, Purchasing Manager, 2719 Lawrence, Chicago, Ill.

SELL Big money-maker to men and women. Easy handwork makes fast-selling useful articles. Sunmade Company, Brockton 64, Mass.

GOLD Lacquered and silver sign letters. Windows, doors, trucks. Standard sizes. Penny each. Free samples. Atlas-P, 544 West 79th, Chicago 20.

SALESMEN, Distributors, fast selling costume jewelry direct from factory. Big picture catalog, free. Pickcraft, M19 Bank, Attleboro, Massachusetts.

HIGH-GRADE SALESMEN

MAN To earn \$90 week up. Long needed invention. Advertised Saturday Evening Post, Colliers. Prospects everywhere. Full or part time. Exclusive. No investment. Free samples. Write Red Comet, Inc., Dept. 16-B, Littleton, Colorado.

EARN Big money fast! Sell finest-quality advertising work uniforms to garages, factories, filling stations, etc. Free selling kit. Topps, Dept. 532, Rochester, Indiana.

AMAZING Discovery, Master Glaze, puts brilliant glass-like surface on cars. Free sample, information. Big commissions. Master Glaze, Dept. 733, 7720 Harwood, Milwaukee, Wis.

MAKE Money introducing world's cutest children's dresses. Big selection adorable styles. Low prices. Complete display free. Rush name. Harford, Dept. G3341, Cincinnati 25, Ohio.

ANYONE Can sell Hoover DuPont nylon uniforms for beauty shops, waitresses, doctors, nurses, others. In white and colors. Exclusive styles. Top quality. Low priced. Exceptional income. Real future. Equipment free. Write fully. Hoover, Dept. B-100, New York 11, N. Y.

WANT To make real money? You can positively make \$50 a day and up selling a brand new item going to every type of food and beverage store, factories, laboratories, hospitals, etc. First time advertised. Samples furnished. Utility Durawear, 53 West Jackson Blvd., Dept. PM-02, Chicago, Ill.

WRITE 3 Words—Collect \$7.65 on 10-second demonstration to merchants. Write on glass with amazing magic crayon—Presto! 5 color advertising message takes fire, glows like brilliant neon. Three sales daily bring \$22.95 profit. Rush postcard for details. Complete sales kit, free! Maxilume Co., 125 W. Hubbard, Dept. CL-8-B, Chicago 10, Illinois.

LEARN The secrets of successful salesmen. \$1.00. Wye & Co., 636 Dorchester Avenue, Boston 27, Mass.

SALESMEN—Get happy! Hundreds different things to sell; all details free! Write what you sell now; what you'd like to sell. Your mail box will run over! Salesmen's Service, Drawer 8711, Fort Worth 12, Tex.

ADVERTISING Book matches—Cash in on big demand; sell union label matches. Cuts for all businesses and political parties. Free powerhouse selling kit, low prices, protection guaranteed on repeat orders. Cash commissions. Superior Match Co., Dept. M-252, 7530 Greenwood, Chicago.

FAST Selling to every commercial establishment; automatic refillable deodorizer package deal plus repeat business. Trojan, 3007 N. Clark, Chicago 14, Illinois.

WIN Suits and earn money! Both easy with amazing plan. Show finest made-to-measure tailoring to friends, neighbors. No experience or investment. Free outfit. Write Pioneer Tailoring, Dept. C-1117, Congress & Throop, Chicago 7, Ill.

\$45.50 IDEAL Wheel balancer leads all! Consistently guaranteeing wide-awake salesmen greatest earnings. Price Sales Company, Dept. PM-2, Sylvania, Ohio.

BEST Source for nylons. Rich Co., 215 W. 98, New York 25.

TWO Rapid-fire sellers. World-famous Hurbut's story of the Bible. One and only marked Bible—Illuminated, deluxe edition. The greatest "one-two" in the religious field. Use time-pay, c.o.d., or cash sales plan. Big cash daily. Write Universal House, 1008-I Arch, Philadelphia 7, Penna.

MAKE Money with fast-selling Bostonian shirts. Blouses too. Spare time, full time. Sales kit free. Bostonian, 89 Bickford, Dept. M-10, Boston 30, Mass.

MAKE Money showing neighbors how to beautify yards with glorious flowering shrubs and trees. Quick-bearing dwarf fruit trees; world-famous Stark patented varieties produce abundant harvests champion-quality apples, pears, peaches, other fruits. Even small plots produce fruit for family-use and to sell. Beautiful sales kit free. Stark Bro's, Dept. 30182, Louisiana, Mo.

NEW Jobs open in selling! Send name, address for five free issues of Opportunity Magazine's money-making guide, listing hundreds of companies who'll pay you well, full or part-time. No experience needed. Opportunity, 28 E. Jackson, Dept. 17, Chicago 4, Ill.

EDUCATIONAL AND INSTRUCTION

HOW To study—How to solve. A new, practical book on how to approach and solve mathematical problems from arithmetic to calculus. A real common sense self teaching aid already used in schools and colleges throughout the country. Price only \$1.00 postpaid. Addison-Wesley Press, Inc., Cambridge 42, Massachusetts.

TELEVISION Servicing. Easy to learn at home, spare time. Learn-by-doing training covers all phases of TV. Large screen, modern receiver, furnished with course, is yours to keep. Pre-TV radio course for beginners. Get illustrated booklet, valuable lesson now! Send 25c to cover mailing, handling. TCI, 205 W. Wacker, Dept. PM-1, Chicago, Ill.

BOOKKEEPERS! Increase your earnings! Operate your own simplified "Dollar-A-Week" bookkeeping and tax service. Full or spare time. Details free. No obligation. Ellis, Box 200-B, Cedar Grove, North Carolina.

MAKE Up to \$45-\$55 week as a trained practical nurse! Learn quickly at home. Booklet free. Chicago School of Nursing, Dept. M-2, Chicago.

PRACTICAL Nursing—Learn easily at home, spare time. Big demand, good earnings. High school not necessary. Write for free facts. Wayne School, Dept. FG-7, 2525 Sheffield, Chicago 14, Ill.

"HOW To Break and Train Horses"—A book every farmer and horseman should have. It is free; no obligation. Simply address Beery School of Horsemanship, Dept. 1102-C, Pleasant Hill, Ohio.

HIGH School—No classes. Study at home. Spare time. Diploma awarded. Write for free catalog HF-17, Wayne School, 2527 N. Sheffield, Chicago 14, Ill.

BE A real estate broker through home study or classroom instruction. Write for free book. Approved for Veterans. Weaver School of Real Estate, Suite 300 Law Bldg., Box CP-2, Kansas City, Mo.

START A collection agency business. Very profitable. Quickly learned. Write Cole & Associates, Syracuse 2, N. Y.

WELDING Training pays at Hobart Welding School, Box M-222, Troy, Ohio. VA contract. Best equipment. Catalog free.

OWN A collection agency. Big money. Franklin Credit, Roanoke 7, Virginia.

YOU Can learn upholstery at home. Big opportunities! Write for free literature. National Upholstery Institute, 6108 East 24th, Indianapolis.

LISTEN—Learn a language by Linguaphone. At home, quickly, easily correctly master Spanish, French, German, Russian, Asiatic—any of 29 languages through Linguaphone Conversational Method. Add to Armed Services job, travel opportunities. Send for free book. Approved for Veterans' Training. Linguaphone Institute, 8302 Radio City, New York 20.

WHY Die? Look under "Miscellaneous!" Bijou, Box M-1727, Hollywood 28, Calif.

GET A gov't job! Start high as \$73.00 week. Men-women. Thousands of emergency program jobs available! Qualify now. Experience usually unnecessary. Free 32-page book shows jobs, salaries, sample tests. Write today: Franklin Institute, Dept. F-24, Rochester, N. Y.

INCREDIBLE! Unprecedented! Look under "Miscellaneous!" Bijou, Box 1727-MM, Hollywood 28, California.

LEARN Priceless secrets of technical metaphysics. Easy, simple. Write Canada School of Technical Metaphysics, 2532 McKenzie St., Vancouver, B.C., Canada for amazing information.

BECOME Expert draftsman. Details free. Monroe Institute, PM-2, Alton, Illinois.

SMASH Worries, fears and problems with our "Thought and Behavior Control" home-study method. Many helped. Rush request for amazing free lecture in plain wrapper. Personal Psychology, Inc., Box 1924-M, Louisville 1, Kentucky.

USED Textbooks, real estate and other educational subjects. Bargains! K. H. Hall, 3519 Remington, Jacksonville, Fla.

\$8-15,000 YEARLY Not unusual for Acme-trained tool and die designers! Industry desperately needs competent men. You can learn quickly by easy home study. No art ability required. Acme graduates go farther faster in tool and die designing. Famous "Cope" system includes same methods and texts used by our resident schools to train tool and die designers. Write today for free literature. Acme School of Die Design, 8 N. Jefferson Street, Dayton 2, Ohio.

USED Correspondence courses bought and sold. Free list. Walsh, 894 Main, Buffalo 2, N. Y.

A College degree by home study. B.A., M.A., Ph.D., degrees by home study. Previous credits recognized. Remain employed and still attain a college education. No residence requirements. State chartered. Fremont College, Santa Fe 34, New Mexico.

INVESTIGATORS Trained, men-women, learn fascinating profession. Spare time study. Big pay. Folders free. Investigator, Box 490, Times Square Station, New York 18, N. Y.

"THOUGHT Of Using Sleep for Learning, Self-Improvement?" Fascinating science explained: "Mental-Power Through Sleep-Suggestion." \$1. Melvin Powers, 1324 Wilshire, Los Angeles 17P, California.

GUNSMITHING, Learn now! Start earning good income. Our residence course is thorough, practical! Approved for qualifying veterans; easy-pay plan for non-vets. Part-time work arranged. Write: Pennsylvania Gunsmith School, 1000M Western, Pittsburgh.

MEDICAL Laboratory technicians in great demand. We train you in your own home. Catalogue free. Imperial Technical Institute, Box 973-J, Austin, Texas.

USED Correspondence courses and books sold and rented. Money back guarantee. Catalog free. Courses bought. Lee Mountain, Pisgah, Alabama.

"BRIDGE To Knowledge" bestirs new heart in you to succeed. \$1.00. Ingraham, Box 9025, Los Angeles 5, Calif.

FREE "Career Chart." Write Professor Martin, Williamsburg, Mich. Mention occupation.

BECOME Expert white metal welder. Instructions \$1.00. L. Spicer, Bath, Maine.

"FINGERPRINT Patterns and individuality"—Interesting, illustrated treatise explaining sensational new discoveries about fingerprints. \$2.00. Don L. Gordon, 2105 Cottage Grove Ave., Des Moines 11, Iowa.

PIANO Tuning pays. Learn this profitable profession at home. Our Tonometer and mechanical aids make learning easy. No knowledge music necessary. Diploma granted. Largest and oldest school—53rd year. G.I. approved. Write for booklet. Niles Bryant School, 78 Bryant Bldg., Washington 16, D. C.

SECRET Investigation. Experience unnecessary. Investigators particulars free. George Wagner, M125 West 86th, New York 24.

USED Correspondence courses and educational books bought, sold, rented. Catalogue free. Educational Exchange, Summer-ville, Ga.

TIRED Of no money, second rate jobs? Like to start a real career with a lifetime of high salaries? Write me about two growing fields that really need men. Ed. Howes, Chief, National Schools, 4000 S. Figueroa Street, Los Angeles 37.

INVESTIGATOR Training. Phillips Secret Service System, 1917-B North Kenneth, Chicago 39.

PLAYS, STORIES, MANUSCRIPTS

MUSICAL Comedy plays. Dorby Publications, P.O. Box 131, Brier Hill, New York.

I Want new writers to cash checks of \$1 to \$100 offered daily. The easiest way to write for pay. No previous experience necessary. Free details. Saunders M. Cummings, 468-11 Independence Bldg., Colorado Springs, Colo.

SPECIAL SERVICES

LETTERS Remailed 25c each. 8 scenic postcards \$1.00. Commissions accomplished. Reliable, confidential. Free details. B & W Association, 1435 Nashville Ave., New Orleans, La.

HARTFORD, Connecticut! City of unlimited opportunities. Help wanted column airmailed \$1.00. Letters remailed 25c. Bob Schafer, 471 Burnside Ave., East Hartford, Conn.

FOUR Letters airmailed, gift stamps, \$1.00 bill. William Caballero, Coronel 1318, Guayaquil, Ecuador.

LETTERS, Cards remailed 25c each. 8 scenic postcards \$1.00. Mailing address \$3.00 monthly. Help wanted and business opportunities columns airmailed \$1.00. Stadler, Box 2335, Hollywood 28, California.

NEED Something from Peru, South America? Letters remailed \$2.00, picture postcards dozen \$1.00. Stamps, coins, curios, purchased. Representation, etc. Tell me your needs. PanAmerican Enterprises, Casilla 1229, Lima, Peru.

INFORMATION And research concerning Florida realty, business opportunities, industries, employment, truck farms, orange groves, other subjects. \$2.00 per inquiry. Florida Information and Research Service, Room A, Box 3451, Station F, Jacksonville, Florida.

LISTING Of manufacturers of article you want 50c. Details free. BGS, 1521 Gentry, Wichita 14, Kan.

HOME Building or remodeling? Need help how-to-do-it? Send questions, \$1.00 to Box 342, San Leandro, Calif.

CARTOONING, COMMERCIAL ART, SHOWCARD WRITING, SIGN PAINTING

"HOW To Make Money With Simple Cartoons"—A book everyone who likes to draw should have. It is free; no obligation. Simply address Cartoonists' Exchange, Dept. 92-C, Pleasant Hill, Ohio.

CASH For simple cartoons. Details. J. Borosky, 300 2nd Avenue, San Francisco, Calif.

LEARN Cartooning, illustrating, portrait drawing, showcard writing, etc., quickly with our new, easy methods. Catalog free. National Artists, 801 North Marsalis, A-2, Dallas 3, Texas.

BE Smart. Get in art. Let me start you free. 25 years experience. Nick Nichols Arts, 39 W. Adams, Chicago 3, Ill.

RAISED Wood letters for signs. Send 10c for catalog. Sign Letter Distributors, P.O. Box 101, Mineola, N. Y.

LEARN Sign painting at home. Test lesson free. Ben Kerns, Box 812-P.M., Greenville, S. C.

SEND \$1.00 For six test art lessons, questions, art opportunities, answers. American, Box 8066, Dallas 5, Texas.

CHALK Talks. Laugh producing program, \$1.00. Catalog 10c. Balda The Cartoonist, Oshkosh, Wisconsin.

ADVERTISING AGENCIES, LETTER WRITERS, FOR ADVERTISERS

ADVERTISE 20 Words 100 newspapers \$6.00. Lists free. York Agencies, Quebec 1, Canada.

MAILING List guaranteed, \$4.00—1000 names. Alban Burke, 1212 Franklin Ave., New York 56.

MAILING Lists: Compiled from our clients most recent inquiries, 1951 letters. Free information. Global Advertising Bureau, Box 496, Times Square Station, New York 18, N. Y.

FREE! 1950 Advertisers Rate and Data Directory. 52 pages! E. H. Brown Advertising Agency, 20 N. Wacker, Chicago 6.

FREE Copy, layout service. Mailorder ad, 1,700,000 nationwide circulation, \$25.90 inch. 24-word classified, 20 big Sunday newspapers, \$30.00. Advertising ratebook free. Chicago Advertising Agency (established 1900), Chicago 4.

ADS Placed in out of town newspapers and magazines. Low rates. Catalogue free. Ideas that pay. Baker Advertising Agency, Successors Ankrum Agency, 189 W. Madison, Chicago 2.

ADVERTISERS! Reach nearly 18,000,000 readers. 25 Sunday national key newspapers, 18 words, \$59.00. "Terrific pullers," 20 popular newspapers, \$11.50. Free booklet. Special—One inch display 2,-\$21.198 circulation, \$51.10. Newmark's Advertising Agency, (Established 1893), 217-7th Ave., New York 11.

MAILING Lists: \$5.00-1000 up. Write Dixie Service, King, N. C.

24 WORDS In 50 weeklies, \$4.96. J. Darnell, 730 Hays, Jackson, Tenn.

ADVERTISE: 24 Words, 40 newspapers \$3.50. Lists free. Advertising Bureau, 10511-C Springfield, Chicago 43.

TYPEWRITERS, DUPLICATORS, OFFICE DEVICES

TYPEWRITERS \$22.50; Duplicators, adders \$13.50. Typewriters, 118 Spruce, Wichita, Kansas.

ADDRESS Thousand envelopes, cards in minutes. Amazing new machine. Low cost. Free details. Dorsett's, 2217 S. Walnut, Muncie, Indiana.

RECONDITIONED Typewriters, printing devices, office machines, equipment. DixieGraph, King, N. Car.

RUBBER STAMPS AND OFFICE SUPPLIES

THREE Line rubber address stamp in pocket case, inked pad, \$1.00. Mark circulars, drawings, music, envelopes, packages. Joe Langdon, Oil City, Penna.

RUBBER Stamps—Send for catalog. Excello, Box 500, Shreveport, Louisiana.

3 LINES 50c; Pads 35c; signature \$2.35. Stamp-Right, Wauwatosa, Wis.

LINE 25c; 2—45c; 3—65c. Stamp Works, Auburn, Nebraska.

PRINTING, MULTIGRAPHING, MIMEOGRAPHING, GUMMED LABELS

1000 TU-Tone gummed stickers \$1.00 three lines. Orwat, 1243 South 54th Street, Philadelphia 43.

5000 #6 $\frac{3}{4}$ ENVELOPES Printed \$3.10 per thousand. 1000 embossed business cards \$4.25. Samples free. Michel, Box 76, New York 16.

500 8 $\frac{1}{2}$ x11 LETTERHEADS And 500 6 $\frac{3}{4}$ envelopes printed, Hammermill \$6.58. Jobbers, Box 31-PM, Girard, Kansas.

100 8 $\frac{1}{2}$ x11 HAMMERMILL Letterheads and 100 envelopes \$2.00. Benneville, Box 1931, Pittsburgh 30, Penna.

OFFSET Plates. Send original copy. Lewis Graphic, N. Tonawanda, N. Y.

100 ENVELOPES. Printed 2-colors \$1.25. Box 523, Rochester 2, N. Y.

EMBOSSED Business cards. Free samples! Vine Ad Press, 582a Courtlandt Avenue, New York 51, New York.

500 GUMMED Address labels 50c. Stephen Komes, 3809 S. Herman, Milwaukee 7, Wis.

ENGRAVED—Effect, process embossed business cards, \$3.95 thousand. Samples free. Universal Line, PM-5, Orange, Mass.

100 TWO Color letterheads \$1.00. Samples. D'Yarmett Printing, Newark, Ohio.

1000 BEAUTIFUL Business cards \$3.25 prepaid. Samples. 500 multicolor address stickers \$1.00. Avere, 112-M Elizabeth, Wichita 12, Kansas.

QUALITY Printing. Stationery, circulars, booklets, publications. Free catalog. Adams, 30 West Washington, Chicago 2, Ill.

100 8 $\frac{1}{2}$ x11 HAMMERMILL Letterheads and 100 envelopes \$1.95. H. Hudson, Centredale, R. I.

200 LETTERS mimeographed on printed letterheads 8 1/2x11 only \$2.00; 500, \$4.25; 1,000, \$6.10. Ross S. Weygant, Box 313P, Wooster, Ohio.

EYE-Appeal mimeographing. Your letterheads. 200, \$2.00; 500, \$4.25; 1,000, \$6.00. Estimates free. Promptway, 5923 N. Maplewood, Chicago 45.

MIMEOGRAPHING—Reasonable. Any copy. Mailers Service, Box 606-F, Chicago 90, Ill.

100 8 1/2x11 LETTERHEADS \$1.00 Postpaid. Envelopes same. Race Printers, Hudson, New York.

SPECIAL Discount price list on political, commercial printing. Dornfeld, Iron Ridge 14, Wis.

50 LETTERHEADS And envelopes \$1.00. Hargraves, Box 517, Corning, N. Y.

BARGAIN Price list free, samples dime. Churchill Print, West Medway, Mass.

JOB Printing. Free estimates. H. L. Wilson Press, New Germantown, Penna.

FREE Samples, prices. Quality work, postpaid. Fast service. Sutton Printing, Box 853-M, Waycross, Georgia.

SEND 10c Now for our 48 page 1952 price list—refunded first order. McColl Press, 1326 South 27th, Omaha, Nebraska.

MIMEOGRAPHING—Letters, pricelists, formulas, instructions. Lowest prices. Lem's Letter Shop, 5710 Stanton, Detroit 8.

BUSINESS Printing. Samples, prices free. Howprint, 723-M Eunice, Webster Groves 19, Missouri.

125 8 1/2x11 LETTERHEADS And 125 6 3/4 envelopes \$2.00, postpaid. 250 of each \$3.50. Going Print Shop, Box 1544A, Muskogee, Oklahoma.

1000 BUSINESS Cards \$2.50 prepaid. Samples free. Reliable Print Shop, 907 East Jefferson, Louisville 6, Ky.

500 3/4x2 1/4 FOUR Line gummed stickers 50c. Red border \$1.00. Moritz Printery, Saginaw, Mich.

PRINTING OUTFITS AND SUPPLIES

MAKE Your own, self-molding, rubber printing cuts. Plexirubber, Argyle 1, Wis.

PRESSES, Type, cabinets, supplies. List for stamp. Lincoln Press Company, 220-E Hartwell, Fall River, Mass.

PRESSES, Supplies, paper. Catalog 10c. Custom, Box 211-P, Springfield, Missouri.

PRINT Your own cards, stationery, circulars, advertising. Save money. Simple rules. Print for others, nice profit. Raised printing like engraving too. Have home shop. Details free. Kelsey Presses, L-11, Meriden, Conn.

PRINTING Presses, type, supplies. Lists 3c. Turnbaugh Service, Loysville, Penna.

PATENT ATTORNEYS

INVENTORS—If you consider your invention to be something of importance, take steps to protect it with a United States Patent which gives you the right to exclude others from making, using and selling your invention as claimed. "Patent Protection for Inventors" outlines steps to take to secure patent protection. Mailed promptly without obligation. Victor J. Evans & Co., Merlin M. Evans, Registered Patent Attorney, 731-B Merlin Building, Washington 6, D. C.

INVENTORS—If you believe you have an invention, you should find out how to protect it. The firm of McMorror, Berman & Davidson with offices in Washington, D. C., is qualified to take the necessary steps for you. Send for copy of our patent booklet "How to Protect Your Invention." We will also send you an "Invention Record" form. No obligation. They are yours for the asking. McMorror, Berman & Davidson, Registered Patent Attorneys, 134-F Victor Building, Washington 1, D. C.

"INVENTOR'S Guide" free. Frank P. Ledermann, Registered Patent Attorney, 154 Nassau Street, New York.

REGISTERED Patent attorney offers services. Sanders, 6430 Evans, Chicago 37, Ill.

PATENTS. "Proof of Invention" free. E. E. Vrooman, Registered Patent Attorney, 507 McKim Building, Washington 5, D. C.

INVENTORS—For "Invention Record" form, contact Carl Miller, Registered Patent Attorney, Woolworth Building, New York.

INVENTORS: Learn how to protect your invention. Unless the inventor is familiar with patent matters, he should engage a competent registered patent attorney or agent to represent him. We are registered to practice before the U.S. Patent Office and prepared to serve you in handling your patent matters. "Patent Guide for the Inventor" containing detailed information concerning patent protection and procedure with "Record of Invention" form will be forwarded to you upon request; without obligation. Clarence A. O'Brien & Harvey Jacobson, Registered Patent Attorneys, 21B-A District National Building, Washington, D.C.

INVENTORS: When you are satisfied that you have invented something of value write me, without obligation, for information as to what steps you should take to secure a patent. Write Patrick D. Beavers, Registered Patent Atty., 935 Columbian Bldg., Washington 1, D. C.

INVENTORS: Write for free brochure "Evidence of Invention." Labiner, World Building, New York 38.

C. A. Snow & Co.—M-427, Snow Building, Washington 1, D. C. Registered Patent Attorneys. Write for information.

INVENTORS: Without obligation, write for information explaining the steps you should take to secure a patent. John N. Randolph, Registered Patent Attorney, 203 Columbian Bldg., Washington 1, D. C.

PATENTS—Irving L. McCathran, 315 McLachlen Bldg., Washington 1, D. C. Registered Patent Attorney.

CANADA—Ramsay Company Registered, 273 Bank Street, Ottawa, Canada.

FOR INVENTORS

INVENTORS! For "copyright, design and patent guide" contact Patent Attorney Metzler, 11 West 42nd, New York 18.

PATENT Searches, \$5.00, including patent copies. Same reliable search as conducted for patent attorneys. Complete inventor's services. Free protection forms. 48 hour service. Patent Service Institute, 945-A Pennsylvania Avenue, Washington 4, D. C.

WRITE For seven basic fundamentals of success. Send \$2.00. Money back guarantee. Personal Development Institute, 1004 Southwest 27th Street, Oklahoma City, Okla.

INVENTORS—If you believe you have an invention, you should find out how to protect it. The firm of McMorror, Berman & Davidson with offices in Washington, D. C., is qualified to take the necessary steps for you. Send for copy of our patent booklet "How to Protect Your Invention." We will also send you an "Invention Record" form. No obligation. They are yours for the asking. McMorror, Berman & Davidson, Registered Patent Attorneys, 134-E Victor Building, Washington 1, D. C.

INVENTORS—If you have a valuable invention, you are advised to authorize a preliminary search through appropriate classes of United States patents. This firm is registered to practice before the Patent Office and is available to make such search and report to you concerning the probable patentability of your invention. Instructive booklet with "Evidence of Invention" form sent upon request. Victor J. Evans & Co., 732-B Merlin Building, Washington 6, D. C.

CASH In on your ideas! Learn which inventions are profitable: how to sell or finance and market your invention. Send only \$2.50 for the big 144-page book "Money From Ideas," a primer on inventions and patents by a real, successful inventor. Popular Mechanics Press, Dept. 104, 200 E. Ontario St., Chicago 11, Ill.

INVENTORS: Learn how to protect your invention. Unless the inventor is familiar with patent matters, he should engage a competent registered patent attorney or agent to represent him. We are registered to practice before the U.S. Patent Office and prepared to serve you in handling your patent matters. "Patent Guide for the Inventor" containing detailed information concerning patent protection and procedure with "Record of Invention" form will be forwarded to you upon request; without obligation. Clarence A. O'Brien & Harvey Jacobson, Registered Patent Attorneys, 21A-A District National Building, Washington, D.C.

INVENTORS: Without obligation, write for information explaining the steps you should take to secure a patent on your invention. John N. Randolph, Registered Patent Attorney, 202 Columbian Bldg., Washington 1, D. C.

SEARCHES—Put your patent searches in the hands of a registered patent attorney or agent, as he qualifies to give a worthwhile patentability report. Record of invention form upon request and information on patent protection. Patrick D. Beavers, Registered Patent Attorney, 936 Columbian Bldg., Washington 1, D. C.

SEARCHES \$5.00. Reliable reports air-mailed within 48 hours. "Record of Invention" free. Capitol Patent Service, Box 664-P, Washington 4, D. C.

INVENTORS—For "Invention Record" form, contact Carl Miller, Registered Patent Attorney, Woolworth Building, New York.

CASH For your idea, 280 manufacturers need inventions, patented or unpatented. List free. Invention Bureau, 208M Clinton, Oak Park, Ill.

PATENT Owner representative. Years of experience. Can I help you? Charles A. Scott, 773PM Garson Avenue, Rochester 9, N. Y.

INVENTORS: If you have an invention for sale, patented or unpatented, write Institute of American Inventors, Dept. 40A, 631-E St. N.W., Washington 4, D. C.

INVENTIONS WANTED

INVENTIONS Wanted. Patented or patent pending. 21 years experience promoting inventions. National Service Bureau, 3120 Meramec, St. Louis 18, Mo.

INVENTORS—Good patented, patent pending inventions wanted by manufacturers. Booklet free. Market Contacts, 719-A2 Magnolia, Tupelo, Miss.

INVENTIONS Wanted by manufacturers. Patented-pending only. Free details. Inventors Exchange, Dept. B, Hartford 1, Conn.

INVENTIONS Promoted. Patented or unpatented. Established 1911. Write Adam Fisher Company, 61 Enright, St. Louis, Mo.

INVENTORS: Hundreds of manufacturers have requested our assistance in locating marketable new products. Complete information free. Institute of American Inventors, Dept. 40-D, 631-E St. N.W., Washington 4, D. C.

PATENTS FOR SALE

PATENT No. 2,560,228—Paint can gadget. Will sell or consider partner. Complete details how I obtained patent, etc. for \$1.00 to cover costs. Joe L. Kosorok, Box 1051, Red Lodge, Mont. Phone 06J4.

PATENT For sale that will tie clothesline anywhere without knots. Write S. P. Darbins, 334 West 15th Ave., Homestead, Penna.

NEW Folding sawhorse, patent pending. Write, Edwin Schriber, Nashville, Ill.

INVENTORS: Test the commercial value of your patented or unpatented inventions, quickly and inexpensively. Write for free information. Institute of American Inventors, Dept. 40-B, 631-E St. N.W., Washington 4, D. C.

MANUFACTURING

MODELS—Small lot manufacturing. Metals, plastics, etc. Milburn, Burlington, Kentucky.

MODELS, MODEL SUPPLIES

FUN—Your fun is our business! We stock TT, HO, S, O gauge model trains. Ship and airplane kits and all supplies. Lionel and American Flyer trains, all associated accessories always in stock. New 1952 "O" gauge catalog, scale and tinplate, 40 pages and big mail 25c. Write Dept. W, All-Nation Hobby Shop, 182 N. LaSalle St., Chicago 1, Ill.

BUILD Fly Luscombe, Piper, Aeronca "Quicky" 18" scale models, all for \$2.00. Glue 15c extra. Airplane folder 3c. Cleveland Model, 4508TC211 Lorain, Cleveland 2, Ohio.

MODEL Railroad catalogs free. Shannon's Hobby, 503 Franklin, Nutley 10, N. J.

SHIP And yacht model fittings; blueprints. Send 25c for illustrated catalog No. 27—listing hundreds of items. A. J. Fisher, 1002-1 Etowah Ave., Royal Oak, Mich.

SHIP Models—Most complete line in New England. Kits, fittings, plans, books, tools, engines, motors. Illustrated catalog 25c. James Bliss & Co., Inc., Dept. SM, 220 State St., Boston, Mass.

BRASS Gears and model supplies for the inventors. Send 10c for catalog. Pierce Model Works, Tinley Park, Ill.

SIONEL: American Flyer, illustrated catalog free. Ben's PM Department, 134 North Dearborn, Chicago 2.

BUILD Historic ship models, complete kits 50c to \$9.00. Catalog 15c. Ideal Models, 19 W. 18th, New York 11, N. Y.

SHIP Models and yacht supplies complete. Large 64 page catalogue 30c. Bill Wild's, 510 East 11 St., New York City 9.

STEAM Locomotives, 1/2", 1", 3/4", 1 1/2" scales. Castings, rail, steam fittings! Thorough drawings with instructions. Catalog 50c. Little Engines, Wilmington, California.

HOME CRAFTSMEN

BALSAWOOD: Two boards four feet long, four to six inches wide one inch thick or one board same size except two inches thick. Grade AA. Postpaid \$2.50. Inquiries for rare woods invited. T. W. Caudill & Co., 245 State St., Auburn, N. Y.

SAVE Thousands of dollars. Build your own home. Book and plans for Popular Mechanics Ranch-Type House ready now! Six rooms and carport for \$5000; add breezeway, garage, extra bedroom \$2500. No experience needed. Book shows you how. Get copy today. Step-by-step instructions, hundreds of photos, drawings. Mail \$3.50 to Popular Mechanics Press, Dept. 101, 200 E. Ontario, Chicago 11, Ill.

90 ALL New, full size lawn ornament and novelty patterns, up to 20" high. Only \$1.00. Mastercraft 22M, 7041 Olcott, Chicago 31, Illinois.

LEATHERCRAFT For pleasure or profit. Make easy-to-assemble purses, belts, gloves, woolskin toys, 100 other items for gifts or to sell. Send 10c today for big catalog. Largest leathercraft stock in U.S. J. C. Larson Co., 820 S. Tripp, Dept. 1675, Chicago 24.

OUR Biggest leather and craft catalog yet! 1000's of items. Send 25c (refunded with first order). Russo Handicraft Supplies, Dept. 2-C, 245 S. Spring, Los Angeles, California.

STRIPKRAFT Is profitable! Make many useful articles with colorful fabric-supported plastic tapes, cords. Send \$1.00 for 20 page illustrated book easy instructions, generous supply materials. Stripkraft, 3816 Montrose, Chicago 18, Ill.

16 NEW Lawn chairs, 22 picnic tables, benches, trellises, etc. All 38 plans with necessary full size patterns, \$1.00. Mastercraft 23M, 7041 Olcott, Chicago 31, Ill.

JIGSAW Owners attention! Start earning money at home cutting out wooden novelties and souvenirs. Write H. Cook, Dept. A, 4407 S. Normal Ave., Chicago 9, Illinois.

300 PROJECTS You can make in Popular Mechanics 32-page Blueprint Catalog. Send 3c stamp for copy. Popular Mechanics Press, Dept. 106, 200 East Ontario St., Chicago 11, Ill.

NEW! "100 Best Woodworking Projects"—144 page Popular Mechanics book with 100 special projects for every member of the family. Furniture, toys, novelties, many more. Send \$2.00 to Popular Mechanics Press, Dept. 105, 200 E. Ontario, Chicago 11, Ill.

89 FULL Size jig saw patterns of beautiful shelves, ornaments, toys, novelties. Plus "How, Where to Sell." Only \$1.00. Mastercraft 24M, 7041 Olcott, Chicago 31, Illinois.

LEATHERCRAFTERS — Metal ornaments, buckles, pocketbook accessories. Cosmopolitan Metalcrafters, Box 176-PM, New York 8.

GENUINE Deerskin leather, soft, pliable, tanned rich saddle shade. Make your own gloves, moccasins, vests, jackets, etc. You get the entire skin of the Doe or Buck. From 4-15 sq. ft. Price \$1.00 sq. ft. Check or money order. A. Frank, 45 Vesey St., New York 7.

LEATHERCRAFT, Leathers of all kinds. Large savings. Also job lots. Free price list. Hyman Zeitlin Co., Inc., 38 Spruce Street, New York 38.

CARVED Wood ornaments, beautify and increase value of any wood project. Send for free illustrated circular of wood carvings designed especially to make your home workshop projects more beautiful and more valuable. Send post card to Hasse Carvings, 35 S. Oxford St., Indianapolis 1, Ind.

VIOLINMAKERS, Amateurs, professionals. Fine tone European wood, materials, supplies, instructions, patterns. Illustrated catalogue 10c, refunded. Premier Violin Supplies, Dept. VZ, 430 South Broadway, Los Angeles 13, California.

ABUNDANT Low priced leathers. Make leather belts, billfolds, purses. Big catalog free. Tandy Leather, Box 397-C, Tulsa, Oklahoma.

JIGSAW, Bandsaw owners, let your machine bring extra profits, fun. Free details. Nu-Art, Dept. B, Box 2235, Boston, Mass.

"TOPS" In everything for leathercraft. Low priced kits, leathers, tools, lacing. Catalog 10c. Crown Leathers, 22 Spruce Street, New York 38.

LEATHERCRAFT, Tremendous stock of leather, tools, supplies, and kits. In leather business over forty years. Send 10c for big catalog. Sax Bros., 1111 No. 3rd, Dept. PM, Milwaukee 3, Wisconsin.

FREE information. How to make money with jig saw. Write Jigsawers, 117-M Worth, New York 13.

WOODCRAFT Patterns — Large what-nots, lawn ornaments, toys, novelties, large assortment \$1.00. Joanness, Box 141-E, Omaha 7, Nebr.

WHOLESALE Shellcraft book 15c. Large shellcraft kit \$1.85 postpaid. Shell-Art Novelty, 5th and Moore, Philadelphia 48, Penna.

OZARK Wood samples. Eleven varieties prepaidd. \$1.50. Davis Lumber, Cabool, Missouri.

\$46 FROM Square foot plywood; jigsaw necessary. Write: Woodarts, Bridgewater, Mass.

KNOCKDOWN Cedar chests. Lumber and veneers. Free price list. Giles & Kendall Company, Huntsville, Ala.

HAVE Fun! Make money! "Working With Leather," 64-page booklet tells how. Send 25c for copy. Free gift if you mention this magazine. Valuable information included. No foreign orders. Wilder & Company, 1039 Crosby, Chicago 10.

30 LAWN Ornament patterns. Ready cut. Full size. Color indicated. \$1.00 postpaid. Lincoln Craft Studio, Columbia, Conn.

100 FULL Size jig saw patterns up to 20" high, only \$1.00. Pattern Service, Medway 9, Mass.

LEATHERCRAFT, Copper tooling, textile painting, many other crafts. Big free catalog shows everything you need. Kit Kraft, 7377 Melrose, Hollywood 46, Calif.

LEATHERCRAFT Supplies catalog. Pleasure and profit. New style handbag patterns, belts. Leathercraft school G.I. approved. 25c for catalog (refund 1st order). Dept. PM, Apache Leather Co., 2004 E. Washington St., Phoenix, Arizona.

LEATHER, Tools, lacings, supplies. Free catalog. National Handicraft, 199 William St., New York 7.

SWISS Music movements, finest make, lowest price. Ask for leaflet. Helaxe Company, 233 West 72nd Street, New York.

MAKE IT YOURSELF

FOUR Wheel drive tractor you can build — Riding, walking from our plans. Used auto parts. Information. Paul's Tractor, 1301 Arrow Fontana, California.

BEAUTIFUL Rustic electric lantern easy to build for a few cents. Simplified instructions, plans and templates, \$1.00. Conti Supply Co., 92 Columbia St., Wood-Ridge, N. J.

LONGED For a beautiful stone home? Precast your own stone. Formulas, illustrations, patterns, complete instructions. Designed for home use. Send \$3.00. Alburg Sales, Box 17, Carrollton, Mich.

PATTERNS, Full-size. Buffalo Boy rocker, 25c; bootshine and stepstool, 25c; wheelbarrow, 35c; clown clothes rack, 25c, or all four \$1.00. Illustrated folder, patterns and kits. Tom Tot Furniture, Box 741, Helena, Montana.

ELECTRIC Clothes drier easily built. Blueprint \$1.00. Northwest Crafts, 134 E. 63rd, Seattle 5, Wash.

FREE Blueprint Catalog! Hundreds of projects—motor scooter, furniture, toys, birdhouses, radios, garden furniture, power tools, boats, workbenches, home freezer, many more! Send postcard to Popular Mechanics Press, Dept. 103, 200 E. Ontario, Chicago 11, Ill.

CONSTRUCTION Blueprints for lovely low cost, two bedroom, basementless home. Sample construction contract free. Send \$1.00. Plans, Box 1007, St. Clair Station, St. Paul 5, Minn.

BUILD Lathes, presses, other production machinery with Kimo Plans, Box 307-P, New York 19. Satisfaction guaranteed. Catalog 25c (refundable).

SMALL Riding tractor: Build from manufacturer's plans. Nothing like it on market today. Many uses. Patent pending. More maneuverable than a "cat." A "cat" locks one track and turns around with the other track. This Turn-O-Bout tractor can have the locked wheel in reverse while the other wheel goes forward (actually turning in its own tracks). Two levers operate the simple control unit which actually eliminates making a clutch, transmission, differential, brakes or steering mechanism. The control unit consists of parts available in your local stores. Retail for \$495.00. Yours for the cost of the parts and spare time. Send today only \$1.00 for simplified easy-to-read prints showing construction and control unit as applied to the hundreds of Turn-O-Bout Tractors now in use. Turn-O-Bout, 1668 Willamette, Eugene, Oregon.

BUILD A model of your "dream house." Complete kit \$5.95 postpaid. Use our professional model-makers' materials — accurately scaled to 1/4 inch. New kit contains plans, instructions, and plywood panels of shingles and siding, and large assortment of plastic doors, windows, etc. Use your own design or our plans. Satisfaction guaranteed. Or send 10c for samples and booklet "How You Can Build Model Homes." Architectural Model Materials, Inc., Dept. M22, 4208 Armitage Ave., Chicago 39, Ill.

GRANDFATHER Clock easily built. Big savings. See ad on page 276.

HOMES You can build for \$4500 to \$7046. Books that take you through every step. Popular Mechanics Famous Concrete Block House, \$2.00. Your Home and How to Build It Yourself, \$3.00. Also full-sized builder's plans for each home at nominal price. Popular Mechanics Press, Dept. 102, 200 E. Ontario St., Chicago 11, Ill.

CIRCULAR Portercraft home. Low construction cost. 23% more efficient. Plans \$1.00. Free details. Portercraft, Box 87A, Mt. Washington, Cincinnati 30, Ohio.

FREE Handbook, build sawmills, block machines, freezers, tractors, scooters, 250 shop, farm, home machines. Nichols Co., Dept. C-1801, Purvis, Mississippi.

INVALIDS—Have your hospital bed motorized inexpensively. Plans \$10; photos, details \$1. (deductible). F. W. Collett, Box 943-M, Fort Pierce, Florida.

STREAMLINED Breakfast, utility bar. Start with orange crates! One evening, inexpensive, easy, sells. Ideal school shop project. Plans 50c. Waynecrafts, Box 9, Gas City, Indiana.

BUILD Your own concrete block machine. Easy. Inexpensive. Motor or hand. Also build mixer. Write. C. Lee, Mountain View, Oklahoma.

STREAMLINED, Built-in kitchen cabinets to fit any kitchen. Illustrated manual describes designing and construction. All for \$1.00. Thombert Company, Newton, Iowa.

SEND 25c Today for new large catalogue of supplies for 21 popular crafts. Dept. D-11, Dearborn Leather Company, 8625 Linwood Avenue, Detroit 6, Michigan.

BUILD Your own "tractor." Free information. Eltraco, D-I, Camptonville, California.

"CONCRETE Block Homes." 32 page booklet on how to build. \$1.00. H. C. Lightfoot, Civil Engineer, Richboro 1, Penna.

WATCHES, OLD GOLD, JEWELRY

WATCHMAKERS — Write for tool and material price list. Fred Harmon, Somerset, Kentucky.

WATCHMAKERS' Hobbyists' complete informative catalog 20c. Bengal Company, Culver City, Calif.

"THE Modern Clock." All about clock repair. 502 pages. 173 illustrations. \$4.95, postpaid. 10-day return privilege. North American, Dept. 12-B, 2018 North Avenue, Chicago 47, Illinois.

RHINESTONES Jewelry settings, camcos, sequins, beads. Send 10c for illustrated catalog. J & M Novelties, Dept. BA-3, Griffith, Ind.

SWISS Watches from importer. For resale only. \$3.25 up. Free catalog. Transworld, 565 5th Ave., New York 17.

WRIST Watches. U. S. Air Corps, Waltham. 16 jewel, water and shock proof, stainless steel case, reconditioned. Value \$55.00—special \$17.95. Public Sport Shops, 11 S. 16th Street, Philadelphia 2, Penna.

NEW Catalog lists over 5000 styles. Gold plated jewelry supplies, Rhinestones, pearls, etc. Complete details, only 10c. Barry's, 47-11 Branford Place, Newark 2, N. J.

HIGHEST Cash paid for old, broken jewelry, gold teeth, watches, silverware, diamonds, spectacles, platinum. Free information. Satisfaction guaranteed. Rose Smelting Company, 29-A East Madison, Chicago.

TOBACCO, SMOKERS' SUPPLIES

REAL Swiss buyere tobacco pipe with Edelweiss flowers engraved. Remit trustfully \$2.00. Kobler, P. Postmaster, Neufeldstrasse 141, Berne, Switzerland.

50 CIGARS, \$2.25. Irregulars of a popular 15c size. Others. Public Cigar Co., East Orange 1, N. J.

SMOKE Genuine Havana cigars. \$9.50 for 25; \$36.00 for 100. Money order to Abel Camacho, Apartado No. 989, Havana, Cuba. References: Bank of Boston, Havana, Cuba.

PIPES, Pipemaking kits, instructions, circular 10c. Carvapipe, 2829 K Dixie, Hamilton, Ohio.

CIGARS, 25 Havanas, \$2.00. S. & E. Co., Red Lion, Penna.

CIGARETTES—Roll 200 mild-tasty for 75c. Particulars free. Pete Moberly, Box 850, Owensboro, Kentucky.

AROMATIC Agents increase smoking pleasure. Information free. Cozza, Pharmacist, Pequannock, N. J.

CIGARS—Clear Havana, handmade. Regularly 15c. \$5.50 for fifty, postpaid. Save \$2.00! Check or money order. C.O.D. (You pay charges). Seco Cigars, Rochelle Park, New Jersey.

OF INTEREST TO WOMEN

MODERNIZE Kitchen cabinets. Custom made slab doors, drawers, hardware, and atomic age accessories. Thombert Company, Newton 15, Iowa.

FOR SALE—MISCELLANEOUS

FREE—War surplus catalog. We sell for less. Prices slashed on welders, motors, generators, hydraulics, pumps. See ours first. LeJay Company, Minneapolis, Minn.

GUARANTEED Fresh names, compiled daily, cash mailorder buyers, opportunity seekers, etc. Thousand \$4.00, trial 300 \$1.00. Our supermalls, 25c. Wright Publications, 2270 Hubbard, Memphis 8, Tenn.

SAVE 50%. Build power mower. Parts list free. Smith Agency, PM, Excelsior Springs, Mo.

EVERYDAY Gift wrapping paper, 30 sheets \$1.50. Celester, 2233 Eastern Ave., Indianapolis 18, Ind.

MAILING List: guaranteed, \$4.00—1000 names. Alban Burke, 1212 Franklin Ave., New York 56.

SAVE Money on chrome cabinet hardware. Write Box 89, Troy, Ohio.

HANDSIGHTING Levels, improved, new model, used for grading land, contouring and laying out fences, piers, roads and gardens, price \$2.50 postpaid. Public Sport Shops, 11 S. 16th Street, Philadelphia 2, Penna.

SAVE Money on army, navy and factory surplus. Write today for new 60-page illustrated catalog. Tennusa Sales Co., Dept. AN, 1451 Market, Chattanooga, Tenn.

WANTED—MISCELLANEOUS

IF You want to swap, buy, sell anything, send \$1.00 for big list people coast to coast, who swap, sell, buy almost anything under the sun. Toole, Bernardin Apts., Evansville, Indiana.

QUICKSILVER, Platinum, gold, diamonds, sterling, dental-jewelry-optometrist scrap. Ship or write. Wholesale Terminal, Norwood, Massachusetts.

SCRAP Mercury (quicksilver) tantalum, bismuth, tungsten. Metallurgical Products Company, Established 1909. 35th & Moore Sts., Philadelphia 45, Penna.

PERSONAL

LETTERS, Errands, services. Reliable. Lowest rates. Skol, Box 62, New York 13, N. Y.

LIKE To cut your own hair? Send \$2.00. Eok Haircutter, Box 1691, Miami 10, Fla.

BORROW by mail. Loans \$50 to \$600 to employed men and women. Easy, quick. Completely confidential. No endorsers. Repay in convenient monthly payments. Details free in plain envelope. Give occupation. State Finance Co., 323 Securities Bldg., Dept. H-14, Omaha 2, Nebr.

INTERESTING Mails. 25c keeps name on mailing list three months. Bentz, (Desk-E/44), Chatawa, Mississippi.

RUPTURED? Positive comfort, no undertraps, no steel, no elastic. Write Smith Manufacturing Co., Preston, Ont.

BITE Fingernails? Order J.M.J. today. For men and women. Mail \$1.00 to The Jamarr Co., 1844 Castle Pl., Dallas 11, Texas.

SURPRISE Your friends. Have us mail, remail 25c each. Let Well-doing do it. Well-doing, 1712 1/2 Nebraska, Tampa, Florida.

PRINT Without a printing press. Big profits! See page 43.

DALLAS Remail 25c each. Simone, 402 West Elmore, 16 Dallas, Texas. View cards 5c.

MEXICAN Law practice reliably conducted. Box 1736, El Paso, Texas.

LOW Cost hearing device. No batteries. No wires. No upkeep. Many satisfied users. Beaudry, 4337-H 30th Ave. S., Minneapolis 6, Minnesota.

"HOW Can I find out?" You can! Information discreetly developed. Any matter, person, problem, anywhere. Worldwide. Officially licensed, bonded service. Established 1922. Reasonable. Confidential. William Herman, 170 Broadway, New York.

HERE'S How and where to borrow \$50.00 to \$300.00 by mail. Confidential. Free particulars. Postal Finance Company, Dept. 45, Sioux City, Iowa.

MISCELLANEOUS

SELECTIVE Metal and mineral detector. Revolutionary design. Distinguishes metals from black sands; readily detects metals under salt water. Free literature. Gardner Electronics Co., Dept. 12, 2018 N. Dayton, Phoenix, Arizona.

RESEARCH: We find, locate buyers, or sellers for anything of value. Registration and listing, \$1.00. Refundable. Wright Publications, 2270 Hubbard, Memphis 8, Tenn.

WHY Die? Know latest medical discoveries and live! "Your Medical Scrapbook" tells everything! Free literature: Bijou, Box M-1727, Hollywood 28, California.

INCREDIBLE! Unprecedented! Become a mental superman overnight! Floor everybody! No studying! "Memoprop" does all your thinking! It's uncanny! Revolutionary! Write: Bijou, Box 1727-MM, Hollywood 28, California.

CARTOONS. The kinds you'll like. Samples 25c. Verret, Raceland, Louisiana.

DELAYED Action wall switch. Walk many steps before light goes out. Enclose \$2.00. Edwill Co., 1246 E. Dickinson, Grand Rapids 7, Michigan.

URANIUM Prospecting information free. Prospector, Box 142-I, North Battleford, Saskatchewan, Canada.

PROTECT Your identification, social security, driver's license cards, wallet size photos; sealed in transparent plastic; 50c each. 3 for \$1.25; 6 for \$2.00. Satisfaction guaranteed. Keeler Products, 1703-PA North Albany, Chicago 47.

CESSPOOL Trouble? Use Peps-It. Rejuvenates fermentation action, saves pumping costs, deodorizes, reduces masses. Costs only \$2.50. Safe. Sanitary. Free descriptive literature. Chemical Cesspool Cleaning Co., Boston 34, Mass.

SQUARE Dance instructions, thirty dances, \$1.00. Wesley Rader, 3926 Alcott, Denver 11, Colorado.

RECEIVE Giant mails, magazines, catalogs! Three months 25c, year 50c. Waddell's Directory, 341B East 76th, New York 21.

CORSAGE Materials, Flower arrangers' supplies, House plant helps. Free catalog. Floral Art, Dept. PMC, Teaneck, N. J.

"HOW To win contests." Secrets exposed, \$1.00. Erickson, 250 McLaughlin, Muskegon, Michigan.

AMAZING Plastic air cushion \$1.00. Wenogart, Box 1495, Philadelphia 5, Penna.

SMASH Worries, fears and problems with our "Thought and Behavior Control" home-study method. Many helped. Rush request for amazing free lecture in plain wrapper. Personal Psychology, Inc., Box 1924-N, Louisville 1, Kentucky.

DRESSES 24c; Shoes 39c; men's suits \$4.95; trousers \$1.20. Better used clothing. Free cat. Transworld, 164-AD Christopher, Brooklyn 12, N. Y.

BE Comedian. Entertaining, profitable. Free particulars, Emclie, Box 983, Chicago 90.

LAWN Mowers. Hand and power sharpening, adjusting and engine care. Easily done by yourself. Knowledge 22 years experience yours for \$1.00 postpaid. Wirt's, 2419 Gnahn, Burlington, Iowa.

LUMINOUS Paint, paper, pigments. New fascinating hobby. Profitable applications galore. Liberal quantities. Complete instructions. Experimental kit \$1.00. Glowell Company, 475 Fifth Ave., New York 17.

EGG Vending. Route operation. Vassar, 3500 14th, Washington 10, D. C.

POEMS Wanted for publication consideration, details free. J. Barnes, Publisher, Box 490 Times Sq. Station, New York 18, N. Y.

FREE Catalog! War surplus clothing. Amazing bargains. N. Y. Clothing Co., New York 29A.

VITAMINS. Special two weeks trial supply of potent Multi-Vims only \$1.00. Satisfaction guaranteed. Vigor Vitamins Company, Box 5, Cedar Rapids, Iowa.

BIG Mails, mail order magazine opportunities 25c. Harvey Teeple, Decatur, Indiana.

OUTDOOR Toilets cleaned, deodorized! Cut digging, pumping, moving costs. Safe, economical. Details free. Wilmette Farm Supply, Dept. 90, Wilmette, Ill.

IMPROVE Your writing—Learn shaded writing and how to make money with penmanship! Write today for free details. Tevis The Penman, Box 25-A, Chillicothe, Mo.

GOLD, Silver, metal detectors. Geiger counters for uranium. Mineralights. Sensational new fully guaranteed models. None finer. Information free. Detector Co., 5631 Cahuenga Blvd., North Hollywood, California.

PORTABLE Electric hot air heater complete with thermostat. Write for free bulletin. Johnson, 1638 Granville, Chicago, Illinois.

PLANE Blades, scissors sharpened. Enclose 35c each. Edwill Co., 1246 E. Dickinson, Grand Rapids 7, Michigan.

BRAZILIAN Orchids. Ask catalog. Orquideario Catarinense, Exporters, Corupa, Santa Catarina, Brazil.

LEATHER Jackets repaired. New knit, zippers or relined. Work fully guaranteed. Jackets made to order. Free circular. Taubers, 689 Mission, San Francisco 5, Calif.

INTERESTING Booklet, "Baseball's Hall of Fame," 25c postpaid. Wells Publications, Box 241B, Alton 4, Illinois.

MEDICAL Laboratory Technicians in great demand. We train you in your own home. Catalogue free. Imperial Technical Institute, Box 973-J, Austin, Texas.

OUTDOOR Toilets, cesspools, septic tanks cleaned, deodorized with amazing new product. Just mix dry powder with water; pour into toilet. Safe, no poisons. Save digging, pumping costs. Postcard brings free details. Burson Laboratories, Dept. C-36, Chicago 22, Illinois.

YOUR Leather jacket renovated expertly. Free circular. Berlew Mfg. Co., Dept. 8, Freeport, N. Y.

GENUINE Buckskin jackets, gloves. Send 50c for buckskin money pouch and free catalogue. Berman Buckskin Co., Minneapolis, Minnesota.

70 BIBLE Lessons, 25c. Bulletin, Box 87, Cathedral Station, New York 25.

TREASURE Finders for gold, silver and minerals. Money back guarantee, best available. Also Geiger counters for uranium prospectors, free information. Write Goldak Company, 1541 West Glenoaks, Glendale 1, Calif.

PANNING Gold lesson and catalogue. Beginners supplies, books, "maps where to go" free. Old Prospector, Box 729D1, Lodi, Calif.

TREASURE—M-Scope Geiger counters, mineral locators. Why buy something inferior when you can buy the best at a lower price? Backed by years of experience. Fully guaranteed by factory. Detects minerals, metals, gold, silver, coins. Payment plan available. Proven superior performance. Free 16 page illustrated booklet. Fisher Research Lab., Inc., Palo Alto, California.

FINE TOOLS NEED FINE OIL!



• Lubricates



• Prevents Rust

• Cleans • Polishes

SOLD EVERYWHERE

3-IN-ONE Oil

GET
UP TO
40%
OFF!

BUY IT WHOLESALE!

START A BUYING SERVICE at home, spare time.

Get big-name merchandise for clients (and yourself) at up to 40% and more below the regular list price. Make fat commissions. Folks eagerly buy through you to get sizeable discounts. Send postcard for details.

AMERICAN BUYERS' SERVICE, 631-R Linden Ave., Buffalo 16, N. Y.

LEARN PHOTOGRAPHY

Famous Low Cost 16 Wk. Home-Study Course. A fascinating Hobby or Money-Making Career can be yours in Portrait — Advertising — News — Magazine — Fashion — Landscape — Photography.

Write for particulars today!

APPLIED PHOTOGRAPHY ACADEMY

910 North Main St.
Akron, Ohio



Don't Send a Cent

Until you see our tires. "REMEMBER" you get only what we advertise. "Not retreads." Not Recapped. Not new treads — that have been recapped. WE SHIP ONLY GOOD USED TIRES. Send for just one tire and see if this trial will make you a satisfied customer.

BUT IF YOU SEND CHECK OR MONEY ORDER IN FULL WITH THIS AD "NOW"—you may take **20%** discount on every tire. SAVE TIME — SAVE MONEY

TUBE GIVEN WITH EACH PASSENGER & TRUCK TIRE

WRITTEN GUARANTEE — Sent with Every Tire You Buy
ONE Quality ONE Price — Why take less? Our Tires used on cars & Trucks for every purpose — 18 YEARS AT THIS ADDRESS

| | | | | | | | |
|--------|--------|--------|--------|--------|--------|--------|--------|
| 600x16 | \$6.73 | 670x15 | \$7.75 | 710x15 | \$7.87 | 760x16 | \$8.95 |
| 750x15 | 7.24 | 700x15 | 7.95 | 750x16 | 8.58 | 820x15 | 8.85 |
| 650x16 | 7.32 | 700x16 | 7.80 | 760x15 | 7.95 | 550x17 | 6.40 |

No Re-Caps. These Tires Will Carry You Twice As Far!

| | | | | | | | |
|--------|---------|----------|---------|---------|---------|---------|---------|
| 600x20 | \$12.18 | 32x6(8) | \$15.00 | 900x20 | \$23.00 | 1000x22 | \$22.75 |
| 650x20 | 12.69 | 32x6(10) | 17.50 | 1000x20 | 22.75 | 1100x22 | 22.95 |
| 700x20 | 15.00 | 34x7 | 17.00 | 1100x20 | 22.75 | 1100x24 | 23.95 |
| 750x20 | 15.71 | 825x20 | 23.00 | 550x18 | 6.50 | 700x17 | 13.00 |

Thousands of tires shipped all over U.S.A. All tires shipped F.O.B. Phila. Send Check or M.O. with this ad. Dept. 2.

STANDARD 834 N. Broad St., Philadelphia 30, Pa.

FREE BOOK AND ACTUAL SAMPLE

Screen Print, Dept. 22
1010 So. Los Angeles St.
Los Angeles 15, California
Dear Mr. Nowak: Please rush me FREE BOOK, ACTUAL SAMPLES, and your amazing new PRINTING PLAN

Name _____
Address _____
City _____ State _____

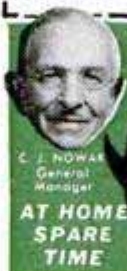

IT'S AMAZING! I'll show you how to make up to \$12.50 per hour

PRINTING WITHOUT A PRINTING PRESS

AMAZING NEW COLOR PRINTING METHOD

A fascinating new miracle-way to print—a secret method that lets you print colorful signs, posters, banners, drapes, wallpaper, flags, glass, fabrics—ANYTHING without an expensive printing press or costly equipment. This new process is revolutionizing the entire printing industry—it's one of America's fastest-growing businesses—it's your "chance of a lifetime" to make Big Money Now! Be the FIRST in your area to profit. The secret can be yours—just mail the coupon above today!

EASY TO LEARN! NO EXPERIENCE NECESSARY! Simple fascinating method! No artistic ability needed. It's possible for anyone (young or old) to make up to \$50 PER WEEK printing in SPARE TIME alone—AT HOME!

START YOUR OWN BUSINESS—BE YOUR OWN BOSS
Wouldn't you be happy if you could take only one hour of your time and \$1.00 worth of materials—and sell your printing for \$15 or more. It's that easy! It's amazing! Your home can be your office—No selling because there's a huge demand everywhere. GOVERNMENT CONTRACTS AVAILABLE TO BID. Biggest opportunity in America—costs you nothing to receive all CONFIDENTIAL FACTS — Mail coupon today!

SCREEN-PRINT, Dept. 22
1010 S. Los Angeles St., Los Angeles 15, Calif.



Print paper of all kinds

PRINT BANNERS

PRINT FABRICS

PRINT INSTRUMENTS

FOR SALE

YOU CAN PRINT ANYTHING WITH



FIX SAGGING FLOORS YOURSELF with TEL-O-POST



Save big repair bills for fixing sagging floors — which cause cracking plaster, sticking doors, open joints. Install Tel-O-Post yourself for only \$10.

Tel-O-Post is the original adjustable steel post with a built-in jack. Used in cellars, under porches, in garages, barns, etc. Only 20 minutes to make installation.. patented locking pin assures safety.

Ask for Tel-O-Post at your building supply, lumber or hardware dealer . . . or send coupon and \$10 check.

BRAINARD STEEL COMPANY, Dept. C-2
Griswold Street, Warren, Ohio

- Send illustrated booklet on Tel-O-Post installation.
- My dealer does not stock. Enclosed is check for \$10 (\$15 West of Kansas City). Ship via express prepaid one No. 1 Tel-O-Post, adjustable from 5' to 8'4".

Name _____
Address _____
City _____ State _____

MONEY-BACK GUARANTEE IF NOT SATISFIED

BUILD A \$15,000 A YEAR FUTURE!

IN THE EXCITING NEW BUSINESS OF LAUNDERING VENETIAN BLINDS

There is big money to be made cleaning Venetian Blinds and a permanent, fast growing, Lifetime Business, besides.

An amazing new kind of business of your own in a field that is growing like mad. Millions of Venetian Blinds need laundering at regular intervals.

With our new patented machine, you can start small—using your basement, garage or utility room to begin with. You can expand as your business increases by leaps and bounds. Income up to \$200.00 daily already being made by others. Small investment for equipment starts your own lifetime business—and monthly payment plan permits you to pay for it as you grow.

FREE Get all the facts about this sensational new kind of machine that launders blinds so fast that your charges are unbelievably low. People would rather send blinds to you than do the work themselves. Yet, you make 700% profit on every blind you clean. Get names of successful owners near you. Get details of the full amazing plan without obligation. Be first in your territory to start a business that has brought \$15,000 PROFITS the first year to others. Wire today or send name on postcard.

VENETIAN BLIND LAUNDRY EQUIPMENT CO. INC.
442 N. SENECA ST. DEPT. 102 WICHITA 12, KANSAS

GREER SHOP TRAINING

2230 So. Michigan Blvd.
Chicago 16, Illinois

Leader in Practical Training for 50 years

Gain success by learning a trade offering security and high pay—go into business for yourself.

Get the "Know-how" at Greer

You learn in our new, large, modern shops by working with latest tools and equipment of the trade—tear down, inspect, repair and rebuild... under supervision of experts. Greer founded 1902. Over 51,000 successful grads. Part time, full time, day and evening. E-Z terms. Mail coupon today.

CLIP COUPON... MAIL TODAY

Greer Shop Training—2230 South Michigan
Chicago 16, Illinois Desk 213

Please send information about trade checked:

In our Chicago Shops: Auto Mechanics

Body, fender Repair Diesel

Welding—Arc, gas Tool & Die

Refrigeration & Air-conditioning

Machine Shop Piano tuning

G.I. approved disabled Vets disch. after
July 25, 1947

Or learn at home—extension courses:

Diesel Refrigeration Plastics

Name _____

Address _____

City _____

State _____

Age _____



Be Your Own Boss

Learn How to Run a MAIL ORDER Business from Your Home

**BIG PROFITS
SMALL INVESTMENT**

No limit to opportunities in Mail Order selling. Only IDEAS count! Get orders and money by mail—ship by mail—get your goods from manufacturers at wholesale—sell at retail. All the profit is yours to keep. Learn the "inside angles" at home in spare time from America's outstanding expert on Mail Order techniques. **Send No Money**—all facts FREE. Rush name and address on postcard for inside information.

The L.W. SURVEY DEPT. 12, CHICAGO 26, ILL.



SILVER SOLDER TORCH & KIT \$7.50

JOINS ALL METALS PERMANENTLY

Do your own repairing. KIT includes one tube silver solder "XCEL-FLUX" paste and 10 5-in. lengths silver solder alloy. Hottest ALCOHOL TORCH known. 2700° F. flame. Operates in any position, indoors or out. Pint of special fuel included. TORCH alone with pint of special fuel \$8.50. KIT alone \$1.50. Add 35c on each order towards shipping charges.

AMERICAN PRODUCTS CORP., 422 S. Dearborn, Dept. 3-B, Chicago



SPORTONE MUFFLERS

Ford & Chevrolet.....\$ 4.45

All other popular cars..... 5.45

V-8 Dual Sets..... 15.95

Chromed Silentips..... 2.95

(Please state make & year of car on all orders.)

SANDEE MUFFLER CO.
5643 Carryna Place • Culver City, California

Quick, EASY Way to REPRODUCE any Object

Make exact duplicates of trays, lamp bases, medals, figurines, vases, etc. right at home over night! New RUBBER MOLD method needs no heat curing. No special skill or tools required. Make perfect reproductions of objects of clay, plastiline, wood, metal, glass, in any quantity! Cost will be only few cents. Send for Brochure 42 which gives exact step-by-step instructions anyone can understand and follow. Send 10c for it today to SCULPTURE HOUSE, 304 West 42nd Street, New York 18, N. Y.



Become a Doctor of PSYCHOLOGY

Win the degree of Ps.D. Teach the secret of contentment, happiness. Solve mental worries. Experience the revelation of truth. Chartered college. Individual help. Write for FREE book. COLLEGE OF UNIVERSAL TRUTH, 5153-B North Clark St., Chicago.

3-WAY LONGER LIFE FOR YOUR BATTERY



NO GADGET!
A basic invention developed in the University of Miami's Electronics Research Laboratories.

HYDROCAPS
Make Water From Battery Gases!



HYDROCAPS capture and recombine escaping gases, return them to battery as water. End low water danger, give high-level safety.

Warn of dangerous overcharge. Prevent costly corrosion. HYDROCAPS keep battery water at safe level 8 times longer! Nothing to refill or go wrong. \$1.95 set of 3, ppd. 90-day factory guarantee. Print battery make, name and address in margin. Send with check or money order today. Sorry, no C.O.D.'s.

S & S CO., 1014 Hardee Road, Coral Gables, Florida

If you can draw, your future is secure

America's 12 Most Famous Artists

now test your art talent!



This exciting test, printed on 8 large pages of 11" x 14" drawing paper, has over 50 illustrations. It tests you seven ways to show your sense of design, composition, form, observation, imagination, originality and picture sense. Yours if you act today.

Thousands paid \$1.00 to take this amazing test. To meet the ever-increasing demand for artists needed for higher-paying jobs, this talent test is now offered **FREE. Quantity limited. Write today!**



FAMOUS ARTISTS COURSE

Studio 6-B, Westport, Connecticut

Send me with no obligation the Famous Artists Talent Test

Mr. _____
 Mrs. _____ Age _____
 Miss _____ (please print)
 Address _____
 City _____ Zone _____ State _____

| | | | |
|--|---|--|---|
| <p>Bass WEEJUNS ... for leisurely comfort</p> | <p>Bass QUAIL HUNTERS ... for field and stream</p> | <p>Bass SKI BOOTS ... for extra control</p> | <p>Bass SPORTOCASINS ... for better golf</p> |
|--|---|--|---|

G. H. BASS & CO.
60 Main Street
Wilton, Maine

LEARN THE VITAL ELECTRIC EQUIPMENT and APPLIANCE SERVICE and REPAIR BUSINESS

I made \$800 in three months while still taking your course.
F. V., New York

and APPLIANCE SERVICE and REPAIR BUSINESS

I made \$14 per day while still learning.
T. E. H.
West Virginia

BIG MONEY—INDEPENDENCE
 Here is the ideal business for the man who is happiest when working with tools. Wide open opportunities in every city, town, village. Everyone a customer for the man trained to service and repair electrical equipment and appliances.

NO PREVIOUS EXPERIENCE NEEDED
 New visual method of instruction teaches you how to repair electric motors, house wiring, refrigerators, auto ignitions, automatic washers, garbage disposals, fluorescent lights, irons, cleaners, etc. **NO PREVIOUS EXPERIENCE NEEDED.** Almost before you know it you will have the knowledge to help you make **BIG, EASY PROFITS** at home in this highly respected and growing field.

Yours!
Big Kit Tools
 Does not cost you one cent extra.

AGE NO HANDICAP
 Young men, older men, even the man of 69, can find a place in this expanding big-money field. Grasp this opportunity for better things today

Your Own Business—Spare or Full Time
 Your own business—your own shop. Complete step-by-step instructions include our book, "HOW TO OPEN YOUR OWN BUSINESS." Costs nothing extra. PTS training more than a home-study course—gives you the "know-how"—all the professional secrets of electrical equipment and appliance repair and service—the operation of your own shop from a business standpoint—what to charge—how to bring your customers to you—everything to start you on the road to success and future security. I'll send you my complete plan that shows you how to learn the electrical equipment and appliance service business. **SEND NO MONEY—WRITE TODAY!**



FREE! Book that tells you how to learn to repair and service electrical equipment and appliances.

MAIL COUPON NOW

PACIFIC TRAINING SCHOOL, Dept. P-522
 7217 S. Broadway, Los Angeles 3, Calif.
 Send me your **FREE** book that tells me what electrical appliance repair and service can mean to me. Remember I am under no obligation

Name _____
 Address _____
 City _____ Zone _____ State _____

New Amazing Invention—"Magic Art Reproducer"

DRAW THE FIRST DAY!

NO LESSONS! NO TALENTS!

You Can Draw Your Family, Friends, Anything From REAL LIFE — Like An Artist Even If You CAN'T DRAW A Straight Line!



Complete for only \$1.98

Also Excellent for Every Other Type of Drawing!

- Human Figures • Outdoor Scenes, landscapes, buildings
- Still life, vases, bowls of fruit, lamps, furniture, all objects • Copy photos, other pictures, portraits, etc.
- Copy blueprints, designs, decorations, etc., for woodwork, machine, for needlework, crocheting, knitting • Copy all cartoons.

Yes, anyone from 5 to 80 can draw or sketch or paint anything now . . . the very first time you use the "Magic Art Reproducer" like a professional artist — no matter how "hopeless" you think you are! Anything you want to draw is automatically seen on any sheet of paper instantly! Then easily and quickly follow the lines of the "picture image" with your pencil . . . and you have an accurate original drawing that anyone would think an artist had done. Also makes drawing larger or smaller as you wish. Anyone can use it on any desk, table, board, etc.—indoors or outdoors! No other lessons or practice or talent needed!

Have fun! Be popular! Everyone will ask you to draw them. You'll be in demand! After a short time, you may find you can draw well without the "Magic Art Reproducer" because you have developed a "knack" and feeling artists have—which may lead to a good paying art career.

Dept. 5802, 296 Broadway New York 7, N. Y.

FREE! "Simple Secrets of Art Tricks of the Trade"

This valuable illustrated guide is yours FREE with order of "Magic Art Reproducer." Easy ABC art tricks that anyone can follow on different techniques, effects, proportions, perspectives, shading, color, animated cartoons, human figures to use with "Magic Art Reproducer" for added touches to your drawings.

SEND NO MONEY! Free 10-Day Trial!

Just send name and address. Pay postman on delivery \$1.98 plus postage. Or send only \$1.98 with order and we pay postage. You must be convinced that you can draw anything like an artist, or return merchandise after 10-day trial and your money will be refunded.

Norton Products

GET THIS "How to do it" BOOK FREE!



PARTIAL LIST OF CONTENTS

- "Better Painting"
- "Refinishing Antiques"
- "A Superb Furniture Polish"
- "Protecting Tools"
- "Waterproofing"
- "Finishing Gun Stocks"

Here are 101 useful ways to use America's finest 100% pure linseed oil. Perfect for painting and the handiest item for every housewife, homeowner and farmer. Available at all stores.

EARN \$2.00 EASY

We will pay \$2.00 for each new practical idea for using Pol-mer-ik Linseed Oil, which is acceptable to our research laboratory. Write Archer Daniels Midland, 603 Roanoke Bldg., Minneapolis, Minnesota.



Guaranteed by Good Housekeeping

ARCHER Pol-mer-ik

100% PURE LINSEED OIL

WAR SURPLUS OPTICAL BARGAINS

35 POWER ERECTING MICROSCOPE

Amazing clarity. "All-Position" Universal mount. 3" of working space from objective to platform. Prism Erectors give you an erect image—exactly as your eye sees it. Ramsden Eyepiece permits fine precision focusing. 3-Element color corrected objective—1" diameter. Microscope body is of brass with black crackle finish. . . 6 1/2" long with base 7"x9". Easily worth \$75.00.

Stock No. 970-H \$29.50 Postpaid

SLIDE PROJECTOR SETS

Consists of all unmounted lenses you need to make the following size projectors:

- Stock #4029-H—35 mm. \$2.85 Postpaid
- Stock #4038-H—2 1/4"x2 1/4" \$3.35 Postpaid
- Stock #4039H—2 1/4"x3 1/2" \$3.35 Postpaid

SIMPLE LENS KITS

—Include plainly written, illustrated booklet showing how you can build lots of optical items. Use these lenses in photography and for dozens of other uses in experimental optics, building TELESCOPES, low power Microscopes, etc.

- Stock #2-H—10 lenses \$ 1.00 Postpaid
- Stock #5-H—45 lenses \$ 5.00 Postpaid
- Stock #10-H—80 lenses 10.00 Postpaid

We Have Literally Millions of War Surplus Lenses and Prisms for Sale at Bargain Prices. Numerous Types of Instruments, Too! Write for FREE CATALOG-H

EDMUND SCIENTIFIC CORP., Barrington, N. J.



New Way to Improve YOUR ENGLISH



A command of effective English gives you added advantages and better opportunities. Poor English handicaps you more than you will ever realize. You can improve your English through Sherwin Cody's 100% self-correcting invention. If you are embarrassed by mistakes in grammar, spelling, punctuation, or pronunciation, this free book "How You Can Master Good English in 15 Minutes a Day" will prove a revelation to you. Send for it now! It is free. No obligation. No agent will call. Address SHERWIN CODY COURSE IN ENGLISH, 52 B&O Building, Rochester 14, N. Y.

BOYS! MAKE YOUR OWN RADIO



Make your own simple, tubeless, batteryless Crystal Radio. SEND 25c for a GENUINE MELOMITE CRYSTAL with complete illustrated instructions for making your own set. Crystal sent postpaid with instructions and our own publication, "THE MAGIC CRYSTAL" which is full of news, diagrams, questions and answers of interest.

SEND 25c FOR YOUR CRYSTAL TODAY!

ALVA ALLEN RADIO Dept. PM-2 Clinton, Mo.

PHOTOGRAPHY



EARN BIG MONEY! PERSONAL ATTENDANCE TRAINING in News-Magazine-Fashion-Portrait-Advertising-Natural Color Photography. Splendid equipment, glamorous models. Or—our COMPLETE HOME STUDY COURSE provides you with a spare time short-cut to success.

Our 42nd year. Write immediately for BIG FREE BOOK!

NEW YORK INSTITUTE OF PHOTOGRAPHY Dept. 49, 10 West 33 St., New York 1, N. Y.

GET INTO TELEVISION

BIG JOBS AT TOP PAY

Earn to \$125 as a TV service man! Over 20,000 jobs waiting now—100,000 by 1955! C.T.I. trains you at home. You build (and keep) a 16-in. receiver. Parts sent. Free job placement. Write for valuable booklet

COMMERCIAL TRADES INSTITUTE, Dept. T 2-2 1400 Greenleaf Avenue • Chicago 26, Illinois

Secrets of VENTRILOQUISM Now Revealed!



Easy to learn in 60 to 90 days with our Home Study Course. RESULTS GUARANTEED. Make Money! Be Popular! Have Fun! Big Opportunity! Radio, Television, Stage Appearances! For FREE Information regarding price and terms, WRITE. You must state your age. Dummy Catalog 25c. FRED MAHER SCHOOL OF VENTRILOQUISM Box 36, Studio B Kensington Station Detroit 24, Michigan

Learn BAKING At Home

Baking is one of America's high industries in wages. Nearly depression-proof. Thorough basic home course lays sound foundation. If you have aptitude, write for FREE BOOKLET, "Opportunities in Commercial Baking." NATIONAL BAKING SCHOOL Dept. 1352 Chicago 14



BIG OPPORTUNITIES OPEN IN THE METAL TRADES



Machinist Trade Only 60 school days - 360 Hours -
Tool & Die Making of practical
Tool & Die Designing Shop Training or Mechanical
Drafting—all branches Structural or Aircraft Drafting



Allied will train you easily and quickly for these Important Trades and place you on a Good Paying Job.

Inquire about our **PAY AFTER GRADUATION PLAN**

INDICATE PREFERENCE - RESIDENT or HOME STUDY

ALLIED SCHOOL of MECH. TRADES
 1338 S. Michigan Ave. Chicago, Ill.
 402 ALLIED BLDG.

Write for **Free Books** a 1¢ postcard will do!



REAL PANSY COASTERS Make Them at Home

EASY — FUN PROFITABLE

Now create new and truly different gift articles like the beautiful pansy coaster shown—made by embedding real pansies in Castolite—the "magic" liquid casting plastic. With our simple step-by-step method you can make hundreds of valuable articles, including smart costume jewelry, chic Hi-Style buttons, colorful key tags, tie-clasps, cuff links, plaques, tiles, many other things. Send 25¢ for Big Castolite Creations Manual. FREE with Manual, inspiring New Home-Success Plan. Write:

CASTOLITE CO., Dept. B-1, Woodstock, Ill.



SAY YOU SAW IT IN POPULAR MECHANICS



MEN! send for this MONEY-MAKING OUTFIT FREE!
MAKE \$15.00 IN A DAY

Do you want to make more money in full or spare time... as much as \$15.00 in a day? Then write for this **BIG OUTFIT**, sent you **FREE**, containing more than 150 fine quality fabrics, sensational values in made-to-measure suits and overcoats. Take orders from friends, neighbors, fellow-workers. No experience needed. You'll say it's the greatest way to make money you ever saw.

SAMPLE SUITS TO WEAR Pay No Money! Send No Money!

Our plan makes it easy for you to get your own personal suits and overcoats without paying 1¢, in addition to your big cash earnings. This offer is limited. Rush your name and address for big **FREE OUTFIT**—today!

PIONEER TAILORING CO., Dept. C-1116
 Congress & Throop Streets, Chicago 7, Illinois

FREE! A BILLION DOLLARS IN CHINESE MONEY



Shipped From China At Last Minute — Offered **FREE** to Secure Your Name For Our Mailing List

HERE'S an amazing offer. Just mail coupon below. We'll rush you a 500-gold-unit bank note—actual face value **ONE BILLION CHINESE DOLLARS**. This money is part of last shipment we received before Reds overran China. NOW remaining stocks of Nationalist money will probably be destroyed—making this bill even more scarce.

Get bill **FREE**. Keep it as collector's item; trade it with other folks for stamps; or sell it. Amaze your friends with this huge amount of money. Do not request more than one bill. Our supply is limited—so offer may never be made again. Rush coupon **AT ONCE** with 10¢ to help cover postage and handling.

LOOK! I JUST INHERITED A BILLION DOLLARS!



ALSO Free! Roosevelt Stamp

Issued by Cuba in memory of F.D.R. Sent **FREE**, together with other offers for your inspection.



Littleton Stamp Co., Dept. PM-2, Littleton, N.H. City State

LITTLETON STAMP CO., Dept. PM-2, Littleton, New Hampshire

Rush—**FREE**—the **ONE BILLION DOLLARS** in Chinese money and the **FREE Roosevelt Stamp**. I enclose 10¢ to help cover actual postage and handling costs.

Name _____
 Address _____
 City _____ State _____

DAVE COOK TACKLE SALE! Save 40%

Glass FLY ROD

DAVE COOK "Majesic" tubular glass. Noted for tremendous power, strength and flexibility. Practically indestructible. 2-piece model. 7½ ft. and 8½ ft. length. **Postpaid \$10.00**

\$17.50 VALUE \$10.00 POSTPAID



\$10.00 \$5.88 Postpaid
No. 750 Perfectorene South Bend Reel

Popular 1950 Model Record breaking low price. Synchronized action. Controlled spooling. Chrome plate frame. Aluminum spool with plastic arbor. Capacity 50 yds., 18 lb. test. **Postpaid \$5.88**

Satisfaction guaranteed or your money back

FREE Clip & Mail Today

DAVE COOK Sporting Goods Co.
 1607E Larimer St., Denver, Colorado

Enclosed is \$_____ for items checked below.
 7½ ft. Rod 8½ ft. Rod
 No. 750 Reel
 Guaranteed 24-Hour Service
 You bet I want your big new 1952 **BARGAIN CATALOG**
 Name _____
 Address _____
 City _____ State _____

GROW Living MIDGET TREES!

EARN \$10.00 PER HOUR!

- AT HOME
- IN SPARE TIME
- NO EXPERIENCE NEEDED



It's new! Amazing! At last, the secret of growing miniature (MING) trees can be yours. FULL GROWN, dwarf trees—only a few inches high. Beautiful miniature fir, orange, oak, Chinese elm, peach, pine, cypress—any kind! ALL BLOOM and even BEAR FRUIT. All perfect healthy specimens—but miniature in size! Make costly home decorations and expensive centerpieces. (SOLD FOR OVER \$1,500 EACH) Big demand. Costs only pennies—takes only minutes per week. IT'S EASY! Fun! A new fascinating hobby—a new fabulous \$\$\$\$ business. Send for free secret plan details.

HELP US FILL HUGE DEMAND!

These trees are being demanded by STORES CLUBS • HOTELS • FLORISTS • HOUSEWIVES • INTERIOR DECORATORS • COLLECTORS • HOBBYISTS—A Big Money Opportunity FOR YOU.

FREE! FASCINATING PROFIT PLAN



NATIONAL NURSERIES, Dept. M2
8620 South Ruthelen Avenue
Los Angeles 47, California
Rush me FREE plan IMMEDIATELY!

Name _____
Address _____ Zone _____
City _____ State _____

You Can Become an Expert User of POWER TOOLS

Brand New Book Shows You How to Select and Operate Home Workshop Machines—How to Use All Popular Power Tools Efficiently in Your Home Workshop

Here's the book that tells and shows you how you can become an expert in the use of all power tools. It covers selection, use and operation of sanders, drill presses, bandsaws, scrollsaws, lathes, shapers, jointers, metal working tools, accessories, etc. Tells how to use tools to make cabinet joints, moldings, compound angles; contains actual plans and instructions for a variety of fascinating projects. A special directory in the back of the book lists names and addresses of various manufacturers and sources of supply.

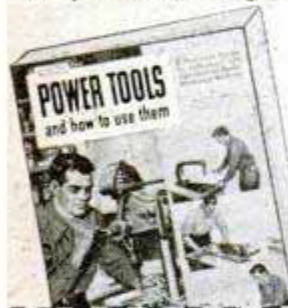

7 Day Money Back Guarantee

Send only \$2.50 today for this big 144 page book with its more than 375 photos, drawings and diagrams. Return it within 7 days for a full refund if it is not entirely satisfactory.

POPULAR MECHANICS PRESS, Dept. 93
200 E. Ontario St., Chicago 11, Ill.

Send at once my copy of POWER TOOLS AND HOW TO USE THEM. I may return it for a full refund in 7 days if it is not satisfactory.

NAME _____
ADDRESS _____
CITY _____ ZONE _____ STATE _____
 \$2.50 enclosed Send C.O.D. (Postage Extra)

Bar Bells

Buy Direct From Factory Approved and Recommended by Karl Koberle (Foremost Ex-Army Instructor on Weight Training). **\$8.95** up

Write for free booklet and price list. **INDEPENDENT IRON WORKS**
2416 East 23rd Street, Dept. B
Los Angeles 58, Calif.

MASTER MIND!

Learn Short-Cut Mathematics
Juggle figures, do baffling number tricks. Make people gasp at your marvelous lightning-quick mind. Multiply 4 figures by 4 figures without using old-fashioned multiplication! Big cloth-bound volume; fully illustrated course.

Sharpen up Your Brain Power
Includes worked-out problems, answers, etc. Sensational bargain, only \$1.95, postpaid or COD plus postage. Satisfaction guaranteed or refund. Order this amazing "Short-Cut Mathematics" today!

NELSON-HALL CO., 210 S. Clinton St. DEPT. 28-2 CHICAGO 6, ILL. **\$1.95 Complete**

Mustang LIGHTWEIGHT \$370.00

(Fed. tax paid at factory)

9.5 hp. 4-cycle. 3-speed. Foot-shift. Over 70 miles per gal. Over 60 m.p.h. Write for free circular.

MUSTANG, Dept. PM
635 W. Colorado, Glendale 4, Calif.

HAUCK FLAME GUN KILLS WEEDS

KILL WEEDS, crab grass, Canada thistle—stalks, seeds and roots. Destroy brush, caterpillar nests, diseased trees, grasshoppers, chinch bugs, etc. Clear irrigation ditches, split rocks, burn tree stumps . . . Sterilize poultry houses, kennels, barns. Use as portable home forge. Melt ice, thaw pipes. Safe, inexpensive. Burns only 6% kerosene, 94% air! Thousands satisfied users. 7 models. Write for FREE CATALOG.

HAUCK MFG. CO., 78 Tenth St., Brooklyn 15, N.Y.

HELPFUL BOOKS

Send post card asking for FREE catalog

Popular Mechanics Press, 200 E. Ontario, Dept. 601, Chicago 11

ARRO-PING

—the Original Arrow Sling-Shot has accuracy and power for small game or target with swift ping of an arrow. Sturdy, smoothly-made wood stick, guided-flight barrel, slender metal-tipped 12-inch arrows. Powerful rubber propulsion sends arrow 300 feet. Try skill in a new hunting thrill.

Postpaid, with five Arrows, \$1. Or Arrows alone 20 for \$1.

ARRO-PING CO.
Box 25H West End Station, Colorado Springs, Colo.

'How to MAKE MONEY with Simple CARTOONS'

A book everyone who likes to draw should have. It is free; no obligation. Simply address **FREE BOOK**

CARTOONISTS' EXCHANGE
Dept. 92A Pleasant Hill, Ohio

FREE CATALOG

All The Best and Latest Garden and Farm Books, Bulletins

A wealth of up-to-the-minute expert advice on how to do wonders on a little land or a thousand acres . . . wonders with flowers, vegetables, fruits, landscaping, poultry, livestock, woodlands, fishponds, composting, soil improvement, etc., etc. Just send name and address for this fascinating FREE catalog by return mail.

COUNTRY BOOKSTORE
Box 2702 Noroton, Conn. Estab. 1943

BRAND NEW



33 MODELS \$14.95 up

BUSHNELL Binoculars

30 DAY FREE TRIAL
High Power BINOCULARS
 Finest Precision Optics
 Featherlight
 Money Back Guarantee
 Easy Pay Plan
 Leather Case Incl'd.
Free! Catalog & Book
"How to Select Binoculars"
 Dealer Inquiries Invited
Bushnell Bldg., Dept. M42
Pasadena 1, Calif.



How to Get Better Paint Jobs!

Send for free illustrated 24-page booklet—tells how to buy and apply right aluminum paint for all jobs around the house. We don't make paint, but prepared this booklet to help you get better results with aluminum paint. Write for free book "Paint it Bright!". **ALUMINUM COMPANY OF AMERICA, 1718G Gulf Building, Pittsburgh 19, Pa.**

ANALYZE HANDWRITING

MORE INCOME, Prestige, Success. Fascinating uncrowded profession-business, full or spare time. **FREE** illustrated lesson & Year Book shows how men and women in home, business and professions analyze handwriting to understand people. **MAKE MONEY, FREE** lesson and information about unusual opportunities if over 21. **I. G. A. S., Inc., 715 Wilhoit Bldg., Springfield, Mo.**



STUDY TO BE A DOCTOR

of Psychology or Metaphysics
 Obtain a Ps.D., Ms.D., D.D., or Ph.D. degree. Be a Teacher, Lecturer or Accredited Practitioner. Teach others how to achieve Health, Happiness and Contentment. Chartered by State. Write for **FREE** book telling how.
THE NEOTARIAN COLLEGE OF PHILOSOPHY
 Desk 8, Pickwick Building Kansas City 6, Missouri

YOU CAN BUILD A VIOLIN FOR PLEASURE OR PROFIT

Now you can build a rich toned mellow violin modeled after a famous "Strad." **YOU CAN MAKE A STRADIVARIUS VIOLIN** contains 8 full scale plans plus complete instructions. You work directly from the plans with no confusing scale of dimensions to translate. Detailed instructions for each step including varnishing and stringing—even shows how to build your own tools. Cloth bound. Order today from **POPULAR MECHANICS PRESS . . . \$3.50**
 200 EAST ONTARIO STREET, CHICAGO 11, ILLINOIS

Say You Saw It in Popular Mechanics

ELECTRIFY your SEWING MACHINE



AMAZING LOW PRICE! \$9.50 BE AN AGENT!

Re-sell at a PROFIT! You make as high as \$9 with each sale. Kit comes fully wired installed in a jiffy. Fits all machines!
 You get **ALL NEW PARTS:**
 • Motor & Bracket
 • AC-DC 115v 60c
 • Multi-speed foot control
 • Cord set & block
 • Easy instructions
 • Steel pulley & belt

FREE . . . reg. \$2.95 chrome SEWLITE given with every kit.
10 DAY FREE TRIAL — MONEY BACK GUARANTEE!
 Send \$5 deposit, pay postman balance plus postage. Please state whether wheel on your machine turns toward you or away from you. Shipping wt. 6 lbs. Write for free sewing machine accessory catalogue. No obligation.
SENIOR SEWING MACHINE CO.
 1046 BEDFORD AVENUE Dept. PM-34 Brooklyn 5, N.Y.

TURN BACK THE HANDS OF TIME WITH THESE COLLECTOR'S ITEMS!
OLD-TIME AUTOS in MINIATURE!
\$1.95 to \$3.95
 SUCH FUN TO BUILD!

The Wicker Basket was a familiar auto accessory in 1903! This detail and scores of others will be found in our 3/4" scale models! So realistic, they're on display in famous museums! Start your collection — enjoy these nostalgic antique autos! Measure 6" to 10 1/2". They come pre-fabricated with all ready-shaped die-cut parts, plastic cast wheels, lamps, radiator, horn, etc. History of each car and step-by-step instructions that a 10-year old can follow, with each kit. At toy, hobby and dept. stores; guaranteed money back if not satisfied. Grand hobby for all from 9 to 90; wonderful for shut-ins and convalescents! Order a complete set! Other models not shown are:

| | |
|--|--|
| 1903 Model "A" Ford—\$2.50 | 1909 Stanley Steamer—\$2.95 |
| 1904 Olds—\$1.95 | 1911 Maxwell—\$2.50 |
| 1914 Stutz Bearcat—\$3.95 | <input type="checkbox"/> 1902 Franklin \$2.50 |
| <input type="checkbox"/> 1906 Columbia Electric \$2.50 | <input type="checkbox"/> 1910 T Ford \$2.50 |
| <input type="checkbox"/> 1910 Internat. Harvester \$2.95 | <input type="checkbox"/> 1909 T Ford \$2.95 |
| <input type="checkbox"/> 1900 Packard \$2.50 | <input type="checkbox"/> 1903 Rambler \$2.50 |
| <input type="checkbox"/> 1903 Cadillac \$2.50 | <input type="checkbox"/> 1913 Mercer Raceabout \$3.95 |
| <input type="checkbox"/> 1911 Buick "Buq" \$2.50 | <input type="checkbox"/> 1906 "Old 16" Locomobile \$3.95 |

Write to us. Add 25c for postage and handling. No C. O. D.'s please.

hudson miniatures OLD TIMERS
 "Originators of Antique Autos in Miniature"
 SCRANTON HOBBY CENTER, Dept. 14, Scranton 10, Pa.

Start a Business in Your Backyard

Earn BIG MONEY MAKING BUILDING BLOCKS

General Concrete Vibrator BLOCK MACHINE
 CAPACITY 1000 BLOCKS A DAY
 only \$218 LESS MOTOR F.O.B. PLANT
 SHIPPING WEIGHT 400 LBS.

Here is a business you can start on small capital—in your own backyard—that earns 100 to 150% profit, with unlimited opportunities. Make concrete or cinder blocks. Millions used for homes, factories, public buildings, garages. Sell all you make to building trade. Do it with a General—and you're headed for success.

1000 BLOCKS A DAY
 The General is a high speed, power-driven block machine at amazingly low cost. Rugged all-steel construction. Simple to operate indoors or outdoors. Makes superior 3 core type block meeting all code requirements. Produces up to 1000 blocks per day. Full operating instructions and mixing formulas supplied. Write for **FREE** details.
Dealer inquiries invited

Wonderful Book Written & Illustrated by Experts
HOW TO BUILD YOUR OWN CONCRETE BLOCK HOME
 Only 1 Prepaid

GENERAL ENGINES CO.
 DEPT. M-22 • 307 HUNTER ST. • GLOUCESTER, N. J.

Includes floor plans for 6 beautiful, easy to build concrete block bungalows. Shows ways to save money. How to lay blocks, lay out building lines, mix concrete, build steps, porches and concrete floors. Mail coupon at once with \$1.

Name.....
 Address.....
 City.....Zone.....State.....

PRINT ANY PHOTO

ON PAPER, CLOTH, LEATHER OR WOOD

SIMPLE, EASY TO USE

Magic liquid takes only 2 minutes to reproduce any snapshot you have onto stationery, handkerchiefs, ties, scarfs, etc. Use same picture over and over again if you wish. Won't wash off. Won't hurt negative or fabric it's used on. Personalize your belongings! An ideal gift. Complete outfit enough to transfer 200 photos — only \$1.95 post paid. Sent C.O.D. for \$2.23.

TIFFANY'S
2128 MONTROSE JG, CHICAGO 18, ILL.

DOUBLE YOUR PAY BY USING THIS BOOK EVERY DAY



The future is unlimited for the man in the shop who has the answers to problems that cause delays and slow production. "UNIVERSAL MACHINISTS' HANDBOOK" has helped thousands of shop workers, all over the country, climb to BIGGER PAY. You get the answers to any mathematical problem on diesel repair and welding operations — the proper use and care of lathes, milling machines, drills, and gears. Plus scores of other job hints based on actual working experience! You'll be on the road to a better job within seven days after receiving the 15th edition of "UNIVERSAL MACHINISTS' HANDBOOK", or we'll refund your money. Start to the top NOW by sending your name, address, and only \$2.00 to: SHIELDS PUBLISHING CO., 3031 N. Broadway, Desk M-1, St. Louis, Mo., USA

FOAM RUBBER CUT SHAPES



Select from this—one of the largest Foam Rubber stocks—whatever shape or thickness you want—Cut circles or squares for upholstering or padding chairs, mattress—es or pads for twin or regular beds, auto seat cushion tops—auto wedges—all new fresh stock—expertly cut to exact size. Lowest prices — satisfaction guaranteed. One day delivery.

| Uncovered Foam Pads 1 1/2" thick | | Auto Seat Pads 24" X 60" | |
|-------------------------------------|--------|-----------------------------|--------|
| 12" X 14"..... | \$1.25 | 1 1/2" thick..... | \$6.45 |
| 16" X 16"..... | 1.35 | 2" thick..... | 7.95 |
| 16" X 22"..... | 1.75 | Mattress Pads | |
| 18" X 24"..... | 2.00 | Twin Size.....\$19.55 | |
| 22" X 24"..... | 2.95 | Full Size.....23.95 | |

Add 10% to these prices for postage and packing.
NO C.O.D. PLEASE — PLEASE PRINT NAME
Ask for catalog No. 201

RIOR RUBBER COMPANY, Dept. 10 B 50 E. CERMAK RD. CHICAGO 16, ILL.

Complete
Only
85c



For Super Models and a Barrel of Fun... Build **SPEEDEE-BILT** flying models

14 Other Thrilling Models Plus Jet Power Race Cars, U. S. Fighting Ships.

With These and Other Plastic Parts

If no store near you send 85 cents, plus 25 cents for postage and packing, to address below. Delivery guaranteed.

Here's thrilling fun for all kids—8 to 80 years old. Genuine SPEEDEE-BILT flying models, including the famous Warhawk, fighter shown above. Easiest models to build. Build one complete and fly it in an evening. Kits contain built-up Monofoil wing, pre-fab fuselage, finished metal and wood parts, plastic 2-3-4-bladed props, pilots, canopies, cannon, rockets, bombs and other plastic parts. Complete catalog of 15 planes, including jets, 5 jet power race cars and 5 U. S. Fighting ships free in every kit. Be sure you get Monogram Models.

MONOGRAM MODELS, Dept. 12, 225 N. Racine Ave., Chicago 7



Covers All Models 1940 to 1952
— All Features — Including Powerglide Transmission

Get the NEW Popular Mechanics Owner's Manual

If you drive a Chevrolet—any model—1940 to 1952—get this new owner's manual today. It will save you money on repairs and service; give you safe, economical and trouble-free motoring and protect your investment in your Chevrolet by keeping it constantly at top value. Can easily be worth hundreds of dollars to you in a single year.

Chevrolet Owners

Spend Less to Own and Drive Your Car

Official, Authoritative Bumper to Bumper Information

Prepared by a noted automotive authority and Popular Mechanics editors with the full cooperation of Chevrolet engineers and service specialists. Covers all phases of Chevrolet operation, service and maintenance. 288 pages of practical information and hundreds of photos, diagrams, charts, and sectional views, make every part, every operation, easy to understand. Complete index enables you to put your finger on the information you want instantly.

Prevents Costly Repairs

Explains everything about your car; what can go wrong; how proper adjustment and servicing should be done; how to prevent major troubles and costly repairs later on. Even if you don't service your car at home the manual will save you important money on every day operation.

Mail Coupon Today

Mail coupon now. Send only \$3.50 for prepaid delivery or you can pay postman, plus charges. See money back guarantee in coupon.

- Learn All About Chevrolet's Powerglide Automatic Transmission
- Know Your Chevrolet Valve-in-Head Engine and How It Operates
- Understand Chevrolet's Center Point Steering and Unitized Knee-Action.
- Protect Your Investment. Know Your Chevrolet.

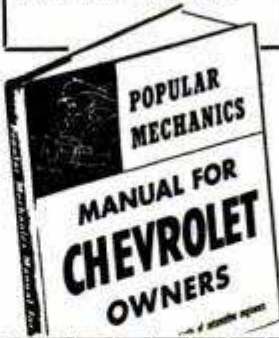

POPULAR MECHANICS PRESS
200 East Ontario St., Chicago

Send Manual for Chevrolet Owners at once. If not satisfactory I will return it within 5 days and you will refund full purchase price.

Remittance for \$3.50 enclosed. Send C.O.D.

Name _____
Address _____
City _____ State _____

SUCCESSFUL...

yet he's
**HARD OF
HEARING!**

Don't let deafness rob you of success and happiness! Do as thousands have done—see your nearest

MAICO
HEARING
CONSULTANT



Write for free booklet "What Every Hearing Aid User Should Know".



THE MAICO CO., INC.
Room 104F, 21 No. 3rd St.
Minneapolis 1, Minn.

WHAM-O SPORTSMAN*

\$1.50
POSTPAID

35-LB.
PULL!

HITS LIKE A .22 RIFLE—
KILLS RABBITS, SQUIRRELS.
Powerful, silent, accurate.
For hunting, target,
routing pests.
Sportsman's choice
sold world
over!

**HUNTING
SLINGSHOT**

Heavy duty 7" ash stock.

40 steel balls, extra rubber target.

GUARANTEED. At dealers, or send \$1.50 to
Wham-O Mfg. Co. Box 8T, South Pasadena, Calif.
* Professional model of Nat'l Slingshot Assn.



WANTED!

MEN AND WOMEN TO EARN SPARE TIME MONEY

Many Popular Mechanics
neighborhood representatives
are making extra cash
for easy, after-hours work.
A few more are needed.

For details, write:

POPULAR MECHANICS
ROOM 408
200 E. ONTARIO STREET
CHICAGO 11, ILLINOIS

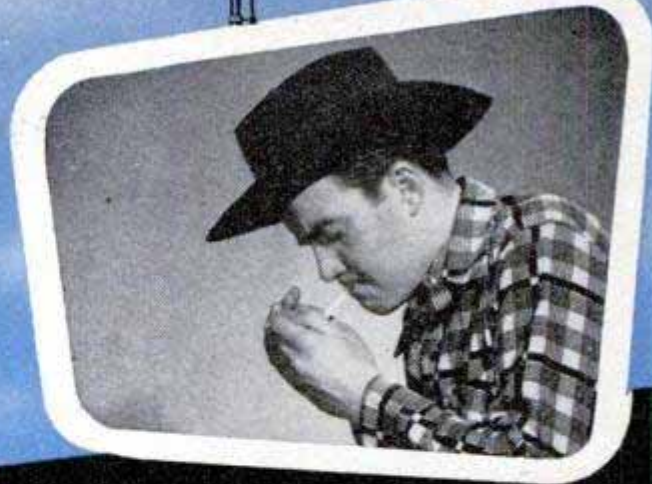

Do You Know
The Reasons For

**Better
Television
Picture Quality?**

Of all the factors which contribute to "Better TV Picture Quality" the most important one is having the right antenna! It is the antenna which intercepts the broadcast signal and carries it to the receiving set. The best and most expensive television sets can present a picture no better than that it receives from the antenna. The booklet illustrated below contains complete information on *all* the reasons for good TV pictures—and presents in detail with graphs and illustrations a discussion of the various types of antennas and their characteristics. In addition, the problem of coordinating the antenna with the location is thoroughly and completely discussed.

send 10¢...

For your copy of this 20-page booklet which tells you how to get the best in television enjoyment...

AMPHENOL



BOOKS *that tell* HOW *and show you*

- PRACTICAL CARPENTRY.** Here at last is a really modern easy-to-understand cyclopedia of building data... all the information you need to learn carpentry trade, remodel or build home of your own. Over 1,100 illus. \$5.00
- AUTOMATIC TRANSMISSIONS SIMPLIFIED.** Learn all about: Fordomatic, Hydramatic, Dynaflo, Powerglide... all other transmissions both new and old. How transmissions are constructed, how they operate, how to service... \$4.00
- AUTO REPAIR KINKS.** Hundreds of kinks (unusual time and money-saving shortcuts) that have helped mechanics out of tough spots. Tuneup specifications all popular cars. Combined experience and KNOW HOW of World's best Auto Mechanics. \$3.00
- AUTO MECHANICS MANUAL ON BRAKES & STEERING (Including Wheel Alignment)** Brand New. Takes mystery out of servicing auto brakes (all passenger cars, trucks) wheel alignment... Technical terms eliminated... the real "gospel" by an expert, in handy, usable form. \$3.50
- AUTO BODY & FENDER REPAIRS.** Gives approved methods for doing professional job. Use book to help get a good job or start business of your own... \$3.50
- DYKE'S AUTO ENCYCLOPEDIA.** Complete course in auto mechanics with special emphasis on fundamentals... trouble shooting, testing, adjusting and repairing. New 22nd ed. 1491 pages, 4600 illus. \$7.50
- MODERN ELECTRIC & GAS REFRIGERATION.** Covers repairs, adjustments, overhauling every type of domestic, commercial equipment. Non-technical. Most helpful and biggest selling book on refrigeration. Used by U. S. Army. 984 pages... \$5.00
- FIX YOUR FORD.** New manual covering servicing and repairing of V-8's and 6's from 1932 up to and including current series. Based on experience of leading Ford mechanics... \$2.50
- AUTO SERVICE MANAGEMENT.** How to start and operate profitable auto business... \$5.00
- MERRY OLD MOBILES ON PARADE.** History of early automotive industry in picture form. Every page is crammed with interest \$2.50
- MODERN WELDING PRACTICE.** Up-to-date encyclopedia of welding information. Covers all types of gas, electric welding, heat treating, metal cutting... including submerged arc, inert gas welding, arc-oxygen cutting, sprayed hard surfacing, powder cutting, etc. \$5.00
- DYKE'S CARBURETOR BOOK** \$3.50
- PLUMBING AND PIPE-FITTING LAYOUT** \$2.50
- A. C. POWER WIRING** \$4.00
- D. C. POWER WIRING** \$4.00
- BAILEY'S HANDBOOK.** Questions and answers for stationary, marine, diesel engineers and firemen \$2.00
- HOUSE WIRING.** Information on all phases. \$3.00
- AIRPLANE WELDING** \$3.50
- SHEET METAL DIE DESIGN** \$2.25
- STORAGE BATTERY SIMPLIFIED** \$3.00

Check books you want, clip this ad and mail with check, money order or U. S. currency, carefully wrapped. **PROMPT REFUND** if not completely satisfied.

GOODHEART-WILLCOX CO.
Dept. 175 1321 S. Michigan Ave. Chicago 5, Ill.

Learn TATTOOING At Home
Earn extra MONEY—Tattoo blood types and designs in your community. Splendid opportunity in every town. Prepare in spare time. Practical instructions. Send 25c for details and list of Tattoo Supplies. No obligations. ZEIS SCHOOL OF TATTOOING • 728 Leslie, Rockford, Ill.



Apache THROWING TOMAHAWK
Balanced to stick

An ancient Indian weapon for killing game - target sport. Easy to throw with our clear instructions. Splits a 2" board at 30'. Will stick from any angle.

Beautiful heavy duty 14" tomahawk. Solid tempered steel. Unusual bargain, limited supply. Sold direct only. Send \$2.98 today to **TECHRITE CORP.**, Box 12K, South Pasadena, Calif.

\$2.98 per set

Rare Souvenir!

TRY HOME STUDY WATCHMAKING

Turn dull winter hours to pleasure and profit. Master watch repairing the thrifty home study way. An exciting hobby or fascinating career. No experience needed. Send coupon today!

FREE Sample Lesson

CHICAGO SCHOOL OF WATCHMAKING
1608 N. Milwaukee Ave., Dept. 122, Chicago 47, Ill.
Send Free Sample Home Study Lesson.

Name _____
Address _____
City _____ Zone _____ State _____

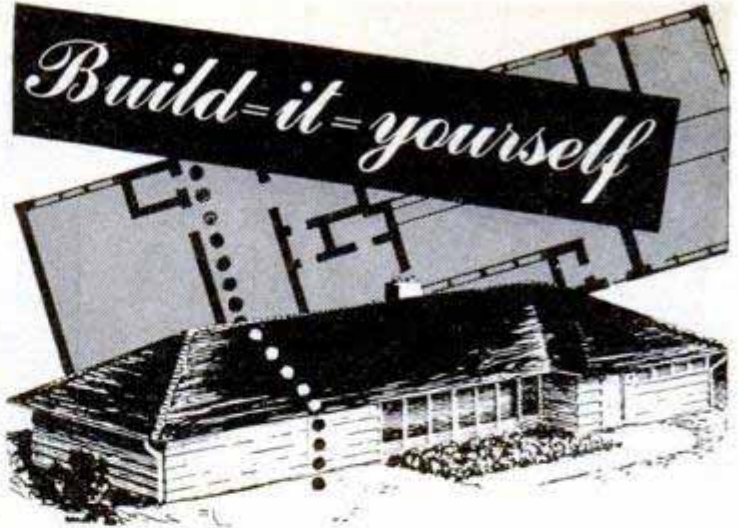

Popular Mechanics Famous RANCH-TYPE HOUSE

Save Thousands of Dollars by Building This Beautiful Home Yourself

Join the more than 100,000 families who have built their own homes in the past few years doing all or most of the work themselves and you can save more than 50% of usual building costs! Here is a dream home designed by the noted architect John J. Whelan, designer of the Drew Pearson home, especially for amateur home builders. You can build the basic five room unit for approximately \$5000. Carport may be converted into third bedroom and breezeway and garage added at your leisure. Basic house is to the right of the dotted line in the picture above; expansion is to the left. House fully expanded is 81 feet long and 29 feet wide.

Order Book and Plans — Save \$7000 to \$10,000

Book gives complete step by step instruction. Hundreds of pictures, photos and diagrams, showing every phase of construction, guide you from start to finish. Ten working size blueprints give floor plans, elevations, notes on construction, framing, lumber list, specifications, plumbing and wiring diagrams.

than he spends for material.

Read How and See How — Simplified Instruction
You read "how-to-do-it" in the book and see how it looks in actual pictures. You follow the plans for dimensions. You make use of labor-saving kinks, special methods.

Order Book, Plans Now
Use the handy coupon below to order **RANCH-TYPE HOUSE BOOK AND PLANS**. Read the book; study the plans and then be prepared to go right ahead when you are ready to build. Even if you have the house mainly built by others you can enjoy a tremendous saving by using the instructions and blueprints.

No Previous Building Experience Required
Any ordinary handy man, using simple tools, can build this house with little or no assistance. And at the same time, save more

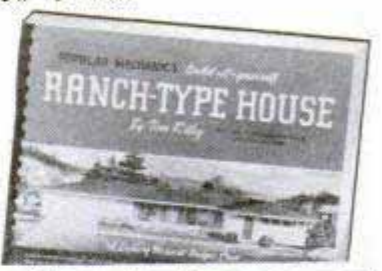

Order on this Handy Coupon

POPULAR MECHANICS PRESS, Dept. RH
200 East Ontario St., Chicago 11, Ill.
Send at once my copy of the Ranch-Type House Book and Plans as checked below:

Remittance enclosed Send C.O.D. (postage extra)

Ranch-Type House Book \$ 3.50
 Set of 10 Blueprints 13.50
 Book and Blueprints 15.00
 Duplicate Set of Blueprints 5.00

Name _____
Address _____
City _____ Zone _____ State _____

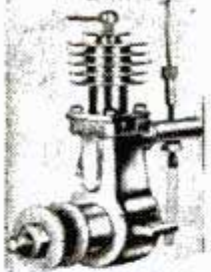

REAL DIESEL ENGINE

\$2.95

- for planes, boats, midget cars
- 7500 RPM; 1/7 HP; ht. 3 1/2"; wt. 5 oz.
- precision machined for smooth operation

You just can't beat this price for a precision diesel engine! Streamlined, compact, easy to install. Thousands of satisfied users all over the world. Fast delivery if you ORDER TODAY! Send \$2.00 plus 25c postage.

GOTHAM HOBBY CORP. Dept. P, 107 E. 126th St. New York 35, N.Y.

PROPANE GAS ON YOUR CAR



with normal operation on gasoline. Switch to either instantly—Save up to 1/2 on fuel. SEND \$2.00 for "How-to-do-it" booklet, photos, drawings and low prices on complete outfits. (refunded on parts order) Rush order today — NOW!

LPG PRODUCTS, Dept. PM-2, KEARNEY, NEBRASKA



HE-MAN VOICE!

★ **STRENGTHEN** your voice this tested scientific way. Yes—you may now be able to improve the **POWER** of your speaking and singing voice . . . in the privacy of your own room! Self-training lessons, mostly silent. No music required.

FREE BOOK Write TODAY for Eugene Feuchtinger's great booklet "How to Develop a Successful Voice." It's absolutely FREE! You must state your age, man will call. Send your name and age **RIGHT NOW!** Perfect Voice Institute, 210 S. Clinton St., Studio B-2, Chicago 6, Ill.

HIGH POWER TELESCOPE

60 POWER—ALUMINUM TUBES—OPENS TO 33"

Variable Power Adjustable to 15X, 30X, and 60X.

\$5.95



Leather Case Included

5 Sections, 4 Ground & Polished Lenses. Also used as 50X Microscope. Ready to use, only \$5.95, POSTPAID.

CRITERION CO. DEPT. AP2

438 ASYLUM ST. HARTFORD 3, CONN.

YOU CAN EARN UP TO \$125 A WEEK IN AUTO MECHANICS

It's easy to learn auto mechanics at home—the trade that Look Magazine ranks No. 1 for job opportunities! C.T.I. offers Shop-Proved home study training that's better than resident school. Free job placement. Write for valuable booklet today!

COMMERCIAL TRADES INSTITUTE, Dept. A 2-2
1400 Greenleaf Avenue • Chicago 26, Illinois

Good NEWS FOR THE RUPTURED!

If the truss you now wear slips, chafes or gorges—don't throw it away! The New Truss Easer Pad, worn under your regular truss pads, puts thousands of soft, air-cushion pillows into that torture zone—for increased holding area—more safety and immediate, heavenly comfort. Only \$1.00 postpaid. Money back guarantee!

ONLY \$1

ACTIVE MAN TRUSS CO., Dept. PMB
549 W. RANDOLPH ST. CHICAGO 6, ILLINOIS POST PAID

HELPFUL BOOKS

Send post card asking for **FREE** catalog

Popular Mechanics Press, 200 E. Ontario, Dept. 601, Chicago 11

Big Profit CHINCHILLAS Fun Educational

Breed Chinchillas for the fur market. Chinchilla garments sell from \$8,000-\$35,000! Establish your own 'gold chip' business. Clean, tame, easy to raise. Write experts. Chapman Chinchilla Farms, originators of Chinchilla breeding farms in America. Send for illustrated catalog full of pictures and instructions today. P. O. Box 221, 4957-P West 104th Street, Inglewood, Calif.

CHAPMAN CHINCHILLAS

Spare Time
\$3.00 AN HOUR
PAYS 3 HOUR
and **MORE**
with



UNIVERSAL Lawn Mower Grinder

Here is a business you can start in your own garage or basement. Sharpen hand and power mowers on the Universal Grinder and make \$3.00 to \$5.00 an hour.

G. Spurlock of Arkansas writes: "I have had my Universal Grinder only 2 months. Live 2 1/2 miles from town. Yet have already made \$227 net profit." J. L. Peterman of Pa. says: "I averaged \$100.00 a week in May, and made \$1,000.00 spare time this season."

REMEMBER—Only on the UNIVERSAL GRINDER can the inside face and edge of the stationary blade, as well as all of the reel blades, be ground to the proper clearance

ALL IN ONE SET-UP

WITHOUT REMOVING ANY BLADE FROM THE MOWER
Rogers Mfg. Co., Dept. PM-22, Lindsey, Ohio

SEND THIS COUPON NOW

ROGERS MFG. CO., Dept. PM-22, Lindsey, Ohio

Please send me full facts about the Universal Lawn Mower Grinder and its big money making opportunities.

NAME _____

ADDRESS _____

CITY _____

STATE _____

Learn CARTOONING

HAVE FUN! MAKE MONEY! Cash in on your sense of humor at HOME — BY MAIL. No experience needed to start. Write today for **FREE TRIAL LESSON** and full particulars.

Moon Gag Cartoon School, Dept. N, Fall Creek, Wis.



Sensational New Invention

Print Anything You Want In Seconds . . .

1001 Different Uses



Now you can print anything you wish quickly and easily with this completely new printing outfit. Sensational "BASE LOCK" sets have complete alphabet of rubber letters and numerals which set **FLAT AND TIGHT** in rubber

tongue and groove holder to give clean, sharp impressions every time. Used by leading firms all over the country. Now for the first time available to you at this moderate price.

Introductory set contains all of the following: More than 250 letters and numbers, Type tweezers, Stamp pad, 3-line holder — and **FREE**, one extra holder. Order now!

MAIL THIS COUPON TODAY

U.S. Rubber Stamp Co. Dept. T 1
229 Fulton Street, New York 7, N.Y.
Please send me the stamp set as listed.

Name _____

Address _____

City _____

State _____

No C.O.D. \$4.95 Postpaid

U. S. RUBBER STAMP CO.

Dept. T, 229 Fulton Street, New York 7, New York

150 DIAGRAMS and HOW TO READ THEM

150 DIAGRAM BOOK

FREE

For Examining Coyne's Great 5-Volume Set On

ELECTRICITY

HERE'S a valuable book of 150 Electrical and Radio wiring diagrams with charts and instructions. Practical information you need to win security and promotion. It's yours FREE merely for examining Coyne's 5-Volume Set on Applied Practical Electricity on 7-day's free trial. This 5-Volume Set COVERS EVERYTHING ELECTRICAL from home appliance repairs to advanced AC-DC motors and equipment. Thousands of diagrams and photos . . . written so both "beginners" and "old-timers" can easily understand.

7-DAY'S FREE TRIAL Send for 5-Volume Electrical Set on 7 day's FREE TRIAL. We'll include Shop Prints Book FREE. If you keep the set, send just \$3 after 7 days and \$3 a month until \$15.95 plus postage is paid (cash price: \$14.95). Or return the set in 7 days and owe nothing. Either way, Shop Prints Book is yours to keep, FREE! Mail coupon AT ONCE!



FREE COUPON NOT AN ORDER - JUST A REQUEST TO SEE BOOKS

Educational Book Publishing Division
COYNE ELECTRICAL & TV-RADIO SCHOOL
 500 S. Paulina St., Dept. 22-R6, Chicago 12, Ill.

Rush 5-Volume Electrical Set for 7 day's FREE Trial per your offer. Include Shop Prints Book FREE.

Name _____ Age _____

Address _____

City _____ Zone _____ State _____

Check here if you are enclosing \$14.95. We pay postage. 7-day Money Back Guarantee.

STOP BURNING OIL!



The manufacturers of Fisher's Compression SEAL want every motorist to enjoy the economies of smooth, powerful engine performance and reduced oil consumption. A proportionate amount of Fisher's Compression SEAL in each cylinder bore, expands 30 times, closing and sealing excessive clearance between cylinder wall and piston.

Satisfaction Guaranteed!

If after having driven 400 miles, you are not completely satisfied with the new efficiency and oil savings obtained from Fisher's Compression Seal, return the used tube for a full refund. \$25,000 indemnity insurance policy is your assurance that it will not harm the finest engine. Only \$3.95 postpaid. Write for free folder. Send cash, check or money order. Dealer Inquiries Invited.

\$3.95

ADVANCED ENGINEERING, Dept. PM-2
 BOX 7013 LOS ANGELES 37, CALIF.

Garlinghouse America's Finest HOME PLAN SERVICE

FOR BETTER HOMES AT LESS COST

Start planning your home now with America's largest, oldest, and most complete home plan service. Hundreds of home plans to fit every purse. Modern, Ranch, Period and many other styles—pictures of homes already built. Sizes from 2 to 4 bedrooms. Many expandable.

- | | |
|--|---|
| 3 Beautiful Plan Books only 50c each. Postpaid. | 1. Choice Selected Homes. Over 75 selected designs. 32 in color. 2. Ranch & Suburban. 158 designs ideal for town and country. 3. Blue Ribbon Homes. 128 most popular designs. 32 in color. |
|--|---|

Blue Prints, Mill Lists, and Complete Specifications available for each design at LOW COST.

L. F. GARLINGHOUSE CO., INC., Box PM-15 TOPEKA, KANSAS

Handy Mail Order Lists

Little Library of Useful INFORMATION

5 for \$1.00
 12 for \$2.00
 25¢ Each

- Here at amazingly low cost is the practical help and information you have always wanted. Articles in previous issues of Popular Mechanics have been classified according to subject and are now available in these handy reprint booklets.
- How to Use Measuring Tools—Micrometers, Calipers, etc.—106.
 - Power Driven Saws—74.
 - Drill Presses, Grinders, Etc.—79.
 - Wood, Metal Turning—Lathes—81.
 - Filing Machine, Hacksaw, Cutoff Wheel, Shaper—82.
 - Lathe Tools You Can Make—101.
 - Workbenches—Tool Cabinets—47.
 - Spray Painting—94.
 - From Pattern to Casting—91.
 - Tool and Saw Sharpening—92.
 - Sharpening Drills, Wood Bits—90.
 - Successful Wood Turning—32.
 - How to Read Blueprint—71.
 - Metal Turning Lathe Kinks—99.
 - Operating a Metal Lathe—100.
 - Heat Treating, Hardening—102.
 - Working With Glass—103.
 - Servicing Elec. Motors—75.
 - Electromagnets & Solenoids—44.
 - Transformer Construction—41.
 - The Boy Electrician—43.
 - Soldering and Brazing—17.
 - Arc and Spot Welders—5.
 - Electroplating With Nickel, Chromium, Cadmium, Etc.—86.
 - Plating Leather, Wood, etc.—87.
 - Lower Your Fuel Costs—31.
 - Curing Leaky Basements—45.
 - Fitting Home Game Room—55.
 - Indoor & Outdoor Fireplaces—88.
 - Backyard Gardening—39.
 - Lawn and Garden Novelties—72.
 - Trellises, Pergolas, Fences—76.
 - Lawn and Garden Furniture—77.
 - Playground Equipment—73.
 - How to Use Your Drill Press—125.
 - Making Serving Trays—53.
 - Knots and Ropework—105.
 - Sanders—80.
 - House Wiring—89.
 - Hanging Wallpaper—38.
 - Built-in Fixtures—78.
 - Bird Houses—7.
 - Magazine Racks—49.
 - Clock Cases—50.
 - Book Ends—52.
 - Small Tables—54.
 - Smoking Stands—56.
 - Desks—58.
 - Book Cases—59.
 - Action Toys—66.
 - High Flying Kites—67.
 - Telescopes—20.
 - Metal Craft—28.
 - Small Looms—37.
 - Gem Cutting—42.
 - Photo Enlargers—1.
 - Photo Kinks—98.
 - Cleaning Formulas—11.
 - Taxidermy—9.
 - Photo Lighting—119.
 - Training Dogs—35.
 - Small Furnaces—36.
 - Working With Plastics—61.
 - Simple Home Improvements—104.
 - Ridding Home of Insect Pests—107.
 - Children's Room Furniture—51.
 - Jigsawed Novelties—57.
 - Doll House & Doll Furniture—60.
 - 25 Shelves You Can Make—64.
 - Novelties Turned on Lathe—62.
 - Inlay Pictures—Veneering—63.
 - Wood, Soap Carving—65.
 - Windmills & Weather-vanes—68.
 - Lamps from Wood, Metal—69.
 - Rustic Furniture—18.
 - Wood Finishing—40.
 - How to Fix Electrical Appliances—111.
 - Painting Your House—117.
 - Build Your Own Relays—123.
 - Rowboats, Small Dinghy—83.
 - Small Sail Boats—84.
 - Two Outdoor Runabouts—85.
 - Build Own Canoe, Kayak—30.
 - Build Class-E Ice Yacht—22.
 - Auto Kinks, Shortcuts—10.
 - Lawn and Garden Equipment—124.
 - Motor-Driven Midget Cars—34.
 - Stop Auto Elect. Troubles—95.
 - Photo Printers and Dryers—25.
 - Photo Darkroom Equipment—96.
 - Trick and Table Top Photos—97.
 - Home Movie Equipment—118.
 - Poultry Houses—108.
 - Guns and Decoys—109.
 - Re-Silvering Mirrors—70.
 - Chemical Experiments—93.
 - Log Cabins, Tourist Houses—14.
 - Using Basic Tools—120.
 - Farm and Garden Tractors—8.
 - Building Extra Attic Rooms—23.
 - Attractive Basement Rooms—24.

Check Titles Wanted, Clip, Mail with Remittance to

POPULAR MECHANICS PRESS, Dept. 23, 200 E. Ontario, Chicago 11

YES! SEND



directly to my door every month

I am enclosing
 \$3.50 for 1 year
 \$8.00 for 3 years

name _____

address _____

city _____ zone _____ state _____

Hand this order to your newsdealer or send it to

POPULAR MECHANICS
 200 East Ontario St. Chicago 11, Ill.

NOW you can learn TV-RADIO servicing at Home

in your
spare time!



BIG DEMAND FOR TRAINED MEN!

Famous CRESCENT SCHOOL of Radio & Television now offers a *complete* HOME STUDY COURSE for those unable to attend classes! CRESCENT SCHOOL's experience of millions of training hours assures you of the finest training available. New simplified lessons and illustrations — *no previous training needed!* Parts-kit included.

Get into this high-paying field with a future! Many students start to earn extra cash while learning. Complete the course as quickly as you can learn. Certificate awarded upon completion of course. CRESCENT SCHOOL's free placement service is available to you!



INCREASED EARNINGS



INTERESTING WORK



AN UNLIMITED
FUTURE

FREE!

Send TODAY for FREE illustrated, interesting booklet & complete details about the HOME STUDY COURSE!

PAY AS LITTLE AS
\$5 MONTHLY

Total cost for complete course
as little as **\$100**

Crescent School — one of the largest of its kind! Multi-million-dollar plant in its own 6-story building.



SEND COUPON TODAY!

CRESCENT SCHOOL Dept. B-2
500 Pacific St., B'klyn 17, N. Y.

Sirs: Rush free booklet & complete details about your HOME STUDY COURSE . . . at no obligation to me.

NAME

ADDRESS

CITY.....ZONE.....STATE.....

TORO

AMERICA'S MOST COMPLETE LINE OF POWER MOWERS

Over 30 models for home and institutional use, plus the finest service system in the industry. Write Toro Mfg. Corp., Dept. M22, Mpls. 6, Minn.



THIS WIRE HAS NOT BEEN OVERSEAS
This high quality two conductor communication wire offered in No. 18 and No. 22 gauge is ideal for intercoms, lead-ins, telephones, indoor and outdoor speaker extensions, doorbells, signal and burglar alarm systems, shotfiring, etc. etc. **SAMPLES ON REQUEST.**

U.S. GOV'T CLOSEOUT

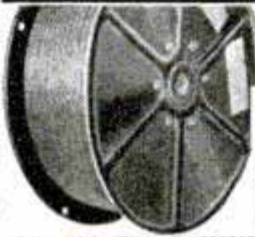

Wire
U. S. Signal Corps
Communication Wire
\$3.50 per 1000 ft. TWISTED TWO CONDUCTOR No. 22 STRANDED
\$3.50 per 1000 ft. TWISTED TWO CONDUCTOR No. 18 STRANDED

ABSOLUTELY NEW AND PERFECT
Mfg'd to rigid Signal Corps specifications

Won't Last Very Long at These Prices
Stock Up Now — Subject to Prior Sale — Order Today
W-110-B—TWO CONDUCTOR #18 STRANDED (four steel and three copper strands) rubber covered plus weatherproof cotton braid and twisted, 5,280 feet per steel reel. Only **\$3.50** per thousand feet (3/5c per ft.) or **\$18.25** per reel.
W-130—TWO CONDUCTOR #22 STRANDED and twisted (one copper and six steel strands) in your choice of rubber or plastic insulation, 10,000 feet per steel reel. Only **\$3.50** per thousand feet (3/5c per ft.) or **\$35.00** per reel.
(Note: Steel strands are incorporated for extra tensile strength and are tinned and treated for efficient conductivity.)
All these way below market prices, our stock will not last long. Take advantage of this exceptional closeout and **STOCK UP NOW!** Minimum order—one reel.
Prices F.O.B. Chicago. Include approx. postage on orders paid for in advance. C.O.D. orders enclose 25%, balance sent C.O.D. **WRITE FOR FREE ILLUSTRATED CIRCULAR.**

U. A. S. Corp. Dept. PM 2, 5637 W. 63rd Pl. Chicago, Illinois

Say You Saw It in Popular Mechanics

AERONAUTICAL ENGINEERING



Design Aircraft & Components — Study with Jets & Rockets — Great Future — Advanced Aeronautical Subjects — World-Wide Enrollment — Fully Accredited — Established 1929 — Approved for Vets — CAL-AERO grads in heavy demand.
WRITE TODAY for Special Information. PM-2

NAME _____ AGE _____
ADDRESS _____
CITY _____ ZONE _____ STATE _____

CAL-AERO TECHNICAL INSTITUTE
GRAND CENTRAL AIR TERMINAL • GLENDALE 1, CALIFORNIA

SPEED & POWER

"SOUP UP" ANY CAR

1952 SPEED AND POWER FOR ALL CARS

128 Page Library Edition Over 300 Illustrations

LEARN HOW TO GET 150 MILES PER GALLON WITH YOUR OWN CAR!
Fascinating construction drawings actually show how you can build fast stock cars, California roadsters, 200 MPH hot rods.
EASY STEP BY STEP METHODS help you save by building your own dual manifolds, superchargers, hot cams, water injectors, high compression heads.
LIGHTNING SPEED AND SUPER POWER
50 BREATHTAKING CHAPTERS TELL ABOUT: Tuning techniques, speed tricks, economy secrets, formulas for getting racing speed and dynamic power. Includes information on: Racing frames, reciprocating masses, jet engines, wheel geometry, dynamometers. Photos and diagrams show how to re-style and customize all cars. Also info. on dual pipes, gears, fuels, porting, relieving, lowering, balancing.
This great book . . . plus big 1952 "Speed Equipment Catalog" . . . plus 46 page "Economy Driving Manual" . . . plus "150 MPG Booklet" . . . all four items . . . ppd. **\$1.98**

NEWHOUSE AUTOMOTIVE INDUSTRIES.
Dept. B-2 5807 E. Beverly Blvd. Los Angeles 22, Calif.

LOOK AT THE WANT-ADS—NOTE DEMAND FOR DRAFTSMEN

"Help-wanted" ads plead for draftsmen—thousands needed! Pay is high—many chances for fast promotions. Easy to learn at home. Professional outfit sent. Low terms. Job placement. Write for valuable booklet.
COMMERCIAL TRADES INSTITUTE, Dept. D 2-2
1400 Greenleaf Avenue • Chicago 26, Illinois

MACHINISTS! CAN YOU . . .

cut 25.4 threads per inch? With "Lathe Threading Any Pitch" you can cut any pitch thread mathematically correct—odd, metric or fractional. No attachments necessary. Use materials on hand. Copyrighted directions — just \$1.00.

VIRGIL H. BEST, 1762 Oakdale St., Pasadena 4, Calif.

CUT ANY THREAD!

FURNITURE for YOUR BEDROOM

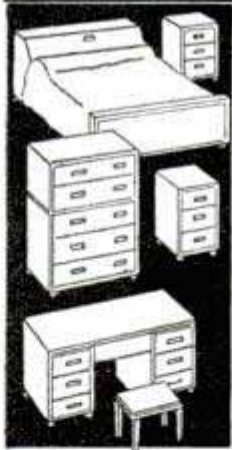

SAVE MONEY, be the envy of your neighbors by making this beautiful bedroom suite yourself! Only a power saw and jointer are needed to turn out this smart suite, featuring bed with storage space, three-piece vanity with cosmetic compartment and makeup mirror, Mr. and Mrs. dresser, and twin night stands with drawers. Letters demanding detailed plans poured in after this furniture was pictured in Popular Mechanics Magazine. Now the 4 plans are ready—easy-to-follow scale drawings—and they're yours for only \$2.00! Send for a complete set today.

POPULAR MECHANICS PRESS
200 EAST ONTARIO STREET, CHICAGO 11, ILL.

ROUND STOCK OR PIPE JAW For Your Vise

\$1.00
Postage .20
\$1.20

H. A. JOHNSON
3921 LaCresta Ave. Oakland 2, Cal.

YOU SAVE UP TO 50% THORESEN'S CASH SAVEWAY!



Recipro-Register

NEW! SHOCK RESIST MODEL CHRONOGRAPH

You can buy plenty of "chronographs" for less money—but remember, Thoresen's is the only **GENUINE RECIPRO-REGISTER CHRONOGRAPH**, distributed exclusively by us in the U.S. A magnificent watch, it also times Races, Planes, Sports, Photography, Shop Work, etc. **INCABLOC** 17 jewel movement resists shocks and rough handling that may ruin other watches. 5 multi-function synchronized dials. Contact clutch starts computation. Brake clutch freezes result. Also **ERASES** back to zero and **REMEMBERS** for you while movement continues to keep time! Stainless Steel back, radium dial, unbreakable crystal, etc. Get the one and only genuine. Not \$100.00. Now only **27.25** plus 10% tax, total **29.98**. Nationally advertised **Cobra Metal Band** (reg. \$3.95) **FREE** of extra cost!



POWERFUL LONG RANGE

Made in U.S. Zone GERMANY

AMAZING VALUE! Compare with domestic binoculars selling up to \$9.95, for clarity, light weight, rugged construction! GERMAN KLAROVIS ground lenses give terrific magnification, wide field of view, and sharp, brilliant detail! Smooth, SYNCHRONOUS centre focusing mechanism. 40mm objectives. NEW! Different! CAUTION: Do not confuse with crudely made binoculars claiming 18 mile ranges! You can depend on **GUARANTEED KLAROVIS QUALITY! Manufactured by German Artisans. Only **\$2.95**.**



24.95

NEW! JET-O-MATIC 360° AUTOMATIC

Superior De-Luxe model **360° FULL SWING AUTOMATIC**. Just set it—then forget it! Winds itself as you wear it. Patented **INCABLOC**—17 Jewel movement of superb accuracy, **WATER & SHOCK RESIST**—drop it, bang it, even swim with it. 100% Stainless Steel Screw-back, radium luminous markings, unbreakable crystal, hairline sweep second, **SPLIT SECOND** calibrations for precise timing. Handsome **THIN** case. De Luxe **GOLD** tone numerals & hands. **CAUTION: Do not confuse with inferior 180° HALF swing automatics!** Thoresen's **JET-O-MATIC** is the **FULL SWING** self-winder—**360°** high compression! Makes ordinary watches old fashioned by comparison. It's our **BEST Automatic**. Not \$75.00. Our price only — **24.95** plus 2.50 tax, total **27.45**.

LOOK! SAVE THORESEN'S CASH-SAVE-WAY!

Be smart! Don't pay **TWICE** as much for credit! Frankly, we'd have to charge you **DOUBLE** for time payments! By big-volume cash selling **DIRECT-TO-YOU**, we save credit "dead boat" losses, high pressure salesmen's commissions and fancy main street rentals. We pass on these savings to **YOU!** Result: You pay only 1/2 and pocket the difference!

10 DAY HOME TRIAL! Use at our risk, without obligation. If not delighted, return within 10 days for **QUICK** refund of price. **Save MORE**—send check or money order for prompt, free delivery. C.O.D.'s sent plus postage.

Unlimited Guarantee

EXCLUSIVE OF PARTS Given with every watch! Never a charge for skilled labor, handling, adjusting, etc. for **LIFETIME** of this business! **NOTICE:** All Thoresen watches certified **BRAND NEW** and **TESTED** before shipment. We never sell "second hand" or surplus watches! Be wise! Shop with 100% safety the Thoresen—**SAVE** way! For **HONEST** values, write now!

Thoresen Direct Sales
Dept. 6-B, 131 West 33rd St.,
New York 1, N.Y.



Original TRANS-KLEER PORTABLE GARAGE \$10

PROTECT YOUR CAR against the ravages of snow, sleet, rain, salt air, grime and dust with a genuine, **ORIGINAL TRANS-KLEER** garage! It's different... it travels with your car everywhere. Whisks on and off quick and easy! Takes little storage. Folds away like a handkerchief. Unique, elasticized **GRIP-PLEAT** bottom offers complete security, winter or summer. Pays for itself many times over. Protects car finish and keeps water out of motor. Saves on car washes too!

Compare **TRANS-KLEER** with any Garage up to \$19.95

Do not confuse **TRANS-KLEER** with inferior plastic materials! Thoresen's Portable Garage is quality made of 100% **HEAVY DUTY TRANS-KLEER**, a miracle of American industry! It's **THICK** and **TOUGH**, yet so **SILKY!** Resists cracking or peeling even in coldest weather! **Live-Flex** action means long life. **TRANS-KLEER** is our very **BEST QUALITY**, longest wearing garage. Tailored in **ALL** sizes for **ANY** car, from an Austin to a Cadillac to ensure better fitting. Thoresen's unique **GRIP-PLEAT** bottom allows you to use it for Farm Machinery, Tractors, Garden Furniture, Small Boats and other equipment. Send only \$10 for **FREE** prompt delivery right up to your door. No collect charges for expressage or postage! Or order **C.O.D.** plus postage. In either case, **TRY IT 10 DAYS AT OUR RISK!** Your \$10 back **QUICK** if not delighted. Mention car make, year and model!



2.95 EACH

LEOPARD

SATIN-LIKE "RICH-TONE" DESIGN

AUTO SEAT COVERS

TERRIFIC VALUE! New, deluxe **RICH-TONE** material looks like **LEOPARD FUR**, gives beauty and distinction to your car. Adds new life to old, worn interiors. Protects new car upholstery against wear, dust, grime, stains, grease, bad weather. Tough, durable, resists cracking! Handsome tailored appearance. For **ALL** cars, **ALL** years, **ALL** makes and models. No pins! No tucks! No sewing! Ingenious **SNAP-TITE** feature. Just **SNAP** on or off in a **JIFFY!** Best of all: they're only **2.95** for front or rear seat. **SPECIAL!** Pair for front and rear, only 4.95. Mention car make, model & year, also if front seat is full front or split coupe front.

THRIFTY BUYS

17 JEWEL STANDARD CHRONOGRAPH
(3 dials — 5 hands)
Our price **18.95** plus 1.90 tax

17 JEWEL AUTOMATIC (180° HALF SWING Model)
Our price **19.50** plus 1.95 tax

HEAVY DUTY PLASTIC PORTABLE GARAGE
Our price **8.69** no tax

SPECIAL! MEN'S SWISS ACCURATE WATCH
Our price **4.69** plus 47c tax

17 Jewel INCABLOC WATER & SHOCK RESIST
Our **LOWEST** price ever! Only **14.50** plus 1.45 tax

Send all orders to old reliable:

THORESEN DIRECT SALES, Dept. 6-B, 131 West 33rd Street, New York 1, N. Y.

AMAZING IMPROVED ELECTRIC SPRAYER MAKES HOME PAINTING EASY

Why wear yourself out using Expensive old-fashioned brushes? **Mistifier Sprayer** quickly, smoothly and evenly sprays glossy enamels, lacquers, insecticides, mothproofers and oils. All in one self contained unit that requires no compressor, motor or accessories. All metal non-corrosive parts makes this unit a **LIFELONG** useful tool. Sturdily constructed, weighs only 2 lbs., uses standard replaceable Mason jar, 80 POUNDS PRESSURE, fingertip control. AC-110 volts. **FOR PAINTING, SPRAYING, DISINFECTING, MOTH PROOFING.** **Mistifier Sprayer** works wonderful when painting wicker and all other furniture, cars, metal cans, partitions, concrete, brickwork, rough wood, boats, wagons, screens, cabinets, venetian blinds. Wonderful for Mothproofing clothes, rugs, drapes, storage closets, etc. **Mistifier is Safe and Easy to use.**



**10
DAYS
FREE TRIAL
UNCONDITIONALLY GUARANTEED**

**Only
995**

Complete —
No Extras
to Buy

We Guarantee that **Mistifier Sprayer** will apply paint smoothly, quickly, easily — or return it within 10 days for full purchase price refund. Only \$9.95 Postpaid or send C.O.D. plus postage. Full Instructions. Order Now.

IMPERIAL SALES

480 LEXINGTON AVE., Dept. 396 NEW YORK 17, N. Y.



SPRAY FURNITURE



PAINT AUTOS

MONTH AFTER MONTH, YEAR AFTER YEAR, YOU SEE OUR AD.

REMEMBER IT'S DANGEROUS to pay less if you want the finest (nonskid) USED tires.

GOOD YEAR Firestone
GOODRICH, UNITED STATES, GENERAL & OTHERS, NOT RECAPS

Our policy is to select your tires so carefully, as if our very future depended on the service given by that particular tire.

FREE TUBE WITH "ALL" BLATT'S GOOD GRADE TIRES

| GOOD GRADE, 16 MONTHS | GOLDEN RULE | GUARANTEE BOND. |
|-----------------------|---------------|-----------------|
| 600-16 \$4.14 | 700-15 \$4.54 | 650-20 \$7.94 |
| 650-16 5.42 | 670-15 4.74 | 700-20 8.54 |
| 700-16 5.04 | 710-15 4.94 | 750-20 8.64 |
| 650-15 4.44 | 550-17 4.64 | 825-20 15.92 |
| | | 1000-20 13.94 |

FINEST GRADE, 26 MONTHS GOLDEN RULE GUARANTEE BOND

| THIS GRADE MADE THE BLATT NAME "WORLD FAMOUS" | | | |
|---|---------------|----------------|----------------|
| 450-20 \$6.00 | 450-21 \$6.00 | 700-15(6) \$10 | 750-16(8) \$15 |
| 600-16 5.49 | 650-15 5.94 | 600-20 9.94 | 900-20 18.54 |
| 650-16 6.42 | 670-15 6.24 | 650-20 9.94 | 1000-20 18.54 |
| 700-16 5.94 | 700-15 6.54 | 700-20 11.94 | 1100-20 18.54 |
| 750-16 7.94 | 710-15 6.34 | 32x6(8) 10.54 | 1000-22 17.54 |
| 550-17 9.94 | 760-15 6.50 | 32x6(10) 13.92 | 1100-22 18.54 |
| 525-18 5.54 | 820-15 7.04 | 750-20 12.54 | 700-17 12.00 |
| 650-19 9.00 | 475-19 5.94 | 825-20 19.84 | 1100-24 21.54 |

| Buy Our "Right" TRUCK TIRES | Std. Guar. 16 Mos. Rugged Guar. 30 Mos. |
|-------------------------------|---|
| For "Your" Job 8-10-12-14-Ply | MILITARY MUD-SNO TREAD |
| 750-20Std. \$10.75 | 750-20Rg. \$19.95 |
| 750-16 Rg. 18.95 | 900-16 Rg. 11.95 |
| 600-16 Rg. 9.95 | 900-16 Rg. 18.95 |

BLATT BLATT BLDG., GIRARD & LANCASTER AVES., DEPT. PM., PHILADELPHIA 31, PA.
Send check or money order and this ad for rush shipment. We won't ship a tire we wouldn't use. The name to trust in rubber. PRICES SUBJECT TO CHANGE
Shipments RUSHED Down South, Up North and Far West

NEW TINYTONE RADIO
Really Works — World's Smallest. New Preset Crystal eliminates All Tubes, Batteries or Electric "Plug-ins" Forever! Sweep band dial—Beautiful Red Plastic case. **GUARANTEED TO WORK** on local stations if used as directed or money refunded—use most anywhere—**SEND ONLY \$1.00** (bill, c.k., m.o.) and pay postman \$3.99 C.O.D., postage or send \$4.99 for P.P. delivery. **COMPLETE WITH EXTRA LONG DISTANCE AERIAL KIT AND PHONE.**
LIMITED SUPPLY — SO ORDER NOW!
MIDWAY CO., Dept. BPM-2, KEARNEY, NEBRASKA

HELPFUL BOOKS
Send post card asking for **FREE** catalog
Popular Mechanics Press, 200 E. Ontario, Dept. 601, Chicago 11

Amazing Midget Wrist Radio
\$2.98
Enjoy music, sports, programs with your own private, portable Wrist Radio! Use indoors or outdoors! Brings in local stations up to 50 miles! Worn like wrist watch, yet receives regular radio stations. Has super-sensitive crystal diode (worth \$1.95 alone!) & needs NO BATTERIES! NO TUBES! NO ELECTRICAL PLUG-INS! Lasts for years with NO EXPENSE! Built-in earphone. Complete with 2 clips. Just connect & set is ready for use. About 2 1/2-in. diameter, colorful plastic case, adjustable im. leather band. Only available at this low price while war-surplus diodes last so order now!
\$2.98
(2 for \$4.98) EACH COMPLETE POSTPAID ONLY.....
JOHNSON SMITH & CO., Dept. 485, Detroit 7, Michigan

FREE CATALOG

Over 300 books on Fishing, Hunting, Home Repairs and Improvements, Bricklaying, Welding, Home Workshop, Power Tools, Hobbies, Crafts, Home Building, Trades, Making Money at Home, Furniture Making, Woodworking, Carving, Photography, Art, Drawing, Mechanisms, Engineering, Refrigeration, Plumbing, Radio-TV, Electricity, Automobiles, Farming, Livestock, Gardening, Decorating, Painting, many, many more. Send for yours today.

POPULAR MECHANICS PRESS, 200 E. Ontario St., Chicago 11

Say You Saw It in Popular Mechanics

SEND ME

every month so I am sure to see each new issue. Here's

\$3.50 for 1 year
 \$8.00 for 3 years

name _____
address _____
city _____ zone _____ state _____
B-22

Hand this order to your newsdealer or send it to
POPULAR MECHANICS
200 East Ontario St. Chicago 11, Ill.



Sensationally NEW for 1952!

MIDWEST TELEVISION



A Magnificent New Line of Beautiful CONSOLES and Complete CHASSIS featuring the Mammoth

20-Inch

RECTANGULAR PICTURE TUBE

FACTORY-TO-YOU

Special Bonus



GIFT!

Illuminated TELEVISION CLOCK

Given With Every Purchase of a MIDWEST RADIO or TELEVISION

LIMITED TIME ONLY!

THE New 1952 MIDWEST "VIDEO GRAND"

20-Inch Television-Radio-Phono

MIDWEST
20-Inch
 TELEVISION
 CHASSIS
 and SPEAKER
 —for easy installation
 in your own cabinet.



We Pay Transportation Charges

WRITE or PHONE
 For This NEW 1952
FREE MIDWEST
RADIO CATALOG



If You Live In One of These Cities Phone and Ask for Your Catalog

- NEW YORK Murray Hill 2-6810
- CHICAGO State 2-5600
- PITTSBURGH Grant 1-0609
- CLEVELAND Prospect 1-7450
- DETROIT Woodward 3-1233
- ST. LOUIS Grand 1161
- PHILADELPHIA Locust 4-1035

or Send Coupon Below

• WRITE IN NAME AND ADDRESS (PLEASE PRINT) ON COUPON OR 1c POSTCARD •

MIDWEST RADIO & TELEVISION CORP.
 Dept. 257, 909 BROADWAY • CINCINNATI 2, OHIO
 Please send me your new FREE 1952 Catalog.

NAME _____

ADDRESS _____

CITY _____ ZONE _____ STATE _____

30 DAYS TRIAL New 1952 MIDWEST "CONSTELLATION" 20-Inch TELEVISION CONSOLE

Also—Powerful New 1952 World-Ranging
MIDWEST Series of RADIOS
 For Beautiful Consoles and Complete Chassis

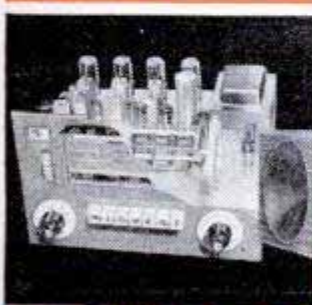

An entirely new line of radios featuring the powerful Series 16 five wave band AM-FM Radio Chassis and the magnificent Symphony Grand Radio-Phonograph with 3-Speed Automatic Internix Record Player.

Easy Terms



MIDWEST RADIO & TELEVISION CORP.
 DEPT. 257, 909 BROADWAY, CINCINNATI 2, OHIO

Make this the greatest outdoor year of your life with a

HARLEY-DAVIDSON

HYDRA-GLIDE®

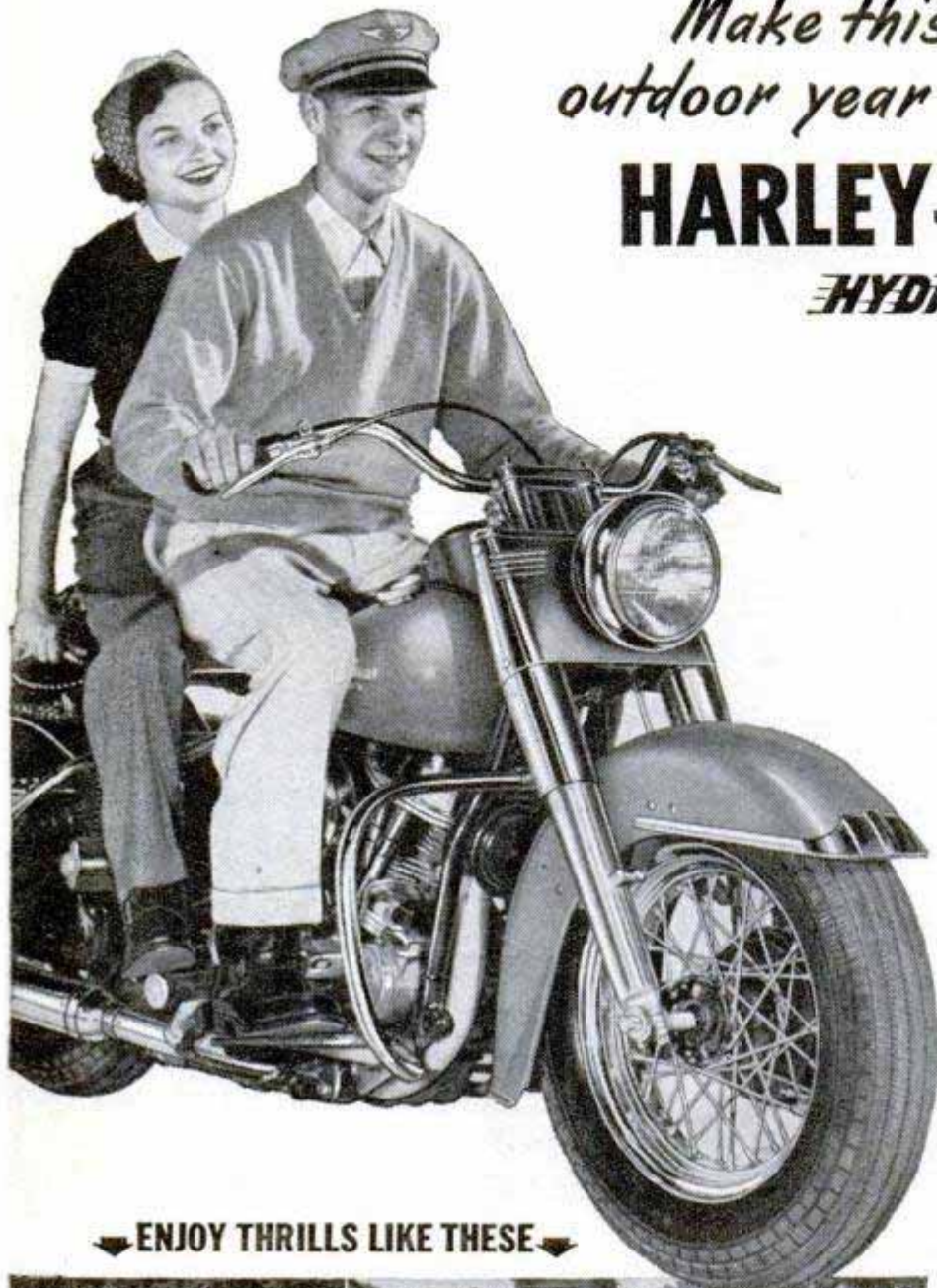

This year get an early start on healthful, invigorating, outdoor fun! Visit your dealer today and ride the new 1952 Harley-Davidson Hydra-Glide. See for yourself how much more it brings you for your money... in quality, performance, economy and endless good times. Check on the many new features... foot shift-hand clutch, Parco-Lubricized valves, power-boosting muffler, longer-life tread contours, luxurious color styling, and others. A Harley-Davidson is your ticket to more real enjoyment than you've ever had before. It opens a whole new world of outdoor sport, travel, adventure... brings you a host of new pals... makes you one of those who "belong"... at delightful gypsy tours, exciting race meets, club runs and other thrilling motorcycling events. Economical and handy, too, for riding to work or school, for a multitude of uses that will suggest themselves once you are in the saddle. See your dealer right away. Mail the coupon.

↙ ENJOY THRILLS LIKE THESE ↘

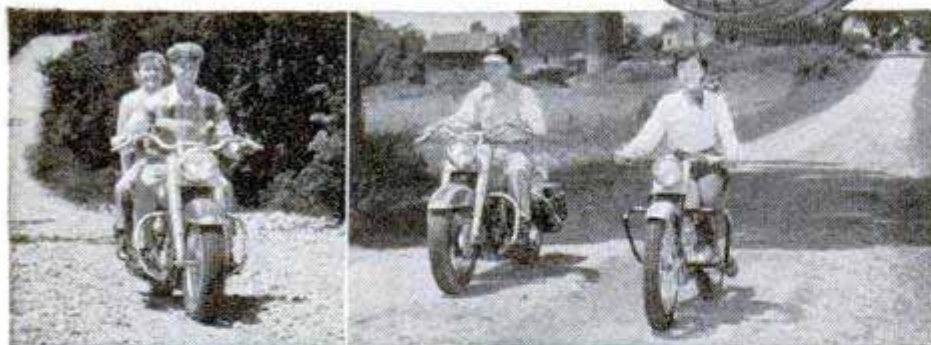

HARLEY-DAVIDSON WINS
 100-mile National Speedway Championship third straight year. Takes first 8 places. Winner Billy Huber sets new A. M. A. record — time 66 min., 17.30 sec.!

HARLEY-DAVIDSON MOTOR CO., Dept. P, Milwaukee 1, Wisconsin

Send me free copy of ENTHUSIAST Magazine filled with motorcycle action pictures and stories; also literature on 1952 models.

Name.....

Address.....

City..... State.....



DEALERS: A few valuable franchises available for the full line of famous Big Twins and the 125 model. Write today.

In Britain a team of chemists has evolved an alkali solution in which two tons of metal can be washed free of rust in an hour and a half.

Through this development, thousands of tons of left-over war equipment—guns, bombs, shells and even radar precision instruments—are being reclaimed from storage dumps.

Guns and projectiles which would have had to be scrapped, melted down and re-made are being laundered whole and returned straight to ordnance stores or explosive-filling plants. Defense ministries are at present taking up 80 percent of the metal laundries' output, and each of the 11 derusting plants operating in Great Britain can deal with 100 tons of equipment a week. The laundry near London cleans and derusts a thousand 3.7-inch antiaircraft shells every day. Rows of shells are laid on special holders—like wine bottles on racks—and dipped by overhead conveyors 56 at a

WRITTEN SO YOU CAN UNDERSTAND IT
VOL. 97

time. Out they come, gleaming like new.

Recently 474 trainer aircraft of the Royal Air Force—urgently needed for the basic instruction of young air crews—were grounded through lack of spare parts. New spares would have taken more than a year to make. With the use of the new derusting solution, the aircraft were all flying within a month.

Until now, derusting processes have depended on violence. Rust flakes can be

RUST MEETS ITS WORST ENEMY

By Eric Bennett

Rack of rusty shells emerges from first tank, where steaming soda solution removes any grease
Photos copyright by Pictorial Press



TRANSFORMER AND RECTIFIER

DRAIN RACKS FOR DERUSTED MATERIALS

ANTICORROSIVE DIP-TANK

SECOND RINSING TANK

DERUSTING TANK CONNECTED TO POSITIVE ELECTRIC LEAD

WATER SUPPLY PIPE

FIRST RINSING TANK

ELECTRIC HOIST

SUPPORTING BARS CONNECTED TO NEGATIVE ELECTRIC LEAD

HOT DEGREASING TANK

STEAM HEATING COIL

STEAM INLET

DRAIN

TANK DRAIN VALVE

COMPRESSED AIR PIPE

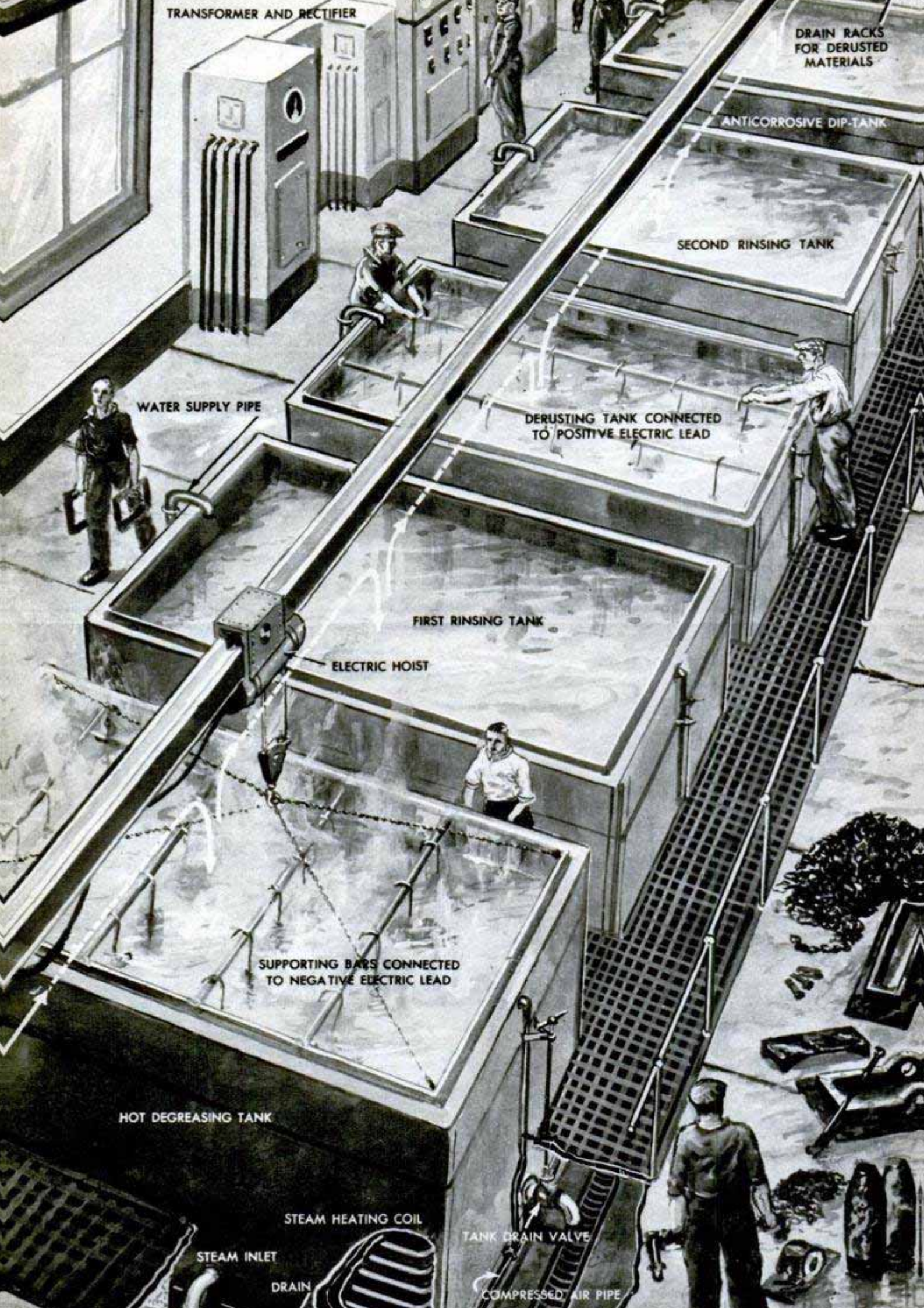

knocked off, or literally shot off. In the sandblasting or shot-blasting processes often used to clean heavily corroded ships' plates, a stream of sand or lead shot is directed against the metal by compressed air or steam. Rust can also be burned off by preparations of phosphoric acid.

The first method can hardly be used on delicate machinery. The second goes too far. The acid will remove the rust, but it may also remove part of the metal surface. And its own corrosive action may continue indefinitely even under a protective coat of paint or grease.

The value of the novel derusting process, perfected by chemists under the direction of Alfred Arthur Grahame-Chapman, is that it does not affect the surface of the metal. Since it uses only alkali activated by an electric current, all the rust can be removed from a precision instrument or from a machine tool gauged to .001 inch. There will be no mark on the metal surface and not the minutest reduction of dimensions. Complicated machines do not have to be dismantled. Calculating machines and typewriters, rusted after being salvaged

←
Material to be derusted is soaked in five successive tanks. In the third tank, rust disappears through combined action of an alkali solution and electrolysis. Final tank coats metal with a protective film

New lamps for old. Rusted old hurricane lamps once might have been scrapped. Now, through the derusting process, they can be converted into gleaming new lamps. Even locomotives have been derusted

from a fire, have been dumped whole into the metal laundry and have emerged clean and in working order.

Chapman set up his first plant in London in 1945 under the name Derustit Ltd. By derusting taffy-wrapping machines, banking and printing plants, cigarette-making machines, electrical equipment and more than 40,000 different items from nuts and bolts to refrigerators, the electrolytic process soon saved industry millions of pounds in capital expenditure.

Dumped in Manchester were unassembled locomotives which had been under construction for the Turkish railway when war broke out in 1939. Some of the heavy cast-iron sections had flakes of rust $\frac{1}{8}$ inch thick in the internal passages. They were laundered and the locomotives were shipped to Turkey some eight years after they had been first built.

A fire in a Lancashire cotton mill gave derusting the chance to show its value to the textile industry. Water used in putting out the fire had made a million steel rollers useless with rust. The roller makers said that it would take at least 18 months to



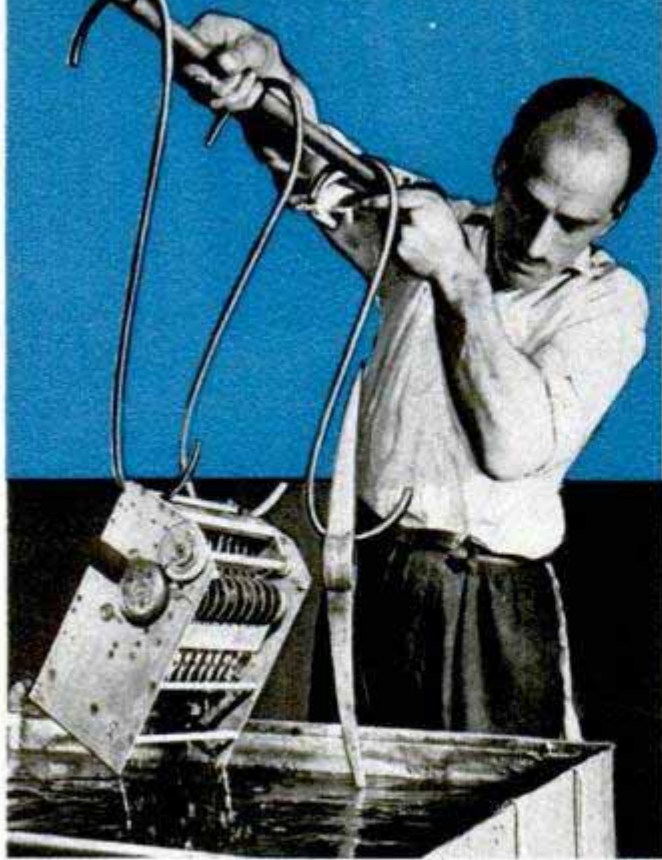

System can be used on intricate machinery. Here an adding machine and a pickax are derusted together

re-equip the mill. Derustit laundered the rollers and the mill was back in production within a fortnight of the fire.

Now the derusting plant at Bury, in Lancashire, does a full-time tubbing service for the textile industry. Rollers in textile mills may not be oiled, and since they are in continuous contact with moist flakes and other damp materials they rust rapidly. Formerly the only way to combat the rust was with sandpaper and elbow grease. After several treatments the rollers were polished out of true dimensions.

These days they are sent regularly to the laundry, like the manager's shirts, and they come back bright and shining—and still true in dimensions. What is more surprising is that the derusted rollers stay bright and shining. Normally there is no bright metal to be seen in a cotton mill. The steel attracts the fluff that fills the air. The derusting process, however, changes the polarity of the steel, so that it repels the fluff and remains clean.

In addition to economies of time and material, the direct saving of money is considerable. Electrolytic derusting can be done cheaply because maintenance and labor costs are low. The most expensive item is the derusting fluid; to fill a 3000-gallon tank with it costs \$3000. But that fluid will give service for six months, and a plant can be run for a full shift by four unskilled men under a foreman with electroplating experience.

The electrolytic process dates back to

1940, when Chapman walked into the electric-lamp factory at Ilford near London after it had been gutted by fire bombs. Delicate machinery had been left a mass of rusty junk. Many of the more intricate machines had been imported from the Continent, and in time of war were irreplaceable. Chapman's job, representing the Emergency Services Organization, was to get bomb-damaged plants working again as quickly as possible.

In charge of a metal department at this factory was an old craftsman named William Buck. As early as 1919, Buck had used an electrolytic process, which was really electroplating in reverse, to clean the rust from ancient suits of armor.

He described his work to Chapman. A derusting tank was made. More than \$100,000 worth of machinery was laundered and emerged rustfree, bright and shining. In less than six months the factory was mass-producing lamps with the restored machinery. Chapman was neither a chemist nor an engineer. But he saw a big future in the derusting process if it could be speeded up. Buck's work, though effective, was slow and therefore costly; some of the machine parts took as long as 26 hours to derust.

In the process worked out by Chapman's team of chemists, a piece of machinery to be derusted is dunked successively in five 3000-gallon steel tanks.

The first tank is the degreaser. It contains a hot caustic-soda solution which removes grease, paint, varnish and enamel from the surface. The solution is kept at 180 degrees F., and by passing an electric current through it, the operators reduce the time needed for the degreasing process from 45 to 18 minutes.

The second tank is a cold-water rinse. Now comes the deruster. This third tank is connected to the positive lead from a rectifier, which converts alternating electric current into direct current. The metal bars, from which the machine is suspended into the secret alkaline solution, are connected to the negative lead.

When the rectifier is switched on, current flows from the side of the tank, which is now emitting a positive charge, toward the negative machine. As it does so it liberates a mass of hydrogen bubbles from the alkaline solution. These bubbles bombard the rusty surface of the machine. They also combine chemically with the rust.

Rust is oxidization, or the combination of the surface metal with oxygen absorbed from the air or from water. Now oxygen and hydrogen together make water, and oxygen has a natural affinity for hydrogen. So the hydrogen bubbles combine with the oxidization on the metal surface and the rust disappears.

Four fifths of the way through the process the electrical current is reversed. The result is that the hydrogen bubbles are forced away, and with them the last flakes of oxidation.

The fourth tank contains another water rinse. Great care is taken to wash off all traces of the derusting solution because it is poisonous and can inflict dangerous chemical burns if it is touched. Finally the derusted machine is dipped into a tank of dewatering oil, which penetrates every part of the metal surface, actually throws off all the water on it and finally coats the metal with a protective film. This last quality is important to the derusting process, because although the electrolytic alkaline bath removes rust it cannot prevent a recurrence.

Derustit Ltd. has already made the first moves toward operation on a worldwide scale. In South Africa, Chapman found that equipment in the damp atmosphere of the gold mines rusted rapidly and that only antiquated methods were used to remove the rust. He has now helped to set up three plants in South Africa, which are working all out on mining machinery. There are also plants working in Italy and Sweden. Negotiations are under way to set up derusting companies in the United States, Canada, Argentina, Australia, New Zealand, Belgium, India, Pakistan, Japan and Germany.



Girl holds samples of shells, one treated and the other untreated. A thousand can be processed daily

Labor costs are low—five men can operate a derusting plant, dipping by hand or with electric hoist

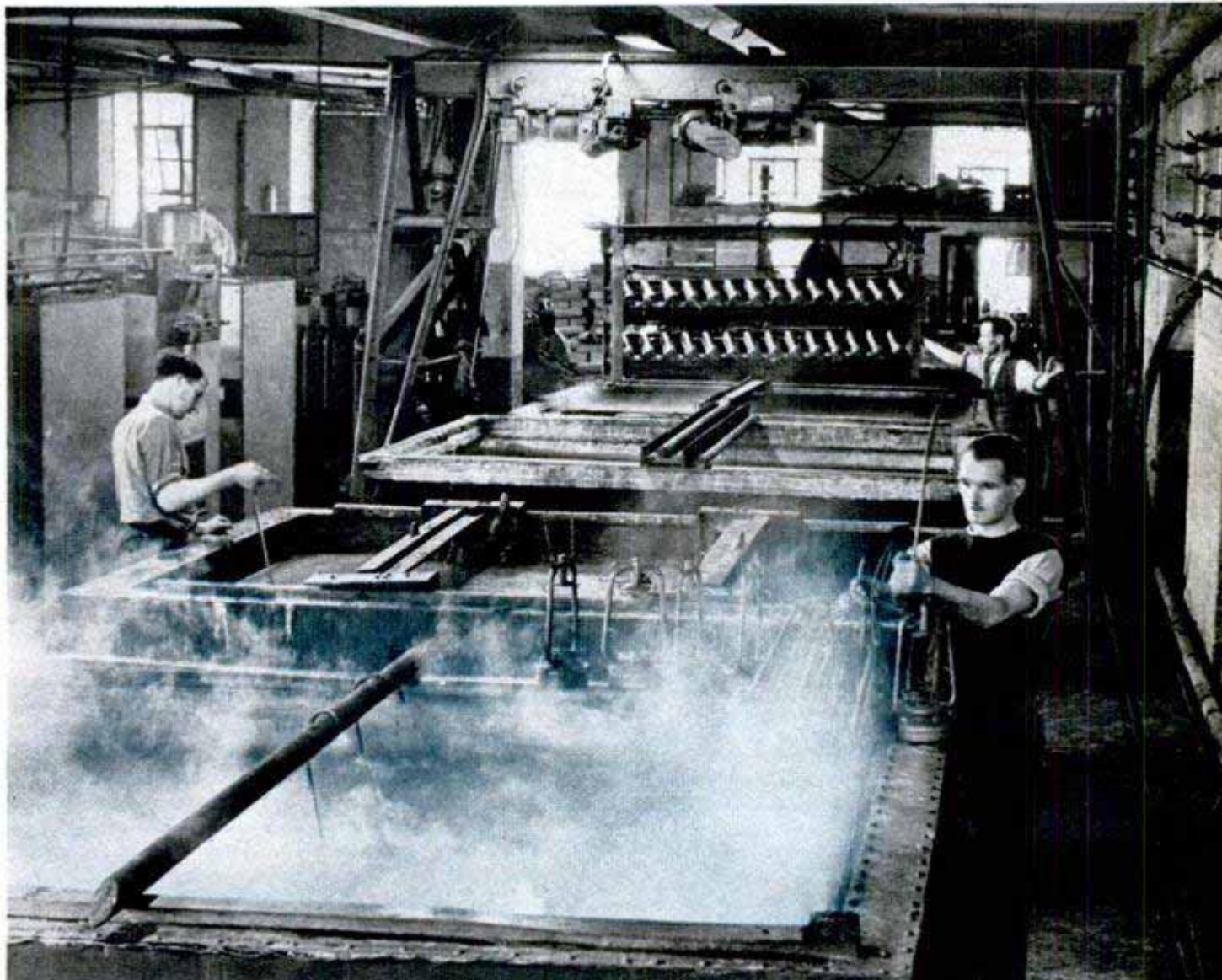

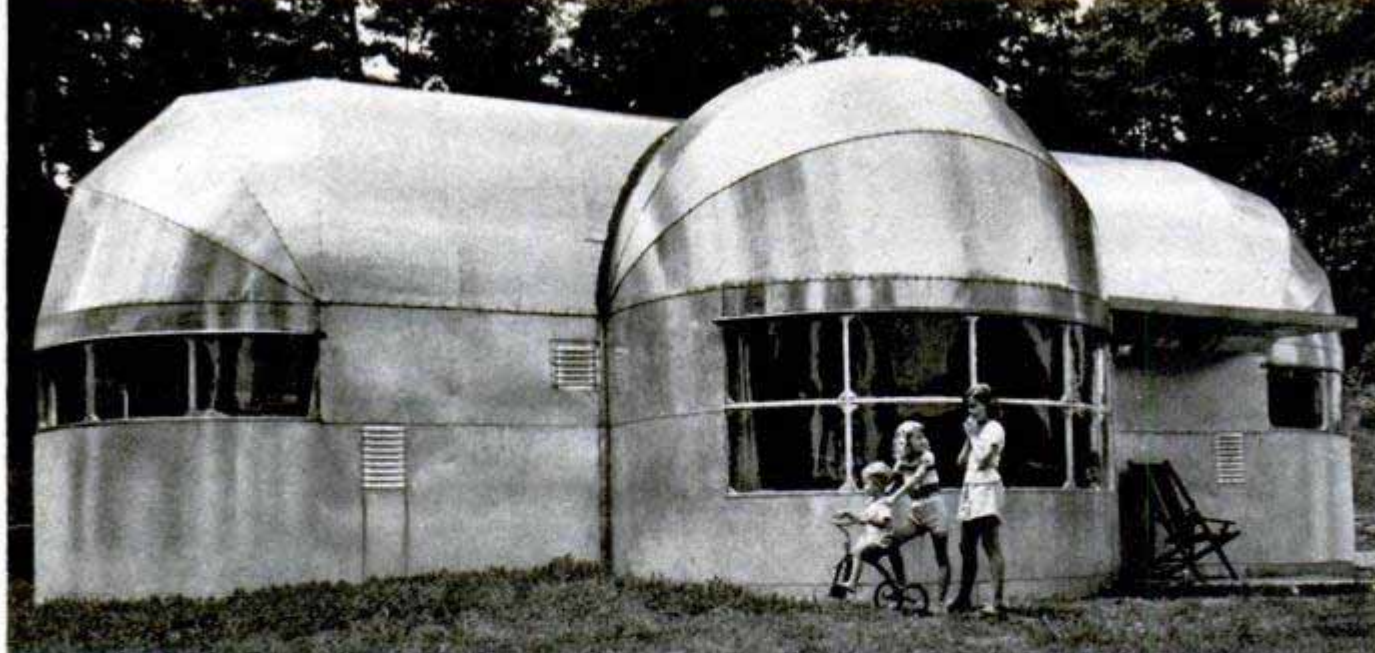

Dustless House

Dust just can't find its way into a new all-metal house built recently near Marion, N. C. Air-conditioning units filter all the dust from air entering the cornerless,

rounded rooms of the house. Built of aluminum alloy, the shiny abode has curved plastic windows which fit the contour of the rooms. The home is said to have floor space equivalent to an average five-room house of conventional lines.

Wheel Rakes

Farmers can mow and rake forage crops simultaneously with a new tractor attachment. Rake-wheels push the cut grain out of the way to the left of the tractor wheels, while on the right side the mower is cutting the next swath. With each wheel individually mounted, the unit adapts itself to uneven ground. The wheels are mounted diagonally and covered to shield the crop from the wind during the raking operation.

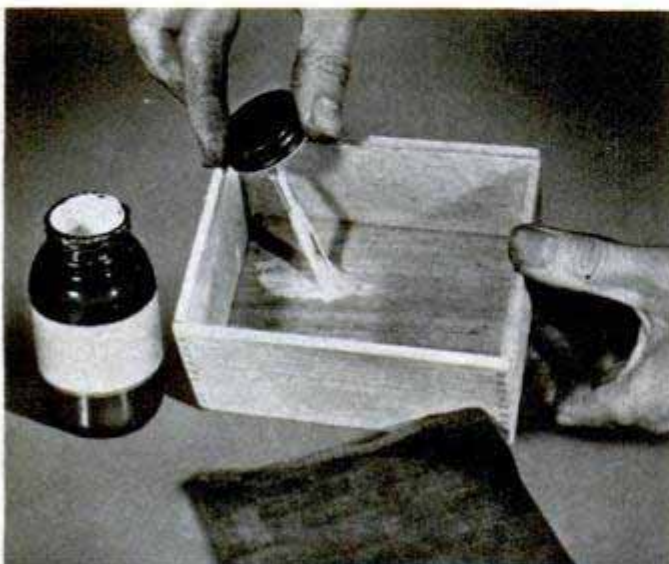
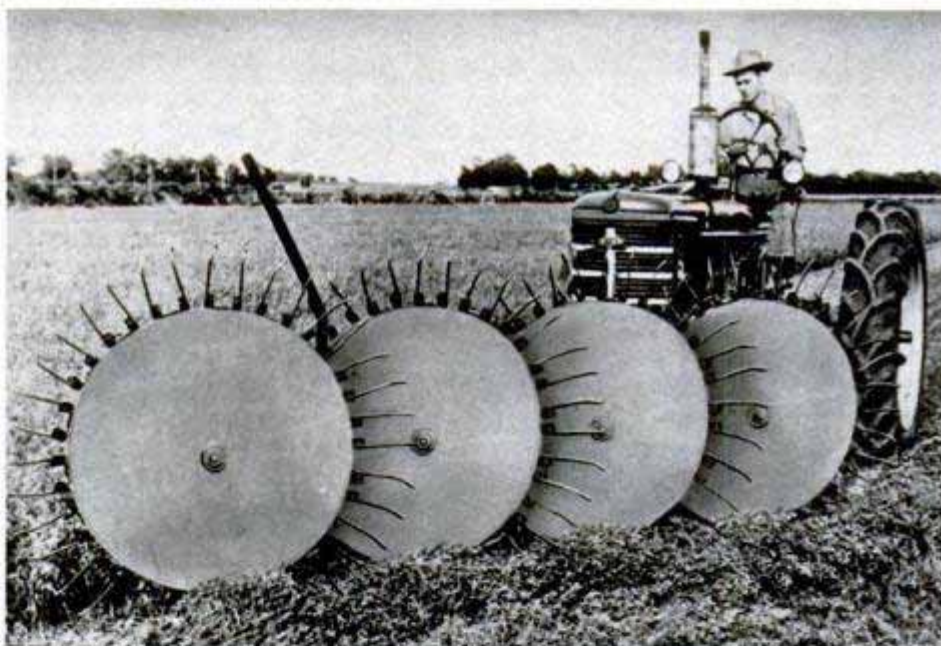

Cement for Fabric

Especially suitable for fastening two or more thicknesses of cloth together, a new nonflammable cement is useful in making women's hats and lining boxes with velvet and other fabrics. It is also used for attaching foil and cementing wood, paper and cardboard.

Sources of available products described in this issue are listed on pages 12, 14 and 16. Sources of further information on other articles are listed in the WHERE-TO-FIND-IT LIST, which is available to readers without charge simply by writing the Bureau of Information, *Popular Mechanics Magazine*, 200 East Ontario Street, Chicago 11, Illinois

Seven-Foot Arm On Jeep Lays Wire

By rigging a Jeep with a collapsible radio antenna, Capt. Francis J. Carr of Dallas, Tex., has produced a vehicle that lays communication wire in Korea at high speeds. The wire runs from a spool up in eyelets on the seven-foot mast and off the tip. The mast is built at an angle so the wire will unreel well to the side of the road. The Jeep also is equipped with a field telephone so the wire-laying crew can remain in constant contact with its headquarters.

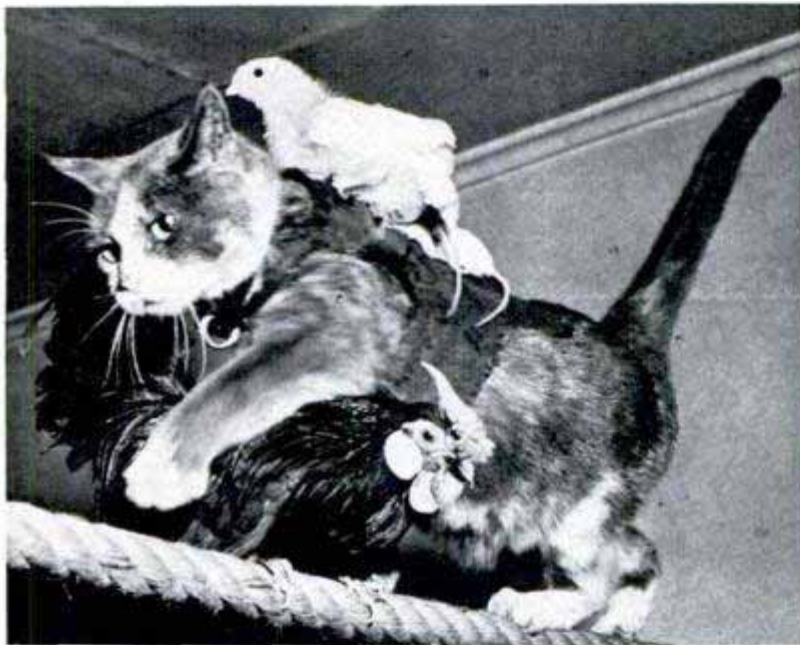

Fisherman and His Pets

Most fishermen have a hobby of some kind and Henry Larsen, lobsterman of Freeport, N. Y., is no exception. He likes to train pets of all kinds. He hasn't yet discovered a way to train the lobster, but he has worked out a tightrope routine starring Sonja, his cat. Sonja gracefully trips across the rope carrying two white mice and a small chicken on her back. To make the act a little more exciting, Julius, a bantam rooster and another of Larsen's pets, perches unconcernedly on the rope, forcing the cat to step over him as she carries her passengers along the rope.

Battery-Powered Baseball Scoreboard

Mounted on rubber-tired wheels so it can be rolled off the field when the game is over, a compact scoreboard shows balls, strikes, hits and errors with colored lights. Current for the lights is provided by battery, the lights being sealed-beam auto headlights. Folded, the board occupies very little space and can be stored easily. When opened, it is 10 feet long and 6 feet high. It is designed for use in parks without a permanent scoreboard.





American Way of Life Photo Contest

7th Prize: "Pied Piper"
Bill Peery, Denver, Colo.

Last month, *Popular Mechanics* printed the top 14 winners in the American Way of Life Photo Contest. This month we present the remaining 18 winners. Seventh and eighth prizes are \$100 each; honorable mention awards are \$25 each.



Honorable Mention:
"Main Street"
Carl Robert Mesterton,
Rye, N. Y.

Honorable Mention:
"Circus Day"
Howard Riome,
Toronto, Can.



8th Prize:
"Sunday Afternoon: U.S.A."
K. F. Kunkel, New York City



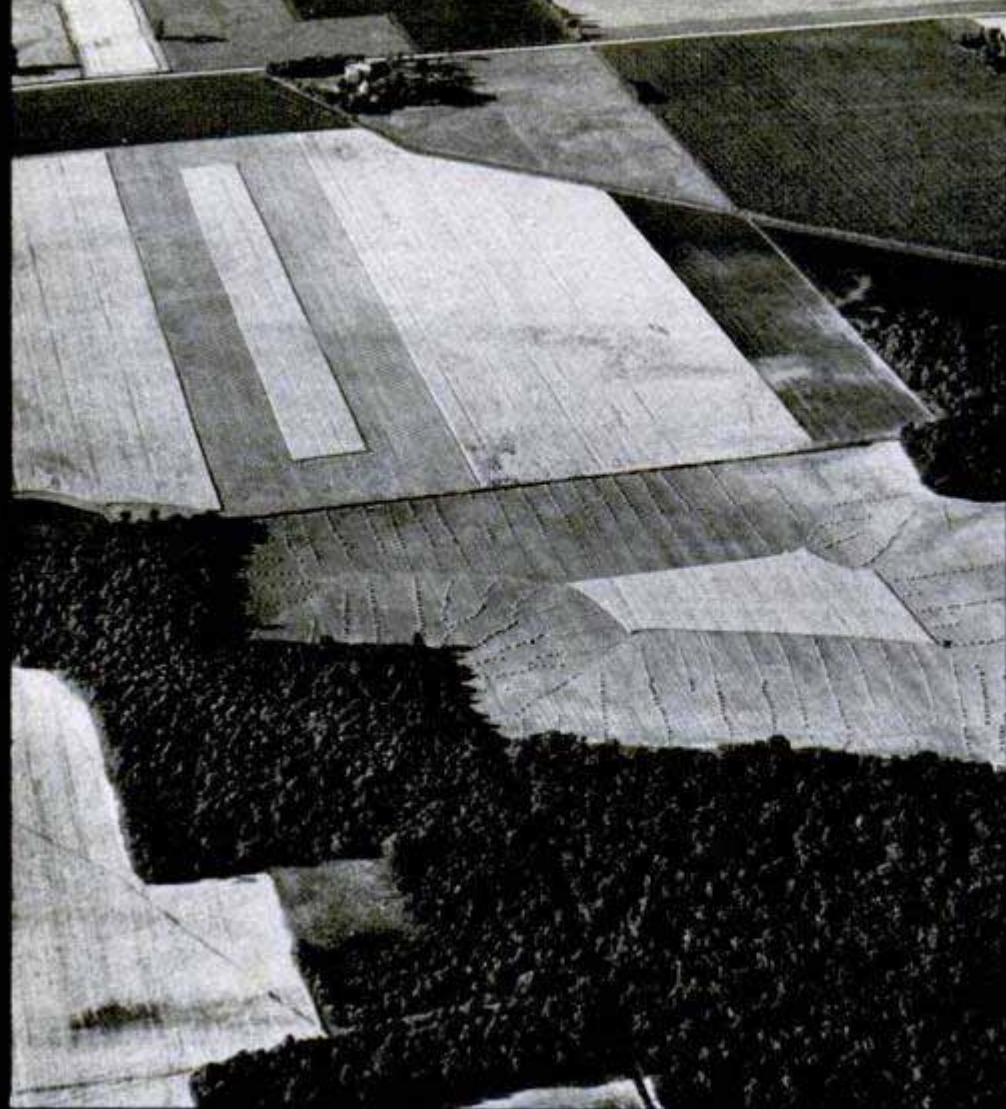

Honorable Mention:
"Land of Plenty"
G. L. Osmanson,
Morris, Ill.

Honorable Mention:
"Come On In"
John Gajda,
Detroit, Mich.





Honorable Mention: "Teddy Bear, Teddy Bear, Touch the Ground!"
Roger Baele, South Bend, Ind.

Honorable Mention: "White Water and Black Shadows"
Vincent Mandese, Santa Barbara, Calif.





Honorable Mention:
"School Days"
Janet Konkle,
Grand Rapids, Mich.

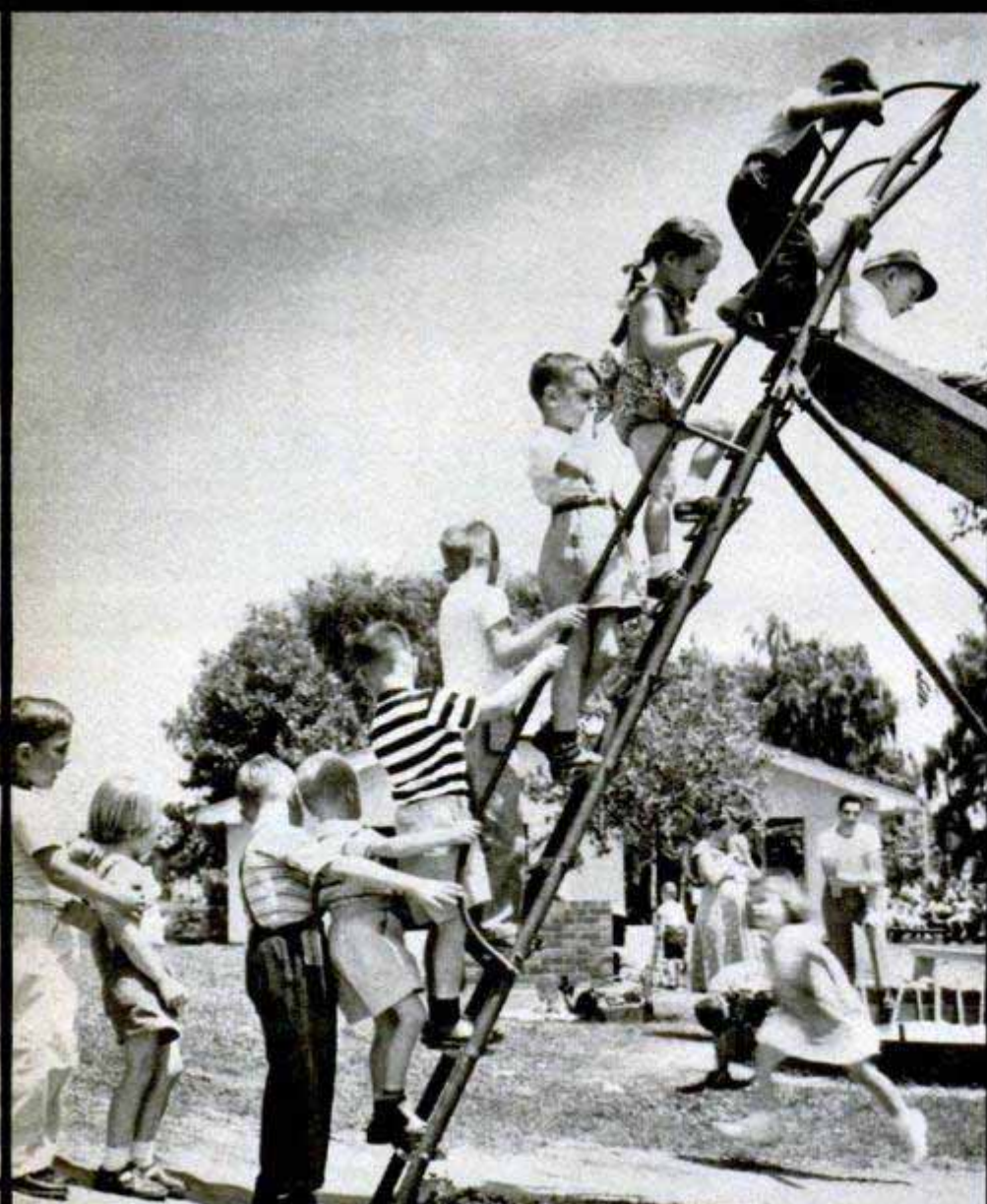

Honorable Mention:
"Wait for Me!"
Charles S. Rice,
New Holland, Pa.

Honorable Mention:
"Lunch-Hour Engineers"
Alvin M. Radin,
Yellow Springs, Ohio



Honorable Mention:
"Boys and Marbles"
Byron W. Campbell,
Watertown, Mass.





Honorable Mention:
"Youth"
Vivienne Lapham,
Norwalk, Calif.

Honorable Mention: "Dear Mr. President"
Percy J. Hussakof, Brooklyn, N. Y.

Honorable Mention: "River of Grain"
Bob Taylor, Cordell, Okla.

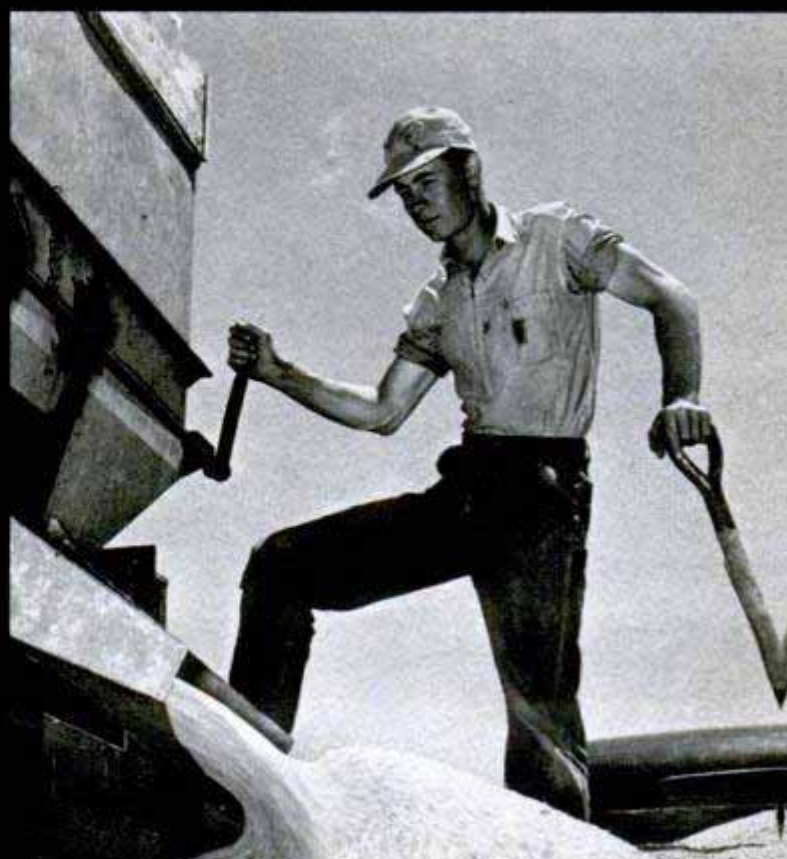
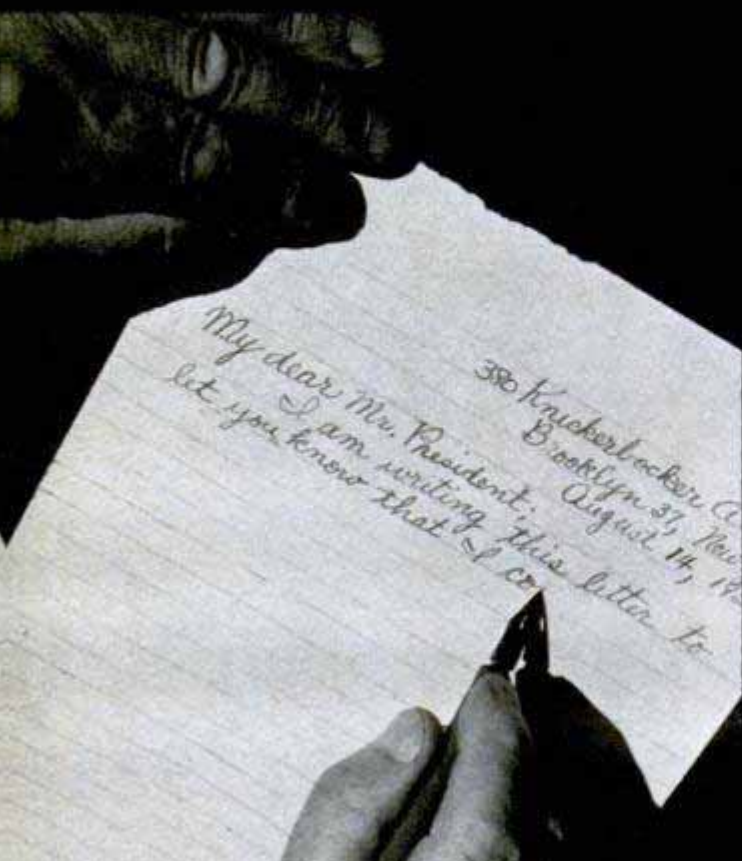

Honorable Mention:
"Family Album"
Sallie Sawyer Smith,
New York City



Honorable Mention:
"Supermarket"
George H. Padginton,
Buffalo, N. Y.



Honorable Mention:
"Reading Lesson"
Lil and Al Bloom,
Chicago



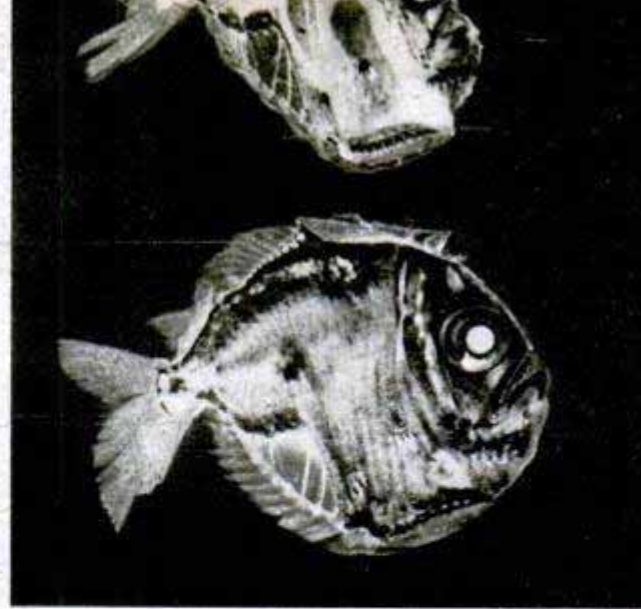

Net, or "trawl," hauled aboard from depths of the Pacific, snares such specimens as these hatchet fish

ELECTRIC FISHING

BY ELECTRIFYING their nets, oceanography experts expect to catch strange specimens of fish from the depths of the Pacific. Dr. Carl L. Hubbs of the Scripps Institution of Oceanography has designed a net with a depressor plate which forces the assembly downward. The net already has collected such weird specimens as fish with telescopic eyes, well-defined necks and extensible stomachs. It now will be electrified with surges of direct current. Experiments show that fish tend to move away from a negative pole and toward a positive pole. The negative pole will be at the net's mouth to prevent fish inside from escaping. In another study, the American Institute of Radiation is investigating the possibility of herding fish toward commercial nets with boats dragging electric cables.

Net soon will be electrified. Then it may yield even stranger fish than "bobtailed snipe eel" and "fangtooth"

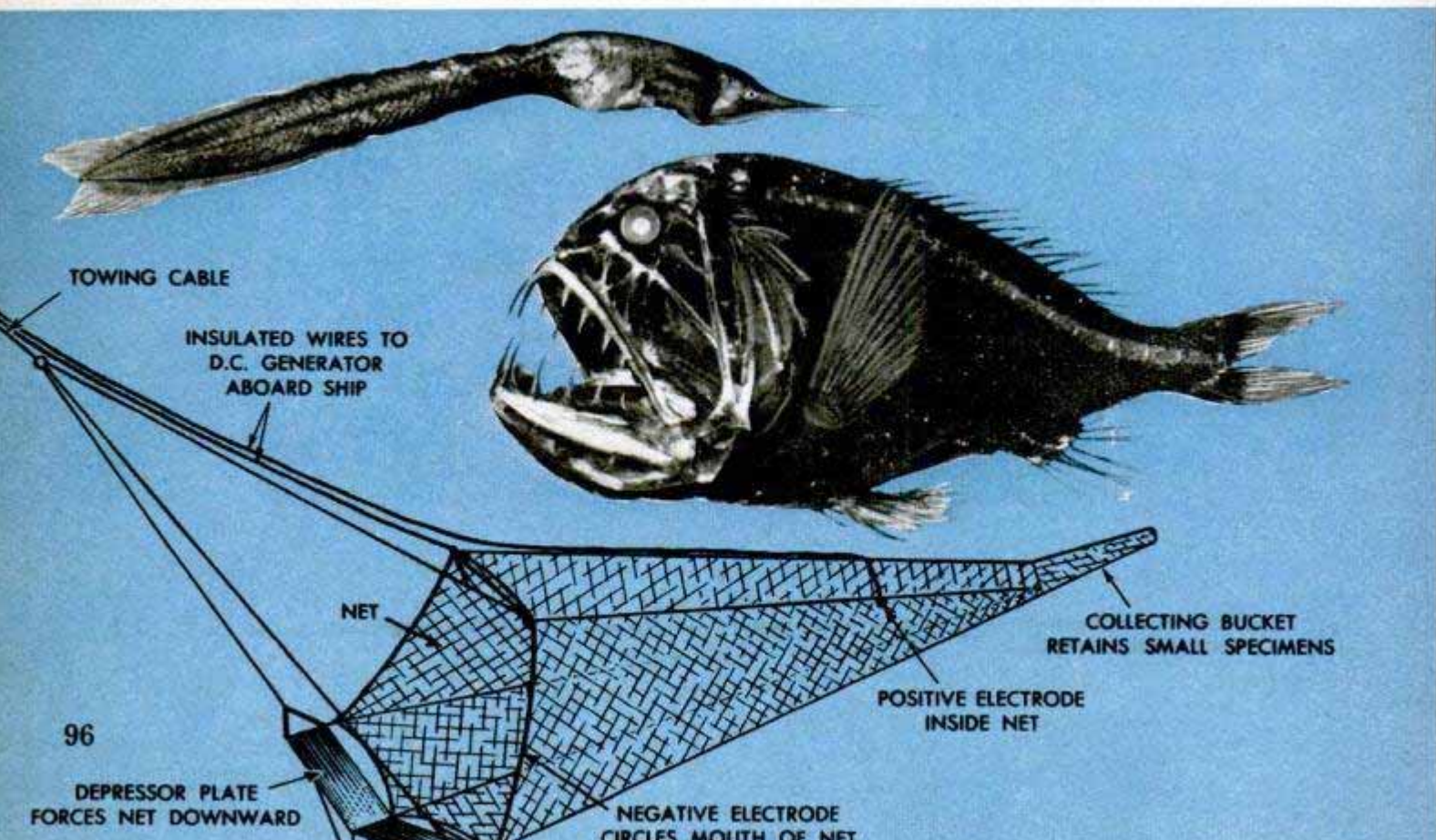

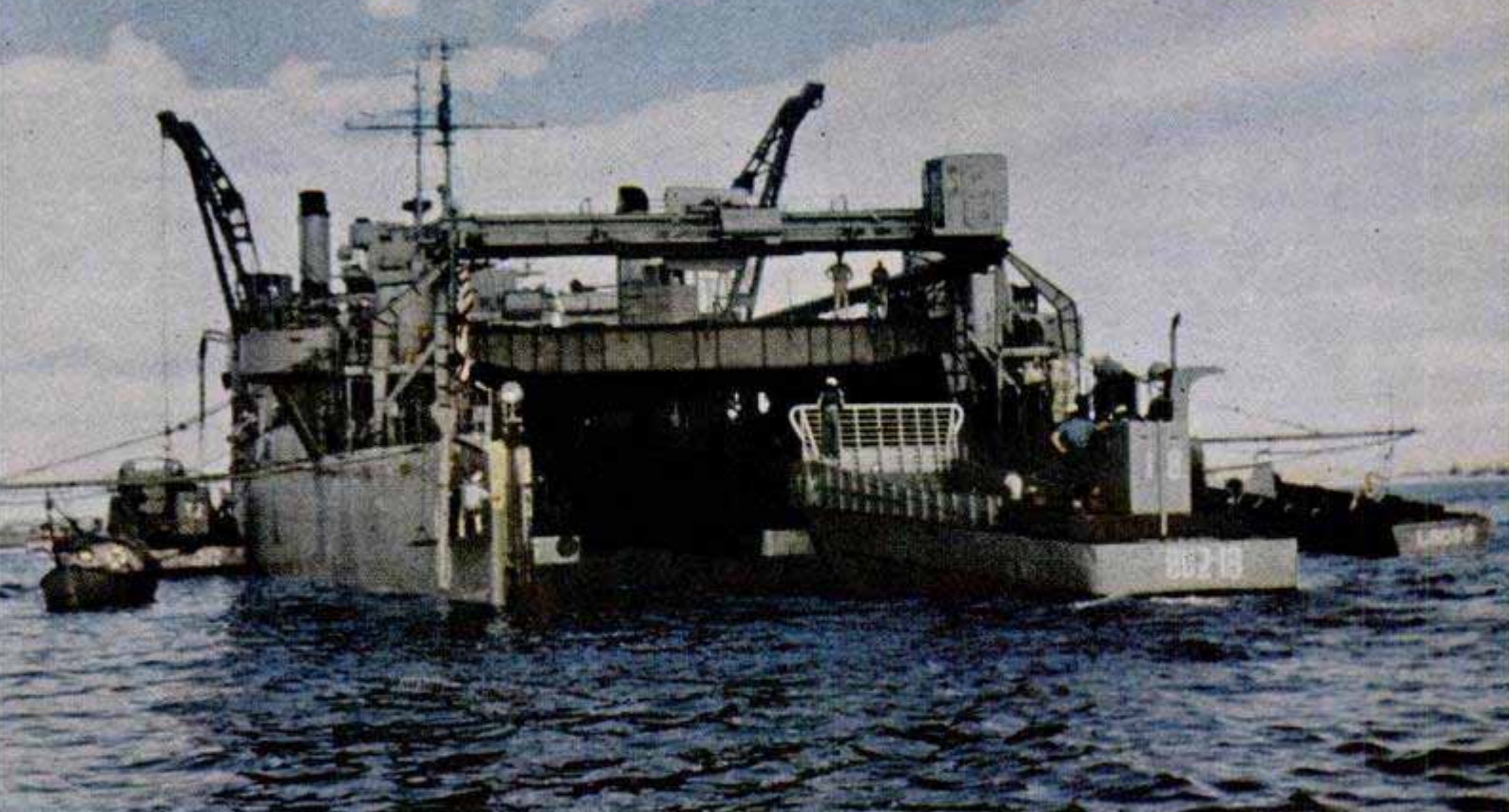

While the USS *Lindenwald*, LSD-6, squats low in the water, baby minesweeper enters cavernous docking well

MOTHER of the MINESWEEPERS

By Richard F. Dempewolff

CAUTIOUSLY, the long hull of the minesweeper USS *Pirate* nosed into unswept waters along the approaches to Wonsan Harbor, Korea, on a bleak October day in 1950. Most of her crew, bearded for protection against the icy spray, lined the rails ready to stream sweeping gear. "Vikings of the modern Navy," they call these rugged men who flirt with sudden death during every instant of operation in mine-infested waters.

Behind the *Pirate* streamed a column of ships, each ship relying on her splinter of a leader to clear a track through the explosive waters. The *Pirate* threaded her way nicely, but there's a limit to the dexterity of 180 feet of steel ship in a hazardous harbor inlet.

Suddenly the lookout yelled, "Shallow mine close aboard starboard bow!" With a lurch, the ship heeled into a hard left turn—one split second too late. With a dull

After its day's job of clearing away deadly mines, a formation of LCMs returns to the waiting mother ship





Small craft edge their way into the mother ship; the superdeck is made of removable sections of steel grating

LSD (LANDING SHIP DOCK)

DIAGRAM SHOWS LSD IN BALLAST WITH "DOCKING WELL" BELOW SEA LEVEL SO BOATS CAN BE LAUNCHED FROM OPEN STERN GATE

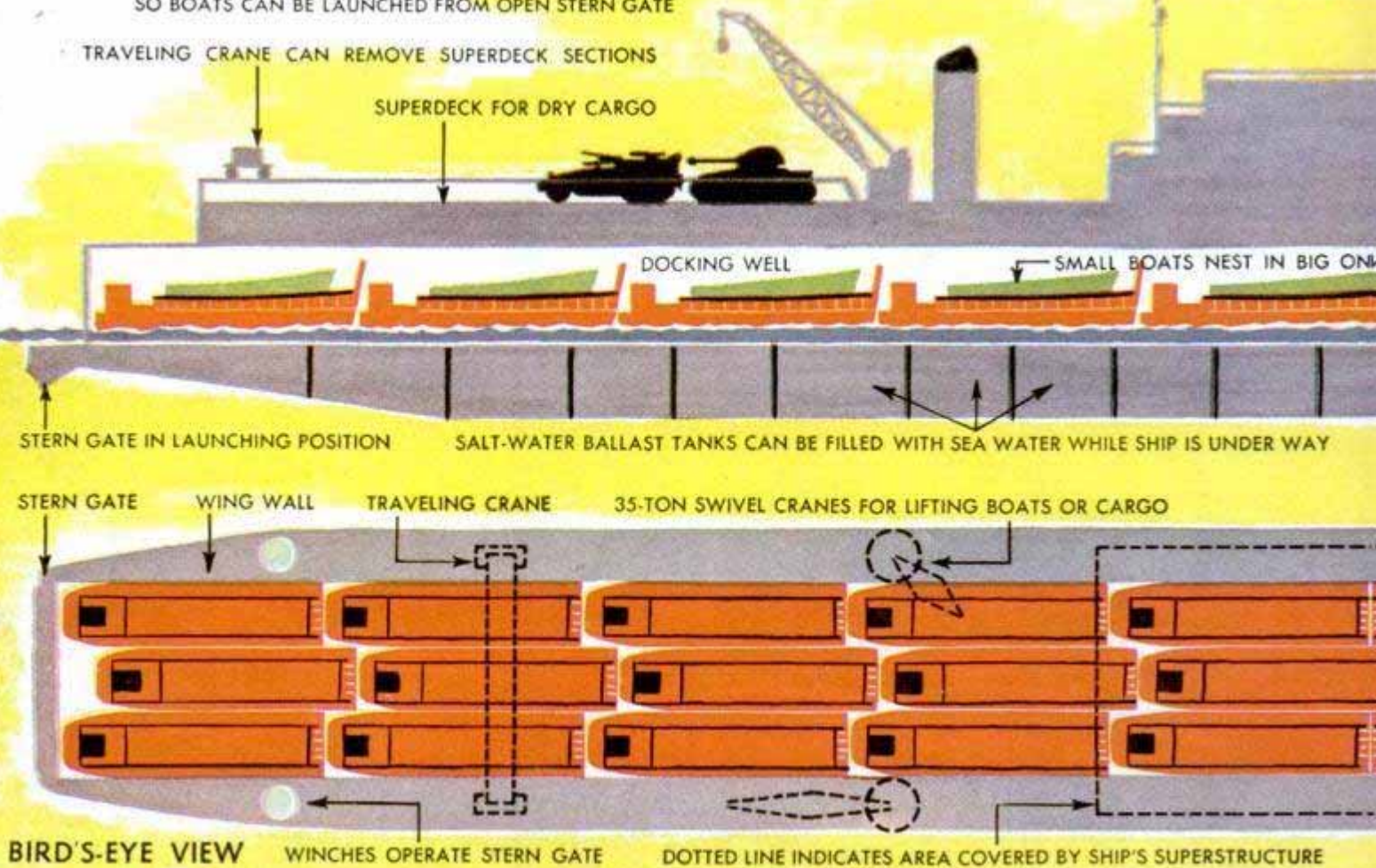

roar, water and flying steel sprayed skyward. Heavy gear skidded across the bouncing deck; mangled men fell, screaming. The captain, thrown against the bridge bulkhead, fell unconscious. Within four minutes, the *Pirate* disappeared in a whirlpool of bubbles and oil.

Shore batteries opened up as rescue boats set out from the other ships to pick up survivors. In the confusion another sweeper, the *Pledge*, struck a mine and went down. Total score: Six missing, 43 injured.

Minesweeping in any water is a tough business. But in confined areas, modern sweepers have a really grim time of it. Ideally, small minesweeping boats might clear a path for bigger sweepers to follow. But small boats can't keep up with a minesweeper convoy making its way from harbor to harbor. Until now, the advantage has been on the side of the minelayers.

In recent months, however, North Korean lookouts, posted by the Reds to count the U.N. ships blowing up in their freshly mined shallow harbors, have been seeing something that probably made their eyes pop.

Out of the fog it comes—a monster ship of war with a blunt, tubby bow, a massive bridge house, and weird lines that slope away to a squared-off stern that looks as

After launching from mother ship, LCM comes around to side where a swivel crane lifts out the smaller LCVP which was nested inside it in the docking well

The diagram shows how the *Lindenwald* accommodates 18 LCMs with an additional 18 LCVPs nested inside them. It takes only about 10 minutes for launching

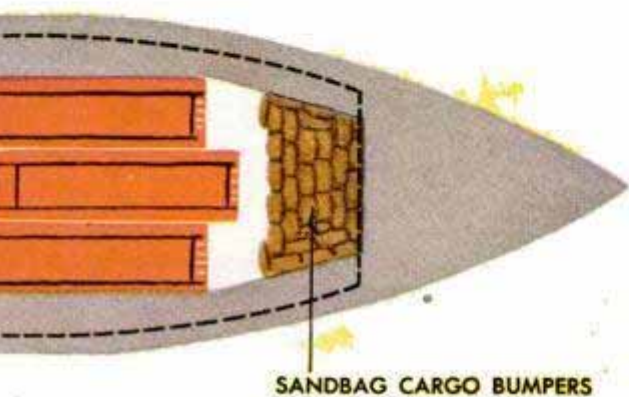
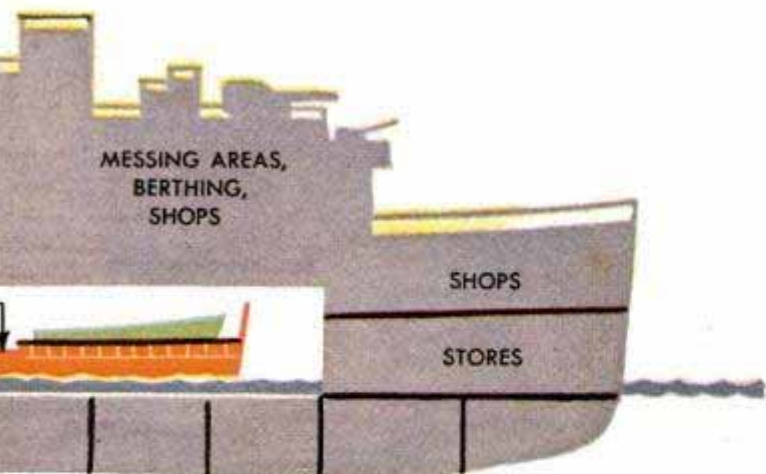

though it were for a gigantic rowboat. Outside the mined harbor channel it stops and slowly squats down in the water like a hen covering her brood, until its hull is half submerged. The flat stern folds downward into the sea, revealing the flooded bowels of the ship.

There's a roar of revving motors. A haze of blue exhaust smoke rises over the superstructure. And through the yawning maw where the stern used to be, pours a whole navy of baby minesweepers—LCMs and LCVPs—all fitted out with special minesweeping gear. As they emerge, they break off into groups, circling behind the mother ship until all are out. They form into echelons, stream their gear and sweep through the harbor—clearing a path for bigger minesweepers that may follow later, or sweeping out shallow areas which no standard destroyer-sized minesweeper could ever reach.

Job done, the baby sweepers stream back to the waiting mother ship, enter the open stern singly or in pairs, until all are safely tucked away in the massive belly. The stern gate closes up behind them, and the big ship steams away to the next harbor, slowly rising out of the sea as heavy pumps suck the water from her ballast tanks, raising the



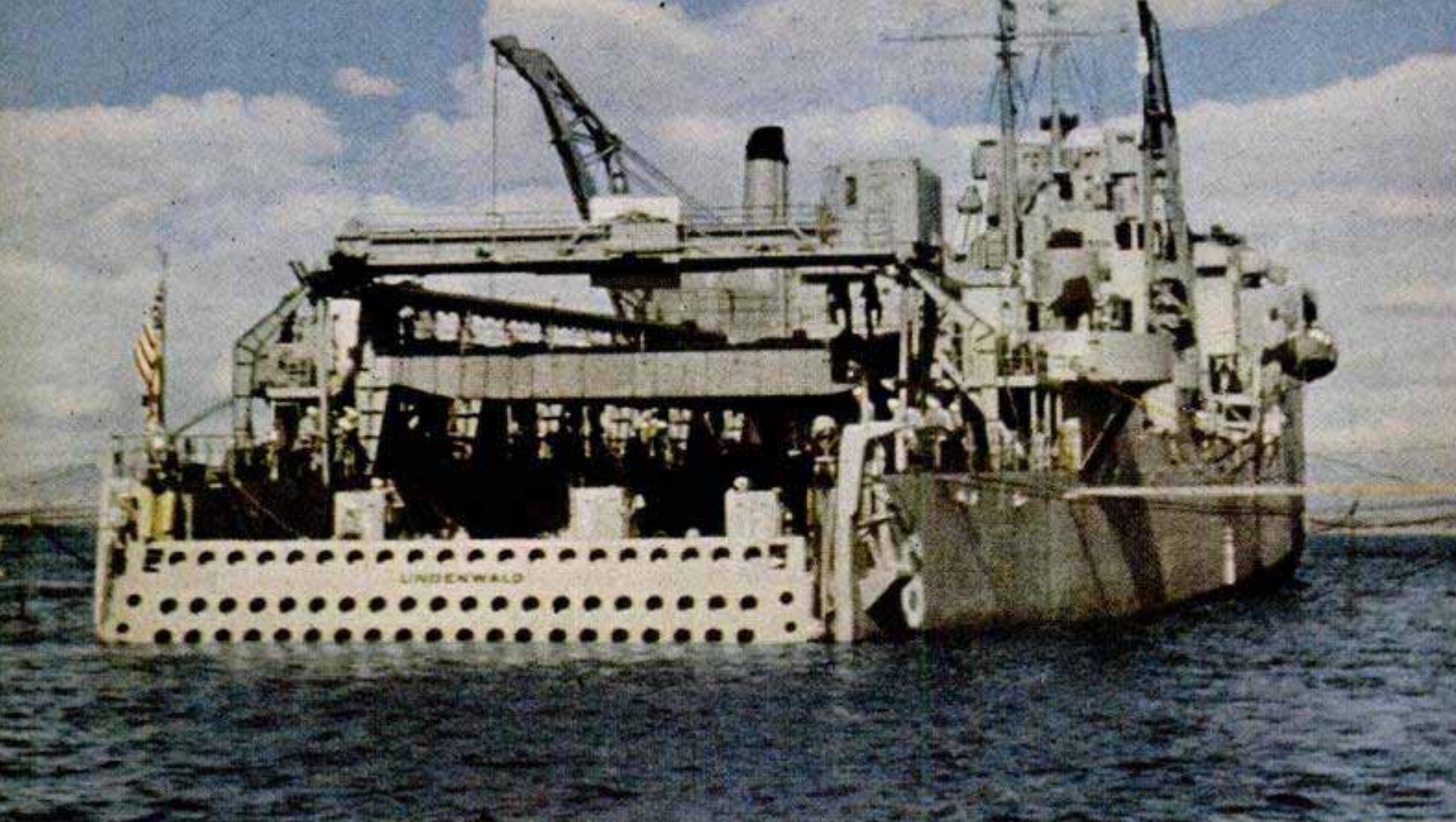

With 18 LCMs packed in its "docking well," the 45-foot-wide stern gate is closed as ship prepares to move on

level of her "docking well" so that the squadron of minesweeping boats inside her belly is soon riding high and dry.

Though little publicized, this fantastic combination ship-submarine and seagoing garage first made her appearance in World War II. Dubbed LSD (for Landing Ship Dock) by its Navy designers, her function was to carry and launch landing craft with the Pacific task forces. But it wasn't long before she was being used for everything else under the sun. Her ability to squat down in the sea and take aboard small boats and ships, made her an ideal dry-dock repair ship. Her huge docking well could carry tremendous cargoes of invasion

equipment. Since the war, she has taken on a host of new chores—minesweeping among them.

The Korean minesweeping stunt of the USS *Comstock*, LSD-12, and her brood of little converted LCM and LCVP sweepers, has been so successful that the Navy today is building specially designed "pickaback" minesweepers, which will be carried by several mother ships like the *Comstock*. Task forces previously hampered by having to move slowly so regular minesweepers could keep up with them, now will be able to steam full tilt. The sweepers will be tucked in the docking well of a fast LSD accompanying the convoy, ready to be

Side view of the mother ship, USS *Lindenwald*, moving on to new location after sweeping job in harbor



turned loose on the spot when they're needed to clear a path for the force.

Today some half dozen of the strange-looking mother ships ride the seas with our Navy. Recently one of them, the USS *Lindenwald*, LSD-6, under the command of Capt. Leland Shaffer, went through its paces for *Popular Mechanics* in the Windward Passage, just outside Guantanamo Bay, Cuba. The first thing you learn from Captain Shaffer is that LSDs are named for famous homes. "Lindenwald" was the estate of Martin Van Buren in Kinderhook, N. Y.

Like her sisters, the *Lindenwald* looks like something the Navy Yard forgot to complete—a tremendous shell of a hull, with a yawning cavity 396 feet long and 44 feet wide tunneling from the stern clear up under the bridge to the bow.

This vast docking well is only 60 feet short of the entire length of the ship. In it will fit 27 little LCVPs, or 18 LCMs six deep and three abreast—each with a smaller LCVP nested inside it.

"We've floated three LSUs in here," says Captain Shaffer, "and have taken aboard an LSM on several occasions. We even floated a destroyer escort in and dry-docked her off Korea during the last war. Anything narrow enough to squeeze through the stern gate can come aboard."

Captain Shaffer revels in the fantastic things his ship has done. The monstrous boom of the biggest crane in the world was trundled over from Germany. "We just tucked it

Aerial view shows the *Lindenwald* under way with open well for small minesweepers packed with boats and equipment for servicing them while en route

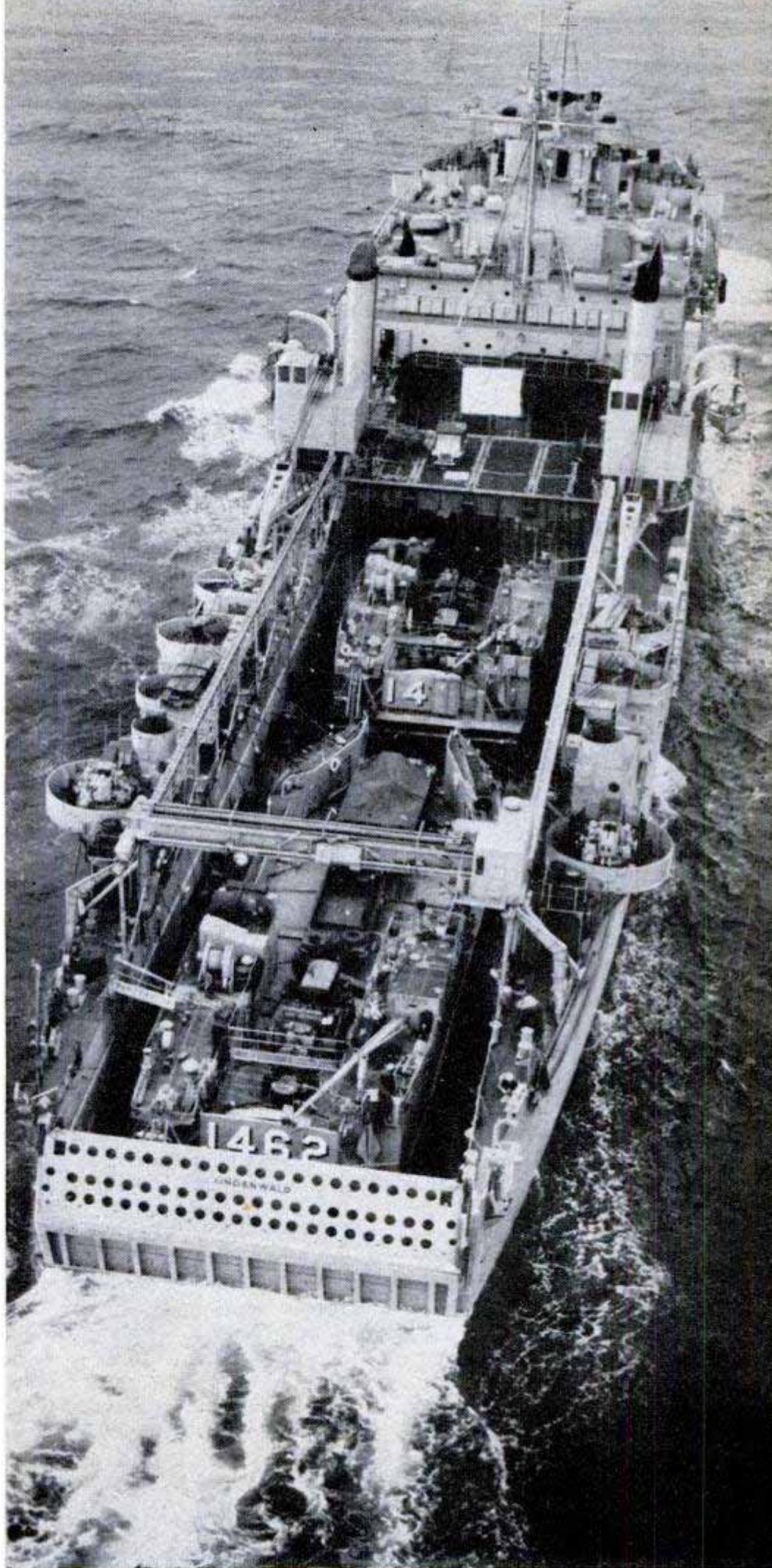

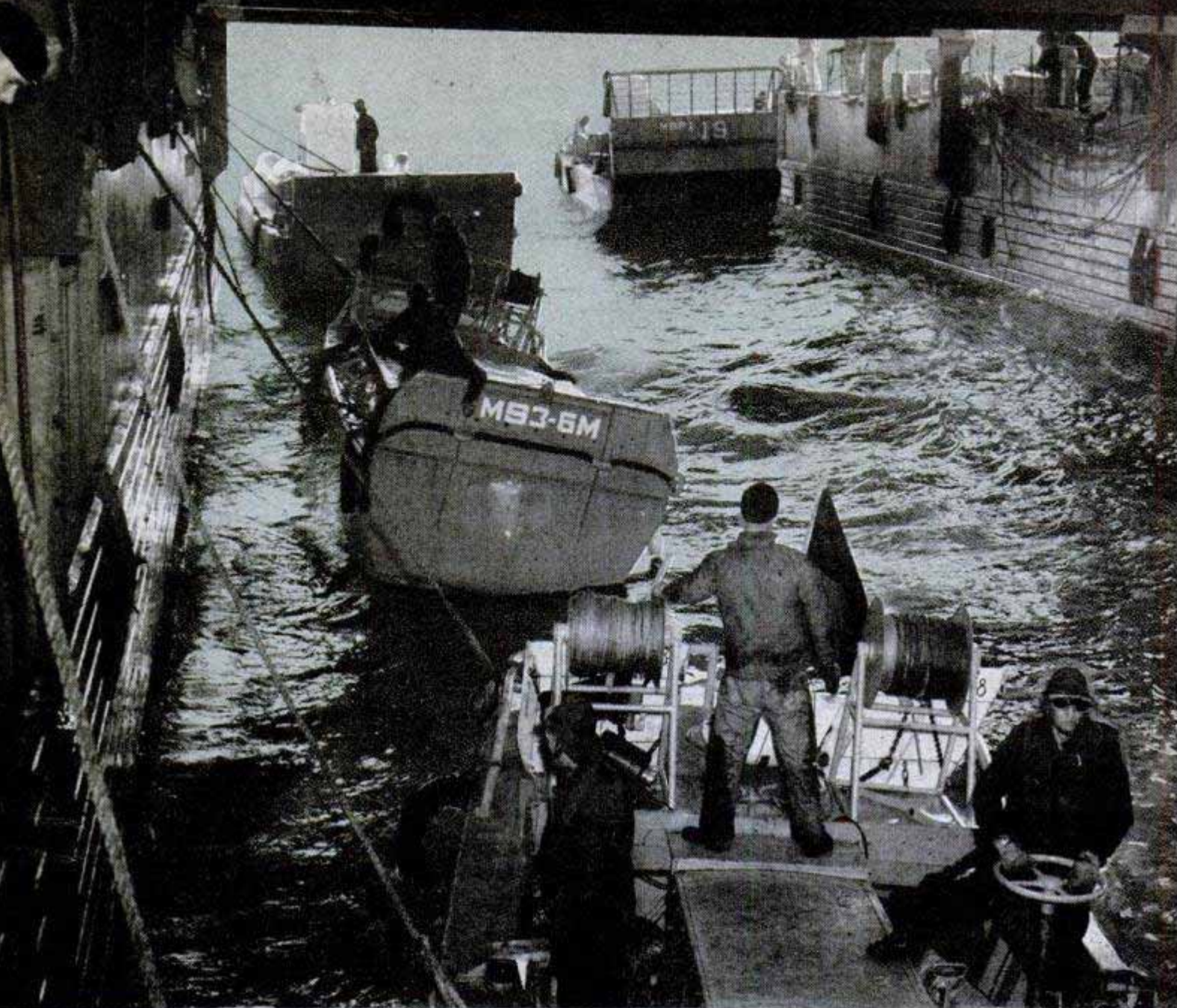

Back from minesweeping operation, small craft enter docking well while men scramble to make lines fast

in our docking well," says Shaffer, "and had room left for a few other things." He tells about lugging a self-propelled gun to Aberdeen, Md., for the Army. "No other ship afloat could take it," he says. "It was so big they had to clear roads and dismantle bridges to get it to the ship."

Besides her tremendous docking well, the *Lindenwald* sports a superdeck of steel grating that bridges the top of her cavernous interior. On this goes 350 tons worth of invasion cargo of all kinds—tanks, cars, trucks, DUWKs, 66 amphibious tanks or other amphibious vehicles. "The superdeck comes in six-ton sections," Shaffer explains, "and that six-ton traveling bridge crane you see, riding tracks along the top of the wing walls, lifts the sections off and carries them to the 25-ton swivel cranes amidship, where we lift them overboard when we don't need them."

It takes 330 men and 18 officers to man the *Lindenwald*, and they're all busy when her snubby bow turns toward the harbor channel and heads for a mission under the smooth heat of her big 7000-horsepower reciprocating engines at 16 knots.

Though operations look simple, they're extremely complex. "It takes an hour and a half to ballast her down until there's enough water in the docking well to float the small craft," explains the skipper. "So we start while we're still underway."

As the ship plows along, you can see preparations being made. Men with telephone gear stand at six different stations around the ship to report ballasting progress. Each phone connects with the ballast-control center—a tiny shelter on the starboard-wing wall, lined with huge panels of wavering dial needles reminiscent of the control room in a submarine. The trembling deck



Top right, an LSU swings her blunt nose in through open stern gate of mother ship. Just below, stern gate is partly opened when taking on ballast so sea can rush in; man standing on top deck "talks" boats in

underfoot tells you the big pumps are pulling sea water into the ship's 36 tanks, located along the keelson, under the wooden planked deck of the docking well.

"We watch like hawks," says Shaffer, "to keep from having any half-full tanks with 'free surface'—where water can slosh around. If the ship is rolling in a heavy swell, free surface water will slosh steeper than the roll, and keep the roll going—an invitation to a capsizing."

The engineering officer on the wing wall orders the 45-foot steel stern gate open a crack, and the first sea spills in around its lower edges as the ship settles in the sea. Slowly, the well fills like a big bathtub. Before the destination is reached, 7000 tons of salt water will flood the docking well to a depth of six feet or more. Actually 3500 tons are enough to float the 40-foot LCMs

sitting snugly side by side, and they soon bob like corks, their steel sides screeching as they rub together in the swell. As the mine field is reached the *Lindenwald's* engines stop and she coasts into the wind.

Gears whir and down goes the gate, folding neatly in half, then doubling back under the stern. Boat engines roar. A blue, smoky, exhaust haze fills the docking well. Three at a time the sweepers emerge from the pungent fumes, through the open stern of the mother ship, and circle on the open blue water near by until all are out of the ship's belly.

At a signal from the pilot leader standing on the stern of his square, tubby boat, the tiny sweepers break off into stepped echelons of two to five boats each. Paravanes stream from each craft, carrying steel cable well out across the bow of the boat behind.

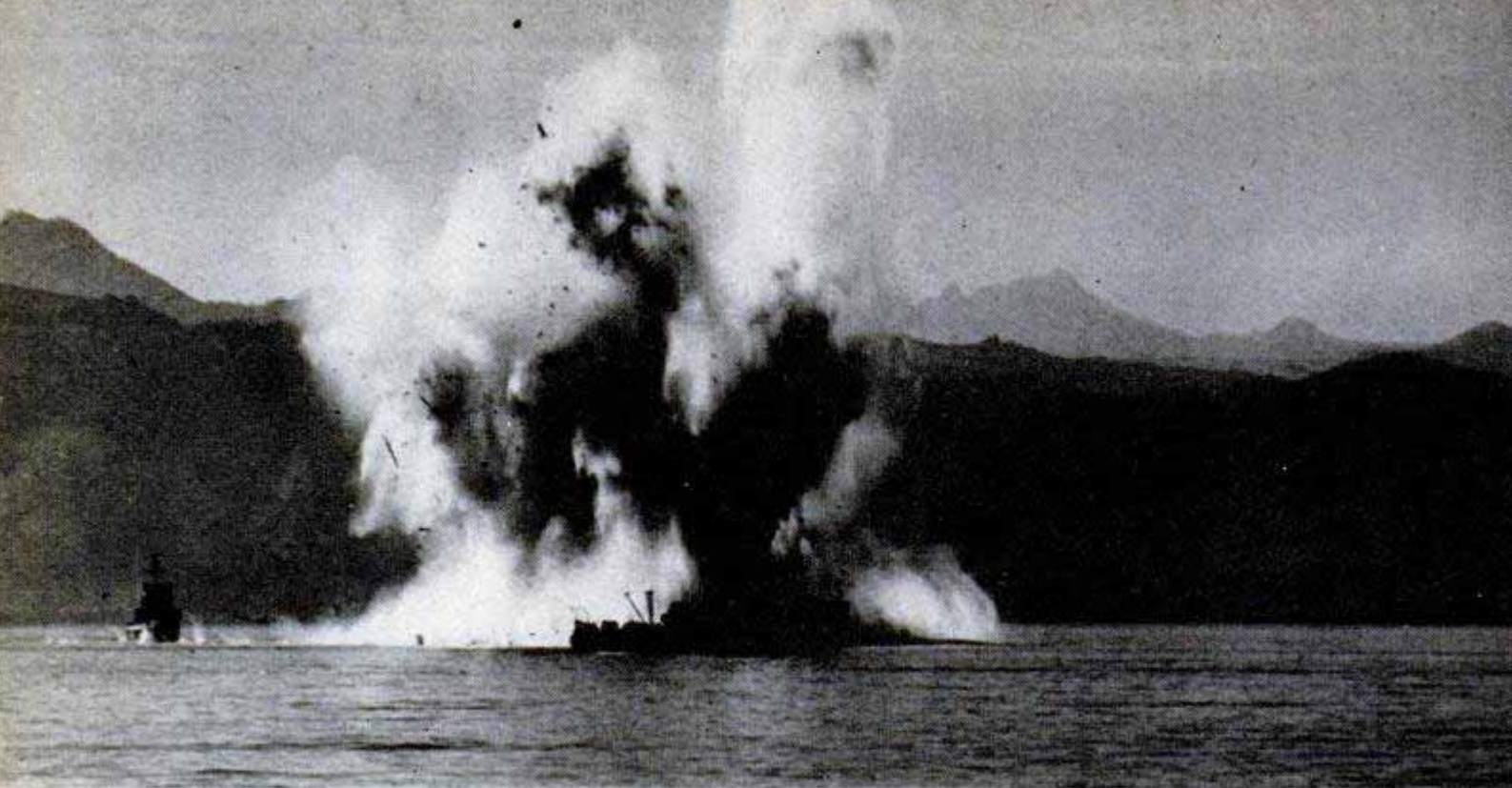

Big minesweeper blows up in Wonsan Harbor, Korea; baby minesweepers carried on mother ships reduce hazards

At intervals along these cables, steel hooks with knife-sharp inverted wedges will snag and cut the anchor lines of any moored mines in their path. As the freed mines bob to the surface, they are exploded by gunfire from the deck.

Thus, the sweeper echelons, overlapping each other, proceed around the bay, carving a cleared path for big sweepers to follow later, and clearing out shallow areas where, with their small draft, they can penetrate without danger of running aground.

Sweeping done, they head for the mother ship, which has been standing by with her stern gate open, ready to receive them. Again the boats form two circles off each quarter of the big ship's stern, revolving

like human "pinwheels" in an aquacade.

Up on the after end of the port-wing wall stands the docking officer, holding a power megaphone with which he calls signals. Like the LSO on an aircraft carrier, it's his responsibility to bring each of the boats aboard again safely. Only he "talks" them in, like this:

"Number six aboard center; seven and eight follow port and starboard," booms the big speaker.

In they come; the first LCM roaring right down the center of the mother ship right up to her bow. Two others follow, flanking it, until they are wedged in and secured. The loading proceeds, three at a time, until the last of the little craft have disappeared into the dark maw of the big ship. Then, the stern gate closes part way, to allow the ocean inside the *Lindenwald's* belly to seep back out where it belongs as the ship de-ballasts underway.

It's a pretty smooth operation in a calm sea. But when the mother ship is heaving and rolling in rough weather, it takes a highly skilled crew to handle bounding, five-ton landing craft. As they enter the heaving docking well, they whirl and spin, bashing the bulkheads and each other as the action of the confined sea water tosses them around like corks in a typhoon. In combat areas, to make matters worse, the boats must be backed in so they can be

(Continued to page 244)

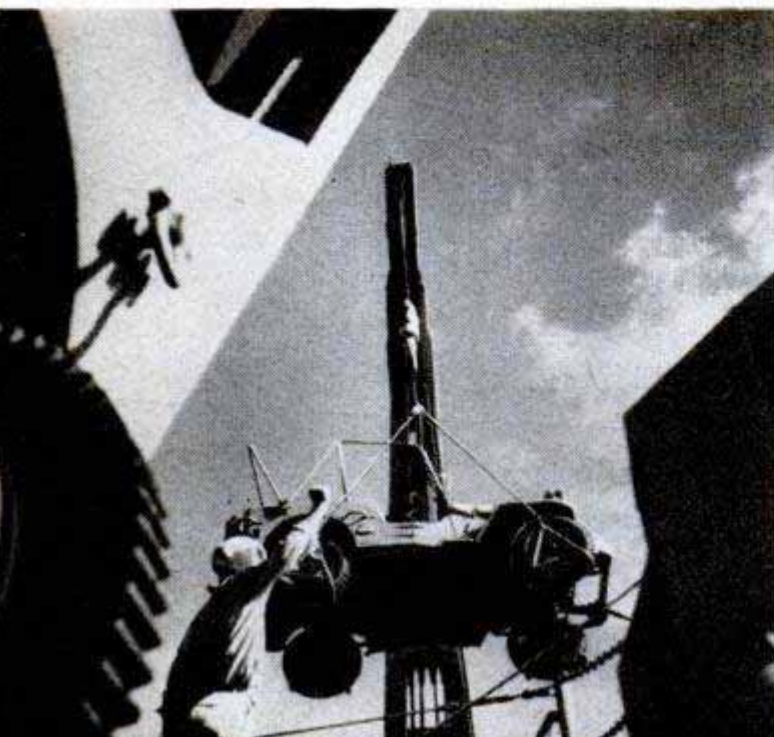

On removable superdecks, LSDs can carry 350 tons of cargo like tanks or trucks. Full load is 66 amphibious tanks for invasion. Here a Jeep is lifted on

Right, in this vacuum chamber models are tested under conditions like those at 200 miles above the earth. Below, low-density chamber for testing at 70-mile altitudes

Windless "Wind Tunnel" For High-Altitude Tests

Simulating conditions in the region from 80 to 200 miles above the earth, a vacuum-chamber "wind tunnel" provides data for improving upper-atmosphere aircraft. University of California scientists developed the wind tunnel that has no wind. Instead, a beam of nitrogen molecules is hurled at supersonic speeds against a test plate. The molecules bounce from the plate in a diffuse pattern which is studied to discover ways of minimizing the turbulence. Another wind tunnel, designed to simulate conditions from 50 to 70 miles above the earth, requires a less complete vacuum than the 200-mile chamber. Shapes to be tested are mounted inside the tunnel and subjected to speeds up to 2.6 times that of sound. Ordinary methods of photographing shock waves won't work in the vacuum chambers because of the rarefied air. Therefore a screen charged with high-voltage electricity is placed in front of the test section to impart an orange-green glow to the air stream, making it visible to the eye and camera.

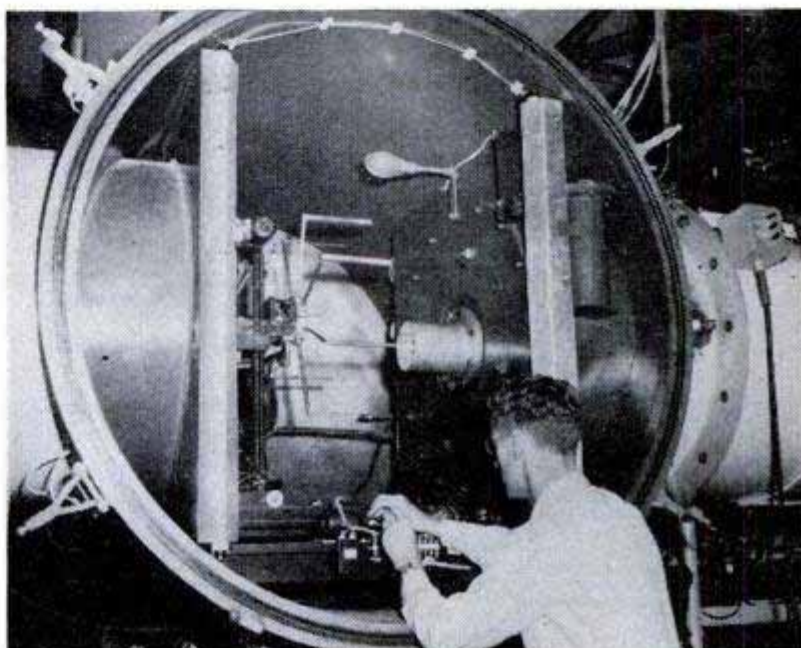
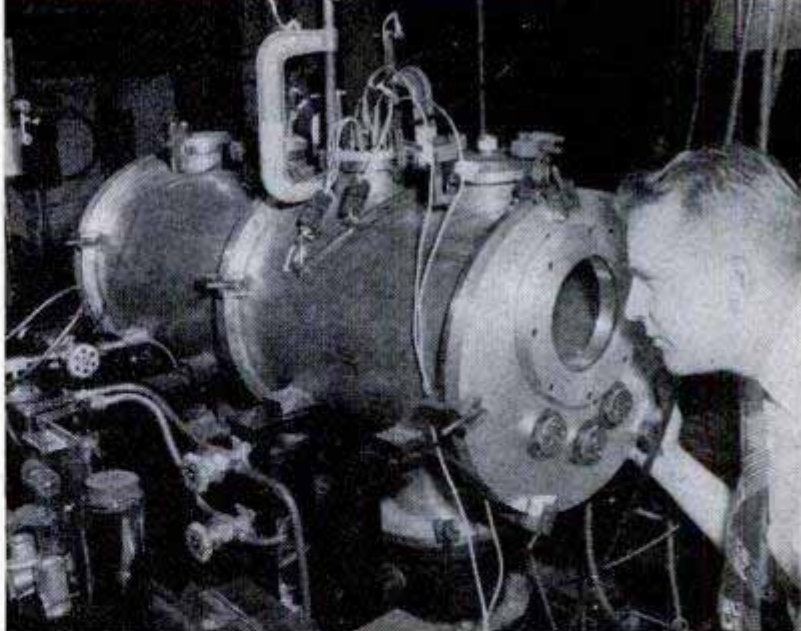

Metal Amphibian Has Plastic-Bonded Plywood Hull

Strategic materials have been spared by building the underwater part of the new Aqua II's hull of plastic-bonded plywood. The remainder of the amphibian is made of metal. Two 225-horsepower Lycoming engines give the six-place craft a top speed of 170 miles an hour. Its stalling speed is 55 miles an hour. To increase the plane's flying efficiency, the powerplant nacelles are formed as a forward extension of the wing. When the plane is used for evacuation missions, four litters, which are loaded through the top-hinged windshield, are put behind the pilot and copilot. The Aqua II's gross flying weight is 4650 pounds, and it has a range of nearly 500 miles. Its wingspan is 36½ feet. Its length is approximately 10 feet. In addition to the craft's

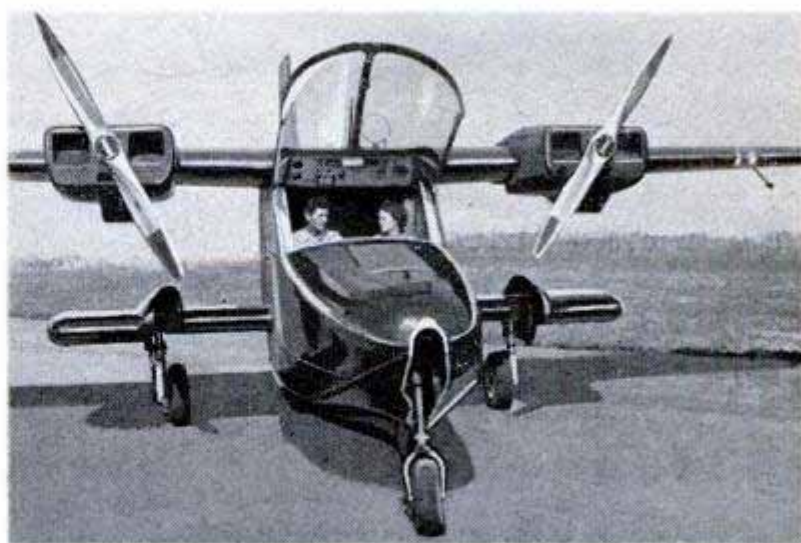

evacuation role, it has military possibilities as a light cargo carrier and for liaison and reconnaissance flights. Meredith C. Wardle of Wilmington, Del., is the designer.



Detroit Listening Post

By Siler Freeman

THE YEAR 1952 may go down as the year of the small car. Hudson has joined the parade of passenger-car manufacturers who are tying their destinies to a smaller, more compact and more economical, if not cheaper, car.

The field already contains Nash's Rambler, Kaiser-Frazer's Henry J and Willys-Overland's first passenger car since World War II days. Of these three only Willys' offering is over 100 inches in wheelbase. The nearest of the present so-called "small" cars is the Ford.

The current level of prices places this triumvirate of pioneers outside what could be called the low-priced field. Certainly, the "Big Three" smaller cars have been

getting farther and farther away from this designation.

Hudson's addition will not be out until some time in the spring and it will follow the 1952 styling in design. It will feature the "step down" styling, combining body and frame, and will seat six average-sized passengers, according to Pres. A. E. Barit. In price, he said it would be "several hundred dollars" lower than any present model. This would still not make it low-priced.

According to Barit's outline of Hudson's planning, the car will have both power and economy. This is the challenge of the independents. Already the Rambler and Henry J have made a niche for themselves in the present market because of high mileage per gallon.

Rambler sales this year should total more than 60,000 units. Henry Js accounted for 50,000 of Kaiser-Frazer's 1951 output. Willys has a late start on its product and will not be able to show any share of the market for a while. However, the looks and comfort plus economy of operation should draw buyers in the restricted market.

Hudson has been working on its light car for several years. It pushed production this year for two reasons: First, it could stretch out its allotment of steel by putting it into this car rather than the larger models. Second, it cannot afford to buck the medium-priced market this year. Dealers have been asking for something less costly to offer their customers.

The struggle will be an interesting one. It is a chance for the independents to get a segment of the market which the Big

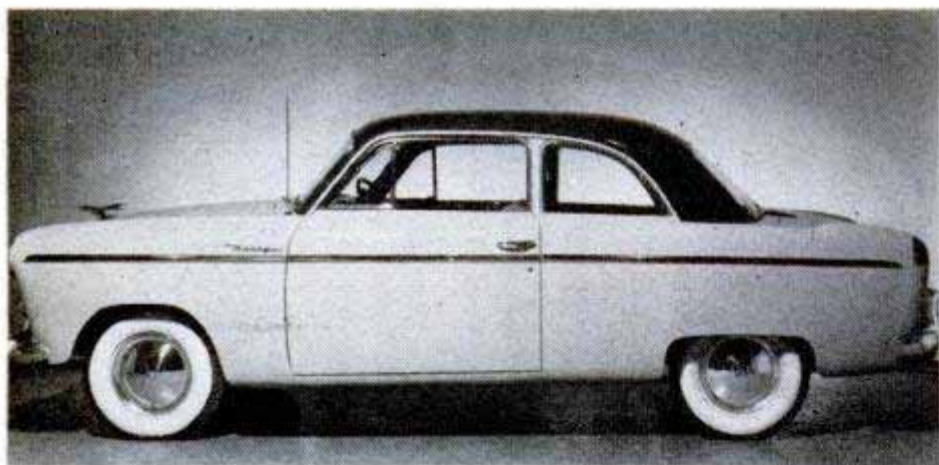

Willys "Aero Wing" two-door sedan, designed for outstanding gasoline and maintenance economy, has a high-compression, six-cylinder engine



Powered by an improved 119-horsepower "Spitfire" engine, '52 Chrysler Windsor club coupe, above, is available with Hydraguide power steering

Three has so far decided to stay away from. Public acceptance will be watched carefully. Light-car programs are costly to undertake, but experimental work may be resumed and put in high gear at any sign that the market prefers lighter cars.

The 1952 models show a trend toward the use of stainless steel. It appears manufacturers have located a good supply of the metal and they are using it liberally in preference to the thin chrome. At any time, however, it may get scarce again and chrome will be back in the brightwork.

The increase in aluminum capacity, as illustrated by Kaiser's New Orleans plant that just went into production, is drawing the attention of the auto builders. General Motors' C. E. Wilson was on hand when the first pour of aluminum was made, and he was in a reflective mood in conferring with both Henry J. and Edgar F. Kaiser.

An automotive engineer recently estimated about 250 pounds of steel in the present car could be replaced with aluminum. Stampings and forgings of aluminum have been successful. Engine blocks of the light metal might be a distinct possibility in the future.



Sears' Allstate, with four or six-cylinder engine, is upholstered in plastic fabrics. Overdrive is optional equipment

Edgar Kaiser has been doing a lot of research and experimental work with aluminum. Price is still a big obstacle to widespread use after the defense program is satisfied. Rival for the postwar use of the aluminum capacity is the canning industry, which has plans to make tops and bottoms of cans from the light metal.

Like *Popular Mechanics*, Nash is celebrating its Golden Anniversary this year. The Rambler had two cars built in 1901 but these were experimental models. The first Rambler offered for sale came out in 1902 and was priced at \$750. During that year,

(Continued to page 270)

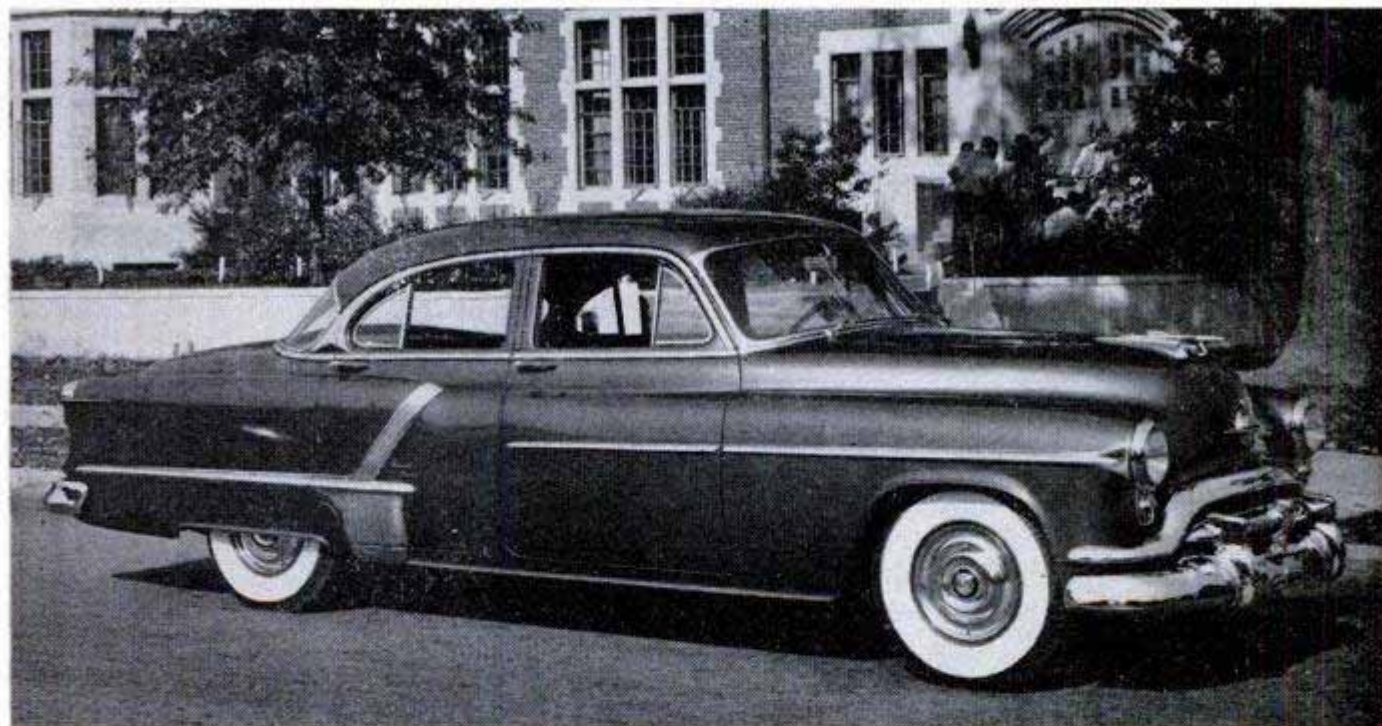

With Hydra-Matic Superdrive transmission, Olds 98 four-door sedan is available with G.M. hydraulic steering

1952 Oldsmobile

Featuring a powerful 160-horsepower "Rocket" engine with high-performance, Quadri-Jet carburetor, the 1952 Oldsmobile 98 is longer and more luxurious. Extra-long-fender contours blend into the body

lines, and broadcloth upholstery in pastel shades adds beauty to Oldsmobile interiors. A new Hydra-Matic Superdrive transmission gives greater performance through a dual-driving range. Two other series offered by Oldsmobile for '52 are the Super 88 and the De Luxe 88.



Mercury's Monterey hardtop convertible, above, has wider windshield, lower hood and raised fender crowns. Following the same lines is Lincoln's Capri hardtop convertible, below, with new 160-horsepower V-8 engine

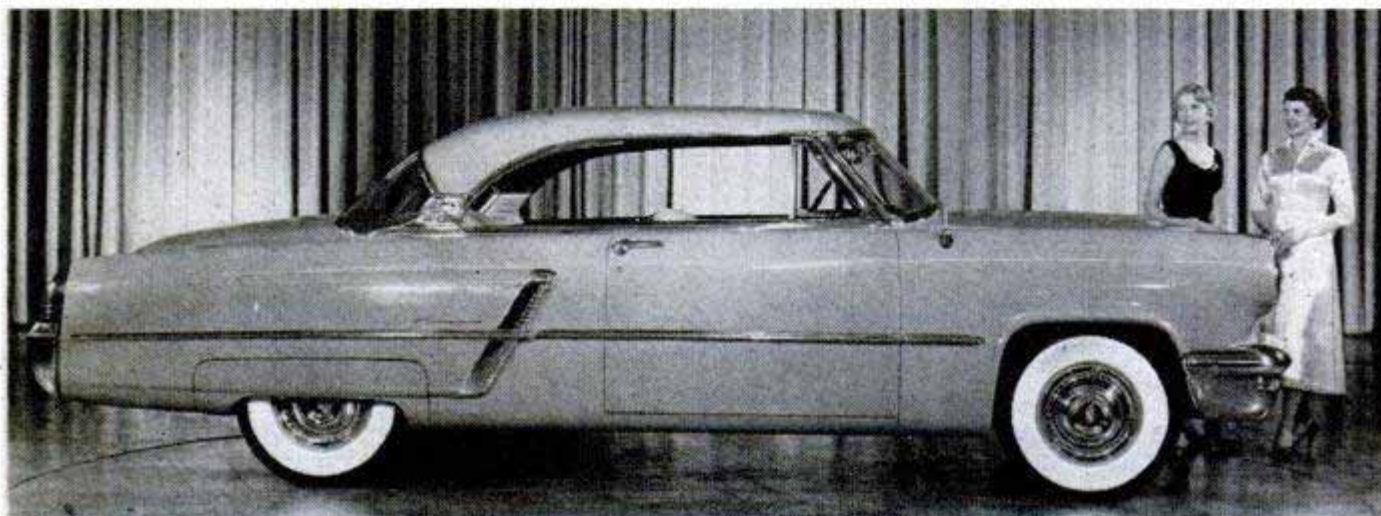

1952 Lincoln and Mercury

THE 1952 LINCOLN is featured by its new styling outwardly and its new 160-horsepower V-8 overhead-valve engine, the first in the Ford Motor Co. line. The Lincoln will come in only two models, the Cosmopolitan and the Capri, the latter being the luxury line. The Cosmopolitan offers a 124-inch wheelbase with an over-all length of 214 inches. It weighs slightly over 4000 pounds. It features a hardtop coupe and a custom four-door sedan. The Capri, on the same wheelbase, has a special custom hardtop coupe with leather-cloth combination trim, or all leather. The four-door sedan uses special fabrics to give it the lush feel. Lincoln's styling is new. It has a high, prominent fender line and low, flat hood contour. Double front-bumper bars give it a massive look. The car is eight inches shorter and one inch lower than the 1951 models, the wheelbase having been cut two inches. Rear legroom is increased three inches and the door height boosted. The chassis uses a frame with an I-beam type of X-member. Brake and clutch pedals are suspended from a bracket between the dash

and instrument panel, making Lincoln the first American car to use this feature. The front-wheel suspension employs ball joints and eliminates kingpin and spindle-support forging. Over-all-steering ratio is reduced from 29.7 to 26.1 to 1. The engine bore is larger than the stroke. It has five main bearings, balanced by eight integral counterweights. Its displacement is 317.5 cubic inches. Compression ratio is 7.5 to 1. It can operate on nonpremium fuels.

The Mercury follows the same basic styling of the Lincoln, with high fenders and low hood. Its wheelbase is 118 inches with an over-all of 202. The engine is the same as last year's but stepped up to 125 horsepower. Compression ratio is 7.2 to 1. The car is slightly lower, narrower and shorter. Headroom is improved. Fuel filler is concealed behind the license-plate holder, below the luggage-compartment lid. Two lines are offered, the Mercury and the Mercury Monterey. Five models are offered in the first and three in the second, with a hardtop coupe in each. The convertible comes only in the Monterey.



Two-door Styleline Chevrolet shows redesigned grille. Optional Powerglide models will have automatic choke

1952 Chevrolet

With new grille and ornamentation, '52 Chevrolets offer greater riding comfort through redesigned shock absorbers and

new three-point rubber engine mountings, engineered to reduce vibration in the passenger compartment. Powerglide models, optional in the De Luxe line, will be equipped with an automatic choke.

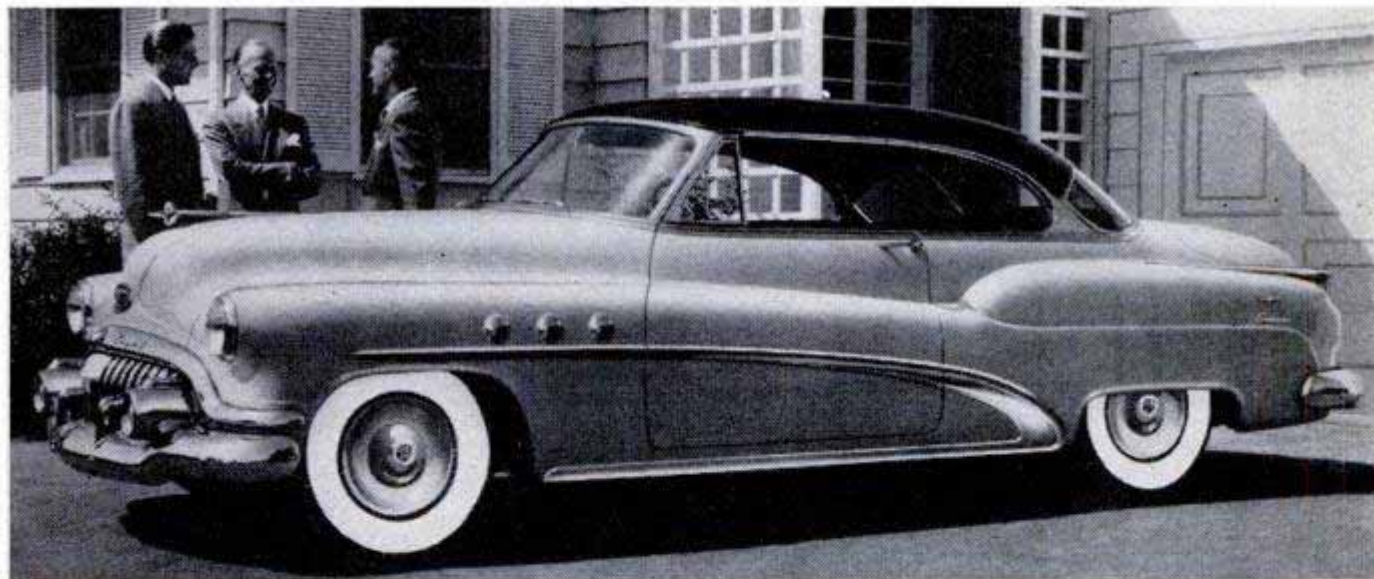

Buick's Super Riviera has bigger front-wheel brakes, more luggage space and shorter decorative sweeppear

1952 Buick

The 1952 Buick line will feature the Roadmaster, the most expensive member of the family. The engine has been stepped up to 170 horsepower and it has been fitted with a new type of carburetor and a power-steering device which, while not as delicate to the touch as Chrysler's Hydraguide, gives similar effect to ease of handling. The decorative spear has been shortened and

the rear lights changed. The grille has fewer members, but is claimed to be stronger. The new carburetor has boosted the engine compression from 7.2 to 7.5 to 1. Horsepower is up 18 from last year. The carburetor is claimed to give additional economy of operation, yet hold reserve power when needed. Interior fabrics have been made to fit the new outside colors. Exterior decorative trim is stainless steel instead of chrome.



Tiny enough to fit in the palm, this cheap electric motor may mean the end of the windup toy

MINIATURE REVOLUTION

By Leonard Engel

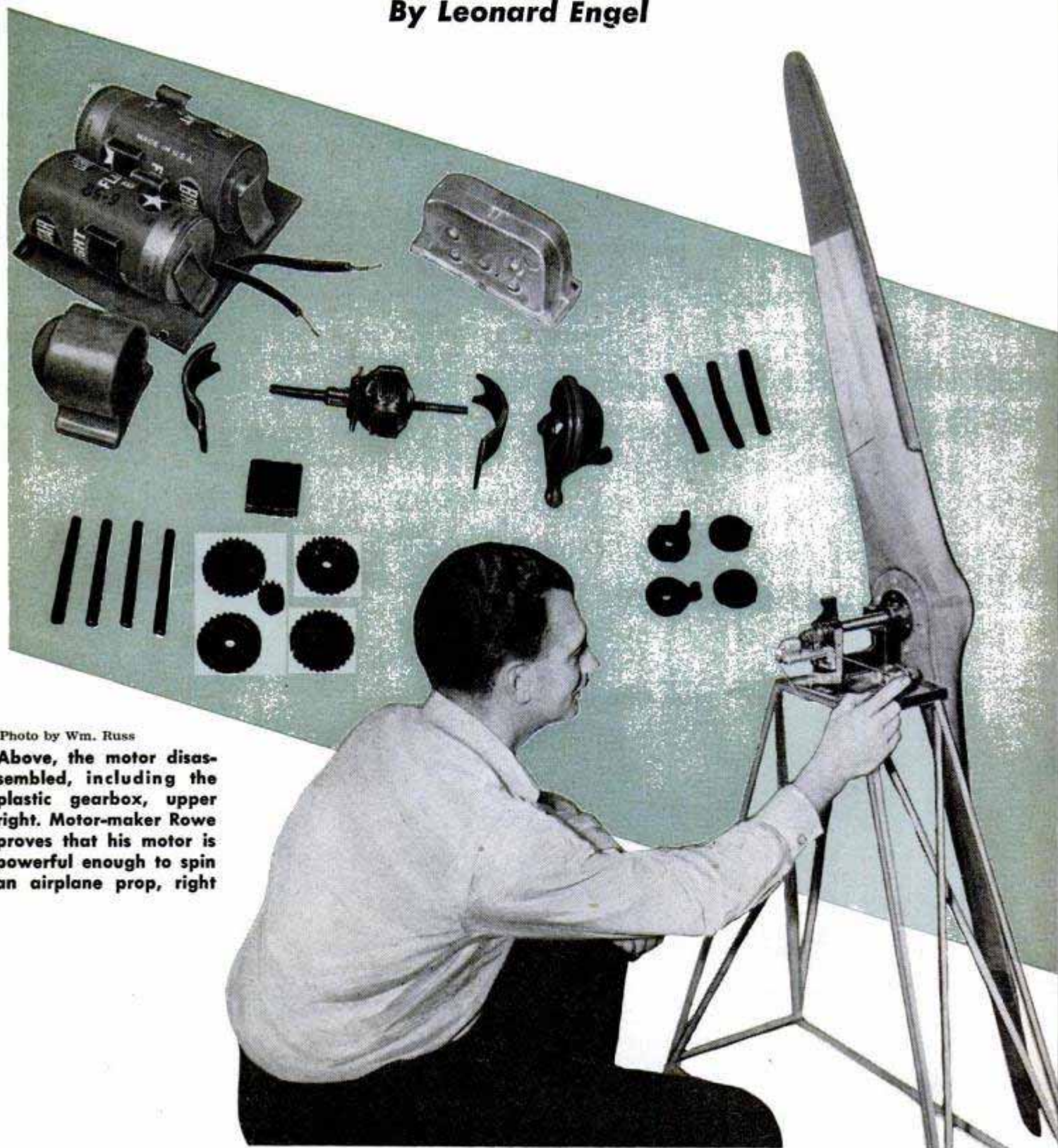

Photo by Wm. Russ

Above, the motor disassembled, including the plastic gearbox, upper right. Motor-maker Rowe proves that his motor is powerful enough to spin an airplane prop, right

THERE'S A REVOLUTION brewing in the toy world. Its cause is a tiny high-speed electric motor—a subminiature of big industrial motors—costing no more to make than any but the cheapest windup motor. Since an electric motor can do things the finest spring motor can't match, the days of the windup toy may be numbered.

The motor, about the size of a walnut, is completely shockproof as it runs on flashlight batteries. So it's safe enough for the smallest child.

Godfather of the electric midget is a tall, engaging Brooklyn-born lawyer turned engineer named Robert L. Rowe. Rowe has been turning the midget out at a rate of several thousand a week for more than a year in a small plant in Sag Harbor, the one-time whaling port at the far end of Long Island.

Rowe's motor is not limited to toy applications. It is also used in a low-cost electric drink mixer and will soon be seen in other inexpensive items. Military applications are likewise in the offing.

This mighty mite measures about one inch in each direction and weighs just over an ounce. Rowe rates it at "10 mouse-power," or, if you really want to be technical about it, .00067 horsepower at its top speed of 7000 revolutions per minute on six volts (four flashlight cells hooked up in

series). On a single cell (1½ volts) it turns over 2400 times a minute. On three volts, the motor is husky enough to spin a six-foot airplane propeller 20 times a minute when properly geared down.

Midget motors, of course, aren't new. Scores of thousands are in use in remote-indicating instruments in aircraft and in the automatic pilot and other servo mechanisms. These, however, have been precision jobs—indeed, some were made with jeweled bearings, though subminiature steel ball bearings are now the rule. Moreover, conventional midget motors are extremely difficult to assemble. As a result, they cost from \$20 to \$100 each.

HO and OO-gauge electric-train models also have small motors. But these are actually considerably larger than either the Rowe motor or servo-driving units, and, as anyone who has ever bought electric trains for himself or his youngster knows, they're not cheap either.

Rowe's midget is made cheaply by a number of novel short cuts. For one thing, the armature (a five-pole unit to assure high speed) is wound on a high-speed automatic winding machine contrived by Rowe out of an old lathe some years ago, when he went after an armature-winding contract to get started in the electrical-manufacturing business. For another, there's no field

Shown below are just a few of the large number of toys that have been electrified with the miniature motor. The car at left has remote controls as well

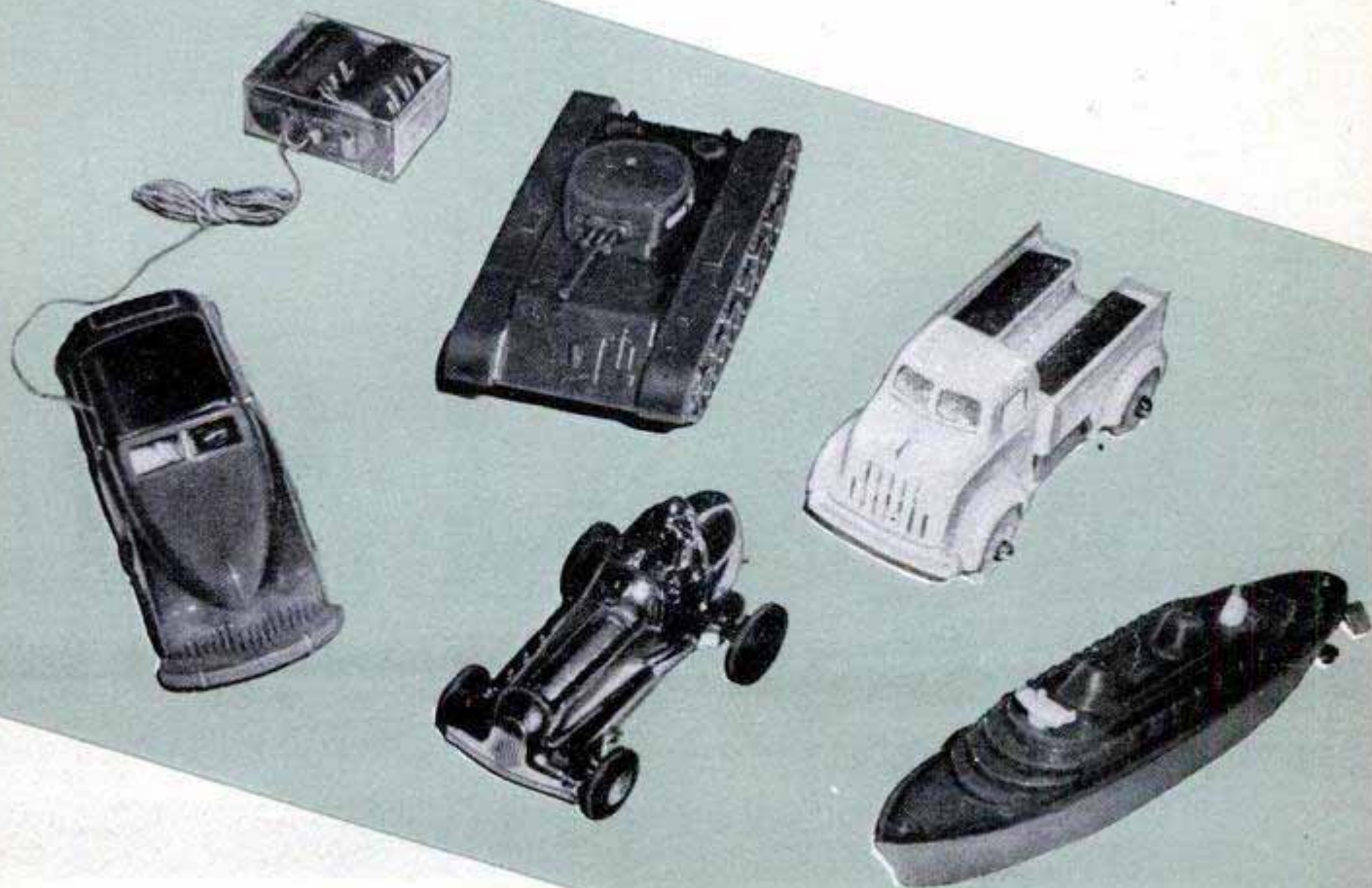



Looking like bonbons in a candy factory, the tiny motors are tested and "run in" until the drain and speed remain constant before they are shipped out

Electrified toy crane, below, not only features a power plant, but it also has an electromagnet for picking up metal pieces. Batteries, motor and gear-box fit neatly inside body of tiny race car, right

Crane photo by Wm. Russ

winding at all. An Alnico permanent magnet and two soft-steel pole pieces provide the magnetic field that interacts with the armature field to turn the motor over. A third cost-cutter is that, despite the extremely high speed of the motor, there are no ball bearings. The armature shaft enters and leaves the housing through an eyelet bearing molded into place in the housing.

Most ingenious is the housing itself. This is formed of polystyrene plastic and is designed to provide insulation for the brushes, which are also molded into place with the housing. This eliminates brush and insulation assembly, one of the most tedious chores in assembling conventional midget motors.

An insulating-plastic motor housing with integral brushes and bearings may not sound extraordinary, but it is, because of the economics of making plastic articles. In fact, there'd be no insulating-plastic motor housing and no cheap midget motor if it weren't for the perseverance of two engineers, Alex Gorfin and Leon Kardorff. The two came to New York from Belgium 10 years ago.

Gorfin and Kardorff got their idea, for

(Continued to page 262)

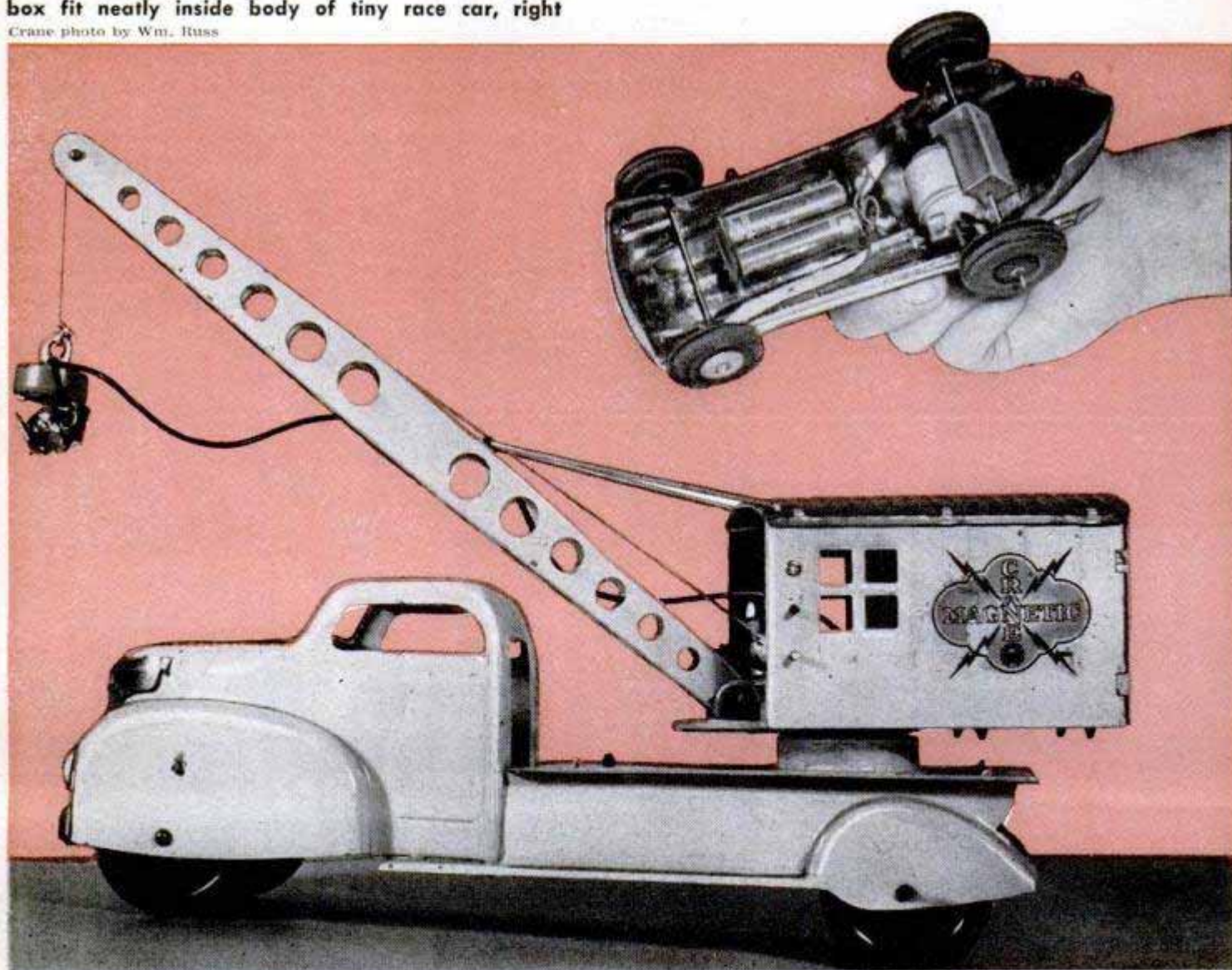

Sea-Water Still

To aid downed flyers adrift at sea, there is a new sun still that makes salt water drinkable. A 24-inch sphere when inflated, it is fabricated of Vinylite plastic sheeting. Inside a black-cloth drain bag is attached at many points to the outer plastic skin. Salt water poured through the still neck fills both the bag and a ballast tube that keeps the unit upright alongside the raft or boat. Sunrays passing through the sphere heat the water-filled drain bag and start the process of evaporation and condensation. The desalted water collects below the bag and is drained off



through a plastic tube. Even on cloudy days the sun's infrared rays produce one to two quarts daily. On an ideal day, 2½ quarts of potable water are produced.

Fuel Preheater

Starting diesel-fueled engines in subzero weather is no problem when a fuel-preheater-igniter unit has been installed. Using a 450 to 500-watt element, the unit will ignite any kind of an oil spray, whether atomized or not. It is battery-operated and requires no starting fluid. The ½-inch-diameter unit is 4½ inches long and is equipped with an adapter nut for installation in the intake manifold. A similar 100-watt fuel heater is easily adapted to almost any car. In many models, it may be installed in the intake manifold through the vacuum take-off port. In other cars, a thin vacuum spacer ring is placed between the

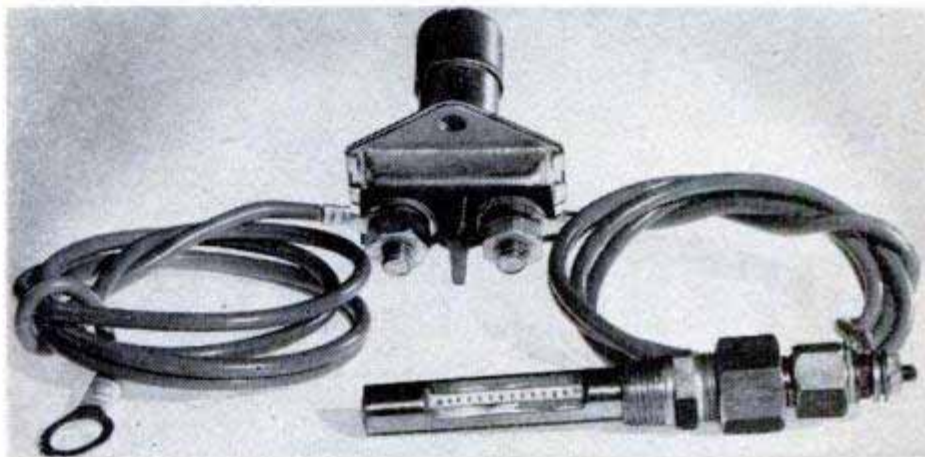

intake manifold and the carburetor. The vacuum line is then moved up to the spacer and the unit is attached in the original vacuum take-off port. A push-button type switch mounted on the instrument panel activates the heater, which develops six B.T.U.s within 30 seconds.

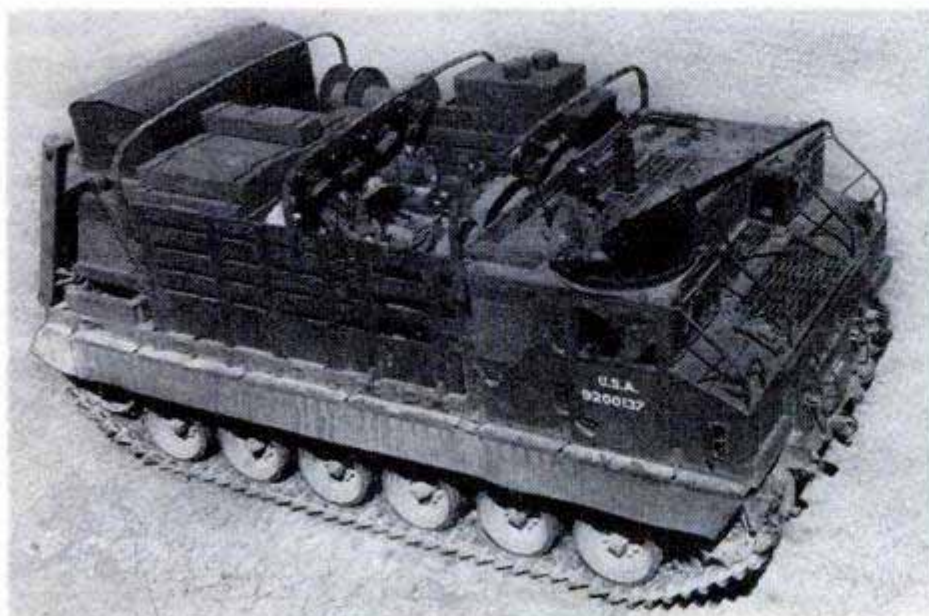

Versatile Tractor Has Many Jobs

Interchangeable bodies enable a new Army tractor to function as an artillery tow, a wrecker, a bulldozer or a general cargo hauler. The 22-ton vehicle has a top speed of 40 miles an hour and can negotiate swamps, trenches and 35-degree slopes. Its primary use will be to tow 75-mm. "Skysweeper" antiaircraft guns, but it also can haul heavier weapons up to an eight-inch howitzer.

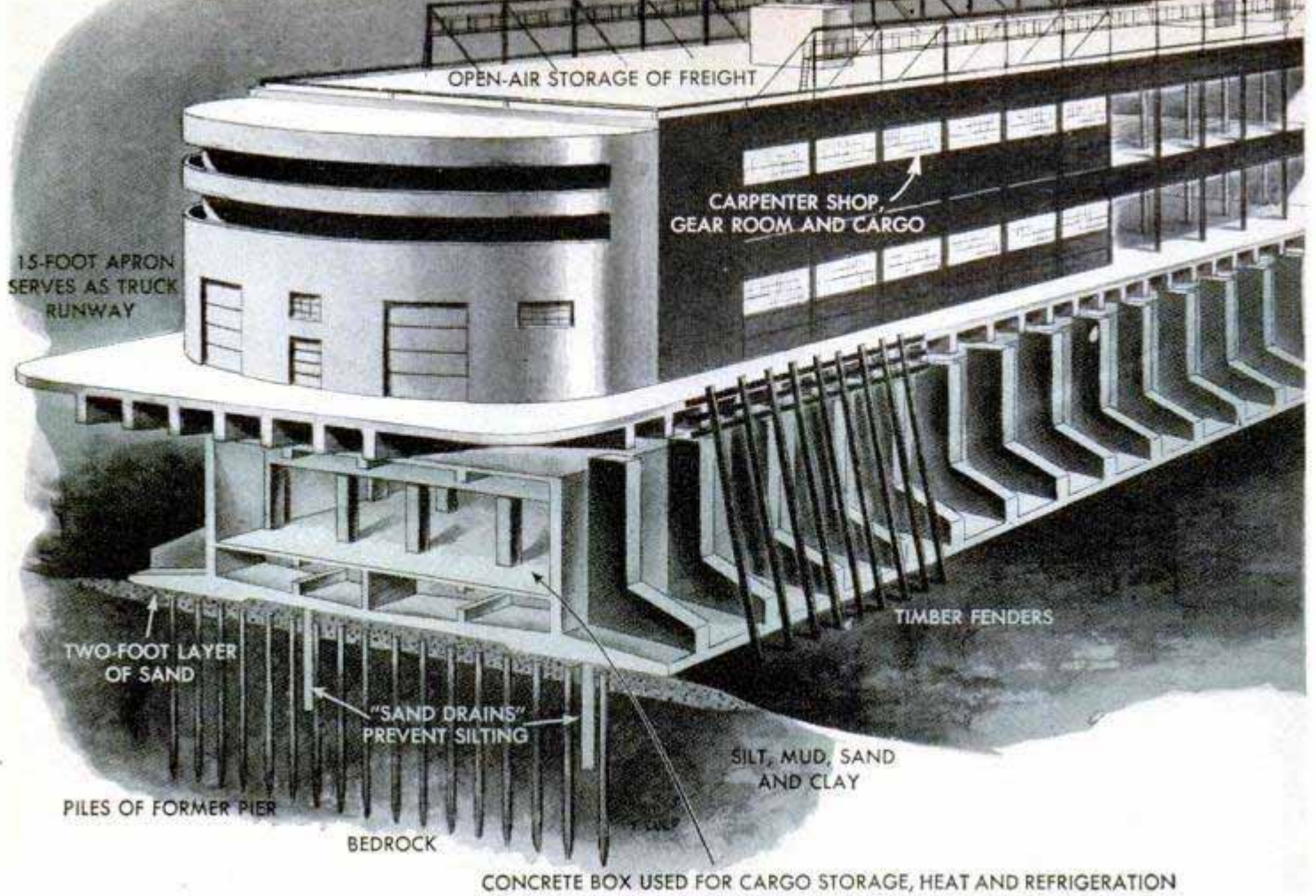

CONCRETE BOX USED FOR CARGO STORAGE, HEAT AND REFRIGERATION

“SUPERPIER” ALMOST FLOATS

UNIQUE in harbor construction is a new pier being built on the North River in New York. Basically the pier consists of three hollow concrete boxes. The huge

boxes will be sunk to the bottom of the river, yet are so buoyant they'll almost float, and will support virtually the entire weight of the superstructure. The unusual pier will

Fire destroyed the old pier in 1947, leaving only a tangled mass of piles, beams, cranes and charred wood



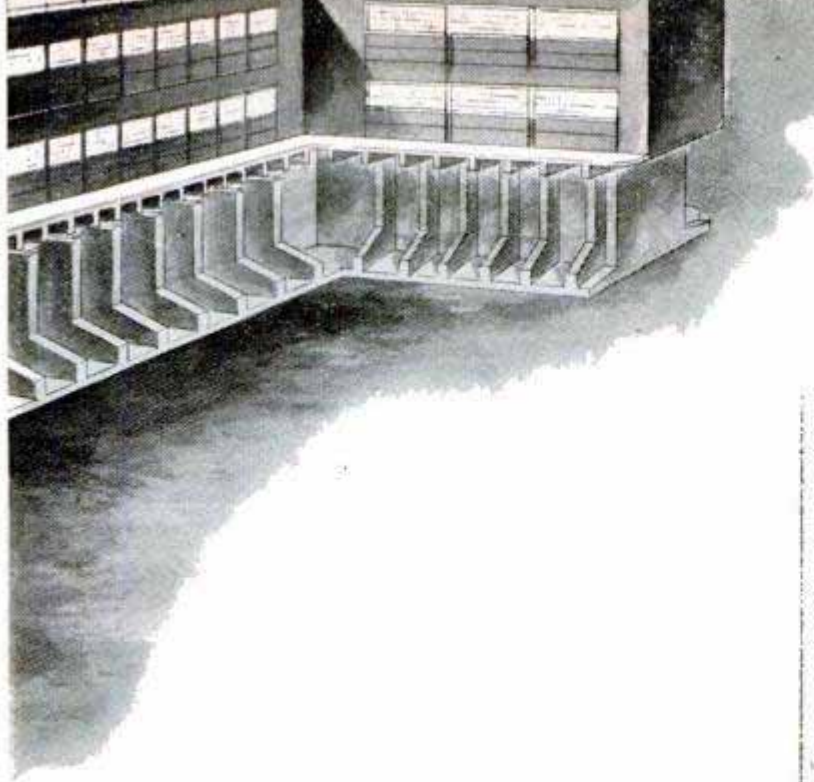

cargo and passenger space of its predecessor. As weight is added to superstructure during construction, water will be pumped from the sunken concrete boxes. New pier will be fire-proof and can't be attacked by marine borers

replace Pier 57, which was destroyed by fire. Only the piles remain, and these will be cut 34½ feet below water level to give added stability to the new pier. Two of the boxes will be sunk end to end jutting out into the river, the other forming the bulk-head along shore. These huge boxes are poured 30 miles upriver in a diked basin. When the dike is removed and the basin flooded, the boxes float and are towed to the pier site and sunk. Gradually, as the superstructure is built, water is pumped out. The pier will have three levels to accommodate cargo and passengers.

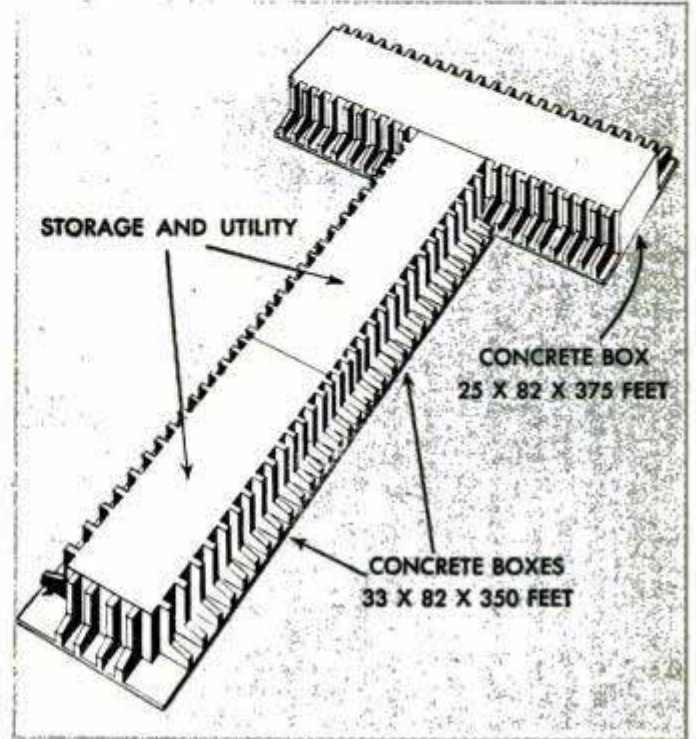

Sides of sunken boxes will be about two feet thick. The boxes not only will support the pier but also will provide much-needed cargo space. The structure will rest on a blanket of sand two feet thick

Piles of the old pier, expensive to remove, will be cut off 34½ feet below water level for added stability

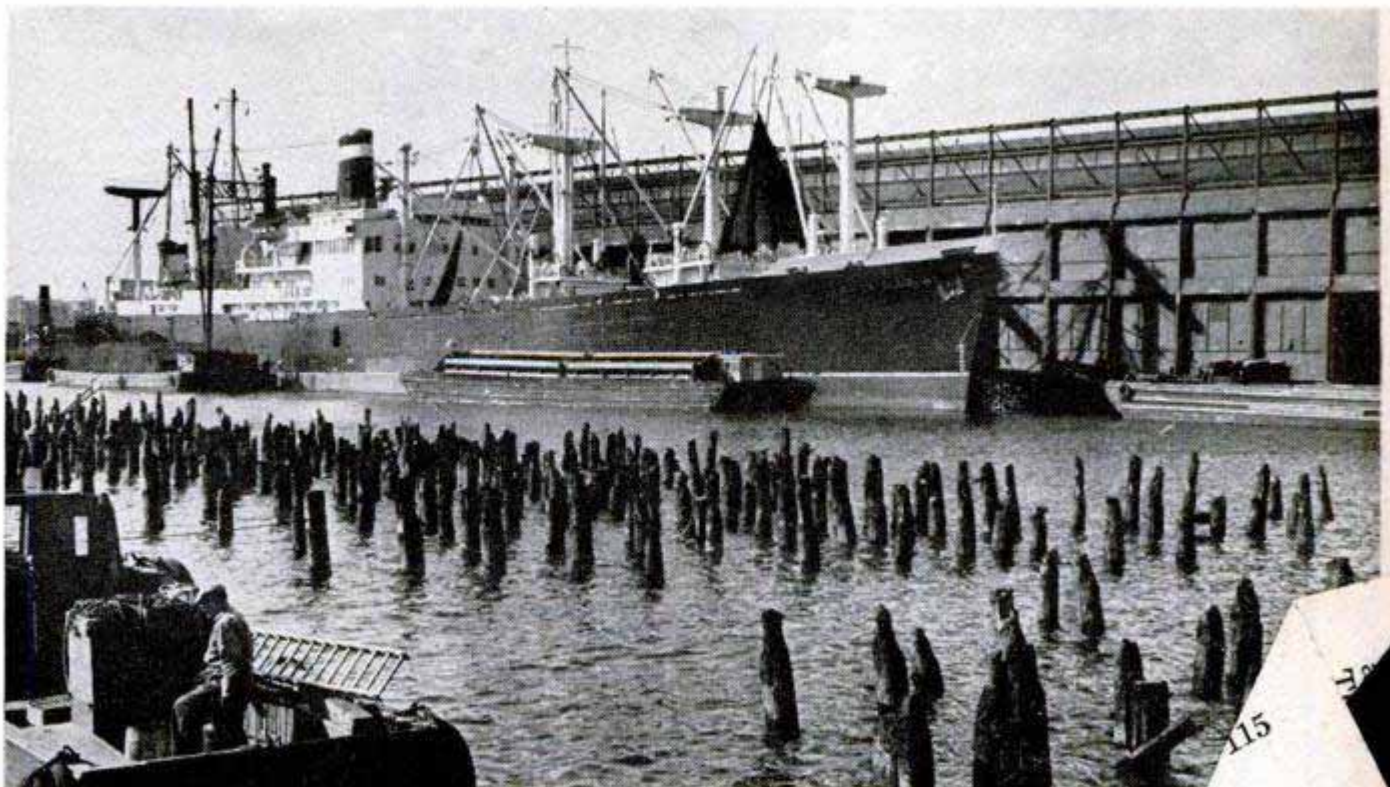

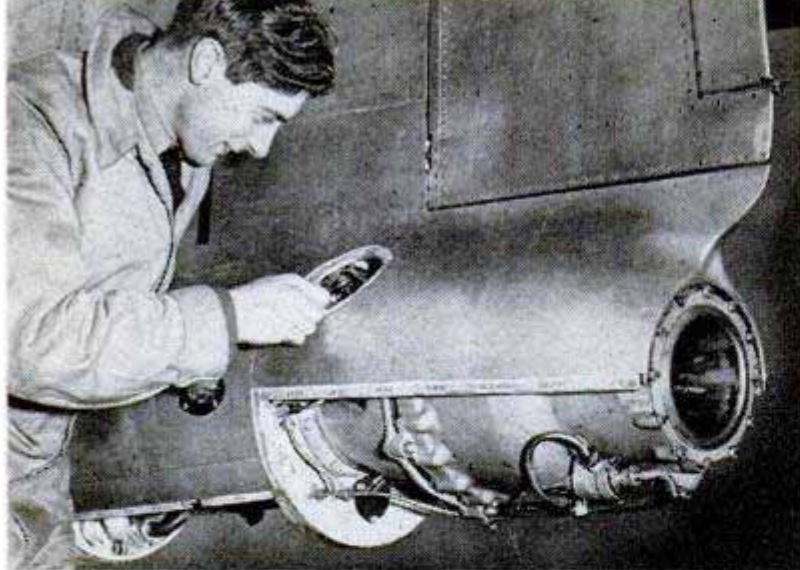

Rocket Motor Doubles Power of Jet Fighters

Designed to double the power of jet fighter planes, a revolutionary rocket motor that can be switched on and off by the pilot has been successfully tested in Britain by Armstrong Siddeley Motors, Ltd. Called "Snarler," the motor has a 2000-pound thrust at sea level and weighs 215 pounds. Using fuel consisting of liquid oxygen and a water-methanol mixture, the motor gains power the higher it goes. The compact new rocket motor fits into a 3-by-6-foot space.

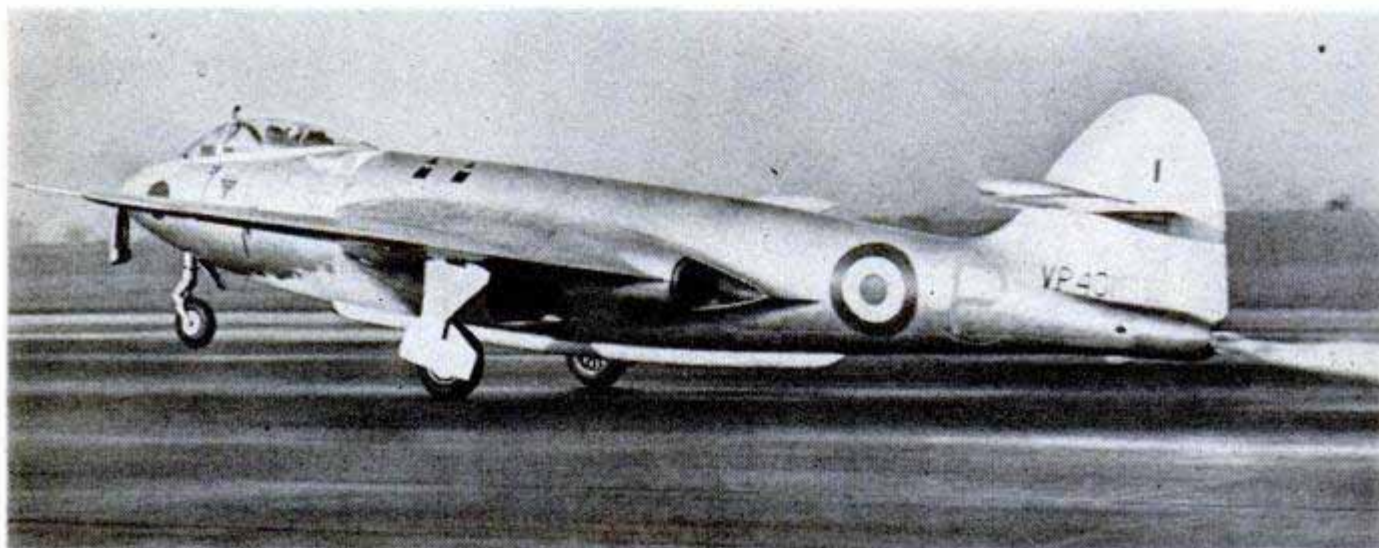

Blood Fractionator

Blood is automatically separated into plasma and red cells at the same time it is being collected from the donor by a processing device known as a blood fractionator. Processing is completed in a totally sealed system. The speed with which the blood is processed will permit stock-piling plasma and red cells for longer periods than is possible with current methods. Portable, the new equipment eliminates the collecting bottle. The blood flows from the donor's arm directly into a small centrifuge which separates the plasma. Separation of blood components and processing of plasma follow in minutes. The entire fractionating operation is conducted in a hermetically sealed system. Theainers filled with blood components can be moved without destroying the seal.

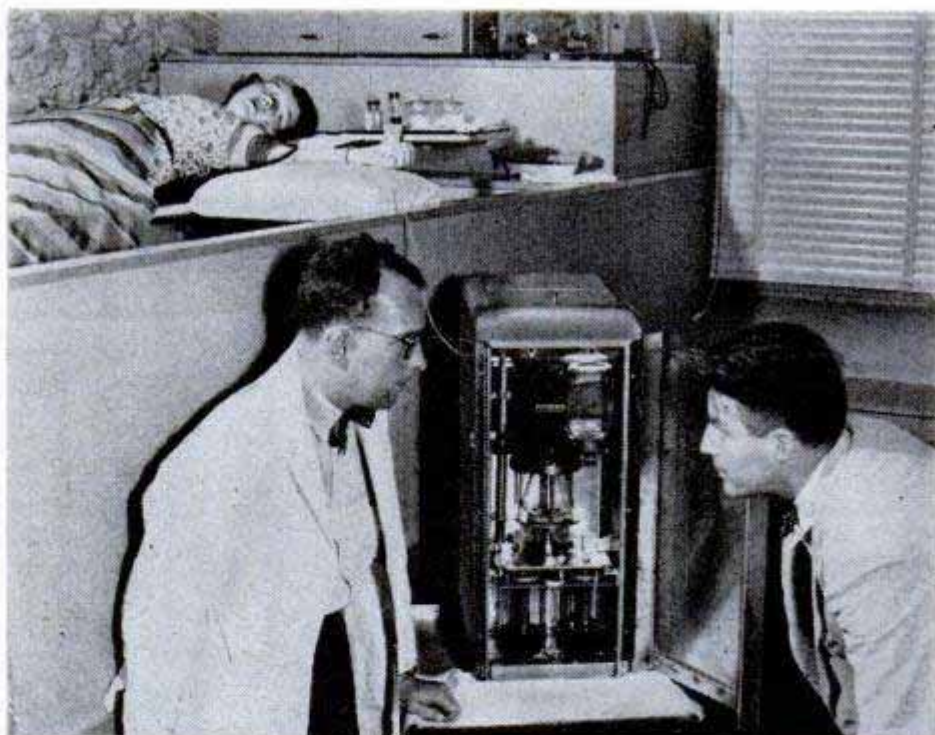

Many trees contain newly discovered chemicals that can kill insects, fungi and bacteria, and these may be synthesized by man, according to Prof. Holger Erdtman of the Royal Institute of Technology in Stockholm, Sweden.

Music writer for the blind has nickel-plated frame in which the stencil slides. Desired symbols are drawn easily by tracing around cutouts in the stencil



SO THAT THE BLIND CAN WORK AND PLAY

By J. Alvin Kugelmass

ABOUT 100 YEARS ago, a small, slight, tubercular man named Louis Braille died alone and embittered in a Paris rooming house. Blind since the age of three, he left a system of reading for the sightless which has been utilized in the home, factory, workshop, hobby shop and school.

Since his day, the method devised by this unsung and unhonored man has been adapted to almost every known tool and device for the benefit of the hundreds of thou-

sands in the world who, either by birth or illness, have lost their sight.

Time was when the blind person was a beggar or a subject for mockery. Today, the sightless take their places as workers, designers, cooks, housewives, electronic experts, pedestrians, assemblers, carpenters, painters, mechanics, authors, construction workers, musicians and even as photographers.

The Braille system utilized raised dots

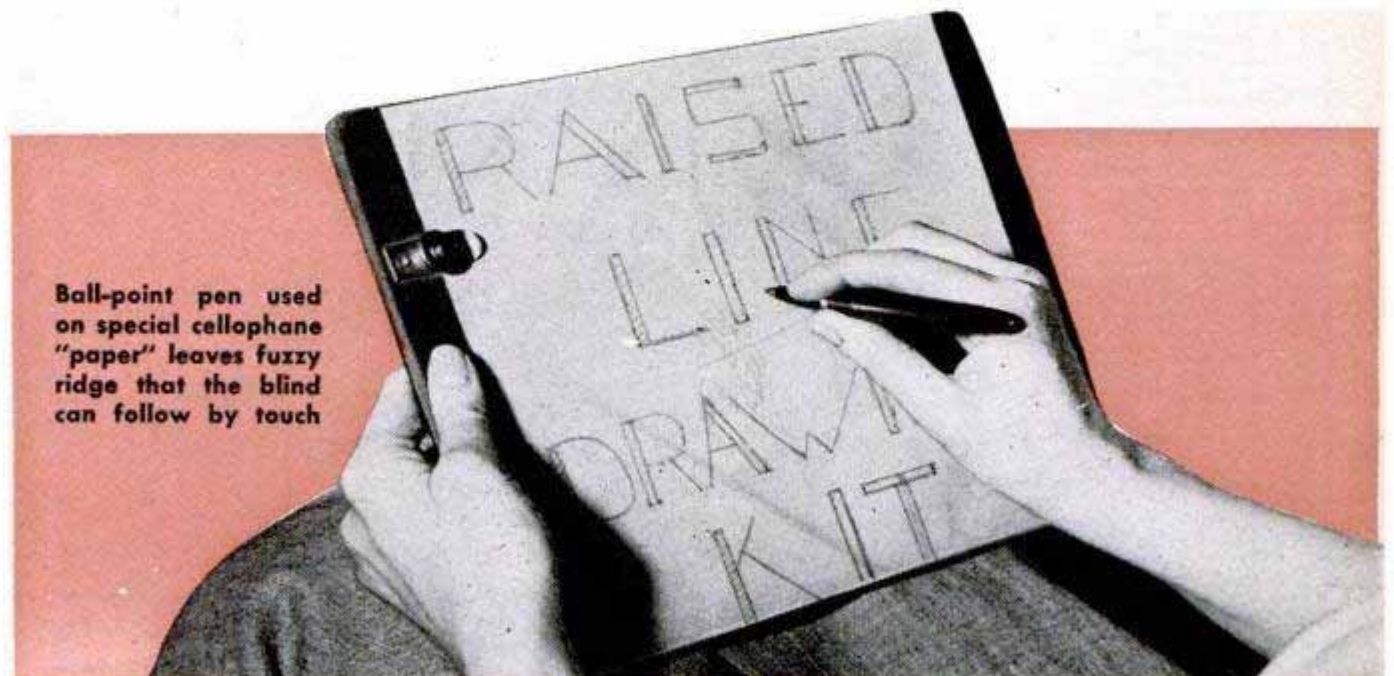

Ball-point pen used on special cellophane "paper" leaves fuzzy ridge that the blind can follow by touch

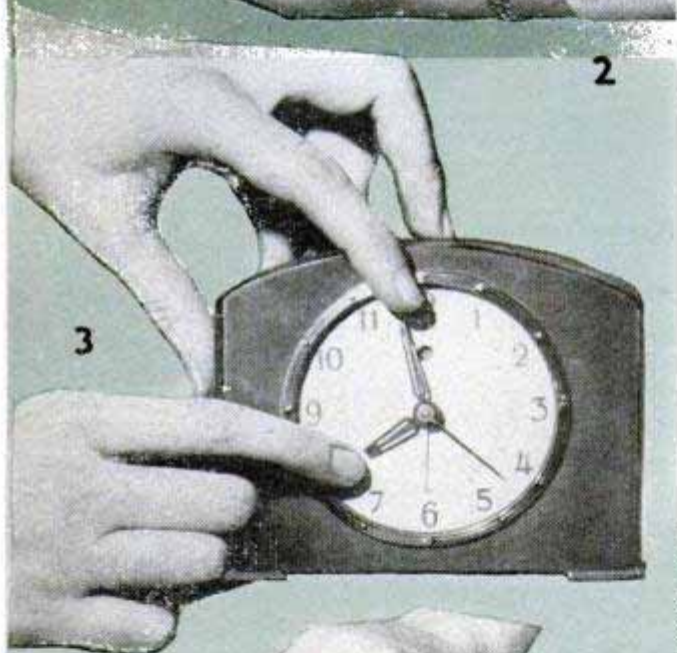

which, when the blind ran their fingers along, gave sense, sensibility and feeling. Today, the blind, because of Braille and science and mechanics, are not much more helpless than the seeing. The blind are enabled to take advantage of this mechanical age and to take their places as productive and earning citizens. Even more, they are enabled to have productive lives, almost as normal as have the seeing.

So widespread is blindness that today large producers of watches, such as the Elgin Watch Company, put out pocket and wrist watches with Braille dots fused on the surface at each hour. Three o'clock is located at the stem as a beginning point. To the seeing this may sound peculiar, but the Braille system works best on fingering two dimensions at right angles as a starting point (close your eyes and see). Tiny models are made for blind women.

There are games for blind persons. The blind can play chess, checkers, dominoes and even a pinball machine where the score is tallied by Braille. It's all a matter of position and precision.

There are Chinese checkers and cribbage boards, ticktacktoe and Braille poker cards, anagrams for blind intellectuals and crossword puzzles.

The blind cannot get much pleasure from travel, except for climate changes. They cannot see old landmarks or appreciate scenes which are historical landmarks. But like many hundreds of thousands of people who cannot travel and who yet like to pore over maps, the American Foundation for the Blind puts out maps which the sightless can finger and trace along even as we, who cannot travel, do before our fireplaces and



on our rugs. They can travel afar by tracing such names as Baluchistan and Zanzibar, and who knows, in their imagination they may travel farther than that.

The blind housewife has a pancake turner which is automatic. This lifts under the egg or batter pancake, and when the handle is squeezed, turns it over neatly and flops it into the same space.

There is the can opener for the blind. When the cycle is completed, it emits a squealing sound because of the juxtaposition of the blade and the can. The sound informs the sightless housewife that the can has been cut through.

There is out now, for example, a drop-at-a-time drop measure. This is a conventional rubber ball and glass medicine dropper. The bulb, however, is reduced in size at the top to leave a little bulb above the main one. When the tiny bulb is depressed, a drop is released, surely an invaluable aid to near-blind persons who must take medicine drops several times a day.

There's a carving knife with a heavy wire guide running back of and parallel with the blade, which may be adjusted manually up to $\frac{5}{8}$ -inch slices. A pressure cooker for the blind housewife has three holes drilled around the circumference. Pressures of 5, 10 and 15 pounds are secured by setting the different holes on a vent pipe in the lid of the pan. One hole may be indicated by a slight file mark so that the different pressures may be identified. One kitchen boon is a set of canisters made of plastic. The gauge consists of a sleeve into which an eight-ounce cup is set to provide measurements of tablespoons or

(Continued to page 236)

Pictured to the left and below are aids for the blind, which make them not much more helpless than the seeing: 1. Collapsible cane measures 12½ inches when it is retracted; 2. Combination try-square and wood-marking gauge has slide that may be locked in any position; 3. Electric alarm clock which has been adapted for touch reading; 4. Carpenters' level consists of a steel ball rolling in V-shaped strip of metal; the calibrated screw shows deviation from level; 5. Kitchen timer is marked with single Braille dots at each minute and double dots every five minutes; 6. Special kit enables the sightless to make their own labels for jars and bottles — Brailled slate ridges will not wear off; 7. Postal scale is graduated up to 1½ pounds, the first eight ounces being marked with Braille dots after which dots appear at 12, 16 and 24 ounces; 8. Insulin syringe permits blind diabetic to administer proper dosage to himself

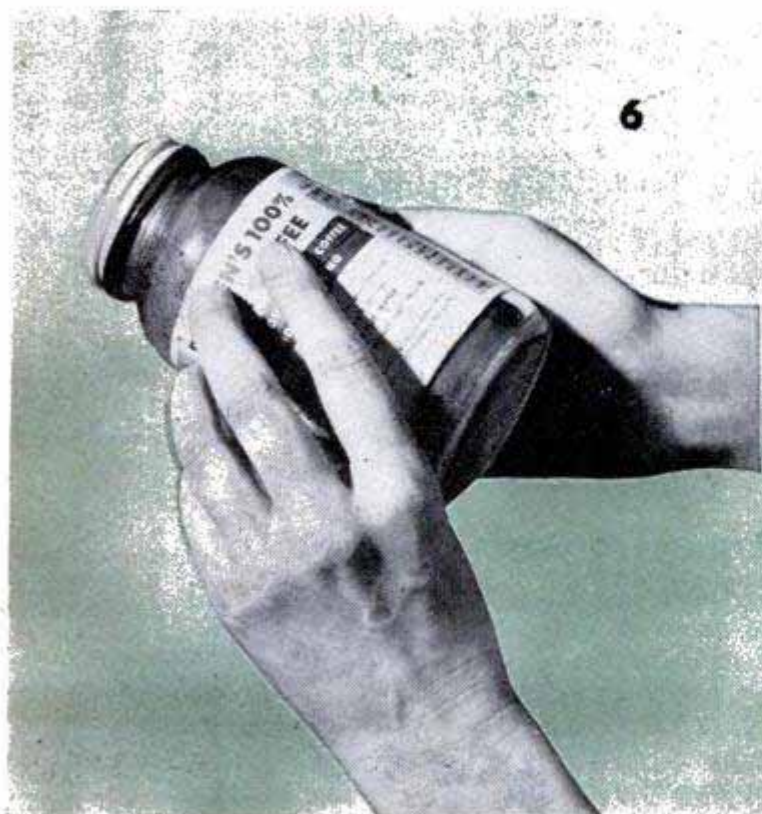
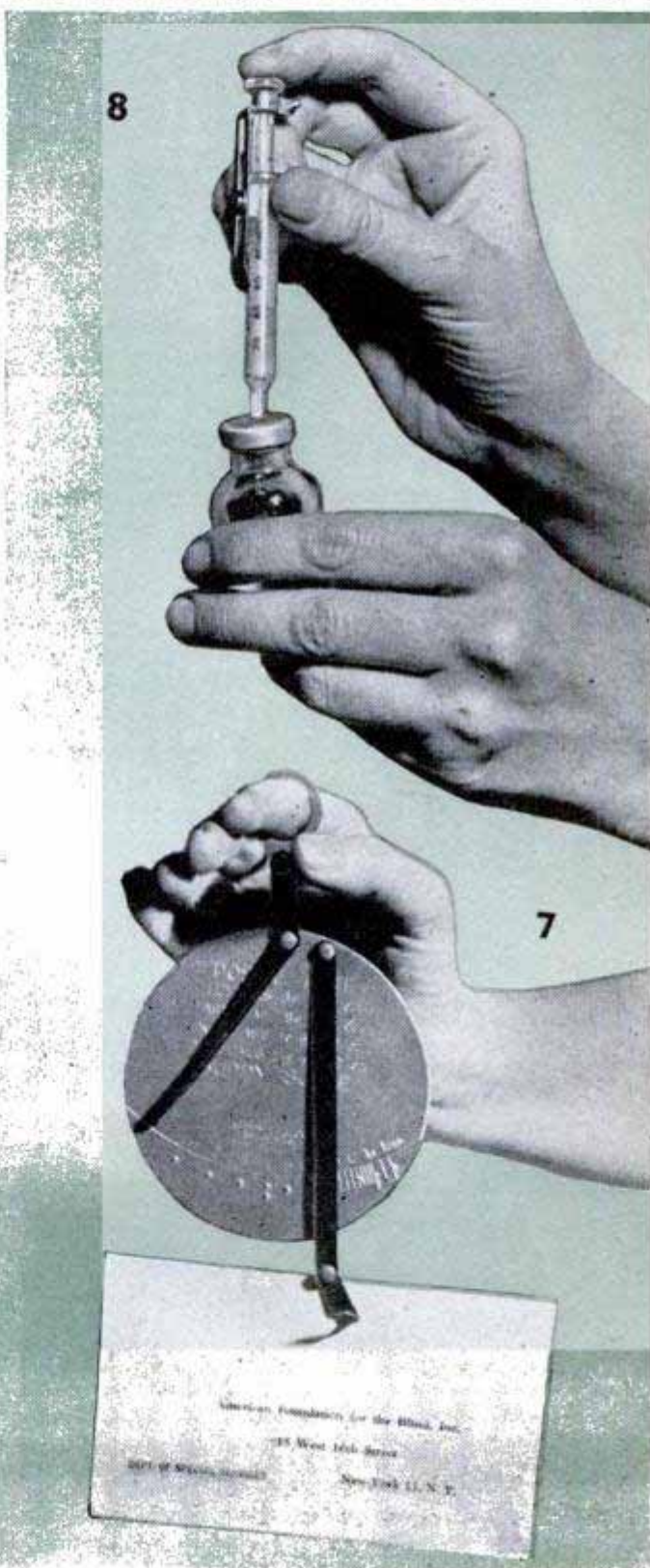

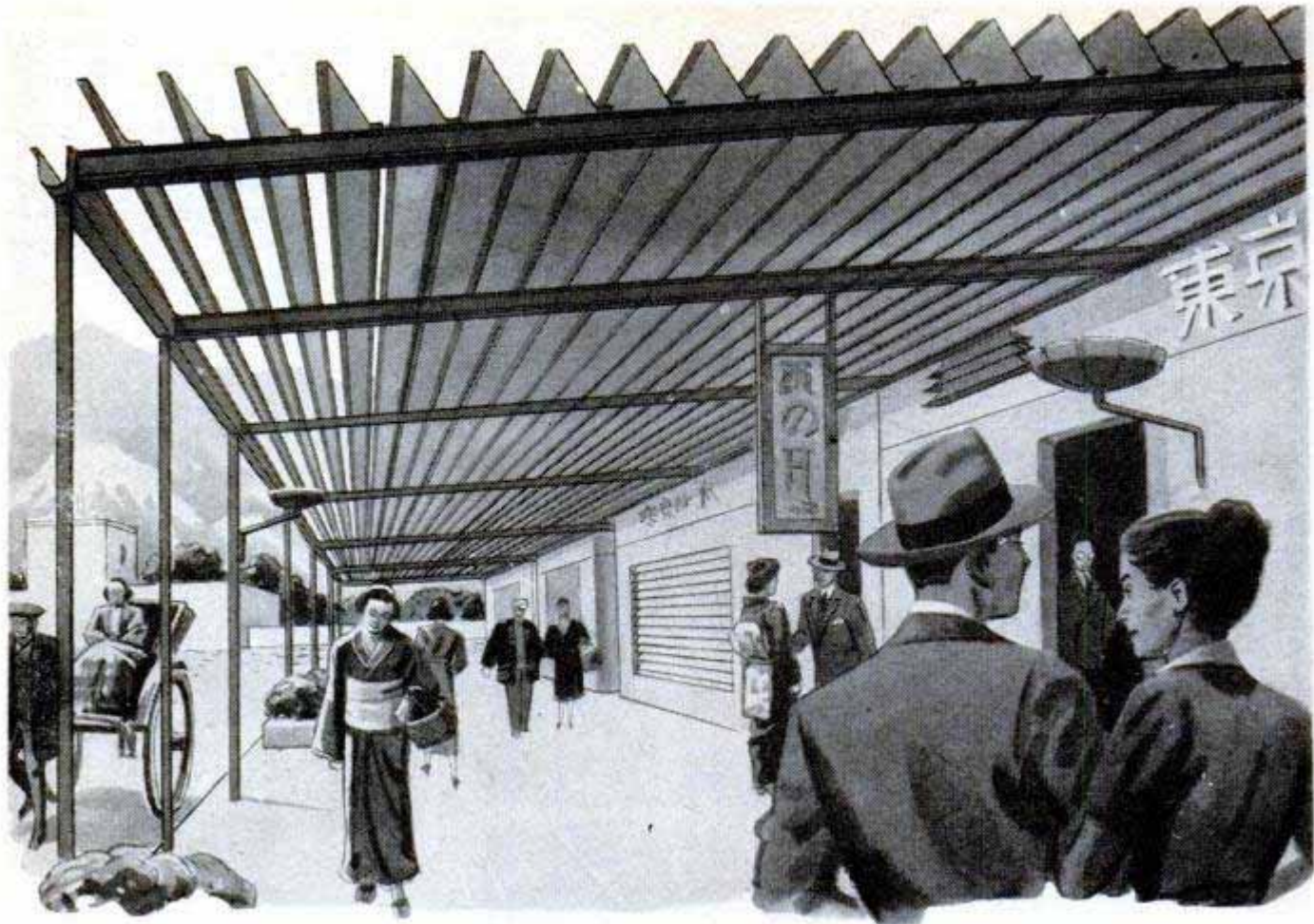

During good weather slats are left open to provide free air circulation. In case of rain, slats are closed over entire sidewalk, as shown in diagram

"Venetian" Awnings

Huge awnings installed above the sidewalks of one of Tokyo's busiest streets operate like Venetian blinds. The slatted awnings, made of light metal alloy, are pivoted by the turn of a handle. When a roof to close out the rain is desired, the slats are turned so their edges join. When only shade is needed, they are opened to provide free air circulation yet shut out the sun's rays.

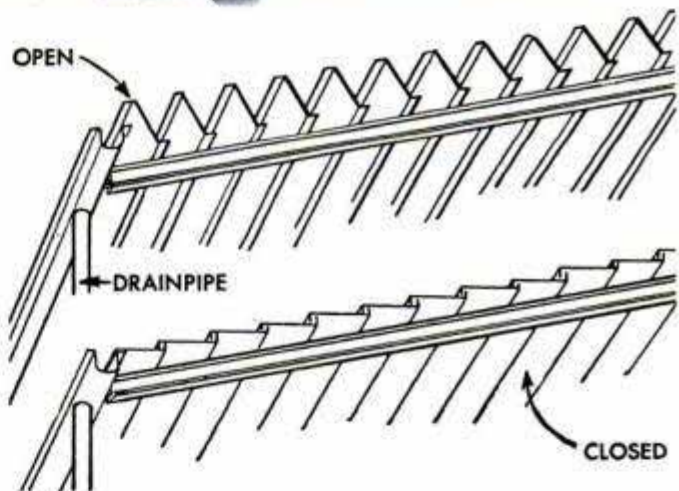

Writing Materials Carried Inside Portable Desk With Sliding Top

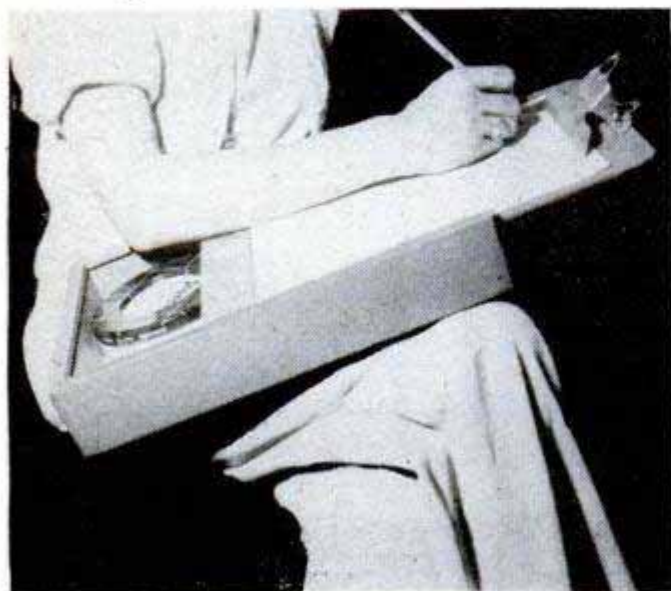

Pencils and paper, order forms and drawing equipment can be carried inside a compact portable desk. The desk is a shallow box with a clipboard which slides into the grooved sides to form a cover. The clipboard can be slipped entirely out of the box. When not in use the portable desk can be fastened shut and hung by the clip.

Japan Transmits by Facsimile

Facsimile now is speeding transmission of news in Japan. The teleprinter, used in this country, is not satisfactory in Japan or China because of the complicated characters used in writing. With facsimile, exact copies of printed pages are received by newspapers subscribing to the service.

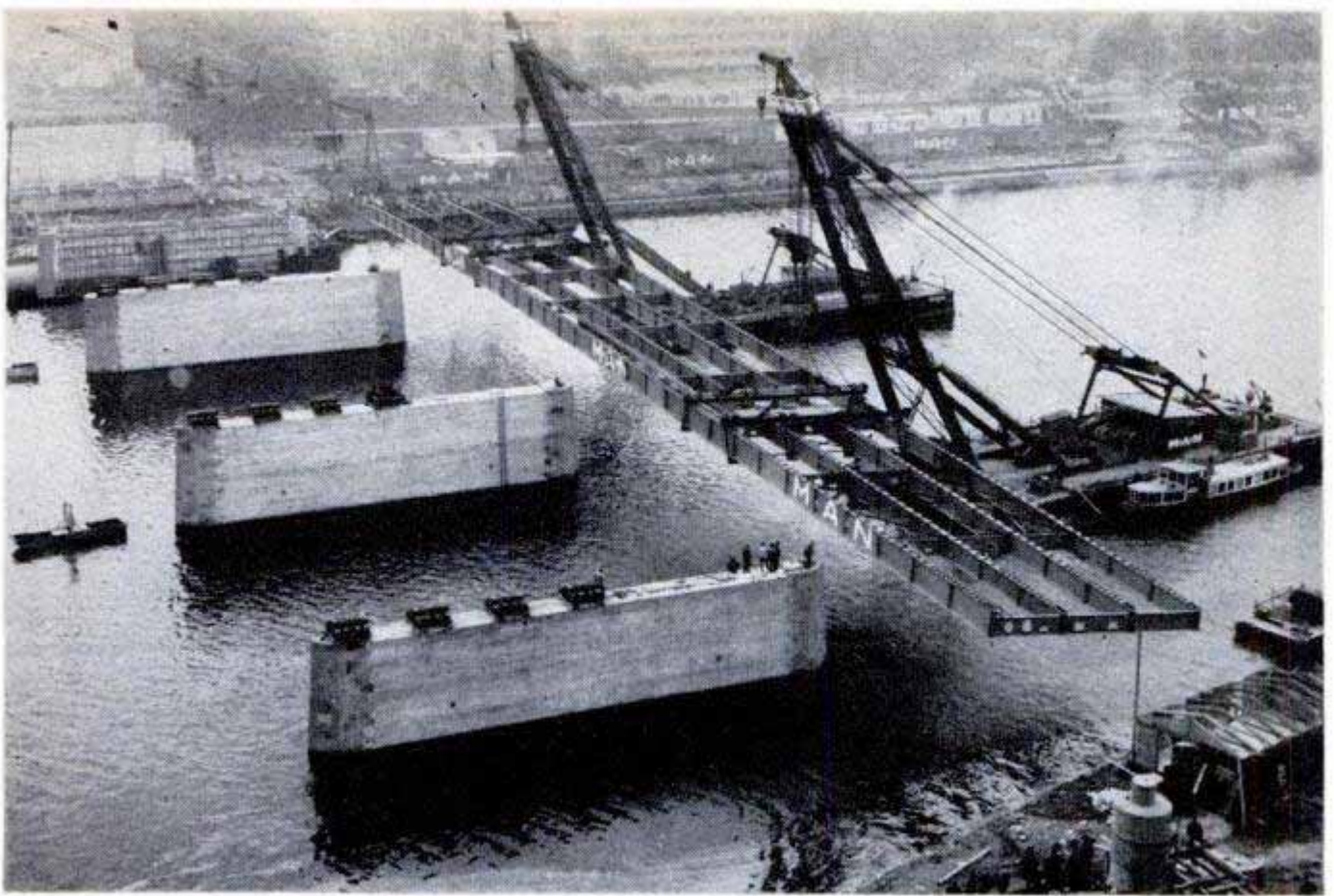

Bridge Floated Downstream Into Position on Piers

To speed construction of a new bridge at Frankfurt-on-Main in Germany, the new span was built while the old one was being dismantled. The long steel spans—two were required for the full width of the roadway—were assembled on the river banks while the wreckers were tearing down the old bridge and erecting new piers. Then two

large river cranes picked up the spans and floated them down the river to the supports. The new bridge replaces the historic Wilhelmsbrücke, which was captured by the Allies in World War II with only minor damage. Repairs by the engineers kept the bridge in operation until the heavy traffic dangerously weakened it.

Crash Canopy on "Cat" Shields Loggers From Falling Trees

Loggers get added protection from a new crash canopy for Caterpillar tractors without sacrificing vision or convenience. It is a socket-type installation designed by Vern Parten, master mechanic for a Yakima, Wash., lumber firm. Canopies welded to the chassis tend to shake loose. To offset this, the structures have had to be "beefed" up with additional supports. This has lowered the operator's chances of leaping clear if a tree falls, the machine rolls over a bank, or a log starts to climb the "cat" on a downhill pull. Parten's canopy is made of heavy-gauge pipe, with welded end socket, fitted onto pipe spurs that are bolted to the chassis. Single vertical supports on each side stiffen the over-arch and there is a heavy sheet-metal top above the driver.



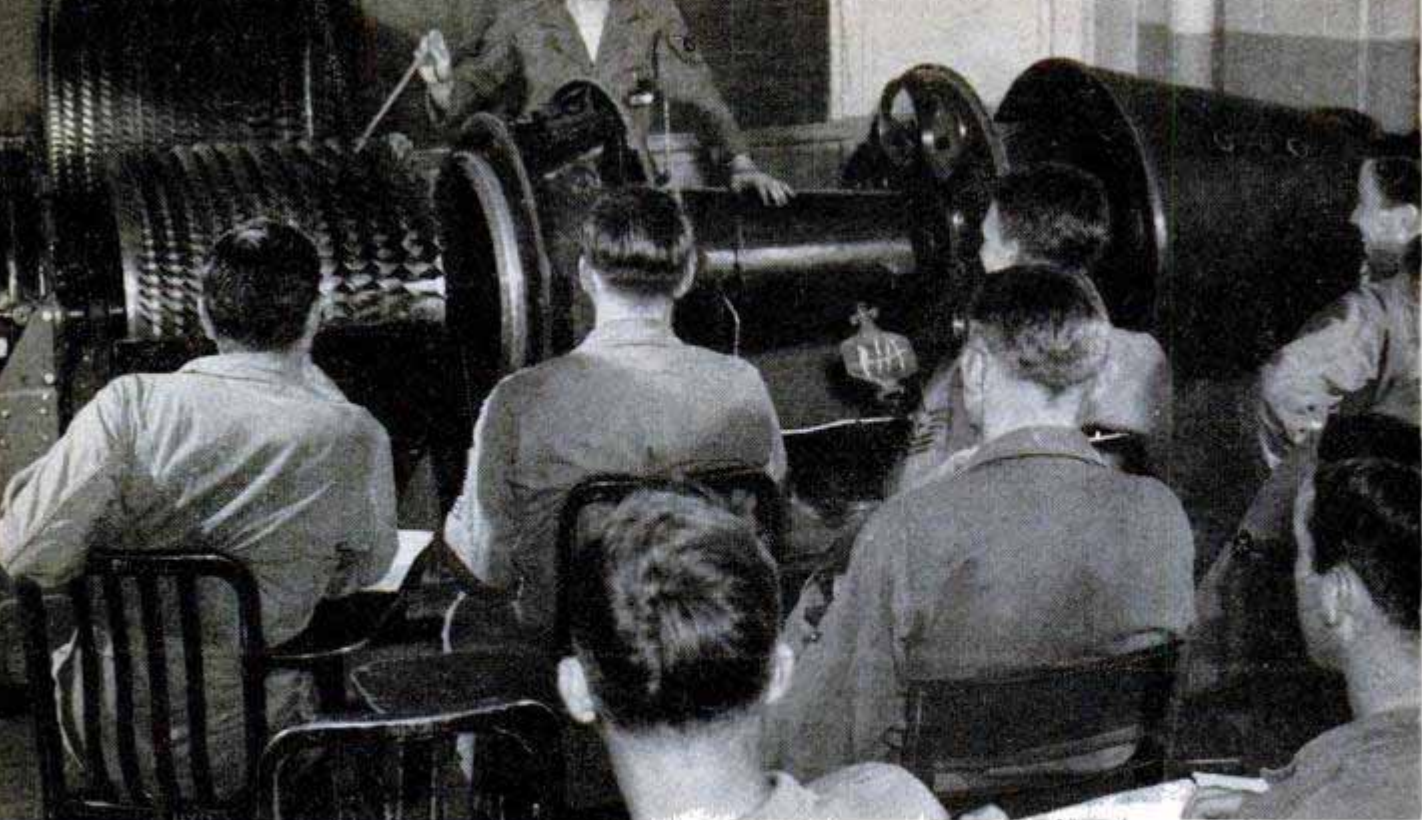

Actual jet engines mounted in classrooms help specialist students to understand technical facts more readily

CAREER SCHOOL for

IT TAKES more than a "hot pilot" to keep a jet fighter aloft. It takes a smart jet mechanic, one of those new specialists who have been added to the U. S. Air Force between wars. A few weeks ago he might have been the fellow at the corner filling station near your home.

Only a misty memory now are the days when the skimpily trained pioneer pilots flew "by the seat of their pants" and gambled their lives on the expertness of mechanics who were often seeing their first

airplane. In this supersonic-speed era, when a single, complex flying machine can cost over a million dollars, the fate of the man and the airplane can't be left to chance.

Knowledge has shoved pure daring out of the picture as the prime requirement for success as a pilot.

With 19-year-old Joe Doakes as our new Air Force recruit, let's tag along closely and see how today's methods attempt to fit square pegs into square holes. Like other newcomers, after induction he'll be headed

By Aubrey O. Cookman, Jr.

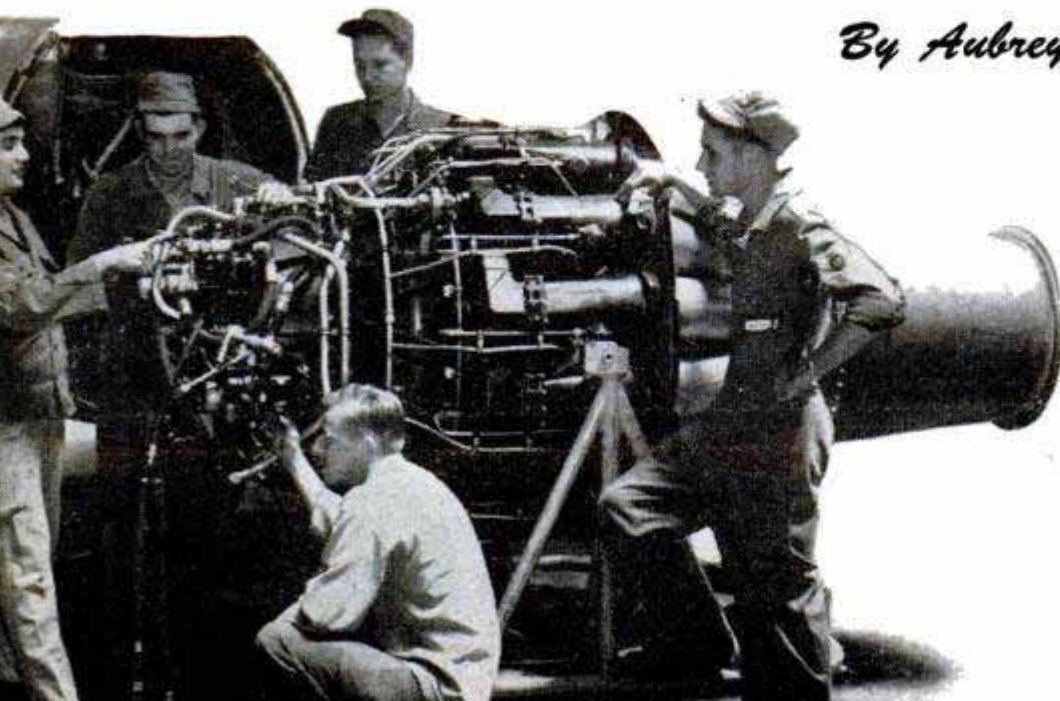

THIS is the second of four articles about the training of our recruits. Next month, the Navy. In April, the Marine Corps.

Class sizes at Chanute are kept small so that each man's questions can get individual attention



Groups marching between classrooms add a military touch to the "campus" at an Air Force technical school

JET MECHANICS

for the "world's largest university," Lackland Air Force Base at San Antonio, Tex., with its 10,000 teachers and 300,000 graduates yearly. So tight and complete is its organization that 15 men handle the training of each man during his 13-week indoctrination period.

Three hours after Private Doakes has hopped off a bus, the last lap to Lackland, he has had a GI haircut, received a basic

uniform and taken the first steps toward completing a detailed record of his pre-military life. Spread over 2000 acres, the busy Texas base is aptly called "The Gateway to the Air Force."

Trained interviewers next pick Joe up and continue the task of discovering what makes him tick. They learn, for example, that he is a hot-rod enthusiast and that his best high-school grades were in shop

Putting their book learning to work, ground crewmen in Korea replace a pylon tank on a Republic Thunderjet

U.S. Air Force photo

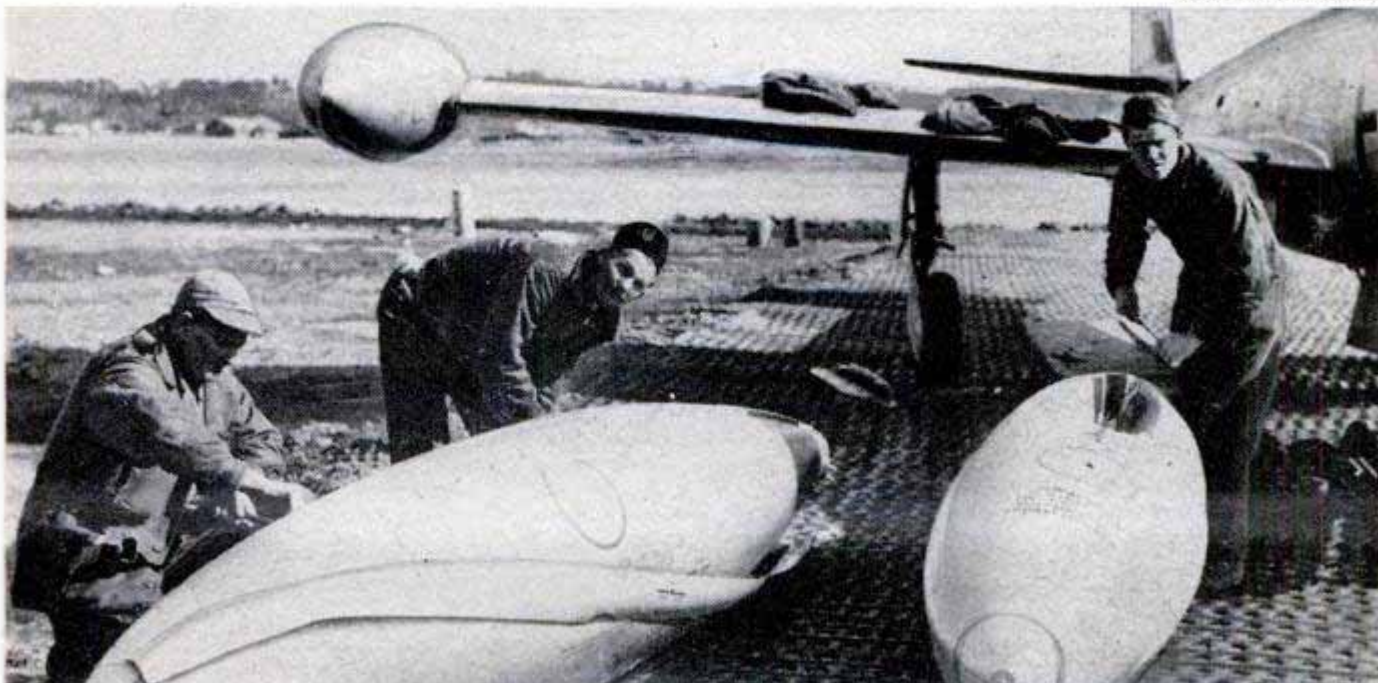



Mechanics hoist a jet power plant back into an F-80 that in a matter of minutes will again be combat-bound against the Chinese Communists

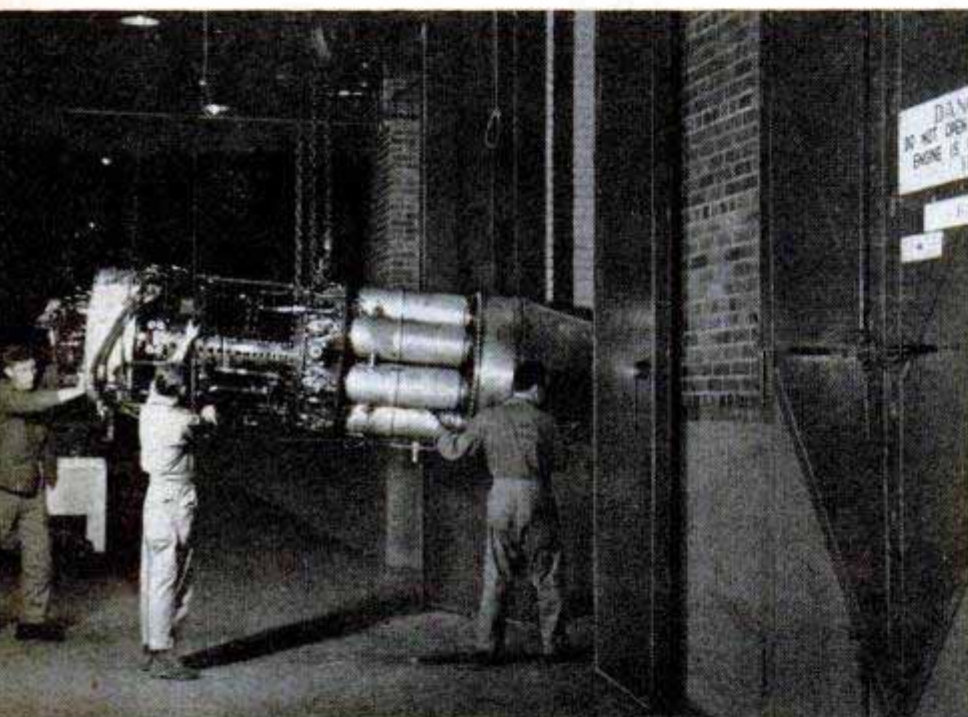

Students guide an engine into one of a long row of test cells at Chanute. Below, an instructor explains fuel flow in a piston engine

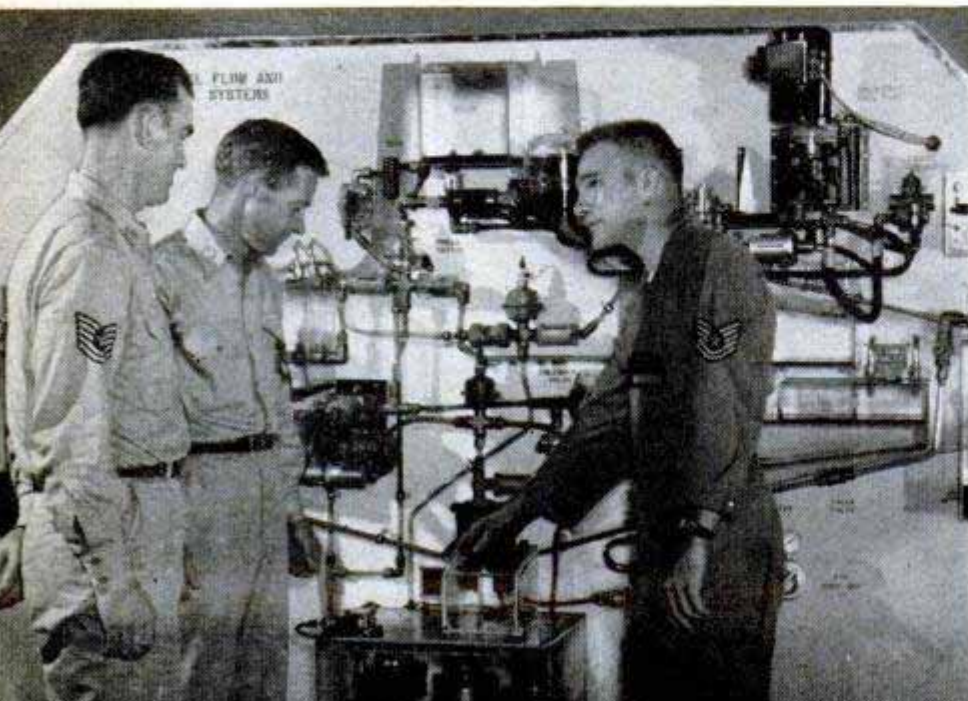

courses. A group counselor then steps in and begins filling in the other part of the picture, advising him and explaining how the Air Force operates.

About here he encounters something that would surprise old-time air trainees of World War II. No longer so heavily emphasized are the familiar psychomotor tests, devised to determine their relative aptitudes for specialized fields of training. Instead, Joe gets a pencil and a batch of examination papers. The answers he comes up with tell more accurately, and in less time, where is his greatest potential usefulness in the service.

Lackland's Human Resources Research Center tries to find "clusters" of ability in each man, leanings or skills that indicate several jobs he'll likely do well. The tests average about three days. Later his subsequent school grades are returned to Lackland, as a double check on both the lab's diagnosis of the man's talents, which they call predictive efficiency, and the adequacy of the training that follows. In some cases the reports lead to correcting flaws in the service's teaching methods.

From Private Doakes' test results and interviews his new employers get surprisingly complete impressions about his qualifications. Joe's own knowledge of his service and the career possibilities it offers is meanwhile reinforced by inspecting miniature displays of men working in dozens of fields of Air Force activity. So lifelike is their detail that one model has a stream with water actually trickling along its bed.

Tests and interviews don't occupy all of Joe's time. The medical station gives him a thorough physical check-up and catalogues his health history. The flight chief, a non-commissioned officer in charge of Doakes' group, begins educating him on the routine facts of military life,

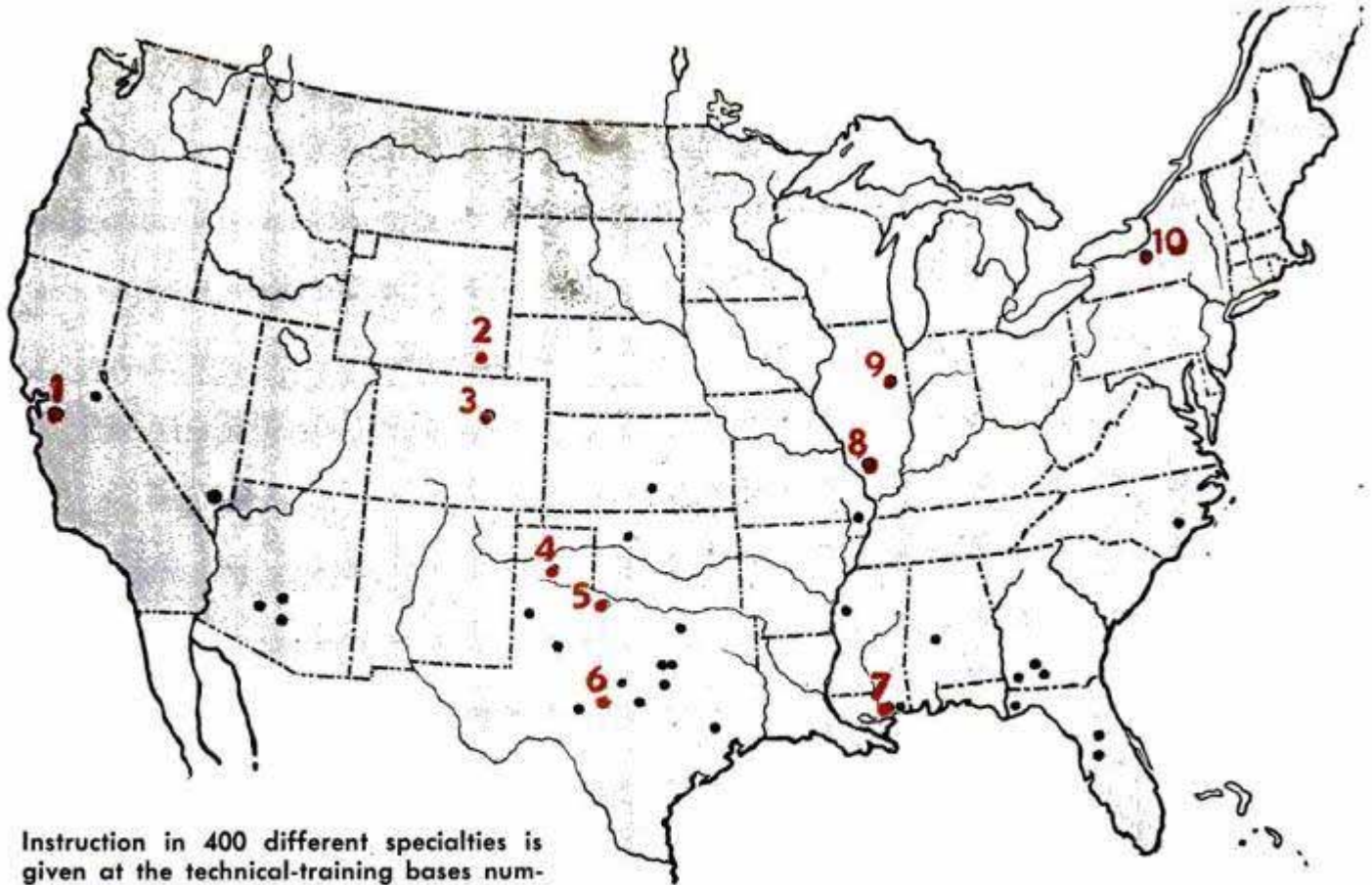

Instruction in 400 different specialties is given at the technical-training bases numbered in red above. Bases 1, 6 and 10 are indoctrination centers at Livermore, Calif., San Antonio, Tex., and Geneva, N. Y. The seven major training schools, with a few of their main courses, are (2) Warren, Cheyenne, Wyo., clerks, Teletype mechanics; (3) Lowry, Denver, Colo., armament, photography; (4) Amarillo, Tex., jet maintenance, overhaul; (5) Sheppard, Wichita Falls, Tex., piston-engine maintenance, overhaul; (7) Keesler, Biloxi, Miss., radar, electronics; (8) Scott, Belleville, Ill., communications and cryptography; (9) Chanute, Rantoul, Ill., welding, weather, special engine courses

like keeping his bunk orderly and his shoes shined. Marching and the handling and firing of a carbine are added to his abilities.

During indoctrination, Joe is asked to select three first choices from among the many technical-training courses, with the reminder that class-size quotas, his qualifications and other factors might make acceptance impossible in some categories. The Air Force's most pressing specialist needs, of course, take precedence over all else in determining for what most of the men will be schooled. Wherever possible, however, recruits are matched up with their first choices.

Joe's performance at Lackland indicates a capacity for mechanics, and after 13 weeks he is shipped to Amarillo, in the Texas panhandle. Others, slated to be pilots, navigators, bombardiers, radar observers and combat crewmen, move on to flight-training bases.

Two technical-school graduates team up to repair a damaged wing on a front-line jet fighter in Korea



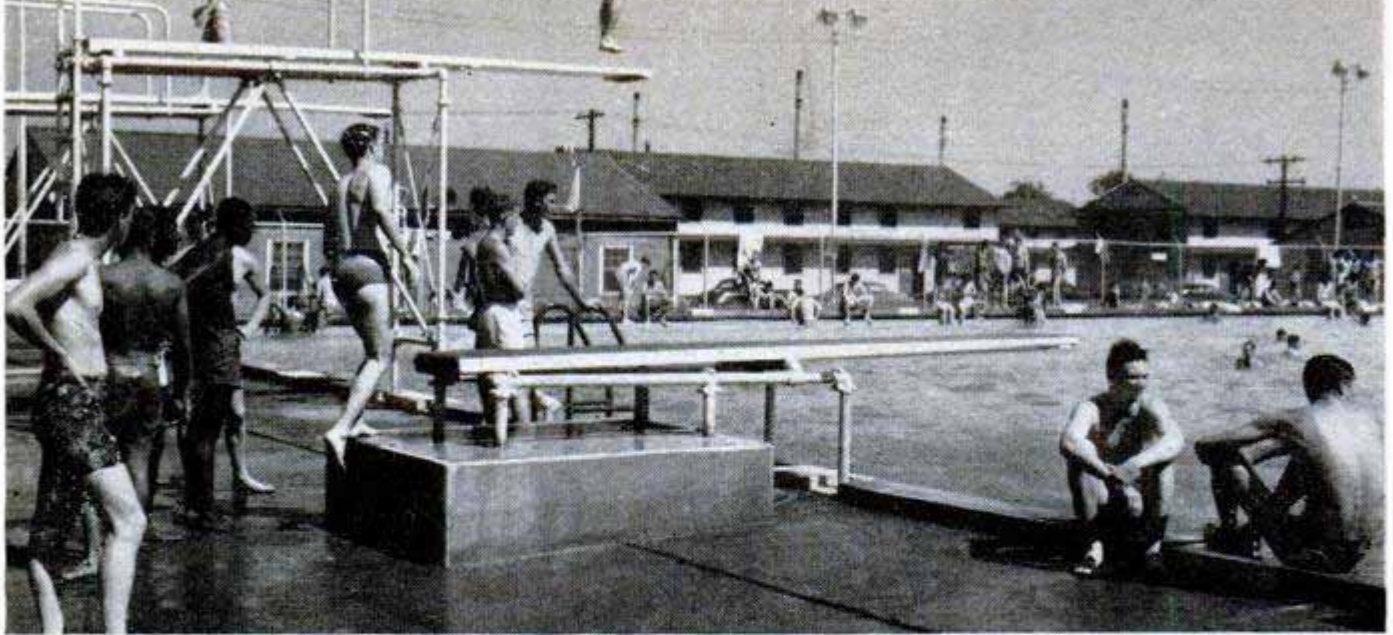

Knowing that "all work and no play makes Jack a dull boy," all the schools provide recreational facilities

At Amarillo, for 26 six-day weeks, he is intensively schooled in classes, hangars and on the flight line in basic aircraft maintenance. Joe's instructors, using movies, cutaways and mockups, gradually peel away the mysteries surrounding such things as airplane electrical and hydraulic systems, panel instruments and the workings of both piston and jet engines.

Already tagged to be a jet specialist, he is now ready for advanced training at Chanute Air Force Base, Rantoul, Ill. While the engine's basic simplicity was stressed during jet's early days, they've become more complicated electronically in the race for supersonic performance. The course on the Allison J-33 engine, for example, in five years has been lengthened from five to seven weeks. The widely used F-80 and F-94 airplanes both use J-33 engines. Other units

like the Westinghouse J-34 and the General Electric J-47 have likewise increased in complexity as well as power.

The atmosphere at Chanute and other Air Force training bases is dominantly scholastic. The men there are getting a concentrated education as technician craftsmen, not as commandos. There is little evidence around the fields of rugged combat exercises or intensive weapons drills.

Among the few military touches apparent are saluting, the marching and singing of groups moving between classes and the fatigue uniforms—loose-fitting coveralls and caps—they all wear during their school shift. Books and note pads are more familiar sights than rifles and metal helmets.

Specialist students like Joe are on one of two shifts, starting at 6 a.m. or noon and lasting six hours. All have two hours of supervised study daily,

plus whatever each individual decides he needs. About 10 percent ask for additional tutoring from counselors rotated from the instructor ranks. Every barracks has a special room set aside for study and counseling.

The age and educational differences among these inductees, more varied than in colleges, present teaching problems. At Chanute they find that many mechanically

(Continued to page 266)

Before they select an Air Force career field the new men view dozens of lifelike miniatures that show typical specialists at work under typical field conditions



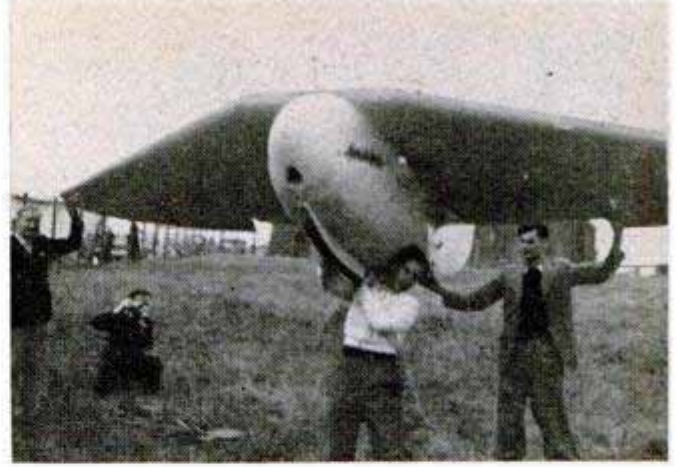

Glider Trainee Gets Over-the-Shoulder Instruction

Glider instruction is simplified in a new German craft that has the teacher's seat directly behind and above that of the student. Only one instrument panel and one steering gear are required and corrections

can be made over the shoulders of the pupil. Another design exhibited at a recent soaring meet was a tailless glider, with a wing-span of more than 20 feet and weighing only 110 pounds.



Electric "Hot Foot"

When your feet are cold, you're cold all over and that is why an electric foot warmer is good news. Made of Goodyear's Pliotherm, the conductive rubber that electricity heats, the foot warmer can develop 100-degree temperatures. Pliotherm has long been used for de-icing airplane propellers and wing surfaces. Made into a square mat, the rubber increases the comfort of persons who work in places where floors are cold and drafty. Being waterproof, it can be used outdoors where it makes more comfortable the job of the taxi starter, doorman and traffic policeman.

Chemical Sterilizer for Fruit Trees

Growth of fruit on trees prized for their shade or appearance can be halted by spraying them at the flowering stage with a stronger mixture of the same solution used to make fruit adhere to trees. Many tree owners object to having lawns littered with undesirable fruit.

Poor Man's "Hot Rod"

One of the most economical cars ever built, both in purchase price and mileage, recently made its appearance in France. It's a little two-seater weighing only 380 pounds. The two-horsepower motor is in the rear. Canvas fastened to a tubular metal framework forms the seats.

☐ In 11 years Capt. L. B. "Buddy" Messenger, a British Overseas Airways pilot, has flown across the Atlantic Ocean 350 times.



Overhead Heater

Installed in the ceiling, a new gas-fired heater distributes warm air horizontally in all directions to eliminate cold spots and direct hot blasts. The warm air passes through seven diffuser rings, mixes with the warm ceiling air, then flows down the walls. Eventually it moves back up to the return air intake in the bottom of the heater. A control keeps the fan in operation even after the gas has been shut off.



All-Night Heater Burns Bottled Gas to Keep Truck Engines Warm

No matter how low the temperature drops, truck and tractor engines are kept warm when not in use by a small heater that burns bottled gas. The heater, a little larger than an oil filter, is mounted on the side of the engine and connected to the block by rubber hoses. As the engine coolant is heated by the small gas burner, it circulates through the block, keeping the engine warm. Invented by a Minnesota mechanic, the heaters keep mining and lumber trucks and equipment warm all night so they start instantly in the morning. An automatic heat regulator controls the burner, which costs about one cent an hour to operate. The block heater is adaptable to any water-cooled engine and is made in three sizes.

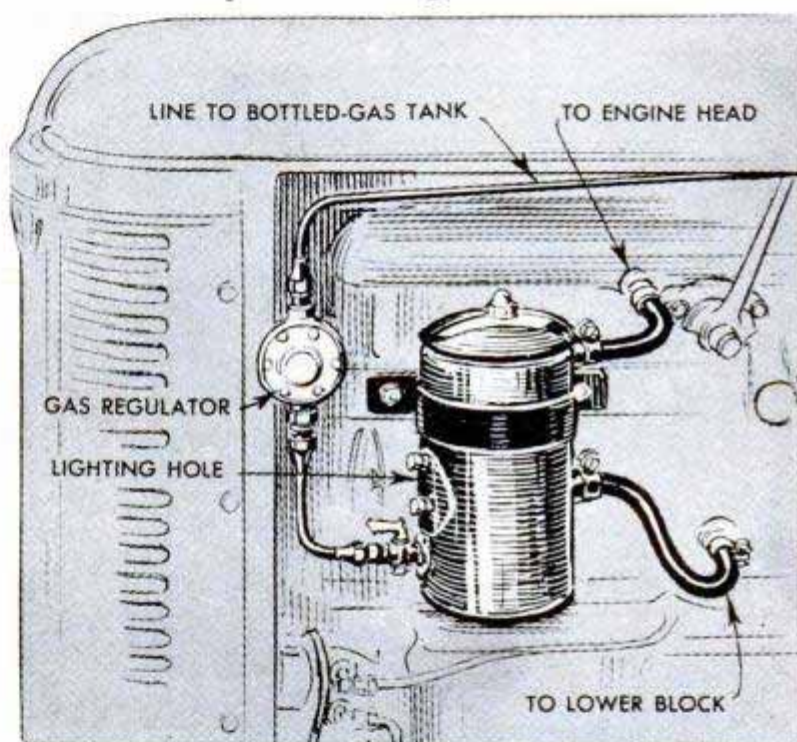

British Use Indoor Wind To Test Their Skiing Form

British skiers faced "gales" of 85 miles an hour—indoors—in preparing for this year's Olympic Games championships in Norway. The athletes used the Royal Air Force wind tunnel at Farnborough, where new jet aircraft are usually put through their paces, to test their ski clothing and perfect a less wind-resistant stance.

☐ Silicone-rubber-treated glass cloth having high heat resistance and excellent flexibility is now being used for electric motor and cable insulation.

Atomic "Furnace" for Use in Industrial Research

Private industry and research institutions now can contemplate building their own reactors, or atomic "furnaces." A small, low-cost, low-power reactor has been designed by North American Aviation for the Atomic Energy Commission. It is estimated that the reactor could be built for about \$1,000,000, which would put it within the reach of many large educational and industrial institutions. The reactor is designed for research only. It could be operated at 160 kilowatts eight hours a day, five days a week for 10 years on a single charge of uranium. Such a reactor would be especially valuable on the West Coast for producing short-lived isotopes, or "tagged atoms," for medical and industrial research. Currently, isotopes must be shipped from Oak Ridge. Some have such

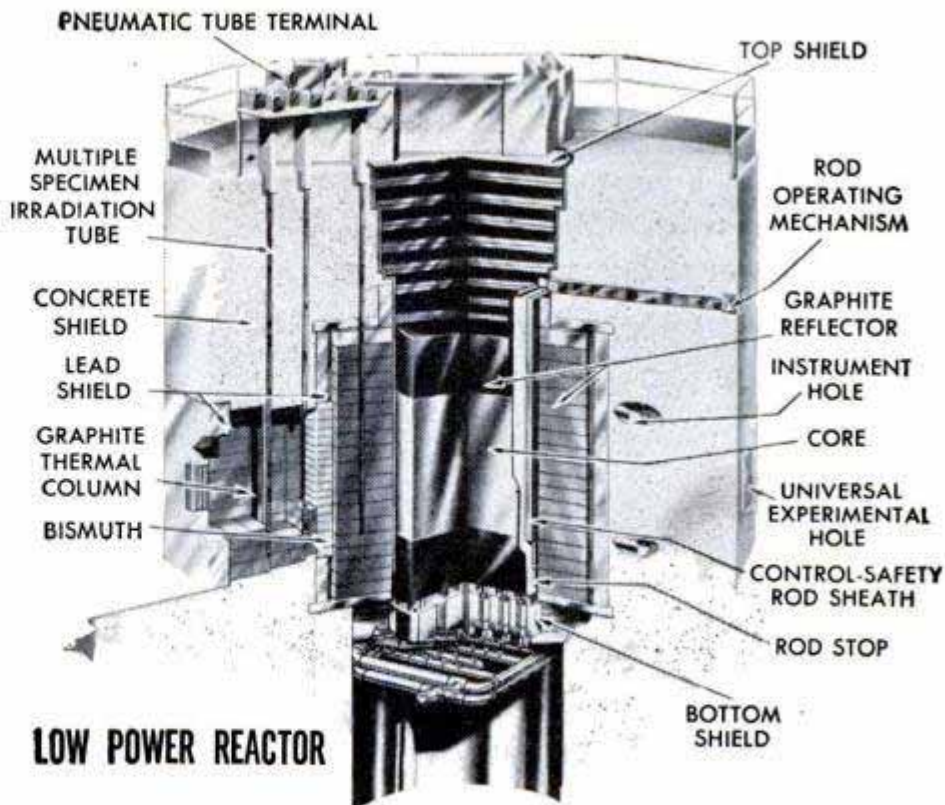

short lives they lose most of their strength by the time they arrive. The reactor is octagonal in shape, stands 11 feet high and weighs about 450 tons.

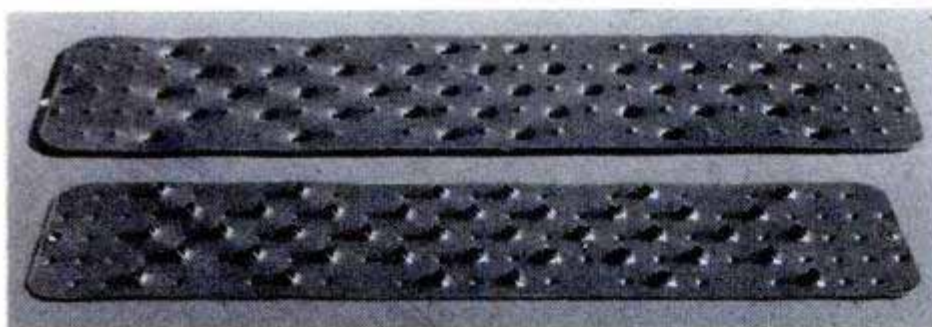

Metal Traction Aid

Built like a giant vegetable scraper, a perforated sheet-metal strip provides traction for starting cars on ice. The underside is covered with sharp points that grip into icy surfaces beneath the rear tires.

Winter Parking Shield for Car Windshields

Ice and snow on the windshield or other glass area of a parked car will be easy to remove if the glass has been covered with a plastic protector. Installed as soon as the car is parked, the 12 by 18-inch shield is fastened by rubber suction cups at each corner. When the car is to be driven again, the plastic panel, together with its wintry coating, is stripped off, affording clear vision immediately.

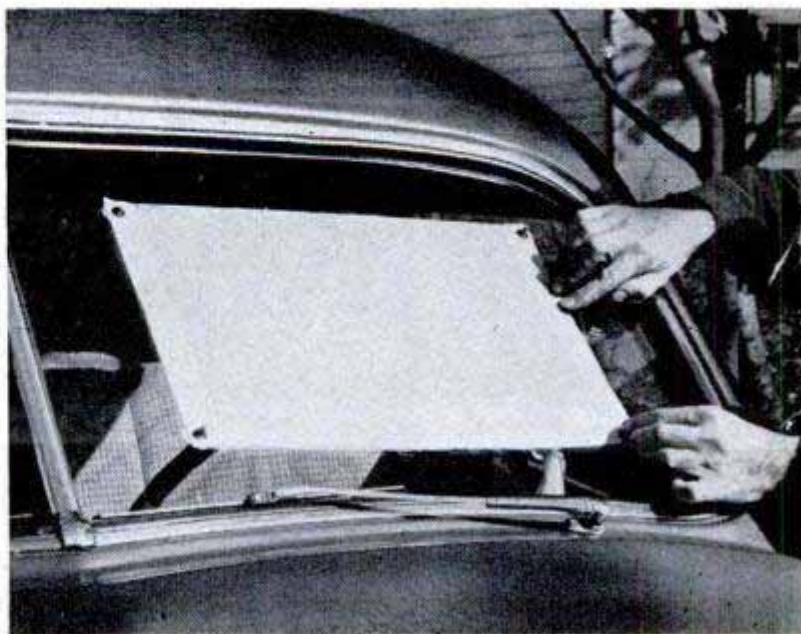

Information not listed on articles in the index often is listed in the WHERE-TO-FIND-IT LIST, available at no cost from the Bureau of Information, *Popular Mechanics*, 200 E. Ontario, Chicago 11

WHAT'S NEW FOR

W



1. COMPACT AIR DRIER removes up to 10 quarts of water a day from air of average room. Small enough to be carried from room to room, it plugs into any electrical outlet. The water is collected in a pull-out drawer or can be piped to a drain

2. THREAD HOLDER ends tangles or knots when you crochet. The two conical endpieces on the spindle automatically hold spools with center holes of any size. Made of smooth plastic, the cones permit the ball to rotate easily as the thread is used

3. DULL SILVER a problem at your house? Then here is good news. It's an invisible coating that prevents tarnishing indefinitely. You just brush it on. When you want to remove it, peel it away from the metal. It protects chrome on cars, too

4. CLOTHES DRIER operates from any 110-volt outlet. The clothes hang on horizontal rods at top and fan forces hot air around them, fluffing them as they dry. Blower-heater can also be used as a room heater and hair drier between washdays



5. PORTABLE BREEZES can be carried on your trips when you have a double-fan unit that weighs less than 20 pounds. It is about the same size as a suitcase and can be stowed in the car trunk. With it, you need not worry about hot hotel rooms

6. KNIFE SHARPENER makes it simple to keep your carving knives as sharp as razors. It is driven by a small electric motor that runs on alternating current. To sharpen the knife blade all you do is draw the cutting edge through the honing slot

7. AQUARIUM-PLANTER will decorate your mantel, dining table or television set. One end of the piece is an aquarium, while in the other end is a glass-lined planter. Under the aquarium is a small bulb that spreads a soft light up through the water



8. CLOTHESLINE HIDEAWAY not only keeps lines out of sight when not in use, but also keeps them clean and dry. Inside the steel box are four spools, each with 50 feet of line. Locks on the spool cranks hold the line taut once you've strung it

9. OVEN BARBECUE slips over the rim of any open roasting pan and suspends the turkey or roast in air, eliminating the searing and rupturing caused by contact with the hot metal. Meat and fowl brown and cook evenly without basting or turning

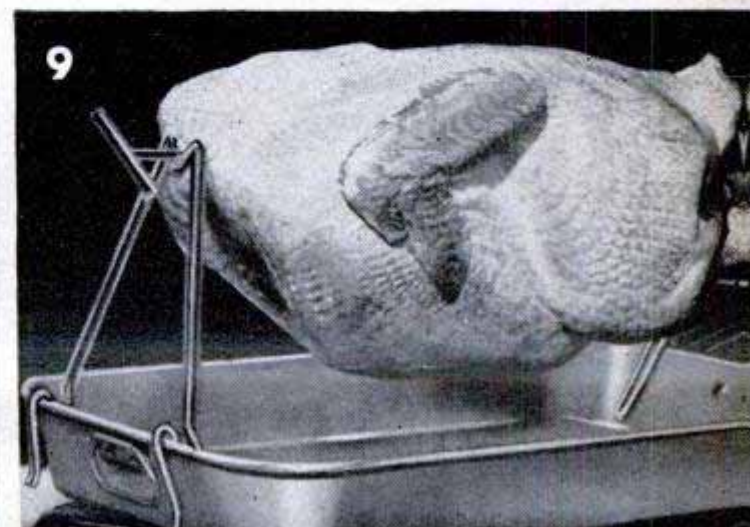
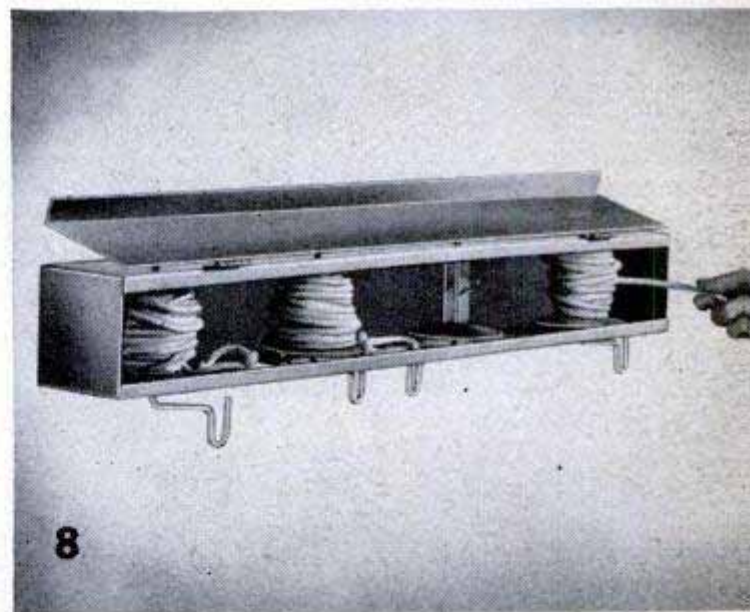



Folding Fairway

Golfers can set up a folding fairway in the back yard for a wide range of practice shots from long drives to delicate chips. The machine tells the golfer the distance and direction of any drive, even indicating whether he has hooked, sliced or driven the ball completely out of bounds. Suspended on a nylon cord from the cradle-like device is a regulation golf ball. When



the golfer makes his drive, the ball travels in an arc at the end of the cord, causing the cradle to pivot against tension springs. The springs measure the distance of the drive, from 25 feet to 350 yards. The cord comes to rest in one of several slots which indicate whether the ball was hooked, sliced or whistled straight down the fairway. The new device, called "Folda Fairway," can be set up wherever there is enough room for a golfer to swing a club.

GI Showers

Hot showers can be set up in the field for combat troops anywhere there is water now that the Army has a mobile shower system. Everything except the showers is built into a small, two-wheel trailer weighing less than two tons. In the trailer is a gasoline engine that pumps the water from a pond or stream, a boiler that heats the water to sterilizing temperatures and two heat exchangers to reduce water temperature for delivery to the shower heads. The heat that is removed after sterilization is not wasted—it preheats the water before it en-

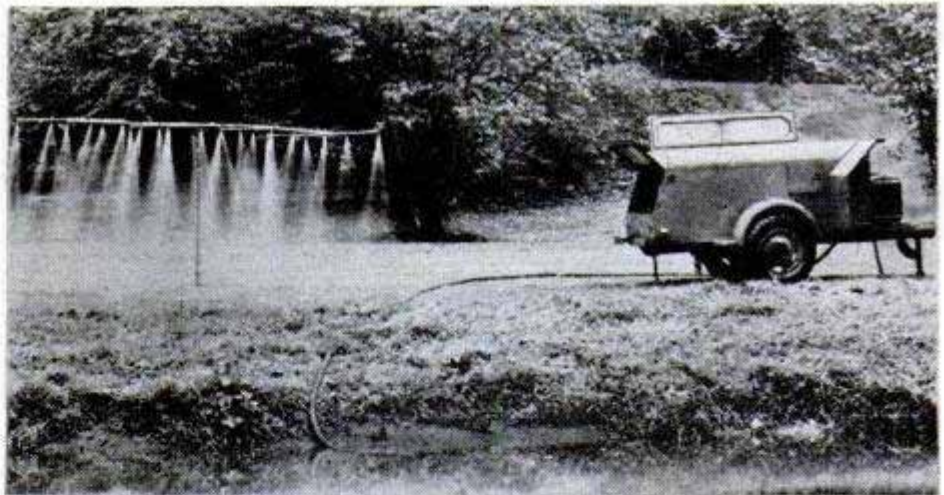

ters the boiler. With the new unit developed by the quartermaster corps, soldiers can enjoy the luxury of hot showers 20 minutes after the trailer pulls up to a water supply.

Air Controller Synchronizes Truck-Tractor Brakes With Trailer

With a new air-controller unit, drivers of truck-tractors with attached trailers can operate air brakes on the tractor and electric brakes on the trailer by a single application of the brake pedal. Developed after years of research, the unit provides syn-

chronization of brakes on the tractor with those on the trailer. The controller actually makes two braking systems available; an air system for the tractor and an electric system for the trailer. If one fails, the second is in reserve for emergencies.

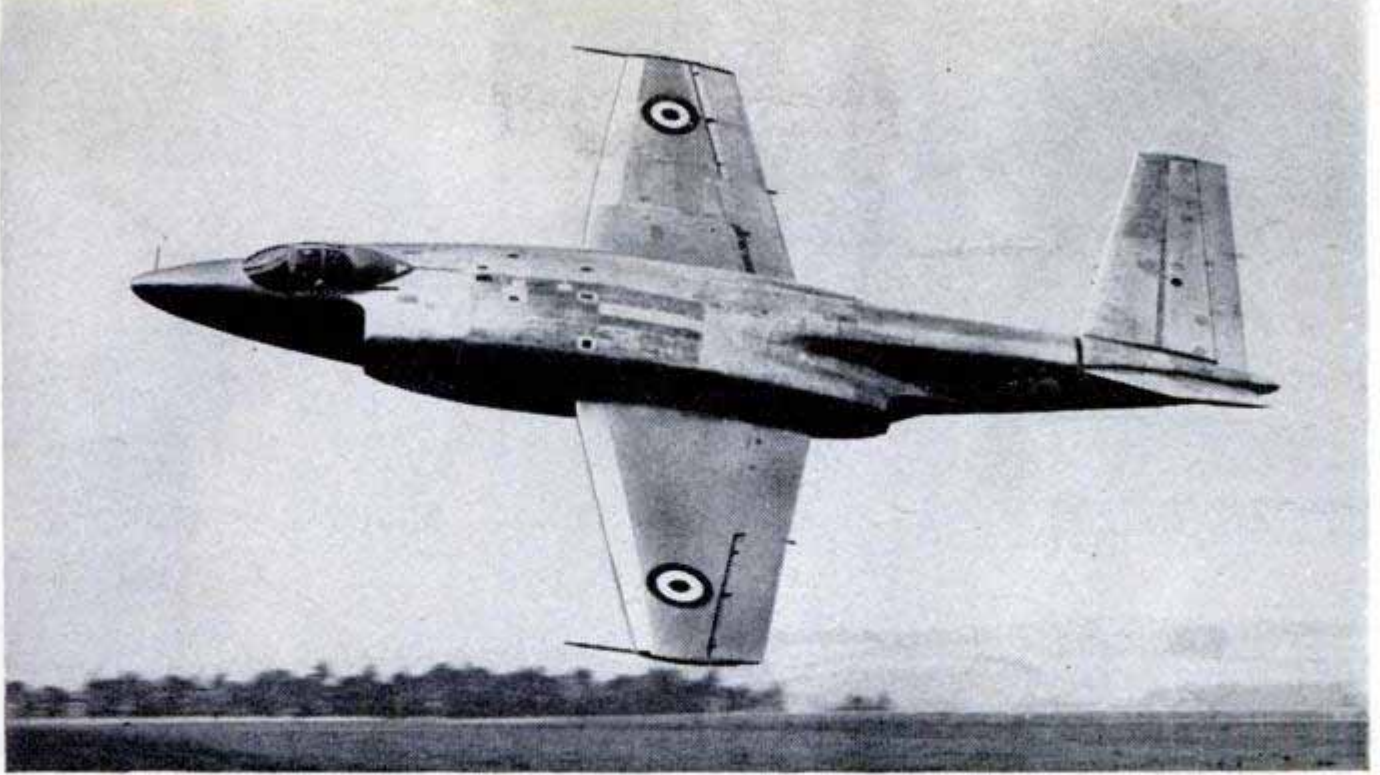

British Carrier-Based Jet Features "Butterfly" Tail

Powered by two Rolls-Royce Avon jet engines that are housed within the fuselage, the Supermarine 508, Britain's latest carrier-based jet fighter, is still on the secret list as far as performance details are concerned. Its "butterfly" tail unit, similar to

that used on the Beechcraft Bonanza, has no separate rudder. The hinged trailing portions work both as elevators and rudders. The Supermarine is the first aircraft of such high performance to use the V-type tail assembly.

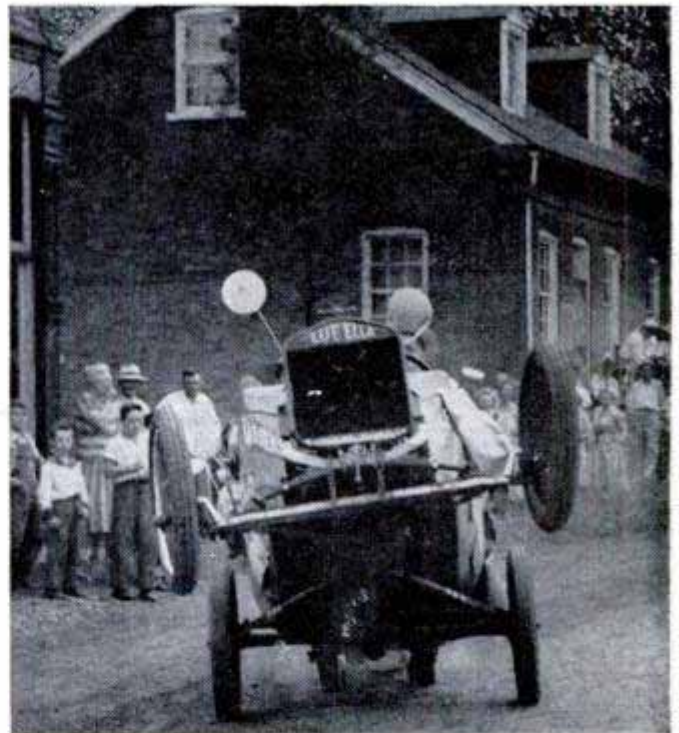
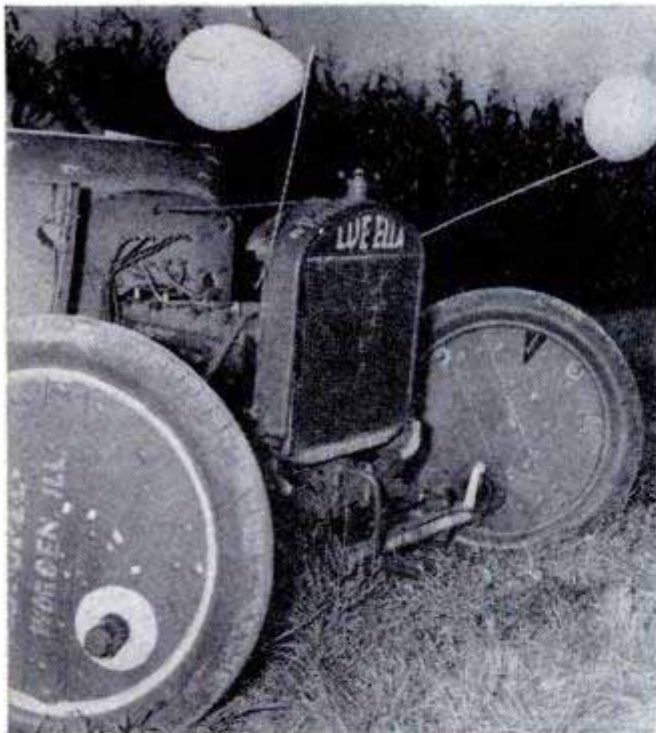

Leaping Model T

When driving his bucking Model-T jalopy, O. F. Opel of Worden, Ill., always has his share of fun in parades. By sawing out wooden disks to replace the spokes in the front wheels and mounting the hubs off center, Opel can make the car weave along

with froglike motion at low speed. Driven faster, the front end leaves the ground like a frisky bronco.

¶ With less than seven percent of the earth's population, the United States produces nearly one half of the world's supply of electricity.



This pontoon bridge across the wide Han River in Korea was built in a few hours by U. S. Army engineers

In Battle, There's Always ONE MORE RIVER TO CROSS

By Michael Day

FOR ARMY ENGINEERS, war is just one river after another, intersecting the battle front like lacy patterns in a bug's wing. Korea is no different. Few of its rivers have bridges over them. Bridges that do exist are soon bombed or dynamited into crumpled heaps of half-submerged concrete and steel as opposing forces blast them during retreats to delay oncoming hordes of attackers.

To minimize these delays, U. S. Army engineers have devised ingenious "packaged" bridges of aluminum or steel that can be thrown across a good-sized river in a matter of minutes or hours. Some are sturdy enough to allow heavy equipment like trains, tanks, supply trucks and weapons carriers to roar across vast bodies of water. Others, floated into place, provide threadlike footbridges across which troops

Sections of a pontoon bridge are floated into place to form treadway bridge across Pyong-yang River





Big tank crosses river in Korea over newest type of "underwater" bridge made of rocks and many sandbags

can pursue, single file, a retreating enemy.

If a packaged bridge is not available, Army engineers know all the tricks for making what they call "expedient" bridges—jerry-rigged spans built of anything handy. Korean chasms and river beds are bridged by some fantastic structures. Bamboo suspension bridges, hanging by cable or twisted vines, sway across canyons. Spindly arches of saplings leap mountain crags. Timber trestle bridges of native trees lashed with rope provide roadways across water for heavy vehicles. At one river the men had plenty of steel treadways for a pontoon bridge, but no pontoons. They rounded up about eight broken stake trucks, pulled out the stakes, drove the trucks into the river and spaced them side by side all the way across, spotting them on high ground so that the truck beds were above water. Then they laid the treadways from truck bed to truck bed, and attacking vehicles roared across the 300-foot-wide river over the backs of those eight trucks.

The knocked-down packaged bridges, of course, are more effi-

In the shadow of a wrecked bridge, U. S. forces build a sturdy structure across the meandering Taedong River at Chinju

cient. They are designed for easy transport and fast assembly. Some, like the rugged, fixed Bailey bridges of latticed truss-steel construction, come in prefabricated sections that bolt together. They make as permanent a span as any you've seen here at home. The difference is that six men can lift and carry into place the heaviest unit in the Bailey package.

Baileys go up with frightening speed. Huge trucks roll to the site, laden with chunks of bridge which are unloaded by built-in cranes that rise hydraulically from the tailboards of the trucks. Engineers swarm in and assemble them on the



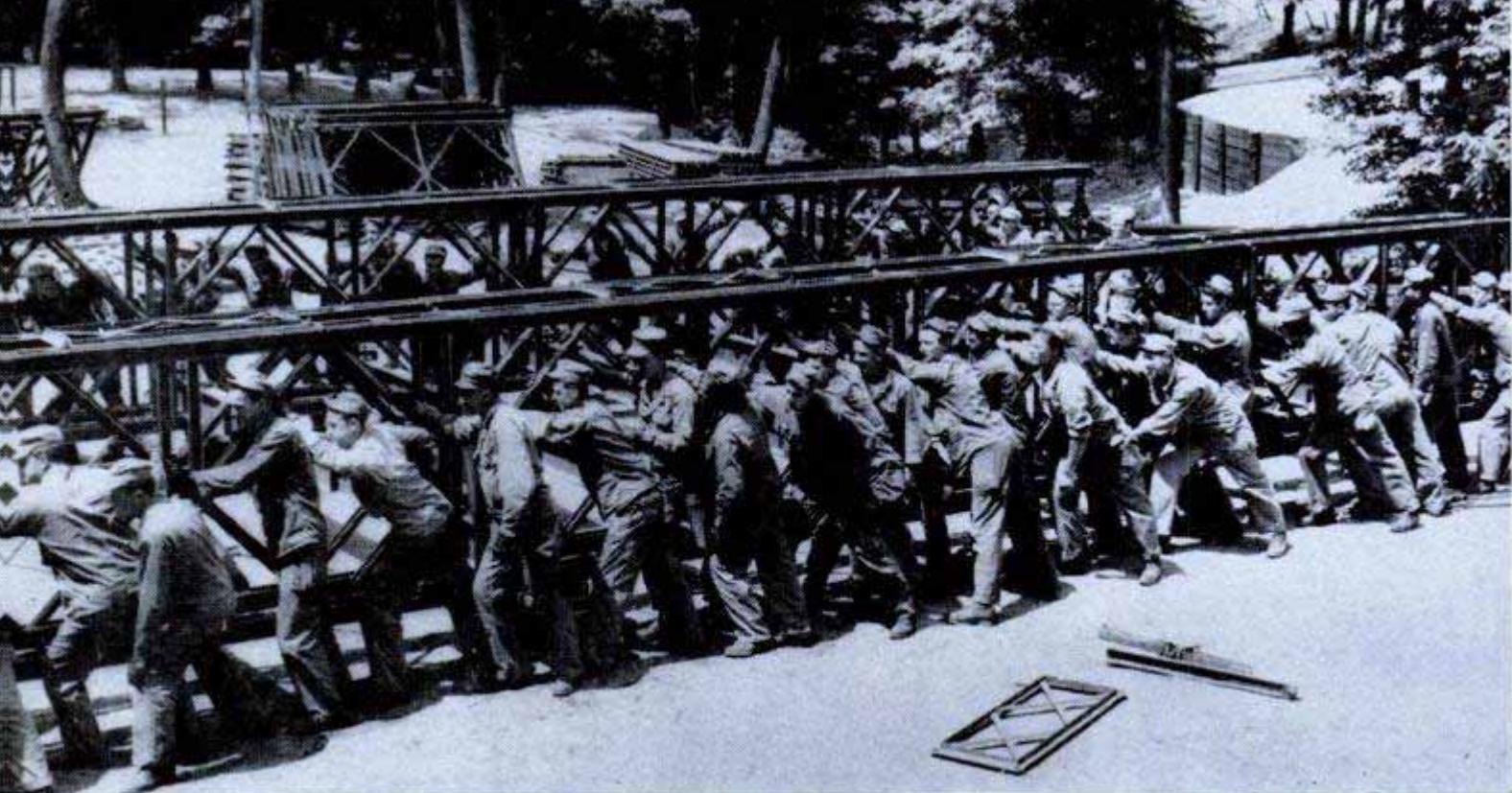

At Fort Belvoir, Va., engineers learn how to handle prefabricated Bailey bridge; sections move on rollers

spot. A complete bridge section, 20 feet long, goes up in half an hour. Long, supporting girders for the span are assembled on rollers at the brink of the gorge or river, and are pushed out over the edge by manpower and cantilevered into position. To help, the men sometimes use a span launcher, which consists of a 100-foot cantilevered I-beam mounted on a flatcar or truck. The launcher picks up an assembled bridge span and lifts it out over the gap

like a long arm reaching across the river.

Complete Bailey bridges 500 feet long have spanned the Han River on old piers within half a day. If no piers are available, Bailey sections can leap across a series of anchored barges and provide a sturdy, "strafeproof" floating bridge whose rugged trusses will support anything on wheels, including railroad trains.

A new Bailey is now undergoing rigid tests at Fort Belvoir, Va., where the engi-

Jeep advances over aluminum treadway paths bolted to steel assault craft with timber supports near shore



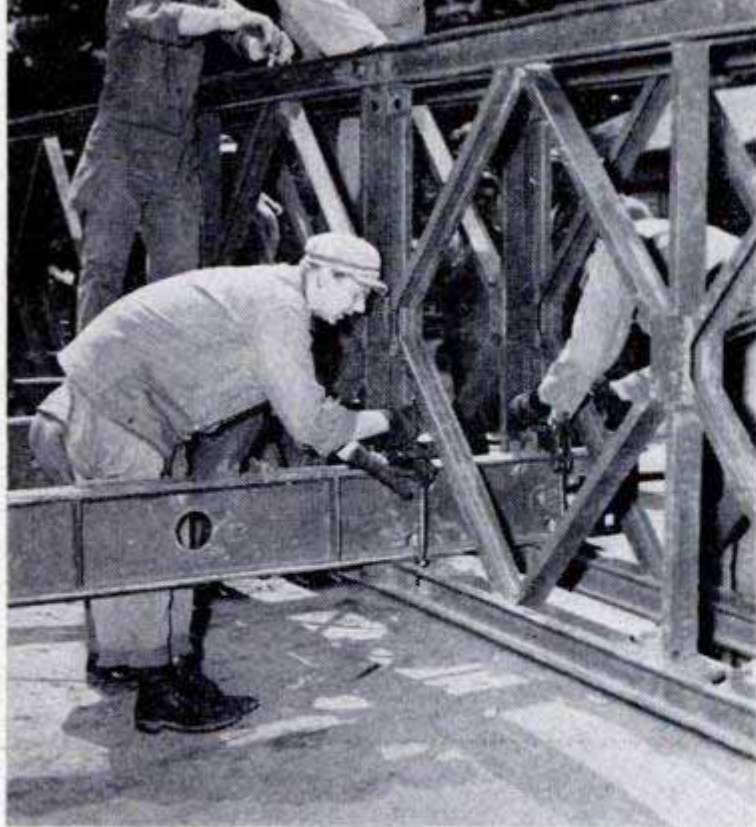

Engineers practice assembling a Bailey bridge. Here trainees clamp on transom which will support deck

neers test out many of their devices. Made of lightweight aluminum, its 20-foot sections will go together in half the time required by its predecessors. It will span chasms up to 640 feet and carry a load of 150 tons.

Since military engineers must design everything with an eye to getting the most possible use from it, new floating treadway bridges—consisting of floats carrying

metal treadways across their backs—use small assault boats instead of the pontoon-type float. pontoons, while light and inflatable for easy transport, are also easy for enemy planes to puncture and sink. The assault-boat floats are steel shells that can also be used to ferry troops across a stream. The little boats stack inside each other like pie tins, for easy transport, and are light enough for swift handling. As floating bridge piers they have one disadvantage; maintenance crews must patrol the bridge continually and bail out the hollow assault craft after rainstorms.

Pontoon or assault-craft bridges, however, can be assembled faster than the Bailey, and it doesn't take experts to do the job. Two platoons of men, waiting as trucks come in laden with floats and treadways, can carry the parts into the water and assemble a 500-foot span, with a 55-ton capacity, in six or seven hours. Known as treadway bridges, these floating roadways come in a vast assortment of combinations. Newer ones consist of big assault boats with slots in the gunwales. The treadways—long, hollow columns of steel—have wide, steel fingers bent at right angles at each end. These fit into the slots, keep the roadway in place and link the floating boats. When laid in overlapping fashion, the treadway pieces form a solid roadway of steel from boat to boat.

Other floating bridges have steel or aluminum treadway sections, about 14 feet long, that fashion a pair of tire tracks over the water. Treadway bridges are versatile, too. A small section of one can double as

Steel-grate treadways bolted to pontoons form this bridge built by the 55th Engineer Battalion in Korea

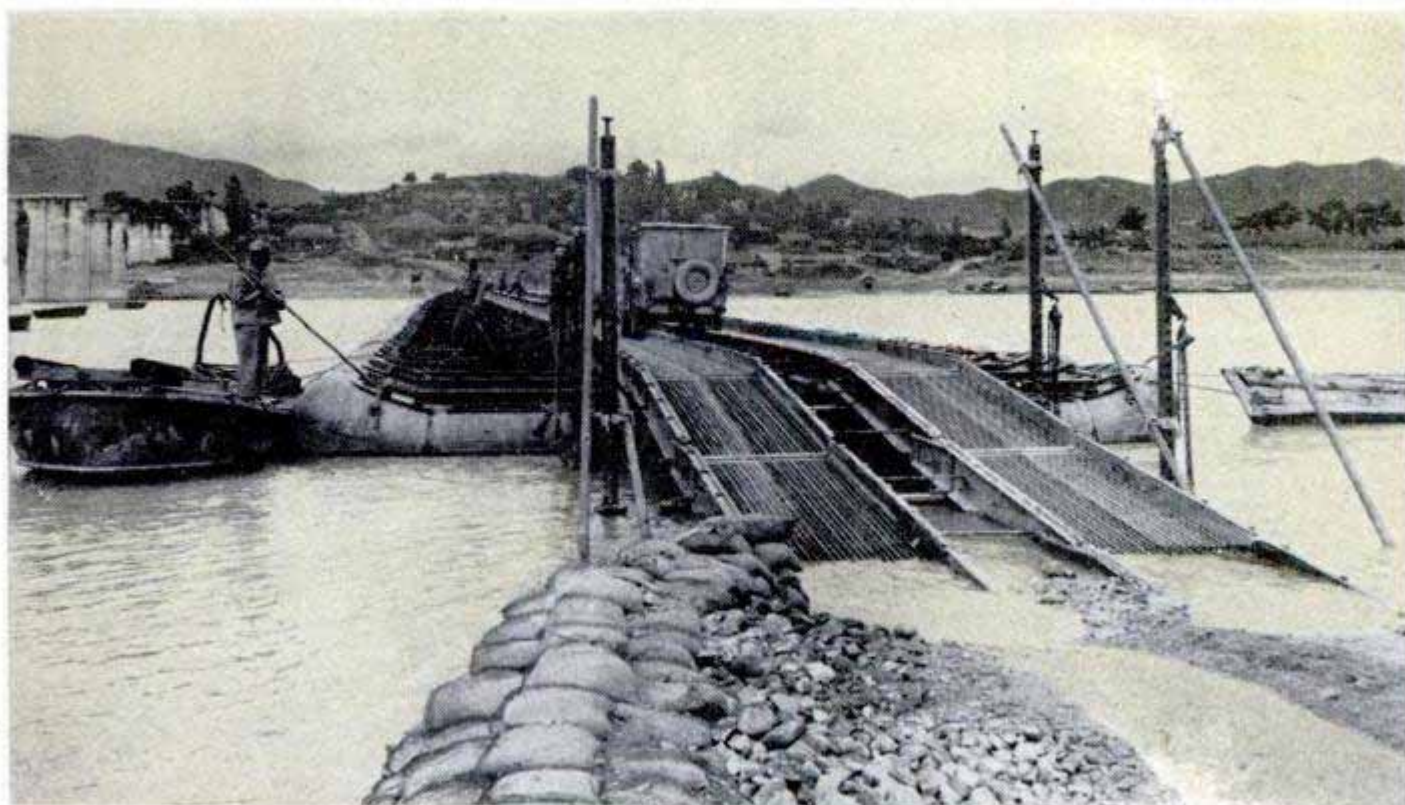



Final link of pontoon bridge is floated into place on the Tong Dong River by the 11th Engineer Battalion

a vehicle ferry when there isn't time to complete a whole bridge. To get tanks and trucks across the Kumho River in a hurry, engineers simply strung together a few assault boats with a few treadway sections of aluminum. Treadway sections on each end were hinged, so that they could be raised like flaps to prevent vehicles from rolling off as the makeshift ferry was towed back and forth by a powerboat.

Even the 14-foot treadways alone are versatile. Bolted together, they can span narrow gullies and streams without benefit of floats. Laid in a single line across special steel pontoons recently devised by the engineers, they form a footbridge for infan-

trymen that can be stretched out over miles of water if necessary.

Besides building bridges, engineers must also know how to destroy them in a hurry when necessary. Every company has its demolition experts who know how to plant minimum charges in just the right places to make a perfectly good bridge useless for the enemy. Floating bridges are blasted loose to sink or float downstream. Fixed bridges can be dumped neatly to the river bottom in sections or all at once without, as one Army engineer puts it, "mussing up the piers so they can be used to build another bridge when we come back that way a second time."

Long hollow-steel columns are arranged below in the same way they are placed over pontoons to form bridge

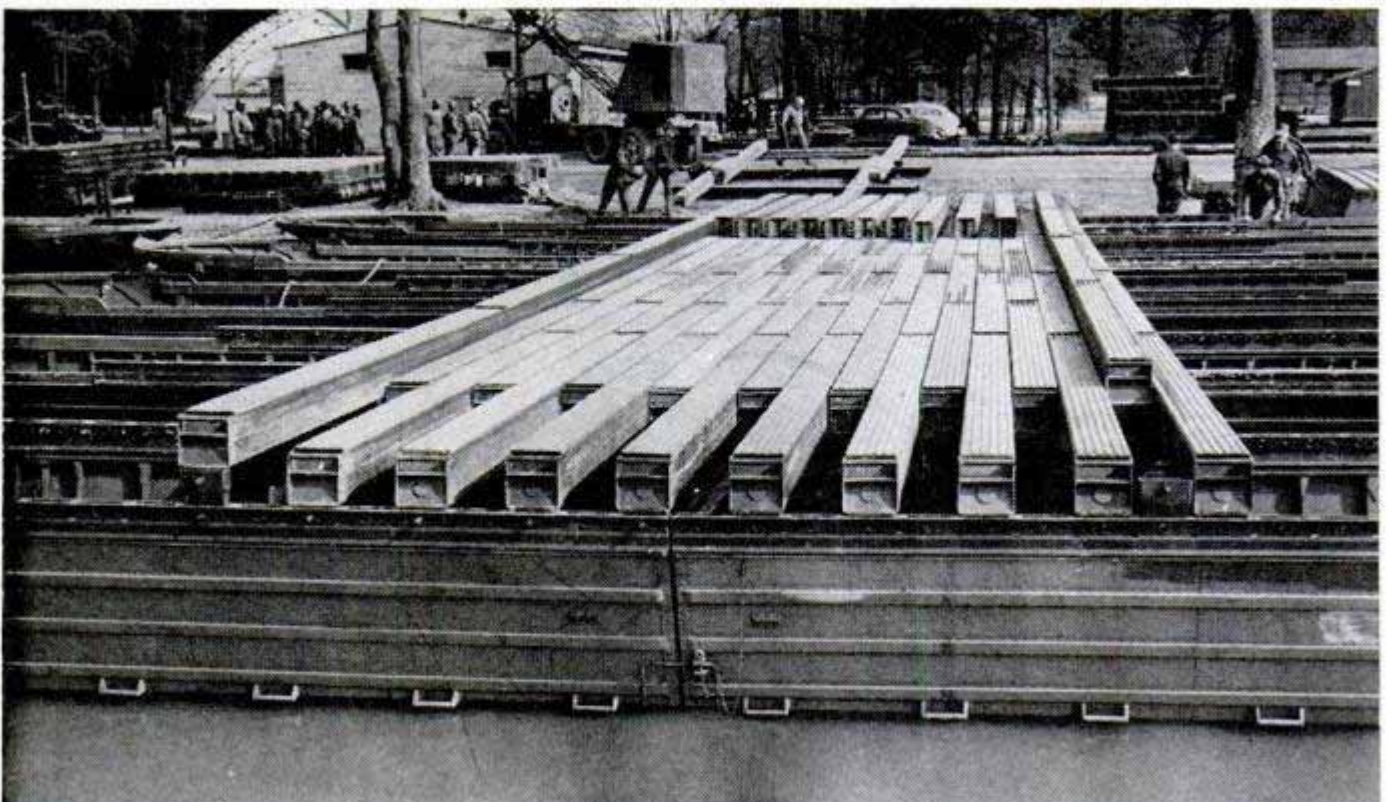

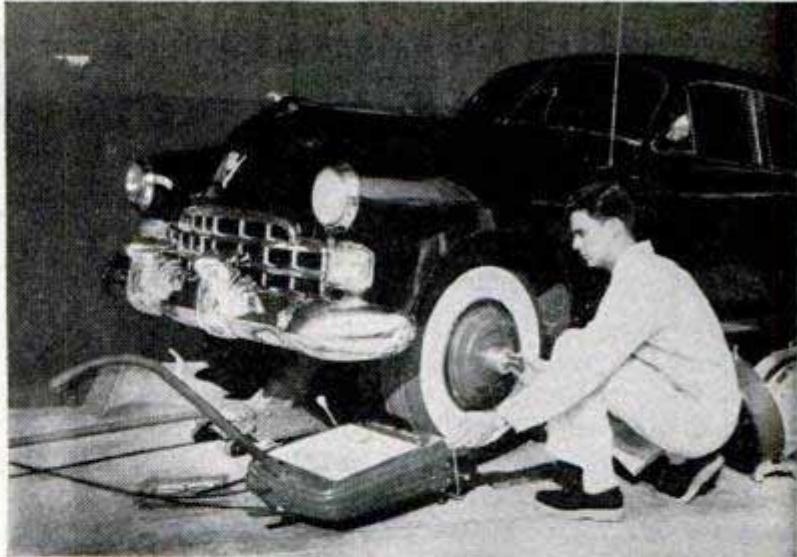
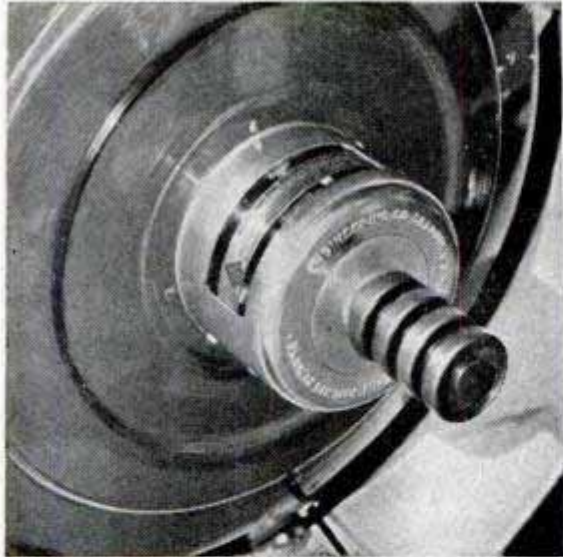

WHEEL BALANCER shows amount and location of weights needed to end imbalance with wheel in place on the car. A motor-driven roller spins the wheel as mechanic "tunes in" corrections on four knobs at the hub



HEEL MAT slips over accelerator pedal to provide a "pillow" for the heel that stops shoe scuffing. Made of rubber, it is put on without tools. It prevents wear on the floor mat, too



GAS-TANK "WATCHDOG" is screened to prevent siphoning. No key is used. Cover is opened by pushing pump nozzle into it

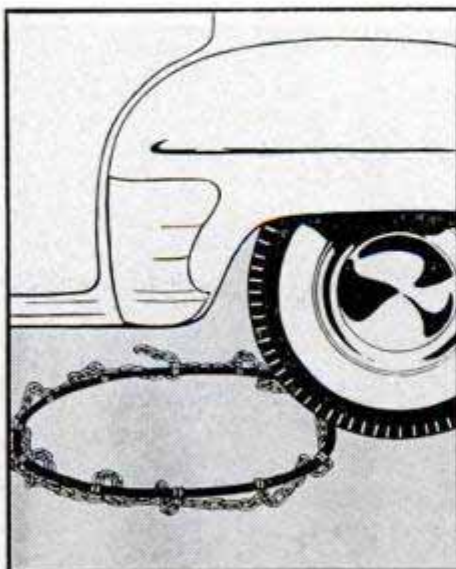

EASY-ON CHAINS eliminate reaching behind wheel to hook inner link because inner band is a rubber hoop, left. Wheel is driven inside hoop, chain lifted over wheel, center, and only outer link has to be snapped



SUN-GAZER'S TELESCOPE

SOLAR ECLIPSES don't happen every day—nor every year for that matter. Yet only during an eclipse can astronomers study the sun's corona, that enormous halo around the sun. From this corona come the radiations that affect us on earth.

Not only are eclipses infrequent, but they're brief. None exceeds $7\frac{1}{2}$ minutes, and most are much shorter. To make things more difficult, eclipses are often seen only in distant parts of the world. There's one this month, but it's visible only in the Middle East and Siberia. The United States will see its next eclipse June 30, 1954, and then for only $2\frac{1}{2}$ minutes.

Fortunately, astronomers can make their own eclipses with a telescope called a coronagraph. An occulting disk mounted in the optical system blocks out, or occults, the bright face of the sun, creating an artificial eclipse. Studies can then be made of the sun's turbulent limb, or edge, and its halolike corona.

Two new 26-foot coronagraphs are being installed in high-altitude, dust-free observatories atop Fremont Pass in the Colorado Rockies and on Sacramento Peak in New Mexico. With these new telescopes, astronomers hope to learn more about the sun and its effect upon us earthlings.



Above, an occulting disk blocked out the sun's face as this 27,000-mile-high prominence was photographed

Below, in 10 minutes, the incandescent hydrogen solar prominence soared to a height of 133,000 miles!

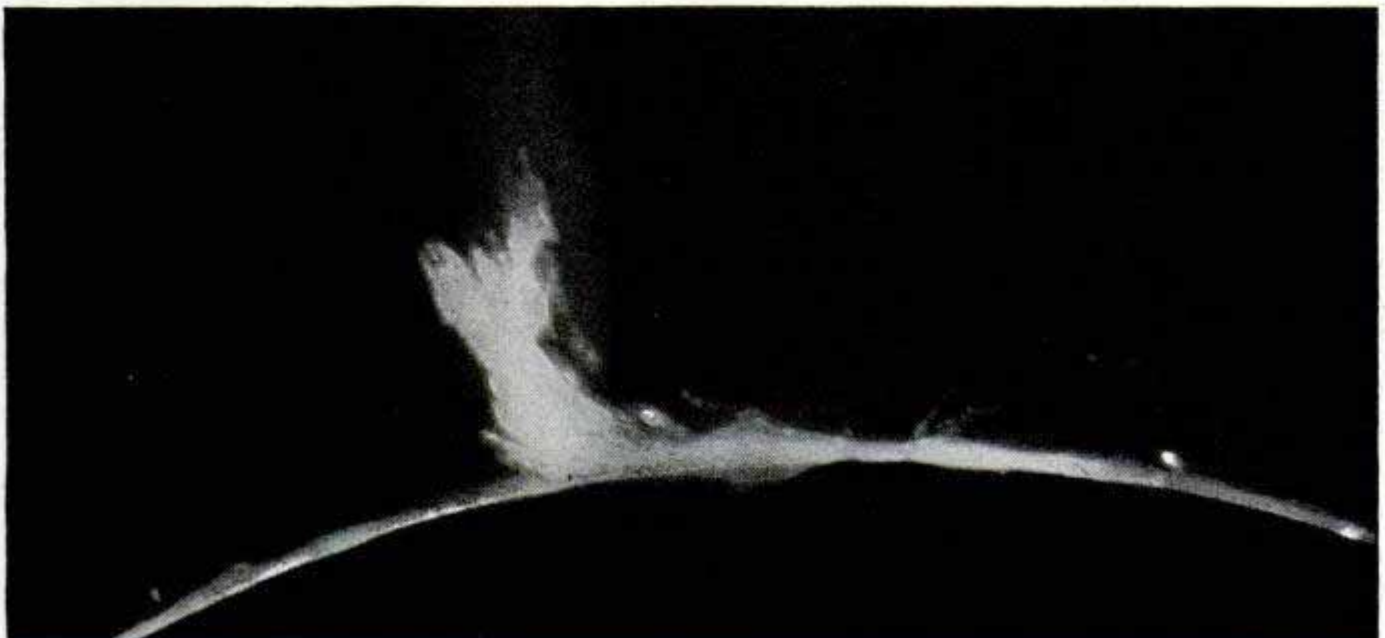

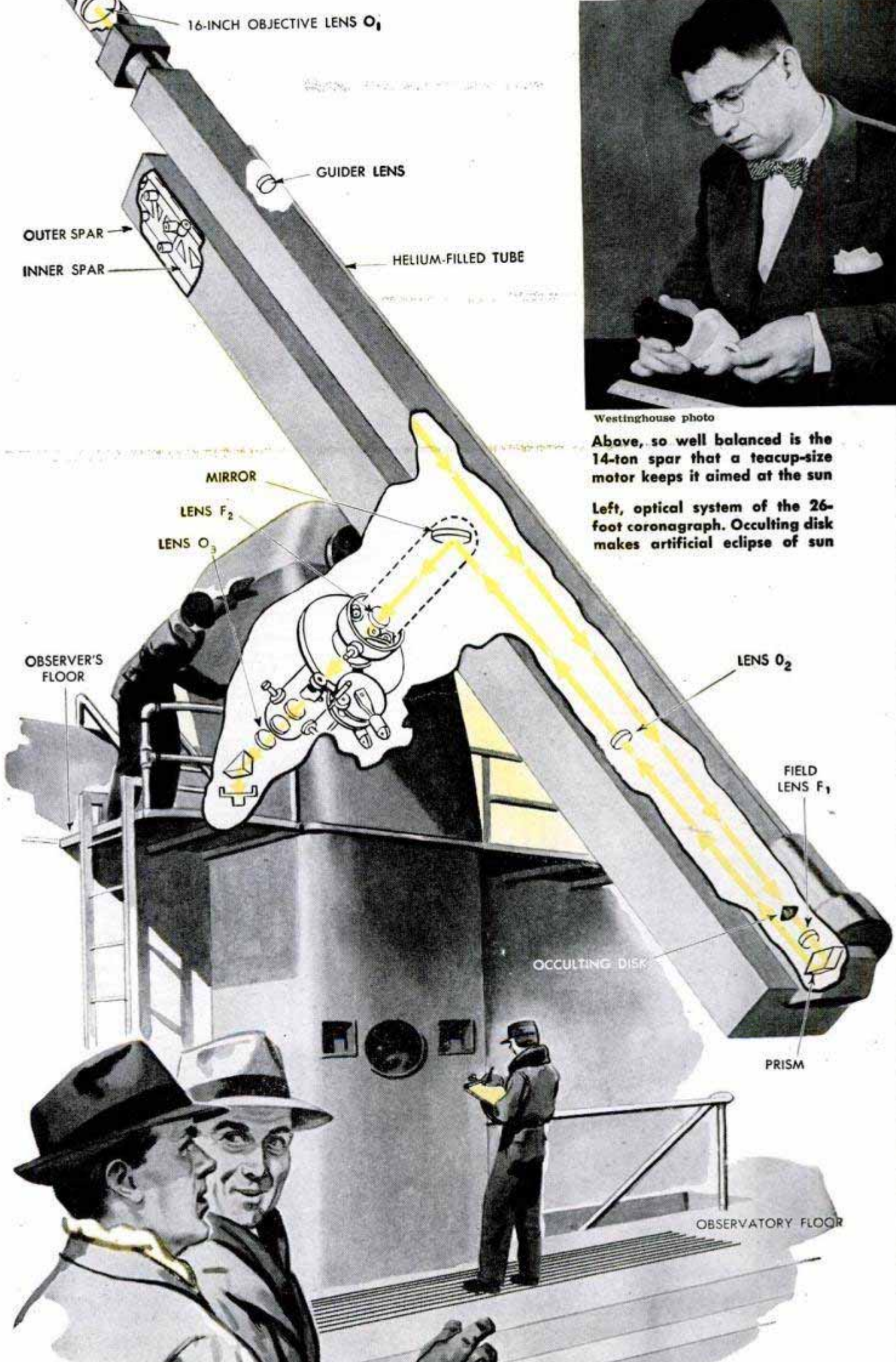

16-INCH OBJECTIVE LENS O_1

GUIDER LENS

OUTER SPAR

INNER SPAR

HELIUM-FILLED TUBE

MIRROR

LENS F_2

LENS O_3

OBSERVER'S FLOOR

LENS O_2

FIELD LENS F_1

OCCULTING DISK

PRISM

OBSERVATORY FLOOR



Westinghouse photo

Above, so well balanced is the 14-ton spar that a teacup-size motor keeps it aimed at the sun

Left, optical system of the 26-foot coronagraph. Occulting disk makes artificial eclipse of sun

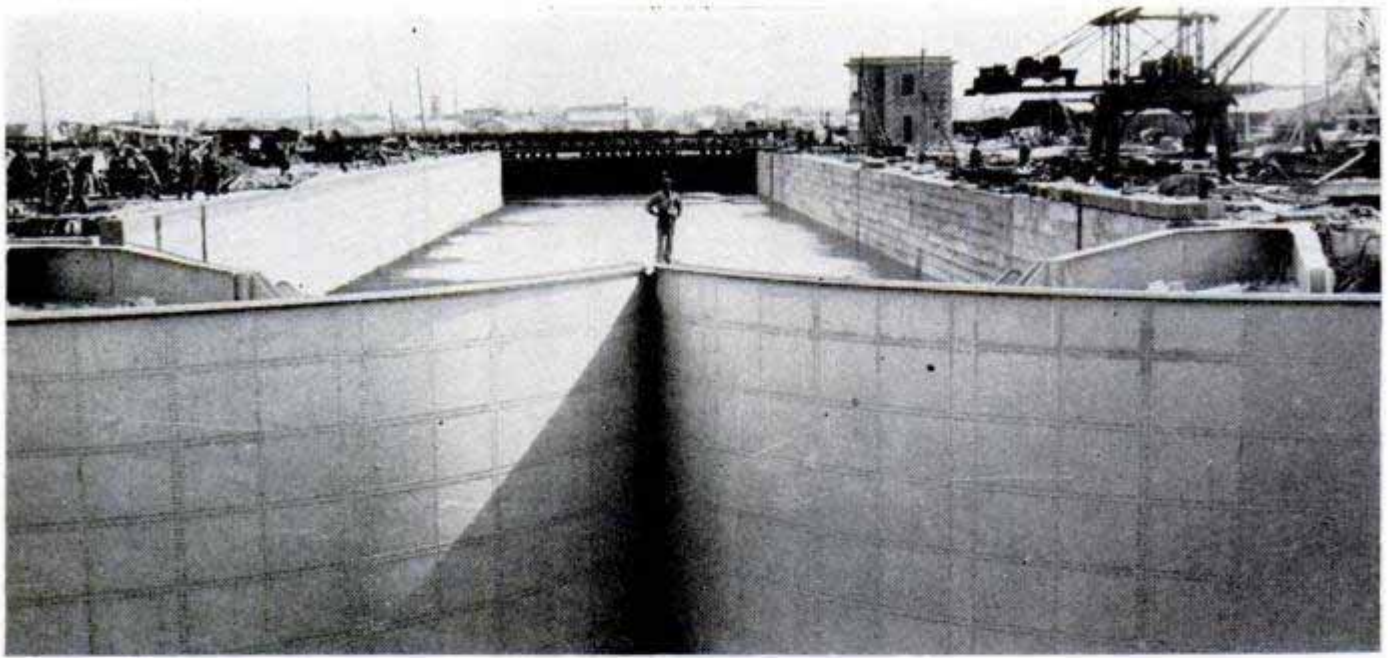

Pneumatic tubes at the joint below man, above, expand to make a watertight seal when the gates are closed

Curved Locks Open by Rotating on Pivot

INSTEAD OF OPENING against the flow of water, curved locks at Saint Malo, France, open by rotating on a central pivot. Just as you can spin a log in a stream although you can't push it against a strong current, rotating locks open with little effort. Another feature is a pneumatic seal

With the lock almost dry, clearly visible are the two sealed bearings on which the heavy lock gate pivots

on each end to provide a tight joint without friction. When the gates are closed, air is pumped into pneumatic tubes which inflate to press against each other and seal the lock tightly. When the lock is to be opened, the air is released and the seal opens. The gates pivot on oil-filled bearings.

Plan drawing of the lock shows the arc shape of the gates and the way they turn around the center point

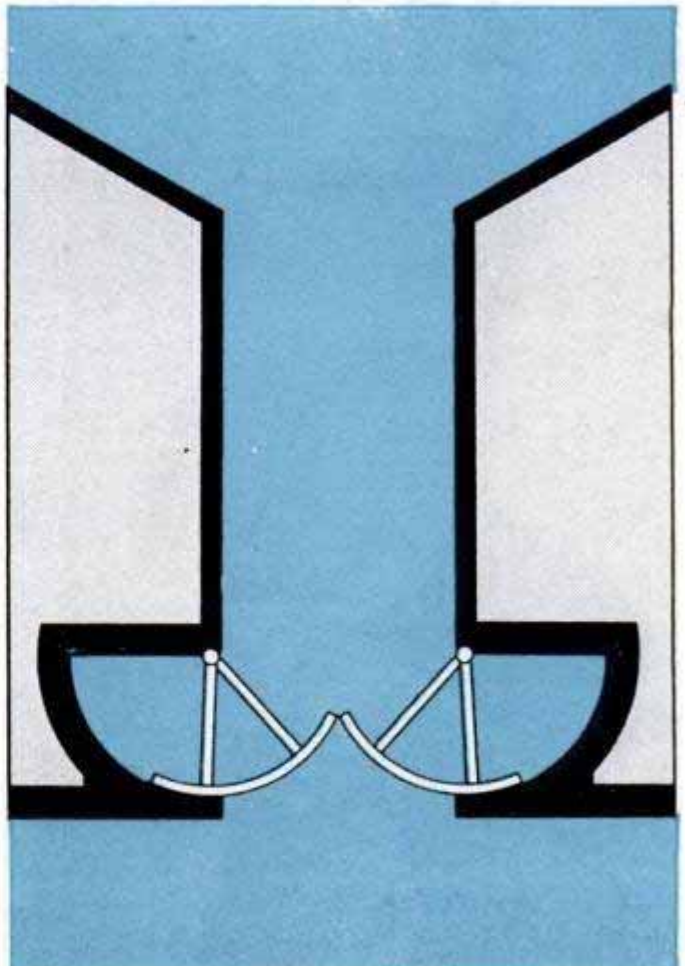

50th ANNIVERSARY
FEATURE

REVOLUTION ON THE FARM

1902 - 1952

**By Wheeler McMillen,
Editor-in-Chief, Farm Journal**

A MERICA'S FARMERS moved into the 20th century convinced that modern times had come. The long ages of primitive drudgery, they felt, had come to an end. Farmers were riding their plows and cultivators, grain binders, mowing machines and hayrakes. A man no longer had to walk from sunrise until dark.

Progressive neighborhoods were putting up telephone lines. Principal roads were being "piked" with gravel and crushed stone. Rural free delivery already was bringing the mail daily. New houses were

going up with furnaces in the basements. Some even had bathrooms and running water in the kitchens.

By 1902, when *Popular Mechanics* was founded, advanced agriculturists were talking about "scientific farming." The agricultural colleges and state experimental stations, organized a decade or so earlier, were hitting their strides. Instructive bulletins were appearing in the mailboxes. Old-timers thought this stuff was nonsense, but nevertheless they went to the Farmers' Institutes to hear

Midcentury farmer harvests 50 bushels of wheat per acre with the aid of a diesel tractor and modern combine
Caterpillar Tractor Co. photo



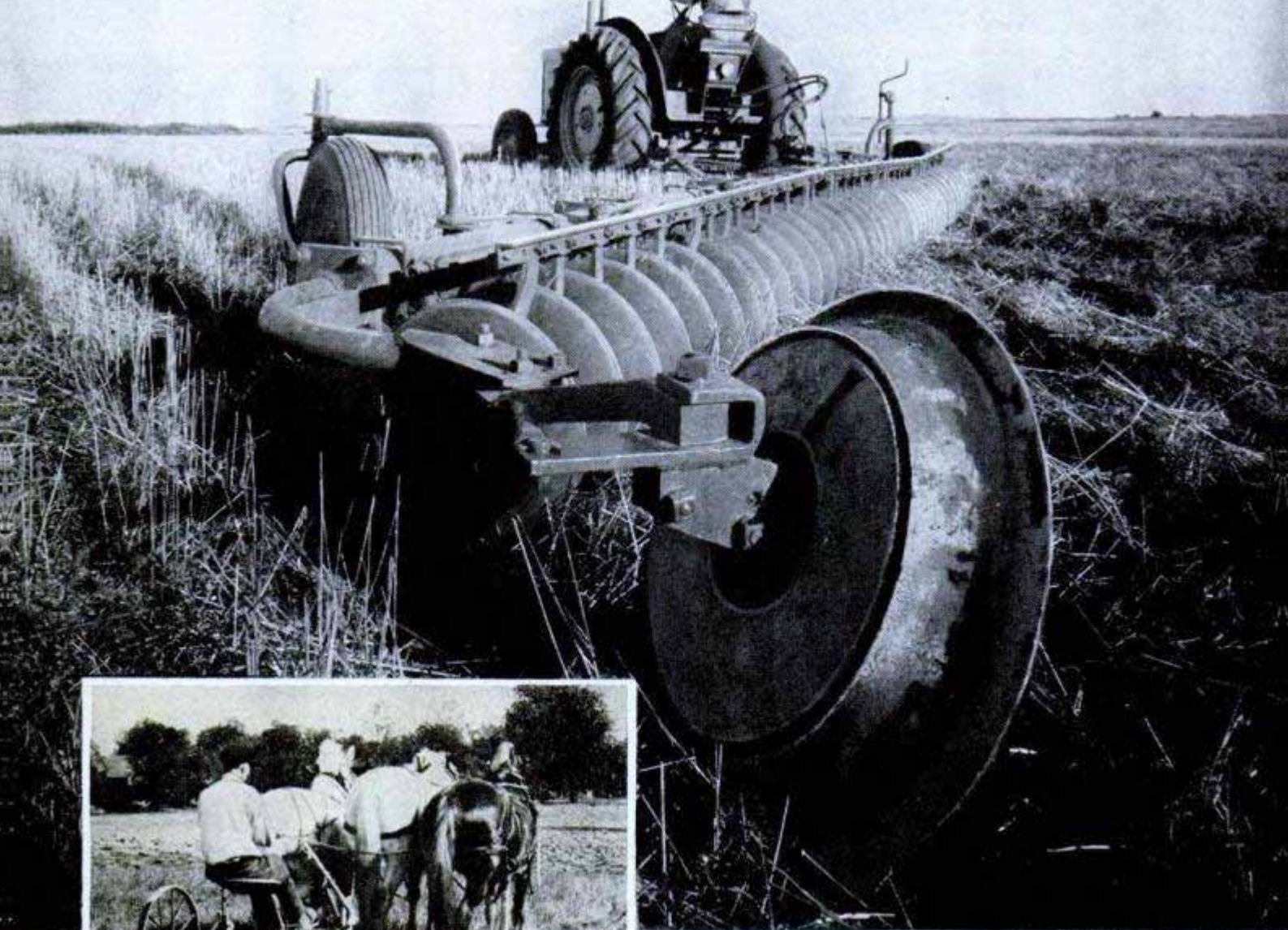

Deere & Company photo

Giant tractor-pulled disk slices a broad swath of earth. With such equipment, modern farmer can cover as much ground in one day as his 1902 forefather covered in two weeks with horse-drawn sulky plow



Modern four-row corn cultivator fertilizes the crop as it moves along. The fertilizer is carried in four cans atop the attachment. Inset, the pre-World War I two-row corn cultivator was pulled by team of horses
Minneapolis-Moline photo

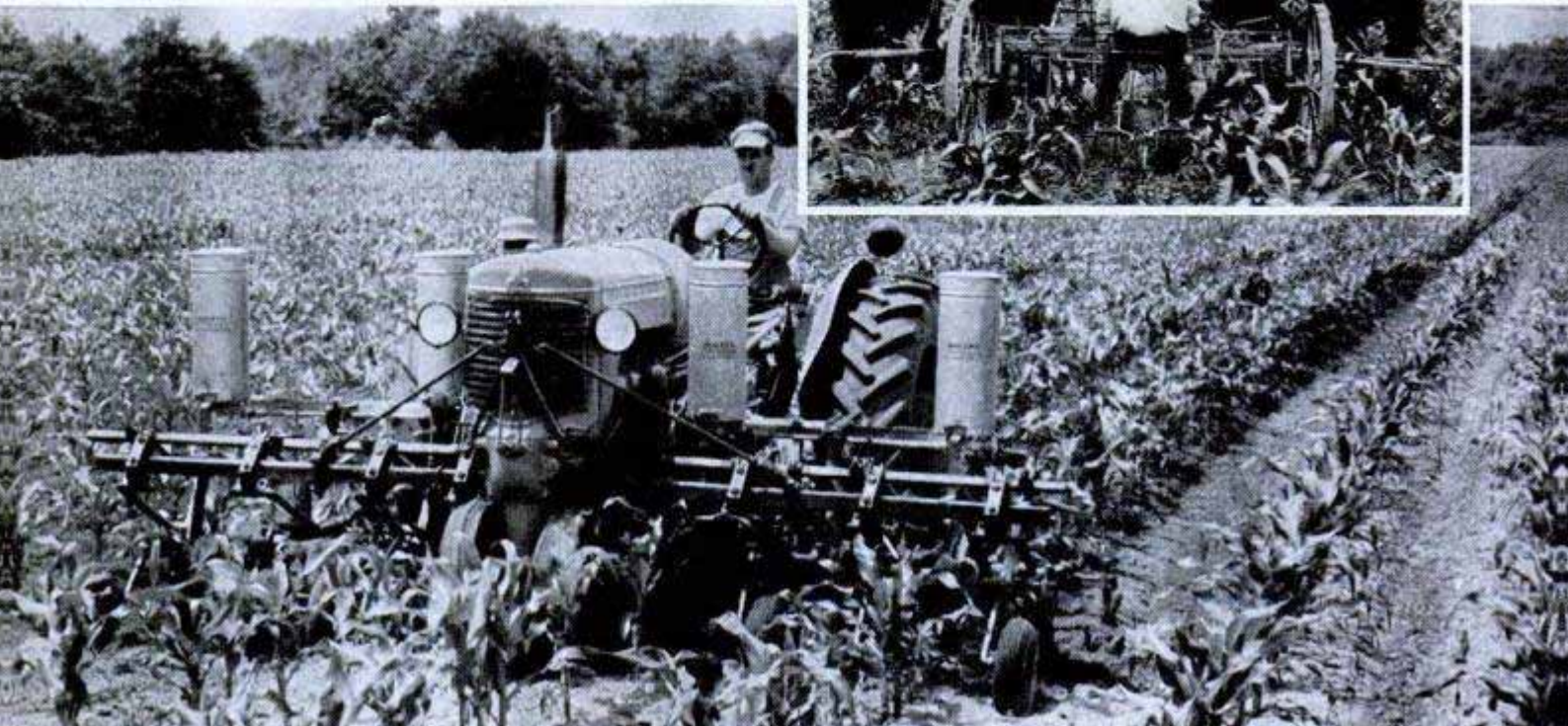
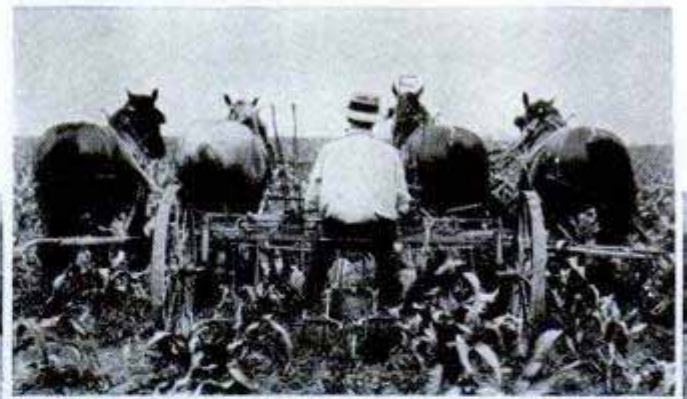



1910 24,211,000 HORSES AND MULES (NOT ALL WORK ANIMALS)



1910 1000 TRACTORS



1951 7,500,000 HORSES AND MULES (ESTIMATED)



1951 4,300,000 TRACTORS (ESTIMATED)

If the above graph were carried to completion, there would be a total of 4300 tractor symbols, representing more than four million tractors now in use. In the past 41 years the number of tractors has multiplied 4300 times and the number of horses decreased two thirds. Each tractor does the work of several horses, and for each horse replaced, an additional five acres becomes available for human food instead of horse feed

about it and some tried out the new ideas.

The improvements in which the farmers of 1902 took pride were indeed astounding when viewed in the light of their grandfathers' experiences. Farmers had ceased to broadcast seed from a heavy shoulder bag. No longer did they harvest with sickles and scythes. They drove horse-drawn grain drills and two-row corn planters, sickle-bar mowing machines, twine binders, and used steam threshing machines. The corn binder and the corn shredder were coming along. Hay loaders were replacing pitchforks. Yet all these remarkable advances, which had unfolded swiftly in the wake of American freedom, were but prelude to what was to appear by 1952. The next half century was to see more agricultural progress than all the previous generations of mankind had accomplished.

"Revolution" is a strong word, to be used

only sparingly. But agriculture in America has been revolutionized during this half century. A bright boy from Horace's Sabine farm could have done good work his first day on Washington's Mount Vernon lands, and he would not have been entirely useless on a farm of 1902. However, if a 1902 farmer were transplanted without notice to the management of a 1952 farm he would be completely unqualified.

Mechanical improvements have created most of the tremendous changes. But by no means all, for unprecedented advances have been made in the management of soil, in seeds, in overcoming diseases and pests, and in the education and environments of farmers themselves. Machinery has only set the pace.

Significant as these 50 years of progress have been to farmers, they have meant even more to the nonfarm people of the

Caterpillar diesel, with attachments, applies gas fertilizer as it cultivates at rate of five acres per hour
Caterpillar Tractor Co. photo



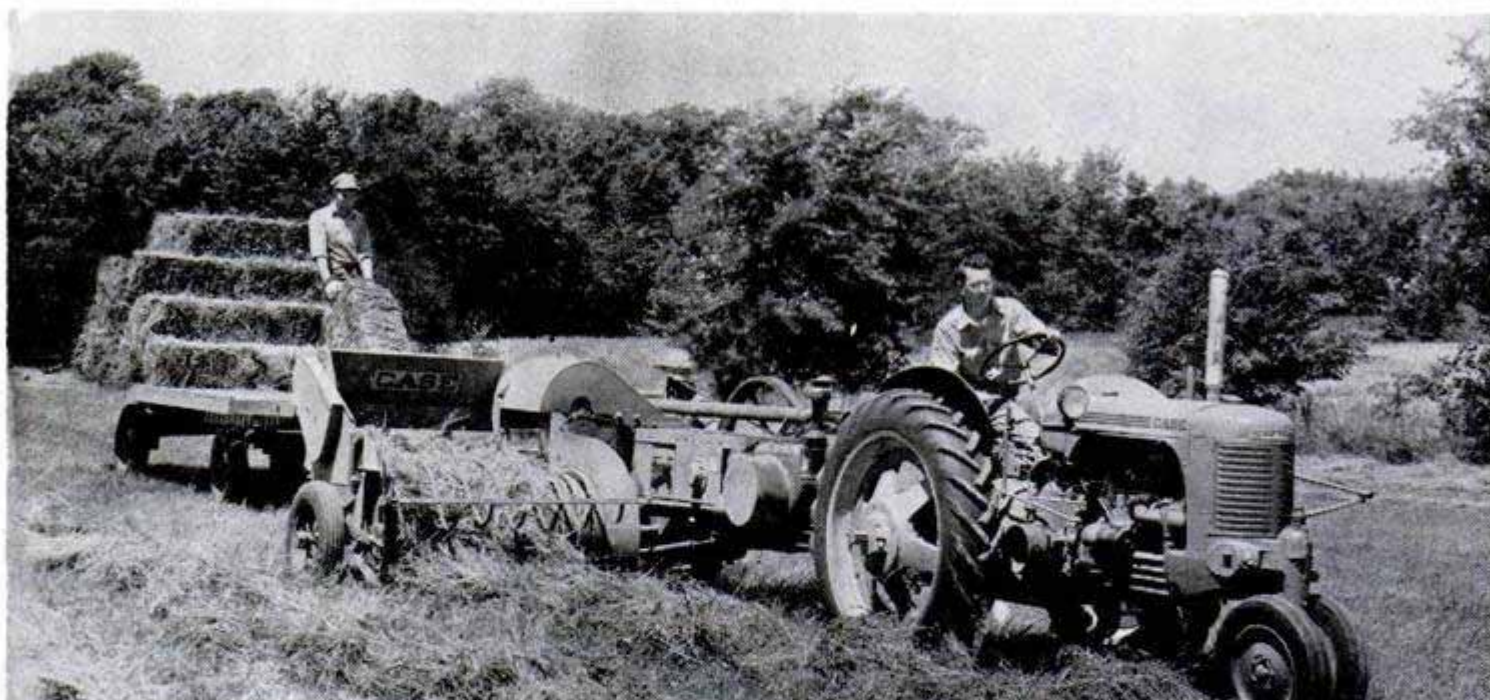

J. I. Case Co. photos

Sun's still hot, but making hay is a lot faster today. Bales are easier to handle and take less storage space than loose hay, left, hoisted to hayrack by horse-drawn loader

nation. By providing the ever-present assurance of ample food supplies, advances in agriculture have permitted city populations to multiply and industry to flourish.

One farm worker in 1902 could support eight other persons. Now he supports 16. The "other people" are enjoying more food of better variety and greater quality and

are working fewer hours daily to pay for it. With abundant and usually not-expensive food supplies, all Americans are able to devote more of their earnings to satisfying other wants.

The 24 million horses and mules that furnished most of agriculture's power in 1902 have dwindled now to seven million. Over

Two-row cornpicker knives through a field in the Midwest. In 1902 the corn farmer worked almost 21 hours per acre; today he works less than four
The Oliver Corp. photo

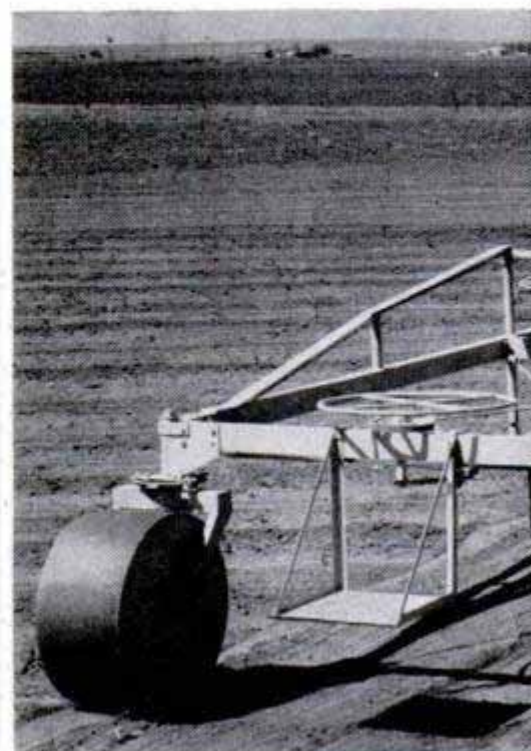



Minneapolis-Moline photo; Inset, International Harvester Co. photo

Modern self-propelled combine does work of old-time binder (shown in inset) and thresher in one operation

four million tractors, two million trucks and great numbers of electric motors energize 1952's farming. In many a corn-belt county more horses are kept for pleasure-riding than for draft. For every disappearing horse another five acres begins to supply human food instead of horse feed.

The 20th-century farm revolution started in 1903 when the gas traction engine first appeared. The word "tractor" came into use around 1906. Men still argue over who really made the first tractor. The numbers

Caterpillar Tractor Co. photo



produced raced upward from 600 in 1907 to 4000 in 1910, 21,000 by 1915 and then, in 1920, 203,207. The spurts came after 1918 when Henry Ford offered the first light tractor, 1924 when the tricycle-type machine adapted tractors to corn cultivation, and 1932 when low-pressure rubber tires increased the tractor's speed, shock resistance and general usefulness.

The automobile had opened the gate for the tractor. Farmers began buying motor-cars in numbers before 1910. The low-priced models, especially the rugged Model T, suited farmers. They became accustomed to the tunes of motors, and were prepared to buy as soon as really useful tractors were offered at reasonable prices.

Naturally, the first tractors were designed to replace horses, which meant that the machines were hitched on behind. Soon the idea dawned that the tractor could do things horses could not do. By 1924 implements began to be mounted directly on the tractor. The tricycle made row-crop cultivation practicable. Weight and bulk were reduced until the tractor could actually perform nearly every operation that could be done with horse teams. By 1930 completely horseless farms were known, where every operation was mechanized.

Farmers had long realized that for most field operations each season offers only a

Here's the easy way to level land for irrigation. Landplane measures 8 by 30 feet, scoops off the high spots to provide a just-right surface for drainage

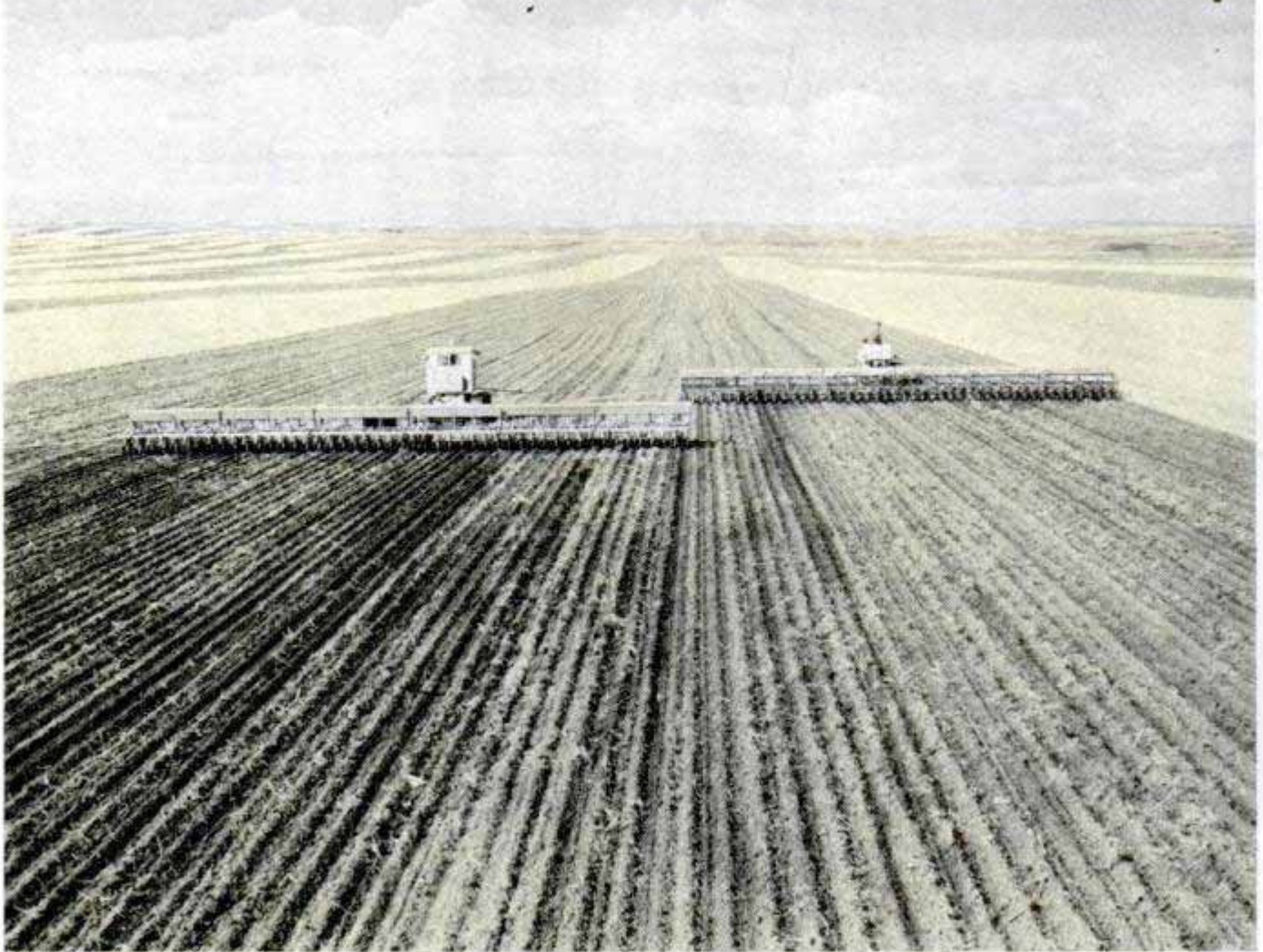

Caterpillar Tractor Co. photo

Out West the farmer thinks big, works big. Two 56-foot furrow drills plant winter wheat at 15 acres per hour

few ideal days. If the grain can be planted, the weeds killed and the harvest gathered on these "just right" days, the profits will be far higher than otherwise. The tractor had the speed and the tireless power to get jobs done at the right times. That one fact has not only paid for countless tractors, but has greatly enlarged U. S. food output.

About all the horse could do was to pull. Tractors never have colts, but they have pulleys and power take-offs. The power take-off meant that more efficient machines could be hitched on, machines that did not have to be half bull wheel. It brought the cornpicker, the combine and the field pick-up baler into business.

The internal-combustion engine, along in the 1920s, began to find another farm job. Hauling a two-ton load of produce or livestock to market with team and wagon had been an all-day task. It limited the choice of sales and buying points to those within a few miles. So the motor truck became a necessary tool on one third of U. S. farms. With the truck, markets could be 50 or 100 miles away instead of 5 or 10. Supplies could be brought from equal distances. Speed lessened spoilage and weight losses. Light trailers serve thousands of farmers whose loads do not call for trucks.

The march of machines through the half

century has steadily clipped hours and minutes off the man-hours of farm production. The wheat farmer who in 1902 plowed with a horse-drawn, two-bottom gang, sowed with a broadcast seeder, used a section harrow, harvested with a binder, shocked the bundles by hand and threshed by steam, was putting in 8.8 hours for an acre and .44 hours per bushel. By 1952 he was handling an acre in 1.82 hours and a bushel in .09 hours with a five-plow tractor, subsurface blade, disk harrow, heavy grain drill, self-propelled combine and motor trucks.

As the corn farmer progressed from 1902 methods of fitting and planting his fields, husking by hand and hauling with wagons, he cut his hours per acre from 20.8 to 3.88 and his hours per bushel from .38 down to .05. Tractors and mechanical pickers reduced hours per acre in cotton fields from more than 100 to fewer than 30, and on the Texas high plains, where four-row tractor equipment and two-row strippers are used, to as few as 6.5.

Likewise the dairyman who milked by hand and cleaned his stables with a manure fork had cut his hours in half. Where once he gave a cow 135 hours of his year, in 1952 he is taking better care of her in 60 to 70 hours. Litter carriers, pen barns, milking

(Continued to page 250)



Lightweight Diver's Suit

Divers have more freedom of movement underwater when they wear a lightweight suit developed by the Army Engineers. Made almost entirely of canvas, the suit has an opening in the back through which the diver enters. The flaps of the opening



are twisted and held tightly closed by a metal clamp. The usual heavy metal head-piece is eliminated. Instead, a glass front-piece is held firmly by rubber straps around the head, the water sealed out by a contour-fitting rubber strip. Divers can work at depths of more than 100 feet with the new suit.

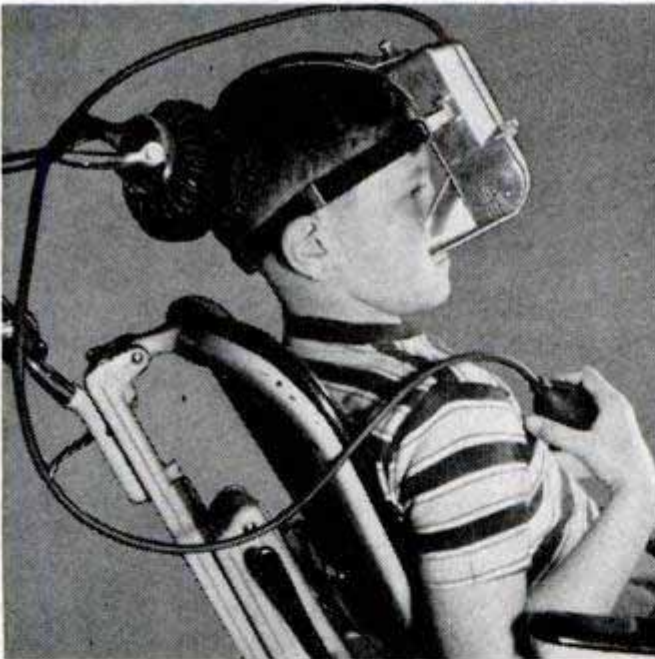

Self-Administered Anesthetic

Medical and dental patients can administer a mild anesthetic to themselves with a bulb-operated instrument designed to relax nervous tension. The instrument fits over the patient's nose. In his hand he holds the rubber bulb which administers the analgesic. When he relaxes he automatically stops pumping the bulb but can resume pumping at any time. The relaxed stage lasts from 1 to 1½ minutes and leaves no ill effects.



Tool Winds Rope Around Cable

Steel cable for ships' shrouds and hand-rails is wrapped with a layer of rope by a new tool. Frank Fagan, a ship's rigger in Seattle, Wash., invented the tool, which is called a serving board. Most older-type serving boards require two men to wrap the canvas-covered cable. Fagan's board holds a large spool of rope. A spring keeps the spool from turning too easily so the cord will wind tightly around the cable, and a notch on the board guides the rope.

LIBRARY of PLANTS

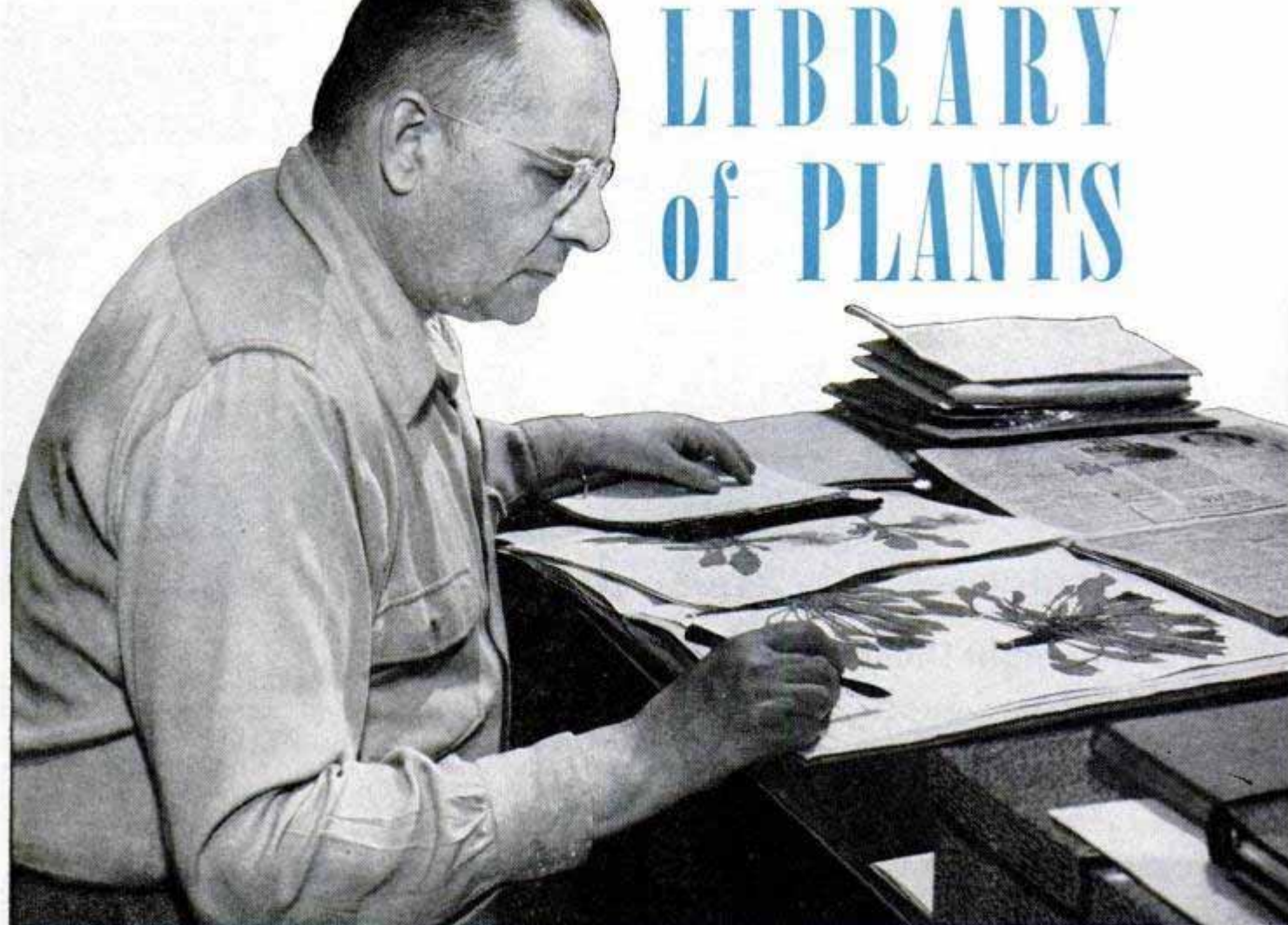

Soil Conservation Service photo

After a trip to the field, the collector identifies and mounts a new plant in his 20,000-specimen collection

By O. A. Fitzgerald

PICKING PLANTS and pressing them between sheets of newspapers or blotters may sound like a soft, genteel and, in every respect, harmless hobby.

Filling a cabinet or two, or a whole room of your home, with mounted plant specimens may seem a needless waste of good space.

But take it from J. H. "Heinie" Christ, Pacific Coast regional director of the U. S. Soil Conservation Service, plant collecting can't be matched as a useful pastime.

During the past 30 years, this energetic posy-picker and his wife, his companion on most of the collecting jaunts, have been towed, lifted, shoved or dug out on roads all over the state of Idaho. They have smacked into snowdrifts in July. They have been rained out, hailed out and blown out of camps and off roads in spots far too numerous to remember. They've had to stop and repair old roads, even built short stretches of new ones to keep rolling.

As head man of the soil-saving forces in five states, California, Oregon, Washington, Nevada and Idaho, "Heinie" is in a position to know the basic value of plant collecting.

"Knowledge of soil and nature's protec-

tive covering never has been more useful than it is today," he declares.

When "Heinie" talks cash value of plant knowledge he's speaking from experience—his own and that of farmers and ranchers. At the start of his posy picking he was in a field frequented only by the scientific botanist. Not today. This generation knows the importance of plants in soil conservation.

"More and more land users are coming to realize that it isn't the number of head of livestock that are run on a particular range or pasture that counts," he declares. "Rather it is the number of pounds of beef, lamb or mutton that can be produced year in and year out that is important."

Because it's the meat that counts, ranchers and farmers are watching the kinds of plants on their hills and in their pastures. Hills can look green and still not produce a lot of meat. Plants that are of little value often make a field just as green as those on which livestock thrive.

"The modern rancher knows the earmarks of a rundown piece of land and knows what needs to be done to rebuild it," the conservationist continues, "and plant knowledge is the starting point. I find that

many ranchers can identify and use the scientific names of plants just as freely as those of us who were brought up in the botanical jargon. To all in the business of soil conservation, that's just about the most encouraging news anyone could ask."

Wesley Cruikshank of Montour, Idaho, is one of those progressive ranchers "Heinie" has in mind. Cruikshank is emphatic that "a rancher must know his grasses and other plants in order to manage his range and livestock properly. It is just as important for him to know plants and their characteristics as it is for the farmer to know varieties of wheat and other crops.

Some ranchers are even building their own amateur plant collections. Frank Lenzie of Paterson, Wash., for instance.

"He's a good botanist in his own right and uses the information in operation of his sheep and cattle ranch," Christ observes.

These ranchers use their collections in just the same way the professional botanist does. When they come in with a specimen picked up on a range ride they turn to the collection to help in identification.

For seeing the country—the mountains, the lakes, the rivers and the lonely sagebrush deserts far off the beaten path—plant collecting is a hobby that can't be beat. Plant collectors must poke into every corner of the country their collections represent.

In building his personal collection of more than 20,000 specimens of Idaho plants, representing some 2500 species and subspecies, Christ has seen just about all there is to see in Idaho's 88,000 square miles.

"When you haven't been on a horse for months, then mount one, you finally get so saddlesore that you decide it's your turn to carry the horse," he says in describing some of his forays into the roadless primitive area.

Bear, deer and elk are readily spotted during plant-collecting trips. "Strangely though," Christ laments, "when I go into the mountains in the fall during the regular hunting season, I seldom get a glimpse of one."

Plant collecting began for Christ when he was a student at the University of Idaho. Later, as superintendent of the branch agricultural experiment station in the northern

Standard tool of the plant collector is a small pick, used to dig deep into the ground for plant roots and to pry out the plants growing in rock cracks

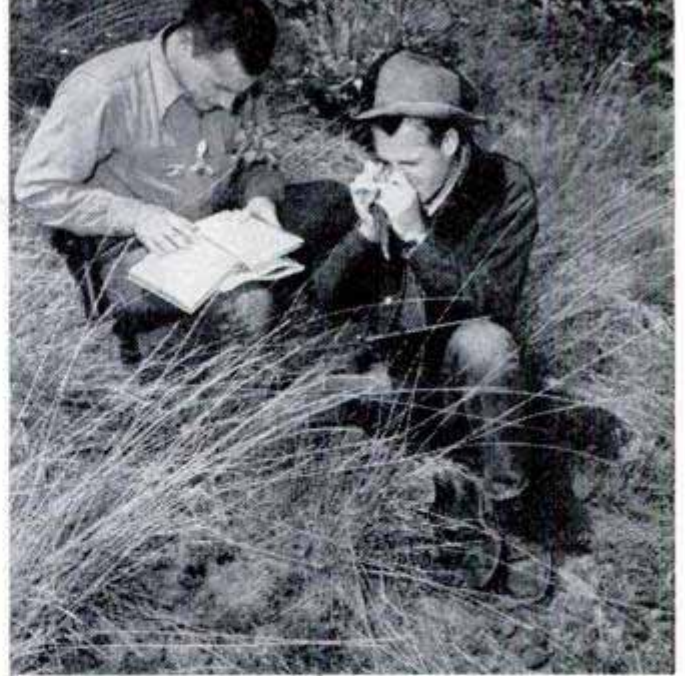

Two university students who soon will be forest rangers use a hand lens and manual to make accurate identification of a plant. Knowledge of plants is especially valuable in lumber and meat industries

part of the state, he collected plants as part of some research work in helping farmers and ranchers get burned-over pasture and range land back into forage. When he discovered that Idaho was a neglected field, botanically, he decided to do something about it. He's been collecting Idaho plants ever since.

Christ estimates there are around 3000 different plants in Idaho. He has around 500 to go. And most of these will come from the rugged peaks and the dusty deserts he has yet to cover.

Plant collecting, even for a personal herbarium, is much more than pulling up some posy and slapping it between the leaves of a book to dry out.

"It actually takes quite a bit of gear to care for plant specimens properly," he explains. "You need lots of old newspapers,





Ready for expedition, plant collector carries a field press, trowel, pick

Into the press goes a new specimen. Newspapers, blotters and cardboard separators speed the drying to help preserve fresh-cut plant

to fold over the plants so they will press to best advantage.

A collecting can, a metal contraption about 20 inches long and six inches deep with a strap for carrying, is the receptacle for holding the day's treasures. Sheets of moist paper layered inside the can hold up the humidity of the pack and reduce wilting.

A small pick is needed for the harvesting. This has a blade on one edge and a pick on the other, and is used to dig down for portions of the root or to pry out plants that have crowded into crevices of rocks. Another handy collecting tool is a garden trowel, used for excavating roots in soft soil.

All collectors carry notebooks in which they note the spot where a plant was obtained and the conditions under which it was growing. Blotters by the hundreds are used to absorb the moisture from the plants. These can be made from the felt paper used under linoleum. Cut size is usually 12 by 18 inches. The Christs take as many as 300 of these blotters on one trip.

Drying the blotters and papers for reuse sometimes is a real task. The Christs have done it in schoolyards, on sidewalks, vacant lots, alleys, parks, road edges and at times in the ovens of stoves in mountain cabins when it was raining so steadily they couldn't do it outdoors.

"Often there is a breeze to contend with," Heinie declares. "Then comes the scramble to recover the blotters and keep the work moving."

Changes of blotters must continue until the plants are thoroughly dry or the specimens may fade or become moldy. Slatted wooden-press covers are placed on the top and bottom of the day's collection and these are cinched up tightly with heavy straps.

Home from the field, the collector turns

to the new job of preparing mountings and identification. Notes must be prepared for each specimen and its identification completed. All of this is recorded on a label that goes with the plant. Running down the exact identity of some plants calls for a visit to a library unless the collector has one of his own, as the Christs do. Theirs is a modest one by college standards. Yet it contains enough books, monographs and bulletins on plants to fill five shelves, each four feet long.

After labeling comes the task of mounting. A card 11½ by 16½ inches is used. On it the plants are arranged for gluing. The specimen is backed with a heavy glue, thinly spread on plain glass and then returned to the card and affixed under pressure. Heavy portions of a plant are taped to the card.

Cabinets about 3½ feet high and 4½ feet wide, divided into compartments, hold the mounted specimens. Here they are arranged by families. Just leafing through the family groups in Heinie's collection brings out the richness of the plant groups that make up so much of the greenery of Idaho. In the collection are eight different huckleberries, more than 30 different kinds of asters, 40-odd daisies and 12 goldenrods. He has more than 25 clovers, 21 evening primroses, 33 different kinds of phlox, 21 delphiniums, about 40 buttercups, more than 60 willows, 18 currants and gooseberries, 20 violets and many others in equally high proportions. The 20,000 specimens come through subspecies and differences because of environment.

"It's a right smart job to keep these separated and properly catalogued, but solving such complexities makes plant collecting one of the world's best hobbies," he says.

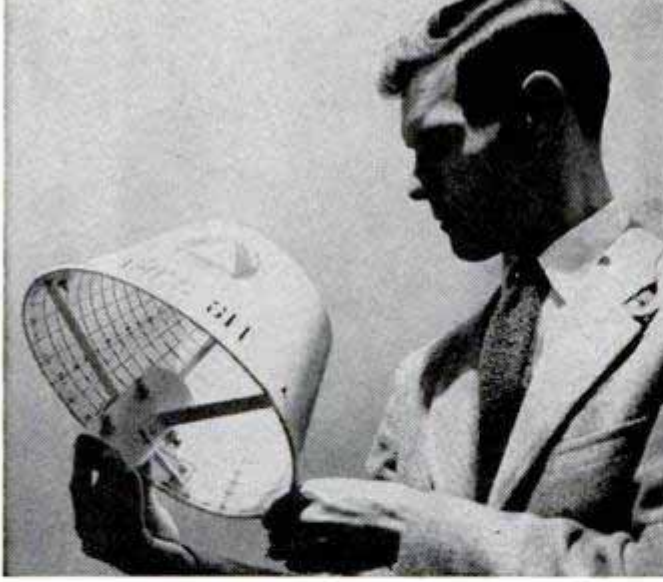

Radiation "Lamp Shade"

Resembling an ordinary lamp shade, a new civil-defense instrument will enable officials to determine quickly and accurately the position of the bomb blast in the event of atomic attack. This information is needed if rescue workers are to perform their duties with maximum efficiency. The "lamp shade" was developed to aid civil-defense officials in Schenectady, N. Y. A number of the instruments would be mounted permanently outdoors around a possible target area. If an A-bomb burst, the heat radiation would scorch the paint on the inside of the lamp shade. A brass rod which runs through the center of the instrument would block the radiation, casting a permanent shadow on the scorched region. Through grid lines, the shadow would plot information showing the height and location of the blast.



"Traffic Lights" for Planes

Mid-air refueling operations by the Air Force now are aided by "traffic lights" installed on the big Boeing tanker planes. The lights help the plane receiving the fuel to maintain the proper position while gas is pumped through the line. They are triggered automatically by relay switches connected with the boom between the two planes. When the planes are in the proper position a green light glows, but when the aircraft receiving the fuel moves away, red lights flash on to advise the pilot to move up, down, forward or aft. Instruction in night refueling was started recently at Castle Air Force Base, Atwater, Calif.



Switch-Box Brackets

Aluminum brackets, pressed into place, hold electric switch boxes in plasterboard, plywood and other materials where screws or nails are impractical. After an opening for the switch box is cut in the wall material, one of the brackets is pushed into place. A rear lip on the bracket holds it against the back of the wallboard and a prong is pressed into the edge of the board. After another bracket is installed on the opposite side, the switch box is slipped into position and the brackets are bent around the edges of the box.



Daniel Boone the Sixth piles coal on the forge in a truncated-pyramid shape as did his ancestors

DANIEL BOONE

KEEPS UP A TRADITION



Preforged units of fleurs-de-lis combine to form an ornate fire screen that is typical of Daniel Boone's colonial craftsmanship

DANIEL BOONE was America's most famous pioneer and trail blazer, but he had a trade, too. In his less exciting moments, he was a wagoner and blacksmith and, history states, was as skilled at the forge as he was behind a rifle. Today, Daniel Boone the Sixth operates a wrought-iron forge in Burnsville, N. C. There the great-great-great grandson of the Indian fighter produces hand-wrought hardware in the finest colonial tradition.



Entirely hand-wrought and forged, a massive set of andirons took weeks to complete, costs about \$1000



Times may have changed, but the village smithy and his clanging anvil are still favorites of the kids

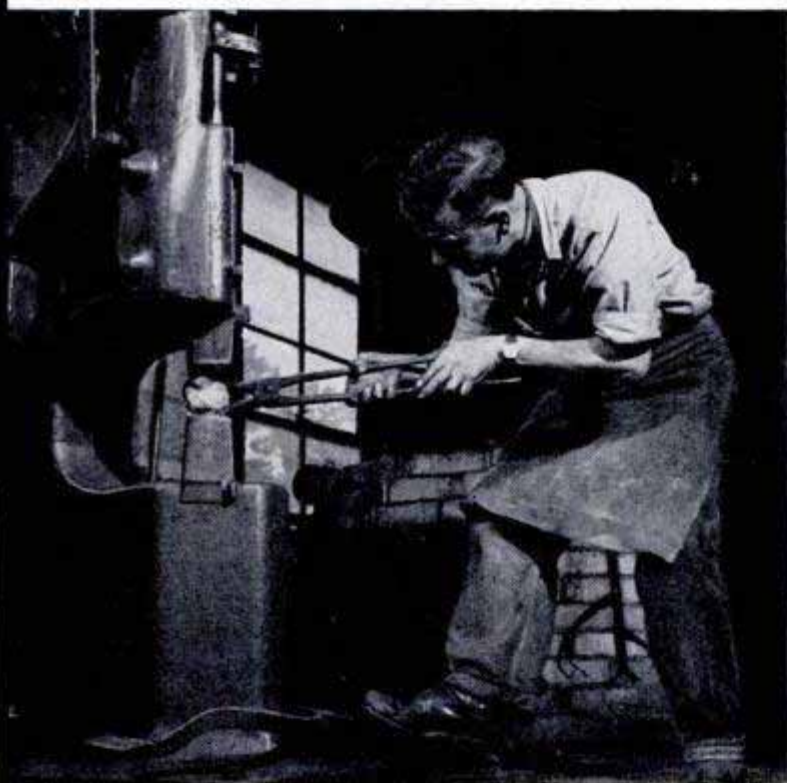

Boone's only power tool is a steam hammer used to shape iron balls, like those on the andirons, at top

Below, the craftsman rings a dinner bell which is completely handmade even to the links of the chain



Heavy steel swage block contains variety of shapes into which metal is pounded to form desired contour

Below, the special chalk that Boone uses to trace the pattern will not disappear in the high heat of the forge



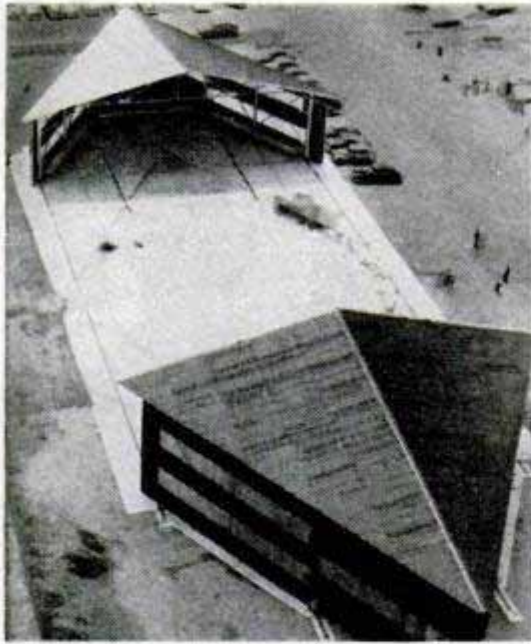

Opened hangar leaves plenty of maneuvering space so a plane in need of repairs can be wheeled onto reinforced concrete apron

"Clamshell" Hangar

Nicknamed the "clamshell" because of its unique closing action, a mobile hangar installed at the Marine Corps Air Station, Cherry Point, N. C., literally closes in around a plane. The building consists of two triangular sections, each mounted on small iron wheels that roll on railroad tracks. Four electric motors move the sections back and forth. An aircraft needing repairs taxis into place between the sections, which then move in to "swallow" the plane. Workbenches and offices are located



Two sections move together to "swallow" the plane. Below, sections glide on power-driven wheels which move on rails

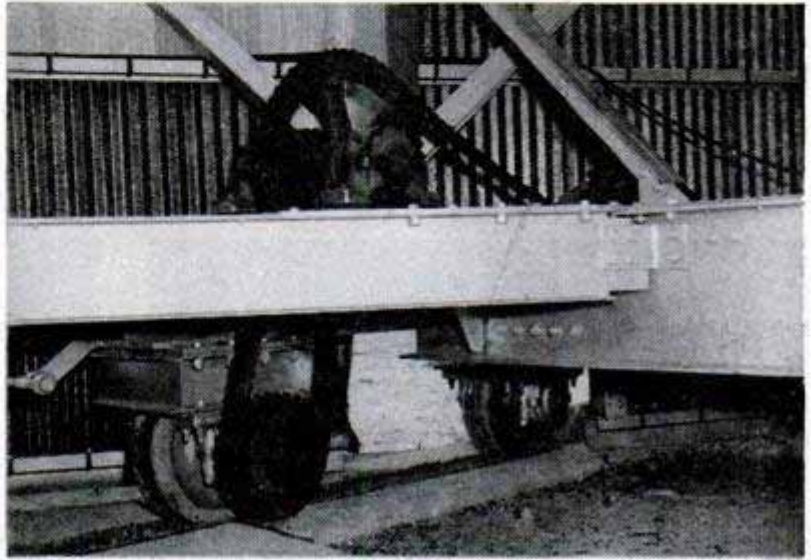

inside the structure and move with it. When the building is closed, the longest diagonal corners are 173 feet apart. The hangar is 29 feet high and can accommodate any plane based at the air station. It takes about two minutes to open or close the hangar, which weighs approximately 118 tons, not including the foundation.

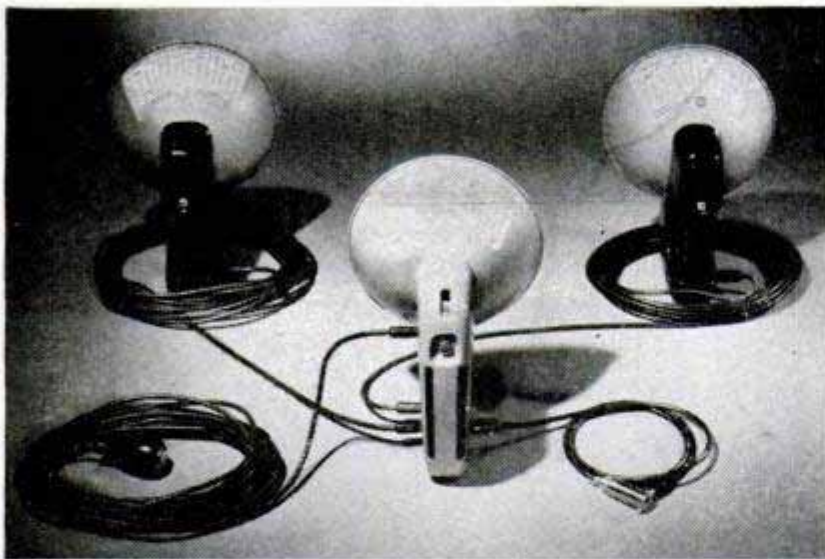

Flash Gun Has Pistol Grip

Using one or two miniature 22½-volt batteries and condensers, a compact photoflash unit features a pistol grip for exact aiming. Batteries last for a year or more. When two batteries are used, the flash system will fire



up to seven lamps in synchronization at the same time. Developed by Eastman Kodak, the new design also permits compact storage of both the main unit and extension lights. The reflectors nest like saucers and the rectangular-shaped guns stack compactly in any carrying case.



Car-Door Pocket

Installed by merely snapping it between the upholstery and window roller or door-handle plate, a handy car pocket holds road maps, sunglasses, cigarettes, baby needs, flashlight and many other small articles. Fitted over a brightly plated metal frame, the pocket is made of plastic trimmed with imitation leather that comes in red, green or blue.

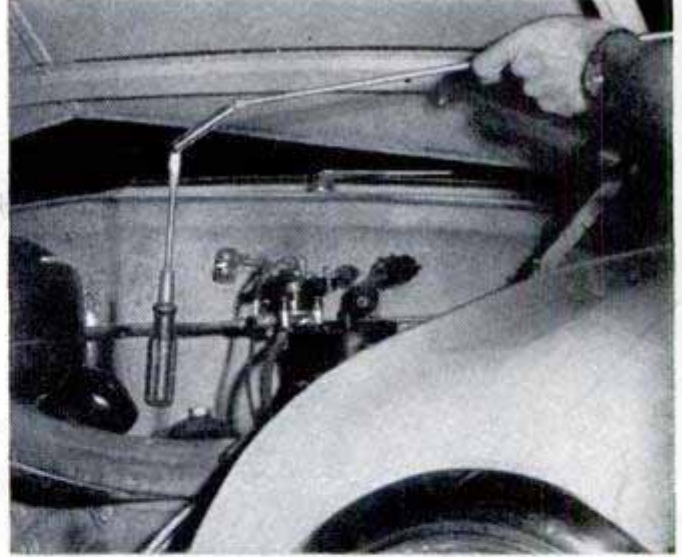

Magnetic Arm

Nuts and bolts or even tools dropped onto the splash pan of an automobile engine are easily recovered without skinned knuckles with a magnetic pickup device. A permanent magnet on the end of a telescoping rod pokes into tight places, around corners, behind generators and starting motors. The magnetic head adjusts to any angle and the rod extends 27 inches.

Shoescraper for Automobiles Without Running Boards

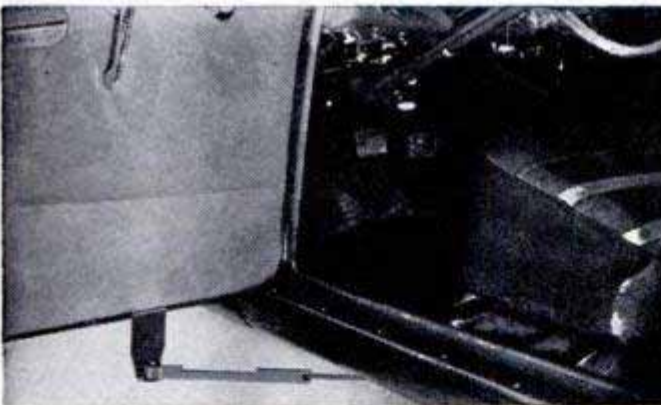

Now that the running board is virtually extinct, the motorist has no place to scrape his shoes before getting into the car. To overcome this deficiency, a sliding scraper has been developed to remove mud or snow from the shoes quickly. One end of the scraper fastens to the underside of the car door. The other end slides through the frame out of sight when the door is closed. When the door is open, the blade-like scraper is easily accessible. It is designed for installation on any car.

Remote-Control Drain Plug Simplifies Oil Changing

Operated by a flexible cable that extends up under the hood of the car, a remote-control drain plug enables the motorist to change oil without crawling under the car. The valve, which is screwed into the drain hole in place of the original plug, has a three-way sealing action. The operating part of the valve fits inside the crankcase so it can't be jarred or torn loose in case the oil pan hits an object on the road.

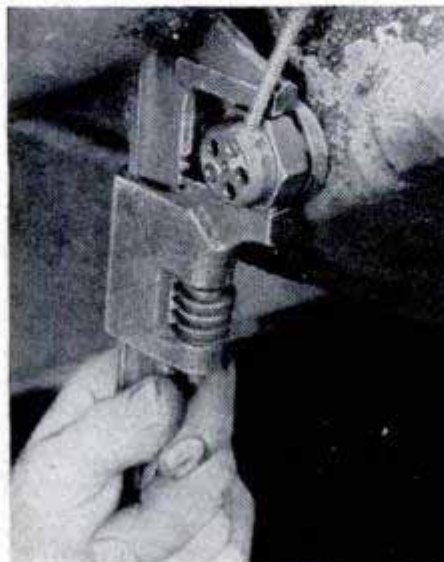



Snow research calls for specialized types of transportation. Track-laying vehicles, above, were used in a snow-surveying trek along Oregon's Cascade Mountain range

Dept. of Agriculture Soil Conservation photo

Two snow surveyors, right, weigh a sample tube of snow in California to determine the snow's density. Top snow may contain a third less water than that near bottom

California Division of Water Resources photo



Our Army engineers are deep in a big investigation this winter—Project Sipre:

THE PRIVATE LIFE OF A SNOWFLAKE

By Thomas E. Stimson, Jr.

WHO CARES WHAT happens to a snowflake?

The Corps of Engineers of the United States Army does.

As a military agency, it is participating in "Project Sipre" (Snow, Ice, and Permafrost) to learn the strength of snow under different weather conditions and, in turn, the sizes and weights of vehicles that the snow can support.

As one of the nation's chief dam-building agencies, it also is studying the life histories of snowflakes and raindrops to find a way of forecasting flood conditions. It's easy to forecast the time that a flood will reach a downstream point after it starts; what the engineers want to predict are the times when flood conditions will be created in

the snowbanks and rivulets far upstream.

Sometimes a warm rain melts the snow and causes a flood. Sometimes the snow acts as a sponge and absorbs the rain, preventing a flood. Forecasting the manner in which a mountain snow pack will behave under a given set of weather conditions is vital for efficient operation of dams used for flood control and water conservation.

Research on both these projects is being conducted at the corps' Central Sierra snow laboratory near Donner Pass in California. The site is a small enclosed mountain basin with only one outlet, an ideal sample of Sierra watershed. The small valley covers four square miles. Its elevation ranges from 7000 feet on the valley floor to 9000 feet at the summits of the sur-

rounding peaks. Here the corps' technical staff under Walter J. Parsons, Jr., keeps close track of precipitation as it falls, observes what happens to it while it remains in the basin, and finally measures it as runoff when it flows down Castle Creek.

Another snow lab in the Rockies, near Glacier National Park in Montana, and a third in the Willamette Valley in Oregon also are used for collecting data. When the forecast formulas are put together they are expected to be of worldwide value as a means of forecasting floods.

The work of the laboratories is separate from the seasonal snow surveys conducted by other agencies. These other surveys answer the question, "How much snow do we have in the bank?" A close estimate of the amount of water to come downstream during the spring runoff season helps farmers select crops to plant, and allows power-plant engineers to plan their power schedules well ahead of time. Army engineers aid in this work, but their main interest is in learning when the peak quantities of water will start flowing, and not in the seasonal totals.

In the summertime their Sierra laboratory area is a pleasant mountain region, but by August it becomes so dry that the staff must haul in water. In the winter it can be a place of raging storms. Forty feet of snow may fall in a season, as much as

four feet a day, and the snow pack averages 12 to 15 feet deep. Precipitation in all forms averages 50 inches of water a year.

The main laboratory at the foot of the valley has exit doors at both the first and second-story levels because of the heights to which the snow often drifts. Sometimes the men have to shovel their way upward through the snow from the second level to get to the top of the drifts when they start out to inspect field instruments. They travel in pairs for safety.

Once two of them almost perished only half a mile from a shelter cabin when their snowmobile broke down in a blizzard and they lost their way on skis.

In seeking the relationship between weather and runoff, Parsons and his staff installed a network of measuring instruments in the valley. Then, to avoid the hazards of daily inspection trips, they connected as many of the instruments as was practical by wires or radio circuits with the laboratory itself.

Sitting in comfort at a desk, one of the snow crew can read instruments that tell the outside temperature, the direction and velocity of the wind and the barometric pressure. Once a day he tunes in on the "radio snow stakes" that measure the depth of the snow at various locations and report the figures by short wave. One set of dials reveals the contents of several seasonal

Water from snow or rain falling in the test valley flows through a measuring gate at the valley's only exit

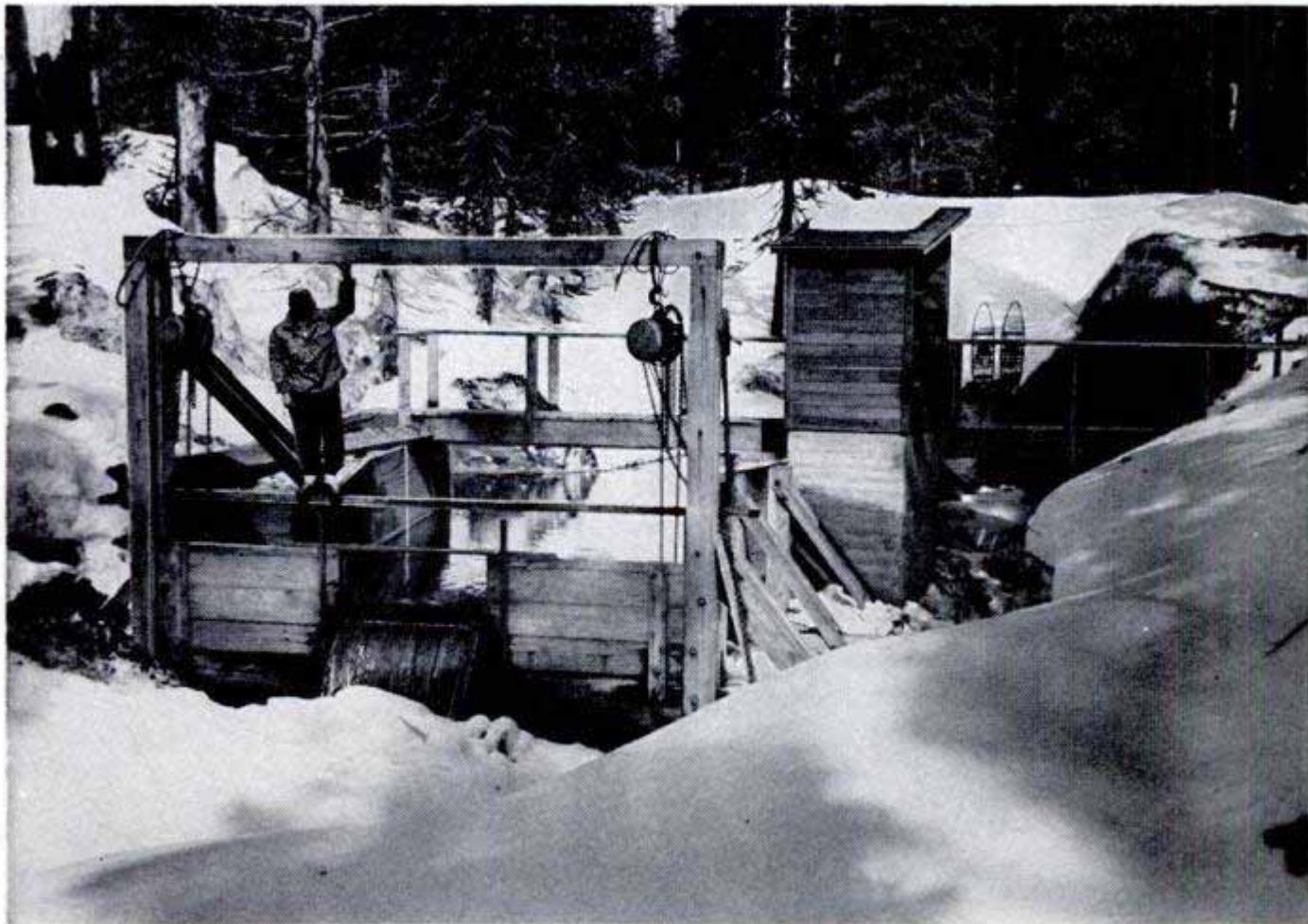



Located around the test valley are snow gauges that collect the snow so the total fall can be measured

snow-storage gauges at remote locations. Still other instruments show the amount of moisture in the soil in other distant parts of the valley.

Even the amount of solar radiation and the amount of this radiation that is reflected back from the top of the snow is measured by remote control. Only one inspection trip a week needs to be made in the field.

Many ordinary weather instruments

don't work well under the severe Sierra conditions, and the staff had to invent new ones in some cases and adapt others to their needs. Snow and rain gauges are dosed with measured amounts of antifreeze solution, for instance, so that their electrical measuring devices won't freeze up solid. Stream-flow instruments that are suspended in water also tend to accumulate ice, so electric lights are suspended overhead to keep them warm.

The research people found that ordinary thermometers gave absurd readings when buried in a snowbank. The snow was at a subfreezing temperature, to be sure, but the thermometer might read as high as 45 degrees F. This was due to solar glare through the snow. The men developed electrical-resistance thermometers that are more accurate.

To learn the amount of moisture in the soil at a certain location, they buried a block of plaster of paris attached to a pair of wires so that it was part of an electrical circuit. The plaster absorbed moisture from the surrounding earth and its electrical resistance was a measure of its moisture content. A block usually gives accurate readings for a week or so, then it's apt to give readings that obviously are incorrect. The trouble, the staff found, was that the local chipmunks like a plaster-of-paris diet and they seek out the blocks and eat them, sometimes leaving nothing but the bare wires. The only solution has been to replace the blocks as soon as they begin to give suspicious readings.

Measuring the depth of the snow at a distant location by remote control was a prob-

Electrical-resistance thermometers take readings at various levels under snow. Canvas screens off solar heat



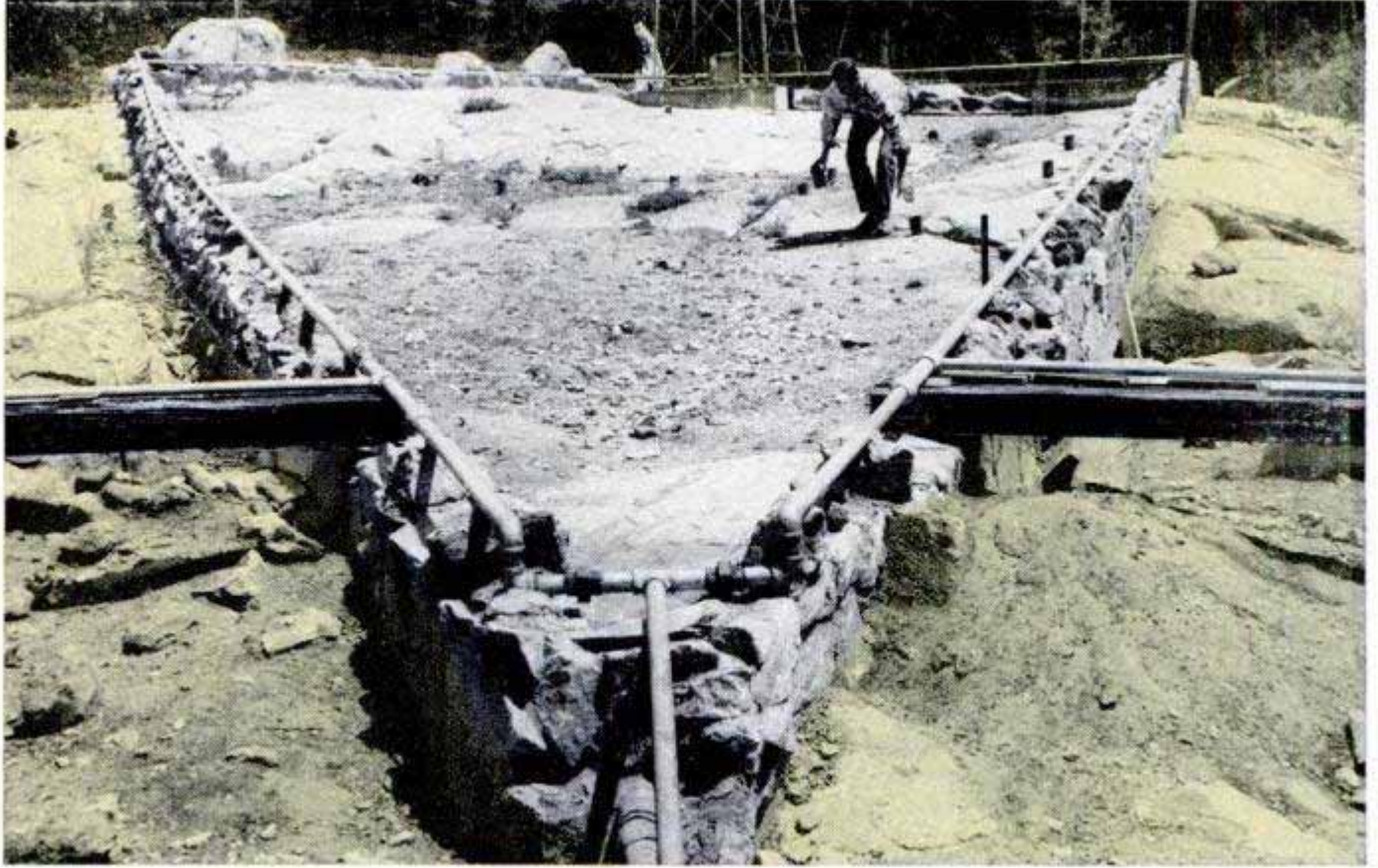

Water spray melts snow on paved triangle so scientists can measure runoff to determine snow's water content

lem that the staff solved with the help of radioactivity. They installed a capsule of radioactive cobalt in a concrete container at ground level and suspended a Geiger tube 15 feet overhead. With no snow on the ground, the Geiger tube gives off a constant

series of clicks. Several feet of snow on top of the radioactive source slows down the number of clicks; 10 feet of snow makes an even greater difference because moisture

(Continued to page 242;

see additional photos on next two pages)

Instruments that record and relay weather data to the lab are housed in shelters at various heights

Snow gauge uses radioactive source in slab. Reading on overhead Geiger counter varies with depth of snow

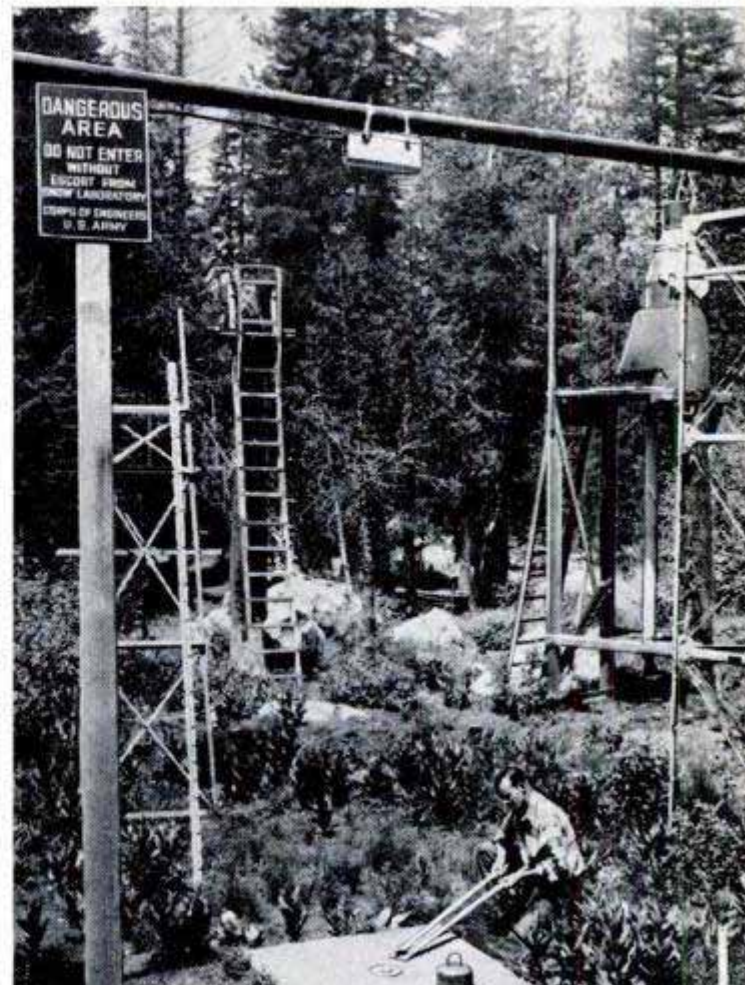
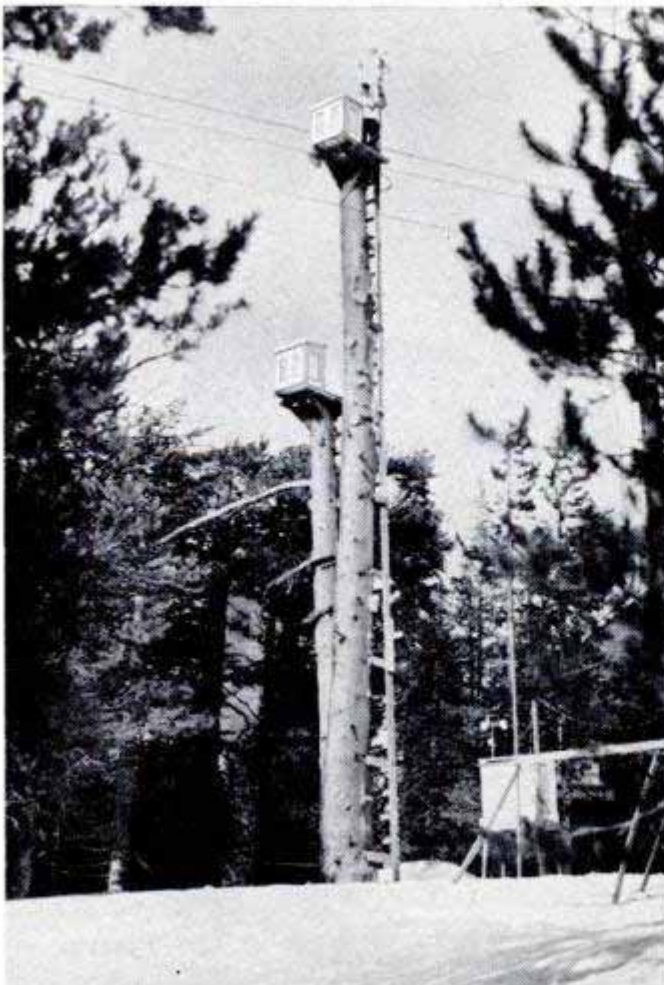



Nothing fazes this vehicle. Its snow tracks wrap around four pontoons that float it across rivers
Dept. of Agriculture Soil Conservation photos

Proving their mettle by climbing over snowbanks, these over-snow rigs are undergoing tests in Idaho



Most of the pictures on these pages were taken during tests held by the U. S. Department of Agriculture. The vehicle below is light and fast, but its rear treads proved too narrow to "float" it over the deep snowdrifts

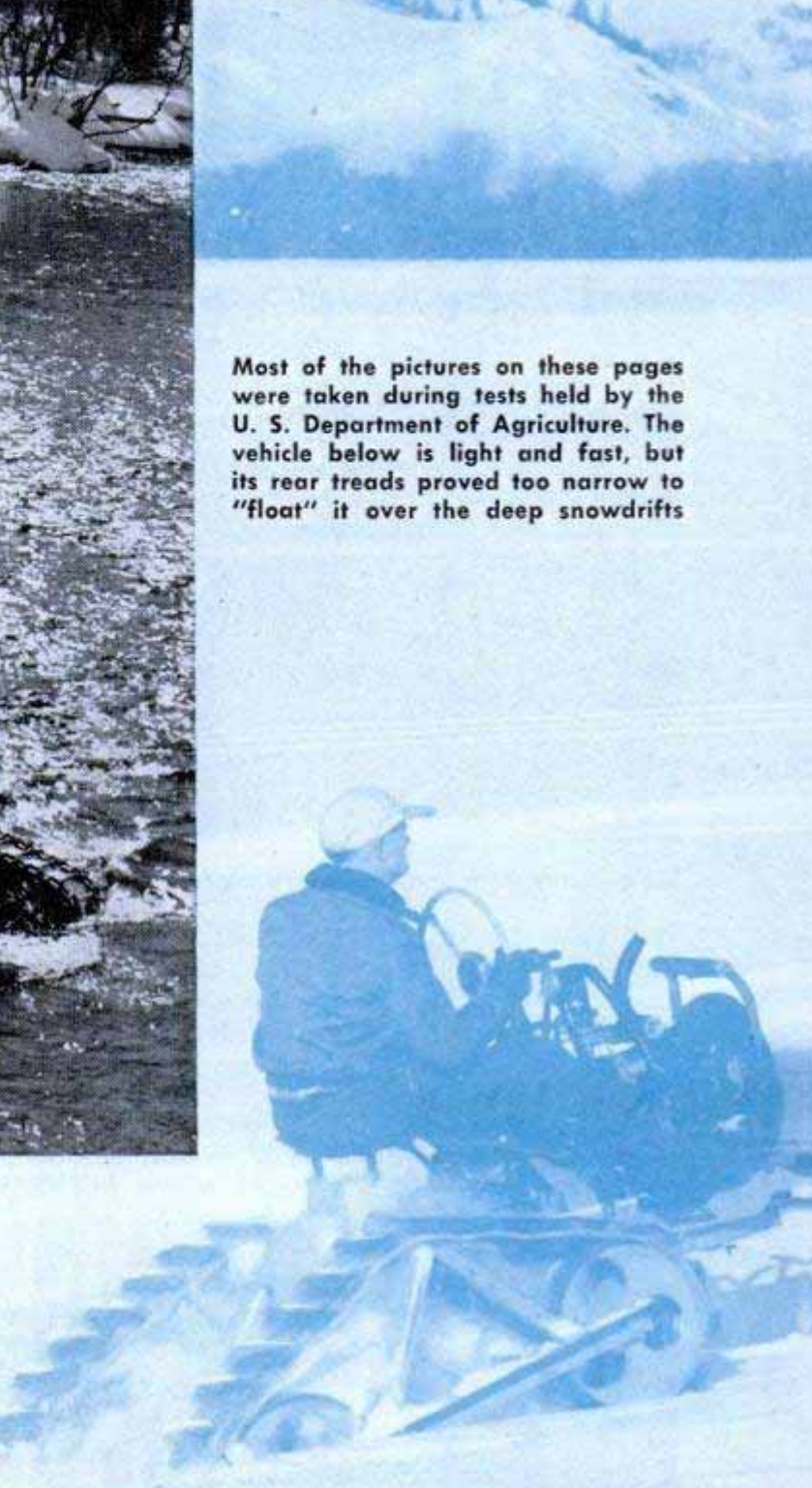

Recording men at the California test valley often travel from station to station in snowmobiles. An extra set of skis for the car is carried in case of emergency as are skis for the men, who always travel the area in pairs



Another type of snow vehicle, right, is powered by a chain-driven series of slats. It floats easily over the snowdrifts because of its wide tread



Also participating in tests at Idaho was this compact snow vehicle, shown here in one of the cross-country runs



Table-Top Workshop

Down in Guatemala City, Luis Francisco Munoz has built a complete "pocket size" workshop of miniature power tools. He made most of the parts by hand, though a few were turned on a lathe. The workshop includes a tiny lathe, drill press and grinder with grinding wheel and buffer. The bed is the only cast piece of the lathe, which has an automatic main feed. The cross-feed is provided with a set of gears for moving the toolholder forward when the handle is turned from left to right. Both the drill press and the lathe have two speeds. Power is supplied by a small sewing-machine motor. The tools are small enough so all three can be mounted on a table measuring only 16 by 18 inches. Munoz estimates he spent 700 hours on the tools. He uses them for camera repairs.

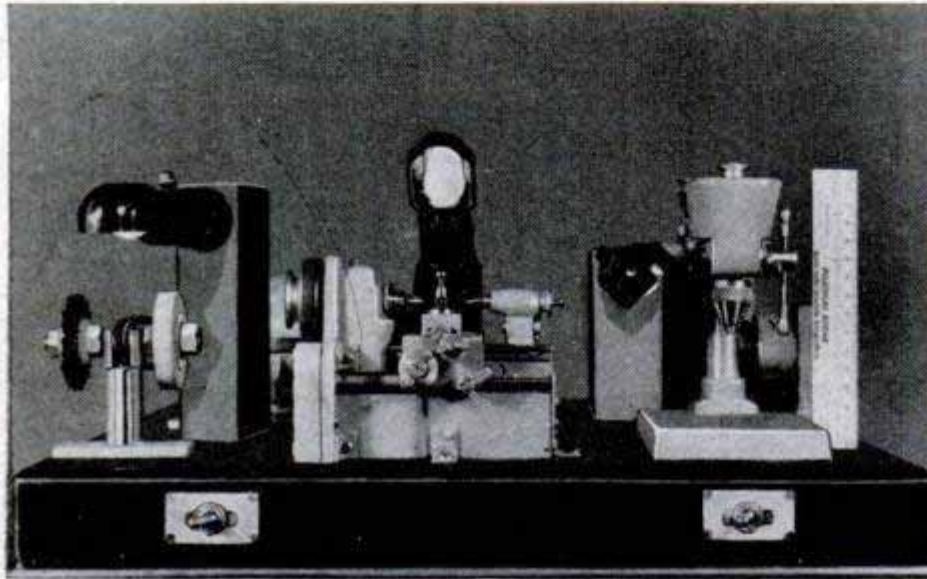

"Tug" For Maneuvering Semitruck Trailers Pivots on One Wheel

Built by a Palm Springs, Calif., mechanic, a dry-land "tug" for maneuvering semitrailer-truck units can pivot on either power wheel. The machine is so maneuverable it turns figure eights in less than twice its own length. The two additional wheels which support the vehicle are mounted on caster-type supports so they automatically swing with the unit. Hydraulic switches lock or unlock the power wheels to steer the unit. With the axle locked the unit will move in a straight line over curbs, rocks and other obstructions. The tug was built from the parts of several trucks. The power and steering systems, according to the inventor, are applicable to fork lifts, skip loaders, tractors and other transport units.



If you do not find the information you need in the index on pages 12, 14 and 16, sources of further information are available without charge from *Popular Mechanics*. Write to the Bureau of Information, 200 East Ontario Street, Chicago 11

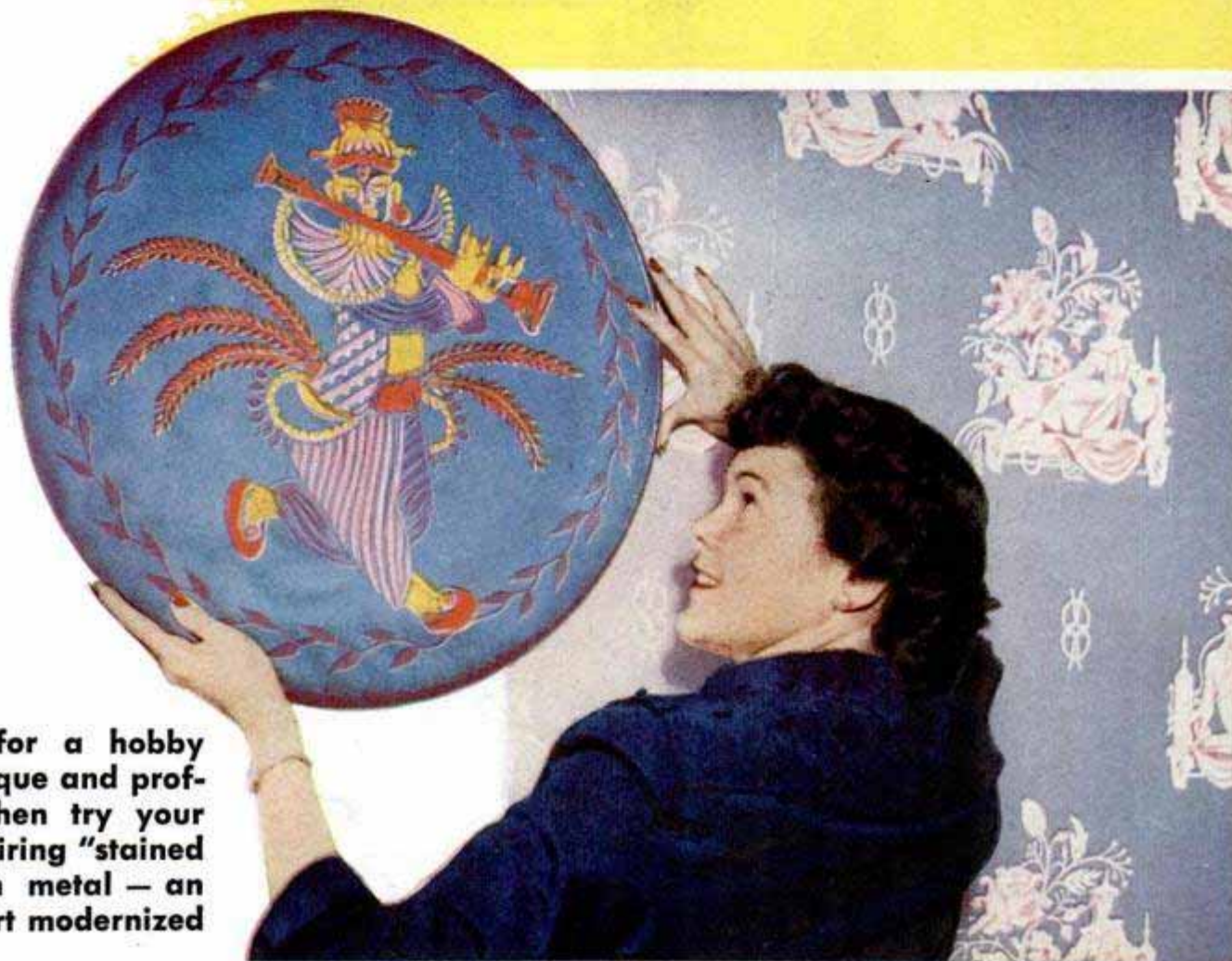

Looking for a hobby that's unique and profitable? Then try your hand at firing "stained glass" on metal — an ancient art modernized

FUSED-ENAMEL FINISHES

By Tom E. Stinson, Jr.

AN ART as old as the pyramids, coating metal objects with jewellike finishes of fused enamel, no longer is limited to a few highly skilled craftsmen. Now that all the necessary materials are available ready for use, this fascinating craft can be enjoyed by the average hobbyist. The enamel, which is nothing more than a special mixture of powdered glass, is applied to a clean metal surface and fused in a furnace. The enameling technique described was developed for use on copper primarily and also on silver. This consists briefly of cleaning the metal surface, applying a gum coat, sprinkling the powder over the gum, and

Large decorative plate shown above must be fired in special oversize kiln. Less pretentious samples of enamelware, pictured at the right, can be handled by the hobbyist who has a small electric furnace

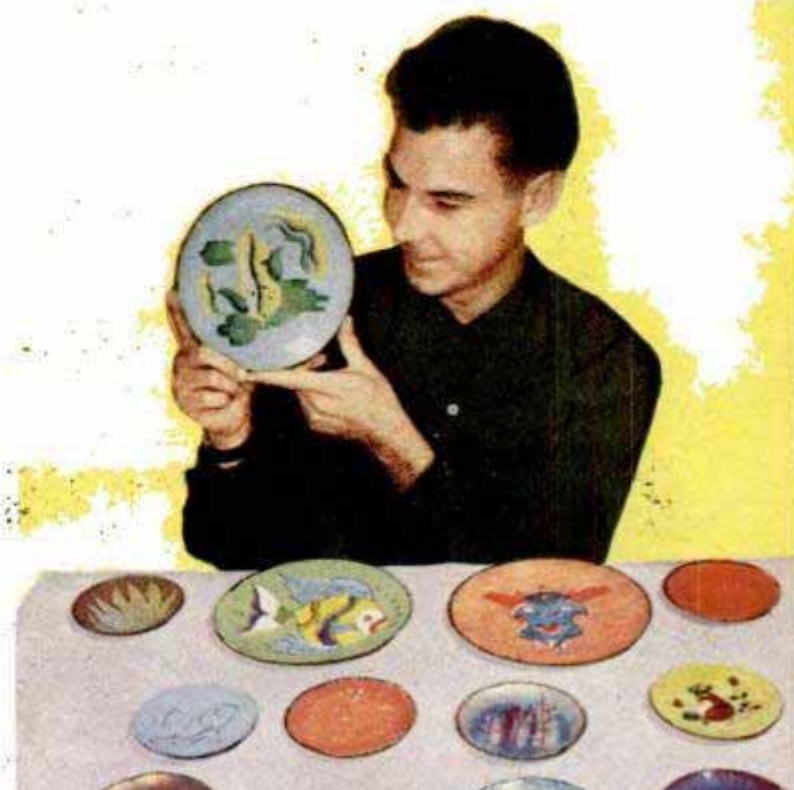



then fusing the enamel by placing the object in a hot kiln (1400-1500 deg.) for two or three minutes. (*Do not inhale the powder or accidentally take it internally.*) The technique for enameling steel is slightly different, as the enamels are painted on the work. A small furnace can be purchased for about the same price as a good-quality power tool, or a kiln can be built from firebrick and high-temperature cement.

The photos on these pages, which were taken at the Grant Beach Art School, Los Angeles, Calif., picture the steps required to make a cloisonné plate. A preformed copper plate or bowl may be used, or one can be formed from sheet copper. The sheet metal should be at least 18 ga. to prevent buckling when fired, and any rough edges rounded with a file. The plate is cleaned with a dilute-acid bath or by scouring with pumice or household cleaner. It is then rinsed and dried.

Next, an even but generous coat of gum tragacanth is brushed on the surface. The gum, purchased from a druggist in dry form, is powdered and sifted into water, using 1 teaspoonful of dry gum to 1 cup of water. This is allowed to stand overnight. Then it is stirred and enough water is added to bring the solution to a creamy

Below, a long pair of iron tongs is used to insert and remove the prepared plate from the furnace or kiln. Plate rests on grille of chrome-nickel mesh or wire to facilitate handling





Enamel flux is sifted on gum coat, completely covering plate. Start near edge and work toward center

consistency. Clear enamel flux is sifted on the tacky gum surface. After a few minutes, the plate is inserted in a preheated kiln. As you inspect the plate during firing, you will notice that the enamel first turns black, next it thickens, and then it acquires a bumpy, glassy appearance. Finally, the humps smooth away, indicating that the fusing is complete. Remove the plate and allow it to cool for about 10 minutes before handling, protecting it from cold drafts that might crack the enamel. Then clean the back of the plate with steel wool and the edges with a file to remove any scales that might fly off during the next firing. This transparent coating forms a binder, which is followed by one or more coats of colored enamel. These are applied basically in the same way as the first coat, applying a fresh coat of gum, spreading the powder over the surface and firing. However, there are several techniques used in applying the decorative coats. A stencil can be pressed into the tacky gum and powder spread over this surface. The powder is removed after the gum dries. Another method is to scratch a fresh layer of enamel with a blunt tool to expose a previously fired layer. This is called sgraffito. A third method, cloisonne, utilizes copper wire to separate areas enameled in different colors. The 18-ga. wire, which is bent to follow a pattern scratched in the surface of the plate, is pressed into a gum coat applied after firing the transparent flux. Firing again, before applying the colored enamel, sinks the wire segments into the flux coat.

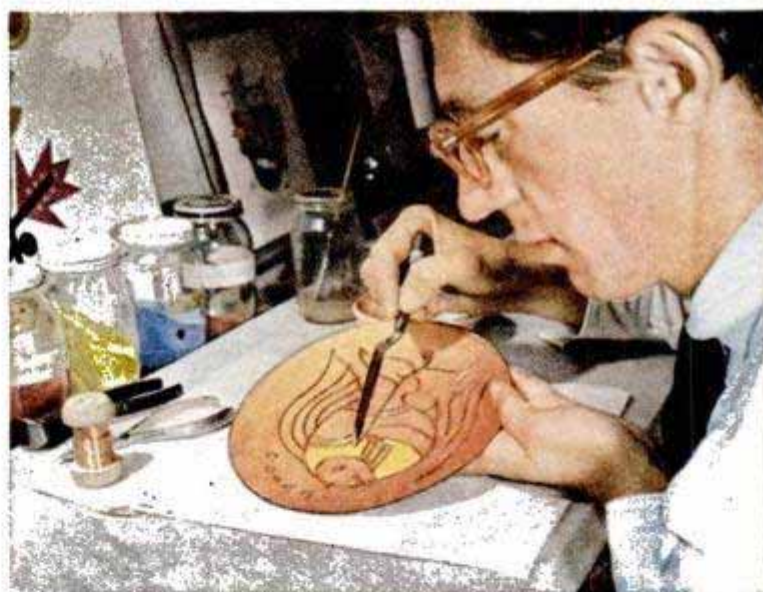

Enamel is mixed with thin gum solution and dropped into sections of cloisonne plate with knife blade. Polish exposed wire with steel wool after firing



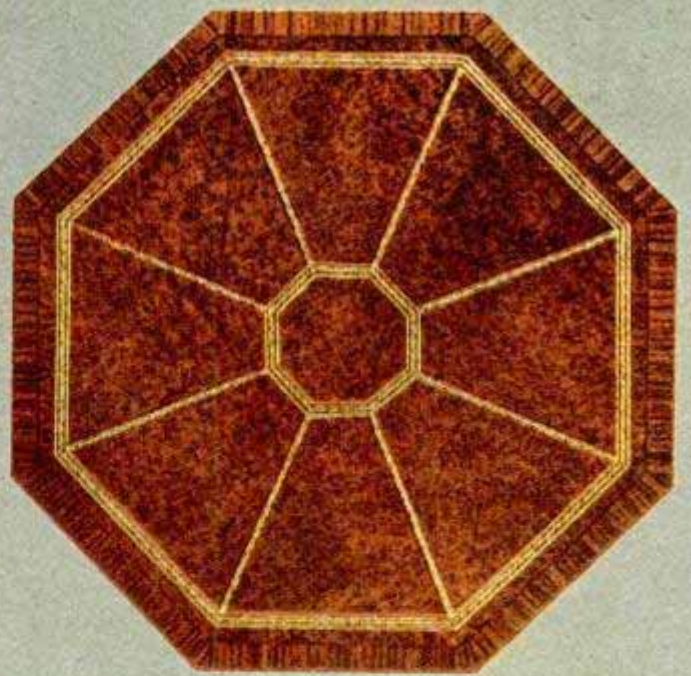
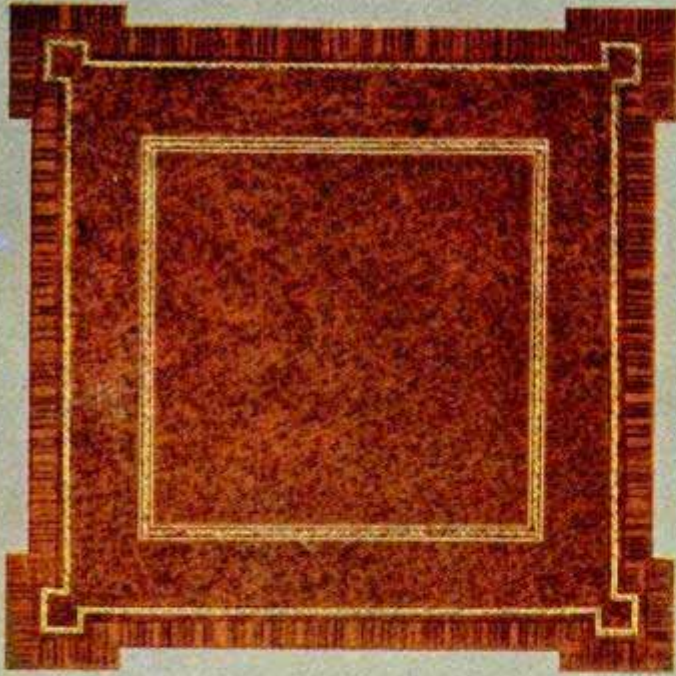

Realistic "tooled leather" in decal form makes it easy to produce beautiful tops for new or old tables at surprisingly low cost

"TOOLED LEATHER" TOPS





Table designs by John Bergen

FOR YOUR FURNITURE

By Wayne C. Leckey

HAVE YOU WISHED you could duplicate the beautiful gold-tooled leather tops featured on smart custom-built furniture? Now, thanks to the makers of plastic veneer, both leather and gold tooling can be applied easily and inexpensively with decals. Closely resembling actual leather, this veneer, which is available in large sheets, has the color and texture of leather printed right on it. When applied and protected with a top coating of lacquer or varnish, the veneer is difficult to tell from the genuine.

First featured in a two-part article beginning in the January 1951 issue of *Popular Mechanics*, plastic veneer offers the craftsman a practical means of beating the high costs of select cabinet woods. In addition to the new leather grain, it is available in many rare wood grains and fine marble finishes. It is low in cost and, being opaque, can be applied over inexpensive materials such as plywood, hardboard and glass, hiding all joinery. Printed from photoengravings of the actual wood, marble or leather, the veneer is uniform in color and grain, thus eliminating the staining operation, which always is a troublesome job for the inexperienced worker.

Plastic veneer comes with a paper carrier that is removed by soaking in water, but, unlike a decal, it is cemented to the

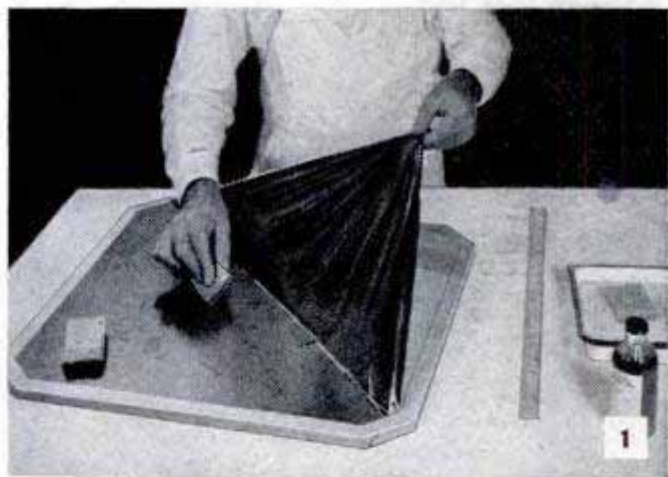

Above, the veneer is squeegeed smoothly to the surface with a soft-rubber block. Below, gold tooling is applied to leather before carrier is peeled off



3

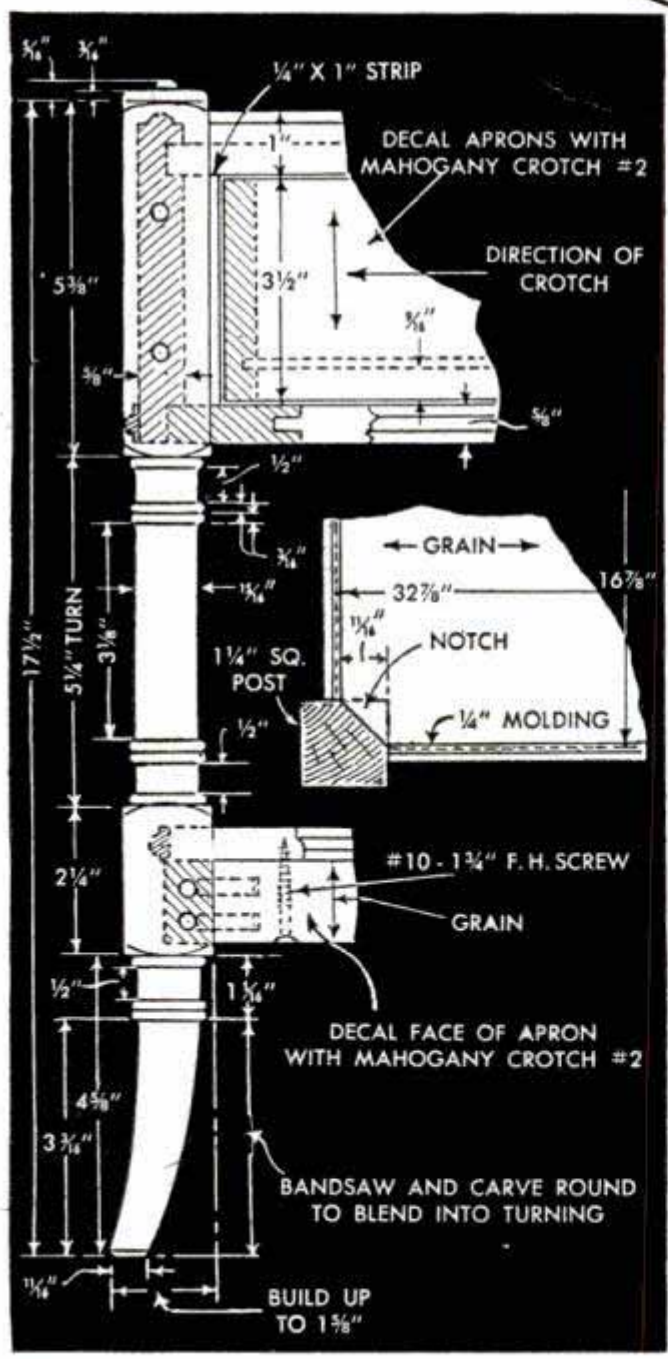
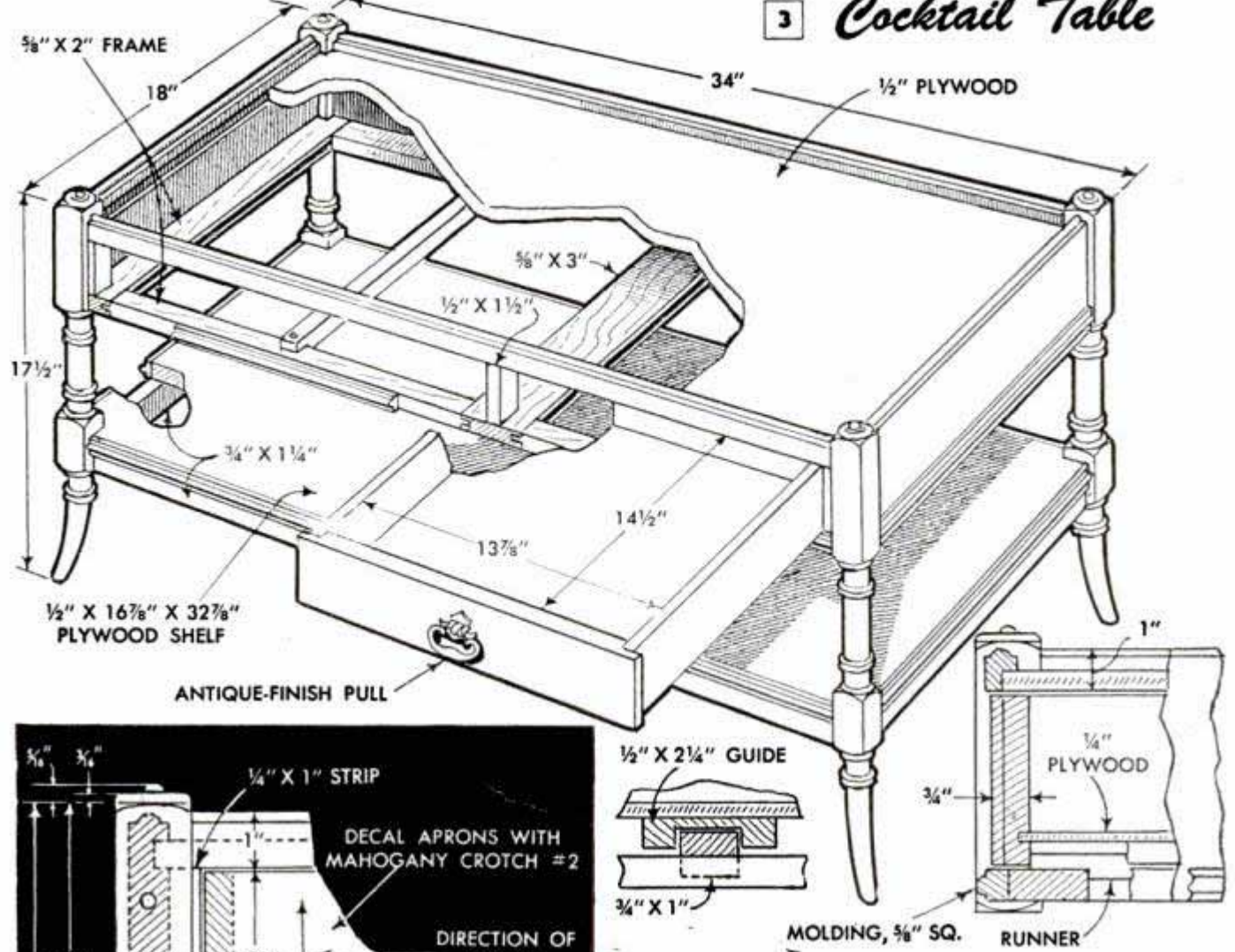

surface with a special, ready-prepared adhesive. The tools needed to work plastic veneer are a razor blade, rubber squeegee, metal straightedge and a cellulose sponge.

Preparing the surface: Fir plywood is not recommended for covering because of its pronounced grain. Nor are any other woods that have a porous or open grain. Poplar plywood is excellent for the purpose as well as being fairly inexpensive. Hardboard also is very good because of its exceptionally smooth surface. The surface to be veneered should be sanded well. As the veneer consists of a film of lacquer and is actually drawn to the surface by the adhesive as it dries, flaws in the surface tend to be even more pronounced. Although the veneer consists of a film of lacquer, the surface to which it is applied must be sealed with shellac, varnish or lacquer, and rubbed down with very fine sandpaper to produce a smooth base for the veneer.

Applying the veneer: The first step is to cut the veneer to size with a razor blade and a straightedge. After the veneer is cut, it is placed in water a few minutes to soak off the paper carrier. While this is being done, the surface is coated with the adhesive supplied with the veneer. This is used as it comes from the can and is swabbed liberally on the surface with a sponge. Next, the ve-

neer is peeled off and the veneer held momentarily to drain off excess water. A soft-rubber block, called a squeegee, is used to smooth out any air bubbles and wrinkles in the veneer. This is done lightly at first and, if it is necessary to lift up the veneer to remove a wrinkle, it is done by lifting a corner as in Fig. 1. Finally, the veneer is wiped off lightly with a dampened sponge to remove any possible film of cement.

Applying the gold tooling: The gold tooling can be applied immediately right on top of the leather veneer. Being printed in gold on a film of clear lacquer, the tooling allows the leather veneer to show through the clear areas of the design and makes it appear that the design is a part of the leather veneer. First cut the strip to length, mitering the ends. Lay a metal straightedge on



4
End Table

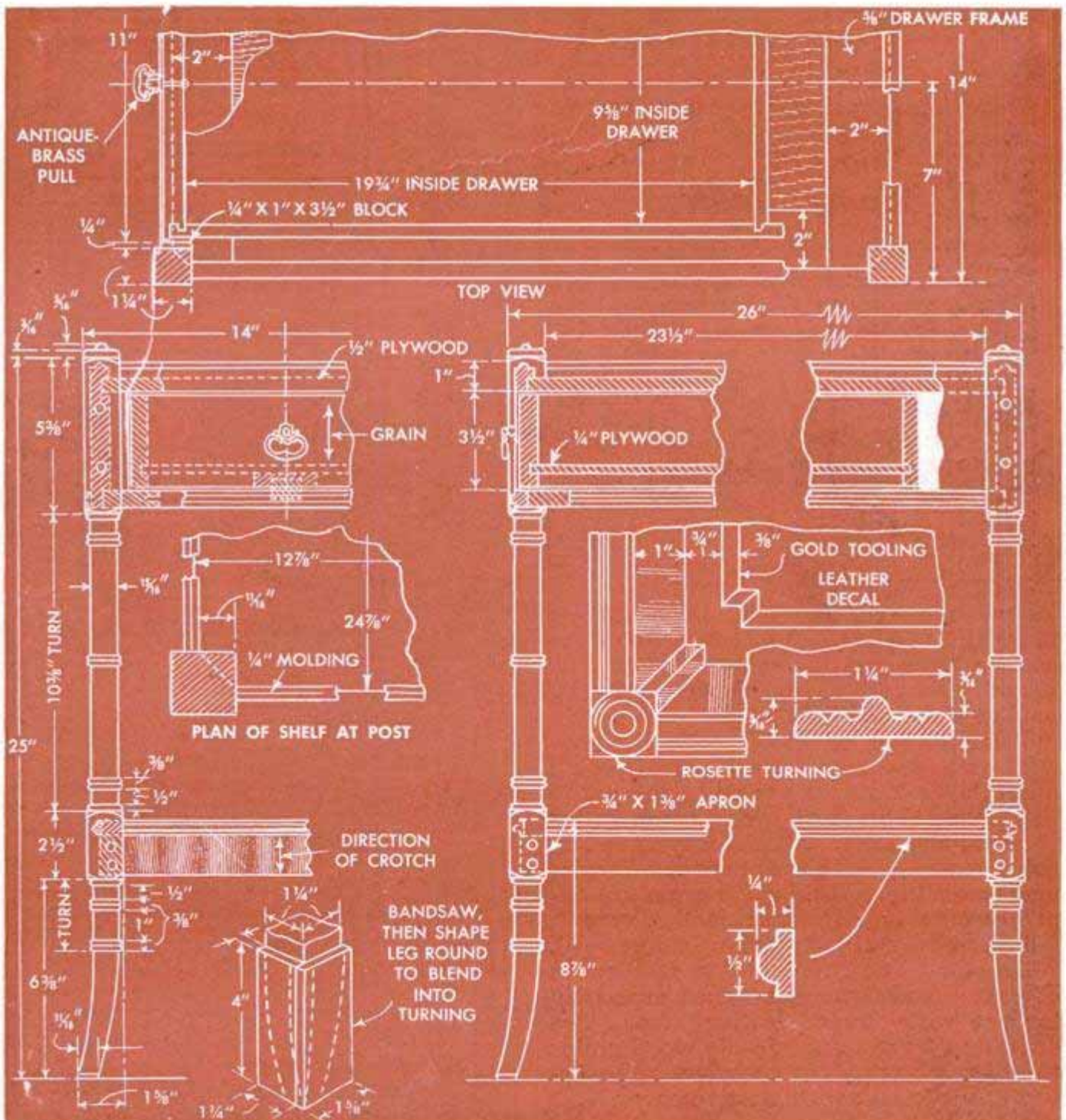

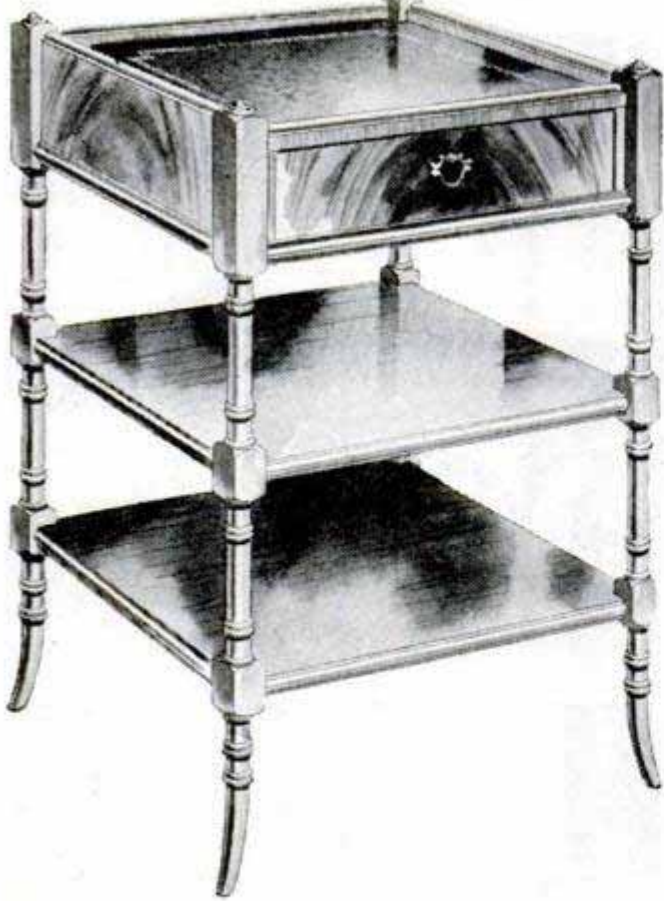

5 Lamp Table

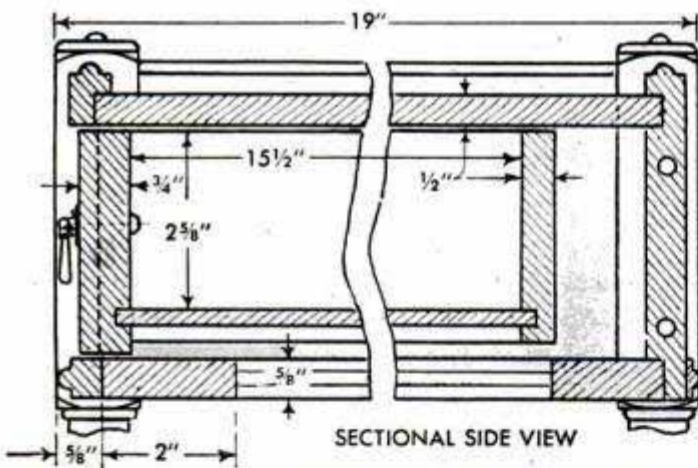

the work to serve as a guide in positioning the strip, and apply the adhesive to the leather. Squeegee the tooling in place, Fig. 2, and then peel off the paper carrier by holding down one end of the tooling with the thumb. This comes off easily if dampened with a sponge. Under the carrier you'll find a layer of rice paper still adhering to the tooling. This is allowed to remain for about 30 min., after which it is removed by rubbing gently with a wet sponge. Border veneers of the desired wood grain are applied around the edge of the leather veneer, following the method previously described.

The three matching tables detailed in Figs. 3, 4 and 5 were designed especially for use with "tooled leather" tops. The drawings suggest appropriate wood grains to use in covering the complete table, except for the legs, with plastic veneer.

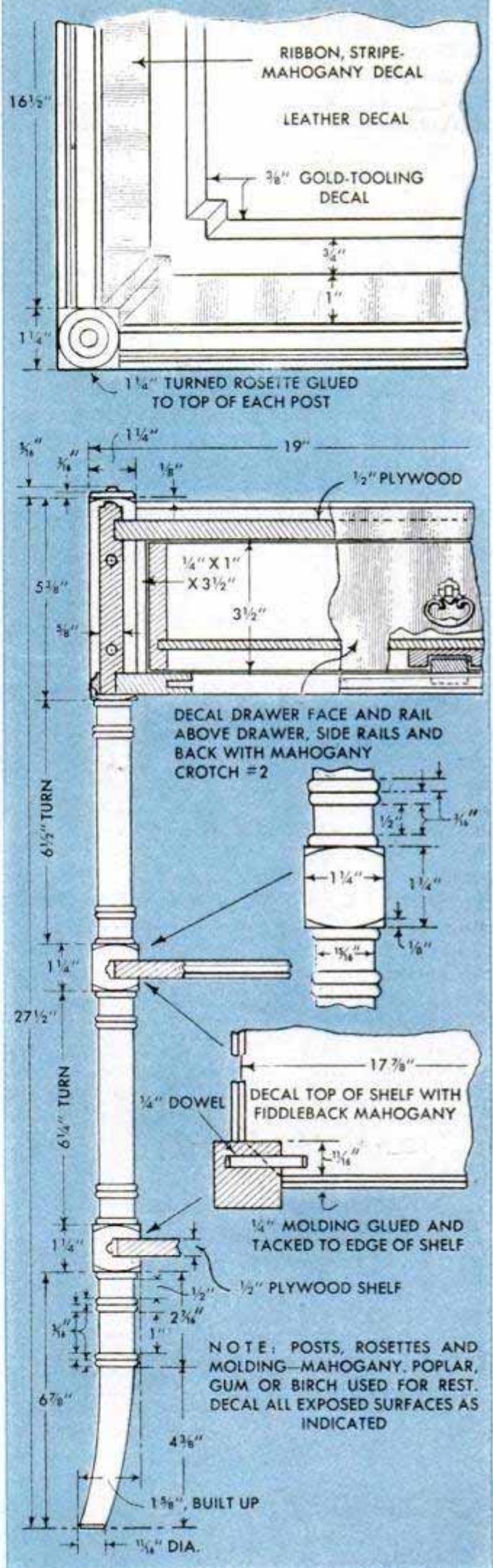

Fitting Oversize Chuck to Spindle Increases Capacity of Drill

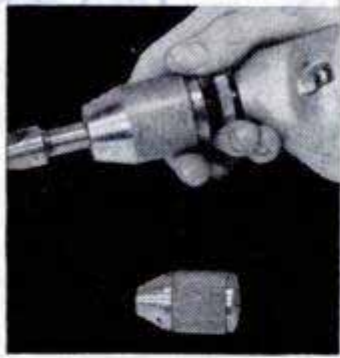

The usefulness of a small electric drill can be increased by attaching a larger chuck to it for occasional heavy work. For instance, a 1/2-in. chuck often can be fitted directly to the spindle of a drill having a 1/4-

in. chuck. While not designed for continuous heavy-duty operation, a small portable drill equipped with a large chuck can be used to drive a buffing or grinding wheel without overloading the drill.

Richard Hanscom, Elmhurst, Ill.

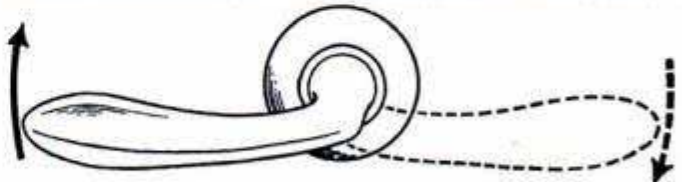

Estimating Paint Coverage

To estimate the approximate number of gallons of paint needed to cover any given surface inside or outside the house, find the number of square feet of area and divide by 400. Following are several "quick" formulas for finding the areas of various surfaces. To figure the outside of a house, first multiply the distance around the house by the height to the eaves, and subtract the total window area. Add the remainder to the total number of square feet in the gables, the area of a gable being found by multiplying one half the height by its width at the base, and you have the total area. When figuring interior walls, deduct 15 sq. ft. for each door and window. The number of running feet in baseboards can be considered as square feet. Use 135 sq. ft. as the total area for an average staircase. Figure roughly 15 sq. ft. for each side of a window, including the sash and frame, and about 35 sq. ft. for each surface of a door and its frame. Four times the amount of the front area of a radiator will approximate its total area.

Worn Spade Used as Shooscraper

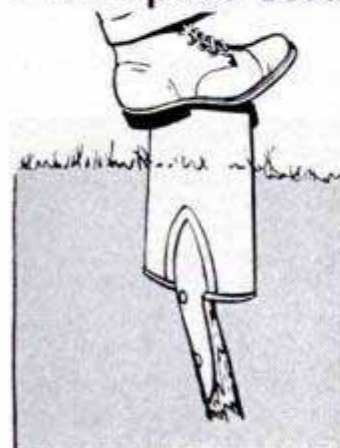

An old spade or shovel can be used as an excellent shooscraper. If the handle is intact, saw it off and square the cutting edge of the blade. Then, embed it in the ground or concrete as shown. — R. M. Woodbury, Natick, Mass.

Reversing Handles on Car Doors Prevents Accidental Opening

A handle that is pressed down to open a car door is a hazard, especially to small children, as the door can be opened when the handle is accidentally leaned on or unknowingly pulled. To avoid this danger, just reverse the position of the handle as shown. Then the door can be opened only by pushing up on the handle.

W. Shields, Bloomington, Ill.

Lighter Fluid Cleans Typewriter

Lighter fluid is an effective cleaner for the type on a typewriter. The long spout on most containers is handy for applying the fluid directly to the type where it quickly loosens the accumulation of dirt and dried ink, which then can be removed with a brush.



or from one motor of the Chrysler group of same period - This permits the 8 hr. battery running time.

of the Chrysler group of same period - This permits the 8 hr. battery running time.

Book for Boys
WTM 53
Toys You Can Make



SIDEWALK PLAY CAR

has electric drive

By Elmer V. Clark

LIVELY youngsters and craftsman fathers alike will get a thrill out of this tiny play car, which looks and drives like a real automobile except that it's scaled down to sidewalk-coaster size and travels at slow, safe speeds. It's driven by an auto starter motor of the type having a built-in reduction gear and is fitted with a foot brake, lever-operated clutch, pneumatic tires and a conventional steering gear. As pictured above, the original car measures 58 in. overall length, with a 42-in. wheelbase and 20-in. tread, but allowable variations in dimensions and the necessity of adapting certain parts according to availability, may change these dimensions slightly. For these reasons certain dimensions have been purposely omitted and adaptation or substitution of parts has been left to the discretion of the builder. An example is the length and type of the springs specified in the construction details. Obviously, these can be longer, or even slightly shorter than the lengths given. The side frames are of 2 x 2-in. oak and, in order to avoid waste in forming the curved ends, or lifts, the members are built up to the rough shape by gluing together strips of 3/4-in. stock. Before gluing the strips together, be sure that there is ample allow-

ance for bandsawing the curved sections at both ends of each piece. Use waterproof glue in the joints. After the glue is dry, bandsaw the curved ends and plane and sand the parts to the finished size. Apply a coat of shellac to prevent absorption of moisture. The side frames are joined near the ends with long studs, or draw bolts, and pipe spacers as shown on the blueprint on a following page. Note that the front and rear-spring shackles are mounted on the draw bolts and that these must be left loose so that the shackles can move freely. Note also that the brake pedal is pivoted on the same draw bolt as the front-spring shackles. In this case two spacers are used to serve only as collars to position the pedal. Exact sizes of the draw bolts and spacers are not important.

Note especially the construction and

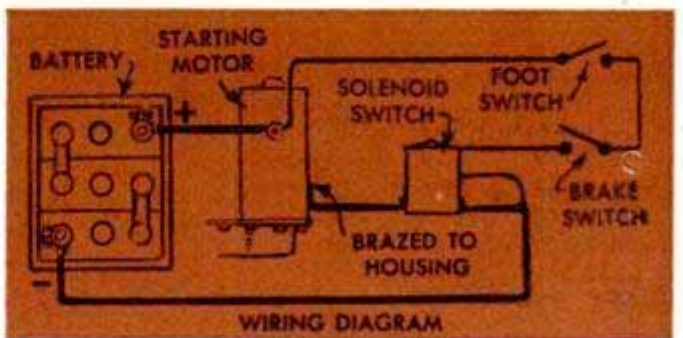

WIRING DIAGRAM

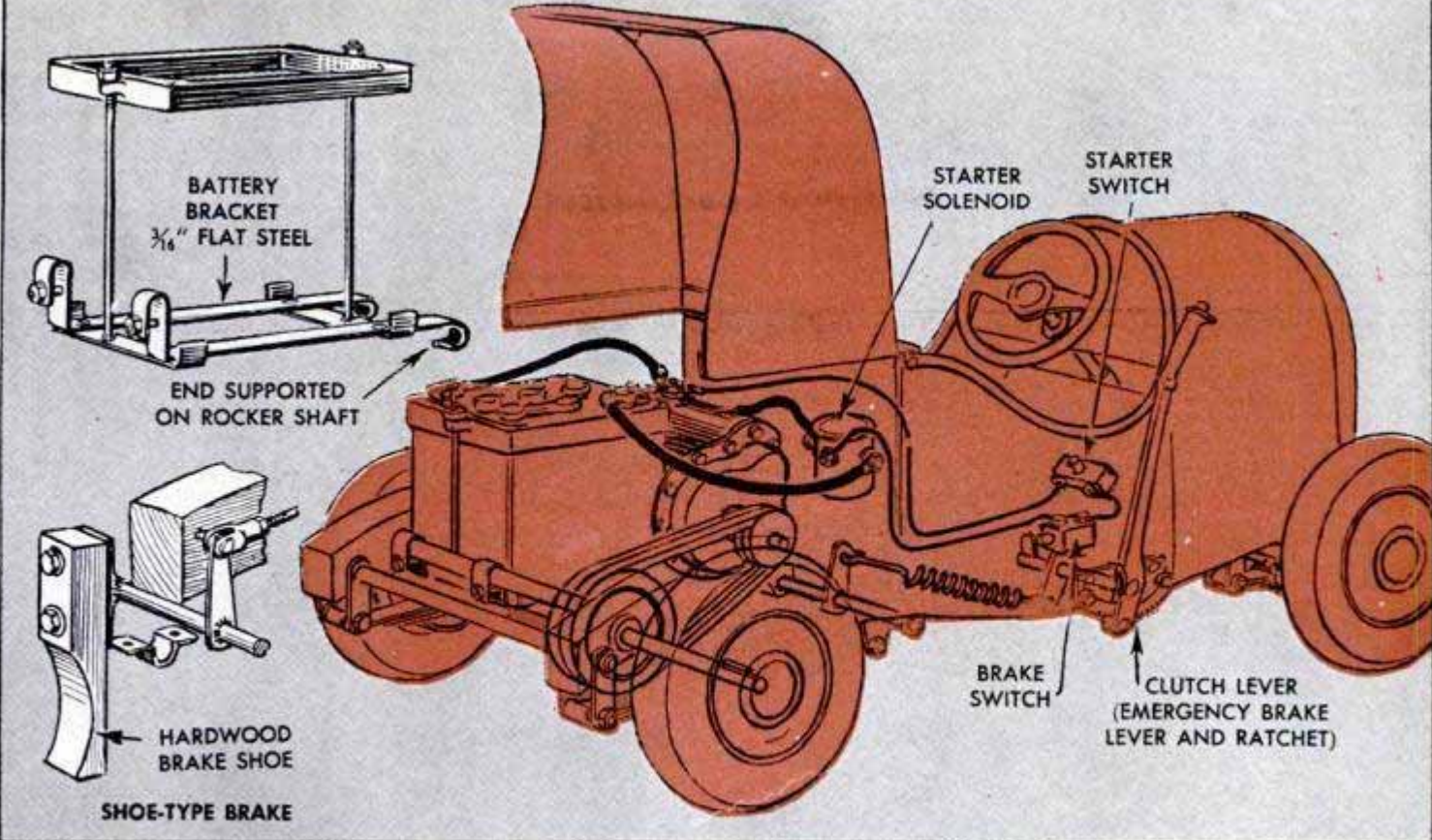

mounting of the front and rear axles on the springs. The front axle is fitted with drilled pads to which the underslung springs are bolted, but at the rear it will be noted that the axle bearings serve as spring pads. Shims of $\frac{1}{8}$ -in. flat steel are placed between the spring and the bearings, one shim being longer and having a drilled lug welded near the forward end to provide a bearing for the brake shaft when the band-type brake is used. When the shoe-type brake, shown in the detail above, is used, the brake-shaft bearing is attached to the car frame.

The front axle is of the conventional auto-type construction, the principal parts being made from pipe and flat steel, bent, welded and bolted together as in the blueprint. The drag link and tie rod can be taken from Ford Model-A steering linkage. Crosley or

American Austin parts may be substituted. Rods with ball joints also can be improvised. A Crosley or Austin steering gear can be used, the gear being mounted on a bracket under the hood. The steering shaft is approximately 22 in. long and $\frac{1}{2}$ in. in diameter and is mounted on a generator bearing at the top end. The lower end of the shaft is fitted into an adapter sleeve, the size and length of the sleeve depending on the type of steering gear used. The steering wheel is 8 in. in diameter, the original being taken from a discarded toy.

Although details on the blueprint show the starter motor welded to a rocker shaft, which passes through a hole drilled in the flange of the reduction-gear housing to which it is welded, for best results weld a bracket to the gear housing and then weld



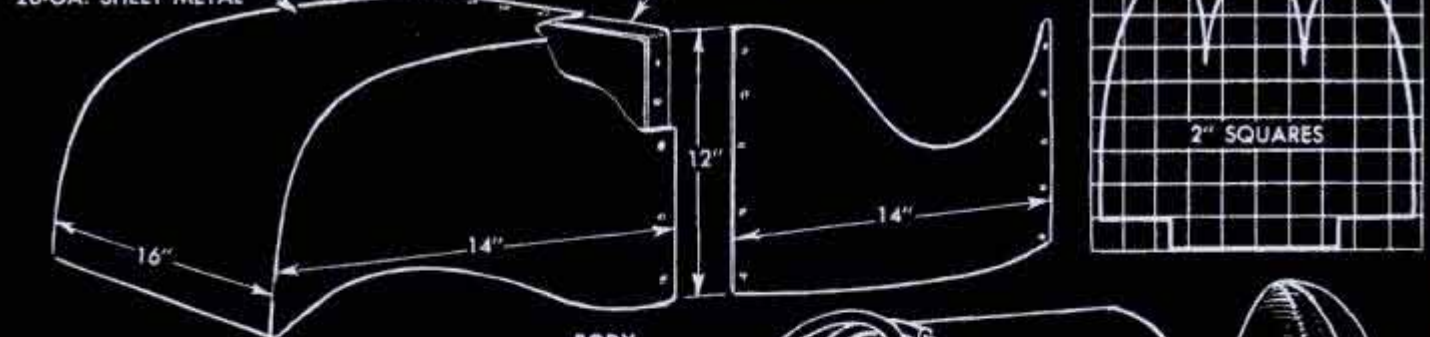

BODY

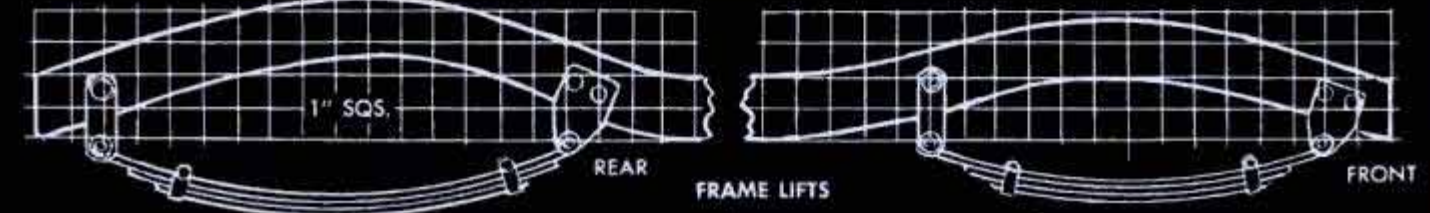
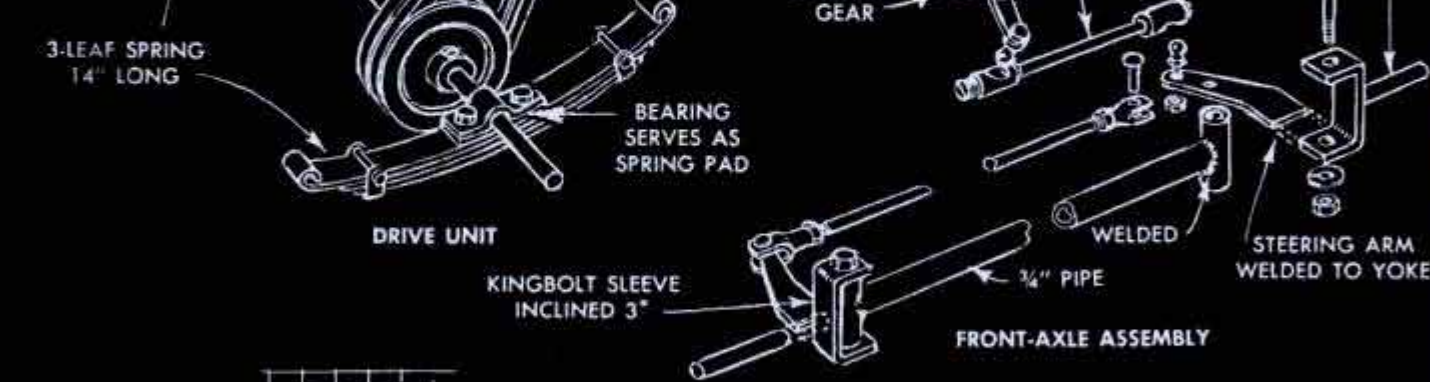
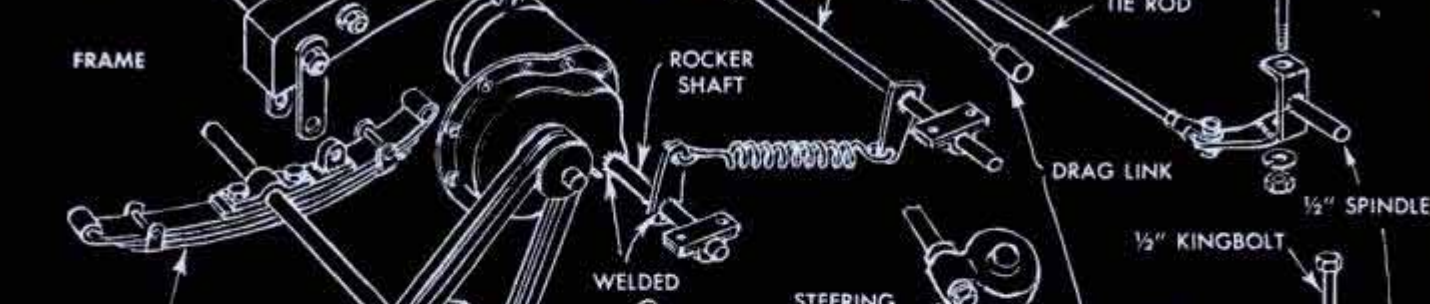
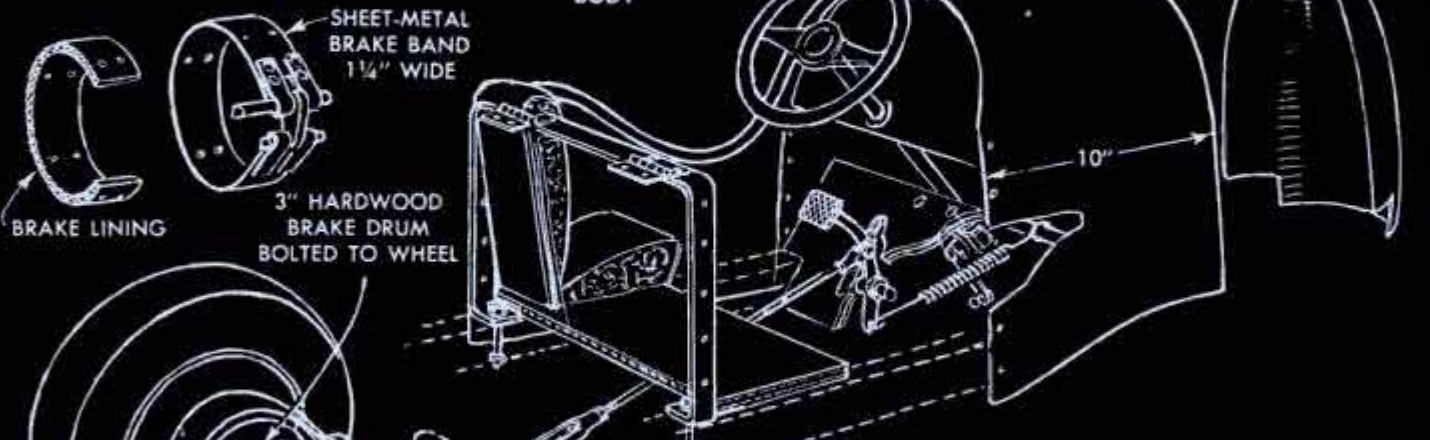

the free end of the bracket to the rocker shaft. This construction will give a somewhat better clutch action when tightening and slackening the double V-belts with the clutch lever. The rocker shaft turns in bearings bolted to the side frames. The clutch shaft, with its tension spring, is mounted in the same manner. Use a 2-in. V-pulley on the reduction gear and a 5-in. pulley on the rear axle. Although double V-pulleys are shown, single-groove pulleys will serve the purpose quite satisfactorily. Only the right-rear ground wheel is fixed on the axle and serves as a driver. The left rear wheel turns free. This arrangement gives the necessary differential when turning.

Details on pages 174 and 175 give the wiring diagram, construction of the battery bracket and the position of the controls. Note the arrangement of the brake switch and how it works in the motor circuit. When it is desired to stop, the clutch lever is pushed forward and the brake pedal depressed. A small lug welded to the inner end of the clutch-lever shaft opens the brake switch and stops the starter motor. The motor cannot be started until the clutch lever is pulled part way back. This arrangement prevents undue idling of the starter motor. With the pulley sizes given and with the gear ratios of the average reduction-gear starter motor, the car travels at a speed of approximately five miles per hour. A 6-volt, 130-amp. battery will give about eight hours of service on one charge.

Construction of the sheet-metal body is quite simple. It is made in three sections which consist of the hinged rear deck, the driver's compartment and the hood, which includes the separate false grille. The pattern for the grille is first laid out on 2-in. squares and then cut to the form shown, before bending and soldering. Sides of the cockpit and the hood are attached to the side frames with screws uniformly spaced. The seat bottom, floor boards and dash are cut from 1/2-in. plywood. The seat can be upholstered if desired. Bumpers, dummy lights and other fittings are optional with the builder.

Muffin Tin Provides Multiple Target For Tiddlywinks Game



The old and entertaining game of tiddlywinks will be increased in fun value if a muffin tin is employed as a target for the disks instead of the usual single cup. The individual cups of the tin may be given different value numbers, or each player must hit a certain cup to score.

Screw Taped to Screwdriver Is Started Easily

Next time you have a screw which must be driven in a restricted place where you cannot hold it with one hand while starting it with the other, tape the screwdriver blade in the screw slot as shown. This will hold the screw

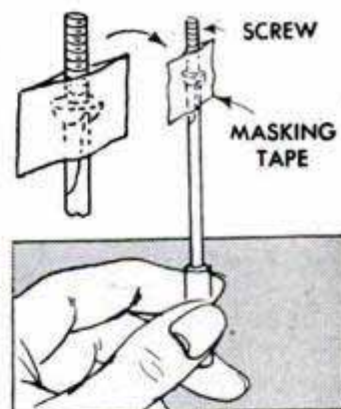

over the edge of tool blade. After the screw has been driven, a sudden pull on the screwdriver will release it from the tape.

Sid Corlin, Chicago.

Legibility of Labels May Be Preserved When Liquids Are Poured From Bottles



When pouring liquid from a bottle where it is desirable to retain legibility of the label, turn the latter upward before starting to pour. In this way, any liquid that may run down the side of the bottle will not touch the label. Another way of preserving labels is to cover them with cellulose tape or, on larger bottles, tape a piece of acetate or wax paper over the label. If any liquid does get onto the tape or paper it can be wiped off before it stains.

Harry J. Miller, Philadelphia, Pa.

tin Cans Hold Insulating Material Around Water Pipes

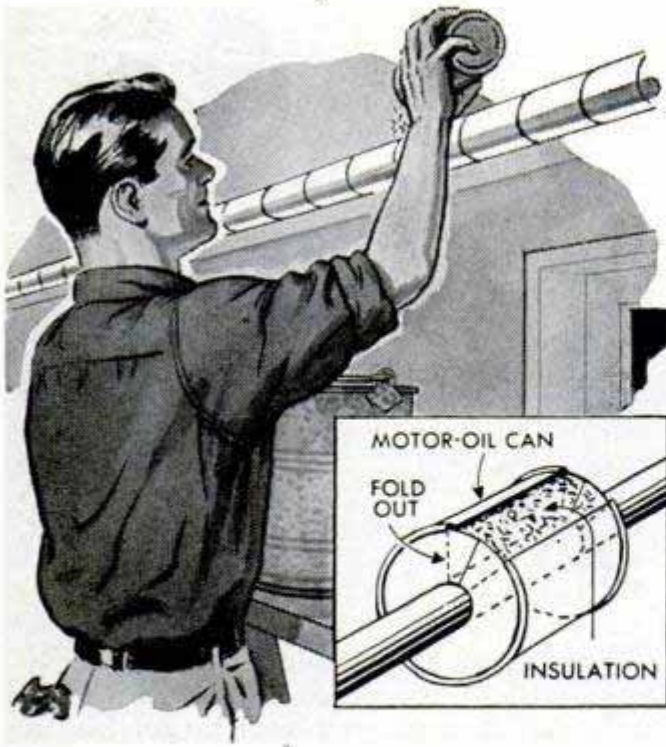

The cost of insulating water pipes in a basement was reduced considerably by one homeowner who did the job himself with a granulated-type insulating material held around the pipes in motor-oil cans. A slot was cut lengthwise in the side of each can and a hole the size of the pipe was cut in each end. The ends were slit, and flaps turned out to permit placing each can over the pipe, after which the flaps were folded back in place and insulation poured into the cans through the slots.

R. W. Natchtrieb, Orland Park, Ill.

Drying Outboard Motor

Should you have to retrieve an outboard motor from fresh water after it has worked loose from the boat, be sure that it is thoroughly dry before using. To dry the motor, first empty the fuel tank. Then, remove spark plugs, carburetor and fuel line, cleaning and drying them. After placing the motor in an upside-down position so any water will drain out, turn the flywheel

slowly with the starter rope. Leave the motor in the sun so that any drops of water on the inside will evaporate. Then reassemble the motor, refill the fuel tank and let the motor run for awhile out of the water, clamping it securely to a large block, drum or barrel.

R. A. Jenkins, Los Angeles, Calif.

Skater's Portable Bonfire Is Towed Across Ice

Danger of a fire spreading when built on the bank of a river, or lake, often induces many skaters to locate their bonfire on the ice away from shore. As this usually results in the ice melting to form puddles around the fire, one sportsman uses a portable bonfire. This was made from an old washtub in the bottom of which was poured a 2 or 3-in. layer of sand to serve as an insulator. Air holes were then punched in the sides of the tub a few inches above the top of the sand layer. A length of rope tied to a handle of the tub permits towing the burning bonfire to any location.



Build a "Wooden Lung" for Your Community

So many requests have come to us for plans for the wooden respirator described in the January 1952 issue, and since adopted as a national project by the U. S. Junior Chamber of Commerce, that *PM's* Craft Editors have prepared large, fully detailed plans for free distribution. These emergency "lungs" are being built throughout the country by "Jay-cee" groups with the cooperation of the National Retail Lumber Dealers Association. If

polio or other lung-crippling disease strikes your community, a respirator will be needed—and minutes will save a life. Organize a civic-minded group in your town, send for our respirator plans—they are free—build the "lung" and put it at the service of your local hospital and doctors. To order the plans for this emergency respirator, just drop a postal card to Popular Mechanics Book Dept., 200 E. Ontario St., Chicago 11, Ill.

Tinkling CENTERPIECE

THREE cherubs revolving near the top of this unique table centerpiece carry strikers which tinkle against a pair of bells. The heat from burning candles drives a sheet-metal impeller at the top of the unit and, in turn, propels the cherubs which are soldered on the ends of three spokes. Although copper is preferred, ordinary tin cans will do for the sheet-metal parts. Heavy wire is used for the base, standard and bell support, the latter being held to the standard with a kite-shaped clamp. The width of the support is determined by the diameter of the bells. The impeller and spokes are soldered to a discarded fountain-pen top which is placed over the end of the standard. The strikers consist of cotter pins or short lengths of heavy wire and are wired to the cherubs through holes drilled in the lower feet. Some adjustment will be necessary so that the strikers just touch the inner surface of the bells and move across them without stopping the motion of the cherubs.

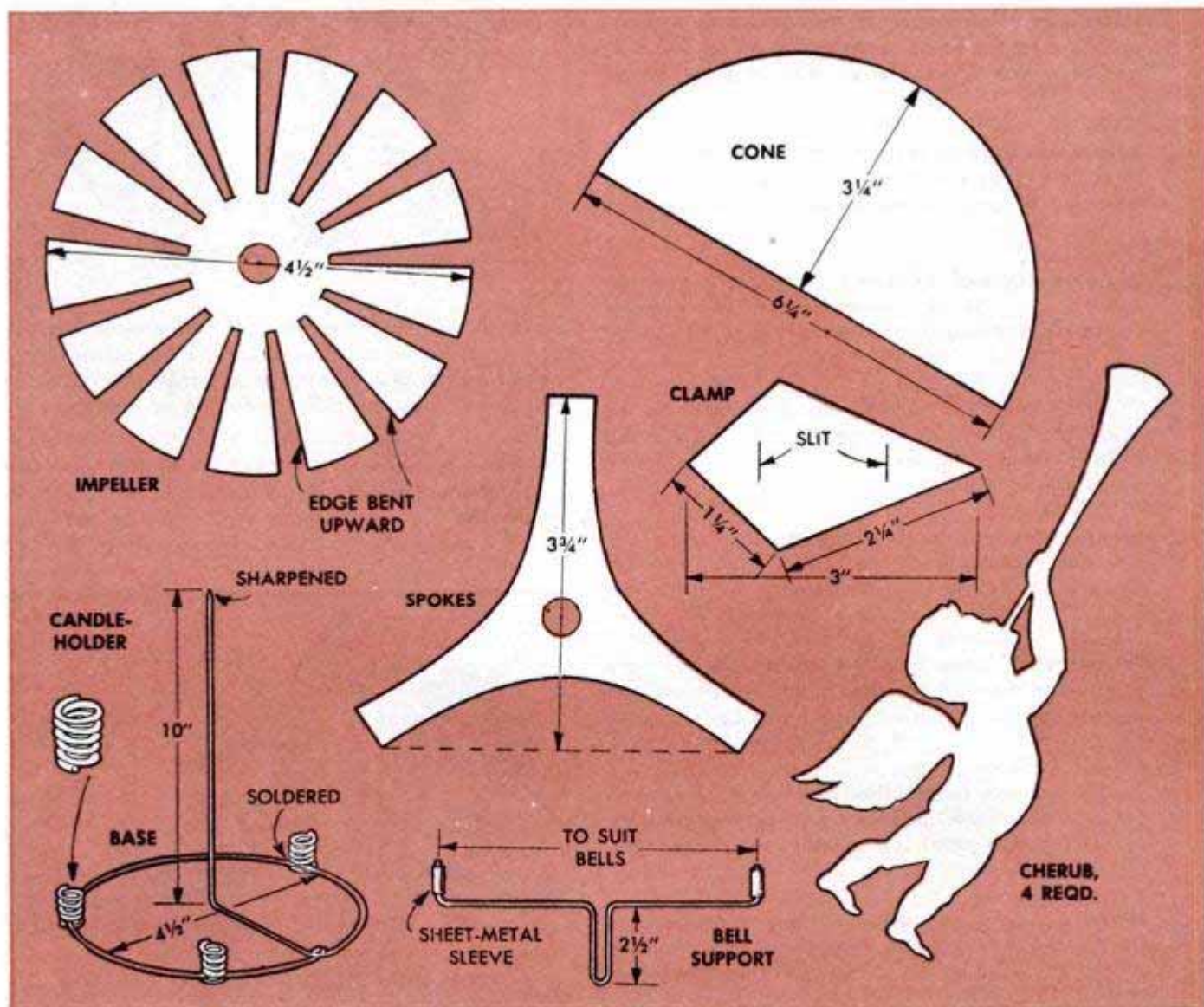
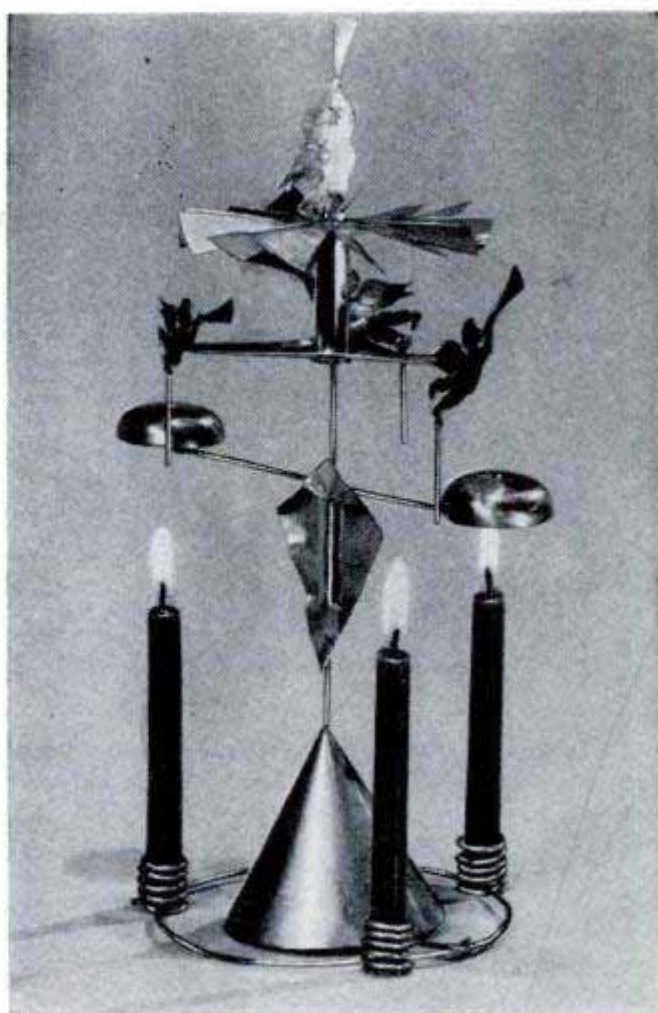

Solving HOME PROBLEMS

- Fastened to the face of a hammer with ordinary adhesive tape, a small magnet will hold tacks and brads for starting in hard-to-reach places
- Plastic squares cut from torn or worn-out tablecloths provide airtight, moistureproof wrappings for storing meats, vegetables and bakery goods
- Use envelopes of the type having a transparent window to store rickrack, bias tape and edging. You can see the color without opening envelope
- When something is spilled on the table, slip a blotter under the tablecloth and place another on top of it to absorb moisture and minimize damage
- Frayed and worn furniture welting is given a new appearance by completely covering with cotton yarn. Use a curved needle to bind the welting
- To keep a mirror from becoming cloudy, do not hang in direct sunlight. Scratches can be prevented by coating back of mirror with clear shellac
- Before boiling a cracked egg, rub common table salt into the cracked portion. Salt will keep the egg white from seeping through the crack
- Instead of using turpentine to remove paint from a child's tender skin, apply baby oil to the area and then wash off the paint with soap and water
- Before unwrapping a package of raisins, warm it in a slow oven for a few minutes. This prevents particles of paper from adhering to the raisins
- Paste swatches of fabric in a matchbook cover before carrying them in your handbag. This protects the fabric and makes it easier to find when needed
- To melt paraffin safely, use the teakettle as a double boiler. Steam the paraffin by placing it in a deep pan set in the top of the kettle
- When painting chair legs, place a jar cover upside down under each leg. This allows room for the brush, and cover catches any paint drippings
- To anchor a loose furniture caster, fill the hole with wood putty or sawdust mixed with glue, and replace the caster. Dried putty holds caster tightly
- Coffee grounds form suitable sweeping compound for basement floor. Instead of discarding grounds, store in gallon paint can or other large container
- When a washing-machine wringer slips because its surface has become glazed, restore "pulling power" by rubbing the rollers with fine sandpaper



Sawdust will take the skid out of icy walks as thoroughly as sand or ashes, and has the advantage of not being harmful to carpets or hardwood floors. Also, the sawdust is easily swept up or washed away

Use fine steel wool, powdered whiting or pumice to clean the underside of an electric iron. These will polish the surface without scratching or scoring it. Don't use harsh abrasives for cleaning the iron



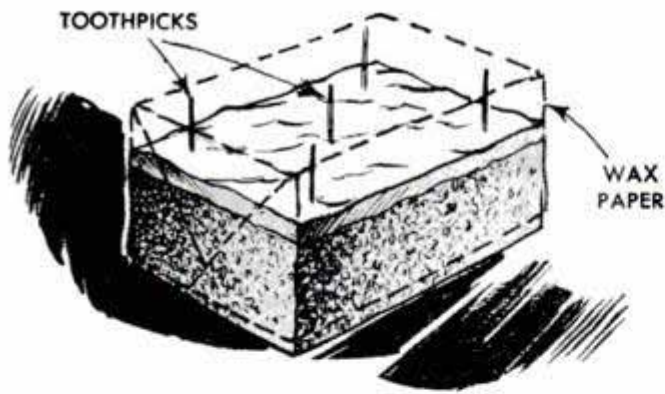

Soft frosting or meringue on cake that is wrapped for carrying in lunches will not stick to the wax paper if toothpicks are used to hold the paper away from the icing. Toothpicks are pressed into icing as shown



Save time spent rummaging through your sewing basket in search of a thimble by pressing the thimbles over small corks glued to the basket lid. The tapered sides of the corks will hold the thimbles in place

Attached to the handle of a shopping bag, a key ring will hold a shopping list for easy reference. Leave the ring on the handle, and when you go shopping, just insert the list between sections of the ring



Indoor clothesline is strung quickly if each end is fitted with screen-door hook. Drive screw eyes into opposite walls and hook line between them

When stitching heavy material on sewing machine, rub soap along the seam before running it through the machine. This saves needles and speeds sewing

To keep brass water faucets bright and shiny, coat them with furniture polish. Before applying polish, clean and dry the faucets thoroughly

Candleholders and tablecloths will not be splattered with wax if drippings are caught by aluminum foil placed in holders before inserting candles

Inexpensive glassware will sparkle like crystal if it is coated with a thin baking-soda-and-water paste, rinsed with cool water, dried and polished

Seams in linoleum floors are sealed by covering them with strips of cellulose tape. Taped surface will withstand usage if coated with shellac

Butter will stay cool but retain its spreadable consistency when stored in the refrigerator, if it is first placed in an insulated ice-cream bag

Save nail-polish brushes and give them to the children for use with their paint sets. Better quality than the average "toy" water-color brush

If carrying keys and change quickly wears out the trouser pockets of your husband's work clothes, line lower portions of the pockets with chamois

Don't try to scrape off paper which has become stuck to a polished table top. To be safe, moisten the paper with olive oil and then rub it off

Stains can be removed from tall, slender vase by filling vase with vinegar, adding tea leaves and, after awhile, shaking the vase vigorously

When necessary to remove stains from clothing or thoroughly scrub small soiled areas, use a coarse-toothed hair comb as miniature washboard

Trying to rub or wash soot from felt or fabric hat only spreads the stain. To clean the spot, cover soot with salt and remove with stiff brush

Pins and needles are stored conveniently in a sewing box by pressing them into block of sponge rubber. Cement the rubber in one corner of box

A worn refrigerator-door gasket that no longer affords a tight seal can be repaired temporarily by covering it with long strips of adhesive tape

Portable Rack Supports Guns Safely When Shooting on Open Range

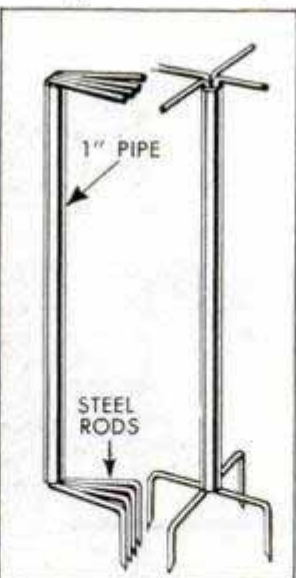

Instead of using a tree or the fender of a car to support guns used in open-range target shooting, one sportsman carries this portable holder, which may be placed in any location desired merely by sticking it into the ground. It consists of a length of steel pipe in which four lengths of steel rod are inserted and bent as indicated. Ends of the rods are sharpened to ease pressing them into the ground.

Sheet Metal Clamped in Vise Cut Out Neatly With Hammer and Cold Chisel

The next time you want to cut a hole in a piece of sheet metal and do not have the regular tools for the job, try using a cold chisel. First, outline the shape of the hole on the metal and then clamp it in a vise with the outline mark flush with the jaws as pictured. In this way the vise will hold the metal firmly so that you can cut accurately and smoothly on the outline. It will, of course, be necessary to turn the metal to keep the outline flush with the jaws.

John E. Wills, Brightwaters, N. Y.



Mirror Reflects Headlight Beams To Warn Oncoming Motorists

Carrying an ordinary shaving mirror in the glove compartment of your car may prevent a serious accident if you should be stalled on the highway. If you don't have a flashlight or if its battery has gone dead, the mirror can be used as a reflector to warn approaching cars.

Bess Ritter, New York City.

Trim Boards Removed Undamaged by Sawing Off Nails



When it is necessary to remove door or window casings, jambs and other trim boards, the job can be done without pulling the nails through the boards or otherwise splitting them if a hacksaw is used to cut the nails before prying off the boards. This can be done with a saw of the type shown. First, use a chisel or heavy screwdriver to lift the board sufficiently to permit entrance of the saw blade behind it. Any projecting nails that have been cut off and cannot be pulled out, can then be driven in and countersunk easily. This will provide a smooth surface for reassembling the casing.

Michael Ligocki, Gary, Ind.

A safe and entertaining toy cannon that shoots short lengths of dowel is made from a discarded bulb syringe and two pieces of 1-in. wood. The barrel is drilled to take the dowels loosely, and the stem of the syringe is cemented to the breach end of the barrel to make an airtight fit. Then the barrel unit is nailed onto a base as detailed. In use, the cannon is loaded through the muzzle, and the projectile is fired by air pressure from a quick blow on the syringe. If the inside of the barrel is waxed, the range of the cannon will be increased considerably. A length of dowel having a smaller diameter than the shells will provide a ramrod for the barrel.

Bulb Syringe Fires Dowel Ammunition From Unique Toy-Cannon Barrel

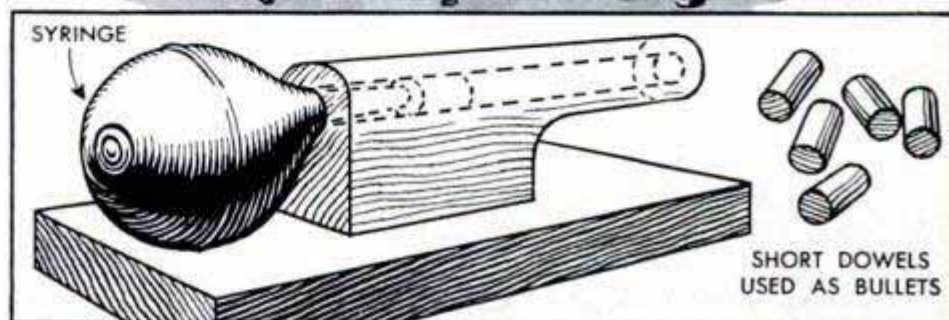
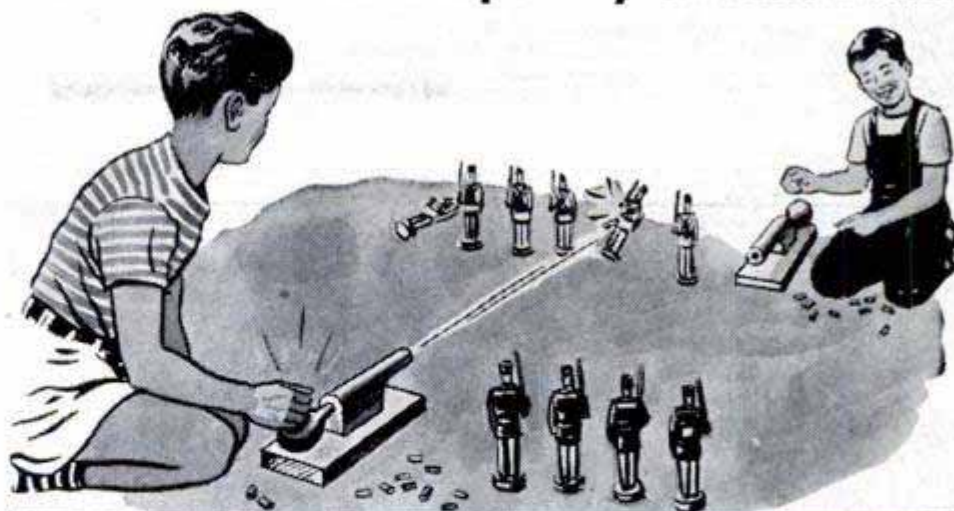

Thin Chrome Plating on New Cars Requires Special Care

Because of government restrictions on the use of nickel by car manufacturers, most of the chrome parts, except bumpers and buffer plates, are now being given only a light film of chrome. This film, in many cases, is protected with a coat of transparent enamel. It is important that you do not wax or polish these parts for the first three months after buying your new car. Instead, wash them frequently

with clean, cold water. After 90 days, a coat of wax may be applied periodically to maintain luster. Should the enamel coating become chipped or scratched, it can be repaired with a colorless enamel recommended by the car dealer. Do not use a colored-type chrome protector, as this may stain or discolor the original enamel. On bumpers and buffer plates, the chrome can be kept bright with liquid wax.

Plastic or Hardboard Reel Eliminates Danger of Tripping Over Lamp Cord

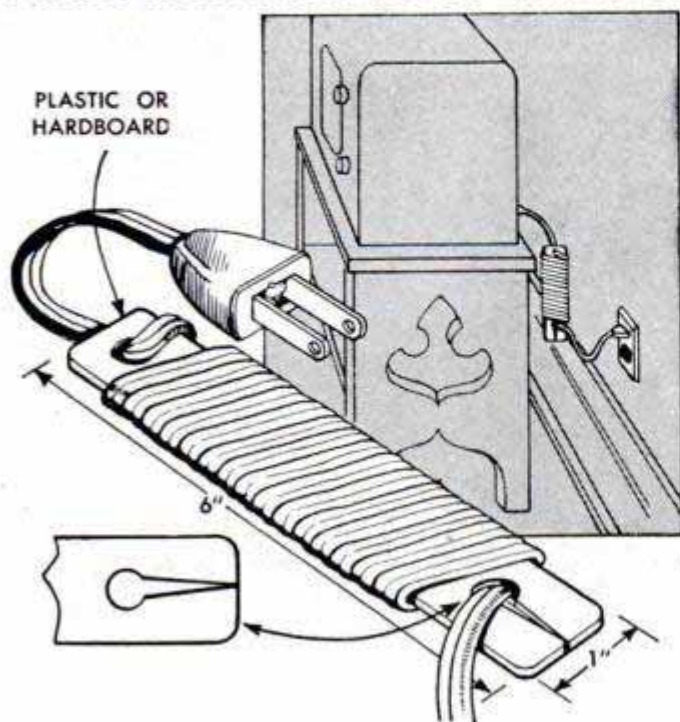

If a lamp or appliance cord is too long, it not only offers a hazard in the home by having someone trip over it, but it also may be dangerous to small children, especially those at the creeping age. Slack in the cord may be taken up by using a reel like the one pictured. It is made from a piece of plastic, which is drilled near each end to take the cord, a tapered slot being cut from one hole to the end of the reel. In use, remove the plug from the cord and thread it through the unslotted hole, allowing the cord to extend a few inches at this end. Then, replace the plug and wind the cord on the reel to take up the desired amount of slack. After this has been done, slip the cord through the slotted end into the hole. This will keep it wound snugly on the reel and permit suspending from the appliance or placing on the floor.

Arthur Trauffer, McClelland, Iowa.

...Dining Chairs Furniture



To offer the home craftsman a wide selection of the very best in build-it-yourself furniture, Popular Mechanics introduces, in this issue, its plan of the month. If you are not ready to start building this particular project, cut out the plan pages, tape them together and save the plan for future reference. Although these modern dining chairs match a table to be described in the plan next month, their styling lends itself to use with the popular drop-leaf tables. So, if you've been wondering what to do about extra chairs, make these of the same wood as your table and upholster them in suitable fabric

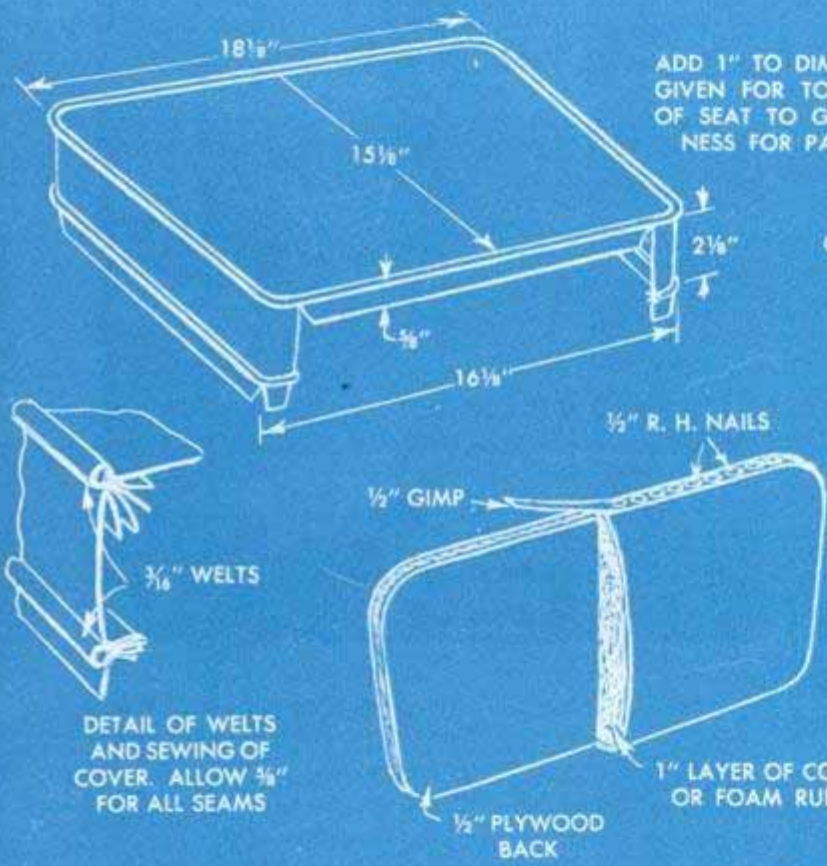

ADD 1" TO DIMENSIONS GIVEN FOR TOP COVER OF SEAT TO GIVE FULLNESS FOR PADDING

1" LAYER OF COTTON OR FOAM RUBBER

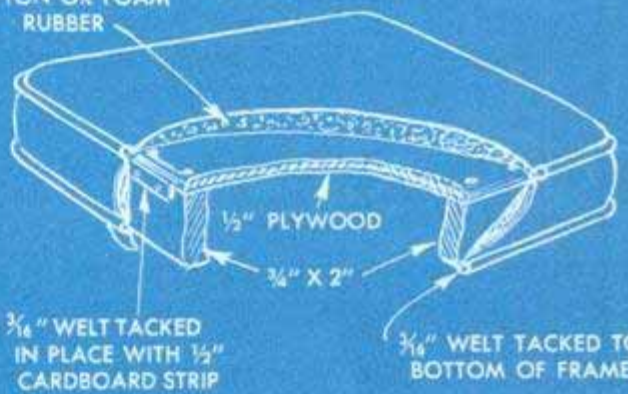

DETAIL OF WELTS AND SEWING OF COVER. ALLOW 3/8" FOR ALL SEAMS

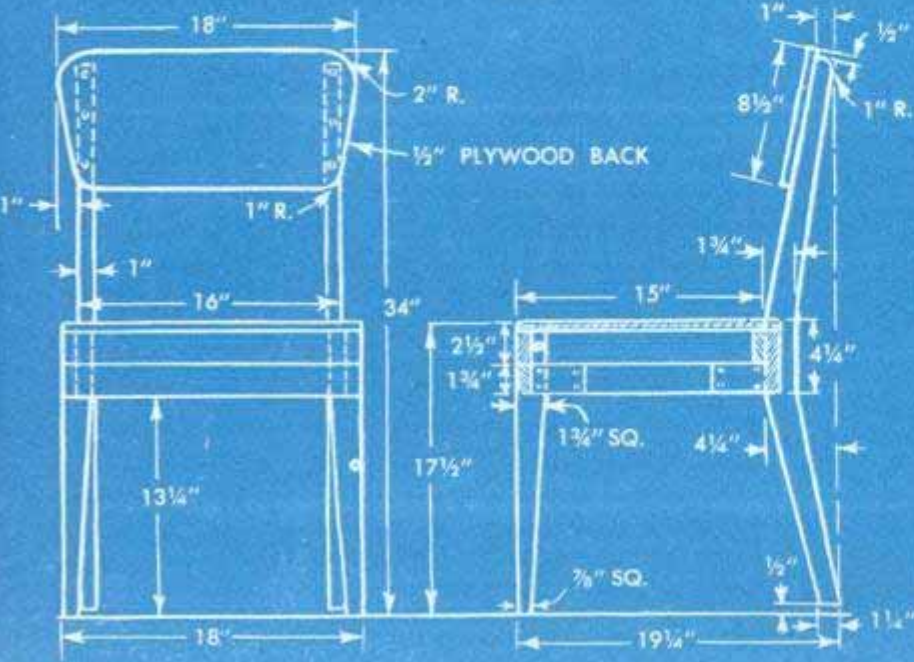

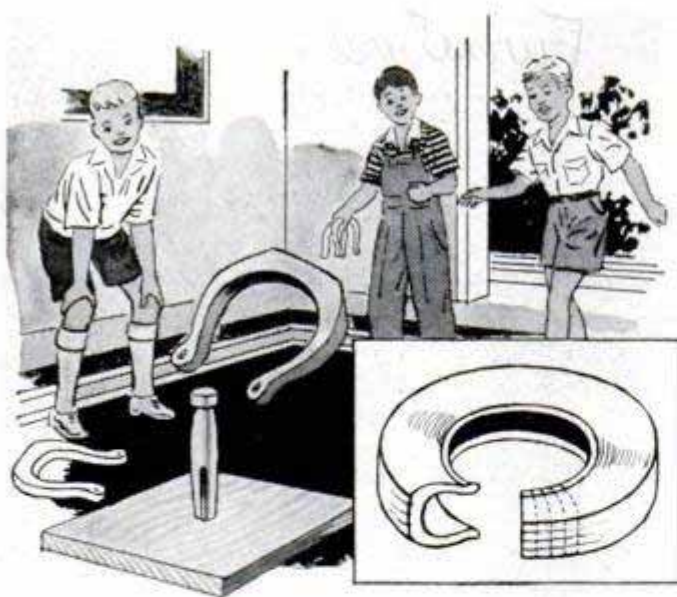

Tire Provides Rubber "Horseshoes" When Game is Played Indoors

Especially suitable for indoor play, this game of horseshoes is ideal entertainment for children on rainy days. As the "shoes" are rubber, being cut from an old car tire as indicated, they cannot scratch the floor and also help to keep the game a quiet one. The stakes are provided by driving two clothespins or wooden pegs into blocks of $\frac{3}{4}$ -in. wood 10 or 12 in. square.

Pulley Hung for Easy Removal Locked With Wooden Block

When a pulley is hung on an open hook, such as those used in conjunction with hay carriers or those on some clotheslines, it can be locked in place by means of a small wooden block. This is simply pivoted above the hook to swing down and close the gap between the point of the hook and the post.

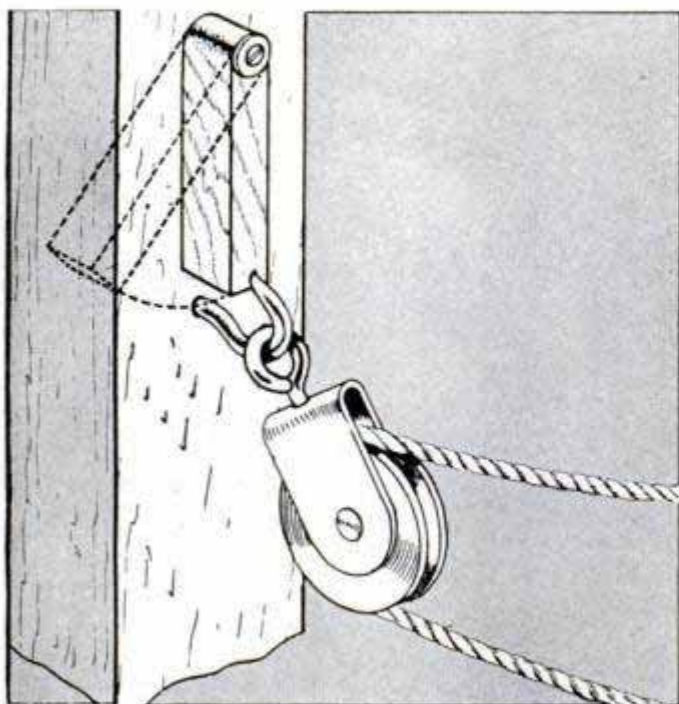

Tape Kept From Sticking to Coins

Before taping coins to a piece of cardboard for mailing, place a strip of paper over them. This will permit easy removal of the coins, as the paper will keep them from sticking to the tape.



Regluing Furniture Joints

If the glued joints on a chair or other piece of furniture loosen, it is possible to reglue them without taking the piece apart. First, drill a small hole at right angles to the tenon of the joint, drilling to a depth that will just reach the tenon. Then, fill the hole about halfway with glue, insert a

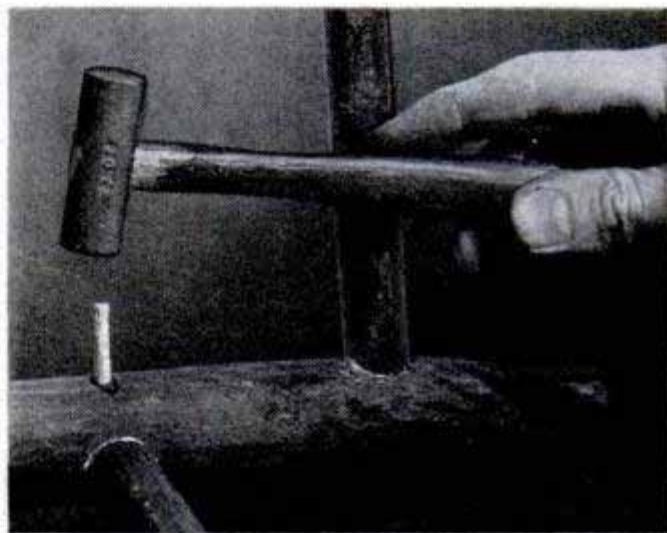

snug-fitting dowel or other plug, and tap it with a hammer. This will act as a plunger and force the glue throughout the joint. Before doing this, it is necessary that the joint be pulled up tightly with clamps.

Walter E. Burton, Akron, Ohio.

Safety Reflectors on Car Doors

Strips of light-reflecting cellulose tape stuck to the edge of the left-hand car door will warn approaching motorists when the door is opened on a dark, heavily traveled street. If desired, a similar effect can be obtained by painting the outer edge of the car door with luminous paint.

W. M. Dierks, Chicago.

☞ Shoes can be waterproofed with a mixture consisting of mutton fat, 1 part, and beeswax, 2 parts. Apply this mixture in the evening and again in the morning. Then wipe the shoes with a piece of flannel cloth before wearing them.

Kiddie COMBINATION - PADLOCK -

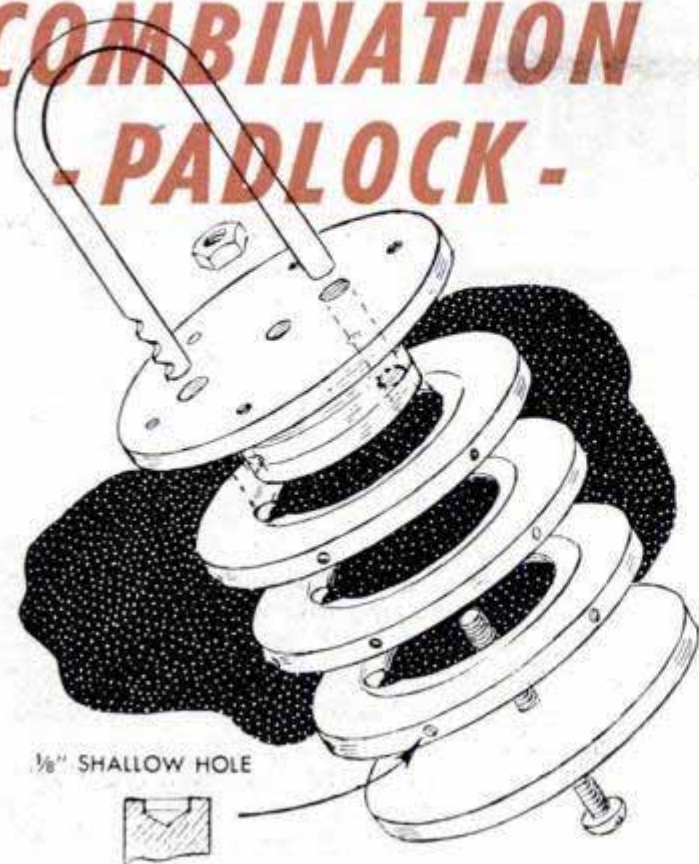

By Marvin Reid Hartley

AN UNUSUAL TOY of lasting interest, this colorful padlock is opened by aligning a specific combination of four colored dots on the sides and top of the lock. The body, which can be made of plastic or hardwood, consists of five disks joined together with a stove bolt. The three center disks are cut out to form rings. These rotate around a core made by cementing the waste cut from the centers of the rings to the underside of the top disk. The latter is drilled to take a yoke of $\frac{1}{4}$ -in. plastic rod, one arm of the yoke being notched to engage the chamfered edges of the three rings. As shown in the detail at the right, the hole for the notched arm is drilled on a $\frac{5}{8}$ -in. radius from the center hole and the hole for the unnotched arm is on a $\frac{7}{16}$ -in. radius. In this way, the yoke is installed off center so the unnotched arm clears the rings. The yoke is released only when notches cut in the rings are aligned with the notched arm. Note in the detail above that six shallow holes are drilled an equal distance apart in the outside edges of each ring as well as in the top of the upper disk. Each of the six holes is painted a different color or fitted with a small synthetic jewel cemented in place. The photo at the right shows a circle cutter being used to cut the disks from sheet plastic.

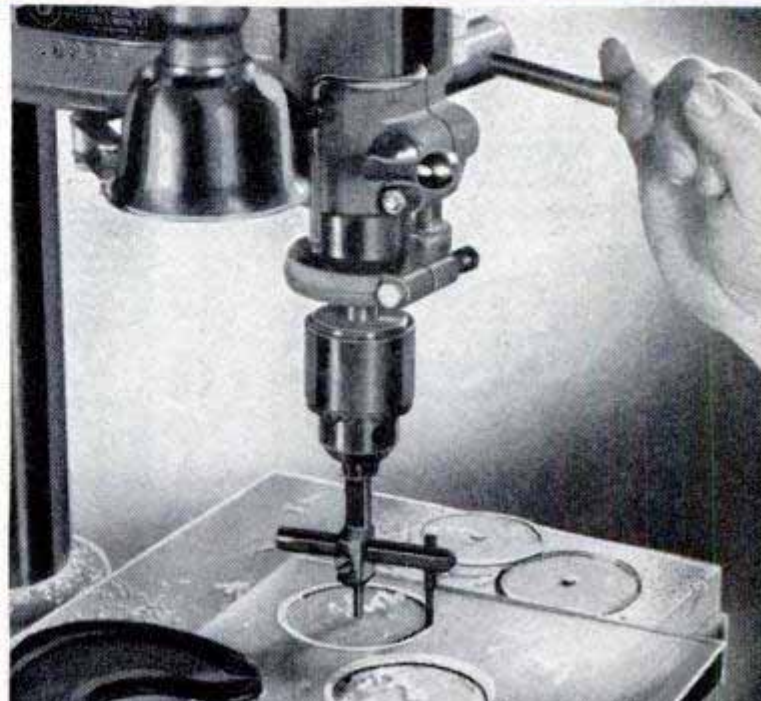
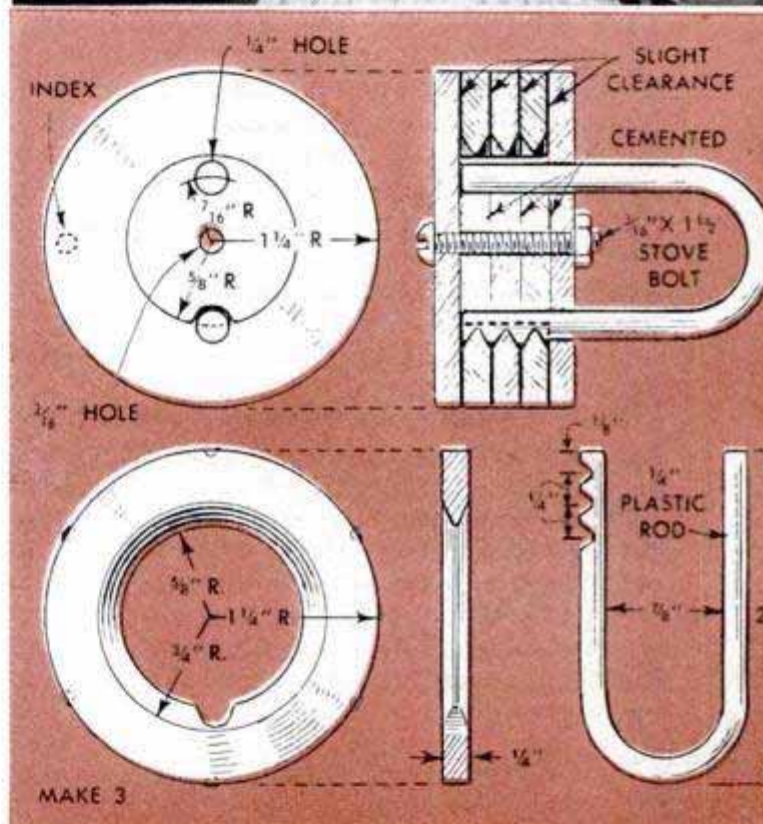

Care and Repair of

MORTISED DOOR LOCKS



By Charles Kimball

BECOMING acquainted with the workings of the door locks in your home is the first step in keeping them troublefree. Although commonly called locks, those faithful guardians mortised in the doors of your home actually consist of two distinct mechanisms—a latch and a lock. The drawings below picture four lever-type tumbler locks in general use, including the popular free-action latch. The various parts of a typical lock are labeled in the lower right-hand detail on the opposite page.

How the latch mechanism works: When the doorknob is turned in either direction, movement is transmitted to the hub via the spindle. The hub, in turn, transmits the movement to the latch bolt by means of two cams which operate through a latch lever or a shoe. This retracts the latch bolt and puts tension on the latch-bolt spring. All the various latch-spring actions illustrated

below are designed to place a strong tension on the hub, so that when the knob is released, it snaps back to an idle position.

How the lock mechanism works: In some locks, the tumbler is on the case side of the lock, while others are made with the tumbler on the cap, or cover, side. The key must raise the tumbler to exactly the right height to allow the tumbler stump on the key bolt to pass between the upper and lower shoulders of the gate in the tumbler. If the tumbler is lifted too high or too low, one shoulder will prevent shooting the bolt, as shown in the detail on page 190.

Where to obtain repair parts: As a rule, hardware stores do not stock extra parts for locks, other than knobs, spindles, trim and key blanks. Thus, in most cases, it is necessary to obtain replacement parts direct from the manufacturer of the particular lock. If the lock has not become obsolete,

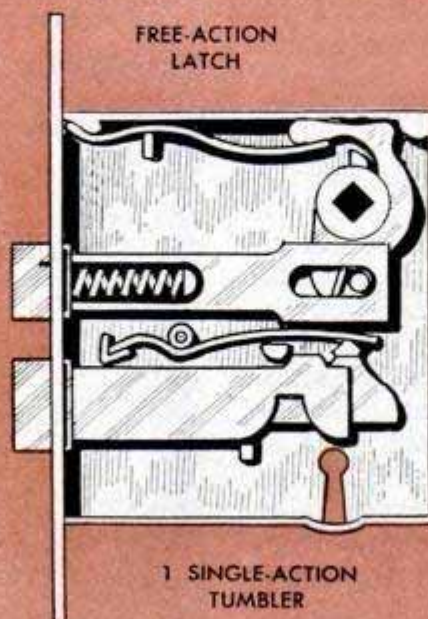
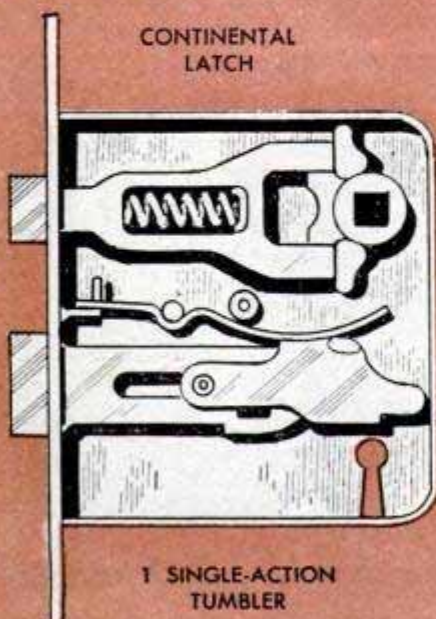

the part needed can be ordered by giving the number of the lock and enclosing a pattern of the broken part. When buying a replacement lock, it is always best to take along the old lock for comparison as to size, thickness, backset and spacing.

Loose front plate: Vibration resulting from slamming a door sometimes causes the front plate to work loose from the case. If the lock is of the type in which the front is screwed to the case, simply tighten the screws. If the front is held by lugs, retighten by pressing the lugs down between the jaws of a vise. To tighten a riveted front, simply peen over the rivets.

Sluggish latch-bolt action: Generally, this condition is due to lack of either cleaning or lubrication, or both, or to a weak spring. If the latch bolt won't extend, look for a broken latch-bolt spring. If this isn't the case, try loosening the cap screw. When the screw is turned too tightly, it will sometimes buckle enough to bind the latch bolt.

Broken tumbler spring: If the mechanism is well lubricated, gravity may move the tumbler down even though the tumbler spring is broken. However, the remedy is to cut and form a new spring and slip it in place. If the lock is of the type having a double-action tumbler, the spring may allow the tumbler to work up and stick at a point where the lower shoulder in the gate will prevent passage of the tumbler stump on the key bolt, making it impossible to operate the lock. If this is the case, remove the broken spring from the notch in the tumbler. If the replacement spring is undersize, it can be enlarged slightly to fit the notch by peening it with a hammer. In the event it is oversize, file down the end for a tight fit and press it in place in a vise.



Above, replacing broken lever spring in free-action latch. Long-nose pliers are used to bend new spring

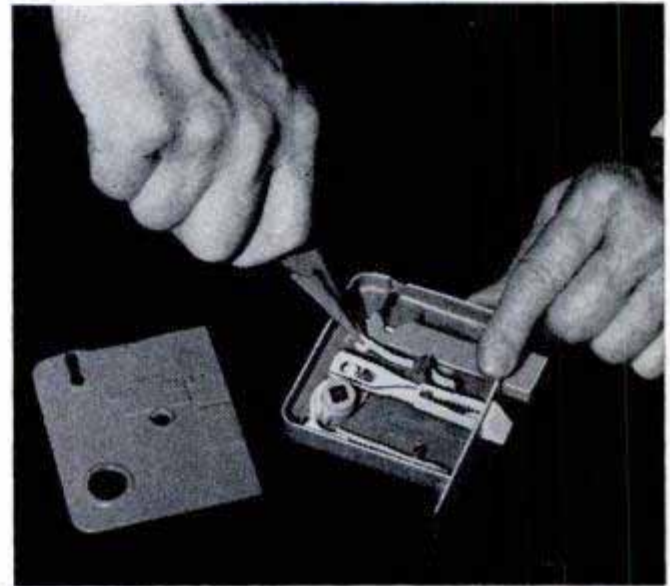

New spring for single-action tumbler is slipped in place, above, after it is cut to length and formed

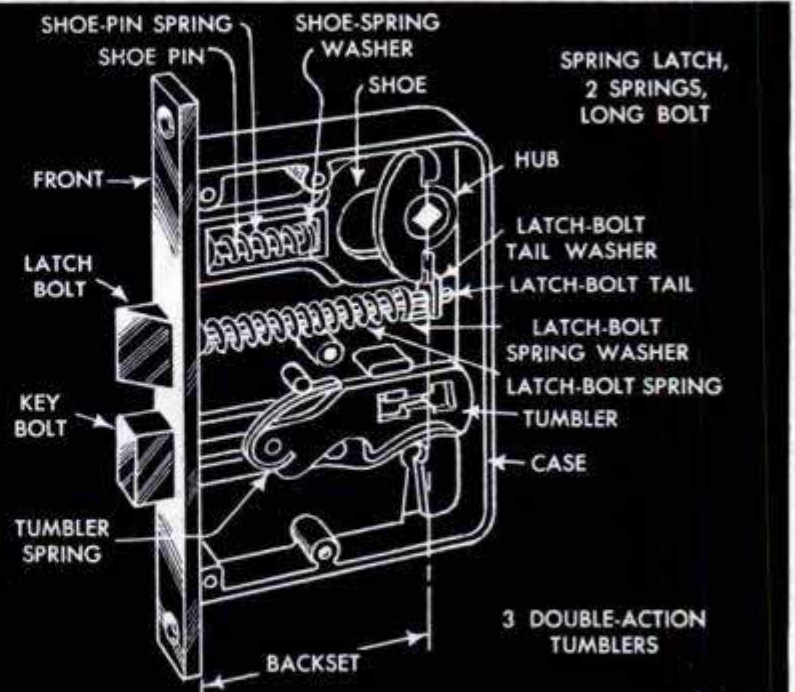
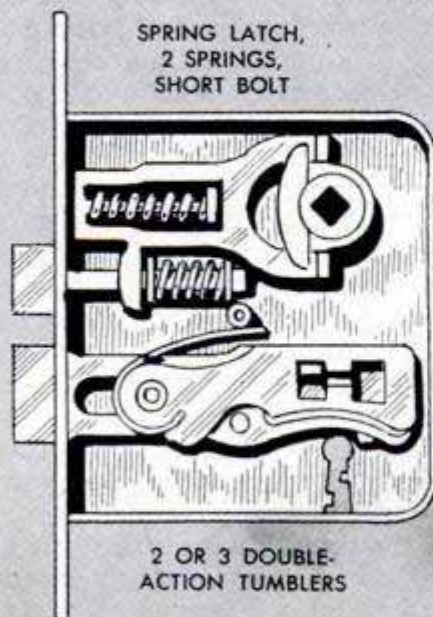

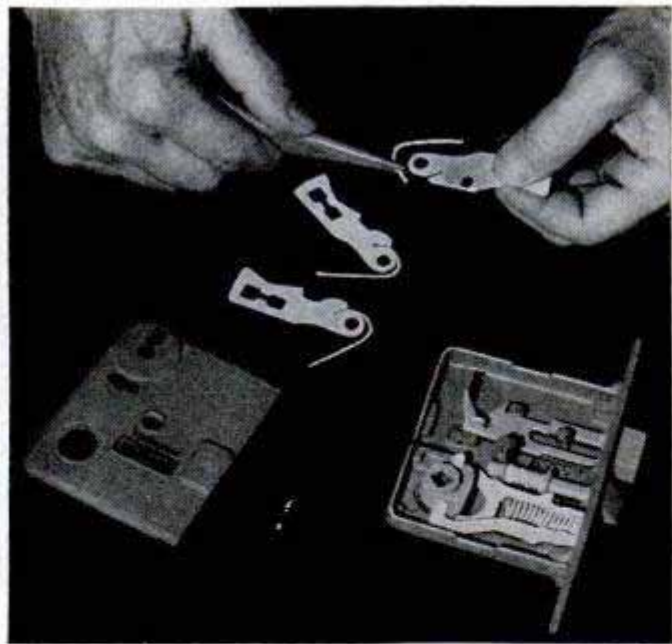

Replacing springs: An important thing in replacing a broken spring is to see that it is of the same tension as the original one. Flat spring stock is available in lengths of 12 in. and longer and is easily cut and bent with pliers. Compression coil-spring stock is sold in lengths of 12 in. and in a variety of diameters. Extension coil springs with eyes formed at both ends are manufactured in assorted sizes and tensions, and some locksmiths have bending machines with which they make coil springs from wire.

Tumblers rusted together: In a seldom-used lock having two or three tumblers, the tumblers sometimes rust together, making it impossible to shoot the bolt. The remedy is to remove the tumblers, clean off the rust with sandpaper and use light machine oil to lubricate the sides of the tumblers which rub together. This is the one instance where oil may be used in mortised locks. Use the same method to restore the usefulness of a lock in which the tumblers have stuck together as a result of gummed oil or prolonged idleness.

Lubrication: Use fine, dry-flake graphite to lubricate a mortised lock. Never use oil or grease, as these catch dust which clogs the mechanism and causes the lock to work sluggishly. Lubricating with graphite can be done without taking the lock from the door. Turn the knob to retract the latch bolt, and blow a few whiffs of graphite into the hole in the front on the beveled side of the latch-bolt head. Release the knob and then inject a little of the graphite into the keyhole. Do not use too much graphite, as a light dose about once a year will afford better results than excessive lubrication at less frequent intervals.

Cleaning: Many lock troubles caused by gummed oil and dust in the mechanism can be cured by cleaning. After removing the lock from the door, soak the lock for several hours in mineral cleaning solvent or mineral paint thinner. Take the lock from the solvent occasionally and work it by inserting a screwdriver or spindle in the hub and moving the latch bolt. Also use the key to lock and unlock the key bolt. After draining the fluid from the lock, dry the mechanism with compressed air or by allowing it to stand overnight in a warm place. Finally, give the mechanism a light dusting with graphite. Cleaning may be accomplished in much less time by disassembling the lock, removing the springs first, and washing the individual parts in solvent and drying them with a cloth. But before lifting out any of the parts be sure to make a diagram of the mechanism, using the cap as a template and drawing as many outlines of the case as there are layers of parts in the particular lock. As you remove each part, trace it on the outline.

Spring in double-action tumbler, above, should fit tightly in notch. Burrs are filed from both sides

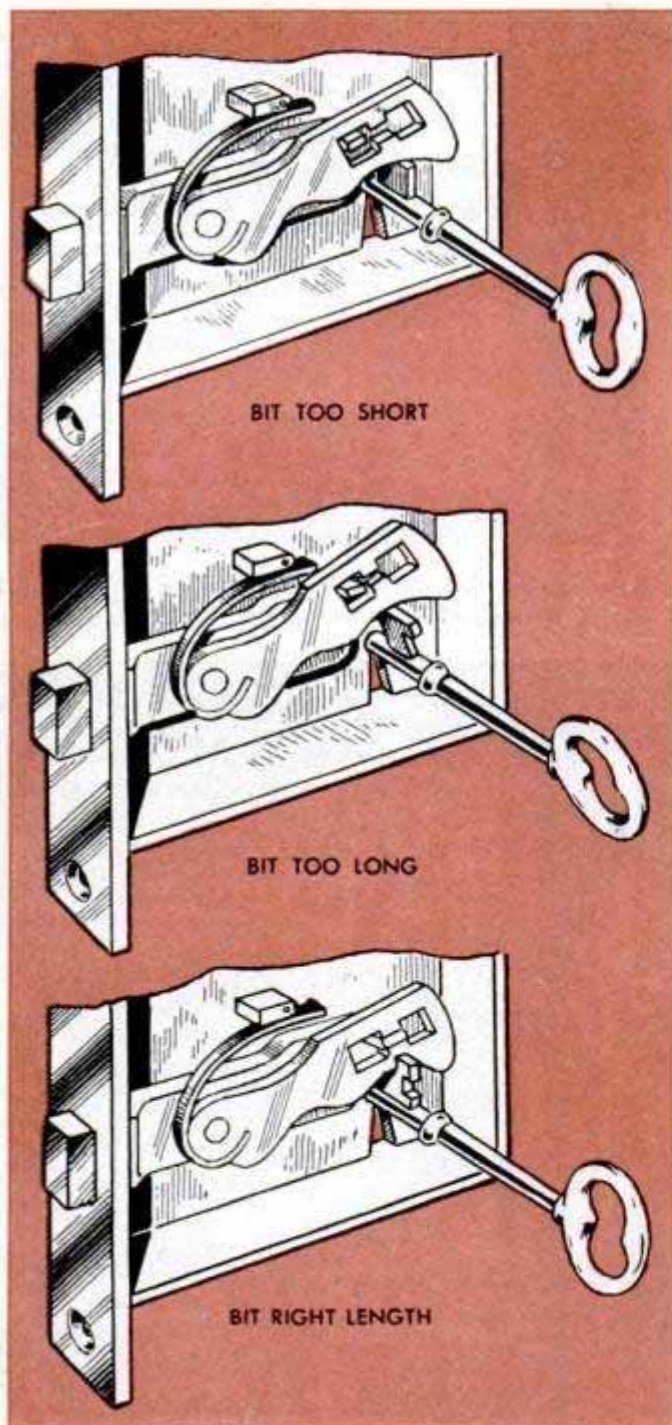

Storing Game Carroms on Cue Stick Keeps Them at Hand



If you have a Carrom game and have been inconvenienced by losing or misplacing some of the Carroms while in storage, try this. Store them on one of the cue sticks by drilling a tiny hole through the stick to take a small rubber band.

Thus, when placing the Carroms on the stick, they can be pushed over the band easily and the rubber will prevent them from falling off. If desired, different colored Carroms can be kept on separate cue sticks.

Paper-Clip Note File



Notes, business cards, special phone numbers and other small papers containing useful information can be kept out of the way but readily at hand by means of an ordinary paper clip. The clip is simply placed part way

over the papers to form a hook for hanging on a nail driven into the wall.

Louis Hochman, Sherman Oaks, Calif.

Towel Rack Holds Boat Oars

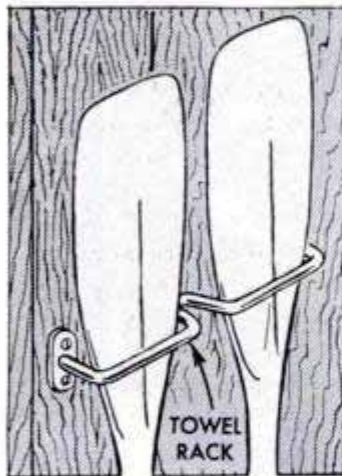

An inexpensive, rod-type towel rack will serve as an ideal holder for a set of boat oars. Just bend it, as shown, and screw it to the wall of the boathouse or garage. If desired, a similar type holder for several sets of oars can be made from a length of rod

slightly larger in diameter. However, before forming it, flatten and drill the ends of the rod, and then bend them to right angles. This will permit screwing the rod directly to the wall.



Handy Tool for Salvaging Lumber Made From Auto-Spring Leaf

Especially designed for salvaging boards when dismantling an old building, this tool is made from a section of auto-spring leaf and a steel rod. One end of the leaf is heated, bent to a right angle and cut off about 6 in. from the bend. A V-notch is cut in the thin end of the leaf and the edges beveled to permit cutting nails. Then, the rod is welded to the spring to serve as a handle.

Tent-Rope "Shrink Absorbers" Prevent Pulling of Stakes

To prevent the shrinkage of tent ropes from pulling the stakes or tearing the canvas, attach the end of each rope to a large rubber band cut from an inner tube. Then, stretch the latter over the stake to tighten the rope. When shrinkage occurs, the band will stretch, yet keep the rope taut.

G. A. Lemmon, Auckland, C. 1, N. Z.

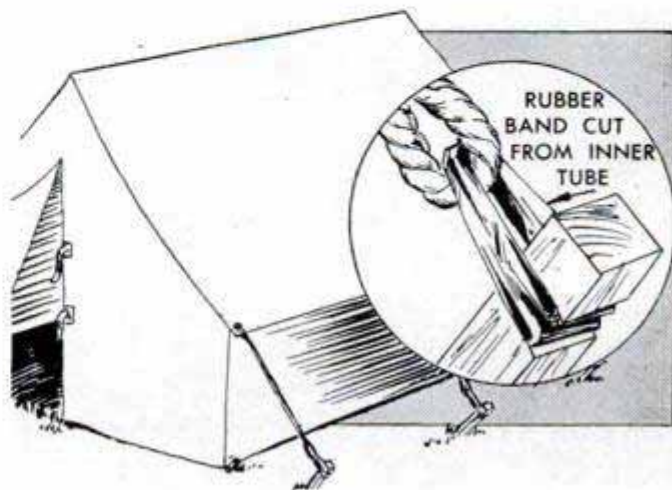

Make a PAPER MENAGERIE

By Allan Carpenter



tracing directly from the magazine page. If you have no objection to cutting the magazine, the page can be pasted to a sheet of cardboard and each pattern cut out with a razor blade to provide accurate master patterns that can be used over and over again. The complete pattern is made by flipping over the half pattern along a center line on your paper. Folding is done on the heavy dotted lines, and the photo below can be followed in shaping each particular animal. Note that the bodies are rounded out to give contour and that the legs are creased to add stiffness. A simple method to use in rounding the bodies is to hold the paper animal between the thumb and a knife or scissors blade and pull the blade across the paper. This will make the paper curl nicely and is especially helpful in producing the right curl for tail feathers of the rooster and wings of the swan.

LIFELIKE paper cutouts are always popular with a youngster, especially when they can be folded to stand by themselves. The six animals included in the representative group shown below will get a child off to a good start on a real circus menagerie and will serve to suggest others. Made of gold, silver or colored paper, the animal cutouts will also make novel party place favors.

Each animal is fashioned in one piece from construction paper. Actual-size half patterns are given on the opposite page for

By cutting each particular animal from paper of an appropriate color, such as yellow for the giraffe, white for the swan, tan for the kangaroo, etc., the coloring can be completed quickly with water-color paints.

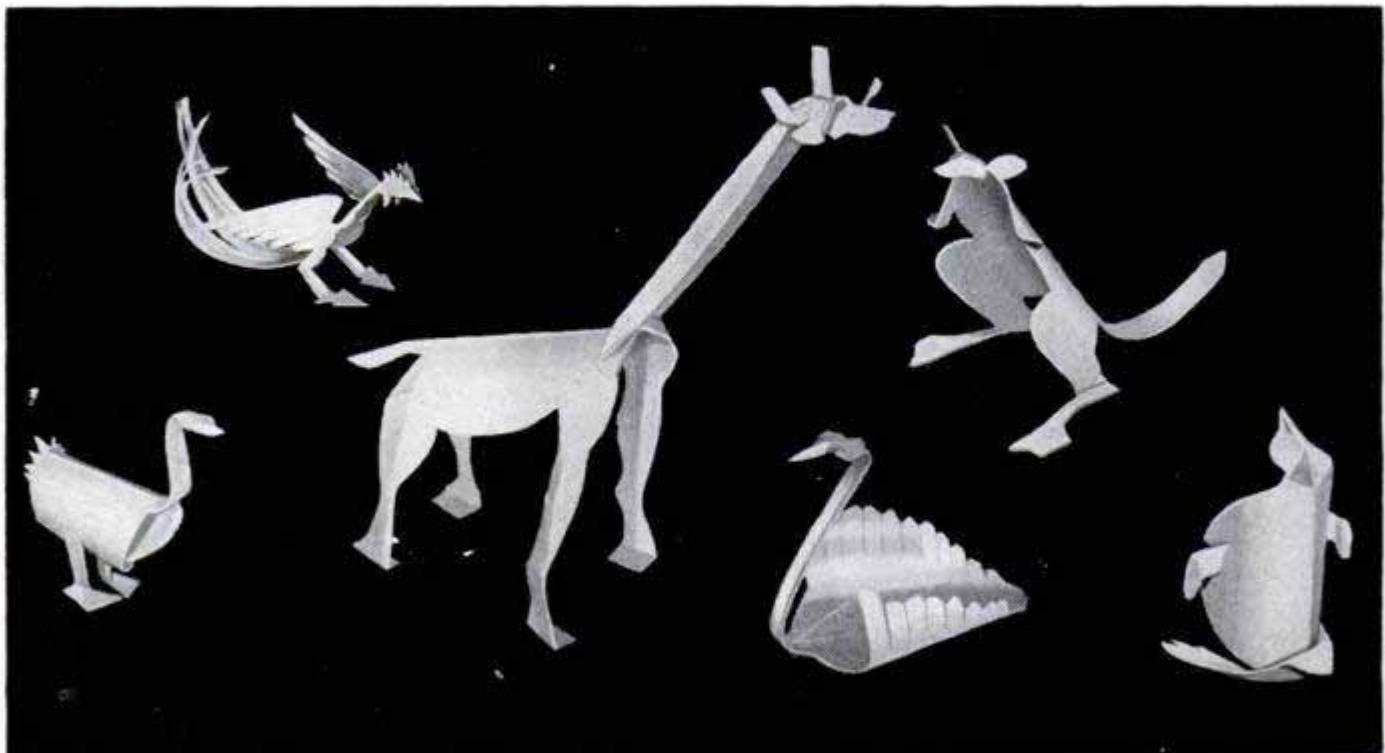



Rooster



Penguin

Kangaroo



CUT ON SOLID LINES
FOLD ON DOTTED LINES

Giraffe

HALF PATTERNS,
ACTUAL SIZE

Goose



Swan





When using brads, glazier points and other small parts, a tray from which the contents may be selected easily is made from a small tobacco can. Just remove the lid and cut out one side of the can as shown. The small parts can be returned to their original container by holding the can on its side and pouring them back into it.

G. E. Hendrickson, Argyle, Wis.

How to Apply Lacquer Without Brush Marks

Brush marks that often mar the appearance of a lacquered finish applied by an amateur painter can be avoided by using

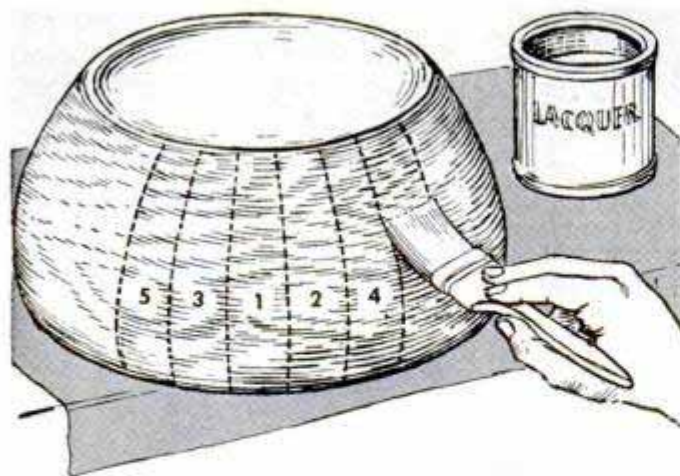

a high-grade brushing lacquer and applying it correctly. Since brush marks usually result from painting over lacquer that has started to set, plan your work so that successive strokes of the brush lap over lacquer which has just been applied. Usually the best way of doing this is to alter-

nate the brush strokes on opposite sides of the starting stroke as shown. Flow on a generous coat with the first brush stroke and work it out as little as possible. Lacquer dries very rapidly, which minimizes the possibility of its sagging when applied to the surface in a heavy coat.

Clinton D. Cook, Richmond, Mass.

Temporary Brake-Hose Repair

Finding myself miles from a service station with a broken brake hose on the left front wheel of the car, I managed to stop the leakage of the brake fluid and restore braking action to the three other wheels. I cut the defective rubber hose near the wheel, doubled the hose back beyond the broken portion and bound the folded hose with tape. This prevented further loss of fluid and retained sufficient braking action on three wheels to allow me to proceed at low speed to the nearest service station. Twine, wire or cloth strips could, of course, be used to bind the broken hose.

John Krill, North Lima, Ohio.

Wax Protects Scale on Rule And Lubricates the Joints



Occasional applications of wax to a folding rule will provide lubrication for the joints and protect the scale figures and markings against abrasion from handling. The hard, wax surface also makes it easier to remove adhesives such as asphalt and glue as well as grease and paint smudges.

Antimoisture Products Are Safe For Mixing With Auto Fuels

Tests made by a West Virginia university indicate that motorists may feel safe in mixing most commercial antimoisture products with gasoline to prevent freezing of carburetors and other failures caused by water in fuel systems. Technically known as "additives," the liquids tested were found to be effective when as little as 1 pt. was mixed with 10 to 15 gal. of gas. However, using in excess of 1/2-gal. additive in a full tank of fuel is apt to interfere with the operation of the engine.

VERSATILE KNITTING TABLE

By Roberta L. Fairall

ATTRACTIVE in appearance and adaptable to a wide variety of uses, this handy knitting and sewing table may also be utilized to hold books and newspapers, candies or floral decorations. It may be constructed easily from $\frac{3}{4}$ -in. white pine and smartly finished in paint or varnish. With the exception of the bottom section, which measures $9\frac{1}{2} \times 14\frac{3}{4}$ in., lay out all members on $\frac{3}{4} \times 5\frac{5}{8}$ -in. stock. A paper pattern is helpful in tracing the outline of the legs and divider section onto wood. Cut the separate pieces just outside the guide lines, using a compass saw on the curved portions. Now assemble ends, sides, divider and bottom sections with glue and finishing nails. After fastening two legs to each leg brace with glue and flatheaded screws, rule diagonal lines from corner to corner of the bottom section. Then center the tops of legs over the lines and attach them to the underside of section. For accurate fitting of parts, glue and nail the pieces together before drilling pilot, shank and countersunk holes and driving in screws. Use a wood rasp to round all edges and sandpaper to provide a smooth surface before application of varnish or paint.

A driftwood finish may be obtained by using yellow pine, sanding down the soft wood around its pronounced grain and



applying a light-gray stain—turpentine, 3 parts, to 1 part clear varnish—to which has been added a little dry pigment or oil colors. When dry, rub with No. 3 steel wool to bring out the grain and leave gray remaining in the low surrounding areas. Tack $\frac{1}{2}$ -in. furniture glides onto sides to give appearance of dowel pegs and paint with gray enamel. Apply two coats of dull-finish clear varnish to complete the job.

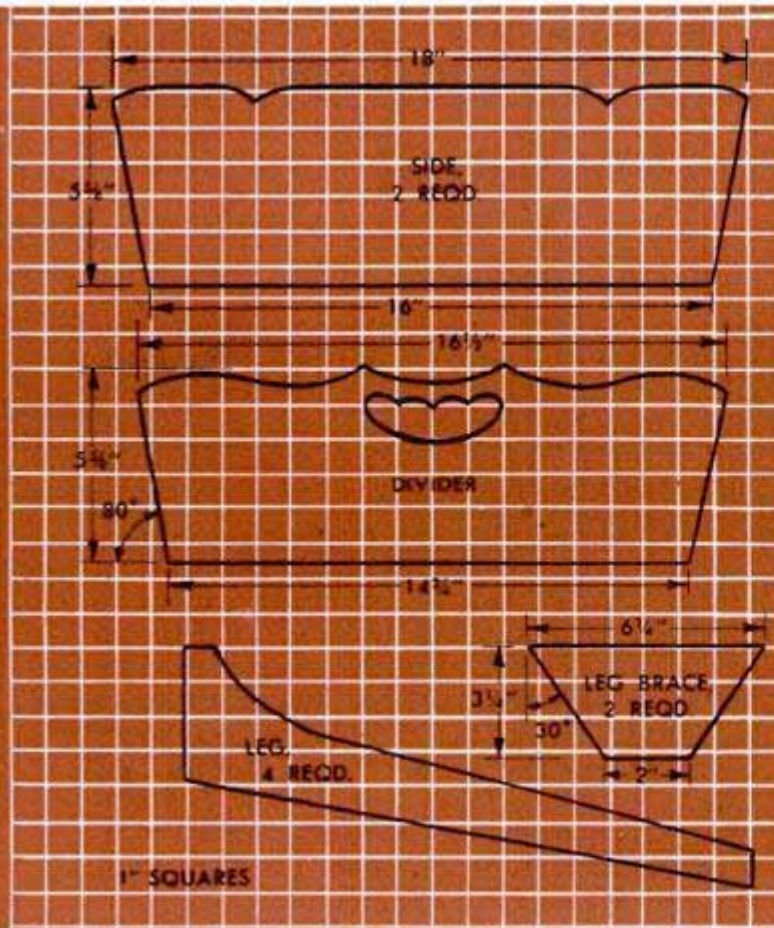

CUT ALL PARTS FROM $\frac{3}{4}$ " STOCK

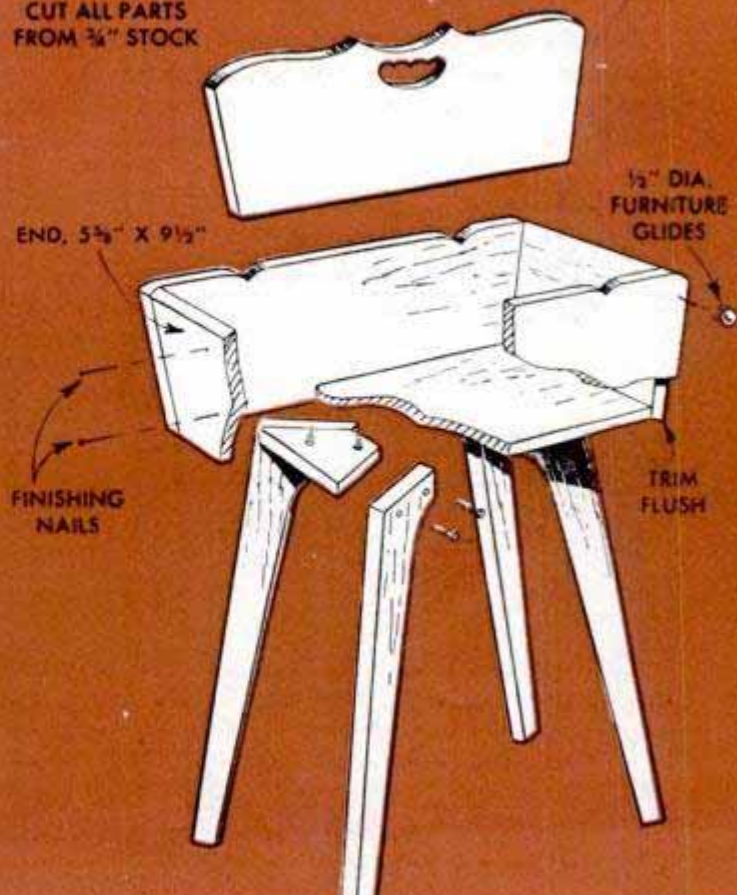



Restring THAT OLD TENNIS RACKET

By Robert M. Kintz

Tightening vertical strings of racket, left, held by tennis vise. Working from center, strings are pulled, slack taken up until end is secured to rim

BEFORE discarding that old tennis racket, or paying to have it renovated, try your hand at restringing it yourself. This simplified method, also applicable for restringing squash and badminton rackets, will not only provide the craftsman with a useful and interesting project, but may eventually provide a pleasant and profitable hobby. Before getting underway, however, the beginner should read the instructions carefully to familiarize himself with the proper sequence of each phase of the operation and with tools and supplies needed for each step. A tennis vise or a billiard, which is pictured on the following page,

combined with an ordinary bench or machinists' vise, and three tennis awls are the only special equipment and tools required. When using the billiard, the handle of the racket is held in the jaws of the bench vise. In addition to these, the beginner must obtain the following tools and supplies before starting to restring a tennis racket: Pliers (those with parallel-acting jaws are best); a leather or rubber-covered dowel; a razor blade or sharp knife; a can of white shellac, and a brush. To complete one racket, a set of tennis strings consisting of one 19-ft. coil and one 17-ft. coil is required. Tennis trimming strings may be included to provide a

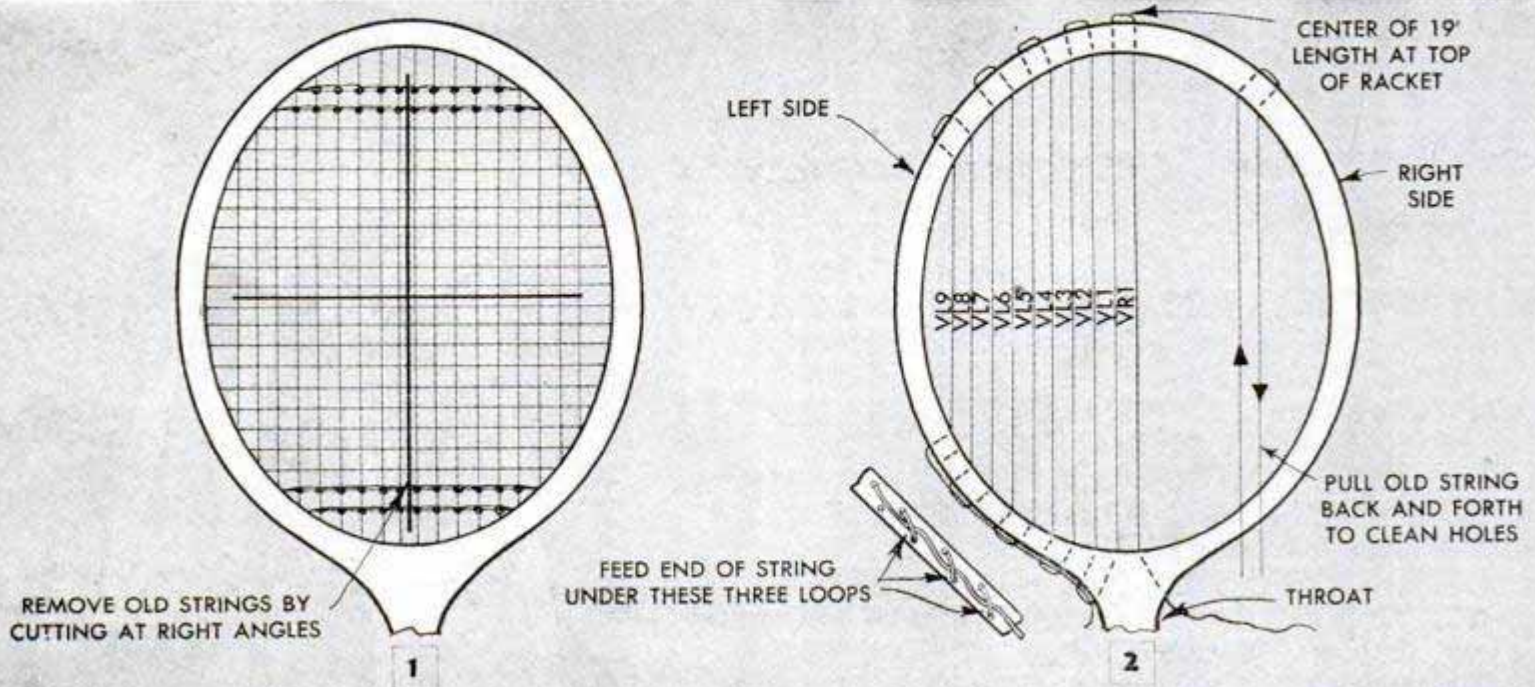

starting, it is wise to check carefully the condition of the racket frame and the edges of each string hole. The racket frame should be examined for any cracked, split or warped condition that permanently weakens it, thus making the racket no longer worth repairing. If the frame proves to be in sound condition, you may then proceed to remove the old strings. This is accomplished by making two cuts in the form of a cross with a razor or sharp knife, Fig. 1. The short lengths of old string which remain are quickly extracted with a pair of pliers. After the strings are withdrawn, ream and clean the holes. In most rackets that have been restrung before, the edges of the holes usually are quite sharp and must be rounded before restringing is begun. To do this, simply take a piece of used string 20 to 24 in. long and pull it back and forth through two holes at a time, as shown in Fig. 2, until the edges are smooth.

Vertical strings: The vertical strings are put in first. It should be remembered when handling new tennis strings that every precaution should be taken to avoid bending or kinking them. They may be damaged beyond further usefulness. With the handle of the racket held firmly in the bench vise, take the 19-ft. length of string and start to thread at the top center of the frame, Fig. 2. Vertical strings should be threaded before attempting to apply and tighten the billiard. The center of the string must be located at the top center of the racket and the two ends threaded back and forth in separate operations until stringing resembles that of the racket shown in Fig. 3. The strings should be kept fairly loose at this stage of the operation to permit the ends of the string to be inserted under string loops

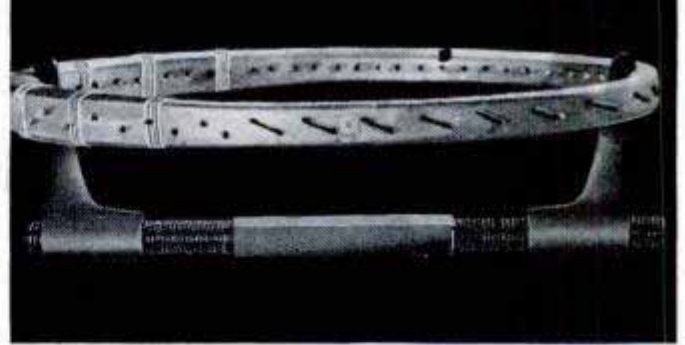

Billiard, above, may be used in place of tennis vise, if racket handle is held firmly by bench vise. The billiard is adjusted by turnbuckle arrangement

around the lower edges of the racket-head rim. This aids in the final securing of strings after they have been tightened. Most present-day rackets have 18 vertical strings, designated VR1 through VR9 for those on right side of racket, and VL1 through VL9 for those on the left side, Fig. 2. For the important task of tightening vertical strings, secure the handle of the racket in the vise so that there is little chance for movement or distortion of the frame while under tension. Now insert awls in holes TR, BL and BR, Figs. 3 and 7. Awl in TR may be used in hole TL, alternating back and forth, as required. Using the finger tips, Fig. 7, pull on VL2 string with one hand to tighten VL1 string, but before releasing it, move your free hand on to VL3 string and take up slack by pulling as before. In the same manner, pull on VL4 string before releasing VL3 string and repeat this operation until tension applied to VL9 string tightens VL8 string. At this stage of the operation, insert an awl in hole TL to hold VL8 string securely, remove awl in hole BL and pull on the loose end of the left string until VL9 string

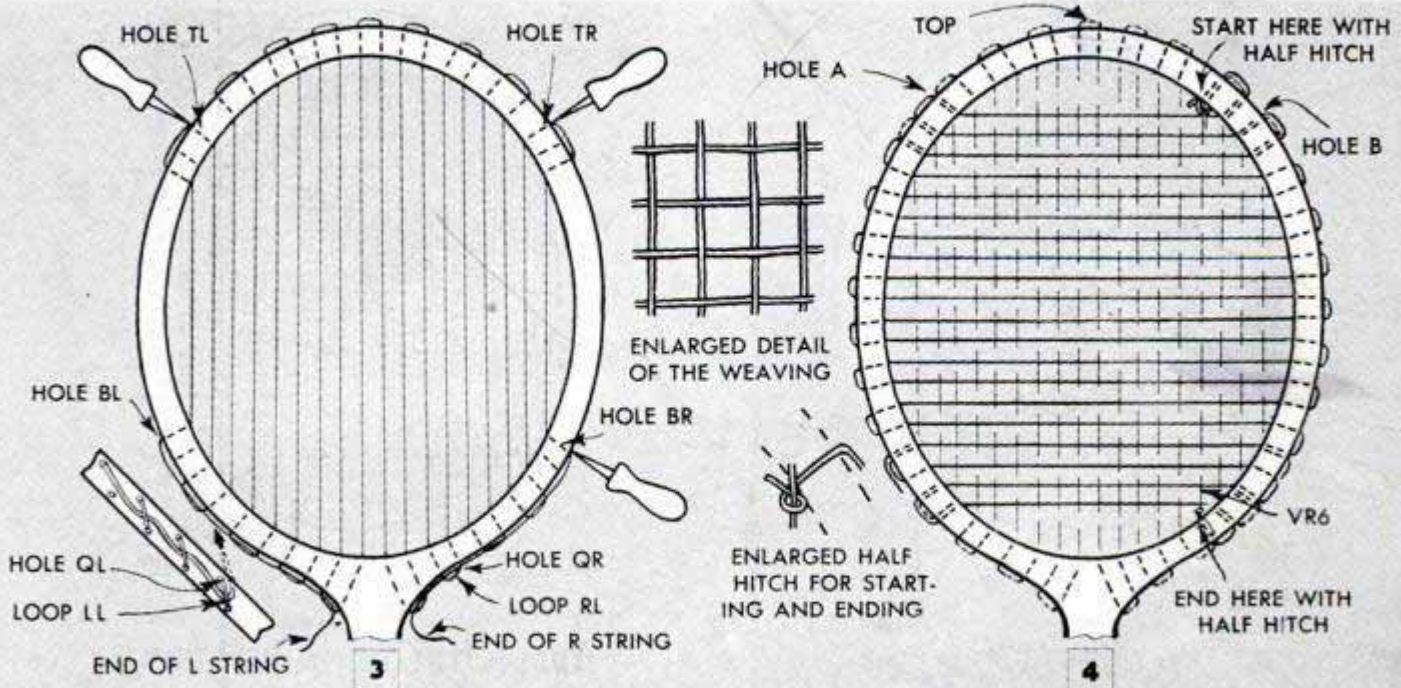

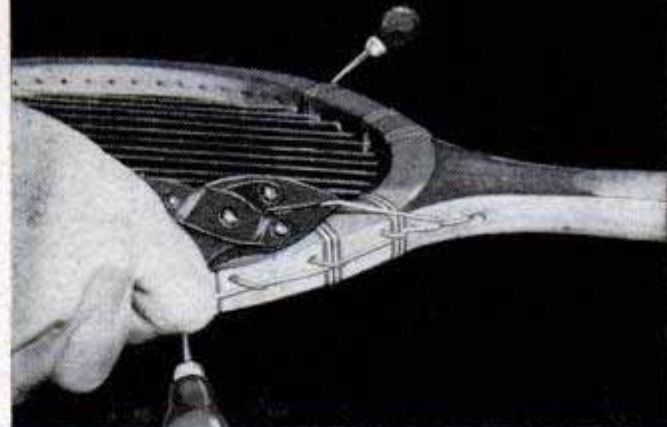

Pliers are used to tighten and turn back left string, for wedging and locking in near-by hole, QL. Awl holds strings in place until ends are secured

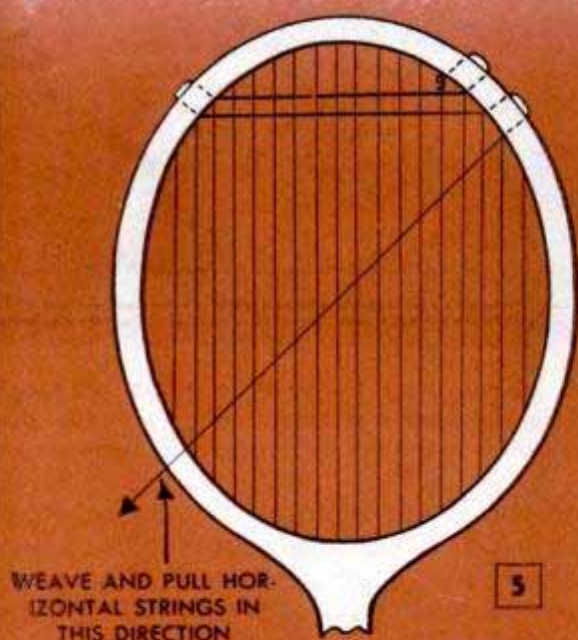

WEAVE AND PULL HORIZONTAL STRINGS IN THIS DIRECTION

5

PROPER METHOD OF STRINGING

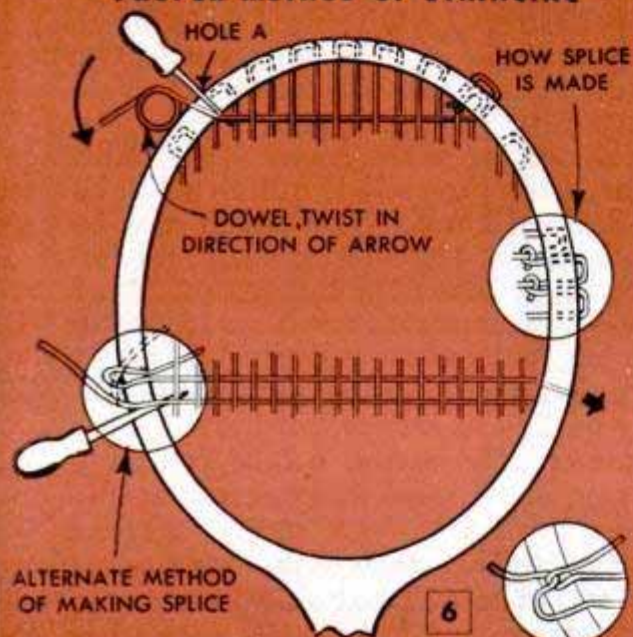

ALTERNATE METHOD OF MAKING SPlice



6

WEAVING HORIZONTAL STRINGS

COMPLETED SPlice

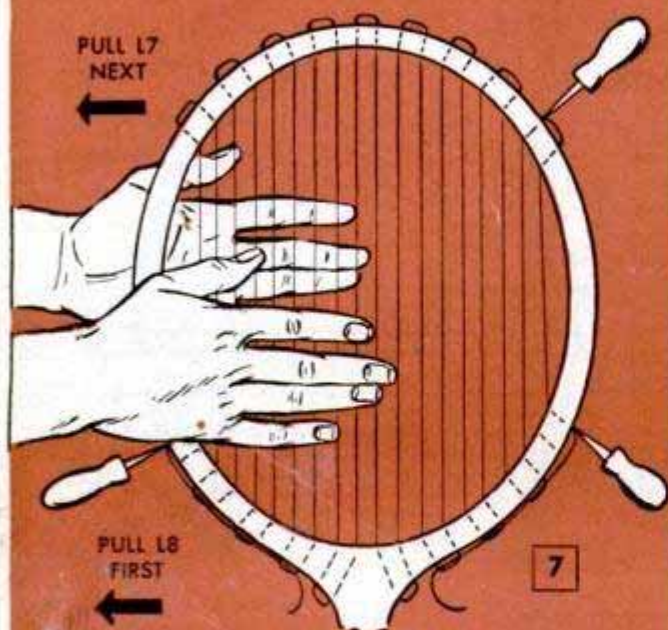

PULL L7 NEXT

PULL L8 FIRST

7

TIGHTENING VERTICAL STRINGS

is tightened. Before removing the awl from hole BL, use pliers to pull the end of the left string tight and to double back for insertion in hole QL, where it is wedged and locked. This operation is carried out in an identical manner for the right side of the racket. An attempt should be made to keep all vertical strings under an equal amount of tension. Tautness of strings may be easily checked by plucking the strings and comparing the pitch of the various sounds that result. The tightening operation usually must be repeated several times before strings can become properly aligned and evenly taut. When the ends of both left and right strings have been made fast in holes QL and QR, respectively, loose ends are trimmed off. Care should be taken to avoid cutting or nicking strings near by.

Horizontal strings: There are 20 horizontal strings in most rackets, designated H1 through H20. It is not necessary to move the racket in the vise for installation of horizontal strings. Taking the 17-ft. length

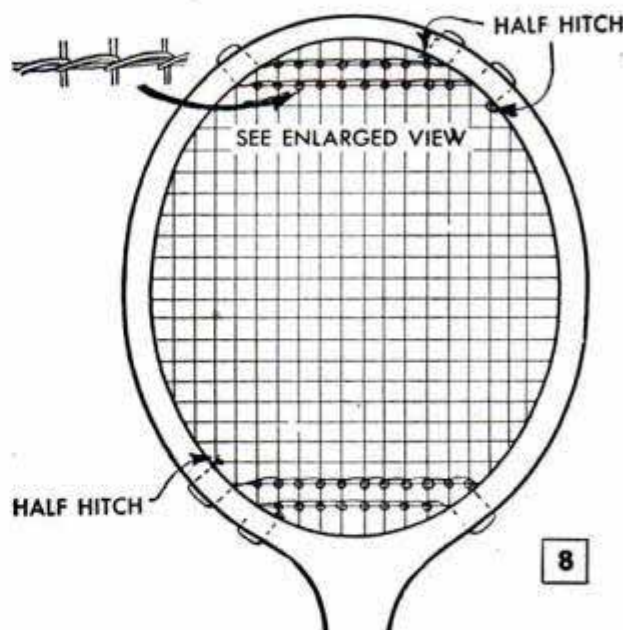

HALF HITCH

8

ADDING THE TRIMMING STRINGS

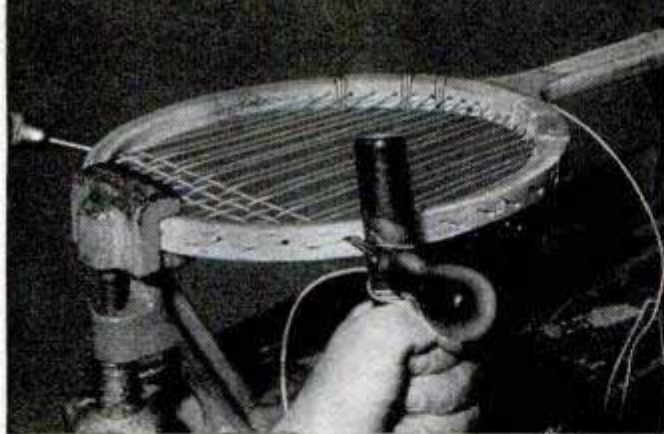

In tightening horizontal strings, rubber-covered dowel is used to pull strings tight. Awl wedges and locks string to free dowel for repeating the operation

of string, start at the top right side of the racket, Fig. 4, and attach end of string, using half hitch, to vertical R6 string. Then proceed to thread string across the racket, weaving over and under vertical strings, until hole A is reached. To avoid twisting or kinking the string, thread across three or four vertical strings and then, pulling diagonally, draw through the remaining string. Repeat this procedure, threading a few strings at a time, until the other side of the racket is reached, Fig. 5. Unlike the vertical strings, each horizontal string is tightened after it is installed in place. In tightening horizontal strings, a rubber or leather-covered dowel, wound with several loops of string, cinches and draws string tight when turned in one hand. Using your free hand, insert an awl in the hole to wedge and secure the string while the remaining strand is threaded—using a reverse weave, this time—to the opposite side of the racket. Again using the dowel to tighten string, the operation is repeated until the final string (H20) is installed, and secured with a half hitch around vertical string R6, Fig. 4. When inserting the awl in the hole, after the horizontal string has been pulled tight with the dowel, Fig. 6, be careful not to release the pressure on the string too suddenly. This may cause the string to slip, resulting in a loose string in the finished racket. Pressure on the string should be released gradually after the awl is inserted, allowing sufficient time for the tapered point of the awl to wedge and lock itself against the string in the hole. While pulling on the horizontal strings, it is important to straighten each string before locking it with an awl and proceeding to the next. A neater job will result and strings won't have to be straightened after restringing has been completed. When all horizontal strings have been installed and secured, ends are trimmed about $\frac{1}{8}$ in. from the half hitch, again taking care to avoid cutting or nicking the strings near by. Before putting in

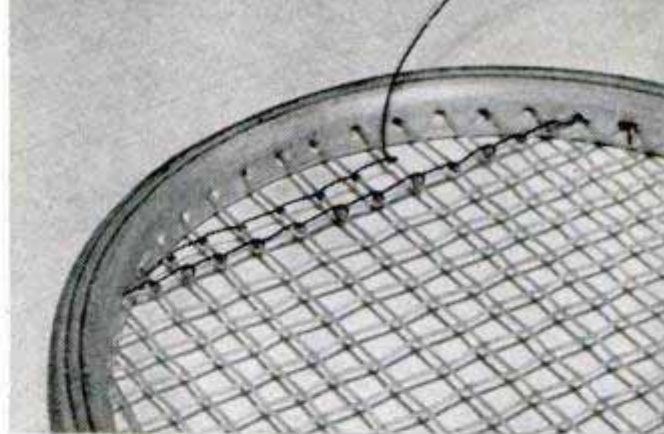

Trimming strings are laced between vertical strings at top and bottom of racket head. These help prevent slipping of other strings under impact of ball

trimming strings, all vertical and horizontal strings should be carefully straightened and aligned with an awl.

Trimming strings: Usually added for decorative effect, trimming strings serve a practical purpose in that they tend to keep other strings from slipping under impact of the ball. They are also used to indicate the "smooth" and "rough" side of the racket, determined by the way in which they are laced. On the smooth side of the racket, loops of string connecting the vertical strings appear uppermost. The side where loops of trimming strings separately encircling each vertical string appear uppermost is regarded as the rough side of the racket. Similar to the toss of a coin, tennis players will generally spin a racket to determine which side of the court each will take before play is begun. Needless to say, care should be taken to see that both top and bottom strings are laced alike to provide identical lacing on rough or smooth sides. Fig. 8 illustrates an easy method for installing the top and bottom trimming strings on a racket. It is advisable to avoid the use of trimming strings on a racket to be strung with nylon strings. Tightly drawn trimming strings will eventually cut through strings of nylon. To apply finishing touches to the restrung racket, carefully inspect the racket to insure that all string ends are neatly tied and trimmed and that all strings are evenly aligned. Now, using a small brush, apply a thin coat of white shellac to both sides of strings and around the frame. The shellac should be cut approximately 50 percent with denatured alcohol. Allow to dry thoroughly. It is recommended that the renovated racket be kept in a racket press and protected by a waterproof cover until ready for use.

☞ Rusty screws can be removed easily with a screwdriver if a hot soldering iron or red-hot poker is held on the head of the screw for a few minutes beforehand.



A glazed bird shelter, such as the one pictured will provide many hours of enjoyment for all members of the family, who can sit comfortably in the living room and watch the birds at their feed. This is made possible by mounting the shelter on the window sill where it offers the further advantage of easy accessibility. Two opposite sides of the shelter are open while the other two are sheets of glass. The latter are slid into shallow grooves cut near the edges of the roof and floor, which may be the ends from a wooden box supported by screwing them to the ends of a section of tree limb as indicated. If desired, a shingle may be tacked onto the roof or heavy cord wrapped around it and coated with creosote. A further pleasing effect may be had by tacking pieces of tree bark onto the floor. With the cardboard backing removed, inexpensive picture frames will provide side panels that are already glazed.

Mrs. Jean Wangler, Ossining, N. Y.

Improperly Mounted Air Cleaner Will Lower Gasoline Mileage

An air cleaner that is mounted with the front toward the radiator of the car can lower gas mileage in two ways. First, it will cause the cleaner to become clogged more quickly than it should, with the result that passage of air is reduced and the fuel mixture enriched. Second, before the cleaner has become clogged, it will permit the entrance of more air than needed,

which will cause the use of a compensating amount of gas in the mixture. On some cleaners, the front is indicated by the portion of the wall that is not perforated, while others have a slight projection at the front that serves to deflect air currents. Thus, when either type is properly mounted, blasts of air and dirt from the fan cannot be blown directly into it.

Ring-Fitted Pocketknife Is Carried in Key Wallet by Clipping to Fastener

You will always have a small pocketknife at hand if you carry it in your key wallet. Purchase a single-blade knife of the type that has a ring at one end and just clip it into one of the fasteners in the wallet.

Harrison Neustadt, New York City.

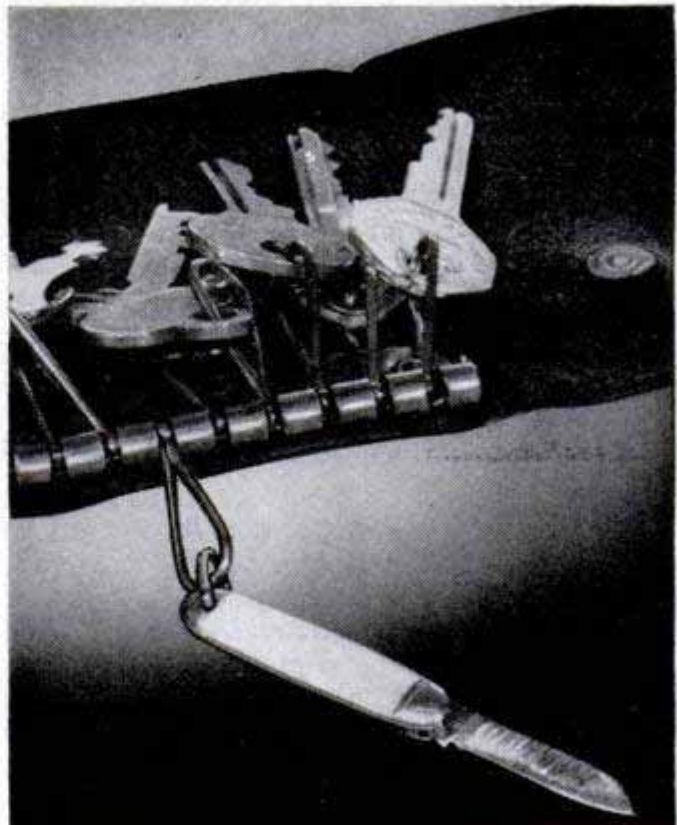

Glue Anchors Switch-Plate Screws

The screws of a wall switch plate can be kept from working loose with a dab of glue. After driving the screws until the heads are about $\frac{1}{8}$ in. in from the plate, dip a toothpick in the glue and wipe off the surplus. Then dab a little glue under the head of each screw before tightening it. Although the glue will keep the screws from working loose, it will not interfere with removing the plate when necessary.

T. F. Watts, Charlotte, N. C.

☐ Rugs that curl up around the edges may be stiffened with hot starch. Brush the starch on the wrong side of the rug and press the rug with a hot iron.

KNOW YOUR CAR'S "NERVOUS SYSTEM"

By William K. Mitchell

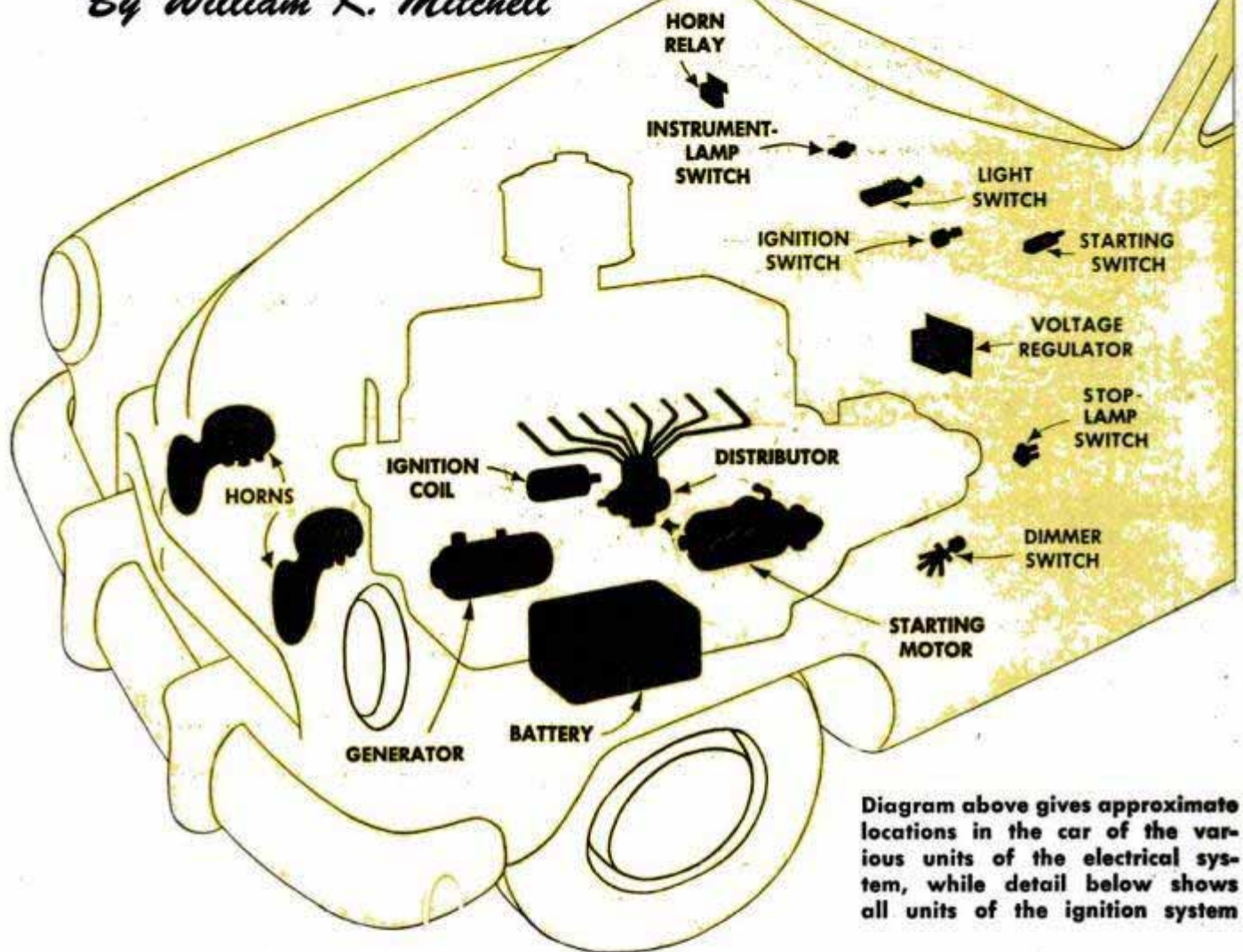
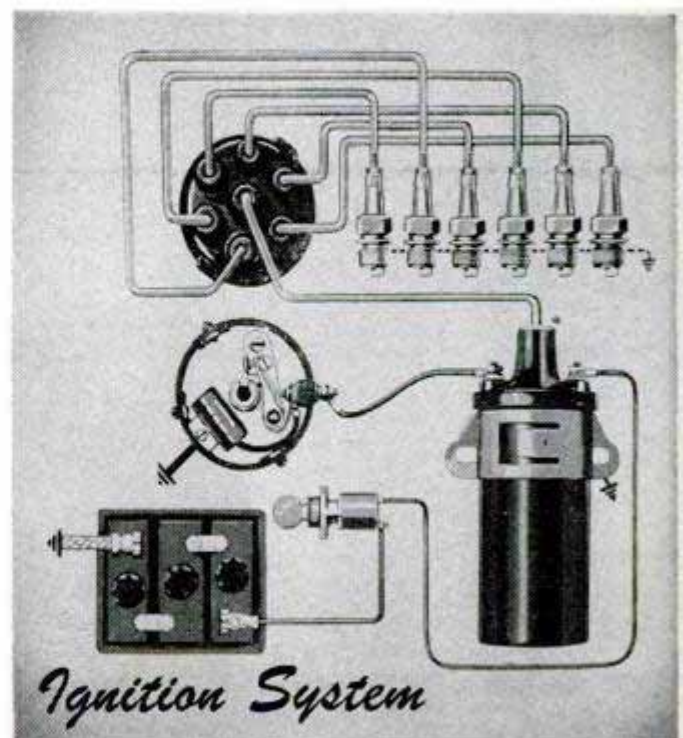

Diagram above gives approximate locations in the car of the various units of the electrical system, while detail below shows all units of the ignition system

KEEPING the electrical system of your car operating at peak efficiency makes a "healthy car" just as a healthy nervous system in your own body makes you feel well; the two are comparable as they both produce the stimulus to make other parts function. Also, both are highly complex and sensitive and are easily thrown out of balance with detrimental results to the parts that depend on them.

Unlike the human nervous system, however, the car electrical system can be understood, adjusted and repaired by the car owner to keep it at peak efficiency. In this and following issues, *Popular Mechanics* will describe each unit of the electrical system and tell how owners can care for them.

Often the terms "electrical system" and "ignition system" are confused. Actually the ignition system is only a branch of the electrical system. The diagram above shows the approximate locations of the parts of





Battery

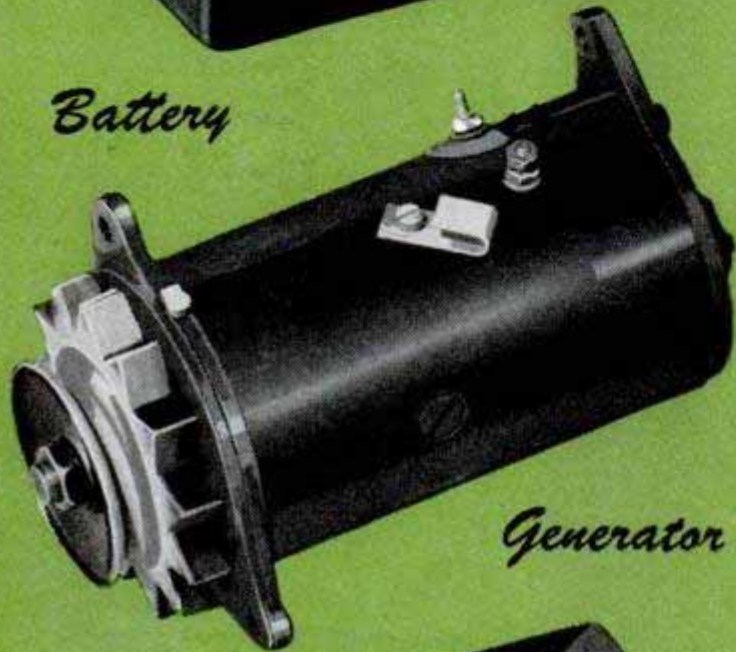

Generator



Voltage Regulator



Horns

Horn Relay

the electrical system and the diagram below it shows the part of the electrical system that is called the ignition system. The units composing the basic electrical system, which are pictured on this and the following page, are the battery, generator, coil, distributor, condenser, starting motor, voltage regulator, spark plugs, switches and relays. To these basic units are added the horns, lights, radio and other accessories.

The ignition system, which handles the job of actually firing the fuel charge in the engine cylinders, includes the battery, coil, distributor, condenser, spark plugs and wiring. With the exception of the battery, these units carry high-voltage current, stepped up from a low six volts by the coil to more than 14,000 volts. This high voltage is necessary in order to make the current jump the gap between the spark-plug electrodes and produce a hot spark to fire the gasoline.

Again, comparing the electrical system to the human body, the battery and generator can be considered the heart of the system, the battery storing the electrical energy and the generator producing it.

The battery performs three functions. First, it supplies current for the starting motor and the ignition system when cranking the engine. Second, it intermittently supplies current for lights, radio, heater and other accessories when the electrical demand of these devices exceeds the output of the generator, or when generator output is not available. Third, the battery acts as a voltage stabilizer in the electrical system. Your car cannot operate dependably unless the battery performs each of these functions satisfactorily. Since the battery can supply the electrical needs only for relatively short periods, it is necessary to provide some other means of carrying the electrical load most of the time. This job is handled by the generator, which performs two functions. It supplies all the current needed for operation of the engine and accessories, and produces the electrical energy stored in the battery.

Since the battery and the generator act as a team to provide electrical current whenever needed, it is essential that some type of control be provided between them to coordinate their efforts. This service is performed by the voltage regulator, which is known as the policeman of the electrical system. This unit protects voltage-sensitive units of the electrical system and prevents the battery and generator from damaging each other. When the generator is operating at charging speed, the regulator permits current to flow to the battery to re-

charge it, but it limits the voltage of the generator so that the battery will not be overcharged. It also limits the total output of the generator, when necessary, to prevent overloading. When the generator slows below charging speed, the regulator automatically breaks the battery-generator circuit to prevent a reverse flow of current from the battery to the generator.

The ignition coil acts as the booster for the system. Its job is simply to step up the primary voltage supplied by the battery or the generator into a high-voltage surge, capable of igniting the gasoline vapor in the cylinders. Essentially, it is a transformer.

The ignition distributor is the brain of the system. It times the high-voltage surge supplied by the coil and directs it to the proper spark plug at exactly the right instant to fire each cylinder in its proper turn.

Included in the distributor is a small but indispensable item known as the condenser. It has but one duty and that is to provide a place where primary current can flow until the distributor contact points are safely apart each time they open. This is necessary to prevent a voltage-sapping arc as the points first begin to separate.

The cranking motor, or starter, as it is commonly called, performs only one job—that of cranking the engine.

The spark plugs provide an electrical gap in the firing chamber of each cylinder, across which the high-voltage surge can jump, igniting the gasoline vapor, which explodes and drives the piston.

In modern gasoline engines the task performed by the ignition system is staggering to the imagination. For instance, on an eight-cylinder passenger car, the system must produce and distribute 12,000 high-voltage surges per car mile. At 90 miles per hour the ignition system is delivering 300 ignition sparks every second. This means that the entire system must go through its complete cycle of ignition each $\frac{3}{100}$ part of a second.

It is readily apparent, therefore, that anything which can be done to keep the electrical-system units in tiptop condition will be a tremendous aid to better car performance. You will be surprised how much you can do, at home, along this line. The first unit to be described next month will be the storage battery.

A knowledge of how the battery operates will enable you to care for it properly, thus increasing its life as well as making car-starting much easier.

Photos and information courtesy Delco-Remy Division, General Motors Corp.

(To be continued)



Starting Motor



Ignition Coil



Distributor



Starting Switch

Light Switch

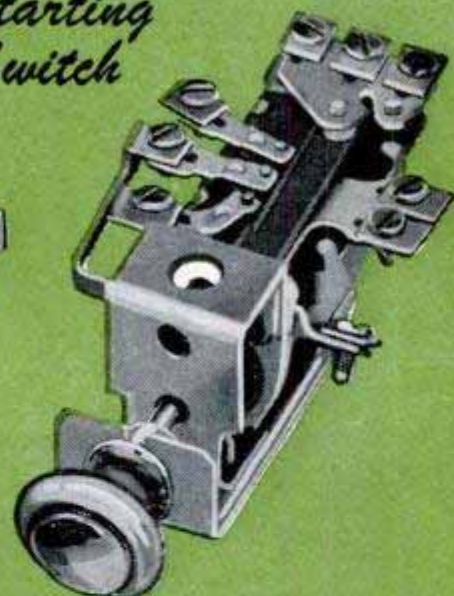

Dimmer Switch



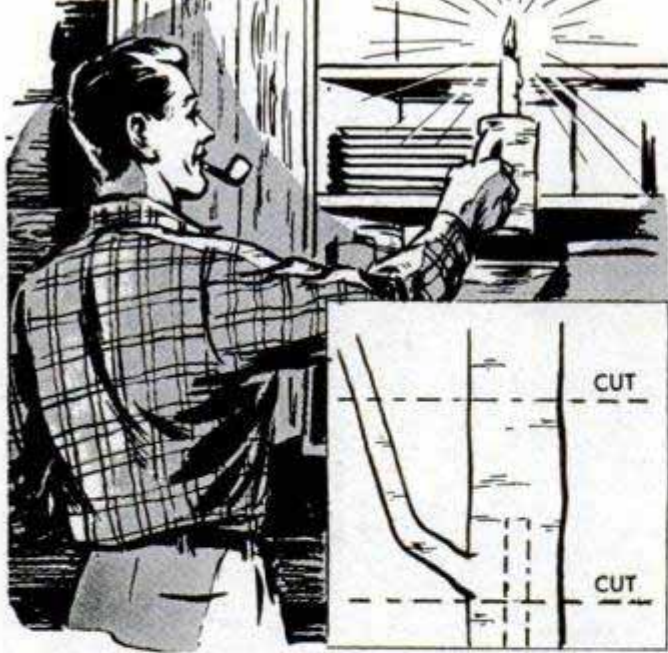

Rustic Candlestick for a Cabin

A novel candlestick or candleholder for use in your summer cottage or camp can be made by cutting a section from a tree limb as pictured in the drawing. The smaller branch serves as a handle for the holder. To insert the candle, a hole of suitable size is drilled lengthwise into the end of the holder. A tree branch 3 in. or more in diameter should be selected for this purpose in order that the holder will have sufficient weight. The candle should not burn down to the holder as this might ignite the wood and cause a fire.

Rubber Pads From Pencil Eraser

If you have need of several rubber disks to pad the bottoms of ash trays, table lamps or similar household items, cut them from a pencil-type eraser. However, be sure it is not the kind used to erase ink, as pads from such an eraser may scratch fine furniture surfaces. The disks also will serve in an emergency as insulating washers if a hole is punched in the center of each.

John J. Rea, Urbana, Ill.

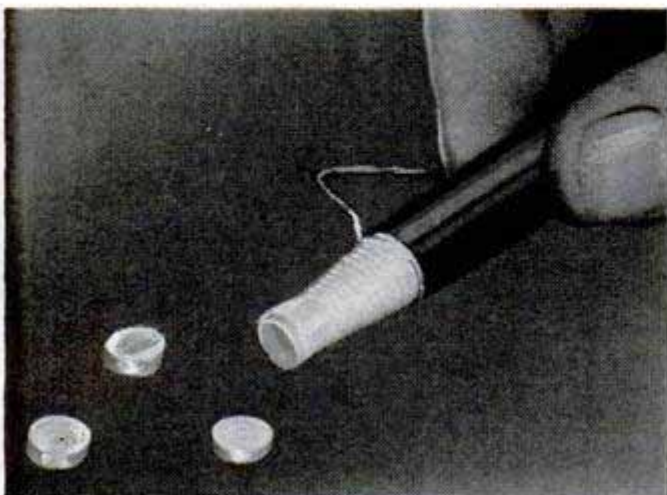

Removable partitions for small drawers can be installed with simple tools by using $\frac{1}{8}$ -in. hardboard. Short lengths of quarter round form channels in which the partitions are fitted.—Frank L. Brunckhorst, Chicago.



Tobacco Tin Holds Steel Wool To Protect Hands

When steel wool is used around the home or the home workshop, it's advisable to use some kind of a holder to avoid getting fine particles of metal in the hands. A good holder for this purpose can be made from an ordinary tobacco tin of the kind a smoker might carry in his pocket. To make the holder, remove the bottom and lid of the

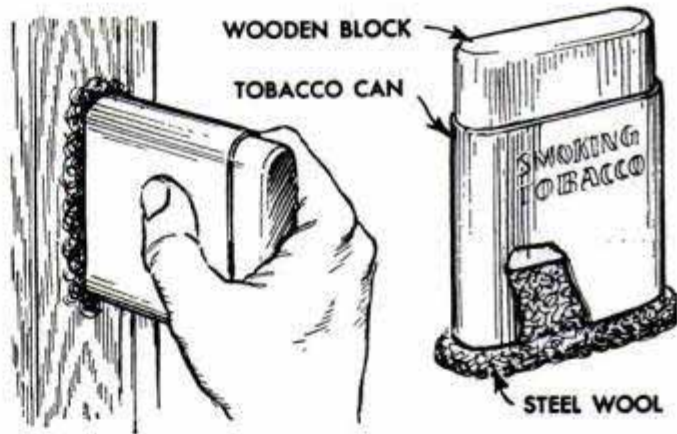

can and pack the tin full of steel wool. Then, make a small wooden plug that will fit inside the tin at one end. This is used to push out the steel wool as it wears away. A simpler way of pushing the wool out as required is to wad paper and put it into the lid end of the can, after which the lid is closed to push the wool out a short distance. This operation is repeated each time it is necessary to push the wool out farther.

Ed Packer, Chicago.

Solder Locks Nut on Bolt

Where it is desirable to lock a nut on a bolt and it is not feasible to use a regular lock washer, place a few drops of solder on the bolt threads just at the point where they extend from the nut. The threads should be cleaned well before applying the solder, and in some cases may have to be tinned to make the solder adhere.

Ervin L. Strayhorn, Beebe, Ark.

CHAIR-LADDER

This unique chair, which quickly flips over to become a sturdy 3-ft. stepladder, will prove to be indispensable to the busy housewife. No longer will it be necessary for her to carry a cumbersome ladder or balance precariously on a step stool or chair to hang draperies and curtains or to reach high shelves. The chair may be made both attractive and comfortable with the addition of a removable cushion. Screws, driven from below, are used to attach the two-part wooden chair seat.

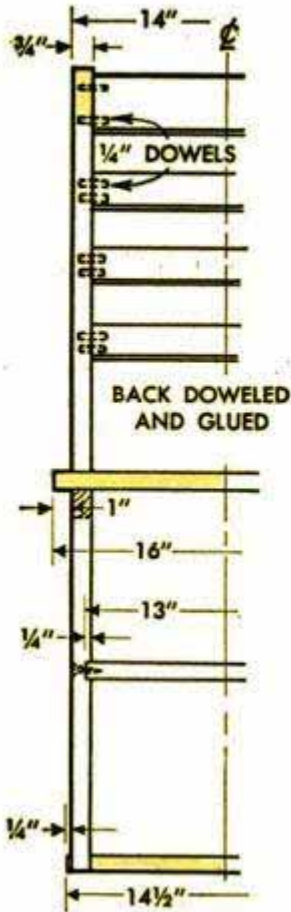
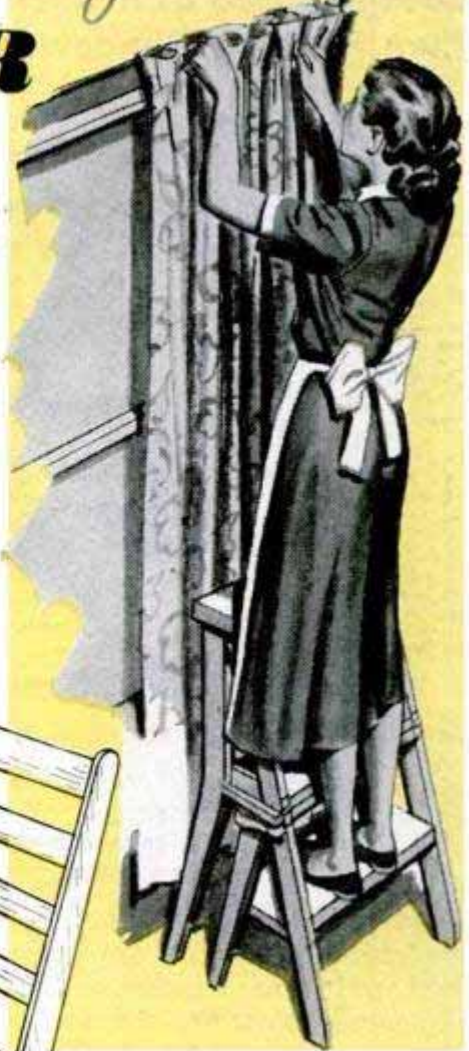

Doweled joints and hardwood construction (birch or oak) are recommended for additional strength. Hook at side, locks unit together when used as a chair

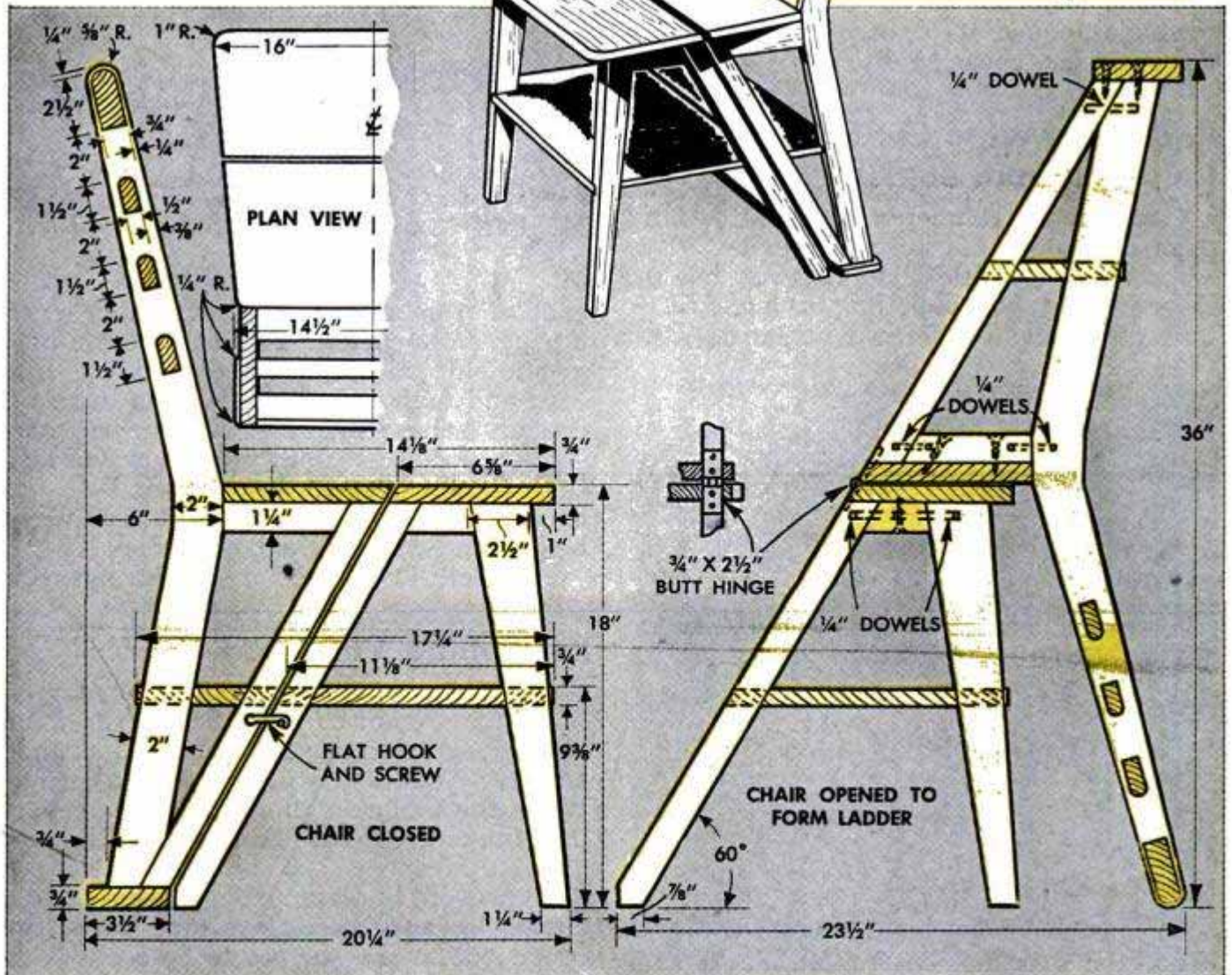

Squeegee Used as a Shield When Painting Windows



A small rubber squeegee is ideal for use as a shield to avoid smearing the panes when painting windows. Just hold the squeegee in position to mask the glass while painting adjacent to it. Keep at hand a cloth dampened with turpentine to wipe the squeegee occasionally.

Rack Screwed to Car Floor Holds Vacuum Bottles

Carrying refreshments in the car on long trips is sometimes more convenient than stopping at roadside stands, but having loose vacuum bottles rolling back and forth under the seat becomes a nuisance. One

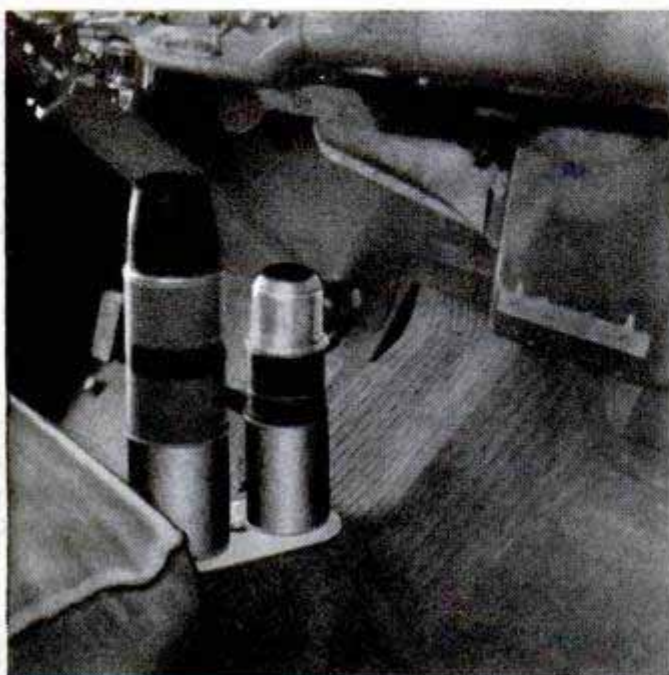

simple rack to hold two vacuum bottles. The rack is fastened to the car floor with a self-tapping sheet-metal screw, and is located as in the photo, where it is within easy reach of the right-seat passenger. The rack consists of two tin cans screwed to a piece of plywood, the cans being just slightly larger in diameter than the bottles they will hold.—Edward Siml, Tucson, Ariz.

Egg Candler Quickly Improvised

If you find it necessary to candle a few eggs occasionally, a candling box can be made at practically no cost by using any small wooden box at hand and fitting it with a light bulb. First, line the box with asbestos paper to reduce the possibility of fire, then install a porcelain lamp socket to the underside of the lid and drill one or two holes in one end of the box, over which the eggs can be held. If the edges of the holes are lined with felt you will be able to hold the eggs in position without any possibility of accidentally breaking them. For emergency use where only a few eggs are to be candled, you can improvise a

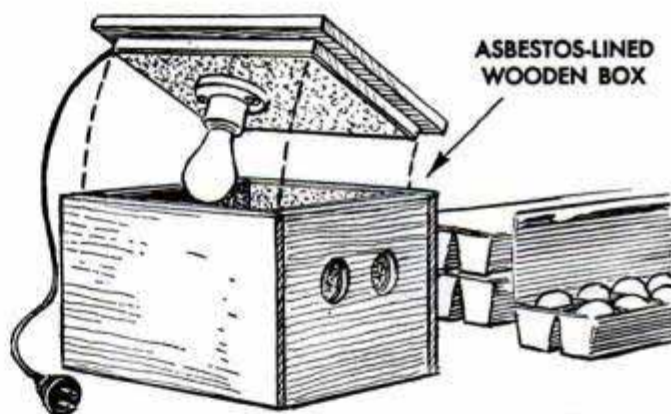

candler from a small cardboard box—even a paper milk carton. To do this, cut a hole in one side of the box and install a drop cord and bulb inside, suspending the bulb directly behind the hole. When this emergency candler is used, put a low-wattage bulb in the drop-cord socket and do not leave it on too long as sufficient heat might be generated to set the box on fire.

Seth D. Wade, Russell Springs, Ky.

Renovating Varnished Floor

Worn spots on a varnished floor may be matched in color to that of the rest of the floor by applying one or two coats of orange shellac. This also will serve as a sealer. When the shellac is thoroughly dry, revarnish the entire floor.—A. E. Fenn, Chicago.

☞ To prevent linoleum from cracking when cutting it, apply cellulose tape along the inner side of the surface to be cut.

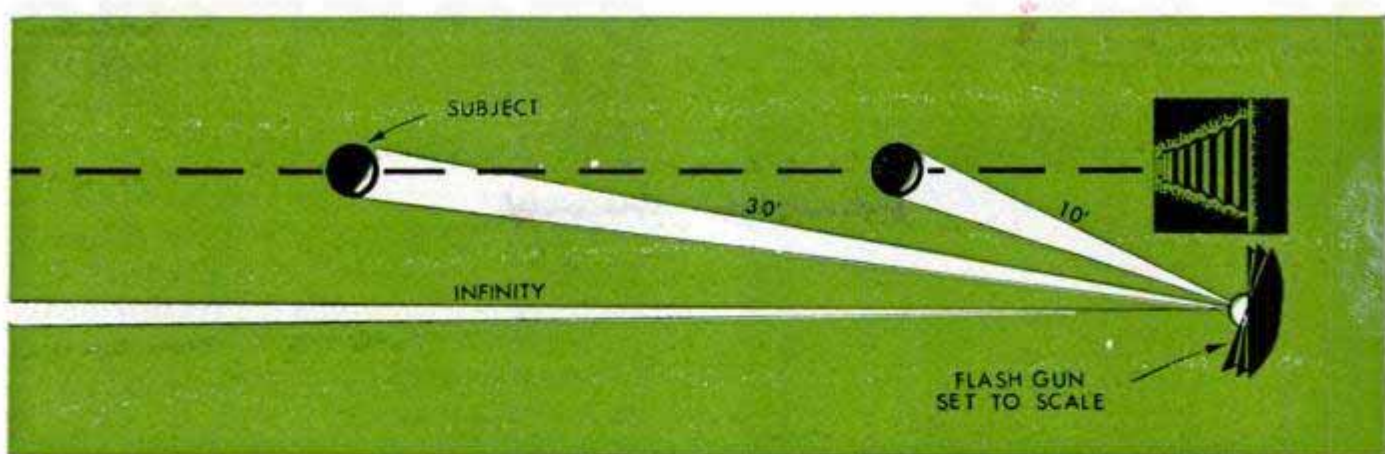

CORRECTING FLASH-GUN PARALLAX

By G. M. Pomeroy

Coordinating the setting of your flash gun with the parallax setting of your view finder is done accurately when the gun is fitted with its own calibrated scale. Whether it's a distance of 30, 20 or 10 feet, you'll not be lighting your subjects with only a portion of the flash intensity, as is generally the case when the gun is directed straight ahead. Synchronizing both flash-gun and view-finder parallax will improve the quality of your negatives and the resulting prints considerably. All you need are two metal collars which are made to slip over the barrel of the flash gun. These are placed above and below the camera bracket and are locked in position with set-screws. The collars allow the gun to be rotated in its mounting bracket for synchronizing with the parallax setting of the view finder. While the detail at the right shows how the collars are used in the case of a Speed Graphic or other press-type camera, the collars easily can be adapted to the bracket on almost any camera. The calibrations may be scratched right on the bracket or inked on paper and glued in place in line with a witness mark made on the upper collar.

Calibrating the scale for your particular camera is done by placing the camera at a point 50 feet from a wall. Next, a test shot is made of a picture hung on the wall by aiming the flash gun as near to the center of the picture as possible. Without disturbing the setup, the negative is developed and then checked for the point of light reflection. The reflection is readily visible when the test shot is made on a dark-colored wall. Test shots are made as many times as neces-

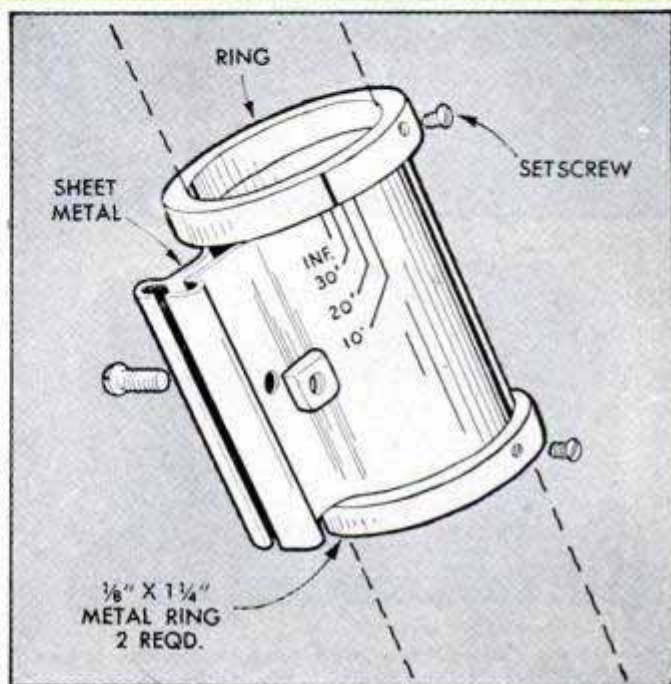

sary to center the reflection in the picture, and when this has been accomplished, a mark is scratched on the bracket in line with the witness mark and labeled INF (infinity). This same procedure is repeated for distances of 30, 20 and 10 feet. When this has been done, the calibrations are tested under actual conditions by shooting a person standing about two feet from the wall. In each case, the subject is brought into sharp focus, the footage scale on the camera bed read and the flash-gun distance scale set to coincide. By having the subject stand two feet from the wall, it is easy to see where the greatest concentration of light is hitting the subject.

Water Controls Print Reduction

If you frequently spoil prints when applying reducer over a light-gray area, try applying the chemical while the print is under water. Use a cotton-tipped applicator and immerse the print in a tray containing about $\frac{1}{4}$ in. of water. Reduction is easily controlled for soft outlines.

Frank H. Tooker, Lakehurst, N. J.

☐ Paste exposure data supplied with film and paper on cardboard for handy reference.

35-MM. SLIDE PROJECTOR

By Kermit A. Slobb

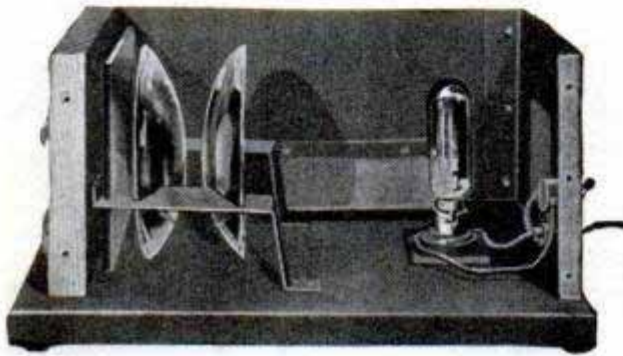
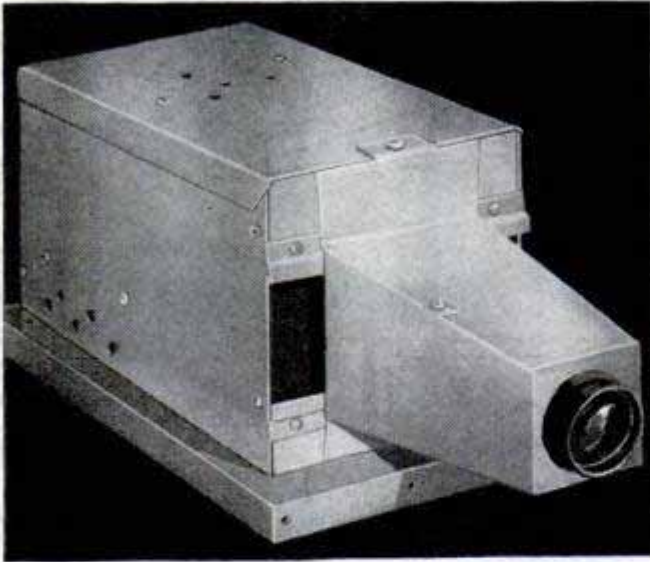

Upper photo shows completed projector while lower photo shows side view looking into the lamp house. Note position of condensing lens and light shield

Details below show how to cut and bend sheet metal to form the extended holder for the viewing lens. After assembly, all joints are sealed with black tape

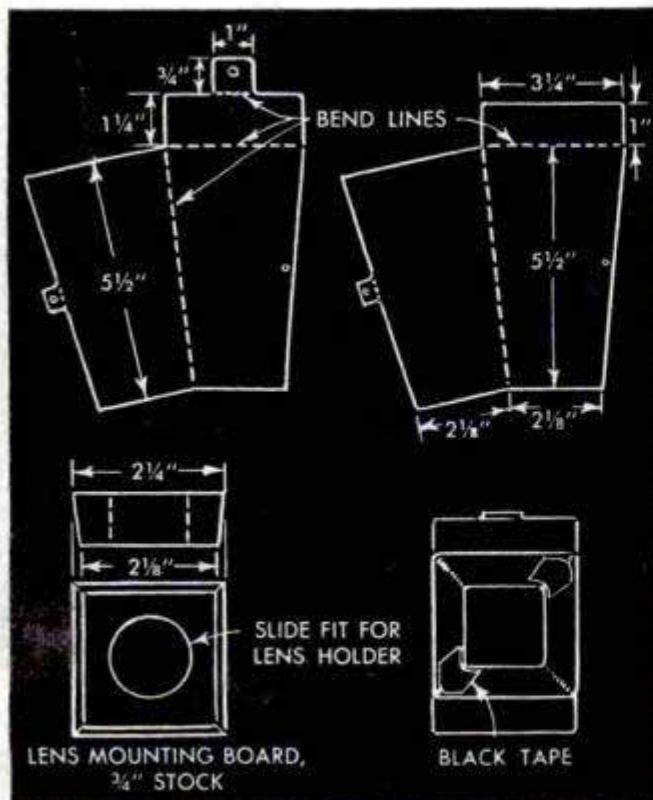

FOR AMATEUR SHOWINGS of standard slides in color, and black and white, this inexpensive projector fills the requirements of photographers with limited budgets. It's built almost entirely from lightweight sheet metal and scrap wood. Use of double condensers and a noncorrected viewing lens reduces cost to a minimum, yet definition is sufficiently sharp to permit distortion-free images on a projection screen of average size. The sheet-metal lamp house is built up on a wooden base, as in the details on the opposite page. Two notched brackets made from flat steel support the condensing lenses and the heat-absorbing glass, which is mounted directly in front of the condensers. A circular baffle is attached to the underside of the lamp-house cover by means of spacers and small bolts and serves as a heat deflector and also as a light trap. Several ventholes are drilled through the cover as shown. A square reflector of aluminum foil is cemented to the inside of the lamp house. Details at the lower left show how to cut sheet metal and assemble the projecting holder for the viewing lens. A wooden mounting board is fitted into the small end of the holder as indicated. The mounting board is drilled to take the cardboard lens mount in a sliding fit. Note that two double-convex lenses are combined to form the viewing lens. These are fitted into the cardboard tube with a spacer between and are held in position by cardboard retaining rings. Center a square hole through the front of the lamp house, then fit the front piece in place and fasten with screws. Attach the brackets which support the condensing lenses and the heat-absorbing glass. Fit and wire the lamp socket and toggle switch, but do not fasten the socket permanently in place. Form S-shaped guides for the photo slides from sheet metal and attach to the front of the lamp house. Be sure these are correctly spaced, then attach the lens holder. Now, with all parts in position except the top, insert a slide in the guides and turn on the lamp. Focus the image on a screen or on the wall. If the lamp is incorrectly placed, an image of the filament may show on the screen. Move the lamp until this disappears, then mark the location of the socket and fasten it permanently in place with screws. Fit light shields inside the lamp house and drill several ventholes through the sides as indicated. Attach the top, or cover, and drive four rubber-headed tacks into the wooden base near the corners.

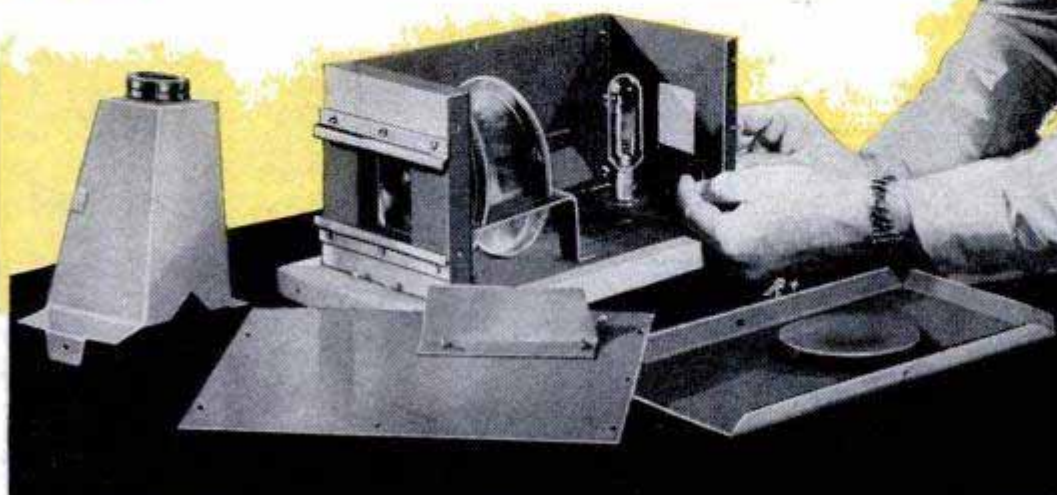
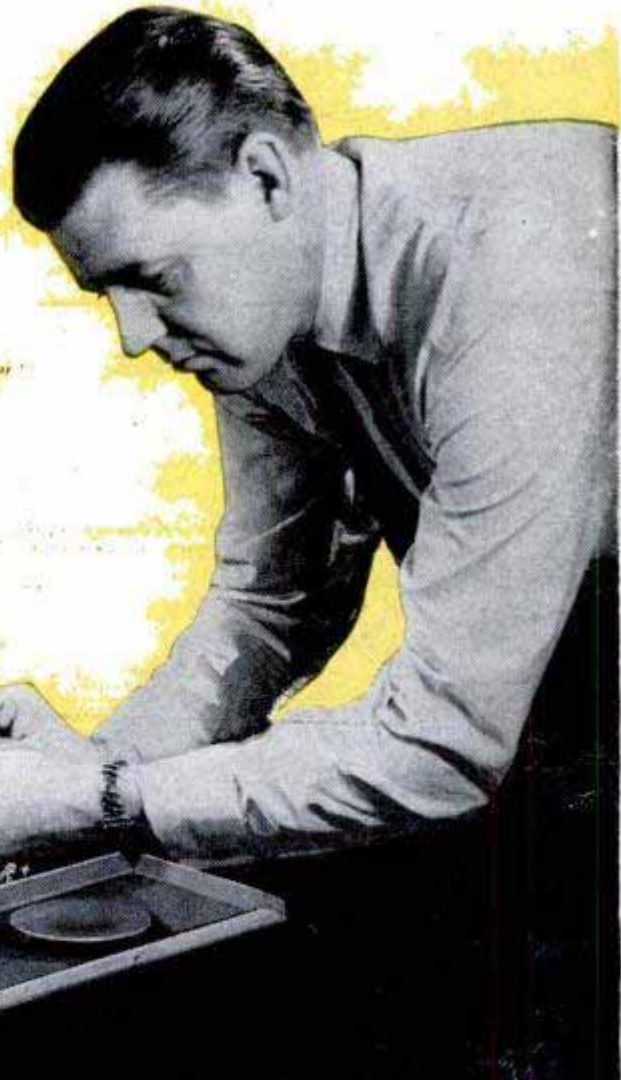
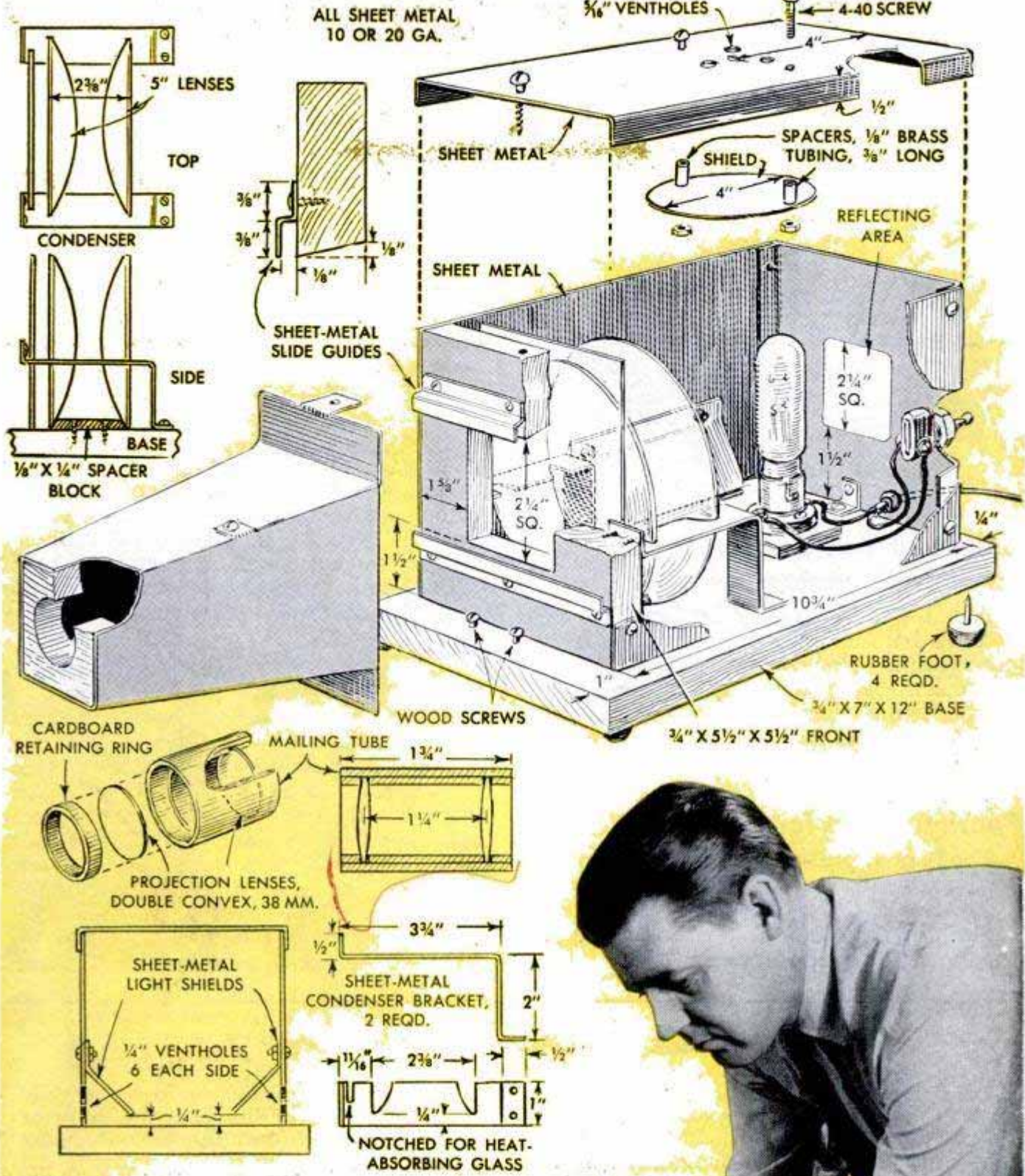



Ball-Point Pen Used as Stylus To Emboss Photographs

A ball-point pen may be used for embossing border lines or other designs in photographs. Remove the ink from the pen and clean the tip thoroughly. Then, place the photo on a hard, flat surface, such as a plate of glass, to do the embossing.

H. Klein, Pittsburgh, Pa.

Pouring Spout for Chemical Can

The handy, pull-up spout on the top of a cardboard salt box can be used to dispense dry chemicals. Cut the complete top from the salt box and tape it over an opening in the top of the chemical can.

Bowl Cover and Cake Pan

Improvise Photo Tray

An emergency tray that will not be affected by photographic chemicals may be improvised from a cake pan by placing a plastic bowl cover in it as shown. The cover, which is hemmed with an elastic band, should be of a size that will stretch tightly around the rim of the pan and, at the same time, sag into it to conform with the shape of the pan.

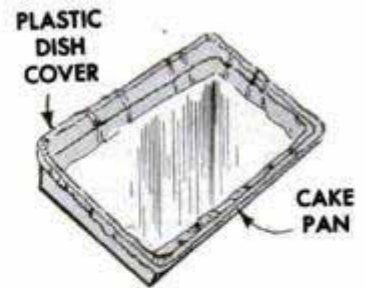

Cleaning Rubber-Cement Brushes

When the brush used to apply rubber cement has become clogged and stiff with dried cement, it can be cleaned with an ordinary pocket comb. Just run the teeth of the comb through the bristles of the brush several times as shown.

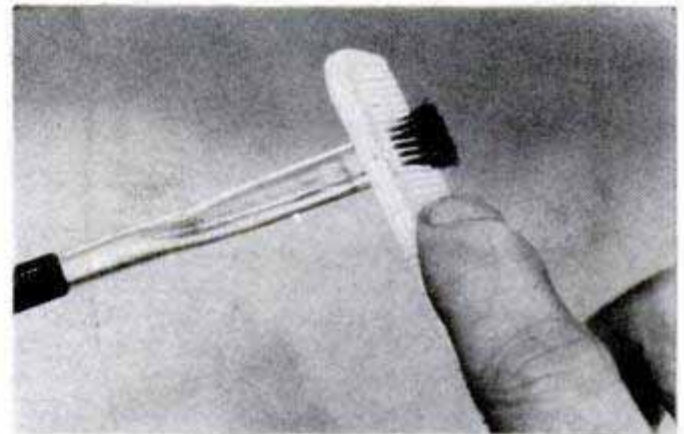

Is Your Garden a "Problem"?

Don't you envy the fellow next door whose lawn is a velvet green carpet, whose garden is profuse with color from the first spring thaw until frost? And your neighbor on the other side grows a nice crop of dandelions and plantain, just right for the prevailing wind to reseed your lawn with weeds. With the greenest thumb in the world, you have your problems!

Some folks can grow prize-winning flowers and lush vegetables, but they lack the knack of planting. Tall delphinium in the front row hide the rich mass of nasturtiums behind, or you give a prominent spot to a group of lilies only to find that their bloom is here today, gone tomorrow.

Well, here's first aid for the green thumb with the irking problems . . . a *Popular Mechanics* book with all the answers implicit in its title: "How to Grow the Best LAWN AND GARDEN in Your Neighborhood."

Now is the season to start reading it, to let

it plan your landscaping, to begin building the arbor or outdoor fireplace, the trellis or rock garden or lawn furniture for the coming summer.

Here are some of the topics in this easy-to-read, easy-to-follow book for the gardener, amateur or expert: Landscaping . . . Getting Rid of Weeds . . . Preparing the Soil . . . Rebuilding the Soil . . . Planting . . . Renovating your Lawn . . . How to Select and Plant Trees . . . Shrubs, Vines, Flowers for the Home . . . Getting Rid of Insect Pests, Diseases . . . Grafting Trees and Shrubs . . . How to Build Your Outdoor Fireplace. . .

This complete guide to home landscaping and gardening, packed with a wealth of down-to-earth information, rich with plans and photographs from which you can build, is yours for \$2.50. Just write to *Popular Mechanics* Book Department, 204 E. Ontario St., Chicago 11, Ill., and ask for LAWN AND GARDEN.

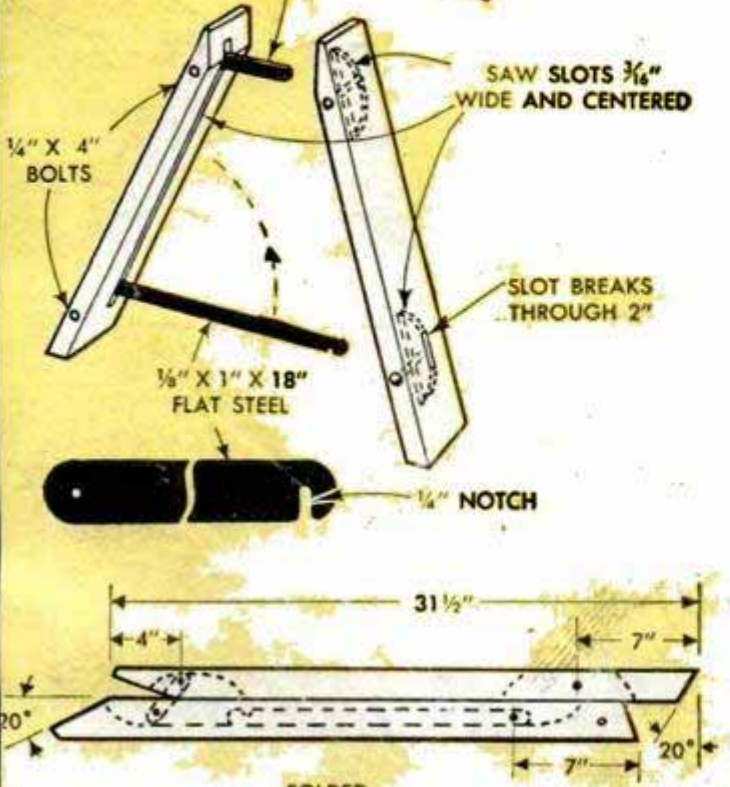
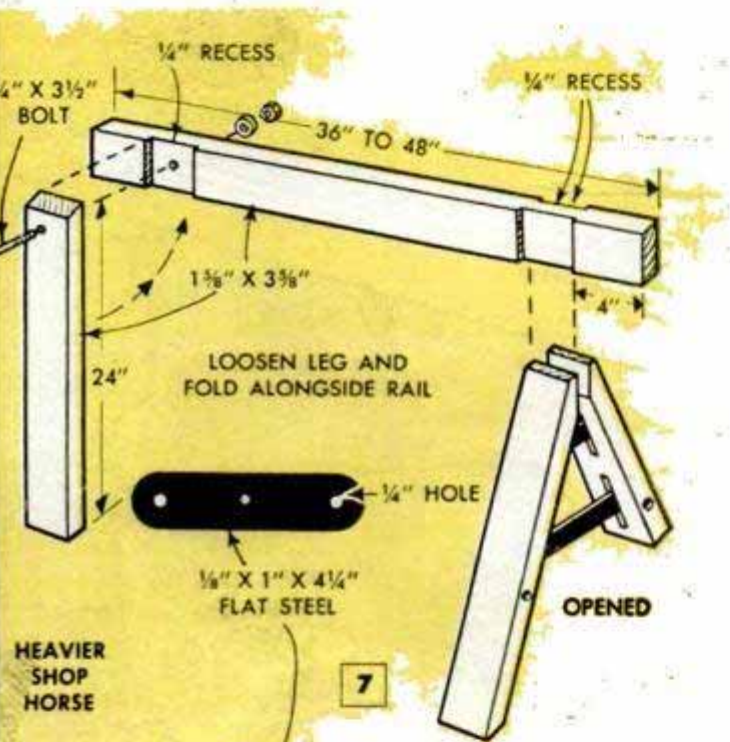
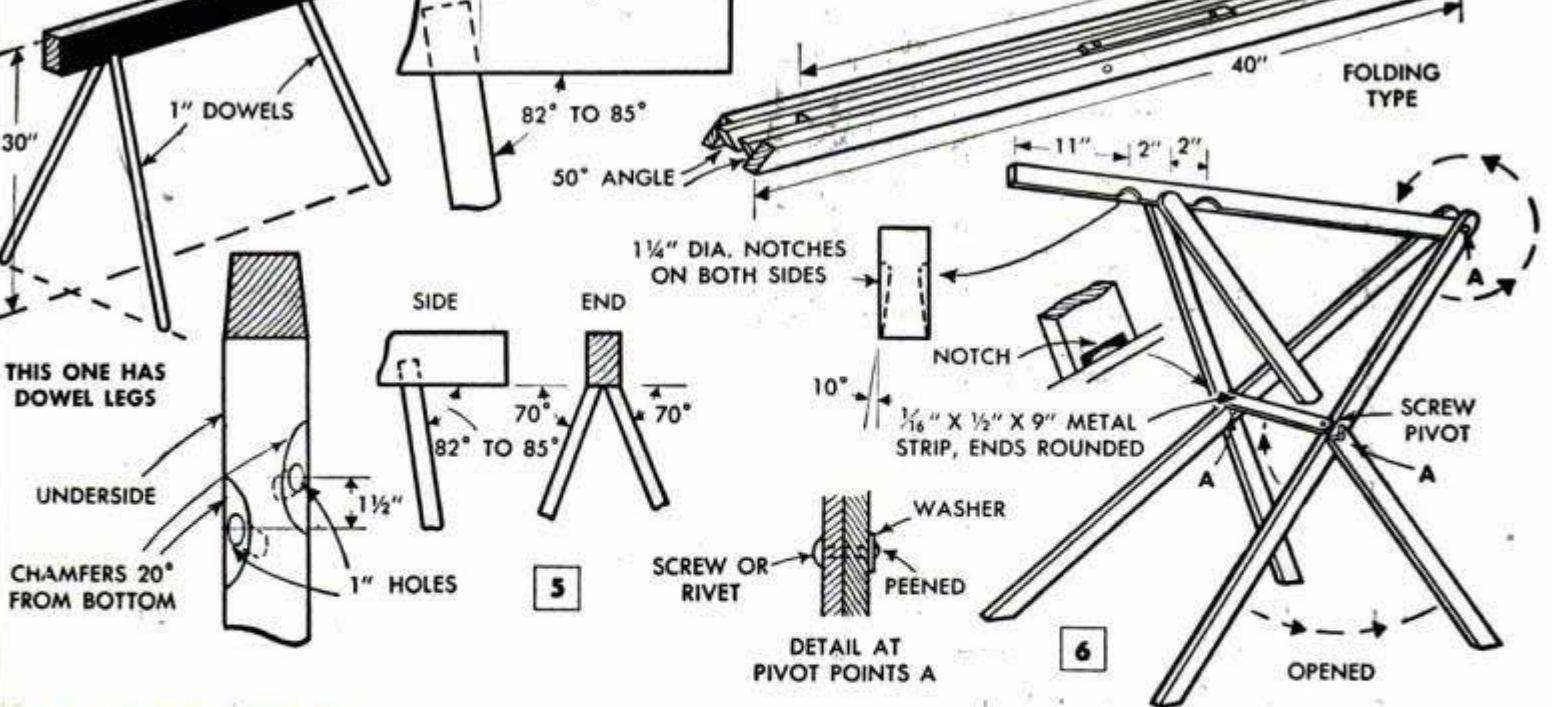

and for scaffolding used on roof work.

Lightweight horses: Figs. 1 to 6 show lightweight 30-in. horses for many everyday jobs such as painting screens and storm windows, wallpapering and light assembly work. Length of rails or stretchers can be varied to suit. The horse shown in Figs. 1 to 3 has a slotted rail that holds the legs vertically. Legs can be given an outward slant to increase the end-to-end sturdiness by cutting the rail grooves at slight angles, but legs should not project beyond the work limits. The rail rests on the leg braces and is locked to the leg units with large nails to prevent the horse from coming apart when it is lifted by the rail. The nails are slipped into holes drilled through the tops of the legs and into the rails. The nails will always be at hand if attached to the legs with lengths of furnace chain. For legs, use white or yellow pine that is free of knots. However, hardwood, if available, gives greater strength.

When used outdoors or on uneven floors, a three-point floor contact prevents wobbling. To gain this advantage substitute a single leg for a double leg as in Figs. 3 and 5. If accurately made, the legs will fit the slots interchangeably, but if there's any variation in the locking holes, mark matching legs and rail slots.

X-legs: Leg units of the horse shown in Fig. 3 do not fold and require more storage space than the folding X-legs of Fig. 4.

These are pivoted near the top so that weight on the horse tends to spread them and, at the same time, tighten the grip on the rail. Close-grained hardwood is best for these legs, particularly if the horse is used for heavier work, as hardwood has greater resistance against splitting. To prevent the legs from slipping off the rail when lifting the horse, tighten the pivot bolt while the legs are pinching the rail. Use washers under the bolt head and nut.

Light, dowel-leg trestles: About the simplest type of horse to make for light work is the three-legged one in Fig. 5. The 1-in.-dowel legs are pushed into holes in the underside of the rail. The legs are slanted outward for greater over-all sturdiness. Adjacent holes at one end for the pair of legs are staggered. Chamfer a flat for each so that boring at the right angle can be controlled easily.

Wallpaper-table trestles: You can set up a worktable for wallpapering instantly by using two folding hardwood horses as shown in Fig. 6. They are adjustable to heights from 30 to 33 in. Similar ones are commercially available at small cost. A convenient work top can be made from a hardboard panel reinforced on the underside to keep it straight.

Sturdy shop horses: Fig. 7 shows a sturdy, folding shop horse for sawing and other work requiring a 24-in. height. To avoid wobbling on uneven floors use a single leg at one end. For storage, this swings alongside the rail, and the twin legs fold together. Note how the latter are grooved centrally (which is done easily with a circular saw) to house the cross braces. The top one on which the rail rests is pivoted to both legs, the lower one to one leg, the other end having a notch that slips on a pin or bolt. If made carefully, the legs grip the rail firmly in the recesses, and pressure on the rail is maintained by the outward push of the lower brace. To assemble, first slip lower brace through the slot in leg having the pin, then place the rail in position, spread the legs outward so that the notch of the lower brace engages the pin.

Scaffold for ceiling work: Scaffold trestles shown in Figs. 8 and 9 provide safe and rigid support besides being adjustable in height. You can use two trestles, or use only one in conjunction with a stepladder. Grooves and recesses must fit joining members snugly so there is no play when bolts are tightened. For installing plasterboard, a couple of T-supports that can be wedged between the ceiling and the scaffold planks enable you to position the board snugly against the ceiling for nailing.

Roof scaffold: When repairing a leaky roof or reshingling it, you need a safe scaffold such as the one in Fig. 10 and the upper

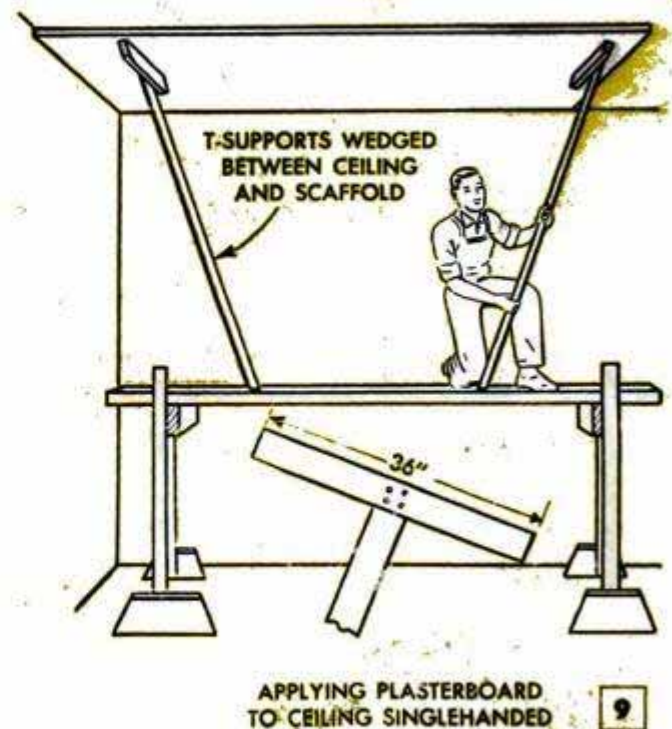
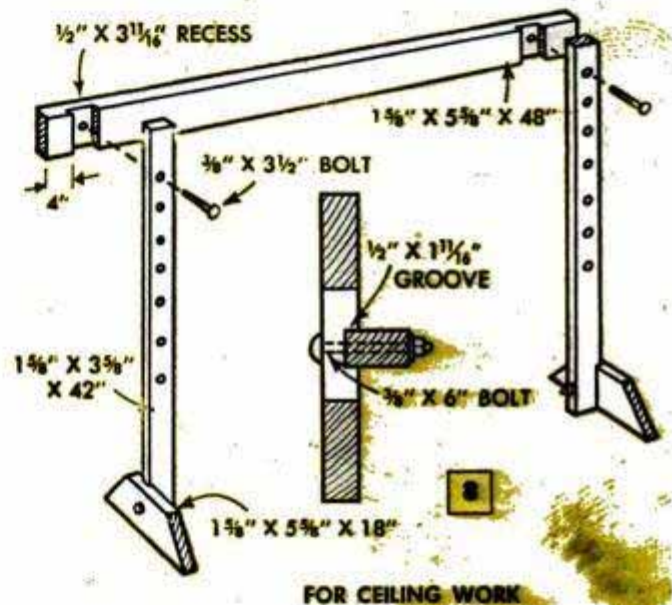
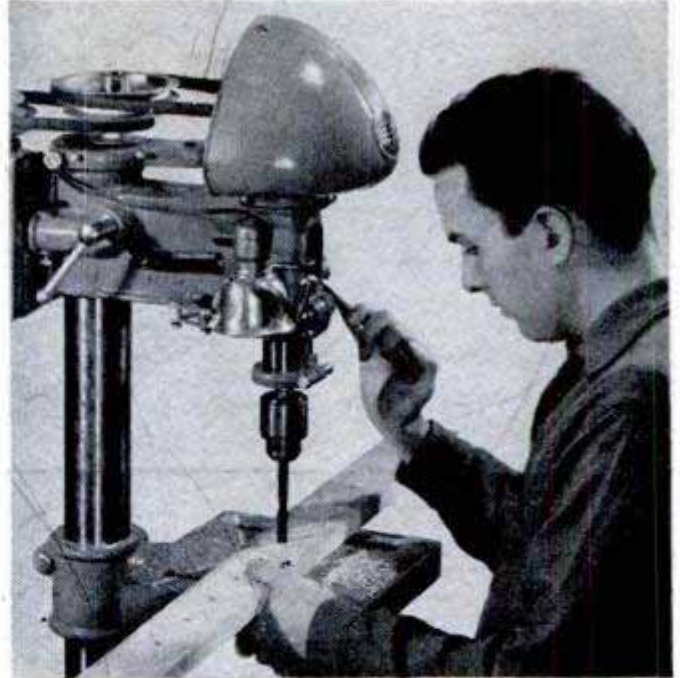

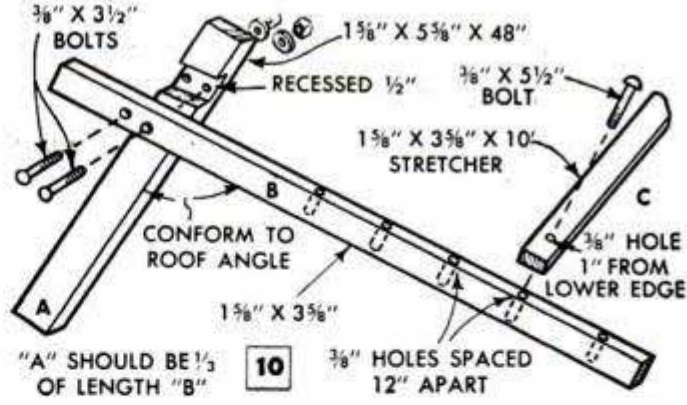
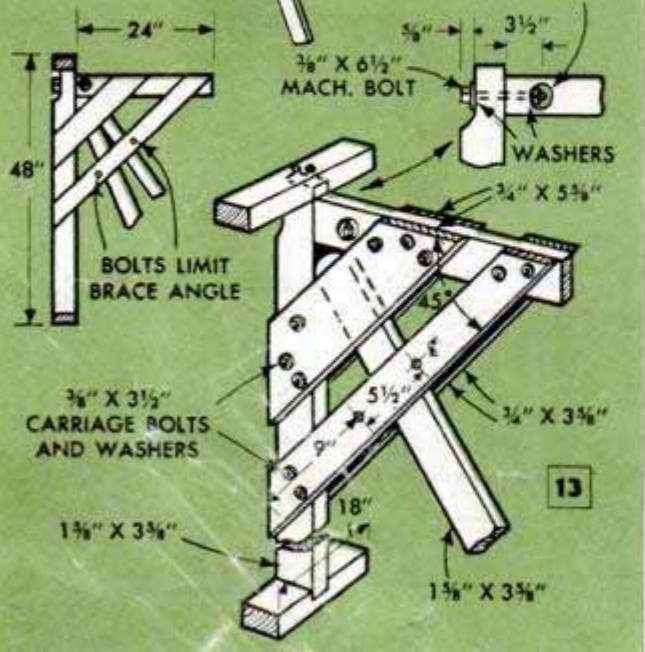
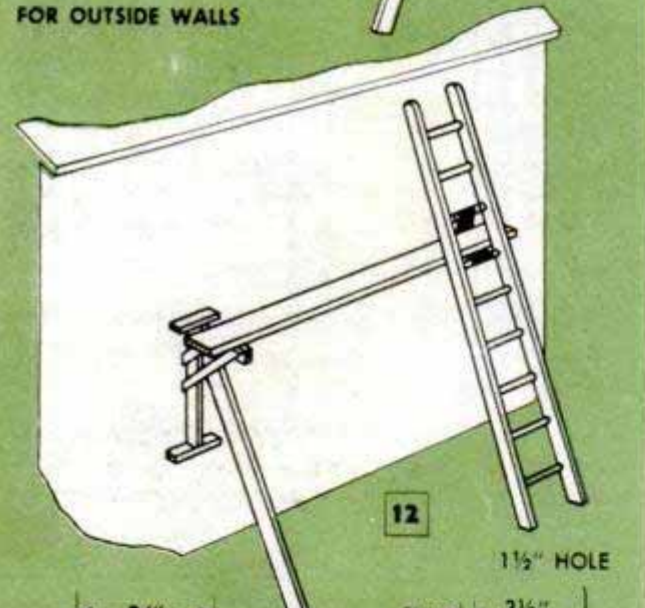
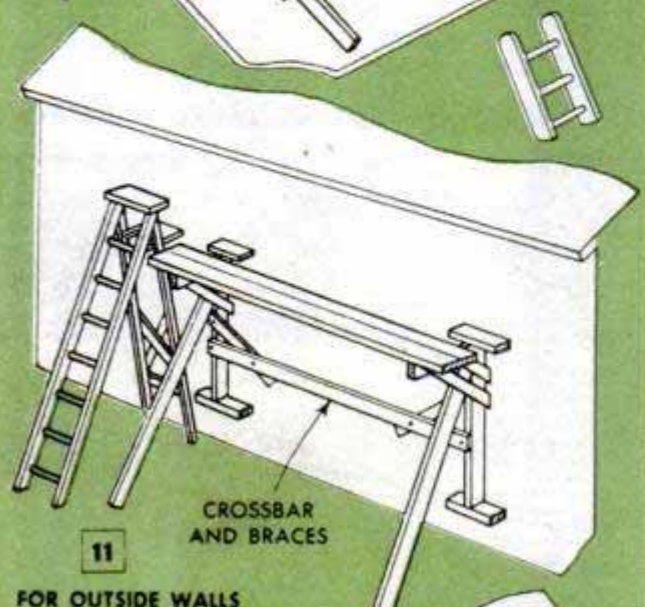
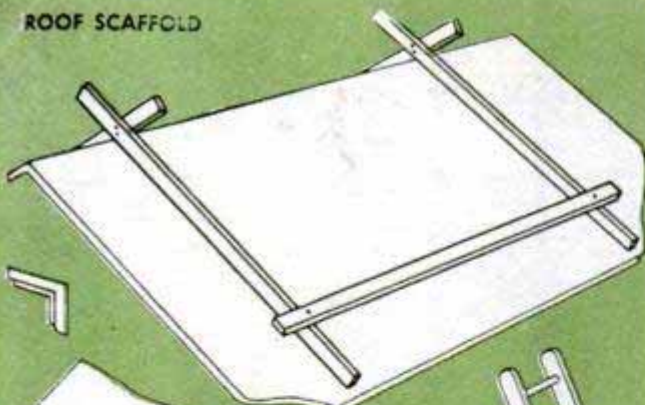

"A" SHOULD BE $\frac{1}{3}$ OF LENGTH "B"

10

$\frac{3}{8}$ " HOLES SPACED 12" APART

detail of Fig. 11. It should fit the roof angle. To find this, measure—from a ladder—the height of the ridge above the edges of the roof at the eaves and get the horizontal distance across the points at the eaves. Then draw a triangle to correspond at a scale of 1 in. per foot. From this you get the angle for cutting the recesses in the hook members A into which pieces B must fit snugly. When tightly bolted—two bolts in this case—pieces A and B cannot spread. The crosspiece C usually is held by long bolts pushed into holes in members B. For extra security you can slip the bolts upward through pieces B and C, and then turn nuts on tightly. More than one crosspiece can be used; one near the eave will enable you to get on the roof from a ladder.

Outside-wall scaffolds: Using two ladders and a pair of ladder jacks is the customary way of holding a plank or extension board to form a scaffold for painting outside walls, cleaning or repairing gutters, or starting a reshingling job. If you have no ladder, you can use wall jacks like the ones shown in Figs. 11, 12 and 13. Made as shown in Fig. 13, with the horizontal member no longer than 24 in. and the vertical leg no shorter than 48 in., and with two crosspieces attached to each jack to minimize side twist, there is all the rigidity required. If two jacks are used, maximum sturdiness is obtained by using a crossbar and diagonal braces as in Fig. 11. However, only one may be used in conjunction with a ladder jack, Fig. 12. The lengths of the supporting legs can be varied for different heights. Note the strong corner construction which is required. The lower braces on the jacks prevent them from twisting toward either side when the two bolts limiting the angle of the supporting legs are tightened firmly.

Washing solution for the windshield of your car may be carried in the glove compartment without danger of spilling if it is kept in a spray-deodorant container. Pry the inner cap and tube from the container, fill to about $\frac{1}{2}$ in. from the top and replace the cap.

Cylinder From Truck Jack Operates Hydraulic Press

Having only occasional use for a press in his garage, one auto mechanic made this press in which the ram can be moved horizontally to any position within the width of the press frame. The latter was assembled from lengths of 6-in. channel steel, the two top cross members being placed parallel and with the channels facing to produce a slot in which the ram slides. A 12-ton hydraulic jack, used as the ram, is welded to a square of steel plate. This is bolted in the center to a second steel plate, which overlaps the lower sides of the steel channels. This plate assembly keeps the jack suspended vertically, yet allows it to be moved from side to side. The supply of hydraulic fluid is stored in a tank connected permanently to the jack inlet by a length of copper tubing. The tank is supported on an arm welded to the jack unit.

L.H. Houck, Jefferson City, Mo.

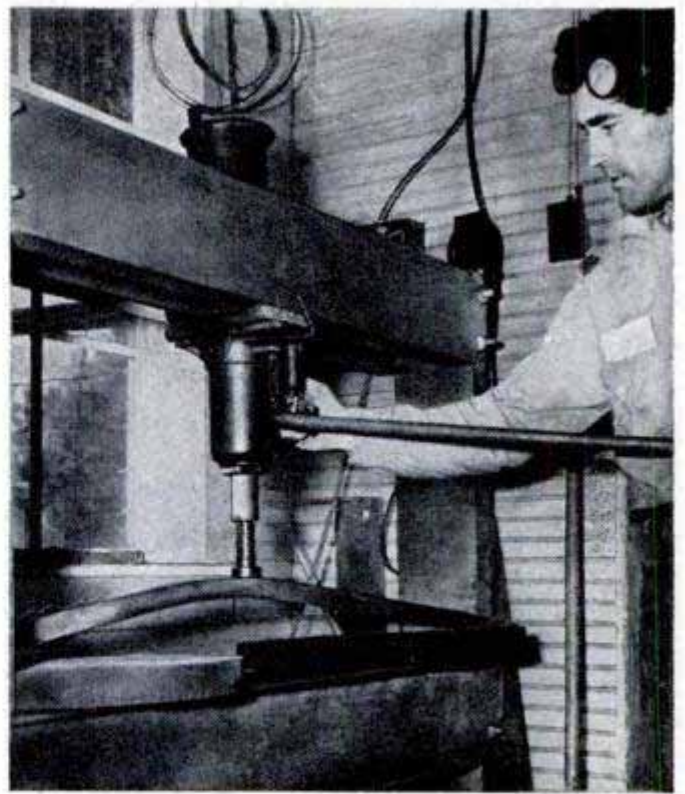

Simple Rules for Installation of New or Used Spark Plugs

When installing new or cleaned spark plugs, proper dissipation of heat through the plugs can usually be assured by following these simple rules. First, clean the threads of the plugs and those in the cylinder head, being sure to remove all accumulation of carbon. Always use new gaskets and take care that they are not seated in a "cocked" position. To avoid this, place

a small amount of grease on each gasket to make it adhere to the body of the plug, and then start the latter with your fingers. If plugs cannot be turned all the way in without the aid of a wrench, apply a small amount of oil to the threads. Finish tightening the plugs with a torque wrench to the value specified by the manufacturer of the plugs used.

Guide Lines on Lathe Steady Rest Help When Centering Work

Scored on the jaws of a steady rest used in a metal-turning lathe, guide lines will save time when adjusting the jaws to center work of different sizes. To locate the lines, chuck a short rod or piece of shaft-

ing in the lathe and move the steady rest close to the chuck so there will be no chance for the piece to bend. Adjust the steady-rest jaws so they ride uniformly on the work and make one score across the face of each jaw with a scribe, using the edge of the casting as a station mark. Then, remove the jaws and, measuring with a machinist's rule, scribe a series of lines so a variety of sizes of work can be accommodated. If care is taken to space the lines exactly the same distance apart on all jaws, the lines will make it possible for you to center the work quite accurately.

Henry Hanscom, Elmhurst, Ill.

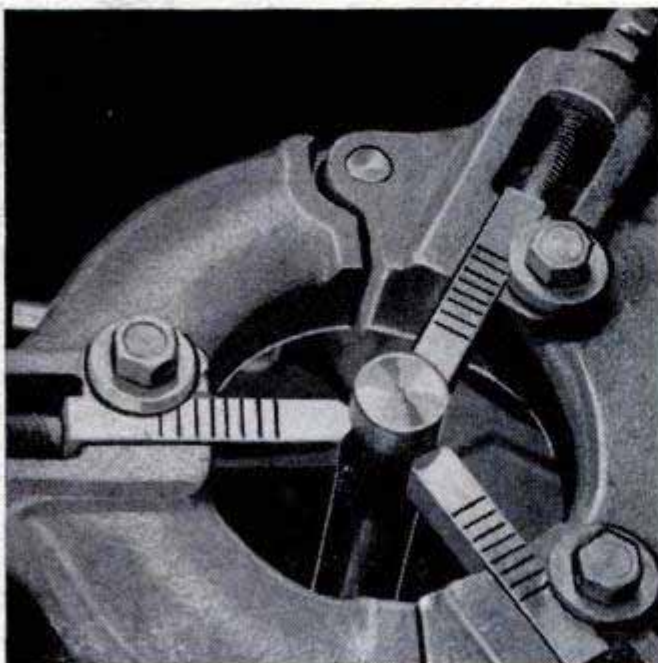

Engine Data Taped to Fire Wall

Frequently needed data, such as spark-plug and point gap, firing order of cylinders, etc., will be readily at hand if typed on strips of adhesive tape and stuck on the fire wall of the car. This eliminates the necessity of referring to the manual each time repairs are made. Clean a spot on the fire wall before applying the tape.



PLUG CUTTING

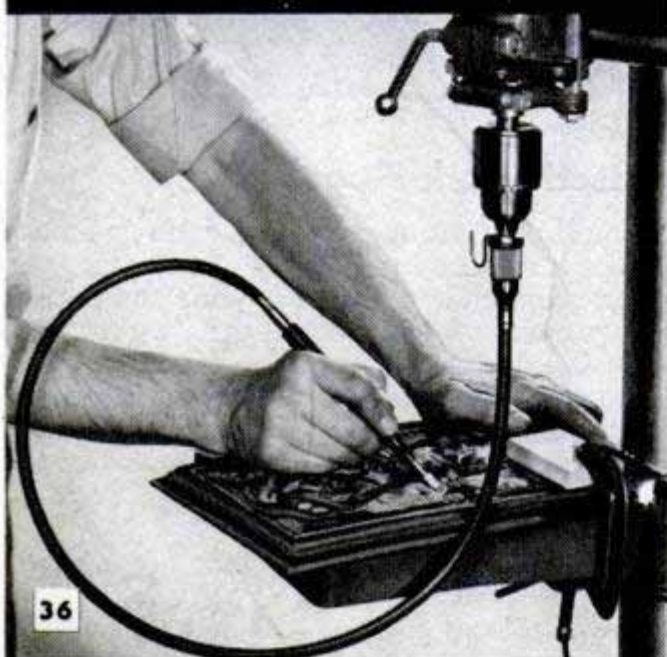

FLEXIBLE-SHAFT CARVING



JIGSAW ATTACHMENT

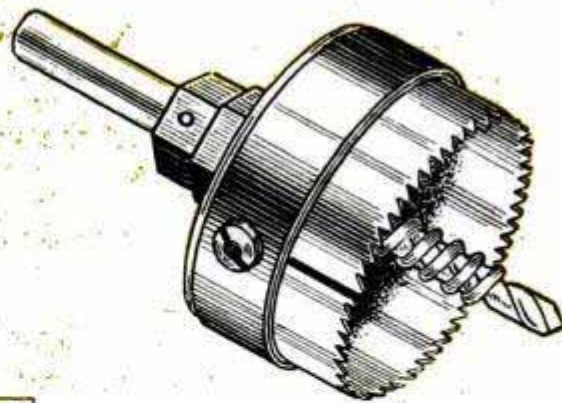

HOLE-CUTTING SAW

24

extra uses
for your

DRILL PRESS

Part II

IF YOU have been using your drill press only for routine jobs of drilling, and mortising, you have not been utilizing it to best advantage. It will save other machines, or even replace them in many cases on light work.

Besides the many uses described in Part 1 of this story last month, your drill press also will handle jobs such as those pictured on this and the following five pages. For example, boat plugs—grain running across the end—can be made in quantities with a special cutter as pictured in Fig. 34.

Large holes and disks: Hole saws from $\frac{3}{4}$ to 3 in. in diameter, Fig. 35, are available for making toy wheels, disks, or simply cutting large holes. Speed should be about one third or one fourth that used on corresponding size drum sanders mentioned in Part 1.

Carving: For carving wood and plastics, small rotary cutters, run at about 5000 r.p.m., may be used with a flexible shaft attached to a drill press as in Fig. 36, or they can be mounted directly in a chuck or an adapter, in which case the work must be moved instead of the cutter.

Jigsawing: With a small attachment chucked in your drill press, as in Fig. 37, a vertical reciprocating movement is pro-

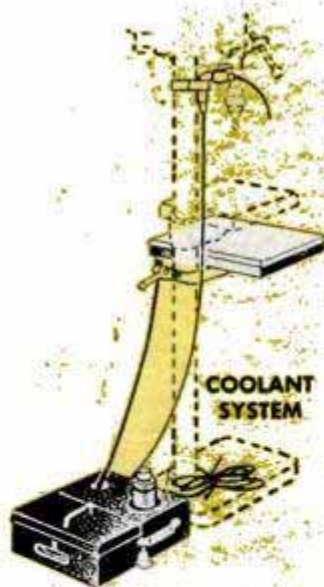

COOLANT SYSTEM

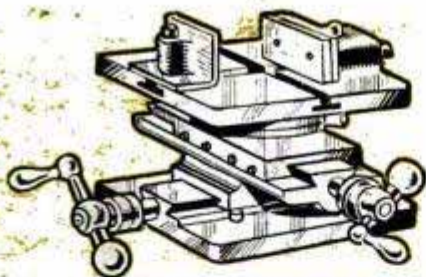

COMPOUND SLIDE AND VISE

38

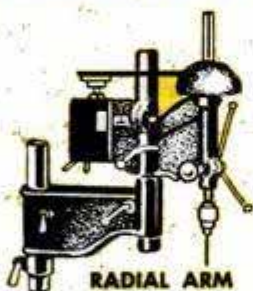

RADIAL ARM

vided, which permits jigsawing with accuracy. The same attachment may also be used for hacksawing. The tool is run at the slowest drill-press speed.

Besides the numerous woodworking applications of a drill press, its versatility extends to many metalworking uses and other functions. Equipment for metalworking may even include a coolant system as in Fig. 38, for milling, tapping and grinding, particularly when engaged in light production work. For precision operations, the work often is held in a compound vise, or in a lathe compound slide rest, the work being clamped down by the tool post or held by a vise attached to the slide. Such provision not only holds the work rigidly, but permits feeding it slowly and evenly.

If necessary, the throat clearance of the drill press can be increased by installing a radial arm as in Fig. 38, in which case a larger table is also required. Other accessories also are available. For example, you can get column collars to hold the head or table so they can be swung sideways. There are also screw-type devices for elevating and lowering the table or head, besides variable speed units. On drill presses having slip-on chucks, you should always use a spindle adapter, special spindle, screw-on chuck or a chuck that is integral with the spindle, to hold tools that exert considerable side thrust when in use, like wheels for grinding, scratch brushing and buffing, and side mills.

Milling: One of the most natural, occasional applications for a drill press is milling, Fig. 39. However, it should be used for light cuts only, employing small cutters, as a drill press is not basically designed for milling, its spindle overhang being much greater than that of a conventional milling

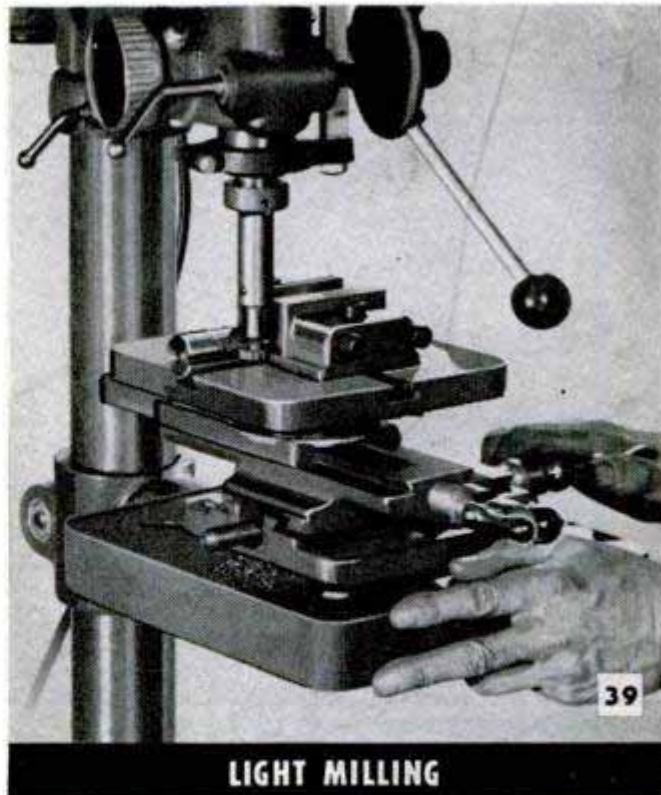

39

LIGHT MILLING

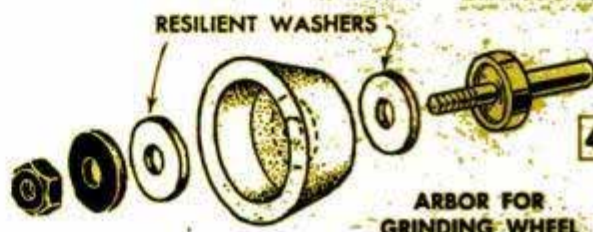

RESILIENT WASHERS

ARBOR FOR GRINDING WHEEL

40

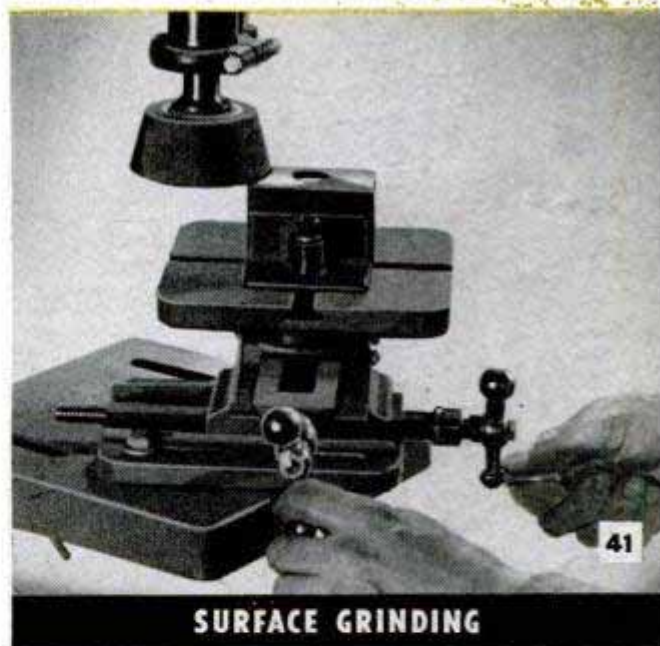

41

SURFACE GRINDING

machine. The work must be mounted rigidly on a compound slide or vise clamped to the table. Either the table is raised or the head is lowered to avoid unnecessary spindle overhang. This assures greater accuracy and minimizes the tendency to chatter. Average speed for light cuts on annealed tool steel should be about 70 feet per minute (peripheral speed of cutter). This requires a spindle speed of about 400 r.p.m. when using a 3/4-in. side cutter, which is about the maximum size advised

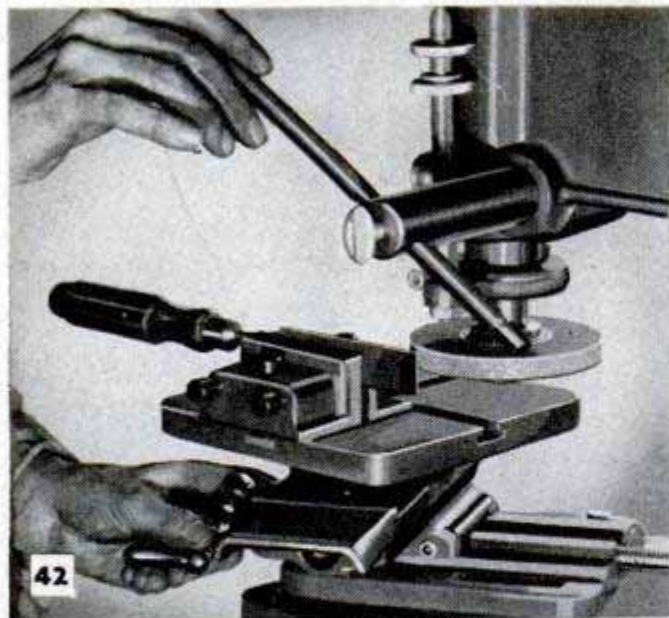

TOOL GRINDING

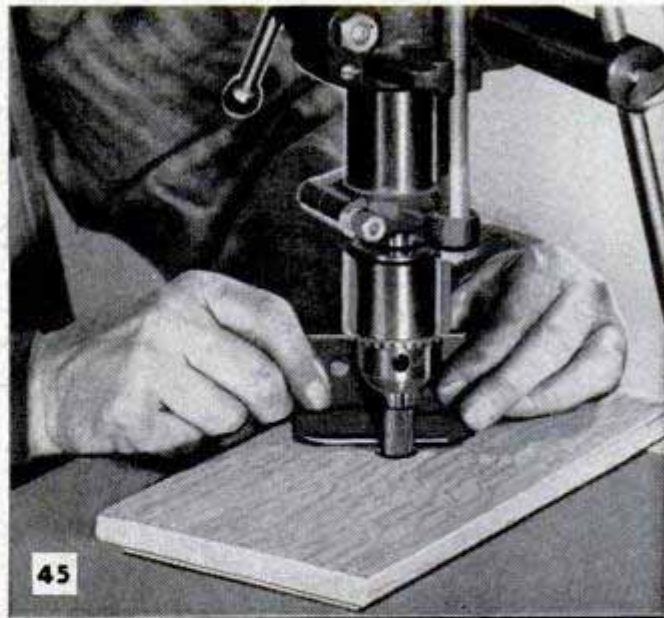

-FILING

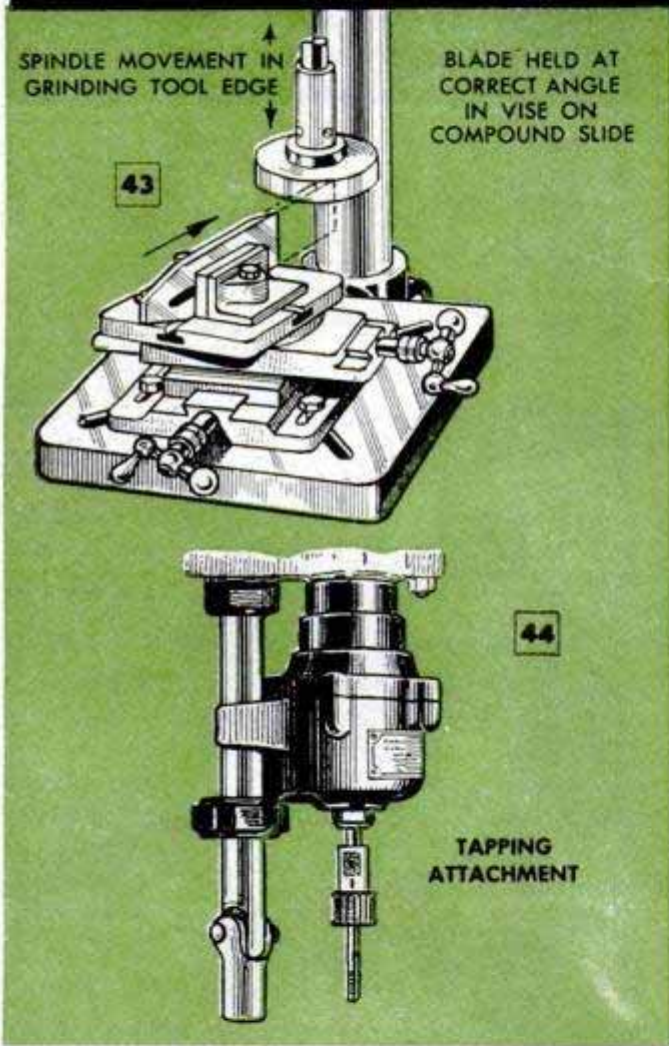

SPINDLE MOVEMENT IN GRINDING TOOL EDGE

BLADE HELD AT CORRECT ANGLE IN VISE ON COMPOUND SLIDE

TAPPING ATTACHMENT

wheel, or whenever a wheel develops irregularities, dress the face true—straight across—except on wheels that are used for contour grinding.

Accurate surface grinding on a drill press, Fig. 41, is done with a cup wheel not exceeding 4 in. in diameter. A medium-hard, 50 or 60-grit aluminum-oxide wheel is useful for average work in grinding tool steel. Support the work rigidly on a compound slide for precision results, although sometimes you can take light cuts by simply holding the work in a drill-press vise and sliding it slowly over the table while the quill is clamped in position. Or, you can lock the vise on the table and swing either the table or the head sideways, using a column collar to support the table or head.

For sharpening straight-edge tools such as chisels and plane irons, use an ordinary flat grinding wheel not over 4 in. in diameter, Figs. 42 and 43. Although freehand grinding is sometimes possible, you usually get more accurate results by mounting the tool in a compound slide, adjusting it to correct grinding angle for the tool. The wheel rotation must be toward the edge, not away from it. Cuts are made by lowering and raising the spindle. As it is essential to keep the tool edge cool to avoid drawing its temper, a small stream of water, supplied through a tube from an overhead container, can be directed against the edge being ground. In this case a splash guard may be necessary.

Generally, grinding is done at high speeds of 5500 to 6000 surface feet per minute. On a 4-in. wheel this would require a spindle speed of 3600 to 5000 r.p.m. However, for grinding hardened and tempered tool edges, slow speeds often are recommended to minimize the tendency to overheat the

for drill-press work. Smaller cutters are run at proportionally faster speeds to obtain the same peripheral speed.

Grinding: Grinding wheels are mounted on special arbors (or special drill-press spindles) and are secured by recessed washers, Fig. 40. Use compressible washers of blotting paper or rubber between the wheel and washers to distribute the pressure uniformly, tightening the assembly just enough to hold the wheel securely. Before grinding with a newly mounted

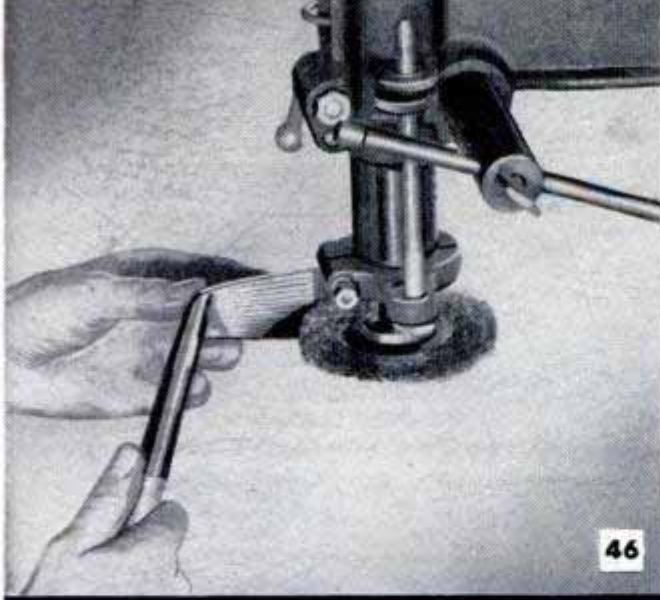

SCRATCH BRUSHING

work. As a safety measure when grinding, scratch brushing and buffing, be sure to wear goggles.

Tapping: For tapping metal you need a special attachment such as shown in Fig. 44. This runs the tap at any speed suitable to the material. It is clamped to the drill-press quill, which is lowered to engage the tap with the work. When the tap reaches the proper depth it reverses automatically at a speed usually twice that of tapping.

Filing: You can do external and internal filing, as in Fig. 45, using special rotary files. However, if such files are not available you get creditable results sometimes with a short piece ground off an ordinary round hand file. The piece must be straight, not tapered, and is wrapped at one end with tough paper if mounted in a screw-on chuck, to protect the chuck jaws.

Scratch brushing: Metal can be cleaned of rust, dirt and hardened grease, and can be burnished to a satin finish by scratch brushing as in Fig. 46. Scratch brushes in various sizes with the wire mounted on the side or end are available. Maximum size for drill-press use is 4 in. in diameter. Hold the work freehand and turn it while feeding. Speed depends on size of brush and type of material. Medium speeds are best generally, but for fine effects on softer metals use high speeds and light feeding. Paint removal by scratch brushing should be confined to painted-metal surfaces since wood surfaces will be roughened.

Buffing: You can buff metal surfaces to a fine luster as in Fig. 47, using 4-in. or smaller buffing wheels and a suitable abrasive such as rouge in cake form. Use speeds of 2400 to 5000 r.p.m. As the work is held by hand, swing the table aside to provide adequate working space. Take care to prevent the wheels from catching the work at sharp

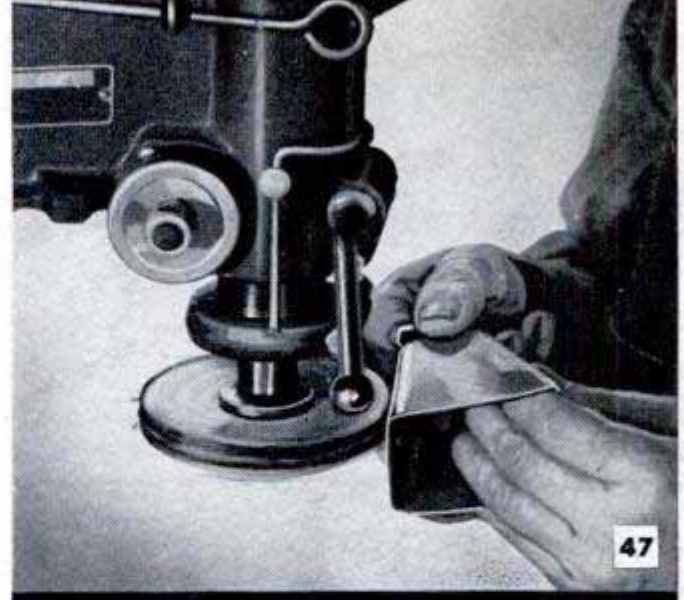

BUFFING

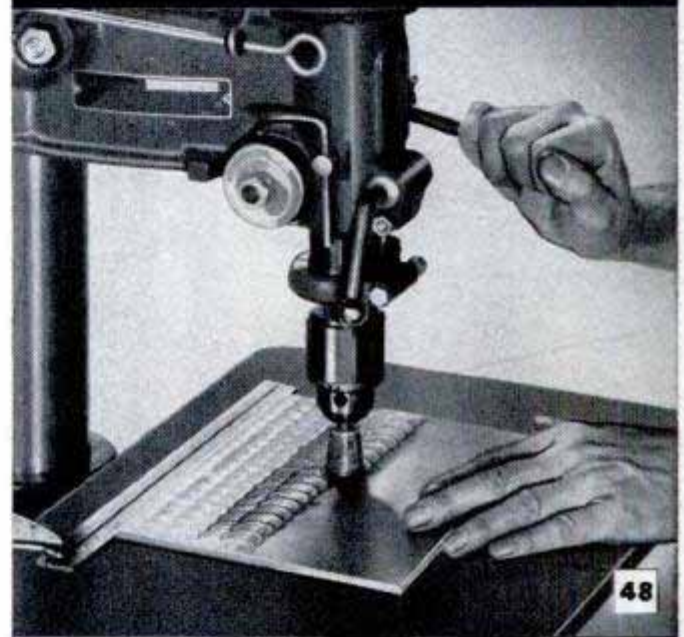

SPOT POLISHING

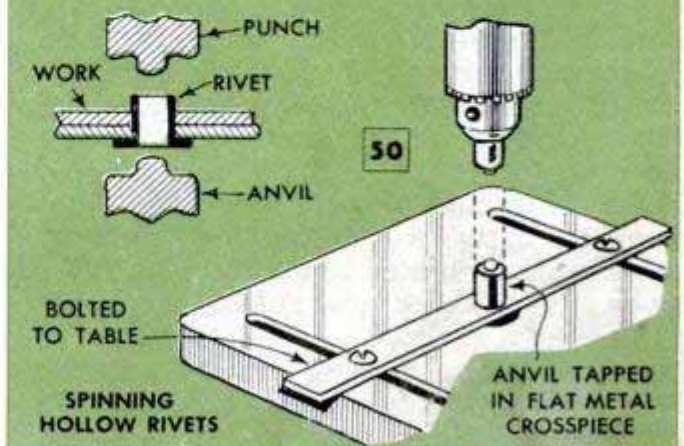
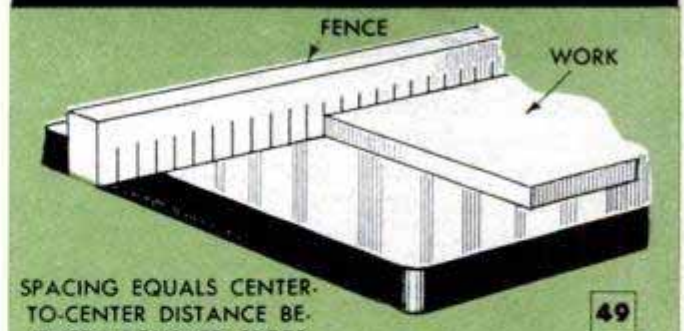

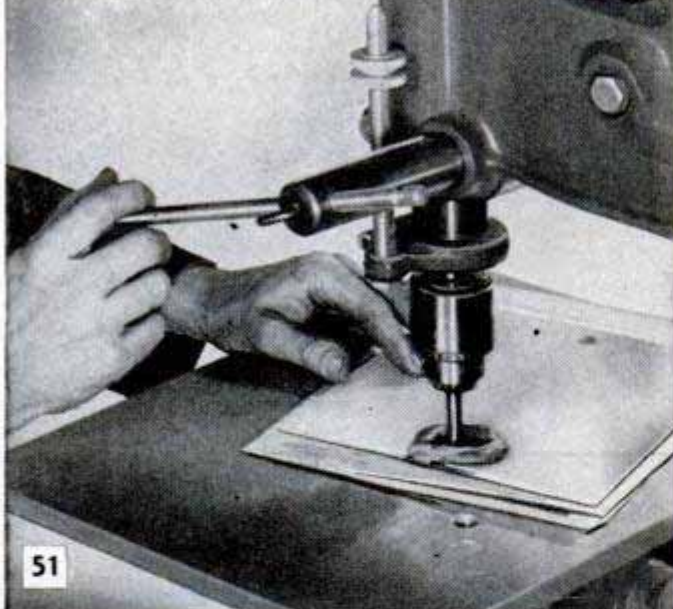

51

DRILLING GLASS



52

MIXING LIQUIDS

corners or in tapered grooves, which may wrench it out of your hands.

Spot polishing: For spot polishing as in Fig. 48, use a dowel with or without a leather facing. If the dowel is of greater diameter than the chuck capacity, turn down one end or drill a hole concentrically for a short metal shank, which is cemented in place. Or, you can use a bottle cork of suitable size in the same way. In any case, the surface contacting the work should be turned or sanded square with the shank axis. Fine valve-grinding compound or emery mixed in oil is applied to the end. The work is slid along a fence and is advanced equally for each spot, using a tough paper scale cemented to the fence as in Fig. 49, or a 1/8-in.-thick steel rule to serve both as fence and scale. The spots should overlap about 1/4 to almost 1/2 of their diameter. The second row is spaced this same distance from the first by simply moving the

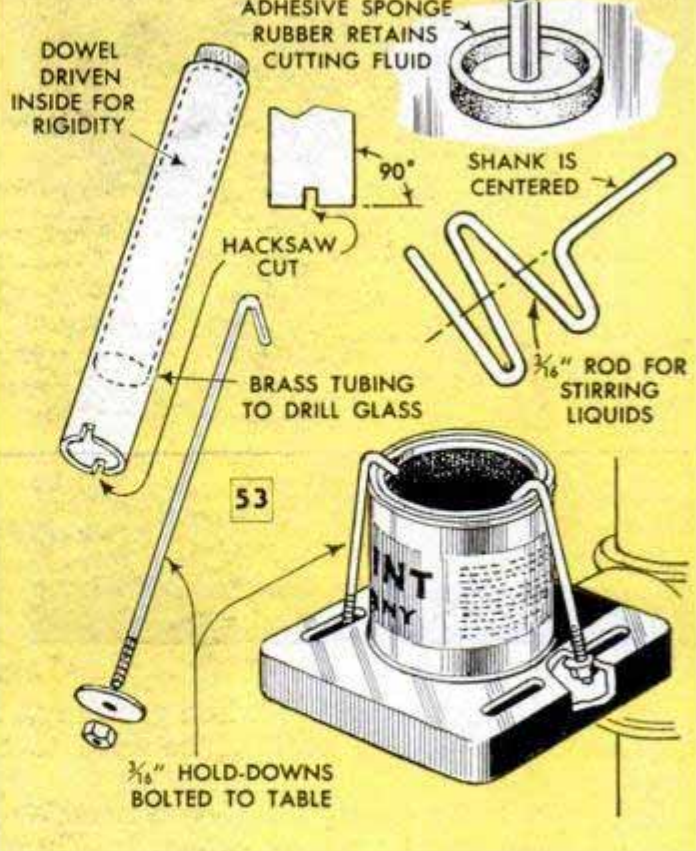

fence, starting at the same end and staggering the spots so that they come midway between those in the first row.

Spinning hollow rivets: Hollow rivets used for fastening sheet metal and other thin materials can be spun tight by using your drill press as in Fig. 50. The anvil, which holds the rivet, is screwed into a flat-metal base bolted to the table so that the anvil is in alignment with the punch mounted in the chuck. The rivet is slipped in place on the anvil, followed by the two sheets to be joined, these having been punched or drilled previously to fit the rivet. For steel rivets, a spindle speed of 2000 to 2500 r.p.m. is used. Lower speeds are effective for brass, copper and aluminum. If much spinning is done the punch should be hardened.

Drilling glass and china: For glass drilling, Fig. 51, best results generally are obtained by using a brass tube of suitable diameter. It is cut off squarely at the working end and is notched with a hacksaw or file as shown in the upper detail of Fig. 53. To prevent a piece of thin tubing from buckling in the chuck, a snug-fitting dowel is driven into the chucking end of the tube. A putty wall retains the cutting fluid. This consists of fine valve-grinding compound or emery mixed with turpentine or oil. The drill press is run at its lowest speed. Intermittent, light contact with the glass will prevent heating and fracturing it. A sheet of glass should lie on a uniform, flat surface, preferably on a sheet of rubber or felt. Other ceramics and baked-enamel finishes

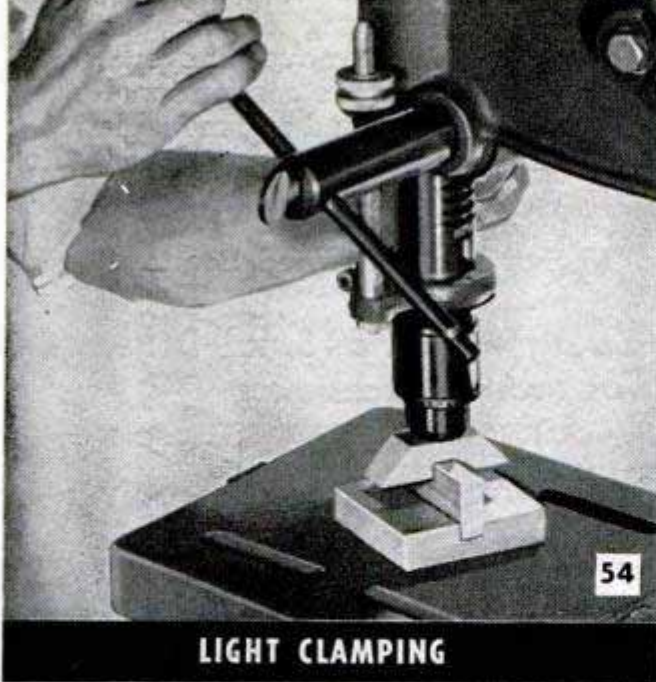

LIGHT CLAMPING

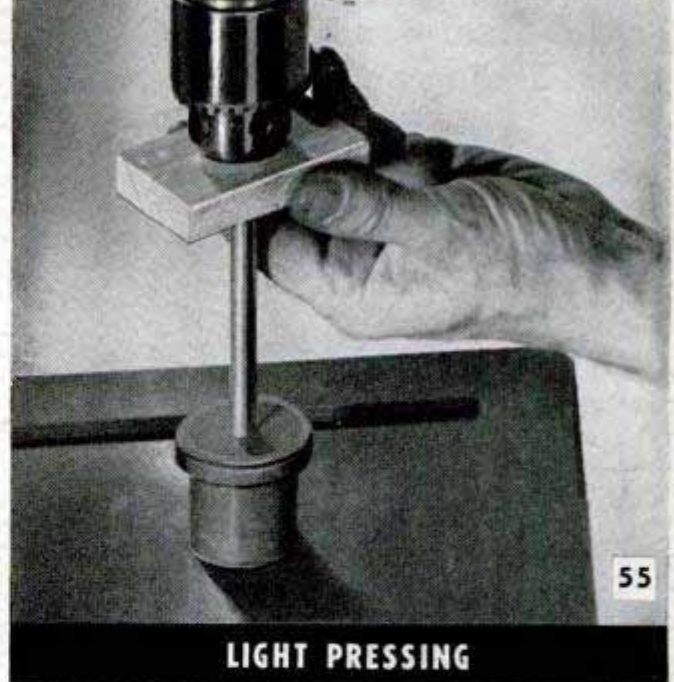

LIGHT PRESSING

on metal can be perforated neatly in this way without chipping.

Glass edges can be ground and polished also on a drill press. Use a fine grinding wheel or drum sander fitted with an emery-cloth sleeve. Polishing is done with a buffing wheel loaded with progressively finer abrasives. The glass must be fed lightly and is kept moving while in contact with the wheel to avoid heating and fracturing.

Mixing liquids: Paint and other liquids can be mixed thoroughly and quickly by means of an improvised stirring rod rotated at slow speed, Figs. 52 and 53. The wings of the stirring rod should extend an equal distance from the shank so that proper balance is obtained. If made of $\frac{1}{8}$ or $\frac{3}{16}$ -in. steel rod, it will not bend out of shape easily. The lower wing should be horizontal to scrape off pigment accumulation on the bottom of the paint cans. The spindle is

raised and lowered while mixing. Clamp the can securely to the drill-press table, by using the method shown in Fig. 53, or hold the can by hand. If this is not done the container may move against the rotating mixer, resulting in spilled paint.

Clamping and pressing: A drill press also makes an excellent clamp where only moderate pressure is required, Fig. 54. Examples of this application are holding pieces of sheet stock together while measuring, laying out and scribing, particularly at points where the pieces are to be joined.

Occasionally, you can use the drill press somewhat like an arbor press for light work such as removing or replacing bushings, sleeves and plugs as in Fig. 55. Parts to be ejected are centered over the hole in the drill-press table. When doing work of this kind keep the pressure light.

(The end)

Hog Wire Used to Protect Grass Seed in Fight Against Soil Erosion

An effective method of preventing erosion and the formation of gullies in newly seeded pastures and other uncultivated fields consists of using woven hog wire to protect fast-germinating grass seed. Two rolls of wire are unrolled, one overlapping the other, and spread across the area to be protected. The wire is staked to the ground and the area is seeded over the top of the wire. During a rain the wire collects soil and debris carried in by the water and a mat is formed which will keep the seed from being washed away.

☐ When using a center gauge to check the angle of a lathe tool bit, hold a small piece of white paper behind the gauge to make it easier to distinguish the space between the bit and the gauge.

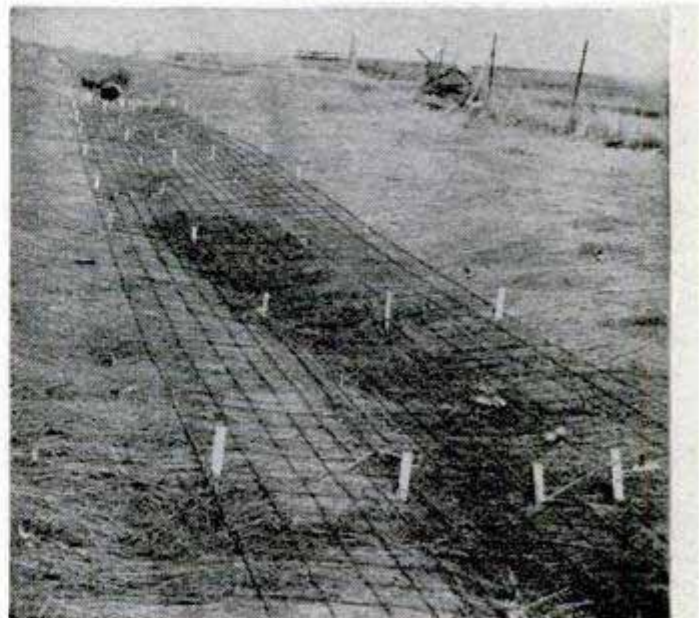

Nonskid Miter-Box Feet Prevent Sliding on Bench

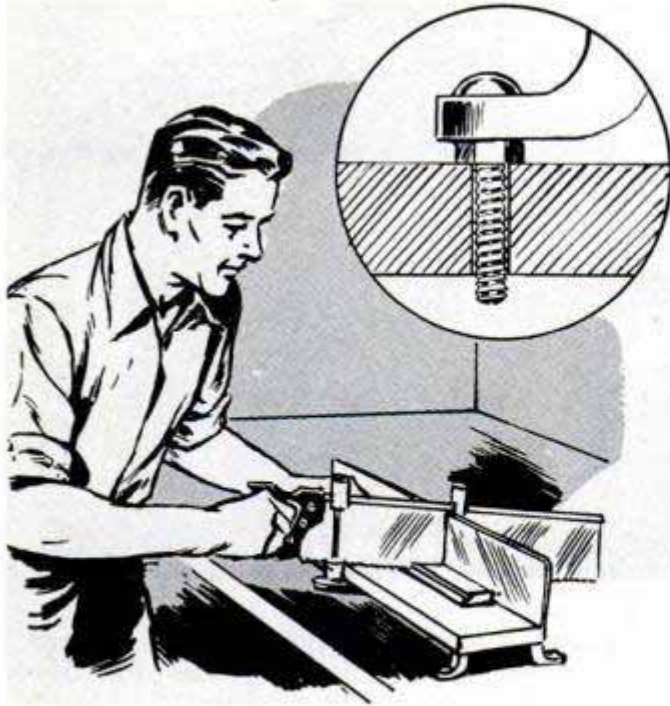

In order to keep his miter box from sliding back and forth on the workbench, one woodworker attached short bolts permanently to the feet of the box to be inserted in holes drilled in the bench top. The bolts are attached as pictured in the detail and serve as pegs, which slip into the holes when the box is in use.

Portable Mop "Bucket" and Wringer For Cleaning Large Floors

Sturdily built for heavy-duty service in an automotive repair shop, this portable wringer was made by cutting a 55-gal. drum in half to form a tank, which is mounted on a rubber-tired tricycle as pictured. The



axle brackets and the yoke for the front caster wheel were built up by welding flat steel parts to form the shapes desired. Then heavy steel angles were welded to the sides of the tank to form a base for the wringer and a single baffle was welded in the tank

to prevent overflowing of the contents when the unit is moved over uneven floors. The wringer unit is the conventional type with one fixed roller and one movable roller. The latter is brought into contact with the fixed roller through the use of a U-shaped treadle.

M/Sgt. James R. Wood, Seattle, Wash.

Drawing Board Has Small Drawers Made From Matchboxes

Tacks, leads and other small parts used by draftsmen or artists can be kept within convenient reach by storing them in small matchboxes

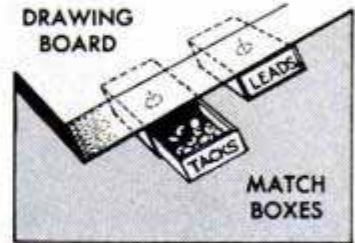

fastened to the underside of a drawing board. Remove the cover of each box and tack or tape it to the board as shown. Then, the contents of each box may be indicated by labeling the outer end.

Damage to Welded Castings Reduced by Baking Process

To avoid porosity and cracking of magnesium castings being repaired by welding, one California metalsmith developed a cleaning and baking process which reduced such damage by 70 percent. Preparatory to welding, the casting is degreased and baked at a temperature of 350 deg. F. for 30 minutes. Then the repair is made using the heliarc method of welding.

George B. Davis, Coronado, Calif.

Lathe Gears Spaced Easily

One of the simplest methods of spacing gears in a loose-change lathe is to use a metal spacer as shown in the photograph.



To prepare it, cut a strip of 33 to 35-ga. sheet metal and feed it between two of the gears while they are turned by hand. This will shape the strip so that it can be slipped into place between gears that are being mounted. A spacer of this type will be ejected as soon as the gears are turned. It's a good idea to drill a small hole in one end of the strip so that it can be hung up when not in use.

☐ The next time you have small tubing to bend, pack it with salt instead of sand. It's easy to remove the salt with water.

BORING-TOOL HOLDER ADJUSTS TO CLOSE TOLERANCES

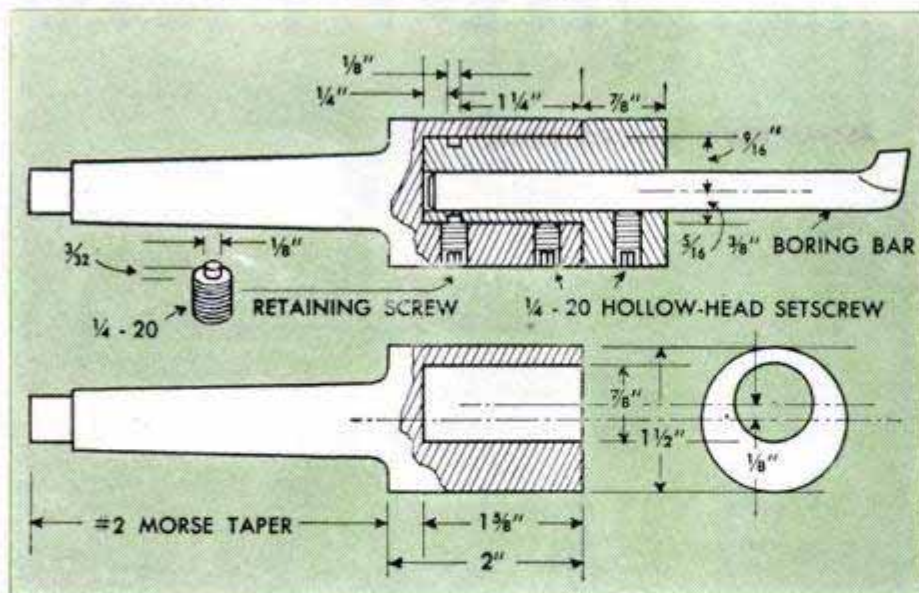

For precision work with a milling machine or the milling attachment of a lathe, this boring-tool holder features an eccentric adjustment which permits setting the cutting radius to extremely close tolerances. The holder consists of two pieces made as shown in the detail. The shank of the body section is turned to a No. 2 Morse taper and the face is drilled $\frac{1}{8}$ in. off center, thus forming an eccentric sleeve to take the shouldered head in which the boring bar is locked. To make the head section, turn the eccentric shank to a sliding fit in the sleeve and turn the shouldered

end to the same size as the outside diameter of the sleeve. The shank should fit the sleeve just loosely enough to permit turning the head by hand when adjusting the boring bar. Cut a groove for the retaining screw near the end of the shank and knurl the surface of the shouldered section. Drill the head, as detailed, to take the boring bar, drilling and tapping both head and sleeve for setscrews and retaining screw. Measure carefully to be sure that the retaining screw engages the groove in the shank of the head section.

C. W. Woodson, Miami, Fla.

Portable Livestock-Loading Chute Is Fitted With Retractable Dolly

Easy portability and stationary rigidity have been combined in this livestock-loading chute by fitting it with a folding, two-wheeled dolly. Wheels from a discarded implement were fitted with an axle of suit-

able length which was pivoted to the frame of the chute by means of two hardwood arms. Wheels are held in the lowered or raised positions by means of two notched levers, the lower ends of which are attached to the axle. The free ends of the levers pass through U-shaped, flat-iron guides and extend to a point near the rear, or low, end of the chute. A lag screw passing through a hole drilled near the lower end of each guide is turned into the hardwood frame member to provide round lugs to engage the notches cut in the levers. Raising the low end of the chute and lifting the levers disengages the dolly.

A. M. Wettach, Mt. Pleasant, Iowa.

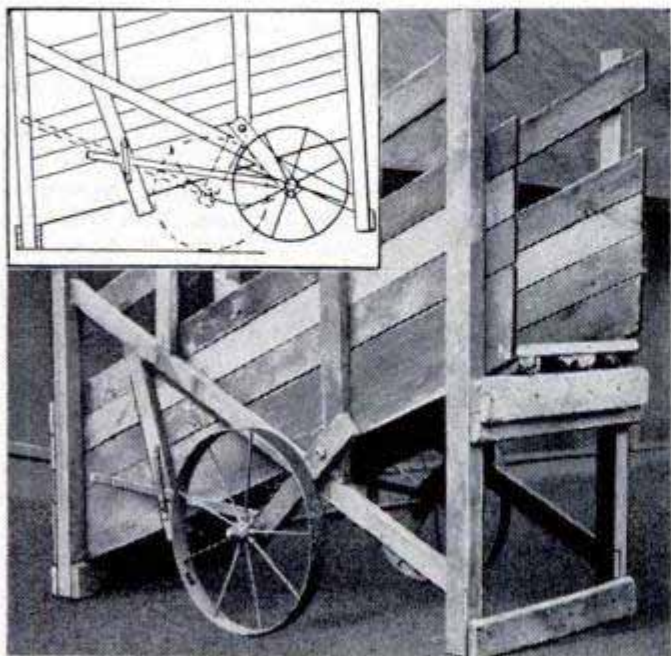

Iodine Loosens Frozen Nuts

Iodine provides an excellent substitute for penetrating oil when it is necessary to remove a frozen nut. Use a medicine dropper to apply a little iodine to the exposed threads at the face of the nut. Allow a few minutes before backing off the nut.

J. R. Spurgeon, San Diego, Calif.

SHOPPING

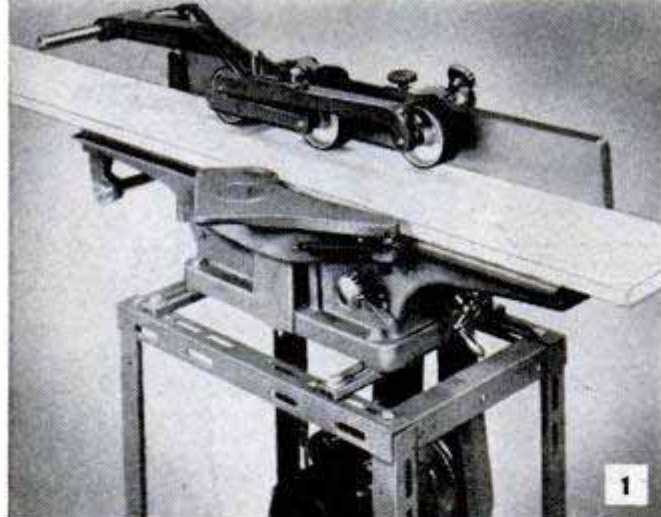

1



2



3

1. HOLD-DOWN ATTACHMENT for small jointers is designed to hold stock securely against jointer fence and at same time exert uniform downward pressure to assure accuracy. Operator starts end of stock under the first roller, then pushes it through with a push stick. Works perfectly on all sizes of flat stock and also handles small moldings and wedge-shaped pieces

2. VALVE LIFTER for 1950 Chevrolet engines enables mechanics to remove and reinstall the valves without damaging the rubber seal on the valve stems. The lifter is easily and quickly positioned and locks with the valve spring compressed, exposing valve keys for removal. Unit comes complete with instructions. Tool can be adapted for use on other valve-in-head engines

3. PAINT HEATER prepares enamels and lacquers for application by the hot-spray method. Unit is electrically operated and automatically controlled. Enamel or lacquer is heated and mixed in original container. Top half of heating unit is clamped in place over container and the switch is turned on. When liquid reaches proper temperature, heat is automatically turned off

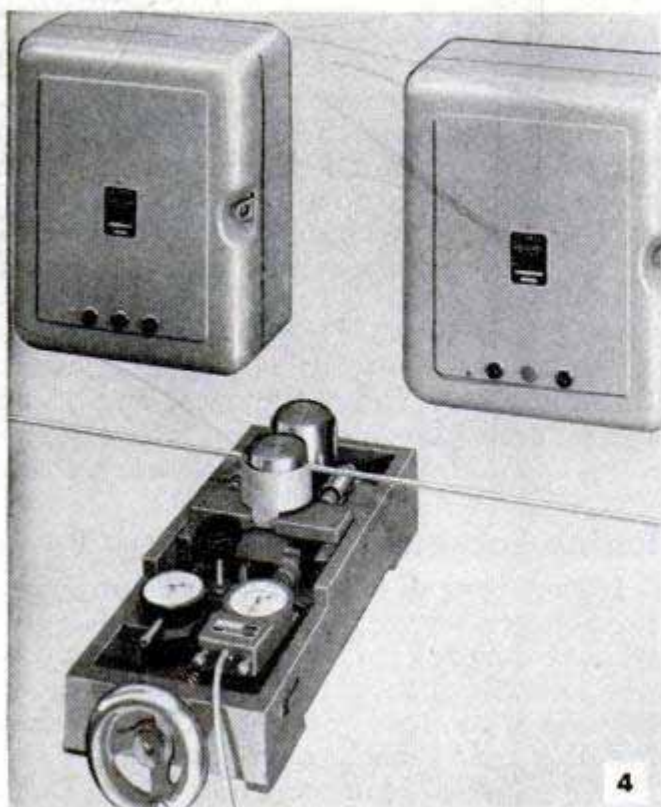

4

4. WIRE-MEASURING GAUGE is designed to control automatically the amount of insulating material the extruder places on the wire. Handles coated wire up to 1 in. in diameter. When set for wire of a given size the unit controls thickness of coating by automatically controlling the speed of the wire as it passes through the extruder, thereby effecting a saving in material

FOR TOOLS

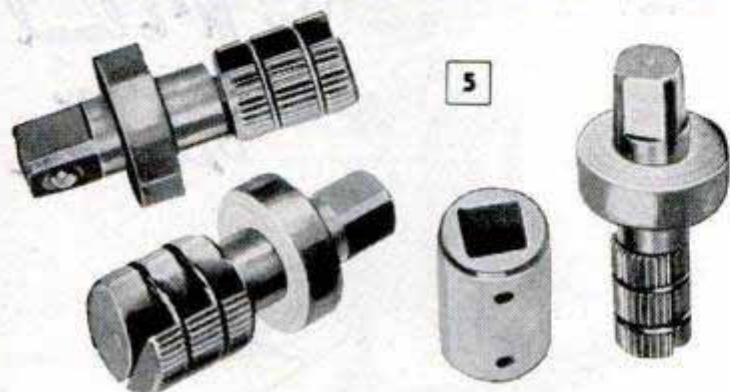

5. INTERNAL PIPE WRENCH grips the inside of pipe when tightening or loosening. Works close against walls, in hard-to-get-at corners and narrow openings. Wrenches are made in five standard pipe sizes and can be operated with a ½-in. ratchet handle, or, if necessary, with an end wrench. Grips pipe in same manner when turned either right or left. Cannot drop into pipe

6. TREETOP HOIST for chain saws enables the operator to raise and lower saw to any position while in the tree. Supports saw securely at any point and permits the operator to release it when changing position in tree. The top anchor plate is fitted with steel prongs that grip the tree trunk or a limb and support the swinging crane to which hoist and saw are attached

7. PUSH-PULL STEEL RULE for inside measurements is housed in a special case having one right-angle corner. This feature makes it possible to measure distances between walls, doorjamb and window frames with extreme accuracy. To use, place end of rule against one side of opening. Extend rule until the square corner of the case is flush against the opposite side. Then press the locking lever to hold measurement

8. PAINT-PAIL HOLDER fits over the side frame and rung of a ladder and holds a 1-gal. paint pail without any danger of tipping. Can be attached to either right or left side of the ladder. There are no screws or bolts to tighten or loosen or adjust when making the change, or when shifting holder to different height on ladder. Suitable also for holding a fruit-picker's bag

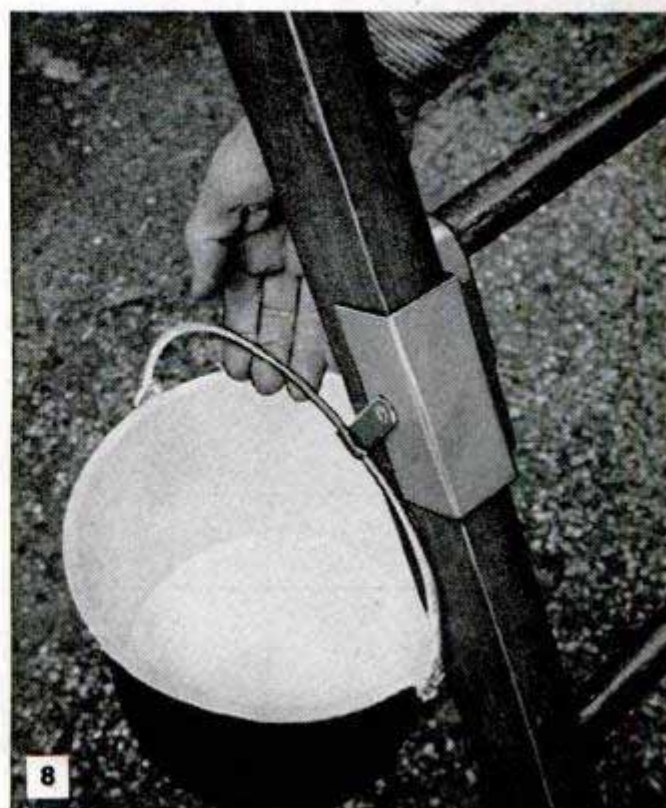
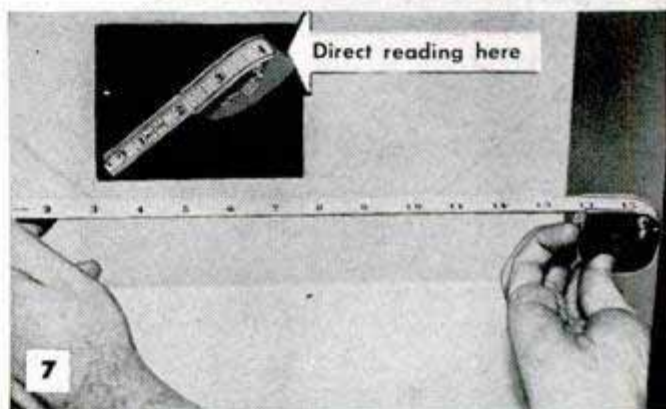

False Bottom Placed in Desk Tray Speeds Removal of Paper



The difficulty of removing typing paper from a box or tray may be overcome by the use of a false bottom of cardboard. This is fitted with a tab of cloth tape long enough to extend over the end of the box. By lifting on the tab, the packet of paper is raised for easy removal of one or more sheets.

How to Transfer Blind Holes

Transferring the location of holes already drilled in one piece to an additional part that must fit accurately in place can be accomplished without measuring by the method shown in Fig. 1. The work is adjusted on the drill-press table under a heavy center drill by inserting the drill in the hole. The work is then clamped to the table and the new part to be drilled set in place, Fig. 2, and the hole started with the drill. After an accurate start has been made, the drill can be changed to the size

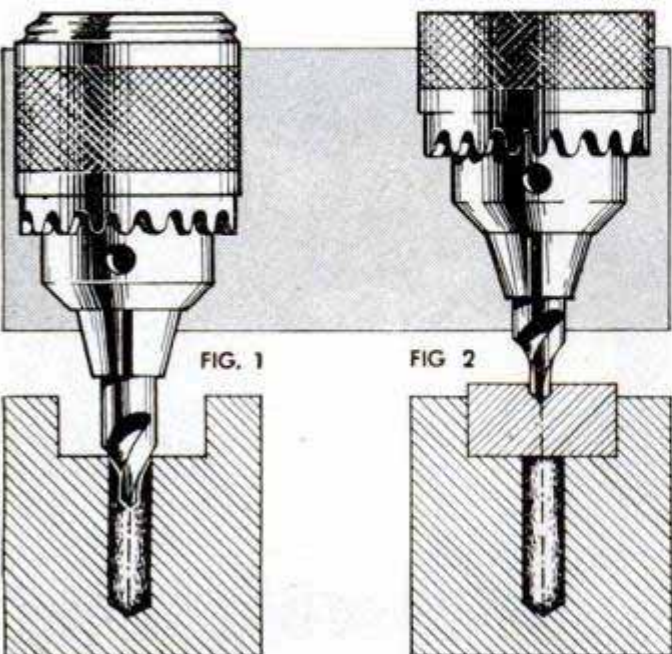

required and the hole continued through the work. If the hole to be transferred is large, the jaws of the drill chuck may be used to center the work, after which the work is clamped and the hole drilled in the new piece.

Portable Electric-Power Unit Drives Farm Machinery

Welded together from scrap metal and utilizing a $\frac{3}{4}$ -hp. electric motor, this lightweight power unit is adaptable for driving various machines around the farm. It is especially useful for turning the windlass on a chopped hay or grain rack, as its reversible speed reducer has an automatic clutch which prevents any breakage



should the windlass become clogged or the rack overloaded. The power unit is mounted on a two-wheeled cart and is adjusted for height by means of a screw-type bumper jack welded to the axle and frame. If necessary, a conventional-type telescoping power-take-off shaft can be used to connect the drive unit to the shaft to be driven on the machine.

Formula for Machine-Screw Sizes

When you want to duplicate a particular machine screw on your lathe, it isn't necessary to search through a handbook to find the diameter to which the blank must be turned. First, remember to multiply the number of the screw by .013 and add .060. Thus, the diameter of a No. 2 screw is $2 \times .013$ plus .060, or .086 in. A No. 3 screw is $3 \times .013$ plus .060 or .099 in.

I. E. Wallace, Los Angeles, Calif.

COLOR TV FOR THEATERS

PROJECTED color-television pictures of theater-screen size were shown recently at the Colonial Theater in New York City by the Radio Corporation of America in tests that revealed further advances in the RCA compatible, all-electronic color-TV system. The color show, produced in the NBC studios at Radio City, was broadcast on channel 4. This enabled owners of all existing television sets in the area to view the same program in black and white.

Sketch A shows the experimental receiver-projector setup in the theater. The principal components of the improved theater tri-color TV receiver-projector system are shown in sketch B. Three projection kinescopes, spherical mirrors and correcting lenses are employed. In the operating apparatus, photo C, these are mounted in the triangular arrangement projecting colors that are superimposed on the large screen as a single brilliant picture. RCA engineers claim that future receiver-projectors of this type will fill full-size theater screens up to 18 x 24 ft. The projection apparatus uses the same type of optical system used in RCA's black-and-white theater TV projectors now installed in theaters in New York, Chicago and other cities. Photo D shows the tri-color camera in operation.

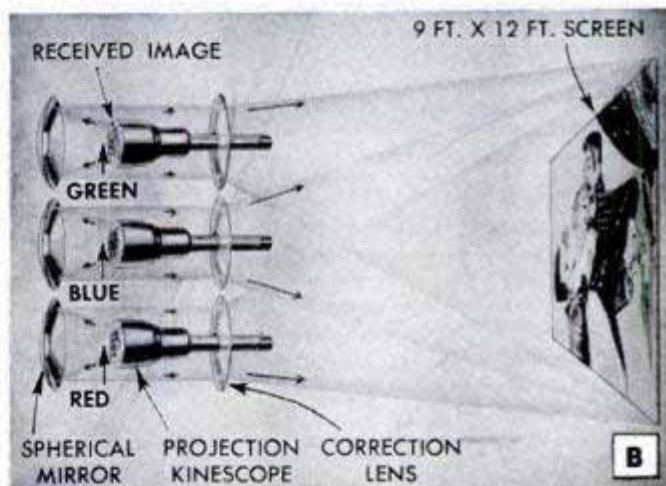
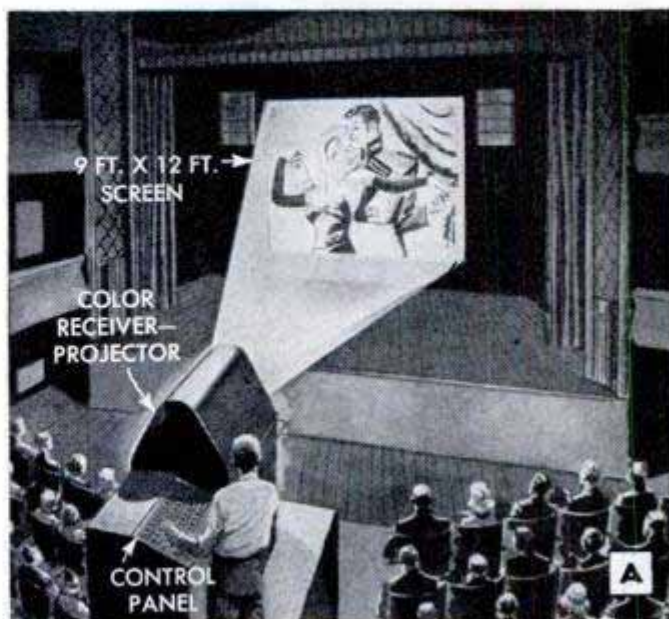

VERSATILE AMPLIFIER SERVES

By Dr. R. C. Hitchcock

PERFECT stability and also unusual gain are outstanding features of this versatile audio amplifier. The undistorted output is 3.8 watts, and the maximum is 4.5 watts. Four input circuits are available and a reluctance pickup can be used in the microphone channel. Two separate phonograph inputs take high-impedance crystal pickups; a low-gain channel will work with radio or television as indicated in Fig. 1-A.

Bass and treble controls are always in the circuit. These may be set to give a variety of frequency curves. With bass and treble set at the halfway point, the output is linear, or high fidelity. Turning the "bass" control gives either minus 10 DB (cut) or plus 8 DB (boost) at 100 cycles per second. The "treble" control gives minus 25 DB (cut) or plus 5 DB (boost) at 5000



A

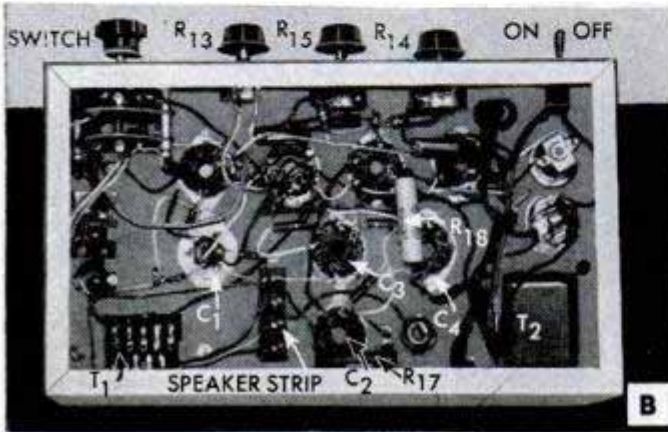

B



C

RESISTORS

- 3—100,000 -ohm, 1/2-watt carbon (R1, R2, R16)
- 2—10,000-ohm, 1/2-watt carbon (R3, R4)
- 2—6000-ohm, 1/2-watt carbon (R5, R6)
- 3—5000-ohm (filter), 1-watt carbon (R7, R8, R9)
- 3—500,000-ohm, 1/2-watt carbon (R10, R11, R12)
- 1—1/2-megohm logarithmic potentiometer Mallory taper No. 1 MR48 (R13)
- 1—100,000-ohm linear potentiometer Mallory taper No. 4 MR41 (R14)
- 1—1-megohm linear I.R.C. potentiometer No. Q 11-137 (R15)
- 1—500-ohm wire-wound (R17)
- 1—250-ohm (Koolohm type) Sprague, 10-watt (R18)

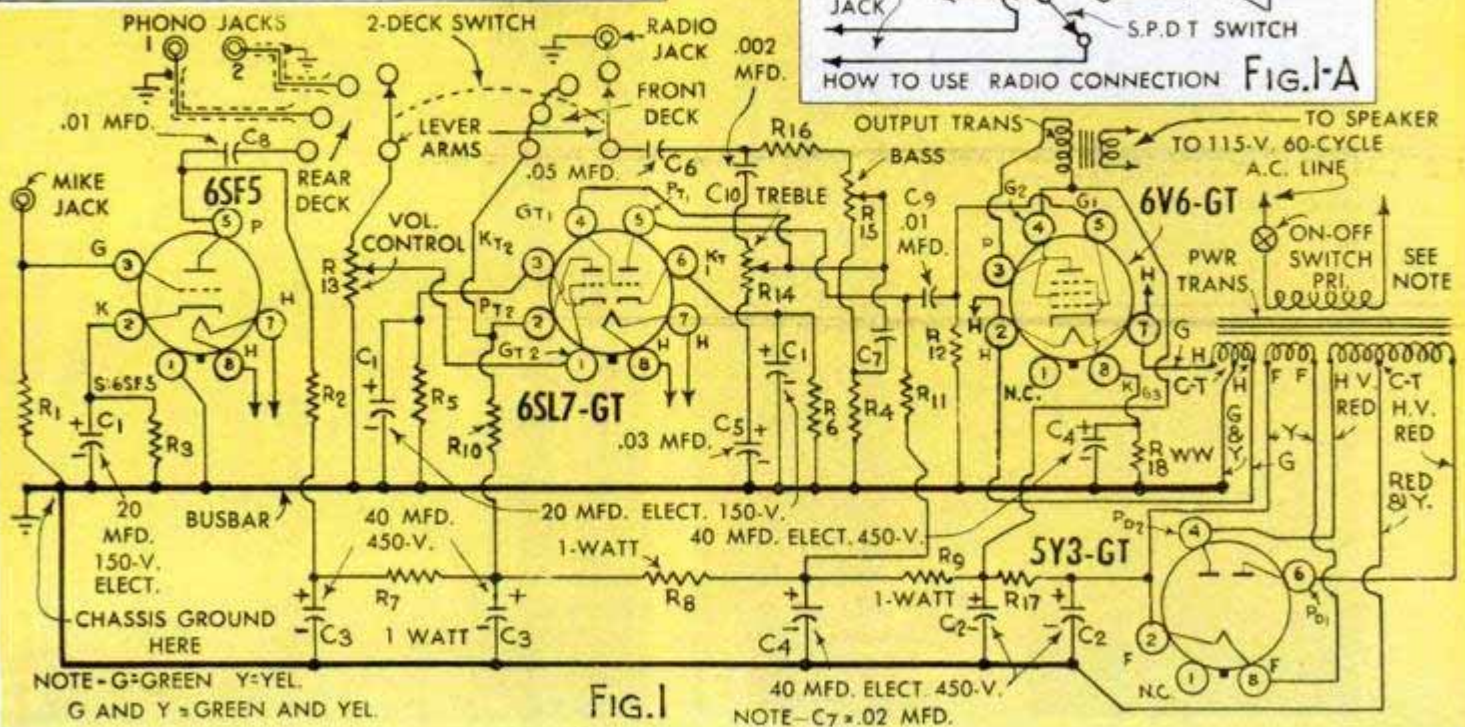
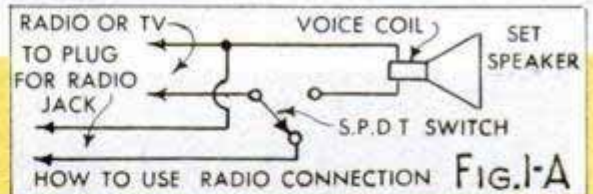

FIG. 1

NOTE—G=GREEN Y=YEL.
G AND Y=GREEN AND YEL.

NOTE—C7=.02 MFD.

PRACTICALLY ANY AUDIO PURPOSE

cycles per second. The "radio" channel bypasses the "volume" control, so that the volume control of the radio set is the only one in use. Good audio quality depends largely on the output transformer; it may be the UTC S-14 used in the model or a Stancor A-2313. The power transformer can be the one specified, or a Stancor P-6119, or P-4078.

The schematic circuit diagram is given in Fig. 1. Photos B, D and E show various views of the completed amplifier. Photos A and C illustrate a convenient unit assembly arrangement of the amplifier with a record player, microphone and radio receiver, using a separate loudspeaker. All drilling details for the 3 x 7 x 12-in. standard chassis base appear in Fig. 2. The external circuit for using a reluctance pickup is shown in Fig. 3. When using this turn the "bass" to full "boost," and the "treble" to full "cut." Tape the leads to the resistor and condenser then cover them with tin or copper foil which should be grounded to the chassis base. The components are miniature types.

A complete bottom-view pictorial wiring diagram, Fig. 6, appears on the following page. Please note that the filter condensers C2, C3 and C4 are of the dual-section electrolytic plug-in type, which makes replacements very simple. The triple-section electrolytic condenser unit C1 is a Mallory twist-lock type, FP 354. All sockets shown in Fig. 6 are bottom view. The a.c. outlet is convenient for operating a record player or radio set. These units are "off" when the amplifier is "off." The two-deck selector switch makes all channel connections. Note the location of the switch arm in Fig. 4. The separate speaker jack, shown connected to the 8-ohm tap, is handy for quick connections. Detailed student material list R-407 is available from Popular Mechanics Radio and Electronics department upon receipt of ordinary letter postage.

(See diagram, Fig. 6, on following page)

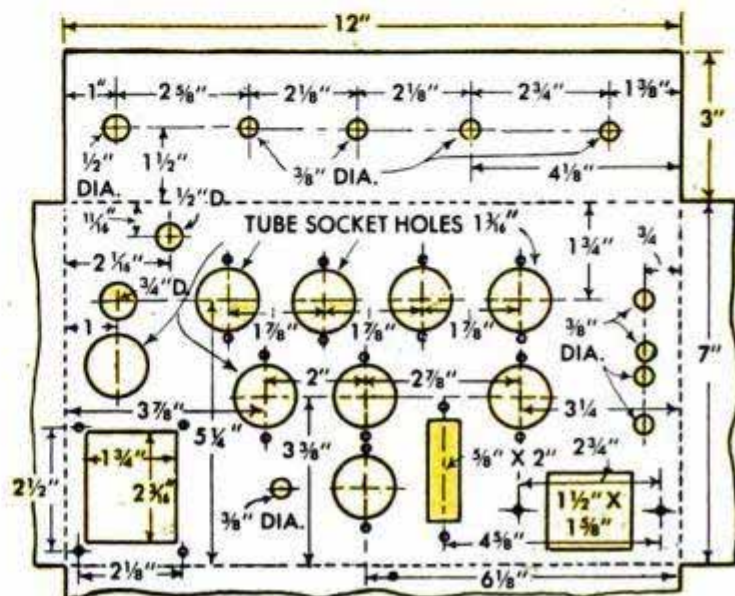
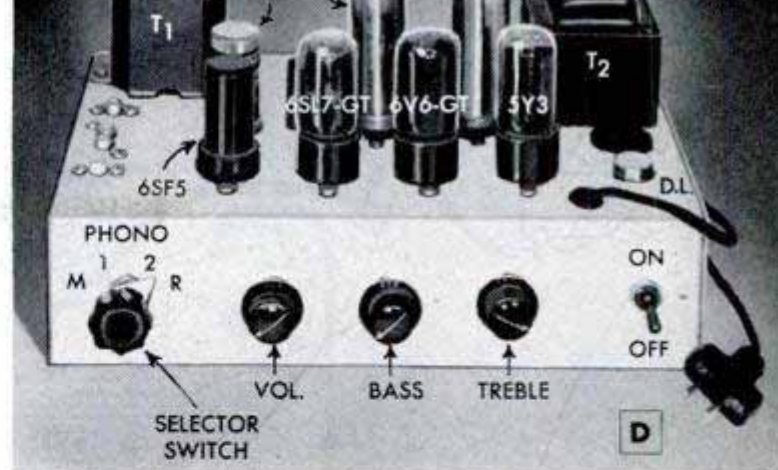

(LOOKING DOWN ON CHASSIS BASE)

FIG. 2

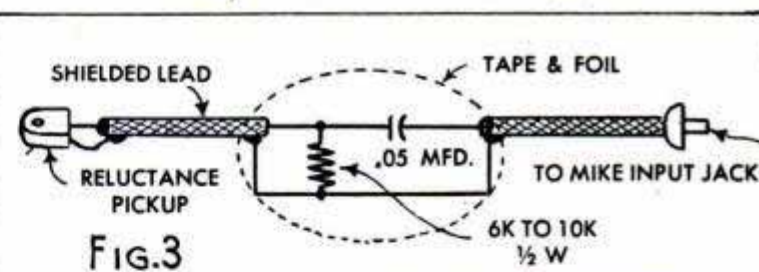

FIG. 3

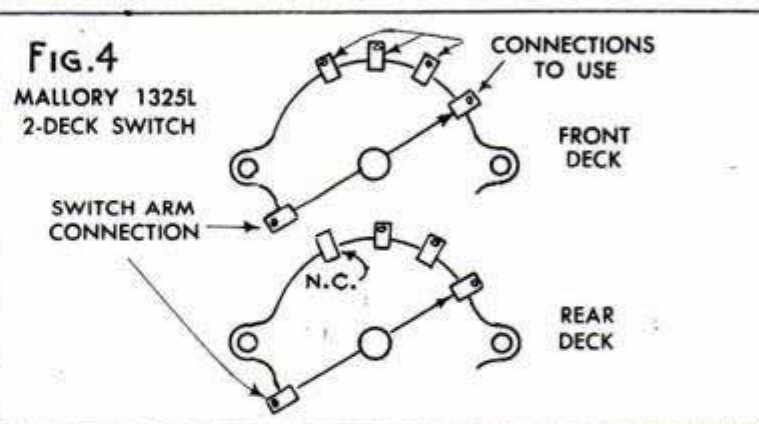

FIG. 4
MALLORY 1325L
2-DECK SWITCH

CONNECTIONS
TO USE
FRONT
DECK
REAR
DECK

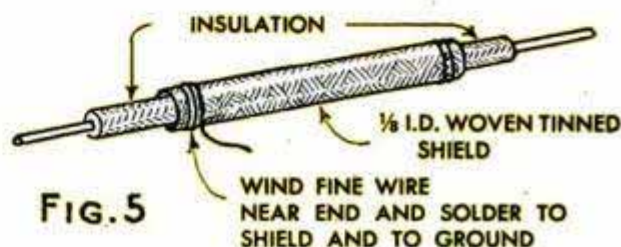
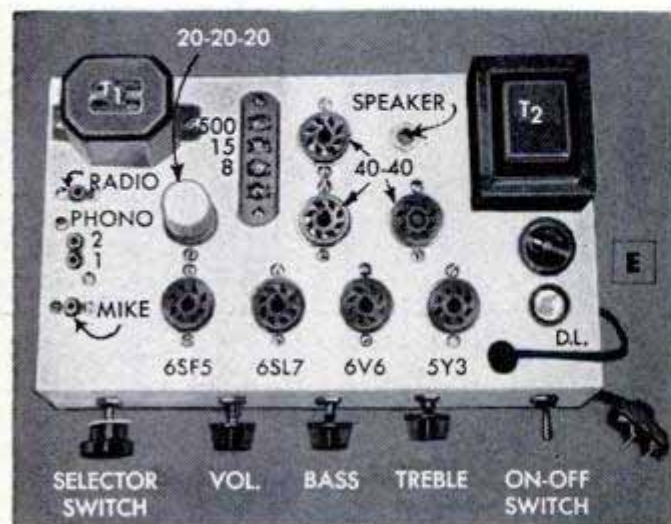

FIG. 5

WIND FINE WIRE
NEAR END AND SOLDER TO
SHIELD AND TO GROUND



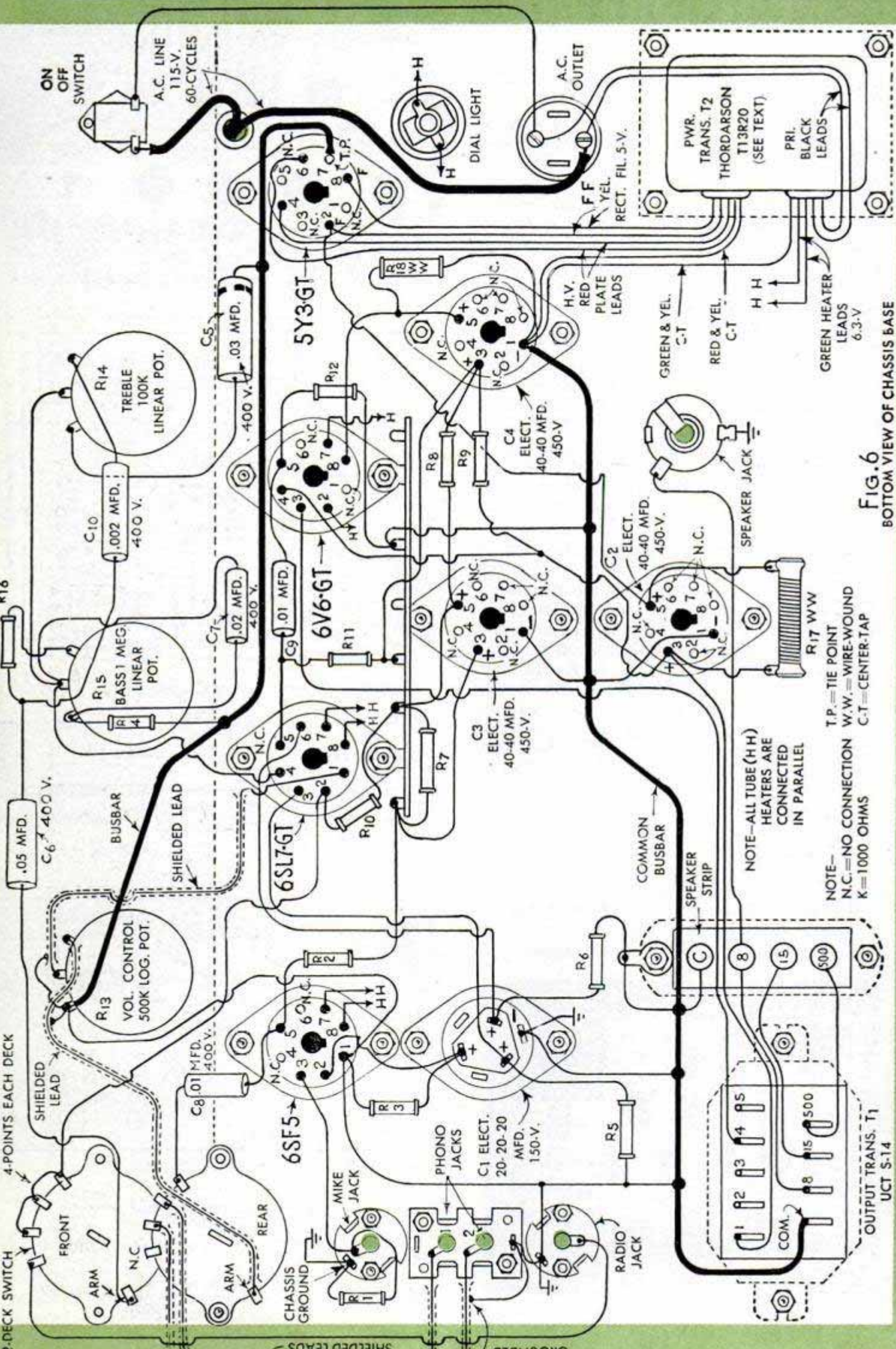

FIG. 6
BOTTOM VIEW OF CHASSIS BASE

NOTE—
N.C.=NO CONNECTION
K=1000 OHMS

NOTE—ALL TUBE (H H)
HEATERS ARE
CONNECTED
IN PARALLEL

T.P.=TIE POINT

W.W.=WIRE-WOUND

C-T=CENTER-TAP

COMMON
BUSBAR

SPEAKER
STRIP

R17 WW

SPEAKER JACK

GREEN HEATER
LEADS
6.3-V

RED & YEL.
C-T

GREEN & YEL.
C-T

H.V. RED
PLATE
LEADS

RECT. FIL. 5-V.

PWR. TRANS. T2
THORNDARSON
T13R20
(SEE TEXT)
PRI. BLACK
LEADS

A.C. OUTLET

DIAL LIGHT

H

H

ON OFF SWITCH

A.C. LINE
115-V.
60-CYCLES

5Y3GT

6V6-GT

6SL7-GT

6SF5

PHONO JACKS

MIKE JACK

RADIO JACK

CHASSIS GROUND

FRONT

REAR

ARM

ARM

N.C.

SHIELDED LEAD

BUSBAR

SHIELDED LEAD

4-POINTS EACH DECK

R16

C6

R15

R14

C10

C5

C7

C9

C8

C3

C4

C2

R11

R12

R8

R9

R7

R10

R6

R5

R3

R2

R1

OUTPUT TRANS. T1
UCT S-14

COM.

8

15

500

8

15

500

8

15

500

TV-BOOSTER HINTS

TELEVISION boosters may increase the signal strength from 5 to 10 times in fringe areas if care is used when making the connections with the twin-lead transmission line. While the manufacturer's instructions for any particular make of booster should be followed, the illustrated hints shown will also be of assistance. A TV booster is usually a self-powered r.f. amplifier unit connected between the antenna and the receiver. It is tuned to receive any of the 12 television channels, from 2 to 13.

A typical TV booster is illustrated in the photos. In some TV receivers the twin-lead antenna line is permanently attached and extends a few inches outside the back cover. In this case, it is always a good idea to guard against the lead pulling loose when the booster is attached. Disconnect the set from the power-line outlet, remove the back cover and tape the line just inside the cover, as illustrated in photo A. Since the terminals on the booster are usually close together, as in photo B, make sure that the fine strands of wire are not shorting them. Use soldering lugs in the antenna twin-leads. The set power plug that goes in the receptacle on the rear of this booster should make good contact, see photo C. The TV-set switch operates both units.

Some boosters employ more than one tube. One operates on the low bands and the other on the high. When these tubes are of the same type an improvement may often be had by switching the tubes from one circuit to the other, as indicated in photo D. A slight pressure on the top of the booster control knob while band changing, photo E, will help you make the adjustment accurately. The twin lead from the receiver that connects to the output terminals of the booster should be as short as possible, as indicated in photo F.

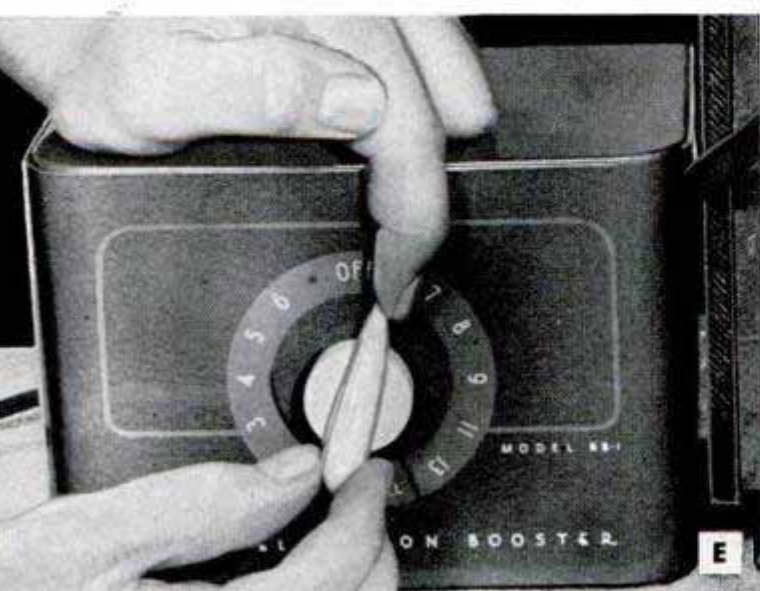
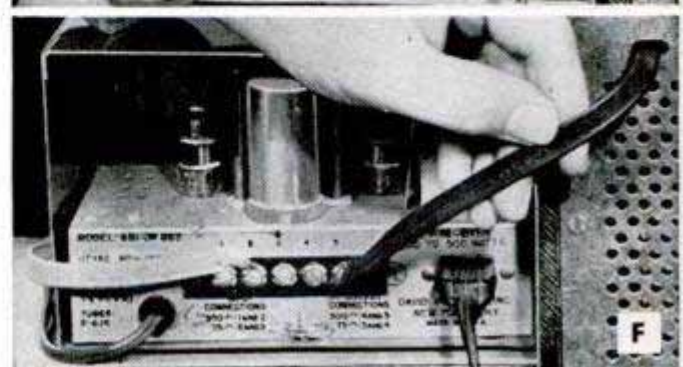
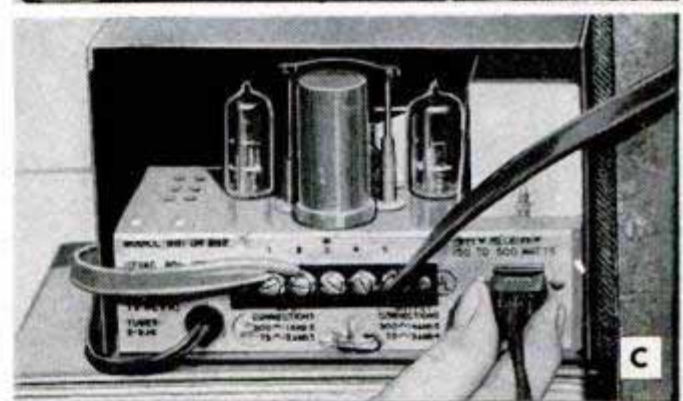
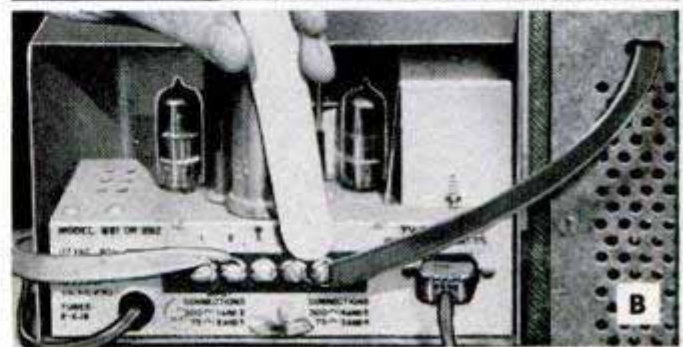
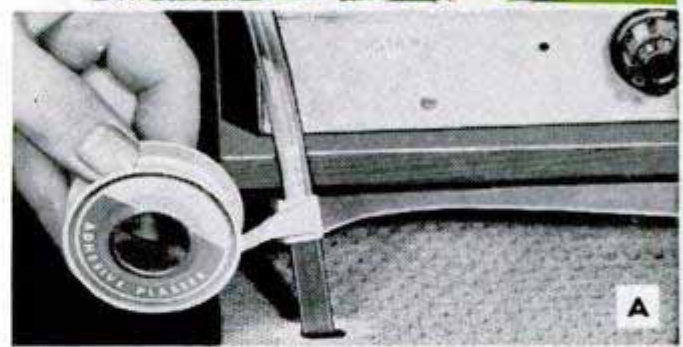

MODERNIZE YOUR OLD RADIO-PHONOGRAPH COMBINATION

By Ken Strelow



IMPROVE the appearance of your living room by getting rid of that old-fashioned radio-phonograph cabinet. The radio receiver and phono turntable are probably just as good as the day you bought the set. Slight alterations in the illustrated plans for the new cabinet, photo A, may be necessary to suit different makes of radio receivers and record-player units. However, you have the old cabinet for all cutout dimensions; the record player lifts out to permit access to the speaker. The cabinet can be finished to fit into any modern decorative scheme. With the plate-glass top, it may be used as an end table, or coffee table, thus doing double duty and conserving valuable space, especially in small apartments where space is at a premium.

Although only general dimensions are given in Figs. 1 and 2 (because you will have to adapt them for your equipment), the following materials were used in the model shown: Two pieces, $\frac{1}{2}$ x 11 x 25 in., for the sides; two pieces, $\frac{1}{2}$ x 11 x 14 in., for the ends, and one piece, $\frac{1}{2}$ x $15\frac{1}{4}$ x $26\frac{1}{4}$ in., for the top. The legs required four pieces, $1\frac{1}{2}$ x $1\frac{1}{2}$ x 24 in. This lumber was all black walnut and the cost was about \$7.00. The plate glass, cut to size, and the edges ground, cost \$3.50.

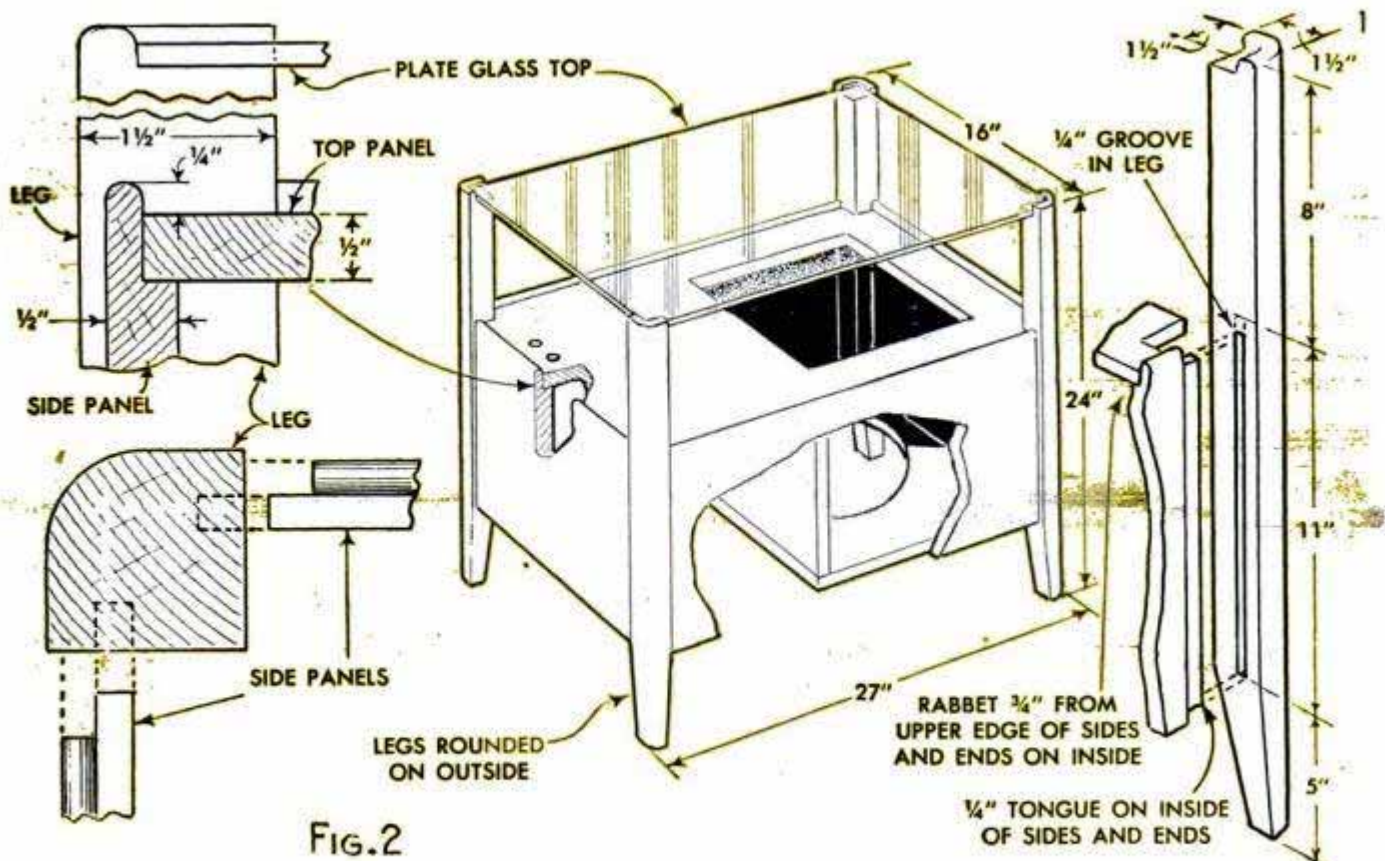
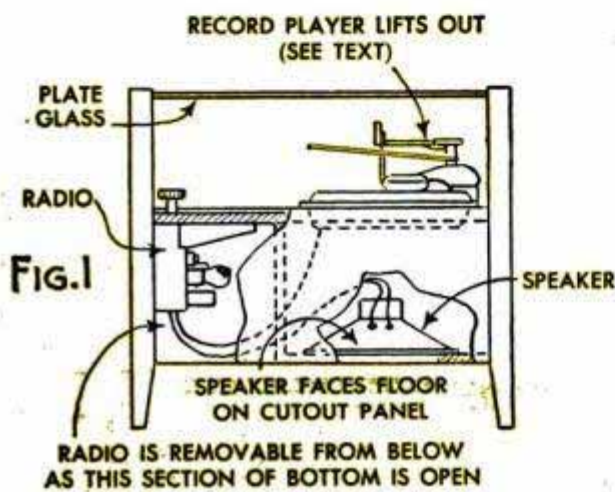

FIG. 2

POPULAR MECHANICS

readers know that they get smoother performance and quick starts when worn-out spark plugs are replaced with

AUTO-LITE SPARK PLUGS

THESE three world-famous Ignition Engineered Auto-Lite Spark Plugs have been selected as original factory equipment on millions of America's finest cars, trucks and tractors.

- **Auto-Lite Resistor Spark Plugs** offer greater gas savings plus benefits found only in automotive type spark plugs with built-in resistors.

- **Auto-Lite Standard Spark Plugs** offer unsurpassed quality and unbeatable performance.

- **Auto-Lite Transport Spark Plugs** are especially suited to rugged farm, truck, bus service and give lowest cost per mile of spark plug operation.

See your Auto-Lite Spark Plug Dealer today, because "You're Always Right With Auto-Lite."

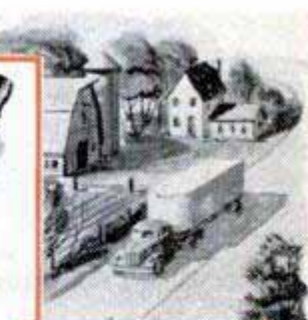
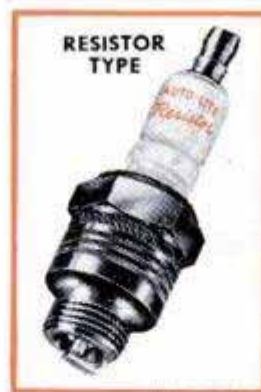

Auto-Lite Spark Plugs—Patented U.S.A.

TUNE IN "SUSPENSE!" . . . C B S RADIO MONDAYS . . . C B S TELEVISION TUESDAYS

Kodak's newest color miniature with world-famous **EKTAR LENS**

Here's a gem of a range-finder "miniature" that boasts a Kodak Ektar Lens (f/3.5 Lumenized)—famed as the finest in countless photographic fields—unsurpassed for producing sharp, brilliant color slides for projection or full-color prints. Be sure to see the Kodak Signet Camera at your dealer's—only \$92.50.

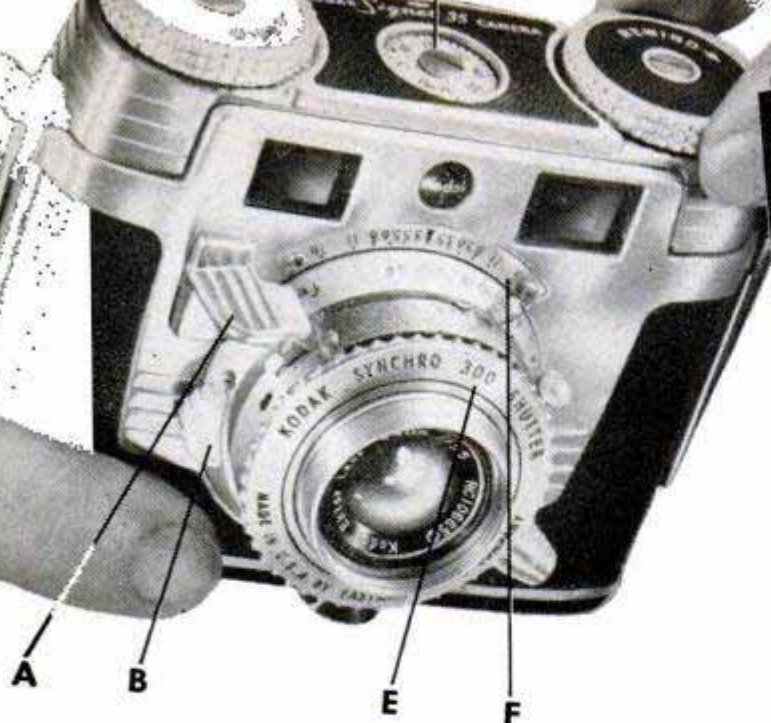

EASY-TO-USE CONTROLS

- A** Feather-touch shutter release bar
- B** Finger-tip control for superimposed-image range finder
- C** Winding knob has interlocks for double-exposure prevention and film stop
- D** Easy-to-read exposure counter
- E** Shutter with speeds up to 1/300, built-in "flash"
- F** All lens-and-shutter settings visible from above

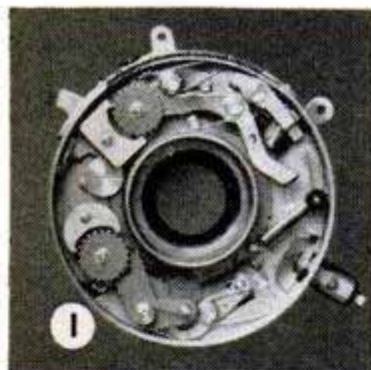

1. Shutter mechanism is sturdily built for lasting reliability. Accurate flash timing for the popular No. 5 and 25 lamps at all speeds—1/25 to 1/300. "B" setting for time exposures. Sturdy, 2-blade design is exceptionally efficient.

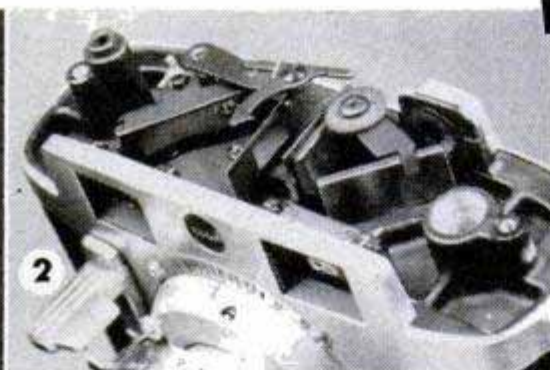

2. Superimposed-image range-finder mechanism is rugged, with all parts generously dimensioned. Spring-loaded, V-block bearings eliminate the small

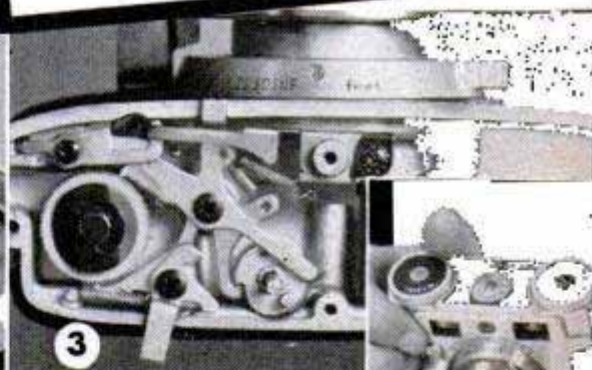

bearing variations that cause serious range-finder errors. Range finder is combined with view finder for rapid focusing and framing through a single window.

3. Film-advance mechanism is smooth and jam-proof. Film can be advanced with a flick of the thumb (see inset). Exposure count and double-exposure prevention are automatic, but deliberate double exposures can be made at the touch of a lever.

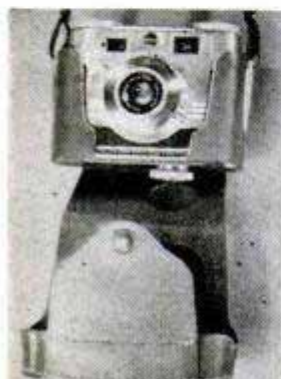

For protection and convenience—Handsome, tan leather field case with neck strap.
\$8.50.

For brilliant indoor shots—the Kodak Flashholder, Model B, is quickly attached for synchronized flash pictures.

\$10.55.



The "payoff" in
color photography
is a

BRILLIANT SHOW

On your screen . . . on your viewer . . . it's the show that counts. 2x2-inch slides of travels, home scenes, lecture subjects sparkle with new brilliance in living room or auditorium when shown with the right equipment. On this page you'll find a selection from which to choose. Ask your Kodak dealer for a demonstration. He'll be glad to help you.



Kodaslide Merit Projector—Features improved slide-feeding mechanism—you feed slides in top of projector, minimizing jarring of instrument. Includes Kodak Projection Ektanon Lens, 5-inch $f/3.5$. \$26.10.



Kodaslide Projector, Model 2A—Ideal for small shows. Heat-absorbing glass protects slides. Powerful lamp projects images up to 7 feet wide. With Kodak Projection Ektanon Lens, 5-inch $f/3.5$, \$52.80.



Kodaslide Table Viewer, Model A—Projector, screen, and slide changer in a single unit. Projects brilliant images even in a lighted room. Takes 75 cardboard or 30 glass slides. \$97.50.



Kodaslide Projector, Master Model—For large-group showings. Fast lenses and 1000-watt lamp can deliver more light to screen than any other 2x2-inch slide projector. Turbine-type fan cools both sides of slide. Choice of four projection lenses. From \$169.

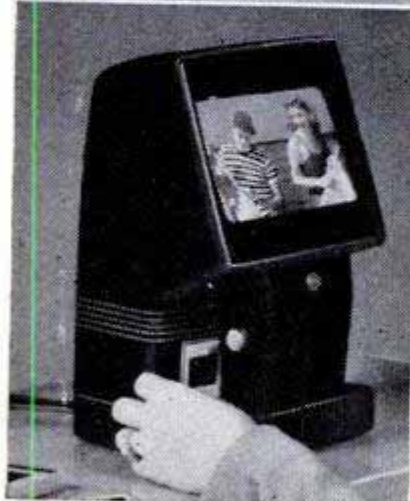

Kodaslide Table Viewer, 4X—This new low-priced viewer enlarges slides more than four times on its built-in screen. Ideal for effortless showings to small groups. \$49.50.

FOR A SURPRISE SHOW—
Treat your audience to professionally prepared color slides, too. Many interesting subjects at nominal cost. Ask your Kodak dealer.

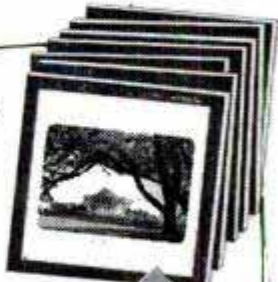

Prices are subject to change without notice and include Federal Tax where applicable

EASTMAN KODAK COMPANY, ROCHESTER 4, N. Y.

Kodak

(Continued from page 119)

fractional cups, and the cup is notched for sight reading. Someone did stop to think that it must be arduous for a blind housewife to measure oatmeal, flour, sugar or coffee.

There's even a fantastic adding machine for the sightless which can total up to \$999.99. It looks something like a small cash register. Five wheels carry tabs around their outside edge, 10 of the tabs always being exposed on each wheel. Every tenth tab is turned to point vertically, while remainder are horizontal. For sighted use, the answers are read in windows across the center of the machine. For touch reading, the answers are found by counting the number of positions the "ten" tabs are down from the top. Addition is accomplished by counting up from the bottom. Thus, to add seven and seven, a blind person counts up to the seventh tab on the right column, and that tab is pulled down. Then repeating, the second wheel pulls down one position and the answer can then be read off as 14. No tape is used on the machine at all, but tape can be inserted that punches out figures in Braille for permanent records.

There are compasses, protractors, tracing wheels, foot rules, yardsticks, weighing scales and even a flameless cigarette lighter, which depends upon the generation of heat by passage of alcohol vapor through a platinum-coated sponge. It works well in strong winds and saves a blind person many a painful burn.

From grocers' scales, to check on those who might cheat a blind person, to bathroom scales, to a pocket calendar in Braille, the new developments are endless. There is hardly a sizable manufacturer in the nation who has not cooperated fully in developing one or more of these aids for the sightless. And, most are sold at cost.

It is difficult to think of an area of life and activity that has been neglected in this merciful development for the handicapped.

Nine-Mile Tunnel Through Mountain Solves Mexico City's Water Problem

Completion of a nine-mile tunnel drilled through the hard rock of a 14,000-foot mountain has won Mexico City a 400-year-old battle for an adequate water supply. It reverses the normal flow of Lerma Lake's water to the Pacific and turns it toward Mexico City, which is on the Gulf watershed. The project, begun 10 years ago, gives the 7600-foot-high capital 400,000 cubic meters more water daily.



Care and Feeding of Engines

BY S. P. CORP

COLD-WEATHER STARTING

One cause of hard starting in cold weather can be ignition trouble. One cause of ignition trouble can be high resistance in the heavy wire to each spark plug, or from coil tower to distributor cap. A leak or dirty connection can cause a lot of trouble.

First: Stop engine. Grasp each wire near top of distributor cap and try to force it down. You may feel it slide into place. Out of place, it could have caused hard starting. *Next: Pull out one wire at a time and see that clip is clean.* Look into wire tower with a flashlight; if dirty, clean with abrasive paper on end of a pencil. Replace wire, making sure it is down in the cap. Do this with each wire, even the coil wire. Clean top of distributor with carbon-tetrachloride.

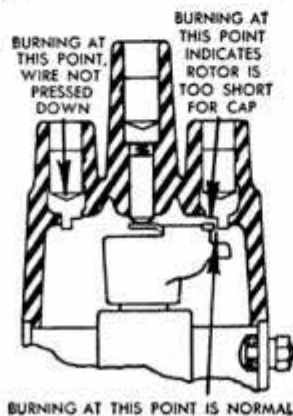

STOP-LIGHT SWITCH

Your stop-light switch can run your battery down. This small hydraulic switch on the brake line is closed by pressure when brakes are applied. Dirt and dust with oil vapor will at times cause a current flow when switch is open. Make sure connections are clean and tight.

When replacing this switch, have the new one ready to install at once, in order to avoid losing brake fluid. Have someone depress brake pedal slightly, to fill fitting as old switch is removed. Install new switch quickly and tightly. Then replace wires. If brakes are then spongy, bleed air from brake line.

IF YOUR CAR SMOKES TOO MUCH

An engine that uses too much oil needs new Sealed Power piston rings. The Sealed Power MD-50 Steel Oil Ring does the world's best job of oil control, even in badly tapered and out-of-round bores. Your dealer has Sealed Power Rings or can get them for you. They save gas, save oil, restore original power to your engine and lengthen its life. A postal to "Sealed Power, Dept. G-2, Muskegon, Michigan," will bring you free a helpful book, "More Power, Less Gas, Less Oil!"



Ball Bearing Arbor—Lubricated for Life!

DUNLAP 8-inch REG. U.S. PAT. OFF. Tilting-Arbor Bench Saw



Saw Only
\$46⁹⁵ Cash
Without motor, ex-
tensions, bench
Only \$5.00 Down on
Easy Terms

Complete Outfit as shown
\$110⁰⁰ Cash \$11.00 Down
\$10.00 Monthly
With motor, pulley, belt, side table ex-
tensions, bench, light and Powr-Pan!

These 5 important features mean
faster, easier, more accurate work..

1. Precision ball bearings — sealed and lubricated for life!
2. 8-inch blade — the most popular size!
3. The tilting arbor feature—blade tilts instead of table!
4. ONE lever locks fence at BOTH the front and the back!
5. Grid type side extensions!

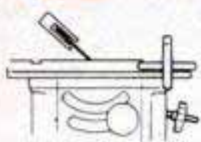

Table ALWAYS level. Work lies flat regardless of angle of cut

Only \$5 Down . . . puts this saw in your shop

We've made many careful comparisons . . . and we know of no other bench saw of this size and type that beats this 8-inch DUNLAP. Its rugged quality and exceptional accuracy in operation are almost unbelievable! At this amazingly low price it is truly a sensational power tool value . . . one of the best we've offered, ever!

Floating-drive motor mounting supports motor on a special mount on bench behind saw . . . smoothes vibration . . . permits easier tilting . . . and eliminates need for a separate motor. (Just slip the belt off, pick up the motor, and use it on other power tools with our regular motor rail clips.)

Super-lubricated sealed precision ball bearings have larger oil chambers than are usually used—NEVER need further lubrication. These double-row ball bearings form integral unit with arbor shaft and prevent misalignment.

Greatly improved fence design. Fence squares directly against front of table instead of usual guide bar, for accuracy. Can be used on either side of blade. Easily removed if desired.

17 x 14-inch table of cast semi-steel has top AND sides machined. 8-inch combination blade (1/2-in. bore) gives up to 2 1/4-inch depth of cut; tilts any angle up to 45°. Not a stripped model—complete with blade, guard, splitter, miter gauge, fence and machine pulley. (Use minimum of 1/2-H.P. motor; 3450 R.P.M. with 2 1/2-in. pulley, 40-in. belt; or 1750 R.P.M. with 5-in. pulley, 44-in. belt.) **Complete Outfit (as illustrated)** includes CRAFTSMAN 1/2-H.P. 3450 R.P.M. ball-bearing capacitor motor (110-120 volt 60-cycle AC); 2 1/2-in. motor pulley; 2 side table extensions; 40-in. belt; adjustable steel power tool bench; tool light; and Powr-Pan! for plugging in. See this DUNLAP Saw today at your nearest Sears Retail Store.

Your nearest Sears Retail Store will furnish you with exact selling prices which will not exceed ceiling prices under applicable price regulation of O.P.S.

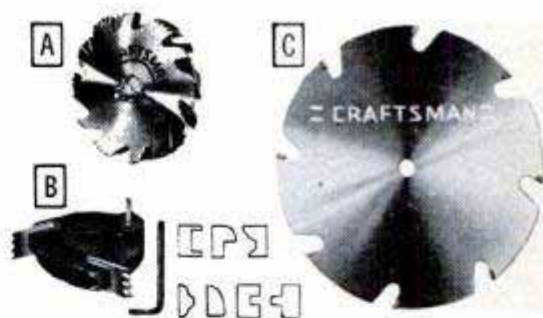

Bench Saw Accessories

- A CRAFTSMAN 6-in. Dado Set.** Dados, rabbets, grooves. 1/2 or 3/8-in. arbor. \$9.50
- B CRAFTSMAN Molding Cutter Head.** Fits most bench saws with 1/2 or 3/8-in. arbor. 4-in. diam. With Allen wrench \$4.50
Cutter Bits for use in above head. 1-in. wide bits cut styles as shown. Styles \$2.95 per set, and up.
- C CRAFTSMAN Carbide-tipped Saw.** New! Safer—has only 8 teeth projecting only .020 in. above non-cutting edge. Tungsten carbide tipped blades last 20 times longer than ordinary circular saw blades! For ripping, cross-cutting or mitering. 5/8 to 10-in. diameters; all arbor sizes. . . \$10.85 and up.

CRAFTSMAN and **DUNLAP** Tools by **SEARS, ROEBUCK and CO.**
REG. U.S. PAT. OFF. REG. U.S. PAT. OFF.

Famous for fine quality . . . precision performance . . . low price!

Here's how for home painters



Radiators — what to beware of; how to take care of. Never finish a radiator in metallic paint. According to the American Society of Heating and Ventilating Engineers, metallic paint reduces heating efficiency. By using same color

paint (Devoe Velour Flat Finish) as you have on walls, you can "hide" an ugly radiator. Apply thin coats, so heat won't crack finish.

Here's the right way to paint a wall. Always start painting in the corner nearest the main source of light. This way you can easily spot any places you've missed. Start right in the corner, working from top to bottom in three-foot strips. Spread paint evenly, stroking with a light up-and-down movement at the finish.



Pour paint accurately — without a funnel. If you have to pour paint from one can to another and no funnel is handy — here's a trick that needs no special equipment. Hold a small stick across the mouth of the pouring can — and pour the paint down the stick. It will

guide the flow accurately, with no spilling.

Easy way to take off old wallpaper. Using the spray attachment on your vacuum cleaner, soak the paper with warm water. When it's soft and saturated, strip it off with a broad scraping knife. Then patch plaster cracks, sandpaper rough spots and you're ready for a priming coat of paint — or new wallpaper.



You can get all the painting accessories that you need — and many more helpful tips at the sign of the Devoe Diamond. Why not stop in and see your Devoe Dealer very soon? You'll find his name listed in the Classified Phone Book.

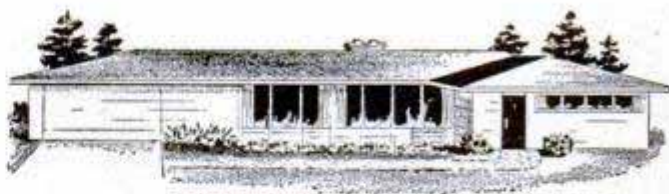

As a service to our readers in solving the hundreds of problems pertaining to a home — inside or out — the editors of *Popular Mechanics* invite you to present your problems to The Clinic Editor for help and advice. Address your questions to The Clinic Editor, *Popular Mechanics Magazine*, 200 East Ontario Street, Chicago 11, Ill.



Screen Stains

Q — I have bronze window screens which have been in use only two seasons, but the bronze wire has turned dark colored and for some reason is causing discoloration of the paint on the screen frames, window sills, and even on the siding below the windows. I had always understood that bronze screening was

corrosionproof and would last indefinitely without any finish being applied. Is there any way I can prevent the discoloration of the window frames and house siding? — A. Y., Calif.

A — If not damaged, the bronze screening will outlast the frames. The coating which forms on the screen does not destroy the metal but will discolor painted woodwork, such as the screen frames, window sills and painted siding directly below the windows as you describe. A good protective finish for bronze screening, also black or galvanized screening, consists of a mixture of varnish, 2 parts, linseed oil, 1 part, and pure turpentine, 1 part. A suitable applicator is easily made by tacking a piece of pile carpet to a small block of wood. There also are available clear-plastic sprays, supplied in pressurized containers which may be used as a coating for bronze screening. Although more costly than the varnish-oil-turpentine mixture, these sprays are less work to apply and may give better results in the long run. Either finish will help to prevent the discoloration of the window frames and siding, but for best results the finish should be renewed periodically.

Preventing Mildew in Clothes Closets

One of our readers in the Philippines, Robert K. Zimmerman, has outlined the following suggestion for preventing mildew in clothes closets:

In the average-sized clothes closet two 60-watt lamp bulbs, kept burning constantly, will supply sufficient heat to "dry" the air in the closet and prevent mildew from damaging clothing and leather or canvas shoes. Use a 60-watt bulb in the ceiling fixture and install an outlet box and socket at a point just above the baseboard. The lower bulb should be protected with a heavy wire guard or some other adequate provision to prevent breakage and should be so placed that no clothing will touch it or hang directly over it. In some cases it may be permissible to control both lamps with a single wall switch, but as a rule it is more practical to install a separate switch for the lower bulb. The closet door should be kept closed at all times while the lamps are burning.

(Continued to page 240)

Get the Extra Production Capacity, Extra Versatility of *Atlas* 10" Lathes

"QUICK-CHANGE" 10" LATHE

- ★ Timken Tapered Roller Bearings!
- ★ Precision Ground Bed!
- ★ Reversible Automatic Power Cross and Longitudinal Feeds!
- ★ 16 Spindle Speeds — 28 to 2072 RPM!
- ★ Quick-Change Selection of 54 Threads and Feeds!
- ★ V-Belt Drive!

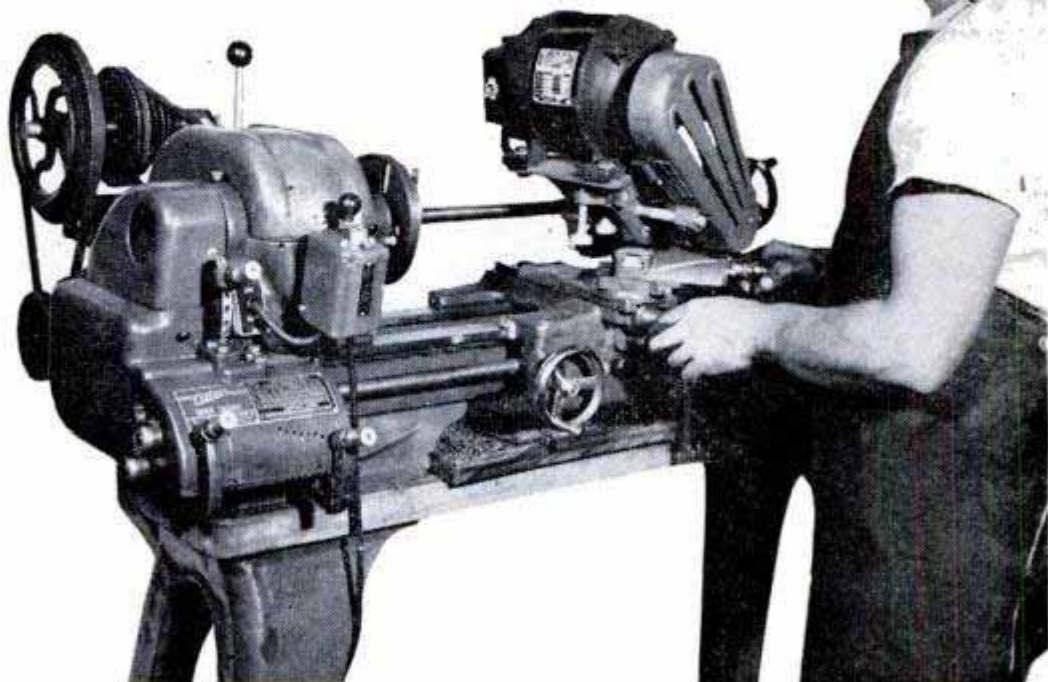

Handle Precision Tooling and Precision Production Runs at Lower Cost



Starting business with one Atlas 10" lathe, this plant has made over 500,000 precision parts.

The many standard construction and performance features you get *without extra cost* make the Atlas 10" lathe the most exceptional value on the market today. For tool room, production, maintenance, service, development work in your plant or home shop — be sure to see how the Atlas can handle your requirements with greater accuracy and efficiency — *at lower cost*. Ask your Atlas dealer or send coupon for latest catalog.



Another Atlas success story. From 2 lathes and 1 drill press to 30 busy machines.

Atlas PRESS COMPANY
243 N. Pitcher St.,
KALAMAZOO, MICH.

Free CATALOG - Send Today!

ATLAS PRESS CO.
243 N. Pitcher St., Kalamazoo, Mich.
Please send your latest 10" Lathe catalog.

Name _____

Address _____

City, State _____

BUILD A BUNKROOM



REMODEL THE ATTIC

with
the
**WESTERN
PINES***

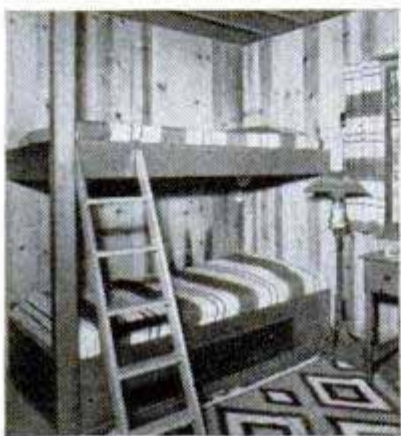

Rugged, he-man quarters for your young buckeroos are a cinch to build with colorful, easy-to-work Western Pines*. Or turn an idle attic into a cozy and hospitable guest room by building double-deck beds of these attractive, economical woods.

The smooth textures and straight, even grain of the woods of the Western Pines*—the wonderful way they grip paint, stain or wax—make them a joy to use on any workshop project. Cabinets, bookcases, tables, built-in fixtures for kitchens or rumpus rooms take on beauty and character from these glowing woods. They have long been favorites with home craftsmen who take pride in turning out a variety of useful and attractive home furnishings.

SEND FOR FREE IDEA PACKET No. 309!

Shows you how, with a little planning and ingenuity, you can work wonders all through your home with the versatile Western Pines*—and have fun doing it. Contains new, colorful illustrated booklet, "Enchanting Homes of Western Pines," "Bunk Bedroom Details," "How to Treat Knotty Pine Paneled Walls," etc. Write to Western Pine Association, Dept. 309-N Yeon Bldg., Portland 4, Oregon.

These are the Western Pines

- * IDAHO WHITE PINE
- * PONDEROSA PINE
- * SUGAR PINE

(Editor's note—It should be emphasized that this arrangement is suitable only for small to medium-sized closets. In some cases it may be permissible to use a lamp cord to supply current to the lower bulb but do not permit the cord to lie loose on the floor as it may be crushed and broken when the door is closed. If the lower bulb is to be installed permanently, consult the requirements of your local electrical code before making the installation in this manner.)

Surfacing Concrete Floor

Q—I'm laying an asphalt-tile floor in my basement recreation room. There are slight irregularities in the troweled surface of the floor which prevent the tile from lying flat. As a remedy, I was told to spread the cement a little thicker in the low places, but this didn't work. Fortunately I discovered this before finishing the job. Isn't there a surfacer available which is suitable for leveling a floor in the condition described?—T.R., Me.



A—Yes, there are surfacers available, but first you will have to dispose of the problem of completely removing the cement which was used under the tile. The manufacturer of the cement used will be able to supply you with a cement solvent, which will be available through your local dealer in floor coverings. When using the solvent, follow the instructions in detail. After the cement has been removed, the floor should be thoroughly scrubbed before the surfacing material is applied. When applying the surfacer, be sure to follow all preparatory steps specified in the instructions. Another method, frequently used to level irregularly surfaced concrete floors, or floors that have cracked from various causes, is to etch the surface with a hydrochloric (muriatic) acid solution and then trowel on a layer of concrete averaging about 1½ to 2 in. This type of "overfloor" should be poured and troweled at one time. It is never advisable to pour it in sections as new cracks may result.

Cedar Closet Lining

Q—I have recently moved into an older-type home which has two cedar-lined clothes closets both on the second floor. The cedar lining seems to have entirely lost its characteristic pungent aroma and appears rather dull and unattractive. I have been told that I can apply a half-and-half mixture of turpentine and boiled linseed oil which will brighten the wood without affecting its moth-repellent properties. Is this advisable?—M.B., Ky.



A—No, unless you wish merely to enhance the beauty of the wood and sacrifice whatever repellent properties it may possess. Ordinarily, cedar closet lining is not finished, as any ordinary finishing material will seal in the natural oils, the slow evaporation of which causes the wood to give off its characteristic aroma. If the lining is dulled with age, you can brighten it up by going over the surface lightly with fine steel wool. This will remove accumulated dust and restore the original color. Then, if you wish, you can apply the special preparation which is supplied for the purpose of restoring cedar closet lining. This consists mainly of certain cedar oils which penetrate the wood without changing its natural color appreciably. When applying this preparation, be sure to follow the manufacturer's instructions in all details. If the wood is rough in places, it's generally a good idea to sand the entire wall, using several grades of sandpaper ranging from medium to fine grit.

Two DREMEL Electric SANDERS with STRAIGHT LINE Action for Guaranteed SCRATCH-FREE Surfaces

Perfect answers to any sanding problem, both Models feature: Only 2 moving parts; 14,400 strokes per min., easy one-hand operation, dust-proof-foolproof; 10-second paper change; 110-120 V., 60 cycle A.C. PLUS—straight-line action for mirror-smooth finishes. Don't settle for less!

MODEL 2000
\$24.50



MODEL 2000 FOR HEAVY DUTY CRAFT AND WOODWORKING PROJECTS

—Fastest seller in the field for rugged power and smoothest finishes at lowest cost. Ample power for furniture and cabinet making, boat building or refinishing, resurfacing large areas. Great for building operations—woodwork, stairs, dry-wall joints, siding, etc. Does a superb polishing job! Weighs 5 lbs.; 21 sq. in. of sanding surface; over-all size 3 1/8" x 4 1/2" x 7". Price includes steel carrying case, 25 asst'd. abrasive sheets, and a sheepskin pad.

MODEL "A" FOR HOBBIES, REFINISHING, REDECORATING

—Finest sander ever offered housewives, homeowners, hobbyists. A lighter-capacity model for woodwork, unfinished furniture, hobby shop projects, etc. Wonderful for polishing waxed surfaces. Also a soothing massager! Weighs only 2 1/2 lbs. Sanding pad 2 1/4" x 5 1/2". Price includes 6 sandpapers, 1 sheepskin, 1 felt pad.

ONLY STRAIGHT-LINE ACTION SANDS WITH THE GRAIN—NEVER MARS OR SCRATCHES
Don't just take our word for it. Ask any professional woodworker about sanding action. He will tell you that only straight-line, with-the-grain sanding can produce a flaw-less finish.

BEFORE YOU BUY ANY SANDER . . . COMPARE!

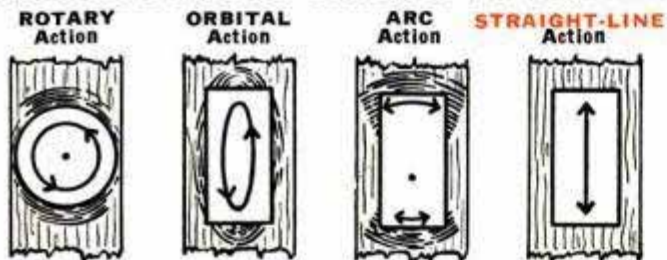

DREMEL Electric COPING SAW

CUTS SCROLLS LIKE MAGIC—SANDS AS IT SAWS



BLADE FACES 4 WAYS

Only \$5.85 with 3 saw blades

MAKE YOUR OWN JIG SAW PLANS FREE!

JUST GUIDE IT!

SAFE! AS A HANDSAW

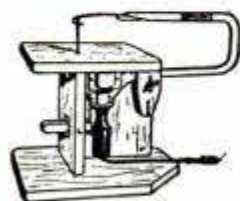

For home, hobby, repair work—no other tool pleases so much for so little cost. Works in any direction—delivers 7,200 strokes per minute smoothly, effortlessly. Saws through 3/4" medium-hard wood at a foot-a-minute speed. Touch-of-the-trigger, foolproof action. Only 2 moving parts, never needs oiling. Uses 110-120 V., A.C. Free plans, packed with each saw, for six useful woodworking projects and for making your own jig saw.

GRINDS • CARVES • ENGRAVES DRILLS • ROUTS • SHARPENS DREMEL Electric MOTO-TOOL

FASTEST MOST POWERFUL TOOL in its class—Approx. 27,000 r.p.m.

Most practical tool a man can own—more powerful than any similar tool you can buy. Works well in wood, plastics, and metal. For home maintenance jobs you'll wonder how you got along without it. For model making it's a must. And for general shop operations it saves time and money. Compare it, try it, buy it. You be the judge!

Check These Important Features

- Oilless sealed bearings • Dynamically balanced armature • Shockproof, Bakelite housing • Dust-filtered air cooling system • Sturdy 110-120 V., A.C.-D.C. motor • Wt. only 1 1/2 oz. • A precision tool widely used in industry for many years.



MOTO-TOOL No. 2 (with 1 emery wheel point)

\$16.50



MOTO-TOOL KIT No. 2 With 23 Accessories (High-Speed Steel Cutters, Grinding Wheels, Polishers)

\$23.50

YOU BE THE JUDGE OF DREMEL PRODUCTS—Our reputation has been built on results rather than sensational claims. We invite comparison of Dremel tools with any similar products made. Then you'll know why we guarantee the most for your money!



WHERE TO BUY—If your dealer doesn't carry, remit in full for postpaid shipment. Or send only \$2 now, pay postman balance plus postage and COD fee. Five-day trial, money-back guarantee!

DREMEL MFG. CO., Dept. 112-B, Racine, Wis.

(Continued from page 161)

imparts insulating qualities to the snow. The tube was hooked up to a short-wave transmitter that automatically turns itself on once a day and broadcasts the Geiger-tube clicks. These are picked up by a receiver in the laboratory, counted on an electrical counter and are transposed directly into a reading of snow depth at the distant location.

The water content of the snow at the location of one of the radio snow stakes is assumed to be the same as at the laboratory, where it is measured from time to time with an electrical instrument fitted with two prongs that serve as electrodes that are plunged into the snow. The conductivity of the snow between the prongs is a measure of its water content.

To learn the amounts of rainwater that may be absorbed and retained by snow that is lying on the ground, the research staff paved a 1200-foot triangle and built a wall around it so that all the moisture that fell in the paved area would have to run off through a single opening where it could be measured.

After winter storms had filled the triangle with snow the investigators sprayed a measured amount of water onto it from

overhead sprinklers, simulating a rain storm, then measured the water that drained away. The difference between the figures told how much of the water had been captured by the snow. The work was repeated under different temperature conditions to provide information on the way a snow pack can hold back or contribute to a flood, depending on temperatures.

This winter the flood research at the Sierra laboratory is being completed and the area is being devoted to the Sipre program. From the flood studies that have been made, formulas and tables are being prepared by which floods and their severity can be forecast quite accurately. With this information, the operators of a dam can lower the water in their reservoir to take care of an oncoming flood by just the proper amount. They won't waste precious water by releasing too much of it, and they won't be inundated when a flood comes down because they hadn't released enough water to balance it.

To get a long-range picture of where flood troubles can be expected later on in a season, the engineers "fly the snow line" during winter months all along the Sierra range, from Mount Shasta in the north to Bakersfield in the south. An observer in the plane maps the lower limits of the snow

(Continued on page 244)



"This proves Wildroot Cream-Oil keeps hair well groomed even if you have cowlicks!"

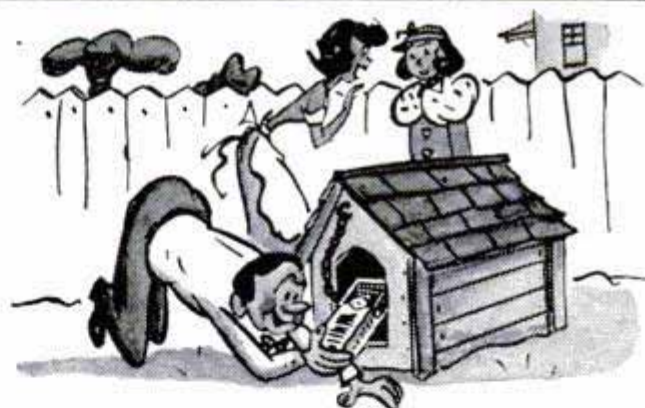

"He keeps his Wildroot Cream-Oil there because it's his hair's best friend"



"Since using Wildroot Cream-Oil I look twice as good!"

REAMER KELLER

YOUR HAIR'S
BEST
FRIEND

America's
Favorite
Hair Tonic!



LB

LUDWIG BAUMANN



POLISHER-WAXER

Gives auto, furniture shining finish!



FINISHER-SANDER

Removes paint and rust... sands wood!



SHARPENER GRINDER

Keeps tools and knives in perfect condition!



SOFT CLOTH BUFFER

Gives all metal articles gleaming finish!



ABRASIVE CUTTER

For glass, plastics and many other materials!



ABRASIVE GRINDER

Easily, quickly cuts everything!



ALL-PURPOSE MIXER

For paints, enamel and many other liquids!

Accounts Opened Anywhere in the United States

34 PC. ALL PURPOSE POWER TOOL SET

3 1/4" AC-DC Drill-O-Matic DRILL and SAW

2-in-1 COMBINATION



1/4" DRILL FOR HAND OR BENCH USE!



SLIP-ON PORTABLE POWER SAW



1/4" CHUCK AUTOMATICALLY CENTERS ALL TOOLS AND DRILL BITS 1/8", 1/4", 3/8", 1/2", 5/8", 3/4", 1" DIA. AND SMALLER!

110-VOLT AC-DC

QUICK-RELEASE TRIGGER SWITCH LOCK

NOTHING ELSE TO BUY... HERE'S WHAT YOU GET:

- Drill-O-Matic Electric Drill, high-torque motor, 1200 RPM free load
- Drill-O-Matic Portable Power Saw
- 3" Cloth Buffer
- 4 1/2" Lamb's Wool Buffer
- 1/4" Chuck
- 4" Combination Rip or Cross Cut Saw Blade
- 12 Coarse, Medium and Fine Sanding Discs
- 4" Rubber Backing Wheel
- 2 1/2" Grinding Wheel
- 3 Carbon Steel Drill Bits 1/16", 1/8", 1/4" Dia.
- Steel Bench Stand
- All Purpose Steel Mixer
- Mounted Abrasive Grinder
- Mounted Abrasive Cutter
- 6 Pc. Spindle Adapter
- Large Carrying Case



USE AS BENCH OR HAND TOOL



SAVE ON THIS VALUE!

We've spared no expense... we've left nothing out... here's a complete ELECTRIC hand or bench tool set, including a portable power saw, the lowest price we've EVER seen! It's sturdy enough for professional mechanics and light enough for women to use for polishing and wiring. Heavy-duty construction for years of perfecting. Underwriters' Approved and covered by Factory Guarantee. No other value COMPARE!

75c A WEEK

\$24.98

LUDWIG BAUMANN 35th at 8th Ave. New York 18, N. Y.

Send me the Drill-O-Matic Drill and Saw Set at \$24.98 (add 75c tax if delivered in New York City.)

First Name _____ Last Name _____
 Address _____ City _____ State _____
 Zip _____
 Husband _____

- Check or Money Order
 Enclosed
 C.O.D. (in full on delivery)
 Open on "L.B." Account.
 I agree to pay \$3.00 on delivery and the balance at \$3.00 per month. Small Credit Service Charge. Charge to my "L.B." _____

LUDWIG BAUMANN

35th Street and 8th Avenue, New York 18, New York

MAIL COUPON

fields and gauges snow depths by observing the tops of fence posts and other objects of known heights. Too, information from the state-conducted snow surveys on the depths of the snow packs in the different watersheds is used.

A river basin that is found to have plenty of snow is regarded as being safe; that is, the snow packs can absorb and retain a great deal of the rainfall, slowing down the runoff, and the main body of water will come down in normal amounts during the spring.

A basin with little snow on the ground, however, is a potential danger area. One warm rain could melt the snow and add the snow water to its own precipitation, causing an immediate and heavy runoff. That's the kind of information the engineers like to have ahead of time.

Mother of the Minesweepers

(Continued from page 104)

launched faster. In dirty weather, not a second can be lost. Men scramble along the wing walls, climbing over each other to grab lines and make them fast. Hoarse shouts add to the din of crashing steel.

Everything is timed to the last instant. As the boats start coming aboard, the mother

ship begins to deballast at once—forward tanks first. If the engineers are on their toes, the forward end of the docking well will be tipped up and dry, and the first boats will be grounded seconds after they're lashed in place. Deballasting proceeds sternward, so that as each threesome of boats is tied up, they'll ground immediately. Hence, they can't bang around as they would if afloat.

Once the stern gate locks in place, everything is snug. "You'd think," says Shaffer, "that heavy seas might splash over the top of the gate, but since we never back down into a sea, we never ship any water—even though the waves tower above the 18-foot-high stern." "But," he adds, "we do get something that no other ship afloat can match. Plenty of times after deballasting, nice big fresh fish are left flopping around the docking well. We've had lots of fresh sea bass for supper as a result."

The business of partial ballasting, so that the after end of the well only is afloat, has other advantages than just beaching the boats in heavy weather. It enables the LSD to become a launching beach for amphibious craft.

LVT's, or amphibious tanks, for instance, can be lowered from the superdeck to the bow end of the docking well by crane.

(Continued to page 246)

UNCLE WALTER

IT SMELLS GRAND



SNIFF IT! YOU'LL SAY "THAT'S FOR ME!"

IT PACKS RIGHT



CUT TO PACK IDEALLY!

IT SMOKES SWEET



JOY YOU'VE DREAMED OF — YOU'LL AGREE!

IT CAN'T BITE!

SIR WALTER RALEIGH'S BLEND OF CHOICE KENTUCKY BURLEYS IS EXTRA-AGED TO GUARD AGAINST TONGUE BITE. STAYS LIT TO THE LAST PUFF. AND NEVER LEAVES A SOGGY HEEL IN YOUR PIPE.



It costs no more to get the best!

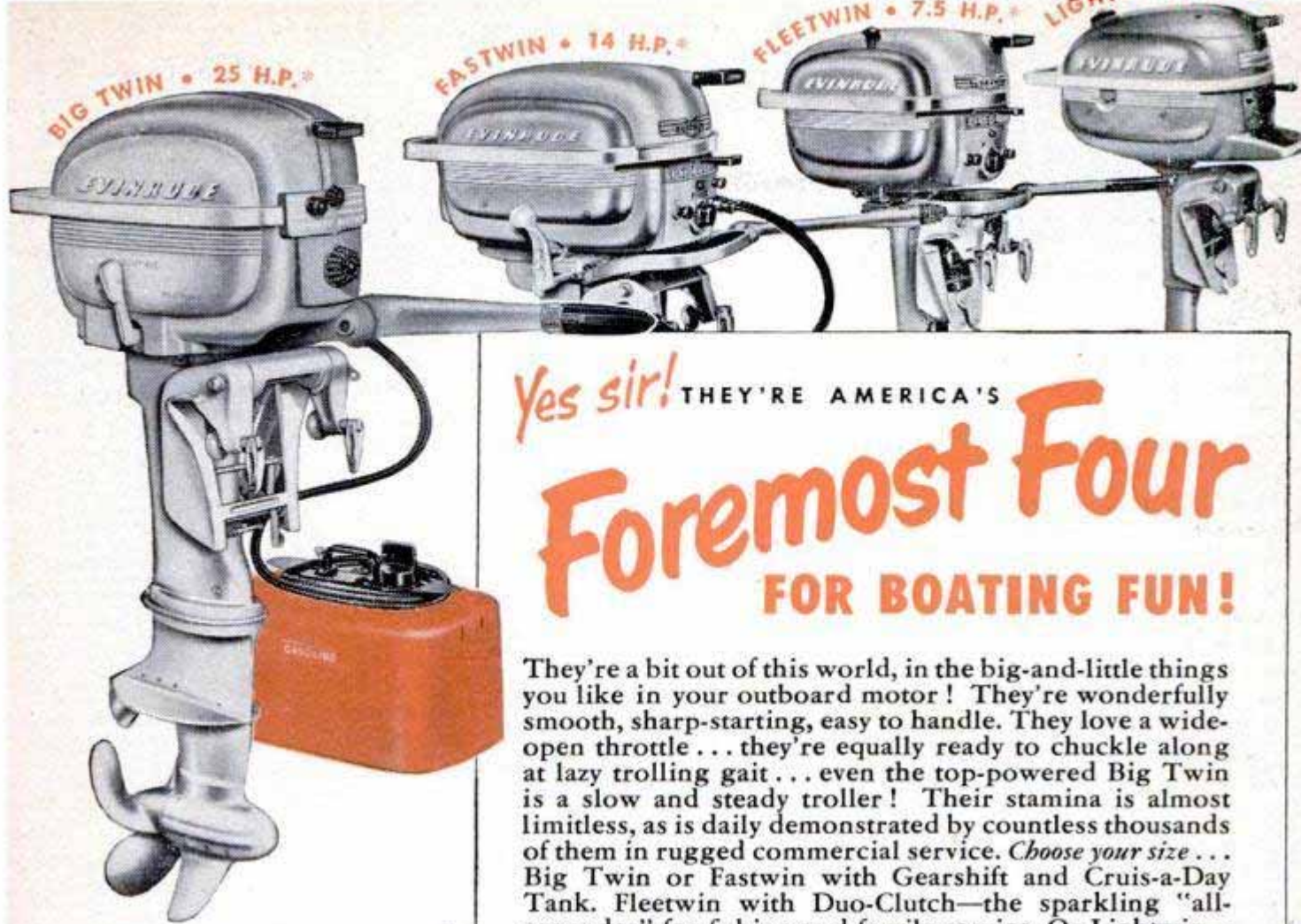

Yes sir! THEY'RE AMERICA'S

Foremost Four

FOR BOATING FUN!

They're a bit out of this world, in the big-and-little things you like in your outboard motor! They're wonderfully smooth, sharp-starting, easy to handle. They love a wide-open throttle... they're equally ready to chuckle along at lazy trolling gait... even the top-powered Big Twin is a slow and steady troller! Their stamina is almost limitless, as is daily demonstrated by countless thousands of them in rugged commercial service. *Choose your size...* Big Twin or Fastwin with Gearshift and Cruis-a-Day Tank. Fleetwin with Duo-Clutch—the sparkling “all-arounder” for fishing and family service. Or Lightwin—*newest on the water*—3 hard-thrusting horsepower—Fisherman Drive—and weighs only 30 lbs.!

SEE YOUR EVINRUDE DEALER—look for his name under Outboard Motors in the yellow pages of your phone book. *Catalog Free!* Write for full-color catalog of the complete Evinrude line. **EVINRUDE MOTORS**, 4744 N. 27th Street, Milwaukee 16, Wis.
In Canada: Evinrude Motors, Peterborough, Ont.



 *Power ratings are O.B.C. certified brake H.P. at 4000 R.P.M. Weights, materials and construction subject to change without obligation.

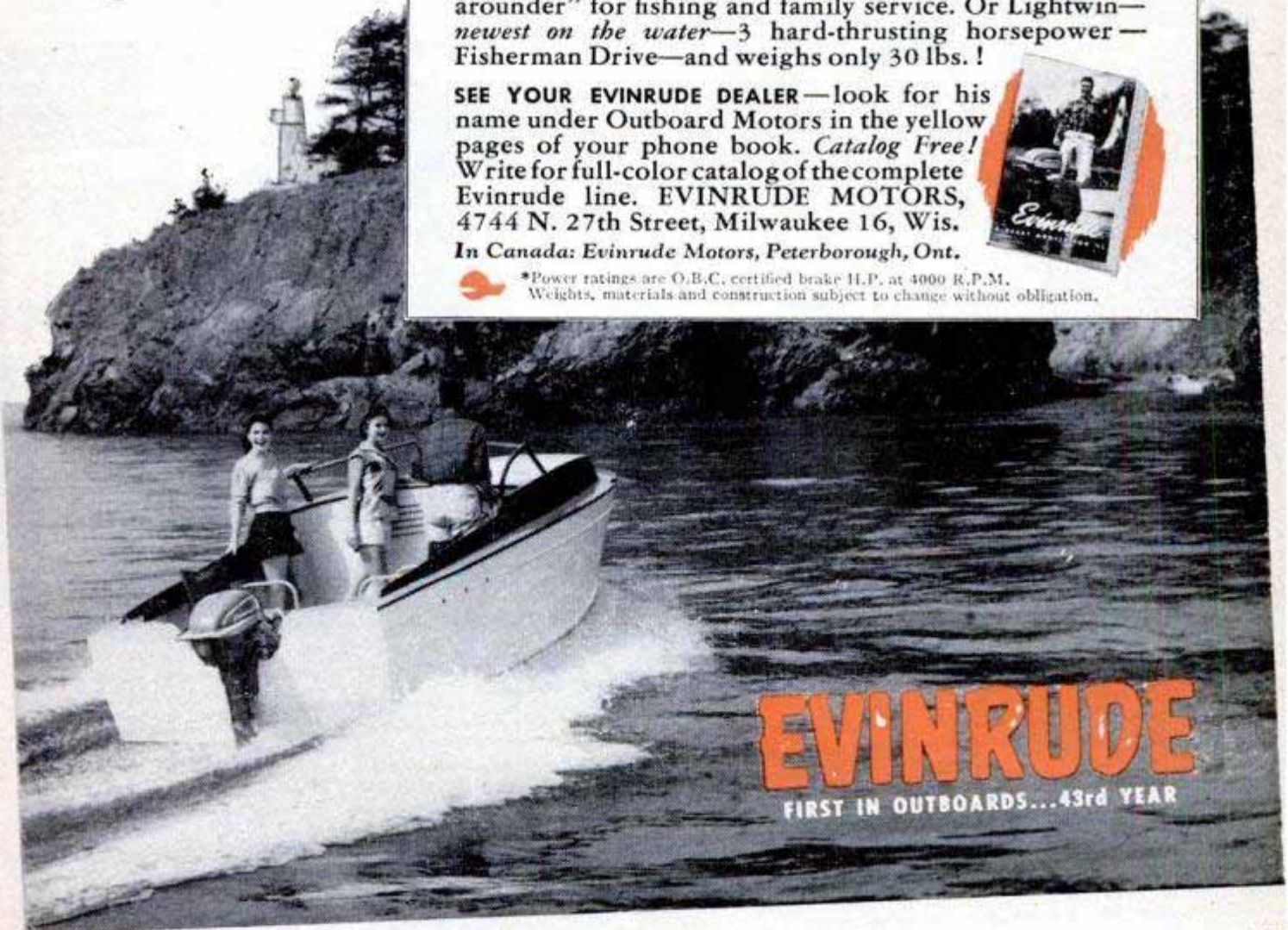

EVINRUDE

FIRST IN OUTBOARDS...43rd YEAR

tanks are filled and the after end of the well sinks into the ocean. The amphib, sitting high and dry in the bow end, simply rumble down the sloping deck as though they were taking off from a beach, enter the water half way down, and by the time they go through the stern gate, they're afloat. As each group of amphib takes off, others are lowered to the "beach" by midship crane from the superdeck.

There is no end to the versatility of this type ship, according to Captain Shaffer. Some even have a mezzanine deck between the superdeck and the docking well, with a special ramp to handle tanks. One of these, the *Casa Grande*, can handle 100 LVTs and 100 DUWKs.

The *Lindenwald* and a sister ship, the *Gunston Hall*, have just been "winterized" for Arctic work. Their hulls are newly strengthened and insulated to brave the ice pack. Crane controls and deck equipment are sheltered. The bridges are housed, and there are steel shacks for bow and gun look-outs. Their new reciprocating engines can give them fast, sudden back-ups in ice-floe regions.

With all of this, LSD-6 and her crew will be able, if necessary, to add more honors to her battle-studded history. According to the bronze tablet on her quarter deck, she

cific battles in World War II—Lingayen Gulf, Okinawa, Kwajalein, Emirau and Saipan.

What the next new role of the LSD will be, no one knows, but you can be sure it will be something fantastic because the Landing Ship Dock is a fantastic kind of ship. Right now a new one—much bigger than any of the 456-footers afloat—is either building or about to be built. What new wrinkles she'll have is anyone's guess.

You get an inkling when Captain Shaffer, standing on the *Lindenwald's* chunky bridge and sweeping the horizon with his glasses, says, thoughtfully—"She's the hottest ship in the amphibious force today. We haven't even begun to scratch the surface of her potential."

Long Haul for Australian Ore

Australia has begun mining its big iron-ore deposit at Yampi Sound, in the north-west corner of the continent, far removed from the steel mills on the east coast. There are an estimated 100 million tons of high-grade ore in the deposit, which can be mined by cheap open-cut methods. The ore is loaded aboard ships which travel 3000 miles to the mills, the equivalent of a crossing from New York to England.

**Sturdy, Substantial
ALL METAL!**
PRECISION GROUND &
POLISHED TABLE

Save \$20 to \$40! Does the work of Power Saws costing
as high as \$60! Shop and compare!

**8-inch ALL METAL
TILT-ARBOR
POWER SAW**



An Amazing Bargain!
\$19⁹⁵
West of the Mississippi \$21.95
8-inch Combination Rip and
Cross Cut Blade.....\$2.95

**BLADE TILTS TO 45° ANGLE!
TABLE STAYS LEVEL!**

- ★ Patented motor mount designed for permanent belt tightness!
- ★ Cuts 2" x 6"s in 2½ seconds!
- ★ Operates on 1/4 or 1/3 h.p. motor. Even a washing machine motor will run it!
- ★ Blade easily raises or lowers!
- ★ Ball bearing floating drive!

**YOLANDS PRECISION TOOL CO., DEPT. B2
20 Boylston Street, Boston 16, Mass.**

Please rush your new ALL METAL 8-INCH TILT-ARBOR POWER SAW. I enclose Check Money Order for \$19.95 (\$21.95 west of the Mississippi) plus \$1.00 for postage. If not delighted I may return the saw within 10 days for full purchase price refund. Sorry, no C.O.D.'s.

Name

Address

City Zone State

If 8" combination Rip and Cross Blade is desired, enclose \$2.95 extra and check square at left.

CUTS 2" x 6s" in 2½ SECONDS!

You can mitre, bevel, or saw any length wood at any angle yet the table and work are always level. A simple adjustment of the patented, improved mechanism tilts the blade up to 45°. Patented built-in motor mount eliminates compli-

ated gears, always keeps belt at correct tension. Has height lock for dadoing. Blade raises and lowers. Does everything a \$60 saw will do! Cuts joists, siding, rafters, frames, joints, slots, etc. Accurately rips, wide or narrow panels! With attachments cuts dadoes and moldings! Mounts on any kind of tool bench!

**YOLANDS PRECISION TOOL CO.
20 Boylston Street, Boston 16, Mass.**

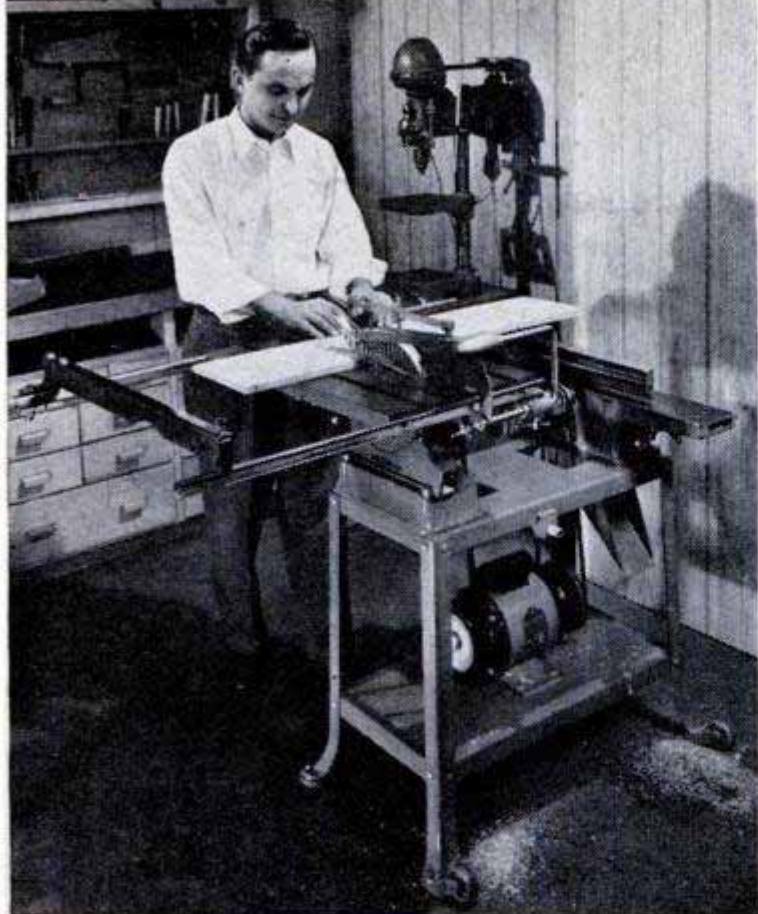

you can do
**almost every
 woodworking job
 you'll ever need
 in this**

DELTA WORKSHOP

**... AND IT COSTS
 LESS TO OWN THAN
 YOU THINK!**

These two Delta Power Tool units are the answer to your need for a complete yet flexible home workshop. For example, look at the tremendous versatility they offer:

- The Saw-Jointer combination performs all basic cuts—rips, miters, cross-cuts . . . makes compound miters, cut-offs . . . joints, planes . . . with accessories it makes dado grooves, shapes, tenons, rabbets, etc.
- With the drill press, you can drill, mortise, rout, carve, sand, shape, polish and grind—and with the exclusive Delta interchangeable spindle, it takes only seconds to put on the new cutting tool.

These power tools are ready to use *when* you want to perform any given operation. Behind them, too, stands the Delta guarantee of quality and precision famous throughout industry.

SAW-JOINTER AND DRILL PRESS

This basic shop will do practically every operation required when you build projects or do home repairs. It is available in sizes to fit your needs and budget.

- **HOMECRAFT UNIT**
 (4" jointer, 8" saw, 11" drill press)..... **\$147.60**
- **HOMECRAFT UNIT**
 (4" jointer, 8" saw, 11" drill press)..... **\$205.90**
- **INDUSTRIAL UNIT**
 (6" jointer, 10" saw, 14" drill press)..... **\$357.40**

Motors and accessories extra.

Talk to your Delta Dealer and compare before you buy—and if you'd like to own this shop, send for free bench plans and a special booklet showing you how to plan your own home workshop. Use the coupon!

DELTA POWER TOOLS Another  **Product**

53 Machines • 246 Models • More Than 1300 Accessories

**DELTA
 MILWAUKEE**

*Wood and Metal Working
 Power Tools* FOR HOME AND
 INDUSTRY

**DELTA POWER TOOL DIVISION
 Rockwell MANUFACTURING COMPANY**

803B E. VIENNA AVE. • MILWAUKEE 1, WIS.

- Please send me the name of the nearest Delta dealer.
- Please send bench plans and free booklet "Woodworking for Fun and Profit."

Name _____

Address _____

City _____ Zone _____ State _____

Chrysler Corporation's program helps people build better products and better careers for themselves

George Heyer, noted magazine photographer, turns his camera for this picture story on a program of importance to American production — how people learn to build new jet engines and military vehicles, and the cars and trucks that play a vital part in American life.

Heyer's pictures were made in Chrysler Corporation factories, classrooms and training shops. He shows a few of the thousands of men and boys now taking part in Chrysler's widespread training and technical education program.



"TOMORROW DEPT." Intent young Robert Chura—son of a Chrysler Corporation employee—learns how to use tools. In special workshops set aside by Chrysler, many boys work in wood, leather and metal under the guidance of veteran Chrysler artisans—borrowing from a "Library of Tools" to finish projects at home.



ON TRAINED MEN



CLASS IN JETS. These men are learning supervisory jobs for jet engine production at the Navy-owned Chrysler Jet Engine Plant in Detroit. Engineer J. E. Engstrom is teaching the latest in jet design. Like most Chrysler Corporation officials, these men came up from the ranks.



"GOOD MACHINES DESERVE GOOD MEN." Albert Bazner learns about grinders from machinist H. A. Nelson. Albert is a Chrysler Industrial Education apprentice, learning a trade—at good pay. In other courses, high school and college students earn both classroom credits and pay.

THEY THINK IN CLAY. At Chrysler Institute of Engineering, employee students D. M. Holiday, *left*, and Paul R. Diehl study body design with engineer Carl Hood. The Institute offers courses that compare with those in leading engineering colleges. At Chrysler, employees find training to improve themselves . . . become more valuable to America now when production need is great.



CHRYSLER CORPORATION

PLYMOUTH, DODGE, DE SOTO,
CHRYSLER CARS & DODGE TRUCKS

Chrysler Marine & Industrial Engines • Oilite Powdered Metal Products

Mopar Parts & Accessories • Airtemp Heating, Cooling, Refrigeration • Cycleweld Adhesives & Building Panels

QUALITY PLUS
PRECISION . . .

Shopmaster

Tools and
Accessories

for
**BUDGET-MINDED
Hobbyists**

CIRCLE SAW BLADES

- 8" blades combination crosscut and rip \$3.95 each
- 8" Hollow-Ground Combination Blade (3/8" bore) \$9.95
- Also 10" and 7" combination blades

QUALITY DADO SETS

5 1/2" . . . \$7.45 to \$10.95

LATHE TURNING TOOLS

Professional set of 5 and 8 tools . . . \$7.95 and \$14.50

JIG SAW BLADES

7 different sizes—package of 6 . . . 35c to 50c

SABER SAW BLADES

3 different sizes—package of 6 55c

The Complete DRILL PRESS MORTISING KIT

Chisel holder, fence, hold-down, bit and chisel . . \$14.50

DRILL PRESS SHAPER KIT—

Adapter and table bearing and three three-wing cutters \$9.75

ROUTER ADAPTER KIT—

Has four 1/2" shank bits of 3/16" 1/4", 3/8" and 1/2" \$5.95

RUBBER SANDING DISC—Includes two 5" sanding discs, one lamb's wool polishing bonnet \$2.25

DRILL PRESS PLANING ATTACHMENT—Knives, cutter head and housing \$9.95

DRILL PRESS VISE—Opens 3" \$5.95

2" DRILL PRESS SANDING DRUM AND GARNET SLEEVE . . \$1.95
Garnet Sleeves for SD-640 Drum, 6 per package . . . \$1.00

FRONT TABLE EXTENSION \$4.45

BAND SAW RIP FENCE—for 10" or 12" \$4.25

DRILL PRESS COLUMN COLLARS \$1.50

6" and 4" JOINTER KNIVES—Set of 3 \$4.95

SHAPER COLLARS—Set of 10 collars. Graduations, 1/16" from 7/8" to 1 7/16" diameter. Have 1/2" centers . . . \$3.50

4 Versatile Tool Stands to select from \$6.45 to \$18.95

Other Lathe Accessories

SCREW CENTER
Use on any lathe with No. 1 Morse Taper headstock . . . \$1.50

FACE PLATES—4" to 6" Face Plate threaded both right and left hand. For 3/4"—16 thread headstock spindle . . . \$2.95

Four Jaw Chuck. Threaded 3/4"—16 \$9.95



SHOPMASTER, INC.

1214 Third St. S., Minneapolis, Minn.

See any one of the 5000 Shopmaster dealers in the United States. If one is not near, write

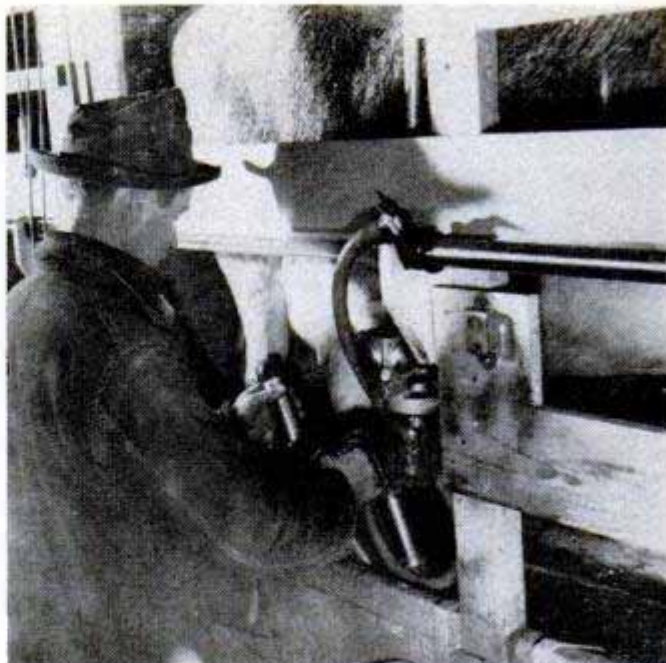

International Harvester Co. photo

Dairy farmers and health experts swear by the milking machine. It pipes milk direct from cow to can

machines, automatic watering, automatic barn cleaners and tractor manure loaders have made the difference.

Although they could not take all the credit for profound changes in farm management and farming practices, machines made many of them possible. Agricultural colleges, which sprang up soon after the Civil War, exerted small impact in their early years because actually they could find little to teach. Aside from formal outlines of geology, botany and a few other subjects, little was known that could be called agricultural science. Recognizing this, Congress in 1887 provided for state agricultural-experiment stations. New

Mechanical pickers have reduced farmer's hours per acre in cotton fields from more than 100 to about 30

International Harvester Co. photo



(Continued to page 252)

With Prices Like These, No Wonder Thousands Choose Professional Quality Westcraft Tools:

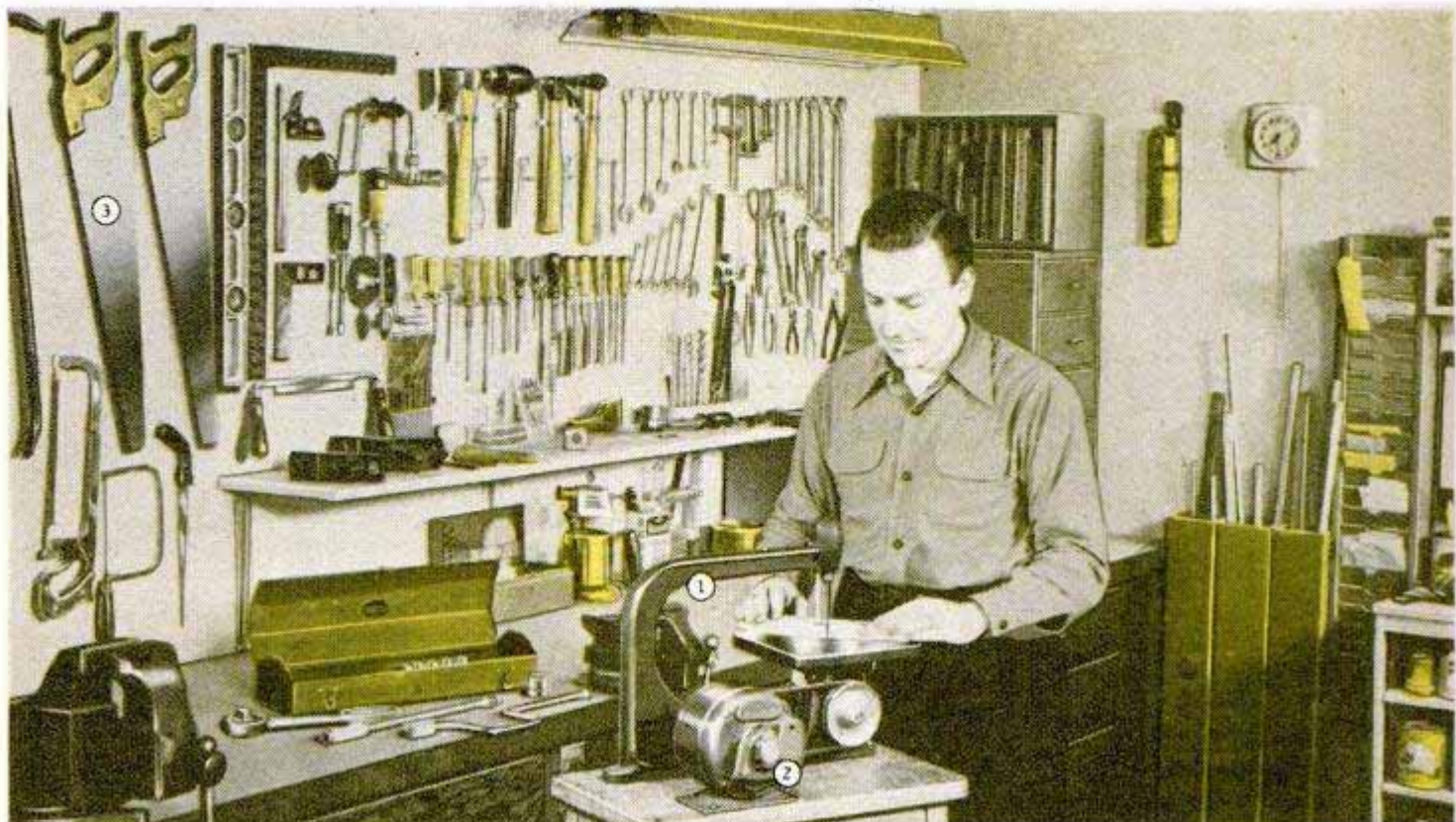

Before you buy any tools be sure to see, try and compare Westcraft. Like thousands of other tool buyers, you'll discover these famous, shop-tested tools give you the same precision engineering and

lasting accuracy of other brands costing far more. Westcraft tools are fully guaranteed and are yours on easy terms. Here are a few from our complete selection — see them at Western Auto this week!

① **Tilt Table Jig Saw**, cuts to center of 24" circle. Scotch yoke, oilite bearings. Uses 5" pin or plain end blade. **\$19³⁵**
Yours now for only(2H1102)

② **½ HP Electric Motor**, 1725 rpm, 115 volt, 60 cycle AC. Split phase. GE guaranteed for 1 yr. Use with jig saw, washer, paint sprayer, etc. **\$17²⁵**
(2H1600)

③ **8-Point Crosscut Saw**. 26", 4 gauge, double tapered blade. Precision tempered and polished. Comfortable hardwood grip. Yet only.....(4HR6329) **\$4⁷⁹**



½" Electric Drill, 115 volt, AC-DC, 60 cycle. Drills metal, wood, plastic. Guaranteed 1 yr.(2H1379) **\$11⁹⁵**



14-Piece Accessory Kit with attachments for sanding, polishing, grinding, etc. **\$4⁷⁵**
Steel tool box....(2H1378)



Hacksaw, chrome-plated adjustable steel frame. Cuts 3 3/8" deep. Safety grip plastic handle. 10" blade (4HR4159) **\$2²⁵**



11-Piece Socket Set, ½" sq. drive. Alloy steel, chrome plated. For small nuts & bolts. Plastic box (HR2924) **\$3⁶⁹**

Professional Quality—Wizards of Performance

WESTCRAFT TOOLS

Sold by the largest group of associated tool departments in America

WESTERN AUTO
STORES & ASSOCIATE STORES

Sold
Only By

NOTE: Western Auto Associate Dealers own their own stores and set their own prices. Terms quoted are recommended terms, subject to variance. ©1952 Western Auto Supply Co., K. C., Mo. (PM22)

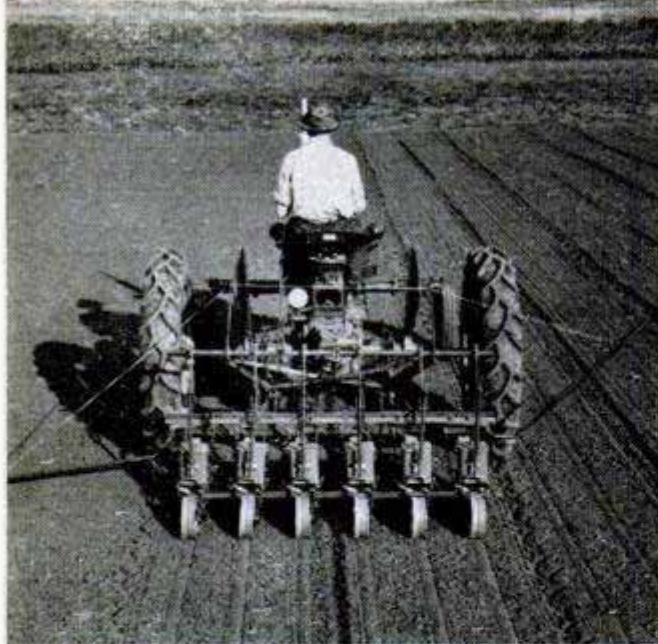

International Harvester Co. photo

Six-row beet planter is one of modern farmer's tools

knowledge emerged from these stations in a steady and important flow, but reached few farmers. The scientists did not know how to write for or talk to farmers. So, in 1914, Congress established the extension system which brought county agents, home-demonstration agents, and later 4-H club leaders into most counties.

The boys' and girls' 4-H (head, heart, hands and health) clubs, and the Future Farmers of America, which later were organized in connection with the vocational agricultural high schools, sharply stepped up farm receptivity toward scientific practices. The youngsters found the practices interesting. Their fathers found them profitable. Then the natural turnover of the generations put most farms by 1940 into the hands of men who had directly or indirectly been schooled by 4-H and F.F.A. ex-



Dearborn Motors photo

Tractor totes a hydraulically operated disk harrow

periences, or had learned to utilize the new techniques.

The techniques which 1952 farmers follow have originated in laboratories of private industry as well as in the Department of Agriculture and in the state experimental stations. Insects will be sprayed with DDT. Weeds will be fought with 2,4-D and other chemicals. Calves, pigs and chickens will grow 10 percent faster than their progenitors because minute quantities of new antibiotics, such as aureomycin and terramycin, will have been mixed into their feeds. These antibiotic effects, discovered only a couple of years ago, have created a multimillion-dollar market already for manufacturers, and have proved highly profitable to their farm users.

During the first half of the 1902-1952

(Continued to page 254)

Hydraulic manure spreader, with loader on front of the tractor, can do the work of many 1902 farmers

New Idea Farm Equipment Co. photo

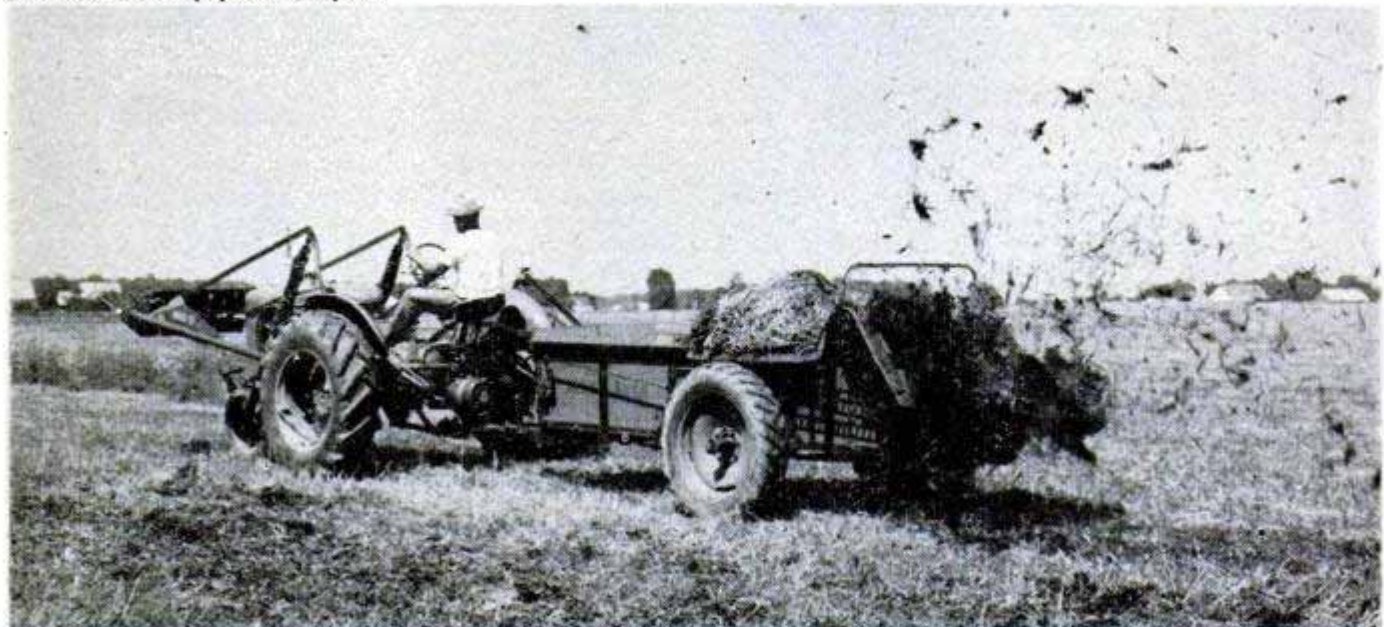



1 Paying Out \$10 to \$30 A Month for "little" engine repairs? Burning up dollars—in gas and oil? Then you're *paying* for a WIZARD-IZED Engine. Why not get it?



2 Afraid To Take Your Car out for fear the engine will "conk out"? Better to put your money in a WIZARD-IZED Engine—than in costly towing and repair bills!



3 Engine Too Sluggish And "Old" to provide the power to pass other cars safely? The money you might pay for repairs could buy your WIZARD-IZED Engine!

Now You Can **"NEW-ENGINE"** Your Car For About The Price Of An Overhaul!

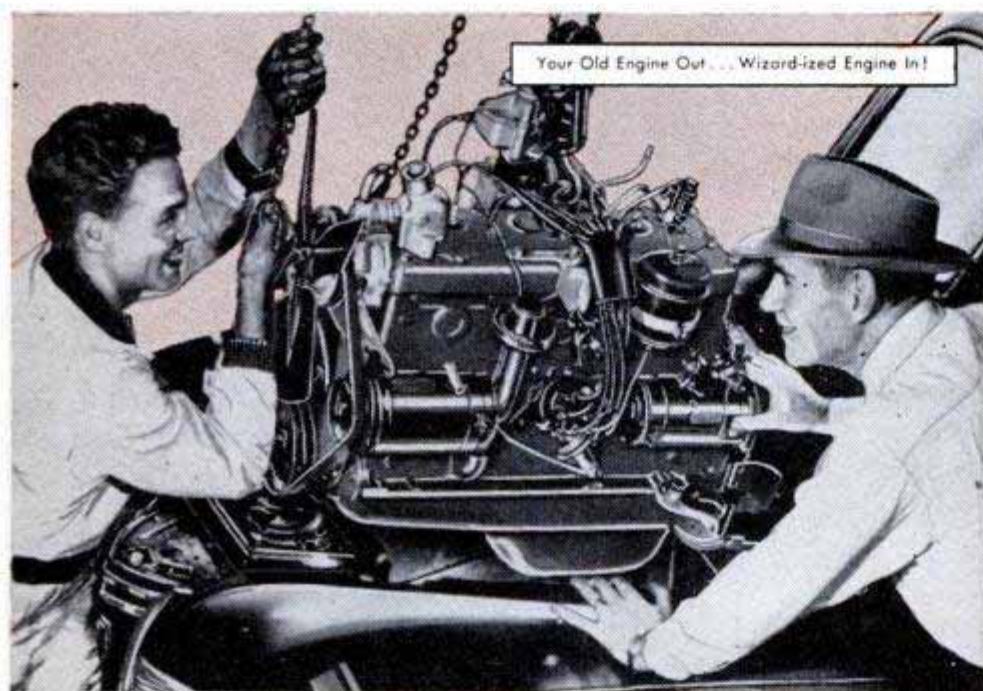

Instead of merely overhauling, "new-engine" your car this easy WIZARD-IZED way — for about what you'd pay for an overhaul. Expert installation by trained

mechanics in fully-equipped garages. And your old engine is worth a generous *guaranteed* trade-in allowance. See your Western Auto man — now!

And A Factory Remanufactured **Wizard-ized Engine** Has A New Engine Guarantee!

That's right! Why pay \$150 to \$180 for a bearing-ring-and-rebore overhaul, and have all the other "tired" old parts left in your engine? — when the same money can buy you a completely remanufactured Wizardized Engine? Why take 10,000 to 15,000 engine miles for your money—when you can get up to 50,000 miles or more?

Here's what we mean by remanufactured: It is **not** just your old engine, overhauled and put into your car! Your Wizardized Engine is precision remanufactured, using original factory block, in one of five large factories that handle no other work. Every part meets new-engine tolerances.

Every moving part is brand new or fully remanufactured to function like original equipment.

New car engine guarantee—backed by Western Auto, the most trusted name in auto parts—plus free 500-mile inspection!

So before you buy any overhaul, see how much more you get in a Wizardized Engine!



Ford as low as \$16.00 down

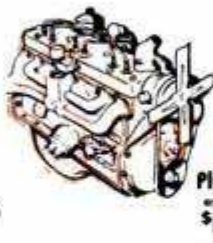

Plymouth as low as \$17.00 down

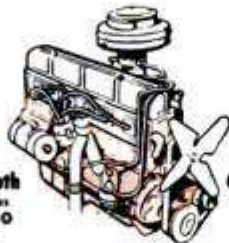

Chevrolet as low as \$14.00 down



(Terms vary by area, make, and model of car)

Wizard-ized Engines

FACTORY REMANUFACTURED

The Engine You Can Buy with New Car Confidence!



NOTE: Western Auto Associate Dealers sell their own stock and at their own prices. Terms and conditions quoted are approximate, and subject to variance. Prices are subject to change without notice. ©1952 WESTERN AUTO SUPPLY CO., 2107 Grand, Kansas City, Missouri (PH2)

NEGLECTED WIRES CAUSE AUTOMOBILE FIRES



The Fire Report of the City of Philadelphia shows "the chief known cause of fires in 1950" was automobile short circuits! And every day . . . all over the country . . . fires caused by defective wires destroy cars, trucks, and buses by the hundred!

Is a fire hazard hitching a ride in *your* car? Better have your wires and cables checked today. Not only to prevent fire—but to prevent hard starting, poor engine performance, battery failure. When wiring is bad, install new genuine Crescent Wiry Joe Wires and Cables. There are none better! Send for free folder "The Effect of Defective Wiring On Car Performance."

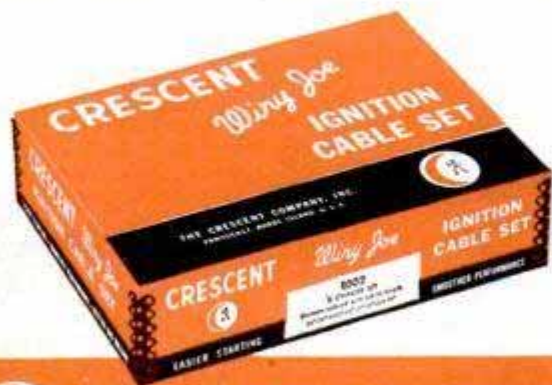

THE CRESCENT COMPANY, INC.
PAWTUCKET, RHODE ISLAND

mained largely unsatisfied. Here and there a farm close to a town could get service. Individual plants, driven by gasoline engines, gained popularity for lighting but were inadequate for power. By the mid-1920s, a few electric utilities began to see possibilities along the highways. Most were deterred by the thought of having only three customers per mile and failed to envision the high power consumption which was to come. The Rural Electrification Administration stimulated their efforts. As a result 1952 finds high-line power reaching 86 percent of all farms.

At first, farmers used current mainly for home lighting. Poultry houses were lighted when higher yields of higher-priced winter eggs paid the bills. Barn lights soon found acceptance for their safety and convenience. Pump motors and pressure water systems followed. Today electric power finds nearly 200 farm applications, and electric motors have become almost as numerous on farms as rubber tires. Power does housework, milks cows, cleans barns, grinds feed, broods chicks and pigs, freezes food supplies, fences livestock and has become famous as the "wired hand" that replaces the hired hand.

The combine-harvester, which first flourished only in the big wheat fields of the West, crossed the Mississippi early in the 1920s to bring down the cost of soybeans and to begin that new crop on its versatile career. The combine now harvests 100 different crops. This economical harvesting machine set the plant breeders to shortening grain sorghum stalks just as the corn-picker called for and got smaller, more uniform cornstalks. Ten years later hybrid strains took hold through the corn states. Their added vigor added an estimated 30 percent to the corn yield, and stimulated breeding studies in many crop plants.

Along in the 1930s, industry discovered the inexhaustible raw-material possibilities latent in crops which can be reproduced every year and which, unlike minerals, are ever-renewable. More than 200 uses have been revealed for soybeans, as many for corn, and hundreds of new markets for other crop ingredients. Industrial and governmental laboratories continue large-scale chemurgic research into the natural chemical compounds which sun, air and moisture build up in plants.

The extraordinary progress which agriculture has achieved through the 1902-1952 period bears tremendous meanings. It has given increasing populations assurance of ample food supplies and freedom from fear of famine. It has permitted a steadily

(Continued to page 256)



Portable LIGHT PLANT

PUSH BUTTON START
500-700 watts 110-120 v. - 60 cyc. A.C. Powered by a sturdy dependable, easy starting, air cooled 1 3/4 hp. gas engine. No wiring necessary, just plug in and operate. Plenty of current for any oil burner, freezer, brooder, pump, emergency lights, etc. which require up to 700 watts. Ideal for Civil Defense, Fire Depts; trailers & camps. Complete with Voltmeter and built-in winding to charge 6 v. auto batteries. Wt. 85 lbs. Fully guaranteed. Be prepared if war or storm knocks out power lines.

- (Item 24) etc. which require up to 700 watts. Ideal for Civil Defense, Fire Depts; trailers & camps. Complete with Voltmeter and built-in winding to charge 6 v. auto batteries. Wt. 85 lbs. Fully guaranteed. Be prepared if war or storm knocks out power lines. **\$143.50**
- Reg. \$275.00 value.
- 700-800 Watt Plant (Item 44)** Same as above but greater output. **\$169.95**
- 1000-1200 Watt Plant (Item 45)** same as Item 24, but larger generator & engine. **\$199.50**

GIANT 2000-2500 WATT PLANT

110-120 V. 60 cyc., A.C. Absolutely the best made - exclusive dynamically balanced armature; heavy windings developed up to 5000 watt overload for motor starting. S.K.D. mounted - portable. Powered by easy starting Briggs or 6 hp. Wisconsin engine - complete with all accessories; engine easily disconnected for other uses. Big outlet box, voltmeter, no wiring necessary. Ample current for all purposes. Factory warranty and instructions included. Wt. 220 lbs. Reg. \$585.00. Special at **\$299.50**

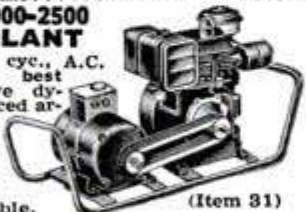

(Item 31)

With Electric Self Starter (Item 179) **\$359.50**
GENERATOR ONLY and control box. **\$169.50**
Drive it with your engine or tractor

HI-LINE 6000 WATT PLANT

Start, 115-230 v. 60 cycle A.C. A brute of a power plant with a rugged 13 hp. Wisconsin engine. Plenty of electricity for ranges, water heaters, freezers, pumps, machinery, etc. Affords both 110 and 220 volts. Ideal where heavy current is needed. Wt. 590 lbs. Easily worth \$995.00. (with self starter) **\$645.00**
Factory special. **\$585.00**
Same plant (with crank starter) (Item 166) Wt. 570 lbs. **\$585.00**
Generator and control box only, belt driven. Use your engine or tractor. **\$345.00**
Wt. 240 lbs.

We Are World's Largest Direct Factory Distributors of Light Plants

Variable Speed Selector

Heavy duty, made by B. F. GOODRICH for industrial use. Provides instant speed changes for any drive. For machine tools, dryers, printing, conveyors, production lines, hoists - any operation requiring variable speed. Ideal for midsize autos. Employs reliable "trouble free" planetary system. No hydraulic power losses or creeping. Infinite range, smooth operation, easy installation. 3 sizes: 1/2-1 hp. wt. 36 lbs.; 1-2 hp. wt. 55 lbs.; 2-3 hp. wt. 105 lbs. Reg. list \$228, \$252 and \$352. Brand new, in Goodrich boxes and guaranteed. Complete installation data included. Unprecedented surplus sacrifice **\$79.50, \$89.50 and \$114.50.**



(Item 68)

HEATING & VENTILATING FAN

(Item 10) Easily installed in furnace pipes. Forces even heat to all rooms. Over range, removes kitchen smoke and odors. Powerful continuous duty motor, 110-120 V. A.C. Quiet, super efficient fan moves huge volume of air (400 to 600 c.f.m.) 8" Fan, wt. 5 lb. **\$6.35**; 9" Fan, wt. 6 lbs. **\$7.45**; 10" Fan, wt. 7 lb. **\$8.45**; 12" Fan, wt. 8 lbs. **\$9.45.**



HIGH PRESSURE HAND PUMP

(Item 53) Positive displacement type. Cap. 550 gph. Completely self priming. 1" pipe thread inlet and outlet. Use for fuel or water transfer on boats, trailers, air craft, etc. Ideal for insecticides, energ. sump pump or as vacuum pump. Wt. 15 lbs. Govt. cost \$95. Our Special. **\$12.95**

GAUGE TESTER

(Item 27) Precision made of solid bronze and steel by Ashcroft. (Cat. #1300-5). Calibrated weights (incl.) acting against hydraulic piston provides quick accurate testing of all pressure gauges up to 500 psi. Brand new. Wt. 90 lbs. Reg. \$318.00. Our Spec. **\$95.00**



IMMEDIATE DELIVERY - ALL ITEMS HEAVY DUTY D-C ARC WELDER



(Item 38)

Use as portable or shop welder. Up to 300 amps. Senior model. Made for years of trouble-free, continuous service. Will handle light or heavy jobs. Easily welds up to 3/4" plate using 1/4" rods. Built-in air-cooling system. Arc is easy to strike and hold, because of specially designed arc stabilizer. Hi-line switch and dial control gives wide range of welding heats. Run welder at 2600 rpm. with tractor, jeep or 15 hp. gas engine, or 7 hp. elec. motor. Complete with instructions, guar. and double V belt or flat pulley. **\$99.75**
Wt. 110 lbs. A \$400 value at.

DUAL CONTROL MODEL same as above but with built-in dual rheostat for low heat soldering, brazing and welding. **\$119.50**

WELDING KIT. Two 10 ft. leads, welding helmet, electrode holder, ground clamp. Sold only with welder at **\$10.50**

A-C ARC WELDER

(Item 168) Master Hi-Line A-C Arc Welder. 20-150 amp. output. Welds or cuts iron, steel, brass, etc. from 24 gauge to 3/8" with single pass. Operates from 220/230 V. 50/60 Cycle A-C line. None better. Meets REA requirements. Handles 1/16" to 1/4" rods. Adjustable output for any job. In sturdy steel cabinet, on casters. Full instrum. and 1 yr. guar. incl. Wt. 210 lbs. Reg. \$250 value. **\$159.50**

20-100 amp. A.C. Welder (Item 169) operates on 110 or 220 V. Wt. 65 lbs. Worth \$125 **\$64.95**

Welding Kit (Item 181) incl. helmet, 2 leads, electrode holder, ground clamp, power cord and rods (sold only with welder) **\$12.50**
Wt. 12 lbs.



CARRY-AIR



(Item 32) Stainless steel tank - capacity 500 cu. in. at 400 lbs. press. complete with inlet and shutoff valves, press. gauge, detachable air hose, tire chuck. Fill at any service station. Carry air for tire inflation, blowing out lines, spray painting, insecticides, etc. One emergency pays back cost. Wt. 10 lbs. Worth \$20.00. Our price. **\$8.95**
(Item 55) With big double tank (1000 cu. in.) **\$11.95**

POTTERS WHEEL

(Item 47) Complete, prof. equip. for making finest ceramics and pottery. Large dynamically balanced cast-aluminum reversible turntable with variable speed drive (38 to 140 rpm) controlled by foot-pedal. Built-in adjustable arm rests, water cup and wedging wire. 16x12" enclosed throwing table - ample area for largest pieces. Reg. 1/4 hp. motor (not incl.). Can be set up on 20x24" table and stored on edge. Complete with pulleys, belts and instructions. Wt. 26 lbs. **\$59.95**
\$145 value at.

Automatic Electric WATER HEATER

(Item 76) Immersion type 115 v. AC - 1250 watts. Convert your present tank to modern automatic hot water heater. Long life Westinghouse or Chromalox element screws into std. 1 1/4 in. opening in tank. Adjustable thermostat keeps water at desired temp. Can also be used in washing machine or tub. Wt. 8 lbs. Heater element and thermostat **\$14.95**
regularly \$49.50. Special. **\$7.95**
Heater only, for manual control. Wt. 3 lbs. **\$7.95**



RUBBER HOSE

New genuine Neoprene Hose - outlasts ordinary rubber 3 to 1. Reinforced with super tough cotton cord plies. Flexible. Easy Flo brass couplings with standard pipe threads for quick connections. Included. Pump water for irrigation, stock tanks, home, barn, fire fighting, etc. Pump Gas or Fuel Oil. Save more than 60%.

TERRIFIC VALUES!

(Inside Diam.) 1" 1 1/4" 1 1/2" 1 3/4" 2"
Length 10 ft. 25 ft. 50 ft. 100 ft. 30 ft.
Price 5.95 9.25 24.75 49.95 14.75

If specified we will send special hose for gas or oil at same prices.



MAKES SNOW REMOVAL REAL FUN! SNOW-BLO



(Item 72)

The sensational device that makes snow removal a real fun. Easy - a child can operate it. Safely guarded whirling impeller quickly scoops up the snow and blows it 25' either side. Big timesaver. Clears driveways and walks in a jiffy. Eliminates dangerous exhaustion and overtaxed heart, which kills so many every winter. BOYS! Make big money clearing snow for neighbors. Easily converted to lawn mower when desired. New silent electric model powered by 1/2 hp. motor clears 16" swath. Complete with shockproof 100' cord (Item 72) **\$139.50**
Gasoline Model with easy starting 2 hp. 4 cycle engine (Item 73) **\$159.50**
For large areas (2 1/2 hp. engine) (Item 74) **\$179.50**
We pay freight on Snow-Blo FREE with purchase of any model, an extra 100' extension cord.

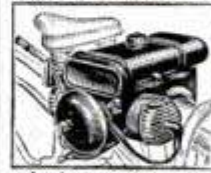

COMMANDO BIKE MOTOR
(Item 90)
New, super-modern 1952 model. This job is the Cadillac of all bike motors. Sensational Auto-Clutch prevents killing motor at each stop. Also selects proper ratio on hills. Mounts behind and drives rear wheel with Dynarotor. Free Wheeling lever permits pedaling if desired. Rear Mounting eliminates fumes, heat, dirt, and hard steering. Easily installed in 15 minutes with home tools. Sturdy, trouble-free, easy starting, light weight, Airplane type engine; up to 150 miles per gallon. Fully guaranteed for fun or profit. Ideal for deliveries, paper routes, messenger service, etc. Ride to work and save.

The Commando Captain, 1 cylinder 1 1/2 hp. **\$99.75**
The Commando General, 2 cylinder 3 hp. (Item 91) **\$125.00**
All Commandos shipped prepaid in U.S.

FIRE EXTINGUISHER

(Item 39) Fully charged at 1,000 lbs. P. S. I. or more) with CO2 (carbon dioxide), the proven miracle fire fighting chemical that smothers oil, gasoline and electrical fires. Play safe; keep one in your car, garage and home. Heavy ICC approved steel cylinder, valve and 3000 lb. gauge that shows available remaining pressure. REFILLABLE at nominal cost. Hose included for emergency tire inflator or air blast. Wt. 4 lbs. **\$19.50**
value. Special. **\$6.95**



GIANT BUNSEN BURNER

(Item 61) Operates equally well on gas or ordinary alcohol. Economical. 1 pt. burns for hours. Produces intense blue smokeless flame. Ideal for lab. or as emergency cooking unit. Fine for camping. Heavy brass burner with shut-off and adj. valve. Simple and safe. 5 ft. flex. hose, 1 qt. tank incl. Wt. 5 lbs. **\$4.95**
A \$15 value. Special. **\$1.49**
(Item 62) Metal Cooking Stand for above (not illustrated) **\$1.49**



EXTENSION CORD

(Item 16) 40 ft. heavy duty, made of specially insulated No. 14 2-conductor wire. So tough that you can drive over it and yet flexible and easy to handle. Resists oil, grease or water. Extends electricity up to 400 ft. without voltage drop. Use indoors or out. Complete with heavy rubber plug and outlet. Wt. 2 1/2 lbs. Usually \$4.50 - Special 40 ft. **\$1.99**
Comb: 2-40 ft. and 1-20 ft. (total 100 ft.) **\$2.95**
100 foot length (one piece) **\$4.85**
WIRE ONLY (Item 50) No fittings, 100 ft. \$4.00



TIRE CHAINS

(Item 43) Extra heavy for triple side links, made by Intl. Chain. Reg. list \$57.50 - our special. **\$19.50**

32 pc. SOCKET SET

32-pc. Socket Set (Item 59) Highest quality guar. non-breakable sockets made by Husky. Beautiful, matched chrome alloy, absolutely the best. Complete range of 21 sockets from 1/4" thru 7/16" in 1/4" drive and 7/16" thru 1-1/16" in 1/2" drive; 2 extensions, reversible 1/2" ratchet, adaptor bit, slide head, all angle coupling, 2 end wrenches, speeder handle and sturdy metal tool box. For prof. mechanics who want the best. Wt. 14 lbs. Easily worth \$41.50. While they last. **\$16.95**



All items brand new. Prices f.o.b. Chicago area. 10 day Money back guarantee. Send check or M. O. **MASTER MECHANIC MFG. CO., DEPT. 16A Burlington, Wis.**

BIG MONEY

in your hands!



BE YOUR OWN BOSS! Men who are determined to get ahead in something for themselves will find this opportunity hard to beat! Where else can a man turn his own labor so quickly and easily into **BIG MONEY!** Earn as high as \$50 and more a day sanding floors with an easy-to-run American Machine—and **YOU ARE BOSS.** Prospects everywhere—old and new homes and remodeling. Pleasant indoor work—steady the year round. No schooling—no experience needed. Age makes no difference—men 18 to 80 are active and successful. Send coupon for “money-making” booklet entitled “Opportunities in Floor Surfacing”—enclose 25c in coin or stamps to cover handling.



AMERICAN

FLOOR MACHINES

SEND

The American Floor Surfacing Machine Co.
535 So. St. Clair St.
Toledo 3, Ohio

Enclosed find 25c in stamps or coin for booklet “Opportunities in Floor Surfacing”, telling me how I can start my own floor sanding business.

Name _____

Street _____

City _____ State _____

produce the food for everybody and has thus released the manpower necessary to the comparable progress which industry has achieved. It has shortened the long hours of farm work and lifted the drudgery from nearly all forms of agricultural production. It has increased profits for farmers until agriculture as a lucrative business compares favorably with other careers.

This half century of farm progress will unquestionably exert far-reaching effects around the world. The American farming idea of high production per man portends high hope for all mankind. Most of the world's population farms for a living and gets a poor living. While American farm methods cannot be transported bodily to such areas as India, they do contain characteristics of progress which can be adapted wherever farmers till the soil. The next half century may see enough worldwide application of American farming ideas to lift the pall of fear, hunger and starvation from much of the human race, and open the way to industrial development in areas where the ever-present problem of food supply leaves few workers free for manufacturing activities. The chemurgic idea that crops are industrial raw materials will open manufacturing opportunities in countries where mineral resources are small.

Few people could have predicted, from the vantage point of 1902, that by 1952 cotton could be picked by machines, the sugar-beet crop entirely mechanized, that airplanes would dust and spray the fields, that flame throwers and chemicals would kill weeds, or that rubber-tired tractors and electric motors would put engine muscles in place of horse and human muscles.

Just as certainly few who now stand on the high ground of 1952 can predict what the years ahead will unfold. The foundations of science and experience are now immensely broader.

Atomic farm power may emerge from the new knowledge of nuclear fission. New electronic applications are reasonable to expect, perhaps some kinds of push-button farming whereby one operator will simultaneously control equipment working in various fields and buildings. Increasing knowledge of plant synthesis and of “why grass is green” may open new agricultural approaches. New plant species will almost surely become crops as organic chemistry explores the values of plants now wild. Food from seaside algae or from synthetic short cuts may supplement field-grown supplies. On-farm industrial processing will become more widespread.

If freedom continues to encourage the

(Continued to page 258)

GROBANS WAR SURPLUS BARGAINS!

BRAND NEW • UNCONDITIONALLY GUARANTEED

General Motors — Allison CENTRIFUGAL PUMP

BRAND NEW

200 GALLONS PER MINUTE

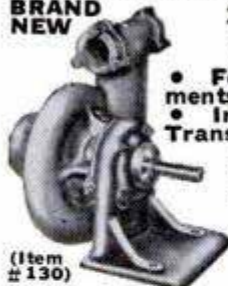

- For Draining Basements
- Fire-Fighting
- Irrigation
- Fuel Transfer
- Swimming Pools
- Home Water Systems
- Dewatering

This General Motors-Allison Centrifugal Pump—designed for use on U. S. Air Force Mustang fighters, now converted for commercial, home, and industrial high volume pumping applications. Inlet, 2 1/2" standard pipe thread, twin outlets with 1 1/2" pipe thread, ball bearing supported 3/4" shaft. Easy, fast simple priming. Rotation, counter-clockwise facing shaft. Shipping wt. 35 lbs. Gov't. acq. cost \$145.00. F.O.B. Chicago

39.50

NOW ONLY

| Suction Lift | Head Pressure | Gal. Per Min | H.P. | R.P.M. |
|--------------|---------------|--------------|------|--------|
| 10' | 75' | 260 | 6.0 | 3500 |
| 10' | 65' | 200 | 5.2 | 3500 |
| 10' | 80' | 40 | 1.5 | 2500 |
| 10' | 50' | 140 | 5.0 | 3500 |
| 10' | 30' | 100 | 3.0 | 2500 |

D. C. GENERATORS



For welders, plating, truck and marine use. D.C. appliances, lights, etc. Aircraft quality — lifetime grease sealed ball bearings. Heavy duty.

ITEM #90—Type P-1, rated 200 Amps.—28 Volts, 2500 RPM. Mfd. by General Electric, Ford, Delco-Remy and Westinghouse. Gov't. Acq. Cost \$300.00. Shpg. wt. 53 lbs. F.O.B. Chicago

22.50

ITEM #91—Type R-1, rated 300 Amps.—30 Volts. Mfd. by Jack & Heintz. Gov't. Acq. Cost \$380.00. Shpg. wt. 59 lbs. F.O.B. Chicago. Each individually packed in wooden box.

35.00

HYDRAULIC SPEED REDUCER WITH FINGERTIP CONTROL

ITEM #115

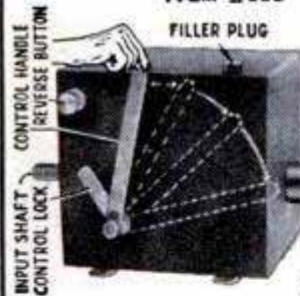

- USE FOR:
- Reamer Drives
 - Midget Cars
 - Feed Mills
 - Canning Machines
 - Conveyors
 - Lathes
 - Milling Machines
 - Motor Boats
 - Cream Separators
 - Garden Tractors
 - Pumps

Variable output speeds from 0 to input speed available by moving control handle. Locking handle maintains setting. Internal relief valves prevent overloading. Use input power of 1/4 to 1 1/2 H.P.

This Westinghouse-Oil Gear Unit converted to commercial use from 40 MM anti-aircraft traversing mechanisms consists of a variable displacement hydraulic pump feeding a fixed displacement hydraulic motor. Adjustable relief valves set at factory for 100 inch pounds of torque may be reset up to 180 inch pounds. Independent reverse control allows full output power and speed selection in either direction of rotation.

Both input and output shafts measure 5/8" diam., include keyway. Input rotation is counter-clockwise facing shaft. Recommended input speed not to exceed 750 R.P.M. Overall dimensions 7 1/2" x 7 1/2" x 11 1/2". Gov't acquisition cost, \$428.00. Shipping weight 31 lbs. Complete with 2 qts. of oil and full instructions. F.O.B. Chicago

54.50

FREE: NEW 1952, 48-PAGE CATALOG, loaded with unsurpassed War Surplus Bargains. Write for yours today!

Write, Wire or Phone Webster 9-3793

PREPARE NOW FOR GENERATING PLANTS

Immediate Delivery—Large Stock—Many Sizes
Designed for Continuous or Intermittent Service
PLENTY OF EMERGENCY STAND-BY OR GENERAL UTILITY POWER, FROM 350 WATTS TO 25 KVA.
Item #183 — 3000 to 4000 WATT GENERATOR SET
FEATURES—Power for your home or business. Simply connect to power panel or house circuit. • Constant voltage regardless of load. • Push button start or stop. • Easily made full automatic start or stop. • Circuit breaker stops plant in event of short circuit.
SPECIFICATIONS—Sizes 19"x30"x48". Steel skids, weatherproof housing, requires no building. Wt. 725 lbs. • Hercules 4-cyl. gasoline engine. Load governor. Oil filter. Quiet muffler. 6-volt generator. • Hobart 115 volt, 60 cycle, 3,000 to 4,000-watt single or three-phase power, 2 or 3 wire. • Panel contains oil circuit breaker, voltage regulator, start button.

Today's Cost Over \$1,200.00. SALE PRICE, F.O.B. Chicago

Item #178—350 watt—115 volt—60 cycle A.C. direct coupled to 1 cylinder Midea engine. Shpg. Wt. 116 lbs. **125.00**

Item #182—Onan Generator—5KW—120/240 volt—60 cycle A.C. single phase, direct coupled to Willy's Jeep 4 cylinder, water cooled engine with push button start, battery ignition. (Battery not included.) Shpg. wt. 1200 lbs. F.O.B. Chicago

795.00

Item #201—PE 95-G—10 KW—110/220 volt—50 cycle A.C.—Single Phase. Totally enclosed. Onan generator direct coupled to Willy's Jeep, 4 cylinder, water cooled engine, push button start, instrument panel with engine and generator instruments, circuit breaker controls, etc. Uses 6 volt car bat. (Battery not incl.) Skid mounted. Ship. wt. 1500 lbs. F.O.B. Chicago

1295.00

Item #180—15 KW—127/220 volt—60 cycle AC—3 phase 1800 RPM. Hrazek & Krachy Generator direct coupled to International Harvester 4 cylinder, water cooled engine with magneto ignition—push button start. Panel has voltmeter, ammeter, 4-wire electrical system, belt driven excitor generator, rheostat voltage control. Engine and generator mounted on steel skids. Shipping wt. 2000 lbs. (Battery not included.) F.O.B. Chicago

1650.00

Item #128—25 KVA—250 volt, Single phase—60 cycle. Totally enclosed-Hobart generator driven by a GMC 270, 6 cylinder gas engine, button start, liquid cooled. Has control panel with full set of instruments for both engine and generator. Shipping weight 2600 lbs. (Battery not included)

2250.00

Write for information on other size generating plants ranging from 350 watts to 25 KVA.

HEAVY DUTY HYDRAULIC EQUIPMENT AIRCRAFT QUALITY

Large supply of new labor-saving, economical hydraulic equipment in many types and sizes. Use these positive, highly efficient smooth pressure hydraulics on presses, arbors, lifts, loaders, power control, positioning, brakes, plastic dies, auto frame alignment, etc., etc.

ITEM #127—Double acting hydraulic cylinder, 1" bore, 1" stroke, 1/2" diam. shaft, 1/2" tubing thread ports. Overall length closed—6 1/2". Clevis mounting at both ends. Perfect for clamping and feeding. Post-paid

5.95

ITEM #29KJ—Double acting hydraulic cylinder, 1 1/2" bore, 26" stroke. Will lift 1760 lbs. with 1000 PSI line pressure. Weight 8 lbs. A \$55.00 value. Now only, Postpaid

16.95

ITEM #126—Four-way, open center control valve with built in adjustable relief valve. Factory set at 1000 P.S.I., spring loaded neutral position, for use with one double acting cylinder. Fully balanced plunger type, smooth, positive, easy operation, can be used as single unit or mounted in series of any combinations desired. Has 3/4" pipe thread inlet and outlet, 1/2" pipe thread cylinder ports. Newly manufactured to our specifications. Shipping weight 8 1/4 lbs. An outstanding Buy!

21.50

ITEM #103—Double acting hydraulic cylinder, 2 1/2" bore, 17" stroke. Clevis mounting. Will lift 4900 lbs. with 1000 PSI line pressure. 1 1/4" diam. shaft. 3/4" tubing thread ports. Overall length closed 28". Shpg. wt. 11 lbs.

21.50

ITEM #6—Double action hydraulic cylinder, 3" bore, 24" stroke, will lift 7070 lbs. with 1000 PSI line pressure. Steel barrel, 1 1/4" stainless steel shaft. Gov't. acq. cost \$178.00. Ship. wt. 26 lbs.

28.00

ITEM #42—Double action hydraulic cylinder, 4" bore, 18" stroke. Rated lift capacity with 1000 PSI line pressure is 12,500 lbs. Ship. wt. 30 lbs. F.O.B. Chicago. An Excellent Buy for

32.50

ITEM #29KJ—Gear Type Hydraulic Pump. Ideal in industrial applications and for operating all hydraulically powered farm implements including loaders, stackers, swathers, plows, etc. Delivers 1000 PSI (may be set at lower PSI if desired), 12 GPM at 400 RPM. Maximum operating speed 800 RPM—rotation counter clockwise. Has built-in relief valve, permanent or torque bar mounting, 1" diameter shaft, 3/4" pipe tap inlet, 1/2" pipe tap outlet.

45.50

NEW MODEL 353 D.C. ARC WELDER

— DUAL RANGE — Stationary or Portable Use. HEAVY DUTY RANGE TO 250 AMPS. NEW 'MAGIC TERMINAL' FOR LOW CURRENT 30 TO 100 AMPS. IDEAL FOR • FARM • FACTORY • GARAGE • WORKSHOP

These precision engineered D.C. Arc Welders contain the highest quality War Surplus aircraft components built to exacting government specifications. They are light in weight, have oversized lifetime grease-sealed ball bearings, air cooled commutator, dial type rheostat for easy pin-point control, a high-low rheostat switch, reactor coil for even arc and the new 'MAGIC TERMINAL' low current welding range for welding lighter materials. Designed for many years of trouble-free service. Run welder from drive pulley or power take off of a tractor or Jeep, 7 1/2 HP electric motor or 10 HP gas engine at 2500 R.P.M. Uses two V belts or flat belt. Continuous output rating 200 amps. Intermittent welding rating 250 amps, 30 volts. This sensational price includes double V or flat belt pulley and complete operating instructions. Shipping weight 107 lbs. \$350.00 Value.

119.50

F.O.B. Chicago

Welds Anything From Auto Fenders To Tractor Frames

ORDER DIRECT FROM AD — SEND PAYMENT OR PURCHASE ORDER TODAY — SATISFACTION GUARANTEED

GROBAN SUPPLY CO. 1139 SO. WABASH AVE., CHICAGO 5, ILL. DEPT. PM-2

For cross-grain planing
and light with-the-grain
cuts — Millers Falls No.
16 Block Plane



For finishing large sur-
faces — Millers Falls
No. 9 Smooth Plane



For truing edges and gen-
eral all-round use — Millers
Falls No. 14 Jack Plane



Three Great Planes

There's a feel and balance and fast-cutting accuracy in Millers Falls planes that has made them favorites for generations with men who use and prize fine tools. So, when you buy a plane — ask for a Millers Falls. Sizes and types for every purpose — smooth-cutting, long-lived tools you will be proud to own.

Millers Falls Company, Greenfield, Mass.

**MILLERS FALLS
TOOLS**

SINCE
1868

®

The Mark of Superiority

urge for betterment, invention and science will provide agriculture with continually improved equipment and methods, probably at an accelerated rate. Those who look back after another half century are likely to regard the farming of 1952 as primitive as the methods of 1902 appear to the eyes of today's farmers.

Calendar of Farm Progress, 1902-1952

- 1902**
- Portable grain elevator
- First successful cylinder corn sheller
- Steel stanchion for dairy cows
- 1903**
- First gas traction engine produced commercially
- 1904**
- Track-type traction engine offered for sale
- Steel thresher
- 1906**
- "Tractor" came into use as a word
- 1909**
- Cornpicker built commercially
- 1910**
- Electric water systems produced in quantity
- Colony-type heated brooder for baby chicks
- Rod weeder for fallow-land farming
- 1911**
- Pressure regulator and air chamber for power sprayer
- 1912**
- Rotary hoe produced commercially
- Automatic, individual water bowls for cows
- 1913**
- Haber-Bosch process for fixing atmospheric nitrogen
- Frameless, or unit, design in farm tractors
- 1914**
- County-agent system launched
- Reel-type, side-delivery rake
- Power-operated milking machine introduced
- 4-H Club named and formally launched
- 1915**
- Motor-cultivator-type tractor
- 1916**
- Garden tractor introduced
- 1917**
- Two-row potato planter
- 1919**
- Farm tractor equipped with power take-off
- 1920**
- American Farm Bureau Federation organized
- Hammermill introduced
- Starter and lights for tractor
- 1921**
- Tool-bar idea for mounting tillage tools on tractors
- 1923**
- Combination tool-carrier for heavy implements
- 1924**
- Mounted-type tractor implements introduced
- Electric ventilating system for dairy barns
- Cultivating or tricycle-type tractor
- 1925**
- Two-row, tractor-drawn rolling stalk cutter
- 1926**
- Cotton stripper built commercially for the high plains
- Jet-type pump introduced

(Continued to page 260)

BUY from C&H - you'll save and be sure!

ALL ITEMS GUARANTEED AS REPRESENTED
Order with confidence from C&H

80-1 ratio GEAR REDUCER

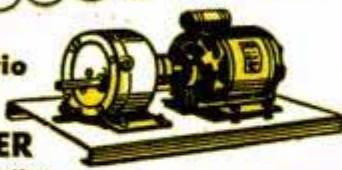

Double reduction. Operates on any 1/8 to 1/2 HP electric motor. 22 RPM. Can be used as winch, barbecue, dummy elevator, operate turntable, electric garage door opener, television antenna. REGULARLY \$45.00. NOW ONLY \$22.00

54 to 1 BOSTON Speed Reducer



Reduces speed of ordinary 1750 rpm electric motor to 33 rpm. Lists at \$35.00. Our price \$29.50



CLUTCHES

For motor scooters, motor bikes, lawn mowers, etc. Centrifugal action enables electric motors or small gas engines to handle heavy starting loads. 3" A belt pulley. NEW. 3/4" bore \$9.95; 1" bore \$10.95; 1 1/2" bore \$11.95



BEARING ARBORS

Grinding and saw arbor, has 1 1/2" double end shaft, 1 1/2" long with 2" center pulley. New Departure double roll ball bearings. Right and left hand thread. Self aligning Dodge pillow block. 10,000 RPM. Bearings alone list at \$10. NEW \$6.95. SLEEVE BEARING ARBOR 1 1/2" shaft 9" long. Only \$3.00

ALARM HORNS • SIRENS



Motor driven (not a vibrator). Heavy duty with great power and long life. Adjustable for high, medium or low tone. 110v. AC current. Weather proof. For alarm or signal horn on boats, school yards, factories, air raid siren, etc. List price \$47.00. Our price NEW \$15.45

HOT ROD SUPERCHARGER



Extra soup and go at a price you can't afford to miss. SEE HOW SIMILAR SUPERCHARGER is used in PICTURE and article on p. 67 AUG. '50 issue of POPULAR MECHANICS. Mfr'd. by Borg-Warner. Specifications: 7 1/2" deep, 7" high. Wgt. 17 lbs. Compact and sturdy. 4 base mounting holes. 3/4" outlet. 5/8" shaft with female Lovjoy coupling. Priced today at \$85. OUR SPECIAL SALE PRICE \$31.00

POWER and HAND WINCHES



For—BOATS, TRUCKS, FARMERS, LOGGERS, CONTRACTORS, ETC.

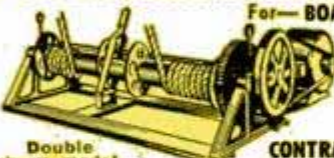

Double drum model WINCHES, 1,000 lb. cap. Hand oper. \$ 9.95 WINCHES, Hand operated ball bearing model, 1500 lb. capacity. 3-1 ratio, hand brake two speeds. \$ 39.50 WINCHES, 6,000 lb. double drum, Hand operated \$ 49.50 WINCHES, 1,500 lb. electric drive. \$ 89.50 WINCHES, 6,000 lb. electric drive. \$188.50 WINCHES, Single drum, 3/4 HP. Motor 110 or 220 AC. Start, stop and reversing switch, belt, pulleys. 100 ft. 3/16" steel cable. 2000 lb. pull. Ratio 12 to 1. NEW \$125.00. Double drum model \$135.00 CABLE, 1/4" preformed stainless steel aircraft. 100 ft. or less \$175/ft. Over 100 ft. \$185/ft.



BOOSTER FANS

Fits any 8", 9", 10" furnace pipe. 1500 RPM motor with 8' cord, mounting frame, 7" blade. Motor, 110 volt, 60 cycle 1550 RPM. Easy to install. Silent operation. Warm those rooms with long runs. Stock #583. Regular \$11.95. Your price \$6.95

| FANS | FAN SHUTTERS |
|---------------------|--------------|
| 10" \$12.95 | \$4.50 |
| 12" \$16.95 | \$4.95 |
| 16" \$23.95 | \$5.95 |
| 20" \$39.95 | \$6.95 |



High Volume BLOWERS

Top performance for forced draft, ventilating, exhausting, cooling and drying. 110 volts AC, Intake 3", discharge 2 1/2". 75 cubic ft. per min. \$10.95 Intake 5", discharge 3" 150 cubic ft. per min. \$13.95

BUILD YOUR OWN DUMB-WAITER ELEVATOR

Get all the convenience of a dumb waiter elevator in store, shop, restaurant or home at lowest cost. We furnish complete parts for elevators similar to those described in ARTICLE on pp. 174-177 Dec. '51 issue of POPULAR MECHANICS. Steel car-Guide Rings—Worm Gear—Limit Switches—Electrical Controls—Steel Cable. SEND 25c for completely diagrammed instructions with list of parts, kits and prices.



ELECTRIC HOT WATER HEATER

Heat water faster, easier with this immersion unit. 115 v. AC—1250 watt Westinghouse or Chromolox element. Manual unit, \$42 value, \$6.95; thermostat Fenwall control \$3.95. Element with Fenwall thermostat \$8.95. 10 gal. steel tanks 12x21" — \$9.95; 8x42" — \$11.95; 18" cord #12/2 or 3 conductor with plug \$2.25.

"JANITROL" AIRCRAFT HEATERS



Warms up fast—just the thing for heating trucks, buses, garages, etc. Has an output of 50,000 BTU's per hour. 24 volts DC. Length 23", diameter 13", weight 14 lbs. Original cost \$130. Our special sale price NEW, only \$19.95

AUTOMATIC AIR COMPRESSOR UNIT



Compressor with 2x1 3/4" piston controlled for intermittent duty by regulator and check valve. Heavy duty capacitor motors 110/220 v. AC. 12x24" tank mounted on rubber tired wheels. 1 1/2 hp. \$99. 1/2 hp. \$109. Tank only \$14.95.

Flexible Shaft Grinder



"MALL" PORTABLE 1/2 HP. 3450 RPM. 110-220 volt dustproof motor mounted on universal trunnion. Heavy base has a convenient tool tray and large easy rolling casters. Flexible shaft is equipped with both full speed, angle spindle and straight spindle. List price \$172.00. Your price with all attachments, NEW \$109.00



NEW TOOL POST GRINDER

1/2 hp. AC-DC 7000 rpm motor with 3 1/2 x 3 1/4" external grinding wheel, smaller internal wheel, 7 ft. rubber cord, switch and attachments. Lists at \$90. Only \$49.50

SAVE OVER 50% ON THESE BRAND NEW WAR SURPLUS POWER UNITS



BE PREPARED for any emergency!

300 WATT 110-220 volt AC, 60 cycle light plant powered by 1 HP gas engine, direct drive, mounted base, wgt. 40 lbs. Ideal for campers, P.A. systems, house trailers, etc. Equipped with handle for easy carrying. \$99.00

750-1000 WATT 110 volt AC, powered by Briggs & Stratton gas engine \$169.00

1000-1200 WATT 110 volt AC \$194.00

2000-2500 WATT 110 volt AC, 60 cycle, slow speed generator, 5.10 HP Briggs & Stratton gas engine. NEW \$294.50 To make plant 110-220 add \$40.00 for transformer.

2500-3000 WATT 110 volt AC, 60 cycle, Leland generator—runs at slow speed (1800 r.p.m.) for longer life. 8.25 HP Briggs & Stratton gas engine. You can rely on this plant for all average home needs—freezer, stoker, pump, hot plate, radio, etc.—and overloads from starting motors. Reconditioned and fully guaranteed. \$295.00, NEW \$345.00

Plants, same as above, built in 1951, with tools and spare parts. Lists at \$790.00. Our price \$426.00 To make plant 110-220 add \$48.00 for transformer.

3000 WATT, 110-220 volt with push button starter. Starter battery is automatically charged by plant. Gas engine same as in plant above \$465.00

5000 WATT, 120 volt, 60 cycle AC, Hercules 4 cyl. gas engine. Generator mfr'd by Hobart Bros. Unit includes remote control cable, 150' 2-wire #6 and 150' 3-wire #18, exhaust pipe, power cable plug, spare parts, manual, battery, radio and TV filtered. Unit is completely automatic. List price today \$1910. Now priced for you at \$675. used. NEW \$895. To make plant 110-220 add \$72. for transformer.

For complete information and specifications on the following plants, WRITE for our FREE circular.

7500 WATT 110 volt AC, 4 cyl. gas engine, NEW \$995.00

10,000 WATT 110-220 AC. Recond'nd \$1195. NEW \$1494

25,000 WATT 220 v. AC, 3 phase, or 110-220 v. AC, single phase. Reconditioned. \$1995.00. NEW \$2495.00

35,000 WATT 110-220 volt, Diesel. Rebuilt. \$2995.00

50,000 WATT 240 v. AC, 3 phase. Diesel. NEW \$5900.00



HEAVY DUTY RUBBER ELECTRIC CABLE

(Nothing less than 50 ft.)

4-Wire #18 Neoprene standard, per ft. 7c
 2 Wire #14 18 ft. with plug \$3.00
 2 Wire #14 18 ft.—NO plug \$2.60
 2 Wire #14 50 to 225 ft., per ft. .17c
 2 Wire #12 12 ft. with plug \$3.50
 3 Wire #10 75 ft., per ft. .30c
 4 Wire #10 75 ft. length, per ft. .40c
 2 Wire #6 150 ft., with connector. \$ 90.
 2 Wire #4 75' reel and connectors. \$ 80.
 1 Wire #4 Concentric 50 to 250 ft. underground, per ft. .60c
 15 Cond. #18 GE Stranded 50-300' O.D. 13/18", per ft. .50c
 10 Cond. #18 Solid, per ft. .10c
 Telephone wire—250', per ft. 2c; 1000' 1 1/2c

BRASS HAND PUMP



Mfr'd. by Red Jacket. Double acting—pumps on both forward and return strokes. Capacity 1000 gal. per hr. at 30 strokes per min. Ideal for boat bilge, basements, cattle troughs or other water transfer. 1 1/2" inlet, 1 1/2" or 2" discharge. 71 lbs. \$48 value. Only \$18.50

GENERATORS



300 Watt, R.P.M. 3400, 110 and 220 volt, 1/2" shaft, \$40.00. 2500-3000 Watt, R.P.M. 1800, 115 volt, AC. \$235.00. 3000 Watt, R.P.M. 2800, 110 volt, DC. Delco ball bearing, 1" shaft. List \$343.00. To you at only \$99.00. 5000 Watt, 115 volt, R.P.M. 1800, single phase \$259.00. 10,000 Watt 110-220 R.P.M. \$550.00

TRACTOR DRIVEN GENERATOR 2500 W. 110-220 volts with floating mount to keep belts tight \$287.00. Generator only \$235.00

and other bargain items

GOODRICH RUBBER HOSE 2" I.D. 2 ply. 25' lengths, worth \$25, at \$3.95; 3 lengths \$10.00

AIR COMPRESSORS from 1/2 HP. 12 gal. tank at \$99.00, to 10 HP. 80 gal. tank at \$777.00

WELDING ROD—Manufactured by Murex. All purpose type S, AC-DC 5/32", 50 lb. box \$3.00

OHMMETERS. Read 25 to 0. In leather carrying case. Reg. \$29.95. Only \$7.95

FYR FYTERS. Fire extinguisher approved by Underwriter's Reg. \$14.95. Only \$6.95

1/2 TON SHOP Utility WAGONS, steel frame, rubber tires, ball bearings. \$48.50

ORDER DIRECT from this ad! All prices F.O.B. Milwaukee. 25% deposit required on all C.O.D. orders. No C.O.D.'s under \$10.00. Many other bargain items not listed. Write for our FREE CIRCULARS!

C&H ELECTRIC MACHINE Co. Inc.
 434D W. Juneau Ave., Milwaukee 3, Wisconsin

INDUSTRIAL BUYERS When you can't find a scarce item — try C & H

**FOR SURE
QUICK STARTS**

**INSIST ON
BOWES**



**Corrodeless
TERMINAL
Battery Cables**



Most battery cable trouble starts at the terminal because of corrosion or bad fit. Bowes "Seal Fast" battery cable terminals positively will not corrode. They are specially engineered, tailored to fit the posts snugly, assuring longer cable life and full power from your battery. Stop battery cable trouble before it begins. For sure, positive starts insist on Bowes "Corrodeless Terminal" Battery Cables—then you'll get all the power your battery is designed to give you.

**BOWES
DEPENDABLE
SPARK PLUGS**

Assure

**SMOOTHER
MOTORING**

There is a Bowes Spark Plug specially designed for your car! Oversize Special Alloy Electrode—with welded construction for positive connection assures longer life. One-piece, leakproof construction.

Every Bowes Plug is individually tested to assure complete motoring efficiency. **INSIST ON BOWES SPARK PLUGS FOR SMOOTHER MOTORING.**

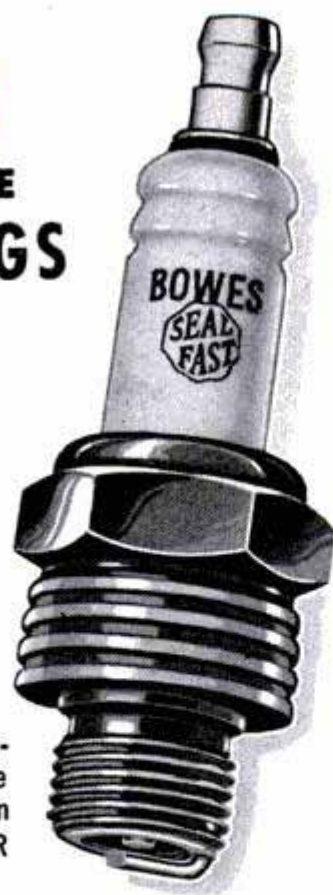

**BOWES "SEAL FAST" CORPORATION
INDIANAPOLIS 7, INDIANA**

- One-way or wheatland disk plows popularized
1928
- Future Farmers of America organized nationally
- Two-row, power-take-off cornpicker, and one-row mounted picker
- Land-leveler for irrigation farming
1929
- Hybrid-corn seed first sold
- Two-row mounted cornpicker
- Attachments for placing fertilizer in bands
1930
- Portable sprinkler irrigation
- Farm tractor equipped with power lift
1931
- First diesel-powered, track-type tractor
1932
- Field pickup baler introduced
- Low-pressure rubber tires for farm tractors
1935
- Lift-type mounted plow introduced
- One-man, power-take-off combine
- Factory-built, high-compression tractor to burn leaded gasoline
- Hydraulic-lift equipment on tractors
- Farm Chemurgic Council organized
1936
- Forage harvester built commercially
1937
- Automatic barn cleaner built commercially
1938
- Self-propelled combine
- Tractor loader built commercially
1939
- Single-seed beet planters available commercially
1940
- Automatic, self-tying pickup baler
- Potato harvester
- Side-delivery rake driven by power take-off
1941
- Successful cotton picker built
- Hydraulic remote control of drawn implements
- Precision planting of vegetable seed
- First factory-built LP gas tractors
- Department of Agriculture's chemurgic laboratories opened
1942
- First commercial planting of segmented beet seed
1943
- First appreciable use of commercial sugar-beet harvesters
- Tractor-mounted cotton stripper
1944
- Duster with attachment to inject liquids
- Low-pressure, low-volume sprayer
- Power-take-off and drawbar dimensions standardized
1945
- Mow-hay finishers built commercially
1946
- Self-propelled cornpicker
- Silo unloader introduced
- Transmission clutch for live power take-off
- Rear-engine tractor
1947
- Equipment to apply fertilizer in vapor form (anhydrous ammonia)
1949
- Hydraulic remote-control cylinder dimensions standardized

Principal source: Farm Equipment Institute



FIRE EXTINGUISHER. For safety's sake order now! Every home, garage, car, workshop should have this handy fire fighting wonder. It's fully charged (at 1,000 lbs. P.S.I. or more) with that miracle CO₂ (carbon dioxide) chemical that smothers oil, gasoline & electrical fires. Anyone can operate, in a hurry. Heavy ICC approved steel cylinder, valve and 3000 lb. gauge that shows available remaining pressure. REFILL costs very little. Hose included for emergency tire inflator or air blast. Wt. 4 lbs. Approx. GOVT. COST \$25. NEW, complete with cloth carrying case, just \$6.50.



CUNO OIL FILTER, permanent type. This is the maximum capacity unit (not the small type) that gives greatest protection to your pump, boat, midget racer or engine. It's the perfect filter to keep motor oil or hyd. fluid clean at all times. Just turn handle and element is clean. Inlet & outlet ports take 3/4" pipe. Accommodates 16 GPM at 30 PSI. Mtg. bracket. Wt. 4 lbs. Approx. GOVT. COST \$35. Cost to you, NEW, \$3.75.



HIGH SPEED DRILLS All new. Fractional & numbered. Orig value \$18. Nationally known brand. Assorted sizes. Set of 30, \$3.50

WOODWORKERS DRILLS



From 5/16" to 1/2" with 1/4" shanks. A \$12.50 value - NEW - just \$2.50 for complete set!

HIGH SPEED STRAIGHT SHANK DRILLS

10 different size H.S. Straight Shank Jobber Length Drills, 1/2" to 1/2". (shank same diameter as drill) \$25 value. NEW - \$3.50.



HIGH SPEED DRILLS

SET from 1/4" to 3/4", 5 sizes with 1/2" shanks-NEW-get this, \$3.00 takes this set!

"BALTIC" SWEDISH TOOLMAKERS VERNIER CALIPER

ULTRA PRECISION-0.6" in .001 graduations. Quick, accurate depth, inside, outside measurements, fine engraving. Extra heavy rule, hand-fitted sliding head, no side play. Rockwell C.60, lapped measuring surfaces. For the extra particular mechanic who must have the best-used and recommended by most critical experimental and research machinists at Lockheed, Douglas, Bendix, GM, RCA, General Electric. Save 60%! A \$37.50 value-only \$14.75, leather case incl. Also a standard grade Mouser Design Caliper made in Germany. For the production machinist, 0-6" in thousands, the most accurate caliper of this type on the market, 1000's of satisfied users. Only \$10.95, leather case incl. These Calipers are of acceptable quality for precision aircraft work. Both are guaranteed buys, money back if not entirely satisfied. Order now! **New low price due to lower import duty!**



LOW VOLTAGE CIRCUIT TESTER

Made for U. S. Ordnance Dept. to rigid specifications. Portable steel hand carrying unit is a self-contained trouble shooting device for making a complete and rapid check of the generator battery circuit, including any circuit and voltage regulators. Battery voltage, regulators, cut-out settings and generator performance can be easily determined. A terrific testing unit for garages, mechanics, truck fleet owners, boat and marine mechanics. Can be used on any 6 or 12 volt system. Govt. cost approx. \$175. NEW-complete with instruction book-only \$32.50. Shipping weight, 20 lbs.



GAS OR FUEL STRAINER. This'll save you money because it protects fuel pump & carburetor... removes foreign particles, water, prevents sludge formation... for all cars, trucks, tractors & boats. Will handle aromatic fuels & light oils. Easy to connect to gas line in few minutes. Design allows for use either right or left-handed without changes. Stainless steel filter screen easy to remove to clean or replace. 3/4" pipe inlet & outlet ports. Quick opening drain cock. Capacity up to 60 GPH., 2 mtg ports. Wt. 2 3/4 lbs. Made to Air Corps specs, type C2C. Approx. GOVT COST \$27.50. NEW! Now only \$3.75.

U. S. BAROMETRIC ALTIMETER



This U. S. Gauge Altimeter is terrific for auto or airplane. Tells altitude accurately, guaranteed! It's NEW! Approx. GOVT. COST \$175. NEW! TO YOU, only \$9.95.

SOCKET-PACK WRENCH SET



Chrome-plated alloy steel, heat treated, broached to close tolerances. Reversible ratchet handle, with screwdriver bit on reverse side. Built-in spring-loaded ball retainer on both handle and extension. Clear top plastic kit. 10 piece set - NEW - complete \$3.75. POSTPAID in U.S.A.

MAGNETIC BASE INDICATOR HOLDER

For all types of dial indicators with guaranteed lifetime ALNICO magnets. V-slotted base has a 45 to 50 lbs. pull, permits immediate application without clamps or special attachments and mountings can be made on cylindrical surfaces. For machinists, tool-makers and inspectors. Base 3 1/2" long by 1 1/2" wide NEW \$3.50 ea.



PORTABLE WELDER



Will weld, bronze, solder and cut all metals up to 3/16". No experience needed, full instructions included. Weld iron, steel, brass, aluminum and other metals. Plug into any 110 Volt A.C. or D.C. line. Save hundreds of hours and money doing repair work for yourself and others. A great item for any mechanic or hobbyist, etc. Not a toy. Comes complete with electrode and carbon holders and an ample supply of electrodes, carbons, flux and necessary components to do a thorough welding job of any type. This unit cannot be duplicated for many times its price. NEW-price \$12.00.



RIVET SETS Universal type, case hardened tips. Set of dies will head up any brazier or round head rivet from 1/16" to 1/2". With adapters for air gun or hand use. All new-cost Govt. approx. \$27.00. Complete 15 piece set (wt. 2 lbs.) \$3.00.

DRILL GRINDER

Sharpens round, square or tapered drills up to 6" long. Even an amateur mechanic can get a new, factory finish on a drill in 25 seconds. New protractor feature gives every drill sharpening angle, with 5 convenient angles already marked off. Usable with hand or power stone. A brand new development. All New \$2.80 ea. Postpaid in U.S.A.



Blades inlaid Wolfram Vanadium, guaranteed to hold edge under constant severe use on heavy gauge metals. Duckbill blades cut straight, circular or irregular forms. Handy spring opening handles for better leverage. NEW-10" size \$2.45 ea.-12" size \$2.95 ea.



HAND MITRE. It pays its way in just 1 day! It's sensational! New HAND MITRE saves 100's of hours, requires only a "flick" of the hand for a precision mitre every time. HAND MITRE will cut any desired angle. Its rugged construction handles hard and soft wood mouldings, plastic trim, base shoe, laminated materials, rubber extrusions, etc. Made of heavy gauge stainless steel. \$3.95 postpaid.

BRAND NEW PUMP AND MOTOR

Pump has 1" connections, built-in relief valve, adjustable up to 1500 lbs. Max capacity 6 GPM. 1 1/2 H.P., 24-volt motor. 4000 RPM. Can be used on 12 or 36 volts. Govt. cost approx. \$350 -our price- NEW LOW PRICE \$9.75



FLEXIBLE SHAFT MAGNET

For picking up cotter pins, nuts, wrenches, etc. from inaccessible places. Removes Babbie Pins, etc. from drains. Lifetime Magnetism Guarantee. Highly polished magnet and handle. \$2.00 postpaid



MICROMETERS

Chrome plated precision engineered, care fully toolled to give long life. All new 0-1" capacity-\$2.25 ea. 1-2" capacity-\$3.50.



HEAVY DUTY DROP-FORGED STEEL SHEARS



NEW, BIG 1952 CATALOG BARGAINS FOR EVERYONE • SEND 25c FOR YOUR COPY TODAY! ORDER from ad NOW!

Send check, money order or cash. 25% deposit required on C.O.D. orders. All prices F.O.B. Culver City, Calif., unless otherwise stated. **AIRBORNE SALES CO., INC** Dept PM 252 **SAVE \$\$\$** CULVER CITY, CALIF.

**Cut Like
the Wind!**



with **SIMONDS**

SI-CLONE

...new low-priced, high-quality
SAWS for home workshops

Yes, these new SI-CLONE Saws cut like the wind . . . and stay sharp longer. All types, including Easy-Cut and Carbide-Tipped, in all diameters up to 12". Furnished with any type or size of centre-hole . . . for use on any table, radial-arm or electric handsaw machine on the market. And remember SI-CLONE Saws are SIMONDS quality, backed by over 75 years of saw-making experience. So "blow in" to your hardware store today and ask for SIMONDS NEW SI-CLONE SAWS.

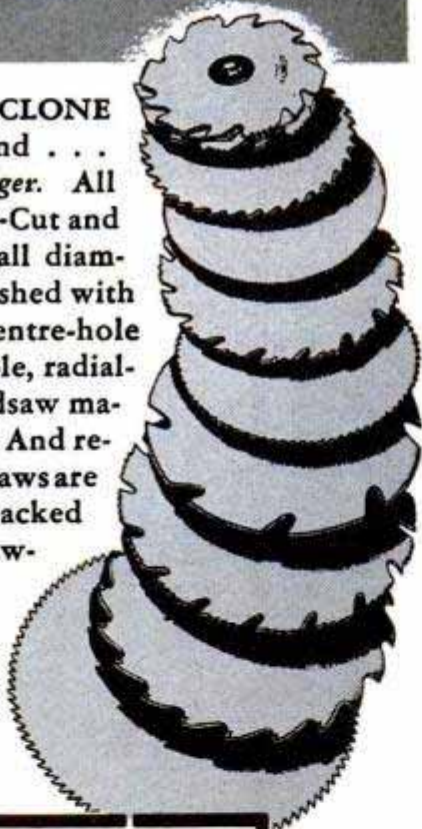

SIMONDS
SAW AND STEEL CO.

FITCHBURG, MASS.

Factory Branches in Boston, Chicago, San Francisco and
Portland, Ore. Canadian Factory in Montreal, Que.

(Continued from page 112)

which they hold a U. S. patent, while working for the Navy during the war. When they tried to get samples made up after the war, however, they came up against two facts harder than the toughest plastic. The molds might cost a couple of thousand dollars a set. And no one in the plastics-molding industry can afford to make fewer than 10,000 impressions from a mold; the molding machines are too expensive and too much time is needed for make-ready. Since as many as a dozen sets of molds and sample housing moldings might be needed before the design proved out, it looked as though it might take \$50,000 to take the midget motor off the drawing board.

Many a good plastic device has died right there. But Gorfin and Kardorff, who now run a small instrument shop in downtown New York, couldn't let their idea go. They slaved over their own molds and devised their own injection-molding machine to make samples. More than a score of sets of molds had to be cut before the housing finally turned out right.

The low-cost midget naturally doesn't have the performance of the high-priced models. But it will run for several hundred hours without trouble. It draws only 250 milliamperes in operation.

Manufacturers are using it in a wide line of toys, ranging from miniature electric fans and kitchen mixers to drawbridges, earthmoving toys, extension-ladder fire trucks, boats and cars. With a plastic gear-box, which Rowe also manufactures, and a bit of plastic-bonding glue, you can motorize junior's fleet yourself.

In addition to the low-cost drink mixer, already on the market, a battery-operated, "use it anywhere" electric shaver that uses the new miniature motor is in the works. Another possible application of the tiny motors is on subminiature power tools such as buffers and drills, for model makers. Still another, now under study, is in the motor-driven telemetering devices that radio back high-altitude weather information from radiosonde balloons. There seems to be literally no telling how far or how high the mighty midget will go.

Atomic Energy Heats Building

For the first time atomic energy is being used to heat a building. "Atomic radiators" have been put into service in an 80-room building at Harwell, the British atomic-research station. Heat from the atomic pile warms coils of water pipes, and the hot water then flows through the heating system.

You CAN Take It With You!

BECKER *Self-Contained* SPRAY GUN

NOTHING ELSE TO BUY

TAKE IT ANYWHERE—the first completely portable spray gun. Needs no compressor, motor, or electrical outlet. Pressure-powered with an inexpensive CO2 cartridge that sprays up to 21 liquid ounces, depending on viscosity. Extra cartridges, 10 for \$1, postpaid, or buy from your dealer.

**PAINTS • VARNISHES • ENAMELS
MOTH-PROOFS • INSECTICIDES**

Every home needs a Becker Spray Gun for dozens of jobs in the house, workshop, garden or garage. Complete instructions furnished for effective results. Order yours today for the season ahead.

HOW TO ORDER—If your dealer can't supply, send \$15.95 and we ship postpaid—or \$2 now and pay postman balance plus postage and fee. Money back if not delighted after 5 days' trial.

SULLIVAN-BECKER CO.
Dept. 112-B, Kenosha, Wis.



ONLY
\$15.95
with 3
cartridges



Starrett

**FRICTION THIMBLE*
MICROMETERS**

Give You

- UNIFORM PRESSURE
- UNIFORM READINGS

Every Time

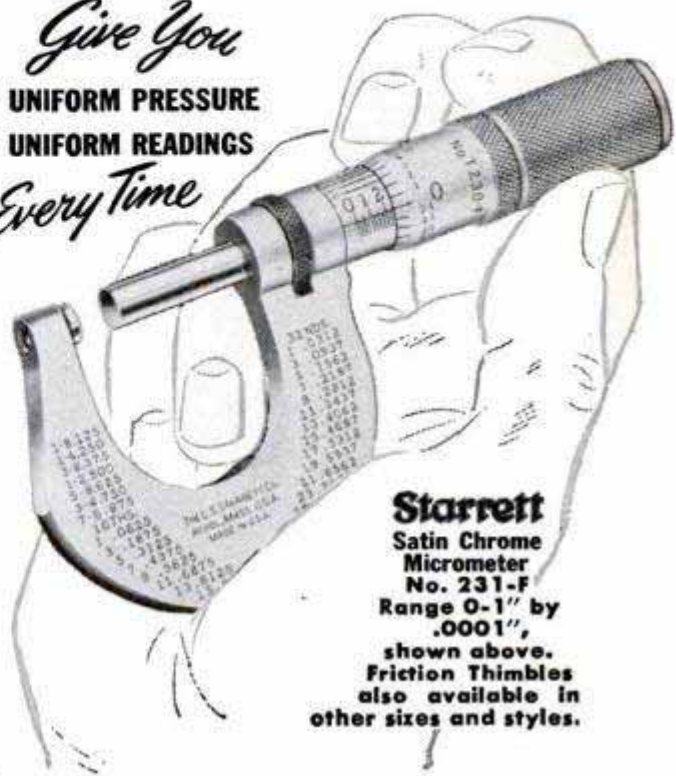

Starrett
Satin Chrome
Micrometer
No. 231-F
Range 0-1" by
.0001",
shown above.
Friction Thimbles
also available in
other sizes and styles.

*An improved ratchet stop mechanism built right into the thimble permits easy, one-hand operation — insures uniform contact pressure for every measurement. You get the same sure accuracy every time . . . plus 12 other big Starrett features including Satin Chrome Finish, Tapered Frame, Hardened Threads ground from the solid and stabilized and Hi-Micro Mirror-Lapped Finish on contact faces. See it at your Starrett Tool Distributor's.

VARIABLE SPEED HYDRAULIC POWER TRANSMISSION



It has Infinite Speeds 0 to 550. Reverse, Automatic Overload Protection; Adjustable Torque up to 180 inch pounds. 5/8" Input and Output Shafts. It will handle 1/4 to 1 1/2 H.P. Motor. Case measures 7 1/2" long, 7" high 6 1/2" wide. VALUE OVER \$300. Shipping Wt. 25#. On C.O.D. Orders we require a 10% only Fob. Chicago

\$54.50

DIRZIUS MACHINE SHOP "K" 1423-25 So. 52nd Ave., Cicero 50, Ill.

**CARBURETOR TOO RICH
MAKES MOTORIST TOO POOR**



Car owners who are wasting money and not getting proper gas mileage due to over-rich mixtures will be pleased to learn how to save gasoline by VACU-MATING over-rich mixtures. VACU-MATIC fits all cars, trucks and tractors. It is automatic and operates on the supercharge principle. Easily installed in a few minutes.

SALESMEN WANTED! Big Profits! Send name, address on penny postcard for free particulars and how to get yours for introducing.

VACU-MATIC CO., 7617-1858 W. State St., WAUWATOSA, WIS.

NEW TOY PATTERNS—6 FOR 25¢

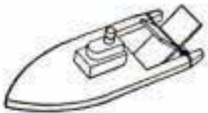

Happy hobbying for you . . . happy playing for the youngsters. Full size patterns—trace and cut out. Send for Patterns P1: Paddle Wheel Boat, Clacker, Tumbling Clown, Cradle, Insert Toy,

and Fighting Roosters, all for 25c post-paid. STANLEY TOOLS, 322A Elm St., New Britain, Conn. In Canada: Stanley Tool Company of Canada, Ltd., 322A Stanley St., Roxton Pond, Quebec.



**PAGE
Garden Tractors**

NEW 1952 MODELS! MORE FEATURES!

Both riding and walking models 2 to 6 HP with complete gear drive and reverse . . . no chains, ratchets, or belts. Quick-hitch for easy changing. Over 50 attachments for all farm and home chores.

Also new, handy 1 wheel Page "Bantam." **LOW PRICES, EASY TERMS**

26 years' experience behind every Page tractor. Every model guaranteed!

PAGE FARM EQUIPMENT

1904 S. 81st St., Milwaukee, Wis.



Write for Free Catalog

SEND FOR IT — ONLY 10¢
Starrett "Tools and Rules" Book shows the right tools for any measuring job. 50 pages, 100 pictures, helpful reference tables. Address Dept. AP



THE L. S. STARRETT COMPANY • ATHOL, MASS., U.S.A.



SINCE 1880
WORLD'S GREATEST TOOLMAKERS

BUY THROUGH YOUR DISTRIBUTOR MECHANICS' HAND MEASURING TOOLS AND PRECISION INSTRUMENTS - DIAL INDICATORS - STEEL TAPES - PRECISION GROUND FLAT STOCK - HACKSAWS, BAND SAWS and BAND KNIVES

**100,000,000
BUILT SINCE 1927**

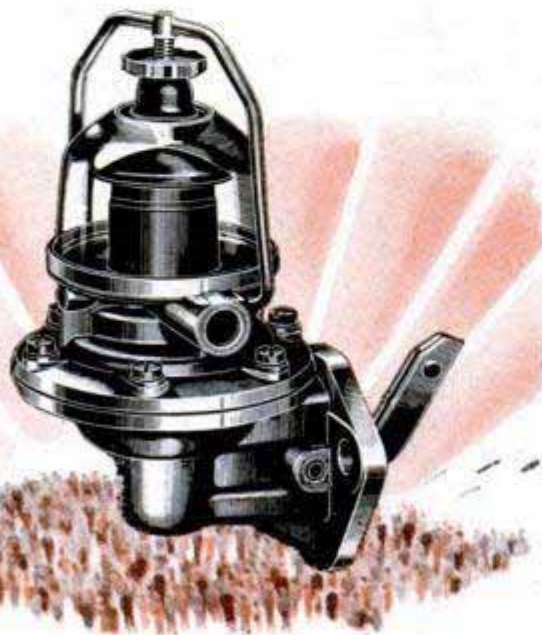

The AC Fuel Pump was the original and is still the finest. It was the first efficient, reliable means of supplying the carburetor with the gasoline necessary to run the engine.

100,000,000 have been built, 40,000,000 are in daily use.

More than 90% of the cars in use were factory-equipped with AC Fuel Pumps.

ACs have held their leadership for 25 years, because they have been constantly improved, to give better service and longer life.

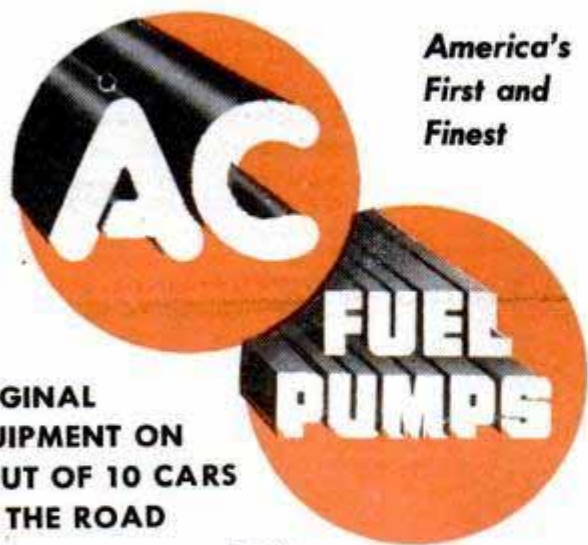

*America's
First and
Finest*

**ORIGINAL
EQUIPMENT ON
9 OUT OF 10 CARS
ON THE ROAD**



AC SPARK PLUG DIVISION GENERAL MOTORS CORPORATION

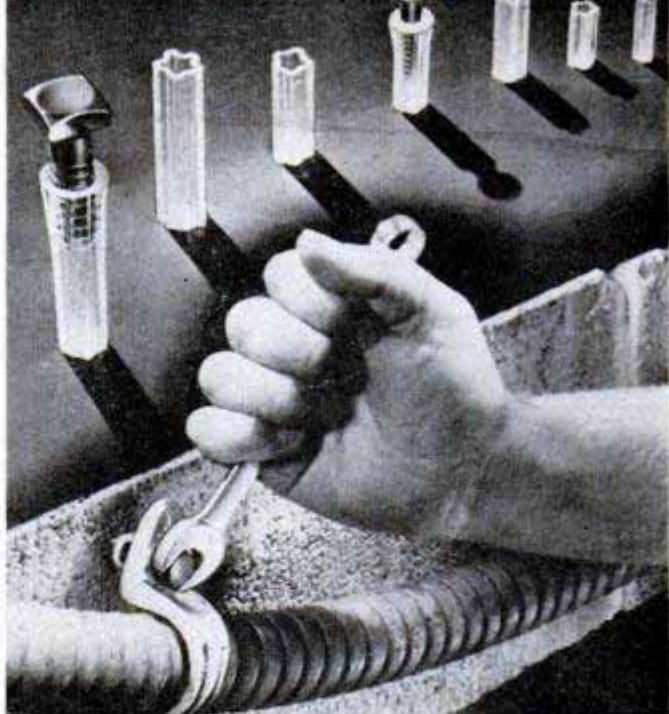

Star-Shaped Tenite Plug Anchors Screw in Concrete

There's no trick to anchoring shelves, conduit or anything else in concrete when you use plastic anchor plugs. You simply drill a hole, drive in one of the Tenite-plastic plugs and run in the screw, either wood or lag type. Being plastic, the plugs are noncorrosive and nonconductors of electricity. Oversize screws up to four sizes larger than the anchor size can be used. The anchor is star-shaped. As the screw is driven in, it expands to grip the sides of the hole tightly.

Magnesium Protects Metals Buried Underground

Bars of magnesium will be buried, for no apparent reason, all around the new Fairless Works of the United States Steel Corporation at Morrisville, Pa. Actually, the magnesium will prevent underground corrosion of structural steel, steel piping and lead-sheathed electric cables. The bars will set up their own electric currents to offset the natural currents that cause underground corrosion of metals. Magnesium is especially effective in setting up a current from itself to lead, copper and steel. Periodically it will be necessary to replace the magnesium bars as they are eaten up by the currents they produce.

Construction of the world's first commercial synthesis plant to produce gasoline and diesel oil from coal will start soon in South Africa about 40 miles south of Johannesburg.



Better Sights
FOR
BETTER "SHOTS"

Sheard "Gold"
Front Sight
\$1.75

Standard
Front Sight
\$1.25



Marble's
Flexible
Rear Sight,
with automatic
spring joint.
Can be locked
down. With 2
discs. Price \$6.00.

At your dealer, or
write for Catalog

Marble Arms & Mfg. Co.

578 Delta Ave. Gladstone, Mich.

For faster, more accurate sighting
equip with a combination of

MARBLE'S SIGHTS



Flat Top Rear. Price \$2.00



Semi-Buckhorn Rear
Price \$2.00



No. 69
Flat Top
Sporting
Leaf.
\$2.00



(532)

NEW 1952 KING MIDGET AUTO

World's Lowest Priced 2 Passenger Car Drive it for 75c per week. Amazing performance. Surprising comfort. All steel construction. Full accessories, top and heater. Ready to run or assemble it with our bolt together parts. Rider agents wanted. Earn your car free. Send 25c for detailed literature or \$1 (refunded first order) for actual assembly book and service manual filled with photos, drawings, specifications, etc.



MIDGET MOTORS MFG. CO.
ATHENS, OHIO

HANDEE

tool of 1001 Uses

- Handicraft Hobbies
 - Household Repairs
 - Auto Maintenance
- Everyone Needs a Handee!

Absolutely the finest in hand power tools. Cool running, controlled power for those countless small jobs. A whole toolshop in your hand... grinds, drills, engraves, cuts, polishes, saws, routs, sands... pays for itself quickly!

HANDEE with 51 accessories, in fitted steel case \$27.50

HANDEE with 7 basic accessories \$19.95

MONEY BACK GUARANTEE! Liberal 10-day free trial offer. Get HANDEE at your dealer's today, or order direct postpaid.



FREE!

New HANDEE Catalog... shows a host of practical applications. Write today!



CHICAGO
WHEEL & MFG. CO.
Dept. PM, 1101 West Monroe Street,
Chicago 7, Ill.

Arc Welding PAYS
BIG PROFITS -
with these HOBARTS

Remote Control

1 KW Power Outlet

250 Amp. Generator

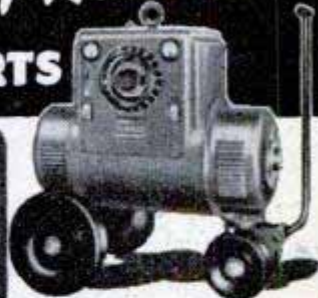

Electric Drive DC Welder

Gas Drive DC Welder

Lowest cost

full size welder on market

Cash in on the big demand for dependable arc welding. Set up your own shop now with Hobart and you'll start earning hundreds of dollars of extra profit monthly. Farmers, contractors, factories, builders will keep you mighty busy based on your reputation for low costs and better work.

LET HOBART HELP YOU!

With mechanical ability and a Hobart "Simplified" Welder, you'll soon be turning out top quality jobs and can handle all types of work. They're the same rugged, dependable, economical welders you'll find in America's leading production plants. You'll get such exclusive advantages as 1,000 combinations of welding heat and remote control (at no extra cost) Auxiliary power outlets let you operate lights, tools, etc. Portable models equip you for profitable emergency outside jobs. Check coupon for complete details.

HOBART SCHOOL teaches you quickly!

Earn extra money by knowing how to do all kinds of profitable welding jobs. Learn quickly and easily at low cost in America's most modern welding school... the non-profit Hobart Trade School. Complete or partial courses. Best equipment, thorough training, experienced instructors.

Send today for these valuable books

• Procedure & Practice

Complete text and lessons book. Covers every phase of welding. 544 pages, over 600 illus. \$3.00

• Lessons Book

Complete operator's training course. 200 pages, fully illustrated. \$1.00

• Practical Design

Hundreds of profitable welding ideas in design form. 3 vols. of 100 designs each. 1 vol., \$3.50; set of 3, \$10.

Check Coupon for Complete Details

HOBART BROTHERS CO., BOX M-22, TROY, OHIO

"One of the world's largest builders of arc welders"

HOBART BROTHERS CO., Box M-22, TROY, OHIO

Send full details on items checked.

Electric Drive Welders Gas Drive Welders Hobart Trade School

Send books checked Proc. & Practice Practical Design: Vol. 1 Vol. 2 Vol. 3 set of 3 Vols. Lessons Book Cash encl. C.O.D.

Free-new booklet "Guide to Better Welding"

NAME _____

ADDRESS _____

CITY _____ STATE _____

Thinking of Building a Boat!



Plan 21—20' Sloop



Plan 25—13 1/2' Runabout



Plan 24—7'9" Dingy



Plan 23—9' Skiff

Choose One of These Easy-to-Build Designs

PLANS AND INSTRUCTIONS ONLY 10¢ EACH

PLAN NOW to log a season full of boating pleasure by building one of these sturdy Exterior plywood boats. Each is designed by a top naval architect. Each is planned with plywood to make it easy to build, light, strong and durable. Big sheets speed work . . . add strength and rigidity . . . eliminate caulking and open seam troubles. Exterior plywood (identified by EXT-DFPA® on panel edge) is bonded with 100% waterproof marine adhesives. Your lumber dealer now sells it at new low prices. See him soon.

Exterior-Type (EXT-DFPA®)

Douglas Fir Plywood
© Douglas Fir Plywood Assn.



MAIL THIS COUPON TODAY!

Douglas Fir Plywood Association (Good USA Only)
Dept. 92, Tacoma 2, Washington
Please send plans checked. I enclose 10c for each.

Plan 21 Plan 23 Plan 24 Plan 25

Check here and enclose additional 10c for 40 page catalog listing source of 250 plywood boat plans, 50 plywood boat kits.

Name

Address

City.....Zone...State.....

(Continued from page 126)

inclined farmboys and others who dropped out of high school have difficulty understanding semitechnical classroom explanations and examination questions. To offset this, a special effort is made to keep sentences short and the terms simple, though many unfamiliar engine-part identifications have to be retained.

Every newcomer gets specific instruction on how to study, with emphasis on learning to read, organizing notes and reviewing more efficiently. The Air Force's pamphlet on the subject, which some of the nation's outstanding educators helped to prepare, would be a useful addition to any college student's bookshelf.

Both servicemen and civilians instruct. Most of the latter, usually in their early 30s, have degrees in education. About 80 percent are veterans. One out of four has always been a jet specialist.

The first 10 days of the jet engine specialists' school are devoted to repair, the next five to the power plant's many accessories and the following 10 to operating and adjusting the engines in test cells. Engine change and inspection occupy the final 10 days. The entire 35 days are spent on one particular engine, like the J-33, with which all the planes in Joe's future squadron will be equipped. There is a separate course for each of the three most widely used power plants.

In contrast to the pre-World War II private's \$21 a month, today's GI moves from \$75 to \$80 automatically after four months' service. In addition there are allotments for dependents. At Chanute most of the students live in temporary wooden barracks, two to a room, though some enjoy the luxury of "Buckingham Palace," a modern brick structure housing some 2000 airmen. Beside using the base's recreational and entertainment facilities, students making passing grades can leave the field during their off-shift hours.

Directing this nation-wide educational system, the largest of its kind in the world, is Lt. Gen. Robert W. Harper, head of the Air Training Command and an officer long experienced in the Armed Service's mass-teaching field. From his headquarters at Scott Air Force Base in Illinois, he supervises 27 flying-training bases and 10 technical-training bases, three of them indoctrination centers like Lackland.

Eighty percent of the men under General Harper's command, biggest in the Air Force, are being technically trained. Seven major schools at Chanute, Scott, Amarillo,

(Continued to page 268)

HIGH SPEED STRAIGHT SHANK DRILLS

- SET 12** different size H.S. Straight Shank Drills, 7X 1/4" to 1/2", lengths up to 7" **\$3.98**
- SET 10** different size H.S. Straight Shank Drills, 8X 1/4" to 1", extra long, \$40 value. New and slightly used surplus **\$6.95**

HIGH SPEED DRILLS

1/4" to 1/2" with 1/4" Shanks
1/2" to 1" with 1/2" Shanks

- SET 6** Different Size H. S. Drills, 3/4" to 1 1/2" all with 1/4" shanks..... **\$3.50**
- SET 10** of 35X above..... **\$4.95**
Set 35X and 36X will fit any 1/4" drill.
- SET 5** Different Size H. S. Drills, 1/2" to 1" with 3/2" shanks..... **\$6.95**
- SET 10** Different Size H. S. Drills, 1/2" to 1" with 1/2" shanks..... **\$12.95**

These new and used H. S. precision drills with 1/2" shanks can be used in a 1/2" electric drill or a 1/2" capacity lathe or drill press.

HIGH SPEED MORSE TAPER SHANK DRILLS

- SET 15** Different Size High Speed Morse Taper Shank Drills up to 9/16" with No. 1 and 2 tapers. New and used. \$50 value. Priced at only..... **\$6.49**
- SET 20** Different Size High Speed Morse Taper Shank Drills from 1/4" to 1". New and used. \$70 value. Priced at only..... **\$12.95**
- SET 10** Different Size High Speed Morse Taper Shank Drills from 1/2" to 1 1/4". New and used. \$50 value. Priced at only..... **\$9.95**
- SET 8** Different Size High Speed Morse Taper Shank Drills from 1" to 2" with No. 3, 4, and 5 tapers. New and used. \$125 value. Priced at only..... **\$29.95**

HIGH SPEED STRAIGHT SHANK CHUCKING REAMERS

- SET 20** Different Size High Speed Straight Shank Chucking Reamers up to 1 1/2". New and used. Priced at only..... **\$7.95**
- SET 15** Different Size High Speed Straight Shank Chucking Reamers from 1/4" to 1". New and used. Priced at only..... **\$6.95**

HIGH SPEED WOODRUFF KEY SEAT CUTTER

- SET 5** Different Size Cutters. Can be used as mounted milling cutter or circular saw. All with 3/8" and 1/2" shanks, widths up to 1 1/4", dia. up to 1". New and used. Priced at only..... **\$3.95**

HIGH SPEED STRAIGHT SHANK DOUBLE-END END MILLS

- SET 4** Right hand twist 7/16 shank end mills, size 5/16 to 7/16. New and used..... **\$3.95**

NEW HIGH SPEED COMBINATION DRILL AND COUNTERSINKS

- SET 8** selected sizes from C2 to F2 (1/16 drill x 13/64 body to 3/16 drill x 7/16 body) 60 degree angle of countersink. New cost on these countersinks 75c to \$2.50 when available. Your price for set of 8 only..... **\$4.95**

6 SLITTING SAWS WITH MANDREL

- SET 6** Different Size High Speed Slitting Saws, 2 3/4" dia. x 1" arbor. Thickness from .040 to .071. Cuts wood, aluminum, brass, steel, etc. PLUS SPECIAL MANDREL which enables use of saws in 1/4" or 1/2" elec. drill. \$25 Value. Only..... **\$4.95**
- 7 selected, sharp H. S. Slitting Saws as above to use on your own mandrel or milling machine. New and used. A bargain at..... **\$4.95**



HIGH SPEED HAND TAPS

- SET 8** different size H. S. Standard Thread Hand Taps up to 5/8", including 2 std. H. S. Pipe Taps. **\$2.95**
- SET 40X 16** same as above..... **\$4.80**

NEW 360° SWIVEL TYPE TOOL HOLDER AND BORING BAR

Here is a tool that will do the work of a left, right and straight tool holder, plus a boring bar, all for a fraction of its original cost.

- TOOL A** takes a 5/16" sq. bit or 5/16" dia. boring tool. Shank size 9/16"x1"x4 3/4". Only..... **\$3.29**
- TOOL B** takes a 3/8" sq. bit or 3/8" dia. boring tool. Shank size 5/8"x1-3/16"x5 3/4". Only..... **\$3.95**
- TOOL BIT SPECIAL:** 1 deg. H.S. 3/16" sq. x 2 1/2" new tool bits..... **\$2.95**

Bargain Tool & Shop Mixes!—PPD

- SPRING MIX:** 300 new springs, compression, tension and torsion types up to 6" in length, only..... **\$1.79**
- HAND REAMER MIX:** 8 different size hand reamers up to 5/8" including 3 taper pin reamers. Majority of reamers in new condition..... **\$3.69**
- MILLING CUTTER MIX:** Assortment of 4 various size H. S. milling cutters, all with 1" arbors; up to 3" dia. only..... **\$3.98**
- GRINDING WHEEL MIX:** 30 grinding wheels with 1/4" arbors, up to 3" in dia., plus mandrel, only..... **\$3.29**
- NEW ROTARY FILE MIX:** 7 different size H. S. files, 1/4" shanks. New cost as high as \$2.00 ea. Only..... **\$4.49**
- DRILL BIT MIX:** Over 300 pcs. (2 lbs.) of used H. S. drill bits up to 1/4". Most require sharpening. Ideal for pin punches, drift pins, etc. up to 1". New and used. Less than 1¢ ea. at..... **\$2.98**

BRAND NEW MOUNTED STONES

- 100 stones 1/8" and 3/16" shanks, rounds, points, cylinder shapes, etc. These 100 pieces, only..... **\$7.98**



MILLING CUTTERS! MILLING CUTTERS!

Just arrived! Several thousand slab mills, side milling cutters, shell mills, shell reamers, etc. Sizes from 1" to 12". Write us for your special needs!

NEW MOUNTED STONES

- SET Mixture of 12 Mounted 27X Stones with 1/4" shanks... \$2.49**
- SET 39X 24** of above..... **\$4.85**



P-1 D.C. GENERATOR: Mfg. by G. E. 200-amp., 28-volt. Gov't light plant. Wt. 70 lbs. approx..... **\$19.50** Tulsa

10 TO 1 GEAR BOX

- Worm gear drive, throwout type clutch, ball-bearing throughout. 1/2" drive spline, 3/4" output gear. Wt. 6 lbs. Rated up to 6 H. P. Only..... **\$6.95**

90° HEAVY DUTY GEAR BOX

- Ball-bearing throughout with 1/2" drive spline. 1:1 gear ratio which can be changed by different size pulleys or gears. Wt. 5 1/2 lbs. Length 1 1/2". Beveled gears. Excellent for hot rods, power mowers, etc. Only..... **\$5.95**

THREE SPEED TRANSMISSION

- Contains 7 assorted spur and beveled gears. Has auxiliary power take-off driven from main drive. Three separate gear ratios are 16:1, 12:1 and 3:1. Contains 10 1/2" dia. ring gear 5", 2 1/2" and 1 1/2" dia. beveled gears; 3 1/4", 4" and 2 1/4" dia. spur gears. All mounted on precision ball-bearings. Main drive has throw-in hand clutch. Auxiliary drive can be engaged or disengaged. Excellent for transmission, winch and many other uses. F.O.B. Wt. 30 lbs..... **\$14.95** Tulsa

VEEDER ROOT COUNTERS

- 3 Digit clockwise rotation type (New)..... **\$1.49**
- 4 Digit clockwise rotation type (New)..... **\$1.89**
- 5 Digit clockwise rotation type (Reconditioned)..... **\$2.89**
- 5 Digit ratchet type (Reconditioned)..... **\$2.49**
- 5 Digit clockwise rotation type with key reset, complete with key, counts in fives. (Reconditioned)..... **\$2.75**
- 5 Digit ratchet type, with key reset complete with key, counts in singles. New cost about \$17.00 when available. (Reconditioned) Only..... **\$3.49**
- All counters guaranteed against mechanical defects

HYDRAULIC DEPARTMENT

- P1A PESCO PUMP** gear type, displacement 1 1/4 GPM at 1,500 PSI. Continuous operating speed, 3,750 RPM. Pump is driven by 1/2" spline..... **\$9.49** Dis. on Quantities



Hydraulic Cylinder

- Bore 2", shaft 7/8", stroke 12 1/2", double action, double-end shaft can be mounted stationary allowing cylinder to slide. Wt. 14 3/4 lbs. Post paid to you at only..... **\$12.95**



3-Way Control Valve

- For use with single action hydraulic rams or cylinders. 800 PSI relief valve. Pointer type handle..... **\$4.98**



NEW MASTER HYDRAULIC CONTROL VALVE

- For controlling two single or double action cylinders, separately or simultaneously. Valve is close center type. 1500 PSI rating, only..... **\$9.98**

400-GPH VANE-TYPE PUMP

- Positive displacement type, built-in relief valve, adjustable up to 200 lbs. PSI. 1/2" drive spline shaft. 1" pipe conn. Rotates either direction. Ideal for use as fuel pump, irrigation, cattle spraying, etc., only..... **\$4.98**



HYDRAULIC HOSE

- 12-in. 250-lb. test with 7/16" tubing conn. 6 pcs..... **\$1.49**
- 2-ft. 1000-lb. test, 7/16" tubing conn. 4 pcs..... **\$1.95**
- 6-ft. 1000-lb. test, 3/4" male pipe conn..... **\$1.95**
- 10-ft. 1500-lb. test, 1/4" female & 1/2" male pipe conn., ea..... **\$3.49**
- 15-ft. 1000-lb. test, 7/16" tubing conn., ea..... **\$3.49**

Money-Back Guarantee—All Mdse. Mixture of New and Reconditioned Tools Unless Specified Brand New—All Orders (Except Those Specified F.O.B. Tulsa) Are Shipped Post Paid, saving you up to 25% on total delivered cost.

Write for Free Catalog Describing Thousands of Bargain Cutting Tools. **T & T TOOL** 221 W. SECOND TULSA, OKLA.



"Don't worry, Spot!..We'll put it back together with 'DUCO' CEMENT!"

Fix it for keeps WITH DU PONT DUCO CEMENT

REG. U.S. PAT. OFF.



BROKEN TOYS
of all descriptions
can be quickly
repaired with
"Duco" Cement . .
without fuss or muss.



**LOSING YOUR
GRIP?** Anchor loose
golf club grips with
"Duco" Cement.
Good for tennis
rackets, too.



**BUILD STRONGER
MODELS.** Quick-
drying "Duco"
Cement is standard
equipment with most
model-builders.



**SNAPPED EYE-
GLASS FRAMES?**
It's not just an emer-
gency repair...they'll
stay fixed when you
use "Duco" Cement.

**STRONG, TRANSPARENT
FLEXIBLE, WATERPROOF**



REG. U.S. PAT. OFF.

**BETTER THINGS FOR BETTER LIVING
... THROUGH CHEMISTRY**

Lowry, (Denver, Colo.), Warren (Cheyenne, Wyo.), Keesler (Biloxi, Miss.) and Sheppard (Wichita Falls, Tex.) give instruction in over 400 different specialty skills. They prepare airmen for such jobs as cryptography, aerial photography, fire fighting, radar repair, air police, Teletype mechanics, statistical clerks, communications and the operation of heavy equipment such as bulldozers and cranes.

The command also has contracts with some 50 civilian institutions to provide instructors and training facilities for students, as well as to house and feed them. A small detachment of officers and airmen assigned to each handles administrative matters and conducts military training.

It isn't looking for trouble, but if it comes the Air Force is readying itself to augment firepower with "brain power" to spell out victory.



Hook Attaches Paintbrush To Old Broom Handle

You can paint your cellar floor or roof without getting "backitis" with a simple attachment that hooks your paintbrush to an old broom handle. The device clamps around the handle of the brush and fastens to the broom handle by a simple wing nut. A grooved circular disk, which fits between the brush and the broom handle, permits the brush to be set at any desired angle. Notches are provided for nailing the disk firmly so that it will not slip. Originally designed for painting the broad, flat steel tops of tanker ships, it is finding increasing use around the house.

COLORCRETE

Lifetime beauty comes out of a gun! Colorcrete is a cementitious plastic, applied by pneumatic pressure to new or old concrete, stucco, etc. Tough, tenacious, enduring. Can be washed or scrubbed. Dirty, drab surfaces become sparkling white or tinted from a range of 30 colors.

"Building-Beautifying" - Your Big Opportunity

Colorcreting is a fascinating and profitable opportunity for men who want to build a substantial, long-term business. Colorcreting is exclusive. Rich in sales appeal to building owners. Income potentials are high; investment is low. We supply complete equipment, full instructions and liberal cooperation. Requires no previous experience or special ability. Write or wire for the Opportunity Book today. Be the first in your community.

COLORCRETE INDUSTRIES, INC.
570 Ottawa Ave., Holland, Mich.



2 DRILLS in 1

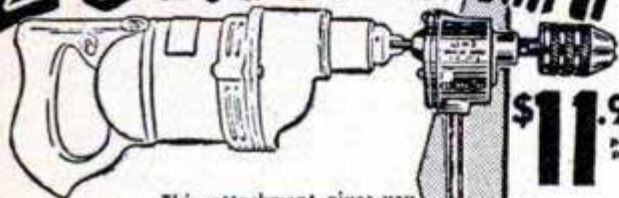

This attachment gives you two drills in one. It converts any 1/4 inch electric drill to 1/2 inch capacity. Reduction gears reduce the drill speed 5 to 1, the average speed of a 1/2 inch drill, and thereby increases the power. Absolutely indispensable for all shop work and home craftsmen.

\$11.95
post paid

Send check
or
Money Order
Satisfaction
guaranteed
Order
yours now

G. M. CO. MANUFACTURING, INC.
1308 43rd AVE.
LONG ISLAND CITY 1, NEW YORK



\$7.75

Money with
order,
Postpaid

ALL-PURPOSE TORCH FOR YOUR SHOP

Adjustable Soldering-Brazing Torch for delicate or heavy work. Air and gas valves adjust flame from needle-point to pencil size. Torch uses air compressor or can be breath-blown. Ideal for silver soldering; light brazing; hardening drills and bushings. Excellent for radiator, electrical and sheet metal work. Lights instantly. Made for natural, artificial or bottled gas. Specify type of gas when ordering. Brass torch, 11 1/2" long. 10 day money-back guarantee.

MASS COMPANY, 1123 W. 4 1/2 St., Davenport 2, Iowa

GARDEN TRACTORS



S P E E D E X
YOUR CHOICE OF TWO TYPES
8 H.P. RIDING
2 1/2 H.P. WALKING

Exceptionally Low Prices Still in Effect

New catalog gives you full details on the famous Speedex. Illustrates many labor-saving uses. Complete descriptions.

SEND POSTCARD FOR YOUR FREE
COPY OF NEW CATALOG TODAY

SPEEDEX GARDEN TRACTOR CO.

Box 216-E1A

RAVENNA, OHIO

P-251-32

Feature for feature ...

YOU CAN'T BEAT LECTRO-SAWS!

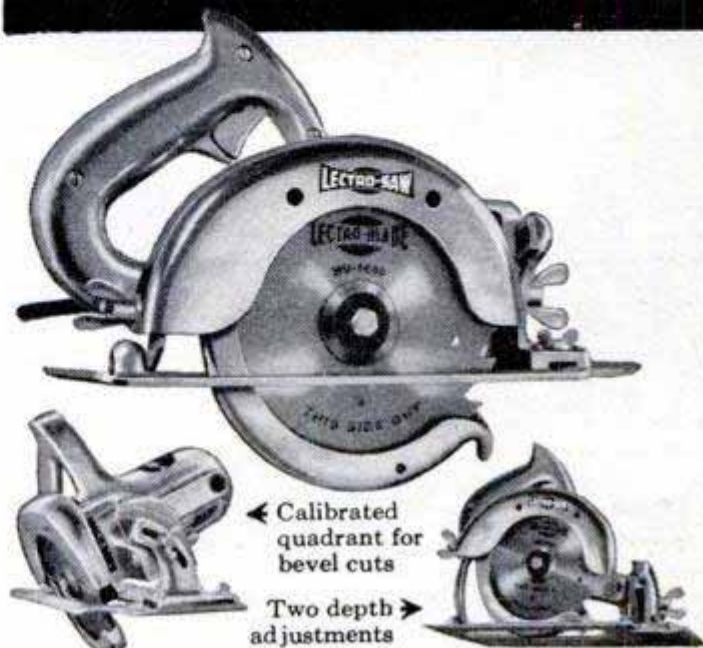

Abundant Power! Powerful motors built by Black & Decker specifically for tough power sawing.

Fast Adjustment! Easily adjusts for bevels from 0° to 45°; read on calibrated quadrant. Two depth adjustments—front and rear—always keep handle at comfortable wrist position.

Easy Handling! Sure-grip handle minimum distance from blade for easy control; close to center of gravity for good balance.

Maximum Safety! Telescoping blade guard automatically covers blade except when sawing. Instant-release trigger switch.

Low Prices! 6" Heavy-Duty Deluxe (shown), \$76.50; 6" Heavy-Duty, \$56.50; 8" Heavy-Duty, \$92.50. Pay for themselves in time saved in a very few jobs! Try them at your hardware, appliance, building supply, implement or department store!

BLACK & DECKER

**ELECTRIC
LECTRO-SAW
SAWS**

The Black & Decker Mfg. Co., Dept. H2M, Towson 4, Md.

tough as they come!



FAMOUS
***Snap-on** Vacuum Grip
pliers

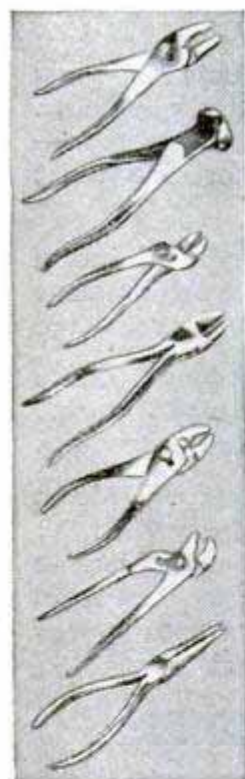

● Pick any Snap-on Vacuum Grip Pliers and you're set for years of faithful service. The way these professional pliers are designed, hammer-forged, oil-tempered, finished, inspected and tested, has just one purpose . . . to make them the finest pliers a man can buy. They handle better. They grip, twist, bend or cut better. They don't slip, in your hand or on the work. They last longer, because close-grained strength is forged and tempered into them. They're tougher.

31 types and sizes to choose from

Heavy-Duty Gripping Pliers ● Combination Pliers ● Lineman Pliers ● Diagonal and End Cutters ● Pin and Needle-Nose Pliers ● Midget Pliers ● Duck-Bill and Ignition Pliers ● Brake Spring, Brake Key, Battery, Water Pump, Snap-Ring and Cotter-Pin Pliers ● Pliers in sets, in leatherette kits, varied sizes. If you are a user of quality tools, send for the free, 104-page Snap-on catalog.

Not sold in stores. Buy from your local Snap-on man or order from factory.

*Snap-on is the trademark of Snap-on Tools Corporation.

**SNAP-ON
TOOLS
CORPORATION**
8062-B 28th Avenue
Kenosha, Wisconsin



Arthur C. Barnett
520 N. Mich Ave.

(Continued from page 107)

the company estimates it sold 1500 cars.

The clamp went on machine tools except for defense needs, but some of the new-engine programs are believed to be at the stage where they may squeeze through. These include Dodge and Buick among the passenger-car builders and the Ford tractor engine.

Buick, which had originally planned the new V-8 for its 1952 offerings and later set it back to 1953, may still come out all right for next year. It is so close to realizing the power plant that it may be permitted to go ahead.

Dodge, too, is close to achieving its modified V-8 FirePower. It still lacks a few vital machines, but it may work around them.

The great experiment of Kaiser-Frazer and Sears, Roebuck and Co. is getting mixed appraisal. Sears' selling of the All-state, a disguised version of the Henry J, may get its big test this spring. K-F plans to step up production on the light car even before Sears' experiment shows results.

Chrysler engineers are busy working out details of their new test track near Ann Arbor. Headed by James C. Zeder, director of the engineering division, they have been visiting present automotive test tracks and getting ideas.

G.M.'s layout at Milford is about the best in the industry today. But Chrysler plans to outdo it in at least one department. The G.M. speed track is designed for speeds up to 100 miles an hour. Chrysler's will have a top speed of 160 miles per hour. This indicates in what direction its engineers are thinking.

Nitrogen Grabbed From Air To Produce Explosives

Two pilot plants soon will be producing nitrogen from the air through a new system developed at the University of Wisconsin. The method uses only air, water and energy as raw materials. One plant already is producing a ton of 60-percent nitric acid per day at San Jose, Calif., and another will be built soon at Sunflower, Kans. Nitrogen is taken from the air in a high-temperature furnace which produces nitrogen oxides. After the oxides are concentrated, water is added to yield nitric acid, vitally needed for fertilizers, explosives and propellants.

Nonbreakable 10-inch, 78-r.p.m. records are now available to aid parakeet owners in teaching their pets to talk.

**RELIEVES PAIN OF
HEADACHE • NEURALGIA
NEURITIS**

FAST

The way
thousands of
physicians
and dentists
recommend



Anacin® relieves headache, neuralgia, neuritis pain fast because Anacin is like a doctor's prescription—that is, Anacin contains not just one, but a combination of medically proven, active ingredients in easy-to-take tablet form. Thousands have been introduced to Anacin through their own dentist or physicians. If you have never used Anacin, try these tablets yourself for incredibly fast, long-lasting relief from pain. Don't wait. Buy Anacin today.



Thousands
in Use

SMALL! POWERFUL!

America's finest low cost tractor. Ruggedly built. Easy to operate. No belts, no chains. Borg-Warner clutch, trans. and diff. 140 to 1 reduction. 40% more drawbar pull than ordinary tractors. 8-1/4 H.P. engine—gasoline or kerosene. 20 quick change implements.

Write for complete details.

ENGINEERING PRODUCTS CO.
915-K2 Niagara Ct.,
Waukesha, Wis.

**ECONOMY
TRACTOR**

SAVE 50% - THOUSANDS HAVE ASSEMBLED

**\$42^{UP} PACKAGED
BOAT KITS**



27 MODELS

Dinghies, skiffs, racers, inboards, outboards and cruisers. Assemble your own boat, it's easy, it's fun!

All parts pre-cut or pre-fabricated from finest materials. Get all the facts from our big 24 page catalog. See how Packaged Boats are built, how they perform, how exclusive construction features make assembly easy. Includes specifications, performance data plus hardware and paints.

SEND 25¢ for NEW 24 PAGE CATALOG

CUSTOM-CRAFT - DEPT. 7 - BUFFALO 7, N. Y.

**BOAT PLANS
PATTERNS**

► Over 50 modern plans and full size patterns. Racing classes, cruisers, inboards, outboards, sail boats. By famous designers. 6' to 30'. DESIGN CATALOG 35¢. Design Catalog and boat building handbook, \$1.00

MARINE MART - DEPT 7 - BUFFALO 7, N. Y.

**WHY PUT
UP WITH
THIS**



**WHEN YOU
CAN START
LIKE THIS**

Easier starting in any
kind of weather

**engine runs to keep it
warm whenever necessary**

(By Automatic Thermal Control)

Redi-Warm

AUTOMATIC ENGINE TENDER

Thermo Stop-Start Engine Warmer

At last the luxury of knowing your car will start as easily on a sub-zero morning as it will on a summer day. With a Redi-Warm Automatic Engine Tender in your car, it makes no difference where you park—how long you park. No plug-ins—no smudge pots—no spark boosters. Just touch your starter, and you're off in a jiffy.

Helps Protect 10 Vital Points

1. Keeps motor block warm.
2. Keeps lubricating oil warm for easy give.
3. Keeps starting motor warm.
4. Extends life of battery.
5. Keeps transmission grease warm.
6. Keeps generator in better condition.
7. Keeps ignition points from corroding.
8. Rewarms car interior.
9. Keeps windshield clear of frost.
10. Keeps windshield wiper from freezing tight.

Write for Redi-Warm FREE
Booklet with pictures and diagrams.

ORDER
TODAY

only
\$24.95
postpaid

- KEEPS ENGINE ALWAYS AT STARTING TEMPERATURE REGARDLESS OF WEATHER.
- CAR CANNOT BE STARTED WHILE REDI-WARM IS SET FOR OPERATION; THIEF-PROOF - FOOL-PROOF DOUBLES BATTERY LIFE.
- SAVES WEAR ON ENGINE; SAVES GAS ORDINARILY USED IN CHOKING.
- SAVES TIME - SAVES TEMPER - ELIMINATES COSTLY TOWING CHARGES.
- PAYS FOR ITSELF OVER AND OVER.

Agents
Wanted

CRAY-LINCOLN
Eng. & Mfg. Co., Inc.
Cray Oil Bldg., North Walpole, N.H., U.S.A.

THE SHAW "DU-ALL"

OUTWORKS THEM ALL

On Small Farms... in Gardens

Rugged 1½ to 5 H. P. Garden Models
Plow ... Harrow ... Cultivate
Fast and Easy

3 H. P. Walking Model with 10-in. Plow.



Sturdy, extra strength construction with the power and traction you need. 3 models, 1½, 3 and 5 H. P. with variable speed transmission, adjustable wheel widths, individual gang tool controls. Power turn models and power take-off attachments available.

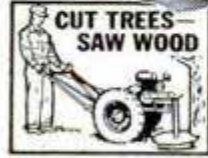

Powerful 5 to 12 H. P. Riding Tractors Do Everything on Good Sized Farm



Lowest cost power for limited acreage or for second tractor on large farm. 5, 8 and 12 H. P. models that will handle 10, 12, even 14-inch plows and do your cultivating, mowing, raking and other jobs with ease. Works astride or between 42-inch rows. Power take-off pulley and attachments available.

GET LOW PRICES, FREE LITERATURE NOW on complete plans. See the Shaw dealer. Write direct to...

SHAW MANUFACTURING CO.
 4502 Front St., Galesburg, Kansas
 668-G N. 4th St., Columbus, Ohio

BUILD YOUR OWN ARC-WELDER
For Light or Heavy Work
 No rewinding necessary—use coils taken from old auto generators. Works on 110 or 220 A.C. Has 20 different heats. Complete plans and BIG Catalog 35c.
LEJAY MFG. CO. 3347 LeJay Bldg. Minneapolis, Minn.

PARTS FOR MILITARY TRUCKS
 FOR JEEP, DODGE, CHEV., GMC, STUDEBAKER, 4 WHEEL DRIVE AND 6 WHEEL DRIVE. ALSO PARTS CATALOG. WRITE

AXLES FOR TRAILERS
 (Surplus) Heavy Duty axles suitable for building of many types of trailers, farm wagons, etc. Standard width straight axle, 2 inch square and is complete with Hubs, Timken bearings, 6 Hole \$69.50
 750x20 or 825x20 wheels, without brakes, only...
 Dual Wheels... add \$15.00 extra

All prices quoted good 30 days FOB, Kansas City
 25% DEPOSIT REQUIRED ON ALL ORDERS

American AUTO PARTS CO. INC.
 1830 LOCUST—DEPT. PM
 KANSAS CITY, MISSOURI

CHAMPIONS

CHOICE of the EXPERTS
 for Dependability, Performance and Long Life

INSIST ON CHAMPIONS FOR YOUR CAR!

CHAMPION SPARK PLUG COMPANY, TOLEDO 1, OHIO

SELL GOLD & SILVER WINDOW LETTERS

300% PROFIT! Fast, easy sales to stores, offices, doctors, lawyers, etc. Individual orders for merchants interested in saving \$\$\$\$ doing their own window lettering. Letters easily applied on glass, wood, metal with varnish-glue (not water). Won't wash off; withstands frost. Write for samples.
METALLIC SIGN CO., 430 N. Clark St., Chicago 10, Ill.

Heads stay put ON AXES and HAMMERS
 ask your dealer for **Red Devil** grady wedges

RED DEVIL TOOLS, IRVINGTON 11, N. J., U. S. A.

Print Your Own
 Cards, stationery, circulars, tags, labels, photo and movie titles, advertising, etc. Save money. **Print for Others, Good Profit!** easy rules sent. Raised Printing like Engraving, too. Sold direct from factory only. Write for free catalog of outfits and all details. **KELSEY PRESSES, M-37, Meriden, Conn.**

PUMP WATER FAST!
DRAIN WASH TUBS, CELLARS, CISTERNS IRRIGATE—FILL TANKS—DRAW WELL WATER

Pumps 2800 GPH. 420 GPH at 75' High or 1600 GPH from 25' well. Sturdy, Rustproof Alloy Metal. Six Blade Impeller. Uses any 1/8 to 1/2 H.P. Motor. Will not leak or clog. Fits any garden hose. Immediate Money Back Guarantee. Send Check, M.O., or C.O.D. **895 IN U.S.**

MOORE MANUFACTURING CO.
 SWEDESBORO 1 NEW JERSEY

ELECTRICITY Anywhere
 FOR PORTABLE, EMERGENCY OR HOME USE

ONAN Electric Plants generate 110-volt, 60-cycle current for homes, farms, cabins and resorts beyond the highline. Lightweight, portable plants cut costs, speed work for contractors. Standby plants protect units against power failure. 400 to 55,000 watts. Gasoline or Diesel-powered. Priced from \$219.00.

WRITE FOR CATALOG

D. W. ONAN & SONS INC.
 5854 UNIVERSITY AVE., MINNEAPOLIS 14, MINN.



BRIKCRETE

High Earning Power for Local Manufacturers

More local Brikcrete plants are needed. You can be one of a country-wide chain manufacturing the world's most modern masonry. Ties in with today's economic conditions that demand elimination of wastefulness in production. Brikcrete is locally made, of local materials, by local labor, for local use. Saves the high costs of transportation and distribution. Brings fine masonry down to the price levels of lumber. Rich in sales appeal to builders who are masonry-minded but cost conscious.

World's Most Modern Masonry

Brikcrete is modern in design, proportion and size. Has exclusive buttressed web. Supplied in wide range of colors. Local manufacturers have broad opportunities for expansion under franchise privileges. High income potentials. Requires only nominal investment. We supply all equipment; easy terms if desired. Write or wire for Brikcrete Book No. 2.

BRIKCRETE ASSOCIATES, INC.

4679 Division Avenue, S.
Grand Rapids 8, Michigan



B1

NEW—Sensational! GEIGER COUNTER



"The SNOOPER"
LOW PRICE ONLY **\$24.95**
COMPLETE

Find a fortune in uranium with this new, super-sensitive Geiger Counter. Get one for atom bomb defense. So small it fits in the palm of the hand or in the hip pocket, and yet more sensitive than many large, expensive instruments. Weighs only 1 1/4 lbs. Uses flashlight battery. Low price includes earphone, radio active sample, instructions. Sold with ironclad moneyback guarantee.

ORDER YOURS TODAY—Send \$5.00 with order or payment in full to save C.O.D. Write for free catalog on treasure finders for gold, silver, etc. and larger, more elaborate Geiger Counters.

Dealer Inquiries Invited

PRECISION RADIATION INSTRUMENTS
4113 PM W. Jefferson, L. A. 16, Calif.

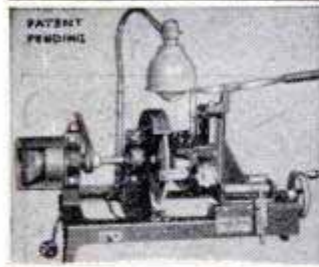

Start a NEW BUSINESS!

or Add to your present Repair Business

SHARPEN DULL PIPE WRENCHES

PIPE TAPS & DIES
"GUM" CIRCULAR SAWS

Write for Information

J. C. MOORE INDUSTRIES
BOX M 276 FREDONIA, PA.



TRAILER COACHES

Here's everything you want to know about trailers, with plenty of pictures and plans and instructions for building three different types. Covers also, history of trailers, trailer parks, camps and overnight-stops information, furniture, furnishings, materials and engineering data. If you want to build a trailer, live in a trailer, or just want to know more about trailers, get this book. Only \$1.50 postpaid. Rush order to:

POPULAR MECHANICS PRESS • Dept. 350, 200 E. Ontario St., Chicago

Build it Yourself!

Complete Trailer Book and Construction Data for 10, 16 and 22 Foot Trailers — Only \$1.50

Partial Contents

Trailer Parks—Living in a Trailer—Towing a Trailer—Floor Plans—Service—Classifications—Balance—Dollies—Jacks—Weight Distribution—Construction—Working Drawings for a Two-Place, Standard Travel and Standard Dwelling Trailers. Size 8 1/2 x 11 1/4 inches.

Make \$20 to \$30 a Week
EXTRA MONEY



MACHINE SAW FILING PAYS UP to \$3 or \$4 an HOUR

• Turn your spare time into CASH—sharpening saws with a Foley Automatic Saw Filer pays up to \$3 or \$4 an hour. You will find you can make \$20 to \$30 a week in your spare time as a starter.

You can work in your basement or garage—no experience necessary. "The first saw I sharpened with my Foley Filer came out 100%"—writes Clarence E. Parsons. No canvassing—"I advertised in our local paper and got in 93 saws"—says M. L. Thompson. The Foley is the only machine with which you can file all hand saws, also band saws and cross-cut circular saws.

SEND FOR FREE BOOK "MONEY MAKING FACTS"

Shows how you can get business from home owners, farmers, carpenters, schools, factories, etc. With a small investment, no overhead, no stock of goods to carry, you can get right into a cash business,—and possibly later on develop into a full-time repair shop. Send coupon today for Free Book. No salesman will call.

"Each saw I filed got me six more and business has been picking up that way since a year ago. If it keeps up I will have to buy another Foley Saw Filer."
William C. Baldwin

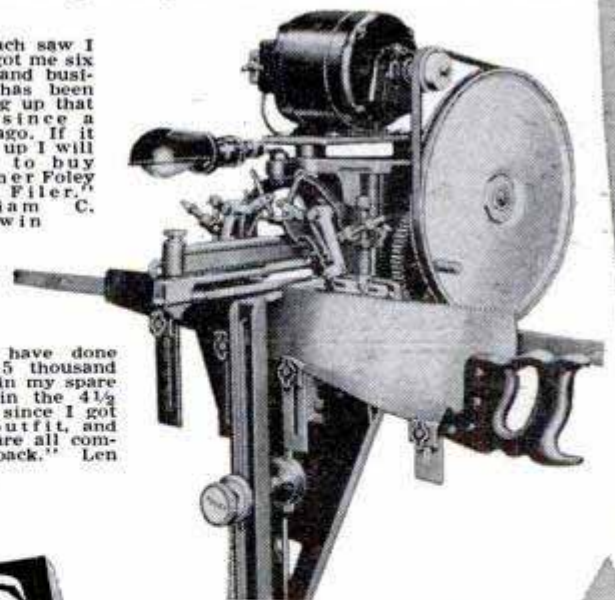

"I have done 4 or 5 thousand saws in my spare time in the 4 1/2 years since I got the outfit, and they are all coming back." Len Crego



Send Coupon for FREE BOOK

FOLEY MFG. CO., 216-2 Foley Bldg. Minneapolis 18, Minnesota

Send FREE BOOK—"Money Making Facts"

Name.....
Address.....

Make A MULTI PURPOSE TOOL

→ sawing, cutting, reaming section → drills hole

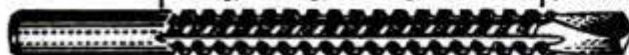

DRILL, SAW, REAM . . .

. . . metal, pipe, wood, plastic, Transite, etc., with the all-purpose International Rotary Cone-Saw Drill-bit shown above. Use with any electric drill, slow drill press, lathe or milling machine. Drills own starting hole—upper part of bit is used to cut, saw or ream circles, ovals, squares or scrolls. Easy to operate. Ideal for carpenters, mechanics, electricians, plumbers, hobbyists, many others. Abrasive resistant, high speed steel. Flutes ground from solid. Will withstand severe continuous use without breaking. Resharpener at no charge. Takes place of up to \$50 in tools. 1/4" diameter, 2" cutting sections, total length 3 1/2". Also available bits specially designed for wood or metal and in 2 3/8" and 1 3/4" lengths. Write for details. Specify all-purpose bit.



Drill Bit
\$3.95
Post Paid

NOW YOU CAN PLANE . . .

. . . with your 1/4" electric drill and the International Drill-Plane Converter. For fast, accurate planing, beveling, ripping. Rips up to 1 1/4" strip, planes 1/4" at one stroke, 15 times faster than any hand plane. Rips boards up to 1 3/4" thick. Nothing like it exists. Too many uses to mention. 2 planing blades made of finest available High Speed steel included. Blades are 1/4" diameter, 2" cutting surface. Electric Drill not included. Regular electric planers cost up to \$150.00.

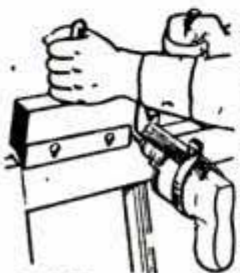

Drill Plane Converter

Send cash, check or M.O.
Money back guarantee
Shipped same day
Dealer inquiries invited

Plane Converter
\$14.95
Completely Assembled

Manufactured & Distributed by:

INTERNATIONAL TWIST DRILL CORP.
618 Wyandotte • Room 638 • Kansas City 6, Mo.

READY CUT HOMES

\$2150 AND UP SAVE UP TO 1/3

Build your own home. SAVE labor costs and builders' profits. All lumber marked and cut-to-fit. Everything furnished, doors, windows, floors, trim, roofing, hardware, nails, glass, paint, etc. Complete building plans ready for filing at low cost. Sold separately if desired. Buy Direct from Mill. Five Easy Payment Plans including Monthly Time Payment Plan.

NEW COLOR CATALOG

SAVE UP TO \$1264

25c

Send 25c IN COIN. Shows 57 modern low-priced designs and floor plans.



INTERNATIONAL Mill and Timber Co.
Bay City, Michigan
Dept. P.M.22

STERLING HOMES Since 1910

DRIVE WITH A HULL AUTO COMPASS AND A ROAD MAP



● SPOT YOUR LOCATION on a map and whether you must travel North, East, South or West to your destination. Then, your dependable Hull Auto Compass tells constantly whether you are driving in the direction the map shows to be correct.

WRITE FOR LOCAL DEALER'S NAME

HULL MFG. CO.
P. O. BOX 246-02 • WARREN, OHIO

Beaconlite \$6.95
STREAMLINE \$4.95

MAKE YOUR OWN!

WITH



GRIFFIN LEATHERCRAFT KITS
Best assortment of tools, materials in U.S.A.! Send 25¢ for 116-page catalog. (money refunded first order)

GRIFFIN CRAFT SUPPLIES

SINCE 1924

5626-A Telegraph Ave., Oakland 9, Calif

AVIATION SURPLUS MATERIALS

We offer one of the largest stocks surplus aircraft parts, supplies, accessories, gadgets, gizmos & gihinkies.

Send only 10¢ for your copy of our latest listings.

AERO PARTS SUPPLY, 8102 Lockheed, Houston 17, Texas

BOYS-IT'S FREE!

"THE WONDERS OF CHEMISTRY"

This exciting new book shows how to amaze your friends with chemical magic. Describes many fascinating home experiments, tells of fun, thrills and big future opportunities for boys who know chemistry. Special atomic energy feature. Send today!

THE PORTER CHEMICAL COMPANY
45 Prospect Avenue, Hagerstown, Maryland



MORE JOBS EASIER QUICKER With Gear-Driven "RED-E" GARDEN TRACTORS



Buy Direct from Manufacturer and SAVE

NO BELTS! NO CHAINS!
Proven For Over 29 Years
NEW 1952 MODELS

Thousands of satisfied users say "RED-E" has solved their tractor problems. You too, will like its smooth, powerful, easy-to-operate, gear-driven action—with power turning clutch for 4 1/2 and 6 H.P. WALKING MODELS and automotive type differential for 7 1/2 H.P. RIDING MODEL. Our 2 and 3 H.P. Walking Models low as \$169.00. Attachments for plowing, sowing, cultivating, wood-sawing, snow-plowing, etc. **EASY TERMS** — Factory-To-You discount. Write TODAY for FREE Catalog. **RED-E TRACTOR CO. RICHFIELD 250, WISCONSIN**

OUTBOARD OWNERS GET THIS CATALOG!

MICHIGAN WHEEL 1952 CATALOG

The FREE Michigan Wheel outboard catalog for 1952 — the outboarder's Bible — tells how to get better general-use performance from your outboard motor — unmatched speed on racing and fast runabouts with motors of 7 1/2 hp and larger. Easily understood recommendations enable you to choose a propeller that is virtually custom engineered to your particular motor, boat and load. Write for your free copy now, Michigan Wheel Co., Dept. PM-12 Grand Rapids, Mich.

● **\$650,000.00 INVENTORY AT TREMENDOUS SAVING**
 ● **DURING SALE, WE PAY ALL SHIPPING CHARGES**

POWER PLANTS and GENERATORS

● **Kato Generators**, 5KW, 115-v, 60-c, 1800 RPM, 1 ph., ball bg. with panel, pulley, base, etc. Cost \$550 **\$259.60**
 ● **Burdex Generators**, 115-v, 60-c, 1 ph. 3600 RPM with pulley and floating base, 500-watt, \$94.50. 1000-watt, \$134.90. 2000-watt, \$159.50
 ● **Homeite Plant**, 1.5 KW, 115-v, 60-c, 1 ph. Air cooled engine. Manual start. Portable. Cost over \$465 **\$259.50**
 ● **Master Plant**, 5 KW, 115/230-w, 60-c, 1 ph. 4 cyl. water-cooled engine. Manual start. Cost over \$1100 **\$597.90**
 ● **Onan Plant**, 5 KW, 115-v, 60-c, 1 ph. 4 cyl. eng. Push but. start. Cost \$1400 **\$715.99**
 ● **Army M-5 Plant**, 3,000-4,000-w, 115-v, 60-c, 4 cyl. engine. Push button start. **\$475.00**

WINCHES and HOISTS

● **Boat, dock, utility hand winch**, 1-4 gear ratio, 1500 lb. **\$19.95**
 ● **Industrial light duty**, Hand 1-3, 1-9 ratio, 2000 lb. **\$29.95**
 ● **Cable** 1/4", 50', with load hook **\$8.95**
 ● **Contr. heavy duty**, hand, 10,000 lb. 1-5, 1-27 ratio **\$89.95**
 ● **Neil Power Winch**, 15,000 lbs. with 150 ft. 1/2" cable. Cost \$290 **\$179.00**
 ● **Coffing Chain Hoist**, Lever ratchet type, 3000 lbs. 100s of uses **\$19.95**

ELECTRIC ARC WELDERS

● **D-C**, 0 to 250 amp. outlet, complete **\$108.90**
 ● **D-C**, 0 to 200 amp. Generator. **\$24.65**
 ● **A-C**, 110-220-v., Welder-brazer. **\$54.70**
 ● **A-C**, 110-v., 3kw, Spot welder. **\$97.50**

MAGNETO and CITY PHONES

● **Rural Magneto**, Compact oak case, Wall, (a) 3 bar, 1000-ohm, \$9.95 (b) 4-5 bar, 1600-ohm, \$13.90. City desk, \$4.99.

TRACTOR WEED SPRAY OUTFITS

● **Winter Special** (good to Apr. 1 only.) 5-row all brass T-jet boom, P.T.O. bronze gear pump, hose, all fittings and controls. Universal mounting. Regular \$140.50 **\$79.50**

AIR COMPRESSOR UNITS

Paint, blow up tires, control termites, use in shop, etc. Build your own unit.
 ● **DeLuxe Kit**, Build your own. Save 50%. Consists S.S. 12"x24" (400 lb. test) tank, 1-cyl. piston 3 c.f.m. compressor, valves, gauge, fittings, hose and excellent paint gun, dust gun, tire chuck, "How-to-Build" instructions **\$45.90**
 ● **Quincy Portable Compressor**, 110-v, 60-c, 100 lbs. pressure, 1-cyl. 2-wheel, with tank, gauge, hose and paint gun, tire chuck, etc. Ready to use. Special **\$74.95**
 ● **Air Components**, Piston compressors (a) 1-cyl. **\$20.50**, (b) 2-cyl. **\$49.50**, Adj. Auto Pressure Switch, (on 50 lb., off 75 lb.) **\$4.95**, Pres. Regulator, (0 to 250 lbs.) **\$2.65**, Gauges (60, 100, 160 lb.) **\$1.89**, Pressure tanks, 6"x24", **\$5.49**, 12"x24", **\$11.95**, Adj. Safety Valve, **\$1.95**. Air hose with fittings, 25' **\$3.35**
 Write for useful Air Data-Catalog

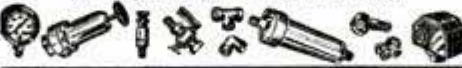

GUY CABLE and TURNBUCKLE

New 12' 1/8" flexible steel cable with 14" turnbuckle. Guy, strength gates, fences, television towers. Gov't. cost \$1.10 each, 10' **\$3.89**, 50' **\$16.47**, Case of 175, **\$42.95**.



WATER PUMPS and SYSTEMS

Save 60%. Expert advice on your problem. Pumps for wells, irrigation, basements, spraying, septic tanks, etc.
 ● **Centrifugal Pumps**, Cast iron case, bronze impeller, stainless shaft, ball bg. To 140 g.p.m. Pressures to 30 lb. 3/4" **\$18.90**, 1", **\$28.90**, 1 1/4", **\$35.60**
 ● **Rotary Pumps**, Low pressure: (to 25 lbs.) Self priming, Hy-Car impeller. To 20 g.p.m. 1/2", **\$12.75**; 3/4", **\$16.95**, 1", **\$22.95**. Hi-Pressure type: Positive displacement. Pressures to 150 lbs. To 20 g.p.m. 1/2", **\$14.50**, 3/4", **\$20.95**, 1", **\$27.95**
 ● **Motor Driven Sump**, 110-v, 1/2 h.p. automatic, 2000 g.p.m., 1" disch. **\$42.97**
 ● **Burdex Shallow Well Water System**, 110-v, 1/4 h.p., 300 g.p.m. 40 lbs. pressure **\$69.50**
 ● **Burdex Deep Well Jet System**, 110-v, 1/4 h.p., 350 g.p.m. 40 lbs. 70 ft. lift **\$109.95**
 Write for special Water Pump catalog-data

MISCELLANEOUS BARGAINS

● **Tachometer**, Direct rd, 0-4000 r.p.m. **\$6.99**
 ● **Compass**, For auto. Cost \$59. **\$8.77**
 ● **Drawing Instruments**, German 13-pc. set **\$9.89**
 ● **Chain Saw**, Electric, 110-v., 8-amp. **\$112.50**
 ● **Chain Saw**, Gas, 4 h.p. 1-man. **\$299.50**
 ● **Hand Saw**, Electric, 6 1/2", 110-v. **\$37.40**
 ● **Drill**, Electric, 1/2" cap. 110-v. **\$26.95**
 ● **Drill**, Electric, 1/4" cap. 110-v. **\$11.76**
 ● **Clock Switch**, 20 amp, 110-v., 60-c. **\$4.72**
 ● **Engineers Sighting Level**, precision **\$5.84**
 ● **Gyro-Motor Unit**, 12-24 volt. **\$1.98**
 ● **City Desk Phone**, upright type with cord **\$1.99**
 ● **Burglar-Fire Alarm**, magnetic unit. **\$1.49**
 ● **Motors**, Hi-speed series, 6-12-v. **\$2.88**
 ● **Hydraulic Cyl.** 3"x31", 10" stroke. **\$18.49**
 ● **Mercury Control**, operates 32° and 105° **.99**
 ● **Abrasive Stone Mix**, 10 stones, 1/2" bore **\$3.98**
 ● **W. E. Microphone**, very compact **.79**
 ● **Cathode Ray Tubes**, 5" experimental **\$4.35**
 ● **Tap and Die Set**, finest, 23 pc. 1/4" to 1 1/2" **\$19.50**
 ● **Binoculars**, 7x50 with case, Tx. Pd. **\$45.95**
 ● **Barometer**, Beautiful precision unit. **\$5.95**
 ● **Bolt-Screw-Nut Mix**, A buy! 6 lbs. **\$1.99**
 ● **Hundreds** other bargains in tools, electronic items, radio, etc.

ORDER FROM AD or Write for Free Catalog!

BURDEN'S 30-Year Policy: ● Everything guaranteed to satisfy. ● We pay all shipping charges in U.S.



BURDEN SALES COMPANY

806 "O" ST.

LINCOLN, NEBR.

NOW—40 different cuts with AMAZING, NEW

Warren DADO SAWING WASHERS

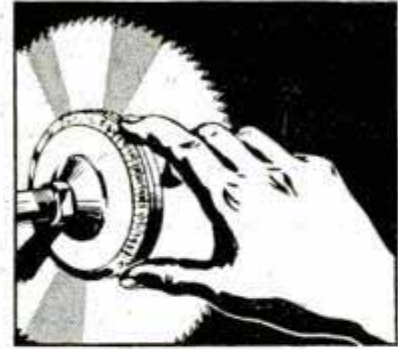

ON YOUR SAW BLADE!
NO Warp...
NO Wobble...
NO Burning!
ONLY \$4.95 PER SET

4 Washers Mean Perfect Balance

Make clean, smooth parallel grooves at any angle—no chewing, no sanding. Just dial your cut—no trick screws, no vibration, strengthens blade for straight cuts. Warren Washers greatest improvement in 30 years—and most copied—look for the name on the box and washers. It costs no more to get the best—WARREN, IT'S GUARANTEED! At your dealer or order direct. Give arbor size—1/2", 3/4", 5/8", 1"—sent postpaid.

WARREN DADO SAWING WASHERS CO.

Dept. 22 ● Box 98 North End Station
 Detroit, Michigan

FEBRUARY 1952

IT'S FUN TO FINISH FURNITURE WITH NEW—



Transvener PLASTIC FILM VENEER

REPRODUCTIONS OF BEAUTIFUL WOOD GRAINS

Transvener makes any smooth surface look exactly like the most beautiful wood! Easily applied film-like sheets cover wood, metal, composition board, glass. Many patterns available. **SPECIAL TRIAL OFFER!** 16"x24" Transvener sheet in beautiful Mahogany grain, Welding Solution, Squeegee, full Instructions—all for only \$1.00 postpaid. Money back guarantee. Order today! Sorry, no C.O.D.'s.

SPECIAL TRIAL OFFER! Postpaid

MAIL COUPON NOW!

TRANSVENER DIVISION, DI-NOC COMPANY

Dept. A-1, Public Sq. Bldg., Cleveland 13, Ohio
 Enclosed is \$1.00. Please send Transvener, Welding Solution, Squeegee and Instructions.

Name _____

Address _____

City _____ Zone _____ State _____

Offer good for limited time only. Offer good only in Continental U. S.

Now You Can Have A Dry Basement

with beautiful colored walls
and floor

PLASTEX gives long-lasting protection against water. Also bright, colorful, easily washable walls and floors. Basements painted with PLASTEX in 1939 are still dry and attractive. Water up to 10 ft. has been successfully kept out by PLASTEX.

PLASTEX is not a water mixed material. It is formulated of synthetic resins especially to resist water pressure. The hard glossy PLASTEX finish is not easily soiled.

PLASTEX is also excellent for use in kitchens and bathrooms — where resistance to water, grease, etc. is necessary. PLASTEX is available in many colors making possible lovely color combinations. Easily applied by brush.

Color chart and complete information will be sent on request.

PLASTEX

Steel Protection &
Chemical Co., Inc.,
252 Bridge St.,
Mooreville, Indiana

BETTER TOOL VALUES!

SEND FOR NEW FREE CATALOG

INDESTRO TOOLS



Ready now—Brand New Mechanic's Catalog of Low-Cost, Long-Service Indestro Tools. Full of photographs and detailed descriptions of regular or special tools your dealer can supply for home workshop or professional use.

Tells how to select good tools and why you get Better Value when you select Indestro Tools—for in-

stance, all sockets "Hot Broached" to make them wear longer.

Offers you big values in Tool Sets, from 5-pc Punch and Chisel Sets to 114-pc DeLuxe Workshop Sets. Reserve your copy of this Dollar-Saving Pocket-Size Tool Catalog.

5464RPM



FILL OUT AND MAIL NOW FOR FREE COPY

Send to INDESTRO MANUFACTURING CORP.
2649 N. Kildare at Schubert, Chicago 39, Ill.

*Write your name and
address in margin space*

New

New



Introductory
Offer
\$1.69

New WINDSHIELD WASHER

- LOWER IN COST
- EASIER TO INSTALL
- SIMPLER TO OPERATE

SEND NO MONEY

Guaranteed trouble free operation . . . outperforms \$8.95 custom models. Can't clog . . . easy to refill. Visible fluid supply. One filling cleans windshield 35 times. TRY 10 DAYS ON YOUR CAR AT OUR RISK. Money back if not delighted. Pay postman plus postage or enclose payment, we pay postage. Act now . . . this low price can't last.

YOUNG PRODUCTS
Dept. 168
2605 ELMHURST AVENUE
DETROIT 6, MICHIGAN

LEATHERCRAFT
TEXTILE PAINTING
COPPER TOOLING

PAY-OFF



Yes, these crafts "pay off" in pleasure and profit. You can do it! Everything you need in Kit Kraft's big illustrated catalog.

Send 10c (credited to first order)
for catalog today!

KIT KRAFT 7377 Melrose Ave., Dept. 27
Hollywood 46, California



BUILD FINE GRANDFATHER CLOCK NOW

The simple sensible Red-i-Kut way as thousands have—SAVE HALF. SHOP TESTED PLANS "SPIRIT OF THE CENTURY" Narrow waist 83" tall or stately straight side "SPIRIT OF AMERICA." EASY-TO-FOLLOW photopack PLANS tell all—plus BROCHURE of heavy brass weight Westminster, tube chime, movements, gorgeous dials, 3/4" solid mahogany case kits. Send \$1.00 today—Both plans \$1.50 NOW.

KUEMPEL CHIME CLOCK CO., #4 Kuempel Bldg., Minneapolis 16, Minn.

DO MORE PLANING JOBS \$215.00 WITH LOW-COST BELSAW



AMAZING 12 1/4-IN. PLANER Does All Ordinary Planing Mill Jobs. Provides attachments for Jointing, Rabbeting, Tongue, Groove, Matching. 12 1/4 x 6-in. capacity, 3-knife solid round all-steel cutterhead. Power feeds at 24 feet per minute, 42 cuts per inch. Provides for full line of accessory attachments—Grind and Joint knives IN THE CUTTERHEAD WITHOUT REMOVING.

FREE
BOOK

BELSAW MACHINERY CO
1018 Field Bldg., 315 Westport Rd., Kansas City 2, Mo.

NONE BETTER! SUPER DRILL GRINDER

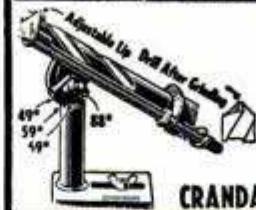

Sharpens round shank drills from 3/32" to 1/2" in diameter, up to 6" long. Grinds old drills like new in 4 different point angles, using hand or power grinding wheels. Money-back guarantee.

Price only \$2.95

At Dealers or Postpaid

CRANDALL MFG. CO. 1512 W. Slauson, Dept. P-12
Los Angeles 44, Calif.

Foley Filer Users—Attention!!

Save on File Expense! Improve Your Workmanship!
Sharpen More Saws With Each File!

"FLOATING ROLLERS" will solve these problems for you! "FLOATING ROLLERS" replace saw carrier clips and have a tension spring which holds the carrier snug to the lower rollers, eliminating irregular size teeth, carrier play, etc., which must be remedied before precision work can be accomplished. Many other features make the "FLOATING ROLLERS" a MUST investment for you. Easily attached in five minutes.

For Model F-16, F-24 or F-61 Foley Filer, equipped with carrier rollers, \$7.50 per set.

For Model F-5, F-16 or F-24 not equipped with carrier rollers, \$10.25 per set.

Order a set today for 30-days trial. If not satisfied in any way, return them and your money will be refunded. Save COD and postage charges by sending check or money order with order, or write for further information.

STADICK MANUFACTURING CO.
Box 73, New Ulm, Minnesota

EASY
TIME PAY
PLAN

What?
POWER
TOOLS
only \$16
EACH!



GRINDER

SANDER

30" LATHE

8" TILTING
TABLE SAW

HORIZONTAL
DRILL PRESS

5 POWER TOOLS IN ONE

FACTORY TO YOU \$79.95

SUPERSHOP offers you a precision-built complete power tool workshop. 100% ball bearing. RUGGED. Accurate. Big capacity. 15 day FREE trial. Money back guarantee. Mail postcard for FREE catalog. Buy on easy pay plan.

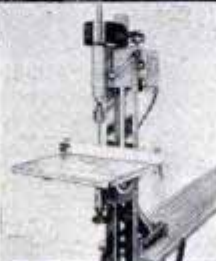

VERTICAL
DRILL PRESS

POWER TOOLS, INC. 132 YATES AVENUE
BELOIT, WISCONSIN

ACE TOOLS



Be permanently
tooled-up for every operation
on your Metal Cutting Lathe.

No. 8-A Ace Tool Set for 9" and 10" Swing Lathes—fits shank size $\frac{3}{8}$ " x $\frac{3}{4}$ ". Includes Turning, Cutting-off, Boring, Knurling and Threading Tools with high speed cutters, blades and wrenches. 8 complete tools in fitted steel case—nothing else to buy. See your local dealer or order direct.

ARMSTRONG BROS. TOOL CO.
5268 W. Armstrong Ave., Chicago 30, Ill.

\$26⁹⁵

SEA SHELL
only \$35

formerly built by
HAGERTY



You'd expect to pay twice \$35 for a rugged yet light (65 lb.) boat like the SEA SHELL. Designed for hard use in fresh or salt water. Easy to row. Takes a small outboard. Carry on your car top. Ample freeboard to hold three husky men in safety. Ideal for duck-hunters, fishermen, all-round use.

You put the SEA SHELL together in a few pleasant evenings—and save money. Kit includes pre-cut waterproof plywood and wood parts, brass screws, oarlocks, seam compound, full instructions. Easy to assemble—only ordinary hand tools needed. Beam 4 ft., depth 16 ins. More than 22,000 in use. Fully guaranteed. Additional kit available to convert SEA SHELL into a lively performing sailboat. Free booklet; or send \$35 and Sea Shell kit will be shipped freight collect.

Sea Shells of Branford
5280 N. Main St., Branford, Conn.

Build your own RADIO
with ALLIED's quality
easy-to-assemble kits

"RANGER" SUPERHET KIT

Complete with Cabinet

Learn radio while you build and enjoy this sensitive AC-DC broadcast receiver. Covers 535-1620 kc; includes built-in antenna; 5" PM dynamic speaker; automatic volume control; handsome walnut plastic cabinet. Easy to assemble from step-by-step instructions. Complete kit includes punched chassis, all parts, tubes and cabinet. Quality components throughout. Shpg. wt., 8 lbs.

83-275. Only. \$17.85



LATEST CIRCUITS

FAMOUS RADIO LAB KIT

10 RADIO KITS IN 1

Here's the most instructive Experimenter's Kit you can buy. With it, you can build a broadcast receiver, phono amplifier, phono oscillator, signal tracer, electronic timer, photo cell relay, code practice set, home broadcaster, electronic switch, etc. Fascinating, instructive. Complete with all parts, tubes, microphone and 12-page manual. Shpg. wt., 10 lbs.

83-265. Only. \$14.25



FINEST PARTS

"SKY-ROVER" PORTABLE KIT

Complete with Carrying Case

Build this powerful 3-way superhet portable for AC, DC, or battery operation. Covers 535-1650 kc AM broadcast band; has built-in antenna, PM speaker, automatic volume control, beautiful carrying case. Easy to assemble from 8-page illustrated manual. High-quality kit includes all parts, tubes and case (less batteries). Shpg. wt., 6 lbs.

83-276. Only. \$17.95
80-596. Battery Kit. \$ 2.11



All Prices
FOB Chicago

ALLIED RADIO

FREE
CATALOG

ALLIED RADIO CORP., Dept. 5-B-2
833 W. Jackson Blvd., Chicago 7, Ill.

Send Kit No.

. \$ enclosed

Send FREE 212-Page Catalog

Name

Address

City Zone State



Build the Best!

EASY TO ASSEMBLE **BOAT KITS**



NEW CATALOG

- OVER 40 PAGES, INCLUDES ALL YOU NEED TO BUILD YOUR OWN
- 1-BOAT KITS-30 MODELS
 - 2-MARINE HARDWARE
 - 3-MARINE ENGINES
 - 4-MARINE CONVERSIONS
 - 5-PAINTS & COLOR CHARTS

All For Only 35c,
SEND COIN TODAY

OUTBOARDS

6 Models 12 to 16 Ft.

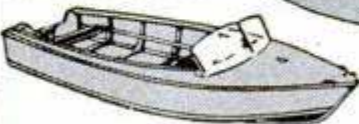

ROWBOATS
8-10-12-14 Ft.
\$39 up



INBOARDS & CABIN CRUISERS

16 TO 23 Ft.



NEW 18 FT. OUTBOARD CABIN CRUISER
FAST VEE BOTTOM HULL - SPEEDS UP TO 25 M.P.H. - ROOMY CABIN, WITH TOILET, SLEEPS TWO

U-MAK-IT PRODUCTS 703P-WHITTIER ST., Bronx 59, N. Y. City



Wonderful way to STRIP PAINT

Apply Wonder-Paste Remover over any paint, varnish or enamel, and the finish soon becomes a soft mass—easily stripped off with a putty knife! No hard scraping or sanding. Harmless to wood, metal, fabric or your hands. At paint and hardware stores. Over 3,000,000 cans sold—it must be good!

Write for leaflet giving hints on paint removing
Wilson-Imperial Co., 119 Chestnut St., Newark 5, N. J.

HOBBYISTS! SHOPMEN! Special ONLY \$54.50

PALMGREN "HOBB-E" Rotary Index, Milling Table
Ideal for Model Parts or Shop Work

Mill-Grind-Drill-Index-Rout curved or straight-Rabbit and Mortise on drill press or lathe. 8" Table, 4" Cross Feed, 360° Rotation, Accurately Graduated. Bolts to table. Order NOW! SAVE \$100. Only \$54.50. Less Rotary Feed \$43.75. Write for "HOBB-E" Tool Circular.

CHICAGO TOOL and ENGINEERING CO.
8365 South Chicago Ave. Chicago 17, Ill.

Reduce RADIO NOISES

NEW CLEAR-TONE LINE-NOISE ELIMINATOR

SIMPLY PLUG Radio or Appliance cord into Noise Eliminator and plug into wall socket. Enjoy reception FREE from many distracting noises. Send No Money, pay postman \$1.25 each (2 for \$2.00) plus postage or send cash and we'll mail postpaid. Try 5 days, money back if not delighted. Many hundreds of satisfied users. Send for yours today.

MERIT SALES, Dept. B-30, 4225 Eldone Dr., Baltimore 29, Md. \$2.00

STANDARD GARDEN AND SMALL FARM TRACTORS

RIDE-WALK Powerful Gas Tractors for Small Farms, Gardeners, Florists, Suburbanites, Fruit and Poultrymen.

1 & 2 Cylinders
Rubber or Steel Tires.

Plow Seed Cultivate Mow Haul. Best Work

Easy Terms - Free Catalog

STANDARD ENGINE COMPANY
MINNEAPOLIS, MINN. NEW YORK, N. Y.
3221 Como Avenue 617 West 26th Street

REAL LEATHER NAVY HELMET

NO HOOKS, TUBES OR HOLES

Brand new NAVY helmet of rich Cordovan Brown leather lined with soft warm fleece. Detachable chin strap. Ideal for flyers, cyclists, farmers, hunters. Children love them! Cost Gov't. \$10.00. Small, medium, large sizes. Send cash, chk. 25% dep. plus postage on C.O.D. Money back guarantee.

\$2.00 PPD.

GRAND-HAWTHORNE SURPLUS
Dept. PM2-52
1439 S. E. GRAND - PORTLAND, OREGON

MODERN LAWN MOWER SHARPENER

FOR LAWN MOWER SHOPS
FIX-IT SHOPS
GOLF COURSES • PARKS
101 OTHER JOBS

Sharpens All Reel Type Mowers • Hand, Power or Gang • 10 to 20 Minutes • No Dismantling • No Extra Attachments Needed.

All reel type mowers, from 5-inch edgers to 36-inch power mowers, are quickly sharpened to extreme ends of both left and right twist blades.

Handle, wheels, roller and motor remain in place when sharpening is in process. Bed knife is sharpened in same brackets. Grinding head rides on five ball bearing races. Easy to operate.

Also sharpens chisels, jointer knives, planer blades. Big profit maker. Own your own business. Send Today for FREE Illustrated Bulletin No. 10-C. Prices Subject to Change Without Notice.

PRICE \$241.50 less motor
\$263.00 with motor

ORDER NOW
Immediate Delivery

MODERN MFG. CO. 160 N. FAIR OAKS AVE. PASADENA, CALIFORNIA

BUILD YOUR OWN POWER TOOLS - TILT/ARBOR SAW

- Exclusive GIL-BILT Build-It-Yourself Features
- No machining—build easily with hand tools only
 - No blueprint reading—step-by-step pictorial plans, full scale patterns, actual photographs
 - Sturdy wood, aluminum, and steel construction
 - Capacity and performance of commercial saws selling for \$60 and up
- BANDSAW**
BELTSANDER
SAVE \$50. OR MORE

GIL-BILT 10-INCH TILTING ARBOR SAW



- 27x28 in. table, 13 1/2 in. capacity in front of blade
 - 10 in. blade cuts 3 1/4 in. deep, tilts full 45 degrees
 - Floor model 34" high, table always stays level
 - New Departure ball bearing arbor, 3/4" precision shaft turned down for 5/8" bore blades, alum. housing, shipped ready to run
 - Jackscrew and 4 1/2 in. dia. handwheel lowers and raises blade
 - Cast aluminum miter gauge and self-aligning rip fence guide
- GIL-BILT Metal Parts Kit includes Plans, ball bearing arbor, miter gauge and bar, rip fence guide, dado insert, lock knobs, jack screw mechanism and handwheel, and all other metal parts (less blade)..... \$20.95
Same Kit with 10" Combination Blade \$24.90
Same Kit with 8" Combination Blade \$23.90

GIL-BILT 12-INCH BAND SAW



- Cuts to center of 24 inch circle
 - Handles stock up to 6 inch thick
 - 18x18 inch table tilts 45 degrees
 - Lower wheel and drive pulley runs on sealed New Departure Ball Bearings; Upper wheel runs on two 5/8" bore Oilite Bronze bearings.
 - Upper wheel tension and tilt mechanism of cast aluminum, completely assembled.
 - Upper and lower blade guides. Each has ball thrust bearing, self-lub bronze jaws
 - Rigid cast aluminum wheels fully machined ready-to-install. Heavy rubber tires.
 - Uses standard 78 inch blades up to 3 3/4 in. wide.
 - Fully enclosed mechanism for utmost safety.
- GIL-BILT Metal Parts Kit includes Plans, rubber tires, aluminum wheels, 1/4 in. blade, ball bearing spindle, tilt mechanism, blade guides, table tilt segments, and all other metal parts..... \$20.95

Return Kits in 10 days for refund if not satisfied.
(Prices include postage within 300 miles. Over 300 add 5%)
Also available—Plans and Parts Kit for Belt Sander and 8" Tilt Table Saw. Order Plans at \$1.00 each—Send postpaid anywhere in the world or write for FREE descriptive catalog.

GILLIOM POWER TOOLS P. O. Box 1-PB, Lambert Field St. Louis 21, Missouri

FREE BOOK!

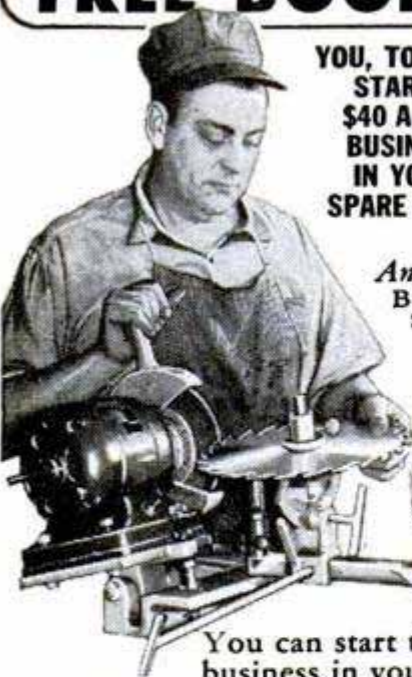

**YOU, TOO, CAN
START A
\$40 A DAY
BUSINESS
IN YOUR
SPARE TIME!**

**LIFE-TIME
SECURITY
WITH
YOUR
OWN
BUSINESS**

Andy Phillips says, "My BELSAW CIRCULAR SAW SHOP gives me BIG PROFITS at LOW expense... I can run 35 to 40 saws in an 8-hour day... That makes me \$40 cash."

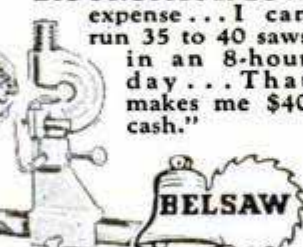

You can start this REPEAT CASH business in your own home or garage, while you are working at your regular job. Easy to operate, no experience needed. "Pays for itself from just 65 saw jobs." — Harvey Jensen.

For as little as \$15 down payment, you can get your BELSAW CIRCULAR SAW SHOP rushed to you.

You can make \$4 to \$5 an hour in your SPARE TIME sharpening and setting CIRCULAR SAWS for builders, lumber yards, factories... No Extra Equipment needed, no canvassing... send postcard for your Free Copy of "Life Time Security" today.

BELSAW MACHINERY CO
3703 Field Building Kansas City 2, Mo.

FREE

**NEW BIG
RADIO CATALOG**

Ready now! Complete with everything in radio, TV and electronics. Newest parts as well as old, standard lines. Paste coupon on penny postcard and mail today!

Lafayette Radio DIV.: RADIO WIRE TELEVISION, INC.

NEW YORK 13.....100 Sixth Avenue
NEWARK 2.....24 Central Avenue
BOSTON 10.....110 Federal Street
BRONX 58.....542 E. Fordham Road

**30 YEARS
OF
VALUES**

LAFAYETTE RADIO, Dept. LB
100 Sixth Avenue, New York 13
Please rush Free catalog to:

Name.....
Address.....
City..... State.....

PASTE
ON
PENNY
POSTCARD

**OWN
Your Own
Business**



Lifetime Income

Clean and Mothproof rugs and upholstery "in the home" or public buildings. If now employed, you can operate in spare time and build up a permanent profitable full-time business. Alert dealers can average \$4.50 hourly gross profit on service they render and \$3 on EACH of their servicemen at National Price Guide charges. Easy to learn... quickly established.

DURACLEAN cleans by absorption! No scrubbing, soaking or shrinkage. Dirt and grease vanish... matted pile rises... colors revive. Furnishings used again same day.

DURAPROOF resists moths and carpet beetles. Your service backed by a National Money Back 4 Year Warranty.

We furnish enough material to return your total investment in War-proof Business. EASY TERMS. Send for FREE booklet TODAY.

DURACLEAN CO., Dept. 2-162, Deerfield, Ill.

MARCOT KEY MACHINE



MARCOT No. 8 KEY MACHINE, less motor... \$110.00
Auto Code Book and Depth Keys... 12.50
75 'Dx. Popular Key Blanks... 60.00
Set - Key File, Follow-Through Rods, Lock Picks, Bit Key Gauge, Thimble, Pins, Springs... 10.50
"Locksmith Trade Books"... 6.75
How to Open Locks without Keys or Picks: Secret of Locksmithing: How to Make Keys by the Impression Method: Master Key Systems.
TOTAL COST... \$199.75

A. J. MARCOTTE CO., 1200 N. Kedzie Ave., Dept. PM, Chicago 51, Ill.

make your own Gems 29.50
F.O.B.

All necessary lapidary equipment is furnished, including a super-charged diamond blade for sawing, and all wheels for grinding, shaping and polishing; also complete instructions. The complete equipment as shown, less motor and belt, for only \$29.50, f.o.b., Burlington, Wisconsin. Write today for information and literature.

B&I MANUFACTURING CO.
Dept. S Burlington, Wis.

**WARN HUB CAP MAKES
2 JEEPS OUT OF 1**

Ends front wheel drag on 4-wheel drive Willys Station Wagons, Pick-ups and Jeeps

Saves gas up to 5 miles per gallon, tire wear, front axles, increases speed and power. Stops shimmy—front wheels coast out of gear! 4-wheel drive handles, performs, climbs like 2-wheel. Install or remove WARN HUB CAPS in 10 minutes. Polished aluminum, guaranteed. Rush check, M.O., or C.O.D. Write for circular.

WARN MFG. CO., Dept. A, 1625-3rd Ave., Seattle 1, Wash.

\$20.00
Prepaid U.S., Canada

CRESCENT TOOLS
Give Wings to Work

ASK YOUR
HARDWARE
DEALER

Say You Saw It in Popular Mechanics

**CONVERT HAND MOWERS
to POWER MOWERS**

Takes less than 3 hours

The Handy-Dandy Lawn Mower Kit fits any hand mower from the 16 to the 20 inch size. Complete with all necessary parts. Kits can be purchased separately, complete with engines or complete with Pennsylvania mower.



Also manufacturers of complete power mowers and garden cultivators.

LE CLAIRE MFG. CO., Le Claire, Iowa, Dept. PM

POPULAR MECHANICS

INSTALL A MILE-O-METER
LEARN HOW TO SAVE GAS AND TUNE YOUR OWN MOTOR . . .

"Mile-O-Meter" on the dashboard registers miles per gallon faithfully at all speeds, under every driving condition . . . Will show what speed your engine delivers its maximum power. Can save you many gallons of gas . . . Provides constant check on engine condition — Warns you of operating imperfections for 31 different motor adjustments . . . Nationally advertised in leading magazines and newspapers . . . Can be installed in a few minutes . . . transferred from old to new car. Fine watch precision . . . Order yours today!



STD. Model
\$9.75
2 3/4" Dia. Ppd. Fed. Tax Incl.

HUGE 24 PAGE INSTRUCTION MANUAL AND MILEAGE CALCULATOR INCLUDED FREE!



Installation requires no experience . . . becomes a constant companion on every trip. Saves cost in a short time. This professional gauge is a must!

\$14.95 DELUXE MODEL with Chrome Ring
3 1/2" Dia. Ppd. Fed. Tax. Incl.

GALE HALL ENGINEERING Dept. 127
BOSTON 18, MASS.
DELUXE MODEL NOW ILLUMINATED

Buy the Mechanic's FIRST Choice
...EMPIRE LEVELS
For Home, Farm, all Trades



See Empire Levels at your dealer, or write for free booklet "Choice and Care of your Level."

Empire No. 151 Aluminum Level: Adjustable vial cases, twin levels, plumbs, 45° vials — 24" — \$7.50.

EMPIRE TOOLS | **EMPIRE LEVEL MFG. COMPANY**

10930 West Potter Rd., Dept. PM., Milwaukee 13, Wis.

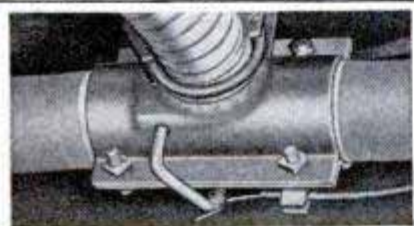

HURRICANE EXHAUST CUT-OUT

This specially engineered cut-out enables you to install special pipes and mufflers without removing the original muffler.

Now control your exhaust tone from a dash control button. Cut back into your original muffler in restricted areas at will. Fits all exhaust pipes from 1 3/4" to 2 1/4" size.

This cut-out is well constructed; actually strengthens exhaust pipe; made of heavy plate steel, designed for easy installation—no special tools required. Sent post-paid for only \$6.95 check or money order. Satisfaction guaranteed or your money back.

ST. LOUIS PRODUCTS CO., Box 24-A, Normandy 21, Mo.

New DUMORE ROUTER

a professional tool at a real bargain price



Only **\$29.50**

Here's a tool that will pay for itself the very first time it is used! Example: you save twice its cost by weather-stripping just 10 windows! You now can rout your own kitchen cabinets; formica sink tops; mouldings, picture frames, and door, lock and window mortises. Also do dovetailing; inlay and scroll work; on-the-job fitting; etc.

DOES WORK NO OTHER TOOL CAN DO

No workshop is complete without a Dumore Router . . . no other tool routs out channels, mortises and forms so smoothly, quickly, accurately. Order yours now. Money back if not satisfied.

DR-3

100% GUARANTEE . . . ORDER TODAY



LOOK FOR THE NAME

UTICA

IT MEANS

INDUCTION HARDENED WRENCH JAWS

Ordinary adjustable wrenches, subject to hard usage, burr over at the jaw edges. UTICA's process hardens the jaws in just these vital areas (indicated by arrows). Tests show that UTICA's last up to 10 times as long as ordinary adjustable wrenches.

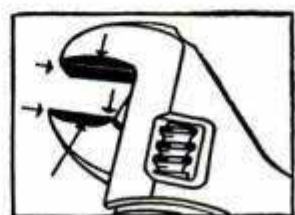

Dark areas are induction hardened for longer wear.

Your hardware dealer has UTICA adjustable wrenches or can get them for you. Insist on UTICA — the longer lasting adjustable wrench.



IT PAYS TO BUY QUALITY TOOLS
and the world's best tools are made in U.S.A.

Say You Saw It in Popular Mechanics

MAGNETS OF ALL TYPES — 10c UP
AMAZINGLY POWERFUL!!
1/2 lb. magnet lifts 25 lbs. \$1.95.
Our Leader, 1 lb. magnet lifts 40 lbs. \$2.95. New alloy—will not weaken! Useful for lifting valuables from tanks, lakes, or rivers easily! 7 small magnets \$1.25 with list of many shop and home uses. Satisfaction guaranteed.
R. EYRICH, 1219 W. MEINECKE AVE., MILWAUKEE, WIS.

SEND for illustrated Router Booklet, "How To Do It"

THE DUMORE COMPANY
Racine, Wisconsin

- Send complete Dumore Hobby Catalog (free) with "How To Do It" Booklet.
- Send Dumore Router as illustrated, \$29.50 enclosed.
- Send Dumore Router, plus template and fence guide attachments, \$34.00 enclosed. (Send check or money order — we'll pay postage. Send 10% and we'll ship C.O.D. plus postage.)

NAME.....
ADDRESS.....
CITY..... ZONE..... STATE.....

Make Tough Jobs **EASY!**

Built by master craftsmen, P & C tools are "muscle saving" and "fun to use." They get into small openings, fit nuts and screws snugly, balance perfectly in the hand. And special analysis alloy steels plus scientific heat treating makes them stay on the job longer. Look for the P & C rotary tool display unit and get "the best tools money can buy."

WRITE FOR new handy pocket catalog, complete data on some 399 P & C Tools.

P & C

P & C HAND FORGED TOOL COMPANY
Box 5926
PORTLAND 22, OREGON

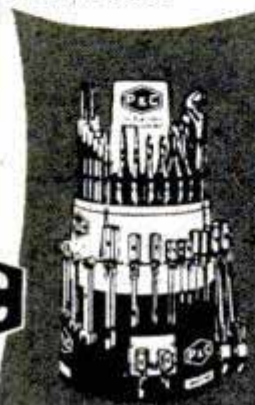

Made \$2,600
LAST SEASON

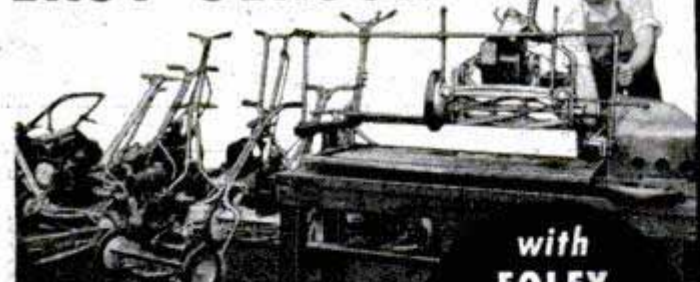

with **FOLEY LAWN MOWER SHARPENER**

99c Profit On Each Dollar

It costs less than 1¢ per mower for electricity and material. The Foley sharpens all blades and cutter bar together just like lawn mower manufacturers do it. Start in spare time in basement or garage. The Foley handles up to 3 or 4 mowers per hour—prices run \$1.50 to \$3.00 for hand mowers—\$5.00 to \$8.00 for power mowers.

FREE—VALUABLE ILLUSTRATED BOOK shows how to sharpen all leading makes of power mowers. Foley prices are low—easy payments available. **FREE PLAN** tells how to start. Write today—no salesman will call.

"Last year we sharpened and repaired about 1000 lawn mowers for a net profit of \$2600," says E. G. "In 1939 I bought a Foley Lawn Mower Sharpener," writes W.T.J., "the best investment I ever made. I have made a good living for my wife and self, and have put money in the bank besides."



SEND FOR FREE BOOK

FOLEY MFG. CO., 207-2 Foley Bldg. Minneapolis 18, Minn.

Send FREE BOOK and FREE PLAN on Foley Lawn Mower Sharpening business.

Name _____

Address _____

THE SPEED SAW FILER

Saves You Time, Money

Now FILE YOUR OWN SAWS

Now you can do expert saw filing at home. Lifetime tool makes precision filing easy for even the most inexperienced. Two simple adjustments make it fit any type hand saw. Keep your saws extra sharp and true-cutting with a Speed Saw Filer. Complete with file, ready to use. Money back guarantee. Cash with order, prepaid (C.O.D. postage extra.)

SPEED CORPORATION Dept. P.M. 512 N. E. 73 AVE. PORTLAND, OREGON

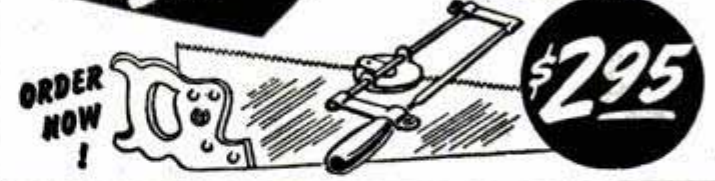

BUILD A BARREL FREEZER

Freeze and store a whole barrel of meat, fruit, etc. Parts are obtainable anywhere for a few dollars. Easy to make. Complete plans & 14 detail photos. **\$1**
MASON FREEZERS, CLIFTON SPRINGS, N. Y.

AC ELECTRICITY ANYWHERE! KATOLIGHT GENERATORS

Provide same kind of current as high-lines. A Katolight generator arranged for tractor drive will protect you from power line failure. Sizes range from 300 watts to 300 kilowatts. Mfgs. of Light plants, rotary converters, high frequency generators, DC and AC motors.

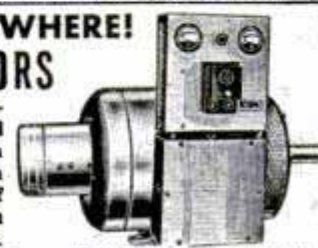

KATO ENGINEERING CO. 1402 FIRST AVENUE, MANKATO, MINNESOTA

FREE CATALOG OF POWER TOOLS

Free pocket size catalog checkoff of power-driven, time-saving tools for electric drill, drill press, circle saw and lathe. Write for your copy today.

BERTRAM V. ENGINEERING AND SUPPLY CO. 3125 HARRISON, KANSAS CITY, MO.

BIG LEATHER & CRAFT CATALOG!

1000's of items for Leathercraft, Textile Painting, Copper Tooling, Kits, Projects, Tools, Supplies, Etc. Send 25c (refunded with 1st order) to:

RUSSO HANDICRAFT SUPPLIES Dept. CD-8, 245 S. SPRING, LOS ANGELES 12, CALIF.

SHEET METAL BRAKES

Forms angles, flanges and Pittsburgh locks. 26 gauge steel, heavier aluminum. Cam locking. Portable, can be bolted to bench, or clamped to edge of truck. All steel, reinforced. Shipped Exp. Coll. 30" size, Wt. 54 lbs., \$26.50. 36", Wt. 66 lbs. \$31.00. 48", Wt. 100 lbs. \$45.00. Floor mountings, portable, 32" high, 30 lbs. \$7.00. **12" BRAKE.** Fits in vise to form difficult compound bends, up to 20 gauge steel. Not illustrated. . . . \$12.50 PP.



24" CURVE FORMER, 2 roll, 16 gauge, 2" to 2' dia. . . . \$10.00 P.P.
IRON BENDER, 1/4x2" capacity, 10 parts. All steel. . . . \$10.00 P.P.

Immediate Delivery. Order direct, cash or C.O.D. or send for folder.
YKKE BRAKE CO., P-1116 So. 27th St., Omaha 5, Nebr.

LAWN ORNAMENT-NOVELTY PATTERNS

28 Lawn Ornament Patterns, 25c. Other Patterns; 15-20" high; Dutch Girl, Dutch Boy, Pirate, Bull Terrier, Mexican Girl, Mexican Boy, Dwarf, Penguin, Flower Girl, 10c each. 25 Novelty Patterns, 30c. All 62 Full Size Patterns, \$1.00 Postpaid. Strother Pattern Service, Dept. CS-8, Box 129, Belington, W. Va.

SHALLOW WELL WATER SYSTEM

\$77.90
f.o.b., Miami



A new, compact Turbo Type Water Pump. Ideal for homes, gas stations, sprinklers, boosting water pressure. Automatic self-priming, capacity 390 G.P.H.—lifts up to 28 ft. 5 gal. Galvanized Tank. Heavy Duty 1/4 H.P. Capacitor type motor, with automatic overload protection! All in original crates. Size H-20", L-18", W-10". Shipping Wt. 50#. Send Check or M.O.

NATIONALLY ADVERTISED & GUARANTEED
FREE: Large, Electrical Supplies & Motor Catalogue
MARKEL INDUSTRIES, INC. 4300 N. W. 2nd AVE. MIAMI 37, FLORIDA

WHY NOT SAVE GAS?

Try Ganes At Our Expense



1/2 Million Use Ganes

BOOK GIVEN FREE TO ALL WHO TRY GANE NEEDLES

GANES REPLACE CARBURETOR IDLING ADJUSTMENT SCREW

Install Ganes in a few minutes on all cars



10 DAY FREE TRIAL IN YOUR CAR

- TEST FOR**
- ✓ BETTER MILEAGE
 - ✓ EASIER STARTING
 - ✓ FASTER PICKUP
 - ✓ BETTER IDLING

MANY GANE USERS REPORT UP TO 25% MORE MILEAGE AND ALL-AROUND BETTER PERFORMANCE . . . but don't take our word for it . . . see for yourself! Test Ganes in your car for 10 days **AT OUR EXPENSE**. Then, compare your mileage and performance and, if fully satisfied, pay only \$1.50 per needle (8 cylinder cars use 2). If not satisfied, simply return them and owe nothing . . . fair enough? Since authorities differ on the merits of Ganes, and some users report no improvement, **TRY BEFORE YOU BUY!**

ALSO FREE . . . Auto Economy Manual—SENT ABSOLUTELY FREE TO ALL WHO TRY GANE NEEDLES, tells how to save fuel, tires and brakes; how to obtain more speed, power and better performance from any car. Also introduces many new, ingenious auto economy products.

WRITE TODAY! ENCLOSE NO MONEY! PAY POSTMAN NOTHING!

List your name, address, make and year of car, no. of cylinders and make of carburetor if known. **YOUR TWO FREE BOOKS AND GANE NEEDLES WILL BE SENT IMMEDIATELY.**
NATIONAL AUTOMOTIVE RETAIL CORP., Dept. J-2
 350 W. Washington Blvd., Venice, California

Rich New Beauty for Dingy Walls!

AMAZING new Gold Bond Color Texture goes on like paint, covers walls like plaster! Covers plaster surface-cracks, gives drab walls new "sculptured" beauty. Perfect decoration for gypsum wall-board. Comes in eight brand-new colors.

3 EASY STEPS. Gold Bond Color Texture mixes with water, goes on smoothly with roller or brush. Then texture the surface with sponge or whiskbroom to get your own finish!

Get Gold Bond Color Texture Now at your paint store or your local Gold Bond Lumber and Building Materials Dealer.



NATIONAL GYPSUM COMPANY
 BUFFALO 2, NEW YORK

EAVESDROP...

behind the "IRON CURTAIN"! hear Aircraft! Ships! Amateurs!

Sensational

TABLE RADIO SW-54 \$49.95



GUARANTEED RECEPTION ON 3 SHORTWAVE BANDS PLUS STANDARD BROADCAST

Turn the knob and—presto!—Radio Moscow is pouring propaganda into your ears! Turn it again and hear music from Paris, or amateurs chatting, or an aircraft control operator! Thousands have discovered a whole new world of listening pleasure with the "Mighty Midget," by the makers of radio equipment for the famed Kon-Tiki Expedition. Write for details and name of nearest supplier.

NATIONAL COMPANY, INC.
 61 Sherman St., Malden, Mass.

Get "inboard control" with this FULL SHIFT outboard

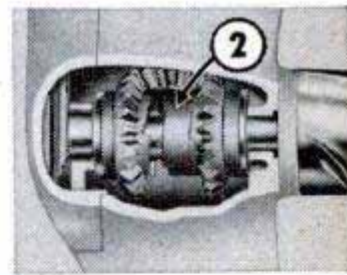

A SCOTT-ATWATER SHIFT MOTOR gives you all the maneuverability of an inboard cruiser—forward, neutral, reverse. Convenient shift lever (1) moves gear selector (2) right to engage reverse gear, left for forward. When selector is centered, motor is in neutral—the propeller doesn't turn. This full shift comes on four Scott-Atwaters, 5 to 16HP. Another reason why...

You get MORE with Scott-Atwater!

SEND FOR FREE CATALOG! Dept. 29, Scott-Atwater Mfg. Co., Inc., Minneapolis 13, Minn.

Name

Address

City State

(Export Dept.—American Steel Export Co., 347 Madison Ave., N.Y. 17, N.Y.)

IT'S EASY TO MAKE \$3 AND MORE SHARPENING LAWN MOWERS

AN HOUR

IN YOUR SPARE TIME

J.S. of Michigan writes "I figure my profits for last season at over \$1,000.00 part time." C. R. of Ohio tried the Universal on a part-time basis and now gives it full time. He says "I have taken in, last season, more than \$3,500.00."

ONLY ON THE UNIVERSAL LAWN MOWER GRINDER can the inside face and edge of the stationary blade, and all reel blades, be ground to proper clearance **ALL IN ONE SET-UP** WITHOUT REMOVING ANY BLADE FROM THE MOWER. Write for details. Learn how to make real big money. **ROGERS MFG. CO., DEPT. PM-22, LINDSEY, OHIO**

SEND THIS COUPON NOW

ROGERS MFG. CO., Dept. PM-22, Lindsey, Ohio
Please send me full details about the profit possibilities of Lawn Mower Sharpening.

NAME _____
ADDRESS _____
CITY _____ STATE _____

Send for this **BIG NEW** Hunt's **WOODWORKERS CATALOG NO. 18**

ONLY 15c

NEW LOW PRICES

Offers greatest selection of fine domestic and imported woods--and hundreds of woodworkers items at bargain prices!

You'll save time and money with this big, new catalog. Contains everything wood craftsman needs. Shows 32 rare and fancy woods in color...43 veneer designs...275 scroll patterns...multicolor inlays, overlays, bandings...all kinds of tools, machinery, cabinet hardware, ornaments, mouldings...and pages of valuable tips, ideas, information, instruction. Send for your copy NOW. Only 15c

144 PAGES

QUICK DELIVERY

- on maple, poplar, oak, mahogany, red cedar, cherry, walnut, and many others--
- all properly seasoned and kiln dried.

MAIL THIS COUPON--TODAY!

CRAFTSMAN WOOD SERVICE CO.
2729 S. Mary St., Dept. A-2
Chicago 8, Illinois

Send me the big, new, money-saving Catalog No. 18. Enclosed is 15c.

Name _____
Address _____
City _____ Zone _____ State _____

SPEEDI-GLU

PLASTIC GLUE FOR WOOD

it's NEW
it's FASTER
it's STRONGER

- EXTRA SPEED--Strong bond in just 30 minutes!
- EXTRA SAVINGS--Spreads 25% further!
- EXTRA EASE--No heating or blending, ready to use!
- EXTRA BEAUTY--Transparent when dry!

This amazing plastic glue replaces old type glues. Ready for immediate use, allows ample assembly time. Use SPEEDI-GLU on woods, linoleum, fabrics, paper, ceramics, leather, porous pottery, felt, fibre, etc. Excellent for gluing formica type plastics to wood.

SEND NOW for . . . Popular Mechanics Introductory offer . . .
8 ozs. SPEEDI-GLU \$1.00 postpaid
The Gallon Economy Size \$7.00 postpaid. Money-back guarantee!

WHITE ADHESIVE CO., Dept. 2H, NEWTONVILLE 60, MASS.

ELECTRIC MOTOR BARGAINS!

| | | | | |
|----------|------------------|----------------------|---|--------|
| 1/4 HP | 1750 RPM | 110 Volt | 60 Cy. | \$8.50 |
| | Split Phase Type | #J100 | | |
| 1/2 HP | 3450 RPM | 110 Volt | 60 Cy. | 19.75 |
| | Cap. type, #333 | | | |
| 1/2 HP | 1750 RPM | 110/220 Volt | 60 Cy. Rep. Ind. type #287 | 27.50 |
| 3/4 HP | 3450 RPM | 110/220 Volt | 60 Cy. Rep. Ind. type #205 | 32.00 |
| 1 HP | 3450 RPM | 110/220 Volt | 60 Cy. Rep. Ind. type #199 | 39.00 |
| 1 HP | 1750 RPM | 110/220 Volt | 60 Cy. Cap. type, #E150 | 52.00 |
| 1 1/2 HP | 1750 RPM | 110/220 Volt | 60 cycles, Ball Bearing, Cap. type #345 | 67.50 |
| 2 HP | 3450 RPM | 220 Volt, 60 cycles, | Repu- sion Induction type #126 | 65.00 |

ROBERTS ELECTRIC CO., 849 W. Grand, Dept. 22, Chicago

JITTERBUG • CATCHES MORE FISH

The old favorite. Noisy surface bait. World's best hooker--day or night. Gurgling, paddling action of the double-lobed lip makes fish strike hard. At your dealer 5/8 oz. or 3/8 oz. \$1.25. Musky size \$2.00.

FRED ARBOGAST & Co., Inc., 2242 W. North St., Akron 3, Ohio

FREE WRITE TODAY FOR YOUR BIG FREE ARBOGAST COLOR CATALOG--FULL OF PICTURES OF CATCHES

DEPENDABLE CRAFT SUPPLIES

LEATHER CRAFT • PLASTICS • POTTERY
CRAFT • BLOCK PRINTING • BELT CRAFT • TEXTILE COLORS • POWER TOOLS • WOOD BURNING • INSTRUCTION BOOKS • ETC.

DWINNELL CRAFT SHOP
Dept. PM-252--Wheeling, W. Va.

WRITE FOR CATALOG SINCE 1928

WAR SURPLUS BARGAINS

\$500,000.00 INVENTORY for QUICK LIQUIDATION

Surplus items--hundreds of them for home, shop, factory, farm and outdoor use. New items, used items, reconditioned items--all at tremendous savings--all priced for quick sale.

Page After Page of Values

This big catalog shows page after page of amazing money saving values. Write for your copy today. Send 10c to cover postage, mailing, etc. Write today!

SEND TODAY FOR YOUR COPY **10c**

STARK'S Dept. 509 So. STATE STREET CHICAGO 5, ILLINOIS



Does The Job
When Other Tools
FAIL!

LOCKS
with
TON-GRIP

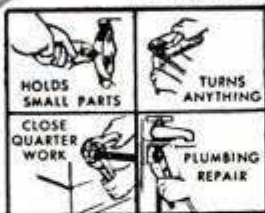

Actually gives your hand Ton Gripping power to do more jobs easier! It LOCKS, CLAMPS, TURNS, TWISTS, PULLS, CUTS, RATCHETS, HOLDS! Has 1000's of uses as a Pipe Wrench, Adjustable End Wrench, Locking Wrench, Super Pliers.

With Cutter—No. 7W, 7", \$2.25; No. 10W, 10", \$2.60. Without Cutter—No. 7C, 7", \$1.95; No. 10C, 10", \$2.25. Straight Jaw model—No. 7, 7", \$1.85; No. 10, 10", \$2.15. Order From Your Dealer.

PETERSEN MFG. CO., Dept. P-2, DeWitt, Nebr.



HOT WATER
From ANY
COLD WATER FAUCET!

It's easy to get as much steaming HOT WATER as required INSTANTLY.

Yes, you can now have continuously running HOT water with the JET INSTANT HOT WATER

HEATER, in kitchen, summer cottage, camp, office, factory or farm. Regulates from LUKEWARM to REAL HOT with a turn of the tap. A cinch to attach to any standard faucet . . . No tools needed. Plugs into any 110 Volt AC or DC outlet. Durable construction of gleaming chromed steel and porcelain. 8 foot U.L. Cord. Only \$4.95 complete.

MONEY BACK GUARANTEE! FACTORY GUARANTEE!

Send only \$1.00 deposit, balance C.O.D. plus postage. Send \$4.95 and we pay postage. THE JET must give you satisfactory service!

SUCCESS PRODUCTS, 246 Roebling St., Dept. 769, B'klyn 11, N.Y.

Complete Telephone Kit Only



AT
TERRIFIC SAVINGS



\$3.98

2 PHONES operate up to 500 ft. on standard No. 6 batteries. Each phone has a call bell—clear, easy-to-hear reception. Here's a convenient time-saver for home, shop, or farm. Simple to install—complete instructions included. Add 25c Postage.

ORDER NOW

U. S. GOV'T SURPLUS
"BARGAIN BOOK"

JUST OFF THE PRESS!

Greatest Bargain Book ever offered . . . low, low prices, terrific savings on scarce war surplus.

Mail 10c TODAY - NOW - begin saving on hundreds of items for farm, home, shop, sports. Get your Bargain Book by return mail.



500 BARGAINS
- FARMS - SPORTS
- HOME - SHOP

MAIL TODAY Only
10c

FISLER SALES CO.

723 WALNUT ST., DESK PM2, KANSAS CITY, MO.



Make Money
with Spare-Time
Plowing & Mowing!

5-HP

GRAVELY Tractor

OFFERS 20 MONEY-MAKING TOOLS!

Make good money this spring plowing gardens with the powerful Gravely Tractor! Perfect seedbed in one operation. It's easy to earn \$30 to \$40 a week—extra!

After plowing season, use Sickle or Lawn Mower attachments for cutting brush, weeds, lawns. Remember, with 20 tools, Gravely does every lawn, garden and field job! All-gear drive, power reverse; moderate investment . . . An easy way to get a Gravely of your own — and make a profit besides! "Power vs. Drudgery" tells you how to put Power to work making money for you! Write today!



GRAVELY

BOX 263 DUNBAR, W VA

FIELD-TESTED FOR 31 YEARS

NU-WAY HEAVY DUTY CUTTING UNIT
with Timken Roller Bearings

PRICE

\$16.50

WHY PAY MORE



Build your own rotary type lawn or weed cutter.

Take the hard work out of weed cutting. Build yourself an up-to-date weed and lawn mower with the Nu-Way heavy duty unit.

Write for Free Circular—We Supply Cutting Unit Complete
TRACTOR-LITE MFG. CO., Spirit Lake, Iowa

Build Your Own Drill Press

vises, clamps, hand tools . . .



Yes, you can have the satisfaction of saying "I made it myself"—and save money, too! I now offer these tested plans to workshop hobbyists after successful applications in over 2500 industrial arts and vocational schools in 47 states! Plans are fully dimensioned and properly engineered to produce high-grade machine and hand tools with a minimum of power equipment! Simply send 50¢ in stamps or coin for big 36-page book of 30 working drawings on a variety of home workshop equipment that you can build yourself.

This book also lists high-quality castings and other basic parts which we can supply for these projects at attractive prices. Money back guarantee. For both the beginner and experienced man. Write: Clarence Struck, Gen. Mgr., **CASTING SPECIALTIES, 1925B N. 49, Milwaukee 8, Wis.**



The original safety saw blade tested and approved by the world's leading laboratories

For a dependable safety saw blade that really minimizes danger and "kick-backs" from circular sawing—insist on the genuine PTI blade. (U.S. Patent No. 2,559,355).

Precision made of chrome vanadium steel by one of the world's leading saw blade manufacturers. Cuts cleaner, quieter, smoother—and requires 30% less power. Available in sizes from 7" to 16" and for standard makes of portable saws.

NEW! PTI saw sharpener for safety blades

Get franchise in your locality! WRITE FOR DETAILS.

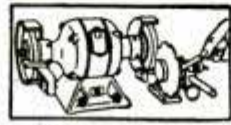

INCORPORATED, 401 Broadway, New York 13

TAKE LESS THAN 1 MINUTE TO

Keep Paint Brushes Like NEW!

Store Them Dry. They Stay Soft and Flexible
READY FOR INSTANT USE!

PROCESS 33

INSTANT PAINT BRUSH CLEANER

- Quickly cleans fresh paint from a paint brush or roller.
- You can paint instantly with another color—or store brush dry—it will stay soft.
- Economical—can be used again and again.
- Safe for all brushes and rollers.

Pint 59¢ | Quart 98¢ | Gallon \$3.25



FILE SAWS THE RIGHT WAY
SO EASY with this new filing jig and jointer anyone can now sharpen any handsaw like new! When file hits hardened steel rollers teeth are finished and EXACTLY THE SAME HEIGHT. All teeth cut and saw runs true and smooth. Jig and instructions \$2.95 postpaid. FREE FOLDER.



SHARPEN YOUR CIRCULAR SAWS

The RIGHT WAY on your own saw table. Sharpens rip, cutoff, hollow ground and combination blades—6" to 10" Saws stay round with correct bevel. Precision made, easy to use. GUARANTEED. Only \$8.95. Includes \$3.00 Grinding wheel.

"TRU-CIRCLE" saw set automatically sets teeth at 10° or more. \$2.95

AT DEALERS OR POSTPAID

A. D. McBurney, 317 E. 4th St., Los Angeles 14, Cal., Dept. A-14

POWER MOWERS & KITS **FREE PLANS**



Build your own quality mower with our LOW COST KITS. Parts, Engines. Free Plans guide you. 3 and 4 Wheel Kits, complete. Parts precision finished, ready to use. Write TODAY for Free Plans, Low Prices, Parts List and Guarantee.

America's Finest Power Mowers completely assembled in 3 and 4 wheel models. Belt or direct drive, 18" and 20" sizes. Nationally known make engine. Latest improved features, sturdy construction and money back guarantee fully described in color folder. Write today.



TRIANGLE MANUFACTURING CO., Box M-10, Fort Scott, Kansas



MANUFACTURE LEATHER LOUNGES FOR KITCHENS AND RESTAURANTS

Frames, springs, filling, construction simplified.

Anyone handy with tools can build one. Send \$5.00 for complete plans and instructions, or 10¢ for brochure.

STEFAN GALENSKI
Designer & Manufacturer

2221 BROADWAY BUFFALO 12, NEW YORK

NEW! CHEAP! OIL BURNER
SWEEPING THE COUNTRY!



SALESMEN BIG MONEY

SLIPS INTO ANY COAL RANGE, STOVE OR FURNACE

Amazing quick, intense heat. By finger-tip control. Cheaper than coal. No more shoveling coal or ashes. SENT ON TRIAL. Prove it pays for itself quickly by what it saves. Big bonus for testing. We'll let you try one in your own home for one month. Write for details today. NORTHWEST MFG. CO., 360-B Main, Mitchell, S. Dak.

TEST YOUR OWN RADIO AND TELEVISION TUBES AT HOME!!!



CONDUCTANCE TUBE TESTER

No tube manual or knowledge of tubes necessary—tests all tubes—100% accurate for direct shorts, opens, burned out tubes. Buy it—Try it—If not satisfied, return in 5 days—Money cheerfully refunded.

ONLY \$4.98

ALSO AVAILABLE!
CONDENSER TESTER
CHECKS SHORTED, OPEN AND LEAKY CONDENSERS **6.98**

E-Z TESTER Co. DEPT. P.M. MACON, GA.

G. N. Coughlan Co. 59 St. Louis, Williams & Taylor

You'll be **KING**
of the open road!

Ride the NEW

Cushman

EAGLE

50 miles per hour

75 miles per gal.

3/4¢ per mile total operating cost

It's a treat to ride the Cushman "EAGLE"—smartly styled, with superb riding comfort, and low cost transportation all in one great new Cushman. The "EAGLE" is unmatched for performance. Operates for less than one penny per mile. You'll save time, money and eliminate high cost maintenance. Go everywhere on a Cushman "EAGLE." Work, school, errands, deliveries—hundreds of uses. It's great for the open road. Go Cushman in '52!

Write for new FREE illustrated literature
See your nearest Cushman Dealer

CUSHMAN MOTOR WORKS, INC.

920 NO. 21 ST., LINCOLN, NEBRASKA



NEW! 10

FORWARD SPEEDS

ALL AT MAXIMUM HORSEPOWER

—PLUS REVERSE

Bready GARDEN
TRACTOR

with SELECT-O-SPEED Transmission

The most practical garden tractor ever built. You can instantly change tractor speed, while tractor is running, yet always have maximum power at the drawbar! You select the speed to suit the job. Other new features include Safety Reverse and Free Wheeling. Complete line of implements for year 'round use. Don't buy a tractor until you've seen the new Bready! WRITE TODAY for free literature, name of dealer.

The **BREADY TRACTOR** and
IMPLEMENT Company

Box 230

Solon, Ohio

FEBRUARY 1952



Handy Hank says:

"Every man's a handyman with
PLASTIC WOOD"

Reset loose drawer pulls—

Replaces splin-
tered wood . . .
makes loose
screws firm!



Seal drafty cracks—

Fills openings
easily . . . dries
tight and hard!
Resists weather!

Repair loose tiles—

Holds tiles
firm on wall!
Easy!



Also useful in filling cracks in floors, nail
and screw holes, repairing broken toys.
Handles like putty . . . hardens into wood!

**PLASTIC
WOOD**

A CELLULOSE FIBRE FILLER

IN CANS
OR TUBES



WEATHER RESISTANT



New!



60 cycle, 110-120 volt AC

No. 504
Write for
FREE
CIRCULAR

DOUBLE ARC MOTION Doubles SANDING ACTION!

Four reasons why new Syncro No. 504 is your best sander buy: (1) tremendous increase in power, (2) exclusive Double Arc Motion combines best features of orbital, straight-line sanding that **DOUBLES** sanding action, (3) light for easy vertical or overhead work, (4) sanding area approx. 14 sq. in.! SYNCRO gives a satin-smooth, high gloss finish. Ideal for polishing, too. COMPLETE with new BUILT-IN Reactance Type Electric Motor, 10 sand-papers, lamb's wool and fabric polish pads, at dealers or write today for new FREE CIRCULAR! (Dealers, Jobbers—write!)



No. 504
DE-
LUXE
with
Metal
Case

SYNGRO SANDER

ELECTRIC

SYNGRO CORPORATION,
Dept. D-22, OXFORD, MICHIGAN

300 Power Import MICROSCOPE \$14.95

Laboratory Model postpaid



Triple revolving turret has 100 power, 200 power and 300 power lenses! No frills, just excellent optical qualities, delicate adjustment, solid construction. Its quality and price astounded biology instructors. A lifetime bargain for students, schools, labs, research, amateurs. *Anyone can now own one.* (Performance cannot be duplicated for \$75.00)
FEATURES: Fine micro adjustment, adjustable plano substage mirror. Dovetail hardwood case included free. If you are not amazed by its quality, send it back in 10 days. Your money refunded immediately. Send check, cash or money order for \$14.95.

PROFESSIONAL DISSECTING KIT \$4.95

FOR MICROSCOPIC SLIDE WORK IN
BIOLOGY, BOTANY, ZOOLOGY

A special purchase for our microscope customers. The professional equipment in this complete kit is worth more than \$15—made to the specifications required by researchers and biologists. Ten pieces in fitted hardwood case; two fine steel scalpels, two prof. dissecting instruments, one magnifying glass, one special scissors, one special tweezers, three blank slides. Perfect for universities, doctors, students. Postpaid..... **\$4.95**



8X COATED PENSCOPE \$4.95

postpaid

20, 40, 60 Power Pocket MICROSCOPE

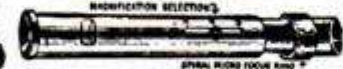

Pocket telescope fits in your pocket with clip like fountain pen, extends to form a powerful scope for spotting game, watching sports events, etc. 8 Power coated lens, more powerful than standard army binoculars. A special bargain at this low price.

Select whichever power you want, then focus to pinpoint sharpness with spiral ring. Finest optics, amazing versatility. A compact new precision instrument for field study.
Postpaid..... **\$4.95**

Money-back 10-day guarantee on all items. Send check, cash or M.O. Free catalog on request or included with order. Calif. residents add 3% state tax.

AKRON ARMY-NAVY STORES 4400 Sunset Blvd. Dept. 2-P
Los Angeles 27, Calif.

WELD ONLY \$1475 F.O.B. complete!

No experience needed. Follow simple instructions, weld on iron, steel, bronze, brass, aluminum, and other metals. Plugs into any properly wired 110 volt A.C. or D.C. line. Make or save time and money doing repair work for yourself and others. Repair men, farmers, tinsmiths, home and auto owners, hobbyists, etc., say **FOUR-WAY** pays for itself over and over. Order today or send for Free details.



Larger Equipment Available on Request
FOUR-WAY WELDER COMPANY, Dept. F2-BC
2326 S. Michigan Ave. • Chicago 16, Illinois

ORDER
NOW
10 DAY
TRIAL

NEW SAW SHARPENER

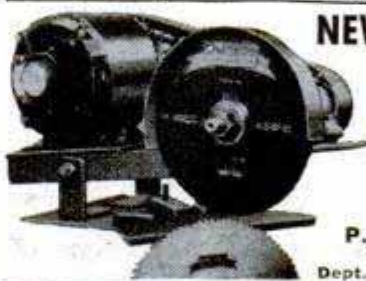

Improved #64 Hand Gummer sharpens all types circular saws 4" to 20" diam. Ideal for saw shops. Self-Centering adjustment for quick, easy set-ups. Complete with 1/4 HP motor, 1 grinding wheel & cord. \$79.50 FOB Portland. Wt. 70#. SEND FOR FREE LITERATURE.

P. T. HOBBS MACHINERY
8375 N. INTERSTATE AVE.
Dept. P.M.-61, PORTLAND 17, OREGON

NOW! GRIND YOUR OWN DRILLS



Sharpen 3/32" to 1" drills like an expert in 30 seconds. Precision lock insures factory accuracy. No experience necessary. Full instructions. Use with any hand or power grinder to keep drills extra sharp and true cutting. Guaranteed. Order Today \$2.95 postpaid (COD postage extra)

Another Speedcor Tool
THE SPEED CORP., PM-2
512 N.E. 73 PORTLAND 16, OREGON

SUMP PUMPS 2,400 GALLON CAPACITY



1 1/4" outlet — No screen to clog — fool proof
The time tested Lokomona sump pump is absolutely automatic — has a special fool-proof trap at the intake—oilless bearings at the bottom. Made of aluminum castings, it's 42" high and carries a 1/4 H.P. 110 V. A.C. heavy duty motor. The pump is designed for continuous service. Enclosed switch. All parts always available. Order yours today. C.O.D. If cash with order, we pay postage.
MONEY BACK GUARANTEE

LOKOMONA PUMP CO., P.O. BOX 86, ROYAL OAK 1, MICH.

Build your own JET ENGINE!



Order these plans today
1. JET PROPELLED BICYCLE. Assemble your own. Photo and instructions, \$1.00.
2. HOW TO MAKE EXPERIMENTAL JET ENGINES. Seven sheets drawings with information and instructions \$2.95.
3. BOTH OF ABOVE in one order \$3.75. SEND NO MONEY. Order both at once \$3.75 C.O.D. in USA plus c.o.d. postage. Send check or Money Order and we pay postage. Get other information too. Rush Order.

J. HOUSTON MAUPIN, Dept. 55, Tipp City, Ohio

POSTPAID ANYWHERE IN U.S.A. WE FURNISH ALL MACHINED METAL PARTS, EVERY SCREW, NUT, BOLT, WASHER, AND COMPLETE PLANS FOR THIS...



BIG 10" POWER SAW
\$10.95 FULL REFUND IF NOT SATISFIED & WOOD IN 10 DAYS
LESS GUARD
COMPLETE PLANS 10c
MARCUS-POLLAK
DEPT. N, ROYERSFORD, PA.

ASSEMBLE IT YOURSELF WITH SIMPLE HOUSEHOLD TOOLS!

Make Money
SELLING
Eshelman
Tractors
and doing
GARDEN
WORK



ESHELMAN FOR BETTER
LAWNS
and GARDENS
also POWER MOWERS
and RIDING TRACTORS
Women can operate it
Also Power Reverse
Free Catalog. Write
ESHELMAN, Dept. 306
119 Light St., Balto 2, Md.

AMAZING NEW WOOD-TURNING TOOLS!

Outlasts Steel
Up to 50 to 1!

SHARPEN ONCE IN 12-YEARS!
(UNDER NORMAL USE)

These remarkable tools tipped with TUNGSTEN CARBIDE will astound you with their performance. They work FREE HAND equally well in wood, plastic or soft metals—and at the same time hold their razor-like edge almost indefinitely. Tests show that they will turn wood or plastic for days and days CONTINUOUSLY without showing any signs of dulling. They are the finest tools available at any price. Beautifully finished 5" blade—flush ground, polished tip—finest brass tube ferrule—9" hardwood handle—over all length 14"—25 tools to choose from: round & square nose from 1/8" to 1 1/2";—1/4 and 3/16 cut off; 1 1/2"x30° skew, spear, r. & l. skews, turning and parting. Amazingly Low Prices! Write at once for free literature.

JOHNS MFG. CO., DUNELLEN 14, N. J.



CAPE COD CHAIRS TRELLISES • ARBORS DUTCH WINDMILLS

Chairs style B-C-A PLANS 50c Ea., all 3 only \$1.00. 12 different trellis designs PLAN of all 12 only 50c. Authentic 40" high Dutch Windmill Detailed PLAN only 75c. Unique 40" high Light-house having copper lantern, ideal for garden or on lake shore of summer home. Large detailed PLAN 75c.

SPECIAL ALL PLANS ABOVE \$3.00 VALUE ONLY \$2.50
SEND 10c for catalogue of many fine projects.
Dept. P37
CRAFTSMAN'S MODEL CO. DELAFIELD, WISCONSIN

HASTINGS STEEL-VENT PISTON RINGS

The best money you can spend on your car!

Clark EXPANSIVE BIT



CUTS BETTER • COSTS LESS!

Accurate, fast; cuts smooth holes in hard or soft wood. Chrome vanadium steel blades, all chrome body. No. 250, 1/2"-1 1/2", \$1.89; No. 251, 7/8"-3", \$2.19. GUARANTEED. At your dealer or write Dept. PM-2

ROBERT H. CLARK COMPANY • Beverly Hills, California

Unlimited Capacity

Only SHOPSMITH has horizontal drill, with 4" quill feed, time-saving jigs, unlimited capacity. Rugged unit converts to saw, sander, lathe and vertical drill press. Write for free catalog.

SHOPSMITH, Dept. 181-B
12819 Coit Rd., Cleveland 8, O.



FOR REPAIRING ALL ELECTRICAL APPLIANCES-MOTORS



- Measures AC/DC Voltages, Current — Resistances, etc.
- Measures current consumption while appliance under test is in operation. Appliance or utility plugs directly into front panel. Insulated clip-end leads included for motors, etc.
- A sensitive direct reading resistance range accurately measures all resistances in appliances, motors, etc. Enables continuity checks and tests for shorts and opens.
- Tests thermostats, radio tube filaments, bulbs, fuses; fluorescent, condensers, switches, field coils, circuit breakers, lighting systems, etc.

Handsome bakelite case. Complete with test leads, instructions..... **1390**

SOLD ON EASY PAYMENTS AT THE NET CASH PRICE

No Interest or carrying charges added. Simply remit \$3.90 with order, pay balance, \$2.00 per month for 5 months.

SUPERIOR ELECTRONIC CO., INC.
Dept. B-53 • 227 FULTON STREET • NEW YORK 7, N.Y.

SPEED-HEDS Ratcheting (NO MOVING PARTS) COMBINATION WRENCH

HERE'S WHY "SPEED-HEDS" ARE 3 TO 5 TIMES FASTER: "SPEED-HEDS" and standard Old style open-end never leave the nut wrenches grip the nut precisely on same wrenches must be ... they actually points! On worn nuts SPEED-HEDS removed and ad-ratchet in place! Grip where socket wrenches slip! Tested at every turn.

CANT SLIP! FULL TURNING POWER! GUARANTEED!

MF-1 3 pc. UTILITY SET 7/16, 1/2 and 9/16" \$3.45
MF-2 5 pc. MASTER SET 3/8, 7/16, 1/2, 9/16 and 3/4" \$5.90
MF-3 7 pc. SUPER SET 3/8" to 3/4" inclusive by sixteenths \$9.40

25% Deposit on C.O.D.'s. CALIFORNIA RESIDENTS add 3% Sales Tax. SEND \$1.00 DEPOSIT (refunded on purchase of \$9.00 or more) for 1952 edition of leather bound, loose leaf CATALOG. Hundreds of time & labor saving mechanics' hand & single purpose specialty tools illustrated & priced at the MINIMUM "Net" prices as recommended by manufacturers for professional mechanics. FACTORY GUARANTEED, nationally known tools by Proto, S-K, Viechek, Utica, Channel-Lock, Rimac, Keolite, California Tool, K-D, All-Power etc. SATISFACTION GUARANTEED! NOT WAR SURPLUS!

CENTRAL TOOL CO. 122 Golden Gate Ave. San Francisco 2, Calif.

DRAINS Cellars, Wash Trays; CIRCULATES Oil; IRRIGATES Gardens!

ORIGINAL "Type P" Pump has 1,001 year "round uses" — home, shop, garden, farm. DRAINS cellars, cisterns, wash tubs, ditches, pools. IRRIGATES gardens, lawns, truck patches. SPRAYS crops, orchards. CIRCULATES oil, coolant. SUPPLIES water to elevated tanks from wells as deep as 25 feet. 2400 gals. per hr. capacity. 360 GPH 75' high. 1500 GPH from 25' well. 1" suction and 3/4" discharge ports fitted for hose. Use 1/2 to 1/2 HP motor or engine. 1/2" Stainless Shaft: Oil-less Bearing. DOES NOT CLOG OR RUST!

ONLY \$6.95



WHICH OF THESE 5 PUMPING UNITS DO YOU WANT?

Easy to Assemble!
Easy to Use!



LITTLE GUSHER Irrigates, drains, waters livestock, fights fires! Pumps 2000 GPH 25' high or 360 GPH 75' high. 2 HP engine with 3" power take-off V-pulley. Adjustable from 1700 to 4500 RPM. Portable. Dollar for dollar, pound for pound, the best pump money can buy. Complete with valve at \$69.00 1 1/2" Bronze Foot Valve, 1 1/2" suction hose, \$1.25 per foot. 1 1/4" discharge hose, \$1.00 per foot.

BIG GUSHER Pumps 7000 GPH. Complete with 3" of 2" suction hose and 2" foot 2" suction hose, valve, only \$89.00 \$1.75 per foot. 1 1/2" discharge hose, \$1.25 per foot.

TYPE C-4

Direct drive. Ideal for plumbing fixtures below sewer line. Complete with 1/4 HP motor, \$25.95. Without motor, only \$11.25.

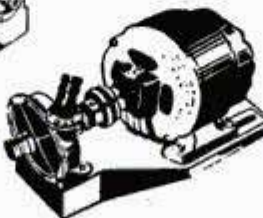

Low-Cost Accessories

All Bronze Foot Valve for 1" hose, \$3.45
1" Suction Hose, per foot \$.38
3/4" Discharge Hose, per foot \$.22

Money Back Guarantee

All prices POSTPAID if money order or check with order. West of Mississippi & Canada, add 50c for Type P; \$1.00 for other models.

LABAWCO PUMPS, Belle Mead 22, New Jersey



TYPE D-3 Cleans 40' well or cesspool quickly! Drains, Irrigates, etc. Operates in any position. 400 GPH 40' high; 1400 GPH 20' high. Complete with 1 1/2 HP motor, \$32.95. Without motor, only \$12.85.

TYPE D-4 Drains cellars, pools, boats. 1500 GPH 5' high; 600 GPH 13' high. Same as D-3 except with 1/2 HP motor \$27.45. Without motor, \$12.85.

AUTOMATIC SWITCH for 24" sump, fits D-3 and D-4. \$4.60.



The **COASTER BRAKE**
with
**SELF-ALIGNING
BRAKE SHOES**



**Ride
a Bike
it's
Fun!**

Self-aligning brake shoes give quicker stops, longer life, easier pedaling. It's another Bendix feature that makes the Bendix® Coaster Brake the outstanding performer in its field. Your dealer will put on the brake you want—so just say "Bendix Coaster Brake." *REG. U.S. PAT. OFF.

**DOUBLE THE FUN
WITH A  BENDIX
COASTER BRAKE**

ECLIPSE MACHINE DIVISION of
Elmira, New York



**BUILD AN
IDEAL
LAWNMOWER SHARPENER
BUSINESS!**

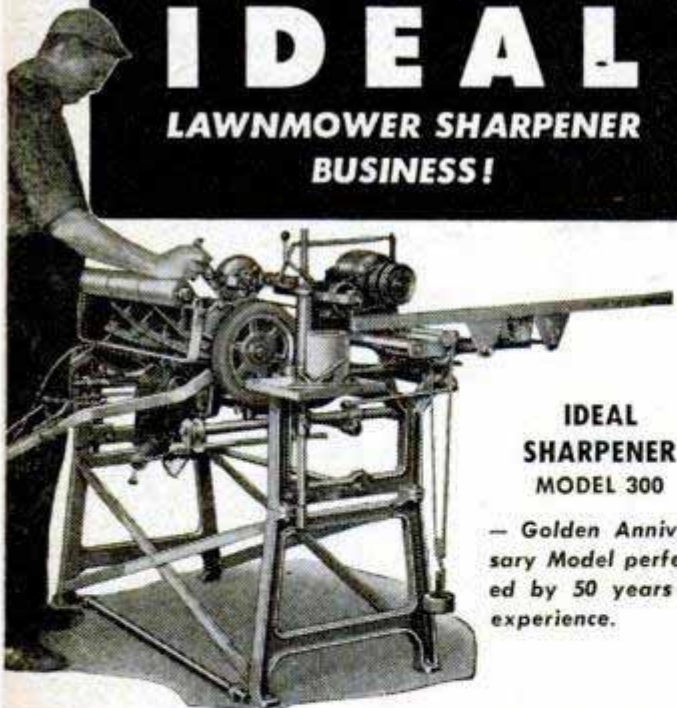

**IDEAL
SHARPENER
MODEL 300**

— Golden Anniversary Model perfected by 50 years of experience.

Build a profitable business of your own with the outstanding lawnmower sharpener — the IDEAL MODEL 300. Ruggedly built, easy to operate, sharpens all mowers without disassembling, handles all mowers. Get your share of profits; write for information today.

THE FATE-ROOT-HEATH COMPANY
Dept. Q-3 — Plymouth, Ohio

DRILL PRESS OWNERS!

HERE'S 1 TOOL WITH 5 DISTINCT USES



**THE BARRON MULTI-PURPOSE
ROTARY WOOD PLANER**

PLANES & SURFACES • PANELS & BEADS
ROUFS & GROOVES • RABBETS • TENONS **\$7.50** COMPLETE

Finest precision performance—certainty of skilled workmanship—time-saving, money saving short cuts—yours with world famous Barron Drill Press Tools. Fifteen important operations—all available on any standard drill press—with Barron Accessories. Equip your shop with these versatile exclusively designed tools—and save up to \$500. 200,000 Barron owners have bought on our liberal 10 day full money back guarantee. Order, or write for catalog.

BARRON TOOL CO. INC.

205 Architects Bldg., Detroit 1, Mich.

**FREE
Workshop
Guide &
Catalog**

**Sure Shot INSTANT
GUN BLUE**

COLD CHEMICAL NEVER FAILS

Ideal rust resistant finish for home workshop projects, tools, instruments, guns and metal sports gear, models and hundreds of other items where a beautiful, longwearing, easily applied blued finish is desired.

Anyone can use it.
2 FL. OZ. BOTTLE \$1.00

BAYPORT CHEMICAL CO., Dept. P, Linden Hills Station
Minneapolis 10, Minn.

**KINKADE GARDEN TRACTOR
and Power Lawnmower**

A Practical Power Plow and Cultivator for Suburbanites, Gardeners, Florists, Estates, Fruit, Nursery & Poultrymen.

Easy Terms - Write Today

American Farm Machine Co.
1058 33rd Ave. S. E. Minneapolis, Minn.



Catalog
Free

WOODWORKING VISE

for amateurs and professionals

USE UPRIGHT - FLAT - AT ANY ANGLE

Only \$9.95, f.o.b. factory. Money-back guarantee.

THE WILL-BURT CO., Dept. PM-12, Orrville, Ohio



SURE FIRE SPARK PLUG INTENSIFIER

NEW UNUSUAL MULTIPLIES HEAT OF SPARK

Insures easier starting, smoother, more economical operation of Outboard Motors, Power Mowers, Generators, any 2 or 4 cycle gasoline engines. NO MORE FOULED PLUGS, SURE FIRE burns excess gas for more power - greater economy - keep plug points clean - lasts longer - pay for itself.

Money back guarantee.

SPECIAL INTRODUCTORY OFFER 50¢ each postpaid
Dealer inquiries invited Wahl Products, Inc.
Eau Claire, Wis.

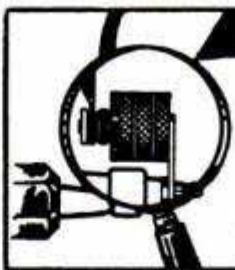

Light!

800 ft. spotlight — brilliant floodlight — from one electric lantern, Delta POWERlite! Convenient. Safe. Economical. Uses one 6-volt dry battery. Buy at hardware, sport, or electrical stores. Try one!

DELTA ELECTRIC CO., MARION, IND.



\$4.95 less battery

Delta POWERlite 2-LITE ELECTRIC LANTERN

AVIATOR'S OXYGEN OUTFITS
 Brand New! Bail out type. Consists of all metal tank, brass release valve, 0-3000 lb. gauge and breather hose, all enclosed in khaki colored canvas bag. Tanks are charged with breathing oxygen at 1800 lbs. pressure. Ideal emergency oxygen supply for airmen, mountaineers, firemen, paint shop workers, and others. Shipping weight, 4 lbs. **NOW ONLY \$5.95**

BRAND NEW RELAYS
 220 VOLT Arrow-Hart & Hegeman Midget Relays, Cat. #28300-U, 220V, 60 C. 10 amps., AC. Single coil, double contacts. 4 mtg. holes. Can be adjusted for 110V applications. Size, 2 5/8" x 1 1/2" x 1 3/4". Shpg. wt., 8 oz. **NOW \$2.55**
ORDER FROM THIS AD! Prices F.O.B. St. Louis, Mo. Include postage with check, cash or Money Order. **MONEY BACK GUARANTEE!**
 Edw. Aguado Trdg. Co. 689-F Arcade Bldg., St. Louis 1, Mo.

PROVOLUTIONARY OIL FILTERS
 Permanent Type Brand New! #G159J-40. The perfect filter to keep motor oil or hyd. fluid clean at all times. Protect your pump, engine, mid-gear or boat with this unit. Just turn handle and element is clean. Inlet and outlet ports take pipe or straight threads up to 3/4". Accommodates 18 GPM at 30 PSI. Mtg. bracket. Shpg. wt. 4 lb. \$13 value. **NOW \$3.95**
FREE! 2 male Reducer Connectors given with every Filter.

SAW WITH AMAZING SPEED & ACCURACY
EVERY 1/4" ELECTRIC DRILL A PORTABLE SAW IN ONE MINUTE!
FOR DEPTH & BEVEL CUTTING
 NO. 445 "ARCO-SAW" \$11.50 with DEPTH-BEVEL-RIP GAGE & 4" ARCO "HYCARBON" Crasscut Blade
 "ARCO-SAW" is ideal for work around the house, shop, factory. Makes the handsaw obsolete. You whiz through wood, plastic, plywood, etc. without effort. And you'll be amazed at its smooth, square cuts.
CUTS 1 1/4" or 2x4 by turning over CAN BE USED WITH ONE HAND!
LOOK AT THESE TERRIFIC FEATURES
 THE ONLY SAW WITH PRECISION GRADUATED GAGES. Depth gage: 0 to 1 1/4" depth, Bevel gage: 0 to 45° angle, Adjustable rip gage, Visual guide for accurate cuts, RIGHT ANGLE GEAR DRIVE eliminates clumsy dangerous direct drive, Safety-yoke for rigid connection and safety, 90-DAY FACTORY GUARANTEE.
 No. 444 "ARCO-SAW". Has same expensive features as No. 445—less gages. STILL ONLY \$9.95
 Depth-Bevel-Rip Gage. Quickly converts any No. 444 "ARCO-SAW" to a No. 445. \$1.95
 Lowest priced quality Replacement Blades. "HYCARBON" 4" Crasscut or 4" Combination \$1.60
TRY "ARCO-SAW" ON OUR UNCONDITIONAL 10-DAY MONEY BACK GUARANTEE.
ORDER TODAY! Insist on "ARCO-SAW" at your dealer. If not available send us check or M.O. (Postpaid). C.O.D.'s—postage extra. Write for literature of other tools.
ARROW METAL PRODUCTS CO.
 Dept. PM-2, 140 West Broadway, N.Y. 13, N.Y.

ONE-MAN SAWMILL LOW \$50.00 AS... \$50.00 DOWN
 Take BELSAW Portable Sawmill right to the trees—turn out valuable lumber for local yards—do "custom sawing" for neighbors. BELSAW lasts a lifetime. No crew needed. Power with old auto engine. Beginners get excellent results. Send postcard for FREE BOOK, "How To Make Lumber."
BELSAW MACHINERY CO.
 8116 Field Bldg., 315 Westport Rd., Kansas City 2, Mo.

DUST-O-VAC
FOR HOME WORKSHOP & INDUSTRY
 FOR ALL MACHINES — Collects & Bags Wood & Plastic Chips, Wood & Metal Dust, Wood Shavings. 110 AC, DC. SEND FOR FREE LITERATURE. **\$19.95**
 F.O.B. Yonkers
HEAVY CAST ALUMINUM BLOWER — ONLY \$11.25
 For workshop, lab., kitchen, cellar, app. 100 CFM. Send for circular.
UNIVERSAL YONKERS CORP., 137 ALEXANDER ST., M-2, YONKERS 2, N. Y.

BATTERIES!—START
 —a factory at home and re-cast junk batteries into new; latest achievement. We supply complete instructions and everything needed. Large daily profits!
BATTERY LABORATORIES, Dept. PM, Minneapolis 4, Minn.

SHARPEN CIRCULAR SAWS LIKE AN EXPERT
THE SUPER GADGET FOR HOME WORKSHOP
 Two simple adjustments. Gets hollow-ground, cross-cut or combination saw blades true and sharp. Fits 9" to 12" blades 1/2" to 13/16" centers. Includes file, complete instructions. \$6.95 postpaid. (C.O.D. postage extra.) Guaranteed—Money back if not satisfied after 10-day trial. Soon pays for itself. Order today. Free Folder.
SURE SHARP MFG. CO., Dept. M-2-2
 P. O. Box 24 Santa Ana, Calif.
\$6.95

FREE! Plans Show How To Build A POWER MOWER
 Also Plans Build A Gasoline Type That PULLS and STEERS ITSELF!
 Save time and work cutting grass and weeds — Build a whirl blade power mower cheaply without special tools or equipment. Send postcard for FREE Building Plans.
For As Little As \$19.95 Whirl Blade Electric Less Motor
WRITE TODAY
T & H MFG. CO., 811 EAST 31 ST., DEPT. 112, KANSAS CITY, MO.

New MOTOR BARGAINS for Home, Farm & Industry

 New Dayton 1/2 H.P. Induction Type 3450 RPM 110 V, 60 cy. 1 Ph. A. C. Motor. #GEH-5. Fob. \$18.50
 #DH-5-2. Same 220V Fob. Only \$15.00
 New General Electric 1/2 H.P. Cap/Ind. Ball Brg. 1750 RPM, double 1/2" shaft. 110 V. 60 cy. \$29.75
 1 Ph. A. C. Motor. #GE-17. Fob. \$29.75
 New General Electric 3/4 H.P. Cap/Ind. Ball Brg. 1750 RPM, double 1/2" shaft. 110 V. 60 Cy. 1 Ph. A. C. Motor. #GE-75. Fob. \$34.50
 New Dayton 1 H.P. Heavy Duty, Cap or Repulsion Induction, 3450 RPM, 110 220 V. 60 Cy., 1 Ph. A. C. Motor. #EH-1. Fob. \$52.00
 Same as above, 2 H.P. 220-V. 3450 RPM #EH-20. Only Fob. \$75.00
 Same as above 3 H.P. 220-V. 3450 RPM, #EH-30. Only Fob. \$97.00
 Write for FAN CIRCULAR: listing Blades, Guards, Motors. All Sizes for building your own Attic Fan, Window Fan or Room Cooler.
C. MARSHALL SALES,
 3546 W. Fullerton Ave., Dept. P-2, Chicago 47

16 to 1 SPEED REDUCERS
 For Display Table — Barbecue Spits — Toy Auto Gear Box — Experimental Uses, Etc. Gears Enclosed in Aluminum Housing. Bronze Gear, Hardened Worm, Input Shaft 1/4 in. Output Shaft 3/8 in. Speed Reducer #R 161 \$3.95 Post Paid

General Utility Motors
 Shaded Pole Motor, brushless, Non-Radio, T.V. Interfering. 110 V.-60 cy. A. C. Speed 1550 RPM for light machine duty, exhaust fans, furnace fans, blowers and many practical and experimental purposes. Handles fan blades from 12 to 20 inches.
 #UM-40. 1/40th H.P. Postpaid. Only \$6.25
 #UM-30. 1/30th H.P. Postpaid. Only \$7.50
 #UM-20. 1/20th H.P. Postpaid. Only \$8.75
 #UM-15. 1/15th H.P. Postpaid. Only \$9.75
FAN BLADES TO FIT THE ABOVE RESPECTIVELY
 12 inch blade. Only \$1.50
 16 inch Blade. Only \$2.75
 18 inch Blade. Only \$3.75
 20 inch Blade. Only \$4.75
 (all above blades are Postpaid)
 Three Speed Motor Control for above motors #1X-474. Postpaid. Only \$4.25

Volume Blowers for Heating, Ventilating, Exhausting
 Blowers for forced drafts, heating boosters, exhausters, coolers, dryers and dust collectors. 110 volt A.C., 50/60 cycle motors.
 #MBL-1 Midget Blower, 5 cu. ft. per minute, skeleton type motor, Postpaid. \$5.95
 #BL-50 Fifty cu. ft. per minute blower and motor, 4 in. dia. wheel, Postpaid. \$9.75
 #BL-75 Seventy-five cu. ft. per minute blower and motor, 4 in. dia. wheel, Postpaid. \$11.25
 #BL-150 Dust collector Blower & hi-speed motor, 150 CFM, Postpaid. \$12.50

112 PIECE ASSORTMENT \$3.95
FOR ELECTRIC GRINDER
 \$10.00 VALUE — ONLY
 Here's what you get! Mounted Stones on 1/4" mandrel, Drum Sander, Sanding Sleeves for sander, Rotary Cutters, Wire Scratch Brush, Bristle Brushes, Circular Saw, Buffing Wheel, Grinding Wheel, Rubber Polishing Wheel, Cut-off Wheels, Rubber Cylinder, Mandrels to fit above tool, asst'd.
 Sanding Discs, Sharpening Stone, etc.



SURPRISE VALUE
100 Pieces \$1.00
FOR ELECTRIC GRINDERS
 Grinding Wheels, Cut-off Wheels, Sanding Discs, Mounted Stones, Sharpening and Honing Stones, Rotary Cutting Burs, Abrasive Cartridges, Mandrels, and many other items.



12 MINIATURE CUTTERS \$1.00
 FOR CUTTING WOOD, PLASTIC, or METAL
 Actual size. Assorted shapes on 3/32" shank. For die makers, home workshop, etc.



20 ABRASIVE ROLLS, \$1.00
 cloth, and 1/8" mandrel for grinding, sanding, deburring metal, plastic, wood or rubber. ONLY....

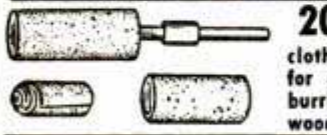

12 MOUNTED WHEELS \$2.95
 and points on 1/4" Mandrel.
 For grinding on plastic, wood soft and hard metals. Regular \$8.40 List Val.
 12 wheels on 1/4" Mandrel \$3.60



18 MOUNTED POINTS ON 3/32" MANDREL \$2.50
2 DRUM SANDERS \$1.50
 With 12 Bands in Assorted Grits. 1 1/2" dia. x 1" long on 1/8" arbor with 12 bands
ONE DRUM, 1" DIA. x 1" LONG ON 1/4" ARBOR \$1.00
 WITH 6 EXTRA SLEEVES



FLEXIBLE SHAFT — ONLY \$4.95
 Fits all electric drills & hand power tools. 35 3/4" long. Oilite bearings. Core of specially wound, high carbon steel wire in flexible steel casing. Will accommodate tool shafts up to 1/8" dia. For lathes, electric drills, etc.



2 CIRCULAR SAWS \$1.50
 ON 2 MANDRELS — ALL AT ONE LOW PRICE
 1" diameter saws on 1/8" Mandrels. For cutting wood, plastic, or soft metals. Order at once! Send Check or Money Order.



ADAPTER CHUCK \$1.50
 With 2 interchangeable collets, opening from 3/32" to 1" on 3/4" mandrel. Price each only.



7 HIGH SPEED TWIST DRILLS \$1.00
 15 DRILLS FOR ONLY \$2.00! Order Today!
 7 Popular Sizes — up to 1/4". Brand new, ideal for home or shop use. Fits all standard chucks.



18 GRINDING WHEELS \$1.00
 and rubber polishing wheels up to 1" dia. For grinding & polishing metals, plastic, wood. With one 3/32" mandrel.
10 CUT-OFF WHEELS 1 1/2" DIA. WITH 1/4" MANDREL \$1.00



18 ROTARY CUTTERS \$5.85
 Value \$13.50
 Assorted sizes cutter on 1/8" or 3/32" shank. Will fit all hand grinders. Ideal for cutting wood, metal, or plastic. Brand new.



SCHUPACK SUPPLY CO., 7331 Cottage Grove, Dept. M-27, Chicago 19, Ill.
 NEW 1952 Illustrated Catalog 10c

MECHANIC'S METAL WORKING KIT!
 WORLD'S BIGGEST MAIL ORDER BARGAIN! HUNDREDS OF BRAND NEW GRINDING, POLISHING AND SANDING TOOLS FOR ALL METALS. A MUST FOR SHOP OR TOOL ROOM.
\$8.75 f.o.b. Chgo.
 Order your assortment today! Regular \$50. value — while they last, only.
HERE'S WHAT YOU GET!
 30 Asst. grinding and polishing wheels from 1 1/2" dia. up to 10 inches in dia. 3/8" arbor holes to 3"
 25 Butterflies and sanding discs 2" to 7" dia.
 1 Drum sander 1"x1" on 1/4" arbor, and 6 extra sleeves
 18 Assorted Mounted Stones on 1/8", 1/4" and 1/2" mandrels
 3 Muslin buffs, 8" dia., 1/2" thick 3 Felt bobs
 1 High speed steel rotary file 1 Tampico polishing wheel
 4 High speed steel twist drills 1 Wire wheel
 5 Cut-off wheels 1 1/2" to 5" dia. 100 Sanding discs 3/4" to 1 1/4"
 10 Abrasive Cartridge rolls and arbor
 Honing stone, sharpening stones, sand paper, 3 Leather bobs
 sheets and many, many more items.
SCHUPACK SUPPLY COMPANY
 7331 Cottage Grove Ave., Dept. M-27, Chicago 19, Illinois
 NEW 1952 Illustrated Catalog 10c



ALNICO MAGNETS LIFT 175-lb.
AMAZING PERMANENT MAGNETS — WILL NOT WEAKEN! NON-ELECTRIC. Retrieve guns, tackle, tools and other steel items from lake, river, plating tanks, drains or other hard-to-reach spots. Recover drills, taps, etc. from floor sweepings. Clear alley of harmful tacks, nails. Many other uses listed. Pays for itself quickly. **GUARANTEED:** Try any magnet one week. Money refunded if you are not well-pleased.
 Cat. No. 675 (Has pull of 175 lbs. on a flat steel block) . . . \$10.50
 Cat. No. 650 (150 lb. pull) \$8.50 Cat. No. 530 (30 lb. pull) \$3.00
 Cat. No. 550 (50 lb. pull) \$4.00 Send M.O. or check. We pay postage.
 Cat. No. 30—Hobbyist assortment of six medium magnets. . . \$1.50
MIAMI MAGNET CO.
 3240 N.W. 27th Ave., Aviation Bldg. No. 43, Miami, Florida



BULL DOG JACKS
 Makes parking or hitching trailers and heavy farm implements an easy, one-man job
 Model No. 60-F Only \$15.75 Post Paid (when paid in advance)
 All steel construction—heavy duty ball bearing swivel action . . . raise and lower with crank . . . complete with bracket, ready to install
HAMMER BLOW TOOL COMPANY
 Wausau 138 Wisconsin



GIANT BALLOONS
 Neoprene; Surplus Govt. Weather and Target Balloons. Terrific attention getters for Lodges, Civic Events, School Functions, Conventions, Exhibitions, Trade Shows. Advertise your special events in the Hollywood manner. Make any occasion a success. Great back-yard fun. Marvellous for parties, dances, fairs, picnics, all festivities.
 3 Ft. Dia. 39c; 6 Ft. Dia. 79c; 13 Ft. Dia. \$1.39
 Add 10% for Postage and Handling. Calif. Res. add Sales Tax.



WAR ASSETS DIV.
Volume Sales Co.
 Dept. M-2-52, 3930 Sunset Blvd., Los Angeles 29, Calif.

E-Z BRACKETS & STANDARDS MAKE THE FINEST—ECONOMICAL SHELVING FOR ALL USES—
ADJUSTS UP & DOWN LIKE A SLIDE RULE
 Bolt Standard to wall—slip butt of bracket into slide slot—lock with single bolt and you have "E-Z" shelf adjustment up or down at any pin-point spot on the Standard. Brackets come in lengths 6" to 30"—on a 2" variation. Build wall and island displays, tables, etc. Ideal for grocery stores, garages, filling stations, home, and workshops. No measuring—no fussing with alignment problems. One man—no experience—simple tools can install "E-Z" shelving quickly.
BIG PROFITS ON EASY INSTALLATION
 Write for Free Catalog Plan Book, and prices. Make money installing "E-Z" either full or spare time. Carpenters, builders get the facts.
STANDARD STEEL WORKS, Dept. PM-1, North Kansas City, Mo.



HULA POPPER - GETS BIG BASS

Surface popping lure. Ideal combination of noise, action, casting and hooking qualities. Pops, plunks, jerks, twitches — obeys your slightest wrist command. Rubber Hula Skirt imitates live bug. At your dealer 5/8 oz. or 1/4 oz., \$1.25. Fly rod size, 75c.



FRED ARBOGAST & Co., Inc., 2252 W. North St., Akron 3, Ohio

FREE WRITE TODAY FOR YOUR BIG FREE ARBOGAST COLOR CATALOG — FULL OF PICTURES OF CATCHES

DRIVE 3 TO 6 DAYS A MONTH



Gas Free!

Users claim, and exhaustive tests have proved that the REMARR AUTOMATIC GASOLINE INJECTOR saves up to 20% on gas, boosts power and pick up on all cars, light trucks and tractors. Install it easily and test for 30 days on your car. IF NOT COMPLETELY SATISFIED, RETURN FOR FULL REFUND. List your name, address, car make, year, model and no. of cylinders; Free Literature on Request **\$9.95** Postpaid. \$1 C.O.D. Deposit **G. B. SCHUYLER, Dept. 72, 2804 10th Street, Berkeley 2, California**

WELLWORTH BARGAINS — ALL NEW EQUIPMENT

Wellworth AIR COMPRESSOR
For Farm and Home Workshop

Compressor has 2" bore, 1 3/4" stroke, 2.8 cfm up to 150 lb. pressure. Motor required: 1/4 h.p. at 100 lbs.; 1/2 h.p. at 125 lbs.; 3/4 h.p. at 150 lbs. or equivalent gas engine. V-belt drive, intake muffler and clean air, bronze bearings, splash lubrication. Wt. 16 lbs. Replacement parts always available. **\$20.50**

COMPLETE OUTFIT. Compressor, pressure tank, air gauge, air chuck, 20 ft. hose, pop valve, copper tubing with 4 brass flared fittings for connecting compressor to tank, 4-way cross and 3 nipples. COMPLETE OUTFIT, wt. 30 lbs. **\$32.45**

Equipment less compressor **\$12.45** Tank only. **\$6.25**

AUTOMATIC COMPRESSOR UNIT

1/2 H.P. heavy duty capacitor motor. AC 110/220 volt, 60 cycle, 2x1 3/4 inch piston type compressor, splash feed lubrication. 12x24 inch tank, automatic pressure switch. CFM 2.8 at 100 lb. pressure, or 150 lbs. pressure for intermittent duty. Check valve, safety valve, air regulator with gauge and filter, 20 ft. air hose with air chuck for inflating tires. V. belt drive. Mounted on 2 wheels, ball bearing, with 2"x10" semi-pneumatic tires. Portable with handle. Shipping wt. 90 lbs. With 1/2 h.p. motor **\$98.50** Less Motor **\$79.50** With 1 1/2 h.p. motor **\$124.50**

WELLWORTH COMPRESSOR BUY

1 Year Guarantee

FEATURES: 2 compression and one oil ring, aluminum alloy connecting rod. Stainless steel valves with brass seats and retainers. Cool-flo cylinder head, spray mist lubrication to every moving part. 10 1/4" V groove fly wheel for 3/8" B section belt.

MODEL W3 2 1/2"x2". 2.55 to 4.80 c.f.m. up to 150 lb. pressure. Operates with 1/2-3/4 HP motor. Special Price **\$27.95** Shipping wt. 24 lbs.

MODEL W7 2 cylinder 2 1/2"x2". 5.10 to 8.50 c.f.m. up to 150 lb. pressure. Operates with 1/2-3/4-1-1 1/2 HP motor. Special Price **\$54.50** Shipping wt. 45 lbs.

2000-2500 WATT LIGHT PLANT
Heavy duty windings

110 v., 60 cy., A.C., takes starting overload up to 5000 watts. Floating Base for Automatic Belt Adjusting, 2-Groove Engine Pulleys, V-Belts, Bolts, etc. 5 H.P. Wisconsin or Briggs & Stratton Model 14 Engine. Voltmeter, 2 plug-in receptacles. Portable Tubular Steel Skid Type Carrier. Dim.: L 34 3/8" x W 17" x H 20". Wt. 180 lbs. **\$299.50**

Generator only, with voltmeter, 2 plug-in receptacles. Shipp. Wt. 75 lbs. **\$169.50**

500 WATT GENERATOR. wt. 55 lbs. **\$99.50**

5000 TO 6000 W. GENERATOR. 110/220V. Wt. 225 lbs. **\$325**

5000 W. LIGHT PLANT. 110/220V. 60 cy. Wt. 575 lbs. **\$645**

WELLWORTH V-BELT CLUTCH

BRAND NEW Takes starting load off engines or motors. When speed is reached, a flip of handle shifts clutch from idling to driving position. Handles "A" belts, 2.35" pitch diameter, 3/8" bore. Ideal for use with lawn mowers, garden tractors, home workshop motors, etc. 3 1/4" long. Safe, easy to mount, sealed bronze bearings, positive action. Shpg. wt. 3 lbs. **\$7.50**

BUSHING FOR 1/2" SHAFT 15c

SAME CLUTCH FURNISHED WITH 3/4" BORE **\$8.50**

PORTABLE SPRAY OUTFIT

1/3 H. P. HEAVY DUTY MOTOR
EXTERNAL ATOMIZING GUN

Paint Sprayer mounted on 6x24 inch tank, 1 1/2 H.P. 110 V. 60 cy. Heavy duty motor with overload relay, 10 ft. cord and plug, V belt drive. Piston type Compressor with 2 Compression rings, 1 oil ring, 2 inch Bore 1 3/4 inch stroke, displacement 2.86 C.F.M. at 60 lbs. pressure. Safety Valve. Gun external atomizing. Flat and round spray, quart cup; maintains 35 to 40 lbs. working pressure. Oil and water extractor, 1 air gauge, 20 ft. heavy duty two-braid air hose with leakproof fittings. Complete with carrying handle. Wt. 60 lbs.

OUTFIT LESS MOTOR... \$52.00

COMPLETE OUTFIT \$67.50

SPRAY GUN AND 20 FT. HOSE... \$12.95

"Wellworth" BLOWER BARGAIN

BRAND NEW Quiet operating. Double wheel inlet, double width blower. For heating, ventilating, cooling, air washing, exhausting and forced draft. DIMENSIONS: 10" wheel; outlet 13 1/2"x11 3/8"; inlet 8 3/4"; Height 19"; Width 18"; Depth 18 1/2"; C.F.M. 1 1/2" S.P. 1600; outlet vel. 1575. Wt. 45 lbs. **\$27.50**

BLOWER LESS MOTOR AND DRIVE With belt and variable speed pulleys, \$2.50 extra. Same blower, complete with 1/4 h.p. motor, **\$47.50.**

AIR REGULATOR & Moisture Trap

5" x 8" tank 400 lb. test with 1/4" air regulator, gauge, safety valve and shut-off cock. Complete as shown. **\$12.95**

Price Shipping weight 6 lbs.

1/12 H.P. MOTOR

Delco 110V, 60-cy. A.C. 1 phase 1750 r.p.m. 2 amps. will take 50% overload. Shaft 3/8"x1 1/4. Heavy duty, bronze sleeve bearing. Size 6" long, 5" high, net wt. 12 lbs. **\$13.50**

List \$21.00. Special **\$12.50**

LOTS OF 3, EA. \$12.50

AIR TANK and ACCESSORIES

Brand New Steel 6"x24", 400 lb. test. Ideal wherever compressed air is needed. Equipped with 500 lb. combination air gauge and inflation valve with core for retaining pressure in tank; tire chuck. 3 ft. high test air hose. **\$7.95**

Ship. Wt. 12 lbs. Complete outfit.

LELAND GENERATORS

2500 to 3000 watts, 110 v. 60 cy. single phase 1800 r.p.m., self excited. Fungus treated for long life. 1951 model. Brand new, in original factory crate. Shipp. wt. 135 lbs. List \$375. SPECIAL PRICE... **\$225**

PRICES F.O.B. CHICAGO. MONEY BACK GUARANTEE. SEND CHECK OR MONEY ORDER TODAY. PROMPT SHIPMENT. WRITE FOR OUR NEW CATALOG. SEND 10c FOR POSTAGE.

WELLWORTH TRADING CO.
1832 S. WABASH AVE. Dept. D-252 CHICAGO 16, ILL.

RED SEAL CONTINENTAL GAS ENGINE

1 1/2 HP with 6 to 1 reduction gear. Operates at 450 R.P.M. For lawn mowers, scooters, garden tractors, pumps, compressors, generators, etc. List Price \$79.50. Shipping wt. 54 lbs. **\$47.50**

SPECIAL PRICE.

TIGHTEN LOOSE FIXTURES

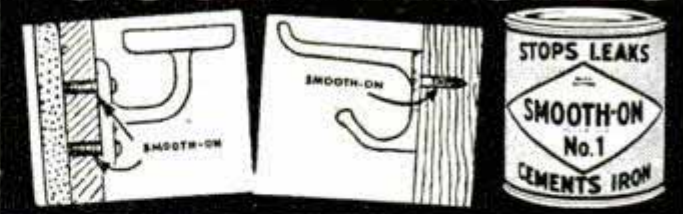

Smooth-On No. 1 Iron Cement applied to your loose hinges, door handles, coat hooks, drawer pulls, knobs, casters, bathroom fixtures, tool and cutlery handles, will tighten them and *keep* them tight. • Get Smooth-On No. 1 in 1/4 oz., 7 oz., 1 lb. or larger sizes at your hardware store. If they haven't it, write us.

FREE Repair Handbook

40 pages, 170 illustrations. Shows you how to make numerous household repairs quickly and easily. Directions are simple, brief.

SMOOTH-ON MFG. CO., Dept. 37B
570 Communipaw Ave., Jersey City 4, N. J.

50 347

Do it with
SMOOTH-ON
IRON CEMENT

USAF THROAT MICROPHONE

Genuine USAF, Type T-30-Q. Gives distinct voice reproduction. Consists of 2 microphones mounted in rubber neckpiece & elastic neck band. 100 to 300 ohm operation. **139**

SIGNAL CORPS TELEGRAPH KEY

The new model J5A with ball type key. Perfectly balanced for positive contact with minimum effort. **189**

4" ALNICO SPEAKER

Model No. S10540-2
Permanent magnet type.
Sturdy, die-stamped steel frame with four hole mounting. Requires only two wire hook-up. Makes an ideal speaker for small radios, multiple communication systems, inter-office, test equipment, etc. **249**

NEW 1/2 TON CAPACITY WINCH PULLER

For LIFTING - STRETCHING - PULLING. Does the job Easier, Faster & Safer. Made of high tensile Manganese Bronze; Duraluminum; Aircraft Cable and Steel-- weighs only 6 lbs. Has a 14 to 1 power ratio and guaranteed 1000 pound capacity. Tested to 100% overload. Fast, dependable operation. No chains to kink, no ropes to tangle. Does the job of bulky chain hoists costing many times as much. Saves time & labor. **ONLY 1795**

Attention GADGETEERS

ELECTRIC GYRO

Turns up to 50,000 RPM. Electric drive motor is integral part of balance wheel. Has double end shaft to drive precision tools or machinery at precise, controlled speeds. Full ball bearing mounted. Operates high or low voltage. A highly precise instrument. Ideal for experimental work, science labs, hobbyists & technical engineers. **495**
A TREMENDOUS BUY!

1 inch GERMAN PRECISION MICROMETER

Calibrated in thousandths. Ratchet stop for absolute accuracy and a lock ring to hold setting secure. Head contains decimal chart. One of the finest quality, imported, precision tools on the market. **ONLY 975**

VERNIER CALIPERS

Measures Inside - Outside & Depth from .001 to 6". Reads both English & Metric scales. Sliding jaw has lock nut to hold setting. Specially hardened, steel. **ONLY 975**

MECHANICAL DRAWING SET

A REAL PALLEY BARGAIN! Made in Germany. Has a 4 1/2" compass with pen and pencil part, a 4 1/2" divider; one 3 1/2" reverse bow compass for pencil and ink; 4 1/2" ruling pen, capsule with extra lead. Complete in velvet lined case, for only **325**

CUNO OIL FILTER

Aircraft type. Easily adapted to autos, etc. Keeps oil clean without cartridge replacement. Installed in minutes. With 3/8" parts. **495**
Lge size, 5/8" tube parts. **695**

HP-3 HYDRAULIC HAND PUMP

Originally an aircraft, emergency, hydraulic hand pump. Operating pressure, 2000 PSI. Capacity, 1.5 cu. in. per complete cycle. **ONLY 925**

AGASTAT Time Delay Relay Switch

Has a 24 volt, DC, energizing coil which operates a double pole, single throw relay switch. Circuit may be held closed from a fraction of a second to 15 seconds by means of an adjustment with a set screw. Ideal for use on animated signs, displays, electric locks, etc. **225**

PROP PITCH MOTOR

Has a gear ratio of 7000 to 1. Ideal for use in rotating your T-V or directional beam antenna or as power for animated signs, displays, etc. Has a 1/2 HP, 20 to 32 volt, AC or DC, motor which turns the bevel gear take-off at approximately 1 1/4 RPM. **1095**

CONTINENTAL GAS ENGINE.

SINGLE CYLINDER, 1 1/2 - 2 HP, 4 CYCLE with a GENUINE RED SEAL, Air Cooled 'L' Head. Comes complete with all accessories such as; mesh type air cleaner, flywheel, magneto, float type carburetor, fuel tank, starter pulley, muffler, blower housing, etc. An ideal power plant for small farm machinery, lighting plants, air compressors, power tools, small boats, etc. Weighs only 43 lbs. **4950**

VALUABLE GEAR BARGAIN

Ideal for revolving radio antenna, television antenna, etc. **675**
85 to 1 ratio.

GEAR BOX VTG-1 - 90° Bevel gear

1 1/2 to 1 reduction. A lifetime value. **395**
Size: 7" x 6"
Has lever control for engaging and disengaging positive clutch. Dust-proof housing, pre-lubricated bearings
Can be adapted to Vickers Transmission.

SEE OPPOSITE PAGE FOR TERMS

POWER HACKSAW \$52.75

LESS MOTOR
F. O. B. Benton Harbor
• Rugged cast iron construction. Wt. 56 lbs. bronze bearings. Draw cut. Auto. return lift. Auto. shut-off. Vise swivels 45°. Cap. 4"x4".
Send for full details and name of nearest dealer.

EXCEL MACHINE TOOLS Dept. PM-12 BENTON HARBOR, MICHIGAN

BRONZE FOUNDRY

Schools and Home Workshops
Make your own castings of aluminum, copper, bronze, silver. Foundry sets are available in three sizes including 2400 Deg. F. blast Furnaces. \$22.50; \$29.50; and \$42.00. f.o.b. Kansas City. Free Circular.

KANSAS CITY SPECIALTIES CO. P. O. BOX 6022, DEPT. P-2 KANSAS CITY, MO.

Gerstner TOOL CHESTS

More Desirable Chests for the good tools of Machinists and Toolmakers. Free Catalog.

GERSTNER TOOL CHESTS

452 Columbia St. Dayton 7, Ohio

Make Your Own POWER LAWN MOWER

with this DRIVE CUTTER ASSEMBLY
Constructed for those who desire to build their own mower or to replace your old cutter assembly. Complete with 18" blade and double ball bearing drive, only **\$12.95**
Add 50c to cover handling and shipping. No C.O.D.'s

ATLAS KEEN MOWER
229 S.W. BLVD. Dept. MP2 KANSAS CITY, MO

HYDRAULIC CYLINDER SPECIAL

20,000 lb. thrust (push-pull) using 1500 PSI line pressure as obtained from our hyd. pumps. Or will produce 40,000 lb. thrust with 3,000 lb. line pressure. Can ALSO BE OPERATED ON LOW PRESSURE AIR SYSTEMS. 4" Bore, 1 1/2" dia. piston shaft, 18" stroke, length: 30 3/4". Equipped with ball bearing loaded clevis type mounting and swivel type high pressure steel pipe bracket for easy use. Ideal for road, farm, & shop machinery, presses, etc. Cost Gov't \$390.00. **29⁹⁵**

We carry the World's largest supply of Special Hydraulic Equipment featuring over 20,000 cylinders in 61 sizes and types. Can also supply all accessories such as Pumps, Valves, Tanks, Hose and Fittings. Write for information.

No. 3 HYDRAULIC CYLINDER
Double action. Bore is 1". Shaft is 3/8". Has a stroke of 2 1/2" to 4". Stroke can be adjusted with internal sleeve stops. Overall length is 8 1/2". Will take 1500 lbs. continuous duty, 3000 lbs. intermittent. Will lift or push up to 1100 lbs. **57⁵**

No. 9-E HYDRAULIC CYLINDER
Double action cylinder. Has a bore of 1-3/8" and shaft of 1". Stroke is 9". Overall length 15 1/4". Built for 1500 lbs. continuous duty. 3000 lbs. intermittent. Will lift or push up to 2300 lbs. Can be adapted to hundreds of uses. **97⁵**

4 WAY VALVE
Poppet, piston type. Off or neutral. Built-in relief valves for limit of cyl. stroke. Inlet & outlet 5/8" AN tube **97⁵**
Cyl. parts 1/2" AN tube.

STRATO-POWER PUMP
With built-in variable flow control valve in head. Positive displacement piston type. Displaces .450 cu. in. per revolution. 2 gal. per min. cap. at 1500 RPM at 1250 PSI. Pressure limit, 1250 PSI continuous, 1400 PSI for 15 sec. Operates at 3750 RPM, intermittent maximum 4500 RPM. Rotates either direction without adjustment. **1950**

VICKERS HYD. VARIABLE DISPLACEMENT PUMP
Will deliver maximum volume at any pressure setting between 600 & 900 PSI. Desired pressure settings obtained with adjusting screw. Pump housing serves as reservoir for system. Has built-in compressed air supercharger which makes system independent of outside atmospheric pressure. Rotation is left hand only. Maximum speed for continuous duty is 3750 RPM. Displacement is .484 cu. in. per revolution or approx. 4 GPM at 1750 RPM. **3250**

ROPER HYDRAULIC PUMP UNIT
Here is a complete Hydraulic pumping unit. Consists of a 300 PSI Roper pump with a 1/3 HP, Leland, heavy duty, roller bearing motor. Motor operates on 110 V AC - 60 cycle current and is directly coupled to pump with rubber universal joint. Unit is mounted on aluminum base with carrying bar. Can be used for transfer pump, power for small hyd., presses, cooling for lathes or in most cases where hydraulic power is used. **97⁹⁵**

SAVE UP TO 85% FROM IN WAR SURPLUS AT GADGETEERS HEAVEN

NOW! MAKE YOUR OWN ARC WELDER!

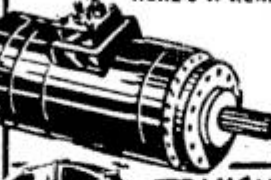

HERE'S A REAL BUY! Finest, Precision built, R-1 Generators, Originally used on B-29 airplanes. These generators cost the Government approx. \$400.00 each. Gives from 300 to 400 amps. at 27 volts. Ideal for all welding, light and heavy, up to 5/8" thickness. Free instructions for converting to welding unit. **27⁹⁵**

3 SPEED TRANSMISSION
Converts a high RPM, low power input into low, RPM, high torque output. Has 2 take-off shafts at 4 tp 1 & 16 to 1 ratio. Gear box has worm drive bronze gears & throw-out clutch. Will operate forward or reverse directions. Adaptable to many uses on power machinery. **19⁹⁵**

VICKERS HYDRAULIC TRANSMISSION
Self contained, 2 H.P., constant torque at all speeds with variable volume reversible, piston pump (controlled by outside lever) supplying piston hydraulic motor. Automatic pressure, dash pot for smooth control. Power output RPM: -0 to 1/3 input RPM in both directions. Input RPM 1800 continuous. 4000 intermittent. Dash pot can be removed for greater RPM. Ideal for lathes, duplicator set-up of mills, conveyors, small cars, drives, gearings, etc. **3750**

4" SPLINE SHAFTS for input & power take-off... **250 PR.**
The two transmissions above can be combined to make an excellent "power booster" or speed controller for many types of power machinery.

ELECTRIC MOTORS

LEAR ELECTRIC MOTOR 24 volt, 6 amps, series wound reversible motor... with overload clutch. Motor turns 11,000 RPM. Has 11 to 1 gear reduction box turning 1000 RPM; at take-off. Adaptable to flex or rigid drive. Limit switch box. Size: 10" x 4" **79⁵**

SAMSELL MOTOR 27 volts, 16 amps, 1/5 H.P. reversible, series wound on motor. 3800 RPM, shaft 9/32" diameter. 12-spline. 4-1/8" x 2-3/8". ONLY **39⁵**

SURPLUS MOTORS
No. 500 - New 1/2 H.P. - 27 Volt, D.C. - A.C. This motor can be readily adapted to deliver up to 1 1/2 H.P. on 110 Volts, A.C. by the simple method of rearranging armature brush-leads. Free Diagram with each order. A SENSATIONAL VALUE. **59⁵**

No. 500-A - Converted to 110 Volts, A.C. Equipped with plug and 3 1/2 ft. heavy duty cord... **849**

HYDRAULIC ACCUMULATOR Type A-5, Vickers. Used to maintain constant pressure in both the "line" and reserve storage and to permit instant action in the hydraulic system. Built to stand 2000 PSI. 10" in diameter. Write for list of our other accumulators and our huge stocks of hydraulic supplies. **197⁵**



OTHER AIRCRAFT GENERATORS
P-5 - 12 to 15 Volts 50 Amps \$12.95
P-1 - 27 VOLTS... 200 AMPS \$15.95
P-3 - 27 VOLTS... 100 AMPS \$25.00

Special GENERATOR BARGAIN
PG-1 - 27 VOLT. 140 AMP. **16⁹⁵**
P-12 - 27 VOLT.. 75 AMP.. **15⁹⁵**

CARBON PILE VOLTAGE REGULATOR
The most dependable type voltage regulator used by the Armed Forces. Suitable for use with any 24 to 28 volt generator (see above). Accurately regulates flow of voltage at any setting between 20 and 30 volts. Comes complete with mounting base. **ONLY 67⁵**

ELECTRIC ACTUATOR
Hundreds of uses for any mechanical device needing controlled 2 way action. Opens, closes, raises or lowers doors.. windows... gates... valves. **69⁵**

CTU-2 Foote linear actuator. 24V. A.C. or D.C., 8500 R.P.M., 1/6 H.P. - Series wound motor. 4 1/2" stroke in 13 1/4 seconds. Compression and tension loads up to 750 pounds. Adjustable micro-switch for limits of travel. Overall length retracted. 11" **69⁵**

GEAR HEAD MOTORS
Heavy duty G.E. Gear Head Motor. 1 1/2 H.P., 24 volt D.C., 125 Amp. reversible motor will drive reduction gear box unit 44.5 to 1, resulting in 168 R.P.M. at 5/8" diameter take-off shaft. Motor contains electro magnetic brake. **109⁵** MOTOR **49⁵** GEAR BOX ALONE **79⁵**

Electronic Transmission GEAR TRAIN
GT-1 - approx. 50 Bronze Spur & Pinion Gears, 3/8" to 4" dia., 5 sets of 7 cluster gears, 2 complete worm and worm gear drive sets. 40 N.D. ball bearings 1/2" to 1 1/2" dia., watch springs bushings, posts, face plates, housings, micro-switches, 2 miniature controlled clutches, etc. Gears in multiple size and sequence, identical teeth ratio, giving 100's of gear reduction combinations. Weight: 19 pounds. **849**

FAMOUS PALLEY GADGET MIXES

A valuable "stock pile" of small parts & supplies for the hobbyist, mechanic or home workshop. Individually packaged, generously assorted "mixes" in SCREWS, NUTS, BEARINGS, ABRASIVES, HINGES, SPRINGS, PULLEYS, RIVETS, FILES, ETC. Have these assorted mixes handy when you need them. SAVE TIME & MONEY! Write for complete, illustrated literature and special, LOW PRICES!

Special HYDRAULIC PUMP UNIT
Complete hydraulic pumping unit. All necessary parts assembled and ready to work at a great saving in time and cost to you. Delivers 3 1/2 GPM at 1500 PSI at 1800 RPM. (other volumes and pressures can be attained by simple adaptations) Unit consists of a gear pump driven by a 2 1/2 HP, DC motor (4000 rpm max.), relief valve, pressure unloading switch, filter, accumulator, reservoir with sight gauge & complete plumbing. Mounted on 19" x 25" aluminum panel. Complete with motor. **499⁵**

WESTINGHOUSE AIR COMPRESSOR
1000's now in use for spraying, inflating, air tools, in garages, laboratories, shops & on trucks, tractors, jeeps, etc. Lightweight but powerful. Operates on 1/2 HP, gas or electric motor. Runs either direction. Delivers approx 3.27 CFM at 600 RPM or 6.54 RPM at 1200 Rpm. Has 2" bore, 1 1/2" stroke. We have motors, tanks and fittings to adapt this unit. **239⁵**

AIRCRAFT CABLE
Rust resistant, alloyed steel. Extra flexible. Pre-formed, 7 x 19 strand. On reels.
1/16" - 4 1/2 ft. 7/32" - 10 1/2 ft.
5/64" - 5 ft. 1/4" - 12 1/2 ft.
3/32" - 5 1/2 ft. 9/32" - 15 ft.
1/8" - 7 ft. 5/16" - 16 1/2 ft.
5/32" - 7 1/2 ft. 3/8" - 18 ft.
3/16" - 9 1/2 ft. 1/2" - 20 ft.
SPECIAL 3/16" cable, 18 feet long, with tumbuckle ends. 99⁵

Stainless Steel Cable - Pre-Formed
1/16" - 6 ft. 5/32" - 20 ft.
3/32" - 14 ft. 1/4" - 26 ft.
Bronze Cable - Not Pre-Formed
1/16" - 5 ft. 3/16" - 23 ft.
1/4" - 17 ft. 1/2" - 38 ft.

Plow Steel Cable Hemp Center 6 x 19
7/8".... 25 ft. - 1".... 28 ft.

FIRE EXTINGUISHER
Kiddie Lux - CO² Type. Built to Gov't specifications. Heavy, shatter-proof case. Recent hydro-static test. Reconditioned and fully charged. LIKE NEW! READY FOR INSTANT USE!!

2 lb. size with Swing Nozzle... 13.75
3 1/2 lb. size with Swing Nozzle... 17.95
7 1/2 lb. size with Horn... 23.75
10 lb. size with New Squeeze Grip Handle & 3 1/2 ft flex hose with Horn. 29.75
15 lb. size with Squeeze Grip hdl, 4ft. flex hose, plastic hom. 42.50
15 lb. size with Wheel Control... 37.95

ORDER FROM THIS AD. All sales final. Prices F.O.B. Glendale. Pay by M.O. or Check. P.O.'s accepted from D & B. Firms. 1/2 deposit with C.O.D.'s.

1952 CATALOG - 230 PAGES

COMPLETELY ILLUSTRATED, SHOWING 1000'S OF ITEMS IN NEW AND WAR SURPLUS! Some at SAVINGS UP TO 85%! Clothing, Household Items, Hand & Power Tools, Camping & Outdoor Equipment, and a huge stock of Hydraulic Equipment, including Cylinders, Valves, Pumps, Motors, Fittings, etc. Send only 50¢ for your copy of this amazing, bargain catalog today.

PALLEY SUPPLY CO 6321 SAN FERNANDO RD. DEPT. P.M.-2 GLENDALE 1, CALIF.



CENTERS AND DRILL PADS

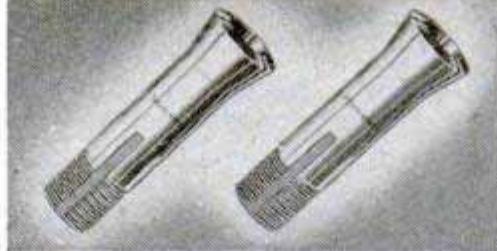

STEEL AND BRASS COLLETS



BALL BEARING LIVE CENTER

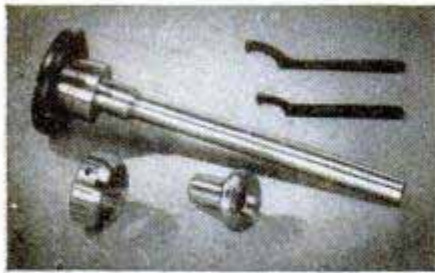

HANDWHEEL COLLET ATTACHMENT

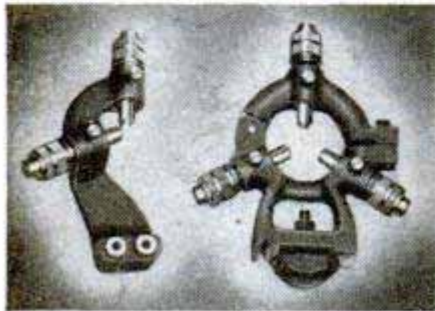

FOLLOWER AND STEADY RESTS

Get More Use Out
of Your Lathe
WITH THESE
SOUTH BEND
ATTACHMENTS

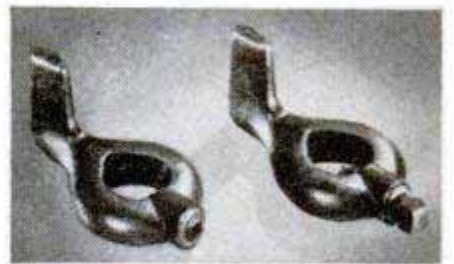

SAFETY and STANDARD LATHE DOGS



ADJUSTABLE COLLET BUSHING CHUCK

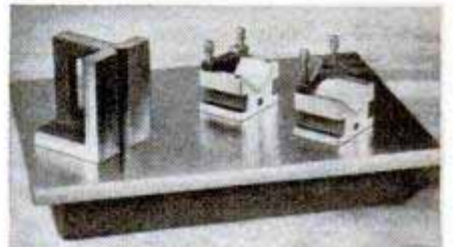

SURFACE and ANGLE PLATES, V-BLOCKS



South Bend Attachments will enable you to do more and better lathe work. Write for Attachment Catalog No. 5102

SOUTH BEND LATHE
BUILDING BETTER TOOLS SINCE 1906 • SOUTH BEND 22, INDIANA

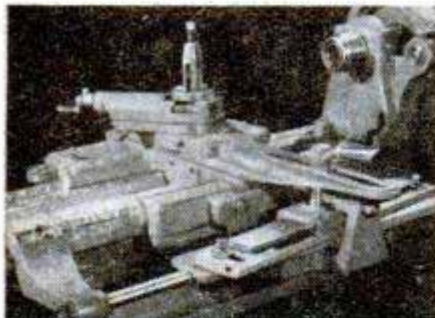

TELESCOPIC TAPER ATTACHMENT

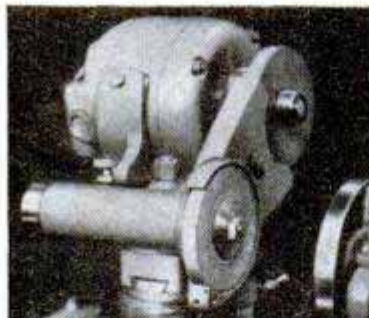

EXTERNAL GRINDER

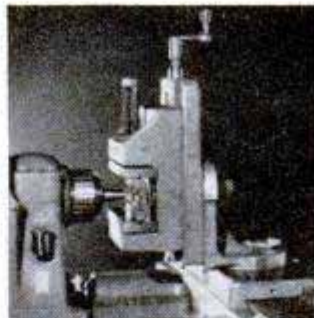

MILLING ATTACHMENT

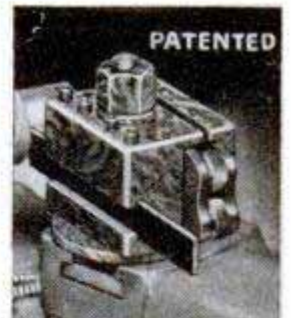

10 in 1 TOOL BLOCK

Send this Information:



CATALOG 5102

LATHE TOOLS, ATTACHMENTS



9" and 10" BENCH LATHES

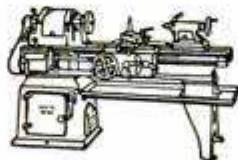

10" TO 16-24" FLOOR LATHES



14" DRILL PRESSES



7" BENCH SHAPERS

Name _____

Street _____

City _____ Zone _____ State _____

1/2" and 1" Collet TURRET LATHES

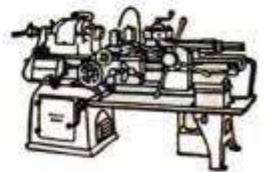

Printed by Popular Mechanics Company, Chicago, Ill., U. S. A.

Get into...

PLASTIC LAMINATING AT HOME!

Sensational New
**"ONE MAN
BUSINESS"**
...pays \$10 to \$20 profit
for each dollar of cost.

Make \$20 to \$30 a day by our
MAGIC MAIL PLAN... get
orders and cash from your mailman!

Here's the newest and most fascinating of all home-operated businesses. For the first time, a simplified machine brings the fabulous profits of Plastic Sealing and Plastic Laminating within the reach of the small operator. Can be

operated in a corner of the kitchen, basement, or garage. And any man or woman, regardless of age, education, or experience—can learn this interesting work in a few minutes of reading—can turn out professional jobs after one hour's practice.

TWO EXCITING FIELDS FOR BIG PROFITS!

No house-to-house canvassing. No face-to-face selling. We not only supply the equipment you need for the work, but also show you exactly how to cash in big daily profits from two big demand fields.

A FORTUNE IN PLASTIC SEALING

Millions of people want to protect valuable cards, photographs, documents and papers against wear, soil, and damage. By our MAGIC MAIL Plan you get this business through the mails. Open envelopes and take out money and orders. Details of this plan will amaze you. It will be sent free. Just mail coupon.

ENORMOUS PROFITS IN LAMINATING

A creative, artistic business. Gift shops sell your entire output. Just a few of thousands of giftwares illustrated on this page. Beautiful colors. Endless designs. Exclusive "one of a kind" appeal brings sales at ten to twenty times the cost of materials. Beautiful illustrations and instructions for making these artistic novelties sent free.

The opportunities in Plastic Laminating are so big that space here does not permit even skimming the surface. To get any idea

FREE at all of the size of these markets and your place in this sensational business you must read the details. See for yourself how easy it is to do the work—how you can put plastic sheets into your machine and take out a fortune—how money and orders come to you in the mail—how gift shops clamor to get more and more of your creations—how you can start with one machine and build up a big production plant with others doing the work—how you can get money and business from every State in the Union—how you can achieve independence without study or experience.

at all of the size of these markets and your place in this sensational business you must read the details. See for yourself how easy it is to do the work—how you can put plastic sheets into your machine and take out a fortune—how money and orders come to you in the mail—how gift shops clamor to get more and more of your creations—how you can start with one machine and build up a big production plant with others doing the work—how you can get money and business from every State in the Union—how you can achieve independence without study or experience.



RUSH COUPON

Never before has such an opportunity been offered the small, home-operator—an opportunity to gain complete personal independence in a big money business of your own. Don't lose a minute. Get the facts at once. All information, fully illustrated with pictures, is free. Send the coupon—or send your name on a penny postcard. There is no charge now, or at any other time. We may be limited in the number of Warner Laminators that can be made up, so don't put this off. Send for the information on this exciting opportunity today.

WARNER ELECTRIC CO.,

1512 Jarvis, Dept. 3-B, Chicago 26, Illinois

WARNER ELECTRIC CO. Dept. 3-B
1512 Jarvis, Chicago 26, Illinois

Rush complete information with illustrations showing the things I can make and the money possibilities in Plastic Laminating. All this is free. I do not pay a penny now or at any other time. No salesman is to call. Send all facts by prepaid mail. Be sure to tell me how I get orders and money from my Postman by your MAGIC MAIL Plan.

NAME _____
ADDRESS _____
CITY _____ ZONE _____ STATE _____

\$5-\$10-and \$20 BILLS COME TO YOU IN THE MAIL

By our MAGIC MAIL Plan you sit at home, send out mail, and get back money and orders. Additional profits in supplying local people with lifetime protection for

SNAPSHOTS—IDENTIFICATION CARDS—DISCHARGE PAPERS—DRIVERS' LICENSES—SOCIAL SECURITY CARDS—VOTERS REG. CARDS—MENUS—BIRTH CERTIFICATES—CREDIT CARDS—BIRTH AND WEDDING ANNOUNCEMENTS—RAILROAD PASSES—IMPORTANT DOCUMENTS OF ALL KINDS.

Lifetime protection. See how laminating protects against wear, soiling, and moisture damage with its smooth, flexible, plastic covering on each side. **LIFETIME PROTECTION** needed for valuable or sentimental objects of all kinds—even a priceless whisp of hair can be laminated. Think of the countless thousands of profit items for your Laminating Press.



Thousands of Beautiful Art Creations

No one yet has been able to list the thousands of gorgeous articles that can be made by Laminating as explained in our Free Information. Just a few are

- COSTUME JEWELRY—CIGARETTE BOXES—JEWEL CASES—GLOVE AND HANDKERCHIEF BOXES—CUFF LINKS—NOVELTY BUTTONS—TRAY—CANDLESTICKS—COASTERS—CLOCK CASES—LAMP BASES—PICTURE FRAMES—BOOK ENDS—PAPER KNIVES—KEY CHAIN CHARMS—CHECKERS—CHESSMEN—ADVERTISING SIGNS—NAME PLATES—BOOKMARKS—BELT BUCKLES—TIE RACKS—KEEP-SAKES OF ALL KINDS.

Why did you change to Camels, HENRY FONDA?

"My voice is important in my career. I smoke Camels because they're mild and have such rich flavor!"

Henry Fonda

Star of Broadway stage play,
"Point of No Return".

Not one single case of throat irritation due to smoking **CAMELS**

Make your own
sensible 30-Day
Camel mildness
test in your
"T-Zone"—
T for Throat,
T for Taste.



— that's what noted throat specialists reported in a coast-to-coast test of hundreds of people who smoked only Camels for thirty days!

Make your *own* thirty-day Camel test, the thorough test of mildness. Enjoy Camel's rich, full flavor and see if you don't agree with Henry Fonda when he says, "The cigarette that suits my throat best is Camel!"

Start smoking Camels today and discover why, after all the mildness tests . . .



CAMEL LEADS ALL OTHER BRANDS — BY BILLIONS!

R. J. Reynolds Tobacco Co.,
Winston-Salem, N. C.