

POPULAR MECHANICS MAGAZINE

WRITE TO UNDERSTAND IT

REG. TRADE MARK, GREAT BRITAIN, NO. 40428

REG. U.S. PAT. OFF.

JANUARY 1952

35 CENTS

Articles by
Lee DeForest
Chas. F. Kettering
Karl Compton
Eddie Rickenbacker

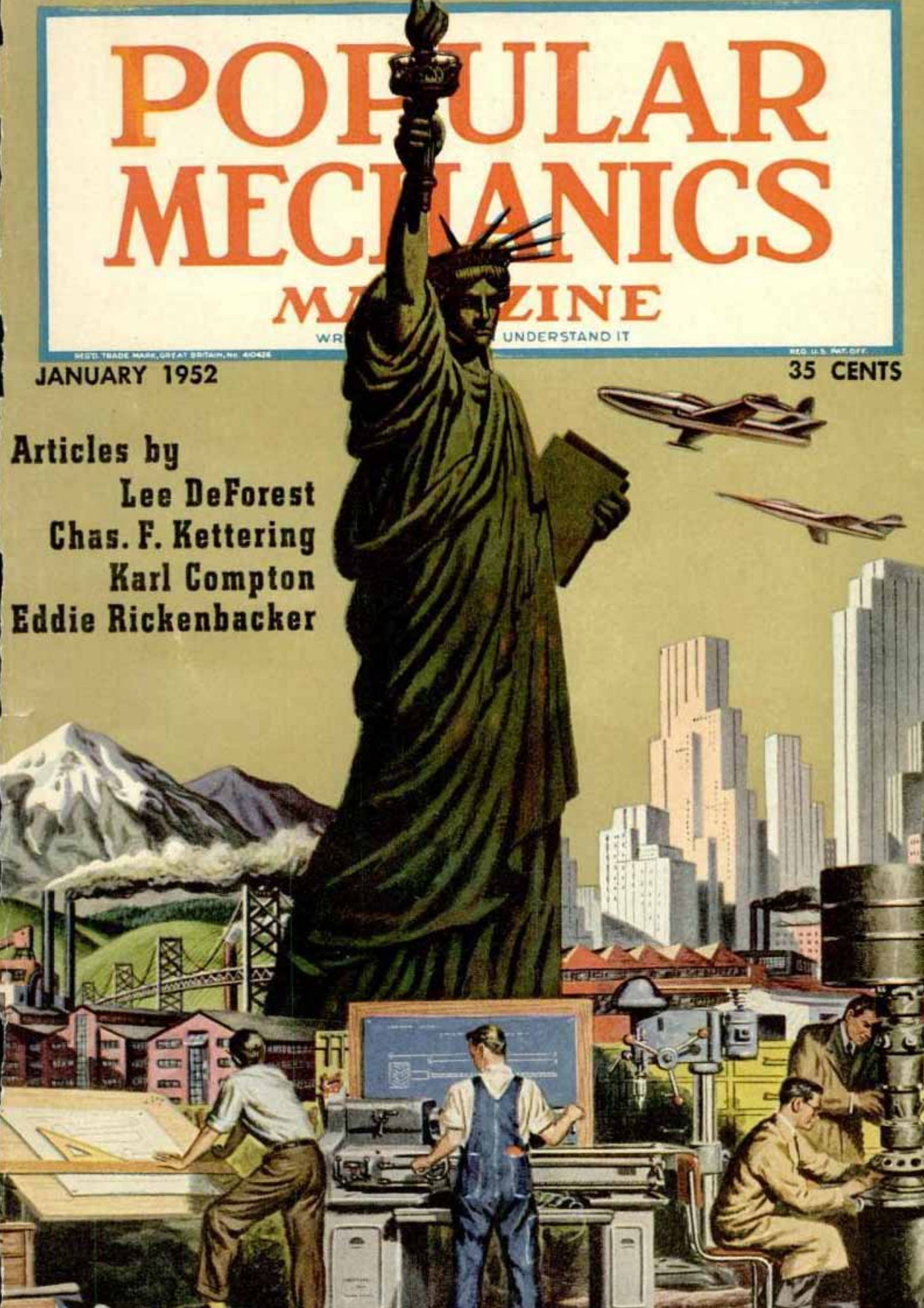

MONTA MOWER

Story



TRIMS AS IT CUTS

The Montamower story is about the thousands upon thousands of people who are mowing their lawns in less time than they ever did before . . . with scarcely half the effort.

With a Montamower you can mow and trim your lawn in one easy operation . . . mow right up to walls, trees, fences . . . under foliage, around close quarter borders . . . with practically no grass left to trim by hand.

Smoothly cut through grass, dandelions, spike grass and tall lawn weeds (including those that always popped back up).

Mow up, down, or across your terraces without scalping the crown . . . anyone can operate it easily and efficiently.

Unsolicited testimonials from thousands of satisfied owners everywhere have convinced us that, in your own hands — on your own lawn, under most conditions, the fine low priced Montamower will prove itself far superior to any other hand operated mower. TRY IT on your own lawn . . . ON APPROVAL with our WRITTEN GUARANTEE! Write today!

HERE'S HOW IT WORKS FOR YOU

Eight pairs of self sharpening, precision made and fitted, tool-steel cutting disks revolving toward each other gather the grass and cut it cleanly at the intersection of the disks. Easily and quickly adjustable to cutting height!

TRY it on YOUR OWN LAWN . . . ON APPROVAL!

Use Coupon Below

TRIMS CLOSE TO WALLS - TREES SHRUBS - FENCES

Weighs Only 8 1/4 Lb. CUTS A FULL STANDARD 16" SWATH

SO DESIGNED, IT CANNOT SCALP TERRACE CROWN

CUTS TALL LAWN WEEDS WITH GRASS

SOLD DIRECT ONLY NO AGENTS NO DEALERS

Montamower Distributing Co. Sales and General Offices P.M. 21 KEELER BLDG., GRAND RAPIDS 2, MICHIGAN

Gentlemen: Without obligation, kindly send me completely illustrated, descriptive literature, price, guarantee information, and full details of your amazing "Try it on your lawn" Approval Offer.

NAME _____

ADDRESS _____

FREE

MAIL THIS COUPON TODAY — PASTE ON A PENNY POST CARD (if possible, for)



NEW FORD PARTS DEPOT at Cincinnati is typical of warehouses Ford is building all over the country. From a depot like this, Ford Dealers will order almost any part for your Ford!

TO SERVE FORD OWNERS BETTER THAN EVER!

Ford's \$500,000,000 expansion program will make Genuine Ford (FoMoCo) Parts easier to get than ever. The depot (above) is only one of ten new parts depots built or being built. Nineteen others are being expanded. This expansion program, designed to triple stock space, is part and parcel of Ford's "Look Ahead" policy to better serve Ford owners.



MADE RIGHT for Fords, Genuine Ford Parts, like this muffler, are specified by wise motorists to save time, money and trouble. They're *right* because they're duplicates of the parts in your Ford—they keep Fords *all Ford*.



FIT RIGHT in your Ford—a "must" for important parts like the Genuine Ford Carburetor above. It's typical of the parts designed by Ford engineers, to work right in your Ford . . . to keep your Ford young longer.



LAST LONGER in Fords. This sign is displayed wherever Genuine Ford Parts are sold . . . at all Ford Dealers and selected independent garages. Specify Genuine Ford Parts . . . made right . . . to fit right . . . to last longer.

KEEP YOUR FORD ALL FORD!

This One



Your voice in Davy Jones' locker

To strengthen voices in the newest submarine cables between Key West and Havana amplifiers had to be built right into the cables themselves. With the cables, these amplifiers had to be laid in heaving seas; and they must work for years under the immense pressure of 5000 feet of water.

For this job, Bell Laboratories engineers developed a new kind of amplifier — cable-shaped and flexible, with a new kind of water-tight seal.

To serve far beyond reach of repair, they developed electron tubes and other parts, then assembled them in dust-free rooms.

The two cables — each has but two conductors — simultaneously carry 24 conversations as well as current to run the electron tubes.

With these deep-sea amplifiers, submarine cables carry more messages . . . another example of how research in Bell Telephone Laboratories helps improve telephone service each year while costs stay low.

BELL TELEPHONE LABORATORIES

- *Exploring and inventing, devising and perfecting, for continued improvements and economies in telephone service.*



Cutaway view of deep-sea amplifier. Tubes and other elements are housed in plastic cases then enclosed in interleaved steel rings in a copper tube. Glass tape, armor wire and impregnated fiber complete the sheath.

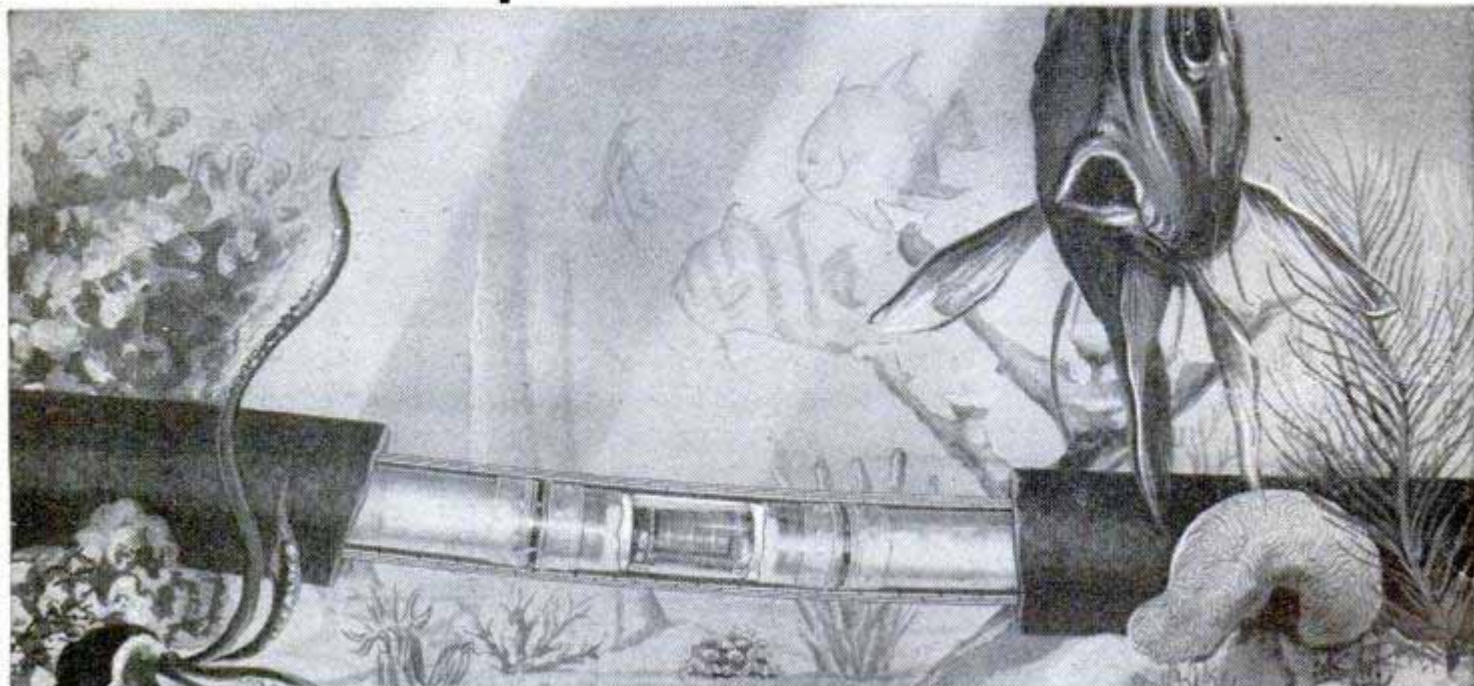

Popular Mechanics Magazine

Registered in U. S. Patent Office and Canada

H. H. WINDSOR, *Founder*

H. H. WINDSOR, JR., *Editor and Publisher*

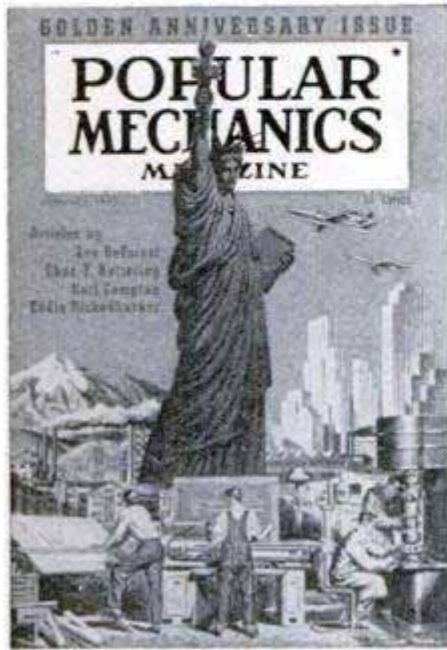

this month's cover

THE AMERICAN WAY OF LIFE symbolized on our cover speaks in many ways—in the crack of bat against ball, the scream of a jet in the sky, the giggle of a child in school. It's the squeal of tires on a boulevard, the rustle of a ballot in a booth. In the most turbulent half century of man's history, spanning the life of this magazine, the American Way has made its power known in the mighty roar of a tank-assembly line, the scratch of a designer's pencil and the whir of a lathe. It has spoken in the tattoo of a rivet gun and the lonely voice of a ham radio operator; the swish of a reaper through a wheat field and the heavy hiss of a river of molten metal. We believe, too, that it speaks of peace through the rustle of wood shavings in a basement workshop and the silent voice of a statue holding one hand high in welcome.

Published monthly by Popular Mechanics Company, 200 E. Ontario St., Chicago 11, Ill. H. H. Windsor, Jr., president; William Harrison Fetridge, vice president; D. F. Windsor, vice president and secretary-treasurer; H. H. Windsor III, vice president; Clover L. Perkins, advertising manager; Alan M. Deyoe, circulation manager. Single copy in the United States and Canada, 35 cents; subscription rates in United States and possessions, Canada, Philippines and countries of the Pan-American Postal Union, 1 year \$3.50; 2 years, \$6.00; 3 years \$8.00. To all other countries add \$1.00 a year over United States prices for overseas postage. If you plan to move, notify us at least 30 days in advance so you will not miss an issue. Give both your old and new addresses. Entered as Second Class Matter, September 15, 1903, at the Post Office at Chicago, Illinois, under Act of March 3, 1879. Entered as Second Class Matter at Post Office Dept., Canada. Registered as Second Class Matter at the Post Office at Mexico, D. F., Mexico, June 20, 1950. Copyright 1952 by Popular Mechanics Company, Copyright under International Copyright Union. Copyright in France. All rights reserved under Pan-American Copyright Union. Printed in the United States of America.

JANUARY 1952

Volume 97

JANUARY 1952

Number 1

Managing Editor.....	Roderick M. Grant
Assistant Managing Editor.....	Wayne Whittaker
Shop Notes and Crafts Editor.....	James R. Ward
Radio-Television, Electronics Editor.....	Frank L. Brittin
Associate Editor, Aviation.....	Aubrey O. Cookman, Jr.
Associate Editor.....	Clifford B. Hicks
Associate Editor.....	Donald R. Brooks
Assistant Shop Notes and Crafts Editor.....	Wayne C. Lecky
Automotive Editor.....	Siler Freeman
Art Director.....	Frank Beatty

Assistant Editors

W. Clyde Lamme	Frank N. Stephany
Arthur R. Railton	Dorothy Hoffmann
	Carlton H. Ihde
Eastern Editor.....	Richard F. Dempewolff
	Empire State Bldg., Room 2906, New York 1, N. Y.
Western Editor.....	Thomas E. Stimson, Jr.
	302 23rd St., Santa Monica, Calif.
London Manager.....	Douglas W. Wedderspoon
	77 Baker St., London W. 1, England
Director, Bureau of Information.....	Allan Carpenter
	200 E. Ontario St., Chicago 11

IN THIS ISSUE

Science on the March - - - - -	120
The Story of Popular Mechanics - - - - -	127
And Then Came the Horseless Carriage - - - - -	137
From Kitty Hawk to Jets - - - - -	146
Dawn of the Electronic Age - - - - -	154
What Was New for Your Home - - - - -	160
Hall of Fame - - - - -	165
American Way of Life Photo Contest - - - - -	173
The Tinker With Million-Dollar Ideas - - - - -	188
Designs for Tomorrow - - - - -	193
Six-Legged Behemoth Mines German Coal - - - - -	204
The Owners Report on the Buick - - - - -	210
Greatest Show in Wax - - - - -	218
From Raw Recruit to Ranger - - - - -	226
Radio, Television and Electronics - - - - -	233

For the Craftsman

Fifty Years of Craftsmanship - - - - -	242
Emergency Wooden Respirator - - - - -	262
TV Radio-Phono Combination - - - - -	268
"ADY-J"—All-Purpose Dinghy - - - - -	278
Know Your Brakes - - - - -	282
Hair Drier Doubles as Darkroom Ventilator - - - - -	286
Thickness Planer for Your Jointer - - - - -	293
Extra Uses for Your Drill Press—Part I - - - - -	298
Shopping for Tools - - - - -	306
Clinic for Homemakers - - - - -	332

Other items, and manufacturers of available products described, are listed on pages 10, 14 and 16

the Progressive Spirit at Utica

IMPROVES PLIERS CONSTANTLY
...TO WORK BETTER FOR YOU

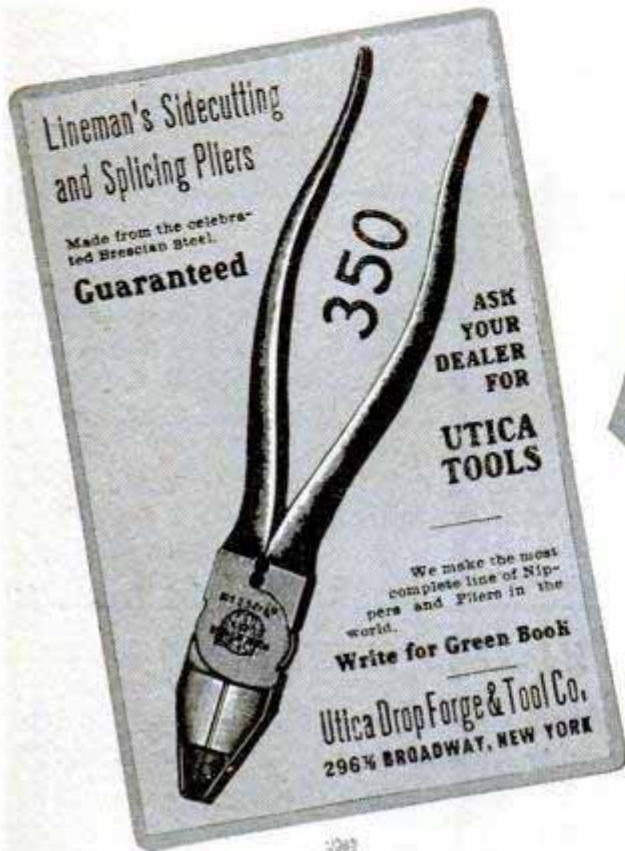

The 1902 model as
then advertised in
**POPULAR
MECHANICS**

Today's
vastly improved
counterpart
of the 1902 model.



- The new **UTICA Lubring Pliers** of 1952 have a ring of porous, oil-carrying iron in the joints. The pliers actually *oil themselves!*

- Skillful drop forging gives these new pliers the *toughness* they need for rugged gripping and twisting jobs. But the cutting edges themselves are electronically induction hardened, just where *hardness* is needed for thousands of cuts *without* nicks or burrs.

The pliers of 1902 look almost the same as **UTICA'S** 1952 models. But don't be fooled by appearance, even for a moment!

To keep one jump ahead of our respected and healthy competition, **UTICA** is improving and refining its products constantly. For example, note just a few of the improvements of the 1952 model over the earlier version.

- The pliers of 1952 are available (on order) with special handles that cushion fatigue or provide insulation against electrical shock.

- Manufacturing skill has progressed to the extent that today's improved model is an even better buy than the 1902 model.

UTICA DROP FORGE & TOOL CORPORATION

Utica 4

New York

IT PAYS TO BUY



QUALITY TOOLS

AND THE WORLD'S BEST TOOLS ARE MADE IN THE U. S. A.



1922

This is the outboard motor that revolutionized small-craft boating 30 years ago. (Many are *still* running!) It brought to America's waterways a rugged, light-weight, easy-to-handle source of power for **DEPENDable** low-cost water transportation. It was the Johnson Sea-Horse, of course.



1952

This is the outboard motor that is revolutionizing boating today — a super-powered, high-efficiency model of sensational light weight and easy handling. 25 hp!* Over 30 mph! Yet it *trolls!* It introduces new thrills to water recreation, and provides new, compact, low-cost power for commercial users. It's the new Johnson Sea-Horse 25!

YOU'RE YEARS AHEAD with a

Johnson

SEA-HORSE



It has *always* been so: It still is. *You're YEARS ahead with Johnson!* Gear Shift; Neutral Clutch; separate, plug-in Mile-Master Fuel Tank; Synchro-Twist Grip Speed Control; Angle-matic Drive and dozens of other modern and patented features that obsolete conventional designs. Your Johnson Dealer will **SHOW** you. Look for his name under "Outboard Motors" in your classified phone book.



*OBC Certified brake h.p. at 4000 r.p.m.

Free

The new Johnson Sea-Horse Handy Chart. Shows the 4 great models for 1952 — including the **ALL NEW** Sea-Horse 3, which weighs only 29 lbs. and features a shock-absorbing, shoal-riding, weed-free drive that will amaze you! Send for the new Handy Chart. A post card gets it.

JOHNSON MOTORS
400 Pershing Road, Waukegan, Illinois
Johnson Motors of Canada, Peterborough

JOHNSON SEA-HORSES FOR DEPENDABILITY



\$10,000

for your family...or
your money back...

...at age 60, 65 or 70!

YES, you can have \$10,000 worth of Life insurance protection for your beneficiary until age 60, 65, or 70, *at which time you will get back every cent that you paid in premiums.*

The advantages offered by this money-back Life insurance policy are so great that every man who wants to retire some day should investigate them.

The policy is called Travelers Cash Settlement 60, 65, or 70, depending on the age at which you plan to retire. It is available at ages 10 to 40 inclusive. This is the way it works:

A \$10,000 Cash Settlement policy at age 35 will cost you \$281.40* a year if you plan to retire at 65. So if you pay this premium for 30 years, the total cost will be \$8,442.*

At age 65, when you are ready to retire, you will automatically receive a *cash payment of \$8,450*—\$8.00 more than you will have paid.*

There are optional settlements, too!

Of course, you don't have to cash in your policy when you reach age 65. Instead, you can elect to have the money paid to you in the form of a

monthly income. . . . **OR:** should you have a continued need for Life insurance, you can elect to take a full paid-up policy in the amount of \$10,000.

When you consider all the advantages and flexibility of The Travelers Cash Settlement Contract, you will be amazed at its low cost.

A telephone call to your Travelers agent or broker will bring you full details of this policy. If you would like to know the name and address of The Travelers agent or broker in your neighborhood, we will be glad to advise you.

*Rates and values slightly different in Canada.

MORAL: INSURE IN

The Travelers

ALL FORMS OF INSURANCE AND SURETY BONDS

The Travelers Insurance Company, The Travelers Indemnity Company, The Travelers Fire Insurance Company, The Charter Oak Fire Insurance Company, Hartford 15, Connecticut. Serving the insuring public in the United States since 1864 and in Canada since 1865.

5 reasons why ACCOUNTANCY

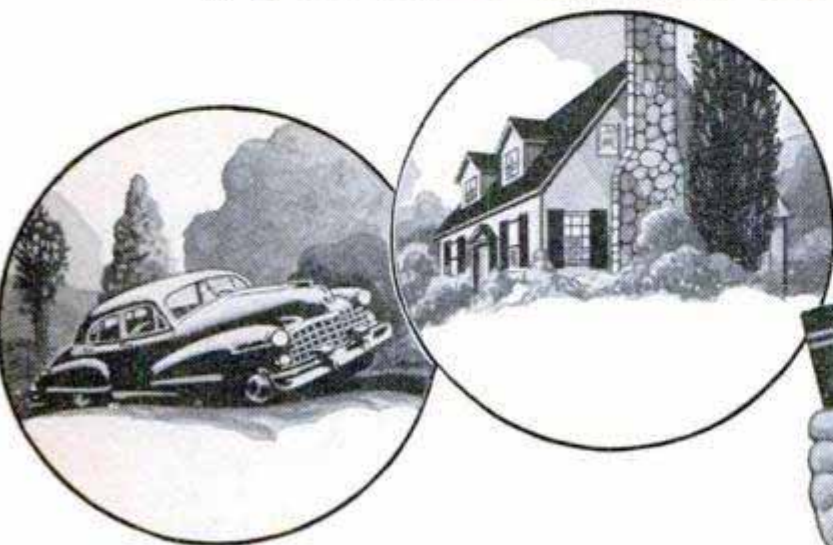

offers you MORE MONEY . . . and SUCCESS!

REASON #1. If you were an expert accountant right now, chances are you would find yourself among the highest-paid of all professional men and women. Even back in "depression years," surveys showed that accountants earned more on the average than men in other major professions.

REASON #2. The demand for accountants is great—everywhere. All businesses must have trained accountants to cope with ever-growing requirements. It's a profession offering wide opportunity—always—to the man who knows.

REASON #3. You can fit into any business, anywhere in the country—because accounting principles are universal. Think what this means in terms of security and independence!

REASON #4. Accountancy is open to all. Any man or woman of good intelligence, who enjoys figure work and is willing to follow LaSalle's systematic "problem method" plan, can rapidly qualify for a highly profitable, enjoyable lifetime career . . . and he doesn't have to finish his training before beginning to "cash in."

REASON #5. Without losing a day from your present work, you can prepare in spare hours at home, at low cost, under LaSalle's step-by-step "Problem Method" of "learning by doing." This famous plan accounts for LaSalle's remarkable record of having trained nearly 10 per cent of all Certified Public Accountants in the U. S. . . . and of having put many thousands of others into high-paying careers.

Send today for LaSalle's interesting booklets, "Accountancy, the Profession That Pays," and "Success Reports." Learn about the five great fields of opportunity . . . and LaSalle's time-tested plan for helping men and women to rapid advancement, higher income, greater prestige and professional standing. The coupon below will bring these fact-filled booklets to you—without cost or obligation—also, a free sample lesson showing LaSalle's famous "Problem Method" plan of instruction.

→ **GET FREE SAMPLE LESSON** ←

**WHICH . . . ?
can help you most ?**

- Accounting—Elements to C.P.A. Coaching
- Bookkeeping
- Cost Accounting
- Auditing
- Income Tax
- C.P.A. Coaching

LaSalle Extension University
— A Correspondence Institution —

Dept. 164HR, 417 S. Dearborn St., Chicago 5, Ill.

Please send me, free of all cost or obligation, a sample lesson in Accounting . . . also, your 48-page illustrated books, "Accountancy, the Profession that Pays," and "Success Reports."

Name Age

Address

City, Zone, State

LASALLE
417 S. Dearborn St.,
CHICAGO 5, ILL.

You



POPULAR MECHANICS
in the World's Most Home of the Mechanical Arts & More
CHICAGO

March 8, 1902.

Double Your SALARY

Our free booklet, "Are Your Hands Tied?" tells you how to do it. Thousands have largely increased their salaries by following our plan.

WE TEACH BY MAIL Mechanical or Electrical Engineering; Drawing; Architecture; Bookkeeping; Ornamental Design; German; Spanish; French, etc. Circular free. State subject that interests you.

International Correspondence Schools,
Box 612, Scranton, Pa.



Mention Popular Mechanics.

**MACHINERY, ENGINES
SHAFTING, PIPE.**

Everything in wood and iron used in constructing and operating; new and second-hand (rebuilt), cheaper than you can buy anywhere else. Write us first.

CHICAGO HOUSE WRECKING CO., CHICAGO

Mention Popular Mechanics.

... SUIT \$1.05

could have made a fortune...

You should have been around in 1902. There were fortunes to be made. A couple of young fellows were working on the first man-carrying airplane. Up in New England, a company was turning out *manufactured* automobiles. The first moving picture theater opened in April. And a pretty good salary for a young man just starting out was \$15 a week.

But you could double that by studying in your spare time with the International Correspondence Schools. Thousands did.

Thousands of I. C. S. students, whose names you will recognize today as leaders in business and industry, won fame and fortune.

Times have changed, of course. But I. C. S. is still doubling salaries, still supplying specialists to the important new industries, *still helping men make fortunes.*

If you want training to be your springboard to a better job with higher pay, why not get the full story of what I. C. S. can do for you? Marking the coupon will do it. Mail it *today!*

INTERNATIONAL CORRESPONDENCE SCHOOLS

60

th Anniversary

BOX 5519-L, SCRANTON 9, PENNA.

Without cost or obligation, please send me full particulars about the course BEFORE which I have marked X:

- | | | | |
|---|---|---|--|
| <p>Business and Academic Courses</p> <ul style="list-style-type: none"> <input type="checkbox"/> Accounting <input type="checkbox"/> Advertising <input type="checkbox"/> Bookkeeping <input type="checkbox"/> Business Administration <input type="checkbox"/> Business Correspondence <input type="checkbox"/> Business Law <input type="checkbox"/> Cartooning <input type="checkbox"/> Certified Public Accounting <input type="checkbox"/> Commercial <input type="checkbox"/> Commercial Art <input type="checkbox"/> Cost Accounting <input type="checkbox"/> Fashion and Book Illustration <input type="checkbox"/> Federal Tax <input type="checkbox"/> First Year College <input type="checkbox"/> Foremanship <input type="checkbox"/> High School <input type="checkbox"/> Good English <input type="checkbox"/> Higher Mathematics <input type="checkbox"/> Industrial Supervision <input type="checkbox"/> Motor Traffic <input type="checkbox"/> Personnel—Labor Relations <input type="checkbox"/> Postal Civil Service <input type="checkbox"/> Retailing <input type="checkbox"/> Retail Business Management <input type="checkbox"/> Salesmanship <input type="checkbox"/> Secretarial <input type="checkbox"/> Sign Lettering <input type="checkbox"/> Stenography <input type="checkbox"/> Traffic Management Aeronautics Courses <input type="checkbox"/> Aeronautical Engineer's, Jr. <input type="checkbox"/> Aircraft Drafting and Design | <ul style="list-style-type: none"> <input type="checkbox"/> Aircraft Mechanic <input type="checkbox"/> Engine Mechanic Air Conditioning and Plumbing Courses <input type="checkbox"/> Air Conditioning <input type="checkbox"/> Heating <input type="checkbox"/> Plumbing <input type="checkbox"/> Refrigeration <input type="checkbox"/> Refrigeration, Domestic <input type="checkbox"/> Refrigeration & Air Conditioning <input type="checkbox"/> Steam Fitting Chemical Courses <input type="checkbox"/> Chemical Engineering <input type="checkbox"/> Chemistry, Analytical <input type="checkbox"/> Chemistry, Industrial <input type="checkbox"/> Food-Plant Sanitation <input type="checkbox"/> Petroleum Production & Refining <input type="checkbox"/> Plastics <input type="checkbox"/> Pulp and Paper Making Civil Engineering and Architectural Courses <input type="checkbox"/> Architecture <input type="checkbox"/> Architectural Drafting <input type="checkbox"/> Bridge and Building Foreman <input type="checkbox"/> Building Estimating <input type="checkbox"/> Civil Engineering <input type="checkbox"/> Contracting and Building <input type="checkbox"/> Highway Engineering <input type="checkbox"/> Reading Structural Blueprints <input type="checkbox"/> Sanitary Engineering | <ul style="list-style-type: none"> <input type="checkbox"/> Structural Drafting <input type="checkbox"/> Structural Engineering <input type="checkbox"/> Surveying and Mapping Communications Courses <input type="checkbox"/> Electronics <input type="checkbox"/> Practical Telephony <input type="checkbox"/> Radio, General <input type="checkbox"/> Radio Operating <input type="checkbox"/> Radio Servicing <input type="checkbox"/> Television <input type="checkbox"/> Telegraph Engineering Electrical Courses <input type="checkbox"/> Electrical Drafting <input type="checkbox"/> Electrical Engineering <input type="checkbox"/> Electric Light and Power <input type="checkbox"/> Lighting Technician <input type="checkbox"/> Practical Electrician <input type="checkbox"/> Power House Electric <input type="checkbox"/> Ship Electrician Diesel Engines Courses <input type="checkbox"/> Diesel Engines <input type="checkbox"/> Internal Combustion Engines Mechanical Courses <input type="checkbox"/> Forging <input type="checkbox"/> Foundry Work <input type="checkbox"/> Heat Treatment of Metals <input type="checkbox"/> Industrial Engineering <input type="checkbox"/> Industrial Instrumentation <input type="checkbox"/> Industrial Metallurgy <input type="checkbox"/> Machine Shop <input type="checkbox"/> Mechanical Drafting | <ul style="list-style-type: none"> <input type="checkbox"/> Mechanical Engineering <input type="checkbox"/> Mold-Loft Work <input type="checkbox"/> Patternmaking—Wood, Metal <input type="checkbox"/> Reading Shop Blueprints <input type="checkbox"/> Sheet-Metal Drafting <input type="checkbox"/> Sheet-Metal Worker <input type="checkbox"/> Ship Drafting <input type="checkbox"/> Ship Fitting <input type="checkbox"/> Tool Designing <input type="checkbox"/> Toolmaking <input type="checkbox"/> Welding—Gas and Electric Railroad Courses <input type="checkbox"/> Air Brake <input type="checkbox"/> Car Inspector <input type="checkbox"/> Diesel Locomotive <input type="checkbox"/> Locomotive Engineer <input type="checkbox"/> Locomotive Fireman <input type="checkbox"/> Locomotive Machinist <input type="checkbox"/> Railroad Section Foreman <input type="checkbox"/> Steam-Diesel Locomotive Engineer Stationary Engineering Courses <input type="checkbox"/> Power Plant Engineering <input type="checkbox"/> Stationary Fireman <input type="checkbox"/> Stationary Steam Engineering Textile Courses <input type="checkbox"/> Cotton Manufacturing <input type="checkbox"/> Loom Fixing <input type="checkbox"/> Rayon Manufacturing <input type="checkbox"/> Textile Engineering <input type="checkbox"/> Woolen Manufacturing |
|---|---|---|--|

Name _____ Age _____ Home Address _____

City _____ State _____ Working Hours _____ A. M. to _____ P. M.

Present Position _____ Employed by _____

Special tuition rates to members of the Armed Forces. Canadian residents send coupon to International Correspondence Schools Canadian, Ltd., Montreal, Canada.

thanks to PYROIL

Famous Speed Boat Racer Smashes World Records!

Edison Hedges, of Atlantic City, famous record-breaking racer, has this to say about Pyroil:

"In my 25 years of racing, I have used Pyroil consistently in establishing world records — I have broken more records in speed boats than any man who has ever lived."

Racing or driving, Pyroil will establish new records for your car. New records of added miles, driving comfort, and less maintenance cost. Pyroil improves lubrication by providing a protective film of oil on cylinder walls and piston rings. Pyroil keeps your motor clean — it prevents rust and gummy deposits.

Speed boat racing requires top lubrication. That's why Edison Hedges uses Pyroil. Pyroil will give you the same top lubrication, too.

Add Pyroil — add miles to your car.

Pyroil for Aircraft Engines

Use Aircraft Pyroil B for lubricating oil, Aircraft Pyroil A for gasoline.

GIVEN! An attractive Pyroil metal savings bank — takes coins up to 50c pieces. **MOTORISTS**, it's yours for the asking — sent postage paid.



Manufactured and Guaranteed by Pyroil Company, 123 Pyroil Bldg. La Crosse, Wisconsin

Canadian Distributors: Central Purchasing Agencies, Ltd., Toronto, Ontario

PYROIL COMPANY

123 Pyroil Bldg., La Crosse, Wisconsin

I want my car to last and run properly. Please tell me more about Pyroil and how it can accomplish this for me.

Name _____

Address _____

City or Town _____ State _____



AUTOMOTIVE

Motor-driven vehicle replaces fire horses.....	153
Crossing the continent in automobiles.....	182
On-the-spot puncture repairs.....	186
"Yield" sign reduces accidents.....	186
Roving machine shop.....	198
Child's car is mongrel—part plane, auto and motorcycle.....	223
Detroit listening post.....	224
"Seamless" sports car.....	225
Custom-made roadster.....	225
Austin Seven.....	231
Wooden track provides traction.....	231
Drivers check their speedometers with giant meter on police car.....	231
Reflector disk warns motorist (Automotive Safety Device Co., 444 Asylum St., Hartford, Conn.).....	424
Alarm for busses foretells brake failure.....	430

AVIATION

Aeronaut's hair-breadth escape.....	126
Airship versus passenger engine.....	153
International balloon race of 1907.....	170
"Dive brakes".....	216

FARM

Milking stool prevents spilling of milk.....	183
Mechanical "spider" weaves string into trellises for beans.....	199
Milk tanker replaces cans.....	217

HOUSE AND HOME

Keyless clocks available for telephone subscribers.....	152
California living room hangs in air from huge plywood arch.....	208
Rechargeable sprayer uses CO2 cartridges (Depend-On Sales, 7305 Vincennes, Chicago 21).....	216
Silver-plating with a cloth (Silvaplate Corp., 1300 Madison Ave., New York City 28).....	326
Aquarium-bookcase.....	388

INDUSTRY

Biggest dam south of equator.....	16
Concrete "tets" plug gap in Columbia River dam.....	192
Tiny carbon spheres are hard enough to scratch glass.....	202
Giant German crane "kneels" in transit.....	215
Spray seals mine shaft.....	217

MEDICAL

Arabogalactan—you can't say it but you may soon be eating it.....	186
Inventions help handicapped to help themselves.....	215
British hospital bed provides variety of postures.....	232

MODELS AND NOVELTIES

Mother can convert baby buggy into one-wheel sidecar for bicycle (Howard Clayton-Wright, Ltd., Wellesbourne, Warwick, England).....	199
Model steamboats piloted by radio.....	202
Dial-operated ship model.....	223
"Live" ponies race to wire (Revell Toys, 212 N. Western Ave., Los Angeles 4, Calif.).....	422

OFFICE, SHOP AND STORE

Self-service upholstery shop.....	208
Laundry-vending machine.....	209
Bantam calculator.....	232
Ink-bottle "fountain pen" (Jet Manufacturing Co., Inc., 288 Hyde Park Ave., Boston 30, Mass.).....	388
Rubber swinging door (Stic-Klip Co., Cambridge, Mass.).....	426

RECREATION

Boxing scoreboard.....	203
Plastic bugs (Sa-reel Bait Co., 1855 12th St., Cuyahoga Falls, Ohio).....	209
Amphibious hunter.....	217
Oscar teaches golf swing.....	430

MISCELLANEOUS

Editorial by H. H. Windsor, Jr.....	117
America's first railroad track built 100 years ago.....	126
Fifty years hence.....	144
The beginning of the horseless age.....	152
One-man submarine torpedo boat.....	164
Wireless telegraphy practicable as cabling.....	181
Bubbling cup can be lifted to user's lips.....	183
Old ads.....	184
"Pretty kettle of fish".....	187

(Continued to page 14)

WHAT Every AUTO MECHANIC Wants to Know

A motor vehicle is a machine of many parts, each part designed and constructed for its own special function. All good mechanics, like good doctors, should know the working theory and operation of each part and understand what causes trouble and how to remedy it.

LET AUDELS AUTO GUIDE SOLVE YOUR PROBLEMS

Every auto mechanic, helper, serviceman and operator can use a copy of AUDELS AUTOMOBILE GUIDE. The information it gives saves time, money and worry. Highly indorsed by all users. It presents the whole subject of auto mechanics from A to Z in plain language and simple terms.

This Big Practical Book gives full information with working diagrams covering the principles, construction, ignition, service and repair of modern cars, trucks and buses.

A complete Guide of 1800 pages, with over 1500 illustrations showing inside views of the working parts, with instructions for service jobs. Diesel engines, Fluid and Hydra-matic drives fully explained.

IT PAYS TO KNOW HOW TO

How to fit pistons—How to locate engine knocks—How to fit connecting rod bearings—How to service main bearings—How to recondition valves—How to time valves—How to adjust fan belts—How to adjust carburetors & chokes—How to rebuild a clutch—How to service automatic transmissions—How to service brakes—How to adjust steering gear—How to cope with ignition troubles—How to service distributors—How to time ignition—How to "tune up" an engine.

INFORMATION IN A HANDY FORM

73 INTERESTING CHAPTERS—Read this partial list of subjects on which practical information is fully given for quick reference under the headings as shown below. Ready Reference Index.

All Parts of an Automobile—Automotive Physics—The Gas Engine—Gas Engine Principles—Multi-Cylinder Engines—Horse Power—Automobile Engines—Stationary Parts—Moving Parts—Pistons—Piston Rings—Connecting Rods—Crank Shafts—Valves—Valve Gear—Cams and Cam Action—Valve Timing—Cooling Systems—Fuel Feed Systems—Dual Fuel Feed—Mixture—Carburetors—Carburetor Service—Automatic Choke—Super-Chargers—Transmissions—Special Transmissions—Fluid and Hydra-matic Drives—Clutches—Universals and Propeller Shafts

A Ready Reference

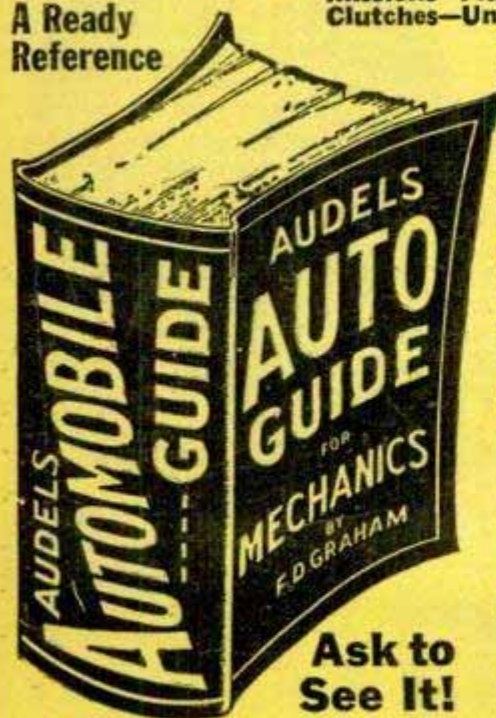

—The Differential—Rear Axles—Rear and Front Suspension—Running Gear—Brakes—Wheel Alignment—Knee Action—Steering Gear—Tires—Lubricants and Lubrication—Automotive Electricity—Ignition Systems—Magneto Ignition—Spark Plugs—Ignition Coils—Distributors—Automatic Spark Control—Ignition Timing—Generators—Starters—Generator and Starter Testing—Lighting Systems—Storage Batteries—Charging and Testing—Diesel Engines and Trouble Shooting.

7 DAYS' FREE TRIAL
TO GET THIS ASSISTANCE FOR YOURSELF SIMPLY FILL IN AND MAIL COUPON TODAY.

\$4 COMPLETE PAY \$1 A ONLY 1 MO.

Ask to See It!



Sent on 7 Days Approval

Step up your own skill with the facts and figures of your trade. Audels Mechanics Guides contain Practical Inside Trade Information in a handy form. Fully illustrated and Easy to Understand. Highly Endorsed. Check the book you want for 7 DAYS FREE EXAMINATION. Send No Money. Nothing to pay postman.

CUT HERE MAIL ORDER

AUDEL, Publishers, 49 W. 23 St., NEW YORK 10, N. Y.

Please send me postpaid for FREE EXAMINATION books marked (X) below. If I decide to keep them I agree to mail \$1 in 7 Days on each book or set ordered and further mail \$1 monthly on each book or set until I have paid price, otherwise I will return them.

- TRUCK & TRACTOR GUIDE, 1299 Pages . . . \$ 4
- AUTOMOBILE MECHANICS GUIDE, 1800 Pages . . . 4
- DIESEL ENGINE MANUAL, 575 Pages . . . 2
- MACHINISTS HANDY BOOK, 1650 Pages . . . 4
- WELDERS GUIDE, 400 Pages . . . 1
- BLUE PRINT READING, 416 Pages . . . 2
- MATHEMATICS & CALCULATIONS, 700 Pages . . . 2
- SHEET METAL PATTERN LAYOUTS, 1100 Pages . . . 4
- SHEET METAL WORKERS HANDY BOOK, 388 Pgs. . . 1
- MECHANICAL DRAWING GUIDE, 160 Pages . . . 1
- MECHANICAL DRAWING & DESIGN, 480 Pages . . . 2
- AIRCRAFT WORKER, 240 Pages . . . 1
- TELEVISION SERVICE MANUAL, 384 Pages . . . 2
- RADIOMANS GUIDE, 914 Pages . . . 4
- ELECTRONIC DEVICES, 216 Pages . . . 2
- ELECTRIC MOTOR GUIDE, 1000 Pages . . . 4
- ELECTRIC WIRING DIAGRAMS, 272 Pages . . . 1
- ELECTRICIANS EXAMINATIONS, 250 Pages . . . 1
- ELECTRIC POWER CALCULATIONS, 425 Pages . . . 2
- HANDY BOOK OF ELECTRICITY, 1440 Pages . . . 4
- ELECTRIC DICTIONARY, 9000 Terms . . . 2
- ELECTRIC LIBRARY, 7000 Pages (12 Book Set) . . . 18
- MARINE ENGINEERS HANDY BOOK, 1258 Pgs. . . 4
- SHIPFITTERS HANDY BOOK, 250 Pages . . . 1
- REFRIGERATION & Air Conditioning, 1280 Pgs. . . 4
- MILLWRIGHTS & MECHANICS GUIDE, 1200 Pgs. . . 4
- POWER PLANT ENGINEERS GUIDE, 1500 Pages . . . 4
- ENGINEERS & FIREMANS EXAMS, 525 Pages . . . 1
- PUMPS, Hydraulics & Air Compressors, 1658 Pgs. . . 4
- ENGINEERS LIBRARY (3 Book Set) . . . 9
- MECHANICAL DICTIONARY, 950 Pages . . . 4
- GARDENERS & GROWERS GUIDES (4 Book Set) . . . 6
- CARPENTERS & BUILDERS GUIDES (4 Book Set) . . . 6
- PLUMBERS & Steamfitters Guides (4 Book Set) . . . 6
- MASONS AND BUILDERS GUIDES (4 Book Set) . . . 6
- PAINTERS & DECORATORS MANUAL, 450 Pgs. . . 2
- HOUSE HEATING GUIDE, 1000 Pages . . . 4
- OIL BURNER GUIDE, 384 Pages . . . 1

Name _____
 Address _____
 Occupation _____
 Employed by _____ 21

AUDEL, Publishers, 49 W. 23 St., New York 10, N. Y.

OWN a Business" Coupon

DURACLEAN CO., 2-161 Duraclean Bldg., Deerfield, Illinois

With no obligation to me, send booklet and letter giving full details. Tell me how I may OWN a growing business of my own built upon satisfied customers.

Name

Address

City..... State.....



Are You The Man?

If you are dependable, honest and willing to work to own a large-profit, lifetime business and become financially independent, we invite you to mail the above coupon for full details. We are now enlarging this 21-year-old, world-wide chain of **individually-owned** service businesses. We'll establish you in YOUR OWN business and help fi-

nance you. You use successful methods of established Duraclean dealers. This is a nationally advertised, lifetime business. You can average \$4.50 hourly gross profit on service rendered by you and \$3.00 on **EACH** of your servicemen at National Price Guide charges. **Easy to learn . . . quickly established.**

Revive, Clean and Protect Upholstery and Rugs!

This remarkable service restores the natural fibre lubrication of wool and other animal fibers. Resiliency returns to the pile. It rises again. Brilliant colors revive. Results in many instances are almost unbelievable.

This service banishes the need of cleaning upholstery, rugs and carpeting by harsh machine scrubbing and soaking. It eliminates harmful solvents and strong soaps.

The aerated foam, created by the **patented** electric Foamovator, cleans by **ABSORPTION**—not by scrubbing. Dirt, grease and many unsightly spots vanish. Your service is recommended nationally by America's foremost furniture and department stores.

Forestall Damage by Moths & Carpet Beetles

The Duraproof patent-protected service not only kills moths and carpet-beetles but is also **WARRANTED** to make fabrics **repellent** to both. The U. S. Government says, "**Moths are present in practically every household. . . . No section of the country seems free from such infestations.**" Damage to household goods and wearing apparel is greater from moths than from fire. This modern treatment **DEFINITELY PROTECTS** rugs, carpets, upholstery, furs, clothing, blankets, piano-felts, auto interiors, etc.

What Dealers Say

W. Lookiebill (20 years a Duraclean dealer): "Have had more business than I could handle."

G. Merriman: "This made me \$700 cleaning with only 13 working days."

P. Freidinger: "We had a big moth-proof business last year; one job alone was \$322.25."

M. Turner: "Took in \$106 that week and worked 15 or 18 hours."

R. Kimbrough: "Finished First White House of Confederacy and am to Duraclean the Governor's Mansion."

Q. Corbett (Canada): "Several hundred dollars in jobs lined up from canvassing."

H. Satterfield: "Duracleaned chair for largest department store and got order for 60-75 chairs, couches & davenport."

E. Schenk: "The customers I had on House and Garden ads were very pleased. Their furnishings came out beautiful."

A. Ullman: "It is very encouraging that every demonstration has been a sale."

L. Johnson: "Each customer leads to 3 or 4 more."

No Shop Needed—EASY to Learn

No overhead expense. Service may be rendered in homes, offices, hotels, theaters, institutions, etc., by your service men. Auto dealers have upholstery revived in used cars. Some Duracleaners establish shops or an office—others operate from their homes.

Start Part or Full Time

No experience needed. We show you 21 ways to get customers. Almost every building houses a potential customer. A waiting market is in small and large towns alike. These year-round services are in constant need.

"Peace or War" Business

A Duraclean dealership prospers during peace or war. During World War II, Duracleaners experienced an unusual increase in business due to calls from customers unable to get service from ordinary cleaners short of help.

EASY TERMS:

A moderate payment establishes your own business—pay balance from profits. We furnish electric machines, folders, store-cards, introduction slips, sales book, demonstrators and enough materials to return your **TOTAL** investment. You can have your business operating in a very few days. Mail the coupon. No obligation.

Repeat & Voluntary Orders

Demonstrations win customers. Duracleaners find **REPEAT** and **VOLUNTARY** orders a main income. Customers, enthused at results, tell friends and neighbors. Magazine ads give your service national prestige.

Double Profits

You enjoy large profits on both materials and labor. To start, you may want to render service yourself. You have cooperation of a world-wide organization interested in YOUR success.

FREE Booklet

Our first letter and 16 page illustrated booklet will explain everything—these modern urgently needed services, the waiting market, how business grows, your large profits, easy terms and protected territory. Mail the coupon **TODAY**. No obligation.

OWN a Growing BUSINESS



Patented Machine converts to carrying case

DURACLEAN CO., 2-161 Duraclean Bldg., Deerfield, Ill.

Mail Coupon TODAY—While Territory Is Open

INVENTORS

Learn how to protect your invention. The U. S. Patent Laws provide that any new and useful art, machine, article of manufacture, or composition of matter, or any new and useful improvement thereof, may be patented if the act of invention is involved. Therefore, every inventor with a valuable invention should take advantage of the Patent Laws and proceed for patent protection in order to safeguard his rights.

A patent gives the inventor the exclusive right to prevent others from making, using, or selling the invention claimed in the patent for a period of seventeen years.

The Patent Laws were enacted for the benefit of the inventor to give him protection for the features of his invention which are patentable. These features must be properly and concisely set forth and claimed in a formal application for patent, in order to comply with the requirements of the Patent Laws. For that reason, unless the inventor is familiar with patent matters, he should engage a competent registered patent attorney or agent to represent him. We are registered to practice before the U. S. Patent Office and are prepared to serve you in the handling of your patent matters.

A specially prepared booklet entitled "Patent Guide for the Inventor", containing detailed information with respect to patent protection and procedure, together with a "Record of Invention" form will be promptly forwarded to you without obligation upon request.

CLARENCE A. O'BRIEN & HARVEY JACOBSON

Registered Patent Attorneys

21-A DISTRICT NATIONAL BUILDING

WASHINGTON 5, D. C.

Everybody Knows

PROTO means
PROfessional
TOols!

Our smart Adjustabull is bellowing that men who really *know* tools demand PROTO. Experts *know* that PROTO gives them outstanding features. —special alloy steels, proper forging, scientific heat treating, accurate manufacture, tested designs. Your PROTO dealer *knows* you want the best and has a great many professional tools for your needs. Buy them today! Send 10¢ for 68-page catalog to

PLUMB TOOL COMPANY
2255L Santa Fe Ave., Los Angeles 54, Calif.

TOOLAGRAM



These PROTO pliers are sturdily constructed from rich alloy steels, and have good balance, solid joints, full polish and induction-hardened cutters.

5186

PROTO TOOLS
Professional Quality

REG. U.S.
PAT. OFF.

LOS ANGELES

MADE
IN U.S.A.

House of cork.....	200
Waterproof rope (South Eastern Cordage, 657 NBC Building, Cleveland 14, Ohio).....	203
Reflector-lighted greenhouse.....	203
Underwater camera.....	209
Sick plants run a fever, too.....	209
Man's hottest flame.....	223
Collapsible fuel tank.....	232
Minerals in beef.....	422
Clear-glass "dog tag" measures atom radiation (Bausch & Lomb Optical Co., 635 St. Paul St., Rochester 2, N. Y.).....	424
Fast winker.....	426
1000-year-old seeds still can sprout.....	428
"Hypnotism" captures grouse.....	428

Radio-Television, Electronics

Color television today.....	233
Popular Mechanics first radio and television receivers for experimenters.....	234
Tomorrow's electronic barbershop quartet.....	237

Craftsman and Shop Notes Index

AUTOMOTIVE

Leather patches around car-door handles improve appearance of interior.....	268
Engine shield for cold weather.....	284
Glare from plated car accessories killed with electrician's tape.....	292
Safe way to inflate truck tires mounted on three-part rims.....	296

FARM

Ends on V-type feeding troughs held with wagon-box bolts.....	296
Converted branding-iron heater used for controlling grass fires.....	297
Snap-on boot cut from overshoe protects tractor distributor.....	304
Fence posts pulled with truck if simple fulcrum is used.....	308

FIXTURES, GAUGES AND JIGS

Fixture rides rip fence to simplify shaping edge of thin work.....	261
Grinding jig used on circular saw permits shouldering round stock.....	261
Stud bolts provide "pipe jaws" for bench vise.....	276
Time saved in setting lathe tool by using simple height gauge.....	304
Prick punch held on wooden block speeds making repeat marks.....	304
Compound miter box.....	305
Making torque-wrench dial easy to read in dim light.....	308

HOUSE AND HOME

Draft through furnace utilized to control dust from ashes.....	253
Flanges mounted beneath steps add rigidity to handrail.....	256
Light bulbs stored in egg carton.....	258
Cleaning copper-bottom pans.....	258
Paper plate lines garbage pail.....	258
Restoring taste to candies.....	258
Ironing skirt pleats.....	258
Refrigerator storage space improved.....	259
Paste wax preserves painted window sills.....	259
Wool yarn wrapped around mothballs.....	259
Improvised clothespole hangers.....	259
Wax paper improves fit of lids.....	259
Erasing rubber-heel marks.....	259
Vanity drawer kept in order.....	260
Telephone pad fastened to wall.....	260
Clothespins hold skirt on hanger.....	260
Zinc-sulphate solution improves "dusty" concrete floor.....	260
Removing rings on varnished furniture.....	260
Tape-covered roller removes lint from garments.....	260
Sample combination sash enclose breezeway to form comfortable room the year 'round.....	273
Folding stand for portable ironer.....	274
Trip grooves hand-cut in records permit playing on changer.....	276
Fertilizer spreader "sands" ice-coated walks.....	276
No rest for your fan.....	277
Child prevented from locking door.....	281

OFFICE, SHOP AND STORE

Stapled areas on papers reinforced with tape.....	268
Small drills stored in lipstick tube.....	275
Metal tray under belt sander reduces dust in the shop.....	281
Empty varnish cans and wooden box provide bins for small parts.....	281

(Continued to page 16)

IMPORTANT NOTICE—It is the intention of this magazine to provide its readers with information regarding the latest developments in the mechanical arts. We take no responsibility as to whether the disclosures contained in our articles are covered by patents and advise readers to investigate this subject before making, using, or selling any of the products, machines, or processes described in order to avoid possible liability for patent infringements.

INVENTORS

If you believe that you have an invention, you should find out how to protect it. The first step is to have a search made of the prior pertinent U. S. patents. If a report on this search indicates that the invention appears patentable you can apply for a patent, and the specifications and claims should be prepared.

The firm of McMorrow, Berman & Davidson, with offices in Washington, D. C., is qualified to take the necessary steps for you. We can make a preliminary search on your invention, advise you whether we think it can be patented, and prepare your application for patent.

Unless you are fully familiar with the U. S. Patent Laws, we recommend that you engage the services of a Registered Patent Attorney to protect your interests. The patent laws are *your* laws. A patent gives you the right to prevent others from making, using or selling the invention claimed in your patent for a period of 17 years.

Use these patent laws for your protection. Investigate whether your invention can be patented. If you have what you believe to be an invention, we suggest that you have this firm make a search for you.

Send for a copy of our Patent Booklet entitled "How To Protect Your Invention," containing information about patent protection and patent procedure. Along with this we will also send you an "Invention Record" form, for your use in writing down and sketching details of your invention. We will mail them promptly. No obligation. They are yours for the asking.

McMORROW, BERMAN & DAVIDSON

Registered Patent Attorneys

PATENTS • COPYRIGHTS • PATENTS

1353 VICTOR BUILDING, WASHINGTON 1, D. C.



MEN OF THE HOUR

are moving UP!

Thousands of Embry-Riddle trained engineers, mechanics, specialists and pilots are making rapid strides in today's booming aviation industry.

These men in the top jobs are undeniably proving that thorough, practical Embry-Riddle training is by far your quickest, surest road to success in aviation. Complete eight-month to two-year Embry-Riddle courses are tailored to practical aviation industry requirements.

The latest, most modern equipment (including jet engines), the finest instructors, the most complete aviation school campus anywhere, are all yours at Embry-Riddle.

If you are now a high school student, a graduate or a veteran, investigate at once the full advantages and tremendous career security of Embry-Riddle training.

If military service interrupts your studies, you're still a long way ahead of the crowd.

Join the Embry-Riddle Men of the Hour. Write for full information today.

4 Keys to Success!

AIRCRAFT & ENGINE MECHANICS
Our C. A. A.-approved school has a quarter-century aviation training experience. Learn fast with modern equipment, including jet... live aircraft, airline-size hangars.

A & E COMBINED WITH COMMERCIAL
Embry-Riddle combination training gives you unusual dual pilot-engineering ability.

AERONAUTICAL DESIGN AND TECHNOLOGY
Embry-Riddle's accelerated 26-mo. Aeronautical Design and Technology Course provides finest training available.

COMMERCIAL PILOT
Benefit from our experience with 30,000 students... best instructors and aircraft, year-'round flying weather.

Embry-Riddle
International
SCHOOL OF AVIATION
MIAMI 30, FLORIDA

CLASSES BEGINNING NOW -- SEND COUPON TODAY!

Dean of Enrollments -- Dept 99
Embry-Riddle School of Aviation
MIAMI 30, FLORIDA
Please Print

NAME _____

ADDRESS _____

City _____

State _____ Age _____

I am interested in...

A.&E. Mechanic

Commercial Pilot

Aeronautical Design and Technology

A.&E. Combined with Commercial Pilot

Flying Mechanic

Check Veteran Non-Veteran

TRAIN IN MIAMI--AIR CAPITAL OF THE WORLD

Apartment workshop290
Soldering iron hung on bench by loop formed in cord.....292
Transparent small-parts holder.....304

PHOTOGRAPHY

Leather cap protects camera lens.....285
Gelatin color-correction filters stored in negative file.....285
Horn switches and rheostat afford positive control of enlarger.....288
Dental mirror reflects settings when camera is elevated.....289
Removing excess rubber cement from mounted photographs.....289
Tape on developing tank prevents exposing film.....289

TOOLS

Hand drill chucked in bit brace holds small twist drills.....261
Nailset tied to wrist is always at hand.....276
Special dog screwed to faceplate saves time in mass-machin-
ing bar stock.....296
Improvised thread-cutting tool.....297
Air-operated fender iron (Chicago Pneumatic Tool Co., 6 E.
44th St., New York City 17).....306
Stamping machine (M. E. Cunningham Co., 83 E. Carson St.,
Pittsburgh 19, Pa.).....306
Bushing-driver set (Bonney Forge & Tools Works, Allentown,
Pa.).....306
Carbide-tipped dresser (Robert Marks Co., 47 Goddard St.,
Providence, R. I.).....306
Depth-gauge attachment (L. S. Starrett Co., Athol, Mass.).....306
Paint roller (Spina Roll-R Co., 838 N. 13th, Milwaukee 3,
Wis.).....307
Potter's wheel (B & I Mfg. Co., Burlington, Wis.).....307
Electric heat gun (Kinetic Products Corp., 31 S. 18th St.,
Philadelphia 3, Pa.).....307
Saw sharpener (Saw-Mgr. Co., 3300 First St., N.E., Minne-
apolis 18, Minn.).....307
Extra lathe dog checks slippage when taking heavy cuts.....308

WOODWORKING

Veneer strips "ironed" on work.....253
Closet-door buffet254
Mahogany knickknack shelf.....257

MISCELLANEOUS

Gate fitted with roller keeps dog in yard.....253
House-trailer sewer hose stored in downspout hung under
chassis256
Shelf protected from acid by rubber stair-tread covering.....256
Emergency pouring spout for screw-cap cans.....256
Technique of filing a radius.....256
Waterproofing leather footwear.....268
Wheels made on disk sander.....273
House cut in half for moving provides two separate homes.....273
Skate wheels on extension ladder make it easier to raise.....275
Picket-fence safety rail prevents animal injury.....276
Sheet-metal paintbrush holder retains shape of bristles.....292
Colorful frames for wall pictures cut from large desk blotters.....292
Damageproof food box for camping trips.....292
Characteristics of lubricating oils determined from simple
tests295
Stake doubles as tightener for mason's chalk line.....296
Wedges hold generator brushes while inserting armature.....304
Marker for measuring tape provided by key ring.....308

Biggest Dam South of Equator

American engineers, executives and foremen are supervising construction of the largest dam to be built south of the equator. It's the Eildon Dam in a remote valley of the Goulburn River in Australia. The dam builders will shift 12,800,000 cubic yards of earth and rock—four times as much material as went into the Great Pyramid—in constructing the embankment. The Utah Construction Company of California was awarded the contract to build the dam, pledging completion in slightly more than four years. Thirty-seven American experts and their families were flown across the Pacific to the construction settlement. Huge excavators, loaders and tractors followed by ship. The big dam, when completed, will rise 260 feet from the bed of the river and will be 1/2-mile long. It will store 2,750,000 acre-feet of water for irrigation, and discharge its water through two turbogenerators with a total capacity of 120,000 kilowatts.

HOW TO FIX ANY PART OF ANY CAR

USED BY U. S. ARMED FORCES

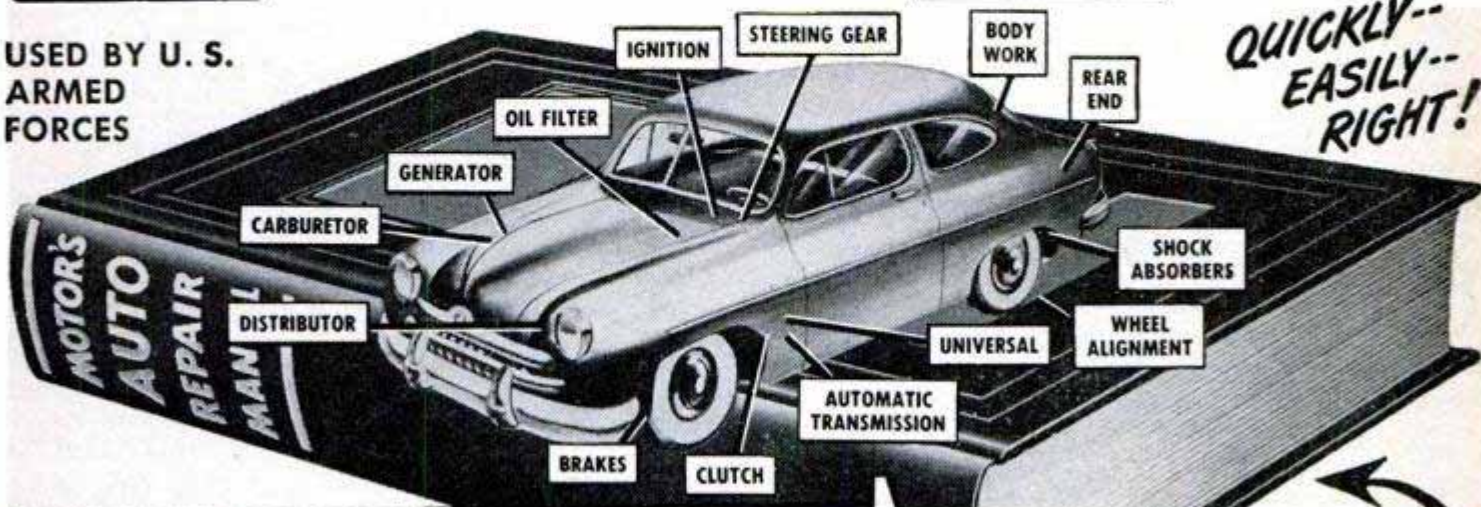

QUICKLY--EASILY--RIGHT!

NOW—Whether You're a Beginner or an Expert Mechanic —You Can "Breeze Through" ANY AUTO REPAIR JOB! MoToR's BRAND-NEW 1951 AUTO REPAIR MANUAL Shows You HOW—With 2300 PICTURES AND SIMPLE STEP-BY-STEP INSTRUCTIONS.

Free 7-DAY TRIAL
Return and Pay Nothing If Not Satisfied!

COVERS EVERY JOB ON EVERY CAR BUILT FROM 1935 THRU 1951

YES, it's easy as A-B-C to do any "fix-it" job on any car whether it's a simple carburetor adjustment or a complete overhaul. Just look up the job in the index of MoToR's New AUTO REPAIR MANUAL. Turn to pages covering job. Follow the clear, illustrated step-by-step instructions. Presto—the job is done!

No guesswork! MoToR's Manual takes nothing for granted. Tells you where to start. What tools to use. Then it leads you easily and quickly through the entire operation!

Same FREE Offer On MoToR's Truck and Tractor Manual
Covers EVERY job on EVERY popular make gasoline truck, tractor made from 1936 thru 1951. FREE 7-Day Trial. Check proper box in coupon.

short-cuts that will amaze you. No wonder this guide is used by the U. S. Army and Navy! No wonder hundreds of thousands of men call it the "Auto Repair Mans' Bible"!

Meat of Over 150 Official Shop Manuals
Engineers from every automobile plant in America worked out these time-saving procedures for their own motor car line. Now the editors of MoToR have gathered together this wealth of "Know-How" from over 150 Official Factory Shop Manuals, "boiled it down" into crystal-clear terms in one handy indexed book!

- Covers 800 Models—All These Makes**
- | | | |
|-----------|-------------------------------------|--------------|
| Buick | Henry J. | Nash Rambler |
| Cadillac | Hudson | Oldsmobile |
| Chevrolet | Kaiser | Packard |
| Chrysler | Lafayette | Plymouth |
| Crosley | La Salle | Pontiac |
| De Soto | Lincoln | Studebaker |
| Dodge | Mercury | Terraplane |
| Ford | Nash | Willlys |
| Frazer | ALSO tune-up adjustments for others | |

Many Letters of Praise from Users
"MoToR's Manual paid for itself on the first 2 jobs, and saved me valuable time by eliminating guesswork."
—W. SCHROP, Ohio.

He Does Job in 30 Min.—Fixed motor another mechanic had worked on half a day. With your Manual I did it in 30 minutes.
—C. AUBERRY, Tenn.

Over TWO THOUSAND Pictures! So Complete, So Simple, You CAN'T Go Wrong!

NEW REVISED 1951 Edition covers everything you need to know to repair 800 car models. 771 giant pages, 2300 "This-Is-How" pictures. Over 200 "Quick-Check" charts—more than 38,000 essential repair specifications. Over 225,000 service and repair facts. Instructions and pictures are so clear you can't go wrong!

Even a green beginner mechanic can do a good job with this giant manual before him. And if you're a top-notch mechanic, you'll find

Try Book FREE 7 Days

SEND NO MONEY! Just mail coupon! When the postman brings book, pay him nothing. First, make it show you what it's got! Unless you agree this is the greatest time-saver and work-saver you've ever seen—return book in 7 days and pay nothing. Mail coupon today! Address: **MoToR Book Dept., Desk 1A, 250 West 55th St., New York 19, N. Y.**

MAIL COUPON NOW FOR 7-DAY FREE TRIAL

MoToR BOOK DEPT.
Desk 1A, 250 W. 55th St., New York 19, N. Y.

Rush to me at once (check box opposite book you want):

MoToR's New AUTO REPAIR MANUAL. If O.K., I will remit \$1 in 7 days (plus 35c delivery charges), \$2 monthly for 2 months and a final payment of 95c one month after that. Otherwise I will return the book postpaid in 7 days. (Foreign price, remit \$8 cash with order.)

MoToR's New TRUCK & TRACTOR REPAIR MANUAL. If O. K., I will remit \$2 in 7 days, and \$2 monthly for 3 months, plus 35c delivery charges with final payment. Otherwise I will return book postpaid in 7 days. (Foreign price, remit \$10 cash with order.)

Print Name.....Age.....
Address.....
City.....State.....

Check box and save 35c shipping charge by enclosing WITH coupon entire payment of \$5.95 for Auto Repair Manual (or \$8 for Truck and Tractor Repair Manual.) Same 7-day return-refund privilege applies.

**RAILWAY
POSTAL
CLERKS**

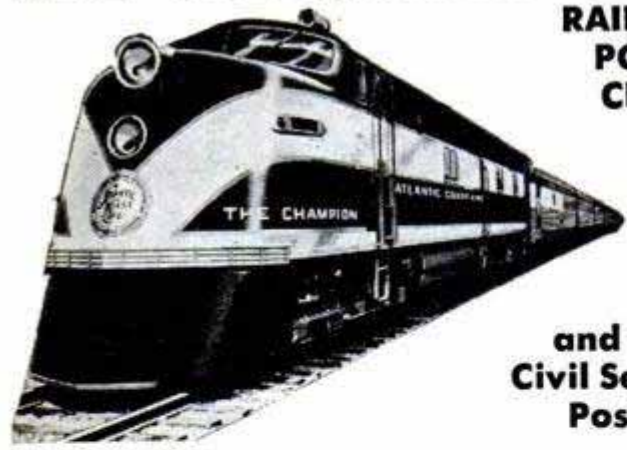

**and other
Civil Service
Positions**

**Start as high as \$3,870.00
a Year**

(Veterans Get Special Preference)

Get Ready Now for 1952 Examinations

City Mail Carriers, Post Office Clerks

Clerks and Carriers now get \$3,570.00 the first year of regular employment and automatically increase \$100 a year to \$4,070.00. Open to Men—Women 18 to 50. Clerks and Carriers can be promoted to other postal positions paying as high as \$8,070.00.

Railway Postal Clerks

Railway Postal Clerks get \$3,870.00 the first year of regular employment, being paid on the first and fifteenth of each month. (\$161.25 each pay day.) Their pay is automatically increased yearly to \$4,270.00. Advance may be had to Chief Clerk at \$6,370.00 a year. Male Veterans only.

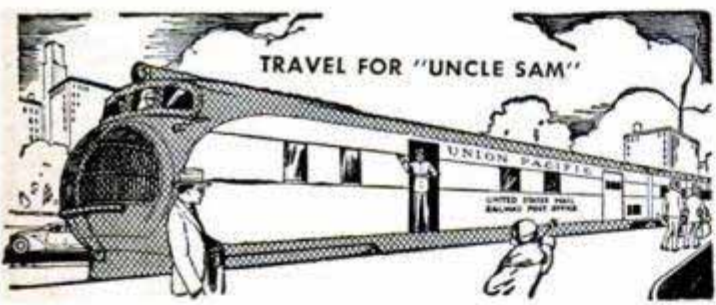

3 Days On — 3 Days Off — Full Pay

Railway Postal Clerks on long runs usually work 3 days and have 3 days off duty or in the same proportion. During this off duty their pay continues just as though they were working. They travel on a pass when on business. When they grow old, they are retired with a pension.

Many Other Positions

Many other positions are obtainable. Rural Carriers—Stenographers—Typists—Patrol Inspectors—Customs Inspectors—etc. Those wishing these positions should qualify at once.

Get Free List of Positions

Fill out the following coupon. Tear it off and mail it today—NOW, at once. Although not government controlled, this can result in your getting a big paid government job.

FRANKLIN INSTITUTE, Dept. D84, Rochester 4, N. Y.

Rush to me, entirely free of charge (1) a full description of U. S. Government Jobs; (2) Free copy of illustrated 32-page book, "How to Get a U. S. Government Job" with (3) List of U. S. Government Jobs; (4) Tell me how to qualify for one of these jobs.

Name _____
Street _____
City _____ Veteran? _____
Use This Coupon Before You Mislays It. Write or Print Plainly.

**THE
EDITORS**



AS THIS GOLDEN Anniversary issue goes to press, we acknowledge gratefully the many salutations that have come to us from long-time readers. We present here as many excerpts from these letters from old friends as space permits:

The first copy of *Popular Mechanics* I ever saw contained an account of the Wright brothers' exploits at Kitty Hawk. My files are fairly complete, going back about 35 years. I will always remember and greatly admire the name of H. H. Windsor, this being the name signed to the letter of acceptance for the first article of any kind I ever wrote for publication. I have contributed numerous articles and used the classified ads beginning about 1908. It is needless to say I am intensely devoted to your magazine; feel almost like it is *my* magazine; feel like every issue is published on my individual account, and that the spirit of Mr. Windsor lives on in the handsome format and interesting pages of the book. I take great pleasure in giving a salute to *Popular Mechanics* and the staff on this their Golden Anniversary, and speeding you along on another half century of great accomplishments.

A. W. Phillips,
Clemmons, N. C.

(Continued to page 22)



Charles La Plant of Crystal Lake, Ill., has read *PM* since it started in 1902 and has saved every copy

Prepare in our
Big Training
Shops for these

GREAT OPPORTUNITY FIELDS!



This big fire-proof building is occupied entirely by Coyne.

TRAINED YOUNG AND OLDER MEN — VITALLY NEEDED IN NATION'S GIANT DEFENSE PROGRAM

Where do you fit in today's gigantic Defense Program and Industrial expansion? Trained young and older men will play an important part in vital fields. Electricity and Television-Radio are essential to our Defense Program in both Industry and Armed Forces. Don't wait to be assigned to a dull, low pay, no future job. Get training and be ready to pick one of many job opportunities or get a better rating if drafted. Today it's not how young or how old you are that counts, but how prepared you are for jobs that demand skilled men. So, whether you are 16 or up to 50 you are needed. Qualify now for:

1. BETTER RATING, HIGHER PAY IF DRAFTED.
2. A VITAL JOB IN INDUSTRY, IF NOT IN DRAFT.

NOT "HOME-STUDY" COURSES

Our famous Television-Radio Practical-Technical method gives you practical experience on a massive outlay of equipment. Not by correspondence, but actual shop work plus necessary technical training. You are trained right here in the great Coyne shops that have been training men and young men for over 50 years.

TELEVISION-RADIO ELECTRICITY

A great opportunity field and vital to Defense. Here at COYNE you're retrained for Construction, Testing, Trouble-Shooting on Radio, Public Address, Sound Units. Training includes FM, Television Installations, Servicing, etc. Many Coyne trained men in good jobs or own well paying Television-Radio businesses of their own.

INCLUDING INDUSTRIAL ELECTRONICS

The Power behind the entire Defense Program. Big future in Power Plant Work, Motors, Armature Winding, Home and Factory Wiring, Appliances, Refrigeration, Maintenance, Illumination, etc. Lifetime job service to Coyne graduates. Send for BIG FREE BOOK.

LARGEST, OLDEST, BEST EQUIPPED SCHOOL OF ITS KIND IN THE U.S.

Mail Coupon for
Big FREE Book!



Whether you prefer Television-Radio or Electricity, train on actual equipment at Coyne. We will send you a Big, fully Illustrated Book. Indicate below, which course interests you most. No salesman will call. Mail coupon TODAY.



START NOW—PAY LATER

Don't let lack of money hold you back. You can finance most of your tuition and pay for it later, in easy monthly payments. Special plan for men of draft age. We'll help you get part time work, if you need it, to help pay living costs while at Coyne.

G. I. APPROVED

B. W. COOKE, President

COYNE SCHOOL

A TECHNICAL TRADE INSTITUTE
CHARTERED NOT FOR PROFIT
Established 1899

500 S. Paulina Dept. 12-72H
Chicago 12, Illinois

ELECTRICITY ★ TELEVISION ★ RADIO ★ ELECTRONICS ★ REFRIGERATION

B. W. Cooke, President
COYNE SCHOOL, 500 S. Paulina St.
Dept. 12-72H, Chicago 12, Ill.

Send me your Big Free book, and details of your special plan for men of draft age. I am interested in field checked below. This does not obligate me.

TELEVISION-RADIO ELECTRICITY

NAME.....

ADDRESS.....

CITY.....STATE.....

Coyne is the Oldest Residential Trade School Advertiser in Popular Mechanics



"Put Your Finger" ON Any Car Trouble

IN A JIFFY!

Handy New Guide Lists 1760 Causes of Faulty Operation, Noises, Break-downs

SAVE TIME AND WORK on any auto repair job by being able to "put your finger" on exactly what's causing the trouble—right from the start! New, indexed **TROUBLE-SHOOTER GUIDE**—prepared by the Editors of the world-famous **MOTOR'S Repair Manuals**—lists 1760 specific causes of car and truck troubles; helps you find the one you're after **FAST**. Book fits right in your pocket for instant reference. Spiral binding lets book stay open while you work. Cross-section **PICTURES** also included.

If car has Fan Belt noise—turn to Fan Belt Section for 8 specific things that can be wrong. **MOTOR'S TROUBLE-SHOOTER** helps you track down noises, knocks, misses, breakdowns—faulty operation from radiator to rear end. Covers engines, clutches, brakes, ignition, new automatic transmissions, etc. Gives quick help to beginners as well as experienced repair men!

Try Book for 7 Days — without obligation!

SEND NO MONEY—Mail Coupon—When postman delivers book, pay him \$1, plus few cents postage and C.O.D. charges. (Or send \$1 with coupon, and we pay shipping charges.) If not delighted, return book in 7 days for full refund. **MOTOR Book Dept., Desk AT, 250 W. 55th St., New York 19, N. Y.**

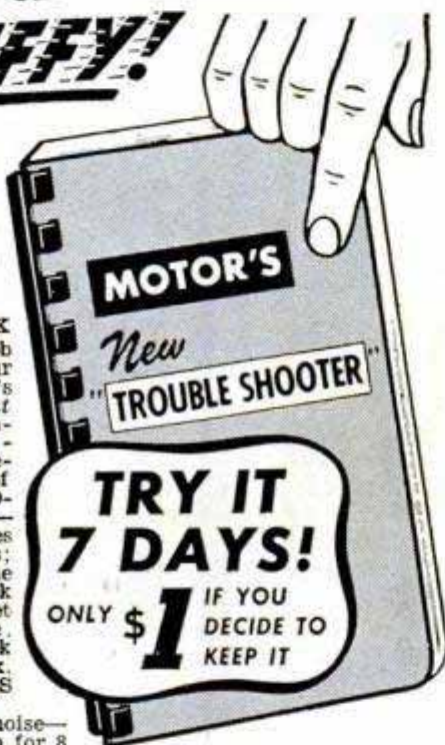

HOW TO SPOT —

87 Automatic Transmission Troubles. 8 Causes of Connecting Rod Noise. 87 Checks for Poor High-Speed Performance. Lack of Power. 82 Causes for Engine "Misses". 17 Checks for Pre-Ignition or Spark Knock. 45 Causes of Excessive Oil Consumption. 14 Causes of Crankshaft Noise. 73 Checks for Clutch Troubles. 66 Causes of Rear-Axle Trouble. 150 Checks for Front Suspension and Steering Troubles. 81 Causes of Brake Trouble. 27 Checks for Faulty Springs and Shock Absorbers. 84 Different Types of Wheel Troubles. **AND MUCH, MUCH MORE!**

MOTOR Book Dept., Desk AT, 250 West 55th St., New York 19, N. Y.

Rush me **MOTOR'S** work-saving **TROUBLE-SHOOTER**. I will pay postman \$1 on delivery, plus few cents postage and C.O.D. charges for each copy ordered. Unless completely satisfied, I may return book in 7 days and my money will be promptly refunded.

Name.....
Address.....

City..... Zone..... State.....

SAVE POSTAGE, C.O.D. CHARGES. Check if you send \$1 with coupon, then we pay shipping costs. Same refund guarantee.

New "Dope" On Automatic Transmissions Covers:
 • **HYDRAMATIC**
 • **BUICK DYNAFLOW**
 • **CHEVROLET POWERGLIDE**
 • **PACKARD ULTRAMATIC**
 • **STUDEBAKER AUTOMATIC**

In the fall of 1902 my first *Popular Mechanics* was purchased. This, I believe, was one of the best investments I have ever made, for I have had *Popular Mechanics* nearly every month since. The results have been much pleasure, education and quite a lot of profit. . . . I am getting old now but will continue to read *PM* as long as I can see.

Frank R. Sprague,
La Canada, Calif.

★ ★ ★

I have been a regular subscriber for nigh onto 50 years . . . still look forward to the new issue every month.

K. M. Becker,
Sparks, Nev.

★ ★ ★

I do not believe that I have missed reading a single copy since 1907. . . . *Popular Mechanics* is first on my reading matter.

Harry Radzinsky,
New York City.

★ ★ ★

I have always felt that there was at least one idea in each issue that was worth more than the price, and I wish you many more successful years.

Dan I. Porter,
Berrien Springs, Mich.

★ ★ ★

We thoroughly enjoy your magazine. Our boys, ages 13 and 15, are as anxious for its arrival as my husband and I. Not one of us can part with a book. We all send our thanks for many hours of enjoyment.

Mrs. A. P. Carter,
De Ridder, La.

★ ★ ★

. . . Have read it almost from the beginning. I am now 74 years old . . . and still operate my own cabinet shop with power machinery. In my work I find *PM* a great help.

Fred MacLaren,
Olympia, Wash.

★ ★ ★

I have been reading *Popular Mechanics* since 1905, and have all editions from 1909.

C. G. Langrill,
Mayor,
Yorkton, Sask., Can.

★ ★ ★

Let the good work continue!

Herbert L. Phillips,
Watertown, Mass.

(Continued to page 24)

GET THE MONEY AND SECURITY YOU'VE ALWAYS WANTED!



L. J. ROSENKRANZ, President, National Schools, the man who has trained many, many men like YOU. Men who now own successful, respected businesses of their own. Men who hold important, high-paying positions in famous companies. You CAN be a success. Mail coupon for more details.

Let Me Show You How! Mail the Coupon for My FREE Books!

Each book has page after page in color. Gives you the complete story about my proved training method...tells how quickly it can train you for a secure, high-paying job. Don't wait. Get the facts. Send today for my valuable books on Radio-Television or Automotive-Diesel. Check the coupon at right and mail it to me today. Absolutely no obligation.

NO SALESMAN WILL CALL!

I'll send you a FREE SAMPLE LESSON TOO, if you act fast! Shows how easy it is to learn with National Schools Home Training.



Let National Schools — a resident-training school for nearly 50 years—train you at home for today's unlimited opportunities in Radio-TV or Automotive-Diesel. National Schools is one of the largest schools of its kind in the world. It has 4 big buildings of modern shops and labs. Its faculty is considered tops. You learn fast from easy lessons —all perfected under actual shop conditions. Approved for eligible vets.



Earn Extra Money while you're learning! I'll show you how!
EASY TERMS • FREE GRADUATE SERVICE
 Mail coupon today—find out more!

NATIONAL SCHOOLS, Dept. B-12
 4000 South Figueroa Street
 Los Angeles 37, California

Mail in envelope or paste on penny postal card

Send me Free the book checked below and the sample lesson. I understand no salesman will call on me.

- "MY FUTURE IN RADIO-TELEVISION & ELECTRONICS" OR
 "MY FUTURE IN DIESEL-AUTOMOTIVE & ALLIED MECHANICS."

NAME _____ AGE _____

ADDRESS _____

CITY _____ ZONE _____ STATE _____

Check here if you were released from the service less than 4 years ago.

WHICH HIGH-PAYING FIELD DO YOU WANT?

TODAY'S SHORTAGE OF TRAINED TECHNICIANS CREATES CHANCE OF A LIFETIME FOR YOU...IN EITHER FIELD!

RADIO-TELEVISION & ELECTRONICS

OR

AUTOMOTIVE-DIESEL AND ALLIED MECHANICS

JOB SECURITY! BIG MONEY! FOR YOU IN TODAY'S EXPANDING INDUSTRIES!

Think of it! With guided missiles, radar and other electronic devices so important to national defense. With big, new developments in color TV. With over 90,000,000 home and auto radios, over 12,000,000 TV sets. With more than 3100 radio stations...over 100 TV stations—and more building every day—imagine the terrific opportunity you have!

You Train at Home—In Your Spare Time

With National Schools Master Shop Home Training, you master all phases of Radio-Television-Electronics. You learn fast from hundreds of pictures and diagrams. All lessons have been developed and tested in National Schools famous shops and labs. No wonder your National Schools training is so up-to-date, practical, interesting. And so easy!

LOOK! WE SEND YOU ALL THESE PARTS! —and you keep them!



We send you lots of standard professional parts. You do lots of practical experiments. You learn step by step. Until you can build the big Superheterodyne Receiver you see above—and other important test units. Mail the coupon—today.

I TRAIN YOU FOR GOOD-PAYING JOBS LIKE THESE

Radio Station Engineer; District Service Manager; Aircraft Radio Inspector; Inspector Technician; Own your own repair shop; Service Specialist; Special Civil Service Positions; Sound Truck Operator; Complete Television Service and many others.

Thousands of National Schools graduates have jobs like these. Why not you? Start your career—be sure to mail the coupon today.

Only National Schools Gives You This Professional Multi-Tester



You get this factory-made new Multi-Tester...an important instrument every Radio-TV man must have.

GREATEST DEMAND FOR TRAINED MEN IN HISTORY! NOW IS YOUR CHANCE!

What an opportunity! With over 8 million older cars needing big service and repair jobs. With defense industry having more high-paying jobs than they can fill. With the Armed Forces offering quick advancement to trained mechanics. YOU ARE NEEDED as never before! Now you can get the good pay, security, the satisfaction of doing what you want to do! Don't delay—mail the coupon NOW!

Right in Your Own Home!

You learn all about Gasoline Engines, Diesel and Special-Fuel Engines, Automotive Tune Up, General Garage Mechanics, Auto Electrical Service. You get complete training for this great, growing industry.

Yet National Schools Home Training is easy! Because it's based on actual shop methods in National Schools big resident school. Mail the coupon for more details—NOW.

National Schools Gives You All These Tools

You start out owning the tools of your trade. A kit of standard, professional tools and equipment. They're all part of your course!

—And you keep them—they're yours!



I Offer You All These!

Basic Lesson Texts, Diesel Installation & Maintenance Instructions, Spare Time Lessons, Engine Service Manuals, Engine Repair Drive Systems, Diesel Electric Power Texts, Special Thermodynamic Instruction.

Attention: Men Going into the Service Soon!

With National Schools training in Radio-Television or Automotive-Diesel, you have the opportunity to get into special service classifications. That means higher pay special service classifications. That means higher pay and grade, more prestige—right away! This is important—so be sure to mail the coupon today without fail.

WHICH OF THESE HIGH-PAYING JOBS WOULD YOU LIKE?

- MOTOR TUNE UP SPECIALIST
- DIESEL ENGINE SPECIALIST
- FARM EQUIPMENT MECHANIC
- YOUR OWN GARAGE OR REPAIR SHOP
- GENERAL GARAGE MECHANIC
- PARTS DEALER
- AUTO ENGINE REBUILDING
- FUEL INJECTION SPECIALIST

You can have secure jobs like these. Just mail the coupon—and find out!

BETTER JOBS BETTER PAY FOR SKILLED MEN!

QUICK TRAINING BOOKS SHIPPED for Examination

SEND NO MONEY! Prepare for a better job at bigger pay by sending the coupon NOW for any set of easy-to-understand self-training text books. These great books, prepared by long-experienced experts, can help you to acquire the "know how" that wins promotions and puts more money in your pocket. Any set of books sent for 10 days examination.

AUTOMOBILE ENGINEERING



4 Big, Thick Books
20th Edition, Over 2700 Pages

These wonder books tell how — step by step — to make the repairs and adjustments that keep any make of car at maximum operating efficiency. More than 2000 illustrations, wiring diagrams, data sheets, etc. Total price only \$24.80. Low monthly payments. Sent on trial.

BUILDING, ESTIMATING and CONTRACTING

Up-to-Date Edition
9 Volumes — 4000 Pages

These 9 practical books can help you to make more money by becoming foreman, superintendent, or running your own business. Drawing plans, estimating, masonry, carpentry, building, remodeling, heating, painting and many other subjects included. 2750 illustrations. Total price only \$34.80. Low monthly payments. Sent on 10 days' trial.



APPLIED ELECTRICITY

INCLUDING RADIO AND REFRIGERATION



New 19th Edition
8 Books — 3700 Pages

NEW, up-to-date edition contains many new subjects in detail, including blueprint reading, electronics, F.M. radio, fluorescent lighting and other modern electrical topics as well as full range of standard practices. 2700 illustrations.

134 tables. Total price only \$34.80. Low monthly payments. Sent on trial.

Publishers since 1898
(A year's consulting privileges with our engineers)
(now given with these books at no extra charge.)

AMERICAN TECHNICAL SOCIETY

Dept. X119 Drexel at 58th St. Chicago 37, Ill.

CLIP AND MAIL COUPON TODAY

AMERICAN TECHNICAL SOCIETY, Dept. X119
Drexel at 58th Street, Chicago 37, Ill.

Send for 10 days' free use, the following set of books:

I will pay the delivery charges only, and if fully satisfied, will send you \$3.00 in 10 days and then \$4.00 a month until the total price of \$_____ is paid. If I return the books in 10 days I will owe you nothing. You are to include a Year's Consulting Privileges with your engineers without extra charge.

Name _____

Address _____

City _____ State _____

Please attach letter stating age, occupation and name and address of employer, and at least one business man's name and address as reference. Men in service also please give home address.

Have been reading *PM* since 1904 . . . have never thrown away or destroyed a copy. . . . I practically grew up on *Popular Mechanics*.

J. N. Parker,
Bedford, Va.

★ ★ ★

I have been a regular reader of *PM* for the past 45 years, and expect to continue for the remainder of my life.

Joseph Sherman,
Chicago.

★ ★ ★

I began with the first issue and have not missed any since. . . . I am 72 years young.

J. W. Thorndike,
Ripon, Wis.

★ ★ ★

It [*PM*] has had a good deal to do with the increase in alertness of the public to new ideas. . . .

A. P. Connor,
Baltimore, Md.

★ ★ ★

I have been reading *PM* for the full 50 years. . . .

Thomas W. Sommerville,
Harrisburg, Ore.

★ ★ ★

Do hope you have many, many more years of keeping Mr. and Mrs. Public up on the happenings of the day.

Elmer D. Klopfer,
Washington, D. C.

★ ★ ★

I do not remember when I ever missed an opportunity to read an issue of *PM*.

R. I. Babbitt,
Scottsbluff, Neb.

★ ★ ★

. . . A great magazine.

W. A. Richardson,
Maitland, Mo.

★ ★ ★

I well remember the day in 1902 when a local grocery-store clerk named Leon Hutchins left a copy of *PM* with my father. . . . It was just out, an entirely new venture in the magazine field, specializing in mechanical objectives. Both my father and I were intrigued with it and he subscribed that same week. . . .

Congratulations on 50 years of splendid service and success!

Lee R. Robbins,
Norwich, Conn.

NOW...GET EVERYTHING YOU
NEED TO LEARN AND MASTER

TELEVISION

RADIO-ELECTRONICS
...AT HOME!

Use REAL commercial-type equip-
ment to get practical experience

Your future deserves and needs every advantage you can give it! That's why you owe it to yourself to find out about one of the most COMPLETE, practical and effective ways now available to prepare AT HOME for America's billion dollar opportunity field of TELEVISION-RADIO-ELECTRONICS. See how you may get and keep the same type of basic training equipment used in one of the nation's finest training laboratories... how you may get real STARTING HELP toward a good job or your own business in Television-Radio-Electronics. Mail the coupon today for complete facts — including 89 ways to earn money in this thrilling, newer field.

Here's the
REAL THING!

SET UP YOUR OWN
HOME LABORATORY

Oscilloscope

R-F Signal
Generator



6-Tube
Radio



Multimeter



HOME
MOVIES

ABOVE: Build and keep a real 16 INCH commercial TV receiver. Optional after completing regular training at moderate added cost.

D.T.I., ALONE, INCLUDES BOTH MOVIES and HOME LABORATORY. In addition to easy-to-read lessons, you get the use of HOME MOVIES — an outstanding training advantage — plus 16 big shipments of Electronic parts. Perform over 300 fascinating experiments for practical experience. Build and keep real commercial-type test equipment shown at left.

MODERN LABORATORIES

If you prefer, get all your preparation in our new Chicago Training Laboratories — one of the finest of its kind. Ample instructors, modern equipment. Write for details!

MILITARY SERVICE!

If you're subject to military service, the information we have for you should prove very helpful. Mail coupon today.

Get BOTH of these
information packed
publications FREE!

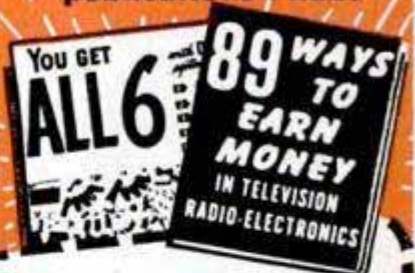

ACT NOW! MAIL COUPON TODAY!

DeFOREST'S TRAINING, INC., Dept. PM-1-1
2533 N. Ashland Ave., Chicago 14, Ill.

Without obligation, I would like your late News-Bulletin showing 89 ways to earn money in Television-Radio-Electronics... and how I may prepare to get started in this thrilling field.

Name..... Age.....
Street..... Apt.....
City..... Zone..... State.....

De FOREST'S TRAINING, INC.
CHICAGO 14, ILLINOIS
A DeVRY INSTITUTION

NOW—BE A FULLY RADIO-TELEVISION

10 MO



**I Send You
18 BIG
KITS
OF RADIO-
TELEVISION
EQUIPMENT**

EXTRA MONEY

Earn While You Learn In Your Spare Hours!

You do all your training with me AT HOME in spare hours. Keep right on with your present job and income while learning—and earn extra cash besides! The day you enroll I begin sending you plans and ideas for doing profitable spare time Radio-TV work. Many of my Sprayberry students pay for their entire Radio-TV training this way!



YOU KEEP THIS VALUABLE EQUIPMENT

The many big kits of Radio-Television parts and equipment are sent to my students "for keeps." Nothing need be returned—it is YOURS! There is absolutely nothing else to buy!

TRAINED, QUALIFIED TECHNICIAN IN JUST MONTHS OR LESS!

New "Package" Unit Training Plan—PAY AS YOU LEARN—YOU SET THE PACE! TRAIN AT HOME IN SPARE HOURS!—No Monthly Payment Contract to Sign!

Now . . . be ready for Radio-Television's big pay opportunities in a few short MONTHS! Frank L. Sprayberry's completely new "Package" training unit plan prepares you in just 10 MONTHS . . . or even less! Equally important, there is NO monthly payment contract to sign . . . thus NO RISK to you! This is America's finest, more complete, practical training—gets you ready to handle any practical job in the booming Radio-Television industry. In just 10 months you may start your own profitable Radio-Television shop . . . or accept a good paying job in this fascinating expanding field in work you've always wanted to do. Mr. Sprayberry has trained hundreds of successful Radio-Television technicians—and stands ready to train you in less than one year, even if you have no previous experience. You learn by DOING . . . actually working with your hands with equipment of special design to illustrate basic theory instead of relying on books alone. Your training is very interesting because it's really practical.

The Sprayberry 10 MONTH TRAINING PLAN includes, Radio, Television, FM (Frequency Modulation), Public Address Systems . . . everything you need to make big money in this fast moving industry. This new Sprayberry "package" plan includes many kits of genuine, professional Radio-Television equipment. While training at home in spare hours you actually perform over 300 demonstrations, experiments and construction projects. In addition, you build a powerful 6-tube standard and short wave radio set, a multi-range test meter, a signal generator, signal tracer and many other projects. All equipment is yours to keep . . . you have practically everything you need to set up your own service shop. The interesting book-bound lessons, manuals, bulletins . . . all are yours to keep. If you expect to be in the armed forces later, there is no better preparation than good Radio-Television training. These are sound, logical, money-in-the-bank reasons why this training is the best training of all for you.

Be Ready for Top Paying Radio-Television Jobs!

Radio-Television is growing with amazing speed. More than 2000 broadcasting stations PLUS an additional 102 Television stations are now on the air. Radio sets and TV receivers are being made and sold in record breaking numbers. If you enjoy working with your hands . . . if you like interesting and varied work . . . YOU BELONG IN RADIO-TELEVISION. But you MUST have good Training to "cash in" . . . the training that starts with basic fundamentals and carries through every circuit and problem of Radio-TV.

MEET A FEW OF MY GRADUATES

Training Leads to Good Radio Job

"Got a job in local radio shop soon after enrolling. Very satisfied with training."
— Stanley Clemmons, Kansas.

Radio Profits Pay Cost of Training

"I have more than taken in the cost of your training doing spare time radio repair work. See bright future ahead."
— Thomas Shearer, N. Y.

Earns Easy Spare Time Cash

"While training I made about \$180.00 in spare time. Thank you for wonderful Radio-TV training."
— Herbert Burroughs, W. Virginia.

No Previous Experience Needed to Succeed

My Training in Radio-Television is so complete, so down-to-earth that previous experience is not necessary. I start you with basic fundamentals and carry you in easy, practical steps through one Radio-Television subject after another. You will be amazed at your rapid progress and your knowledge of Radio-Television. Best of all, you put this knowledge to work making spare time cash soon after you enroll! You may train as fast or as slowly as suits your convenience. Each of my students receives individual training!

IF YOU ARE EXPERIENCED IN RADIO

Men already in Radio who seek a short intensive 100% TELEVISION Training with FULL EQUIPMENT INCLUDED are invited to check and mail the coupon at the right.

Sprayberry Academy of Radio, Dept. 10-E
111 North Canal St., Chicago 6, Ill.



Mail Coupon Today!

**NO OBLIGATION
No Salesman
Will Call**

FREE 3 Big Radio and Television Books

I want you to have ALL the facts about my complete system of Radio-Television Training! Act now! Rush the coupon for my three big Radio-Television books: "How To Make Money in Radio-Television," PLUS my new illustrated Television bulletin PLUS an actual sample Sprayberry Lesson—all FREE with my compliments. No obligation and no salesman will call on you. Send the coupon in an envelope or paste on back of post card. I will rush all three books at once!

SPRAYBERRY ACADEMY OF RADIO, Dept. 10-E
111 North Canal St., Chicago 6, Ill.

Please rush to me all information on your Radio-Television Training plan. I understand this does not obligate me and that no salesman will call upon me.

Name..... Age.....

Address.....

City..... State.....

Please Check Below About Your Experience

Are You Experienced?

No Experience

In your Mind's Eye

The Secret of MENTAL CREATING

IF you just like to dream, read no further. There comes a time when your fancies *must be* brought into light—and stand the test of every-day, hard realities. Are you one of the thousands—perhaps millions—whose thoughts never get beyond the stage of *wistful wishing*? Do you often come to from a daydream with the sigh, "If only I could bring it about—*make it real!*"

All things begin with thought—it is what follows that may take your life out of the class of those who hope and dream. Thought energy, like anything else, can be dissipated—or it can be made to produce actual effects. *If you know how to place your thoughts* you can stimulate the creative processes within your mind—through them you can assemble things and conditions of your world into a happy life of accomplishment. *Mental creating* does not depend upon a magical process. It consists of *knowing how* to marshal your thoughts into a power that draws, compels and organizes your experiences into a worth-while design of living.

ACCEPT THIS *Free* BOOK

Let the Rosicrucians tell you how you may accomplish these things. The Rosicrucians (not a religious organization), a world-wide philosophical fraternity, have preserved for centuries the ancients' masterful knowledge of the functioning of the inner mind of man. They have taught men and women how to use this knowledge to *recreate their lives*. They offer you a free copy of the fascinating book, "The Mastery of Life." It tells how you may receive this information for study and use. Use coupon opposite.

The ROSICRUCIANS
(AMORC)

SAN JOSE

CALIFORNIA

SCRIBE: C.S.R.
The Rosicrucians (AMORC),
San Jose, California.

Please send free copy of "The Mastery of Life,"
and I shall read it as directed.

Name.....

Address.....

City.....

VOTE TODAY

FOR THE FUTURE YOU WANT!

AMERICAN SCHOOL, Dept. G145, Drexel at 58th, Chicago 37, Ill.
Without obligation, please send FREE and postpaid, full particulars about the subject checked below.

- Accounting
- Air Conditioning
- Architecture & Building
- Automotive Technician
- Better Foremanship
- Bookkeeping
- Business Management
- Contracting
- Diesel Technician

- Drafting—Building Trades
- Drafting—Machine Trades
- Electrical Engineering
- Electricity—Practical
- Electronics—Industrial
- High School Courses
- Machine Shop Operations
- Mathematics & Slide Rule
- Mechanical Engineering

- Plastics Engineering
- Plumbing—Practical
- Private Secretary
- Refrigeration
- Retail Merchandising
- Salesmanship—Outside
- Sheet Metal Work
- Tool Making

NAME.....

HOME ADDRESS.....

CITY.....

OCCUPATION.....

AGE.....

STATE.....

THIS IS YOUR BALLOT

Check the career that interests you most, Fill in spaces and mail at once—no obligation

● Today, choose the job you want — and prepare for it in spare time at home. Or if you are already engaged in the work you like best, start training *now* for quicker promotion. In hours you might otherwise waste, gain the knowledge and skill that can help you to get ahead faster, make more money, and have greater security.

Thousands before you have followed this plan and were able to step out ahead of others who didn't fit themselves for advancement or who seemed willing to trust to luck.

Training Backed by 54 Years of Experience

For over half a century American School has helped ambitious men and women

toward success by providing specialized training for commercial and technical advancement. At a cost you can afford you can prepare *at home* to climb in the kind of work you prefer. American School's study program for *you* has been planned by experts with years of experience in the subject you select and they will give you needed guidance every step of the way.

Don't Delay Your Start

Give serious thought to the list of training courses listed above. Pick the opportunity that interests you, check it and add your name and address. (Check more than one if you are undecided as to which appeals most.) Finally clip out and mail the "ballot" and full information will be supplied, without cost or obligation.

PRACTICAL, EFFECTIVE HOME STUDY TRAINING SINCE 1897

AMERICAN SCHOOL, Dept. G145, Drexel at 58th, Chicago 37, Ill.

THE SOONER YOU START, THE SOONER YOUR GOAL CAN BE REACHED

Immediate Comfort And Relief for You with RUPTURE-EASER

A Piper Brace Product
For MEN, WOMEN and CHILDREN

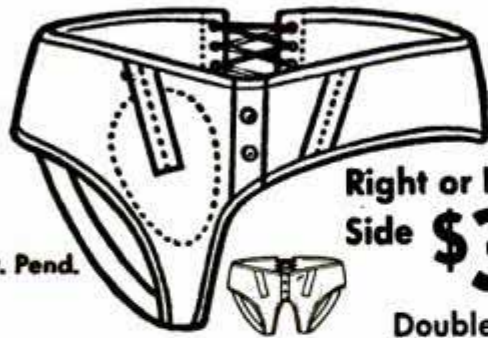

Pat. Pend.

Right or Left
Side **\$3.95**
Double **\$4.95**

A strong, form fitting washable support designed to give you relief and comfort. Adjustable back-lacing and adjustable leg straps. Snaps up in front. Soft flat groin pad—**NO STEEL OR LEATHER BANDS**. Unexcelled for comfort, **INVISIBLE UNDER LIGHT CLOTHING**. Washable. Also used as after operation support.

- **THE MOST EFFECTIVE HERNIA SUPPORT.**
Thousands of people who have tried old-fashioned, expensive devices turn to Rupture-Easer for new comfort.
 - **RUPTURE-EASER IS SANITARY.**
Can be washed without harm to fabric—you never offend when you wear Rupture-Easer.
 - **NO FITTING REQUIRED.**
Just measure around the lowest part of the abdomen and specify right or left side or double.
- Over 300,000 Grateful Users**

R. C. of Corvallis, Oregon, Air Mails: "Send me another Rupture-Easer so I will have one to change off with. It is enabling me to work at top speed at my press machine 8 hours a day."

M. S. of Anderson, Ind., thanks us and says: "It is one of the finest things I have ever worn and has made my life worth living. It has given me untold ease and comfort."

O. B. R. of Boston: "Send me another . . . I wish to say to everyone who suffers as I did, 'Oh what relief I have found from its help!'"

Blessed Relief Day and Night—You can sleep in it—you can work in it—you can bathe in it.

10-DAY TRIAL OFFER.



Money-back guarantee if you don't get relief.
PIPER BRACE CO., DEPT. PM-152
811 Wyandotte, Kansas City 6, Mo.

Piper Brace Company, Dept. PM-152
811 Wyandotte, Kansas City 6, Mo.
Please send my RUPTURE-EASER by return mail.

Right Side \$3.95 Measure around lowest part of
Left Side \$3.95 my abdomen
Double \$4.95 is.....INCHES.

(Note: Be sure to give Size and Side when ordering.)
We Prepay Postage except on C.O.D.'s.
Enclosed is: Money Order Check for \$_____ Send C.O.D.

Name.....
Address.....
City and State.....

RUSH THIS COUPON NOW!

MEN! WOMEN!

New Car given as Bonus!



TAKE ORDERS for
Nationally Advertised
NYLONS

GUARANTEED NINE MONTHS
Sensational Guarantee creating a tremendous demand for Wilknit Nylons! If they run, wear out or even snag from any cause whatever... within NINE MONTHS... depending on quantity... they are replaced **FREE OF CHARGE**. No wonder it's easy to quickly build up fine, steady, year-round income. Earnings start immediately. Look at these exceptional figures—**Ralph Shearer** made \$67.11, **first week**—**Mrs. Paul Estes**, \$42.92—**Mrs. Ivey Gentry**, \$43.37. **Doris Jensen** in addition to making as much as \$17.00 in a single day, earned two cars as **EXTRA BONUSES**. Learn how you can make money in your full or spare time without a bit of previous experience.

**EARNED
TWO NEW CARS**
... and as much as
\$120.00 in one week
That's the exceptionally fine record of Chas. Mills with the famous Wilknit hosiery line. Offer of New Chevrolet as a bonus open to EVERYONE. Send name for facts **FREE**.

SEND NO MONEY... Just Hose Size
When you send for Selling Outfit, I also send your choice of Nylons or Socks for your personal use. Don't lose a minute. Rush name on penny postcard for full money-making facts on Sensational Sales Kit. Send hose size, too. **Lowell Wilkin.**
WILKNIT HOSIERY CO., 3021 Midway, Greenfield, Ohio

FREE CATALOG

Old New - **Tandycraft** Patterns

"Tandycraft" Western Scabbard Pattern No. PH-4 (as illustrated) with complete instructions. 25c post-paid. All kinds of leathers . . . we sell for less. Since 1919.

Send for **FREE** catalog No. 72

Send for **FREE** Leather Price List No. 272.

TANDY LEATHER CO.
P. O. BOX 791-AB
FORT WORTH, TEXAS

TOOTHACHE?

Ask your Druggist for **DENT'S**

**TOOTH GUM
TOOTH DROPS
POULTICE**

SHOE SHINE STOOL

NEW! So handy! So useful! Strong, braced, non-tip step-stool, foot-rest—"step" for kiddies in bathroom, at windows, as chair. Top raises to make perfect shoe-shine stool. Space inside for shining kit. Beautiful hand-rubbed maple or blond finish. Antiqued edges. Strong hinges, fastener. 13 1/2" x 7 1/2" x 7 3/4".

SEND NO MONEY Send card with name. Pay postman \$4.95 plus small pstg. Money Back Guar.

4.95
Ppd. in USA.

LINNWOOD MFG. CO., Dept. P, SEWARD, NEBR.

Sure Shot INSTANT GUN BLUE

COLD CHEMICAL NEVER FAILS

Ideal rust resistant finish for home workshop projects, tools, instruments, guns and metal sports gear, models and hundreds of other items where a beautiful, longwearing, easily applied blued finish is desired.

Anyone can use it.
2 FL. OZ. BOTTLE \$1.00

BAYPORT CHEMICAL CO., Dept. P, Minneapolis 10, Minn.

MASTER WATCHMAKING



AT HOME

WATCHMAKER'S
LATHE

with this
**PROFESSIONAL
EQUIPMENT**

CSW Course 202 Furnishes
**EVERYTHING YOU NEED
To Complete Your Lessons**

Without leaving home or present employment, you can master the fundamentals of watch repairing... enjoy a profitable hobby... or prepare for a new career. Step by step, the amazing Sweazey System of Home Study shows you how to fix watches from start to finish. It's fascinating! And Watchmaking, a well-paid, respected profession, can lead to a business of your own, if you wish.

**16 SHIPMENTS • 225 ITEMS:
PRACTICE WATCHES • SUPPLIES
PROFESSIONAL TOOLS AND EQUIPMENT!
Plus a Wealth of Text and Reference Material**

STAKING
TOOL

Yes, every tool, including staking tool and watchmaker's lathe, motor and chucks (with portable mount for use on table) as well as the supplies and practice watches you need to learn watchmaking at home are all included in our present plan. Never before, so much for so little cost. We send 10 lessons the day you enroll!

IMPORTANT EXTRAS INCLUDED

- Money-Making Ideas
- New, illustrated handbook on Tools and Materials
- The Modern Clock, 500 p. book on clock repair
- The Watchmaker's Lathe, 200 p. book
- How to Repair Universal Chronographs
- Modern Shop Methods
- 10 Business Guide Manuals
- 2 weeks' personal training at our famous Resident School... and many more!

CSW HAS BEEN TRAINING MASTER WATCHMAKERS SINCE 1908...

Let us show you our successful methods. Our exclusive lesson texts were written by certified Master Watchmakers with years of business and teaching experience. Emphasis is on practical training. You work with watches from your very first lesson. You learn tested short cuts... modern, approved shop methods as practiced by leading watchmakers. Home study assignments are short to fit brief spare time periods. Age is no barrier... and no previous experience is needed. Get the facts!

**SEND COUPON TODAY
For Complete Information**

MASTER WATCHMAKING
**SAMPLE
COUPON**
ENTIRE 10-12-1951

FREE SAMPLE LESSON

CHICAGO SCHOOL OF WATCHMAKING
1608 N. MILWAUKEE AVENUE, DEPT. 112 • CHICAGO 47, ILLINOIS
Please send free sample lesson and full information on home study course in Master Watchmaking.

(This offer limited to USA and members of Armed Forces overseas. Other plans available for foreign students.)

Name _____
 Address _____
 City _____ Zone _____ State _____

CHICAGO SCHOOL OF WATCHMAKING

FOUNDED 1908

1608 MILWAUKEE AVENUE
CHICAGO 47, ILLINOIS

PRACTICE
WATCHES



Why Die Before Your Time?

YOU CAN LIVE YEARS LONGER . . . By Recognizing These Unconscious Urges That Are Dragging You Toward An Early Grave.

YOU tried to commit suicide today. Maybe you didn't notice it. Most of us don't.

Psychologists have found that (without our knowing it) most of us do something every day that pushes us closer to an early grave. Your desire to live is constantly battling an unconscious urge to do away with yourself.

Some people excuse this self-destructive urge — call it ambition or duty or love of family. But at 47 or 53, they keel over. And everybody says, "He was too young to die" or "She was such a devoted mother."

"DOCTOR . . . Will I Die Young?"

Are YOU unconsciously shortening your life? Step into a doctor's office. Have him examine you. Then ask, "Doctor, will I die young?"

"You have been abusing your body and nervous system," the doctor will tell you. "But if you are willing to put long life above ANY petty ambition or pride—you can live a full life."

Stop Killing Yourself

For over 25 years people have enacted the drama described above in the office of Dr. Peter J. Steincrohn — prominent specialist. He has written a new book (entitled "How to Stop Killing Yourself") which presents what a doctor might tell YOU about the forces that are tearing you down . . . how to recognize them . . . and what to do about them.

Some of Book's 33 Chapters

Overweight — 12-day diet that can slim you; help you live longer, too.

Your Heart — Wonderful new treatments.

Smoking — How to break the habit—if you must.

Coffee, Sleeping Pills and Stimulants

High Blood Pressure — A simple routine that adds years to lives of sufferers.

Alcoholism — How a few ounces a day can help you live longer. How to help a "chronic alcoholic."

Cancer — The Uninvited Guest. What to do if you suspect cancer.

Successful Failures Have Ulcers — How to live happily with an ulcer.

Meeting the Strains of Everyday Living — Recuperating quickly from intense strain.

Your Thyroid — Is it drugging you?

Exercise — Who should exercise; who shouldn't.

Worry and Indecision — How to control your worries before they control you.

Overwork Is for Failures — Gary Cooper's "Stay-young" formula

The Time for Retiring Is Early — How to plan your retirement age.

The Surrender to Calendar Age — The gentle art of feeling and staying young.

This new book conveys Dr. Steincrohn's deepest feelings about how to preserve health and enjoy long life. He does not preach to you or scold you. Through fascinating case histories about others he shows you how to live longer, happier.

Read the Book FREE for 5 Days

SEND NO MONEY. Just mail coupon to get book for 5 days' FREE examination. Read a chapter or two. If not convinced it can help you (or someone dear to you) combat the insidious urges that constantly threaten your life . . . send the book back and owe nothing. Or keep the book and send only \$2.95 plus postage in full payment. Mail coupon now to the publishers, Wilfred Funk, Inc., Dept. K491, 381 Fourth Ave., New York 16, N. Y.

WILFRED FUNK, INC.

Dept. K491, 381 Fourth Avenue, New York 16, N. Y.

Send — for 5 days' FREE EXAMINATION — Dr. Steincrohn's new book, *How to Stop Killing Yourself*. If I keep it I will send \$2.95 plus postage charges. Otherwise I will return it without further obligation.

Name _____

Address _____

City _____ Zone No. _____ State _____
(if any)

Check here if enclosing \$2.95 WITH coupon, and WE will pay all postage charges. Same return privilege, for full refund, applies. (Canadian Orders—send 25c extra for carrying charges. Only U.S. currency accepted.)

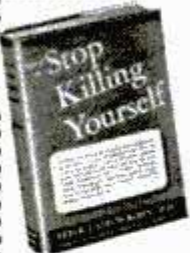

PRESTO! MASTER GLAZE



Car Owners! Meet Master Glaze—the sensationally different luster for new and used cars! Not a wax—not an oil polish—not a paint!—nothing that "smears" over the surface.

MASTER GLAZE is a unique discovery—a creamy liquid—quick and easy to apply! Gives a hard, glass-like surface. Even gasoline cannot dull it! Lasts six months to a year! Amazing luster—beautiful, sparkling clean and brilliant! Doesn't finger-mark—doesn't smear! A match box full glazes an entire car. Seals the pores—protects! **NOTHING LIKE IT!**

AGENTS

An unusual opportunity! Quick, flashy demonstrator. Big profits. Good territory. Write today!

FREE SAMPLE

Just send your name and address to **MASTER GLAZE CO., 7720-726 W. Harwood Ave., Milwaukee, Wis.**

CAR TRAY



Dinner Table in Your Auto!

No more balancing food on steering wheel, seat or dash . . . install CAR TRAY permanently under dash in a few moments. Swings out into any desired position, fits snugly under dash when not in use. **Ideal** as car writing desk, ladies makeup table, feeding table for infants.

Made of steel in beautiful hammerhead finish . . . \$2.98
Chrome-Plated . . . \$4.49

SEND CASH. CHECK OR M.O. POSTPAID; C.O.D. PLUS POSTAGE. 10 DAY MONEY BACK GUARANTEE.

MIDLAND SALES

Box 5625

Chicago 13, Ill.

Now Many Wear

FALSE TEETH

With More Comfort

FASTEETH, a pleasant alkaline (non-acid) powder, holds false teeth more firmly. To eat and talk in more comfort, just sprinkle a little **FASTEETH** on your plates. No gummy, gooey, pasty taste or feeling. Checks "plate odor" (denture breath). Get **FASTEETH** at any drug store.



MAKE EXTRA MONEY with Larson Leathercraft

Easy-To-Assemble Kits No Experience Needed

Get started now. **LARSON** Beginners' Kits of ready-cut projects require no tools or experience. Free instructions included. Make belts, gloves, moccasins, billfolds, woolskin animals and mittens, other attractive leather items. Also America's most complete stock for advanced hobbyists and professional craftsmen. **SEND 10c TODAY** for big illustrated catalog. **J. C. LARSON CO., 820 So. Tripp Ave. Dept. 818 CHICAGO 24, ILLINOIS**



Hey
SKINNY!
...YER RIBS
ARE SHOWING!



I Can Make YOU a New Man, Too, In Only 15 Minutes a Day!

CHARLES ATLAS
Holder of title, "The World's Most Perfectly Developed Man."

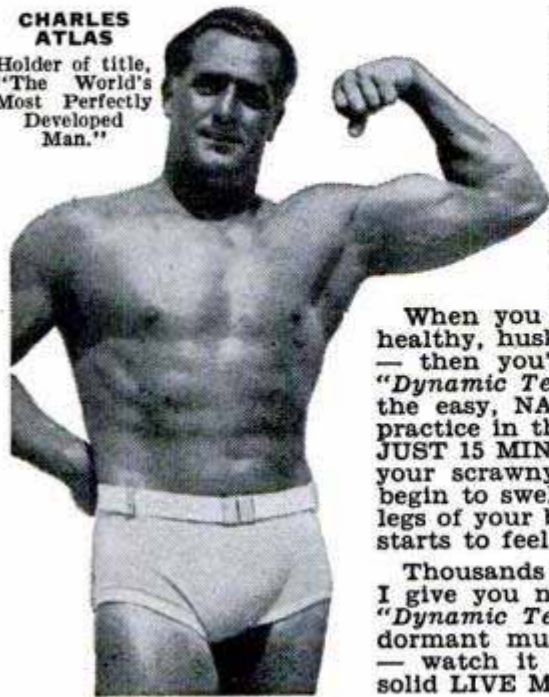

PEOPLE used to laugh at my skinny 97-pound body. I was ashamed to strip for sports or for a swim. Girls made fun of me behind my back. THEN I discovered my body-building system, "Dynamic Tension." It made me such a complete specimen of manhood that I hold the title, "The World's Most Perfectly Developed Man."

What's My Secret?

When you look in the mirror and see a healthy, husky, fellow smiling back at you — then you'll be astonished at how fast "Dynamic Tension" GETS RESULTS! It is the easy, NATURAL method and you can practice in the privacy of your own room—JUST 15 MINUTES EACH DAY. Just watch your scrawny chest and shoulder muscles begin to swell . . . those spindly arms and legs of your bulge . . . and your whole body starts to feel "alive," full of zip and go!

Thousands are becoming husky — my way. I give you no gadgets to fool with. With "Dynamic Tension" you simply utilize the dormant muscle-power in your own body — watch it grow and multiply into real, solid LIVE MUSCLE.

FREE My 48 Page Illustrated Book is Yours — Not for \$1.00 or 10c—But FREE

Send for my book, *Everlasting Health and Strength*. 48 pages of photos, valuable advice. Shows what *Dynamic Tension* can do, answers vital questions. A real prize for any fellow who wants a better build. I'll send you a copy FREE. It may change your whole life. Rush coupon to me personally: Charles Atlas, Dept. 8N, 115 E. 23rd Street, New York 10, N.Y.



CHARLES ATLAS, Dept. 8N,
115 East 23 St., New York 10, N.Y.

Send me—absolutely FREE—a copy of your famous book, *Everlasting Health and Strength*—48 pages, crammed with photographs, answers to vital questions, and valuable advice. This book is mine to keep, and sending for it does not obligate me in any way.

Name.....Age....
(Please print or write plainly)

Address.....

City.....State.....

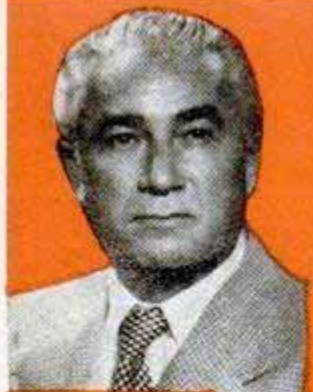

I'll show you how to **EARN**
BIG MONEY
IN PLASTICS
 without tools or machinery!

A NEW HOME INDUSTRY

NEVER BEFORE has such a **GREAT OPPORTUNITY** like this been offered! The **CHANCE OF A LIFETIME!** The chance to learn and **START** a new, fascinating and **HIGHLY PROFITABLE** business of your own! We have started **THOUSANDS** of ambitious people in this wonderful and thrilling new business because the work is so easy and pleasant (many turn it into a profitable hobby), requires only a **FEW** dollars investment, can be started **ANYWHERE** by **ANYONE** . . . at home, garage, basement, den, shop, etc. and most important, **WITHOUT TOOLS OR MACHINERY** you can produce in **QUANTITY** exceptionally attractive and desirable plastic things of such great variety and usefulness beyond your imagination! All this valuable knowledge and instruction is yours **FREE** . . . we teach you, help you get started and buy part of your production! We also help you obtain **DEFENSE WORK!**

MAKE ANYTHING

This new method of creating unlimited quantities of useful things without machinery is **CASTING** . . . the extremely simple process of pouring liquid plastics into molds; *the entire method is as easy as pouring water out of a glass!* No machinery or tools required! In a few minutes the liquid turns into a beautiful solid, hard, durable, colorful or transparent plastic in the form of Jewelry, Novelties, Gadgets of every shape and form, Machine Parts, Fishing Lures, Bookends, Cig. Lighters, Tools, Dies, Handles, Knobs, Pensets, Figurines, Souvenirs, Toys, Dolls, Baby Shoes . . . **A THOUSAND USEFUL THINGS!** Some of our plastics are transparent and sparkling clear, ideal for imbedding flowers, photos, curios, etc. Others are like beautiful Ivory, Ebony, Marble, Ce-

ramics, Etc. The field is really **UNLIMITED**. Practically anything your imagination can create can be **CAST** with our plastics, one or a thousand!

BILLIONS FOR DEFENSE

The government has started the greatest defense program in history! **BILLIONS** are being spent! Our liquid plastics can be used in **THOUSANDS** of vital defense applications. With our catalog we will include instructions how **YOU** can obtain defense work, how **YOU** can take part in this tremendous program to insure the future of America! A grand opportunity to combine patriotism and profit! A grand opportunity of obtaining **THOUSANDS OF DOLLARS** of defense work!

1000 OPPORTUNITIES

Regardless what you are doing now you can get into the **CASTING BUSINESS** in your spare time or evenings; we assure you, once you do, you will be eagerly devoting all of your time to this very easy, fascinating and **HIGHLY PROFITABLE** business. Countless letters from enthusiastic busy **PLASTICAST** users testify to successful businesses developed as a result of answering this ad! **BUT LET US PROVE IT:** send only 25c for our big 48 page catalog of Casting Materials, Molds, etc. We will also send you, absolutely **FREE**, an attractive **CASTING** to show you what can be done with our plastics in a few minutes! **IN ADDITION**, we will also send you a valuable instruction book giving details on the **ART & BUSINESS OF CASTING!** Yes, all this for only 25c, but write for it today . . . *this may be the lucky coin that will start the most fascinating and profitable phase of your life!* Don't delay anything that can mean so much to your future—Write today.

PLASTICAST CO. (Dept. "C")

P. O. BOX 6737 Write to P. O. BOX 987
 CHICAGO 80, ILL. nearest address PALO ALTO, CALIF.
 CANADIAN CUSTOMERS: Send 35c for catalog to Canadian Ind. Plastics, 1056 1/2 W. Pender St., Vancouver, B.C.



BIG PAY JOBS
 for men who qualify in
DIESEL



TRAIN NOW FOR A DIESEL FUTURE. Steady, high-pay jobs await men qualified in Diesel, Tractor, and Heavy Equipment. Are you qualified for job and advancement opportunities in this fast-growing field? You can qualify!

COMPLETE DIESEL COURSE NOW AVAILABLE. If you are ambitious and want to get ahead in this big money field, you'll want to know about the complete Diesel home training course now offered by Interstate Training Service. Covers all phases of operation, repair, service. Easy to master in spare time. No interference with present job. Up-to-the-minute. Regularly revised to cover new developments. We invite comparison of material offered. Advisory placement service for our students.



YOU OWE IT TO YOURSELF to investigate Interstate Training Service Diesel Training. Thousands agree it has helped them to better jobs...better pay. It can do the same for you!

WRITE FOR FREE INFORMATION TODAY

INTERSTATE TRAINING SERVICE, Portland 13, Ore.
 Please see that I receive FREE 24-page book, "Getting Ahead In Diesel." (3-A)

NAME _____ AGE _____
 ADDRESS _____
 CITY _____ ZONE _____ STATE _____

START YOUR OWN BUSINESS. Wonderful opportunity backed by world-wide industry. 200 Home Necessities on credit. Hundreds average \$5,000—\$28,500 sales year after year. Write Rawleigh's, Dept. A-U-1-PPM, Freeport, Ill.

MAKE MONEY
Lending

amazing new invention to your friends for trial — and writing up their orders. All Facts Free. Rush your name and address to

WARM NIGHTS
 125 W. Hubbard St., Dept. WN-11
 Chicago 10, Ill.

FREE TRIAL



**DO ANY JOB.. EASIER.. QUICKER
MAKE MORE MONEY**

Goodheart-Willcox books are authoritative—up to date, cover live, important fields in which there are many possibilities for promotion. Such books can be of tremendous help to you in equipping yourself for the competitive struggle ahead.

Here is the HELP YOU NEED

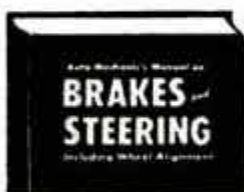

Auto Mechanic's Manual on BRAKES and STEERING
(Including Wheel Alignment)

New Book. Takes the mystery out of servicing auto brakes, aligning wheels . . . covers all systems used on passenger cars, trucks. Explains principles of natural, mechanical forces. \$3.50.

PRACTICAL CARPENTRY
GIANT NEW VOLUME
(WEIGHS ALMOST 5 LBS.)

Tells how to modernize present home, build yourself a new home (from stock plans) without hiring SKYHIGH labor. Crystal clear text and drawings reduce every job to simple steps. Over 1100 illustrations. \$5.00.



FORD SERVICE & REPAIR (JUST OUT)

Serviceing and repairing Ford V-8's and 6's from 1932 up to and including the current series, based on experience of leading Ford mechanics throughout the U.S. Describes lots of shortcuts, kinks. \$2.50.

AUTOMATIC TRANSMISSIONS Simplified (New Book)

Learn all about: Fordomatic, Merc-O-Matic, Hydramatic, Dynaflo, Ultramatic, Powerglide . . . all other transmissions. Tells how transmissions work, what goes wrong, how to service them. \$4.00.

AUTO REPAIR KINKS New and different guide to doctoring up ailing autos, describes hundreds of ideas that have helped mechanics, owners, out of tough spots . . . brings you combined KNOW-HOW of World's top auto mechanics. Complete tuneup specifications all popular cars. \$3.00.



Modern Welding Practice (New Edition)

Information on latest developments in Submerged Arc, Inert Gas Welding, Arc-Oxygen Cutting, Underwater Welding, Flux Cutting, etc. Covers every known welding practice. Non-technical, easy-to-use. \$5.00.

MODERN ELECTRIC & GAS REFRIGERATION

Serviceing of hermetic (sealed) units and frozen food refrigerators now included in this famous book. Theory and practical applications of refrigerator work in all branches, much of which is not available in any other form. \$5.00.

PLUMBING AND PIPE-FITTING

Be the one who lays out the jobs for others to follow. This book will teach you how to do it. \$2.50.

Auto Body & Fender Repairs [1951 Ed.]

Covers every phase of auto body and fender repairing including frame straightening . . . how to do professional job, operate shop profitably. \$3.50.

Merry Old Mobiles On Parade [New Book]

Fascinating collection of photos, drawings, cartoons of pioneer autos. Every page is crammed with interest and we'll bet that once you pick up the book you won't lay it down until you have read from cover to cover. \$2.50.

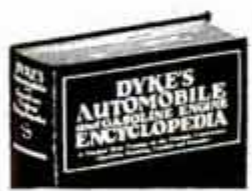

DYKE'S AUTO ENCYCLOPEDIA
New 22nd Edition

World's greatest auto book. A complete course of instruction in automotive mechanics with special emphasis on fundamentals. An indispensable aid in serviceing of all cars no matter when and where made. 1491 pages, 4600 illustrations. \$7.50.

DYKE'S CARBURETOR BOOK
Recognized authority on subject. \$3.50.

SPECIAL MONEY BACK OFFER - MAIL COUPON

Goodheart-Willcox Co., Dept. 172
1321 S. Michigan Ave., Chicago 5, Ill.

Send at once books checked below. I understand I may return any book not satisfactory in 5 days and you will refund full amount paid.

- Remittance for \$_____ enclosed. Send post-paid.
- Send C.O.D. (In U.S. only) I will pay postman plus delivery charges.
- PRACTICAL CARPENTRY Just Published.....\$5.00
 - MERRY OLD MOBILES On Parade. All about Pioneer Autos, with Photos, Drawings..... 2.50
 - BRAKES & STEERING. Mechanics Manual. Wheel Alignment included 3.50
 - MODERN WELDING PRACTICE. New Edition.. 5.00
 - AUTO REPAIR KINKS 3.00
 - AUTOMATIC TRANSMISSIONS Simplified — All types including Fordomatic, Merc-O-Matic.... 4.00
 - DYKE'S Auto Encyclopedia (new 22nd edition) 7.50
 - AUTO Body & Fender Repairs (New 1951 Ed.).. 3.50
 - DYKE'S Carburetor Book 3.50
 - AUTOMOTIVE Service Management 5.00
 - MODERN Electric & Gas Refrigeration..... 5.00
 - D. C. POWER WIRING 4.00
 - A. C. POWER WIRING 4.00
 - PLUMBING & Pipe Fitting..... 2.50
 - STORAGE Battery Simplified 3.00
 - BAILEY'S Handbook for Engineers-Firemen... 2.00
 - FORD SERVICE & REPAIR (Just Out)..... 2.50

✓
Check Titles Wanted
Examine Books In Your Own Home Without Obligation
Money Back if Not Satisfied

Name _____ (Please Print)
Street _____
City _____ State _____

GOODHEART - WILLCOX CO. INC.
1321 S. MICHIGAN AVE. CHICAGO 5

(Publishers of helpful Home Study, School, Reference Books for over 30 Years.)

Hey You SKINNY Bag of Bones!

That's what the boys shouted at me ONLY A FEW WEEKS AGO . . . But look at me NOW, PAL . . . A Trophy-Winning JOWETT HE-MAN Like YOU can be SOON!



YOU can WIN This big Silver Trophy Your Name on it.

YES! John Sill like millions, mailed me 10c and a coupon like the one below YOU MAIL NOW!

5-WAY PROGRESSIVE POWER can make YOU an ALL-AROUND WINNER

- In Civilian Life or Armed Services.
 - A Winner of Success on JOB.
 - A Winner of FRIENDS, GIRLS.
 - A Winner at ALL SPORTS.
 - A Winner of Trophies.
 - A Hero on the DANCE FLOOR.
 - A Hero at BEACH, GYM.
 - A Hero to your SWEETHEART.
 - A LEADER in any crowd.
- This "Easy as Pie" NATURAL Method gives you All-Around CHAMP STRENGTH—All-Over MR. AMERICA BUILD!

Let me Prove in 10 THRILLING MINUTES A DAY I can make YOU An ALL-AMERICAN ALL-AROUND HE-MAN FAST—OR IT WON'T COST YOU A CENT

SAYS GEORGE F. JOWETT— WORLD'S GREATEST BUILDER OF HE-MEN

YES! YOUR SUCCESS STORY can soon be like Sill's—

How weakling wins trophy as MAGNIFICENT HE-MAN! Few weeks ago everyone picked on John . . . No guts to fight for his rights. TODAY everyone admires John's movie-star build—his mighty ARMS, BROAD BACK, heroic CHEST. His ATHLETIC ability. His ENERGY at work. His POPULARITY. How GIRLS go for him! NO! I don't care if you're 14 or 40; if you're SKINNY or flabby. Give me 10 EXCITING MINUTES to make you over in your home by the method I turned myself from a wreck into A WORLD CHAMPION.

YES! Add INCH on INCH of MIGHTY MUSCLE to your ARMS. Deepen your CHEST. Broaden your SHOULDERS. Gain SIZE, SPEED, POWER! Become an All-American HE-MAN! A WINNER in everything you tackle — or you won't pay one cent!

DEVELOP YOUR 520 MUSCLES Gain POUNDS, INCHES fast! Friend, I travelled the world. Made a LIFETIME study of EVERY way known to build your body. Then I devised the BEST, "5-WAY PROGRESSIVE POWER", the ONLY method that builds you 5 WAYS fast Save YEARS, DOLLARS, like MANY THOUSANDS like you did. Mail Coupon NOW!

AMAZING ALL 5 Picture-packed courses while the supply lasts—only 10c

MILLIONS SOLD at \$1 and more

FREE PHOTO BOOK of FAMOUS STRONG MEN DEPT. PM-21

"Jowett Courses greatest in World for Building All-Around HE-MEN."
—R. F. Kelley Physical Director

JOWETT INSTITUTE OF PHYSICAL TRAINING 230 FIFTH AVENUE, NEW YORK 1, N. Y.
Dear George: Please mail to me FREE Jowett's Photo Book of Strong Men, plus all 5 HE-MAN Building Courses: 1. How to Build a Mighty Chest, 2. How to Build a Mighty Arm, 3. How to Build a Mighty Grip, 4. How to Build a Mighty Back, 5. How to Build Mighty Legs—Now all in One Volume "How to Become a Muscular He-Man" ENCLOSED FIND 10c FOR POSTAGE AND HANDLING (No C.O.D.'s).

Name (Please print plainly) Age.....
Address
City Zone State

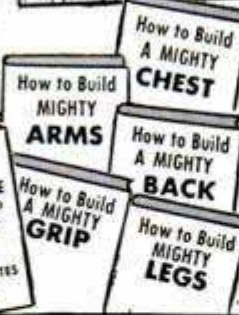

DO YOU MAKE THESE MISTAKES IN ENGLISH?

MANY PERSONS say "between you and I" instead of "between you and me" — or use "who" for "whom" — or don't know whether to spell certain words with one or two "c's" or "m's" or "r's," etc. Every time you speak or write you show what you are. Mistakes in English reveal lack of education, refinement. Real command of English will help you reach any goal.



Only 15 minutes a day with Sherwin Cody's new invention—and you can actually SEE your English improve. It teaches by HABIT—makes it easier to do the RIGHT way. Wonderful self-correcting lessons.

FREE BOOK. Lack of language power may be costing you thousands of dollars every year. See what Mr. Cody's method can do for you; it costs nothing to find out. Write now for free book, "How You Can Master Good English in 15 Minutes a Day." Sherwin Cody Course in English, 51 B & O Bldg., Rochester 14, N. Y.

WEATHER-PROOF YOUR CAR...



LIKE THE NEW CADILLAC, FORD, HUDSON, CHRYSLER, etc.

Drive thru rain, snow, puddles, protected by SEALTIGHTS — the original ignition weather-proofing insulators.

SEALTIGHT IGNITION INSULATORS

AMERICA'S FINEST INSULATORS!

Weatherproof, short-proof all cars, trucks, tractors, gas motors with Sealtights on spark plugs, distributor, coil, magneto. ASK YOUR GARAGE or SERVICE STATION, or write us for details, giving make and model of car.

SEALTIGHT CORP., Dept. PM12, Cedar Rapids, Ia.

500 TRICKS MAGIC TRICKS



IT'S FUN TO DO MAGIC

Be popular! Amaze—mystify—entertain! For 30 years Douglas has satisfied customers all over the world. Now, you can enjoy this fascinating hobby. Only 10c brings our Catalog 500 Tricks, containing brand new tricks for pocket, parlor, stage. Join in the fun — send 10c today!

Douglas Magicland, Dept. A, Dallas, Texas

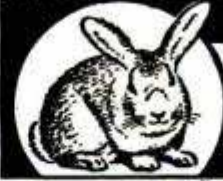

Make BIG MONEY!

RAISE CHINCHILLA RABBITS!

Cash Markets Supplied for Your Production
FREE - Illustrated Booklet - WRITE TODAY!
ROCK HILL RANCH, SELLERSVILLE 36, PA.
World's Largest Breeder of Chinchilla Rabbits

Watch Repairing Pays Big Money Learn at home

Free Literature Tells How

Watch repairers in big demand. You train step-by-step in 10 easy lessons. You learn to take a watch apart—repair and put in perfect working order. We furnish all tools, and a 15 jeweled watch. Practice movement with first lesson.



Turn spare time into cash—perhaps a business of your own. A licensed school. Students 18 to 65 have profited by our training. Low cost.

Write Today for All the Facts—No Obligation

ILLINOIS SCHOOL OF WATCH REPAIRING 2870 Elston Ave., Dept. PM-1, Chicago 18, Ill.

HERE'S A READY-MADE FUTURE FOR YOU

MILLIONS OF HOMES IN U.S. HAVE 6-12 SMALL APPLIANCES YEAR. MILLIONS MORE SOLD EVERY YEAR. MILLIONS NEED REPAIR NOW WITH THE NEED INCREASING DAILY!

Start Your own Business IN

ELECTRICAL APPLIANCE REPAIRING

EARN WHILE YOU LEARN

Only had your course a few short weeks and have already made \$800.00. Going to quit my job paying \$250.00 straight salary to operate my own business. — J. D. S., St. Louis, Mo.

Make \$15.00 Saturdays and more. Am only able to operate in my spare time. It is just what a mechanical minded man needs. — G.O.P., Thomasville, Ga.



IN YOUR OWN KITCHEN, BASEMENT OR GARAGE

Learn at home in your spare time this fascinating big paying profession.

If you are mechanically inclined, can hold and use tools, we can give you the training and time saving kits that will enable you to . . . Command More Money At Work . . . A Better Paying Job Elsewhere . . . Or A Business Of Your Own!

New Shop Method Home Training teaches you both the technical and practical side of Electricity by having you work with your hands, Building, Testing, Repairing. All instruction manuals are written in easy-to-understand language chock full of hundreds of detailed photos and drawings.

We show you how to quickly locate the trouble, how to fix it and what to charge. ALSO, how to solicit business and keep business coming to you!

\$5.00 TO \$6.00 AN HOUR

Often charged for making ordinary repairs. We show you how to repair refrigerators, vacuum cleaners, washing machines, motors, etc.



3 EASY STEPS

- 1 We Send You An ELECTRONIC KIT.
- 2 We Teach You Electrical Appliance Repairing.
- 3 We Show You How To Get Business.



WE GIVE YOU THIS ELECTRONIC KIT TROUBLE FINDER



SEND FOR FREE BOOK!

CHRISTY TRADES SCHOOL, Dept. D-203
4432 N. Kedzie Ave., Chicago 25, Ill.

Please send me FREE Illustrated Book on Electrical Appliance Repairing and special form for paying later from earnings.

NAME _____ Age _____

ADDRESS _____

CITY _____ Zone _____ State _____

FREE!

10 HITLER STAMPS!



**10 SCARCE STAMPS
ALL DIFFERENT
SENT FREE**

TO SECURE NAMES FOR OUR
MAILING LIST

MAIL coupon at once. We'll send you this fascinating set of 10 Hitler stamps. Different sizes, colors, values. NO COST TO YOU. Stamps were issued by short-lived nation of Bohemia-Moravia. Much sought after. Now becoming SCARCE. Our supply is limited. Don't ask for more than one set. We'll also include other interesting offers for your inspection—PLUS a FREE copy of our helpful, informative book, "How to Collect Stamps." This special offer may have to be withdrawn soon—so rush coupon NOW to: Littleton Stamp Co., Dept. PM-1, Littleton, N. H.

Copyright 1952, L. S. Co.

LITTLETON STAMP CO.
Dept. PM-1, Littleton, N. H.

Send — AT NO COST TO ME — the ten Hitler stamps and informative booklet, "How To Collect Stamps."

Name _____
Address _____
City _____ State _____

New! PRINT YOUR OWN ADVERTISING POST CARDS

ROTO-PRINT STENCIL DUPLICATOR prints and illustrates Advertising Announcements and Club Notices on Government Post Cards, Also Price Lists, Labels, Order Forms, etc. Easy to use. Gets amazing results in sales and inquiries. Hundreds of uses for every type business and organization.

UNCONDITIONALLY GUARANTEED Comes complete with necessary supplies, instructions, FREE Book of money-making ideas.

FREE TRIAL OFFER! Write and a will be sent you postpaid. Try 10 days—then send only \$9.95 (Low, Direct-to-You Price), or return ROTO-PRINT with no questions asked.

Write NOW!

AGENTS WANTED!

ROTO-PRINT CO., 211 North 7th St., Dept. B-8, St. Louis 1, Mo.



BEING PUSHED AROUND??



Why take any more nonsense from bullies, wise guys and other pests? The next time they try to act smart—give them the surprise of their lives! It's easy when you know POLICE JIU JITSU! This complete, fully illustrated course comes to you in one volume. The same as taught to police, marines, "G" men, soldiers, sailors and members of the U.S. Coast Guard. By all means, just pin \$1 to this ad and we will send POLICE JIU JITSU to you postpaid by return mail. Satisfaction guaranteed or your money back.

BOOKS PUBLISHING CO., 56 W. 24th St., N.Y. 10

FREE BERRY'S NEW POULTRY BOOK



Gorgeously illustrated, describing DAY-OLD and 4-WEEK CHICKS. 50 varieties, sexed or unsexed. AMERICA'S FINEST; also Ducks, Geese, Guinea. ORIGINAL BERRY'S FARM, for over 50 years. Beautiful book and LOW PRICE LIST FREE, stamps appreciated. BERRY'S POULTRY FARM, Box 23, Clarinda, Iowa



ANY BOOK IN PRINT

Delivered at your door. We pay postage. Standard authors, new books, popular editions, fiction, reference, medical, mechanical, children's books, etc. Guaranteed savings. Send card for Clarkson's 1952 Catalog.

FREE Write for our great illustrated book catalog. A short course in literature. Buying guide of 300,000 book lovers. Free if you write Now—Today!

Dept. PM521 **CLARKSON PUBLISHING COMPANY**
1257 S. Wabash Ave. Chicago, Ill.



DRAFTING PAYS

Learn at home in spare time. Drafting offers excellent salaries, unlimited advancement opportunities, constant employment. Light, pleasant work vital in war effort. CTS gives you 50 illustrated drafting books, professional instruments, drafting table, everything you need. Send name now for FREE book and special PAY LATER form.

Christy Trades School,
4432 N. Kedzie, Dept. DB-1303
Chicago 25.

Big MONEY

LOOK for Rupture Help



Try a Brooks Patented Air Cushion appliance. This marvelous invention for most forms of reducible rupture is GUARANTEED to bring YOU heavenly comfort and security—day and night—at work and at play—or it costs you NOTHING! Thousands happy. Light, neat-fitting. No hard pads or springs. For men, women, and children. Durable, cheap. Sent on trial to prove it. Not sold in stores. Beware of imitations. Write for Free Book on Rupture, no-risk trial order plan, and Proof of Results. Ready for you NOW!

BROOKS APPLIANCE CO., 373-A State St., Marshall, Mich.

Electricity Illustrated

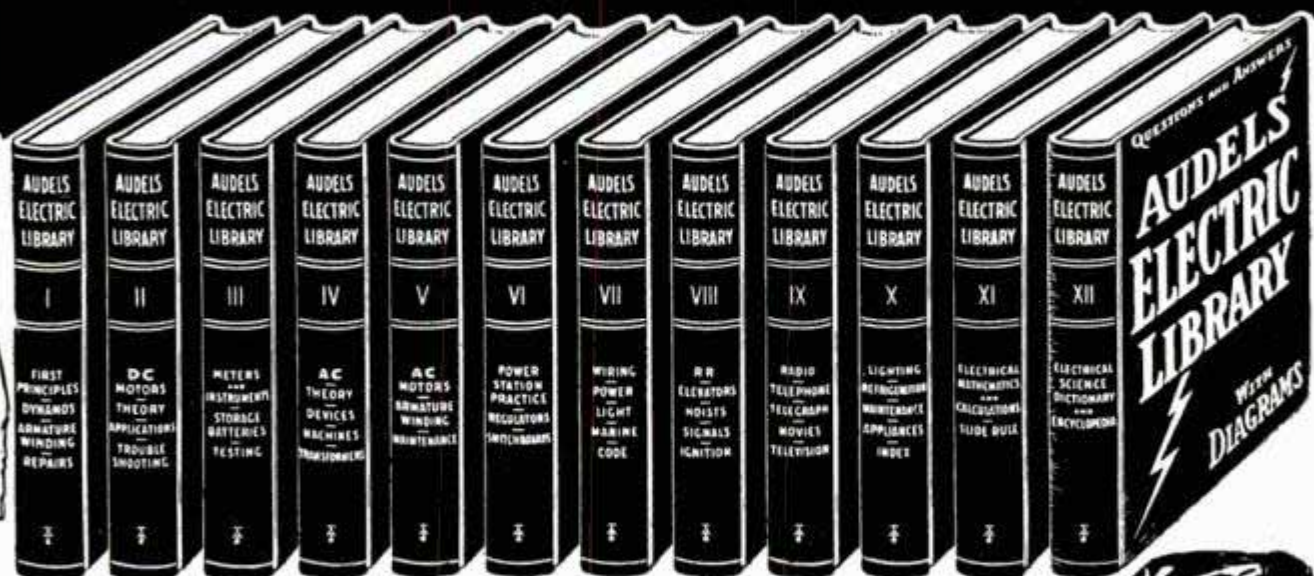

HERE are 9500 Simplified and Concise Explanations of the Theories and Application of Electricity. 7200 pages of useful and practical information relating to Construction, Operation and Maintenance for Ready Reference or Home Study. Price \$1.50 a volume, sold separately.

ANSWERS OVER 1000 VITAL QUESTIONS ON ELECTRICAL PROBLEMS
Today, every man in every branch of the electrical field is often expected to have some knowledge of the entire field—let us say that a specialist is well advanced in his line of work and stops there—he might be embarrassed or stuck on a motor trouble—or a lighting problem.

TRUE VALUE—ASK TO SEE THEM

"Audels Electric Library" is a helpful reference and a complete practical home study course for engineers, electrical workers, mechanics, maintenance service men and students.

It contains a Quick, Accurate Reference System. Highly endorsed, these handy size volumes are easy to read, understand and own. Only \$1.50 a volume, sold separately.

INFORMATION IN A HANDY FORM COVERING

VOL. I. Electrical Principles, Ohms Law, Armature Winding, Repairs. 480 pages. 700 illustrations.

VOL. II. Construction, Installation, Maintenance, etc. 418 pages. 573 illustrations.

VOL. III. Testing Instruments, Storage Batteries, Engineering. 472 pages. 631 illustrations.

VOL. IV. Alternating Current Principles, Diagrams, Power Factor, Transformers. 484 pages. 801 illustrations.

VOL. V. A-C Motors, all types, Windings, Converters, Switches, Fuses. 498 pages. 1,489 illustrations.

VOL. VI. Relays, Condensers, Rectifiers, Meters, Switchboards. 548 pages. 689 illustrations.

VOL. VII. House, Light and Power Wiring, Marine Wiring, Transmission, Underwriter's Code. 728 pages. 1,218 illustrations.

VOL. VIII. Railways, Signals, Elevators, Ignition and Starters. 812 pages. 1,078 illustrations.

VOL. IX. Radio, Telephone, Telegraph, Television, Sound Apparatus. 576 pages. 793 illustrations.

VOL. X. Refrigeration, Illumination, Fluorescent and Neon, Welding, X-ray, Index. 674 pages. 1,084 illustrations.

VOL. XI. Key to Practical Understanding of Mathematics, Fully Illustrated, Practical Mathematics, Electrical and Shop Calculations with Questions, Mechanical Engineering, How to Use Slide Rule. 700 pages.

VOL. XII. Defines over 9,000 words, terms and phrases, is also encyclopedia of electricity and related subjects. Answers many questions.

AUDELS BOOK-A-MONTH PLAN

You receive your first book for 7 days Free Trial and Examination. If you are satisfied, send us only \$1.50. If you are not satisfied, return the book to us and you owe us nothing. When we receive your \$1.50 in payment for the first book, we send you the second book.

REMEMBER: You can Start Your Subscription with Any Number or Stop at Anytime. Mail Today.

Not a Cent to pay until you see the books. No obligation to buy unless you are satisfied. Fill in coupon in pencil.



AUDELS, PUBLISHERS, 49 W. 23rd ST., NEW YORK



YOUR OPPORTUNITY! Cut this Coupon and Mail it Today

AUDELS, PUBLISHERS, 49 West 23rd ST., New York 10, N. Y.

Please enter my subscription for
AUDELS ELECTRIC LIBRARY
12 Volumes (Price \$1.50 a Vol. Postpaid)
On 7 Days' Free Trial and Examination
 Mail one volume each month, for which I will remit \$1.50 promptly after arrival. Start my subscription with Vol.
(It is understood I may cancel at any time.)

NAME

ADDRESS

OCCUPATION

EMPLOYED BY

If interested in owning the entire library at once. Save 5%—send \$17.10 cash with order. Money back if not 100% satisfied. P.M.

CUT HERE

FREE 5-Day Trial

How to Make Your Own CABINETS, BOOKCASES and WALL SHELVES

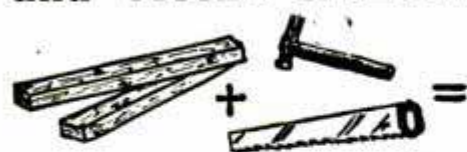

NOW — You Can Build the Things You Want at Big Cash Savings — Without Expensive Tools

YOU don't have to be an experienced craftsman—you don't even have to understand blue prints. The amazing new **GIANT-SIZE BIG HOME-PROJECT CRAFTSMAN MANUAL** shows you step-by-step, with easy-to-understand illustrations how to make your own useful things for your home and earn or save hundreds of dollars. Here are detailed drawings so simple, that even a child can understand and follow. This **HUGE** new atlas-book guides you every step of the way on any of the 77 up-to-date projects you decide to make.

Big Money-Market for Every Project Made

These hand built pieces of furniture whether they are a Chest, Cupboard, or Night Table bring many, many dollars in the market. Yes, you too, can share in the profits to be made in this lucrative field. Cash in on this golden opportunity of getting into a hobby that really pays off in gold dust.

Enrich Your Own Home

The 27 styles of cabinets alone, shown in this wonder-book can produce outstanding results for your home—watch your friends gasp when they see the practical bookcases (19 styles) and magazine racks you can make. You'll find yourself turning out modern cabinets, book shelves, hanging racks, chests and dozens of other things you need, "just like magic."

Follow Expert Advice

Scores of experts including furniture designers, woodworking instructors, master craftsmen and cabinet makers put their heads together to give you a book that will enable you to make the things you always dreamed of having. Clear-cut photos guide you as you work. The complete drawings and dimensions shown make every job so easy you will marvel at how quickly you can turn out these fine pieces.

SEND NO MONEY Risk Nothing—**READ on 5-Day FREE TRIAL** Just fill in coupon and mail. Use **CABINETS, BOOKCASES AND WALL SHELVES** for 5 days FREE. If not delighted, return the book within 5 days and owe nothing or keep it and send only the low price of \$3.95 (plus postage). Order **NOW!**

CRAFTSMAN PUBLISHING, Dept. PM2, 115 Worth St., New York 13, N. Y.

—5-Day FREE TRIAL COUPON—

CRAFTSMAN PUBLISHING, Dept. PM2, 115 Worth Street, New York 13, N. Y. Mail NOW

Please send me **CABINETS, BOOKCASES AND WALL SHELVES**. If not delighted, I will return the book within 5 days and owe nothing, otherwise I will keep it and send you only \$3.95 (plus postage).

Name.....

Address.....

City & Zone.....State.....

SAVE. Send payment (check or money order) NOW and We pay postage. Money back if not delighted.

MAKE THESE THINGS
Wardrobe Chests, Dresser, Night Table, Breakfast Cupboard, Phonograph Record Cabinet, Modern Chest Units, Sewing Cabinet, Book Shelves, Wall Shelves and dozens of other pieces.

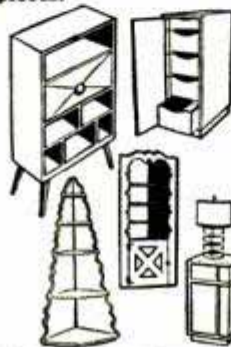

630 PHOTOS & DRAWINGS BIG BOOK 9" x 12"

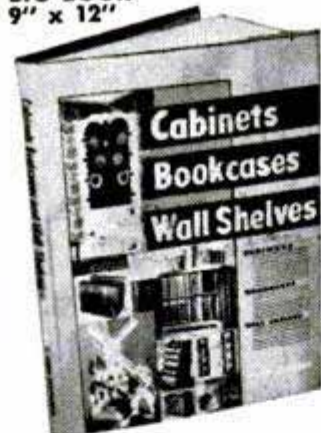

LIFE OF THE PARTY!

There's nothing like a set of drums in your house to bring the gang together!

Whether artist or amateurs, you and your friends will have great times and loads of fun.

BUY SLINGERLAND—the make that KRUPA uses.

Send for

FREE catalog!

SLINGERLAND DRUM COMPANY

1329 Belden Ave.

Chicago, Illinois

Protect the Heart of your car

with a **Rayclean**

FILTER

- COMPACT, LIGHTWEIGHT
- SPECIAL SYNTHETIC FILTER ELEMENT
- POSITIVE SEALING



Rayclean does a better job of removing dirt, rust, sludge and gummy particles from gasoline because, for the first time, it incorporates the principles of precise industrial filtration in a small unit designed for automotive use.

Made of aluminum, a Rayclean filter weighs only 3½ ounces... is only 2¼ inches wide by 2½ inches high. Hangs right in fuel line without other support... no "plumbing job" needed to install. Double surfaced filter plates covered with special non-woven rayon cloth give maximum filtering area, while positive sealing actually ends by-passing completely.

SEE YOUR DEALER

LIST PRICE, complete with fittings.....only \$3.95
Several territories still open. For information, contact

SPARKLER MANUFACTURING CO., Mundelein, Illinois

Manufacturers of fine industrial filtration equipment for more than a quarter of a century.

NOW! BECOME EXPERT AT

Radio-Television

IN 4 EASY STEPS!

**1. UNDER-
STAND
RADIO**

Complete Self-Training Course in RADIO and TELEVISION Prepared by Famous Experts — Starts From Scratch, Takes You BY SIMPLE LOGICAL STEPS From Basic Theory to Advanced Problems of Repair, Installation, Color TV, etc.

**MAKE GOOD
MONEY! BE
YOUR OWN
BOSS!**



**2. FIX
RADIO**

NOW you can do ANY Radio-TV installation, service, or repair job like an expert; operate field-testing equipment; understand problems of TV broadcasting, FM-AM transmission, etc. You can step into a good-paying job — or start your own service business. And you can train yourself for your career AT HOME... IN YOUR SPARE TIME... with the McGraw-Hill Basic Course in Radio and TV.

trations, cross-section diagrams, etc. The review questions and answers "nail down" everything you learn. At-a-glance "trouble-shooting" charts show how to diagnose instantly any radio or TV breakdown... and how to repair it expertly and quickly.

The course will pay for itself many times over. It can qualify a beginner for FCC's 1st-Class License test; gives an experienced technician more confidence, shows him new tricks.

**3. UNDER-
STAND
TV**

**2296 Pages—
1611 Illustrations**

SEND NO MONEY

The men who wrote this complete 4-volume course are among the outstanding radio and TV instructors in America today. They are practical, shirt-sleeved technicians. They know the questions you want answered. Every detail is clearly explained in over TWO THOUSAND PAGES of step-by-step instruction and over SIXTEEN HUNDRED "how-to-do-it" illus-

Mail coupon below to examine this complete four-volume course FREE for 10 days. No obligation. WITH course, you get ABSOLUTELY FREE (to keep whether or not you keep course) a valuable illustrated book, "Successful Soldering." (reg. price: \$2.00)

Or you may examine individual books FREE for 10 days by checking the proper boxes in coupon. Don't delay. Mail coupon at once!

**4. FIX
TV**

FREE 10-DAY TRIAL COUPON

**McGraw-Hill Book Co., Inc., Dept. PM-1-52
327 West 41st St., New York 18, N. Y.**

Please send me for 10 days' FREE EXAMINATION.

McGraw-Hill's Basic Course in Radio & TV... including Essentials of Radio, Elements of Radio Servicing, Basic Television, Television Servicing (Total retail price of the four books is \$23.75 — Special Course Price: Only \$19.05 in easy installments). Also send ABSOLUTELY FREE, "Successful Soldering." If not satisfied with course, I will return the four course books; pay nothing; and keep "Successful Soldering" free. Otherwise, I will send you only \$1.95 plus postage then; and the balance in 6 monthly installments of only \$3.00 each.

If you wish to examine any of these books individually, check below the ones you wish us to send you for 10 Days' FREE EXAMINATION:

Essentials of Radio, \$6.50 **Elements of Radio Servicing, \$4.75**
 Basic Television, \$6.50 **Television Servicing, \$6.00**

For whichever of these books I decide to keep, I will send you \$2.00 plus postage, at the end of 10 days; balance in easy monthly installments.

Name _____

Address _____

City _____ Zone _____ State _____

WE'LL PAY DELIVERY CHARGE if you enclose first payment of \$1.95 when ordering the course, or the full price of book when ordering individual books (see prices above). Same 10-Day Return Privilege for full refund.

**ESSENTIALS
OF
RADIO**

**ELEMENTS
OF
RADIO
SERVICING**

**BASIC
TELEVISION**

**TELEVISION
SERVICING**

**Qualifies
You for
FCC'S
New FM,
TV 1st
Class
License
Test**

**PARTIAL
CONTENTS
ESSENTIALS OF
RADIO, 800 pages,
433 illus.**

Circuit Analysis • Functions of a Receiver • Vacuum Tubes Circuits: Detector, Amplifier, Tube Oscillator, Power Supply, Transmitting and Receiving • Audio Units • Test Equipment • etc.

**ELEMENTS OF RADIO
SERVICING, 475 pages,
375 illus.**

24 big chapters: Multimeters • AC Power Supply • Speakers • Antennas • Automobile Radios • Push-Pull Output Stage • etc.

**BASIC TELEVISION,
592 pages, 415 illus.**
Camera Tubes • Scanning • Synchronizing • Video Signal • Brightness Control and

DC Reinsertion • Picture and FM Alignment • Picture Tubes • VHF and UHF transmission, reception • Operating Oscilloscope • etc.

TELEVISION SERVICING, 429 pages, 388 illus.

Antennas, Transmission Lines • Test-pattern, Picture Analysis • Localizing Reception Troubles • Interference Remedies • Deflection Circuits • High-voltage and Low-voltage Power Supplies • etc.

ABSOLUTELY FREE

yours to keep whether or not you keep the course. "Successful Soldering" (reg. price: \$2)



Everything you want to know about: Soldering coppers; fluxes. Tinning; sweating; stainless-steel, other special solders... heating methods. Many illustrations. A valuable book for every radio technician, home craftsman.

NOW! *Your Choice of* Popular 4 Courses! LEARN UPHOLSTERING AT HOME



Upholstering needs more trained men for good steady jobs! Now you can prepare for a better paying position — or your own business — or a hobby that "pays off!"

Whether you take the:
COMPLETE COURSE IN CUSTOM UPHOLSTERY
BASIC COURSE IN CUSTOM UPHOLSTERY
HOME REPAIR AND HOBBY COURSE
BASIC COURSE IN SLIP COVERS

YOU LEARN WITH REAL EQUIPMENT—YOU BUILD REAL FURNITURE—YOU GET A COMPLETE TOOL KIT & ALL MATERIALS. ALL AT NO EXTRA COST!

FREE! Big, illustrated brochure, sample lessons and details of "Pay As You Learn Plan." No obligation.

YOURS TO MAKE AND KEEP THIS FOOTSTOOL, BOUDOIR CHAIR AND LAWSON CHAIR

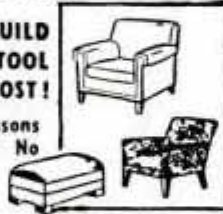

SEND THE COUPON TODAY!

FIELD SCHOOL OF UPHOLSTERY, DEPT. A1

39 West 19th Street, New York 11, N. Y.
 Rush FREE illustrated brochure, sample lessons and details of

- Complete Course in Custom Upholstery
- Basic Course in Custom Upholstery
- Home Repair and Hobby Course
- Basic Course in Slip Covers

Name _____ Age _____

Address _____

City _____ Zone _____ State _____

Lawn Care CAN MAKE YOUR WISH FOR A Beautiful Lawn COME TRUE

With Scotts FREE Lawn Care bulletins to guide you, you'll know the easiest and best way to get the lawn of your dreams . . . the thick, healthy Scotts kind that everyone admires. After reading Lawn Care, you'll agree with thousands who tell us, "We credit our lovely yard to Lawn Care aid."

For your lawn's sake, drop us a card for a FREE 2 year subscription. Just say, Lawn Care please, no obligation, of course.

O M Scott & SONS CO
 10 Spring St, Marysville, Ohio
 also Palo Alto, California

"SCOTTS." AND "LAWN CARE" ARE REG TM'S OF O M SCOTT & SONS CO

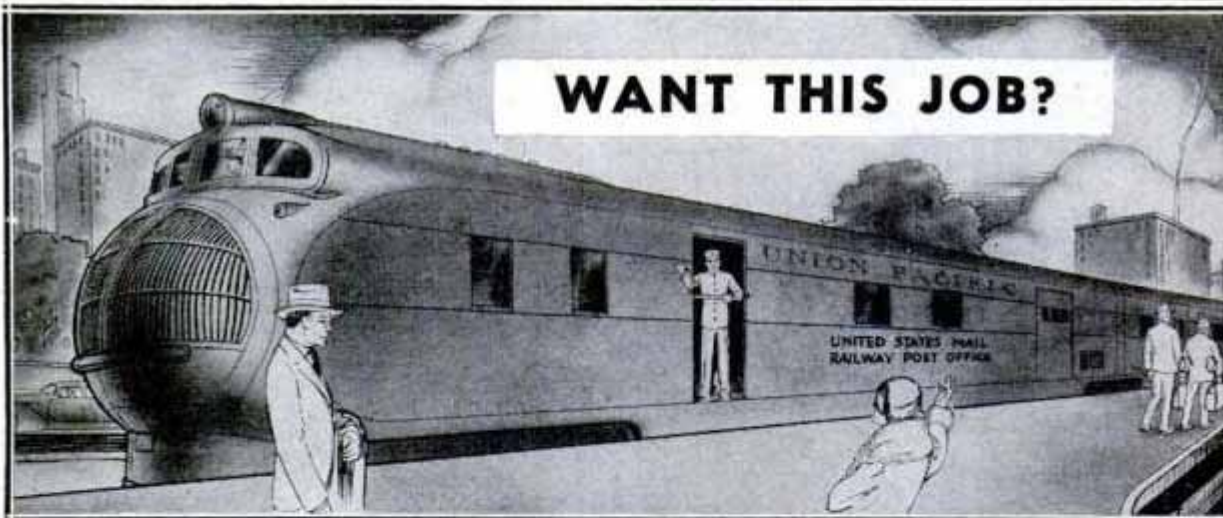

WANT THIS JOB?

RAILWAY POSTAL CLERKS

\$3,870 First Year Regular
Raise to \$4,270
COMMON EDUCATION SUFFICIENT

Get ready immediately for this and other examinations

MEN-WOMEN 18 to 62

Mail Coupon
— Today Sure

FRANKLIN INSTITUTE

Dept. D83, Rochester 4, N. Y.

(Not Government Controlled)

Rush to me, entirely free of charge (1) a full description of U. S. Government Jobs; (2) Free copy of illustrated 32-page book, "How to Get a U. S. Government Job;" (3) List of U. S. Government Jobs; (4) Tell me how to qualify for a U. S. Government Job.

Name.....

Street.....

City..... Age.....

Use This Coupon Before You Mislays it—Write or Print Plainly



Complete step-by-step directions for building beautiful modern bed with Hollywood headboard

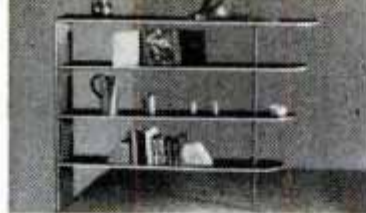

Shelves to divide a room—easily made of low-cost stock lumber, with simple hand tools.



Children can use this as a play table. But as they grow up it becomes a handsome desk!



Complete working drawings and instructions show how to make this attractive bunk bed.

ENJOY A WONDERFUL HOBBY—SAVE MONEY! MAKE MONEY!

NOW—It's EASY and FUN to MAKE YOUR OWN FURNITURE!

FREE
7-DAY TRIAL

HOW TO BUILD YOUR OWN FURNITURE



MAN, IT'S SO EASY! NO SPECIAL TOOLS NEEDED, AND MY FRIENDS ARE AMAZED!

Amazing new step-by-step guide shows you exactly "how to do it" — Over 300 photos, drawings, diagrams

NOW you can beat the high cost of furniture—and have lots of fun in the bargain! Make handsome pieces of furniture and accessories for every room—tables, chairs, bookcases, lamps, cabinets, etc.—at a fraction of store cost! It's EASY to do with brand-new book, "HOW TO BUILD YOUR OWN FURNITURE."

Imagine making a beautiful cocktail table, a bunk bed the kids will be "crazy about," a modern lamp—for the price of materials alone! Your chest will swell with pride; your friends will be amazed. You'll have the time of your life with this wonderful hobby—even make good money in spare time.

For Beginner or Expert Alike

This furniture has been specially designed for ease in making and low cost. Even a beginner can't do wrong—you get complete directions, photos, crystal-clear working drawings, photos, and diagrams that lead you every step of the way. No special tools needed. Skilled woodworkers will enjoy the variety and beauty of these pieces. Designed by George Daniels, master craftsman, whose articles appear in national magazines like *Mechanix Illustrated*, etc. Shows secrets of the experts, "tricks of the trade," time-saving shortcuts.

Here is furniture for living room, dining room, kitchen, nursery, basement, bathroom, bedrooms, and outdoors. Partial contents below give you only an inkling into the scores and scores of beautiful things you can easily make. PLUS how to select and use tools; how to buy wood, materials; how to remodel old furniture into striking new pieces, etc. Now you can have a beautifully furnished home that will be the envy of the neighborhood!

Easy-to-follow working drawings—crystal-clear directions



Easy-to-make cabinet



Attractive Modern Lamp



Telescoping TV Seats

SEND NO MONEY

Try Book FREE 7 Days

Just mail coupon and book will be sent to you for a full week's FREE trial. If not completely delighted, simply return it, owe nothing. Just one piece of furniture you make will save you many, many times the low cost of this book. You don't risk a penny, so mail coupon now. **Greystone Press, Dept. PM-1, 100 Sixth Ave., New York 13, N. Y.**

FREE EXAMINATION COUPON

Greystone Press, Dept. PM-1, 100 Sixth Ave., New York 13, N. Y.

Send me, for a full week's FREE trial, a copy of "HOW TO BUILD YOUR OWN FURNITURE"—256 large 7"x10" pages, over 300 photos, drawings, diagrams. If not delighted, I will return it in 7 days and owe nothing. Otherwise, I will send only \$1.50 then, plus few cents shipping charges, and a final payment of \$2.00 a month later in full payment.

Name _____ (Please print)

Address _____

City _____ Zone _____ State _____

SAVE MONEY! Check here if enclosing \$3.50 WITH coupon as full payment. Then WE pay all shipping charges. Same 7-day return privilege. Full refund guaranteed. In Canada: 3rd Ave. E., Owen Sound, Ont.

Shows How to Make All These Beautiful Pieces—and More!

- LIVING ROOM**
- Multi-purpose Table
 - Shelves to divide a room
 - Module Type Unit
 - Television TV Chair
 - Telescoping TV Chairs
 - 4-in-1 Music Cabinet
 - Add-a-Unit Bookcases
 - Desk that doubles as Buffet Table
 - Built-In Bookcase and Cabinet
 - Coffee Table
 - Chair with Storage Space
 - Fireplace Bench
 - Drum Style Cocktail Table
- DINING ROOM**
- Modern Dining Table
 - Modern Chair
 - Serving Table
 - Wall

- Cabinet for Glass and China
- Serving Wagon
- Sideboard
- Cel-larette
- KITCHEN**
- Disappearing Vegetable Bin
 - Spice Cabinet
 - Snack and Breakfast Bar
 - Clothes-Drying Rack
 - Folding Stool-Step-ladder
- ENTERTAINMENT ROOM**
- Home Bar Stools
 - Game Table
 - Upholstered Wall Seats
 - Game Room Chair
 - Lazy Susan
 - Magazine Rack
 - Folding Party Bar
 - Hanging Shelves
 - Hassock

- CHILDREN'S ROOM**
- Bunk Bed
 - Novel Toy Chest
 - Wardrobe Closet
 - Play Pen
 - Child's Desk that "Grows Up"
 - Indoor-outdoor Playhouse
 - Bed Table
 - Bulletin Board
- BEDROOM**
- Hollywood Headboard
 - Modern Bed
 - Dressing Table
 - Modern Night Table
 - Chest of Drawers
 - Boudoir Chair
- PLUS:** How to select, use tools; how to buy material; how to remodel old furniture; how to finish furniture, etc., etc.

INVENTORS

If you consider your invention to be something of importance — if you have invented any new and useful art, machine, manufacture or composition of matter or improvement thereof — you are advised to protect your invention by applying for a U. S. patent.

This firm is registered to practice before the U. S. Patent Office and is available to assist in the preparation and prosecution of your patent application.

The "Evidence of Invention" form mentioned below is offered as a convenience to you in making your disclosure to us for search purposes.

You should date and sign your disclosure and have it witnessed by two or more persons who are capable of understanding your invention.

Your disclosure should be mailed to us together with a letter authorizing us to conduct a preliminary search among previously granted U. S. patents for similar types of invention.

We then make this search and prepare a report of the probable patentability of your invention. If such report is favorable, we recommend the further course for you to take.

The "Evidence of Invention" form and booklet are suggested as conveniences to you and us in starting action on your invention.

VICTOR J. EVANS & Co. *Merlin M. Evans*
REGISTERED PATENT ATTORNEY

730-A MERLIN BUILDING, WASHINGTON 6, D. C.

PATENTS

COPYRIGHTS

We shall be glad to send you promptly and without obligation, an instructive booklet, "Patent Protection for Inventors", which was prepared to give inventors detailed information and steps to take toward patent protection—also our convenient "Evidence of Invention" form. Use address Victor J. Evans & Co., 730-A Merlin Building, Washington 6, D. C.



5-HP

GRAVELY Tractor
offers 20 Tools to Save You Work!

Rugged, dependable POWER for day-in and day-out plowing, mowing, cultivating—20 jobs in all! With the powerful 5-HP Gravely Tractor, metal muscles do your toughest jobs—better, faster . . . with less work!



All-Gear drive, power reverse. Field tested—30 years. Only the Gravely does so many jobs so well!

FREE

"Power vs Drudgery" tells how to put POWER to work for you! Write today!

GRAVELY MOTOR PLOW & CULTIVATOR CO.
BOX 163 DUNBAR, W. VA.

LEARN CARTOONING Get in the BIG MONEY

Former Landon students are really cleaning up. Creators of "Steve Canyon", "Freckles", "Out Our Way", "Winnie Winkle", "Regular Fellers", "The Neighbors", "Strange as it Seems" are just a few of them. Simplified Landon Picture Chart method makes progress quick, exciting, easy. Earn while learning. Rush 10c for Picture Chart (to test your ability) and full details. Please state age.



Landon School of Cartooning, 5201 CTS Bldg., Cleveland, O.

PAINT STRIPING TOOL

Works Like a Fountain Pen
Stripes with PAINT instead of INK!

New Master Painters' STRIPING TOOL makes it easy to do expert striping on furniture, bikes, model planes, autos, signs, linoleum, toys, wall board, etc. Makes plain, painted walls look like tile. Paint straight lines, curved, circular or evenly spaced parallel lines the same way a professional painter does. Simply fill Tubular Glass Paint Fountain with any color paint & wheel tip feeds paint evenly. Tips interchangeable — jaws split apart for easy cleaning. Tool complete with tip for 1-16 in. stripe only \$1 postpaid. Other complete tools with 1-64, 1-32, 3-64, 1-16, 5-64, 3-32, 1-8 in. tips, \$1.50 ea. Extra tips, 75c. Complete Kit with tool and 7 tips, \$5.96. Handiest tool in painter's kit. Get it now. C.O.D.'s postage collect.

WENDELL MFG. CO.

4234 N. Lincoln Avenue
Dept. 3-A, Chicago 18, Illinois
Paints Curved, Circular or Straight Lines



DEALERS

Paint Striping Tool

Packed in attractive Display Cartons of one dozen. Fast, profitable seller. Write for illustrated circular, discounts.

Thumb and Finger Rests. Easy to Guide Tool

Knurled Wheel Distributes Paint

\$15.20 an hour!

This is the average earning reported by Presto salesman WILLIAM F. WYDALLIS. "The sky's the limit" on Presto profits because of America's serious need for this new fire extinguishing discovery.



WILLIAM F. WYDALLIS

"Most specialty salesmen are always on the lookout for a 'natural.' The 'natural' of this decade is the PRESTO FIRE EXTINGUISHER... because it is handy in size, simple to operate, and in the right price range.

"For every hour I have devoted to the Presto, I find that I have earned an average of \$15.20 an hour. I am now convinced that extraordinary money can be made in this safety field. I am devoting more of my time to this product now since I have discovered that the earnings on this item are greater than any item I have handled in the past."

—William F. Wydallis
Van Wert, Ohio

CHARLES KAMA



This Presto salesman from Texas was featured at "Salesman of the Month" on the

front cover of a sales magazine. He told the magazine's reporter:

"I think I've succeeded pretty well. I'm making more than a thousand dollars a month—and I haven't touched bottom yet."

Folks Are Amazed when you Tell Them This New Kind of Protection Costs Only **\$3.98**



WOULDN'T YOU like to be making the kind of money William F. Wydallis is making? His story (printed at right) is just one example of the brilliant success that Presto salesmen are meeting everywhere! A Florida salesman earned \$600 in one month. An Ohio man earned \$2100 in 2 months. A New York salesman earned \$1500 in one month. A New Hampshire salesman added the Presto as a *sideline* and picked up an extra \$1800 in 20 months.

What is the Secret?

PRESTO contains an amazing new chemical "Chlorobromomethane" or "C.B." developed as a secret defense against fire during the war.

In comparing the effectiveness of "C.B." in fighting various kinds of fires an authoritative testing laboratory states: "It has been proved that 'C.B.' is about 1.5 to 6 times as effective as other common extinguishing agents on an equal weight basis."

This extra effectiveness of "C.B." means that Presto can be made light and handy enough for even a woman or child to use. Just a twist of the knob . . . and flames disappear! "Sells on sight" to civil defense workers, owners of homes, cars, stores, farms, service stations, boats, motorcycles, factories, offices and to stores for re-sale.

Why Large Presto Profits Are So Easy

Everyone is terrified at the very thought of **FIRE!** Every year fire kills more than 11,000 people. Most people who see Presto in action want one or more — **ESPECIALLY WHEN THE PRICE IS ONLY \$3.98 EACH!**

You can demonstrate Presto in a few minutes, and every sale will net you \$1 or more. We refill your demonstrator free . . . and we give you dramatically powerful printed sales material to "talk from" . . . free certificates testifying that Presto is **GUARANTEED FOR 20 YEARS.**

YOU DON'T NEED TO INVEST A PENNY. Just collect and *keep* \$1 or more every time you write an order — we collect the balance and deliver the extinguisher. (Or if you *wish*, you can buy from us at extra-low wholesale prices and then make up to \$2.18 profit per unit supplying both dealers and retail customers — we'll send you free details.)

Start Now — Mail Coupon

Get started in this rich new field now. Don't "put it off"! Every day you hesitate may cost you \$10, \$15, or even \$50 you could otherwise be making. Mail the coupon at right **NOW** for everything you need to get started right away!

MERLITE INDUSTRIES, Inc., Dept. 51, 201 East 16th Street, New York 3, N.Y.

Best Selling Months Just Ahead! Don't Delay — Mail Coupon Now!

MERLITE INDUSTRIES, Inc., Dept. 51, 201 East 16th Street, New York 3, N. Y.

Please send me illustrated sales literature, liberal profit plan, order blanks—everything I need to get started making good money introducing the Presto Fire Extinguisher in my locality.

CHECK HERE IF YOU WISH TO ORDER A REGULAR PRESTO TO BE USED AS A DEMONSTRATOR (\$2.50). Pays for itself many times over in increased sales. Can be returned as often as you like for FREE re-fill. You needn't enclose any money now—we'll send Demonstrator C.O.D. (Or if you wish to save money, enclose \$2.50 and we'll pay postage.)

Name.....

Address.....

City..... Zone No. (if any)..... State.....

IN CANADA: Mopa Co., Ltd., 371 Dowd Street, Montreal 1, P.Q.

Only Presto Has All These Features!

- Ends Fire as Fast as 2 Seconds
- Chemical Contents 1.5 to 6 Times More Effective than Others on an Equal Weight Basis
- Weighs Less Than 1 Lb.
- Easily Held in One Hand—Even by a Child
- Needs No Inspection or Re-Charging — Does Not Corrode or Deteriorate
- Costs Only \$3.98 — Yet Out-Performs Bulky Extinguishers Costing Several Times as Much
- Automatic Pressure — No Pumping
- Guaranteed for 20 Years — Certificate is Packed with Every Presto

TRAIN NOW FOR
A BIG PAY FUTURE IN
DIESEL
& SCIENTIFIC MOTOR TUNE-UP

- Diesel Construction
- Diesel Engine Repairman
- Diesel Operator
- Industrial Maintenance
- Auto Engine Rebuilding
- Bus & Truck Maintenance

Be a Trained Diesel Man

Go places with DIESEL! Farms, factories and power plants, trains, ships, trucks, busses all use DIESEL POWER... all need DIESEL-trained men! You can start your DIESEL training at home, in spare time, with tested, proved U E I training. Course includes practical work on Diesel engines under skilled instructors. You learn the operation, maintenance, servicing of all types of Diesel engines, PLUS Scientific Motor Tune-up.

ACT NOW! If you have mechanical ability, you'll like Diesel! High School diploma not necessary. Write now for FREE book, "EARNING POWER IN DIESEL." Act Today!

MAIL NOW FOR FREE BOOK! →

UTILITIES ENGINEERING INSTITUTE, Dept. DC-17
2521 Sheffield Ave., Chicago 14, Ill. (Founded 1927)
O. K.! Rush, without obligation, FREE Book on DIESEL.

NAME _____
ADDRESS _____
CITY _____ ZONE _____ STATE _____
 Check here for information if under 17.



Men!

Reading This
Message Could Be
the Most Important
40 Seconds In Your Life

From every indication Auto Body and Fender Repair work will continue to be one of America's Big Income fields. Here at U.E.I. we're training men for it—a proven plan that combines spare-time, home study and actual shop practice. Men from coast to coast have successfully completed the U.E.I. course in Auto Body and Fender Repair—many earned money while learning—many now have their own shops. What about you? Isn't this the time for you to see what this big-pay field offers you? Do this: Mail the coupon below and we'll send you our big, descriptive book, "Opportunities." It's Free — Mail the Coupon.

UTILITIES ENGINEERING INSTITUTE, Chicago 14, Illinois
Founded 1927

UTILITIES ENGINEERING INSTITUTE,
2523 Sheffield Ave., Dept. XC-11, Chicago 14, Illinois
Please send, Free, Your Book "Opportunities".

NAME (print) _____ AGE _____
ADDRESS _____
CITY _____ (Zone) _____ STATE _____
 Check here for information if you are under 17.

EAR NOISES!

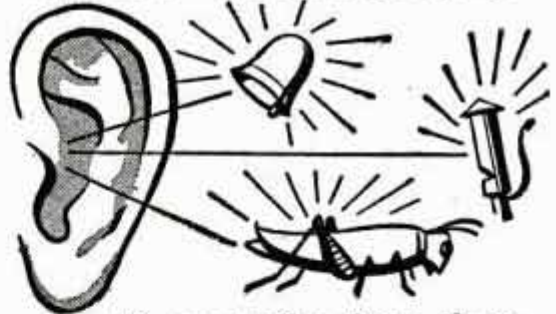

If you suffer from those miserable ear noises and are Hard of Hearing due to catarrh of the head, write us NOW for proof of the good results many people have reported after using our simple home treatment. **NOTHING TO WEAR.** Many past 70 report ear noises relieved and hearing improved. **SEND NOW FOR PROOF AND 30 DAYS TRIAL OFFER.**

THE ELMO CO.
DEPT. 2PM1 DAVENPORT, IOWA

LEARN WATCH REPAIRING



AT HOME. By our modern and original system of instruction you can learn every part of the **WATCH REPAIRING TRADE AT HOME.** Prepare yourself for a well-paying position or start in business after completing our course of instruction. Good watch repairers are in demand and generally earn very good salaries. For particulars apply to the **WISCONSIN SCHOOL OF WATCH REPAIRING** 759 North Milwaukee St., Milwaukee 2, Wis.

It's Easy... REPAIR YOUR OWN TELEVISION

Every owner needs our new complete TELEVISION OWNER'S HANDBOOK. Easy to read... easy to follow. Only \$1.00 Post Paid. Send Check, Money Order or Cash to—
CLARK ELECTRONIC RESEARCH CO.
1267 First National Bank Bldg. St. Paul, Minn.



Money In Hamsters

The new wonder animals from Syria. Often called Toy Bears. Delightful pets. Everyone wants them. Laboratories use thousands. Clean, odorless. Raise anywhere. NOW, spotted and golden breeds. We furnish breeders, equipment and manual of instruction. Write today for free illustrated literature.

GULF HAMSTERY 1536 BASIL ST., MOBILE 17, ALA.



CARTOONING

HAVE FUN! MAKE MONEY! Cash in on your sense of humor **AT HOME—BY MAIL!** No experience needed to start. Write today for **FREE TRIAL LESSON** and full particulars.
Moon Gag Cartoon School, Dept. M, Fall Creek, Wis.

RUPTURED?

Get Relief This Proven Way

Why try to worry along with trusses that gouge your flesh—press heavily on hips and spine—enlarge opening—fail to hold rupture? You need the Cluthe. No leg-straps or cutting belts. Automatic adjustable pad holds at real opening—follows every body movement with instant increased support in case of strain. Cannot slip whether at work or play. Light. Waterproof. Can be worn in bath. Send for amazing **FREE** book, "Advice To Ruptured" and details of liberal truthful 60-day trial offer. Also endorsements from grateful users in your neighborhood. Write:

CLUTHE SONS, Dept. 31, Bloomfield, New Jersey.

TRAIN FOR GOOD PAY IN A FIELD THAT ISN'T CROWDED!



NOW you can LEARN ELECTRIC MOTOR REPAIR
... A good-paying, modern profession



OPPORTUNITIES EVERYWHERE

Don't drift into a rut! Don't train for something that everybody and his brother are studying! Consider the facts. . . . The average small home has at least 11 electric motors! Big homes have many more—in phonographs, recorders, oil burners, refrigerators, washers, fans, clocks, mixers, cleaners, air conditioners, etc., etc. Millions more in office, industrial, mining, and transit equipment. Be the well-paid expert who can keep them working!

... for only \$6 FOR THE COMPLETE TRAINING

Every day, more and more electric motors and motor control systems are being used BOTH in industry and in home appliances. The expert who can install, repair and keep them working properly is a valuable man in this Electrical Age. The pay is surprisingly good. The field is tremendous—and growing rapidly. Trained men find opportunities everywhere for full or part time work. **ELECTRICAL MOTOR REPAIR**, the big 560-page training course book teaches you the work step by step—quickly and easily—at home in spare time. There is no other book like it. Ideal for beginners or for actual bench use in busy shops. Thousands of copies are already in use in leading vocational schools, shops, and most important of all, home study.

FREE STUDY GUIDE

A unique Study Guide booklet of 500 practical motor study questions—priced and sold separately at 25¢—is yours FREE with your request to examine **ELECTRIC MOTOR REPAIR** book. Makes learning easier—speeds up the work! See coupon.



SHOWS YOU HOW ... Every Step of the Way!

Based on what you can learn quickly at home from **ELECTRIC MOTOR REPAIR** you can train for prompt, profitable installation, servicing, repairing and complete rewinding of practically any motor in use today. You learn fast! You learn right! Every subject is clearly and simply explained by text AND ALSO by more than 900 clear-cut illustrations and diagrams. You not only read what to do—you actually SEE how it is done. Quick reference guides tell you how to handle specific jobs. When a certain motor comes in for repairs, just look it up. **ELECTRIC MOTOR REPAIR** tells you what to do—and exactly how to do it.

ELECTRIC MOTOR REPAIR is designed for use right at the service bench. Unique Duo-Spiral Binding divides the book into two sections so that both text and related diagrams can be viewed together. An instructor standing by your side could hardly do better! **ELECTRIC MOTOR REPAIR** covers the entire field—from alternating- and direct-current motors and generators, etc., to mechanical and electrical and electronic control systems. Right down the line, it explains every detail of trouble diagnosing, repair, rewinding and maintenance in a way you can easily understand.

PRACTICE FROM IT 10 DAYS AT OUR RISK!

You don't risk a cent! Use coupon for 10-day examination of this famous home training book.



LEARN FAST... No Lessons to Wait for!

If sold as a course and sent to you in lesson form, **ELECTRIC MOTOR REPAIR** would be a bargain at 10 times the price! You get it all at once. You learn rapidly. Here are just a few of the subjects covered:

- Split-Phase Motors
- Capacitor Motors
- Repulsion-type Motors
- Polyphase Motors
- Alternating-Current Motor Control
- Direct-Current Armature Winding
- Direct-Current Motors
- Direct-Current Motor Control
- Universal, Shaded-pole, and Fan Motors
- D-C Generators, Synchronous Motors and Generators
- Electronic Motor Control
- ... and essential motor data



10-DAY EXAMINATION COUPON

Dept. PM-12, RINEHART BOOKS, Inc., Technical Division, 232 Madison Ave., New York 16, N. Y.

Send me the 560-page **ELECTRIC MOTOR REPAIR** home-training book for 10-day FREE EXAMINATION. At the end of 10 days, I will either return book to you postpaid in good condition or send you the sum of \$6.00 in full payment.

Name _____
 Address _____
 City, Zone, State _____
 Your Employer's name & address _____

THE HISTORY OF AIR POWER IS
THE HISTORY OF **SPARTAN**...

1928 - 1952



Aviation offers unlimited opportunities to young men with ability, ambition and training. SPARTAN can give you that training and you can qualify in a very short time for a position in this highly-paid field.

SPARTAN SCHOOL OF AERONAUTICS has been training young men for successful careers in aviation since 1928. Students come from nearly every country and graduates of this famous School are now employed all over the world.

Write SPARTAN immediately for complete information.

SPARTAN
SCHOOL OF AERONAUTICS
TULSA, OKLAHOMA

MAIL COUPON TODAY

Spartan School of Aeronautics
Tulsa, Oklahoma Dept. PM-12
Please send me complete information on: Course _____
Name _____ Age _____
Street _____
City _____ State _____



Ball-Bearing SPEED WHEELS



JUVENILE WHEELS (No bearing, solid tires)	
4"	40c
5"	45c
(Semi-pneumatic tire, ball bearing)	
8 x 1.25	1.85
8 x 1.75	1.95
8 x 2.00	2.20
10 x 1.25	2.20
10 x 1.75	2.30
10 x 2.00	2.65
12 x 1.75	3.45
INDUSTRIAL WHEELS	
Lug Base, Semi-Pneumatic tire	
5 x 1.75	3.65
6 x 2 SW	3.45
6 x 2.00	4.00
8 x 2.00	5.20
8 x 2.50	5.40
10 x 2.00	2.00
10 x 2.75	5.15
12 x 2.00	6.90
12 x 3.00	9.20
16 x 4.00	15.15
Smooth Base, Pneumatic tire and tube	
8 x 3.00	11.00
10 x 2.75	6.80
10 x 3.50	10.55
12" x 4.00	12.10
4.00 x 8	13.10
14 x 4.50	13.40

Dealers, Jobbers, and Manufacturers! Our new prices will interest you.

No c.o.d. orders. Write for circulars on all wheels. Prices F.O.B. our plant.
JIM BROWN TOY COMPANY
1095 HOME AVENUE AKRON 10, OHIO

COMPLETE NEW



FALSE IN 24 PLATE HOURS

FROM YOUR OLD \$14.95 NOW LOW AS... **14**

Brand new process transforms your old, broken, cracked or loose plates into new light-weight plastic plates.

NO IMPRESSION NEEDED. Let us help you enjoy life again. You will marvel at this revolutionary new method. Using your own old plates, we will remake them completely in only 24 hours. Missing teeth are carefully matched and replaced. Work is done on an absolute **MONEY BACK GUARANTEE.**

SEND NO MONEY — Just rush your name and address to us for full FREE DETAILS. If your teeth are loose, we'll tell you how to tighten them before duplication. Act now. Quit suffering!

TRU-GRIP DENTAL LABS.
7th Fl. 127 N. Dearborn St. Dept. PM Chicago 2, Ill.

DRAW FOR MONEY — BECOME YOUR OWN BOSS!

BE AN ARTIST



Amazing WSA Way Teaches You to Draw Step-by-Step — At Home in Spare Time

TWO BIG ART OUTFITS INCLUDED

First set of art materials comes with first set of lessons. Advanced outfit comes when you need it later in course — all at no extra cost.

EARNED \$300 — for one illustration. "WSA has given me the know-how to earn while learning" — Floyd M. Green, Seattle, Wash.

\$50 WEEKLY IN SPARE TIME — "Art stores buy all my work. I earn around \$50 a week in just my spare time. I highly recommend 'WSA'." — Mrs. T. Teichman, Northfield, N.J.

WRITE FOR FREE BOOK "ART FOR PLEASURE AND PROFIT"

Tells about our course and opportunities for you in Art. See reproductions of student and graduates' artwork and read about results enjoyed by WSA trained artists.

OUR 38th YEAR!

Now you can prove to yourself that you have art talent! Our famous 38-year-old home study method makes it easy to get started. Get the facts about how you can prepare for a profitable career or fascinating hobby. Qualify for a good position in the exciting world of art — and earn \$75, \$100 and more weekly. Learn Commercial Art, Designing, Cartooning — all in one complete home study course. *You don't need previous experience* — WSA teaches you from the beginning. Low cost — easy monthly terms.



FREE BOOK gives details

WASHINGTON SCHOOL OF ART
Studio 121F, Washington 5, D. C.
Send me without obligation, Free Book, "Art for Pleasure and Profit." No salesmen. (Please Print)

Name

Address

City

I am interested in your new Trial Plan

WASHINGTON SCHOOL OF ART

"WHAT A PITY more people don't know about this wonderful, EASY WAY TO LEARN MUSIC!"



Over 850,000 Have Discovered It Already—But There Are Millions More to Whom It Can Bring a Lifetime of Joy! **FREE BOOK** Tells About It

SO MANY people needlessly deprive themselves — all their lives — of the pleasures of playing! They miss out on the good times, the increased popularity, the wonderful feeling of accomplishment that comes with the ability to play!

And why? Simply because they imagine that learning to play requires "musical talent" and long hours of practicing scales and exercises. But that's not true any more — and it's a pity more people don't realize it.

Even If You Don't Know A Single Note NOW

You can sit right down at the piano (or any other musical instrument) and actually play a piece of real music in your very first week. Your skill will improve steadily and rapidly. And soon you'll find yourself playing all your favorite pieces — easily, confidently, and properly — by note.

The famous U. S. School of Music method makes learning music an exciting hobby. No boring exercises and scales. You learn by playing pieces, delightful pieces. And you do it right in the privacy of your own home — in the spare time of your own choosing — and for only a few cents per lesson, which includes all sheet music!

Which Is YOUR Favorite Instrument?

Do you love the piano, guitar, accordion, or violin? Regardless of which is your favorite instrument, you'll soon find yourself playing it so well that your friends will be amazed. You will be invited out everywhere, be the "key person" at every party.

Many of our 850,000 students didn't know a single note when they started; others had "given up" their music years ago and were eager to get back to it. Today they are enjoying the happiness which music can give.

Let us tell you all about it. Let us send you the **FREE BOOK** and **FREE INSTRUCTION-SAMPLE** you will read about below.

WHY MISS OUT ON ALL THE FUN!



THOUSANDS NOW PLAY Who Never Thought They Could

Now Plays For Dances

"I DIDN'T KNOW ONE NOTE OF MUSIC! Three months later I started to play for dances. I have been invited to many parties and made people very happy with my music." — Miss Rosie Montemurro, Vancouver, B. C., Canada.



"Never Dreamed I Would Play"

"I never dreamed I would ever play. I didn't know one note from the other. Today I can play six delightful pieces after only two months." — Mrs. Dallas B. Kerk, Lodgepole, Nebr.



Learns Faster Without Teacher

"I have no special talent — but thanks to your method, I play my guitar (according to impartial people) better than many students who have taken lessons from teachers for longer periods, and naturally at a higher cost." — Myrella-Muquette Saint-Andre, Montreal.



Now Famous Orchestra Leader

"I got my start in music with a U. S. School Course. How easy it is to learn to read notes and play an instrument this 'teach yourself' way! In fact, this school did so much for me that I've enrolled my two daughters." — Lawrence Weik, famous orchestra leader.



Amazes Friends

"I bet some friends that I could learn to play the piano quickly. They didn't believe me—because I am slow learning. Imagine their surprise last night when I played for them. One said, 'Why, Louise, it sounds like you've been playing for years!'" — Louise Gomez, Oakland, Cal.



"Easy As Falling Off Log"

"It's easy as falling off a log. I have always wanted to play and now a life-long dream is being fulfilled." — Mrs. Phyllis B. Jones, Blanding, Utah.



FREE BOOK and Free Instruction-Sample

Check in the coupon which is your favorite instrument and we will mail to you our Free Book—also a Free Instruction-Sample showing how interesting and simple our method really is. Then you will realize why it has been so successful for 54 years—why 850,000 people have turned to it to make their dream of playing come true! Mailing the coupon places you under no obligation whatever—and no salesman will call upon you. So mail it at ONCE. Don't delay putting this wonderful accomplishment into your life. **U. S. School of Music, Studio B-301, Port Washington, N.Y.** (Special Reduced Prices on instruments to our students)



U. S. School of Music, Studio B-301, Port Washington, N. Y.

I am interested in learning to play, particularly the instrument checked below. Please send me your free illustrated booklet, "How to Learn Music at Home"—also the free Instruction-Sample of your simplified words-and-pictures teaching method. **NO SALESMAN IS TO CALL UPON ME.**

- | | | | |
|--|--|---|--|
| <input type="checkbox"/> Piano | <input type="checkbox"/> Saxophone | <input type="checkbox"/> Tenor Banjo | <input type="checkbox"/> Modern Elementary Harmony |
| <input type="checkbox"/> Guitar | <input type="checkbox"/> Trumpet, | <input type="checkbox"/> Ukulele | <input type="checkbox"/> Mandolin |
| <input type="checkbox"/> Hawaiian Guitar | <input type="checkbox"/> Cornet | <input type="checkbox"/> Clarinet | <input type="checkbox"/> Practical Finger Control |
| <input type="checkbox"/> Violin | <input type="checkbox"/> Pipe, Reed, | <input type="checkbox"/> Trombone | |
| <input type="checkbox"/> Piano Accordion | <input type="checkbox"/> Hammond Organ | <input type="checkbox"/> Flute, Piccolo | |

Do you have the instrument?.....

Mr.
Mrs.
Miss (Please Print Carefully)

Address

City..... State.....
(Insert Zone Number, If Any)

NOTE: If you are under 18 years of age parent must sign coupon

Do you want

- ..to go to College?
- ..or to enter a Profession?
- ..or get an Office Position?

(Such as Accounting, Architecture, Nursing, Dentistry, Teaching, Social Work, Osteopathy, Beauty Culture, Optometry, Embalming, Chiropody, Law, Medicine, etc.)

To get anywhere, you practically **MUST** finish High School **FIRST**. You can complete our simplified High School Course in **SPARE** time at home, as **FAST** as your time and abilities permit. Equivalent to resident school work—prepares you for college, pre-professional examinations, business, industry. Standard texts furnished. Diploma. Credit for H.S. subjects already completed. Single subjects if desired. Low tuition, easy terms. American School, Chicago, est. 1897—endorsed by educators. Finish your high school education **NOW**, Write **TODAY!**

High School Course at Home

Many Finish in 2 Years

American School, Dept. H145, Drexel Ave. at 58th St., Chicago 37, Ill.

Gentlemen: Send me **FREE** information covering special training in subjects checked below. No obligation on my part.

- | | |
|--|--|
| <input type="checkbox"/> High School Course | <input type="checkbox"/> Diesel Engineering |
| <input type="checkbox"/> Architecture and Building | <input type="checkbox"/> Drafting and Design for Men & Women |
| <input type="checkbox"/> Automotive Engineering | <input type="checkbox"/> Plastics |
| <input type="checkbox"/> Business Management | <input type="checkbox"/> Private Secretary |
| <input type="checkbox"/> Electrical Engineering | <input type="checkbox"/> Mechanical Engineering |
| <input type="checkbox"/> Elec. and Gas Refrigeration | <input type="checkbox"/> Aviation |
| <input type="checkbox"/> Air Conditioning | <input type="checkbox"/> Salesmanship |
| <input type="checkbox"/> Railway Training | <input type="checkbox"/> Radio |
| <input type="checkbox"/> Electronics, Industrial | |

Name.....

Address.....

Learn this Profitable Profession



IN 90 DAYS AT HOME

Money-Making Career Open to Men and Women, 18 to 60

Hundreds of men and women between 18 and 60 make \$10 to \$20 in a single day giving scientific Swedish Massage and Hydro-Therapy treatments. There is big demand from doctors, hospitals, sanatoriums and clubs. Graduates earn large full time incomes from these or in private practice in their own offices. Others make good money from home treatments given in spare time. Learn this interesting money-making profession in your own home, through our home study course. Same instructors as in our nationally known resident school. You can win independence and prepare for future security by qualifying for your Diploma. Course can be completed in 3 to 4 months. Many earn while they learn. Begin your training at once.



NEW 32-PAGE BOOKLET FREE

Fill in the coupon below (please print name and address) and mail it for your **FREE** copy of 32-page Information Booklet. If you act at once we will include Anatomy Charts and Success Booklet which supply additional information you should have. All will be sent postage paid.

THE COLLEGE OF SWEDISH MASSAGE

Dept. 264A, 41 E. Pearson St., Chicago 11, Illinois

Please send me **FREE** and postpaid New 32-Page Illustrated Booklet, Anatomy Charts and Success Booklet at once.

Name..... Age.....

Address.....

City..... State.....

GOOD WOODWORKING



IS A CINCH WHEN YOU HAVE

THESE PLANS

Save money by making your own furniture in your spare time. Rogers simplified project sheets will show you how step-by-step. Send only 15c for which we will send you a full-size jar of Rogers famous Gorilla Grip Glue and include these valuable plans **free**. Write to Rogers Isinglass & Glue Co., Gloucester, Mass. Ask for Rogers Glue at your local hardware store.



ROGERS

the best LIQUID FISH GLUE
GLOUCESTER, MASS.



"A Ton of Strength in Every Drop"

FALSE TEETH

KLUTCH holds them tighter

KLUTCH forms a comfort cushion; holds dental plates so much firmer and snugger that one can eat and talk with greater comfort and security; in many cases almost as well as with natural teeth. Klutch lessens the constant fear of a dropping, rocking, chafing plate. 25c and 50c at druggists... If your druggist hasn't it, **don't waste money on substitutes**, but send us 10c and we will mail you a generous trial box.

KLUTCH CO.

Box 5293A

ELMIRA, N. Y.

BOYS-IT'S FREE!

"THE WONDERS OF CHEMISTRY"

This exciting new book shows how to amaze your friends with chemical magic, describes many fascinating home experiments, tells of fun, thrills and big future opportunities for boys who know chemistry. Special atomic energy feature. Send today!

THE PORTER CHEMICAL COMPANY
44 Prospect Avenue, Hagerstown, Maryland



LEARN MEAT CUTTING At Home - In Spare Time



Get into the vital meat industry. Concise, practical Home Training based on 25 years proven instruction methods used at National's famous resident school. Prepares you for bigger pay as Meat Cutter, Supervisor, market manager or more money in your own store. Go as rapidly as your spare time permits. Diploma. Start **NOW** to turn your spare hours into money. Send for **FREE** bulletin today. No obligation.

NATIONAL SCHOOL OF MEAT CUTTING, INC., Div. U-136, Toledo 4, Ohio

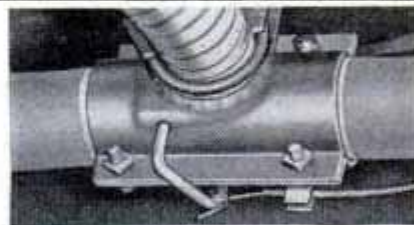

HURRICANE EXHAUST CUT-OUT

This specially engineered cut-out enables you to install special pipes and mufflers without removing the original muffler.

Now control your exhaust tone from a dash control button. Cut back into your original muffler in restricted areas at will. Fits all exhaust pipes from 1 3/4" to 2 1/4" size.

This cut-out is well constructed; actually strengthens exhaust pipe; made of heavy plate steel, designed for easy installation—no special tools required. Sent post-paid for only \$6.95 check or money order. Satisfaction guaranteed or your money back.

ST. LOUIS PRODUCTS CO., Box 24-A, Normandy 21, Mo.

COULD YOU SELL NYLONS AT 49¢?

Would you like to earn up to \$3 an hour for your spare time? YOU CAN DO IT! It makes no difference whether you are 18 or 80—whether you ever sold anything before or not—whether you have one hour or fifty hours a week to spare. You don't have to be a "salesman" because this isn't "selling"—it's more like giving something away. We'll establish you in your own business at our expense! You pay nothing—risk nothing.

Women buy over two million pairs of nylons every day. Most pay \$1.35 to \$1.75 the pair. Suppose you offered finest quality, nationally advertised nylons at 49c a pair, what woman would hesitate to order? Yet, that is all they cost if they run or snag within guarantee period up to THREE WHOLE MONTHS! This sensational low cost includes your commission, bonus and even the postage!

There is nothing for you to buy or deliver. Nothing to learn or study. You can start making money one hour after you receive the free outfits. Just show the line — the amazing written guarantee of free replacement — display the free sample stocking given to you and write orders! Could anything be easier?

We deliver and collect. You get cash in advance on every order you write and can easily earn the huge cash bonus that increases your earnings by 40%! You can never know how easy it is for you to get a steady extra income until you have the free, complete money-making Kendex outfit. Your ONLY cost is a postage stamp to mail the coupon. Send it now. You pay nothing now or later. Show the outfit to 5 women. That's all. When you see how eager most women will be to give you orders, you'll thank your lucky stars that you saw this advertisement.

KENDEX CORPORATION
BABYLON 946, N. Y.

LIFETIME FUTURE

H. Armstrong of Tenn. earned \$202 in 9 days. C. Watkins of Oregon sent 92 orders in one day. Almost a million dollars has already been earned by others just like yourself. You can start making money next week.

AMAZING GUARANTEE

No matter what the cause—whether it is use or abuse—Kendex stockings are replaced FREE if they run, snag or become unfit for wear within full guarantee period up to three whole months!

MEN'S HOSE Guaranteed One Year

Separate outfit of complete men's hosiery line will be included free for added income. These wonderful socks are actually guaranteed for ONE FULL YEAR or replaced free with no questions asked! Positively the world's most sensational guarantee!

YOU CAN BECOME A MANAGER

Appoint agents, beauty parlors, etc., to take orders for you. Get cash for every order taken. Complete plans included with outfits.

FREE SAMPLE STOCKING!

Date _____

KENDEX CORPORATION
Babylon 946, N. Y.

Send me, absolutely free and prepaid, your complete money-making outfits including free sample stocking. It is understood I am under no obligation and if I am not satisfied with the money I make, I will throw the outfits away.

Name _____

Address _____

City _____ Zone _____ State _____

COME TO THE

UNIVERSITY OF HOUSTON

FOR YOUR

TECHNICAL AND VOCATIONAL TRAINING

ONE OF AMERICA'S LARGE AND MOST MODERN UNIVERSITIES

Select from these fascinating fields

- | | |
|---|---|
| <input type="checkbox"/> Aeronautics | <input type="checkbox"/> Industrial mechanics |
| <input type="checkbox"/> Air conditioning and refrigeration | <input type="checkbox"/> Drafting |
| <input type="checkbox"/> Automobile trades | <input type="checkbox"/> Machine shop |
| <input type="checkbox"/> Body and paint | <input type="checkbox"/> Welding |
| <input type="checkbox"/> Mechanics | <input type="checkbox"/> Woodworking |
| <input type="checkbox"/> Upholstery and trim | <input type="checkbox"/> Photography |
| <input type="checkbox"/> Diesel | <input type="checkbox"/> Radio |
| <input type="checkbox"/> Electricity | <input type="checkbox"/> Stationary Engineering |
| <input type="checkbox"/> Electronics | <input type="checkbox"/> Television |

PREPARE FOR YOUR FUTURE NOW . . . with the very latest methods and equipment, at the modern University of Houston School of Technology. For entrance: high school diploma, or over 18 and ability to profit from instruction. Beautiful campus—250 wooded acres in Houston, Texas—the city of tomorrow. Full college activities . . . sports . . . social life. Day or night, short or longer courses. Cooperative work and study programs . . . earn part of tuition and expenses with part-time job in your own career field, while you learn. Personal vocational counselling. Diploma or B.A.S. degree on completion—and job placement assistance. Sept., Feb., June semesters. G.I. approved. — V. A. on campus. Send for Free illustrated brochure now!



EZEKIEL W. CULLEN BUILDING

University of Houston, School of Technology

Dept. 112 — HOUSTON 4, TEXAS

Without cost or obligation, please send me fully-illustrated brochure and full particulars. I am interested in subject marked X above.

Name.....Age.....

Address.....

City.....State.....

STOPS AUTO THIEVERY!

SENSATIONAL NEW ROYLES FOOLPROOF - TAMPERPROOF

HOOD LOCK



TRUNK LOCK



FOR 1950-51 DE SOTO, DODGE, PLYMOUTH, CHEVROLET

FOR 1950-51 CHRYSLER, DODGE, DESOTO, PLYMOUTH. ALSO DOORS, GMC PANEL.

Positive action hood lock protects against theft of horns, batteries, other valuable parts. Royles trunk lock handle revolves freely when locked, no shear pin, cannot be opened without key. Tamper-proof.

EASY TO INSTALL. Both hood and trunk lock come in simple kit with all parts, complete instructions. MONEY BACK GUARANTEE. Send money order or check to:

HOOD LOCK \$4.95
TRUNK LOCK \$4.95
BOTH FOR \$8.90
POSTPAID

ROYLES PRODUCTS COMPANY

1017 Magazine St., New Orleans, La.

MONEY for MEN ALL DATA FREE

THE PLASTEX Industry needs manufacturers on small scale and for big production of Lamp and Clock Stands, Art Goods and Novelties in Plastex and Marble imitation. Experience unnecessary. 1/2c material makes regular 10c store sellers. Rubber moulds furnished for speed production. Small investment brings good returns. We are now placing big Chain Store Orders with manufacturers. Ambitious men have chance for real prosperity. Our Free booklet will interest and benefit you.

PLASTEX INDUSTRIES, Dept. A
3400 Third Ave. New York 56, N. Y.

STUDY TO BE A DOCTOR

of Psychology or Metaphysics

Obtain a Ps.D., Ms.D., D.D., or Ph.D. degree. Be a Teacher, Lecturer or Accredited Practitioner. Teach others how to achieve Health, Happiness and Contentment. Chartered by State. Write for FREE book telling how.

THE NEOTARIAN COLLEGE OF PHILOSOPHY
Desk 8, Pickwick Building Kansas City 6, Missouri

How to Make Money with Simple Cartoons



A book everyone who likes to draw should have. It is free; no obligation. Simply address

FREE BOOK

CARTOONISTS' EXCHANGE
Dept. 91D Pleasant Hill, Ohio

TREASURE! URANIUM!

GEIGER COUNTERS—METAL DETECTORS
GEIGER COUNTERS for Uranium. METAL DETECTORS for gold, silver and buried treasure. 5 models from which to choose. We have one in your price range. No finer instruments available anywhere. FREE ILLUSTRATED FOLDERS.



THE Detectron CO. Model DG-7
5631 CAHUENGA, NO. HOLLYWOOD, CALIF.

YOU SAVE UP TO 50% THORESEN'S CASH SAVEWAY!



Recipro-Register

NEW! SHOCK RESIST MODEL CHRONOGRAPH

You can buy plenty of "chronographs" for less money—but remember, Thoresen's is the only **GENUINE RECIPRO-REGISTER CHRONOGRAPH**, distributed exclusively by us in the U.S. A magnificent watch, it also times Races, Planes, Sports, Photography, Shop Work, etc. **INCABLOC** 17 jewel movement resists shocks and rough handling that may ruin other watches. 5 multi-function synchronized dials. Contact clutch starts computation. Brake clutch freezes result. Also **ERASES** back to zero and **REMEMBERS** for you while movement continues to keep time! Stainless Steel back, radium dial, unbreakable crystal, etc. Get the one and only genuine. Not \$100.00. Now only 27.25 plus 10% tax, total 29.98. Nationally advertised Cobra Metal Band (reg. \$3.95) **FREE** of extra cost!



POWERFUL LONG RANGE
Made in U.S. Zone **GERMANY**

AMAZING VALUE! \$2.95

Compare with domestic binoculars selling up to \$9.95, for clarity, light weight, rugged construction! **GERMAN KLAROVIS** ground lenses give terrific magnification, wide field of view, and sharp, brilliant detail! Smooth, **SYNCHRONOUS** centre focusing mechanism. 40mm. objectives. **NEW!** Different! **CAUTION!** Do not confuse with crudely made binoculars claiming 18 mile ranges! You can depend on **GUARANTEED KLAROVIS QUALITY!** Manufactured by German Artisans. Only \$2.95.



24⁹⁵

NEW!
JET-O-MATIC
360° AUTOMATIC

Superior De-Luxe model **360° FULL SWING AUTOMATIC**. Just set it—then forget it! Winds itself as you wear it. Patented **INCABLOC**—17 Jewel movement of superb accuracy. **WATER & SHOCK RESIST**—drop it, bang it, even swim with it. 100% Stainless Steel Screw-back, radium luminous markings, unbreakable crystal, hairline sweep second, **SPLIT SECOND** calibrations for precise timing. Handsome **THIN** case. De Luxe **GOLD** tone numerals & hands. **CAUTION!** Do not confuse with inferior 180° **HALF SWING** automatics! Thoresen's **JET-O-MATIC** is the **FULL SWING** self winder—**360°** high compression! Makes ordinary watches old fashioned by comparison. It's our **BEST** Automatic. Not \$75.00. Our price only — **24.95** plus 2.50 tax, total **27.45**.

LOOK!

SAVE THORESEN'S CASH-SAVE-WAY!

Be smart! Don't pay **TWICE** as much for credit! Frankly, we'd have to charge you **DOUBLE** for time payments. By big-volume cash selling **DIRECT-TO-YOU**, we save credit "dead beat" losses, high pressure salesmen's commissions and fancy main street rentals. We pass on these savings to **YOU!** Result: You pay only 1/2 and pocket the difference!

10 DAY HOME TRIAL!

Use at our risk, without obligation. If not delighted, return within 10 days for **QUICK** refund of price. **Save MORE**—send check or money order for prompt, free delivery. C.O.D.'s sent plus postage.

Unlimited Guarantee

EXCLUSIVE OF PARTS
Given with every watch! Never a charge for skilled labor, handling, adjusting, etc. for **LIFETIME** of this business! **NOTICE!** All Thoresen watches certified **BRAND NEW** and **TESTED** before shipment. We never sell "second hand" or surplus watches! Be wise! Shop with 100% safety the Thoresen—**SAVE** way! For **HONEST** values, write now!

Thoresen Direct Sales
Dept. 6-A, 131 West 33rd St.,
New York 1, N.Y.



Original TRANS-KLEER

PORTABLE GARAGE \$10

PROTECT YOUR CAR against the ravages of snow, sleet, rain, salt air, grime and dust with a genuine, **ORIGINAL TRANS-KLEER** garage! It's different... it travels with your car everywhere. Whisks on and off quick and easy! Takes little storage. Folds away like a handkerchief. Unique, elasticized **GRIP-PLEAT** bottom offers complete security, winter or summer. Pays for itself many times over. Protects car finish and keeps water out of motor. Saves on car washes too!

Compare **TRANS-KLEER** with any Garage up to \$19.95.

Do not confuse **TRANS-KLEER** with inferior plastic materials! Thoresen's Portable Garage is quality made of **100% HEAVY DUTY TRANS-KLEER**, a miracle of American industry! It's **THICK** and **TOUGH**, yet so **SILKY!** Resists cracking or peeling even in coldest weather! **Live-Flex** action means long life. **TRANS-KLEER** is our very **BEST QUALITY**, longest wearing garage. Tailored in **ALL SIZES** for **ANY** car, from an Austin to a Cadillac to ensure better fitting. Thoresen's unique **GRIP-PLEAT** bottom allows you to use it for Farm Machinery, Tractors, Garden Furniture, Small Boats and other equipment. Send only \$10 for **FREE** prompt delivery right up to your door. No collect charges for expressage or postage! Or order **C.O.D.** plus postage. In either case, **TRY IT 10 DAYS AT OUR RISK!** Your \$10 back **QUICK** if not delighted. Mention car make, year and model!



2⁹⁵ EACH

LEOPARD

SATIN-LIKE "RICH-TONE" DESIGN

AUTO SEAT COVERS

TERRIFIC VALUE! New, deluxe **RICH-TONE** material looks like **LEOPARD FUR**, gives beauty and distinction to your car. Adds new life to old, worn interiors. Protects new car upholstery against wear, dust, grime, stains, grease, bad weather. Tough, durable, resists cracking! Handsome tailored appearance. For **ALL** cars, **ALL** years, **ALL** makes and models. No pins! No tacks! No sewing! Ingenious **SNAP-TITE** feature. Just **SNAP** on or off in a **JIFFY!** Best of all: they're only 2.95 for front or rear seat. **SPECIAL!** Pair for front and rear, only 4.95. Mention car make, model & year, also if front seat is full front or split coupe front.

THRIFTY BUYS

17 JEWEL STANDARD CHRONOGRAPH
(3 dials — 5 hands) plus
our price **18.95** plus 1.90 tax

17 JEWEL AUTOMATIC (180° HALF SWING Model)
our price **19.50** plus 1.95 tax

HEAVY DUTY PLASTIC PORTABLE GARAGE
our price **8.69** no tax

SPECIAL! MEN'S SWISS ACCURATE WATCH
our price **4.69** plus 47c tax

17 Jewel INCABLOC WATER & SHOCK RESIST
our **LOWEST** price ever! plus
only **14.50** plus 1.45 tax

Send all orders to old reliable:

THORESEN DIRECT SALES, Dept. 6-A, 131 West 33rd Street, New York 1, N. Y.

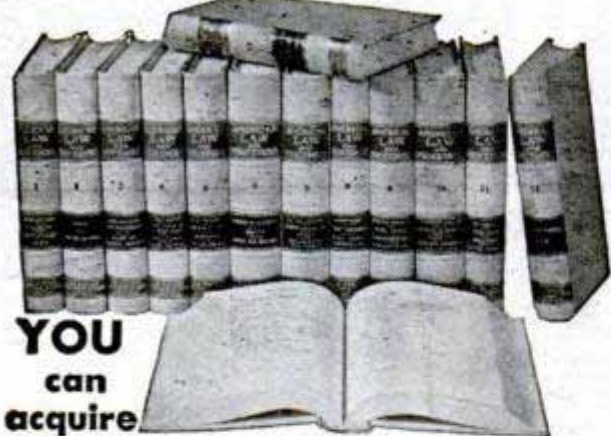

**YOU
can
acquire**

**LAW NIGHTS AT HOME!
L. L. B. DEGREE**

LaSalle's famous Law Library—used as reference in many Law libraries and Law offices—has enabled thousands to master Law surprisingly fast, in spare hours at home, for business and professional advancement.

These 14 remarkable volumes, compiled by leading professors and lawyers, cover the whole basic field of Law in condensed, orderly, simplified manner.

You advance rapidly with this great library, plus special lectures furnished. We guide you step-by-step with personalized Problem Method of instruction . . . you learn by doing—handling legal problems—not by memorizing rules.

Send for two FREE 48-page booklets, "Law Training for Leadership," and "Evidence," answering questions about Law and its value to you, and telling how LaSalle Law graduates are winning rapid advancement in business and public life. Mail coupon below. No obligation.

**LA SALLE EXTENSION UNIVERSITY
A Correspondence Institution**

417 S. Dearborn St., Dept. 164L, Chicago 5, Ill.

Send me your two FREE booklets described above, without obligation.

Name.....Age.....

Street.....

City, Zone & State.....

**ENGINEERING DEGREE IN
27 MONTHS**

Big Demand for Graduates

Aeronautical, Chemical, Civil, Electrical, Mechanical and Radio Engineering (including Television)

Hundreds of young men are earning engineering degrees in this recognized institution each year—continuous operation. New terms start quarterly. Many students earn a major part of their college expenses in this large industrial center.

Low tuition. Competent instruction. Thorough, intense, practical program. Modern laboratory facilities including new physics lab. and modernized wind tunnel. Individualized instruction emphasized.

Approved for Veterans. Engineering preparatory courses. Students from 48 states and 21 foreign countries. Enter March, June, September or December. Send coupon for free catalog and full information. Enroll now.

SEND COUPON TODAY

INDIANA TECHNICAL COLLEGE

512 E. Washington Boulevard
Fort Wayne 2, Indiana

Please send me free information on B.S. Engineering Degree in 27 months as checked.

Aeronautical, Chemical, Civil, Electrical,
 Mechanical, Radio-Television

Name.....

Address.....

**MIRACLE TOMATO
Yields 2 BUSHELS
To a Vine**



Now—You can grow the world's most amazing Tomato right in your own garden and get from 2 to 3 bushels of delicious, ripe tomatoes from every vine.

**BURGESS CLIMBING
TRIP-L-CROP**

TOMATO grows 16 to 20 feet high. Huge, meaty, solid fruit, wonderful flavor. Some weigh as much as 2 pounds each. Unsurpassed for canning and slicing. Blight free—drought and disease-resistant. Grows in any garden. Outyields all other varieties.

TRIAL PACKET 10c
Postpaid. Order Today
3 Packets for 25c

Write for FREE complete Catalog listing many unusual Seeds, Plants and Bulbs.

BURGESS SEED & PLANT CO.
117 B. Galesburg, Mich.

BOYS! MAKE YOUR OWN RADIO



Make your own simple, tubeless, batteryless Crystal Radio. SEND 25c for a GENUINE MELOMITE CRYSTAL with complete illustrated instructions for making your own set. Crystal sent postpaid with instructions and our own publication, "THE MAGIC CRYSTAL" which is full of news, diagrams, questions and answers of interest.

SEND 25c FOR YOUR CRYSTAL TODAY!
ALVA ALLEN RADIO Dept. 199 Clinton, Mo.

GROW MINIATURE TREES

FOR PROFIT & PLEASURE



Fabulous Money—Real Fun! Grow genuine live dwarf (Ming) trees. A terrific new business and hobby. Astounding details Free. Write —

DWARF TREES, Dept. 28
P. O. Box 355, Briggs Station
Los Angeles 48, Calif.

**LEARN AT HOME
LOCKSMITHING**

YOU CAN MAKE GOOD PROFITS ALL YEAR ROUND IN FULL OR SPARE TIME!

Locksmiths are always in big demand! Age is no disadvantage in this respected, permanent field. Learn how to make keys, fix locks, make duplicates, etc. Practical, illustrated lessons by experts show you how! All materials and special tools supplied. Send for FREE booklet.

INSTITUTE OF LOCKSMITHING
Dept. P-26 15 Park Ave. Rutherford, N. J.
Licensed & Approved by State of New Jersey VA Approved

**BIG MONEY for You
Showing NEW MIRACLE
Labor Saving Discovery**

MEN! WOMEN! Enjoy amazing profits with new "Miracle" Copper Cote Ironing Pad. Plastic Coating saves housewives time, labor, money. 1-minute demonstration sells it. Experience unnecessary. Write for FREE Sample Offer. Send for FREE facts about COPPER COTE, and our other new fast-selling products. SEND NO MONEY. Write for details, sample offer to THE SHELDON CO., Dept. 854 1223 South 23rd St., Milwaukee 46, Wis.



MAKE MORE MONEY

and Build for Yourself
PERSONAL SECURITY
 in a Steady Trade or a Small
Sound Business of Your Own
watch and clock repairing



LEARN AT HOME—IN YOUR SPARE TIME
 Prepare now for a happy future of prosperity, security. Fascinating high-grade occupation for men of almost any age or physical condition. You can earn while you learn.
PRACTICAL COURSE IN HOROLOGY How-to-do-it lessons for beginners as well as those already in the trade. Thorough self-instruction training in American and Swiss watches, clocks. Contains a wealth of helpful photos, drawings, diagrams, charts, etc. Only \$5.95 for everything, complete. Satisfaction or refund guaranteed. Mail no-risk coupon below.

SWEDISH BODY MASSAGE

Now available at low cost, this course of instruction in the art of body massage and Hydrotherapy. Lessons are collected together in handy one-volume manual. Contain interesting information on the fundamentals of anatomy, physiology, procedure for complete massage, approved exercises. Easy to read—simple to understand. This study may open the door to a basic knowledge of the profession. Excellently illustrated throughout; step-by-step explanations with diagrams. Complete, only \$6.95 postpaid. Money-back guarantee. Mail coupon at bottom of page today.



practical RADIO servicing

SELF-INSTRUCTION COURSE Teaches you the practical side of radio . . . repair, adjustment, operation, alteration, trouble-shooting. No previous knowledge necessary. Prepare to set up a shop of your own—or train for the big industrial electronics field. Simplified lessons, including mathematics, review questions, problems, answers. Up-to-date! Only \$3.95, complete. Money-back guarantee. Use coupon below.

REAL ESTATE BUSINESS

The foundation of all wealth is land! Train yourself for a career in this booming profession. Here is the information you need on how to get started and how to get ahead in real estate. Includes instructions in appraisals, valuations, management, investments, practical real estate operating, low cost housing, the law on real estate transactions including legal forms, etc., salesmanship, and many other subjects a successful real estate man must know. Strictly up-to-date. Complete, only \$6.95. Money-back guarantee. Use No-Risk coupon below.

INSURANCE BUSINESS. How to make money selling life insurance. Virtually a self-training course on how to get started in this profitable profession, how to get prospects to buy NOW, plus practical instructions on nearly every other important phase of life insurance business! Actual examples given throughout—no generalized discussion. All brass-tacks money-making facts you can turn into quick cash. Full price only \$6.95. Mail No-Risk Coupon below.

APARTMENT HOUSE MANAGEMENT. Wonderful field for ambitious men and women, especially those over 40. Experienced managers have steady work, good pay and SECURITY. Satisfaction or money-back guarantee. Complete, only \$5.95. Mail coupon below today.

WRITING FOR MONEY COURSE. Specific, practical instruction on how to get frequent checks for \$5, \$10 and more writing shorts, fillers, etc., for magazines, newspapers. Complete in 5 volumes, including "Where and How to Sell Manuscripts." Full price only \$5.95.

JEWELERS' & WATCHMAKERS CYCLOPEDIA. Packed with trade secrets, manufacturing processes, little-known formulas, etc., for opticians, stone setters, engravers, case makers, horologists, photographers and others. 1001 money-making ideas for the practical man! Only \$1.95.

HOW TO BUY & SELL OLD GOLD, ETC. A new to-the-point Technical Bulletin to teach you how to make money dealing in precious metals—broken jewelry, old gold, silver, platinum, etc. Enormous opportunities for those with experience. Only \$1.00.

HOW TO RUN A FARM. Of course you can learn from experience but why wear yourself down and squander several years finding out the hard way. Illustrated instructions on "Fundamentals of Farming and Farm Life" cover: poultry, livestock, soil, implements, crops, gardens, trees, milk products, etc. Only \$2.69.

COMPLETE SHORTHAND COURSE. Full 12-lesson self-study course in standard system used by thousands of lightning-quick male court reporters and expert stenographers, 5 times faster than writing longhand! Complete outfit for self-instruction, only \$4.95.

PRACTICAL ACCOUNTING. For men who want to follow accountancy as a profession and for managers and owners who want to increase their business profits. "Principles of Accounting" covers whole subject and includes hundreds of sample forms, problems, solutions, etc. Full price, only \$4.95, complete.

How to Order: In coupon to right check courses you want, print your name and full address, then mail coupon. Send payment with order and we'll pay all postage charges. On C.O.D. shipments you pay charges.

Satisfaction Guaranteed or Your Money Back
NELSON-HALL COMPANY (Established 1909)
 210 S. Clinton St. Dept. A-2 Chicago 6, Ill.

LOCKSMITHING and KEY MAKING

New Practical
Up-to-Date Course!

Prepare to go into business for yourself as a locksmith—or learn locksmithing as a sideline to increase your present earnings. Here is MONEY-MAKING knowledge for carpenters, mechanics, hardware dealers, gunsmiths, cycle shops, fix-it shops, service stations, maintenance men, etc. And certainly every homeowner and handyman will find it profitable to know how to tinker intelligently with locks and keys.

53 EASY ILLUSTRATED LESSONS

Written by a Master Locksmith. Teaches you professional "secrets." How to adjust locks, de-code, make masterkeys, install and service key systems, etc. Step-by-step detailed instructions explain and illustrate every operation. You'll thoroughly ENJOY this interesting work! **FULL PRICE, ONLY \$4.95.**

Look over this unusual one-volume course at our risk. You must be delighted—or you get your deposit back and the inspection won't cost you a penny. Complete, only \$4.95; nothing more to pay. Fill in the No-Risk Coupon at bottom of this page . . . and mail it today! You'll be glad you did.



Short-Cut Mathematics COMBINED WITH Practical Mechanics Simplified

Be a "master mind." Learn how to juggle figures, do baffling tricks with numbers. Add long columns of figures this lightning-quick, short-cut way. Multiply 4 figures by 4 figures without old-fashioned multiplication. Here are speedy, simplified systems used by stage "wizards," expert accountants, engineers. Only \$1.95. Course includes illustrations, problems, answers. Mail coupon below!

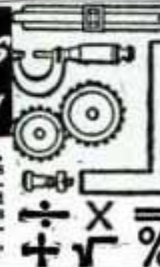

COMPLETE BLUEPRINT READING COURSE

Interesting, simplified self-instruction lessons for builders, mechanics, electricians, plumbers, welders, carpenters, automotive & aviation workers, etc. 24 volumes include over 600 actual blueprints, diagrams, other instructive step-by-step pictures. Unusual bargain for any practical man. Complete, only \$6.95, postpaid. Satisfaction or refund. Coupon below.

BUILD IT YOURSELF

Be a practical handyman. Save time and money with these professional Tricks-of-the-Trade. Carpentry made easy! New self-instruction course in one handy volume, complete with full page photographs, diagrams, etc. Teaches woodworking, painting & decorating, upholstering, power tools, cabinet making, etc. Full price only \$2.49. Money-back Guarantee. Mail coupon today!

"HOW TO GET ALONG IN THIS WORLD"

Boiled-down tips on SUCCESS! Here, gathered together for the first time, are 5000 gems of worldly wisdom on how to live joyously, successfully . . . how to handle people, make money, be happy. Written out of actual experience by the best brains of mankind . . . during the past four thousand years! To-the-point, workable instructions on the practical art of getting ahead. Included are lessons on HOW TO USE these quotations in your daily life. Complete, only \$1.00, postpaid. Check "How to Get Along" in coupon below.

CIVIL SERVICE

Looking for a government job? (Federal, State, City). Or a job with some big industrial or business organization? Or work in an institution? Then you NEED this complete "Practice Tests for All Jobs." Explains in detail how intelligence tests and aptitude tests are given—how they are used for hiring, classifying, assigning and promoting—and how they should be handled for best results. Shows you what the tests are like, gives you a very definite idea of the kind of questions you will be asked, tells you what you have to know, how to get a top mark. Contains practice materials, study outlines, sample tests, etc. For anyone interested in mental self-improvement! Full price only \$3.95. Check "Civil Service" on No-Risk Coupon below. Satisfaction or refund guaranteed.

MAIL THIS NO-RISK COUPON TODAY!

NELSON-HALL CO., 210 S. Clinton, Dept. A-2, Chicago 6

Please rush me the practical courses I am checking below. Each is complete and I understand this is the full price. If I am not more than satisfied I will return the material and you will make full immediate refund, without question or quibble.

- | | |
|--|---|
| () Watch & Clock Repairing . . . \$5.95 | () Practical Accounting . . . \$4.95 |
| () Swedish Body Massage . . . 6.95 | () Locksmithing Course . . . 4.95 |
| () Practical Radio Servicing . . . 3.95 | () Short-Cut Mathematics . . . 1.95 |
| () Real Estate Business . . . 6.95 | () Blueprint Reading Course . . . 6.95 |
| () Life Insurance . . . 6.95 | () Build It Yourself . . . 2.49 |
| () Apartment House Mgmt. . . 3.95 | () How to Get Along . . . 1.00 |
| () Writing for Money Course . . . 5.95 | () Civil Service . . . 3.95 |
| () Jewelers' Cyclopeda . . . 1.95 | () How To Buy & Sell Old Gold, Etc. 1.00 |
| () How to Run a Farm . . . 2.69 | |
| () Complete Shorthand Course . . . 4.95 | |

I enclose \$ in full payment. Ship entirely postpaid.
 Ship C.O.D. for \$ plus postage.

NAME

ADDRESS

CITY STATE

CORTINAPHONE
makes it FUN to Learn

French-Spanish RUSSIAN-GERMAN Italian, Brazilian, Japanese —in your own home!

BIG OPPORTUNITIES and JOBS await Americans who can speak a foreign language. Millions of dollars being spent each year by government and industry in Europe, Latin America, Asia create fascinating, well-paying jobs here and abroad. Travel booming. World conditions now make a second language more valuable than ever.

Only 15 Minutes a Day

Speak **FRENCH, SPANISH, RUSSIAN, German, Italian, Brazilian or Japanese** like a native! The **CORTINA-PHONE** method, famous for over 70 years, teaches you — **BY LISTENING** to these **CORTINA** recordings. In your own home, relaxed, at ease.



Send for FREE BOOK!

Many **THOUSANDS** have learned a second language this easy way for **PLEASURE, BUSINESS, TRAVEL, CULTURE**. Valuable book, "Cortina Short-Cut" sent **FREE**. Describes method fully—tells how developed—why it works so amazingly fast—and about **FREE TRIAL** offer. No obligation.

Mail coupon **TODAY!**

**ALL NEW RECORDINGS ON
UNBREAKABLE RECORDS**

Write Today—NOW!

CORTINA ACADEMY (Established in 1882)
Dept. 641, 105 West 40 St., New York 18, N. Y.

Please send me—without obligation—your free book. I am interested in (check)

French Spanish German Italian
 Russian Brazilian Japanese

Name _____

Address _____

City _____ State _____

VETS! Check if **NOW** eligible under G. I. Bill.

AERONAUTICAL ENGINEERING



Design Aircraft & Components—Study with Jets & Rockets—Great Future—Advanced Aeronautical Subjects—World-Wide Enrollment—Fully Accredited—Established 1929—Approved for Vets—**CAL-AERO** grads in heavy demand.
WRITE TODAY for Special Information. P.M.-1

NAME _____ AGE _____

ADDRESS _____

CITY _____ ZONE _____ STATE _____

CAL-AERO TECHNICAL INSTITUTE
GRAND CENTRAL AIR TERMINAL • GLENDALE 1, CALIFORNIA

MAKE EXTRA MONEY **PLASTICS** **LEARN AT HOME**

LEARN HOW TO MAKE fast selling PLASTIC NOVELTIES FURNITURE JEWELRY SIGNS TOYS LAMPS



There are **RICH OPPORTUNITIES** for **MEN and WOMEN** with "know-how" in **Plastics**. Interstate's amazing new **Plastics** course tells and shows how to make hundreds of fast selling items out of **Plastics**. Gives complete training in fabrication, casting, lamination, molding, etc., in simple, easy, step-by-step language and pictures.
START A PLASTICS BUSINESS OF YOUR OWN. No other industry holds such promise for the future. You can make big money manufacturing novelties, toys, signs, etc., in your own home in spare or full time. Don't wait! Learn **NOW** how Interstate's **Plastics Training** qualifies you for success in the plastics field.

Write for **FREE Information Today!**

INTERSTATE TRAINING SERVICE

School of Plastics
PORTLAND 13, OREGON

(Dept. C-3A)

REAL ESTATE BE A BROKER

PAYS BIG! SEND FOR FREE, BIG, ILLUSTRATED CATALOG NOW! No obligation. Graduates report making substantial incomes. Start and run your own business quickly. Men, women of all ages, learn easily. Course covers Sales, Property Management, Appraising, Loans, Mortgages, and related subjects. **STUDY AT HOME** or in our classrooms in big cities. Diploma awarded. G.I. approved. Nationally known.

WEAVER SCHOOL OF REAL ESTATE (Est. 1936)
Suite 300 Law Bldg., Dept. PM, Kansas City, Mo.

FREE BOOK TELLS HOW

EASY TO LEARN CODE

Learn or increase speed with an Instructograph—the Radio-Telegraph Code Teacher that takes the place of an operator-instructor and enables anyone to master code without further assistance. Available tapes from beginners alphabet to typical messages on all subjects. Speed range 5 to 40 WPM. Always ready—no QRM. Thousands have "acquired the code" with the Instructograph System. Write today for convenient rental and purchase plans.

INSTRUCTOGRAPH COMPANY

4701-V Sheridan Road, Chicago 40, Illinois



ITALIAN ACCORDIONS

Hand Made. Very Best. Buy Direct from Factory Representative at lowest wholesale prices and Save Money. Send Name and Address for **FREE** catalog.

ITALIAN ACCORDION MFG. CO.

7600 Cottage Grove Ave., Dept. PM-1, Chicago 19, Ill.

Learn ACCOUNTING BOOKKEEPING

This nationally renowned school has demand for graduates in good salary positions thru Nationwide recognition and placement service. Write Department PMF today for Big 32 **FREE** page Success Book to be sent to you

Hills BUSINESS UNIVERSITY AND EXTENSION SCHOOL

619 W. MAIN ST. OKLAHOMA CITY 2, OKLAHOMA

Say You Saw It in Popular Mechanics

WEATHER DAMP—Car Won't Start?

SHORTSTOP

starts damp motors quick

Just press button on handy aerosol can and spray plugs and wires. New, improved formula contains silicone. One treatment protects for months.

Get Shortstop at your service station, garage or auto supplies store.

ZACO LABS • 1360 W. 9th, Cleveland, O.



FOLLOW THIS PLAN:

Become an Electrical Engineer

★ **MAJOR IN ELECTRONICS OR POWER**

★ **B. S. DEGREE IN 36 MONTHS**

★ **TECHNICIAN CERTIFICATE IN 12 MONTHS**

U. S. faces critical shortage of Technicians and Engineers! Here is how this College and Technical Institute develops men for these vital positions.



Build your career on a *plan* that meets the demands of this dynamic era. This plan has been developed and tested through almost a half-century of service to over 48,000 men. Here are some of its *major advantages* to you and to our nation:

1. You can enter employment earlier — The option of *year 'round study* can save up to a full year for the man seeking his degree. Also, you can receive *advanced credit* for prior training gained in the armed forces, other schools or field experience.

2. Enjoy greater security — You become an Electronic or Electro Technician within 12 months after enrolling in the Electrical Engineering course. Thus, you are already trained for specific work if unexpected events should then force you to leave school.

3. Gain an outstanding education — Be sure to write . . . you will receive full facts on the complete program.

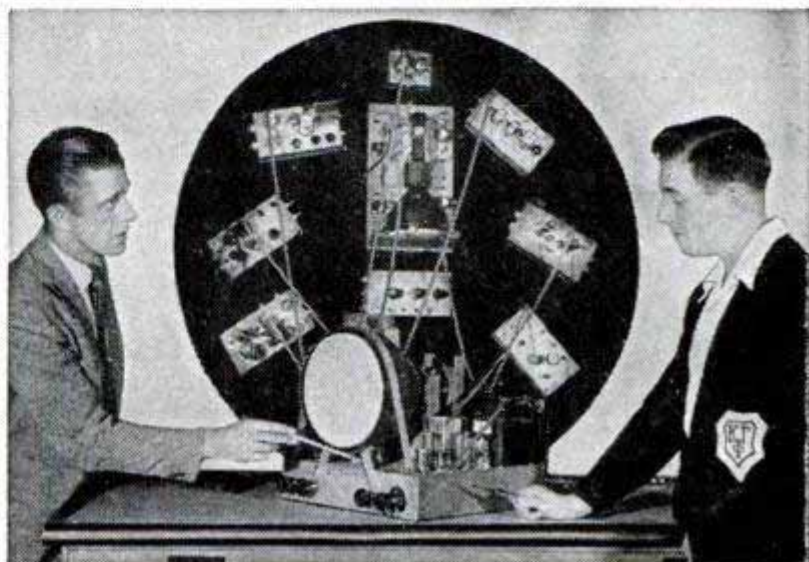

The Plan also Opens Your Door to RADIO-TV. All courses keep pace with technological progress. Example: This school developed the nationally-famous "Unit Chassis System" to teach TV . . . you become equipped to cope with all TV designs including the advent of *color-TV*.

The Radio course, while complete in itself, is *one-third* of the college program (Electronics major). Simply add 6 months to the Radio course to become a Radio-Television Technician.

Industrialists and educators have recommended it — this College offers it! Now you can train for all branches of Electrical Engineering and also take specialized studies for the *ONE* of *three fields* in which *YOU* will most likely succeed: (1) Design and research; (2) Manufacturing; (3) Sales and management.

TERMS OPEN APRIL, JULY, OCTOBER, JANUARY

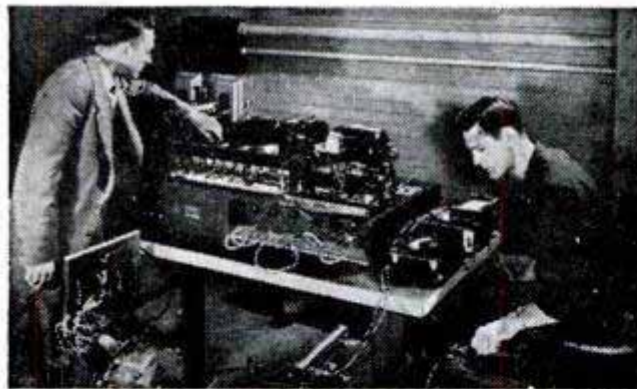

The World-famous courses in Electronics and Power each offer an exceptional number of subjects in *design*, in addition to technical specialty subjects. You receive practical technical laboratory experience on modern equipment *immediately*—along with a fundamental education in engineering and the humanities, as demanded by industry.

Over 1900 students enrolled annually from all states and over 20 foreign countries. Faculty of specialists, 89 industrial advisers,



MILWAUKEE SCHOOL OF ENGINEERING
MILWAUKEE, WISCONSIN

WRITE TODAY for this free, helpful, guidance literature.
MILWAUKEE SCHOOL OF ENGINEERING
Dept. PM 152, 1025 Milwaukee St.,
Milwaukee, Wisconsin

112-page catalog and 44-page "Your Career" bulletin; Facts on students' part-time job opportunities; Preparatory courses; 6-month Electrical Service course; **CAREER-GUIDANCE** booklets on Electrical Engineering; Major in Electrical Power; Electronics; also Radio-TV; Air-conditioning, Heating, Refrigeration; Welding.



Name.....Age.....

Address.....

City.....Zone.....State.....

If War Veteran, state date of discharge:.....

C. T. C. TRAINING IN DRAFTING

PREPARES FOR
PROMOTION
•
MORE MONEY
•
SUCCESS



"Here I am at work making good money as a draftsman. I'm glad I sent the coupon to Chicago Tech for that Free Trial Lesson and found out how easy it is to learn Drafting in spare time at home. Today, I feel secure in my job. What's more, I feel I'm slated for promotion and more pay."

LEARN IN SPARE TIME—AT HOME!

(or at the College in Chicago)

A few hours of pleasant home study every week—that's all. All the tools you need; drawing outfit included. This tested method—developed over 47 years of C.T.C. progress—prepares men quickly for good positions in industry.



FREE INFORMATION—SEND COUPON
To prove to you how easy it is to learn Drafting at home by the Chicago Tech method, we will send you this FREE TRIAL LESSON. No charge for this lesson, now or later. Fill out and mail coupon, or send post card today.

CHICAGO TECHNICAL COLLEGE

A-250 Tech Bldg., 2000 So. Michigan Ave.,
Chicago 16, Illinois

Mail me FREE Lesson with information about big opportunities in DRAFTING.

Name _____ Age _____

Address _____

City _____ Zone _____ State _____

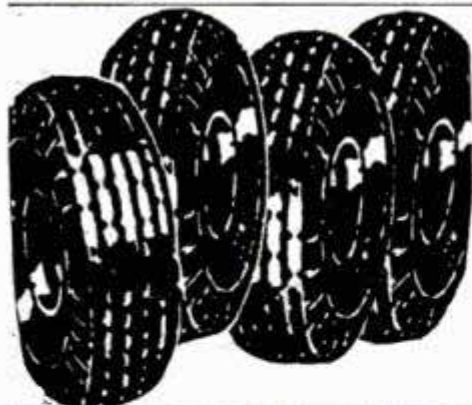

WRITTEN GUARANTEE SENT WITH EVERY TIRE YOU BUY

PLEASE NOTE: Our Tires are NOT Retreaded or Re-Capped

GOOD USED TIRES

A TRIAL OF ONE TIRE WILL CONVINCE YOU.

TUBE GIVEN WITH EACH PASSENGER & TRUCK TIRE AT NO EXTRA COST—SEND THIS AD!

If your size is not listed, write for prices. 18 YEARS AT THIS ADDRESS

600x16 \$5.12	670x15 \$6.12	710x15 \$6.12	760x16 \$7.72
650x15 5.52	700x15 5.92	750x16 6.52	820x15 6.72
650x16 5.52	700x16 5.42	760x15 5.92	850x17 5.22



600x20 \$9.52	32-6(8) \$10.42	1000x20 \$18.02
650x20 9.52	32-6(10) 13.82	1100x20 18.42
700x20 11.62	825x20 17.92	1000x22 17.42
750x20 11.92	900x20 17.72	1100x22 18.02

No extra charge for tubes—Tube given with every pass. and truck tire purchased, regardless of grade.

600x16 \$5.39	670x15 \$6.20	710x15 \$6.32	760x16 \$7.95
650x15 5.75	700x15 6.50	750x16 6.86	820x15 6.95
650x16 5.86	700x16 5.75	760x15 6.42	850x17 5.02



600x20 \$9.75	32x6(10) \$14.02	1000x20 \$18.35
650x20 9.95	750x16(8) 8.95	1100x20 18.35
700x20 11.75	825x20 18.50	1000x22 17.35
750x20 12.75	900x20 18.50	1100x22 18.35

Thousands of tires shipped all over U.S.A. All tires shipped F.O.B. Phila. Send Check or M.O. with this ad. Dept. 2.

STANDARD 834 N. Broad St., Philadelphia 30, Pa.

EVERYTHING YOU NEED TO MAKE MONEY REWEAVING

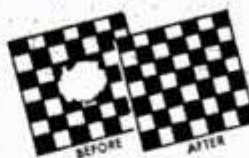

1. 64-pg. instruction book on French Reweaving, Material Splicing, etc.
2. Imported Ball-point needle.
3. Device for patch weaving.

Easiest way to get into profitable invisible reweaving business, full or part time. Repair moth holes, burns, tears. Big demand, little competition. Guaranteed that you can learn and do reweaving with Culver kit!

ONLY
\$375
ppd.

CULVER PRODUCTS CO. "Suppliers to Reweavers"
Culver City 10, California

BECOME AN EXPERT IN TRAFFIC

Traffic men earn \$4,000 to \$10,000 and up. Thousands of firms need experts on rates, tariffs, regulations. We train you thoroughly in spare time at home for executive traffic jobs. Personal training under traffic authorities. Placement counsel and help. Write for free 48-page book "Traffic Management—the Fast Growing Profession."

LASALLE Extension University, 417 So. Dearborn St.
A Correspondence Institution Dept. 164T Chicago 5, Ill.

FREE CATALOG

All The Best and Latest
Garden and Farm Books, Bulletins

A wealth of up-to-the-minute expert advice on how to do wonders on a little land or a thousand acres... wonders with flowers, vegetables, fruits, landscaping, poultry, livestock, woodlands, fishponds, composting, soil improvement, etc., etc. Just send name and address for this fascinating FREE catalog by return mail.

COUNTRY BOOKSTORE

Box 2701 Noroton, Conn. Estab. 1943



KLEENSMOKS® ARE COSTLY!

Cost 3 times as much to build as the best of old-fashioned pipes. But KILL TONGUE BITE, STOP DRINK. FREE circular tells WHY. Send postcard to:

KLEENSMOK PIPE CO.

P. O. No. M-597, Johnson City, Tenn.
R-Reg. U.S. Pat. Off. Pat's. and Pat's. Pend.

A "GOOD HAND" HELPS YOU SUCCEED!

LEARN TO WRITE WELL

Your Name

beautifully written, plus special pen-point for shaded writing.

Only 10¢

Handwriting quickly improves with our easy-to-understand picture lessons! Put your spare time to good use; send today for FREE BOOKLET, "How to Become a Good Penman," or check volumes wanted below at \$1 each: Business Writing Artistic Writing Card Writing Bird & Design Flourishing Engraving Alphabets. COMPLETE SET \$4.50. Ask for price list of penman's supplies.

OUR 53rd YEAR
TAMBLYN SCHOOL OF PENMANSHIP
S. A. Ziller, Pres., 442A Ridge Bldg., Kansas City, Mo., USA

NEW—Sensational! GEIGER COUNTER



"The SNOOPER"

LOW PRICE ONLY **\$24.95**

COMPLETE

Find a fortune in uranium with this new, super-sensitive Geiger Counter. Get one for atom bomb defense. So small it fits in the palm of the hand or in the hip pocket, and yet more sensitive than many large, expensive instruments. Weighs only 1 1/4 lbs. Uses flashlight battery. Low price includes earphone, radio active sample, instructions. Sold with ironclad moneyback guarantee.

ORDER YOURS TODAY—Send \$5.00 with order or payment in full to save C.O.D. Write for free catalog on treasure finders for gold, silver, etc. and larger, more elaborate Geiger Counters.

Dealer Inquiries Invited

PRECISION RADIATION INSTRUMENTS
4113 PM W. Jefferson, L. A. 16, Calif.

MARDO'S NATIONWIDE SALE!

Use Any Article For 10 DAY FREE TRIAL!

POWERFUL MIDGET MOTOR

DRIVES MODEL PLANES, BOATS, CONSTRUCTION SETS, Etc. WITH AMAZING SPEED! RUNS ON FLASHLIGHT BATTERIES!

BOYS! MODEL-MAKERS! Get this new MIGHTY MIDGET D.C. Electric Motor. It's a honey! Looks and runs just like a big one. Motor is powerful yet measures only 1 x 1 x 1 1/4 inches; weighs one ounce! Turns up to 6800 r.p.m.'s. REVERSES instantly. Motor is in durable black plastic housing. Comes complete with two 1 1/2 volt batteries in clip holder, transparent plastic gearbox — PLUS ten extra gears and pulleys for working out your own ratios. No shocks, sparks or shorts. And no transformer is needed. Endless hours of fun. Educational, too! Money back guarantee!

YOU GET ALL THIS PLUS THE MOTOR FOR \$2.98

 <p>Runs on Ordinary Flashlight Batteries!</p>	 <p>Multi-Ratio Gearbox Included!</p>	 <p>Plus 10 Extra Gears and Pulleys!</p>
--	--	---



ONLY \$2.98

PORTO SAW

Porto Saw makes your Electric Drill do Double Duty.

- Newly introduced saw kit is rugged.
- Bronze oilless bearings.
- Shock absorbing.
- Impregnated gears.
- Swedish chrome alloy.
- Spring-set saw blade.
- Convenient detachable drill clamps.
- Lifetime greased gear box.
- One or two hand operation.
- Cuts 2 x 4's by turning.
- Extra large sole plate and visible guide.



many safety features, which include safety yoke and housing, gives rigid connections and perfect safety. Depth gauge permits cuts from 0 to 1-3/16 inches, perfect for dados, grooving, and bevelling; has bevel adjustment and rip gauge. This wonder saw value,

\$9.95

PORTO SAW is a dependable tool with right angle gear drives which permit easy operation. Has

complete, only.....

PAINT SPRAYER

A Powerful Professional Type

Use on any hard to brush surface . . . chairs, wicker furniture, screens, autos, boats, in fact anything that needs painting. MOTH PROOF clothes, rugs, drapes, storage closets, etc.

NO EXTRAS TO BUY

- Just plug in and spray . . . glossy paints, enamel, varnish, lacquers, stain, oils, disinfection, insecticides, mothproofers, etc.
- All metal parts—non-corrosive
- A lifelong, useful tool
- Simple, easy to use. **\$8.95** UNCONDITIONAL GUARANTEE and Instructions.



Sale! SWISS-AUTHENTIC RE-REGISTER CHRONOGRAPH

Genuine RE-REGISTER model that computes distance and speed accurately to 1/5 of a second. RE-REGISTER is shock proofed—has full 17 Jewel movement, again resistant to shock of hard play or work. RE-REGISTER keeps accurate count of elapsed time while regular movement keeps accurate time of day. Perfect TIMER for Games, Events, Races, Shop Work, Photography, Engineers and Experimenters. AUTOMATIC SYNCHRONIZED Multi-Function dials are coupled for instant computation. Two Lever Models for starting and braking and re-registering on all dials. STAINLESS STEEL back, Radium Dials, Sweep-second hand, Krystal Klear crystal. THIS IS NOT AN INFERIOR MODEL that often requires repair. RE-REGISTER IS UNCONDITIONALLY GUARANTEED!



Never a charge for adjustment or mechanical changes with the exception of parts. **SALE PRICED AT \$21.95 TAX INC.**

LIGHT WEIGHT MAGNESIUM LADDERS

Full 26 inch height. Weighs only three pounds. Folds compactly, and stores out of the way. Complete with rubber treads to avoid marking floors. Will outlast any other metals, and carry better than 300 pounds of weight. **Only \$8.98**



AMAZING NEW FLASHLIGHT

Operates without batteries. Here at last a wonderful new imported invention that never leaves you unprepared. Self Generating power that gives a strong white beam. Useful in the Home, AUTO, Boat or anywhere you need an ever-ready flashlight. **ONLY \$4.98**

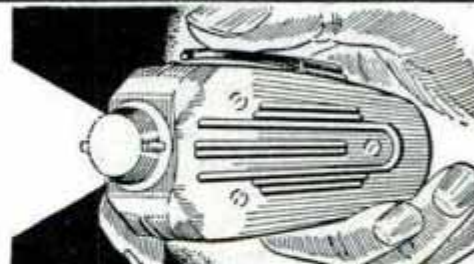

PORTABLE GARAGE

USE IT ANYWHERE!
(Extra Heavy Gauge) **\$10.95**

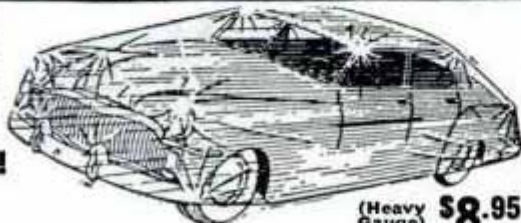

(Heavy Gauge) **\$8.95**

Prestoflex Awarded Good Housekeeping Seal

- Goes wherever your car goes
- Folds compactly
- Keeps rain, snow, dust, salt air, sun or sleet away
- Will withstand Extreme cold without cracking and protects your car's finish
- Perfect for storage of Cars, Furniture, Machinery Equipment
- Durably constructed of clear transparent vinyl plastic that is long wearing and tough
- Nylon threads and grommets for extra security
- Spring-tite elasticized bottom, holds securely in all kinds of weather
- Fits all makes and models.

MAIL HANDY ORDER COUPON NOW!

MARDO SALES CORP. Dept. 768
480 Lexington Ave. New York 17, N. Y.

- Please send me the items I have checked:
- | | |
|--|--|
| <input type="checkbox"/> Mighty Midget Motor only \$2.98 | <input type="checkbox"/> Porto Saw \$9.95 |
| <input type="checkbox"/> Portable Garage \$8.95. Ex. Heavy Gauge \$10.95 | <input type="checkbox"/> Bevel and Straight cuts Flashlight \$4.98 |
| <input type="checkbox"/> Magnesium Ladder . . . \$8.98 | <input type="checkbox"/> Paint Sprayer \$8.95 |
| <input type="checkbox"/> Please send C.O.D. I pay postage and C.O.D. charges | <input type="checkbox"/> 17 J. Chronograph . . \$21.95 |
| | Tax inc. I enclose check or money order. You pay postage |

Name _____
Address _____
City _____ Zone _____ State _____

SALESMEN!

**WRITE
THREE
WORDS
COLLECT
\$7.65**

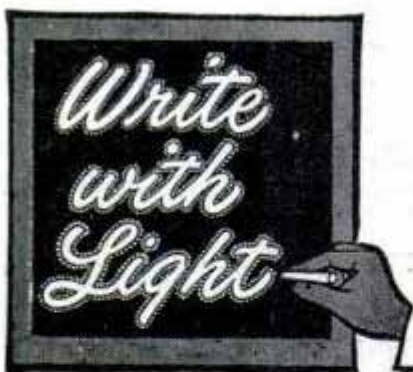

SENSATIONAL NEW ADVERTISING SIGN

YES, MAKE \$7.65 on 10-second demonstration to merchants. Write on glass with amazing magic crayon and presto—a 5-color advertising message takes fire and glows like a brilliant neon sign! Three sales a day and \$22.95 profit is for "lazy" men. Workers can double to triple that amount. FREE SALES KIT. Don't wait. Rush your name and address on a penny postcard for full details and complete sales kit—ALL FREE.

**MAXILUME CO., 125 W. Hubbard
DEPT. L-81 CHICAGO 10, ILLINOIS**

Print your own postcards!

Print your own postcards or start your own advertising business with a real postcard duplicating machine! NOT A TOY! Complete with one stylus, ink, correcting fluid, signature writing plate, and one full quire of 24 stencils without extra charge. Automatic feed, roller release.

1 Quire Stencils with each order FREE

12.95

Many uses: businesses, churches, hobbies, clubs, etc.

Send No Money

A postcard brings you KARD-KWICK Duplicator. Pay the postman \$12.95 (a \$15.50 value), plus postage. Your money back if not satisfied. Or save postage charges by sending your check or money order for \$12.95 NOW!

UNCONDITIONAL MONEY-BACK GUARANTEE

The KARD-KWICK CO. 1364 So. Lafayette Denver 10, Colorado

WHY DON'T YOU WRITE?

Writing short stories, articles on business, sports, hobbies, travel, shop crafts, local and club activities, etc., will enable you to earn extra money. In your own home, on your own time, the New York Copy Desk Method teaches you how to write the way newspaper men learn—by writing. Our unique "Writing Aptitude Test" tells whether you possess the fundamental qualities essential to successful writing. You'll enjoy this test. Write for it, without cost or obligation.

Veterans: Course approved for Veterans' Training.

NEWSPAPER INSTITUTE OF AMERICA

SUITE 5592-A, ONE PARK AVENUE, NEW YORK 16, N. Y.

NEW ECONOMY MODEL **ROCKLIN BUZZMOBILE** **AS LOW AS \$97.50**

- ★Clears Brush★Mows Weeds, Grass
- ★Falls Trees★Cuts Hedge★Trims Limbs
- ★Cuts Logs★Makes Fence Posts

Write for BONUS WEED MOWER OFFER

WORLD'S LOWEST PRICED
Easier to Operate with LARGER 20" WHEELS

ROCKLIN MANUFACTURING CO.
Dept. A10, Sioux City, Iowa

The Steady Pay Profession Good Times or Bad!

SCIENTIFIC CRIME DETECTION



It Is Easy to Learn!

I will teach you this fascinating science during your spare time at home. It pays to be an expert in Finger Printing, Firearms Identification, Police Photography and Criminal Investigation. I have trained hundreds of men and women now successfully serving in identification bureaus throughout America. You, too, may quickly prepare yourself to become a well-paid valued officer of the law, often sharing in the generous rewards offered for wanted criminals.

FREE! OVER 800

"BLUE BOOK OF CRIME"

This book is full of exciting information on scientific crime detection. It will show how you can get started in a grand career. Now, at amazingly low cost. Clip coupon now... Mail it today.

of all Identification Bureaus in the U. S. employ students and graduates of I. A. S. A majority of these men are heads of Bureaus. Many of them knew nothing about crime detection before training with me. Now they have steady jobs, good salaries and a fine future. Write today for full particulars and free book. Give age. No salesman will call.

INSTITUTE OF APPLIED SCIENCE

(A Correspondence School since 1916)

1920 Sunnyside Ave., Dept. 1351, Chicago 40, Ill.

INSTITUTE OF APPLIED SCIENCE
1920 Sunnyside Ave., Dept. 1351, Chicago 40

Gentlemen: Without any obligation on my part, send me the "Blue Book of Crime," and complete list of Identification Bureaus employing your students or graduates, together with your low prices and Easy Terms Offer. (Literature will be sent ONLY to persons stating their age.)

Name..... Age.....
Address..... R. F. D.....
City..... State.....

WOODWORKING VISE

for amateurs and professionals
USE UPRIGHT - FLAT - AT ANY ANGLE
MAIL CARD FOR FREE FOLDER TODAY
THE WILL-BURT CO., Dept. PM-11, Orrville, Ohio

No More Frozen Car Locks, Windshields, Garage Locks, Gas Caps, etc., with the

JET LOCK DEFROSTER

This compact, precision-built, scientific instrument works on a chemically-proven principle and will defrost the most stubborn lock or frozen surface in about twenty seconds. A jet of superheated steam does the trick, and is guaranteed to work every time. **\$1.00**

ONLY.....
Postpaid or C.O.D. plus postage.

COMMERCIAL SALES CO.
Dept. PM-1, 1303 Fulton Street, Brooklyn 16, N.Y.

Saves Digging, Pumping, Moving!

OUTDOOR TOILETS CESS POOLS • SEPTIC TANKS Cleaned — Deodorized

Banish offensive odor of disposal units with amazing new product! Just mix dry powder with water and pour into outdoor toilet, cess pool or septic tank. That's all! Absolutely safe—nontoxic, no poisons. Works like magic to reduce mass, to unclog walls and pipes... to facilitate free and easy drainage. One treatment lasts months and months.



FREE! Just send your name and address on a postcard and get exciting details BY RETURN MAIL. Discover how you can clean, deodorize and sanitize your disposal unit QUICKLY and EASILY... at amazing low cost. LEARN HOW YOU CAN AVOID DIGGING, PUMPING AND MOVING. Write TODAY for complete details sent FREE!

BURSON LABORATORIES, 951 Willard Ct., Dept. 800, Chicago 22, Ill.



Sensationally NEW for 1952!

MIDWEST TELEVISION

A Magnificent New Line of Beautiful CONSOLES and Complete CHASSIS featuring This MAMMOTH

FACTORY-TO-YOU

20-Inch
Rectangular
PICTURE TUBE

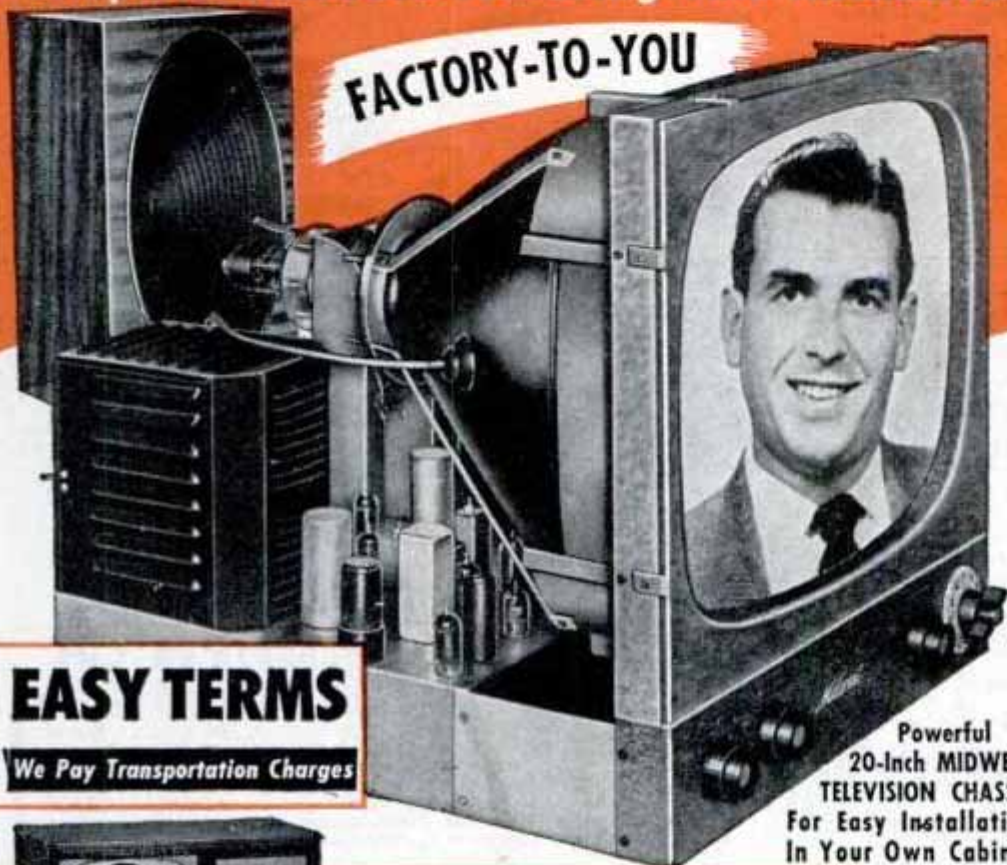

EASY TERMS

We Pay Transportation Charges

Powerful
20-Inch MIDWEST
TELEVISION CHASSIS
For Easy Installation
In Your Own Cabinet

Special Bonus



GIFT!

Illuminated
TELEVISION CLOCK

Given With Every
Purchase of a MIDWEST
RADIO or TELEVISION
LIMITED TIME ONLY!



Video Grand
**20-Inch TELEVISION-RADIO-
PHONOGRAPH CONSOLE**

A luxurious instrument that offers the Mammoth 20-Inch Rectangular Picture Television, plus powerful AM-FM Radio, plus 3-Speed Automatic Intermix Record-Changing Phonograph in a beautiful mahogany veneer console.

Also—Powerful New 1952 World-Ranging
MIDWEST Series of RADIOS
For Beautiful Consoles and Complete Chassis

An entirely new line of radios featuring the powerful Series 16 five wave band AM-FM Radio Chassis and the magnificent Symphony Grand Radio-Phonograph with 3-Speed Automatic Intermix Record Player.

Easy Terms



WRITE or PHONE

For This **NEW 1952**

**FREE MIDWEST
TELEVISION
RADIO CATALOG**

If You Live In One of These Cities
Phone and Ask for Your Catalog

NEW YORK MURRAY Hill 2-6810
CHICAGO State 2-5600
PITTSBURGH GRant 1-0609
CLEVELAND PRospect 1-7450
DETROIT WOODward 3-1233
ST. LOUIS GRand 1161
PHILADELPHIA LOcust 4-1035

or Send Coupon Below

• WRITE IN NAME AND ADDRESS (PLEASE PRINT) ON COUPON OR 1c POSTCARD •

MIDWEST RADIO & TELEVISION CORP.
Dept. 256, 909 BROADWAY • CINCINNATI 2, OHIO

Please send me your new FREE 1952 Catalog.

NAME _____

ADDRESS _____

CITY _____ ZONE _____ STATE _____

MIDWEST RADIO & TELEVISION CORP.
DEPT. 256, 909 BROADWAY, CINCINNATI 2, OHIO

DRAW ME

TRY FOR A
FREE ART COURSE

5 PRIZES! 5 Complete \$280 Art Courses, including Drawing Outfits!

Draw the girl and try for a prize! Find out if you have profitable art talent. You've nothing to lose—everything to gain. Mail your drawing today!

Amateurs Only! Our students not eligible. Make copy of girl 5 ins. high. Pencil or pen only. Omit lettering. All drawings must be received by February 29, 1952. None returned. Winners notified.



Latest Winner List! Free course winners in previous contest—from list just released: A. Martell, 108 W. San Antonio, El Paso, Tex.; R. Kerzman, YMCA, Milwaukee, Wisc.; J. Miller, 7645 N. Sheridan, Chicago, Ill.; Mrs. E. Chandler, RR 1, E. St. Louis, Ill.; A. Tedesco, 140 Havre, E. Boston, Mass.; G. Daniels, Frontier Villa, Cheyenne, Wyo.

ART INSTRUCTION, INC., Dept. 1132

500 S. 4th Street, Minneapolis 15, Minn.

Please enter my attached drawing in your February drawing contest.
(PLEASE PRINT)

Name _____ Age _____
 Address _____ Phone _____
 City _____ Zone _____ County _____
 State _____ Occupation _____

NEED EXTRA CASH?

Rush Coupon for

FREE SALES KIT

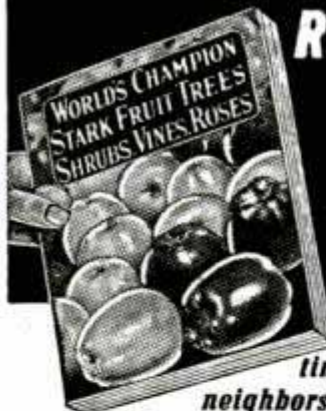

Make Money spare time, full time, taking orders from friends, neighbors, and others for world-famous

STARK FRUIT TREES

Cash in now taking orders for Stark Bro's world-famous hardy Apples, Pear, Peach, Plum, Cherry, Quick-Bearing fruit trees. Sensational new U. S. Patented varieties—PLUS amazing new Stark "Dwarf" Trees to make selling easy. Boost earnings showing homeowners, others how to landscape beautifully with Stark Trees, Gorgeous Flowering Shrubs and Roses. Big demand. Get set now with America's largest, oldest nursery—186-year-old reputation for quality and reliability.

Teacher Sells SPARE TIME

John W. Simmons, W. Va., has earned big money spare time during past 21 years selling Stark Fruit Trees, Shrubs, etc.

SEND NO MONEY Get Giant FREE Outfit! Mail coupon today for big demonstration outfit, beautiful Full Color Photo Plate Book, and instructions. No experience needed. Big season starting—ACT NOW!
STARK BRO'S Dept. 5512, Louisiana, Missouri

STARK BRO'S Dept. 5512, Louisiana, MISSOURI

Please RUSH FREE Sales Outfit. I am ready to make money!
 PM 1-52

NAME _____
 ADDRESS _____ COUNTY _____
 TOWN _____ STATE _____



FOAM RUBBER CUT SHAPES

Select from this—one of the largest Foam Rubber stocks—whatever shape or thickness you want—Cut circles or squares for upholstering or padding chairs, mattresses or pads for twin or regular beds, auto seat cushion tops—auto wedges—all new fresh stock—expertly cut to exact size. Lowest prices—satisfaction guaranteed. One day delivery.

Uncovered Foam Pads 1 1/2" thick	Auto Seat Pads 24" X 60"
12" X 14".....\$1.25	1 1/2" thick.....\$6.45
16" X 16"..... 1.35	2" thick..... 7.95
16" X 22"..... 1.75	Mattress Pads
18" X 24"..... 2.00	Twin Size.....\$19.55
22" X 24"..... 2.95	Full Size..... 23.95

Add 10% to these prices for postage and packing.
 NO C.O.D. PLEASE — PLEASE PRINT NAME
 Ask for catalog No. 201

RIOR RUBBER COMPANY, Dept. 201 50 E. CERMAK RD. CHICAGO 16, ILL.

BE A HIGH-PAID MAN IN YOUR COMMUNITY WITH THIS LONG NEEDED INVENTION



Earn up to \$10,000 or more per year! Nothing to invest! Be your own boss!

U.S. Pat. D 153853- D 153854

A worldwide product needed by every home, business and farm... priced to sell quickly! Automatic Red Comet goes into action as soon as fire starts... smothers fire without human aid. It's a sales 'natural'!

FREE SALES KIT

Demonstrator units, sales literature, etc., furnished you FREE. Handsome leather-type kit. Tried and proved, it will make you an independent businessman. ACT NOW! Someone in your community will be appointed soon. Write for details, today!



RED COMET, INC.
 Dept. 84-A, R.C. Bldg., Littleton, Colo.

POPULAR MECHANICS



Leonard C. Lane

B.S., M.A., Exec. Dir. of Pierce School of Radio and Television. Licensed by the State of N. Y. - President of Radio-Television Training Association. Approved as a Correspondence School under the Laws of the State of N. Y.

I CAN TRAIN YOU **AT HOME**

FOR BIG PAY JOBS IN

TELEVISION RADIO

ELECTRONICS

WITHIN MONTHS!!

AT NO EXTRA COST!
YOU GET A ROUND TRIP TO NEW YORK CITY

FROM ANYWHERE IN THE U.S. OR CANADA—PLUS 2 solid weeks; 50 hours of laboratory training on the most modern, complete, electronic equipment at the World-Famous **PIERCE SCHOOL OF RADIO AND TELEVISION**. After completing your Radio-Television Training Association Home-Study course, you receive two weeks' advanced instruction at the training shops and laboratories of Pierce School while you are in New York City—**AT NO EXTRA COST!** Only RTTA makes this amazing offer!

COMPARE THESE EXTRA BIG FEATURES!

RADAR

"The Electronic MIRACLE"—Only Radio-Television Training Association includes RADAR in your practical AT HOME training . . . PLUS

FCC STUDY AIDS

Get Higher Rating—More Pay in Army, Navy and Air Force!

WE FURNISH EVERYTHING

Including large picture TV Tube; can be converted for color TV. You BUILD and KEEP all units shown PLUS a C-W Telephone Receiver, AC-DC Power Supply unit (not illustrated). RTTA's effective method can help you toward a **FAT PAY CHECK — OR YOUR OWN BUSINESS!**

MODERN, ADVANCED NEW YORK LABORATORIES

Every modern, advanced electronic equipment for up-to-the-minute Radio-Television Electronic training, PLUS CBS and RCA Color Systems, PLUS operating Pierce Radio Station Club (W2G5V), PLUS Code Machine Set Up, PLUS complete TELEVISION STUDIO operating under supervision, by students! All the BEST to TRAIN you BEST!

I TRAINED THESE MEN and HUNDREDS MORE!

 9/14/51 "My FCC License plus your practical Shop-Training Methods upped my earnings. Highly recommend your school."—Jim Stapleton

 12/20/51 "Your training prepared me for this TV Technician job with security. I'll always be glad I chose your school."—Gil Grossinger

 6/15/51 "I can look forward to a profitable future, as a TV Ser. Tech., thanks to your training."—I. Samuels

 8/10/51 "It takes your type of training to get good jobs. As a TV Tech. I make good money."—Bill Atkinson

BOTH FREE



ACT NOW!
FOR LIFETIME SECURITY

SET-UP YOUR OWN HOME LABORATORY WITH THE 15 BIG TELEVISION-RADIO KITS WE SEND YOU (At No Extra Cost)



YOU BUILD AND KEEP THIS GIANT SCREEN TELEVISION SET AND OTHER ILLUSTRATED UNITS

PLUS a C-W Telephone Receiver, AC-DC Power Supply unit (not shown here)

EARN EXTRA MONEY IN SPARE TIME!

Earn as much as \$5 an hour while learning! Many students pay for entire course with spare-time earnings! We show you how! Free employment help! Pierce graduates are holding good-pay jobs at NBC-TV, CBS-TV, RCA, DUMONT, EMERSON, FEDERAL TELEPHONE, PHILCO, ADMIRAL, HUGHES AIRCRAFT . . . Also at other leading Radio Stations, electronic firms as well as in the Armed Services!

BECOME A CERTIFIED TV TECHNICIAN

RTTA Shop-Methods Tops in Recognition! You owe it to yourself to get the BEST practical training AT HOME! Radio-Television Training Association can help you!

No Previous Experience or Training Needed!

Now, get in on the fastest growing, billion dollar field of Television-Radio-Electronics!

MAIL COUPON TODAY!

ONLY RTTA IS LOCATED AT TIMES SQUARE "IN THE HEART OF THE TELEVISION WORLD" WHICH OFFERS THIS UNIQUE, PRACTICAL HOME TRAINING PROGRAM!

Mr. Leonard C. Lane, President, Dept. 21
RADIO-TELEVISION TRAINING ASSOCIATION
1629 Broadway, New York 19, N. Y.

Dear Mr. Lane:
Show me how I can make **BIG MONEY IN TELEVISION** within MONTHS! Rush by return mail my **FREE** Sample Lesson and **BIG FREE** Manual.

Name

Address

City Zone State.....

(PLEASE PRINT PLAINLY)

Spare Time
\$3.00 AN
PAYS 3 HOUR
and MORE
with



UNIVERSAL Lawn Mower Grinder

Here is a business you can start in your own garage or basement. Sharpen hand and power mowers on the Universal Grinder and make \$3.00 to \$5.00 an hour.

G. Spurlock of Arkansas writes: "I have had my Universal Grinder only 2 months. Live 2½ miles from town. Yet have already made \$227 net profit." J. L. Peterman of Pa. says: "I averaged \$100.00 a week in May, and made \$1,000.00 spare time this season."

REMEMBER—Only on the UNIVERSAL GRINDER can the inside face and edge of the stationary blade, as well as all of the reel blades, be ground to the proper clearance

ALL IN ONE SET-UP

WITHOUT REMOVING ANY BLADE FROM THE MOWER

Rogers Mfg. Co., Dept. M-12, Lindsey, Ohio

SEND THIS COUPON NOW

ROGERS MFG. CO., Dept. M-12, Lindsey, Ohio

Please send me full facts about the Universal Lawn Mower Grinder and its big money making opportunities.

NAME _____
 ADDRESS _____
 CITY _____ STATE _____



for ... POWER LAWNMOWERS,
 MOTOR SCOOTERS, GARDEN
 TRACTORS, MOTORBIKES, ETC.

MODELS AND SPECIFICATIONS

Model No.	Bore Size	Pulley Diam.	Belt Size	Engage Speed	Disengage Speed	H. P. Rating	Price
18C1	½"	2"	A	1800 for light load	1500	1 ½	\$ 6.50
18C4	¾"	2"	A		1400	1 ½	6.50
18C5	¾"	2 ½"	B		1300	2	6.50
18C12	¾"	2 ½"	B		1200	3	7.95
18T9*	¾"	2 ¾"	A		1200	2	7.95
18T10*	¾"	2 ¾"	B	2500 for heavy load	1200	2	7.95
18T14*	¾"	3 ¾"	B		1200	3	10.95
S-18C1‡	½"	2"	A		1500	1 ½	7.95
A655*	Fits Doodle Bug Scooters						7.95

* Requires belt slack compensator for low gear operation.

‡ Manually-controlled neutral position.

The Way to transmit Power Smoothly

V-PLEX CLUTCHES automatically tighten drive belt as throttle is opened, eliminate belt slippage, cut wear, permit idling engine. Easily installed on any gas engine; practically indestructible. Fit ½", ¾", ¾" drive shafts. See dealer or write.

SEND
 POSTCARD
 FOR
 FOLDER

MFG. BY V-PLEX CLUTCH DIVISION
 LIGHT INSPECTION CAR WORKS — HAGERSTOWN, INDIANA

PRINT YOUR OWN POST CARDS

The GEM STENCIL DUPLICATOR saves money... gets results quickly! Hundreds of uses for every type of business and organization. We ship the GEM complete with all supplies, Guide Board for accurate printing and 60-page Book of Ideas at the special low price of only \$8.50 (a \$15 value).



FREE TRIAL OFFER

Our
 21st Year

Use the GEM FREE at our expense! SEND NO MONEY. Write and complete GEM outfit will be sent you postpaid. After ten days, send us only \$8.50 or return the GEM. You must be satisfied!

BOND EQUIPMENT CO. Dept. 48
 6633 Enright • St. Louis 5, Mo.

ENGINEERING DEGREE IN 27 MONTHS

INDIANA TECHNICAL COLLEGE

B. S. DEGREE, Aeronautical, Chemical, Civil, Electrical, Mechanical and Radio Engineering (inc. television), Drafting, 1-yr. Government approved for G.I.'s. Low rate. Earn board. Large industrial center. Students from 48 states, 21 countries. Demand for graduates. Enter March, June, September, December. Write for catalog, 1612 E. Washington Boulevard, Fort Wayne 2, Indiana.

EARN
 UP TO
 \$100.00
 A
 WEEK!

MAN WANTED!

Prominent Wis paint manufacturer offers unexcelled opportunity to experienced salesman, full or partime, to handle established paint line and specialty items. Aggressive man can make to \$100 and better. Send details.

GILL PAINT MANUFACTURERS
 Wisconsin Rapids, Wis.

Learn PHOTOGRAPHY at Home

Splendid opportunities. Prepare in spare time. Practical basic training. Long-established school. Send for free book, "Opportunities in Photography." No obligation.

American School of Photography, 835 Diversoy Parkway, Dept. 1351, Chicago 14, Ill.

BIG MUSCLES don't just happen

Build Them the York Barbell Way!

Don't be fooled! There's no easy way to strength, health, and a beautiful body. But it's fun the York Barbell way. Let Bob Hoffman, famous Olympic weight-lifting coach, show you how! Send postcard, ALL THIS FREE: Copy of Strength & Health, York Barbell Catalog, Bob Hoffman's Tips.

"Muscletown"
 YORK BARBELL CO. York 22, Pa.

FOR BIG MEN ONLY!



SEND
 FOR
 FREE
 CATALOG

SIZES 10 to 16 WIDTHS AAA to EEE

We SPECIALIZE in large sizes only— sizes 10 to 16; widths AAA to EEE. Loungers; Nylon Mesh; Dress Oxfords; Moccasins; High, Low Work Shoes; Slippers; Rubbers; Overshoes; Sox. Enjoy the finest fit, comfort, style at amazingly low cost. Mail only. Write for Free Style Book TODAY!

KING-SIZE, Inc., 769, Brockton, Mass.



Learn by Mail to Mount Birds

Animals, Game-Heads, Fish, Pets, to Tan Skins

Men, Boys! Be a **Taxidermist**. Learn at home in spare time. Easily, quickly learned, **Grand Fun**. A wonderful, profitable hobby, for expert hunters, also for amateurs, even young boys. Mount wild-game, although wild-game is not necessary. Use common, domestic specimens, squirrels, pigeons, even frogs. This famous, reliable school in business more than 35 years. **More than 300,000 delighted students**. Think of that!

Hunters Save Your Trophies — Have a Home-museum Be a Taxidermy Artist

You will be **THRILLED** and **DELIGHTED**. You learn **QUICKLY**, easily **AT HOME**. Your friends will be amazed. Hunters from near and far will bring their **TROPHIES** to be mounted. You can earn fine **profits** in **spare time**. Many students earn \$80 to \$100 a month, in season. **Rush the coupon today**, and learn all about wonderful taxidermy. **DO IT NOW!** Save your own hunting trophies. Have a lifelong hobby. Have a home museum that you are proud of, and that makes you popular and well-known far and wide. **BOYS**, wild-game is **not** necessary. Use common specimens, squirrels, pigeons, owls, domestic birds and animals. **It's wonderful**. Inquire today. **Kill fewer game-birds. Double your fun and pleasure.**

Fun — Fascination — Profit

And so easily learned in spare time. Wild-game is growing scarcer. Help preserve it. Shoot only a **FEW** fine ducks and other game-birds. **MOUNT THEM** for home and den, and have **MORE FUN** and **PLEASURE** than killing the legal limit every day. **Help preserve the wild-game.** Remember you learn to mount expertly, **birds, animals, game-heads, fish, pets, to tan skins and furs**. Investigate! You will be delighted. Send for **free book today**. "Eat your trophies and have them too."

THE N. W. SCHOOL OF TAXIDERMY, 2501 Elwood Bldg., Omaha 8, Nebr.

FREE BOOK!

Yes **FREE**, 44 pages, with 100 unique pictures of taxidermy work. No other book in the world like this. It will amaze and thrill you. **Ask today for your free copy. State your AGE.**

Send the Coupon!

Write name plainly in coupon or margin, or a **post card** will do. **Rush** your request, as **free books** may be exhausted quickly. **Decide now**. Don't wait a moment. **State your age.**

FREE BOOK

Northwestern School of Taxidermy, 2501 Elwood Bldg., Omaha, Neb. Send me your free illustrated book, "How to Mount Game". Also tell me how I may learn this fascinating art easily and quickly by mail. No obligation. State your age.

Name _____ Age _____
Address _____



not everyone does as well, but E. O. Lockin, who started a business of his own, reports...

for 12 months I've averaged \$800 PER MONTH INCOME

—most of it clear profit for me!



You, too, can start your own business. No special skill, no large investment required. Costs nothing to find out—no obligation. Mail coupon today for interesting **FREE** book.

.....
• **VON SCHRADER MFG. CO.,**
• 1130 "R" PL, Racine, Wisconsin
• Send at once (no obligation) your **FREE**
• booklet containing information about your
• **ELECTRIC RUG WASHER** and how I can start my
• own permanent, profitable business.
• Name _____
• Address _____
• City _____ Zone _____ State _____
•

• Mr. Lockin expresses his grateful thanks for the opportunity to make a decent living on his own. Many men have discovered how to be independent, to be freed of bosses and layoffs—to build their own future on a steady, dependable foundation. L. A. Eagles grossed more than \$200 his first week. R. E. Traynor says, "I made \$62 gross in one day." Others report gross from \$100 per week to \$12,000 per year.

How much you make depends largely on you. You need no special skill, no large investment to start.

No shop necessary. Our **ELECTRIC RUG WASHER** cleans rugs and carpets like new right on the floor... removes dirt and grime and helps to show their natural color and beauty. So efficient and safe for carpets, it is used by largest hotels and railroads.

You take no risk. Machines fully guaranteed. Mail coupon today for complete information including how to start making big profits quickly in **YOUR OWN** business. **BIG** opportunity. Send coupon now.

VON SCHRADER MFG. CO., RACINE, WIS.

HANDIEST WORKSHOP TOOL

welds • cuts • solders • brazes
...even charges batteries

Turns your spare time to spare cash!

Make money for yourself while you save money for your neighbors. Fix their garden tools, children's toys, car bodies or fenders, build metal furniture and do 1001 other profitable jobs this easy, low cost way. The money you make soon pays for your "Lincwelder" ... then helps buy other tools for your workshop.

ORDER
YOUR WELDER
NOW

Fill out
and mail to
The Lincoln
Electric
Company
Dept. 191
Cleveland 1,
Ohio

"LINCWELDER 60" LINCOLN ARC WELDER



- Comes complete with full instructions.
- Approved by Underwriters Laboratories.
- Operates from 115 volt grounded circuit. (No. 12 wire fused for 20 amps.)

- Ship me the "Lincwelder 60" with accessories \$48.00. (Including headshield, electrodes, carbons, electrode holder, ground clamp and cable.) Arc Torch \$6.25 extra.
 Battery Charging Attachment \$10.00 extra.
Enclosed is check money order.
 Send me free bulletin on the new "Lincwelder 60."

Name _____
Address _____
City _____ State _____ 191

a new pocket in 6 seconds!

ONLY
25¢
PAIR



Described on Page
109, Sept. 1951
Popular Mechanics

- The pocket you IRON IN — not sew in.
- Over 1,000,000 sold this year.
- Nothing like it on the market.
- Taking the country by storm.
- So EASY — any child can do it.

SIMPLY place this amazing new pocket over the old worn one and press with a hot iron. PRESTO—the new pocket is in for keeps! Revolutionary heat-sensitive tape fastens new pocket so firmly it can't come off even when trousers are washed or dry-cleaned. DOUBLE DUTY—use for either hip or side pockets. At leading department, variety and chain stores. If your favorite store does not stock, send coupon TODAY! Money-back guarantee.

ALT MFG. & DIST. CO.

201 Summit St. Toledo 4, Ohio

I enclose _____ Please send me the following NO-SEW Pockets, postpaid. 1 doz. pairs (24 pockets) \$3.00, 4 pairs (8 pockets) \$1.00, 1 pair (2 pockets) 25c.

Name _____
Address _____
City _____ Zone _____ State _____

MAKE YOUR CAR LIGHTS—DIRECTIONAL SIGNALS TOO!

with this easily installed complete
kit . . . Flashes turns . . . Eliminates hand signaling.



ONLY \$6.95 POST-PAID

C.O.D.'s EXTRA

All wire, bulbs, fixtures and materials supplied in complete kit, plus handsome control switch with reminder light that flashes when signals flash. Use existing parking & tail lights. No drilling necessary. No outside mountings. Easy-to-follow instructions. Tested and Approved to meet S.A.E. standards.

Specify make & year of car when ordering. Money-back guarantee.
RAY PRODUCTS CO., Dept. M-1, 139 N. Clark St., Chicago 2, Ill.

RUPTURED?

DON'T SUFFER TORTURE, IDLENESS and DISCOMFORT with an old-fashioned TRUSS

Get back to normal living with this new appliance innovation that lets you run, play, work, lift, stoop or squat like any normal person. This radically new appliance is as supple as a rubber-band—flexes with every body movement, yet gives positive 3-point support. Won't slip, shift, gouge, rub or chafe. Gives you a new lease on life—new freedom of movement—and a degree of comfort you never thought possible. See for yourself. There is no obligation. A penny postcard brings details. Don't delay. Write today.

ACTIVE MAN APP. Dept. MP-A, 549 W. RANDOLPH CHICAGO 6, ILLINOIS

Is Your Life
Crowned
With Success?

LEXIPOWER



WE THINK IN WORDS. THOUGHT IS POWER. Let this New Science show you how to WIN WITH WORDS—financially, socially, culturally. Develop a MASTERFUL VOCABULARY. Influence others, improve your personality, manifest your latent ability. You are judged and rated by every sentence you utter. Start using the POWER of LEXIPOWER after the first Lesson. Write NOW for FREE details about LEXIPOWER. Dime-a-Day LESSON CLUB.

LEXIPOWER LESSON CLUB

517-J W. Deming Place Chicago 14, Illinois

'How to' MAKE MONEY with Simple CARTOONS



A book everyone who likes to draw should have. It is free; no obligation. Simply address **FREE BOOK**

CARTOONISTS' EXCHANGE

Dept. 91A Pleasant Hill, Ohio

SHORTHAND IN 6 WEEKS

LEARN AT HOME—LOW COST

Write 120 words per minute. Age no obstacle. Famous Speedwriting Shorthand system. No signs; no symbols; no machines; uses ABC's. Easy to learn and use. Fast preparation for a position. Nationally used in leading offices and Civil Service; also by executives, writers, speakers, lawyers, scientists, students at college. Over 100,000 taught by mail. The very low cost will surprise you. Also typing. 29th year.

WRITE FOR FREE BOOKLET TO

Speedwriting
Dept. 1501-2, 55 W. 42 St., N. Y. 18

Don't Renew Your TV Service Contract! ... Don't Buy A TV Set!

UNTIL YOU READ THIS!

SAVE up to \$100 a Year on Your TV REPAIRS!

SAVE UP TO \$150 ON A NEW TV SET!

NOW! You Can Fix Your Own TV Set
Easily • Safely • Quickly with
Sensational NEW TV OWNER'S Guide
... Just Published!

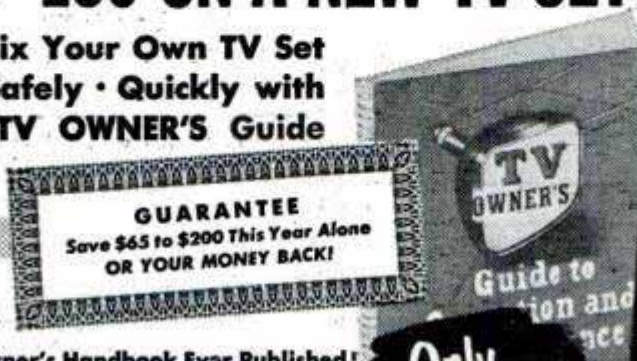

GUARANTEE
Save \$65 to \$200 This Year Alone
OR YOUR MONEY BACK!

Fix Any Set—Any Make

The Biggest, Most Complete TV Owner's Handbook Ever Published!
All The Money Saving Information You Want—Easy To Follow—
No Experience Needed—Easy as A-B-C Picture Instructions
Show You How To Improve Reception, Make 90% Of Your TV
Repairs In 1 to 5 Minutes—Only Tool Needed Is Screwdriver!

AT LAST, James Contos, Chief Engineer of a leading electronics corporation, for years in charge of servicing N. Y. department store TV sets, has just published his BRAND NEW TV OWNER'S GUIDE—the book that saves you money every time you open it!

YES! We Will Send You This Amazing New Money-Saving Book For A Full Year! We Guarantee Whether You Now Own A TV Set, Or Plan To Buy One, You Will Save \$65 to \$200 This Year!—or it won't cost you a penny!

IF YOU NOW OWN A TV SET

- This Book Shows You How To:
- ... Fix Your Own Television Set—In 1 to 5 Minutes!
 - ... Build Your Own Color Converter—In 1 Weekend!
 - ... Install Your Own Special Antennas—Filters—Boosters!
 - ... Double and Triple Reception In Bad Or Fringe Areas!

IF YOU PLAN TO BUY A TV SET

- This Book Shows You How To:
- ... Save Up To Half The Price When You Buy!
 - ... Get The Best Possible Set For Your Area!
 - ... What To Watch For When Buying!—Don't Be Cheated!
 - ... Get The Top Trade-In Value On Your Old Set!

Tells You Everything You Have To Know

Are you one of the thousands needlessly plagued by troubles and distortions on your set? Are you still throwing out \$5—\$10—\$20 every time a service man twists a knob on your set, or turns the same screw you can turn with your thumbnail? Isn't it foolish to spend \$65 or \$100 for a service contract, and then wait 3 or 4 days for repairs?... when it's so easy to fix your set yourself, AND SAVE! Save up to \$75 on special antennas, color converters, filters—SAVE \$65 to \$200 IN 1 YEAR!

Clear—Simple—You Can't Go Wrong!
No Technical Diagrams—Easy as A-B-C,
with Hundreds of "Show-How" Pictures

This new TELEVISION OWNER'S GUIDE is so complete, so easy to follow, so FOOL-PROOF, it's like having a top-notch television engineer right at your elbow! Regardless of the make or year of your set, HUNDREDS OF

BEDFORD COMPANY
Dept. PM1 699 Madison Ave. New York 21, N.Y.

Send No Money

"HOW-TO" PICTURE INSTRUCTIONS track any trouble right to its source, show you exactly what to do, and then lead you step-by-step through the entire repair! It's so easy, and there's absolutely no danger when you do it our way. In less than 5 minutes you'll be fixing those jumpy or distorted pictures, cutting out static, ghosts, snow, herring-bone effects, lines,—making major repairs such as burnt out tubes, blurred pictures, shorted picture tubes, even if you've never seen the inside of a set before! ... and without spending one cent for special equipment!

1001 Money-Saving Tricks

Learn the 1001 money-saving shortcuts and professional tricks that take all the expensive "hocus-pocus" out of television. Learn how to save up to 50% when buying your set, installing your set, adding accessories. Know when you need a serviceman, and when you don't; what has to be done, how much it should cost, how to adjust rear set controls or best reception. Even includes a chapter on Radio Repairs! It's the most complete, authoritative, up-to-the-minute volume on television ever published, and it's yours to use for an entire year at our risk if you send today!

Only \$1.98
FULL YEAR MONEY BACK GUARANTEE

FREE!

(Yours to keep even if you return book!)

MAGIC "TROUBLE SPOTTER"

Now! Spot Your TV Trouble at a Glance ...

and see how to fix it, fast.

Big 11 by 44 inch chart pictures 90% of TV troubles! You instantly spot your problem, and see exactly what to do to fix it! Here are just a few samples of the many repairs you'll be making yourself, in 1 to 5 minutes, and saving \$5 to \$20 every time!

If Set Suddenly Goes Black
No waiting 3 or 4 days for service or getting "soaked" by independent repair man. Magic Trouble Spotter tells what's wrong, and shows what to do!

If Picture Tube Shuts Out
Why throw away \$25 for repair? Magic Trouble Spotter and screwdriver give you miracle repair in 4 minutes!

No Picture, No Sound
No need to run to neighbor's house for favorite program! Magic Trouble Spotter has set operating again before commercial is over!

Picture Blurred? Stretched?
Magic Trouble Spotter gives you movie-clear picture in 30 seconds, easy as A-B-C!

SAVES You MONEY 24 Ways!

This Book Shows You:

- How To save up to \$150 when buying your set.
- How To get the best set for your viewing area.
- How To buy a "top brand" set for up to 50% less.
- How To avoid hidden installment payments.
- How To get the top trade in on your old set.
- How To avoid being gypped.
- What to watch for when buying your new set.
- What you must know about your warranty, and service contract.
- How To double and triple fringe or bad area reception without a special antenna.
- How To bring in weak channels clearly with only 5 minutes work.
- How To install your set.
- How To install your own antenna—built in, indoor, or outdoor.
- How To be sure you're getting an honest repairman.
- How To repair your own set, on the spot, with no special equipment, no experience.
- How To avoid repair rackets.
- How To know what the repair should cost, and avoid overcharges.
- How To avoid long waits when you give your set to a repairman.
- How To light your room correctly to avoid television eyestrain.
- How To correct minor defects and avoid major breakdowns.
- How To buy at auction sales—discount houses—second hand shops.
- How To know your legal rights with your landlord, repair man, service contract.
- How television can benefit your child.
- How To get more enjoyment from your TV set.
- How Your television set really works.

... and so much more!

Amazing Full Year's GUARANTEE

Read this daring introductory guarantee! TV OWNER'S GUIDE must save you \$65 to \$200 this year alone, whether you now own a TV set or plan to buy one in the future, or you may return the book even a year from today for full money back.

Signed
BEDFORD COMPANY

ACT NOW!

Special Offer Gives You Magic Trouble Spotter FREE!

Send TODAY and get Magic Trouble Spotter FREE, with your TV OWNER'S GUIDE. Examine up to a full year. If not convinced book will pay for itself in 1 day—if it doesn't save you \$65 to \$200 in 1 year, return for money back, keep Magic Trouble Spotter as FREE GIFT!

SEND NO MONEY! Mail Free Gift Coupon NOW!

Bedford Co., Dept. PM1 699 Madison Ave., N. Y. 21

Gentlemen: Without obligation, please rush me the new TV OWNER'S GUIDE for no risk examination and trial. I agree to pay postman on arrival \$1.98 plus postage. If I am not satisfied I may return at any time within a year for full money back.

Also send me ABSOLUTELY FREE, the Magic Trouble Spotter chart, mine to keep as a FREE GIFT whether or not I keep the TV OWNER'S GUIDE.

NAME.....
ADDRESS.....
CITY..... ZONE..... STATE.....

SAVE MORE! If you send \$1.98 with coupon, we pay all postage charges. Same money back guarantee.

CAN A MAN MY AGE Become A Hotel Executive Even Though He Has No Previous Hotel Experience?

Would you like to step into a well-paid position in a Hotel, Club, Restaurant, essential Defense Cafeteria or Housing Project? Would you like to look forward happily to the future? The success of Lewis graduates from 18 to 50 PROVES you can — though you have no experience in hotel work.



**Nelson Davis, Newspaper Route Man,
Now Assistant Manager, Knew
Nothing About Hotel Work**

"I had nothing to look forward to but monotonous work and poor pay. Then I answered a Lewis advertisement and shortly afterwards, enrolled. Soon after graduation, the Lewis School placed me in a fine Pennsylvania hotel. Now Assistant Manager. Lewis Training did it all."

Step Into a Well-Paid Hotel Position FREE Book Gives Fascinating Facts

Our FREE Book, "Your Big Opportunity," explains how you can qualify for a well-paid position at home, in leisure time; tells how you are registered FREE of extra cost in the Lewis National Placement Service. Most important, it shows how you can be a Lewis Certified Employee—certified to "make good" when placed in a position. Mail the coupon NOW!

Course Approved for Veterans' Training

LEWIS HOTEL TRAINING SCHOOL
Room VA-324, Washington 7, D. C.

**36th SUCCESSFUL
YEAR**

Send me the Free Book, "Your Big Opportunity," without obligation. I wish to know how to qualify for a well-paid position at home, in my leisure time.

Name _____
(Please Print Name & Address)
Address _____
City _____ Zone _____ State _____

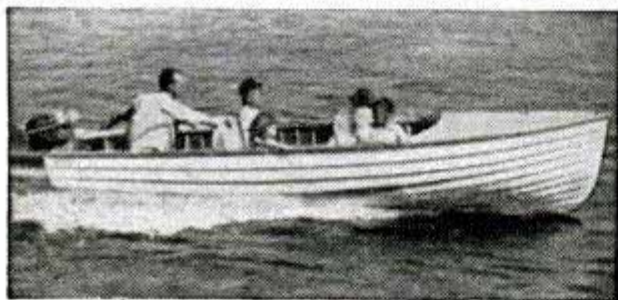

FAST—Old Town Lapstrake Boat

SMOOTH lines of this lapstrake outboard boat help you start in a hurry—and get there fast! She's roomy, too, with wide cross seats (folding backs) and long seats on both sides at the stern. Handles easily, with deep bow to fight stormy waves! Built of hand-some woods for strength and service. Upkeep is easy.

FREE CATALOG shows just the model you need. Write for one today! Also rowboats, sailing dinghies, sailboats, canoes.

OLD TOWN BOATS

Old Town Canoe Co., 841 Elm St., Old Town, Maine
PLEASE SEND ME FREE CATALOG

Name _____
Address _____
City _____ State _____

BUILDING SHIP MODELS is a satisfying Hobby



Capture the romance of clipper ship days. Build the RED JACKET. 21" long. Kit contains fully shaped hull, shaped parts, tapered masts, and ALL fittings. Easy step by step instructions. \$9.95 postpaid

One Night of Fun...
Result! A Collector's Piece
YORKTOWN FIELD GUN

Brass barrel, cast wheels, all parts & fittings—ready to assemble in one evening, 7" long Only \$5.50



Get this 68 page CATALOG. A treasury of interesting ship model and model gun information. 50c Teachers, Scoutmasters — write

MARINE MODEL CO., INC.
DEPT. G-55 HALESITE, L.I., N.Y.

AMAZING NEW CHEMICAL MAKES

OLD BUMPERS LIKE NEW!



Not a Paint! Not a Polish! Looks like expensive chrome plating!

Wonderful new chemical puts chrome-like finish on car bumpers, door handles, trim, etc. No electricity—no plating tanks—no acids needed. Just smooth it on and watch it gleam! Takes a brilliant polish JUST LIKE CHROME—so simple a child can do it. REFINISH BUMPER IN 10 MINUTES! WORKS LIKE MAGIC—finish lasts for years. Increases resale value of your car and adds NEW beauty to other chrome plated or metal items. TRY AT OUR RISK. SEND NO MONEY! Just send name and address. Pay postman amazing low price of \$1.25 plus few cents postage for each kit ordered, or send cash and we pay postage. Try kit 10 days. If not delighted return for instant refund! BUMPER RE-NU CO., Rm. 24, Box 147, Dept. A-3, Hamtramck, Mich. **\$1.25**

GREAT PROFITS
MAKE YOUR OWN RUBBER MOLDS

Make your own rubber molds quickly, cheaply with X.L. RUBBER. Cast thousands of perfect figurines, book ends, plaques, ornaments, ash trays, etc. GREAT PROFITS! Write for NEW Catalog.

X.L. Rubber, Pts. \$2.50; Qty. \$4.00 (postage extra). Models and enough for 3 molds \$1.50 prepaid.



SEND FOR FREE FACTS

PLASTIC ARTS STUDIO Dept. 2, 3403 S. MADISON ST., Muncie, Ind.

Rupture Troubles Ended

Advanced method has healed thousands. No leg straps, no elastic, no plasters. No pressure on hips or spine. Flexo-pad. Entirely different. Endorsed by doctors, mechanics, clerks. Very light. **INEXPENSIVE. GUARANTEED.** Write for information and trial.

SMITH MANUFACTURING COMPANY
EST'D 1893 DEPT. PM PRESTON, ONTARIO

TRI-STATE COLLEGE

**B. S.
DEGREE IN
27 MONTHS**
Founded 1884
World-Wide
Enrollment

Mech., Civil, Elect., Chem., Aero, Radio and Telev. Engineering; Bus. Adm., Acct. Visit Campus, see well equipped buildings and labs. Low cost. Prep. courses. Personalized instruction. Big demand for graduates. Serious shortage of engineers indicated for immediate future. Prepare now. Enter Jan., March, June, Sept. Write for Catalog. 412 College Ave., Angola, Ind.

Use Your Spare Time
Learn ENGRAVING
As a Career or a Hobby

WRITE TO

Build a business for yourself; Engrave Silver—Jewelry—Trophies right in your own home. Learn this fascinating craft by the NEW "SILENT TEACHER" HOME STUDY METHOD. Inquire today — or at our resident school.

KANSAS CITY SCHOOL OF WATCHMAKING
1218 Admiral Blvd. Kansas City 6, Missouri

An Amazing New Invention — Magic Art Reproducer

DRAW The First Day

**NO LESSONS!
NO TALENT!**

You Can Draw Your Family, Friends, Anything From REAL LIFE— Like An Artist... Even if You CAN'T DRAW A Straight Line!

Anyone can Draw With This Amazing New Invention — Instantly!



Complete for only
\$1.98

Also Copy Any Picture — Can Reduce or Enlarge Any Picture!
Yes, anyone from 5 to 80 can draw or sketch or paint anything now... the very first time you use the "Magic Art Reproducer" like a professional artist — no matter how "hopeless" you think you are! It automatically reproduces anything you want to draw on any sheet or paper. Then easily and quickly follow the lines of the "picture image" with your pencil... and you have an accurate original drawing that anyone would think an artist had done. Also makes drawing larger or smaller as you wish. Anyone can use it on any desk, table, board, etc. — indoors or outdoors! No other lessons or practice or talent needed!

Have fun! Be popular! Everyone will ask you to draw them. You'll be in demand! After a short time, you may find you can draw well without the "Magic Art Reproducer" because you have developed a "knack" and feeling artists have — which may lead to a good paying art career.

FREE! "Simple Secrets of Art Tricks of the Trade"

This valuable illustrated guide is yours FREE with order of "Magic Art Reproducer." Easy ABC art tricks that anyone can follow on different techniques, effects, proportions, perspectives, shading, color, animated cartoons, human figures to use with "Magic Art Reproducer" for added touches to your drawings.

**SEND NO MONEY!
Free 10-Day Trial!**

Just send name and address. Pay postman on delivery \$1.98 plus postage. Or send only \$1.98 with order and we pay postage. You must be convinced that you can draw anything like an artist, or return merchandise after 10-day trial and your money will be refunded.

**NORTON PRODUCTS, Dept. 581A
296 Broadway, New York 7, N. Y.**

ALSO EXCELLENT FOR EVERY OTHER TYPE OF DRAWING!

- Human Figures
- Copy all cartoons, comics
- Outdoor Scenes, landscapes, buildings
- Copy photos, other pictures, portraits, etc.
- Still life, vases, bowls of fruit, lamps, furniture, all objects
- Copy designs, blueprints, decorations, etc. for woodwork, machines, for needlework, crocheting, knitting

FREE 10-DAY TRIAL COUPON!

**NORTON PRODUCTS, Dept. 581A
296 Broadway, New York 7, N. Y.**

Rush my "Magic Art Reproducer" plus FREE illustrated guide *Simple Secrets of Art Tricks of the Trade*. I will pay postman on delivery only \$1.98 plus postage. I must be convinced that I can draw anything like an artist, or I can return merchandise after 10-day trial and get my money back.

Name.....

Address.....

City & Zone..... State.....

Check here if you wish to save coupon by sending only \$1.98 with coupon. Same Money Back Guarantee!



FOR
HOMES, SHOPS,
FACTORIES,
GARAGES,
HOTELS, STORES,
OFFICES, FARMS

24 LARGE DRAWERS
72 HANDY COMPART-
MENTS

STURDY CONSTRUCTION

JIFFY STEEL FRAME CABINET

You'll find hundreds of uses for this handy all-metal Jiffy Cabinet! 24 aluminum drawers in one 15 1/2"x9 1/2"x6" unit. Each drawer is 5 3/4" long, 2 3/4" wide, 1 1/4" deep — perfect for storing nails, buttons, stamps, and other small articles you need and use. Each drawer is divided into three separate compartments, by removable metal dividers... actually 72 compartments to the cabinet! Drawer labels included. Sturdy steel frame, finished in silver-gray color. 8-drawer size, only \$4.95 (32-drawer size, \$12.95; 64-drawer size, \$24.95). We pay all postage. Send cash, check or money order. 7-day money back guarantee. **Order NOW.**

ONLY
\$9.95
post-paid

TIMESAVERS, Dept. 1-PM

2 West 45th St.

New York 19, N. Y.

RUPTURED

**Relief
or Your
Money
Back!**

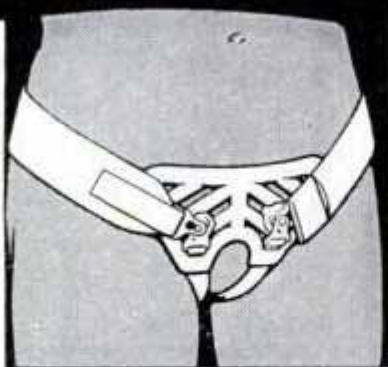

You risk nothing to find out why thousands of rupture sufferers can now work and play in comfort with the help of the patented Web Truss.

No matter what truss you are wearing our free booklet on rupture care will help you. Write for it today.

WEB TRUSS CO.
DEPT. 52, HAGERSTOWN, MD.

SHOOTING?



The AMERICAN RIFLEMAN will give you a wealth of information about guns of all types, rifles — pistols — shot-guns, foreign and domestic, sporting and military, modern and antique; the most effective calibers and loads; the proper iron and scope sights for maximum accuracy; detailed "how-to-do-it" information on reloading and gun remodeling; experienced technical advice on new equipment, accessories and gadgets. Every 96-page issue is packed with interesting and helpful data—exclusively about guns and shooting.

Send \$4.00 for subscription to 12 monthly issues—and receive two back numbers, free. And for no extra cost you can become a member of the N.R.A.—along with 260,000 other sportsmen! Full price refunded if not satisfied, after receiving first three subscription issues. (If you prefer, just say "Bill Me"; invoice will follow.)

NATIONAL RIFLE ASSOCIATION
1608-E Rhode Island Ave., N.W., Washington 6, D.C.

WANT TO
Write Stories
Articles
Mysteries?



FREE BOOK
tells how you
learn at home

Would you be willing to spend a few hours a week learning to write so you may earn \$300-\$1200 a year part-time? Or many thousands full-time? FREE book, "Art of Writing Salable Stories" tells how to get started writing short stories, radio-TV scripts, articles, business items. Many students earn while learning (A.B. Aretz sold first 2 stories for \$255). Endorsed by famous authors, scores of successful graduates; approved for veterans. Send today for FREE book (no salesman will call).

PALMER INSTITUTE OF AUTHORSHIP, Founded 1917
1680 N. Sycamore Hollywood 28, Calif. Desk T-12

PLASTICS CATALOG

Small Quantities — SPECIAL PRICES — Large Quantities
There's more information and tricks-of-the-trade and a larger variety of plastics materials listings packed into this catalog than you've ever seen before. Sheets, rods, tubes, casting, draping, molding plastics, supplies, findings, etc. We make our own Carving Dyes. "Gem-Coat" Fiberglass and Polyester coating. For fast, courteous, personalized service. TRY US. CATALOG 10c,—or Airmailed for 25c in U.S.

GEM-O-LITE PLASTICS CO.

5350B Riverton Ave., North Hollywood, Calif.

LAW FREE BOOK



Your FREE copy of "The Law-Trained Man" shows how to gain prestige and greater earnings through Blackstone home law study. All instruction material furnished including 17-volume Law Library written by 65 well-known law authorities. Lawyers, judges among our graduates. LL.B. degree. Low cost; easy terms. Write today.

BLACKSTONE COLLEGE OF LAW 225 N. Michigan Ave.
Dept. 51, Chicago 1, Ill.
A Correspondence Institution Founded in 1890

Buy Direct
Save HALF Slight
Factory Imperfect
Dress PANTS

Genuine GABARDINE - Values Up To \$12.95

Save half what you'd pay elsewhere! Order 2 pairs — save still more — get \$2.50 belt FREE! Imperfections very slight, do not affect wear. 2-way, 2-ply rayon gabardine. For dress, school, play, work. Firm hard finish. Holds crease. Retains neat press. Shine resistant. Zipper front. Blue, Tan, Gray, Light Brown, Dark Brown, Blue-Gray, Green. WAIST: 28 to 42 pleated; 28 to 50 plain.

\$5.95 PR.



SEND NO MONEY Send name, waist size, 1st, 2nd and 3rd color choice. State if 1 or 2 pairs (belt free with 2 pairs.) Pay postman price plus small postage. Or send money and save postage. Money Back Guarantee.

2 PAIRS \$11.75

FREE \$2.50 Belt

LINCOLN TAILORS Dept. PM-1, Lincoln, Nebr.

LEARN MEAT CUTTING AT NATIONAL

Pay After Graduation

NOW—train in JUST 8 WEEKS at famous National School for a big-pay job with a SECURE future in the dependable trade of Meat Cutting, Meat Merchandising and Self Service Meats.

Be an expert Meat Cutter, Market Manager, Supervisor and make an expert's pay. Get a profitable market OF YOUR OWN. Unlimited opportunities in this vital, nationwide field.

You learn easily, quickly the National Way. You have your own tools and meat to work with. Expert instructors show you how. You get actual, practical experience right here in our big, modern school where we have been training top meat men for nearly 30 years.

Cutting, percentage, pricing, advertising, selling, buying, A COMPLETE RETAIL MEAT EDUCATION. Diploma. FREE employment help. Thousands of successful graduates.



everything to gain. Paste coupon on postcard or mail in envelope TODAY.

TRAIN NOW — PAY LATER

Get your training NOW. Pay tuition in easy installments after you graduate. We'll get you a job, if you need it, to PAY ALL YOUR EXPENSES while at school.

If you want to BE A SUCCESS—have a secure future—send coupon AT ONCE for our big 52-page school catalog showing students in training and telling about our LEARN BY DOING method. Read letters from graduates. GET ALL THE FACTS. No obligation. You have

National School of Meat Cutting, Inc., Dept. 50-A, Toledo 4, Ohio

Send me your FREE school catalog on National Training at Toledo in Meat Cutting, Meat Merchandising and Self Service Meats. No obligation. No salesman will call.

Name _____
 Address _____
 City _____ State _____

EXAMINE FIRST... FREE! FASCINATING NEW PROFIT PLAN

I'LL SEND YOU EVERYTHING TO EXAMINE IN YOUR OWN HOME, LOOK IT OVER — THEN DECIDE!

SHOES

Tired of monotonous — low-pay jobs — of working for the other fellow? Tap rich profits in huge NEW field. Have your own lifetime business—make REAL money—say goodbye

forever to time clocks—bosses! Become part of tremendous expanding industry—have your own business, spare or full time. No big investment, no long leases, operate at home.



PAINT WITH SUEDE! COVERS ANY SURFACE



PROFIT UP TO \$500 PER HOUR

LEARN IN A FEW DAYS THROUGH PROVED, TESTED METHODS

to start making more money with this amazing MIRACLE finish—gives a velvety, luxurious surface to radios, lamps, toys, signs, store displays, figurines, auto dashboards — hundreds of items. FREE PROFIT PLAN offers everything you need to start learning at once. Mail coupon today. Do it NOW! Be first in your area!

USE COUPON FOR FREE SAMPLE-PROFIT PLAN

COAST INDUSTRIES Dept. 21
 1004 S. Los Angeles St., Los Angeles 15, Calif.
 Gentlemen: Please rush me your FREE Profit Plan.

NAME _____
 STREET _____
 CITY _____ STATE _____

FLOK KRAFT
 SEND NO MONEY Get Facts FREE!

BIG DEMAND FOR NEW MIRACLE FINISH

We show you every step... Fill huge year-round-demand... easy to understand instructions tell you how. Earn up to \$5 an hour spare—full time. A few cents' worth of materials — brings you dollars! Here is the opportunity you have been waiting for!

GRASP THIS OPPORTUNITY TODAY. It's too good to miss... Fill out coupon, mail today. Get FREE sample. FREE plan, big IDEA booklet. No salesman will call! Do it NOW... be first in your community to cash in on this huge new market!

COAST INDUSTRIES Dept. 21 1004 S. Los Angeles St., Los Angeles 15, Calif.

LEARN THE VITAL ELECTRIC EQUIPMENT

and APPLIANCE SERVICE and REPAIR BUSINESS

I made \$800 in three months while still taking your course.
 F. V., New York

I made \$14 per day while still learning.
 T. E. H.
 West Virginia

BIG MONEY—INDEPENDENCE

Here is the ideal business for the man who is happiest when working with tools. Wide open opportunities in every city, town, village. Everyone a customer for the man trained to service and repair electrical equipment and appliances.

NO PREVIOUS EXPERIENCE NEEDED

New visual method of instruction teaches you how to repair electric motors, house wiring, refrigerators, auto ignitions, automatic washers, garbage disposals, fluorescent lights, irons, cleaners, etc. NO PREVIOUS EXPERIENCE NEEDED. Almost before you know it you will have the knowledge to help you make BIG, EASY PROFITS at home in this highly respected and growing field.

Your Own Business—Spare or Full Time

Your own business—your own shop. Complete step-by-step instructions include our book, "HOW TO OPEN YOUR OWN BUSINESS." Costs nothing extra. PTS training more than a home-study course—gives you the "know-how"—all the professional secrets of electrical equipment and appliance repair and service—the operation of your own shop from a business standpoint—what to charge—how to bring your customers to you—everything to start you on the road to success and future security. I'll send you my complete plan that shows you how to learn the electrical equipment and appliance service business. SEND NO MONEY—WRITE TODAY!



FREE! Book that tells you how to learn to repair and service electrical equipment and appliances.

MAIL COUPON NOW

PACIFIC TRAINING SCHOOL, Dept. P-521
 7217 S. Broadway, Los Angeles 3, Calif.

Send me your FREE book that tells me what electrical appliance repair and service can mean to me. Remember I am under no obligation

Name _____
 Address _____
 City _____ Zone _____ State _____

Yours!
 Big Kit Tools
 Does not cost you one cent extra.

AGE NO HANDICAP

Young men, older men, even the man of 69, can find a place in this expanding big-money field. Grasp this opportunity for better things today

A FLUSHING TOILET and SEWAGE DISPOSAL UNIT *Easily Installed*

IN RURAL HOMES, TRAILERS AND SUMMER COTTAGES

This modern McPherson flush-type toilet with its sewage processing feature grinds, liquifies and aerates fully all sewage for quick absorption into the soil thru an inexpensive sub-surface irrigation system. Real expensive plumbing installations are no longer necessary with this entirely new water-driven sewage disposer.



Install in
a few hours.

No Freezing
Drains Dry

No Chemicals
or
Septic Tanks

Write Today
for
Free Catalog



Complete
Only
\$155.00

McPHERSON, Inc.
7450 N. Milwaukee Chicago 31, Ill.

**\$47⁵⁰ LIST
VALUE**

Only

\$17⁸⁸

3-SPEED Record Changer



Popular General Instruments Automatic Changer. Plays 7", 10" and 12" records at 33-1/3, 45 and 78 RPM . . . plays them All automatically from One tone arm and permanent long life needle—simply and easily. All adjustments in front. Capacity is (12) 10" or (10) 12" records at 78 or 33-1/3 RPM or (14) 7" 33-1/3 or 45 RPM records. Build new or modernize old record players and radio-phono combinations at less than 1/2 usual cost. Mounting space required 12 x 12 3/4", 5 1/2" above, 3" below motor plate. Operates on 105-125 V. 60 cycles AC. Shpg. wt. 19 1/2 lbs. No. 34A216. Brand New—Fully Guaranteed. **\$17.88** While They Last, Special Each. Include allowance for postage if shipment by parcel post is desired.

BURSTEIN-APPLEBEE CO.

Dept. P, 1012-14 McGee St.
Kansas City 6, Mo.

I enclose \$.....for.....Changers.
 Send me FREE your 1952 Catalog
No. 521.

Name.....
Address.....
City.....State.....



FREE!
**BIG 1952
RADIO
CATALOG**

CHINCHILLAS

Big Profit

BREED CHINCHILLAS for the fur market. Chinchilla garments sell from \$8,000 to \$35,000! Establish your own "Gold Chip" business. Clean, tame, easy to raise. Easy terms. After a few short years, G. S. H. says, "I have more than my original investment back and also a foundation or herd. They truly have been well worth while" (name on request).

Write experts—Chapman Chinchilla Farms...originators of Chinchilla breeding farms in U.S. Send for instructions and picture catalog today. P. O. Box 221, 4957-D West 104th St., Inglewood, California



CHAPMAN CHINCHILLAS

GET INTO REAL ESTATE *Business*

FREE BOOK TELLS HOW

Start your own business—very little capital needed. Good pay jobs available. Taught by easy method in Home Study Course. G.I. Approved. Can earn up to \$1,000 monthly. PREPARE FOR LIFETIME CAREER AND BIGGER MONEY. Write for Free Book TODAY. No obligation.

WEAVER SCHOOL OF REAL ESTATE, Dept. NC-2
Suite 300 Law Bldg. Kansas City, Missouri

PHOTOGRAPHY



EARN BIG MONEY! PERSONAL ATTENDANCE TRAINING in News-Magazine-Fashion-Portrait-Advertising-Natural Color Photography. Splendid equipment, glamorous models. Or—our COMPLETE HOME STUDY COURSE provides you with a spare time short-cut to success.

Our 42nd year. Write immediately for BIG FREE BOOK!

NEW YORK INSTITUTE OF PHOTOGRAPHY

Dept. 49, 10 West 33 St., New York 1, N. Y.

Learn TATTOOING At Home

Earn extra MONEY—Tattoo blood types and designs in your community. Splendid opportunity in every town. Prepare in spare time. Practical instructions. Send 25c for details and list of Tattoo Supplies. No obligations. ZHS SCHOOL OF TATTOOING • 728 Leslie, Rockford, Ill.



SEND FOR THIS **FREE!**

Make money. Know how to break and train horses. Write today for this book FREE, together with special offer of a course in Animal Breeding. If you are interested in Gaiting and Riding the saddle horse, check here () Do it today—now.

BEERY SCHOOL OF HORSEMANSHIP
Dept. 1101D Pleasant Hill, Ohio

FOAM RUBBER

FOR HOBBYISTS, CRAFTSMEN, EXPERIMENTERS



Lowest Prices—SAVE 50%		AUTOSEAT TOPPER PADS	
16 x 16 x 1 1/2" ..ea.	\$1.35	24" x 60" x 1 1/2" ..ea.	\$6.45
16 x 22 x 1 1/2" ..ea.	1.75	24" x 60" x 2" ..ea.	7.95
18 x 24 x 1 1/2" ..ea.	2.00	24 x 24 x 1 1/2" ..ea.	1.25
24 x 24 x 1 1/2" ..ea.	2.95		

Use for furniture cushion fillers, mattresses, mattress pads, cushions. Foam Rubber is available in any size or thickness. Send For Free Price List. Immediate delivery. No C.O.D.'s. Add 10% for Postage & Handling to Above Prices. Please print.

FOAM-KING RUBBER CO., Dept. MP-12
P.O. Box 2676, 1174 W. Monroe St., Jacksonville, Florida

Get a *Big Beam*

Model No. 211

It's the Best
Anywhere...
Any Time...



For Powerful Brilliant Light

Quality built, sensibly priced,
long lasting. Has 5" polished
chrome lamphead with triple-
plated reflector. Weather-
proof, rustproof.

HOLD DOWN ACCESSORY
for securely fastening lamp in car trunks,
on prows of boats, etc.

See your dealer or write for folder

U-C LITE MFG. CO., 1066 W. Hubbard St., Chicago 22, Ill.

Play *GUITAR* in 7 DAYS

OR GET YOUR MONEY BACK!

Let Ed Sale teach you to play with his famous diagram photo system. Book contains 53 photos, 43 diagrams, showing exactly how to place your fingers. Gives you 110 popular songs, words and music—along with complete, easy to learn instructions. Imagine your joy when you find after 7 days you are playing beautiful music! Amaze your friends! Be the life of the party! **SEND NO MONEY.** Pay Postman \$1.98 Plus Postage. **ED SALE, Dept. PM-1, Point Pleasant, N. J.**

\$5000.00 in PRIZES

DRAW MY HEAD

OPEN TO AMATEUR ARTISTS ONLY!
1st & 2nd Prizes Complete \$130.00 ART COURSES
80 other VALUABLE PRIZES



Take this test and try for a thrilling prize. Discover if you have profitable Art talent. You may gain a lifetime of happiness and high earnings if you mail your drawing today. Amateurs only. Our present students not eligible. Copy this girl 4" to 6" high in pen or pencil, and mail to us. None returned. Winners notified. New \$5000 contest each month. Send your drawing now and include your name, address, age and occupation. Enter today.

WALLER ART EXCHANGE, Studio 55, 1000 N. CHARLES ST. BALTIMORE-1, MD.

Fishermen!



FREE!

Helpful, Colorful 1952 *Shakespeare* Tackle Book and Fishing Calendar

FEATURING —

- NEW! Shakespeare Spinning Reel with 11 revolutionary features!
- NEW! Shakespeare Direct Drive Reels with NYLON GEARS!
- NEW! "Formula 12-0-9 Finish" Fly Lines—toughest, smoothest, longest-wearing ever developed!
- NEW! Fiber Glass Wonderrods—Better 4 Ways—(See Pittsburgh Testing Laboratory Report). Full length rod, just \$7.95.
- NEW! "Spinning" Questions and Answers—by Henry Shakespeare.
- Joe Godfrey's Famous Fishing Calendar—shows best days to fish in 1952!
- Casting lessons, tackle suggestions by 4-time U. S. Pro. Champion, Ben Hardesty.
- "Fitting the Tackle to the Man—or Woman"—by Jason Lucas!

Shakespeare

WONDERRODS • REELS • LINES • BAITS

Dept. PM-1, Kalamazoo 2, Michigan

Amazing Attachment MAKES OLD REFRIGERATORS INTO MODERN Automatic Defrosters!

Thirty Million Prospects. Sell without "selling pressure" on sensational Free Trial Plan. Just plug it in and leave it. Frees women from drudgery and mess of defrosting. Saves electricity. Keeps food longer, better. Gives longer life to refrigerator. Secret "follow-up" Plan often brings five additional sales by making every user your agent. Big season now on!

SENT FREE... JUST SEND NAME!

Don't send a cent—just your name on penny postcard. We'll send you the biggest money-maker you ever got your hands on and guarantee your sales at profits as high as \$5.00 on each sale. Rush your name!

MAXILUME COMPANY, 125 West Hubbard Street, Dept. D-81, Chicago 10, Illinois

Women buying by the thousands!

Salesmen Cleaning up on "Free Trial" Sales Plan Sent Free with Instructions.

Make as high as \$5 on Every Sale!





Make \$5 An Hour
at PROFITKRAFTS

IN YOUR SPARE TIME AT HOME!

"PROFITKRAFT" wholesale catalogs, and "PROFITKRAFT" kits are now available to all who wish to change their spare time into excellent earnings. Many are now making \$5 an hour! Many sell hundreds of dollars worth every month! Talent or experience are not necessary.

Assemble Rhinestones, Moonstones, and simulated Pearls in Rhodium and 24 kt. Hamilton gold plate costume jewelry. Dress lovely dolls in sumptuous chenille. Make unbelievably real wood fibre flower corsages. Make handsome shell-craft items, and many other fascinating things. Sold at excellent profits, these finished items are still bargains, and always sell on sight. Friends, relatives, bazaars, stores, taverns, and clubs, all offer ready markets. Have fun making good money at home!

- RHINESTONE JEWELRY STARTER KIT (Makes 8 pieces) — \$5.95
Contains genuine imported rhinestones and settings
- PEARL JEWELRY STARTER KIT (Makes 8 pieces) — \$3.95
Glossy simulated pearls and finely crafted settings
- MOONSTONE JEWELRY STARTER KIT (Makes 8 pieces) — \$3.95
Large, impressive, glowing stones and polished settings
- "VELVET PRINCESS" CHENILLE DOLL KIT (Makes 3 dolls) — \$3.95
Perfectly featured dolls and sumptuous two-color ensemble
- CHENILLE "BRIDE DOLL" KIT (Makes a truly beautiful doll) \$1.65
Contains doll, beautiful costume, veil and tiny bouquet
- WOOD FIBRE CORSAGE KITS (Contain complete materials)
- Sweet Peas (4 cors.) — \$1.75 Gardenias (2 cors.) — \$1.45
- Apple Bloss (2 cors.) — \$2.00 Roses (8 cors.) — \$3.25
- Rose Buds (2 cors.) — \$1.79 All 5 kits (8 cors.) — \$8.95
- SHELLCRAFT BEGINNER'S KIT (Makes 14 pieces) — \$2.95
- C-15 PROFITKRAFT CATALOG — 10c
- J-16 HOME JEWELER'S WHOLESALE CATALOG — 10c

MINIMUM ORDER is \$2.00 plus 35c pack-post. charge (up to \$3.50 orders.) Above \$3.50 add 10% for pack-post. If not fully satisfied, return unworked items in 5 days for refund

CLEVELAND MODEL & SUPPLY CO.
4508TD12 Lorain Ave., Cleveland 2, Ohio, U.S.A.



INVENTORS

Before you make any effort to market your invention, you should take the first steps toward proceeding for patent protection.

I shall be pleased to furnish you with information relative to patent procedure, upon request from you, and this will be without any obligation on your part.

PATRICK D. BEAVERS

Registered Patent Attorney

934 Columbian Building Washington 1, D. C.

INVENTORS

Send for
PATENT INFORMATION
Book and
INVENTOR'S RECORD
without obligation

REGISTERED PATENT ATTORNEY

Patent Attorney & Advisor
U.S. NAVY DEPT. 1930-'47

GUSTAVE MILLER
12-PM WARNER BUILDING
WASHINGTON 4, D.C.

ASSOCIATE EXAMINER
U.S. PAT. OFF. 1922-1929
PATENT LAWYER

**INVENTIONS DEVELOPED
and manufactured on royalty basis**

Earn royalties quickly. We will help you develop your practical ideas. Our factory has extra capacity for engineering and producing machined and fabricated products. Company and products nationally known. Write stating what you have.
LANTZ MANUFACTURING CO., Inc., Valparaiso, Ind.

INVENTORS

Whether an invention is patentable can be substantially determined by a search of the U. S. Patent records. Without obligation, write for information explaining the steps you should take to secure a patent.

JOHN N. RANDOLPH

Registered Patent Attorney

201 Columbian Building, Washington 1, D. C.

PATENTS
C. A. SNOW & CO.
REGISTERED PATENT ATTORNEYS
WRITE FOR INFORMATION TO
428 SNOW BUILDING, WASHINGTON 1, D. C.

INVENTORS

IF YOU WISH TO PROTECT YOUR INVENTION, You should take steps to protect it by a U. S. Patent. Write me for "INVENTION RECORD" form

CARL MILLER
REGISTERED PATENT ATTORNEY
WOOLWORTH BLDG., 35th FLOOR, 12A
NEW YORK CITY

**STOP THAT
OIL EATER!**



GET NEW CAR PERFORMANCE WITH
PISTON SEAL
WITHOUT COSTLY OVERHAULING

Piston Seal—the amazing compound that forms a self expanding, pliable lubricating seal around pistons that compensates for wear. Eliminates oil burning, restores power and compression. Can be applied in a few minutes.

GOOD FOR 10,000 MILES



SIMPLY REMOVE
SPARK PLUG AND SQUEEZE

FOR COMPLETE, FREE
DETAILS WRITE TO

RICHIE DISTRIBUTING CO. 1628-A COHASSETT AVE.
LAKEWOOD 7, OHIO

**RELIEVES
HEADACHE
NEURALGIA
NEURITIS PAIN**

FAST



Here's Why...

Anacin® is like a doctor's prescription. That is, Anacin contains not one but a combination of medically proved active ingredients. Anacin is specially compounded to give FAST, LONG LASTING relief. Don't wait. Buy Anacin today.

**NEW HAMPSHIRE
MIDGET WATERMELON**

1951 All-America Gold Medal Winner. Delicious flavor, size of a grapefruit for simple refrigerator storage. Deep red, very early, hardy. Makes two good servings. Another of Prof. Yeager's fine products. Packet only 15c.

WILLIAMS' BIG NEW 1952 CATALOG FREE.
OSCAR H. WILL & CO.
Box 245 Bismarck, N. Dakota



ROLL-O-KITE

Thrill to this revolutionary spool-type kite and its amazing spinning action.



\$1.00 POSTPAID

Kit contains durable ready-cut balsa, brightly colored discs, easy-to-follow assembly and flying instructions. Measures 15x6 in.

ROLL-O-KITE, Box 182A, Lemita, Calif.

**DYNAMIC POWER TOOL
COMBINATION**

INCLUDES: Cummins 1/4" Electric Drill; Cummins Saw Attachment; Combination Saw Blade; Set of Drills; Lambs Wool Bonnet; 6 Sanding Disks; Steel Arbor and Attachments; Cloth Buffing Wheels; Grinding Wheel; Wire Wheel Brush; Steel Point Mixer; Steel Bench Stand; Portable Steel Carrying Case.

Price of Dynamic Power Tool Combination complete is \$26.95

**SHIPPED ON APPROVAL
NO MONEY WITH ORDER - NO C. O. D.**

Try it ten days before you buy. If completely satisfied then send \$2.95 and pay balance at rate of \$4.00 per month for 6 months—No Interest or Carrying Charges Added. If not completely satisfied, return to us, no explanation necessary.

KAPNER HARDWARE, INC.

Dept. A-23, 2248 Second Ave., N. Y. 29, N. Y.

**NO MORE
"Bay Window!"**

**Boy! I Feel
GREAT!**

Say, is a bulging belly making you look and feel "all-in" — like an "old timer"? Just put on a "Chevalier" Health-Supporter Belt and presto! that "bay-window" looks smooth and sleek... like a real Beau Brummel figure! You'll say, "Boy, I look and feel great!"

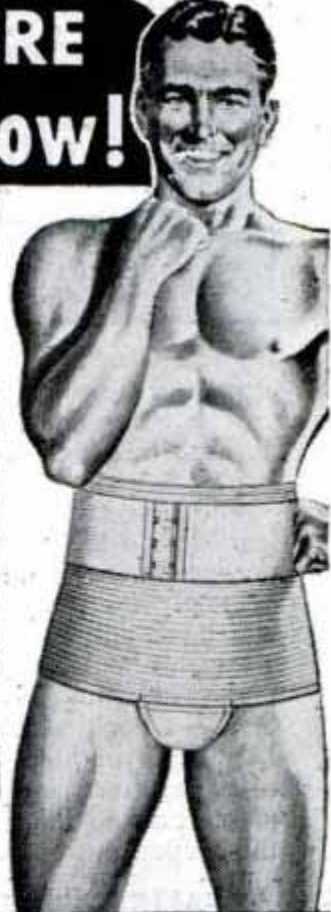

**Look! IT FITS YOU
JUST RIGHT!**

**only \$3.98
POSTPAID**

**The "CHEVALIER"
HEALTH SUPPORTER BELT**

**Amazing "wrap around"
band adjusts to
EXACT SIZE you want!
YOU APPEAR
SLIMMER INSTANTLY!**

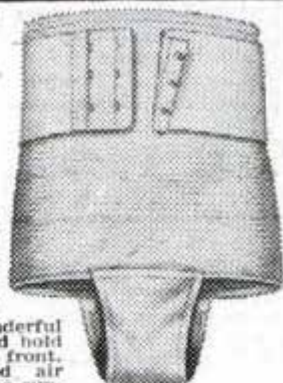

YOU SEE A CHANGE in your appearance the very instant you put on a "Chevalier"! That's because you can adjust it instantly for a perfect fit with perfect comfort—you streamline your abdomen the way you want it, right away! Chevalier is scientifically made of fine quality natural elastic s-t-r-e-t-c-h cloth that will give wonderful support to the small of your back and hold in your dragging belly paunch in the front. Comes with scientifically designed air cooled pouch (detachable) for masculine support and protection.

Wear a "Chevalier" Health-Supporter Belt and see what an amazing difference it makes in the way you look and feel! That's our guarantee. You can try a "Chevalier" on FREE TRIAL at our risk. Only \$3.98—If you keep it! See our absolute no-risk offer below. Mail coupon today!

FREE Extra Pouch. The Chevalier has a removable pouch made of a soft, comfortable fabric that absorbs perspiration. So that you can change it regularly we include an extra pouch. Limited offer. Order yours today.

**SEND NO MONEY
-YOU TRY IT BEFORE YOU BUY IT**

**RONNIE SALES, INC., Dept. 6913-E
487 Broadway, New York 13, N. Y.**

Send me for 10 days' FREE TRIAL a CHEVALIER HEALTH-SUPPORTER BELT. I will pay postman \$3.98 (plus postage) with the understanding that includes my FREE pouch. In 10 days, I will either return CHEVALIER to you and you will return my money, or otherwise my payment will be a full and final purchase price. My waist measure is _____ (Send string the size of your waist if no tape measure is handy)

Name _____

Address _____

City _____ Zone _____ State _____

SAVE up to 60c. We pay postage if you enclose payment now. Same Free Trial and refund privilege.

Enclose payment on Canadian or Foreign _____



**RONNIE
SALES, INC.
Dept. 6913-E
487 Bway.
N.Y. 13, N.Y.**

MORE PAY through HOME STUDY TRAINING in SPARE TIME

Do you want a better position—a larger salary? They are within your reach—now. LaSalle experts will guide you step by step in gaining business training which leads to greater earnings.

The time-saving, interesting LaSalle Problem Method helps you prepare at home, without interference with your present duties.

Simply mark on the coupon the field in which you desire success, and we will mail you a valuable book describing the opportunities in that field—plus "Ten Years' Promotion in One"—a book which has helped many men. Let us tell you how we have started thousands of average men and women on the high road to success and more money. Check and mail the coupon now.

LASALLE EXTENSION UNIVERSITY

A Correspondence Institution

417 S. Dearborn St., Dept. 164-R, Chicago 5, Ill.

Send me full information regarding the course I have marked—without obligation—plus "Ten Years' Promotion in One."

- | | |
|--|---|
| <input type="checkbox"/> Higher Accountancy | <input type="checkbox"/> Salesmanship |
| <input type="checkbox"/> C.P.A. Coaching | <input type="checkbox"/> Traffic Management |
| <input type="checkbox"/> Bookkeeping | <input type="checkbox"/> Foremanship |
| <input type="checkbox"/> Law: LL.B. Degree | <input type="checkbox"/> Industr'l Management |
| <input type="checkbox"/> Business Management | <input type="checkbox"/> Stenotypy
(Machine Shorthand) |

Name.....Age.....

Address.....

City.....Zone.....State.....

SHOP BY MAIL & SAVE ON JEEP PARTS!

MILITARY AND CIVILIAN

JEEP CABS Full or Half Size



Complete protection against winter weather. Sliding safety glass windows in side doors. Constructed of heavy gauge aluminum with sufficient welded stiffeners for maximum rigidity.

World's Largest Stocks of Jeep Parts — Write for Your Special Requirements



CANVAS TOP FOR MILITARY JEEPS

A3216 \$25.00
GPW1152700

Also for Civilian Jeeps — Write for Prices



REBUILT SHORT BLOCK ASSEMBLY

Outright \$148.00

Exchange \$128.00

Civilian or Military

GAS TANKS for Military Jeeps, A6618, GPW9002B... \$25.85

RADIATORS—A1214, GPW8005... \$29.70

HEAVY DUTY SKID CHAINS, pair... \$ 8.50

VALVE REGRINDING GASKET SETS—A1537, GPW18387... \$ 7.50

BELL CRANK—A8249, GPW3131... \$ 5.50

SEALED BEAM MILITARY UNITS

A1033 - GPW13007

\$1.75

SEAT CUSHIONS

A2986 — GPW1162900

\$2.75

Thousands of other parts and accessories available (Both Civilian and Military). SHOP BY MAIL—Order direct from this ad today

BERG TRUCK & PARTS CO., INC.

1603 So. Wabash Avenue, Dept. P-12, Chicago 16, Ill.

Develop Hidden Earning Power

STUDY LAW

at home! LL.B. Degree

Qualify yourself in spare time for advancement, greater earnings, business success. Now, more than ever, legal ability is in demand! Easy-to-understand step-by-step lessons and text material furnished — invaluable for permanent reference. 43 years expert teaching. 114,000 students enrolled. Easy payments. Find out now, at no cost, how study of law can help you. Write today for FREE Book "Law and Executive Guidance."

AMERICAN EXTENSION SCHOOL OF LAW

Dept. PM-46, 646 N. Michigan Ave, Chicago, Ill.

BECOME AN EXPERT IN ELECTRICAL CONTROL

Earn up to \$700/mo. Only basic knowledge of electricity needed. Home course.

ELECTRICAL INSTRUCTIONS, DEPT. PM-1
AUDUBON STA., BATON ROUGE, LA.



FIGURINE HOBBYIST

A complete line of figurine paints, glazes, brushes, powders, figurines - plaques - lamps - as new items are added you automatically will receive catalogue sheets at no extra cost to you. Send us your name and address for our original catalogue along with ONE DIME to cover cost of mailing.

CIMAROLI SALES Box 277 PM Sparta, Wisc.



FREE TO RUPTURE SUFFERERS

Penny post-card brings free information on newly invented three-contact, painless pad that holds hernia at upper break thru, center and point of swelling. Safe! Comfortable! Write Dept. PMA

ACTIVE MAN APP., 549 W. Randolph, Chicago 6

FRONTIER CHUCK WAGON

Complete model kit of wood. Plastic wheels. 1/8" scale. 12" long. Easily assembled for pleasure or to sell. Dandy for home or business display. \$1.65 Prepaid.

Other 1/8" scale kits are: Stage coach \$1.60; top buggy \$1.35; covered wagon \$1.60; buckboard \$1.10; ranch wagon \$1.25; beer wagon \$1.60; surrey \$1.85; Hansom cab \$1.60. Attractive horse and harness kit to go with above models \$1.60 each. Order today. Illustrated folders 10c.



TONTZ COUNTRY STORE DEPT. M-1, ELSINORE, CALIF.

SAY YOU SAW IT IN POPULAR MECHANICS

Amazing NEW REST-RITE

Head Rest for Motorists makes Auto Travel Easy



- Converts any front seat into easy chair comfort
- Adjusts to fit anyone. Will last a lifetime
- Instantly installed. Complete instructions incl.
- Ideal for tourists, salesmen, doctors, hunters, invalids
- Polio victims, disabled vets, outdoor movie viewing
- Chrome plated tube steel, upholstered in neutral shades

See Your Dealer or Order Direct

ONLY \$25.00 F.O.B.

PENN PRODUCTS, INC. BOX 453 BOTHELL, WASH.

Sore Tired Feet?



for Soothing, Cooling
RELIEF

Bactine

BRAND Reg. U.S. Pat. Off.



● You'll get quick, refreshing relief for tired aching feet with a foot bath of BACTINE.

FOR ATHLETE'S FOOT—full strength BACTINE is gentle to skin and will kill fungus germs that cause over 90% of all Athlete's Foot. BACTINE brings fast relief! Checks itching—doesn't stain—smells fresh and clean!

This new antiseptic cleanser deodorizes and helps relieve painful itching.

AT ALL DRUG STORES — 30c and 70c SIZES

New Car?



No, New Shocks

Don't buy a new car just to get a new car ride. Save your money and get new shock absorbers instead. It's thriftier and easier than you think to replace old, rough riding shock absorbers with new smooth riding MONROE Hydraulics.

Send 10¢ FOR INSTRUCTIONS ON HOW TO INSTALL SHOCK ABSORBERS

One thin dime brings you our A B C Manual and other valuable information on shock absorber installation and service... tells which shocks fit your car, takes you step by step over everything you need to know.

MONROE SHOCK ABSORBERS are Standard Equipment on more makes of new cars than any other brand.



MONROE AUTO EQUIPMENT CO., Dept. A MONROE, MICH.

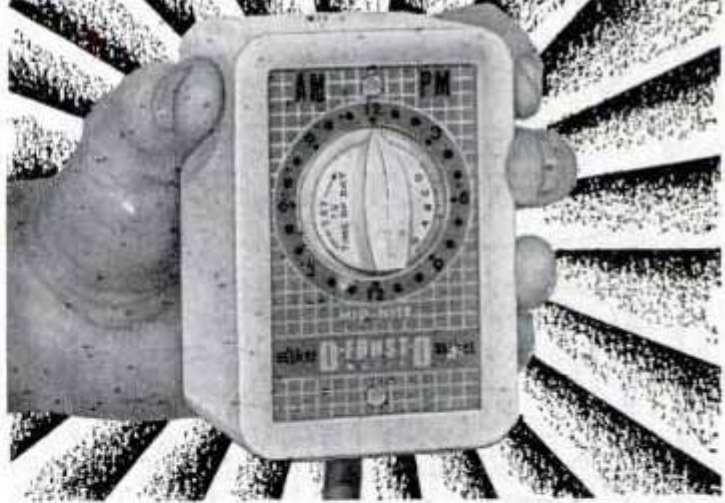

AMAZING INVENTION EXCITES MILLIONS!

Owners of electric refrigerators are excited about an amazing invention that automatically defrosts these "ice boxes" every night, without mess, work, or attention.

The tremendous demand for this Patented invention, the D-Frost-O-Matic, is creating big-money-making opportunities for men and women. They use a FREE TRIAL plan that assures sales in three out of five homes.

They earn up to \$210.00 a week just spending a few hours a day plugging in units on a Free Trial basis.

FIRST VERNIER GEAR USED IN A TIME CONTROL

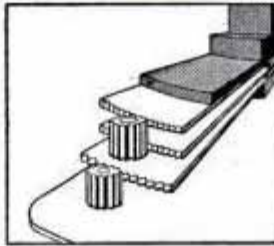

Never before has a Vernier gear been used in an automatic control of this type. The unit is greatly simplified, and gives trouble-free service for years. Designed by Carl Brocken, member of the Society of Industrial Designers.

Independent Laboratory Test Makes Selling Easy

Tests by the famous U. S. Testing Company, Inc.* proved the D-Frost-O-Matic saves 20% of electricity, saves excess wear on refrigerators, and keeps food fresh and appetizing for longer. The Free Trial plan is making up to \$21.00 an evening for men and women who sell in spare time, with far larger sums for full time.



If you would like to make a great deal of money mail the coupon below right now, for the D-Frost-O-Matic FREE TRIAL plan.

SEND COUPON NOW!

Mr. Sidney Lewis
D-Frost-O-Matic Corp.
173 W. Madison St., Dept. D-6
Chicago 2, Ill.

Please RUSH your GUARANTEED PROFIT and FREE TRIAL plans, with the U. S. Testing Company's report on the new Patented D-Frost-O-Matic.

Name _____

Address _____

Town _____ State _____

*Test No. E-2059

WE'RE SAVING FUEL,
YET KEEPING WARM,
'CAUSE **INNER-SEAL**
KEEPS OUT THE STORM!



SEAL UP LEAKY DOORS AND WINDOWS

WITH
INNER-SEAL
WEATHERSTRIPPING

STAYS LIVELIER LONGER . . . SAVES MORE FUEL



RESISTS WEAR . . . water-proof neoprene coating preserves it.

TOUGH AND SPRINGY . . . live sponge rubber bead.

FLEXIBLE, INSTALLS EASY . . . woven spring-wire attaching strip, fits corners easily, accurately.

WHAT'S THE "JUMP TEST"?

Ask at your hardware or building supply store.

PAGE

GARDEN TRACTOR

New 1952 line walking and riding models, 2 to 6HP, all gear drive with reverse. No belts or chains. All running parts in oil, no slippage or wear. 26 years of experience behind every Page tractor.

WRITE FOR
FREE CATALOG



New!

One-wheel
"Bantam"

PAGE
FARM EQUIPMENT

1904 S. 81st, Milwaukee, Wis.

Shoot your own
TALKING PICTURES!

...with the New "Cine-Voice"
16mm Sound-On-Film Camera.
\$695⁰⁰, money-back guarantee.



Write for free illustrated folder.

BERNDT-BACH, Inc. 7333 Beverly Blvd., Los Angeles 36, Calif.

16mm SOUND-ON-FILM EQUIPMENT SINCE 1931

REAL LEATHER NAVY HELMET

NO HOOKS, TUBES OR HOLES

Brand new NAVY helmet of rich Cordovan Brown leather lined with soft warm fleece. Detachable chin strap. Ideal for flyers, cyclists, farmers, hunters. Children love them! Cost Gov't. \$10.00. Small, medium, large sizes. Send cash, chk. 25% dep. plus postage on COD. Money back \$2.00 PPD. guarantee.

GRAND-HAWTHORNE SURPLUS

Dept. PM1-52
1439 S. E. GRAND - PORTLAND, OREGON



**World's
Fastest
Boats!**



Build your own high speed racing boat from a Champion plan! Send 25c for catalogue containing pictures and description of 18 models. Hydroplanes, Utilities and 3 Points. 6 to 20 ft. lengths. **CHAMPION BOATS**, 1524 W. 15th St., Long Beach 13, Calif. Dept. 15 M.

Tune in the
AUTO-LITE
Show

"Suspense!"

CBS Radio Mondays
CBS Television Tuesdays



**WARN HUB CAP MAKES
2 JEEPS OUT OF 1**

\$20.00

Prepaid
U.S., Canada

Ends front wheel drag on 4-wheel drive Willys Station Wagons, Pick-ups and Jeeps

Saves gas up to 5 miles per gallon, tire wear, front axles, increases speed and power. Stops shimmy—front wheels coast out of gear! 4-wheel drive handles, performs, climbs like 2-wheel. Install or remove WARN HUB CAPS in 10 minutes. Polished aluminum, guaranteed. Rush check, M.O., or C.O.D. Write for circular.

WARN MFG. CO. - 1625 Third Ave., Seattle 1, Wash.

**Paint 'Em
Yourself!**



Start your military miniature collection now with this 8-soldier kit. Includes one authentic hand-painted Grenadier as a guide, plus paints and brush.

\$3.75 postpaid

(Double Set: \$6.50 ppd.)

Illustrated Catalog Sent With First Order
No C.O.D.'s please

Military Miniatures

America's Foremost Miniature Figure Shop
Dept. M12 1384 Lexington Ave. New York 28, N. Y.

EAT ANYTHING WITH FALSE TEETH!

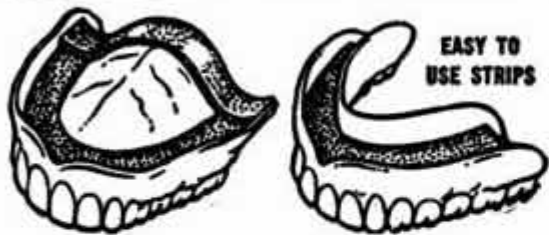

● If you have trouble with plates that slip and rock and cause sore gums—try Brimms Plasti-Liner. One application makes plates fit snugly without powder or paste, because Brimms Plasti-Liner hardens permanently to your plate. It relines and refits loose plates in a way no powder or paste can do. Even on old rubber plates you get good results six months to a year or longer. **YOU CAN EAT ANYTHING!** Simply lay soft strip of Plasti-Liner on troublesome upper or lower. Bite and it molds perfectly. *Easy to use, tasteless, odorless, harmless to you and your plates.* Removable as directed. Money back if not completely satisfied. *Ask your druggist!*

BRIMMS PLASTI-LINER THE PERMANENT DENTURE RELINER

NEW SEED CATALOG



Free

Write today for Will's big New 69th Anniversary 1952 CATALOG. 80 pages packed with the finest hardy northern grown flowers, vegetables, fruits, berries, trees, evergreens, farm seed and Pioneer Hybrid Corn. Early, hardy varieties. Special low mail order prices for early orders. Send card or letter today for **FREE COPY.**

OSCAR H. WILL & CO.

BOX 246 BISMARCK, N. DAKOTA

AUTO MECHANICS

EARN TOP PAY LEARN AT HOME

Look Magazine says Auto Mechanics is America's No. 1 trade! Earn to \$125 a week—and more. Easy to learn at home with C.T.I. Shop-Proved lessons. Low terms. Free job placement. Write for valuable booklet today!

COMMERCIAL TRADES INSTITUTE
1400 Greenleaf Ave., Dept. A2-1 Chicago 26, Ill.



MEN - WOMEN, LEARN

Skill-Weaving

MAKE GOOD MONEY AT HOME

SECRETS OF FRENCH INVISIBLE REWEAVING

Now, learn invisible reweaving at home. Repair burns, tears and moth holes in suits, dresses, coats, etc., like new, at big profit. No previous experience needed. Big profit orders come from Homes, Cleaners, Dept. Stores—also mail orders. Up to \$5 an hour possible, spare or full time without overhead or expense for materials. Complete Skill-weave Instructions yours to examine at home, without risk, **FREE** details—write **NOW**. Airmail reaches us overnight.

SKIL-WEAVE, 1715-PK Westwood, Los Angeles 24, California.

NOW — Get this expert **SELF-TRAINING** —

ENJOY BIG PAY AS MACHINIST

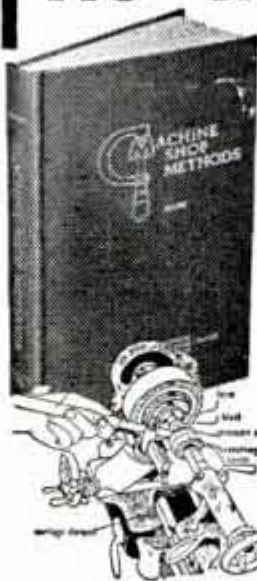

FREE 10-DAY TRIAL

For big-pay job as machinist, get this sure-fire working knowledge **NOW**. *American industry demands thousands more machinists for today's huge production output.* Opportunities in every town for men who are handy with tools, like to work with machines, and able to figure. Get expert "know how" from 376-page reference book and reading course, "MACHINE SHOP METHODS."

Tells you, step-by-step, how each tool is used and how to do machine shop work efficiently. **432 SPECIAL DRAWINGS** show clear details every tool, every operation. Easy-to-read text explains each machining problem in clear, simple language. Examine **FREE** for ten days — you take no risk. Just mail coupon.

Every Basic Machine Shop Operation Explained

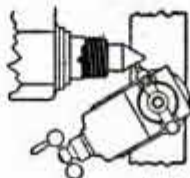

You get full information on how to operate lathe, shaper, planer, miller, drill press, tool grinder. How to use accessories such as chucks, adapters, boring bars, threading gage, twist drills, calipers, lubricants, coolants, etc. How to work from drawings and specifications. How to use gage blocks, sine bar, center gages, calipers, verniers, micrometers, etc.



You get expert guidance on details of turning work between centers; work supported by headstock; outside machining such as taper turning, knurling; and parting; inside machining such as drilling, reaming, boring, counterboring, countersinking, slotting, broaching, and tapping. Also explains threads and thread cutting, gears and gear cutting, how to achieve accuracy in machining, how to assemble machine parts, how to process and finish metals.

NO PREVIOUS KNOWLEDGE OF SHOP TECHNIQUES REQUIRED. This remarkable volume takes you step-by-step from elementary beginnings to shop practices through every detail you need to know to work each type of machine and perform each machining operation properly.

EXAMINE BOOK 10 DAYS FREE. Send no money. Just mail coupon to get "MACHINE SHOP METHODS" for **FREE** ten-day trial.

MAIL THIS COUPON NOW

PRENTICE-HALL, Inc., Dept. M-PM-152
70 Fifth Avenue, New York 11, N. Y.

Send me, for **10 DAYS' FREE TRIAL**, a copy of "MACHINE SHOP METHODS." I will return it in ten days and pay nothing—or keep it and send only \$1.00 down (plus postage) and \$2 monthly for 2 months.

Name _____

Address _____

City _____ Zone _____ State _____

SAVE! Send \$5 WITH THIS COUPON, and we will pay postage and packing. Same return privilege. Money-back guarantee.

Say You Saw It in POPULAR MECHANICS

When You **• You Can Earn More in •**
WATCHMAKING
LEARN By KCSW's Outstanding Method

High-paying jobs now open. Pleasant work. Or build a business for yourself right in your own home, repairing clocks and watches.

Inquire today about the opportunities in this high-paying trade, through the latest **HOME STUDY TRAINING**. Also Resident School.

KANSAS CITY SCHOOL OF WATCHMAKING
1218 Admiral Blvd. Kansas City 6, Missouri

PICTURE BOOKLET  SENT FREE

CONVAIR

in Sunny San Diego
has a **JOB** for you:

OPPORTUNITIES NOW OPEN:



1. TOOL DESIGNERS
2. TOOL PLANNERS
3. PATTERN MAKERS
4. TOOL & DIE MAKERS
5. JIG & FIXTURE BUILDERS
6. MACHINISTS
7. LOFTSMEN

San Diego offers you California living at its best — and Convaair gives you the top working conditions. Employee Retirement Plan. Group Insurance. Two weeks vacation. Eight holidays annually. Free Housing Office and much more — plus that wonderful San Diego climate.

Send this coupon now for booklet, details and Application Blank.

Employment Office
Consolidated Vultee Aircraft Corporation
3302 Pacific Hiway San Diego, California Dept. 700

NAME _____
OCCUPATION _____
ADDRESS _____
CITY _____ STATE _____

LEATHERCRAFT
TEXTILE PAINTING
COPPER TOOLING

PAY-OFF 

Yes, these crafts "pay off" in pleasure and profit. You can do it! Everything you need in Kit Kraft's big illustrated catalog. Send 10¢ (credited to first order) for catalog today!

KIT KRAFT 7377 Melrose Ave., Dept. 27
Hollywood 46, California

HELPFUL BOOKS

Send post card asking for **FREE** catalog

Popular Mechanics Press, 200 E. Ontario, Dept. 601, Chicago 11

HOME "MECHANICS" Keep household gadgets, garden tools lubricated, polished, rust free with

Ever-Ready OIL



15¢

YOU CAN BUILD A VIOLIN FOR PLEASURE OR PROFIT



Now you can build a rich toned mellow violin modeled after a famous "Strad." YOU CAN MAKE A STRADIVARIUS VIOLIN contains 8 full scale plans plus complete instructions. You work directly from the plans with no confusing scale of dimensions to translate. Detailed instructions for each step including varnishing and stringing—even shows how to build your own tools. Cloth bound. Order today from

POPULAR MECHANICS PRESS . . . \$3.50
200 EAST ONTARIO STREET, CHICAGO 11, ILLINOIS



"IDEAL" EXPOSURE METER

Accurate photo-electric light meter, for perfectly exposed pictures. Reads directly in "f" stops, — no calculating. Simple, quick, easiest to use. For all movie and still cameras, regular or color film.

THREE YEAR GUARANTEE **\$9.95** incl. tax



"IDEAL" RANGEFINDER

Precision optical instrument shows exact distance for perfect focusing and clear, needle-sharp pictures. Just look through finder and turn knob until double images come together. Specify metric or feet scale.

THREE YEAR GUARANTEE **\$2.95** incl. tax

AT YOUR DEALER
OR SEND CHECK OR MONEY-ORDER DIRECT. WE PAY POSTAGE.

FEDERAL INSTRUMENT CORP.
DEPT. PM-1 14-02 BROADWAY
LONG ISLAND CITY 6, N. Y.



HAVE A BIGGER — MORE EFFICIENT HOME WORKSHOP

Popular Mechanics' **PLANNING YOUR HOME WORKSHOP** shows you how to make use of every inch of space in your workshop; detailed floor plans, wiring layouts and power tool hookups plus actual photographs of famous home workshops you can use as models. Save money by building your own shop furniture. Special Where-to-Buy-It Guide. 450 Illustrations. Cloth Bound. Working Diagrams. Order your copy today from **\$2.50**

POPULAR MECHANICS PRESS
200 E. Ontario Street Chicago 11

HAUCK FLAME GUN KILLS WEEDS



KILL WEEDS, crab grass, Canada thistle — stalks, seeds and roots. Destroy brush, caterpillar nests, diseased trees, grasshoppers, chinch bugs, etc. Clear irrigation ditches, split rocks, burn tree stumps. Sterilize poultry houses, kennels, barns. Use as portable home forge. Melt ice, thaw pipes. Safe, inexpensive. Burns only 8% kerosene, 94% air! Thousands satisfied users. 7 models. Write for **FREE CATALOG**.

HAUCK MFG. CO., 75 Tenth St., Brooklyn 15, N. Y.

FREE CATALOG

Over 300 books on Fishing, Hunting, Home Repairs and Improvements, Bricklaying, Welding, Home Workshop, Power Tools, Hobbies, Crafts, Home Building, Trades, Making Money at Home, Furniture Making, Woodworking, Carving, Photography, Art, Drawing, Mechanics, Engineering, Refrigeration, Plumbing, Radio-TV, Electricity, Automobiles, Farming, Livestock, Gardening, Decorating, Painting, many, many more. Send for yours today.

POPULAR MECHANICS PRESS, 200 E. Ontario St., Chicago 11

Learn BAKING At Home



Baking is one of America's high industries in wages. Nearly depression-proof. Thorough basic home course lays sound foundation. If you have aptitude, write for **FREE BOOKLET**, "Opportunities in Commercial Baking."

NATIONAL BAKING SCHOOL
835 Diversey Pkwy. Dept. 1351 Chicago 14, Ill.



350 WEEK GROSS
IN MY OWN BUSINESS
 Some Make More, Some Less...
 Start This Business for **YOUR OWN**

VON SCHRADER MFG. CO.
 1130 "D" PL, Racine, Wisconsin

Send at once (no obligation) your FREE booklet containing information about your Electric Upholstery Cleaner and how I can own my own permanent, profitable business.

Name _____
 Address _____
 City _____ Zone _____ State _____

George Held earned \$350 in one week with
ELECTRIC UPHOLSTERY CLEANER

• Here's YOUR chance to start a money-making, year-'round business of your own and make the success you've dreamed about. R. O. Donnelly took in \$40 in seven hours. O. W. Ware landed a \$750 hotel job and made a fine profit. J. S. Corbit grossed \$279.50 his first month. P. D. Ash cleaned 23 auto seats at \$5 each in one week. And so it goes. Homes, hotels, offices, clubs, all places where furniture is used, offer you big profit possibilities. Auto seats and interiors, also.

NO SHOP OR OFFICE NECESSARY
 You clean furniture on customers' premises. No hauling costs. No high rents. Supplies are in-

expensive and you operate, at low cost, from your home. What you take in is mostly profit. Surely YOU will want to investigate an opportunity like that — right away. Own your own business. Be your own boss. If you are ambitious, honest and courteous, we will help you to start and succeed.

FULL INFORMATION FREE MAIL COUPON TODAY

Send the coupon or write for Furniture Cleaner Booklet. It tells all about this electric cleaner—how to start YOUR business—how to make a profitable success. Don't delay. It's your BIG opportunity.



MAIL COUPON TO VON SCHRADER MFG. CO., 1130 "D" PL, RACINE, WIS.

GET THIS "How to do it" BOOK FREE!



- PARTIAL LIST OF CONTENTS**
- "Better Painting"
 - "Refinishing Antiques"
 - "A Superb Furniture Polish"
 - "Protecting Tools"
 - "Waterproofing"
 - "Finishing Gun Stocks"

Here are 101 useful ways to use America's finest 100% pure linseed oil. Perfect for painting and the handiest item for every housewife, homeowner and farmer. Available at all stores.

EARN \$2.00 EASY
 We will pay \$2.00 for each new practical idea for using Pol-mer-ik Linseed Oil, which is acceptable to our research laboratory. Write Archer Daniels Midland, 603 Roanoke Bldg., Minneapolis, Minnesota.



ARCHER Pol-mer-ik 100% PURE LINSEED OIL



ADDRESS IT QUICK

\$10.95
 Complete with Supplies

SAVE TIME—MONEY—EFFORT

• Address anything mailable—tags, labels, envelopes of any size—with a swift, one-hand motion. Does one hour's work in 12 minutes at amazing low cost of 6c per 1,000 names! No messy inks, plates, ribbons! Money back if not satisfied. By HEYER, creators of fine duplicating equipment since 1903.

See your Office Supply Dealer or use coupon.

THE HEYER CORPORATION, 1856 S. Kostner Ave., Chicago 23

- Send literature and name of nearest dealer.
- Ship 1 Model 100 ADDRESSER postpaid at \$10.95.
- Check or Money Order enclosed. Send C. O. D.

Name _____
 Address _____
 City _____ State _____

PRICES HIGHER IN CANADA - CONTACT BROWN BROS., LTD., TORONTO

pictorial room and suggested furnishing layout. To right of dotted line is BASIC HOUSE. Expansion to the left. Designed for easy building in two convenient steps.



Basic house includes living room, dining area, two bedrooms, kitchen, bath, utility room and car port. Can be built for about \$5000.

More than 100,000 families have built their own homes in the past few years, doing all of the work, or most of it themselves. Right now, one of every five homes being built is at least partially owner-built. This proves that you too, if you can use hammer and saw, can build your own home and save more than one-half of the cost.



Build the Basic House First



Add When You Need More Room

When expanding you add garage and breezeway, and car port becomes third bedroom. About \$2500.

Get this Newest Popular Mechanics "Build-It-Yourself" Book and Building Plans and Save Many Thousands of Dollars

Book gives complete step by step instruction in simple language. Hundreds of pictures, actual photos and diagrams, showing every phase of construction, guide you from start to finish. Ten working size blueprints give floor plans, elevations, notes on construction, framing, lumber list, specifications, plumbing and wiring diagrams.

part of it. And at the same time, save in labor costs, more than he spends for material.

Order Book and Plans Now

Use the handy coupon below to order your copy of the RANCH-TYPE HOUSE BOOK AND PLANS. Read the book; study the plans and then you will be prepared to go right ahead when you are ready to build. Even if you have the house mainly built by others, you can still enjoy a tremendous savings by using the instructions and blueprints from Popular Mechanics.

Read How and See How — Simplified Instruction

You read "how-to-do-it" in the book. You see how it looks in actual pictures. You follow the plans for dimensions and details. You make use of labor-saving kinks and special methods developed especially for the project.

No Previous Building Experience Required

Any ordinary handy man, using only simple tools, can build this house with little or no assistance and enjoy every

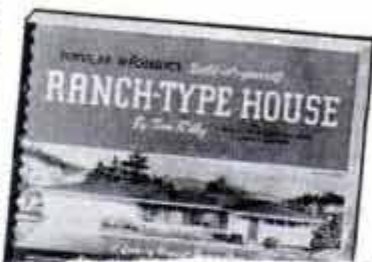

Build this Popular Mechanics RANCH HOUSE Yourself! Save Over One-Half

Beat the High Cost of Home Owning It's Easier Than You Think

Here is a dream home that can become a reality without too much worry about money. Build this beautiful Ranch Type Home yourself. Simply follow the Popular Mechanics RANCH TYPE HOUSE BOOK AND PLANS. You can save \$7,000 to \$10,000 and have one of the most desired homes of these times. You can build it all now—or part of it—and add garage, breezeway and another bedroom later on without affecting the basic house.

Modern Design • Fully Finished • All-Season Build this Home Anywhere and Save

Designed for Popular Mechanics by John F. Whelan, famous West Coast architect and designer of homes and entire villages. It's a year 'round house, 81 feet long and 29 feet wide. Fully insulated. Finished outside and inside with durable plywood and requires no plastering. Brick "island wall" and big fireplace in living room. Heating, unique ventilating system and latest development in electric wiring included. A dream home that can easily come true and a home that can grow with the family.

Reduced size illustrations from book. Building roof truss on floor for easy construction. Mrs. Tom Riley, Portland, Oregon, shingles the roof on her Popular Mechanics Ranch Type House



Use This Handy Order Coupon

POPULAR MECHANICS PRESS, Dept. 70 200 East Ontario St., Chicago 11, Ill.

Send at once my copy of the Ranch-Type House Book and Plans as checked below:

- | | |
|--|--|
| <input type="checkbox"/> Remittance enclosed | <input type="checkbox"/> Send C.O.D. (postage extra) |
| <input type="checkbox"/> Ranch Type House Book | \$ 3.50 |
| <input type="checkbox"/> Set of 10 Blueprints | 13.50 |
| <input type="checkbox"/> Book and Blueprints | 15.00 |
| <input type="checkbox"/> Duplicate Set of Blueprints | 5.00 |

Name _____

Address _____

City _____ Zone _____ State _____

**WORLD'S
BEST
WANT AD
MEDIUM**

CLASSIFIED Advertisements



Advertisements in this section 85 cents per word, each insertion, minimum 10 words, payable in advance.

To be inserted under proper classification, copy must be in our office the
20th of the second month preceding date of issue

F. W. Johnson, Manager, Classified Advertising
Popular Mechanics Magazine, 200 East Ontario Street, Chicago 11, Illinois

YOU'LL PROFIT

By reading and answering the classified
ads in this section. Hundreds of oppor-
tunities for you to make and save money

AUTOMOBILES, MIDGET CARS

LATEST 1952 Edition! Just out — 100 new pages! Get world's largest auto accessory and parts catalog and save money. Over 50,000 items, including Hollywood accessories, hi-speed equipment, rebuilt engines, all parts and accessories for all cars and trucks. We have that hard-to-get part! Jam packed with bargains. Completely illustrated. Send 25c (refundable). J. C. Whitney, 1919 Archer, Chicago 16.

MAKE Ford use diesel fuel. \$1.00 for plans. Refiner, Box 292, Columbus, Nebr.

GENUINE Crosley parts, tires, accessories, rebuilt engines. Walraven Motors, Marion, Ohio. Phone 2-4135.

AUTOMATICALLY Reflects dim to approaching or following cars. Safer driving. \$1.00 postpaid. Collins Dim-Lite, 4329 Lovers Lane, Dallas, Texas.

AUTO Racing photos—Official 1951 Indianapolis and many others. Sample photo and free list 15c. Spot Photos, P.O. Box 66, Culver City 1, Calif.

ATTENTION! Ford owners. Model A, B and T parts. Model A Motors, Unionville, Conn.

NON-Profit organization offers literature—Old, new and foreign automobiles; shop manuals, engineering papers, data books, glossy photos, free motor magazines. Contact auto nuts everywhere. Write today; get name on free mailing list. Auto Maniacs, Stockbridge, Mich.

BIGGEST Speed equipment catalog in world! Save, order direct — Hollywood mufflers \$4.95, dual mufflers \$18.95, headers \$27.50, cut outs \$6.95, dual intake manifolds \$12.95, racing cams \$29, hi-compression heads \$26.95, water injectors \$6.95, customizing kits \$1.98. Chrome accessories at discounts! Catalog plus Hot Rod Handbook—25c. Alquist Engineering, Milford 14P, Penna. Dealers wanted.

SAVE — California custom accessories headquarters. Buy direct from original designers. Chrome dash panels, electric push button door-trunk conversions, fender skirts, dual mufflers, lowering kits, speed-dress up equipment. 40 page catalog, hundreds of photos—25c. Eastern Auto, 3319A South Grand, Los Angeles 7, Calif.

WIGLESWORTH-Chasteen's Automobile History Scrapbook. 160 pages. Old time pictures and advertisements of automobiles from 1899 to 1934. \$1.50. Deluxe binding \$3.50. Wiglesworth-Chasteen, 7134 PM Alhambra, Mission, Kansas.

FROM Speedway to roadway! Track-proved hi-speed heads and manifolds for your passenger car! No special tools needed! Increase horsepower 30%! Astounding getaway! Free illustrated catalog. (Dealers wanted.) Speedsport, 4866-D Milwaukee, Chicago 30.

BUY Racing heads, dual manifolds. Hot coils, etc., without money. Information free. Newhouse Automotive Industries, Los Angeles 22.

WATER Injection. Also economy, power, methods. Free illustrated information. Neher Industries, La Verne, California.

AUTO SUPPLIES AND EQUIPMENT

DRESS Up your car with a personalized auto emblem. 3 initials and frame \$2.49. Made of highly polished cast aluminum. W. J. F. Mfg. Co., 2018 So. Broadway, St. Louis 4, Mo. P.M.

SPEED Equipment. Edelbrock, Offenhauser, Navarro heads, manifolds, Winfield cams, dual ignition points. Chev. 37-51, Ford 49-51. Deetone mufflers, headers, dual muffler sets, Mallory coils, distributors. Speed catalogue 25c. Urzi's Auto Supply, San Jose, California.

REG. \$19.95 Convertible top covers, now! only \$12.95 complete postpaid. C.o.d.'s accepted. Give make, year, model. Carnegie Auto Seat Cover Company, 8838 Carnegie Ave., Cleveland 6, Ohio.

CAR Owners. New book tells how to save money on repair bills — spot overcharging, padding. The spark plug and wheel balancing rackets. Tricks used to hide defects in used cars. How to choose a car by dollar values. Plus numerous other factual articles that can mean a real saving to you. If you don't save money as a result of reading this book, send it back (within 7 days) for immediate refund. \$2.00 postpaid. Jack Bannick, Box 5176-A Southfield Station, Detroit 35.

REMANUFACTURE Your automobile or light truck engine from clutch to water pump, or install one of our factory re-built units, for 50% new engine cost, units run in and performance tuned under own power. New engine specifications guaranteed. Prices and complete information by return mail. Skaggs Brothers, Dept. C, 5425 South Vermont, Los Angeles.

WILLYS Overland new and used auto parts. Phone or write Pap's Motors, 7122 W. Ogden Ave., Stanley 8-2011, Berwyn, Illinois.

NEW Type rubber cement applicator. Auto window weather strips sealed, easily, economically. \$1.00. Peninsular Specialties, 79 West 45, Bayonne, N. J.

MOTORIST Save gasoline by Vacuumating overrich mixtures. Fits all cars. For free particulars write Vacuumatic, Dept. 1830, Wauwatosa, Wis.

WELDING Hose two line 15c foot, fittings extra, \$1.50 set. Air and spray paint hose 10c foot, fittings 50c extra. Heater hose 10c foot. Any length V-belt 1/2" face 50c each. COD. Bate's Rubber, Box 501, Wildwood, New Jersey.

FOR Sale—An automotive necessity sells for 89c. Patents U. S. and Canada. Wonderful for man traveling. Will sell all rights and stock. Donn Mfg. Co., 2150 E. 18 St., Cleveland 15, Ohio.

LIGHT Your Powerglide dial. Free information. Galser, Box 25, Kokomo, Ind.

YES Lachapelle's patented treatment puts bearings on the pistons. \$3.00 postpaid. Ferns Products, 8120-B Walnut Dr., Los Angeles 1, Calif. (Data on request.)

89 WAYS To increase gasoline mileage. \$1. Holloway, Box 225, Bijou, Calif.

"HOW To Soup-Up Your Car" Hot Rod Handbook plus equipment catalog — 25c postpaid. Alquist Engineering, Milford 16P, Pennsylvania.

BE Independent, save money. Grind crankshafts without disassembling engine. New hand operated tool \$3.75. Literature. D. McGee, 719 Cascade, Wenatchee, Wash.

WATER Injector. Build your own economically. Illustrated instructions \$1.00. Box 3066, Glendale 1, California.

FOR Economical operation of cars, trucks, tractors install Octa-Gane Alcohol-Water injector. Write Shade, Webster 1, N. Y.

OFFENHAUSER'S New catalog available. Send 25c. Complete line of speed equipment. Offenhauser Equipment Corp., 5054-p Alhambra Ave., Los Angeles 32, California.

CHEVROLET Owners — Save money; make your Chevy run better, last longer! Get Popular Mechanics big Manual for Chevrolet Owners by Ed Packer today. 304 pages; hundreds of illustrations. Find out how to make your own repairs; keep your Chevy in tip-top shape. First minor adjustment or repair saves you many times cost of book. Send \$3.50 today to Popular Mechanics Press, Dept. CH, 200 E. Ontario, Chicago 11, Ill.

MOTORISTS: Reporting 3 to 5 more miles per gallon. Guaranteed gasoline vaporizer; increases power. Easier starting. \$3.50 each. Turb-O-Vane, 1024 West Vine, Stockton, Calif.

AIR Horns! Bermuda bells, etc. Free catalog. John McCanna, 148 1/2 East 40th, New York 16.

CHEVROLET Owners—Let the Hydraulic Spring in oil adjusting screw stop your tappet noise. Will last the life of your motor. Simple and easy to install. Complete set \$5.95. Kaye Products, P.O. Box 1423-P.M., Milwaukee, Wisconsin.

AUTO Parts and accessories. Briggs Automotive Engineering of Chicago, P.O. B. 3454 Merchandise Mart, Chicago 54, Ill.

HOW To buy speed equipment without money. No selling. Information free. Newhouse Automotive Industries, Los Angeles 22.

LATEST 1952 Edition! Just out — 100 new pages! Get world's largest auto accessory and parts catalog and save money. Over 50,000 items, including Hollywood accessories, hi-speed equipment, rebuilt engines, all parts and accessories for all cars and trucks. We have that hard-to-get part! Jam packed with bargains. Completely illustrated. Send 25c (refundable). J. C. Whitney, 1919 Archer, Chicago 16.

NEW And used guaranteed parts for civilian and army cars and trucks. Largest stock in America. Mail orders. Pioneer Auto Wrecking Co., 734 W. 13th Ave., Denver, Colorado.

NEW Government surplus. Low voltage circuit tester in steel box cost \$202. Our price \$27.50. Will test batteries, starters, generators, voltage regulators, grounds, short circuits. Wilt Electrical Company, 7829 S. Racine Ave., Chicago 20, Ill.

SEND For free life membership card. "Water Burners" of America, La Verne, California.

GET Your colorful copy of the largest, most modern automotive catalog ever presented. Over 1000 items, completely illustrated, priced and indexed. Custom, speed and power equipment. Mail 50c today to Auto Accessories, 127-P W. Washington Blvd., Los Angeles 15, California.

AUTO TRAILERS

TRAILER Axles! Remanufactured from auto front ends. Suitable for utility or house trailers. Complete with usable tires, tubes, brakes, springs and hangers. \$49.50 f.o.b. Hartford. Bob Schafer, 471 Burnside Ave., East Hartford, Conn.

125-M. Wausau, Wisconsin.

PLANS 18' Sportsman trailer, expertly prepared, ideal for craftsmen, \$2.00. Freeland Engineering, 16587 Freeland, Detroit 35, Michigan.

BUILD. Streamlined, telescoping house trailer. No canvas used. Plans \$2.00. Literature and pictures 10c. Thomas Comstock, 820 No. 17th, Parsons, Kansas.

MOTORCYCLES, BICYCLES, MOTORSCOOTERS AND SUPPLIES

WHIZZER Motor \$10; 1946 Servicycle \$15; homemade motorbike \$10; Crosley convertible \$50; Electric Motorette \$55; midget car less motor \$10. Four airplane tires \$3 (mailorder only). Send 25c for new catalogue Number 45, just out listing these and hundreds of other bargains in new and used midget cars, motorscooters, homebuilders parts, plans, engines, transmissions, war surplus, etc. (35c by first class mail). Midget Motors Directory, Athens, Ohio.

AMERICAN, English bicycles, parts. Whizzers, Dynacycle, bicycle motors, parts. Art's Cycle Hobby Shop, 816 E. 75th Street, Chicago 19, Ill.

MOTORCYCLE Pistons, parts, new, used. Harley, Indian, Henderson. List and wings pin 25c. Ballak, 811 N. 9th, St. Louis 1, Missouri.

RECONDITIONED Motorcycles and motors. Chromium accessories. Complete stock Indian parts. Expert rebuilding. Fast service. Indian Motorcycle Sales, Kansas City 1, Mo.

CATERPILLAR Kid-size crawler tractor—Electric motor driven! Rugged full-track pulls loads easily over lawns, fields, pavements. Most sensational child's vehicle made! Catalog free. Mystic River Sales Co., Box 312-P, Mystic, Conn.

HARLEY-Davidsons—All models and prices. Genuine late and old model supplies. Expert service. Send 25c for bulletin. Knuth's, 1753 Muskego, Milwaukee, Wis.

U. S. Govt. surplus "45" Harley Davidson motors, complete with carburetor and generator, in running condition—\$69.50 f.o.b. Chicago. 25% deposit with order. Parts and accessory catalog 25c. Triangle, 2157 Harrison, Chicago.

MOTORCYCLE Magazine—Worldwide coverage. Yearly subscription \$2.00. Sample 20c. Motorcycle News, 5424-A Sawyer, Chicago 25.

REBUILT Gasoline engines \$17.00 to \$37.00. Cauffiel Motor Industries, Temperance, Michigan.

AVIATION

WAR Aviation surplus catalogue sent for stamp. Ort, Thomasville, Penna.

SURPLUS Tires, aircraft, 56", excellent condition, f.o.b., cash, \$19.95. Aero Parts Supply, 8102 Lockheed, Houston, Texas.

PROPELLERS: For snowsleds, boats. Literature. Standard Aerocraft, Box 387, Ft. Worth, Texas.

JET Engine plans \$1.00. Very simple—make own. J. Symonds, 500 N. Tamarind, Fontana, Calif.

FREE 168 Page illustrated catalogue of aviation products. Complete bonded warehouse stocks, write AMC Supply, P.O. Box 1440-M, Fort Worth, Texas.

PROPELLERS, Plans, skis, engines for snow sleds, air boats. Fastest service, lowest prices. Catalog 20c. Banks-Maxwell, Box 3301E, Ft. Worth, Texas.

BATTERIES, GENERATORS

EDISON Non-acid storage batteries. Amazing long life. Any voltage. 37 to 600 ampere hour sizes. Lighting plants, generators, motors. Literature. Hawley Smith Co., Croton Falls 1, N. Y.

ELECTRICAL SUPPLIES

FREE—New catalog. Bargains in welders, motors, generators, surplus equipment. Or, build your own kits—save. LeJay Company, Minneapolis, Minnesota.

DIRECTIONAL Electric signs. Many inscriptions. Free folder. Kelly Specialty, 5958 Washington, Chicago.

WATT HOUR Meters \$5.00. Excellent condition. Miller, 1011 West 16th St., Davenport, Iowa.

more a day making beautiful, fast-selling lamps at home. No equipment needed. Illustrated course teaches you quickly. Course, parts catalog, wholesale price list—only \$2. Gearon Co., Dept. 200-B1, 27 S. Desplaines, Chicago 6, Ill.

ELECTRIC Pencil—Writes, engraves all metals. \$2.95. Reb Industries, 265-DZ, Elmhurst, Illinois.

EARN Big profits rebuilding starters, generators, voltage regulators. Introductory manual \$1. Modern, Box 4704, Kansas City, Mo.

ELECTRICAL Wiring simplified so that you can understand and pass any test. Send \$1.00. Federal, Box 57, Argt, Kansas City 6, Kansas.

LAMP Supplies—Wholesale. Any amounts. Prompt shipment on all parts for repairing and building lamps. Illustrated catalog 15c. Brown Lamp Co., Box 501, Wellston Sta., St. Louis 12, Missouri.

ELECTRIC Pencil: Engraves all metals \$1.50. Beyer Mfg., 10511-H Springfield, Chicago 43.

LAMPS—Had trouble finding repair parts? Your search is ended. 25c brings 64 page illustrated catalog also containing wiring charts. Gyro Lamps, 5402P Clark, Chicago 40.

WELDING, SOLDERING, PLATING

RADIATOR Repairing, cleaning, recoring. How to equip small shop at low cost. Supply sources, trade secrets. Instructions \$3.50 postpaid. Radiator Service, McBain, Mich.

ACETYLENE Welding outfits new \$49; used \$29; arcwelders \$49. Eagle Welding, Dept. PM, 5085 Broadway, Chicago 40, Ill.

A.C. Welders. 4 sizes, lowest prices. Free literature. Holgeron's Service, Canton 1, Kans.

ELECTRO Plating equipment—New and used. Complete assemblies. All sizes for all types of plating. Baby shoe metallizing sets. Mounts, supplies. Free catalog. Hollywood Bronze Supply, Dept. 2, 1624 E. First Street, Los Angeles 33, California.

MACHINERY, TOOLS, SUPPLIES

FLEXIBLE Shaft tool by Fairchild for grinding, polishing, sanding, buffing, carving. Original price \$19.95. While they last! Special price \$12.95. Public Sport Shops, 11 S. 16th Street, Philadelphia 2, Penna.

FREE! Complete catalog of precision tools for any job. Big stocks—famous brands: Lufkin, Starrett, Brown & Sharpe. Immediate delivery. Wide selection. Write for your copy today! Mid-City Hardware & Supply Company, 318 South Halsted Street, Chicago 6, Illinois.

FOLEY Saw filer and retoothing. John Briggs, 2935 Dubuque, Des Moines, Iowa.

WATCHMAKERS' Staking set, 50 punches, 6 stumps, \$39.50. Larger set 100 punches, 20 stumps, \$49.50. Public Sport Shops, 11 S. 16th Street, Philadelphia 2, Penna.

IMPORTED German precision dial indicators .0005" \$12.95. Marko, Box 1448, Oroville, California.

SAVE 90% On power tools. Handbook 25c. Robert Fellows, Caledonia 4, N. Y.

TUBULAR Rivets, washers, tools. Complete kit, page 414. Dealers invited.

BOATS, OUTBOARD MOTORS

BOATING Bargains—Now you can save on boat needs. Our fall and winter value lists just off press. Assemble your own boat from a dinghy to cruiser. Power it with a Masters rebuilt inboard or outboard motor. All three lists 25c. Free boat fitting list. Act now and save dollars. W. L. Masters & Son, Inc., Dept. P, 212 W. Chicago Ave., Chicago 10, Ill.

CURE That leaking boat with Fiberglass-Plastic covering. Ends caulking and painting. Nationally approved process. Easily applied, complete instructions. Industrial Plastics, 3807 Harrison Street, Oakland 11, Calif.

FASTEST Boats in the world—Build now. Complete plans available for sleek three point racing hydroplanes, runabout and others. Send 25c immediately for illustrated catalogue. Champion Boats, P.O. Box 9038, Dept. 22-M, Long Beach 7, Calif.

Outboard Motor Mart, Inc., 309-A Atlantic Avenue, Boston 10, Massachusetts.

MARINE Conversions for Ford and Jeep engines. Catalog 10c. Lehman Manufacturing Company, 972D Broad Street, Newark 2, New Jersey.

SAVE Money, have fun—Build your own boat. Popular Mechanics "23 Boats You Can Build" tells and shows you how. 192 pages, 500 illus., detailed diagrams and material lists. Everything from 10 ft. dinghy to 25 ft. cabin cruiser. Only \$2.00. Order today from Popular Mechanics Press, Dept. PTB, 200 E. Ontario, Chicago 11, Ill.

"P38 Belly tanks," steel, \$9.95. Free picture. Bucks Auto Parts, Box 89, Merced, Calif.

BOAT Patterns, kits. Descriptive literature and 24 page illustrated book on boat construction 40c postpaid. Germain Boat Company, West Saginaw 3, Michigan.

ARE You interested in boats? Write for free copy The Rudder, a magazine on boats and boating. 15 Murray St., New York 7.

FULL Size, cut to shape boat patterns blueprints, 7 1/2-38 feet. Illustrated "Build a Boat" catalog, 25c (coin). "How to Build Boats" book, \$1.00. PolyWog houseboat plans \$10. Marine catalog \$1.00. Marine Specialty Mfg. Co., 3107 Detroit Ave., Cleveland 13, Ohio.

NEW, Used, rebuilt marine motors. Marine conversions, fittings. Free catalog. Stokes Marine Supply, Dept. 24, Coldwater, Michigan.

CONVERT Fords and Jeep to 100% marine engines with Osco's world famous Convo-Kits. Deluxe catalogue 25c (coin). Oscomotors, 3627B Lawrence, Philadelphia 40, Penna.

SAVE 3/4 Cost. Assemble your own boat. We furnish parts. No experience necessary. Rowboats, cruisers. Illustrated catalog 25c. Midwest Boat Company, Menomonee Falls, Wisconsin.

INBOARD Speed boat hulls, \$365 up. Literature 10c. Huebl Boats, LeSueur, Minn.

ENGINES, MOTORS, DYNAMOS

MOTOR Winders, free bulletins. Winding and testing equipment. Motor Industries, Quincy, Illinois.

LATEST 1952 Edition! Just out—100 new pages! Get world's largest auto accessory and parts catalog and save money. Over 50,000 items, including Hollywood accessories, hi-speed equipment, rebuilt engines, all parts and accessories for all cars and trucks. We have that hard-to-get part! Jam packed with bargains. Completely illustrated. Send 25c (refundable). J. C. Whitney, 1919 Archer, Chicago 16.

REBUILT Gasoline engines \$17.00 to \$37.00. Cauffiel Motor Industries, Temperance, Michigan.

WINDING Data, listing 225 motors, single and three phase, \$1.00. Motor Data Co., Box 7631, Kansas City 3, Mo.

ATHLETIC EQUIPMENT, BODY BUILDING COURSES

GREAT Strength easily obtained. Write Joseph Dryer, Box 5527-P, Chicago 80.

100 TRICK Knockouts for self defense. \$1. 1c each. Priest, Box 251, Evanston, Ill.

DEADLY Judo—Fiercest fighting technique. Trick knockouts. (Over 200 illustrated pictures.) Expert instructions; three volumes. Complete \$2.25. Variety House, Box 46-B Wall Station, New York 5.

BARBELLS. Exercise equipment. Courses. Free booklet. Good Barbell Co., Reading, Penna.

GAIN Weight! 4 exercises will increase weight. Complete \$1.00. Body Builders, 36 Nevada Street, Winthrop, Mass.

TRAINING Bags, to develop punch and speed. List 15c (stamps). Andre's Gym, 3466 Mt. Elliott, Detroit 7, Michigan.

SPORTING GOODS, GUNS, FISHING TACKLE, ARCHERY, TRAPPING

"CROW Hunting," complete book and "Toad's" guaranteed multi-tone crow call, \$1.00. Toad Co., Lamar, Missouri.

RAISE Fishworms, easy, profitable. Stamp please. Alton Tozier, Freeport, Florida.

LEARN Gunsmithing! Free information. Gunsmith, 3118 Montrose, Chicago, Illinois. We buy, sell, trade.

120 PROFUSELY Illustrated pages antique pistols, swords, daggers, armor, etc. 50c. Robert Abels, M860 Lexington Ave., New York 21.

ANTIQUA Modern guns. Bargain list 10c. Martin Rywell, Harriman, Tennessee.

SHOTGUNS, Rifles, Revolvers, 500 modern, obsolete. Also cartridges. Each list 10c coin. Ed Howe, 52 Main, Coopers Mills, Maine.

CAST Iron molds—For casting your own sinkers. Free booklet. Reading Instrument Co., Box 78, Reading, Penna.

5000 BARGAINS, Firearms, binoculars, war relics. Catalog 50c. Smith Firearms, Runnemed, N. J.

MOLDS, (For fisherman's sinkers, squids, jigs and lures.) Handled and hinged. Quality fishing tackle. Free catalogue. E. L. Sweet & Son, Tonawanda, New York.

TAXIDERMISTRY

MODERN Taxidermist Magazine, Greenfield Center 2, N. Y. Devoted entirely to taxidermy, photos, articles, methods. Trial year's subscription, \$1.00.

BINOCULARS, TELESCOPES, MICROSCOPES, MAGNIFIERS

AMAZING Prices, imported precision binoculars. Free trial. Pricelist, folder "Selecting Binoculars" free. Prentiss Importers, Mercury Bldg., Los Angeles 25, Calif.

BINOCULARS, Telescopes, microscopes. Our 20th year of leadership in optical values. Bargain catalog free. Brownscope Co., 24 West 45th Street, New York.

ASTRONOMICAL Telescopes, binoculars, microscopes, bought, sold, repaired. Books. Lists 10c. Rasmussen-Reece, Amsterdam, N. Y.

POWERFUL Astronomical telescopes easily made. Perfect lenses and instructions; 100X \$3.00; 100X and 200X \$4.00; 100X, 200X and 400X \$6.00. Full power, clear vision guaranteed. Instructions alone 10c. Suffolk Science Service, Riverhead, N. Y.

MAKE Your 6" telescope reflector. Glass, abrasives, instructions—\$8.50. F. Cameron, Box 85, Inwood, N. Y.

REFLECTOR Telescope kits, refractors. Free illustrated bulletin. Esco Products, 911 Willow Ave., Hoboken, N. J.

GIANT Astronomical telescope with 6 ft. tripod \$15.00, f.o.b. factory. 100 power. (10,000 area magnification). Clear vision, full power guaranteed. Ready for use. Suffolk Science Service, Dept. BT, Riverhead, N. Y.

BINOCULAR Specialists, all makes repaired. Authorized Zeiss, Hensoldt dealer. Tele-Optics, 5514 Lawrence, Chicago 30, Illinois.

SAVE 50% On new binoculars! Free catalog. Free book, "How to Select Binoculars." Write today! Bushnell's, 43-M-31 Green, Pasadena 1, California.

FREE 20-Page binocular catalog. Over 60 different models. United, Dept. A-3508, 9043 S. Western, Chicago 20.

BAUSCH & Lomb's finest all-around binocular. Used slightly. Write Rance's Radio Service, Plain Dealing, La.

ALUMINIZED Telescope mirrors—3" to 12" diameters. Eyepieces, prisms, tubing, parts. Priced right. Postcard brings plans. Lists. Pfeegor Optical Co., PM-1, Sunbury, Penna.

WAR Surplus bargains—Binoculars, telescopes, sextants, millions of lenses, prisms, reticles, eyepieces, objectives, etc. Mail 10c for big "Catalog CH." Send \$1.00 for Stock CH-10-piece lens kit and big instruction booklet. Edmund Scientific Corp., Barrington, N. J.

PETS—DOGS, BIRDS, RABBITS, HAMSTERS, ETC.

FREE Big 1952 poultry and pet catalog. Knoll, P.O. Box 2, Holland, Mich.

SUPERB Golden hamsters. Selected pets and breeders \$1.25 each. Cages, wheels. Mineral Springs Hamstery, Clyde, New York.

RAISE Rabbits. Profitable business. Booklet dime. Tayco Rabbitry, Hapeville, Georgia.

NATURALIST'S Catalog 10c. Chameleon 50c. 200 mealworms \$1.00. Quivira Specialties, Topeka 51; Kansas.

ANGORAS, Giant chinchillas. Finest heavy-producing, prize-winners. Catalog free. P. M. Grinsteeds, Edwardsville, Ill.

HAMSTERS—Golden or spotted. Cages and equipment. Free illustrated details. Lakeview Hamster Colony, Newfield, New Jersey.

MONKEYS Are the bestest pets—Intelligent, easily trained, inexpensive. Send 10c for catalog. Tropical Hobbyland, 1525R N.W. 27th Avenue, Miami, Florida.

RAISE Canary birds. Large profits. Small space needed. Steady sales to pet shops. Send 25c for book of details. William Pruitt & Son, Canary Farms, Manassas, #3, Virginia.

RACCOONS—Minks, bred females. Baby skunks. Catalog, 25c. Shady Fur Farm, Springfield, Minnesota.

BOOKLET "Treatise on Breeding and Raising Canaries"—\$1.00. Audubon Publishing Co., 3449-PM N. Western, Chicago 18, Illinois.

RAISE Mink; Free booklet, pen plans, inside "secrets", feed, care. Mink are money makers. Investigate today. Lawrence Molgard, Brigham City 12, Utah.

SPORTSMEN: 200 Pointers, Setters, straight Cooners, combination hunters, rabbit and fox hounds. Reasonable. List free. Ramsey Creek Kennels, Ramsey, Ill.

MAKE Big money! Raise Chinchilla rabbits. Cash markets supplied. Write today! Rockhill Ranch, Sellersville 15, Penna.

EARN Up to \$400 monthly raising Angora or New Zealand rabbits. Plenty markets. Particulars free. White's Rabbitry, Newark 38, Ohio.

RAISE Guinea pigs. Money makers. Booklet free. Taylors, B426A, Hapeville, Georgia.

MINK Raising information free. Complete. Lake Superior Mink Farm, Superior, EEl, Wisconsin.

A Practical beginning to successful rabbit raising. 48 page illustrated booklet. Dime. American Rabbit Breeders Association, 36 AR & CBA Bldg., Pittsburgh, Penna.

PLANTS, SEEDS, NURSERY AND GARDEN SUPPLIES

RAYNER'S Special berry garden. Luscious, fresh fruit grown in your own garden. Strawberries: 100 early, 100 midseason. 100 late top quality plants for \$6.99. Blueberries: 4 early, 4 midseason, 4 late giant cultivated bearing age plants \$7.69. Nationwide shipments. Also fruit trees, ornamentals. Catalog free. Rayner Brothers, Salisbury 99, Maryland.

DAHLIAS. Ask for 1952 book. 350 varieties. Springhill Dahlia Farm, R. 2, Box P, Grand Rapids, Mich.

MULTIFLORA Rose, the living self-repairing fence. For ornament, erosion control, windbreak, snow fence, other uses. Rapid grower. Raise from seed. Free planting guide. Woodlot Seed Company, Norway 4, Michigan.

FARMS, FARM LANDS, REAL ESTATE

5-ACRE Florida garden farm, high and dry, beautifully wooded, only \$375, payable \$10 monthly. Near famous Panama City pleasure resort. World's finest beaches. Wonderful fishing, hunting. Grow fruits, berries, vegetables, poultry. Glorious climate. Desirable community. Ideal for vacation or retirement home. Booklet free. Wendell Wood, Box 873, Houston, Texas.

UNITED Farm Agency's big free winter catalog of farm and country real estate bargains can help you plan soundly for your future security in the country. Good pictures, many states, easy terms, many equipped, feed and hay included. For special service, state requirements, desired location. Write for your catalog today—it's free! United Farm Agency, 220-PM South State St., Chicago 4, Ill.

\$5.00 PER Acre: Ozark land; cash or monthly payments. Write for free list and maps. Box 2M165, Cole Camp, Mo.

TWO Strout catalogs. East and mid-west red cover; west coast edition blue. Farms, homes, businesses, bargains galore. Either mailed free. Strout Realty, 7 So. Dearborn St., Chicago 3, Ill.

\$5.00 MONTHLY Buys 40 acres near town; price \$200.00. Free list. Box 425-P, Carthage, Missouri.

INVEST For future in Armstrong's Ozark lands. Retirement farming, specialty farming. Timbered, grazing, fruit lands, small farms and resorts. Free list. Easiest terms. Lowest prices. Write M-Armstrong, Shook 34, Missouri.

FLORIDA—Hunting, fishing, fruit growing, 5 acres, \$245.00, \$10.00 down, \$10.00 month. G. B. Potterfield, Union Building, Charleston, West Virginia.

FARM And business catalog free. Big 1952 edition. Over 1000 bargains from \$1000 up! Maine to Florida. West's, M-1, Pittsburgh 17, Penna.

FARM-Ranch opportunities. Favorable conditions, Washington, Minnesota, Montana, Idaho, Oregon, North Dakota. Literature, farm descriptions. Specify which state. J. W. Haw, 119 Northern Pacific Ry., St. Paul 1, Minn.

FLORIDA. New Lake County development adjoining Ocala National Forest. Best fishing, hunting. Safe from bombs. Nice homesites \$245 at \$10 monthly. Folder free. Howard Vernor, DeLand, Florida.

HOMESITES \$300—Convenient payments. California's finest garden section. On Morro Bay's scenic shores. Wonderful fishing, boating, bathing. Fertile soil, softest water, temperate climate, congenial community. Free literature. Richard Otto, Department M, San Luis Obispo, Calif.

WESTERN Ranch lands. Virgin timber. Hunting, fishing, river and highway frontage tracts. \$5 to \$10 acre full price. Easy terms. 10c (coin) brings Land Catalog, pictures. Pacific Lands, Box 2350BW, Hollywood 28, California.

POULTRY, FARM SUPPLIES

BABY Chicks, America's finest, 50 varieties, 8 crossbreeds, bloodtested, sexed or unsexed, low prices. Gorgeous poultry book free. Berry's Farm, Route 12, Clarinda, Iowa.

POULTRY Farmers, broiler growers, turkey raisers read the new American Poultry Journal for latest ideas and greater profits. 12 months, 50c. Special offer, 4 years, \$1.00. American Poultry Journal, 531 South Clark, Chicago.

KNOW How to raise poultry for profit. Read Poultry Industry. Every issue packed with helpful hints and practical suggestions. Latest articles on breeding, feeding and management. Subscribe now. 1 year 65c. 2 years one dollar, foreign subscriptions \$1.00 a year. Poultry Industry, Dept. P.M., 376 Boylston St., Boston 16, Mass.

RAISE Turkeys the new way. Write for free information explaining how to make up to \$3000 in your own backyard. Address National Turkey Institute, Dept. 3, Columbus, Kansas.

PROFITABLE OCCUPATIONS

TURN Your spare time into cash. Make quick-selling, highly profitable lamps—every home a prospect. No experience or special tools required. New 1952 56-page illustrated catalog shows shades, shade frames, figurines and bases, oil lamp converters, boring compounds, and dozens of similar items. Also all kinds of sockets, cords, pipes, harps, finials, bases, and hundreds of other parts—everything you need. Special 8-page section shows 6 beautiful lamps in kit form ready to assemble. You buy wholesale, sell at retail—make big profits. Hundreds doing it. You can, too. Send 25c today for catalog and wholesale price list. Refundable first order. Gearon Co., Dept. 500-B1, 27 S. Desplaines, Chicago 6, Ill.

WANT A diesel job? Our approved, up-to-the-minute diesel training program can help you qualify for steady, big pay jobs or specialized military training. Covers diesel, tractor, heavy equipment repair, service, operation. Easy to master. High grade mechanics tools, worth \$50 come with course. No loss of present income. Job placement advisory service. Investigate! We invite comparison of material and service. Write for information today. Interstate Training Service, Dept. 3A, Portland 13, Oregon.

FOREIGN Employment construction men, building trades, helpers, office men, others, interested in foreign projects. High wages, quarters, trans. Listings of firms actively working on U.S. foreign, intercontinental projects. Send \$1 for foreign construction compendium and application forms. Foreign Service Bureau, Dept. PM-1, Box 295, Metuchen, New Jersey. (Not an employment agency—No fees.)

spare time occupation. Small investment necessary. Complete easily followed instructions covering all details. \$1.00. R. Meininger, Doylestown, Penna.

"HOW To Make Money With Simple Cartoons"—A book everyone who likes to draw should have. It is free; no obligation. Simply address Cartoonists' Exchange, Dept. 91-CP, Pleasant Hill, Ohio.

MAKE Money at home with Larson leathercraft. No experience needed. Easy-to-assemble belts, purses, gloves, etc. Send 10c for big catalog of 100 ideas. Largest stock in U. S. J. C. Larson Co., 820 S. Tripp Ave., Dept. A75, Chicago 24.

MAKE, Sell candy. Interesting information free. Schenck, 717-P W. Penn. Butler, Penna.

BOOKKEEPERS Operate profitable book-keeping-tax service. Details free. Universal, Box 664-MM, Springfield, Missouri.

START Profitable mailorder business. Postcard brings details. Gail's, Box 33, Station A, Atlanta, Georgia.

FOREIGN And Latin American employment. 1952 "Foreign Service Directory" gives up-to-minute facts on military and civilian construction, government jobs, major oil listings, aviation, transportation, steamship lines, mining, importers, exporters, how-when-where to apply, application forms, not list firms hiring. \$1.00 postpaid. Global Reports, P.O. Box 883-P, Hollywood 28, Calif.

HOME Electroplating kits. \$14.95. Free details. Reed Engineering, 620 S. Inglewood, Inglewood, Calif.

ALASKA—Last American frontier. \$1.00 brings 1952 business directory, government map, construction projects military and civilian, homestead and highway facts, hunting-fishing-game rules, mining, aviation. List of firms hiring. How-when-where to apply. Alaska Opportunist, P.O. Box 883-P, Hollywood 28, California.

INVESTIGATE—Locate missing persons! Different! Quickly learned! Free details! Pacific Institute, 492 44th Street, Oakland 9, Calif.

A Good business of your own for one dollar. Write for free information about our range burner repair book. R. G. Swift, P.O. Box 534, Portsmouth, N. H.

CONSTRUCTION Job list. Published monthly. \$1.00. Dempster's Construction Scout News, Dept. 268-JC, Bridgeport, Ill.

WRITING Fillers and short features for magazines pays off. Spare time. Previous skill unnecessary. Receive checks \$3 to \$100. "Write Fillers for Profit." Send \$1.00 for complete proven plan. John Lathrop, Box 576, Oakdale, California.

RAISE Earthworms for profit. Folder. "David's Folly." Earthworm Farm, Westbrookville, Maine.

STRIPKRAFT Is profitable! See our ad under "Home Craftsmen" classification.

READ Tip Top Salesman. Three months 25c. Kohler, Box 5910, Philadelphia 37, Penna.

VANILLA Flavoring. You make it and you sell it in your own home. Your own business on small capital. Sell to homes, bakeries and restaurants. Just add water to our concentrate. Send two dollars for enough to make one gallon. Your profit will more than double on your two dollar investment. We furnish full simple instructions and labels free. Dolan Flavoring Co., 43 William St., Portland 5, Maine.

START A buying service, buy wholesale thousands nationally advertised products. Make big profits selling at sizable discounts. Send postcard for details. American Buyers' Service, 631-P Linden, Buffalo, New York.

GROW Herbs for pleasure, profit. Detailed booklet, seed source 50c. Domesticated earthworms convert garbage to fertilizer. Make big harvests easy. Valuable booklet 10c. Avarm, 112-S Elizabeth, Wichita 12, Kansas.

RAISE Earthworms. Outstanding opportunities. \$200 monthly possible! Get free details. Ozark Worm Farm-J, Willow Springs, Missouri.

PRINT Without a printing press. Big profits! See page 110.

RAISE Fishworms easy. Profitable. Complete instructions 25c. Huffman's Worm Ranch, Rives Junction, Mich.

FREE Book "505 Odd, Successful Businesses." Work home. Expect something odd! Pacific, Oceanside, Calif.

full time. We pay \$3.00 pound. Free book. Mushrooms, 2954 Admiral Way, Seattle, Wash.

OWN A printing business. Good profits printing cards, stationery, etc., in spare time. Easy rules furnished. Have home shop. Send dime for illustrated printer's supply book and samples. Kelsey, Inc., T-24, Meriden, Conn.

"EVERYBODY Likes candy"—Learn to make professionally. (Our 40th year.) Ragsdale Candies, D6, East Orange, New Jersey.

EARN Up to \$400 monthly raising Angora or New Zealand rabbits. Plenty markets. Particulars free. White's Rabbitry, Newark 61, Ohio.

MAKE Flexible molds! Cast plaques, bookends, figurines! Free sample! H. Tooker, 630-M Chestnut, Hamilton, Ohio.

RAISE Pheasants on the \$100 week plan. Little capital and space can make you independent. Free details. Great Central Game Management System, Columbus 1, Kansas.

\$40.00 WEEKLY Made growing mushroom, fresh, dried. Dominion patent 331583. Free spawn. North American, 169P Yonge, Toronto, Canada.

BE The Popular Mechanics representative in your neighborhood and earn big profits in your spare time. Write Popular Mechanics Magazine, Room 408M, 200 E. Ontario St., Chicago, Ill.

MUSHROOMS Grown. Boxes. Barrels. Instructions 50c. Spawn \$1.00. Manureless process. \$2.00. Gordons, 328 Bannerman, Winnipeg, Manitoba.

ALASKA! Just released! Over 50 gigantic new construction contracts! Names, addresses companies hiring, \$1.00 complete. Alaskan Opportunities, (O L) Box 362, Kenmore, Wash.

BOOKS, PERIODICALS, PICTURES POSTCARDS

SHIP Photographs, lists 10c. Scozafava, 1648 59th Street, Brooklyn 4, N. Y.

POPULAR Novels 3 for \$1.00, pocket books 8 for \$1.00. Catalog 10c. Miller, 5255-M Page, St. Louis 13, Mo.

ILLUSTRATED Humor library—Jokes, gags, after dinner stories, and more—24 pocket size booklets. \$1.00 with free fascinating catalog. Aladdin Book Co., 210-P Fifth Avenue, New York 10.

BOOKS—Government surplus. Textbooks, including International Correspondence School's Home Study Pamphlets. One half million volumes. Bargain prices. Free catalog. Long's College Book Co., Dept. PM, Columbus 1, Ohio.

MAGAZINE Subscriptions wholesale! Details upon request. Bedard Publications, Dept. P.M., Box 637, Detroit 31, Michigan.

FACTUAL Texan frontier historical narrative "The Houston Story," 240 pps., originally \$3.00, economical edition, \$1.00. Frontier Bookshop, 8102 Lockheed, Houston, Texas.

TEACHER'S Laboratory manual, hobbyist construction guide, theory and construction Van De Graaff "lightning" generator. American Electrostatic Co., 1726 So. Yorktown, Tulsa, Oklahoma.

VALUABLE Almanac! Send 10c postage. Tipword, 1145 11th, Charleston, Illinois.

REQUEST Subscription information. Arlington Magazine Service, Box 87, Floral Park, New York.

FREE Giant Popular Mechanics 40 page Golden Anniversary Book Catalog! Over 400 books on workshop planning, home building, household repairs, projects, motoring, sports, photography, money making opportunities, machinery, inventions, crafts, hundreds more. Many not available in stores. Send postcard today to Popular Mechanics Press, Dept. PMC, 200 E. Ontario, Chicago 11, Ill.

ENJOY Surprises? Wonderful package, six books, pocket size, 50c. Story, 13-A Norwood, Rockport, Massachusetts.

MACHINISTS Compact reference book. Tables, shop and drafting helps. Send \$1.00. A. Knudsen, 523 48 St., Brooklyn 20, N. Y.

USED And out-of-print books. Catalogue free. Balliol, Box 85, Station K, Toronto, Canada.

MAGAZINES (Back dated)—Foreign, domestic—Arts, books, booklets, subscriptions, etc. Catalog 10c (refunded). Cicerone's, 86-22 Northern Blvd., Jackson Heights, N. Y.

ILLUSTRATED Comic booklets, 12 for \$1.00, 24 for \$2.00, all different. Free gift with each \$2.00 order. V. M. Rogers, Dept. PM-4, Box 14738, Cimarron Station, Los Angeles 18, California.

BOOK "Breeding of Parakeets" and cage-bird magazine—\$1.00. Audubon Publishing Co., 3449-PM N. Western, Chicago 18, Illinois.

BOOKHUNTERS! Scarce, unusual, miscellaneous books supplied. Atlantic Book Service, Lawrence Avenue, Charlestown 29, Massachusetts.

FASCINATING, Entertaining once-in-a-lifetime book! "Fifty Years of Popular Mechanics." Tremendously exciting story of most fabulous years in American history. Describes birth of auto, radio, airplane, television; hundreds of other inventions and world shaking events. Nostalgic old time ads and prediction of fabulous inventions to come next fifty years. Giant size—500 pages; 8½"x11". Order now while stock still available. Send \$5.00 to Popular Mechanics Press, Dept. 50, 200 E. Ontario, Chicago 11, Ill.

MAGIC TRICKS, PUZZLES, JOKER NOVELTIES

MAGIC Monthly. Year 25c. New 1952 Magic catalogue 10c. New joke lists 3c. Magic Factory, Minneapolis 2, Minn.

8 AMAZING Mystifying tricks, no gadgets \$1. Edwards, 16751 Ashton Road, Detroit 19.

ESCAPE From handcuffs, bank vault, trunk, etc. Eight professional secrets, 50c. Charles, Box 271, Ballston Spa, N. Y.

WORLD'S Largest professional magic shop, keeps you in touch with latest tricks. To receive mailings, send \$1.00 for new catalog. Holden's, M220 West 42nd St., New York.

BIG Fun kit! Tricks, jokes, novelties, books. Real clever stuff. Howls galore, \$1.00. Johnson, 414 McRae, Wilmington, N. C.

16 CARD Tricks and catalog 25c. Sterling Magic, Royal Oak, Mich.

FREE Trick and large illustrated catalog, 35c. Lerro Magic, 509 80th Street, Brooklyn 9, N. Y.

LATEST Magic for pocket, parlor, stage. Catalog 500 tricks, only 10c. Unequaled magic service for 30 years. Douglas Magicland, Dept. 1, Dallas, Texas.

512-PAGE Catalogue of 2500 tricks, pocket, parlor, stage. World's finest magic. Send \$1.50 for catalogue (refunded first \$6.00 order). Kanter's, M-1311 Walnut, Philadelphia 7.

PROFESSIONAL Catalog, 124 pages, 25c. Williams, 900 Plymouth, Ellwood City, Penna.

BE A magician. Large professional magic catalog of latest tricks, 35c. Ireland, C-109 North Dearborn, Chicago 2.

BE A Magician. Cigarette through handkerchief, magic disappearing cigarette case, Chinese ring illusion. Three magical tricks, \$1.00. Royall's, 1920 Heights Boulevard, Houston, Texas.

VENTRILOQUISM Self taught. Quick, easy instructions, 25c. "Ventriloquist," Cal-Allen, Texas.

BE Popular through magic. Write today for free catalog on magic tricks and jokers' novelties. Knobby's, Dept. F, 316 James St., Syracuse 3, N. Y.

VENTRILOQUISM Taught. 3c stamp brings particulars. Smith, 801 Bigelow, Peoria 5, Ill.

TWELVE "Betcha Can't Tricks" and catalog, 25c. "Magician," Cal-Allen, Tex.

FREE Trick with 1952 illustrated catalogue 10c. Maj Magic Products, 23 Friends Lane, Westbury, N. Y.

200 ELECTRIC Stunts, 110 volts, \$1. Kutting Sons, Los Altos, Calif.

COINS, TOKENS, CURRENCY

WE Pay \$5 to \$500 each for hundreds of old or odd U. S. and foreign coins. Keep all until posted. Send 20 cents for illustrated coin value book, with bargain lists free. 45 years in business. Coin Exchange, Le Roy 7, N. Y.

FREE! Foreign coin, banknote and coin collectors illustrated catalog to approval service applicants. Send 3c postage. Tatham Coinco, Springfield 30, Mass.

St. Louis, Mo.
FIFTY Assorted Indian cents, \$1.50.
Rare 1931-S cents, \$1.00. Giant fifty-two
page illustrated bargain catalog, 10c. Ben's
PM Department, 31 North Clark, Chicago 2.

COIN Collector's Magazine. Largest in-
dependent, over 1000 pages per year. Sam-
ple copy 30c; \$3.00 per year. Hewitt, 5450-J
Clark, Chicago 40.

JAPANESE Invasion notes for United
States 1c to \$1,000.00; set \$2.00. Illustrated
coin catalogue 25c. Shultz, Salt Lake 10,
Utah.

GENERAL MacArthur set (2) \$3.75; Vati-
can Holy Year set (4) \$1.00; 256 page re-
tail guidebook \$1.50; premium handbook
\$1.00; giant bargain catalogue 25c. Bebee's,
1180 East 63rd, Chicago 37, Illinois.

FOREIGN Coins 10 different 25c. For-
eign Bills 10 different 15c. Lists. Oliver
Arnold, Macon, Missouri.

ALL Different: 30 foreign \$2; 15 liberty
nickels \$2.50; 15 Morgan dimes \$3; 5 large
cents \$1; 12 Indianheads 50c; 4-2c pieces
\$1; Grab-bag of 100 American coins \$5.
Fairway Company, Rye, N. Y.

"HOW To become coin dealer". \$1.00.
Nelson Exchange, Rye, N. Y.

WANTED—1894-S Dime pay \$500.00.
1913 liberty head nickel \$1000.00. 1901-S
quarter \$20.00 to \$150.00. 1856 flying eagle
cent \$40.00 to \$100.00. 1877 cent \$5.00 to
\$25.00. 1909 SVDB Lincoln cent \$6.00.
1914-D cent \$2.25 to \$20.00. 1923-S quar-
ter \$5.00. 1922 Grant half dollar \$2.00 to
\$42.00. 1928 Hawaiian 50c—\$30.00. \$4.00
gold piece \$300.00 to \$1000.00. Hundreds
of others wanted half cents, large cents,
2c pieces, 3c pieces, half dimes, old nickels,
dimes, quarters, half dollars, silver dol-
lars, gold dollars, colonial coins, paper
money, commemorative coins, etc. Know
their true value. Send 25c for our large
illustrated complete guarantee buying and
selling catalogue. Money refunded if not
satisfied. Worthycoin Corporation, Lead-
ers of Numismatic Quotations, 294 Wash-
ington (R-824), Boston 8, Massachusetts.

OLD Money wanted. Will pay fifty dol-
lars for nickel of 1913 with Liberty head
(not buffalo). We pay cash premiums for
all rare coins. Send 4c for large coin folder.
May mean much profit to you. Numis-
matic Co., Dept. 20, Fort Worth, Texas.

WHAT Are your coins worth? Amazing
Fell's United States coin book. Every-
thing on every single coin minted—Worth,
value, how to sell, speculating, invest-
ment; other valuable facts on coins. Cloth-
bound, 150 illustrations. Send no money.
Pay postman only \$1.50 (plus postage) or
\$1.50 postpaid (refundable). Order now!
Fell Publishers, 386MM 4th Ave., New
York 16, N. Y.

FOUR Large cents \$1.00. Bargain coin
lists 10c. Press, 1480 Febris, Columbus,
Ohio.

GET Profit and pleasure in collecting
old coins. Send 10c for 56 page illustrated
coin catalog. You'll be delighted with it.
Send for it now. B. Max Mehl, 370 Mehl
Bldg., Fort Worth Texas. Largest rare
coin establishment in U. S. Established
52 years.

FOREIGN Money, wooden nickels, and
"coin collector's" big new magazine 10c.
Lawrence Brothers, Anamosa, Iowa.

AMERICAN Illustrated coin catalog with
buying and selling prices \$1. Canadian
catalog \$1.50. List 10c. Coin Exchange,
(Canada), Box 35, Toronto A, Canada.

FOREIGN Coins, many worth big cash
premium now! Guaranteed prices. Send
\$1. for premium book modern foreign
coins. 25 years buying coins. Marsh, 915
Anderson Lane, Austin, Texas.

\$10.00 EACH For certain Lincoln pen-
nies; Indianheads \$50.00. Send dime for
catalogue listing prices paid. Lincoln Coin
Company, Elkhart 29, Indiana.

NICE Large cent and lists 35c. Bolus,
1139 11th N.W., Canton 3, Ohio.

OLD STAMPS WANTED

I Will pay \$100.00 each for 1924 1c green
Franklin stamps, rotary perforated eleven
(up to \$1,000 each unused). Send 10c for
large illustrated folders showing amazing
prices paid for old stamps, coins and col-
lections. Vernon Baker, PM-21, Elyria,
Ohio.

FREE—Belgium complete set of 17
stamps to approval applicants. (We pay
return postage.) Frank Newman, 3539
Hartford St., St. Louis 18, Mo.

YOU Are cordially invited to partake in
this golden opportunity special. Laurel-
bilt deluxe collection containing 200 dif-
ferent U. S. postage, commemoratives, and
airmails—\$1.49. Free catalog. Long Beach
Stamp Company, Long Beach, New York.

FREE! Big United States catalog! In-
valuable guide and check list. Hundreds
of illustrations. Harris & Co., Boston
17, W—Mass.

500 EXOTIC Japan stamps—10c. Ken-
more, Richford, J-57, Vermont.

SCARCE Nicaragua Roosevelt, Madagas-
car, Turkey, Martinique, Ecuador, Somali
Coast, Cuba. Mints. Send \$3. Silas Stamps,
Box 55-X, Triborough, New York 35, N. Y.

ARE You looking for better U. S. on
approval? Write New-Way Stamp, Law-
rence, Mass.

ARE You satisfied? If not, write us
today. Ask for 1c and 2c foreign approvals.
U.S. at bargain prices. References appre-
ciated. Roseland Stamp Co., Dept. 10-B,
Spring Lake, Michigan.

UNBEATABLE! Over 100 different with
triangles, Liberian stamps, Fezzan, Borneo,
Caymans, etc. Everything 10c with
approvals. Reeve, 578c Crawford, Windsor,
Ont., Canada.

FINE Approvals. Fast, personal service.
What countries do you prefer? I'll send
their stamps. Skinner, 438 Locust, Long
Beach 12, California.

CLUB Journal, \$1.50 yearly. D. Herold,
4209 77 Street, Elmhurst 73, N. Y.

MINT, Army, Navy set 50c, twelve mint
commemoratives 50c. Complimentary to
approval customers. Charles Mekeel, 2101
East Market, York, Penna.

FREE! Abyssinia to Zanzibar packet plus
2 Monaco Holy Year triangles, to new ap-
proval applicants. Moulblow, 740 Hagney,
Bronx 56, N. Y.

PAYING High prices for approvals? If
your collection numbers under 15,000 try
our 1c and 2c approvals. In books of 1,000
different. Lots to choose from at lowest
prices. Also special offer to customers.
Clark, Box 544P1, Muskegon, Michigan.

FREE: Mint British Colonies from Niue,
Gilbert Ellice, Nauru, Turks Caicos, Brunei,
Caymans, Tonga, Pitcairns, Sarawak
—Free with approvals. Viking, 130-Z Clinton
St., Brooklyn, N. Y.

CANADIAN Collection free—Includes
early Victorian issues, jubilees, high
values, commemoratives, special issues,
Newfoundlands, pictorials, etc., etc., to-
gether with Philatopic Magazine all free.
Send 5c postage. Empire Stamp Company,
Dept. PM, Toronto, Canada.

FREE Beautiful commemoratives, air-
mails, topicals. Eight countries. Approvals
enclosed. Green and Company, Nor-
wood 12, Ohio.

FREE Complete set of famous Ameri-
cans, flags, parks and presidentials to ap-
proval buyers. Send 3c for 15 of the above
stamps plus full particulars. Triboro
Stamp Company, 145 Nassau Street, Dept.
101, New York 38, N. Y.

110 DIFFERENT Hitlers, Roosevelt,
Liberia, Haiti, etc. with approvals 10c.
Buckey, 208 Ludlow Bldg., Dayton 2, Ohio.

U. S. Specialists! Stamps, coins. Write
210 South Sixth Street, Minneapolis.

SATISFACTION Or refund. 200 differ-
ent, beautiful stamps, 60 countries, \$3.00.
Concord Stamp Company, Beville, Texas.

FREE Packet with introductory appro-
vals. Luther Chick, 436 No. Main, Brewer,
Maine.

PENNY Approvals by country. M. H.
Hoerning, 115, Farmington, Ark.

DEALERS—Wholesale list. Postage 3c.
Frank, 5031 Queensberry, Baltimore 15,
Maryland.

TEN Dandy sets, 10c, approvals. Fas-
zold, 10055c Northgate, St. Louis Co. 15,
Mo.

FREE! 25 Different Switzerland with
swell approvals. Kardell, 209 Bower, Santa
Fe, New Mexico.

MIXTURE 1000 Christmas, charity seals
\$1.00. Eckert, 5043 Warwick, Chicago.

U. S. Price list free. P. Wetterquist,
1635—13th Avenue, Rockford, Illinois.

FREE! Chinese "midget" war set. Ap-
provals included. Seminole, North Miami,
Florida.

SEND 10c For attractive 72-page maga-
zine with full information. "Stamp Col-
lectors' Exchange Club," Hickson 24, On-
tario, Canada.

U. S. Commemoratives. 90 different
\$1.00. 500 only \$8.00. Mixture 5# \$2.00.
Superior, Grafton, Ohio.

100 DIFFERENT Spain 25c. Penny ap-
provals included. Reed, Box 980, Chi-
cago 90, Ill.

1000 MIXED United States. Over 160
varieties. \$1.05. Quaintance, Box 178F,
Upper Sandusky, Ohio.

INTERNATIONAL Exchange Club. Estab.
1933. Free prospectus. Leonard, P.O. Box
1066, Minneapolis 1, Minnesota.

FREE! Big illustrated catalog! "Every-
thing for the stamp collector." Harrisco,
202 Transit Bldg., Boston 17, Mass.

FREE—Illustrated catalog! Kenmore,
Richford, C-57, Vermont.

COMIC Stamp collector cartoons. Hun-
dred laughs. 25c. Pauly, 2295 Concourse,
Bronx 53, N. Y.

ILLUSTRATED, Complete U. S. list—6c
postage. Hantak, 1030 Euclid, Cleveland
15, Ohio.

STAMPS. World-different. 500, 50c;
1000, \$1.00; 2000, \$2.25; 3000, \$5.00. Coins
—1909-S—VDB—v.g. \$8.00. Russell, P.O.
Box 2011A, Natural Bridge, St. Louis 15,
Mo.

PENNY Approvals by countries. Miracle
Stamp Service, Miracle Hot Springs 2,
Calif.

50,000 STAMP Grabbags 25c each. An-
derson, 630B Bingaman, Reading, Penna.

NUDES Set and colorful approvals—10c!
Atlas, 2830-A Eisenhower, Racine, Wis.

LIBERIAN Triangulars, 10c with appro-
vals. Vargo Stamps, 6044 South Fairfield,
Chicago 29, Illinois.

¹/₂c-1c APPROVALS! Bargains galore!
Cole, 43-a Rinewalt, Buffalo 21, N. Y.

310 BRITISH North America early issues,
airmails, commemoratives, all off paper,
catalog value over \$7.00 with Canadian
price list and Emco Journal included. Send
only 25c. Marks Stamp Company, Dept.
P, 92 Adelaide St. W., Toronto, Canada.

FREE. 750 Mixed U. S. for dime post-
age. Weatherby, Medina, Ohio.

SPECIAL 2000 Superb value. \$2.50.
Hale, 7809 Grand, Minneapolis, Minnesota.

2c APPROVALS! Colorful high catalog
foreign. Moffat's, 921 College, Rock Hill,
S. C.

FREE! 250 Stamps from all over the
world to approval applicants. Send 3c
postage. Thrifty Stamps, Silver Spring,
Md.

U. S., Foreign, and coins. Free list.
Slikes, 1831 E. Allegheny, Philadelphia 34,
Penna.

SCANDINAVIA!—100 Different, 18c. 50
Norway, 10c. 50 Finland, 10c. Free lists.
Hantak, 1030 Euclid, Cleveland 15, Ohio.

50 DIFFERENT U.S. 10c. 100, 25c. Gift.
Bellet, Mapledale, Hazel Park, Mich.

* WINGS Over the world! 21 exciting air-
mails from 21 countries. Senegal, Spanish
Morocco, Niger, etc. "Air-approvals" in-
cluded. Send 5c. Airline Stamp Company,
4472 North 39th Street, Milwaukee 16, Wis.

FREE! Your choice! 25 different from
first "penny approvals" booklet. Hanlon,
Box 407-M, Upper Darby, Pennsylvania.

FREE 109 Stamps to applicants for our
approvals sending 3c postage. Hoyt, Lowell
Road, Hudson, N. H.

ALBUM! Holds 2000 stamps! Only 10c!
Glammore Company, Manchester, Conn.

FREE! Rare, colorful Falkland Islands
complete set—With unusual, bargain-
priced approvals. "PG," 195 Park, Lewis-
ton, Maine.

STAMP Wallet containing small Ireland
collection, 3c with approvals. Amberg,
537D 35th, Union City, N. J.

FREE—Sudan, Transvaal! Bonus ap-
provals. Stampmart, Box 28A, Rutherford,
N. J.

FREE Illustrated catalog for U.S., Con-
federate states stamps, albums, supplies.
Stone, 45 Bromfield, Boston 8, Mass.

approvals. Stampex, 116-MP Nassau Street, New York City.

10,000 PENNY Approvals waiting for you. Many from exotic countries, pictorials, airmails, new issues. Tilbury, Box 862, Newark 1, N. J.

IRON Curtain countries! Hitler! Boy king! William Tell! Castles! Inflation! Beautiful mint sets! 527 different and approvals, just 25c! Niagara Stamp Company, 14 Queensway, Niagara-on-the-Lake, Can.

FREE, 25 Different U.S., approvals accompany. Village Stamps, 90-39P 214 St., Queens Village 28, N. Y.

FREE! Scarce U.S. occupation set with selection most attractive stamps ever offered. Riedell, Greensburg, Penna.

GREENLAND Set free. Approvals accompany. Tidewater, 7423 East Kenmore, Norfolk, Virginia.

SERIOUS Collectors! Custom-made approvals to your requirements. State your needs. Brooks, 2352W East 23rd Street, Brooklyn 29, New York.

FLAG Stamp—Free with hydrate U.S. approvals. Wenigman, 1933 Patterson, Chicago 13.

55 DIFFERENT United States, including airmails, presidentials, commemoratives, revenues, etc. Only 5c. Approvals. Free big lists. Bookman, Maplewood, N. J.

FREE Collection — Over 100 different stamps of world; commemoratives, animals, natives, ships, famous men, others all to approval buyers; also Scott albums, catalogs. Bell Stamp Service, Dept. S-2, Bell, Calif.

POUND Stamps containing thousands \$1.00. Longacre Shop, 581 Sixth Ave., New York 11.

START Your own stamp business. Send for free circular. Donald Shepard, Box 1147, Chicago.

FREE Sample—Interesting, informative, illustrated! National Stamp News, Anderson, South Carolina.

ZOUNDS! Amazing "queer countries," savage and exotic lands packet. Absolutely free with approvals! Saxon, Vista, Calif.

100 DIFFERENT Sweden 25c. Approvals. Gronberg, Box 5441 P, Philadelphia 43, Penna.

POLAR Bear triangle, giant George Washington, six colored Ecuador, Arctic triangle, first American commemorative, Corsica, Devils Island, others. Everything free with approvals. Capital Stamps, Little Rock 2, Ark.

TRIANGLES—5 Different, 5c with approvals! Stearns, 1249-B Griswold, Detroit 26, Michigan.

BARGAIN! 100 Different United States stamps, including commemoratives, airmails, 10c to approval applicants. Sunset, Dept. 295, Box 47, South Gate, Calif.

APPROVALS That please—U. S., foreign. Turbyfill, 513 W. 29, Norfolk 8, Va.

100 DIFFERENT—Commemoratives, airmails, triangles, diamonds. 10c. Kostillo, Bellaire, Ohio.

GERMANY B218-229, "Nazi army" warplanes, machine gunners; free to approval buyers. William Deems, Ravenswood, West Virginia.

205 AUSTRIA—All different only 10c. Beautiful commemoratives, pictorials, airmails, high values. Catalog price nearly \$6! Approvals. Garcelon, Calais 111, Maine.

NICARAGUA Sports, Costa Rica agriculture sets 10c with approvals. Seminole Stamps, Box 1138-P, Coral Gables 34, Fla.

LIBERIAN Triangles free with approvals. Ottervik, Box 75, East McKeesport, Penna.

4 GERMANY Fair sets. Free to approval buyers. Pleasure Stamps, 1865P 52nd, Brooklyn 4, N. Y.

FREE U.S. List! Postage 3c. Brock, 10516 Clifton, Cleveland 2, Ohio.

FRENCH Colonies—300 different \$1.00. Approvals. Royal Stamp Company, Tamaqua, Penna.

ILLUSTRATED Stamp Magazine — 3 months 25c. Stamp Journal, Kalamazoo, Michigan.

APPROVAL Selections that are different. Free stamps with purchases. Write today. LeRoy Stamps, 645 W. 2nd Street, Winston-Salem, N. C.

UNITED States approvals—Select, used, mint. Kingsbury, South Woodbury 2, Vt.

1000 MIXED U. S. and foreign 25c. Monjar, Fairmount, Cincinnati 14, Ohio.

MONACO Pope triangles, Zanzibar, 5c. approvals. Potomac Stamps, Washington 15, D. C.

GIANT Selection, penny stamp. Wahl's Stamp Exchange, 7008P Farragut, Chicago 31.

FRENCH Colonies 300 different pictorials \$1.00. Burtner, 709 Washington, Reading, Penna.

10,000 DIFFERENT 1c Each! Gordon Davison, Box 1019S, Manchester, N. H.

200 DIFFERENT U. S. nice selection. No post cards or cut square envelopes. 60c. C. P. Steger, Steger, Ill.

100 NETHERLANDS. All different. Beautiful assortment. 10c with approvals. Thomson's, Box 4074-P, Miami, Florida.

SENSATIONAL Free offer, 50 different beautiful commemoratives, selected approvals. Morrison, Milmont Park, Penna.

312 MIXED U.S. only 10c to "gold nugget" approval applicants! Nothing like them. Kessel's, Folsom, California.

OLD Scarce U. S. seconds on approval. Slightly defective. Bargain prices. Hernefield, Clintonhill Station, Newark 8, N. J.

FREE—Monaco holy year short set, including two triangles. Sent to approval applicants. Pegasus Stamp Company, 716-M DeKalb Ave., Brooklyn 16, N. Y.

FREE. Scott's International Album. Other big premiums. Full particulars with approvals. Raymax, 123-Z William St., New York City 38.

50%-75% DISCOUNTS! Approvals from 33,000 collection—½c up! Schur, Box 235, Buffalo 12, N. Y.

GERMANY—Colonies, offices, states. Mostly 1/2-1/5 catalogue. Approvals—lists 3c. Myers, VanZandt Ave., Little Neck, N. Y.

FREE! "What's My Name?" Fascinating illustrated quiz booklet. Barrels of fun for everyone; valuable prizes for correct answers. This booklet absolutely free! Send today. Approvals! Stamp Quiz, Calais 600, Maine.

ROOSEVELTS Complete; plus 25 other U.S., 10c with United States approvals. Locust, Box 305-T, Harmon-on-Hudson, New York.

750 FRANCE And colonies stamps 10c. Littleton Stamp Co., Littleton 25, N. H.

FREE! 50 Different Japanese stamps! Approvals, Star Stamps, 225 Willard, Jamestown, New York.

300 DIFFERENT Given free with approvals. Postage 3c. Windsor Stamps, 1435 East 67th Place, Chicago 37.

WONDERFUL Offer. 7 complete mint sets Manchukuo, Bohemia, etc., only 10c with approvals. Reich Stamp Co., 4647 Kenmore, Chicago 40, Illinois, Dept. M23.

50 DIFFERENT U. S. 10c. No approvals. Seidenberg, 944, Appleton, Wis.

STAMPS Wanted. Collections, duplicates, surplus stock, mint and used. Buy outright if bargain. What have you? Vanroy Shirk, Lebanon, Penna.

500 DIFFERENT 40c With approvals at wholesale to clear. K. S. Holmes, London, Canada.

77 DIFFERENT United States—25c. Approvals. Utechts, 1143-D North Keeler, Chicago 51.

307 ALL Different—Only 15c! Beautiful collection: commemoratives, triangles, high values, bicolored stamps, etc. Garcelon, Calais 400, Maine.

NOTHING Free. Just good stamps reasonable. Send dime for seventy-four page catalog. Ben's Stamp Shop, 31 N. Clark, Chicago 2.

"HOW To Recognize Rare Stamps." Free book illustrated! Kenmore, Richford, H-57, Vermont.

FREE U. S. price list, postage 3c. Mark Hanna, 335 5th Ave., Pittsburgh 22, Penna.

AMAZING Offer! 500 United States stamps—including commemoratives, airmails, high values to \$5.00. Only 10c to approval applicants! Illustrated bargain lists free. Mystic Stamp Co., Dept. 80, Camden, New York.

FIRST U. S. (1847) government reissues 5c, 10c, plus giant bargain U. S. collection—only 5c to applicants U. S. approvals. Metropolitan, Box 312G, Jackson Heights, N. Y.

Calais 17, Maine.

WOW! 203 All different Germany 10c! Zeppelins, semipostals, airmails, high values, etc. to new customers. Jamestown Stamp, Jamestown 512, New York.

WORLD'S Largest stamp (7½x14 inches). A real curiosity! Retail for 50c, only 3c to approval applicants. Tatham Stamp Co., Springfield 30, Mass.

UNITED States stamps nearly 100 years old. Roosevelt set, others, 40c value—only 5c to applicants United States approvals. Wakonda, Box 272K, Jackson Heights, N. Y.

500 STAMPS For only 10c! This mammoth value includes airmails, pictorials; stamps from strange countries, cataloging up to 25c each! Also approvals. Mystic Stamp Company, Camden 80, New York.

COLUMBIANS, Trans-Mississippi, Pan Americans, Pan Pacific, ten other different commemoratives. All 10c with your request for U.S. approvals. Moda Stamps, Box 251-X, C.S.A., New York 8.

FREE! Powerful magnifying glass. Jamestown Stamp, Jamestown 202, New York.

200 DIFFERENT Including Roosevelt triangle, 5c to approval applicants. M. Avalon Stamp Company, Springfield, Mass.

OVER 1,000,000 Sold; 200 different stamps 10c with approvals. Carlton's, Tujunga, Calif.

U. S. Collectors—Write today for free material. Eagle Stamp Co., 2221-A Romine, Pittsburgh 26, Penna.

100 DIFFERENT World wide 10c. Lists free. E. Terreson, Box 218, Bellmore, N. Y.

FREE! Big illustrated catalog! Send today! "Stamps by Mail," 2133 Lunt, Chicago 45.

ANTIQUES, RELICS, INDIAN GOODS, CURIOS

ANTIQUE Handguns popularly priced. Beginners or general collectors list 10c. Hi-Fulton Gun Corner, 413 South High, Columbus 15, Ohio.

FREE! Indian relic catalog. Nirscher's, 111 South 31st, Belleville, Illinois.

PRECIOUS STONES, MINERALS

MINERALS, Gems, cutting material, fluorescents. Free list. Warren's, P.O. Box 277, San Diego 7, Calif.

GEMS, Precious and semi-precious, genuine, from world-wide sources. Deal direct, no overhead, save money. Catalog 10c. Hill Co., 5450-G Portland Rd., Salem, Oregon.

MINERAL Samples and geological rocks analyzed by former states-geologist: 15 minerals for pupils: \$3.00. 32 different specimens (geological) \$10.00. 60 wonderful minerals for high school students and boy scouts: \$15.00 (postpaid). Prospecting & Geophysical Office, 38-14 218th Street, Bayside, L. I., New York.

FIND Tungsten, mercury, uranium with mineral light. Free brochure. Write Dept. PM8 Ultra-Violet Products, South Pasadena, California.

SAMPLE Uranium ore postpaid for dollar bill. Prospector, Box 592, Truth or Consequences, N. M.

JADE, Agates, titanite. Free list. North West Gems, Box 305, Tacoma 1, Wash.

GEMCUTTING, Silvercraft authority. Illustrated magazine tells how. Cut rocks, make jewelry. 150 ads illustrating equipment, offering gems for collectors, cutters. Postal brings literature. Lapidary Journal, Drawer B, Palm Desert, Calif.

GEMSTONES, Mineral specimens. Every variety. Lowest prices. Postcard brings free booklet. Plummer's, 2183C Bacon, San Diego 7, California.

HOBBIES AND COLLECTIONS

WANTED—Cigarette, tobacco cards. Write Charles Bray, East Bangor, Penna.

EXCHANGE Stamps, coins, views, etc., with members everywhere. Details free. Box 474, Saint John, N.B., Canada.

UNUSED Matchbook covers—100 different \$1.00 36-page catalog 25c. Charles Edelman, 1311C East 84, Cleveland 3, Ohio.

INVENTING Can be an interesting and profitable hobby. Write for complete particulars. Institute of American Inventors, Dept. 40-E 631-E St. N.W., Washington 4, D. C.

BASS Says: Trading cameras a national habit since 1910. Write to Bass the old "horse trader." A postcard will do. Simply say: "Bass, I have and I want. How much will you allow me?" It's fun to trade with Bass. Satisfaction guaranteed. Bass buys, sells, and trades. Bass Camera Company, Dept. AG., 179 W. Madison St., Chicago 2.

FREE Photographic bargain book packed with hundreds of sensational values in still and movie cameras, lenses and latest accessories. Super savings for you in new and used equipment. Liberal trade-in allowances, too, on your equipment. Write now for your free copy to Central Camera Company, Dept. 9L, 230 S. Wabash Ave., Chicago 4. (Photographic headquarters since 1899.)

FREE Instructions. 300 power telephoto camera. Easily made. Trifling cost. Telescopic Cameras, Manorville, N. Y.

ADD "Spice" to home projection shows with colorful old-time Nickelodeon slides. 2x2. Write for free list. Nickelodeon Co., New Fleidner Bldg., Portland 5, Oregon.

PHOTOGRAPH Collectors! Here is your chance to get authentic on the spot shots of disasters, wrecks, floods, etc. State your wants, we fulfill. 8x10's \$1.00. 5x7's 75c. Finished in dull or glossy. Morelock's Photography Co., 205 East 16th, Vancouver, Washington

SHUTTER Bugs! Learn "how to sell your pictures and make money" plus, "Simplified Photography Handbook," Hollywood glamour, photos, diagrams. Only \$1.98. Muir Studios, Milford 7, Penna.

PHOTOCOPY Anything—Papers, books. No darkroom, 8½" x 11" complete \$6.95. Fotoflek, 8555 Plainfield Lane, Cincinnati 36, Ohio.

PHOTOMURALS. Your negative or ours. Catalogue 25c. Photomammoth Murals, Dept. M, 12048 Vanowen Street, North Hollywood, California.

BUY Photographic supplies wholesale. Films, cameras, binoculars. Free catalog. Capitol Photo Supplies, 2428 Guadalupe, Austin, Texas.

HOMES You can build for \$4500 to \$7046. Books that take you through every step. Popular Mechanics Famous Concrete Block House, \$2.00. Your Home and How to Build It Yourself, \$3.00. Also full-sized builder's plans for each home at nominal price. Popular Mechanics Press, 200 E. Ontario St., Chicago 11, Ill.

PHOTO FINISHING

CUSTOM Photofinishing absolutely guaranteed. 8 exp. 35c; 12, 50c; 16, 70c. 35-mm., \$1.00. Free mailer. Flash Foto, Parkville Station, Box 36, Brooklyn 4, N. Y.

MAIL Us your films. Prompt service. 8 exposures developed and printed 30c. Foto Art Studio, Box 406, San Francisco, Calif.

10 PHOTO Postcards from your negative \$1.00. W. Dornfeld, Iron Ridge 9, Wis.

16 PRINTS Or 8 jumbos from roll. 25c with this ad. S. Skrudland, Lake Geneva, Wis.

6 OR 8 Picture roll 35c, 12 or 16 picture roll 55c. Each roll printed and developed. Handy album pack. If you fail to get pictures on your film a new roll will be sent you without extra cost. Send coin with roll. No c.o.d.'s. Mailing containers sent free. DeLux Film Service, Box 1268-A, Shreveport, Louisiana.

QUALITY Photo finishing, prompt service at prices you like to pay. 8 exposure roll, 1 deckledge print, each 30c; 2 each. 40c. 1 each oversize, 40c. Other rolls priced equally low. Send for prices and mailer. Keepsake Photographic Laboratories, Box 7968P, Kansas City 3, Missouri.

ENLARGEMENTS! Dollar specials. Eight 5x7's; four 8x10's. Jerome Printing Service, 1969 Jerome, New York City 53.

8 CONTACTS 30c, Jumbos 40c, 12-45c, jumbos 55c, reprints 4c, jumbos 5c. Western Photo, Dept. PM152, Box 298, San Francisco 1, Calif.

YOUR Film developed and custom printed, contact, "Pure as Snow" process, 50c. Photo Park, Canton, New York.

8-EXPOSURE Roll developed and printed, jumbo size. 40c; 12-60c, 16-80c. All prints in attractive memory albums. Free mailers. Crown Photo Service, Box 392B, Augusta, Ga.

SEND Now for free snapshot magazine, offers, mailers. Houghton's, Athol, Mass.

ALMOST Free—with Blackhawk's big 28-page film bargain catalog—one brand new film (our selection) postpaid; 100' 16mm. sound, 98c; or 100' 16mm. silent, 59c; or 150' 8mm., 99c—as special get-acquainted offer. Typical Blackhawk bargains: New 1-reel 16mm. sound films, \$7.95 (formerly \$19.75); new 1-reel 16mm. silents, \$2.19 (formerly \$9.75); new 1-reel 8mm. \$1.19 (formerly \$5.50). Used Panoram 100' 16mm. musicals, \$9.98 per dozen. Similar bargains in used films of all types. Used sound projectors—Ampros, Bell & Howells, Victors—often available low as \$129.95. Write today for Blackhawk's free catalog. Blackhawk Films, Inc., "Sixteen's Super Market," 1206 Putnam Bldg., Davenport, Iowa.

THE World's greatest story. "Entire Life of Christ," 8 mm., 16mm. Sound and silent. Rent or purchase. Hemenway Film, 33 F Melrose Street, Boston 16, Mass.

MISCELLANEOUS 16MM sound film. Rush \$2.00 for 300 foot postpaid. Pastime Movies, Wood-Ridge, N. J.

FREE Sample and movie title list. Elite, Box 526M, Minneapolis.

16MM. Sound films features \$33. Shorts \$5. Bedner, 5300 S. Talman, Chicago.

16MM Kodachrome Sound films of Hawaii. Cinepic, 1847 Fort Street, Honolulu, Hawaii.

ODD, Unusual, glamour. 8-16 movies. 10c for list. Maurice, 3126 16th St., San Francisco, Calif.

NEW And used sound film for sale at less than cost. Soundies, shorts, features. Write for listing. Lawrence Camera Shop, Box 1597, Wichita, Kansas.

LEARN Free lance, educational, Hollywood, and television film technique at home. State licensed. Write for free catalog. Motion Picture Institute, Birmingham 4, Michigan.

FREE Movies. Thousands of subjects. Interesting. Entertaining. Fascinating. New Directory, only 50c. National Cine, 126 Lexington, New York 16, N. Y.

UNUSUAL 8-16MM. movies. Full-color projection length sample, \$1.00. Color Tru-Art slides, three samples \$1.00. Big catalog, 25c (refundable). National Film Supply, Toledo 9-H, Ohio.

5000 NEW—Used 8-16mm. silent-sound films. International, 2120 Strauss, Brooklyn 12.

8-16MM. Silent-sound films. Complete rental library. All latest subjects. Free catalogue, sample film 10c. Garden Film, 317 West 50th, New York 19.

BASS Says: Leadership since 1910 guarantees satisfaction. Finest Cine equipment: 8mm., 16mm., and 35mm., silent and sound. Write the old "horse trader." Satisfaction or your money back always! Bass Camera Company, Dept. A, 179 W. Madison St., Chicago 2.

RENT 16MM. sound films, 50c reel. Large selection; free catalog. Film Service, 128 Chestnut St., Roselle Park, N. J.

GUARANTEED Fresh 8mm. roll, magazine; 16mm. roll, magazine movie films. Color, b&w. Free catalog. ESO-S, 47th Holly, Kansas City 2, Missouri.

MOVIE Camera film: 8mm. roll \$1.50, 16mm. 100' \$3.00. Free processing. Better Films, 742 New Lots, Brooklyn, N. Y.

MUSIC AND MUSICAL INSTRUMENTS

MUSICAL Instruments, accordions, guitars, 10-day trial, free bargain list. Meyers, 454-A Michigan, Detroit 26, Michigan.

GUITARS, Accordions, clarinets, etc. Terms, (specify instrument). Ribner's, 74 Ferncroft Rd., Milton 87, Mass.

SONGWRITERS! This is the thing! Free information. Trans-World Music Co., 6356 Hollywood Boulevard, Suite 230C, Hollywood 28, Calif.

GUITAR. Master only 12 chords, play hundreds of songs. \$1. Money back guarantee. Bennett, 629 N. St. Andrews Place, Hollywood 4, Calif.

POPULAR Piano lessons. Chord system. Beginners; advanced. Free booklet. Stuart Studios, 1227½ Morris, Union, N. J.

1952 ACCORDIONS — Wholesale. Free catalog. American Accordion Center, 5329 Belmont, Chicago.

RECORDS. Guaranteed new latest Hillbilly, Pops, Blues, Spirituals, low as 4 for \$1.00. Free catalog. CI Mailor, 570 N. Gay Street, Baltimore, Maryland.

A New patriotic song of our times: Roll Up Your Sleeves. Just off the press. 35c. James Gilmore, Warrensburg, Missouri.

POEMS Wanted for musical setting. Send poems for free examination. Five Star Music Masters, Beacon Bldg., Boston, Mass.

MUSIC Arranged. Songs printed. Frank Wildt, Music Publisher, Lancaster, Penna.

ACCORDIONS—Save 50% and up. Cash or terms. New and used. All brands. Wholesale to every one. Free catalogue. Del Principe, 307 South Wabash, Chicago, Ill.

SONGWRITERS! Outstanding, ethical offer. Hibbeler, C-5, 2157 N. Avers, Chicago 47.

ELECTRIC Guitars, amplifiers, wholesale. Free catalog. Carvin PM, Baldwin Park, Calif.

SEND For free booklet, How To Write and Sell Songs. Get the facts first. Poems examined free. Reliable Music Service, Box 430-P, Hollywood 28, California.

SONGWRITERS! Protect your ideas! Hold all songs; poems! Write for Safe Correct Procedure first! Song Service, Dept. P, 333 W. 56th St., New York 19, N. Y.

POEMS Wanted. Broadcast consideration. Sooner Song Co., 22PM North West 8th, Oklahoma City 2.

SONGWRITERS! Send poems, songs. Music Service, 243 West 72nd St., PM, New York 23.

SWING Piano—By mail. 30 self-teaching lessons \$3. (Samples.) Phil Breton Publications, P.O. Box 1402, Omaha 8, Nebr.

POEMS Wanted to be set to music. Free examination. Send poems. McNeil, Master of Music, 510-PM S. Alexandria, Los Angeles, California.

WRITE Songs. Big money and reputation. Write for information. J. Gordon Pub. Co., 4700 South California Avenue, Chicago.

WANTED! Poems for musical settings. Write Songwriters' Service, Clifton, N. J.

RADIO AND TELEVISION

20' TELEVISION Tower easy to erect and safe to climb may be made 40' by telescoping pipe through tower. Complete with saddle roof hinge base, f.o.b. \$25. Youngstown Steel Towers, 1825 Wilson Ave., Youngstown 8, Ohio.

BUILDER'S "Pictorial Construction Plans." Free list. Alena, Box 24, Astoria 6, New York.

CRYSTAL Radio experimenters. Write Leslie Hulet, R 2, Lakewood, New Jersey.

TELEVISION Telescoping 50 foot steel mast, housetop, simple one-man installation, \$49.00. Four-stack V-cone antenna, reception to 200 miles, \$29.00 f.o.b. Television Engineering Co., 303—34th St., Bakersfield, California. Cash or money order. Practical detailed fringe area instruction manual and tips, \$1.00.

RADIO — Television Trade Gazette 10c. Trowbridge, 655 W. 81st, Chicago 20.

CIRCUIT Diagrams and data for radio, T.V., F.M., record changers. \$1.00 each, cash or m.o. Raymond Conover, Stone Ridge, New York.

EXTRA—Loud crystal, catwhisker, latest radio plans: 25c. Amorose's, R4, Richmond, Virginia.

WESTERN Electric fixed crystal. No adjusting. Excellent detector. 99c. Free lists. Radio City Labs, 30 Church Street, New York, N. Y.

NEVADIUM Training year, batteryless receiver set \$15.00. Sign-boards \$1.00. Brokerage, Milbank, S. D.

ENJOY Color television now with 3 color celanese plastic filter screen. Thirty seconds to attach. Reduces glare, blur, and snow. Easy on the eyes. Only \$1 any size. Zingo Products, Johnstown, N. Y.

CRITICAL Shortage of commercial radio operators exists! New 230 page streamlined home study course trains you quickly for top jobs. Complete. \$9.95 or write Streamlined Self Study Courses, 509—5th Ave., New York City.

TELEVISION Tubes. Fluorescent fixtures. Wholesale prices. Naturalite, 1520 Ardmore, Chicago 26.

LONG Distance TV and FM antennas. Yagi beams, stacks, etc. Wholesale Supply Co., Lunenburg 1, Mass.

AMATEURS — Radio Engineering Questions answered \$1.00. With schematics \$2.50. Henry Twillmann, R.R. #1, Chesterfield, Missouri.

FREE! 212 Page Radio-Television-Electronic Catalog! World's largest stocks, lowest prices. Complete supplies for builders, experimenters, amateurs, servicemen. Latest radios, phonos, television, recorders, sound equipment. Thousands of parts, tubes, test instruments, books, diagrams. Top quality money saving values. Get yours now! Allied Radio Corp., 833 W. Jackson Blvd., Dept. 34, Chicago 7, Ill.

MAKE Simple, tubeless, batteryless, distance-getting crystal radios. Crystal and illustrated instructions 25c postpaid. Allen, 427-P, Clinton, Mo.

BUSINESS OPPORTUNITIES

START Your own mail order business with hundreds of live repeat hobbycraft items. No stock to carry. We pack and ship for you. Free details. Write Dept. A1, Mail Order Service, 845 S. Wabash, Chicago 5.

AMAZING New Cedarwall! Makes permanent cedar closets, trunks, drawers! Laboratory approved; guaranteed. Easily and quickly applied like paint. Building supply dealers, lumber yards, stores, contractors, housing developers buy quantities. Attractively packaged. Exclusive distributors supported by powerful newspaper advertising. Wire, write now for samples, literature, full details. Millen Mfg., 90 Summit Ave., Brookline, Mass.

MAKE \$6.73 Every time you sell one—and they're amazingly easy to sell! We have new adding machines in original factory cartons you can sell for only \$14.95 and you make 45%. They're executive model portables, precision built with automatic clearance, direct subtraction, fully guaranteed. Send for life size color photo with full details. Write today to Lightning Adding Machine Co., Inc., Dept. P13, 1260 West Second Street, Los Angeles 28, Calif.

START Your own business on credit. Always your own boss. 1437 dealers sold \$5,000 to \$28,500 in 1950; their average \$6704. We supply stocks, equipment on credit. 200 home necessities. Selling experience unnecessary to start. Wonderful opportunity to own pleasant, profitable business backed by world-wide industry. Write Rawleigh's, Dept. A-U-PPM, Freeport, Ill.

INVISIBLE Reweaving — Big profit, big demand, easy-to-learn with low-cost complete course—nothing else to buy, ever. Details free, write today: Fabricon, Dept. N, 8342 S. Prairie Ave., Chicago 19, Ill.

BIG Money! Spare or full time in your home. No selling! Spray new miracle finishes, plush and suede, on signs, radios, automobiles, figurines, lamps, toys, etc. Our business is booming. Help us fill huge demand. New easy Flok-Kraft methods. Material costs few pennies. You get dollars. Free samples, complete powerful money-making plan free. Write now! Coast, 1002A S. Los Angeles St., Los Angeles 15, Calif.

QUICK Sign painting. Use letter patterns, avoid sloppy work, wasted time. Write for sample. John Rahn, A1330 Central, Chicago 51.

TRADE Magazines help you to success. Get latest copies through our easy-to-get-acquainted service. Hundreds of business, professional, craft, advertising, agricultural, amusement, architecture, art, astronomy, athletic, automotive, aviation, baking, banking, barber, beauty shop, beverage, book, brick, building management and others covering all interests. Send for list today. It's free. Commercial Engraving Publishing Company, 34C North Ritter, Indianapolis 19, Indiana.

GOOD Paying business silvering mirrors, plating autoparts, reflectors, bicycles, bathroom fixtures, etc., by late method. No tanks or shop required. Outfit furnished. Free booklet. Gunmetal Co., Ave. H, Decatur, Illinois.

LEARN Sewing machine repair. Electrify, rent, trade, sell. Make "big money" at home, spare time. New motors, machines, etc. wholesale. Details free. Taylor Service Co., Hamilton PM-1, Ohio.

137 WAYS To make money, in home or office, business of your own. Full particulars free. Elite Co., 220 Grand St., New York 13.

START A venetian blind laundry. Profit opportunity for lifetime business. New machine method. Free booklet on request. F. C. Co., 442 N. Seneca, Wichita 12, Kans.

MAKE Money at home as renewal stationer for all magazines. Liberal commissions. No experience, no capital needed. Supplies furnished. Write for free catalog. McGregor Magazine Agency, Dept. 500B, Mount Morris, Ill.

EXPORT-Import! Represent manufacturers! Conduct barter exchange. War-peace time big profit business. Buy-sell by mail operating at home. Let experts show you how. No previous experience needed. Get free facts now. International Trades, 246-P, Fifth Ave., New York 1.

BOOKKEEPERS — Boost income operating franchise bookkeeping service. Kern, 4942 Vineland, North Hollywood, Calif.

SELL By mail, free details; instructive booklet 25c. Manhattan House, Box 51-M, St. Albans 12, New York.

ESTABLISH Profitable automatic shoe shine route. Proven. Write Jiffy Shine, 1630 S. 2nd St., Philadelphia, Penna.

INVISIBLE Reweaving. Men-women. Instructions shipped for no-risk examination. \$5.00 hour possible spare-full time. Reweave burns, tears, moth-holes like new at home. Free details. Skilweave, 1717-AY Westwood, Los Angeles 24.

YOU For president of your own credit-collection agency. Many who answered our ads now have their names on office doors. Franklin Credit, Roanoke 7, Va.

1001 OPPORTUNITIES Club, 1495 Westchester Ave., New York 72, offers real money making ideas. Free information.

FREE Big mail. Send name. Publisher-31, 4121 Wyoming, St. Louis 16.

MAKE Tough, durable plastic—1c pound. Makes attractive floors, walls, built-ins, roofs. Build good home, \$150 room. Bays Laboratory, Oklahoma City 9.

AMAZING New patented labor-saving, precision screw-holding screw drivers! Removes, inserts, holds screws hard-to-get-at places! Tremendous profits; stores, factories, plants, shops, city, state, Gov't dep'ts. buy quantities. Exclusive state distributors. Toolco, 90A Summit, Brookline, Mass.

MAKE Mail order business pay. Necessary basic knowledge. Recommended by mail order experts. Only 25c. Maxted Book Agency, Western Springs 5, Ill.

MAKE Perfumes at home. Write, Carey Laboratories, 1914 Chouteau PM-1, St. Louis 3, Missouri.

GET \$3.00 Orders. Keep money. Orders filled free. Free details. Corcoran, 2233 N. Winchell, Portland 17, Oregon.

\$35 WEEKLY! Home! Two hours daily! Invisible reweaving, 17 samples, 48 lessons, automatic latch steel tool assembly, material for life \$3 complete. (27 other unusual home projects.) Guaranteed. Details free. Walsh, 894 Main, Buffalo 2, N. Y.

SAWDUST. Turn it into cash. Twenty methods. Instructions 50c. Charles Company, 12-CTA, Norwood, Ohio.

PROFITABLE Home business. Electroplate novelties, autoparts, mirrors, baby shoes, etc. Portable Tyco Electro-Plater \$5.95. Free booklet. Tyco Metals, Box 13231-MC, Houston 19, Texas.

FREE Literature. Your own business. Profitable permanent. Hubbard, 6 North 6th Street, Yakima, Washington.

YOU Can have a steady lasting income with my copyrighted system in the mail-order business, right at your own home. Write me, I'll tell you how. F. Little, R.D. 1, Glenshaw, Penna.

INFORMATION Bonanza — 100 money-making plans, supply sources, 30c. Publisher Cutler, Reading, Penna.

BREED Earthworms — Profitable, easy, gardens feed tropical fish, frogs, fishing. 400 babies \$5.00. Wisconsin Earthworm Farm, Oshkosh, Wisconsin.

OPERATE Mail order business. Small capital. Free details. Main Service, 157 Britannia, Hamilton, Canada.

CASH From newspaper clippings. Details free. Ralph Underhill, Beebe, Ark.

START Mail business, everything furnished \$15.00. Good merchandise. Good profits. Details 25c, credited. Novelty, 888-1 Washington, Stoughton, Mass.

NATURE'S Best fish bait—"Soft" crawfish! Process and store at home. Instructions \$1.00. Simco, 515 Columbia, Lafayette, Indiana.

VALUABLE Aid for beginners. Booklet 64 pages, 21 departments explains everything about mail-order business. Postpaid \$1.00. G & G Products, Box 7, Planetarium Station, New York 24, N. Y.

GET money every day by mail. Pleasant home operated business. New booklet tells how. Only 25c. Esco Print, 8 Holt St., Dayton 7, Ohio.

PROFITABLE Home mfg. business. Make waterless hand cleaner. Over 300% repeat profit. No machinery. Formula \$1.00. Allen Research, Roslyn Heights, N. Y.

OPERATE Profitable mailorder business. Particulars free. George Lenhoff, Lincoln 8, Nebraska.

EARN Extra money operating mailing-addressing service. Also type manuscripts for authors. Particulars free! Vernon Torrey, Melrose 76, Mass.

RADIO Advertising without risk! Pay "per order." Further details, 10c. (Refundable.) Simon-P4, 59 Park Avenue, New York City 16.

"SIX Secrets for Success," plus five formulas, all for a dime. Lexington Mail Service, 5538 Lexington, Chicago 44.

BUILD A lifetime repeat mailorder business, just mailing letters. We supply everything. Free details. Tru-Art Service, 28 North Main Street, Freeport, N. Y.

UNLIMITED Profits! Pleasure! Preserve live flowers, leaves indefinitely, inexpensively. Rich, untapped market. Ideal home business, hobby or pastime. Extraordinary, "easy-to-follow" instructions, \$1.00. Satisfaction or money refunded. S. Butowsky, 1918 North 32nd, Philadelphia 21, Pennsylvania.

FREE Illustrated instructions, casting novelties. Genuine latex for molds. Major Chemical & Latex Co., 25 Allerton St., Boston 19, Mass.

EXCITING Beauty table lighter. She's a hot seller. Boxed sample and wholesale prices \$1.00 postpaid. New York Article Company, G. P. O. Box 405, New York 1, New York.

TIN-Cans. Turn them into cash. Nine methods. Instructions 50c. Charles Company, 12-CTB, Norwood, Ohio.

START Big-paying business. Operate from your home. Full or sparetime. Amazing new service for homes, offices, hotels, apartments, public buildings. Free details. Americlean Co., Inc., Dept. G-29, 211 North 7th St., St. Louis, Missouri.

PUBLISH A monthly magazine in your community. Very profitable. Low co-op rates. Details for stamp. TIC Publications, 35th-Arcade Bldg., 204-B, Chicago 16.

EARN Big money at home. Make genuine rubber molds, plaques, figurines, etc. Complete line of Dresden-Craft supplies. Catalog free. Ken-Dor Studio P, Lake Geneva, Wisconsin.

MAKE GIFTS, novelties, jewelry, from sea shells, fish scales, plastics. No tools needed! Learn secret methods of bronzing, pearlizing, gilding, silvering, metalizing, luminizing, dyeing. Write: Giftcrafts, Box 4550-PM, Coral Gables, Florida.

VALUABLE Wholesale sources for mail-order. Ferguson, 521 Midland, Little Rock, Arkansas.

EARN Money at home with your typewriter! Spare time! Details free. Edwards, Publisher, 3915-PM 12th, Des Moines 13, Iowa.

FISHWORM Business. Raise and sell fishworms. Big demand, large profit. This booklet, "Raising Worms for Pleasure or Profit," gives complete details. \$1.00 postpaid. Tennessee Worm Hatchery, Box 265-A4, Nashville 2, Tennessee.

HOW To set up and run a mirror shop! Resilvering mirrors, making chipped glass nameplates. Electroplating salts and rectifiers. John Sprinkle V60, Marion, Ind.

POPCORN And potato chip equipment. Long Eakins Company, 5260 High, Springfield 99, Ohio.

DOLLARS In your mail. Big profit-plan. Free details. Veejay, Los Angeles 18, California.

FREE Particulars "Profitable Home Business Projects" plus wholesale sources 740,000 items. Cottage Industries, Omaha 12, Nebr.

COMPLETE Vitamin business \$50! Includes vitamin stock worth \$126.00, labels printed with buyers name, prepared literature and automatic selling plan. Terrific local, national, foreign sales. Immense profits. Man or woman can operate anywhere. Durkin, 410E West 9th St., Los Angeles 15, California.

BUY Wholesale. Thousands articles. Supply directory, 10c. Idealco, Park Ridge, Illinois.

Y.
ESCAPE Wage slavery. Easily. Operate your own profitable lifetime business. Free literature. Corley, H285 Carlton, East Rutherford, New Jersey.

MAKE Perfume. Profitable mailorder business. Catalogue free. "International," 6347 Parnell-PM-1, Chicago 21, Illinois.

OPERATE Profitable mail order business. Splendid opportunity. For details write W. Bitterman Productives, 133 Boren North, Seattle 9, Washington.

LEARN Silk screen printing; invisible reweaving; repair dolls; make rubber stamps; repair sewing machines. Natural Rubber for molds. Free sample. Universal, Box 1076-a, Peoria, Ill.

SAVE, Profit—Buy thousands nationally advertised articles direct from manufacturers. Literature free. E. L. Gray, Box 456, Tombstone, Arizona.

MAKE \$50-\$300 Weekly at home—Dozens of ideas to choose from. Start now. Write: Graybill, R. 4-S, Lancaster, Penna.

SELL Lambswool polishing buffers for home electric tools. Two 5½" buffers \$2.00 value for \$1.00 postpaid. Braun, P.O. Box 1227, Milwaukee, Wisconsin.

A Big-paying business for a man in his 50's. One of our men makes \$11,000 in a year; other top men in their 50's earn up to \$5,000 to \$8,000 right from the start. We pay earnings in advance. Require no investment. Write confidential letter to Vice President, Dept. PM, Box 676, Dayton 1, Ohio.

GOOD With figures? \$48 day—spare time expanding lifetime business urgently needed. Season starts immediately. Manual \$3. Money back guarantee. Details free. Advance Supply, Box 61-F, Oakland Park, Florida.

PROFITS! Sell books by mail! Thousands wanted! Complete professional instructions \$1. Paramount Book Service, 39 Hopedale Street, Allston 34, Boston, Mass.

RUBBER Molds! New catalog illustrating over 100 professional molds. 10c. Castcraft Studios, 508-P Marion St., Brooklyn 33, N. Y.

SPARE—Time office work at home. Free details. Business Publishing, 127-T Broad, Boston 10, Mass.

URANIUM, Gold. A million dollar opportunity. Write today to Belgian-Congo, the biggest uranium producer in the world; ask for booklet with full information. Join. \$1.00. D.E.V.U.F.R.A., B.P. 302, Leopoldville, Belgian, Congo.

DISTRIBUTORS Wanted. Aluminum awnings. Big profits. Big demand. Make your own. Everything supplied. Details free. Kramer Industries, 321 S. Anita, Los Angeles, Cal.

EARN Extra Money! "Homeworker Magazine" tells how. Sample 25c. Sizemore, Box 7, 4917 Kostner, Chicago 30.

VENDING Machines earn big money! An investment as low as \$10.50 will start you in this fascinating, profitable business that can lead you to the road of success and independence. Routes can be established and operated in either full or spare time with no experience needed. Write for full details and our free catalog illustrating our nut, candy, gum and stamp vendors; also pin ball machines, music boxes, etc. Write immediately to Parkway Machine Corporation, Dept. 7, 715 Ensor Street, Baltimore 2, Maryland.

PRODUCE Flowers, concrete ornaments, cheap homes. Write: Shiffers, Box 129, Millersburg, Penna.

BUY Direct wholesale 750,000 articles. Write Publishers, Box 1486-PI, Detroit 31.

EARN Money mailing dollar-pulling circles—Keep 90c. Everything furnished. Genmerco, Box 142-P, Dorchester 24, Mass.

PRINT Without a printing press. Big profits! See page 110.

BUY—Sell using coupons both ways. How 25c. Artcraft, B814, Ft. Worth 1, Tex.

LIQUID Marble—Colorful, glossy! Molded, brushed, sprayed! Cast novelties, statuary, colored tiles. Flexible molds. Composition floors. Particulars free. Marbleizing Service, Edwardsville, Illinois.

OPERATE Profitable mailorder bookshop at home. Write Publishers, Drawer 1486-PI, Detroit 31.

BE Listed to receive latest mail order offers, samples, propositions. National, Box 88-P, Dorchester 22, Mass.

LEARN Professional candy making profitable home business. Details free. Pate, Kissimmee, Florida.

NEW Exceptionally profitable plans, ideas for home operated mail business. Rush name. Miller, 1772-P Carlyon Road, East Cleveland 12, Ohio.

WHY Job worry? Start electroplating, metal finishing business. Free information, trade secrets. Plater M Hyde, 327 West 120th Street, Los Angeles 61, California.

TO \$35.00 Weekly. Spare time, home operated mail order business. Successful small "beginner's" plan. Everything supplied. Lynn, 5710-M Bankfield, Culver City, California.

BOOKKEEPERS, Keep books, small firms spare time. Manual latest technique by C.P.A., \$3.00. Modern Business, Box 406, Youngstown 1, Ohio.

FIX Typewriters. Free booklet describes our modern, inexpensive home-study course. Factory methods taught. Write: Typewriter, 1215 Corbet, Tarentum, Penna.

DEALERS, Agent, distributors, wanted. High grade plastic wall tile. Large profits. Write manufacturers, Artistic Tile, 3010 W. Irving Park, Chicago 18, Illinois.

FREE Book "505 Odd, Successful Businesses." Work home! Expect something odd! Pacific, Oceanside, Calif.

NATURAL Molding Latex. Extra thick. Free sample. W. Wooley, 115-A Donald, Peoria, Ill.

FREE Money-making mail ideas. Publisher-30, 4121 Wyoming, St. Louis 16.

\$46 FROM Square foot plywood; jigsaw necessary. Write: Woodarts, Bridgewater, Mass.

MAKE Big money at home with Magic Pearl Finish. Free plan. Pearl-Art, 7216 Bear, Bell, Calif.

YOUR Name and address on postal will bring many local and mail business opportunities. Apex Supply, Box 165, New York 18, N. Y.

MAKE Money spare or full time, casting metal toys and novelties. Big 1952 wholesale and chain store orders for cast metal autos, soldiers, ashtrays, banks, etc., keep manufacturers busy. Production molds furnished for up to 100 and more castings per hour. No experience or special place necessary. Write for information and illustrations of patterns needed. Metal Cast Products Co., Dept. A, 1696 Boston Road, New York 60, N. Y.

CONVERT Hand mowers to power mowers. Do it now, this winter. Sell the Handy-Dandy conversion kits. Easily installed on 16 to 20" mower. Use any small gasoline or electric motor. Quick delivery. Kits purchased with or without engines. Also new garden cultivator. Cultivates 3" deep. Attachments available: weed cutter, lawn mower and snow plow. Discount to dealers. LeClaire Manufacturing Company, LeClaire, Dept. PM, Iowa.

QUICK Money! Repairing car batteries! At home! Easy too! Batteryman, Grand Junction, Colorado.

EXTRA Money—No selling, operate vendors. Amazing profits, details free. Silver King, Suite 220, 622 Diversey, Chicago 14.

PROFITABLE Home mfg. business. Make waterless hand cleaners, household and auto specialties, etc., by simply adding water to basic concentrates. Over 300% profit, up to \$500 monthly, on steady repeat orders. Formulas free. Western B Aircraft, Los Angeles 19.

WANTED! At once! Home producers by manufacturers in our clearing house service. Become a sub-contractor casting plastic products for these companies. Thousands of easy to make items required. Cash in at home, without previous experience. For details write Plastic Service Guild, Dept. SPM, E. Boston 28, Mass.

BABY Shoe metallizing. Amazing offer. Send card. Schoettle, Friendship 12, Ohio.

BOOKKEEPERS, Earn up to \$520 month serving small firms part or full time. Proved plan; simplified system. Particulars free. Tax Saver System, Dept. A, Ft. Worth 2, Texas.

BIG Money and fun growing live miniature Ming trees on your window sill. Write for free rare tree seed and plan. National Nurseries, 8620A Ruthelen, Los Angeles 47, California.

free. Olsen, 1231-A East Third St., Duluth 5, Minn.

FIGURINE Molds and many others, liquid rubber, statuary plasters, flock finishes, etc. Illustrated catalog and "Plastercraft" manual free. Blue Rapids Supply, Blue Rapids, Kansas.

\$25 WEEKLY Working two hours daily. No canvassing. No manufacturing. Lycke, Box 2471-A, Cleveland 12, Ohio.

MOLDING Rubber \$2.95 quart, \$9.95 gallon prepaid! Plastercraft Supply Company, 3051 St. Clair Avenue, Cleveland 14, Ohio.

FREE Booklet "How to Make Backyard Profits!" Pickett's, Florence, Kentucky.

HOW And where to obtain capital, details free. Star Service, Wapakoneta, Ohio.

BEST Tested moneymakers. Over 40,000 words 25c. Business secrets, formulas, wholesale supply, sources galore. Money-back-guarantee. VeeJay, Box 14707M, Los Angeles 18, Calif.

EARTHWORM Breeding? First, get unusual story. "An Earthworm Turned His Life." Free. Earthmaster, Dept. 14, El Monte, Calif.

MONEY In new greaseless doughnuts. Start in kitchen. No smoke. Sell stores. Free recipes. M. Ray Company, 3605 South 15 Ave., Minneapolis 7, Minnesota.

WHERE To buy at wholesale 100,000 articles. Free list. Also extra-income literature. Maywoode, 1133 Broadway, New York.

GROW Mushrooms. Cellar, shed. Spare, full time. We pay \$3.00 pound. Free book. Mushrooms, 2954 Admiral Way, Seattle, Wash.

INCOME From local information. No selling. Write Neherco, La Verne, Calif.

MAKE Flexible molds! Cast plaques, bookends, figurines! Free sample! H. Tooker, 630-R Chestnut, Hamilton, Ohio.

NEW Profitable home business repairing zippers. Thousands of customers waiting. No experience required. We furnish everything. Write Texas Specialty Company, 204-B Texas, Texarkana, Texas.

UNPAINTED Bookends, plaques, statues, figurines. List. Haverly Products, 822-17th St., Altoona, Penna.

START Mailorder bookshop—Everything furnished. 25c brings booklet, samples, exciting ideas. General Publications, Ossining, N. Y.

OPERATE Profitable mail order business. Write Walter Service, 4159-A East 112th, Cleveland 5, Ohio.

DOLLARS In personalized baby record books. Sell by mail. Use same literature we do. No-Co-Ro, Oakland 6, Calif.

FABULOUS Earnings—Fascinating pastime. Growing genuine, living miniature (ming) tree. New sensational business or hobby. Astounding information free. Dwarf Gardens, Box 355B, Briggs Station, Los Angeles 48, Calif.

GET Into high paying new sewing machine field! Save \$100 on a brand new electric portable sewing machine by assembling yourself. Complete parts cost only \$48. Can be completely assembled in less than an hour. Same machine retails for \$169.50. Builds into beautiful full-size round bobbin machine. All parts brand new. Make up kit contains following parts: 1 Star round bobbin head, completely assembled, \$30. Motor \$6.00. Foot control \$2.00. Light \$1.50. Wire 50c. Leatherette portable case \$8.00. Total complete kit \$48.00. Build one for your wife or mother. Assemble and sell these machines at big profit. Buy direct from manufacturer. Send cash, check or money order to: Star Sewing Machine Wholesalers, 1130 S. Western Avenue, Los Angeles, Calif.

COMMERCIAL Deep frying course. Mock chicken legs, potatoes. New and proven methods. Learn about this money-making field. \$2.50 p.p. Concession, Toledo 13, Ohio.

MADE \$24,500 Using money making plans from Schemer Magazine, world's oldest mailorder publication. Box 275M, Canfield, Ohio. Year \$2.00. Sample 20c.

MINK Raising information free. Complete. Lake Superior Mink Farm. Superior, EE1, Wisconsin.

COPUBLISH Leading m.o. paper. Latest copy Mail Sale Advertiser, details, dime. Vanrov Shirk, Lebanon, Penna.

products, novelties, ties. Basement leak-sealing. Money-making projects. Booklet, details free. Men only. National Potteries Company, Grand Rapids, Minnesota.

READ "Advance"—The voice of mail order. Offers money-making opportunities, sources of supply, personal guidance, etc. Issued monthly. Sample copy 25c. Yearly subscription \$2.00. Advance Publishing Company, 313 East 21st Street, Suite 450, New York 10, N. Y.

LIQUID Rubber. Make flexible molds. Free sample. Chaney, 1130 E. 16th St., Jacksonville 6, Fla.

MAILING Postcards selling repeat merchandise is profitable. Everything supplied. Details free. Gordan Publishers, Box 23, Pawtucket, R. I.

MEN—Women. Everybody likes candy. Learn to make professionally. Our 40th year. Ragsdale Candies, D5, East Orange, New Jersey.

MONEYMAKING OPPORTUNITIES

EARN Money at home—Steady income. Make jewelry, shellcraft artificial flowers, novelties, dolls. Sell on sight. Business plan. Profitkraft catalog 10c. Cleveland Model, 4508TC207 Lorain, Cleveland, Ohio.

EARN Money evenings, copying and duplicating comic cartoons for advertisers. Adservice, Argyle 1, Wisconsin.

MONEYMAKING Opportunities. Free literature. National Hobbies, Box 524, Rochester, Minnesota.

"MAGIC-Mousie" Tricky! Funny! Makes you money! Sample 25c. Unicraft, 4932 Eighth, Philadelphia.

"HOW To Make Money With Simple Cartoons"—A book everyone who likes to draw should have. It is free; no obligation. Simply address Cartoonists' Exchange, Dept. 91-CM, Pleasant Hill, Ohio.

HOME Mail business supplies, lists free. Lincoln, Box 449, Irwin 4, Penna.

PROFITABLE Sideline! Supply dealers with books! Thousands wanted! Full professional instructions \$1. Paramount Book Service, 39-P Hopedale Street, Allston 34, Boston, Mass.

CHOP Suey bean sprouts, amazingly profitable spare room income. Growing, selling, plus 30 delicious sprout recipes. \$5.00. Texas Health Products, Box 23, Beeville, Texas.

INCOME Tax consultants earn \$100 daily. Easily prepared for. Details free. Universal, Box 664-M, Springfield, Mo.

MAKE Money at home or travelling. Full particulars free. Emly Enterprises, Box 319, North Hollywood, California.

UNPAINTED Plaques, bookends, novelties. Stamp brings list. Umlauf, 239 S. Luther, Detroit 25, Mich.

BUY And sell surplus. Tremendous profits. Big copyrighted report tells how. Price \$1.00. Satisfaction guaranteed. S. & S. Publications. Goldthwaite 1, Texas.

WIN Cash, cars in prize contests! Write for copy filled with current contests, winning hints and tips. Send only 30c. Wright Contest Digest, Dept. 17-A, P.O. Box 2266, St. Louis 9, Mo.

WORRIED About a job? Learn how to make \$5000 a year. Yes, anyone can operate this plan successfully in United States no matter how old they are—Man or woman. Free information. DeSpain Products, Box 473, Port Huron, Michigan.

BIG Money jobs in foreign employment for construction men, building trades, helpers, office men, others, interested in foreign projects. High wages, quarters, transportation. Listings of firms actively working on U.S., foreign, intercontinental projects. Send \$1 for foreign construction compendium and application forms. Foreign Service Bureau, Dept. M, Box 295, Metuchen, N. J.

OLD Phonograph records wanted—Paying up to \$300. Complete price list of over 1500 records and details \$1.00. International Mart, 6912-M, Hollywood Blvd., Hollywood 28, California.

FREE Nationwide advertising, publicity! Advertise your products to 51 million readers thru 77 national magazines, free of charge! Broadcast on 400 radio stations without risking a penny! Send 25c (refundable) for details today! Treasury, 149 Storer, New Rochelle 3-L, New York.

SELL Box tops! Information 25c. Everett Turlington, Box 587, Dunn, N. C.

EARN Money. Send 25c. Box 71, Sta. D, Atlanta, Georgia.

LEARN Mailorder selling. Free details. Greenlawn Enterprises, 15378-X Greenlawn, Detroit 21, Michigan.

"HOW To Build Your Own Mail Order Business." Facts that save losses for beginners and mail-dealers, 25c postpaid. Satisfaction guaranteed. Bennett Enterprises, 1215 Central, Louisville 8, Kentucky.

MAILORDER Magazine, homework offers, 10c. William Woodrow Jenkins, Lucasville, Ohio.

SELL Repeat item to all stores, gasstations, garages. Soldax, Hoosick Falls, N. Y.

SAWDUST Can put you in business—easily. 25c and secret yours. "Income," 1156 Greenfield Ave., Pittsburgh 17, Penna.

TOOL Men—Solder paddle sideline pays your expenses. All garages, body shops buy. Natural repeater. Fairwood Products, Station AA, Alliance, Ohio.

50,000 ARTICLES Wholesale. Source directory, dime. Nelko, Box 3462-DR, Chicago 54.

START A profitable subscription business in spare time! We need men and women (young or old) as representatives for all leading national magazines. Liberal commissions paid for new and renewal subscriptions. Start earning money in this pleasant work at once! Clip this ad and send with your name and address to: International Circulation Division, Dept. PM, Hearst Magazines Inc., 250 W. 55th St., New York 19, N. Y.

\$100-\$200 WEEKLY. No selling or manufacturing. Part or full time. Mahaffey, 3032-B Weldon, Los Angeles 65.

580 MONEY Making secrets, \$1.00. Book Service, P.O. Box 453, Port Chester, New York.

HOBBIES That make money. Free details. Cornell, 421 Ocean Ave., Lynbrook, New York.

TIE-Breaker picture puzzles exposed, \$1.00. Wenograd, Box 1495, Philadelphia 5, Penna.

FREE Book "505 Odd, Successful Businesses." Work home. Expect something odd! Pacific, Oceanside, Calif.

BE Appointed State Notary Public now! Details: Stationers, Helotes, Texas.

GROW Mushrooms. Cellar, shed. Spare, full time. We pay \$3.00 pound. Free book. Mushrooms, 2954 Admiral Way, Seattle, Wash.

PUBLISH Your own magazine. Handsome 52 page format, well edited, illustrated. Cost low as \$1.00 month. Brings you prestige, profits. 25c brings sample, details. National, Ord, Nebr.

READ Progressive Mailtrade, the magazine that tells how to make money by mail. Dime brings sample and special offer. Progressive Mailtrade, Box 357, Sheboygan, Wisconsin.

FORMULAS, PLANS, ETC.

REAL Manufacturing formulas. Lists free. Cummings, Chemist, Gordon Ave., Syracuse 4, N. Y.

112 FORMULAS \$2.00. One- and two-ingredient. Sensational Disinfecto formula, sample and plan included. Pharmacist, 750 East 225th, New York 66, N. Y.

ANY Formula \$2.00. Satisfaction guaranteed. Jack, Chemist, 4292 Parkside, Philadelphia 4.

ANY Formula \$1.00 or refund. Write Doctor Paul, 11559 Kling, North Hollywood, California.

FORMULAS; All kinds. Latest, best. Literature free. Kemixal, Park Ridge, Ill.

YOURS. Free catalog profitable formulas. Consultants, Box 201, Cincinnati 14, Ohio.

LATEST Manufacturing formulas, for profitable, easy to make chemical specialties. Lists free. Automotive Chemical Laboratories, Box 393-A, Hicksville, N. Y.

FORMULAS For big profit, fast-selling products. Free literature. Majestic, 530 1/2 S. Main, Elkhart, Indiana.

FORMULAS, Trade secrets, for nearly everything. Catalog free. Creative Publishers, Winnetka 6, Illinois.

TESTED Formulas. Interesting descriptive booklet free. Pont, Box 635-PM, Terre Haute, Indiana.

NEW Liquid casting plastic. Clear, colors. Embed flowers, insects, coins. Saw, drill, carve. Send 25c for wholesale catalog and new sales manual showing how to make money at home. Castolite, Dept. A-101, Woodstock, Illinois.

ACETATE, Cellophane, Plexiglas. Folders, specialties. Acetate assortment \$1.00. Major's, 3510-W Palmer, Chicago 47.

HI-Profits—Gifts, jewelry. Free catalogue, details. Pilot Plastics, 67-C, Fulton St., New York City 38.

STRIPKRAFT Plastics for profit. See our ad under "Home Craftsmen."

LEARN Plastics at home. Small cost, spare time. Dime brings sample plastic, three experiments, full details. Plastic Projects, Box 5151, Detroit 35, Mich.

LUCITE, Plexiglas. Any size sheets, masked. Square foot (12 x 12) cost, 1/16", \$1.20; 1/8", \$1.40; 3/16", \$1.75; 1/4", \$2.08. Include 10% postage. Almac Plastics, 230 Fifth Ave., New York 1, N. Y.

PLASTIC, Sheets, rods, tubes, etc. Free list. Plastic Supply Co., 2901 N. Grand Blvd., St. Louis 7, Mo.

CHEMISTRY

OH Boy! New book of science. Experiments, formulas, secret processes, together with catalogue of laboratory supplies, only 25c. National Scientific Company, Dept. 16, 2204 North Avenue, Chicago 47, Illinois.

SAVE Money! Supplies catalog 15c, refundable. Laboratory Sales, Box 161-A, Brighton, Mass.

CHEMICALS And apparatus for industrial, analytical, and private laboratories. Catalog 20c. Dept. M-50, Biological Supply Co., 1176 Mt. Hope Ave., Rochester 20, N. Y.

CATALOG Of chemicals, apparatus, kits, minerals, uranium ore, 10c. Rex Laboratories, 2849-A Birchwood, Chicago 45, Ill.

LABORATORY Apparatus, chemicals, microscopes, complete chemistry sets, minerals, uranium ore. 10c brings catalog. Porter Chemical Company, Hagerstown 1, Maryland.

SPECTROSCOPE For quick chemical analysis \$3. Kutting Sons, Los Altos, Calif.

NEW Idea chemical and apparatus outfits for home experimenting. Photo-scales, microscopes, chemicals, biological and laboratory supplies in small quantities. Catalog 25c. Established 1931. John H. Winn, 124A West 23rd Street, New York, N. Y.

ILLUSTRATED Catalog: Chemistry, mineralogy, biology. 10c. Tracey Laboratories, Evanston, Illinois.

HELP WANTED

TIRED Of no money, second rate jobs? Like to start a real career with a lifetime of high salaries? Write me about two growing fields that really need men. Ed. Howes, Chief, 456 W. Santa Barbara Avenue, Los Angeles 37.

AGENTS WANTED

PHOTO-Salesmen, agents. Sell beautiful hand colored plastic enlargements and sensational new photo compacts, rings, bracelets, lockets, etc. Collect deposit, we deliver. Profitable sideline. Send card, for free sample kit. Novel Portrait Co., 3343 North Ave., Chicago, Ill.

MEN! You can make a fortune if you join us now. We are introducing Kantlash. Greatest fishing equipment accessory ever manufactured. Sales already pouring in. We want distributors immediately! Retails \$2.95. Big, easy profits. Write today! Kantlash, Evanston 7, Illinois.

ALL-Occasion greeting cards that are such terrific sellers all you have to do is show them. 21 boxed sell for \$1.00. Over 100 other wonderful boxes including birthday, get-well, etc. Profits to 100% plus bonus. Write for free samples. Kit on approval. Regal Greeting Card Co., Dept. 34, Ferndale, Michigan.

ABSOLUTELY Free! Big package actual sample fabrics and style presentation of dresses, lingerie, hosiery, etc. Take orders. Commissions big. Send no money. Melville Co., Dept. 6616, Cincinnati 25, Ohio.

I'LL Put a "shoe store business" in your pocket! Nation's leader trains you to make big money! Fit men, women. Free sample outfit. Write today! Consolidated Shoe System, Dept. C1-98, Chippewa Falls, Wis.

JUST OUT! New thrilling sensation in everyday cards. Rich foils, satins, velours sell on sight, 21 for \$1. Make up to 100% profit. 50 assortments, imprint stationery and book matches, gift items. Two \$1 assortments on approval. Imprints free! Joy Greetings, 507 N. Cardinal, Dept. P-60, St. Louis, Mo.

MAKE Money fast—Sell big value greeting cards. Four new 21 card \$1.00 all-occasion assortments, birthday, Easter, novelty cards. Gift wrappings, stationery, notes. Unusual gift items. Over 100 fast-sellers. Amazing profits. Write for samples on approval and "get-started" plan. Hedenkamp, 361 Broadway, Dept. PM-17, New York.

BE A money maker. Use your home as magazine headquarters. Liberal commissions. No experience—No capital needed. Everything furnished. Write for free catalog. McGregor Magazine Agency, Dept. 500A, Mount Morris, Ill.

DO You need money? \$40.00 is yours for selling only 50 boxes of our 300 greeting card line. And this can be done in a single day. Free samples. Other leading boxes on approval. Many surprise items. Experience unnecessary. Free samples personalized stationery, napkins. Write today. It costs you nothing to try. Cheerful Card Co., 425 White Plains, New York.

MAKE Money introducing world's cutest children's dresses. Big selection adorable styles. Low prices. Complete display free. Rush name. Harford, Dept. G2341, Cincinnati 25, Ohio.

WHOLESALE Deal. Power mowers. Extra profit. Sell other dealers. Rotacut-PM, Excelsior Springs, Mo.

SELL Amazing value greeting cards—For less than 5c each. Show friends, neighbors gorgeous box assortments. Experience unnecessary. Big profits. Bonus. Surprise gift offers. Request feature all-occasion assortments on approval, free samples name imprinted stationery, napkins, towels and free catalog. New England Art Publishers, North Abington 604-D, Mass.

CALENDARS, Advertising novelties, matches. All styles, including religious, varnished. 12 sheet, girls. Hundreds of advertising novelties, book matches, etc. Fleming Calendar Co., 6539 Cottage Grove, Chicago 37, Ill.

MAKE Money calling on friends. Show nationally advertised greeting cards—New all-occasion assortment and laugh-packed barrel-of-fun. Also sensational pinafores and parasols personal notes. All three dollar sellers. Up to 50c profit for you. Big line, includes gift wrappings, stationery, gift items, etc. Get three assortments on approval. Write Wallace Brown, 225 Fifth Ave., Dept. G-4, New York 10.

SELL New automatic floor waxer. Retail \$2.95. Profit 125%. Write J. Smith, Inc., Greenfield 35, Mass.

SELL Sunshine exclusive everyday cards and make big money the easy friendly Sunshine way. Complete selection greeting cards, stationery, gift wraps, novelties, etc. 21 deluxe miniature everyday cards—75c. Many others. Send postcard today for your Sunshine sample kit on approval to: Sunshine Art Studios, Dept. PM-1, 115 Fulton St., New York 38, New York.

"FOG-Stop" Windshield cloth. Instantly removes blurry mist, frost, sleet, snow. Stops windshield fogging. Samples sent on trial. Kristee, 140, Akron, Ohio.

NEED Extra cash?—Get it selling Blair's unusual line of household and food products. Every housewife a prospect. Send for samples free. Write Blair, Dept. 31HA, Lynchburg, Va.

DOUBLE Edge blades \$7.50 1,000 post-paid. Agents wanted. Schmieder, 1402 Cass St., Saginaw, Mich.

QUALITY Merchandise wholesale, small lots. Warren Wallace, Kittell Road, C, Fayetteville, N. Y.

NAMEPLATES For homes, desks, etc. Free sample. Whitney Co., West Springfield 22, Mass.

WHOLESALE Catalogue free! Appliances, cameras, watches, etc. Cam Company, 1717—58th, Brooklyn 4, N. Y.

FREE Samples, and amazing plan, giving you gorgeous dress without penny cost. Rush name today with dress size. Harford, Dept. G-235, Cincinnati 25, Ohio.

"NEW Products and Services." 600 products, 80 pages, 75c postpaid. Max Saltzman, 748 East 179 Street, Bronx 57, New York.

BUY Wholesale—25,000 items. Catalogue 25c. Matthews, 1472-B6 Broadway, New York City.

CALIFORNIA Sweet smelling beads. Sensational sellers. Free particulars. Mission, 2328PM West Pico, Los Angeles 6, Calif.

AT Last! Something new and sensational in everyday cards, 21 for \$1. Make extra money fast! Show satin, velour, metallic cards. Get orders easy. Big line \$1 assortments, scented stationery, personal matches, kiddie books. Imprints free. Two \$1 boxes on approval. Puro Co., 2801 Locust, Dept. 240-A, St. Louis 3, Mo.

PLASTIC Party demonstrators, 300 household items. Free catalog. Esty, 888A River, New York 52.

3c SIGNS! Samples 25c. McConnell, 1051 North Main, Akron 10, Ohio.

SELL Beautiful chenille flowers and novelties. Free catalogue. Midwest Supply Co., Box 2193, Casper, Wyo.

MAKE Wedding profits. Sell invitations, napkins, matches. Samples free. Dunbar's, Middlebush 3, N. J.

"DRY" Wallpaper cleaner. No messy liquids. No sticky "dough." Simply wipe wallpaper, painted walls. Samples sent on trial. Kristee 141, Akron, Ohio.

SPILL-Proof baby feeding cups and dishes—Ideal for training baby to feed itself. Sell fast to every young mother. Excellent gifts. Good profits—full or spare time. Details free. Write Keeler Products, 1703-K North Albany, Chicago 47.

MEXICAN Feather pictures. Sell on sight; 200% profit! Free details; sample 10c stamps. Sylvia PT, Apartado 9036, Mexico City.

LUNCH Counter game. Gigantic profits! (Skill.) Start route. \$59.40 dozen, samples \$7.50 each, prepaid. Industries, 15, Box 929, Long Beach 1, Calif.

MEXICAN Feather pictures. High profit! Fast sellers! Adelphi, Box 57-B, Belle-rose 6, N. Y.

\$50 WEEKLY Selling finest razor blades, other items. Free details. Edisons, Box 274, Far Rockaway, N. Y.

EMBOSSSED Business cards, lowest prices. Velazquez, 696-P Elton Avenue, New York 55.

MEXICAN Feather pictures, unusual novelty, \$1.00 (stamps) brings \$2 worth samples. Refunded if unsatisfied. Aztec Art, Apartado 762, Mexico City.

BIG Profits, fast sales with 7 sensational new items! Free samples! Durever, 2781-D Atlantic Avenue, Brooklyn, N. Y.

\$60 RING And valve job for \$6.00—While you drive! Guaranteed for life of car! Increases mileage, stops oil pumping. Patented. Nerlino, Box 7, Inglewood, Calif.

NEED Money? \$50-\$100 and more is yours—easily, pleasantly, quickly. In spare time just show friends irresistible Elmira assortments of all-occasion greeting cards, wrappings, personalized stationery, napkins, matches, many other exclusive, profitable specialties. No investment. No experience. Success assured. Bonus. Special prizes. Promptest service. Write today. Free samples, assortments on approval. Elmira Greeting Card Co., Elmira 109, N. Y.

3 BILLION Greeting cards bought yearly. You can cash in on this million dollar market. Make 100% profit easily with Fanmour greeting, imprint stationery, napkins, gifts. Complete selling outfit on approval. Fanmour Corp., 200 Fifth Avenue, Dept. PM-1, New York 10.

BUY Wholesale thousands nationally advertised products at big discount. Sent free "The Wholesale Plan." American Buyers' Service, 629-P Linden, Buffalo, N. Y.

WORLD'S Best hair dressing! 100% profit! Won't rub off on upholstery, etc.! Good repeater. Everyone wants it. Sample, details free. Hikell Products, 1220 Burbank Blvd., Burbank, Calif.

HUGE Profits. Assemble rhinestone jewelry. Sample kit \$1.79. Sells for \$6.50. Giant 56 page idea packed wholesale cat. only 25c. House of Hobbies, Box 790B, Evanston, Ill.

SELL Perfumes. Sample outfit furnished. Tropical, Box 5652, Chicago, Ill.

"GLASS Tabs." Amazing new discovery. Small tablet dropped in water makes 1 quart glass cleaner. Whirlwind seller. Quick repeater. A gold mine for profit. Exclusive territory. Write immediately.

ULTRA-Blue stock signs—7c, sell 50c. 2000 slogans, 7" x 11", comedy, religious, general. 15 samples, \$1.00. Lowy, 812 Broadway, Dept. 646, New York 3.

NYLONS! New! Fancy heels! Guaranteed! Earn \$1.00 box. Roma Hosiery, 833 Columbus Avenue, New York City.

MAGIC Words give you daily cash! "Kendex nylons are free unless satisfactory." New style 300 only 98c including your commission, bonus and postage. If these wonderful sheer DuPont nylon stockings run, snag or are not satisfactory within 1½ months of receipt, we refund the full 98c so they will cost nothing! What woman will hesitate to wear fine nylons at our risk? Just write orders. We deliver and collect. Advance cash plus huge bonus. Spare or full time. No experience necessary. Postcard brings you sample stocking and money-making outfit free and prepaid. No obligation. Kendex Corporation, Babylon 43, N. Y.

\$500 MONTHLY Possible. Free catalog. Bava, 3655 E. Canfield, Detroit 7, Mich.

BIG Profits selling ties. (\$2.00 values) \$6.50 dozen. Free catalog. Empire Cravats, P648 Broadway, New York 12.

AMAZING Miracle auto polish—Plastone! New scientific discovery contains pure Carnauba wax, genuine plastic plus silicones! Sensational money maker! Nationally advertised! Sold by leading firms. Used by America's largest organizations. Only \$1 retail. 100% profits. Sales experience unnecessary. Exceptionally easy sales. High repeat sales. Choice protected territories. Once in a life time opportunity for large steady earnings. Only limited number of agents accepted. Write today. Plastone Company, 2950 W. Grand, Dept. PM-1, Chicago 22, Illinois.

PRINTING—Salesbooks, envelopes, tags. Free illustrated catalog. Ersco, Bronx 72, N. Y.

SCHOOL Seniors! A postal will bring you our wonder, Kwick-Sell Cardalog of popular graduation name cards. Biggest profits! Only firm giving free Golden Memory Book and Souvenir Chest. Don't miss out. Hurry that postal! Craftcards, Box 235L, Pittsburgh 30, Penna.

YOUR Own business—Used overcoats 50c; mackinaws 34c; shoes 12½c; ladies' coats 30c; dresses 10c. Enormous profits. Catalog free. Moro, 558-AA Roosevelt, Chicago 7.

SCHOOL Seniors—Earn sensational profits selling classmates America's most beautiful graduation name cards. Largest selection. Outsells all others. Free sample kit. Printcraft, Dept. M, 1425 E. Elm St., Scranton 5, Penna.

NEED Extra cash? Take orders for personal initialed belts and buckles, cap badges, tie holders, etc. Choice of 3000 emblems. Free sales kit. Hook-Fast, Box 1425PM, Providence, R. I.

EXCELLENT Sideline for printing and advertising salesmen. Decalomania name plates in small quantities. Great demand. Also, make money with our line of automobile initials and sign letters. Free samples. "Ralco" XL-Roxbury, Boston 19, Mass.

AGENTS: Stamping names on key protectors. Sample 25c. Stamping outfits, checks, social security and name plates. Hart Mfg. Co., 303 Degraw St., Brooklyn, N. Y.

AGENTS—300% Profit selling genuine gold window letters: stores and offices. Free samples. Metallic Letter Co., 438-B North Clark, Chicago.

WANTED—Purchasing agents. No money or experience required. Write Dept. C, Purchasing Manager, 2719 Lawrence, Chicago, Ill.

SELL Big money-maker to men and women. Easy handwork makes fast-selling useful articles. Sunmade Company, Brockton 64, Mass.

GOLD Lacquered and silver sign letters. Windows, doors, trucks. Standard sizes. Penny each. Free samples. Atlas-P, 544 West 79th, Chicago 20.

SALESMEN, Distributors, fast selling costume jewelry direct from factory. Big picture catalog, free. Pickcraft, M19 Bank, Attleboro, Massachusetts.

DRESSES, Used 18c; Coats \$2.00, blouses 35c. Free catalog. Crown, 164-P Monroe Street, New York.

GET Into million dollar work clothes business! Earn big money now, unlimited future! Sell finest-quality, embroidered uniforms and work clothes to factories, garages, service stations, lumber yards, everybody! Huge profits possible. No experience needed. Gorgeous selling kit, actual fabric samples, everything free! Write Topps, Dept. 531, Rochester, Ind.

UP To \$50.00 in a week spare time and tailored suit for yourself without paying one cent. Write for plan and free sample case. Progress Tailoring Company, Dept. B-217, 500 S. Throop, Chicago 7, Ill.

ANYONE Can sell Hoover DuPont nylon uniforms for beauty shops, waitresses, doctors, nurses, others. In white and colors. Exclusive styles. Top quality. Low priced. Exceptional income. Real future. Equipment free. Write fully. Hoover, Dept. A-100, New York 11, N. Y.

ADVERTISING Book matches—Cash in on big demand; sell union label matches. Cuts for all businesses and political parties. Free powerhouse selling kit, low prices, protection guaranteed on repeat orders. Cash commissions. Superior Match Co., Dept. 152, 7530 Greenwood, Chicago.

MAKE Money with fast-selling Bostonian shirts. Blouses too. Spare time, full time. Sales kit free. Bostonian, 89 Bickford, Dept. M-10, Boston 30, Mass.

SPARE Time—Full time. \$20.00 day easy in commissions working only few hours. No experience needed. Sell iron entrance railings to new home owners. Easily self-installed. Write: K. Jerome Co., 740 W. Superior, Cleveland 13, Ohio.

MAN To earn \$100 week up. Long needed invention. Advertised Saturday Evening Post, Colliers. Prospects everywhere. Full or part time. Exclusive. No investment. Free samples. Write Red Comet, Inc., Dept. 80-A, Littleton, Colo.

WANT To make real money? You can positively make \$50.00 a day and up selling a brand new item going to every type of food and beverage store, factories, laboratories, hospitals, etc. First time advertised. Write for free details today. Johnson-Hartmann, 53 West Jackson Blvd., Dept. PM-01, Chicago 4, Illinois.

TOOL Salesmen. Buy tool specialties wholesale. Catalog free. Mechanico, 3561 Lakeshore, Oakland 10, Calif.

TWO Little water squirts cleans windshields. Guaranteed. Sample \$2. Big profits. Free particulars. National, B552, Memphis 1, Tenn.

REPRESENT America's largest factory selling advertising pencils. High commissions. Attractive line. Send \$1.00 for pencil kit (refundable). Union Pencil Company, 389 Broadway, New York City.

"GLASS Tabs." Amazing new discovery. Small tablet dropped in water makes 1 quart glass cleaner. Whirlwind seller. Quick repeater. A gold mine for profit. Exclusive territory. Write immediately. Tennessee Supply Co., Greeneville, Tenn.

AMAZING Discovery, Master Glaze, puts brilliant glass-like surface on cars. Free sample, information. Big commissions. Master Glaze, Dept. 732, 7720 Harwood, Milwaukee, Wis.

AD Matches! Sell amazing designs—20, 30, 40 and 240-light book matches. Bigger spot cash commissions; every business a prospect. Low prices for high quality. Repeats. Start without experience; men, women; full, part time. Buy nothing! Sales kit furnished. Match Corp., Dept. PM-25, Chicago 32, Illinois.

RICH Opportunity for men in their 50's. Healthful, pleasant occupation. No investment needed. 150 of our men made \$500 to \$3,000 in one month; many just beginners. Heckman made \$104 first 2 hours! Crowley made \$224 first day; exceptional earnings. Openings available. Write President, Dept. PM, Box 711, Fort Worth 1, Texas. (If you live in Canada, write President, P.O. Box 88, Postal Station J, Dept. PM, Danforth, Toronto Six, Ontario.)

MAKE Money showing neighbors how to beautify yards with glorious flowering shrubs and trees. Quick-bearing dwarf fruit trees; world-famous Stark patented varieties produce abundant harvests champion-quality apples, pears, peaches, other fruits. Even small plots produce fruit for family-use and to sell. Beautiful sales kit free. Stark Bro's, Dept. 30182, Louisiana, Mo.

Show nylon, lingerie, men's socks with amazing free replacement guarantee against runs, snags, tears. Write for free sales kit. Group organizers invited. Rosalee Hosiery Co., Clifton 58, N. J.

NEW Jobs open in selling! Send name, address for five free issues of Opportunity Magazine's money-making guide, listing hundreds of companies who'll pay you well, full or part-time. No experience needed. Opportunity, 28 E. Jackson, Dept. 17, Chicago 4, Ill.

EDUCATIONAL AND INSTRUCTION

GUNSMITHING, Learn now! Start earning good income. Our residence course is thorough, practical! Approved for qualifying veterans; easy-pay plan for non-vets. Part-time work arranged. Write: Pennsylvania Gunsmith School, 1000M Western, Pittsburgh.

MAKE Up to \$45-\$55 week as a trained practical nurse! Learn quickly at home. Booklet free. Chicago School of Nursing, Dept. M-1, Chicago.

BOOKKEEPERS! Increase your earnings! Operate your own simplified "Dollar-A-Week" bookkeeping and tax service. Full or spare time. Details free. No obligation. Ellis, Box 200-A, Cedar Grove, North Carolina.

"HOW To Break and Train Horses"—A book every farmer and horseman should have. It is free; no obligation. Simply address Beery School of Horsemanship, Dept. 1101-C, Pleasant Hill, Ohio.

MINERALOGY Course, \$5.00. Western School of Mineralogy and Mining Inc., Box 1130, Long Beach, California.

MEDICAL Laboratory technicians in great demand. We train you in your own home. Catalogue free. Imperial Technical Institute, Box 973-J, Austin, Texas.

START A collection agency business. Very profitable. Quickly learned. Write Cole & Associates, Syracuse 2, N. Y.

BOOKKEEPERS! Free! "What You Should Know About a Bookkeeping Service." James, Box 1281, Lubbock 2, Texas.

USED Correspondence courses and books sold and rented. Money back guarantee. Catalog free. Courses bought. Lee Mountain, Pisgah, Alabama.

BE A real estate broker through home study or classroom instruction. Write for free book. Approved for Veterans. Weaver School of Real Estate, Suite 300 Law Bldg., Box CP-1, Kansas City, Mo.

BECOME A Doctor of Psychology or Metaphysics. Teach secret of contentment, happiness. Win degree of Ps.D. or MsD. Solve mental worries. Free book. College of Universal Truth, 5153-C North Clark, Chicago.

EXPORT-Import pays big. Conduct by mail. No previous experience necessary. Bulletin \$1. Benko, 246-P, Fifth Ave., New York 1.

HOW I quit smoking in one wheezy lesson. Humorous booklet. If you don't die laughing, you'll probably use the author's new approach to break the strangle-hold of the smoking habit. \$1. postpaid. Satisfaction guaranteed. Leon Knowles, Salisbury, Missouri.

LEARN Painless secrets of technical metaphysics. Easy. Simple. Write Canada School of Technical Metaphysics, 2532 McKenzie St., Vancouver B.C., Canada, for amazing information.

"BRIDGE To Knowledge" bestirs new heart in you to succeed. \$1.00. Ingraham, Box 9025, Los Angeles 5, Calif.

FREE "Career Chart." Write Professor Martin, Williamsburg, Mich. Mention occupation.

SECRET Service, fingerprint training, also books on palm prints, tracing, self defense, criminology, etc. Write Associated Special Investigators, Box 474, Saint John, N.B., Canada.

INCREDIBLE! Unprecedented! Look under "Miscellaneous!" Bijou, Box 1727-ML, Hollywood 28, California.

LISTEN And learn a language by linguaphone. At home, quickly, easily, correctly master Spanish, French, German, Russian, Chinese—any of 29 languages through Linguaphone Conversational Method. Add to service, job, travel opportunities. Send for Free book. Approved for Veterans' Training. Linguaphone Institute, 8301 Radio City, New York City.

YOU Can learn upholstery at home. Big opportunities! Write for free literature. National Upholstery Institute, 6108 East 24th, Indianapolis.

WAKE Up your sleeping success ability with personal education home-study. Many helped. Free lecture sent in plain wrapper. Write Pres. Ballard, Box 1924-M, Louisville 1, Kentucky.

HIGH School—No classes. Study at home. Spare time. Diploma awarded. Write for free catalog HF-16, Wayne School, 2527 N. Sheffield, Chicago 14, Ill.

EARN Free instruction. Accounting, mathematics, law, English, economics. Professor, 7621 Second Avenue South, Birmingham, Alabama.

PRACTICAL Nursing—Learn easily at home, spare time. Big demand, good earnings. High school not necessary. Write for free facts. Wayne School, Dept. FG-6, 2525 Sheffield, Chicago 14, Ill.

WONDER Drugs! Look under "Miscellaneous!" Bijou, Box 1727-XM, Hollywood 28, California.

BECOME Expert white metal welder. Instructions \$1.00. L. Spicer, Bath, Maine.

GET 1952 Gov't. job! Start high as \$73 week. Men-women. Thousands of emergency program jobs available! Qualify now. Experience usually unnecessary. Free 32-page book shows jobs, salaries, sample tests. Write today: Franklin Institute, Dept. E-24, Rochester, N. Y.

LEARN Shorthand at home. 30 days EZ longhand system. Zinman, 215-P West 91 Street, New York 24, N. Y.

ENGRAVING. Artistic hand engraving. Renzelman, 510 Seybold Bldg., Miami 32, Fla.

"FINGERPRINT Patterns and individuality"—Interesting, illustrated treatise explaining sensational new discoveries about fingerprints. \$2.00. Don L. Gordon, 2105 Cottage Grove Ave., Des Moines 11, Iowa.

USED Textbooks, real estate and other educational subjects. Bargains. K. H. Hall, 3519 Remington, Jacksonville, Fla.

MAKE More money. Learn to use a slide rule. Instruction booklet with accurate rule \$1. Zingo Products, Johnstown, N. Y.

WELDING Training pays at Hobart Welding School, Box M-122, Troy, Ohio. VA contract. Best equipment. Catalog free.

SECRETS Of Successful Salesmen, \$1.00. Wye & Co., 636 Dorchester Ave., Boston 27, Mass.

DRAFTING Pays big—Learn now. Monroe Institute, PM-1, Alton, Illinois.

LEARN To write music! New, easy instructions remove the mystery! Learn how to put your melodies on paper! Make money—set your own and others' song poems to music, prepare "lead sheets" to send publishers, etc. Previous musical training unnecessary! Get facts free—write today to Meadowlark Music School, 11-121 Sumner Road, Colorado Springs, Colo.

BUY Used correspondence courses direct from owners, eliminate dealer profits. Catalog 25c. Press, Liberty Center, Ohio.

PIANO Tuning pays. Learn this profitable profession at home. Our Tonometer and mechanical aids make learning easy. No knowledge music necessary. Diploma granted. Largest and oldest school—53rd year. G.I. approved. Write for booklet. Niles Bryant School, 78 Bryant Bldg., Washington 16, D. C.

SECRET Investigation. Experience unnecessary. Investigators particulars free. George Wagner, M125 West 86th, New York 24.

USED Correspondence courses and educational books bought, sold, rented. Catalog free. Educational Exchange, Summer-ville, Ga.

LEARN Electrical contracting, earn while learning. Estes, P.O. Box 2103, Louisville 1, Ky.

TIRED Of no money, second rate jobs? Like to start a real career with a lifetime of high salaries? Write me about two growing fields that really need men. Ed. Howes, Chief, National Schools, 4000 S. Figueroa Street, Los Angeles 37.

YOU Can learn piano tuning inexpensively. Information free. Piano Tuners Exchange, 3434 Urban Ave., Santa Monica, California.

PREPARE For career in private investigation or public law enforcement work. Write for free booklet. National Detective Academy, 239-P So. Oxford Ave., Los Angeles 4, Calif.

INVESTIGATOR Training. Phillips Secret Service System, 1917-B North Ken-neth, Chicago 39.

MUSICAL Comedy plays. Dorby Publications, P.O. Box 131, Brier Hill, New York.

I Want new writers to cash checks of \$1 to \$100 offered daily. The easiest way to write for pay. No previous experience necessary. Free details. Saunders M. Cummings, 468-11 Independence Bldg., Colorado Springs, Colo.

BUSINESS SERVICE

OBTAIN A distinctive New York mail address. Business or personal. Particulars. New York Mail Service, 210 Fifth Ave., New York 10, New York.

YOUR Business mail receiving and re-forwarding service can best be handled by Dunn Mail System, 216 West 69 Street, New York 23, N. Y.

SPECIAL SERVICES

INFORMATION, Ideas, errands; reasonable. Unbiased Research, 699 "D" St., Port Clinton, Ohio.

LISTING Of manufacturers of article you want 50c. Details free. BGS, 1521 Gentry, Wichita 14, Kan.

DALLAS Remail 25c each. Lema, P.O. Box 2106, Dallas, Texas.

ENGRAVED Nameplates made to your specifications on brass and plastics. Folder. Ackerman, Malden-on-Hudson, N. Y.

LITERATURE Folded, addressed, mailed. Job or contract. Reliable. Established 1944. Bourque, 858 Allo, Marrero 1, Louisiana.

HOME Building or remodeling? Need help how-to-do-it? Send questions, \$1.00 to Box 342, San Leandro, Calif.

LETTERS Remaild from Chicago, Ill. 25c each. Elsewhere in the states 30c each. 2 scenic postcards mailed 25c. Valuable Chicago address \$5.00 per month. C. Mack's Mail Order, 5656 N. Hermitage, Chicago.

LETTERS Remaild 25c each. 8 scenic postcards \$1.00. Los Angeles help wanted and business opportunities columns air-mailed \$1.00. Stadler, Box 2335, Hollywood 28, California.

CHICAGO Remail service 25c. Donald French, 7526 Eggleston, Chicago 20, Ill.

CARTOONING, COMMERCIAL ART, SHOWCARD WRITING, SIGN PAINTING

LEARN Cartooning, illustrating, portrait drawing, showcard writing, etc., quickly with our new, easy methods. Catalog free. National Artists, 801 North Mar-salis, A-2, Dallas 3, Texas.

LEARN Brush lettering. Easy method anyone can learn. Profitable. Alphabets included free. Send \$1.00. Satisfaction guaranteed. Midwest Art School, Fort Wayne 2, Indiana.

BE Smart. Get in art. Let me start you free. 25 years experience. Nick Nichols Arts, 39 W. Adams, Chicago 3, Ill.

"HOW To Make Money With Simple Cartoons"—A book everyone who likes to draw should have. It is free; no obligation. Simply address Cartoonists' Exchange, Dept. 91-C, Pleasant Hill, Ohio.

EARN And learn original drawing at home. Free kit offer. Pacific Art Institute, Box 1284, San Jose, California.

RAISED Wood letters for signs. Send 10c for catalog. Sign Letter Distributors, P.O. Box 101, Mineola, N. Y.

LEARN Sign painting at home. Test lesson free. Ben Kerns, Box 812-P.M., Greenville, S. C.

LEARN How to write showcards quickly, easily. No special skill needed. Profitable, lifetime business of your own. Details free. Sherwood Publishing Co., Irvington 10, N. J.

SEND \$1.00 For six test art lessons, questions, art opportunities, answers. American, Box 8066, Dallas 5, Texas.

CHALK Talks. Laugh producing program. \$1.00. Catalog 10c. Balda The Cartoonist, Oshkosh, Wisconsin.

ADVERTISING AGENCIES. LETTER WRITERS, FOR ADVERTISERS

FREE! 1950 Advertisers Rate and Data Directory. 52 pages! E. H. Brown Advertising Agency, 20 N. Wacker, Chicago 6.

ADVERTISE At no cost. \$4,000 sales from free ads. Publicity Advertising, 1501 Trailsend, Kalamazoo, Mich.

ad, 1,700,000 nationwide circulation, \$25.90 inch. 24-word classified, 20 big Sunday newspapers, \$30.00. Advertising ratebook free. Chicago Advertising Agency (established 1900), Chicago 4.

FREE! Radio advertising without investment! Commission basis. Information 10c (refundable). Jakiela, 2145-P Potomac, Chicago 22.

GUARANTEED Fresh names compiled daily, cash mailorder buyers, opportunity seekers, etc. Thousand \$4.00, trial 300, \$1.00. Wright Publications, 2270 Hubbard, Memphis 8, Tenn.

ADS Placed in out of town newspapers and magazines. Low rates. Catalogue free. Ideas that pay. Baker Advertising Agency, Successors Ankrum Agency, 189 W. Madison, Chicago 2.

ADVERTISERS! Reach nearly 18,000,000 readers. 25 Sunday national key newspapers, 18 words, \$59.00. "Terrific pullers." 20 popular newspapers, \$11.50. Free booklet. Special—One inch display 2-821,198 circulation, \$51.10. Newark's Advertising Agency, (Established 1893), 217-7th Ave., New York 11.

MAILING Lists; \$5.00-1000 up. Write Dixie Service, King, N. C.

24 WORDS In 50 weeklies, \$4.96. J. Darnell, 730 Hays, Jackson, Tenn.

ADVERTISE: 24 Words, 40 newspapers \$3.50. Lists free. Advertising Bureau, 10511-C Springfield, Chicago 43.

TYPEWRITERS, DUPLICATORS, OFFICE DEVICES

DUPLICATORS \$2.75 Up. Choice of 18. Dime brings literature. Municipal, 2178 Longwood, Merchantville 10, N. J.

ADDRESS Thousand envelopes, cards in minutes. Amazing new machine. Low cost. Free details. Dorsett's, 2217 S. Walnut, Muncie, Indiana.

RIBBONS: Two for \$1.06. Specify typewriter. M. Schmidt, 7350 N. Hoyne, Chicago 45.

ADDRESSER Home-built. Free details. Roberts, Box 184-b, Walpole, Massachusetts.

TYPEWRITERS \$22.50, duplicators, adders \$13.50. Typewriters, 118 Spruce, Wichita, Kansas.

RECONDITIONED Typewriters, printing devices, office machines, equipment. DixieGraph, King, N. Car.

RUBBER STAMPS AND OFFICE SUPPLIES

RUBBER Stamps made. Free style list. Criterion, Box 2326, Denver 25, Colo.

RUBBER Stamps. Send for catalog. Excello, P.O. Box 500, Shreveport, Louisiana.

BETTER Stamps, reasonable. Prompt service. Catalogue. Johnson, Box 6-A, New York City 26.

LINE 25c; 2-45c; 3-65c. Stamp Works, Auburn, Nebraska.

PRINTING, MULTIGRAPHING, MIMEOGRAPHING GUMMED LABELS

STATIONERY, Letterheads, free samples. Southern Printers, Box 331, Lake Charles, Louisiana.

75 8 1/2 x 11 LETTERHEADS With envelopes \$1.50 prepaid. John L. Boulette, 23 Sycamore Street, Millbury 5, Mass.

PRINTING. Booklet and publication specialists. Guaranteed. Merchants Press, Taylor, Texas.

100 EACH 8 1/2 x 11 Letterheads, 6 3/4 envelopes, 4 lines, \$1.80 postpaid. Kautz Printers, Cuero, Texas.

500 LETTERHEADS, 500 Envelopes, \$7.58. Hammermill, Jobbers, Box 31, Girard, Kansas.

QUALITY Printing. Stationery, circulars, booklets, publications. Free catalog. Adams, 30 West Washington, Chicago 2, Ill.

ENVELOPES, Letterheads, statements, etc. Samples, prices. Mercury Press, Box 69M, Marengo, Iowa.

100 8 1/2 x 11 HAMMERMILL Letterheads and 100 envelopes \$1.95. H. Hudson, Centredale, R. I.

REALLY Distinctive business cards. Save money. Make favorable impression. Free samples. Roscoe Heavener, Colmar, Penna.

MIMEOGRAPHING — Reasonable. Any copy. Mellers Service, Box 606-F, Chicago 90, Ill.

ment \$6.75. Minimum 2500. Schollerm, 530 Dunwoody, Pittsburgh 12, Penna.

NEED Printing? Request samples, prices. Gooch, 202PM, Hernando, Miss.

100 8 1/2 x 11 LETTERHEADS \$1.00 Postpaid. Envelopes same. Race Printers, Hudson, New York.

QUALITY Printing. Free samples, price-list. Farleyprint, 205 Cedar, Kingsport, Tennessee.

PRINTING—Business, advertising, publication. Prompt, low quotations. D'Yarmett Printing, Newark, Ohio.

ENGRAVED—Effect, process embossed business cards, \$3.95 thousand. Samples free. Universal Line, PM-4, Orange, Mass.

1000 BUSINESS Cards \$2.40 postpaid. Samples free. Tickets, Inc., 35th-Arcade Bldg., 204-A, Chicago 16.

1000 ENGRAVED Business cards \$3.95. Samples free. Harold Banjock, Freeland, Pennsylvania.

SPECIAL Discount price list on political, commercial printing. Dornfeld, Iron Ridge 14, Wis.

1000 TU-Tone gummed stickers \$1.00, three lines. Orwat, 1243 South 54th Street, Philadelphia 43.

8 1/2 x 11 HAMMERMILL Letterheads, 225 for \$2.00! Envelopes, same price. Quality Service Press, Mansfield, Illinois.

50 LETTERHEADS And envelopes \$1.00. Hargraves, Box 517, Corning, N. Y.

75 MONARCH Envelopes and 100 bi-fold letterheads \$2.00. Samples. Walt's Printing, P.O. Box 285, Plainville 6, Conn.

BARGAIN Price list free, samples dime. Churchill Print, West Medway, Mass.

1000 EMBOSSED Business cards \$3.95; 5000 #6 3/4 envelopes printed \$3.10 per thousand. Free samples. Michel, Box 76, New York 16.

JOB Printing. Free estimates. H. L. Wilson Press, New Germantown, Penna.

250 8 1/2 x 11 LETTERHEADS, 250 Long envelopes, printed, \$5 postpaid. Glennard Corn, Hendersonville, N. C.

QUALITY Printing, fast service. Special, 5000 6x9 circulars \$15.00. U.S.A. only. Other quality printing, state requirements. Modern Printing, 441 Perry, Pontiac 16, Michigan.

GLOSS Blotter business cards, 150, \$1.00; 1000, \$4.75. Postpaid. Acme Printing, Hendersonville 5, North Carolina.

PHOTO Offset lithography. Forms, catalogs, folders, etc. Amazingly low cost. Free estimators chart. Printing Consultants, Box 636, Newark 1, N. J.

OFFSET Printing—5000 8 1/2 x 11 \$24. Get offset copy instructions, price list. Kale Brothers, 2250 Milwaukee, Chicago 47.

FREE Samples, prices. Quality work, postpaid. Fast service. Sutton Printing, Box 853-M, Waycross, Georgia.

SEND 10c Now for our 48 page 1952 price list—refunded first order. McCall Press, 1326 South 27th, Omaha, Nebraska.

BUSINESS Cards. Raised lettering. 1000 \$3.95. Samples free! Vine Ad Press, 582A Courtlandt Avenue, New York 51, New York.

MIMEOGRAPHING—Letters, pricelists, formulas, instructions. Lowest prices. Lem's Letter Shop, 5710 Stanton, Detroit 8.

BUSINESS Printing. Samples, prices free. Howprint, 723-M Eunice, Webster Groves 19, Missouri.

125 8 1/2 x 11 LETTERHEADS And 125 6 3/4 envelopes \$2.00, postpaid. 250 of each \$3.50. Going Print Shop, Box 1544A, Muskogee, Oklahoma.

1000 BUSINESS Cards \$2.50 prepaid. Samples free. Reliable Print Shop, 907 East Jefferson, Louisville 6, Ky.

500 3/4 x 2 1/4 FOUR Line gummed stickers 50c. Red border \$1.00. Moritz Printery, Saginaw, Mich.

PRINTING OUTFITS AND SUPPLIES

MAKE Your own self-molding, rubber printing cuts. Plexirubber, Argyle 1, Wis.

PRESSES, Type, cabinets, supplies. List for stamp. Lincoln Press Company, 220-D Hartwell, Fall River, Mass.

PRESSES, Supplies, paper. Catalog 10c. Custom. Box 211-P, Springfield, Missouri.

ulars, advertising. Save money. Simple rules. Print for others, nice profit. Raised printing like engraving too. Have home shop. Details free. Kelsey Presses, L-11, Meriden, Conn.

PRINTING Presses, type, supplies. Lists 3c. Turnbaugh Service, Loysville, Penna.

PATENT ATTORNEYS

INVENTORS: Learn how to protect your invention. Unless the inventor is familiar with patent matters, he should engage a competent registered patent attorney or agent to represent him. We are registered to practice before the U.S. Patent Office and prepared to serve you in handling your patent matters. "Patent Guide for the Inventor" containing detailed information concerning patent protection and procedure with "Record of Invention" form will be forwarded to you upon request; without obligation. Clarence A. O'Brien & Harvey Jacobson, Registered Patent Attorneys, 21B-A District National Building, Washington, D.C.

INVENTORS—If you believe that you have an invention, you should find out how to protect it. The firm of McMorrow, Berman & Davidson is qualified to take the necessary steps for you. Send for copy of our patent booklet "How to Protect Your Invention" and "Invention Record" form. No obligation. McMorrow, Berman & Davidson, Registered Patent Attorneys, 134-D Victor Building, Washington 1, D. C.

PATENTS. "Proof of Invention" free. E. E. Vrooman, Registered Patent Attorney, 507 McKim Building, Washington 5, D. C.

INVENTORS—If you consider your invention to be something of importance, take steps to protect it with a United States Patent which gives you the right to exclude others from making, using and selling your invention as claimed. "Patent Protection for Inventors" outlines steps to take to secure patent protection. Mailed promptly without obligation. Victor J. Evans & Co., Merlin M. Evans, Registered Patent Attorney, 731-A Merlin Building, Washington 6, D. C.

INVENTORS: When you are satisfied that you have invented something of value write me, without obligation, for information as to what steps you should take to secure a patent. Write Patrick D. Beavers, Registered Patent Atty., 935 Columbian Bldg., Washington 1, D. C.

"INVENTOR'S Guide" free. Frank P. Ledermann, Registered Patent Attorney, 154 Nassau Street, New York.

INVENTORS — For "Invention Record" form, contact Carl Miller, Registered Patent Attorney, Woolworth Building, New York.

REGISTERED Patent attorney offers services. Sanders, 6430 Evans, Chicago 37, Ill.

INVENTORS: Write for free brochure "Evidence of Invention." Labiner, World Building, New York 38.

C. A. Snow & Co.—M-427, Snow Building, Washington 1, D. C. Registered Patent Attorneys. Write for information.

INVENTORS: Without obligation, write for information explaining the steps you should take to secure a patent. John N. Randolph, Registered Patent Attorney, 203 Columbian Bldg., Washington 1, D. C.

PATENTS—Irving L. McCathran, 315 McLachlen Bldg., Washington 1, D. C. Registered Patent Attorney.

CANADA—Ramsay Company Registered, 273 Bank Street, Ottawa, Canada.

FOR INVENTORS

INVENTORS—If you believe that you have an invention, you should find out how to protect it. The firm of McMorrow, Berman & Davidson is qualified to take the necessary steps for you. Send for copy of our patent booklet "How to Protect Your Invention" and "Invention Record" form. No obligation. McMorrow, Berman & Davidson, Registered Patent Attorneys, 134-C Victor Building, Washington 1, D. C.

PATENT Searches, \$5.00, including patent copies. Same reliable search as conducted for patent attorneys. Free protection forms, 48 hour service. Complete inventor's services. Patent Service Institute, 845-A Pennsylvania Avenue, Washington 4, D. C.

vention, you wish to authorize a preliminary search through appropriate classes of United States patents. This firm is registered to practice before the Patent Office and is available to make such search and report to you concerning the probable patentability of your invention. Instructive booklet with "Evidence of Invention" form sent upon request. Victor J. Evans & Co., 732-A Merlin Building, Washington 6, D. C.

INVENTORS: Learn how to protect your invention. Unless the inventor is familiar with patent matters, he should engage a competent registered patent attorney or agent to represent him. We are registered to practice before the U.S. Patent Office and prepared to serve you in handling your patent matters. "Patent Guide for the Inventor" containing detailed information concerning patent protection and procedure with "Record of Invention" form will be forwarded to you upon request; without obligation. Clarence A. O'Brien & Harvey Jacobson, Registered Patent Attorneys, 21A-A District National Building, Washington, D.C.

I Found seven basic fundamentals of success. Send \$1.00 guaranteed to E. V. Smith, 1004 SW 27th Street, Oklahoma City, Oklahoma.

INVENTORS! For "Copyright, Design and Patent Guide" contact Patent Attorney Metzler, 11 West 42nd, New York 18.

INVENTIONS — Promoted, developed, drawings, engineered and designed. Confidential. Estimates free. Adamec & Bednar, 55 West 42nd St., Rm 212-A, New York 18, N. Y.

SEARCHES—Put your patent searches in the hands of a registered patent attorney or agent, as he qualifies to give a worthwhile patentability report. Record of invention form upon request and information on patent protection. Patrick D. Beavers, Registered Patent Attorney, 936 Columbian Bldg., Washington 1, D. C.

INVENTORS—Develop and market your invention through unique plan. Free literature. Inventors' Intermediaries, Inc., 11 West 42nd St., New York 18, N. Y.

CASH In on your ideas! Learn which inventions are profitable: how to sell or finance and market your invention. Send only \$2.50 for the big 144-page book "Money From Ideas," a primer on inventions and patents by a real, successful inventor. Popular Mechanics Press, Dept. PMI, 200 E. Ontario St., Chicago 11, Ill.

PATENT Searches \$5.00. Protection forms free. Patent drawings prepared. Write Patent Engineering Service, 1404 New York Avenue, Washington 5, D. C.

PATENT Searches \$5.00. Record of invention forms free. 48-hour service. Write Miss Ann Hastings, P.O. Box 176, Washington 4, D. C.

SEARCHES \$5.00. Reliable reports airmailed within 48 hours. "Record of Invention" free. Capitol Patent Service, Box 664-P, Washington 4, D. C.

INVENTIONS, Sold, leased. Complete services. M. Joyce Humphries, 1424 Landtitle, Philadelphia 10.

INVENTORS — For "Invention Record" form, contact Carl Miller, Registered Patent Attorney, Woolworth Building, New York.

PATENT Searches \$5.00. 48-hour service. Protection forms free. Write Raymond L. Smith, Patent Searcher, 410 Bond Building, Washington 5, D. C.

INVENTORS: Without obligation, write for information explaining the steps you should take to secure a patent on your invention. John N. Randolph, Registered Patent Attorney, 202 Columbian Bldg., Washington 1, D. C.

CASH For your idea, 280 manufacturers need inventions, patented or unpatented. List free. Invention Bureau, 208M Clinton, Oak Park, Ill.

PATENT Owner representative. Years of experience. Can I help you? Charles A. Scott, 773PM Garson Avenue, Rochester 9, N. Y.

INVENTORS: If you have an invention for sale, patented or unpatented, write Institute of American Inventors, Dept. 40A, 631-E St. N.W., Washington 4, D. C.

INVENTIONS WANTED

INVENTIONS Wanted. Patented or patent pending. 21 years experience promoting inventions. National Service Bureau, 3120 Meramec, St. Louis 18, Mo.

ers. Get the "Inventors Guide." Gives step by step helpful instructions, before going to expense of patents, how to make money from inventions, list of needed products, record of invention forms. Send only 50c. Inventors Creative Service, 354 South Spring Street, Los Angeles 13, Calif.

INVENTORS — Good patented, patent pending inventions wanted by manufacturers. Booklet free. Market Contacts, 719-A2 Magnolia, Tupelo, Miss.

INVENTIONS Wanted by manufacturers. Patented-pending only. Free details. Inventors Exchange, Dept. B, Hartford 1, Conn.

INVENTIONS Promoted. Patented or unpatented. Established 1911. Write Adam Fisher Company, 61 Enright, St. Louis, Mo.

INVENTORS: Hundreds of manufacturers have requested our assistance in locating marketable new products. Complete information free. Institute of American Inventors, Dept. 40-D, 631-E St. N.W., Washington 4, D. C.

PATENTS FOR SALE

STEAM Electric wallpaper remover, light, safe, inexpensive. Patent pending. J. E. Lawton, 115 Parkridge Ave., Buffalo 15, N. Y.

INVENTORS: Test the commercial value of your patented or unpatented inventions, quickly and inexpensively. Write for free information. Institute of American Inventors, Dept. 40-B, 631-E St. N.W., Washington 4, D. C.

TWO Patented wonder toys for sale. Write Arvin Gussa, 2123 Burrough St., San Diego 11, Calif.

MANUFACTURING

MODELS — Small lot manufacturing. Metals, plastics, etc. Milburn, Burlington, Kentucky.

MODELS, MODEL SUPPLIES

LIONEL, American Flyer sales service. Complete stock parts, accessories year 'round. Free hobby catalog. Art's Cycle & Hobby Shop, 816 E. 75th St., Chicago 19.

READY — Our 1952 catalog on "O" gauge model trains, 40 pages of parts, diesels, steam locomotives, car kits, etc., for only 25c. Great stock of HO-TT-S-gauges too. Ship model and airplane kits and parts galore. Lionel and American Flyer trains always in stock. Write Dept. W, All-Nation Hobby Shop, 182 No. LaSalle St., Chicago 1, Ill.

FAMOUS Catalogs. (Ships 120 pg. historic models, hundreds fittings) 50c. World's electric trains and accessories 50c. H.O. scale trains (ready Dec.) 50c. Old time vehicles 15c. Hobby books 15c. Collectors soldiers 25c. Polks Hobbies, 314-M 5th Ave., New York City 1, N. Y.

SHIP Models—Most complete line in New England. Kits, fittings, plans, books, tools, engines, motors. Illustrated catalog 25c. James Bliss & Co., Inc., Dept. SM, 220 State St., Boston, Mass.

BRASS Gears and model supplies for the inventors. Send 10c for catalog. Pierce Model Works, Tinley Park, Ill.

LIONEL, American Flyer, illustrated catalog free. Ben's PM Department, 134 North Dearborn, Chicago 2.

BUILD Historic ship models, complete kits 50c to \$9.00. Catalog 15c. Ideal Models, 19 W. 18th, New York 11, N. Y.

SHIP Models and yacht supplies complete. Large 64 page catalogue 30c. Bill Wild's, 510 East 11 St., New York City 9.

SHIP And yacht model fittings; blueprints. Send 25c for illustrated catalog No. 26—listing hundreds of items. A. J. Fisher, 1002-1 Etowah Ave., Royal Oak, Mich.

STEAM Locomotives, 1½", 1", ¾", ½" ¼" scales. Castings, rail, steam fittings! Thorough drawings with instructions. Catalog 50c. Little Engines, Wilmington, California.

TINY Power steam models—Locomotives, stationary engines, boilers, fittings. Model machining to order. Catalog 35c (coin). Chas. Arnold, Box 218, Corvallis, Oregon.

HOME Models and doll houses are fun to build, profitable to sell, with our accurately scaled, pre-fabricated materials. Send 10c for samples and booklet, "How You Can Build Model Homes." Architectural Model Materials, Inc., Dept. M12, 4208 Armitage Ave., Chicago 39.

BUILD, Fly Luscombe, Piper, Aerona "Quicky", 18" scale models, all for \$2.00. Glue 15c extra. Airplane folder, 3c. Cleveland Model, 4508TC208 Lorain, Cleveland 2, Ohio.

HOME CRAFTSMEN

LEATHERCRAFT Supplies. Tops in leather, tools, designs. Illustrated catalogue 25c. For pleasure and profit. Govan Craft Supplies, 3908 Grove Street, Oakland 9, California.

LEATHER Cut to your sizes: Order just what you need. Finest quality, top grain, 3½ oz. tooling steer in natural, black, t-utone brown, med. brown, 1½c sq. inch. ppd. Finest quality 2½ oz. tooling calf in natural, black, med. brown, 2c sq. inch. ppd. No c.o.d.'s. Leather Crafters, Box 412-M, Evanston, Illinois.

BEAUTIFUL Desert hardwoods. Athel, Mesquite, Condalia, Ironwood, many others. 8 large samples, 50c. List, 15c. G. McArthur, Redlands, Calif.

ABUNDANT Low priced leathers. Make leather belts, billfolds, purses. Big catalog free. Tandy Leather, Box 397-C, Tulsa, Oklahoma.

89 FULL Size jig saw patterns of beautiful shelves, ornaments, toys, novelties. Plus "How, Where to Sell." Only \$1.00. Mastercraft 14M, 7041 Olcott, Chicago 31, Illinois.

JIGSAW Owners attention! Start earning money at home cutting out wooden novelties and souvenirs. Write H. Cook, Dept. A, 4407 S. Normal Ave., Chicago 9, Illinois.

LEATHERCRAFT For pleasure or profit. Make easy-to-assemble purses, belts, gloves, woolskin toys, 100 other items for gifts or to sell. Send 10c today for big catalog. Largest leathercraft stock in U.S. J. C. Larson Co., 820 S. Tripp, Dept. 1575, Chicago 24.

JIGSAW, Bandsaw owners, let your machine bring extra profits, fun. Free details. Nu-Art, Dept. B, Box 2235, Boston, Mass.

90 ALL New, full size lawn ornament and novelty patterns, up to 20" high. Only \$1.00. Mastercraft 12M, 7041 Olcott, Chicago 31, Illinois.

VIOLINMAKERS, Amateurs, professionals. Fine tone European wood, materials, supplies, instructions, patterns. Illustrated catalogue 10c, refunded. Premier Violin Supplies, Dept. VZ, 430 South Broadway, Los Angeles 13, California.

OUR Biggest leather and craft catalog yet! 1000's of items. Send 25c (refunded with first order). Russo Handicraft Supplies, Dept. 1-C, 245 S. Spring, Los Angeles, California.

MAKE, Sell, artificial flowers, corsages, chenille dolls, jewelry. Starting kits, wood-fiber, leaves, shellcraft, rhinestones, sequins, findings. Wholesale profitcraft catalog. 10c. Cleveland Models, 4508TC1 Lorain, Cleveland 2, Ohio.

OVER 100 Plans for \$1, corner and wall shelves, furniture, novelties, with easy to follow instructions. Send \$1 to Woodcraft Plans, 3933 N. 28th St., Milwaukee 16, Wisconsin, Dept. 12.

LEATHER—Assorted colors. Ideal for purses, billfolds, box coverings, guaranteed weights. Make wonderful gifts. 6 lbs., \$3.50 ppd; 10 lbs., \$5.75 ppd. Jumbo box 20 lbs., only \$11.00 ppd. Add 25c postage west of Mississippi river. No c.o.d.'s. Leather Crafters, Box 412-M, Evanston, Ill.

16 NEW Lawn chairs, 22 picnic tables, benches, trellises, etc. All 38 plans with necessary full size patterns, \$1.00. Mastercraft 13M, 7041 Olcott, Chicago 31, Ill.

PLYWOOD Cuttings; flocks; unpainted novelties. Henry Kiewiet, R. 4, Kalamazoo 84, Michigan.

"TOPS" In everything for leathercraft. Low priced kits, leathers, tools, lacing. Catalog 10c. Crown Leathers, 22 Spruce Street, New York 38.

STRIPKRAFT Is profitable! Make many beautiful, useful articles with colorful fabric-supported plastic tapes, cords. Send \$1.00 today for 20 page illustrated book of easy instructions and generous supply of materials. Stripkraft, 3816 Montrose, Chicago 18, Ill.

5" SHEEPSKIN Polishing bonnets, 3 for \$1.00. Kovler, Clementon, New Jersey.

LEATHERCRAFT, Tremendous stock of leather, tools, supplies, and kits. In leather business over forty years. Send 10c for big catalog. Sax Bros., 1111 No. 3rd, Dept. PM, Milwaukee 3, Wisconsin.

BEAUTIFUL Bamboo planter lamp, window box; bases for aquarium, radio, etc. Stunningly "different"! Easy. Inexpensive. \$1.00 brings plans, pictures, instructions and sources of bamboo and lamp parts. Lanning, Box 535, South Bend, Ind.

CACTUS Wood, lamp size sample, \$1.00 postpaid. 214H East Yavapai, Tucson, Arizona.

GRANDFATHER Movements converted from old shelf movements without disassembling, striking, accurate. Instructions \$1. Weissenbach, Worcester, Penna.

FREE Information. How to make money with jig saw. Write Jigsawers, 117-M Worth, New York 13.

PROFESSIONAL Type furniture finishing and refinishing supplies. Beautiful new, complete, illustrated catalog and complete simplified instruction manual 50c. Colorall, Dept. M, 515 Cedar Lane, Teaneck, N. J.

WOODCRAFT Patterns—Large what-nots, lawn ornaments, toys, novelties, large assortment \$1.00. Joanness, Box 141-E, Omaha 7, Nebr.

LEATHERCRAFT Bargains! Lacing. Francis Byrd, 3406 Montrose Ave., Richmond, Va.

SWISS Music movements, finest make, lowest price. Ask for leaflet. Helaxe Company, 233 West 72nd Street, New York.

NEW! "100 Best Woodworking Projects"—144 page Popular Mechanics book with 100 special projects for every member of the family. Furniture, toys, novelties, many more. Send \$2.00 to Popular Mechanics Press, Dept. PWP, 200 E. Ontario, Chicago 11, Ill.

WHOLESALE Shellcraft book 15c. Large shellcraft kit \$1.85 postpaid. Shell-Art Novelty, 5th and Moore, Philadelphia 48, Penna.

OZARK Wood samples. Eleven varieties prepaid. \$1.50. Davis Lumber, Cabool, Missouri.

46 FROM Square foot plywood; jig saw necessary. Write: Woodarts, Bridgewater, Mass.

LEATHERCRAFTERS: Big illustrated catalog of materials, tools, kits, 10c. Art Leather, 411 Joseph Ave., Rochester 5, N. Y.

HAND Wood-carvings, elaborately tooled, give your next project that artistic touch. Sample center piece, \$1.25; 3 piece group ornament, \$1.60. Walnut or mahogany. Satisfaction guaranteed. Hasse, Carvings, 35 S. Oxford, Indianapolis 1, Ind.

SOMETHING New and profitable. Log cabin bank. Makes ideal Christmas presents for everyone. Send \$1.00 for sample and instructions. Robert Butler, 208 Troy Street, Dayton 4, Ohio.

KNOCKDOWN Cedar chests. Lumber and veneers. Free price list. Giles & Kendall Company, Huntsville, Ala.

HAVE Fun! Make money! "Working With Leather." 64-page booklet tells how. Send 25c for copy. Free gift if you mention this magazine. Valuable information included. No foreign orders. Wilder & Company, 1039 Crosby, Chicago 10.

SAVE Thousands of dollars. Build your own home. Book and plans for Popular Mechanics Ranch-Type House ready now! Six rooms and carport for \$5000; add breezeway, garage, extra bedroom \$2500. No experience needed. Book shows you how. Get copy today. Step-by-step instructions, hundreds of photos, drawings. Mail \$3.50 to Popular Mechanics Press, Dept. PRH, 200 E. Ontario, Chicago 11, Ill.

MINIATURE Furniture kits. Solid cherry. Easily assembled. Large selection. Catalog 20c. Culver Miniatures, 194 Sixty First St., Dept. A, Niagara Falls, N. Y.

30 LAWN Ornament patterns. Ready cut. Full size. Color indicated. \$1.00 postpaid. Lincoln Craft Studio, Columbia, Conn.

100 FULL Size jig saw patterns up to 20" high, only \$1.00. Pattern Service, Medway 9, Mass.

LEATHERCRAFT, Copper tooling, textile painting, many other crafts. Big free catalog shows everything you need. Kit Kraft, 7377 Melrose, Hollywood 46, Calif.

LEATHERCRAFT Supplies catalog. Pleasure and profit. New style handbag patterns, belts. Leathercraft school G.I. approved. 25c for catalog (refund 1st order). Dept. PM, Apache Leather Co., 2004 E. Washington St., Phoenix, Arizona.

80 FULL Sized patterns, lawn ornaments, toys, novelties, \$1.00. Modern Woodcraft, Saginaw, Mich.

LEATHER, Tools, lacings, supplies. Free catalog. National Handicraft, 199 William St., New York 7.

MAKE IT YOURSELF

LONGED For a beautiful stone home? Precast your own stone. Formulas, illustrations, patterns, complete instructions designed for home use. Send \$3.00. Alburg Sales, Carrollton, Michigan, Box 17.

EARLY American working model spinning wheel. Also grandfather clock case to fit any pocket watch. Both models 12" high. Blueprints and instructions on how to make \$2.00 each. Williams Woodcraft, 6408—31st Ave., Kenosha, Wis.

BEAUTIFUL Rustic electric lantern. Easy to build for a few cents. Simplified instructions, plans and templates \$1.00. Conti Supply Co., 92 Columbia St., Wood-Ridge, N. J.

CLOCK Movements. Complete line. R. Holwick, 177 S. Anacapa St., Ventura, California.

BUILD Your own concrete block machine. Easy. Inexpensive. Motor or hand. Also build mixer. Write. C. Lee, Mountain View, Oklahoma.

OIL Drum concrete mixer, easily made. Plans, \$2.00. Mitkos, 8802 Corwin, Jennings 21, Mo.

BANDSAW, Jigsaw owners! Profit opportunity. Different. Nu-Art, Dept. H, Box 2235, Boston, Mass.

MY-Best, cheapest, riding garden tractor. Details, dollar. Tractorman, 3211-M Pleasant Plain, Elkhart, Ind.

TRUMPETER Swan child's rocker, in shape of almost extinct Montana swan. Full-size pattern, 50c. Catalog. Tom Tot Furniture, PM, Box 741, Helena, Montana.

PLANS \$4.00. Electric, concealed, pistol firing mechanism. B. B. Carlton, Cherokee Hotel, Cleveland, Tenn.

GRANDFATHER Clock easily built. Big savings. See ad on page 407.

GARAGE A problem? Don't let the weather ruin your car. Build the inexpensive and space-saving car-trellis. Complete plans \$1.50. DeWan, 984 Beacon St., Newton Centre, Mass.

CARNIVAL Rides from auto parts. Plan catalog 35c. Box 875, Peoria, Illinois.

MAKE Candles! Detailed manual explains everything—Casting, dipping, scenting, decorating, marketing. Price only \$1.00, with full return privileges. Candlecraft, Sylvan Lake, Mundelein, Illinois.

STREAMLINED Kitchen cabinet plans—instructions 50c. Playnecabinets, 4617 Johnson, Western Springs, Illinois.

ELECTRIC Clothes drier easily built. Blueprint \$1.00. Northwest Crafts, 134 East 63rd, Seattle 5, Wash.

BUILD Lathes, presses, other production machinery with Kimo Plans, Box 307-P, New York 19. Satisfaction guaranteed. Catalog 25c (refundable).

FREE Plans for building rotary power lawn mower. No obligation. Low factory price on any or all essential parts. Also complete mowers. B-M Mower Company, Box 66-PM, Blue Mound, Kansas.

FREE Handbook, build sawmills, block machines, freezers, tractors, scooters, 250 shop, farm, home machines. Nichols Co., Dept. C-1701, Purvis, Mississippi.

FREE Blueprint Catalog! Hundreds of projects—motor scooter, furniture, toys, birdhouses, radios, garden furniture, power tools, boats, workbenches, home freezer, many more! Send postcard to Popular Mechanics Press, Dept. PBP, 200 E. Ontario, Chicago 11, Ill.

STREAMLINED, Built-in kitchen cabinets to fit any kitchen. Illustrated manual describes designing and construction. All for \$1.00. Thombert Company, Newton, Iowa.

SEND 25c Today for new large catalogue of supplies for 21 popular crafts. Dept. D-11, Dearborn Leather Company, 8625 Linwood Avenue, Detroit 6, Michigan.

BUILD Your own "tractor." Free information. Eltraco, D-I, Camptonville, California.

"CONCRETE Block Homes." 32 page booklet on how to build. \$1.00. H. C. Lightfoot, Civil Engineer, Richboro 1, Penna.

WATCHES, OLD GOLD, JEWELRY

"THE Modern Clock." All about clock repair. 502 pages. 173 illustrations. \$4.95, postpaid 10-day return privilege. North American, Dept. 12-A, 2018 North Avenue, Chicago 47, Illinois.

WATCHMAKERS' Journal contains instructive articles for watchmakers and beginners. \$1.00 year. Sample copy 20c. Dean Co., Box 3218, Daytona Beach, Fla.

UNREDEEMED Diamond, 1-carat, \$295. 30-day refund. Free catalog. Broff's Diamond Loan Association, 411 Smithfield, Pittsburgh, Penna.

WATCHMAKERS, Hobbyists! Complete informative catalog 20c. Bengal Company, Culver City, Calif.

WATCHMAKERS' Tools, materials, supplies, repairs, catalog. Gales, Box 1000, Chicago 90, Ill.

RHINESTONES, Jewelry settings, cameo, sequins, beads. Send 10c for illustrated catalog. J & M Novelties, Dept. CA-3, Griffith, Ind.

WRIST Watches, U. S. Air Corps, Waltham, 16 jewel, water and shock proof, stainless steel case, reconditioned. Value \$55.00—special \$17.95. Public Sport Shops, 11 S. 16th Street, Philadelphia 2, Penna.

NEW Catalog lists over 5000 styles! Gold plated jewelry supplies, Rhinestones, pearls, etc. Complete details, only 10c. Barry's, 47-11 Branford Place, Newark 2, N. J.

HIGHEST Cash paid for old, broken jewelry, gold teeth, watches, silverware, diamonds, spectacles, platinum. Free information. Satisfaction guaranteed. Rose Smelting Company, 29-A East Madison, Chicago.

TOBACCO, SMOKERS' SUPPLIES

CIGARS, 25 Havanas, \$2.00. S. & E. Co., Red Lion, Penna.

PIPES, Pipemaking supplies. Instructions 10c. Carvape, 2829-C Dixie, Hamilton, Ohio.

CIGARETTES—Roll 200 mild-tasty for 75c. Particulars free. Pete Moberly, Box 850, Owensboro, Kentucky.

AROMATIC Agents increase smoking pleasure. Information free. Cozza, Pharmacist, Pequanock, N. J.

CIGARS—Clear Havana, handmade. Regularly 15c. \$5.50 for fifty, postpaid. Save \$2.00! Check or money order. C.O.D. (You pay charges). Seco Cigars, Rochelle Park, New Jersey.

RAZORS, BLADES, SHARPENING

SENSATIONAL Durasharp razor blade outlasts all. \$1.00 postpaid. B. C. Haupt-postlagernd, Solingen, Germany.

OF INTEREST TO WOMEN

MODERNIZE Kitchen cabinets. Custom made slab doors, drawers, hardware, and atomic age accessories. Thombert Company, Newton 15, Iowa.

START Profitable sparetime business making artificial flowers, woodfiber corsages, chenille dolls, shellcraft, rhinestone jewelry, novelties. Starting kits, materials. Wholesale profitcraft catalog, business plan, 10c. Cleveland Models, 4508TC Lorain, Cleveland 2, Ohio.

FOR SALE—MISCELLANEOUS

AMAZING Snow scoop. Remove snow easily 24x24" welded steel \$14.95 c.o.d. delivered. Reliable, Lisbon St., Lewiston, Maine.

EVERYDAY Gift wrapping paper, 30 sheets \$1.50. Celester, 2233 Eastern Ave., Indianapolis 18, Ind.

LID-Crib for storing assorted pot-lids neatly and easily selectable. For shelf or wall. Ovenware-crib similarly files baking dishes. Both praised in leading magazines \$1.50 each, postpaid. Size about 12x7x7, brightly plated. Elgin Novelties, 529-M Commercial St., Provincetown, Massachusetts.

MAILING List: guaranteed. \$4.00—1000 names. Alban Burke, 1212 Franklin Ave., New York 56.

SAVE Money on chrome cabinet hardware. Write Box 89, Troy, Ohio.

SAVE Money on army, navy and factory surplus. Write today for new 60-page illustrated catalog. Tennusa Sales Co., Dept. AN, 1451 Market, Chattanooga, Tenn.

HANDSIGHTING Levels, improved, new model, used for grading land, contouring and laying out fences, piers, roads and gardens, price \$2.50 postpaid. Public Sport Shops, 11 S. 16th Street, Philadelphia 2, Penna.

DRESSES, Used, 18c; coats \$2.00; blouses 35c. Free catalog. Crown, 164-PA Monroe Street, New York.

WANTED—MISCELLANEOUS

QUICKSILVER, Platinum, gold, diamonds, sterling, dental-jewelry-optometrist scrap. Ship or write. Wholesale Terminal, Norwood, Massachusetts.

IF You want to trade, sell anything, send \$1 for big list firms, individuals, coast to coast, who buy, trade almost anything under the sun. Toole, Bernardin Apts., Evansville, Indiana.

SCRAP Mercury (quicksilver) tantalum, bismuth, tungsten. Metallurgical Products Company, Established 1909. 35th & Moore Sts., Philadelphia 45, Penna.

PERSONAL

LIKE To cut your own hair? Send \$2.00. Eok Haircutter, Box 2833, Washington 13, D. C.

MEXICAN Law practice reliably conducted. Box 1736, El Paso, Texas.

SAN Francisco—Your address. Mail forwarded, outgoing letters remailed, \$3 mo. TBS, 742 Market St., San Francisco, Calif.

PRINT Without a printing press. Big profits! See page 110.

ANYONE Can mimic movie stars! Buddy Lewis, famous (Palace Theater) mimic, shows you how in his "Secrets of Mimicry." \$1.00 postpaid. Unicorn, 4932 Eighth, Philadelphia.

INCENSE—Talismans, forecasters. Write for literature. Stellar Incense Mfg. Co., Steelville, Missouri.

CLAIMS Adjusters needed. Exciting, fascinating, big pay. Many earning up to \$125 week. Qualify now. Write today! Universal Schools, M-53, Box 8202, Dallas 5, Texas.

BORROW By mail. Loans \$50 to \$600 to employed men and women. Easy, quick. Completely confidential. No endorsers. Reply in convenient monthly payments. Details free in plain envelope. Give occupation. State Finance Co., 323 Securities Bldg., Dept. G-14, Omaha 2, Nebr.

KEY To a better life. Send for booklet, "Truth and the Micrometer Calliper," 25 cents. C. H. Marshall, P.O. Box 2143, Boston 6, Mass.

MIAMI Postmark, letters remailed 25c; postcards, glamorous hotels, scenes, you address, we mail, 3 for 25c, coin please. Fred's Service, Box 3501, Miami 22, Fla.

VALUABLE Big mails, four months listing, 25c. Wright Publications, 2270 Hubbard, Memphis 8, Tenn.

PAPERHANGERS: Mix Mannatex Compound with paste. Prevents mold, keeps wall paper from cracking, makes it stick. Guaranteed trial size \$1.00 p.p. Paperhangers Supply Co., P.O. Box 37B, Louisville 1, Kentucky.

LOW Cost hearing device. No batteries. No wires. No upkeep. Many satisfied users. Beaudry, 4337-H 30th Ave. S., Minneapolis 6, Minnesota.

"HOW Can I find out?" You can! Information discreetly developed. Any matter, person, problem, anywhere. Worldwide. Officially licensed, bonded service. Established 1922. Reasonable. Confidential. William Herman, 170 Broadway, New York.

HERE'S How and where to borrow \$50.00 to \$300.00 by mail. Confidential. Free particulars. Postal Finance Company, Dept. 45, Sioux City, Iowa.

MISCELLANEOUS

BIG Mails, mail order magazine opportunities 25c. Harvey Teeple, Decatur, Indiana.

COIN Changers—Newsboys, route men, gas stations, taxis. Information free. Campbell Products, Urbana 2, Ill.

OUTDOOR Toilets cleaned, deodorized! Cut digging, pumping, moving costs. Safe, economical. Details free. Wilmette Farm Supply, Dept 90, Wilmette, Ill.

TRADE Magazines help you to success. Get latest copies through our easy-to-get-acquainted service. Hundreds of business, professional, craft, executive, canning, cartooning, cemetery, chambers commerce, chemical, chiropractic, civil service, clothing, coal, coin collectors, commercial, confectionery, construction, container, convention and others covering all interests. Send for list today. It's free. Commercial Engraving Publishing Company, 34E North Ritter, Indianapolis 19, Indiana.

GET Plenty power from new kind, low, homemade windmill. No mortising, riveting, welding. Write: Ziembak, 6123 Orchard, Dearborn, Mich.

SELL-Buy-trade anything. In "Trading Post Magazine." Details. Thorne's, 523 Dewey, Jackson 15, Michigan.

MAGNETSTIK Cements everything, wood, celluloid, glass, metals, china, bakelite, marble, plastic. Sample 15c. Rosenblum, 267 Canal St., New York 13.

ROLL-On curtain pinner. 25c postpaid. Yarger Mfg. Co., Morgantown, W. Va.

IMPROVE Your writing—Learn shaded writing and how to make money with penmanship! Write today for free details. Tevis The Penman, Box 25-A, Chillicothe, Mo.

GOLD, Silver, metal detectors, Geiger counters for uranium. Mineralights. Sensational new fully guaranteed models. None finer. Information free. Detectron Co., 5631 Cahuenga Blvd., North Hollywood, California.

PORTABLE Electric hot air heater complete with thermostat. Write for free bulletin. Johnson, 1638 Granville, Chicago, Illinois.

BROKEN False teeth easily repaired at home. New fast weld cement mends broken plates in one hour. Fully guaranteed, postpaid \$1. Fast Weld, Box 303, Latrobe, Penna.

EARN Up to \$200 month, inventing toys, games, gadgets. Write Hendrickson, Argyle 1-A, Wisconsin.

CAN You make \$40 a week, typing at home, in your spare time? Write Hood's, Kannapolis 12, N. C. (Inclose stamped, addressed envelope.)

INTERESTING Mails. 25c keeps name on mailing list three months. Bentz, (Desk-E/33), Chatawa, Mississippi.

SQUARE Dance instructions, calls, 25 sets, \$1.00. Rayburn, Eureka Springs, Arkansas.

300 PROJECTS You can make in Popular Mechanics 32-page Blueprint Catalog. Send 3c stamp for copy. Popular Mechanics Press, Dept. BP, 200 East Ontario St., Chicago 11, Ill.

INCREDIBLE! Unprecedented! Become a mental superman overnight! Floor everybody! No studying! "Memoprop" does all your thinking! It's uncanny! Revolutionary! Write: Bijou, Box 1727-ML, Hollywood 28, California.

REFLECTORIZE Roadside signs for night display. Brilliant, microscopic lenses reflect sign colors. Introductory offer \$1.00. Glowell-lite, 475 Fifth Ave., New York 17.

SMASH Worry, nerves, indecision and inferiority with personal education home-study. Many helped. Free lecture sent in plain wrapper. Write Pres. Ballard, Box 1924-N, Louisville 1, Kentucky.

HOLLYWOOD Design Rag Rug Custom Weavers, Milbank, S. D. Material unprepared \$1.50 yd., prepared 95c.

HORSERADISH—Make your own. Root, instructions 75c. A. Loebig, 5647 N. Ottawa, Chicago 31.

WONDER Drugs! Painless dentist's drills! Atomic cures! Rejuvenation! Latest medical discoveries! Unique, lifesaving knowledge! "Your Medical Scrapbook" tells everything! Write: Bijou, Box 1727-XM, Hollywood 28, California.

DELICIOUS Ribbon cane syrup, No. 10 can \$2.25 postpaid. Goodwill Bargains, Fullerton, La.

INCOME Tax or bookkeeping headaches? Send for free information on simplified system. Bomel Co., 6635b Delmar, St. Louis, Mo.

RESEARCH: We find, locate buyers, or sellers for anything of value. Registration and listing, \$1.00. Refundable. Wright Publications, 2270 Hubbard, Memphis 8, Tenn.

MEN—Thrilling new experience awaits you in effortless shaving. Nothing like it! Exciting details free. Write: Kenmore Distributors, 3819-M Kenmore, Chicago 13.

HAIRCUT As you like it. Free circular. Booklet 25c. Mastrolia, 5½-BK Jane, New York City 14.

SHEET Metal tables. 10,000 answers. Setback and bend allowance. No charts. Shipman, 9044 Ione, St. Louis 23, Mo.

HOT Coffee, hot soup, cooked in seven minutes—two ounce vest pocket stove. Colorless, odorless heat, 60c each, extra heat 25c for 50 minutes. Charlotte Chemical Laboratories, Charlotte, N. C.

CLEAN Leather jackets, leather gloves with Realkleen. Cleans like new, leaves leather soft and pliable. Satisfaction guaranteed. 8 oz. \$1.00 postpaid. H. Schiefelbein, Berlin, Wis.

INCREDIBLE! "Easy Off" removes any size boot, galosh. No stooping or touching shoes, galoshes. Beautiful finish. Not available in stores, \$2.00. "Easy Off," Box 349-P, North Chicago, Illinois.

BUILDING Plans for small space saving 25 ft. dia. circular home. \$1.00. Porter-craft, P.O. Box 87, Mt. Washington, Cincinnati 30, Ohio.

LUCKY Pennies 25c. Lord's Prayer, Commandments, or Crucifixion inscribed 50c for 3. Peerless, 2726 Sturtevant, Detroit 6, Mich.

GEIGER Counters, \$23.95-\$29.50. Morgan Instruments Company, 21420-B Valerio, Canoga Park, Calif.

SPECIAL! Five bottlejack \$2.98. Hurry! Buy now! Corin, Hauptpostlagernd Koblenz, Rheinland, Germany.

PLYMOUTH Owners save money with big 288-page manual. Tells how to keep your Plymouth in tip-top shape; how to make repairs and recognize troubles. Hundreds of diagrams, drawings and illustrations. \$3.50 postpaid or order c.o.d. Popular Mechanics Press, 200 E. Ontario St., Chicago 11, Ill.

NEW. Wonderful thrill for your youngster! Inland Tractall looks like real tractor. Chain drive. Perfect for children up to 12 years old. Sold direct. Literature free. Write Inland Mfg. Corp., Dept. 104-C, 164 Ellicott, Buffalo 3, New York.

FLANE Blades, scissors sharpened. Enclose 35c each. Edwill Co., 1246 E. Dickinson, Grand Rapids 7, Michigan.

DELAYED Action light switch. Walk 87 steps before light goes out. Enclose \$2.00. Edwill Co., 1246 E. Dickinson, Grand Rapids 7, Michigan.

BRAZILIAN Orchids. Ask catalog. Orquideario Catarinense, Exporters, Corupa, Santa Catarina, Brazil.

ARE You concerned about the hereafter and probable world-wide destruction? After exhaustive study, reference and interpretative work you may have authentic information from the most reliable sources the Christian world offers. If not satisfied your fifty cents will be returned plus postage. Bible Answer Service, P.O. Box 291, Kokomo, Ind.

BOXES, Paper. Small quantities. Printed, plain. Also display cards, easels. Burtch Carton Co., Route 5, Kalamazoo, Mich.

REVOLUTIONARY Toilet tank ball and guide works every time. Anyone can install in five minutes. Instructions included. Fits practically all toilets. \$2.00 check or money order postpaid. Completely satisfactory or money back. Specialties, P.O. Box 6032, Station B, Albuquerque, New Mexico.

LEATHER Jackets repaired. New knit, zippers or relined. Work fully guaranteed. Jackets made to order. Free circular. Taubers, 689 Mission, San Francisco 5, Calif.

INTERESTING Booklet, "Baseball's Hall of Fame," 25c postpaid. Wells Publications, Box 241B, Alton 4, Illinois.

MEDICAL Laboratory Technicians in great demand. We train you in your own home. Catalogue free. Imperial Technical Institute, Box 973-J, Austin, Texas.

OUTDOOR Toilets, cesspools, septic tanks cleaned, deodorized with amazing new product. Just mix dry powder with water; pour into toilet. Safe, no poisons. Save digging, pumping costs. Postcard brings free details. Burson Laboratories, Dept. C-36, Chicago 22, Illinois.

YOUR Leather jacket renovated expertly. Free circular. Berlew Mfg. Co., Dept. 8, Freeport, N. Y.

GENUINE Buckskin jackets, gloves. Semi 50c for buckskin money pouch and free catalogue. Berman Buckskin Co., Minneapolis, Minnesota.

70 BIBLE Lessons, 25c. Bulletin, Box 87, Cathedral Station, New York 25.

DRESSES, Used, 18c; coats \$2.00; blouses 35c. Free catalogue. Crown, 164-PM Monroe Street, New York 2.

HOW-To-do-it books on every subject. Written in Popular Mechanics' famous easy-to-understand style and profusely illustrated. Subjects include workshop planning and practices, projects, hobbies, household repairs, motoring, outdoor sports, photography, home building, and many others. Also booklets on specific topics. Write for free illustrated catalog. Popular Mechanics Press, 200 E. Ontario St., Chicago 11, Ill.

CESSPOOL Trouble? Use Peps-It. Rejuvenates fermentation action, saves pumping costs, deodorizes, reduces masses. Costs only \$2.50. Safe. Sanitary. Free descriptive literature. Chemical Cesspool Cleaning Co., Boston 34, Mass.

SQUARE Dance instructions, thirty dances, \$1.00. Wesley Rader, 3926 Alcott, Denver 11, Colorado.

RECEIVE Giant mails, magazines, catalogs! Three months 25c, year 50c. Waddell's Directory, 341B East 76th, New York 21.

TREASURE Finders for gold, silver and minerals. Money back guarantee, best available. Also Geiger counters for uranium prospectors, free information. Write Goldak Company, 1541 West Glenoaks, Glendale 1, Calif.

PANNING Gold lesson and catalogue. Beginners supplies, books, "maps where to go" free. Old Prospector, Box 729DI, Lodi, Calif.

TREASURE—M-Scope Geiger counters, mineral locators. Why buy something inferior when you can buy the best at a lower price? Backed by years of experience. Fully guaranteed by factory. Detects minerals, metals, gold, silver, coins. Payment plan available. Proven superior performance. Free 16 page illustrated booklet. Fisher Research Lab., Inc., Palo Alto, California.

MAIL COUPON FOR A...

FREE BOOK & LESSON AND BUILD AND KEEP A POWERFUL GIANT SCREEN TV SET!

SHOWING HOW YOU CAN

THIS YOURS TO BUILD AT HOME ENJOY FOR YEARS

PERHAPS NEVER AGAIN AN OFFER LIKE THIS!

NOW! The greatest history-making offer in our 15 years! Your chance to get into high-paying Radio, Television field by *actual practice* on kits so valuable you simply can't afford to pass this up! Just imagine! You build and KEEP beautiful giant screen TV Set—build and KEEP 6 tube superheterodyne RADIO. We give you professional MULTITESTER you can use in your own service shop PLUS more than 12 other valuable kits! Also, you get amazing shop-type "learn by doing" training developed by world famed electronic experts—a great new method that has been universally acclaimed as a MARVEL of SIMPLICITY in over 40 DIFFERENT COUNTRIES! At least INVESTIGATE this marvelous training that has already placed THOUSANDS OF MEN in high-paying RADIO and TV jobs or in business! Graduates in U.S. and Foreign countries state CETI easy-to-learn lessons are FAR SUPERIOR TO ALL OTHERS! For your own future you MUST INVESTIGATE TODAY! Mail coupon above for fascinating free book and free lesson thousands have used as stepping stones to big jobs in RADIO-TV! ACT NOW!

STUDY IN SPARE TIME AT HOME

MAIL COUPON TODAY! GET FREE TV FACTS-TV IDEAS

BONUS 12 BIG KITS OF RADIO PARTS

CALIFORNIA ELECTRONICS & TELEVISION INSTITUTE
DEPT. PM 1121 W. PICO BLVD., LOS ANGELES 15, CALIF.

Send, without obligation, your Big Book containing hundreds of TV-RADIO Facts and Ideas plus Free Lesson. (No salesman will call.)

Name _____
Address _____
City _____ State _____



New-Sensational SCULPTURE-PAINTING—You can do!



Even if you've never drawn a line, you can enjoy the thrill of artistic creation with this fabulous hobby-time achievement . . . and make a good p-r-o-f-i-t doing it! By the startling invention of Nick Nichols, the famous cartoonist, pictures of anything can be Sculpture-Painted to an amazing lifelike third-dimension relief, then colored. Any

subject can also be traced and Sculpture-Painted in relief on paper, wood, metal, or cloth. Sculpture-Paint directly over photographs of faces for lifelike third-dimension portraits for real money!

FAMOUS ARTIST HELPS YOU. After much persuasion by enthusiastic art lovers, Mr. Nichols has duplicated his secret formulas and perfected the materials for others to enjoy and profit by. So, now you can get his complete Sculpture-Painting Kit and exact instructions for only \$3.95 complete and postpaid. Try your hand at once and enjoy your biggest thrill of accomplishment. Send \$3.95 today—or, send your name and we will ship C.O.D. for \$3.95 plus postage and C.O.D. fee. Your \$3.95 refunded after 5 day trial if not delighted.

Nick Nichols' ARTS 39 W. ADAMS ST., Dept. 21 CHICAGO 3, ILL.



Note the "jumping-out-effect" of Water-Skier sculptured in relief on a magazine cover.

BUILD A \$15,000 A YEAR FUTURE!

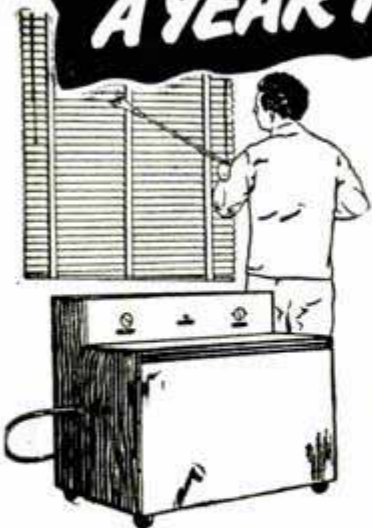

IN THE EXCITING NEW BUSINESS OF LAUNDERING VENETIAN BLINDS

There is big money to be made cleaning Venetian Blinds and a permanent, fast growing, Lifetime Business, besides.

An amazing new kind of business of your own in a field that is growing like mad. Millions of Venetian Blinds need laundering at regular intervals.

With our new patented machine, you can start small—using your basement, garage or utility room to begin with. You can expand as your business increases by leaps and bounds. Income up to \$200.00 daily already being made by others. Small investment for equipment starts your own lifetime business—and monthly payment plan permits you to pay for it as you grow.

FREE Get all the facts about this sensational new kind of machine that launders blinds so fast that your charges are unbelievably low. People would rather send blinds to you than do the work themselves. Yet, you make 700% profit on every blind you clean. Get names of successful owners near you. Get details of the full amazing plan without obligation. Be first in your territory to start a business that has brought \$15,000 PROFITS the first year to others. Wire today or send name on postcard.

VENETIAN BLIND LAUNDRY EQUIPMENT CO. INC.
442 N. SENECA ST. DEPT. 101 WICHITA 12, KANSAS



Let **MASTER CHEFS** teach you the money-making art of Fine Cooking!

The **CULINARY INSTITUTE OF AMERICA** gives you the right start in a career that offers big income opportunities! If you're going into service you'll improve your chances for a better job with Uncle Sam too! Learn all phases of preparing and serving fine foods. National recognition by Hotels and Food Industries has created tremendous demand for **CULINARY INSTITUTE** graduates—many are now dining-room managers, club stewards, high salaried chefs, or owners of their own restaurants. Send for free brochure. Scholarships available. Enrollment for Spring term closes February 15.

THE CULINARY INSTITUTE OF AMERICA
393 Prospect St., New Haven, Conn.

Without obligation, please send free brochure to:

Name _____
Address _____
City _____ State _____

How to Always Have **HOT WATER**

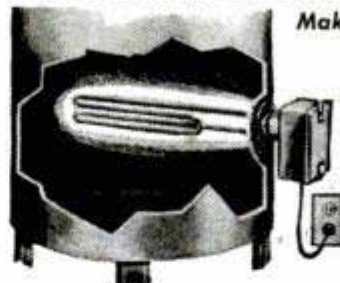

Make Your Own Automatic Electric Water Heater **\$19.95**
now for only

INSTALL IN 5 MIN.
No disturbing or draining of tank or pipes

Why suffer without hot water? Enjoy lots of it to wash, bathe, shave. Heater keeps water **HOT** in your present tank. Turns **ON** when needed—**SHUTS OFF** when water is heated. No fire, dirt, fire!

ONE YEAR GUARANTEE
U. L. Approved Heater

Ideal for 30-gal. tanks! Heater screws into any size boiler tap as shown. Plugs into outlet... 1320 w. 110 v. AC. (Also 2000 w. 220 v. model for BX cable \$19.95)... works automatically thereafter. Temperature adjustable between 120 to 180 degrees. Replaces coal, oil, gas in home, store, summer cottage, green house, farm, barn, stock tank, poultry scalding, factory. Uses only 1/4 to 1/2 c electricity per gallon hot water. Why burn expensive main furnace unit for hot water? Send check or M. O. NOW; save postage, shipping charges. **ORDER NOW . . . TODAY.** Money back in 10 days if not delighted.

COLLOID EQUIPMENT CO., INC. Dept. PM1, 50 Church Street, New York 7, N. Y.

Have an **OFFICE of YOUR OWN!**

LEARN NEW PROFITABLE PROFESSION
At Home in 60 Days, Men & Women, 18 to 70!

Be Your Own Boss and the Boss of Others. Be Respected. Meet Interesting People.

Earnings of men and women in this profession run as high as \$5,000-\$15,000 yearly. Others make good money in spare time. Little money needed to start. A business where your earnings begin sooner. Easy to learn. No selling or goods to buy. No experience necessary. A depression-proof business. A course of action to guide you step by step as you earn. All 53 lessons sent at once to use as operating manuals. Easy terms. Diploma. Money-back agreement. Write for **FREE BULLETIN.**



FRANKLIN CREDIT SCHOOL

Dept. 71-M ROANOKE 7, VIRGINIA

BY MAIL in Easy Lessons

Secrets of **VENTRILOQUISM** Now Revealed!



Easy to learn in 60 to 90 days with our Home Study Course. **RESULTS GUARANTEED.** Make Money! Be Popular! Have Fun! Big Opportunity! Radio, Television, Stage Appearances! For FREE Information regarding price and terms, **WRITE.** You must state your age. Dummy Catalog 25c.
FRED MAHER SCHOOL OF VENTRILOQUISM
Box 36, Studio M Kensington Station
Detroit 24, Michigan

ANALYZE HANDWRITING

MORE INCOME, Prestige, Success, Fascinating uncrowded profession-business, full or spare time. FREE illustrated lesson & Year Book shows how men and women in home, business and professions analyze handwriting to understand people. MAKE MONEY. FREE lesson and information about unusual opportunities if over 21.

I. G. A. S., Inc., 715 Wilhoit Bldg., Springfield, Mo.



Say You Saw It in Popular Mechanics

LEFAX POCKET SIZE TECHNICAL DATA BOOKS \$1. EACH

Printed on loose leaf, six hole, 6 3/4" x 3 3/4" bond paper, each book contains about 140 pages of technical data, presenting condensed, accurate and essential data for the student, engineer, technical worker and business man.

Architecture	Building Constr.	Piping Data
Home Heating	Radio	Surveying Tables
Illumination	Television & FM	Trig-Log Tables
Electrician's Data	Electricity, AC	Metallurgy
Builder's Data	Electricity, DC	Analytic Chem.
Lumber Data	AC Motors and	Highway Eng.
Air Conditioning	Generators	Mech. of Materials
General Math.	Transformers,	Pwr. Trans. Mach.
Math. Tables	Relays, Meters	Thermodyn. Tbls.
Physics	Hydraulics	& Charts
Chemical Tables	Surveying	Phys. & Thermo-
Metals	Mech. Drawing	dyn. Data
Gen. Chemistry	Machine Design	Phys. & Org. Chem.
Reinf. Concrete	Machinists Data	

Write for **FREE** catalogs (over 2000 listings). See for yourself how helpful **LEFAX** can be to you. Send \$1 for each book. (or \$5 for any six books listed above) to

LEFAX DEPT. PM-10 PHILADELPHIA 7, PA.

GREER SHOP TRAINING

2230 So. Michigan Blvd.
Chicago 16, Illinois

LEADER IN PRACTICAL TRAINING FOR 50 YEARS

Greer Shop Training, one of America's leading Trade Schools, has prepared over 50,000 men for high paying jobs in industry since 1902. In our new, large modern shops YOU LEARN BY DOING — over 100,000 square feet devoted to practical, personal instruction with the tools, machines and latest equipment of the trades. You learn from experts.

Industry needs skilled men in these good paying trades:

Diesel Mechanics	Machine Shop	Correspondence courses:
Auto Mechanics	Tool & Die Design	Diesel Mechanics
Body and Fender Repair	Gas & Arc Welding	Refrigeration
Refrigeration	Piano Tuning	Plastics

G. I. approved for disabled vets and those discharged after July 25, 1947.

Plan now to increase your chances for success by learning a trade which offers you security, promotion, high pay and the opportunity to go into business for yourself. Greer Shop Training can prepare you and give you the "Know How" of the trade you choose. Investigate the field of your liking today . . . act now!

For complete information, write Desk 212A . . . Give the trade you are interested in . . . or phone Victory 2-2300. Visitors always welcome.

Agents Wanted.



FINEST HAND MADE ITALIAN ACCORDIONS **LOWEST WHOLESALE PRICES**

Be the proud owner of a famous Glorich Italian Accordion—and save 50% by buying direct at lowest wholesale prices. These gorgeous, hand made instruments are the very best. Satisfied owners all over U.S.A. Self-instruction course included. Write today for free folder of 1952 models at lowest wholesale prices. **AMERICAN ACCORDION CENTER, Dept. A-1** 5329 Belmont Ave. Chicago 41, Ill.

JUST OUT! **1952 EDITION**

It's New! It's Different! Get world's largest Auto Accessory & Parts Catalog and save money. Over 50,000 items, including Hollywood Accessories, Hi-Speed Equipment, Rebuilt Engines, all parts & accessories for all cars & trucks. We have that Hard-To-Get part! Jam packed with bargains. Completely illustrated. (100 pages) Send 25c (refundable).

J. C. WHITNEY & CO., 1917-XP Archer Ave., Chicago 16, Ill.

SO BADLY NEEDED—

—that Our Men are NOW SELLING—

5 to 10 in One Home—
10 to 80 in One Office—
50 to 432 in a Factory.

Men Actually Making \$40 to \$60 A DAY! Right NOW!



PAT. NO. 1,790,666

Read the facts in the column at the right. Then you'll understand how Riggs could make \$187.26 in three hours—how Jackman got an order for 432 with a five minute demonstration—why an office girl in spare time could sell 87 in just two calls in one building. No more tangled phone cords, appliance cords, extension cords on power tools. No more danger of fires from short circuits in broken, twisted wires. No more knocking papers all over the desk every time the phone is used. So badly needed that there are millions and millions waiting for just one demonstration to give orders for five, fifty, or a hundred. There's never been anything like it for fast money for any kind of salesman. Companies

like Std. Oil, Pure Oil, Bank of America buy in large quantities. Cities buy, States buy. Hospitals buy. Everyone buys. And our salesmen are coining cash, hand over fist.

GET TWO SAMPLES QUICK

Two models fit all needs. Retail at 95c each. You make as high as 120% profit markup on your cost. Rush name and a dollar bill. We'll send two Collettes—one of each model, as samples. Money back if you return them in ten days. The stampede is on. Salesmen and crew managers are throwing other lines overboard. Get in now on the biggest "pay-off" in years.

A simple little piece of coiled piano wire takes the kinks out of all electric cords—Recoils the wire in a neat stack each time it is used — on phones, fans, irons, vacuums, adding machines, power tools. Two minute demonstration sells 8 out of 10 prospects—and almost every prospect buys from 3 to 100. Re-orders will swamp you. You have to see it to understand. Send for two samples today.

MAXILUME CO., Dept. T-8-A, 125 W. Hubbard St., Chicago 10, Ill.

FREE



★
1952

ALLIED RADIO & TV CATALOG

**EVERYTHING IN RADIO
AND TV AT LOWEST PRICES!**

SEND FOR IT

**212 PAGES
Value - Packed**

**Everything for
Experimenters, Builders, Amateurs,
Servicemen, Engineers, Soundmen...**

Save money on every Radio and TV need! Get the big 212-page 1952 ALLIED Catalog featuring the world's largest selections of top-quality electronic equipment at lowest, money-saving prices. See the latest in TV, home radios, Amateur equipment, P.A. systems and Hi-Fidelity custom sound, recorders, test instruments, builders' kits—plus thousands of parts, tools, books and diagrams. Get more for your money from the World's Largest Radio Supply House. Send today for your FREE 1952 ALLIED Catalog!



Save on
Everything
in Radio & TV



**FREE
CATALOG**

SEND FOR IT TODAY

ALLIED RADIO

ALLIED RADIO CORP., Dept. 5-AA-2
833 W. Jackson Blvd., Chicago 7, Ill.

Rush FREE 1952 ALLIED 212-Page Catalog

Name _____

Address _____

City _____ Zone _____ State _____

A
WORLD
CHAMPION

For Low Cost
Transportation!

Cushman

TOTAL OPERATING
COST
3/4¢ per mile

- FAST
- CONVENIENT
- ECONOMICAL
- NO PARKING PROBLEM



Cushman—the world's best buy when it comes to economy—75 miles per gallon—up to 40 miles per hour—superior riding features—easy to own, maintain and operate. You get maximum power and dependability with Cushman. Over fifty years of engineering experience. Go Cushman this year. You'll be time and money ahead.

Write today for Free Illustrated literature.
See your nearest Cushman dealer.

CUSHMAN MOTOR WORKS, Inc
919 NO. 21 ST., LINCOLN, NEBRASKA

This NEW TYPE ACCORDION

*is much easier
to play*

With our New Method every
average person can actually
learn to play all by himself



For free information write to

HUNIBEL ACCORDIONS
5154 N. CLARK ST. CHICAGO 40, ILL.

LEOPARD SEAT COVERS

SWEEP TO SENSATIONAL NATIONAL POPULARITY

EXCLUSIVE WITH "KEY" AGENTS



Salesmen jamming pockets with \$10⁰⁰ bills!

TAKING ORDERS FOR "KEY" EXPERTLY TAILORED AUTO SEAT COVERS!

LOOK AT THESE FEATURES

- Extra Fine Fit and Tailored Appearance
- Seven Different Designs — Seven Price Ranges
- Every Car Owner A Prospect

The "Leopard"

The selling sensation of the year! Satin-like, its iridescent sheen delights the eye. Beautiful "Leopard" cloth trim assures the ultimate in sheer luxury.

FOR ALL CARS— ALL YEARS— ALL MAKES AND MODELS

BIG SEASON NOW STARTING

The "Pacemaker"



Genuine fibre seat covers, plastic coated, to wash easily. Will not stain. Sheds dirt and dust like a duck sheds water. Beautiful Plaid design blends with any car interior. Brings a new conception of driving comfort.

The "Streamliner"



The multi-colors of this genuine Saran Woven Plastic complement the colors of the car's upholstery. The finest you can buy, Saran Woven Plastic is impervious to climatic conditions. Snag proof. Water proof. Flame resistant.

You've heard of the tremendous demand for Leopard auto seat covers that built up overnight from one end of the country to the other. Car owners are paying \$50.00, \$60.00 and \$70.00 and more for car seat covers with Leopard design. Now you can serve that eager demand at a fraction of the cost your customers would expect to pay! No wonder salesmen are making money hand over fist with this sensational new Key Seat Cover line!

Make big money daily. Take orders from car owners everywhere. Permanent year around income. Meet and beat all competition with covers cut to accurate patterns like the finest suit of clothes. Slick, wrinkle-free fit adds an accent of elegance to any car . . . just like an original upholstery job! **CASH IN ADVANCE DAILY.** Direct-from-factory low price. Customers expect to pay twice as much as the low price you quote for these genuine, expertly tailored Auto Seat Covers. Your customers instantly recognize the real bargain you are offering! And you make top profit on each sale! Earnings in advance every day!

COMPLETE SALES KIT FREE!

Nothing at all to buy. Complete sales kit including actual samples of materials used - trim, Leopard cloth, plastic, leatherette, etc. Beautiful illustrations. Big supply of C.O.D. order taking forms. Everything you need to start cashing in immediately. Get in on this lucrative business. Write for selling kit, including Bonus Offer of FREE Seat Covers for your own car.

JUST SEND COUPON ALL FREE!

KEY PRODUCTS CORP., DEPT. 41 800 N. CLARK STREET, CHICAGO 10, ILLINOIS

Rush me Free Sample Outfit at once so that I can start making real money with Key Products. (If you own a car include the following information):

MAKE OF CAR.....YEAR.....
 MODEL..... 2-Door 4-Door
 NAME.....
 ADDRESS.....
 CITY..... STATE.....

RUSH NAME FOR FREE SAMPLE

Give Make, Year and Model of Your Car

Anyone working full or spare time can realize big money. No need to search for prospects. Every car owner is one. Make year around STEADY PROFITS. Get free selling kit at once. ACTUAL SEAT COVERS GIVEN FREE TO PRODUCERS FOR OWN USE! Write for full details -or mail coupon below-TODAY!

KEY PRODUCTS CORP.

800 No. Clark St., Dept. 41, Chicago 10, Ill.

Get into BUSINESS for Yourself!

METALIZING BABY SHOES AT HOME IN SPARE TIME



Get facts about amazing money-making Warner Success Plan that shows you every easy step in completely charted path to personal independence—with your home as your headquarters... This proved and tested Plan is working like magic. It's backed by an old, reliable company... And we send it to you on a No-Risk Trial Money Back Guarantee.

QUICK CASH WAITING

Demand for METALIZED Baby Shoes and other keepsakes is growing bigger daily. Our Tested Plan Shows How to Do the Work, How to Bring in the Business, How to Make as much as \$5 an Hour. Spare or full time, big steady profits are waiting for you. Send penny postcard or mail coupon for FREE Facts. Act! Time is precious.

FREE
offer of
COMPLETE MONEY MAKING PLAN
•
SEND NO MONEY
Just Mail
COUPON

Ray Brandell, Mgr., Warner Electric Co.,
1512 JARVIS AVE., DEPT M-3-A, CHICAGO 26, ILL.

Please rush complete details about your No-Risk Trial Money Back Plan for Metalizing Baby Shoes. Everything you send is FREE and costs me nothing—now or ever.

NAME _____

ADDRESS _____

CITY _____ ZONE _____ STATE _____

6 WAYS TO SAVE AND MAKE EXTRA MONEY



Famous How-To-Do-It Books Shipped Anywhere Under Money-Back Guarantee

Get a Drake Book to help you on your job—to develop extra spare time earnings—to help you start your own business—to save money on your home and equipment. Newest, practical books now sent by mail.

MACHINE SHOP PRACTICE

Covers layout, measurement, use of hand tools and all standard operations on lathes, shapers, millers, drill presses, etc. 408 pages. 310 illustrations. \$3.00

WOOD FINISHING

Detailed instructions and formulas for every type of plain and decorative wood finishing. Covers methods, tools and materials. 360 pages. Fully illustrated. \$2.50

ELECTRIC APPLIANCE REPAIR AND SERVICE

Covers care, trouble shooting and repair of all home electrical appliances by use of simple hand tools. 250 pages. 188 illustrations. \$3.00

Check books wanted. Clip this ad and mail with name and address, and check, money order or currency. Postpaid delivery guaranteed. **COD** if you prefer. Money refunded on any book if returned in 5 days.

BUILDING

Practical instruction for amateur and professional carpenters and builders. Includes small houses and low cost garages. 220 pages. 531 illus. \$2.50

SPRAY PAINTING

Newest edition including auto painting. Now covers every type of spray painting. Complete guide for amateur and professional. Fully illustrated. \$2.00

HOUSE WIRING (Practical Electricity)

Earn extra money. Save hundreds of dollars. Do your own electrical wiring with this book. 287 pages. 250 illustrations. \$2.00

FREDERICK J. DRAKE & CO., Dept. 11, 117 GREEN BAY ROAD, WILMETTE, ILL.



READ ABOUT TRAILERS BEFORE YOU BUY

TRAILER TOPICS MAGAZINE

Brings you the latest in Trailer Coaches—Equipment—Accessories—Trailer Trips—Trailer Parks and many other interesting monthly features at only — \$3.00 for 2 years.

(6 month trial subscription \$1.00)

Send your subscription to
TRAILER TOPICS MAGAZINE, (Room 1530)
28 EAST JACKSON BLVD. CHICAGO 4, ILL.

Learn CARPENTRY BRICK LAYING

Get into the billion dollar building trades. Learn now while opportunities are greatest. Train in our completely equipped shops under expert instructors. Enroll now. Limited classes. Write for details about our **PAY AFTER GRADUATION PLAN** and **FREE Catalog.**

MIDWEST SCHOOL OF BUILDING TRADES, Dept. PM-1
411 N. Center St. Bloomington, Ill.

WRITE 3 WORDS MAKE \$6.00 PROFIT—

—on 10-Second Demonstration to merchants. Write on glass with amazing Magic Crayon—Presto!—5 color advertising message takes fire, glows like brilliant Neon. Three sales daily bring \$18 profit. Rush name for FREE Sales Kit.

MAXILUME CO., 125 W. Hubbard, Dept. L-8-A, Chicago 10, Ill.



TASOPE PHOTO-ENGRAVING PLANTS



Establish your own profitable **PHOTO-ENGRAVING** business. Make cuts for newspapers, printers, and advertisers. Make etched name plates, plaques etc. Instructions furnished, no experience necessary. Sold direct from factory since 1931. First five hundred cuts sold locally or by mail will pay for plant and pay you well for your time. Write for **FREE catalog.**

TASOPE DEPT. PM10, AURORA, MO.

LEARN MOVIE PROJECTION THEATRE MANAGEMENT



The Motion Picture Theatre Business offers big opportunities for trained men. Get into a fascinating field with a peace time future. Train at home in spare time. Free catalog. Established 24 years.

THEATRE INSTITUTE, 370 Washington St., Elmira, New York

STEADY PROFITS!



Your Own Business With CORADIO

Coin Operated Radio

Place these specially built radios that play 1 or 2 hours for 25c in the thousands of available hotel rooms, tourist courts, etc. They yield immediate profits and steady income. Minimum capital required \$750 for equipment. Expansion unlimited. For further information write:

CORADIO Coin Operated Radio
DEPT. NO. 1-PM Phone: 212 BROADWAY, NEW YORK 7, N. Y.
BEekman 3-0038-9

STORM WINDOWS \$1.00 ea.

- Put Them Up Yourself in Minutes!
- Save \$100 or More!
- Pay for Themselves in Fuel Savings!
- Tested on 500,000 Windows!

No need to buy expensive glass storm windows! Keep warm and save fuel this winter with these transparent storm windows! All you need is a hammer and selsors—and you can put them up yourself! Made of strong, transparent Bakelite Vinylite. Won't tear, shatter or rattle. You get a 36"x72" sheet of vinylite, framing strips, tacks, plus easy directions. Guaranteed waterproof, windproof, stormproof and non-inflammable. Cleans easily with a damp cloth. Only \$1.00 plus 10c postage each. Get one for each window in your home! Money back in 10 days if not delighted.



DAMAR CO., 603 Damar Bldg., Treat Pl., Newark 2, N. J.

GET UP TO 40% OFF! **BUY IT WHOLESALE!**
START A BUYING SERVICE at home, spare time. Get big-name merchandise for clients (and yourself) at up to 40% and more below the regular list price. Make fat commissions. Folks eagerly buy through you to get sizeable discounts. Send postcard for details.
AMERICAN BUYERS' SERVICE, 631-PM Linden Ave., Buffalo 16, N. Y.

Improved Americanized

JUDO

"THE BIGGER THEY ARE — THE HARDER THEY FALL!"

Two Big Books Clearly Illustrated. Over 1200 Show-How Photos. Many New Holds! 71 Complete Lessons.

Protect yourself and others. Size and strength mean nothing. Knowledge and skill enable you to master any situation even against biggest bullies and armed thugs. Illustrations showing each hold from start to finish. Complete satisfaction guaranteed or your money refunded.

NOW VOL. I & VOL. II \$5.00 pp'd. or \$3.50 ea. \$1.00 deposit with C.O.D.'s.

No C.O.D.'s outside U.S.A.

IMPROVED JUDO, INC. Dept. PM-1, P.O. Box 7355, Sta. L, Los Angeles, Calif.

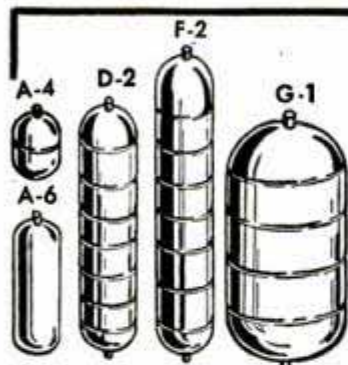

STEEL AIR TANKS

Steel pressure tanks suitable for compressors, pneumatic units, gases, hydraulics, and liquids. Rated at 500 lbs. per square inch pressure. 1/4" standard pipe thread openings on tank ends as shown.

	Size	Wt. Lbs.	Internal Volume	Price
A-4	Stainless Steel—New	7 1/2"x5 1/4"	1 1/2	104 cu. in. \$1.50
A-6	Carbon Steel—New	14 1/2"x5 1/2"	3 1/4	280 cu. in. 3.50
D-2	Stainless Steel—New	24"x6"	5	500 cu. in. 5.50
D-2A	Carbon Steel—New	24"x6"	5	500 cu. in. 4.50
F-2	Stainless Steel—New	45"x6"	11	1000 cu. in. 9.50
F-2A	Carbon Steel—New	45"x6"	11	1000 cu. in. 5.50
G-1	Stainless Steel—New	24"x12"	18	2100 cu. in. 11.50
G-1A	Stainless Steel—Used	24"x12"	18	2100 cu. in. 9.50

Prices F.O.B. Chicago. Include approx. postage on orders paid for in advance. C.O.D. orders enclose 25%, balance sent C.O.D.

U. A. S. Corp. Dept. PM1, 5637 W. 63rd Pl. Chicago, Illinois



FLOYD CLYMER POPULAR MOTOR BOOKS

CLYMER says— "YOU WILL LIKE MY MOTORBOOKS!" I now offer 70 titles on automobiles, motorcycles and motor racing. Start your Clymer book library NOW. More than 1,300,000 readers of these world-famous books.

✓ Check books wanted below. All postpaid.

AUTO OWNER'S COMPLETE HANDBOOK.....\$2.00

A new repair manual clearly written for the layman... 232 pages, over 300 drawings, charts, illustrations. An authoritative guide for any automobile owner interested in maintaining his own car. Explains simple home-workshop machining methods, chassis and suspension repairs. Complete data on engine overhaul, fitting of new parts. Clutch, transmission, differential problems dealt with in detail.

FORD OWNER'S HANDBOOK.....\$1.50

Complete maintenance and repair data. All models 1932 to 1950. Charts, drawings, photos, tables of clearances and adjustments. Data on Ford SIX included. A COMPLETE Ford repair book.

CHEVROLET OWNER'S HANDBOOK.....\$1.50

Complete new service data book, all Chevrolets 1929 to 1950 including Powerglide model. Every Chev. owner needs this manual. Many charts, drawings, sketches on every important unit. \$1.50.

SOUPING THE STOCK ENGINE.....\$2

Explains the 5 paths to power, covers all engines from road to track, effective speed tuning theories, tells why and how, 150 charts, photos, drawings, fuels. \$2.

HOW TO HOP UP FORD & MERCURY V8 ENGINES..\$2.00

Over 120 authentic graphs, charts, photos, a history of Ford V8 engine included. Tells how to get most for your money, short cuts to increasing power output, how to plot results. 160 pages.

HOW TO HOP UP CHEVROLET & GMC ENGINES...\$2.00

160 pages, over 120 illustrations. Treats all phases, including block, con rods, pistons, fuel & carburetion, ignition, supercharging, and others. Special emphasis on economy & 5 Paths To Power.

THE MODERN CAR CHASSIS.....\$2

Complete data on Suspensions, Steering, Shocks, Brakes, Weight distribution. New book for owners modern cars, sports cars, Stocks, Hot Rods, Specials. \$2.

MODERN AUTOMATIC TRANSMISSIONS.....\$2

Contains latest data on modern automatics & torque converters, including Hydra-Matic, Ultramatic, Dynaflo, Powerglide, Studebaker, Mercury-Ford, Chrysler M-6, Allison, Fuller and White Hydro-Torque. By noted S.A.E. authorities. \$2.

SPORTS CAR ENGINE.....\$1.50

A new book. 40 photos, charts, drawings. Technical and all other data on all Sports Car Engines. A MUST for Sports Car Fans. \$1.50.

SPECIALS, SPORTS CARS AND HOT RODS.....\$1.50

Over 160 photos, charts, drawings on Special Race Cars—England, Germany, France, Austria, U.S., Italy. A complete Manual of Speed data. Handbook for construction. \$1.50.

BRITISH CAR OWNER'S HANDBOOK.....\$2.00

This Autocar Handbook, compiled for the lay owner of any British car, has complete data on engine repair, lubrication, carburetion, electrical, etc. 252 pages, 240 charts, drawings. Newly revised.

MEXICAN ROAD RACE...\$2

Complete history 2135 mile race across Mexico. 132 stock cars. Articles by famous authorities, drivers, personalities. Rules, leg by leg description. Travelogue over Mexico's famous new Highway. 152 pages, 300 photographs.

TREASURY OF EARLY AMERICAN AUTOMOBILES.....\$5

New Clymer antique car book. 224 large pages. 500 photos, N.Y.-Paris, Indianapolis, Vanderbilt Cup races. Glidden Tour data. Cartoons, songs, early motor styles, costumes. Gas, steam, electric, spring driven automobiles shown. 1600 makes U. S. Cars named. Clymer's latest, finest, largest automobile history book. Many cars never before shown. Beautiful cloth binding with attractive colored cover. \$5.

Write for Free Catalog of 90 Motorbooks.

FLOYD CLYMER 1268 S. ALVARADO P-1, LOS ANGELES 6, CAL.

"World's Largest Publisher of books relating to Automobiles, Motorcycles, Motor Racing and Americana"

CATALOG OF NEW U.S. AUTOMOBILES \$2
 Illustrates latest models with detailed information as to specifications, heretofore unobtainable information by Engineers.

CATALOG OF NEW BRITISH CARS... \$2
 All British latest models with photos and complete detailed information — in a unique sports cars.

MAIL ORDER

FLOYD CLYMER PUBLICATIONS

1268 S. Alvarado, P-1, Los Angeles 6, Cal.

Send postpaid books checked above. Servicemen delivery guaranteed.

Send Free Catalog. I now own some Clymer books. I am a new customer.

Name _____

Address _____

City _____ Zone _____ State _____

Remittance enclosed Send C.O.D. (postage extra) Add 10% on foreign orders

GROW Living MIDGET TREES! PER HOUR!

- AT HOME
- IN SPARE TIME
- NO EXPERIENCE NEEDED



It's new! Amazing! At last, the secret of growing miniature (MING) trees can be yours. FULL GROWN, dwarf trees — only a few inches high. Beautiful miniature fir, orange, oak, Chinese elm, peach, pine, cypress—any kind! ALL BLOOM — and even BEAR FRUIT. All perfect healthy specimens—but miniature in size! Make costly home decorations and expensive centerpieces. (SOLD FOR OVER \$1,500 EACH) Big demand. Costs only pennies — takes only minutes per week. IT'S EASY! Fun! A new fascinating hobby—a new fabulous \$\$\$\$ business.

Send for free secret plan details.

HELP US FILL HUGE DEMAND!

These trees are being demanded by STORES CLUBS • HOTELS • FLORISTS • HOUSEWIVES • INTERIOR DECORATORS • COLLECTORS • HOBBYISTS — A Big Money Opportunity FOR YOU.

FREE! FASCINATING PROFIT PLAN



NATIONAL NURSERIES, Dept. M1
8620 South Ruthelen Avenue
Los Angeles 47, California
Rush me FREE plan IMMEDIATELY!

Name _____
Address _____ Zone _____
City _____ State _____

Get a "HEAD START" WITH NORTHROP Training!

★ AERONAUTICAL ENGINEERING
★ AIRCRAFT & ENGINE MECHANICS

Get a "head start" in your Aviation career with Northrop training. Qualify FASTER for a profitable, permanent, and interesting future! NORTHROP TRAINING can bring promotion and bigger pay YOUR way. A Northrop Graduate is backed by the prestige of the famous Northrop name—he has a "head start" to opportunity and success in Aviation.



Excellent Training Facilities At Northrop you'll use the newest training aids—live jet engines, wind tunnel, single and multi-engine aircraft, outstanding laboratory and shop equipment. Northrop instructors keep up-to-the-minute with the rapidly advancing science of aviation. You'll learn thoroughly in minimum time!

Military Advantages For You In civilian or military life, Northrop training counts. For example, NAI engineering graduates are qualified educationally to become Air Force or Naval Aviation Cadets or Officer Candidates.

Northrop Aeronautical Institute

APPROVED FOR VETERANS
1527 E. Broadway, Hawthorne, Los Angeles County, Calif.

NORTHROP AERONAUTICAL INSTITUTE
1527 E. Broadway, Hawthorne, Los Angeles County, Calif.
Please send me immediately the Northrop catalog, special military information and employment data, and schedule of starting dates of classes. I am interested in:

Aeronautical Engineering ★ Aircraft & Engine Mechanics

Name _____ Age _____
Address _____
City _____ Zone _____ State _____

VETERANS—Check here if you are entitled to training benefits under the G. I. Bill.



BIG OPPORTUNITIES OPEN IN THE METAL TRADES



Machinist Trade Only 60 school days - 360 Hours -
Tool & Die Making of practical
Tool & Die Designing Shop Training or Mechanical
Drafting all branches Structural or Aircraft Drafting

Allied will train you easily and quickly for these Important Trades and place you on a Good Paying Job.

Write for **Free Books** a 1¢ postcard will do!

Inquire about our **PAY AFTER GRADUATION PLAN**

INDICATE PREFERENCE RESIDENT or HOME STUDY

ALLIED SCHOOL 1338 S. Michigan Avenue
401 Allied Building
Chicago 5, Illinois

Home Movies WESTERN THRILLERS in 8mm & 16mm

JOHN WAYNE
RANDOLPH SCOTT
BUSTER CRABBE
GAIL PATRICK
RUSSELL HAYDEN

- Heritage of the Desert
- Knights of the Range
- Drift Fence • Forlorn River
- Hell Town • To the Last Man

8mm: 50' 1.75, 200' 4.25
16mm: 100' 2.75, 400' 8.75, sd 17.50

HOLLYWOOD FILM ENTERPRISES 6040 Sunset Blvd. Hollywood 28, Calif.

TRAIN in Our SHOPS -

in AIR CONDITIONING, REFRIGERATION, ELECTRICITY, ELECTRONICS, TELEVISION, MAJOR APPLIANCES, AUTOMOTIVE MECHANICS, BODY and FENDER REBUILDING

If interested write or wire
COMMERCIAL TRADES INSTITUTE Inc. of Ala.
200 S. 20th ST. BIRMINGHAM, ALA. 254 IVY ST. N.E. ATLANTA, GA.

***** VETERANS ASK ABOUT G I TRAINING *****

LOCKSMITHING & KEYMAKING

HOME TRAINING OUTFIT INCLUDES KEY MACHINE, SUPPLIES AND TOOLS TO GET STARTED IN BUSINESS
Professional outfit. Get practical training from Master Locksmiths. Learn to cut keys by code, master locks, change combinations, quickly identify key blanks, many profitable "tricks of the trade." Booklet of information FREE. Write today. **UNITED SUPPLY & SERVICE**, 3231 Washington Blvd., Dept. PM-1, Chicago, Illinois.

LEARN PHOTOGRAPHY

Famous Low Cost 16 Wk. Home-Study Course. A fascinating Hobby or Money-Making Career can be yours in Portrait — Advertising — News — Magazine — Fashion — Landscape — Photography.

Write for particulars today!
APPLIED PHOTOGRAPHY ACADEMY
910 North Main St. Akron, Ohio

BRAND NEW! THE ENGINEERS' ILLUSTRATED THESAURUS

By HERBERT HERKIMER

JUST PUBLISHED IN 1952

A Book That Shows You Over 8000 ILLUSTRATIONS AND DESIGNS of Mechanical Movements, Devices, Contrivances and Details

The newest, largest, most comprehensive and useful reference work of its kind ever put together. Every conceivable kind of mechanical motion, machine design and detail is briefly explained and illustrated in this one-volume encyclopedia. Here at your fingertips, classified and arranged for easy reference—are over 8000 illustrations, the largest collection ever assembled; and as far as known the only work now in existence which aims to provide side by side suggested sketches of various methods in use for accomplishing any particular mechanical movement or work. Every engineer, inventor or mechanic finds the need of devising, simplifying or improving some mechanical process, method or detail. In doing this, he has to rely on memory or experience. HERE HE WILL FIND COUNTLESS SUGGESTIONS, TESTED AND PROVEN, FOR ACCOMPLISHING WHAT HE SEEKS.

PARTIAL CONTENTS

FASTENERS: Anchors, Bolts, Screw and Nut Design Types, Commercial Nuts, etc. Nails and Spikes, Clamps and Locking Devices, Chucks and Grips, Keys and Cotters, Manholes, Hand-holes, Covers, Doors, Riveted and Miscellaneous Joints. **ADJUSTING DEVICES, SUPPORTS AND STRUCTURES:** Machine Frames and Bedplates, Frames of Welded Design, Girders, Columns and Struts, Bridge Trusses. **BASIC MECHANICAL MOVEMENTS:** Kinematic Chains, Application of Energy to Machines, Levers, Parallel and Straight-Line Motions, Links and Connecting Rods, Guides and Slides, Cams, Tappets and Wipers, Toothed and Epicyclic Gearing, Rolling Contact and Friction Gearing, Pawls and Ratchets, Shifting and Reversing Gears, Circular and Reciprocating Motion. **ELEVATORS, DERRICKS, CRANES, CONVEYORS:** Slings, Feeders, Bucket Ele-

vators, Conveyors. **TRANSMISSION OF LIQUIDS AND GASES:** Reciprocating-Pump and Pump Valves, Packings, Rotary Pumps, Refrigerating Compressors and Valves, Steam Traps and Separators. **COMBUSTION:** Mechanical Stokers, Vaporizing Oil Burners. **PRIME MOVERS:** Steam-Engine Valves and Valve Gears, Steam Turbines, Principles of Gas Turbines, Rockets and Jet Propulsion, Diesel-Engine, Hydraulic Turbine, Compressed-Air Power, Sea-Wave Power. **TRANSPORTATION:** Vehicle Bodies, Underframes and Trucks. **INDUSTRIAL PROCESSES:** Weighing, Measuring, Pressure, Speed and Heat Measurements, Crushing and Grinding, Sifting, Screening, Straining, Chopping, Slicing and Mining Apparatus, Mixers, Washing and Winding Apparatus, Cutting Tools, Sanitation: Water Closets and Septic Tanks. **ELECTRICAL APPLIANCES:** Static Electricity, Magnetism, Electromagnets, Batteries, Transformers, Induction Coils, Telephones, Measuring Instruments, Generators, Alternating-Current Motors, Direct-Current Motors and Generators, Infrared and Electric Heating, Electromagnetic Apparatus, Inductance and Capacitance, Electron Tubes, Radio Communications Systems, Cathode and X-Ray Tubes. **HEATING, COOLING, AND AIR CONDITIONING:** Steam, Hot-Water Systems, Radiant Hot-Water, Radiant, Warm-Air Hook-Ups, Unit Heaters, Ventilators, Air Conditioners, Refrigeration Systems.

If you work with machinery of any kind, you need this ENGINEER'S ILLUSTRATED THESAURUS by Herbert Herkimer—580 pages, durably printed and bound in cloth. Price...

\$6.95

Order by mail. If payment sent with order, we pay postage; or sent c.o.d. plus delivery charges. Money back if not fully satisfied. **Homecrafts, 799 Broadway, Dept. E-7, New York 3, N. Y.**

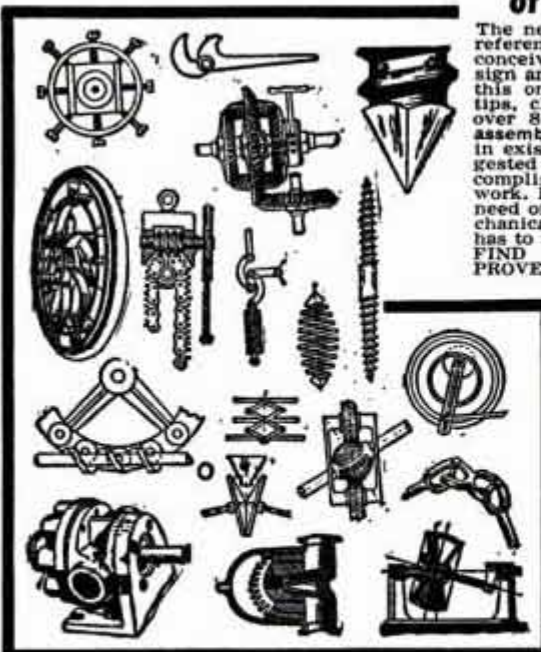

FAMOUS 15 & 17 JEWEL BULOVA WRIST WATCH \$16.95 PLUS TAX



WERE UP TO \$59.50
Save \$42.55

Also Choice of
• BENRUS
• GRUEN
• WALTHAM
• ELGIN

You get these unredeemed UNLIMITED GUARANTEED famous make watches in latest style Yellow Gold Cases at this sensationally low price because we bought out SURPLUS STOCKS of leading New York and Md. jewelers. Order now while they last. Specify make preferred and whether men's or ladies! Only \$16.95, plus \$1.70 tax. Order right now!

UNLIMITED WRITTEN GUARANTEE

FREE 10 DAY TRIAL

FREE EXPANSION BAND WITH EACH ORDER

SAVE \$44 ON THIS 17 JEWEL WRIST WATCH \$14.95 PLUS TAX

FORMERLY SOLD FOR \$59.00
INCABLOC SHOCK PROTECTED WATER & DUST PROOF
Worn by ARMY, NAVY & MARINES

Luminous dial, sweep second hand. Super Accurate. Imported Swiss precision movement and case. You get these brand new UNLIMITED GUARANTEED watches now for a small fraction of the original price. You save \$44, because we bought out surplus stocks. Order men's style \$14.95 plus \$1.50 tax or ladies' and nurses' style, \$16.95, plus \$1.70 tax. Order now at this low price.



NURSES' MODEL \$16.95 Plus tax

WEAR AT OUR RISK!
Money Back guarantee in 10 days if not delighted!

SEND ONLY \$1 DOWN PAYMENT with order. Pay balance to postman on arrival plus postage. Or we pay postage if you enclose full payment plus tax.

MARYLAND DISTRIBUTORS, Dept. 338

501 E. BALTIMORE ST. BALTIMORE-2, MARYLAND

FREE! WATCH AND JEWELRY CATALOG AT ALMOST WHOLESALE PRICES!

FURNITURE for YOUR BEDROOM



SAVE MONEY, be the envy of your neighbors by making this beautiful bedroom suite yourself! Only a power saw and jointer are needed to turn out this smart suite, featuring bed with storage space, three-piece vanity with cosmetic compartment and makeup mirror, Mr. and Mrs. dresser, and twin night stands with drawers. Letters demanding detailed plans poured in after this furniture was pictured in Popular Mechanics Magazine. Now the 4 plans are ready—easy-to-follow scale drawings—and they're yours for only \$2.00! Send for a complete set today.

POPULAR MECHANICS PRESS
200 EAST ONTARIO STREET, CHICAGO 11, ILL.

America's Most Sensational MODEL AIRPLANES 85c



14 Other Thrilling Models Plus Jet Power Race Cars, U.S. Fighting Ships. Here's thrilling fun for all kids—8 to 80 years old. Genuine SPEEDEE-BILT flying models, including Navy's famous gull-wing, carrier-based, fighter shown above. Easiest models to build. Build one complete and fly it in an evening. Kits contain built-up Monofoli wing, pre-fab fuselage, finished metal and wood parts, plastic 2-3-4-bladed props, pilots, canopies, cannon, rockets, bombs and other plastic parts. Complete catalog of 15 planes, including jets, 6 jet power race cars and 6 U.S. Fighting ships free in every kit. Be sure you get Monogram Models.

MONOGRAM MODELS, Dept. 11, 225 N. Racine Ave., Chicago 7

At All Hobby Shops or Sent by Mail
If no store near you send 85 cents, plus 25 cents for postage and packing, to address below. Delivery guaranteed.

FREE BOOK AND ACTUAL SAMPLE

Screen Print, Dept. 21
1010 So. Los Angeles St.
Los Angeles 15, California
Dear Mr. Nowak: Please rush me FREE BOOK,
ACTUAL SAMPLES, and your amazing new PRINTING PLAN

Name _____
Address _____
City _____ State _____



C. J. NOWAK
General Manager
**AT HOME
SPARE
TIME**

IT'S AMAZING! I'll show you
how to make up to \$12.50 per hour

PRINTING WITHOUT A PRINTING PRESS

AMAZING NEW COLOR PRINTING METHOD
A fascinating new miracle-way to print—a secret method that lets you print colorful signs, posters, banners, drapes, wallpaper, flags, glass, fabrics—ANYTHING without an expensive printing press or costly equipment. This new process is revolutionizing the entire printing industry—it's one of America's fastest-growing businesses—it's your "chance of a lifetime" to make Big Money Now! Be the FIRST in your area to profit. The secret can be yours—just mail the coupon above today!

EASY TO LEARN! NO EXPERIENCE NECESSARY!
Simple fascinating method! No artistic ability needed. It's possible for anyone (young or old) to make up to \$50 PER WEEK printing in SPARE TIME alone—AT HOME!

START YOUR OWN BUSINESS—BE YOUR OWN BOSS
Wouldn't you be happy if you could take only one hour of your time and \$1.00 worth of materials—and sell your printing for \$15 or more. It's that easy! It's amazing! Your home can be your office—No selling because there's a huge demand everywhere. **GOVERNMENT CONTRACTS AVAILABLE TO BID.** Biggest opportunity in America—costs you nothing to receive all CONFIDENTIAL FACTS—Mail coupon today!

SCREEN-PRINT

1010 S. Los Angeles St., Los Angeles 15, California



Print paper of all kinds



PRINT BANNERS

PRINT FABRICS



PRINT INSTRUMENTS



PRINT SIGNS FOR SALE

YOU CAN PRINT ANYTHING WITH



FIRST AID FOR TV SET OWNERS!

H. G. CISIN's "TV DOCTOR"
Shows you how to fix your own set rapidly and SAFELY!



YOURS TO TRY 5-DAYS FREE!

Save money, throw away service contracts. Here's a real "fix-it-yourself" book—an amazing, quick, copyrighted method of locating & fixing TV troubles. Written by a noted inventor & educator, H. G. Cisin, in language you can understand.

TUBES CAUSE 80% OF TV TROUBLES!

"TV DOCTOR" shows you how to quickly locate and change all defective tubes with complete safety.

WITHOUT EXPERIENCE!—PICTURES & TEXT MAKE FIXING IT YOURSELF EASY

Reveals many closely guarded TRADE SECRETS. Lists over 123 trouble conditions. Method applies to all TV sets, even newest RCA's, Philco's or any 2,000 models, old & new. Copyrighted TROUBLE SHOOTING GUIDE pin-points hundreds of troubles.

11 money-saving, fact crammed, detailed, illustrated chapters include: practical ways to combat interference & ghosts, how to appraise & buy a TV set, valuable information on antennas, lead-ins, color, explains TV, terms, lists names & addresses of TV mfgs.—a veritable encyclopedia.

Save Expensive Service Calls!

Be Assured of Continual TV Pleasures!

Only \$1. — you'll say it's worth hundreds.

SPECIAL OFFER: A new "TV PICTURE GUIDE" with illustrations explaining TV terms & selling for \$1; H. G. Cisin's famous "TV TROUBLE SHOOTING METHOD", which trains you to be a TV diagnostician & TV serviceman... sells for \$1. **PLUS** the "TV DOCTOR"—all 3 for only \$2. postpaid... you save \$1.

H. G. CISIN, Consulting Engineer,
Dept. PM-2,
200 Clinton St., Brooklyn 2, N. Y.

Enclosed find \$2. full payment for "TV DOCTOR", "TV TROUBLE SHOOTING METHOD" & "TV PICTURE GUIDE"—rush copies postpaid.
Enclosed find \$1. in full payment for "TV DOCTOR", rush copy postpaid.

Name _____
Address _____
City _____ Zone _____ State _____

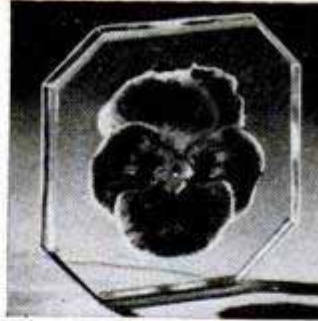

REAL PANSY COASTERS
Now create new and truly different gift articles like the beautiful pansy coaster shown—made by embedding real pansies in Castolite—the "magic" liquid casting plastic. With our simple step-by-step method you can make hundreds of valuable articles, including smart costume jewelry,

chic Hi-Style buttons, colorful key tags, tie-clasps, cuff links, plaques, tiles, many other things. Send 25c for Big Castolite Creations Manual. FREE with Manual, inspiring New Home-Success Plan. Write:

CASTOLITE CO., Dept. A-1, Woodstock, Ill.

MAKE MORE MONEY IN MANAGEMENT PRODUCTION

Great opportunities today for men skilled in Production Management. In spare time at home add to your present ability the knowledge which can prepare you for a better job and more money. Training built by experienced factory men and taught by management experts. Placement counsel and help. Write today for FREE book "Industrial Management" showing how you can climb higher—faster.

LASALLE Extension University, 417 So. Dearborn St. A Correspondence Institution, Dept. 164-IM Chicago 5, Ill.

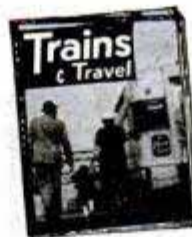

You'll enjoy this popular magazine of railroading! Go to your newsstand today! Get **TRAINS & TRAVEL**—packed with pictures, maps & stories!

STUDY AT HOME

WITH AN EDUCATIONAL INSTITUTION

Courses in ARTS AND SCIENCES: Philosophy; Education; Letters; Public Health; Medical Jurisprudence; Psychology; Sociology; Physics; Chemistry; Geology; Pol. Science; Theology; Law; Business and Commerce; Accounting; Mathematics; Statistics; Agriculture. **Courses in ENGINEERING:** Electrical, Civil, Mechanical, Drafting, Architectural, Automotive, Steam, Diesel, Aeronautical, Radio, Structural, Mining, Industrial, Petroleum, Marine, Refrigeration, Air Conditioning, Chemical. Send for free catalog.

McKinley-Roosevelt Incorporated, 4610-K3, Sheridan Rd., Chicago 40, Illinois

SAY YOU SAW IT IN POPULAR MECHANICS



Finished Photos in 2 Minutes!
Great Quick Photo Invention
P D Q CHAMPION PHOTOMASTER

Takes and finishes 30 to 40 everlasting, black and white or sepia photos an hour. No dark room. Guaranteed not to fade. Photos taken on "SUPER-SPEED" direct positive paper. Picture size 2 1/2 x 3 1/2 in. Complete, easy-to-operate portable photo studio. **700% PROFIT.** Write quick, get details about the great PHOTOMASTER.

P D Q CAMERA CO.
1161 N. Cleveland Ave., Dept. PM-1
Chicago 10, Ill.

EASY TO ASSEMBLE **BOAT KITS**

NEW CATALOG

- OVER 40 PAGES, INCLUDES ALL YOU NEED TO BUILD YOUR OWN
- 1-BOAT KITS-30 MODELS
 - 2-MARINE HARDWARE
 - 3-MARINE ENGINES
 - 4-MARINE CONVERSIONS
 - 5-PAINTS & COLOR CHARTS



All For Only 35c, SEND COIN TODAY

OUTBOARDS
6 Models 12 to 16 FT.

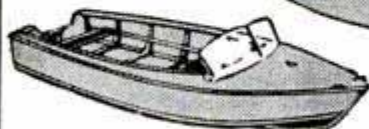

ROWBOATS
8-10-12-14 FT.
\$39 up.



INBOARDS & CABIN CRUISERS
16 TO 23 FT.



NEW 18 FT. OUTBOARD CABIN CRUISER

FAST VEE BOTTOM HULL - SPEEDS UP TO 25 M.P.H. - ROOMY CABIN, WITH TOILET, SLEEPS TWO



U-MAK-IT PRODUCTS 703P-WHITTIER ST., Bronx 59, N. Y. City

Bar Bells



Buy Direct From Factory \$8.95 up
Approved and Recommended by Karl Koberle (Foremost Ex-Army Instructor on Weight Training).
Write for free booklet and price list.
INDEPENDENT IRON WORKS
2416 East 23rd Street, Dept. B
Los Angeles 58, Calif.

LEOPARD COWHIDE
\$2.98



REVERSIBLE AUTO SEAT COVERS
Made of FLEXTON
Approved by Good Housekeeping

Order direct from manufacturer and save!

- LEOPARD SKIN on one side COWHIDE on the other.
- Made of Heavy Gauge plastic for long wear • WATER-PROOF and STAINPROOF • Simple to attach — with REINFORCED OVERLAP side grip elastics that hold securely • PERFECT FIT COVERS are made roomy and dress up your car's interior • PATENTED SHIRRING holds seat and back neatly. Sewn with NYLON THREAD for long wear. LONG WEARING-DOUBLE DUTY
- 5 DAY MONEY-BACK GUARANTEE!**
- CHOICE OF SPLIT OR FULL FRONT SEAT STYLES only \$2.98. Complete set for front and rear seats only \$5.00. When ordering specify make of car and style of seat. Order NOW. Enclose payment and save shipping charges. C.O.D. orders sent collect plus postage.
- MARDO SALES CORP., Dept. 257**
480 Lexington Avenue New York 17, N. Y.

A forceful he-man voice can bring you more **SELF-CONFIDENCE AND POISE!**

Let me show you how I train new **LIFE** into your voice—to improve your earning power and leadership



YES it's true! Now you can get ahead in business and social life to the limits of your ability—no longer need you be held back by a weak, apologetic voice that makes you "hide your light under a bushel."

SOLID VOICE

Use your FULL voice to get things done fast. People listen to and respect a hearty voice.



Success-Winning Voice

Dramatize your voice and you'll be more convincing. A strong voice aglow with enthusiasm is almost irresistible.



YOUR VOICE—AND YOUR PERSONALITY

A virile voice is a friend-winner and a success-magnet. People admire the man whose voice possesses calm, controlled power.



My aim is to put *backbone* into a normally weak voice. I make you *sound* BIG and effective...you talk with more volume, easily and comfortably, without straining because your voice is stronger.

TIME-TESTED METHOD
More than 125,000 students trained since 1916

The Feuchtinger Voice-Method has helped many famous actors and singers but I am more interested in the good we have done for businessmen, clergymen, teachers, lawyers, salesmen, executives, union officials, etc., etc.

The results my students achieve are very often AMAZING! These sensational benefits are reported by many men who, before they enrolled, didn't even realize they needed voice training!

FREE BOOK sent without any obligation

See for yourself why my method is so effective. Let me send you, in plain envelope, interesting information about how my home-study course can help you—in the privacy of your own room. Mail coupon below. No salesman will call. Perfect Voice Institute, 210 S. Clinton Street, Studio A-2, Chicago 6, Ill.

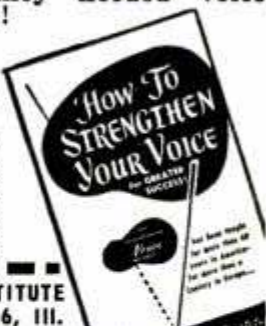

Eugene Feuchtinger, PERFECT VOICE INSTITUTE
210 S. Clinton St., Studio A-2, Chicago 6, Ill.

Please send me—free and without obligation—your helpful book "How to Strengthen Your Voice for Greater Success." Mail in plain wrapper. No salesman will call. I am mostly interested in the following: (Please check one or more)

Business advancement; Public Speaking; Singing

Name

Address

City & State

My age is:

EVERYTHING BUILT IN

"This seals the wall"

"This primes the surface"

"This acts as undercoat"

"This kills paint odor"

"This makes it scrubable"

"This dries it quickly"

SATIN LUMINALL

With Satin Luminall the job is done when other paints have just begun! Primes, seals, undercoats and finishes in one fantastically easy application . . . Dries in 20 minutes! Non-flammable! No unpleasant odor, fumes or fuss! It's the satin finish America loves best in a paint you really can scrub!

FREE! The famous "Match-a-Chip" Color Chart
GET IT! YOU'LL LOVE IT!



Luminall Paints
3610 SOUTH MAY STREET
CHICAGO 9, ILLINOIS

Please send me a free copy of the Match-a-Chip Color Chart with 50 genuine Satin Luminall paint chips and facts about the rubber paint with everything built in.

NAME _____
ADDRESS _____
CITY _____ ZONE _____ STATE _____

New Advertising Machine



Prints & Illustrates Gov't Post Cards

FREE Learn how thousands of business men, in every line, are boosting sales in spite of conditions—with ad messages—printed and illustrated in a few minutes on gov't post cards—with amazing new patented **CARDMASTER**. Your "today's" ideas, read by your prospects next morning. Not a toy, but a sturdy advertising machine, built to last for years. Low price, sold direct. Guaranteed for five years. Send name today.

SEND NAME We'll send **FREE** illustrated book of money-making **IDEAS** for your business and complete, unique advertising plans. **RUSH YOUR NAME TODAY.**

CARDMASTER COMPANY
1920 SUNNYSIDE, Dept. 131, CHICAGO 40, ILL.

RADIO ENGINEERING, Broadcasting, Television, FM, Servicing, Electronics, Aviation, Marine & Police Radio taught thoroughly. Engineering course equivalent to 3 years' college radio work. Approved Veteran Training. Catalog free.

VALPARAISO TECHNICAL INSTITUTE, Dept. D, Valparaiso, Ind.

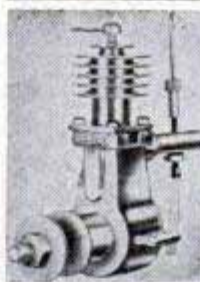

Our 443rd Advertisement
REAL DIESEL ENGINE
\$2.95

- for planes, boats, midget cars
- 7500 RPM; 1/7 HP; ht. 3 1/2"; wt. 5 oz.
- precision machined for smooth operation

You just can't beat this price for a precision diesel engine! Streamlined, compact, easy to install. Thousands of satisfied users all over the world. Fast delivery if you **ORDER TODAY!** Send \$2.95 plus 25c postage.

GOTHAM HOBBY CORP. Dept. P, 107 E. 126th St. New York 35, N.Y.



STOP FORGETTING!

At last—a new scientific way to remember! Names, faces, dates—**EVERYTHING**. Your super memory will be envied by all. Popularity and success can be yours!

FREE FOLDER — Write Today
MEMORY INSTITUTE — BOX 261 JM
Staten Island 1, N.Y.

PageFinder

At Last—Find Reference Articles Easily
Stop losing those magazine articles you wanted to keep. Neat, handy Page Finder slips on in a jiffy to mark subject and page where it can be seen and not forgotten weeks, months, or years later. Introductory price, 100 for \$1.00. Postpaid. Order today.

PAGE FINDER CO., 209 Westwood Drive, North, Minneapolis, Minn.

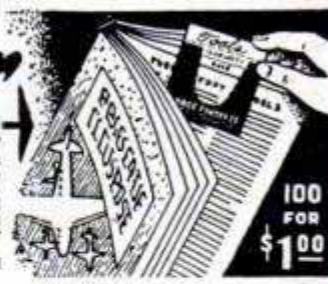

NEW! CHEAP! OIL BURNER

SWEEPING THE COUNTRY!

SALESMEN BIG MONEY

SLIPS INTO ANY COAL RANGE, STOVE OR FURNACE
Amazing quick, intense heat. By finger-tip control. Cheaper than coal. No more shoveling coal or ashes. **SENT ON TRIAL.** Prove it pays for itself quickly by what it saves. Big bonus for testing. We'll let you try one in your own home for one month. Write for details today. **NORTHWEST MFG. CO., 360-A Main, Mitchell, S. Dak.**

NOW you can learn TV-RADIO servicing at Home

in your
spare time!



BIG DEMAND FOR TRAINED MEN!

Famous CRESCENT SCHOOL of Radio & Television now offers a *complete* HOME STUDY COURSE for those unable to attend classes! CRESCENT SCHOOL's experience of millions of training hours assures you of the finest training available. New simplified lessons and illustrations — *no previous training needed!* Parts-kit included.

Get into this high-paying field with a future! Many students start to earn extra cash while learning. Complete the course as quickly as you can learn. Certificate awarded upon completion of course. CRESCENT SCHOOL's free placement service is available to you!

PAY AS LITTLE AS
\$5 MONTHLY

Total cost for complete course
\$100
as little as

Crescent School — one of the largest of its kind! Multi-million-dollar plant in its own 6-story building.



INCREASED EARNINGS



INTERESTING WORK



AN UNLIMITED
FUTURE

FREE!

Send TODAY for FREE illustrated, interesting booklet & complete details about the HOME STUDY COURSE!

SEND COUPON TODAY!

CRESCENT SCHOOL Dept. B-1
500 Pacific St., B'klyn 17, N. Y.

Sirs: Rush free booklet & complete details about your HOME STUDY COURSE . . . at no obligation to me.

NAME

ADDRESS

CITY.....ZONE.....STATE.....

WAR SURPLUS BARGAINS

Here is One of Our Greatest Offerings!

35 POWER ERECTING MICROSCOPE

Amazing clarity. "All-Position" Universal mount. 3" of working space from objective to platform. Prism Erectors give you an erect image—exactly as your eye sees it. Ramsden Eyepiece permits fine precision focusing. 3-Element color corrected objective—1" diameter. Microscope body is of brass with black crackle finish. . . 6 1/2" long with base 7"x9". Easily worth \$75.00.



Stock No. 970-H \$29.50 Postpaid

SLIDE PROJECTOR SETS

Consists of all unmounted lenses you need to make the following size projectors:

Stock # 4029-H—35 mm. \$2.85 Postpaid
 Stock # 4038-H—2 1/4"x2 1/4" \$3.35 Postpaid
 Stock # 4039H—2 1/2"x3 1/2" \$3.35 Postpaid

SIMPLE LENS KITS

—Include plainly written, illustrated booklet showing how you can build lots of optical items. Use these lenses in photography and for dozens of other uses in experimental optics, building TELESCOPES, low power Microscopes, etc.

Stock # 2-H—10 lenses \$ 1.00 Postpaid
 Stock # 5-H—45 lenses 5.00 Postpaid
 Stock # 10-H—80 lenses 10.00 Postpaid

SPECIAL! NON-WAR SURPLUS HAND WARMER

Amazing! Carried in Pocket! Keeps hands warm in coldest weather. Works by itself—no wires, no batteries. Magic heater element reacts with fuel, stays warm 24 hrs. at a time! Absolutely safe. Practical, proven! Used by Sportsmen, outdoor workers of all kinds. Excellent in the sickroom or wherever dry heat is needed.

Stock # 98-H Only \$2.49 Postpaid

BINOCULARS

—An opportunity to own a truly fine pair of American-made Glasses at substantial savings. Light-weight, dust-proof, moisture-proof, expertly collimated. Optics low reflection coated. Metal parts chemically treated to prevent corrosion. Sturdy Carrying Case included. Guaranteed for full year against any defects in workmanship or materials. Sold with 10 DAY MONEY BACK PRIVILEGE.

Stock # 963-H 6x30 \$75.00 Postpaid
 Stock # 964-H 7x35 85.00 Postpaid
 Stock # 965-H 7x50 98.50 Postpaid
 Stock # 966-H 9x50 99.50 Postpaid

(Be sure to add 20% Fed. Tax)

MOUNTED ANASTIGMAT LENS

—Free booklet with your order: "How to Make Your Own Enlarger." Speed f/7.7, focal length approx. 127 mms. Suitable for pictures, negatives, positives up to 3 1/2"x4 3/4".

Stock No. 8004-H \$7.50 Postpaid

Order by Stock No. — Send Check or M.O. — Satisfaction Guaranteed

We Have Literally Millions of War Surplus Lenses and Prisms for Sale at Bargain Prices. Numerous Types of Instruments, Tool Write for FREE CATALOG-H

EDMUND SCIENTIFIC CORP., Barrington, N. J.

A PENNY POSTCARD CAN PUT YOU IN BUSINESS!

Rush card TODAY for FREE SELLING OUTFIT. Your friends, neighbors, fellow-workers will GRAB this line of Horsehide, Ponyskin, Suede, Cape Jackets—other warm garments, even Nylon, Wool and Lambskin, styled for military or regular wear. And as our man in your territory, you'll make BIG MONEY on every sale. Rush the card NOW—no obligation. You'll be glad for the rest of your life you sent it. CONSOLIDATED SHOE SYSTEM, Dept. C1-67, Chippewa Falls, Wis.



Wheels Wheels Wheels



- 5" Disc Wheel 3/8" Tire 5/16" or 3/8" Sleeve 30c ea.
 - 6" Disc Wheel 3/8" Tire 5/16" or 3/8" sleeve 35c ea.
 - 7" Disc Wheel 3/4" Tire 3/8" sleeve 45c ea.
 - 8" Disc Wheel 1 1/8" Tire 1/2" sleeve 70c ea.
 - 7" Disc Wheel 1" Tire 1/2" ball bearing 80c ea.
 - 8" Disc Wheel 1 1/8" Tire 1/2" ball bearing \$1.00 ea.
 - 8" Disc Wheel 2" semi-pneum. T. 1/2" B.B. \$1.35 ea.
 - 10" Disc Wheel 1.75 semi-pneum. T. 1/2" B.B. \$1.50 ea.
 - 12" Disc Wheel 1.75 semi-pneum. T. 1/2" B.B. \$1.85 ea.
- Above wheel prices includes hub cap.

UNITED OFFICIAL SOAP BOX DERBY WHEELS

<p>Model 110</p> <p>Steel Disc Wheel 10 1/2 in. O.D. 1/2 in. ball bearing 1 3/4 in. hub thickness 1 in. extruded tiring Painted Red With hub cap. Each . . . \$1.35</p>	<p>Model 111</p> <p>Steel Disc Wheel 11 in. O.D. 1/2 in. ball bearing 1 3/4 in. hub thickness 1.50 in. semi-pneumatic tire Painted Red With hub cap. Each . . . \$1.75</p>
--	---

Plus postage. C.O.D.'s accepted.

UNITED WHEEL STAMPING CO.
 12131 S. PEORIA STREET PM-1 CHICAGO 43, ILLINOIS



CLEANS WINDOWS WITHOUT WATER

NEW CHEMICAL MITT
 Sensational! DRY Window Cleaner! Uses no water, no messy liquids. Chemically Treated. Simply glide over windows; leaves glass sparkling clear. No heating water, no heavy buckets to carry. No rags, powders, sponges, chemicals. No mess or muss. No red chapped hands. Dust, dirt, grime, fog disappear like magic. Take orders from friends! Earn money!

SAMPLES FOR TRIAL Sample offer sent immediately to all who send name at once. Hurry. Postcard will do. **SEND NO MONEY** — just your name. KRISTEE CO., Dept. 691, AKRON 8, OHIO

Apache THROWING TOMAHAWK

Balanced to stick
 An ancient Indian weapon for killing game - target sport. Easy to throw with our clear instructions. Splits a 2" board at 30' Will stick from any angle

Beautiful heavy duty 14" tomahawk. Solid tempered steel. Unusual bargain, limited supply. Sold direct only. Send \$2.98 today to **TECHRITE CORP., Box 12K, South Pasadena, Calif.**



YOU'LL CATCH BIGGER FISH

and have more fun catching them after you read Popular Mechanics HOW TO TEMPT A FISH. Here is the experience of veteran guides and fishermen brought to you for hours of enjoyable reading. Many pages of brilliant full color kodachrome plates. Covers every phase and style of fishing—even tells where to find the big ones and what baits to use. Hundreds of kinks and tips to make every trip more enjoyable. Endorsed by leading sportsmen throughout the country. 128 pages. 62¢ illus.



POPULAR MECHANICS PRESS \$2.00
 200 E. Ontario Street, Chicago 11

AUTO RACING TRAILER Coaches



Famous for authoritative, detailed information on auto racing, every type of race car, rules, specifications, working drawings, plans, etc. No duplication. Every book different. Money back if not satisfied.

AUTO RACING • 6th Edition AUTO RACING • 4th Edition

Championship cars, big cars, mid-gets, roadsters, Offenhauser dirt track car. Specifications on Indianapolis cars, four-wheel drive details, front drive drawings, etc. Plans for Ford 60 midget, roadster racer. Data on engines, gear boxes, friction and dog clutches, axle ratios, compression ratios, independent suspensions. Indianapolis rules and regulations, etc. More than 100 illustrations. \$2.00.

Includes eight working drawings and complete building instructions for standard midget racers, drawings for midget road cars. Miller-Ford V8 front-drive racers are illustrated and described and other big-time data given. Technical pictures give the inside dope on these cars, together with authentic descriptions. 50 pages. 66 illustrations. \$1.00.

AUTO RACING • 5th Edition TRAILER COACHES

Tells you—Why the Fast Ones are Fast—How to Make Them Fast—How to Build Engines—How to Build Chassis—How to Build Bodies—Who Holds What Records—What the International Formula Is—What Midget Racing Rules Are—How World's Record Cars Are Built—How to Speed Up Ford V8 Cars. \$1.00.

By Ray F. Kuns. Contains information on the history of trailers, trailer parks and camps; materials, furnishings, trailer chassis, engineering, etc. Construction data on 10, 16 and 22 foot trailers which you can build yourself. 100 illustrations. \$1.50.

ORDER ON COUPON

POPULAR MECHANICS PRESS, Dept. 31, 200 E. Ontario St., Chicago

Remittance for \$_____ enclosed. Send books checked, postpaid.

Auto Racing, 5th Edition Trailer Coaches
 Auto Racing, 6th Edition Auto Racing, 4th Edition
 Send C.O.D., postage extra.

NAME _____
 ADDRESS _____
 CITY _____ ZONE _____ STATE _____

Sterling READY-CUT HOMES

CUT-TO-FIT HOMES CUT BUILDING COSTS

ORDER NOW SAVE UP TO 1/3

CHOICE OF 57 DESIGNS

Build your own home and save the builders' profit—plus savings in lumber and labor with Sterling Ready-Cut-Homes. Anyone can assemble with simple, easy to follow plans furnished. Every house complete with all lumber, roofing, nails, glass, hardware, paint, doors and windows marked ready to erect. Freight paid. Complete building plans ready for filing at low cost. Sold separately if desired. Write today!

PRICED FROM \$2150 up
Five Easy Payment Plans
Send 25c for NEW COLOR CATALOG

INTERNATIONAL MILL AND TIMBER CO.
BAY CITY, MICHIGAN

Ads like this appear regularly in 24 magazines. The **FLAMINGO** \$4677

PRICED FROM \$2150 UP *Freight Paid

As Popular Mechanics celebrates its 50th Anniversary, International Mill & Timber Company, America's Pioneer in the development and perfection of cut-to-fit houses, proudly presents the Sterling Ready-Cut Homes for 1952. In design, quality and workmanship these Sterling homes are the finest we have offered during the 27 years we have been advertising in this publication. Today, more than ever before, you can **Save Real Money** by building your own home the Sterling Ready-Cut way. Anyone can assemble these beautiful, modern homes with ordinary household tools. Everything is furnished, cut-to-fit and plainly marked for location with simple, easy-to-follow plans. You have choice of 57 different designs and floor plans . . . and 5 easy plans of payment, including monthly payments. *Prices quoted are freight paid to most areas.



Beautiful, 2 bedroom ranch type home with loads of living space and garage included. Spacious living room can include fireplace. Modern picture windows in living room and front bedroom. Attractive kitchen and dinette. Overall 34 Ft. x 48 Ft.

BUY DIRECT FROM THE MILL and SAVE!

1. You save all of today's high labor costs.
2. You save all of the building contractors profits.
3. You save all the builders overhead, insurance, taxes.
4. You save the architects charges for drawings and plans.
5. You save the usual lumber and material wastes.
6. You save time and costly mistakes in construction.

Sterling Ready-Cut Homes are modern, attractive homes designed for comfort, convenience and livability . . . with plenty of closet and cupboard space, picture windows, flower boxes, etc. They are available in a wide variety of designs in both conventional and ranch type styling. Owners everywhere are most enthusiastic about their Sterling Homes—many report savings of from 1/4 to 1/2 in actual building costs. Before you buy or build any home be sure to —

The **MARLEEN** \$4246



A charming, modern home—both inside and out. Extra large living room, dining room, step-saving kitchen, 2 spacious bedrooms and bath. A Sterling Engineering triumph in beauty and value! Also available in 3 bedroom floor plan. Overall 39 Ft. x 36 Ft., 6 In.

Send 25c FOR BEAUTIFUL — NEW 4 COLOR CATALOG

Colorfully illustrates 57 beautiful low-priced designs and floor plans. Gives complete details on quality and savings of genuine Sterling Ready-Cut Homes. 25c charge covers handling and mailing costs only.

MAIL COUPON TODAY



(Please Print Name And Address)

NAME _____

ADDRESS _____

CITY _____ STATE _____

Please enclose 25c to pay handling and postage costs for mailing you our new, illustrated, 4 color Sterling Home Catalog, price list, etc.

INTERNATIONAL MILL & TIMBER CO.
DEPT. P.M. 12 BAY CITY, MICHIGAN

Piston Ring Progress

1945



The life of tank and aircraft engines early in the North African campaign was measured not in terms of months, weeks, or days . . . desert heat and sand wore out cylinders, pistons and rings in a matter of *hours!* Prolonged efficient operation was a military necessity and it was achieved through the application of solid chrome plate to the piston rings.

1946-50



The experience with chrome under the most severe operating conditions was applied by Perfect Circle engineers to peacetime service in tractors and trucks. Improvements were made in ring design and plating techniques . . . astonishing records were established for economy, piston ring and cylinder life.

1951



The advantages of solid chrome plating on both oil and compression rings were then made available to car owners everywhere in the Perfect Circle 2-in-1 Set. And, to assure peak performance regardless of cylinder condition, two springs were supplied with each oil ring . . . normal pressure, for new, rebored, or slightly worn engines . . . HiPressure for badly worn engines or known oil pumpers.

TODAY the 2-in-1 Set is recognized as an outstanding example of piston ring progress. Sustained power for thousands of extra miles, positive oil control, more than double the life for cylinders, pistons and rings . . . all are features that make the Perfect Circle 2-in-1 Chrome Piston Ring Set a success unequalled in piston ring history.



Perfect Circle

PISTON RINGS

The Standard of Comparison



Fifty Years ago this month the first issue of *Popular Mechanics* made its appearance. It was an innovation in magazine publishing. For the first time, it presented in simple language and with graphic illustrations the progress of mechanics, science and discovery.

Between that first issue and this, the Golden Anniversary issue, *Popular Mechanics* has been privileged to record and report a half century unmatched in history for dramatic achievement in science and industry and human welfare. It seems appropriate, therefore, that on this occasion we should not only look forward but look back as well over the stirring events of our lifetime.

To help us in this genuinely important task, some of the men whose greatness has enhanced all civilization have contributed to this issue. We are proud to present them to you. After reading their messages, I am sure you will join with us in finding new faith and confidence that human destiny will surmount all obstacles and that in the years ahead civilization will reach new heights.

Editor and Publisher

THE WHITE HOUSE
WASHINGTON

August 2, 1951

Dear Mr. Windsor:

I am pleased to congratulate Popular Mechanics Magazine upon its Fiftieth Anniversary.

America is known through the world for its mechanical genius, and I am glad that translations of your magazine are available in various foreign countries.

America's mechanical genius has played an important part in raising the standards of living and in assuring victory in war. Our hope today is that this warranty will continue to improve our standard of living on the one hand and make us so strong on the other hand that the threat of war will be ended forever.

I realize that your publication is limited to the mechanical field. However, I think America ought to be even more famous for the ideals which have made our lives worthwhile. Invention can be helpful in preserving our freedom, but it is freedom that is the goal without which invention may not be worthwhile.

Very sincerely yours,

Mr. Henry H. Windsor, Jr.,
Editor and Publisher,
Popular Mechanics Magazine,
Chicago, Illinois.

Los Pinos, D.F. a M.
de septiembre de 1951.

Correspondencia Particular
del Presidente de los
Estados Unidos Mexicanos

Señor H. H. Windsor Jr.
Popular Mechanics Co.
Chicago, Ill.- E. U. A.
Muy señor mío:

Me es grato felicitar a usted y unirme a su regocijo y al de esa Institución, al celebrarse el Aniversario de Oro del POPULAR MECHANICS MAGAZINE, que ha llegado a sus cincuenta años de vida, desarrollando una encomiable labor de difusión y cultura entre el público de habla inglesa.

Asimismo, me es muy satisfactorio presentarle mis -- congratulaciones con motivo del Quinto Aniversario de MEXANICA POPULAR, la versión en Español, que ha venido a traer a México y en general a los países Latino Americanos, una magnífica información que los mantiene al día sobre los últimos adelantos en esa multitud de pequeños conocimientos en que se basa el saber y desarrollo de los pueblos.

Ruego a usted que haga extensivas mis felicitaciones a todos y cada uno de los elementos de esa Editorial, cuya labor en conjunto es tan meritoria, al elevar en forma práctica el nivel cultural de los pueblos.

Salúelo cordialmente.

Translation of letter from President
Miguel Aleman of Mexico:

"It is a pleasure to congratulate you upon the Golden Anniversary of Popular Mechanics Magazine and to join in your celebration of fifty years of publication devoted to such praiseworthy diffusion of knowledge among the English-speaking public. At the same time, it gives me great satisfaction to add my congratulations on the Fifth Anniversary of MEXANICA POPULAR, the Spanish edition, which is providing Mexico, and Latin America in general, with a wonderful source of information which keeps them up-to-date on the latest advances of that multitude of facts upon which the knowledge and progress of peoples depend. I beg you to extend my congratulations to each and every member of your company who is performing the meritorious duty of elevating in practical form the cultural level of nations."

The Waldorf Astoria Towers
New York 22, New York
August 5, 1951

My dear Mr. Windsor:

Please accept my sincere
congratulations on the occasion of
this fiftieth anniversary of Popu-
lar Mechanics Magazine.

The vital contribution
your publication is making in the
field of scientific journalism is
most praiseworthy. May your or-
ganization continue to grow and
prosper.

Yours faithfully,

Mr. Henry H. Windsor, Jr.
Editor and Publisher
Popular Mechanics Magazine
Chicago, Illinois

LE PRÉSIDENT
DE LA
RÉPUBLIQUE

Les progrès chaque jour accélérés de la
science et de la technique ne valent que dans la
mesure où ils servent l'Homme et la Société.

Il importe donc non seulement d'informer
et d'éclairer un public de plus en plus large sur les
possibilités nouvelles qui lui sont offertes d'améli-
orer ses conditions d'existence mais encore de mettre
à sa portée, d'une manière pratique, accessible à tous,
les inventions - même les plus modestes - qui contri-
bueront à accroître son bien-être.

Translation of statement by
Vincent Auriol, the President
of France:

"The ever-accelerated prog-
ress of science and technol-
ogy is only valuable in the
measure that it serves man-
kind and society. Therefore
it is important not only to
inform and educate an ever-
growing public about the
new possibilities offered to
them for improving their
standard of living but also to
place within their reach in a
practical form, understood
by everyone, the new inven-
tions—even the most modest
ones—that contribute to their
welfare."

SCIENCE ON

By **Dr. Karl T. Compton**
Chairman of the Corporation,
Massachusetts Institute of Technology

THE AMERICAN TRADITION of mechanical skill and inventiveness, often called "Yankee Ingenuity," goes far back of the turn of this century. It grew out of the challenge of pioneer life to a people of high native intelligence engaged in forging a new way of life in an environment of rich but undeveloped resources. But our development of scientific knowledge and its useful applications is, despite a few notable predecessors like Benjamin Franklin, Joseph Henry and Thomas Edison, essentially an achievement of the last 50 years.

During the last five years of the preceding century, three epoch-making scientific discoveries had been made in Europe: X rays, radioactivity and electrons. As we shall see, these underlie much of the enormous scientific progress since that time. But first look at some of the general indices of scientific progress.

Fifty years ago the American Association for the Advancement of Science, with which are affiliated practically all the professional scientific groups, had a total membership of about 1900; today this membership has grown to 46,000. The first edition of *American Men of Science*, in 1906, contained the biographies of 4000 scientists;

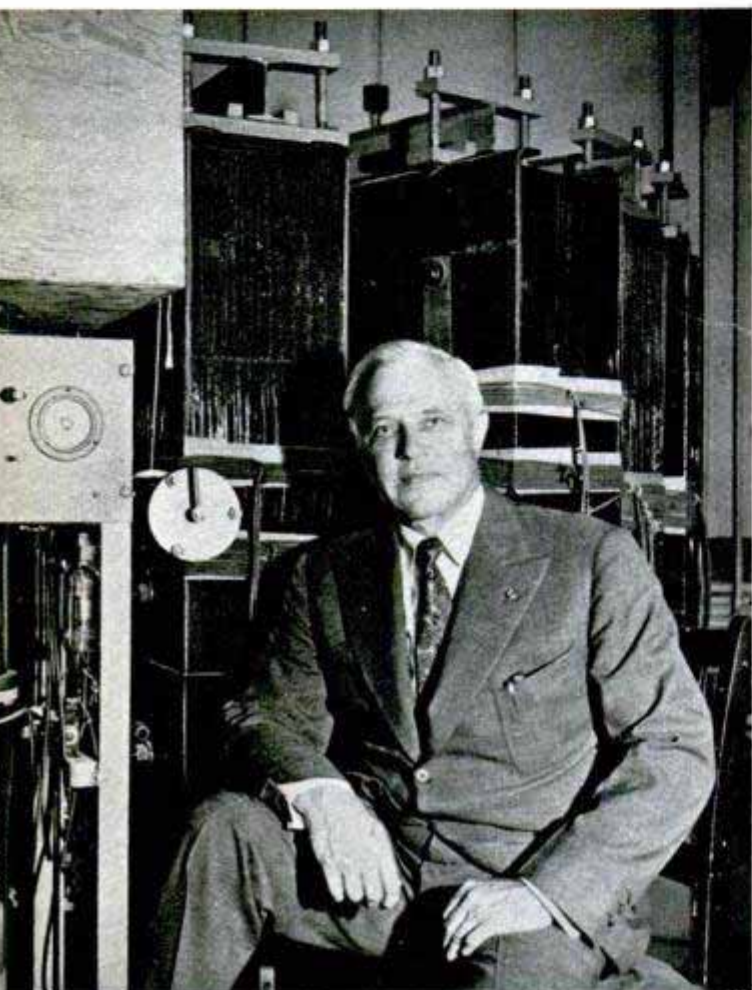

Dr. Karl T. Compton, noted physicist and educator, posed for this Anniversary Issue photo in an M.I.T. laboratory. Below, GE scientist studies crystals by measuring the angles at which they scatter X rays

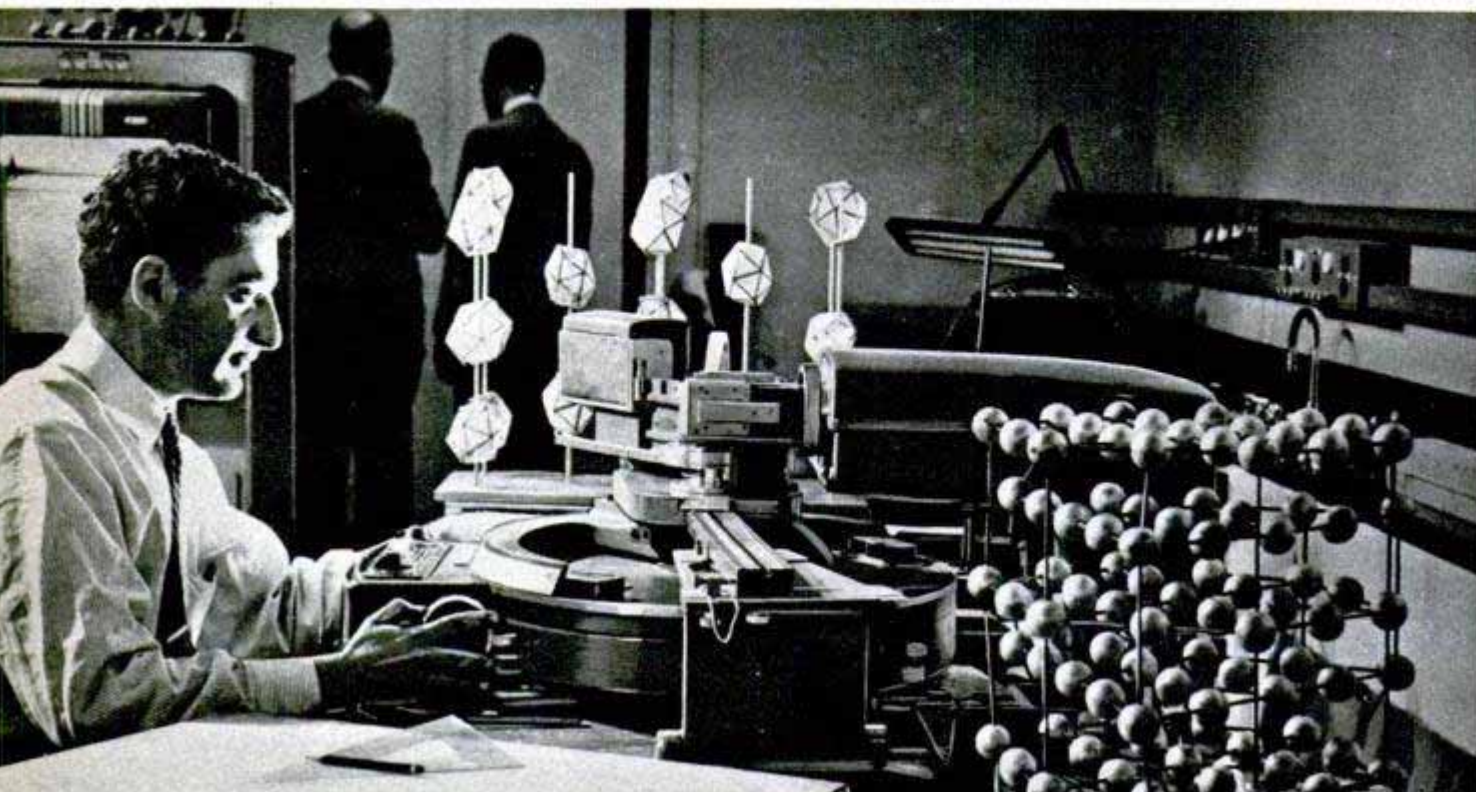

THE MARCH

the latest edition, in 1949, contained 50,000.

In 1901, in an old barn in Schenectady, the General Electric Company established the first modern industrial-research laboratory. Its staff consisted of Dr. Willis R. Whitney and one assistant. Today there are some 2800 industrial-research laboratories, with aggregate staffs of at least 70,000.

I have been unable to locate any estimate of the national expenditure for research in the United States at the beginning of the century. The amount was probably too small to induce any agency to go to the trouble of assembling the figures. In 1920 it was about \$60,000,000. In 1930 it was \$166,000,000; in 1940, \$355,000,000; at present, certainly over \$2,000,000,000.

What are some of the influences which have contributed to this remarkable increase in America's scientific activity? Basically, it is part and parcel of the similar worldwide trend. Every investigator who starts out to study one problem finds a half dozen new ones. Every scientist who publishes the results of his research stimulates critical and constructive thinking about his subject by thousands of fellow scientists all over the world, and many of them take his work as their starting point for new discoveries. Every development of a new scientific instrument or method opens the way for its application in new areas by the entire scientific fraternity. Thus scientific activity proceeds in compounded geometric progression. But there have been several stimulating influences which have been particularly effective in the progress of science in America during the past 50 years.

The first of these influences was the departure from almost total dependence on the old European universities for postgraduate training in research. When I did

my postgraduate work in Princeton University in 1910-1913, I was one of the first substantial group of ambitious young scientists who sought their higher education in America, instead of going for it to Germany, England or France. To be sure, most of our professors had themselves been trained in, or imported from, Europe. But from about that date it became increasingly possible to secure in this country a quality of postgraduate education and indoctrination into the spirit and methods of research which was on a par with what had previously been available only to those few who had been able to seek them in Europe.

A second influence was the stimulus provided by the exigencies of war. We were then faced with the necessity of mobilizing every resource to meet and overpower a highly skillful and technically competent adversary. Scientists and engineers were mobilized in teams and their abilities were extended to the limit to develop methods for handling chemical warfare, control of artillery fire, the submarine menace, air combat, communications, new explosives and new materials for war production.

Balloons for cosmic-ray research are released at University of Chicago at scene of first atomic pile



This symbolic drawing by A. Leydenfrost, the noted illustrator, traces the progress during *Popular Mechanics'*

To do these things, every resource of science and technology was drawn upon and further developed. The results were so strikingly important that, for the first time in our history, the public became convinced that science was a resource worth exploit-

ing for the national welfare as well as for the intellectual joy of discovery. The result was a significant increase in the prestige of science, and its financial support by government, industry and educational institutions. By and large, it can be stated that

1952

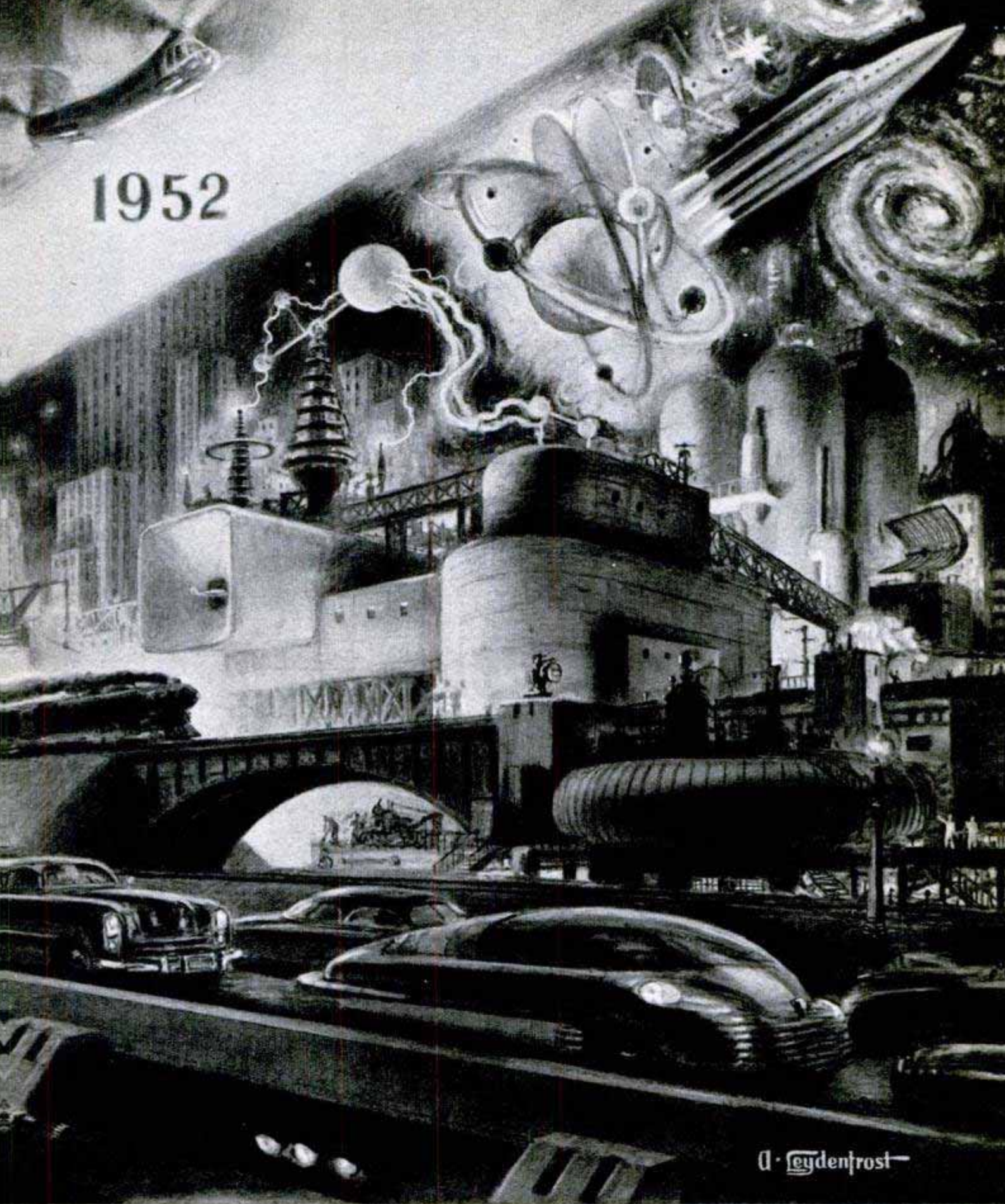

A. Leydenfrost

half century in the fields of mechanics and science. See explanatory chart of the drawing on page 125

the great development of American chemical industry dates from the World War I period.

This type of stimulation of systematic group attack on technological problems was even more pronounced during World

War II, with complete mobilization of the nation's scientific resources under the Office of Scientific Research and Development and the military departments. Guided missiles, radar, bombsights and fire-control instruments, penicillin and hundreds

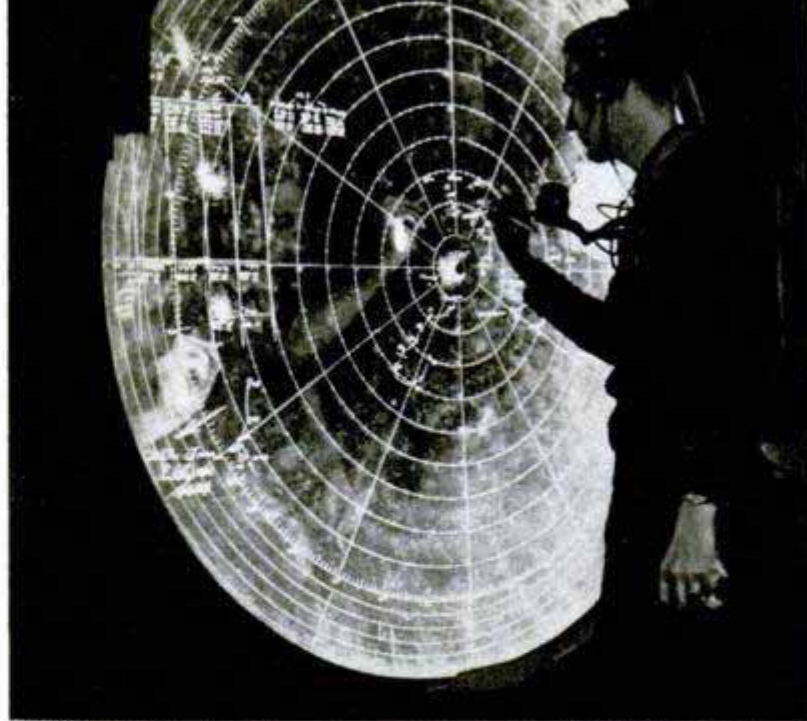

Navy photo

The radar-plotting screen of an aircraft carrier. Compton points out that radar evolved from wireless

Left, a guided missile streaks skyward, steered by electronic controls developed in Bell Laboratories

of other developments culminating in the atomic bomb, are too freshly in mind to need comment. But the result of these successes is reflected in the great postwar movement to amplify still further the development of science and its applications for defense, industrial, agricultural and medical research. Recent evidences of this trend are the formation of the National Science Foundation and the doubling of the military appropriations for research and development. Other evidence is found in the strong support which many industrial corporations are now giving to scientific research and the training of research workers in our educational institutions.

One further important influence is the support given by the great foundations to the development of science through the education of outstanding young scientists. No small part of America's progress in aviation is due to the opportunities created by the Guggenheim laboratories for aeronautical engineering at a selected group of universities and engineering schools. The Guggenheim fellowships and research grants from the Carnegie Corporation and others have been very helpful. Most significant of all was the establishment in the early 1920s by the Rockefeller Foundation of a great program of postgraduate fellowships, on a nationwide scale, in the physical, biological and medical sciences. This kind of program was undertaken for the purpose of building up the strength of the country in pure science, since World War I had interrupted the normal educational program and had diverted many scientists

from their fundamental scientific fields into the work of practical applications. One proof of the effectiveness of this fellowship program is the very large proportion of the present heads of research organizations and university science departments, as well as the predominant leadership in World War II scientific work, supplied by former holders of these National Research Fellowships financed by Rockefeller.

With this background of the general progress of scientific activity during the past half century, especially in the United States, and of some of the contributing factors, we pass to the more specific consideration of major achievements. Whole libraries could be written, and have been written, on this subject. The story is told of a distinguished physicist of Oxford University whose large study is lined on all four walls with scientific books from floor to ceiling. A lady visitor, on being shown his study exclaimed, "Professor, how do you ever find time to read all these books?" He replied, "Madam, I don't read them. I write them." How can I hope to do justice to this subject in my few remaining remarks?

In August 1912, *Popular Mechanics* polled

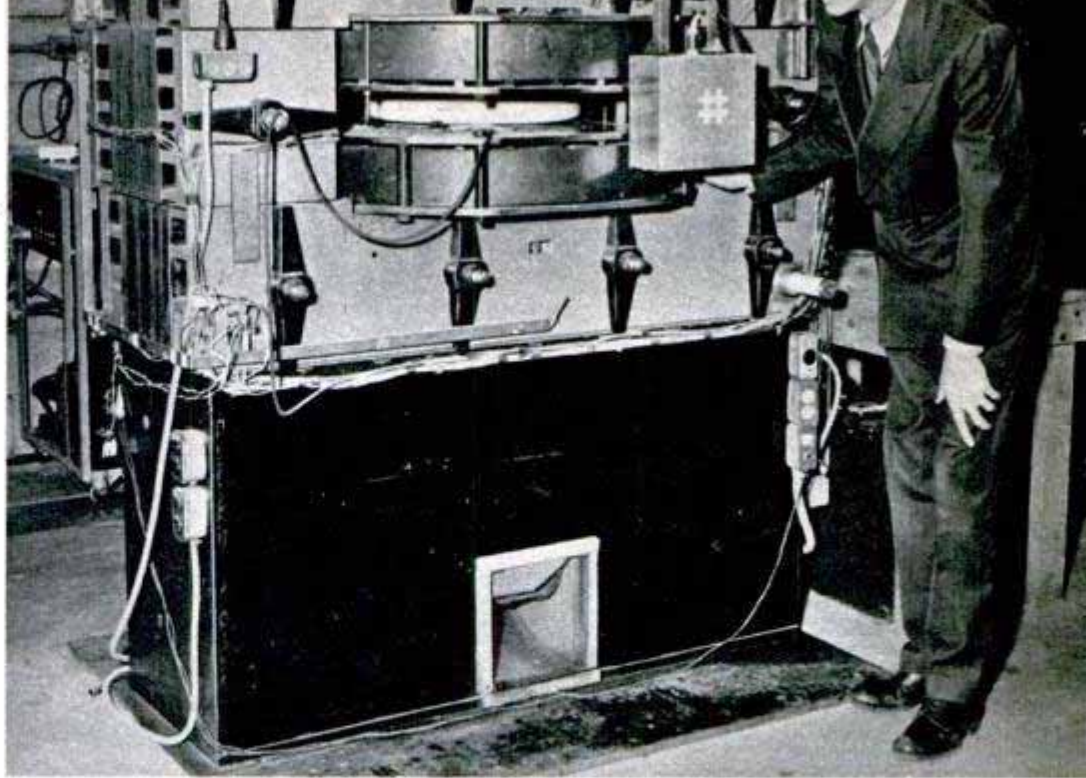

Photo courtesy of the University of Illinois
Dr. Donald W. Kerst, inventor of the betatron, inspects the 20,000,000-volt machine used in medical research for cancer. It reduces damage to tissue

nearly a thousand scientists from all over the world to select The Seven Wonders of the Modern World. In the order of votes cast, these were selected as wireless telegraphy, telephone, airplane, radium, antiseptics and antitoxins, spectrum analysis and X ray. In 40 years' retrospect, we can applaud the insight which then led to these selections, for much of scientific progress since those days has been by amplification of these scientific wonders.

Take, for example, the wireless telegraph
 (Continued to page 400)

CHART BELOW indicates symbolic advancements of the past 50 years depicted in the Leydenfrost illustration on pages 122-123: 1. G.E.'s first research laboratory located in a barn; 2. Early scientists at work; 3. Experimental biplanes and triplanes; 4. World War I aircraft; 5. First rigid-wing monoplanes; 6. Experimental balloon; 7. Two-engine plane; 8. Huge dirigible; 9. Flying boats; 10. Flying wing; 11. Jets; 12. Multiengine plane; 13. Experimental rockets; 14. Age of jet aircraft; 15. Helicopter; 16. Meteorological balloons (flying saucers); 17. Transport helicopters; 18. Dawn of steel building construction; 19. Astronomical instruments; 20. Skyscrapers; 21. Manmade bolts of lightning; 22. Atomic construction of matter; 23. Rocket ship; 24. Ring-shaped nebulae; 25. Comet; 26. Steam locomotive; 27. Wind tunnel; 28. Modern research laboratory; 29. Factory for synthetic products; 30. Spiral nebulae; 31. Diesel train; 32. Cyclotron; 33. Radar; 34, 35 and 36. Evolution of the automobile; 37. Laboratory rabbits; 38. Research in chemistry; 39, 40 and 41. Atomic composition of matter; 42. Electronic tube; 43. Instruments for electronic research; 44. Elevated concrete highway for high-speed traffic

KEY TO LEYDENFROST ILLUSTRATION

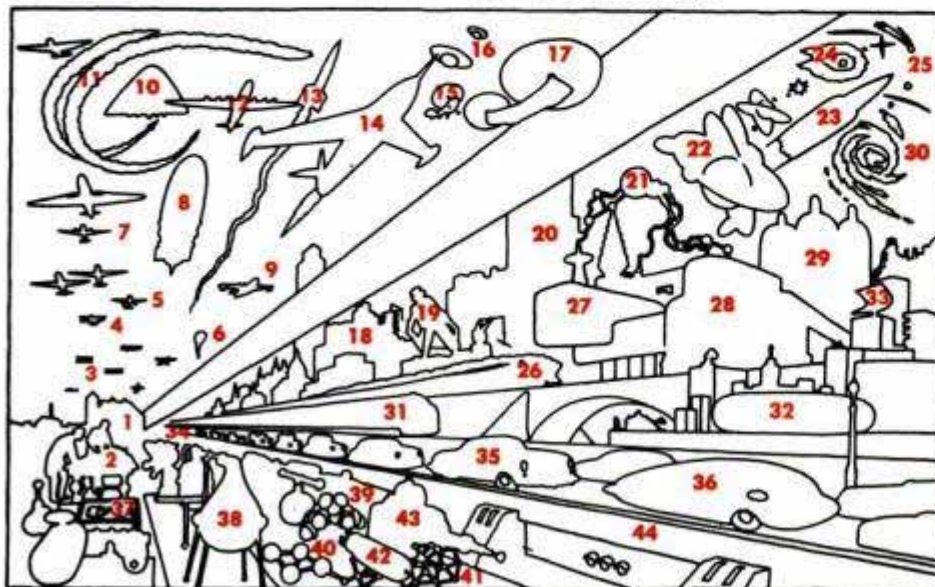

Aeronaut's Hair-Breadth Escape

By
Prof. Carl E. Meyers



That careful aerial navigation is not essentially dangerous is proven by the fact that I am before you today, alive and unharmed

—after a quarter century spent in aerial travels ranging over thousands of miles, twenty-one of these United States, the District of Columbia and the Canadas. During all this time the only real danger that I seem to have run was from a single possible collision between my airship and a railroad locomotive. I had made a flight with my skycycle from Pittsburg, Pa., in the presence of 300,000 spectators, gathered at one Fourth of July celebration when the temperature was 105 degrees in the shade on the ground. It was a great relief to get up in the cooler air, and the scene below me was the most wonderful of my experience, for three great rivers united beneath me, dividing a labyrinth of winding roads that circled the hillsides, making the whole territory visible as an enchanted landscape garden, flat as any map or mosaic. After I had strolled about in the air half an hour tracing the paths below me, I sought a safe

place for a landing, away from the mob, which would have destroyed me in their excitement had I landed in their midst. The only space clear from trees or people in my vicinity was the railroad track. I hovered close over it while two long trains met and passed, and then dropped just behind on the clear rails and began emptying my gas, when along came a wildcat locomotive with a terrible racket of bell and whistle and I almost lost my life through fright before I could hustle my half-empty gas spindle off the track. What would have happened to me and that careless locomotive had my wasting gas suddenly exploded I can't think.

This is the only time in my high career that I have been "real scared," but at another time I nearly frightened to death a young Cannuck farm hand near Lewiston, Me., one November day when I landed in freezing weather and a 30-mile wind and the only person in sight ran away screaming when I called for help to check my skycycle. He ran into the farmhouse yelling, "Oh Lord, come quick, the devil is after me big as a house and talks like a man!"

America's First Railroad Track Built 100 Years Ago

1909—According to Frank H. Taylor of Philadelphia, the first practical railway track built in America was constructed in Philadelphia in 1809. At that time, remnants of the line of defenses erected against the rebel colonists by British troops in 1777 still remained, and here a civil engineer named John Thompson, and a Scotch millwright named Somerville, constructed a track of wooden rails while the staid citizens of Philadelphia looked on in amazement. The rails rested on sleepers eight feet apart and the roadbed had a grade of $1\frac{1}{2}$ inch to the yard. When completed, this experimental piece of railway track extended 180 feet. Upon this a car with grooved wheels was placed, and it was found that one horse could pull a heavy

load upon these rails with more ease than could several horses upon a wagon road. Thereupon John Thompson secured a contract to build such a line from a quarry to a river landing, 10 miles distant. This line, the first of its kind in America, was operated for 19 years, horses being the motive power. The son of this engineer, John Edgar Thompson, afterwards had an important part in the building of the early railroad lines which now form part of the Pennsylvania system, and later he became president of that corporation.

1905—Several railway systems are considering the installation of a wireless telegraph system for communication between moving trains and stations at large cities

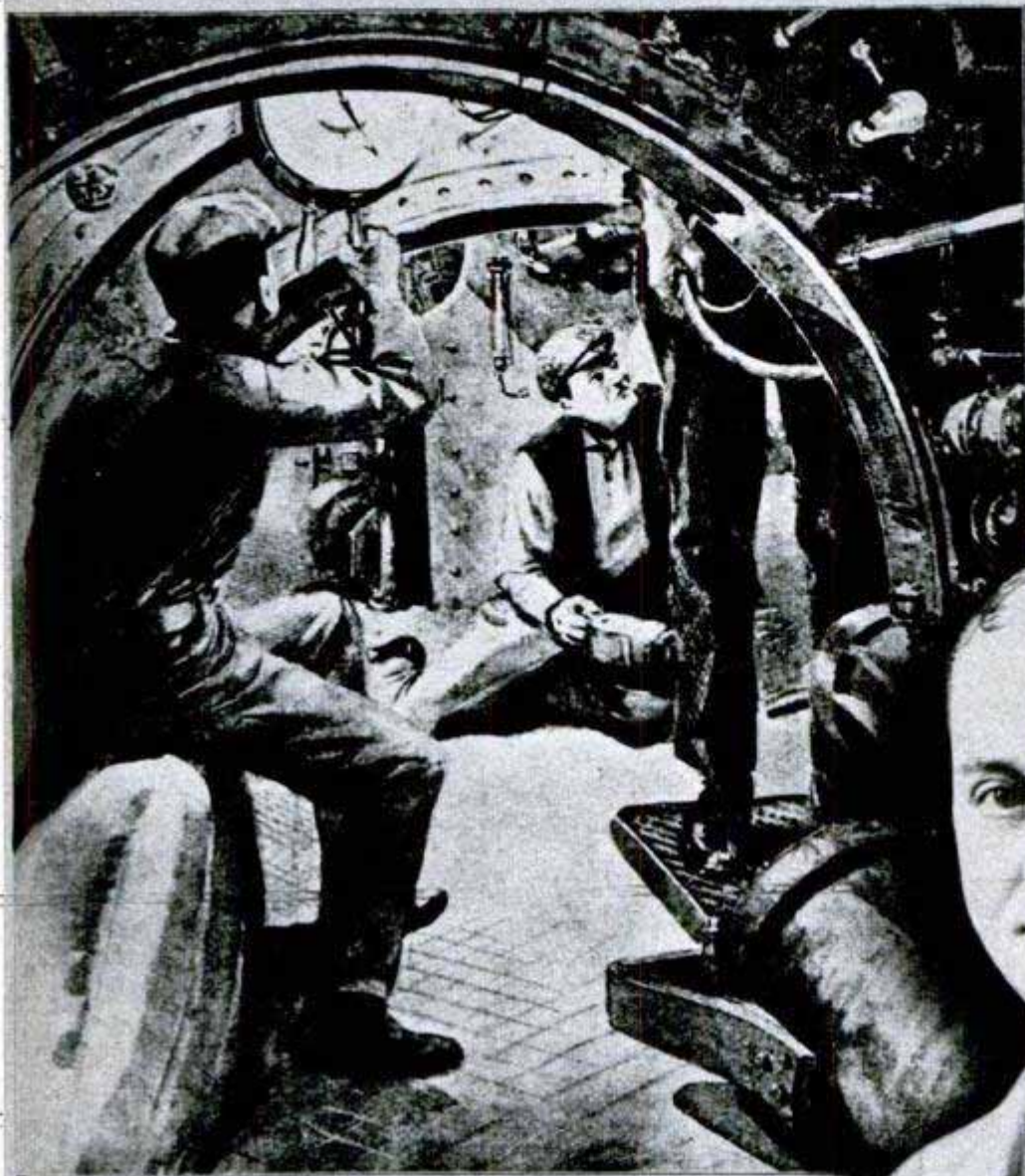

INTERIOR FIRST SUBMARINE BOAT FOR BRITISH NAVY.

H. H. Windsor, founder of *Popular Mechanics*, and first issue of the magazine, Jan. 11, 1902

The Story of POPULAR MECHANICS

By **Wayne Whittaker**

Assistant Managing Editor

DURING THE LAST 50 years, the pages of *Popular Mechanics Magazine* have told the story of civilization's advance during the greatest half century of progress the world has known. It has been a tumultuous period with life revolutionized by the achievements of this challenging technical age. *Popular Mechanics* has not only reported but shared in the tumult and participated in the progress. It has grown from a handful of subscribers in 1902 to many millions of readers in 1952. It is known and read in every country of the world. Its

readers include the mighty and the humble, but they all share a devotion for this magazine that makes its editors ever respectful of their responsibility.

In these 50 years, *Popular Mechanics* has become an American institution.

Staff members of the magazine are constantly asked about the magazine: "How did it start?" "Where do you get all the varied material?" From the vantage point of 50 years, it seems proper to tell its story. It begins appropriately with its founder, Henry Haven Windsor, for it was he who

dreamed the dream that was to be fulfilled on January 11, 1902, when the first edition of *Popular Mechanics* was published. It had five subscribers and a few hundred newsstand buyers. And it was his faith during those difficult early years which overcame doubt and debt, disappointment and discouragement, to establish the magazine firmly as a part of the American scene.

He was born in a log cabin in Iowa, the son of a Congregational minister, the Rev. William Windsor, who had come West in a covered wagon. The Windsor family moved to Marshalltown, Iowa, when Henry was a small child. At the age of 12, the boy had acquired a printing outfit and was doing a flourishing business in handbills for local merchants. As he grew older his interest in printing, publishing and writing increased with every year.

After high school and Grinnell College, young Windsor went to work on the Marshalltown *Times-Republican* and soon became city editor. He learned about the "who, what, when, where and why" of a news story, about deadlines and some of the problems of printing a newspaper. He was born with an instinct to recognize what was newsworthy. He was born, too, with a burning ambition to edit and publish a

magazine of his own and he determined early never to be satisfied until that ambition was realized. His key to success was: Study.

Before coming to Chicago, Mr. Windsor spent a brief period in St. Paul, working for the Northern Pacific Railway. He came to Chicago in 1883 to accept a position with the Chicago City Railway, and in his spare time he founded the *Street Railway Review*. He also started a magazine called *Brick* for the building trades. You could not keep printer's ink off his fingers.

The years slipped by, and slowly his savings grew toward the realization of his dream. A new century dawned.

Windsor studied the magazines of the day and found them stodgy, particularly those in the mechanical and scientific fields, where his interest was strongest. With the new horseless carriage, balloon flights, telegraphy and all this talk about man trying to fly, he could see a mechanical age awakening. There was a great need, he thought, to tell the public about the interesting things developing every day.

One bright morning during the autumn of 1901, fortified with his life's savings and his never-failing courage, he determined that the time had come to start the magazine he had decided long before to call *Popular Mechanics*. Fortunately, in those days it did not take a huge fortune to start a national magazine.

He promptly quit his job, rented an office in an old building on Washington Street

Magazine's top executives are H. H. Windsor, Jr., editor and publisher, seated beside his wife, Dorothy F. Windsor, vice-president and secretary-treasurer. Standing, H. H. Windsor III, left, and William Harrison Fetridge, right, vice-presidents of the corporation





The Popular Mechanics building in Chicago was specially built to house all activities of the magazine, including its printing. Drawing at the right shows (from bottom up) the basement where tons of paper are stored and location of small presses that print the Spanish edition; first floor is the pressroom where, for this anniversary issue alone, the modern high-speed presses printed over 400 million pages; at either end of the second floor is the bindery equipment with storage and mailing space in the center as shown; the third floor houses the advertising, subscription and the book departments; on the fourth floor are the executive offices, accounting and circulation departments; editorial department, bureau of information and the library are located on the fifth floor; the art department, the composing room, the photo studio and classified-advertising department are on six; on the seventh floor are a big photo studio, workshop, offices for the Spanish edition as well as for Science Digest, which is also published by Popular Mechanics Company

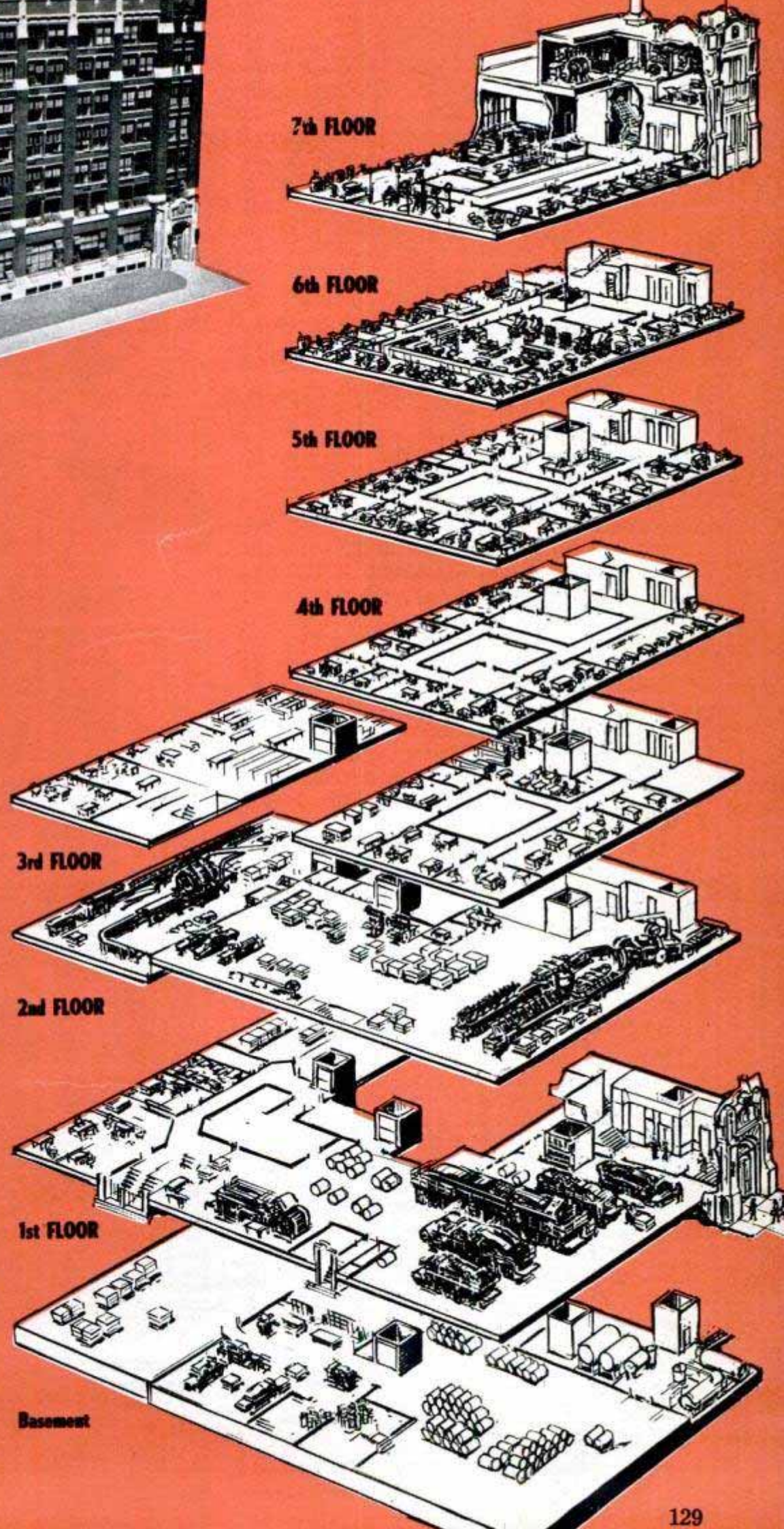

7th FLOOR

6th FLOOR

5th FLOOR

4th FLOOR

3rd FLOOR

2nd FLOOR

1st FLOOR

Basement

and hired a mail clerk. This, of course, was putting the clerk before the mail but he was positive there would be mail soon. Then he hired an experienced young bookkeeper, Miss Helen Elizabeth Toole, who obviously was not impressed with the small office of her employer. She agreed to try the job "for a few weeks." She stayed 45 years. Now retired, Miss Toole lives only a few blocks from the magazine plant in Chicago and still "keeps track" of the business.

"Those early days of the magazine were such a struggle," she said recently, "that I hate to think of them. That first week the magazine came out our subscribers barely outnumbered the three employees. It began as a weekly and sold for five cents. Mr. Windsor had scurried around and found a few advertisers and wrote the entire magazine himself.

"Then came years of losing money, with the loans dwindling away and the bills piling up. Many a time we could not meet the slender payroll, and with notes falling due it was a bookkeeper's nightmare. I was as positive that bankruptcy was just around the corner as Mr. Windsor was convinced that success lay just over the horizon. He was the most fearless and courageous person I have ever known. Frequently, late in the day he would pat me on the shoulder and say, 'Don't worry, Nellie, I'm sure some money will arrive in the morning mail.' His optimism was usually rewarded. Never once did he lose faith in the magazine."

Henry Haven Windsor knew his magazine idea was sound. *Popular Mechanics* was the first magazine to present mechanical and scientific material with a popular approach—in language that was easy to understand. In a day of highly technical writing, Mr. Windsor advocated simplicity and clarity. He coined the phrase "Written So You Can Understand It." It still is the motto of the magazine.

It was a revelation to the public that technical subjects could be handled in simple everyday words. Every issue of the magazine carried numerous photographs; in fact, the entire first page of the first edition was given to a picture of the interior of a British submarine.

Popular Mechanics became America's pioneer picture magazine. From its first issue it was national and international in scope. The magazine was dedicated—and still is—to happenings in the present and glimpses into the future, with hardly a backward glance. It ignores the political

The montage shows some of the many operations for producing *Popular Mechanics*. In upper-left corner are rolls of paper before a big press and at lower right is the finished product. Other scenes are from the art, photographic, editorial and composing rooms







Norman Guess, book manager, inspects an array of numerous books issued by Popular Mechanics Press and Windsor Press

covered Britain's first submarine, a new electric headlight for locomotives, an electric car that ran a mile in 63 seconds and the rapidly growing use of the telephone (2,278,717 installations) in the U. S. Another up-to-date item told of the startling innovation of telephones being installed in every room at Chicago's Auditorium Hotel. For the craftsman there was the beginning of a series, "Elementary Studies in Electricity," ar-

and the controversial and through the years has been a show window of the American way of life, reporting man's accomplishments in the fields of mechanics, science and discovery.

From the beginning the magazine has been divided into two general sections, one devoted to news and the other to craftsmanship. News items in the first issue

ticles on how to clean sponges, how to prepare cement for repairing cast-iron tanks and a new way to etch on glass. It was obvious from the first that H. H. Windsor had given long and careful thought to the format of his magazine. He set the pace that the magazine has followed through the years and others have copied.

(Continued to page 366)

The April 1910 cover (below) featured an exciting race between auto and a newfangled flying machine

Another 1910 two-color cover shows an early auto rigged up with runners for a spin through the snow

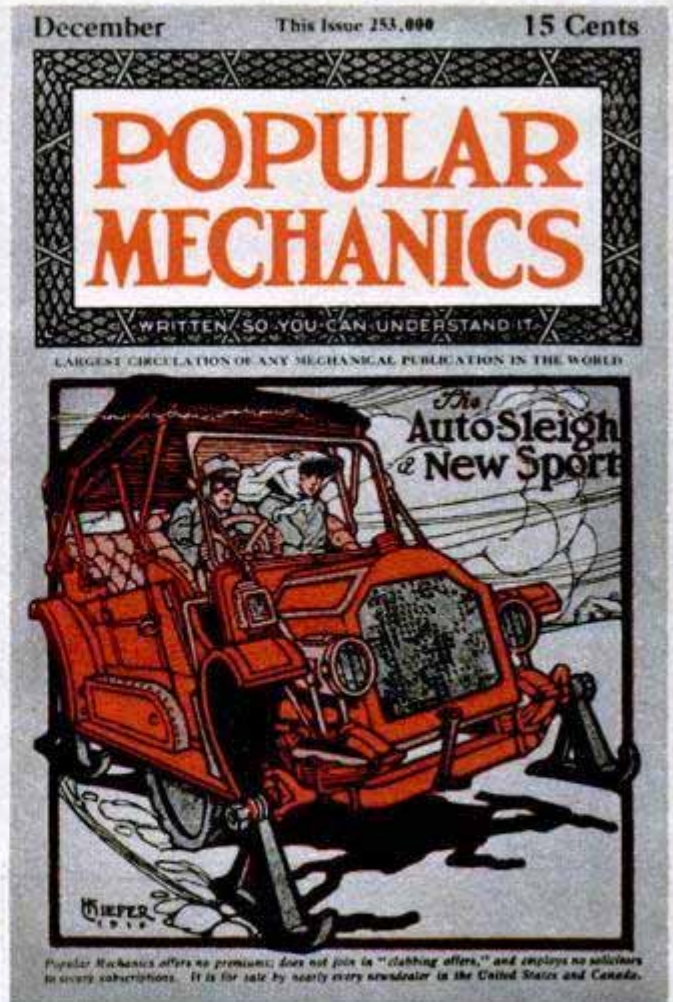
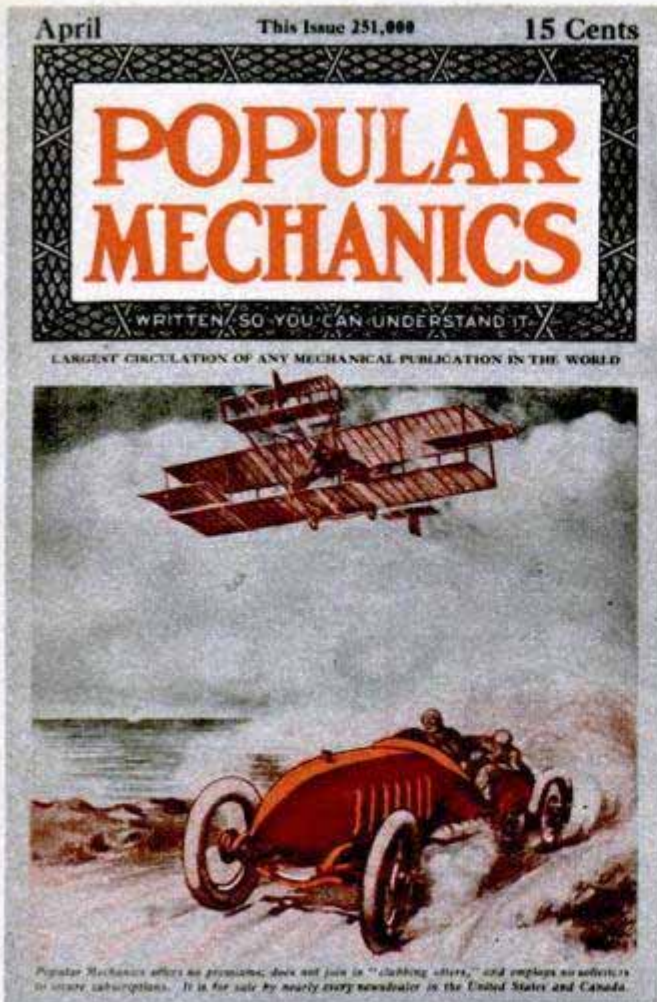

POPULAR MECHANICS

MAGAZINE

WRITTEN SO YOU CAN UNDERSTAND IT

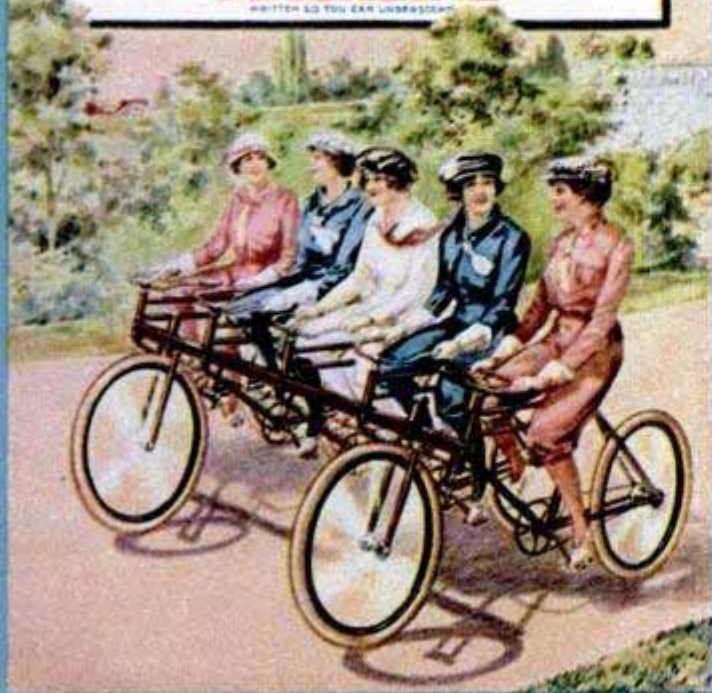

Back in 1916, a Cleveland dealer built this seven-wheel bike to accommodate a gay quintet. The master control is from steering wheel on bike at the right

The sporty motorist of 1915 crossed a bay on West Coast on this barge propelled by the car it carried. Driving wheel for auto ferry attached to car wheel

POPULAR MECHANICS

MAGAZINE

WRITTEN SO YOU CAN UNDERSTAND IT

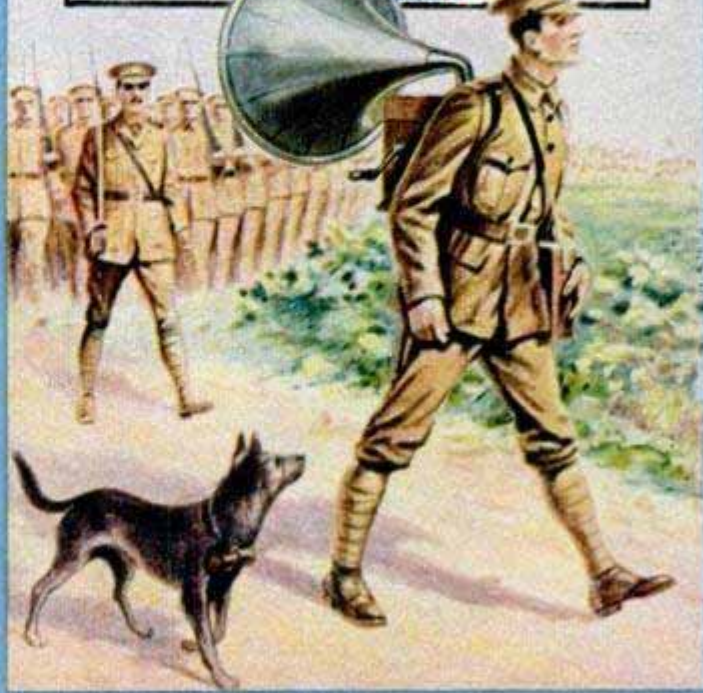

The popular talking machine of 1917 was used by a British unit to replace a marching band in drills. During World War I the phonograph helped recruiting

A life raft for airplanes introduced in 1921 was such a novelty that it rated a PM cover painting. Rafts of this type have since saved scores of lives of aviators

August

15 Cents

POPULAR MECHANICS

MAGAZINE

WRITTEN SO YOU CAN UNDERSTAND IT

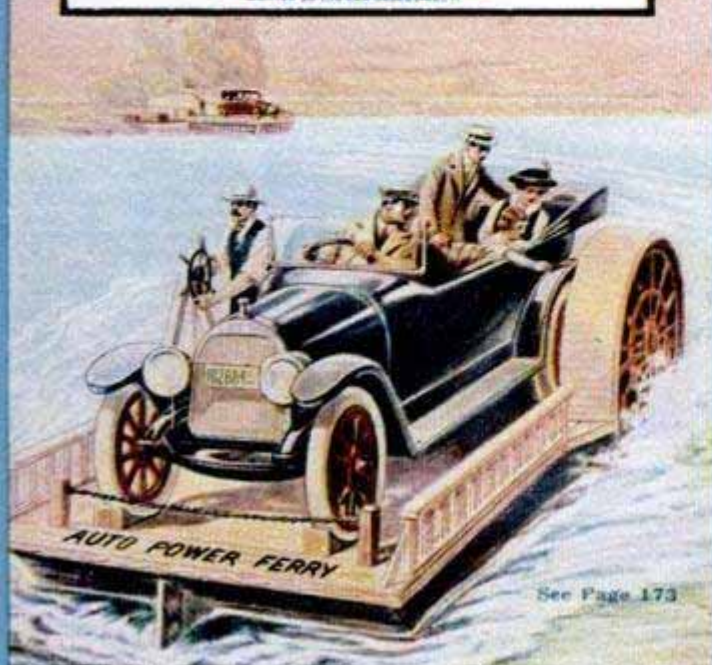

See Page 173

November

25 Cents

POPULAR MECHANICS

MAGAZINE

WRITTEN SO YOU CAN UNDERSTAND IT

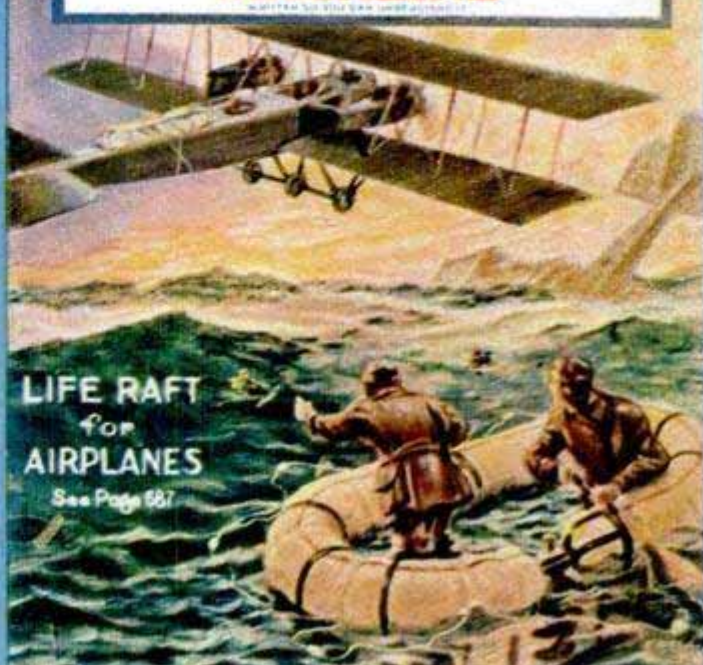

LIFE RAFT
for
AIRPLANES

See Page 67

POPULAR MECHANICS

MAGAZINE

WRITTEN BY YOU CAN UNDERSTAND IT



ABRAHAM LINCOLN'S
FIRST INVENTION
PAGE 360

In March 1924 somebody in the Patent Office discovered that Abraham Lincoln was once an inventor and patented a device to lift vessels over shoals

In 1938, the flying wing was still a dream of Lockheed's chief engineer, H. L. Hibbard, who wrote an article about it. Northrop built the first one to fly

POPULAR MECHANICS

MAGAZINE

WRITTEN BY YOU CAN UNDERSTAND IT



MARCH
25 CENTS
\$3.00 IN CANADA



SEE PAGE 362

This 1935 cover was linked to an article on inventions and prophecy. The top line shows that DeForest was writing about television all of 17 years ago

When this Santa Fe diesel appeared on the cover in 1941, it was the most powerful locomotive in world and heralded a new era in transportation on rails

THE MAKING OF A RACE DRIVER

POPULAR MECHANICS

MAGAZINE

WRITTEN BY YOU CAN UNDERSTAND IT



SEE PAGE 232

JUNGLE EXPLORING BY TRAILER

By Commander Attilio Gatti

POPULAR MECHANICS

MAGAZINE

WRITTEN BY YOU CAN UNDERSTAND IT



JUNE
25 CENTS
\$3.00 IN CANADA

SEE PAGE 8

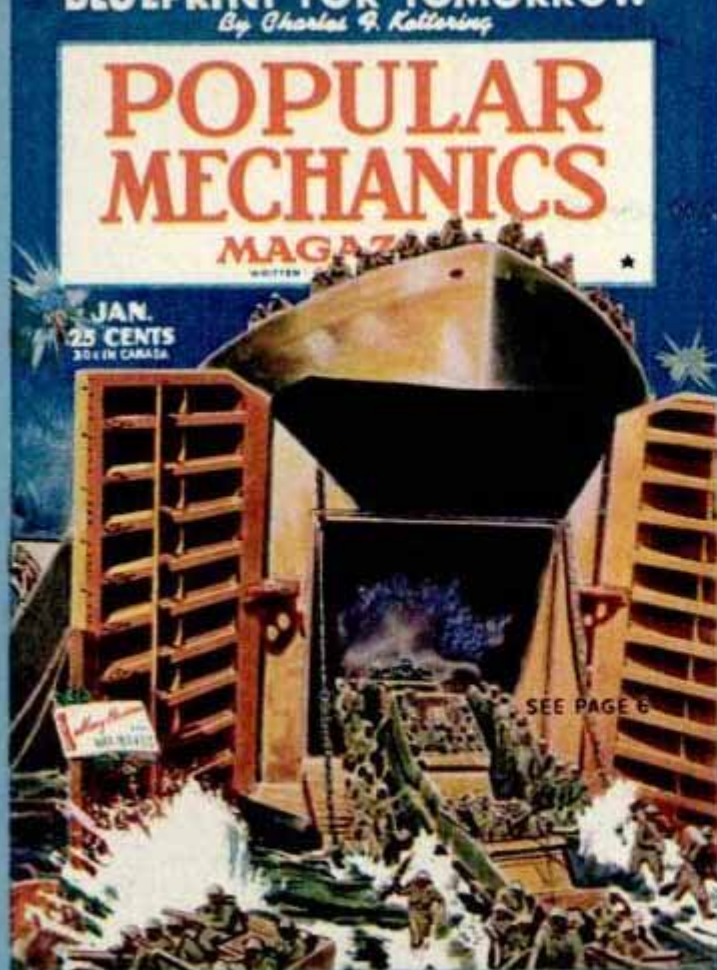

One of PM's best World War II covers was this fine painting of an LST (Landing Ship, Tanks) in 1944. The ship landed thousands of men on hostile beaches

Bell Aircraft's postwar rocket-powered XS-1 flashed across this cover in 1947, a new aviation milestone pointing the way to supersonic speeds of the future



Another wartime cover (1945) was an oil painting of "Big Mo." The original was given to President Truman and hung in the White House until remodeling began

PM's ranch house was featured on the cover last May. It is one of several houses that have been designed and built by the magazine as a how-to-do-it feature



Printed in Five Languages on Its Golden Anniversary, Popular Mechanics Magazine Is Read 'Round the World

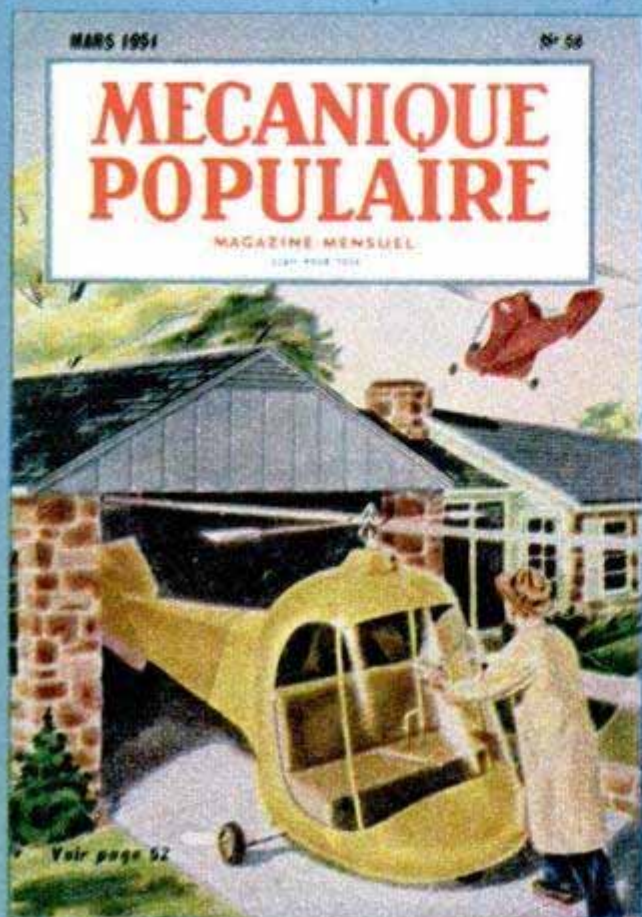

The French edition of Popular Mechanics—*Mecanique Populaire*—is familiar to thousands of our readers abroad. It was the magazine's first foreign edition

The Swedish edition of Popular Mechanics is translated and published at Copenhagen, Denmark, for readers in Sweden. It was first published in 1950

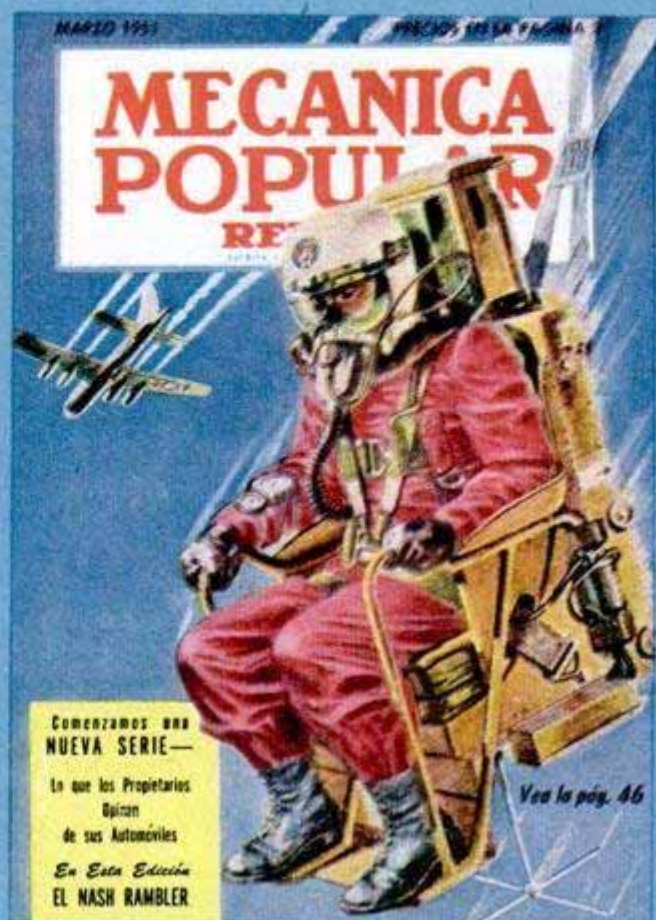

Comenzamos una NUEVA SERIE—
La que los Propietarios Opican de sus Automoviles
En Esta Edición EL NASH RAMBLER

Vea la pag. 46

South of the border, from Mexico to the tip of South America, goes *Mecanica Popular*, Spanish-language edition which was introduced in 1947

First of the Scandinavian editions was the Danish, which is also published at Copenhagen. This magazine is distributed in both Norway and Denmark



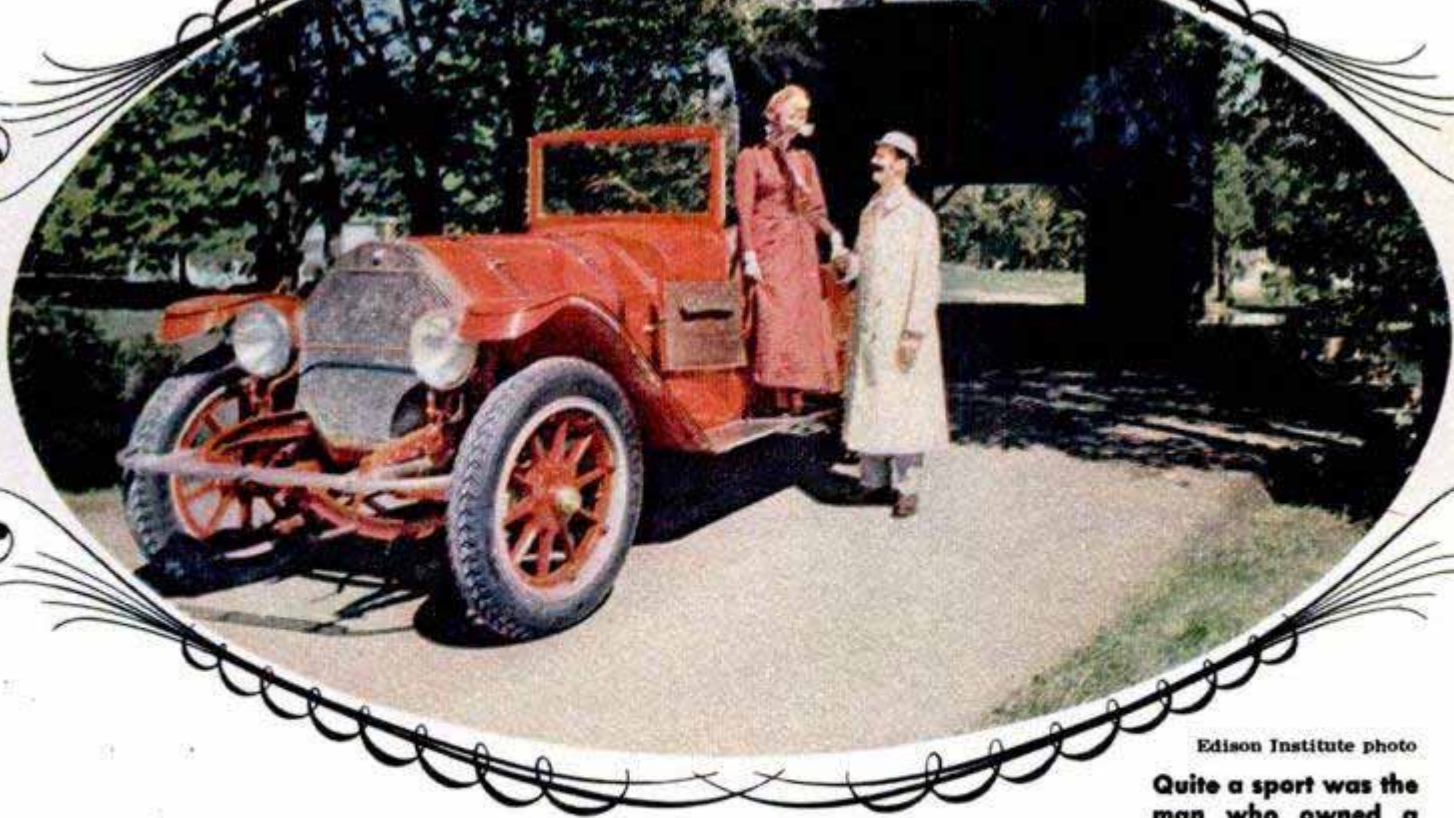

Edison Institute photo

Quite a sport was the man who owned a 1914 Thomas Flyer

...And Then Came the Horseless Carriage....:

By Charles F. Kettering

WHEN HENRY WINDSOR decided to bring out a new magazine, *Popular Mechanics*, early in 1902, some other things were happening around the country which were destined to have an impact on the future of the new venture.

In another midwestern city, Detroit, Ransom Olds had just finished building more than 400 curved-dash horseless carriages, or runabouts, which he sold for \$650 each. Up to that time there had never been so many automobiles built at such a low price. Mr. Windsor seemed keenly aware of this innovation in transportation because he persuaded F. L. Faurote, the Olds advertising manager, to address the annual convention of rural-mail carriers. As a result, Faurote introduced into the United States post-office service the first Oldsmobile



Kettering and 1912 Cadillac, first with self-starter



Early Ford, which entered the controversy over superiority of gas, steam or electric power, was this 1903 model which cost \$900

Ford photo



Ford photo

First Ford, built in 1893, had a two-cylinder engine mounted between rear wheels. Below, hold your hat! 1918 Chevrolet zipped along with its V-8 engine

Edison Institute photo



Edison Institute photo

Packard runabout, 1903 vintage, cost \$2500, averaged 50 miles per day in cross-country tour. Below, 1903 Cadillac had one-cylinder engine, chain drive

Edison Institute photo





Edison Institute photo

runabouts, which became the first gasoline cars to be used in mail service.

But Ransom Olds' venture into the automobile business had much wider implications. First, his auto's low price gave a new slant on the low-cost, individual-transportation problem. Second, his utilization of the progressive-assembly technique marked the beginning of mass production in the automobile industry. Third, his new factory in Detroit was the first in this country erected for the sole purpose of manufacturing automobiles. But beyond these contributions, Olds was greatly instrumental in helping change the old order of things.

To appreciate this last statement fully let us go back to Columbus, Ohio, where I was a student in that year of 1902. As I remember it, Columbus in those days was a pretty good-sized city—around 150,000 people. It had about 100 miles of improved streets and about 90 miles of electric street railway. And it had a reputation as a manufacturing center—building buggies and carriages “sold in every state and every country on the face of the earth.” Fourteen hundred people turned out over 28,000 vehicles every year. Columbus had a horse and mule population of 6000 to pull some of these vehicles. But, in addition, in those days, I recall seeing a lot of bicycles—in fact I found out there were some 12,000 of them on the streets. Buggies, carriages, wagons, horses, mules and bicycles plus street railways—that was city transportation in 1902! In the country you were lim-

If you were the owner of a sporty 1906 Franklin runabout, you no doubt were a man-about-town with the ladies. This cream-colored job had a four-cylinder, air-cooled engine, two speeds forward and one reverse

ited to buggies and wagons, horses and mules—the pavement stopped at the city limits.

But Columbus was not asleep. The editor of the *Board of Trade Bulletin* editorialized regarding new developments in science and invention: “Perhaps the most important of the ‘newfangled’ things is the automobile. Although its appearance, in an experimental way, has been very recent, it is in practical use in many parts of the country and its general adoption is retarded only by the ability of the maker to supply the demand.”

So it was at the turn of the century—“the good old days.” But the *Trade Bulletin* editor, when he used the phrase “in an experimental way,” should have received a prize for understatement. Unless you have driven one of those early “newfangled” things it is hard to appreciate just what “in an experimental way” meant.

It meant you stood beside a vehicle that resembled a topless buggy without a horse, patiently twisted a crank until, eventually, the one-cylinder engine under the seat started to cough and shake the entire vehicle. Then before it gave up the ghost, you leaped into the seat, grabbed the tiller bar, put it in gear and rolled coughing and jerking down the street at perhaps 10 or 15





Sleek and luxurious 1952 Packard makes its debut. Its styling is a far cry from the 1903 model on page 138

miles an hour. From then on you were at the mercy of the road, the tires, the weather and the whims of a temperamental power plant. And when you did break down, you called on the local blacksmith who had a wealth of experience—mostly with horses and buggies.

Volumes have been written on the evolution of the automobile since those days, so I won't attempt to repeat that story. However, I have been associated with several of these automotive developments so perhaps it would be better if I gave you a few high lights of three or four of the things with which I am personally familiar—things which fit into a much larger story of American science and invention.

In the first decade of the century, the horseless carriage became the automobile—engines grew in size and power and performance improved, the passengers were made more comfortable, and the new vehicle became easier to handle.

There was an exception to this, though, that deterred some men and most women—engines still had to be cranked by hand. Even husky men found this rugged and often suffered broken arms. Mr. Henry Leland, head of Cadillac, told me in 1910 five of his men had suffered broken arms and that one of his best friends, Mr. Carter, died as a result of a broken jaw caused by a kicking hand crank.

I told Mr. Leland I thought something could be done about an electric self-starter, and we began the uphill battle that was to last for a long time. I say "battle" because we had to fight prejudice, misinformation and bad breaks—all things every inventor must face when he tries to do a new thing.

The experts said it would take an electric motor of two to five horsepower to spin the engine, and there existed no electric battery with enough capacity to do this particular job. And, of course, carrying these batteries around in a car was ridiculous.

There was just one thing they overlooked—an ordinary man cranked a car and he didn't put out several horsepower continuously! What was needed was a small motor that would give a big spurt of power for a short time and a generator to charge the battery between spurts.

It sounded simple, but like every inventor I didn't fully appreciate the things we were going to run into—ridicule from the motor and battery people, misfortunes such as the fire that destroyed our only demonstrator, a broken leg and the skepticism of nearly everybody. But Mr. Leland was most patient and in August 1911 the self-starter was approved as equipment on the new-model Cadillac. *Popular Mechanics* came out with a timely article on the device and, as a result, the derision of many people was transferred from me to the editor. A number of his readers called him to task for including pipe dreams in his articles!

I have been accused of a lot of things in my day, but I believe Christy Borth is stretching things a little when he said the self-starter was responsible for women taking their places behind the steering wheel and as a consequence, mark you, adopted more suitable attire such as short skirts and discarded things such as "bustles, layers of petticoats and towering coiffures." However, since today nearly all women drive, maybe I should take the blame for some of that.



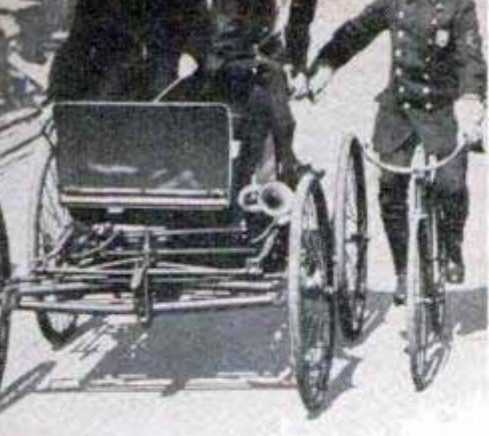

Automobile Mfrs. Assoc. photo



General Motors photo

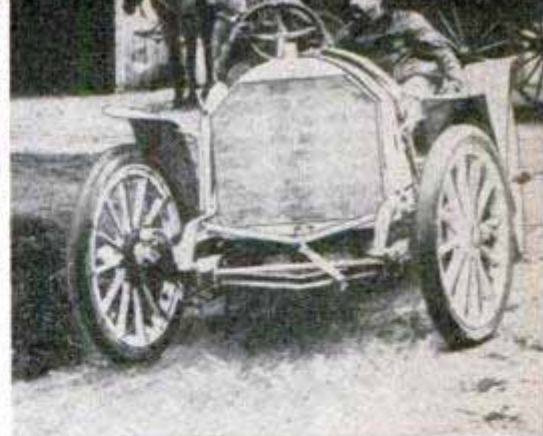

Automobile Mfrs. Assoc. photo

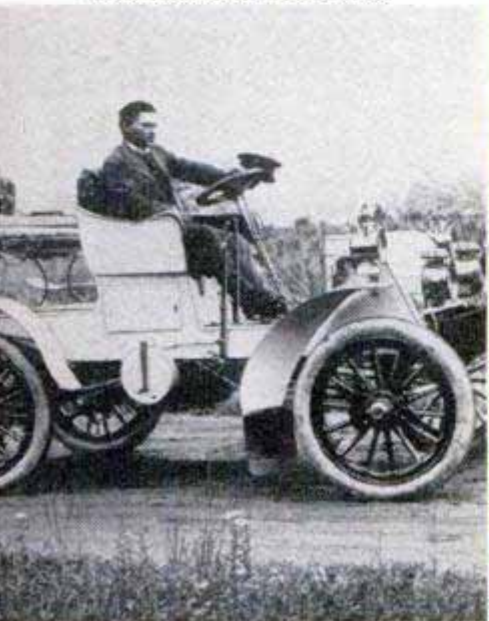

PIONEERS

ELWOOD HAYNES, above left, built one of first autos. Here, driving his own car, he's overtaken by bicycling cop

RANSOM E. OLDS, above, sparked the "Merry Oldsmobile" and the Reo car. Famous curved-dash Olds sold for \$650

LOUIS CHEVROLET, above right, at the wheel, leans around corner in 1905 race

JAMES WARD PACKARD, left, was dissatisfied with first car he bought so he built his own. This is his 1902 model

HENRY FORD, right, pioneer in assembly lines, here inspects first car he built

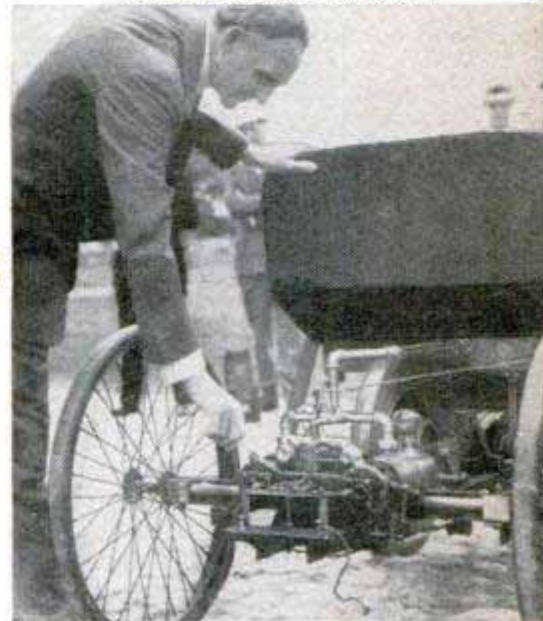

Ford photo

As we entered the second decade, the automobile began to change the landscape and the habits of the people. Everyone wanted a car and with this demand manufacturers multiplied, and new ways and means were sought to build more and still more. Car registrations rose from a half million in 1910 to over nine million in 1920. New techniques for mass production were added yearly: improved continuous-assembly processes, division of labor, standardization of parts and new materials all helped to supply the ever increasing demand for more cars.

But in their careful analysis of methods of increasing this flow of cars, the manufacturers always came face to face with a serious bottleneck. Chassis were assembled with precision and came off the line with clocklike regularity. Bodies were put together with gratifying speed and sent to the finishing department. But there the rhythm of production stopped. Highly skilled finishers would prepare the metal and skilled painters would spend hours brushing on the varnish. The body then went to the

drying room and then to the rubbers who laboriously produced a glasslike finish. This process went on for days and weeks as coat after coat was applied. It was not unusual for a plant visitor to see hundreds of bodies in the drying warehouse just waiting for the finish to harden between coats. It was the needle eye through which all production must pass.

Something had to be done about it, so a committee was formed to investigate new finishes. The one that looked most promising was an ancient one—lacquer. Since 1905 a synthetic lacquer, a sort of "liquid cotton," had been marketed but it had limitations. It could be quickly sprayed on with an air-pressure gun, but it was pretty thin stuff and lots of coats had to be sprayed on to get the right color and thickness. If you thickened up the solution it would come out of the gun like bullets. The old-time varnish dried too slowly and the lacquer too fast. That is where the chemists came in and, after years of research, finally found a new low-viscosity cellulose that held lots of pigment, could be easily sprayed



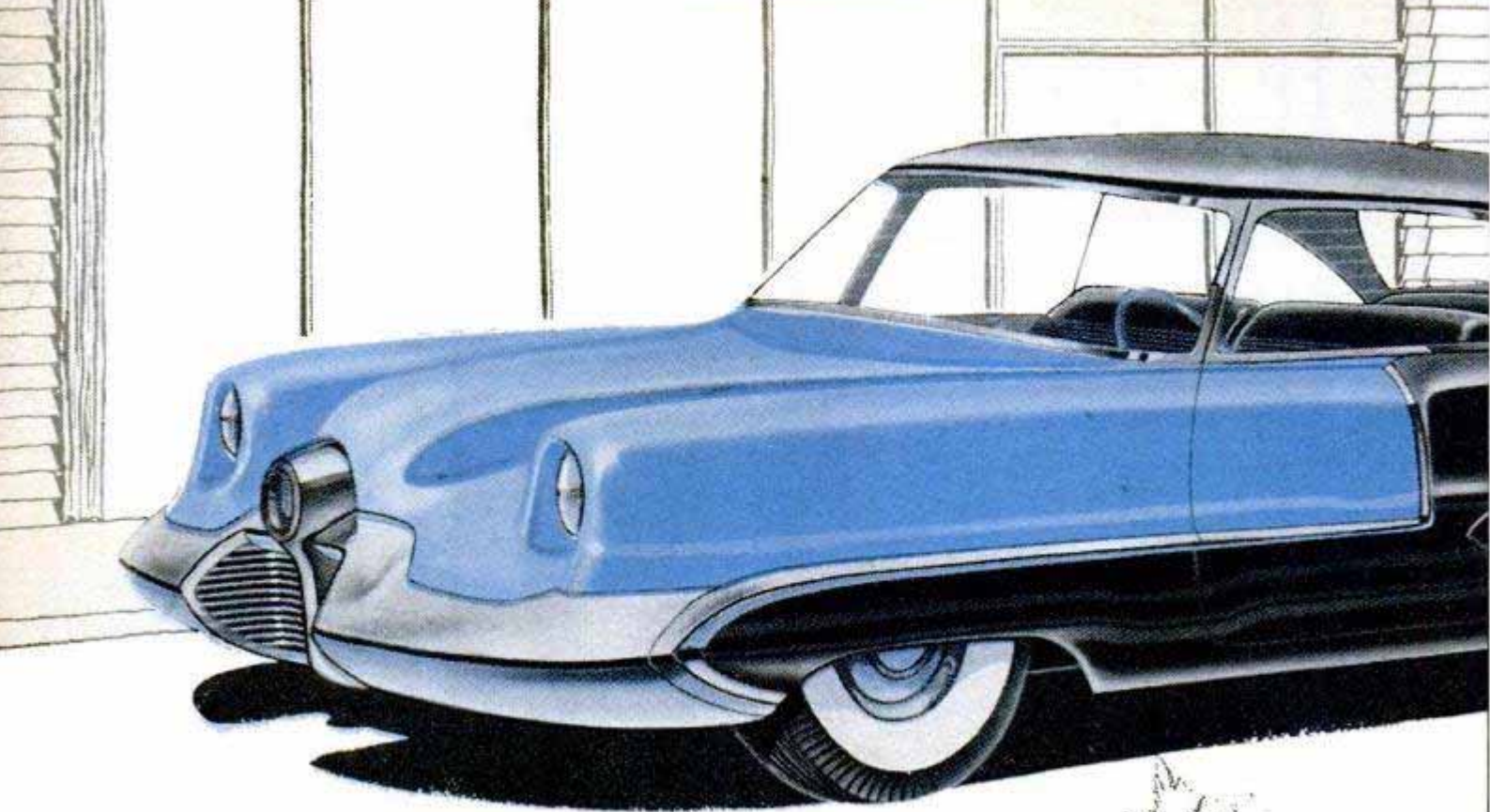

Car of the near future? General Motors' stylists sketched this car for PM's Anniversary issue. It features bumpers running length of pontoon fenders, one-piece bumper-grille, polarized windows

and gave a greater film thickness with a few coats.

As a consequence, a car body could be covered in a more durable, colored finish in about five hours, instead of weeks, and the bottleneck was broken. The spray gun replaced the hand brush in many other industries, and lacquers invaded the home bringing color to furniture, household appliances and hundreds of other things all around us.

As we see the gleaming, many hued cars rolling by us today, it seems to me we should regard them not as just so many automobiles but rather as symbols of the research man's ability to find quicker and better ways of doing many things handed down to us by our forefathers.

As the public became more automobile conscious, it asked for more refinements, reliability and performance. Soon there was a variety of closed bodies in many colors and practically all cars were equipped with self-starters, electric lights and more dependable engines.

But increased engine performance was usually achieved by adding more cylinders and increasing their size until it was not an

unusual sight to see an engine five feet long producing 60 horsepower. Engineers knew even before World War I that by increasing the compression ratio—squeezing the fuel in the combustion chamber more—you could get more power from the same size engine. But they also knew that if you did this the engine would knock unbearably.

So Tom Midgeley and I started into the long battle against knock—to find out what caused it and, if we could, a cure. By developing a lot of our own instruments and putting a quartz window in the side of the engine, we found that the fuel was the chief offender so we began the long search for something we could add to the fuel that would reduce the power-robbing knock. Thousands of chemicals were patiently tried—some good, some bad—until we began to get a picture of the type of chemical compound that would do the job. And with the assistance of some able chemists we obtained a sample of the ideal antiknock—tetraethyl lead. It did the job all right and the knock disappeared! Now we had some control over the knock that stole power, if we could only produce the new fuel on a commercial basis.



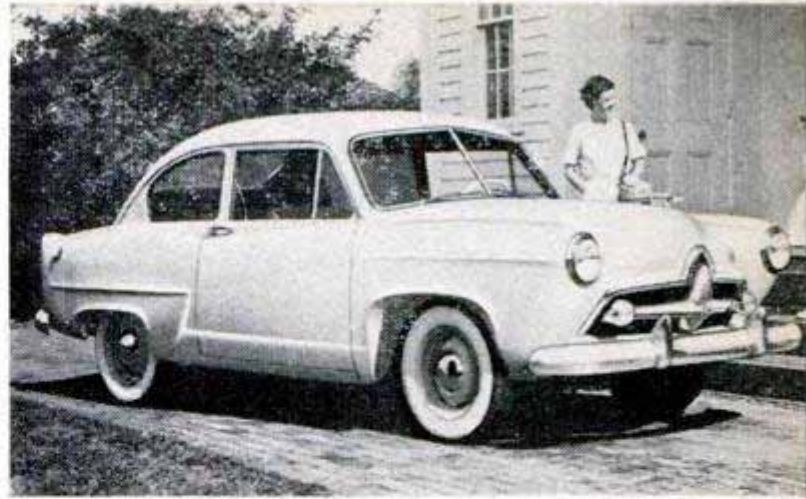
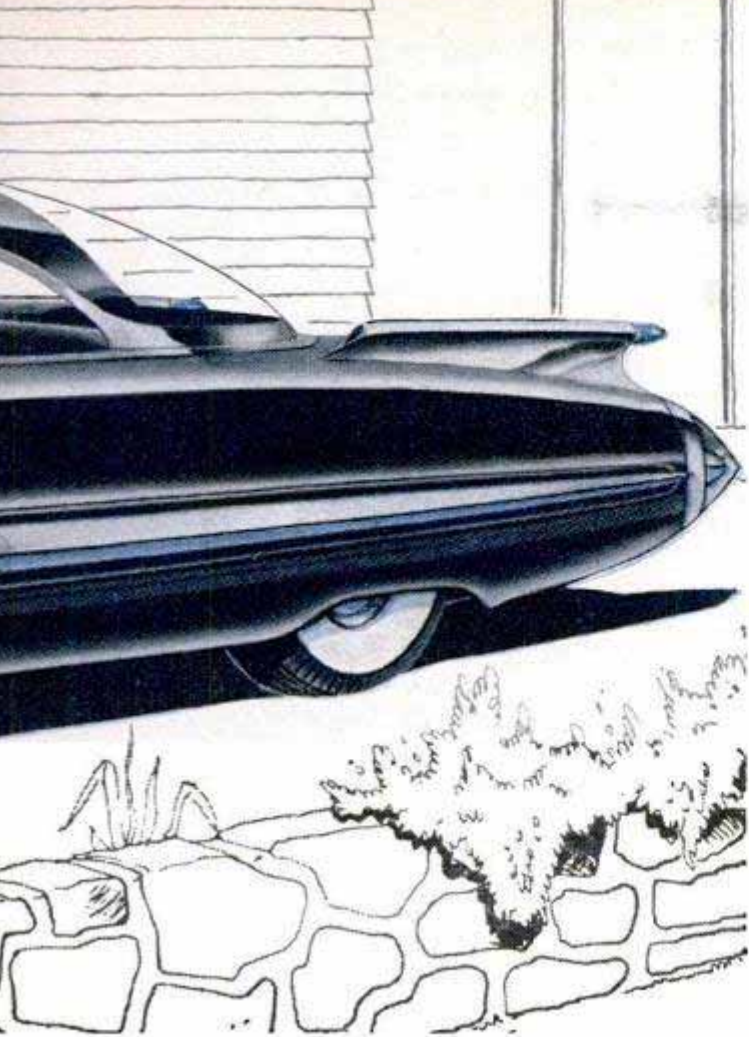

Late example of the horseless carriage is the Henry J, light car built on trim lines. It has a very high horsepower-to-weight ratio and yields excellent mileage

ance. But in the case of ethyl gasoline the results were well worth the battle because by its use, together with better fuels and mechanical improvements, smaller and more powerful automobile engines resulted and the motoring public's fuel bill was reduced by a third.

When Hitler threw down the gauntlet and challenged the world, he underestimated this country's ability to mass produce mechanical horsepower and the things that went with it. He banked on a rapid-fire mechanized war—blitzkrieg. In World War I an infantry division required about 3500 mechanical horsepower to keep moving. A World War II armored division required over 400,000 horsepower. And Hitler thought he was all set because he had been stock-piling mechanical horsepower for years and we were still turning out so-called "luxury" items such as automobiles, refrigerators and radios. There wasn't a chance that the U.S. could convert her factories to producing war goods in time to stop him.

That is where he made his big mistake. He overlooked our not-so-secret "secret weapon"—our ability and "know how" to change models quickly. For years we had been doing this once a year. True, it would take some time to get machine guns off a line that produced refrigerators, but if the blueprints and the sample model of the gun were okay, no people in the world could get into production faster than we could.

And that is the way it turned out. Taking the example of the machine guns: An entirely new plant was built, 2000 machines were installed, employees were trained and *six months later* the guns were delivered!

(Continued to page 340)

The problem of developing a commercial process was almost as great as that of the initial discovery. It meant trips to Egypt and the Dead sea on a floating-laboratory ship; all to find a cheap source of bromine, one of the basic ingredients. At last a method of extracting it from sea water was developed, a plant was built and in February 1923 ethyl gasoline first went on sale at a station in Dayton, Ohio.

The next year saw a wider and wider use of ethyl, and the engine designers were beginning to take advantage of the new frontier opened to them. But several newspapers uncovered what they thought was a good story, and late in 1924 one of them carried the following statement: "20,000,000 automobiles on American highways are belching exhaust gases impregnated with poisonous dope." So a different kind of battle started, and it was not settled until January 1926 when a committee appointed by the U. S. Surgeon General gave lead-treated gasoline a clean bill of health.

This will give you a sketchy idea of the difficulty of doing any new thing—you must first make your idea work, then make it commercial and, last, win public accept-



Twenty years ago Winston Churchill, then a young British statesman yet to attain the stature of Prime Minister during World War II and most eminent Briton of our times, wrote for *Popular Mechanics* this brilliant article prophetic of the atomic age . . .

FIFTY YEARS HENCE

THE great mass of human beings absorbed in the toils, cares and activities of life are only dimly conscious of the pace at which mankind has begun to travel. We look back one hundred years and see that great changes have taken place. We look back fifty years and see that the speed is constantly quickening. This century has witnessed an enormous revolution in material things, in scientific appliances, in political institutions, in manners and customs.

The greatest change of all is the far greater numbers which in every civilized country participate in the fuller life. In the United States, scores of millions have lifted themselves above primary necessities and comforts, and aspire to culture—at least for their children. Europe, though stunned and lacerated by Armageddon, presents a similar, if less general, advance. We all take the modern conveniences and facilities as they are offered, without being grateful or consciously happier. But we simply could not live if they were taken away. We assume that progress will be constant . . . if it were stopped, or reversed, there would be a catastrophe of unimaginable horror.

Mankind has sometimes traveled forward and sometimes backward, or has stood still for hundreds of years. It remained stationary in India and China for thousands of years. Now it is moving very fast.

What is it that has produced this new prodigious speed of man? Science is the cause. This power called science has laid hold of us, set us to work upon its highways and in its arsenals; rewarded us for our services, healed us when we were wounded, trained us

when we were young, pensioned us when we were worn out. The changes have been so gigantic that no period in history can be compared with the last century.

By observing all that science has achieved in modern times, and the knowledge and power now in her possession, we can predict with some assurance the inventions and discoveries which will govern our future. We can but guess, peering through a glass darkly, what reactions these discoveries and their applications will produce upon the habits, the outlook and the spirit of men.

The most wonderful of all modern prophecies is found in Tennyson's "Locksley Hall":

For I dipt into the future, far as
human eye could see,
Saw the Vision of the World, and all
the wonder that would be;

Saw the heavens fill with commerce,
argosies of magic sails,
Pilots of the purple twilight, dropping
down with costly bales;

Heard the heavens fill with shouting,
and there rain'd a ghastly dew
From the nations' airy navies grappling
in the central blue;

Far along the world-wide whisper
of the south wind rushing warm,
With the standards of the peoples
plunging through the thunderstorm;

Till the war-drum throb'd no longer
and the battle-flags were furl'd
In the Parliament of man, the
federation of the world.

Slowly comes a hungry people, as a lion,
creeping nigher,
Glares at one that nods and winks
behind a slowly-dying fire.

Reprinted in condensed form
from the March 1932 issue
of *Popular Mechanics*

by
**WINSTON
CHURCHILL**



These six stanzas of prediction, written eighty years ago, have already been fulfilled. The conquest of the air for commerce and war, the world struggle of Armageddon, the League of Nations, the Bolshevik revolution—all divined in their true sequence by the great Victorian, all now already in the history books and stirring the world around us today.

Whereas formerly the utmost power that men could guide and control was a team of horses, or a galley full of slaves, or a gang of laborers like the Israelites in Egypt, it is today already possible to control accurately from the bridge of a battle cruiser all the power of hundreds of thousands of men. Or, to set off with one finger a mine capable in an instant of destroying the work of thousands of man-years. These changes are due to the substitution of molecular energy for muscular energy, and its direction and control by an elaborate, beautifully perfected apparatus. These immense new sources of power, and the fact that they can be wielded by a single individual, have made possible novel methods of mining and metallurgy, new modes of transport and undreamed-of machinery. They substitute the 100,000-kilowatt turbo-generators at Niagara Falls for the mill wheel of our forefathers. Each invention acted and re-

acted on other inventions, and with ever-growing rapidity that vast structure of technical achievement was raised which separated the civilization of today from what the past has known.

There is no doubt that this evolution will continue at an increasing rate. We know enough to be sure that the scientific achievements of the next fifty years will be far greater, more rapid, and more surprising than those we have already experienced. The slide lathe enabled machines of precision to be made, and the power of steam rushed out upon the world. And through the steam clouds flashed the dazzling lightnings of electricity. But this is only a beginning. High authorities tell us that new sources of power, vastly more important than any we yet know, will surely be discovered. Nuclear energy is incomparably greater than the molecular energy we use today. The coal a man can get in a day can easily do five hundred times as much work as the man himself. Nuclear energy is at least one million times more powerful still. If the hydrogen atoms in a pound of water could be prevailed upon to combine

(Continued to page 326)



Bettman Archive photo

Man's first powered flight, by Orville Wright in 1903, above, was 120 feet long and 10 feet high. Now a Lockheed Neptune can fly 11,236 miles nonstop



"Captain Eddie," the author, now a top airline executive

From *KITTY HAWK*

IT SEEMS ONLY yesterday that I walked into the hangar of the 94th (Hat-in-the-Ring) Squadron at Villeneuve, France, and stepped aboard the little French single-seater Nieuport biplane that was to take me through scores of aerial dogfights. The Nieuport was a fairly "hot" airplane in March 1918. It had a rotary-type engine, a ceiling that varied from 16,000 to 20,000 feet depending on how the plane felt that day, a hair-raising speed of 120 miles an hour with a following breeze and it could outdive the enemy's famous Fokker—provided the fabric didn't peel off the wings in the process.

The fabric hazard was no joke. It brought a number of our group fluttering down in crashes. The first time it happened to me, I

Four jet and six piston engines, each of the latter generating 3800 horsepower, keep giant B-36 aloft

In 1909 the Wrights had to rely on a 30-hp. engine to keep their "Flyer" airborne an hour in Army test

Bettman Archive photo

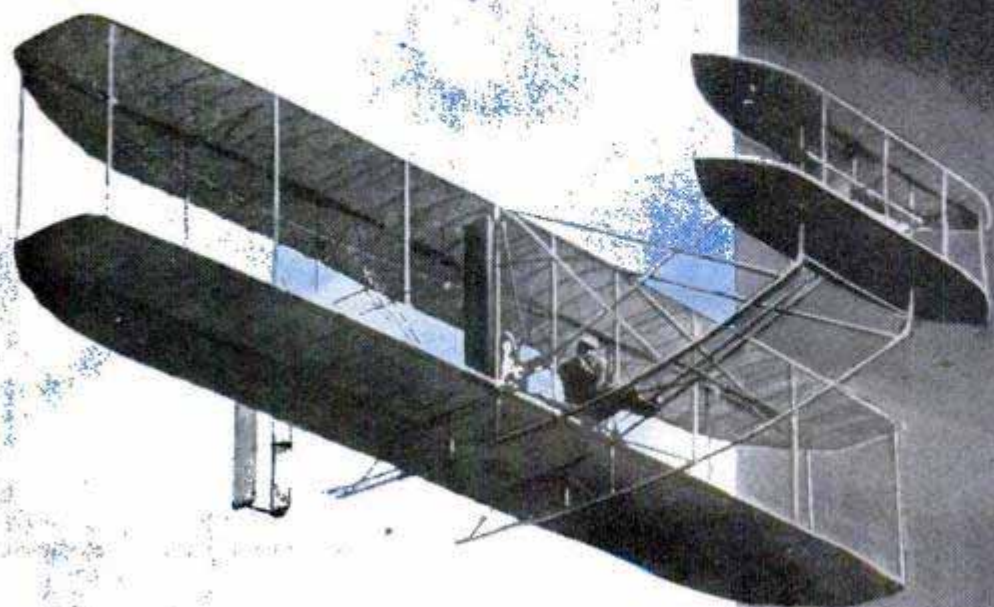

was roaring in on a flight of three armed German Albatros photographic planes headed for Allied lines north of St. Mihiel, and closed in on the trailing plane until, at 50 yards, the pilot saw me and went into a dive. I was on his tail in an instant and, as he came into line with my sights, my tracers ripped along the fuselage until they disappeared into the back of his seat. His plane careened earthward out of control.

Then I eased back on the stick to pull out of my dive—too late. With a ripping crack, my lower-right wing collapsed and the entire spread of taut canvas on the top

Consolidated Vultee photo

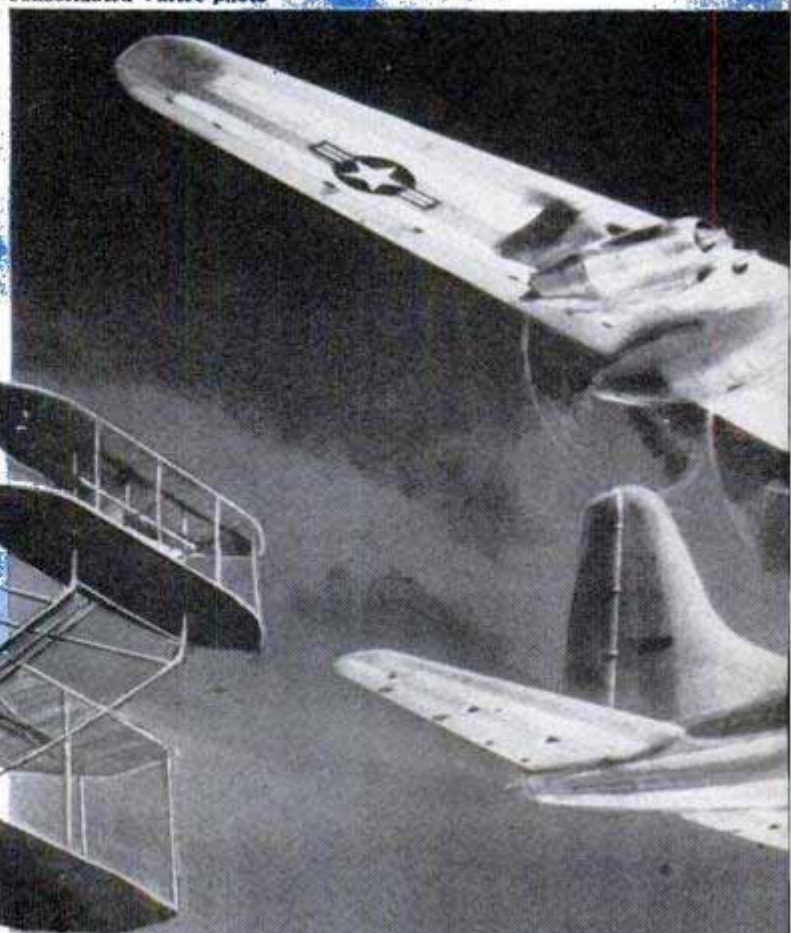

In less than four hours a six-jet B-47 spanned U. S., averaging 607 miles an hour
Boeing Aircraft Co. photo



to *JETS*

By Capt. Eddie Rickenbacker
President and General Manager,
Eastern Air Lines, Inc.

wing tore loose and went flapping away in shreds. I fell into a spin and spiraled downward for 10,000 feet. In desperation, at 3000 feet, I gunned the throttle. Amazingly enough, it brought the crippled ship into horizontal position and kept it there until I skimmed over the hangars of our airdrome and onto the dirt runway amid a cloud of dust, noise and debris. How I walked away from that mess without a scratch is a thing no mere man can explain.

Thinking back on those action-filled months when my squadron mates and I flew the 94th's collection of nuts, bolts,

struts and wires to many victories and our share of defeats against the finest that Von Richthofen's Flying Circus could put in the air, brings a man up with a jolt. When we stepped into those rickety crates back in 1918, it was a 50-50 chance that if a sharp German pilot didn't knock us from the sky, the plane would fall apart under us. Yet we thought they were as nearly perfect as planes could be.

Now, 34 years later, we talk in terms of gleaming, dart-shaped aircraft that pierce the ether at speeds faster than sound, pull out of power dives intact under pressures



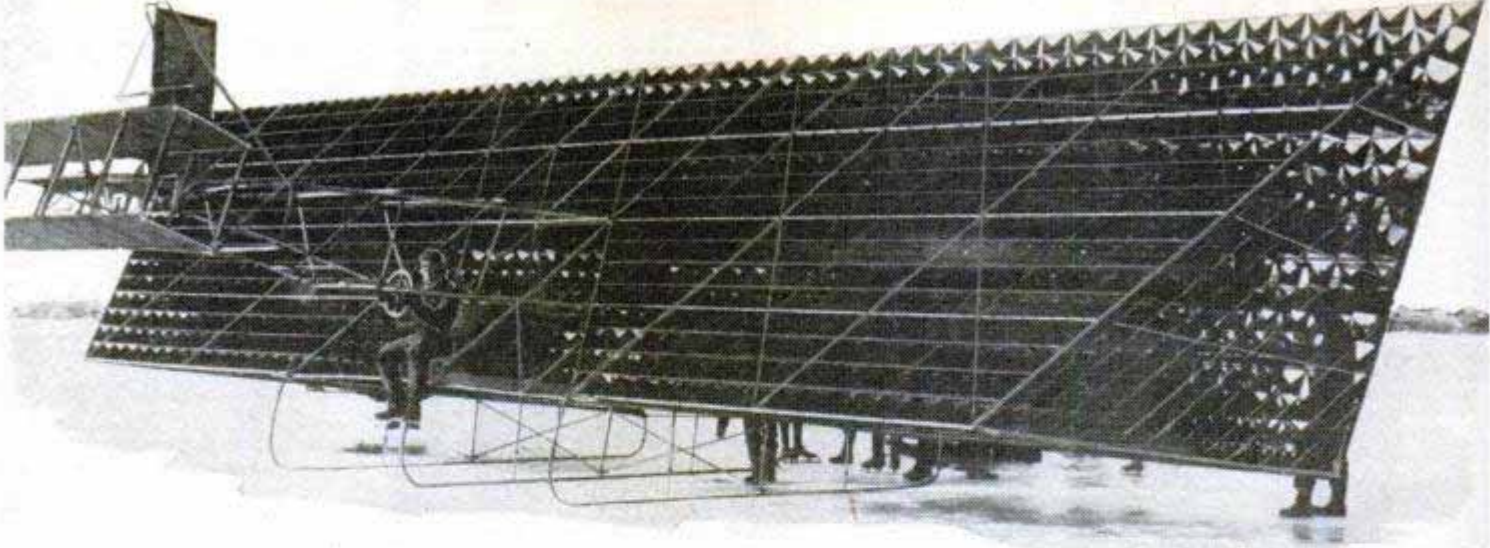

Sherman Fairchild Collection photo

In exploring flight theories, Alexander Graham Bell evolved this tetrahedral kite, with its many wind pockets

that can crumple steel, and climb more than four miles high. The "big" three-seaters of World War I have grown into airborne mammoths that will carry two hundred men. It's safe to say that along with electronics and nuclear physics, aviation has advanced more rapidly than any of the other sciences benefiting mankind today.

Since 1903, when man first found wings through the successful experimenting of

the Wright brothers, an estimated 3000 different models and styles of heavier-than-air craft have flown the skies. If you took all the issues of *Popular Mechanics* since it began publication (incidentally, about the time man started to fly) and attempted to read through them in one afternoon, the best you could possibly do would be to catch a few glimpses of events, facts and personalities as the pages flipped past.



Bettman Archive photo

One of the first of a long line of famous seaplanes built by Glenn Curtiss skims over the water. Below, test pilot Eugene Ely flying off deck of the U.S.S. Birmingham, November 1910, in a Curtiss biplane

Sherman Fairchild Collection photo

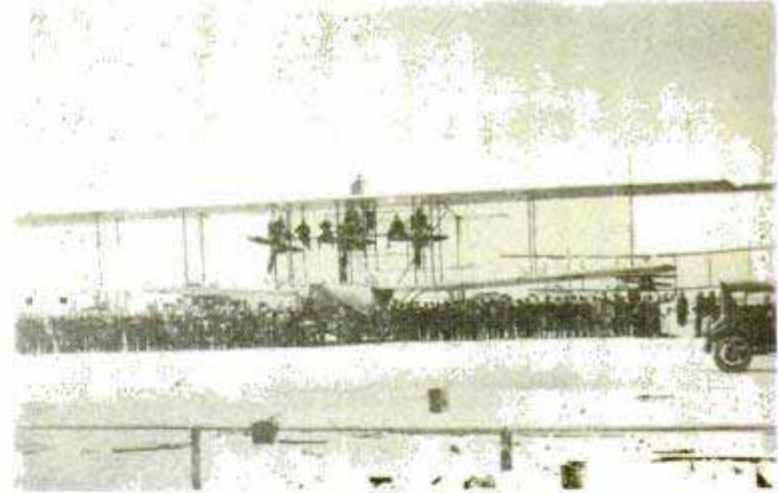
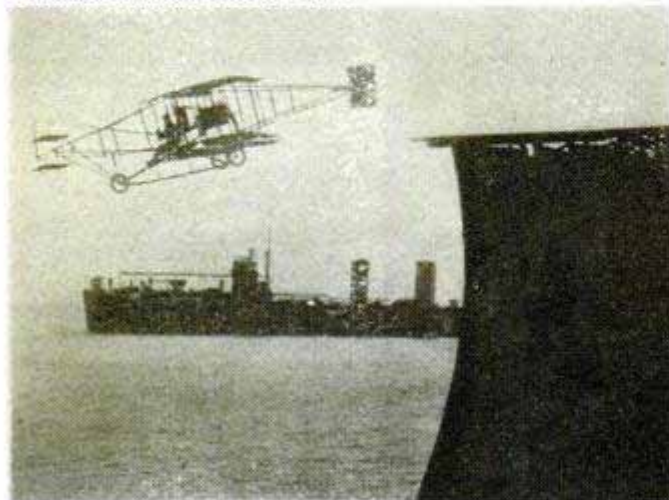

Trans-Atlantic flying was pioneered in 1919 by the NC-4, the first aircraft of any type to cross the ocean. Below, virtually every U. S. World War I pilot got his first taste of flying in a "Jenny" (JN-4D)

Curtiss-Wright photos



That is the kaleidoscopic view you get when you glance back over the short 50 years of aviation. An even greater rate of progress lies ahead in the next half century. Transportation through the air in the year 2000 is bound to be miraculous and spectacular.

Although we date man's ability to propel himself through the air in controlled flight back to the Wright brothers, Americans were interested in, and contributed to, aeronautics for 120 years before that historic event took place at Kill Devil Hills, near Kitty Hawk, N. C. Benjamin Franklin was probably one of our first aviation enthusiasts. His correspondence in 1783 and 1784 indicates not only a keen interest in the mechanics of the gas-filled balloon, but a prophetic understanding of its future application in warfare. Before the United States Constitution was drawn up, Americans were flying.

A 13-year-old boy, Edward Warren, is believed to be the first American to soar above the earth. One June 24, 1784, he volunteered to make a flight in a captive balloon and took off from a site near Baltimore, Md. The balloon was built by a man named Peter Carnes. In November of the



Cargo compartment of a Fairchild Packet, above, has space nearly equal that of standard railroad boxcar



North American Aviation photo

Fastest of U. S. fighters in World War II was the F-51 Mustang, with a speed over 450 miles an hour

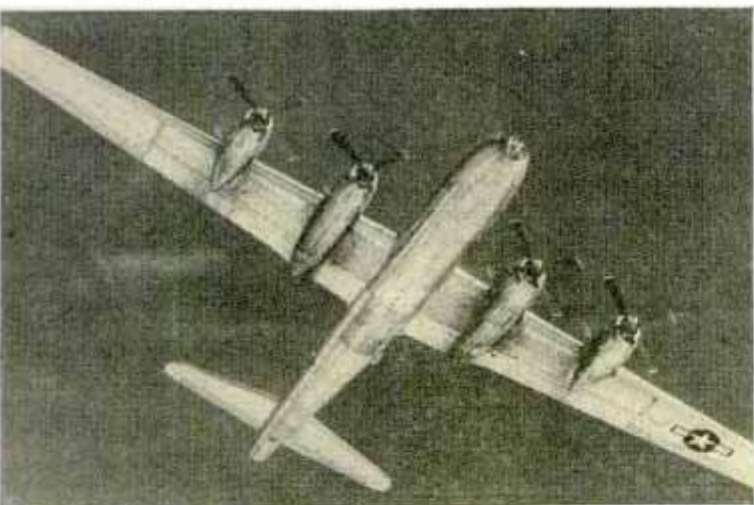

Boeing Aircraft photos

A study in rapid growth: By the time World War II ended, the largest U. S. bomber was the 120,000-pound B-29, above, double the size of the 1941 B-17, below



Republic Aircraft photo

Sturdy and heavily armed, F-47 Thunderbolts carried the brunt of much of the air fighting against the Nazis. Below, Marine-piloted Corsairs loaded 2000 pounds of bombs on long missions against Japanese

Chance Vought Aircraft photo



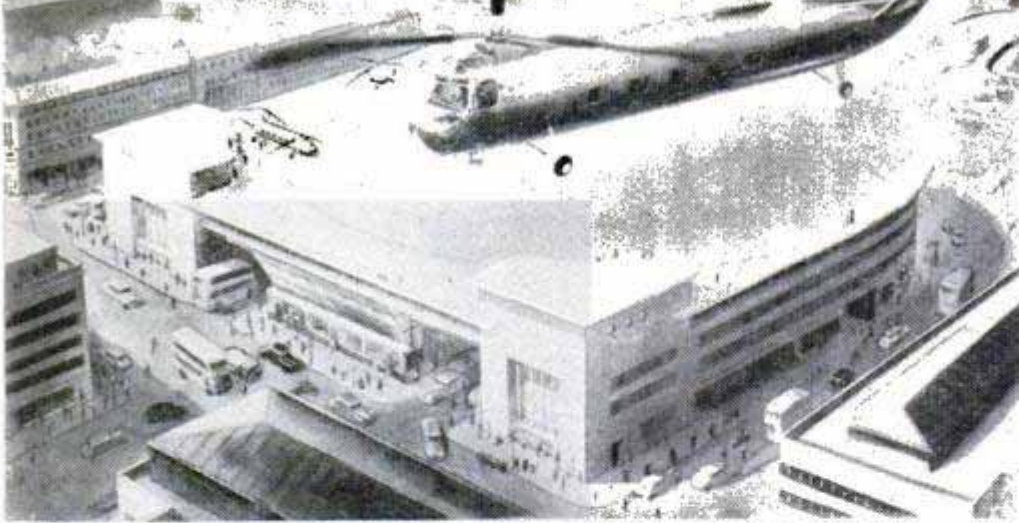

Along with their growing military usefulness, the author underscores the great potential role of helicopters in carrying passengers between airports and the business districts. This is the Air Force's concept of the helicopter's future use

same year, Dr. John Jeffries of Boston sailed across the English Channel in a balloon with Pierre Blanchard, a Frenchman.

During the 35 years leading up to the 20th century, there were increasing numbers of persons who conceived and patented different types of flying machines, ranging from flying steamships to aircraft with flapping wings. During the 1880s and 1890s, experiments with gliders were carried on by Octave Chanute in Michigan and John J. Montgomery in California. These two probably paved the way for the final invention of the airplane. Montgomery is reputed to have soared aloft as early

as 1883. It is an established fact that he made numerous successful flights at Otay Mesa, Calif., in subsequent years. Chanute's book, *Progress of the Flying Machine*, stirred the imaginations of a number of practical men.

Among these were Prof. Samuel P. Langley, assistant secretary of the Smithsonian Institution, and two brothers, Wilbur and Orville Wright, who operated a bicycle-repair shop in Dayton, Ohio. Langley succeeded in building a 13-foot model which flew successfully with a miniature steam engine, but his man-carrying machine of similar design crashed into the Potomac on

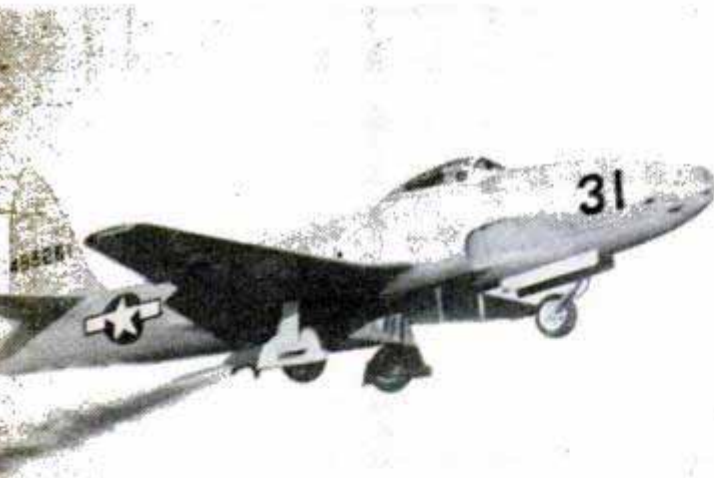

First operational U. S. jet was the Lockheed F-80, in the 600-mile-an-hour class. It was the workhorse of early fighting in Korea. Below, holder of the world's speed record, 670 m.p.h., is the swept-wing F-86 Sabre
North American Aviation photo



Two of the Navy's most powerful shipboard aircraft. The jet unit of the Grumman Panther, above, delivers 6250 pounds of thrust. The McDonnell Phantom, below, in 1946 became the first twin-jet carrier fighter



two futile endeavors to launch it in 1903. Orville and Wilbur Wright experimented with controllable box kites and gliders until they felt certain they could handle similar craft in powered flight. Not until then did they go about designing and building an engine for their airplane.

It is history that Orville Wright made the first test flight December 17, 1903. He traveled approximately 120 feet and damaged his machine upon landing. The original flight didn't equal the wingspan of a modern four-engine airliner. But don't forget that both Orville and Wilbur had to learn how to fly after they were airborne.

America and the world did not take to the air overnight after the Wright brothers made their flight. As a matter of fact, during the entire year of 1904 the total flying time of the brothers combined was only 45 minutes, although they built a second airplane. The next year they made 50 flights, but during the year 1906 they did no flying whatsoever, devoting all 12 months to perfecting a new engine having vertical, rather than horizontal, cylinders. At the end of 1907 only seven men in the U. S. had flown. In addition to the Wright brothers, they were A. M. Herring, F. W. Baldwin, Lt. Thomas Selfridge, Glenn H. Curtiss, and J. A. D. McCurdy.

(Continued to page 350)



Douglas Aircraft photo

For more than a decade earlier versions of the DC-3, above, were the backbone of U. S. air transportation



Latest models of the graceful Lockheed Constellation, above, have a cruising speed of more than 330 m.p.h.



Northrop Aircraft photo

One of the most unusual planes ever to fly was the pusher-type B-35, with a 172-foot wingspan and a length of 53 feet. Years of popularity won Piper Cub, below, description of "Ford of private flying"



On a flight from Honolulu to California, a 72½-ton Martin Mars, above, carried a record 144 passengers. Below, developed from the wartime B-29, double-decked Stratocruisers are pressurized for high altitudes

Boeing Aircraft photo



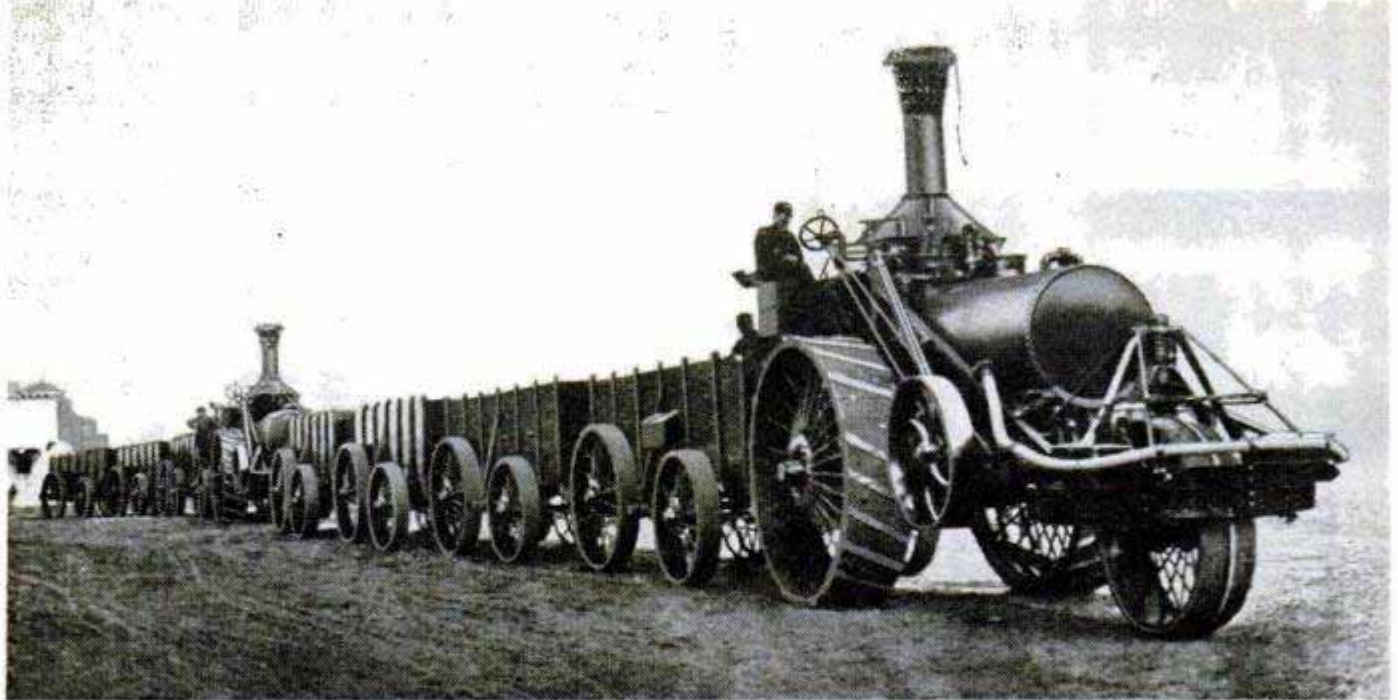

THE BEGINNING OF THE HORSELESS AGE



We have already crossed the threshold of the horseless age. Not that the time will ever come when the inborn love which man possesses for the horse will cease, nor horses entirely disappear from the boulevard, and town and farm; but henceforth machinery will perform the heavy work now done by animal power, just as the harvesting machine has taken the place of the sickle. The largest displacement of horses thus far was when street railways adopted electricity to operate their cars. To do the work performed by the trolley cars of the United States today, would require not less than 300,000 horses or mules, and these would have to be replaced every four years.

Automobiles propelled by steam, gasoline and electricity are already in use by thousands, and that village is far remote where at least one of these flying roadsters has not been seen. This week we illustrate several types of machines built for practical work.

California is a state of magnificent distances. Its railroads are few and far between as yet. To reach the nearest shipping point, hundreds of farmers must team the

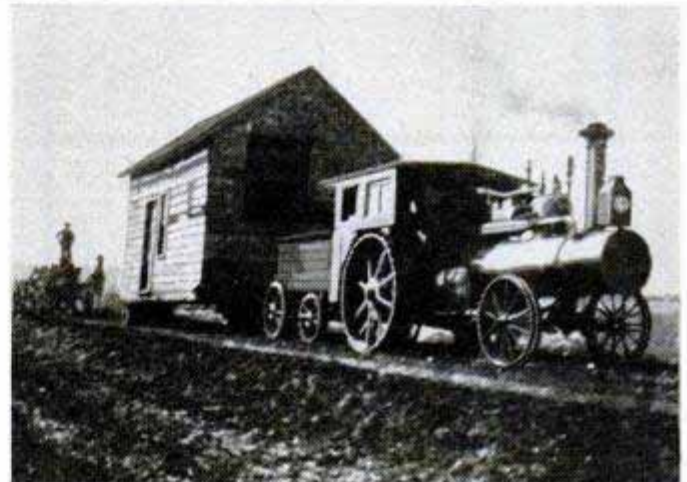

grain and other products of thousand-acre farms many miles. This has resulted in the construction of thousands of miles of the finest highways in the country. Many of these roads are kept sprinkled at public expense for seven months in the year. The common method of hauling is in wagon trains of six or more big wagons, fastened one behind the other, and drawn by 16 to 20 horses. Two men constitute the crew. Travel is mostly by night when the air is cool. One of these trains carries upwards of 25 tons, and makes three to four miles an hour.

Keyless Clocks Available for Telephone Subscribers

1907—The good old-fashioned clock operated with weights or springs is being crowded out of existence in these electrical days, and is rapidly becoming a curiosity. Telephone companies are now furnishing their subscribers, at a small annual rental, self-winding electric clocks that give absolutely accurate time. The clock, or clocks, can be placed anywhere in the house and

are connected to the telephone wires by means of concealed wires. The telephone clock never stops, for it never runs down. Should it vary a second or two in the course of 24 hours, it will be correct again within a few hours, for once each day all the telephone clocks in the city are synchronized. This setting is done from the central office at an hour when the phone is least used.

Airship Versus Passenger Engine



An airship race from New York to St. Louis during the coming World's Fair has been proposed by a New York aeronaut. This, it is claimed, would give the entire country lying on the route between the two cities an opportunity of witnessing the ships in flight and would prove the most sensational race in history. Of course, there is no airship at present that would undertake the long journey, but Santos Dumont claims that he will have a craft in readiness by the time of the World's Fair that can safely fly across the American continent.

The same claim is made by Professor Stanley, who is building the monster aluminum airship in San Francisco, and by a Chicago aeronaut.

While some of the inventors say that their ships will be able to double the speed of a passenger train in the race, the New York Central officials say they have no fears of anything that flies, walks or rolls, making better time than the 20th Century Limited, the fastest long-distance train in the world. The suggestion has been made to enter the Limited in the race, should it materialize. The accompanying illustration shows the relative position of the racers as they would appear at the end of the fifth

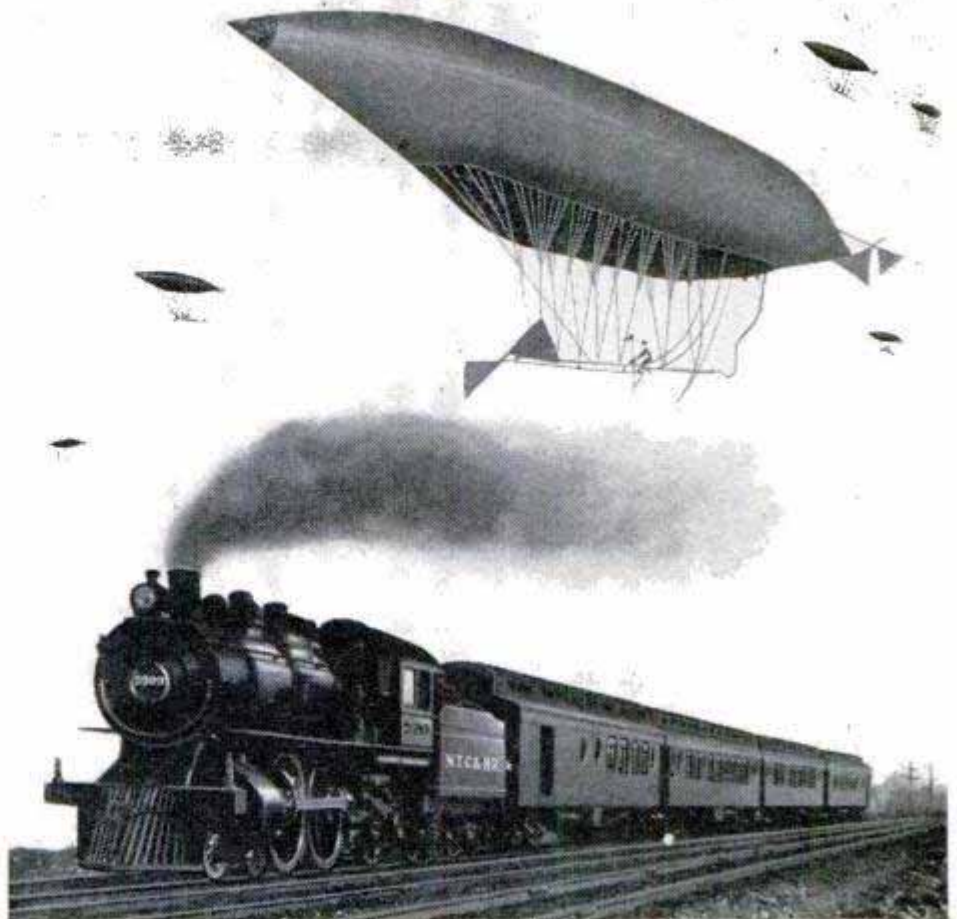

mile, according to the calculations of railway engineers, who claim they have made due allowance for the increased speed capacity that may be attained by the new airships yet to be built. The train leading the racers is the famous 20th Century Limited; pressing close behind is Santos Dumont's airship being propelled by the renowned aeronaut. Next in order is Spencer's aerial craft; next Stanley's and others are "also rans." Of course, this all comes from the fanciful dreams of railways officials; but things that looked stranger than this vagary have come true, and it may be that scenes like the one above will become familiar sights to persons even now living.

Motor-Drawn Vehicle Replaces Fire Horses

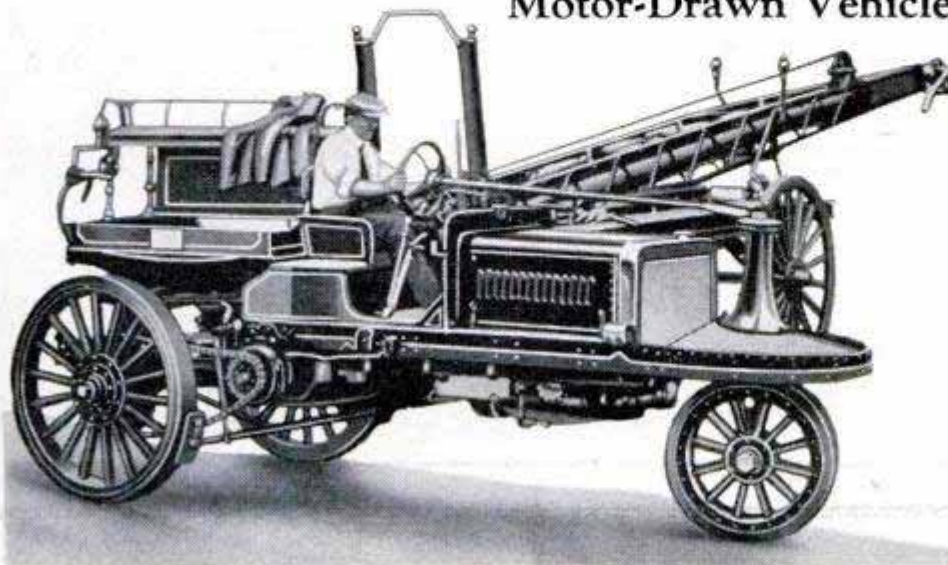

1912—A horse-drawn water-tower of the Springfield, Mass., fire department has been converted into a motor-drawn vehicle. A single front wheel, mounted on the apparatus in place of the front truck, makes it possible for a complete turn to be made with the vehicle on a pavement that is only 30 feet wide. The over-all length of this tower and motor car is 57 feet.

Dawn of the

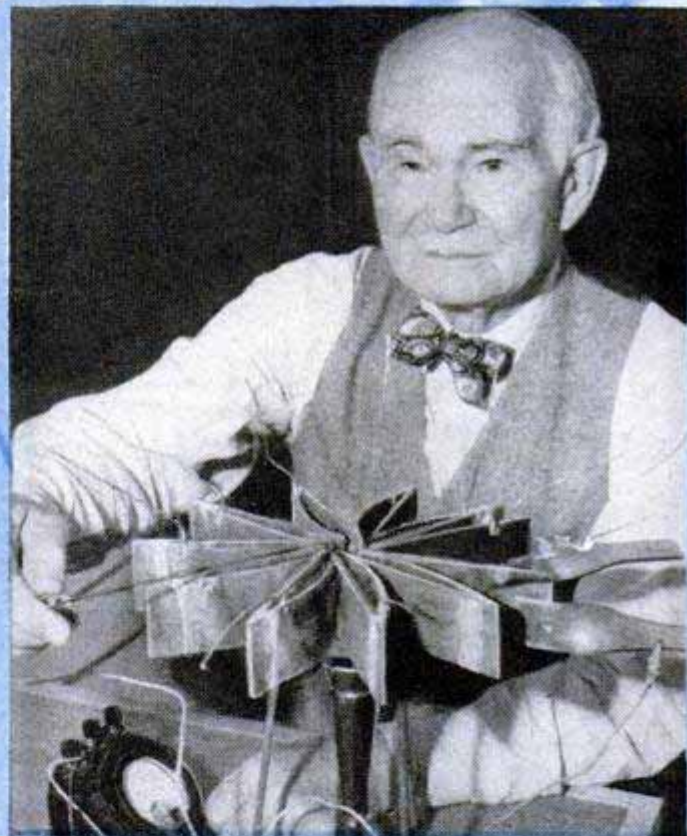

Lee deForest writes of the electronic age, which began in 1906 when he invented the three-electrode tube

With the giant antenna, at left, Army Signal Corps engineers made the first radar contact with the moon in 1946, only 40 years after the electron tube was invented by the "Father of Radio"

Electronic Age



DeForest's patent of a "device for amplifying feeble electrical currents" is one of most valuable ever issued

By Lee deForest
("Father of Radio")

WHEN VOCAL SOUND first became articulate the ancestor of man leaped suddenly from the dumb shackles of the brute. The first crude sign writing, whereby thoughts might be recorded, helped to bring scattered men and tribes into social units and establish contact with future generations through the permanency of the written word. For ages, ecclesiastics maintained a monopoly of reading and writing. Then came movable type and the printing press of Gutenberg. Reading and writing became common heritage. The postal service followed, fostering a moderate exchange of thought between people. Ancient Greeks developed a crude method of heliograph for military signaling. Then flags by day and fires by night conveyed information over wide distances. Later, the system of signaling by semaphore devised by Claude Choppe during the French Revolution blazed the path leading to the electric telegraph of Morse. Scarcely more than a cen-

tury ago came the first telegraph, an instantaneous means for communicating over great land distances, followed by the submarine cable for spanning the oceans. Bell, experimenting with a new form of telegraphy, came upon the telephone, and as a result business and social life were immeasurably increased in tempo.

Late in the 19th century, wireless telegraphy entered the communications field,

Right, from the crude sets of early radio (three are seen here with the Audion tubes mounted on their front panels) to the magic of radar and television, the electron tube has been the heart of each instrument





U. S. Army photos

Above, halfway up a Korean mountain, this Army radio operator uses a complex VHF receiver-transmitter. Left, his 1904 counterpart takes down a radio message on an early receiver at Fort Mason



first as a means of spinning threads between ships and shores, and robbing the sea of its sinister silence; later as a practical means of transoceanic communication. Inspired by the classical formulas of Maxwell in England, Hertz in Germany in the 1880s discovered electromagnetic waves, proving them akin

to light waves but of vastly longer wavelengths and lower frequencies.

Although signaling by means of these hertzian waves, generated first by a condenser discharge across the crude spark gaps of Hertz, Marconi, Lodge and others, and controlled by the telegrapher's key into dots and dashes of the Morse code, preceded by 10 years the advent of the radio tube, those historic crudities could scarcely be considered as properly belonging to the electronic age.

By common consent today, that era was born with the discovery that electrons traveling across an evacuated space could readily be controlled by a simple grid electrode interposed between the electron emitter, a heated cathode, and a cold plate connected to the positive terminal of a battery, preferably of low voltage, its negative electrode being connected to one



Below, Dr. Vladimir Zworykin and a reflected-image television set he made in 1929. Left, today's TV cameras are literally jammed with electronic tubes and parts



In 1916, DeForest went aloft in this plane, making what is said to have been the first time radiotelephone was used in a plane. It was so successful the Army ordered two sets



end of the filamentary cathode. In that so-called "B," or secondary, circuit was inserted a signal-indicating device, usually some form of telephone receiver; later a loudspeaker was used.

The date of my discovery of this small acorn from which has sprung the gigantic oak that is today world-embracing, was the latter months of 1906. But it was not until 1912 in Palo Alto, Calif., that the Audion was used as an amplifier, first of radio signals, then for long-distance telephone communication. This rediscovery was made just in time to render possible the fulfillment of A. T. & T.'s contract with the Panama Pacific World's Exposition to establish transcontinental telephone service between New York and San Francisco before January 1915. Later that year the Western Electric Company, now further licensed under the Audion-amplifier patents, succeeded in transmitting by radiotelephone the human voice from Arlington, Va., to

the Paris Eiffel Tower, and also to Honolulu, more than 6000 miles distant.

This gigantic step in radio speech was made possible by the discovery, also in Palo Alto in 1912, that the Audion amplifier, when properly connected in a "feed back" circuit, became an oscillator or generator of alternating currents of practically any frequency, numerically dependent upon the dimensions of the circuit elements that were involved.

That invention of the oscillating tube and circuits began forthwith to force into disuse the spark-gap, open, rotary, or quench types, and also high-frequency alternators. Today the use of the tube oscillator is universal, found in every radio and television station for the generation of long, short, or "ultra short" waves around the world.

No greater influence has been at work in molding our civilization than the telephone. Today we have some 50,000,000 telephones installed throughout the world, connected

U. S. Navy photo



Westinghouse photo

Above, two early experimenters in the beaming of radio waves use a highly polished reflector behind an antenna. Experiments such as these led to the subsequent development of the radar

Crude as its beginnings were, radar is today complex beyond the understanding of the layman. Some radar antennas on the island of the U.S.S. Hornet give a clue as to its value

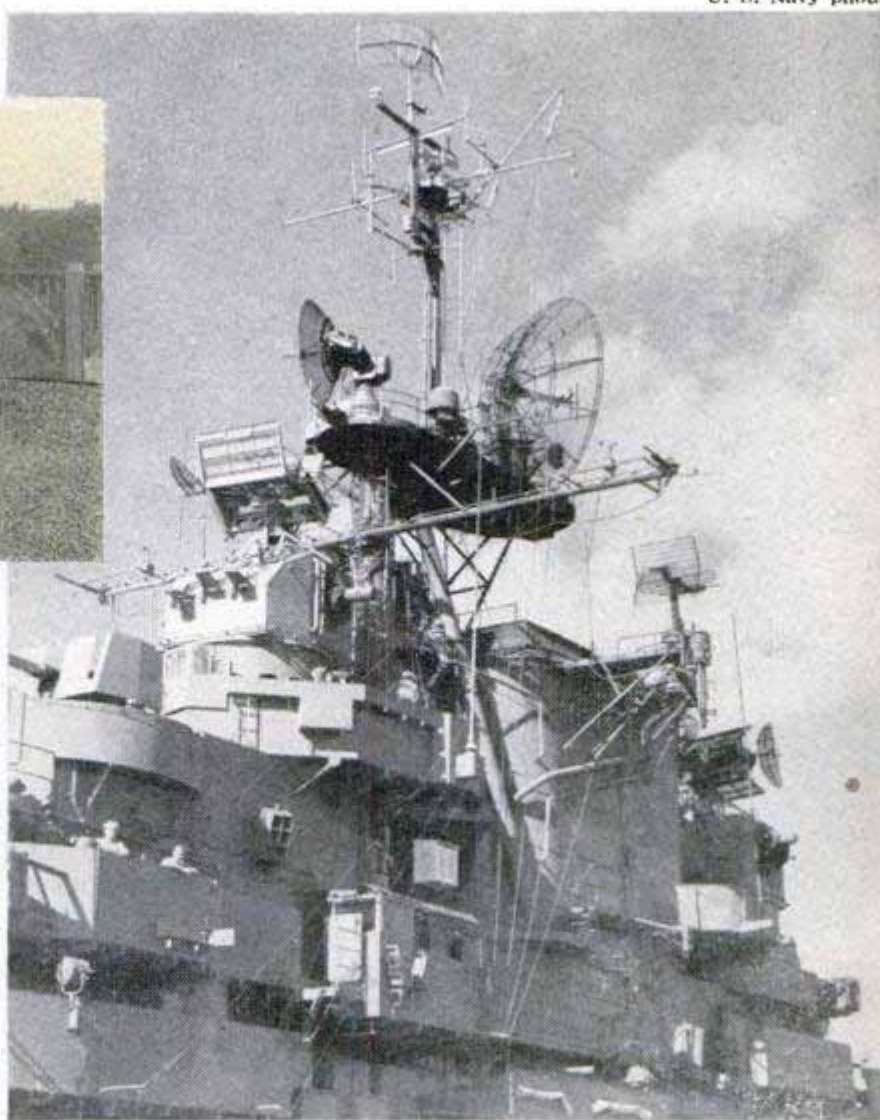

by some 100,000,000 miles of wire and unnumbered miles of "etheric" linkage. And in all telephone lines today longer than 50 or 75 miles you will find electron "booster" tubes so that one can speak from Los Angeles to Paris with the same voice volume as used in local calls.

The actual poetry of this engineering triumph was first brought stunningly upon me in 1915 when I sat in an audience in San Francisco and heard the breaking of the surf upon the far Atlantic shore. There our modern sophisticated generation was able to appreciate for the first time the deep significance of that historic phrase, first signaled over Morse's wire: "What hath God wrought?"

During its early years there was every indication that radio would be employed mainly for military purposes. The Navy and then the Signal Corps were for years its chief proponents. Then the widespread clan of radio hams, or amateurs, tiring of dot-dash conversation reached eagerly for the new implement, the Audion, and soon global conversations began. It was such hosts of young pioneers in the short-wave ocean of space, after the long waves were officially denied them, that demonstrated

the unexpected ability of such high frequencies to span the globe and to reach out into empty space. Thus instructed, every effort was hastened by the radio engineer to speed up transoceanic service. Soon we had fast facsimile, followed by unbelievably accurate transfer of photographs.

Today photographs, drawings, fingerprints, printed matter, handwritten and typed messages, business and legal documents are flashed across the sea in facsimile form and accepted at their face value. Thus a new business day opens when a person in New York can sign his name to a document in Japan or Berlin within the hour.

The microphone-amplifier-loudspeaker combination is having an enormous effect on our civilization. Not all of it is good! Consider to what heights of impudence and tyranny, and to what depths of moral depravity, has radio broadcasting and the loudspeaker attained in that recent monstrosity, Transit Radio, Inc. Almost incredible is the loathsome fact that already in 21 cities bus riders must listen to never-ending, blatant advertising and unwelcome jitterbug and bop music, "viciously repugnant to the spiritual and intellectual assumptions of American life," as Prof. Charles

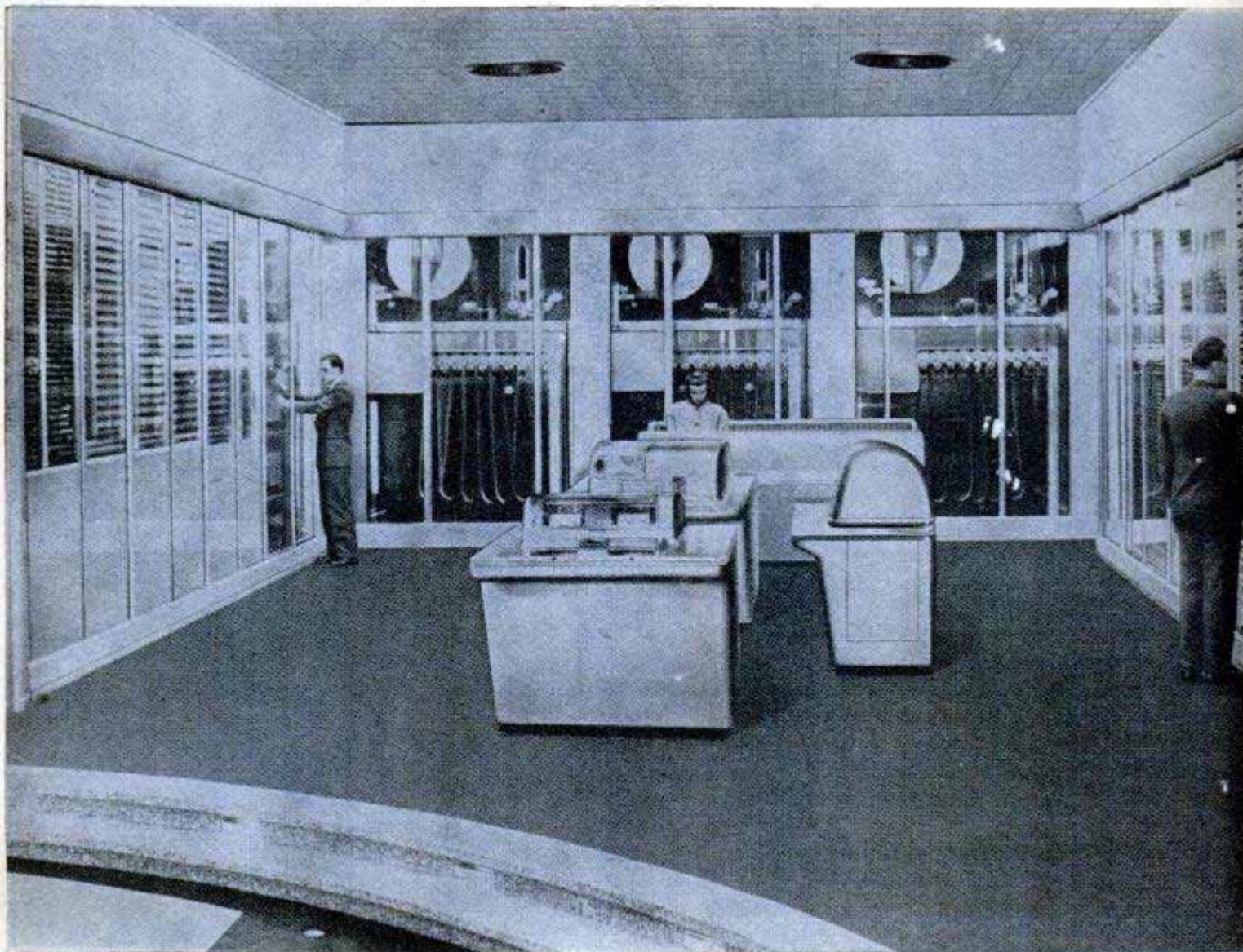

Black of Columbia University wrote. This outrage is unquestionably the all-time low to which radio broadcasting can sink.

Such crimes notwithstanding, it is questionable whether science has contributed in one single instance more to present and future civilization than it has in the gift of broadcasting. In 1907 I began to build radiotelephone transmitters for the United States Navy. In testing these devices I placed their output "on the air" and played phonograph records by the hour. The tests attracted widespread attention and gave me the idea of mass communication or "broadcasting." Three years later Caruso's voice was broadcast from the

(Continued to page 358)

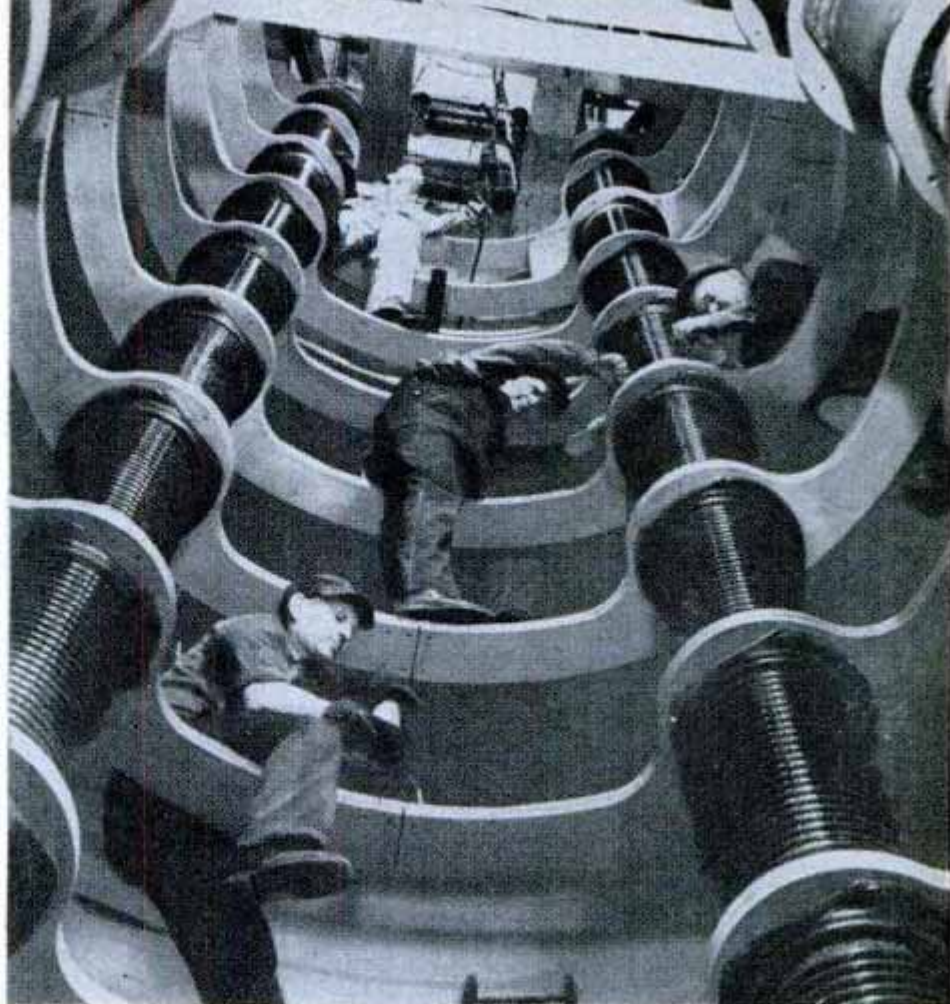

Westinghouse photo

Electron tubes are vital to much research. Without them, atom smashers like this wouldn't exist

From the first three-electrode vacuum tube, which DeForest made in 1906, have come such electronic marvels as the big selective-sequence calculator
IBM photo

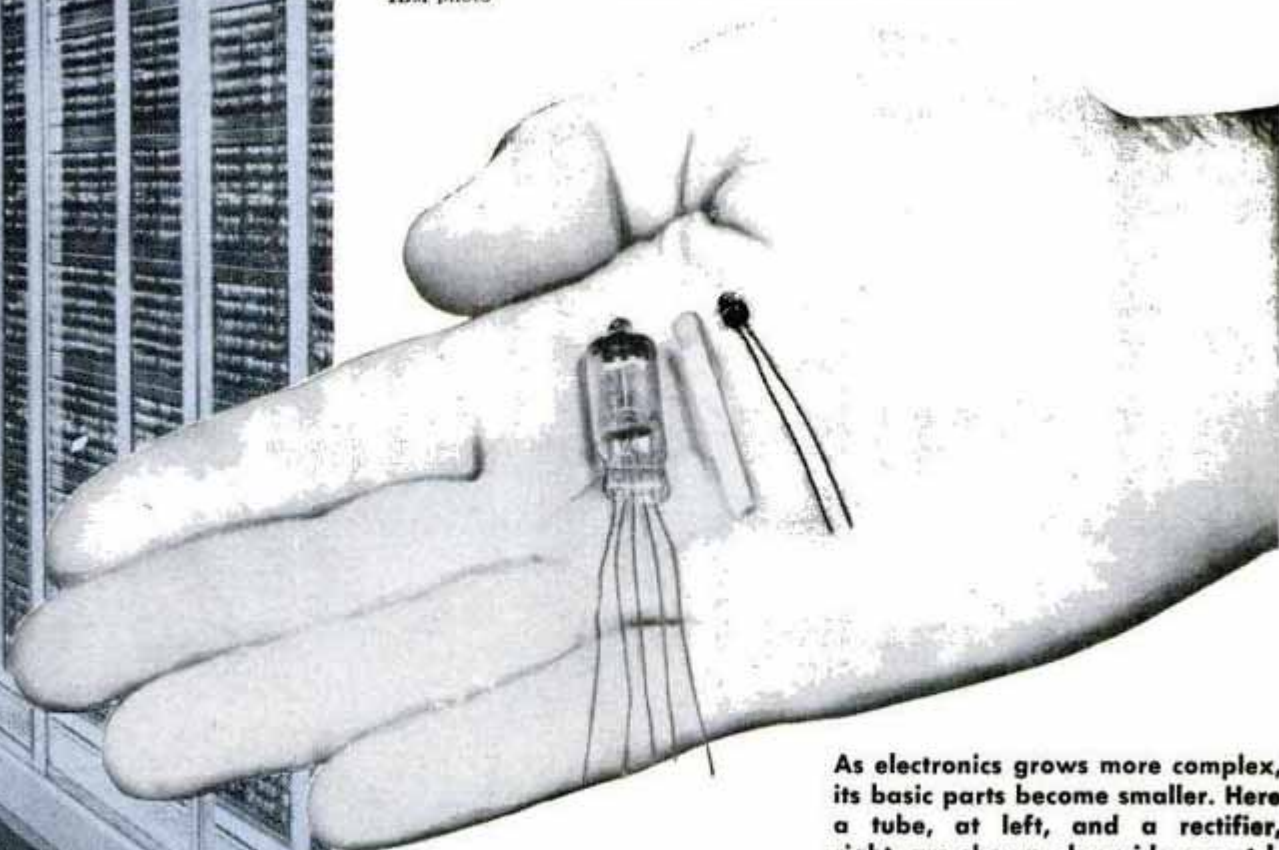

As electronics grows more complex, its basic parts become smaller. Here a tube, at left, and a rectifier, right, are shown alongside a match

**What WAS New
for Your HOME
when Popular Mechanics
was young**



Back in 1920, PM's pages reported that the lady above brushed dust from her garments with a new rotating electric brush regulated by a handy toe switch

The de luxe coal-burning range with an attachment for gas was quite a sensation in gala pre-World War I days. A chute to the cellar handled the ashes

Roll-away beds were the rage in 1916, and beds popped out of 'most anything. This desk-bed pushed back out of sight under elevated floor in adjoining room

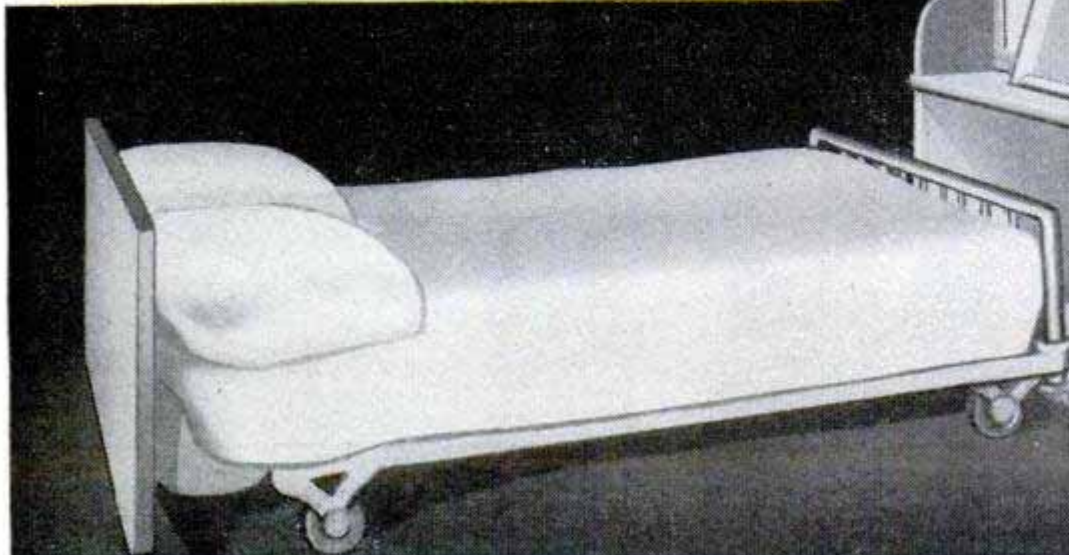
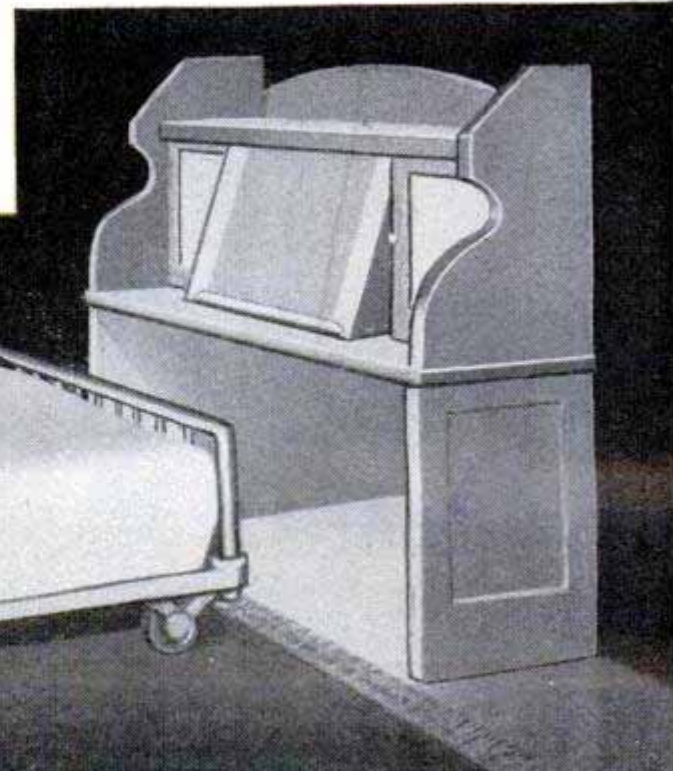
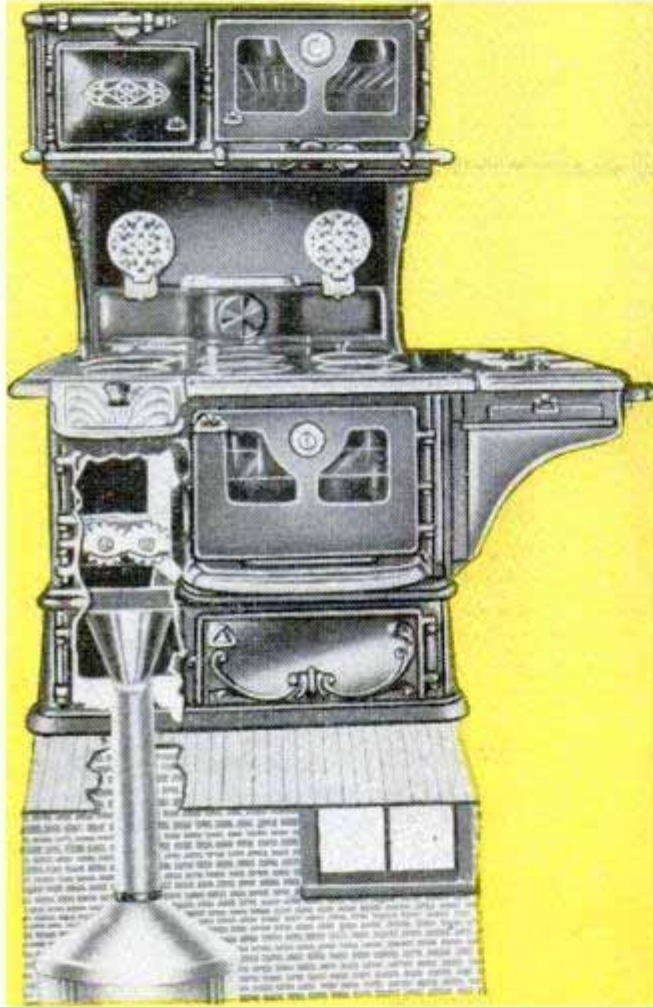



No home was complete in 1915 without a hammock and the one above rated an article in PM with its new-fangled stand-up feature. The reason? Feet could be rested on the ground without twisting body to side

There's muscle under the left sleeve of the lady at the right with the 1911-model vacuum cleaner. She had to pump the bellows with one hand while guiding the suction nozzle with the other. Notice harness

Below right, an early type electric dishwasher was introduced in 1920. It had a paddle wheel to throw hot water on the dirty dishes, and when the unit was closed up (inset) it served as a handy work table

Below, the latest thing in washing machines in the early '20s was this model with a reciprocating cone in the center to keep the clothes from massing together, and assuring a good sousing in the hot suds

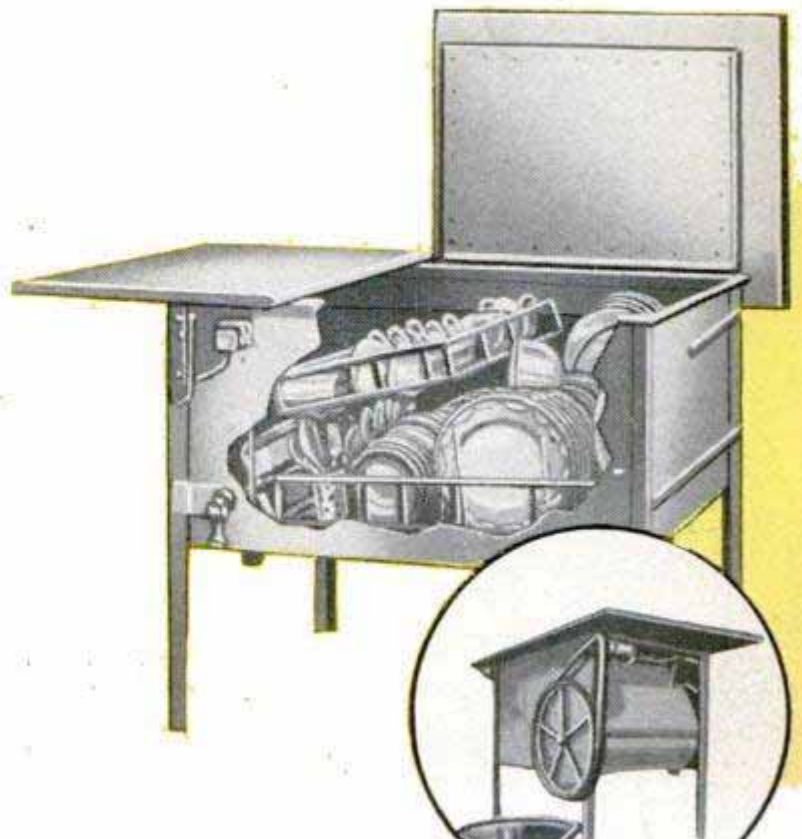
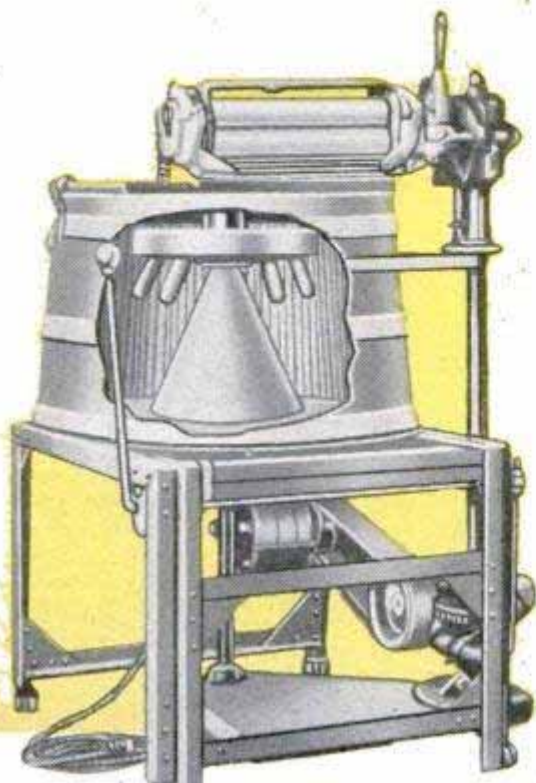

What WAS New for Your HOME when Popular Mechanics was young



A 1914 article introduced a new toaster to turn bread automatically by merely turning a knob on patented frame

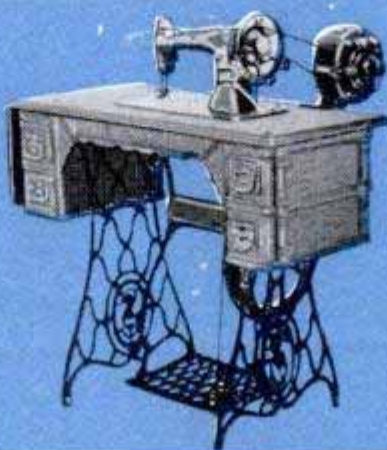

The floor polisher and sweeper, at left, and the sewing machine with an electric motor, above, were 1908 examples of how electricity was heralding the day "when the weary duties of daily housekeeping should be relieved of their terrors." The porch lamp, above, has a bug screen below the shade. Below, the bobbed-haired 1925 "flapper" is demonstrating her completely modernized kitchen with a roller cabinet that tucks under the sink, and the shelves just above. And that was only 26 years ago!

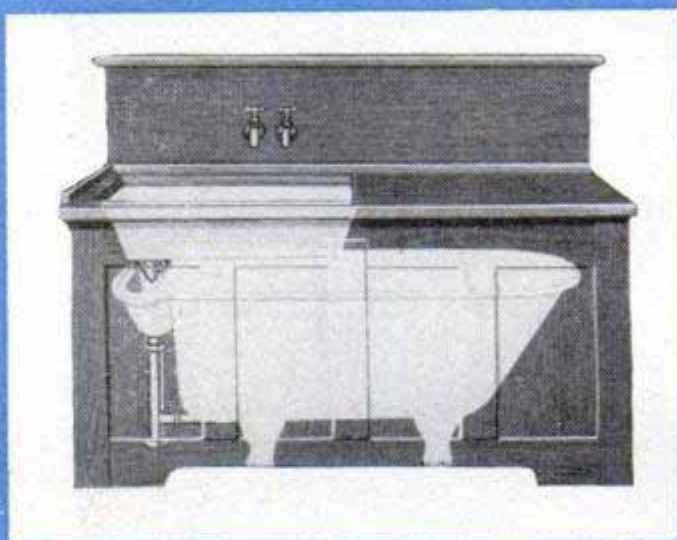

Just the thing for the Saturday-night bath in 1916 was this tub concealed under the kitchen sink. The cabinet had to be moved, however, to get into tub



Sliding drawers on this refrigerator featured in a 1925 article eliminated stooping and were easy to clean. A neat item was the water bottle on the top



This small electric range which plugged into a wall socket made its bow in PM's pages in 1920. A double element in oven permitted four cooking operations

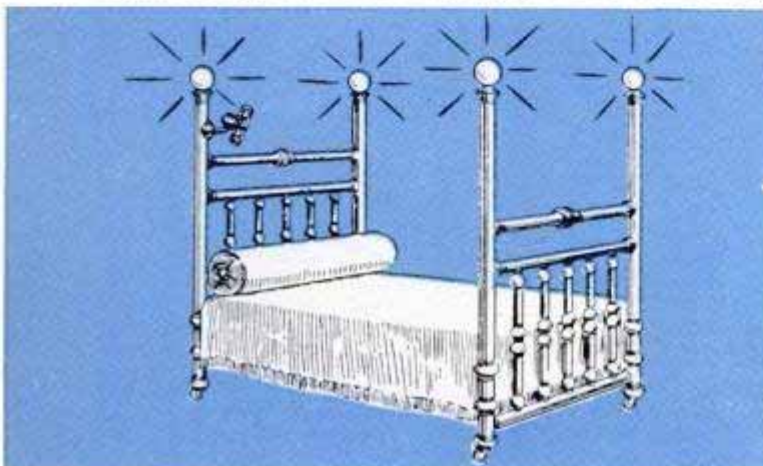

Electricity ran wild back in 1912 and a Cleveland company turned out the brass bed, above, with light bulbs on all four posts, electric fan and heat pad

An elegant import from France in pre-World War I days was the silvered fly screen, below, to be set over dishes of food. The lamp has a side reflector

The happy housewife below has just discovered the new 1920 model "drier." The hook shown in detail was clamped to the edge of the tub while milady twisted

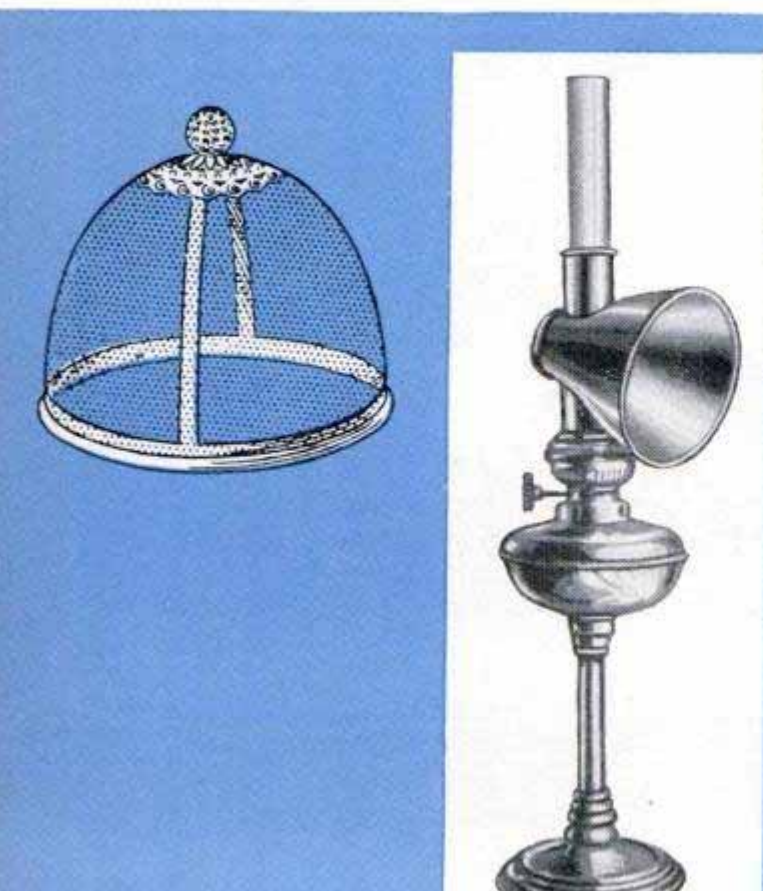

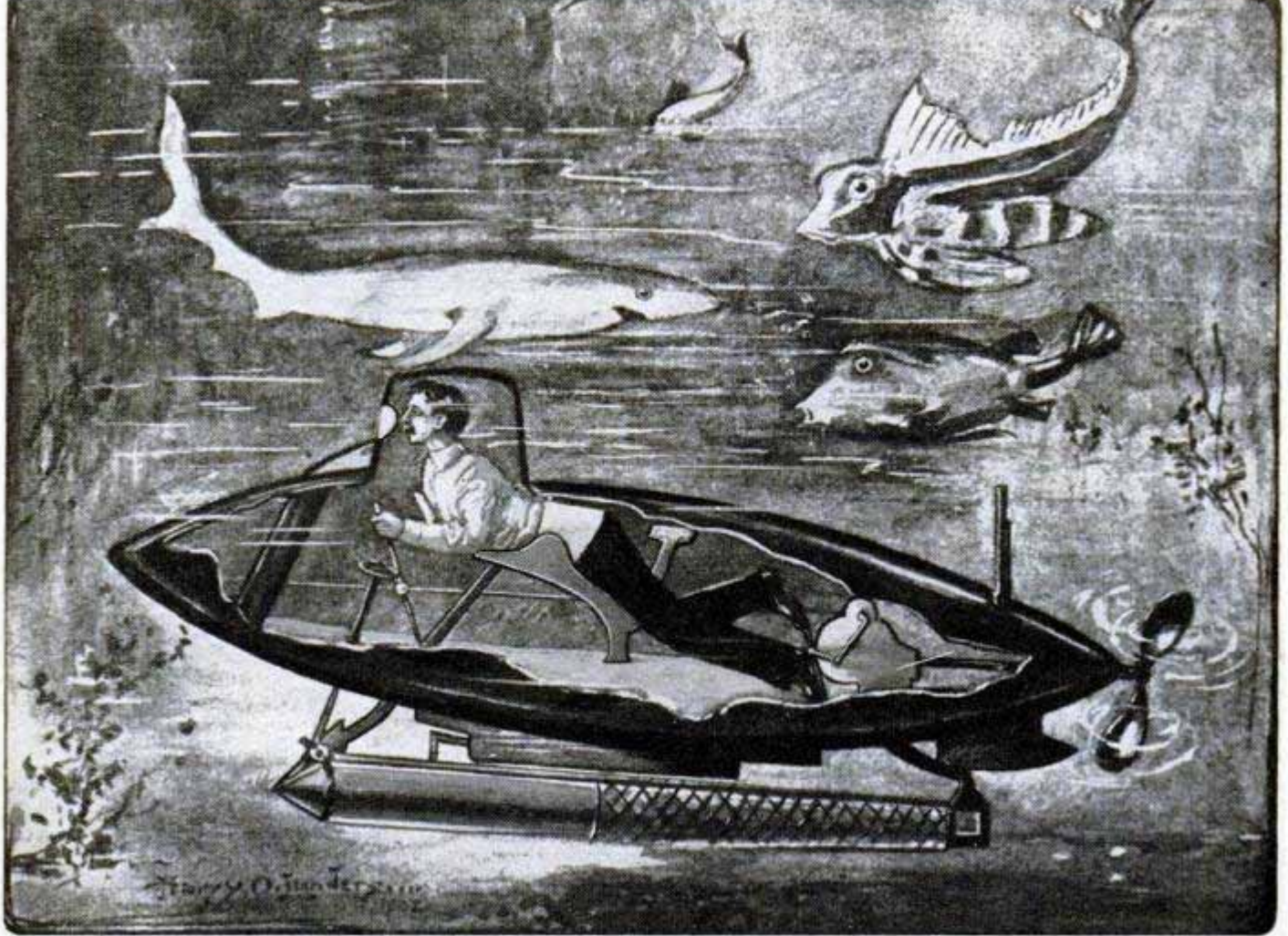

ONE-MAN SUBMARINE TORPEDO BOAT



A new terror of the deep has made its appearance in the form of a torpedo boat, only 11 feet long, built for one man only, the inven-

tion of Thomas J. Moriarty, of the Newport Manufacturing Company, Newport, R. I. It can dart about on top of the water, under the water, and defy the most tempestuous seas.

The greatest war vessels of the earth's power would be at its mercy in the event of war. With no danger of detection, the tiny boat can slip down, plant a torpedo on the bottom of the largest man of war, make its escape and rise to the surface again in time to see the iron-clad monster be blown into fragments.

Looking like a fish as it glides about on the surface, it can drop down into the ocean's depths and change its course at the operator's will. It will open up anew to man the mysteries of the deep and make him at home in the realm of the fishes. To the water it is what the perfected flying machine will be to the air.

Almost as long as man has been trying to invent a flying machine he has been trying to invent a one-man submarine boat, but this is the first time he has succeeded in

devising such a boat—one that will delve into the mysterious deep, rise and sink at the will of the operator. "The boat is guided, submerged and controlled by one person only," says the American Ship-builder, "and is provided with a conning tower about the size of a bucket. The operator rests in an inclined position on a padded frame. This position gives free play to his legs in operating the pedals connected with the propeller shaft. The man keeps his head in the conning tower, which is provided with a glass front through which he can observe his course and objects about him. Two handles, connected with the propeller shaft, are in easy reach of his hands."

In addition to the foot and hand power, there is a little engine, also connected with the propeller shaft, which is utilized for moving the boat. A submersion tank permits the boat to be submerged until the base of the conning tower is level with the surface of the water. Four movable fins enable the boat to rise or plunge beneath the surface when in motion.

A torpedo, suspended in a casing beneath, serves as a keel. When this has been discharged, a collapsible keel is let down from a recess in the bottom of the boat.

POPULAR MECHANICS
FIFTIETH ANNIVERSARY

HALL OF FAME

1902-1952

FROM THE VANTAGE POINT of a half century during which *Popular Mechanics Magazine* has observed and reported the noteworthy accomplishments in the fields of mechanics, the sciences and discovery, its editors pay tribute in this Golden Anniversary Hall of Fame to 50 Americans, native or naturalized. These are the men whose achievements in these fields have contributed in such high degree to the welfare of mankind as to deserve signal honor of their fellow men. There are other men of eminence whose lives reached into the 20th century but whose significant work occurred before 1902; these have been omitted from this roll of honor. Throughout the years, the pages of *Popular Mechanics* have reflected the accomplishments of every man on this distinguished roster.



Carl D. Anderson

For his discovery in 1932 of the positron, a part of the atom, which was a vital contribution to new research on the structure of matter. Faculty member, California Institute of Technology, Pasadena



Edwin H. Armstrong

For his inventions as an electrical engineer in the field of radio; FM static-free radio, 1939; super-regenerative circuit, 1920; superheterodyne, 1918, and others. Faculty member, Columbia University

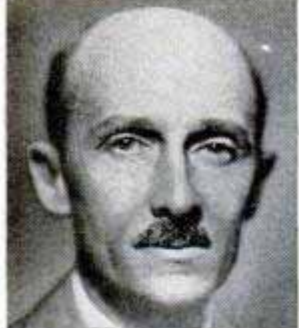

William Beebe

For his explorations in which he has given man a glimpse into new frontiers; for his descent into hitherto-unknown ocean depths in the first bathysphere; and many other contributions in zoology



Ewing Galloway

Richard E. Byrd

For explorations in the Arctic and Antarctic; for flights over the North Pole (1926) and the South Pole (1929); for the discovery of great land areas in the Antarctic and his solitary 5-month vigil



Hugh H. Bennett

For his work in soil conservation, which for generations to come will be a boon to agricultural nations; for founding the Soil Conservation Service, Department of Agriculture, of which he is chief



George W. Carver

For his work as an agricultural chemist in helping revolutionize agriculture in the South; for the creation of new products from peanuts, soybeans, sweet potatoes and cotton stalks. Died in 1943



Hans A. Bethe

For basic research in theoretical physics; for his theory of atomic nuclei; for his discoveries on the energy production of stars; for his shock-wave theory. Faculty member, Cornell University, Ithaca

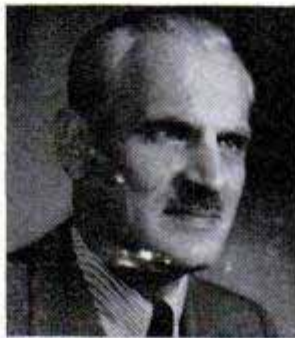

Arthur H. Compton

For directing the work at the University of Chicago which resulted in the first atomic chain reaction; for important discoveries on X rays and also on cosmic rays. Chancellor, Washington Univ., St. Louis, Mo.



Percy W. Bridgman

For discoveries on the physical effects of high pressures; for research on the electrical conduction of metals and the properties of crystals. A member of the faculty, Harvard Univ., Cambridge



Karl T. Compton

For his discoveries in the field of electrical discharges; for research on the harnessing of atomic energy; for leadership of development board, Nat'l Military Establishment. Chairman of Corp., M.I.T.



Luther Burbank

For the creation of new fruits, grains, grasses, vegetables, flowers and trees; for his work on the crossing and selection of plants which he conducted until shortly before his death in 1926



Glenn H. Curtiss

For pioneer work in the development of aircraft; for his Navy-Curtiss flying boat which made the first flight across the Atlantic Ocean in 1919; for building World War I planes. He died in 1930



Vannevar Bush

For his work as director of the Office of Scientific Research and Development in coordinating war research for an electrical superpower system and many inventions. President, Carnegie Institution



Lee deForest

For the invention of the radio tube and 300 other inventions in wireless, telegraphy, radiotelephone, wire telephone, sound-on-film talking pictures, facsimile and the television. Los Angeles

**Albert Einstein**

For his theories of relativity, on which all atomic research is based; for revolutionizing mankind's ideas of time and space; for his law of photoelectric effect. Faculty member, Princeton University

**George E. Hale**

For research in astronomy on solar and stellar spectroscopy, depths of the universe and the stellar evolution, for his work as organizer and director of Mt. Wilson Observatory, Pasadena. Died in 1938

**Lincoln Ellsworth**

For polar exploration; for Amundsen - Ellsworth Nobile transpolar flight in 1926; Antarctic flight, 1935, when he claimed 300,000 square miles of new land for the United States. He died in 1951

**Edwin P. Hubble**

For his theory of the expanding universe and for other research on outer space; for work on the design of 200-inch Hale telescope at the Palomar Observatory. Cosmologist, Palomar, Mt. Wilson

**Enrico Fermi**

For discoveries in atomic research as pertaining to the magnetic moments of nuclei, beta-ray emission, artificial radioactivity as well as for devising the first atomic pile. Faculty, the University of Chicago

**Edward C. Kendall**

For research and discoveries in biochemistry; for isolation of thyroxine from thyroid gland and hormones of the adrenal cortex, also synthesis of the latter. The Mayo Clinic at Rochester, Minnesota

**Henry Ford**

For his pioneer activity in the automotive field; for his original assembly-line methods and mass production which made it possible for the average American to own an automobile. He died in 1947

**Charles F. Kettering**

For his pioneer work as automotive engineer and inventor; for the self-starter, lighting and ignition systems; for improved auto fuels; for nearly 50 years of vital research. Dayton, Ohio

**James Franck**

For research on energy exchange between electrons leading to discoveries in photochemical processes and in photosynthesis. A member of the faculty, chemistry, at the University of Chicago

**Morris S. Kharasch**

For work in organic chemistry, seed disinfectants and fungus diseases; for isolation of ergot; for his discoveries in antiseptics and hormones as well as in synthetic rubber. The University of Chicago

**George W. Goethals**

For his work as chief engineer and chairman of the commission which completed one of the greatest of engineering feats of all time — the Panama Canal. Colonel Goethals died in 1928

**Irving Langmuir**

For chemical research and molecular physics; for the development of the gas-filled tungsten lamp, electron-discharge apparatus, a high-vacuum pump, surface chemistry. General Electric Company



Ernest O. Lawrence

For his invention of the cyclotron and other vital machines for nuclear physics; for important research into the nature of the atomic nucleus. Director of Radiation Laboratory, University of Calif.



Robert E. Peary

For the discovery of the North Pole in 1909 after years of Arctic exploration; for his courage in proceeding on foot with a small group when most of his party had turned back. Peary died in 1920



Charles A. Lindbergh

For planning and executing the first solo flight across the Atlantic Ocean on May 20-21, 1927, in The Spirit of St. Louis; he flew 3600 miles in 33½ hours; for his inspiration to aviation development



I. I. Rabi

For discoveries in physics pertaining to magnetism in regard to molecules resulting in much new information in the atomic and molecular structures; also for radar research. Faculty, Columbia Univ.



Thomas Midgley, Jr.

For his discovery of the antiknock properties of tetraethyl lead, principal ingredient of the ethyl and the high-test aviation gasolines and vital to powerful modern engines. He died in 1944



John L. Savage

For outstanding work in civil engineering; for directing design and the building of Grand Coulee, Hoover and other dams and irrigation projects throughout the world. The Bureau of Reclamation



Robert A. Millikan

For his work in physics, including determination of fundamental electrical charge on the electron; for his research on the properties of cosmic rays. Prof. emeritus and v.p., California Institute Tech.



Glenn T. Seaborg

For discoveries and continuing research in nuclear physics pertaining to the elements heavier than uranium; codiscoverer of plutonium and others. Member of faculty, University of California



J. Robert Oppenheimer

For extensive research in nuclear physics; for his direction of the Los Alamos laboratory in New Mexico during the perfection of the atomic bomb; for work on Atomic Energy Comm. Princeton, N.J.



Alexander P. deSeversky

For the invention of the fully automatic bomb-sight, for airplane design, including a single-seat fighter plane, air-cooled engine with a turbo-supercharger for high altitude flight. New York City



Linus C. Pauling

For his resonance theory of chemical bonds; for his discoveries in the fields of physics, biology, chemistry and medicine; for atomic structures of protein molecules. California Institute of Technology



George H. Shull

For the development of hybrid corn, which has increased the annual corn crop by millions of bushels — believed to be one of greatest food boons of modern times. Faculty member, Princeton Univ.



Igor I. Sikorsky

For the development of first successful helicopter built in the United States; for building and flying the first multiengine planes; for work in developing many long-range planes. Sikorsky Aircraft



Nicola Tesla

For early research on electric current; for the substitution of alternating current for direct current; for a system of arc lighting; for a high-frequency generator; for the Tesla coil. Died in 1943



Elmer A. Sperry

For his contribution to aviation with early instruments for blind flying, the Sperry gyrocompass, airplane and ship stabilizers and scores of other important inventions. He died in 1930



Harold C. Urey

For the discovery of the hydrogen atom of atomic weight two and for the production of heavy water and uranium-235; for extensive research on the construction of atoms. University of Chicago



Charles P. Steinmetz

For his electrical inventions, including magnetite-arc lamps, induction regulators, transformers and measuring instruments; for protection against lightning. General Electric. He died in 1923



Frank Lloyd Wright

For the major role he played in the development of modern architecture; for his originality in arranging interior spaces and for his exteriors of functional design. Wisconsin and Arizona



Louis H. Sullivan

For his work in architecture; for applying many new principles to skeleton-steel buildings; for introducing "functionalism" as the basis of modern architecture. Chicago. Sullivan died in 1924



Orville Wright

For the invention, with his brother, Wilbur, of the first successful airplane; for being the first man to fly in the historic power-driven airplane at Kitty Hawk, N. C., Dec. 17, 1903. He died in 1948



Leo Szilard

For his work with Enrico Fermi in devising the first atomic-pile chain-reaction system composed of uranium and graphite used in the earliest atomic experiments at the University of Chicago



Wilbur Wright

For the invention, with his brother, of the first airplane; for the successful promotion of the plane to the United States government; for early glider research with Orville Wright. He died in 1912



A. Hoyt Taylor

For pioneer research in the development of radar during the years 1922-1945 at the U. S. Naval Research Laboratory; for research in radio; for his electrical measurements. Taylor retired in 1945



Vladimir Zworykin

For the development of the iconoscope, an electronic tube which made modern television possible; for the development of the electron microscope. R. C. A. Laboratories, Princeton, N. J.

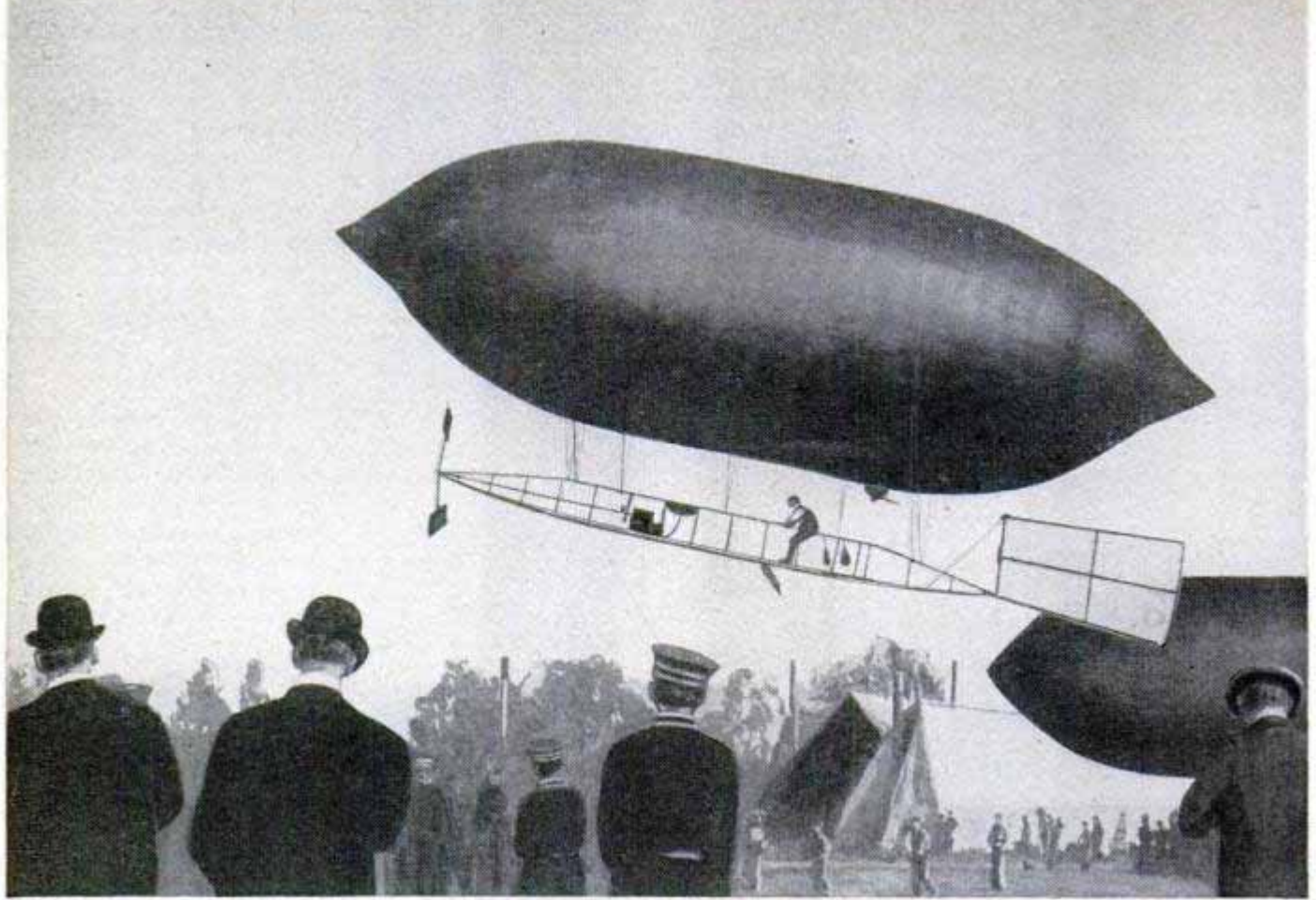

In exhibition of dirigibles (controlled airships) Lincoln Beachy demonstrates proper position for ascent

INTERNATIONAL BALLOON RACE OF 1907

By H. H. WINDSOR—*Founder of Popular Mechanics Magazine*



"One, two, three, four, five, six, seven, eight, nine, ten, go."

It was the official starter counting off the remaining seconds of the five-minute interval allowed each balloon to start on the International Race which occurred in St. Louis, October 21, 1907.

As the moment approached for the contest, 150,000 excited spectators surged around the inclosure where the nine great gas bags were swaying at their moorings. The Pommern, German prize-winning balloon, was the first to start. As it rose majestically, bands played and the gathered thousands shouted. From away up in the air floated back a farewell. Meanwhile, a score of men were moving the next balloon to its place. So perfect were the arrangements, there was no delay in any of the ascensions. The first occurred at four p.m.,

and 45 minutes later the last one was sailing away in the hope of winning the Bennett cup and a cash prize of \$2500.

The International Balloon Race of 1907 was altogether the greatest event in aeronautics ever seen in this country. Not only did each balloon start with several thousand pounds of sand ballast, but provisions for seven days were taken. Even though the balloon came down after 24 or 36 hours, it might land in a wilderness several days' journey on foot to the nearest dwelling.

It may be well to state here that the balloons were of the old-fashioned round gas-bag type of enormous size, but without any means for steering or propulsion. They could, of course, rise to a higher level at any time by unloading ballast, and likewise come down by letting out gas and, in this way, seek a more favorable current of air. For instance, when the Pommern started, it rose almost vertically to about 8000 feet,



Cromwell Dixon, 14 years old, starts on flight in foot-powered dirigible that weighs only 75 pounds

and remained there directly over the grandstand for nearly two hours. It had passed through the air currents near the surface and rested at the chosen altitude where there was not, at that time, any air moving. That this policy proved best is seen in the ultimate result, for the Pommern won the prize.

The U. S. balloon United States, in charge of Major Hersey, U.S.A., rose only to a height of 80 or 100 feet and, being immediately caught in a surface breeze, bounded away at a stiff pace and was soon lost to sight. Five minutes before the start, a messenger arrived all out of breath and handed Major Hersey some weather reports. The Major, being in charge of the weather bureau of Milwaukee, refused to take advantage of his office, but had a copy delivered to each balloon. It was a special report fresh from the wires, giving the prevailing winds in all parts of the country. Just before ascending, the Major traced his expected course on a map; and the course he took was almost identical with the prediction he made.

For the distance flown, the balloon United States made the best speed, covering 624 miles in 26 hours. The United States' average speed was 24 miles an hour and the Pommern's speed 22 miles an hour.

An exhibition of dirigibles was given on the second day, in which three ships made ascensions. The standard dirigible has a

horizontal, cigar-shaped gas bag, sharp-pointed at both ends. Near the middle is placed the gas engine, geared to a hollow propeller shaft which extends to the bow and terminates in the propeller blades. The ease and certainty with which the dirigible turns corners, or plows into the teeth of the wind, appeared fully equal to the control of a horse-drawn buggy on a good street or a motor launch of equal length.

In the exhibition of dirigibles, the first prize was won by the youngest aeronaut in the world, Cromwell Dixon, of Columbus, Ohio, 14 years of age. He constructed his own framework and machinery, his mother assisting in sewing the gas bag. This bag is 25 feet long and 10 feet in diameter. The complete outfit before inflation weighs 75 pounds. His propeller is driven by foot power, secured by using a bicycle frame and pedals. The ascension of this bright boy, who has not yet outgrown his knickerbockers, was made with the deliberation and coolness of an old-timer. On leaving the grounds, he narrowly escaped being wrecked in a tall tree, but by emptying ballast, putting the rudder hard about, and a diligent use of the pedals all in a few seconds, he cleared the obstruction. His strength was insufficient to hold out long against the wind, so climbing to an elevation of 1200 feet, he sailed east over the city, crossed the Mississippi and landed safely in Illinois eight miles away.

American Way of Life

PHOTO CONTEST

FOR A HALF CENTURY—a vivid, swift-moving, often turbulent half century—*Popular Mechanics* has mirrored to Americans and interpreted to the people of the world our American Way of Life.

On our pages have been inscribed the diary of a growing nation. Through these pages have moved the great people and the small, the Edisons and DeForests and Bells, the Ketterings and Lindberghs and the thousands of lesser men and women who have contributed their ideas and achievements to the enrichment of this nation and the world.

Enrichment not alone in the material things, but in the nourishing of the American tradition of freedom to think and learn, to worship, to work and to play; to pay allegiance not to emperor, usurper or dictator, but to leaders chosen for their devotion to trust; and to develop and share with others the bounty with which a provident Nature surrounded the pioneers who founded this nation.

This is the theme of this Golden Anniversary Issue of *Popular Mechanics*. In keeping with this theme, we present on the following pages the first 14 of the prize-winning photographs submitted by our readers in a \$5000 contest. The pictures portray the individual photographer's interpretation of the American Way of Life. Additional prize-winning photographs will be presented in the February issue.

The Winners

BLACK-AND-WHITE DIVISION

1st PRIZE: \$1000

C. E. Westveer,
63 Amherst Rd.,
Pleasant Ridge, Mich.

2nd PRIZE: \$500

Grant M. Haist,
1200 Lake Ave.,
Rochester 13, N. Y.

3rd PRIZE: \$300

Joseph G. Principato,
72 Aberdeen St.,
Lowell, Mass.

4th PRIZE: \$100

Earle W. Brown,
19355 Greenlawn,
Detroit 21, Mich.

5th PRIZE: \$100

Leonard Nadel,
132 North Clarence St.,
Los Angeles 33, Calif.

6th PRIZE: \$100

Nicholas Cannistraro,
26 Clark Lane,
Waltham 54, Mass.

7th PRIZE: \$100

Bill Peery,
1223 Leyden St.,
Denver, Colo.

8th PRIZE: \$100

K. F. Kunkel,
326 East 30th St.,
New York 16, N. Y.

Prize-winning pictures not shown in this issue will be printed in February.

(Continued to page 348)

The Judges



David W. Lockwood, vice-president and art director, Foote, Cone and Belding advertising agency, Chicago



Valentino Sarra, one of the world's greatest photographic illustrators with studios in New York and Chicago and
The Editors of *Popular Mechanics*



1st Prize: "Penny Arcade"
Norman A. Wilkes, New Hyde Park, N.Y.

COLOR DIVISION

1st PRIZE: \$1000
 Norman A. Wilkes,
 80-36 Langdale St.,
 New Hyde Park, N. Y.

2nd PRIZE: \$500
 Henry S. Brinkerhoff,
 622 E. Mt. Airy Ave.,
 Philadelphia 19, Pa.

3rd PRIZE: \$300
 Walter Singer,
 6239 Broadway,
 New York 71, N. Y.

4th PRIZE: \$100
 Gottlieb Hampfler,
 Longwood,
 Kennett Square, Pa.

5th PRIZE: \$100
 Robert E. Wiles,
 14 Coleridge St.,
 Springfield, Mass.

6th PRIZE: \$100
 Jack Zehrt,
 4211 Flora Place,
 St. Louis 10, Mo.

7th PRIZE: \$100
 Robert A. Buchanan,
 217 Harvard Rd.,
 Linden, N. J.

8th PRIZE: \$100
 Carl Mansfield,
 151 North Fourth St.,
 Steubenville, Ohio

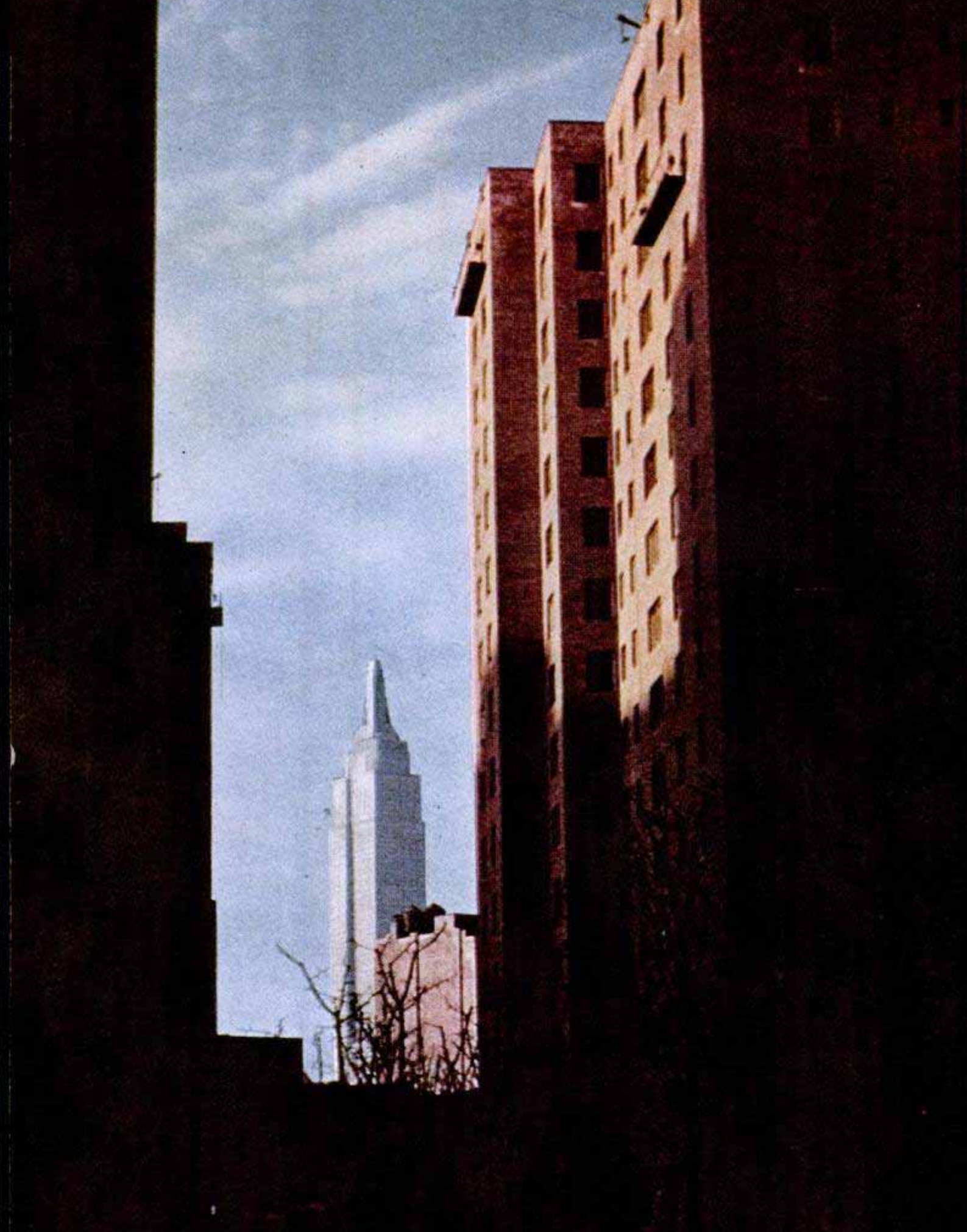

2nd Prize: "Reaching Upward"
Henry S. Brinkerhoff, Philadelphia, Pa.



3rd Prize: "Vanilla, Please"

Walter Singer, New York, N. Y.

4th Prize: "Gloucester Fisherman"
Gottlieb Hampfler, Kennett Square, Pa.

5th Prize: "Tying a Bucktail"
Robert E. Wiles, Springfield, Mass.





6th Prize: "Choosing Sides"
Jack Zehrt, St. Louis, Mo.

**BLACK AND WHITE
DIVISION**

1st Prize:
"Street Scene, U.S.A."
C. E. Westveer,
Pleasant Ridge, Mich.



7th Prize: "Washing the Family Car"
Robert A. Buchanan, Linden, N. J.

8th Prize: "Threshing" Carl Mansfield, Steubenville, Ohio







2nd Prize: "Picking Up the Mail"
Grant M. Haist, Rochester, N.Y.



3rd Prize: "Playing Hooky"

Joseph G. Principato, Lowell, Mass.

4th Prize: "Home From School"

Earle W. Brown, Detroit, Mich.





5th Prize:
"Friendship"
Leonard Nadel,
Los Angeles, Calif.

6th Prize:
"New England Church"
Nicholas Cannistraro,
Waltham, Mass.



Wireless Telegraphy Practicable as Cabling

By *Guglielmo Marconi*



Wireless telegraphy across the ocean is now as practicable as cabling. We have sent more than 2000 words in all from Glace Bay to

Poldhu and have reached a speed of 15 words a minute which, considering our clumsy sending apparatus—a mere wooden lever to connect and disconnect the current—indicates what we can do when we substitute a sending key designed for speed. With proper sending key we can get off 30 words a minute, and I shall be surprised if we do not soon send at a higher rate.

The Atlantic cables average about 21 words a minute in their regular work, I believe. And there is this vital difference in the two systems of transoceanic telegraphy: As the cable grows longer, the rate of speed in sending messages decreases, while distance makes no difference in the rate at which we can send by the wireless system.

With properly tuned instruments we can make the reading of our trans-Atlantic messages very difficult. To read a wireless message, an outside station would have to be in exact tune or vibratory unison with our stations at the same moment. It would cost a rival not less than \$50,000 to try the experiment on the smallest scale.

Besides, we can arrange our apparatus so that the tune, or rate of vibration, can be automatically changing every moment at the same rate in the sending and receiving stations on each side of the ocean.

In England I offered to pay a large sum of money to anyone who could pick up one of our wireless ocean messages after notifying me that it was to be attempted, and I even offered to lend apparatus to anyone



who desired to try the experiment. No one took up my offer. But even if it were possible to read our signals—and I do not admit it is a contingency to be feared—it would be the simplest matter in the world to use a constantly changing secret code between our stations.

Even if secrecy were actually impossible, there are thousands of messages to be sent by a cheap system of telegraphy which are not necessarily secret in their nature. If it were not so, postal cards would not be used so extensively. If a man in New York wants to send a sailing date or a birthday message or any other such communication to a man in London, what does he care whether his message is read by an outside operator or not?

Locomotive Will Haul Train of Cars Two Miles Long

1907—The interest of the locomotive world is at present centered in the three articulated compound locomotives now building at the Schenectady works of the American Locomotive Co., for the Erie Railroad. These engines will be the heaviest and most powerful locomotives ever built and will break all records in locomotive construction. They are of the type known as the Mallet compound and will have 16 drive wheels, arranged in two independent groups of eight each. The high-pressure cylinders, which are 25 inches in diameter by 28-inch stroke, drive on the rear group of driving wheels and the low-pressure cylinders, which are 39 inches in diameter by

the same stroke, drive on the forward group of wheels. The four rear pairs of wheels are arranged in frames which are rigidly attached to the boiler. The forward four pairs of drivers are, however, carried in frames which are not rigidly connected to the barrel of the boiler, but which are in fact a truck; this truck swivels radially from a center pin located just in advance of the high-pressure cylinders.

The locomotive, without tender, will weigh 205 tons, and will haul on the level 320 loaded freight cars, or a train about two miles long. The boiler is over 43 feet long and the inside diameter of the largest ring is eight feet.

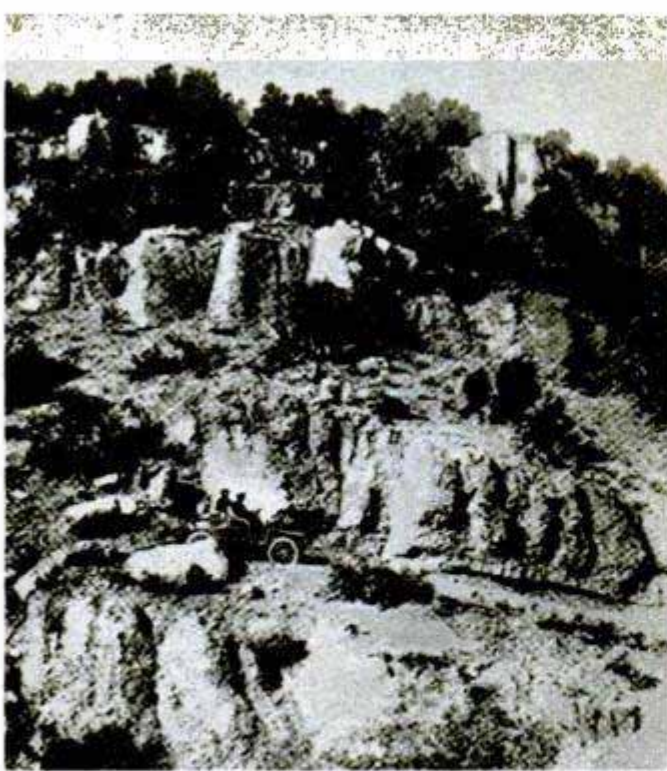

Left, pulling out of the swamp at Spanish Fork, Utah. Right, Soldiers' Canon, Utah, seemed almost impassable

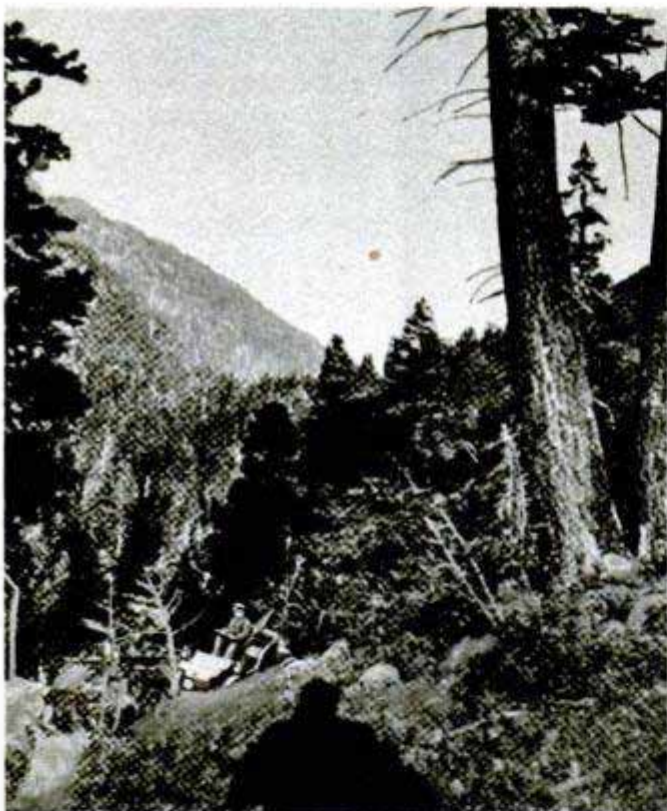

Perilous spot in Utah was one of the worst obstacles

Crossing the Continent In Automobiles



Crossing the continent in automobiles is ceasing to be regarded as a remarkable feat. Since the first trip from San Francisco a short time ago others have been made and several more have been planned. A Packard automobile and a Winton have already made the journey and an Oldsmobile is now on the way from Pasadena, Calif., to New York. The trip in the Packard was made by E. T. Fetch and M. C. Krarup in their car, named the "Pacific." Some remarkable conditions were experienced on this trip that will be of aid to future expeditions of the kind. In Carson Valley a most treacherous and obstructive sand bed was encountered. The road here is twisted around the mountain side so as to measure six miles in length in a distance which, in a horizontal plane, would measure less than two miles. The road, in many places, pitched as

Left, the meeting with old "Pacific" outside Denver, Colo. Right, treacherous sands near Thompson, Utah



steep as 17 percent. The road was so deep in sand that rubber tires were often completely submerged and steering was exceedingly insecure.

Then there was a terrible swamp at Spanish Point, Utah, and a "flume" that made the tourists often fear that their vehicle would be swallowed up by the deceptive earth on which they journeyed. At Soldiers' Canon, Utah, Fetch and Krarup halted and debated a long time as to whether it was possible to continue their peregrinations. This spot seemed absolutely impassable for a time. Huge walls of rock stood in defiance on every side and there were bogs and streams and thickets that made the autoists think they had certainly strolled beyond the domains of human aggression. An indefatigable perseverance and determination, however, successfully steered them from out this unearthly region and they proceeded on their trip.

The *Automobile Review*, discussing transcontinental automobile trips, says: "The great feat of crossing the continent in



Fording a dangerous flume at Spanish Fork, Utah

an automobile, will in a short time be a thing of the past and the trip is destined to become a summer outing for the enthusiastic automobilists."

It is likely, however, that a person will not be over-anxious for more than one trip in an ordinary lifetime.

Milking Stool Prevents Spilling of Milk



1916—By preventing the spilling of milk, a combination milking stool and pail holder makes possible a considerable saving. It consists of a metal frame, aluminum painted, with four spreading legs which can be folded under the frame when not in use. On the frame is a seat resting on ball bearings which permit it to be moved forward or backward a distance of four inches. At the opposite end of the stool from the seat is a circular holder that can be adjusted to hold a pail of any size. It is so hinged that the pail can be quickly swung to one side in case the cow begins to move about.

Bubbling Cup Can Be Lifted To User's Lips



1912—The one disadvantage of the ordinary bubbling-cup sanitary fountain lies in the fact that the drinkers must place their lips to the cup instead of placing the cup to the lips. To remedy this, one fountain manufacturer has designed a bubbler which may be raised to the lips while the user is in a standing position.

Mr. Edison says:

"I want to see a Phonograph in every American home."

HERE is the "King of Entertainers," the Edison Phonograph just as you receive it for a free trial in your own home—records and all. An extremely short trial will convince you that you have been without a phonograph too long already. The perfect naturalness of vocal and instrumental reproduction on the new style 1907 model Edison Outfit has surprised and pleased even the most critical judges.

An Offer open to every responsible person.

Thomas A. Edison

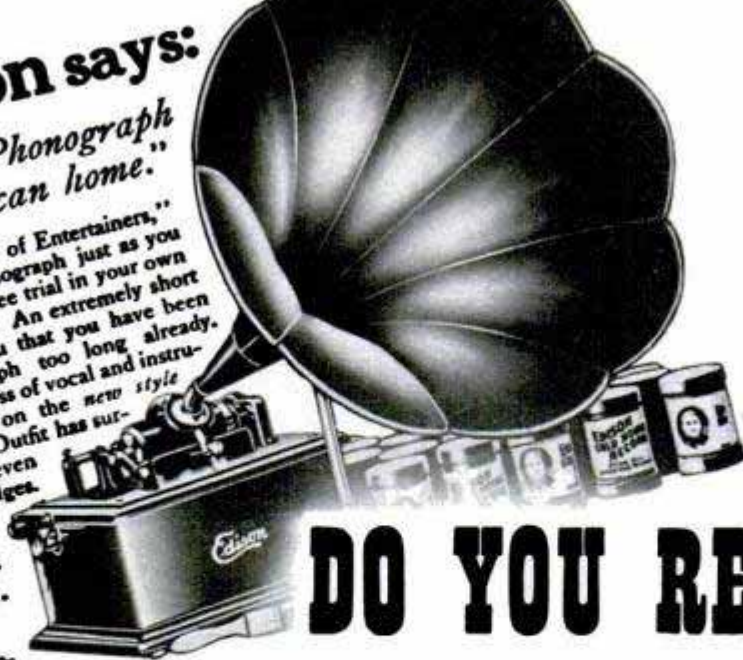

1910



DO YOU REMEMBER?

New Invention!

FOR THE HOME

Air Now Does All the Work

Cleans Carpets, Rugs, Mattings, etc., on the floor, by the Vacuum Process

The Home Vacuum Cleaner

WEIGHS FOUR POUND 1910

Operated by child or weakly woman. Air is drawn through body and fibre of carpet at terrific speed. Carries all dust, dirt, grit, germs, etc., into the Cleaner. No dust in room, it all goes into Cleaner. Supercedes broom, brush, sweeper, dust pan and dust cloth. Cleans, Sweeps and Dusts in one operation. Keeps house clean, does away with house-cleaning. Portable, dustless, always ready. Adapted to every home—rich or poor—city, village or country. Does same work as expensive machines. Costs nothing to operate—costs nothing for repairs.



\$6.00

Not Sold in Stores

"Star" Lathes

Foot or Power

9-in. to 16-in. swing

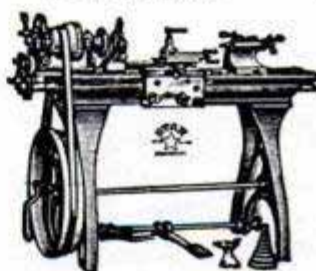

High-grade screw-cutting engine lathes, with or without compound rest, taper, draw-in chuck, milling and gear-cutting attachments, friction countershaft, metric lead screw, etc.

(m-1)

Send for catalog "B"

1907

The Seneca Falls Mfg. Co.

102 Water St., Seneca Falls, N. Y., U. S. A.

1908

Speed! I Guess Yes!

\$375 to \$450

—And economy, too, in the



Black MOTOR RUNABOUT

Write Today

Travels any road —up hills, through mud. 2 to 25 miles per hour. 30 miles on one gallon of gasoline. Engine 10-h-p., 2 cylinders, air-cooled. Chain drive gear—Double brake. No tire troubles. Safe, reliable, handsome. Also Top Motor Buggies and Surries. Write for free book No. A. 204 BLACK MFG. CO., 124 E. Ohio St., Chicago

WATERLOO VAPOR COOLED GASOLINE ENGINES

The only horizontal vapor cooled gasoline engine in the world.

Absolutely frost proof and cannot freeze.

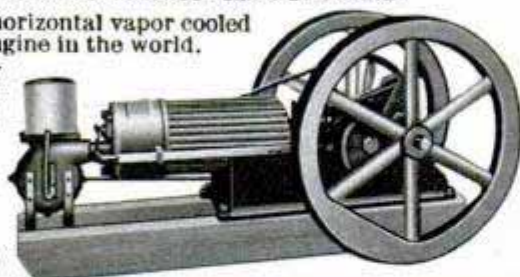

Patented May 15, 1906

1907

1907

5-Acre FRUIT, TRUCK AND CHICKEN Farms, \$60 Only \$2.00 a Month



In Lake and Muskegon Counties, near Muskegon, Mich., a city with 30,000, with five million dollars in factories. Finest crops of peaches, pears, plums, apples, cherries, grapes, and all kinds of vegetables and small fruits; pure water, perfect climate, fine fishing and hunting. Grapes and cherries yield \$500 per acre profit. Daily boats and transportation, only \$3.50 round trip from Chicago. Do not delay. Send \$2 today. Money returned promptly if received too late. [This house and 20 acre farm only \$450 at \$5 monthly.]

FEDERAL REALTY CO.

Suite 812, 105 Washington St., Chicago

We have deposited a bond for \$10,000 with
 Chicago Loan & Trust Co. operating in the
 city of Chicago for the purpose of
 insuring them or to pay back in Chicago

\$10 dresses you complete in latest style

We are the originators of the plan of dressing a lady or gentleman complete from head to foot for less than half the price ordinarily charged by others. We operate one of the largest tailoring departments in the country, and in order to gain new friends and customers, make this remarkable offer.

- Note Carefully, then send for Free Samples, measurement blanks, etc.**
- For \$10 we send a complete lady's outfit as follows:**
- 1 genuine pure wool or wool mixed latest style tailor-made Eton suit (strictly to measure).
 - 1 very neat satin-finish petticoat.
 - 1 entirely new pattern shirt waist.
 - 1 beautiful latest style hat.
 - 1 pair of long, serviceable shoes.
 - 1 pair genuine silk-thread stockings.
 - 1 latest style seal-grain leather belt.
 - 1 beautiful 2000 pattern silk tie.
 - 1 genuine Irish linen lace handkerchief.
- Every article good honest value.**
- For \$10 we send a complete man's outfit as follows:**
- 1 latest style, pure wool or cheviot, tailor-made suit (strictly to measure).
 - 1 Derby, Fielow or Panama style hat.
 - 1 pair latest style satin calf shoes.
 - 1 pair Late-English hose.
 - 1 rub underwear, heavy or light weight.
 - 1 latest style percale shirt.
 - 1 collars. 1 cuffs to match.
 - 1 silk bow, neck or four-in-hand tie.
 - 1 gold-plated scarf pin.
 - 1 pocket handkerchief.
 - 1 pr. fancy suspenders.

You need not pay till you receive the goods and find them exactly as represented.

SENT G. O. D. with privilege of examination

We are a co-operative association and divide our dividends with our members. Anyone may belong—want you nothing. Send for our "Proposition," also send for catalogues of Ladies' Wear and Men's Wear. We issue ten different catalogues. Address Tailoring Department

NATIONAL CO-OPERATIVE MERCANTILE ASSOCIATION,
 241 to 251 E. Madison St., Chicago, Ill.

1903

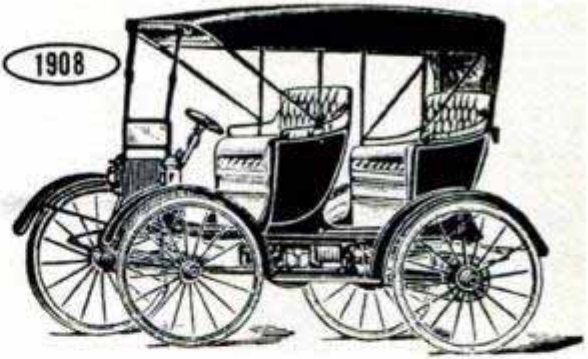

KIBLINGER MOTOR VEHICLES

P.M. ads from the good old days

THE QUESTION OF QUALITY



in
Telephones
 is
Satisfactorily Answered

Our instruments are the best that long experience, skilled workmen and a complete equipment can produce. Our prices are the only cheap thing we offer. Let us

Acme Electric Co.

200 S. Clinton St. Chicago, Ill.

\$19.90 BIG PARLOR ORGAN

FOR \$19.90 we furnish this big handsome solid golden oak Parlor Organ, stands 6 feet high, 4 feet long and 2 feet wide, latest style for 1904-5, guaranteed the equal of organs sold by others for nearly double the price. Shown by a large picture and fully described in our big free Organ Catalogue sent to ANY ADDRESS FOR THE ASKING.



AT \$25.95 to \$51.95 we sell other beautiful ORGANS, all made in our own organ factory and sold direct to you at only a little above actual manufacturing cost, at much LOWER PRICES THAN ANY DEALER CAN BUY.

WHY we can build and sell the best ORGANS in the United States for so much less money

other manufacturers and dealers, is all explained in our new free Organ Catalogue, **OUR NO MONEY WITH ORDER PLAN, FREE TRIAL offer, OUR TWENTY-FIVE YEARS BINDING GUARANTEE**, all fully explained in the **BIG FREE ORGAN CATALOGUE, SENT ON REQUEST.**

HAVE YOU ANY USE FOR AN ORGAN? If not, have you a friend who could use an organ if the price was low enough, the offer liberal enough, the greatest chance ever known! If so, cut this ad out and send to us, and the catalogue, our several propositions, and our new and most astonishingly liberal offer ever made, will all go to you **FREE** by return mail, postpaid. Write for our Free Organ Catalogue at once. Address, **SEARS, ROEBUCK & CO., Chicago, Ill.**

"A Kalamazoo Direct to You"

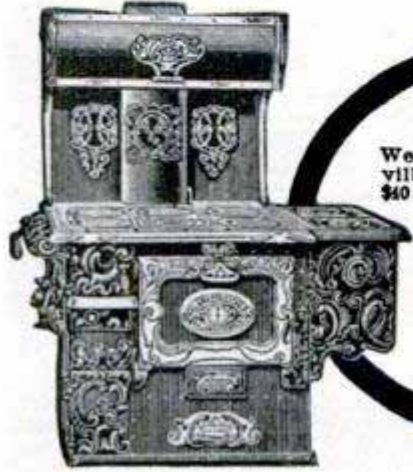

We have more than 100,000 satisfied customers in more than 17,000 cities, villages and towns in the United States who have each saved from \$5 to \$40 by buying a Kalamazoo stove or range on

360 DAYS APPROVAL

direct from our factory at actual factory prices. No stove or range has a higher reputation or gives better satisfaction. You run no risk. You save all dealers' profits. We pay the freight.

Send Postal For Catalog No. 473

and see list of towns where we have satisfied customers.

Kalamazoo Stove Company, Mfrs., Kalamazoo, Mich.

Our patent oven thermometer makes baking and roasting easy.





“Yield” Sign Reduces Accidents

Warning motorists to give the right of way to cars on the intersecting road, a new “Yield” sign is already reducing accidents in Tulsa, Okla., where it was developed. Designed for use in areas where traffic generally is not heavy enough to warrant full-stop requirements, the sign definitely places responsibility without requiring a complete stop. Motorists approaching the sign must slow down to at least 10 miles an hour and yield the right of way to any car approaching along the intersecting roadway. Any driver becoming involved in a collision at an intersection after passing a yield sign is automatically deemed to have violated the law.



On-the-Spot Puncture Repairs

Punctures can be repaired as soon as they occur and without removing the inner tube from the tire with a new tool not much larger than a pencil. When a puncture

occurs, the offending nail is pulled out and the tire partially inflated. Then the tip of the tool simply is held against the hole and a handle turned, forcing a compound through the hole and against the tube. The compound seals the puncture at once.

Arabogalactan—You Can't Say It But You May Soon Be Eating It

If you like jelly beans or take aspirin tablets, you may soon be getting your share of arabogalactan (pronounced arabo-glack-tan). This strangely named chemical is a palatable, adhesivelike material found in all woods in small quantities. Recently, however, it has been found to be abundant in larch—enough to make recovery commercially practical. Manufacturers of aspirin tablets, jelly beans, marshmallows

and other confections are looking to the promised supply of arabogalactan to free them of their present dependency upon imported gum arabic as a binder material for their products.

☐ One cubic inch of powdered carbon (used in gas masks and water filters) has an internal and external surface exposure area of about 20,000 square yards.

"Pretty Kettle of Fish"

Because the huge McNary Dam, now under construction on the Columbia River, has blocked the annual salmon run, U. S. Army engineers are lifting the fish above the dam with a huge bucket. The scoop, about six feet in diameter and eight feet high, dangles from a crane atop the dam. It is lowered into a shaft which eventually will contain a fish elevator. At the bottom of the shaft is a fish trap. As the bucket slips into the trap, the operator closes a door. Then he raises the bucket—now holding 1000 gallons of water and countless salmon weighing up to 60 pounds—to the water level above the dam. Here the door is opened and the fish swim away to their spawning grounds. The bucket lifts about 10,000 fish every 24 hours and is in operation night and day during the salmon run. Other salmon manage to make their way through the locks.

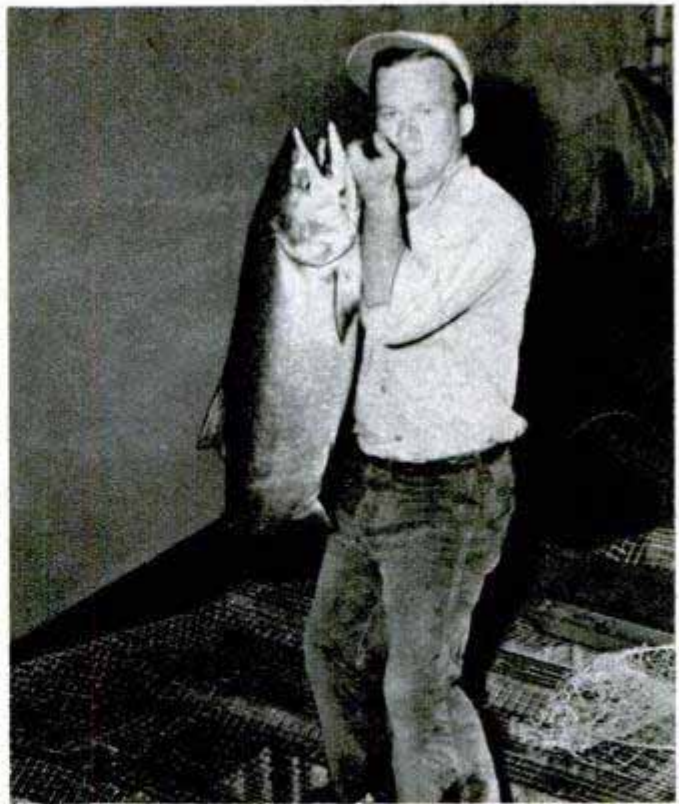

Big Chinook salmon comes up in the fish bucket with his smaller brothers. This one weighs about 40 pounds

Left, up the elevator well comes a "kettle" of fish. After it is swung over locks, fish will be released

Below, permanent crane installed atop dam operates the fish lift, dipping bucket into elevator well

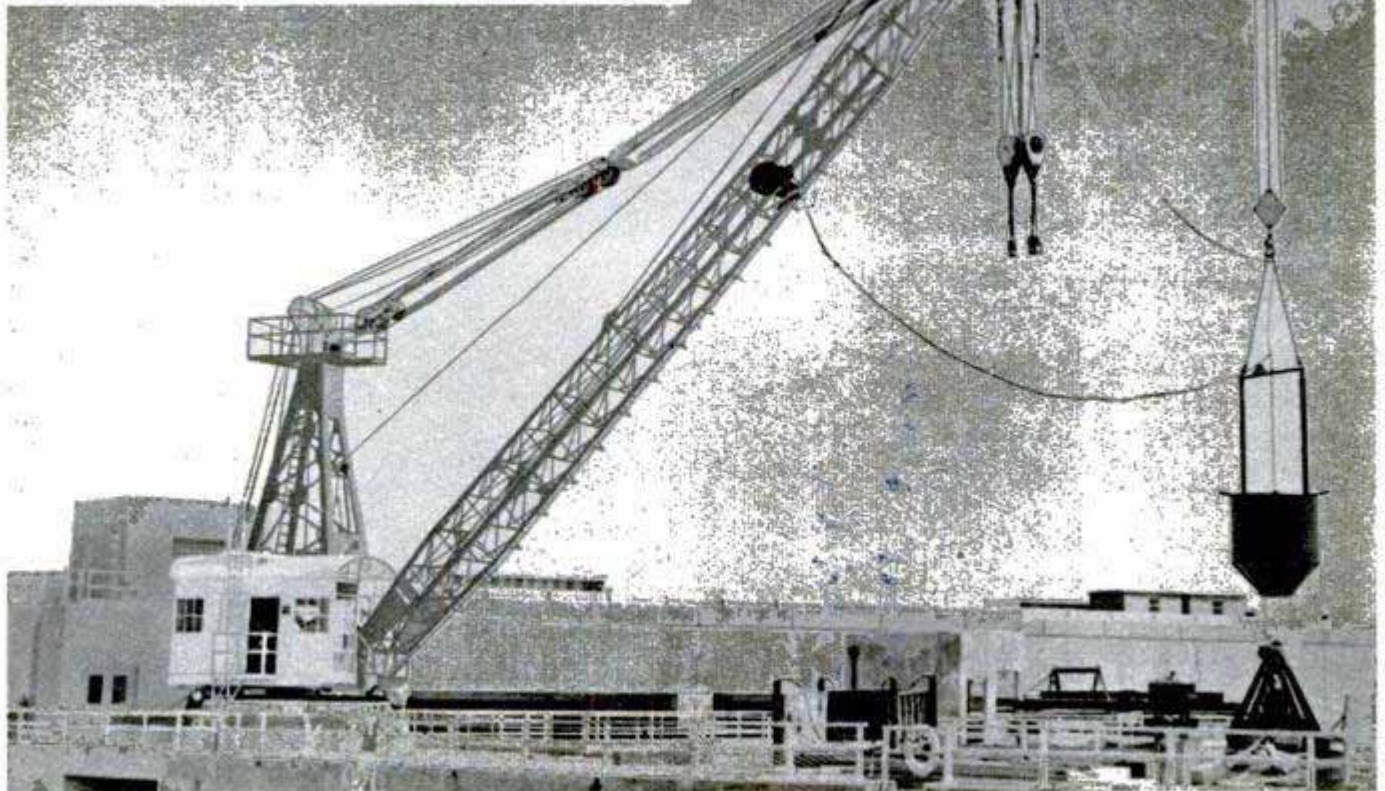
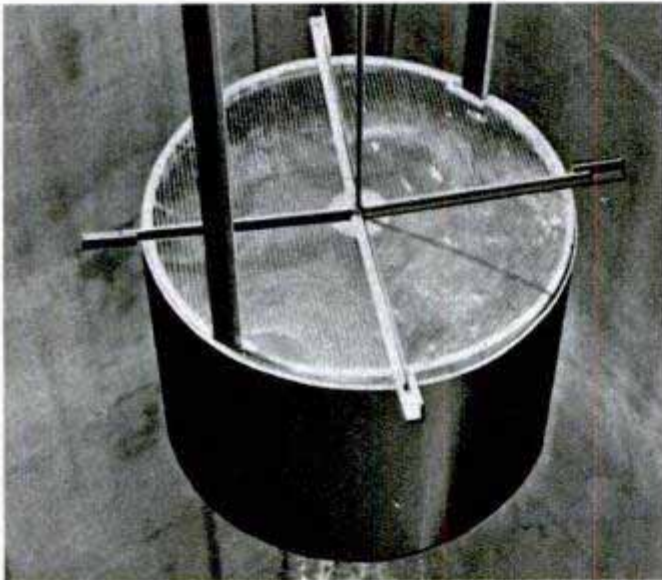

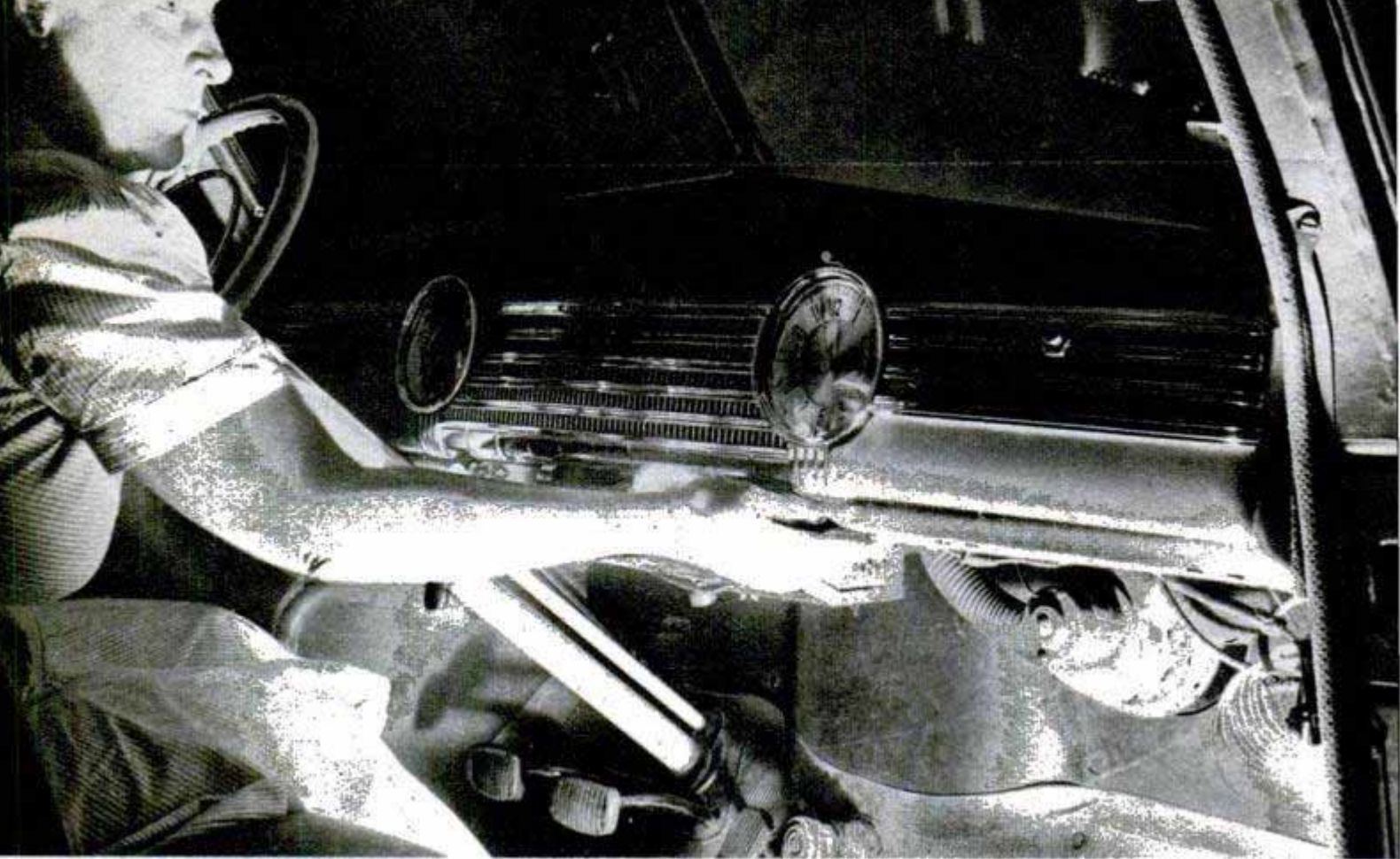

With a tiny transmitter in their car, Mrs. Kearsley signals her husband that

The TINKER with

By Don Romero

WHEN General Electric invited William K. Kearsley to join its famous research laboratory, the young inventor replied modestly, "I'm just a tinker who is more interested in helping people with their everyday problems than in making profits. If I join your staff, you'll just have to let me putter around with whatever I

For U. S. Air Force, Kearsley developed an electrically heated flying suit, shown at left, and nonfrosting goggles, below



*Mount Dora,
Florida*





she has arrived at GE parking area. Kearsley, in research lab, hears wife's signal on his crude receiving set

MILLION-DOLLAR IDEAS

think I can do." GE agreed to his terms.

In 45 years of puttering Kearsley has produced machines which have saved industry millions of dollars every year, has provided our armed forces with some of their critical devices and has contributed much to the health, comfort and safety of everyday living.

GE has never regretted hiring its mighty tinker. Take the case of the surgeon friend who complained to Kearsley that his spectacles often "misted up" right in the middle of an operation. Kearsley promptly solved the problem by running a small battery-powered heating wire around the edges of the lenses, thus keeping them too warm for moisture to condense. Years later when Army Air Force officials came to Kearsley in a frantic search for aviation goggles that wouldn't fog up at high altitudes, he handed them the model he'd developed for his friend. On that one patent alone—and General Electric has received a total of 40 from Kearsley—GE made two million dollars.

Kearsley has always believed there is no profession more rewarding than inventing. "Help one person solve a problem," he says, "and the chances are you'll help mil-

lions." When a neighbor complained of the "fuzziness" of television, Kearsley devised an accessory which sharpens the image. When Mrs. Kearsley mentioned that some clothes she'd stored had been ravaged by moths, he created the electric moth killer now in wide use. When some camping friends complained of the weight and bulkiness of the food supplies they had to carry, he developed the electronic process used subsequently by manufacturers of dehydrated foods. And when Kearsley grew tired of lying under a heavy load of blankets to stay warm in bed, he created GE's now-famous electrically heated blanket.

Kearsley was born in St. Louis, Mo., the son of a railroad auditor. He knew what he wanted to do by the time he was 15. Against strong parental opposition, he left high school in his freshman year, built himself a workshop and started tinkering. His first invention was a treadle which swung open the cellar door when he rode up to it on his bicycle. When his family moved to Washington, D.C., he rushed to the Library of Congress to read about the newly developed "wireless." A month later, getting some of his parts from an old ice-cream freezer and grounding his circuit on a fire



Untiring efforts of the master tinker were largely responsible for perfection of the Inductotherm, a device which makes high-frequency heat treatments possible

hydrant, he built one of this country's earliest amateur transmitters.

At 19 Kearsley became an apprentice electrician at GE's Edison Lamp Works in Newark, N. J. For the next 15 years, after

leaving his job each day, he would study and putter far into the night building ingenious little devices for himself, his family and his friends.

Then one day Kearsley was sent to GE's huge research laboratory in Schenectady to do a routine repair job on X-ray tubes. After finishing his task, Kearsley hesitantly began to tell the laboratory director how the tubes could be improved. The director, eyeing the presumptuous young electrician, began to question him. Kearsley shyly told of his workshop, of the devices he'd built. The director seemed impressed. "How much formal education have you had?" "None," replied Kearsley. The director thought hard, then said, "No matter. You've got something a lot more important—curiosity. If you like, you can start developing your new ideas here in the lab." The next day the astounded young gadgeteer found himself a colleague of such world-famous GE research scientists as Whitney, Langmuir, Coolidge and the electrical wizard, Steinmetz.

Shortly after joining the lab, Kearsley married a young girl from New Jersey. Mary MacHattie, a genial, unaffected woman who has always accepted her husband's accomplishments with modest pride, for 34 years has given Kearsley calming sympathy in his struggles with seemingly insoluble problems.

Kearsley is often amused by the strange problems that sometimes beset people. A restaurateur wrote asking if there was a quicker way of opening oysters than with a

Constantly solving other people's problems, Kearsley invented a hospital bed operated by push buttons

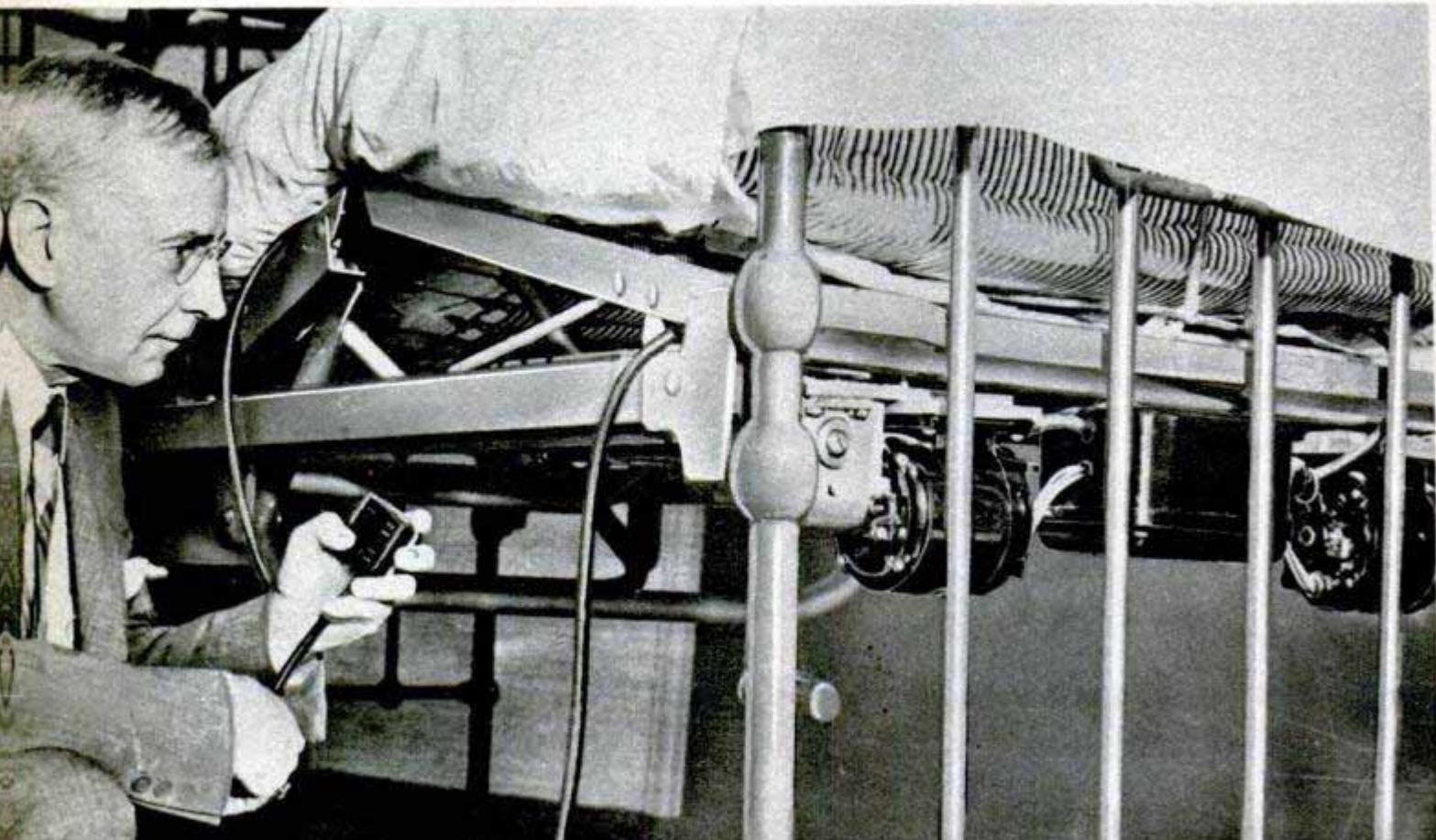

knife. Kearsley produced a traveling belt on which the oysters moved between electrodes which caused the bivalves to pop open. For an animal trainer who couldn't make his ferocious gorilla behave, he devised an electric stick with which the animal could be harmlessly shocked into docility. And for a fellow inventor in quest of a realistic method for testing razor blades, he produced a mechanical face that "grows" its own whiskers.

Literally nothing is too small for Kearsley's omnivorous ingenuity. Mrs. Kearsley is probably the only woman in America who is reluctant to ask her husband to perform even the simplest chore. "Whenever I do," she sighs, "he invents something." Her husband found her attempting to wash the ceiling one day. So he produced a machine to do the job for her. When she accidentally scorched a shirtwaist by leaving a hot iron on it while rushing to answer the phone, he contrived the thermostatically controlled iron now found in most households. When she suffered a broken leg and had to be taken to the hospital, he developed an electrical push-button affair—now used in many hospitals—by which she could raise or lower the head or foot of her bed without having to call the nurse. When she was ready to come home, he presented to her astounded doctor a simple device for removing the cast easily and painlessly. And when she finally arrived home and found the front porch miraculously free of mosquitoes, it developed that, as a homecoming gift, he had invented an electric insect repellent—now found in many

(Continued to page 392)



Tired of lying under a heavy load of blankets to keep warm, GE's master tinker came up with the now-famous electric blanket, being tested above



To cut down dishwashing when preparing greasy foods, Mrs. Kearsley lines frying pans with aluminum foil, as suggested by her ingenious husband

Operated by a photoelectric-cell device, a trap door was installed in the Kearsley basement to let their black cat come and go as she pleased

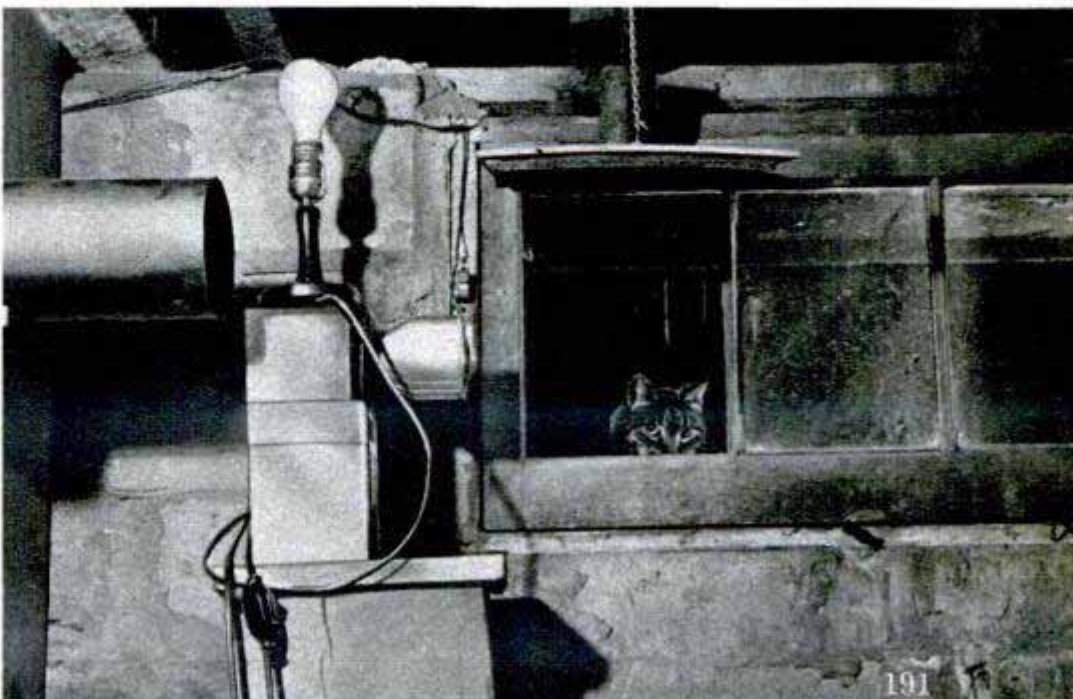

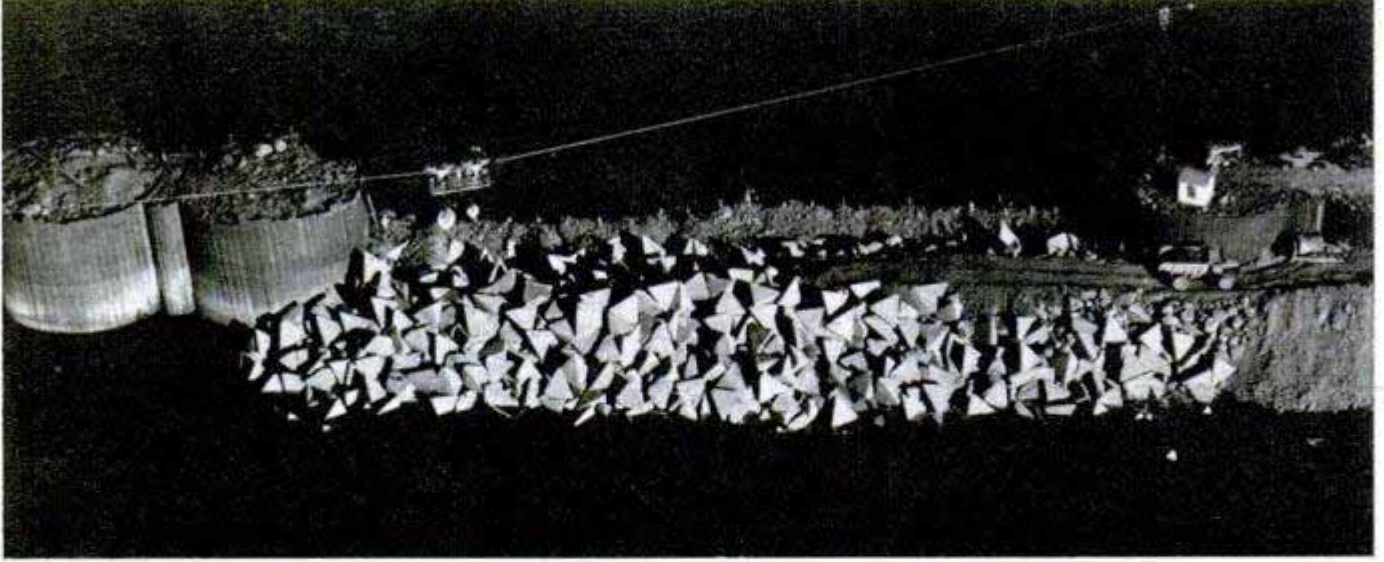

Above, dropped into the gap from a cable, the heavy tetrahedrons effectively plugged the gap in the dam

Concrete "Tets" Plug Gap In Columbia River Dam

Closing the final 240 feet of the cofferdam for the McNary Dam across the Columbia River was like trying to stop the stream from a fire hose with your hand. The powerful river, 60 feet deep at that point, swept everything downstream as fast as it was dumped into the channel. Army engineers, after laboratory tests, completed the closure by using 3280 concrete tetrahedrons, each weighing 12 tons. Hauled over the opening in the cofferdam by a cableway and dropped into the water, the "tets," in effect, "bombed" the gap shut. Five weeks were required to complete the job. The sharp angles of the four-faced castings plus their tremendous weight kept them jammed together despite the swift current, diverting it so construction could continue.



Above, close-up of the four-faced concrete castings in position across the gap. Below, the tetrahedrons were cast at the dam site in forms like this one. Below right, one of the "tets" on its way to the dam

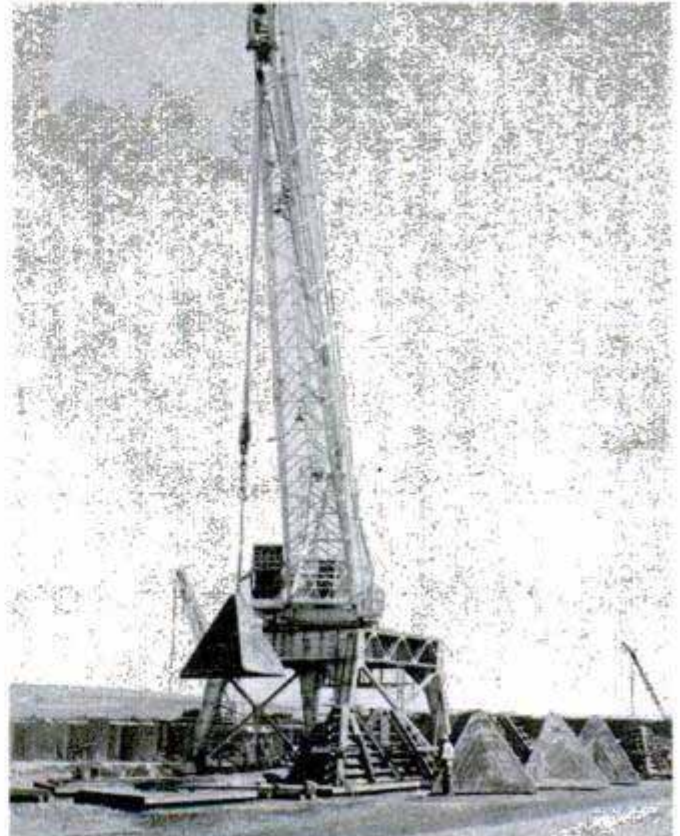
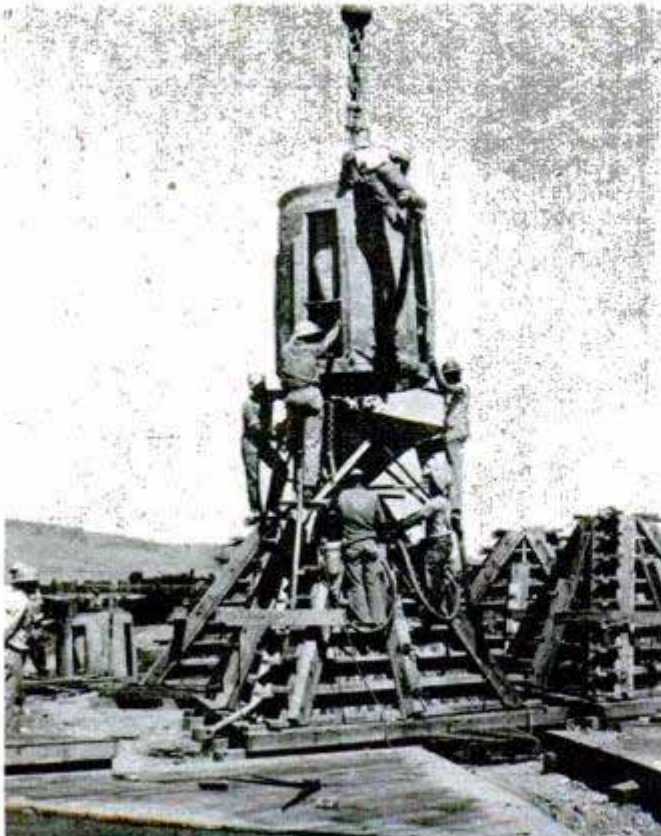

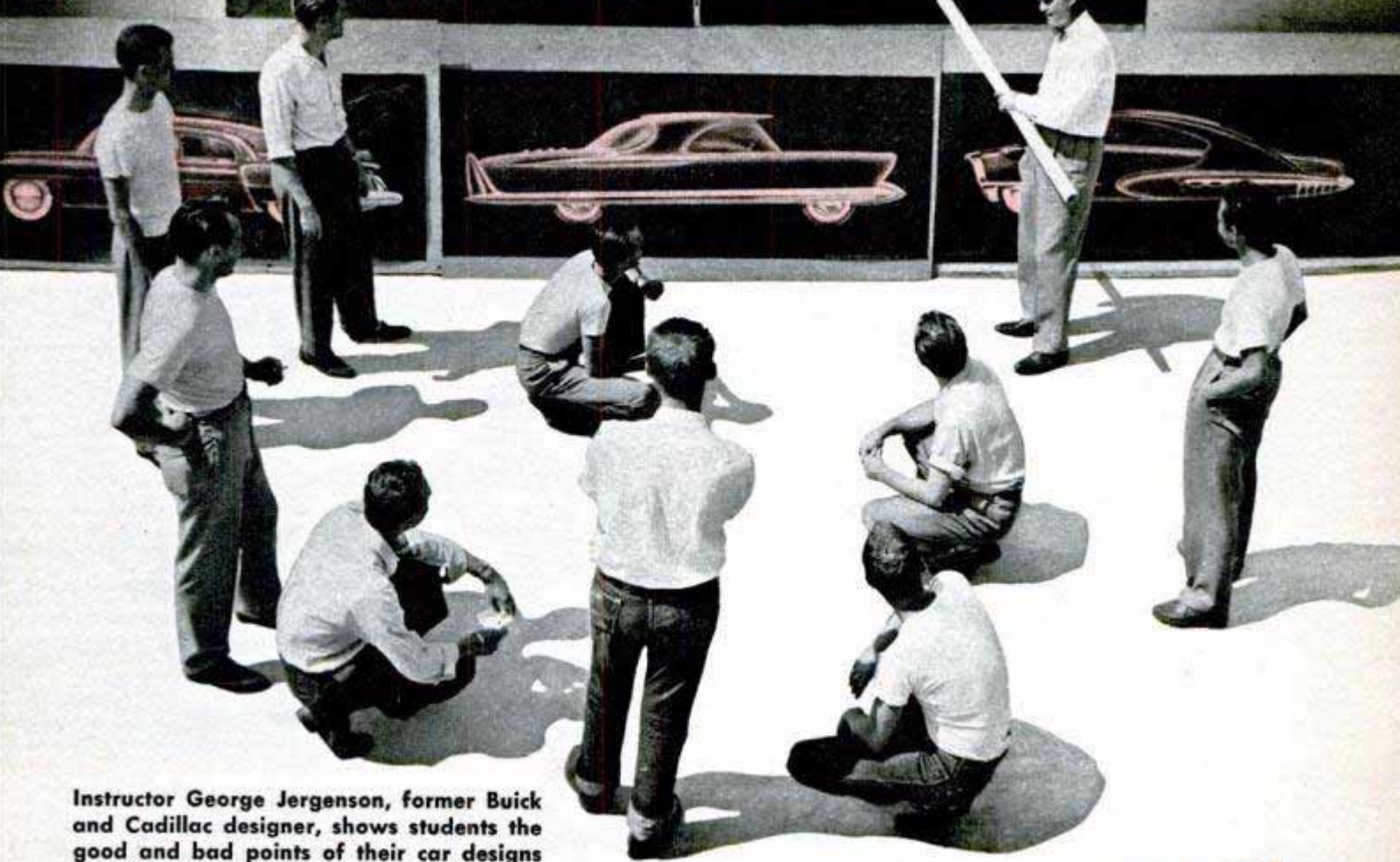

Instructor George Jergenson, former Buick and Cadillac designer, shows students the good and bad points of their car designs

Here is a school without a textbook, without a clock, and without a full-time professor. Out of its classrooms come . . .

By Thomas E. Stimson, Jr.

- PROBLEM:** Invent an electric waffle iron that won't scorch the finish of a table.
- PROBLEM:** Design a light, inexpensive camping trailer arranged so that its outdoor kitchen can be used from inside during wet weather.
- PROBLEM:** Determine the best way of collecting passenger fares on a high-speed

Students make models of their designs in clay. The clay is modeled over a wood skeleton called a buck

Designs for Tomorrow

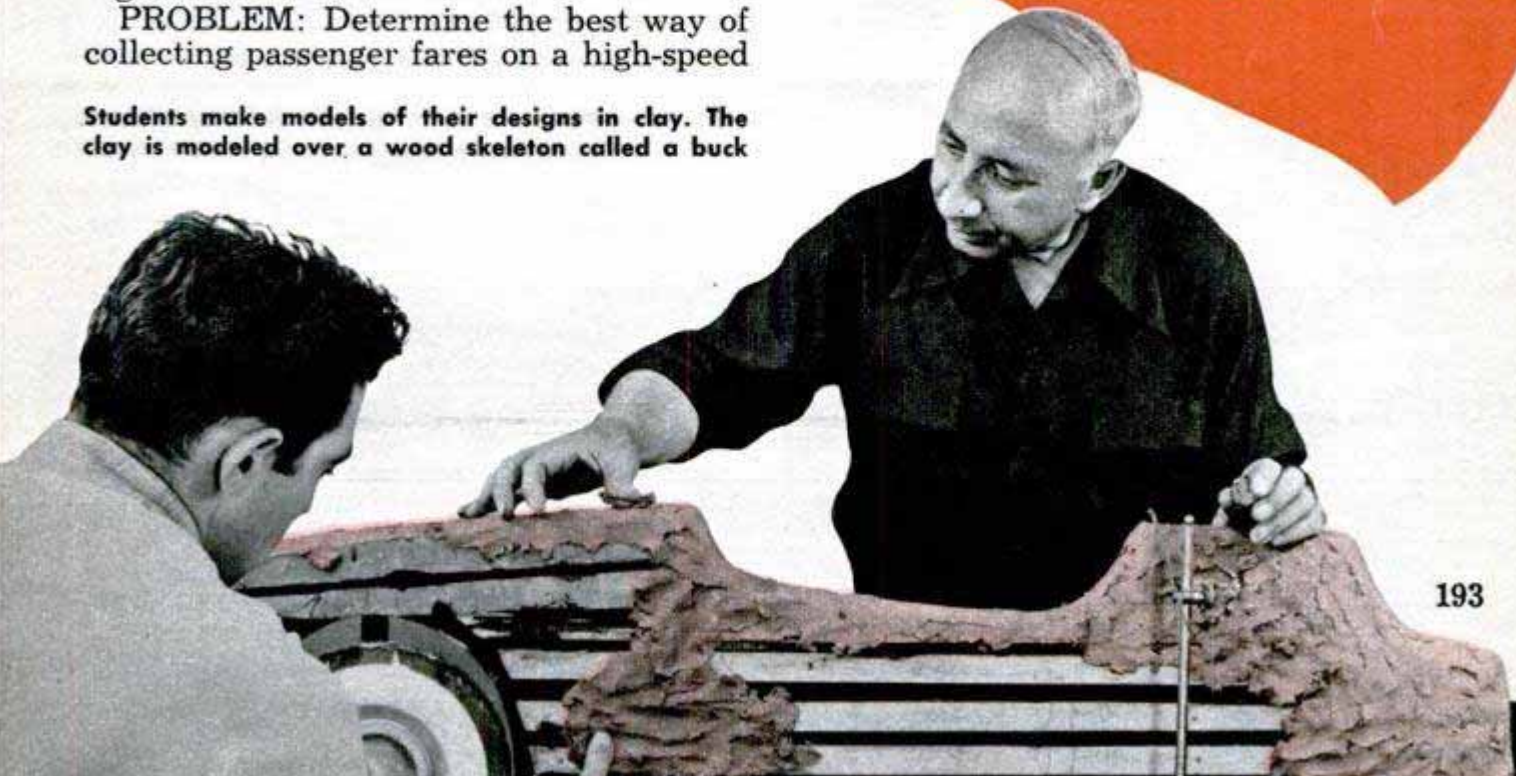

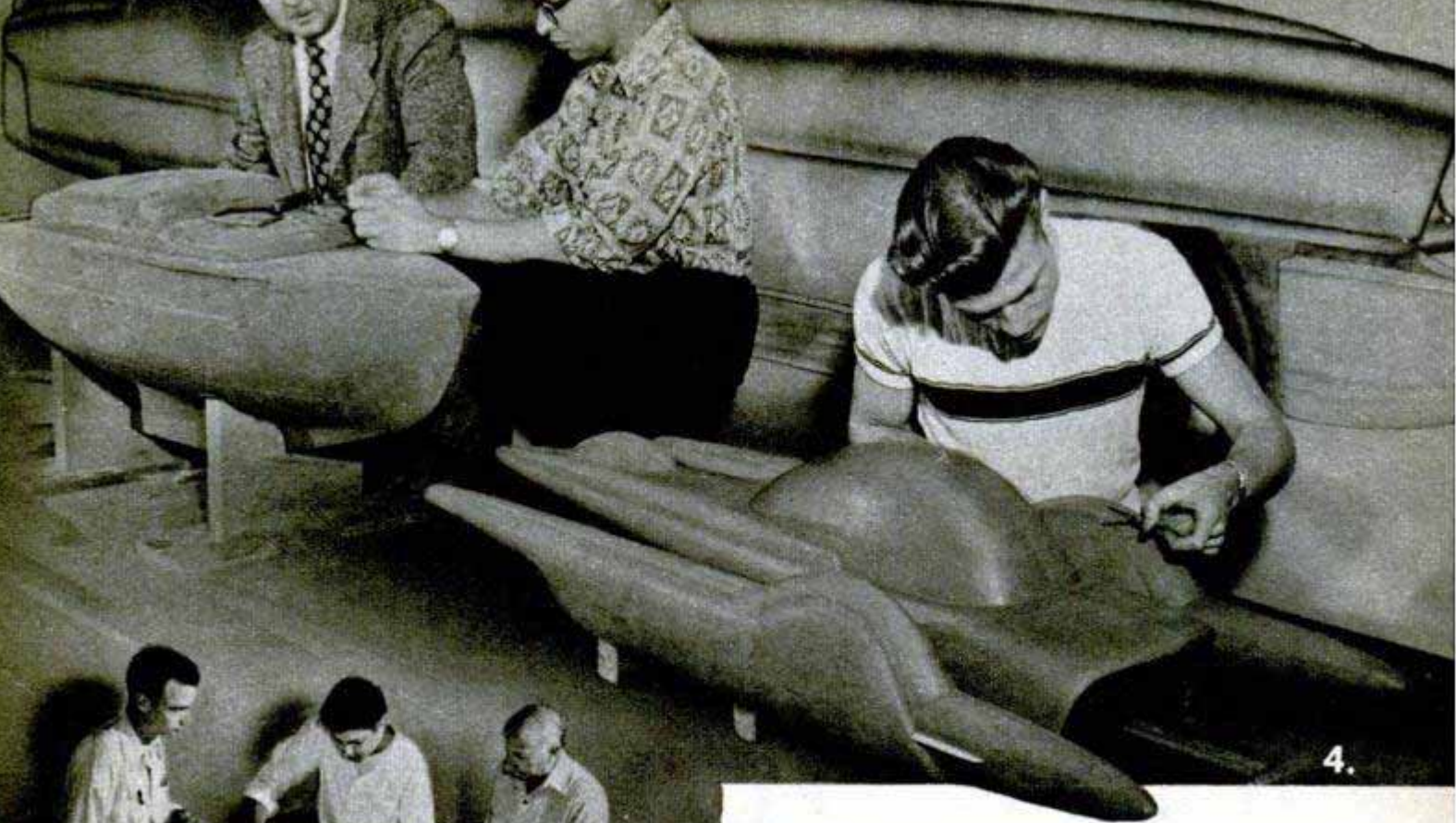

4.



3.

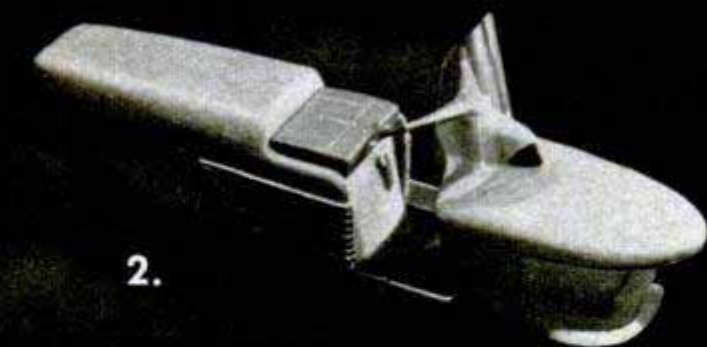

2.



1.

On these pages are shown some of the students' work: 1. Design for a railroad club car; 2. Sleek are the lines of a motor scooter; 3. Plaster model of range has sloping front to direct heat away from control knobs; 4. Modeling a racing car and boat with clay; 5. Composite design resulted when each student was assigned one part of the car; 6. Back-yard swimming pool and dressing rooms; 7. Motor scooter for hauling luggage at airports; 8. Bandsaw design; 9. Two cars designed for a monorail-transportation system

monorail-transportation system such as has been proposed for Los Angeles.

PROBLEM: In view of the metal shortage, design for mass production a wooden pull toy that has sound and animation.

These sound like major projects for trained engineers; actually, they are typical assignments that are handed out to students of industrial design at the Art Center School in Los Angeles. This nonprofit institution produces graduates skilled as artists, engineers and inventors.

"Basically, an industrial-design student learns to combine art and mechanics," explains George Jergenson, who heads the school's industrial-design section. "He becomes a creative artist for mass production."

This concept works so well that aircraft and automobile manufacturers, among others, depend on the school for supplying numbers of their young industrial specialists. About half the students have been hired over long-distance telephone by the time they graduate. They go direct to jobs that quite frequently pay as high as \$5000 a year to start.

Art Center uses no textbooks because

5.



the latest books are out of date for its needs by the time they are published. There are no clocks on the classroom walls because classes last all day. And the school has no full-time faculty members. Instead, industrial-design specialists who are tops in their profession are brought in to teach and lecture on a part-time basis.

Jergenson, for instance, is an old graduate of the school who since has spent 11 years with the styling section of General Motors and was the principal designer of the "Train of Tomorrow." Another part-time instructor is Strother MacMinn, whose experience includes work with General Motors, John Deere tractors and the industrial-design firm of Henry Dreyfuss. A third, John Coleman, is another early graduate of the school who has had considerable automotive experience, as well as having done design in the airline and appliance fields. All these men are operating their own concerns in industrial design. In charge of the school's modeling laboratory is Joseph D. Thompson, whose experience

6.



7.



8.



9



goes all the way back to the prototype of the Model-A Ford.

Mere restyling of an object isn't enough. There must be a reason for changing a shape. And a change that adds complications to manufacture or operation is poor practice; the best improvements are simple ones. These tenets govern the class studies.

In the case of the electric waffle iron mentioned above, for instance, the best solution that the students found was to elevate the iron on short legs to prevent direct heat transfer to the table. The modification is simple and effective.

Likewise the camping-trailer project was based on simplicity of design. The average small, camp trailer is too simple; it is merely a covered bed on wheels with a lid at the rear that opens out to expose a gasoline stove and some shelves. After discussion the students made two changes. They altered the bed arrangement so that you can sit down inside to change muddy shoes without soiling the bed, and they made the kitchen accessible from inside the trailer

as well as from its exterior. Around these ideas they designed a 10-foot trailer of laminated Fiberglas and plastic aimed at the \$1000 market.

Sometimes it's possible to make basic improvements in a product simply by changing its shape. One student learned this after he was handed an ordinary hand-held hair drier and was told to work it over. It was an awkward thing to hold and it didn't do an efficient job.

After study, the student changed the angle of the motor inside the case. This one operation permitted a more comfortable shape and also left room inside for a second air impeller and a larger heating element. The improved drier would cost a little more to manufacture, but would be much more efficient without using excessive power.

"What can you do to improve a small table radio?" instructor Coleman asked another of his students. All small radios are pretty much the same and this suggests that manufacturers think there's little room for improvement. But the student

was able to make a simple change that opened up a brand-new market for small radios. Using all the original parts, he redesigned the chassis into a thin, flat package. His radio can be used on a table as usual, and now it can also be hung on the kitchen wall like an electric clock, saving valuable working space.

When several groups of students tried their hands at designing a better lavatory their research led them to conclude that present shapes and sizes are just about ideal.

Once the design has been modeled in clay, a plaster cast is made of it, like this one of the cruiser model

Below, the completed plaster model, expertly painted and polished, has every detail of the designer's work

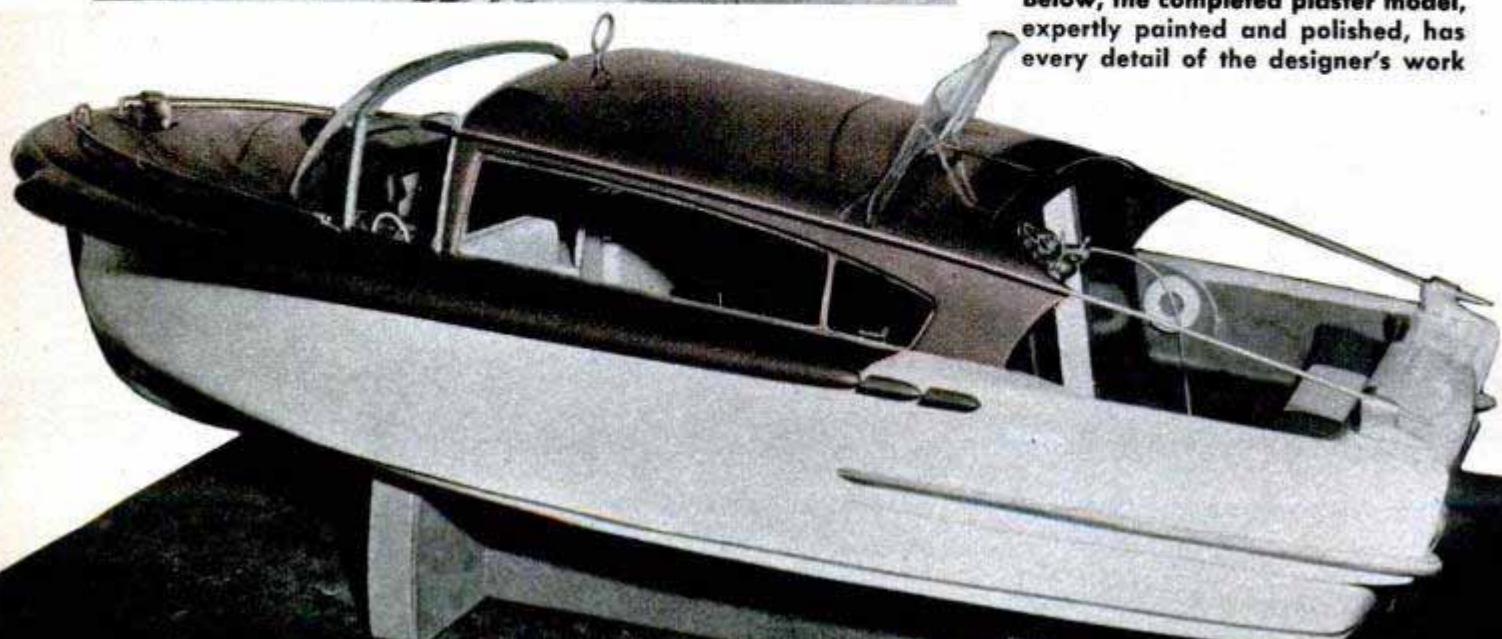
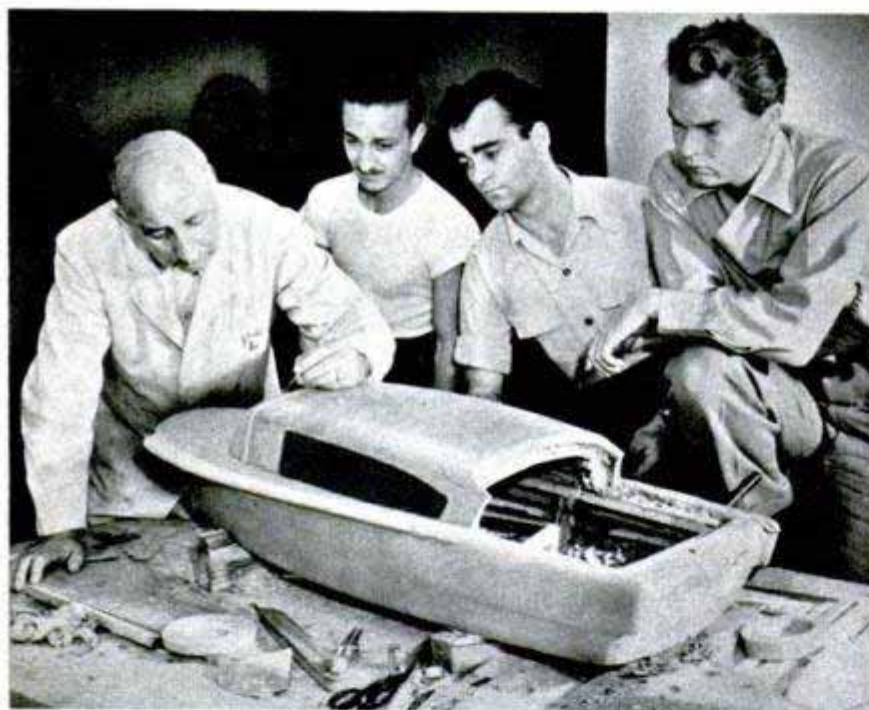

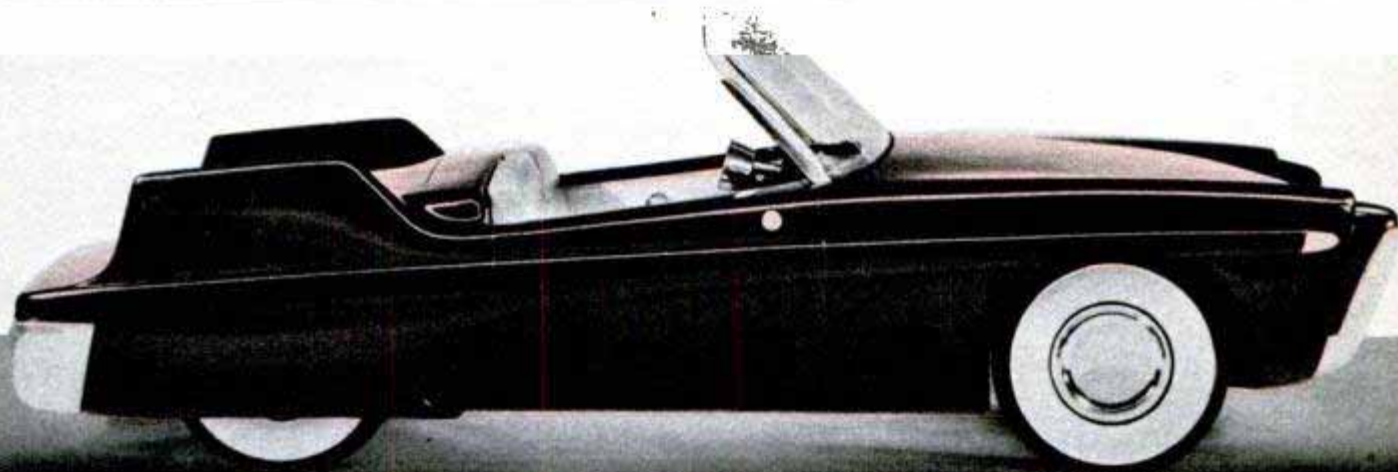

Above, design and modeling of sport cars are two favorite occupations at the Art Center School in Los Angeles

Then they originated one good idea. To hide the unsightly display of water and drain pipes under the bowl of a wall lavatory they added a removable fairing that conceals the plumbing. It fits up under the bowl and streamlines it into the wall.

Not only is the new lavatory more attractive, the chances are that it could be produced at only a slight increase in price. Pipes and fixtures would need no finishing or plating when they are concealed and this saving would just about balance the cost of the fairing.

Engineers who are asked to visit the industrial-design classes to criticize student projects sometimes leave with their heads filled with new ideas for their own products. Take the case of a gas cookstove that was a recent group project. It has several new features that eventually may be placed on the market.

One of the troubles with modern tabletop stoves, the students found in their re-

search, is that heat from the oven rises upward and makes the burner control knobs almost too hot to handle, in spite of the usual insulation. In their own design they sloped the front of the stove so that the heat is directed away instead of being allowed to rise. The control knobs remain cool.

They designed and tested their own cast-iron grills for the top of the stove and they perfected their own design of aeration bowl or collar that fits around the burner. These collars can be removed for cleaning. In addition to these improvements the stove was engineered to pass the 57 different tests to which the American Gas Association subjects new stoves before they are approved for marketing.

New students are encouraged to execute radical ideas regardless of how impractical or expensive their designs might prove to be. This helps to "free their thinking." Then they are brought down to earth by

(Continued to page 398)

Roving Machine Shop

Any small garage in the vicinity of Covington, Ky., can call in a roving machine shop to do special repair work on autos. The shop, built in a truck, rolls right up to the door. It has all the power equipment needed to do pin fitting, valve reseating, cylinder re-boring, crankshaft grinding and motor rebuilding for garages that do not have this equipment. Furthermore, no service charge is made for local calls, as the shop is operated by an auto-parts company which charges only for the parts and the labor. Standard auto parts required for the work are kept in storage cabinets, and those used each day are replaced when the roving shop returns to its home base in Covington.



Skilled mechanic in the traveling shop is using a piston-pin honing machine. The shop draws its power from the garage being serviced by means of its long extension cable

Right, overload springs are about the only extra used in the truck chassis. It is a standard $\frac{3}{4}$ -ton van-body truck. Total weight with all its equipment is 7600 pounds

Below, drawing of the interior of the mobile workshop shows how equipment is arranged to give the mechanic satisfactory work space. Inset, lower right, the floor plan



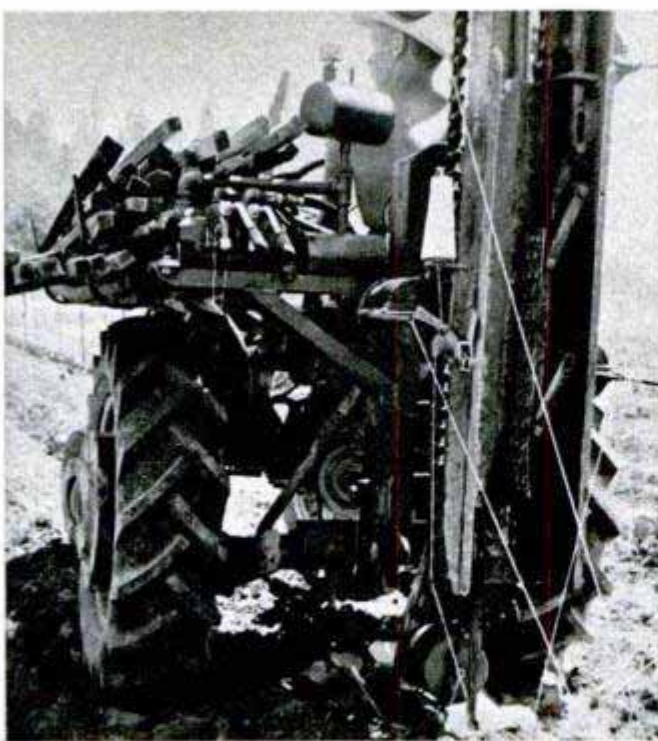

Upright assembly on right holds poles while they are driven. Spools on chain move in circle to form web

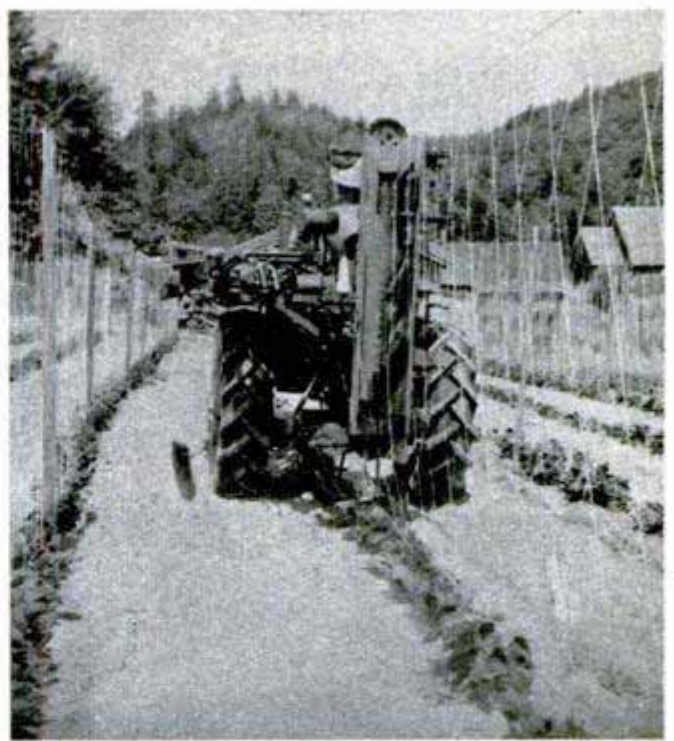

Wire unreels along top of the poles and cord unreels along bottom to form framework for crisscross strings

Mechanical "Spider" Weaves String Into Trellises for Beans

Making trellises for pole beans involved too much handwork for Fred Maloney, near Tacoma, Wash., so he developed a mechanical "spider" which automatically weaves a web for the beans to climb. Pole-and-string trellises are erected for the beans on thousands of acres each year. Maloney's trellis-maker is attached to a tractor. Seven-foot poles are placed by hand in a vise at the rear of the tractor. The

vise then thrusts the pole 14 inches into the ground. At the same time a wire unreels along the top of the poles and a string unreels along the bottom. To weave the web of strings, Maloney attached an endless chain to the tractor's power take-off. To this he welded five steel fingers, each containing a ball of string. Now when the tractor crawls down a row of beans, the fingers circle to wind the string into a web.



Mother Can Convert Baby Buggy Into One-Wheel Sidecar for Bicycle

In a few seconds a new baby buggy, developed in England, can be converted into a bicycle sidecar. The mother pulls two steel arms from under the buggy and positions them against a steel plate on the bicycle. She presses a locking lever and the

buggy is securely attached to the cycle. Then she folds back the hinged handle of the buggy, the action lifting three of the wheels off the ground, reducing the drag on the bicycle. A curtain fitted with a window keeps the baby dry in wet weather.

Sombreros and shoes, doormats and dinner pails — Portugal finds them all in its unique . . .

HOUSE of CORK

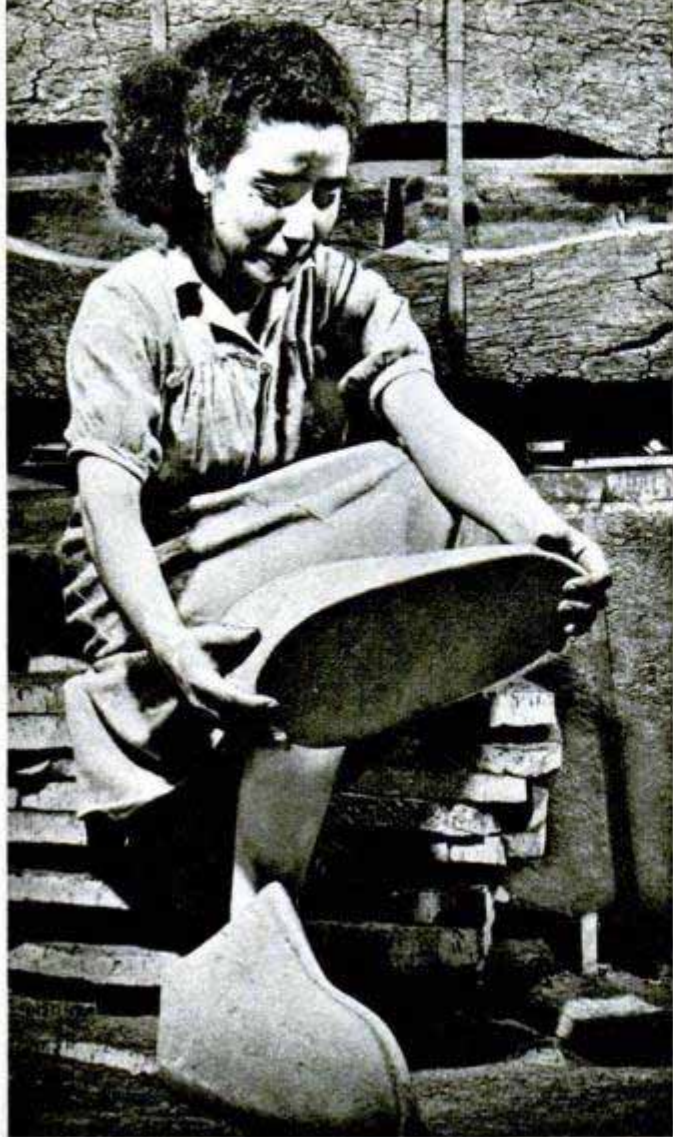

Above, real "gunboats," cork shoes keep the feet dry and warm in cold, wet weather and weigh very little

Right, broad-brimmed cork sombreros are light as a feather and act as insulation to keep the head cool

Below left, first step in production of cork dinner pail is to bend a sheet and cement it in that shape

Below, cork pail is not quite round so lid fits only one way and correct position is indicated by a notch

Below right, slipproof and dry are these bath and kitchen mats made by stringing cork pieces on wire

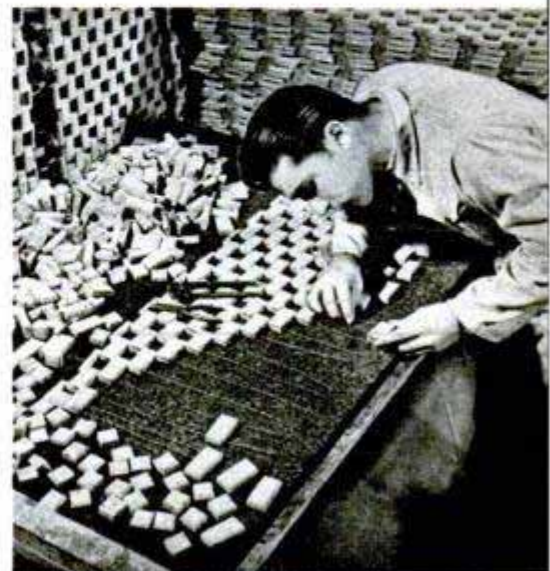

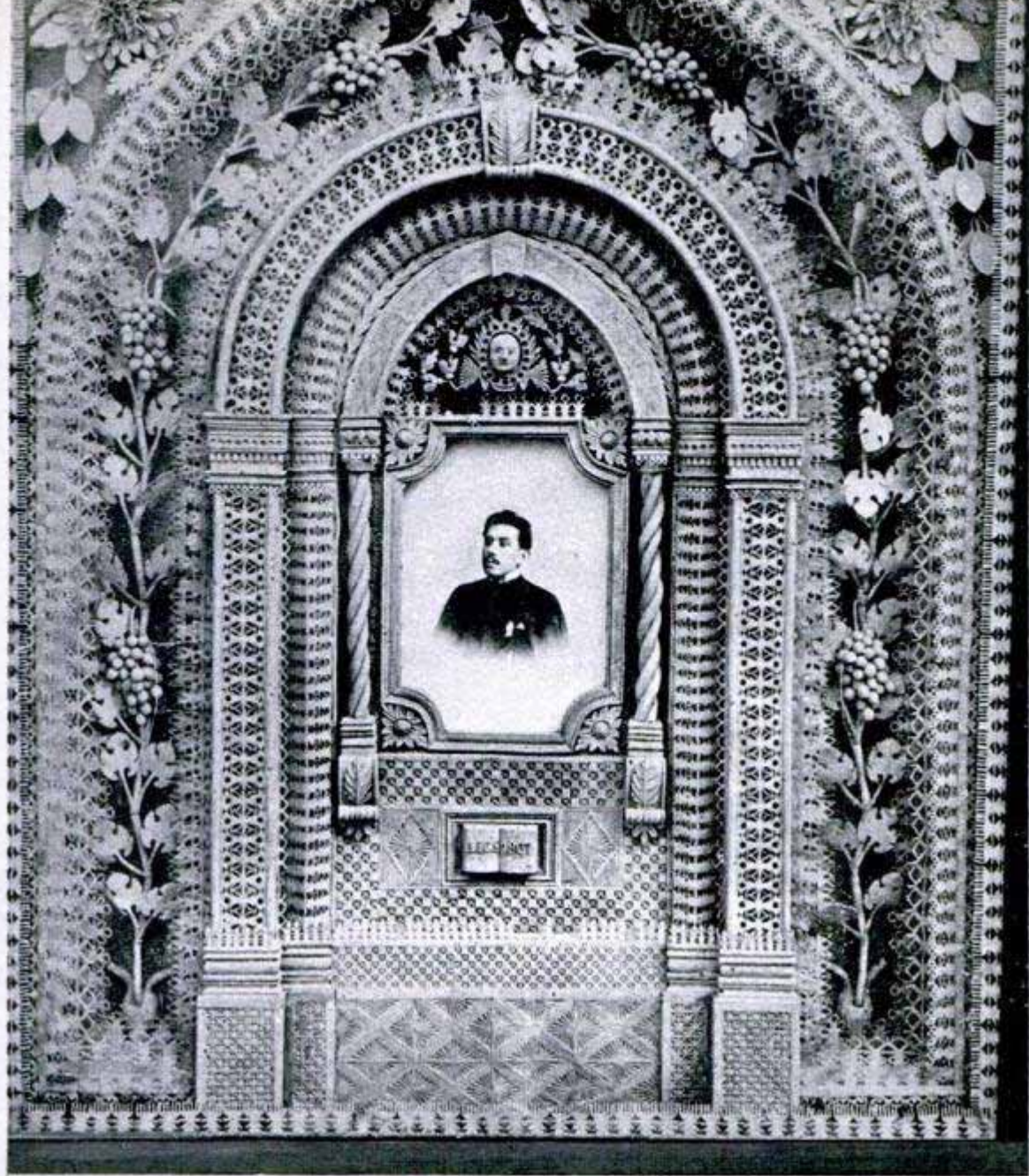

ONE OF Portugal's most profitable exports is cork, so it's no wonder that the light, resilient bark has many uses there. In Lisbon, at the Casa das Corticas, which means the House of Cork Things, you'll find picture frames so delicately carved in cork that they look like huge, old-fashioned lace valentines. There are cork hats that flap in the wind, dinner pails of cork that are self-insulating and, of course, the usual items such as cork shoes and mats. Only the finest cork can be used for the intricate designs.

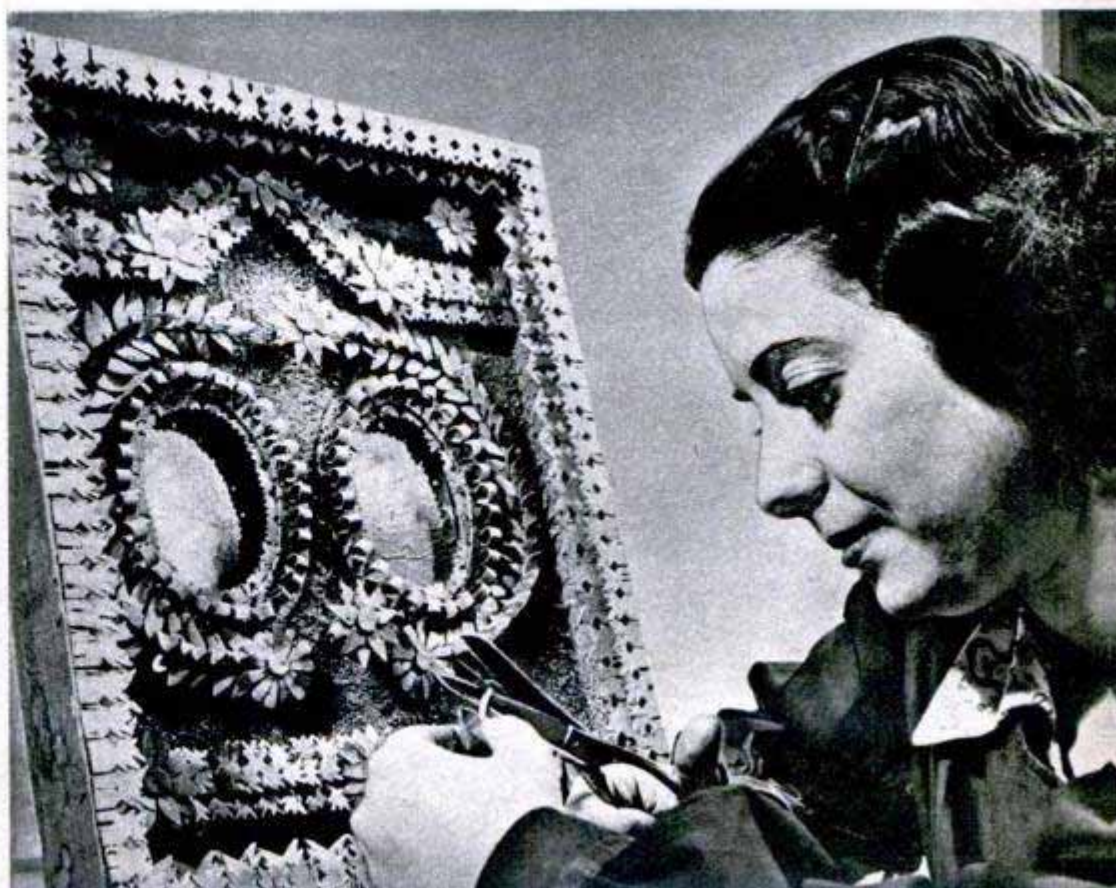

Model Steamboats Piloted by Radio

Under its own power, the Consulator II steams into position in front of its pilot who steers it by the radio he is holding. Why does he wear waders? Well, just in case something goes wrong out in "midocean"



As real looking as the riverboat after which it is modeled, the Delta King is powered by a steam engine

Radio waves control the movements of a pair of model steamers that operate on steam just like the full-size originals. Members of the San Francisco Model Yacht Club, famous for its trophy-winning sailboats, are finding radio-controlled steamers even more exciting than sailers. An ocean-going tug, the Consulator II is 74 inches long and weighs 125 pounds. Its engines develop one third horsepower. Another

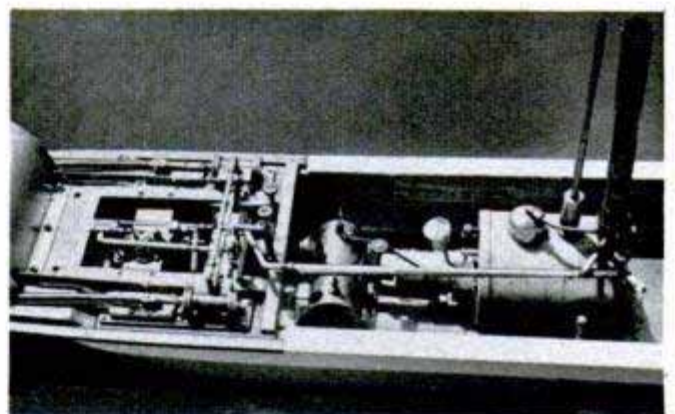

Engine room of the Delta King with superstructure removed. Each part operates as the boat puffs along

model is the Delta King, a scale model of a riverboat that once plied the upper San Francisco Bay. Radio signals give five elements of control; forward and backward, to port and starboard, and the whistle, which can be blown at any time. The operator simply presses a button and the boats respond. An antenna about two feet long and highly directional beams the signals from the control transmitter to the boats.

Tiny Carbon Spheres Are Hard Enough to Scratch Glass

Tiny spheres of pure carbon, so hard they will scratch glass, have been developed by the Bell Telephone Laboratories. The shiny little globes are an intermediate carbon stage between graphite and diamonds, the hardest substance known. They are so abrasive they will probably be used in grinding operations, and may replace diamond dust in some cases. Because the

spheres are so pure and uniform, they also can be used in making carbon rods which are used to "moderate," or control, atomic piles. Diameter of the spheres varies from one millionth to one sixteenth of an inch. Formed by heating a chemical, polydivinyl benzene, to 1050 degrees Centigrade, the spheres can be worked into sheets, filaments, films or other desired shapes.

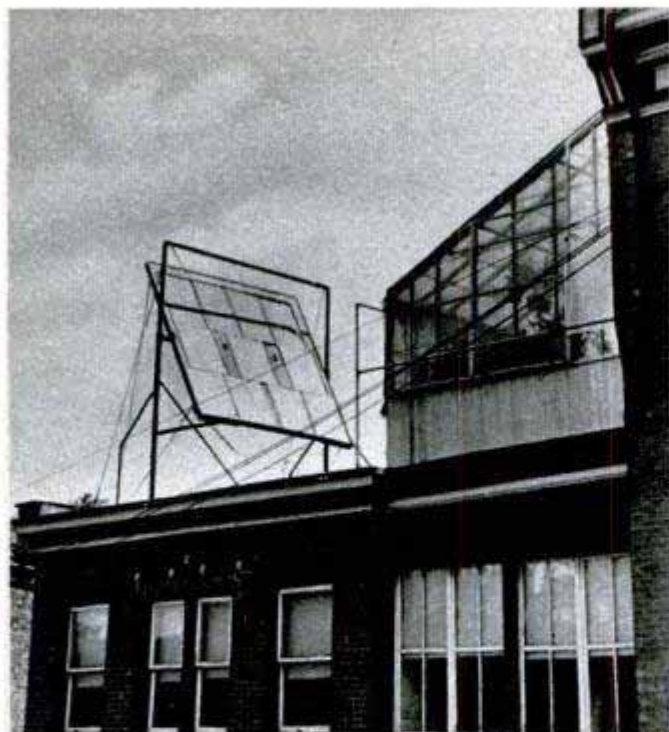

Reflector-Lighted Greenhouse

Blocked from the sun by a brick wall, a small greenhouse in downtown Philadelphia gets its sunlight with the help of a large reflector. Developed by Maurice Mandelkern, a Philadelphian whose hobby is raising orchids, the novel system involves



the use of an 8 by 10-foot reflector made with 11 large mirrors. In the summer months, the greenhouse is shaded with plastic to reduce some of the reflected light, but in winter, when the sun is low in the sky, the shades are removed and the reflector bounces the sunlight on the plants, causing fall blooms to flower in spring.

Boxing Scoreboard

Round by round, the balloting of the referee and two judges is flashed to fight fans by an electrical scoreboard invented by Michael J. Mesi of Portland, Ore. The board, which also keeps a cumulative total of points scored throughout the fight, can be hung at any vantage point in the arena. A light behind any number from 1 to 15, across the top of the panel, indicates the round in progress. None of the scoring lights flashes on until all three officials have registered their votes on separate control boxes at the ringside. Their scoring panels remain lighted until the 10-second warning whistle for the beginning of the next round. Totals accumulate at the bottom under the headings "black" and "white"—depending on which corners the fighters occupy. Mesi's board, which has 546 lights,

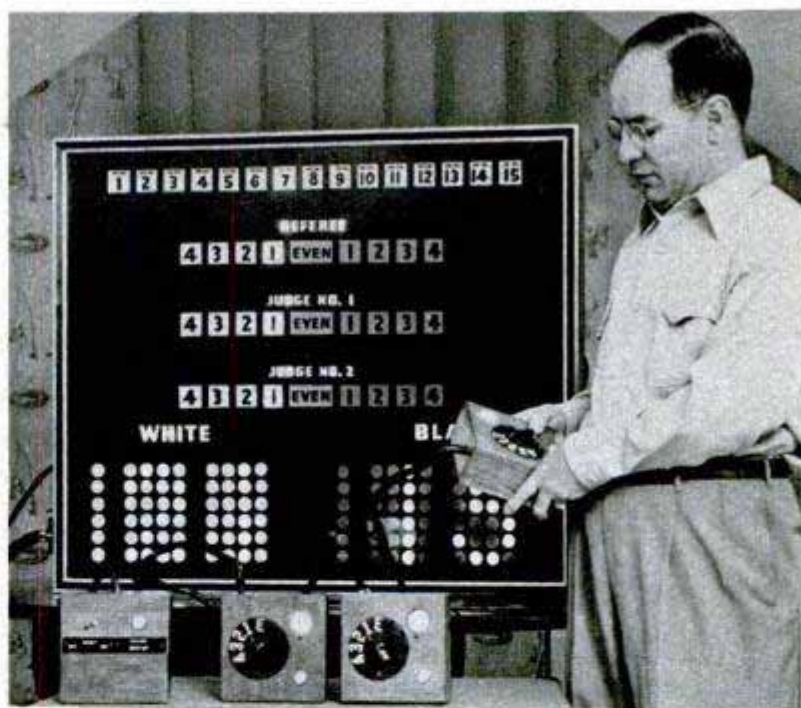

32,000 feet of wire and 12 relays, was made from parts of old pinball machines with the aid of one mechanic.

Waterproof Rope

Possessed of remarkable resistance to moisture absorption, specially treated Manila rope now available is designed for the protection of linemen, maintenance men and workers who face electrical hazards.

Popular Mechanics provides two sources of further information concerning articles published in each issue; the WHERE-TO-BUY-IT INDEX, to be found on pages 10, 14, and 16; and the WHERE-TO-FIND-IT LIST, available from the Bureau of Information, 200 E. Ontario St., Chicago 11

OVERBURDEN

CABLE WHEELS

COAL SEAM

DRIVING
GEAR

CUTTING-WHEEL CONTROLS

APPROX. DIA. OF CUTTING
WHEEL, 16 TO 18 FT.

Foreman directs operations as the excavator's giant cutting wheel, fitted with steel-toothed buckets, bites into coal seam

FOREMAN GIVES DIRECTIONS TO
CUTTER-WHEEL CONTROL BOX

G. H. TAVI'S

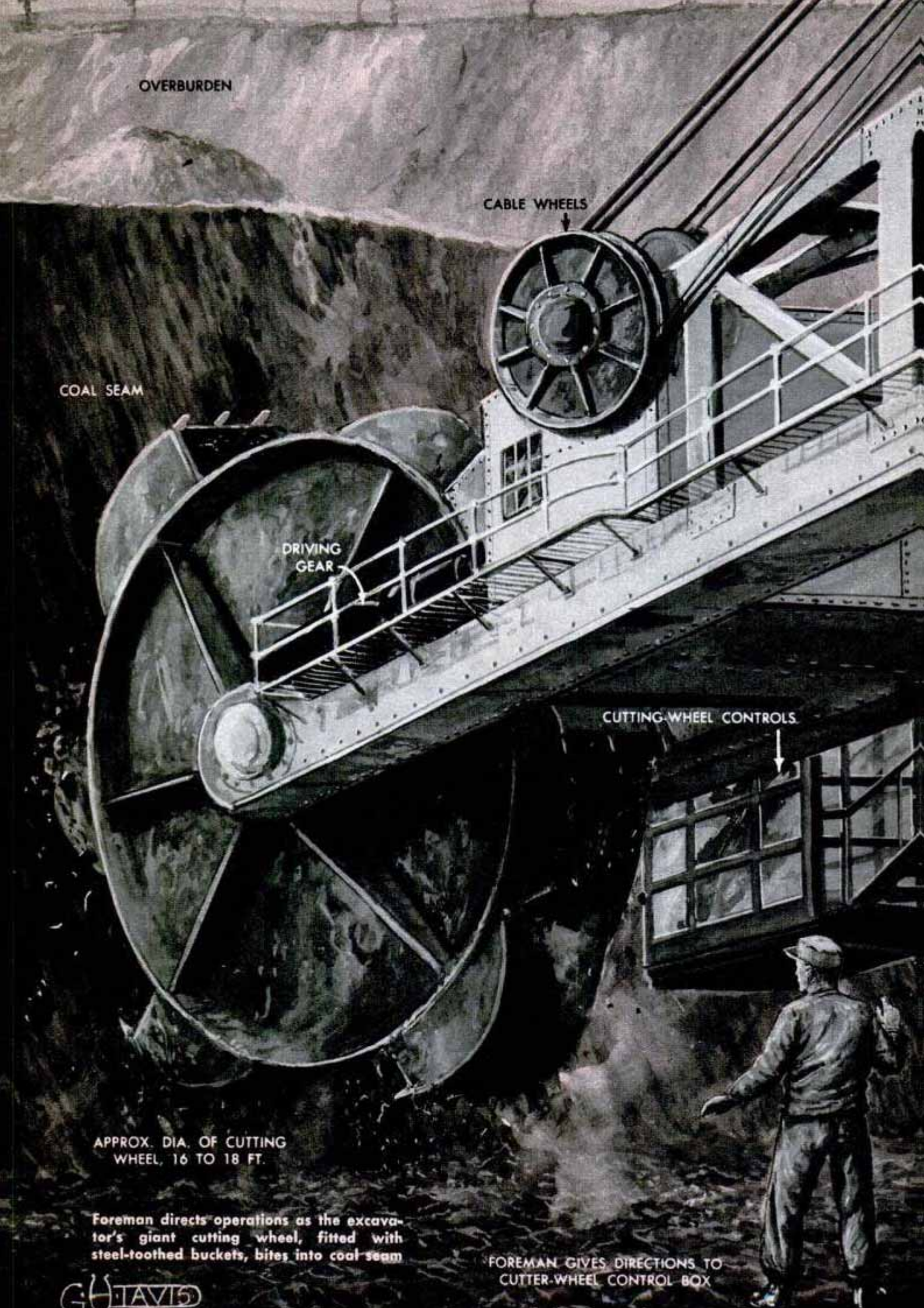

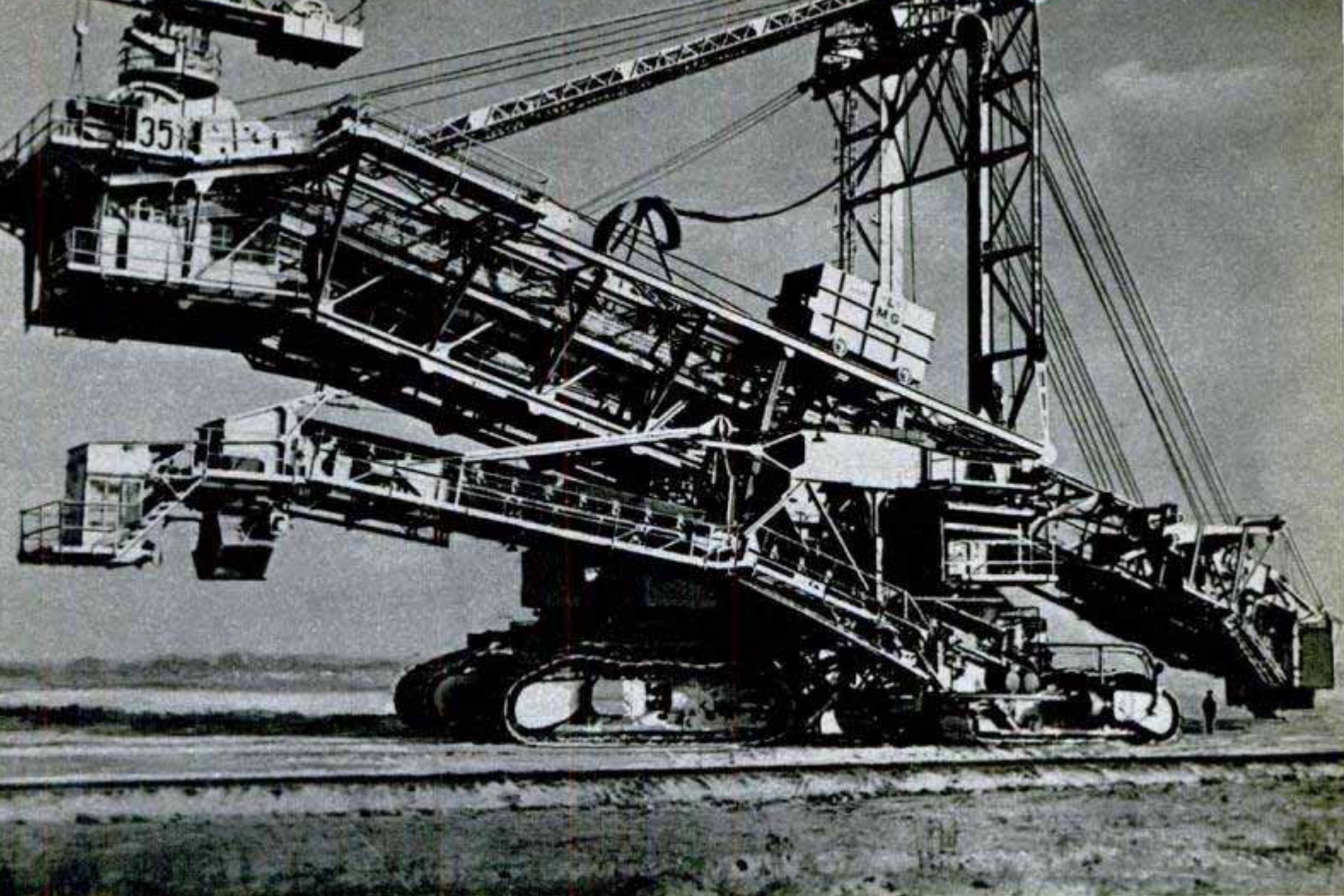

"Walking" down road near Helmstedt, Germany, 1000-ton coal-digging monster displays its maze of girders

SIX-LEGGED BEHEMOTH MINES GERMAN COAL

By G. H. Davis

IN A MIGHTY PIT at Helmstedt, Germany, stands a gigantic machine created by a Leipzig engineering firm to increase the output of coal in that area.

As the 1000-ton monster slowly moves on its six enormous Caterpillar feet (each track is over seven feet wide and ten feet high), the whirl of its numerous electric motors fills the air. The giant cutting wheel at the end of a central arm of the machine eats into the coal seam, filling its steel-toothed buckets and dumping them on conveyor belts that carry the coal through the machine and deposit it from the rear-end hopper into waiting coal wagons.

Located throughout the machine to drive all of its various working parts are 40 electric motors fed by a heavy electric cable that snakes along the coal floor of the pit from a commercial power supply.

Only three workmen are visible around

the giant digger when it is in operation: One sits in a forward cabin and controls the digging wheel; another, in a similar enclosure near the coal chute, controls the supply of coal to waiting cars, and a foreman watches the cutting and gives hand signals to the cutting-wheel controller.

As the excavator works along the coal face digging upward and sideways, the staggering weight of the machine exerts a pressure of seven pounds per square inch on the ground. It is only possible to realize the enormous size of the "walking" monster by standing near it and looking up at the towering, intricate latticework of girders that extends 86 feet into the air. From one end of the machine to the other, the over-all length is approximately 241 feet, with the telescopic arm in its retracted position, as illustrated in detail on the following pages.

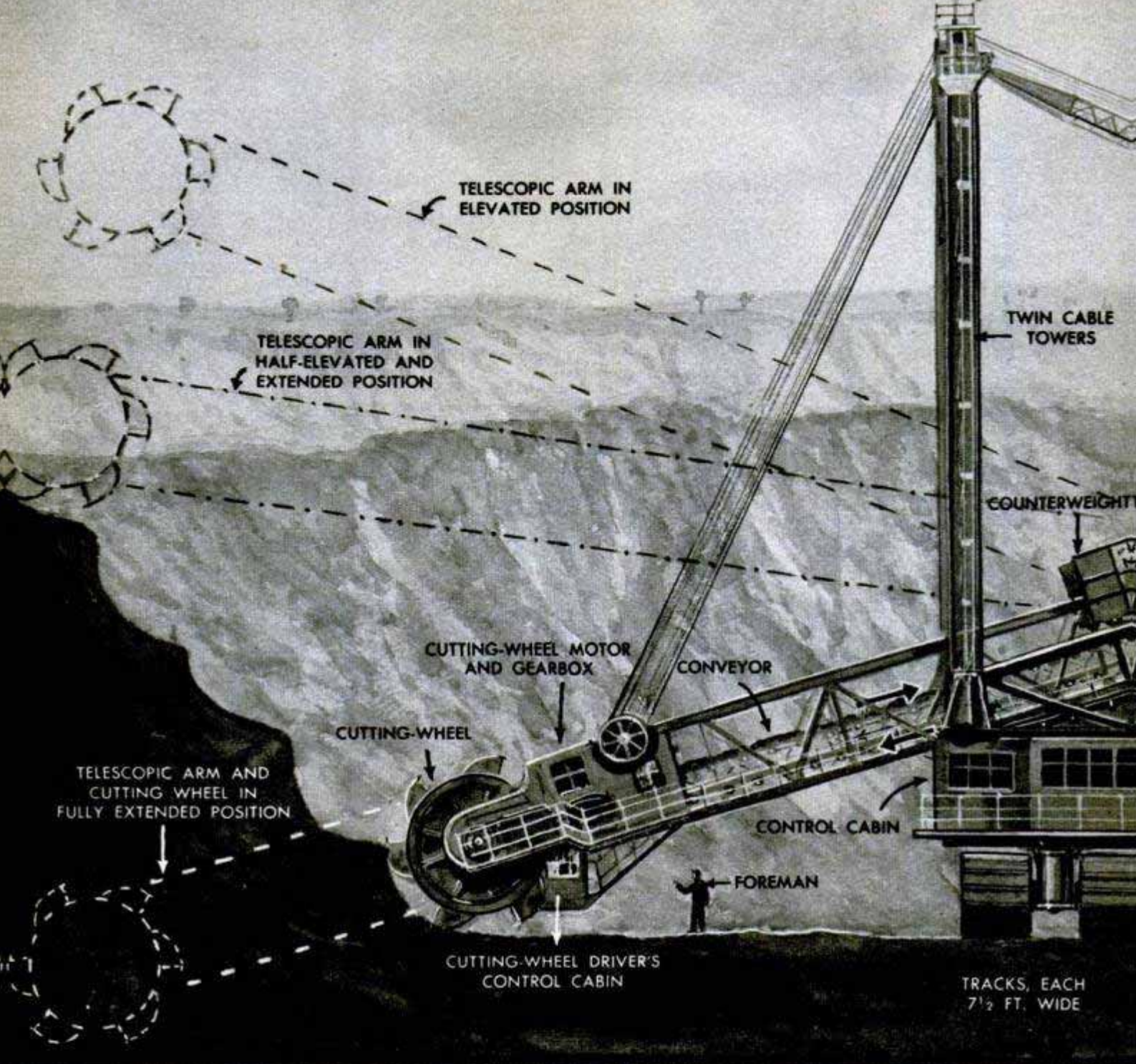

**PLAN VIEW
SHOWING
FIXED AND
TELESCOPIC
ARMS**

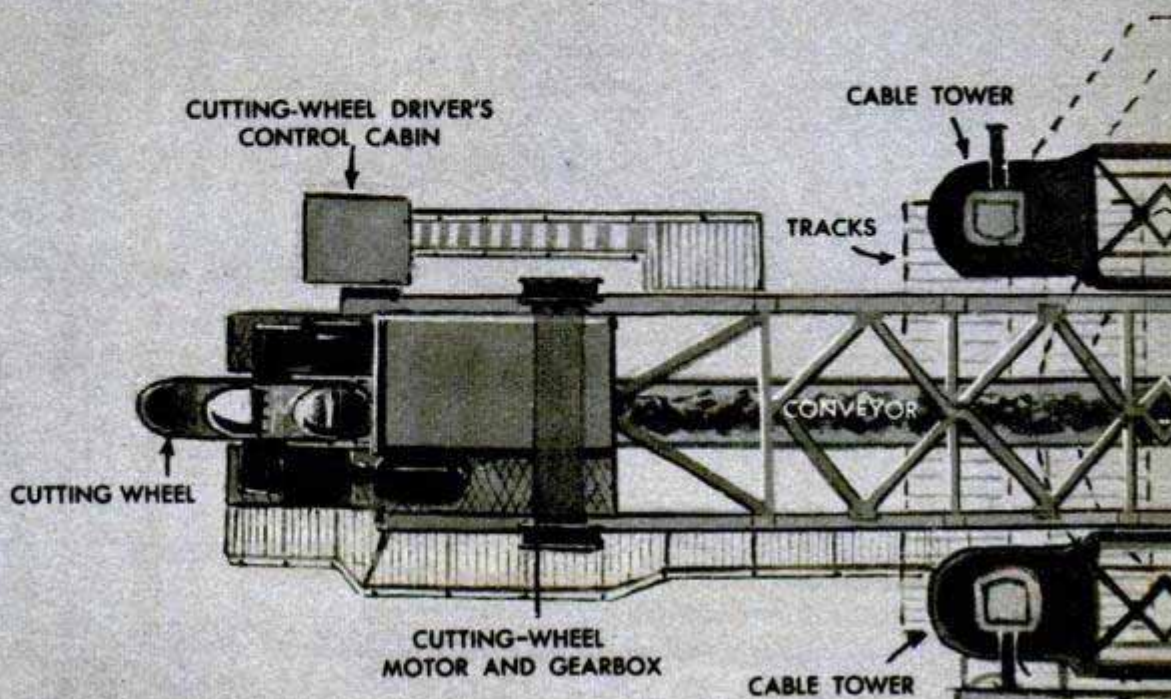

SIDE ELEVATION OF GIANT COAL EXCAVATOR AT HELMSTEDT, GERMANY

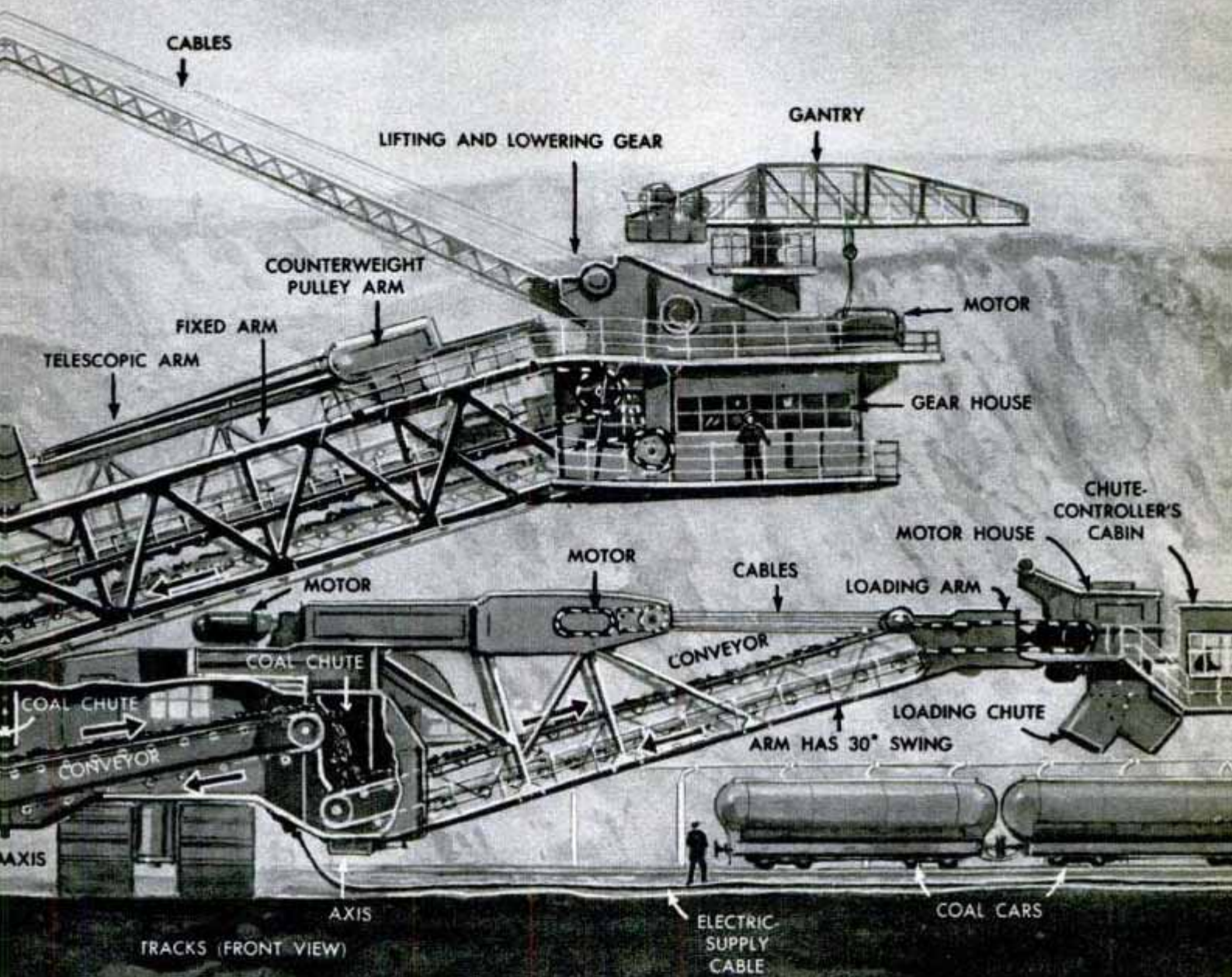

LENGTH OVER-ALL 241 FT. WITH ARM NOT EXTENDED

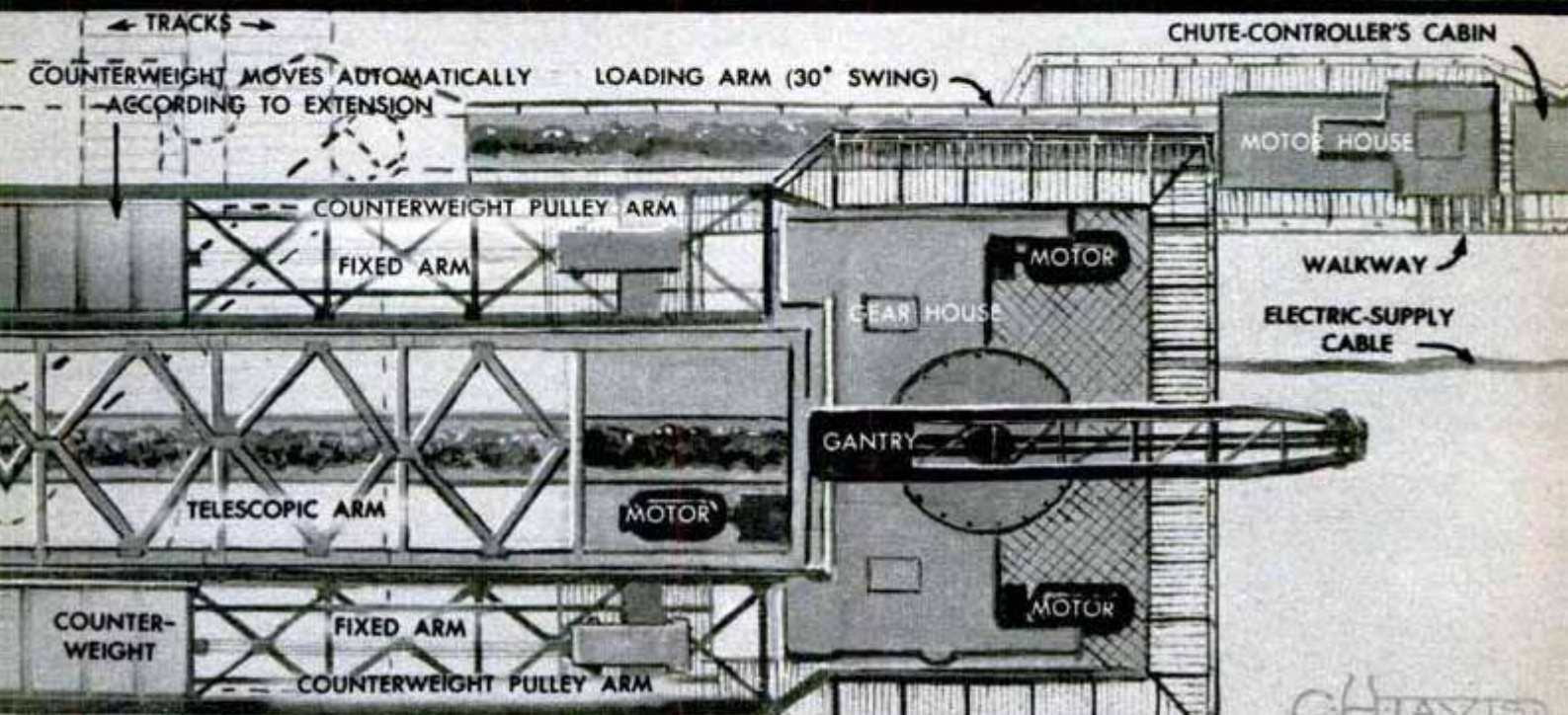



Self-Service Upholstery Shop

Novices can upholster their own furniture under professional guidance in a self-service workshop at Wichita, Kans. A local furniture store has installed a complete upholstery shop divided into six stalls, which customers may rent on an hourly or daily basis. All the tools needed in uphol-

stery work are available, including extra-heavy-duty sewing machines. Experienced upholsterers are on hand to guide each customer in his project. The novice can buy anything he needs in the way of fabrics, foam rubber, decorative nails and other supplies in the shop. It is estimated that the self-service arrangement saves the customer about 50 percent on each job.

California Living Room Hangs in Air From Huge Plywood Arch

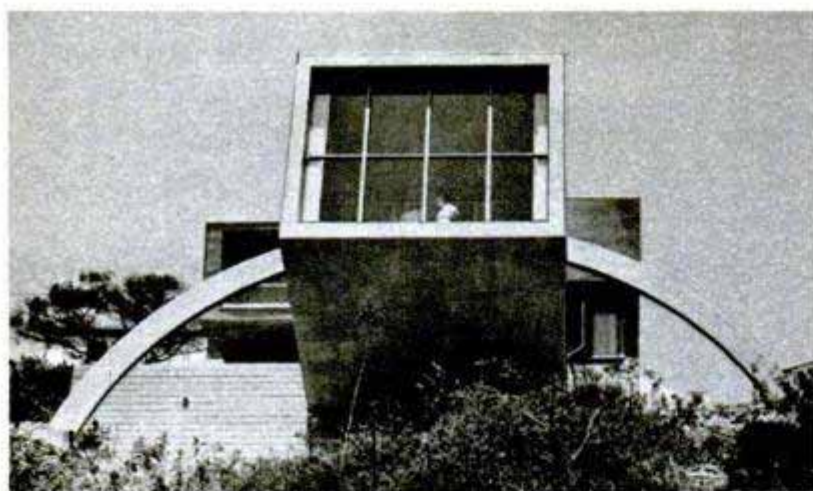

In a new hillside home in Hollywood, the living room projects out into space to provide an airplane-like view of the surrounding area. Instead of resting on a conventional concrete foundation, the room is supported high above the hillside by a 60-foot arch made of laminated plywood. The arch, with its ends anchored in concrete footings, passes through the walls of the room. The portion of the house supported by the arch consists of a two-story living room, one end of which is all windows, and a balcony. The weight of this section is 20,000 pounds. Installed, the arch cost \$1400 and required a 70-foot crane to set it into position on its footings. Inside the room, the balcony is built over the top of the arch, providing extra living space for the homeowner.

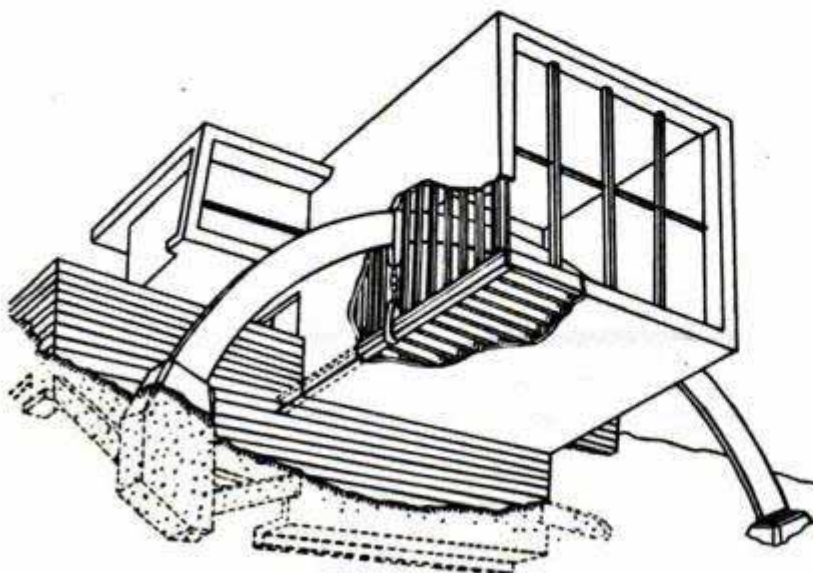

Popular Mechanics provides two sources of further information concerning the articles published in each issue; the WHERE-TO-BUY-IT INDEX, starting on page 10, and the WHERE-TO-FIND-IT LIST, which may be obtained without charge by writing the Bureau of Information, *Popular Mechanics Magazine*, 200 East Ontario Street, Chicago 11

Plastic Bugs

Insects molded of plastic—to serve as fishing lures—are so lifelike they're difficult to distinguish from their real counterparts. The plastic bugs include crawfish, crickets, roaches, water crickets, grubs, grasshoppers, stone flies and weed worms. The natural coloration of these insects is closely followed in the lures. Each bug hides a fishhook. The lures can be used for still or fly fishing, and are resistant to sun, water and aging.



Laundry-Vending Machine

Now, in Cleveland, there's a vending machine to handle your laundry and dry cleaning. It receives money, gives the correct change, returns incorrect deposits and opens its doors, all without manual aid. Each unit consists of a series of lockers and a control panel equipped with a telephone. The customer simply lifts the phone and advises the operator in a central office of the laundry or cleaning to be done. The operator assigns and unlocks a locker by remote control. Trucks arrive at the lockers at frequent intervals to pick up and deliver the clothing left by customers.

Underwater Camera

Shaped like the tail structure of an airplane, a French movie camera is designed for underwater photography. The lens is said to be corrected for the refraction of light under water. Completely self-contained, the large camera even has an oxygen bottle mounted on it for the use of the operator.

Sick Plants Run a Fever, Too

Like sick human beings, sick plants can run a fever, according to Prof. C. E. Yarwood, plant pathologist at the University of California. In studying plants infested with virus and fungus diseases, Yarwood found temperatures of diseased plant leaves from 0.1 to 2 degrees Centigrade above healthy plants. He also found that fungus diseases produced higher temperatures in plants than virus diseases.



on the BUICK



Popular Mechanics was observing its first birthday when Buick made this two-cylinder job back in 1903

Foot-operated parking brake on Buick, right, is released by pulling a hand knob located on the dash



The true test of an automobile begins when the owner takes the wheel. This is another report from owners of 1951 cars who answered questionnaires sent by Popular Mechanics to 1000 Buick owners from coast to coast

By Floyd Clymer

BEST BUY on the market for the money." That phrase was repeated time and again in answer to our survey question, "Why did you buy a Buick?"

It soon became apparent as the results of the questionnaires were tabulated that those who drive Buicks, by and large, are among the happiest of car owners today. Thousands of owners buy Buicks time and again and many reported they would buy no other make of car. As always, there were suggestions for improvements.

A Denver mechanic said, "I work on all cars, day in and day out. I prefer Buick as my own car. Dynaflo, which slips some in starting, is the best and smoothest drive of

all. Buick can take abuse in the rough mountain roads."

A Los Angeles contractor said, "I've owned 50 cars in 50 years—19 of them Buicks. Despite some criticism, it's the best buy of all cars made today."

"I have been driving Buicks for 15 years," wrote a Dundalk, Md., machinist, "and as a former Roadmaster owner, I believe the new Special is far better than any car in its field for comfort, roadability, design and trim. The horsepower is more than adequate. As for economy, considering the size of the car, it is sufficient."

On the other hand, an Indianapolis chemist was asked what he disliked about his



"Buick took the rough stuff with little effort," says Floyd Clymer after driving the car 1590 miles

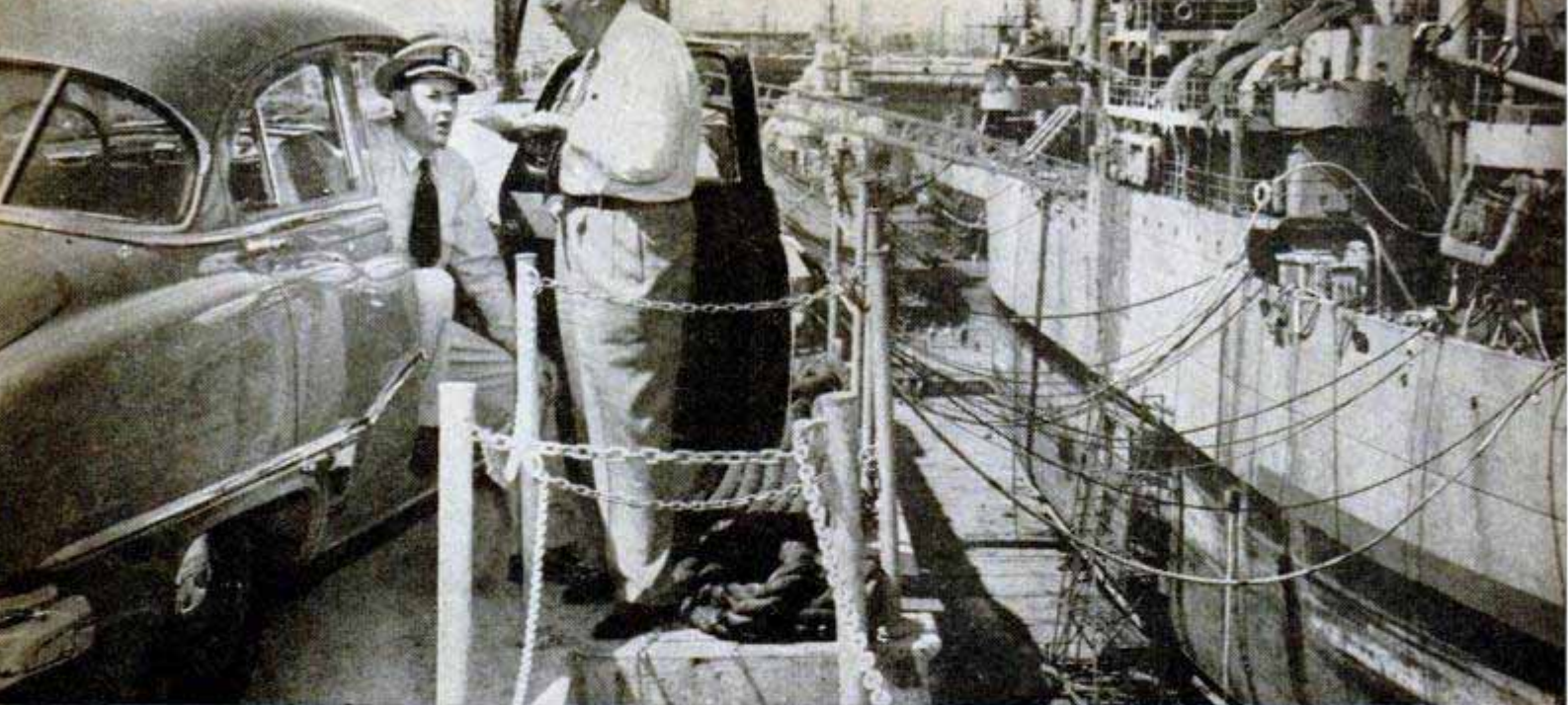

In polling Buick owners, Clymer interviews Lt. Cmdr. W. E. Jones at the Long Beach, Calif., Naval Shipyard

Special, and he replied, "It's just that it isn't a Roadmaster."

A Macon, Ga., traveling salesman pointed out one advantage: "I use only the Buick Special. In small towns it can very easily be serviced or parts can be replaced in almost any Chevrolet place if no Buick agency is available."

It is noteworthy that many buyers of new cars still are war-conscious. Several Buick owners said they bought '51 models "to last through any war in the near future."

A few random replies to our question, "What do you like about the Buick?" were:

"It has all the comforts of a rich-man's automobile and still is within the price range of a working man." — Minneapolis pharmacist.

"Increased visibility and the ventilation system." — Milwaukee tool engineer.

"Starter under the gas pedal and 'step on' parking brake." — Glen Burne, Md., truck driver.

"G. M.'s research backing." — Washington, D. C., diplomat.

Samplings of criticism of the 1951-Buick models included these comments, mostly from otherwise satisfied owners:

"I can't understand why, of all G. M. cars, Buick seems to have the poorest upholstery and body workmanship." — Springfield, Mo., truck driver.

"I have owned nine Buicks, and the doors and windows on the last four never have been completely satisfactory. The inspection of new cars these days must be made by a one-eyed man. The rubber molding on the car is faulty. The gasoline gauge on my new Super has been worked on three times and still does not work. . . . The radios in my last three cars have required about three overhauls before giving satisfaction." — Liberty, Mo., attorney.

"The 1951 Buick with Dynaflo needs a small light for night driving under the 'P-N-D-L-R' on the shift indicator." — Buyer for El Paso, Tex., department store.

"The rear-view mirror is not good. . . . Either a lower mirror or a higher glass in the rear is needed." — Richmond, Va., apartment manager.

"The body assembly is terrible and for this reason alone I never would buy another Buick." — St. Louis, Mo., executive.

Among the owners' survey, 88 percent approved of Buick's Dynaflo drive and said they want it on their next car. (Of all 1951 Buicks, 86 percent were Dynaflo-equipped.) A Springfield, Minn., woman

ACCELERATION TEST

Buick Special with Dynaflo

¼ mile from zero	23.90 sec. — Drive range only
	21.50 sec. — Low and Drive
½ mile from zero	34.80 sec. — Drive range only
	33.60 sec. — Low and Drive
0 to 30 m.p.h.	9.25 sec. — Drive range only
	6.40 sec. — Low range only
0 to 60 m.p.h.	21.90 sec. — Drive range only
	20.10 sec. — Low and Drive

(In tests using both Low and Drive, shift from Low to Drive was made at 30 m.p.h.)

Top speed by speedometer.....98-100 m.p.h.
Actual top speed, about nine percent less (speedometer variation)

Percentages From P. M. Poll

Owners of Special models	49%
Owners of Super models	36%
Owners of Roadmaster models	15%
Owners of Dynaflo	77%
Owners of standard transmission.....	23%
Average gasoline mileage in country—	
Special and Super	16.9 m.p.g.
Roadmaster	14.7 m.p.g.
Average gasoline mileage in city—	
Special and Super.....	13.9 m.p.g.
Roadmaster	12.2 m.p.g.
Use premium gasoline	82%
Use regular gasoline	18%
Owners who change oil	98%
Average mileage for change of oil	1474
Owners who add oil (also change periodically)....	18%
Average mileage for adding oil	1170
Maneuverability excellent	80%
average	19%
unsatisfactory	1%
Acceleration outstanding	37%
very good	50%
average	13%

Best-Liked Features

Increased visibility	98%
Coil springing.....	97%
Sweepspear styling	95%
Step-on parking brake	95%
8-cylinder OHV engine	94%
Interior finish	87%

(These percentages are based on the answers to direct questions on the questionnaires.)

Owners' Rating of Car

Excellent	66%	Average	5%
Good	28%	Poor	1%

General Information

Prefer in-line engine	66%
Prefer V-type engine	34%
Prefer eight cylinders.....	98%
Prefer six cylinders	2%
Prefer overhead valves	92%
Prefer side valves	8%
Prefer automatic transmission	82%
Prefer standard and overdrive	9%
Prefer standard only	9%
Prefer Dynaflo drive	88%*
*(The above figure means 88% of the 82% preferring automatic transmissions.)	
Prefer makes other than Dynaflo	12%
Like low-pressure tires	87%
Average pounds carried above recommended pressure (by 45% of owners reporting).....	3.9 lbs.
Previous Buick owners	68%
Have owned five or more Buicks	14%
Will buy another Buick	71%
Might buy another Buick	27%
Will not buy another Buick	2%
Dealer service good	62%
average	28%
poor	10%

Most frequent objections:

1. Body fitting and assembly; 2. general interior finish; 3. location of rear-view mirror

bookkeeper said that Dynaflo gives "a smoother start, and ease in winter driving." A Winston-Salem, N. C., safety supervisor thought Dynaflo "overrated," but a Huntington, Ind., trucking manager, who has owned 19 Buicks, said Dynaflo provides "easy getaway and comfortable driving." Reports on gasoline mileage always are

interesting in our surveys. Buick owners of all models averaged from 12.2 to 16.9 miles per gallon in both city and highway driving.

Much discussion has surrounded the curb and road clearance of 1951 cars, including Buick. In the present survey 95 percent of Buick owners said clearance is satisfactory,

Optional E-Z-Eye glass in Buick screens out some heat rays and glare that would pass through ordinary glass

REGULAR GLASS

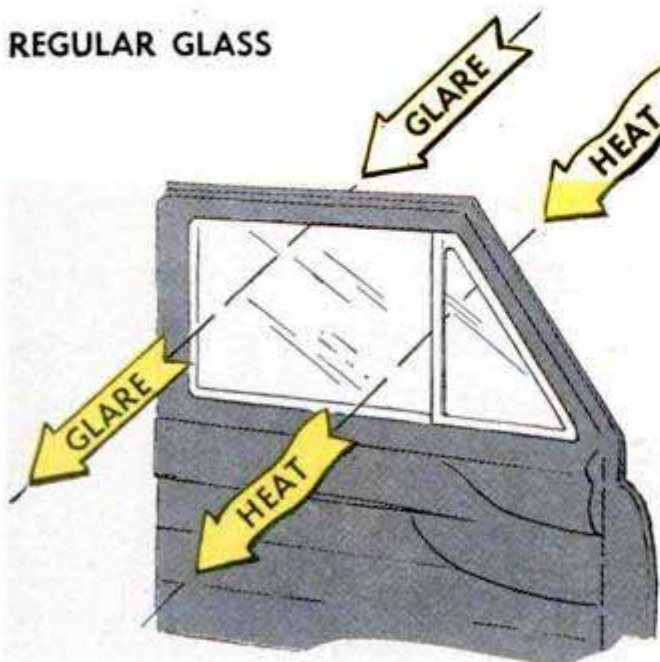

E-Z-EYE GLASS

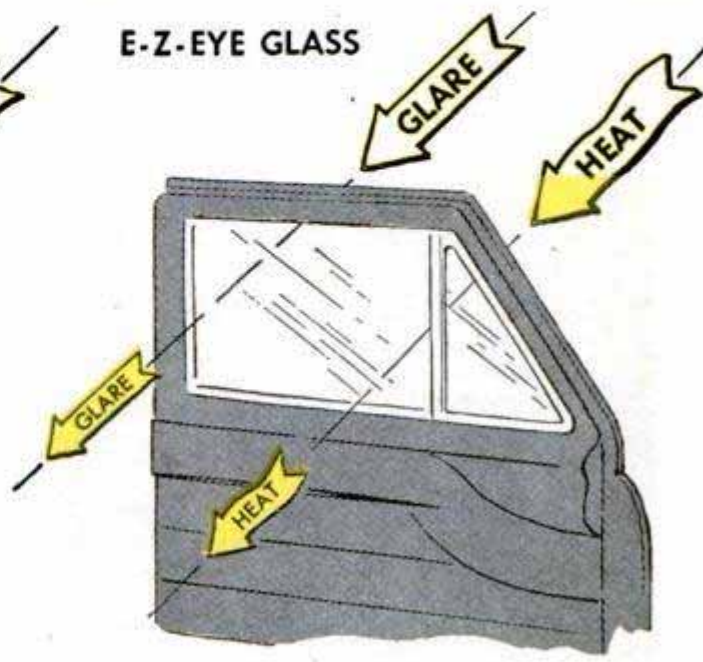

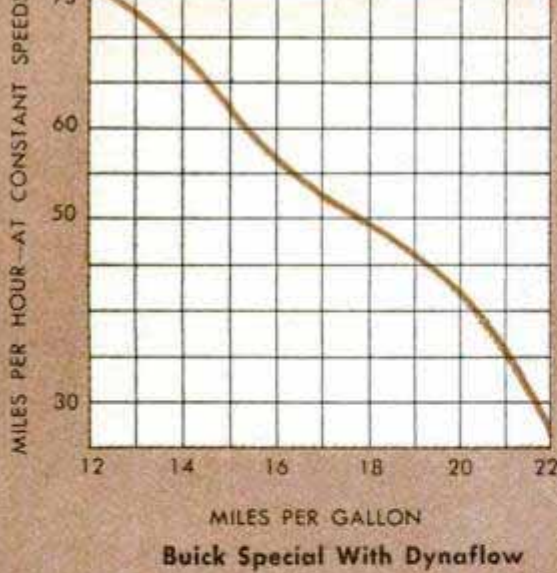

Buick Special With Dynaflow

Speed (m.p.h.)	Miles Per Gallon
At constant 30 m.p.h.	21.70 m.p.g.
At constant 50 m.p.h.	17.90 m.p.g.
At constant 60 m.p.h.	15.20 m.p.g.
At constant 75 m.p.h.	12.20 m.p.g.

CROSS-COUNTRY MILEAGE

(Speedometer showed only 49 miles at start of test)

Flint, Mich., to Springfield, Ill.	15.80 m.p.g.
(Car new, quite heavy traffic)	
Springfield, Ill., to Kansas City, Mo.	17.10 m.p.g.
Kansas City, Mo., to Denver, Colo.	18.70 m.p.g.
(Premium gasoline of various brands was used on test)	

while only five percent said that it is too low.

Regular gasoline was used by 18 percent of the owners replying; 82 percent used premium. In this respect, a Wichita, Kans., man wrote: "I know the gasoline mileage indicated in my report seems pretty good. However, this was my experience: For the first 2000 miles, my Special averaged 15.4 miles per gallon on over-all driving, two thirds in the city with regular gasoline. I switched to premium gas because of carbon ping. For the next 1476 miles I averaged 17.46 miles per gallon."

A suggestion from an Indianapolis meat packer read as follows: "The 1951 Special can be improved by using the Super-Roadmaster dash panel. The Special dash panel is not as distinctive as the 1950 Special, which has the speedometer dial located in the center: The entire Buick line can be substantially improved with heavier moldings and bumpers and conversion to the V-type engine. Heavier chrome moldings such as Cadillac uses would be worth the extra cost."

One satisfied Dynaflow customer was a Ft. Lauderdale, Fla., retail-store owner. He said: "My Super holds the road well. . . . I can drive all day with minimum fatigue. . . . Dynaflow is the smoothest in taking off or slowing down."

A Kansas City broker said: "If you are careful with Dynaflow you can get more gas mileage than other cars of similar size with automatic transmissions. Even if I don't get as good mileage, I'd still buy Buick because of satisfaction I get in driving one, high-trade-in value and good dealer service. Yes sir, I'm a dyed-in-the-wool Buick fan—no other make for me."

An Illinois farmer says: "There may be better cars than Buick, but I've never found one. Don't like the rear coil springs—my only kick."

Amateur car designers are uncovered in

every survey. This time a Minneapolis architect could find nothing wrong with his Super model, but drew a diagram to explain the "rubber bumpers on rear of frame strike metal seat when car is loaded. As rubber strikes slanting surface a squeak is produced. This design could stand some improvement."

A Racine, Wis., retail merchant said he would not trade his Roadmaster for a Cadillac. "Why are Buick engines noisy?" is the only complaint I ever hear," he wrote. (Actually, the new hydraulic valve lifters greatly reduce OHV engine noise.)

A Topeka, Kans., dentist bought a Buick this time because of its performance in mountain driving. "Buicks seemed to pass us easily when we drove other makes," he noted on his questionnaire.

Several owners complained of Buick's body workmanship. One of these, a Norfolk, Va., marine engineer, writes: "Because of my observance of various makes of cars in the lower-class field, I have found the workmanship of the bodies and interiors such as door fit and moldings around windows as good or better than in the two Buicks I have owned."

A Milwaukee fireman driving a Special Dynaflow model dislikes "the sound of being in second gear in city driving." He also would "like to see an over-all increase in gas mileage." (Who wouldn't?) "Combining overdrive and Dynaflow might give it to you," he observed.

An Arlington, Va., physician who owns a Special reported that he had that rarity of rarities, an automobile clock which keeps good time.

Finally, Buick received this mash note from a Danville, Ill., trucking owner: "I cannot describe the pride my wife and I have in our Buick Roadmaster."

My own test: The test car was driven

(Continued to page 314)

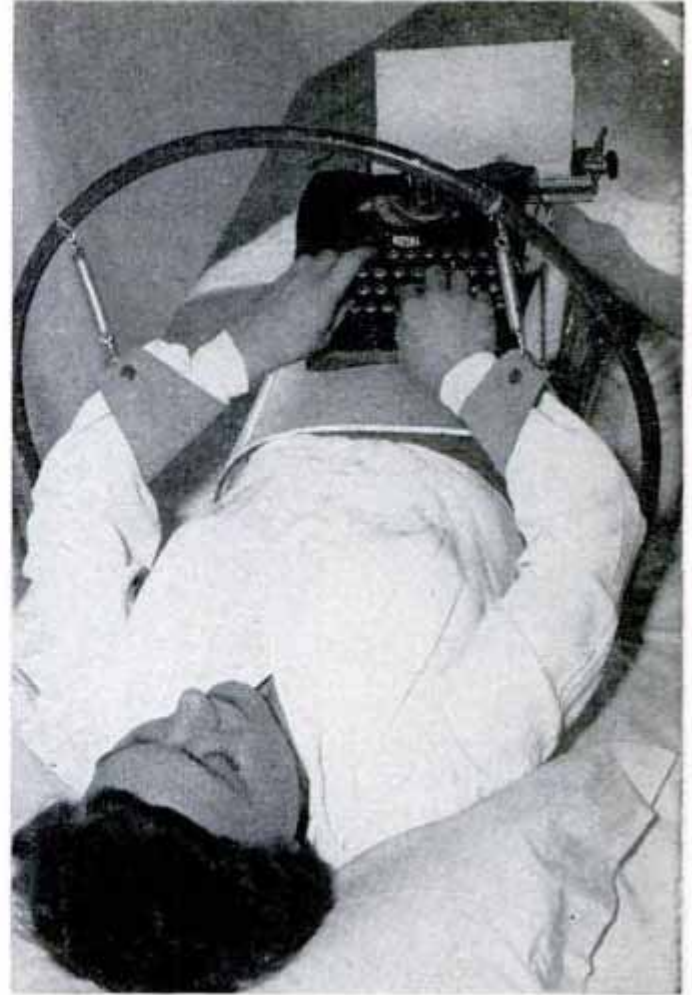
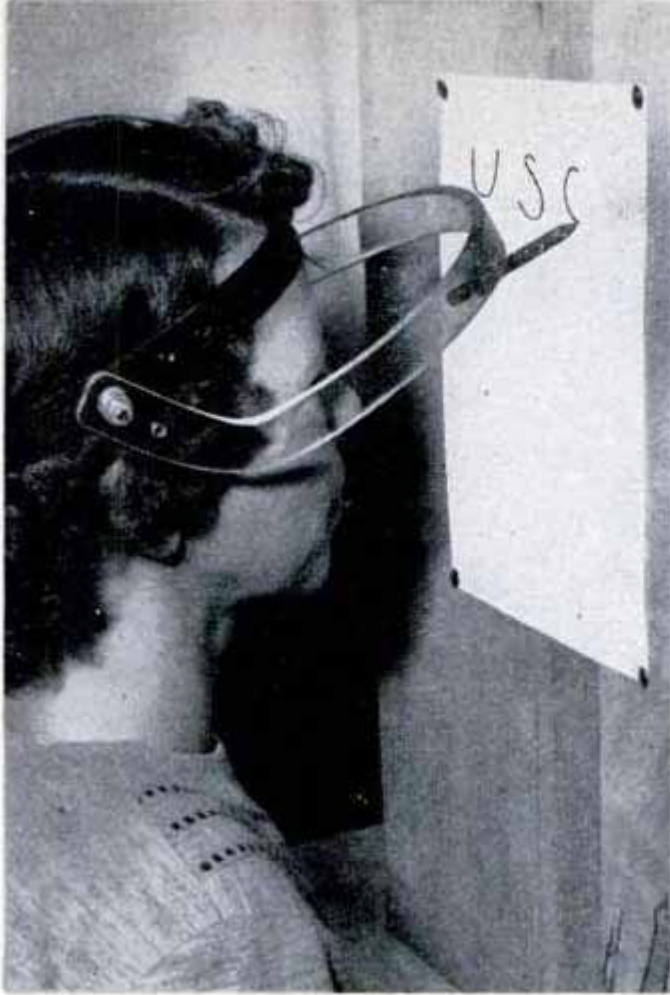

Inventions Help Handicapped to Help Themselves

Invented at the occupational-therapy department of the University of Southern California, two ingenious devices help handicapped persons perform various acts. One device fits inside an iron lung and holds

the patient's wrists above a typewriter keyboard so she can pound out words although she cannot raise her arms. Another device fits on a patient's head and holds a pencil so she can write on the wall.

Giant German Crane "Kneels" in Transit

With a capacity of 30 tons, a German railway crane used to rebuild bombed bridges "kneels" almost flat to comply with clearance requirements of the right-of-way. Four cars carry the crane and accessories. Over all, the train is about 150 feet long. The crane weighs 175 tons. Power comes from an electric generator driven by a diesel engine. An electromagnetic brake holds the load in any position. Cast-iron counterweights are used to prevent the crane from tipping and these weights have to be distributed throughout the train when the crane is in transit.

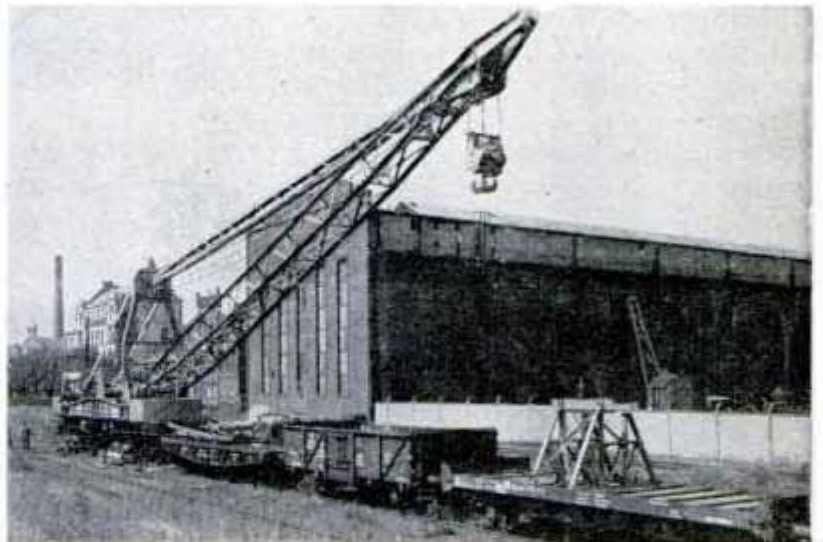

With its boom up and ready to lift anything from a bridge to a locomotive, the giant German railway crane looks like this. But when it's time to get rolling over the rails, the whole machine collapses, drawing below, to extend over three cars

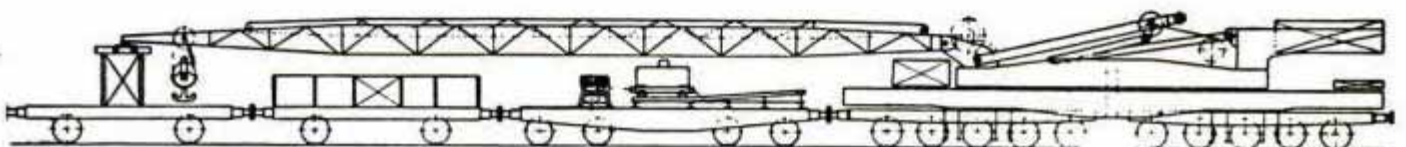



Test "bodies" dropped from plane, above, are slowed down by automatic "dive brakes" before they land, below

"Dive Brakes"

In testing wings, tails and control surfaces considered suitable for flight faster than sound, research engineers at the Ames Laboratory, Moffett Field, Calif., mount them on streamlined "bodies" to be dropped from planes at altitudes of 35,000 to 40,000 feet. As the free-falling bodies are loaded with valuable instruments to measure such factors as drag and lift, the engineers have devised a system of "dive brakes" and a self-contained parachute to increase the possibility of instruments being recovered. Located toward the rear of the body, the brakes open at a set point, and a hydraulic-fluid metering system limits the brake force to a predetermined value, thus avoiding the terrific impact of a suddenly opened parachute. When the body has been slowed

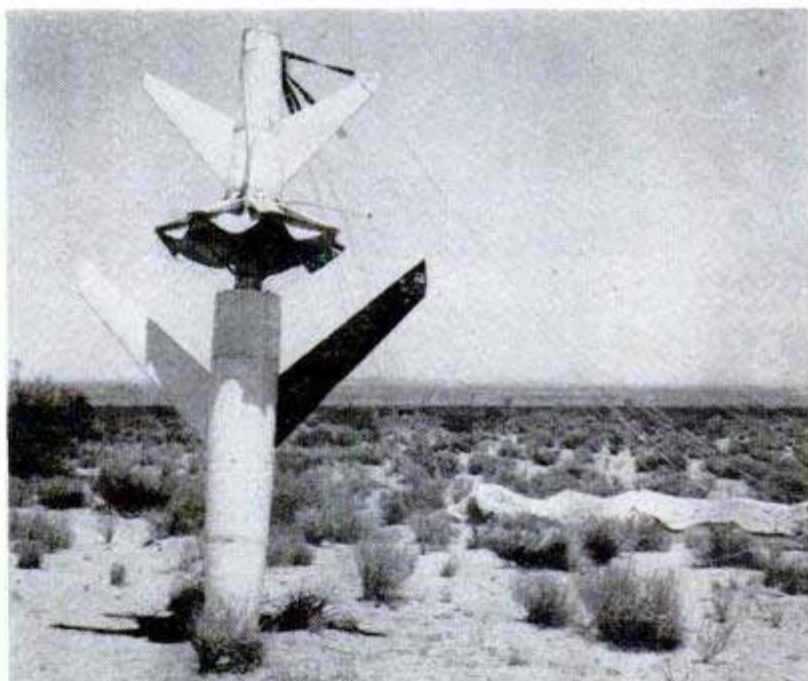

to a point where the chute can be used safely, it is released automatically from a compartment in the tail.

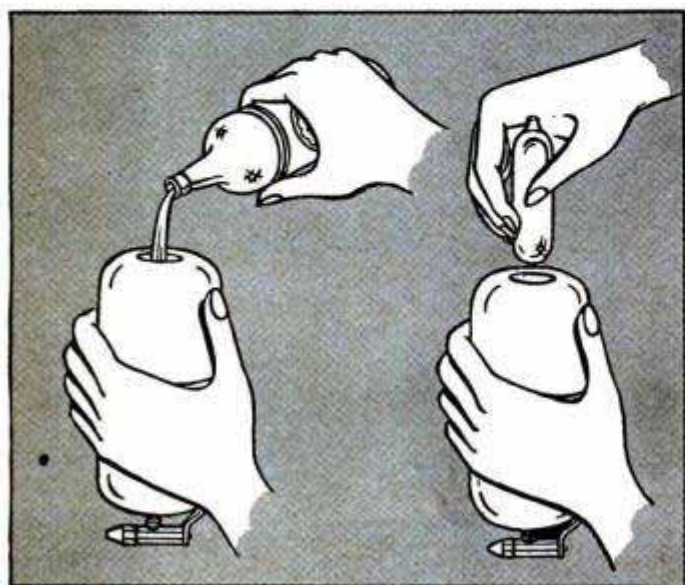

Rechargeable Sprayer Uses CO₂ Cartridges

You can spray any liquid you want from a refillable and rechargeable spray "bomb" that is powered by a CO₂ gas cartridge. Insecticides, deodorants, cleaners, weed killers or any noncoagulating, nonviscous liquid can be loaded into the bomb. One of the cartridges is inserted and the cover screwed on tightly. The compressed gas in the cartridge then sprays the liquid in a fine mist.

☐ A new insulated rubber boot for combat Marines operates on the principle of sealed insulation, similar to a vacuum bottle.



Milk Tanker Replaces Cans

Bacteria don't have a chance in a pickup system for bulk milk in use in Connecticut that eliminates the familiar milk cans. The milk is poured into a holding tank in the sterile milkhouse immediately after milking. A refrigerating system cools the milk down to 38 degrees and holds it there until the pickup truck arrives. This pickup truck is an insulated semitrailer tanker that carries the milk to the dairy, maintaining its temperature at below 40 degrees to retard bacteria breeding. The milk is weighed and sampled for butterfat on the farm.

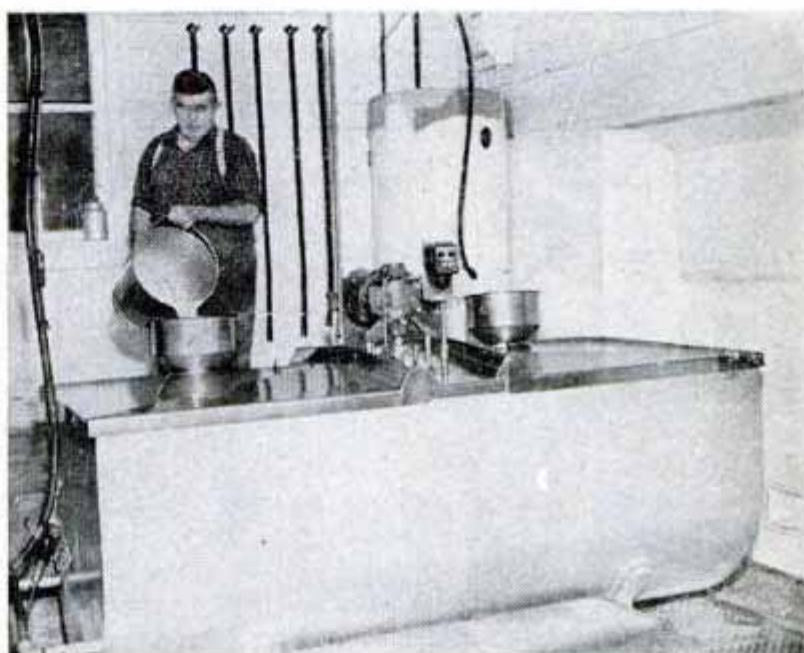

Amphibious Hunter

Austrian hunters can walk on water now in their quest for ducks. Inflated boots enable them to paddle and glide noiselessly across the water. Straps inside hold the hunter's legs steady while firing. Afterward he can coast through the reed beds on his pontoons to pick up the fallen game.

Spray Seals Mine Shaft

Coal mines improve ventilation by sealing unused shafts with a spray-on plastic that blocks gas and moisture. A vinylite plastic, the liquid is sprayed on cloth-covered frames or walls to form a film durable like that used to protect stored military equipment.



Step right up and speak to His Majesty, The King. One of the most popular displays is England's royal family

Meet the King and Danny Kaye. They live side by side in London, peaceably, with Joe Stalin, Abe Lincoln, Napoleon and Mae West at a Baker Street address made famous by Madame Tussaud's . . .

GREATEST SHOW IN WAX

By James F. Scheer

WHEN YOU WALK through the door of a plain, three-story brick building on Baker Street in London's West End you're in for the jolt of your life. In the tiled lobby, a pretty girl smiles at you. She holds booklets listing exhibits. You try to buy one, but the gal won't talk or sell. She's wax. When you see another smiling girl with booklets, you start to turn away. But she moves. She's not wax.

You climb a flight of stairs, and at the door of Madame Tussaud's world-famous Wax Museum you see a guard in a blue uniform. You accidentally bump him and apologize, but rudeness doesn't matter to him. He's wax. Farther on, another guard is standing stiff as a statue. To experiment, you dig a sharp elbow into his ribs. He explodes with a bellow of pain in the most

outraged cockney you have ever heard!

By the time you reach the displays in the Grand Hall, you've lost all ability to judge the wax from the real. Just about the only false note in the entire museum is one you can't see—most of the 500 figures, the royalty, presidents, statesmen, great military men, religious leaders, film stars and assorted criminals wear long underwear—the real, old-fashioned gray "long johns"! From Mae West and President Truman to Napoleon and Danny Kaye, the figures are woolly warm.

The reason? These unglamorous bristly underthings protect the plaster-of-paris bodies from wear when suits, gowns, and capes are brushed and cleaned. Further, they make outer clothing drape better and add just one more realistic note to wax

figures that almost move about and speak. Lifelike realism in the smallest of details has been the exhibition's policy since the museum was established in Paris during the French Revolution and, later, moved to London by Madame Tussaud. In fact, this policy—added to natural curiosity of patrons about the great, the near great, the famous and notorious of today and yesterday—accounts for the fact that Tussaud's is still one of the world's greatest shows, even in the atomic age.

Already as much of a tradition for tourists and native Britishers as Westminster Abbey, this exhibition of wax artistry draws about 3000 cash customers daily at an annual profit nearing \$400,000. And, of course, the Tussaud clan is represented, mainly in the person of scholarly looking Bernard Tussaud, great-great grandson of the museum's founder. He's an unassuming artist who likes bright tweed jackets and enjoys transforming mere beeswax into celebrated personages.

Madame Tussaud's—which has survived a devastating fire in 1925, the depression of the '30s and the Luftwaffe's aerial blasts in the last war—spares no expense or effort to make every figure so lifelike it seems ready to speak.

Turning out one wax bust, for instance, is a drawn-out and exacting job that would exhaust the patience and fray the nerves of an average man. A finished replica for the exhibition costs more than \$500 for labor and materials. A few have run as high as \$5000 by the time they have been fitted with elaborate robes and jewelry, many of which are genuine.

Before Bernard Tussaud even raises a finger to interpret his subjects in wax, a great deal of work must be done. What happened to screen star Danny Kaye is typical of the experience most celebrities endure to gain near immortality at Madame

Bernard Tussaud heats a glass eye for Prime Minister Attlee, then painfully positions it with bare fingers

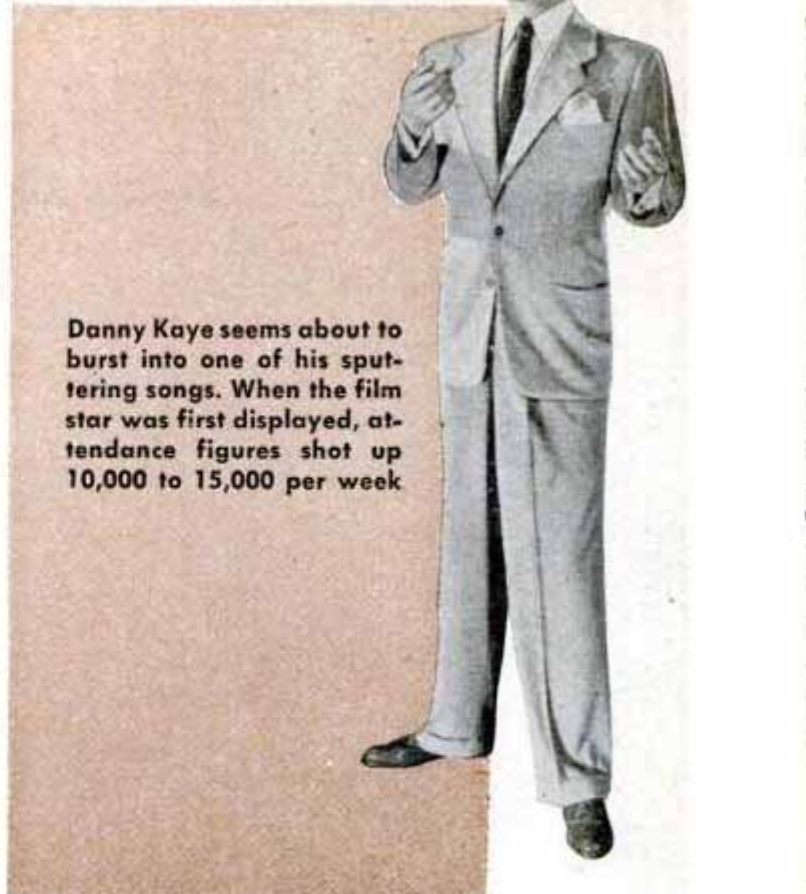

Danny Kaye seems about to burst into one of his sputtering songs. When the film star was first displayed, attendance figures shot up 10,000 to 15,000 per week

Tussaud's Wax Museum on Baker Street.

Danny had to sit and stand for 12 stereoscopic photographs as well as for 20 to 24 more or less candid shots. Then he had a thorough going over with a pair of calipers for finding eight head measurements—between eyes, from tip of nose to point of chin, from point of chin to back of head, between lobes of ears, between base of nose and lower ear-tip, lower lip to point of chin, upper lip to base of nose and bridge of nose to hairline.

Before Kaye knew what had happened he felt tape measures around ankles, wrists and neck. Then came measurements for vital statistics such as tailors keep on file for their most exacting customers. Next

Working from a set of enlarged photos, Tussaud carefully sculpts a clay bust of a cabinet minister





a barber shaved on the most minute hair of his hands, up to the wrists. With plaster of paris applied as a cast from wrist to finger tips, Kaye was forced, for an hour and a half, to refrain from talking by hand.

After the ordeal, he had left behind all impressions necessary for Bernard Tussaud to begin work. Here is how the job customarily is done. A dozen of the best photos are enlarged and arranged on a table before the artist. One of these is the master photo, the main source of data. Then Tussaud molds moist clay into a likeness. This takes anywhere from two to six weeks. The completed bust has to be true to the eight caliper measurements.

It has always been distressing to the management of Tussaud's that so many men and women achieve fame late in life, at an age when they have white hair—an item that's hard to get and costly—and many wrinkles. The plaster-of-paris head mold

◆ Thoughtful Ben Franklin was made almost 170 years ago, taken from life while Franklin was in Paris. Other figures, clockwise, are Andrew Johnson and William Penn, who look on as wardrobe mistress rearranges Abe Lincoln's tie. Just below are France's King Louis XVI, Marie Antoinette and their family. George Bernard Shaw's beard gave hair-planter long weeks of hard work. Movie-goers should recognize Greer Garson, and at center left, Bernard Tussaud tidies up figure of his great-great grandmother, Madame Tussaud, who made this replica of herself

Rough edges of a plaster-of-paris body are rasped off by an employee. It'll soon be ready for a head

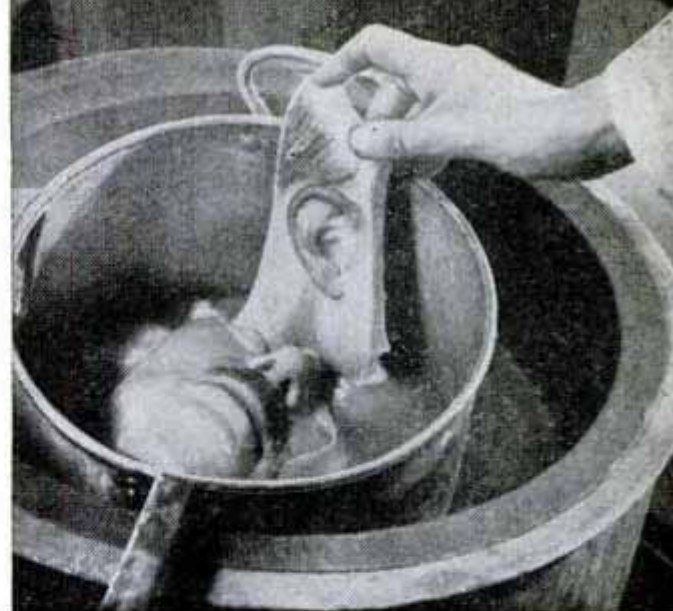

Into the melting pot goes the head of a man no longer considered famous enough to rate a figure in Tussaud's



Eerie scene is this room where wax heads are broken apart. Smiling Lord Beaverbrook is getting the mallet

Stars, crowns and jewelry must be kept bright and sparkling. One of Madame Tussaud's descendants cleans a medal worn by wax figure of an English king



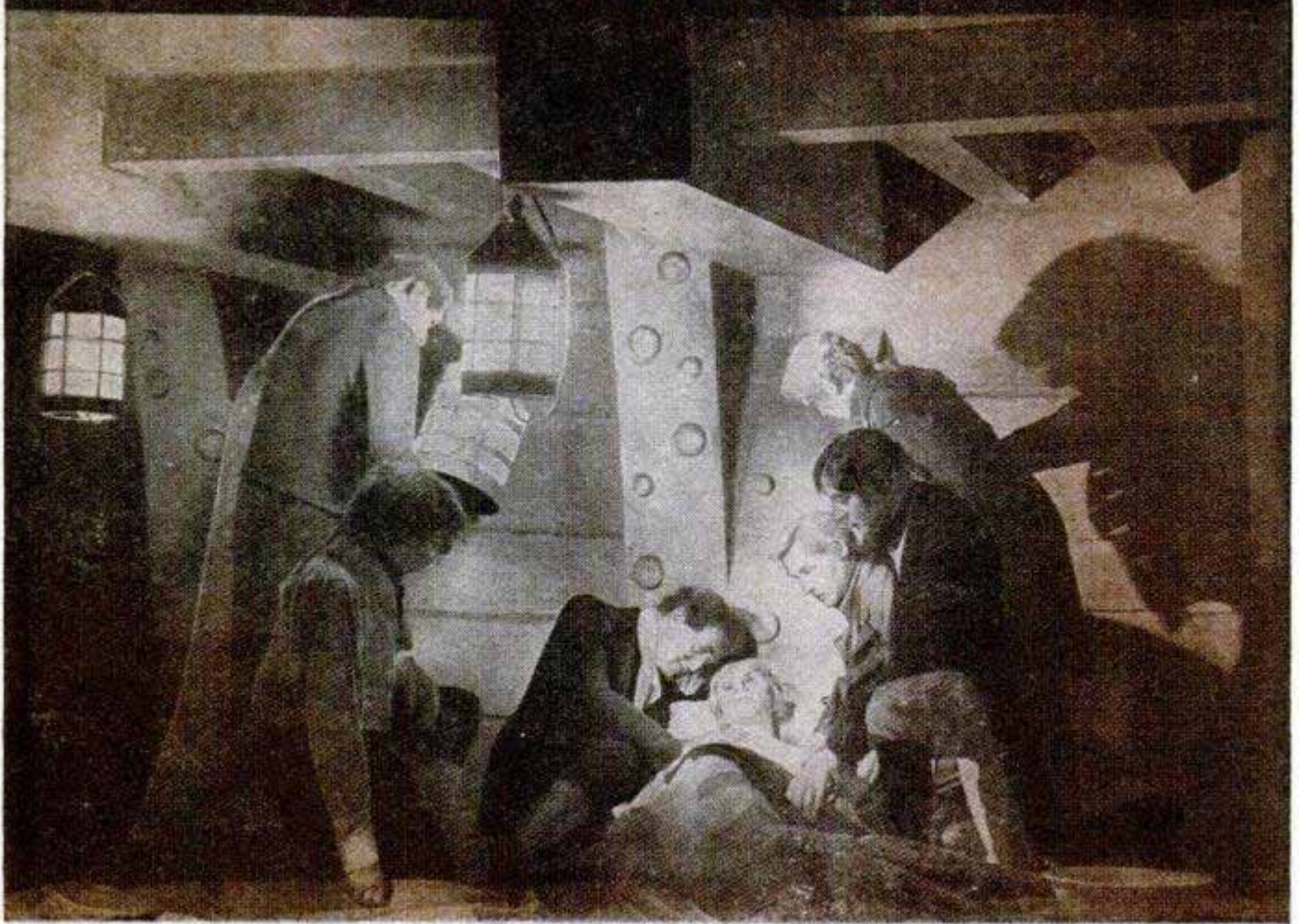

In an elaborate tableau at Tussaud's, England's immortal Admiral Nelson dies in the arms of his comrades



is usually cast in about 12 pieces, but many wrinkles make much undercutting necessary. This means extra work and more pieces—as many as 18. Before plaster of paris is applied, two long, thin, Vaseline cords are crossed at a 90-degree angle over the clay head. When the plaster cast has become firm, the cords, one at a time, are pulled up through the plaster of paris. By means of these openings, it is possible to lever off the head segments with a blunt tool.

Once the piece mold is fitted together and tied with tough string, the head is literally stood on its head. Molten beeswax, with a small quantity of vegetable wax—for added hardness of the finished product—is poured in. The wax cools against the mold first. When a crust about an inch thick has formed, wax that is still liquid in the center is poured off. Within three hours the mold is cool, resulting in a hollow wax casting.

One of the tasks that gives the maker of wax men a great deal of pain, physically, is the fitting of eyes into figures. From the prewar supply of 5000 pairs of German-made glass eyes, valued at almost \$30 a pair, Bernard Tussaud considers the many

(Continued to page 328)

Man in the Iron Cage looks weirdly down on Chamber of Horrors, most famous section of the museum

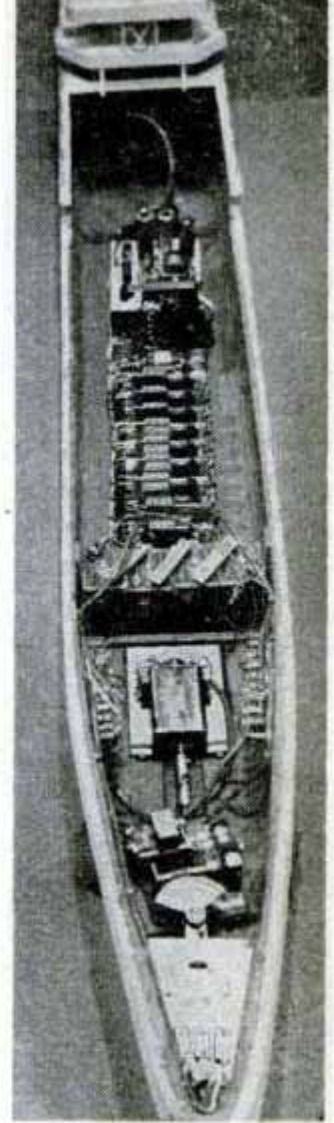
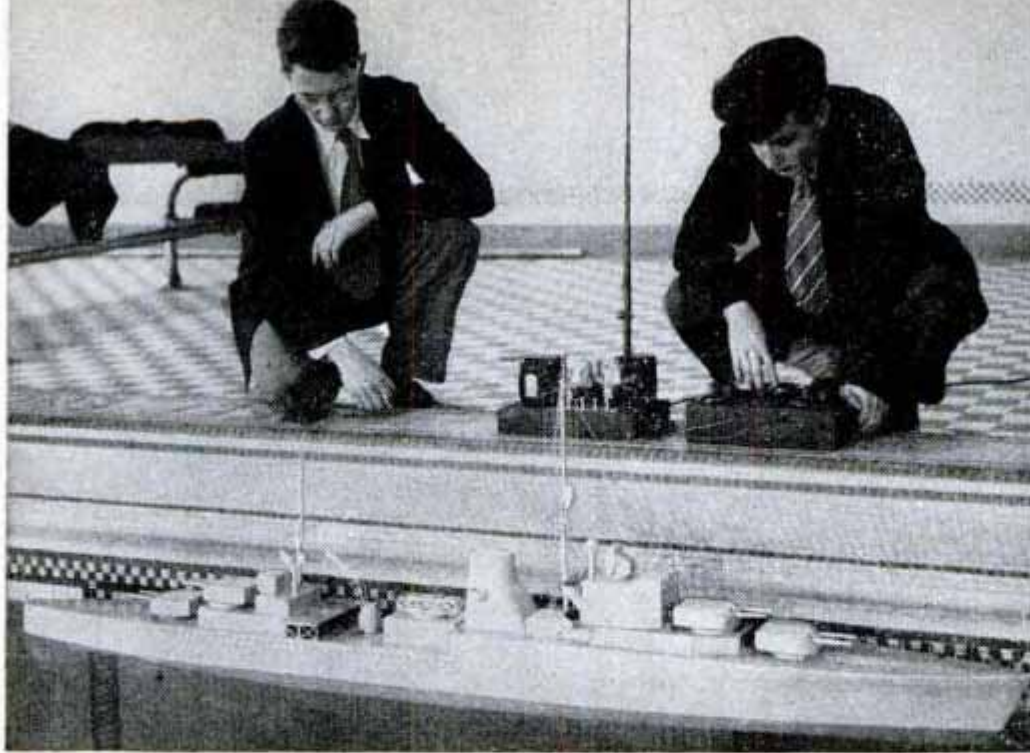

Dial-Operated Ship Model

Two teen-agers at Upper Canada College in Toronto can maneuver their big, radio-controlled ship model merely by turning a telephone dial. The ship, which displaces 75 pounds, is a scale model of the British cruiser H.M.S. Ajax. It is powered

by two batteries, one of which operates the propeller and the other the rudder. The "captain" dials the appropriate number on the telephone dial. A radio transmitter sends a signal to the ship, where the signal actuates the proper relay.

Child's Car Is Mongrel — Part Plane, Auto and Motorcycle

There's a little bit of everything in a custom-made car that six-year-old Pat Cantrell drives. The chassis was once part of a 1934 Chevrolet; the front end is from a Cushman package car; the engine and rear wheel are from a motor scooter and the steering mechanisms from a Crosley. The wheels, seats, windshield and steering wheel are from airplanes. Pat's father, Dennis Cantrell, an Arkansas airport operator, built the small vehicle. A centrifugal clutch eliminates the clutch pedal. Pat drives the small car skillfully and safely at speeds up to 25 miles an hour.



Man's Hottest Flame

Anything known on earth can be burned by a hydrogen-fluorine torch developed at Temple University's Research Institute. The flame from the torch burns at 8000 degrees F., the highest temperature man has ever created. The temperature of the flame can be increased by boosting the atmospheric pressure in which it burns and scientists expect to reach the sun's temperature (9000 degrees) by raising the pressure beyond that used in their recent experiments.





Detroit Listening Post

By Siler Freeman

IF GOVERNMENT controls persist in plaguing the automotive industry—such as the recent one reserving all new machine tools for military and defense purposes after February 1—the few really new 1952 cars may be the last ones the public will see for some time.

One of these is the new passenger car introduced by Willys-Overland. This car is no midget and is right up in the front line of competition with the Ford-Chevrolet-Plymouth group in size, horsepower and price.

The Willys is on a 108-inch wheelbase, has an F-head Hurricane engine especially designed for it with 90 horsepower and a top speed of about 90 miles an hour. During tests at sustained speeds of 30 miles per hour, the car got up to 35 miles per gallon of gasoline and 25 miles per gallon at 60 miles per hour. Although the engine has a compression of 7.6 to 1, it is said to operate efficiently on regular gas. This is an important factor in the face of a dwindling supply of high-test fuels.

All of the 1952 Chrysler line—Chrysler, DeSoto, Dodge and Plymouth—are appearing on schedule. A new V-8 engine of 160 horsepower has been announced for the DeSoto. Chrysler is dazzling the public with a so-called "car of the future" with a 310-horsepower experimental engine and

radical design. The sports sedan, designated as the K-310, was built in Turin, Italy, at a cost of \$400,000.

Many of the new '52 cars will not vary much outwardly from their predecessors. Packard is featuring its new power brake at the head of a list of 76 improvements. The company's "bread and butter" 200 model has the cuplike chrome decorations on the rear fender which distinguished the 300 and 400 series last year.

The power brake is Packard's big bid for public favor. The Bendix-made device is called Easmatic. It reduces pedal pressure 40 percent and cuts down the time required to swing the foot from accelerator to brake pedal by 29 percent. Mechanically, it appears to be a simple device. Power is supplied by vacuum from the engine through a cylinder mounted under the toeboard and directly connected to the brake treadle.

Another feature is a large cooling fan to save copper. It enables a reduction in the size of the core. Another saver of scarce material used in the new models is a nylon speedometer gear, which saves on brass. It needs no machining, according to William Graves, engineering chief for Packard, and has longer life.

While other automotive officials expect a shortage of new cars around the first of

(Continued to page 410)

Experimental Chrysler sports sedan, K-310, has low sweeping lines and is powered by 310-horsepower engine

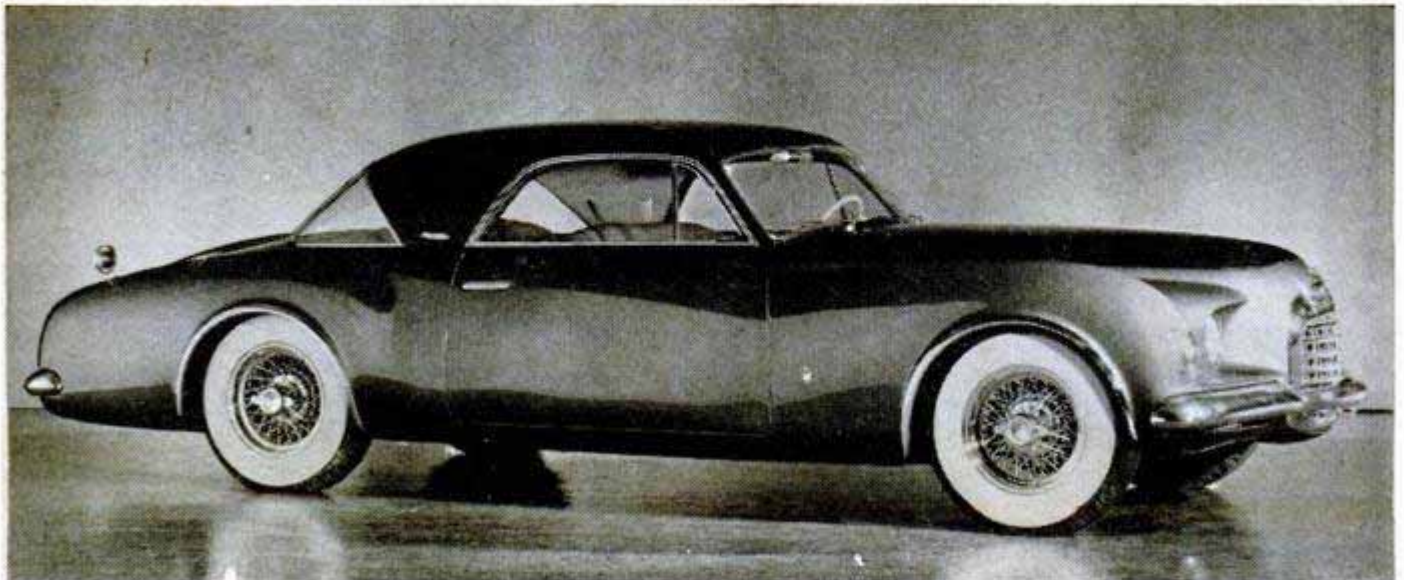



Custom-Made Roadster

By lowering the floor so much that the driveshaft "tunnel" serves as an armrest, Bob Trammel converted his 1941 Ford coupe into a ground-hugging roadster. Most of the original body was discarded and new sections handmade to form the new contours. Road clearance is only two inches less than originally, but the floor was dropped nine inches. A reworked Mercury engine that develops 206 brake horsepower replaced the original engine.



"Seamless" Sports Car

You have to look long and hard to spot a seam or projection on a sleek sports car built from a Ford V-8 convertible. Owner and builder, C. C. Alexander of Miami, Fla., says it will do 125 miles an hour. The engine is a souped-up Mercury. Hood and front fenders are one piece which lifts to permit access to the engine. An airplane-type steering wheel and dashboard padding are features of the interior. Alexander has invested over \$4000 in the car.



By Richard F. Dempewolff

BLACKBOARDS and dull lectures are something the Army's new recruits won't gripe about. Today on our vast training reservations the recruit is learning first hand what he'll be up against at the front. Machine guns chatter across infiltration courses, and live ammunition snaps over the head of the crawling GI. He goes out on night problems to "get" an objective which is not just a vague hilltop, but an actual fieldpiece, truck or tank—life-sized, but made of inflatable rubber. As he creeps through the woods, live TNT charges explode a few feet from him.

At Fort Benning, Ga., the modern infantryman may sit in front of huge terrain models—complete with hill-sides, houses, gun emplacements, pill-boxes, tank traps—and show the instructor how he would move a platoon across the rolling papier-mache hills to the objective. Tomorrow's forward observer sits before "puff

Rangers learn 14 ways of knifing an enemy sentry so he'll drop without a sound. Here a ranger practices his work in mockup village



With shells popping overhead and a tank rumbling past, these recruits get a realistic taste of simulated combat



board" trainers, table-top models of a country landscape molded from screening. Scanning the board with field glasses, he calls a position for artillery fire, and a puff of smoke rises from the "ground" on the spot—activated by a man with a pneumatic bulb at the other end of the table.

Realism is the byword in today's training center. In World War II, recruits sat in bleachers while artillery was fired over their heads to accustom them to the noise. No more. Reports of the "Taylor Mountain Problem" at Fort Dix, N. J., basic-training camp, where 20,000 raw recruits at a time are now being processed into hardened soldiers, sound like battle accounts out of Korea. Men wake to the sound of heavy fire, stiff and sore in slit trenches, and surrounded by guards and camouflaged tanks. Up ahead a tank platoon, guns chattering with live ammunition, grinds toward an objective behind a crashing artillery barrage. Real shells whistle overhead.

Today's recruit has a much better deal than his World War II predecessor. His base pay is \$75 a month. He gets a \$152.09 clothing allowance, plus \$4.50 a month for replacements. Last July, the basic-training period was extended from 14 to 16 weeks in order, says Gen. Mark Clark, "to give



Ranger equipped for combat travels light for fast and stealthy movement, but he packs a miniature arsenal

Ranger trainees cross a swift stream by rubber boat. They may carry rope across, then use boat as a ferry





On confidence course, rangers face hazards they may meet on regular mission. These four men tightrope across a pair of cables, simulating a chasm crossing

Up and down a giant ladder with rungs three feet apart moves a group of ranger trainees. Confidence course teaches man his capabilities and limitations

Future ranger must shinny up to second story of a "house," then lower himself from the window by rope



every man extra time devoted to combat skills and physical conditioning."

Today, instead of one aptitude test, there are 11: Radio code ability, radio information, automobile information, electrical information, arithmetical reasoning, clerical speed, shop mechanics, mechanical aptitude, pattern analysis, reading and vocabulary. It's part of the Army's determination to put square pegs in square holes. Records show that civilian truck drivers are actually becoming Army truck drivers, and auto mechanics actually are assigned to the motor pool.

At the end of his 16 weeks, the recruit may be sent to one of the Army's 17 schools for special training. Or he may volunteer for special duty with one of a dozen rugged outfits, where hundreds of devices from jump towers 250 feet high to small pillbox models are used to teach him the ropes. To see how it works, *Popular Mechanics* sent me to Fort Benning, Ga., to watch the making of rangers as they kicked up the yellow dust of that reservation's 360 square miles under the Army's new plan of training ranger specialists to serve in every fighting unit.

To become a ranger a man must volunteer, then be selected. He may choose airborne training or ground-infantry training. Rangers are professional combat patrolmen — experts in explosives, communications, hand weapons, concealment and rough, tough commando-type operations. Every infantry company will have about 12 of these men. They may be sent out to destroy bridges, cut supply lines, sabotage railroads, ambush enemy

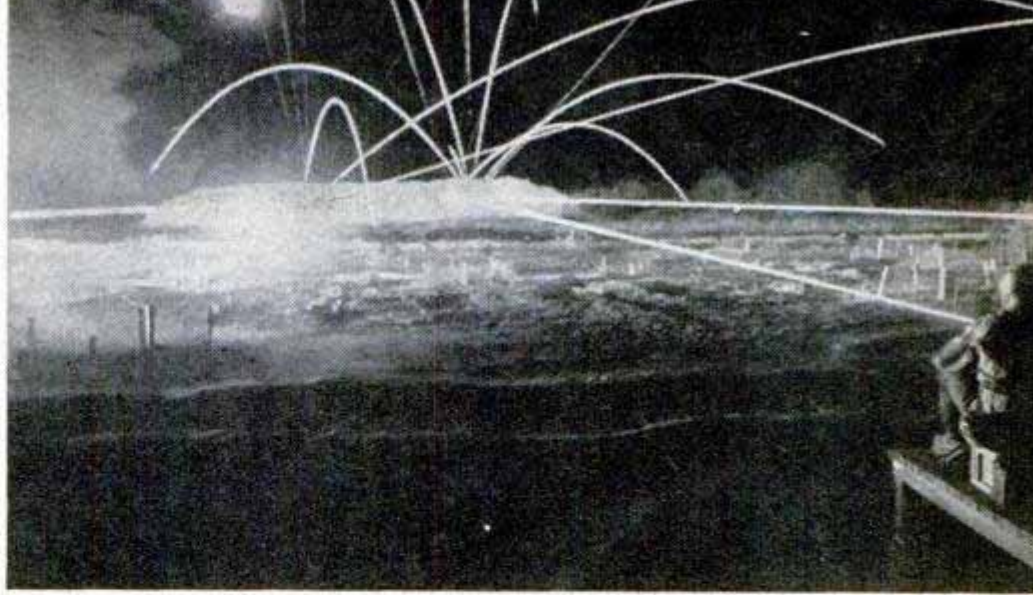

Tracer bullets curve just above the heads of recruits crawling through an infiltration course — just one part of infantrymen's realistic training



Five well-trained rangers demonstrate five different types of camouflage suits and makeshift camouflage. Ranger, when he finishes the course, can virtually vanish in the countryside. Below, trainee learns to handle a flamethrower by actually using it to assault an "enemy" pillbox objective





Rifles crack and smoke rolls through the air as rangers race in to capture a realistic town. Rangers learn village fighting to the tune of live TNT explosions

New-type rifle grenade, propelled by special cartridge, has a shaped charge that will pierce armor

Below left, ranger leaps from plane mockup. He'll get jolt of chute opening, then go for a cable ride



troops, take prisoners, kill with stealth and cunning. The ranger knows how to operate entirely behind enemy lines, day or night, where he may be dropped by parachute—or go himself, scaling snow-capped peaks if necessary.

Under the new program at Fort Benning, the selected volunteers get an eight-week workout that leaves them panting, and winnows out all but the iron men. It's no disgrace to be washed out. The men are on the go 57 hours a week, plunging through swamps (it takes eight hours to go through 2000 yards of the worst one), working over courses while demolitions explode within yards of them, leaping from planes and drop towers day and night. In a life-sized mock-up town they learn village fighting. The last three weeks they're out until three a.m. on night problems, but must be on deck at six for another strenuous day—haggard and hollow-eyed.

The ranger gets a thorough shakedown in everything from intelligence to unarmed defense. When he's through, he knows how to stick an enemy sentry with a bayonet or knife 14 different ways so the man will drop without making a sound. He is equally versed in the quiet method of throttling a man with a garrote.

The rugged ranger atmosphere drops like

(Continued to page 384)





Left, the control device for the test speedometer is mounted on the dashboard. Right, the speedometer dial

Drivers Check Their Speedometers With Giant Meter on Police Car

Motorists won't be able to plead, "My speedometer must be wrong," when picked up for speeding in Seattle now that the police provide a mobile test service. Mounted on the rear of a patrol car is a huge semi-circular meter marked in miles an hour from 15 to 40. As the police car rolls along the street, the speed in miles an hour is

automatically flashed on the dial by lights behind the markings. Motorists driving behind the car can check their own speedometers instantly. A new model of the mobile speedometer will also announce the speed limit for the stretch of road over which the car is operating. Two such cars are used by the Seattle police department.

Austin Seven

In answer to a worldwide demand for cheaper motoring, the new Austin Seven has all the "feel," comfort and safety of modern big-car travel, according to its London manufacturers. Integral construction has been used to reduce weight, but front fenders are detachable to minimize repair costs. Additional design features include a tool kit, simplified by the introduction of a combined crank, jack handle and wheel brace, and seats of molded foam rubber. The car has a fuel capacity of $5\frac{3}{4}$ gallons, four speeds forward and an over-all length of $136\frac{5}{8}$ inches. With a compression ratio of



7.2 to 1, the four-cylinder, overhead-valve engine delivers 30 horsepower at 4800 revolutions per minute.



Wooden Track Provides Traction

Designed like a corduroy road, a wooden track provides traction for the rear wheels on ice or snow. There's no bother of attaching the device to the wheel. You simply toss it on the ice directly in front of the wheel and drive up on it. It is made of a number of thick wooden strips connected by two lengths of rope and is said to replace the bucket of sand that you usually carry in the trunk of your car during the winter months.

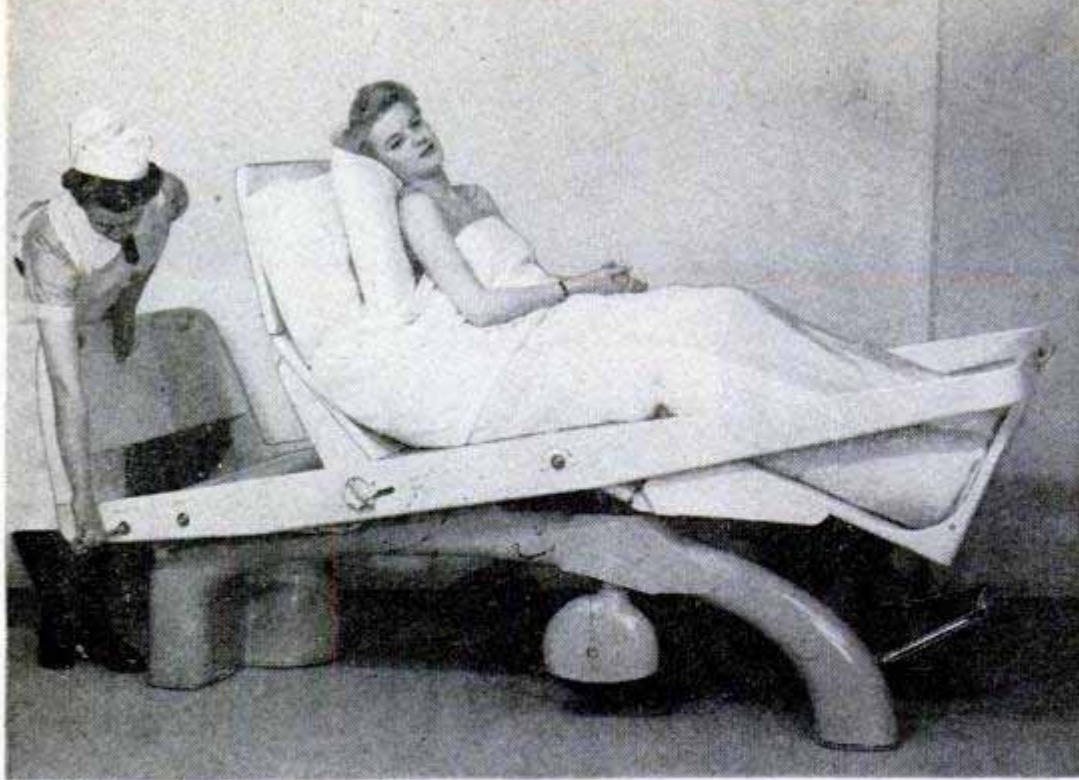

Copyright Essex Aero Ltd.

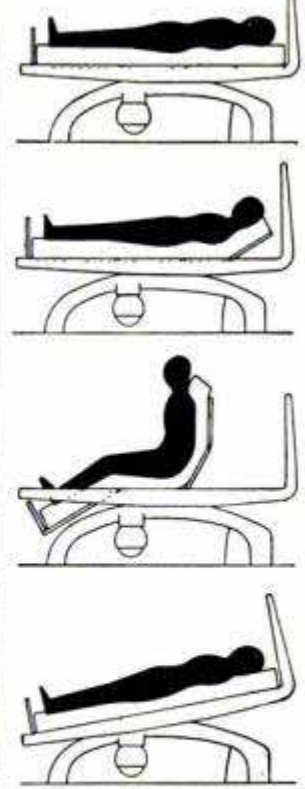

British Hospital Bed Provides Variety of Postures

Equipped with a retractable three-wheel undercarriage, a British hospital bed can be wheeled around easily by one nurse. A hydraulic lift, actuated by a foot pedal, raises and lowers the undercarriage. Four

panels, three of which are hinged, replace the spring and adjust to various positions for the patient. Made of magnesium alloy, the bed is about half as heavy as a conventional hospital bed.

Collapsible Fuel Tank

Army engineers have developed a collapsible storage tank for use near the front lines. The tank holds about 10,000 gallons of gasoline or oil. Easily transported, it can be rushed to a combat area and placed in operation as a fuel point for tanks, trucks and bulldozers until more permanent facilities can be built. It can be folded when empty.

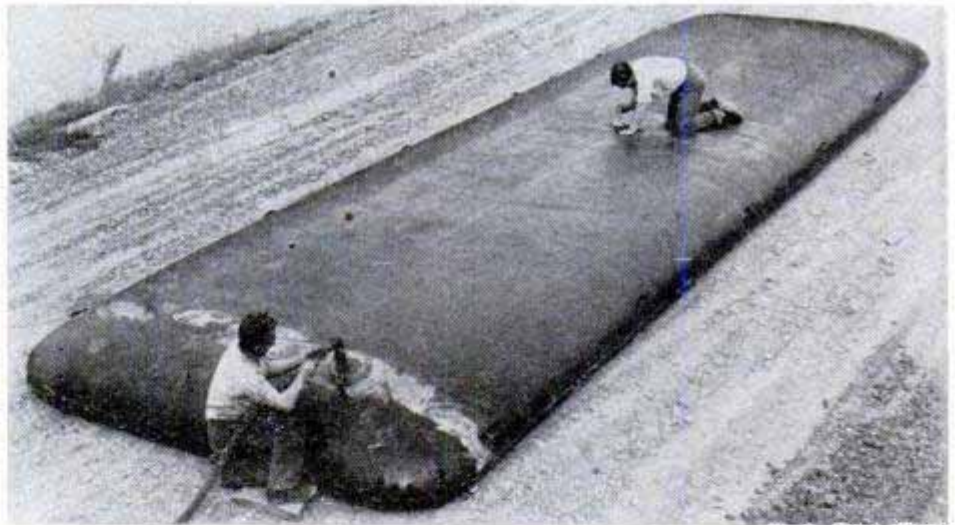

U. S. Army photo



Bantam Calculator

Built like a fine watch, a bantam calculating machine can be carried in the pocket to provide salesmen, estimators and engineers with a device that computes quickly and accurately. It has a capacity of 11 numbers in the results mechanism. Other characteristics of the tiny machine, which is produced in Germany, include a visible register for the feeding numbers, a shift lever for dividing and continuous gearing between counting mechanisms. Virtually noiseless in operation, the tiny calculator weighs slightly more than eight ounces.

COLOR TELEVISION Today

ALL-ELECTRONIC color television, fully compatible with the present standard black-and-white system, has made rapid strides in the past two years as demonstrated in recent field tests. Owners of TV sets in the New York area responded favorably to reception of the RCA color programs in black-and-white. A new RCA experimental color-TV receiver appears in photo A. NBC studio shots, and outdoor scenes, photo D, were picked up by the color cameras during the tests. In the RCA color-TV system the equipment is all-electronic—at the studio, transmitter and receiver as illustrated in sketch B.

Late in September a new contender made a thrilling entry in the color-television field with a handmade experimental model of a compatible all-purpose TV picture tube. Basically it employs the same idea as the RCA color tube—but simplified. The inventor, shown with the new tube in photo C, is Prof. Ernest O. Lawrence, atomic physicist at the University of California and the inventor of the cyclotron. The tube employs a wire grid for color switching, and automatically switches from one system to another. Experts say that, if it proves successful, the tube can be mass-produced at comparatively low cost.

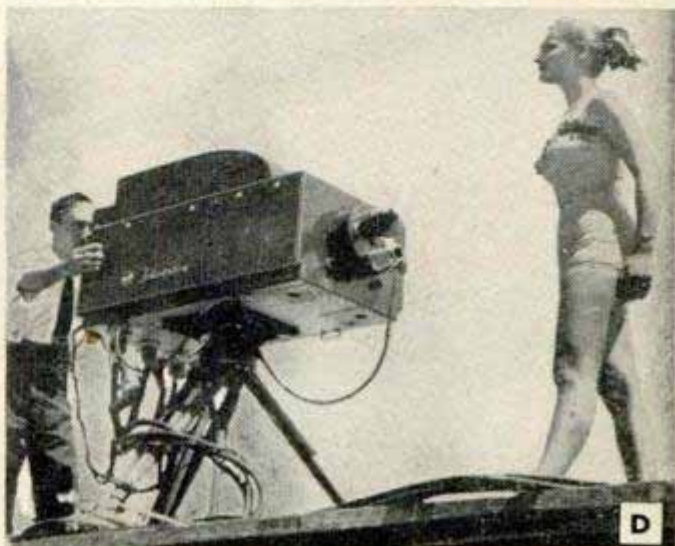

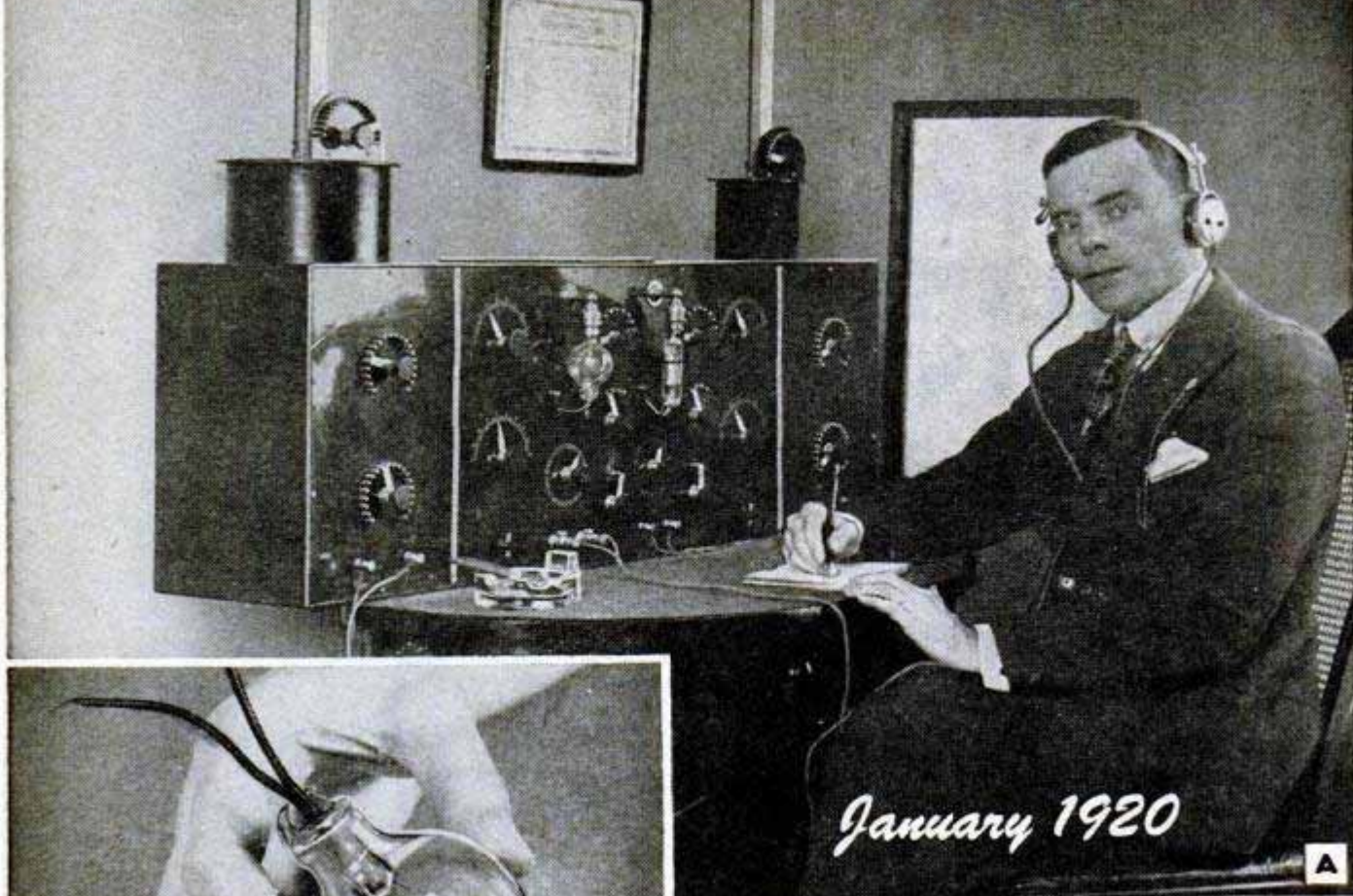

January 1920

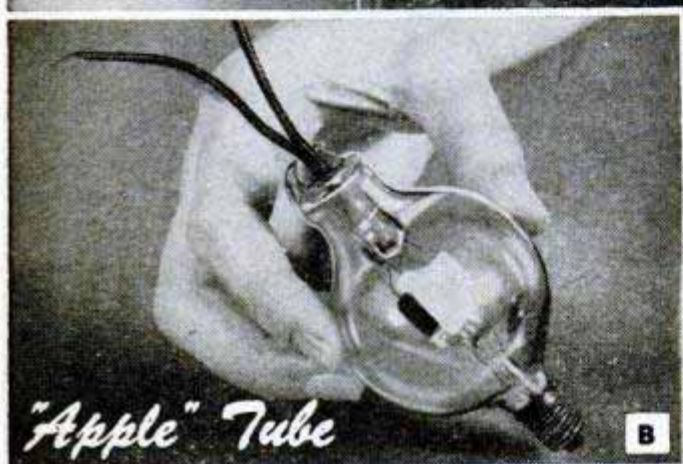

"Apple" Tube

Popular Mechanics

FIRST RADIO and TELEVISION RECEIVERS

FOR EXPERIMENTERS

By Frank L. Brittin W9DCX

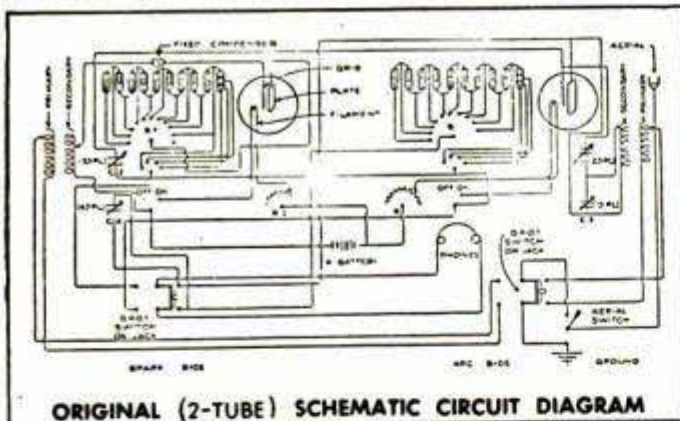

ORIGINAL (2-TUBE) SCHEMATIC CIRCUIT DIAGRAM



Five Years Later

PERHAPS there is no better way to make us realize and appreciate the convenience, entertainment and educational value of today's radio, television and electronic devices than to take a quick look at some early models. *Popular Mechanics Magazine*, now celebrating its 50th Anniversary, was a pioneer in keeping readers informed about these comparatively new modern arts that have developed so rapidly.

Today we can put radio receivers in our pockets—but the first vacuum-tube receiver ever described in *Popular Mechanics Magazine* for construction by experimenters was 9 in. deep, 14½ in. high, 41½ in. long and employed only two tubes. It appeared in the January 1920 issue. For photo A above, the caption read, believe it or not, as follows: Taking up Only a Small



Amount of Space in the Corner of the Room, the Cabinet is an Inconspicuous Article of Furniture, and if Properly Finished, may be a Real Ornament. However, in those days it was considered to be a keen performer, bringing in long-wave signals from IDO (Rome, Italy), POZ (Nauen, Germany) and YN (Lyons, France), as well as from the American stations such as Sayville, Arlington and others. It also tuned in the short-wave ham band. This was, of course, all "wireless telegraphy" as voice broadcasts did not come until later.

A 6-volt storage battery provided the A-supply; the B-battery consisted of two banks of 10 flat-type three-cell flashlight batteries. The two-tube circuit employed a \$7.50 DeForest Audion tube, photo B, (known to the "wireless fraternity" as an "apple" tube), and one \$5.00 Audio-Tron tube. Both the primaries and secondaries of the large couplers (tuning coils) were multitapped. The elevator devices for raising and lowering the secondaries were lead counterweights operating on pulleys; the antenna used was a single wire, 160 ft. long.

The builder of all of the receivers shown was a Radio Operator, Commercial First Grade, license No. 14540, and also a radio "ham." *Popular Mechanics'* radio section continued to keep its readers informed of every improvement in this rapidly advancing art. Soon, voice and musical programs were available and five years later, in the February and March 1925 issues, an "eight tube superheterodyne receiver" was described for construction. This popular student receiver, photo C, was housed in an attractive homemade cabinet and used a loop antenna. Radio quickly became an ideal cooperative hobby for father and son. A surprising number of the outstanding radio and electronic engineers of today will tell you that they began by building and repairing radio sets and electronic devices at home for fun. From these early days to the present time *Popular Mechanics* has been one of the chief feeders of new students to the large radio and television training schools.

Television started to show promising

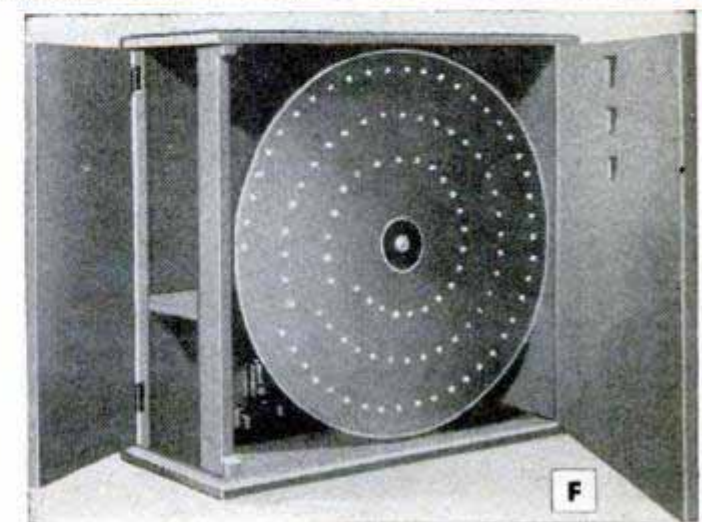
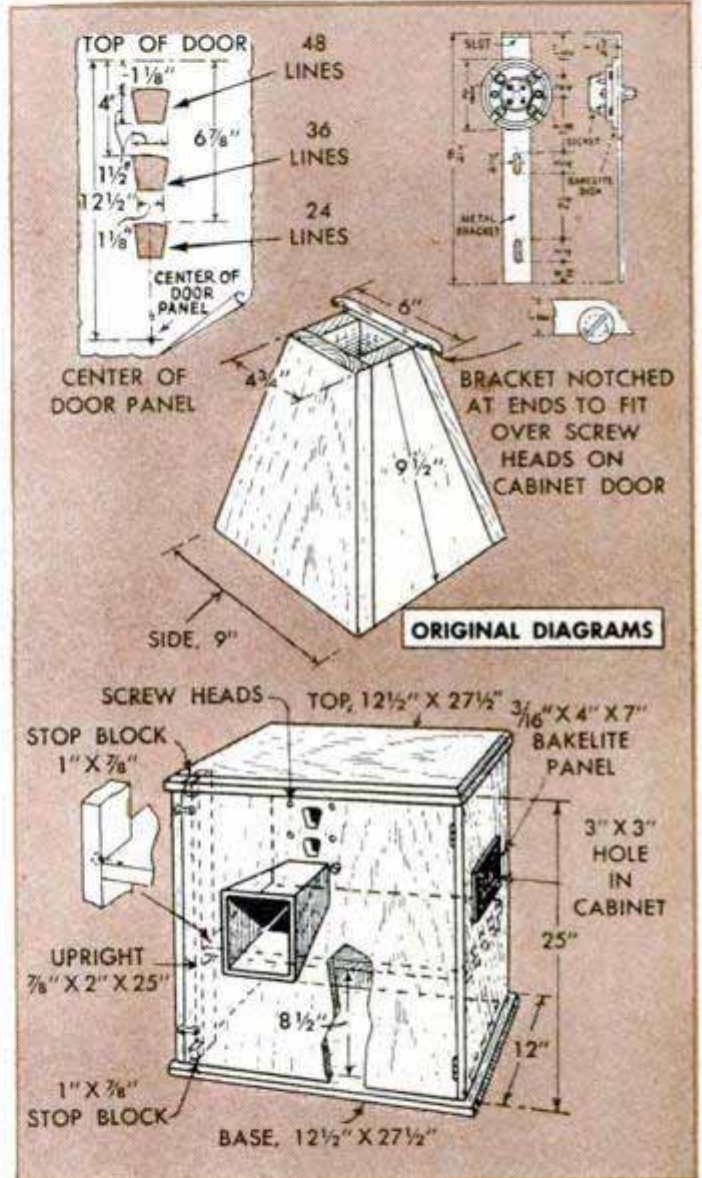



G

Experimental television programs were on the air in New York, Chicago and Los Angeles in 1928 and 1929. These were rather crude efforts as measured by today's standards. TV engineers of the 1920s used Paul Nipkow's idea of the 1880s for scanning pictures with a perforated spinning disk. These scanning disks, and a neon lamp, or "tube," used with them, photos E and G, were made available in 1928. They were used in *Popular Mechanics'* experimental television receiver construction article that appeared in the December 1928 and January 1929 issues. Photos D, F and H show various views of this receiver, which, with the aid of a condenser lens, gave a pinkish picture about 3 in. square. The original cabinet and circuit diagrams are reproduced. Three perforated spirals in the scanning disk, and corresponding openings in the cabinet, permitted the operator to tune in either 24, 36 or 48-line pictures.

Today we look forward to peacetime all-electronic, three-dimensional color television, and radio astronomy.

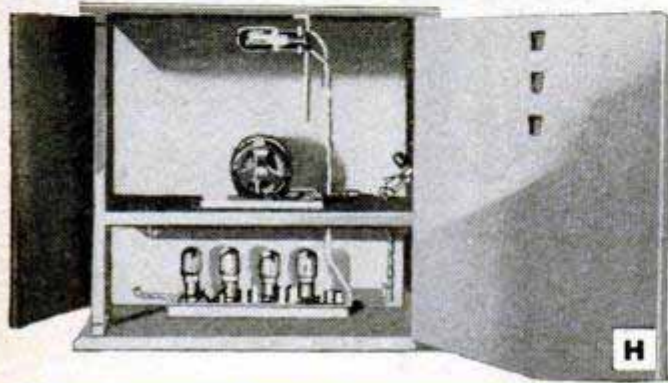

H

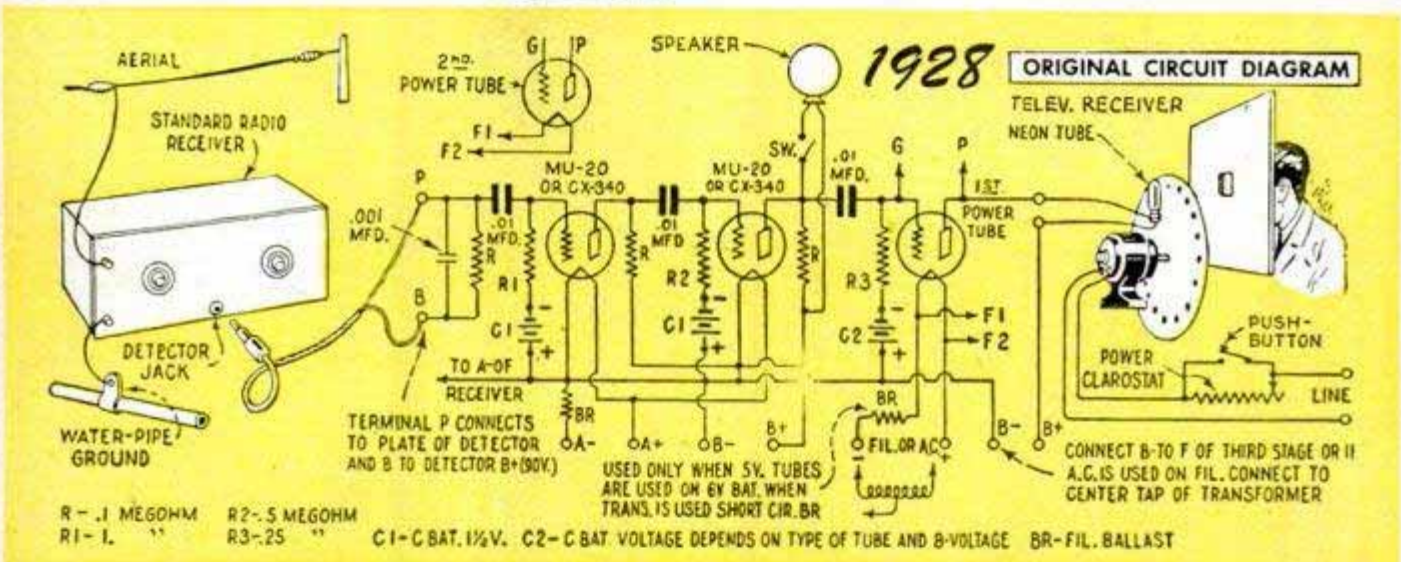

A CORNER OF POPULAR MECHANICS' RADIO-TV AND ELECTRONICS LABORATORY TODAY

I

TOMORROW'S ELECTRONIC BARBERSHOP QUARTET

By L. A. Meacham

MUSICALLY inclined communications engineers have all, at one time or another, connected a laboratory oscillator to a speaker and twiddled the frequency dial to play themselves a tune. But did anyone ever bother to provide four people with four oscillators, so that they might play electronic barbershop quartets?

Here is a promising facet of electronics which, up to now, so far as the author has been able to discover, has been left singularly unexplored. The question came up while searching for a novelty to entertain members of a Bell Laboratories glee club at their annual party. The result of preliminary research (conducted in the author's cellar, since it was not an official company project) was a complete electronic "wobble organ" which was received so enthusiastically at the party that improved models were designed in the basement workshop. Playing techniques were improved, and concert experience was obtained before several surprised and delighted audiences.

The present state of the art is represented by the units described in this article. The units employ standard inexpensive radio parts which are available from radio-parts houses, and the project offers interesting possibilities for home recreation of the "participation" kind, as well as for the various entertainment fields involving large groups. However, speculation on uses may more properly follow an inspection of the various photos and diagrams.

The four players sit around three sides of a card table, as shown in photos A and D. The fourth side is turned toward the audience, and may conveniently be faced by a music rack if desired. In front of each player is a small "playing console." On the floor near the table is a cabinet containing a power supply, an amplifier, and a speaker. Pairs of playing consoles that are adjacent to one another are plugged solidly together mechanically and electrically as shown in photo C and diagram Fig. 3, the whole set of four being connected to the amplifier in the speaker cabinet by a six-conductor cable. Note the positions of the bass, tenor, alto and soprano consoles.

Each playing console, Fig. 1, contains a thyatron saw-tooth oscillator, with suitable control circuits, and a simple waveform-shaping network which emphasizes or suppresses various harmonics in the

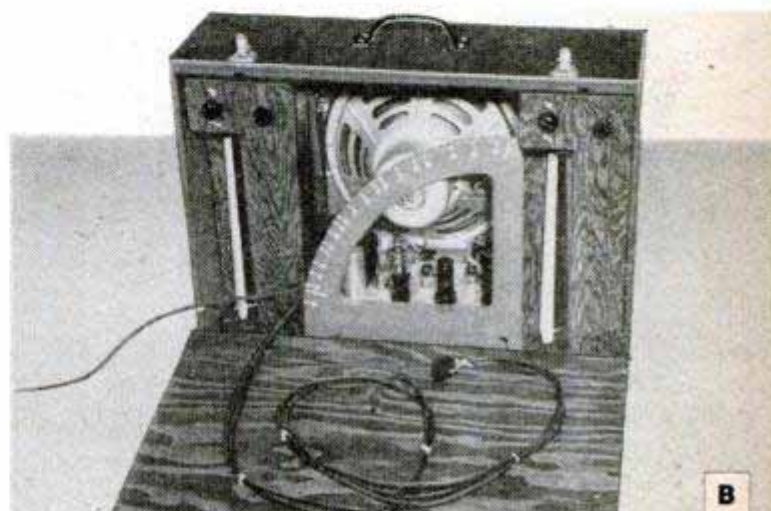
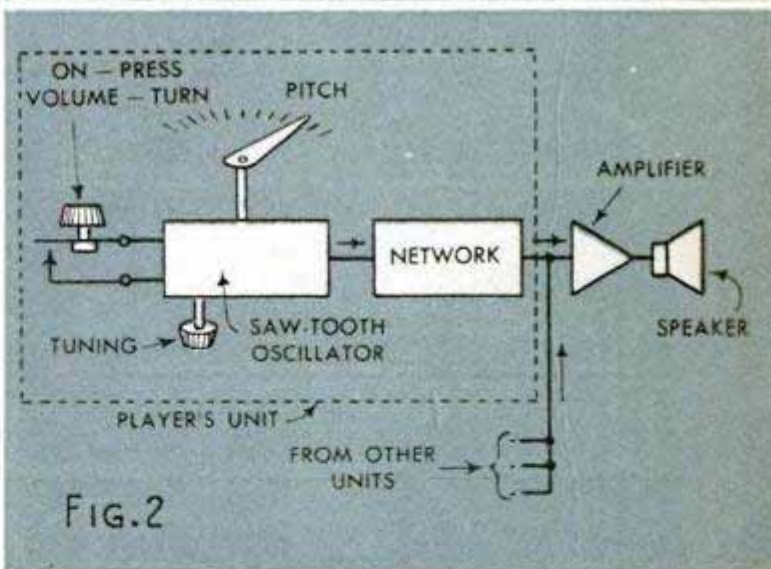
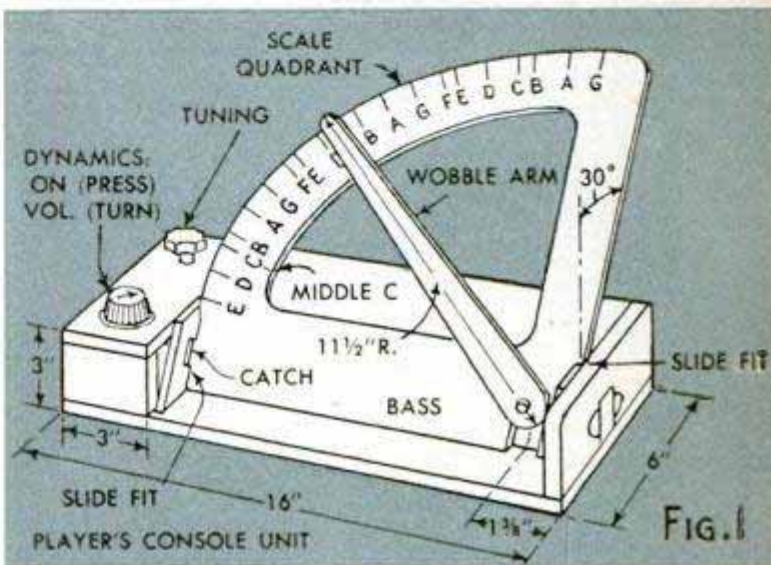

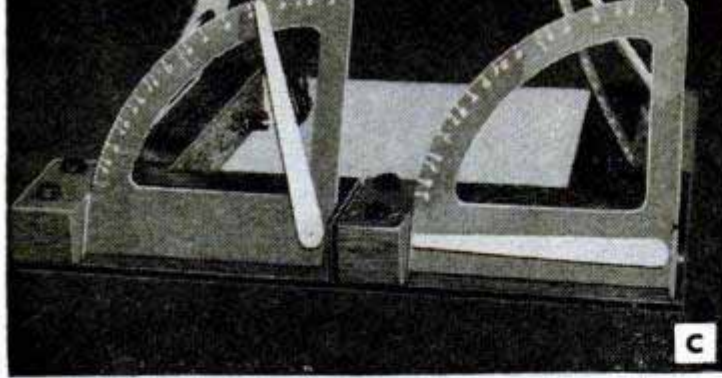

C

complex saw-tooth wave providing a distinctive tone quality, different for each player. The wobble arm controls the pitch by varying potentiometer R5. Two other potentiometers control volume and tuning, Fig. 2. The main control, of course, is the wobble arm, which is fastened to the potentiometer shaft that extends through the sloping front of the console. This control is designed to vary the pitch over a range of more than $2\frac{1}{2}$ octaves (about six to one in frequency). This range is at least that of the human voice, and in the present model is located differently on the frequency spectrum for each console, covering the vocal ranges of soprano, alto, tenor and bass, respectively. (A "male quartet" model could be obtained merely by changing capacitance values.) Figs. 4, 6 and 7 show construction details for the playing-console units. The schematic circuit diagram for these playing units appears in Fig. 5. The front end of each unit is the same up to connections A and B. The networks for the other tonal ranges connect to the oscillator stage in the same manner, as indicated.

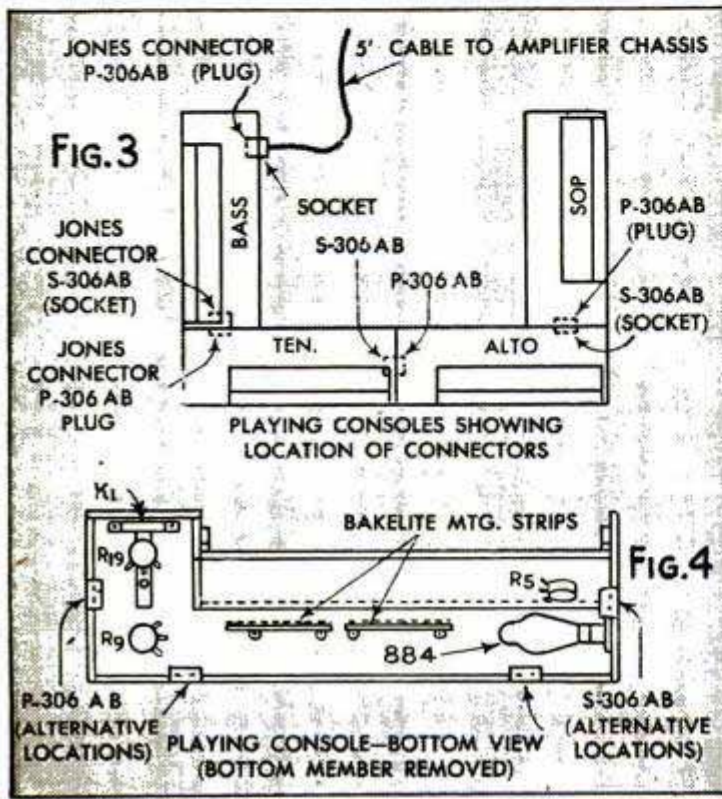

The consoles are made of $\frac{3}{8}$ -in. plywood, with scale quadrants of $\frac{1}{8}$ -in. pressed hardboard. Each scale quadrant is made removable to facilitate storage, being mounted in slides at its edges. A simple catch is provided to support the free end of the wobble arm when not in

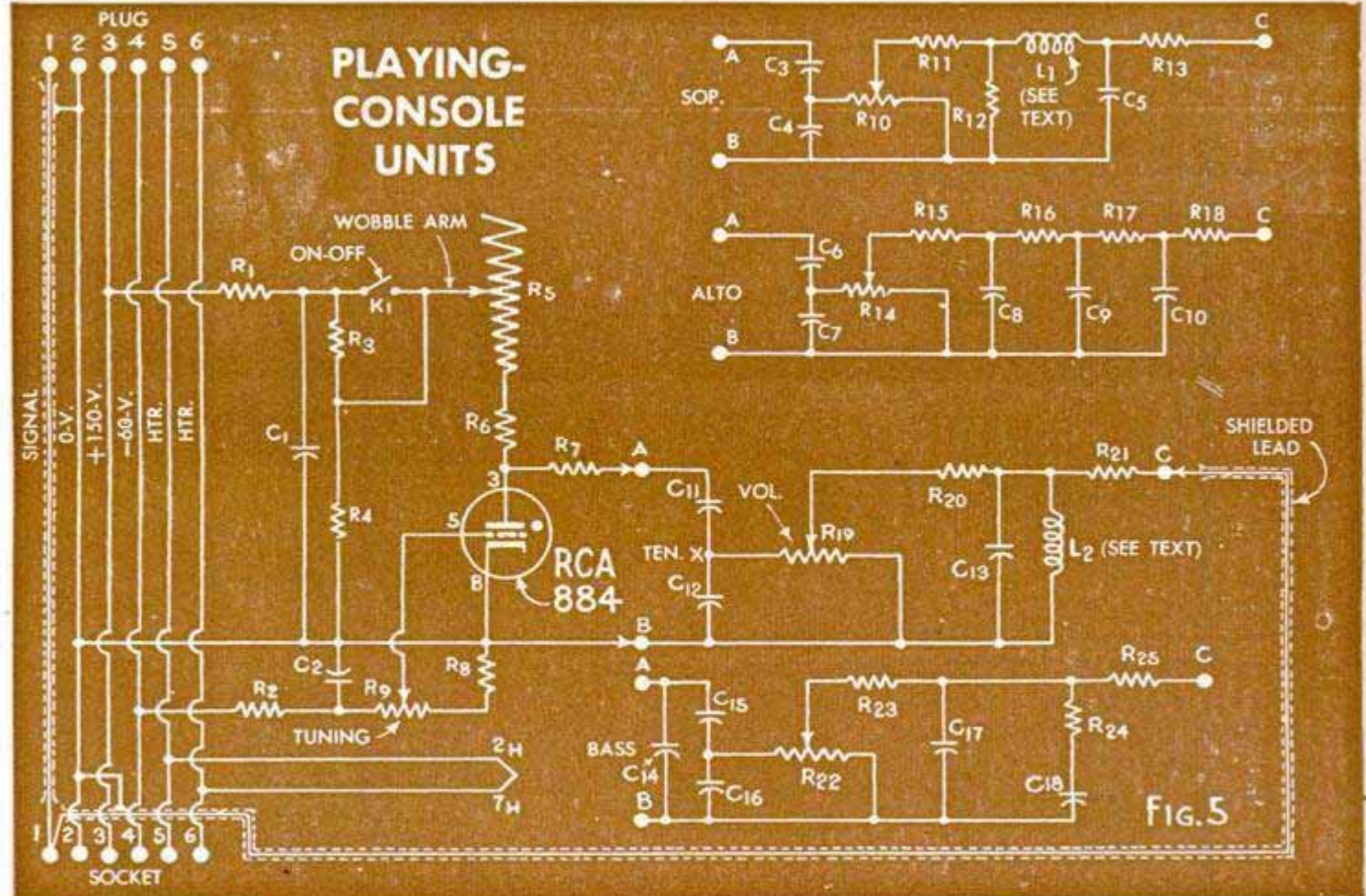

sole is removable for access and the principal dimensions are given in Fig. 1. The design of the speaker cabinet is conventional, the only novel feature being the provision for storage space for the playing consoles, two at each side of the speaker as shown in photo B. Thus the entire wobble organ is made portable in a single suitcase-sized unit. This cabinet is made of $\frac{3}{8}$ -in. plywood except the top and bottom which are $\frac{3}{4}$ -in. plywood. The inside dimensions are $7\frac{1}{2} \times 17 \times 24\frac{1}{2}$ in. The chassis base for the audio amplifier, Fig. 8, is centered in the bottom of the cabinet. This sheet-metal base is $2 \times 7 \times 11$ in. This amplifier is conventional except for special voltage regulation. It includes the power supply and the socket for the 5-ft. cable to the playing consoles. The layout is not critical. However, keep the low-level

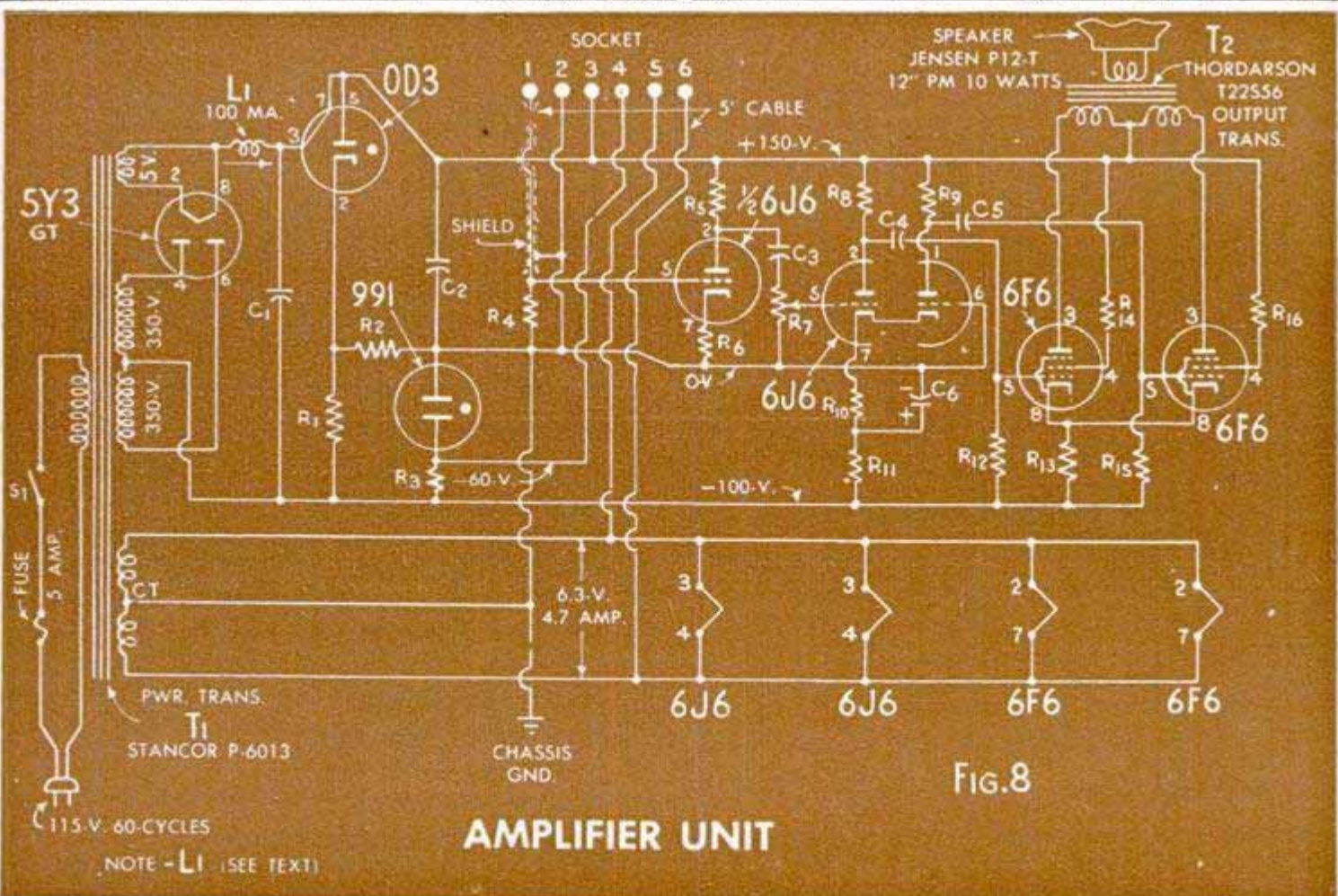
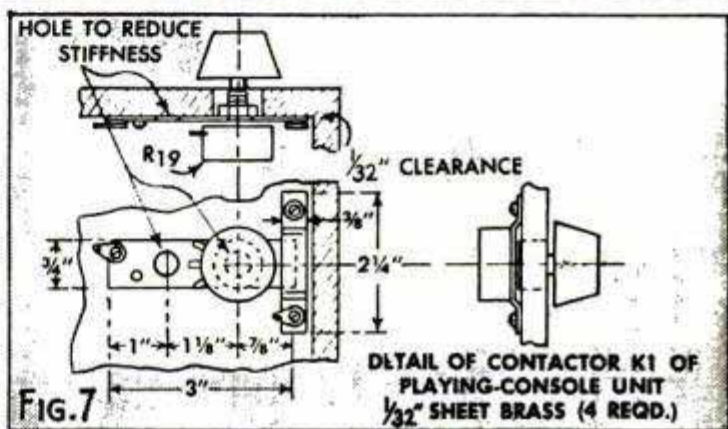
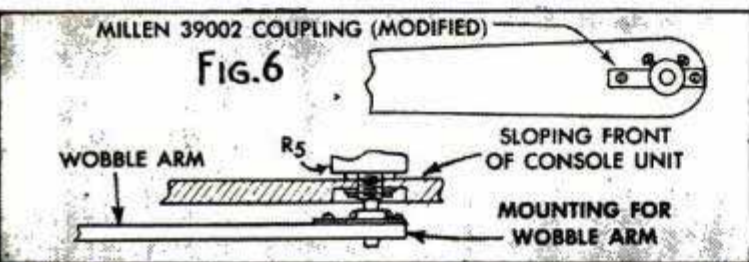
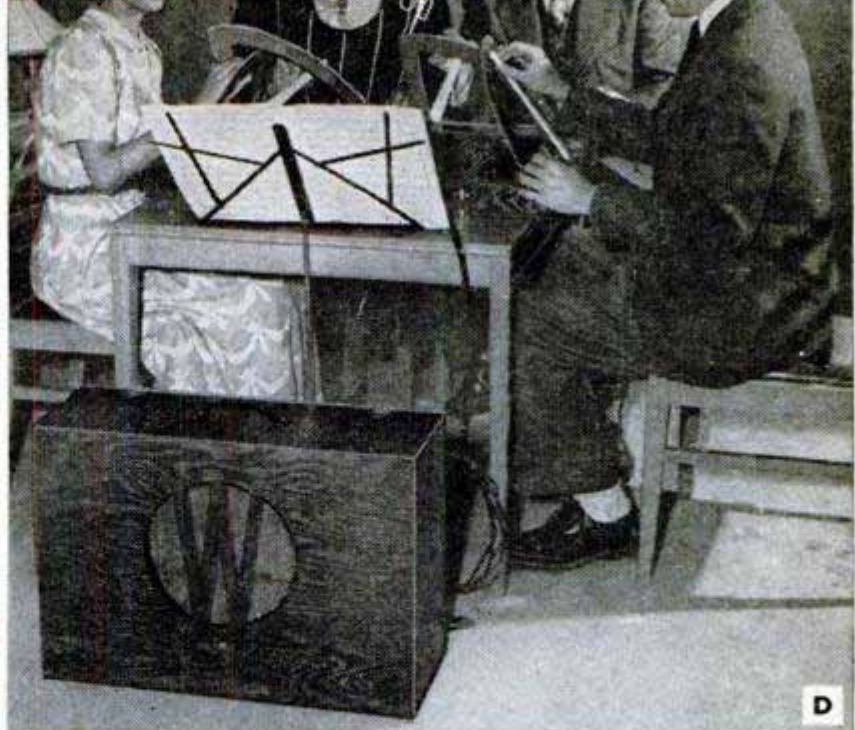

4 SETS REQUIRED

- K1—Special contactor (see sketch Fig. 7)
 C1=8 mfd. 150-V. Wkg. electrolytic condenser (Cornell-Dubilier BR815)
 C2=.1 mfd. 400-V. tubular-type paper cond.
 R1=560-ohm, ½-watt carbon resistor
 R2=150,000-ohm, ½-watt carbon resistor
 R3=1,300,000-ohm, ½-watt carbon resistor
 R4=510,000-ohm, ½-watt carbon resistor
 R5=1-megohm, potentiometer (Ohmite "AB" pot. type CB-1052 log. taper)
 R6=10,000-ohm, ½-watt carbon resistor
 R7=300-ohm, ½-watt carbon resistor
 R8=15,000-ohm, ½-watt carbon resistor
 R9=25,000-ohm, potentiometer (Ohmite "AB" type CU-2531, linear taper), TUBE=RCA 884
 1=Millen No. 39002 coupling (modified) for wobble-arm mounting

- NOTE—All carbon resistors $\pm 10\%$
 L1=.45 H Graybar Electric No. D-170718 retard coil
 L2=Same as above
 C3=.02 mfd. 400-V. tubular-type paper cond.
 C4=.22 mfd. 400-V. tubular-type paper cond.
 C5=.003 mfd. 600-V. tubular-type paper cond.
 C6=.025 mfd. 400-V. tubular-type paper cond.
 C7=.15 mfd. 200-V. tubular-type paper cond.
 C8=.002 mfd. 600-V. tubular-type paper cond.
 Note—C9 and C10 are same as above
 C11=.05 mfd. 200-V. tubular-type paper cond.
 Note—C13, C15, and C17 are same as above
 C12=.5 mfd. 200-V. tubular-type paper cond.
 C14=.03 mfd. 400-V. tubular-type paper cond.
 C16=.5 mfd. 200-V. tubular-type paper cond.
 C18=.25 mfd. 400-V. tubular-type paper cond.
 R10=250,000-ohm potentiometer (Ohmite "AB" type CU-2541 linear taper) NOTE—R19 and R22 are same as above
 R11=24,000-ohm, ½-watt carbon resistor
 NOTE—R13, R21, R23 and R25 same as above
 R12=51,000-ohm, ½-watt carbon resistor
 NOTE—R15, R16, R17 and R18 same as above
 R14=1-megohm potentiometer (Ohmite "AB" type CU-1052 linear taper)
 R20=10,000-ohm, ½-watt carbon resistor
 R24=5100-ohm, ½-watt carbon resistor
 NOTE—All carbon resistors $\pm 10\%$
 All tubular-type paper cond. Aerovox P88

1 SET REQUIRED

RESISTORS AND CONDENSERS FOR AMPLIFIER UNIT

- R1=5000 ohms, 5-watts (Ohmite Brown Devil)
 R2=100 ohms, ½-watt carbon
 R3=11,000 ohms, ½-watt carbon
 R4=20,000 ohms, ½-watt carbon
 R5=100,000 ohms, ½-watt carbon
 R6=3300 ohms, ½-watt carbon
 R7=1-megohm pot. Ohmite "AB" type CA-1052 (LOG)
 R8=100,000 ohms, ½-watt carbon
 R9=100,000 ohms, ½-watt carbon
 R10=39,000 ohms, ½-watt carbon
 R11=27,000 ohms, ½-watt carbon
 R12=510,000 ohms, ½-watt carbon
 R13=360 ohms, 2-watt carbon
 R14=100 ohms, ½-watt carbon
 R15=510,000 ohms, ½-watt carbon
 R16=100 ohms, ½-watt carbon

- NOTE—All carbon resistors $\pm 10\%$
 C1=80 mfd., 300-volt, Cornell-Dubilier UP-8030
 C2=20 mfd., 250-volt, Cornell-Dubilier UP-2025
 Note—Above are electrolytic types
 C3=.1 mfd., 400-volt tubular paper type
 C4=.1 mfd., 400-volt tubular paper type
 C5=.1 mfd., 400-volt tubular paper type
 C6=1 mfd., 200-volt tubular paper type

NOTE—SEE TEXT FOR ALL OTHER PARTS

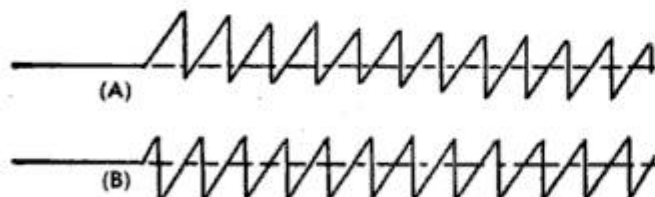

WAVE FORM AT POINT X (FIG. 5) AT START OF OSCILLATION. (A) WITHOUT BIASING RESISTORS R3 AND R4. (B) WITH BIASING RESISTORS R3 AND R4

FIG. 9

separated and arrange the taller elements where they will not interfere with the speaker in the cabinet. Voltage-regulating tubes OD3 and 991 provide the necessary regulation to avoid fluctuations of pitch with line voltage, and to insure stable plate and bias potentials. Choke L1 in the amplifier is a Chicago Transformer Corp. RC-8105, 8 hy., 103 ohms, approximately 100 ma. The 5Y3-GT and OD3 tubes require octal sockets; the 991 tube uses a bayonet candelabra double-contact socket; the 6J6 tubes use seven-pin miniature sockets and the 6F6s require octal sockets. The shielded single-conductor wire in all units is Belden type 8411 (about 15 ft. required).

In the playing consoles, Fig. 5, the 884 oscillator tube is a type used in oscilloscope sweep circuits, with the variable timing resistance used for the main pitch control, and the grid bias for tuning. The use of a 1-meg. logarithmic potentiometer (R5) in series with the 10,000-ohm fixed resistor (R6) for each frequency control provides a relationship between shaft angle and musical pitch which is linear over a resistance range of 16,000 to 450,000 ohms, with a slope of about 30 degrees per octave. Accordingly, each half tone occupies $2\frac{1}{2}$ degrees and each whole tone 5 degrees. The wobble arm swings over more than 75 degrees, giving the desired $2\frac{1}{2}$ octaves, and is set on its shaft so that the minimum total resistance actually used is 75,000 ohms. The potentiometer should have a molded carbon element so that mechanical wear will not affect the scale calibration. A voltage divider across the 150-volt supply (resistors R3 and R4 in Fig. 5) holds the plate of the thyatron at about 40 volts above cathode potential while the "on" contact is open. The tube does not conduct in this condition because its firing point for normal tuning is designed to be near 80 volts. The effect of this bias is illustrated in Fig. 9. If

(Continued to page 322)

Full-color reproductions of the painting by Robert Korta on the opposite page are available to Popular Mechanics readers. The print measures $10\frac{1}{4}$ by $13\frac{3}{8}$ inches and is suitable for framing. Send 10 cents to cover the cost of mailing to: Department C, Popular Mechanics Magazine, 200 East Ontario St., Chicago 11

MECHANICS CRAFTSMAN

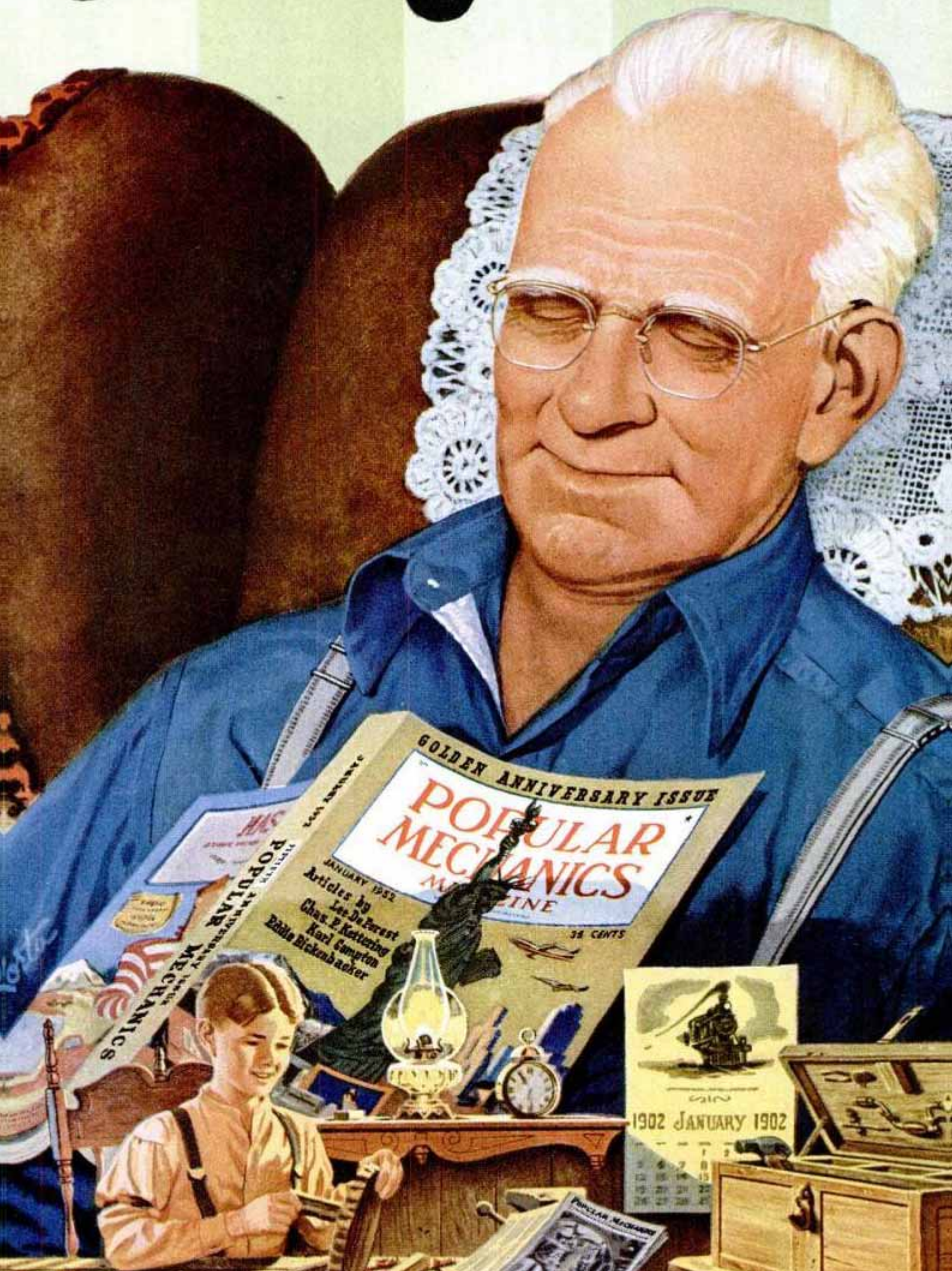

1902

By
Wayne
C.
Leckey

(Asst. Crafts Editor)

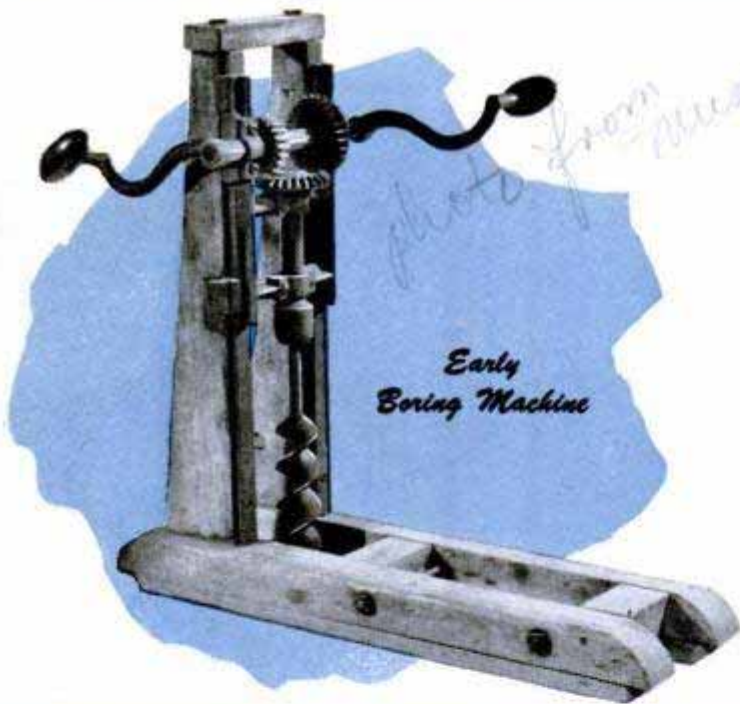
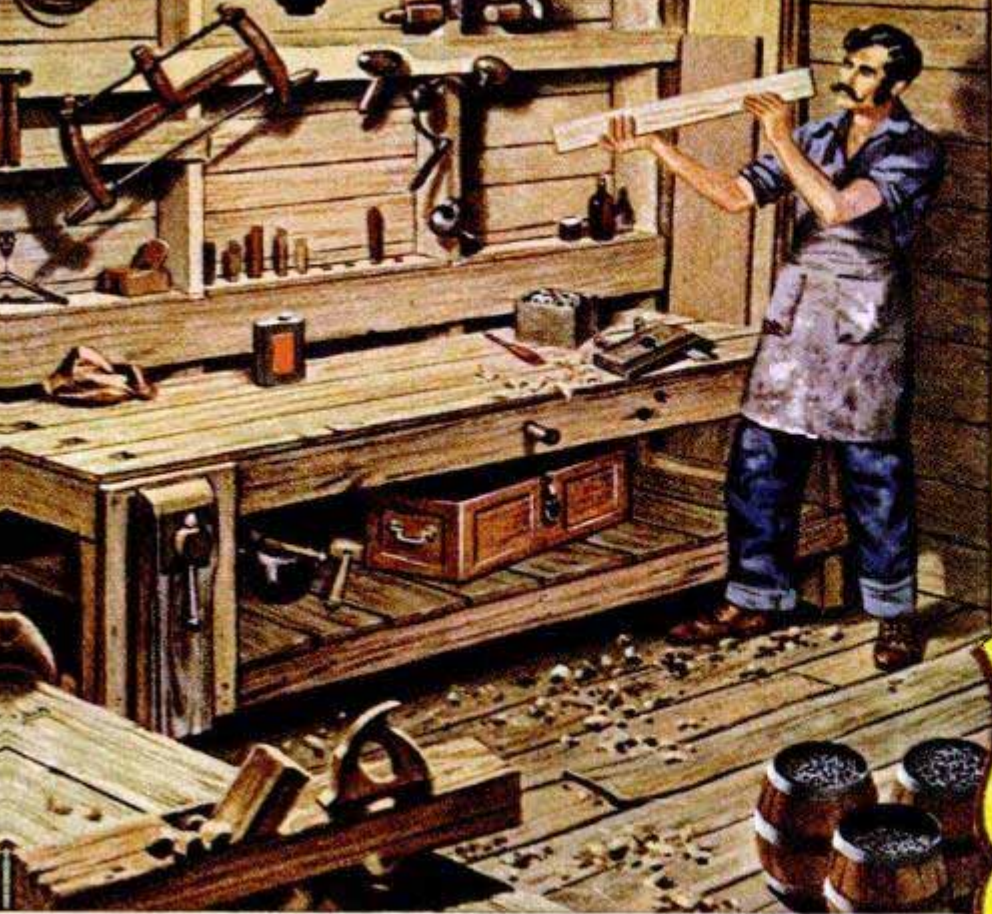
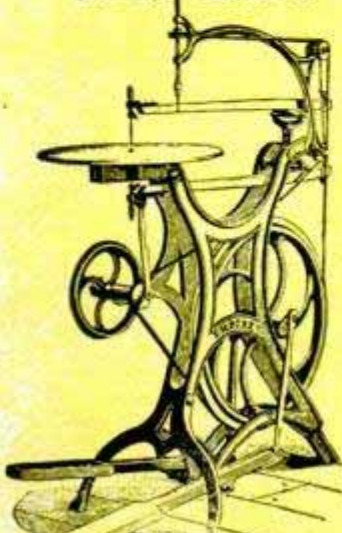

photo from Museum

*Early
Boring Machine*

BACK IN 1902 when the first weekly issues of *Popular Mechanics* were being read by a mere handful of mechanically minded men, anything remotely resembling what is now known as a home workshop was limited to the primitive shops of the skilled cabinetmakers. To envision the day when the average man could have his own workshop of motorized tools right in the basement of his home was beyond the wildest dreams of the most far-thinking craftsman. His was an era of producing by hand with crude and simple implements. The turn of the century found treadle

*Treadle
Scrollsaw*



Foot and Hand-Driven Saw

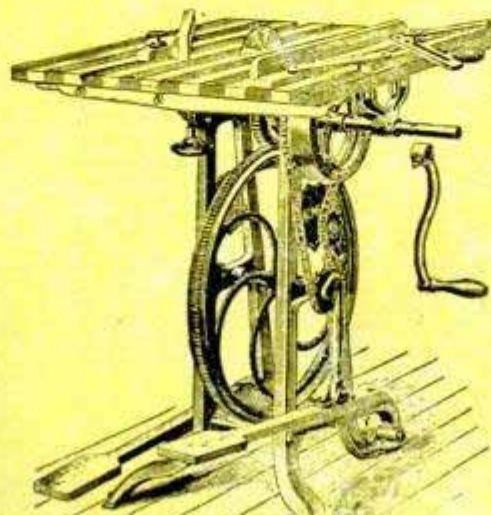

Self-Feed Ripsaw

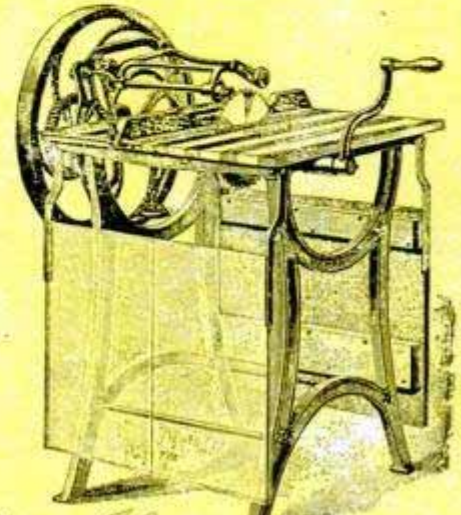

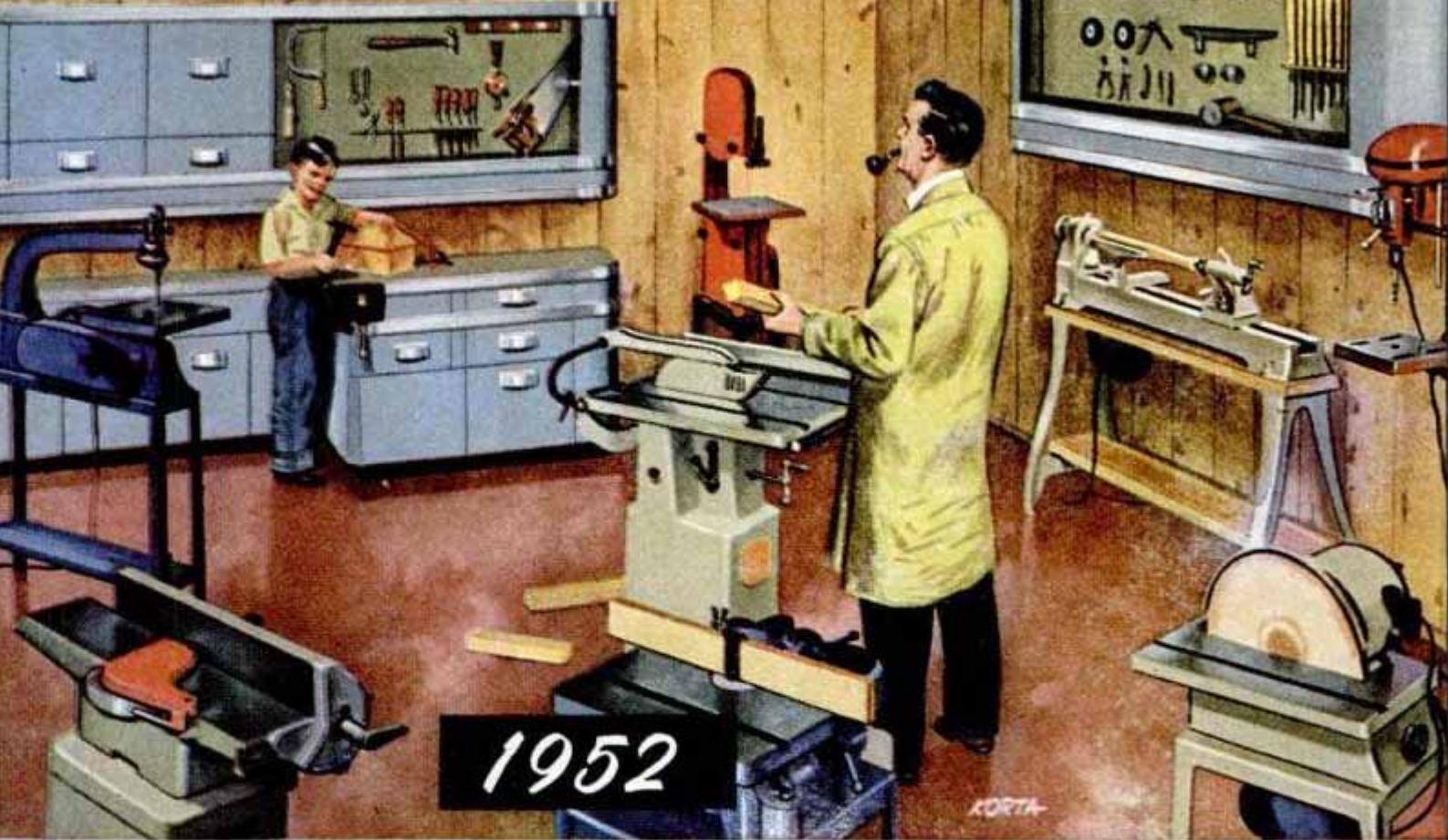

OF CRAFTSMANSHIP

and hand-operated machines beginning to take their place in the woodshops. No doubt, many *Popular Mechanics* readers remember such machines, and, perhaps, even may have operated them. Included among these machines were those reproduced below from an old catalogue of Seneca Falls Machine Co. Considered a great step in man's constant desire to better his lot and lessen his labors, these treadle-driven machines, still far from high speed, permitted far greater accuracy and saved considerably more time than was heretofore known. In a sense, these early machines provided the first opportunity to "mass produce" duplicate work to any degree of accuracy. But while these machines were a mere beginning in the march of progress to come, they were costly in the days when butter was only a

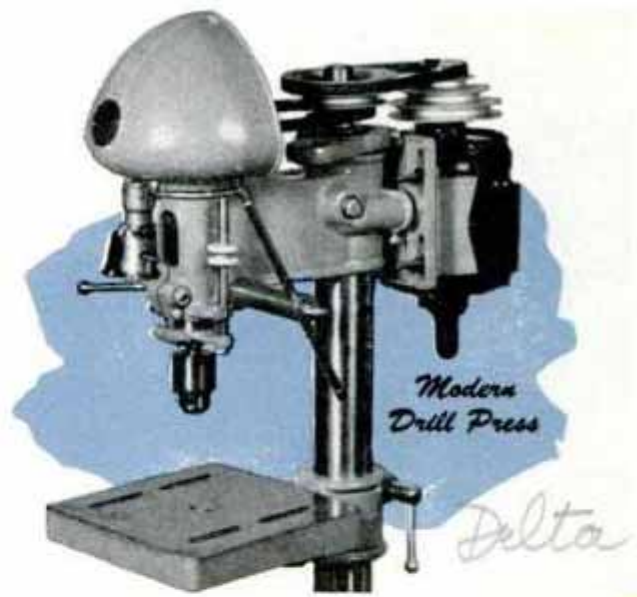

Modern Drill Press

Delta

Mortising Machine

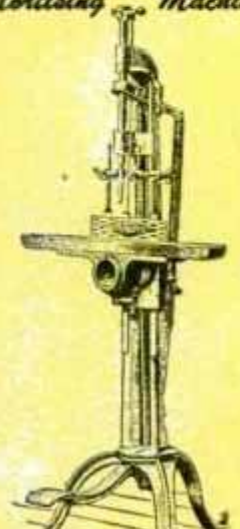

Light-Duty Wood Lathe

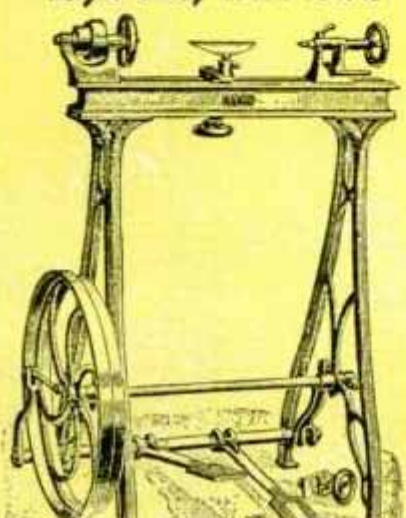

Heavy-Duty Wood Lathe

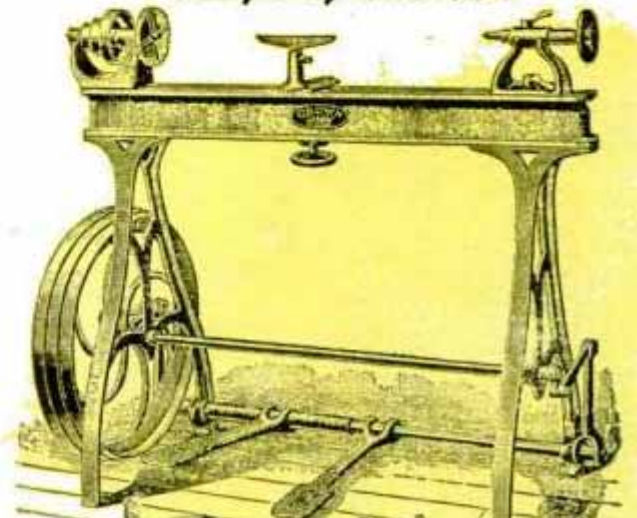

1902

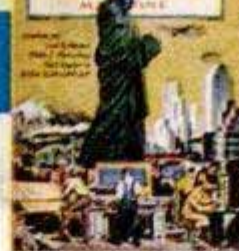

1952

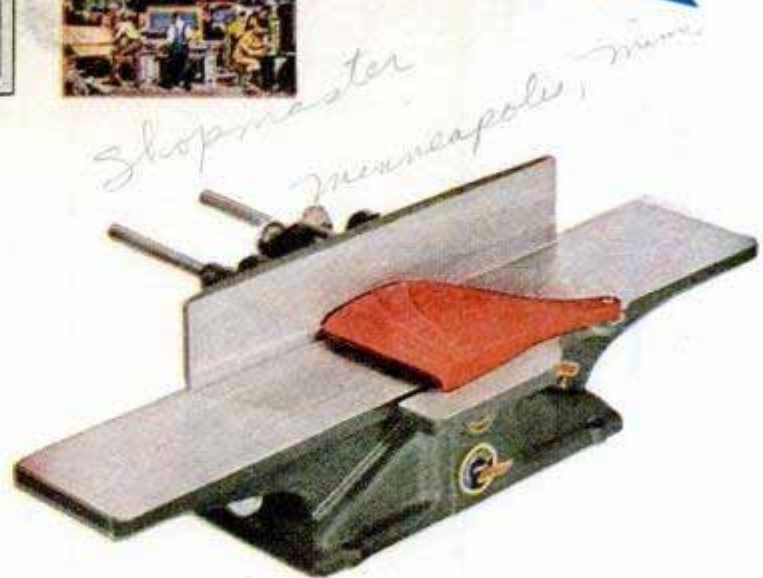
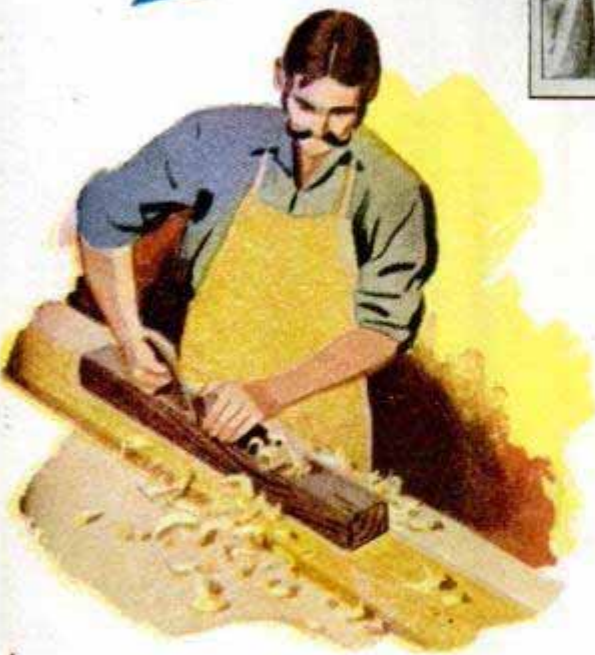

Hand jointing and surfacing were laborious jobs for the 1902 craftsman, and considerable skill was required to plane a true edge. Now, to joint and dress his lumber accurately and quickly, the 1952 craftsman needs little more than the ability to hold the work in position on a precision-built woodworking machine called a jointer

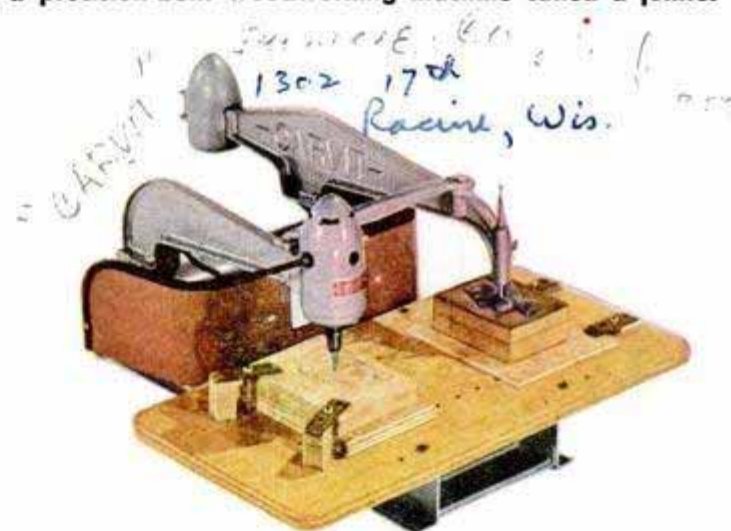

Compared to the old woodcarver who had to be endowed with extraordinary skill in handling a chisel, the man who takes up the hobby of woodcarving in 1952 has merely to guide the high-speed carving bit of a duplicating machine. Likewise comparing modern bandsaw to crude turning saw of 1902 illustrates how contour sawing has been simplified to point of merely following a line in producing accurate cut in stock up to 6 in. thick



Hand Tools That Granddad Used



A—Wooden brace with metal jaw
 B—All wood bit brace
 C—Screwdriver brace

D—Gimlet
 E—Taper reamer
 F—Auger bit

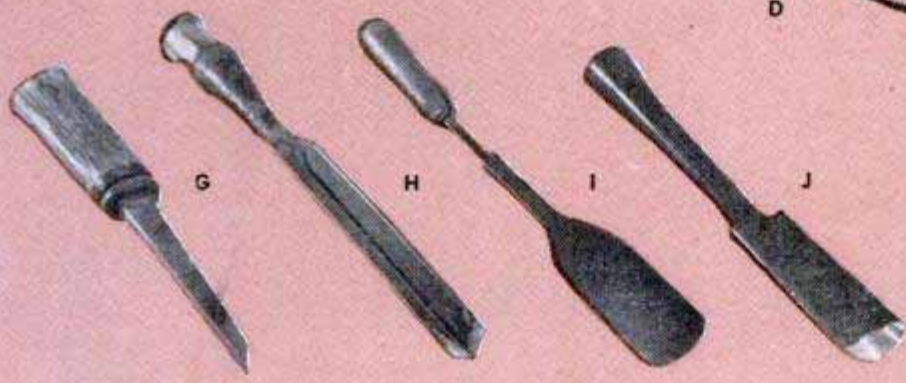
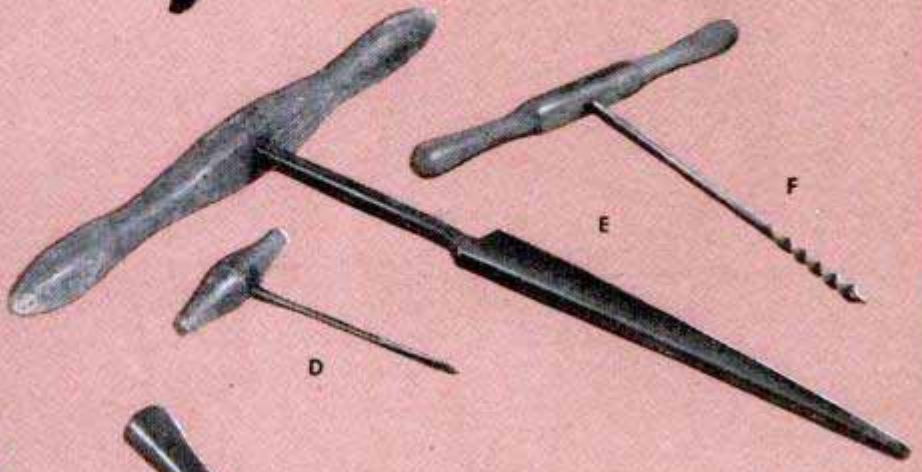

G—Mortise chisel
 H—V-gouge
 I—Spoon gouge
 J—Wide gouge

K—Finishing adz
 L—Forming adz
 M—Flat-blade adz
 N—Wooden block plane
 O—Molding plane
 P—Screw box and tap

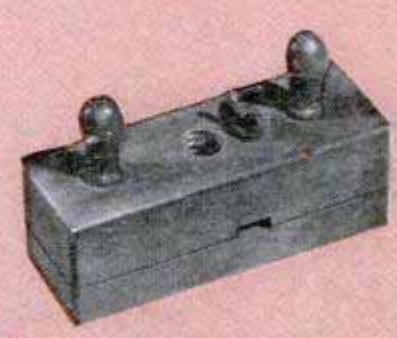
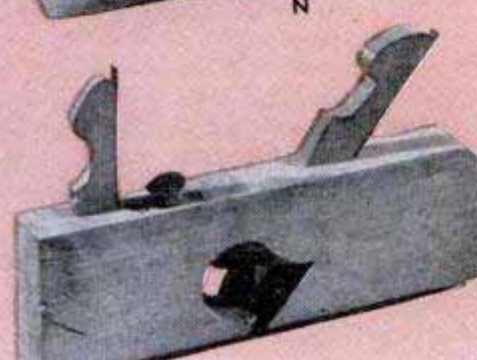
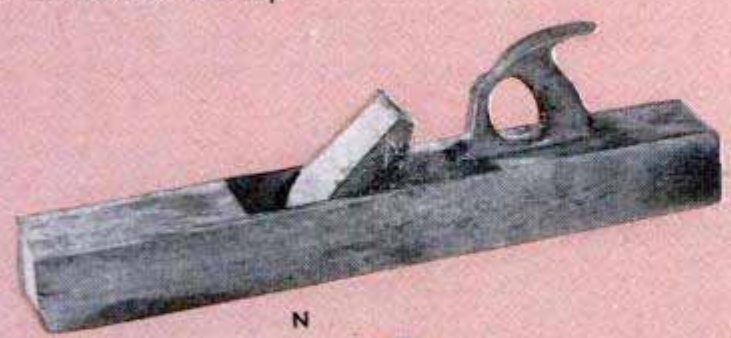

*photos from
 ...*

The Wood Lathe

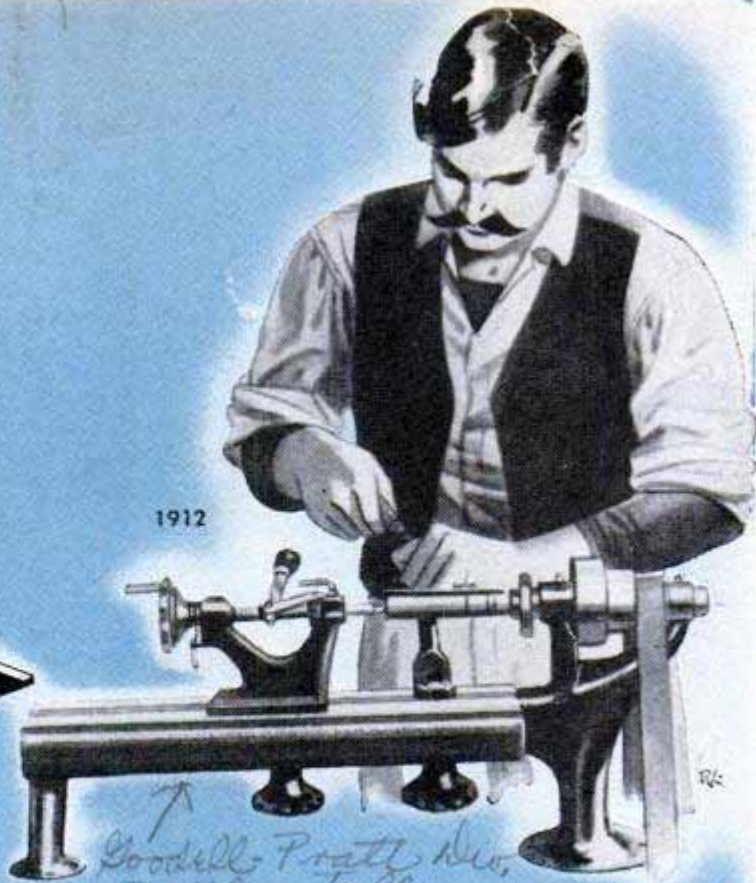
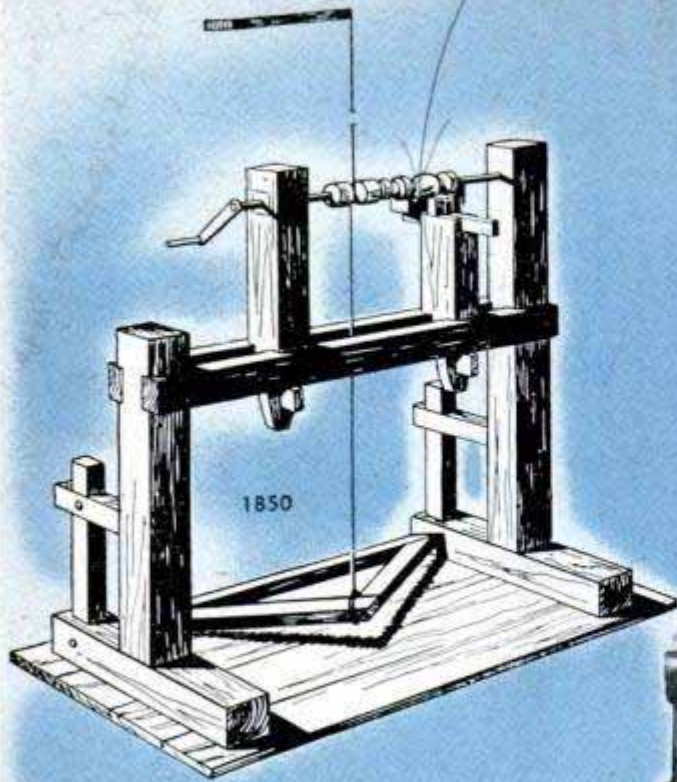

Walker-Turner
catalog

The evolution of the wood-turning lathe is graphically pictured in this representative group of models dating from one of the earliest forms up to the present. From the early treadle type that relied on an overhead sapling to provide momentum up to modern gap-bed model, basic design has remained the same

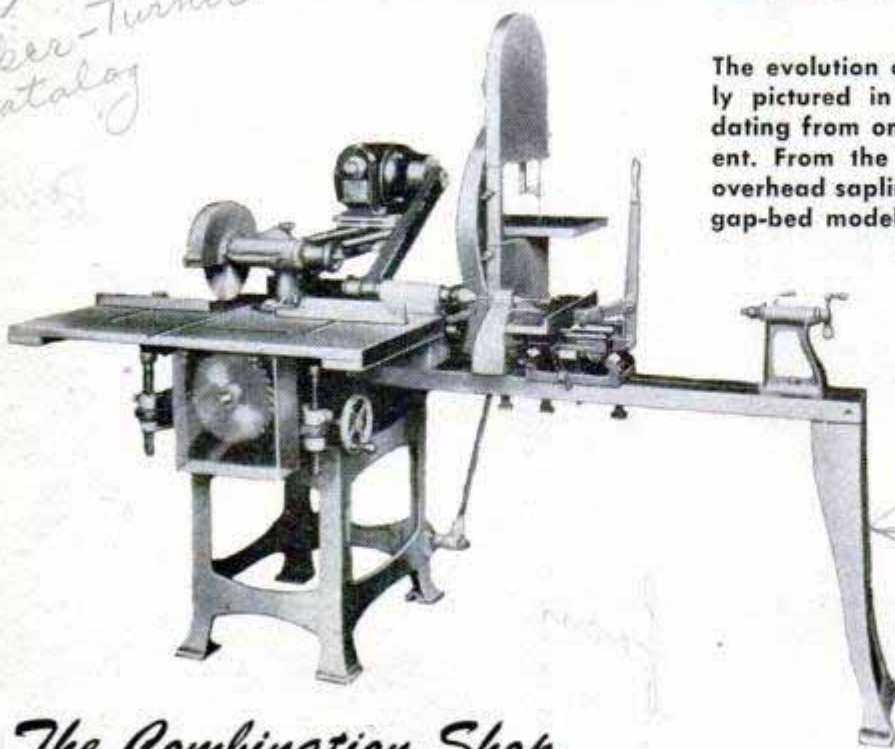

Representing one of several combination shops to hit the market, this Ever-Ready Woodworker was offered by Porter-Cable Co. in 1930. Featuring individual tools driven by one motor, this husky outfit included all the basic tools to make it a favorite among patternmakers and craftsmen alike

The Combination Shop

not available any more

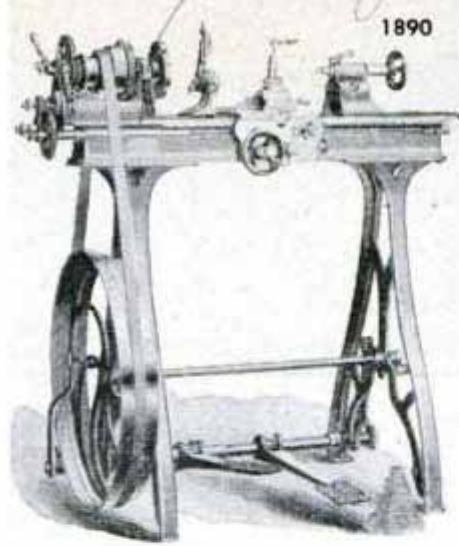

1890

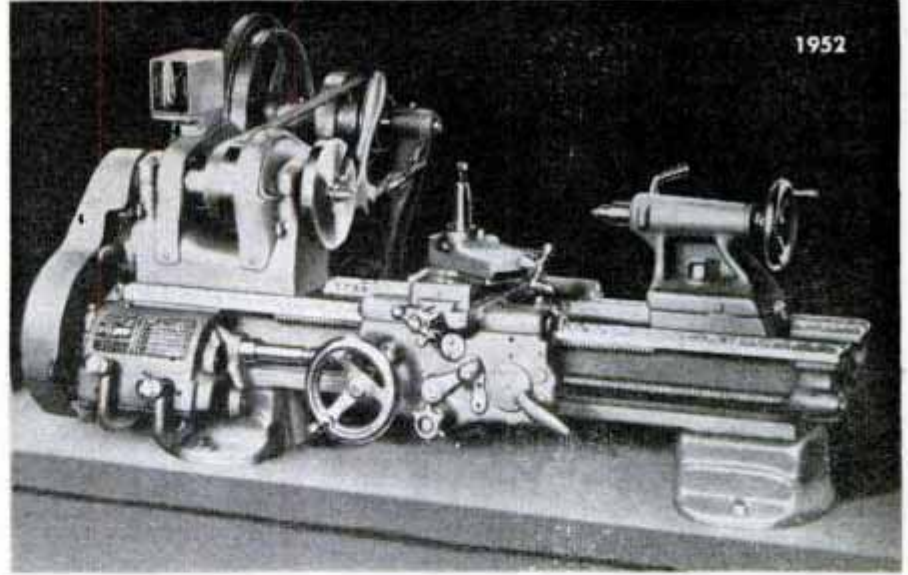

1952

The Screw-Cutting Lathe

Typical screw-cutting lathe found in use around 1900 compared to modern motorized bench model. Large flywheel provided three-step pulley ratio and lent momentum to new-type "walking" treadle drive

dime a pound and, for the most part, the machines were limited to professional use.

Today, fifty years later, it's a far different story. In 1902, it was necessary for the craftsman to rely entirely on his skill and dexterity in the use of hand tools to produce a fine piece of furniture. He had to possess the ability to cut a board squarely, to plane an edge true or to bore a hole accurately. It was up to him to guide the tool with a skill acquired only from years of apprenticeship and practice. Until the advent of the treadle-driven machine, he had no means other than hand. The 1952 craftsman knows well what little effort it takes to saw a board, plane a block or drill a hole. The machine has taken over!

This ease of doing things is responsible for the existence of the thousands of home workshops and their ever-increasing popularity. The man or woman with a desire for a hobby, whether it be woodworking,

Tilting-Arbor Saw

1952

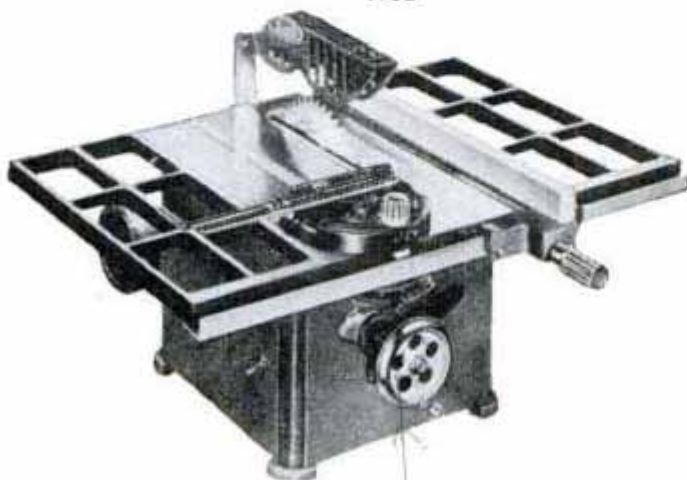

1914

A forerunner of the first commercially successful tilting-arbor saw, this pilot model is a far cry from the modern one below, left



The Line-Shaft Shop 1929



Playing an important part in the early development of the home workshop, this famous "Driver" shop will be remembered by craftsmen of the early thirties

metalworking, leathercrafting or one of the many other crafts, and who possesses but a minimum of mechanical aptitude, can produce a creditable job from the very beginning. Development of the modern power tool and its attachments has all but eliminated the need for exacting skill on the part of the "crafter." Whereas in 1902 it was up to the individual to guide the tool, the primary concern of the 1952 craftsman is the simple procedure of guiding the work. Jigs, guides and fixtures have made it easy to become an expert.

In an endeavor to better early labor-saving machines, treadle-driven models gave way to such improvements as two tools in one. Scrollsaws were made to include a small "drill press." Circular saws were designed with built-in jigsaw, molding and boring features. Self-feed attachments were added to rip-saws so that one man could crank the blade and feed the work at the same time. An improved double treadle, featuring a new "walking motion" principle, gave the operator greater foot leverage and a more positive, continuous

A marked contrast between the old and the new is shown in the photos below of the three-wheel bandsaw. Early Wallace model, left, found greatest popularity during the jigsaw-puzzle craze some years ago

FIRST THIS

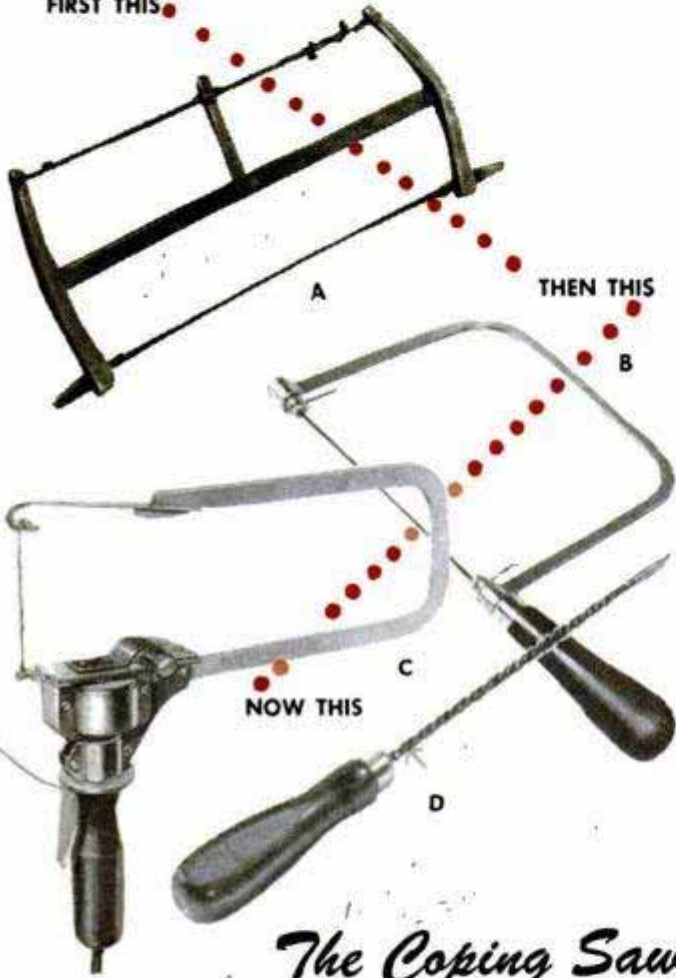

The Coping Saw

Picture history of the coping saw includes crude turning saw, A; familiar metal-frame model, B; and magnetic saw, C. Latest addition is a file-shaped tool, D, that drills own entrance hole and saws in any direction

Three-Wheel Bandsaw

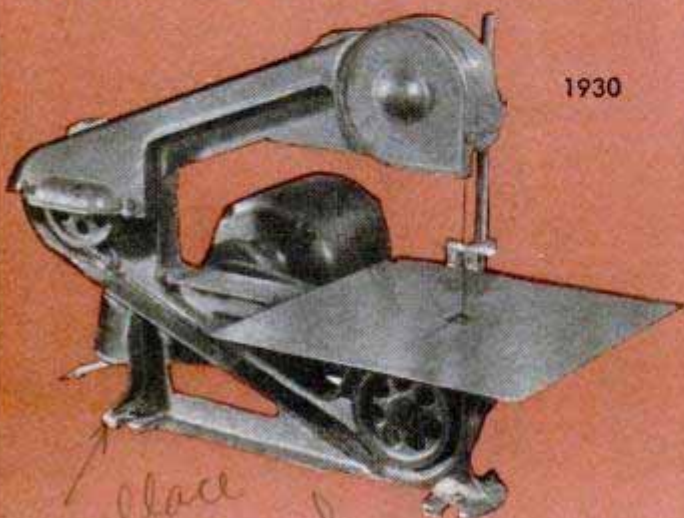

1930

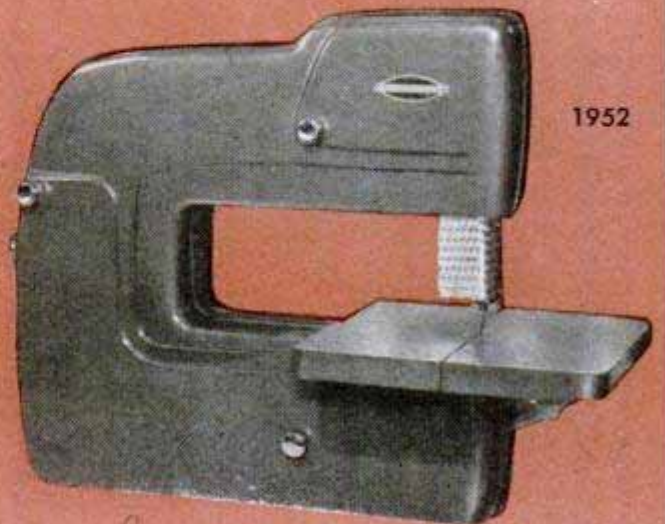

1952

*Maya Engineering
110 Binaldfield Dr.
Menlo Park, Calif.*



GROOVING SAW



Where the craftsmen of 1902 used a series of thick individual blades, today he "wobble" saws dados of various widths with a single blade. New geared type is adjusted for width of cut with socket-head wrench

drive. Soon the pedals gave way to steam-engine drive and water power and, finally, to electricity with the invention of the electric motor and the dynamo.

In 1914, the J. D. Wallace Co. developed and produced the first commercially successful tilting-arbor saw. Crude compared to the streamlined, precision models of today, this early design was a forerunner of the present popular-type saw. Boring machines advanced from the early types in which the operator sat on the tool and cranked the bit with both hands, to the modern multispeed drill press. A highly versatile machine, special attachments have made the drill press virtually a workshop in itself. Saw blades of the day were the common rip and crosscut type. The combination and the hollow-ground planer blade were unheard of, and little did the craftsman of the horseless-carriage era dream of the day when there would be a carbide-tipped blade with which he could saw right through a nail with the greatest of ease without fear of dulling the blade.

Emerging from World War I, the country set a dizzy pace and enterprise was on the

A marvel to the craftsman of '52 is the revolutionary carbide-tipped blade. The new design prevents kick-back, and extreme hardness of teeth permits sawing through nails or concrete without dulling the blade

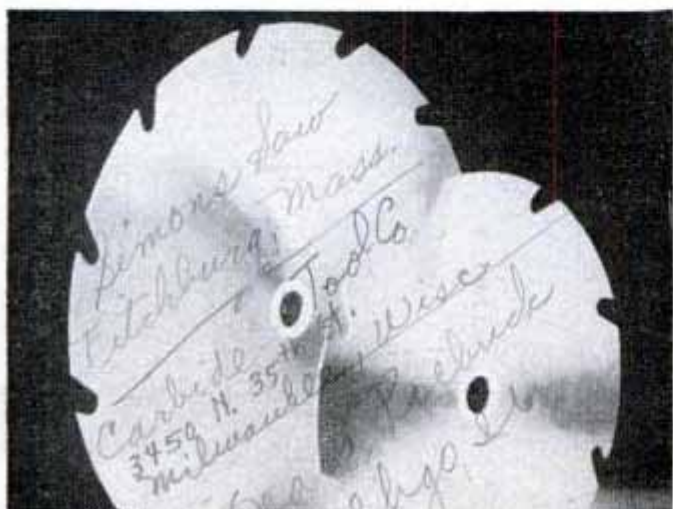

*Evolution of
the Jigsaw*

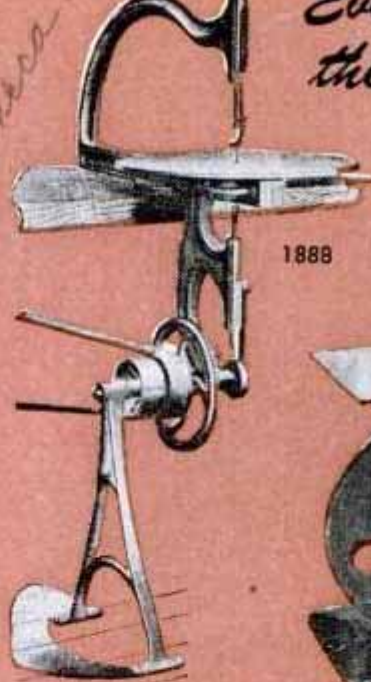

1888

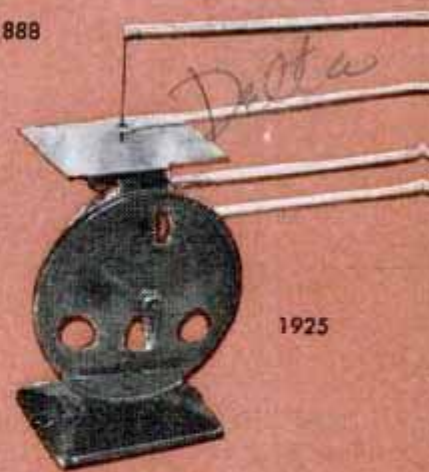

1925



1929



1950

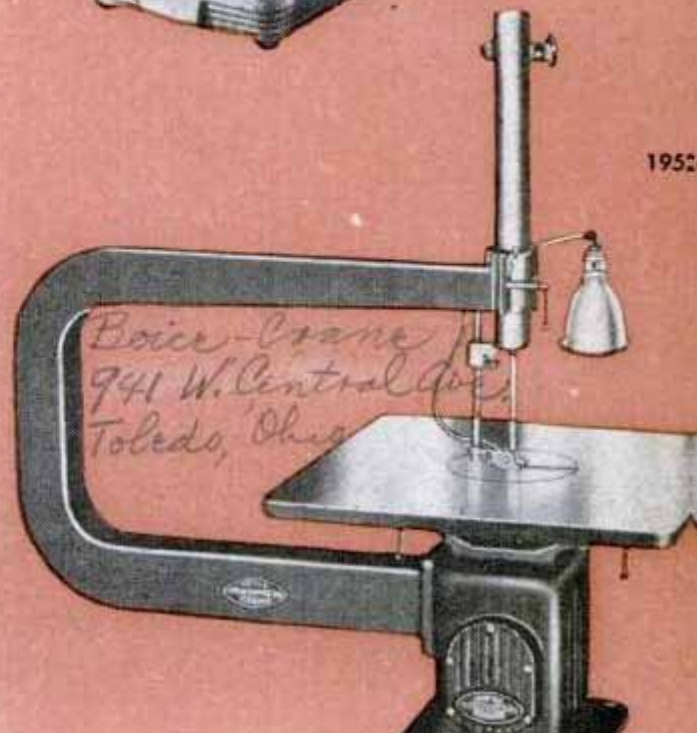

1952

*Boice-Crane
941 W. Central Ave.
Toledo, Ohio*

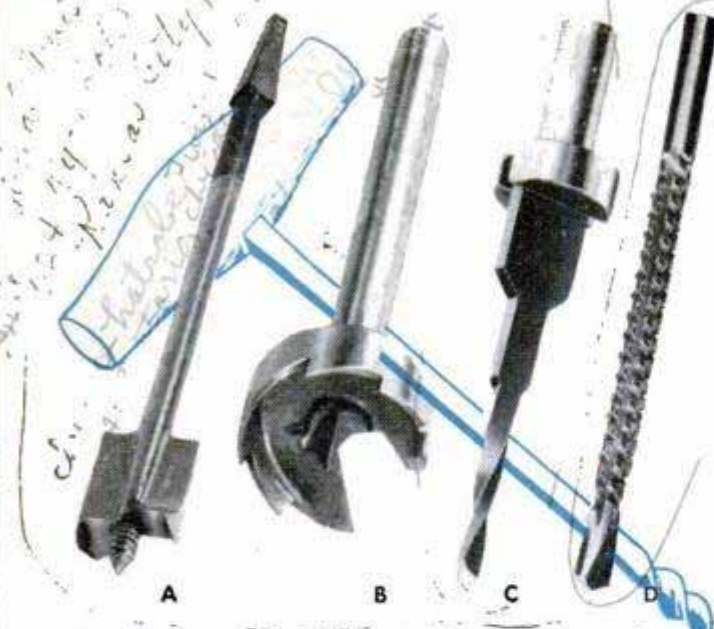

Among the many new boring bits familiar to the modern craftsman are the radically designed auger bit, A; the saw-edge Fostner bit, B; the three-in-one screw-hole bit, C; and the rotary cope-saw drill bit, D

Typical of the advancement of the portable power tool are the examples of the old and new sander, saw and drill. Basically the same, the modern and improved designs have added the 1952 streamlined touch

upswing. In 1925 a young firm, remembered best as the old Delta Specialty Co., began making a small bench-model scrollsaw. Little more than a hand-cranked toy at first, it was later converted to a belt drive. At a time when the jigsaw-puzzle craze hit the country, this little saw marked the beginning of a power-tool era. However, it was not until the depression years of the thirties that the hobby spirit really took hold. It was then that unemployment gave birth to the home workshop. With thousands of people thrown out of work, their livelihood cut off, they turned to the home shop as a source of income. Small businesses of many descriptions sprouted overnight. Manufacturing widely sought puzzles helped many victims weather the depression. Others with more leisure from their jobs sought a hobby to occupy idle hours of unemployment. The hobby business grew by leaps and bounds.

Pioneer and new manufacturers were quick to see the potential market, and many of the older readers of *Popular Mechanics* will recall such famous old trademarks as Driver, Workace, Handi-Shop,

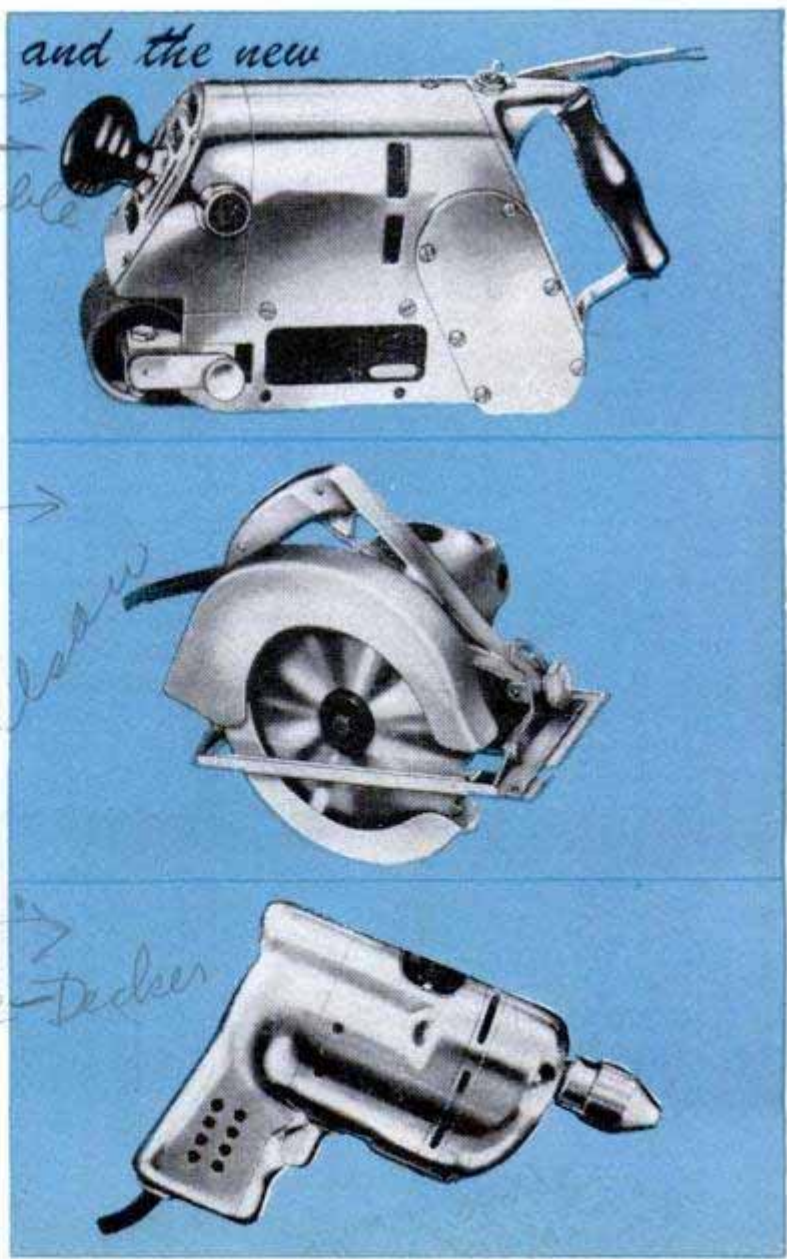
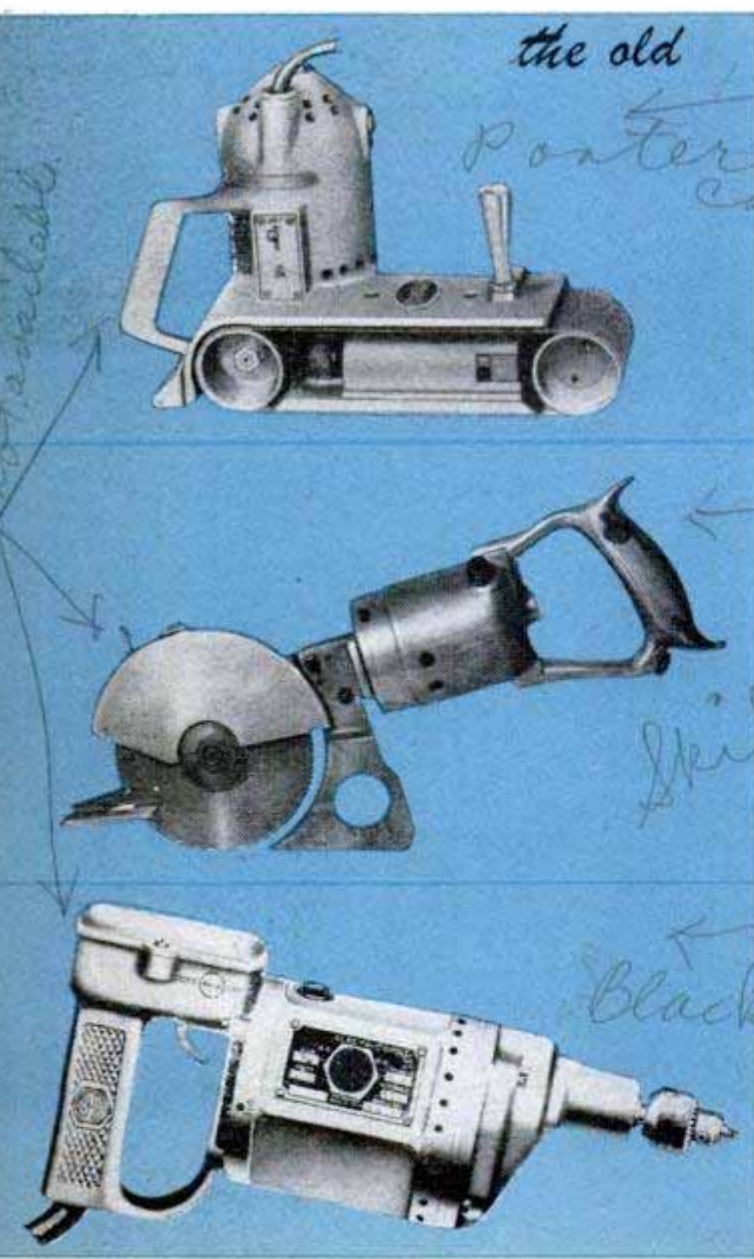

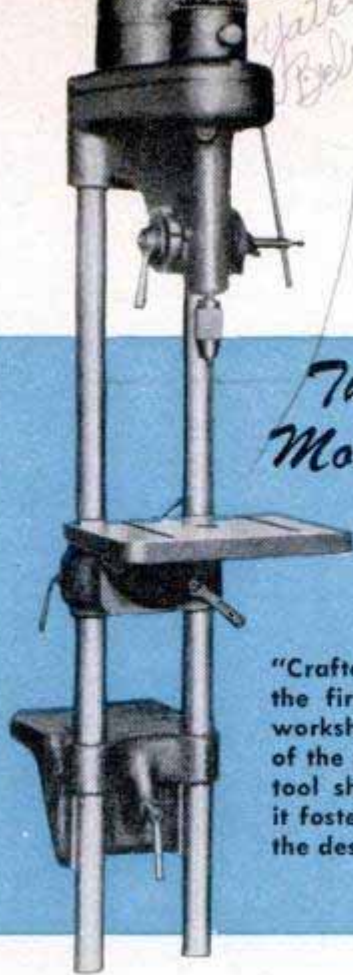

The One-Motor Shop

"Crafters" of 1934 saw the first conversion-type workshop. A forerunner of the present five-in-one tool shown at the right, it fostered a new idea in the design of power tools

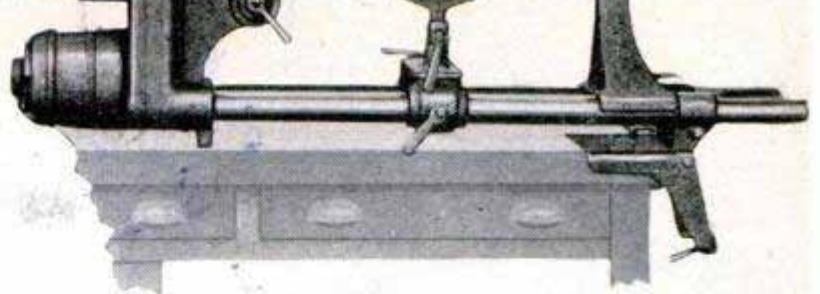

1934

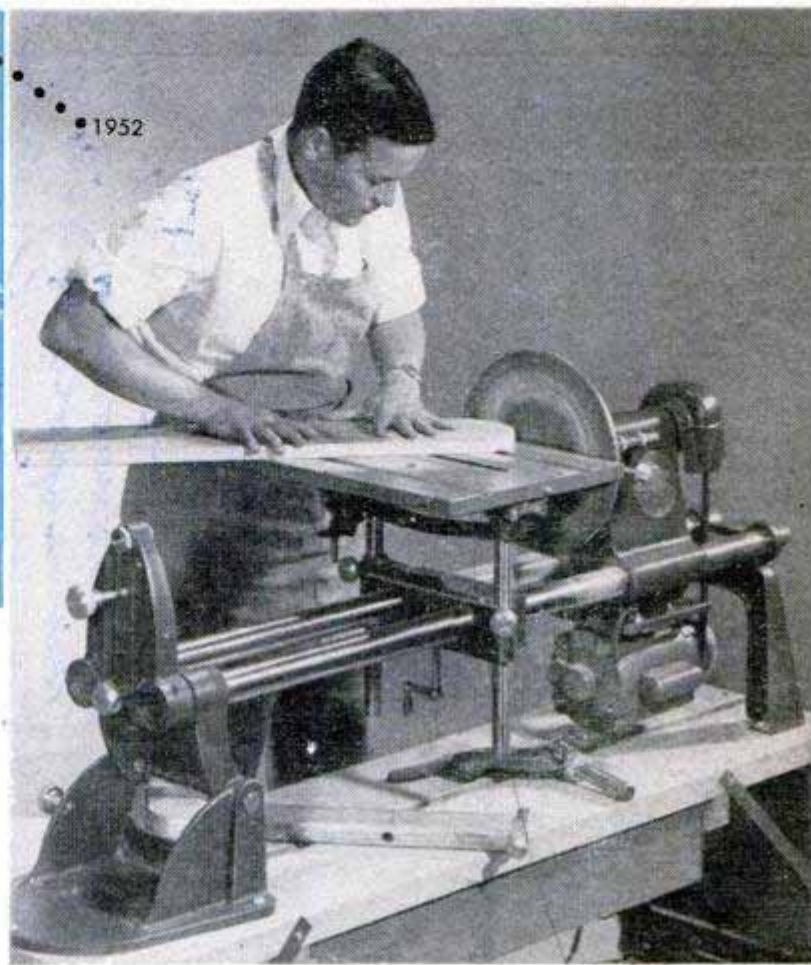

1952

Red Jacket, Ever-Ready, Shop-King and others. Chain stores and mail-order houses began to offer low-price power tools. One could buy a little 6-in. lathe for as low as \$4.00, a jigsaw for \$6.40 and a bench saw for \$9.75. While they were still Tom Thumb versions of their big industrial brothers, these little machines and others like them found a tremendous market. It brought a boom to a prostrate tool industry.

The hobby impact was felt also by *Popular Mechanics* and other craft publications. Now that he owned the tools, the hobbyist was eager for ideas of what to make, to be

Craftsmen with more than a few years of experience will quickly recognize the three old-timers shown below. Picturing three different types of drives featured through the passing years, these early-model drill presses were considered excellent tools in their day

Drill Presses When Popular Mechanics Was Young

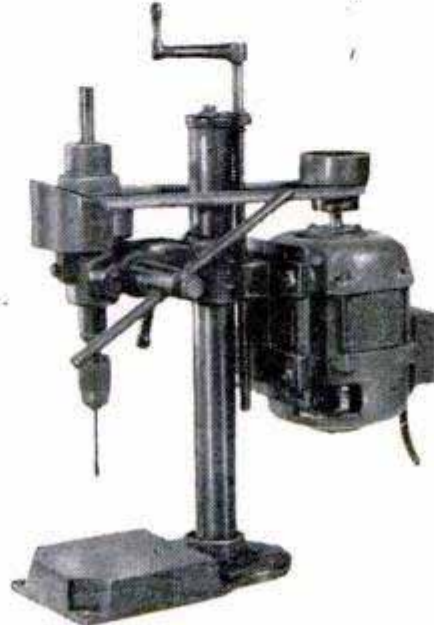
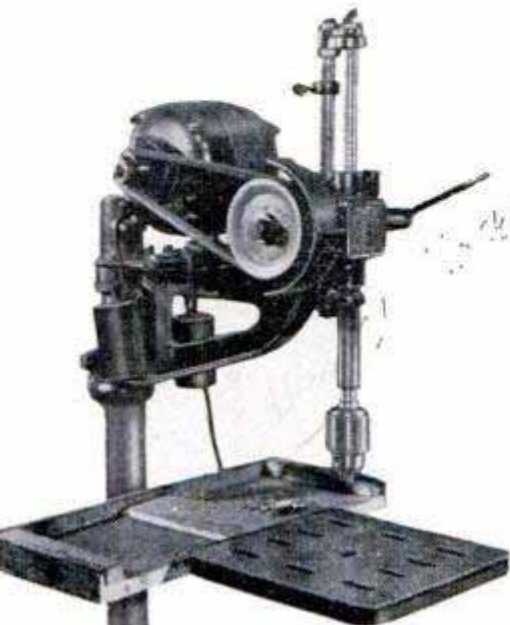



1902

*Raywell Corp.
801 Andrews Bldg.
Minneapolis, Minn.*

*Telco Corp.
815 Central Bldg.
Minneapolis, Minn.*

1952

*Kapner Hardware & E. 22nd St.
2245 Second Ave.
New York, N.Y.*

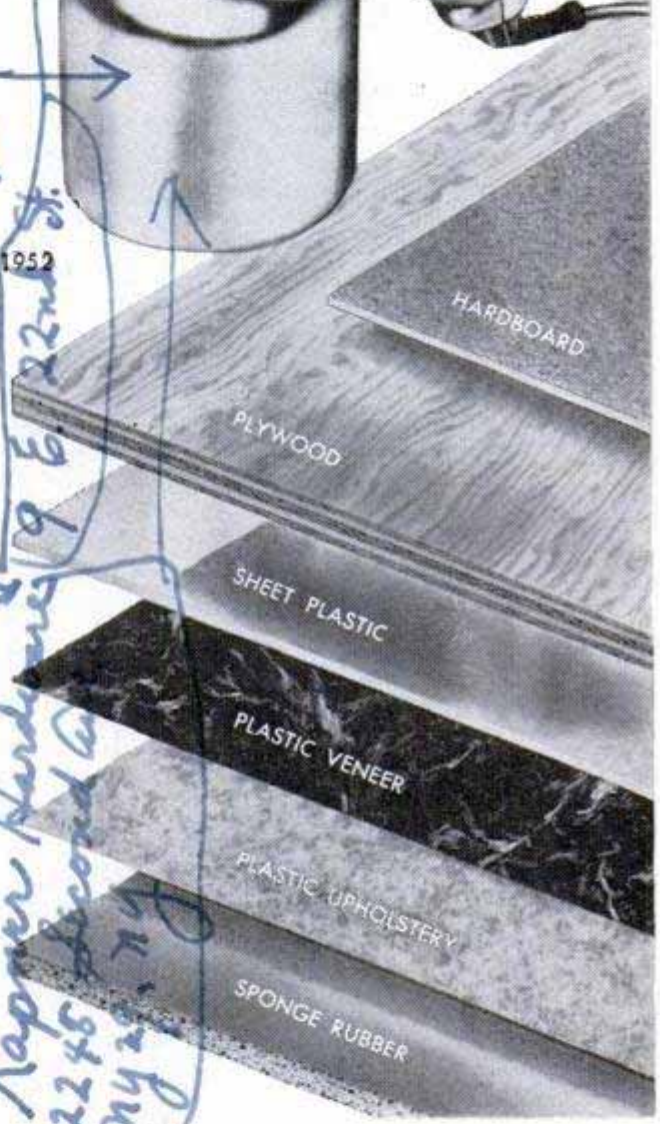

New Finishes and Craft Materials

told how to use the tools and, most of all, how to put them to work making money during those lean years. As competition became keen, better tools were designed and developed. Line-shaft shops became popular, and several firms featured combination shops powered by one motor. In 1934 the Yates-American Machine Co., an old established builder of industrial machines, built a new conversion-type workshop that incorporated several tools in one. Made for a few years and then discontinued, this tool marked the beginning of the combination versus the individual power

tool, and bore a strong likeness to its present-day counterpart, a five-in-one space-saving tool that combines all basic wood-working operations in a single machine. As with tools, craft materials, as well as finishing materials and methods, have changed considerably since 1902. Such materials as plywood, hardboard, sheet plastic, sponge rubber and plastic veneer and upholstery were something out of this world. Whereas it was customary to see the old gluepot on the stoves of 1902 shops, the 1952 craftsman has many strong, fast-setting adhesives from which to select, includ-

ing the latest hide, fish and resin glues which require no heating. Lacquer applied with modern spray equipment has antiquated slow, brushing methods of early days when finishes were built up by dozens of coats and rubbed by hand. In this power age, finishing now is done in a very short time, motorized rubbing machines supplant hand methods, while flat and rubbed-effect lacquers and varnishes simulate the real thing beyond detection. Spray equipment has advanced to the point of including the compressor right in the gun, and the development of the pressurized container has made it possible to spray paints, enamels and other finishing materials directly from the can.

Looking to the future, indications point to an even greater growth of the home workshop. Hobby clubs and vocational teaching in the schools and among handicraft groups of various civic organizations will continue to promote the value of a hobby in fostering both health and happiness. In years to come, the home workshop is apt to move out of the basement. The present popularity of the basementless home is a strong indication and the tendency will be more and more to include hobby space in an attached garage. In the coming years, the cutting edges of hand and power tools no doubt will be carbide tipped to make them far outlast present tools. Like the craftsman of 1902, the 1952 craftsman will be amazed with things to come fifty years hence, and it is sincerely hoped that many 1952 readers will be on hand to compare the present with the new in the 2002 centennial issue of *Popular Mechanics Magazine*.

Veneer Strips "Ironed" on Work

Veneering edges of plywood need not be a troublesome job involving the use of bar clamps, blocks, etc. Here is a method which one craftsman uses to do the job quickly and effectively. It requires only a household iron. The veneers should not be thicker than $\frac{1}{16}$ in. and the glue used should be of a nonstaining, plastic-resin or urea-resin type, which is available in powdered form and mixed with water as needed. After brushing glue on both the work and the veneer, place the latter in position and apply the hot iron firmly to one area, rocking it slightly to assure a positive contact. When the heat of the iron causes the glue to bubble out at the edge in the form of little beads, move the iron to the next area. Although scorching can be removed from the veneer when the work is sanded, deep burns should be avoided by controlling the temperature of the iron.

Sid Christofferson, Phoenix, Ariz.



Draft Through Furnace Utilized To Control Dust From Ashes

Instead of wetting down the ashes in a furnace when removing them in order to check flying dust, one homeowner suggests the following method of doing the job. Shovel the ashes into a shallow container placed directly in front of the ashpit opening as shown in the photograph. Remove ashes only when the draft damper is completely open, and most of the dust will be pulled into the ashpit by the draft.

Ivan Grosvenor, Richmond, Ind.

Gate Fitted With Roller Keeps Dog in Yard

If your dog leaves the yard by jumping over the gate, the habit usually can be broken by attaching a wooden roller across the top. As the dog undoubtedly uses the edge as a "springboard" to clear the gate, the roller will prevent getting a foothold at this point.

A roller from a window shade may be used, or even a suitable length cut from a broom handle. A couple of long screw eyes will support the roller if nails or screws are driven into the ends to serve as small axles.

Hi Sibley, Nuevo, Calif.

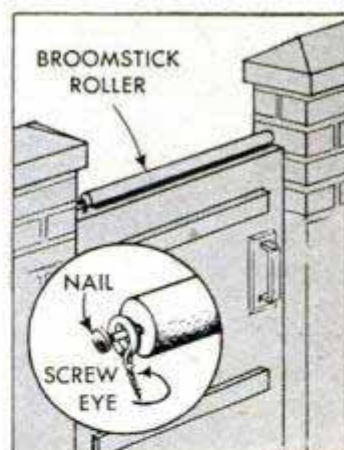

☞ Should you hear cracking and creaking noises in the house during winter nights, it doesn't necessarily mean that the house is haunted. Chances are that the house is groaning from a lack of humidity.

CLOSET-DOOR BUFFET

WHY NOT MAKE a closet door serve double duty?" thought Edward R. Lucas of Poulsbo, Wash., and here's how he replaced a standard door with an attractive swinging buffet. Fitted with shelves for china, a drawer for silverware and a cabinet for linens, this "built in" unit truly is the answer to the problem of space in small living quarters. A rubber-tired caster relieves strain on the hinges, and a strong friction catch takes the place of the regular door lock. Fitting the top of the door casing with a scrolled header adds to the deception and makes the door look even more like a built-in cabinet.

While over-all dimensions will have to be

taken from the actual opening in each particular case, the drawings show how the cabinet is assembled. As weight is a factor to consider, a lightweight wood, such as pine, is best. This can be common lumberyard stock, the back being covered with either hardboard or plywood. The entire cabinet is made of 1-in. stock, which actually measures $\frac{3}{4}$ in. thick. To provide the necessary clearance for the buffet to swing properly, you'll note that the swinging side of the cabinet is built up of two pieces and joined at an angle. The degree of angle required is determined in the manner shown in the drawing. To obtain a close fit in the door opening, hang the cabinet be-





House-Trailer Sewer Hose Stored In Downspout Hung Under Chassis

A length of downspout attached to the underside of a house trailer provides ideal storage space for a sewer hose while the trailer is in transit. The spout should be plugged at one end and then suspended from the chassis with pipe straps or heavy wire. A second plug is used to cap the open end of the spout when the hose is stored.

Cliff Segerblom, Boulder City, Nev.

Shelf Protected From Acid Burns By Rubber Stair-Tread Covering



The shelf on which strong acids are stored can be protected from burns by covering the shelf with a stair tread, section of inner tube or a similar piece of sheet rubber. The covering simply is

tacked in place with the front edge overlapping the shelf as indicated.

George Kapitan, Bronx, N. Y.

Flanges Mounted Beneath Steps Add Rigidity to Handrail

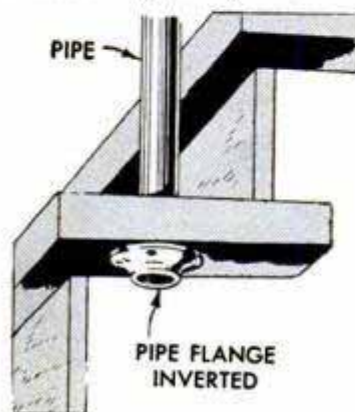

When anchoring a pipe railing to the steps of a wooden porch, the usual practice is to screw the floor flanges to the top surface of the step treads. However, one homeowner found that a far more rigid job

could be had by drilling holes through the steps and mounting the flanges on the underside as shown. With the vertical rail supports passing through the step, extra rigidity was gained to provide a more sturdy railing.

Emergency Pouring Spout For Screw-Cap Cans

Difficulty in pouring liquids from cans that have screw caps, such as those containing solvent, can be overcome by using the rubber pouring spout from a battery water dispenser. Just hold the spout over the neck of the can as shown.



In fact, the spout can be used as a funnel if one is needed in an emergency.

R. F. Donovan, Guttenberg, N. J.

Technique of Filing a Radius

Rounding the corners of either wood or steel stock can be a simple job once you learn this technique. The secret lies in moving the file with a rocking motion, starting at the end of the cut farthest from you and working backward, as pictured in the three steps below. Note that the angle of the file constantly changes for each stroke, resulting in a uniform removal of stock from the curved surface. Keep in mind that the two movements of the file (forward and downward toward the work) are made at the same time.

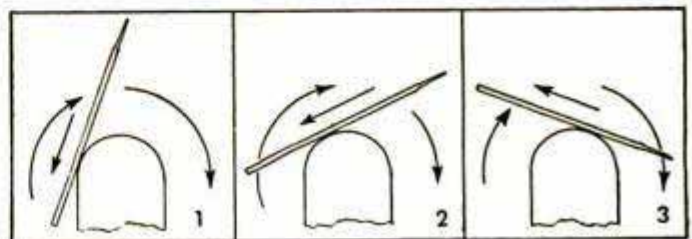
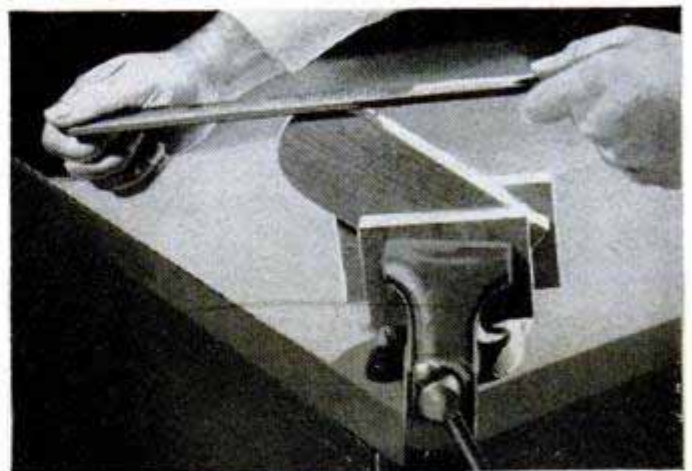

Mahogany Knickknack Shelf

Challenging your hand at fine craftsmanship, this distinctive scrolled knickknack shelf provides opportunity to test your skill at both the lathe and jigsaw. Solid cabinet stock, either mahogany or walnut, is the wood to use for this elegant piece from the scrapbook of John Bergen, noted furniture designer

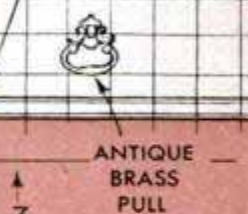
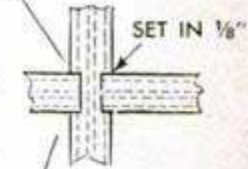
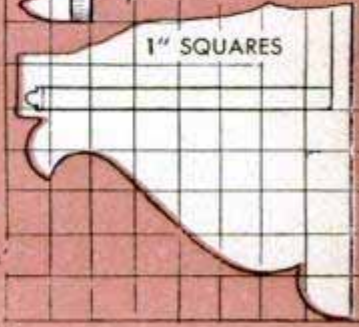
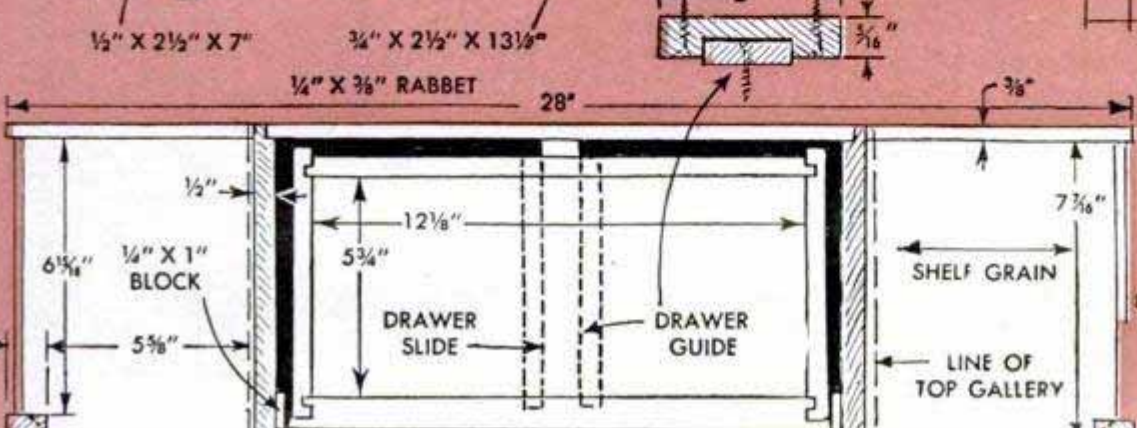
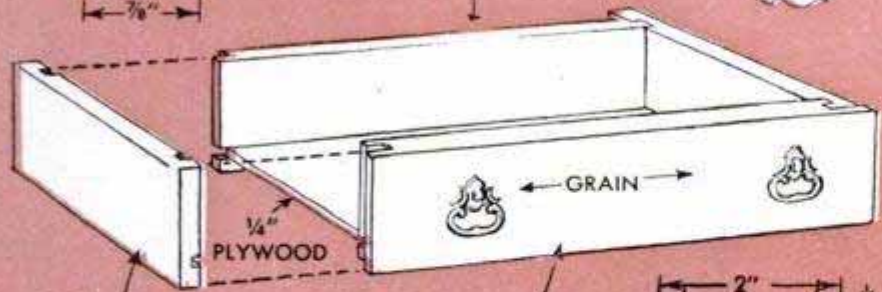
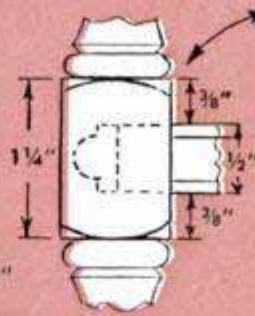
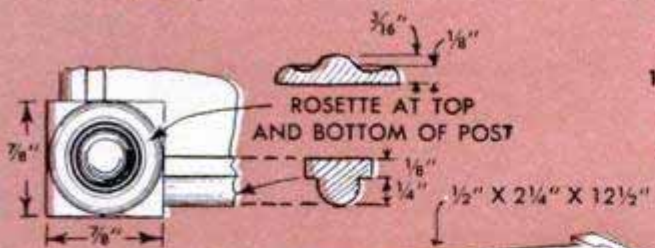
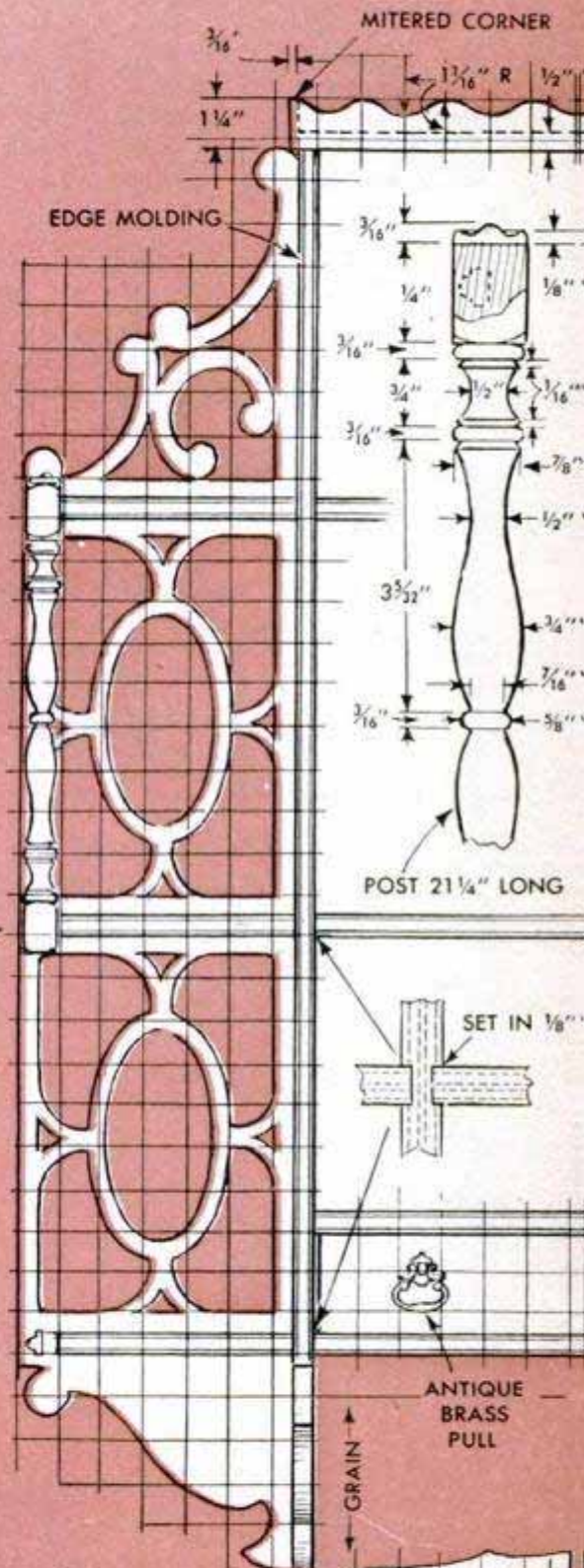
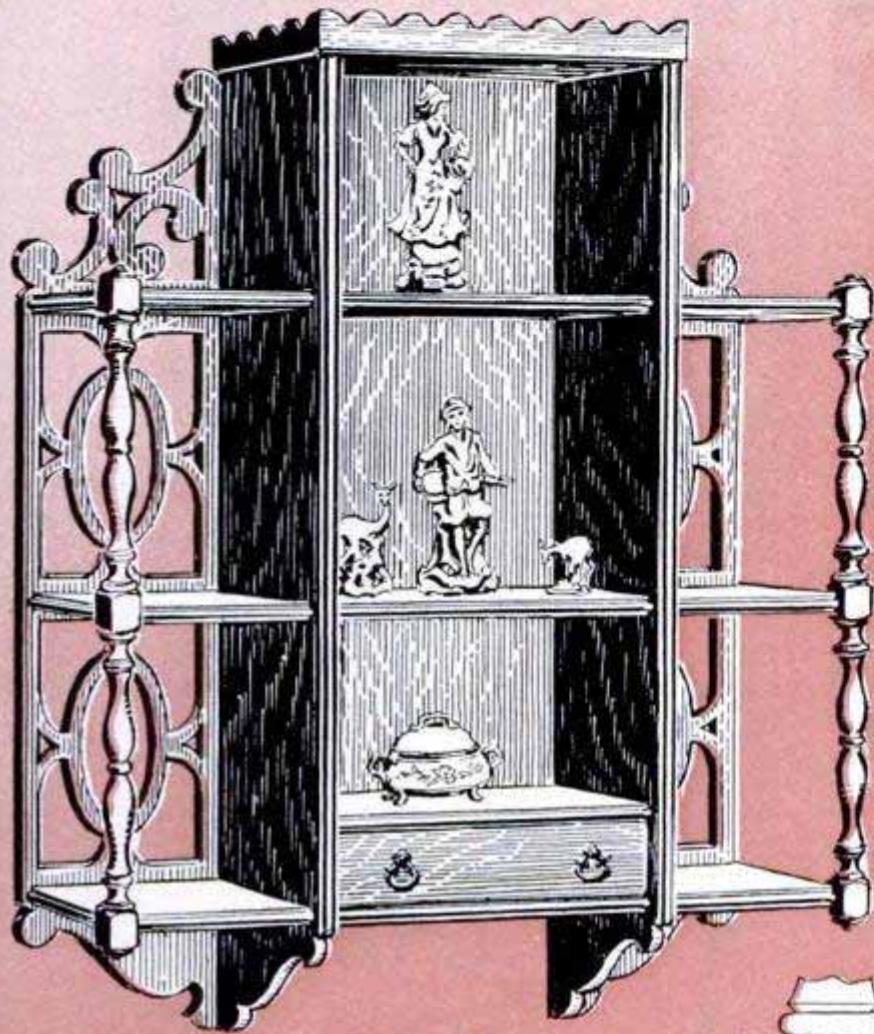

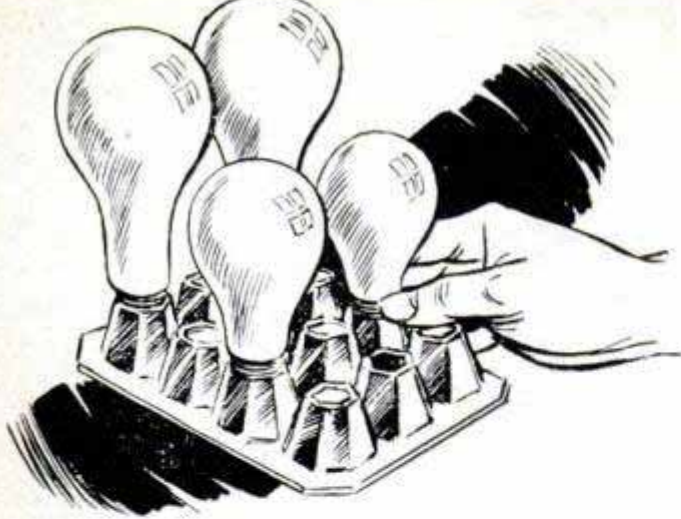

Inverted egg carton, above left, provides novel storage rack for light bulbs. Egg compartments are cut out to take bases of bulbs. Above, stains can be removed from copper-bottom pans with salt and vinegar. Wipe stained surface with vinegar and sprinkle with salt. After few minutes, wipe again

Solving HOME PROBLEMS

Rusting of a step-on garbage pail can be retarded by lining the bottom of the pail with a paper plate. The latter absorbs any leakage from the bag of garbage and can be easily replaced when necessary

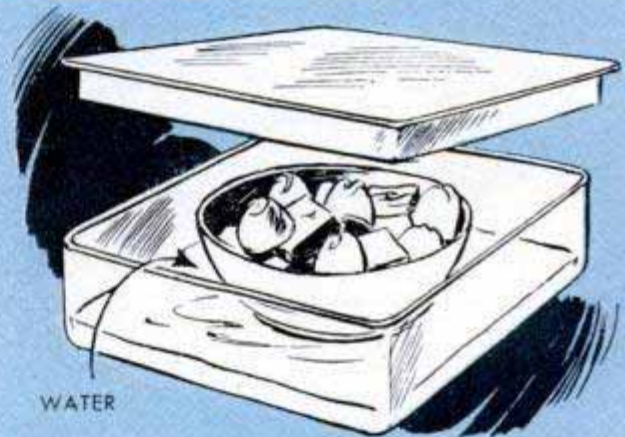
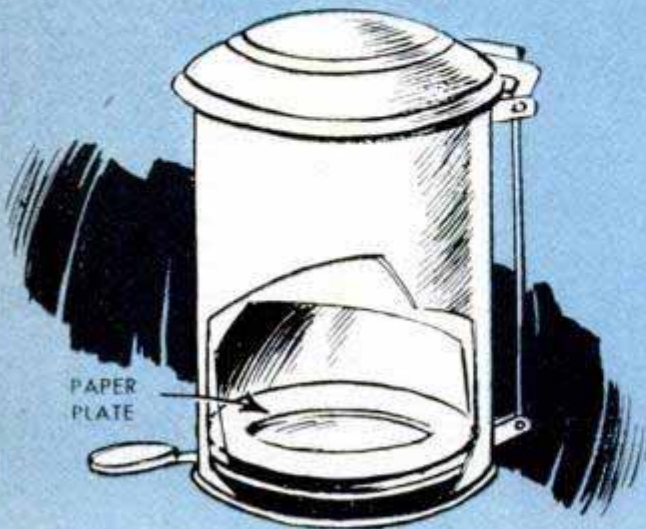

To restore tastiness to fudge, bonbons and similar candies, place candy dish in covered "bowl" which contains a little water, as above, and leave for a few days. Below, skirt pleats can be given a sharp crease by first ironing with dampened cloth. Then, before pleats dry, press with wrapping paper over fabric



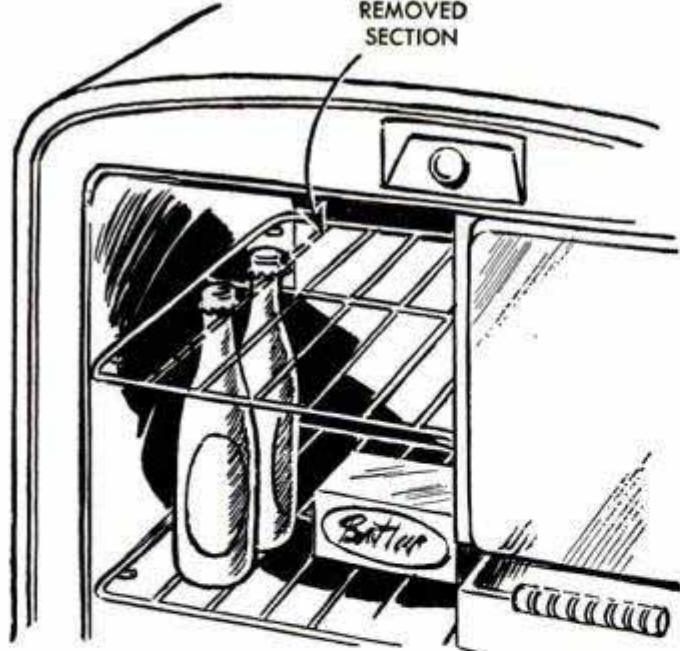

If your refrigerator does not allow enough storage space for tall beverage bottles, provide extra "head-room," as above, by removing section from shelf. Right, coating painted window sills with paste wax speeds dusting and wiping up finger marks. Remember to remove the wax with turpentine before repainting



Above, leftovers of woolen yarn are stored without fear of moth damage if wrapped around mothballs. Below, metal shelf brackets form neat hangers for clothespoles that are not installed between closet walls. Screws driven in ends of pole hold it between the brackets which are screwed to shelf or ceiling

When lids of kitchen utensils fit too tightly, "wax" them by laying several sheets of wax paper over the rim, as above, before replacing the lid. Below, if rubber-heel marks are marring the appearance of your hardwood floors, erase the marks by rubbing them lightly with fine steel wool





Tacking a strip of elastic to the front of a vanity drawer forms a convenient holder for bottles of fingernail polish and vials of perfume. The polish can be applied without removing bottle from holder

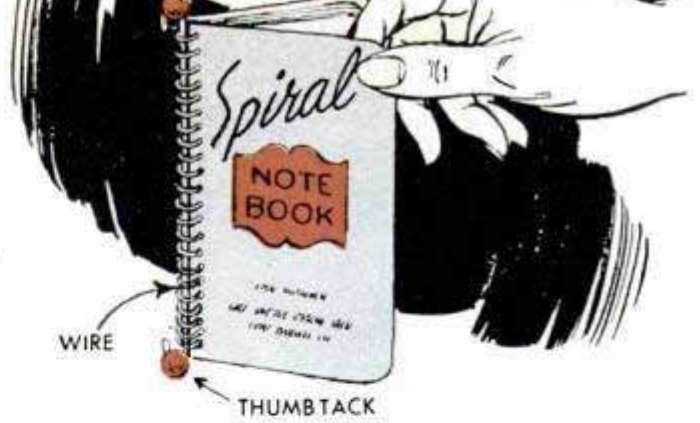

Spiral notebook fastened to wall with thumbtacks, as above, becomes handy telephone pad. Book is held by wire slipped through binding. Below, threading clothespins on coat hanger and kinking wire at points indicated spaces pins to prevent bunching of skirt

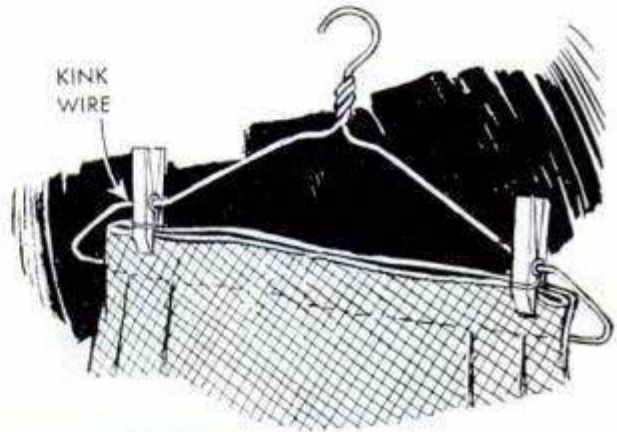

Solving HOME PROBLEMS CONTINUED

Pouring zinc-sulphate solution onto a "dusty" concrete floor results in hard, dust-free surface. Use 3 lbs. of chemical to 1 gal. of water, brush solution into pores of concrete and, when dry, sweep clean

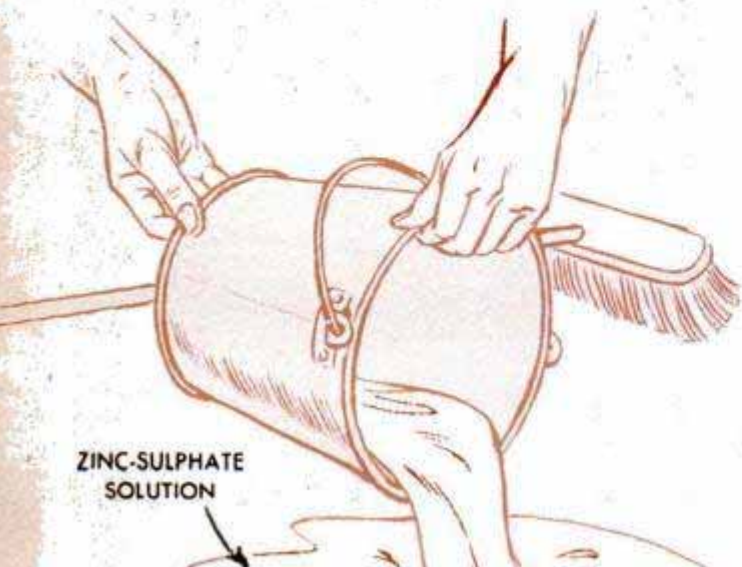

Above, "rings" on varnished furniture caused by hot dishes and spilled beverages usually can be removed by polishing with toothpaste. Below, tape-covered roller removes lint quickly from garments and upholstery. Dowel fitted with wire handle is wrapped with surgical tape, adhesive side out

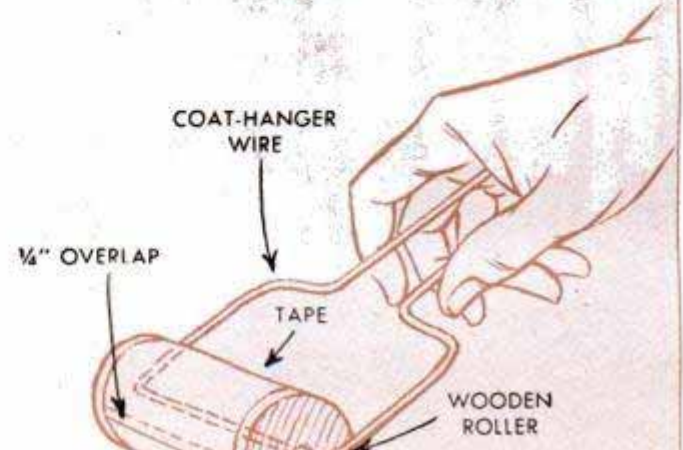

Fixture Rides Rip Fence to Simplify Shaping Edge of Thin Work

The difficult job of shaping the edge of thin work with a molding head is simplified greatly with this jig, which is used to support the work securely as it passes over the cutters. The jig straddles the ripping fence with a sliding fit, and the work is held vertically in the jig with C-clamps. Note that the adjustable strip of the jig is drilled at each end to slide on two horizontal guide pins. In use, the work is clamped between the "jaws" of the jig and, after the saw fence is adjusted to bring the work into position, the jig is merely pushed along the fence.

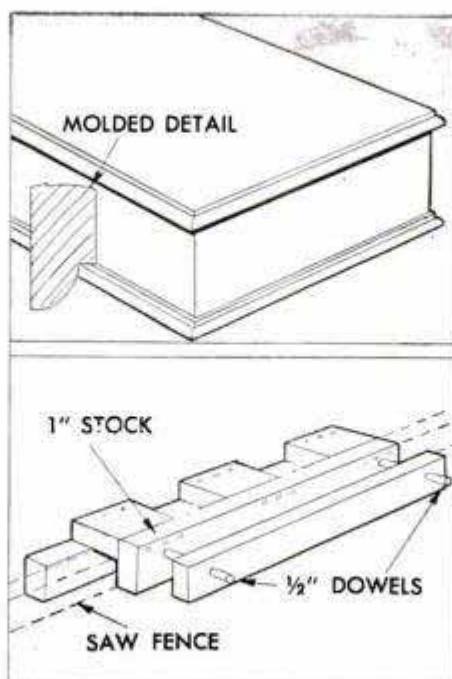

Grinding Jig Used on Circular Saw Permits Shouldering Round Stock

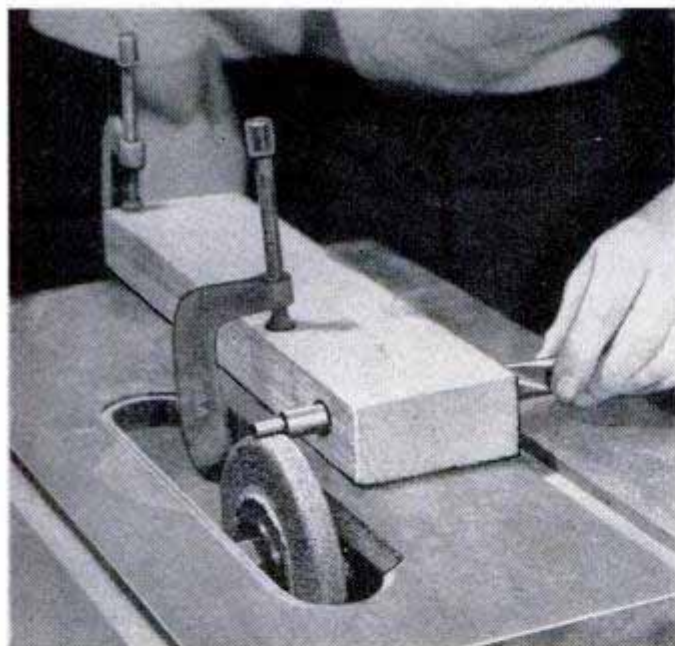

When it is necessary to make a shoulder cut on round stock or reduce the diameter of a large drill shank, the job can be done on a circular saw fitted with a grinding wheel. First, a simple jig is made by drilling a hole crosswise through a length of 2 x 4 to take the work. This is clamped to the saw table parallel with the grinding wheel as illustrated. Then, the work is inserted in the hole and is ground by turning it slowly into the wheel. The jig may be drilled in several places to take various size rods and also is useful, with the saw blade attached, for cutting tenons on dowels.

D. J. Murphy, Springfield, Mass.

Hand-Drill Chucked in Bit Brace Holds Small Twist Drills

Drilling through metal by hand normally requires the extra pressure that can be applied with a bit brace over that of a small hand drill. But where a small drill of less than 1/8-in. dia. is being used, it is impossible to chuck it in the split-type chuck of a brace. However, in an emergency, you can use both tools to do the job by chucking the hand drill in the bit brace. This is done, of course, by first pulling off the tight-fitting wooden handle of the drill and removing the large handwheel drive.

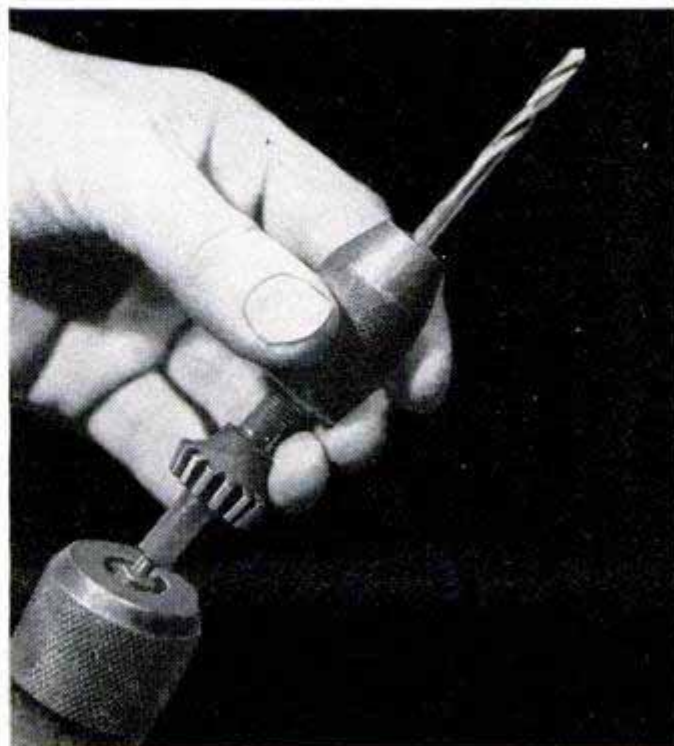

Emergency WOODEN

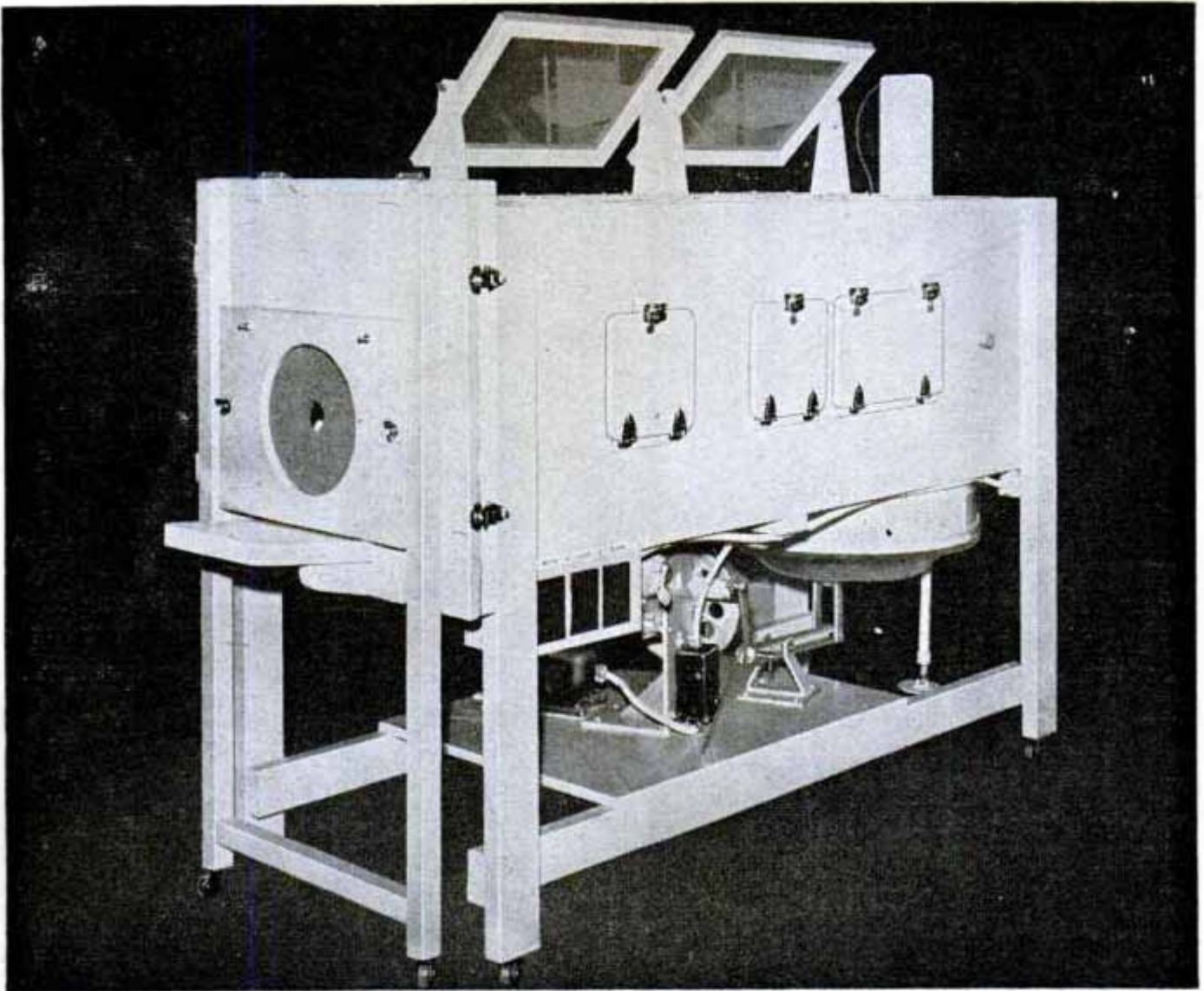

Could a life have been saved in your community if a mechanical respirator had been at hand for immediate use? Often just a matter of minutes means the difference between life or death for a little child stricken with polio, or a victim of drowning or a paralyzing accident. Here's a chance for every community to be ready at little expense for such emergencies. Members of clubs and civic organizations can do a great service by making one of these respirators and placing it in competent hands. Save a life — maybe your own

IN TENDED only for emergency use until a commercial respirator could be obtained, this "wooden lung" was designed by engineers and built by a volunteer group under the supervision of Dr. Gerald M. Cline, Dr. Homer O. Dolley, and Sister Celine of the medical staff of St. Joseph's Hospital, Bloomington, Illinois. On completion, the unit was put into immediate use in emergency treatment of eight-year-old Rudy Landheer, a victim of polio in the epidemic of 1949. The original unit did emergency service for 12 hours until a conventional iron lung could be obtained.

The unit, detailed on the following pages, has been approved only for emergency use under the direct supervision of a doctor or registered nurse. The motor-driven mecha-

nism can be changed to hand operation in a few seconds, if necessary. As detailed, drive ratios have been arranged to give the proper diaphragm action, and a variable-speed pulley on the motor can be adjusted to give a respiratory frequency within the required range of 12 to 20 cycles per minute. The large sprocket on the final drive shaft has 26 teeth.

The cabinet and frame, Fig. 2, are of the simplest construction, all joints in the cabinet assembly being glued and screw-fastened. Note that the bed, Fig. 1, and the end panel and headrest are joined to form one unit which rolls on swivel casters. When the bed is in position in the cabinet, luggage clamps placed at the four corners hold the head panel, Fig. 4, and draw it

RESPIRATOR

tightly against the gasket. Note that all openings into the cabinet, Fig. 3, are fitted with gaskets and that the access doors are fitted with ordinary sash locks, which exert sufficient pressure on the gaskets to assure an airtight seal when the doors are closed and locked. The top openings into the cabinet are closed with clear-plastic panels screwed over sponge-rubber gaskets. Note that the clamp which holds the sponge-rubber head gasket in place is drilled to slip over two bolts in the head panel and is locked with wing nuts. Although the photo on page 262 shows two hanger bolts located above the wing nuts, two additional

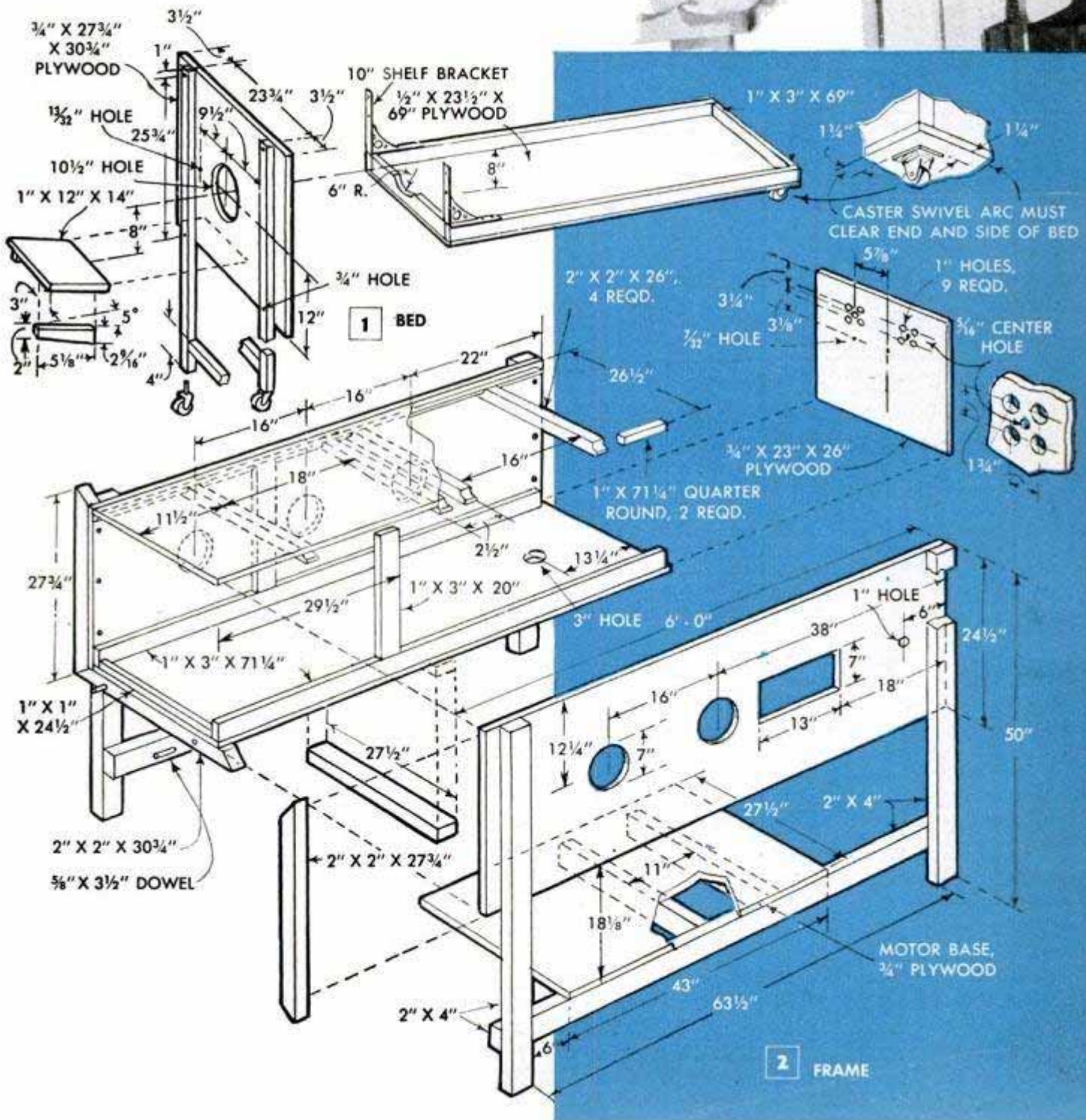

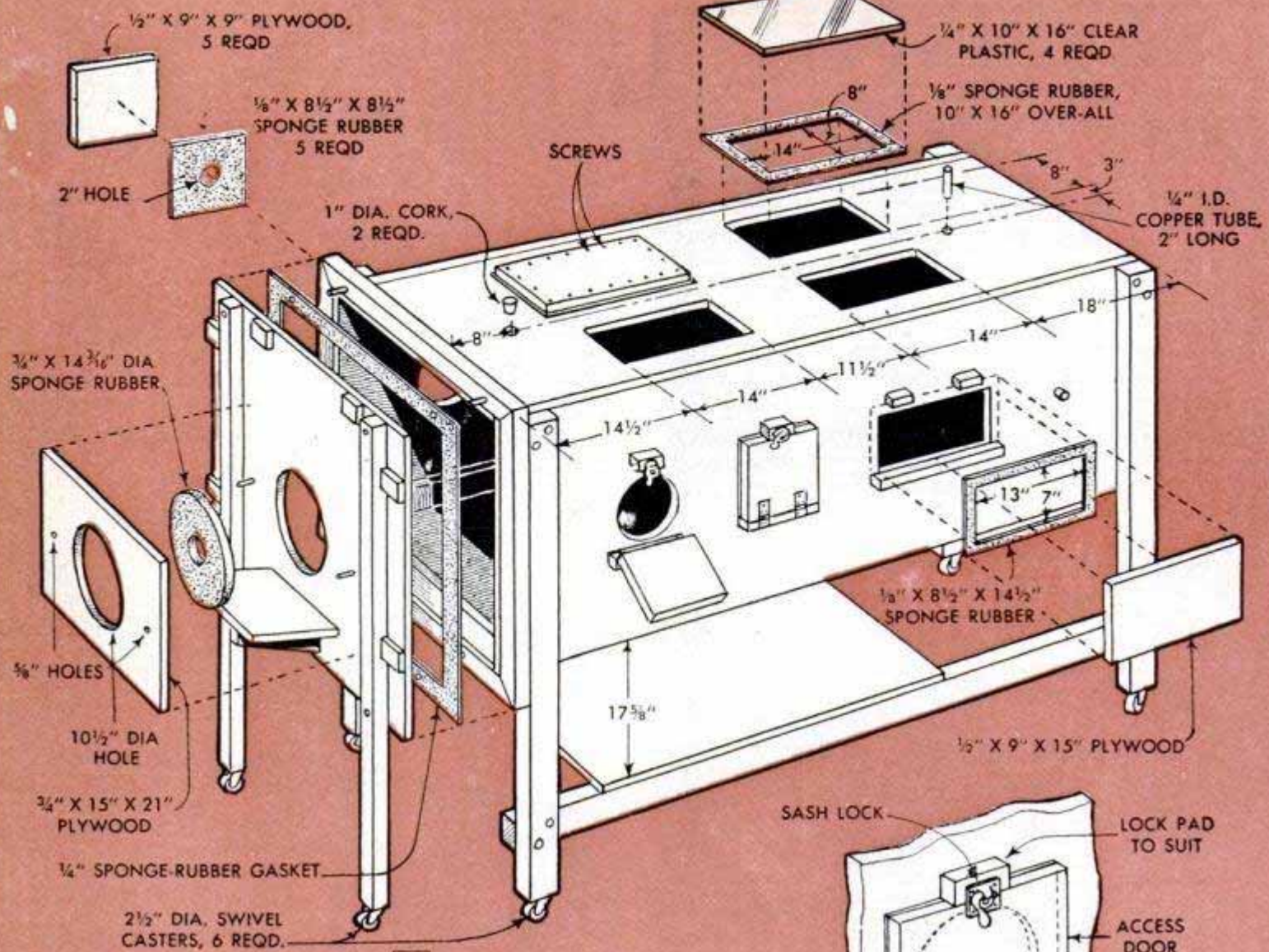

3 CABINET ASSEMBLY

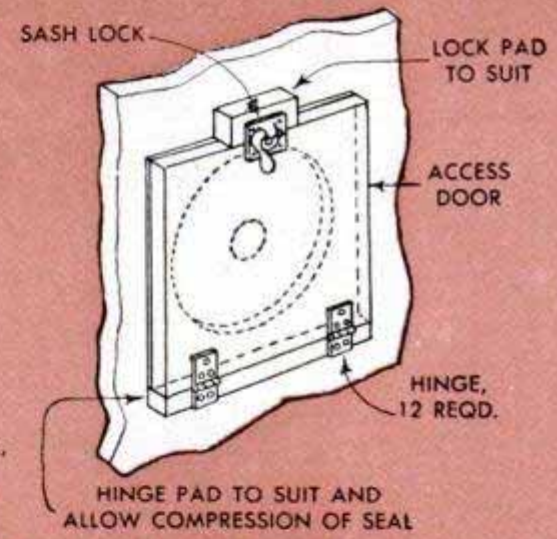

ACCESS DOORS AND SEALS CENTERED OVER ACCESS HOLES

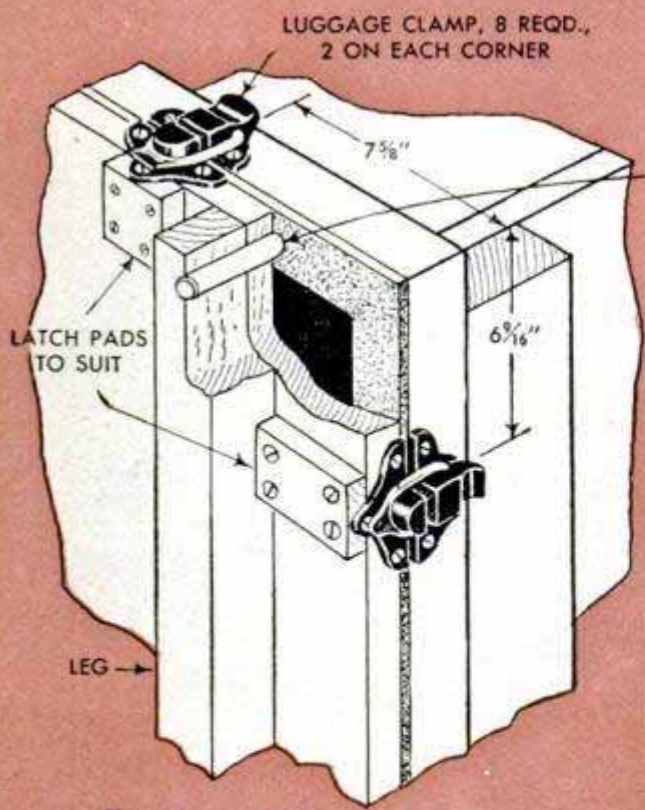

4 BED AND CABINET-LOCK DETAIL

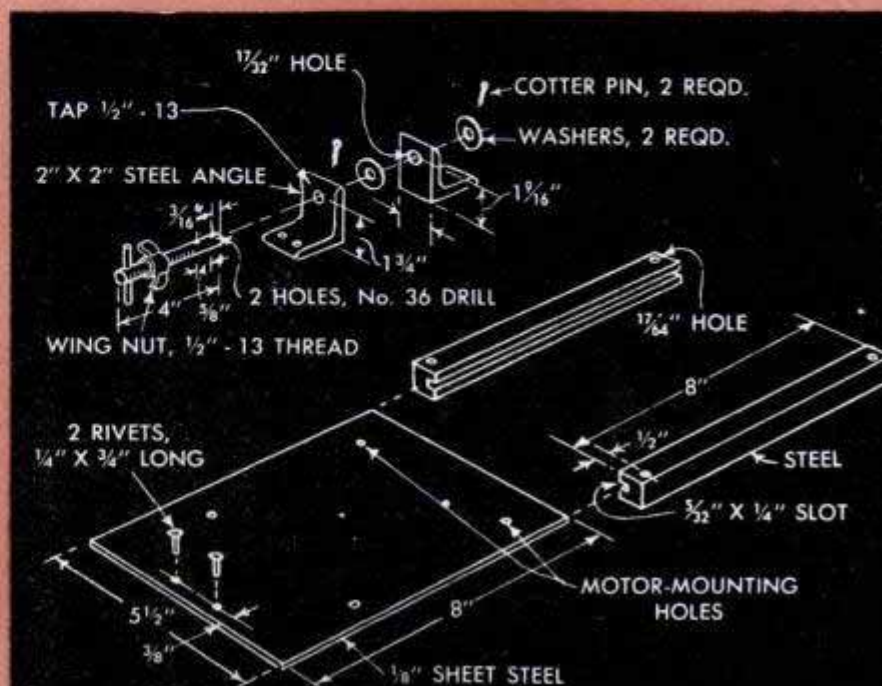

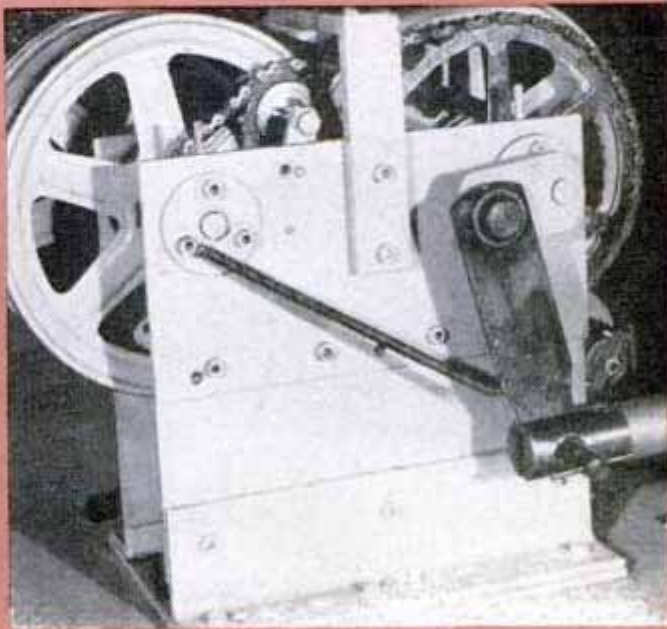
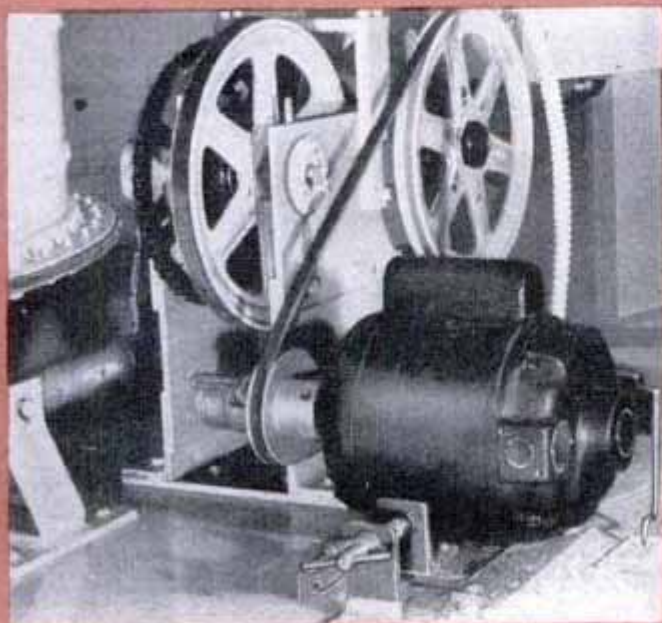
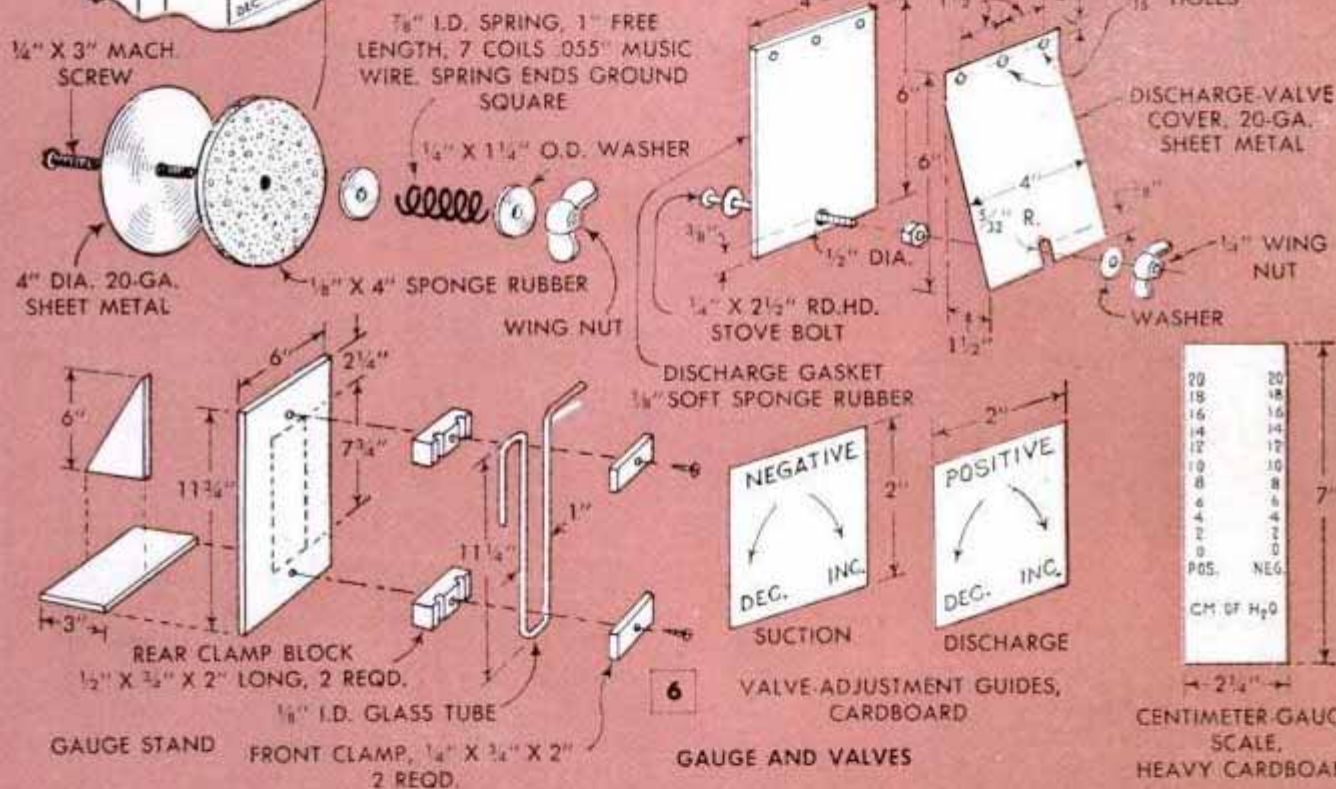
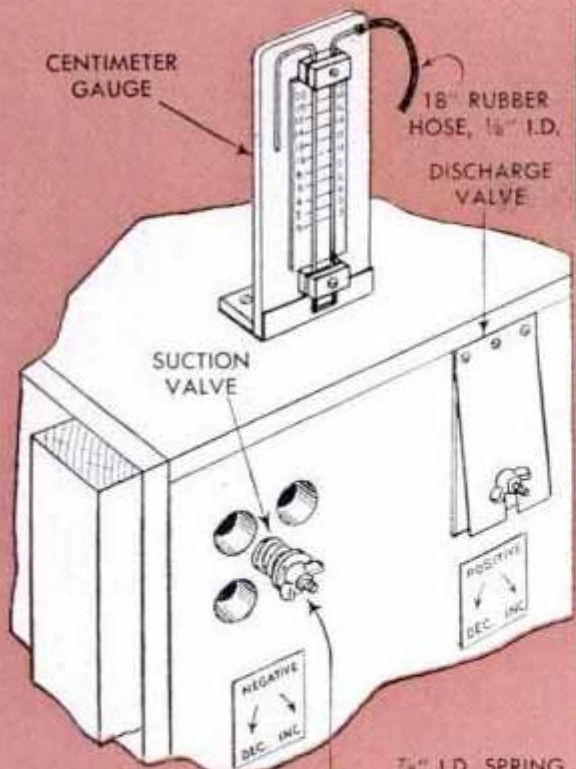

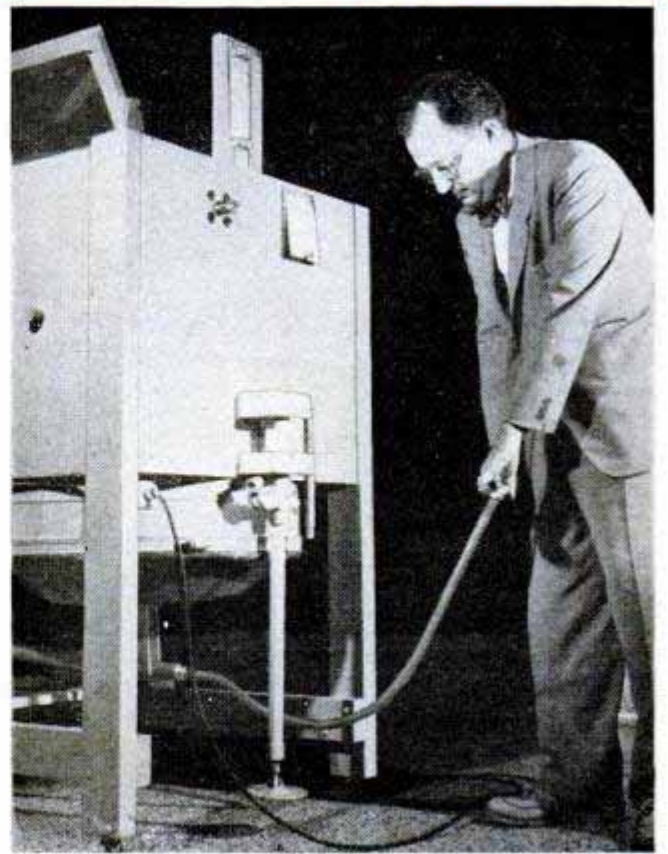
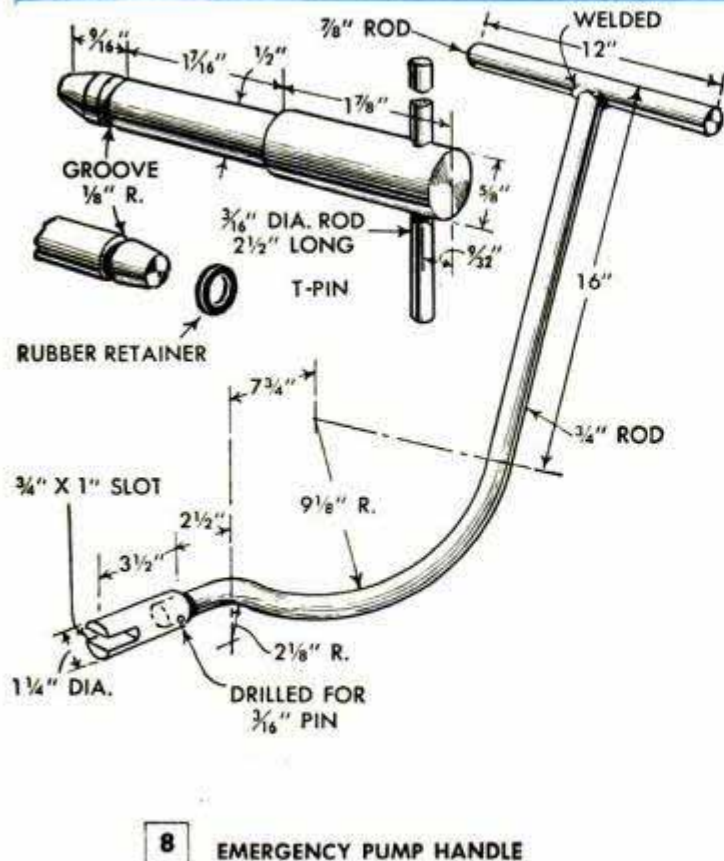
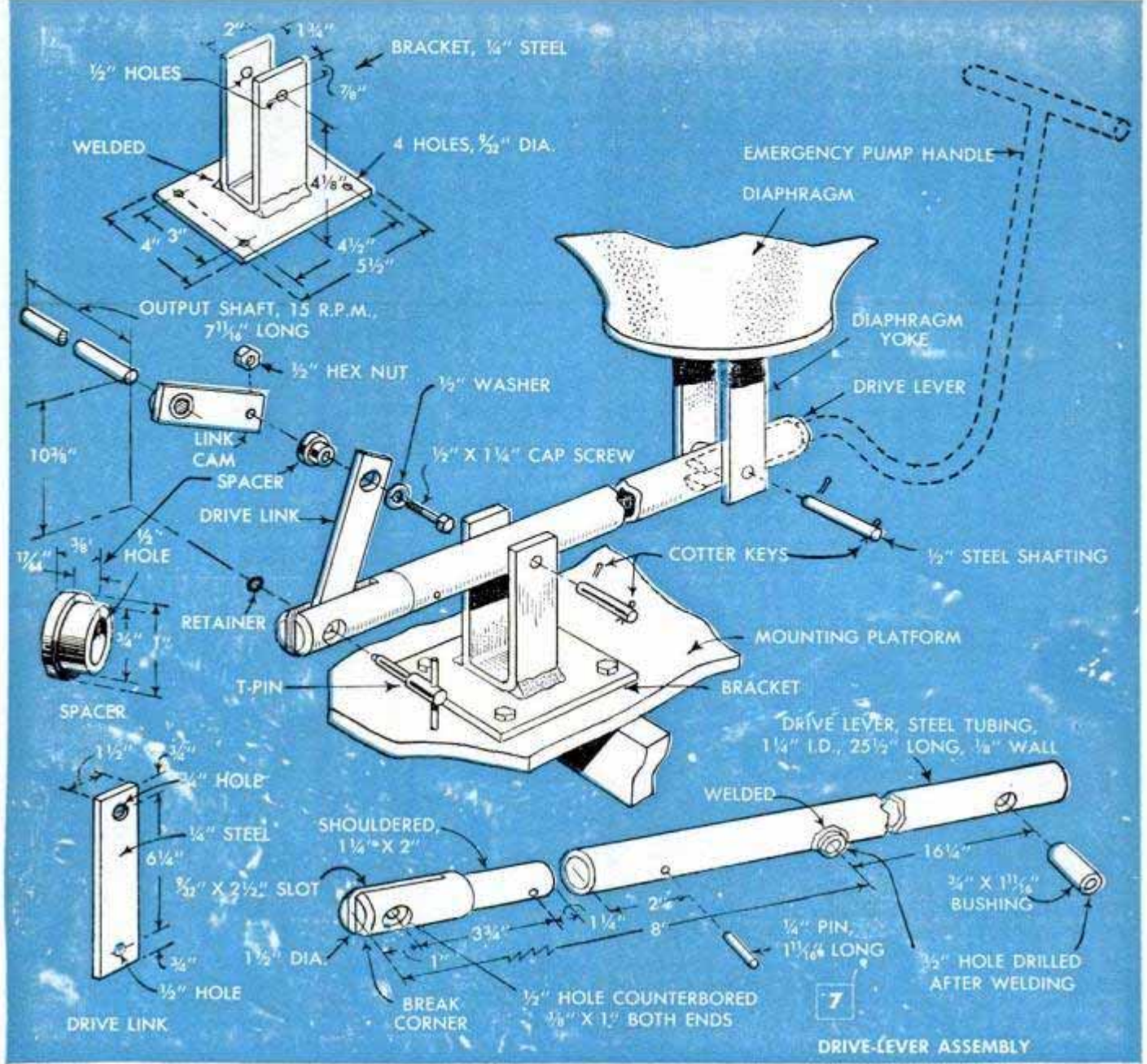

Patches Around Car-Door Handles Improve Appearance of Interior



You can "tone up" the appearance of your car interior and at the same time reinforce the upholstery around the handles of the doors by applying neat patches of artificial leather or plastic material. To do the job, remove the handles and cut holes for the handle shafts

in the patches. Then apply each patch with quick-drying cement, placing the upper edge under the window molding.

Waterproofing Leather Footwear

To keep your feet dry in rainy or snowy weather, and also to preserve the leather of your boots or shoes, rub them periodically with a solution consisting of pine tar, 2 oz. and cod-liver oil, 3 oz. Heat the two ingredients together over a low flame, and while the mixture is still hot, thoroughly rub it into the tops of the leather footwear.

R. A. Jenkins, St. Louis, Mo.

Stapled Areas on Papers Reinforced With Tape

When stapling together two or more papers that will be handled often, the area of paper around each staple can be reinforced with cellulose tape. Just stick a small piece of tape on the front and back of the group of papers and drive the staple through both pieces of tape.

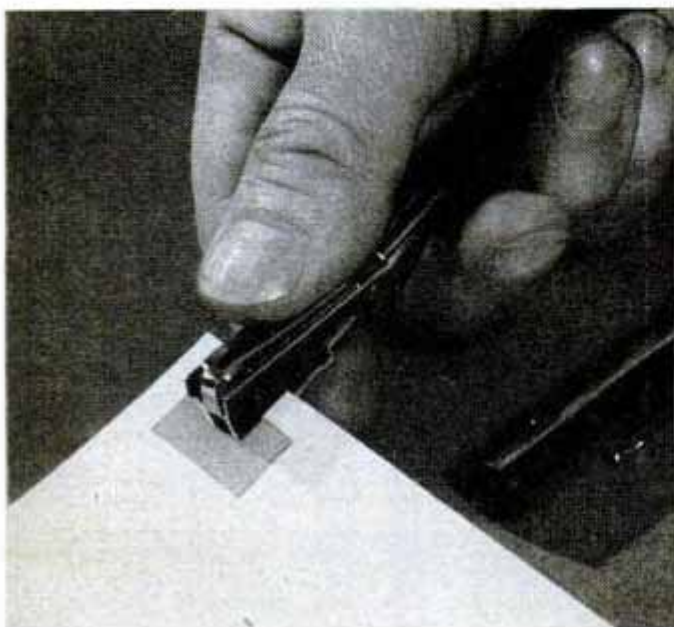

RADIO-PHONO COMBINATION

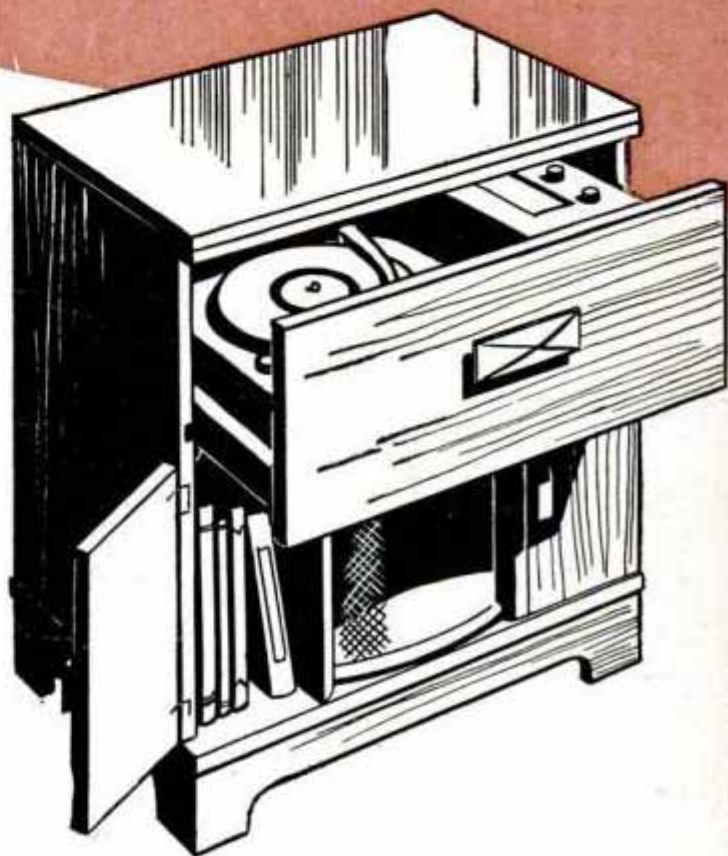

Group your present table-model TV set, radio and record player in this striking cabinet and you will have a combination unit equivalent to one costing several hundred dollars. Has swivel top for best TV viewing and storage for record albums

DESIGNED to serve as a base for a table-model television set, this cabinet has a top that pivots on a ball-bearing swivel so the TV set can be swung to the best viewing position with the touch of a finger tip. It includes a smoothly operating drawer, which houses your small radio or its chassis and a record player, a baffle for a large speaker, and two record-album compartments. The radio speaker may be mounted on the baffle board of the cabinet for better reproduction and used for both the radio and record player. Should your record player be of the type having a self-con-

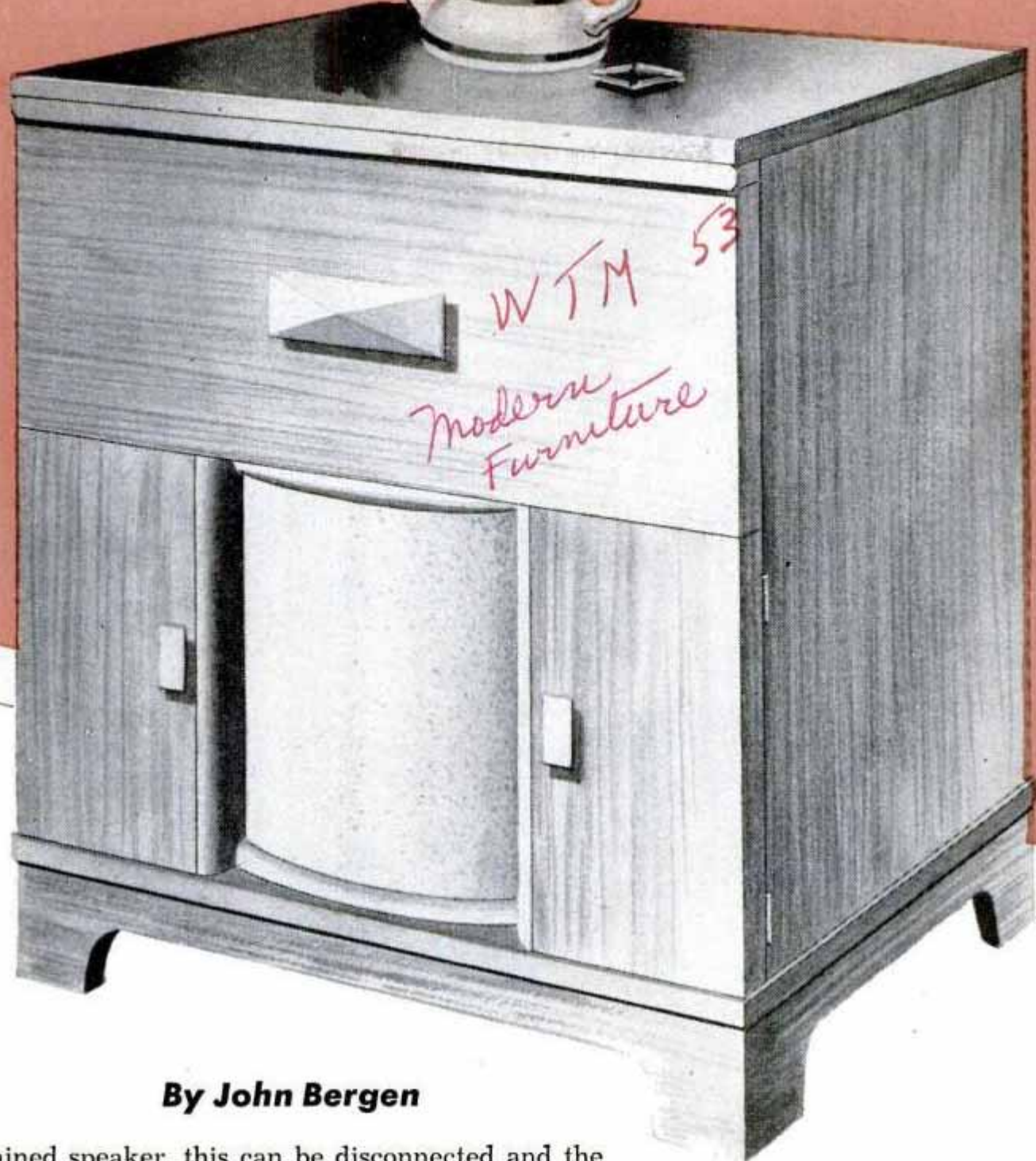

By John Bergen

tained speaker, this can be disconnected and the lead wires run to the radio speaker. However, a switch must be installed in the lead wires from the record player. If desired, you can purchase a single larger speaker and use it for the entire combination. Your TV-radio serviceman will install it for a few dollars.

As the cabinet is likely to be the outstanding piece of furniture in your living room, its finish is very important. If oak, walnut or other cabinet woods are used for the exposed rails, and plywood faced with the same veneer for the doors, panels and drawer front, your choice of the many popular finishes can be applied. However, if you wish to hold the material cost to a minimum, the cabinet can be built of less-expensive birch, poplar or gum in both solid stock and plywood, covering all the visible surfaces with wood-grain plastic veneer. When finishing in this way, additional savings may be had by utilizing $\frac{1}{4}$ -in. hardboard for the swivel top and side panels. Application of plastic veneer was fully described in the January

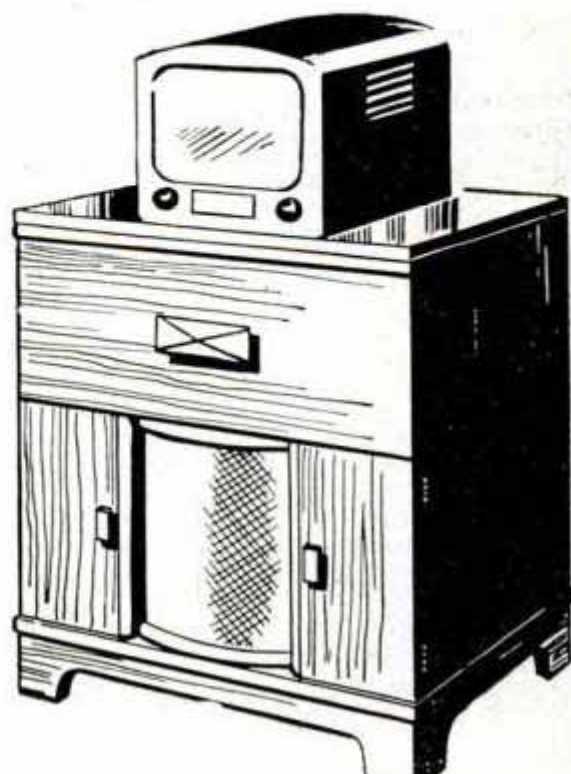

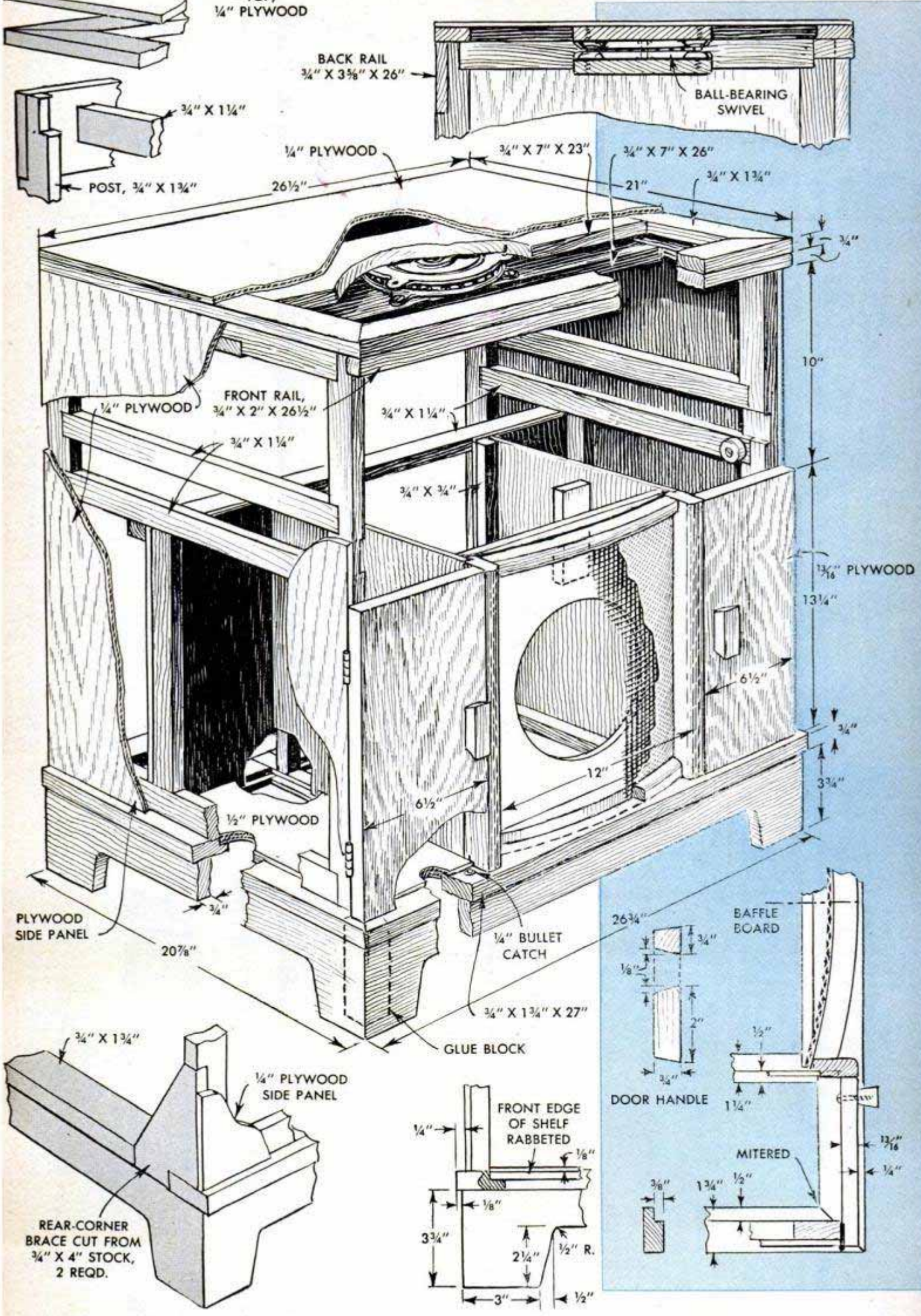

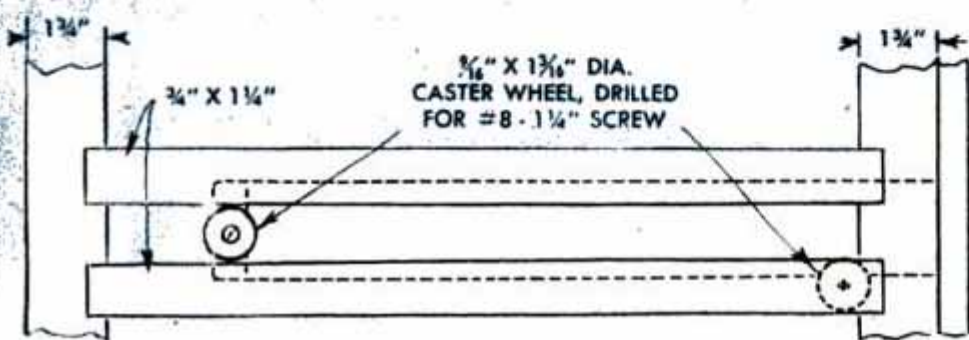
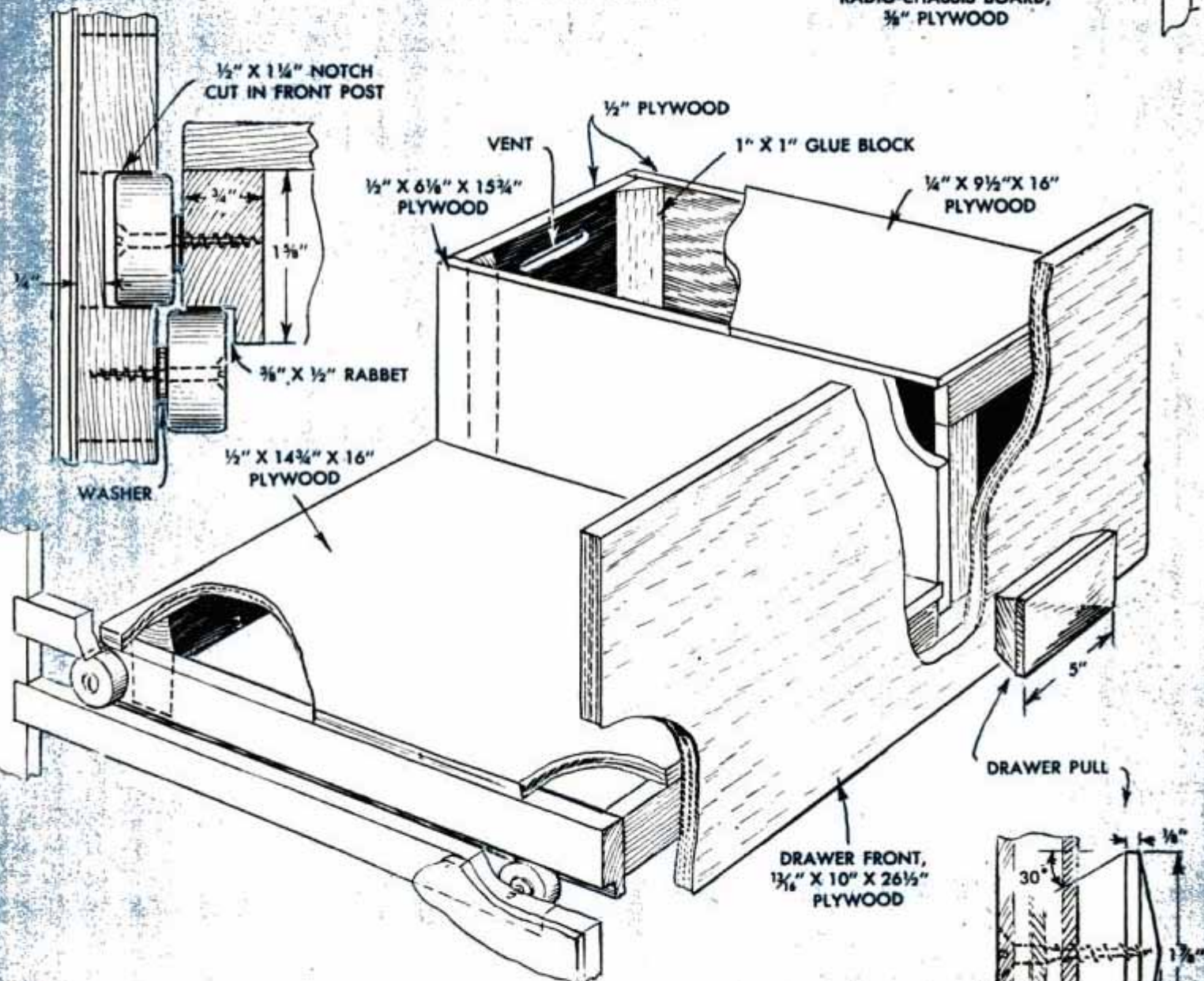
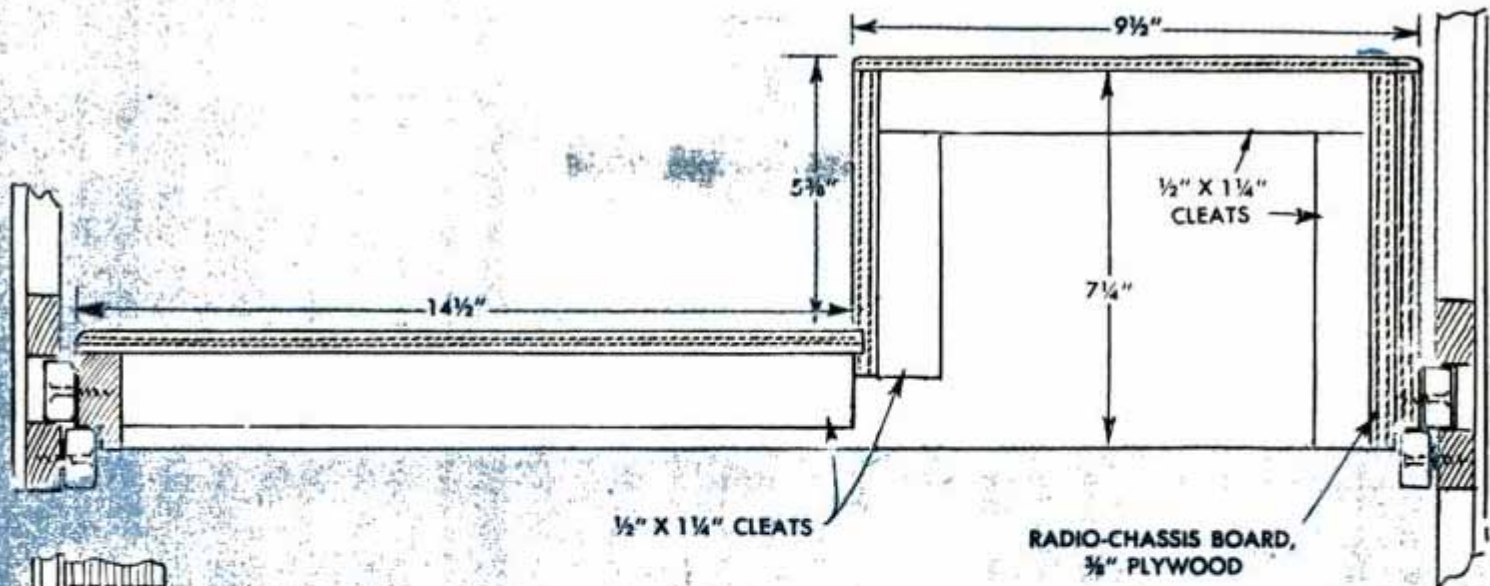

1/2" x 1 1/2" x 4"

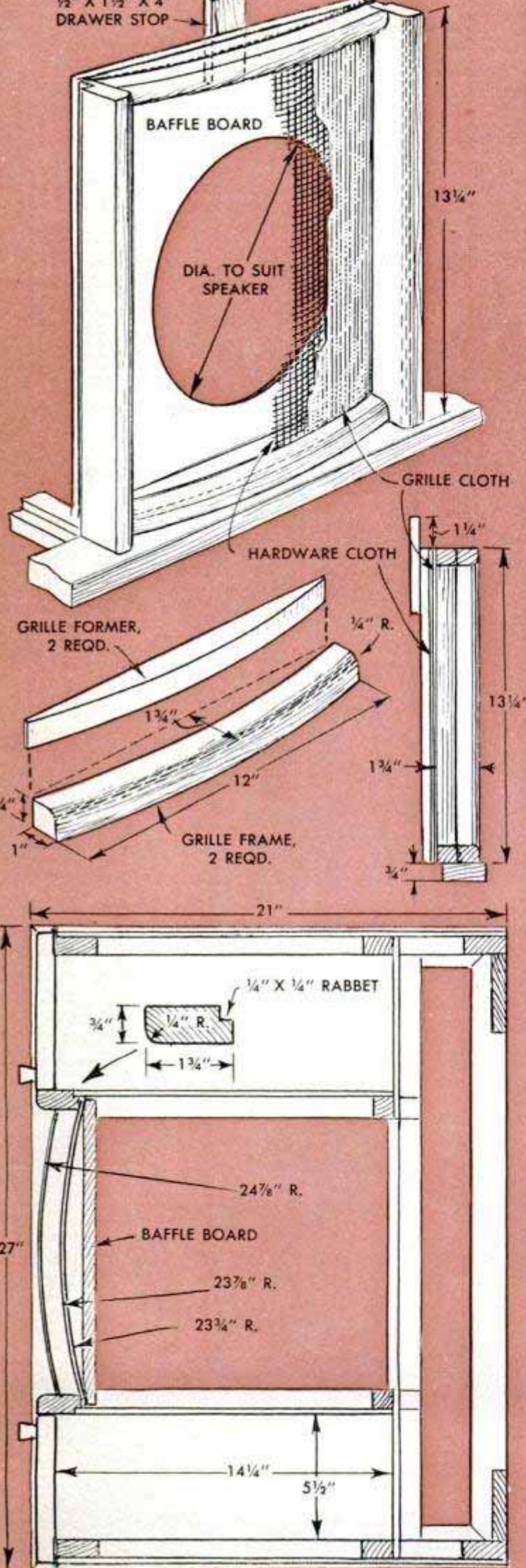

1951 issue of *Popular Mechanics Magazine*.
 Should you wish to build the radio-phonograph combination and use it for a time without a TV set, be sure to weight the back of the cabinet, as otherwise pulling out the radio-phono drawer is likely to cause the entire cabinet to tip forward. Of course, this does not have to be done when the TV set is in place on the swivel top, as the cabinet was designed so that the weight of the set would counterbalance the weight of the open drawer. But, keep this in mind if the TV should be sent out for repairs.

Construction of the cabinet and the phono-radio drawer and installation of the swivel top and caster guides is apparent from the details. Note that the upper guide rails hold the drawer in a level position when extended, and that a vertical stop is screwed to the baffle board after the drawer is installed. The plywood record-changer base is drilled to suit the particular changer and the top panel of the radio compartment is drilled and cut out to take the radio dial and knobs. The radio chassis is mounted on a plywood chassis board, which is bolted to the side panel of the drawer. Flat-headed stove bolts are set permanently in the side panel, and the chassis board is drilled so it can be slipped over the bolts.

MATERIAL YOU WILL NEED

Plywood

- 1 pc. 1/4" x 21" x 26 1/2" — top
- 2 pcs. 1/4" x 20" x 24" — sides
- 1 pc. 1/4" x 9 1/2" x 16" — dial panel
- 2 pcs. 1/4" x 13 1/4" x 13 3/4" — album-comp. sides
- 2 pcs. 1/4" x 7 1/4" x 13 3/4" — album-comp. backs
- 2 pcs. 1/2" x 5 1/2" x 14 1/4" — album-comp. bottoms
- 1 pc. 1/2" x 6 7/8" x 16" — drawer side
- 1 pc. 1/2" x 7 1/4" x 22 3/4" — drawer back
- 1 pc. 1/2" x 6 1/8" x 15 3/4" — drawer partition
- 2 pcs. 1 3/16" x 6 1/2" x 13 1/4" — doors
- 1 pc. 1 3/16" x 10" x 26 1/2" — drawer front
- 1 pc. 1/2" x 14 3/4" x 16" — phonograph board
- *1 pc. 3/8" x 7 1/4" x 14" — radio-chassis board
- *1 pc. 1/2" x 12 3/4" x 13 1/4" — baffle board

* Fir Plywood Suitable

Lumber

- 2 pcs. 3/4" x 3 3/4" x 26 3/4" — front and back base
- 2 pcs. 3/4" x 3 3/4" x 20 7/8" — side base
- 2 pcs. 3/4" x 1 3/4" x 27" — base rails
- 2 pcs. 3/4" x 1 3/4" x 21 1/8" — side base rails
- 1 pc. 3/4" x 1 3/4" x 26 1/2" — front rail
- 2 pcs. 3/4" x 1 3/4" x 26 1/2" — top frame
- 2 pcs. 3/4" x 1 3/4" x 21" — top side frame
- 4 pcs. 3/4" x 1 3/4" x 24" — posts
- 8 pcs. 3/4" x 1 1/4" x 18" — side rails
- 1 pc. 3/4" x 3 5/8" x 26" — back rail
- 2 pcs. 3/4" x 1 1/4" x 26" — album-comp. back rails
- 2 pcs. 3/4" x 1 1/4" x 11 1/2" — album side rails
- 2 pcs. 3/4" x 3/4" x 13 1/4" — album corner braces
- 2 pcs. 3/4" x 1 3/4" x 13 1/4" — grille side posts
- 2 pcs. 3/4" x 1 3/4" x 12" — grille frame
- 1 pc. 3/4" x 7" x 23" — swivel-top brace
- 1 pc. 3/4" x 7" x 26" — swivel-top mount
- 1 pc. 3/4" x 1 7/8" x 5" — drawer pull
- 2 pcs. 3/4" x 3/4" x 2" — door handles
- 1 pc. 1/2" x 1 1/2" x 4" — drawer stop

Miscellaneous

- 4 1 1/2" x 1 1/2" butt hinges
- 2 1/4" bullet catches
- 4 casters
- 1 pc. grille cloth
- 1 pc. hardware cloth, 1/4" mesh
- 1 ball-bearing swivel

Purchased from a secondhand shop at exceptionally low cost, sample combination sash were used to enclose this year-round breezeway. The sample sash, designed for counter displays and salesmen's presentations, function exactly like full-sized combination screen and storm sash. This provides a well-ventilated breezeway for the summer and a tightly sealed room for winter living. Note in the detail that the sash are screwed directly to 2 x 2-in. studs spaced to suit the width of the sash. Plywood is used to cover the face of the studs at the bottom of the enclosure, after which the plywood is framed with 1 x 2-in. material. A door made by glazing a frame of 2 x 2-in. stock with four of the sample sash completes the enclosure. If desired, a

Sample Combination Sash Enclose Breezeway To Form Comfortable Room the Year 'Round

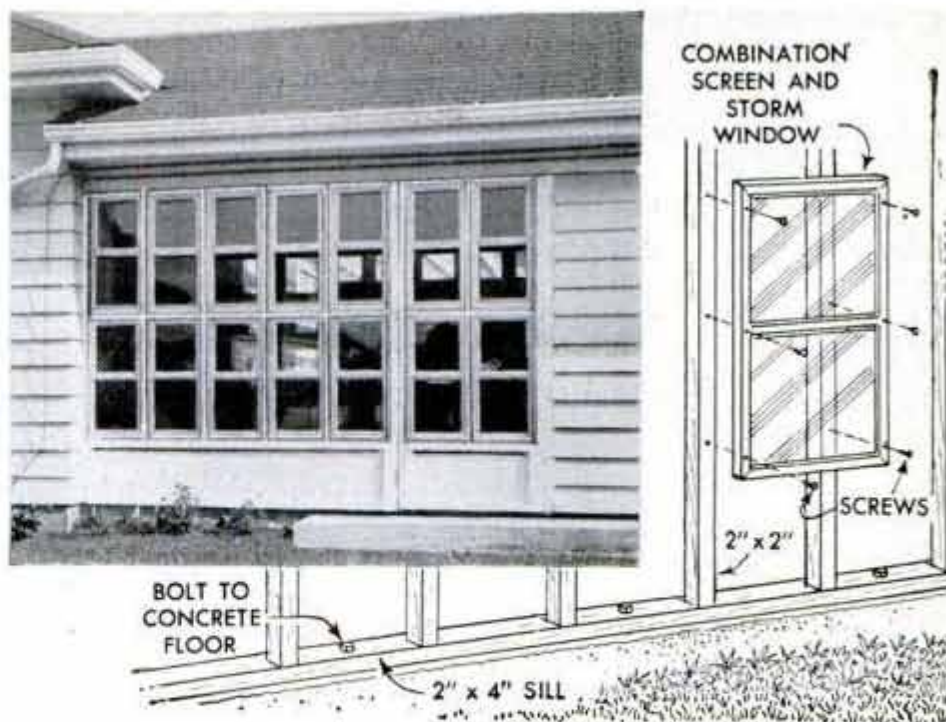

stock combination storm door can be used, and the interior of the breezeway finished in panel board or knotty pine.

Wheels Made on Disk Sander

Needing a couple of thick, wooden wheels for a piece of lawn furniture, but not having a bandsaw in his shop to cut them, one home craftsman made this jig and "turned" the wheels on his disk sander. The jig is simply a 1/4-in.-plywood base drilled near one end to take a short dowel. Each wheel is roughed out and drilled at the center to fit over the dowel. Then the jig is clamped loosely to the sander table, and the wheel held against the sander until it has been cut to the desired diameter at one spot. The jig is clamped in this position and the work is rotated on the pin.

Harry Truchelut, Atlanta, Ga.

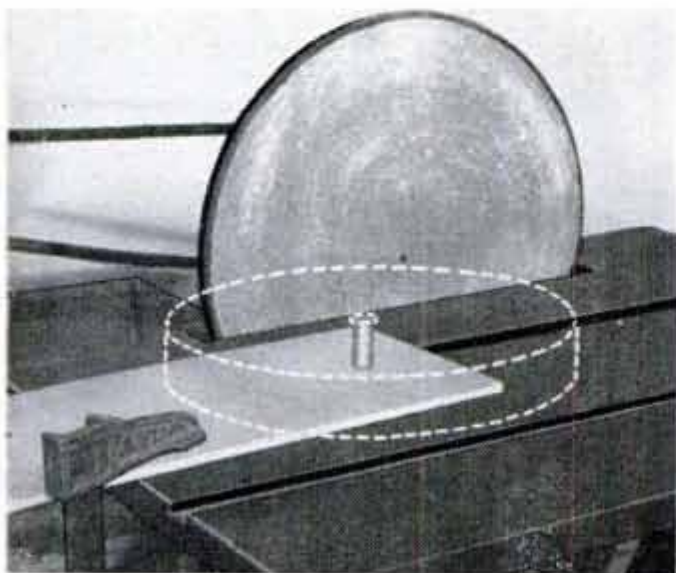

House Cut in Half for Moving Provides Two Separate Homes

One homeowner, who found it necessary to move his two-story house from its original location, decided to separate the first from the second floor and move the two floors individually. This allowed plenty of clearance for overhead utility lines, and each floor was then utilized as a separate dwelling. To do this, the entire house was first placed on moving dollies. Then the upper floor was separated from the lower one and jacked up with timbers which were supported by cribs built at each side of the house. After the lower floor was pulled from under the upper one, the second floor was gradually lowered onto dollies and moved in the same way as the first floor.

Evans W. Buskett, Joplin, Mo.



FOLDING STAND FOR PORTABLE

By Elma Waltner



MOST OWNERS of portable electric ironers find that the average kitchen table is too high to permit operating the machine from a comfortable sitting position. But, for lack of space to store a separate table of the right height, the housewife generally puts up with this inconvenience. However, the problem of comfort and storage is solved nicely with this rigid little plywood stand. Its height of approximately 24 in. is just right for the average machine and, being collapsible, the stand folds flat for storing in a minimum of space. Compactness when folded is made possible by the manner in which the support brackets fold flush within the thickness of the plywood legs. This is accomplished by recessing the hinges at the points indicated and by using loose-pin hinges to lock the legs and table wings in position.

Assembly of the stand is apparent from the details given below. Placement of the strips which form a recess for the ironer is determined by the particular model at hand. Openings for the hinged brackets are jigsawed.

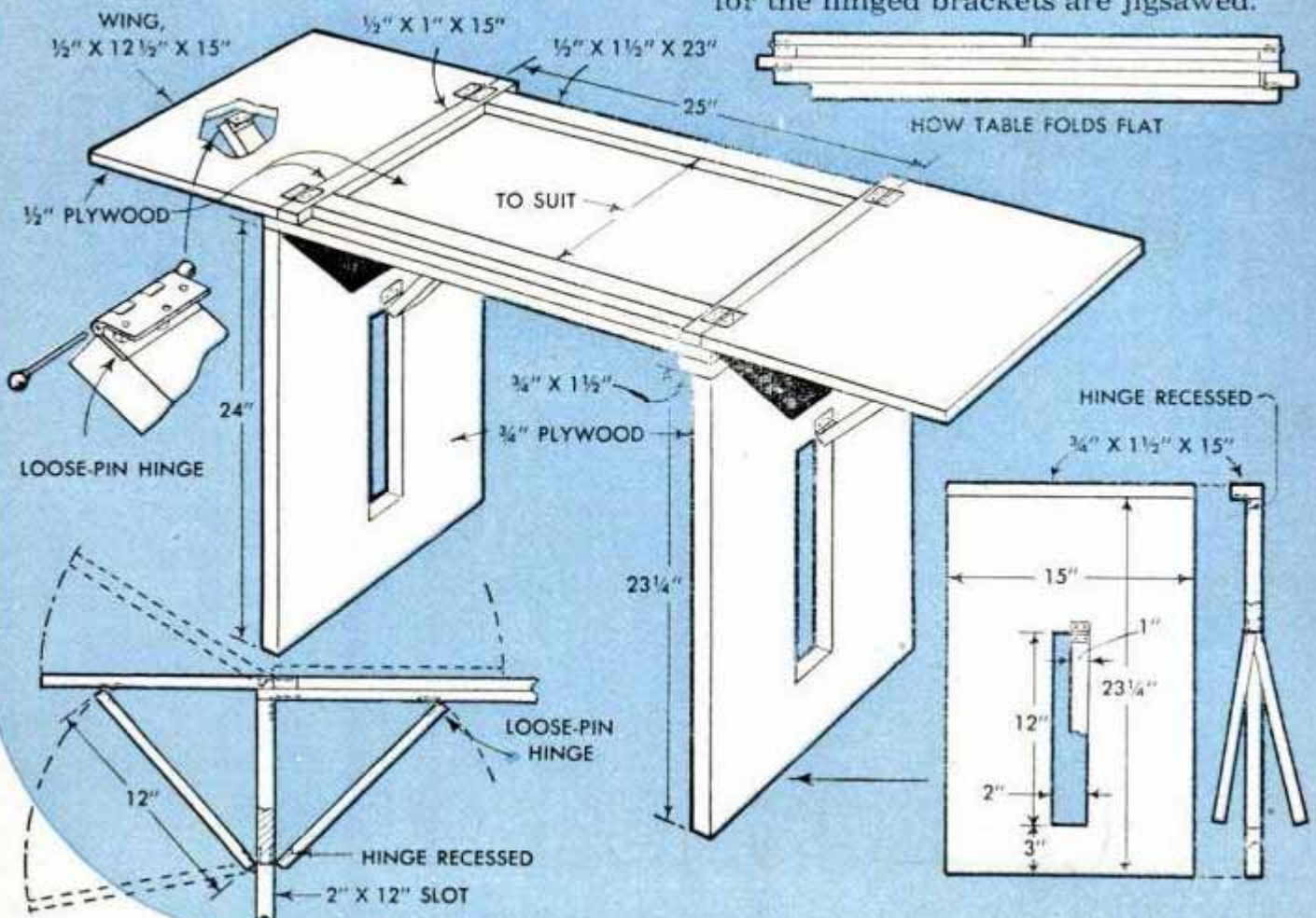

IRONER

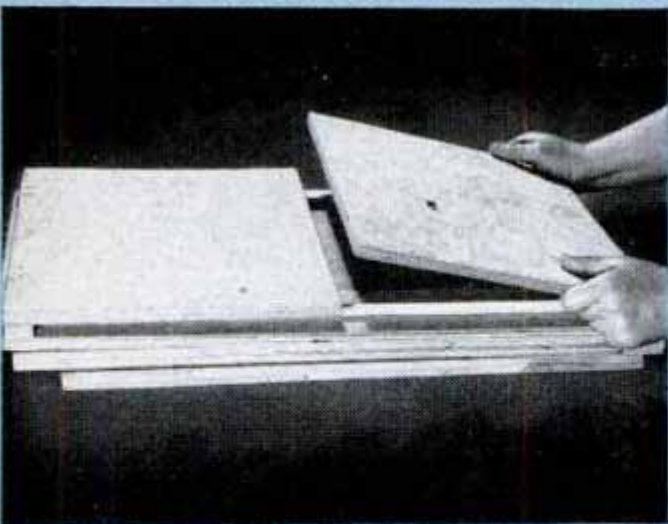

The wings fold down over the top, while the legs fold up against underside of the stand. Folded unit takes only 4 x 15 x 20-in. space

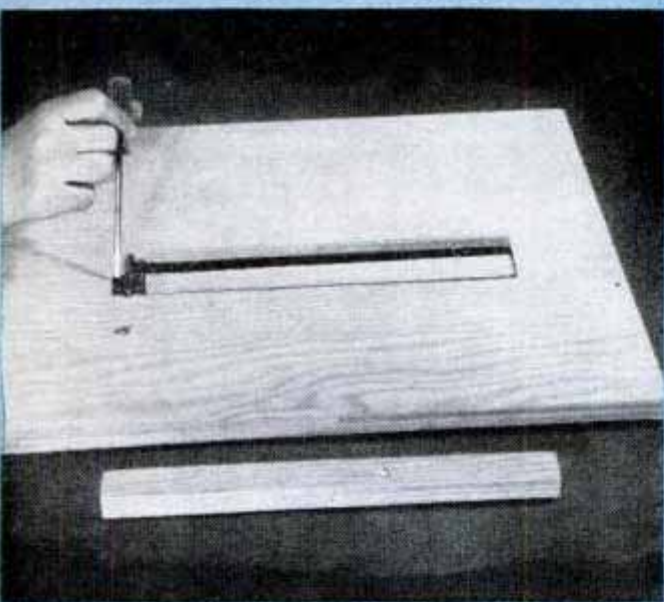

Above, the pair of brackets in each opening is hinged to swing in opposite directions. Below, the hinges which pivot the legs to the top are recessed flush for folding legs flat

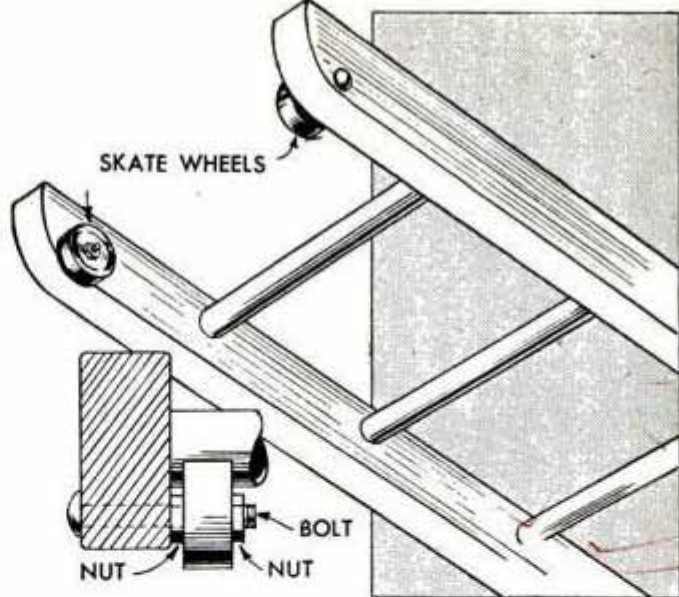
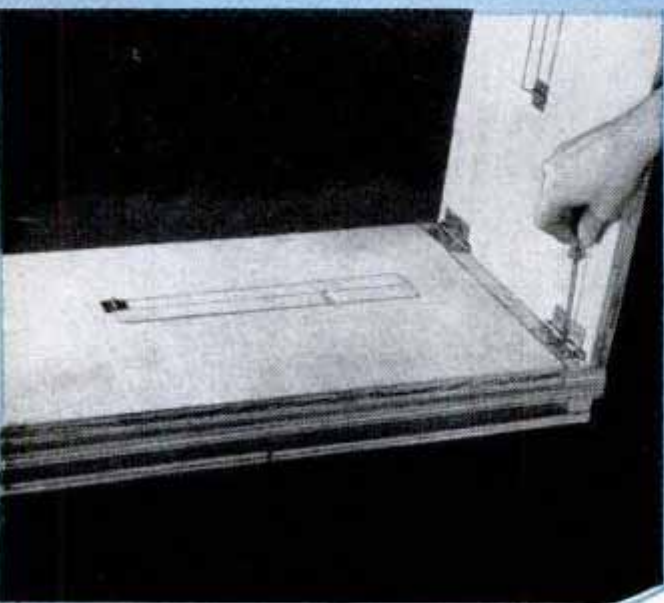

Skate Wheels on Extension Ladder Make It Easier to Raise

Difficulty often experienced in raising long extension ladders singlehanded against a house was overcome by one painter who fitted skate wheels to the upper ends of the ladder rails. The wheels reduced friction between the ladder and the side of the house and also minimized marring of the siding. The under corners of the ladder rails were rounded and the wheels, which are attached with bolts, are located to project beyond the edge of the ladder rail.

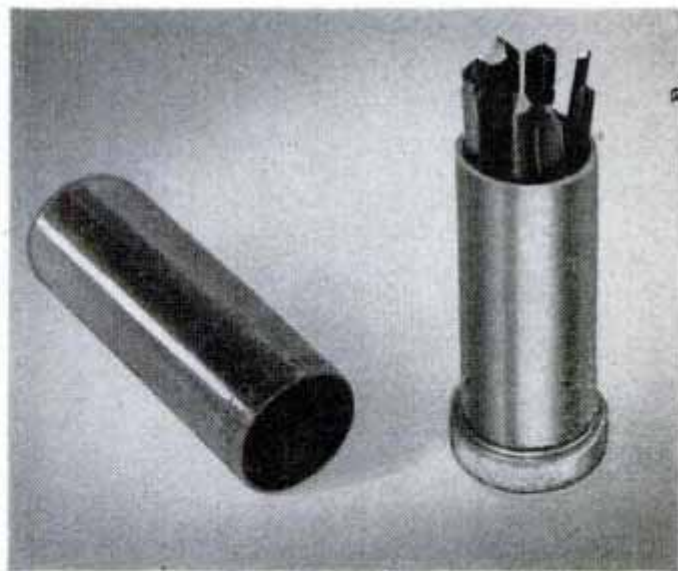

Small Drills Stored In Lipstick Tube

You will find a large lipstick container ideal for storing small drill points such as those used with push drills. A wad of cotton, dampened with light oil and pressed into the bottom of the container, will help keep the drills from rusting.

☞ The metal "saw edge" from an empty wax-paper box, when broken to the desired length, makes a fine cutter for cheese.

Nailset Tied to Wrist Is Always at Hand

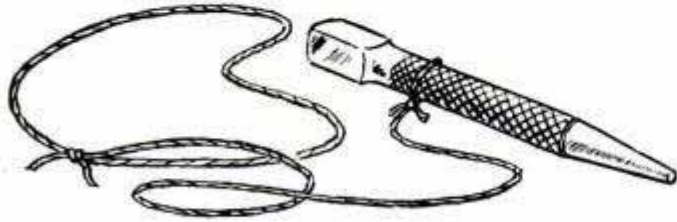

On jobs requiring frequent use of a nailset, considerable time can be saved by tying the set to your wrist. This eliminates the possibility of misplacing the set and the necessity of fumbling through your pocket or going to the tool kit each time the tool is needed.

Trip Grooves Hand-Cut in Records Permit Playing on Changer

To permit home recordings and many old-time records to be played on an automatic record changer, here's a method for hand-cutting the eccentric and run-in grooves required to trip the changer mechanism. Using a pair of dividers, or a compass fitted with a phonograph needle, the eccentric groove is cut first. The legs are set $1\frac{5}{8}$ in.

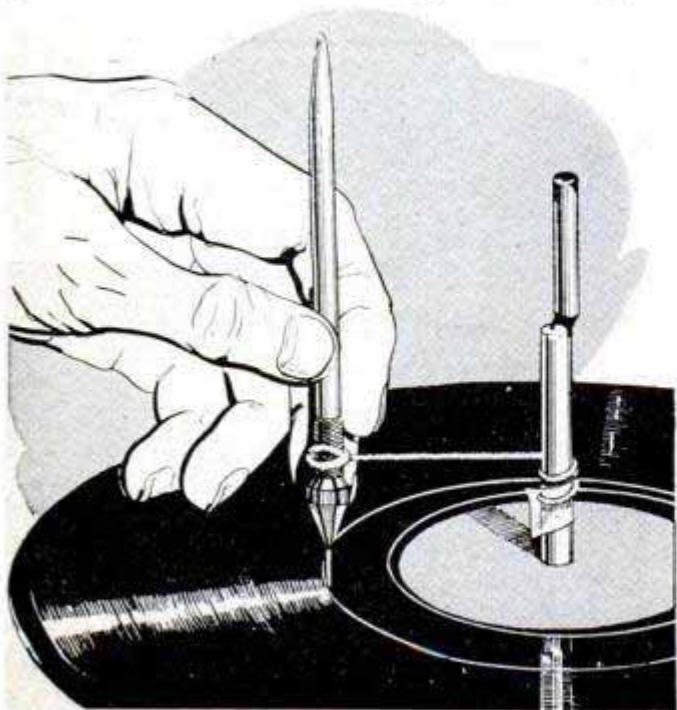

apart. Then one leg is set at the edge of the center hole in the record and the eccentric groove cut by scribing a circle, going over it several times to make the groove deep enough. The spiral or lead-in groove is cut with a scriber and a length of string, the latter being taped to the center post of the player and tied to the scriber. Starting at the end of the last playing groove and keeping the string taut, the spiral is cut by wrapping the string around the post. In this way, the spiral groove is drawn inward gradually until it runs into the eccentric groove.—Ken Murray, Colon, Mich.

Stud Bolts Provide "Pipe Jaws" For Bench Vise

When a pipe vise is not available, a bench vise and four equal-diameter bolts often can be used as a substitute. Just clamp the bolts in the vise with the work, as illustrated, so that the threads of the bolts will serve as "teeth." However, if tubing is held and must be clamped very tightly, the portion gripped should be plugged to prevent crushing it.

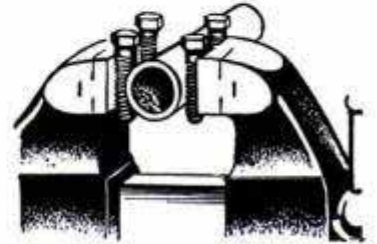

Hugh Lineback, Stillwater, Okla.

Picket-Fence Safety Rail Prevents Animal Injury

The danger of a dog getting its neck caught between the pickets of a fence can be eliminated by installing a safety rail on the fence. This is simply an extra cross member nailed near the top as pictured.—Hi Sibley, Nuevo, Calif.



Fertilizer Spreader "Sands" Ice-Coated Walks

Sand can be spread uniformly and economically on ice-coated walks and driveways with a spreader of the type used to seed and fertilize lawns. Fill the hopper about half full of screened sand and set the controller to spread the sand in a thin, uniform coating. Crushed or granulated rock salt may be spread in the same way. However, on walks and driveways adjacent to lawns, it is best to use sand only, as salt will damage the grass.

Mrs. Michael Fey, New York City.

NO REST FOR YOUR FAN

By Charles P. Fitz Patrick

ARE PRESENT-DAY COSTS forcing you to put up with an inadequately heated house or apartment due to an improperly installed or outmoded heating system? If, on bitter-cold days, the rooms become uncomfortably chilly near the floors or in corners opposite the source of heat, usually it means that the heating system does not provide adequate air circulation. Whether you have a warm-air system of the gravity type, a hot-water system or simply a space heater, you will find that the small electric fans used to keep the rooms comfortable in summer will help keep them warm in winter. The photos picture four different ways of using the fans to improve air circulation when the house is heated with a hot-water or warm-air system, but there are many other ways in which the fans can be employed to even the room temperature. The right positioning of the fans to correct your particular heating problem may be found by a little experimenting. With a space heater, an oscillating fan mounted on a shelf above the heater will help circulate the warm air. If the heater must warm two or more rooms, its efficiency can be increased by installing fans over the doorways to blow warm air from the ceiling of the heated room into the adjoining rooms.

Cold-air pockets in gravity-type heating system can be eliminated by installing grille in the floor to "drop" cold air into basement. Fan at floor grille or at grille in furnace jacket helps circulate air



Fan set on warm-air register gives occupants full benefit of heated air by directing it across room at "living level." Fan pictured below speeds gravity circulation by blowing air into cold-air register



Placed on radiator, the fan in photo below serves much the same purpose as fan on warm-air register. Even though directed upward, fan keeps room temperature even by forcing warm air down from ceiling



X72



ADRIENNE JEAN All-Purpose Dinghy

Lightweight, plywood construction and easy portability make this trim, seaworthy boat ideal for the hunter or fisherman who desires a boat that can be carried on top of his car

ANYONE—even the most inexperienced craftsman—can build this lightweight dinghy at small cost. It takes relatively little storage space and can be loaded on a car singlehanded. If you are not interested in a boat for hunting or fishing, but like to take your family on week-end trips to a lake or river, this boat will add to your pleas-

ure. Just load the family in the car, put the boat on top and take off.

It rides high and level in the water, making it safe for the children to handle, and easy to row or scull in shallow backwaters for fishing or wildfowl hunting. A 25-in. skeg holds the craft steady if you wish to power it with an outboard motor.

The boat is assembled almost completely on a building board. Two full frames, two side frames, and the stem are joined by iron join chines and clamps, and by rubber battens, to provide a strong support for the 1/4-in. plywood bottom and sides.

To start construction, lay out the building board on a flat surface, such as the garage floor, and cut the five notches for the frames. Then make all the frames and attach them to the building board in the order indicated in the detail on the opposite page. Note that the full frames are reinforced with plywood knees, or gussets, attached with screws and waterproof glue. After the frames are in place on the building board, brace them to



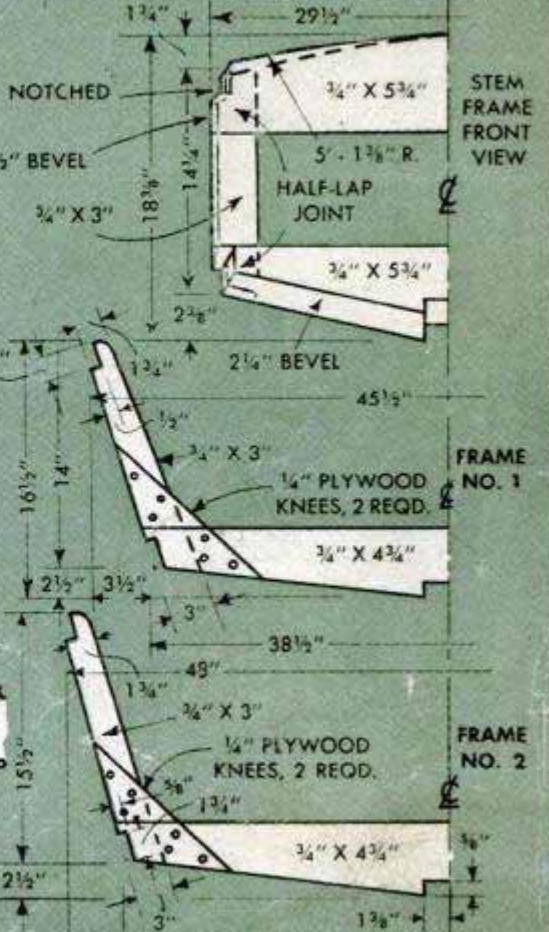
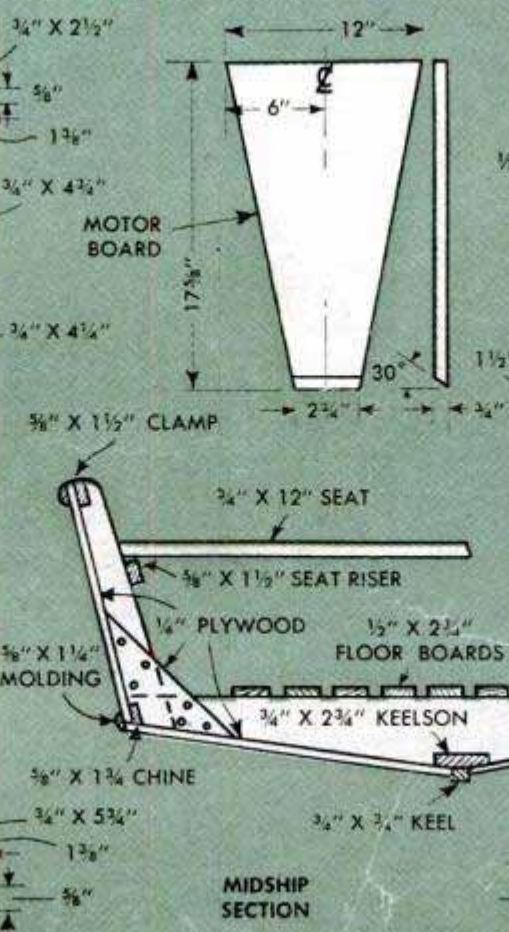
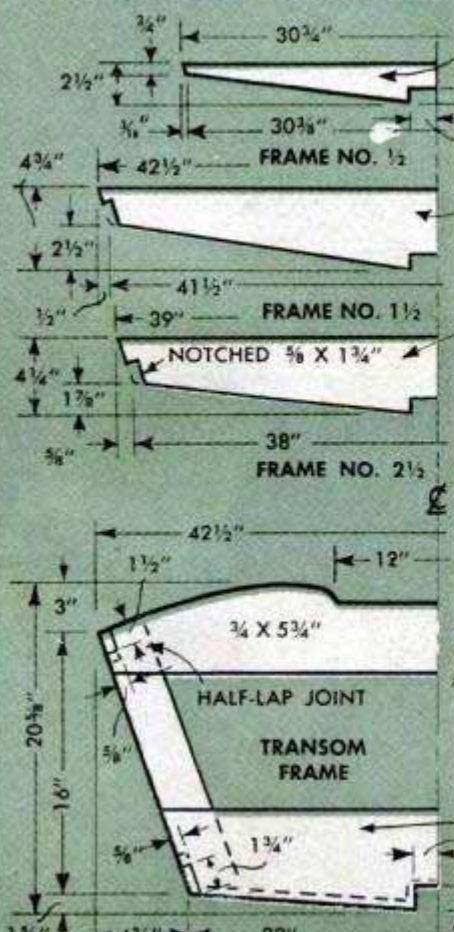
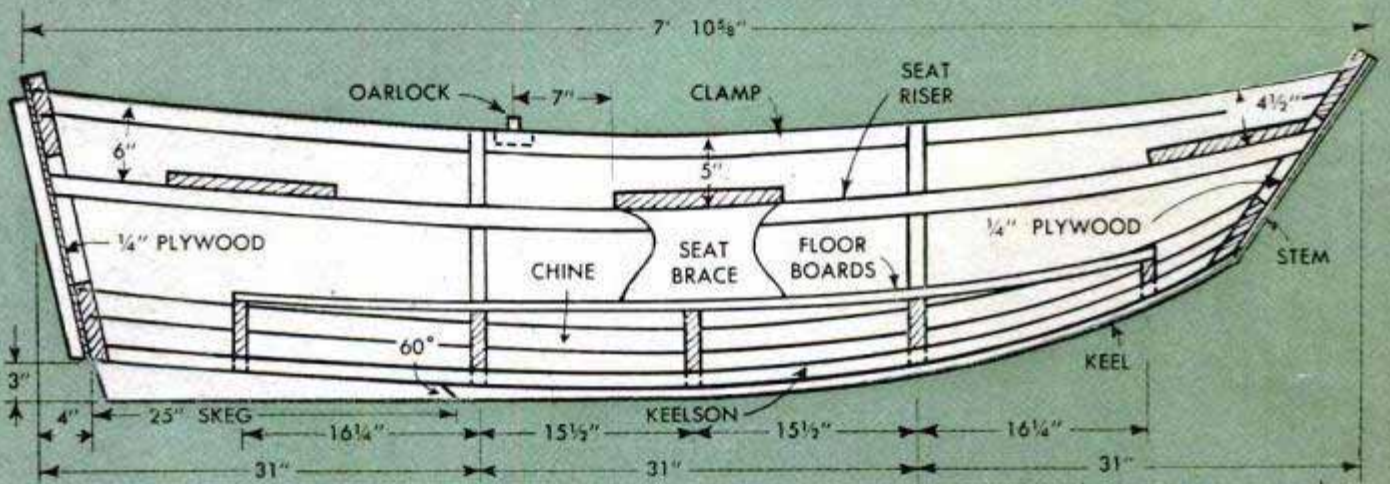
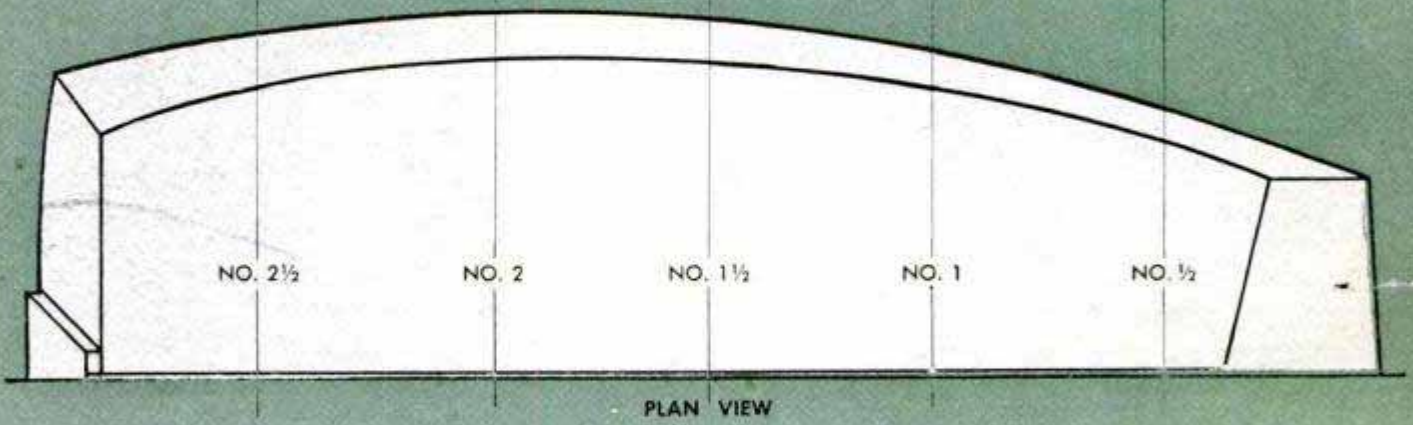
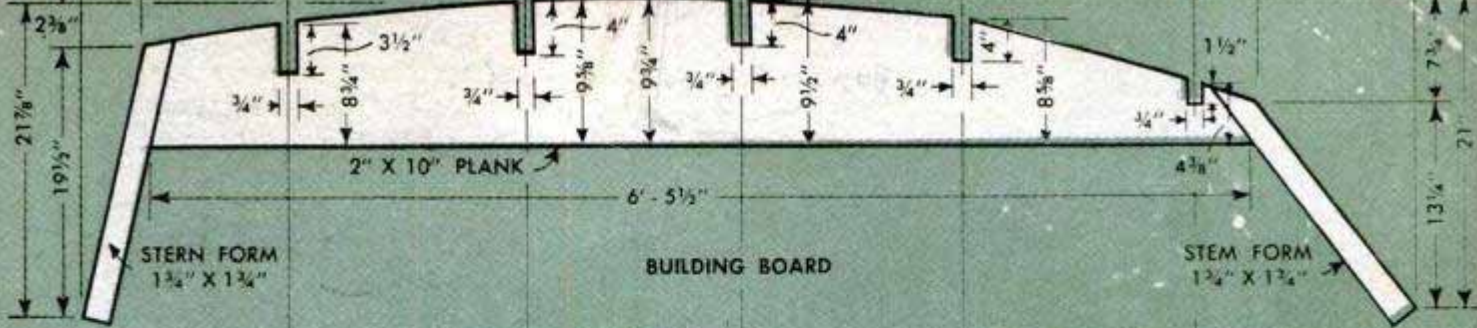

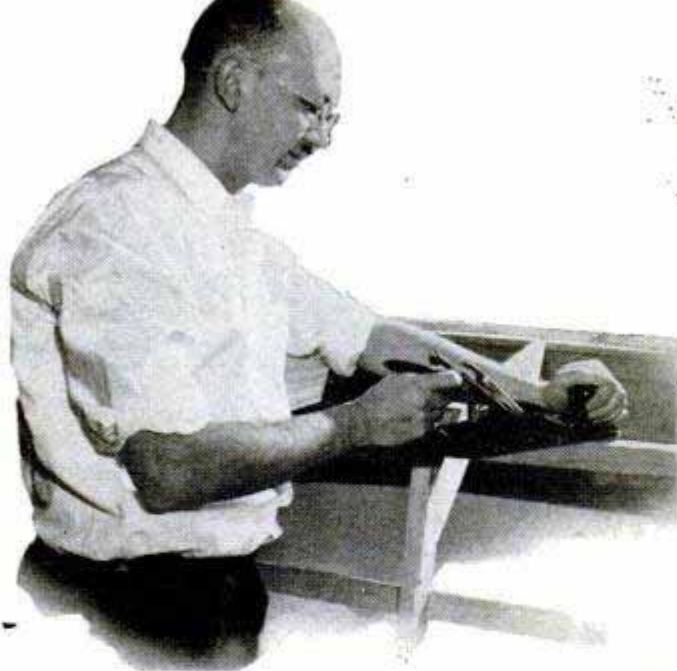

the floor in the level position with small strips. Now, cut and fit the keelson, making sure that the bottom of each notch is properly beveled so that the keelson is a snug fit in each lapped joint. Join the keelson to the frames, including the stem and transom, with screws and marine glue. Install the chines and clamps with the same method of fastening, but be sure to make an accurate fit of the chines in the notches, especially at frames Nos. $\frac{1}{2}$, 1 and $2\frac{1}{2}$ and also at the stem and transom. In this case, it probably will be necessary to bevel the bottom of each notch to receive the chine and clamp with a full bearing across the width of the frame stock.

Next, the frame members and chines must be faired in—hand planed as in the photo at the left—to take the sides and bottom with a full-width bearing. This means that the outer edge of each chine and one edge of each frame member must be beveled slightly so that the plywood bottom pieces and the sides will lie flat on the chines and frame members. This is an important operation as the structural strength and seaworthiness of the boat depend on the fit of these joints. Be sure that the keelson is beveled in two directions before fitting the keel and skeg. Join the latter two parts to the keelson with screws and marine glue, wiping off the excess glue after the joint has been made. For added strength, drill a $\frac{5}{16}$ -in. hole through the skeg and keelson at a point just aft of frame No. $2\frac{1}{2}$ and fit a $\frac{5}{16}$ -in. galv. or bronze bolt. Due to the absence of a stopwater at this point, it is advisable to set the bolt in marine glue. It's regular practice on a boat of this type to use cotton tape in all joints where the plywood joins the frame. Spread a coating of marine glue, lay the tape over the glue, then apply a second coat of glue before joining the parts. Use this procedure when joining the plywood to the frame. Now, cover the stem and transom frames with $\frac{1}{4}$ -in. marine plywood, joining with screws, marine glue and tape in the manner described.

MATERIAL LIST Marine Fir Plywood

1 pc.	Bottom	$\frac{1}{4}$ " x 4' - 0" x 8' - 0"
1 pc.	Sides	$\frac{1}{4}$ " x 4' - 0" x 8' - 0"
1 pc.	Transom and stem	$\frac{1}{4}$ " x 2' - 0" x 6' - 0"

Oak

2 pc.	Chines	$\frac{3}{4}$ " x $1\frac{3}{4}$ " x 8' - 0"
2 pc.	Clamps	$\frac{1}{2}$ " x $1\frac{1}{2}$ " x 8' - 0"
2 pc.	Moldings	$\frac{5}{8}$ " x $1\frac{1}{4}$ " x 8' - 0"
2 pc.	Seat risers	$\frac{3}{4}$ " x $1\frac{1}{2}$ " x 8' - 0"
1 pc.	Keelson	$\frac{3}{4}$ " x $2\frac{3}{4}$ " x 8' - 0"
1 pc.	Keel	$\frac{3}{4}$ " x $\frac{3}{4}$ " x 8' - 0"
1 pc.	Top and bottom of transom and stem frame	$\frac{3}{4}$ " x $5\frac{3}{4}$ " x 12' - 0"
1 pc.	Transom and stem sides and frame side ribs	$\frac{3}{4}$ " x 3" x 12' - 0"
2 pc.	Bottom ribs	$\frac{3}{4}$ " x $4\frac{3}{4}$ " x 9' - 0"
2 pc.	Seats	$\frac{3}{4}$ " x 12" x 14" - 0"
1 pc.	Seat brace	$\frac{3}{4}$ " x 12" x 8"
4 pc.	Knees	$1\frac{1}{4}$ " x 7" x 10"
1 pc.	Motor board	$\frac{3}{4}$ " x 12" x 21"
9 pc.	Floor boards	$\frac{1}{2}$ " x $2\frac{3}{4}$ " x 4' - 6"

Building Board

1 pc.	2" x 10" x 7' Common lumber
1 pc.	$1\frac{3}{4}$ " x $1\frac{3}{4}$ " x 4' Lumber

Fastenings

1 qt.	Marine glue
20 yds.	Cotton tape
5 gr.	1" - #8 brass flat-head screws
2 doz.	$1\frac{1}{2}$ " - #8 brass flat-head screws
2 doz.	$1\frac{3}{4}$ " - #8 brass flat-head screws

Paint

$\frac{1}{2}$ gal.	Sealer (clear)	$\frac{1}{2}$ gal.	Paint
1 qt.	Spar varnish		

Fittings

1 pr.	Oarlocks	1	Eyebolt
2	Lifting handles		

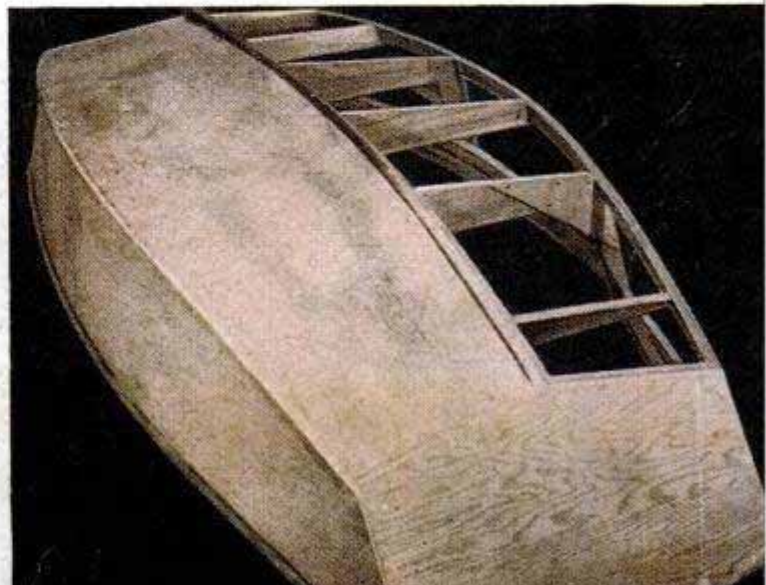
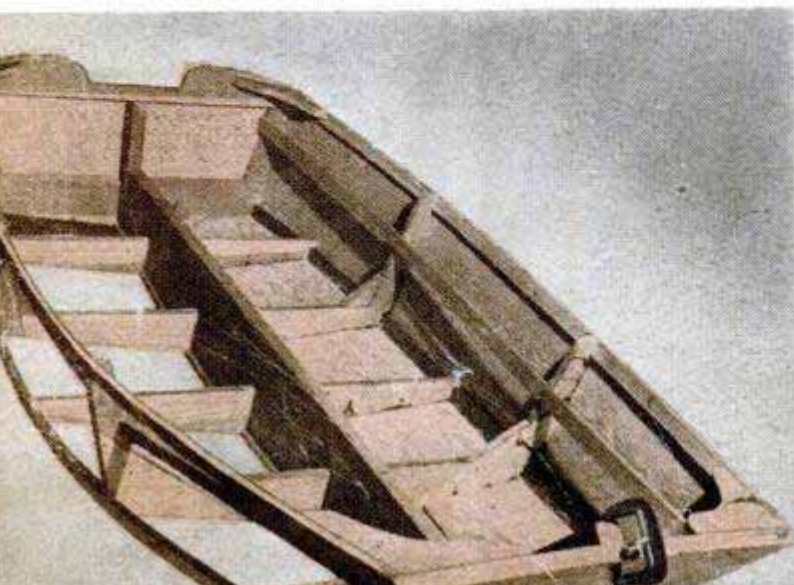

the curve of the bottom and sides. Cut, fit and join the side planking, using the same material and method of fastening. Fair the edges of the plywood to the angle of the frames. At this point the boat can be removed from the building board.

Cut the plywood bottom pieces to the rough size and bevel plane to a perfect fit at the keel and skeg. Then join with screws, marine glue and tape, applying the glue liberally where the bottom pieces join the keelson and butt against the keel and skeg. Drive the screws flush and in straight rows. Space all planking screws approximately 1½ in. apart. Plane the edges of the bottom pieces flush with the sides and finish the upper edges of the side planks flush with the clamps. Sand all joints and exposed edges smooth. Fit oak corner knees fore and aft as in the lower left-hand photo on the opposite page, and join to the end frames and clamps with long screws driven through from the outside. Use a water-resistant resin glue in these joints. Before fitting the half-round molding at the chines and gunwales, apply a coat of fir-plywood sealer to all inner and outer plywood surfaces. Fill the exposed edges of the plywood with marine putty and sand lightly after the putty is dry. Then sand all surfaces lightly and round corners to prevent splintering of the wood. Use fine sandpaper for this job. Coat the frames and interior plywood surfaces with marine enamel or spar varnish as desired.

Install the floor boards and join to the frames with screws only. Do not use any glue in these joints. Then add the seat risers and seats and install the motor board. All these parts should be of selected oak and finished with a natural wood filler and two coats of spar varnish. Install the half-round molding at the chines and gunwales, spacing the screws about 3 in. apart. Apply a copper-base paint to the bottom, and finish the sides, stem and transom with two coats of marine enamel. Finally, install the fittings given in the material list.

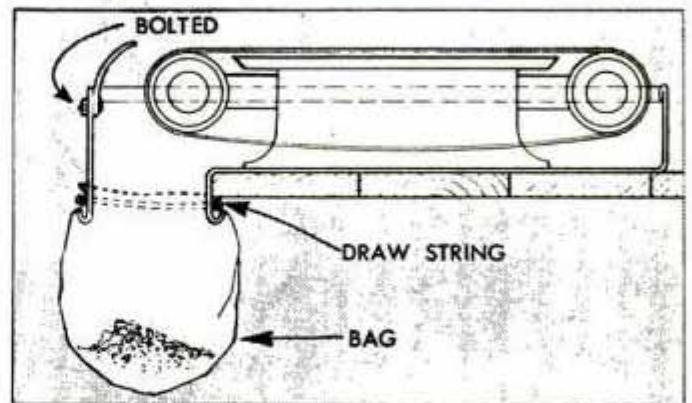
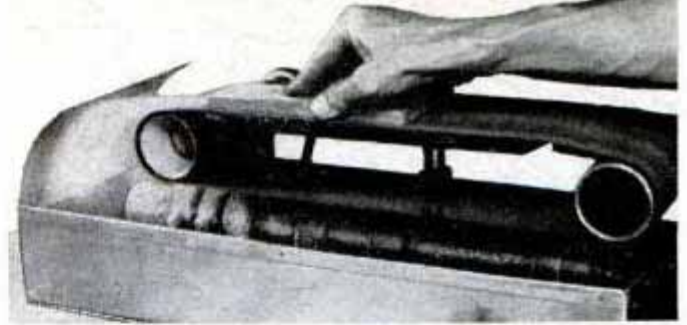

Metal Tray Under Belt Sander Reduces Dust in the Shop

By mounting your bench sander in a shallow, sheet-metal tray, such as the one shown, dust in the shop will be reduced considerably. Note that a shield is bolted to one end of the tray, and that a bag is tied over an opening directly under the shield. This catches the dust at the point where most of it is thrown off the belt. Dust that gathers in other parts of the tray is pushed into the bag when necessary.

Child Prevented From Locking Door

To prevent a small child from locking herself in a room, fill the lower slot in the strike plate of the lock with putty or modeling clay. Then cover the slot with a strip of adhesive tape and paint over it with quick-drying enamel or clear fingernail polish. When the child grows older, the tape can be taken off and the putty removed.—Bess Ritter, New York City.

Empty Varnish Cans and Wooden Box Provide Bins for Small Parts

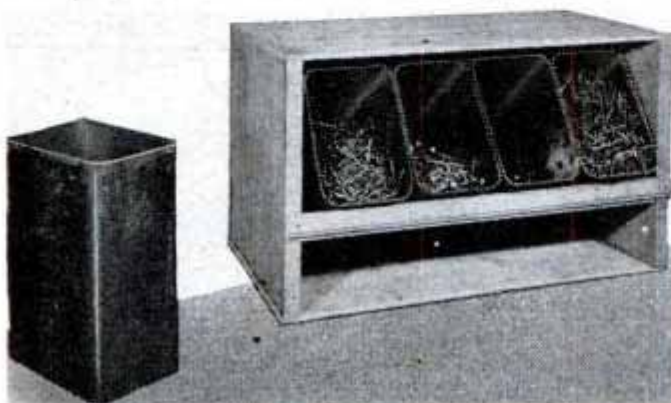

Rectangular gallon cans, such as those commonly used for varnish, provide ideal storage bins for nails, screws, etc. They will fit compactly into a rack, which can be made, as shown in the photograph, by nailing a divider across the open end of a wooden box to hold the bins at a convenient angle. Remove the tops of the cans with a can opener, clean them and, if desired, give them a coat of paint to prevent rusting. If the edges of the openings are rough, tape them to prevent injuring your hands.



KNOW YOUR BRAKES

By Ed Packer

KNOWING the condition of your brakes and how much you can expect from them in an emergency often means the difference between just a sudden stop and a collision. Although brakes on modern cars are built to "take it" over long periods of severe service, a lot of unnecessary wear on linings and mechanical parts can be saved if you treat the brakes right. To get the maximum in long and reliable service, the brakes on a new car will require more careful breaking in than the engine. It takes a little time for brake linings to wear in to a perfect fit against the drums, which makes this period the critical one that determines brake life. During this period, the linings do not contact the drums over

the whole of the effective area when the brakes are applied. Sudden, hard application concentrates braking effort in a comparatively small area of the individual linings. This results in hot spots that localize expansion of the drums which may result in distortion of the drums and burning of those surfaces of the linings that are forced to do the work. The details in Fig. 2 will serve to emphasize this point. Because of this danger, it's a good idea to "wear in" the brakes during the first 500 miles or so by repeated soft applications while you're driving on the open road at comparatively slow speeds. During the break-in period, try to avoid traffic congestion where sudden, full stops may be necessary. Also, it's

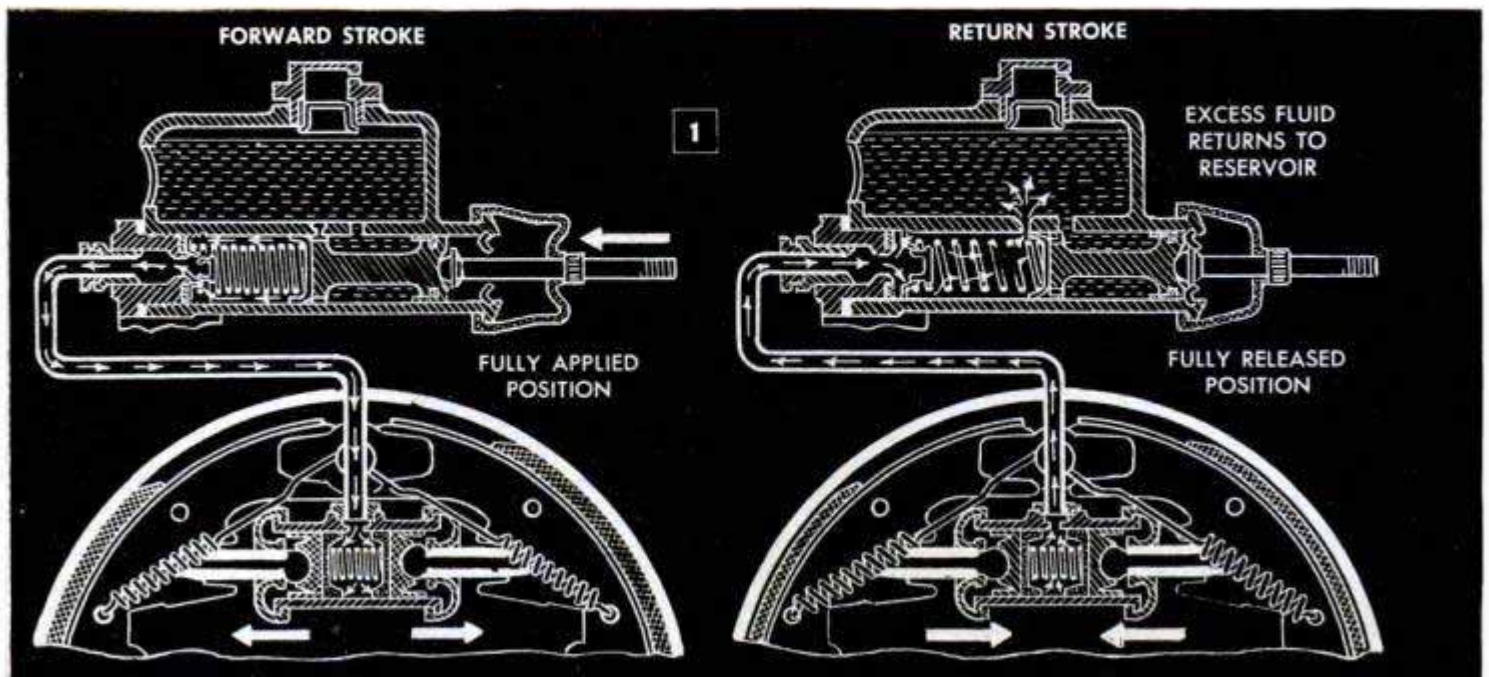

a good idea to keep in mind that while the brakes slow down and stop the wheels, it's the friction between the tire treads and the road surface that stops the car. This brings up another point in good brake usage. Sudden, hard stops not only generate excessive heat in the brake mechanism, but also set in motion forces which are dissipated through the springs and frame of the car, thus placing heavy, twisting strains on various parts of the chassis. Fig. 6 shows how these forces are transmitted through the brake backing plate to the rear axle, springs, shackles and the frame of the car. Locking the wheels by brake action on a car traveling at moderately high speed on a dry hard-surfaced road may break a rear spring, twist the spring shackles or distort the car frame.

"Standing" on the brake pedal when the car is new may seriously damage the drums and may break the weld where the rib of the brake shoe is joined to the rim. Excessive heating of the parts due to prolonged abnormal use can cause distortions of both the drum and the shoes which make it impossible to obtain reliable braking action by adjustment alone. One of the most common results of brake abuse is the tendency of the drum to take a bell-mouth shape as in Fig. 5. This is especially true on cars having all-steel brake drums. On those equipped with cast drum rims, the shoe is more apt to be distorted. Shoes damaged by excessive heat tend to take a permanent set and usually they are inclined inward, causing the linings to contact the drums at their edges. This results in rapid wear of the linings and unsatisfactory brake operation. When brakes have been damaged in this manner, the only safe and permanent repair is renewal of all the affected parts.

The details in Fig. 1 show the operation of the hydraulic-brake system with the

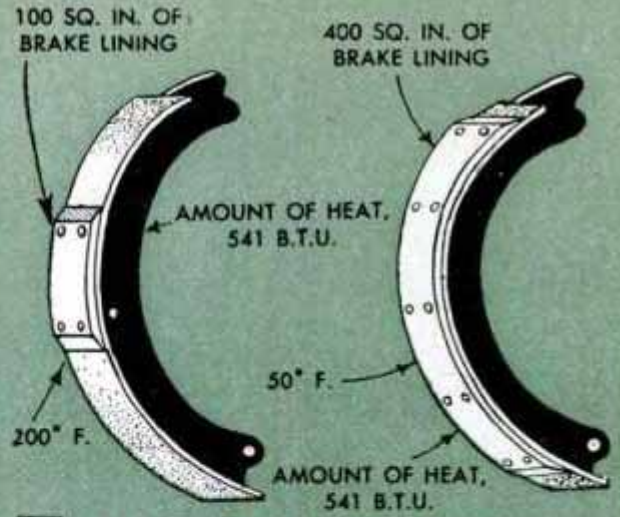

2 BRAKE-LINING TEMPERATURE

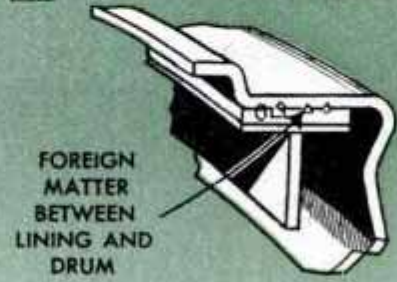

3 SCORED BRAKE DRUM

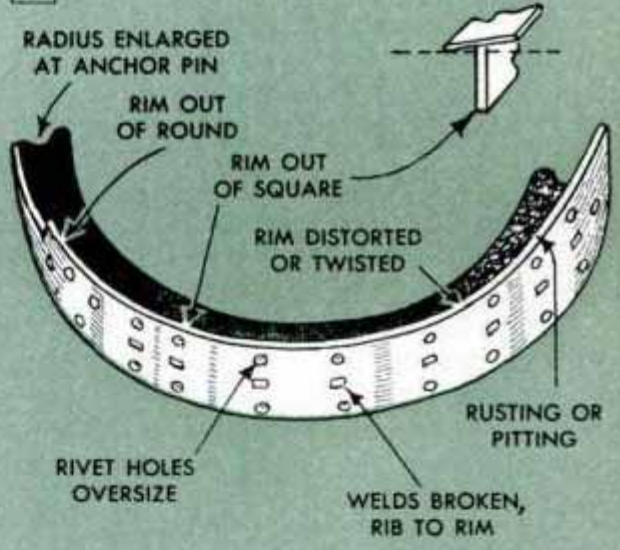

4 BRAKE-SHOE DEFECTS

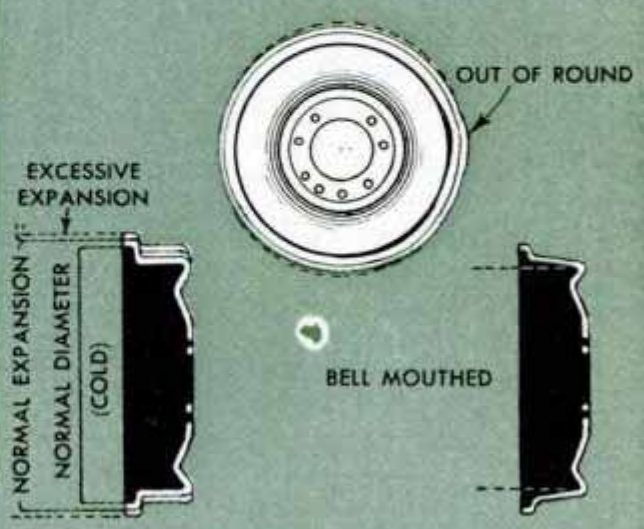

5 DISTORTED BRAKE DRUM

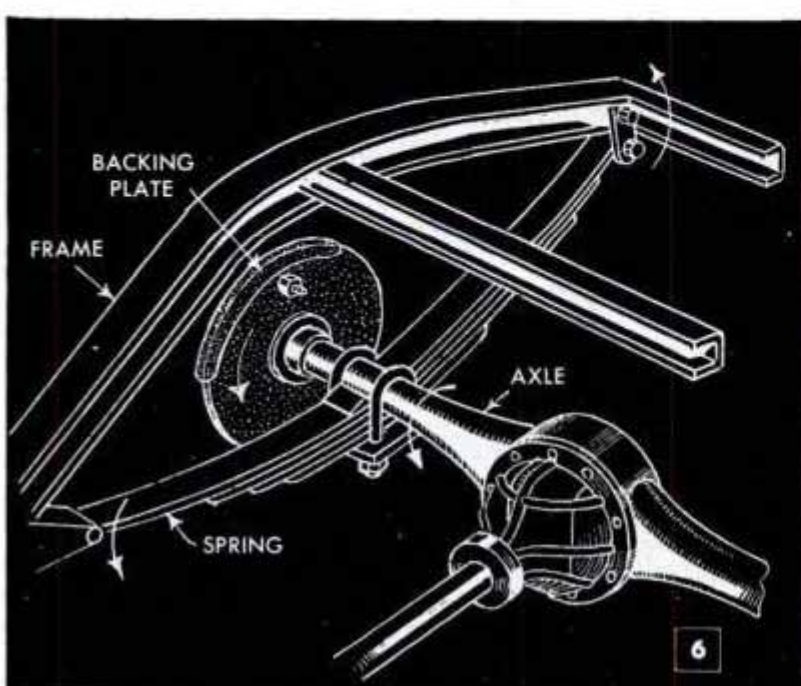

6

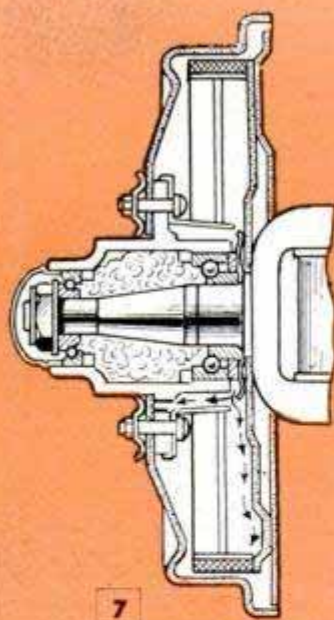

7
**LINING SOAKED
 BY EXCESSIVE
 LUBRICATION**

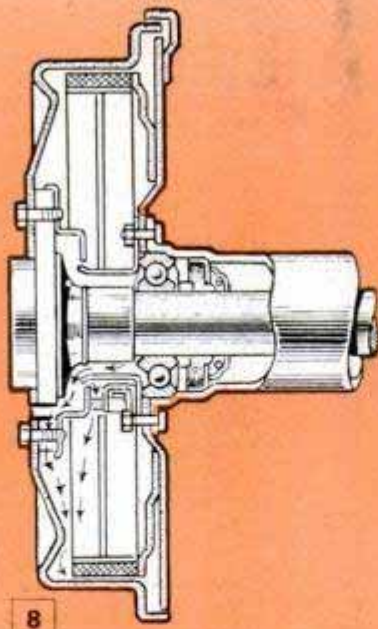

8
**LEAKING OIL SEALS
 CAUSE SOAKED
 BRAKE LININGS**

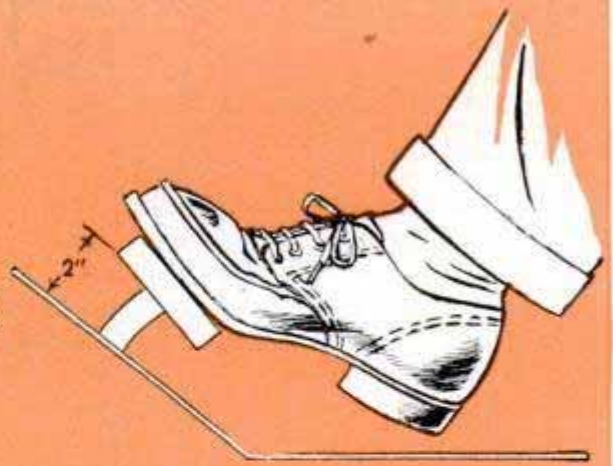

9
**BRAKES NEED ADJUSTMENT
 WHEN PEDAL RESERVE
 IS 2" OR LESS**

piston in the master cylinder in the "fully applied" and "fully released" positions. Arrows indicate the direction of fluid flow when the brakes are applied and released.

Owners of cars fitted with brake shoes having bonded linings never experience the troubles due to faulty riveting of the linings, or to linings so badly worn that the rivet heads touch the brake-drum rim. Other brake-shoe defects also can cause scoring of the drums as shown in Fig. 4. If the scores are not too deep, scored drums can be salvaged by turning the braking surface down in a brake-drum lathe. After turning in the lathe, the new braking surface should be ground smooth. Well-equipped service shops can handle this job at a nominal cost. The faulty shoes should be relined with oversize linings and the brakes broken in in the same manner as new brakes. Bonded brake linings seldom cause damage to the drum but scoring can result from a small particle of abrasive matter that may find its way into the brake and become embedded in the lining, Fig. 3.

If your brakes grab or chatter at any time, it is quite possible that the faulty performance is due to a leaking oil seal in either a front or rear-wheel bearing. Over-lubrication of the front-wheel hubs and excessive lubricant in the rear axle are indirect causes. The excess may be forced past the oil seal and into the brake drum where it collects on the linings. A coating of oil on the linings will cause the brake to slip and grab alternately. The manner in which oil leaking from either the front or rear-axle bearings can find its way to the brake linings is shown in Figs. 7 and 8. Oil-soaked brake linings always should be

replaced. Another thing to watch in an older car is the pedal reserve. Many owners of these cars form the habit of checking this each time the car is driven. Simply depress the brake pedal through its full travel and note the clearance between the bottom of the pedal and the floor board. As shown in Fig. 9, this should be about 2 in. although, of course, manufacturer's recommendations may vary somewhat. If the clearance is less than 2 in., or if the pedal feels "soft" throughout its travel, then examine the brake system before driving the car. Greatly lessened pedal reserve, or a soft pedal, may mean a slow leak in the hydraulic system, presence of air in the system, or badly worn brake linings. Often, merely bleeding the system and replenishing the fluid in the master cylinder will remedy the fault in a newer car, but in an older one it also is well to keep a close check on the condition of the brake linings.

Engine Shield for Cold Weather

To operate your car on minimum fuel consumption it is necessary that the engine be operated at the recommended temperature at all times. To help the engine quickly reach this temperature during cold weather, one motorist wires a single thickness of burlap to the radiator core. This admits sufficient air to avoid overheating of the engine, but shields it against cold. It also will keep out drifting snow. If you live in a region where cold weather is sporadic and frequently followed by warm periods, it will be convenient to stretch the burlap over a heavy wire frame, which will be easy to install and remove as needed.

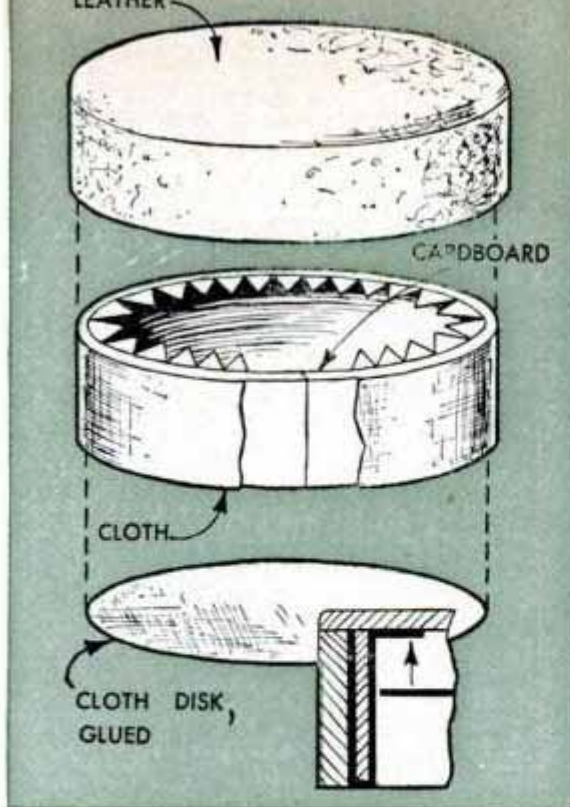

LEATHER CAP PROTECTS CAMERA LENS

By **Walter E. Burton**

Full protection against dust, finger smudges and abrasive particles is afforded by a tight-fitting leather lens cap and making one to fit any ordinary camera lens is so simple that you can finish the whole job in one evening. For larger lenses, use a grade of leather known as carving cowhide, which is about $\frac{3}{32}$ in. thick. For smaller lenses, use tooling calfskin. Measure the depth and diameter of the lens barrel, then cut a strip of leather of a width equal to the depth of the barrel, and of a length 1 in. greater than the circumference of the barrel plus an allowance for the cloth lining, which is fitted inside the leather ring. Skive $\frac{1}{2}$ in. of each end of the leather strip to a feather edge and join the skived

ends with a leather cement. Now cut a strip of blue velvet about three times as wide as the leather strip and wrap it around a strip of thin cardboard with the pile side out and with about $\frac{1}{4}$ in. of one edge overhanging. Cement the fabric to the cardboard, then notch or pink the overhanging edge as in the center detail above. Cut a disk from the same fabric to a close fit inside the ring formed by the fabric and cardboard. Cement the fabric disk to the serrated edge. Now, cut a disk from leather and cement it to the top of the leather ring and to the fabric. Trim the edges of the leather disk flush and polish and finish the leather with shoe-sole dressing, which is similar to lacquer. When applying this finish, follow directions on the container. The completed cap should fit the barrel snugly.

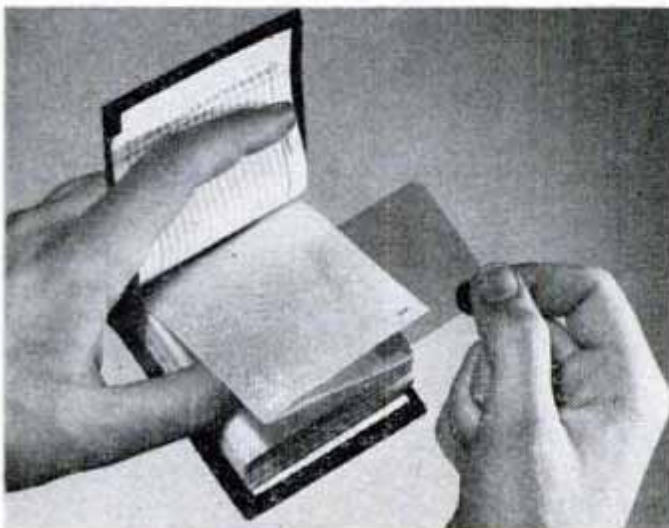

Gelatin Color-Correction Filters Stored in Negative File

Negative files, the type consisting of numerous glassine folios bound in a little book, can be used for storing gelatin color-correction filters. Such files usually have indexes in the front where the numbers of the filters can be entered, making it possible to find the desired filter quickly.

Paul T. Hutchinson, Wheaton, Ill.

☐ A few dabs of luminous paint at strategic points in a darkroom will enable you to keep yourself oriented when working in total darkness.

as Darkroom Ventilator

By M. G. Winterton

MANY HOMEOWNERS who have converted from coal to gas or oil heat have transformed newly acquired coalbin space to a basement darkroom. Whether the existing walls of the coalbin are used or new ones are built for the darkroom, there's always the difficulty of ventilating such a confined, light-tight room. This posed a problem for me until I thought of my wife's electric hair drier and began to plan how it could be used to draw fresh air in through the window formerly used to fill the bin. By providing a wire bracket to cradle the drier in front of a light-trap ventilator, the drier would be instantly available when needed for its original purpose, and also readily accessible when needed to speed the drying of films and

prints. Replacing the center pane in the window with a panel of plywood solved the problem of installing the ventilator, and painting the glass black made the window light-tight. When completed, the arrangement proved even more ideal for a general airing of the darkroom when desired, as the bracket in no way interfered with opening the window.

I set to work making the light-trap ventilator first, Fig. 1. I found that a can of the type in which pressurized liquids are packaged was perfect for part B. To cut the five elongated slots around the base of the can, $\frac{1}{4}$ in. up from the edge, I used a hand grinder, first drilling holes at each end and removing the waste with a small grinding wheel. If you do not own a hand grinder, tin snips can be used to remove the waste between the holes. To form parts A and D, I selected a can of the type in which lubricating grease is sold and cut a hole in both the bottom and the lid, the one in the bottom being the same diameter as part B. Except for the bottom of part B, I painted all other parts with flat black lacquer, inside and out.

The cutaway detail at the top of Fig. 1 shows how the four parts are assembled, part B being centered in part C and spot-soldered to the bottom through four small holes. Part C is cut down from a common can measuring about $3\frac{1}{2}$ in. in diameter. Finally, part B is placed in the hole in the bottom of part A and soldered to it at a point $1\frac{3}{4}$ in. from the end. To prevent insects from entering the ventilator, I soldered a piece of screen wire over the hole

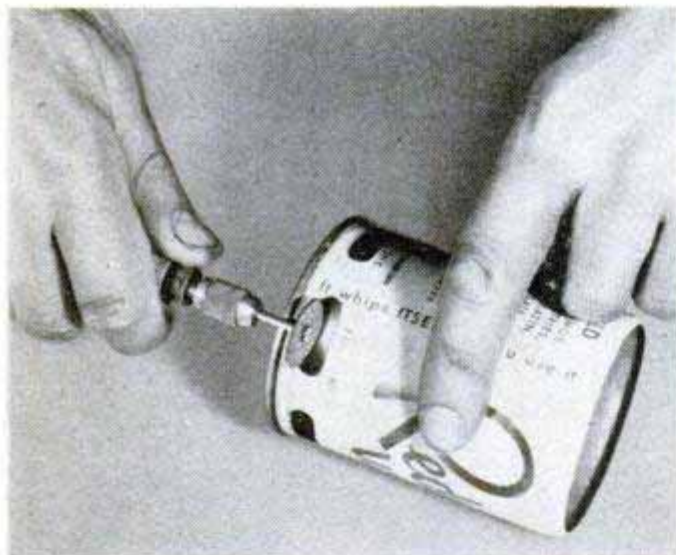

Above, a hand grinder was used to cut the slots in the inner can of the original ventilator. Below, a neat hole for part B is made with a metal hole cutter

Here are three of the four parts that make up the ventilator and the order in which they fit together. Slots in inner can permit entrance of air but not light

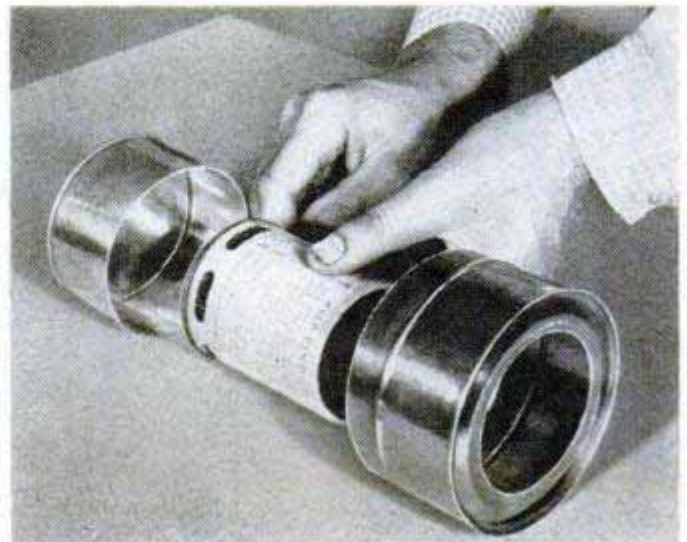
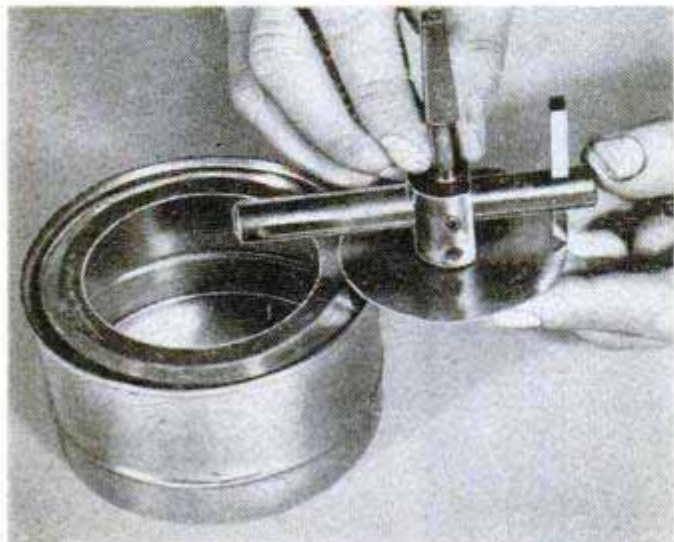

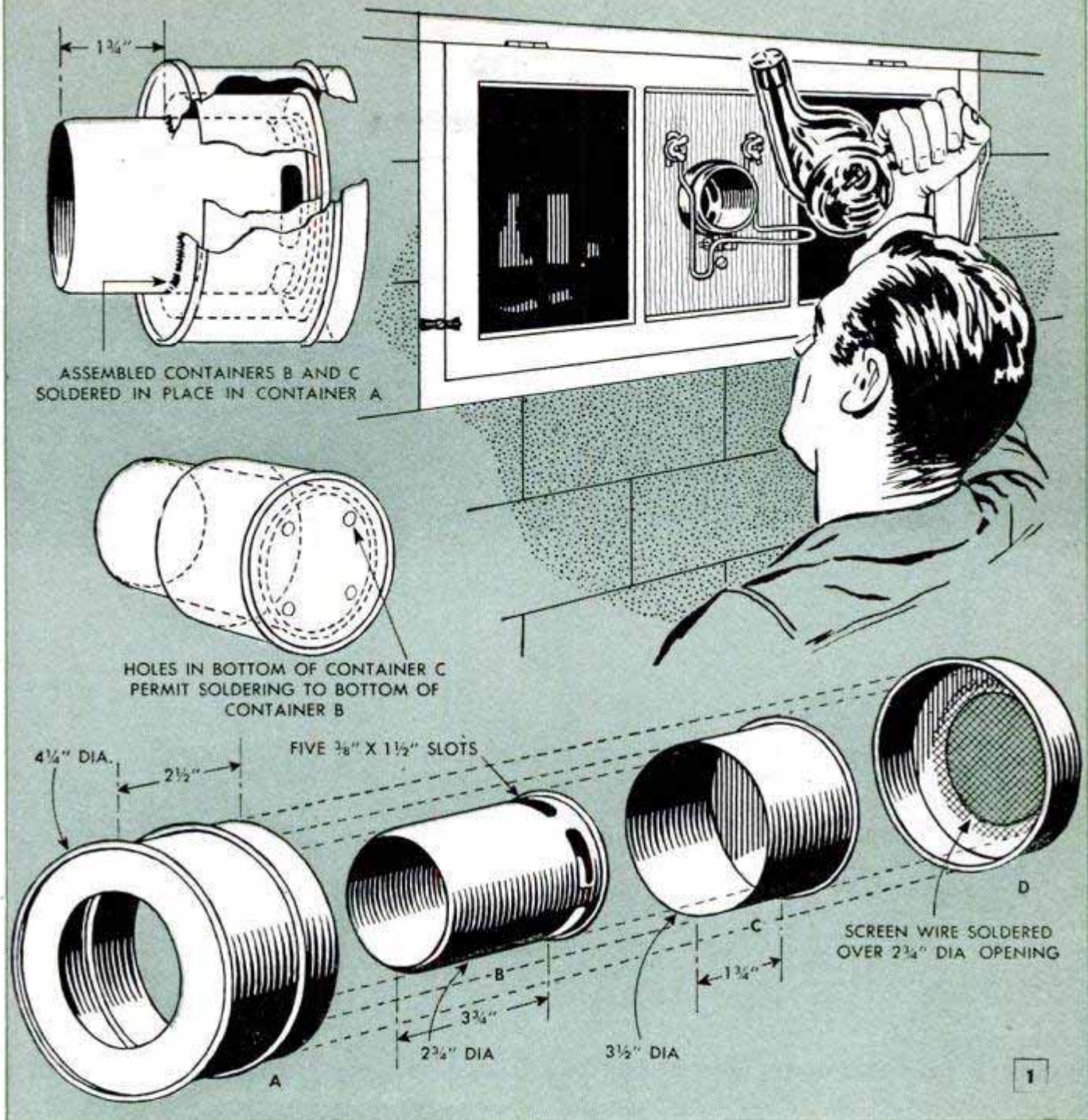

Except for the bottom of part B, all surfaces of the ventilator are painted black before the parts are soldered together. Flat drying lacquer is recommended

A hole is cut in the lid of the can which forms part A, and a disk of screen wire is soldered to the inside of the lid to keep insects from entering the ventilator

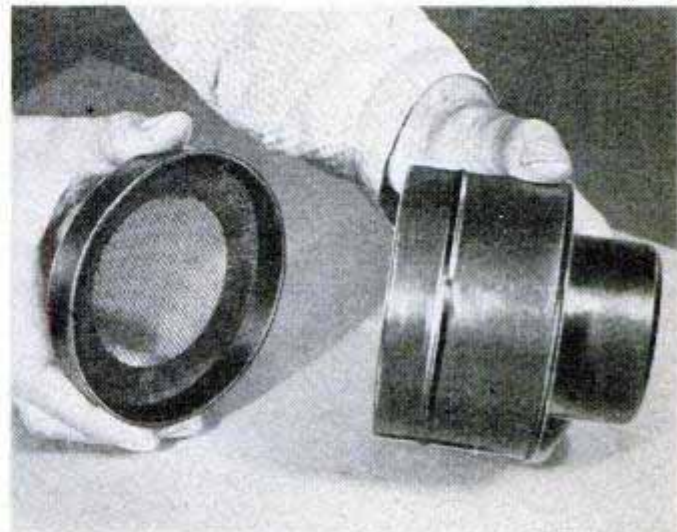

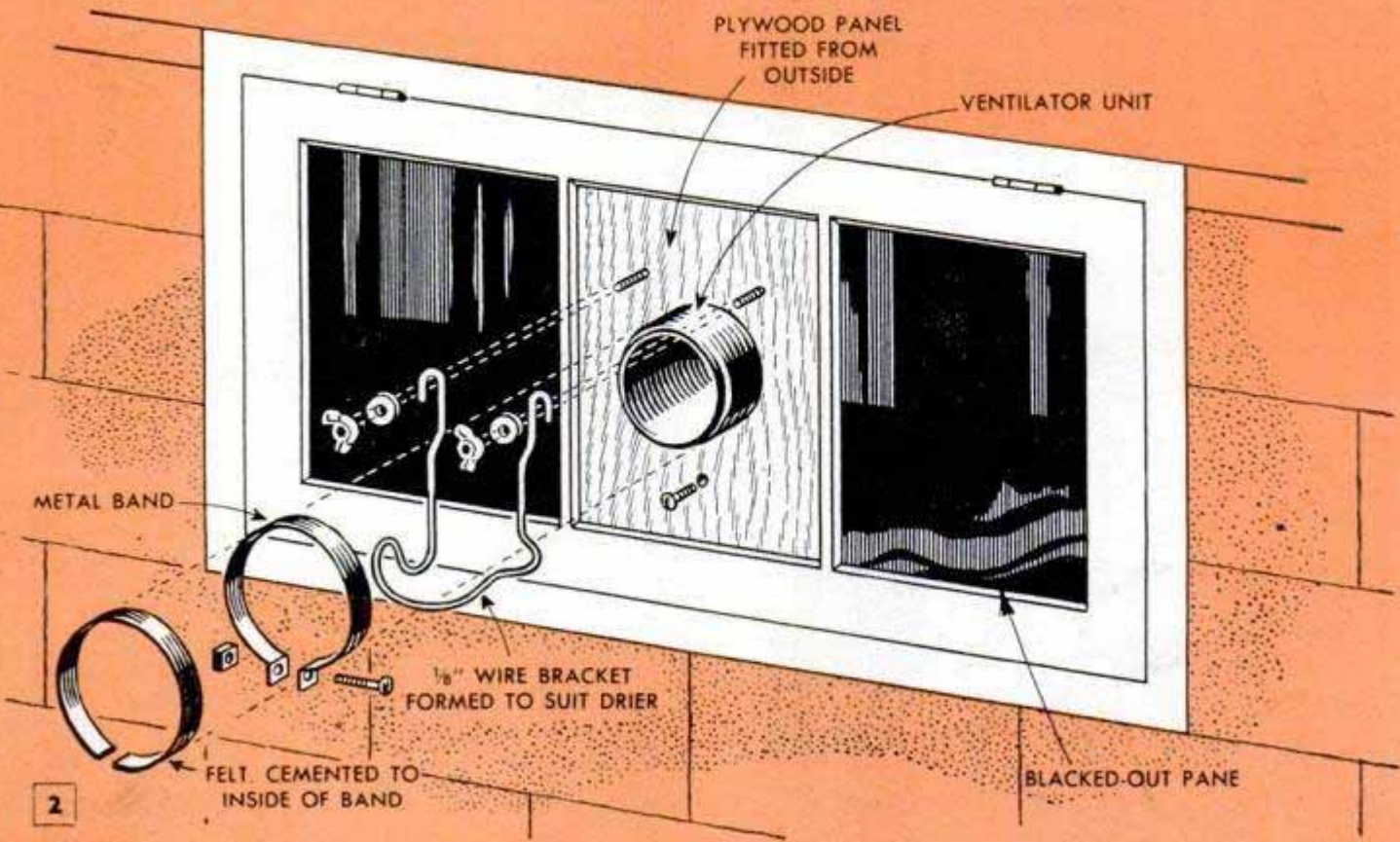

in the lid, part D, placing it on the inside. Fig. 2 shows how I formed the wire bracket to fit my particular drier, although the exact shape of this will vary according to the drier used. The ventilator passes through a hole jigsawed in the plywood window panel and is held in place with a felt-lined band, similar to a hose clamp, that

slips around the protruding end of the ventilator. Wing nuts and washers are used to attach the wire bracket to two stove bolts in the plywood. With the bracket positioned to hold the drier directly in line with the open end of the ventilator, I found it most convenient to install or remove the drier whenever desired.

Horn Switches and Rheostat Afford Positive Control of Enlarger

Two switches and a rheostat wired to his enlargers permit one photographer to control the equipment with his foot or knee, thus allowing more accurate timing of exposures than when a hand-operated toggle switch is used. In addition, this arrangement leaves both hands free for dodging and burning-in the prints. The knee and foot switches are wired in series so that either one can be used to operate the equipment. Both are improvised from auto-horn buttons, distributor points being soldered to the horn-button contacts. The foot switch is mounted on an 8-in. plywood disk, and the knee switch is fastened to the leg of the enlarger table at a convenient height. The variable rheostat (4 contacts) consists of a 1000-watt electric-range coil suspended on insulators inside a section of 3-in. tubing. Use of the rheostat permits selection of four graduated light intensities, thus increasing the life of the enlarger

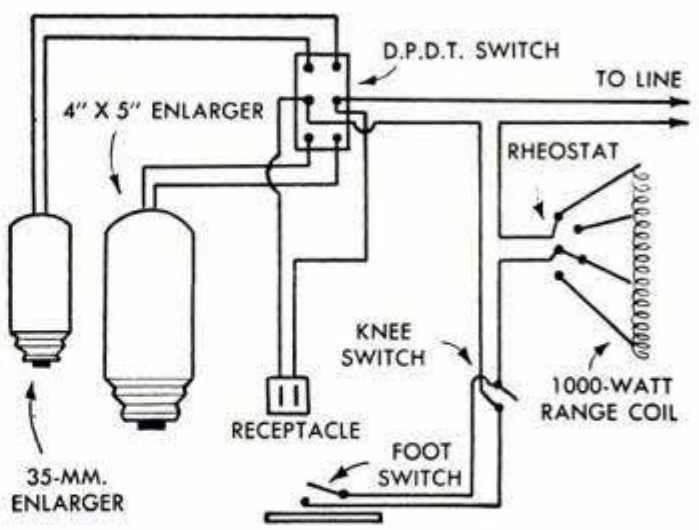

bulbs. Note in the diagram that two enlargers are wired to a D.P.D.T. (double-pole double-throw) switch and that a receptacle is provided for connecting the contact printer. However, the control switches may be wired to a single enlarger.

Dental Mirror Reflects Settings When Camera Is Elevated

If a camera is used on a tripod above eye level, a dentist's mirror will enable you to easily read the scales on the camera. The mirror can be attached to a length of tubing, metal rod or wood dowel to provide a handle. The mirror also can be used to advantage when doing photomicrography, where the lights and subject matter must be placed so close to the camera lens that the settings are blocked from view.

Louis Hochman, Sherman Oaks, Calif.

Removing Excess Rubber Cement From Mounted Photographs

A pencil eraser of the type shown is ideal for removing excess rubber cement from the edges of mounted prints. Being pointed, the eraser permits getting near the very



edge of the print. Larger areas can be cleaned by rubbing them with a ball made by peeling and kneading the dried cement found remaining in a used container.—
John J. Rea, Urbana, Ill.



Tape on Developing Tank Prevents Exposing Film

When film is placed in a developing tank, but is not immediately developed, stretch a strip of cellulose tape across the top of the tank. This will remind you and others that the film in the tank is undeveloped, and that the tank should not be opened.—Virginia Hanson, Los Angeles, Calif.



50 YEARS WITH POPULAR MECHANICS BOOKS

Since the first issue in 1902 all the important developments and advances in the fields of mechanics and the sciences have been pictured and described in *POPULAR MECHANICS*. Many of these stories have again been brought to life in our new book, *50 YEARS OF POPULAR MECHANICS*, which has just been published by Simon and Schuster, outstanding New York publishers, and commemorates our 50th Anniversary.

This volume enables you to see the great inventions and scientific developments of 50 fabulous years happen over again in articles and pictures prepared and first printed when the events took place. In essence, this volume is the story of American progress. Great men such as Pierre Curie, Guglielmo Marconi, Winston Churchill, Charles F. Kettering and Thomas A. Edison have written for us, in addition to the Wright brothers, Du Pont and Jules Verne.

It is the perfect gift for father, son, husband and brother, and of course would make a fascinating addition to your own library. It contains 320 pages, more than 600 illustrations and the final chapter is devoted to "Things to Come and A Glimpse into the World 50 Years from Now." Early automobiles, the birth of the airplane, the phonograph, motion pictures, radio, television, the invention and development of machines, appliances and devices are all here in nostalgic abundance.

Send for your copy today. Price, \$5.00. If you send your remittance with your order we will stamp your name or donee's name in gold on the cloth-bound cover without extra charge.

Shortly after the birth of *Popular Mechanics Magazine*, readers requested that we reprint in

one book the most interesting how-to-do-it articles so they could have them in their libraries for use as reference books. Our annual book, *SHOP NOTES*, was the first book of this type and was to be the forerunner of such famous and familiar titles as *WHAT TO MAKE*, *THE BOY MECHANIC*, *THE BOAT BOOK* and scores of others. *SHOP NOTES* has been published every year since 1905 and we believe the current 1952 issue to be the best we have ever published. In addition to many interesting how-to-do-it articles, it contains a 31-page article entitled "Table Top Workshops" in which our craftsman editor tells how you can start a miniature workshop that can be stored in a drawer when not used. It also contains a four-color article on plastic veneer which, as indicated by letters from our readers, is one of the most famous how-to-do-it articles ever published in *Popular Mechanics Magazine*. This story tells how to cover old pieces of furniture or make new ones of cheap woods and cover them with plastic veneer, which comes in simulated wood grains as well as marble grains. As an introductory offer, you can get the issues of *SHOP NOTES* for 1948, 1949, 1950, 1951 and 1952 for \$3.98, postpaid. The regular price of these five issues would ordinarily total \$5.00.

Many of you remember *THE BOY MECHANIC*, the set of books which was first published in 1913 and became the outstanding volumes in encouraging youngsters to build things and in developing their latent skills. For many years, these four volumes set the standard for manual accomplishment. Total sales of this title are well over 200,000 copies. In 1945 *THE BOY MECHANIC* was published in an inclusive single-volume edition at \$2.00. Get a copy today for that boy who is the apple of your eye.

Apartment WORKSHOP

By Joseph Whitehill

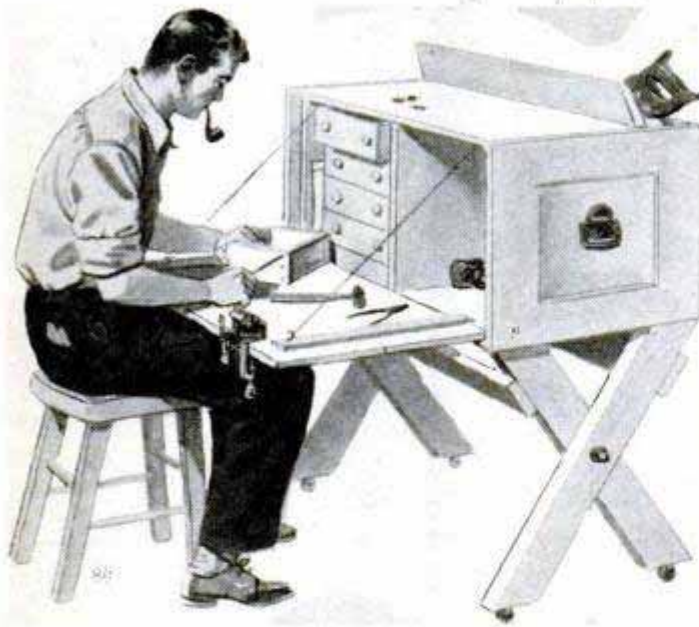

DOES THE kitchen table serve as your workbench, much to the annoyance of your wife? If so, this article is especially for you. It shows how you can have a workbench and tool chest all in one within the confines of a compact trunklike box. Supported by a folding detachable sawbuck stand, both parts of this workshop can be stored in a minimum of space. It's the perfect setup for the man who resides in an apartment, or the owner of a basementless house who likes to tinker, build models or keep the household appliances in repair. Everything is at hand when you want to "set up shop" and, when you're through, tools can be quickly packed away for another day. It's as simple as that.

You literally "set up shop" when you roll out this compact little workshop. Combining a chest and bench in one, it's the answer to the apartment "crafter's" prayer for a convenient place to work and store tools

Chain-supported drop lid lowers to form a handy lap-type bench top when chest is open. Compartment at rear affords storage for handsaws, square, level, etc. Drawers care for countless small tools

The photo below shows how the box is divided into compartments and fitted with four drawers for regimenting small tools, parts and materials. Features of the box are a separate compartment at the back for storing two handsaws, and a lid that drops down to provide a bench top. The drawing on the opposite page details construction. Crate lumber will do for the box, although pieces of plywood are best for forming the compartments and drawers.



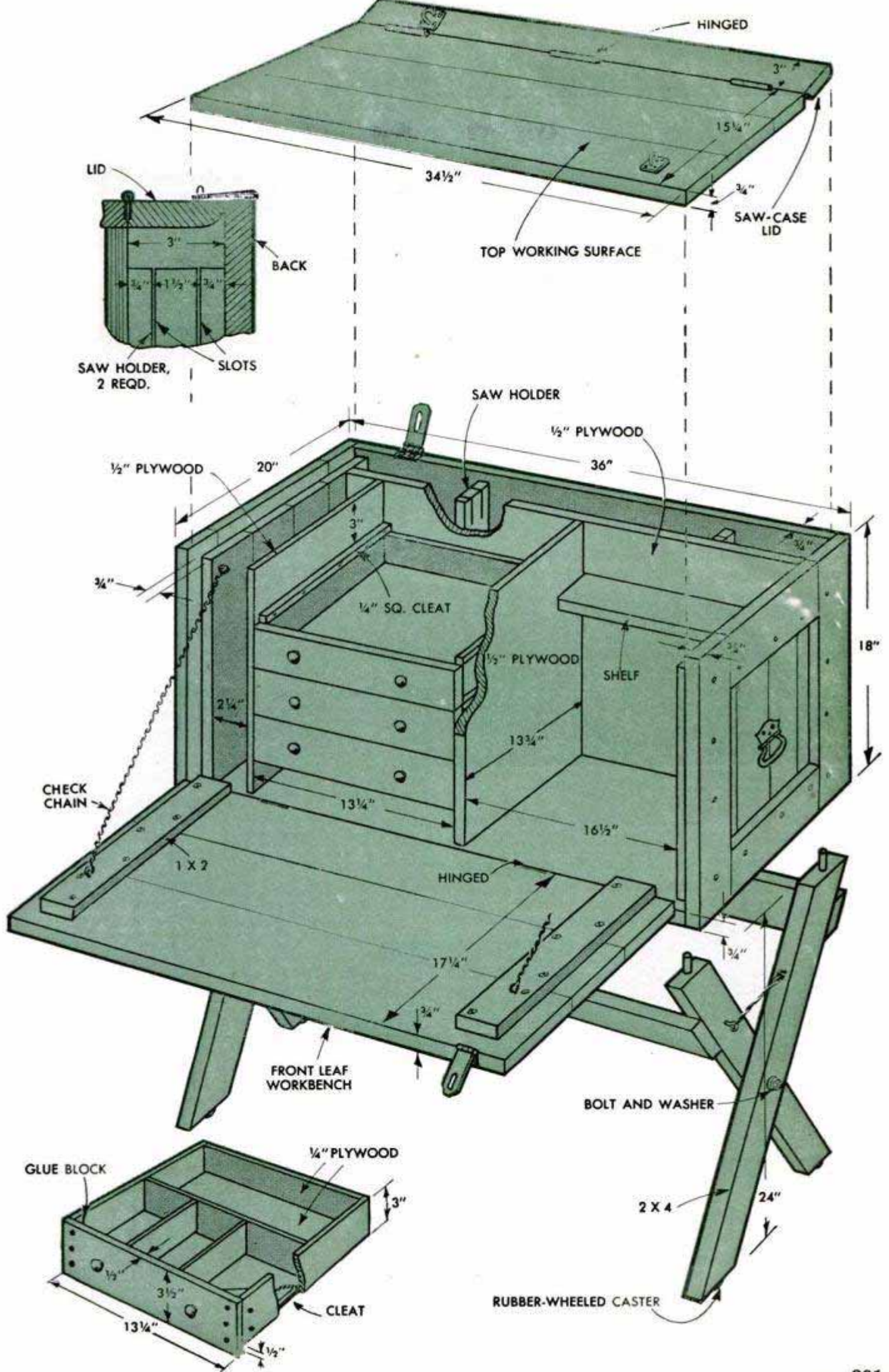

Colorful Frames for Wall Pictures Cut From Large Desk Blotters

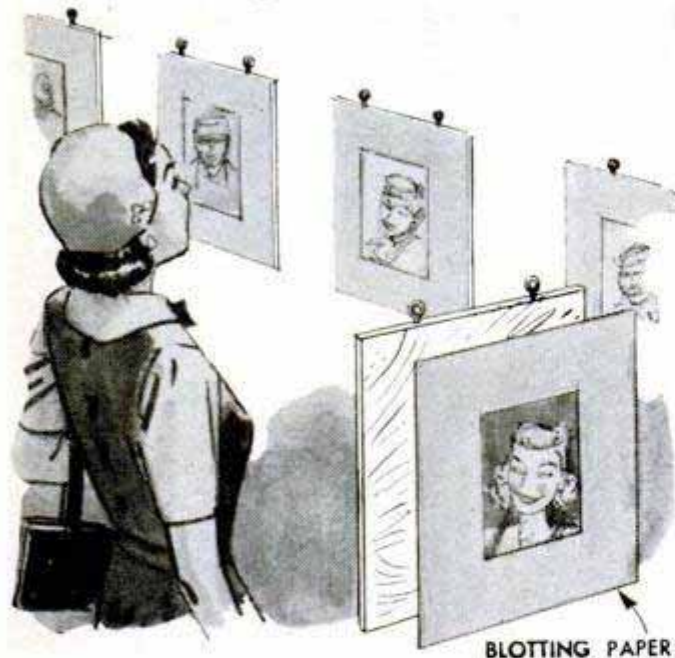

Attractive frames for photos or other pictures can be cut from large desk blotters. These may be obtained at most dime stores and are available in a wide variety of colors and interesting textures. The framed pictures should be tacked directly to the wall or backed with $\frac{1}{4}$ -in. plywood having screw eyes driven into the upper edges to permit hanging. Or, if desired, omit the screw eyes and attach easels to the plywood backs.

Glare From Plated Car Accessories Killed With Electrician's Tape

Driver discomfort caused by reflection from plated spotlight handles and other accessories can be avoided by killing the glare with plastic tape of the type used



for making electrical splices. Such tape adheres tightly to clean metal surfaces and is peeled off easily at any time. Areas of an instrument panel that reflect in the windshield may be similarly covered.

Walter E. Burton, Akron, Ohio.

Sheet-Metal Paintbrush Holder Retains Shape of Bristles

To prevent the bristles of a paintbrush from bending when left in a can, place the brush in a holder submerged in the can as shown. The holder is merely a strip of tin which is bent to the shape of the letter M.



Damageproof Food Box For Camping Trips

A beverage case of the type having hinged lids that close together at the center is ideal for carrying food on a camping trip. Coat the case with orange shellac to make it water resistant, and also to discourage mice, pack rats and other pests from gaining entrance by gnawing holes through the sides. For storing flour, meal, sugar, etc., inside the box, use salt containers of the type having metal pouring spouts, and shellac the outside surfaces. These containers are filled through the spouts with a funnel and, in use, will not require the removal of lids or covers that may be lost or misplaced. Bacon and salt pork should be kept in plastic bags to prevent them from soiling other foods. Lard and butter will remain clean and will be easy to get at if stored in tin cans having press-fit lids.

Soldering Iron Hung on Bench By Loop Formed in Cord

One shop worker avoids the possibility of burns from his hot soldering iron by hanging it on a hook at the end of the bench when not in use. A loop was formed in the cord of the iron near the handle

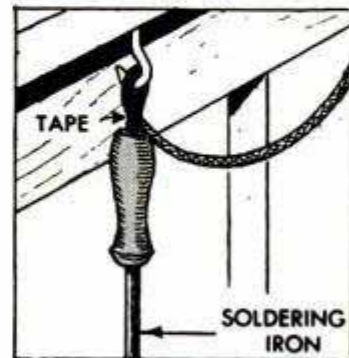

and wrapped with friction tape to hold it in shape. Being able to hang the iron out of the way is especially good when it is set aside to cool.



SHOP NOTES

THICKNESS PLANER

from your jointer



By Norman E. Schultz

YOUR JOINTER will do double duty as a thickness planer when fitted with this unusual "pickaback" attachment. It works equally well on either a 4 or 6-in. jointer, and enables you to dress rough-sawn boards to finish dimensions, or plane re-sawed stock from $\frac{1}{8}$ to 2 in. in thickness. Simplicity of construction will be apparent from the detail and photo on the following page, but the dimensions given may have to be altered somewhat when fitting the unit to different makes of jointers. First, the front and rear jointer tables are drilled and tapped for machine screws which hold two flat springs with upturned ends. These springs serve a twofold purpose, as anti-kickbacks and also as pressure springs to support the stock tightly against the overhead surface plate, which substitutes for the regular table in the conventional thickness planer, or surfacer. On nearly all types of small jointers it is possible to attach a length of channel iron to each side of the machine frame by means of cap screws and

Photo at right shows flat pressure springs being fastened to jointer tables which have been tapped for machine screws. Note upturned ends of springs

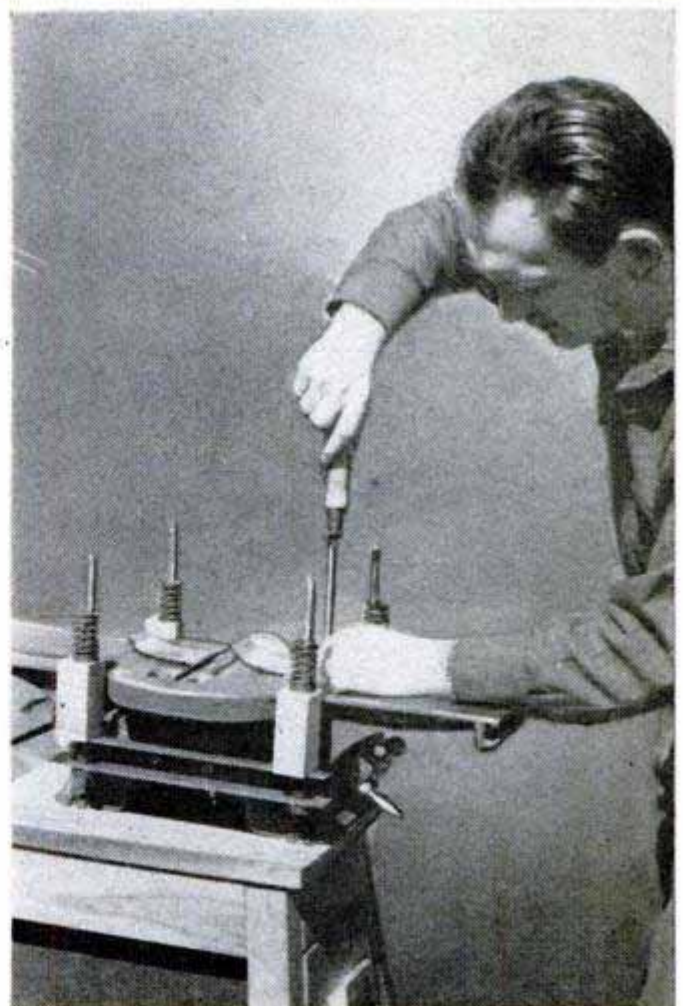

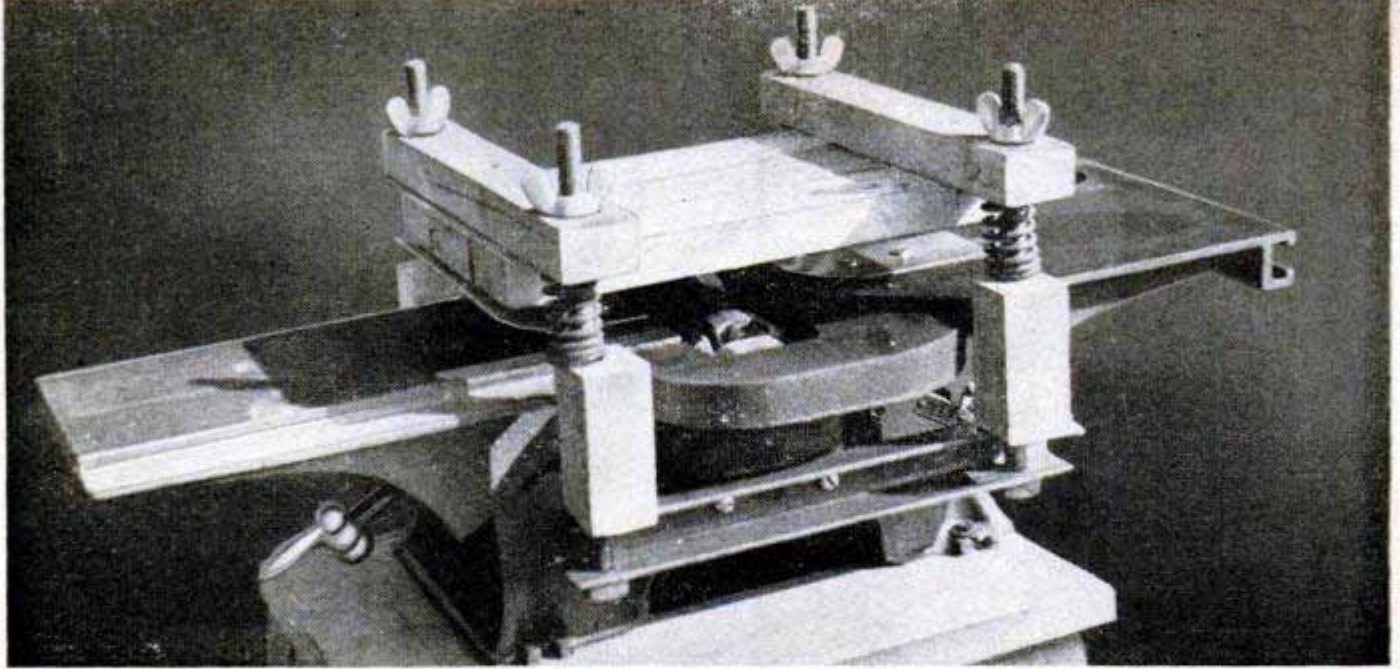

Close-up pictures thickness-planer adapter mounted on jointer. Springs force surface plate against wing nuts

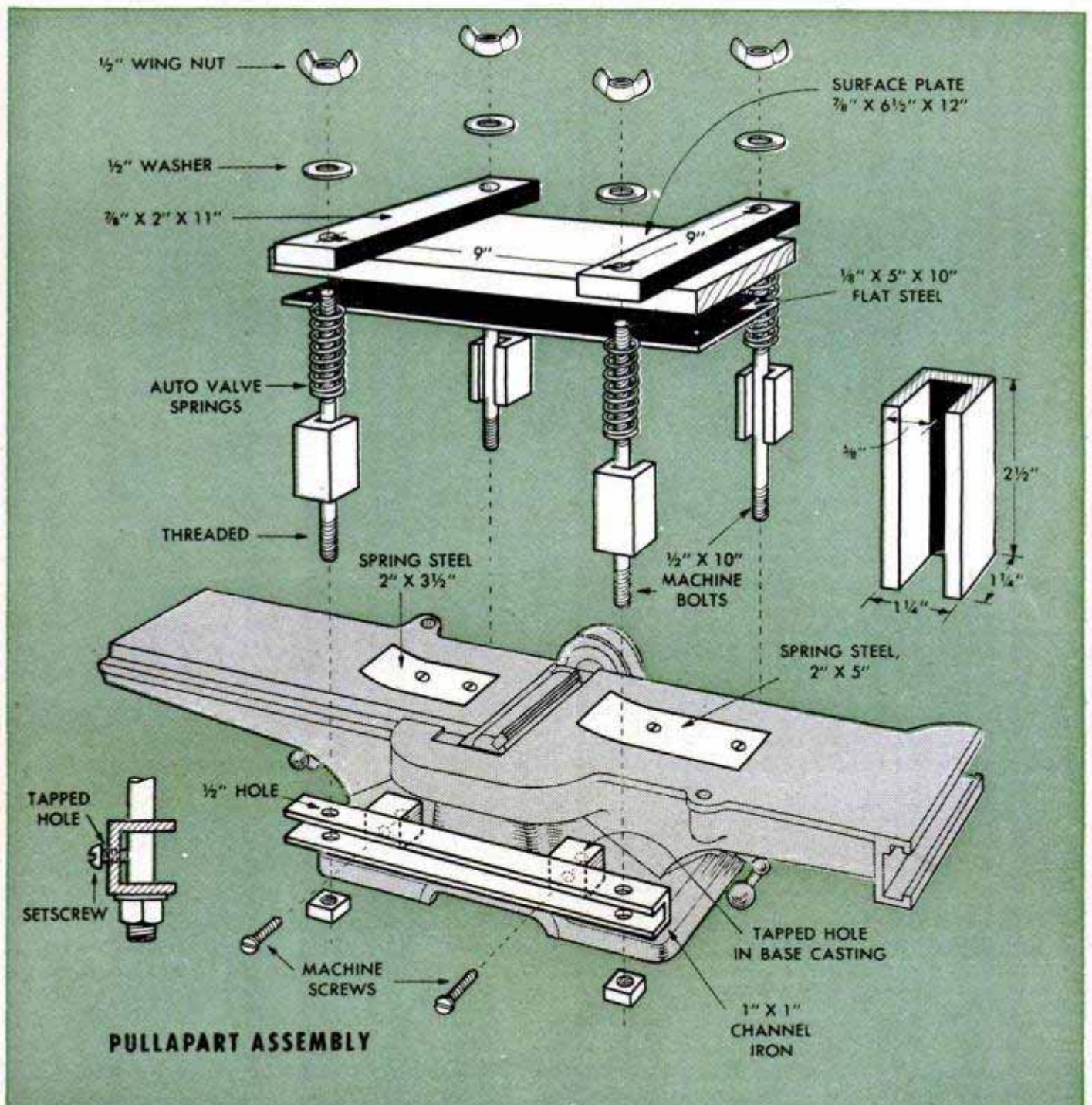

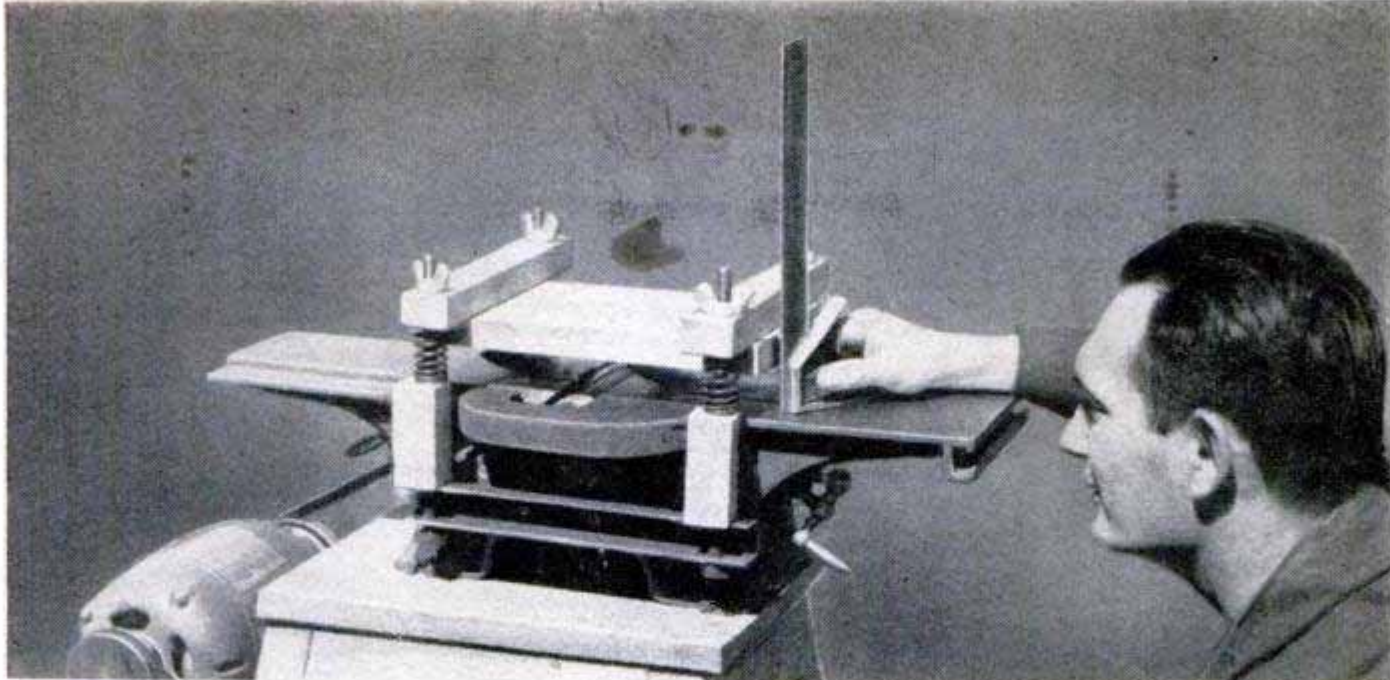

Above, square is used to be sure surface plate is parallel with jointer table and to check distance above head. Right, jointer ready for planer unit

spacers as shown in the detail. Note that the legs of the channels are drilled near each end to take $\frac{1}{2}$ -in. studs. You can make the studs from $\frac{1}{2}$ x 10-in. machine bolts by cutting off the heads and threading the ends to accommodate wing nuts. Note also that the webs of the channels are drilled and tapped to take setscrews which are tightened on the studs to hold them in a fixed position. The surface plate is made from hardwood, cleated as shown for additional strength, and the bottom is faced with flat steel ground and polished smooth on the lower face. The steel plate is attached with flat-headed wood screws, the heads being countersunk slightly below the surface. The unit is assembled on the jointer as in the photos above and on the opposite page. The surface plate is supported on coil springs such as auto-valve springs, the lower end of each spring bearing against a hardwood spacer block grooved lengthwise to fit over the studs. This arrangement permits easy removal of the entire attachment and, at the same time,

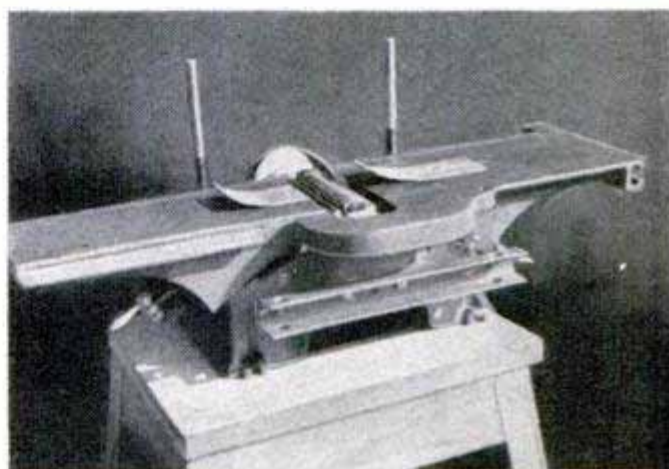

provides a fine adjustment of the surface plate when planing stock to a given thickness. To adjust for depth, set the jointer tables at the same height with the cutting circle of the knives projecting above the tables sufficiently to take a light shaving cut, allowance being made for the thickness of the flat springs. Then place a square on the jointer tables as shown in the photo above and adjust the surface plate to give the thickness desired. Run a trial piece to check the accuracy of the setting. In ordinary work, the surface plate must always be set parallel with the jointer tables.

Characteristics of Lubricating Oils Determined From Simple Tests

Here are three tests that anyone can make to determine the relative characteristics of lubricating oils used in journals, etc. To check for tenacity, or "staying" ability, place two drops of different oils, which are labeled as having the same viscosity, on a sheet of plate glass. Tip the glass to a near-vertical position and note the oil that is slowest to run down the glass. That one has the greater tenacity. To determine shock-resistance capacity of the same two oils, place a drop of each on a steel plate,

and then strike each with a hammer. The lubricant that splatters least under the impact is the one most likely to prevent metal to metal contact when in use. You can tell if an oil has sufficient lubricity by dipping a piece of cardboard about 4 in. wide into it, and then lifting the board out to watch the way the oil drains off. If it falls in a film from the entire edge of the board, it passes the test. With your finger, rub a few drops of this oil on the palm of your hand and notice the absence of frictional heat.

Ends On V-Type Feeding Troughs Held With Wagon-Box Bolts

Hog raisers who find that V-type wooden feeding troughs serve their purpose best often have trouble with the ends of the troughs working loose and causing feed waste.

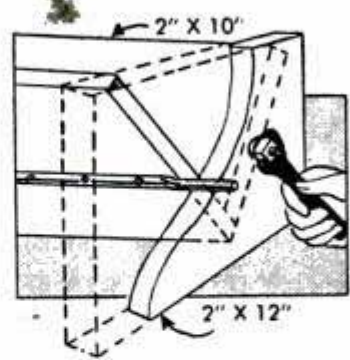

One good way to prevent this is to attach the ends to the trough with wagon-box strap bolts. The straps are riveted to the sides of the trough with the threaded ends projecting far enough to permit bolting

on the ends. Use wagon-box rivets with washers at both ends; also use washers under the bolt nuts to prevent them from cutting into the wood as they are tightened. When making troughs of this kind, be sure that the ends of the boards used for the sides are perfectly square. This will assure tight joints and will help prevent leaks as well as add rigidity to the troughs.

A. M. Wettach, Mt. Pleasant, Iowa.

Special Dog Screwed to Faceplate Saves Time in Mass-Machining

When mass-machining bar stock of duplicate sizes, holding the work between centers and turning it with this special dog will save considerable setup time. Having a square hole centered over the headstock spindle, the work is automatically chucked in the dog by merely inserting it in the hole. The dog is made by filing a square hole in the center of a strip of flat steel and forming it into a U-shaped bracket. A hole is drilled at each end for mounting the dog to the faceplate with cap screws.

C. W. Woodson, Miami, Fla.

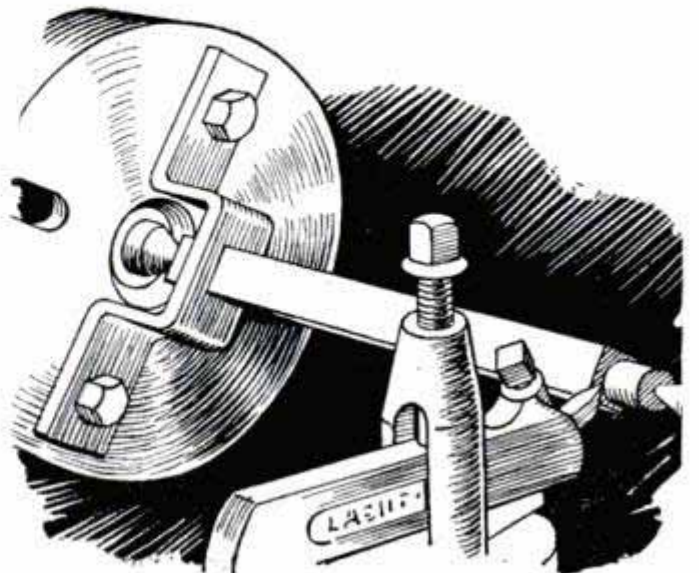

Safe Way to Inflate Truck Tires Mounted on Three-Part Rims

To avoid injury when inflating a truck tire mounted on a three-piece rim, which has a removable side that sometimes "blows off," one service-station owner offers this advice. After mounting the tire and assembling the rim, put a few pounds of air in the tire and tap the locking ring in several places with a hammer to be sure it is seated properly. Then, before inflating the tire fully, place it on the floor with the removable side of the rim down. In this way, the floor and the weight of the tire will absorb the impact of the removable rim should it be forced off.

L. W. Crosby, West Medway, Mass.

Stake Doubles as Tightener For Mason's Chalk Line

Not only will this wire stake serve as a reel for a mason's chalk line but its hairpin shape permits it also to function as a tightener. Pivoted on one leg, which is longer than the other, the stake is rotated to tighten the line by merely pulling it up sufficiently for the short leg to clear the ground.

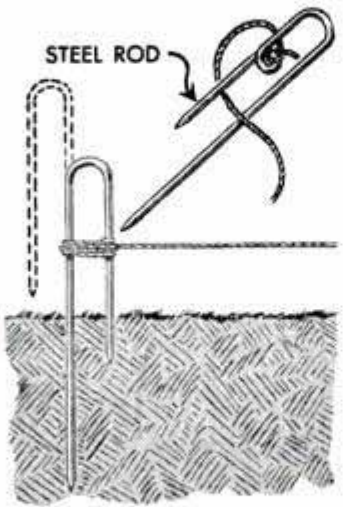

With the slack taken up, the stake is pushed back into the ground where the extra leg will prevent the stake from rotating.

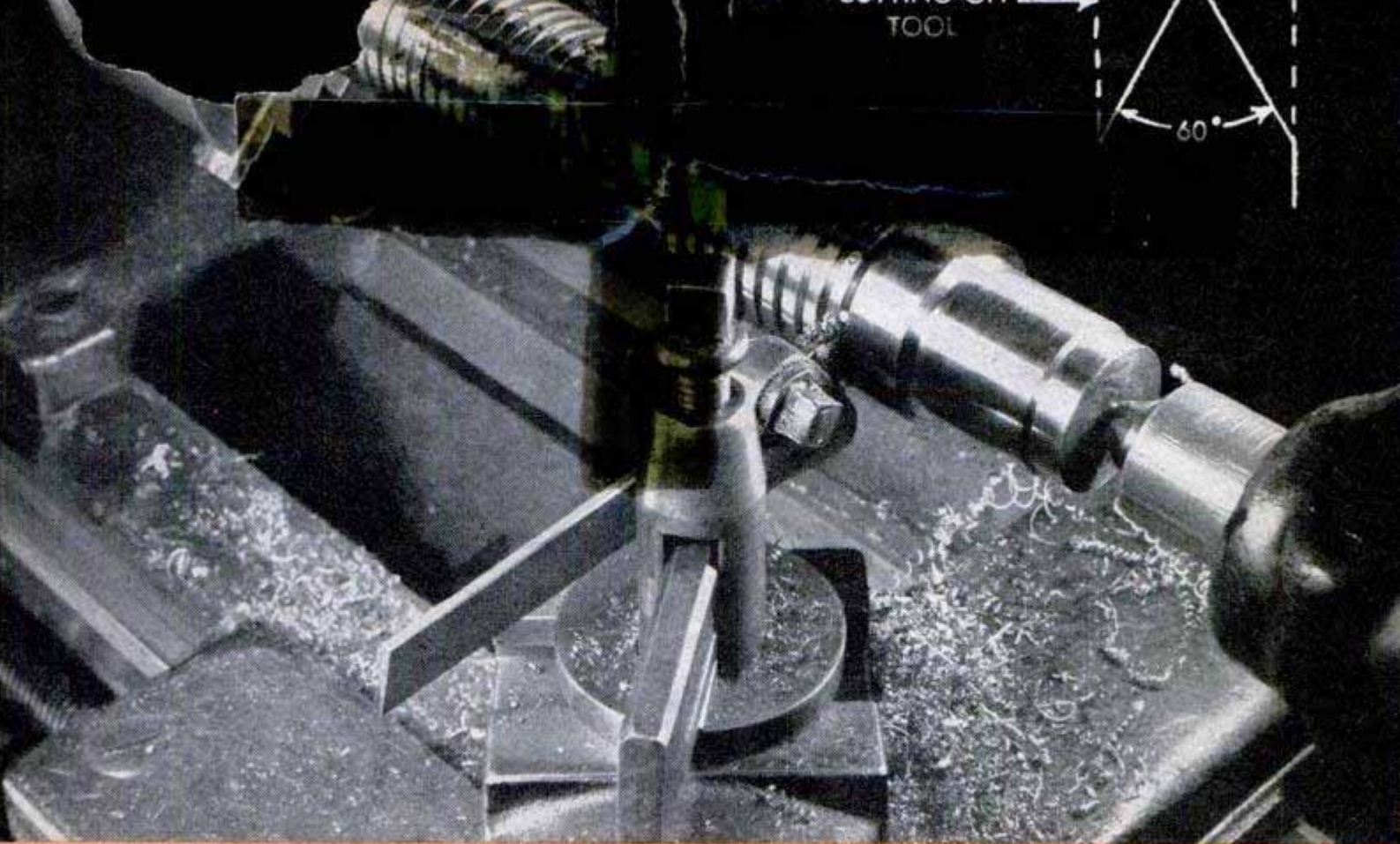

IMPROVISED THREAD-CUTTING TOOL

When no suitable threading tool is available, machinists sometimes improvise one by grinding the thin blade of a cutting-off tool to a 60-deg. point with a 3-deg. clearance. The top of the tool is then ground flat. On brass and other metals which produce short chips, the top of the tool is ground with a slightly negative rake, which results in somewhat smoother work. Such an improvised tool is especially suitable when cutting fine-pitch threads on large-diameter work and also is useful for making V-shaped scores on ornamental turnings

Converted Branding-Iron Heater Used for Controlling Grass Fires

Desiring some means of rapidly starting backfires for the control of weed fires, one ranch foreman converted a branding-iron heater into a flame thrower. Fueled on butane from tanks mounted in a pickup truck, the firing equipment can be transported quickly to wherever needed, and backfires can be started by an operator riding in the bed of the truck. The flame thrower also is useful for burning weeds on right-of-way land alongside railroad tracks and highways and for other similar firing jobs, which ordinarily require the use of heavy, hand equipment. To convert the heater, it was necessary only to replace the fuel hose with a longer one and to attach a steel pipe to the heater jet.

J. Garland Smith, Aurora, Colo.

☐ If you experience difficulty in engaging the splines of a transmission shaft with those in a new clutch-plate hub, bevel slightly the ends of the splines on the transmission side of the plate.





CHECK SPINDLE RUNOUT

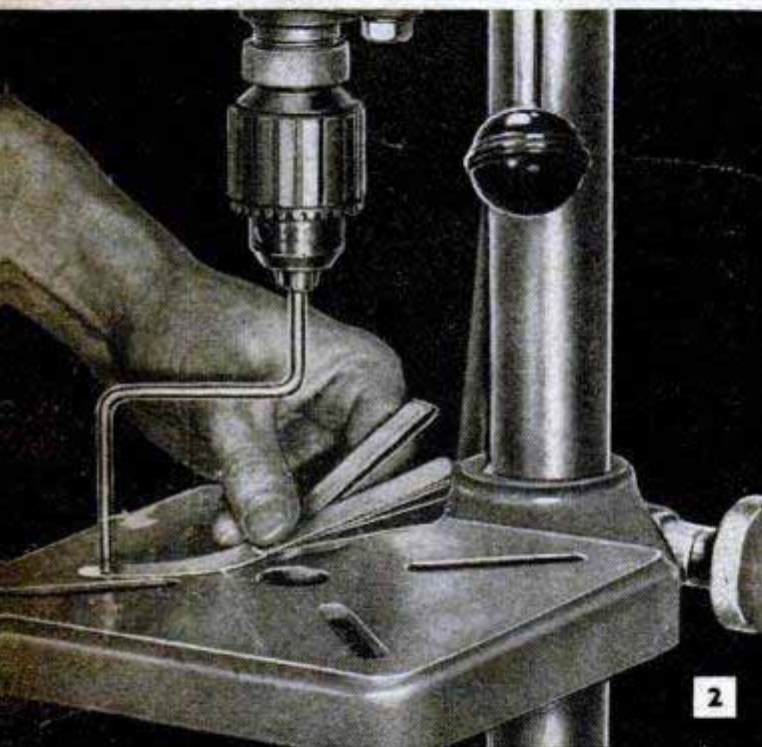

TEST TABLE ALIGNMENT

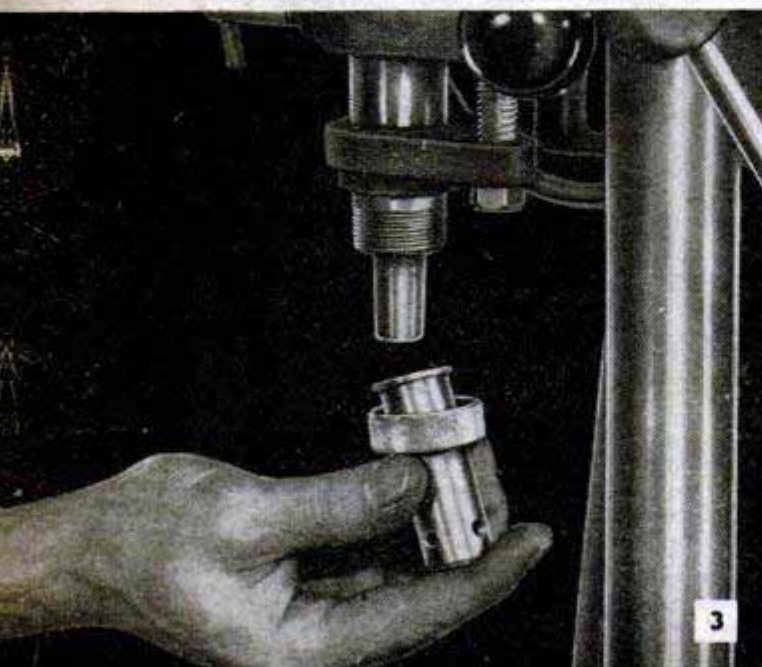

USE A SPINDLE ADAPTER

extra 30 for your DRILL PRESS

By E. R. Haan

Part I — Woodworking

OFTEN considered just a hole-puncher by the average inexperienced person, a drill press is one of the most versatile power tools for use in both wood and metal. It can double as a high-speed boring machine, router, hollow-chisel mortising machine, surface planer, shaper, dovetailer and so on through a long list of special applications. However, when used for these jobs, the drill press must be in good mechanical condition, and should be checked thoroughly.

Excessive play between the spindle and its bearing requires replacement of these parts. Although spindle run-out sometimes can be corrected, it generally is best to replace a bent spindle. To check for spindle run-out, remove the chuck and use a dial indicator as in Fig. 1. Then turn the spindle

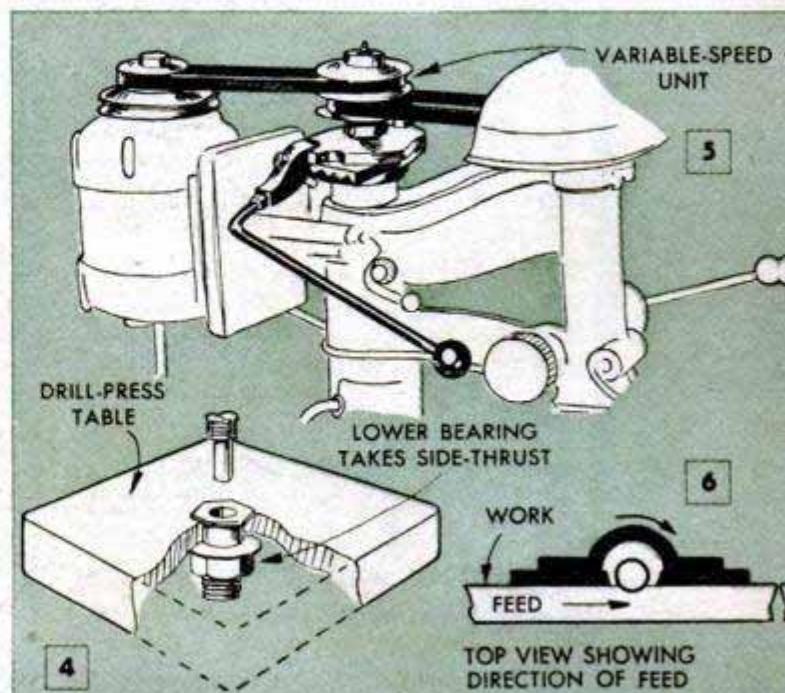

WOODWORKING

You can carve, shape, rabbet, rout; cut mortises, flutes, disks, large holes, beads, dovetails and plugs; sand with drums or belts, or, even jigsaw, and taper dowels

METALWORKING

In metal you can do milling, grinding, tapping, filing, buffing and polishing, as well as scratch brushing, spot finishing, countersinking and other machining jobs

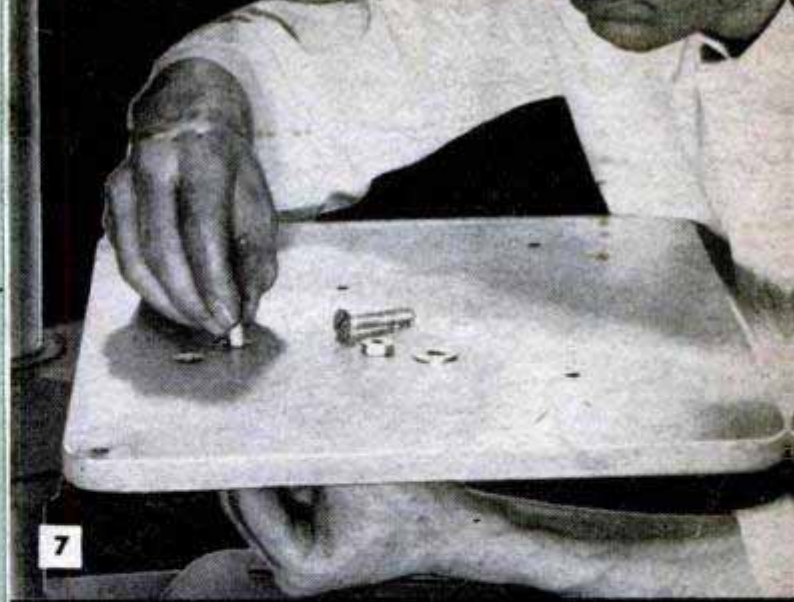

AUXILIARY TABLE

by hand. Any considerable variation of the needle indicates run-out.

Next, with the table in the horizontal position, check it to see if it is at right angles to the spindle axis. Use a light rod bent to the shape shown in Fig. 2. Chuck this and lower the spindle until the rod just clears the table. Lock the quill in this position and use a feeler gauge to see if the clearance is the same at various points. Most tilting tables can be shimmed between the table boss and column clamp to correct misalignment.

Chucks on tapered spindles may be used to hold tools when the cutting thrust is upward, but may loosen if the thrust is sideways. Therefore, when using high-speed tools, such as shaper cutters and large router bits involving side thrust, a special spindle adapter, Fig. 3, should be used.

In some operations, the tool overhang makes it advisable to provide a bronze bearing in the table for the end of the tool

as pictured in Fig. 4. Also, unusually high-speed operations make it necessary to use a variable-speed drive similar to the one shown in Fig. 5.

Feeding the work: Work that contacts the side of a rotating cutter or abrasive tool should be fed against the direction of rotation as in Fig. 6. For example, when shaping with the drill-press head above the work, feed from left to right but, when the head is mounted below the work on a floor-type drill press, the feed and direction of rotation are in the opposite direction.

If a larger work area is required than that provided by the regular table, you can purchase an auxiliary table, Fig. 7, or make one from $\frac{3}{4}$ -in. plywood, Fig. 9. For cross-feeding, you can improvise a slide as shown in Fig. 8.

Routing: A drill press can be used for routing in a range from small inlay grooves to large recessed areas. Spindle speed

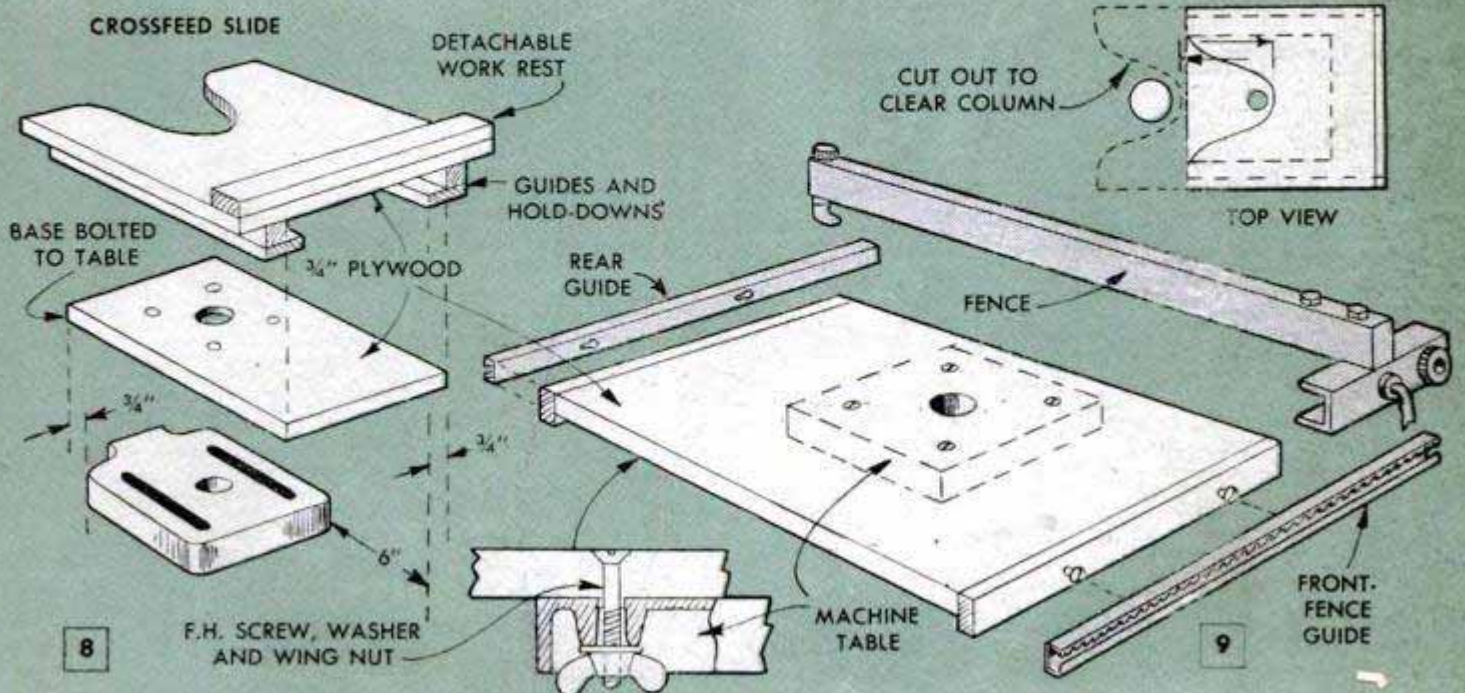

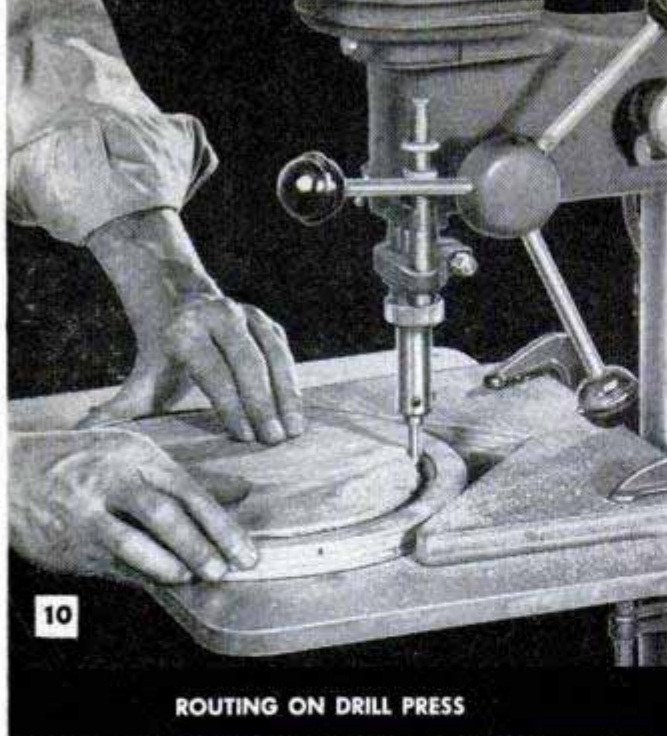

10

ROUTING ON DRILL PRESS

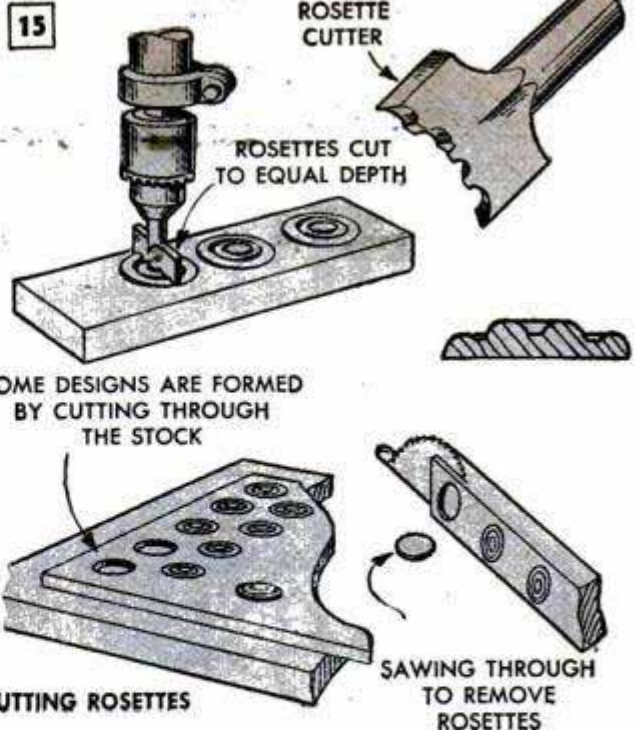

SOME DESIGNS ARE FORMED BY CUTTING THROUGH THE STOCK

CUTTING ROSETTES

should be about 5000 r.p.m. For straight cutting, always use a fence. For circular cuts, you can use the guiding method shown in Fig. 10. A guide is clamped to the table and guide pins are set in the table securely. Sometimes a guide cut out to the same radius as the work is better than the angular cut pictured. When routing a groove wider than the diameter of the bit, the fence or guide is set over for an overlapping cut.

For routing irregular-shaped recesses, use a plywood template bradded to the underside of the work as in Fig. 13. A guide pin of the same diameter as the router bit is set in the plywood auxiliary table directly under the bit. To start the cut, place the cut-out section of the template over the guide pin, lower the bit to the desired cutting depth, lock the spindle and then move the work until an edge of the template contacts the guide pin. Outline the recess with a continuous cut, and clear out the waste. With a larger router bit chucked in the drill press, you can cut round-end mortises by placing

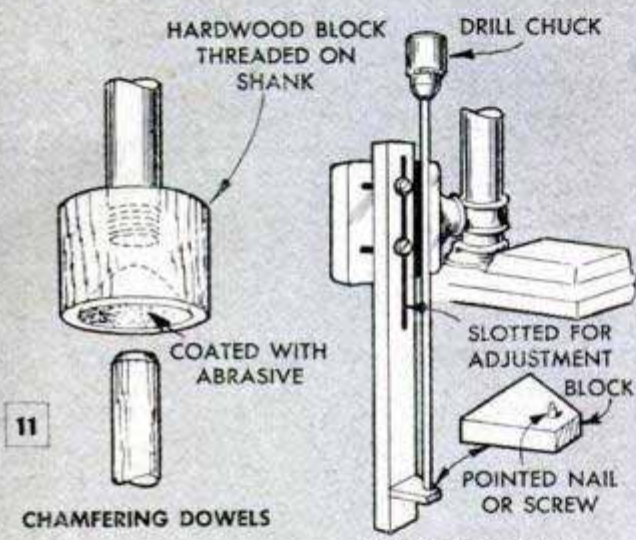

11

CHAMFERING DOWELS

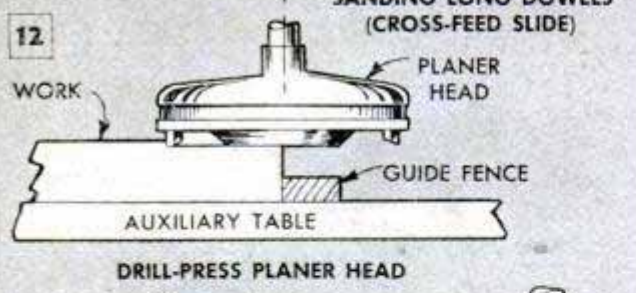

12

DRILL-PRESS PLANER HEAD

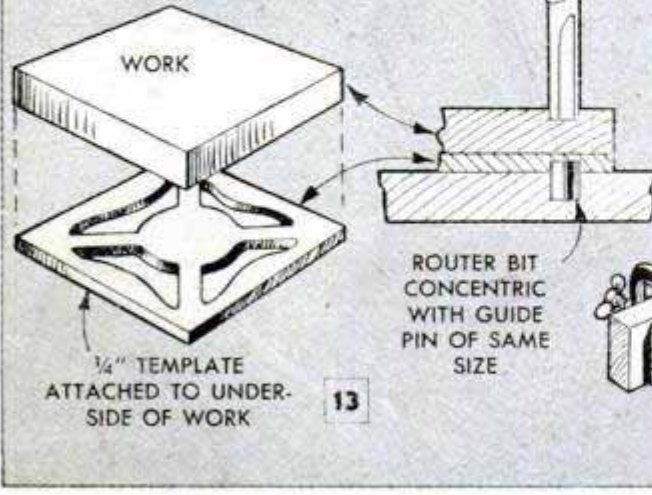

13

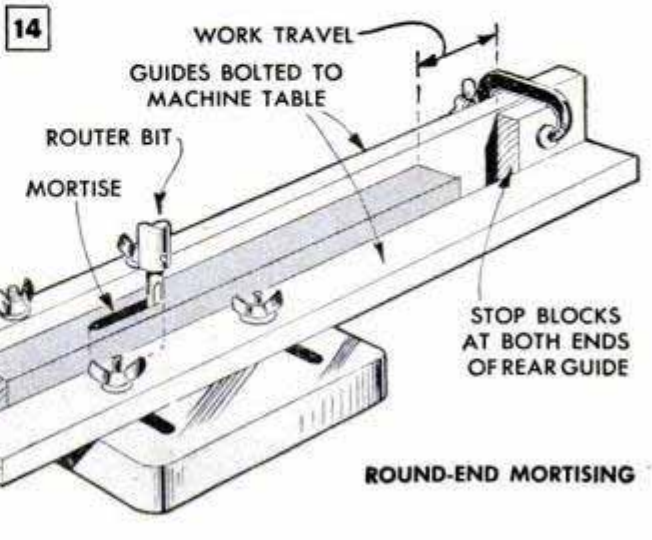

14

ROUND-END MORTISING

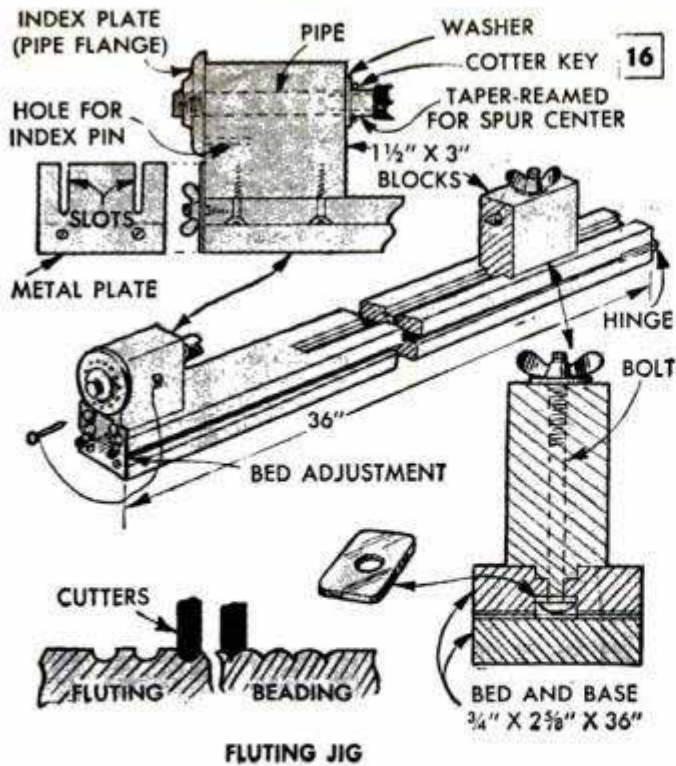

FLUTING JIG

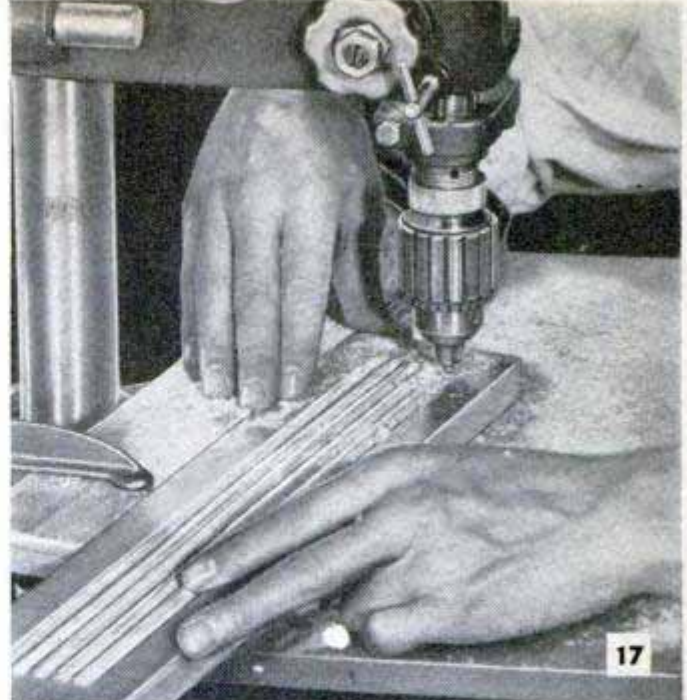

FLUTING AND BEADING

the work in a box-type fixture, Fig. 14.

Fluting and beading: In fluting, parallel grooves are cut with a special fluting bit instead of a straight router bit. Beading is formed by cutting parallel V-shaped grooves with rounded corners as in Figs. 16 and 17. When doing such work on round or polygon-shaped table legs, you need the special jig in Fig. 16. This is fitted with an indexing disk, and one end can be raised so cuts on tapered legs are made in a horizontal plane. The jig slides along a fence clamped to the table.

Dovetail joints: With a dovetail cutter and a jig to advance the work into the cutter, you can cut blind dovetail joints in a professional manner. The jig detailed in Fig. 18 holds the work vertically and permits it to be moved in two directions. The dovetail pins are spaced by means of a slotted metal bit guide. The dovetail sockets are cut in the second piece by clamping the metal guide to the inside face of the work and feeding freehand. For cutting buttons and rosettes from wood or plastics, use specially ground rosette cutters, Fig. 15.

Using shaper cutters: For shaping on the drill press, Fig. 19, use cutters of the solid-shank, three-lip type, or a special shaper head into which the individual cutters are clamped as in Fig. 25. A set of depth collars of different sizes is required to control cutting depth when shaping curved work where a fence cannot be used. On straight work an adjustable shaper fence, Fig. 20, is used. Use a ring guard, Fig. 22, when shaping curved work.

Narrow pieces of irregular shape are best held on a base as in Fig. 21, permitting you to grip the holder instead of the work. Such a base can be used as a template to guide

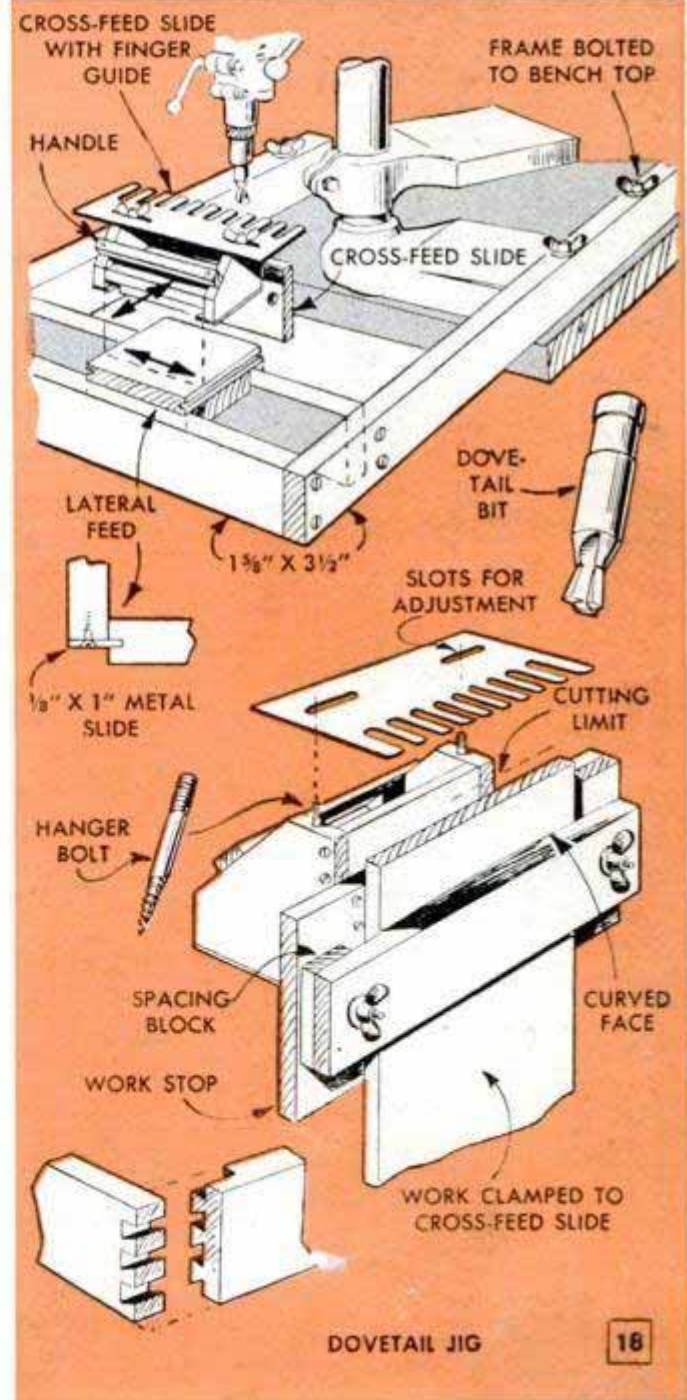

DOVETAIL JIG

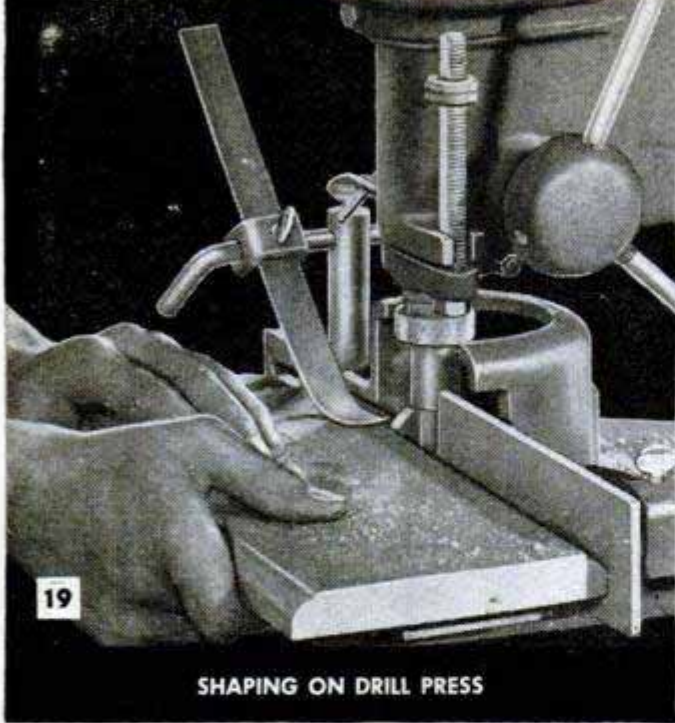

SHAPING ON DRILL PRESS

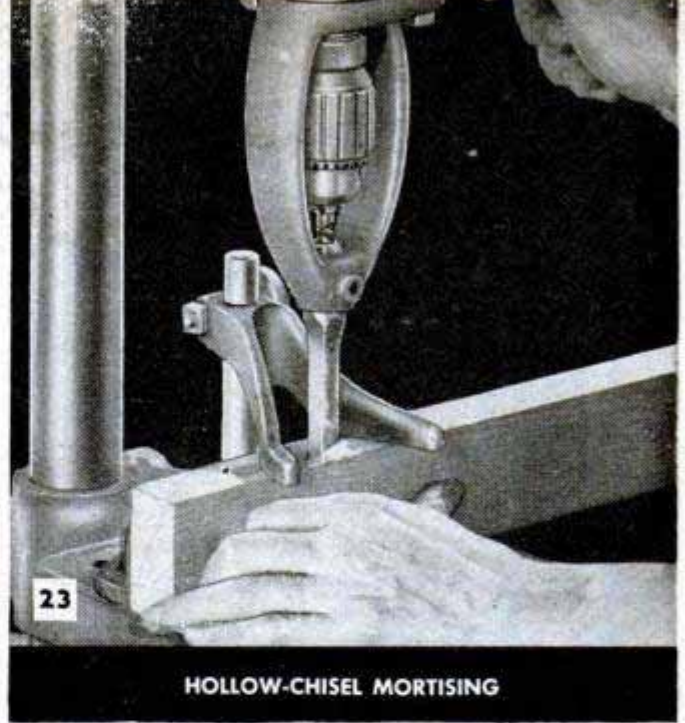

HOLLOW-CHISEL MORTISING

work against a collar, in which case the template edge must be identical to that of the work. Spindle speed for shaping operations should be at least 5000 r.p.m.

Hollow-chisel mortising: Special attachments are supplied for hollow-chisel mortising, Figs. 23 and 24. Spindle speed for mortising should not exceed 900 r.p.m. when driving small chisels. After the first

cut has been made, about three quarters of the chisel width is used for overlapping successive bites. Chisels are sharpened on a drill press with a pointed abrasive stone.

Planing: With a rotary planer head of the type shown in Fig. 29, a drill press can be used for surfacing. It also is useful for rabbeting, cutting tenons, etc. For straight cuts, use a fence or cross-feed slide; for circular

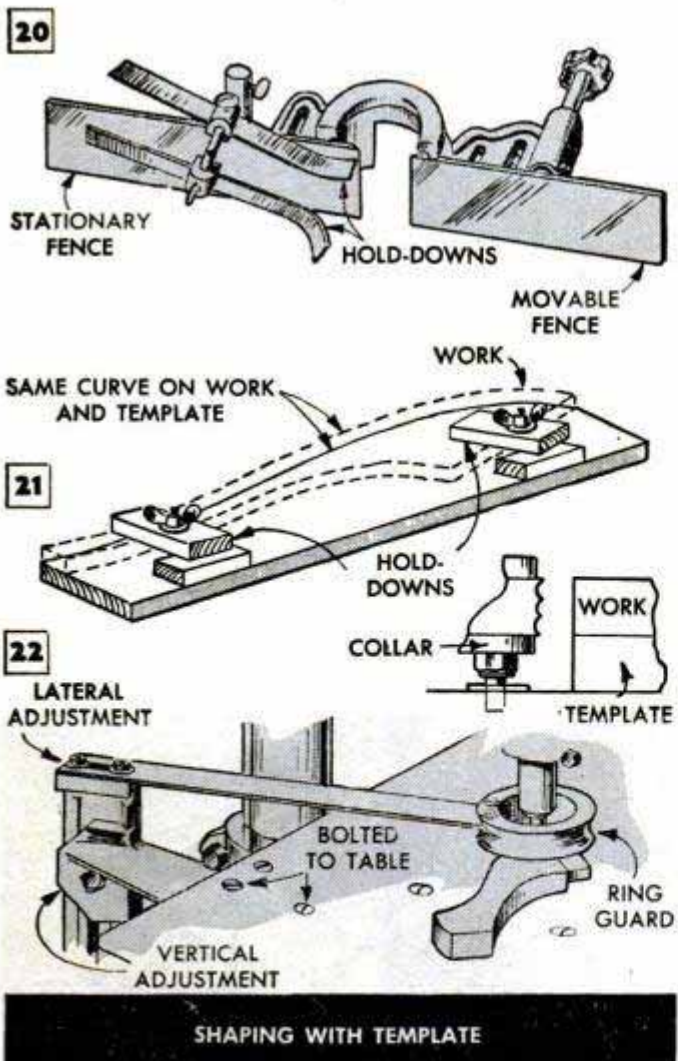

SHAPING WITH TEMPLATE

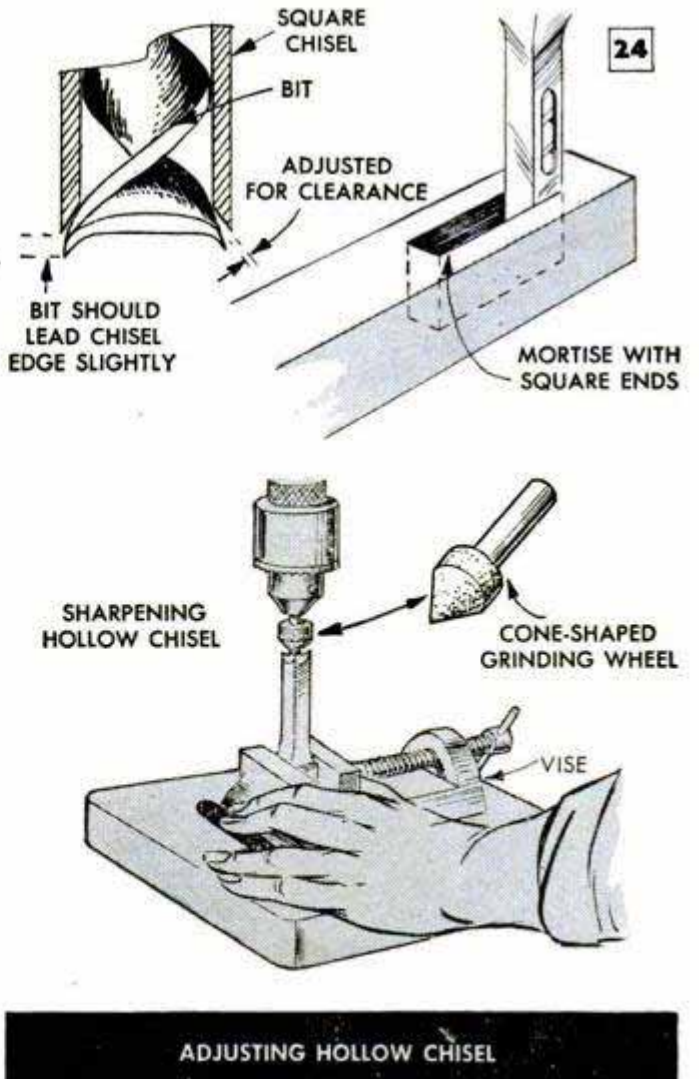

ADJUSTING HOLLOW CHISEL

work, use a guide as in Fig. 12. Spindle speed is about 5000 r.p.m.

Sanding: Small drum sanders up to 3 in. in diameter, Fig. 30, are handy for edge sanding. To get a uniformly smooth surface, use a fence, Fig. 31, for straight work and a depth collar of the same diameter as the drum for curved work. Flat table legs can be fitted accurately to a turned column if the ends are sanded concave, Fig. 32. Speeds for drum sanders vary; about 1800 r.p.m. for a 3-in. drum, 2700 for a 2-in. drum and 4100 r.p.m. for a 1-in. drum.

Four other types of sanders are also convenient. A small belt sander, Fig. 33, presents a vertical, flat, sanding surface and is run at a spindle speed of 1500 to 1800 r.p.m. Disk sanders, Fig. 26, for use in a drill press, should not exceed 4 in. in diameter and are run at 1800 to 2400 r.p.m. Irregular-shaped work is sanded with a contour sander, Fig. 27. In the absence of a shaper, you can make moldings with a form sander, Fig. 28.

The ends of plugs and dowels may be chamfered by touching them to a cone-shaped form sander, Fig. 11. To taper long dowels for use as model-boat masts, etc., chuck them in the drill press and support the lower end with a jig clamped to the table set vertically as in Fig. 11.

(Continued next month)



PLANING ATTACHMENT

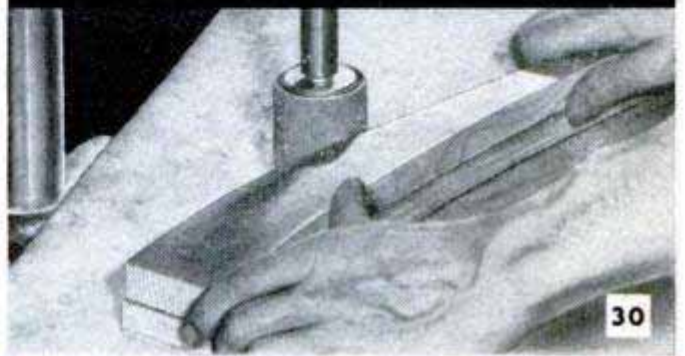

30

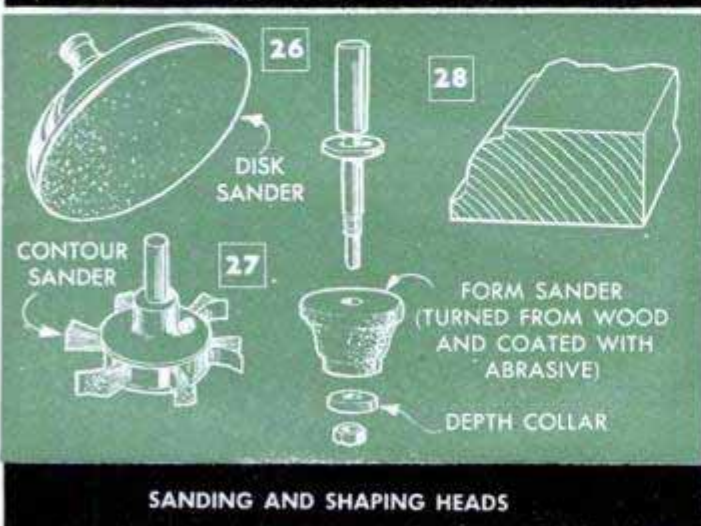
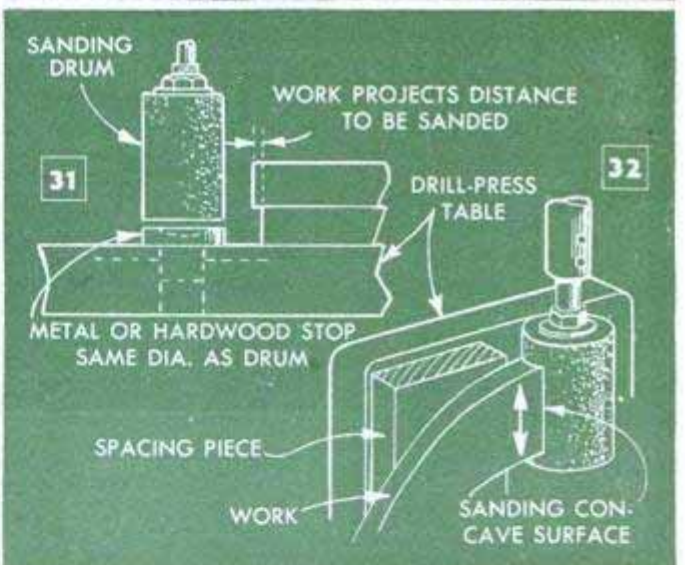
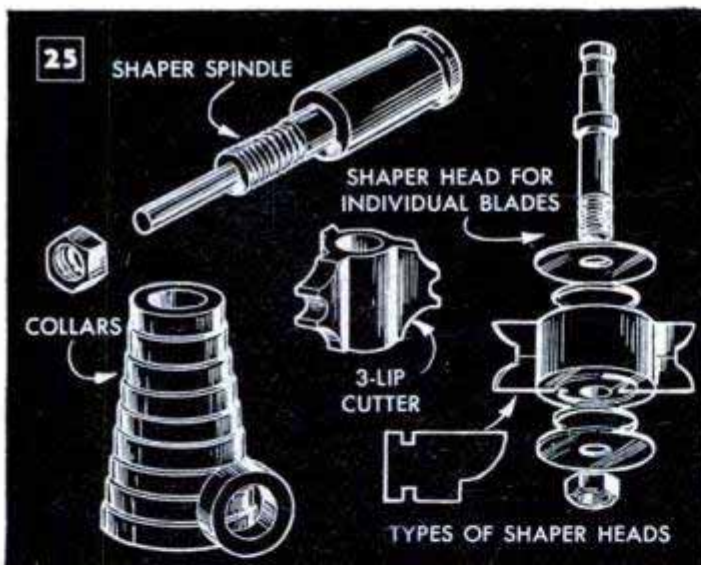

SANDING AND SHAPING HEADS



BELT-SANDING ATTACHMENT

with a lid, a piece of masking tape, stretched over the top, will cap the end.

C. W. Philpot, Laurens, S. C.

Wedges Hold Generator Brushes While Inserting Armature

When reassembling a generator or starter, the difficulty of inserting the commutator past the extended brushes can be overcome by wedging the latter back out of the way with small pieces of sheet metal. These are filed or hammered thin enough on one end to permit forcing them between the brushes and their holders.

Herbert E. Fey, New Braunfels, Tex.

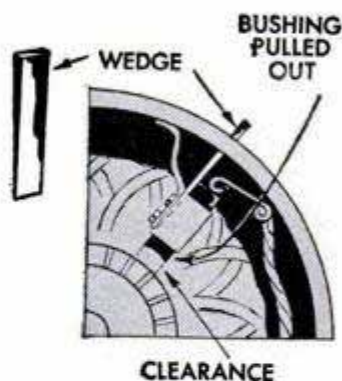

Time Saved in Setting Lathe Tool By Using Simple Height Gauge

Considerable time will be saved in setting a lathe cutting tool exactly at the horizontal axis of the work by using this simple gauge. It consists of a short length of 1-in. bar steel to which a small flat-steel arm is screwed

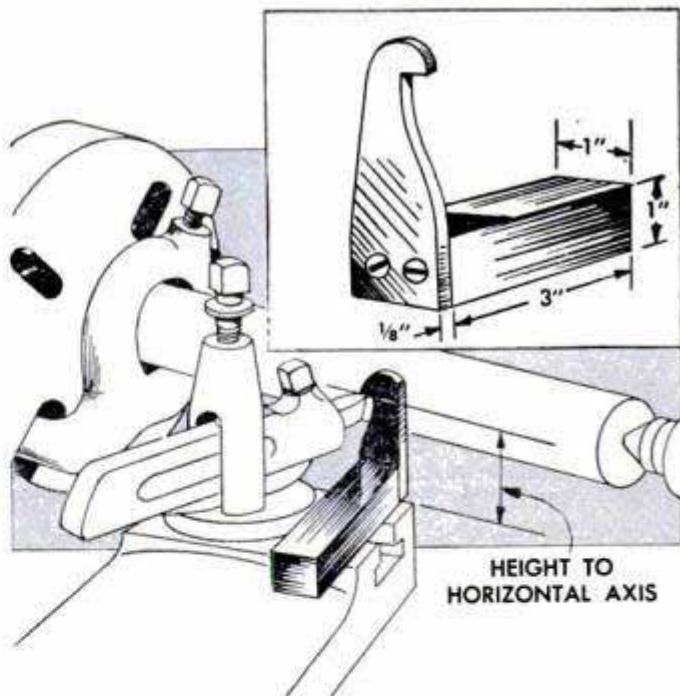

vertically, the arm having been ground to the shape shown to provide an overhanging lip at the proper height. In use, the gauge is placed on the compound rest and the tool adjusted to the height of the underside of the lip. If desired, the gauge may be used to set tools at other heights by grinding steps in the underside of the lip, each step representing a required height.

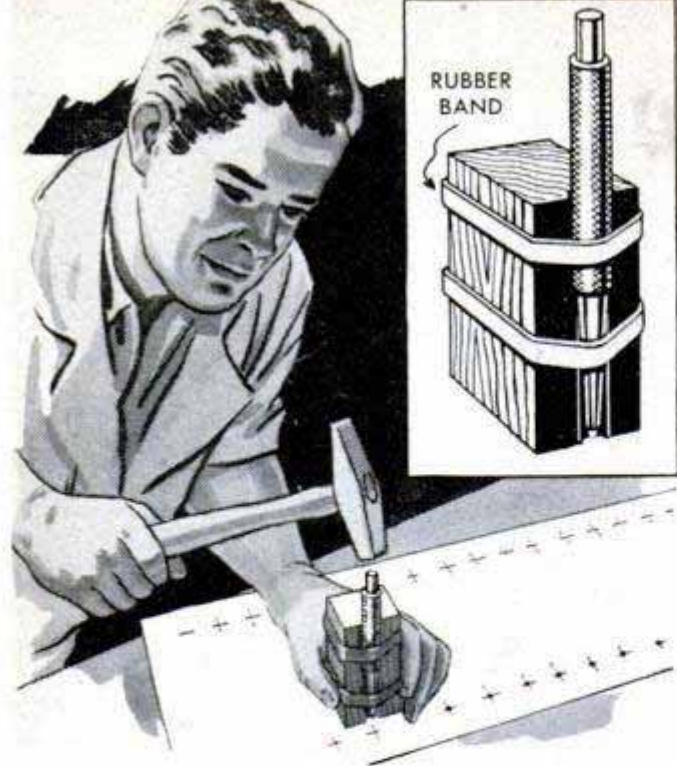

Prick Punch Held on Wooden Block Speeds Making Repeat Marks

Frequently having a number of punch marks to make in large sheets of metal, one tinsmith finds he can do a faster and more accurate job by using a block of wood and two rubber bands to hold the punch. The block was squared and a slight groove cut in one side to hold the punch at a right angle to the work. In use, the punch is set under the bands with the point suspended just above the work so that the block can be slid over the work without scratching it.

Snap-On Boot Cut From Overshoe Protects Tractor Distributor

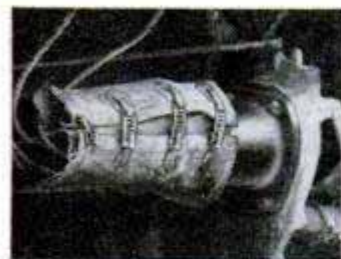

If it is necessary to leave a tractor outdoors, the distributor can be protected from rain or snow with a cover made from the top of a four-buckle overshoe.

The boot is simply cut off just below the lower buckle and then buckled around the distributor body.

Transparent Small-Parts Holder

A plastic toothbrush container provides a convenient holder for small nuts, bolts, brads, etc. As the container is transparent, it is not necessary to pour the contents from the holder to see if the part needed is on hand. Being small, the container is easily

COMPOUND MITER BOX

By Marvin Hartley

DESIGNED for those special jobs that require angle cuts in boards too wide to be handled in a regular miter box, this novel unit rides the work and features a tilting saw guide which permits compound cuts to be made at angles up to 45 degs. In use, the cut to be made is marked on the work and the saw guide adjusted accordingly. Although the box can be held in place when sawing, it is better to clamp it to the work with C-clamps.

The pull-apart drawing below shows the various parts and how they go together. Plywood, $\frac{3}{4}$ in. thick, is best for the wooden parts, although solid stock will do. A circular opening is cut in the base piece to provide a handhold for holding the miter box in position against the edge of the work. The curved edge of the base piece is faced with a strip of metal to provide a clamping surface for the adjusting thumbscrew on the miter guide. Note that the outer saw guide is 1 in. longer than the inner guide so that it supports the blade when tilted to make a compound-angle cut. An adjusting arm, attached to the guide unit and to a sliding clamp, provides a means of adjusting the saw guide to any angle vertically from the 90 to the 45-deg. positions. By adjusting both the miter and saw guides it is possible to cut any compound angle within this degree range. Only slight play should be allowed between the saw guides.

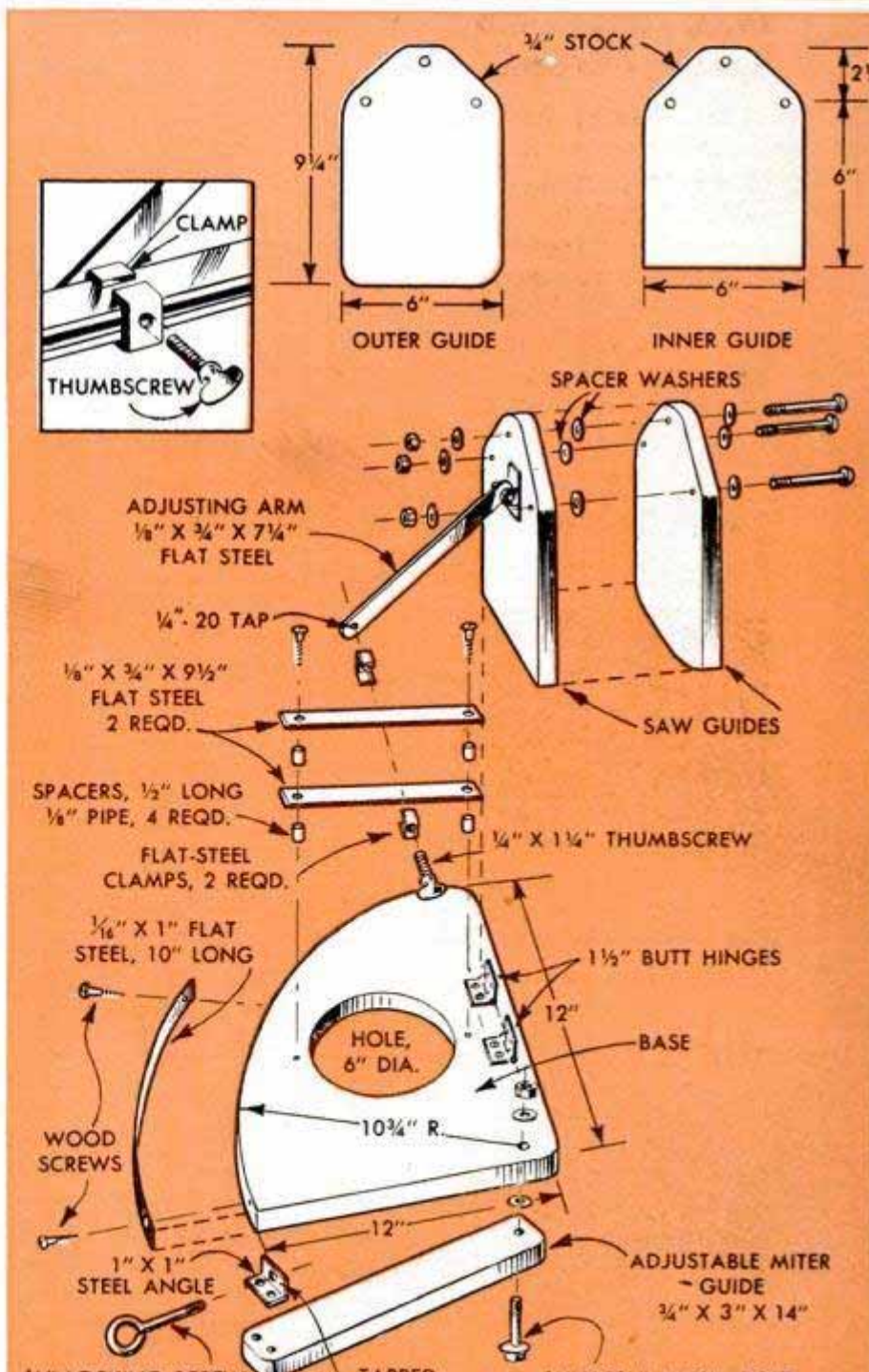
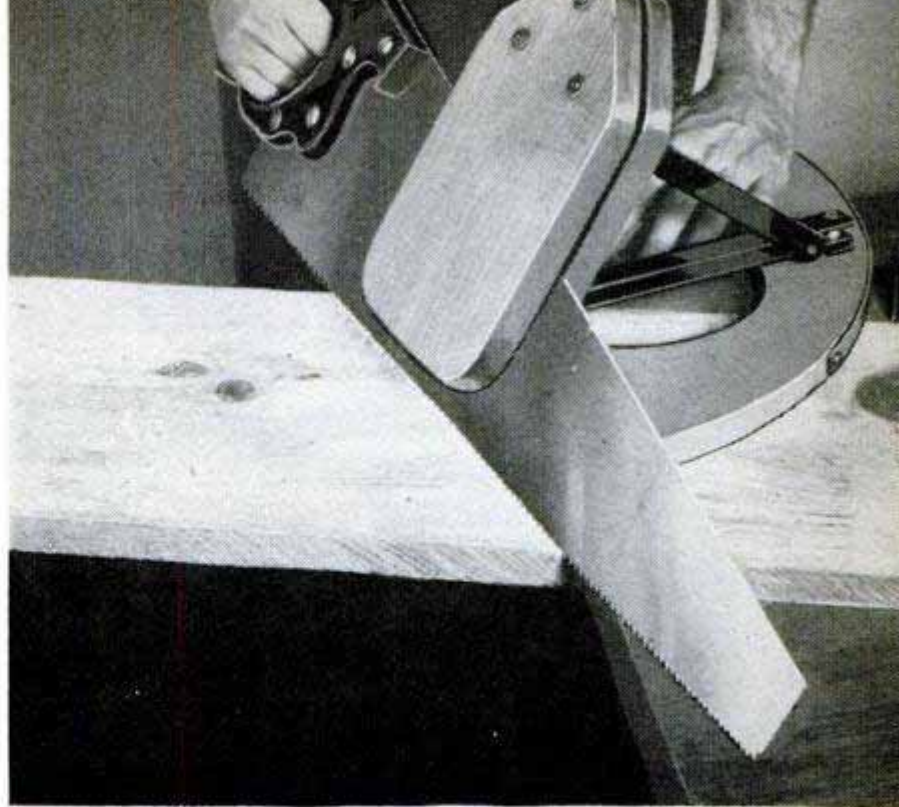

SHOPPING



AIR-OPERATED FENDER IRON for smoothing out dents, dimples and rough spots on auto or truck fenders, turret tops and other sheet-metal parts, handles most of the rough-out work and does the finish ironing in 50 percent less time. Separate die prevents stretch

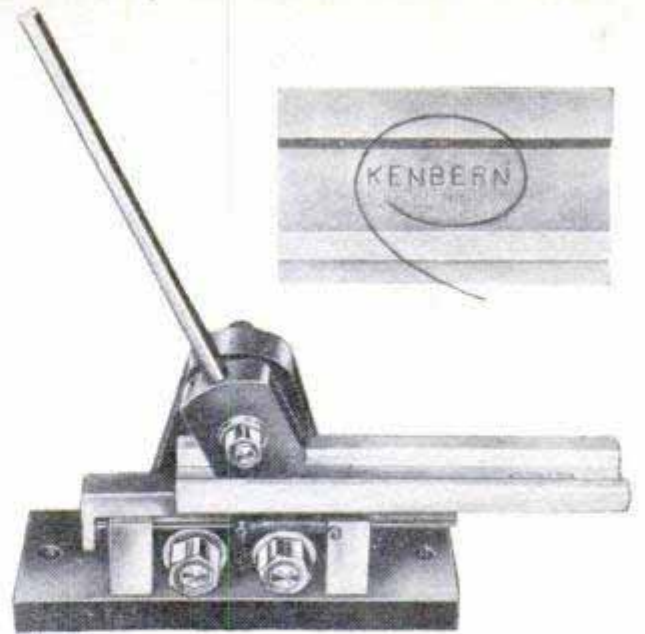

STAMPING MACHINE for embossing trade names, addresses or code marks on aluminum channels and other metal parts, rolls a deep, clear-cut mark without distorting the metal. The channel is marked simply by swinging the lever from left to right in one easy motion

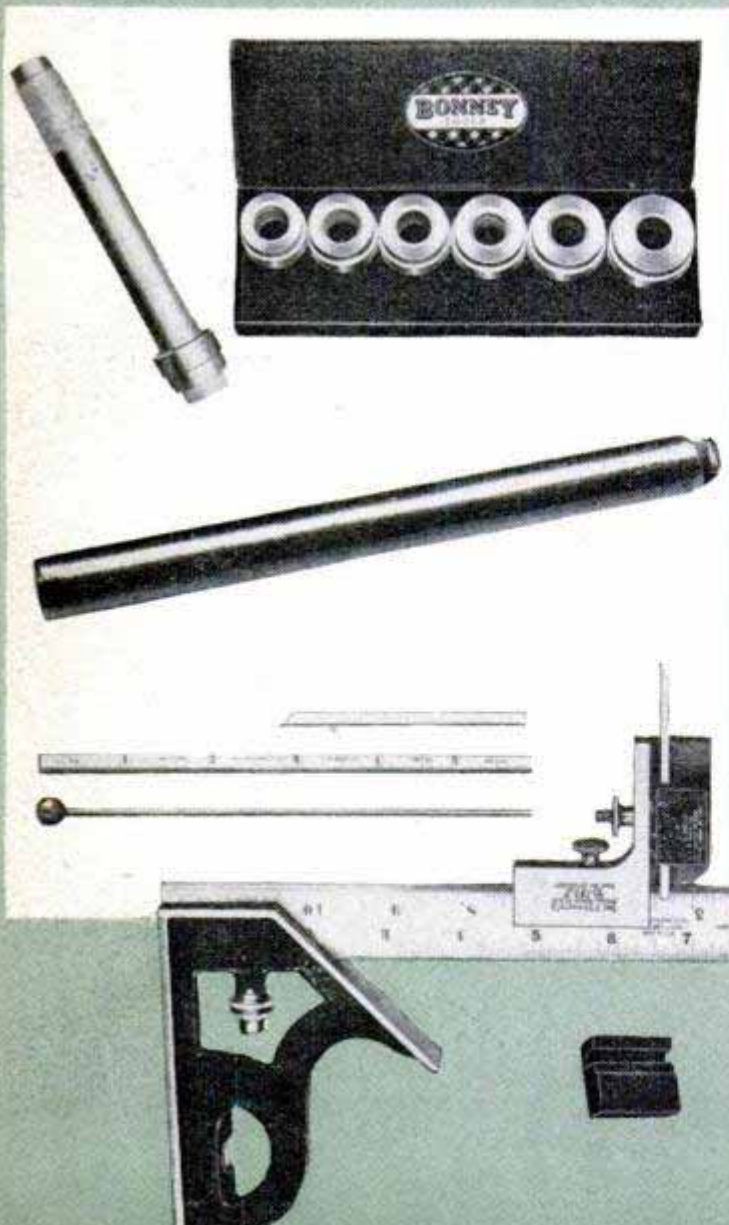

BUSHING-DRIVER SET has been assembled especially to meet the requirements of mechanics working on trucks, busses, tractors and road machinery. Drivers range in size from 1-5/16 to 1 7/8 in. and are made from selected alloy steels heat-treated to withstand hard use

CARBIDE-TIPPED DRESSER for grinding wheels of the softer grades trues the wheel more accurately than either a carbide stick or a conventional disk-type dresser. Consists of aluminum handle fitted with carbide insert for freehand dressing of wheels up to 10 in. dia.

DEPTH-GAUGE ATTACHMENT converts a combination square into a height or depth gauge. Attachment is supplied with a scribe, 6-in. rule and a rod for measuring depths in stepped holes and narrow slots. Clamp block, shown separately below, provides a ready means of mounting the scribe, rod or rule. When fitted with the scribe, the square is converted into a practical height gauge for measuring or marking vertical distances from a plane surface or scribing layout lines

FOR TOOLS



PAINT ROLLER of a new type has been designed for easy cleaning by simply sliding the wool jacket onto a holder as pictured. Then the jacket can be dipped in a solvent and cleaned and dried by spinning as shown

POTTER'S WHEEL is equipped with a foot control and a variable-speed reducer which gives a range of speeds varying from 38 to 130 r.p.m. Other special features are reversible throwing head, built-in water container, adjustable armrests and attached wedging wire. The reversible throwing head permits molding plaster bats on one side while reverse side has concentric circles for ease in centering. Available with or without motor

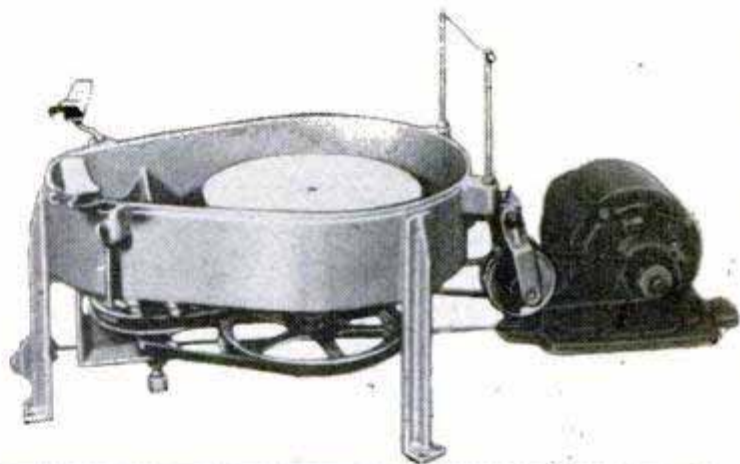

ELECTRIC HEAT GUN softens paint, melts adhesives, thaws frozen pipes and does any other similar job where heat must be applied without open flame. Reduces fire hazard to minimum in shop and home. Operates on either 110-v. a.c. or d.c.

SAW SHARPENER attaches to miter gauge on your circular-saw table and supports blade over a grinding wheel mounted on saw arbor. By tilting the saw table, or arbor, it is possible to grind correct tooth shape on any circular blade. Use 3/16-in. saw-gumming wheel

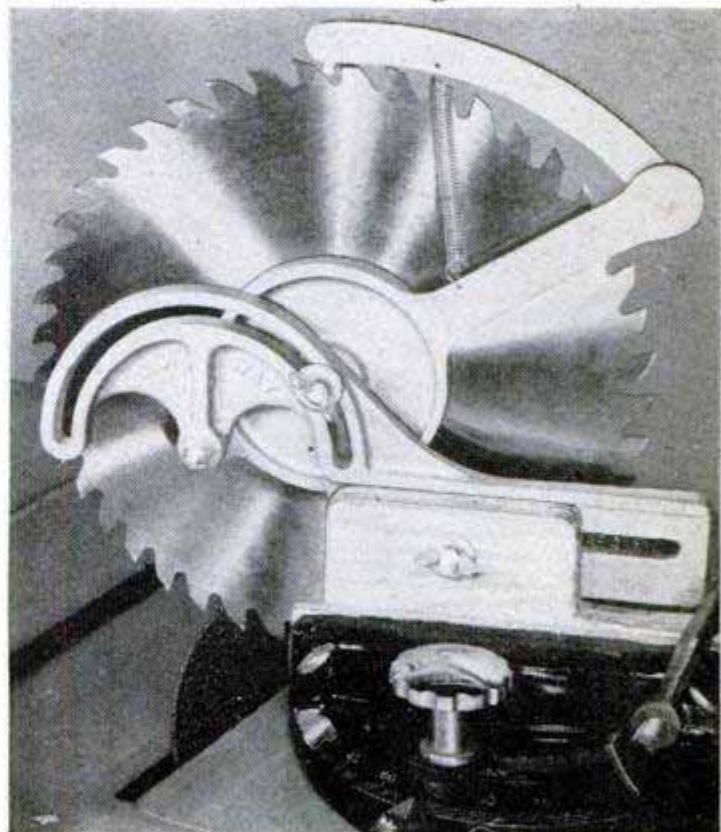

Fence Posts Pulled With Truck If Simple Fulcrum Is Used

Fence posts can be pulled quickly by using the simple device shown in the detail. A chain is attached to the frame of the truck and grab-hooked to the post just above the ground. Then a 4-ft. length of 4 x 4 is placed under the chain at approximately the angle shown to serve as a fulcrum. When the truck is driven forward, the post is pulled from the ground without damage. This method also may be used to pull shrubs and tree roots.

Hugh Lineback, Stillwater, Okla.



Marker for Measuring Tape Provided by Key Ring

Surveyors, real-estate men or farmers who have occasion to lay out equal divisions of a plot of land, such as when marking the positions of posts for a fence line, can save time and be assured of accuracy by using a measuring tape marked with a key ring. The latter should be the type illustrated and is simply slipped onto the tape over the number representing the distance between points. Thus, the number can be found quickly and the chance of error is eliminated.

Making Torque-Wrench Dial Easy to Read in Dim Light

To make a torque wrench easier to read in dim illumination, stick a narrow strip of tape on the lens of the dial directly in line with the zero mark. Then set the dial so that the needle points to the desired torque. In use, the correct torque will be applied when the needle reaches the tape.

Ed Packer, Chicago.

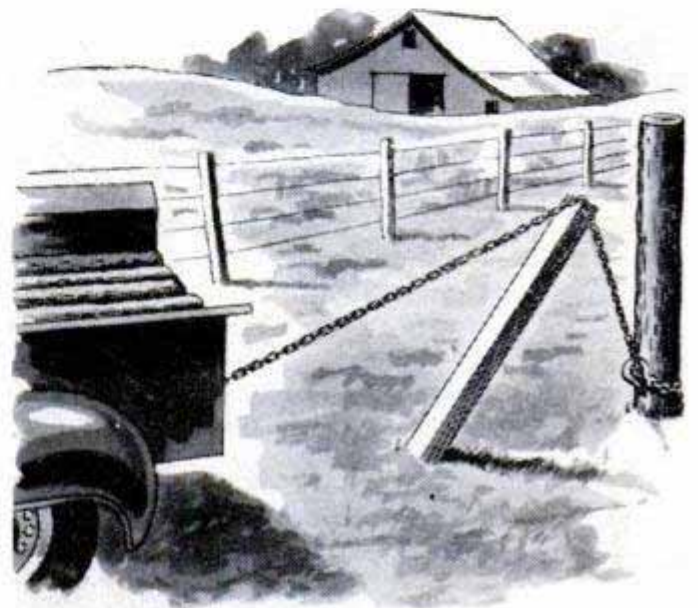
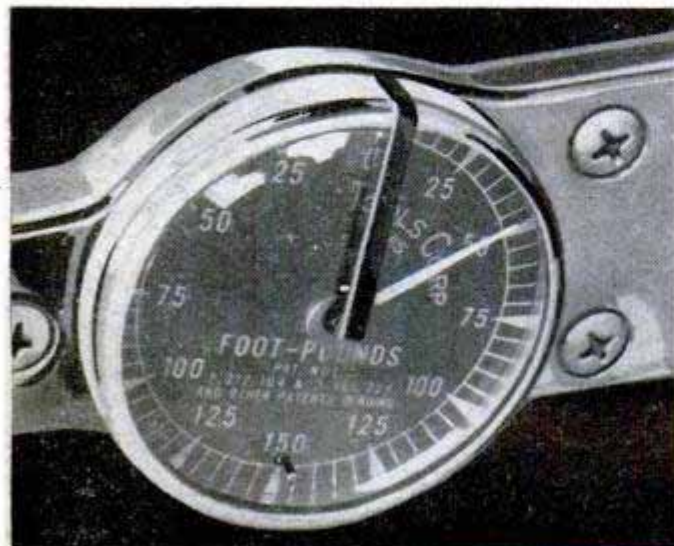

Extra Lathe Dog Checks Slippage When Taking Heavy Cuts

Slipping of work held by a single lathe dog when taking heavy cuts can be prevented by adding a second dog. Just mount it on the work in front of the original dog as indicated.

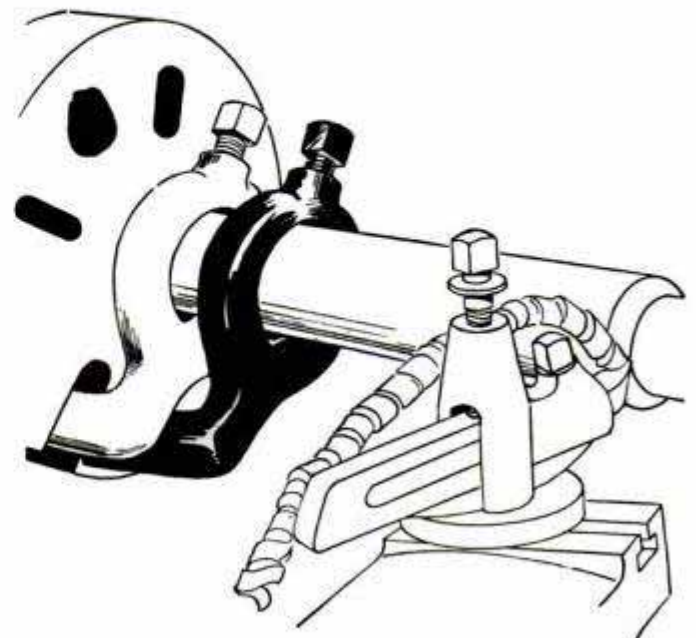



PRIDE IN PERFECTION

It is an inborn trait. The real mechanic thinks precisely. His materials and equipment must be flawless. He makes no compromise with quality in tools. He applauds perfection in the work of other artisans.

Pride in perfection. That is the reason Bonney wrenches are America's finest —unmatched for lightness, strength, balance, and precision.

Bonney wrenches are the pride of the men who make them . . . the pride of the men who use them.

BONNEY FORGE & TOOL WORKS
Allentown, Pennsylvania



Pride in perfection is exemplified in the precision ball and roller bearings produced by leading bearings manufacturers such as SKF, Timken, Fafnir, BCA, and Norma-Hoffmann.

Contributing to Industrial Progress since 1855

On July Fourth, 1855, a new industry was born. In his foundry in Chicago, R. T. Crane poured the molten metal to make the first Crane casting. America was on the threshold of a mighty era of progress—an era that would show dramatic advance in the development of power—in transportation—in industrial production. The valves and fittings manufactured by Crane Co. have played a vital part in the building of industrial America. Below are a few of the many fields that Crane has served for nearly a century.



IN OIL PRODUCTION—Coal oil for lamps—this was the petroleum industry in 1855. Crane piping has served in the mighty advances made in the production, as well as the refining, of oil and in the processing of the many petroleum by-products.

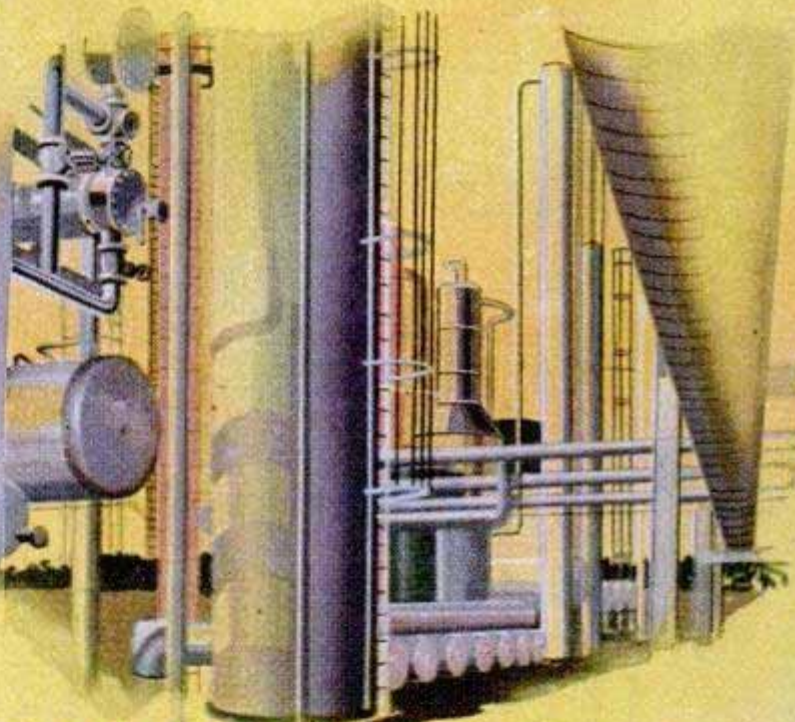

IN RAIL TRANSPORTATION—It's a far cry from the chugging little wood burner of 1855 to the slick streamlined diesel of today. On locomotives and in passenger cars, in shops and roundhouses, in fact, wherever piping is used, Crane Valves and Fittings are serving the nation's railroads.

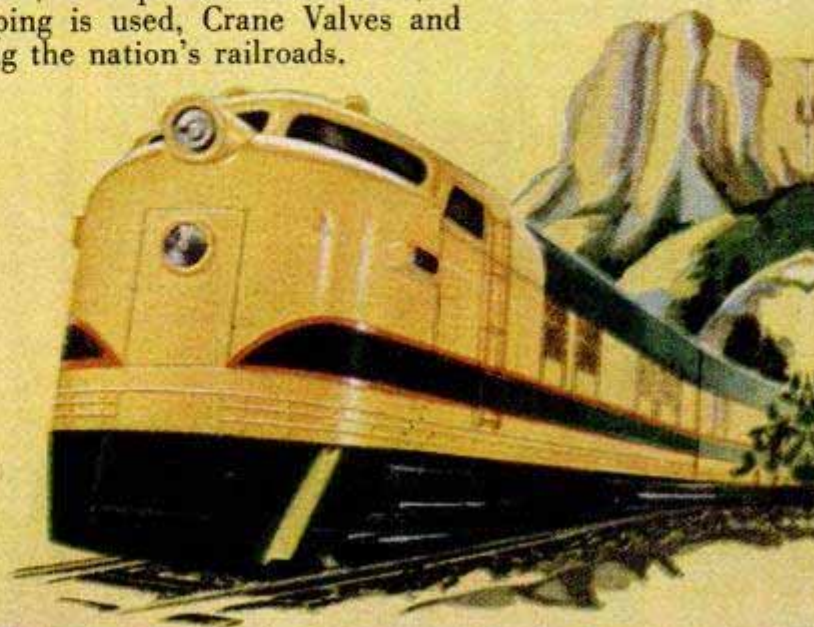
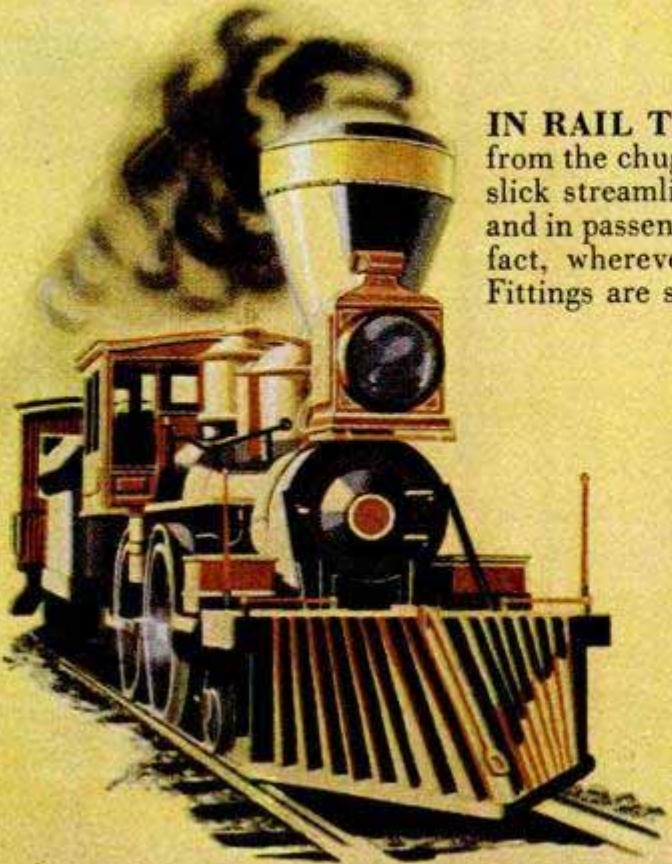

foundry, this company has grown to the world's largest supplier of pipe, valves and fittings. Crane products today are designed to handle and control the flow of air, gas, steam, and liquids in all industrial applications.



Crane Foundry 1855

Crane Chicago Works 1952

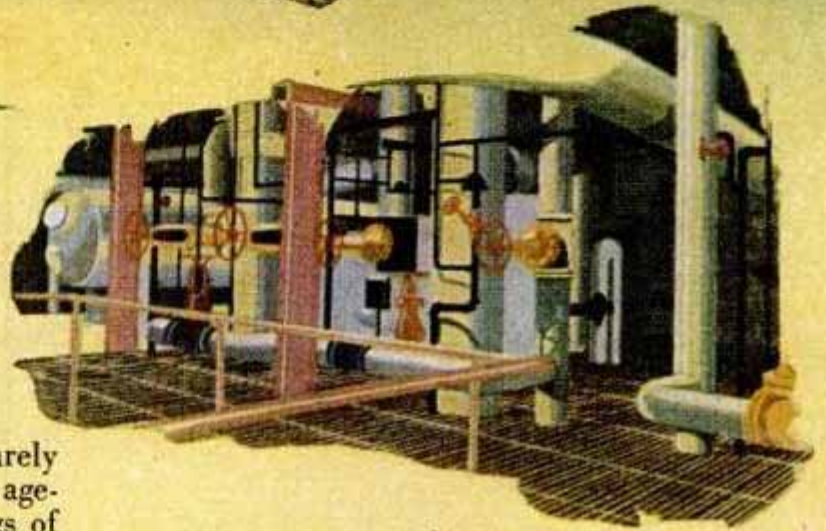

IN POWER—Manufacturing moved at a leisurely pace in 1855 when power was provided by the age-old water wheel. But already the first stirrings of the Industrial Revolution were creating a demand for more and more piping. This demand Crane has filled for almost a century.

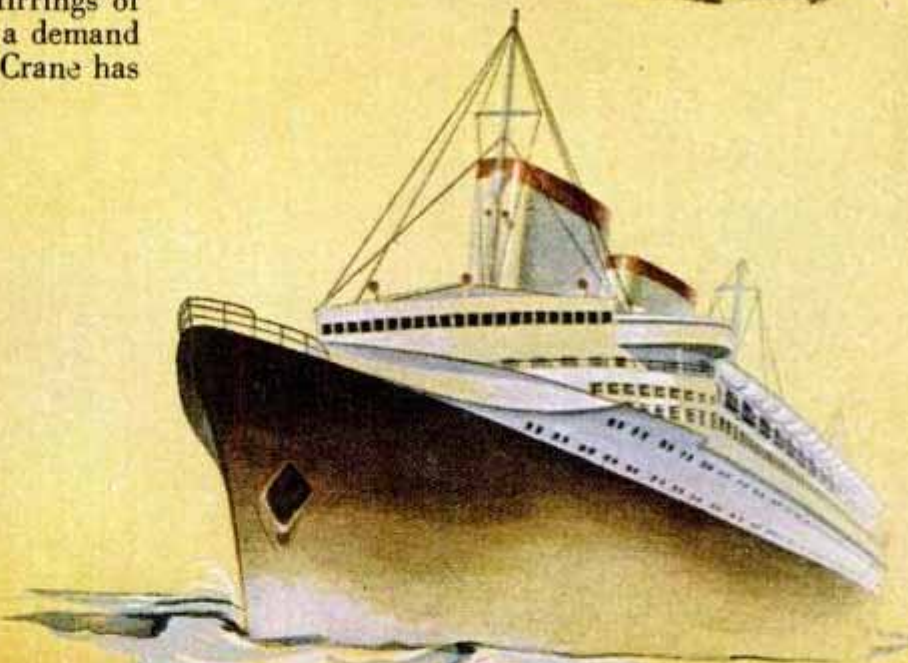

IN THE MARINE FIELD—The swift clipper was queen of the seven seas in 1855. Then the steam auxiliary brought the doom to sailing vessels. On tankers and freighters, stately luxury liners and Uncle Sam's fleet, Crane Valves and Fittings are helping carry American goods and American men to the four corners of the earth.

CRANE CO.

General Offices: 836 S. Michigan Ave., Chicago 5, Ill.

Announcing

Ultramodern

... with the versatile new Kodak Ektalux battery-condenser system

You'll find features galore in this sensational new lighting system for flash photography. Kodak Ektalux Flashholder, the basic unit, can be used alone, or with as many as six Ektalux Extension Units in perfect synchronization—B-C power from the Flashholder supplies all the energy.

Addition of the new Kodak Ektalux Solenoid permits you to use the accessory Remote Release for exposure control at a good distance from the camera.

And for cameras that have non-flash shutters, you get a complete external synchronizer by adding the Solenoid and Synchro-Switch to the basic Flashholder. Choice of brackets permits quick, rigid attachment of the Flashholder to practically any type of camera.

In all cases you benefit by the new pistol-

grip handle...the durable, light magnesium construction. Be sure to ask your Kodak dealer to put this versatile Flashholder system through its paces. You'll be amazed.

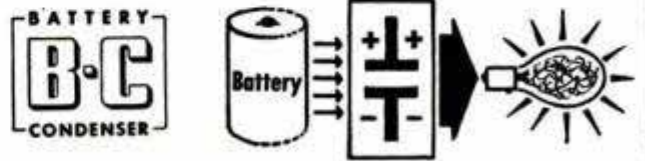

How battery-condenser power works

The B-C system brings to the Kodak Ektalux Flashholder a revolutionary new power supply. A small 22.5-volt photoflash battery feeds power to a condenser which stores the power until needed. The condenser then fires the lamp in a single surge *15 times as strong* as the force of the usual 1.5-volt flashlight battery. This uniformly high power surge insures flash performance of far greater dependability and scope than is possible with conventional battery operation.

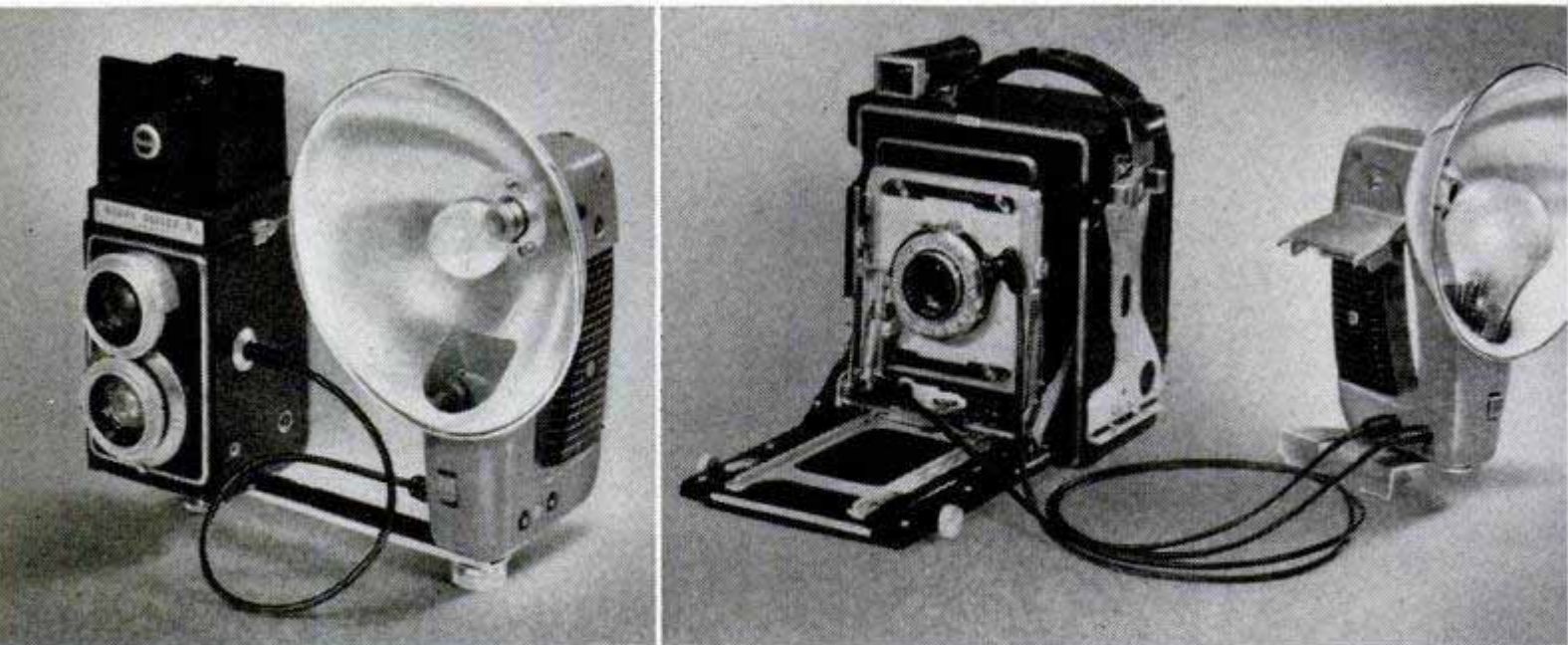

"Ektalux" quickly adapts to amateur or professional cameras

Use with practically any roll-film camera—Standard Bracket fits Ektalux Flashholder to most reflex, folding, or miniature cameras. For cameras that have built-in flash synchronization, no further attachments are required for this new high in dependable "flash" picture taking.

Ideal teammate for press-type cameras—By means of the Press Bracket, the Ektalux Flashholder can be fitted to most press-type cameras. Camera and Flashholder firmly lock together or detach quickly. A special bracket is also offered for the Polaroid Land Camera.

Flash

Kodak Ektalox Flashholder

- With Standard Bracket.....\$34.75
- With Press Bracket..... 39.50
- With Bracket for Polaroid Land Camera..... 35.75

ACCESSORIES EXTRA

Prices are subject to change without notice and include Federal Tax applicable when this advertisement was released for publication.

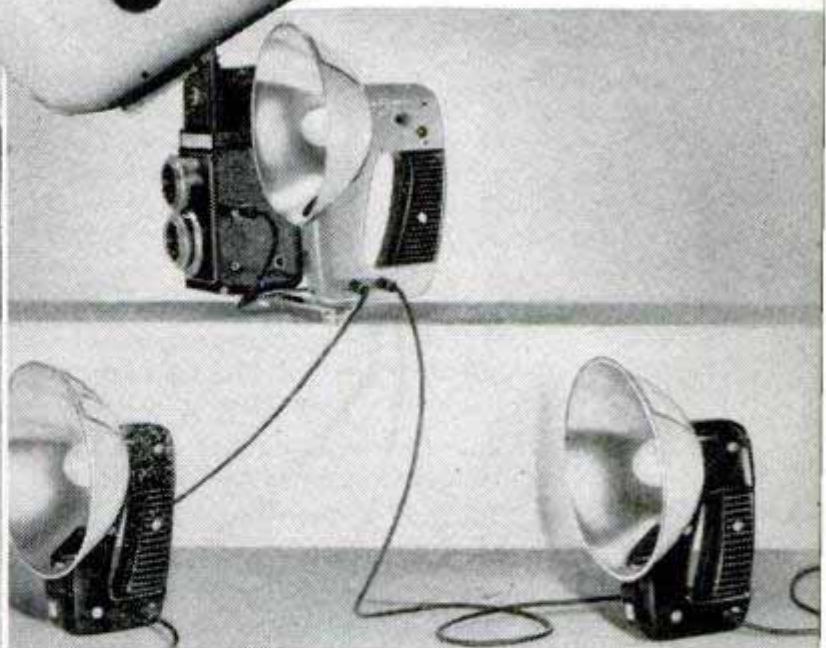
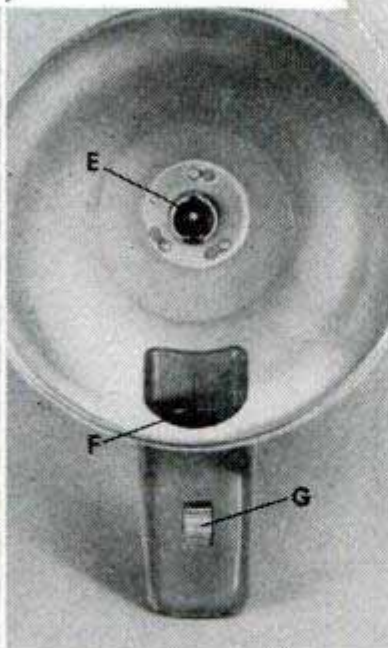
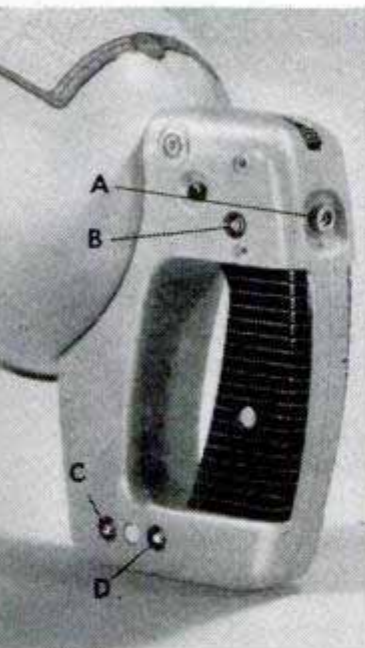

Accessory outlets are handy—Button **A** is Solenoid release that permits tripping shutter from Flashholder. Outlet **B** accepts the Remote Release. Outlets **C** and **D** take Extension Units. The entire system is series-wired.

Lamp system is flexible—For midget lamps, note socket **E**; provides for two-way focus. Ejector is in back. **F** is socket for medium-base lamp, with its ejector **G**. A handy exposure table is on back of reflector.

Outstanding choice for multiple flash—Extension Unit cords may extend to either side of the camera. Each unit can then be hooked to another unit. Units stand steady on flat surface. Socket in base fits tripod or Clamp. Removable reflectors nest; handles stack for storage.

Kodak

South Bend's

SENSATIONAL NEW

SMOOTHCAST REEL



Fast

Smooth



NYLON GEARS



Here's a sparkling new reel unlike any other you've ever cast. Its action is fast—smooth, quiet, free-running. Nylon gears and direct drive give this new SmoothCast Reel thrilling, sensational performance. Dual spool adjustments free it from backlashes. Corrosion resistant chrome steel frame with maroon plastic head ring. Weight 7.7 oz. No. 900 — \$22.50

2 OTHER MODELS!

No. 780 SmoothCast Reel — \$12. Another beautiful performer! Lightweight — only 5½ oz. Maroon finish. Aluminum alloy frame and spool.

No. 790 SmoothCast Reel — \$12. A sturdy reel for long, rugged service. Chrome plated brass frame and spool. Weight 8½ ounces.

Write for literature

**SOUTH BEND
BAIT COMPANY**
891 High St.
South Bend 23,
Indiana

SOUTH BEND
A Name Famous in Fishing

The Owners Report on the Buick

(Continued from page 214)

from the factory in Flint, Mich., to Kansas City, then over the Santa Fe Trail to Pueblo, Colo., and on to Denver, a distance of 1590 miles, which included some side-road testing. The model used was the Special four-door sedan with 128-horsepower engine, 121½-inch wheel base and Dynaflow-equipped.

The smallest car in the Buick line and the most popular in sales was better than any other Buick I've ever used in my previous tests. The car handled well, cruised nicely at 80 to 85 miles per hour, with a top speed of 98 to 100 miles per hour by speedometer — which, like most speedometers, was fast by about nine percent.

Steering is excellent with about the proper ratio, by American standards. A good "feel" of the wheel at all speeds is evident, and spring steering-wheel spokes reduce wheel vibration to a minimum. There was some steering-column vibration at about 75 miles per hour. Springing was a little soft on the front end. The rear end, with torque tube and coil springs, had a tendency to hop around a little and break away in high-speed cornering. I attribute this to heavy unsprung weight of torque-tube construction and coil springing. Heavily loaded, the car sometimes hit bottom on hard bumps. (I prefer leaf rear springs.) The ride is soft and comfortable and the driving position, as well as the vision, is good.

The Dynaflow (torque converter) is undoubtedly the smoothest in operation of all automatic transmissions, and has been improved since the first units were built. There is no evidence of abrupt gear change — no jerking, and the flow of power is even and smooth; the torque multiplies rapidly as the speed increases. You've heard of slippage in torque converters, and it's true about Dynaflow. Definitely, there is a noticeable slippage or "mushiness" when accelerating from zero to perhaps 40 miles per hour. This slippage is magnified by a rather loud accelerating "hum." While you do not get the sensation of a quick take-off, actually you are gaining speed faster than you think. Faster acceleration from zero can be had by starting in Low and shifting quickly to Drive at about 30 miles per hour without releasing the throttle. Dynaflow drivers can waste gas by improper handling of the throttle. The mileage a Dynaflow driver gets depends much on the lightness of his throttle foot. In accelerating from zero to 40 miles per hour, a wide-open throttle really is unnecessary and wastes

(Continued to page 316)

SLASH ENGINE REPAIR COSTS with

Nurlizing

Perfect Circle's
exclusive method of restoring worn pistons



Yes, Nurlizing reduces engine overhaul costs by making worn pistons re-usable—with *absolute safety*. And, that's only the *first* saving because Nurlizing permits closer piston fit, better lubrication and longer life.

Here's how: Nurlizing accurately and permanently increases piston diameter by displacing metal in the piston skirt in a regular pattern. Not only can the overall increase be precisely controlled but the increase in diameter can be varied to compensate for piston collapse or excessive wear. The resulting interrupted surface also provides small "reservoirs" for oil, assuring adequate lubrication at all times . . . closer fit is possible without danger of scuffing or scoring and piston slap is eliminated.

For better, more economical performance—for thousands of extra trouble-free miles—insist upon Nurlized pistons for your engine overhaul. See your Doctor of Motors or write Perfect Circle Corporation, Hagerstown, Ind.



Perfect Circle Nurlizing

Proved on the highways...



Why Permaglas

AUTOMATIC WATER HEATERS

outlast all others

Glass-surfaced Steel Tank. That's the secret of Permaglas water heater longevity!

It took years of research and experimentation before A. O. Smith engineers and

technicians perfected the glass surfacing that provides the ultimate in sanitation and protection for water heaters.

Glass surfacing withstands impact and thermal shocks... has the same expansion coefficient as the steel to which it is permanently fused!

Glass surfacing pays off in benefits for home owners all over America by giving them water heaters that *can't rust* because *glass can't rust*... eliminating stained bath-water, spotted laundry and ruined fixtures!

In **Permaglas** water heaters you get this positive protection from tank corrosion... the cause of frequent replacement... and at no extra cost, for *Permaglas*...



Heavy mallet blows cannot chip or crack the diamond-tough glass-surfaced steel.

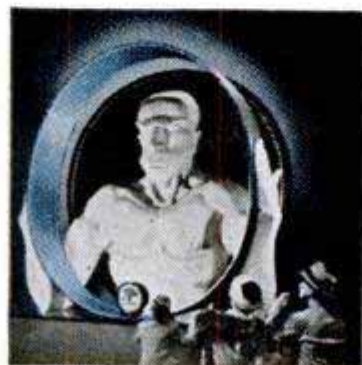

More than 2,000,000 bends by this mechanical giant, yet the glass-surfaced steel "ring" is good as new!



Sudden shock of ice cold or scalding water does not affect the glass surface of *Permaglas* water heaters.



Permaglas Automatic Water Heaters, 20 to 80 gallon sizes, are available in Electric, Gas and LP-Gas types.



COSTS NO MORE

THAN ORDINARY WATER HEATERS!

Contact the merchant plumber, appliance or utility company displaying this emblem and get the whole, interesting *Permaglas* story... or use the handy coupon, today.

A.O. Smith

AUTOMATIC WATER HEATERS



A. O. SMITH CORPORATION
Water Heater Division, Dept. PM-152
Kankakee, Illinois

Send me complete information on your *Permaglas* Gas Electric LP-Gas Automatic Water Heaters, including your illustrated booklet on "Ceromitron" Construction.

Name _____

Address _____

City _____ Zone _____ State _____

3 Ways to Handsome Hair! Right Now!



*Fights
Dandruff!*

*Relieves
Dryness
and Itching!*



*Grooms
Hair
Perfectly!*



Lucky Tiger grooms your hair perfectly. But it does a lot more besides. Lucky Tiger kills on contact the dandruff germ, *Pityrosporum ovale*, removes loose dandruff and gives your scalp a clean, wide-awake tingle. Treat your hair to all this, plus natural, greaseless grooming. Ask your barber, he knows.

LUCKY TIGER 3-PURPOSE Hair Tonic



Sold at all toilet goods counters.

gear unexpectedly as in some automatic units.

Six quarts of oil are carried in the converter (7½ quarts in 70 models) and Dyna-flow cooling is controlled by 1½ additional quarts of water capacity over regular-transmission models.

The eight-cylinder, in-line, high-compression (7.2:1), 128-horsepower Fireball engine is smooth and flexible and causes little vibration. The engine is, of course, OHV design, which Buick has used for 47 years. Even the first two-cylinder Buicks had OHV and Buick never has offered for sale any car without an OHV engine (they call it valve-in-head) under Buick name, but the firm did once offer a Buick-built Marquette with a side-valve engine.

The gear ratio of 3.6:1 (3.9:1 on Roadmaster) gives the car a nice cruising ratio, comparable to an overdrive on other makes. The engine is extremely quiet for OHV design, partly because of the hydraulic valve lifters. Pistons are aluminum alloy—Buick calls them “hump” and “depression” design—to shorten flame-wave travel, prevent ping and gain better combustion. They are good. Even with regular gasoline there was little pinging.

A unique flexible oil ring now used by Buick apparently helps in keeping oil consumption low, as my test showed that little oil was used.

The brakes are good, operate easily, but could have a little more pedal “cushion.” With no clutch pedal, I would prefer a wider brake pedal. The emergency-brake-lever operation is unusual in that it is controlled by the left foot, and the release is easy, by a knob operated by the left hand. Women especially will like this novel brake arrangement. Not a bad idea, either, as actually a Buick driver has two foot brakes in event of emergency.

The Fisher body is tight and solid. Very little body noise or rumble is heard at high speeds. Doors open and close nicely, but with a little harder pressure than seems necessary. The windows have a quick wind-up and that's good! I found no dust leaks and no water came in while driving 300 miles in the rain. No squeaks or rattles developed.

Whether or not you approve of the gaudy “sweepspear” outside-body design with lots of metal and chrome, it does offer good parking-lot protection when the driver of another car alongside swings his door recklessly, as some do.

The names “three holer” and “four holer,” as Buicks were referred to a while back, has given way to the more dignified term “fender ports.” The number of holes

(Continued to page 412)

"GOOD OLD DAYS"
were terrible

**J&L
STEEL**



IRON ROLLING MILL more than half a century ago from a painting by Adolph Menzel, loaned by Professor W. Trinks of Ohio, Pa.

FIFTY YEARS ago iron and steel workers had a 12-hour day, 7 days per week. They worked largely with their hands—and their backs—and earned a base pay of 14¢ per hour.

Today steel workers have an 8-hour day, 5 days per week. They operate huge modern machines that give them finger-tip control of thousands of horsepower—and earn an average base pay of \$1.36* per hour.

The quality of steel has greatly improved, too. Fifty years ago there were only two steels—"mild" and "hard." Today steels are "tailor-made" with a different grade for almost every application.

The same pattern of progress applies to other workers and products in other industries. Powerful machines make it possible for Americans to produce more goods per hour worked than any other workers anywhere.

*December, 1951

The secret of America's success is America's ability to produce. And the secret of America's ability to produce is the genius of Americans to invent machines and the willingness of industry to invest huge sums in their purchase, so that *men can produce more in less time with less effort.*

Money to pay for these modern machines comes from one source and one source only—*profits.*

If any group of players on the shareholder-worker-management team demands too much of these profits for its share—or if the referee, Uncle Sam, takes too much in taxes, the ability to buy new machines vanishes and we stop progressing.

The next 50 years can be the greatest in our history—if we all work together.

If anybody tells you we should return to the good old days—tell them the good old days were terrible.

JONES & LAUGHLIN STEEL CORPORATION

Announcing the Great New '52

With Spectacular Dual-

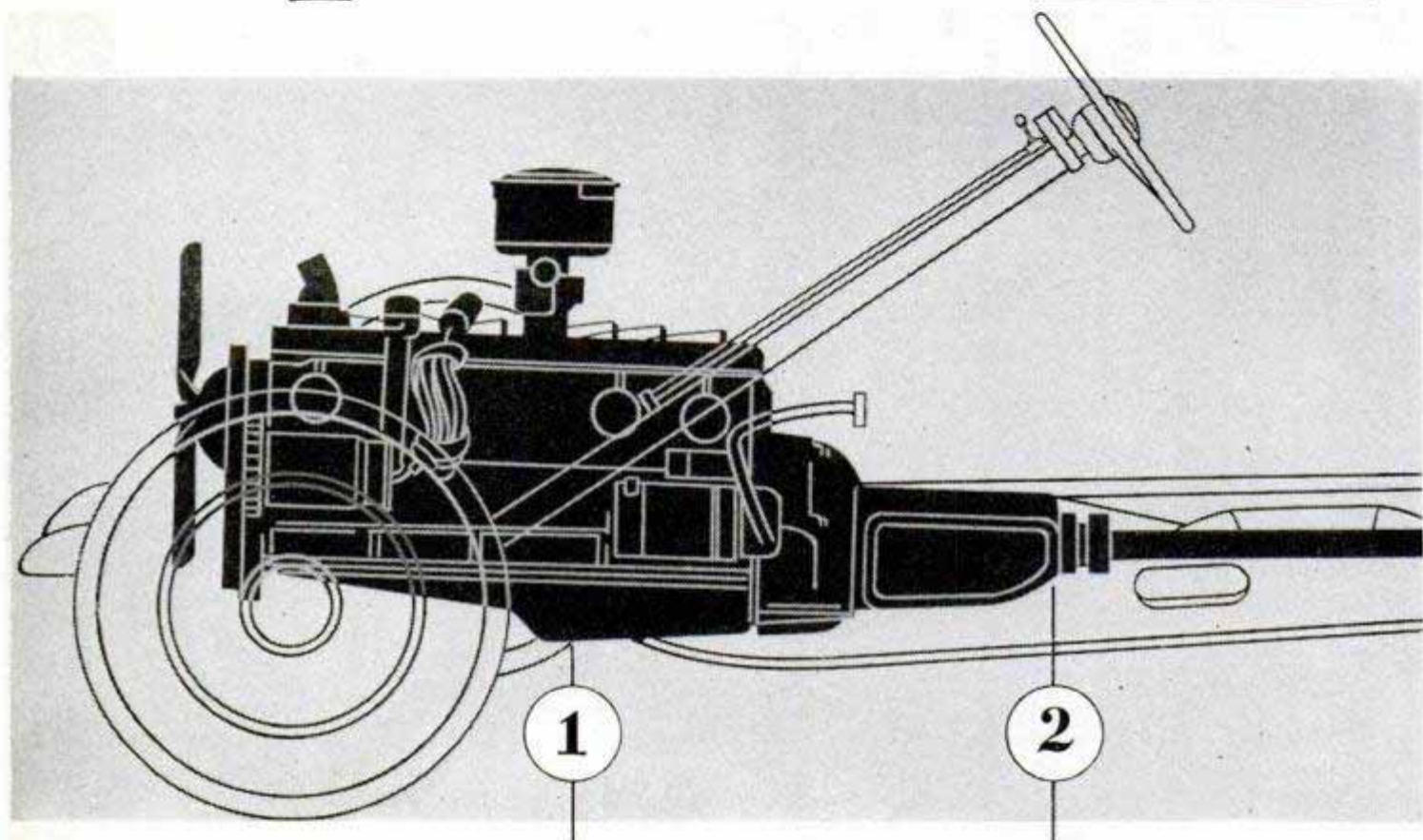

THE POWER YOU WANT • WHEN YOU

You'll be hearing a lot about the great new '52 Pontiac with Dual-Range Performance. It's an exclusive engineering advancement that combines Pontiac's powerful, high-compression engine with new Dual-Range Hydra-Matic* and a new economy axle. The results are nothing short of *spectacular!*

With this new "power train" Pontiac offers finger-tip control of two different driving "ranges." One brings amazing

new acceleration and flexibility in congested traffic *and* increased engine braking ability for steep grades. The other offers improved gasoline economy for highway cruising, quieter operation and a feeling that approaches "coasting."

Pontiac is not only the *first* car to bring you this amazing development—it is the *lowest-priced* car to offer it for 1952! Better see it and drive it yourself!

*Optional at extra cost.

SEE YOUR NEAREST PONTIAC DEALER

Pontiac

Range Performance!

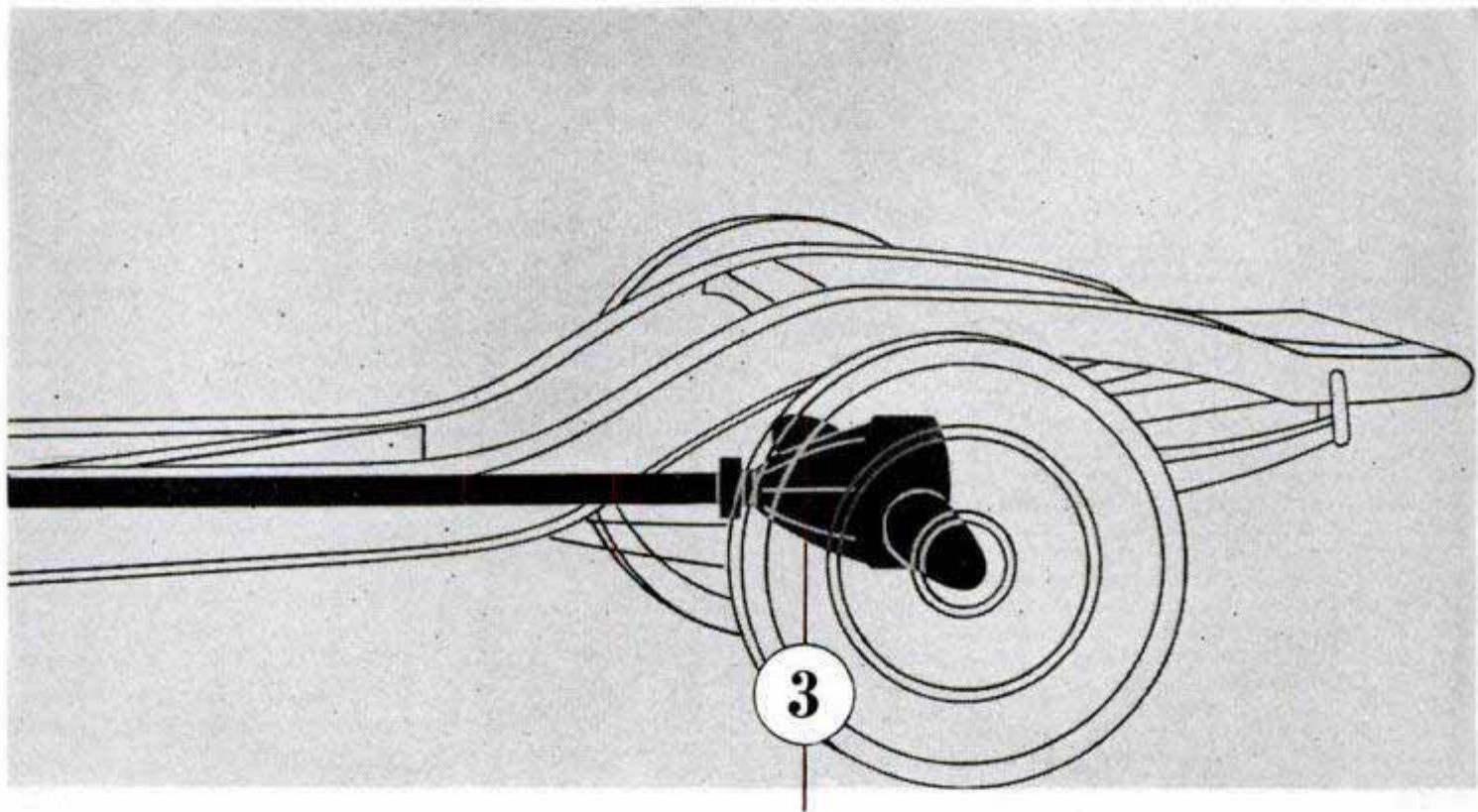

WANT IT • WHERE YOU WANT IT

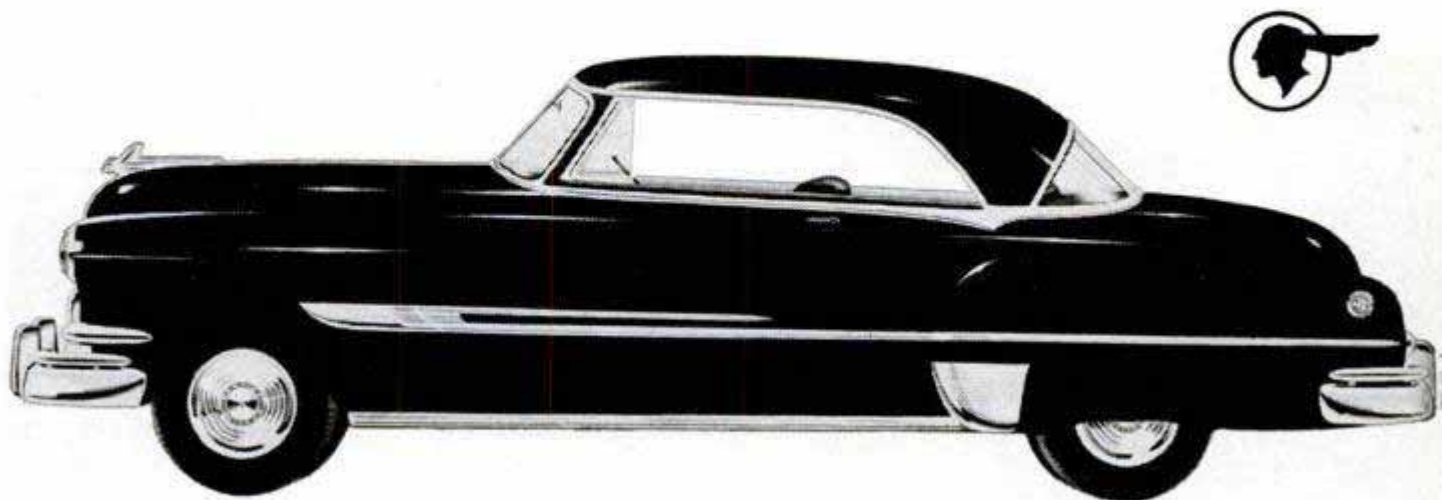

DOLLAR FOR DOLLAR YOU CAN'T BEAT A '52 PONTIAC!

INSTALL IT YOURSELF

RA-TOX FOLDING DOOR



GIVE YOUR HOME MORE ROOM and NEW BEAUTY THIS *Low Cost-Easy Way!*

With Ra-Tox Folding Doors alone, you can work near-miracles in your home. For greater useful room area, save the space now wasted by swing-type doors; Ra-Tox Doors hang from overhead track and fold to side. If you want to give rooms a definite glamour and really new look . . . there's nothing equal to Ra-Tox Doors. Harmonize with any room design. Made of woven wood slats. Supplied complete with all hanging hardware and finish painted. Your choice of ten colors or Natural wood finish. Easily installed in few minutes time. Simply screw track overhead, and hang door from track.

UNIQUE FEATURE . . . slat construction lets air pass through door. Perfect for wardrobe and clothes closet ventilation. Ends moisture condensation and musty air . . . permits air flow for proper heating and air conditioning.

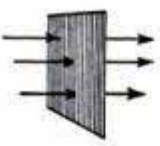

CUTS NEW CONSTRUCTION COSTS
Here's typical clothes closet construction. Ra-Tox Doors eliminate costly door wall. Hang Ra-Tox Door from wall to wall and ceiling to floor. Makes closet interior easy to build no cramped area for wall finishing.

Ra-Tox Folding Doors are supplied in any door or room divider size. Now used everywhere by builders and architects. Easy installation. Low cost . . . meets any budget. For home remodeling . . . and savings in new construction, use Ra-Tox Folding Doors. For sale at Building Material Dealers or Lumber Yards . . . or send 10c for Ra-Tox Door Bulletin.

THE HOUGH SHADE CORPORATION
Ra-Tox Division • Janesville • Wisconsin

FOR WARDROBE • CLOTHES CLOSET • BETWEEN-ROOM DOORS



AND ROOM DIVIDERS

Tomorrow's Electronic Barbershop Quartet

(Continued from page 240)

not used, there would be a noticeable "thump" at the beginning of each note.

The RCA 884 tube in the console units requires an octal socket. Three Jones connectors, type S-306AB (sockets), and four Jones connector P-306AB (plugs) are required for the playing consoles. Eight six-terminal mounting strips are also needed. One Jones S-306CCT socket is required for the amplifier cable. All other parts are listed above Fig. 9.

Several interesting facts have developed from playing and experimenting on this instrument. First, although steady tones without vibrato are desirable in some kinds of music, a much more "live" effect can be obtained by wobbling the pitch control smoothly through a small range above and below the position of true intonation. This corresponds to the vibrato used in playing a violin or trombone, or occurring naturally in the human voice. This motion, as may be guessed, accounts for the name "wobble organ."

The pitch control, or wobble arm, is operated by the right hand of the player in relation to the musical-scale designations on the sloping "scale quadrant." These designations need be used only as a rough guide, but they are of great value even to an experienced player in making rapid and accurate changes over large musical intervals. Accurate intonation and blending of the four "voices" depend upon the players' musical ear and judgment. Operation of the tone source or oscillator is not continuous; each one can be turned on and off at will by the performer; the instrument is normally silent. Oscillation is started by a slight downward pressure of the player's left hand on the "dynamics" knob shown at the left front of the console, Fig. 1. This pressure closes a contactor (the simple sheet-brass cantilever spring switch, K1) detailed in Fig. 7 thus applying plate voltage to the oscillator. This permits the player to use a "portamento" between notes (leaving the tone on) or "detache" (momentarily interrupting it), as desired. The volume of the sound delivered by the individual console to the common speaker is also under the control of this knob, which can be turned as well as pressed by the player's left hand. The rotation can be calibrated in musical symbols, *pp*, *p*, *mp*, *f* and *ff*, indicating different degrees of loudness; these are not indicated in Fig. 1. The switch action (K1) is obtained by simply mounting the potentiometer near the free end of

(Continued to page 324)

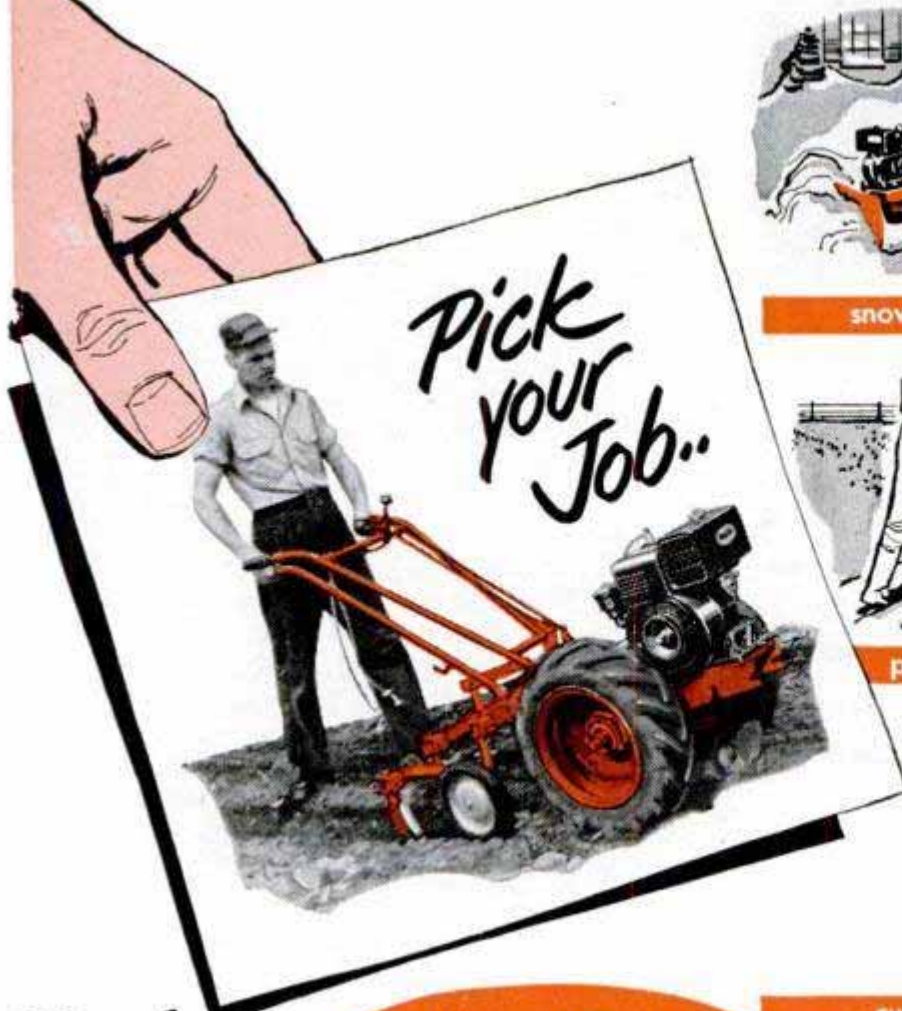

snow removal



auxiliary power



plowing



disc harrowing



ride while you work

Do it WITH **Simplicity**
3 H.P. 520 2 H.P. 415

Owners *everywhere* know that EVERY MONTH is a LABOR-**SAVING MONTH** for a Simplicity with implements. Versatile and reliable, Simplicity makes light work of a multitude of hard jobs (and patented "Quick-Hitch" allows implement changes in less than a minute, *without tools!*) Does so much—it quickly pays for itself in savings of time and work.

THE RIGHT TRACTOR FOR EVERY JOB

3 H.P. Model M-1—5 speeds forward. Fully enclosed gears.

2 H.P. Model L-1—Same features as the M-1 . . . designed for lighter work.

52-week Utility • 28-way Versatility



Discover these benefits for yourself—write for **FREE ILLUSTRATED FOLDER** and for the name of the Simplicity dealer nearest you or see the classified section of your telephone book.

Simplicity America's **NO. 1** Garden Tractor

Simplicity Manufacturing Company
 5201 Spring St., Port Washington, Wis.



lawn mowing

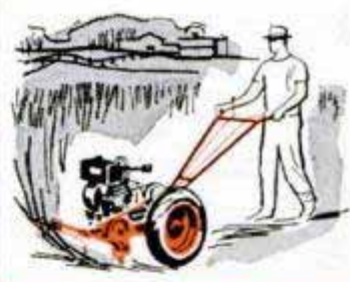

weed cutting



hauling



grading



felling trees



sawing cordwood

In the Home, as in Industry, the choice is **WISS METAL SNIPS**

The superior quality of famous **WISS** Metal Cutting Snips has made them the first choice in the home and in industry. Every pair is rigidly tested and guaranteed to cut easily and efficiently for an unusually long time. Carefully adjusted blades are set precisely to reduce wear and permit maximum cutting power with a minimum of effort.

WISS METAL MASTER COMPOUND ACTION SNIPS



Compound leverage produces amazing cutting power with minimum effort. Will cut holes, circles and complicated patterns in metals to 18 gauge. Rubber grips recommended. M-1 (Cuts Left) 10" long; M-2 (Cuts Right) 10" long; M-3 (Cuts Straight) 10" long; M-5 (Bulldog Combination) 9 $\frac{1}{8}$ " long.

WISS SOLID STEEL STRAIGHT CUTTING SNIPS



Economical in price, these snips meet government specifications. Made of a specially selected grade of solid tool steel. For general metal-cutting. Four sizes, 8" to 12 $\frac{1}{4}$ " long.

WISS SOLID STEEL COMBINATION SNIPS



Will cut straight, curves or irregular shapes with ease. Two sizes, 7" and 13" long.

J. WISS & SONS CO.
NEWARK 7, N. J.



the flat cantilever spring, the fixed end of which is screwed to the underside of the console top as indicated in Fig. 7. A downward motion of about $\frac{1}{32}$ in. brings the free end into electrical contact with a fixed metal detail that also limits the travel. The tuning adjustment compensates for temperature variations. This tuning knob is readily adjustable by the player's left hand while the corresponding wrist presses down the "dynamics" knob and his right hand aligns the wobble arm with the scale mark (such as "middle C") corresponding to the pitch of the reference source to which he wishes to tune.

It may be noticed in Fig. 1 that the scale quadrant is calibrated with high notes toward the left and low notes toward the right. This comes about because logarithmic potentiometers having a left-handed taper are not commonly stocked in suitable sizes. Although players quickly become accustomed to this arrangement, it has been found that most of them would prefer to have the scale changed to match the convention of the piano keyboard, and of course this can be done by ordering special left-handed units.

Experience has been obtained both with family groups playing for their own entertainment, and with quartets well rehearsed for public performance. Some solo work has also been done using a single console with piano accompaniment. In every case enjoyment and recreation value have been strikingly evident. Even two professional symphony players who took part in one of the quartets were highly entertained, and incidentally behaved like amateurs in that they played awkwardly at first but improved very rapidly. The music used has varied from simple "rounds" and folk songs to Bach chorales. Although no suggestion is intended that the wobble organ may ever join the ranks of the serious musical instruments, nevertheless it can do things with Bach that are actually rather satisfying. It has a voicelike quality, and yet overcomes certain vocal restrictions. The soprano never has to strain for the high passages, the alto cannot possibly run short of breath, the tenor never cracks and the bass has power at his command for his very lowest note in this electronic barbershop quartet. Volume control R7 in the audio amplifier permits adjusting the instrument for any size room up to a fairly large auditorium.

This Wobble Organ is covered by Meacham patent No. 2544466 but may be built by (or for) you for your own use. Permission to build this electronic device or copy these plans for resale purposes is NOT granted.

something you didn't know

about OUTBOARD MOTORS

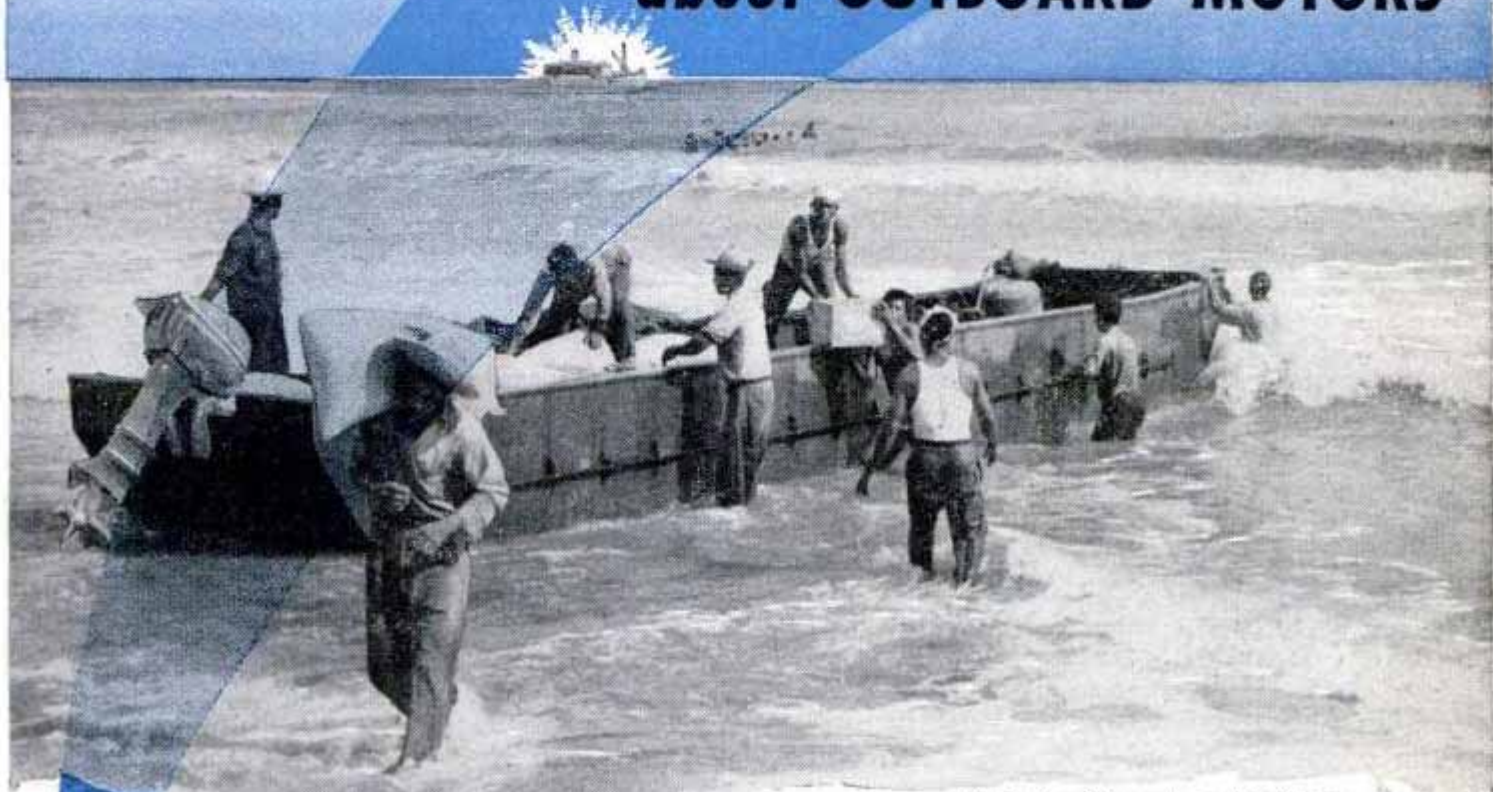

Lightering Cargo from Freighter
on an Unprotected Coast

SURE... they're used "for fun" ... the outboard motors millions see in familiar everyday service. They power the boats of fishermen and vacationers. They drive sleek runabouts ... tow water skiers ... take families picnicking ... perform any number of similarly pleasant tasks.

But such service is only *part* of the picture. Actually, hundreds of thousands of outboards *work for a living*. Outboard motors were "born into hard labor." Not sportsmen, but hard-bitten toilers of the sea were first to sense the real importance of the "outboard idea." 42 years ago it was their orders, scrawled in many languages, that made Ole Evinrude's struggling enterprise a solid success ... and established a new American industry!

Today 23% of all outboards, (Department of Commerce estimate) are in *commercial service*. *Essential serv-*

ice, for, wherever shallow water may be encountered, *there is no satisfactory, economical substitute for outboard motors!*

Small cargo lighters, freighters, ferries are widely powered with outboards. And commercial fishing boats in vast numbers. And rescue boats, police boats, construction tenders. Thousands are in round-the-clock service in many of the country's most productive oil fields.

Even "pleasure" outboards render vital service. In every major flood catastrophe the call is broadcast, "Outboards ... send more outboards." And outboards play their part in national defense ... in World War II they served in all branches of our armed services ... the historic crossings of the Moselle, Roer, and Rhine were made in swift storm boats driven by powerful Evinrude Motors.

Our experience in the use of outboard power for work-boat duty is available to all commercial boat operators. Write

EVINRUDE MOTORS
4730 N. 27th St., Milwaukee 16, Wis.
In Canada: Evinrude Motors, Peterborough, Ontario

EVINRUDE
OUTBOARD MOTORS



Fifty Years Hence

(Continued from page 145)

and form helium, it would suffice to drive a 1000-horsepower engine for a whole year. If the electrons—those tiny planets of the atomic systems—were induced to combine with the nuclei in the hydrogen, the horsepower liberated would be one hundred and twenty times greater still. What is lacking is the match to set the bonfire alight, or it may be the detonator to cause the dynamite to explode. The scientists are looking for this.

The discovery and control of such sources of power would cause changes in human affairs incomparably greater than those produced by the steam engine. Schemes of cosmic magnitude would become feasible. Geography and climate would obey our orders. Fifty thousand tons of water would, if exploited as described, suffice to shift Ireland into the middle of the Atlantic. The amount of rain falling yearly on the Epsom race course would be enough to thaw all the ice at the arctic and antarctic poles. The changing of one element into another would transform all our standards of values. Materials thirty times stronger than the best steel would create engines fit to bridle the new forms of power. Communications and transport by land, water and air would take unimaginable forms if, as is in principle possible, we could make an engine of six hundred horsepower weighing twenty pounds and carrying fuel for a thousand hours in a tank the size of a fountain pen.

Wireless and television would enable their owner to connect up to any room similarly equipped and hear and take part in the conversation as well as if he put his head in through the window. The congregation of men in cities would become superfluous. There would be no more object in living in the same city with one's neighbor than there is today in living with him in the same house.

Up till recent times, the production of food has been the prime struggle of man. That war is won. There is no doubt that the civilized races can produce or procure all the food they require. But food is at present obtained almost entirely from the energy of sunlight. Radiation from the sun produces from the carbonic acid in the air carbon compounds which serve people in plants and vegetables. We use the latent chemical energy of these to keep our bodies warm, we convert it into muscular effort. We employ it to replace the wasted cells of our bodies. Many prefer food in what the vegetarians call "the secondhand form," i.e., after it has been digested and convert-

ed into meat by domestic animals. In all these processes, however, ninety-nine parts of the solar energy are wasted for every part used.

Great improvements are probable here. Microbes, which at present convert the nitrogen of the air into the proteins by which animals live, will be fostered and made to work under controlled conditions. New strains of microbes will be developed and made to do a great deal of our chemistry for us. With a greater knowledge of hormones, the chemical messengers in our blood, it will be possible to control growth. We shall escape the absurdity of growing a whole chicken in order to eat the breast or the wing, by growing these parts separately. Synthetic food will, of course, also be used. Nor need the pleasure of the table be banished. That gloomy Utopia of tabloid meals need never be invaded. The new foods will be practically indistinguishable from the natural products from the outset, and any changes will be so gradual as to escape observation.

If the gigantic sources of power become available, food would be produced without sunlight. Vast cellars, in which artificial radiation is generated, may replace the cornfields and potato patches. Parks and gardens will cover our plowed fields. When the time comes, there will be plenty of room for the cities to spread themselves.

But equally startling developments lie just beyond our fingertips in the breeding of human beings and the shaping of human nature. It used to be said of scientific progress: "You have taught the dog more tricks, but you cannot alter the breed of the dog." This is no longer true. A few years ago London was surprised by a play called *Rossum's Universal Robots*. The production of such beings may well be possible within fifty years. They will not be made, but grown under glass. There seems little doubt that it will be possible to carry out the entire cycle which now leads to the birth of a child, in artificial surroundings. Interference with the mental development of such beings, expert suggestion and treatment in the earlier years, would produce beings specialized to thought or toil.

Silver-Plating With a Cloth

Copper, brass and bronze surfaces can be silver-plated by rubbing them with a cloth dampened by a special liquid. The liquid deposits a coating of genuine silver in a few seconds. Worn areas on old silver-plated objects can be covered with the coating, and new objects completely silver-plated. An eight-ounce bottle of the liquid plates about 4800 square inches.

Bite's Out

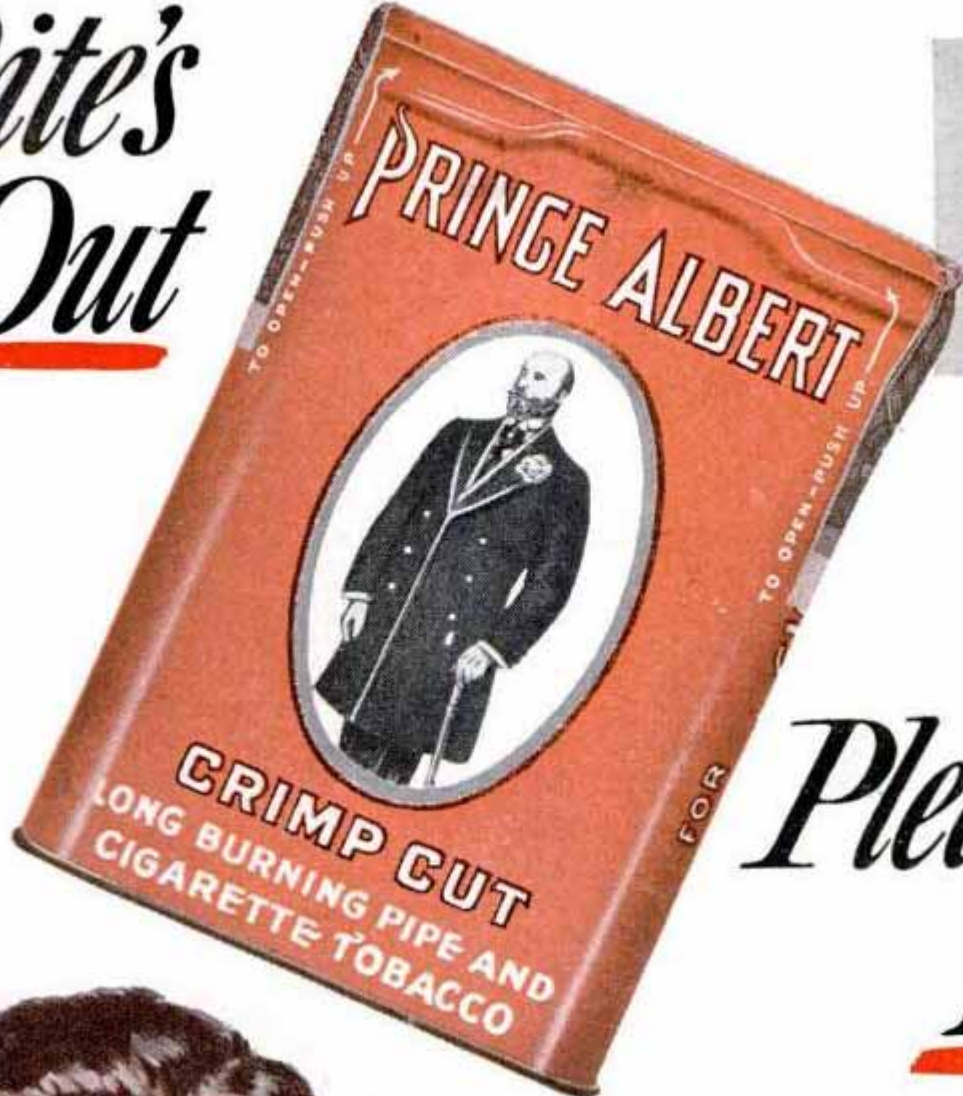

*the
National
Joy Smoke*

Pleasure's In



**— AND THERE'S MORE TOBACCO IN EVERY TIN!
Prince Albert's patented* "no-bite"
process means real smoking comfort**

... Prince Albert is made to give you more smoking enjoyment than any other tobacco! P.A. is specially treated to insure against tongue bite. Rich-tasting and mild... No wonder it's the big favorite with roll-your-own smokers and pipe smokers alike!

*Process patented July 30, 1907

MORE MEN SMOKE

Prince Albert

THAN ANY OTHER TOBACCO



R. J. Reynolds
Tobacco Company
Winston-Salem, N. C.



National Sanders



A Complete Line...

**ELECTRIC OR AIR DRIVEN
STRAIGHT LINE OR ORBITAL ACTION**

Superior tools for sanding and rubbing plastic, wood, metal, stone, or leather. National Air and Electric Driven Block Sanders are in use in industries throughout the world.

LIGHTWEIGHT—VIBRATIONLESS

Write for...

FREE—Illustrated—20 page catalog on sanding methods and equipment! Ask for Bulletin A.



**NATIONAL AIR SANDER, INC.
2820 AUBURN ST., ROCKFORD, ILL.**

Greatest Show in Wax

(Continued from page 222)

sizes, shapes and colorings carefully. Placing the eyes is precision work that requires accuracy to .001 inch. The eyes are heated and, through the hollow neck and head, are brought up into position. Cotton and wool wedge sticks are the only usable tools outside of the human hands. When the wedge tools, held like chopsticks, fail, the artist must manipulate the burning-hot eyes into the wax. Tussaud's finger tips are frequently glassy from burns.

Another unpleasant job is planting hair in the bald wax heads of subjects. Tussaud is glad he can sit this one out. Vera Bland, another skilled artist, has handled the tonsorial department since 1930. Working from photos, Miss Bland, using a blunt, thin-bladed knife, inserts each hair individually, working within three inches of an electric bulb that heats the wax. Once the wax cools, the human hair set in by Miss Bland is as hard to pull out as the variety that really grows.

It usually takes her about a week or 10 days to insert hair, eyelashes, brows and mustaches. General Eisenhower, with his sparse growth, took less than a week, as did England's Field Marshal Montgomery. Joseph Stalin, a problem to the entire world, was no small one to Miss Bland, who had difficulty finding the right color and texture of hair, and then spent three weeks planting the Russian's hair and thick wiry mustache. Tussaud's never tries to fake. Under beret, hat or shawl, each figure has a complete head of hair—that is, assuming he or she has one in real life.

An equal amount of attention is paid to getting the subject's teeth to seem natural. Wax impressions similar to those made by dentists are taken of the person's teeth and his mouth formation. Teeth, like eyes, are inserted from within, through the neck.

Before the head is ready to join its plaster-of-paris body equipped with wax limbs and hands, it must have the proper skin coloring. Complexions are made by means of special pigmentary water colors known only to insiders at the museum. How far Tussaud's goes to re-create subjects accurately is shown in Miss Bland's method for duplicating a shadow beard. With a knitting needle, she pricks small pores into skin in the beard area and artfully rubs in blue paint. Flesh color is put over this, and the result is just short of five o'clock shadow.

Ever since Madame Tussaud herself operated the museum, it has been a custom for subjects to offer suits or dresses from their own wardrobe to clothe the wax

(Continued to page 330)



New portable radiotelephone, of less weight but longer range, designed and built by RCA engineers.

*Longer range, but lighter weight
for the "Take-along Radiophone"*

You've read how useful our Armed Forces found their portable "walkie-talkie" radiotelephones. But now this almost indispensable military instrument has become even more efficient.

At the Signal Corps' request, RCA engineers undertook to streamline the older, heavier model—which many a soldier of World War II called "the backie-breakie." Following principles of sub-miniaturization—pioneered at RCA Laboratories—every one of its hundreds of parts was redesigned. Models were built, tested, rebuilt, and finally

RCA came up with an instrument weighing only 29 pounds. Its range is double that of the World War II model.

Even more important, under present conditions, RCA was able to beat the most optimistic estimate of the time needed to design such an instrument by nearly three months. Signal Corps engineers have called this "A major engineering and production achievement."

* * *

See the latest wonders of radio, television, and electronics at RCA Exhibition Hall, 36 West 49th Street, New York. Admission is free. Radio Corporation of America, RCA Building, Radio City, New York 20, New York.



RADIO CORPORATION of AMERICA

World Leader in Radio — First in Television



Care and Feeding of Engines

BY S. P. CORP

PLUG YOUR LOSSES

When a cylinder block is cast, large holes are provided in the side of the casting for cleaning. These holes are stopped up with plugs known as expansion plugs or Welch plugs. They are about two inches in diameter,

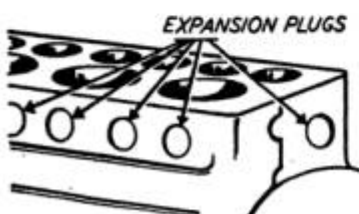

and are forced into position to keep water from leaking out. At times they do leak, and you lose expensive anti-freeze.

To remove one of these plugs, drive a small punch into its center, which will dish the plug so it falls

out. Clean the hole of all rust and dirt. Make sure new plug is free of sharp edges. Fit new plug into its seat in the engine block, curved side out, and expand it by flattening it with a blunt drift and hammer. A good sealing compound may be placed around plug before installing. Check engine for water-tightness.

MUSTN'T BE TOO TIGHT

Don't draw a cylinder head down too tight, or it may cause engine to pump oil. When checking engine head for winter operation, use a Torque wrench to make sure all cap screws and nuts are tightened evenly. Center cap screw or nut should be tightened first, then next row on each side, as in diagram.

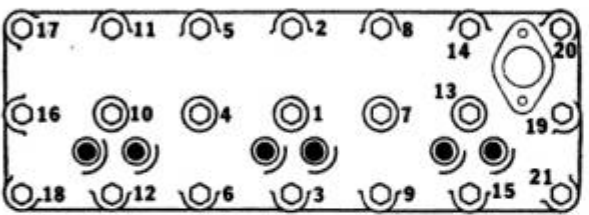

This method will iron out the head gasket, preventing leaks and distortion. Apply 65-70 foot-pounds of pull for cap screws and 50-60 for cylinder head nuts.

IF YOUR CAR DRINKS TOO MUCH

An engine that uses too much oil needs new Sealed Power piston rings. The Sealed Power MD-50 Steel Oil Ring does the world's best job of oil control, even in badly tapered and out-of-round bores. Your dealer has Sealed Power Rings or can get them for you. They save gas, save oil, restore original power to your engine and lengthen its life. A postal to "Sealed Power, Dept. G-1, Muskegon, Mich." will bring you free a helpful book, "7 Ways to Save Oil."



models of themselves. Shortly after World War II, President Truman sent over a double-breasted suit, a light-blue poplin shirt, and a dark-blue tie with narrow stripes by means of a high-salaried delivery man who was in the U. S. at the time—England's Prime Minister Attlee. The famous and the infamous in recent world history were only too glad to ship Tussaud's a military uniform to keep their wax facsimiles decent—Adolf Hitler, Hermann Goering, Joseph Stalin and even Marshal Tito. Tussaud's makes such arrangements through foreign embassies.

Often a celebrity contributes a new suit that he has never worn. Either he is asked to break it in for greater realism, or the museum has one of its employees of comparable size wear the suit until the new, stiff look is gone.

Even though shortages have eased up somewhat in Britain, Tussaud's is still operating along austerity lines—not wasting any of the precious materials of which the noted and notorious persons are made.

Once the plaster-of-paris head molds have been made, used and stored, the original clay from which their impressions were taken is sliced up and beaten down for future use. Wax hands that become broken or damaged beyond repair are saved to be melted for reuse. Old heads are broken up to be melted down for new. And, of course, the glass eyes are removed, cleaned, graded for size and color, matched for pairs and sorted into their proper boxes.

Tussaud's, with a reputation for salvaging everything but the souls of wax figures, cannot reclaim hair. This is strained from molten wax and discarded. During the war and immediately after, the museum had quite a time staying with its custom of using only real hair, rather than wigs. The main source was women and men in rural areas on the continent.

Museum executives will never forget the time and money it cost to present the wax model of a U. S. war hero, Admiral Stark, with his proper growth of thick hair. All of London was scoured for the needed fine, white variety, the hardest kind to get, that was planted in his scalp at 333 hairs per square inch. At \$20 an ounce, Admiral Stark's hair alone cost more than \$100.

Although Madame Tussaud's opens at 10 a.m. daily, men and women behind the scenes start at six. The first order of the day is brushing specks of dust off clothing of figures. Everyone from Henry Landru, the French Bluebeard, and Kemmler, the first man to be electrocuted in the States—displayed in the Chamber of Horrors—to Princess Elizabeth and her husband in the

Famous Cars of Early Years Used Sealed Power Piston Rings



CADILLAC "Thirty" with four cylinders and 30 horsepower was priced at \$1600 and offered as "Touring Car, Demi-Tonneau, or Gentleman's Roadster." Cadillac was one of the earliest users of Sealed Power Piston Rings.

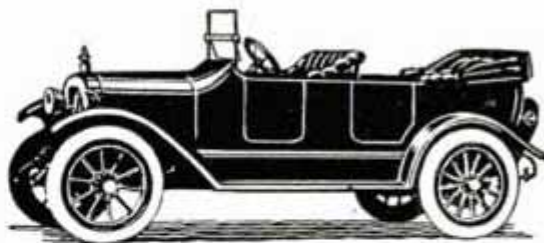

MAXWELL assured prospects that this 1915 model would "hold the road at 50 miles an hour." It was offered as touring car, roadster, or cabriolet, at prices ranging from \$595 to \$840. Sealed Power Piston Rings were right in there, pitching.

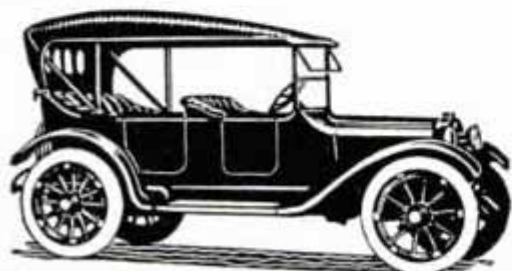

DODGE BROTHERS created a considerable sensation with this first model, featuring an all-steel body, in 1914, when Horace and John Dodge had America on its toes to see what they would produce. Sealed Power Piston Rings contributed to its performance.

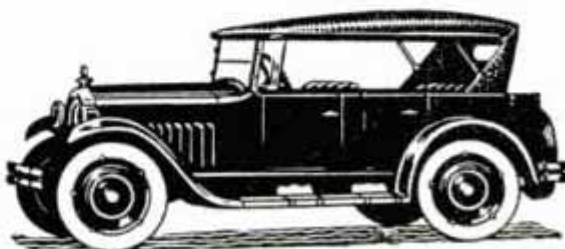

OLDSMOBILE featured this "SIX Sport Touring" at \$915 in 1924, or the roadster in the same model could be had for only \$785. Of course, the sport job included windshield cleaner, which was \$1.25 extra if you bought the roadster. Sealed Power Rings were standard on all five models, however.

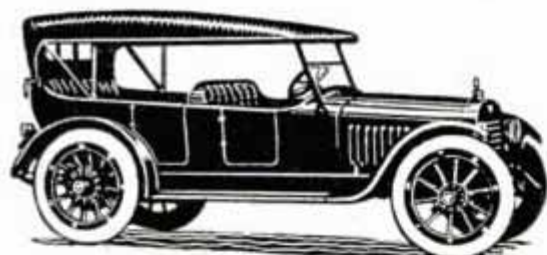

HUDSON, in 1918, urged "Farmers, Listen! Buy a Hudson Super-Six and Be Free From the Annoyances of a Car That Won't Run Unless It Is Under Constant Attention." You could choose from any of ten different body types. Sealed Power Rings, of course.

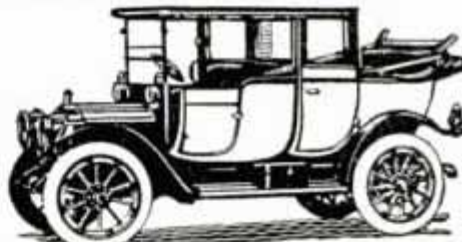

PACKARD in 1912 was offering a "30" with 40 horsepower at \$4100, an "18" with 26 horsepower at \$3200, and a "Six" with 48 horsepower—wow!—at \$5000! This is the Packard "18" Landaulet. Packard has used millions of Sealed Power Piston Rings since those early days.



LINCOLN produced this first model in 1922, soon after Ford bought the Lincoln Motor Company and began the production of higher priced cars. Sealed Power Rings were used as original equipment.



STUDEBAKER manufactured this "Big-Six" in April, 1918. It made a world's record of 490,000 miles in 5½ years. Studebaker was one of the earliest manufacturers to adopt Sealed Power Piston Rings as original equipment.

Descendants of these cars are still using Sealed Power Piston Rings. In fact, Sealed Power products are used as original equipment by manufacturers of more than 80% of all passenger cars. If your car smokes too much, drinks too much, spends too much, or loafs too much, it's a sure sign you need new Sealed Power Piston Rings to save gas, save oil, save engine wear. Best in new cars! Best in old cars! Write for free booklet: "7 Ways to Save Oil." Sealed Power Corporation, Muskegon 60, Michigan.

Now it's **EASY**
to have modern
oak floors

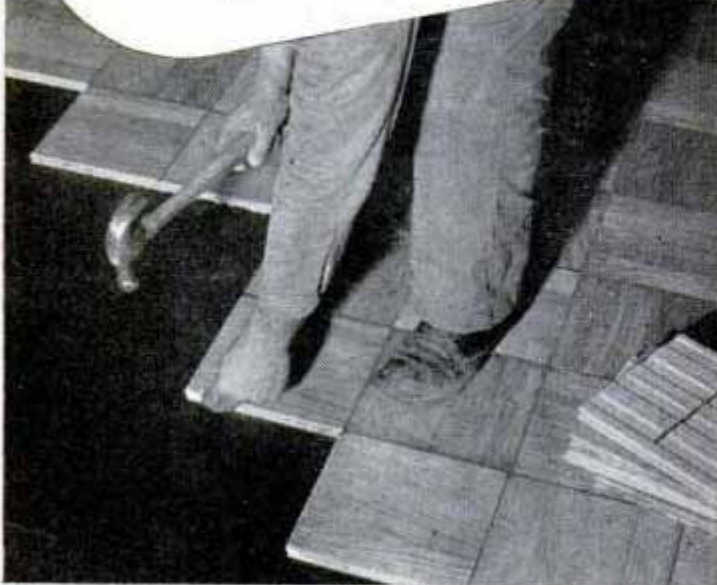

Your choice of Block, Strip or Ranch Plank

Just lay prefinished Bruce oak flooring right over your old floors...no sanding or finishing

You can give your home new beauty at low cost with a prefinished Bruce Hardwood Floor. Completely finished—even waxed—at the factory, this highest quality oak flooring can be nailed right over old floors. No sanding or finishing . . . no mess or smell. Ready for use as soon as laid. Made in strip or block (parquet) design.

"Scratch Test" Finish — The Bruce factory-applied finish is baked into the pores of the wood. The "Scratch Test" (left) will prove to you that this durable finish does not scratch or chip or mar like an ordinary floor finish.



Moderate in cost — A new Bruce Hardwood Floor will cost you less than a good rug or carpet. Easy to keep clean and beautiful, too. It's just the thing to use in fixing up or adding a room. Let your lumber dealer give you an estimate. Mail coupon below for colorful literature.

MAIL FOR FREE LITERATURE

E. L. Bruce Co., Box 397-A, Memphis 1, Tenn.
Send complete information on prefinished Bruce Hardwood Floors.

Name.....

Address.....

City..... State.....



Bruce Hardwood Floors
Product world's largest hardwood flooring maker

Clinic for Homemakers

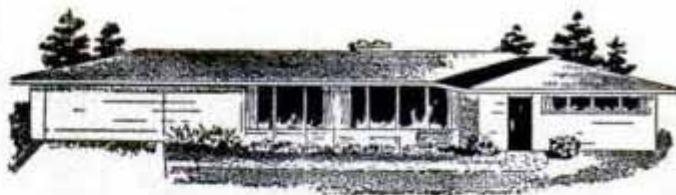

As a service to our readers in solving the hundreds of problems pertaining to a home—inside or out—the editors of *Popular Mechanics* invite you to present your problems to The Clinic Editor for help and advice. Address your questions to The Clinic Editor, *Popular Mechanics Magazine*, 200 East Ontario Street, Chicago 11, Ill.



Circular Saw Heats

Q—I have a small circular saw in my home shop with an 8-in. blade and whenever I cut pine or other soft woods, pine especially, the blade binds and heats unduly. I've checked the alignment of the ripping fence with the blade as directed by the manufacturer and it seems to be correct. Still the blade binds. What's my trouble?—B.U., Calif.

A—If you will take the blade off the arbor and examine it closely, you probably will find a small hard deposit of resinous pitch under the cutting point of each tooth on the leading edge. This changes the clearance angle of the tooth and is a cause of the trouble you describe. In other words, the pitch deposit prevents the blade from cutting freely. This is a common trouble when cutting material having a high moisture content and, especially, certain grades of pine containing pitch, as it is commonly called. In production work the trouble usually is corrected by filing the saw teeth with a greater clearance angle, but in the home shop this procedure is not practical, as a blade filed in this way will be unsuitable for other work. You generally can cure the trouble by keeping the teeth filed sharp and cleaning the blade at frequent intervals with spirits of turpentine, or a special solvent which is supplied for this specific purpose. Usually you can obtain this solvent from your hardware dealer.



Chiming Mantel Clock

Q—Recently I purchased an old chiming mantel clock and although it seems to run satisfactorily, the chiming mechanism does not operate properly. The chime is too rapid, the notes being struck so fast that they sound almost like one—because of the sustained tones, I suppose. What is the cause of this trouble, and how can I correct it?—W.F., Mass.

A—We are assuming that you are referring to a clock of American make striking a full chime on rods mounted below the movement. If this is one

(Continued to page 334)

THIS ALADDIN 5-ROOM HOUSE \$1974 PAID FREIGHT

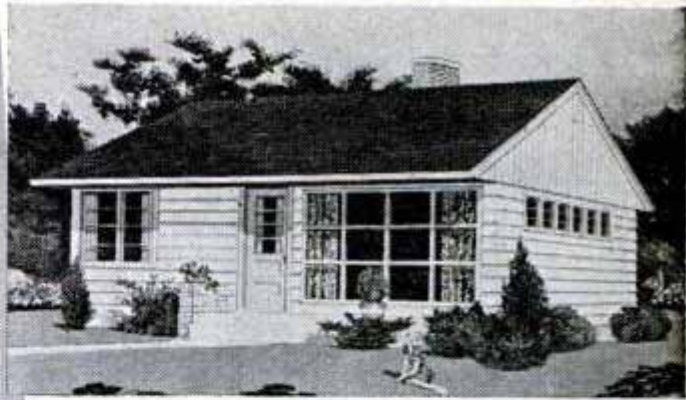

YOU CAN BUILD THIS ALADDIN READI-CUT HOUSE YOURSELF—and Save Hundreds of Dollars!

For over 45 years Aladdin has manufactured its own houses and sold them direct to home builders. The finest quality DRY lumber is used. This lumber is cut to exact size on fast, precision machines in Aladdin's own mills. Because Aladdin's Read-Cut System eliminates expensive hand measuring and cutting you save as much as 30% on labor. You save 18% on waste also. And you can choose the size and style house you want from Aladdin's



71 beautiful designs. **YOUR COMPLETE HOUSE** will be delivered **IN ONE SHIPMENT** direct from our mills. Not only will you save money but you'll have a house to be proud of throughout the years.

THIS IS THE WAY TO BEAT THE HIGH COST OF BUILDING!



Every hour you put in on the construction of your Aladdin house means a saving to you of from \$2 to \$3 per hour—\$14 to \$21 a day! Total carpenter work runs from 300 to 1200 hours, depending on the house you choose. **WITH MOST OF THE SKILLED LABOR ALREADY PERFORMED AT THE ALADDIN MILLS** think how

easy it should be for you to bring the cost of your new home down to practically a pre-war level. Our drawings and instructions are simple to follow and cover everything from the foundation up so you can save any or ALL labor costs.

**THERE'S AN ALADDIN HOUSE NEAR YOU
—WRITE US**

WHAT YOU GET WHEN YOU BUY AN ALADDIN HOUSE

You get **ALL THE LUMBER** cut on precision machines to fit exactly, each piece marked and numbered, ready to erect practically without the use of a saw. **ALSO** Siding, Flooring, Trim, All Millwork, Doors, Windows, Mouldings Glass, Hardware, Nails, Roofing, Paint and complete Drawings with Instructions. Hundreds of Aladdin home buyers have erected their own houses.



**IMMEDIATE
DELIVERY**

ALADDIN HOUSES ARE NOT PREFABRICATED



THE ALADDIN CO.
BAY CITY, MICHIGAN

Est.
45
Years

Send 25¢
FOR BEAUTIFUL
NEW FULL-COLOR
CATALOG No.
RM-1

BURGESS

Chrome Protection



Guards against POWER LOSS when not in use!



Your flashlight will stay bright longer with Chrome Protected Burgess Batteries! This exclusive Burgess development curbs internal action when your flashlight is not in use . . . keeps the power fresh and ready. Try Burgess and see the big difference!

Buy **BURGESS** 4-Star Performance!

- ★ SEALED IN STEEL AND PLASTIC
- ★ PLAINLY DATED
- ★ IMPROVED BATTERY DESIGN
- ★ GUARANTEED FRESH

BURGESS BATTERIES

BURGESS BATTERY COMPANY
FREEPORT, ILLINOIS • Niagara Falls, Can.

(Continued from page 332)

of the older spring-driven chiming movements, then it is possible that the speed of the chiming mechanism is controlled by what is known as a "fly" fan, which is located on one of the high-speed shafts. If this fan is bent or otherwise damaged, or is missing entirely, this could be a cause of the trouble you describe. Replacing the fan will, of course, correct the defect, provided the missing fan is the cause, but it is not possible to determine the proper size without having the original part. Usually the fly fan is simply a rectangular piece of sheet metal (brass) and is either fitted with a hub drilled to a press fit over the shaft, or is center-slotted to form an opening through which the shaft passes. If the original fan is not at hand, then it will be necessary to determine the size of the new one by experiment. Rather than try to make this repair yourself, we would suggest that you either write to the manufacturer of the clock and get his recommendations, or take the clock to your local jeweler.

Warped Siding

Q—I have an older house sided with narrow, beveled siding having a molded lower edge. The siding boards have warped in several places on the walls and have opened, leaving spaces between the boards ranging from 1/8 to 1/4 in. Should I draw the boards down with nails or fill the openings with a calking compound? — T. N., Wis.



A—You did not say whether you recently have insulated the walls with a blow-in type of insulating material, or whether the condition of the siding is of recent origin. The reason we are raising this question is that we are inclined to suspect that the presence of moisture behind the board is the cause of the trouble. This could result from condensation of moisture within the walls, or could be caused by a leak in the roof over the plate, which is permitting water to get behind the siding in some manner. If this is so, then it will not be advisable to nail the boards until the cause of the trouble is corrected. Otherwise, it probably is permissible to nail the warped boards at the lower edges, spacing the nails whatever distance apart is necessary to draw each board down tightly. It is suggested that you use aluminum nails, if they are available, as the heads will not rust and cause streaks on the paint. In most cases it will be necessary to drill holes before driving the nails as otherwise, the siding may be split. Generally it is best to begin nailing at the center of each board, rather than nailing from one end to the other.

Plastered Walls Crumbling

Q—The plastered walls in my new home, in one room especially, are beginning to crumble. The surface seems unusually soft and it dusts—breaks away in fine particles—when rubbed lightly with a finger. What has caused this? Will paint sealer bind the surface or is there some other preparation available?—O.R., Del.

A—Any condition which unduly delays the setting action of the materials used in ordinary plaster is likely to produce a soft wall. While your description of the condition of the walls makes it rather difficult to judge with any certainty, we are inclined to believe that the present condition of the walls is due to what plasterers call "dry out." This results from a too-rapid evaporation of the water contained in the plastering materials when they were applied. The surface affected in this manner usually is soft and crumbly, as you describe, and has a chalky appearance. Plasterers generally try to correct this condition by successive applications of water to the surface in a fine, light spray which is continued for several hours until the plaster sets hard and firm. As a rule this treatment will prove successful where the plaster is comparatively new.



the right step to
MAKE BIG MONEY
all your life!

BE YOUR OWN BOSS!

Here's the big **LIFETIME OPPORTUNITY** for the man who wants to get ahead in something for himself—wants to earn \$35 to \$50 a day—wants to *be his own boss* and keep all the profits from his own labor!

It's easy to start a floor sanding business of your own with American Machines! Thousands of men have been successful with our plan. No experience or special schooling needed. American Sanders are easy to operate, speedy, dependable. Your age makes no difference—men 18 to 80 are active in floor surfacing and make a good living.

Pleasant indoor work . . . steady all year round. Prospects everywhere . . . new and old floors. No large investment. Work out of your own home. Use passenger car for taking equipment from job to job. Easy to get jobs—business mushrooms—and *you are boss!* Send today for "money-making" booklet entitled "Opportunities in Floor Surfacing"—use coupon and enclose 25c in coin or stamps to cover handling.

**SEND FOR
 TELL-ALL
 BOOKLET!**



The American Floor Surfacing
 Machine Co.
 535 So. St. Clair St.,
 Toledo, Ohio

Enclosed find 25c in stamps or coin for booklet "Opportunities in Floor Surfacing", telling me how I can start my own floor sanding business.

Name.....
 Street.....
 City.....State.....

A M E R I C A N
F L O O R M A C H I N E S

Grand Hall gets the treatment. Hands and faces are dusted with down-soft cloths. Hair, beards, and mustaches are combed. It is indeed an experience to watch Marie Antoinette—one of the originals made by Madame Tussaud herself—having a shampoo. (This happens at least every few months with all figures.) The French Queen's upper portions are removed from the rest of her body. First her blond hair is combed to remove the powder. Then come the washing and elaborate combing and setting.

By a few minutes before ten, Bernard Tussaud makes a complete tour of inspection, as rigid as any carried on at officers' training schools. Every necktie must be straight. All shoes must be shined and laces neatly tied. Belts and military insignia must be up to parade-ground standards.

But despite the best-laid plans, sometimes things go amiss anyhow. The staff of Tussaud's remembers clearly what happened to the Sleeping Beauty of Versailles, the figure of a lovely court lady which is near the wax model that Madame Tussaud made of herself at an advanced age. This beauty is different from all other persons displayed. Reclining on a couch, she seems to be alive, actually breathing. Her breast rises and falls, through efforts of a noiseless, mechanically operated cam.

One afternoon a throng of spectators gathered around the Sleeping Beauty, and unrestrained laughter echoed through the otherwise quiet halls. Reginald Edds, Tussaud's historian, says that a guard and a museum executive hurried over to learn the reason. They found that the Beauty was having difficulties—so many that it must have been hard for her to remain sleeping. The cam rod had become dislodged and was walking around under her dress, causing her to inhale and exhale in the most peculiar places.

Such events make the management and, especially, the guards, even more watchful. And yet unforeseen things happen. There is some stealing and occasional vandalism. During the war, blubbery Hermann Goering, the man in danger of falling face down for weight of medals, could never keep his latest military decorations very long. Museum property men had to replace so many that the battle was a losing one. They gave up. Hermann looked almost nude without a medal. Hitler's iron crosses usually vanished shortly after being pinned on.

Almost \$28,000 worth of jewelry, equipment and clothing is stolen annually. Queen Victoria recently lost a miniature gold dress crown, complete with jewels and red velvet. A substantial piece of Henry

(Continued to page 340)

Build it, Fix it

with

AMBROID "It stays stuck!"

- Ready-to-use
- Fast drying
- High tensile strength
- Transparent
- Waterproof

Dries entirely by evaporation of the solvent. Quick setting — no distortion. Ideal for assembling, repairing, Home crafts, hobbies, electrical work, factory, workshop or household use. Send post-card for free literature.

Art galleries, museums, and leading industrial concerns, rely on AMBROID.

Try a Tube TODAY

At most hardware stores and hobby shops where you see this Display Box.

If your dealer cannot supply you, send 25c for big 2 oz. tube, postpaid.

MONEY BACK GUARANTEE

Try Ambroid in your business, too. For over 40 years recognized as the leading industrial adhesive of its type.

AMBROID CO.

ESTABLISHED 1910

303 Franklin Street, Boston 10, Mass.



Around the clock usefulness...

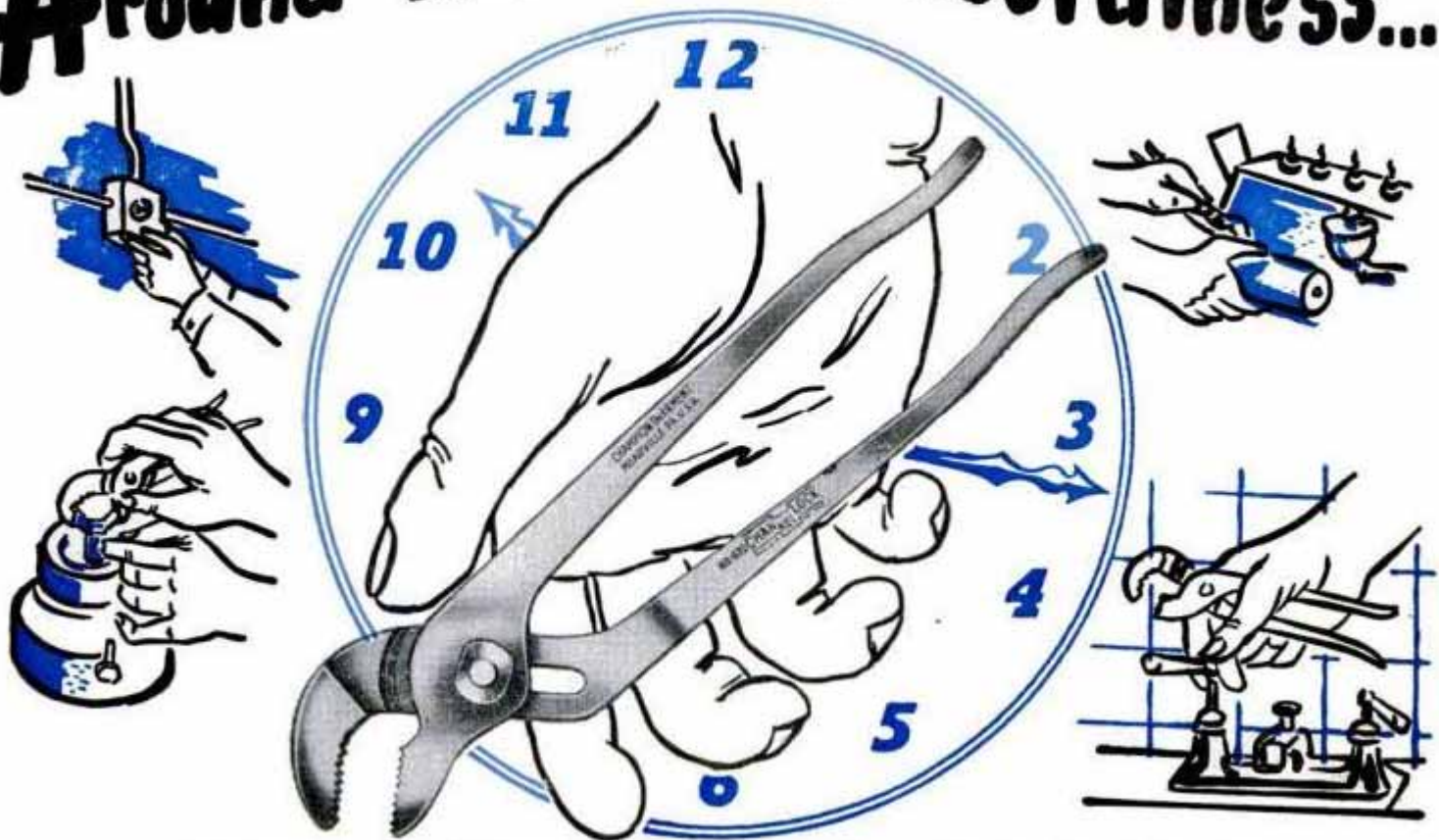

CHANNELLOCK PLIERS

Made only by CHAMPION DEARMENT!

No matter what the job—plumbing, electrical, automotive or whatever, Channellock pliers are handy to have around. The patented Channellock principle permits a wide range of size adjustments without decreasing gripping power or leverage.

Channellock pliers are made by Champion DeArment—for nearly 3/4 of a century manufacturers of highest quality tools.

Dad, Mom, or the kids will find plenty of uses for Channellock pliers.

And remember—Only Champion DeArment makes Channellock.

Send for Catalog D 15 today.

CHAMPION DEARMENT TOOL CO. • Meadville, Pa.

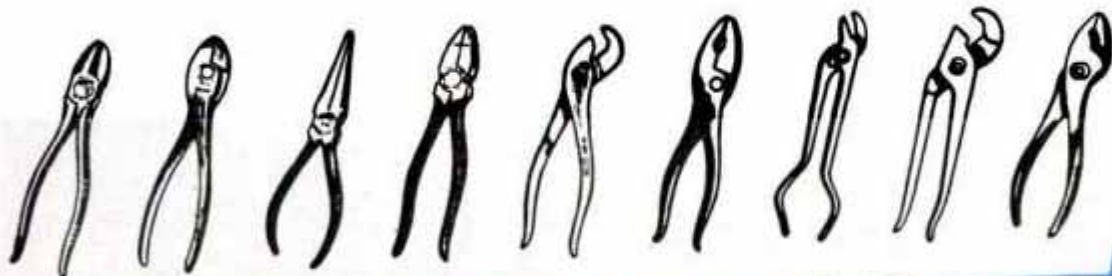

Channellock pliers are listed in the Yellow Pages of most Telephone Directories under "Tools"



Only CHAMPION DEARMENT...

makes

CHAN NEL LOCK

TRADE MARK REG.

U. S. PATENT OFFICE

America's most complete line

Saving money for industry . . . Giving greater pleasure in the home workshop
Designed with plus-performance and features professional craftsmen want

Man! Look at these big, rugged, streamlined beauties . . . and look at their amazing low prices! No wonder Sears lead all America in power tool sales! All are precision-built by the most expert, efficient manufacturing methods known. All are laboratory-tested . . . and GUARANTEED to give you complete satisfaction or your money back!

CRAFTSMAN and DUNLAP Power Tools come in a complete range of types and sizes for industrial or home workshop use. Buy with confidence! See these sensational extra-value tools at your nearest Sears Retail Store TODAY! Compare them feature-by-feature with ANY others . . . and prove to yourself that Sears Power Tools give you more for your money!



CRAFTSMAN 1/4-inch Electric Drill

\$25.00* \$2.50
Cash Down

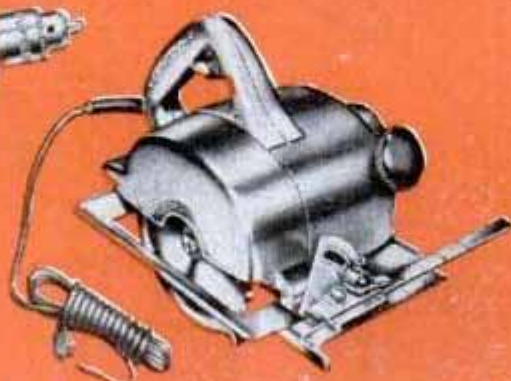

CRAFTSMAN 6 1/2-inch Electric Hand Saw

\$55.00* \$5.50
Cash Down
Without case

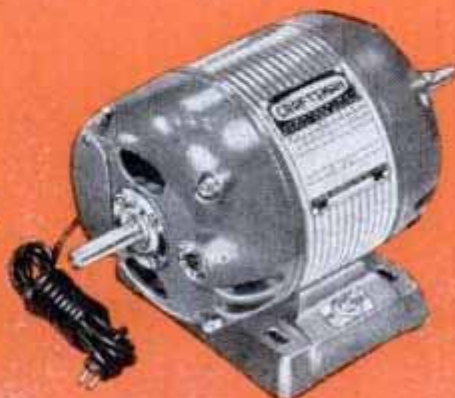

CRAFTSMAN Ball Bearing Capacitor Motor

\$28.00* \$3.00
Cash Down
1/2-H.P. 1750 R.P.M.



DUNLAP 1/2-inch Electric Drill

\$32.95* \$3.50
Cash Down



CRAFTSMAN Disc Sander-Polisher

\$35.95* \$4.00
Cash Down
Without case



CRAFTSMAN Wood Shaper

\$51.50* \$5.50
Cash Down
Without motor



CRAFTSMAN Rotary Tool Outfit

\$26.95* \$3.00
Cash Down
Complete 54-piece set



CRAFTSMAN Sander-Polisher

\$15.95* \$2.00
Cash Down
Complete



DUNLAP 1/4-H.P. Electric Grinder

\$29.95* \$3.00
Cash Down

CRAFTSMAN and **DUNLAP** Tools by **SEARS, ROEBUCK and CO.**
REG. U.S. PAT. OFF. REG. U.S. PAT. OFF.

of fine quality Power Tools!

Compare them yourself! We don't think you can match these values anywhere!
Just a small down payment on Sears Easy Terms puts one or more in your shop!



Free!

1952 CRAFTSMAN Power Tool Catalog! Get yours NOW from the Hardware Department of your nearest Sears Retail Store!

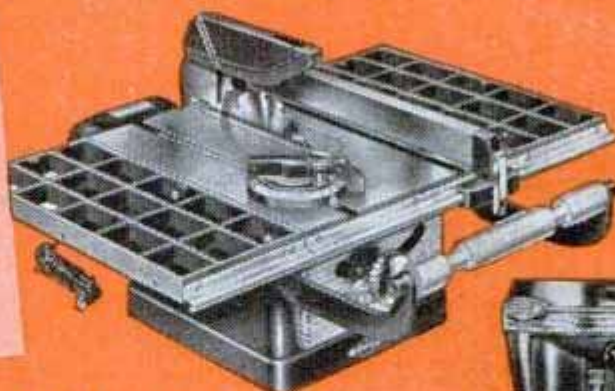

CRAFTSMAN 8-inch Tilting-Arbor Bench Saw

\$60.00* \$6.00
Cash Down
Less guard, motor, extensions



CRAFTSMAN Ball Bearing Drill Press

\$82.50* \$8.50
Cash Down
Without motor



CRAFTSMAN 3-Drum Belt Sander

\$58.95* \$6.00
Cash Down
Without case

CRAFTSMAN Metal Turning Lathe

\$47.50* \$5.00
Cash Down
Without motor

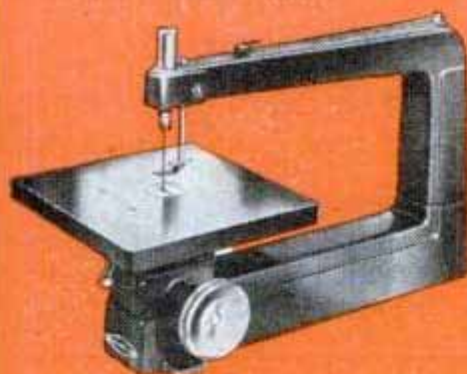
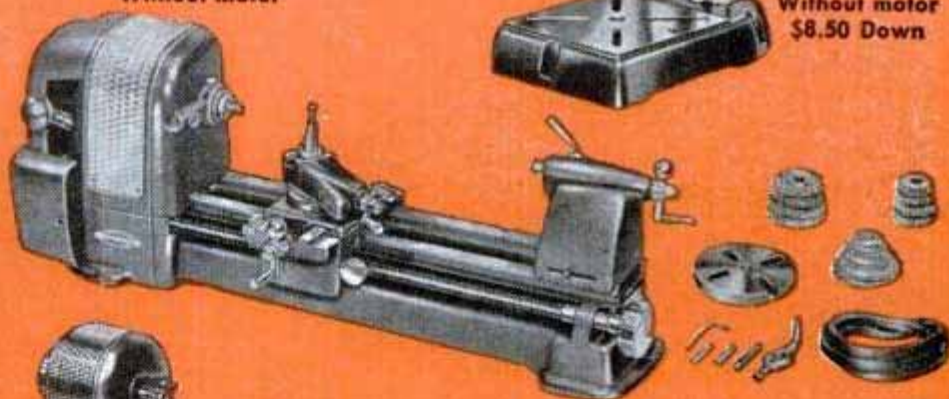

CRAFTSMAN 18-inch Jig Saw

\$32.50* \$3.50
Cash Down
Without motor



CRAFTSMAN Ball Bearing Wood Lathe

\$43.95* \$4.50
Cash Down
Without motor



CRAFTSMAN 3-wheel Band Saw

\$49.50* \$5.00
Cash Down
Without motor



CRAFTSMAN 4 1/2-inch Jointer-Planer

\$48.50* \$5.00
Cash Down
Without motor

* Prices slightly higher south of the Ohio and west of the Mississippi rivers.

Famous for fine quality... precision performance... low price!

MECHANICS! CRAFTSMEN!

*They measure your worth
by the tools you own*



BUY THE BEST!

Starrett PRECISION MEASURING TOOLS

Good men and good tools go together. That's why skilled workers who own Starrett Tools get the best jobs and the biggest pay checks. When so much depends on it, why buy anything less than the best — Starrett Tools.



No. 230
"Satin Chrome" Micrometer. 1" capacity, tapered frame, Sycamore case.

No. 440
"Satin Chrome" Micrometer Depth Gage. Range 0-3". 2 1/2" base.



No. 711 F
"Last Word" Test Indicator. Reversible action, hard chrome plated contact point.

No. 11
Improved Combination Square. With 12" hardened blade, reversible lock bolt.



No. 327
6" Flexible Steel Rule. Graduated two sides; 16ths, 32nds, 64ths.



SEND FOR IT — ONLY 10¢

Starrett "Tools and Rules" Book

50 page booklet shows the right tools for any precision measuring job. 100 pictures plus helpful reference tables. Send only one dime. Address Dept. AP.



THE L. S. STARRETT COMPANY • ATHOL, MASS., U.S.A.



TRADE MARK
Starrett
REG. U.S. PAT. OFF.

SINCE 1880
WORLD'S GREATEST TOOLMAKERS

BUY THROUGH YOUR DISTRIBUTOR MECHANICS' HAND MEASURING TOOLS AND PRECISION INSTRUMENTS • DIAL INDICATORS • STEEL TAPES • PRECISION GROUND FLAT STOCK • HACKSAWS, BAND SAWS and BAND KNIVES

VIII's real-ermine robe was snipped off. King Edward VII lost his jeweled Order of the Garter. A string of pearls was removed from Queen Elizabeth's neck. The regent of Mary Queen of Scots found himself without the gem-studded hilt of his sword. Greece's General Metaxas lost his hat. At Madame Tussaud's, Anne Boleyn fared much better than she did in actual life with Henry VIII. She lost only a golden necklace instead of her head.

So far as vandalism goes, it seems that in all periods of history, there are prominent persons considered villains and whose wax images are molested by museum visitors.

During World War I, Kaiser Wilhelm took a number of manhandlings. An Australian soldier on leave seized the German emperor's sword and bisected the royal fellow's head. A number of others tried to maul the Kaiser on various occasions, and he was put in storage until things cooled down.

Adolph Hitler was attacked by a pair of Communists in 1936 and splashed with red paint. This bit of sport cost the Reds \$160. Then during World War II, shortly after raiders of Dieppe were put in chains by the Germans, inebriated Canadian soldiers jumped der Fuehrer. One of the pair tried to pull him over but failed because Hitler, like all figures, was secured to the floor. The other, waving his revolver in ever-widening circles, was stopped just in time.

As yet Joe Stalin hasn't been molested unduly. True, his mustache has been tweaked and his hair mussed, but he's just as good as ever today. And the operators of Tussaud's hope he stays that way—at least in his wax form.

... And Then Came the Horseless Carriage

(Continued from page 143)

ered! By the end of the war 350,000 machine guns were made by this plant. So it went throughout industry. Automobile-assembly lines became tank and airplane lines and the same know how was applied to producing 200,000 tanks, 300,000 airplanes and thousands of other war items.

We all know the result and from it we should recognize the value of this most powerful weapon.

Our system of mechanically duplicating things—as developed by the automobile makers—is one of the most valuable assets our nation possesses. It can give us more and better things in time of peace and is the backbone of our defense in times of war.

(Continued to page 344)

AMERICA'S FINEST WORKSHOP TOOLS — AT BUDGET PRICES

Precision built Shopmaster tools are known for their durability. They're especially designed for the home workshop. Shopmaster tools have features found only in higher priced tools. With available accessories, each tool will adjust to handle many tasks. Convenient operating mechanisms, sealed-for-life ball bearings and large working surfaces. A Shopmaster tool will do any job better and easier.

QUALITY PLUS
PRECISION . . .

Shopmaster

Tools and
Accessories

for
BUDGET-MINDED
Hobbyists



12" TILTING TABLE BAND SAW. Table work surface 12" x 18". Cutting depth, 6 1/8". Table tilts to 45°. Ball bearings. **\$87.50**

Also available in 10" size. \$46.45

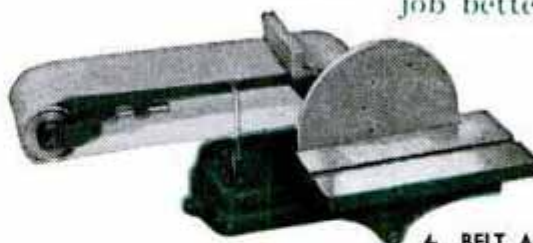

BELT AND DISC SANDER. Belt 6" wide, 48" long. Disc diameter 10". Adjustable table tilts to 45° **\$51.50**



8" TILTING ARBOR BENCH SAW. Table size 16" x 20". Depth of cut, 2 1/2". Blade tilts to 45°. Includes Rip Fence, Mitre Gauge, Guard. **\$76.95**



15" TILTING TABLE JIG SAW. Table size 10" x 10". Cutting depth, 2 3/4". Table tilts 45° **\$27.95**

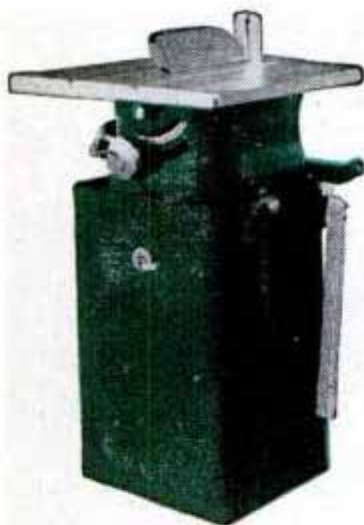

7" TILTING TABLE BENCH SAW. Table size 14" x 18". Depth of cut, 2 1/4". Sealed-for-life ball bearings. **\$33.95**



10" FLOOR MODEL TILTING ARBOR SAW. Table size 26" x 20". Depth of cut, 3 1/2". Arbor tilts 45°. Heavy construction plus ball bearings for accuracy. Complete with stand **\$105.00**



SABER SAW. Table size 10" x 10". Depth of cut 1 1/2". Table tilts to 45°. **\$17.95**



7" TILTING ARBOR BENCH SAW. Ball bearing arbor. Heavy cast construction. Depth of cut, 2 1/8". Blade tilts to 45°. Ideal for the small shop. **\$47.95**

12" DRILL PRESS. Ball thrust bearing. Jacobs Chuck, 3-spoke feed wheel, plus many accessories make this a most versatile tool. **\$47.95**
Also available in a floor model. \$54.00



10" WOOD TURNING LATHE. Capacity, 10" swing 31" center to center. Rugged frame, sealed-for-life ball bearings. **\$45.95**

Write today for catalog of COMPLETE line

SHOPMASTER INC.

1214 Third St. S., Minneapolis, Minn.

"JOB #1 SOLD ME



1 "Big-job capacity. I don't know of any other 8-inch saw that matches the capacity of SHOPS MITH. The table extension gives you a working area 17" x 54". Sawing long boards and 4' x 8' plywood panels is a one-man job."

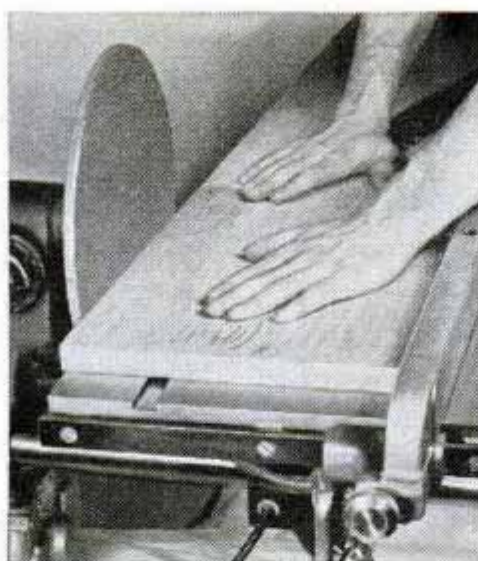

2 "Smoothing edges with the disc sander is a SHOPS MITH exclusive. It's done by setting the rip fence at a slight angle to the disc. Work fed between fence and disc is jointed to precise widths. The big, tilting table gives plenty of support."



3 "Perfect doweling is possible with SHOPS MITH in the horizontal drill press position. Work is laid flat on the table and backed up by the rip fence. Drill is fed in from the side. Ball and crank table-raiser accurately adjusts table height."

See SHOPS MITH demonstrated at leading hardware and department stores or any Montgomery Ward store. FREE! 16-page information-packed catalog. Gives details and specifications on SHOPS MITH and accessories. Write for it.

Basic SHOPS MITH includes all attachments for . . .

8" circular saw • 15" drill press
12" disc sander • Horizontal drill
33" wood lathe

5-tool unit complete except for motor* **\$189.50**

*Special 1/2-hp., capacitor-type motor, \$34.50

ON SHOPSMITH!



"A built-in wardrobe cabinet was my first real SHOPSMITH project. And what an eye-opener it was! I never realized that SHOPSMITH could do so much in so many different ways in such limited space.

"I like the way SHOPSMITH converts quickly and easily from saw to disc sander to wood lathe to horizontal and vertical drill press. I like the way it's made—four ball bearings, heavy castings, precision-fitted parts. Best of all, I like its

flexibility and the fact that, in each of its five positions, it has features you won't find in any other power tools. Simplified micro-adjustments and convenient, ready-to-use jigs, for example.

"In making the cabinet, I found that no job was too big, too difficult, or too unusual for my SHOPSMITH. Being able to use the right tool the right way saved me hours of time. And the accuracy I got was mighty satisfying. It was a big job, but SHOPSMITH made it easy!"



4 "Face to face. SHOPSMITH is the only lathe that lets you face your work while turning knobs, bowls or other flat or hollow objects. The full-swivel tool rest makes it easy to get into and behind faceplate turnings. Lathe has 15" swing, 33" capacity."



5 "Tall trimming. I needed to trim 3" off the side of the doors for the wardrobe. So I set SHOPSMITH in the vertical saw position and used the floor as a fence guide. It was a lot faster than hand sawing—and far more accurate."



6 "Built-in jig. When it came to drilling dowels for the drawer pulls, SHOPSMITH again showed its flexibility. The fence and tilting table formed a V-block for holding the dowel accurately. SHOPSMITH as a drill press is second to none!"



MAGNA ENGINEERING CORPORATION
Dept. 186-B
at factory nearest you:
12819 Coit Road, Cleveland 8, Ohio, OR
Menlo Park, California

Please send me free 16-page SHOPSMITH catalog.

Name _____

Address _____

City _____ State _____

DEAD BLADES MAKE DEAD DRIVERS



THIS DEAD WIPER BLADE still may look okay but it streaks glass dangerously. **DEAD** blades make **DEAD** drivers!



THIS LIVE ANCO BLADE wipes clean . . . clears rain . . . clears muck . . . lets you SEE. Protects you and your loved ones from smashups.

**Get Live New ANCO Blades . . .
Fit Your Car Quickly . . . At More
than 260,000 Service Stations**

Even the best wiper rubber goes dead . . . from exposure . . . often in six months or less. Don't be a Dead Blade Driver. Don't risk facing criminal negligence charges, after a needless storm-bred smashup, with dead blades found on your car.

Come Clean! Replace at once your Dead wiper blades with **LIVE** new ANCO Blades. They are best for most miles of quicker, cleaner wiping. Get yours today.

ANCO RAIN-MASTER model for Flat windshields. Fits all cars. World's largest selling replacement blade.

ANCO CLEAR-FLEX model for Flat or Curved windshields. Fits all cars having Curved windshields . . . best for Flat windshields, too.

THE ANDERSON COMPANY
Gary, Indiana, U. S. A.

Last spring I drove through Ohio and, in passing through the countryside, I couldn't help but compare it with my youthful impressions. The old dirt highway was gone, horses were seldom seen, a school bus loaded with children passed me, a tractor was busy harrowing a near-by field and I had to stop to let a truck loaded with crates of chickens pull out in front of me. Everywhere the gasoline engine had left its imprint, relieving the farmer's burden and making his family's life fuller.

On my way down I stopped in Columbus and talked to one of the boys in the Chamber of Commerce. We went over some figures he had handy, and I'll just give you a few of them for the sake of 50 years' comparison. In a half century the city's population has more than doubled, and it covers 40 square miles as compared to a little over 17 in 1900. The people who own automobiles and trucks have insisted on paved streets; there are 540 miles of them, over five times as many as in 1900. The electric

Milestones of Speed

1903	C. S. Rolls	63.1 m.p.h.
1904	Henry Ford	91.3 m.p.h.
1910	Barney Oldfield	131.7 m.p.h.
1924	Malcolm Campbell	146.1 m.p.h.
1927	H.O.D. Segrave	203.7 m.p.h.
1935	Malcolm Campbell	301.1 m.p.h.
1938	John R. Cobb	350.2 m.p.h.
1947	John R. Cobb	394.1 m.p.h.

(On one run at Bonneville, Utah, in 1947, Cobb was timed at 403.135 miles per hour, the fastest ever traveled by man on land.)

railways are disappearing, but last year 98 million bus riders traveled over 236 miles of bus routes. You may recall I mentioned Columbus as being a manufacturing center for buggies and carriages in 1902 and the industry employed 1400. This industry has gone but, just for the record, one of our plants there that makes only automobile hardware employs over 4000 people!

Columbus, Ohio, is just one of thousands of communities that have been transformed in that period by the automobile. No one thing in our history has so changed the habits of our people, has created employment, either directly or indirectly, for every one out of seven of us and brought us all closer together.

If events permit us to continue our steady engineering developments, the automobile of tomorrow will not resemble today's any more than today's resembles the horseless carriage. Engines will take advantage of higher compression ratios, new mechanical designs, new fuels and new materials. They

(Continued to page 348)

Popular Files for the Home Workshop

NICHOLSON
U.S.A.



Any reasonable poll or survey will show Nicholson and Black Diamond files the first choice among top mechanics. You'll find these world-famous files in pattern, toolmakers and fine-instrument shops—where precision filing is highly essential. . . . In industrial plants where fast filing is a production "must." . . . In home workshops where fine tools as well as fine accomplishments are owners' pride.

Whatever the requirement, the superiority of Nicholson and Black Diamond files shows up in results—through correct design, accurate cut, proper hardening, uniformity, and maximum wear. Shown here are some of the types most widely carried by hardware and industrial supply houses in popular lengths and range of coarseness. They represent a practical home workshop assortment toward having on hand The right file for the job, saving time and materials, and improving work.

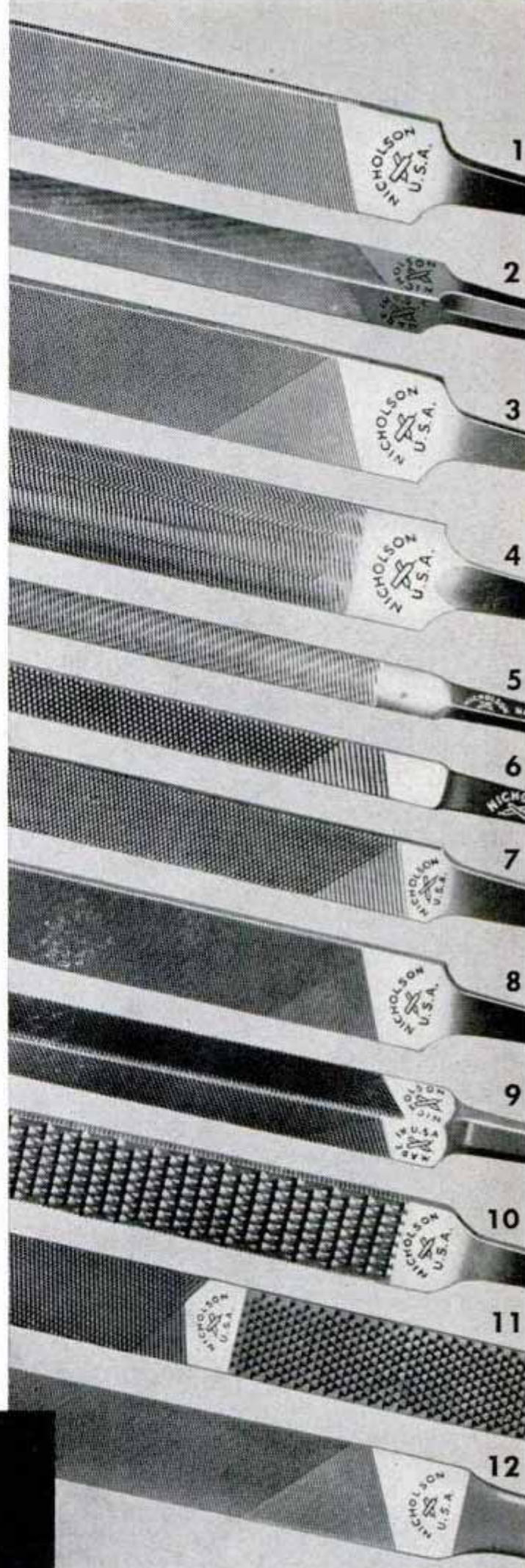

- (1) **MILL** — for smoothing, edge-sharpening, large-tooth-saw filing.
- (2) **TAPER** — Regular, Slim, Extra Slim, Double Extra Slim — for small-tooth-saw and other delicate filing.
- (3) **FLAT** (4) **HALF ROUND** (5) **ROUND** (6) **SQUARE** (7) **PILLAR** (8) **KNIFE** (9) **THREE SQUARE**. Mostly double-cut — for fast stock removal.
- (10) **WOOD RASP** — flat and half round types, for woodworking.
- (11) **SHOE RASP** — with many uses, on wood, metal, plastics, etc., as well as leather. Half round; half of each side rasp cut, other half file cut.
- (12) **HANDY FILE** — with forged-on handle; two types of cut — single on one side, double on other.



FREE BOOK, "File Philosophy," on kinds, use and care of files . . . 48 interesting, illustrated pages. Write to —

NICHOLSON FILE CO.
22 Acorn St., Providence 1, R. I.
(In Canada, Port Hope, Ont.)

NICHOLSON
FILES FOR EVERY PURPOSE



Atlas and Typical American



Atlas
10" FLOOR SAW
NO. 3170



Atlas
10" FLOOR SAW
NO. 3160



Atlas
10" BENCH SAW
NO. 3060



Atlas
8" BENCH SAW
NO. 3020



POWER KING
8" BENCH SAW
NO. 3102



POWER KING
7" BENCH SAW
NO. 3001



Atlas
12" BAND SAW
NO. 912



Atlas
BELT and DISC SANDER
NO. 5010



Atlas
15" FLOOR DRILL PRESS
NO. 1060



Atlas
15" DRILL PRESS
NO. 1020



Atlas
12 1/4" DRILL PRESS
NO. 1010



POWER KING
11 1/4" DRILL PRESS
NO. 611



Atlas
SPINDLE SHAPER
NO. 3500

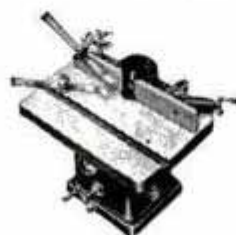

POWER KING
SPINDLE SHAPER
NO. 411

Precision engineered . . . built to industrial quality standards . . . economically priced . . . backed by 41 years of tool building experience — that's the brief story of Atlas products.

Whether you use compact precision tools in your business, or enjoy the practical hobby of a home shop, these tools give you greatest efficiency, lifetime service, and many exclusive performance features. You'll like their smooth operation, dependable accuracy, preci-

POWER KING TOOLS

Products For "Doing Things Better"



Atlas
6" JOINTER-PLANER
NO. 6000



POWER KING
4" JOINTER-PLANER
NO. 6050



Atlas
12" WOOD LATHE
NO. 7122



POWER KING
9" WOOD LATHE
NO. 7090



Atlas
24" JIG SAW
NO. 4021



POWER KING
18" JIG SAW
NO. 4010



Atlas
10" QUICK-CHANGE LATHE
NO. QC42



Atlas
6" LATHE
NO. 618

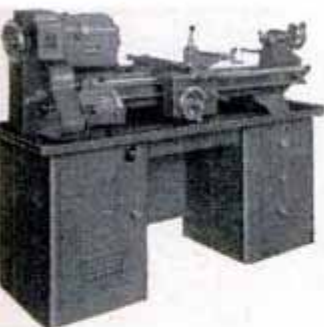

Atlas
22" LATHE NO. 6300

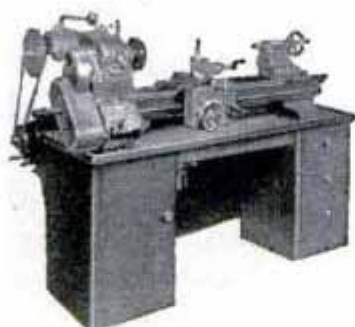

Atlas
12" LATHE NO. 4800



Atlas
7" SHAPER
NO. 7B



Atlas
MILLING MACHINE
NO. MFC

on ground table, and ball bearing construction. The range in capacities and price lets you select the tools best fitted for your particular needs. Ask your Atlas-Power King dealer for all details.

FREE CATALOGS—Send Postcard

Write for latest catalogs, indicating the tools at interest you.

40TH YEAR
Atlas

ATLAS PRESS COMPANY

143 N. Pitcher Street, Kalamazoo, Michigan

JUST FOR FUN-

reclaim idle space
with Western Pines*!

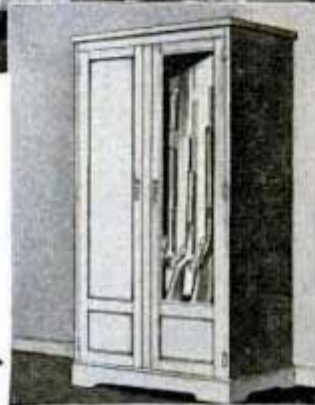

TURN that idle space in attic or basement into a fun room for the whole family! You'll be surprised how easily you can work this transformation when you use versatile Western Pines*. These soft-textured, even-grained woods cut and shape so beautifully, are naturally lovely waxed and rubbed to a mellow glow, stained or painted. Ideal for paneled walls, trophy display shelves, bookcases, record cabinets, gun racks, and other built-ins that give individuality and personality to a family fun center.

You'll enjoy using these woods of the Western Pines* in many workshop projects. This handsome gun-and-rod rack, for instance, for the safekeeping and display of weapons and fishing gear. Sturdy and good-looking when built of Knotty Pine throughout or in a combination of Knotty Pine and Clear Pine. Stain or paint to match room, or finish natural. You'll have satisfaction in making it and pride in its finished beauty!

FREE! IDEA PACKET No. 305-N

Chock-full of remodeling ideas, illustrated how-to-do-it folders and booklets: New, colorful "Enchanting Homes of Western Pines," "How to Make a Rod and Gun Cabinet," "How to Treat Knotty Pine Paneled Walls." Write Western Pine Association, Dept. 305-N, Yeon Bldg., Portland 4, Oregon.

These are the Western Pines

* IDAHO WHITE PINE
* PONDEROSA PINE
* SUGAR PINE

will be smaller but more powerful and what is most important, they will use less of our precious fuel reserves. In fact, in the next decade or so you will probably be traveling a third more miles on the same gallon of fuel.

It is difficult to predict the appearance of tomorrow's car but this we know—it will be even more comfortable and easier to operate than today's. New materials—metals, plastics, fabrics and rubber—will change entirely today's conception of the automobile. Probably some of you visited the Futurama at the New York World's Fair about ten years ago. At the time you probably said to yourself, "Fascinating, but fantastic." Yet, if we look around us ten years later does it appear quite so fantastic? Aren't we actually planning transcontinental highways, multiple-level streets for cities and some of the other things predicted in that exhibit?

The automobile is a typical example of the American way of doing things. The first crude examples opened our eyes to new possibilities in transportation. Men, many men, worked and experimented year after year until today, 50 years later, we see the results of their work transform the country and the habits of its people. But today Americans still are not satisfied with everything around them. I hope I never see the day that happens. So we keep on working, experimenting with many things, and some fine morning we shall wake up and find these dreams have become accomplished facts. That's what happens again and again in this land of ours.

American Way of Life Photo Contest

(Continued from page 172)

Black-and-White Division

Honorable Mention (\$25 each):

- Roger Baele, 1626 S. Taylor St.,
South Bend 14, Ind.
Lil and Al Bloom, 5412 Ridgewood Ct.,
Chicago 15, Ill.
Byron W. Campbell, 364 Arlington St.,
Watertown 72, Mass.
John Gajda, 12893 Riverview, Detroit 23, Mich.
Percy J. Hussakof, 380 Knickerbocker Ave.,
Brooklyn 37, N. Y.
Mrs. Janet Konkle, 819 North Ottilia St., S.E.,
Grand Rapids, Mich.
Vivienne Lapham, 13923 Fairford Ave.,
Norwalk, Calif.
Vincent J. Mandese, 1130 Punta Gorda,
Santa Barbara, Calif.
Carl Robert Mesterton, 66 Milton Rd., Rye, N. Y.
G. L. Osmanson, 715 Liberty St., Morris, Ill.
George H. Padginton, 641 Northumberland Ave.,
Buffalo 15, N. Y.
Alvin M. Radin, 406 Winter St.,
Yellow Springs, Ohio
Charles S. Rice, 19 New St., New Holland, Pa.
Howard Rlome, 704 Yonge St., Toronto, Ont., Can.
Sallie Sawyer Smith, 182 Waverly Place,
New York 14, N. Y.
Bob Taylor, Cordell, Okla.

Community Enterprises

*Allied with Building Industry
Open to Profitable Development*

BRIKCRETE



**Local Manufacturers
Have Broad Opportunities**

Brikrete manufacturers operate compact, self-contained plants under franchise privileges in protected territories. Each is an independently owned unit in a country-wide chain, using local materials and local labor to supply the world's most modern masonry for local building needs.

Brikrete is rich in sales appeal because it is ahead in design, style, size, color, economy. Easily the preferred masonry. But because local production eliminates economic wastefulness, Brikrete can be sold at a lower-than-lumber price. Yet still allow a generous profit margin.

Brikrete offers much to men looking for a community enterprise on a nominal investment. We supply complete equipment; easy terms when desired. Liberal cooperation. Write today for Brikrete Book No. 2—while territory is still open.

BRIKCRETE ASSOCIATES, INC.

4679 Division Avenue, S.
Grand Rapids 8, Mich. E2

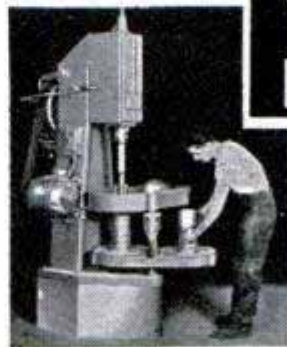

**You Can Make
DRAIN TILE**

**and Build a Profitable
Community Enterprise**

Farm drainage, home building, reclamation projects, highway construction. From these and other sources come the biggest demand for drain tile in history. More local plants are urgently needed.

Millions of dollars' worth of drain tile are used annually. Much of it, ordinarily, is shipped from far distant points. Local manufacturing is economical, logical, profitable. The Champion Drain Tile Machine makes manufacturing easy. Pares production costs. Requires no skilled labor. Makes all sizes from 3" to 12". Yet requires only a moderate investment.

Outstanding Manufacturing Opportunity

Champion-made cement tile are dense, strong, and truly round. No distortion, no shaling. Worth more than clay tile, but can be sold for less—and still leave a handsome profit margin.

Write for the DrainTile Book. Tells about cement tile as a local manufacturing enterprise. Tells about easy-payment terms. Write today.

Concrete Equipment Company
522 Ottawa Ave., Holland, Michigan



E2

C1

COLORCRETE

Drab or dirty masonry—concrete, stucco, etc., becomes gleaming white. Or there's a range of sparkling colors—ivory, cream, pink, blue, green, and 25 more. Colorcrete is fused to masonry surfaces under pneumatic pressure. Stays put and stays beautiful. Highly water resistant. Used for more than a quarter century.

**There's Profit-Appeal
in Stucco Spraying**

The business of applying Colorcrete is a community enterprise, with special appeal to men of limited capital. Equipment is compact, simple to operate, practically wear-proof. Work is easy, interesting and rich in profit potentials. Broad opportunities for development. We supply all equipment and full instructions.

No experience or special ability needed. Write or wire today for the Opportunity Book.

**COLORCRETE
INDUSTRIES, INC.**
570 Ottawa Ave.
Holland, Mich.



**Can You Run a Local
Dunbrik-Dunstone Plant?**

More local plants are needed. You can be one of a national chain. Simple, compact equipment. Moderate investment. 100%—150% mark-up on basic costs. Broad protection and liberal co-operation.

**Outstanding
Manufacturing
Opportunity
for Right Man**



Tie in with today's demand for smart, colorful, low-cost masonry for homes and other buildings. Dunbrik-Dunstone has beauty, strength, modernity. Easily America's finest masonry, with tremendous appeal to building owners.

Yet costs less than lumber because locally manufactured from local materials by local labor for local consumption.

W. E. Dunn Mfg. Co.
600 W. 24th St., Holland, Mich.



Write for descriptive book "Blueprints for Profit."

DUNBRIK-DUNSTONE

(Continued from page 151)

Despite this period of apparent inactivity, things were happening behind the scenes. New companies were being formed, new patents were being issued and the military had taken an interest in flying. Our present-day Air Force had its beginning in July 1907, when the Aeronautical Division of the Army was established in the Office of the Chief Signal Officer. In December the Signal Corps advertised for bids on an airplane.

A glance at a few of the aircraft designs tried out by 1915 would lead you to believe that "everybody was trying to get into the act." There were monoplanes, biplanes and triplanes—and even airplanes with four or five wings. Some people seemed to think that the more wings the plane had the better it would fly. There were others who didn't believe in wings at all. They built flying machines with circular air scoops. From the back yards and small shops of America emerged an endless procession of contraptions ranging from a pedal-powered "Cycleplane" to Dr. Alexander Graham Bell's tetrahedral kite, "Cygnet II."

World War I not only demonstrated the potentialities of the airplane as an implement of war, but it forced the United States and its allies into a competition with the enemy to produce better airframes and engines. The "flying machine" grew up into an airplane.

By the middle of the war, the German Fokker appeared on the scene. It was a real plane in every sense, with a cruising speed respectable even today, plus rugged climbing and diving ability. It ruled the skies through 1916 and 1917. In the race to outdo it, the French built the little Nieuport, which could outmaneuver it. Then came the Spad to outspeed, outdive and outclimb the German menace. The British developed the S.E. 5, which could outmaneuver and outdive the enemy, but couldn't outrun him. The British also had the Camel and the Snipe, barely off the drawing boards, which bettered all the planes in many respects. The latter was rumored to have the unheard-of ceiling of 33,000 feet and a speed of upward of 250 miles per hour.

In the 94th, we used to sit around our Nieuport at the airdrome—a tiny sod area no more than ½ mile square, accommodating about 80 craft—and eat out our hearts for these new "hot" biplanes. We finally got some Spads, but for the first few months we fought in the old Nieuports. Though we grumbled about them, there were some

(Continued to page 352)

**NO FROZEN
FUEL LINES**



BOWES

COMBUSTION AID

For Fast Starts; Driving Protection

Be sure of quick, easy starting this winter! BOWES Combustion Aid absorbs the water in your fuel lines, keeps them free of gums, softens and removes carbon. Easy to use . . . just put it in your gas tank . . . and have dependable, inexpensive cold weather protection! Your Bowes "Seal Fast" dealer can supply you.

START

Faster . . .

DRIVE

Smoother!

It will pay you to visit your nearest Bowes dealer for fire and tube repairs . . . fan belts . . . oil filter cartridges . . . battery cables with terminals that *can't corrode* . . . and other fine automotive services and accessories "for smoother motoring."



**DRIVE IN WHERE YOU
SEE THIS BOWES EMBLEM**

BOWES "SEAL FAST" CORP., INDIANAPOLIS

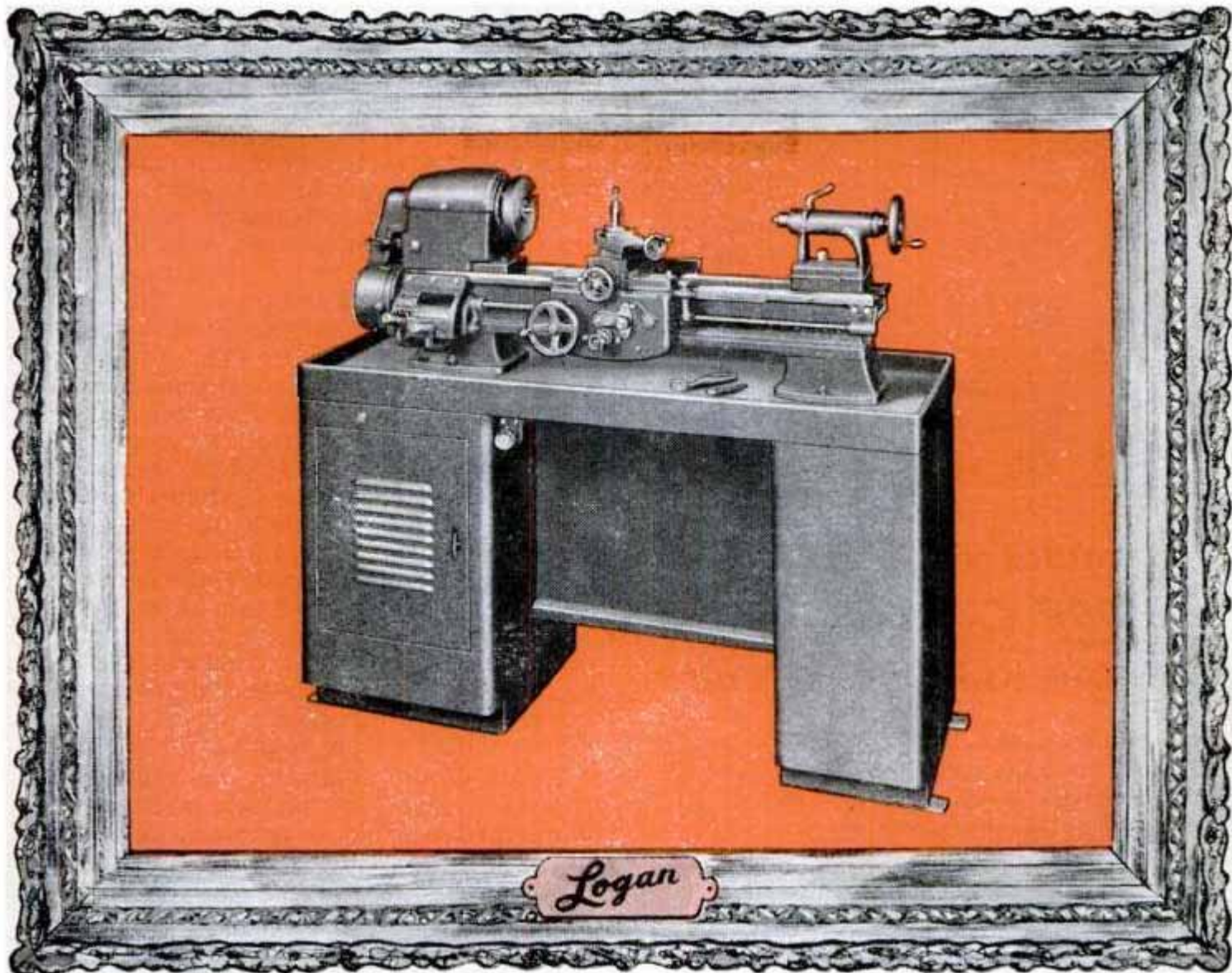

RARE PICTURE:

**Logan No. 955—Quick Change
Gear Lathe, 11" Swing, 1" Collet
Capacity, 1 $\frac{3}{8}$ " Spindle Hole**

A *Logan* LATHE

That's Idle . .

Look down the production lines of metal-working industry, through tool rooms, and large and small machine shops . . . you'll find the workhorse schedules assigned to Logan Lathes.

Logan Lathes keep busy because they do many jobs well. They are quickly and easily set up for any type of lathe operation, a heavy cut, a tool room precision job, a high speed production run, or large volume second operation work. Their sustained accuracy and

rugged durability keep production going at top efficiency. With 11" swing and 1" collet capacity they handle a big percentage of any shop's work. Rugged as well as accurate, they are lathes you can depend on, not only the first year, but for years after. Remember, too, that no other lathe of comparable specifications can match the Logan in economy.

LOOK TO LOGAN FOR BETTER LATHES AND SHAPERS

LOGAN ENGINEERING CO.
4901 West Lawrence Avenue, Chicago 30, Illinois

Write for the
Vest Pocket
Folder

All Logan
Lathes briefly
described in
this compact
folder



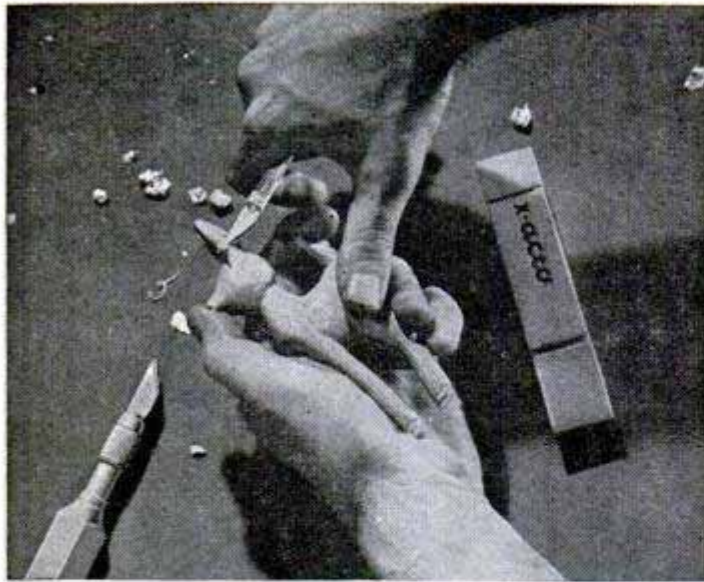

make your **HANDS** **MORE CREATIVE** with **x-acto Knives and Tools**

Creative hands can be your greatest asset... X-acto knives and tools help the intelligent coordination of active minds and agile fingers... they can develop skill and dexterity in any art or handicraft you select.



Whether it's boat whittling, model airplanes, wood-carving, leathercraft, model railroads or any other handicraft, you can make your hands more creative with "designed-for-the-job" precision-engineered X-acto knives, tools and handicraft kits.



X-acto offers the complete line of handicraft knives, interchangeable blades, tools and attractive kits



From 25¢ to \$30.—at dealers everywhere.



No. 82
X-ACTO KNIFE CHEST
\$4.20



Send 15c to cover postage for our new illustrated 28-page Catalog.



X-acto Crescent Products Co., Inc.
440 Fourth Avenue, New York 16, New York

real advantages to those kites. You could roar earthward with the plane in almost any condition of disintegration short of afire and stand a good chance of walking away from it.

However, one of our boys, Sumner Sewall, even lived to tell about being shot down in flames. In trying to escape an attacker who had set his whole tail assembly and rear fuselage afire, he whipped into a dive, doused the flame in the process, landed in a shell hole, somersaulted into another, and crawled away dazed but whole.

The planes would stay airborne under incredible circumstances. On one of my first sorties with Maj. Raoul Lufberry, one of our great aces and C.O. of the 94th when I joined it, my heart sank when I saw his prop go dead and his plane dip into a long dive. I dove after him, circling as he flattened out and plummeted into a muddy field, where he whipped over in a shattering somersault. A second later "Luf" crawled from under the wreckage, grinned up at me, waved and started hiking for the airdrome. The plane had blown a cylinder head. Luf sustained only a tiny scratch.

Twice, Jimmy Meissner, our rugged ace from Brooklyn, stripped the skin off his wings in his gritty determination to out-dive enemy craft in running combat. The first time, he completely peeled the top wing, leaving only a frightening view of ribs. But he nursed the crazy plane back across the lines, crash landed and crawled from the pile of debris unscathed. The second time, all the fabric was ripped from his right wings and Jimmy pulled the same stunt. He was the only man I knew who could consistently fly a Nieuport to a satisfactory landing with or without wings.

In one running fight with an Albatros I wouldn't have given much for my life. Right in the middle of the dogfight, with my sights lined up on the enemy pilot, my guns jammed. I jarred them free with my "jam hammer" and tried again. They jammed again at the crucial moment. Then to top it all, my oil ran out and the engine froze solid. I slid off in a dive, got away from the Albatros, hedgehopped over some barbed wire and was able to set the dead plane down in a perfect landing on a narrow field. I brought her in again with half the prop shot away, and she sat down like a feather.

One of our boys even landed in the treetops with a dead engine. The Nieuport crashed through the branches, rolled over and over, bounced to the ground in several sections, and the pilot walked home without a scratch. Another actually fell asleep as he was coming over the field to land his

(Continued to page 354)

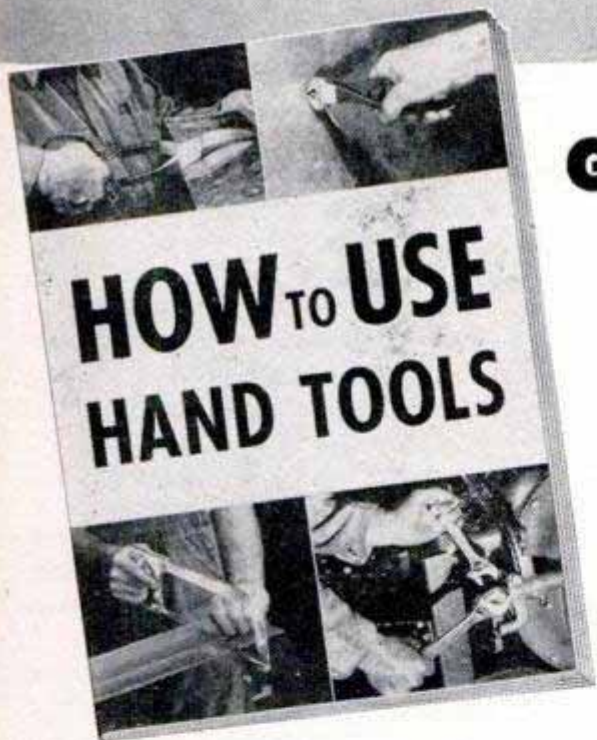
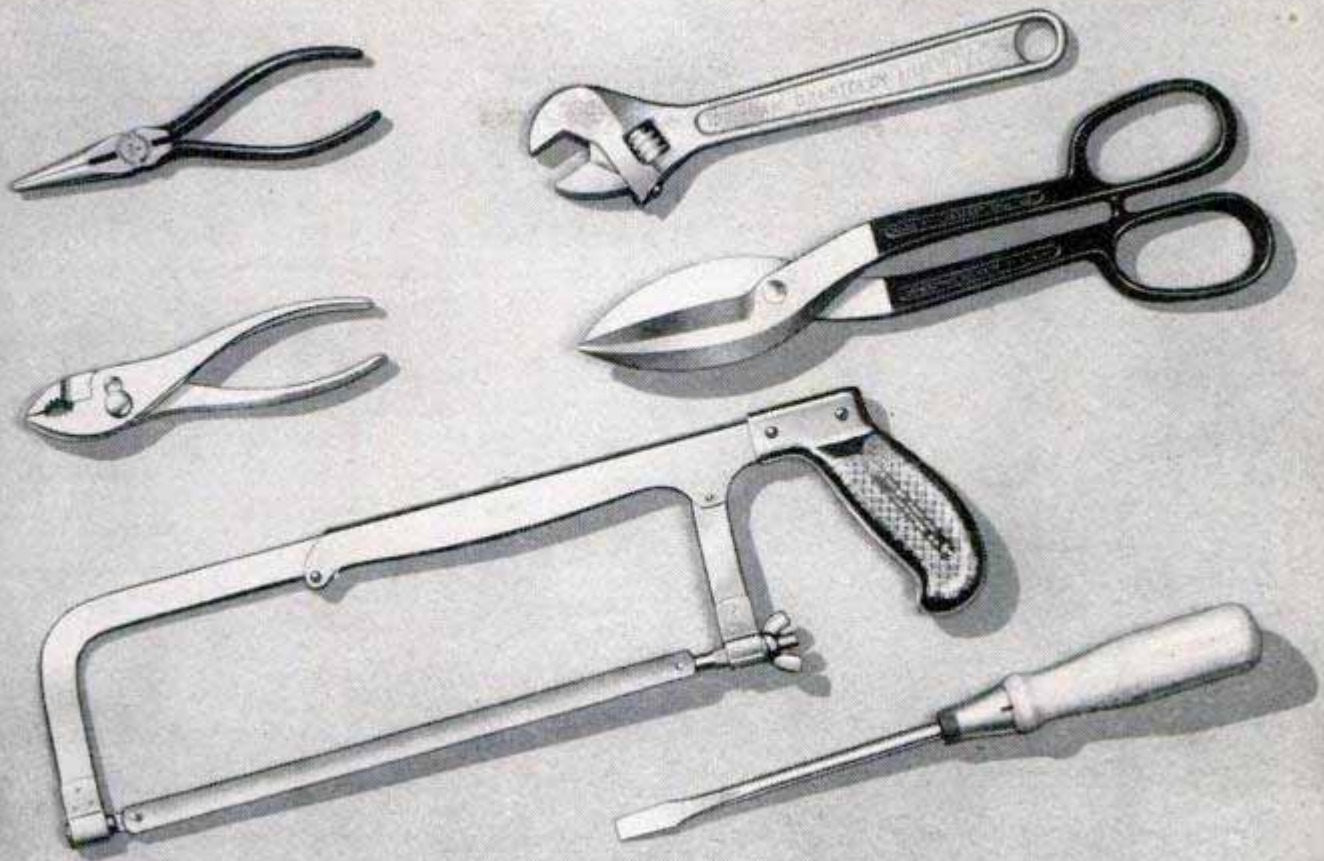

GOOD TOOLS

... save time ... reduce costs

Users of Crescent and Crestoloy Tools have long since learned the economy of paying just a little more (than "cheap" tools cost) to get a whole lot more in hand tool quality. Superior tool design not only reduces worker fatigue but produces more and better output. The longer life of Crescent and Crestoloy Tools definitely reduces maintenance and replacement costs.

GET YOUR FREE COPY . . .

This new 20-page booklet provides many useful how-to-do-it ideas for both amateurs and professional mechanics, as well as basic information on the proper selection, use and care of hand tools. 93 illustrations. Write today.

CRESCENT TOOLS

Give Wings to Work

*Sign of the Artisan
Symbol of Excellence*



The engine bearings

for your
present car engine



have been

over 50 years



in the making

**YES, OVER 50 YEARS OF KNOW-HOW
GO INTO FEDERAL-MOGUL OIL-CONTROL
ENGINE BEARINGS FOR YOUR CAR!**

... that's why mechanics everywhere use Federal-Mogul engine bearings for replacement when owners complain of oil-pumping. Your mechanic will tell you that new rings are not enough to correct the sluggish operation, poor pick-up and performance that result from motor-fouling oil waste. When the trouble is caused by worn connecting rod and main bearings, correction must start there, too. Replace with Federal-Mogul Oil-Control Bearings—they are engineered for the job! Ask your mechanic!

FEDERAL-MOGUL SERVICE
Division of Federal-Mogul Corporation
DETROIT 13, MICHIGAN



CONTROL OIL-PUMPING

WHERE IT STARTS—REPLACE WITH

FEDERAL-MOGUL

OIL CONTROL

BEARINGS



Spad. He overshot, woke up to find his wheels skimming treetops, circled back, whammed into some scrub brush and completely demolished the plane. Yet he came trudging up to the hangar with nothing more serious than a sheepish grin to show for the episode.

In spite of this hair-raising era of "growing up," the airplane was here to stay. When we entered the war on April 6, 1917, the air arm was still the Aviation Section of the Signal Corps and consisted of 35 pilots, 1987 enlisted men and 55 training planes. The Navy had 35 officer-pilots, 163 men and 54 airplanes. By the time the armistice was signed, the Army Air Force consisted of 20,568 officers, 174,456 men and 8403 planes. The Navy had built its air strength of 2853 officers, 32,873 men and 2127 planes. In addition, there were 282 officers and 2180 men in Marine Corps Aviation.

In the 1920s, aviation's second generation, the youngsters who entered the field after the war took over and the air age streaked ahead like a comet. Many of the men we regard as pioneers were hardly old enough to shave daily when they made their marks in history—Charles Lindbergh, James H. Doolittle, Clarence Chamberlin, Adml. Richard E. Byrd and a long list of others. Still others blazed trails for succeeding generations to follow. To the engineers and technicians of 20 years ago goes much of the credit for enabling planes to conquer the air over the oceans, around the globe and at each of the poles.

As one of the results of this pioneering, aviation operations, as well as aircraft manufacture, became an industry. Beginning with a few open-cockpit mail planes flying through the night, private operators built a transportation industry of staggering proportions, which now carries passengers, mail and air cargo to all corners of the earth. The average number of passengers carried by the domestic scheduled lines alone during 1950 was nearly 1,500,000 per month.

We are actually conducting our business today with aircraft built for the future. The next logical advancement in commercial air transports will be jet propulsion. Airliners being integrated into our fleets today are designed so that their reciprocating engines can be removed and replaced by jet power plants driving propellers. These days engines become obsolete faster than airframes. To protect our enormous investment in new planes, we are making sure that basic aircraft are adaptable to several stages of more powerful engines.

The time is not far distant now when

(Continued to page 356)

Famous "MILE-O-METER"

REG. U.S. PAT. OFF.

mileage meter & motor conditioner gauge

Shows You How to Save Gasoline -- Pays For Itself

Over a Million in Use

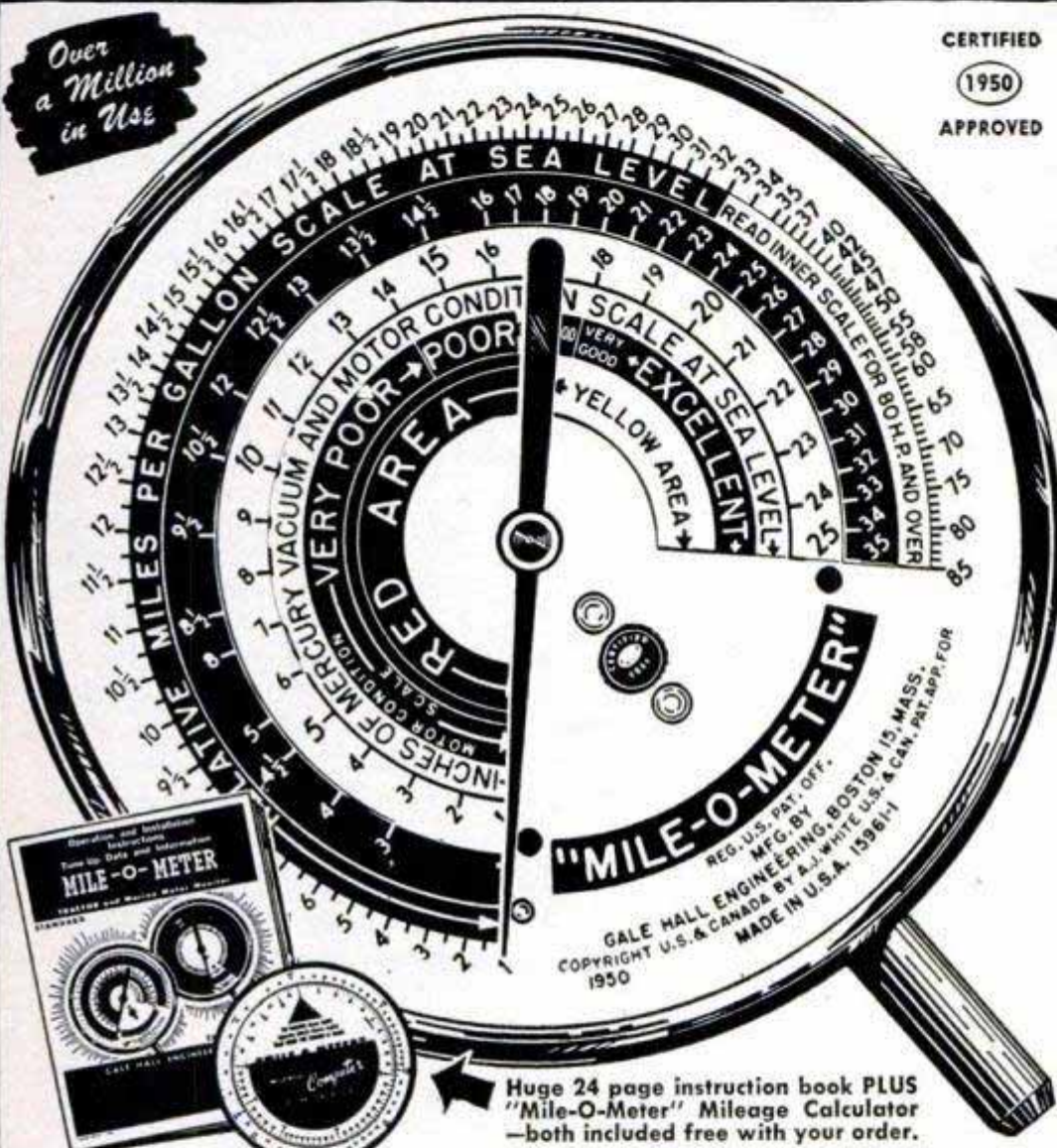

CERTIFIED
1950
APPROVED

DELUXE CHROME MODEL
3 3/8" Dia. **\$14.95** Ppd.
STANDARD MODEL
2 3/8" Dia. **\$9.75** Ppd.
(Both include Fed. Tax)

Look What You Can Do



Huge 24 page instruction book PLUS "Mile-O-Meter" Mileage Calculator — both included free with your order.

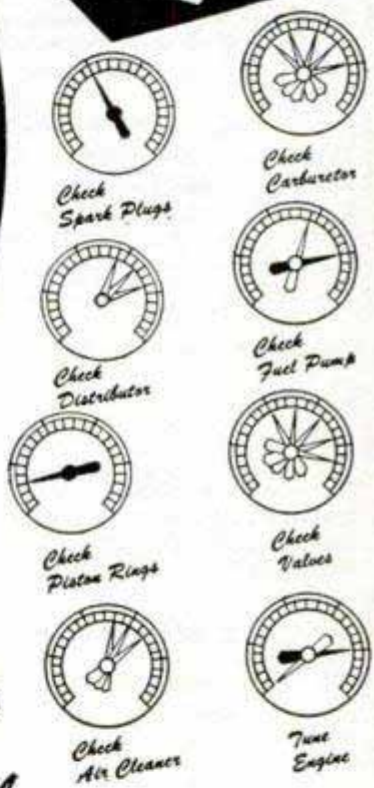

- Check Spark Plugs
- Check Distributor
- Check Piston Rings
- Check Air Cleaner
- Check Carburetor
- Check Fuel Pump
- Check Valves
- Tune Engine

"Mile-O-Meter" on your dashboard will register the miles per gallon faithfully at every speed and under every driving condition. It will show at what speed your engine will deliver its maximum power and can actually save you many gallons of gasoline. That isn't all—it serves as a constant check on the condition of your motor, and warns you of any operating imperfections for 31 different motor adjustments. Built with a fine watch precision, like the professional testers used by leading service stations and will save you \$5.00 to \$10.00 for each service check-up. "Mile-O-Meter" is nationally advertised. It can be installed in a few moments and transferred from old to new car for continued service. Order yours today!

Easy to Install



GUARANTEED FOR 100,000 MILES

No previous experience required to install and understand the "Mile-O-Meter." A "Mile-O-Meter" will become your constant companion on every trip, and enable you to save its cost in a very short time. This professional Miles Per Gallon & Motor Tune-Up Gauge is the outstanding contribution to the motoring public in 20 years.

DELUXE CHROME MODEL 3 3/8" Dia. \$14.95 Ppd. Fed. Tax Incl.
STANDARD MODEL 2 3/8" Dia. \$9.75 Ppd. Fed. Tax Incl.

The most important new meter in America



MAIL THIS COUPON—TODAY!

order from **GALE HALL Engineering Dept.**
107 Northampton St., Boston 18, Mass. 54
World's Largest Producer of Tune-Up Gauges

Please send — DELUXE — STANDARD — Mile-O-Meters at \$ _____
NAME _____
ADDRESS _____
CITY _____ ZONE _____ STATE _____

Check enclosed C.O.D. Gift Wrapped (Free) (1950)
Makes a perfect gift. **MONEY BACK GUARANTEE**

HELPFUL HINTS* ON PISTON RINGS



*FOR CAREFUL CAR OWNERS AND "POPULAR MECHANICS"

Select important replacement parts for your engine carefully. Burd offers these helpful hints on piston rings for assuring the maximum in care-free motoring.

- 1 When excessive oil consumption demands new piston rings be sure to replace with the proper Combination Set for your *particular engine, its specific condition, and class of operation*—since no *one* combination of piston rings can be expected to correct *all* engine conditions.
- 2 Piston ring installation is no job for a dub, so choose a reputable mechanic. No good mechanic will guarantee an *incomplete* job. Too often a perfectly installed set of piston rings is blamed for poor performance and oil waste caused by other engine ailments.
- 3 If your engine is already "down" for a piston ring replacement, you should have valves ground; install *Burd* valve packing to prevent costly leaks, remove carbon; replace worn bearings, pins, etc., to save labor cost.
- 4 Give newly installed *Burd* piston rings a chance to deliver maximum efficiency. Change oil regularly. Keep it *clean* with a good oil filter and replace cartridge frequently. This is especially important in winter to prevent formation of sludge and carbon that hurts piston ring performance.
- 5 Last but not least, consider the *brand* of piston ring you buy. BURD—a famous name in the automotive industry—has for 40 years enjoyed a rightfully earned reputation for tops in performance on passenger cars, trucks, tractors, and hundreds of industrial piston ring applications.



WRITE FOR A FREE COPY OF THIS 48-PAGE AUTOMOTIVE HANDBOOK

To motorists and mechanics who believe that "care will save your car," we invite requests for this educational booklet. Written by experts, it is an excellently condensed text on automotive operation and maintenance.

BURD PISTON RING CO., Rockford, Ill.
DIVISION OF THE GABRIEL COMPANY



PISTON RINGS • VALVE PACKING • VALVE GUIDES
HaDees HOT WATER CAR HEATERS

passenger planes will be driven by pure jet engines at 500 to 600 miles per hour cruising speeds. Specifically, this means that you will fly from New York to Miami in some two hours. In four or five hours you will span an ocean that Columbus struggled against for three long months.

From the passenger's standpoint, these planes will be the last word in luxury. Cabin interiors with supersoft reclining seats and roomy club-car motif will surpass anything ever attempted before. Pressurization and air conditioning will afford a superb "climate," even though you are cruising six to seven miles above sea level. Your plane of the future will be practically noiseless. It will have little or no vibration. You will read, write, work, play games, visit with fellow passengers or just relax while you travel from continent to continent as casually as you once went downtown to shop.

Other aspects of air travel will undergo drastic changes. The larger air terminals will become small cities within themselves. Baltimore's new Friendship International Airport is an indication of what the most modern will be like. There will be stores, shops, hotels, banks and other facilities where you can buy any article or service you require.

Despite these improvements, the odds are in favor of air travel becoming still cheaper rather than more expensive. Increased speeds will reduce almost all of the direct flying costs now paid by commercial operators. They will be able to pass these savings on to passengers. Ultimately, aviation will provide our cheapest means of transportation.

Experiences in Korea have high-lighted the use of the helicopter for short-haul trips between cities close together and from business districts to airports. Such service is already in operation in Los Angeles and similar service is planned for New York. Eastern Air Lines pioneered in this type of operation in 1939 when it operated autogyro mail service from the Camden, N. J., airport to the roof top of the Philadelphia post office. The project was discontinued after a year because of the impending war emergency. During the period it flew, the autogyro carried 83,766 pounds of mail and completed 85.8 percent of its schedules.

What's coming in the distant future? Frankly, I'm reluctant to hazard a guess. Atomic energy may fly airplanes in the next generation. Somebody alive today may take a voyage in a spaceship. Anyone who has watched aviation closely for the past half century is justifiably hesitant to even predict what the shape of the future

(Continued to page 358)

Fine tools at their best - for 84 Years

For generations, craftsmen have known you can always count on Millers Falls for the newest and best in tools. Send 25 cents to cover postage and handling on Catalog 49 - 176 pages illustrating and describing the greatest line in Millers Falls 84 years of quality toolmaking.



New No. 714 Bench Plane - last word in smooth, fast-cutting performance.



No. 5010 Bit Brace - top model in the world's largest-selling line of quality bit braces.

No. 300 Hack Saw Frame with unique, fast-acting lever for tensioning blade.



No. 185A Automatic Drill - the world's favorite tool for boring small holes.



No. 61A Screw Driver. Drives and draws automatically. Fast and dependable.



No. 2 Hand Drill. Powerful, smooth-acting, built to last a lifetime.



No. 624 Die Cast Aluminum Level - light and rigid - permanently accurate.



Unbreakable "Tenite" Handle Screw Drivers with torque tested, alloy steel blades.



World's most advanced line of metalcutting hand and power saws, including amazing "Jet-Edge", "Blu-Mol" and "Blu-Flex".

Heavy Duty Bench Grinders. Powerful, smooth-running, precision - balanced motors.



Langdon Acme Precision Mitre Box - First choice of professionals.



MILLERS FALLS COMPANY
Greenfield, Mass., U.S.A.

MILLERS FALLS TOOLS

SINCE
1868

The Mark of Superiority

BUILD YOUR OWN POWER TOOLS

Exclusive GIL-BILT Build-It-Yourself Features

- No machining—build easily with hand tools only
- No blueprint reading—step-by-step pictorial plans, full scale patterns, actual photographs
- Sturdy wood, steel, and aluminum construction
- Capacity and performance of commercial tools selling from \$60 to \$210.00
- Proven design—nationally advertised and sold for over 5 years

SAVE \$50 OR MORE

GIL-BILT 10-INCH TILT/ARBOR SAW



- 27x28 in. table, 13½ in. capacity in front of blade
- 10 in. blade cuts 3¼ in. deep, tilts full 45 degrees
- Floor model 34" high, table always stays level
- New Departure ball bearing arbor, ¾" precision shaft turned down for 5/8" bore blades, alum. housing, shipped ready to run
- Jackscrew and 4½ in. dia. handwheel lowers and raises blade
- Cast aluminum miter gauge and self-aligning rip fence guide

GIL-BILT Metal Parts Kit includes Plans, ball bearing arbor, miter gauge and bar, rip fence guide, dado insert, lock knobs, jack screw mechanism and handwheel, and all other metal parts (less blade) \$20.95
Same Kit with 10" Combination Blade \$24.90
Same Kit with 8" Combination Blade \$23.90

GIL-BILT BELT SANDER

- 84 sq. in. sanding surface. Over 4 times the effective area of a 10 in. disc sander.
- Belt operates in either vertical or horizontal position, does all sanding operations.
- Driver drum and pulley turn on sealed New Departure ball bearings; tension drum turns on Chrysler Oilite bronze bearings.
- Spindle and tension mechanisms of cast aluminum, completely machined and assembled.
- Belt travels 1800 ft. per min. Over a MILE of straight sanding action every three minutes. Saves more "elbow grease" than any other tool.

GIL-BILT Metal Parts Kit includes Plans, ball bearing spindle, 4 in. driver drum, 3 in. tension drum, tension mechanism, table tilt segments, rubber tires, cloth sanding belt, and all other metal parts \$16.95.



GIL-BILT 12" BANDSAW

- Cuts to center of 24 inch circle
- Handles stock up to 6 inch thick
- 18x18 inch table tilts 45 degrees
- Lower wheel and drive pulley runs on sealed New Departure Ball Bearings; Upper wheel runs on two 5/8" bore Oilite Bronze bearings.
- Upper wheel tension and tilt mechanism of cast aluminum, completely assembled.
- Upper and lower blade guides. Each has ball thrust bearing, self-lub bronze jaws.
- Rigid cast aluminum wheels fully machined ready-to-install. Heavy rubber tires.
- Uses standard 78 inch blades up to 3/8 in. wide.
- Fully enclosed mechanism for utmost safety.

GIL-BILT Metal Parts Kit includes Plans, rubber tires, aluminum wheels, ¼ in. blade, ball bearing spindle, tilt mechanism, blade guides, table tilt segments, and all other metal parts \$21.95

NEW FOR '52—18" BANDSAW

- Cuts to center of 36 inch circle
- Maximum height under top guide 12 inches
- 26x28 in. table tilts 45 degrees
- Floor model. Motor and all moving parts fully enclosed
- Heavy ¾" drive shaft. Oilite bronze bearings never need oiling
- Rigid cast aluminum wheels precision machined, 18¾ in. dia. with rubber tires
- Upper and lower blade guides. Each has ball thrust bearing, self-lub bronze jaws
- Upper wheel tension mechanism of aluminum and steel, completely assembled

GIL-BILT Metal Parts Kit includes Plans, rubber tires, aluminum wheels, ¼ in. blade, drive shaft and bearings, tension mechanism, blade guides, table tilt segments, and all other metal parts. Available soon

Return Kit in 10 days For Refund if Not Satisfied (Prices include postage within 300 miles. Over 300 miles add 5% to above prices.)

Also available — Plans and Parts kit for 8" Tilt/table saw. Order Plans at \$1.00 each — Sent postpaid anywhere in the World or write for FREE descriptive catalog.

GILLIOM POWER TOOLS

P. O. Box 1-PA, Lambert Field, St. Louis 21, Missouri



for several years. Experiments with guided missiles may result in drastic changes in our aircraft. An airframe not even on the drawing boards today may be the conventional design at the close of this century.

The engineers tell me that tomorrow's multijet airliner at 150,000-foot altitude could travel from New York to Miami in 15 minutes. If you're talking about airplanes, it's wise not to scoff at anything. Picking up an old album the other day, I saw a picture of the Gee-Bee Super-Sportster. I don't expect to ever see a stranger-looking airplane. Yet Jimmy Doolittle won the 1932 Thompson Trophy Race with it at an average speed of 252.68 miles per hour.

In this business, the impossible may only take a little longer, but its accomplishment is certainly probable.

Dawn of the Electronic Age

(Continued from page 159)

stage of the Metropolitan Opera House. Other stars followed. I continued my broadcasts until 1917, then resumed after the war, first in New York, later in San Francisco. Then broadcasting struck the public fancy. It spread swiftly. First came the programs on the air, then the public urgently seeking equipment to listen in. There began the growth of the multi-billion-dollar radio industry as we know it today, with some 2000 transmitters and 50,000,000 receivers in day-and-night operation. Business soon saw here a wonderful medium for the commercial "good will" message (too frequently, crass commercial advertising breeding anything but good will) and so generously sponsored the programs that today sales of AM-station franchises are frequently reported in the millions of dollars.

A melancholy view of our national mental level is obtained from a survey of the moronic quality of the majority of today's radio programs. So few of the owners of radio stations or the sponsors of their programs realize their unequalled opportunities for uplifting the cultural level of our public. Neither the church nor the public school has so powerful an influence over the mass mind of America. There are many outstanding exceptions to the average mediocrity, like the programs of the "music stations," and educational programs. The same may be said regarding the television stations now operating. The engineers and scientists have done a most outstanding, almost miraculous, job in giving us the marvelous electronic-television system of which all Americans may well be proud.

(Continued to page 360)

BEFORE YOUR ENGINE GETS BALKY...

MAKE THIS ROAD TEST

with

MARVEL

mystery oil

Next time you change oil, add a quart of Marvel
... you'll marvel at the difference it makes

- Prevents hydraulic valve troubles
- Prevents internal motor rust
- Prevents carbon formation
- Provides ring seal
- Frees sticky valves

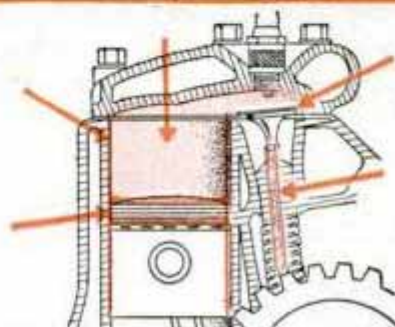

SAFER! Marvel Mystery Oil is the result of more than 30 years of lubrication research and improvement — specially developed for today's high-compression engines. Unlike many other oil additives, it contains no harmful acids or graphites — instead, it protects and adds to the life of your motor!



SMOOTHER! Marvel goes to work where regular oils stop. It combats top-cylinder dry-firing . . . reduces wear . . . keeps your engine free of gum, sludge and varnish. That means a dream of a ride, even under the most extreme conditions of pressure and heat.



SEE YOUR REGULAR GAS STATION OR DEALER
... write us for FREE information
and the name of your nearest supplier.

BE ENGINE WISE... MARVELIZE NOW!

Use Marvel Mystery Oil in the crankcase,
gas tank or any top-cylinder oiler.

EMEROL MANUFACTURING CO., INC.

Dept. 113 • 242 West 69th Street, New York 23, N. Y.



Just Like Magic

for making or mending
— these amazing
Wizards with Wood

Handy with your hands? Have your own workshop? Like to do odd jobs? You'll bless the day you discover the magical results you can obtain with Firzite, Satinlac and Weldwood Glue. At hardware, paint and lumber dealers. And mail coupon for free leaflets.

A MUST for Finishing Fir Plywood



Tame that wild grain with FIRZITE. Virtually prevents grain raise or checking... readies the surface satin-smooth for paint, stain or enamel. (For blond, pickled, or tinted effects on soft or hard woods, use White Firzite).

FIRZITE*

Newer than Shellac or Varnish



Pints, Quarts,
Gallons

For "natural wood" finishes on furniture, panelling or woodwork, there's nothing like Satinlac. Brings out natural grain and color beauty of any plywood or solid wood. Avoids that "built-up" look; will not turn yellow or darken with age. "Water-clear," easy to brush or spray, dries ready for next coat in 2 or 3 hours.

SATINLAC*

Glue That's Stronger than Wood



To make things or fix things, use Weldwood Glue for all wood-to-wood bonds. Makes joints stronger than the wood itself. Mixes easily with water. Stain-free, rot-proof... highly water-resistant!

WELDWOOD® PLASTIC RESIN GLUE

*Trade Marks

United States Plywood Corporation,
Dept. 364, 55 West 44th St., New York 18, N.Y.
Send me free leaflets on Weldwood Glue, Firzite
and Satinlac.

NAME _____

ADDRESS _____

But many who are given to use this splendid instrument are so clumsy, so stupid, so shamefully dull-witted.

As though the present refinements of black-and-white TV were not sufficiently marvelous, television engineers have now in readiness for public approval two systems of color. One by CBS has had the too-hurried approval of the F.C.C., an approval upheld recently by the Supreme Court. It is mechanical, uses a whirling tri-color disk, is limited in size to a 10 or 12-inch picture, is incompatible, so that even in black and white not one of the existing 15,000,000 receivers can reproduce the picture without an adapter gadget. By contrast RCA has an all-electric system, not limited in picture size and wholly compatible. Every existing receiver can reproduce that picture in black and white. It is clear which of these two systems will be more patronized by the advertising sponsors! The choice made here by F.C.C. is therefore one of today's outstanding marvels of bureaucratic bungling. National welfare demanded no such haste!

In four years World War II gave to electronics a stimulant and boost which 15 years of peaceful development might not have produced. The foremost development was radar; then came sonar, loran, the proximity fuse, the guided missile, the blind-landing systems for aviation, ground altimeters, ground-speed indicators, automatic pilots, as well as a hundred less-spectacular electronic devices within the inner working of today's airplane. Today's surging preparation of more complicated weapons for defense and offense is finding hourly new uses for, and new forms of, that Promethean device, the grid tube—evacuated or hydrogen filled.

At one time in 1906 I held in my coat pocket the entire world's supply of three-electrode tubes, two in number. Last March the month's output of small receiving and amplifying tubes reached the astronomical figure of 42,400,000. All in one man's lifetime! Such is the progress of science and technology in free America in this mid-20th century.

The old, long-waged, unsuccessful battle of wireless telegraphers for static suppression led Edwin Armstrong to his frequency-modulation system, an old idea long discarded as impractical. Since that accomplishment we have had a new growth in broadcasting transmitters in friendly competition with the old AM stations. Both systems have their special merits.

In the vacuum-tube amplifier, in whose operation the grid (by controlling the B current) is itself the key, reside most of

(Continued to page 362)

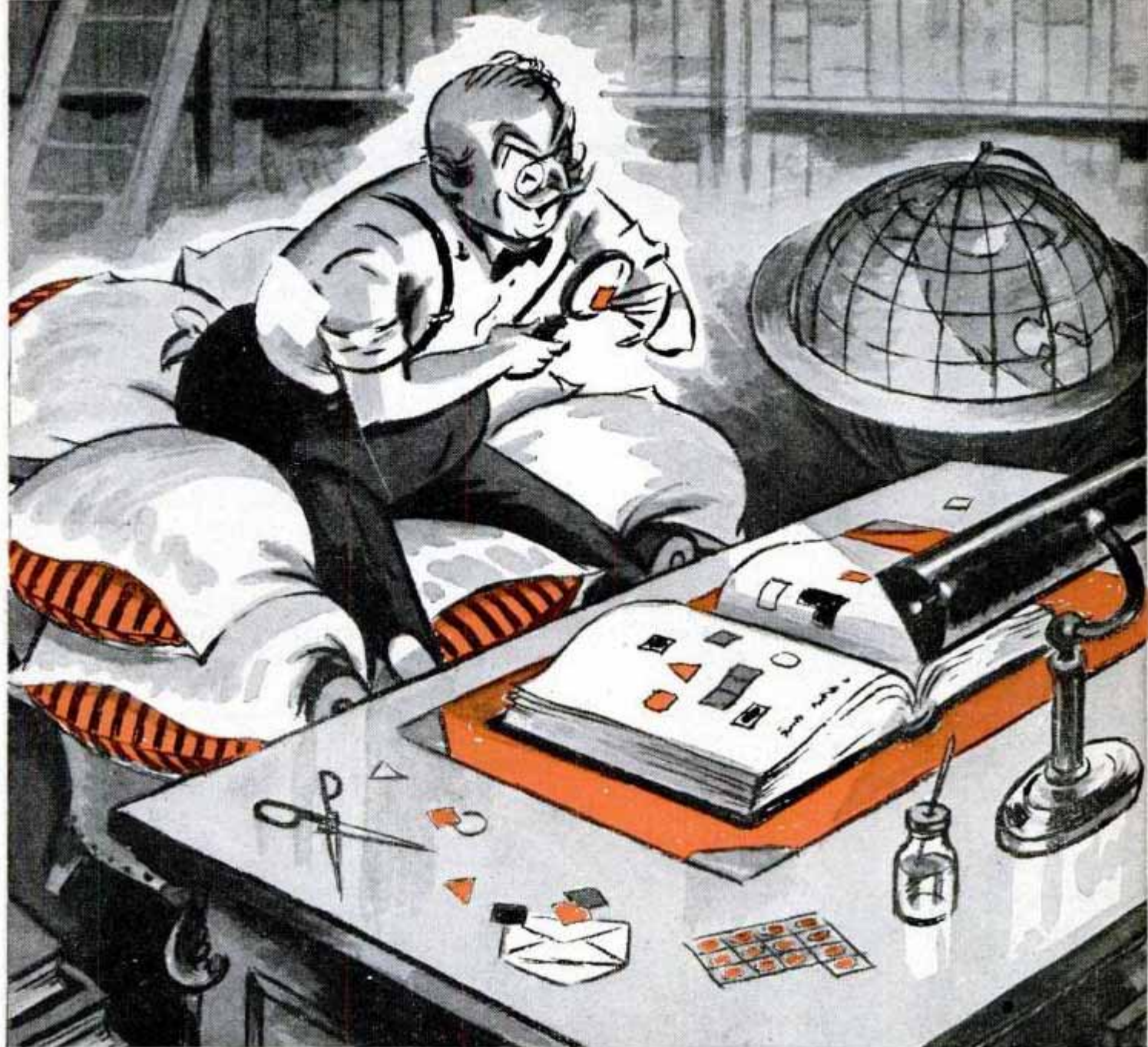

MARFAK MADE HIS CAR RIDE SO CUSHIONY HE'S SPOILED

This winter, get longer lasting lubrication protection for your car's chassis. Get *Marfak* lubrication. It lasts for 1,000 miles or more! *Marfak* guards against winter's slush and snow—it resists wash-out. Specially made to resist jar-out and squeeze-out, too. Get "cushiony" riding that *lasts*. For *Marfak* lubrication see your Texaco Dealer, *the best friend your car ever had*.



Faithfully yours
50
 for Fifty Years

THE TEXAS COMPANY
TEXACO DEALERS IN ALL 48 STATES

Texaco Products are also distributed in Canada and in Latin America



TUNE IN . . . TEXACO STAR THEATER starring MILTON BERLE on television every Tuesday night. METROPOLITAN OPERA radio broadcasts every Saturday afternoon. See newspaper for time and station.

First for fine work!

There's one point on which all mechanics agree—Stanley Tools are first for fine work. That's why you'll see these Stanley Tools in the tool chests of skilled woodworkers everywhere. Accuracy and easy action make these tools perfect partners for fine workmanship. Look for this famous **STANLEY** at your hardware dealer's. It's the sign of top quality tools.



No. 106 "Zig-Zag" Rule
Green ends. Large, easy-to-read numerals. New protective plastic finish. 6' and 8' sizes.



No. 610 Hand Drill, New!
Enclosed gears for safety. Drills holes easier, faster to full 1/4" capacity.

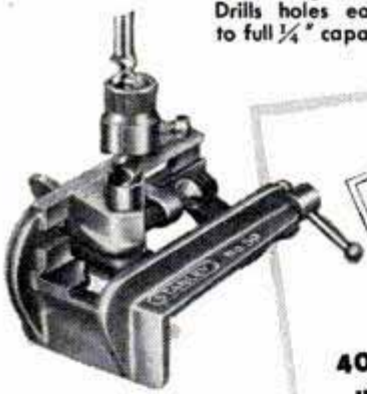

No. 59 Doweling Jig
For boring holes accurately and easily in the edge, end or surface of boards. Furnished with depth gauge and six guides — 3/8, 1/2, 5/8, 3/4, 7/8, 1"



40 PAGES OF TOOL "KNOW HOW"...
only 25c

Stanley Tool Guide contains full information on how to use all common hand tools. Invaluable to beginners, helpful to experienced craftsmen. Send for your copy with coupon below.

Stanley Tools,
New Britain, Conn.

The Tool Box of The World



Reg. U.S. Pat. Off.

HARDWARE • TOOLS
ELECTRIC TOOLS
STEEL STRAPPING • STEEL

SEND STANLEY TOOL GUIDE

Stanley Tools, 312 Elm St., New Britain, Conn.
(In Canada: Stanley Tool Co. of Canada, Ltd.,
312 Stanley St., Roxton Pond, Quebec)

Send me..... Stanley Tool Guide.
Enclosed is 25c per copy.

Name.....
Address.....
City..... State.....

the present and future possibilities of electronics. Space permits only the briefest mention of some tubes and their uses. A compact maze of diode elements may constitute an electron-multiplier tube having an amplification factor of several thousand, in a tube the size of your finger. Such tubes are indispensable in the image-orthicon TV camera that "photographs" electronically your favorite television program.

I can merely mention today's employment of "counter" tubes, the basis of all computing machines, solving in seconds complex equations which would require months of tedious mathematical analysis, but basically employing the old Eccles-Jordan "tick tack" circuit, useful in the instantaneous advance computation of the course of projectiles.

The oscillating tube has a hundred uses beside those of radio transmission, as in diathermy (physical therapy), plastic molding, metal fusing, welding, tin plating and plywood manufacture. The cyclotron, synchrotron and bevatron, atom-smashers, generating up to a billion volts, depend on high frequencies generated by the oscillating vacuum tube. Thus has this tube ushered in the atomic age. Now we have the protective radar barrage triggered with megawatts of pulse energy generated by a grid-controlled hydrogen-filled tube to protect us from a future Pearl Harbor! What more important achievements can one ask for the grid to perform?

With grids working half-time only we have the thyrotron, ignitron, using mercury vapor and argon, hydrogen or helium gas, carrying thousands of amperes in some sizes. Electronic devices control high-speed wrapping of packages, fill bottles to the proper level, remove slate from coal at the mines, level elevators, open doors, detect smoke and fumes, measure vibrations and thickness, cement, select and count, saving man from limitless hours of tedious toil. The traveling wave amplifier of ultrashort waves and the transistor will more and more supplement, but never supplant, the Audion.

As a growing competitor to the tube amplifier comes now the Bell Laboratories' thermistor, a three-electrode germanium crystal of amazing amplification power, of wheat-grain size and low cost. Yet its frequency limitations, a few hundred kilocycles, and its strict power limitations will never permit its general replacement of the Audion amplifier.

In optical engineering the combination of a phototube and the electron amplifier tube is omnipresent, indispensable. It makes possible the talking motion picture

(Continued to page 364)



... this 1952 ALLIED catalog mirrors the Electronic Age!

**SEND FOR YOUR
FREE COPY!**



**212 PAGES OF ELECTRONIC PRODUCTS—HIGHEST
ACHIEVEMENT OF AMERICAN INGENUITY AND PROGRESS**

American achievements in the field of electronics rank at the top of the momentous accomplishments of the past fifty years. In Radio, in Television, in the application of Electronics to industry, defense and everyday living—American ingenuity and inventiveness have set the pace.

From the early pioneering days in electronics, ALLIED RADIO has performed a continuous reliable service, supplying engineers, service technicians, Amateurs, experimenters and builders with quality equipment to meet all their needs.

Today, as always, the 1952 ALLIED Catalog is the one authoritative, complete, up-to-date buying guide to Radio, TV and Industrial Electronics. Its pages mirror the Electronic Age. Here you will find the world's largest stocks of quality equipment at

lowest money-saving prices. You will see the latest in electronic apparatus: new TV, FM and AM receivers; High-Fidelity Audio components, P.A. systems and accessories; recorders; Amateur receivers and station gear; specialized industrial electronic equipment; test instruments; builders' kits; huge listings of parts, tubes, tools, books—*everything* in Electronics. And ALLIED gives you every buying advantage: speedy delivery, expert personal help, lowest prices, assured satisfaction. Get the 1952 ALLIED Catalog—and stay ahead in Electronics!

**GET YOUR COPY OF RADIO'S
LEADING BUYING GUIDE**

FREE SEND FOR IT NOW



ALLIED RADIO

*specialists in the supply of
EVERYTHING IN RADIO, TV,
AND INDUSTRIAL ELECTRONICS
for more than a generation*

ALLIED RADIO CORP., Dept. 5-A-2
833 W. Jackson Blvd., Chicago 7, Illinois

Send FREE 212-page 1952 ALLIED Catalog

Name

Address

City.....Zone.....State.....

POWER TOOLS

need
WRENCHES
that fit!



Expensive, precision-made power tools work better — last longer — when they're serviced with Billings LIFE-TIME® Wrenches. Billings famed quality steel — accurate openings — clearly marked sizes — smooth, machined surfaces and perfect finish — make these fine wrenches the favorite of mechanics and craftsmen from coast to coast, (according to Popular Mechanics magazine's unbiased study of fixed opening wrenches) and... the BUY OF A LIFE-TIME!



BILLINGS® LIFE-TIME® WRENCHES

Available at your favorite hardware store, singly or in practical service kits. Engineers' — Combination — 45° & 15° Box patterns.



NEW PRACTICAL TIE CLASP!

Genuine BILLINGS Wrench made into handsome TIE CLASP suitable for work or play! Brilliant plated finish over Billings quality steel. Engineers' pattern Wrench (3/16" & 1/4" opening).
ONLY 50¢

Write today! Only one per person.
THE BILLINGS & SPENCER CO. HARTFORD CONNECTICUT
Specialists in Drop Forgings of all kinds since 1869

as well as television, measures the energy of stars infinitely distant from our telescopes. The electron microscope, with magnification of 25,000 diameters, makes visible the infinitesimal universe.

As to the future of the electronic age we can foresee a multiplication and extension of every discovery and development which these first 45 years have revealed. In detail: I foresee great refinements in the field of short-pulse microwave signaling, whereby several simultaneous programs may occupy the same channel, in sequence, with incredibly swift electronic communication; vastly important developments in microwave technique, whereby present clumsy connecting leads between wall or floor sockets and electric devices like toasters and vacuum sweepers may become unnecessary; gigantic magnetrons and klystrons, or their successors, will generate megawatts in microwaves; living rooms and their occupants will be heated by high-frequency waves from walls or ceilings; short waves will be generally used in the kitchen for roasting and baking, almost instantaneously, with far better results than in the past; insect pests will be eliminated by like means; bacteriological and biological research will be enormously advanced by short and microwaves of selective frequencies; plant growth amazingly hastened and improved by similar means.

Automobile collisions will be rendered impossible, or unlikely, by radar-controlled brakes and warning signals. By means of the radio space-analyzer, or "telescope," astronomers' knowledge of our universe will be vastly widened. (I do not foresee "spaceships" to the moon or Mars. Mortals must live and die on Earth or within its atmosphere!)

In yet more remote decades electron physiologists will solve the mysteries of biologic "wave emanations," akin to but very different from hertzian waves of any form or frequency, so that radiated "thought or brain waves" may be picked up at some distance, transformed into electrical phenomena, analyzed, measured in units, eventually to make a definite science of the transference of brain and body radiations and emotional disturbances; so that joy and grief can be measured in definite, quantitative units! Eventually, a professor may be able to implant knowledge into the reluctant brains of his 22nd-century pupils. What terrifying political possibilities may be lurking there! Let us be thankful that such things are only for posterity, not for us.

As is eloquently engraved in stone on the National Archives Building in Washington: "What's Past Is Prologue."

look for
this sign



This expert

knows all makes
of carburetors
"inside-out"

He's the Hygrade
System Mechanic

see him--
save gas!



The Hygrade System mechanic locates the trouble faster and does a more thorough job. He replaces all worn parts and parts that wear with brand new parts.



AUTO

MECHANICS: Become a recognized carburetor expert. Open a Hygrade System Carburetor Dept. Write for FREE booklet to Hygrade, 37-20 Northern Blvd., Long Island City 1, New York.

TAKE YOUR
CAR TO THE

HYGRADE SYSTEM
SHOP FOR PEAK CARBURETOR PERFORMANCE

New! Easy! Quick!



Flexible, Crystal-Clear PLASTIC SPRAY COATING

Waterproofs, Rustproofs, Protects 1001 Things!

- Auto chrome
- Auto ignition systems
- Spark plugs
- Auto seatcovers
- Photographs
- Luggage, leather goods
- Precious documents
- Books
- Jewelry
- Wallpaper

Scores of other uses in the home, office, garage or shop! Get CLEERON! Mail coupon today for name of nearest dealer!

Made by the makers of
HEET
for faster cold weather starting!

Just Spray On
CLEERON

Mail Coupon Now

HEET DIVISION—DeMert & Dougherty, Inc.
3001 W. 47th St., Chicago 32, Illinois

I'm interested in amazing CLEERON. Where can I buy it?

Name _____

Address _____

City _____ Zone _____ State _____

The Story of Popular Mechanics

(Continued from page 132)

The early years of financial struggle were not reflected in the lively pages of the magazine. The Panama Canal was presented in maps, diagrams and text. Another 1902 item told of Emperor Wilhelm Hohenzollern's new yacht, "with splendid furnishings including a silver service weighing two tons and valued at \$1,250,000." A British steamship was first to cross the Atlantic fueled only by oil. Chicago was busy turning a river around and creating the Chicago Sanitary and Ship Canal. There was a picture story, "Drilling the Great Subway Under New York."

Progress was noted in the development of the automobile in an article that appeared in November 1902. The title was "The Ferocious Automobile Is Tamed." An excerpt: "Like a wild bronco of the Texas plains it would buck and lunge and pitch until few had the nerve to tempt its ferocity. Sometimes it would charge backward when the chauffeur tried to make it go forward, or switch around sideways, jump upward and endways. It was a hard matter to tell which way the 'mechanical beast' would go. But now all these troubles of the automobilists are over."

The advertising columns told their story, too. International Correspondence Schools urged readers to double their salaries with a simple arithmetic problem showing that \$15 plus \$15 equals \$30! The Century Manufacturing Company of East St. Louis advertised a buggy at \$33.50, also "elegant parlor organs, \$25 and up, elegant upright pianos, \$125, elegant sewing machines, \$13." Another ad featured a fountain pen as "a miracle of ingenuity."

Other high lights of that first year included the introduction of the Shop Notes department in the Craftsman section, a bow to the steam locomotive, which was observing its 100th anniversary, and a boost in circulation from the original few hundred to 17,000!

In 1903 the magazine achieved a mark of distinction with an article by Guglielmo Marconi, inventor of the new wireless telegraphy. Marconi's was the first of the many truly distinguished by-lines that have appeared in *Popular Mechanics*. Thomas A. Edison, Theodore Roosevelt, Adm. George Dewey and Pierre Curie also contributed to early issues. Curie wrote: "It is difficult to predict the future of radium, but I believe its field will be in the domain of medicine rather than of warfare and commerce."

During the first decade of *PM's* existence, the magazine's pages reflected a nation

(Continued to page 368)

Now a Kentile Floor for Only \$17⁷⁵* for a 7' 6" x 9' room

IT'S SO EASY TO INSTALL
GUARANTEED KENTILE
YOURSELF...AND
SAVE MONEY



Here's the floor anyone can lay — and thousands are doing it! Kentile is precision-cut to go down tile by tile, quickly and simply over any smooth, firm underfloor.



Low-Priced Kentile Floors are Guaranteed...and only your Kentile Dealer can make this Offer!

KENTILE resists dirt and stain... colors are *guaranteed* not to wear off. Mild soap and water cleanings preserve the beauty of a Kentile Floor and an occasional no-rub waxing keeps it colorfully bright and fresh as new.

*Price quoted is for a 7' 6" x 9' Kentile Floor installed by you. Your Kentile Floor may cost you less or slightly more depending on size of room, colors selected and freight rates.

Look under FLOORS in the classified pages of your local phone directory. In Canada—at T. Eaton Co., Ltd. FREE estimate will show you how surprisingly little Kentile costs.



KENTILE®

The Asphalt Tile of
Enduring Beauty



KENTILE INC., 58 Second Ave., Dept. G-1, Brooklyn 15, N.Y.

**I'LL SHOW YOU
HOW TO INSULATE
YOUR HOME FOR AS
LITTLE AS \$67.60***



**Do It in an Afternoon
... Save on Fuel Bills!**

In just a few minutes your dealer can show you how to insulate your attic in one afternoon with Zonolite vermiculite Insulating Fill. It flows easily, snugly in attic joists or sidewall studs, completely seals off heat leaks. And Zonolite will save up to 40% on fuel bills—will give you greater comfort summer and winter! Visit your lumber or building supply dealer or send for Free Booklet. Write today.

*Cost of Insulating average attic.



**FIND OUT ALL
ABOUT THIS WONDER
INSULATION NOW:**

Zonolite Company, Dept. PM-12
135 S. LaSalle St., Chicago 3, Ill.

Please send me at once, "Your Home . . . Its Comfort and Protection." No obligation to me, of course.

Name.....

Address.....

City.....Zone.....State.....

SEE YOUR LUMBER OR BUILDING MATERIAL DEALER

Build your own SMITH Compressor

Operates spray guns, rock drills, tampers, paving breakers, sandblasting . . . Uses only 1 gallon of gas an hour!



Save Money—build your own Smith Air Compressor! Famous the world over! Capacity 60 cu. ft.; pressure up to 100 lbs. per sq. inch. Just order the Smith Compressor Head and Accessories with complete instructions for assembling. All you need is a Ford Motor and shop facilities. Head equipped with high speed compressor valves; automatic unloading and idling.

Write for complete information!

GORDON SMITH & COMPANY, Inc.
410 College Street • Bowling Green, Ky.

struggling to learn to drive an automobile and, what's more important, to keep it going; a nation intensely interested in man's frantic efforts to fly; a nation that marveled at the wonders of wireless, the telephone, the phonograph and at the multitude of uses for electricity. From research laboratories throughout the land came mechanical aids to help alleviate the drudgery of everyday life and make the world a better place in which to live. One of the latter, a boon to the farmer, was the small gasoline engine.

In the summer of 1903, an automobile performed the "daring feat" of climbing Pikes Peak. This was duly recorded in an early issue of *Popular Mechanics*.

On December 17, 1903, two young men from Dayton, Ohio, Wilbur and Orville Wright, made history by flying their crude plane at Kitty Hawk, N. C. *Popular Mechanics* promptly published "The Truth About the Flying Machine," which concluded, "So long as flying machines have gotten off the ground their conquest of the air is only a matter of time, of money, of patience and of brains."

The year of 1904 also saw the beginning of *Popular Mechanics'* book department. *Shop Notes* was the first book brought out and was the forerunner of such familiar titles as *What to Make*, *The Boy Mechanic*, *The Amateur Craftsman* and scores of others. Millions of books and pamphlets bear the imprint of the Popular Mechanics Press and in more recent years the Windsor Press. Norman Guess, well-known in the book world, is the present director of PM's flourishing book department.

First-decade readers of the magazine followed the exploits of Commander Robert E. Peary (later Captain, finally Admiral) in his efforts to reach the North Pole. Climaxed by the Pole's discovery in 1909, a subsequent article by the admiral was entitled, "What the World Gains by the Discovery of the Poles." That year—1909—the magazine also reported a new record for the flying Wright brothers, who stayed aloft for one hour, 53 minutes and 59 seconds; the development of a European "gyropter" that had two umbrellalike whirling propellers—granddaddy of the helicopter; the soaring of a Frenchman to a new altitude record of 1800 feet; the first flight across the English Channel by Louis Bleriot, and the introduction of anti-aircraft guns in Germany. Craftsmen were building mission-style furniture, and the magazine featured a seven-room, four-bedroom house that could be built for \$5500. That was also the year of a cover announcement that read: "Largest Circulation of Any

(Continued to page 370)

A NEW THRILL for Home Builders . . .

HEATHKITS

PROFESSIONAL QUALITY
RADIO and LABORATORY
INSTRUMENTS IN KIT FORM

Heathkit 5" OSCILLOSCOPE KIT

A laboratory quality oscilloscope 5" cathode-ray tube—every part supplied including instructions for operation and assembly. Includes ten tubes—all controls—high gain .03 Volt RMS per inch vertical sensitivity useful to 5 Mc. An outstanding buy. Shipping weight, 29 lbs. — Model O-7

\$43.50



Heathkit VACUUM TUBE VOLTMETER KIT

A complete electronic voltmeter in kit form. All parts supplied: cabinet, 200 microampere 4½" meter, tubes, test leads and instructions. Has 11 megohm DC input resistance. Measures full scale voltages AC and DC of 0 - 3 - 10 - 30 - 100 - 300 - 1000 Volts and resistance between ½ ohm and one billion ohms. The outstanding VTVM available today. Shipping weight, 7 lbs. — Model V-5.

\$24.50



Heathkit SUPERHETERODYNE RECEIVER KIT

A high quality AC operated superheterodyne receiver in kit form. Complete with five tubes—six inch slide rule dial—all coils—transformers and ready punched chassis and instructions. Learn about radio by building this outstanding receiver.



Model BR-1
Shipping Wt. 11 lbs.

\$19.50

Heathkit 6 WATT ECONOMY AMPLIFIER KIT

A powerful 6 watt amplifier kit. Complete with tubes—transformers and all parts. Use it for music reproduction—public address system—factory call—school dances, etc. Easily assembled. Rent it in your community and it will quickly pay for itself.



Model A-4
Shipping Wt. 8 lbs.

\$12.50

SAVE
2/3 THE COST

GAIN
VALUABLE
KNOWLEDGE

HAVE
A COMPLETE
LABORATORY
FOR A FEW
HUNDRED DOLLARS

BUILD
OSCILLOSCOPES
V.T. VOLTMETERS
SIGNAL
GENERATORS
AMPLIFIERS . . .
BRIDGES and 20
Other Instruments



Easy STEP BY STEP INSTRUCTIONS WITH PICTORIAL DIAGRAMS . . .
MAKE ASSEMBLY EASY FOR ANYONE.
All metal parts ready punched. Only pliers, screwdriver and soldering iron needed for assembly.

ORDER TODAY OR WRITE FOR CATALOG . . . **HEATH COMPANY** BENTON HARBOR 17, MICHIGAN

PEEL OFF PAINT with Klean-Strip



**New-type
remover is fast,
safe, clean, and
easy to use!**

No wash! • Non-inflammable!
Sold at leading paint, hardware and
department stores everywhere.
Product of W. M. BARR & CO.
2360 S. Lauderdale
Memphis 2, Tenn.

KLEAN-STRIP TAKES OFF ANY FINISH

HOME CRAFTSMEN AND HOBBYISTS!

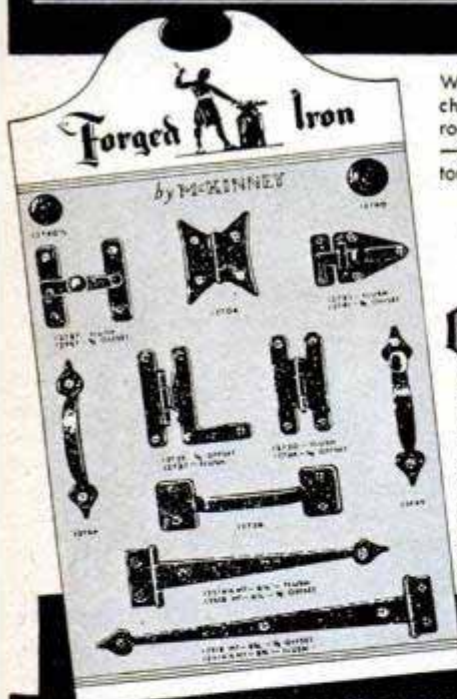

When you build cabinets,
chests, furniture, remodel
rooms, redecorate your home
—add the distinctive finishing
touch by using

MCKINNEY

Forged Iron Cabinet hardware

Attractive authentic Heart
pattern strap hinges, H and
L hinges, latches, drawer
pulls and knobs, etc. in dull
black or Swedish iron finish.
Buy them at your local
hardware, lumber or paint
dealer. Look for the
McKinney display.

**SEND FOR
FREE
FOLDER**

**SHOWING MCKINNEY PERIOD PATTERNS
AND SUGGESTED USES.**

McKinney Manufacturing Company
1400 Metropolitan Street, Pittsburgh 33, Pa.
Please send free folder on McKinney Forged Iron Hardware to:

NAME _____
ADDRESS _____
CITY _____ STATE _____ PH. _____

Mechanical Publication in the World"—a proud statement that has been sustained through the years. After seven years of struggle the magazine was successfully established.

One of the turning points in the magazine's success was founded on the faith of two members of the advertising department—Clyde Blair and Charles Minor. They came to work for Mr. Windsor in 1907 and today—45 years later—are still actively selling advertising space. When the going was roughest they shared Mr. Windsor's belief in the future of *Popular Mechanics*. Their youthful vision has made them two of the most successful and famous advertising salesmen in the country.

Early in 1912 *Popular Mechanics* polled 1000 of the world's leading scientists to name the seven wonders of the modern world.

This proved to be one of the outstanding features that year in any American magazine. The results from the poll of 1000 scientists were reported in the August issue. The seven wonders selected were: Wireless, telephone, airplane, radium, antiseptics and antitoxins, spectrum analysis and X ray. Close runners-up were the Panama Canal, anesthesia and synthetic chemistry. Alexander Graham Bell contributed an article on the telephone to that issue.

During those pre-World War I years *PM* readers studied "Lessons From the Titanic Disaster"; they learned about flying boats from Glenn H. Curtiss; they followed the step-by-step completion of the Panama Canal; they hunted "The Biggest Game of All" with Roy Chapman Andrews; they read with unbelieving eyes that a man named Charles F. Kettering had invented a self-starter for automobiles, and promptly wrote to Editor Windsor complaining about such an impossibility being recorded in *Popular Mechanics*; they read about a mantle lamp that "beats all electric or gasoline-lighting facilities" and a toaster that "turns bread automatically"; they saw pictures and a story of the completion of the transcontinental telephone line (final link was from Denver to San Francisco).

World War I, from its beginning in 1914 to the armistice in 1918, was extensively covered by *PM*. One issue alone (December 1914) carried 50 war pictures out of 300 appearing in the magazine. One article, "Size and Power of German Howitzers Surprising Development of the War," pointed out that "never before have such terrible engines of annihilation been carried by an invading army." These guns fired a 16.5-inch projectile and a single shot

(Continued to page 372)



SINCLAIR RESEARCH LABORATORIES—nine buildings containing the most modern testing equipment known—have contributed many of today's most important developments in petroleum products, production and

refining. Under the Sinclair Plan, the available capacity of these great laboratories is being turned over to work on the promising ideas of independent inventors who have no such facilities within their reach.

An Offer of Research Facilities To Inventive Americans Who Need Them

The Sinclair Plan is opening up the Company's great laboratories to every American who has an idea for a better petroleum product

INVENTIVE Americans are often at a loss today. Not because of any lack of ideas, but because of a need for large and expensive facilities to find out if and how their ideas work.

This was no obstacle in our earlier days. The Wright Brothers designed their first airplane with the help of a foot-square homemade "wind box"—and the plane flew.

In contrast, the man with a new idea in airplane design today often needs a supersonic wind tunnel costing millions.

In short, science and invention have become so complex that a man with an idea for a better product often needs the assistance of an army of specialists and millions worth of equipment to prove his idea has value.

Within the petroleum field, the Sinclair Plan now offers to provide that assistance.

Under this Plan, Sinclair is opening up its great research laboratories at Harvey, Illinois, to independent inventors who have sufficiently good ideas for better petroleum products or for new applications of petroleum products.

If you have an idea of this kind, you are invited to submit it to the Sinclair Research Laboratories, with the provision that each idea must first be protected, in your own interest, by a patent application, or a patent.

The inventor's idea remains his own property

If the directors of the laboratories select your idea for development, they will make, in most cases, a very simple arrangement with you: In return for the laboratories'

investment of time, facilities, money and personnel, Sinclair will receive the privilege of using the idea for its own companies, free from royalties. This in no way hinders the inventor from selling his idea to any of the hundreds of other oil companies for whatever he can get. Under the Plan, Sinclair has *no control* over the inventor's sale of his idea to others, and has *no participation* in any of the inventor's profits through such dealings. Moreover, it is a competitive characteristic of the oil business that the new products adopted by one company are almost invariably adopted by the whole industry. This means that the very fact of his agreement with Sinclair should open up to the inventor commercial opportunities which might otherwise be hard to find.

How to proceed: Instructions on how to submit ideas under the Sinclair Plan are contained in an Inventor's Booklet available on request. Write to: W. M. Flowers, Executive Vice-President, Sinclair Research Laboratories, Inc., 600 Fifth Avenue, New York 20, N. Y. for your copy.

IMPORTANT: *Please do not send in any ideas until you have sent for and received the instructions.*

SINCLAIR

A Great Name in Oil

EXPAND YOUR HOME!

**USE
YOUR
ATTIC**

**Install the
PRECISION
Folding Stairway
at a cost of
\$60 to \$75**



Makes your home more livable by providing extra rooms and storage space in the most economical way. Fits all ceilings—Just saw a 26x54 inch hole in your ceiling, frame the hole with 2x6's, nail the stairway in place and cut off at the calibrated ceiling height.

SIMPLE AND EASY TO OPERATE—A slight pull of the cord and the counter weights silently ease the stairway into down position. The same counter weights return the stairway to its up position with equal ease. **RUGGED AND STRONG**—Construction of No. 1 kiln dried poplar. Brackets, rocker arms and hinges of heavy cast aluminum alloy. All parts numbered and interchangeable. Panel insulated and protected with tough chip board. Steps covered with safety treads. **FITS ANY CEILING**—from 7 feet to 10 feet 3 inches high. Runners graduated to facilitate cutting off for different ceiling heights. **REQUIRES NO ATTIC SPACE**—Full height above attic floor only 36". Folds completely into opening in ceiling. **SHIPPED IN ONE PACKAGE**—Each stairway thoroughly inspected, assembled and ready to install. Shipping weight 130 pounds. Sold by more than 12,000 dealers in U.S.A. and Canada. **APPROVED BY F.H.A. EVERYWHERE.** Mail coupon TODAY for descriptive folder and complete information concerning delivery, prices and installation.

**TO MAKE YOUR HOME MORE LIVABLE,
Mail This Coupon today!**



PRECISION PARTS CORPORATION
402 North First Street, Nashville 7, Tenn. **PM**

Please send me **FREE** folder and complete information on **PRECISION** folding stairways.

Name _____
Address _____



HOLD-E-ZEE

THE ORIGINAL AUTOMATIC GRIP
SCREWDRIVERS

FIRST CHOICE OF
SKILLED CRAFTSMEN



Models for All
Types of Screws

At Leading
Dealers
Everywhere

Gripper Recedes
into Handle

Upson Bros., Inc. Rochester 14, N. Y.

had destroyed the principal defense of Liege.

German U-boats. Spies. Camouflage. Torpedoes. Dogfights in the sky over France. The Lusitania. The Battle of Jutland. 1917—President Wilson. General Pershing. The draft. Slackers. Hoarding. Liberty Loan. Chateau Thierry. Gas masks. "Over There." Every phase of the war, from saving walnut shucks to the sensational British tank, was reflected on the pages of *Popular Mechanics*.

Then, late in 1918, H. H. Windsor wrote: "With a silence like that which follows the mighty crash of a great organ, the Great War came suddenly to an end."

By this time the magazine had moved its offices to 6 N. Michigan Ave. Meanwhile, *PM's* circulation boomed and advertising poured in from every corner of the country. Thousands of businesses got their start with a few lines of advertising in *Popular Mechanics*. The files of the magazine are filled with letters paying tribute to the part the magazine has played in many a flourishing enterprise.

After the war, *PM's* pages reflected the intense interest in aviation that swept the country. Everybody was airminded and America's future in aviation was a prime topic. Who would be first to fly the Atlantic? Would it be a seaplane or a landplane? Army or Navy? U. S. or foreign? Prizes galore awaited the first pilot or crew to accomplish this milestone in aviation.

A number of flyers soared out across the ocean never to be heard from again. Then on June 14-15, 1919, two British Army flyers, Capt. John Alcock and his navigator, Lt. Arthur W. Brown, flew a Vickers-Vimy biplane from Newfoundland to Ireland. They covered 1950 miles in 16 hours and 12 minutes and won \$75,000 in cash and world renown for the first nonstop crossing. That same year, the British dirigible R-34 made a round-trip flight across the Atlantic. U. S. Army flyers made a trip around the world and covered 24,000 miles—and this in only 5½ months! This outstanding feat led Brig. Gen. William "Billy" Mitchell to predict "16-hour service between New York and San Francisco and round-the-world passenger service."

Another postwar interest, closer to home for most *PM* readers, was radio. The magazine introduced its popular radio department in 1920, and Frank L. Brittin began immediately telling readers how to build crystal sets, a two-tube set (this unit was a whopping 4½ feet long and used headphones), and in rapid succession followed plans for making sets up to nine tubes. In the early '20s everybody was getting into

(Continued to page 374)



1 SEEDBED PREPARATION—Without Change of Attachment!
No more changing from plow to disc to harrow as with ordinary "garden tractors"! Much easier — much quicker — much less expensive!



2 CULTIVATING — With Far Less Damage to Plant Roots!
Think what this means for raspberries, grapes, corn and all your other crops which have lots of tender surface roots!



3 POWER COMPOSTING — For Miracles of Soil Improvement!
No more hauling, turning, watering of messy compost piles! No more need to buy expensive, hard-to-get manures!



4 WHAT A LAWN MOWER!
Cuts velvet-smooth 25" swath! Has no casters or over-hanging wheels — leaves no untrimmed edges! Follows contour of ground perfectly!



5 AS POWER SCYTHE IT'S A DOWNRIGHT JOY!
Tall weeds, hay, brush, heavy grass melt away in front of your ROTO-ETTE —without clogging! Cuts 30" wide!

New Low-Cost Wonder Does Your Toughest Yard & Garden Jobs

... Spend More Time Relaxing While Others "Break Their Backs" Trying to Match Your Beautiful Garden and Grounds



Really 8
Yard and
Garden
Machines
in 1



THIS FREE BOOK

Brings You the Whole Wonderful Story

THIS big FREE 68-page book, "A Little Power — A Lot of Living," was written for you by Ed Robinson, author of the famous "Have-More" Plan. Ed is an enthusiastic ROTO-ETTE owner.

Packing his 68-page book full of scores of interesting photographs, Ed shows just how his ROTO-ETTE improves the soil, eliminates weeds, composts by machine, cultivates garden, berries, fruit—and does dozens of other outside jobs. Also included are the actual, low-cost delivered prices, and the name of your nearest ROTO-ETTE Dealer, in case you'd like a demonstration. No obligation whatsoever. Simply mail coupon at right.

THE NEW 1952

Lightning ⚡ Change

ROTO-ETTE
Reg. U. S. Pat. Off.

DOES A WHOLE DAY'S CHORES IN AN HOUR!

CAN you imagine employing a skilled gardener who would work for less than a dollar a day? And can you further imagine that this gardener could do the work of eight men, *all at the same time?*

That's the kind of "gardener" you get when you own this amazing New Lightning-Change 1952 ROTO-ETTE! Here is an easy-to-operate, low-cost, yard-and-garden machine that makes it fun for anyone to maintain beautiful lawns and gardens without outside help. Here, in but ONE machine, with simple, lightning-change attachments, is your answer to leisure country living!

Grow All the Fresh Vegetables, Berries, Fruits You Want Without Outside Help!

Now you can have acres of crisp, fresh vegetables, berries, fruits—lovely broad lawns — all kinds of flowers — without having to hire a single gardener! Now you can really ENJOY country living—for the New 1952 Lightning-Change ROTO-ETTE can do a day's back-breaking chores in a single hour!

And what more versatile mechanical gardener can you find anywhere? Just see (pictured here) the 8 different jobs it does so quickly, so perfectly—everything from cultivating to wood-sawing. Even if you've never before thought about getting a "garden tractor," you owe it to yourself to find out about this amazing, new LOW-COST Wonder!

MAIL COUPON FOR FREE BOOK

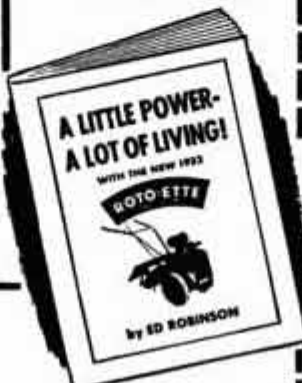

6 SNOW PLOWING — GRADING, LIGHT BULLDOZING!
Wonderful for cleaning walks and roads of snow. Perfect for grading new lawns.

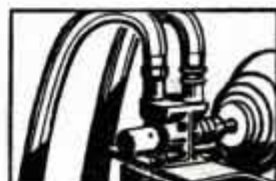

7 EASILY PORTABLE POWER — For Dozens of Other Jobs!
A year-around power source for water pumps, electric generators, insecticide and paint sprayers, trailers, grain grinders, etc.



8 CUTS FIREPLACE AND STOVE WOOD LIKE BUTTER!
In a couple of hours you can cut enough wood for a month. Pays for itself over and over again if you have a wood lot.

Rototiller, Inc.
Dept. 201, Troy, New York

Please send me FREE, by return mail, a copy of your Big 68-page Illustrated BOOK, "A LITTLE POWER—A LOT OF LIVING," by Ed Robinson, author of the famous "Have-More" Plan.

Name _____

Address _____

City _____ County _____ State _____

Look What's Happened

to the bedroom nobody wanted

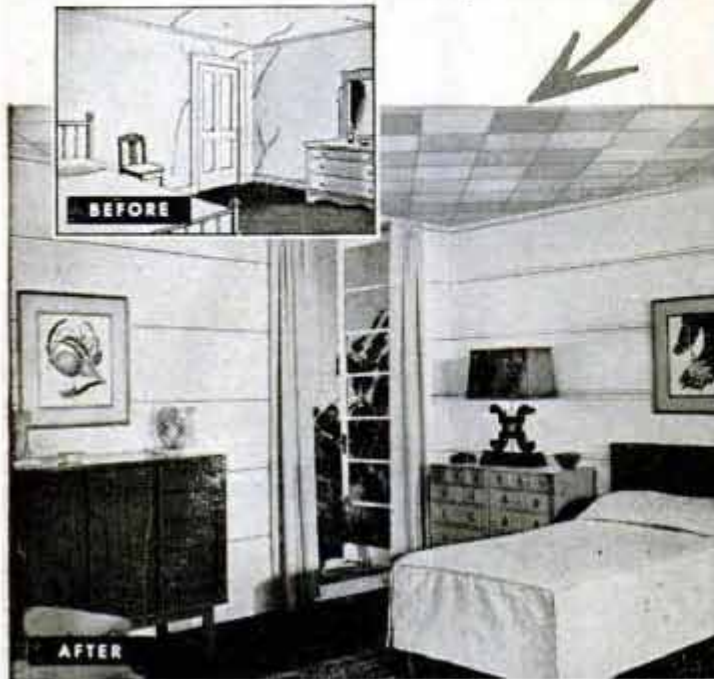

The walls of this beautiful room are Celotex White Finish Plank applied horizontally... the ceiling, Celotex Ripple Blend Tile Board.

Do it with Celotex for only \$49⁵⁰*

*Approximate cost of Celotex Interior Finish materials for walls and ceiling of average 10' x 12' room.

Make old-looking rooms cheery and comfortable again, or build new rooms in your attic or other unused space. It's easy, thrifty with Celotex Insulating Interior Finishes! These strong, handsome panels build, insulate, decorate—all at one low cost. Just staple or nail in place.

No painting or papering! Celotex Insulating Interior Finishes are *pre-decorated*. Smart, exclusive blended colors in Tile Board, Building Board, Finish Plank. See them at your Celotex Dealer's. Mail coupon for booklet now!

Insist on genuine **CELOTEX** Insulating Interior Finishes

The Celotex Corporation, 120 S. LaSalle St., Chicago 3, Illinois

MAIL TODAY!

The Celotex Corporation, Dept. PM-12
120 S. La Salle St., Chicago 3, Ill.

I enclose 10c in coin. Send me the new Celotex Interior Finish booklet giving ideas on how to remodel present rooms or build new rooms at low cost. Plus "how-to-do-it" instructions!

Name _____

Address _____

City _____ Zone _____ State _____

the act. There were pictures of dancers leaping over loudspeakers, of radios on boats, automobiles, on straw hats, on the beach, in player pianos, in kitchens and schoolrooms. There were pictures of Mary Pickford and Douglas Fairbanks making their radio debut and of a snake charmer with her pet reptile wound around a loudspeaker. Brittin is still radio editor of the magazine, but his title has kept pace with the times and is now "radio, television and electronics editor."

Influenced by the Jazz Era, *Popular Mechanics* published one of the few musical articles in its history: "Where Jazz Comes From." Notice was also taken of prohibition with a report on the Coast Guard's activities in "The Battle of Rum Row." There was an article on Babe Ruth's home-run secrets.

During all this postwar hullabaloo, H. H. Windsor planned, built and moved into the structure at 200 E. Ontario St. in Chicago that is the home of *Popular Mechanics* today. The June 1923 issue showed a color picture of the seven-story brick building. At last the boy from Marshalltown had achieved his dream with giant presses that printed his magazine by the hundreds of thousands. Through the years these early giants have been replaced by newer, bigger and faster presses, including the recent additions of a five-color unit and a two-color rotary press that can print 1,190,000 pages an hour and use 30 tons of paper a day. Incidentally, a single edition of the present magazine requires about 20 carloads of paper, according to Lyle R. Howard, printing-department superintendent.

Henry Haven Windsor's dream came true just in time, for less than a year after moving into the new building he died. The date was May 11, 1924. His last words written for the magazine concerned radio and its infinite possibilities for communications and education: "One cannot cross our great Western plains by railroad or motorcar and fail to note the number of radio aerials... surely radio is the fairy godmother with something for every need."

Mr. Windsor's responsibilities were taken over by his only son, H. H. Windsor, Jr. The son soon demonstrated that printer's ink was part of his inheritance. During the more than a quarter century of his stewardship—despite years of depression and war—*Popular Mechanics* has won respect and attention from every corner of the world. Under his leadership, circulation has more than doubled, advertising sales have been spectacular and every phase of the company has grown substantially. In 1949, on his 25th anniversary as president of the

(Continued to page 376)

HANDEE - Everybody's Hobby

How about You?

Today all over the land, men and boys . . . and the ladies, too . . . turn to HANDEE - the complete, one-package tool kit - for genuine fun and relaxation. Why? Well, HANDEE's a hobby that everyone, young and old, can quickly enjoy. It's so easy to operate . . . you don't need any special skill.

And what a world of hobby projects awaits your attention - model building, wood carving, costume jewelry making, plastics engraving, gift initialing, etc. Just about everything you can think of . . . you can do with your HANDEE . . . today . . . right now.



HANDEE

Besides hobbycraft, you need a HANDEE for household repairs and auto maintenance. HANDEE gives you sure, smooth running controlled power for countless small jobs . . . grinds, drills, engraves, cuts, polishes, saws, routs, sands. There's no other tool in the world as versatile nor so precisely engineered. HANDEE is virtually a workshop you can hold in your hand. Pays for itself quickly.

ULTRA DELUXE HANDEE with 51 matched accessories in fitted carrying case. Tool weighs 12 oz.; speed 25,000 r. p. m.; 110-volt AC-DC; 25-60 cycles.

\$27⁵⁰



Easy to Use
Tool of 100! Uses!

HANDEE with 7 accessories
\$19.95



HI-POWER

Heavy duty model for production jobs. Full dynamic and static balance for vibrationless performance. Detachable motor; forced ventilation. 20,000 r.p.m.

110 volt AC-DC, 25-60 cycles. Jacobs Chuck. Weight 5 lbs. 10 oz. **\$49⁵⁰**



HANDEE '85'

Complete workshop with 41 accessories. Suitable for shop or home use . . . does precision routing, molding cuts. Tornado ventilation; cool running. 27,000 r.p.m.

110 volt AC-DC, 25-60 cycles. Interchangeable spring collet chuck. **\$29⁹⁵** Wt. 2 lbs.



CHICAGO WHEELS

Mounted Wheels - for every kind of grinding and polishing. Faster cutting . . . longer wearing. Abrasive Saw Blades - cut almost everything: glass, plastics, tubing, steels, etc. Fit any circular saw, bench grinder, motor or lathe. Easy to use!

Send for Free Literature on Handee Tools

All Chicago Wheel products are sold by leading dealers from coast to coast. See these tools at your nearest dealer - or write direct. Ask for giant illustrated 64-page Catalog.

CHICAGO WHEEL & Mfg. Co.
1101 West Monroe St., Dept. PM, Chicago 7, Ill.
Offices in Principal Industrial Centers

best
white tape
made

ONLY
98¢*



The new "Evans White-Tape" has everything you'll find in tapes costing over \$1.50—plus.

- snow-white blade with bold, legible, jet-black numerals and graduations. Graduated in 32nds for first 6 inches.
- sturdy die-cast case heavily chrome-plated, calibrated for quick reading inside and outside measurements.
- blade 1/2" wide made of finest high carbon steel—tempered—Bonderized—enamelled—baked.
- blade replaceable in seconds—without tools—without even opening case. And Evans replacement blades cost far less.
- every "Evans White-Tape" is unconditionally guaranteed.
- exclusive Evans automatic brake gives smoother push-pull action with absolutely no "creeping" of tape into case.
- underside is white, too. Mark with ordinary pencil, remove mark with flick of thumb.
- unheard-of low price*: 10-ft. \$1.49; 8-ft. \$1.19; 6-ft. 98¢. Prices higher in far west and Canada.

Evans & CO. • Elizabeth, N.J. • Montreal, Que. © 742.
Makers of Evans 6-ft. Folding Rule and "Folding Yardstick"

Sold only through retailers.

"MOTO-MOWER" WEED TOPPER *with*

first
fundamental improvement
in Power Lawn Mowing
now available on
MOTO-BOY and SCOUT
as optional equipment at the factory



The most outstanding accessory and improvement for a lawn mower developed in fifty years.

MOTO-BOY and SCOUT (illustrated) models so equipped, perform double duty. Topping the weeds ahead of the reel enabling the reel to cut the obnoxious weeds off short.

... at same time that it cuts grass to normal height. . . . Other MOTO-MOWER models sizes 17 1/2" to 71". Send for complete information and the name of the nearest dealer.

*This is strictly a WEED TOPPER—not a hay mower.

The best known name in power lawn mowers for thirty-three years
MOTO-MOWER
4615 Woodward Ave. Detroit 1, Michigan Company

Popular Mechanics Company, Mr. H. H. Windsor, Jr., was presented with a memorial plaque by the employees. In 1949, H. H. Windsor III became the third active generation in the business. Another son, W. T. Windsor, joined the staff in 1951.

Popular Mechanics' report on the roaring '20s was climaxed by the Lindbergh story. "My name is Charles Lindbergh," he had said to Ambassador Myron T. Herrick after he landed the Spirit of St. Louis at Le Bourget Field near Paris. How was he to know during those dark hours over the Atlantic that the name of Lindbergh was in every headline? An article reporting his flight appeared in the August 1927 issue and an interview, "Lindbergh Tells Future of Aviation," appeared in the November issue. It still makes good reading today.

An article in 1928 entitled "Television for the Home" explained the workings of a whirling-disk set that never got very far. However, the article held some historic predictions for TV.

The home workshop boomed in the depression '30s when everybody wanted to save money or make a little extra. More readers than ever before started building their own furniture, repairing their houses, tinkering with their automobiles, painting and papering their homes, developing and printing photographs, even making their own jigsaw puzzles. The advent of diesel locomotives and big passenger planes helped take the public's minds from their pinched pocketbooks.

In 1939 the pages of *Popular Mechanics* had a foreboding resemblance to those of 1913. There was approaching war between the lines about new guns and bombers, paratroopers and cargo planes. Soon after Adolf Hitler lighted the fuse for World War II, the editors of *PM* were startled to learn that copies of the magazine were being sent out of the country in diplomatic pouches to reach Axis governments. With Pearl Harbor came censorship. With almost every article devoted to war and war machines, the magazine worked closely with the Army, Navy and Air Force. On numerous occasions the magazine was gratified to learn that something a soldier had learned from past issues of *Popular Mechanics* had helped him do a better job of fighting the war.

Our staff men were often in possession of military secrets, but not once during the war did the magazine encounter censorship troubles by revealing anything that might have aided the enemy. *Popular Mechanics* was one of the first U. S. magazines invited to publish an overseas edition. When the war ended more than a million men a

(Continued to page 378)



Which lamp is ready to burn out?

ONE of the General Electric "All-Glass" headlamps on the test car above has just been lighted for the first time. It's at the beginning of its life. The other G-E lamp... the one on the left... has been burning day and night for many, many months. Yet when the photo was taken it was impossible to see any difference in the light output of these 2 lamps!

That's because General Electric "All-Glass" headlamps give an average of 99% as much light just before burning out as when new. Both the lens and reflector of the G-E head-

lamp are made of hard glass, fused together into one piece. Road and laboratory tests prove that this one-piece unit keeps out the dirt and moisture that might otherwise gradually rob the lamp of light output.

Because they **DO NOT GROW DIM**, G-E "All-Glass" headlamps mean easier, SAFER night driving. Use them to replace burnouts whenever you need a replacement.

**G-E "All-Glass" Headlamps
DO NOT GROW DIM!**

You can put your confidence in—

GENERAL  **ELECTRIC**

New Projects For your Workshop



**Fresh
New, Modern
Projects in
Every Issue!**

6 ISSUES OF A NEW KIND of Project Magazine

Prepared by a practical craftsman especially for the home workshop. Refreshingly new material—up to the minute—presented with photographs, plan drawings, step by step instructions, that even a beginner can follow easily. For the home craftsman who is looking for stimulating, different and modern ideas.

**Only
\$1.00**

A Goldmine of Project Ideas

A year's issues bring you complete how-to-make instructions for furniture, household equipment, toys, novelties, wood and plastic jewelry, home accessories, games, puzzles, garden furniture, shop equipment—all new, different and "off the beaten path," for only 25c an issue—or you can save 33½% and get 6 issues for only \$1.00.

Send Coupon Today

Send \$1 today for bargain value of 6 full issues. Any time you are not delighted—your subscription will be refunded.

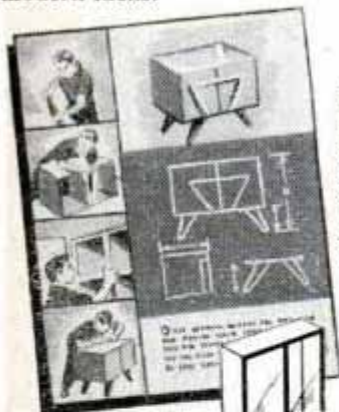

DURO METAL PRODUCTS CO.,
2685 North Kildare Avenue, Chicago 39, Illinois

- I enclose \$1 for one year's subscription to the "DURO CRAFTER" (6 issues). I understand satisfaction is guaranteed or money refunded.
- I enclose 25c for single copy of "DURO CRAFTER."

Name.....

Address.....

City..... Zone..... State.....

month were reading this edition like a letter from home.

Corregidor. Guadalcanal. The B-17 Flying Fortress. PT boats. War bonds. Defense plants. The Norden bombsight. Mechanized warfare. Over the Hump. President Roosevelt. General Eisenhower. General Doolittle. Bombs for Tokyo. Iwo Jima. Submarine detectors. The U. S. S. Missouri. The invasion of France. The atom bomb. Month by month the story of the war unfolded across the pages of *PM*.

In the early days of the war, Mr. Windsor and all other publishers received word from Washington that no further mention was to be made of uranium-235. For years *PM* had followed closely the developments in nuclear research. One of the earliest articles which touched on this subject was written by Winston Churchill. (A condensation appears in this anniversary issue.)

A January 1941 article told "The Miracle of U-235," and another article in November the same year was the last to appear on the subject until after the bombing of Hiroshima and Nagasaki.

After World War II, the pages of *PM* mirrored America's return to peacetime pursuits with an energy that matched that of the war effort. New cars by the millions. Television. Bigger and faster airliners. Jet planes. New homes. New furniture. Washing machines. Refrigerators. Cameras. Air conditioning.

During the last decade there have been changes in the magazine, too. A new type face makes it easier to read. Modernized layout makes the magazine more attractive, and full-color illustrations have delighted readers. It is safe to say that new equipment of some kind is added every month to each mechanical department—pressroom, composing, engraving, bindery and subscription departments. Except for the rush holiday season, all subscriptions are handled in about three days.

A question many readers and old friends of the magazine ask is: "Where do all the articles come from?"

About half of the feature articles are written by the staff from material gathered all over the world. Roderick M. Grant, managing editor, sends *PM* writers to far-away places to get firsthand stories—Bikini, Alaska, Germany, Japan and South America. The short items come from approximately 5000 correspondents, from industry, from government sources, from any corner of the earth where something new is happening in the fields of mechanics and science. The magazine maintains its own photographic studio and staff, and in addition, every month the editors scan several

(Continued to page 380)

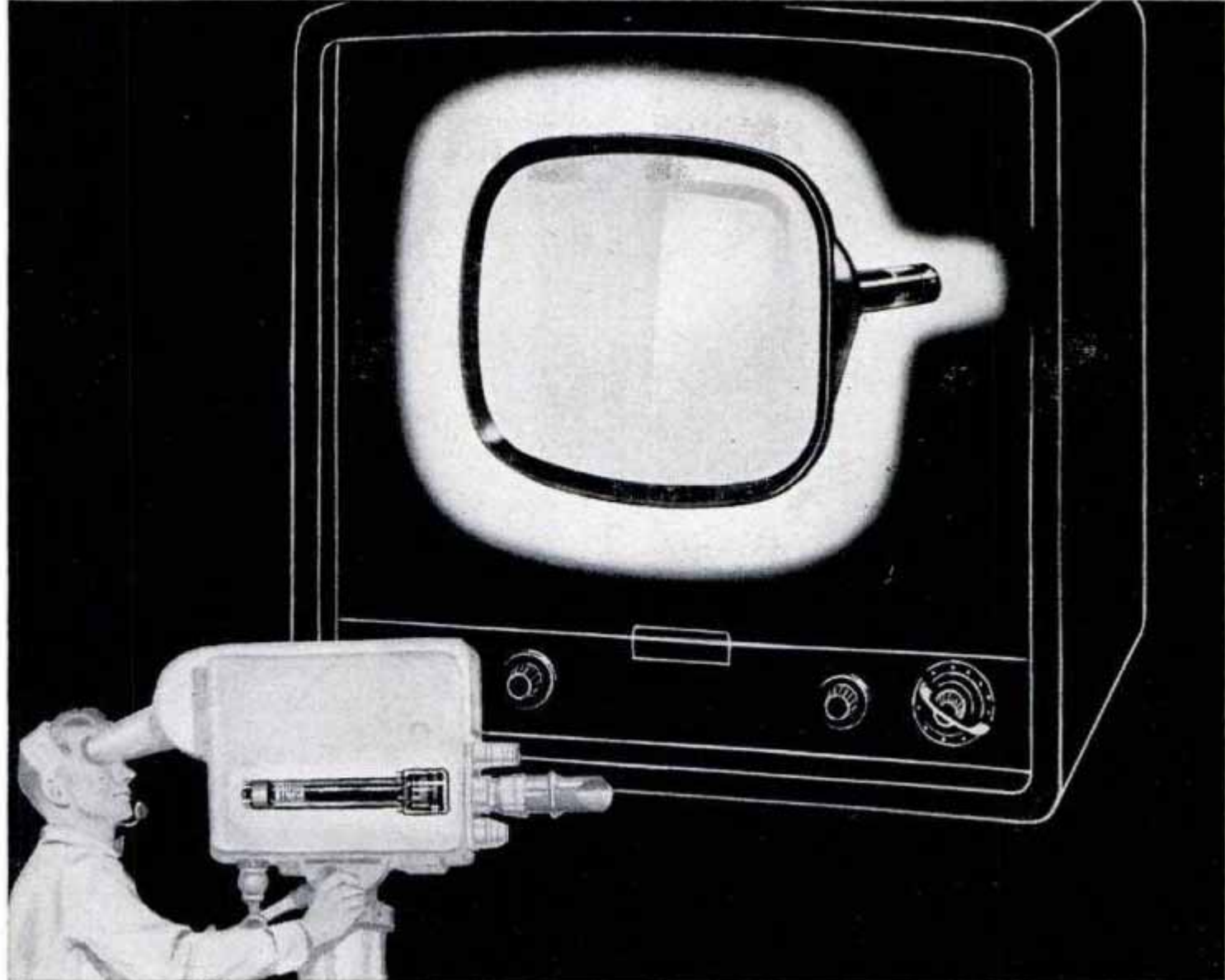

Two electronic hearts that beat as one

... to bring you better television pictures

The heart of every television camera is the image orthicon, or camera tube... the heart of every television receiver, the kinescope, or picture tube. Both were developed by RCA as integral parts of today's modern, all-electronic system of television. The camera tube and the picture tube work hand-in-hand to bring you the best pictures modern television has to offer.

Modern, all-electronic television is a glowing example of the American system of free enterprise at work. It has opened up new avenues of employ-

ment... established new entertainment vistas... and elevated the American standard of living.

RCA pioneered all-electronic television as it is known today... and through continued research and the development of mass production methods, has improved the product and lowered the cost.

RCA engineering leadership in the field of television is your assurance that the highest possible quality is built into every RCA picture tube. That is why RCA picture tubes have been in use in more sets, for a longer time, than any other brand... and why more are in use today.

To get the clearest, brightest pictures from your television set—ask your television serviceman for a genuine RCA picture tube.



RADIO CORPORATION of AMERICA
ELECTRON TUBES

HARRISON, N. J.

SWITCH TO

MILD

KENTUCKY CLUB

The Thoroughbred
of
Pipe Tobaccos



Get Fine Pipes at Worth-while Savings

— You bet it pays to switch to Kentucky Club. It's the thoroughbred of pipe tobaccos—choice white Burley specially blended to give you a mild, smooth smoke with grand taste and aroma. In addition, every package of Kentucky Club contains a valuable Dividend Coupon. Save these Coupons and get your choice of fine pipes at *big savings*. Beautiful pipes of imported briar made by expert craftsmen. 14 shapes. Do these two things today. Buy your first tin of Kentucky Club.

Mail coupon for free catalog.



FREE

Illustrated catalog showing Kentucky Club Dividend pipes and other premiums.

Mail Pouch Tobacco Co., Dept. 65
Wheeling, West Virginia
Please send—free—Kentucky Club Catalog.

Name.....

Street.....

City..... State.....

thousand photographs submitted by a variety of contributing sources.

One of the big illustrating jobs is for the Crafts section of the magazine. James R. Ward, able crafts editor, and Frank Beatty, art director, make sure that every detailed specification on all drawings is correct. In the news section of the magazine appears frequently the work of artists like G. H. Davis of England, famed for his diagrams and cutaways, and A. Leydenfrost. Covers are painted by such well-known artists as Dave Mink (who did the anniversary cover), Bruce Bomberger, Wendell Kling, John Howard, Roswell Brown, James Sessions and Robert Korta. (Korta's fine painting of the old-timer reading *PM* opens the Craftsman section in this issue.)

Since World War II, *Popular Mechanics* has not only increased its circulation to over a million copies every month, but has added four foreign editions. Alan M. Deyoe is circulation manager. Shortly after the war one of France's war heroes, Maj. Adrien Albarranc of Paris, made a trip to Chicago enthused over the idea of publishing a French edition of the magazine. During the war Albarranc was impressed with the way his American companions fought to get the overseas edition of *PM*. There was no magazine like it in France and he felt his country needed such a magazine. H. H. Windsor, Jr., and William Harrison Fetridge, vice-president, listened to Albarranc's story and the result, a few months later, was the introduction of *Mecanique Populaire*. The magazine is translated in Paris and printed in Strasbourg. It was an immediate success and is now widely read in France, Belgium, Switzerland, parts of Germany and North Africa. The French government showed its appreciation in 1949 by making Mr. Windsor an officer of the French Academy and decorating him with the Order of Palms for "Services rendus a l'influence francaise."

The Spanish edition of *PM*, under the direction of Senor Samuel Melo, formerly of Mexico, D. F., is printed in the main plant in Chicago. It is called *Mecanica Popular* and is distributed throughout Latin America and Spain. The Danish edition, *Populaer Mekanik*, and the Swedish, *Popular Mekanik*, are issued from Copenhagen under the joint supervision of Jorgen Grusgaard and Jorgen Norredam. The magazine also maintains offices on famed Baker Street in London, where Douglas W. Wedderspoon represents the company.

In the United States, the magazine has branch offices in New York, Cleveland, Detroit, Los Angeles, Portland and San Francisco. A Florida office will open soon.

(Continued to page 382)

"GUNNING

IS MY GAME"

says **TED ROBBINS**
famous guide, Transquaking Gun Club
Cambridge, Maryland

"And This
Marlin 90

OVER-AND-UNDER

Is My Idea of a GREAT GUN!"



"Canvasback, teal, turkey . . . you name it and we've got it on the Eastern Shore," says this famous gunner. "And upland or in the blinds, I'll take my Marlin Over-and-Under every time. It gives you a fast first shot right where you want it. The recoil is lighter and straight back so you get faster recovery.

How the Marlin folks can put this precision-built baby out for the money is a mystery to me. But, if you want more birds, you'll pack a Marlin 90."

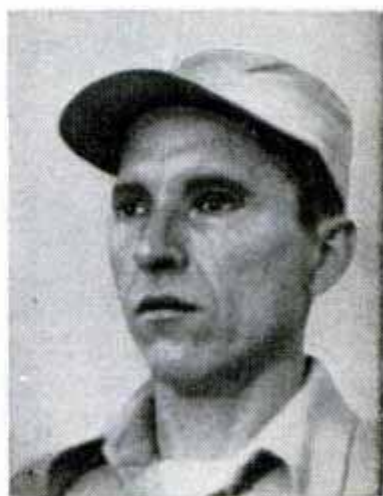

AMERICA'S BEST OVER-AND-UNDER!

Ideal for field, trap and skeet. In 12, 16 and 20 gauges. Hammerless, cocks on opening. Positive, automatic safety. Easy take down. Single sighting plane. Handles and leads like polished lightning and reaches

'way out with a fine, even pattern. A gun you'll prize for years to come. See your local dealer. If none available write us for name and address of nearest one. Try Marlin's new, sensational *Magnetized* double-edge razor blades. Marlin products are available in Canada.

THE NAME FOR GAME

Marlin

FINE GUNS SINCE 1870

---VALUABLE COUPON - MAIL TODAY---

THE MARLIN FIREARMS CO., Dept. PM-A, New Haven, Conn.

Send me catalogue with full information and photo-illustrations of Marlin Guns. I understand you will also send me pack of (please check) . . . single or . . . *Magnetized* double-edge Marlin Blades. I enclose 10¢ for postage.

NAME _____

STREET _____

CITY _____ ZONE _____

STATE _____

Clover L. Perkins is the advertising manager. F. W. Johnson, veteran *PM* executive, is classified advertising manager. The magazine publishes more pages of classified advertising than any general American magazine. Royal Lee is promotion manager. Including all departments, the magazine's employees today total 475. Many have been with the organization over 25 years.

We know that 28 percent of our readers are over 46 years old, only six percent are under 17, the other 66 percent falling between those two groups. Our typical reader owns his own home. He can be either

rich or poor, but one thing is certain: He has the type of mind that likes to know what is under the hood of an automobile; he is interested in mechanical things and why they perform as they do; he likes to do things with his hands; he enjoys reading an article "written so you can understand it" with graphic illustrations; he has an alert, forward-looking mind with only a casual interest in the past. In other words, he is typically American.

We like to think that *Popular Mechanics* is, too, because the story of the magazine is also the story of the American way of life during this last half century.

Build A MODERN READY-CUT HOME! Costs You Less!

Shipped
Direct
from Our
Mill



Liberty Homes

\$3184



31 Designs to Choose From

AS LOW
AS . . . \$2180

Recommended by Banks and
Building and Loan Associations

Save 30% to 40%
on Your New Home..

Don't pay several hundred dollars more than necessary when you build a home! Buy direct from our mill at our low factory price. We ship you the lumber cut-to-fit, ready to erect. Paint, glass, hardware, nails, etc., all included in the price—no extra charges. Plans furnished—also complete building instructions. No wonder our customers write us that we saved them 30% to 40%. Architecturally approved construction. (Not built in sections.)

Visit a Liberty Home!

Many thousands of Liberty Homes have been built in all parts of the country. There is one near you that you can visit and inspect. Write us and we will give you its location.

Handsome Big CATALOGUE

Pictures wonderful homes in colors at money-saving prices. Designs to suit everyone. Send 25c for catalogue today.

BIG BOOK
of
House Plans
in Colors
25¢

LEWIS MANUFACTURING CO.

1221 LAFAYETTE AVE.,
BAY CITY, MICH.

Make **MONEY... Save MONEY!**

It's Easy
with a

SHAW WALKING or RIDING TRACTOR

QUALITY
BUILT...
PRICED
LOW

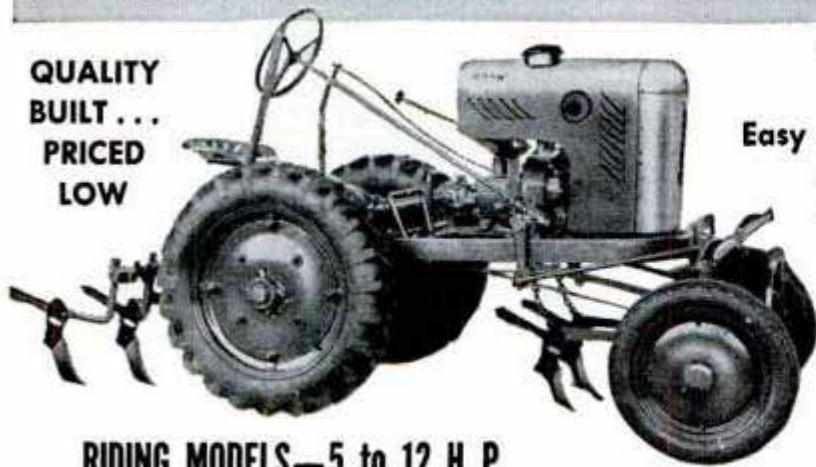

RIDING MODELS—5 to 12 H. P.

Easy and
Cheap to
Operate,
Use the
Year
'Round

WALKING MODELS

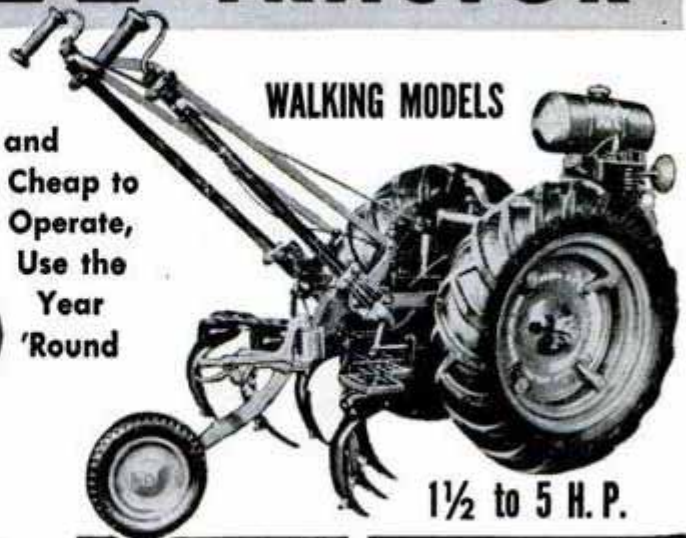

1½ to 5 H. P.

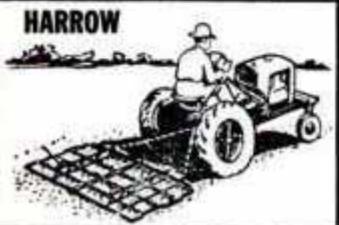

HARROW

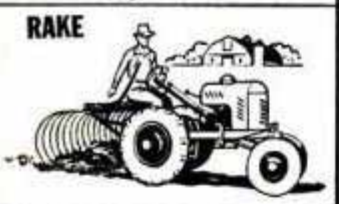

RAKE



BULLDOZE & PLOW SNOW

A Great Time and Money Saver on Small Farms, Gardens, Nurseries, Golf Courses, Poultry Farms, Cemeteries

The sooner you get a Shaw Garden Tractor the sooner you'll save money, time and lots of hard work around your place.

TRIED AND PROVEN! For nearly 50 years SHAW Tractors have proved dependable, low-cost helpers on scores of jobs... in gardens, truck farms, nurseries, orchards, cemeteries, golf courses, poultry farms and estates. Great for plowing, cultivating, discing, tree-felling and wood cutting, seeding, harvesting, spraying, mowing. Riding tractors with bulldozer also used in foundries and by building contractors. Also for running belt machinery. First cost is low; low operating cost.

BUILT TO GIVE BETTER, LONGER SERVICE— SHAW tractors are built right... to do the job right... with quality materials and expert engineering. Equipped with high-grade air-cooled gasoline or oil engines. Full year guarantee against any defect in material or workmanship.

WALKING AND RIDING MODELS— You'll find a SHAW Riding or Walking Model Tractor just fitted to your needs... 1½ to 12 H. P. A SHAW will do things a big tractor can't. Easy to operate by elderly persons, boys and girls. We can supply many attachments at low prices.



SAW
DOWN TREES



CUT
STOVE WOOD



PLOW



CULTIVATE



MOW

ATTENTION DEALERS!

Write us regarding dealership for Shaw tractors. Choice territories open to responsible dealers. Write today.

GET FREE CATALOG and PRICES! Many dealers throughout the U. S. sell SHAW tractors. See them... see their many great, exclusive features. In the meantime, fill out and mail coupon for FREE Catalog, prices, etc. Get all the SHAW Facts now!

SHAW MANUFACTURING CO.

4501 Front Street, Galesburg, Kansas or
668-G North 4th Street, Columbus, Ohio.

Send me Free Catalog and Prices on SHAW Tractors.

NAME _____

ADDRESS _____

FILL OUT AND SEND COUPON NOW!

(Continued from page 230)

HOBART Arc Welding PAYS BIG!

If you have this versatile, all around HOBART arc welder, you're equipped to start your own welding business—to cash in on the demand for dependable arc welding.



Costs LESS than you think!
This big 250 amp. gas drive welder is today's biggest value

A FULL CAPACITY WELDER THAT STANDS THE GAFF... OPERATES ON ALL TYPES OF JOBS.

YES, AND YOU CAN TAKE THIS GAS DRIVE WELDER AND WELD ANYWHERE, IT MAKES ITS OWN POWER

Hobart is made in gas and electric drive models—port. or stationary.



Welds anywhere... plus power for lights and tools

You learn RAPIDLY at the HOBART TRADE SCHOOL

Prepare now to step into a big pay defense job or to start your own profitable welding business. Learn to do all kinds of welding quickly, easily, at low cost in America's most modern welding school... the non-profit Hobart Trade School. Complete or partial courses. Best equipment, experienced instructors, thorough training. Check coupon for full details



HOBART BROTHERS CO., Box M-12, Troy, Ohio

"One of the world's largest builders of arc welders"

Start your own welding shop. Earn big, extra profits monthly. All you need is a Hobart "Simplified" Welder and average mechanical ability. You'll soon be swamped with work.

Hobart Welders are used in leading production plants everywhere—give you 1,000 combinations of heat, let you make fine adjustments at the job—no returning to machine.

● **Procedure & Practice.** Complete text and lessons book. Covers every phase of welding. 544 pages, over 600 illus. \$3.00

● **Lessons Book.** Complete operator's training course. 200 pages, illustrated. \$1.00

● **Check the coupon for Complete Details**

a pall over the rookie on his first day. First Sgt. Herbert Brewer, who went through last spring, still remembers every detail. "We began with a two-mile run at eight a.m.," he says, "followed by 35 minutes of calisthenics. We ran through a class in concealment and hit the confidence course a few times—not counting miscellaneous push-ups for misunderstandings with the C.O., who was very free with push-ups."

The confidence course at Benning would batter a football guard. The ranger climbs a "ladder" with rungs three feet apart between two 100-foot pine trees. He writhes through the logs of a backbreaker called "the weaver," rolls across a row of loose logs suspended 15 feet in the air and practices second-story work through the windows of a tree hut 20 feet above the ground. He crosses a pair of cables strung over a chasm between two trees, climbs sheer log walls, wriggles, squirms and tightrope-walks his way through a maze of horrors.

During his first week, the volunteer airborne ranger is working on his first jump training. He starts by leaping 15 times through the door of a mockup plane into a sand pit. Then he moves to the 34-foot tower, a rugged pile of timber, crowned by a metal mockup of the center section of a flying boxcar. Inside the mockup, men line up as they would for a regular jump. Static lines are fastened to their dummy-chute harnesses and out they leap into space. But instead of being hooked to a canopy, the risers are attached by pulleys to cables outside. "One thousand . . . two thousand . . . three thousand . . . four . . ." yells the jumper, coming up with a jolt as the risers snap taut, and he goes for a bouncy 100-yard cable ride dangling like a fish on a line. "Most men would rather leave a plane than the 34-foot tower," says Sergeant Brewer. "You see those logs going by, and when the shock hits, you know you came a long way. The risers burn your neck. If one gets under your arm, you can dislocate a shoulder. Most of our washouts happen right there." Brewer, a 180-pound stalwart, tried four times before he made a qualifying leap. One man who wouldn't give up, hung up a record of 23.

By his second week, the airborne ranger has moved over to the four 250-foot free-drop steel towers, modeled after the carnival drop at the New York World's Fair. Here parachutes, with canopies hitched to conical cages on one end and a ranger on the other, are hauled by cable 250 feet in the air and released. Down float the rookies

(Continued to page 386)

● **HOBART BROTHERS CO., Box M-12, Troy, Ohio** **Free**

Please send complete information and literature on items checked.

- Electric Drive Welders
- Gas Drive Welders
- Hobart Trade School
- Send books checked—
- Procedure & Practice
- Lessons Book
- Send COD
- Cash encl.

New booklet "Guide to Better Welding"



NAME _____

ADDRESS _____

CITY _____ STATE _____

advanced
engineering

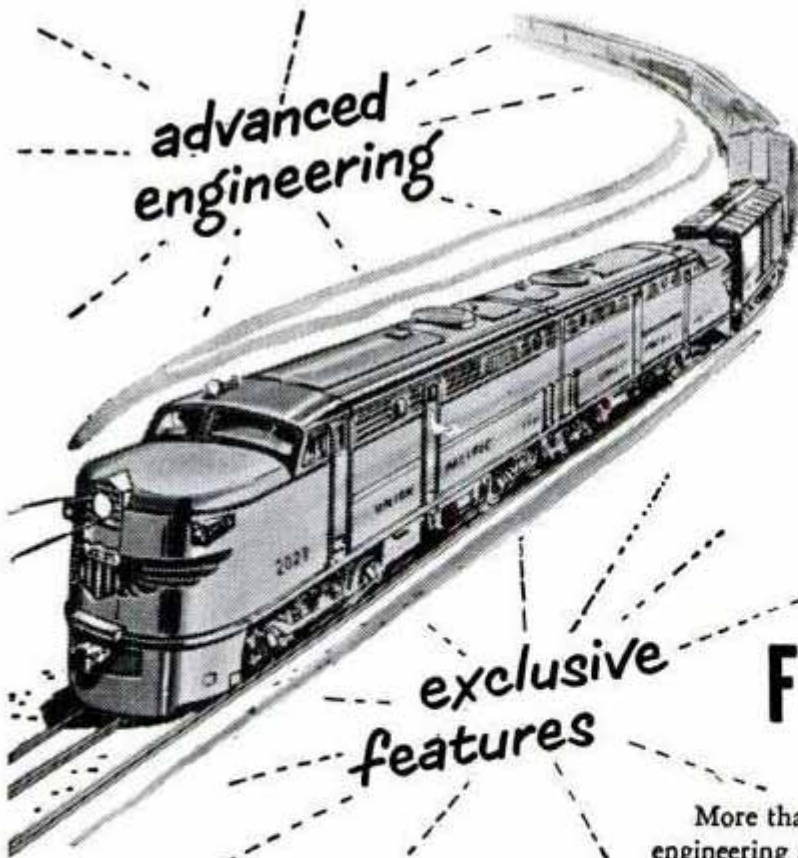

LOOK TO LIONEL TRAINS

FOR THE REAL THING

exclusive
features

More than 50 years of model railroad engineering are behind every detail of these great LIONEL TRAINS. More than 50 years of pioneering... *inventing* sensational new features. Lionel was the first to give you trains that puff real smoke, and whistle by remote control. Lionel stepped even farther ahead with the only real R.R. remote-control knuckle couplers and exclusive Magne-Traction.* You get the World's Finest when you get LIONEL trains and accessories. Free catalogue at your dealer's... or send for special coupon offer.

*available in all "0" gauge sets and in most "027" sets.

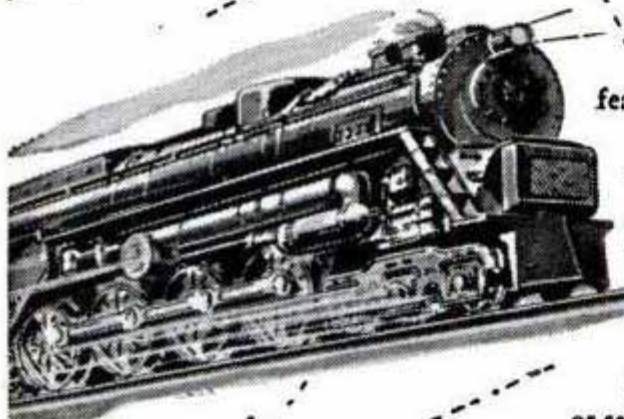

most
realistic
design



the finest
performance in
50 years of
model
railroading

fun for
all!

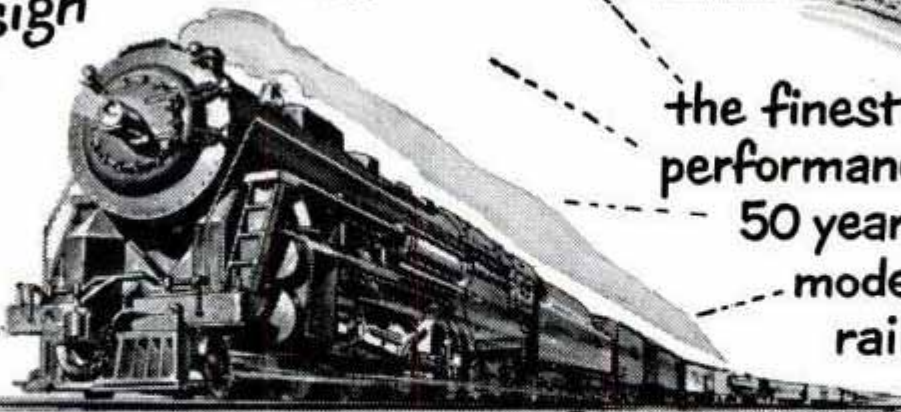

10 Full Color
Billboards



Hear... Bells... Horns
whistles on this Rail-
Road sound effect record

SEE all the LIONEL TRAINS
and accessories in the new
catalogue



ALL FOR ONLY 25¢

LIONEL TRAINS, P. O. Box 354
Madison Square Station, New York, N. Y.

Please send me special Lionel Train catalogue offer, postage pre-
paid. I enclose 25¢ to cover postage and packing.

1. The new 36-page full-color Lionel catalogue.
2. The new 5 1/2" double-faced record* of whistles, bells, railroad sound effects and Diesel horns.
3. 10 full-color miniature billboards.

Name _____

Address _____

City _____ State _____

*Plays on all 78 RPM phonographs except some spindle or automatic changers.

This is the famous Schick Injector Razor...



PICKED 5 TO 1 FOR FINER SHAVES*

Over all other razors...all other blades...including our own old blades!

WORLD'S ONLY RAZOR with all these big advantages:

Blades change *automatically*—"lock" at same, precise angle—no adjusting...

Light weight makes shaving easier! Safety-Bar smooths skin... "Fits" around nose, lips... Uses new "Gold Pack" Blades!

*HERE'S FULL SCORE FROM SHAVING TESTS
Smoother Shaves 5½ to 1 Safer Shaves 7 to 1
Cleaner Shaves 5 to 1 Faster Shaves 5 to 1
More Shaves per blade, nearly 2 to 1

*Men in 10 cities nationwide compared New Schick Injector Razor and Blades with whatever they had been using. About 80% of the men had a preference. Of these, the votes were in the ratios shown above.

©1951 Eversharp Inc., 350 5th Ave., N. Y. C.



SCHICK INJECTOR RAZOR & BLADES

instructions and insults over a loudspeaker as the men fall:

"Number one—left slip; number three—forward slip and straighten out. You look like a Buddha. . . ."

"If you follow instructions," says Brewer, "you'll never hit the cold steel." Several recruits, failing to take wind into account, have drifted into the towers, broken legs and arms and scared themselves out of the rangers. Luckily all have had the sense to hang on to the tower framework as their chutes collapsed around them, until men climbed up to rescue them. Those who were able wound up doing pushups for goofing the act.

In his third week, the airborne ranger is making live jumps. Here there's no time for nonsense. At 2000 feet above the drop area the men are ready and the jumpmaster sounds off:

"Stand up! Hook up! Check equipment! Sound off equipment check! Stand in the door! . . . GO!" A good jumpmaster will get 32 men out of a plane in five seconds flat. As chutes pop open, each man makes a sideslip to avoid fouling the chute of the man beneath him.

If he's still in the running, the ranger goes on to night drops.

If a qualified ranger goofs up, or stages a "refusal" at the plane door, he never gets to try again. He rides back to the field, rolls up 2000 static lines and shakes out a dozen chutes. Then he walks 15 miles back to the ranger area and, as a crowning blow, is relieved of his airborne status.

In the fourth and fifth weeks, the ranger is introduced to a group of life-sized cargo planes and mockups. In rows of tin-roofed replicas of flying boxcars, he loads big trucks and fieldpieces and learns to lash them down. To give him the concept of keeping cargo balanced, and illustrate lashings, instructors use models of trucks and jeeps, which they load into plywood plane models with cargo patterns marked out on their walls. The ranger is taught the principle of the chain and belt releases, which send trucks, tanks and 105 howitzers scooting out the back door for parachuting behind the lines. He learns that by lashing his droppable cargo to a platform, it will take a much harder jolt on landing. This is sometimes illustrated by dropping an egg on the floor—with and without cardboard under it. The egg with the cardboard platform won't break.

All through this training, and finally full time during his last three weeks at Benning, the ranger is out on squad, platoon and company missions. At supply depots

(Continued to page 390)

YOU GET MORE FOR YOUR MONEY WHEN YOU BUY A HARLEY-DAVIDSON

for a happier you in '52

**RIDE THE PLEASURE-AND-
PERFORMANCE "CHAMP"**

1952 HARLEY-DAVIDSON *HYDRA-GLIDE*®

The 1952 Harley-Davidson Hydra-Glide brings you more real enjoyment than you've ever had before...after hours, week ends, on vacations. It opens a whole new world of outdoor sports, travel, adventure. It introduces you to the greatest bunch of guys and gals you've ever known...at exciting race meets, gypsy tours, club runs and other thrilling events. Economical and handy, too, for riding to work or school. And this year, it's better than ever...with 4-speed foot shift-hand clutch, Parco-Lubricized valves, rich-toned, power-boosting muffler, flatter, wider tread tires for longer life, luxurious new color styling and other advanced features. Why not see your Harley-Davidson dealer now... and get set for a happier you in '52. Mail coupon.



PLAN NOW FOR FUN LIKE THIS ▼



HARLEY-DAVIDSON MOTOR CO., Dept. P, Milwaukee 1, Wisconsin

Send me free copy of ENTHUSIAST Magazine filled with motorcycle action pictures and stories; also literature on 1952 models.

Name.....

Address.....

City..... State.....

DEALERS WANTED: A few valuable franchises still available for the full line of famous Big Twins and the 125 Model. Write today.

KNOWN FOR THEIR FINER QUALITY

GENSCO

IMPORTED

SWEDISH TOOLS

WOOD CHISELS

Finest Swedish steel blades with unbreakable, machined plastic handles. Take and hold a better cutting edge. Sizes from 1/4" to 2" widths.

MORA HUNTING KNIVES

Seven models, all with leather sheaths. Hand forged, hand honed Swedish steel blades. Polished curly birch handles.

BUSHMAN BOW SAWS

Fastest cutting saw you can own for firewood and rough work. For campers, home owners, farmers, ranchers. 24", 30", 36", 42" sizes.

AT BETTER HARDWARE STORES EVERYWHERE

GENSCO TOOL DIVISION

GENERAL STEEL WAREHOUSE CO., INC.

1832 North Kostner Ave. • Chicago 39, Ill.



AS
LOW AS
\$950

"Brownlee" SECTIONAL LOG CABINS

Easy to Erect, Saving Labor Costs!

Save money on your log cabin! Get a "Brownlee"—the cabin that you can erect yourself! Shipped in sections, with doors and windows installed. White cedar logs, pre-treated. Impervious to moisture. Termite resistant. Weather-proof. Factory-caulked exterior walls. Complete materials furnished for erection. A variety of attractive designs—two to five rooms—as low as \$950. Also lodges, camp buildings and tourist cabins. Send 25c today for catalog. (Some territories still open to dealers.)

Send 25c for
CATALOG!

THE BROWNLEE CO.
3508 Guardian Bldg.
Detroit 26, Mich.



Aquarium-Bookcase

Now fish can swim through your furniture. An aquarium and a bookcase are combined in a new piece of furniture designed for rooms with modern decor. Top shelf is reserved for the fish, and there's a removable lid for feeding the inmates and cleaning the tank.



Ink-Bottle "Fountain Pen"

Useful for making price tags, posters and show cards, an inexpensive "fountain pen" with a felt tip uses the ink bottle as a fountain. The ink supply, always visible, will write a line five miles long. The ink is available in eight colors and can be used on any surface. It is waterproof and permanent.

☞ Slowly, buffalo are coming back, according to the Canadian Wildlife Service, which reports that there is a herd of bison in Wood Buffalo Park totaling between 12,000 and 15,000 animals.



JOE GODFREY
founder of the
Sportsmen's Club
of America

Says:

"I take my Coleman Camp Stove and Lantern along on every outing for good eats, good light and more fun."



(Left)
Model 413D
2-Burner Camp
Stove. Also avail-
able in 3-Burner
Model. Folding high
stand extra.

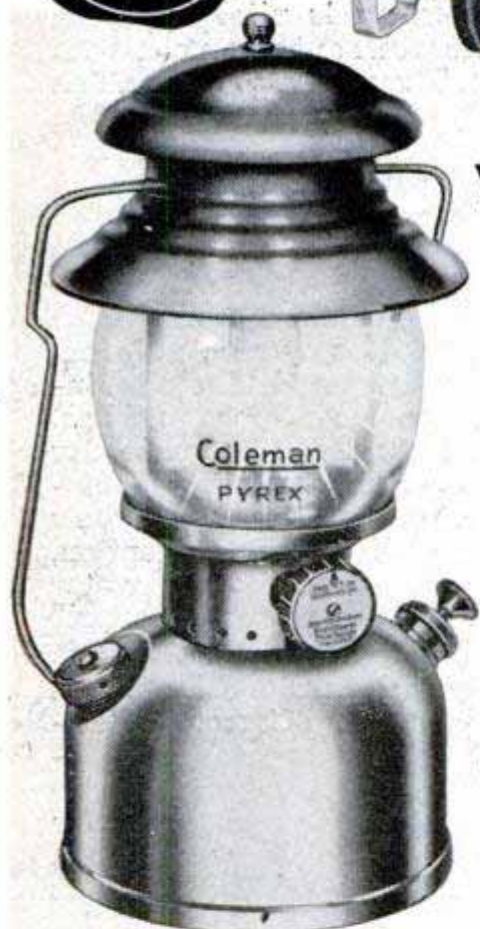

You always have
Good Food and Good Light
with these Outing Pals along!

The Coleman Camp Stove means hot, tasty food wherever you go! Cooks like a city gas range. Lights instantly. Folds up and carries like a suitcase. Durably built for years of service. Safe; helps prevent forest fires. Means more fun for fishing, hunting, vacations, backyard picnics.

Coleman Folding **CAMP STOVE**
Floodlight **LANTERN**

New, powerful Coleman All-Purpose Lantern gives plenty of brilliant light along the trail or in camp at night. Compact, sturdier. 8 to 10 hours lighting service from one filling. Lights instantly. Floodlights 100-ft. area. Safe; can't spill fuel. Stormproof.

Coleman Camp Stoves and Lanterns make and burn their own gas from gasoline. Be sure you get the Genuine Coleman—look for the name. Ask your dealer.



POWERFUL SPOTLIGHT

Easily attached Coleman Reflector makes a high-power spotlight of your Coleman Lantern. See it lighted at your dealers.

The Coleman Company, Inc.
Wichita 1, Kansas

MAIL COUPON TO The Coleman Co., Inc., Dept. 201-PM, Wichita 1, Kans.

Please send me free literature about Coleman Camp Stoves, Lanterns and other Coleman Appliances.

NAME _____

ADDRESS _____

CITY _____ STATE _____

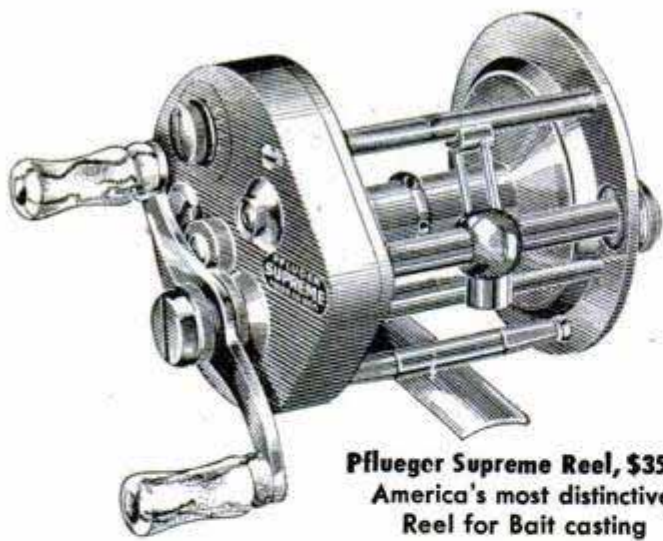

Pflueger Supreme Reel, \$35.00
America's most distinctive
Reel for Bait casting

PFLUEGER

Pronounced "FLEW-GER"

A GREAT NAME IN TACKLE



was 38 years old when
Popular Mechanics was
started 50 years ago

Both Pflueger and Popular Mechanics have grown in stature and prestige during the memorable 50 years that have passed. Today, as in time long ago, Pflueger is considered by everyone who knows fishing tackle to be the leader in the production of Reels, Baits and other Fishing Tackle Products. Millions of fishermen and women demand Pflueger Reels and Baits for their enjoyment of fishing at its best.

More prize winning catches are won each year with Pflueger Reels than with any other brand.

THE ENTERPRISE MFG. CO., AKRON, OHIO
88 years making fishing tackle

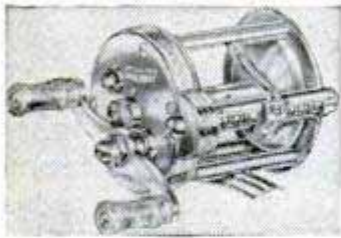

Pflueger Skilkast Reel \$10.50
Its anti-back lash control makes a skilled caster out of anyone within five minutes.

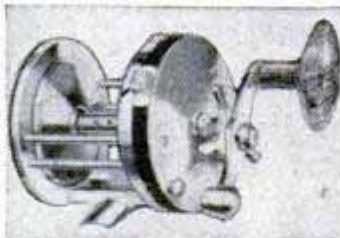

Pflueger Capitol Reel—For Surf Casting or Salt Water Trolling. 3 sizes—\$13.75—\$15.40—\$16.95



Pflueger Pal-O-Mine Minnow Floats—Dives—Wiggles—Wobbles.



Pflueger Tandem Spinner
Luminous blades—it catches fish in the dark.

you can see rangers busy every morning inflating life-sized rubber trucks, guns, trailers and tanks. These are set out in the woods, and "enemy" forces placed to defend them. Everything is ultra-realistic. The "enemy" is even dressed in foreign uniform. On night missions, the "attackers" black their faces under the dim headlights of a jeep, study a sand table model of the area, don camouflage suits and plan their attack. Off they sneak through the woods, floating noiselessly from tree to tree. If they break through the enemy's perimeter defense, they plant a TNT satchel charge near the rubber objective and race for the woods. When it goes off, they've won. More often, the crack of rifle fire in the night indicates resistance. Some of the encounters are so realistic the boys get overenthusiastic. Recently, one successful platoon got so deep in the spirit of the game they planted their satchel charge in the breach of the rubber howitzer and blew it to a thousand pieces.

Since river crossing is vital in patrol work, the rangers work out on a river with a strong current. They learn to hook a line to a rubber raft, row upstream along the edge, then cross quickly, dragging the line behind them. One end is tied to a tree on the embarking shore, the other to a tree on the landing. The line is then used to pull the boat back and forth like a ferry for quick transferring of troops. Sometimes a line is shot across on a dummy rifle grenade. But rowing it across should take 15 minutes. Anything less calls for pushups. Classic in this line was one patrol leader whose men disgraced him by taking 40 minutes and fouling up everything. On their return to shore, he called them to attention, marched them chin deep into the water and barked: "Now, give me ten pushups!"

By the end of his eight weeks at Benning, the ranger is only partly trained. He moves out to Camp Hale or Camp Carson in Colorado and spends three more weeks clambering over crags, climbing chimneys, driving pitons, working ropes and knots. He hauls casualties down the slopes on litters, using ropes to ride the stretcher across chasms.

He learns survival in extreme weather. He gets to use all his weapons on mountain field problems, and practices aerial resupply in mountain valleys. Before he leaves he must run a conditioning course of two miles in 15 minutes—over crags, along ridges and rolling hills, and over a slide that slips out under his feet. The last 1000 yards is uphill.

When he's all through, the average ranger is a rough, tough soldier, slippery as an

(Continued to page 392)

Expert Woodworking...

YOU can do it!



ELECTRIC TOOLS

Develop Your Skill Increase Your Pleasure

Enjoy the satisfaction of doing expert woodworking . . . turn out home workshop projects that look custom made . . . save yourself hundreds of dollars on home repairs. *You can do it!*

Guild Electric Tools make your hands pay off. They develop your talents—increase your skill—extend the range of carpentry work and cabinet making you can handle with confidence and sure success.

Guild Electric Tools were specifically designed for you, the home craftsman and hobbyist, with all the ruggedness and extended tool-life demanded by professionals. See them at your dealer's. Learn what they can do—for you. For more information, write—

PORTER-CABLE

MACHINE COMPANY

6161 North Salina Street
Syracuse 8, N. Y.

Manufacturers of SPEEDMATIC
and GUILD Electric Tools

In Canada write: Strongridge, Ltd.,
St. Catharines, Ont.

Unmatched speed and power!

POWERFUL 6" SAW (Model A-6)

Instantly adjustable for depth of cut between 0" and 2". Built-in tilt for bevel cutting. Powerful—rips through any material. Rips, crosscuts, ploughs, grooves, bevels. Weighs only 12 lbs.

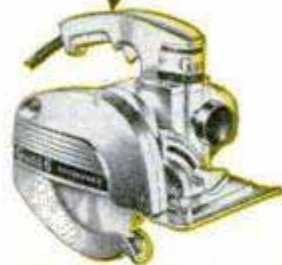

10 times faster than hand sanding! SURFACING SANDER (Model A-2)

Levels joints, removes paint, grinds, polishes any material. Rests solidly on the work—sands flat and true. Belt size 2" x 21". Speed, 600 SFPM. Net weight, 9 lbs. A real labor saver.

Zooms through wood at 20,000 rpm! POWER PLANE (Model 101)

Does weatherstrip grooving, levels stock and planes accurate edges in a fraction of the time required by hand methods. Width of cut, 1 1/8". Depth of cut, 0 to 1/8". Wt., 8 lbs.

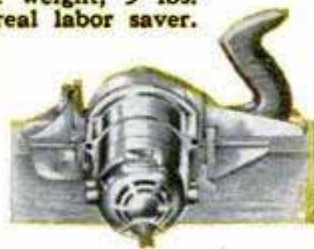

Sands all directions—without marring! FINISHING SANDER (Model 106)

Sands with, against, across the grain. Pad moves in 1/4-inch orbits at high speed—no scoring; no pattern. Powerful AC-DC motor—4000 rpm under load. Patented paper clamp holds abrasive flat and tight. Gearless—no lubrication.

Speeds up hundreds of jobs!

COMBO-TOOL (Model D-6)

Does high speed grinding, drilling, cutting, polishing on wood, metal, tile, masonry. Wire brushes. Mixes paint. Can be purchased separately or complete with accessories in four different kits.

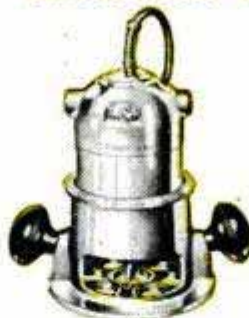

Saves hours on woodworking projects! HANDY ROUTER (Model 100)

Makes decorative cuts quickly and accurately. Routs, grooves, moulds, chamfers, rabbets, coves, dadoes, veins. Absolutely essential for fine furniture and cabinet work . . . handy for around-the-house repairs—picture framing, making moldings. Fast—20,000 rpm!

Grinds flat or curved pieces!

BELT GRINDER (Model CN2)

Uses flexible belt for irregular shaped pieces; a platen for flat surfacing; formed idler wheel for contours. Grinds metal, wood, glass, plastics, etc. Operates in vertical or horizontal position.



Trims 100 feet in less than 1/2 hour! HEDGSHEAR

Cuts on both edges. Perfectly balanced to minimize wrist and arm fatigue. Self-sharpening teeth. Continuous chain action. Lightweight. Stands up under steady use on home gardens and shrubbery, nurseries, parks, country clubs and estates.

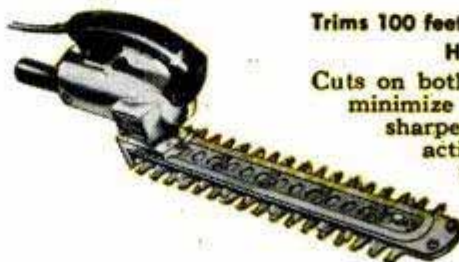

If you like
fine tools



...get



The minute you take hold of a GREENLEE tool, you can "feel" the fine quality and extra craftsmanship that goes into its making.

And when you put it to work, you'll immediately see how GREENLEE tools are built to speed your jobs and help you finish them off with a skillful touch.

The next time you buy Auger Bits, Chisels, Gouges, a Spiral Screw Driver, an Automatic Push Drill, a draw knife, or other fine hand tools . . . "get GREENLEE" . . . at better hardware and building supply dealers across America.



HANDY WOODWORKING CALCULATOR... ONLY 25c

Converts linear to board feet, gives nail specifications, tool sharpening tips, compares woods, answers countless other questions in seconds.

GREENLEE TOOL CO., 2101 Columbia Avenue
ROCKFORD, ILLINOIS: Enclosed is 25c (not stamps), send Handy Calculator to:

NAME.....

ADDRESS.....

CITY..... STATE.....

eel and a threat to any enemy. The rangers report to their companies where they give the rest of the men a good dose of ranger training.

Recently one group of rangers, finished with a night problem in an active war area, noticed a U. S. artillery group bivouacked nearby. The sentries were half asleep. Just for practice, the rangers slipped through the artillery company lines, stuffed the muzzles of the guns with mud and put fake TNT charges in the breeches. Then they left notes saying: "Kilroy was here. So were the rangers."

"What if a guard had seen you and somebody'd been shot?" asked infuriated artillery officers next day.

"It would have been a good chance to practice tactics and first aid," replied the ranger officer. "And the guy who'd drawn fire would have gotten a black mark for goofing up."

The Tinker With Million-Dollar Ideas

(Continued from page 191)

suburban homes throughout the country.

To Kearsley, every inventive undertaking is an exciting adventure into the unknown. Once he sets out he never knows where he is going to land. To chart a course he uses his "magic wand." "I try to visualize what kind of a device I would have if I could create it with the mere wave of a wand. The moment I get a 'vision' I set out to make it a reality. Sometimes I can hit the vision right on the nose. Other times I'll miss—or hit something even better."

His famous electric blanket was a mile-wide miss. Actually, he set out one summer to find a bed-cooling device. His wand gave him an idyllic vision of lying in a cool breeze. This he produced by piping cold air in from his household refrigerator. Before he could get the device perfected, however, winter rolled around, and he turned his thoughts to a bed warmer. This time he envisioned a private "sun" in his room, which he produced by means of resistance wires and a reflector which he hung over his bed. "It worked fine," says Kearsley, "except that my electric bill jumped \$200 that month." He then recalled a foot-warming pad—made of resistance wires stitched between two muslin sheets—which he'd contrived in his home-workshop days. This he developed into a full-bed-sized blanket and then added a thermostat which regulated the current according to the temperature of the room.

When husbands and wives wrote complaining that the blanket was a "failure" because they couldn't agree on an ideal

(Continued to page 394)



IF THE FIXTURES
IN YOUR HOME
HAVE THAT
FALLING DOWN →
APPEARANCE,
USE **MOLLY**
SCREW ANCHORS

IT'S EASY TO INSTALL THESE FIXTURES WITH
MOLLY SCREW ANCHORS

SINKS • SOAP DISHES • TOWEL RACKS • CURTAIN
FIXTURES • VENETIAN BLINDS • KITCHEN AND
BATH ROOM CABINETS • STAIR HAND RAILS •
DOOR CHIMES • WALL CLOCKS • MIRRORS • SHELV-
ING • FUSE BOXES OR ANY WALL MOUNTED APPLIANCE

MOLLY SCREW ANCHORS ARE SOLD BY LEADING
HARDWARE DEALERS EVERYWHERE.



**MOLLY FASTENS FIXTURES SECURELY TO WALLS, FLOORS AND
CEILINGS. EASY TO INSTALL. NO SPECIAL TOOLS NEEDED.**



1. FIRST DRILL HOLE
SAME SIZE AS
MOLLY . . THEN
INSERT MOLLY

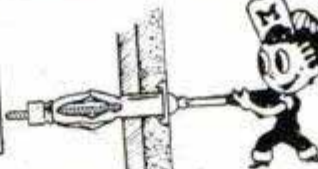

2. USE A
SCREW-
DRIVER TO
TURN SCREW

NOW MOLLY
3. IS FULLY
INSTALLED

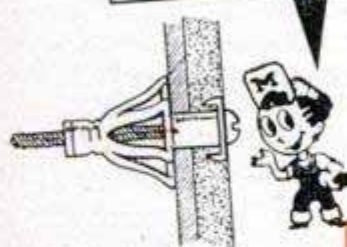

4. NEXT . .
REMOVE THE SCREW

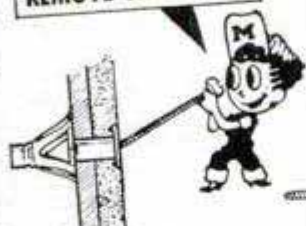

5. NOW PLACE FIXTURE
IN POSITION . . RETURN
SCREW AND TIGHTEN

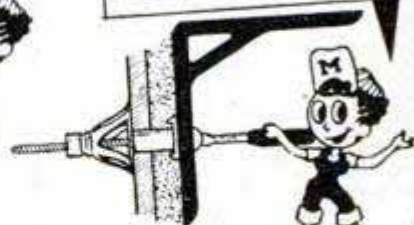

"WHERE SCREWS WON'T HOLD!"
USE
MOLLY
SCREW ANCHORS

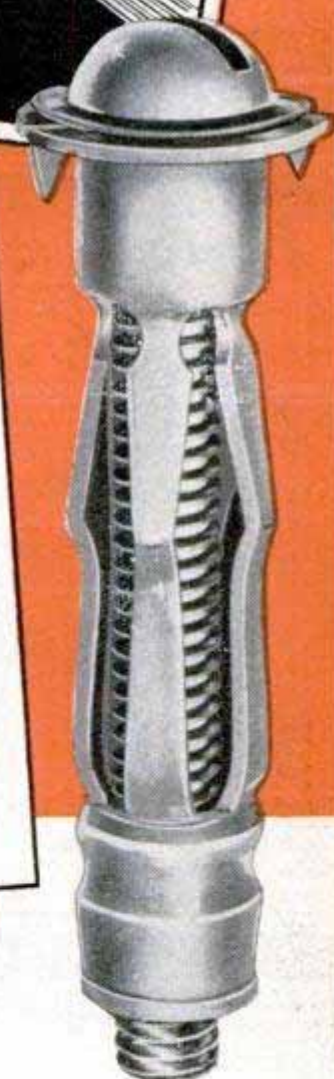

Write For **FREE** Descriptive Folder Explaining The Many Uses For Molly In The Home.

MOLLY CORPORATION Dept. 177

READING, PA.



**RUST STAINS
LIKE THESE
CAN'T HAPPEN
WHEN YOU USE
NEVER-STAIN
ALUMINUM
NAILS**

- ★ WILL NEVER STAIN OR STREAK PAINTED SIDING OR COLORFUL ROOFING
- ★ COST LESS TO APPLY—NO PUTTYING OR COUNTER-SINKING NECESSARY
- ★ ALMOST 3 TIMES AS MANY PER LB.

They pay for themselves in the savings they make — and they may save you a \$300 repaint job! Now packaged for the job — each with quantity, size, type, and coverage clearly indicated.

THERE IS NO SUBSTITUTE FOR ALUMINUM!

Write for FREE Samples.

Address Dept. PM.

**NICHOLS WIRE
& ALUMINUM CO.
DAVENPORT, IOWA**



AMAZING NEW WAY TO FINISH FURNITURE



Transvener PLASTIC FILM VENEER

**REPRODUCTIONS
OF BEAUTIFUL
WOOD GRAINS**

Transvener makes any smooth surface look exactly like the most beautiful and

costly wood! Comes in easily applied film-like sheets. Covers wood, metal, composition board, glass.

SPECIAL OFFER! 16"x24" *Transvener* sheet in beautiful Quartered Pencil Stripe Mahogany grain, Welding Solution, Squeegee, full Instructions—only \$1.00 postpaid. Money back if not completely satisfied. Order today! Sorry, no C.O.D.'s.

SPECIAL TRIAL OFFER **1.00** POSTPAID

MAIL COUPON NOW!

TRANSVENER DIVISION, DI-NOC COMPANY

Dept. A—Public Square Bldg., Cleveland 13, Ohio

Enclosed is \$1.00. Please send *Transvener*, Welding Solution, Squeegee and Instructions.

NAME _____

ADDRESS _____

CITY _____ zone _____ STATE _____

This offer expires April 1, 1952

temperature, he invented dual controls, by which one half of the blanket can now be set for one temperature, and the other half for another. GE has sold well over a million of his blankets, and has issued manufacturing licenses for the blanket to several other large companies.

Some of Kearsley's greatest inventive efforts have been to relieve the pain and suffering of the sick. As a result he's created four of the most valuable instruments now employed in medical science. His current stabilizer helped perfect X-ray photography. For victims of arthritis and similar painful ailments, he developed the portable Inductotherm with which patients can be treated in their own homes. His brain-wave recorder detects tumors and incipient epilepsy and aids in the diagnosis of brain diseases.

For 40 years Kearsley's inventions have been the "aspirin tablets" that have cured many of industry's headaches. Among his many time, money and life-saving devices now being used are a "doctor call" which can be installed on the lighting system of any hospital, a high-frequency leather drier for shoe manufacturers, a safety device which prevents explosions of the inflammable gases used in hospitals and dry-cleaning plants and an electrical dust remover which was first used by Walt Disney Studios in the filming of *Snow White*.

Kearsley pays dearly for his inventions. Once he finds a really challenging idea he attacks it with grim tenacity. All social life is shut out as he sinks into a lonely, silent world of intense concentration, during which he paces the floor endlessly and barely listens or speaks to anyone. Thus engaged, he will actually work 24 hours a day—"with my hands during the day, with my mind in the evening and with my subconscious when I'm asleep." Often he will wake in the middle of the night to find he has solved an important part of a problem. Because he does his best thinking lying in bed staring at the ceiling, however, he seldom gets enough sleep. As he often forgets to eat, he also loses weight. After a couple of torturous months of this, gaunt-faced Kearsley will appear to be on the verge of collapse. Yet should someone remind him of his approaching annual vacation, he will snort indignantly, "Don't be silly. I can't leave now. I'm having too much fun."

Although always ready to help solve the other fellow's problem, Kearsley invariably feels guilty of laziness when he solves his own. He explains it this way: Because he is too lazy to raise or lower the sliding door of his garage, he installed a short-wave

(Continued to page 396)

See, try, compare — you, too, will choose Westcraft Tools over all other brands



Like thousands of other tool buyers, you'll be surprised to discover how much you save by choosing famous, professional-quality Westcraft Tools. They give you the precision engineering

and lasting accuracy you'd expect to find only in more expensive tools. See the complete line of guaranteed Westcraft Tools this week . . . yours on easy terms at Western Auto.

① **1/4" Electric Drill**, 115 volt; AC-DC; 60 cycle. 650 RPM Chuck. Lightweight, ideal for general utility. 1-year guarantee. Only . . . (2H1379) **\$11.95**

② **14-Piece Accessory Kit** for electric drill. Attachments for sanding, polishing, grinding, etc. Baked enamel steel box. Real time-saver. (2H1378) **\$4.75**

③ **4-Piece Wood Bit Set**, converts 1/4" drill to bore holes up to 1/2" diameter and 3 3/4" deep. Yours for **\$2.47** only (4HR6750)



17-Piece Socket Set, 1/2" Square Drive. Alloy steel, chrome plated. Complete with 12 sockets, reversible ratchet, 4 fittings. Heavy gauge steel tool box with red, baked-on enamel finish. A low-cost basic kit for mechanics, home owners, farmers. (HR2951) **\$19.45**

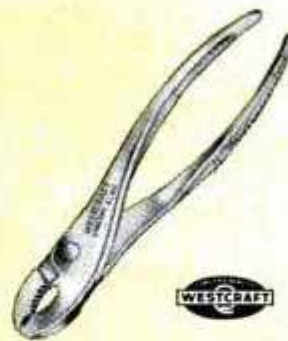

7" Lobster Claw Plier. Patented leverage design gives 50% more gripping power, 1/2" to 1". No other like it. . . . (HR1125) **\$1.29**



Screwdriver, alloy steel, chrome-plated, 4" sq. blade. Positive-grip, shockproof plastic handle. Professional quality. (HR1361) **85¢**

Professional Quality—Wizards of Performance

WESTCRAFT TOOLS

Sold by the largest group of associated tool departments in America



NOTE: Western Auto Associate dealers own their own stores and set their own prices. Terms and conditions quoted are recommended, and subject to variance. Prices are subject to change without notice. ©1952 (PM-12)



BELL
Hi-Fidelity
AMPLIFIER

**Finest Phono-Radio Reproduction
At Surprisingly Little Cost**

Now—as never before—you can have brilliant clarity in phono or radio reproduction for a surprisingly little cost. Measuring only 7½" x 6" x 11½" this Bell Unit can be easily built directly into either your present or custom-built console... enabling you to get the utmost from fine music! Embodies *pre-amplifiers* for various type magnetic pickups. Two special inputs for these pickups, with individual equalization, assures proper match and response. Separate input for radio tuner and crystal pickup. Bass and treble boost, plus attenuation, gives exact tone control. Also available with remote controls.

Write For Free Bulletin



BELL SOUND SYSTEMS, Inc.
665 Marion Rd., Columbus 7, Ohio

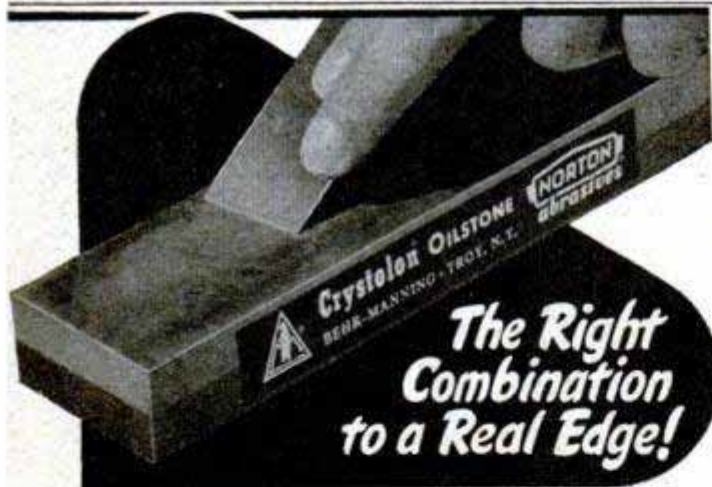

*** USE A CRYSTOLON® STONE**

Coarse one side, fine the other, its grinding-wheel grit restores dulled edges to razor-sharp keenness. CRYSTOLON stones are oil-filled, sharpening time is reduced, and the stone lasts a lifetime. Get a CRYSTOLON Stone at your hardware store, or direct.

*** SHARPEN THE RIGHT WAY**

Tools, like people, don't like to be rubbed the wrong way. Sharpen tools correctly and their edges will cut cleaner—last longer. It's easy when you know how. This 32-page booklet, "How to Sharpen" shows you. Send 10c today for your copy to Dept. PM-1.



BEHR-MANNING, TROY, N. Y.
(Division of Norton Company)

Coated Abrasives • Sharpening Stones • Masking Tapes

transmitter in his car which puts the door up and down at the touch of a button; and because he couldn't be annoyed with letting in or putting out the cat, he contrived an elaborate photoelectric-cell device which would let his own jet-black pet come and go as she pleased through a trap door in the cellar, but would bar passage should a cat of another color try to enter.

Today at 68 Kearsley is a slim, gray-haired, soft-spoken man with the sober manner of a country minister. He is deeply religious, regularly attends the Episcopal church, and has recently been made a vestryman of his parish. He enjoys Canasta, archery and short motor trips with Mrs. Kearsley. His favorite hobby, however, is rifle shooting, at which he is expert. He tends to be absent minded. When his wife asks him to do an errand, he shifts his penknife from his right coat pocket to his left as a reminder. "His only invention that still needs to be perfected," says Mrs. Kearsley.

Kearsley was high on the list of scientists who were called upon during World War II to work out technical problems for our armed forces. For the Army he developed an "iron lung" to cure frostbitten feet, a hot-wire device for cutting irregularly shaped bandages, and a portable electronic sterilizing machine. For the Navy he created a long-range submarine detector. And for the Air Force he produced an electrically heated flying suit and an aluminum "umbrella" which, when launched from the rear of a bomber, scrambled the Nazis' radar-controlled anti-aircraft guns.

Three years ago, having reached GE's compulsory retirement age of 65, Kearsley moved to Florida. He went determined to do nothing but loaf. After a week of nerve-racking leisure he built a workshop in his basement where he has since been hard at work on electrified wallpaper as a more efficient means of household heating, a radio attachment which will automatically cut out commercials and a self-operating police camera which will photograph the license plates of speeding cars. And, as usual, in his spare time he is helping people with their everyday problems. For a northern friend who doesn't like to get out of bed in a cold room, Kearsley has produced a mechanical arm which closes his bedroom window on wintry mornings, lights the fire in the fireplace and turns on the radio. For Mrs. Kearsley he has created an ingenious cooking device on the dashboard of their car where she can brew herself a cup of tea as they drive along a Florida highway.

And for himself—because he is so lazy—he has developed an alarm clock which after waking him, lures him from bed with tempting odors of toast and coffee.

CHOOSE THE MODEL BEST FOR YOU!

Two DREMEL Electric SANDERS with

STRAIGHT LINE Action for Guaranteed SCRATCH-FREE Surfaces

Perfect answers to any sanding problem, both Models feature: Only 2 moving parts; 14,400 strokes per min., easy one-hand operation, dust-proof-foolproof; 10-second paper change; 110-120 V., 60 cycle A.C. PLUS—straight-line action for mirror-smooth finishes. Don't settle for less!

MODEL 2000 FOR HEAVY DUTY CRAFT AND WOODWORKING PROJECTS

—Fastest seller in the field for rugged power and smoothest finishes at lowest cost. Ample power for furniture and cabinet making, boat building or refinishing, resurfacing large areas. Great for building operations—woodwork, stairs, dry-wall joints, siding, etc. Does a superb polishing job! Weighs 5 lbs.; 21 sq. in. of sanding surface; over-all size 3 1/8" x 4 1/2" x 7". Price includes steel carrying case, 25 asst'd. abrasive sheets, and a sheepskin pad.

MODEL "A" FOR HOBBIES, REFINISHING, REDECORATING

—Finest sander ever offered housewives, homeowners, hobbyists. A lighter-capacity model for woodwork, unfinished furniture, hobby shop projects, etc. Wonderful for polishing waxed surfaces. Also a soothing massager! Weighs only 2 1/2 lbs. Sanding pad 2 1/4" x 5 1/2". Price includes 6 sandpapers, 1 sheepskin, 1 felt pad.

ONLY STRAIGHT-LINE ACTION SANDS WITH THE GRAIN—NEVER MARS OR SCRATCHES
Don't just take our word for it. Ask any professional woodworker about sanding action. He will tell you that only straight-line, with-the-grain sanding can produce a flaw-less finish.

BEFORE YOU BUY ANY SANDER . . . COMPARE!

ROTARY Action



ORBITAL Action



ARC Action

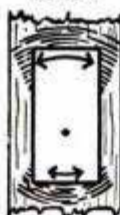

STRAIGHT-LINE Action

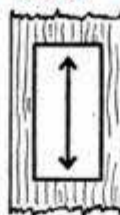

DREMEL Electric COPING SAW

CUTS SCROLLS LIKE MAGIC—SANDS AS IT SAWS

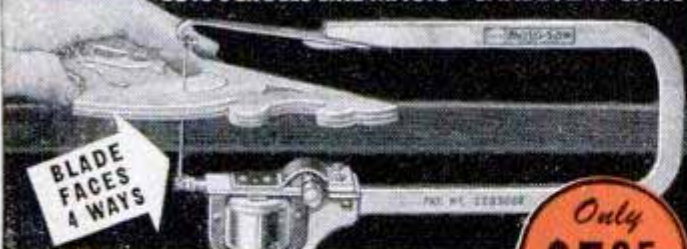

BLADE FACES 4 WAYS

MAKE YOUR OWN JIG SAW PLANS FREE!

JUST GUIDE IT!

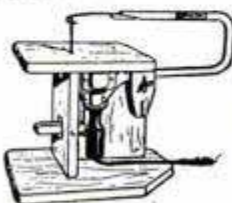

SAFE! AS A HANDSAW

For home, hobby, repair work—no other tool pleases so much for so little cost. Works in any direction—delivers 7,200 strokes per minute smoothly, effortlessly. Saws through 3/4" medium-hard wood at a foot-a-minute speed. Touch-of-the-trigger, foolproof action. Only 2 moving parts, never needs oiling. Uses 110-120 V., A.C. Free plans, packed with each saw, for six useful woodworking projects and for making your own jig saw.

YOU BE THE JUDGE OF DREMEL PRODUCTS—Our reputation has been built on results rather than sensational claims. We invite comparison of Dremel tools with any similar products made. Then you'll know why we guarantee the most for your money!

MODEL 2000

\$24.50



14,400 SANDING STROKES PER MIN.

MODEL "A" \$14.85

GRINDS • CARVES • ENGRAVES
DRILLS • ROUTS • SHARPENS

DREMEL Electric MOTO-TOOL

FASTEST MOST POWERFUL TOOL in its class—Approx. 27,000 r.p.m.

Most practical tool a man can own—more powerful than any similar tool you can buy. Works well in wood, plastics, and metal. For home maintenance jobs you'll wonder how you got along without it. For model making it's a must. And for general shop operations it saves time and money. Compare it, try it, buy it. You be the judge!

Check These Important Features —Oilless sealed bearings • Dynamically balanced armature • Shockproof, Bakelite housing • Dust-filtered air cooling system • Sturdy 110-120 V., A.C.-D.C. motor • Wt. only 13 oz. • A precision tool widely used in industry for many years.



MOTO-TOOL No. 2 (with 1 emery wheel point)

\$16.50



MOTO-TOOL KIT No. 2 With 23 Accessories (High-Speed Steel Cutters, Grinding Wheels, Polishers)

\$23.50



WHERE TO BUY—If your dealer doesn't carry, remit in full for postpaid shipment. Or send only \$2 now, pay post-man balance plus postage and COD fee. Five-day trial, money-back guarantee!

DREMEL MFG. CO., Dept. 112-A, Racine, Wis.

CAMPBELL-HAUSFELD Spray Painting Outfits

*Outperform
them all!*

DO more and better painting in an hour than you can brush on in a day. Same compressor inflates tires, lubricates cars, tractors, implements.

4 models, precision built for trouble free service. Last a lifetime. Gasoline or electric power.



See them at your dealer
or write for literature,
giving his name.

**pressure
maid**

New Low Priced
Pressure Maid . . . dwarf
in size . . . giant in power.

THE CAMPBELL-HAUSFELD CO.
1046 RAILROAD AVE. HARRISON, OHIO



Garlinghouse HOME PLANS for Better Living

America's Pioneer
Home Plan Service

5 LATEST PLAN BOOKS — 1 TO 4 BEDROOM SIZES

● "CHOICE SELECTED HOMES"
Over 75 homes pictured — 32 in
full color 50c

● "RANCH AND SUBURBAN"
158 plans most practical for town
and country. Ranch styles and
many others 50c

● "YOUR NEW HOME PLANS"
108 plans in modern and tradition-
al styles. 64 pages (16 in color) 50c

● "AMERICA'S BEST HOME
PLANS"
Over 125 designs, many in colors.
A wonderful selection 50c

● "BLUE RIBBON HOMES"
128 plans, 32 in full color. Those
most popular by actual sales. . 50c

In these five beautiful Home Plan Books are several hundred varied home designs from which to select the home of your choice. You'll find all sizes and styles of homes printed from actual photographs and colored drawings. Floor plan and accurate description shown with each. Blue-print drawings, Lumber and Mill Lists, and Specifications available for each design at LOW COST . . . complete, ready to turn over to your contractor. Prices on each are shown in plan books. Used by Contractors, Home Builders, Lumber Yards everywhere — since 1910.

ORDER YOUR BOOKS TODAY

All Books POSTPAID. No C.O.D.'s Please

Our Complete Home Plan Library — 22 Books and over
1,250 Home Designs — A \$12.50 value — Only \$10.00

L. F. GARLINGHOUSE CO., INC., Box PM-14 TOPEKA, KANSAS

Designs for Tomorrow

(Continued from page 197)

such prosaic studies as cost analysis, the necessity of working within a budget, the limitations of metals and other materials under different methods of fabrication and the necessity of designing each part so that it can be produced quickly and cheaply by available equipment.

It's easy for a student to design a beautiful lighting fixture, for example, but all his effort is wasted if the fixture throws spotty illumination or if it costs so much that it can't compete with other fixtures.

The student learns that when he adds one rivet to an assembly he really is adding two million rivets or whatever the annual production quota might happen to be.

He makes engineering drawings of the products he designs, prepares sketches that show the exterior appearance and then makes a three-dimensional model to check on his paper work. He goes as far as he can without building an actual operating prototype.

This procedure was followed by Kadry M. Ragheb, son of an Egyptian diplomat. Kadry is now employed by the industrial-design firm of Raymond Loewy Associates. His last assignment before he graduated from school was to design a car that would combine the high performance of a European sports car with the greater comfort of an American automobile. The chassis was to be encased in an attractive body that would suggest speed and power by its lines.

Under the guidance of instructor George Jergenson, Ragheb first made a thorough study of both kinds of cars. Partly by combining their measurements, he arrived at his own specifications.

He worked his figures up into full-scale, three-view drawings from which he took basic section lines. Next a wooden buck or skeleton of the car scaled to $\frac{3}{8}$ of the actual size and clay was molded over the buck to conform to the section lines. From the clay model a plaster mold was made and the mold was then used for making a plaster cast of the car body.

The cast was smoothed down and sprayed with several coats of enamel to simulate a rich finish. Wooden tires and wheels were painted and attached to the body. Metal hub caps were designed and added, wooden bumpers were shaped and metalized to give them a polished chrome surface and a metalized wooden steering wheel of unique design was installed. The car was completed by adding a curved Lucite windshield. The finished model is not only an

(Continued to page 400)

The Biggest Money Saving Idea in Car Maintenance in 20 Years



STOP those endless repairs that keep pulling \$10 bills out of your pocket.



STOP expensive overhauls that still leave things undone to break down later.



STOP paying high gas, oil and maintenance bills on an unsafe, worn-out engine.

New Kind Of Replacement Engines ...Successor To Costly Overhauls!

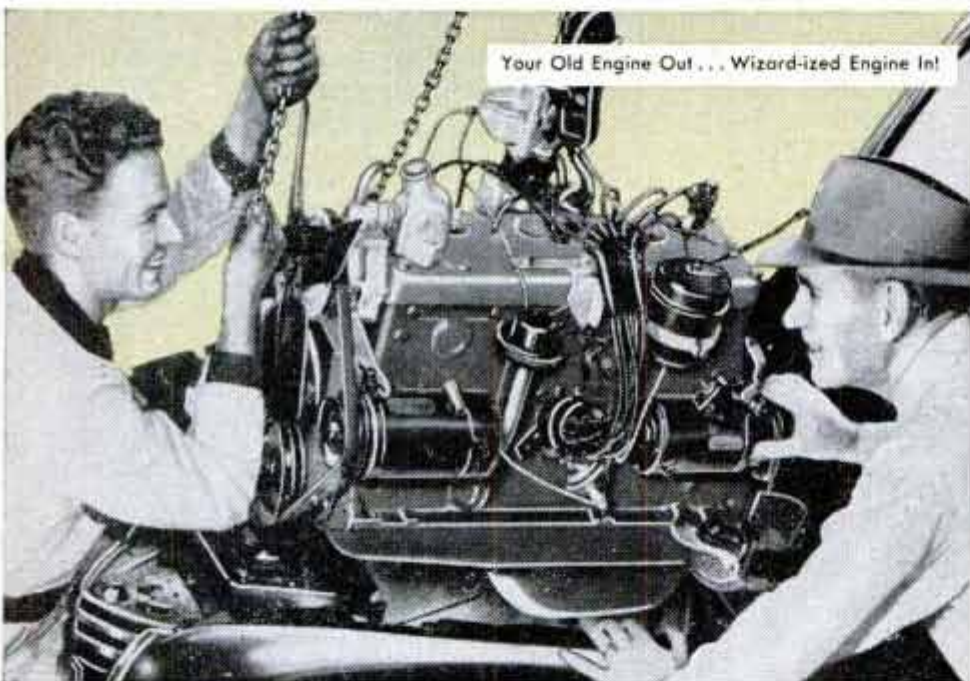

Your Old Engine Out . . . Wizard-ized Engine In!

Enjoy again the new-car thrill of an engine that's packed with surging power . . . power to level any hill . . . power to pull out of tight spots in traffic . . . power that means years of care-free driving and day after day dependability. You

can have it now in one complete, guaranteed package in a Wizard-ized Engine. (Attached engine accessories are used from old engine, or may be replaced new.) Yours on easy Western Auto terms!

No Regular Overhaul At Any Price Can Match Your New Factory Remanufactured*

Wizard-ized Engine!

HERE, AT LAST, is a new kind of replacement engine for your car! . . . so much better than partially rebuilt engines or ordinary overhaul jobs that thousands call it the successor to costly overhauls!

*NOT A SO-CALLED "REBUILT" but completely remanufactured in 5 large factories, this Wizard-ized engine gives you an easy, low-cost way to end costly repair bills. And you can . . .

GET ANOTHER 50,000 OR MORE MILES from your present car! That's because . . .

EVERY MOVING PART IS BRAND NEW top quality or fully remanufactured to function like new. Over 150 new parts. That's why you can buy with new car confidence. In fact, Western Auto gives you . . .

THE SAME GUARANTEE THAT COMES WITH A NEW CAR ENGINE—plus a free 500-mile service inspection of our installation. Still this Wizard-ized Engine is . . .

PRICED FAR BELOW THE COST OF A NEW ENGINE . . . or about the cost of a bearing, ring and rebore overhaul! Our . . .

INSTALLATIONS ARE MADE BY trained mechanics in fully equipped garages. So . . .

SEE YOUR WESTERN AUTO MAN TOMORROW . . . ask about his trade-in allowance for your old engine!



Ford

as low as \$16⁰⁰ down



Plymouth

as low as \$17⁰⁰ down



Chevrolet

as low as \$14⁰⁰ down

(Terms vary by area, make and model of car)

GUARANTEED
New Car Engine Performance for
Chevrolets, Fords, Plymouths, Chryslers, Pontiacs, Mercurys, Dodges, Studebakers, DeSotos, Olds and other popular makes.

Wizard-ized Engines

FACTORY REMANUFACTURED

The Engine You Can Buy with New Car Confidence

Sold Only By **WESTERN AUTO**
STORES & ASSOCIATE STORES

© 1952 Western Auto Security Co., K. C., Mo.
NOTE: Western Auto Associate Dealers own their own stores and set their own prices. Terms quoted are recommended terms, subject to variance.

PM-12

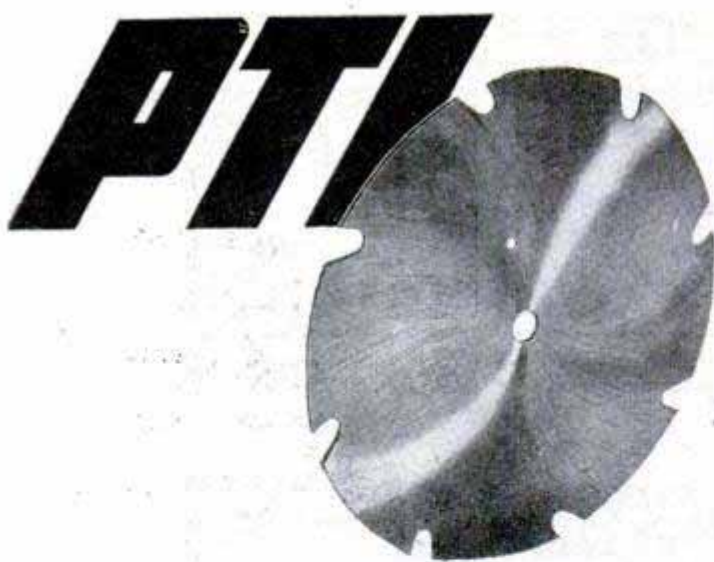

The original safety saw blade tested and approved by the world's leading laboratories

For a dependable safety saw blade that really minimizes danger and "kick-backs" from circular sawing—insist on the genuine PTI blade. (U.S. Patent No. 2,559,355).

Precision made of chrome vanadium steel by one of the world's leading saw blade manufacturers. Cuts cleaner, quieter, smoother—and requires 30% less power. Available in sizes from 7" to 16" and for standard makes of portable saws.

NEW! PTI saw sharpener for safety blades

Get franchise in your locality! WRITE FOR DETAILS.

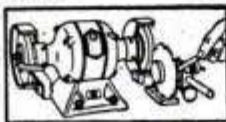

INCORPORATED, 401 Broadway, New York 13



NEWEST EDITION

**CONSTANTINE'S
MANUAL FOR
WOODWORKERS
HOBBYISTS
HOME OWNERS**

... and The Craftsman Bible on woods, hundreds of illustrations, 10 pages in color, charts, how to do it articles and a complete Catalog of . . . Rare and domestic woods, veneers, lumber, plywood and inlay panels, inlay designs and borders, finishing materials, hard-to-get hardware, plans, patterns, picture mouldings, hand and power tools. Full color wood identification panel of 60 different woods suitable for framing. Leathercraft, decorative metals, hard to get items of all kinds. All items at lowest prices from America's Biggest Supplier to Craftsmen. Manual sent postpaid for only 50c with 1 year's subscription to "Chips and Chats".

SEND FOR YOUR COPY TODAY

With each copy of our Master Manual, you get a year's subscription to Chips and Chats, a breezy bimonthly to keep you up-to-date on what craftsmen are doing.

ALBERT CONSTANTINE & SON, INC., DEPT. PM-1
797 East 135th St., New York 54, N. Y.

Enclosed find 50c for a copy of your "Master Manual" and one year's subscription to Chips and Chats.

NAME _____

ADDRESS _____

CITY _____ STATE _____

outstanding example of good craftsmanship, it shows exactly what the full-size car would be like.

This particular automobile may never be built, but instructors and students alike agree that it shows the trend toward the cars of tomorrow.

Art Center School offers four-year courses of college level, leading to degrees in industrial design, advertising design, photography, illustration and creative painting. Of the student body of 700, some 150 are enrolled in industrial design and represent most of the states and several foreign countries. Entering students must possess at least a high-school education and show evidence of ability in the subject they select. Even so, about 20 percent are flunked out before graduation. Full tuition costs about the same as a high-priced automobile, although for outstanding students this cost may be offset by scholarships that the school offers from funds made available by several corporations.

Industrial-design students major in transportation, in design of general products, in specialized structures which include laying out community developments, furniture design or in packaging and display. In all cases they get the same basic studies in perspective, technical drawing, industrial color and surface development. General academic subjects are included in the curriculum to round out the instruction.

Not all the students wait for graduation before beginning to practice their profession. Allan B. Johnson, for one, designed a novel combination of coffee table and magazine rack as a class project, laying out each part so that it could be shaped with the equipment in an average furniture factory. Then he took his design and a model to a local manufacturer. Today his glass-topped table with sloped magazine rack below the glass is being sold all over the country.

Science on the March

(Continued from page 125)

and the telephone. Whereas in 1912 we could send dot-dash messages by wireless, we can now send voice conversation and pictures. In other words, we now have radio and television. By further development of wireless we now have radar, by which we can locate otherwise-unseen objects, do blind navigation, measure the distance to the ionosphere or the moon and do many other things. Similarly, the telephone of today is a far more powerful and flexible instrument than was the telephone of 1912. These developments have come principally from the tremendous advances in the art

(Continued to page 402)

Workhorse Engines of the Nation's Largest Airfreight Lines Depend on Champion Spark Plugs

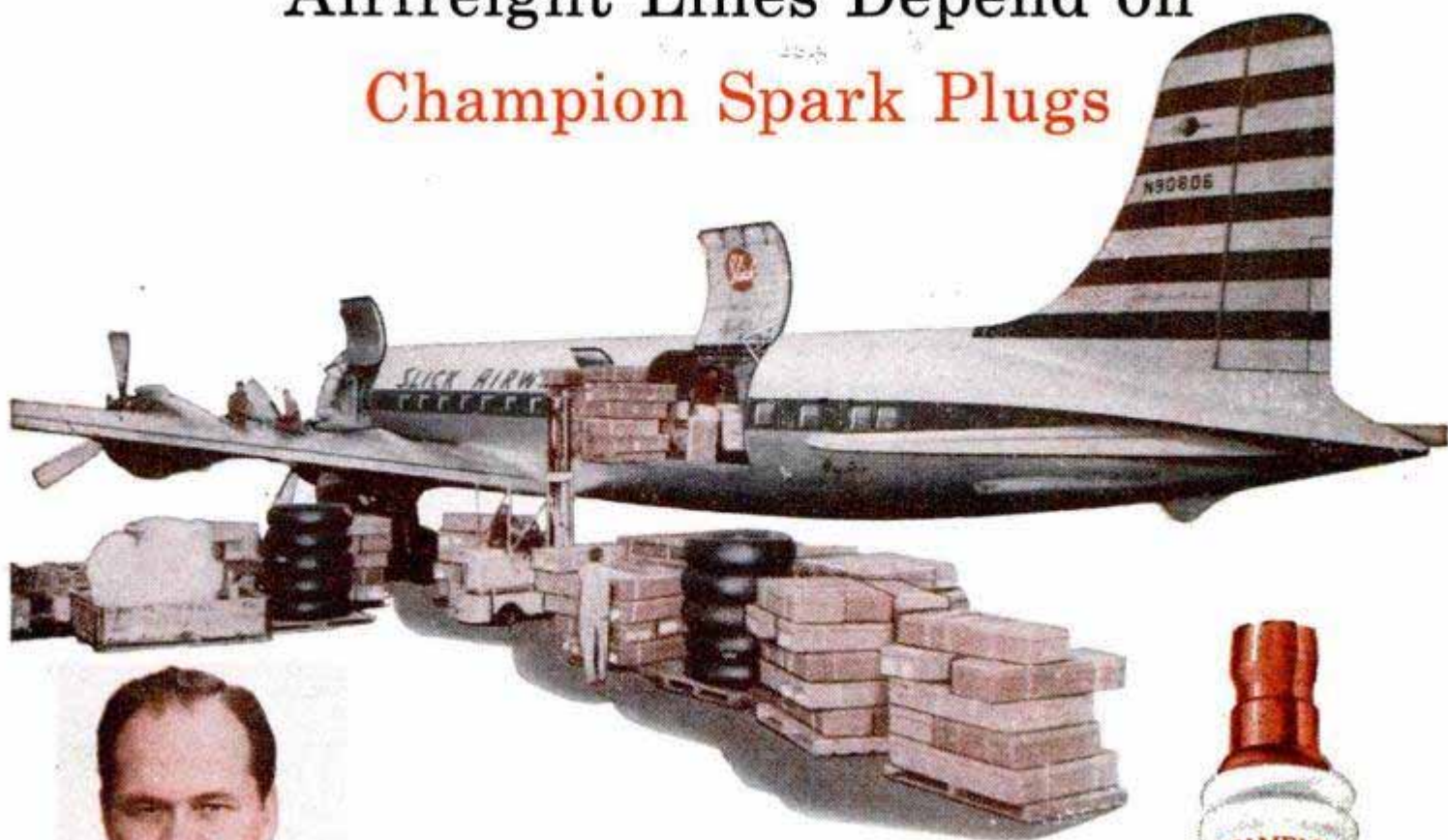

MR. THOMAS L. GRACE,
*President of Slick Airways, Inc.,
Burbank, California, says:*

"Hauling Airfreight from coast to coast, every hour around the clock, means keeping many airplanes in the air . . . for many hours of every day. Slick guarantees its customers the finest and fastest Airfreight service in the country, and only by the finest performance of every piece of equipment can we uphold this claim. For this reason we set extremely high standards of excellence for maintenance and replacement parts. Tops on our equipment list are Champion Spark Plugs. All of our maintenance people, from the superintendent to the line mechanics, swear by Champions and, quite frankly, will not use any other spark plug."

You can profit by the experience of Slick Airways and of every other major airline in the country all of whom use dependable Champions. If you want the same spark plug performance, insist on Champions for your car. They are products of the identical research, engineering and uncompromising quality standards in manufacture.

CHAMPION SPARK PLUG COMPANY, TOLEDO 1, OHIO

FOLLOW THE EXPERTS

DEMAND DEPENDABLE CHAMPIONS FOR YOUR CAR

The Sign of Dependable Service!



and science of electronics. From electronics have come also a great variety of automatic-control devices, high-speed

mathematical computers and countless other devices. Today I should group all such things together in a modern wonder of the world—electronics.

Similar is the story of radium. For 50 years after the discovery of radioactivity, its interest was purely scientific, except for a few practical uses like cancer therapy and luminous watch dials. It was the phenomenon whose study threw the most light on the inner constitution of atoms, just as spectrum analysis and X rays gave us our knowledge of their outer structure. But studies of radioactive substances led scientists to try various methods of prodding into the innermost secrets of the nuclei of atoms, and for this purpose were devised the various types of atom-smashing machines—high-voltage generators, cyclotrons, linear accelerators, betatrons and synchrotrons. With these it was found possible at will to realize the old dream of the alchemists: To transform atoms into different types of atoms. This has been the most fundamental scientific discovery of our generation.

But, out of this work with radioactivity, and guided by Einstein's deduction from his famous theory of relativity that mass and energy were equivalent and interchangeable (if only means to effect the interchange could be found), came the atom

(Continued to page 404)



RCA photo

One of the wonders of the modern world of science is the electron microscope. This is a table model

UNCLE WALTER

IT SMELLS GRAND

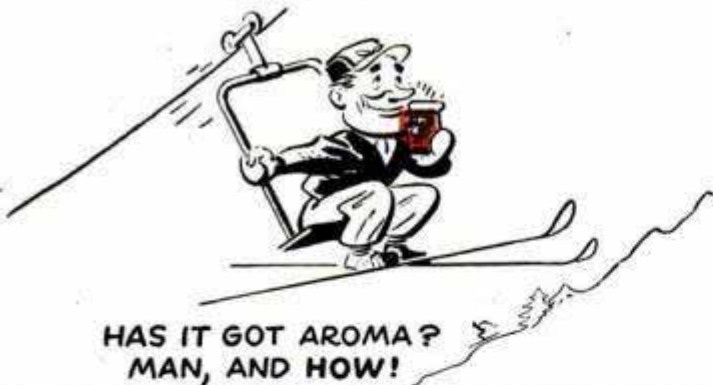

HAS IT GOT AROMA?
MAN, AND HOW!

IT PACKS RIGHT



AND IT PACKS SO NEAT
IT RATES A BOW

IT SMOKES SWEET



IT'S THE PIPE-BLEND CHAMP
YOU MUST ALLOW

IT CAN'T BITE!

A BLEND OF CHOICE KENTUCKY BURLEYS,
EXTRA-AGED TO GUARD AGAINST TONGUE
BITE. SIR WALTER RALEIGH STAYS LIT
TO THE LAST PUFF — NEVER LEAVES A
SOGGY HEEL

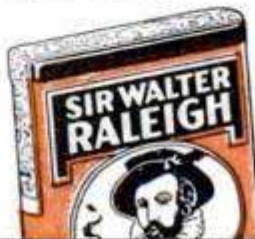

*It costs
no more
to get
the best!*

HOME IMPROVEMENT IDEAS!

How to Remodel for Window Beauty with

Windowalls

WINDOWALLS will bring cheery sunshine, fresh air and a view into your home. They'll wall out cold, save fuel.

Be sure your remodeling plans include Andersen WINDOWALLS, famous, top-quality wood window units.

Send today for free literature—and then see your builder or lumber dealer for complete details.

FREE BOOKLETS!



Chock-full of picture ideas for window beauty, when you enclose your porch, add a room, build a dormer. Mail today.



EXTRA LIVINGROOM, cheery and comfortable, a porch enclosed with Andersen Casements.

Andersen Corporation COMPLETE WOOD WINDOW UNITS

Andersen Corporation
Bayport, Minnesota

PM12

Please send WINDOWALLS booklet and remodeling information.

NAME.....

ADDRESS.....

CITY.....ZONE...STATE.....



Build This Handy SHELF-DOOR WARDROBE With Easy-To-Use Plywood

HERE'S a brand new idea in built-ins—a single storage unit that combines a big, roomy wardrobe for coats and dresses . . . ample drawer space for shirts and sweaters . . . plus *extra* storage space for socks, odds and ends and jewelry inside the generously shelved doors. Easy to build. All you need are a few sheets of plywood, some framing lumber, hardware, ordinary tools and common sense. Ideal "handy man" project.

Douglas Fir Plywood

AMERICA'S BUSIEST BUILDING MATERIAL

This ingenious shelf-door wardrobe, designed by E. W. Hanson, Stillwater, Minn., was awarded first prize in national architectural competition for plywood built-ins. Complete plans, bill of materials and finishing instructions are available for only 10c. Also available: Portfolio of over 50 top contest designs. 10c. Mail coupon today!

DOUGLAS FIR PLYWOOD ASSOCIATION
Department 91, Tacoma 2, Washington

(Good USA Only)

Please send material checked. I enclose 10c for each.

Wardrobe Plans

Name.....

Design Portfolio

Address.....

City.....Zone...State.....



**Take advantage of
your HOME-UTILITY
Tool's amazing
versatility!**

**buy
HOME-UTILITY
accessories**

RECEIVE a Black & Decker Home-Utility Drill or Sander-Polisher for Christmas? Pleased as punch with the way it helps you build and repair things? Then you're in for more good news when you discover how many more times useful you can make it by buying Home-Utility accessories! There's a whole raft of them to choose from—for everything from sharpening knives and making picture frames to polishing your car and shining up pots and pans. Try them at your hardware, appliance or department store!

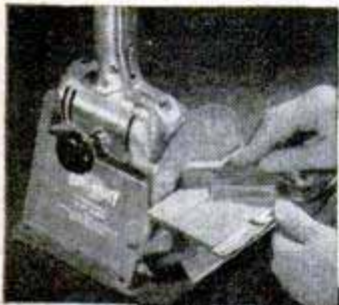

**Disc Sanding Table
only \$7.75**

Ideal for rapid, accurate sanding of picture molding, plastics and hobby parts. Easily handles small, odd-shaped, curved pieces.

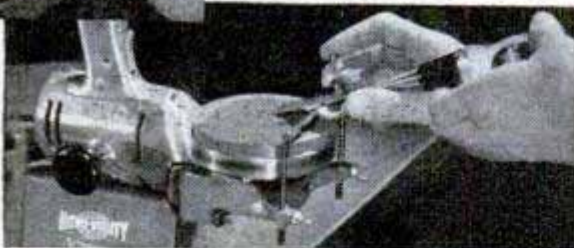

Roto-Hone Attachment only \$10.95

Hones knives, chisels, plane bits, lathe tools to razor edge. Clamp and guide bar for accurate angle. Stone has rough and fine sides.

PLUS stands, auger bits, masonry bits, counter-sinks, wire wheel and cup brushes, sanding discs, lambswool bonnets, auto polish, electric wax, saw blades, protractors, etc. **THE BLACK & DECKER MFG. Co., Dept. H1M, Towson 4, Md.**

BLACK & DECKER

**ELECTRIC
HOME-UTILITY
TOOLS**

DRILLS • SANDER-POLISHERS • LECTRO-SAWS

bomb and the prospect of atomic power. Once the clue to the release of atomic energy through nuclear fission was given by the observations of Hahn and Strassman in 1939, the developments came with dazzling speed. Knowledge of this German discovery was brought to the United States promptly by the Danish scientist, Niels Bohr. Within a month after the original discovery, it had been verified and extended in several laboratories in this country and in at least three European countries. Within a year, more than a hundred scientific papers had been published on the subject, and there had been conferences on nuclear fission in Washington and, we are told, in Moscow. A few months later some possible military applications had been envisaged, secrecy was clamped down, thousands of Allied scientists were mobilized on the project, and on August 6, 1945, an atomic bomb was dropped to devastate Hiroshima and bring the war to a speedy end in the Pacific.

Now our Atomic Energy Commission supervises the greatest scientific and engineering project of all time, and the governments of all nations of any significance have similar agencies, in some proportion to their means. Undoubtedly, we have as yet only a glimmering of the potentialities of this new science of nucleonics. Certainly, as of this date, atomic energy must be accorded a high place among the modern wonders of the world.

Space permits only mention of several other significant wonders. I have chosen to enlarge on those above, in order to illustrate the way in which such things come about. Equally interesting stories could be told about modern scientific wonders in other fields. I think of plastics and synthetic textile fibers; of antibiotics like penicillin, streptomycin, aureomycin and the others of this fast-growing group; of the sulfa drugs and others which fool a germ or virus into feeding on them to its destruction; of the discoveries in genetics which have led to the breeding of agricultural products of greater yield, food value and resistance to disease; of the role of enzymes in life processes; of the regulation of the endocrine glands by chemical agents (hormones) like insulin and cortisone; of our knowledge of the internal constitution of the stars and of the atomic fuel which keeps them hot; of the identification of new fundamental constituents of matter such as neutrons, positrons, mesons and photons; of the widening use of radioactive isotopes to study and control a great variety of scientific and industrial and medical phenomena; of catalysts and chemical-engineering

(Continued to page 406)



KIEKHAEFER

Move up to a **MERCURY**

the outboard **MORE** people want **MOST!**

Every day, you see more Mercurys! An impartial survey by a leading outdoor magazine shows that the demand for Mercury has increased far more than the demand for any other outboard:

Here's a mighty Mercury—the "Super 10" Hurricane — no other outboard in the 20 cubic inch class offers such a range of performance, from slowest troll to record-slashing racing speeds.

RATE OF INCREASE OF PREFERENCE

MERCURY	46.8%
Outboard A	21.3%
Outboard B	13.1%
Outboard C	7.4%

When you **MOVE UP TO A MERCURY**, you're marked as a man who chooses thoughtfully and well. You're moving up to the outboard that sets the pace for the entire industry . . . the outboard that gives you *the most* performance per dollar and per horsepower. The **ONLY** outboard with the engineered bonus of Full Jeweled Power — ball and roller bearings at all vital points for an all-round anti-friction ride.

See your Mercury dealer for a demonstration!

*Send for **FREE** Booklet — "PICK OF THE PILOTS"*

KIEKHAEFER CORPORATION, FOND DU LAC, WISCONSIN



Features of Mercury Outboard Motors are protected by issued or pending patents.

An all-around electrical trouble shooter

FOR REPAIRING ALL ELECTRICAL APPLIANCES-MOTORS



- Measures AC/DC Voltages, Current — Resistances, etc.
 - Measures current consumption while appliance under test is in operation. Appliance or utility plugs directly into front panel. Insulated clip-end leads included for motors, etc.
 - A sensitive direct reading resistance range accurately measures all resistances in appliances, motors, etc. Enables continuity checks and tests for shorts and opens.
 - Tests thermostats, radio tube filaments, bulbs, fuses, fluorescent, condensers, switches, field coils, circuit breakers, lighting systems, etc.
- Handsome bakelite case. Complete with test leads, instructions.....

13⁹⁰

SOLD ON EASY PAYMENTS AT THE NET CASH PRICE

No interest or carrying charges added. Simply remit \$3.90 with order, pay balance, \$2.00 per month for 5 months.

SUPERIOR ELECTRONIC CO., INC.

Dept. B-49 • 227 FULTON STREET • NEW YORK 7, N.Y.

a "Must" for every mechanic
FREE, NEW CATALOG of those



"doggone good"

DURO-CHROME TOOLS

A new pocket-size Duro-Chrome Mechanic's Catalog. Crammed with pictures and detailed descriptions of the latest ideas in tools. Shows the right Duro-Chrome Quality Tool for every mechanic's needs, PLUS hard-to-find and "special job" tools your dealer has or can get for you.

Explains why Duro-Chrome Tools have been preferred by professional shopmen for over 30 years. Tells what to look for in picking good tools; how Duro

puts Extra quality into every tool; for example, gets 25% more wear on Sockets, by exclusive Hot Broaching process.

Shows Duro-Chrome Tool Sets from 5-pc Punch and Chisel Sets up to 114-pc DeLuxe Workshop Sets. Send for your copy of this "yclopedia" of fine tools.



USE THIS COUPON NOW TO GET FREE COPY
SEND IT TO DURO METAL PRODUCTS COMPANY

2649 Kildare Avenue, Chicago, Ill.

Write your name and address in margin space

techniques which permit mass production of essential chemicals.

If one were to evaluate new developments in terms of their impact on our ways of living rather than on the elegance and fundamental character of scientific discovery, then other wonders should be added to the list. The modern automobile—about which the *Encyclopedia Britannica* says: "Until 1909-1912 the automotive industry was in general chiefly concerned with developing a product that at least would operate"—has revolutionized our pattern of living and doing business outside of the home. Within the home, probably any housewife would say that the modern ways of preserving, packaging and distributing food have similarly revolutionized the feeding of the family.

All of these things, and more, are products of scientific research within the span of the 50 years during which *Popular Mechanics* has played its useful role of spreading information and creating interest and ambition in those things which are so significant in this rapidly expanding technological age. Many of these things are only the early stages of still more significant developments in the future.

What will these future developments be? If we could reverse our sights from 50 years of past achievement to the next 50 years of scientific progress, what would we see in the year 2002?

Some answers to this question seem clear, and others seem very uncertain. It is safe to predict that the 2002 person will be clothed with synthetic textiles which will not fade, shrink or wrinkle and in which the desired creases will stay put. Atomic energy will be in use for special, but not for general, power purposes. Gasoline will be coming more from oil shale than from oil wells, and may be already produced commercially from coal. Cancer may then be as well under control as tuberculosis is now. Television may have proved to be an instrument to perpetuate dictatorship, or to make the democratic process more effective, depending on the trends of control and public concern. But let me close with mention of one great threat which hovers over the uncertain future.

Certain to be critical, sooner or later, is the problem of overpopulation in a world of limited and diminishing natural resources. The conquest of disease, the elimination of famine, the hoped-for abolition of war all result in increasing the population and the demands for production of food and goods. Can technological progress in production and in discovery of substitutes for exhaustible natural resources

(Continued to page 408)

for home — farm — shop
 you'll find **101 USES**
 for this basic shop tool

Steel slide—enclosed
 screw, greater
 strength

One-piece Handle
 non-pinching type

Swivel base

Cut-off tool for
 wire, leather, etc.

Anvil with horn —
 pounding surface

Hardened steel jaw
 inserts

Semi-steel body

Accurately made



Make all your shop work easier, faster, with a Desmond-Simplex Utility Vise; it gives you the most practical features and versatility, yet costs no more than ordinary vises. See it at your LOCAL HARDWARE STORE. Ask for free new valuable folder showing many ways to use your Desmond-Simplex Utility Vise. THE DESMOND-STEPHAN MFG. CO. URBANA, OHIO

DESMOND-SIMPLEX VISES

ROTO-HOE

The Pioneer
 Complete,
 High Quality,
 Low-Priced
 Garden
 Tool

2 H.P. ROTO-HOE (as shown)

only **\$134.00**

A complete tool for the garden —
 Tills, Cultivates, composts (also a
 portable power unit)

YEAR ROUND ATTACHMENTS

- ★ 20" ROTO CUTTER — for excellent lawn care. (only \$40. extra)
- ★ 12" TRIMMER-MULCHER (\$24. extra)
- ★ 17" SNOW BLOWER — saves 75% time and work on snow removal (only \$34.50 extra)

Ask your Dealer for a Demonstration.
 Write today for FREE folder.

ROTO-HOE & SPRAYER CO.

BOX 19 NOVELTY, OHIO



BUILD FINE GRANDFATHER CLOCK NOW

The simple sensible Red-i-Kut way as thousands have —
SAVE HALF. SHOP TESTED PLANS "SPIRIT OF THE CENTURY" Narrow waist 83" tall or stately straight side
"SPIRIT OF AMERICA," EASY-TO-FOLLOW photopack plans tell all — plus **BROCHURE** of heavy brass weight Westminster, tube chime, movements, gorgeous dials, 3/4" solid mahogany case kits. Send \$1.00 today — Both plans \$1.50 NOW.
KUEMPEL CHIME CLOCK CO., 4 Kuempel Bldg., Minneapolis 16, Minn.

Save Time and Trouble On the Road



Drive by HULL AUTO
 COMPASS—eliminate wrong turns,
 back-tracking, tension and fatigue.
 For proved accuracy, dependability,
 insist on a Hull—the one
 famous name in auto compasses.

"SURE DIRECTIONS WITHOUT STOPPING"

Write for local
 dealer's name,
 free literature.

HULL MFG. CO.
 P. O. BOX 246-D1 WARREN, OHIO

Beaconlite \$6.95
 Streamline \$4.95

SAY YOU SAW IT IN POPULAR MECHANICS

Free...



YOUR 1952 PHOTOGRAPHIC CATALOG

OVER 1800 ITEMS. Everything you'd expect
 in the largest camera store. More than
 100 pages of rotogravure and full color.

WHAT'S NEW IN '52. All the important
 advances of the year—new still and movie
 cameras, projectors, enlargers, flash
 and strob units, and all the accessories.

NEW STEREO DEPARTMENT. An enlarged
 section of 3-dimension cameras, viewers,
 projectors, and mounting accessories.

NEW, TESTED PHOTO INFORMATION. Nearly
 18 pages of How-to-do-it editorials,
 short cuts, and hints.

Montgomery Ward

Chicago • Albany • Baltimore • Denver
 Ft. Worth • Kansas City • Oakland
 Portland, Ore. • St. Paul

Mail coupon to nearest Ward city—NOW!

MONTGOMERY WARD, Dept. HPM12

Please send me the new 1952 Photographic
 Catalog as soon as printed (about May 1)

Name _____
 (PRINT plainly)

Street Address
 or Box _____

Postoffice _____ State _____

For Better Work — FASTER — EASIER

THE ZEPHYR Electric Drill



only \$18⁹⁵

Handy... Speedy... Powerful. Has many uses around the home... in the shop... on the farm. Built to Last. Full 1/4" Capacity.

DRILL STANDS Add Many Uses for Zephyr Drill



Horizontal Drill Stand— for Polishing, Buffing, Grinding, etc.

Price \$1.00

Adjustable Vertical Drill Stand— for drill press operations
Price \$10.95



Includes above ZEPHYR Drill, plus 28 accessories for buffing, cleaning, drilling, grinding, mixing paint, polishing, sanding, sharpening, waxing, and wire brushing.

Price \$27.35



De Luxe Electric Work Saver Kit

At Hardware, Implement, and Building Materials Dealers, and Department Stores—or Write Direct

PET TOOLS PORTABLE ELECTRIC TOOLS, INC.
324 West 83rd Street, Chicago 20, Illinois

In Canada: Portable Electric Tools, Ltd., 369 Danforth Rd., Toronto 13, Ont.

keep ahead of these increasing demands? On the answer to this question, or, alternatively, to some intelligently applied social control of population growth, depends the fate of civilization on this planet.

Thus far technology has done pretty well in the race. Improved agricultural production and distribution now support a vastly larger world population than could have been fed by the techniques of a century ago. But without rapidly continued progress both in food production and in the arts of living together in crowded communities, population increase may have forced on our citizen of 2002 the beginnings of some terrific social upheavals.

Let me describe just one of several directions in which science may help us to keep ahead of overpopulation disaster. I refer to cultivation of the sea for food; not by stocking it with little fish, but by far more fundamental chemical and biological methods. Why should ways not be found to "farm the sea" with the same scientific skill with which we farm the land?

The bases of all sea life are the algae, vegetable organisms which provide the food for the small fish. The fish population is limited by the amount of this algae food, which in turn appears to be limited by the amount of nitrate salts in sea water illuminated by the sun. Hence one project for increasing the supply of fish is by fertilizing the sea with nitrates. This may produce useful results in restricted sea areas, but the sea is very big, and perhaps this proposal is too gigantic to be practical.

Another approach, which can probably be made practical, is to grow algae in transparent pipes or channels through which sea water is slowly pumped. These channels may cover any area exposed to the sun, and nitrates or other enriching chemicals may be added to the circulating sea water. The algae would be of strains specially selected to produce fats or proteins which can be extracted and processed.

What the economics of this type of farming may prove to be remains to be discovered as the method is developed and tested. All that can be said now is that sooner or later something radically new must be developed in the food-production line to keep ahead of population growth, and this scheme seems worth working on. In any case it illustrates the sort of new and unexpected technological development which may be stimulated by the problems of living 50 or more years hence.

Whether we look backward or forward, or examine the present situation we see that it is the continual concern with things yet to come which is the inspiration and motive power of the scientist.

Start a Business in Your Backyard



Earn BIG MONEY MAKING BUILDING BLOCKS

General Concrete Vibrator BLOCK MACHINE
CAPACITY 1000 BLOCKS A DAY

Only \$329 LESS MOTOR F.O.B. PLANT
SHIPPING WEIGHT 400 LBS.



Here is a business you can start on small capital—in your own backyard—that earns 100 to 150% profit, with unlimited opportunities. Make concrete or cinder blocks. Millions used for homes, factories, public buildings, garages. Sell all you make to building trade. Do it with a General—and you're headed for success.

1000 BLOCKS A DAY

The General is a high speed, power-driven block machine at amazingly low cost. Rugged all-steel construction. Simple to operate indoors or outdoors. Makes superior 3 core type block meeting all code requirements. Produces up to 1000 blocks per day. Full operating instructions and mixing formulas supplied. Write for FREE details.

Wonderful Book Written & Illustrated by Experts



GENERAL ENGINES CO.

DEPT. M-12 • 307 HUNTER ST. • GLOUCESTER, N. J.

Includes floor plans for 6 beautiful, easy to build concrete block bungalows. Shows ways to save money. How to lay blocks, lay out building lines, mix concrete, build steps, porches and concrete floors. Mail coupon at once with \$1.

Name.....
Address.....
City..... Zone... State.....

You CAN Take It With You!

BECKER *Self-Contained* SPRAY GUN

NOTHING ELSE TO BUY

TAKE IT ANYWHERE—the first completely portable spray gun. Needs no compressor, motor, or electrical outlet. Pressure-powered with an inexpensive CO2 cartridge that sprays up to 21 liquid ounces, depending on viscosity. Extra cartridges, 10 for \$1, postpaid, or buy from your dealer.

PAINTS • VARNISHES • ENAMELS
MOTH-PROOFS • INSECTICIDES

Every home needs a Becker Spray Gun for dozens of jobs in the house, workshop, garden or garage. Complete instructions furnished for effective results. Order yours today for the season ahead.

HOW TO ORDER—If your dealer can't supply, send \$15.95 and we ship postpaid—or \$2 now and pay postman balance plus postage and fee. Money back if not delighted after 5 days' trial.

SULLIVAN-BECKER CO.
Dept. 112-A, Kenosha, Wis.



ONLY
\$15.95
with 3
cartridges



BeMaCo Dependable

AUTOMATIC SAW SET

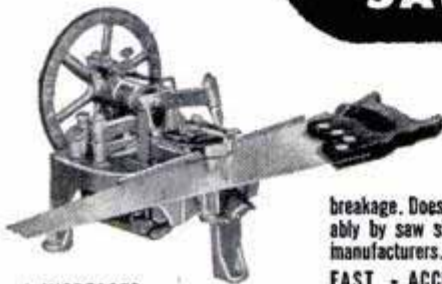

Sets 400 teeth per minute on hand or band saws 4 to 16 point. Hammer and anvil action sets teeth accurately and uniformly. . . . No tooth

breakage. Does a perfect job. Used profitably by saw shops everywhere and saw manufacturers. Every machine guaranteed!

FAST - ACCURATE - DEPENDABLE

★ INCREASES
PROFITS

BEAVER MFG. CO.

Saw Machine Div. #10M
800 SO. ISIS AVE. • INGLEWOOD, CALIF.



Print Your Own

Cards, stationery, circulars, tags, labels, photo and movie titles, advertising, etc. Save money. **Print for Others, Good Profit!** easy rules sent. Raised Printing like Engraving, too. Sold direct from factory only. Write for free catalog of outfits and all details. **KELSEY PRESSES, M-37, Meriden, Conn.**

STOPS LEAKS PERMANENTLY

Cut your fixture replacement, water and fuel bills with Economy Renewable Seats. Make economical, permanent repairs quickly and easily with the Junior Kit (illus.). Repair bathroom, kitchen and laundry fixtures. Everything you need included in steel box. This is a natural for the "Fixit" shops — get extra income from making permanent repairs on your customers' faucets.

Senior Master Kit also available—repairs faucets and valves up to 1" pipe.

Write for illustrated circular.
JUNIOR KIT, only \$22.50
with 15 assorted Renewable Seats
"Less than the cost
of a set of kitchen
sink fixtures."

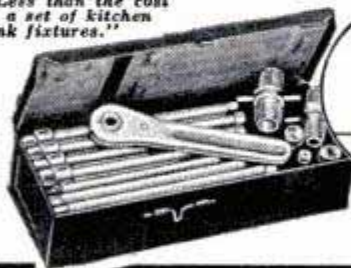

ECONOMY VALVE SEAT CO.

1430 N. Keating Ave. Chicago, Ill.

SAY YOU SAW IT IN POPULAR MECHANICS

The Best

IN 1869...



DANIEL C. STILLSON

WALWORTH
GENUINE
STILLSON

The Best today

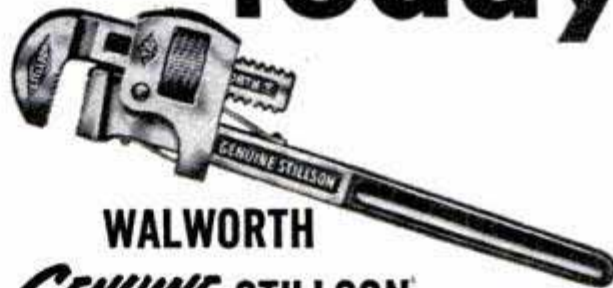

WALWORTH
GENUINE STILLSON

Daniel C. Stillson invented the famous Stillson Wrench while an employee of the Walworth Company in 1869. Walworth has continuously manufactured and improved this famous wrench since that time. Today's GENUINE Stillson is better . . . stronger than ever before, thanks to its original unbeatable design, and the latest metallurgical improvements.

Get a Walworth GENUINE Stillson from your dealer today!

The Stillson Diamond Trade Mark
identifies the
Walworth Genuine Stillson



No shop is complete without
Genuine Stillson Wrenches

WALWORTH

New York, N. Y.

VALVES . . . PIPE FITTINGS . . . WRENCHES

**EVERY 1/4" ELECTRIC DRILL
A PORTABLE SAW IN ONE MINUTE!**

"ARCO-SAW" (Over 100,000 Sold)



At Better Hardware Stores Everywhere

Pat. Pend.

No. 444 "ARCO-SAW" with 4" "HYCARBON" Crosscut Blade

9.95

CAN BE USED WITH ONE HAND!
"ARCO-SAW" works like a high priced Portable Saw. **RIGHT ANGLE GEAR DRIVE** eliminates clumsy, dangerous direct drive with drill sideways. **CUTS 1-5/16"** or 2x4 by turning over. **FEATURES:** Safety-yoke assures rigid connection and absolute safety. Visual guide and wide shoe-plate for straight, square cuts. Big handle affords firm grip for two hand operation. Precision one-piece gear box. Self-lubricating lifetime bearings.

'ARCO SAW'

NEW! No. 445 "ARCO-SAW" for DEPTH & BEVEL CUTS

HAS ALL FEATURES LISTED ABOVE PLUS:

No. 445 "ARCO-SAW" with all Gages and 4" "HYCARBON" Crosscut Blade. (Also Available! No. 444G DEPTH-BEVEL-RIP GAGE. Easily attaches to any No. 444 "ARCO-SAW" . . . \$1.95)

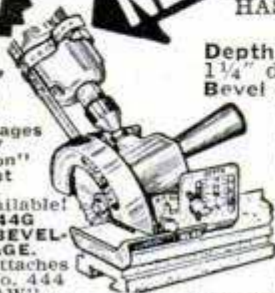

Depth gage graduated from 0 to 1 1/4" depth (for grooves, dados). Bevel gage graduated from 0 to 45° angle (for dovetails, bevels). Rip gage with sideways adjustment. Visual guide with adjustment to follow lines on both straight and bevel cutting.

"HYCARBON" REPLACEMENT BLADES. 4" Crosscut or 4" Combination. **\$1.60**

90-DAY FACTORY GUARANTEE

ORDER TODAY at your dealer or send us check or M. O. (Postpaid). C.O.D.'s—postage extra. Ask for literature of other tools.

UNCONDITIONAL 10-DAY MONEY BACK GUARANTEE

DEALERS—Write for nearest jobber.

ARROW METAL PRODUCTS CO.

DEPT. PM-1, 140 WEST BROADWAY, NEW YORK 13, N. Y.

Detroit Listening Post

(Continued from page 224)

the year, LeRoy Spencer, executive vice-president of Packard, sees only a good balance between supply and demand in the first quarter of 1952, because of higher prices and the tax burden. Around mid-1952, he sees a "mild seller's market." He expects Washington to maintain production at least at the 4,000,000-car level for next year to avert an economic crisis.

Ford is stepping up its pace to get out its Six the latter part of January.

The new Six will go up an inch in wheelbase to 115. But it will appear to be much longer, at least as large as the Oldsmobile Super 88 Deluxe. Like the Super 88, it will have a vertical chrome decoration just forward of the rear wheels.

The Ford Six will still have no sign of rear fenders but a one-piece windshield and a large wrap-around rear window will give it class. The grille will be a simple affair with only one spinner, instead of the present two. It will have only one bar in keeping with the trend toward simplicity among modern body designers.

The new engine for the Six will be of the overhead-valve type, have a compression ratio of 7 to 1 and will be rated at 97 horsepower at 3600 r.p.m., about the same as Plymouth's.

Mercury will use the same basic body, but a longer wheelbase will necessitate a different hood and front fenders. It will use the present engine at first.

Lincoln will have only the Cosmopolitan in 1952. Headlights will protrude from front fenders. Chrome strips along the rear fenders will also be used. It looks like a low and very wide car with an ultrastreamlined look. The new engine is rated at 160 horsepower. It has overhead valves and a 317-inch displacement.

George Walker will take the bows on the new Ford line. He is also working on two custom jobs to rival General Motors' LeSabre and the XP-300. He has been given *carte blanche* by Henry Ford II to outdo G.M., and his designs will be the center of the Ford's golden anniversary next year.

Oldsmobile is putting a bit of heat on its engineering to bring out its new models the latter part of January. The feature will be the new 98, with a completely new body and a bigger, more powerful engine. It must keep in step with DeSoto's new V-8.

Buick has put its XP-300 on display and is getting as much attention with it as Harley Earl did with his LeSabre. The car does not look quite so "Buck Rogerish" as the LeSabre, but it is eye-catching. These "dream cars" all are experimental jobs.

WYTEFACE
TRADE MARK
STEEL TAPES

No squinting, no guessing when you use WYTEFACE Steel Tapes. Jet black markings (foot numbers in red) on a white background. Easier to read in any light. Faster, more accurate measurements. Rust-resisting, hard to kink, simple to clean.

Protected by U. S. Patent 2,089,209

K+E

"I'll take the WHITE one every time!"

KEUFFEL & ESSER CO.

A HOLLOW GROUND Hand Saw
World's First and Only Saw Blade
That Has Maximum Clearance
WHERE YOU NEED IT MOST!

The ONLY BLADE
 with full clearance in the
WORKING AREA

Patent
 Pending



For the easiest, fastest, smooth-
 est sawing action known, get
 a hollow ground saw!

FREE Valuable tips on easier
 sawing, and hints on saw care.
 New folder shows amazing ad-
 vantages of *hollow ground* hand
 saws over ordinary taper-ground
 saws. Send for *free* copy today.

**THEY
 COST
 NO
 MORE!**

Sold thru
 dealers only

The **LARSAN Mfg. Co.** 23 South 11th St., Newark, Ohio

NEW 1952 KING MIDGET AUTO

World's Lowest Priced 2 Passenger Car Drive it for 75c per week.
 Amazing performance. Sur-
 prising comfort. All steel construction. Full accessories, top and heater.
 Ready to run or assemble it with our bolt together parts. Rider
 agents wanted, earn your
 car *Free*. Send 25c for de-
 tailed literature or \$1 (re-
 funded first order) for ac-
 tual assembly book and
 service manual filled
 with photos, drawings,
 specifications,
 etc.



MIDGET MOTORS MFG. CO.
ATHENS, OHIO

DO MORE PLANING JOBS \$215.00
WITH LOW-COST BELSAW

AMAZING 12 1/4-IN. PLANER Does All Ordinary Planing
Mill Jobs. Provides attachments for Jointing,
 Rabbeting, Tongue, Groove, Matching. 12 1/4 x 6-
 in. capacity, 3-knife solid round all-steel cut-
 terhead. Power feeds at 24 feet per minute, 42
 cuts per inch. Provides for full line of accessory
 attachments—Grind and Joint knives **IN THE**
GUTTERHEAD WITHOUT REMOVING.

BELSAW MACHINERY CO
 1018 Field Bldg., 315 Westport Rd., Kansas City 2, Mo.

**FREE
 BOOK**

ELECTRICITY Anywhere

FOR PORTABLE, EMERGENCY OR HOME USE

ONAN Electric Plants gener-
 ate 110-volt, 60-cycle current
 for homes, farms, cabins and
 resorts beyond the highline.
 Lightweight, portable plants
 cut costs, speed work for
 contractors. Standby plants
 protect units against power
 failure. 400 to 55,000 watts.
 Gasoline or Diesel-powered.
 Priced from \$219.00.



WRITE FOR CATALOG
D. W. ONAN & SONS INC.
 5853 UNIVERSITY AVE., MINNEAPOLIS 14, MINN.

be SURE of STARTING in any kind of weather!



buy the **SENSATIONAL NEW**
Redi-Warm
TRADE MARK
AUTOMATIC ENGINE TENDER

Thermo Stop-Start Engine Warmer

At last the luxury of knowing your
 car will start as easily on a sub-zero
 morning as it will on a summer day.
 With a Redi-Warm Automatic Engine
 Tender in your car, it makes no differ-
 ence where you park — how long
 you park. No outside electrical con-
 nections necessary — no smudge pots
 — no spark boosters. Just touch your
 starter, and you're off in a jiffy.

Widely acclaimed by automotive engi-
 neers, Redi-Warm is a marvel of sim-
 plicity. It consists of only three small
 units — a thermostatic control which
 clamps easily to the engine head; a
 neutral switch which permits Redi-
 Warm to operate only while the car
 is in neutral; and a dash switch with
 which to put Redi-Warm in operation.

Saves Engine Wear—Saves Gas

It is a well-known fact that the most
 wear on an engine occurs during the
 minutes required to start it. Redi-
 Warm, by keeping the engine at nor-
 mal temperature — regardless of
 weather conditions — insures quick,
 easy starting — preserves the motor,
 saves on gas. Besides the comfort
 and convenience it affords, Redi-Warm
 will more than pay for itself in a
 few cold weather months.

Why risk loss of time — loss of
 temper — expensive towing charges?
 If your local dealer does not have
 Redi-Warm in stock, send for it direct
 from the factory. It costs only \$24.95
 postpaid; comes with complete instruc-
 tions for the simple wiring. Do it
 yourself, or ask your neighborhood
 serviceman. Sold on an absolute guar-
 antee of full satisfaction.

A.



MAIN UNIT

B.



NEUTRAL SWITCH

C.



DASH SWITCH

only \$ **24.95**
 postpaid

- KEEPS ENGINE ALWAYS AT STARTING TEMPERATURE REGARDLESS OF WEATHER.
- CAR CANNOT BE STARTED WHILE REDI-WARM IS SET FOR OPERATION; THIEF-PROOF — FOOL-PROOF. DOUBLE BATTERY LIFE
- SAVES WEAR ON ENGINE; SAVES GAS ORDINARILY USED IN CHOKING.
- SAVES TIME — SAVES TEMPER — ELIMINATES COSTLY TOWING CHARGES.
- PAYS FOR ITSELF OVER AND OVER.

CRAY-LINCOLN
 Eng. & Mfg. Co., Inc.
 CRAY OIL BLDG.
 North Walpole, N.H., U.S.A.

Agents
 Wanted

**NOW—40 different cuts
with AMAZING, NEW**

Warren

**DADO SAWING WASHERS
ON YOUR SAW BLADE!**



**NO WARP...
NO WOBBLE...
NO BURNING!**

**4 WASHERS
MEAN PERFECT
BALANCE**



Make clean, smooth parallel grooves at any angle—no chewing, no sanding. Just dial your cut—no trick screws, no vibration, strengthens blade for straight cuts. Warren Washers greatest improvement in 30 years—and most copied—look for the name on the box and washers. It costs no more to get the best—**WARREN, IT'S GUARANTEED!** At your dealer or order direct. Give arbor size— $\frac{1}{2}$ ", $\frac{3}{4}$ ", $\frac{5}{8}$ ", 1"—sent postpaid.

**ONLY
4⁹⁵
PER
SET**

**WARREN DADO
SAWING WASHERS CO.**

Dept. 21 • Box 98, North End Station
Detroit, Michigan

(or ports) and the insignia in the openings indicate the model of the car.

Parking lights and the front turn-indicator lights are protected in a housing above the bumper.

The new, slightly blue-green-tinted glass not only gives eye comfort but reduces incoming sun glare to 18 percent and sunheat 45 percent over safety glass, according to Buick engineers.

The instrument panel is attractive and massive. Vision is good through the one-piece curved windshield. The hood is unconventional in that it lifts from either side, permitting easy accessibility to the engine. A knob on either side must be pulled to unlock the hood latch and this is good, as it offers some protection against theft of under-hood equipment.

The directional signals and dimmer indicator are easily seen by lights located directly in front of the steering wheel. The ventilating system and the heating is excellent. It has a two-stage blower with easy-to-operate controls. Twin map lights for night use are a nice feature. The switch key is operated by the left hand and can be removed while the engine still is running—a feature I do not like. The starter is operated by depressing the throttle. The radio has good reception. The bumpers are massive and offer good protection in case of accident. They also give more license-plate protection than bumpers on other cars.

The trunk space is ample, and the self-locking lid opens easily. I like the upright location of the spare tire. The same key is used for ignition, glove compartment and doors. Smokers will like the two ash trays in front on the instrument panel, as it eliminates long reaching by either driver or passenger.

After every conceivable kind of test and abuse given the test car, I have much praise for the new Buick—and little criticism. Buick offers real value in today's inflated-price market. Hundreds of thousands of Buick owners, past and present, attest to the high quality of Buick design, dependability and workmanship. The car has to be good to hold its high sales position (fourth in sales of all makes of 1951 cars).

I wouldn't say a Dynaflow Buick is the easiest car on gas I've ever driven, but I found that by proper and careful use of the throttle I secured reasonable mileage (see economy chart).

It is fitting that this Buick-owners' survey and test report should appear in the 50th-Anniversary issue of *Popular Mechanics*, because few names of any world product throughout the years have been held in higher regard than Buick.

It's our 50th Anniversary, too!

Congratulations to POPULAR MECHANICS on 50 years filled with brilliant successes and faithful reporting.

Just a half-century ago, as the first issue came off the press, The Root Brothers Company introduced the Ideal Lawnmower Sharpener. A short time later the message, "Mr. Repair Man," was placed in POPULAR MECHANICS and was repeated again and again during the coming years.

Yes, 1952 is truly a banner year—the Golden Anniversary of POPULAR MECHANICS—and THE IDEAL LAWNMOWER SHARPENER.

The 50th Anniversary Model 300 Ideal Lawnmower Sharpener has all the improvements and features perfected by five decades of experience. Mr. P. H. Root, associated with the first Ideal, is still active in its engineering. There is no substitute for experience—and Ideal performance is your proof!

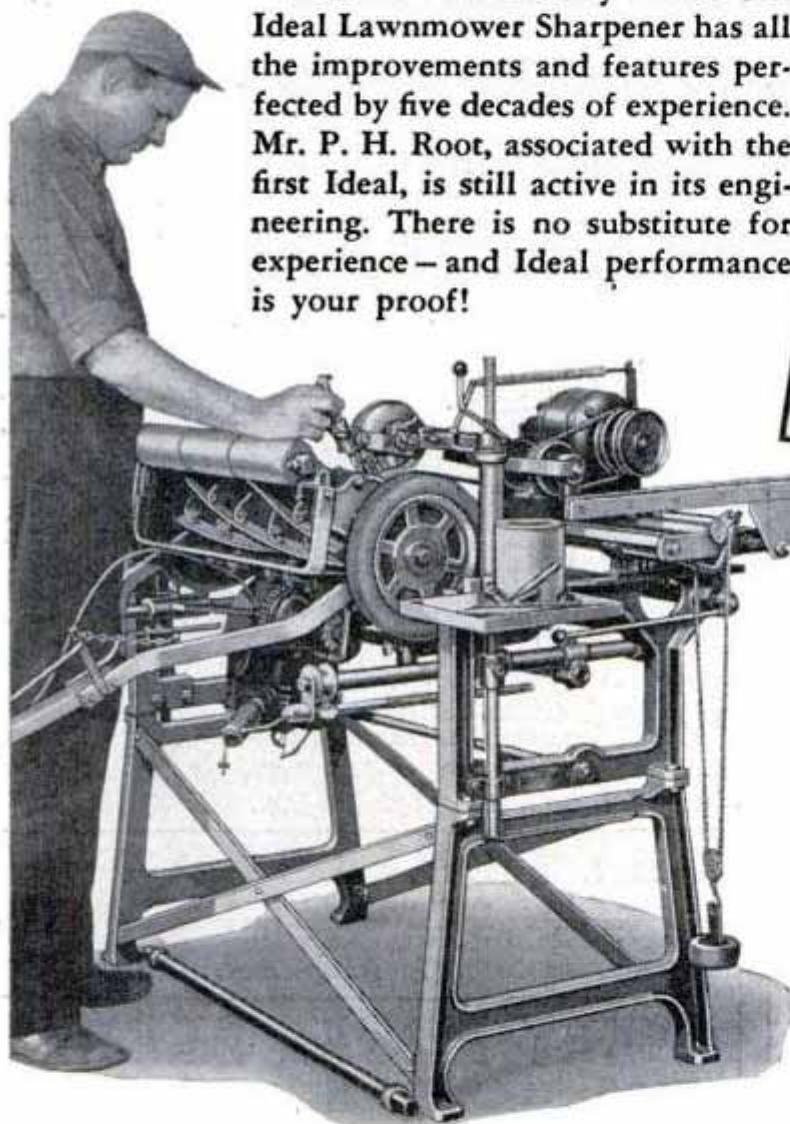

MR. REPAIR MAN

You are blind to your own interests if you fail this Spring to install one of the famous



IDEAL LAWN MOWER GRINDERS

and sharpen your Lawnmowers in the old-fashioned, safe, rigid, accurate and scientific way. The new model is now ready and contains features that make it useful the year round. We can't begin to mention them here, but a postal will bring full description, price, etc. Ask your jobber about this machine.

The Root Bros. Co., Sole Manufacturers
PLYMOUTH, OHIO

**NOW
GREATER THAN EVER
THE 50TH ANNIVERSARY
MODEL 300**

IDEAL LAWN MOWER SHARPENER

Cash in now on the profits. Start towards independence and security in your own business, either part time or full time. The Ideal completely sharpens hand or power mowers without disassembling, includes Bed Knife Grinder and Reconditioner.

Send coupon for complete catalog today!

THE FATE-ROOT-HEATH COMPANY
Dept. N-3, Plymouth, Ohio

Please send me free catalog on "How to Build a Business with the Ideal Lawnmower Sharpener."

Name _____

Address _____

City _____ State _____

send for **FREE CATALOG**



America's Foremost
money-making
MECHANICS' TOOLS

It's easy to own the same "pay-off" tools used and endorsed by America's top-earning mechanics throughout the automotive, aviation and industrial fields! Snap-on tools help you handle every repair job faster, easier, better. And they LAST... pay for themselves over and over again! Start building your own tool set now with basic Snap-on units—add others any time. Genuine Snap-on tools are never sold in stores—direct to users only. Mail coupon for free catalog.



SNAP-ON TOOLS CORPORATION
8062-A 28th Ave., Kenosha, Wisconsin
Send me free catalog of Snap-on tools.

Name _____
Address _____
City _____ Zone _____ State _____

ask your dealer for
Red Devil
FP-33
**Keeps Floors
Gleaming**



\$64⁵⁰

Tackles any job—scrubbing, waxing, polishing, buffing, sanding... any surface. Twin 6" brushes—no bucking, no sideslip. Write for free folder Dept. PM.

RED DEVIL TOOLS, IRVINGTON 11, N. J., U. S. A.

make your own Gems **29⁵⁰**
F.O.B.

All necessary lapidary equipment is furnished, including a super-charged diamond blade for sawing, and all wheels for grinding, shaping and polishing; also complete instructions. The complete equipment as shown, less motor and belt, for only \$29.50, f.o.b., Burlington, Wisconsin. Write today for information and literature.

B&I MANUFACTURING CO.
Dept. S Burlington, Wis.



new RIVET-KRAFT KIT **ONLY \$2.95**

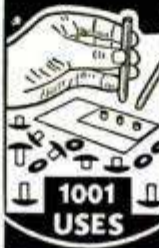

Make Neat Repairs & Assemblies

Ideal for sheet metal, plastics, cardboard, moving parts, Electronics, models, novelties, REPAIR appliances, toys, fix-it items, etc. Semi-TUBULARS are best for Shop & Home. Kit contains 180 Brass & plated 3/32" & 1/4" Dia. Rivets, Washers, 2 steel CLINCHER TOOLS, and Instructions. Send only \$2.95 Postpaid.

(Calif. Residents add 9c Sales Tax.)

Dealers **LLOYD'S CRAFTLINES, Dept. PM-1**
Invited. 921 E. Cedar Ave., Burbank, Calif.

DEPENDABLE CRAFT SUPPLIES

LEATHER CRAFT • PLASTICS • POTTERY
CRAFT • BLOCK PRINTING • BELT CRAFT •
TEXTILE COLORS • POWER TOOLS • WOOD
BURNING • INSTRUCTION BOOKS • ETC.

DWINNELL CRAFT SHOP
Dept. PM-152—Wheeling, W. Va.



BATTERIES!—START

—a factory at home and re-cast junk batteries into new; latest achievement. We supply complete instructions and everything needed. Large daily profits!

BATTERY LABORATORIES, Dept. PM, Minneapolis 4, Minn.



SHEET METAL BRAKES

Forms angles, flanges and Pittsburgh locks. 26 gauge steel, heavier aluminum. Cam locking. Portable, can be bolted to bench, or clamped to edge of truck. All steel, reinforced. Shipped Exp. Coll. 30" size. Wt. 54 lbs., \$26.50. 36", Wt. 66 lbs. \$31.00. 48", Wt. 100 lbs. \$45.00. Floor mountings, portable, 32" high, 30 lbs. \$7.00 **12" BRAKE**. Fits in vise to form difficult compound bends, up to 20 gauge steel. Not illustrated. \$12.50 P.P.



HYDRAULIC PRESS BRAKE forms 1/4x4, or 1/4x2-in. 3/4" Pipe Bender and Bar Bender and Straightener up to 1/2" thick, also can be used to form various shapes in heavy sheet metal with shop-made dies. Uses your 5 ton jack, \$18.50 **POWER CUT-OFF MACHINE** cuts steel pipe and rods, and cuts grooves, notches, bevels, etc. up to 4-inches. Smooths longer pieces. Cut-off saw for wood, brick, tile, rock and concrete. Size 15x15. Ball bearing arbor. Uses 1/4 HP motor. \$28.50 **24" CURVE FORMER**, 2 roll, 16 gauge, 2" to 2' dia. \$10.00 P.P.

IRON BENDER, 1/4x2" capacity, 10 parts. All steel. \$10.00 P.P.
Immediate delivery. Order direct, cash or C.O.D. or send for folder.
VYKE BRAKE CO., P-1116 So. 27th St., Omaha 5, Nebr.

FREE
NEW BIG RADIO CATALOG



Ready now! Complete with everything in radio, TV and electronics. Newest parts as well as old, standard lines. Paste coupon on penny postcard and mail today!

Lafayette Radio DIV.: RADIO WIRE TELEVISION, INC.

NEW YORK 13.....100 Sixth Avenue
NEWARK 2.....24 Central Avenue
BOSTON 10.....110 Federal Street
BRONX 58....542 E. Fordham Road

30 YEARS OF VALUES

LAFAYETTE RADIO, Dept. LA
100 Sixth Avenue, New York 13
Please rush Free catalog to:

Name.....
Address.....
City..... State.....

PASTE ON PENNY POSTCARD

WATER SYSTEM LASTS UP TO 40% LONGER WITH LIFE-LOK FEATURE

Cutaway drawing of Burks Super Turbine Pump

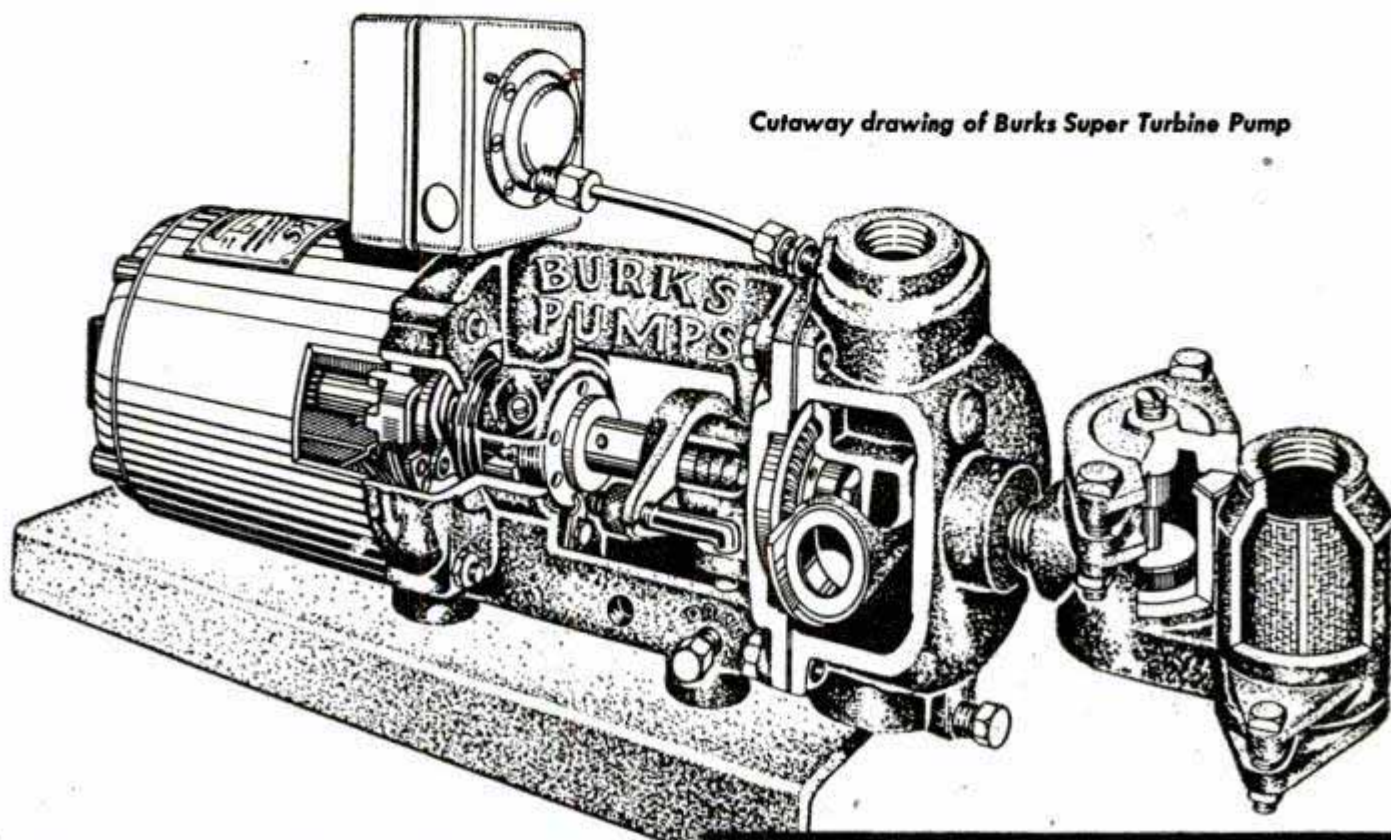

A unique feature—exclusive with the BURKS Super Turbine Water System—LIFE-LOK is the amazingly accurate adjustment between impeller and raceway made possible by the unique mounting of the ball bearing.

Thanks to this feature, the BURKS Super Turbine Water System lasts up to 40% longer than any other kind, delivers more gallons of water per minute, and provides like-new performance and efficiency when other types would be worn out.

Only one moving part. The world's finest-engineered water system, the fully automatic BURKS Super Turbine System is designed, engineered and built to watchlike precision. With only one moving part (the bronze impeller), owners are assured a long life of finest water service, with unusual freedom from pump troubles and maintenance expense.

Other outstanding features include: adaptability to either shallow or deep well application without mechanical pump change; self-priming; repulsion start induction long hour service motor with stainless steel shaft; perfectly matched annular grooves on faces of both impeller and raceway—no metal-to-metal contact.

Exclusive BURKS development also enables pump to deliver larger capacities against higher heads for greater efficiency



Sectional view of Impeller and Raceway showing perfectly matched sealing grooves. No metal-to-metal contact.

FREE LITERATURE

Send now for free literature describing the BURKS Super Turbine Water System with LIFE-LOK. See why it lasts years longer—why it's the finest water system you can buy. Or get full details from your nearest BURKS dealer.

SEND FOR FREE ILLUSTRATED BOOKLET

DECATUR PUMP CO., 67 Elk St., Decatur 70, Illinois
Send me, free of charge, your illustrated booklet "Water—Giver of Life." Also folder describing the Burks Super Turbine Water System.

NAME _____

ADDRESS _____

TOWN _____ STATE _____

BURKS
SUPER-TURBINE
PUMPS

DECATUR PUMP CO.
67 Elk St., Decatur 70, Ill.

TRY PREFABRICATED MODEL AIRPLANES!

HANDSOME NEW CLEVELAND DESIGNS LOOK JUST AS REALISTIC AS EVER — NOW CAN BE ASSEMBLED IN RECORD TIME

NEW "QUICKY" MODELS READY TO FLY IN 30-60 MINUTES. UNBELIEVABLE? - TRY IT! Anyone can assemble them. Even your youngest can fly them! No knife needed, no tissue used, and no painting. Sturdy, interlocking, pre-decorated balsa parts. Just assemble, using any cement, wind the motor, then fly it.



59c each



18" PIPER CUB

BIG, SLEEK "SIMPLEX" MODELS OF FAMED U. S. JETS ARE AUTHENTIC SCALE PREFAB JOBS Interlocking, diecut parts, keel fuselages, bubble canopies, preformed wire, excellent tissue, tricolored decals, and many other features make "Simplex" kits the easiest-to-build, best looking one-dollar models ever offered.



\$1 each



20" BANSHIEE

If you cannot get these kits locally, SEND YOUR ORDER DIRECT. Minimum order is \$2. Add minimum of 35c for pack-post, or 10% of orders over \$3.50. SEND 5c FOR FOLDER OF ALL MODELS IN THE CLEVELAND LINES

CLEVELAND MODEL & SUPPLY CO.

The Most Reliable Name in Hobbies & Crafts • "Since 1919"

4508TD13 Lorain Ave., Cleveland 2, Ohio. U.S.A.

LOCKS onto the work "HOLDS ON," after you let go.

Finest locking plier because...

Clamps on better with patented swivel jaw which adapts itself to shape being held. Faster working because of patented jaw size indicator; you pre-set jaw size to approximate size of object. Easier opening with patented lock release; finger-operated lever readily releases 2000 pound bite.

\$1.95
7" size
10"—**\$2.50**
Both bright nickel finish

At your dealer's. Send for FREE folder.

SEYMOUR SMITH "Snap-Lock"

PLIER - WRENCH

SEYMOUR SMITH & SON, INC.
21201 Main St., Oakville, Conn.
100 years of quality tools

SEYMOUR SMITH
The Lens of Quality
SINCE 1850

The SPEED SAW FILER

Saves You Time, Money

Now you can do expert saw filing at home. Lifetime tool makes precision filing easy for even the most inexperienced. Two simple adjustments make it fit any type hand saw. Keep your saws extra sharp and true-cutting with a Speed Saw Filer. Complete with file, ready to use. Money back guarantee. Cash with order, prepaid (C.O.D. postage extra.)

SPEED CORPORATION Dept. P.M.
512 N. E. 73 AVE.
PORTLAND, OREGON



ORDER NOW!

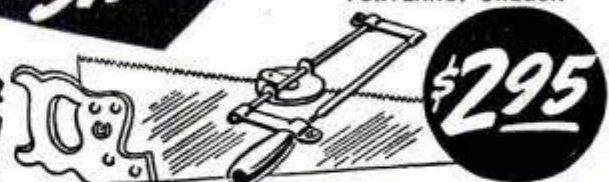

\$295



BRONZE FOUNDRY

Schools and Home Workshops

Make your own castings of aluminum, copper, bronze, silver. Foundry sets are available in three sizes including 2400 Deg. F. blast Furnaces. \$22.50; \$29.50; and \$42.00. f.o.b. Kansas City. Free Circular.

KANSAS CITY SPECIALTIES CO. P. O. BOX 6022, DEPT. P-1
KANSAS CITY, MO.

POSTPAID ANYWHERE IN U.S.A.

WE FURNISH ALL MACHINED METAL PARTS, EVERY SCREW, NUT, BOLT, WASHER, AND COMPLETE PLANS FOR THIS...



BIG 10" POWER SAW

\$10.95 FULL REFUND IF NOT SATISFIED IN 10 DAYS
LESS GUARD & WOOD

ASSEMBLE IT YOURSELF WITH SIMPLE HOUSEHOLD TOOLS!

COMPLETE PLANS 10c
MARCUS-POLLAK
DEPT. N, ROYERSFORD, PA.

SELL GOLD & SILVER WINDOW LETTERS

\$300% PROFIT! Fast, easy sales to stores, offices, doctors, lawyers, etc. Individual orders for merchants interested in saving \$\$\$\$ doing their own window lettering. Letters easily applied on glass, wood, metal with varnish-glue (not water). Won't wash off; withstands frost. Write for samples.
METALLIC SIGN CO., 430 N. Clark St., Chicago 10, Ill.

Build your own JET ENGINE!

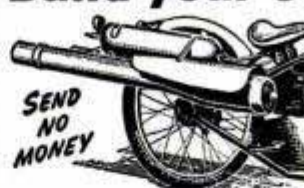

SEND NO MONEY

Order these plans today

1. JET PROPELLED BICYCLE. Assemble your own. Photo and instructions. \$1.00.
2. HOW TO MAKE EXPERIMENTAL JET ENGINES. Seven sheets, drawings with information and instructions \$2.95.
3. BOTH OF ABOVE in one order \$3.75. SEND NO MONEY. Order both at once \$3.75 C.O.D. in USA plus c.o.d. postage. Send check or Money Order and we pay postage. Get other information too. Rush Order.

J. HOUSTON MAUPIN, Dept. 55, Tipp City, Ohio

NOW YOU TOO CAN BUILD 15 RADIOS



The Progressive Radio "Edu-Kit" is a Home Radio Course in kit form. No previous knowledge of radio is required. No additional parts necessary. Tools included. Easy-to-follow instructions. Theory, Practical Work, Trouble-shooting are taught. Used in many radio schools. Excellent background for television.

Kit includes all parts, instructions, radio tester, electric soldering iron, trouble-shooting guide, quizzes, television book, consultation service. \$19.95 is complete price. Nothing else to buy. Everything you build is yours to keep. All parts and equipment guaranteed.

Order your kit today, or send for further information. You risk nothing. 10 Day Money-Back Guarantee.

Postage prepaid on cash orders. C.O.D. orders accepted in U.S.A.

PROGRESSIVE ELECTRONICS CO.
497 Union Ave., Dept. P.M.-2 Brooklyn 11, N. Y.

Removing Paint?

You'll be glad you tried WONDER-PASTE—the time-tested paint remover used by professional painters. Just apply it over any paint, enamel, varnish or lacquer and let it penetrate. Then see how *easily* you can strip off the old finish! No hard scraping or sanding. *Won't run* on upright surfaces. At leading paint and hardware stores.



Write for Leaflet

WONDER-PASTE Over three million cans sold—it must be good!

Wilson-Imperial Company, 119 Chestnut St., Newark 5, N. J.

PORTO-VISE

WITH "MULTI-SET" CLAMP

Most versatile vise made! Clamp permits changing vise to standard, vertical or horizontal working positions in seconds—no bolts needed. Semi-steel casting. Perfect gift. Wt. 5 lbs. **4.95**

Money back guarantee. Postpaid with check or money order.

Ideal for hobbyist, plumber, electrician, mechanic, carpenter.

Dealer inquiries invited.

NORTHERN INDUSTRIES, INC.
310 North Water St., Milwaukee, Wis.



5" Width
2 1/2" Depth
Pressed wood inserts. Full length pipe grooves.



Gerstner Tool Chests

Correctly Designed for the good tools of Machinists and Toolmakers.

Free Catalog.

GERSTNER TOOL CHESTS
452 Columbia St., Dayton 7, Ohio



BUILD YOUR OWN MACHINE TOOLS CASTINGS-DRAWINGS



Catalog with complete construction drawings of either No. 1 or No. 2 Bench Millers 25 cents per set postpaid or send one dollar for drawings of three millers, three lathes and a shaper. Refund on castings order.

POOTATUCK CORPORATION, 100 Sammis Pl., Stratford, Conn.

SAY YOU SAW IT IN POPULAR MECHANICS

\$14
POST PAID

PRECISION CALIPER

M.Z.B. Mauser-Type Vernier Calipers guarantee highest accuracy for any kind of precision work. This chrome-steel, spring-tempered instrument measures inside, outside, thread and depth to .001" and 1/20mm (#30-64) or .001" and 1/128" (#30-61) 8" overall 6" graduation. Glass hard measuring surfaces. This is your opportunity to buy a first class precision tool at about half the price of comparable tools. Either one also available in stainless steel at \$16.50 each.

Other models also available. Shipment from stock. Order yours now. Leather Cases \$1.00 extra. You pay postage on C.O.D. Money Back Guarantee.

Send for descriptive literature, also on our fine imported precision pliers.

INTER-CONTINENTAL TRADING CORP.
90 WEST STREET, NEW YORK 6, N. Y.

Build A FIREPLACE



around this scientifically designed steel form which also provides circulating heat that assures perfect fireplace operation.

free folder tells how

TELLS HOW TO BUILD YOUR FIREPLACE—Step by Step

- Foundation
- Steel heat-circulating form
- Cold and warm air ducts
- Chimney and flue construction
- Mantel or decorative front



Foundation

ASK FOR BOOK "100 FIREPLACE IDEAS"

Beautiful fireplace designs modern and conventional—shows artistic use of available material.

Enjoy circulating heat and the radiance of an open fire in your Home, Playroom, Cottage or Camp.



Fireplace form set on foundation includes firebox, damper, down draft shelf and smoke dome.

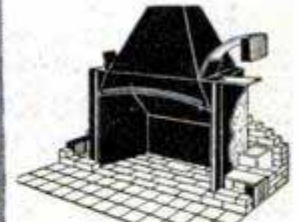

Brick, stone or cement block can be used around the form.

- Send free directions for building heat-circulating fireplace.
- Send Book "100 Fireplace Ideas." Pocket size book, sent free.
- Send larger book, 8 1/2 x 11, beautifully illustrated, 25c.
- Send outdoor fireplace folder with 10 beautiful designs Free.

Name

Street

City

Sold Through Leading Building Materials Dealers

PRICE FIREPLACE HEATER & TANK CORP.
191 W. Austin Street, Buffalo 7, New York

Performance ...
Endurance ...
Great Pleasure
Insurance!



Hydro-drive Champion

Independent Propeller Control Hydraulic Clutch

OUTBOARD MOTORS
FORWARD • NEUTRAL • REVERSE
without shifting gears!

CHAMPION MOTORS CO., MINNEAPOLIS, MINN.

2 DRILLS in 1

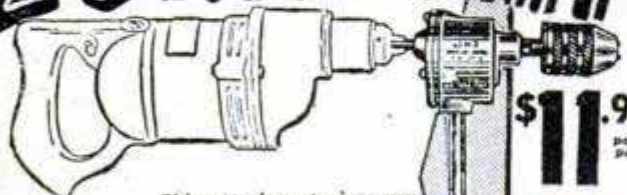

\$11.95
post paid

This attachment gives you two drills in one. It converts any 1/4 inch electric drill to 1/2 inch capacity. Reduction gears reduce the drill speed 5 to 1, the average speed of a 1/2 inch drill, and thereby increases the power. Absolutely indispensable for all shop work and home craftsmen.

Send check
or
Money Order
Satisfaction
guaranteed

Order
yours now

G. M. CO. MANUFACTURING, INC.
1308 43rd AVE.
LONG ISLAND CITY 1, NEW YORK

TOOLS AT WHOLESALE

DIRECT FROM FACTORY

Full line of top quality, fully guaranteed, chrome, factory-new mechanics hand tools. You save **HALF REGULAR PRICE** for tools of this quality.

Pay
EASY MONTHLY TERMS

WRITE TODAY FOR FREE CATALOG

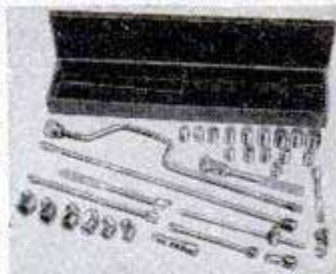

MECHANICS CO-OP

Dept. A OAKLAND 8, CALIFORNIA

1/3 H.P. ELECTRIC MOTORS

UNUSED STANDARD ELECTRIC DAYTON MOTORS. Below dealer's cost from mfr. Individually packed in cartons! 1/3 H. P. capacitor type, sleeve bearing, 110/220 single phase 60 cycle, 1,725 R. P. M., rubber mounted, 5/8" shaft, standard base. \$14.95 ea. F.O.B. Peoria, Ill. Write—wire—call. Orders will be accepted in any amounts.

H. P. MANDEL & SONS

2840 S. KEDZIE AVE. CHICAGO 23, ILLINOIS
Bishop 7-7890



Thousands
In Use

SMALL! POWERFUL!

America's finest low cost tractor. Ruggedly built. Easy to operate. No belts, no chains. Borg-Warner clutch, trans. and diff. 140 to 1 reduction. 40% more drawbar pull than ordinary tractors. 8-1/4 H.P. engine—gasoline or kerosene. 29 quick change implements. Write for complete details.

ENGINEERING PRODUCTS CO.
915-K1 Niagara Ct.,
Waukesha, Wis.

SILVER SOLDER TORCH & KIT \$7.50

Joins All Metals Permanently
EQUAL TO WELDING FOR MOST PURPOSES

Do your own repairing. Kit includes one tube silver solder flux and 10 5-in. lengths silver solder alloy. Hottest ALCOHOL TORCH known. 2700° F. flame. Operates in any position, indoors or out. Pint of special fuel included. TORCH alone with pint of special fuel \$6.50. Kit alone \$1.50. Complete instructions included. Add 35c on each order towards shipping charges.

AMERICAN PRODUCTS CORP., 422 S. Dearborn St., Dept. 3-A, Chicago 5

BUFFING BONNETS LIKE IN 60 SECONDS! **NEW**

O'Brien SIXTY SECOND BONNET CLEANER

- Amazing new tool cleans, fluffs, vitalizes buffer bonnets in seconds!
- Simply guide tool from outer edge to center of buffing bonnet and back while bonnet is rotating on electric tool.
- Eliminates washing—will not injure bonnet or pad—prolongs life of bonnets. Pays for itself many times over. Pat. Pending. Money-back guarantee. **ORDER NOW.**

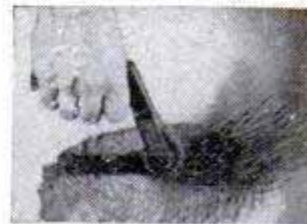

• See editorial, page 216, Dec. 1951 Popular Mechanics

THE O'BRIEN MACHINE CO.
1620 W. Highland Avenue • Chicago 26, Ill.

Only
\$3.50
POST
PAID

CARBURETOR TOO RICH MAKES MOTORIST TOO POOR



Car owners who are wasting money and not getting proper gas mileage due to over-rich mixtures will be pleased to learn how to save gasoline by VACU-MATING over-rich mixtures. VACU-MATIC fits all cars, trucks and tractors. It is *automatic* and operates on the supercharge principle. Easily installed in a few minutes.

SALESMEN WANTED! Big Profits!
Send name, address on penny postcard for *free particulars* and how to get yours for introducing.

VACU-MATIC Co., 7617-1818 W. State St., WAUWATOSA, WIS.

GET MORE PROFIT FROM YOUR LAND WITH THE

SEAMAN ROTARY TILLER

DEALERS. Some territories still open for men properly qualified.

And you will, because SEAMAN-tillage actually increases the ability of your soil to produce. SEAMAN-tillage up-grades your crops and brings you a higher cash return... But more—the SEAMAN TILLER means much less cash outlay for labor. You can generally prepare a complete seed-bed in only one operation. Your labor saving can be as much as 50%. Add to that a big saving in fuel... Want proof? Write, giving us number of acres you till. We'll send complete details and a FREE copy of important book "Benefits of Rotary Tillage" to show you the way to greater profit from SEAMAN-tillage.

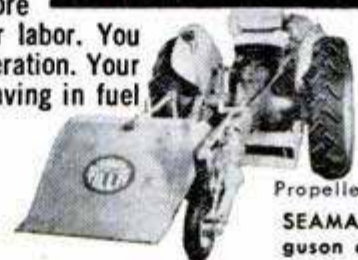

SEAMAN MOTORIZED Pull-type (6 and 7 ft.) or Self-Propelled TILLERS (7 ft.). Gas or Diesel. SEAMAN TILLIT. 3 ft. width. For Ford, Ferguson and other 2 plow tractors.

SEAMAN MOTORS, INC., 364 N. 25th St., Milwaukee 3, Wisconsin

Communication Problems Solved! with ARMY FIELD TELEPHONES & WIRE



EE8 FIELD TELEPHONES
Factory reconditioned, Ex. LIKE-NEW. Per pr. \$18.50 \$36.50
USED—FACTORY TESTED Per pr. \$16.50 \$32.50
GUARANTEED

Construction men, engineers, farmers, and industrial men everywhere are using portable Army Field Telephones for quick, dependable 2-way to 8-way communication. These phones were built to serve combat forces reliably under battlefield conditions. Simple to install. Just string this 2-conductor wire, attach phones, ring and talk any distance up to 17 miles! Powered by flashlight batteries. No maintenance required.

ACT NOW! LIMITED SUPPLY!
All prices FOB Sacramento, No COD. (Calif. residents add 3% for sales tax.)
Write for FREE FOLDER. Send check or money order
LORIS SALES, P. O. Box 1896-B1, Sacramento, California

TELEPHONE WIRE

ALL-PURPOSE — ALL-WEATHER

This is genuine W110B Army Field Wire on original steel reels. Insulated, 2-conductor, copper-steel strands. Excellent for all types of communication. Used extensively by telephone companies, industry, engineering projects, ranches, public address systems, etc.

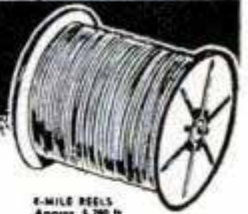

GRADE 1 — Unused, excellent condition.
Mile Reels \$22.50 (wt. 160 lbs.)
Half-Mile Reels \$12.50 (wt. 80 lbs.)
500 ft. reels, \$4.95

Important News!

PORTO-WELD * 8 Handy Tools in 1



PORTO-WELD MODEL 2A
Recommended for repair, maintenance, and installation work. Comes as illustrated above with... welding shield and ground cable. Operates on 110 or 220 volt, 60 Cycle A.C., D.C. 7 welding ranges and welds up to 1/2" steel. Uses up to 1/8" rod. (150 Amps.) Shipping \$85.00 wt. approx. 80 lbs...

- * ● WELDS ● POLISHES
- BRAZES ● BUFFS
- GRINDS ● QUICK
- SANDS BATTERY
- BRUSHES CHARGER

A self-contained motor generator, just like the larger industrial units — just plug it in and use.

Here is an Economy Combination Tool that is of vital importance in every shop — regardless of size — it pays for itself on the first job. Low cost, economical operation. Easy to take to the job. No special wiring required. No sticking — even an amateur welds like a pro. Versatile, too, use as grinder-buffer. Use portable power unit for saws, etc.

Fully Guaranteed in Writing
SEND REMITTANCE WITH ORDER; WILL SHIP C.O.D. (\$5.00 Deposit)
DEALER INQUIRIES INVITED
GENERATOR SALES CO.
1625 N. DAMEN AVE. CHICAGO 47, ILL.



MOTOR-WELD MODEL 1A
Recommended for Hobby and Home work shops. Comes as illustrated above. Operates on 110 volt 60 cycle A.C. or D.C. Has four speeds and welds up to 1/4" steel. Uses up to 3/32" rod. (80 Amps.) Ship- ping wt. 40 lbs. \$45.00

FORTY-TWO YEARS OF SERVICE TO THE *Youth* OF AMERICA



JOIN THE CELEBRATION!

Scouting's Birthday
February 6th—12th



There's a Unit in your community that will welcome you into its ranks. Ask your Scout friends for the time and place of the next Scout meeting.

Cub Scouts	8-10 years
Boy Scouts	11-13 years
Explorers	14 years and over

FORWARD
On Liberty's
Team . . with the
BOY SCOUTS
OF AMERICA

FROM THE Valvoline Motor Album

A SALUTE TO POPULAR MECHANICS
50th ANNIVERSARY

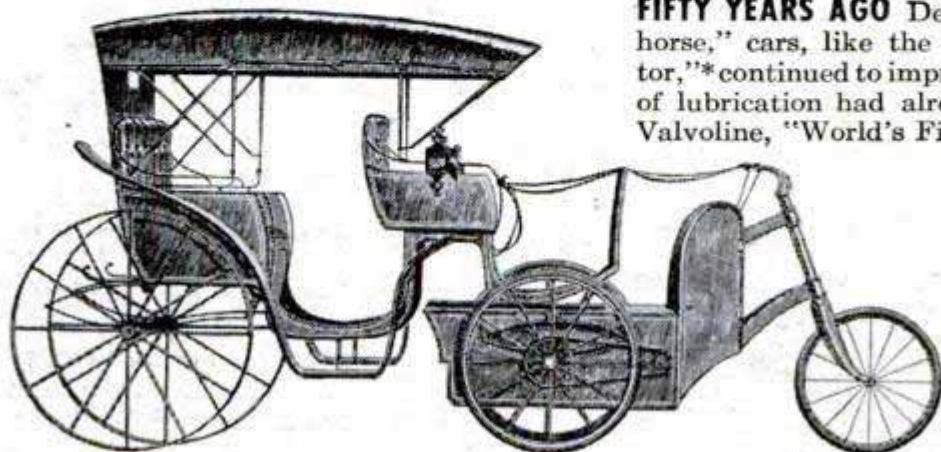

FIFTY YEARS AGO Despite cries of "get a horse," cars, like the 1901 "Phelps Tractor,"* continued to improve. The big problem of lubrication had already been solved by Valvoline, "World's First Motor Oil."



NEW Experimental cars often contain many new advanced features. Valvoline keeps pace with this engineering progress. For instance, a special mild detergent is added to clean your engine and minimize troublesome carbon, sludge, and varnish.

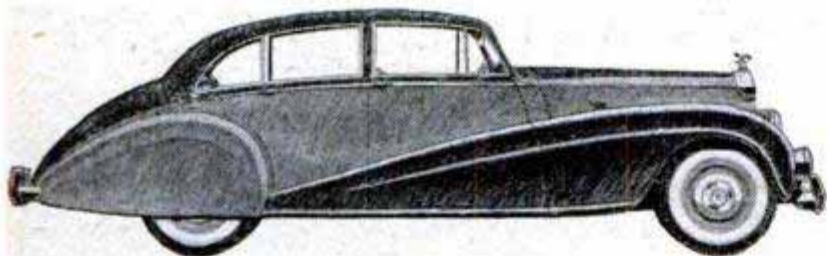

FOREIGN First choice of Kings and Mahara-jahs, the Rolls Royce has no equal. One famous feature is quietness. To maintain smooth quiet power, Valvoline keeps full lubricating quality mile after mile after mile.



YOUR CAR Valvoline saves you money and lengthens the life of your car by guarding the motor against Friction, Acid and Dirt. This is made possible by Valvoline's selective refining: the nation's finest crude oils, scientifically processed to keep all their natural oiliness and give lasting protection.

We Guarantee Valvoline Performance in Your Car!

VALVOLINE

MOTOR OIL

World's First Motor Oil

FREEDOM-VALVOLINE OIL COMPANY, FREEDOM, PENNSYLVANIA

An Affiliate of Ashland Oil & Refining Company

If your car manufacturer recommends heavy duty oil, use Valvoline HPO

*Courtesy Floyd Clymer's Historical Scrapbook

Minerals in Beef

In these days of high prices, a refreshing bit of news comes from the Armour Research Foundation; a pound of hamburger contains just as many health-giving minerals as a pound of the finest sirloin. Foundation scientists have identified and "weighed" the trace elements in beef. Many of the trace elements are known to be nutritionally important. For example, the body contains less than .14 ounce of iron, yet this minute amount prevents anemia. The research men cut as much fat as possible from the meat, which then is dried overnight, placed in a platinum cup and ashed for 24 hours at 1000 degrees F. The ash then is concentrated and analyzed with a spectrograph. The research indicates that the average American, who ate about 60 pounds of beef last year, also consumed 19 different minerals, ranging from 4.7 ounces of potassium to .000003 ounce of nickel. The trace-element contents of veal, pork and lamb will be studied in the future.

☐ There are an estimated 500 billion barrels of shale oil—17 times our known petroleum reserves—in a 1000-square-mile area of Colorado that is a mere fraction of the total deposit covering 16,500 square miles, according to the U. S. Bureau of Mines.

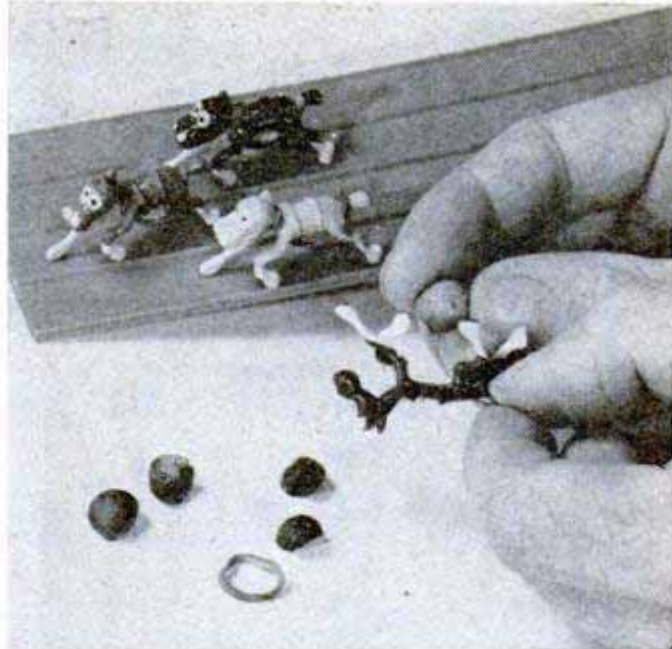

"Live" Ponies Race to Wire

Mexican jumping beans provide the "push" for a novel race-track game in which four plastic horses race each other down an inclined track. Each horse races in a separate groove so there is no interference. The beans are fastened to the underside of the horses and as they "jump" they cause the horse to slide down the ramp. Normal life of the bean is about five months, although heat will rejuvenate them briefly.

Only **TAC** has perfected the open-end ratchet wrench...

This TAC Open End Ratchet Wrench is doing spectacular jobs in the Armed Forces and Defense Industries. Made in Socket Type and Crowfoot type.

Sizes $\frac{3}{8}$ " to 4". Will operate with as little as 7° ratcheting arc on fittings, tubing, pipe, rod, cable, etc. Fully protected by patent

TAC does what no other tool can do.



TUBING APPLIANCE CO.
10321 ANZA AVENUE
Los Angeles 45, California

TAC

© 1951—TAC

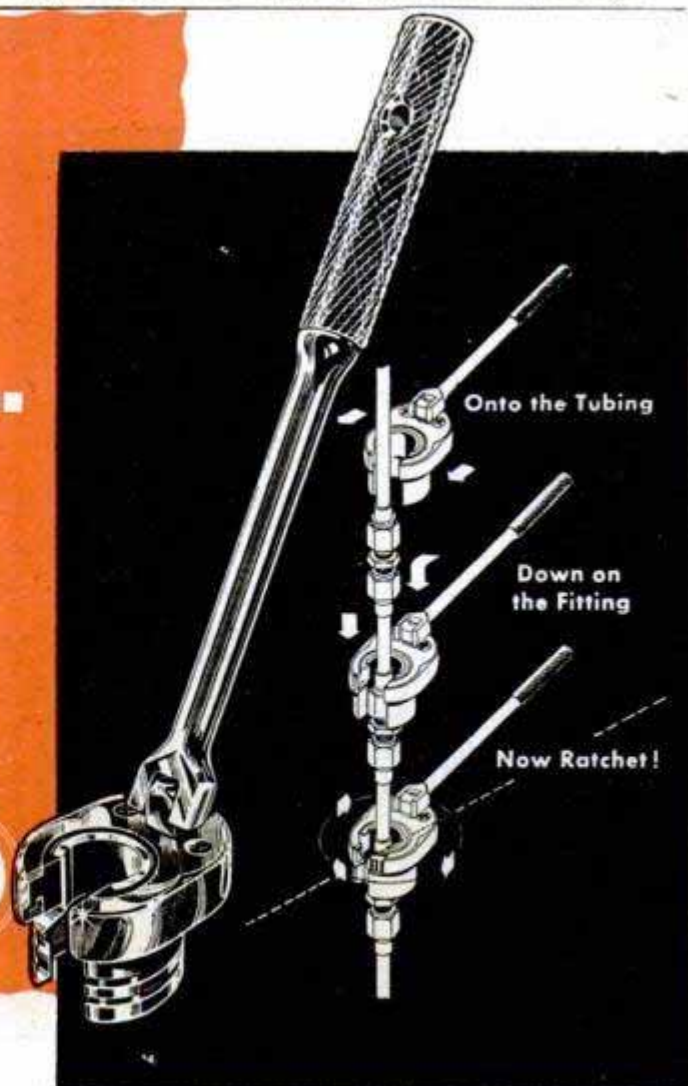

**NEW BAND SAW CUTS METAL,
FIBER, PLASTIC FASTER, MORE
ACCURATELY AND AT LOWER COST!**



NOW every shop can have the advantages of band sawing. Wells new Model 49A is a rugged, horizontal cut-off saw that will do a man sized job. Welded steel frame and tubular base along with

many design features proved in Wells' widely used larger machines make it portable and easy and economical to operate. Automatic shut off at end of cut. Capacity—rectangular, 3½" x 6¾"; rounds, 3½" diameter. Shipped ready to operate complete with heavy-duty 1/6 H.P. Motor.

WELLS MANUFACTURING CORP.
95 Mechanic Road • Three Rivers, Michigan

Regular Price of a
Slide Rule \$4 and up

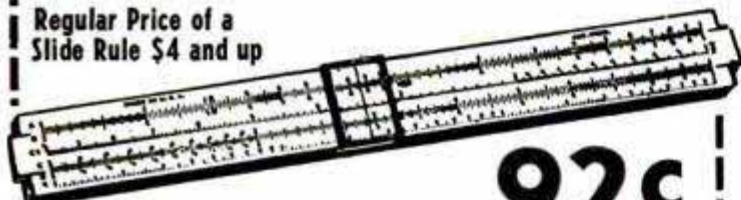

Slide Rule

92c

and this coupon
Add 8c Postage

If you know how to use a pencil you can use a slide rule. For bookkeepers, accountants, salesmen (figuring commissions, cost, etc.), farmers, housewives, etc. For Armed Forces highly important. Men's most useful tool. Easy to calculate instantly. Multiplying, proportions, division, extracting roots, etc. "High Vision" Clear View Slide. Full 10" Rule. A, B, C, D, C1 and K scales. FREE 28-page instruction book on how to get correct answers instantly without pencil or paper.

Gene Loewy, 545 5th Ave., N. Y. 17
Dept. 143-A Limit three rules to each coupon

FREE BINOCULAR CATALOG!



Listing over 60 sizes, types, of brand new binoculars including UNITED, German Carl Zeiss, Hensoldt, American Wollensak, Swiss, etc. Bargain priced from \$14.95 by America's leading Binocular Retailer. Written Guarantee certificate. Rush name for your FREE 20 PAGE two color money-saving Binocular catalog.
UNITED BINOCULAR CO., Dept. ARF-3608
9043 S. Western, Chicago 20. Dealers Wanted.

Say You Saw It in Popular Mechanics



TRUE "PERIMETER" HEATING

The leading hot water baseboard heating. For new homes or old. Folder on request to Dept. PM-1, Warren Webster and Company, Camden 5, N. J.

Webster
PERIMETER FORCED HOT WATER
BASEBOARD HEATING

WISE-GRIP

WRENCH

*World's Most
Famous Hand
Tool!*

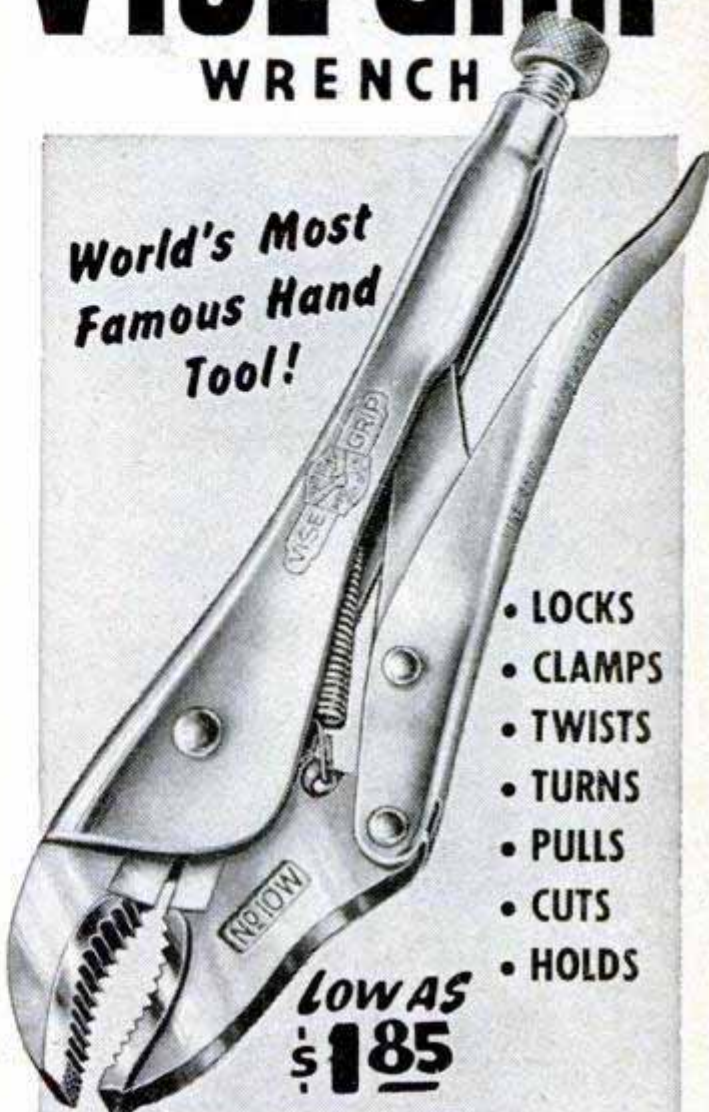

- LOCKS
- CLAMPS
- TWISTS
- TURNS
- PULLS
- CUTS
- HOLDS

**LOW AS
\$1.85**

DOES JOBS NO OTHER TOOL CAN DO



WISE-GRIP locks to any size work! Gives one hand Ton-Gripping power! Makes ideal Pipe Wrench, End Wrench, Locking Wrench, Super Pliers, Toggle Press, and Vise.



WISE-GRIP Welding Clamp

LOCKS and aligns parts — frees hands. U-shaped jaws give extra visibility and working space. Adjusts to 1½".

WISE-GRIP Sheet Metal Tool

Eliminates tiring hand gripping! Does bending, seaming, crimping, straightening easier, more accurate, faster.



Order From Your Dealer

Manufactured by **WISE-GRIP** Only by
PETERSEN MFG. CO., INC.
Dept. P-1 DeWitt, Nebraska

Made
\$900
IN SPARE TIME

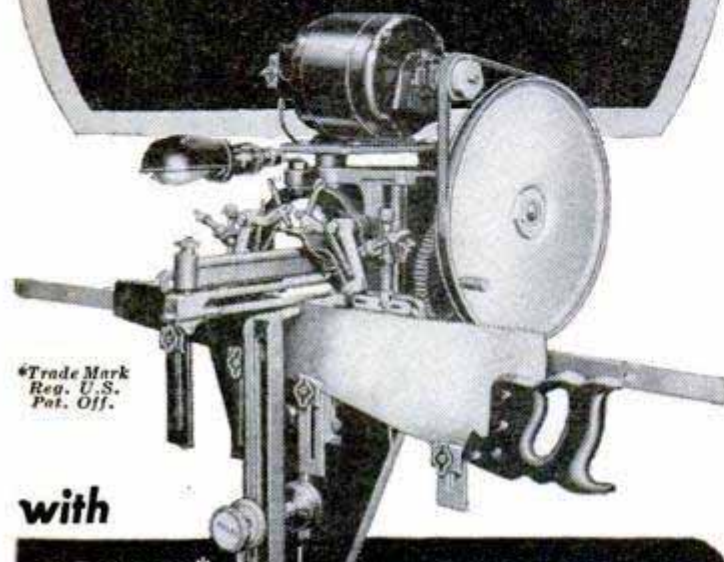

*Trade Mark
Reg. U.S.
Pat. Off.

with
FOLEY* automatic SAW FILER

"I did very well last year with my Foley equipment, sharpening about 950 saws in my spare time. About \$900 for me." Leo H. Mix

"I have done 4 or 5 thousand saws in my spare time in the 4½ years since I got the outfit, and they are all coming back." Len Crego

Make up to \$3 or \$4 an hour in Spare Time
With the high prices of food, clothing and everything else, just think what you could do with extra money every week! With a Foley Automatic Saw Filer you can file hand, band and circular saws better than the most expert hand filer. "The first saw I sharpened with my Foley Filer came out 100%" — writes Clarence E. Parsons. Cash business, no canvassing. No eyestrain, no experience needed.

(FOLEY congratulates POPULAR MECHANICS on its 50th ANNIVERSARY issue. The first Foley Saw Filer was built in 1900 — now in its 52nd year of progress.)

FREE BOOK Shows How to Start
Tells just what to do to start your own spare time business in your basement or garage. Just think—with a small investment, no overhead, no stock of goods to carry, you can get right into a cash business. Send coupon today—no salesman will call.

Also see *Foley Lawn Mower Sharpener*, page 432, and *Foley Saw Retooler*, page 452



Send Coupon for FREE BOOK

FOLEY MFG. CO.,
116-2 Foley Bldg., Minneapolis 18, Minn.
Send FREE BOOK — "Independence After 40"

Name _____
Address _____



Reflector Disk Warns Motorist

Highly reflective, a small disk shines like a caution beacon, warning oncoming motorists of pedestrians or bicyclists on the highway. It clips to the lapel or belt and is 220 times brighter than white paint in the light of approaching vehicles. Because it is small and lightweight, it is easily carried in the purse or pocket during the day and is always ready for night use. Motorists can also use these disks to warn approaching traffic when parked for tire changing or engine trouble.

Clear-Glass "Dog Tag" Measures Atom Radiation

Measuring about an inch square, a clear, colorless-glass "dog tag" is a reliable detector of atomic radiation. Developed by Navy scientists and chemists at Bausch and Lomb Optical Company, the glass shows the amount of atomic radiation it has been subjected to when it is viewed under ultraviolet light. Under ordinary light, the dog tag is unchanged in appearance. Invisible in the glass are appreciable quantities of dissolved silver that produce an orange fluorescence under black light after radiation. The device is called a dosimeter and is extremely sensitive to small amounts of radiation—as little as 10 roentgens. It is economical to make by mass-production methods. The amount of fluorescence depends upon the extent of exposure, a characteristic that provides an accurate measure of the degree of radiation exposure.

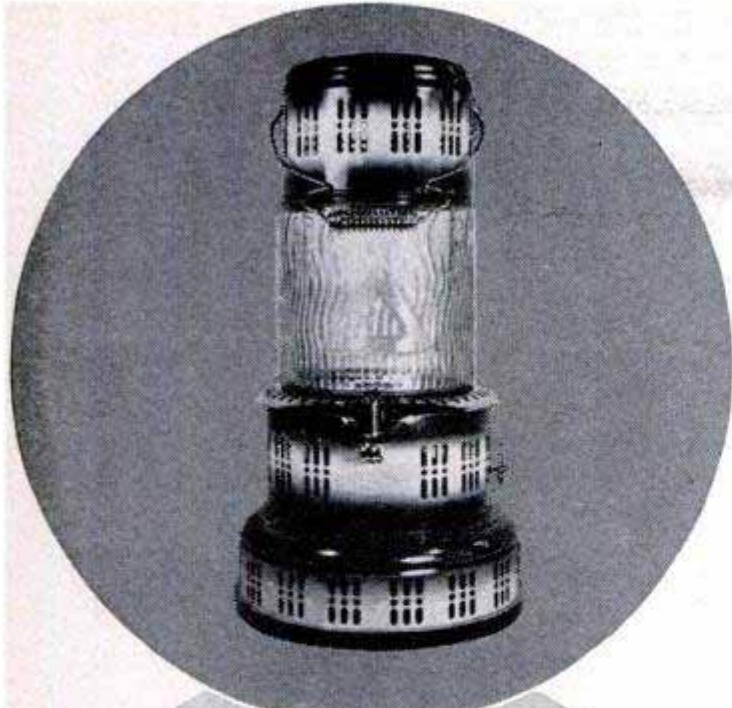

The handiest portable heater made

More than 12 million Perfection Portable Heaters have been sold around the world for use wherever clean, quick heat is needed. Ideal for workshops . . . chilly rooms . . . garages . . . hunting camps . . . cottages . . . recreation rooms . . . duck blinds or on the ice with fishermen.

Easy to use, sturdily built, you can carry the heat where you want it. Economical, too, for it heats a 1500-cu. ft. room for 12 to 17 hours on a single filling—less than a gallon of kerosene.

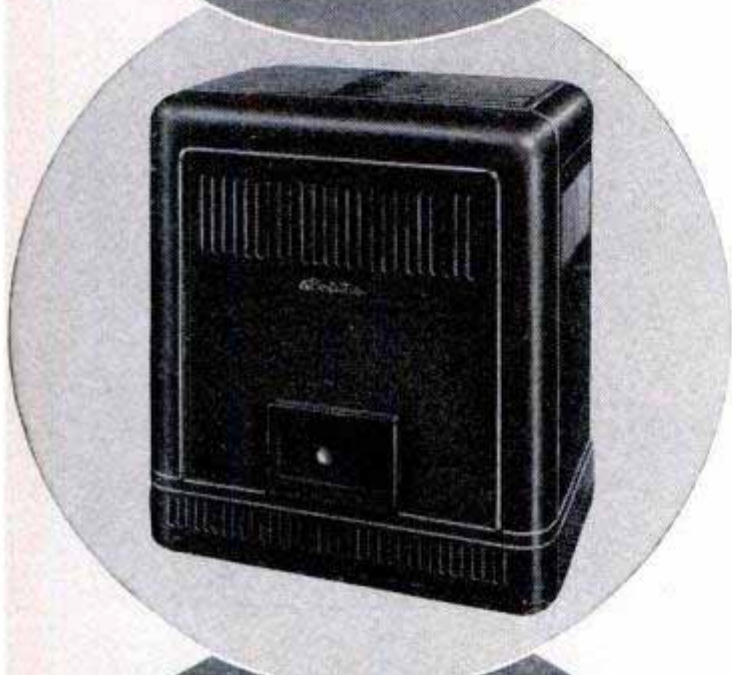

Oil home heater based on new burner-pilot principle

Perfection's exclusive "Midget" Pilot . . . a tiny separate fire, not just a low fire . . . alternates with the high or low flame of the burner to give economical comfort at all times. No more roasting or shivering, no more wasted oil . . . and no more bothersome relighting.

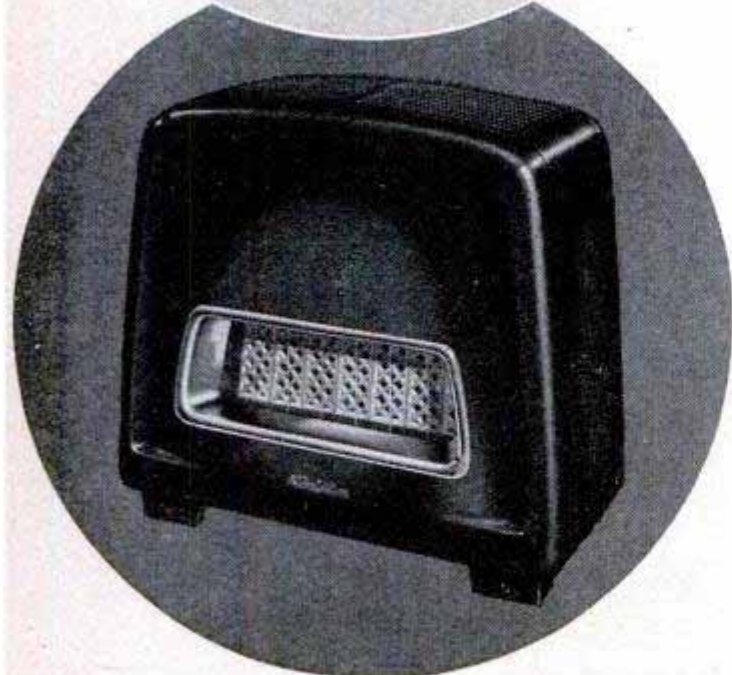

Gas heaters for comfort, cleanliness, economy

Attractive, all-porcelain Perfection Gas Heaters in a wide range of sizes, with or without radiants, vented or unvented, up to streamlined console models of 60,000 B.t.u. capacity. Popular prices.

PERFECTION STOVE COMPANY
7340-A Platt Avenue, Cleveland 4, Ohio



Please send information on complete line of heaters as checked:

- Portable Heaters
- Oil Heaters
- Gas Heaters

Name

Street

City State

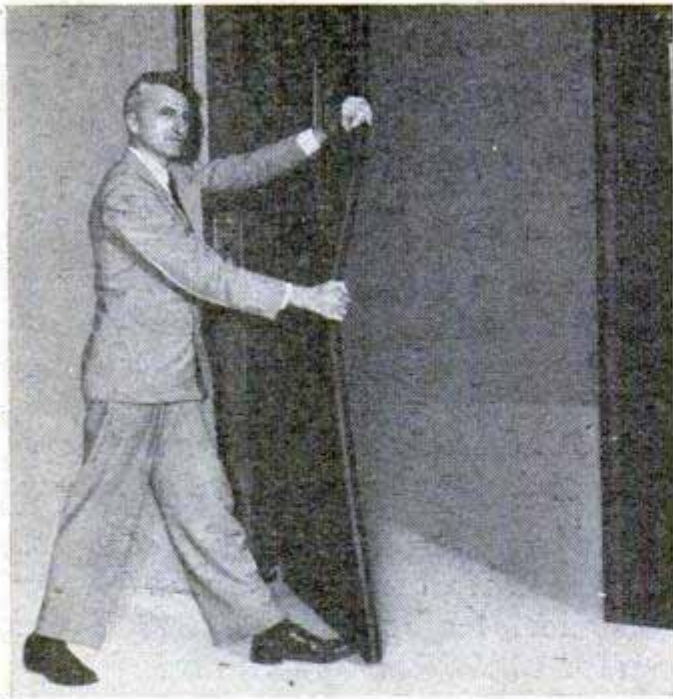

insulation value and can be bent to a 45-degree angle without damage. It consists of an outer layer of heavy cloth-inserted rubber covering a two-inch, rubber-tubing frame. Fifteen to 25 inflated rubber bladders run crosswise inside the facing, between rubber spacers, and are inflated by a hand pump through protruding valves. The complete assembly is suspended on hinges attached to steel strips running along one side. Though designed specifically for cold-storage warehouses, the door's design is believed applicable to hospitals and schools where ease of passage or absorption of shock is desired.

Rubber Swinging Door

Opening at the pressure of a finger, a new swinging rubber door for cold-storage warehouses is one third the weight of the conventional metal-protected wood type. It will eliminate the costly maintenance and damage of wood doors caused by power trucks banging into them. Though only 2½ inches thick, the new door has high

Fast Winker

With a range up to five miles, signaling searchlights for the U. S. Navy's newest-type minesweepers are equipped with a "Venetian blind" shutter capable of winking three times a second. Measuring 24 inches in diameter, the units use a carbon arc to produce a beam of over 50 million candlepower, according to Westinghouse engineers who are "tailor making" the searchlights. In tests, the units must be able to withstand drops ranging up to 40 feet and still continue to operate, in addition to passing the "shutter test," which requires a minimum of two million blinkings.



They're Such Fun and So Easy to Build!

ANTIQUE AUTO SETS

Only \$1.95 to \$3.95

Authentic Miniature ¼" Scale Models of Old-time Autos!

Fascinating nostalgic miniatures — so realistic they bring the early days of the automobile back to life! Get ALL 16 MODELS for your den, library, what-not corner or whoopee room! So authentic they are on display in famous museums. Length 6" to 10½" when completed. They come pre-fabricated with all ready-shaped die-cut parts, plastic cast-wheels, lamps, radiator, horn, etc. Authentic history with each car; also step-by-step instructions that a 10-year old can follow with ease! Parents and children love this educational and historical recreation. At toy, hobby and department stores. Nationally known; guaranteed money back if not satisfied. A grand hobby for all from 9 to 90; wonderful for shut-ins and convalescents. Start NOW — ORDER A COMPLETE SET!

Check "OLD TIMERS" You Want:

- | | |
|--|--|
| <input type="checkbox"/> 1911 Maxwell \$2.50 | <input type="checkbox"/> 1911 Buick "Bug" \$2.50 |
| <input type="checkbox"/> 1904 Olds. \$1.95 | <input type="checkbox"/> 1903 A Ford \$2.50 |
| <input type="checkbox"/> 1910 T Ford \$2.50 | <input type="checkbox"/> 1902 Franklin \$2.50 |
| <input type="checkbox"/> 1909 Stanley Steamer \$2.95 | <input type="checkbox"/> 1906 Columbia Electric \$2.50 |
| <input type="checkbox"/> 1909 T Ford \$2.95 | <input type="checkbox"/> 1910 Internat. Harvester \$2.95 |
| <input type="checkbox"/> 1903 Rambler \$2.50 | <input type="checkbox"/> 1900 Packard \$2.50 |
| <input type="checkbox"/> 1913 Mercer Raceabout \$3.95 | <input type="checkbox"/> 1903 Cadillac \$2.50 |
| <input type="checkbox"/> 1906 "Old 16" Locomobile \$3.95 | <input type="checkbox"/> 1914 Stutz Bearcat \$3.95 |

 1906 Columbia Electric \$2.50	 1902 Franklin—\$2.50
 1910 International Harvester—\$2.95	 1909 Model "T" Ford \$2.95
 1911 Buick Bug — \$2.50	 1914 Stutz Bearcat—\$3.95
 1903 Model "A" Ford \$2.50	 1913 Mercer Raceabout—\$3.95
 1909 Stanley Steamer \$2.95	 1906 "Old 16" Locomobile—\$3.95

 1904 Oldsmobile — \$1.95	 1903 Rambler — \$2.50
 1911 Maxwell \$2.50	 1900 Packard — \$2.50
 1903 Cadillac — \$2.50	 1910 Model "T" Ford \$2.50

Write direct to us. Add 25c for postage and handling. No C. O. D.'s, please.

HUDSON MINIATURES **OLD TIMERS** "Originators of Antique Autos in Miniature"
SCRANTON HOBBY CENTER
Dept. 14, 315 Adams Ave., Scranton 10, Pa.



PATENTED
CORALOX
INSULATOR



Selected for the Super-Powered

BUICK *XP-300*

...and for nearly as many new cars as all other makes combined

AC scores another triumph, with the selection of AC Spark Plugs to fire the 300 horsepower supercharged engine of Buick's "Dream Car," XP-300.

With its higher speed and extra high compression—using premium fuel up to 125 H.P. and methanol above 125 H.P.—the XP-300 develops terrific combustion chamber heat. No spark plug insulator before **CORALOX** could withstand it.

CORALOX, AC's patented Insulator, is the greatest contribution to spark plug efficiency in 40 years. It provides greater resistance to heat shock—better insulating qualities—greater resistance to fouling.

You, too, can enjoy **CORALOX** advantages, no matter what your make of car. You can have easier starting, surer firing at all engine temperatures. You can have spark plugs that also stay cleaner and last longer—if you insist on AC's.

BUICK'S XP-300 experimental masterpiece, with a host of ultramodern features, including a 300 horsepower high-compression V-type engine, sets the pattern for advanced performance, greater comfort and conveniences you may enjoy in the future.

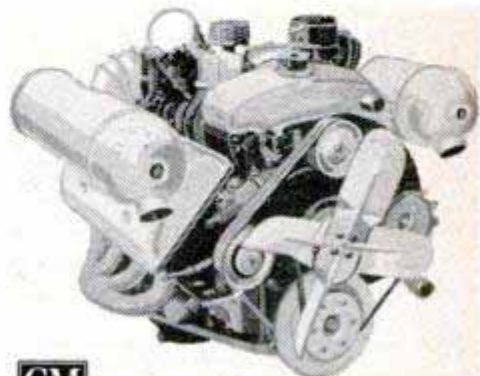

AC SPARK PLUG DIVISION • GENERAL MOTORS CORPORATION

Rustproof Metal!

"KRYLON-ize

home and garden tools—fishing rods and other sports equipment—nailheads and screwheads — children's playground equipment — lawn furniture—screens—hundreds of other objects!



If you prize it—**"KRYLON-ize" it!**

Krylon is a miracle of modern chemistry—a crystal-clear ACRYLIC coating that seals out water, air, moisture, dirt. Just press the button on the aerosol can and spray Krylon on. That's all there is to it! Krylon won't change color, crack or dry out. Waterproof, non-flammable. There's absolutely nothing like Krylon. It's America's Acrylic spray. Spray Krylon on almost any paper, leather, wood or metal surface. Protects, preserves, beautifies. "KRYLON-IZE" leather bags and luggage, valuable papers, photographs, washable walls, etc., etc. Hundreds of uses in every home! At hardware and paint counters everywhere in the big 12 oz. aerosol spray can.

KRYLON is also available in ALUMINUM and BRIGHT WHITE. All the qualities of clear Krylon, plus brilliant color. Go farther, last longer, clean easier, easier to apply than paint or enamel. Big 12 oz. aerosol spray cans.

KRYLON, INC.
2601 N. Broad St.
Philadelphia 32, Pa.

Say "KRYLON" at Your
Hardware Counter



"Hypnotism" Captures Grouse

Biologists in North Dakota catch ruffed grouse by "hypnotizing" them with the aid of a flashlight and a rocking tree! During the winter months, biologists of the state fish and game department tramp through the woods until they flush a bird. It flies into a tree. The biologist then aims a blinding beam of light from the flashlight at the grouse and, at the same time, rocks the tree back and forth until the bird becomes dizzy and falls to the ground. A net is tossed over the stunned bird, which is then transported to a distant part of the state where the grouse population is becoming depleted. Field biologist Wilford L. Miller, who developed the system, says the technique has been more successful than any other in capturing live grouse without injury.



EASY PROFIT IN PAINT SPRAYING

Paints walls, ceilings, screens, furniture and machinery faster, better. All complete as shown less motor. Carry anywhere. Fully guaranteed. Could be used with 1/4 H.P. motor or less. Price \$35.00 less motor F.O.B. Chicago. \$5.00 deposit balance C.O.D. or see your dealer. With motor \$55.00.

IDEAL AUTOMATIC PUMP CO., Dept. P.M.1
801 W. Washington Blvd. Chicago 7, Ill.

BE A FROGMAN!

Join the new national FROGMAN CLUB today. All you have to do is send \$1.00—be sure to include your name and address—and here's what you get:

- 1) A miniature pair of Frog Feet. Can be worn on key chain, lapel or hung on windshield as lucky charm.
- 2) An attractive membership card.
- 3) A Frogman decal to be used on your windshield, bicycle or notebook.
- 4) A booklet on "How To Swim Underwater" and "The Supreme Sport of Spearfishing".
- 5) Periodic bulletins on the latest developments in Frogman equipment and news.
- 6) Complete catalog of Frogman equipment available for purchase.
- 7) A free coupon for \$1.00, which can be used toward the purchase of a pair of regular size Frog Feet, \$6.95 or equivalent in value. This is redeemable at your local sporting goods dealer, drug store, auto supply store or toy departments. If no such dealer available in your area, we will handle direct.

BE A FROGMAN — Send your dollar today!

Sea-Net Mfg. Co.

1428 Maple Avenue, Dept. PM-1, Los Angeles, 15, Calif.

1000-Year-Old Seeds Still Can Sprout

Shown to be over 1000 years old by the atomic calendar at the University of Chicago, ancient Manchurian lotus seeds are still able to sprout and grow. Dr. Willard F. Libby, professor of chemistry at the university's Institute of Nuclear Studies, measures minute amounts of naturally occurring, radioactive carbon 14 in archaeological findings. By computation he determines accurately their ages. The seeds, hard and pebblelike, had to be soaked in an acid solution to soften their tough skins before they could sprout. Other objects that Libby has dated include some Stone Age bones computed to be 12,000 years old, a Danish house built almost 10,000 years ago and the famed Biblical Dead Sea scrolls that were confirmed as being almost 2000 years old.

A New ... and Better Push Drill by "YANKEE"

No.
45

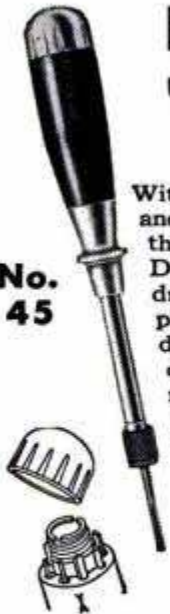

With a handle that fits your hand and a flange to rest your thumb, the ALL-NEW "Yankee" Push Drill No. 45 makes quick work of drilling small holes . . . in wood or plastics. Magazine handle holds 8 drill points ($\frac{1}{8}$ " to $\frac{1}{4}$ "). Improved chuck . . . drills can't pull out. Automatic return action clears chips. Buy it from Hardware Dealers and Industrial Supply Houses everywhere. Send for booklet "How 'Yankee' Tools Make Good Mechanics Better" FREE. North Bros. Mfg. Co., Dept. 4, 215 West Lehigh Avenue, Philadelphia 33, Pa.

"YANKEE" TOOLS
NOW PART OF

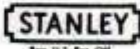

THE TOOL BOX
OF THE WORLD

NORTH BROS. MFG. CO., Philadelphia 33, Pa.

PROTECT

YOUR LOVED ONES!

Build a Small Atomic
Shelter for Your Family
& Valuable Possessions

Write now for blueprints

Complete set \$7.50

BLUEPRINTS FOR SURVIVAL

35 West 53rd Street, N. Y. 19, N. Y.

Jointer Owners!

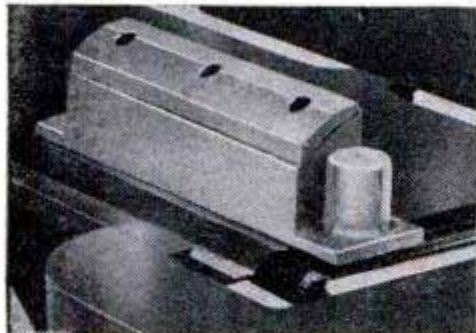

Jig-gauge in place on back table

This combination sharpening jig and reinstallation gauge makes it easy for you to grind and reinstall your 4 and 6" jointer knives in fifteen minutes. All you need to do is install the grinding wheel in your drill press, put each knife in the jig, and pass it under the special cupped grinding wheel several times. Reinstallation is easy. The gauge—mounted on one end of the jig—tells you quickly and easily when the edge of the knife is exactly even with the top of the back jointer table.

Satisfaction GUARANTEED or your money back.

Sharpening jig with gauge, and grinding wheel complete with arbor

\$12.65

See your dealer or order direct. Postage paid on pre-paid orders.

HARTMEISTER MFG. CO., 2020 W. Barbary Pl., Denver 4, Colorado



Handy Hank says:
"Every man's a handyman with
PLASTIC WOOD"

Reset loose drawer pulls—

Replaces splintered wood . . .
makes loose screws firm!



Seal drafty cracks—

Fills openings easily . . . dries tight and hard!
Resists weather!

Repair loose tiles—

Holds tiles firm on wall!
Easy!



Also useful in filling cracks in floors, nail and screw holes, repairing broken toys.
Handles like putty . . . hardens into wood!

PLASTIC WOOD

A CELLULOSE FIBRE FILLER



IN CANS
OR TUBES



WEATHER RESISTANT

Quick as a FLASH...

you're on the target with this
new 15-shot, 22 caliber

AUTOMATIC
with **OPEN SIGHTS**

Ask for Mossberg Model 151K
at your dealer's

**GOOD SPORTSMANSHIP:
THE AMERICAN WAY:**
To the hunter, this means con-
servation — forest fire preven-
tion and strict observance of
game laws — and courteous
consideration for the prop-
erty owner on whose land
he hunts.

Send for
FREE catalog.

No sales
at factory

MODEL 151K
15-shot "auto"
\$31.95

(\$32.95 west of Rockies)
Compare—for value!

O.F. Mossberg
® & SONS, INC.

29701 St. John St., New Haven 5, Conn.

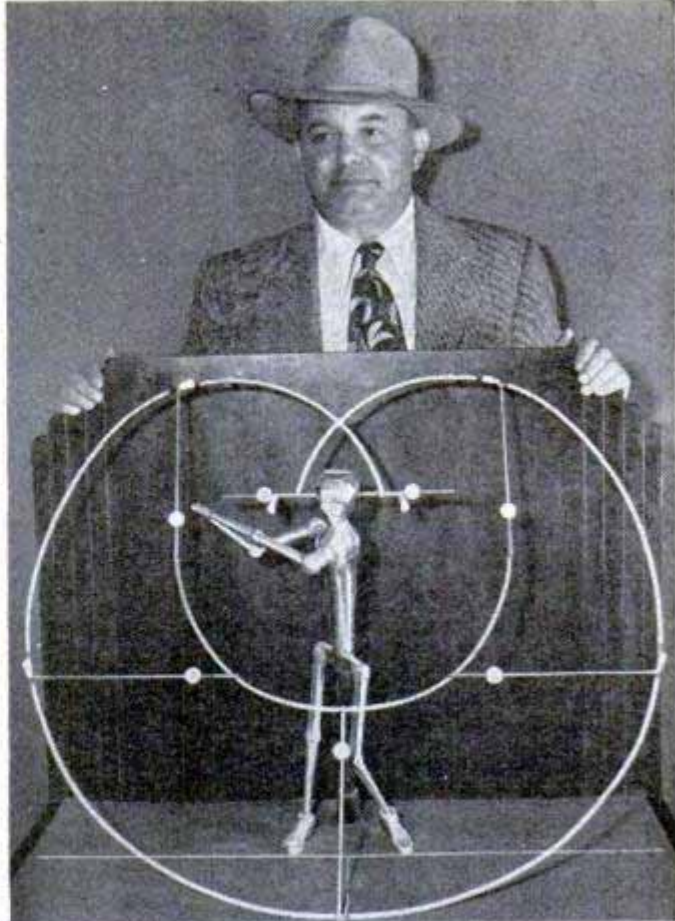

Oscar Teaches Golf Swing

Oscar, a 19-inch-tall robot, helps instructors at Los Angeles' Sunset Fields Links demonstrate in slow motion the proper body positions throughout an entire golf swing. The aluminum-and-steel-golfer's hips, shoulders, arms and head are motor driven through coaxial tubular shafts. His precise motions and perfect timing are made possible by a series of compound gears and cams. Oscar's hands always move in the inclined plane of the swing, with the hips pivoting through 45 degrees and the shoulders through an arc of 90. His head remains in a fixed position—with eye on the ball—until the ball has left the club face, then it turns with the body.

Alarm for Busses Foretells Brake Failure

Bus drivers are warned of possible brake failure by a new electric alarm actuated by loss of oil in the hydraulic system. A sensory cartridge is placed in the oil reservoir of the system and connected with a battery and an alarm lamp or buzzer. The cartridge contains a "thermistor" — a device in which the electrical conductivity is altered by the temperature.

Tests show that deer and rabbit repellents do not damage fruit trees even when sprayed on double strength.

I need 500 Men TO WEAR SAMPLE SUITS

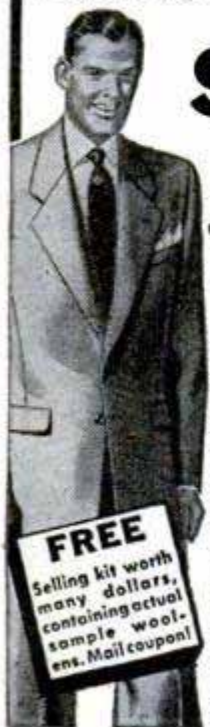

**Pay No Money—
Send No Money**

My values in made-to-measure suits are so sensational, thousands of men order when they see the actual garments. I make it easy for you to get your own suit to wear and show — and to **MAKE MONEY IN FULL OR SPARE TIME!** My Plan is Amazing! Just take a few orders at my low money-saving prices — that's all! Get your own personal suit, and make money fast taking orders. You need no experience. You need no money now or any time. Just rush your name and address for complete facts and **BIG SAMPLE KIT** containing more than 100 **ACTUAL** woolen samples. It's **FREE!** Send your name and address **TODAY!**
W. Z. GIBSON, Inc., Dept. B-516
500 S. Throop Street, Chicago 7, Ill.

MONTH AFTER MONTH, YEAR AFTER YEAR, YOU SEE OUR AD.
REMEMBER IT'S DANGEROUS to pay less if you want the finest (nonskid) USED tires.

GOOD YEAR **Firestone**

GOODRICH, UNITED STATES, GENERAL & OTHERS, NOT RECAPS

Our policy is to select your tires so carefully, as if our very future depended on the service given by that particular tire.

FREE TUBE WITH "ALL" BLATT'S GOOD GRADE TIRES

GOOD GRADE, 16 MONTHS GOLDEN RULE GUARANTEE BOND.					
600-16 \$4.14	700-15 \$4.54	650-20 \$7.94	32x6(8) \$8.64		
650-16 5.42	670-15 4.74	700-20 8.54	32x6(10) 9.94		
700-16 5.04	710-15 4.94	750-20 8.64	900-20 13.94		
650-15 4.44	550-17 4.64	825-20 15.92	1000-20 13.94		

FINEST GRADE, 26 MONTHS GOLDEN RULE GUARANTEE BOND

THIS GRADE MADE THE BLATT NAME "WORLD FAMOUS"

450-20 \$6.00	450-21 \$6.00	700-15(6) \$10	750-16(8) \$15
600-16 5.49	650-15 5.95	600-20 9.94	900-20 18.54
650-16 6.42	670-15 6.24	650-20 9.94	1000-20 18.54
700-16 7.94	700-15 6.54	700-20 11.94	1100-20 18.54
750-16 7.94	710-15 6.34	32x6(8) 10.54	1000-22 17.54
550-17 5.94	760-15 6.54	32x6(10) 13.92	1100-22 18.54
525-18 5.54	820-15 7.04	750-20 12.54	1200-22 22.54
650-19 9.00	475-19 5.94	825-20 22.84	1100-24 21.54

FACTORY REBUILT NU-TRED SNOW TIRES - 26 MONTH GUARANTEE

640-15	650-15	550-16
550-15	700-15	600-16
670-15	760-15	650-16
710-15	820-15	550-17

ANY SIZE \$11

MILITARY • NOT RECAPS

RUGGED GUAR. 30 MOS.	750-20 STD. \$10
" RUGGED \$16	750-16 RUG. \$19
900-16 RUG. \$11	

BLATT BLATT BLDG., GIRARD & LANCASTER AVES., DEPT. PM., PHILADELPHIA 31, PA.

Send check or money order and this ad for rush shipment. We won't ship a tire we wouldn't use. The name to trust in rubber. PRICES SUBJECT TO CHANGE

Shipments RUSHED Down South, Up North and Far West

1/2" ELECTRIC DRILL \$2.95

ADAPTER takes all drill sizes to 1/2". Fits any small 1/4" Electric Drill — in just a second! Well-made and a Mighty Handy Tool!

DANIELS PRODUCTS CO.
 M-1-822 W. 22nd St., Kearney, Nebr.

Postpaid in U.S.A. Order Now

INDUSTRIAL QUALITY AT LOW COST SHOP ACCESSORIES FULLY GUARANTEED

Circular Saw Blades for 1/2-5/8-3/4" Arbors
 MADE FROM CHROME-NICKEL MOLYBDENUM STEEL

FLAT GROUND		HOLLOW GROUND	
RIP • CROSSCUT • REGULAR OR NOVELTY COMBINATION		MITER OR PLANNER BLADES FOR SMOOTHER CUTTING	
6" dia. \$1.88	8" dia. \$2.39	6" dia. \$2.75	8" dia. \$3.85
7" dia. \$2.18	10" dia. \$3.18	7" dia. \$3.19	10" dia. \$4.80

SHAPER HEADS FOR YOUR TABLE SAW 1/2-5/8-3/4" ARBOR Only \$4.50

6 IN. DADO HEADS CHROME-NICKEL-MOLY STEEL 1/2-5/8-3/4" ARBOR
 Cuts 1/8 to 13/16" in steps of 1/16" Only \$9.95

8 IN. SANDING DISCS FOR YOUR TABLE SAW 1/2-5/8-3/4" ARBOR
 Includes 1 coarse, 1 fine on each side Only \$4.95

MOULDING CUTTERS Only \$3.85 per set CHOICE OF 38 PATTERNS

2 Hollow Ground Blades \$9.95
 3 Inside Chippers

Extra Sandpaper 5 grits 80c
 Sanding Disc Cement 40c

SEND CHECK OR M. O. All prices prepaid—WRITE FOR FREE CATALOG P-1

JAXON COMPANY • 369 ELLICOTT ST. • BUFFALO 3, N. Y.

Taking Vitamins?

Cuts Your Costs up to 50%

A Penny Postcard Will Bring You **FREE CATALOG** that lists practically every known combination of vitamins and vitamins and minerals.

Also FREE Vitamin Guide Book that shows you how to read a vitamin label and compare values.

No longer need you pay \$4, \$5, \$6, up to \$15, per 100 capsules for the same vitamins your Doctor advises. After 20 minutes' reading of this Guide Book you will understand vitamins as you never have before. You will not be fooled again by confusing, mysterious labels; you will be able to pick up any vitamin product and know if you are getting your money's worth. In this free catalog you are sure to find the combination of vitamins or vitamins and minerals you are now using. Compare the potencies and the prices and you'll be amazed at the savings of up to 50%. Stop buying vitamins blindly. Send postcard today for free guide book and catalog to Vitamin-Quota Dept. 782, 880 Bway, New York 3, N. Y., or 1125 Crenshaw Blvd., Los Angeles 19, Cal.

No. 150 **SpeedWay SpeedSander**



SANDS SMOOTHS **RUBS BURNISHES**

\$34.50

Makes dull, tiresome jobs fun. With this professional, motor-driven, orbital-motion SpeedSander, you can quickly and easily re-surface and refinish furniture, woodwork, walls or metal . . . can sand-off old paint, stain, enamel, rust or corrosion; smooth rough plaster; or buff, burnish or rub to a "piano finish." Operates with wet or dry abrasives. Three 4 1/2" x 6 1/2" covers cut from 9"x11" sandpaper or abrasive sheet. Your local dealer will gladly demonstrate.

No. 150K SpeedWay SpeedSander Kit

Everything you need in fitted steel carrying case—18 each of 5 grades of sheet abrasive, 2 free abrasive felts, thick neoprene contour pad, steel surfacing plate, lambs wool polisher and cover template.

\$49.50



No. 400 1/2" (in steel) \$39.50

SpeedWay SpeedDrills

No. 79 3/8" (in steel) \$22.50

No. 200 1/4" (in steel) \$16.50

Far advanced in design and construction these new SpeedDrills are lighter, handier, yet more powerful and faster-drilling than more costly old type drills. Drill steel, wood or concrete. Quality built for lifetime service, of die-cast aluminum with cast-in air cooling system and self-lubrication. Heavy cut-steel gears. Ball thrust bearings. Your SpeedWay Dealer will point out the many other superior features.

SpeedWay Kits Make Ideal Gifts

Any craftsman or "Mr. Fix-it" will be thrilled with a SpeedDrill Kit that drills, grinds, sands, buffs, polishes. No. 79 Kit provides a No. 79 3/8" capacity (in steel) SpeedDrill, a SpeedStand, wire brush, sanding discs and backer plate, cloth and lambs wool polishers, paint stirrer and 5 steel drills—31 pieces in all in fitted steel carrying case, complete **\$32.50**

No. 79 KIT

No. 200 Kit. (Not illustrated) Similar to No. 79 Kit but with No. 200 1/4" capacity (in steel) SpeedDrill and 28 accessories in fitted case, complete . . . **22.50**

GA KIT 20,000 r.p.m. SpeedWay No. 129 Hand Grinder with 16 mounted cutters, brushes, and wheels, complete in leatherette case. **\$14.50**

Bench SpeedGrinders—\$16.50 to \$32.50—Ask your dealer to show them to you.

No. 128 Bench SpeedGrinders

SpeedWay MANUFACTURING CO.
 1863 SO. 52nd AVE., CICERO 50, ILL.



Turn your Spare Time
into **CASH**

with the **FOLEY
LAWN MOWER
SHARPENER**



Start this steady repeat cash business in your garage or basement in spare time. The Foley sharpens all sizes and types of hand and power mowers in 15 or 20 minutes (with handles on). Prices run from \$1.50 to \$3.00 for hand mowers and from \$5.00 to \$8.00 for power mowers. 99¢ out of each dollar you take in is YOUR PROFIT. This is the way to make money!

The Foley Electrakeen System is the same as used by the lawn mower factories. It puts a perfect cutting edge on any reel blade mower in ONE operation, 2 to 3 times faster than any other method.

The beautiful work turned out by the Foley pleases your customers and brings them back. Its speed and ease of operation enables you to handle more mowers and make more profits. No experience needed with the Foley. Here's a business with low overhead and a cash income right from the start.

FREE — "HOW TO SHARPEN POWER MOWERS"

This valuable illustrated book shows how to sharpen all leading makes of power mowers. Foley prices are low—easy payments available. Free plan shows just how to start — no canvassing. Send coupon today — no salesman will call.

Also see *Foley Saw Filer*, page 424, and *Foley Saw Retooler*, page 452

SEND FOR FREE BOOK

FOLEY MANUFACTURING CO.,
107-2 Foley Bldg., Minneapolis 18, Minn.
Send FREE BOOK and FREE PLAN on Foley Lawn Mower Sharpener business.

Name _____
Address _____

**SHARPENS
1,000 MOWERS
PER SEASON**

"I have sharpened over 10,000 mowers in my Foley Lawn Mower Sharpener in the last 10 years — only repairs needed were new belts." — Charles H. Smith, Calif.

**MADE
\$2600.00**

"Last year we sharpened and repaired about 1000 lawn mowers for a net profit of \$2600," says E.G.

**PAID ITS COST
IN 30 DAYS**

"The Foley Lawn Mower Sharpener paid its cost the first 30 days after installing. It's O. K. in every way," says M. H. Engler, Mo.



**Army Air-Drops Liquids
In Pancake-Shaped Disks**

Free-fall deliveries of gasoline, water and other liquids to troops may soon be made in a synthetic-rubber container resembling an inflated pancake. When empty the five-gallon container being tested by the Army quartermaster corps is about two feet in diameter and weighs five pounds. On impact with the ground after falls from 400 to 2000 feet it stretches to almost double its normal size and settles near the point of contact after a rebound. No parachute is needed to check its drop.

**Glass Fiber and Plastic Panels
Line Bulletproof GI Jacket**

Jackets lined with glass fiber and plastic panels that can stop a .45-caliber bullet at point-blank range are being tested by medical corps litter men in Korea. The protective panels, 1/8 inch thick, are inserted in pockets all over a sleeveless cotton jacket. Some are flat and others are shaped to fit the body's conformations. Tests of this and another jacket, made of pressed-nylon-fabric layers, are being made with and without sponge-rubber padding next to the body. The rubber lessens the shock when the missile hits the clothing.

Fourteen rare minerals, used as dioxiding agents in the production of stainless steel, have been discovered in a 4 1/2-square-mile area of eastern California.

make your WORKSHOP PAY



make your AMMUNITION, safely and easily.

Savings per 100 rounds: (examples)
30/06 cal. \$13.80; .22 Hornet \$6.40
45 Automatic \$6.23;
Shotgun Shells \$4.48

Full details and instructions in
the illustrated Ideal Reloading
Hand Book, 184 pages ... 75¢

The Lyman Gun Sight Corp.
MIDDLEFIELD, CONN.



NO FROZEN PIPES

When You Use WRAP-ON ELECTRIC HEATING CABLE

Protects to 35° Below Zero

No more worry, expense or inconvenience from frozen pipes! Just wrap plastic coated cable around exposed or shallow underground pipes and plug into 115 volt outlet. Maintains low heat — like electric blanket. Uses only small current. Thermostat turns on only when needed. No radio or TV interference. Low prices — complete with connections — from one dollar. Satisfaction or money back.

E-Z-WRAP Pipe Insulation. Thick blanket of glass fibres. Vapor seal wrapping. Conserves heat. Gives greater protection. Easy to apply. Stops drip from cold pipes in hot, humid weather. Saves heat on hot water pipes. \$1.00 per package. Covers 17 ft. 1/2" pipe. Write for full information and free catalog.

CLYDE J. SMITH CO.

11141-8 MORANG AVE., DETROIT 24, MICH.
Tuxedo 5-5828

Free
Catalog

DELCO MOTOR

\$5²⁵

You can't beat this sensational buy! Triple Rubber Mounted DELCO Motor for fans, refrigeration, air conditioning units, etc.

1/75 H.P. 115 Volt 50-60 Cy. A.C. 1500 R.P.M. Over-all Ht. 7 3/4".

Tested! Guaranteed! Powerful! Quiet! Cool Running! Immediate delivery. ORDER NOW! Weight, 5 lbs. complete with suction blade.

10 day money back guarantee
Send check or money order

FREE: WRITE FOR LARGE ELECTRICAL, PLUMBING, AND REFRIGERATION CATALOG

Dept. PM 1 4300 N. W. 2nd Avenue
MARKEL INDUSTRIES, INC. MIAMI 37, FLORIDA



ONE-MAN SAWMILL LOW \$50⁰⁰ AS ... DOWN

Take BELSAW Portable Sawmill right to the trees—turn out valuable lumber for local yards —do "custom sawing" for neighbors. BELSAW lasts a lifetime. No crew needed. Power with old auto engine. Beginners get excellent results. Send postcard for **FREE BOOK**, "How To Make Lumber."

BELSAW MACHINERY CO
8116 Field Bldg. 315 Westport Rd., Kansas City 2, Mo.

**IT'S EASY
TO MAKE \$3.⁰⁰ AN HOUR
AND
MORE
SHARPENING LAWN MOWERS**

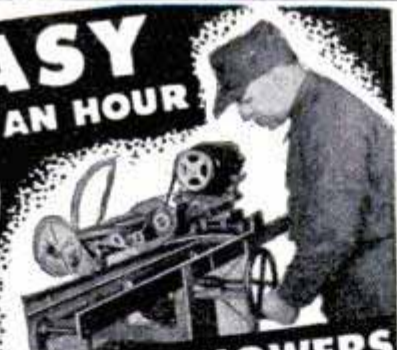

**IN YOUR
SPARE TIME**

J.S. of Michigan writes "I figure my profits for last season at over \$1,000.00 part time." C. R. of Ohio tried the Universal on a part-time basis and now gives it full time. He says "I have taken in, last season, more than \$3,500.00."

ONLY ON THE UNIVERSAL LAWN MOWER GRINDER

can the inside face and edge of the stationary blade, and all reel blades, be ground to proper clearance **ALL IN ONE SET-UP**

WITHOUT REMOVING ANY BLADE FROM THE MOWER
Write for details. Learn how to make real big money.
ROGERS MFG. CO., DEPT. PM-12, LINDSEY, OHIO

SEND THIS COUPON NOW

ROGERS MFG. CO., Dept. PM-12, Lindsey, Ohio
Please send me full details about the profit possibilities of Lawn Mower Sharpening.

NAME _____
ADDRESS _____
CITY _____ STATE _____

A "GOOD HAND" HELPS YOU SUCCEED! LEARN TO WRITE WELL

Handwriting quickly improves with our easy-to-understand picture lessons! Put your spare time to good use; send today for **FREE BOOKLET**, "How to Become a Good Penman," or check volumes wanted below at 51¢ each: Business Writing Artistic Writing Card Writing Bird & Design Flourishing Engraving Alphabets. **COMPLETE SET \$4.50.** Ask for price list of penman's supplies.

TAMBLYN SCHOOL of PENMANSHIP
S. A. Zilher, Pres., 4428 Ridge Bldg., Kansas City, Mo., USA

CONVERT HAND MOWERS to POWER MOWERS

Takes less than 3 hours

The Handy-Dandy Lawn Mower Kit fits any hand mower from the 16 to the 20 inch size. Complete with all necessary parts. Kits can be purchased separately, complete with engines or complete with Pennsylvania mower.



Also manufacturers of complete power mowers and garden cultivators.

LE CLAIRE MFG. CO., Le Claire, Iowa, Dept. PM

**Burden's Gigantic
Winter Clearance**

MAIL SALE

• War Surplus
• Excess Inventory
• Bankrupt Stock



\$650,000.00 INVENTORY TOP QUALITY EQUIPMENT AT TREMENDOUS SAVING DURING SALE, WE PAY ALL SHIPPING CHARGES IN U.S.A.

POWER PLANTS AND GENERATORS

- **Kato Generators.** 5000-w, 115-v, 60-c, 1800 R.P.M. Sing. phase. Ball bg. With panel, meters, pulley, etc. Cost over \$550. **\$259.50**
- **Burdex Generators.** 2000-w, 115-v, 60-c, 3600 R.P.M. Sing. phase. Ball bg., panel. **\$159.50**
- **Burdex Generators.** Same as above, except 1000-w. **\$134.90**
- **Burdex Generators.** 500-w. **\$94.50**
- **Onan Plants.** 5000-w, 115-v, 60-c. Sing. phase. 4-cyl. water cooled eng. Push-but. ton start. Cost over \$1200. **\$715.50**
- **Master Plants.** 5000-w, 115-v, 60-c. Sing. phase. 4-cyl. air cooled eng. Manual start. Cost over \$1100. **\$597.90**
- **Homelite Plants.** 1500-w, 115-v, 60-c. Sing. phase. 1-cyl. air cooled eng. Manual start. Cost over \$465. Special. **\$259.50**

WATER PUMPS AND SYSTEMS

Finest units at big savings. Get expert advice on your pumping problem. Use pumps for wells, garden irrigation, basements, floods, spraying, septic tanks, etc.

- **Centrifugal Pumps.** BURDEX. Cast iron case, bronze impeller, stainless steel shaft. Ball bearing. 40 to 140 G.P.M. 5 to 30 lbs. pressure. Model #75, #84, **\$18.90**, #100, 1", **\$28.90**, #150, 1 1/4", **\$35.60**.
- **Economy Die Cast stainless shaft with 2 1/2" pulley.** Inlet and outlet threaded for garden hose. 30 g.p.m. Special. **\$11.95**
- **Allison Hi-Capacity.** Ball bearing. Double outlet, 2 1/2" inlet, twin 1 3/4" outlets. To 200 g.p.m. **\$39.50**
- **Rotary Pumps.** Low pressure type. All bronze, stainless shaft, precision bearings. Flexible Hy-Car rubber impeller. Self priming to 10 ft. Lift to 22 ft. 6 to 20 g.p.m. 5 to 25 lbs. pressure. Model #12, 1 1/2", **\$12.75**, #34, 3/4", **\$16.95**, #10, 1", **\$22.95**. Hi-Pressure Type. Same construction as above, except has bronze rotor with nylon rollers. Pressures to 150 lbs. #612, 1/2", **\$14.50**, #63, 3/4", **\$20.95**, #610, 1", **\$27.95**.
- **Special Pumps.** Motor Driven Sump, 110-v, 60-c, 1/2 h.p. Automatic 2250 g.p.h. 1" disp., **\$42.97**. Motor Driven Utility. Handled made. Self-priming pump mounted directly on 3/4 h.p. heavy-duty finest 110-v, 60-c. motor with carrying handle. Garden hose threads. Cap. to 5 g.p.m. Pressure to 30 lbs. **\$37.49**. Hollow Shaft Pump Only. Same as above except pump only. Slips over any 1/2" motor shaft. Mount in 30 sec., **\$13.99**. Bronze Gear Pumps (weed spray, etc.) Top quality all bronze stainless shaft. Cap. to 12 g.p.m. Pressure to 150 lbs. **\$21.50**. Weed Spray Long Wear Pump. The world famous hi-pressure model. Special formula stainless steel cast. Resists heaviest wear. Outlasts 3 to 4 ordinary pumps. For direct tractor drive. Pressure to 400 lbs. Replace worn-out weed spray pumps with this unit **\$54.50**. Rotary Gasoline Hand Pumps. Use for filling cars and tractors from barrels or U G tanks. Model #36, (all bronze) 15 g.p.m. **\$19.90**. Model #42 (zinc alloy) 8 g.p.m. **\$14.75**.
- **Water Systems.** Burdex shallow-well rotary (22 ft. lift with foot valve.) Full automatic. 110-v, 60-c, 1/4 h.p. 300 g.p.h. 40 lbs. pressure. Easy to install. **\$69.50**. Burdex Deep Well Jet (70 ft. max. lift.) 35 lbs. Full automatic, 100-v, 60-c, 1/4 h.p. 350 g.p.h. 35 lbs. Full installation instructions. **\$109.95**.
- **Other systems for wells up to 160' lift.** Save 60%. Install your own. Our flexible plastic pipe eliminates threading, cutting.
- **Accessories.** Bronze Foot Valves, 3/4" **\$2.49**, 1" **\$3.15**, 1 1/2" **\$4.90**. Bronze Check Valves, 3/4" **\$2.95**, 1" **\$3.49**, 1 1/2" **\$5.89**. Brass Intake Strainers, 3/4" **\$1.35**, 1" **\$1.39**, 1 1/2" **\$1.72**.

Write for Special Water Pump Catalog, Data

NORTON ABRASIVE STONE KITS

- **Finest Air Corp Abrasive Stones.** Assort. of grits, shapes and sizes. Offered in kits at fraction of cost. Kit #1, 1/4" bore, **\$1.98**. Kit #2, 3/8" bore, **\$2.79**. Kit #3, 1/2" bore, **\$3.98**. Kit #4, 3/4" bore, **\$3.69**. Kit #5, 7/8" bore, **\$3.59**.

Home BATTERY CHARGER

- **Top quality leading make 110-v, selenium-type charger.** 6-amp. taper charge. Will not overcharge. For home, farm, resort, charging auto, truck, tractor, power-boat, airplane, etc. Re-pays low price quick. Complete with ammeter. List **\$18.95**. **SALE \$13.49**

WINTER NO-FREEZE UNITS

- **For cars, pipes, pumps, etc.** Unit #1, 110-v, 600-w coil with 36° F thermostat, **\$2.59**. Unit #2, 110-v, thermostat, wraps around pipe, pump, etc. Plug into 110-v, 10' (50-w) **\$3.79**. 20' (140-w) **\$5.45**. Vacuum-stat 36° F. (10-amp) **99c**. Unit #3, 110-v, Auto Headbolt engine heater with Telechron clock switch. Permanently replaces headbolt. Clock turns on heater at preset time. Warm engine for easy starting. Specify make and model of auto. Special. **\$14.73**

Miscellaneous Surplus Bargains

- Other typical Burden bargains. Every item a guaranteed value.
- **Tachometer.** 0-4000 R.P.M. Direct rd. **\$6.79**
 - **Compass.** Tank & plane. Cost \$50. **\$8.97**
 - **Compression Tester.** Precision mechanics type. **\$4.69**
 - **Hot Water Heaters.** 110-v, 20 g.p.m. **\$33.96**
 - **Drawing Sets.** 13-pc. good quality. **\$9.89**
 - **Electric Chain Saw.** 110-v, 8 amp. **\$112.50**
 - **Gas Chain Saw.** 4 h.p. 30" 1-man **\$299.50**
 - **Electric Carpenters Saw.** 110-v. **\$31.68**
 - **Electric Drill.** 1/2", 110-v. **\$26.95**
 - **Clock Timer Switch.** 110-v, 60-c. **\$4.72**
 - **Engineers Precision Hand Level.** **\$5.84**
 - **Nichrome Heater Element.** 110-v. **.99**
 - **Circular Ring Heaters.** 110-v, Pair. **.59**
 - **Car Vacuum Cleaners.** 110-v. **\$14.71**
 - **Motor-Gyro Units.** 12-24-v D-C. **\$1.98**
 - **City Upright Desk Phone.** **\$1.99**
 - **Binoculars.** 7x50 with case, Tx. Pd. **\$45.95**
 - **Burglar Fire Alarm.** 110-v. **\$2.88**
 - **Motors.** Hi-speed series. 6-12-v. **\$8.95**
 - **Motors.** Slow speed, 80 r.p.m. **\$8.95**
 - **Hydraulic Cyl.** 3"x31" 10" stroke **\$18.49**
 - **Fire-Freeze Mercury Control.** **.99**
 - **Ammeters.** Triplet A-C. 0-30 amps **\$4.95**
 - **Surface Plates.** mech. precision. **\$27.60**
 - **W. E. Lip Microphones.** Cost \$10.50 **.79**
 - **Fluorescent Fixtures.** 110-v, 15-w **\$4.71**
 - **Cathode Ray Experimental Tubes.** **\$4.35**
 - **Bolt-Screw-Nut Mix.** 6 lb. ass't. **\$1.99**
 - **Tap-Die Set.** 23 pc. 1/4" to 1 1/2". **\$19.50**

Tractor Weed Spray Outfits

- **Winter Closeout.** leading make, complete. 4-5 row, all brass T-jet boom, tractor direct-drive bronze gear pump, valves, hose, etc. Universal mounting. \$140 list. Save almost half in special sale. **\$79.50**

G. E. Industrial Electric Heaters

- **Expensive 220-v. 3000-w Chromolux elements.** 3-heat switch. Wall mounting. Will heat large living rooms, shops, etc. 5"x18"x20". Cost over \$75. Save more than half in Special Sale. **\$32.70**

Magneto and C. B. Telephones

- **Rural Magneto,** compact oak case wall phones. (a) 3-bar, 1000-ohm. **\$9.95**. (b) 4-5 bar, 1600-ohm, **\$13.90**. City upright desk phones with bells. **\$4.99**.

Welding Generator Kits

- **\$276 Aircraft 200-250 amp, 28-v. generators.** Complete with cooling fan, field rheostats and "How To Build" welder instructions. **\$24.65**

SPECIAL Flexible Guy & Turnbuckle

New 12-ft. 1/8" flexible steel cable, 14" turn-buckle. Guy, strengthen gates, fences, bldgs., television towers, etc. Cost \$1.10 ea. Sale. 10 for **\$3.89**, 50, **\$16.47**, 100, **\$29.32**.

AIR COMPRESSOR — PAINT SPRAY UNITS

- **Paint, blow up tires, control termites, solvent, clean greasy engines, blow out dust, etc.** Buy or build your own portable air supply unit.
- **Economy Air Outfit Kit.** Build your own. Consists 1-cyl. piston compressor. 6" x 24" (400 lb.) tank, pressure gauge, valve, blow gun, relief valve, tire chuck, 15' hose, set fittings, set drawings, "How To Build" instr. **\$50 value, \$31.90**
- **DeLuxe Air Outfit Kit.** Same as above except 12"x24" tank, adjustable pressure regulator (0-250 lb.) quality spray, paint gun, etc. **\$45.90**
- **BURDEX Portable No. 1 Outfit.** Top quality factory-built unit. Pressure to 120 lbs. and to 3 c.f.m. Finest heavy duty 110-v. motor, paint gun, blow gun, tire chuck, ball bearing wheels, etc. List **\$195.50**. **SPECIAL \$139.50**
- **Quincy Portable Outfit.** Similar to above except smaller tank. No paint gun furnished. Finest heavy duty 110-v, 60-c. motor **\$74.95**
- **Air Compressors.** Leading make piston compressors. 1-cyl. 150 PSI, 2 c.f.m. **\$20.50**. 2-cyl. 100 PSI, 9 c.f.m. **\$49.50**. 2-cyl. 125 PSI, 18 c.f.m. with suction unloader. **\$130.25**

AIR ACCESSORIES

- **Air Regulator** 0-250 lbs. **\$2.65**. **Pressure Gauges**, 60, 100, 160, 300 lbs. **\$1.89**. **Pop-Off Adj. Relief Valve.** 0 to 250 lbs. **\$1.95**. **Automatic Adj. Pressure Switch** for 110 or 220 volt motors. #A (to 50 lbs.) **\$4.95**. #B (to 100 lbs.) **\$4.95**. #C (to 160 lbs.) **\$5.87**.
- **Air Filter** removes moisture, dirt, oil. **\$2.49**. **Tire Chucks** for 1/4" hose, **49c**.
- **Paint Spray Accessories.** Leading make precision professional units. **Spray Guns**, internal mix. #121, all purpose, **\$8.95**. #112, all purpose home type, **\$6.95**. #115, Light work, touch-up, etc. **\$4.50**. **Auto Power Spray Outfit.** Two spark plug units with hose and #121 gun, 2.5 ft. air at 40 lbs. Excellent unit. **\$14.49**. **Burdex All Electric Spray Unit.** 110-v, 60-c. Complete, ready to use. Many uses in home. **\$10.95**. **Pressure Paint Tank.** Use with any outfit and gun when painting houses. Holds 3 gals. Air and paint hoses. **\$18.95**.

WINCHES — CLUTCHES — BLOCKS

- **Boat, dock, utility hand winch.** 1-4 gear ratio. Steel. **\$19.95**
- **Truck, farm, business hand winch.** 1-3, 1-9 ratio. **\$29.98**
- **Contractors heavy duty hand winch.** 1-5, 1-27 ratio. 10,000 lbs. capacity. Brakes. Free wheeling. Easily arranged for motor drive. Most powerful hand winch made. **\$89.95**
- **Hoist Winch.** Drive with motor. Use for bldg. or contr. elevator, boat cargo unloader, hay hoist, etc. Holds 1000' cable. wt. 280 lbs. **\$98.90**
- **Gar Wood Power Winch.** Heavy duty. 15,000 lbs. Clutch. Top quality, 150' 1/2" Hi-strength cable. Special **\$179.50**
- **Chain Hoist.** Lever type, 21" lift. 3000 lbs. pull. **\$19.50**
- **Winch Cable.** Top quality, Hi-strength 1/2" (4000 lbs.) 13c. 3/4" (8000 lb. 16c. 1/2" (12,000 lb.) 18c.
- **Snatch Block.** Heavy duty. Cost \$18. **\$9.95**
- **Snatch Block.** Med. duty. 3000 lb. **\$5.49**
- **Clutch.** Utility, many uses, 6 h.p. **\$14.95**
- **Clutch.** Jeep, sliding spline, 3 h.p. **\$8.75**
- **Clutch.** V-belt el. mtr. type 1 h.p. **\$7.49**

FREE BOOK **BURDEN SALES COMPANY**

805 "O" STREET LINCOLN, NEBRASKA

Make Your
Attic
Part of Your
Home
with the

Economy
**DISAPPEARING
LADDER**



- LOW IN COST
- FITS ANY OPENING 18" WIDE OR WIDER
- NO ALTERATIONS TO AN EXISTING OPENING NECESSARY
- NO INSTALLATION EXPENSE

Write for full information & name of nearest dealer!

EZ-WAY SALES, Inc.

BOX 300, DEPT. PM, ST. PAUL PARK, MINNESOTA

MECHANICS PARADISE

ALL KINDS OF TOOLS ALWAYS AT CUT PRICES

10¢ EA. ASSORTED SIZES
Send for Catalog

TWIST DRILLS BRAND NEW HIGH SPEED

NATIONALLY KNOWN BRAND
Straight shank. Hand picked slightly imperfects. Good assortment of sizes. Satisfaction guaranteed!
SET OF 50 Postpaid 4.98
SET OF 25 Postpaid up to 5/16" 2.49

Set of 100 up to 3/8" \$35.00 value
9.95
Post Paid

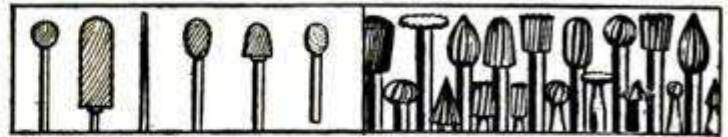

ROTARY FILES
BRAND NEW HIGH SPEED
1/4" shanks. Set of 6 different pieces for metal, wood or plastic
15.00 post-value..... **2.95** paid

ROTARY CUTTERS
BRAND NEW HIGH SPEED
3/32" shank. 24 different shapes and sizes for metal, wood or plastic.
\$3 mortised wood box included. 21.00 value. **5.45** paid

316 E. HENN. **Josid HARDWARE** MINNEAPOLIS, MINN.



LEARN FASCINATING

Leathercraft

Make your own bags, belts, wallets, etc. Learn fascinating, profitable leathercraft in spare time. Send 25c for valuable Catalog, has over 200 photographs. (refunded first purchase).

BURTONS LEATHERCRAFT

Dept. PM-1, 1755 1/2 Glendale Boulevard, Los Angeles 26, Calif.

MORE JOBS



EASIER - QUICKER

You'll like the smooth, powerful, gear-driven, easy operating action of the 4 1/2 or 6 H.P. WALKING MODEL with power turning clutch or the 7 1/2 H.P. RIDING MODEL with automatic type differential. Our 2 and 3 H.P. Walking Models low as

with **'RED-E' GARDEN TRACTORS**

\$169. Attachments for plowing, sowing, cultivating, wood-sawing, snow-plowing, etc.

Write for FREE Catalog New 1952 models on Easy Terms—special Factory-To-You discount.

RED-E TRACTOR CO., Richfield 233, Wis.

Fully Guaranteed
BUY DIRECT
from Manufacturer
and Save

THE EXCEL No. 6 CUTTER AND TOOL GRINDER

WILL SHARPEN AND RESTORE REAMERS — C'BORES — MILLING CUTTERS — END MILLS AND MANY OTHER CUTTING TOOLS TO THEIR ORIGINAL ACCURACY



ALSO CAN BE READILY ADAPTED TO BOTH INTERNAL AND EXTERNAL CYLINDRICAL GRINDING WITH SPECIAL ATTACHMENTS THAT ARE AVAILABLE

DETAILED BULLETIN AND NAME OF NEAREST DEALER WILL BE MAILED ON REQUEST BY WRITING TO DEPT. PM612

Designed and Built by

COVEL PRECISION GRINDERS
BENTON HARBOR, MICH.

BUILD YOUR OWN FAN



One-piece cast aluminum propellers for cooling and ventilating

Size	Polished	Unpolished	Bore
Inches 2 Blade 3 Blade	2 Blade 3 Blade	2 Blade 3 Blade	Inches
15	\$3.00 \$4.00	\$2.50 \$3.00	1/2, 5/8, 3/4
18	3.75 5.00	3.00 4.00	1/2, 5/8, 3/4
20	4.00 5.50	3.25 4.50	1/2, 5/8, 3/4
24	4.50 6.50	4.00 5.50	1/2, 5/8, 3/4

Write for pamphlet on larger fan blades, wire guards, fan bases, shutters, pillow blocks, exhaust fan frames, etc. Shipped prepaid if money accompanies order. Dealers write for discount.

KLOPPENBORG ALUMINUM FDY., Dept. PM-1-52, Davenport, Iowa

MODERN LAWN MOWER SHARPENER

FOR LAWN MOWER SHOPS
FIX-IT SHOPS
GOLF COURSES • PARKS
101 OTHER JOBS

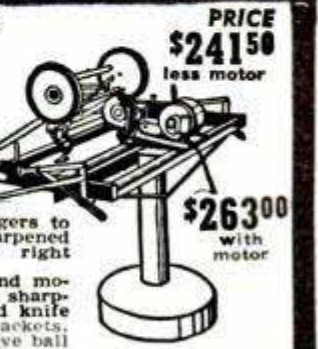

Sharpens All Reel Type Mowers • Hand, Power or Gang • 10 to 20 Minutes • No Dismantling • No Extra Attachments Needed.

All reel type mowers, from 5-inch edgers to 36-inch power mowers, are quickly sharpened to extreme ends of both left and right twist blades.

Handle, wheels, roller and motor remain in place when sharpening is in process. Bed knife is sharpened in same brackets. Grinding head rides on five ball bearing races. Easy to operate. Also sharpens chisels, jointer knives, planer blades. Big profit maker. Own your own business. Send Today for FREE Illustrated Bulletin No. 10-C
Prices Subject To Change Without Notice

MODERN MFG. CO. 160 N. FAIR OAKS AVE PASADENA, I CALIFORNIA

Tough hobby jobs

made easy
with

PALMGREN

ROTARY TABLE

NOW ONLY

\$54⁵⁰

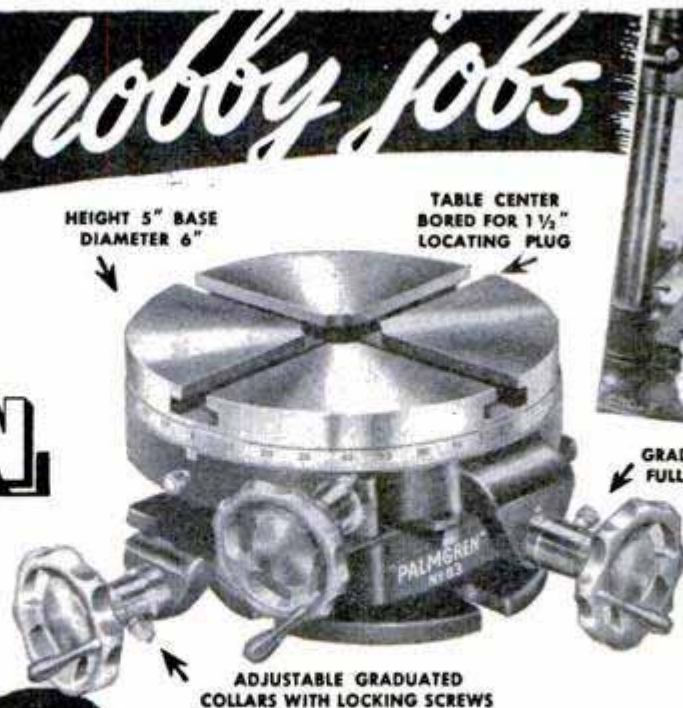

The Only Table Having ROTARY FEED Combined With DUAL CROSS FEEDS!

It's sensational—in price, in construction, in performance. Makes your drill press a vertical milling machine. You can rout, straight or curved-rabbit-drill-sand or mortise. Also hundreds of other jobs such as milling slots, grooves, keyways, squares, hexagons, curves, flats, dovetails, indexing and laying out work.

Designed for use on Drill Press or Milling Machine, it will handle large tough jobs or small model parts on all types of metal and woodworking projects.

Built by Specialists for LIFETIME SERVICE

Precision built. Permits close tolerances. Rotary feed is calibrated in degrees-cross feeds in thousandths. Cross slides and feeds are 2 1/8" each side of center—4 1/4" overall. Adjustable gibs on cross slides—40 to 1 worm and gear ratio in rotary feed. 4 Bolt slots—2 lock screws.



FREE! SPECIAL GIFT OF SET OF JAWS FOR LIMITED TIME

No.	Base Keyway	T-Slots	Table Dia.	Base Dia.	Ht.	Wt.	Price
83	5/8"	5/8"	8"	6 1/4"	5"	28 lbs.	\$54.50
82	As above without ROTARY FEED					26 1/2 lbs.	43.75

CHICAGO TOOL and ENGINEERING CO.

Mfrs. of PALMGREN PRODUCTS for over 30 years
8366 SOUTH CHICAGO AVENUE • CHICAGO 17, ILLINOIS

OTHER "HOBB-E" TOOLS

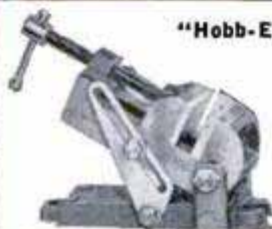

"Hobb-E" ANGLE VISES
for quick accurate set-ups and any angle. Save hours of time. XI-VISE 1 1/2" Jaws \$4.95. No. 000-2 1/2". Jaws Only \$8.75



"HOBB-E" MILLING ATTACHMENTS
Mill on your lathe. Make T-Slots-Dovetails-Keyways, Etc. Fits any lathe. Graduated for rotary or vertical feeds. Attaches to tool post in 10 Seconds. No. 150-1 1/2" Jaws \$20.65. No. 250-2 1/2" Jaws \$27.25. No. 400-4 Jaws \$43.75



"Hobb-E" BENCH-DRILL PRESS VISES
A handy combination. Use on bench for hand work—slide vise off adaptor to use on drill press. Swivel bench Base — 2 1/2" Jaws. V grooved for holding round pieces. Only \$12.95



"Hobb-E" DRILL PRESS VISES
Designed especially for Hobbyists, to make operations on small article more convenient. No. 6—1 1/2" Jaws \$3.30. No. 30—2 1/2" Jaws \$5.50



"Hobb-E" HAND VISE
A handy device with unlimited uses in finishing operations. Grips smallest pieces for buffing or grinding without damage and safeguards hands and fingers. No. 15—1 1/2" Jaws Wt. 7 oz. Only \$2.15

Order Today!

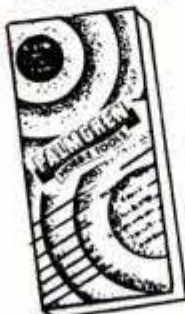

Send for FREE BOOKLET

MAIL COUPON

USE THIS CONVENIENT COUPON!

CHICAGO TOOL and ENGINEERING CO. • 8366 South Chicago Ave., Chicago 17, Ill.

Enclosed find { Check for \$ _____ Please M. O.

send postpaid items marked below:

No. _____ ROTARY TABLE

No. _____ MILLING ATTACHMENT

No. _____ DRILL PRESS VISE

No. _____ ANGLE VISE SEND FREE "HOBB-E" BOOKLET

No. _____ COMB. VISE

No. _____ HAND VISE

NAME _____

STREET _____

TOWN _____ STATE _____

PLEASE WRITE DEALERS NAME IN MARGIN

48 ROTARY CUTTERS ONLY \$3.00 POSTPAID



The above is an enlarged illustration of cutter heads. Assorted sizes (approximately 1/32" to 3/32") and shapes, these miniature cutters are ideal for the home workshop. Used for cutting metal, wood, or plastic. 3/32" shafts.

- 12 Miniature cutters, assorted sizes and shapes, 3/32" shafts \$1.00
- 2 Circular saws, HS steel, 1" and 1 1/4" x .025", and 2 1/4" mandrels... \$2.25
- 2 Circular saws, tungsten steel, 3/4" x .025", and 2 1/4" mandrels..... \$1.50
- 12 Abrasive stones, assorted shapes and sizes..... \$1.25
- 12 Mounted points, assorted shapes and sizes, 1/4" shafts..... \$2.75
- 24 Mounted points, assorted shapes and sizes, 1/8" shafts..... \$5.25
- 20 Tungsten steel cutters, assorted shapes and sizes, 1/8" shafts..... \$7.50
- 15 HS steel cutters, assorted shapes and sizes, 1/8" shafts..... \$8.00
- 45 Rubber abrasive wheels and points, 3 mandrels... \$2.50
- Transparent plastic container, holds forty 1/8" shaft cutters..... \$1.20
- 12 Felt polishing wheels to 1" diameter..... \$1.15
- 6 Muslin buffs to 2" diameter..... \$1.45
- 12 Imported Swiss files, length 5 1/2", all different..... \$6.00
- 300 Accessories for handgrinders and flexible shaft equipment. Burs, cutters, brushes, mounted stones, buffs, felts, mandrels, rubber wheels, etc. \$8.95
- 20 Wire gauge twist drills from No. 61 - 80... \$3.75
- Drill case for No. 61 - 80 drills..... \$1.00
- Reversible collet pin vise and hand drill, capacity 0 - .125..... \$1.50
- Vernier caliper 5" capacity, measures to 1/128"..... \$2.00
- Imported Swiss jewelers screw drivers, set of 8..... \$2.50
- Transparent hinged plastic boxes. Ideal for small tools or parts. Specify number of compartments.

Size	Number of Compartments	Price Each
8 1/4" x 4 1/4" x 1 1/4"	18 - 12 - 6 or 1	\$1.00
7" x 3 1/2" x 1 1/4"	12 - 7 or 1	.75
4 1/2" x 2 3/4" x 1"	8 - 6 - 4 or 1	.50

Orders over \$2.00 for above items shipped postpaid in U. S., if less please include postage. All the above merchandise is new, and fully guaranteed.

80 page illustrated catalog of accessories for handgrinders and flexible shafts, small tools, brass and other metals for the model maker, gold and silver for the amateur jeweler, 25c. Illustrated price list of over 30 sizes of plastic boxes free.

WRITE DEPARTMENT PMS1

SCHRADER INSTRUMENT CO., INDEPENDENCE, IOWA



MEN! send for this MONEY- MAKING OUTFIT **FREE!**

MAKE \$15.00 IN A
UP TO 15 DAY

Do you want to make more money in full or spare time... as much as \$15.00 in a day? Then mail coupon below for this BIG OUTFIT, sent you FREE, containing more than 150 fine quality fabrics, sensational values in made-to-measure suits and overcoats. Take orders from friends, neighbors, fellow-workers. No experience needed. You'll say it's the greatest way to make money you ever saw.

SAMPLE SUITS TO WEAR

Pay No Money! Send No Money!

Our plan makes it easy for you to get your own personal suits and overcoats without paying 1c, in addition to your big cash earnings. This offer is limited. Rush coupon for FREE OUTFIT—today!

STONE-FIELD CORP., Dept. B-816
532 S. Throop St. Chicago 7, Ill.

STONE-FIELD CORP., Dept. B-816
532 S. Throop St. Chicago 7, Ill.

Dear Sir: I WANT A SAMPLE SUIT TO WEAR AND SHOW, without paying 1c for it. Rush Valuable Suit Coupon and Sample Kit of actual fabrics, ABSOLUTELY FREE.

Name.....Age.....

Address.....

City.....State.....

Build Your Own Drill Press

vises, clamps, hand tools . . .



Yes, you can have the satisfaction of saying "I made it myself"—and save money, too! I now offer these tested plans to workshop hobbyists after successful applications in over 2500 industrial arts and vocational schools in 47 states! Plans are fully dimensioned and properly engineered to produce high-grade machine and hand tools with a minimum of power equipment! Simply send 50c in stamps or coin for big 36-page book of 30 working drawings on a variety of home workshop equipment that you can build yourself. This book also lists high-quality castings and other basic parts which we can supply for these projects at attractive prices. Money back guarantee. For both the beginner and experienced man. Write: Clarence Struck, Gen. Mgr.,

CASTING SPECIALTIES, 1925A N. 49, Milwaukee 8, Wis.

1/4" DRIVE SOCKET SET only **198** POST PAID

GOV'T SURPLUS \$4.00 VALUE

Eight Nationally Advertised Sockets FLEX HANDLE-Range from 1/4" to 7/16" Sorry no C.O.D.'s

WRITE FOR FREE CATALOGUE FEATURING BARGAINS ONLY

DENTAL SPECIALTY & SALES CO. • BOX 692 • GREAT NECK, N. Y.

\$7.75

ALL-PURPOSE TORCH FOR YOUR SHOP

Adjustable Soldering-Brazing Torch for delicate or heavy work. Air and gas valves adjust flame from needle-point to pencil size. Torch uses air compressor or can be breath-blown. Ideal for silver soldering; light brazing; hardening drills and bushings. Excellent for radiator, electrical and sheet metal work. Lights instantly. Made for natural, artificial or bottled gas. Specify type of gas when ordering. Brass torch, 11 1/2" long. 10 day money-back guarantee.

Money with order Postpaid

MASS COMPANY, 1123 W. 4 1/2 St., Davenport 1, Iowa

MARCOT KEY MACHINE



- MARCOT No. 8 KEY MACHINE, less motor..... \$110.00
- Auto Code Book and Depth Keys..... 12.50
- 75 Dz. Popular Key Blanks..... 60.00
- Set - Key File, Follow-Through Rods, Lock Picks, Bit Key Gauge, Thimble, Pins, Springs..... 10.50
- "Locksmith Trade Books"..... 6.75
- How to Open Locks without Keys or Picks; Secret of Locksmithing; How to Make Keys by the Impression Method; Master Key Systems.
- TOTAL COST..... \$199.75

Immediate Delivery
A. J. MARCOTTE CO., 1200 N. Kedzie Ave., Dept. PM, Chicago 51, Ill.

LAWN ORNAMENT-NOVELTY PATTERNS

28 Lawn Ornament Patterns, 25c. Other Patterns: 15-20" high: Dutch Girl, Dutch Boy, Pirate, Bull Terrier, Mexican Girl, Mexican Boy, Dwarf, Penguin, Flower Girl, 10c each. 25 Novelty Patterns, 30c. All 62 Full Size Patterns, \$1.00 Postpaid. Strother Pattern Service, Dept. CR-8, Box 129, Belington, W. Va.

An Outstanding METAL HAND PUNCH with unusual performance

Needed by every Mechanic in every Shop

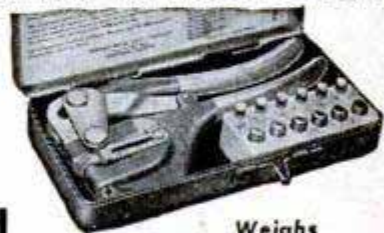

No. 5 Jr. HAND PUNCH
CAPACITY—1/4" THRU 16 Ga. Mild Steel. 3/32" — 1/8" — 5/32" — 3/16" — 7/32" — 1/4" — 9/32" —
Punches and Dies Furnished.

Weights 2 3/4 lbs.
THROAT DEPTH 2 inches only **\$9.00**

ORDER YOURS TODAY! Postpaid in U.S.A.
Write for FREE Catalog on other tools.

WHITNEY METAL TOOL CO., Dept. PM-1, Rockford, Ill.

HIGH SPEED MORSE TAPER SHANK DRILLS



Reconditioned and sharpened—ready to go! Many drills with extra lengths of flute. Immediate delivery. These drills are priced as low as 25% of your present cost and shipped post paid to you.

Size in In.	Twist Lgth.	Price	Size in In.	Twist Lgth.	Price
37/64	6 1/4	\$1.00	13/32	6	\$3.33
37/64	20	4.00	17/64	9	4.00
39/64	6 1/4	1.05	1-7/8	8 1/2	4.00
47/64	3/4	1.57	1-5/32	6 1/2	3.75
49/64	4 1/4	1.64	1-11/64	7 1/4	3.95
13/16	4	1.82	1-7/32	8 1/2	4.14
13/16	22	8.00	1-15/64	7 1/2	4.51
55/64	5 1/2	2.02	1-21/64	5 1/2	5.38
7/8	4 1/4	2.02	1-11/32	9 1/2	5.38
57/64	5 1/4	2.12	1-15/32	8	6.13
15/16	9 3/4	2.20	1-17/32	7	7.16
15/16	5 1/4	4.00	1-11/16	12	9.13
61/64	4 1/7	2.42	1-3/4	5	6.00
31/32	4 1/4	2.42	2-5/16	24	27.50
1-1/32	6	2.76	2-3/8	24	30.00
1-3/64	8	2.82		9	34.50
1-1/16	7 1/4	3.22			
1-5/64	7 3/4	3.33			

Large quantities available in every size. 5% DISCOUNT ON PURCHASES OF \$50 OR MORE. 10% DISCOUNT ON PURCHASES OF \$100 OR MORE.

HIGH SPEED MORSE TAPER SHANK DRILLS



SET 9W 15 Different Size High Speed Morse Taper Shank Drills up to 9/16" with No. 1 and 2 tapers. New and used. \$50 value. Priced at only... **\$6.49**

SET 10W 20 Different Size High Speed Morse Taper Shank Drills from 1/4" to 1". New and used. \$70 value. Priced at only... **\$12.95**

SET H. S. STRAIGHT SHANK DRILLS. 10 different sizes; 1/4" to 1/2". 7W lengths up to 7". New and used. Shank diameter same as drill, only... **\$3.98**

HIGH SPEED DRILLS

1/4" to 1/2" with 1/4" Shanks
1/2" to 1" with 1/2" Shanks



For the first time at these low prices! **HIGH SPEED DRILL BITS UP TO 1/2" FOR YOUR 1/4" DRILL AND HIGH SPEED DRILL BITS UP TO 1-3/16" FOR YOUR 1/2" DRILL.** The Tungsten steel content of these drills means they will outlast carbon and regular steel drills many, many times! Drills are used surplus; have plenty of flute length, are sharpened and ready for your drill.

DRILLS UP TO 1/2" FOR YOUR 1/4" DRILLS!

Will Fit Any Size Chuck 1/4" and Larger.

SIZE	PRICE EA.	SIZE	PRICE EA.
1/4	\$3.30	25/64	\$6.60
17/64	.45	13/32	.60
9/32	.45	27/64	.65
19/64	.48	7/16	.65
5/16	.48	29/64	.73
21/64	.50	15/32	.73
11/32	.50	31/64	.75
23/64	.55	37/64	.90
3/8	.55	17/32	.90

DRILLS UP TO 1-3/16" FOR YOUR 1/2" DRILLS!

Will Fit Any Size Chuck 1/2" and Larger.

SIZE	PRICE EA.	SIZE	PRICE EA.
33/64	\$0.91	55/64	\$2.25
17/32	.91	7/8	2.25
37/64	1.24	57/64	2.25
19/32	1.24	59/64	2.40
39/64	1.30	15/16	2.43
41/64	1.43	31/32	2.50
21/32	1.43	1-1/32	2.80
43/64	1.55	1-1/16	3.05
23/32	1.70	1-5/64	3.56
47/64	1.80	1-3/32	3.60
49/64	1.80	1-7/64	3.60
25/32	1.80	1-9/64	3.98
51/64	1.86	1-5/32	3.98
13/16	2.05	1-11/64	3.98
53/64	2.05	1-3/16	4.10

Large quantities available in every size with special discounts for quantities. We can furnish drills from 1" up, with any size shank. Write us your special needs.

High Speed Taper Shank Chucking Reamers



SET 15 Different Size High Speed Morse Taper Shank Chucking Reamers up to 1 1/2" with No. 1 and 2 tapers. New and used. Priced at only... **\$6.95**

SET 8 Different Size High Speed Morse Taper Shank Chucking Reamers from 1/4" to 1". New and used. Priced at only... **\$4.95**

SET 10 Different Size High Speed Morse Taper Shank Chucking Reamers from 1/2" to 1 1/2". New and used. \$65.00 value. Priced at only... **\$9.95**

SET 5 different size H. S. Morse Taper Shank Chucking Reamers from 1" to 2 3/4". New and used. Priced at only... **\$11.95**

HIGH SPEED HAND TAPS

SIZE	PRICE EA.	CONDITION	PRICE EA.
8-3/6 (new)	\$3.25	5/8-NF	\$.66
1/4-NC or NF	.26	3/4-NF	.80
5/16-NC or NF	.29	1-NF	1.25
3/8-NC or NF	.33	1 1/8 pipe	1.25
7/16-NC or NF	.35	3/8 pipe	.50
1/2-NC or NF	.47	1/2 pipe	.90
9/16-NC	.60	3/4 pipe	1.25

NEW CARBIDE TIP MASONRY DRILLS

Carbide tip goes through any masonry. Set of 5 bits containing one 7/32"; three 1/4" and one 5/16", all five, \$10 value. Priced at only... **\$2.49**

4 H. S. SLITTING SAWS WITH MANDRELS

SET 4 different size H. S. 14W Slitting Saws, 2 3/4" dia. by 1" arbor. Thickness from .040 to .071. Cuts wood, aluminum, brass, steel, etc. Plus special mandrel which enables use of saws in 1/4" or 1/2" electric drill. New and used. Added FREE of charge, two 3/2" arbor grinding wheels which will fit above mandrel. All 7 of above items, only... **\$3.49**

7 selected, sharp H. S. Slitting saws as above to use on your own mandrel or milling machine. New and used. A bargain at... **\$4.95**

GRINDING WHEEL DEPT.

All grinding wheels are new standard brands.

2"x1/4"x1/4" arbor MIX polishing wheels	25c ea.
2"x3/8"x1/4" arbor 60-grit wheels	25c ea.
2"x3/8"x3/8" arbor 60-grit wheels	25c ea.
3"x1/4"x1/4" arbor MIX polishing wheels	30c ea.
3"x1/2"x1/4" arbor 60-grit wheels	30c ea.
4"x1/16"x1/4" arbor cut-off wheels	20c ea.
4"x1/4"x1/4" arbor 180-grit polish wheels	35c ea.
Mandrel for using above stones in 1/4" drill	12c ea.
2 1/4"x1"x5/16" arbor 80-grit vitrified bond wheels	35c ea.
2 1/4"x1 1/2"x1/2" arbor 60-grit red wheel	25c ea.
2 3/4"x3/8"x1/2" arbor 40-grit red wheel	30c ea.
4"x1/2"x1/2" arbor Norton 130-grit wheel	65c ea.
8"x1 1/2"x1/2" arbor cut-off wheel	70c ea.
6"x1/4"x5/8" arbor A303-S-B7 wheel	50c ea.
8"x1/4"x5/8" arbor Aluminum oxide resinoid 1-20A75 wheel	75c ea.
8"x1 1/2"x5/8" arbor cut-off wheel	70c ea.
Mandrel for using above stones in 1/4" or 1/2" drill	30c ea.
50 1/4" & 3/16" shank mounted stones, rounds, points, cylinders, etc.	\$4.95
12 1/4" shank, mounted stones, various shapes	\$1.98

H. S. DRILLS & REAMERS BY THE POUND!

A tremendous bargain! Over \$20,000 worth in a 2000-lb. mixture of H. S. taper shank drills and reamers, sizes from 1/2" to 1 1/4". Approximately 2500 pcs. These are good used drills and reamers, sharp, in excellent condition and ready to go! Your choice of drills, reamers or proportionate mixture of both at an amazing low price of... **\$1,000**
F.O.B. Tulsa

Money-Back Guarantee—All Mide. Mixture of New and Reconditioned Tools Unless Specified Brand New—All Orders (Except Those Specified F.O.B. Tulsa) Are Shipped Post Paid, saving you up to 25% on total delivered cost.

Write for Free Catalog Describing Thousands of Bargain Cutting Tools.

HIGH SPEED WOODRUFF

KEY SEAT CUTTER

SET 5 different size cutters. Can be used as mounted milling 4W cutter or circular saw. All with 3/8" and 1/2" shanks, widths up to 1 1/4", dia. up to 1". New and used. Priced at only... **\$3.95**



Bargain Tool & Shop Mixes!—PPD

FILE MIX—BRAND NEW: Set of 12 different files, lengths 6, 8, 10, 12 in. Half rounds, bastards, knife, mills, etc. First line Nichols, Heller and other brands... **\$3.49**

SPRING MIX: 300 new springs, compression, tension and torsion types up to 6" in length, only... **\$1.79**

HAND REAMER MIX: 8 different size hand reamers up to 3/8" including 3 taper pin reamers. Majority of reamers in new condition... **\$3.69**

MILLING CUTTER MIX: Assortment of 4 various size H. S. milling cutters, all with 1" arbors; up to 3" dia. only... **\$3.98**

NEW ROTARY FILE MIX: 7 different size H. S. files, 1/4" shanks. New cost as high as \$2.00 ea. Only... **\$4.49**

DRILL BIT MIX: Over 300 pcs. (2 lbs.) of used H. S. drill bits up to 1/4". Most require sharpening. Ideal for pin punches, drift pins, etc. Less than 1c ea. at... **\$2.98**

SURPRISE MIX!

Over 50 pcs. for your 1/4" electric drill including rotary files, drills, bits, reamers, grinding wheels and arbors for our customers who like pleasant surprises. Your money back if you aren't satisfied... **\$2.98**

90° HEAVY DUTY GEAR BOX:

Ball-bearing throughout with 1/2" drive spline. 1:1 gear ratio which can be changed by different size pulleys or gears. Wt. 5 1/2 lbs. Length 11", beveled gears. Excellent for hot rods, power mowers, etc. Only... **\$5.95**

10 TO 1 GEAR BOX: Throw-out type clutch, ball-bearing throughout. 1/2" drive spline, 3 1/4" output gear, rated up to 6 H.P. Wt. 5 lbs... **\$6.49**

BRAND NEW PUMP AND MOTOR

Pump has 1" connections, built-in relief valve, adjustable up to 1500 lbs. Max. capacity 6 GPM. 1 1/2 H.P., 24-volt motor, 4000 RPM. Can be used on 12 or 36 volts. 500 units available at quantity discounts. **\$9.98**
counts. CLOSE OUT AT... F.O.B. TULSA



NEW MASTER HYDRAULIC CONTROL VALVE

For controlling two single or double action cylinders separately or simultaneously. Valve is close center type. 1500 PSI rating, only... **\$9.98**

Hydraulic Hose, 10-ft. sections, 1500-lb. test, 3/8" male pipe connections, only... **\$3.25 ea.**

6-ft. section, 1500-lb. test, 1/2" male pipe connections, only... **\$1.98**

P1A PESCO PUMP gear type, displacement 1 1/4 GPM at 1,500 PSI. Continuous operating speed, 3,750 RPM. Pump is driven by 1/2" spline... \$9.49



Dis. on Quantities

HIGH SPEED STRAIGHT SHANK DOUBLE END END MILLS

SET 4 Right hand twist 7/16 shank end mills, size 5/16 to 7/16. New and used... **\$3.95**



ARMSTRONG



Tool Holders and Tools

ARMSTRONG has made many distinguished contributions to the growth of American industry. By introducing the Armstrong System of Tool Holders, ARMSTRONG... replaced individually hand forged cutting tools with readily available permanent multi-purpose ARMSTRONG TOOL HOLDERS; reduced tooling-up for any operation on lathes, planers, slotters and shapers to the selection of the correct ARMSTRONG TOOL HOLDER.

In its 60 years of specialization in the manufacture of quality tools, ARMSTRONG has also contributed much to the improvement of drop-forged Wrenches, Clamps, Lathe Dogs, Jacks and pipe working tools... contributed much not only in the "tool sense" tool strength and lower tool costs but in the refinement of tool designs, aptness, balance and finish.

There are no finer tools than ARMSTRONG TOOLS, which carry the Arm-and-Hammer Trade Mark. Look for this quality emblem. It guarantees complete satisfaction.

Write for Catalog

ARMSTRONG BROS. TOOL CO.

5268 W. Armstrong Ave., Chicago 30, U.S.A.



IT'S NEW! IT'S SIMPLE! IT WORKS!

START THAT COLD CAR RIGHT NOW

PROMPTLY — SURELY — SAFELY

Make a few simple changes in your ignition circuit and forget about starting difficulties, winter or summer! No removal or replacement. Parts available everywhere for under \$10.00.

Mass production of this sub-circuit in our factory has been inhibited by defense orders.

Send for the Simple Print, with Full Instructions and Unconditional Guarantee, only 1.00, postpaid. Ask for Packet 12.

OTIS RADIO AND ELECTRIC CORP.
BOX 152, HAWARDEN, IOWA

NEVERSLIP PULLEY

Transmits more power with less belt wear, unaffected by weather. No pulley covering, no belt dressing required. Replace troublesome pulleys with NEVERSLIPS. All sizes. Money-back guarantee. Ask for NEVERSLIP Pulleys on ALL power machinery you buy. Write for Folder and prices.

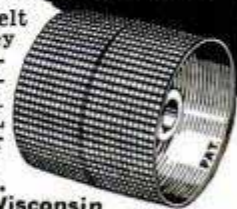

ROSENTHAL CORN HUSKER CO.
Box 16 Milwaukee, Wisconsin

SPORTONE MUFFLERS

Ford & Chevrolet.....\$ 4.45
All other popular cars..... 5.45
V-8 Dual Sets..... 15.95
Chromed Silentips..... 2.95
(Please state make & year of car on all orders.)

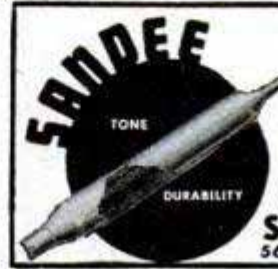

SANDEE MUFFLER CO.
5643 Corryne Place • Culver City, California

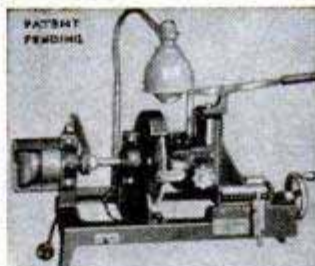

Start a NEW BUSINESS!

or Add to your present Repair Business

SHARPEN DULL PIPE WRENCHES

PIPE TAPS & DIES
"GUM" CIRCULAR SAWS
Write for Information

J. C. MOORE INDUSTRIES
BOX M 276 FREDONIA, PA.



"I CAN SAVE YOU 50% ON NEW BINOCULARS!"

says DAVE BUSHNELL



Again the BUSHNELL PLAN saves you money! These vastly improved, 1952 models are designed and triple-tested for greatest Hunting efficiency — Both give you • New, superior optical systems • Achromatic, color-corrected lenses. • All lenses-prisms hard coated. • X-Cello weatherlight sealing. • AL TEMP lubrication. • Hard leather case and straps.

7 POWER 35MM ALL PURPOSE

• Featherlight magnesium body—17 oz. • Field 375', 4 3/4" x 5 3/4". . . AND all the features above.

(Heavier aluminum model \$54.50* (\$150 Value)
\$45.50*)



NEW! 7 POWER MODEL

• Palm-pocket size 2 1/4" x 4". Wide field. 15mm obj.

Wt. 5 oz.... AND all the features above. Never before at this special low price. \$19.95* (\$49 value)

30 DAY FREE TRIAL!

MONEY BACK GUARANTEE LIFETIME REPAIR & SERVICE PLAN SUPPLY GREATLY LIMITED! ORDER NOW!

*ADD USUAL 20% FEDERAL TAX

33 Additional Models \$17.95* UP

"How To Select Binoculars"

BUSHNELL Binoculars

Dept. M41 Bushnell Bldg., Pasadena 1, Calif.



MAKE YOUR OWN!



GRIFFIN LEATHERCRAFT KITS

Best assortment of tools, materials in U.S.A.! Send 25¢ for 116-page catalog. (money refunded first order)

GRIFFIN CRAFT SUPPLIES

SINCE 1924

5626-A Telegraph Ave., Oakland 9, Calif

over 100 PLANS \$1.00

Build Shelves, Furniture, Games, Novelties, Ornaments!

New... plans for over 100 items that you can build at home. Finest selection available. Easy to make, full instructions included. Furniture for kitchen, living room, lawn, plus novelties, games and shelves. Send \$1 to...

WOODCRAFT PLANS, Dept. 23
3933 N. 28th ST. • MILWAUKEE 16, WIS.

ALNICO MAGNETS LIFT 175-lb.

AMAZING PERMANENT MAGNETS — WILL NOT WEAKEN! NON-ELECTRIC. Retrieve guns, tackle, tools and other steel items from lake, river, plating tanks, drains or other hard-to-reach spots. Recover drills, taps, etc. from floor sweepings. Clear alley of harmful tacks, nails. Many other uses listed. Pays for itself quickly. GUARANTEED: Try any magnet one week. Money refunded if you are not well-pleased. Cat. No. 675 (Has pull of 175 lbs. on a flat steel block).....\$10.50
Cat. No. 650 (150 lb. pull) \$8.50 Cat. No. 530 (30 lb. pull) \$3.00
Cat. No. 550 (50 lb. pull) \$4.00 Send M.O. or check. We pay postage.
Cat. No. 30—Hobbyist assortment of six medium magnets.....\$1.50

MIAMI MAGNET CO.,
3240 N.W. 27th Ave., Aviation Bldg. No. 43, Miami, Florida



KEEP UP...

the easy,
entertaining way with the
latest in every field of science:

read **SCIENCE DIGEST**, the pocket size review of up-to-the-minute science news.

From thousands of reports of important science events, only the best are selected for the pages of **SCIENCE DIGEST**. Skilled editors condense each report for quick reading, replacing difficult technical terminology with easy-to-read language . . . even complicated science discoveries are clear to the **SCIENCE DIGEST** reader.

To understand the facts about what this changing world means to you, see **SCIENCE DIGEST** every month. Use the handy coupon below to order **SCIENCE DIGEST** for the time you prefer . . . or, if you would rather not clip your copy of **POPULAR MECHANICS** Golden Anniversary issue, send your order on any stationery.

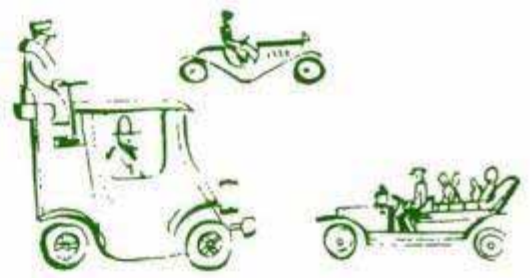

YES SEND ME

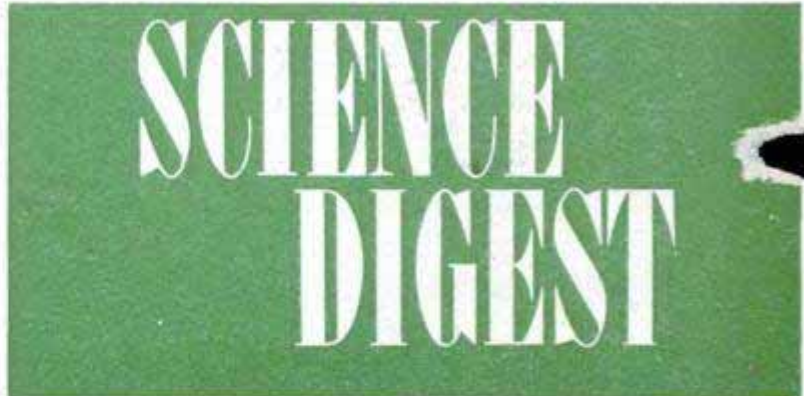

I am enclosing \$3.00 for one year \$5.00 for two years

Name.....

Street.....

City..... Zone..... State.....

Clip and mail with your check or a money order to

SCIENCE DIGEST,
200 E. Ontario Street, Chicago 11, Illinois

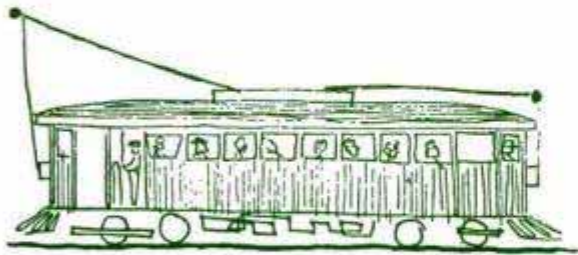

Heike's 1952 Hobby Catalog - 35c



Collector's Catalog of historical and scientific items. — Selling: 450 historical firearms — 20,000 Indian Relics — Collectors Cartridges — Coins — Confederate Money. — Revolutionary, Civil War, Indian Wars, Flintlocks, percussion muskets, Swords, Bayonets, Pistols, Revolvers, Ramrods, Bullet Molds, Percussion Caps, Powder Flasks, Powderhorns, Blunderbusses, Civil War Handgrenades, — Stagecoach Carbines, Winchester Rifles, Kentucky Rifles, Pepperboxes, Gun Barrels — Locks — Nipples. — **ARROWHEADS**, Tomahawks, Battle Axes, Gempoints, Spearheads, Peace Pipes, Arrow making stones, Discoidals, Bannerstones, Gorgets. — Steerhorns, Buffalo Horns, Eagle Feathers, Deer Horns, Elk Antlers, Bo-wood, Blohorns, Mounted Squirrels, Pheasants, Ducks, Owls, Qualls. — **AGATES**, Fossils, Minerals, Marine Shells, Violin Wood — Daguerreotypes, Ambrotypes, Scalping Knives, Duelling Pistols, Gold Dollars, etc., too numerous to mention.

SPECIAL: 5 Arrowheads \$1.23 — Tomahawk \$3.85 — Hammerstone \$1.85 — Civil War Musket \$28.00 — Bayonet \$1.98 — Civil War Sword \$8.88 — Powderhorn \$9.45 — Scalping Knife \$1.88 — 25 Indianhead Cents \$2.45 — Agate, Fossil, Rattler Geode, Galena, Pyrite, Gastropod, Molybdenum, Crinoid, each \$.48 — all for \$62.00.

Send for your profusely illustrated 1952 catalog today. Only 35c, to cover handling.

R. HEIKE, 152 M Street, Wenona, Ill.

LIQUID MARBLE

Mold, Brush, Trowel, Spray It!



material makes \$1 seller. Make Marbelized floors, Tile Walls. Colorful, glossy, amazing! Easily learned; start in garage or basement. Particulars free.

MARBELIZING SERVICE, Dept. 10-F, Edwardsville, Ill.

COMPOSITION FLOORS FLEXIBLE MOLDS MOLD novelties, Statuary, Art Goods in Flexible Plastic Molds; 5c



AUTOMATIC RETOOTHER

MAKES NEW PROFITS

for HAND SAWS

Cuts new teeth in 50 seconds — any size 4 to 16 points. Old teeth fall off as chips. Easy to operate. A perfect job.

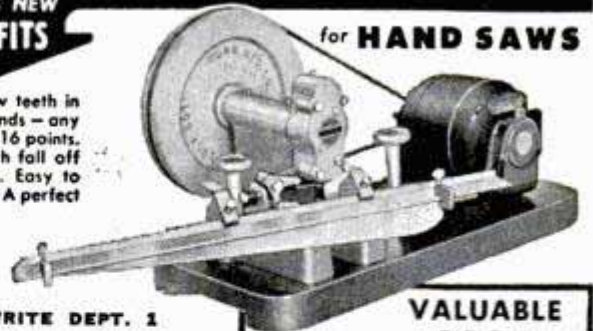

WRITE DEPT. 1

BURR MFG. CO.
8933 VENICE BLVD.
LOS ANGELES 34, CALIFORNIA

VALUABLE BOOK

25¢

Order Burr's Blue Book of Coast to Coast prices for saw shop services

MAKE MONEY SELLING ESHELMAN TRACTORS PLOWING SNOW FROM ROADS AND DRIVEWAYS

RAKES PLOWS CULTIVATES HARROWS HAULS SPRAYS SAWS DOZER MOWS CUTS ROLLS TILLS SNOW PLOW

ESHELMAN

1 1/2-3 1/2 H.P.

\$95 PLUS TOOLS



MAKES WINTER JOBS EASIER

Also SNOW PLOWS & RIDING TRACTORS & POWER REVERSE Women can operate it.

Free Catalog. Write ESHELMAN, Dept. 305 119 Light St., Balto. 2, Md.



WOODWORKING VISE

for amateurs and professionals

USE UPRIGHT — FLAT — AT ANY ANGLE MAIL CARD FOR FREE FOLDER TODAY

THE WILL-BURT CO., Dept. PM-11, Orrville, Ohio

TRAILER AXLES

2 TON LOAD CAPACITY FINGER-TIP CONTROLLED

14"x2" Electric Brakes

New Never Used Surplus.

2" Sq. Solid Steel. Adaptable for Dual Wheel Mounting.



Comes complete with wiring springs for light and heavy duty load... spring saddles... U-bolts and shackles... hubs and Timken bearings... 20" wheels and brake controller.

60" Tread Straight Axle \$88.00
72" Tread 4" Drop Axle \$106.00
84" Tread 4" Drop Axle \$116.00
All prices F.O.B. 40% deposit required with order.

Broadway Trailer Center U. S. HWY. 22, NORTH BRANCH, N.J.



U. S. AIR CORPS FLYING HELMETS 3 for \$1.00

Brand New! Send only \$1.00. We will prepay one small, one medium and one large size genuine Air Corps Flying Helmet. For pilots, racers, sportsmen, etc. Excellent gift.

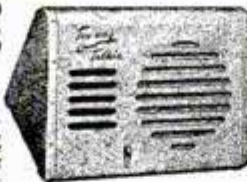

TWO-WAY TALKIES

BRAND NEW Mfg. & Guaranteed \$16.95 Pair by Dictograph Corp. Two way conversation from room to room, office to office, building to building, etc. No outside power required, operates on standard flashlight batteries. Additional stations may be added as needed. Two stations, complete with wire, guaranteed... ready to use only \$16.95. Payment with order—we pay postage.

FLASH



2250 McKinley, Dept. M-1 SHAW'S SURPLUS FRESNO, CALIF.



WORK BENCH

Built to Last a Lifetime!

With Bottom Shelf and 18" Sq. Drawer. 2"x6", Solid Plank, Grooved and Dovetailed Top and 1"x8" Back Rail, Shellacked to a Smooth, Satiny Finish.

MOHAWK LUMBER CO. Dept. 33 14525 W. Chicago Blvd. Detroit 27, Mich. Enclosed Check Money Order for \$..... Ship..... CHIEF WORK BENCHES at Quantity \$19.95 each, F.O.B. Detroit, Mich. Send C.O.D., \$5 Deposit Enclosed.

NAME..... ADDRESS..... CITY..... STATE.....

6 Ft. Long • 34" High • 26" Deep. Shipped Knock-down, with Bolts, Nuts and Screws and ABC Chart for Quick, Simple Assembly.

Prompt Delivery MOHAWK LUMBER CO. 14525 W. Chicago Boulevard DETROIT 27, MICHIGAN



\$19.95 F.O.B. DETROIT

Send Check or Money Order, or Will Ship C. O. D. (\$5 Deposit)



You can do
80% of your
Woodworking
Jobs

WITH THIS
DELTA
Saw-Jointer
UNIT

A BASIC SHOP IN ITSELF—rips, miters, cross-cuts, angle rips . . . makes double miters, cut offs . . . joints, planes . . . with accessories, it makes dado grooves, shapes, tenons, rabbets, etc.

Here's the greatest time-effort-space saver you ever saw! It performs most of your woodworking operations, without converting. That means each operation can be performed *in sequence*, without changing over your machine between steps.

For example:

1. Set the circular saw to within $\frac{1}{16}$ " of dimension and make your cut.
2. Set the jointer for $\frac{1}{16}$ ", run the piece through—and there you are, with a perfect, true, square edge.

These two basic tools are run by the same motor. You can operate both at the same time, or either one individually. Each tool is of correct working height and there's no interference.

This efficient combination tool is a favorite with experienced home-crafters. It has the dependable, built-in precision quality that has established Delta's fine reputation in Industry and among home-shop enthusiasts.

See this great tool at your Delta dealer. Also send for the valuable free book "How to Start Your Home Workshop"—packed with pictures, good ideas, practical suggestions. Use the coupon.

SEE HOW DELTA ACCESSORIES ENABLE YOU TO DO
COUNTLESS EXTRA THINGS

With the Delta Moulding Cutter Head and a set of cutter knives you can cut almost any conceivable moulding shape. You can add more knives as you want them. Other versatile accessories include tenoner and a dado head.

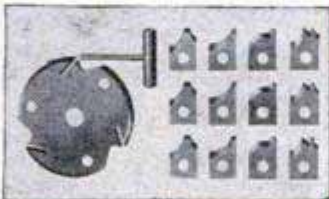

DELTA POWER TOOLS

Another  Product

DELTA Wood and Metal Working
MILWAUKEE Power Tools FOR HOME AND INDUSTRY

DELTA POWER TOOL DIVISION
Rockwell MANUFACTURING COMPANY
803 A E. VIENNA AVE. • MILWAUKEE 1, WIS.

- Send me free "How to Start Your Home Workshop"
 Send me the name of the nearest Delta dealer

Name _____

Address _____

City _____ Zone _____ State _____

53 MACHINES • 246 MODELS • MORE THAN 1300 ACCESSORIES

SAVE 50% - THOUSANDS HAVE ASSEMBLED

\$42^{UP}

PACKAGED BOAT KITS

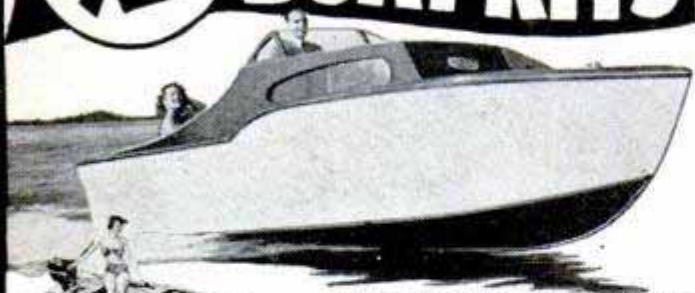

27 NEW MODELS

● Yes, thousands have assembled Packaged Boat Kits, dinghies, skiffs, racers, outboards, inboards, cruisers . . . and so can you! Experience is not necessary. Only simple household tools are needed. It's easy, it's fun, and you save 50%! All parts are furnished pre-cut or pre-fabricated from the finest materials. Many exclusive construction features assure easy and rapid assembly. You'll get all the facts from our big 24 page catalog. You'll see how Packaged Boats are built, how they perform, how exclusive "Girder Construction" makes possible setting up the basic framework without driving a screw. All 27 models fully illustrated including specifications and performance data plus a complete line of marine hardware and paints.

SEND 25c for CATALOG

New 1952 Models



CUSTOM-CRAFT - DEPT. 8 - BUFFALO 7, N. Y.

BOAT PLANS PATTERNS

Over 50 modern plans and full size patterns. Racing classes, cruisers, inboards, outboards, sail boats. By famous designers. 6' to 30'. DESIGN CATALOG 35¢. Design Catalog and boat building handbook, \$1.00.

MARINE MART - DEPT 8 - BUFFALO 7, N. Y.

NEW! CHEAP! OIL BURNER SWEEPING THE COUNTRY!



SALESMEN BIG MONEY SLIPS INTO ANY COAL RANGE, STOVE OR FURNACE. Amazing quick, intense heat. By finger-tip control. Cheaper than coal. No more shoveling coal or ashes. **SENT ON TRIAL.** Prove it pays for itself quickly by what it saves. \$1 bonus for testing. We'll let you try one in your own home for one month. Write for details today. **NORTHWEST MFG. CO., 556-A Main, Mitchell, S. Dak.**

50-CAL. STEEL AMMO. BOX

Govt. Surplus. A handy, sturdy, welded steel case, 6"x8"x12", with recessed handle. Suitable for valuable instruments, and tools. Protect important papers and records from fire. Armed Forces used it for ammunition because of moisture-tight, dust-tight seal. Needed by mechanics, fishermen, hunters, electricians, machinists, cameramen. Brand new inside. O-D. color. Can take terrific abuse. Limited quantity. As long as they last at this amazingly low price. Add 50c each for Postage and Handling. Sorry, no C.O.D.'s. Satisfaction guaranteed.



GIANT BALLOONS



Neoprene; Surplus Govt. Weather and Target Balloons. Terrific attention getters for Lodges, Civic Events, School Functions, Conventions, Exhibitions, Trade Shows. Advertise your special events in the Hollywood manner. Make any occasion a success. Great back-yard fun. Marvelous for parties, dances, fairs, picnics, all festivities.

3 Ft. Dia. 39c; 6 Ft. Dia. 79c; 13 Ft. Dia. \$1.39
Postage Paid On Pre-Paid Orders
Calif. Res. Add Sales Tax

WAR ASSETS DIV.

Volume Sales Co.
Dept. M-1-52, 3930 Sunset Blvd., Los Angeles 29, Calif.



HOT RUNNING WATER!

Attaches easily, quickly to any standard faucet. Regulates temp. by turning faucet. Operates AC or DC. Comes with 8-ft. rubber cable and plug. Our DELUX heater has delighted many thousands of users. Send \$4.95 cash, check or M.O. — we will ship prepaid or, if you wish, we will ship C.O.D. — you pay postman \$4.95 plus few cents postage. Order 3 for \$12 — save \$2.85.

METROPOLITAN ELECTRONICS CO.
Dept. 360, 106 Fifth Ave., New York 11, N.Y.

ELECTRIC MOTOR BARGAINS!



Every Motor Fully Guaranteed ALL PRICES F.O.B. Write for 32-volt Bargain List

- 1/4 HP 1750 RPM 110 Volt 60 Cy. Split Phase Type \$8.50
- 1/2 HP 3450 RPM 110 Volt, 60 Cy. Capacitor Type 19.75
- 3/4 HP 3450 RPM 110 Volt 60 Cy. Rep. Ind. & Cap. Types 32.00
- 1 HP 3450 RPM 110/220 Volt 60 Cy. Rep. Ind. Type 39.00
- 1 HP 1750 RPM 110/220 Volt 60 Cy. Capacitor Type 52.00

ROBERTS ELECTRIC COMPANY
849 W. Grand, Dept. 19, Chicago 22.



MANUFACTURE LEATHER LOUNGES FOR KITCHENS AND RESTAURANTS

Frames, springs, filling, construction simplified.

Anyone handy with tools can build one.

Send \$5.00 for complete plans and instructions, or 10¢ for brochure.

STEFAN GALENSKI
Designer & Manufacturer

2221 BROADWAY BUFFALO 12, NEW YORK



WAR SURPLUS BARGAINS

\$500,000.00 INVENTORY for QUICK LIQUIDATION

Surplus items—hundreds of them for home, shop, factory, farm and outdoor use. New items, used items, reconditioned items—all at tremendous savings—all priced for quick sale.

Page After Page of Values

This big catalog shows page after page of amazing money saving values. Write for your copy today. Send 10c to cover postage, mailing, etc. Write today!

SEND TODAY FOR YOUR COPY **10c**

STARK'S Dept. 509 So. STATE STREET CHICAGO 5, ILLINOIS

SW-54 \$49⁹⁵

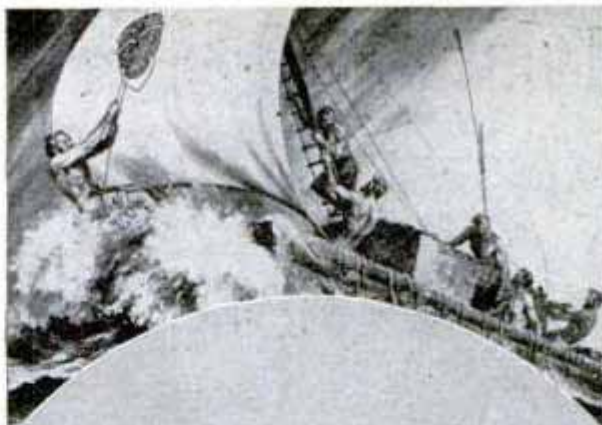

Amazing broadcast and shortwave radio by the makers of professional radio equipment for the

KON-TIKI

expedition of book and movie fame

COVERS THE RADIO WORLD!

Covers all frequencies (broadcast, police, ships, aircraft, amateur) between 540 kcs. and 30 mcs. Uses new miniature tubes for maximum sensitivity. Precision-built. Measures only 11" x 7" x 7"!

Yes, a radio receiver and transmitter built by National, world's most respected maker of professional radio equipment, kept the famed Kon-Tiki Expedition in touch with civilization despite storms, salt spray and even total immersion! Now, at modest cost, you can enjoy a broadcast and shortwave radio with the same rugged, built-in dependability!

Write for name of nearest supplier.

National



NATIONAL COMPANY, Inc.
MALDEN, MASSACHUSETTS

100 POWER MICROSCOPE COMPLETE KIT

\$5.95
postpaid



12-PIECE SET includes full 100 power adjustable focus imported microscope with adjustable plano substage mirror, four blank slides for your own specimens, one small inspection magnifying glass, one eye dropper, one pair tweezers, one tickler, two specimen holders with tops, one sturdy field case. A wonderful gift for all occasions sent postpaid for \$5.95!

Half Price Sale! Imported MAGNIFYING GLASSES

Fine optically ground lenses. Relieve eyestrain on precision work and reading. 2" diameter, special \$1.00 postpaid. 2 1/2" dia., special \$1.35 ppd. 3" dia., special \$1.95 ppd. 3 1/2" dia., special \$2.25 ppd. 4" dia., special \$2.50 ppd.



8X COATED PENSCOPE

\$4.95 postpaid



POCKET TELESCOPE fits in your pocket with a safety clip like a fountain pen, extends to form a powerful scope for spotting game, watching sports events, etc. 8 power coated lens, more powerful than the standard army binocular. A special bargain at this low price.

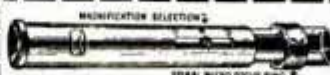

20, 40, 60X POCKET MICROSCOPE

You select power, then focus with spiral ring. Finest optics, a new precision instrument for field use! **\$4.95** Postpaid.....

IMPORTED 300 POWER MICROSCOPE \$14.95!

POSTPAID

LABORATORY MODEL
Triple Revolving Turret Holds 100, 200 and 300 Power Objective Lenses

No frills, just excellent optical qualities, delicate adjustment and solid construction. Its quality and price astounded biology instructors. A lifetime bargain for students, schools, labs, research, amateurs, *Anyone can now own one!* (Performance cannot be duplicated for \$75.00.)

FEATURES: Fine micro adjustment, adjustable plano substage mirror. Dovetail hardwood case included free.

USES: Animal, plant and mineral research. Study plant cells, microscopic animal life, crystalline structure, etc. See the complex anatomy of tiny insects, larvae, eggs. 300 magnifications makes a fly look as large as a bird. If you are not amazed by the quality of this microscope send it back in 10 days. Your money will be refunded immediately. \$5.00 deposit on C.O.D.'s. Send check, cash or money order for \$14.95.



Money-back 10 day guarantee on all items. Send check, cash or M.O. Free catalog on request or included with your order. Calif. residents add 3% state tax.

AKRON ARMY-NAVY STORES 4400 Sunset Blvd. Depl. 1-P
Los Angeles 27, Calif.

WHY NOT SAVE GAS?

Try Ganes At Our Expense



1/2 Million Use Ganes

BOOK GIVEN FREE TO ALL WHO TRY GANE NEEDLES

GANES REPLACE CARBURETOR IDLING ADJUSTMENT SCREW

Install Ganes in a few minutes on all cars

HOW TO GET **150 MILES PER GAL**



Notes for Air flow

10 DAY FREE TRIAL IN YOUR CAR

- TEST FOR**
- ✓ BETTER MILEAGE
 - ✓ EASIER STARTING
 - ✓ FASTER PICKUP
 - ✓ BETTER IDLING

MANY GANE USERS REPORT UP TO 25% MORE MILEAGE AND ALL-AROUND BETTER PERFORMANCE . . . but don't take our word for it . . . see for yourself! Test Ganes in your car for 10 days **AT OUR EXPENSE**. Then, compare your mileage and performance and, if fully satisfied, pay only \$1.50 per needle (8 cylinder cars use 2). If not satisfied, simply return them and owe nothing . . . fair enough? Since authorities differ on the merits of Ganes, and some users report no improvement, **TRY BEFORE YOU BUY!**

ALSO FREE . . . Auto Economy Manual—SENT ABSOLUTELY FREE TO ALL WHO TRY GANE NEEDLES, tells how to save fuel, tires and brakes; how to obtain more speed, power and better performance from any car. Also introduces many new, ingenious auto economy products.

WRITE TODAY! ENCLOSE NO MONEY! PAY POSTMAN NOTHING!

List your name, address, make and year of car, no. of cylinders and make of carburetor if known. **YOUR TWO FREE BOOKS AND GANE NEEDLES WILL BE SENT IMMEDIATELY.**
NATIONAL AUTOMOTIVE RETAIL CORP., Dept. J-1
 350 W. Washington Blvd., Venice, California

Handy Flexible SHAFT

With 1/8 Inch Adjustable Chuck

ONLY \$3.95

Converts any motor, drill press, (electric drill, electric fan (10 inch or larger) into a handy rotary tool.

Attach ROTA-SHAFT in a jiffy. Use for grinding, polishing, sharpening, cleaning, engraving, making tools, carving on metal, plastic, wood, leather, glass. Handles tools from zero to 1/8 inch diameter. 40-inch overall length. Complete with buff and sanding disc ready to use in a drill press chuck. **ORDER TODAY!**

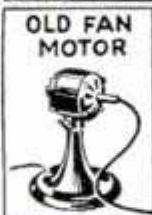

OLD FAN MOTOR



VACUUM CLEANER MOTOR

SEND NO MONEY! Mail your order. Pay postman only \$3.95 plus postage on delivery. Try 10 days — if not delighted return for money back. For use on motor—35c extra for Special Coupling. Give exact size of motor shaft diameter.

STRADER PRODUCTS CO., Dept. E-101
 259 Strader Ave. Cincinnati 26, Ohio



Clark EXPANSIVE BIT

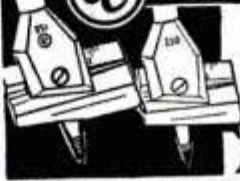

CUTS BETTER • COSTS LESS!

Accurate, fast; cuts smooth holes in hard or soft wood. Chrome vanadium steel blades, all chrome body. No. 250, 1/2" - 1 1/2", \$1.89; No. 251, 3/8" - 3", \$2.19. **GUARANTEED.** At your dealer or write Dept. PM-1

ROBERT H. CLARK COMPANY • Beverly Hills, California

SURPLUS BARGAIN SALE

(all postpaid for cash)



ELECTRIC MOTOR, Delco Model A8364, Cont., 115V., 60Cv., 1 Ph., 6.1 amp., 1/3 hp., 1725 rpm., type SP, unused, tested, wt. 21 lbs. **\$11.95**

GENERATOR, AAF P-1, 200 amps, 28V. etc., Good, Used. **\$16.95**

ACTUATOR, Aircraft, Airsearch electric, 115V., 400Cy., 1 ph., 5500 rpm., .025 hp., 4.5 in. oz. torque, 3" stroke, adj. microswitch limits travel, o.a. length retracted 11 1/2", two rod-end bearings for mounting. **\$3.95**

PUMP, aircraft oil scavenger type, ports not threaded. **\$2.95**

AIRPLANE INSTRUMENTS: some overhauled, some used; airspeeds, tachometers, air, oil, fuel pressures, your choice each. **\$2.95**

CYLINDER, hydraulic, two-way, aircraft hi-pressure quality, 10x1 1/2", stroke 4 3/8", w/fittings (no hose), (6 or more \$3.00) **\$3.95**

REEL OUT, Cordomatic, for reel out lights, solder bench, etc. Extends 9", retracts into housing, w/wire. **\$4.50**

WIRE, field telephone, insulated (4 steel, 3 copper strands each wire), double stranded 2700' spools, single strand over 1 mile. **\$32.50**

DUCK CALLS, Crow calls; good voice, fine wood, choice, each. **\$1.00**

TOGGLE SWITCHES, AAF, "off-on", "on-off-on" (also either momentary contact), each \$.35

WIRE ROPE (flexible cable) 1/4", 6/7 strands, hemp center, 100' for. **\$7.95**

MACHINE SCREWS, round head, standard thread, mixed sizes up to 1 1/2", various lengths, cadmium plated, 10 lbs., postpaid for. **\$2.95**

PUMP, hydraulic hand type wobble, up to 2000# pressure, Good, Used. **\$11.95**

Send cash, check or money order & we'll prepay transit charges.

AERO PARTS SUPPLY, 8102B Lockheed, Houston 17, Texas

Reduce RADIO NOISES



NEW CLEAR-TONE LINE-NOISE ELIMINATOR

Simply Plug Radio or Appliance cord into Noise Eliminator and plug into wall socket. Enjoy reception **FREE** from many distracting noises. Send No Money, pay postman **\$1.25** each (2 for **\$2.00**) plus postage or send cash and we'll mail postpaid. Try 5 days, money back if not delighted. Many hundreds of satisfied users. Send for yours today. **MERIT SALES, Dept. A-30, 4225 Eldone Dr., Baltimore 29, Md. \$2.00**

DUST-O-VAC

FOR HOME WORKSHOP & INDUSTRY

FOR ALL MACHINES — Collects & Bags Wood & Plastic Chips, Wood & Metal Dust, Wood Shavings. 110 AC, DC. **SEND FOR FREE LITERATURE.**

HEAVY CAST ALUMINUM BLOWER — ONLY **\$11.25** For workshop, lab., kitchen, cellar, app. 100 CFM. Send for circular. **UNIVERSAL YONKERS CORP., 137 ALEXANDER ST., M-1, YONKERS 2, N. Y.**

ELECTRIFY SEWING MACHINE

your **NEW LOW PRICE!**

\$11.50 1 YR. GUARANTEE

Buy direct from manufacturer and save! Kit comes fully wired, installed in a jiffy. Fits all machines! You get **ALL-NEW PARTS:**

- Motor & Bracket
- AC-DC 115v 60c
- Multi-speed foot control
- Cord set & block
- Easy instructions
- Steel pulley & belt

FREE . . . reg. \$2.95 chrome SEWLITE given with every kit.

10 DAY FREE TRIAL — ORDER NOW! Send no money, pay COD or send money order and we'll pay postage. Please state whether wheel on your machine turns toward you or away from you. Shipping wt. 6 lbs. **SENIOR SEWING MACHINE CO.** 1046 BEDFORD AVENUE Dept. PM-33 Brooklyn 5, N. Y.



NOW.. *Martin* GIVES YOU



AQUAMATIC

Twist-Shift

SHIFT-SPEED-STEER...with One-Hand Control



Martin
"75"

Aquamatic
Twist-Shift
(Illustrated)
Alternate
Firing Twin
7.5 H.P.
49 lbs.

FREE!

Complete, colorfully
illustrated literature
on all the great, new
MARTIN MOTORS
for 1952. Write:
MARTIN MOTORS,
Dept. 5210,
Eau Claire, Wis.

SEE

the great,
new for '52
MARTIN
MOTORS
at all leading
boat and sport
shows.

**NOW!
FOR THE
FIRST TIME**

... outboards that give you COMPLETE ONE-HAND CONTROL as you face forward! With MARTIN AQUAMATIC *Twist-Shift* you start in Neutral—SHIFT—SLOW DOWN—SPEED UP—STEER—all with ONE HAND! Gives you new ease, new safety in docking, dodging water traffic—more CON-troll-ABILITY at all times!

MARTIN AQUAMATIC *Twist-Shift* makes outboarding as simple as automatic transmission makes driving. MARTIN AQUAMATIC *Twist-Shift* MOTORS are *More Fun to Run!*

EXCLUSIVE *Martin*
"Performance Tested" FEATURES:

MECHANICALLY-CONTROLLED POPPET VALVES

... Give you automotive smoothness, flood-proof starting, steady acceleration from turtle-pace trolling to thrilling full-throttle ... in seconds!



OIL-SEALED LOWER UNIT ...

Each moving part in a constant OIL bath ...NO greasing ever!

MULTIPLE DISC CLUTCH ...

Does away with shear pins! If propeller hits a snag it stops, as motor runs! Cleared—propeller engages and starts—AUTO-MATICALLY!



PLUS ... Inboard swivel (available on "45" and "75" models) ✓ Full 360 degree steering ✓ Micro-Gem forged counter-balanced steel crankshaft ✓ Matched, diamond-bored connecting rods ✓ Machined and hardened chromoly steel gears ✓ Quiet, muffled, pre-cooled under water exhaust ✓ Improved carburetion and cooling systems ✓ And many others.

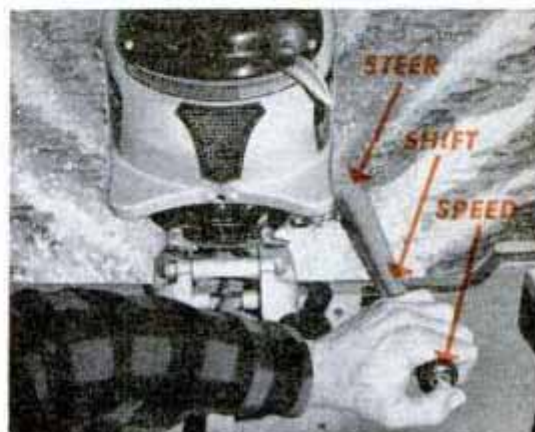

A FULL YEAR GUARANTEE

... and here for the first time ... outboards so precisely engineered, so sturdy, so PUNISHMENT-PROOF that their builders back them with a HISTORY-MAKING FULL-YEAR FACTORY GUARANTEE! Your iron-clad assurance of peak performance and trouble-free enjoyment of your outboard motor, whether you're trolling or speeding, fishing or "just cruising!" Another reason for MARTIN leadership in the outboard motor field!

Ask your MARTIN Dealer to show you how the amazing new MARTIN AQUAMATIC *Twist-Shift* can double your outboard motor fun for years to come!

**Backed by a History-Making
FULL YEAR GUARANTEE**

This protection is given to you in writing in the MARTIN MOTOR GUARANTEE BOND which comes direct-to-you from the factory at Eau Claire, Wisconsin. Never before has such an all-inclusive guarantee been offered by any outboard motor manufacturer! Ask your MARTIN MOTOR dealer for complete details!



OUTBOARD MOTORS

© 1952 M. M.

MARTIN MOTORS

Division: National Pressure Cooker Co., Eau Claire, Wis.

Canadian Sales by: MARTIN MOTORS

Division: National Pressure Cooker Co., (Canada) Ltd,
Wallaceburg, Ontario

"Best Outboards Ever Built!"

NEW!

JUST TWIST AND RAP
TWIST AND RAP

IF YOU USE A
SCREWDRIVER OR
WRENCH YOU NEED AN ...



**SENSATIONAL! FOR LOOSENING
OR TIGHTENING NUTS, BOLTS
OR SCREWS!**

An amazing new development to save tempers and skinned knuckles... hours and dollars... for everyone who works on screws, nuts or bolts. Impakdriver translates the impact from a hammer's blow into a great amount of torque and starts ornery screws, nuts or bolts with unbelievable speed and ease! And it's great for loosening or tightening in hard-to-get-at places. A simple inexpensive tool, yet it beats the toughest problems and the worst time-killers. Belongs in every tool box... mechanics, machinists, repairmen, home handymen, hobbyists, everyone who uses screwdriver or wrench. Pays for itself on the first tough job made easy!



Sold in different set combinations with specially designed attachments for Hex sockets up to 9/16" and two sizes of Phillips and ordinary screwdriver bits.

See the Porter Impakdriver at your dealers or write for folder showing all details.

H. K. PORTER, INC., Somerville 43, Mass.
Porter Cutters Porter Pruners
PORTER-FERGUSON Autobody and Fender Repair Tools

\$300.00
A WEEK FOR YOU
ON ONLY 5 ORDERS
A DAY!

Now—for Millions of Homes!

TEMP-O-MATIC

Amazing Electric "Brain"
URNS HEAT DOWN
at NIGHT — UP in MORNING
AUTOMATICALLY!



The big-profit opportunity of a lifetime! TEMP-O-MATIC, new, "wonder-invention" thermostat control that turns heat DOWN at night and UP in the morning—AUTOMATICALLY! No more remembering—or forgetting—to turn thermostat down at bedtime. No more getting up in a cold house to turn heat up in morning. TEMP-O-MATIC does BOTH — AUTOMATICALLY! Attached in a jiffy to most any type thermostat. Returns its amazing LOW COST first season in fuel savings alone!

Sure-Fire FREE TRIAL SALES PLAN!

Thousands of homes in your territory will say "Yes" when you say "Try TEMP-O-MATIC FREE"—and 8 out of 10 won't let you take it out! Only 5 sales a day can pay you \$300.00 a week cash profit! Act NOW to be first in your territory with TEMP-O-MATIC! Rush your name and address on the coupon below for full details. Don't wait! Mail the coupon NOW!

TEMP-O-MATIC, Dept. D-304, 173 W. Madison, Chicago 2, Ill.

TEMP-O-MATIC, Dept. D-304
173 W. Madison, Chicago 2, Ill.
Please rush "Via Air Mail" complete details about TEMP-O-MATIC and about your sensational FREE TRIAL Sales Plan.

Name.....
Address.....
City..... State.....

MIDGET TRACTOR READY!

CONTRACTORS: load skip mixers, small trucks, level earth!
MUNICIPALITIES: clear snow, back-fill parking trenches, control weeds!
FOUNDRIES: many uses!
FARMERS, ESTATES: clean barn, till soil, plow snow, etc.

**6 FOOT
LIFT!**



Also A
Powerful Bulldozer

Mead's "MIGHTY MOUSE" HI-LIFT Tractor-Dozer pivots within its own length. Weighs only 1300 lbs. yet dozes and hydraulically lifts a 5 cubic foot capacity bucket up to 6 feet! Machine only 40 1/2" wide, 95" long, 3 speeds, 6 H.P. engine. M6-HI-LIFT'S size, maneuverability make it ideal for contractors, municipalities, railroads, farmers, estate owners — where larger units cannot work. Accessories such as dozer blade, mower, etc. available. Write for Free Circular. (Dealers write!)

**MEAD
SPECIALTIES
COMPANY**

Dept. PM-12
4114 No. Knox Avenue,
Chicago 41, Ill.

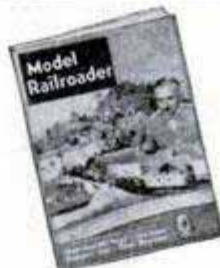

Model railroading is more fun than you think — it's inexpensive too. Get the latest **MODEL RAILROADER** from your newsstand today!

MAGNETS OF ALL TYPES — 10c UP
AMAZINGLY POWERFUL!
1/2 lb. magnet lifts 25 lbs. \$1.95.
Our Leader, 1 lb. magnet lifts 40 lbs. \$2.95. New alloy—will not weaken! Useful for lifting valuables from tanks, lakes, or rivers easily! 7 small magnets \$1.25 with list of many shop and home uses. Satisfaction guaranteed.
R. EYRICH, 1219 W. MEINECKE AVE., MILWAUKEE, WIS.

STANDARD GARDEN AND SMALL FARM TRACTORS
Plow Seed Cultivate Mow Hay and Lawns
Powerful Gas Tractors for Small Farms, Gardeners, Florists, Poultrymen, Fruit Growers, Suburbanites.
1 & 2 Cylinders
High Wheels, Rubber or Steel Tires, Walk or Ride.
Easy Terms — Free Catalog
STANDARD ENGINE CO.
MINNEAPOLIS, MINN.
3221 Como Avenue
NEW YORK, N. Y.
617 West 26th Street



ANTIQUE GUN PRICES



NEW ILLUSTRATED BOOK gives up-to-date prices of over 2,000 American pistols, revolvers. Describes every make, model from flintlock through automatic. Plus information how to collect old guns, make money, etc. Valuable for Buying, Selling, Collecting.

ONLY \$1 postpaid. Order Now. Dept. PO

PIONEER PRESS
Harriman, Tenn.

I'VE BEEN OILING THINGS FOR 50 YEARS WITH 3-IN-ONE



3-IN-ONE OIL

P.S. Reset loose casters and drawer pulls easily with **PLASTIC WOOD**

MASTER ADDRESSER

Lowest Cost Addressing!

MODEL 25
\$2450

(Fed. Tax and supplies extra)

**NO STENCILS
NO PLATES**

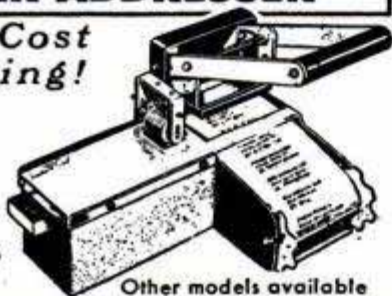

Other models available

Prints from carbon impressions typed on a long strip of paper tape—up to 20 addresses per minute—reproduces from 50 to 100 times. Clean, simple, easy to use. Write for information.

Master Addresser Co.

6500-P West Lake Street • Minneapolis 16, Minnesota

Say You Saw It in Popular Mechanics

AUTO SEAT COVERS

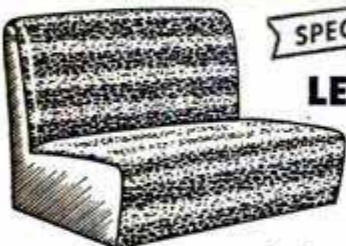

SPECIAL OFFER!

LEOPARD SKIN

Fits All Cars!

- Resists Burns
- Stainproof
- Looks Like Genuine Leopard
- Waterproof
- Greaseproof

Add instant class to your car! Snap-on action holds 'em tight. Color fast. No fade! No Shrink! Wash with damp cloth. **SEND NO MONEY.** Order TODAY at our risk! Give year and make of car, 2-door, 4-door or coupe. Pay postman plus postage. Or, send Cash, Check or Money Order and we pay Postage. Keep 10 days — return for full refund of purchase price if not fully satisfied, but **HURRY** — they'll sell like hot cakes.

Complete Set: FRONT AND REAR

2.98
COUPE OR FRONT SEAT

\$5

YOUNG PRODUCTS

Dept. 96 2605 Elmhurst, Detroit 6, Mich.

Modernize with MARLITE

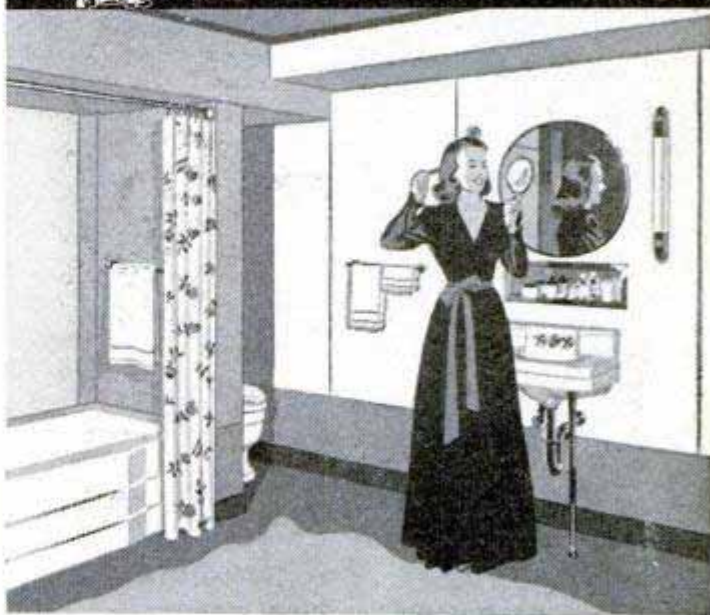

the prefinished wallpanel you can install yourself

With just a little ingenuity and a few carpenters' tools you can enjoy beautiful, sparkling walls and ceilings in your kitchen, bath, recreation room, utility room with Marlite plastic-finished panels. And you can carry out your own personal decorative theme, too. For versatile Marlite offers a wide choice of 63 striking color and pattern combinations.

Year after year, Marlite will save you money. The large wall size panels go up fast and easy. Plastering, painting, periodic redecorating are eliminated. The durable finish is easily cleaned with a damp cloth; hours of housekeeping time are saved. *Plan now to remodel with Marlite.*

Your lumber and building material dealer has genuine Marlite. Mail coupon for free "do-it-yourself" literature.

MARSH WALL PRODUCTS, INC.,
Dept. 142., Dover, Ohio
Subsidiary of Masonite Corporation

Please rush Marlite "how-to-do-it" instructions and full-color folder. I understand there is no obligation.

NAME _____

ADDRESS _____

CITY _____ STATE _____

MARLITE for creating beautiful interiors

SHAVES A WEEK'S
GROWTH SLICK
AS ONE DAY'S



Only
\$15.95

**Whisker® THE SHAVER
THAT CONVINCED THE BARBERS**

Whisker's refined hair-clipper action and .002" thin blade removes 1 to 7 day beards clean and close. Fast . . . 14,400 strokes per minute. Quiet . . . operates on 110 v., 60 cycle AC. No TV or radio interference. Women like Whisker, too, for safely removing superfluous hair on legs and under arms. Get Whisker at your Barber or Dealer.

ELECTRO TOOL CORPORATION
DEPT. W522-A RACINE, WISCONSIN

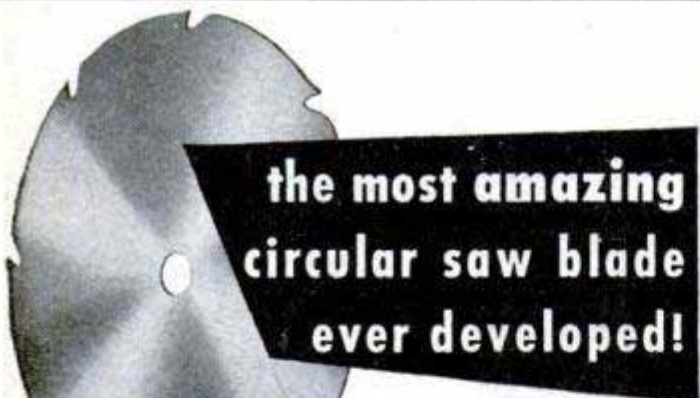

the most amazing
circular saw blade
ever developed!

the NEW Pacific Safti-Cut!

11 improved features...gives truer, smoother cuts ready for edge-gluing without additional finishing.

Using a wedge-like cutting action similar to that of a plane or jointer, the new Pacific Safti-Cut gives cuts so smooth they're ready for gluing without additional finishing! "Kick back" and serious injuries are almost eliminated because the cutting teeth (only 8 or 12) project on 20/1000" above the non-cutting edge. This makes it practically impossible for the blade to pick up the wood and hurl it back at the operator. OTHER IMPORTANT ADVANTAGES... fewer teeth make resharping easy... reduces noise and blade stalling... operates on 30% less power... teeth stay sharper longer because they're made from nickel chrome steel.

Order your Safti-Cut NOW!

Dia.	8 tooth	12 tooth
6"	\$3.60	
7"	4.25	\$4.25
8"	4.89	4.89
10"	6.09	6.09

Specify arbor hole dia.

Send check or money order to: WESTERN SAW MFR., INC., 1840 X West Washington Blvd., Los Angeles 7 Agents and dealers wanted

**WELD IT YOURSELF!
IN A JIFFY!**

**Weld, Cut, Braze, Solder
IRON, STEEL, BRONZE, BRASS,
ALUMINUM & OTHER METALS**

Tool and Equipment breakdowns are always annoying and costly. Don't let them bother you. Get a Dynamic Arc Welder. You can do expert work on your very first job. Welders operate from any properly wired 110 V. AC line. The handiest "tool" in your workshop. A Dynamic Welder will save its low cost over and over again in time and money.

**DYNAMIC INDUSTRIAL type
transformer Arc Welder
75 amp. output for Industrial or Workshop use.**

**DYNAMIC
WELDER CO.**

Dept. D2-AC, 13 E. 23rd St.
Chicago 16, Ill.

*Everything
YOU NEED*

One low price gives you a complete welding outfit ready to use. Save Money! Buy direct! Sold on 10 day money back guarantee. Send today for FREE details.



Free Details and "How to Weld"



NEW SAW SHARPENER

Improved #64 Hand Gummer sharpens all types circular saws 4" to 20" diam. Ideal for saw shops. Self-Centering adjustment for quick, easy set-ups. Complete with 1/4 HP motor, 1 grinding wheel & cord. \$79.50 FOB Portland. Wt. 70#. SEND FOR FREE LITERATURE.

P. T. HOBBS MACHINERY
8375 N. INTERSTATE AVE.
Dept. P.M.-61, PORTLAND 17, OREGON

VARIABLE SPEED HYDRAULIC POWER TRANSMISSION



It has Infinite Speeds 0 to 550, Reverse, Automatic Overload Protection; Adjustable Torque up to 180 inch pounds. 5/8" Input and Output Shafts. It will handle 1/2, 1 1/2 H.P. Motor. Case measures 7 1/2" long, 7" high 6 1/2" wide. VALUE OVER \$300. Shipping Wt. 25#. On C.O.D. Orders we require a 10% only Deposit.

\$54.50

DIRZIUS MACHINE SHOP "J" 1423-25 So. 52nd Ave., Cicero 50, Ill.

SET-UP - KNOCKDOWN SAWHORSE with *Jiffy* BRACKETS



No nails or bolts... use 2x4's for legs, 2x4 or wider for crossbar. Rugged, sturdy, easy to move, saves storage space. Sold by hardware and building material dealers, or order direct.

GRAND HAVEN STAMPED PRODUCTS CO., Grand Haven, Mich.

GET 150 MILES PER GALLON

ENGINEERS HAVE PROVEN THIS POSSIBLE

The Electronic Spark Intensifier is only one of many ways you can gain "peak" performance. The manufacturer guarantees the following results or it costs you nothing!

- ✓ Quick Starts On Cold Mornings
- ✓ More Power ✓ Better Mileage

Easily installed in the center hole of the distributor cap of all cars, trucks and tractors, the intensifier boosts the high voltage passing through the distributor . . . giving a "hotter spark." This permits a wider spark gap which reduces misfiring and consequent ring and cylinder wear. A built in resistor protects plugs and other ignition points. FREE TRIAL, send \$2.00 cash, check or money order . . . if not fully satisfied, return for full refund.



ELECTRONIC DEVELOPMENT CO.
Dept PM-1, Box 17716 Los Angeles 34, Calif.

AIRBORNE SALES ♦ WAR SURPLUS AND OTHER BARGAINS ♦ SAVE UP TO 90%

WET BATTERY PLATE
 Extra long life, rechargeable, ideal for portable radios, mobile units, etc. 2 V. 20 Amps. Only 5" high ball float hydrometer, built-in Lucite case. Shipped dry. Used singly or in multiples. Shipping wt. 3 1/2 lbs. Govt. cost approx. \$8-NEW-\$1.95.

HAND MITRE
 It pays its way in just 1 day! It's sensational! New HAND MITRE saves 100's of hours, requires only a "flick" of the hand for a precision mitre every time. HAND MITRE will cut any desired angle. Its rugged construction handles hard and soft wood mouldings, plastic trim, base shoe, laminated materials, rubber extrusions, etc. Made of heavy gauge stainless steel. \$3.95 postpaid.

"BALTIC" SWEDISH TOOLMAKERS VERNIER CALIPER
 ULTRA PRECISION—0.6" in .001 graduations. Quick, accurate depth, inside, outside measurements, fine engraving. Extra heavy rule, hand-fitted sliding head, no side play. Rockwell C.60, lapped measuring surfaces. For the extra particular mechanic who must have the best—used and recommended by most critical experimental and research machinists at Lockheed, Douglas, Bendix, GM, RCA, General Electric. Save 50%! A \$37.50 value—only \$14.75, leather case incl. Also a standard grade Moser Design Caliper made in Germany. For the production machinist, 0-6" in thousandths, the most accurate caliper of this type on the market, 1000's of satisfied users. Only \$10.95, leather case incl. These Calipers are of acceptable quality for precision aircraft work. Both are guaranteed buys, money back if not entirely satisfied. Order now! **New low price due to lower import duty!**

MAGNETIC BASE INDICATOR HOLDER
 For all types of dial indicators with guaranteed lifetime ALNICO magnets. V-slotted base has a 45 to 50 lbs. pull, permits immediate application without clamps or special attachments and mountings can be made on cylindrical surfaces. For machinists, tool-makers and inspectors. Base 3 1/2" long by 1 1/4" wide. NEW. \$3.50 ea.

LOW VOLTAGE CIRCUIT TESTER
 Made for U. S. Ordnance Dept. to rigid specifications. Portable steel hand carrying unit is a self-contained trouble shooting device for making a complete and rapid check of the generator battery circuit, including any circuit and voltage regulators. Battery voltage, regulators, cut-out settings and generator performance can be easily determined. A terrific testing unit for garages, mechanics, truck fleet owners, boat and marine mechanics. Can be used on any 6 or 12 volt system. Govt. cost approx. \$175. NEW—complete with instruction book—only \$32.50. Shipping weight, 20 lbs.

FLEXIBLE SHAFT MAGNET
 For picking up cotter pins, nuts, wrenches, etc., from inaccessible places. Removes Bobbie Pins, etc., from drains. Lifetime Magnetism Guarantee. Highly polished magnet and handle. **\$2.00 postpaid**

RIVET SETS Universal type, case hardened tips. Set of dies will head up any brazier or round head rivet from 1/16" to 1/4". With adapters for air gun or hand use. All new—cost Govt. approx. \$27.00. Complete 15 piece set (wt. 2 lbs.) \$3.00.

DRILL GRINDER Sharpens round, square or tapered drills up to 6" long. Even an amateur mechanic can get a new, factory finish on a drill in 25 seconds. New protractor feature gives every drill sharpening angle, with 5 convenient angles already marked off. Usable with hand or power stone. A brand new development. All New \$2.80 ea. Postpaid in U.S.A.

HIGH SPEED DRILLS All new. Fractional & numbered. Orig. value \$18. Nationally known brand. Assorted sizes. Set of 30, \$3.50

WOODWORKERS DRILLS
 From 3/16" to 1/2" with 1/4" shanks. A \$12.50 value—NEW—just \$2.50 for complete set!

HIGH SPEED STRAIGHT SHANK DRILLS
 10 different size H.S. Straight Shank Jobber Length Drills, 1/4" to 1/2" (shank same diameter as drill). \$25 value. NEW—\$3.50.

HIGH SPEED DRILLS
 SET from 1/4" to 3/4", 5 sizes with 1/4" Shanks—NEW—get this, \$3.00 takes this set!

POCKET-PACK PRECISION WRENCHES
 Made of first quality chrome-molybdenum steel, heat treated and hardened for extra strength. Each wrench accurately broached to close tolerances. Open end wrench on one end and twelve point box on the other means double usefulness and double value. NEW, complete with plastic case—\$1.75 ea. complete—postpaid in U.S.A.

SOCKET-PACK WRENCH SET
 Chrome-plated alloy steel, heat treated, broached to close tolerances. Reversible ratchet handle, with screwdriver bit on reverse side. Built-in spring-loaded ball retainer on both handle and extension. Clear top plastic kit. 10 piece set—NEW—complete \$3.75. POSTPAID in U.S.A.

HEAVY DUTY DROP-FORGED STEEL SHEARS
 Blades inlaid Wolfram Vanadium, guaranteed to hold edge under constant severe use on heavy gauge metals of all types. Duckbill blades for cutting straight, circular or irregular forms. Handy spring opening handles for better leverage. Full hand grip. These shears were imported from Germany and only because we made a terrific deal on them can they be priced—NEW—10" size, \$2.45 ea. 12" size, \$2.95 ea.

MICROMETERS
 Chrome plated, precision engineered, carefully tooled to give long life. All new. 0-1" capacity—\$2.25 ea. 1-2" capacity—\$3.50.

NEW, BIG 1952 CATALOG BARGAINS FOR EVERYONE • SEND 25c FOR YOUR COPY TODAY! ORDER from ad NOW!

Send check, money order or cash. 25% deposit required on C.O.D. orders. All prices F.O.B. Culver City, Calif., unless otherwise stated. **AIRBORNE SALES CO., INC Dept. PM152 CULVER CITY, CALIF. SAVE \$\$\$\$**

SAY YOU SAW IT IN POPULAR MECHANICS

There's BIG MONEY in UNIFORMS and Work Clothes that ADVERTISE!
 Every business and businessman is swinging over to employee uniforms and work clothes, embroidered with company name, trademark, sales message, etc. The field is new. Prospects are everywhere—garages, service stations, factories, coal dealers, dairies—and hundreds more. Profits are huge. You take orders by the dozen and gross! One man made over \$800.00 on a single deal! You get the business everytime because you offer latest style and finest fabrics. Big selling kit sent FREE!
TOPPS, Dept. 611, Rochester, Indiana

THE NEW WATERBORG MILLING ATTACHMENT FOR YOUR DRILL PRESS
 **MAKES AN IDEAL MILLING MACHINE FOR HOME AND SHOP**
 Do model work, tool making or experimental work in your spare time and earn extra money. Sturdy and accurate. Hardened and ground spindle, bronze spindle-bearing, bracket swings out of the way when not in use. 5"x12" table top, 10" longitudinal travel, 7" cross slide. Only \$77.75 complete with bracket for 13", 14", or 15" drill press, 17" bracket \$2.00 higher. Brackets or tables also sold separately. A few jobs will pay for the attachment. Illustrated Circular on request.
WATERBORG MACHINE CO. 2830 RAPIDS DRIVE Dept. PM, RACINE, WIS.

LUFKIN
TAPES
RULES
PRECISION TOOLS

your
standard
of accuracy
for all your
measuring
needs

BUY **LUFKIN**
at your hardware
or tool store

152

THE LUFKIN RULE CO., SAGINAW, MICHIGAN
132-138 LaFayette St., New York City, Barrie, Ontario

BIG PROFITS
Sharpening
Saws!

Cut Perfect New Teeth in a Jiffy
with **FOLEY POWER RETOOTHER**

DOUBLE YOUR PROFITS!
That's exactly what you can do in your own saw repair business with the Foley Saw Retoother! It cuts brand new teeth right over old ones in less than 1 minute, without removing saw handle,—and saves you HALF your filing time. Cuts 20 sizes of teeth from 4 to 16 points per inch on both rip and cross-cut saws, straight or crowned edge. Simple adjustments, no eye strain—no experience needed. Start at home in spare time.
FREE—Foley Price Guide of saw sharpening charges—actual prices in all states—plus Foley Retoother circular. Send coupon today—no salesman will call.

PROOF!
"I don't see how anyone who files saws can get along without the Foley Retoother; it cuts my filing costs and time over one-half!"
H. W. Miller
"Business is very good!—you haven't got a saw repair shop without a Foley Retoother."
Clint Miller

Also see Foley Saw Filer, page 124
and Foley Lawn Mower Sharpener, page 132

**FOLEY MFG. CO., 170-2 FOLEY BLDG.
MINNEAPOLIS 18, MINN.**
Send FREE Price Guide and Foley Retoother circular.

Name _____
Address _____



PARTS FOR MILITARY TRUCKS
FOR JEEP, DODGE, CHEV., GMC, STUDEBAKER, 4 WHEEL DRIVE
AND 6 WHEEL DRIVE. ALSO PARTS CATALOG. WRITE

AXLES FOR TRAILERS

(Surplus) Heavy Duty axles suitable for building of many types of trailers, farm wagons, etc. Standard width straight axle, 2 inch square and is complete with Hubs, Timken bearings, 6 Hole
\$69.50
750x20 or 825x20 wheels, without brakes,
only.....
Dual Wheels.....add \$15.00 extra

All prices quoted good 30 days FOB. Kansas City
25% DEPOSIT REQUIRED ON ALL ORDERS

American AUTO PARTS CO. INC.
1830 LOCUST—DEPT. PM
KANSAS CITY, MISSOURI

**DRAINS Cellars, Laundry Tubs;
CIRCULATES Oil; IRRIGATES Gardens**

Original "Type P" Pump has 2400 GPH capacity. 360 GPH 75' high, or 1500 GPH from 25' well. Use any 1/8 to 1/2 HP motor. DOES NOT CLOG. 1" intake; 3/4" outlet.
Only \$6.95 postpaid if cash with order. (West of Mississippi, add 50c.)
\$6.95
SATISFACTION GUARANTEED OR MONEY BACK!

LABAWCO PUMPS, BELLE MEAD 7, N. J.

SURE FIRE SPARK PLUG INTENSIFIER

NEW UNUSUAL MULTIPLIES HEAT OF SPARK
Insures easier starting, smoother, more economical operation of Outboard Motors, Power Mowers, Generators, any 2 or 4 cycle gasoline engines. NO MORE FOULED PLUGS. SURE FIRE burns excess gas for more power—greater economy—keep plug points clean—lasts longer—pry for itself.
Money back guarantee.

SPECIAL INTRODUCTORY OFFER 50¢ each postpaid
Dealer inquiries invited
600-610 Randall St.
Wahl Products, Inc.
Eau Claire, Wis.

NEW WOOD FASTENERS
hardened steel

Don't Split Wood — Use "CHEVRONS"
Draws wood together eliminating doweling, mortising, Hammer in—"Presto"—a firm joint. No distortion. 3/8" depth, for thickness wood up to 1 1/2". At your dealer or send only \$1.00 NOW for GIANT box, postpaid. Money back if not delighted.

E. B. PACKARD CO., Inc.
Dept. PM-1
139 CEDAR ST.,
NEW YORK 6, N. Y.

Say You Saw It in
POPULAR MECHANICS

SAVE MONEY Build this 18 ft. House Trailer yourself \$286.00.
Blueprints, Building instructions and 1952 parts catalog 50c. Don't Delay, Write Today
NATIONAL TRAILER EQUIPMENT COMPANY
Dept. PM-1, 431 W. MITCHELL ST., MILWAUKEE 4, WISCONSIN

POWER MOWERS & KITS **FREE PLANS**

LOW FACTORY PRICES DIRECT TO YOU

Build your own quality mower with our LOW COST KITS, Parts, Engines. Free Plans guide you. 3 and 4 Wheel Kits, complete. Parts precision finished, ready to use. Write TODAY for Free Plans, Low Prices, Parts List and Guarantee.

3 & 4 Wheel Model 4 Wheel Direct Drive

3-WHEEL KIT NO. T-800

America's Finest Power Mowers completely assembled in 3 and 4 wheel models. Belt or direct drive. 18" and 20" sizes. Nationally known make engine. Latest improved features, sturdy construction and money back guarantee fully described in color folder. Write today.

▼ **TRIANGLE MANUFACTURING CO., Box M-9, Fort Scott, Kansas**

Do Many Home and Farm Jobs FASTER, EASIER with this Multi-Service, Heavy-Duty

Model 381 Mall Drill
Ruggedly Built for Years of Hard Use!



Pay More... Get More!

\$48.00



Equipment: Jacobs geared chuck and key, 10-ft. 3-conductor rubber-covered cord, plug and adapter.

- 3/8" Capacity In Metal — 3/4" in Wood, Masonry, Concrete
- Always Runs Cool Under Load
- Never Stalls Under Hand Pressure
- Perfectly Balanced For Use In Either Hand
- Weighs Only 5 Pounds
- 115-Volt AC-DC Universal Motor

There's a MALL Attachment For Handling All These Shop Uses:



SAWING — Work-saving Slitting Saw cuts wood, plywood, masonite, plasterboard, non-ferrous metals. 0 to 7/8" depth adjustment. 4" Combination blade and adaptor. Only **\$7.50**
 No. 32940

DRILLING — for high-speed, smooth wood boring. 5-Bit Kit No. 38320 — 1/4" to 1/2" dia. by 16ths. **\$4.95**



5-Bit Kit No. 38310 — 1/4" to 3/4" dia. by 8ths. **\$5.50**



Flat Wood Bit Kit drills accurately through hard or soft wood, plywood. Six 3/8" to 1" bits, for straight or angle boring. **\$6.50**
 No. 38850 In Plastic Covered Box.

BELT SANDING — Do professional edge and surface smoothing on cabinets and wood-craft projects with this 2" MALL Belt Sander attachment. 3 assorted belt grits. Light, easy to use. No. 38170. **\$14.95**

DISC SANDING — Mall Sanding Kit for resurfacing floors, walls, woodwork, furniture, touching up auto bodies and fenders. Includes backing pad, 6 abrasives, assembling wrench. No. 35555. **\$4.20**

POLISHING — Put high gloss on metal or wood with 4" Lambs Wool Polishing Pad Attachment. No. 21717. **\$.75**



OTHER TOOLS

- | | |
|---------------------------------------|-------------------------|
| Timber Chain Saws | Flexible Shaft Grinders |
| Impact Wrenches | Electric Planes |
| Pneumatic Saws | Concrete Vibrators |
| Pneumatic Drills And High Cycle Tools | Concrete Surfacers |
| Electric Polishers | Rail Grinders |
| | Electric Screwdrivers |

Write For Complete MALL Catalog

MALL TOOL COMPANY

7805 S. CHICAGO AVE., CHICAGO, ILL.

MASONRY DRILLING — Concrete or brick drill goes fast with a Mall Masonry Drill Kit. Set of 1/4", 3/8", 1/2", 5/8" & 3/4" capacity bits in leather kit. No. 29179. **\$14.15**

To use with Model 381 Mall Drill, use No. 32182 Adaptor **\$1.50** with 1/2" Jacobs Chuck—1/8" to 1/2" Capacity. No. 32081 **\$2.25**.



SCREW DRIVING — Mall Screw Driver Attachment for speedy insertion in wood or metal. 1/4" hex bit capacity for No. 10 wood or No. 12 flat-head screws. No. 26260. **\$10.00**



Mall Sanding & Polishing Kit

Model 381 Drill with adaptors and attachments for sanding and polishing. All-steel carrying case. No. 35100 Kit **\$58.00**



Mall Drill Kit

Handy packaged outfit contains Model 381 Mall Drill, 8 hardened steel drill bits, in all-metal carrying case. No. 28950 **\$59.00**



Mall Grinding Kit

Converts 381 Drill and pedestal to handy turning lathe, grinding and sharpening outfit. Kit includes guides, rests, arm assemblies, grinding wheel, nuts and bolts, No. 23140. **\$7.00**



Heavy Duty Drill Pedestal

Converts 381 Mall Drill to handy stationary position on bench for sanding, grinding, buffing. Fine for handling small model parts, polishing household items. No. 23145— **\$4.00** (Without drill or wheel.)

SEE ALL these top-quality Mall Power Tools and Accessories at your local Mall dealer. If no dealer nearby, your mail order will be promptly filled from Mall factory. Use handy coupon below.

Get This FREE Book

— filled with useful facts about care and maintenance of Electric Drills. Check on coupon below.



AT YOUR DEALERS— OR ORDER DIRECT

MALL TOOL COMPANY, 7805 S. CHICAGO AVE., CHICAGO, ILL.

Please ship prepaid Mall Power Tools and Attachments listed below, subject to money-back guarantee.

Item	Number	Price

() Send FREE Copy "More Holes In A Hurry"

NAME _____
 Address _____
 City _____ Zone _____ State _____



"This proves Wildroot Cream-Oil keeps hair well groomed even if you have cowlicks!"



"He keeps his Wildroot Cream-Oil there because it's his hair's best friend"



"Since using Wildroot Cream-Oil I look twice as good!"

REAMER KELLER

**YOUR HAIR'S
BEST
FRIEND**

America's
Favorite
Hair Tonic!



**NEWEST-FASTEST
PAINT
ROLLER**

**PAINTS A BIG WALL
IN ONE DIP**

**JUMBO "LONEL" ROLLER
HOLDS FULL PINT OF PAINT**



SENSATIONAL E-Z-PAINTR

FOUNT-O-MATIC

*Look for this
colorful*

**FOUNT-O-MATIC
PACKAGE AT
YOUR DEALERS**

Now — cut home painting time in half with Sensational E-Z Paintr FOUNT-O-MATIC! It's the "World's Fastest" paint roller. The secret . . . is the deep-cushioned JUMBO roller of amazing new LONEL pile fabric. Holds a full pint at one dip. Yet there's no cylinder to balance, fill and clean.

FOUNT-O-MATIC applies all paints, even rubber base types and gives you smooth uniform finish on rough or smooth surfaces.

NO TRAY NEEDED
box serves as tray for filling roller. **DISPOSABLE** Liners included for quick color changes.

Ask your paint dealer for FOUNT-O-MATIC today.



Write for free folder on amazing Lonel.

E-Z-Paintr Corporation

Department P-1 BUTLER, WISCONSIN



GOLD-SILVER-COINS

Easily located with new Lightweight M-Scope Detector. Superior performance, lowest price, monthly payment plan.

FREE LITERATURE
FISHER RESEARCH LAB., INC.
PALO ALTO CALIF.

Build Your Own (Not a Toy)

Whiz-Master TABLE SAW

**Full Size Workshop Saw
18 x 20" Table**



\$16⁹⁵

for Everything
COMPLETE
Prepaid

Amazing Value!

- Table Size, 18 x 20"
- Total Height, 12 1/2"
- 7" Saw Blade Furnished (8" blade can be used)
- Depth of cut 1 3/4"
- Saw Arbor Shaft 1/2"
- Oil-Lite Bearings
- Saw Speed, 4000 RPM
- Recommended Motor Pulley, 5"

Kit includes plans, saw blade, fence, miter gauge. Nothing else to buy. Only tools needed are hammer and screw driver.

Save money and have fun. The 18 x 20" wood table top, braces and body for saw are all pre-machined, ready to assemble, to produce an efficient, sturdy saw that performs like saws costing many times this price. Saw arbor and all mechanical parts made of first quality steel.

Cross Cut .. Ripping .. Miter .. Groove .. Dado
Money-Back Guarantee. If not delighted with kit you may return in 5 days for full refund. Send \$16.95 by check or money order. We ship prepaid.

W. B. VERMILLION CO. 2205 Grand Ave., Kansas City, Mo.

Get this **BIG, NEW** book...

The Woodworker's "Bible" Save Time! Save Money!



● **1500 ITEMS AND IDEAS FOR THE WOODWORKER**

● **144 PAGES OF BARGAINS AND HELPFUL INFORMATION**

From cover to cover, it's packed with the world's greatest selection of--fine domestic and imported woods...mouldings...cabinet hardware...tools...machinery...fittings--everything you need at money saving prices.

Guide for Amateur and Expert

Whether you're a beginner...or...an advanced wood craftsman--you should have a copy of Hunt's New Catalog No. 18 for Woodworkers. This remarkable big, new book will show you how you can make hundreds of valuable items in wood--beautiful articles you will be proud to make and use. It will tell you how to get started, what to make, how to save time and money on materials and equipment. It's literally filled with step-by-step instructions, how-to-do-it information, dozens of time and money saving practical hints and ideas, plus all kinds of inviting projects you can easily make at bargain prices you can afford.

It's Full of Bargains

Thousands of beginner and advanced wood craftsmen all over the world have sent for Hunt's New Catalog No. 18 for Woodworkers--the woodworker's "bible." It illustrates 32 rare and fancy woods...5 matched veneers...54 multicolored inlay bandings...and 40 artistic inlays and overlays--all in natural color. Also shows 31 embossed mouldings...24 carved ornaments...and...275 scroll patterns. And it includes 51 pages of all kinds of tools, equipment, and supplies at bargain prices--besides pages of valuable ideas, professional instructions, and up-to-date information. It is the ONE source for everything you need to get started and keep going in woodworking. All woods listed are properly seasoned and kiln dried, and all are correctly graded. You'll get quick delivery on--one board or a carload. Everything is guaranteed. Mail coupon and 15c today--you'll be glad you did.

144 Pages
only **15¢**

THIS FAMOUS BOOK OFFERS YOU . . .

- World's finest selection of imported and domestic woods
- Wide assortment of plywoods, veneers
- Hundreds of mouldings, ornaments, scroll patterns
- 51 pages of tools, equipment, cabinet hardware, fittings
- Pages packed with ideas, information and instructions

EVERYTHING AT MONEY SAVING PRICES

Woodworking--for PROFIT

Hundreds of woodworkers enjoy the thrill of working with rare and beautiful woods . . . and . . . turn their spare time into cash making valuable articles for others. You can, too. Catalog No. 18 lists hundreds of projects you can choose from, whatever your skill.

CRAFTSMAN WOOD SERVICE CO.

2729 S. MARY STREET, DEPT. A-1
CHICAGO 8, ILLINOIS

CRAFTSMAN WOOD SERVICE CO.
2729 S. Mary Street, Dept. A-1
Chicago 8, Illinois

Please send me Hunt's BIG, NEW time and money saving Catalog No. 18 for Woodworkers. Enclosed is 15c

NAME _____

ADDRESS _____

CITY _____ ZONE _____ STATE _____

MAIL THIS COUPON NOW!

NEW TOOLS FOR Craftsmen!

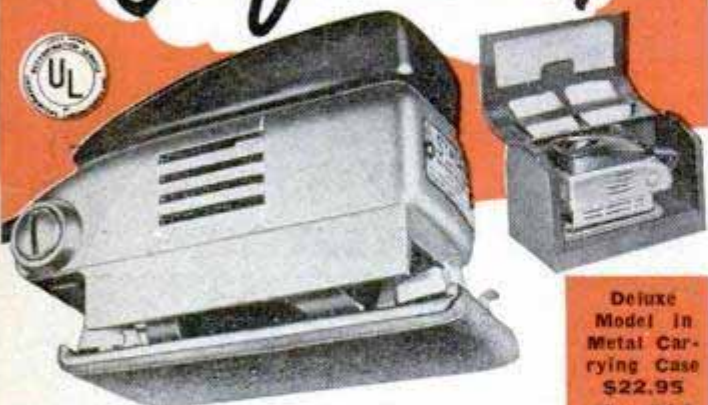

Deluxe Model in Metal Carrying Case \$22.95 No. 504

SYNCR0'S DOUBLE ARC MOTION DOUBLES Sanding Action

Syncro's exclusive Double Arc Motion combines the best features of orbital and straight-line sanding for a satin-smooth finish. Try the Syncro No. 504 before you buy any Sander. Perfect for polishing, too. With new BUILT-IN Reactance Type Electric Motor, \$19.95. Deluxe No. 504 in metal case \$22.95 at dealers or post-paid!

Amazing SAFE JIG SAW CUTS 1" WOOD!



Most powerful, largest of its kind! SAFE—does not pull fingers toward blade. QUIET—ideal for apartments. No Radio or TV interference. Adjustable "any length cut" arm. With BUILT-IN New Reactance Type Electric Motor, \$22.95, at dealers or postpaid.

UL
SYNCR0 POWER UNITS GUARANTEED AGAINST BURN-OUT DURING YOUR OWNERSHIP OR REPLACED FREE!

Those Who Know Buy

SYNCR0

QUALITY ELECTRIC TOOLS

U.S.A. Models: 60 Cycle, 110-120 Volt AC. Other Voltages, Cycles available.

USE COUPON FOR CIRCULAR OR DIRECT ORDER

SYNCR0 CORPORATION, Dept. D-12, OXFORD, MICHIGAN, U.S.A.

SANDER ORDER. I enclose \$_____. Send No. 504 Sander postpaid with Case, \$22.95—without Case, \$19.95.

SAW ORDER. I enclose \$22.95. Send No. 201 postpaid.

FREE CIRCULAR. Send New Syncro Products Circular.

(All Syncros Sold on 10 DAY MONEY BACK TRIAL!)

WRITE NAME, ADDRESS BELOW — MAIL TODAY!

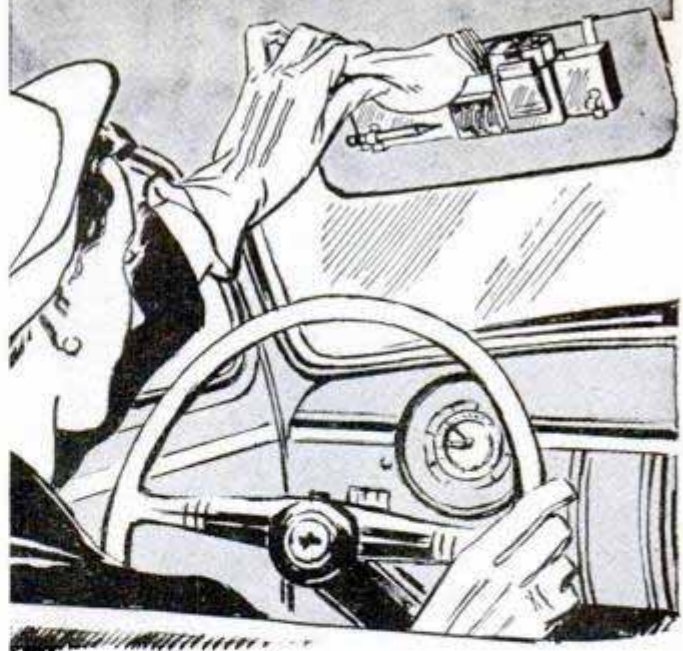

Visor "Hold All"

Attached to an auto visor with two spring clips, a plastic holder is molded with just the right size compartments to store a package of tissues, cigarettes, matches, pencil and small personal items. The holder fits any car and is available in red, blue, green, amber or transparent plastic.



Rat Cafeteria

Baited with a rodent killer called warfarin, a steel box-shaped cafeteria for rats slowly kills all its steady "customers." It has a continuous-supply feed trough with enough bait for 60 to 90 days and a water supply, which tests indicate lures 25 percent more rats than are attracted to waterless traps. The cafeteria's lethal effectiveness is increased by the fact that warfarin is odorless and colorless, and that it requires minute doses over a long period to kill, leaving no outward signs to educate other rats as to the cause of death. It may be padlocked so that children and pets are prevented from coming into contact with the bait.

WHAT? YOU PUT BATS IN THE ATTIC?

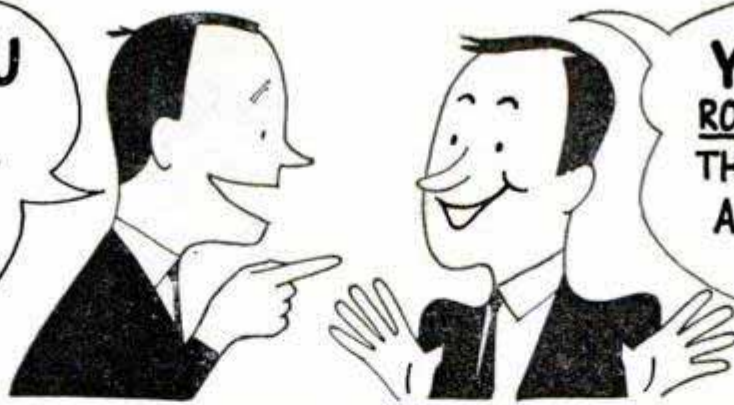

YES! GOLD BOND ROCK WOOL BATS—THEY ADD COMFORT AND SAVE MONEY TOO!

WITHOUT INSULATION THE FURNACE HEAT WAS GOING RIGHT UP THROUGH THE ROOF.



SO I PUT FIREPROOF GOLD BOND ROCK WOOL IN THE ATTIC—COMES IN BATS AND BLANKETS.

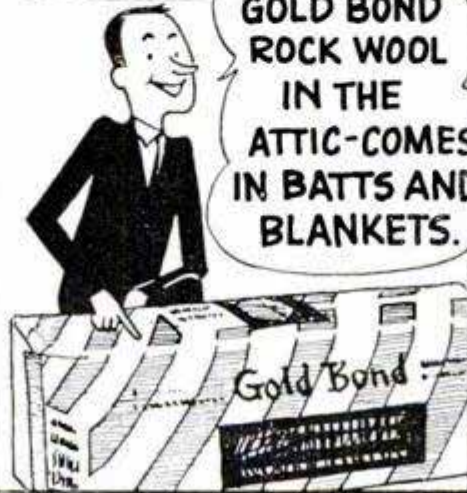

IN THE UNFINISHED PART, I JUST LAID THE BATS WITH THE VAPOR SEAL DOWN.



IN OUR FURNISHED ATTIC ROOM I USED NEW 8 FT. BLANKETS LIKE THIS—IT WAS A CINCH.



MY GOLD BOND LUMBER AND BUILDING MATERIAL DEALER FIGURED THE WHOLE JOB—SHOWED ME HOW LITTLE IT WOULD COST....



AND LOANED ME A STAPLING GUN—(NAILING IS EASY, TOO!)

BUILD BETTER WITH Gold Bond BUILDING PRODUCTS

MY FUEL SAVINGS HAVE MORE THAN PAID THE COST. THE WHOLE HOUSE IS WARMER IN WINTER AND MUCH COOLER IN SUMMER! WHY DON'T YOU SEE YOUR GOLD BOND DEALER ABOUT INSULATING NOW!

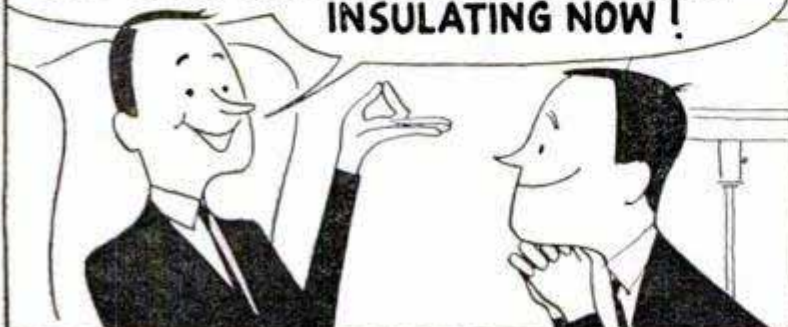

LOOK FOR THE ORANGE AND TAN STRIPED PACKAGE



NATIONAL GYPSUM CO. BUFFALO 2, NEW YORK

You'll build or remodel better with Gold Bond

Announcing the NEW...POPULAR MECHANICS MAGAZINE LIBRARY FILE



Check these Outstanding Features

- 1 Convenient size, measures 6 $\frac{3}{4}$ " wide, 3 $\frac{3}{8}$ " thick x 10" high. Ideal for tabletop, shelf or bookcase storage.
- 2 Special Reference Index Form, printed on back, records exact location of selected articles, diagrams and other information.
- 3 Date Label Stickers—enough to index ten years issues, furnished FREE.

NEW! NOVEL! INEXPENSIVE!
Never before so much convenience and utility at such a low price. So act now. Place your order today!

INGENIOUS CUSTOM-BUILT STORAGE FILE

A Sensational Popular Mechanics Value Scoop!

Now you can preserve every issue of Popular Mechanics Magazine in orderly, chronological sequence... indexed and ready for instant reference! Made of high quality kraft fibre board, printed in rich colors and constructed to look like an attractively bound book, Popular Mechanics Magazine Library Files enhance the reference value and double the usefulness of your collection of Popular Mechanics Magazines.

Serviceable, convenient, handsome in appearance, Popular Mechanics Magazine Library Files make every volume and article instantly accessible. No more hunting for the issue or special data you want. No misplaced copies. A "must" for every reader of Popular Mechanics. Order now for immediate delivery. Use the handy coupon below.

PER SET OF 2
(Set holds 12 issues)

Only

70¢

POSTAGE PAID

5 SETS **\$3.10**
ONLY

10 SETS **\$6.00**
ONLY

POSTPAID

Best of all, production economies by the distributor service organization appointed by us to serve your needs—plus our large volume purchases—makes the phenomenally low cost of the Libraries possible.

USE THIS COUPON...Mail Today

POPULAR MECHANICS MAGAZINE, Dept. PL
200 East Ontario Street, Chicago 11, Illinois

PM-1-52

Please rush PREPAID _____ sets Popular Mechanics Magazine Library Files.

Remittance for \$ _____ is enclosed.
(AMOUNT)

PRICES — 1 set (2 files) Holds 1 yr's. issues only \$.70
5 sets (10 files) Holds 5 yr's issues only \$3.10
10 sets (20 files) Holds 10 yr's issues only \$6.00

Includes Prepaid Parcel Post anywhere in U.S. and Possessions

Name _____

Address _____

City _____ Zone _____ State _____

AUTO SEAT COVERS

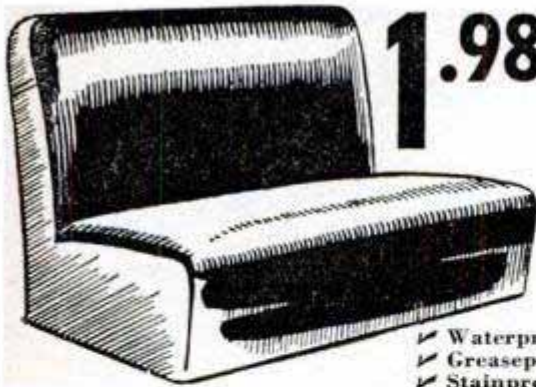

1.98 FRONT SEAT

FRONT AND REAR 3.89

- ✓ Waterproof
- ✓ Greaseproof
- ✓ Stainproof
- ✓ Non-Inflammable

"MIRACLE PLASTIC" 5 LUSTROUS COLORS
RED — BLUE — GREEN — MAROON — GREY

Also **LEOPARD SEAT COVERS** available.
 \$2.98 Front Seat, \$5 for Complete Set!

SEND NO MONEY! Give Name, Address, City or Town, Make of Car, Year, Model (4-door, 2-door, or coupe), and your color choice. (Also state 2nd color choice). Pay Postman, plus postage. Or send cash, check, or money order and we ship prepaid. Keep 10 days. If not satisfied, return for refund!

YOUNG PRODUCTS

Dept. 95 2605 Elmhurst Detroit 6, Michigan

NEW TINYTONE RADIO

Really Works — World's Smallest. New Preset Crystal eliminates All Tubes, Batteries or Electric "Plug-ins" Forever! Sweep band dial—Beautiful Red Plastic case. **GUARANTEED TO WORK** on local stations if used as directed or money refunded—use most anywhere—**SEND ONLY \$1.00** (bill, c.k., m.o.) and pay postman \$3.99 C.O.D., postage or send \$4.99 for P.P. delivery. **COMPLETE WITH EXTRA LONG DISTANCE AERIAL KIT AND PHONE.**

LIMITED SUPPLY — SO ORDER NOW!

MIDWAY CO., Dept. BPM-1, KEARNEY, NEBRASKA



Ask Your Hardware Store for
FULLER'S
Unbreakable Amber Handle
SCREW DRIVERS

America's most popular line of moderately-priced screw drivers! Wide range of sizes. Fuller Tool Co., Inc., 915 Faile St., New York 59 World's largest makers of Amber-Handle Tools Export Sales Dept., John H. Graham Co., 105 Duane Street New York, U.S.A.

WHAT! NO LIGHTS!

Katolight Plants furnish the same kind of A.C. current as the High-lines. Sizes 500 Watt to 300 Kilowatt. Also manufacturers of Rotary Converters, Frequency Changers, D.C. Motors 1/4, 1/2, and 1/2 H.P., A.C. Motors, single phase in 2, 3, and 5 H.P., high frequency Generators.

KATO ENGINEERING COMPANY
 PM-1 1402 FIRST AVENUE
 MANKATO, MINNESOTA

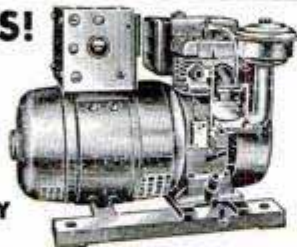

SHARPEN CIRCULAR SAWS LIKE AN EXPERT

THE SUPER GADGET FOR HOME WORKSHOP

Two simple adjustments. Gets hollow-ground, cross-cut or combination saw blades true and sharp. Fits 6" to 12" blades 1/2" to 13/16" centers. Includes file, complete instructions. \$6.95 postpaid. (C.O.D. postage extra.) Guaranteed—Money back if not satisfied after 10-day trial. Soon pays for itself. Order today. Free Folder.

SURE SHARP MFG. CO., Dept. M-1-2
 P. O. Box 24 Santa Ana, Calif.



\$6.95

YOUR HOME
and
TV SET



with an **AMPHENOL**

LIGHTNING ARRESTOR

Send 10c and coupon below for complete information on safe antenna installation and better TV picture quality.

To prevent loss of life and property, the National Electric Code requires an approved lightning arrestor on every unshielded outdoor antenna lead-in. The Amphenol Lightning Arrestor is Underwriters' Laboratories Approved. It is small and simple to install — no cutting or splicing of the transmission line. For proper mounting and installation procedures, send the coupon below.



Play safe, ask your TV service-man for an Amphenol Lightning Arrestor TODAY!

AMERICAN PHENOLIC CORPORATION
 1830 SOUTH 54TH AVENUE
 CHICAGO 50, ILLINOIS

Send me this book on safe antenna installation and all factors influencing TV picture quality. 10c enclosed for postage and handling.



NAME _____

ADDRESS _____

BURN WATER in your CAR

with the **AMAZING OCTA-GANE "50"**

Yes, burn water, alcohol or both with this all bronze, exhaust operated pressure injector. It is adjustable to burn up to one gal. of water or alcohol to every 10 gal. of gas. U. S. Agricultural Dept. scientists say: "Mileage Of New High Compression Auto Engines Can Be Increased Up To 30% With Alcohol-Water-Gasoline Fuels."

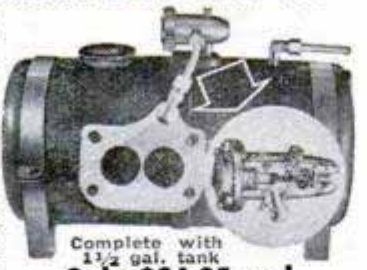

Complete with 1 1/2 gal. tank
Only \$24.95 ppd.
(Send \$2, balance C.O.D.)
List car make, year, & cyl.

DEALER INQUIRIES INVITED

World's largest firm specializing in hi-performance & hi-mileage equipment for all makes of cars.
NEWHOUSE AUTOMOTIVE INDUSTRIES, Dept. B-1, 5807 E. Beverly Blvd., Los Angeles 22, Calif.

WRITE FOR: **FREE ILLUSTRATED LITERATURE**



1952 **SPEED AND POWER** FOR ALL CARS

128 Page Library Edition Over 300 Illustrations

SPEED & POWER "SOUP UP" ANY CAR



LEARN HOW TO GET 150 MILES PER GALLON WITH YOUR OWN CAR!
Fascinating construction drawings actually show how you can build fast stock cars, California roadsters, 200 MPH hot rods. **EASY STEP BY STEP METHODS** help you save by building your own dual manifolds, superchargers, hot cams, water injectors, high compression heads.

LEARN HOW ANY CAR CAN ATTAIN LIGHTNING SPEED AND SUPER POWER
50 BREATHTAKING CHAPTERS TELL ABOUT: Tuning techniques, speed tricks, economy secrets, formulas for getting racing speed and dynamic power. Includes Information On: Racing frames, reciprocating masses, jet engines, wheel geometry, dynamometers. Photos and diagrams show how to restyle and customize all cars. Also info. on dual pipes, gears, fuels, porting, relieving, lowering, balancing.

This great book... Plus big 1952 "Speed Equipment Catalog"... Plus 46 page "Economy Driving Manual"... Plus "150 MPG Booklet"... All four items... ppd. **\$1.98**

New MOTOR BARGAINS for Home, Farm & Industry



New Dayton 1/2 H.P. Induction Type 3450 RPM 110 V. 60 cy. 1 ph. A. C. Motor. #GEH-5, Fob. **\$18.50**
#DH-5-2. Same 220V Fob. Only **\$15.00**

New General Electric 1/2 H.P. Cap/Ind. Ball Brg. 1750 RPM, double 1/2" shaft. 110 V. 60 Cy. 1 Ph. A. C. Motor. #GE-75. Fob. **\$34.50**

New Dayton 1 H.P. Heavy Duty, Cap or Repulsion Induction, 3450 RPM, 110/220 V. 60 Cy., 1 Ph. A. C. Motor. #EH-1. Fob. **\$52.00**

Same as above, 2 H.P. 220-V. 3450 RPM #EH-20 . . . only . . . Fob. **\$75.00**

Same as above 3 H.P. 220-V. 3450 RPM, #EH-30 . . . Only . . . Fob. **\$97.00**

Write for FAN CIRCULAR: listing Blades, Guards, Motors. All Sizes for building your own Attic Fan, Window Fan or Room Cooler.

C. MARSHALL SALES, 3546 W. Fullerton Ave., Dept. P-1, Chicago 47



16 to 1 SPEED REDUCERS

For Display Table — Barbecue Spits — Toy Auto Gear Box — Experimental Uses, Etc. Gears Enclosed in Aluminum Housing. Bronze Gear, Hardened Worm, Input Shaft 1/4 in. Output Shaft 3/8 in. Speed Reducer #R 161 **\$3.95** Post Paid



Shaded Pole Motor, brushless, Non-Radio, T.V. Interfering, 110 V.-60 cy. A. C. Speed 1550 RPM for light machine duty, exhaust fans, furnace fans, blowers and many practical and experimental purposes. Handles fan blades from 12 to 20 inches.

- #UM-40 . . . 140th H.P. Postpaid Only \$6.25
 - #UM-30 . . . 130th H.P. Postpaid Only \$7.50
 - #UM-20 . . . 120th H.P. Postpaid Only \$8.75
 - #UM-15 . . . 115th H.P. Postpaid Only \$9.75
- FAN BLADES TO FIT THE ABOVE RESPECTIVELY**
- 12 inch blade Only \$1.50
 - 16 inch Blade Only \$2.75
 - 18 inch Blade Only \$3.75
 - 20 inch Blade Only \$4.75
- (all above blades are Postpaid)
- Three Speed Motor Control Singular for above motors #1X-474 . . . Postpaid Only \$4.25

LOW VOLTAGE A.C. BACKGEAR MOTORS



For Power Displays — Toys — Experimental Work, Etc. Slow Speed 1 1/2 RPM, from double 5/16 in. shafts. Low Voltage 18 to 24 volts 60 cy. A.C. Operates from toy transformer or connect in series with light bulb. Sturdy gears and bearings. Special Low Price **\$5.95** #BG 15 Postpaid.

Transformer for using above motor on 110 V. A.C. #TI . . . Postpaid Only \$3.75



WILL CUT YOUR GAS BILL — OR MONEY REFUNDED IN FULL



USERS CLAIM AND EXHAUSTIVE TESTS BY AUTOMOTIVE ENGINEERS HAVE PROVED THAT THE REMARR AUTOMATIC GASOLINE INJECTOR GIVES UP TO 20% BETTER GASOLINE MILEAGE. MORE POWER, QUICKER STARTS AND BETTER ALL AROUND PERFORMANCE. Easily installed in a few minutes on all cars, light trucks and tractors, this great new economy product quickly pays for itself in gas savings alone. **TEST IT ON YOUR CAR AT OUR EXPENSE FOR 30 DAYS . . . IF NOT COMPLETELY SATISFIED . . . JUST RETURN IT FOR A FULL REFUND.** List your name, address, car make, year, model and number of cylinders. Send cash, check or money order.

ONLY **\$9.95** POST PAID

G. B. SCHUYLER, Dept. 81, 2804 10th St., Berkeley 2, Calif.

DUNCAN LIFETIME SPINNER

SEALED BEARINGS
BEAUTIFUL ALUMINUM CASE
LIFETIME



WEATHER PROOF

HEAVY DUTY FOR MITTENED HANDS

\$2.25 EACH

SEE YOUR DEALER OR WRITE

IRRIGATION PUMP CO. COLUMBUS 3, NEBRASKA

WANTED!

MEN AND WOMEN TO EARN SPARE TIME MONEY

Many Popular Mechanics neighborhood representatives are making extra cash for easy, after-hours work. A few more are needed.

For details, write:

POPULAR MECHANICS

ROOM 408
200 E. ONTARIO STREET
CHICAGO 11, ILLINOIS

WAR SURPLUS BARGAINS

ALTIMETER



U. S. Navy surplus altimeters, 0-10,000 ft. range. Adjusts to sea level setting of terrain. Requires no hook-up . . . for auto or aircraft installation.

BRAND NEW . . . \$12.95 ea.



Kollsman and Bendix Sensitive Altimeters. 0-35,000 ft. range, cal. in 100's of feet. Barometric setting adjustment. No hook-up required . . . for auto or aircraft installation.

Used, GOOD . . . \$7.95 ea.

GENERATORS 115V-AC

FOR AUXILIARY LIGHT PLANTS



NOW . . . here's the buy of the year. Brand new Eclipse Generators in the original box. These generators have an AC output of 115 volts, 10.4 amps,

1200 watts, single phase, 800 cycles at 2400 R.P.M. They also have a DC output of 28.6 volts, 60 amps. The unit has a spline drive shaft and is self excited. It will serve as a dependable 115 V-AC auxiliary light plant when driven by a gasoline engine for farms, cottages, flood lighting, trailers, boats, or wherever power is not readily accessible. Shipping wt. 55 lbs. Govt. cost more than 10 times selling price. F.O.B. Pasadena.

ONLY \$29.95

BRAND NEW POLE CLIMBERS

Buckingham pole climbers in their original package. (Without Straps) Per Pair

STRAPS & PADS . For Climbers, Used \$1.50 Set

LINEMAN'S TOOL & SAFETY BELT

Brand new web-type belts in their original box. **\$3.95**



All Equipment F.O.B. Pasadena • Enclose Full Amount With Order

C and H Sales Company

BOX 365-JM • EAST PASADENA STA. • PASADENA 8, CALIF.

To skilled men:

LOCKHEED

in

CALIFORNIA

offers you a

BETTER JOB

in a

BETTER PLACE TO LIVE

Lockheed is building planes for defense, planes for the world's airlines. It's all part of our long-range production program. It means there's not only a better job for you at Lockheed, but a better life. For here in sun-swept San Fernando Valley you find living conditions beyond compare.

Lockheed needs:

**Machinists
Tooling Men
Engineers**

Aircraft experience is not necessary. Lockheed will train you.

Lockheed offers you: Top wages, generous travel allowances to be paid after six month's employment at Lockheed, retirement plan and many other benefits only a company like Lockheed can provide.

Middle-age is no barrier to a job at Lockheed. Skill and ability, not years, count here.

To Family Men: Housing conditions are excellent in the Los Angeles area. Approximately 30,000 rental units are available. Huge tracts are under construction for home ownership. Lockheed Employee Service will help you get settled.

Write today for job application blank and illustrated brochure describing life and work at Lockheed in Southern California. Use handy coupon below.

M. V. MATTSON, Employment Manager
LOCKHEED AIRCRAFT CORP., Dept. PM-1, Burbank, Calif.

My Name _____

My Type of Work _____

My Street Address _____

My City and State _____

Build this Beautiful LAWN FURNITURE YOURSELF



PORCH CHAIR

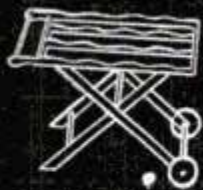

SERVING CART



GARDEN LOUNGE



PICNIC TABLE



PORCH GLIDER



ADIRONDACK CHAIR

NO EXPERIENCE NEEDED

Smart Exclusive Styles By John Bergen . . . Four Big Plans Drawn to Scale . . . Complete Material List

Now with just a few spare time hours and some inexpensive materials you can build gay comfortable lawn furniture that will make your garden more attractive . . . more comfortable and more fun this summer.

No need to pay a small fortune for lawn furniture when you can build your own and save over 50% of what it would cost you already built!

Popular Mechanics four big drawn-to-scale plans show every step to follow. Complete material list tells you just what sizes of wood to buy so there will be no waste.

Make your lawn and garden the finest and most attractive on your block by building this smartly styled furniture. Enjoy real comfort during those hot summer months by making your garden your outdoor living room. Send today for your plans and material list. Complete set of four plans only \$2.00. Complete satisfaction guaranteed or your money refunded.

POPULAR MECHANICS PRESS

200 E. Ontario St.
Chicago 11

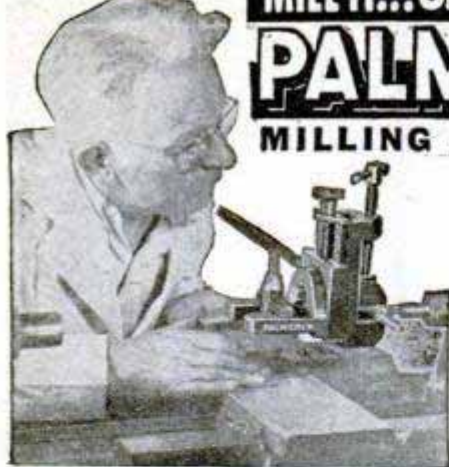

PALMGREN

MILLING ATTACHMENT

3 SIZES

No. 250 Illustrated

2 1/2" JAW \$27.25 Only

CONVERT LATHE IN TO SECONDS

Now you can Mill, Slot, Grind, Groove, Square Shafts, Saw at Angles, Recess and many other important jobs. **SAVE TIME and MONEY!** Why send work out or use costly methods when a PALMGREN MILLING ATTACHMENT will solve your problem.

Precision built, it has accurate graduations for rotary angle adjustments, also graduated vertical feed screw. Fits South Bend, Atlas, Craftsman, Logan, Sheldon and all other lathes. Thousands now in use in small and large machine shops, repair shops, railroads, schools, home work shops, etc. **ORDER SIZE NEEDED TODAY!**—it will quickly pay for itself.

IMMEDIATE DELIVERY

Nos.	Width Jaws	Depth Jaws	Jaws Open	Weight Pounds	Fits Tool Post	Price F.O.B. Factory
150	1 1/2"	1"	1-5/8"	6 1/2	1" Dia.	\$20.65
250	2 1/2"	1-7/16"	2 1/4"	11	1 1/4" Dia.	27.25
400	4"	1 1/2"	4"	25	2" Dia.	43.75

Order From Your Dealer or Jobber: Write for Circular No. 353

Mfrs. of PALMGREN PRODUCTS

Since 1915

8365 South Chicago Avenue Chicago 17, Ill.

CHICAGO TOOL and ENGINEERING CO.

JUST A FEW OPERATIONS YOU CAN DO ON YOUR LATHE!

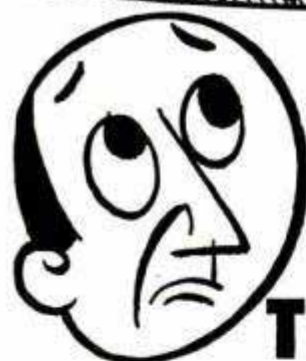
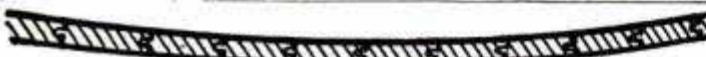
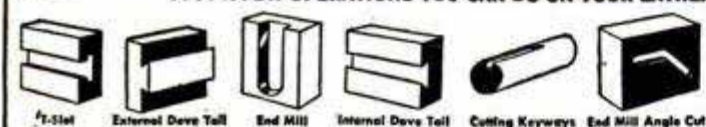

FLOORS SAG?

YOU NEED **TEL-O-POST**

Give your floors a "lift" with TEL-O-POST... the original adjustable steel post with a built-in jack. Use it for proper support in cellars, under porches, in garages and other buildings.

Patented locking pin assures safety—and permits quick and simple installation. Ask for TEL-O-POST by name at leading building supply and lumber dealers.



Brainard Steel Co., Dept C-1
Griswold Street, Warren, Ohio
Send TEL-O-POST booklet on floor support points

Name _____
Address _____
City _____ State _____

WRITE FOR FREE TEL-O-POST BOOKLET

MAKE LAMPS AT HOME

for fun or profit!

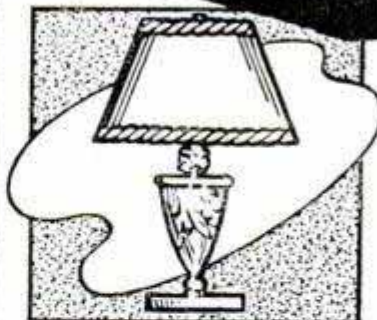

TURN your spare time—into cash. Make quick-selling, highly profitable lamps—every home a prospect. No experience or special tools required. New 56-page illustrated catalog shows hundreds of lamp parts—everything you need.

Special 8-page section shows 6 beautiful lamps in kit form ready to assemble. You buy wholesale, sell at retail—make big profits. Hundreds doing it. You can, too. Send 25c today for catalog and wholesale price list. Refundable first order.

WRITE DEPT. 100-BI

THE GEARON COMPANY
27 S. Desplains St. ★ Chicago 6, Ill.

AMAZING MYSTERY BUTTON



Startles Everybody. With this Electronic Button you can make your own Telephone-Amplifier-Dectectophone. Attach this button to piece of cardboard—transmit conversation to another room. Music also transmitted to distant places. Most interesting electrical apparatus ever discovered. Enables you to perform hundreds of experiments. So tiny it can be concealed in dozens of places. A Pre-War Product. Electronic Button including 5000 word instruction booklet with 50 illustrated experiments, postpaid, only **\$1.00**

ELECTRONIC PRODUCTS COMPANY, SAINT CHARLES 9, ILL.

SIGNS EASILY AND EXPERTLY
PAINTED WITH LETTER PATTERNS
AND SHOWCARDS
MANY SIZES & STYLES
WRITE FOR FOLDER!
JOHN F. RAHN
1330-31 N. Central Ave.
CHICAGO 51, ILL.

100 POWER...
Telescope Lens Kit COMPLETE ONLY \$3.00

Bring planets and distant objects 100 times closer. Enlarge areas 10,000 times. Lens kit contains a 3 in. diameter 75 in. focal length ground and polished objective lens plus 2 astronomical eyepieces, 50 and 100 power. Simple to follow directions for assembling in 1 or 2 evenings. Mounting and tripod not included, but easy to make from directions.

HERBERT LEVINE 3412 W. JACKSON BLVD. CHICAGO 24

BUILD SOLID MODELS for display



Bonanza Kit, 69c

Wingspread, 8-1/4"; length, 6-1/2".

Planes—trains—ships! Accurate scale models to decorate home or office, display on mantel, desk, or in collector's groups. All parts ready-shaped for easy assembly. Wide range of subjects, including newest ships,

planes, and historic trains. Also solid model cars for HO layouts. See them at your Hobby Dealer.

StromBecker

Send for free circular describing all models
STROMBECK-BECKER MFG. CO., Dept. PM-1, Moline, Illinois



The Right Tool for
a Right Job
IN YOUR WORKSHOP
EMPIRE LEVELS



Get more value
for less money! Make
Your Choice an Empire Level

No. 151 Aluminum Level. Extremely accurate with adjustable-interchangeable vials. Has 2 levels, 2 plumbs, and a choice of 2 45° vials or 2 additional plumbs. Beautifully finished, easy to work with. A tool you can be proud to own.

18" . . . \$6.75 24" . . . \$7.50 28" . . . \$8.50
Order EMPIRE Levels from your local dealer, or write



**EMPIRE LEVEL
MFG. COMPANY**

Dept. PM

10930 W. Potter Rd., Milwaukee 13, Wis.

PROPANE GAS ON YOUR CAR



with normal operation on gasoline. Switch to either instantly—Save up to 1/2 on fuel. SEND \$2.00 for "How-to-do-it" booklet, photos, drawings and low prices on complete outfits. (refunded on parts order) Rush order today — NOW!

LPG PRODUCTS, Dept. PM-1, KEARNEY, NEBRASKA

MAKE MONEY with Bostonian SHIRTS

Take orders for famous line finest quality dress and sport shirts. Also women's man-tailored blouses. All styles, fabrics, colors, sizes. Low Prices. No experience needed. FREE Big, beautiful Sales Kit with actual fabric samples. Send no money, but rush name now! **Bostonian Mfg. Co.**, 89 Bickford St., Dept. M40, Boston 30, Mass.



BULL HACKSAW

for any 1/4" electric drill or drill press

Easy to carry, easy to use—a "must" for every home craftsman! Full chip clearance on any wood, metal or plastic stock up to 3/4". No gears, no bearings, nothing to wear out. Weight: 11 ozs. Guaranteed and only \$4.95!

Send Cash, Check or M. O. Today!

BERTRAM S. ENGINEERING AND SUPPLY CO.
3127 Harrison St. Kansas City, Mo.

**POWERFUL!
PORTABLE!
POCKET-SIZE!**
\$4.95

For Portable and Emergency ELECTRIC POWER

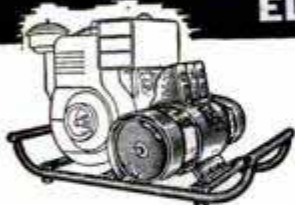

Choose a **Winco**
**POWER INSURANCE
A. C. GENERATOR**

TRACTOR POWERED OR GAS ENGINE SETS
Pictured is a 3000 Watt 115/230 Volt 60 Cycle AC Gas Engine Generator. Engine-Generators in 1250 and 300 Watt capacities; Farm Tractor powered Generators from 3000 to 10,000 Watts for use as stand-by power Generators for shop use, for radio amateurs, for portable power plant needs including welding. Generators are available with or without gas engines. For Complete Information Write to

WINCHARGER CORPORATION Dept. A22 Sioux City 2, Iowa



"How I built this \$1425 room
for only \$421* with my

SKIL

HOME SHOP SAW

You too can build a beautiful room like this—quickly, easily—with a SKIL Home Shop Saw. You'll save construction costs and a lot of tedious, time-wasting work in cutting lumber too.

A SKIL Home Shop Saw is portable, lightweight, perfectly balanced. It's got the power, speed, and accuracy you need. Instantly adjustable for bevel angles and depth of cut. Safe too . . . with trigger switch and telescoping guard.

At the low price of \$59.50 your SKIL Home Shop Saw quickly pays for itself in savings.

*For materials only, including desk, for 10 1/2' x 15' room depending upon where you live.

**SKIL Home Shop
Saw model 520.**

5/8" diameter blade. Weight 10 1/2 pounds. Depth adjustment from 3/4" to 1 7/8". Quickly adjustable for bevel cutting any angle up to 45°. \$59.50.

Prices subject to change without notice.

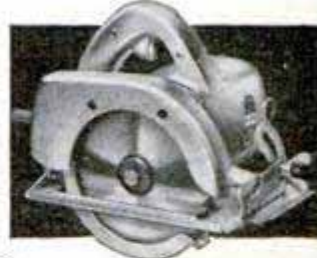

SKIL home shop Tools

Made only by
Skilsaw, Inc., Chicago

In Canada: 66 Portland St.
Toronto, Ontario

FREE! SKIL-Chart shows you how to buy materials and build a room like this. We'll also send you full information on the complete line of SKIL Home Shop Tools. Mail coupon today! Skilsaw, Inc., Dept. C-12, 5033 Elston Ave., Chicago 30, Ill.

Name _____

Street _____

City _____ State _____



For Loose Caster Guides

Remove the guide, fill the hole with a putty-like mixture of Smooth-On No. 1 Iron Cement and drive the guide back in. It will stay in place, because Smooth-On, in hardening, expands slightly and takes hold tight. Use Smooth-On for tightening other loose parts and also for stopping leaks in boilers, furnaces, piping, radiators, etc. Buy Smooth-On No. 1 in 1 3/4 oz., 7 oz., and 1 lb. size at your hardware store. If they haven't it, write us.

FREE Repair Handbook

Shows how to save time and money, making many household repairs. 40 pages. 170 pictures. Clear directions. Send today. SO-313

SMOOTH-ON MFG. CO., Dept. 37A
570 Communipaw Ave., Jersey City 4, N.J.

Do it with

SMOOTH-ON

THE IRON CEMENT OF 1000 USES



ADDING MACHINE

IDEAL FOR BUSINESS AND PERSONAL USE — GUARANTEED ACCURATE. Not a toy. Operates with only a finger flick. Adds, subtracts, multiplies, divides. only \$2.95
Counts up to one billion. Pays for itself over and over. Ideal Gift — for Business, Income Tax and School use. MONEY BACK GUARANTEE. Send name and address. Pay postman only \$2.95 plus postage. (Send full cash if outside U.S.) Beautiful rich-looking Leatherette Case included at no extra cost. Money back in 10 days if not delighted. AGENTS WANTED.

CALCULATOR MACHINE CO., (Mfrs.)
Dept. PM-1
Glenview, Illinois

POWER HACKSAW \$52.75

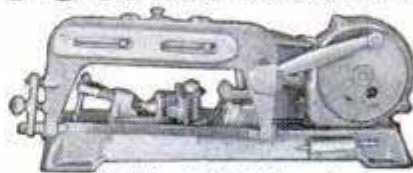

LESS MOTOR
F. O. B. Benton Harbor

● Rugged cast iron construction. Wt. 56 lbs. bronze bearings. Draw cut. Auto. return lift. Auto. shut-off. Vise swivels 45°. Cap. 4"x4".

Send for full details and name of nearest dealer.

EXCEL MACHINE TOOLS BENTON HARBOR, MICHIGAN Dept. PM-12

HELPFUL BOOKS

Send post card asking for FREE catalog
Popular Mechanics Press, 200 E. Ontario, Dept. 601, Chicago 11



\$ Free Course! Big Profits! \$ Flocks & Sandblasts

Dual Purpose Spray Gun! Uses only 25 lbs. Air Pressure
● Thousands of uses in Home, Shop, Industry: Makes Auto Interiors Clean & New, Lines drawers, Marproofs lamp bases, Refinishes any object. All in colorful Flock. Etch & Frost windows, glassware, etc. Removes Paint & Rust from Autos, Tools. Guaranteed! Send \$24.75 or write for free information. Flocking supplies!

BLASTO SPRAY GUN MFG.
Dept. PM-10, 7007 Haas Avenue, Los Angeles 47, Calif.



MAKE A "Stradivarius"

VIOLIN

BOOK AND PLANS ALL YOU NEED

—For Pleasure
—For Profit
—For Your Own Use

You Can Do It at Little Cost! It's Easy! It's Fun!

Here is the "tops" of all home crafts projects. Make a violin—a replica of a famous "Strad"—the original of which sold for \$80,000.00. Joe Reid who has made hundreds of fine violins makes the job so easy—so inexpensive—in his new book, "You Can Make a 'Stradivarius' Violin." You don't need any tools. Reid shows you how to make all the tools you need from old table knives, worn out files, sheet metal, etc. Eight full-size plans, 16x23 inches, folded into the book give you every detail in actual size.

Violins Bring High Prices

Make a violin and you probably will never want to sell it. But good tone modern violins bring terrific prices, yet the materials cost comparatively little. With Reid's plans and step-by-step instructions you can make such a violin for yourself. 15 chapters guide you in selection of wood, fashioning the belly, back, sides, mold, lining, neck, scroll, purfling. Other chapters cover varnishing, finishing, stringing. Others show how to make tools and clamps at little or no cost.

Order Book Today.

Money Back if Not Satisfied.

Make your own violin for pleasure or profit. Get book and plans now. Clip this ad and mail with check, money order or cash for only \$3.50 or we will send C.O.D. Money back in 5 days if not satisfied.



Complete Instructions

8 Actual Size Plans
How to Make the Tools You Need
Where to Get the Materials

You trace or work direct from actual size plans. No measurements to translate or confuse you. You see the entire violin in the plans. You read the how-to-do-it instructions in the book.

POPULAR MECHANICS PRESS Dept. 30
200 E. Ontario St., Chicago

AT LAST!—LOW COST "QUICK HOT" (3 to 5 Seconds) SOLDERING GUN

250 WATTS
120 VOLTS—AC



for HOME CRAFTS, REPAIRS, SHOP

Handles most all soldering requirements of home work shops, the varied jobs of service and repair shops, even light factory production. Beautifully balanced, light, cool—it's a joy to work with. Heats instantly when trigger is pressed, and automatically spot lights work. Long tip reaches spots otherwise inaccessible. Tips easily replaced. See your dealer or—

Only \$12.95

Guaranteed against mechanical defects for 1 year.

Mail this coupon Today!

WEN PRODUCTS, INC.

5806 Northwest Highway, Chicago 31, Ill.
Enclosed find Check or Money Order for \$12.95 for which send me Post Paid 1 "Quick Hot" Soldering Gun.

NAME.....

STREET.....

CITY..... STATE.....

Send for our FREE WAR SURPLUS Catalogue

Send for our FREE WAR SURPLUS Catalogue

Send for our FREE WAR SURPLUS Catalogue

Largest Surplus Sale! New Imported BINOCULARS

Largest Binoculars Dealers in the West! Our Prices INCLUDE ALL TAXES!
1st Quality precision, prismatic color-corrected Binoculars at prices the average man can afford. Imported directly by us; compare with Binoculars selling for 3 and 4 times more. Unconditional Money Back Guarantee. ALL our Binoculars have COATED ACHROMATIC LENSES!



6 x 30 \$27⁵⁰	7 x 35 \$32⁹⁵	8 x 30 \$28⁵⁰	7 x 50 \$37⁹⁵
8 x 30 Center Focus \$39⁹⁵		6 x 15 Theatre and Sports Glass. Pocket size—powerful. With Leather Case and Straps. \$16⁹⁵	

Glasses have Leather Shoulder Straps. **FREE DELIVERY** Finest all leather, plush lined saddle stitched case with safety clasp lock. For 6x30, 7x35, 8x30 **\$3⁹⁵** For 7x50, 10x50, 9x40 **\$4⁹⁵**

Handsome DeLuxe ALL LEATHER BINOCULAR CASES

Feather SLEEPING BAG

DeLuxe Quality in Every Respect. Save about 1/2!



NEW! 2 AIR MATTRESS POCKETS. Fine grade, water repellent, weather proof khaki cover. Filled with soft, fluffy feathers for warmth, comfort. 2 Bags zip together to make Double Sleeping Bag. Head Flaps for wet weather. Heavy duty all-around zipper for easy air-ing. Double inner lining with plastic backing to keep out all cold and moisture. Rolls into easy-to-carry pack. **\$25 VALUE**
\$13⁹⁰ Free Delivery
New! 75% feathers, 25% Kapok SLEEPING BAG—\$17.00 Value. Full size 34 x 78, 100% water repellent, plenty of soft filling, zipper opening. A top quality sleeping bag at a bargain price. Money-Back Guarantee. **\$9⁵⁹** FREE DELIVERY

SAVE! COMFORTERS

Filled with 6 lbs. of soft, warm 100% fluffed processed cotton lintens. Khaki dyed, fine quality long wearing cover. All passed the strict California bedding regulations. Ideal for home, cabin, trailer and any place you can use a high quality, really warm covering. (Cut Size 72 x 80). **\$6⁷⁵**



FREE DELIVERY A \$10.95 VALUE.

SEND FOR OUR "FREE" WAR SURPLUS CATALOGUE

UNIVERSAL ENTERPRISES • 946 SO. MAIN, LOS ANGELES 15, CALIF.



DO IT YOURSELF!

CALK WITH
Nu-CALK
SPEED LOAD

It's easy to calk those cracks around window and door frames. Just slip a Speed Load into the gun and you're ready! It's the fastest, most economical way to apply Nu-Calk — the world's finest calking compound.

REPAIR ROOFS WITH
Nu-Phalt
PLASTIC ASPHALTIC CEMENT

Don't put up with leaky roofs or flapping shingles. Use Nu-Phalt—the ready-to-use asphalt base cement—on chimney flashing, gutters and general roof repairs. Has outstanding adhesive qualities on wet or dry surfaces. Can be applied with a calking gun, or with a putty knife.



On Sale at all Leading Hardware, Lumber and Building Supply Dealers

AVAILABLE WITH OR WITHOUT PLASTIC NOZZLE



MACKLANBURG DUNCAN CO.
OKLAHOMA CITY, OKLA.

AVAILABLE WITH OR WITHOUT PLASTIC NOZZLE

Make YOUR ELECTRIC DRILL A MULTI PURPOSE TOOL

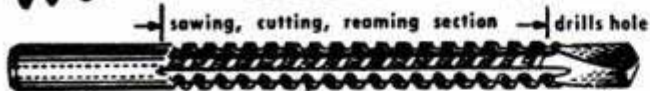

DRILL, SAW, REAM . . .

metal, pipe, wood, plastic, Transite, etc., with the all-purpose International Rotary Core-Saw Drill-bit shown above. Use with any electric drill, slow drill press, lathe or milling machine. Drills own starting hole—upper part of bit is used to cut, saw or ream circles, ovals, squares or scrolls. Easy to operate. Ideal for carpenters, mechanics, electricians, plumbers, hobbyists, many others. Abrasive resistant, high speed steel. Flutes ground from solid. Will withstand severe continuous use without breaking. Resharpens at no charge. Takes place of up to \$50 in tools. 1/4" diameter, 2" cutting sections, total length 3 1/2". Also available bits specially designed for wood or metal and in 2 3/8" and 1 3/4" lengths. Write for details. Specify all-purpose bit.

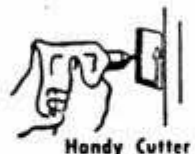

Drill Bit
\$3.95
Post Paid

NOW YOU CAN PLANE . . .

with your 1/4" electric drill and the International Drill-Plane Converter. For fast, accurate planing, beveling, ripping. Rips up to 1 1/4" strip, planes 1/4" at one stroke, 15 times faster than any hand plane. Rips boards up to 1 1/4" thick. Nothing like it exists. Too many uses to mention. 2 planing blades made of finest available High Speed steel included. Blades are 1/4" diameter, 2" cutting surface. Electric Drill not included. Regular electric planers cost up to \$150.00.

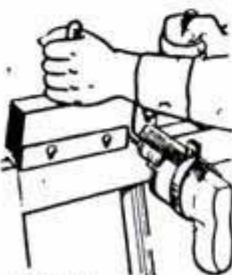

Drill Plane Converter

Send cash, check or M.O.
Money back guarantee
Shipped same day
Dealer inquiries invited

Plane Converter
\$14.95
Completely Assembled

Manufactured & Distributed by:

INTERNATIONAL TWIST DRILL CORP.
618 Wyandotte • Room 637 • Kansas City 6, Mo.

PESCO CENTRIFUGAL

HVY. DUTY ELECTRIC PUMP
Brand New! Complete. Has built-in 1/4 H.P. motor. Self-contained, explosion proof. Ideal for pumping gasoline, oils, water and non-corrosive liquids. Applicable for 24V AC/DC or on 110V AC. The discharge is for 3/4" hose connection. Capacity 400 GPH. Use them for cottages, basements, laboratories, boats, etc. Shpg. wt., 7 lb. Never before offered at such a low price. \$85.00 value. **NOW . . . \$9.95**



PESCO FLOW EQUALIZER

& Pressure Balancer Valve Brand New! Guarantees equal flow and equal pressure for two cylinders or two systems. Capacity 360 GPH. 1500 PSI. Shpg. Wt., 3 lb. Never before offered at such a low price. \$75.00 value. **NOW . . . \$9.95**



AVIATOR'S OXYGEN OUTFITS

Brand New! Bail out type. Consists of all metal tank, brass release valve, 0-3000 lb. gauge and breather hose, all enclosed in khaki colored canvas bag. Tanks are charged with breathing oxygen at 1800 lbs. pressure. Ideal emergency oxygen supply for airmen, mountaineers, firemen, paint shop workers, and others. Shpg. wt., 4 lb. **NOW . . . \$5.95**



ORDER FROM THIS AD! Prices F.O.B. St. Louis, Mo. Include postage with check or Money Order. **MONEY BACK GUARANTEE!**

Edw. Aguado Trdg. Co. 689-E Arcade Bldg., St. Louis 1, Mo.

JEWELER'S SCREW DRIVERS

8 Jeweler's Screw Drivers. A must for every hobbyist and model builder. Ideal for precision work, camera and fine instrument repairs. In 8 sizes—from the smallest size 9 up to size 2. Finest tempered steel blades. Lowest price! **ONLY \$2.00** **MONEY BACK GUARANTEE IF NOT SATISFIED** C.O.D. \$2 plus postage, or send \$2 and we pay postage.

PINE WATCH CO. 50 ELDRIDGE STREET Dept. M N. Y. 2, N. Y.

SET OF 8

FANS! FANS! ALL TYPES — ALL SIZES

Kitchen Ventilators, Exhaust Fans, Attic Fans, Blowers, Heat Boosters, \$7.95 up, Desk Fans, Window Fans, Blades, Guards, Shutters, Motors, etc. Free illustrated catalogue, dealers inquiries invited. **EDWARDS BROS. ESTAB. 20 YEARS** WESTERN APPLIANCE CO., INC. 5650 Grand River Ave., Dept. P, Detroit 8, Mich.



WAR SURPLUS INSTRUMENTS—RADIO—CAMERAS



ELGIN — WALTHAM — BULOVA
Waterproof, shockproof, Type A-11 hack watch. 16 J black face, white numerals. Sweep second hand. Used by AAF. Built to exact specifications of U.S. Govt. Genuine War Surplus. State first and second choice as limited quantity available. **\$19.75 ONLY** . . . Add \$1.98 Federal Tax



WESTON VOLTMETER
Model 433 0-150 V. A precision-built laboratory instrument. Hairline pointer on mirror scale. 25-2400 cycles. 3 1/2"x5"x6". Guaranteed. Govt. cost \$85.00. Limited quantity. **Now . . . \$29.95**



MOTOR BLOWER
24V AC-DC squirrel cage blower complete with motor. Ideal for dark rooms, kitchens, ventilators, etc. Can be used on 110 V with small transformer. Govt. cost \$34.90. **Now . . . \$2.95**



HEAD PHONES
Built to govt. specifications. Used but guaranteed. Per set. **\$1.59**

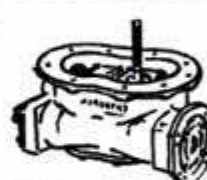

PRECISION GEAR BOX 56-1
RATIO 56 to 1. Beveled gears. Single or dual input. Pre-lubricated bearings. Spline shaft. Mfd. by Western Gear Works for U. S. Navy. Terrific torque. Brand new. Govt. cost \$165.00. **Now . . . \$5.95**



MAGNESYN INDICATOR
For remote indicating compass. Automatic direction finder. Calibrated from 0 to 360 degrees. Govt. Cost \$90.00. **Now . . . \$3.75**

PHOTO PAPER AND FILM
9 3/8"x200' Bromide enlarging Contrast #1. Per roll. **\$3.95**
7"x125' Aero Enlarging Contrast #1. Per roll. **\$1.95**
16mm x 50' Magazine Super X — developing included. **\$2.50**
16mm x 100' Super X negative. **\$1.50**
35mm x 100' Negative. **\$1.29**
WAR SURPLUS — OUTDATED BUT GUARANTEED



SOUND POWERED PHONE
No batteries needed. Your voice generates current. O.K. for 25 miles. Perfect intercom for shop, office, farm, dark-room. WAR SURPLUS. Orig. Govt. Cost \$58.00 ea. **Now \$10.95**

All merchandise guaranteed. Order these Surplus Bargains Today. 20% Deposit on C.O.D.'s.

Semlers' ASSOCIATED SURPLUS Dept. PM-1, 5730 WILSHIRE BLVD., LOS ANGELES 36, CALIF.

Why does your engine wear out faster in winter?

Ask your mechanic—and he'll say it's because it takes time (up to five minutes) for oil to reach engine parts after starting. And in winter, cold oil is sluggish, moves slowly. So friction works longer... causes "Engine Ulcers" as dry metal grinds against dry metal.

But not when you use *Miracle Power in your gas and oil!* The colloidal synthetic graphite in *Miracle Power* clings to surfaces... lubricates until oil gets there. Reduced friction means your engine starts easier, runs with less effort, uses less gas. Try *Miracle Power* next time you get gas.

Miracle Power Division
THE AP PARTS CORPORATION
 851 AP BUILDING, TOLEDO 1, OHIO



At better service stations, garages and car dealers, or use this coupon for your introductory offer.

THE AP PARTS CORPORATION
 851 AP BUILDING, TOLEDO 1, OHIO

Enclosed find \$_____ for which please send me postpaid:

_____ trial cans of *Miracle Power* at 75c each (1 for gas, 1 for oil)

Please send me free literature on making my car last longer.

Name _____

Address _____

City _____ Zone _____ State _____

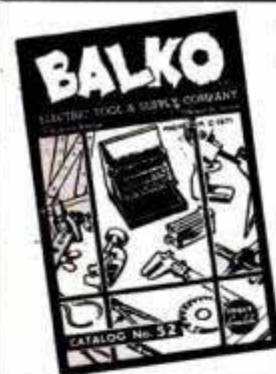

SEND FOR BALKO'S NEW SHOP CATALOG

Everything in Tools and Accessories for Metal and Wood

PACKED WITH VALUES FROM COVER TO COVER

Make BALKO's new 1952 Power Tool Catalog your complete guide for best nationally known brands... Atlas, Cummins, Delta, Logan, Mall, Millers Falls, Porter-Cable, Shopsmith and others. Contains newest items and standard best selections in saws, lathes, drills, sanders, jointers, planers, shapers, routers, grinders, hand tools and every known accessory. Whether you need a pillow block, a belt, pulley or a 12" metal working lathe, we have it... guaranteed and best value. Easy payments, prompt delivery, full satisfaction. Send for this new catalog now while supply lasts. There's no book like it anywhere.

Send 10c in Stamps to Cover Postage and Handling

BALKO ELECTRIC TOOL & SUPPLY CO., 2305 Devon Ave., Chicago 45, Illinois

It's easy! MODERNIZE YOUR HOME THE MONEY-SAVING, "SLIDE-ALL" WAY!

Now... You can install your own sliding doors... do the complete job yourself... in just 15 minutes.

Buy any size door or hardware either separately or in a prefabricated package with no extras needed.

Hardware is overhead track with ball bearing rollers. *Unconditionally guaranteed* for smooth, silent performance by America's largest manufacturer of Sliding Doors.



GET THE FACTS TODAY! SEND COUPON BELOW FOR FULL INFORMATION

SLIDE-ALL COMPANY

2084 First Ave., New York 29, N. Y.

PM-1

Please send me complete information on your sliding doors and hardware for self-installation.

Name..... (Please print)

Address.....

City..... Zone..... State.....

Make Your Drill a Power Saw with

Power Saw with

FEDCO

MADE IN U.S.A.

Saw-Rite

The ONLY Power Saw with a full ONE-YEAR GEAR GUARANTEE

Makes ANY 1/4" Drill a Power Saw

Featuring the Unique BEVEL-TILT-DEPTH-RIPGAGE . . . which allows depth of cut from 1/8" to 1 1/8". BEVEL cuts any angle from 0 to 45 degrees WITH NO SCREWS TO MOVE. RIPGAGE adjustable for accurate width molding, etc.

Model 605
Only
\$10⁹⁵

Complete with Combination 4" Blade and Bevel-Tilt Ripgag. Fully adjustable.

Tens Of Thousands Now In Use! • Easy One-Hand Operation! • Zips Through Wood, Plastic, Wall-board, Etc. • Acclaimed the Best in the Field!

Once you work with the FEDCO "Saw-Rite" you will never want to use a handsaw again. Saves time, saves work, does a better, neater job. It grooves, dados, cross-cuts, rips, hour after hour without sharpening. Cuts plywood, shelving, wallboard, 2x4's to 2x10's, in two cuts, one from each side. Special sighting guide notch enables you to accurately follow line in both straight and bevel cuts. Quick-acting, worm-drive, EXCLUSIVE clamp gets the "Saw-Rite" on and off your drill in seconds. Combination blade is chrome nickel steel, correctly heat treated, balanced and fitted. Extra wide base plate for better balance. One or two hand operation. Lifetime Oilite bearings, finest quality hardened shafts and coppo-steel gears. One-piece aluminum housing.

FEDCO Replacement Blades:

- #504C 4" Combination . . . \$2.00
- #504R 4" Rip . . . \$2.00
- #504M 4" for Soft Metals . . . \$3.00

DEALERS . . . Write for Nearest Jobber. Dept. M 1-52

FREE 15-Day Trial . . . money refunded in 15 days if not completely satisfied. Order from your Jobber, or send us your check or M.O. All prices postpaid, except on C.O.D.'s.

FEDERAL ENGINEERING CO., M. 1, 37 Murray St., New York 7, N. Y.

FOR YOUR BEDROOM

your neighbors with the beautiful bedroom suite in honey maple, oak or walnut! Here's a bed with storage space . . . a three-piece vanity with cosmetic compartment and make-up mirror . . . a Mr. and Mrs. dresser . . . twin night stands with drawers!



Send for Complete PLANS Only \$2.00

YOU MAKE IT YOURSELF! Only two power tools, a saw and a jointer, are needed to turn out this modern bedroom furniture. No other project of Popular Mechanics Magazine in recent years has captured the fancy of home craftsmen as has this easy-to-build suite. Letters demanding detailed plans poured in after the suite was pictured in Popular Mechanics. And now the plans are ready! They're detailed scaled drawings—a complete set of 4. Send for them today!

POPULAR MECHANICS PRESS, Dept. 26
200 East Ontario Street, Chicago 11, Illinois

I enclose _____ for a complete set of plans for making the modern bedroom suite illustrated above.

Name _____

Address _____

City _____ Zone _____ State _____

SAY YOU SAW IT IN POPULAR MECHANICS

ALL PURPOSE ELECTRIC TESTER

You can locate your electrical troubles INSTANTLY with the NEW VEST POCKET ALL PURPOSE ELECTRIC TESTER. IT PROBES . . . IT TESTS . . . IT LIGHTS . . . IT SAVES on all electric repairs. The patented TEST LIGHT traces, then BEAMS on disorders in appliances, circuits, motors, tools, receptacles and EVERYTHING ELECTRICAL, for home, factory, and farm. Tests continuity, shorts and grounds from 110 to 600 Volts. No batteries required. Ready-to-use, 2 1/2 oz. complete, pocket-size, 6 ft. high-test flexible plastic insulated test cord, with patented plastic case and complete instructions. Fully guaranteed.

SAFE!

SWIFT!

SURE!

Order TODAY—only \$2.98 postpaid, or pay postman \$2.98 plus delivery charges. IMPERIAL SALES CO., 480 Lexington Ave., Dept. 079, New York, N. Y.



NEAR RECEPTACLE TEST



SHIRT TRIMMER



BEFORE ORDER



STOP! DON'T PUT YOUR TRAINS AWAY

Enjoy miniature railroading the year round. Spend happy, fun-filled hours with your boy. Toy Trains Magazine tells how.

Plan landscaping, lineside structures, signaling systems. Make your layout the envy of your neighborhood. Toy Trains describes dozens of projects you can do yourself. Each issue bulges with pictures, diagrams, articles. Text and plans so simple a child can follow. Take advantage of SPECIAL GET-ACQUAINTED OFFER.

NEXT 4 BIG ISSUES \$1.00

(Regular newsstand price 35c. Yearly \$4.00. Save 40c. Send \$1.00 today.) Money refunded if not satisfied.



TOY TRAINS
RAMSEY 29, N. J.

Make Your Own LOW COST POWER TOOLS

Use Wood, Scrap, Discarded Materials—Make Practical, Proven Machines

Order today the new "Forty Power Tools You Can Make." Even though you have the older edition, get this new book with twenty brand new tools — 40 in all. Make your own motorized lathe, drill press, sander, shaper, circular, band, scroll and jig saws from old auto and other discarded parts. Make forty different tools following simple instructions, diagrams and photos and have an efficient, up-to-date shop. Save money, time and hard work and do a better job with low-cost power tools. Sent postpaid for only \$1.50 with order. Avoid high C. O. D. charges.

POPULAR MECHANICS PRESS
200 E. ONTARIO ST., CHICAGO 11, ILLINOIS



SEAL OUT WINTER'S COLD and DRAFTS

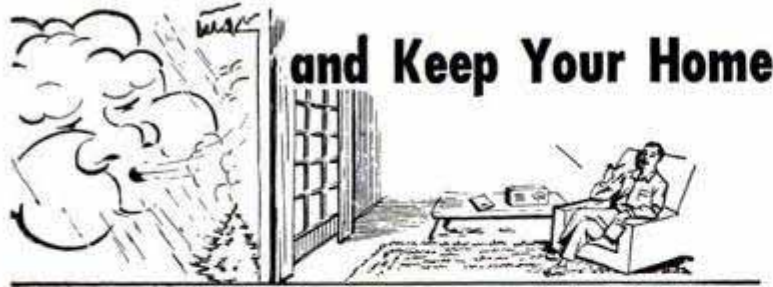

WARM

"No-Draft" TRANSPARENT PLASTIC STORM WINDOWS

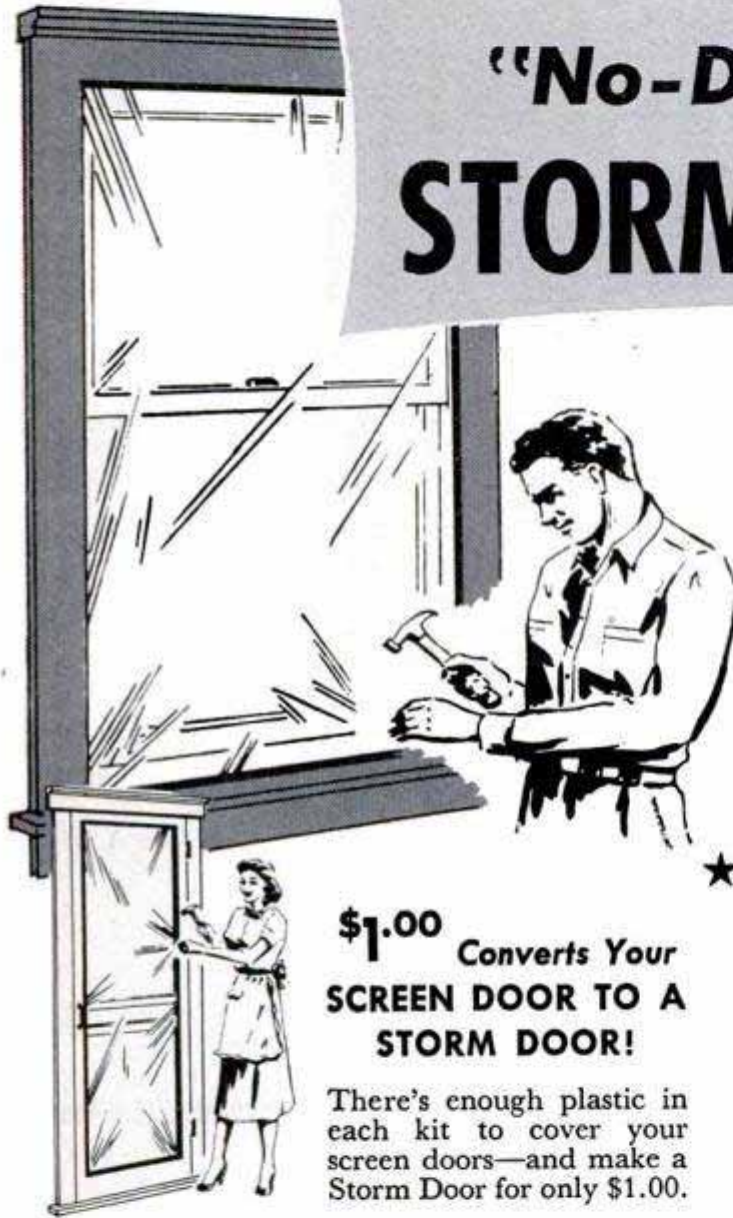

\$1.00 Converts Your SCREEN DOOR TO A STORM DOOR!

There's enough plastic in each kit to cover your screen doors—and make a Storm Door for only \$1.00.

Each \$1.00 Window Kit is complete with 36" x 72" plastic sheet, framing strips, tacks, and simple instruction sheet. Use inside or outside windows or doors.



SALESMEN—STORES!

Demand for this item has been sensational! Write for dealer proposition.

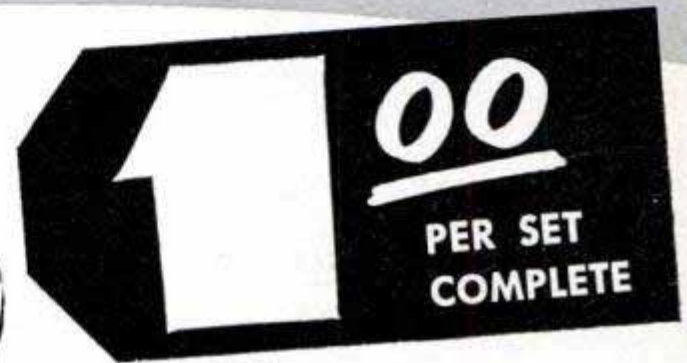

- ★ ANYONE CAN INSTALL—Quickly!
- ★ FITS ANY WINDOW—Small Doors!
- ★ SAVE \$100 over Regular Storm Windows!

Here's the really economical way to enjoy winter comfort—and save on fuel bills. Now you can protect your entire home (or garage, barn, cabin, etc.) against drafts, colds, snow and rain with these wonderful easy-to-install Storm Windows. Made of genuine Silenite cast-vinyl transparent pliable plastic—they're absolutely windproof, rainproof, non-flammable. Save you so much on fuel costs they'll pay for themselves almost immediately. Easy to install—in minutes! Buy one for every window in your home.

ORDER BY MAIL

GAYLORD

DEPT. PA-8

Fifth & Hamilton, Pittsburgh 6, Pa.

Send sets of Plastic Storm Windows at \$1. set complete. (Add postage: 1 set, 10¢; 3-6 sets, 20¢ over 6 sets, postpaid free). I enclose Check M.O. Send C.O.D. (must accompany by \$1. deposit).

MONEY-BACK GUARANTEE

(Print name and address in margin)

70c CAN SAVE YOUR CAR



by "Hil"

Just a few pennies for a can of WARNER LIQUID SOLDER may save your car from ruin. You see, a radiator leak, no matter how small, may lead to overheating that can literally burn up your engine. Non-metallic WARNER LIQUID SOLDER repairs leaks quickly by depositing tiny fibers in the holes. And WARNER LIQUID SOLDER is easy to use — just shake, pour and fret no more.



WARNER-PATTERSON COMPANY
CHICAGO 5, ILLINOIS



old man Element and the BARGAIN RULE!

When you buy an inferior folding rule, "Old Man Element" goes to work. Slyly he stretches each joint and wears away the finish. Then comes his knockout punch — moisture. Now the rule is inaccurate and ruins everything you measure... Be smart — don't just ask for a rule. Demand a MASTER BLUE TIP. Completely element proof, friction tested; patented brass joints won't stretch under roughest usage. Get BLUE TIP at your hardware store today. Regular or flat-reading, only \$1.10.



Master Rule Manufacturing Company, Inc., Middletown, New York

I am enclosing \$_____ Please send me _____ BLUE TIP rules.

NAME _____

ADDRESS _____

CITY _____ ZONE _____ STATE _____

MASTER

MASTER RULE MFG. CO. INC. Middletown, New York

WOOD AND STEEL TAPE RULES

PAY RAISING—EXTRA MONEY BOOKS

Use these books to prepare for a better job — bigger pay — to start a profitable spare time or full time business of your own, improve your home, or start a hobby. Popular Mechanics specializes in supplying outstanding self-help books on many subjects. Send for our FREE catalog.

- Outdoor Sports Manual
Hunters, Fishermen, Trappers, Campers, Archers, Boatmen, here is your book!...\$2.00
- Shop Notes Library
5 Vols.—1951, 50, 49, 48, 47 (No Dup. Matter)...\$3.98
- Shop Notes 1951...\$1.00
- Money From Ideas. Patent and sell your invention...\$2.50
- Photo Handbook
A complete guide to better pictures and darkroom technique. Dozens of handy gadgets you can make...\$2.00
- Practical Carpentry
New, easy-to-understand encyclopedia of building information, over 1,100 illus...\$5.00
- Automatic Transmissions Simplified. How to locate trouble, service all types...\$4.00
- Dyke's Auto Encyclopedia. World's Greatest Auto Book! New 1950 Edition...\$7.50
- Garden Book
Build your trellises, lawn furniture, fireplaces, ornaments, etc...\$1.50
- Diving, Cutting and Welding in Underwater Salvage Operations. Only book of its kind...\$2.00
- Picture Framing
Modern methods for making and painting picture frames. Fully illustrated...\$2.75
- Radio-TV and Electronics Handbook. How to service radio and TV sets; build receivers, phonographs, portables, student sets, etc...\$2.50
- Money Making Hobbies. 132 ways to make money...\$2.00
- 210 Deluxe Small Homes \$1.00
- Trailer Coaches by Kuns. Complete information for construction of trailers...\$1.50
- Concrete Handbook
New book on using concrete around home, garden, farm...\$2.00
- Veterinary Guide for Farmers by Stamm. What every farmer should know about taking care of farm animals. 288 information packed pages with more than 150 big illustrations. Covers ailments of cattle, hogs, sheep, horses, etc...\$3.50
- Welding, Brazing and Soldering 1950 Ed. How to build your own equipment and how to use it effectively...\$1.75
- Modern Electric and Gas Refrigeration. New 1950 Ed. includes sealed units — home freezers...\$5.00
- Complete Book of Home Repair and Improvements. Radio's famous "Fix-It" book. Everything about repairing and improving your home. Cloth Ed. \$2.98; Deluxe Binding \$3.98
- You Can Make A "Stradivarius" Violin. Instructions. 8 full scale plans...\$3.50
- Oil Burner Handbook...\$2.50
- 23 Boats You Can Build. Rowboats, canoes, sailboats, 25 foot cabin cruiser. Working diagrams, material lists. \$2.00
- House Wiring (No. 89)...\$.25c
- Turn Scrap Into Money
Convert old auto generators into motors, welders, etc...\$1.00
- Popular Mechanics Farm Manual Packed with practical ideas and usable information that can easily be worth hundreds of dollars to every farm family and to homeowners everywhere. Send for free descriptive folder giving complete contents!...\$3.00
- Woodworking for Every-body...\$2.75
- Sheet Metal Work...\$3.00
- Tool and Saw Sharpening (No. 92)...\$.25c
- Forging Practice...\$1.50
- Action Toys (No. 66)
Plans for 21 easy-to-make toys...\$.25c
- Foundry Work...\$2.25
- Pattern Making
Wood, metal...\$2.25
- Forty Power Tools
Build own saw, drill, lathe, sander, etc., from scraps — save money...\$1.50
- Carpentry...\$2.50
- The Young Craftsman
Over 450 things boys can make...\$2.00
- Five Acres and Independence
How to make money on small farm...\$2.50
- Your Home and How to Build It Yourself. Step-by-step construction of the famous Popular Mechanics house. Wonderfully illustrated...\$3.00
- Manual for Plymouth Car Owners
How to get the most from your Plymouth and save on repair bills...\$3.50
- 100 Beautiful Pieces of Furniture You Can Build. Complete suites for living room, dining room, bedroom shown in brilliant color. Exclusive styles by John Bergen. Working diagrams...\$3.00
- Motorist's Handbook
Popular Mechanics scores again. A 160 page guide to automotive happiness...\$2.00
- Planning Your Home Workshop.
How to use every inch of space. Build cabinets, benches, etc. How to wire...\$2.50
- What to Make for Children
Junior tough on toys? Build him playthings that will last...\$2.00
- LeJay Manual of Homemade Electric Equipment. How to construct 50 items that are scarce and valuable...\$1.50
- How to Estimate for the Building Trades: Material and labor costs for masonry, plumbing, electricity, carpentry, heating, hardware, painting, etc. 629 pages...\$5.50
- Auto Racing—6th Edition...\$2.00
- Tool Making...\$4.00
- Tool Design...\$4.50
- Plumbing Installation & Repair...\$2.00
- Ropp's Calculator
Figuring Made Easy...\$.50c
- Slide Rule Simplified...\$2.75
- Drake's Refrigeration Service Manual...\$2.00
- Power Tools and How to Use Them. Tools to start with; tools to add; how to use them and where to buy them...\$2.50
- America's Best Low Cost Homes
125 popular practical designs...\$1.00
- Toys You Can Make of Wood...\$2.50
- A.B.C. of Poultry Raising \$2.50
- Lawn Furniture
Make attractive sturdy lawn furniture with Popular Mechanics big plans. Save over 50% of the usual cost. Four plans...\$2.00
- Furniture Joinery...\$2.00
- Essentials of Upholstery...\$3.25
- The Frog Industry by Hannaca. Covers every phase of frog farming; shows you how to make big money. Full of valuable information about this fascinating, profitable industry...\$3.00
- Home Haircutting Made Easy by Mercia. Instructions for cutting your family's hair...\$1.00

MAIL THIS COUPON TODAY

Check the books you want, write your name and address below, and mail this advertisement with money order or check. Outside U. S. A. include 15% additional for shipping charges. Books selected will be mailed promptly on our "money back if you're not entirely satisfied" guarantee.

Name _____

Address _____

City _____ State _____

Mail to POPULAR MECHANICS PRESS
DEPT. 700—200 EAST ONTARIO ST., CHICAGO 11, ILL.





THE MOST AMAZING OFFER IN TIRE HISTORY. EVERY PASSENGER TIRE UNCONDITIONALLY GUARANTEED plus TIRE INSURANCE FREE

10% OFF ON ORDERS FOR TWO OR MORE TIRES

TRIPLE INSPECTED PASSENGER TIRES

Unconditional		One Year Guarantee plus Tire Insurance Free	
600-16	\$5.59	700-16	\$7.59
600-16(6)	6.50	600-15	5.59
650-16	5.79	650-15	5.59
		700-15	\$5.59
		750-16	12.25
		550-17	5.75
		475-19	5.75

LO-PRESSURE TIRES FOR EASY RIDING

Unconditional		One Year Guarantee plus Tire Insurance Free	
640-15	\$5.75	710-15	\$6.50
670-15	5.95	760-15	6.75
		820-15	\$7.50
		760-16	\$7.50

MUD AND SNOW TIRES

2 YEAR WRITTEN GUARANTEE
600-16 \$6.95 | 900-16 \$12.95 | 750-20 Regular \$12.50 | Special \$15.95

EXTRA VALUE TRUCK TIRES

One Year Written Guarantee	
600-20	\$10.75
650-20	11.75
700-20	12.50
750-20	\$14.50
825-20	\$21.50
900-20	19.50
1000-20	20.00
1100-20	\$26.95
1100-22	24.50
750-20(10)	18.00

TRACTOR TIRES available in all sizes. Complete line of High Mileage Tires in stock. Write for price list for sizes not listed. Take off 10% on orders for two or more tires. Prices subject to change.

MAIL ORDERS PROMPTLY FILLED. Send check or money order with this ad. **THE SAFTYRE CO.** "FOR THAT SAFE TIRE"
Dept. PM, 920 W. CARY ST., PO BOX 2254, RICHMOND, VA.

RETAIL PRICE \$125.00
FACTORY TO YOU \$79.95



SUPERSHOP includes precision-built 8" tilting table saw, vertical and horizontal drill press, 30" lathe, sander, grinder. 100% BALL BEARING. Write for FREE catalog, full details, trial plan. Easy Pay Plan.

POWER TOOLS, INC.

131 YATES AVENUE
BELOIT, WIS.

WHAM-O SPORTSMAN

\$1.25 45-LB. PULL!

HITS LIKE A .22 RIFLE—KILLS RABBITS, SQUIRRELS. Powerful, silent, accurate.

For hunting, target, routing pests.

Sportsman's choice sold world over!

HUNTING SLINGSHOT

Heavy duty 7" ash stock.

40 steel balls, extra rubber, target.

GUARANTEED - at dealers, or send \$1.25 to

Wham-O Mfg. Co., Box 81, South Pasadena, Calif.

* Professional model of Nat'l Slingshot Assn.

**DON'T BALANCE
DON'T ALIGN**

YOUR WHEELS UNLESS YOU USE

The EDUCATED NUT

ASK ANY AUTOMOTIVE ENGINEER MONEY-BACK GUARANTEE



Pat. No. 2365433

Long used by truck fleets (200,000 now in use) the "Educated Nut" is now available for all passenger cars. Allows you perfect adjustment on front wheel bearings every time. Replaces front wheel bearing nuts now on your car. When you "back-off" your present front wheel bearing nuts to insert cotter pin, you loosen your bearing adjustment enough to cause as much as 3/4" wobble on the tread. This causes "scuffing" and "snaketracking", costs you speed, rubber, gas, brake-lining and \$\$\$\$\$.

THE EDUCATED NUT
• Adds up to 5,000 miles more tire life
• Stops bearing breakage
• Makes steering easier, safer
• Increases brake efficiency, stops 90% of all brake squeaks

HOW TO INSTALL
Screw threaded piece up to perfect adjustment (turn up tight, then back till wheel revolves free). Then line up cotter pin holes in cap with hole in spindle, snap on steel cap. Insert cotter pin. You never "back-off" more and destroy adjustment to insert cotter pin as with old style nuts.

SEND JUST \$2.95 with name and address, make and year of car. A complete set of "Educated Nuts" (2 nuts, 2 caps, 2 pins) and instructions will be sent postpaid. Install and try. Feel the difference in driving immediately. If not satisfied, return complete set in 2 weeks. Your money will be promptly refunded. Dealer, truck owner inquiries invited.

POLIZZI PRECISION PRODUCTS COMPANY

5024 LANKERSHIM BLVD.

NO. HOLLYWOOD, CALIF.

Dept. 11-M

Here it is... The NEW ACME-LITE **MAGNETIK** All-Purpose Utility Lamp with dual action **MAGNETIC BASE**



- ★ Attaches instantly to any steel surface
- ★ Magnetic swivel adjusts to any angle
- ★ Holds vertical, horizontal, diagonal
- ★ Brings light right to work area
- ★ Easily removed quickly transferred

PUT ACME-LITE **MAGNETIK** ANYWHERE USE IT EVERYWHERE

Only \$8.95 Postpaid

You can use **MAGNETIK**—anywhere, everywhere—in your home...garage...home shop...office...factory. Just attach to steel surface...plug into electrical outlet...adjust reflector to position wanted—and you have plenty of light exactly where you need it.

In the Home—On sink, stove, wash-tubs, home shop, furnace.



In the Garage—On motor block, instrument panel, chassis



In the Office—On file cabinets, steel shelves, typewriters.



In the Factory—On lathes, punch presses, benches, spray booths.



Lifetime Alnico Magnetic Base will last indefinitely. Patented Turn-Nob on-off switch controls light. Reflector finished in sea-green hammerloid. Size—4 1/4" diameter, 5" depth. Only \$8.95 postpaid. Money back if you're not satisfied. Use coupon, order today. Immediate delivery.

ACME-LITE MANUFACTURING CO.

401 N. Wood Street • Dept. GC-1 • Chicago 22, Ill.

The new **MAGNETIK ALL-PURPOSE UTILITY LAMP** with **MAGNETIC BASE** certainly sounds okay to me. Send me _____ (state quantity)—at \$8.95 each, postpaid. Check enclosed. If I'm not 100% satisfied I can make return in 5 days and get my money back.

NAME _____
ADDRESS _____
CITY _____ ZONE _____ STATE _____

Acme-Lite MANUFACTURING COMPANY
401 North Wood Street • Chicago 22, Illinois

**Reduced Prices! WESTINGHOUSE
AIR COMPRESSORS**

Reg. \$60.50 **24⁵⁰**
Model T-1 Complete FOB PGH

New shipment—just received! With new larger direct-drive pulley for easier operation. These are top-quality brand-new Surplus Westinghouse double-piston type compressors, 6.54 CFM volume, at a big saving from the \$60.50 list price. Made to most rigid gov't. specifications. Runs off power take-off or 1/2 H.P. motor. For farm, home, industry, painters. Instructions included. Send check or money order.

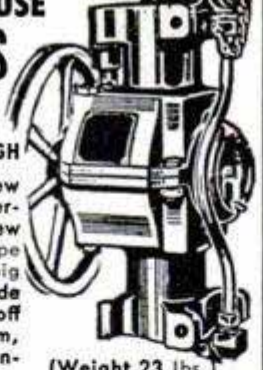

(Weight 23 lbs.)

AIR HOSE to fit, 25-ft. length with fittings & chuck \$3

NEW 1000 Cu. in. Complete Double Pressure Tank Assembly

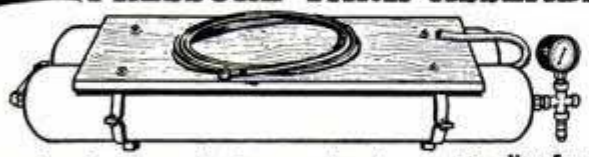

Complete low-cost Air-Storage Receiver outfit for mounting T-1 compressor. Includes two aircraft quality 6"x25" 500 lb.-test pressure tanks, frame ass'y, heavy plywood platform, pipe, elbows, nipples, 4-way cross copper tubing, flared fittings, relief valve, 160 lb. gauge, hose and tire chuck. Entire ass'y bolts together and tanks are easily removed. Easily made portable.

14⁹⁵

"CARRY TANK" Single 6"x25" with 3 ft. hi-pressure hose, fittings, tire chuck and filler check valve. Fill at any service station — carry anywhere. Only..... **5.95**

CUTLER HAMMER Automatic Pressure Switch..... 8.50

SPARE PARTS — COMPLETE LINE!

NATIONAL EQUIPMENT CO. Westinghouse Ave. Box 66
Wilmerding, Pa.

**AMAZING TOOL
for FARM and HOME!**

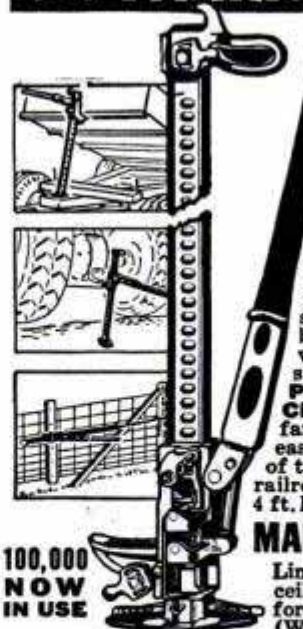

**LIFTS 3 TONS!
PULLS POSTS!
STRETCHES WIRE!
WAGON BED HOIST!
Hundreds Of
Other Uses!**

Amazing **HANDYMAN** jacks up trucks, tractors, wagons, or buildings; unexcelled as auto bumper jack; pulls posts, pipes, roots, small stumps; stretches woven or barbed wire fence; splices wire; makes hoist, clamp, spreader, etc. **LIFTS, PULLS, PUSHES with 3 TON CAPACITY.** Hundreds of uses around farm, home, garage. Simple and easy to use. One man can do work of ten. Sturdily constructed of railroad steel and malleable iron. 4 ft. long—27 lbs. Will last years.

MAIL Your Order NOW!

Limited number available. Rush ceiling price of only \$14.85 now for your **HANDYMAN TOOL.** (West of Denver, \$15.85). Actually a \$20.00 value. We pay postage. Satisfaction guaranteed or your money back. **MAIL YOUR ORDER TODAY.**
HARRAH MFG. CO., Dept. A-8, Bloomfield, Indiana

EXTRA INCOME THE YEAR 'ROUND

Earn additional income and have fun at the same time! Popular Mechanics **MONEY MAKING HOBBIES** shows you how to make 132 different projects at home in your spare time! Complete instructions with over 600 illustrations, photographs, drawings and diagrams. Projects for everyone regardless of experience. Excellent resale value. Start making your hobby pay a profit by ordering a copy of **MONEY MAKING HOBBIES** today from



POPULAR MECHANICS PRESS \$2.00
200 E. Ontario Street Chicago 11



SMALL BALL BEARING ASSORTMENT

100 POPULAR SIZES & MAKES IN PARTITIONED PLASTIC BOX

NEW - PRECISION FACTORY LIST PRICE ON BEARINGS OVER \$250.00

Bearings are SKF—FAFNIR—MRC—NEW DEPARTURE—NORMA—FEDERAL and others. Sizes from 2mm to 8mm inside diameter, and 4mm to 24mm outside diameter. **MECHANICS—TECHNICIANS—HOBBYISTS**—just the thing for servicing small machines such as Washing Machines, Vacuum Cleaners, Home Appliances, Cameras, Toys, Instruments, Automotive and equipment of all kinds.

No. MA-1 Assortment of 100 Ball Bearings in Plastic Box complete as shown, postpaid

ONLY \$19⁹⁵

ORDER Now

No. MA-2 Junior Assortment of 50 Ball Bearings in Plastic Box complete, postpaid

ONLY \$10⁹⁵

MEDALLION MFG. CO., 25 E. 25th St., Chicago 16, Ill., PM-1

Send me postpaid, Ball Bearing Assortment No. _____ in Plastic Box. I enclose check (or Money Order) for \$_____.

Name _____
Street _____
City _____ State _____

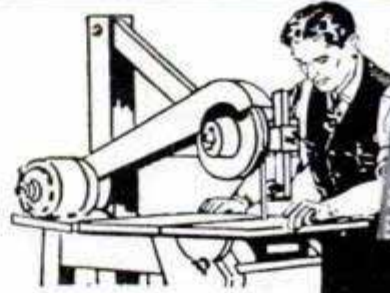

TURN WOOD, SCRAP AND WASTE INTO PRACTICAL POWER SHOP TOOLS

Don't limit your workshop fun to use of hand tools. Get the new edition of "Forty Power Tools You Can Make" with many new tools, and make your own power machines. Step up your fun and production. Do a better job with power tools. Make them yourself from wood and old discarded materials at small cost.

This book gives every detail in plain language you can understand and follow. Hundreds of pictures and plans show every step to follow. Mail coupon with \$1.50 today. Even though you have the old edition get this new book with 20 new tools. Money back if not satisfied.

40 Power Tools You Can Make at Little or No Cost

Some of the 40 Tools You Can Make

- | | |
|--------------------------------|---------------------------|
| Table Saw with Tilting Arbor | Wood Lathe Power Hacksaw |
| Saw Sander Unit | Double Duty Sander |
| Drill Press from pipe fittings | Jig Saws |
| Bending Brake | Band Saws |
| Thickness Planer | 40 Different Tools in All |

**POPULAR MECHANICS PRESS, Dept. 33
200 E. Ontario St., Chicago 11**

Send the new edition of "Forty Power Tools You Can Make."
 Remittance for \$1.50 enclosed.

Name _____
Address _____
City _____ Zone _____ State _____

**Basically DIFFERENT!
Basically BETTER!**

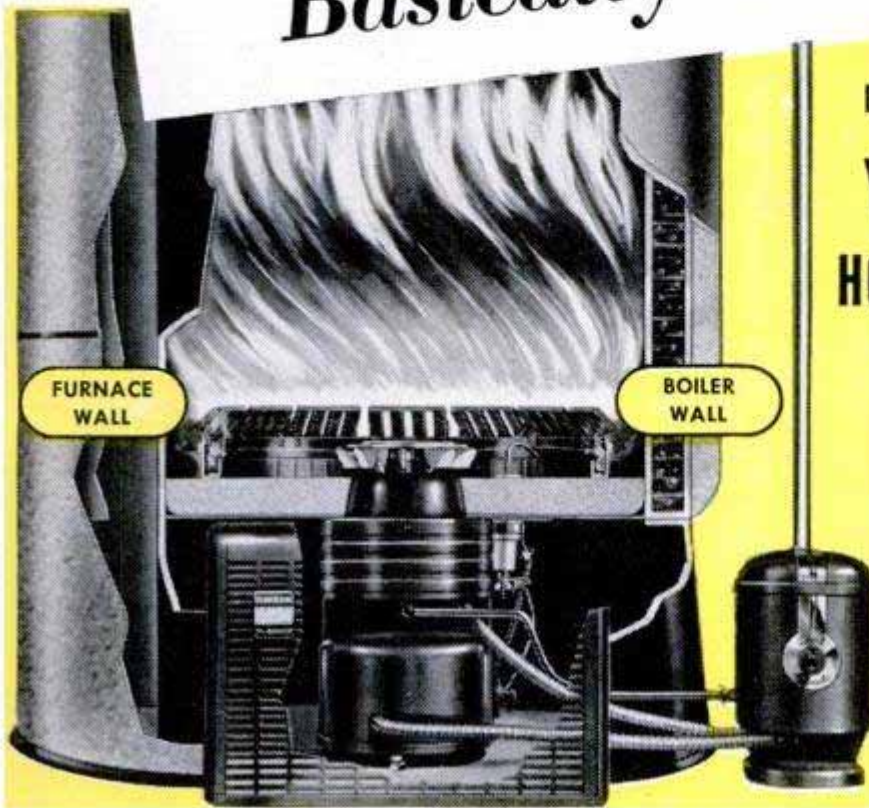

**DESIGNED AND BUILT TO GIVE YOU
YEARS OF ECONOMICAL
HOME HEATING COMFORT!**

Here you see how the Timken Silent Automatic Wall-Flame Oil Burner works in furnaces and boilers. The left half is a sectional view of a warm air furnace, the right half a sectional view of a typical boiler. Note how the burner flame blankets the combustion chamber walls for quick, economical heating—how the hearth, installed at the grate line, seals against loss of heat through basement and ashpit floor.

TIMKEN *Silent Automatic* **WALL-FLAME OIL BURNERS**

True heating comfort is *more* than just automatic heat! The unit must be built to serve you dependably and economically for years and years to come!

Once you've installed a Timken Silent Automatic Wall-Flame Oil Burner you can *relax* in clean, convenient comfort—knowing this unique burner has every needed feature for quiet, dependable,

economical operation! The natural-burning, high-intensity wall-flame turns every drop of oil into useful heat. There's only *one* moving part (self-lubricated) for utmost dependability. And the burner is backed by more than 25 years of heating experience—as are the more than 93 other models of Timken Silent Automatic heating equipment for oil, gas and coal!

MAIL THIS COUPON TODAY FOR ILLUSTRATED LITERATURE!

Timken Silent Automatic, Jackson, Michigan
Please mail illustrated literature. I am interested in:

_____ (type of equipment)

NAME _____

STREET ADDRESS _____

CITY and STATE _____

If you are a student, please check here () for special information.



TIMKEN
Silent Automatic
HEAT

TIMKEN SILENT AUTOMATIC DIVISION
The Timken-Detroit Axle Company • Jackson, Michigan
The Timken-Detroit Axle Company of Canada, Ltd., Toronto, Ont.



PM152

thousands use it!
**SAVE GAS...
 CUT REPAIR
 BILLS**
 as they drive!



**NEW STEWART-WARNER
 MOTOR MINDER**

quickly pays for itself in savings

Get yours now! See at a glance how to keep your motor at gas-saving speed. How to spot engine trouble in advance. Clearly marked, illuminated Motor Minder dial warns against faulty spark plugs, valves, timing, piston rings, manifold, muffler. Gives a constant check on engine performance with the same accuracy factory-trained mechanics use in motor tune-ups. Easily attached on instrument panel or steering post. Fits most cars and trucks. Only \$10.95.

Ask Your Dealer Now! Or Write

STEWART-WARNER

Instrument Division, Dept. N-12
 1840 Diversey Parkway, Chicago 14, Ill.



WEAR?
 I'LL SAY... BUT MAN!
 SO SOFT!

**WOLVERINE
 Pigskins**

Dry Soft... Stay Soft

Here's a new high in work glove comfort. Enjoy it! You'll find that it doesn't cost a cent because Wolverine's famous secret process tans tough native pigskin soft as buckskin yet retains all its enormous resistance to wear. No other work gloves on earth made like 'em.

Try a pair and see!

Free

WOLVERITE PENCIL

A genuine *Wolverite Mechanical Pencil* sent FREE if you write for name of nearest Wolverine dealer. No obligation. Offer limited to Continental U.S. only.

WOLVERINE

Dept. IG-1

Rockford, Michigan

Save Fingers with

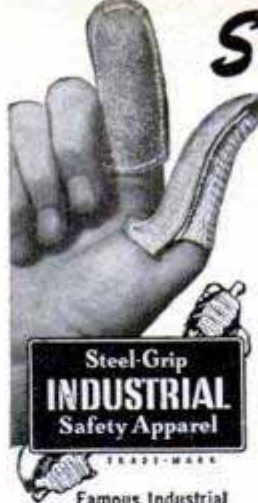

**Steel-Grip
 INDUSTRIAL
 Safety Apparel**

Famous Industrial
 Safeguards Since 1910

**Steel-Grip Finger Guards
 Lower Your Hand Protection Cost**

Hundreds of factories save time and injuries by protecting workers with Steel-Grip Open End Finger Guards. For handling rough, sharp articles, buffing, grinding, sanding, and punch press work, hundreds of other jobs. Protect fingers or thumbs, front or back, from cuts, abrasions or blisters. Various designs in leathers and other materials; elastic web back for snug, cool, comfortable fit. Sizes for men and women. Send 10c for sample. *Catalog of Safety Apparel Free.*

INDUSTRIAL GLOVES CO.

A Corporation
 1413 Garfield St., Danville, Ill.
 (In Canada, Safety Supply Co., Toronto)

**BUILD YOUR OWN
 DUMB-WATER ELEVATOR**
 PLANS • PARTS • MOTORS and WORM DRIVES

Now you can have all the convenience of a dumb waiter elevator in store, restaurant, shop or home at lowest cost. We furnish complete parts for elevators similar to those described in ARTICLE on pp. 174-177 Dec. '51 issue of POPULAR MECHANICS. You can easily build a hand or power operated elevator from our diagrammed instructions.

SEND 25c for completely diagrammed instructions with list of parts, kits and prices. Mail to Dept. A.

See our large color ad on p.p. 484, 485 in this issue for other money saving buys!

**C&H ELECTRIC
 MACHINE Co. Inc.**

434 W. Juneau Ave., Milwaukee 3, Wisconsin



12 Months Driving for \$4.95

A new tire guarantee with each used tire. Positively Not Re-Caps—Every Tire Machine Inspected

600-16 \$4.95 Two for \$9.50 650-16 \$5.50
 670-15 \$5.95 700-15 \$5.95

Send this ad with order. Mail orders rushed on receipt of check or money order for the size desired.

Dept. B
 West Park Tire Sales, 14018 Beach Ave., Cleveland, O.

HELPFUL BOOKS

Send post card asking for FREE catalog

Popular Mechanics Press, 200 E. Ontario, Dept. 601, Chicago 11

**NEW: PRECISION KEY CHUCK
 with SELF CENTERING ARBOR**

ELIMINATES DRILL RUN-OUT. When attached to even a worn under-sized shaft the Arbor's 6 Set Screws will center and hold the positively precision-made 0-3/8" cap. Chuck. Easily you can MAKE AN ACCURATE POWER DRILL from any 1/2" shaft or motor, without losing its power to drive, as other usual equipment. Any 3/4" bore pulley fits over the 2 1/4" long Arbor.

POSITIVE MONEY-BACK GUARANTEE



MAIL ORDER TODAY

only \$7.95 (slightly higher Postpaid in Canada.)

BEST TOOLS, INC., 2432 So. 61st Ave., Dept. PM, CHICAGO 50



TRAILER COACHES

Here's everything you want to know about trailers, with plenty of pictures and plans and instructions for building three different types. Covers also, history of trailers, trailer parks, camps and overnight-stops information, furniture, furnishings, materials and engineering data. If you want to build a trailer, live in a trailer, or just want to know more about trailers, get this book. Only \$1.50 postpaid. Rush order to:

POPULAR MECHANICS PRESS • Dept. 350, 200 E. Ontario St., Chicago

Build it Yourself!

Complete Trailer Book and Construction Data for 10, 16 and 22 Foot Trailers — Only \$1.50

Partial Contents

Trailer Parks—Living in a Trailer—Towing a Trailer—Floor Plans—Service—Classifications—Balance—Dollies—Jacks—Weight Distribution—Construction—Working Drawings for a Two-Place, Standard Travel and Standard Dwelling Trailers. Size 8 1/2 x 11 1/4 inches.

PROTECT YOUR CAR'S CHROME FROM SALT PITTING — RUST — CORROSION

PROTEX Chrome Protective Coating keeps the chrome on your car looking like new through the meanest weather. Gives bumpers, trim, etc. a tough, acid resistant coating that laughs at snow, salt, mud, calcium chloride and other elements that rust and corrode. Easy to brush on — one application lasts all winter. PROTEX also protects brass, copper and aluminum from pitting, rust and corrosion. Keeps unused tools, sports equipment, and TV antennas in top shape. Comes in transparent, green, gold, blue, or bronze. Satisfaction absolutely guaranteed or money refunded. At Service Stations, Car Dealers or Parts Stores or Order Direct.



COMPLETE KIT ONLY **\$2.00**

Send today. State color wanted.

PROTEX CO.

2465 W. Davison, Dept. PM2, Detroit 6, Mich.

FREE! Plans Show How To Build A

POWER MOWER



Also Plans Build A Gasoline Type That **PULLS and STEERS ITSELF!**

Save time and work cutting grass and weeds — Build a whirl blade power mower cheaply without special tools or equipment. Send postcard for FREE Building Plans.

For As Little As **\$19.95** Whirl Blade Electric Less Motor

WRITE TODAY

T & H MFG. CO., 811 EAST 31 ST., DEPT. 111, KANSAS CITY, MO.

Build Your Own Motorized Workshop

This Famous Book Shows How to DO IT!



Easy-to-Make 40 Different Power Machines

Make them yourself — lathes, drill presses, sanding machines, shaper, circular, band and scroll saws and other power tools — from wood, pipe, and discarded parts that cost little or nothing. Get the new edition of "Forty Power Tools You Can Make" even though you have the older edition. This new book has 20 new tools. Make yourself up-to-date, efficient power machines that will save you hundreds of dollars. Send \$1.50 with order and save high C. O. D. charges. Your money back if not satisfied.

POPULAR MECHANICS PRESS, 200 E. Ontario St., Chicago 11, Ill.

Say You Saw It in POPULAR MECHANICS

FILE SAWS the RIGHT WAY

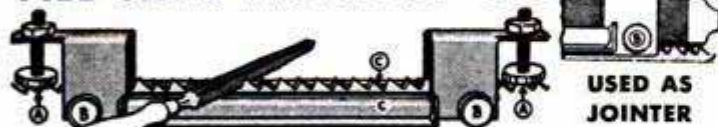

USED AS JOINTER

SO EASY with this new filing jig and jointer anyone can now sharpen any handsaw like new! When file hits hardened steel rollers teeth are finished and EXACTLY THE SAME HEIGHT. All teeth cut and saw runs true and smooth. Jig and instructions \$2.95 postpaid. FREE FOLDER.

SHARPEN YOUR CIRCULAR SAWS

The RIGHT WAY on your own saw table. Sharpens rip, cutoff, hollow ground and combination blades — 6" to 10". Saws stay round with correct bevel. Precision made, easy to use. GUARANTEED. Only \$8.95. Includes \$3.00 Grinding wheel.

"TRU-CIRCLE" saw set automatically sets teeth at 10° or more. \$2.95

AT DEALERS OR POSTPAID

A. D. McBurney, 317 E. 4th St., Los Angeles 14, Cal., Dept. A-13

You must be satisfied with DUMORE TOOLS or your money back!

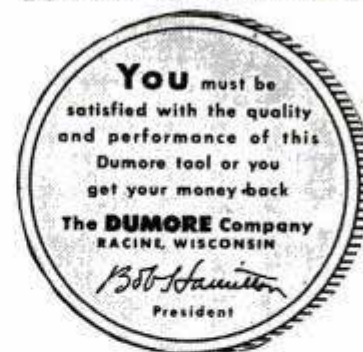

This seal of guarantee goes with every Dumore Tool. It's your assurance that Dumore Tools are your best buy!

DUPLEX GRINDER

Most powerful hobby handgrinder, handles 1/4", in addition to 1/8" and 3/32", mounted accessories. 1/14 HP, 17,000 RPM. Full line of attachments available for converting Duplex to flexible-shaft tool, lathe or bench grinder, and sander.



- No. 3-011 — Standard Duplex Grinder with 9 accessories in attractive carton - - - \$24.95*
- No. 3-021 — De Luxe Duplex, in attractive steel case with 51 accessories - - - \$34.50*

DUMORE HOBBY-FLEX Top favorite with model makers — handy men. Amazingly versatile. Pen-type tool holder easily works in tight places. 1/20 HP, 15,000 RPM. Handles all 1/8" and 3/32" mounted accessories.

- No. 19-021 — Standard Hobby-Flex - \$24.50*
- No. 19-011 — De Luxe Hobby-Flex in steel case with 10 accessories - - - \$29.50*

Hobby Tool HANDGRINDER

Tool of a hundred uses — sands, grinds, saws, drills, polishes, sharpens, carves, etc. Full 1/40 HP, 28,000 RPM. Handles all 1/8" and 3/32" mounted accessories.

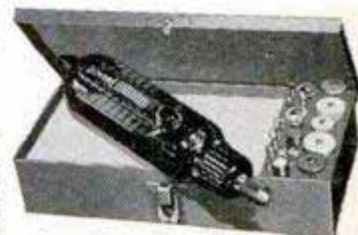

- Handsome red and black housing. Instant quick-change chuck. No. 4-021 — Hobby Tool Handgrinder in attractive carton with 2 accessories - - - \$19.50*
- No. 4-011 — Same as above in handsome steel case with 50 accessories - - - \$27.50*

New DUMORE ROUTER Best yet for inlay or cabinet work. Mortises for locks, hinges, weather-stripping, etc. A "must" for modern carpenters. Use as shaper, too! Full 1/8 HP, 19,000 RPM. Handles all 1/4" shank bits and cutters.

- No. 22-011 — Router, for use on 115V, AC or DC. \$29.50
- No. 22-200 — Router Attachment Kit, consisting of Fence Guide and Template Guide. \$4.50*

CARVIT Duplicator

Learn skilled woodcarving in 20 minutes . . . turn out beautiful, saleable carved signs, bookends, plaques, statuettes, etc., in wood or plastic. Just guide Carvit tracer pin over model you want to duplicate. A complete profitable hobby in one tool.



- No. 15-100 — Complete Carvit for flat work, including sample model and instructions - - - \$67.50*
- No. 15-105 — Index attachment and instructions for doing 3-dim. work - - \$9.75

If dealer can't supply you — send check or money order. We ship postpaid anywhere within U. S. A. Write for free catalog 49C.

The DUMORE Company

1300 17th STREET, RACINE, WISCONSIN

Export address:

13 E. 40th St., New York, N. Y., U. S. A.

*Prices slightly higher West of Rockies

Bronson Presents

*The finest reel
money can buy!*

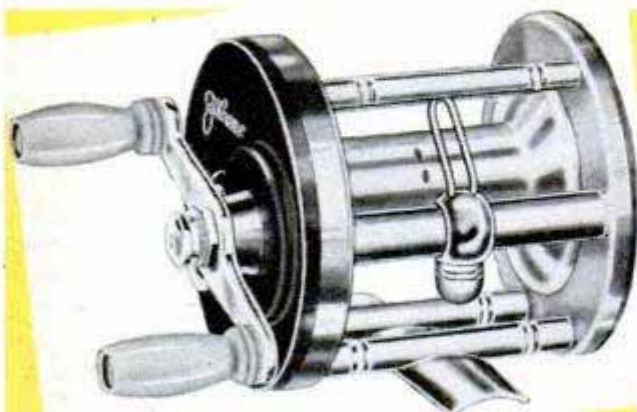

J. A. Coxe 25-C Coronet
\$33.00
... with the sensational
one-piece spool

You'll agree it's the finest when you see this new Bronson-made automatic free-spool reel. Handles automatically disengage and do not turn on the cast. One-piece aluminum spool is the lightest yet, weighs only 33/64 oz. It's stronger, too—and machined inside and out for perfect balance. Spool revolves on a stationary shaft for perfect alignment. 10-second takedown without tools.

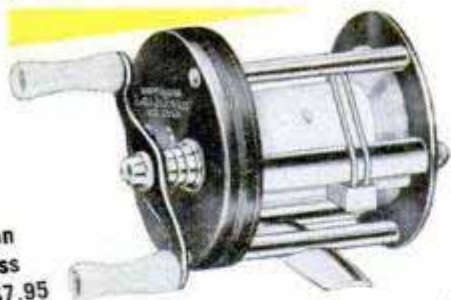

Bronson Lashless
1710—\$7.95

For a lightweight reel at a medium price, choose the Bronson Lashless. Precision built, beautifully balanced, modern in every detail. Green anodized aluminum, weighs in at 4 3/4 oz. 3-piece takedown, snap-on plastic arbor. Famous Bronson Duo-Pawl doubles the life of the reel. Take a new Coxe or Bronson reel on your next fishing trip. \$2.95 to \$33.00.

Bronson

WRITE FREE CATALOG Bronson Reel Co., Bronson, Michigan
Dept. P (Division of Higbie Manufacturing Co.)



Permanent Highway Stripe Eliminates Costly Maintenance

Traffic stripes on highways, applied by a new method, are expected to last as long as the pavement itself. The stripe is a plastic material spread in a recess in the pavement. The new method is expected to reduce highway-maintenance expense and eliminate traffic disruptions caused by periodic repainting of faded traffic lines.

Stainless-Steel Coating Protects Metal Surfaces

Applied with brush or spray, a stainless-steel coating protects metal surfaces against rust, corrosion and other types of deterioration caused by salt air and water, industrial atmospheres, alkalis and most strong acids. The coating, which gives the appearance of unpolished stainless steel, dries to touch in 30 to 60 minutes. Applications of the material around the home include metal window sash, exposed plumbing connections, pipe and metal stair railings. Although the coating will not adhere to chromed surfaces, it can be used to touch up spots where plating has been scratched or knocked off.

☐ In Bolivia, where one airport's clay runways became dangerously slick in wet weather—and there is no rock or gravel near by—engineers baked clay bricks in ovens and broke them up to stabilize the runways.

IT'S LEJAY FOR WAR SURPLUS — BARGAINS GALORE

HYDRAULIC EQUIPMENT



No. 8—Double Action Cylinder 1½" bore, 5" stroke. ½" shaft. Lifting capacity 1760 lbs. with 1000 P.S.I. input. Overall length 15¾". Ball bearing mounts. **\$7.95** on both ends.

No. 6—Double Action Cylinder 1½" bore, 26" stroke. 1" shaft. Lifting capacity 1760 lbs. with 1000 P.S.I. input. Overall length 35". Bolt mount at bottom, clevis at top. \$55.00 Value—now only **\$15.95**

No. 3—Double Action Cylinder 3" bore, 24" stroke, 1-3/16" shaft. Lifting capacity 7070 lbs. with 1000 P.S.I. input. Overall length 34½". Clevis mount both ends. Cost Gov't. \$176.00 **\$27.50** Only.

No. 2—(As Illustrated) Double Action cylinder 4" bore, 18" stroke, 1½" shaft, lifting capacity 12,500 lbs. with 1000 P.S.I. input. Overall length 30½". Clevis mounting at bottom, threaded shaft at top. Cost Gov't. \$300.00—Special... **\$29.75**



No. H.12—Hand Pump with handle. Built in check valve—Capacity 2000 lbs. Pressure. \$55.00 Value... **\$11.25**

No. 194—Pesco Type pump for oil, water, air, ½" pipe thread ports. Splined self-aligning shaft... **\$12.50**



No. 211—Pesco Type pump for oil, water, air, 1" pipe thread ports. Splined self-aligning shaft... **\$15.25**

WELDER SPECIAL!

Yours for only \$67.90 Assemble Yourself



Powerful 200-250 ampere Welder built for light or heavy duty work. Heavy duty Aircraft Generator. Built in Arc-Stabilizer and HI-LO switch with dial control. Complete with all parts including pulley as shown and ready for assembly (You save \$29.60) No. AW9 Kit **\$67.90** complete.

2 or 3 jobs quickly pays for it. Same Welder, Factory assembled ready to go. Part No. 100... **\$97.50**



Accessory Kit

EXTRA! A \$14.95 Accessory Kit Complete for only \$12.95! Includes Welding Helmet, Electrode Holder, 5 lbs. Ass't Rods, Two 10 ft. Welding Leads with terminals and ground clip, plus Audel's Welding Guide. Sold with any Welder Kit... Special Price **\$12.95**

MITE WINCH HOIST

No. WH6—A giant little hoist—lifts 1000 lbs. Bronze gear drive 30 to 1. Drum 4" x 1¼". Perfect for Farm, shop, factory, boats, etc. (Cost many times our price)... **\$12.75**



ORDER FROM THIS AD

MOTOR GEAR UNIT

No. E9—Eclipse 24V. motor gear unit. Gear ratio 4 to 1. Can also be adapted for 2-1 to 20-1 ratio. Gear unit with separate A. C. Motor makes perfect garage door opener, hoist, pump jacks, hay lift, etc., also works good on 6 or 12 volts. Cost Gov't. \$221.00—while a few last... **\$12.95**



32 VOLT D. C. MOTOR

New Century Ball Bearing Motor 1/6 H.P. 1750 R.P.M. Compound wound, 6.4 Amps. Totally enclosed with base. Regular \$35.00 Value. Our Special **\$24.95**



115 Volt A.C. Motor

New Delco Ball Bearing Motor 1/2 H.P. split phase 1725 R.P.M., 60 cycle 115 Volts for vertical or horizontal mounting. With 5½ feet heavy rubber cord and safety switch. Very special at... **\$16.45**



MOTOR GENERATOR

General Electric or Emerson Ampidyne Motor Generator. Input 27 volts at 44 amps., 7,500 R.P.M. Excellent for portable light plant. Cost over \$140.00. Our price... **\$7.50**



SPECIAL MOTOR

A ½ H.P. Emerson 24 volts D.C. Motor, self contained fan, 4000 R.P.M. Delivers 1/10 H.P. on 6 volts 900 R.P.M. or ¼ H.P. on 12 volts 1800 R.P.M. A real buy... **\$5.95**



MONEY BACK GUARANTEE — Send Check or Money Order—or small deposit and we will ship C.O.D. Catalog of additional Surplus Bargains upon request.

LEJAY MANUFACTURING CO., INC.
747 LeJay Bldg., Minneapolis 8, Minn.

AMERICA'S FIRST HIGH PERFORMANCE LIGHTWEIGHT



First in America with 3-speed, foot-shift gear box. First with telescopic forks. Famous Mustang 9.5 h.p., 4-cycle engine. First place in many endurance contests. First choice at the low price of only \$370.00 Fed. tax paid at factory Glendale, Calif. See it at your dealer's or write . . .



\$370
Fed. Tax Paid at Factory Glendale, California

MUSTANG MOTORCYCLE CORPORATION, Dept. AN, 635 W. Colorado, Glendale 4, California

Say You Saw It in Popular Mechanics

Make \$20 to \$30 a Day with this new **ONE MAN**

MAIL ORDER BUSINESS



DO PLASTIC LAMINATING AT HOME!

Would you like to get orders and cash from your mailman—then in space of hours make and ship the things people ordered from you? If you have spare time and a little spare room in kitchen, garage, or basement, get the facts about the newest and most fascinating of all home operated businesses. For the first time a simplified machine brings the fabulous profit of **Plastic Sealing and Plastic Laminating** within the reach of the small operator. Any one can learn to operate the machine with a few minutes practice—then

with our **Magic Mail Plan** can get mail orders pouring in daily with cash in every envelope. No canvassing—no selling. We even supply the circulars you mail to bring back cash and orders. Don't waste a minute. Rush your name. We'll send you, **FREE** and postpaid, pictures, prices, details, all the facts you need to start. Mail coupon or send name on postcard. No charge.

Make Thousands of Beautiful Art Creations

COSTUME JEWELRY • CIGARETTE BOXES TRAYS • CANDLESTICKS • COASTERS LAMP BASES • BOOK ENDS...ALL IN SPARKLING COLORED PLASTIC



WARNER ELECTRIC CO., 1512 Jarvis Av. DEPT. PL-31 - CHICAGO 26, ILLINOIS

WARNER ELECTRIC CO., 1512 Jarvis Av. Dept. PL-31, Chicago 26, Ill.

At no cost to me, please rush complete details postage prepaid. I am under no obligation.

Name.....
Address.....
City..... Zone..... State.....

THIS MAN . . .
is taking out of the machine a Plastic Sealing Job—ordered by mail—only 11¢ in material cost brings back \$2.58 in cash by mail. Capacity of machine: \$25.00 profit per hour of operation.



Honestly now— would you prefer a shrinking violet?

The advertisers in this magazine all claim their products are “tops.” They are full of pride in their brand names.

Every so often you meet someone who objects to what he calls the “boastfulness” of advertising, but *most* of us Americans like it.

We like it because we know that deep *pride* in things well made goes way back into the factories and is reflected in the fine products we have to choose from when we go to buy the things we use in our homes or on our persons.

We like it because we know that pride is a spur to make better merchandise; and that it is the driving power that keeps men striving each to outdo the other in new ideas, new and better ways of doing things. The end result is a steady stream of new and better *means* to make life comfortable; more and better jobs for us to earn the means of buying them.

We will take the *Proud* ones—and let some other land cultivate the shrinking violets.

Brand Names Foundation

INCORPORATED

A non-profit educational foundation • 119 West 57th Street, New York 19, N. Y.

Foley Filer Users—Attention!!

Save on File Expense! Improve Your Workmanship!

Sharpen More Saws With Each File!

"FLOATING ROLLERS" will solve these problems for you! "FLOATING ROLLERS" replace saw carrier clips and have a tension spring which holds the carrier snug to the lower rollers, eliminating irregular size teeth, carrier play, etc., which must be remedied before precision work can be accomplished. Many other features make the "FLOATING ROLLERS" a MUST investment for you. Easily attached in five minutes.

For Model F-16, F-24 or F-61 Foley Filer, equipped with carrier rollers, \$7.50 per set.

For Model F-16 or F-24 not equipped with carrier rollers, \$10.25 per set.

Order a set today for 30-days trial. If not satisfied in any way, return them and your money will be refunded. Save COD and postage charges by sending check or money order with order, or write for further information.

STADICK MANUFACTURING CO.
Box 73, New Ulm, Minnesota

•• A SHOE BUSINESS IN YOUR HAND! ••

EARN \$60 WEEKLY
WITH ONLY
3 SHOE ORDERS A DAY!

Make more money with famous 30 year old company. Show complete line quality shoes for men, women, children. Commissions to \$4.00 per pair, PLUS Cash Bonus to 75¢ per pair, PLUS Paid Vacation! Smash hit styles with magic comfort heel-to-toe cushion are selling dynamite. No experience or investment needed.

Actual shoe samples supplied without cost. Write TODAY for full information and FREE 60 page Spring Catalog.

TANNERS SHOE CO., 917 Boston 10, Mass.

THE
BIGGEST
SELLER
IN
30 YEARS



HEEL
TO
TOE
CUSHION

WHAT TO MAKE 1952



Best Issue
Ever Published
Twenty Pages
in Full Color
Over 200
Useful Projects
240 Exciting
Fun-Filled Pages
Only \$1.00
Per Copy

Get Your Copy of This Valuable Book Today
While Copies Are Still Available!

Go to your newsstand now and get your copy of the 1952 edition of *What to Make* while it is still available. Never before has there been an issue such as this with its twenty pages of full color plates and fascinating array of projects. An exclusive article tells you how to build your own outdoor kitchen complete with fireplace, picnic table, etc. Others tell and show how to make your own Christmas cards; how to work with metal and leather; how to build magazine racks, gushing table fountain, corner cupboards, knick knock shelves and scores more. Hundreds of drawings, photos and diagrams illustrate the projects. Order from your newsdealer now or send \$1.00 to

Popular Mechanics Press, 200 E. Ontario, Chicago 11

Big, Money-Saving Offer Repeated by Popular Demand

MEYERCORD'S AMAZING, LIFELIKE

PLASTIC VENEER

it's easy to
DECORATE

- furniture
- cabinets
- lamp bases
- book ends
- walls, doors
- table tops
- re-finish old pieces

Re-creations of
rare wood grains
and fine marble

SAVE NOW! SEND FOR
INTRODUCTORY PACKAGE!

Now—Meyercord, originators of Plastic Veneer, again offers you re-creations of rare wood grains and fine marbles at a big saving! Used on furniture and TV cabinets for years, yet easy to apply at home—on wood, metal, glass or composition. Praised by thousands

of home craftsmen for amazingly beautiful results! Plastic Veneer can be used on any flat or simple curved surface—can be top-coated, rubbed or waxed. Start your first project today! Order a supply now!

INTRODUCTORY OFFER!

3 sheets of plastic veneer

1 can of cement \$5.00

1 squeegee

ALL FOR ONE PRICE

POST
PAID

CHECK COUPON—MAIL TODAY!

THE MEYERCORD CO., Dept. 57-1, 5323 W. Lake St., Chicago 44, Ill.

Please send me your \$5.00 introductory offer of 3 sheets of Meyercord Plastic Veneer, squeegee, cement and complete instructions. Patterns are checked below.

Enclosed find check m.o. for \$5.00. Additional sheets of wood grains, pearl or gingham @ \$1.50 ea.; marbles @ \$1.75 ea. Every sheet contains approx. 6 sq. ft.

- | | |
|--|---|
| <input type="checkbox"/> Prima Vera | <input type="checkbox"/> Carpathian Burl |
| <input type="checkbox"/> Aspen Crotch | <input type="checkbox"/> French Rosewood |
| <input type="checkbox"/> Straw Carpathian | <input type="checkbox"/> Butt Walnut |
| <input type="checkbox"/> Satinwood | <input type="checkbox"/> Walnut Stump |
| <input type="checkbox"/> Straw ZebraWood | <input type="checkbox"/> Italian Walnut |
| <input type="checkbox"/> Limed Oak Tan | <input type="checkbox"/> Rhododendron Burl |
| <input type="checkbox"/> Straw Stump | <input type="checkbox"/> Macassar Ebony |
| <input type="checkbox"/> Blond Harewood | <input type="checkbox"/> Guineawood |
| <input type="checkbox"/> Bleached Mahogany | <input type="checkbox"/> Fiddleback Walnut |
| <input type="checkbox"/> Bleached Fiddleback | <input type="checkbox"/> Walnut Angle Grain (45°) |
| <input type="checkbox"/> Gray Harewood | <input type="checkbox"/> Mottled Pearl—Gray |
| <input type="checkbox"/> Prima Vera Gray | <input type="checkbox"/> Mottled Pearl—Maroon |
| <input type="checkbox"/> Limed Oak Gray | <input type="checkbox"/> Mottled Pearl—Blue |
| <input type="checkbox"/> Striped Mahogany | <input type="checkbox"/> Red-White Gingham |
| <input type="checkbox"/> Fiddleback Mahogany | <input type="checkbox"/> Blue-White Gingham |
| <input type="checkbox"/> Mahogany Crotch | <input type="checkbox"/> Black and Gold Marble |
| <input type="checkbox"/> Mahogany Stump | <input type="checkbox"/> Breche Rose Marble |
| <input type="checkbox"/> Walnut Crotch | <input type="checkbox"/> Jaune Benou Marble |
| <input type="checkbox"/> French Walnut | <input type="checkbox"/> Mexican Onyx |
| <input type="checkbox"/> Quartered Walnut | <input type="checkbox"/> Rose de Brignole Marble |
| <input type="checkbox"/> Ribbon Walnut | <input type="checkbox"/> Skyros Marble |
| <input type="checkbox"/> Striped Walnut | <input type="checkbox"/> Verdi Antique Marble |

NAME _____

ADDRESS _____

CITY _____ ZONE _____ STATE _____

(Offer good in continental U.S.A. only)

DISSTON®

THE SAW MOST CARPENTERS USE



DISSTON D-23 . . . lightweight, straight-back. The favorite with saw users who demand quality and workmanship. Disston Steel blade, thin-back, true taper ground. Both rip and cross-cut; all popular lengths and points.



DISSTON NO. 2 COMPASS SAW

Open-grip handle for easy control. Disston Steel blade, toothed to point; taper ground. Hardwood handle, Disston weatherproof finish.



DISSTON COPING SAWS and BLADES

For cutting curves, shaping, scroll work, etc. Frame of Disston Steel; hardwood handle. Blades of spring sawsteel; filed and set.



DISSTON DE LUXE CIRCULAR SAWS

Made of Disston Steel; high, smooth finish; keen teeth; accurate fitting. Special styles to fit all makes of bench and portable electric hand saws.



DISSTON HACK SAW FRAMES and BLADES

Sturdy, well-made frames adjust to 8, 10, or 12 inch blades; four cutting positions. High-Speed, Dimol and Tungsten steel blades; uniform tooth spacings and shapes.

ASK YOUR HARDWAREMAN
to show you these fine Disston Saws

FREE BOOKLET! New edition, famous Disston Saw, Tool, & File Manual. Tells how to choose and use tools; how to care for them. Gives helpful hints on wood working, metal working, and selection of materials. **FREE**—ask your Hardwareman for a copy, or write us.

HENRY DISSTON & SONS, INC.

111 Tacony, Philadelphia 35, Pa., U.S.A.
In Canada, write: 2-20 Fraser Ave., Toronto 3, Ont.

YOU CAN MAKE THESE WITH
POPULAR MECHANICS

PLANS AND BLUEPRINTS

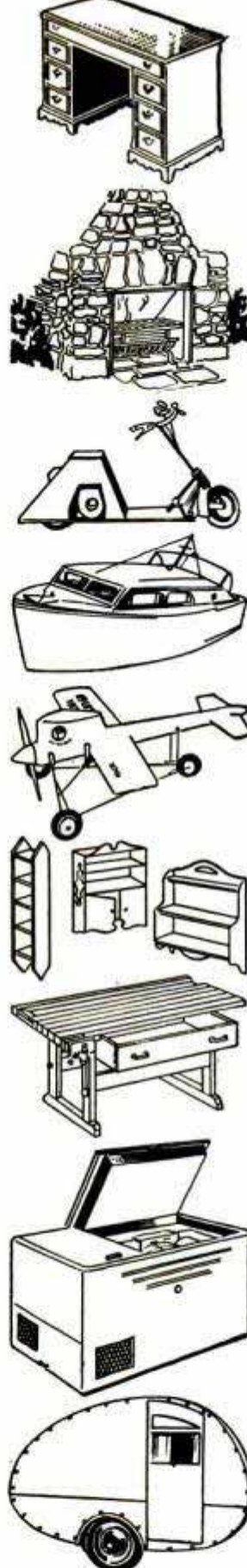

- 501—Colonial Grandfather's Clock. 25c
- 507-508—Doll-House, 5-Rooms, Open staircase, fireplace 50c
- 526—Queen Anne Coffee Table: True replica of antique 25c
- 528—Duncan Phyfe Console Table: 30 in. high 25c
- 529—Lawn Chair: Southern style . . . 25c
- 593—Three Attractive Corner Shelves: Scroll-sawed 25c
- 596—Three Hanging Type Shelves: Hold books, china, etc. 25c
- 661—Rocking Horse: Scroll-sawed from plywood 25c
- 707—12 Ft. Rowboat: Flat-bottom, four seats 25c
- 795—Two Handsome Cedar Chests. 25c
- 811-812—16 Ft. Canoe: Canadian type, cedar planking 50c
- 813-814—Pops Outboard Racer: 10 ft. long, stepped bottom . . . 50c
- 828-835—Sovereign of the Seas: English warship model \$2.00
- Sovereign of the Seas: Instruction Book \$1.00
- 836—12 In. Bandsaw: Uses plywood, cuts two in. stock 25c
- 839—Melrose Corner Cabinet: Old Colonial design 25c
- 846-848—Governor Winthrop Desk: True copy of original 75c
- 896-897—Three Easily Made Workbenches—Simplified construction. 50c
- 906-909—Midget Auto: 58 in. wheelbase, 1/2 to 3/4 h.p. \$1.00
- 910—Circular Saw Table: Hardwood, 24" x 36", Stationary 25c
- 917—Outdoor Fireplaces: Several simple but practical 25c
- 920-922—Lawn and Garden Furniture: Swings, arbors, tree seat . . 75c
- 923—Indoor Fireplaces: Standard Sizes 25c
- 926-927—Venetian Blinds: Three different styles 50c
- 930—Hooked Rug Frame—Quilting Frame 25c
- 933—Cape Cod Cupboard: 4 ft. wide, 5 ft. 8 in. high 25c
- 935—Knee-Hole Desk: 40 in. long, 30 in. high, 31 1/2 in. wide 25c
- 936—Modern Coffee Table: 24 in. long, 15 in. wide 25c
- 952—Child's Crib in Maple 25c
- 958—Colonial Corner Cupboard: 6 ft. 8 in. high 25c
- 961—Hanging China Cabinet: 38 in. long, 40 in. high 25c
- 969—Combined Chest and Writing Desk: 35 1/4 in. high 25c
- 970—Modern Clothes Chest: Built of Plywood 25c
- 977—Bookcase in Chippendale Style: 47 in. high, 10 in. wide . . . 25c
- 978—Lawn Chair on Wheels: Lightweight, easy to wheel 25c
- 981—Colonial Wall-Shelf: 30 in. high, 19 in. wide 25c
- 984—Duncan-Phyfe Drop-Leaf Table: Reproduction of historic piece . . 25c
- 986-987—Utility Trailers: Built of old auto parts 50c
- 989-990—Speedy Motor Scooter: Gas engine, 40 to 60 miles on gal. of gas 50c
- 991—Gun Cabinet: Handy cabinet includes rack for rifles 25c
- 993—Twin-Deck Beds: 6 ft. 4 in. long, 31 1/2 ft. wide 25c
- 1106-1112—SEACRAFT—25 FT. CABIN CRUISER: Adaptable as sport fisher, express cruiser, or utility boat. Cruises at 15 knots with marine engine or converted auto engine. Cabin sleeps four. Galley has fresh-water tank, sink, and cook stove. Set of seven large-sized blueprints scaled 1 in. per ft. plus 40-page two-color illustrated booklet, only \$10.00
- 1011—Fireplace Fittings: Andirons, log rack, etc. 25c
- 1080-1081—Banta: 12 Ft. Plywood Runabout: Vee-Bottom, 3-passenger 50c
- 1086—Black Forest Corner Shelf: Scroll-sawed 25c
- 1089-1090—Home-Constructed Freezing Unit: reaches minus 30 degree temp 50c
- 1091-1096—17 ft. trailer, 7 ft. wide. Steel chassis \$1.50
- 1102-1105—Midget Trailer: "Teardrop" body. Sleeping quarters for two \$1.00
- 1113-1114—Gold Rush of '47: The A.M.A. Open Class B Record Holder Plane Model \$1.00

FILL OUT AND MAIL THIS COUPON NOW

POPULAR MECHANICS COMPANY, Dept. 19
200 E. Ontario St., Chicago 11

Please send the following plans _____

I am enclosing \$ _____

Name _____

Address _____

1903 Barney Oldfield lowers track record at Indianapolis.

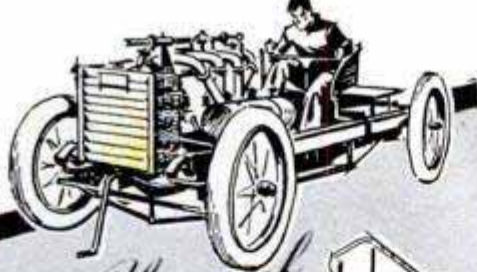

1909

Wright Brothers make new flight record.

1925

Popular Mechanics sensational Superheterodyne Eight.

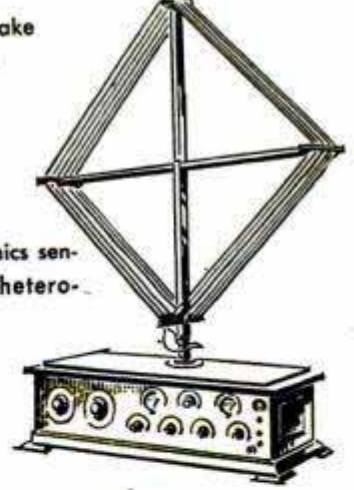

1944

The atomic powered auto.



Fifty Years of
POPULAR MECHANICS

Fifty Years of
POPULAR MECHANICS

A Book You Will Be Sure to Want . . . to Keep . . . to Treasure Forever

See It Happen All Over Again!

Thrill again as the years unfold in FIFTY YEARS OF POPULAR MECHANICS. See the great inventions and scientific developments of '50 fabulous years happen all over again in articles and pictures, prepared and first printed when the events took place. Thrill to the accounts of the first channel flight and the jet-propelled airplane . . . to the pedal-propelled submarine and to the terrifying atom bomb.

History-Making Inventions • World-Shaking Events

Live again from the days of the first motorized sewing machine to the age of nylon and cellophane. See the automobile emerge; the birth of the airplane, the phonograph, motion pictures, radio and television. Follow the scientific development of two world wars. Read the fascinating articles by and about such personages as Pierre Curie, Guglielmo Marconi, Jules Verne, Winston Churchill, Lamot Dupont, Thomas Edison, the Wright Brothers and hundreds of other famous people.

The Once-in-a-Lifetime Book

FIFTY YEARS OF POPULAR MECHANICS is without a doubt one of the most fascinating, informative and entertaining books you can own or give to others. It's a big book too—Size 8½ x 11 inches with 320 pages and more than 600 illustrations. The final chapter is devoted to things to come and a glimpse into fifty years from now. Price \$5.00. Order your copy, with your name in gold on the cover, today.

The Awe-Inspiring Story of American Progress Depicted in Memorable Pages from a Half Century of Popular Mechanics

Since 1902 Popular Mechanics has faithfully recorded and accurately reported, in word and picture, the greatest 50 years of mechanical and scientific progress in human history.

More than 150,000 fascinating pages have been printed. A selection of these pages, with explanations and comments printed in an extra color in the margins, has been put into a big 320-page book by Simon and Schuster, New York publishers. The title of the book is FIFTY YEARS OF POPULAR MECHANICS.

Here is a book you will want to own — to cherish and keep forever. Your name stamped on the cloth-bound cover without extra charge. Order on coupon below.

YOUR NAME IN GOLD ON THE COVER FREE — MAIL COUPON!

**POPULAR MECHANICS PRESS,
200 East Ontario Street, Chicago 11, Ill.**

Send at once ___ copies of FIFTY YEARS OF POPULAR MECHANICS at \$5.00 each, postpaid, with names stamped in gold. Remittance enclosed \$_____. (Please print name below exactly as you want it to appear on book. When more than one book is ordered use margin or separate sheet for extra names.)

NAME _____

ADDRESS _____

CITY _____ STATE _____

The easy way to paint!

Speedy Sprayer

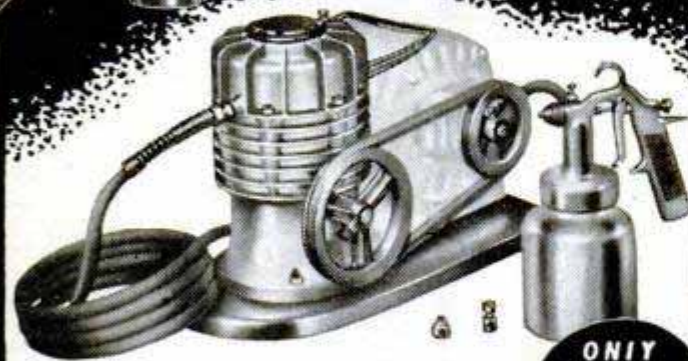

ONLY
\$32.50
LESS
MOTOR

Favorite of home owners and craftsmen for 20 years! SPEEDY SPRAYER gives your work that professional paint finish everyone admires. Sprays paint, enamel, varnish, lacquer, etc. . . . 4 to 7 times faster than hand brushing! Lightweight, portable, uses any 1/4 H.P. motor. Improved diaphragm principle assures clean, oil-free air. You'll find dozens of time and money saving uses for SPEEDY SPRAYER, including spraying insecticides 2-4-D and DDT. Complete outfit, without motor, only \$32.50.

At leading hardware, lumber, and auto supply dealers. FREE—write for handy booklet "How to Spray."

W. R. BROWN CORPORATION
2635 N. Normandy • Chicago 35, Ill.

Here's the one that

WON'T SHRINK
it does more
but costs less

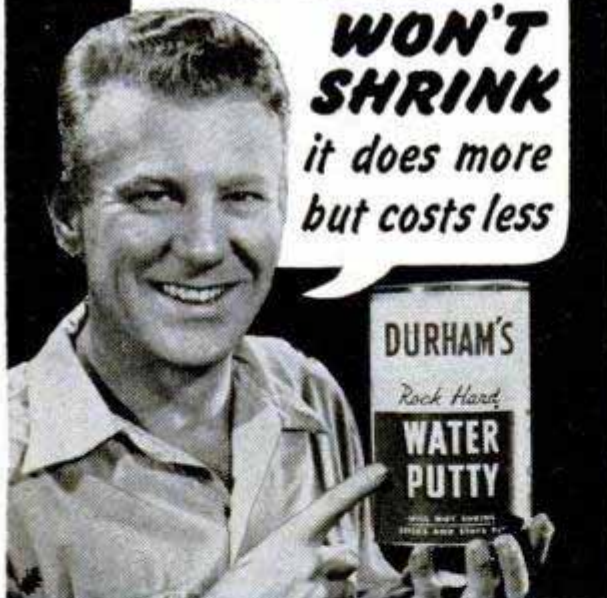

There's no limit to the things you can do with Durham's Rock-Hard Water Putty, the modern repair-plastic in powder-form. Smooths-up rough lumber. Fills knot or nail holes. Sets drawer pulls. Makes lasting repairs in wood, plaster or tile. Molds fascinating figures. Fills chipped places in antiques. Keeps indefinitely. So economical—just mix with water. Hardens quickly—then saw or chisel, paint or polish it. Most patching materials eventually shrink, chip off or fall out. But Durham's sticks and stays put. Big 1-lb. can, 35c at hardware, lumber or paint stores.

SPECIAL — 4 LB. can only \$1.25. In U.S., we will send the giant 4-lb. can postpaid for only \$1.25. We guarantee satisfaction or refund your money. Order today.

DONALD DURHAM COMPANY
DEPT. 804-M DES MOINES, IOWA

64" Flexible Shaft WITH HANDLE

WOVEN WIRE CORE

Coupling to fit 1/2" motor shaft; other end fits standard chuck. Durable, heavy. Use it for grinding, polishing, buffing, drilling, etc. A real bargain—cannot be duplicated for \$15.00. Chuck for same—\$1.25.

only
\$5.95
P. P.
Prepaid



Just what you have been looking for. Money refunded if not satisfied. No C.O.D.'s. Send check or money order.

HARRY W. RETTEW

400 WEST AVE., JENKINTOWN, PA.

GETTING AROUND

With over 100 miles per gallon on a **VELOCETTE LE 200** Motorcycle



The **WATER-COOLED, SHAFT-DRIVEN LE 200**

Silent, Clean, Comfortable. Excellent weather protection. Opposed twin cylinder; hand starter; adjustable spring frame. Designed to be as reliable and safe as an automobile; useful as a second car.

\$615.09

Credit Terms Available Write for Free Catalog FOB Los Angeles 2019 W. PICO BLVD., Dept. PM-1 LOS ANGELES 6, CALIF.

BRANCH MOTORCYCLE SALES

No Leak Lamp

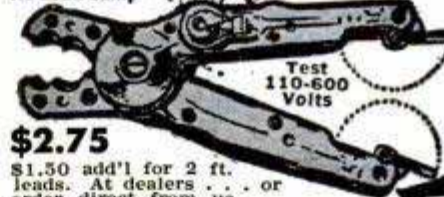

TEST Circuits, Fuses, Outlets easily, quickly, safely. Shockproof. Pull fuses 10 to 100 Amp.

\$2.75

\$1.50 add'l for 2 ft. leads. At dealers . . . or order direct from us. Mailed **POSTPAID**

STAR FUSE CO., 233 Canal St., New York 13, N. Y.

STAR TEST-PLIERS

INCREASE SAW SHARPENING PROFITS!

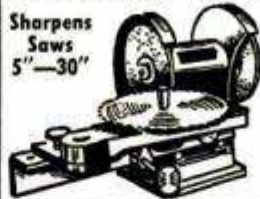

REYNOLDS CIRCULAR SAW GRINDER
Produces top quality results in fraction of time usually necessary for resharpener, jointing, gumming and tooth forming. Any hook or pitch of tooth and depth of cut is quickly adjusted. Both hands are free to control position of saw while grinding. Write now for **FREE** circular!

PROVIDENCE SAW & KNIFE COMPANY
305 Eddy St. Providence 3, R. I.

TEST YOUR OWN RADIO AND TELEVISION TUBES AT HOME!!!



CONDUCTANCE TUBE TESTER

No tube manual or knowledge of tubes necessary — tests all tubes — 100% accurate for direct shorts, opens, burned out tubes. Buy it—Try it—if not satisfied, return in 5 days — Money cheerfully refunded.

ONLY \$4.98

ALSO AVAILABLE! CONDENSER TESTER
CHECKS SHORTS, OPENS, INTERMITTENTS AND CAPACITY. **6.98**

E-Z TESTER Co. DEPT. P.M. MACON, GA.

**the MOST POWERFUL
FLASHLIGHT MADE . . .
and it's CONVERTIBLE, too!**

Yellow-Flash-8

**8 CELL FLASHLIGHT
gives 2,500 FOOT BEAM!**

Get the brightest flashlight made . . . the Convertible YELLOW FLASH 8, made by JUSTRITE. Uses 8 standard flashlight batteries or 6 volt lantern battery. Lightweight, only 8" over-all, yet strong and sturdy. Has focusing beam, adjustable head, folding handles. Bright yellow enamel case, rust proof metal trim. Buy it by name . . . the YELLOW FLASH 8, At your dealer.



\$3.95

(less batteries)

JUSTRITE MFG. CO., CHICAGO 14

Save Time, Save Work

Save Yourself



**Do more work faster and easier with
BOLENS garden tractors**

Save time and enjoy extra hours for relaxation. Make yard and garden jobs easier and more fun with a BOLENS garden tractor — proved best by impartial test. Only BOLENS offers: patented design features, finger-tip controls and perfect balance for easier handling . . . superb engineering, rugged construction for years of trouble-free service.

PROVE to YOURSELF that BOLENS tractors are superior — offer more for your money. See your dealer today.

Models illustrated: A. 2.5 HP Power-Ho DeLuxe, B. 1.6 HP Handi-Ho, C. 6 HP Ridemaster. Others available. Complete line of attachments save you time and effort all year 'round.



**CUT BUILDING COSTS 2/3!
Make Your Own Concrete
BLOCKS and BRICKS
To Use or Sell**

New superior moulds make absolutely square, true, easy-to-lay blocks which will pass any building code. Production is fast . . . easy. One durable \$30 machine will make four 5"x8"x12" blocks per minute—1,000 a day. Pays for itself in one day! Sell blocks for big profit . . . or save 2/3 building cost for yourself. POST CARD BRINGS FREE FOLDER.

**ECONOMY MFG. CO.
DEPT. P STONE MOUNTAIN, GA.**

**SAY YOU SAW IT IN
POPULAR MECHANICS**

\$1 With One Extra Band Postpaid

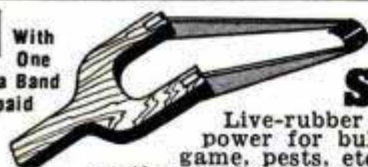

**Extra Powerful
Sweet-Shooting
SLINGSHOT**

Live-rubber propulsion has extra power for bullet-like hitting of small game, pests, etc. Yet its balanced proportions and sturdy light weight make it a new type of Pocket Slingshot. One-piece band with pouch cemented on. Smoothly finished. Extra Bands 15c.

POCKET SLINGSHOT CO.

Box 25H West End Station Colorado Springs, Colo.

A POSTCARD

**CAN PUT YOU IN A
FINE BUSINESS!**

Rush Card TODAY for FREE SELLING OUTFIT

Get in highly profitable, direct-from-factory, repeat-order shoe business! Sell amazing line of Air-Cushion Innersole comfort shoes to friends, neighbors, fellow workers. Dress, sport, work, safety shoes for men, women. Never sold in stores. Make \$10 to \$75, as much as \$200 monthly just in spare time. No investment. Send card TODAY for FREE SELLING OUTFIT!

**MASON SHOE MFG. CO., Box M-898
Chippewa Falls, Wisconsin**



ALLEN TEMPLATE TRANSFER PUNCHES

THIS NOT THIS



Locates And Centers Instantly With Accuracy And Speed
Used by Template—Tool and Die—sheet metal workers, etc., with Allen Template Transfer Punches the apprentice mechanic can transfer layout from template to work easily—quickly—accurately. Specially made precision punches instantly locates exact center—makes the right kind of mark—punches and holder of finest tool steel—point is proper size and exactly centered—accuracy to .0004.

Set consists of 11 popular size punches from No. 60 to 5/16, prick-punch and holder with stand for quick size selection. Satisfaction guaranteed or money back. Order today — send M.O. or check. \$2.00 deposit on C.O.D.

ONLY \$7.80

POSTPAID COMPLETE

5/16" 1/4" 3/16" 1/8"
3/32" 1/16" Pr. Punch



**H. D. ALLEN, DEPT. M1
3201 Casitas Ave.
Los Angeles 39, California**

Mail coupon today

BOLENS Products Division

Food Machinery and Chemical Corporation
265-1 S. Park St., Port Washington, Wis.

Please send free literature and name of nearest dealer.

Name.....

Address.....

City.....(.....) State.....



B-17B

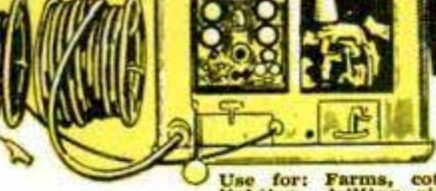

WAR SURPLUS POWER UNIT

**BE PREPARED
for any emergency!**

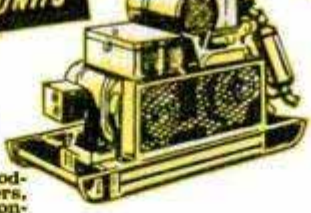

Use for: Farms, cottages, stores, garages, flood-lighting, drilling rigs, refineries, house trailers, fire departments, sound trucks, yachts, tugs, construction, airports, police radios, etc.

LIGHT PLANT BUYERS in emergency telephone collect—unit shipped same day!

100 WATT 110-220 v. AC, 60 cycle light plant powered by 1 HP gas engine, direct drive, mounted base, 40 lbs. Ideal for campers, P.A. systems, house trailers, etc. Equipped with handle for easy carrying. **\$99.00**

10-1000 WATT, 110 v. AC, 60 cycle, direct drive, air cooled, Briggs & Stratton gas engine, Model AP, Pioneer generator, radio filter, self-exciter, rope start, 190" long, 20" wide, 16 1/2" deep with carrying handle. New. **\$169.00**

100-2000 WATT 110 v. AC **\$194.00**

100-2500 WATT 110 v. AC, 60 cycle, slow speed generator, 5.10 HP Briggs & Stratton gas engine. **\$294.50**

NEW 110-220 add \$40 for transformer.

100-3000 WATT 110 v. AC, 60 cycle, Leland generator, runs at slow speed (1800 rpm) for longer life, 5.10 HP Briggs & Stratton gas engine. You can rely on this plant for all average home needs—freezer, stoker, pump, hot plate, radio, etc., and overloads from starting motors. Reconditioned and fully guaranteed. **\$345.00**

NEW 110-220 add \$48 for transformer.

100 WATT, 110-220 volt with push button starter. Starter battery is automatically charged by generator. Gas engine same as in plant above. **\$465.00**

TRACTOR DRIVEN PORTABLE DC 3000 WATT Briggs & Stratton 5-7 HP gas engine with Delco generator and other three wheels. Used. **\$220.00**

100 WATT 120 v., 60 cycle AC, Hercules 4 cyl. gas engine. Generator mfr'd by Hobart Bros. Unit includes remote control cable, 150' 2-wire #6, and 150' 3-wire #8, exhaust pipe, power cable plug, spare parts, manual, battery, radio and TV filtered. Unit is completely automatic. List price today \$1910. Special price for you at **\$675 used. NEW. \$895.00**

To make plant 110-220 add \$72 for transformer.

7500 WATT 110 v. AC, 4 cyl. gas engine. **NEW. \$995.00**

10,000 WATT, 110-220 volt AC, 60 cycle. Remote control. Powered by a Jeep 4 cyl. gas engine. Used but like new **\$1495.00**

NEW. \$1995.00

25,000 WATT, 220 volt AC, 3 phase or 110-220 volt single phase. Used but like new and **GUARANTEED. \$2495.00**

1995.00. NEW. \$2495.00

35,000 WATT, 110-220 volt. **\$2995.00**

Diesel. Rebuilt

50,000 WATT, Cummins Diesel generator. 240 volt, 3 phase, 60 cycle, AC 1200 RPM. 150 amps. Rating 50% continuous exciter. **NEW—GUARANTEED. \$5900.00**



**HEAVY DUTY RUBBER
ELECTRIC CABLE**

(Nothing less than 50 ft.)

4 Wire #18 Neoprene standard, per ft. 7c

2 Wire #14 18 ft. with plug. **\$3.00**

2 Wire #14 18 ft. NO plug. **\$2.60**

2 Wire #14 50 to 225 ft., per ft. **17c**

2 Wire #12 12 ft. with plug. **\$3.50**

3 Wire #10 50 to 225 ft., per ft. **30c**

4 Wire #10 75 ft. length, per ft. **40c**

3 Wire #6 150' with connector. **\$125.**

2 Wire #6 150' with connector. **\$90.**

2 Wire #4 75' reel and connectors. **\$ 80.**

2 Wire #4 Concentric 50 to 250 ft. underground, per ft. **60c**

1 Wire #10 Rubber 50-500', per ft. **54c**

15 Cond. #18 G.E. Stranded 50-300' O.D. 13/16", per ft. **50c**

10 Cond. #18 Solid, per ft. **10c**

Telephone Wire 250', per ft. 2c; 1000' **1 1/2c**

SPRAY BOOTH FAN

18 inch

Handles all spray booth and air exhausting jobs with absolute safety in atmospheres containing dust. Totally enclosed 1 HP Motor, 220/440, 3 phase, 3400 R.P.M. Sealed lifetime bearing. Reconditioned. **\$109.00**



HOT ROD SUPERCHARGER



Extra soup and go at a price you can afford to miss. SEE HOW SIMILAR SUPERCHARGER is used in PICTURE and article on p. 67 AUG '50 POPULAR MECHANICS. Mfr'd by Borg-Warner. Specifications: 7 1/2" deep, 7" high. Wgt. 17 lbs. Compact and sturdy, 4 base mounting holes, 3/4" outlet, 3/8" shaft with female Lovejoy coupling. Priced today at **\$85.00.**

OUR SPECIAL SALE PRICE \$31.00

BRASS HAND PUMP

Mfr'd by Red Jacket. Pumps 300 gal. in 30 strokes. Ideal for boat bilge, basements, cattle troughs or other water transfer. 1 1/2" inlet, 1 1/2" or 2" discharge. 78 lbs. \$48 value. Only **\$24.50**



COLD WEATHER

HEAT CONTROL



Made by Minneapolis-Honeywell—a name known for the best in controls. 1000 watts—115 to 200 v. Element length 10 ft. Range 70° to 212° F. Controls, fans, motor, furnaces. Makes an ideal automatic combination when hooked up to the heat boosters at right! List price **\$16.00.** Your price **\$6.95**

PREVENT FROZEN WATER PIPES

WRAP-AROUND HEATING CABLE

Electric. Prevents frozen water pipes at temperatures as low as 35° below zero.

26 ft. 80 w. **\$4.00**

56 ft. 140 w. **\$5.00**

112 ft. 280 w. **\$7.00**

Thermostat for above set at 35° F. **\$5.50**

"JANITROL" AIRCRAFT HEATERS



Warms up fast—just the thing for heating trucks, buses, garages, etc. Has an output of 50,000 BTU'S per hour. 24 v. DC. Length 23", diameter 13", wgt. 14 lbs. Original cost \$130. Special, **NEW. \$19.95**

ORDER DIRECT from this ad! All prices F.O.B. Milwaukee. 25% deposit required on all C.O.D. orders. No C.O.D.'s under \$10.00. Many other bargain items not listed. Write for our FREE CIRCULARS!

**BUILD AND SELL
Grandpa Breidert's BIRDHOUSES**



For fun and profit! Beautify your own yard, or sell to home owners, golf clubs, etc. My complete kit gives detailed plans and instructions for many types of birdhouses, Martin houses, with 10 to 66 compartments, also other valuable data. Send \$1.50 for each kit, check or money order.

GEORGE J. BREIDERT
Dept. 3 P. O. Box 1283 La Canada, Calif.

**AMAZING NEW
WOOD-TURNING
TOOLS!** Outlasts Steel
Up to 100 to 1!



**SHARPEN ONCE IN 12-YEARS!
(UNDER NORMAL USE)**

These remarkable tools tipped with TUNGSTEN CARBIDE will astound you with their performance. They work FREE HAND equally well in wood, plastic or soft metals—and at the same time hold their razor-like edge almost indefinitely. Tests show that they will turn wood or plastic for days and days CONTINUOUSLY without showing any signs of dulling. They are the finest tools available at any price. Beautifully finished 5" blade—flush ground, polished tip—finest brass tube ferrule—9" hardwood handle—over all length 14"—25 tools to choose from: round & square nose from 1/8" to 1/2"—1/8" and 3/16" cut off; 1/2"x30° skew, spear, r. & l. skewers, turning and parting. Amazingly Low Prices! Write at once for free literature.

JOHNS MFG. CO., DUNELLEN 12, N. J.

JOHNS MFG. CO.
Dunellen 12, N. J. **MAIL NOW**

Please send me free details and price list of your Tungsten Carbide Turning Tools.

Name _____

Address _____

City _____ State _____

**Now Available
FROM YOUR NEWS DEALER**



NEW 1952 EDITION

Each year Popular Mechanics publishes four famous books—Home Kinks, Useful Ideas, Shop Notes and What to Make. This year, one of these volumes is being published every three months to bring you wonderful practical information throughout the year. Now—Useful Ideas is ready. It's chock-full of time and money saving ideas for you. Get your copy at your newsstand today for only 35c, or order direct. Be on the look-out for Shop Notes in August and What to Make in October.

POPULAR MECHANICS PRESS
200 E. Ontario St., Chicago 11, Ill.

**EASY TO WORK WITH!
FOAM
RUBBER**



Your money back if you aren't satisfied with the perfect Foam Rubber! Re-cushion chairs, make your own pillows, mattresses, chair-pads, cushions! You'll save up to 50%—because you buy direct! **SEND FOR FREE PRICE LIST.** No C.O.D. Add 10% for postage and handling.

**DO IT YOURSELF AND
SAVE 50%!**

Shaped to fit
AUTO SEAT TOPPER PADS 24x60x1 1/4" **\$6.45**
FOAM RUBBER MATTRESS TOPPER PAD 30x60x1 1/2" **\$10.95**

16 x 16 x 1 1/2" **\$1.30**
16 x 20 x 1 1/2" **1.65**
18 x 24 x 1 1/2" **2.00**
24 x 24 x 1" **2.60**
24 x 60 x 1/2" **4.30**

All sizes approximate

ADAMS FOAM RUBBER
5611 Broadway • Chicago 40, Ill. **DEPT. 13**

Flexible Shaft
 1/2 HP, 3450 rpm 110 or 220 v. dustproof motor mounted on universal swinging trunnion. Heavy base has convenient tool tray and large, easy rolling casters. Flexible shaft is equipped with full speed, angle, and straight spindles. Lists at \$172.00. Your price with all attachments. **\$109.00**

NEW TOOL POST GRINDER
 1/4 HP AC-DC 7000 rpm motor with 3 1/2" x 3/4" external grinding wheel, smaller internal wheel, 7 ft. rubber cord, switch and attachments. Lists at \$90.00. Only **\$49.50**

BALL BEARING ARBORS
 Grinding and saw arbor, has 1/2" double end shaft, 1 1/2" long with 2" center pulley. New Departure double roll ball bearings. Right and left hand thread. Self aligning Dodge pillow block. 10,000 RPM. Bearings alone list at \$10. Complete arbor new **only \$6.95**

ALARM HORNS • SIRENS
 Motor driven (not a vibrator). Heavy duty, adjustable for high, medium or low tone. 110 volt AC current. Weather proof. For alarm or signal horn on boats, school yards, factories, air raid sirens, etc. Lists at \$47.00. **NEW** Your price **only \$15.45**

with confidence from C&H

AUTOMATIC AIR COMPRESSOR UNIT
 Compressor with 2x1 3/4 inch piston controlled for intermittent duty. Regulator and check valve. Heavy duty capacitor motor 110/220 v. 12 x 2 1/2 inch tank 1/2 HP. \$99. mounted on rubber 1/2 HP. \$109. ber tired wheels. Tank only \$14.

MERCURY CLUTCHES
 For motor scooters, motor bikes, lawn mowers, etc. Centrifugal action enables electric motors or small gas engines to handle heavy starting loads. 3" A belt pulley. **NEW**. 5/8" bore. \$9.95. 3/4" bore. \$10.95. 1" bore. \$11.95.

HEATING SPECIALS

BOOSTER FANS
 Fits any 8", 9", 10" furnace pipe. 1500 RPM motor with 6" cord, mounting frame, 7" blade. Motor 110 volt 60 cycle. 1550 RPM. Easy to install. Silent operation. Warm those rooms with long runs. Stock #583. Regular \$11.95. Your price **\$6.95** 10" ball bearing fan Mfg. by Redmond. Can be run vertically or horizontally. 110 volt AC 60 cycle motor with plug and cord. New in original box. Use it for the kitchen as an exhaust fan, heat booster, etc. High pitch blade. 1/25 HP 1550 RPM only **\$11.95**

High Volume BLOWERS
 Top performance for forced draft, ventilating, exhausting, cooling and drying. 110 volts AC. Intake 3", discharge 2 1/2". 75 cubic ft. per min. **\$10.95** Intake 5", discharge 3". 150 cubic ft. per min. **\$13.95**

ELECTRIC WATER HEATER
 Westinghouse or Chromalox immersion heating unit. 110 v. AC adjustable from 312-626-1250 watts and automatic cut valve. Valued at \$42.50. Only **\$5.95**. Combination price with heat control above. **\$9.95**

GEAR REDUCER
 Double reduction. Operates on any 1/6 to 1/2 HP electric motor. 22 RPM. Can be used as winch, operate turntable, electric garage door opener, television antenna, barbecue, dummy elevator. Regular \$45.00. Now only **\$22.00**

54 TO 1 BOSTON SPEED REDUCER
 Reduces speed of ordinary 1750 rpm electric motor to 33 rpm. Lists at \$53.00. Our **\$29.50** sale price

AIR COMPRESSORS
 Gas or electric. Awarded from government.

1/2 HP	12 gal. tank	\$ 99.00
1 HP	50 gal. tank	239.00
1 1/2 HP	50 gal. tank	285.00
2 HP	50 gal. tank	295.00
3 HP	60 gal. tank	410.00
5 HP	60 gal. tank	485.00
7 1/2 HP	80 gal. tank	675.00
10 HP	80 gal. tank	775.00

POWER AND HAND WINCHES

FOR BOATS, TRUCKS, CONTRACTOR FARMERS LOGGERS, ETC

Double drum model
WINCHES 1,000 lb. capacity. Hand operated. \$ 9.
WINCHES Hand operated ball bearing model, 1500 lb. capacity, 3-1 ratio, hand brake, two speeds. \$ 39.
WINCHES 6,000 lb., double drum. Hand operated. \$ 49.
WINCHES 1,500 lb. electric drive. \$ 89.
WINCHES 6,000 lb. electric drive. \$188.
WINCHES Single drum, 3/4 HP motor 110 or 220 A. Start, stop and reversing switch, belt, pulleys. 10 3/16" steel cable. 2000 lb. pull. Ratio 12 to 1. NE \$125.00. Double drum model. \$135.
CABLE 1/4" perforated stainless steel aircraft, 100 or less. 1/4" 17c per ft. Over 100 ft. 15c per

and other bargain items

GOODRICH RUBBER HOSE 2" I.D. 2 ply. 25' length. Value \$25. Only **\$3.95**, or 3 lengths for **\$10**.
BINK'S SPRAY GUN HEADS Stainless steel. Take a liquid. Value \$10.00. Only **\$1**.
OHMMETERS Read 25 to 0. In leather carrying case. Regularly \$29.95. Only **\$7**.
FYR FTYERS Fire extinguisher approved by Underwriter's. Regularly \$14.95. Only **\$6**.
1/2 TON SHOP UTILITY WAGONS, steel frame, rubber tires, ball bearings. **\$48**.
WELDING ROD Manufactured by Murex. All purpose type S. AC-DC, 5/32", 50 lb. box. **\$3**.

C&H ELECTRIC MACHINE Co. Inc.
 434A W. Juneau Ave., Milwaukee 3, Wisconsin

INDUSTRIAL BUYERS When you can't find a scarce item — try C & H

NEW AUTO WASHER
 Your car sparkling clean—in a jiffy—magic "sponge" cleaning-cloth. Simply glide over car. PRESTO! Dust, grease, dirt, grime disappear like magic. Your car gleams like a mirror. *Take orders! Make money!*

SAMPLES for TRIAL
 Sample offer sent immediately to all who send name at once. Hurry, postal will do. **SEND NO MONEY**—just your name.

QUICK EASY!

KRISTEE CO., Dept. 690, Akron 8, Ohio

FULL SIZE PATTERNS JUST TRACE ON YOUR MATERIAL

All patterns illustrated here—Plus garden cut-outs, bird houses, corner shelves, child's clothes tree, five beautiful plastic projects — Plus 80 page Hobby & Handcraft Reference Book. All for \$1.00.

WALL SHELF **SEWING CABINET** **HOBBY HORSE** **CHILD'S WHEELBARROW** **PLASTIC JEWELRY BOX**

SEND \$1.00 to CRAFTERS OF PINE DUNES 201 Poplar St., Oostburg, Wis.

FREE Book on Painting

Get this illustrated 24-page book absolutely free. Full of facts on how to get better results with aluminum paint—which type to use for different jobs. Absolutely no obligation—just write:

ALUMINUM COMPANY OF AMERICA 1718A GULF BLDG., PITTSBURGH 19, PA.

Lockwood All-Purpose Knife

One knife that CUTS EVERYTHING!

Craftsmen, Hobbyists, Home Mechanics hail this knife as the most valuable tool ever devised. Four interchangeable blades will cut everything from paper to 1/2" wallboard. Cuts all types of material. Yours... the Lockwood All-Purpose Knife with 2 blades of each style, (8 in all) for only **\$1.98** POSTPAID

AUTOMOBILE RACING

Three Authoritative Books Every Fan Needs!

AUTOMOBILE RACING, 6th Ed.
 ★ Championship cars, big cars, midgets, roadsters, Offenhauser dirt track car. Specifications on Indianapolis cars, four-wheel drive details, front drive drawings. Plans for Ford 60 midget, roadster racer, data on engines, gear boxes, clutches, axle ratios, compression ratios, etc. Indianapolis rules and regulations. More than 100 illustrations. Only \$2.00.

AUTOMOBILE RACING, 5th Ed.
 ★ Tells you—Why the Fast Ones are

POPULAR MECHANICS PRESS, Dept. 350, 200 E. Ontario St., Chicago

EXCLUSIVE WITH LOCKWOOD INDUSTRIES, 8917 Mansfield Ave., Merton Grove, Ill.

I enclose \$ _____ Send me _____ Knives

Name _____

Address _____

City _____ State _____

Groban's WAR SURPLUS ELECTRIC PLANTS

IMMEDIATE DELIVERY • LARGE STOCK • MANY SIZES
ALL UNITS BRAND NEW

PREPARE NOW FOR ANY EMERGENCY

Plenty of general utility and emergency stand-by power to operate your Oil Burner, Home Freezer, Lights, Milking Machines, Power Tools, Pumps, Water System, Construction Equipment, Tourist Cabins, Schools and Institutions, etc. NOW AVAILABLE at unsurpassed Bargain Prices!



Item #183

Item #183 — Type M5-3KW-3.75 KVA-125 VOLT-60 Cycle AC, 130 Volt - 50 Cycle AC 3 phase, Hobart generator direct coupled to Hercules Model ZXB, 4 cylinder water cooled engine with push button start. Control panel equipped with full set of engine and generator instruments. Utility double receptacle mounted on side of generator. Two-wire single phase lines for supplying power to lights, oil burner, pump, etc., may be connected direct to terminal board. Use standard 6 volt car battery. (Battery not included.) Shipping wt. 600 lbs. F.O.B. **465.00 Chgo.**

Item #182—Type PE-95, 5 KW - 120/240 Volt - 52.5/26 Amp.-60 Cycle A.C.-single phase Onan generator direct coupled to Willys Jeep, 4 cylinder, water cooled engine, with push button start, battery ignition. Has provisions for remote starting and stopping. Use standard 6 volt battery. (Battery not included). Shipping Wt. 1200 lbs. **795.00 F.O.B. Chgo.**



Item #182

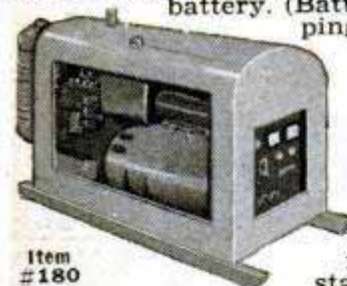

Item #180

Item #180—15 KW-127/220 volt-60 cycle AC-3 phase 1800 RPM. Brance & Krachy Generator direct coupled to International Harvester 4 cylinder, water cooled engine with magneto ignition — push button start. Panel has voltmeter, ammeter, 4-wire electrical system, belt driven excitor generator, rheostat voltage control. Engine and generator mounted on steel skids. Shipping weight 2000 lbs. **1650.00 F.O.B. Chicago**

Item #128—25 KVA-250 volt, 3 phase-120 volt, single phase - 60 cycle. Totally enclosed - Hobart generator driven by a GMC 270, 6 cylinder gas engine, button start, liquid cooled. Has control panel with full set of instruments for both engine and generator. Shipping weight 2600 lbs. **2250.00 F.O.B. Chgo.**

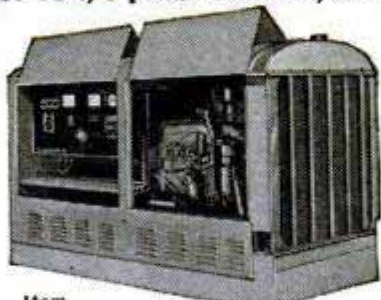

Item #128

ASK FOR FREE INFORMATION on other size generating plants ranging from 350 watts to 25 KVA. Write, Wire or Phone WEBster 9-3793

GROBAN SUPPLY CO. Dept. PM-1
1139 S. WABASH AVE., CHICAGO 5, ILL.

CHECK BATTERY CONDITION

without leaving the driver's seat!
DETECTO-CELL



Amazing, instant visual check on battery strength, condition of cells, need for service!

Saves Money by Prolonging Battery Life...

Add as much as 70% to battery life! DETECTO-CELL shows instantly — in glowing lights — battery strength, condition of each cell, water levels, warns of battery weakness in time to prevent failure. No more unexpected dead batteries, no more needless, costly replacements!

Works with any 3 cell battery, on any car. Simple installation, takes just a few minutes and ordinary hand tools. No moving parts, fool-proof operation. Will last life of your car, or longer. Send check or money order today!

MYRIATRON CORP., Pontiac, Mich.
Dept. K

\$8.95 complete.



DEALERS • JOBBERS
Write—We've got a good deal for you!



SUMP PUMPS

2,400 GALLON CAPACITY

1 1/4" outlet — No screen to clog — fool proof

The time tested Lokomona sump pump is absolutely automatic — has a special fool-proof trap at the intake—oilless bearing at the bottom. Made of aluminum castings, it's 4 1/2" high and carries a 1/4 H.P. 110 V. A.C. heavy duty motor. The pump is designed for continuous service. Enclosed switch. All parts always available. Order yours today. C.O.D. If cash with order, we pay postage.

MONEY BACK GUARANTEE
LOKOMONA PUMP CO., P.O. BOX 86, ROYAL OAK 1, MICH.

\$44.50 COMPLETE
\$26.00 LESS MOTOR
\$22.50 PUMP ONLY

BIG LEATHER & CRAFT CATALOG!

1000's of items for Leathercraft, Textile Painting, Copper Tooling, Kits, Projects, Tools, Supplies, Etc. Send 25c (refunded with 1st order) to:

RUSSO HANDICRAFT SUPPLIES Dept. CD-7, 245 S. SPRING, LOS ANGELES 12, CALIF.

Only **\$27.50** other models to \$44.

Amazing NEW! SHAPE-AWL
FILE • SAW • SHAPE • ON YOUR DRILL PRESS!

PACIFIC MACHINE TOOL CO. 5447 SAN FERNANDO RD. WEST, LOS ANGELES, 39 CALIF.

GREATEST SAVING EVER OFFERED!

U. S. GOV'T SURPLUS

"BARGAIN BOOK"



SAVE ON WINTER NEEDS!

It's loaded with bargains in genuine Gov't Surplus for farm-home-industry. Save up to 85% on clothing, hardware, sporting goods, etc. The "Book of the Year". Send 10c for yours today.

MAIL TODAY Only **10c**

500 BARGAINS!
• FARMS • SPORTS
• HOME • SHOP

FISLER SALES CO.

723 WALNUT ST., DESK M-1, KANSAS CITY, MO.

SAVE ON THESE BRAND NEW

WAR SURPLUS SPECIALS

UNCONDITIONALLY GUARANTEED

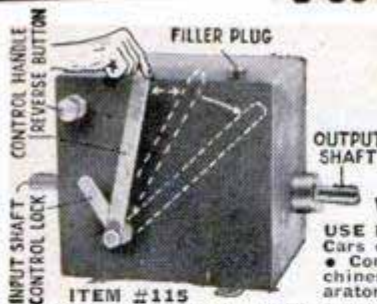

HYDRAULIC SPEED REDUCER

with FINGERTIP CONTROL

USE FOR: Reamer Drives • Midget Cars • Feed Mills • Canning Machines • Conveyors • Lathes • Milling Machines • Motor Boats • Cream Separators • Garden Tractors • Pumps

Variable output speeds ranging from 0 to input speed now available. Merely move control handle until desired speed is attained. Then turn locking handle to maintain the setting. Internal relief valves prevent overloading. Use input power of 1/4 to 1 1/2 H.P. This Westinghouse-Oil Gear Unit converted to commercial use from 40 MM anti-aircraft traversing mechanisms consists of a variable displacement hydraulic pump feeding a fixed displacement hydraulic motor. These components are contained in a crackle-finish steel oil reservoir (capacity 2 qts.). Adjustable relief valves set at factory for 100 inch pounds of torque may be reset up to 180 inch pounds. Independent reverse control allows full output power and speed selection in either direction of rotation. Both input and output shafts measure 5/8" diam., include keyway. Input rotation is counter-clockwise facing shaft. Recommended input speed not to exceed 750 R.P.M. Over-all dimensions 7 1/2"x7 1/2"x11 1/2". Gov't. acquisition cost, \$428.00. Shipping weight 31 lbs. Complete with 2 qts. of oil and full instructions. F.O.B. Chicago

54.50

IMMEDIATE DELIVERY - LARGE STOCK - MANY SIZES. GENERATING PLANTS

DESIGNED FOR CONTINUOUS OR INTERMITTENT SERVICE
PREPARE NOW FOR POWER FAILURE!
 PLENTY OF CURRENT TO OPERATE YOUR • OIL BURNER • REFRIGERATOR • HOME FREEZER • SUMP PUMP • POWER SAW • BROODER • CREAM SEPARATOR • INCUBATOR • VENTILATING FANS • MILKING MACHINES • BLOWERS • YARD LIGHTING • OTHER APPLIANCES

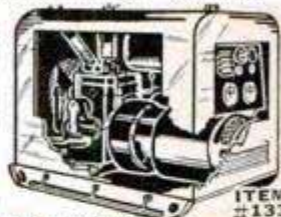

Item # 133 - 3 KW - 120 Volt

60 Cycle A.C. Single Phase HEAVY DUTY

Totally enclosed power unit with 2 cylinder water-cooled Hercules Model BXB engine direct coupled to generator. Magneto ignition, crank start, 4 gallon gas tank, 3 qt. oil capacity. Skid mounted with handrails for carrying. Instrument panel including killer button, oil pressure, water temp. gauges, voltmeter, ammeter.

Shipping wt. 560 lbs. F.O.B. **395.00**

Chicago
 ITEM #178—350 watt—110 volt—60 cycle A.C. direct coupled to 1 cylinder Midco engine. Shpg. wt. 116 lbs. F.O.B. Chicago **125.00**



AIRCRAFT QUALITY HYDRAULIC EQUIPMENT

HEAVY DUTY - Large supply of new labor-saving, economical hydraulic equipment in many types and sizes. Use these positive, highly efficient smooth pressure hydraulics on presses, arborers, lifts, loaders, power control, positioning, brakes, plastic dies, auto frame alignment, etc. etc.



ITEM #70—Purolator hydraulic oil filter. Permanent element type. 3/8" female pipe thread ports. Capacity 16 gallons per minute. A \$13.00

ITEM #127—Double acting hydraulic cylinder, 1" bore, 1" stroke, 1/2" diam. shaft, 1/4" tubing thread ports. Over-all length closed 6 1/2". Clevis mounting at both ends. Perfect for clamping and feeding. Postpaid **4.95**

ITEM #33C—Double action hydraulic cylinder, 1 1/2" bore, 4 1/2" stroke. Clevis mountings at both ends. Uses 1/4" pipe fittings. Postpaid **5.95**

ITEM #16C—Double acting hydraulic cylinder, 1 1/2" bore, 26" stroke. Will lift 1760 lbs. with 1000 PSI line pressure. Weight 8 lbs. A \$55.00 **8.95**

ITEM #126—Four-way, open center control valve with built-in adjustable relief valve. Factory set at 1000 P.S.I., spring loaded neutral position, for use with one double acting cylinder. Fully balanced plunger type, smooth, positive, easy operation, can be used as single unit or mounted in series of any combinations desired. Has 3/4" pipe thread inlet and outlet, 1/2" pipe thread cylinder ports. Newly manufactured to our specifications. Shipping weight 8 1/4 lbs. An outstanding buy! F.O.B. Chicago **16.95**

ITEM #103—Double acting hydraulic cylinder, 2 1/2" bore, 17" stroke. Clevis mounting. Will lift 4900 lbs. with 1000 PSI line pressure. 1 1/4" diam. shaft, 3/8" tubing thread ports. Overall length closed 28". Shpg. wt. 11 lbs. F.O.B. Chicago **21.50**

ITEM #6—Double action hydraulic cylinder, 3" bore, 24" stroke, will lift 7070 lbs. with 1000 PSI line pressure. Steel barrel, 1 1/4" stainless steel shaft. Gov't. acq. cost \$176.00. Ship. wt. 26 lbs. F.O.B. Chicago **28.00**

ITEM #42—Double action hydraulic cylinder, 4" bore, 18" stroke. Rated lift capacity with 1000 PSI line pressure is 12,500 lbs. Ship. wt. 30 lbs. F.O.B. Chicago. An Excellent Buy for **32.50**

ITEM #29KJ—Gear Type Hydraulic Pump. Ideal in industrial applications and for operating all hydraulically powered farm implements including loaders, stackers, swathers, plows, etc. Delivers 1000 PSI (may be set at lower PSI if desired), 12 GPM at 400 RPM. Maximum operating speed 800 RPM - rotation counter clockwise. Has built in relief valve, permanent or torque bar mounting, 1" diameter shaft, 3/4" pipe tap inlet, 1/2" pipe tap outlet. Shipping weight 22 lbs. F.O.B. Chicago **45.50**



GENERAL MOTORS - ALLISON

BRAND NEW

CENTRIFUGAL PUMP

200 GALLONS PER MINUTE

- For Draining Basements • Fire-Fighting • Irrigation • Fuel Transfer • Swimming Pools
- Home Water Systems • Dewatering

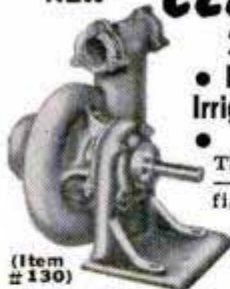

This General Motors-Allison Centrifugal Pump—designed for use on U. S. Air Force Mustang fighters, now converted for commercial, home, and industrial high volume pumping applications. Inlet, 2 1/2" standard pipe thread, twin outlets with 1 1/4" pipe thread, ball bearing supported 3/4" shaft. Easy, fast simple priming. Rotation, counter-clockwise facing shaft. Shipping wt. 35 lbs. Gov't. acq. cost \$145.00. F.O.B. Chicago **39.50**

Suction Lift	Head Pressure	Gal. Per Min.	H.P.	R.P.M.
10'	75'	260	6.0	3500
10'	65'	200	5.2	3500
10'	80'	40	1.5	2500
10'	50'	140	5.0	3500
10'	30'	100	3.0	2500

D.C. GENERATORS

For welders, plating, truck and marine use, D. C. appliances, lights, etc. Aircraft quality—lifetime grease sealed ball bearings. Heavy duty.



ITEM #90—Type P-1, rated 200 Amps.—28 Volts, 2500 RPM. Mfd. by General Electric, Ford, Delco-Remy and Westinghouse. Gov't. Acq. Cost \$300.00. Shpg. wt., 53 lbs. F.O.B. Chicago. **22.50**
 ITEM #91—Type R-1, rated 300 Amps.—30 Volts. Mfd. by Jack & Heintz. Gov't Acq. Cost \$380.00. Shpg. wt. 59 lbs. F.O.B. Chicago. Each individually packed in wooden box. **35.00**

NEW MODEL 353 - DUAL RANGE

ARC WELDER

for Stationary or Portable Use
 HEAVY DUTY RANGE TO 250 AMPS.

NEW 'MAGIC TERMINAL'
 FOR LOW CURRENT
 30 TO 100 AMPS.

IDEAL FOR
 • FARM • GARAGE
 • FACTORY • WORKSHOP



These precision engineered D. C. Arc Welders contain the highest quality War Surplus aircraft components built to exacting government specifications. They are light in weight, have oversized lifetime grease-sealed ball bearings, air cooled commutator, dial type rheostat for easy pin-point control, a high-low rheostat switch, reactor coil for even arc and the new 'MAGIC TERMINAL' low current welding range for welding lighter materials. Designed for many years of trouble-free service. Run welder from drive pulley or power take off of a tractor or Jeep. 7 1/2 HP electric motor or 10 HP gas engine at 2500 R.P.M. Uses two V belts or flat belt. Continuous output rating 200 amps. Intermittent welding rating 250 amps, 30 volts. This sensational price includes double V or flat belt pulley and complete operating instructions. Shipping weight 107 lbs. \$350.00 Value, Item #65 Now Only **119.50** F.O.B. Chicago

VICKERS - PISTON TYPE HYDRAULIC PUMP

Ideal for use with hydraulic cylinders and valves described in this page ad. Vickers constant displacement piston type pump delivers .507 cubic inches per revolution, 8 gallons per minute at 3750 RPM, 1000 PSI. Has 1 1/2" diam. shaft, 3/4"-18 thread inlet and outlet ports. Rotation—clockwise. Postpaid. **19.90**



FREE: NEW 1952, 48-PAGE CATALOG jam-packed with Brand New War Surplus Bargains for the farm, home, factory and workshop. Write for yours today. WRITE, WIRE or PHONE Webster 9-3793

ORDER DIRECT FROM AD - SEND PAYMENT OR PURCHASE ORDER TODAY - SATISFACTION GUARANTEED

GROBAN SUPPLY CO. 1139 SO. WABASH AVE., CHICAGO 5, ILL. DEPT. PM-1

Carroll's illustration of this page

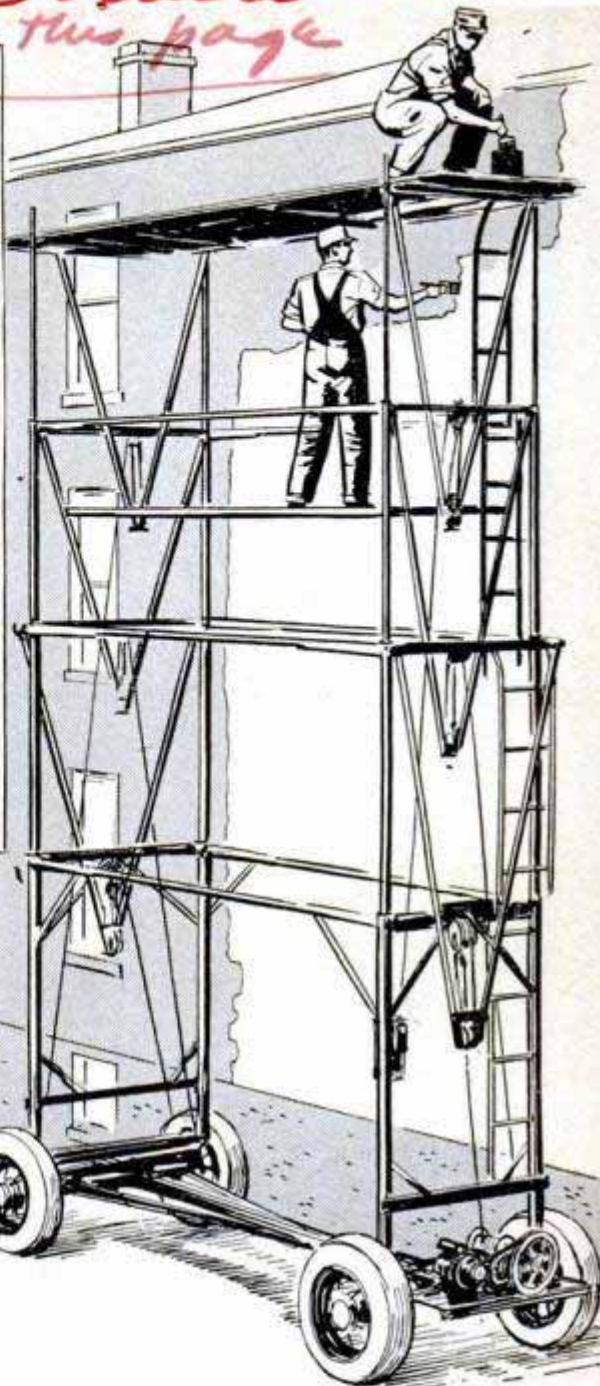
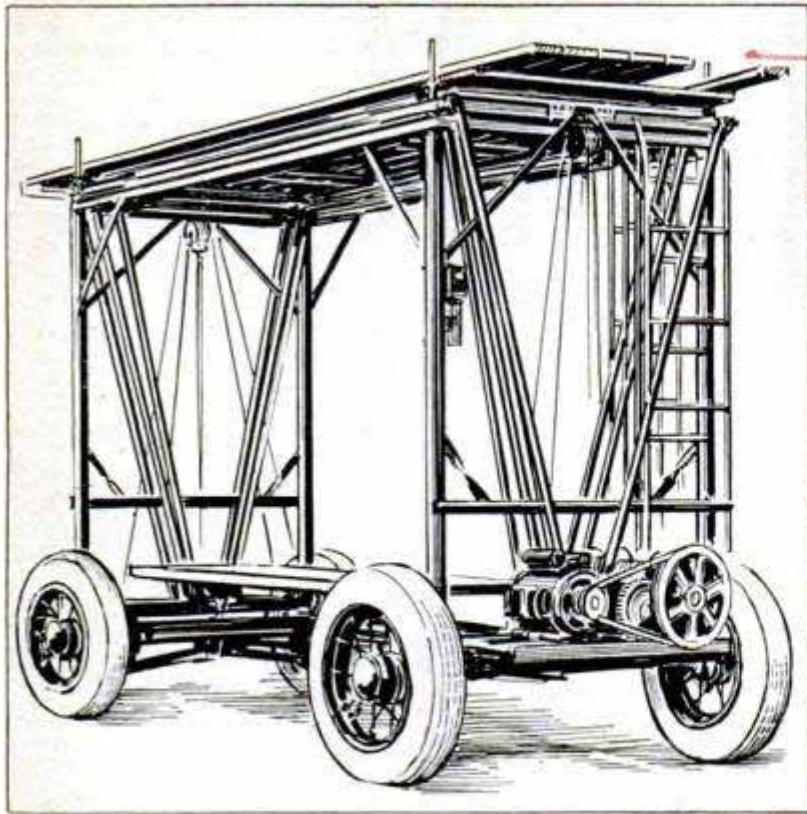

Telescoping Scaffold

Powered by an electric motor, a telescoping scaffolding raises itself at the flip of a switch. It can be made in various sizes to extend to almost unlimited heights. The scaffolding is "pushed" rather than pulled upward. A pulley arrangement pushes the second section into the air from within the legs of the first section. As the second section moves upward, it pushes the third and so on until the desired height is reached. A small model for painters and plasterers operates on the same principle, but by hand.

Inlaid Table Top Has Wood From Every Nation in World



Every remote corner of the world will be represented by a wood chip in a table top being built by Joe Schuld of Kingston, Pa. Schuld began collecting wood specimens 10 years ago and now has 1000 different types, with at least one piece from every country in the world. His table top will be inlaid with hundreds of small wood diamonds arranged in the shape of an eight-pointed star. It will show all the colors found in natural wood, from dark brown to red, from yellow to green and white. Schuld also has constructed a map of the United States, with a specimen of wood from each state, and a map of Pennsylvania with samples from each county.

HYDRAULIC SPEED REDUCER

with FINGERTIP CONTROL

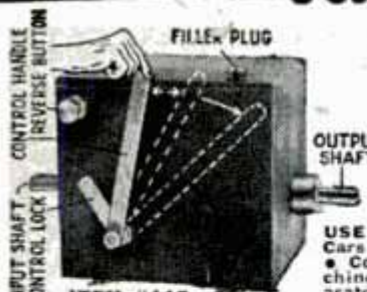

ITEM #115
 Variable output speeds ranging from 0 to input speed now available. Merely move control handle until desired speed is attained. Then turn locking handle to maintain the setting. Internal relief valves prevent overloading. Use input power of 1/4 to 1 1/2 H.P. This Westinghouse-Oil Gear Unit converted to commercial use from 40 MM anti-aircraft traversing mechanisms consists of a variable displacement hydraulic pump feeding a fixed displacement hydraulic motor. These components are contained in a crackle-finish steel oil reservoir (capacity 2 qts.). Adjustable relief valves set at factory for 100 inch pounds of torque may be reset up to 180 inch pounds. Independent reverse control allows full output power and speed selection in either direction of rotation. Both input and output shafts measure 5/8" diam., include keyway. Input rotation is counter-clockwise facing shaft. Recommended input speed not to exceed 750 R.P.M. Over-all dimensions: 7 1/2" x 7 1/2" x 11 1/2". Gov't. acquisition cost, \$428.00. Shipping weight 31 lbs. Complete with 2 qts. of oil and full instructions. F.O.B. Chicago

54.50

IMMEDIATE DELIVERY - LARGE STOCK - MANY SIZES GENERATING PLANTS

DESIGNED FOR CONTINUOUS OR INTERMITTENT SERVICE
 PREPARE NOW FOR POWER FAILURE!
 PLENTY OF CURRENT TO OPERATE YOUR • OIL BURNER • REFRIGERATOR • HOME FREEZER • SUMP PUMP • POWER SAW • BROODER • CREAM SEPARATOR • INCUBATOR • VENTILATING FANS • MILKING MACHINES • BLOWERS • YARD LIGHTING • OTHER APPLIANCES

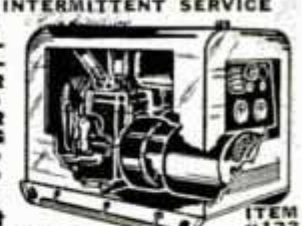

Item #133 - 3 KW - 120 Volt
60 Cycle A.C. Single Phase HEAVY DUTY
 Totally enclosed power unit with 2 cylinder water-cooled Hercules Model BXB engine direct coupled to generator. Magneto ignition, crank start, 4 gallon gas tank, 3 qt. oil capacity. Skid mounted with handrails for carrying. Instrument panel including killer button, oil pressure, water temp. gauges, voltmeter, ammeter.
 Shipping wt. 560 lbs. F.O.B. **395.00**
 Chicago

Item #178 - 350 watt - 110 volt - 60 cycle A.C. direct coupled to 1 cylinder Midco engine. Shpg. wt. 116 lbs. F.O.B. Chicago **125.00**



AIRCRAFT QUALITY HYDRAULIC EQUIPMENT

HEAVY DUTY - Large supply of new labor-saving, economical hydraulic equipment in many types and sizes. Use these positive, highly efficient smooth pressure hydraulics on presses, arbors, lifts, loaders, power control, positioning, brakes, plastic dies, auto frame alignment, etc., etc.

ITEM #270 - Purolator hydraulic oil filter. Permanent element type. 3/4" female pipe thread ports. Capacity 16 gallons per minute. A \$13.00 value, now postpaid. **4.95**
ITEM #127 - Double acting hydraulic cylinder, 1" bore, 1" stroke, 1/2" diam. shaft, 1/4" tubing thread ports. Over-all length closed - 6 1/2". Clevis mounting at both ends. Perfect for clamping and feeding. Postpaid. **5.95**
ITEM #33C - Double action hydraulic cylinder, 1 1/2" bore, 4 1/2" stroke. Clevis mountings at both ends. Uses 1/4" pipe fittings. Postpaid. **8.95**
ITEM #16C - Double acting hydraulic cylinder, 1 1/2" bore, 26" stroke. Will lift 1760 lbs. with value. Now only, Postpaid. **16.95**
ITEM #126 - Four-way, open center control valve with built-in adjustable relief valve. Factory set at 1000 P.S.I., spring loaded neutral position, for use with one double acting cylinder. Fully balanced plunger type, smooth, positive, easy operation, can be used as single unit or mounted in series of any combinations desired. Has 3/4" pipe thread inlet and outlet. 1/2" pipe thread cylinder ports. Newly manufactured to our specifications. Shipping weight 8 1/4 lbs. An outstanding buy! F.O.B. Chicago. **21.50**



ITEM #103 - Double acting hydraulic cylinder, 2 1/2" bore, 17" stroke. Clevis mounting. Will lift 4900 lbs. with 1000 PSI line pressure. 1 1/4" diam. shaft. 3/8" tubing thread ports. Overall length closed 28". Shpg. wt. 11 lbs. F.O.B. Chicago. **21.50**
ITEM #6 - Double action hydraulic cylinder, 3" bore, 24" stroke. Will lift 7070 lbs. with 1000 PSI line pressure. Steel barrel, 1 1/2" stainless steel shaft. Gov't. acq. cost \$176.00. Ship. wt. 26 lbs. F.O.B. Chicago **28.00**
ITEM #42 - Double action hydraulic cylinder, 4" bore, 18" stroke. Rated lift capacity with 1000 PSI line pressure is 12,500 lbs. Ship. wt. 30 lbs. F.O.B. Chicago. An Excellent Buy for. **32.50**
ITEM #29KJ - Gear Type Hydraulic Pump. Ideal in industrial applications and for operating all hydraulically powered farm implements including loaders, stackers, swathers, plows, etc. Delivers 1000 PSI (may be set at lower PSI if desired), 12 GPM at 400 RPM. Maximum operating speed 800 RPM - rotation counter clockwise. Has built in relief valve, permanent or torque bar mounting, 1" diameter shaft, 3/4" pipe tap inlet, 1/2" pipe tap outlet. Shipping weight 22 lbs. F.O.B. Chicago. **45.50**



GENERAL MOTORS - ALLISON

CENTRIFUGAL PUMP

200 GALLONS PER MINUTE
 • For Draining Basements • Fire-Fighting • Irrigation • Fuel Transfer • Swimming Pools • Home Water Systems • Dewatering

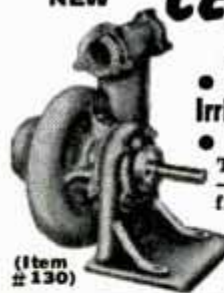

This General Motors-Allison Centrifugal Pump - designed for use on U. S. Air Force Mustang fighters, now converted for commercial, home, and industrial high volume pumping applications. Inlet, 2 1/2" standard pipe thread, twin outlets with 1 1/4" pipe thread, ball bearing supported 3/4" shaft. Easy, fast simple priming. Rotation, counter-clockwise facing shaft. Shipping wt. 35 lbs. Gov't. acq. cost \$145.00. F.O.B. Chicago **39.50** Now Only

Suction Lift	Head Pressure	Gal. Per Min.	H.P.	R.P.M.
10'	75'	260	6.0	3500
10'	65'	200	5.2	3500
10'	80'	40	1.5	2500
10'	50'	140	5.0	3500
10'	30'	100	3.0	2500

NEW MODEL 353 - DUAL RANGE

ARC WELDER

for Stationary or Portable Use
HEAVY DUTY RANGE TO 250 AMPS.
NEW 'MAGIC TERMINAL' FOR LOW CURRENT 30 TO 100 AMPS.



IDEAL FOR FARM • GARAGE • FACTORY • WORKSHOP
 These precision engineered D. C. Arc Welders contain the highest quality War Surplus aircraft components built to exacting government specifications. They are light in weight, have oversized lifetime grease-sealed ball bearings, air cooled commutator, dial type rheostat for easy pin-point control, a high-low rheostat switch, reactor coil for even arc and the new 'MAGIC TERMINAL' low current welding range for welding lighter materials. Designed for many years of trouble-free service. Run welder from drive pulley or power take off of a tractor or Jeep. 7 1/2 HP electric motor or 10 HP gas engine at 2500 R.P.M. Uses two V belts or flat belt. Continuous output rating 200 amps. Intermittent welding rating 250 amps, 30 volts. This sensational price includes double V or flat belt pulley and complete operating instructions. Shipping weight 107 lbs. \$350.00 Value. Item #65 Now Only. **119.50** F.O.B. Chicago

D.C. GENERATORS



For welders, plating, truck and marine use, D.C. appliances, lights, etc. Aircraft quality - lifetime grease sealed ball bearings. Heavy duty.
ITEM #90 - Type P-1, rated 200 Amps. - 28 Volts, 2500 RPM. Mfd. by General Electric, Ford, Delco-Remy and Westinghouse. Gov't. Acq. Cost \$300.00. Shpg. wt. 53 lbs. F.O.B. Chicago. **22.50**
ITEM #91 - Type R-1, rated 300 Amps. - 30 Volts. Mfd. by Jack & Heintz. Gov't Acq. Cost \$380.00. Shpg. wt. 59 lbs. F.O.B. Chicago. Each individually packed in wooden box. **35.00**

VICKERS - PISTON TYPE HYDRAULIC PUMP

Ideal for use with hydraulic cylinders and valves described in this page ad. Vickers constant displacement piston type pump delivers .507 cubic inches per revolution, 8 gallons per minute at 3750 RPM. 1000 PSI. Has 1 1/2" diam. shaft, 3/4" - 18 thread inlet and outlet ports. Rotation - clockwise. Postpaid. **19.90**



FREE: NEW 1952, 48-PAGE CATALOG jam-packed with Brand New War Surplus Bargains for the farm, home, factory and workshop. Write for yours today.

WRITE, WIRE or PHONE Webster 9-3793

ORDER DIRECT FROM AD - SEND PAYMENT OR PURCHASE ORDER TODAY - SATISFACTION GUARANTEED

GROBAN SUPPLY CO. 1139 SO. WABASH AVE., CHICAGO 5, ILL. DEPT. PM-1

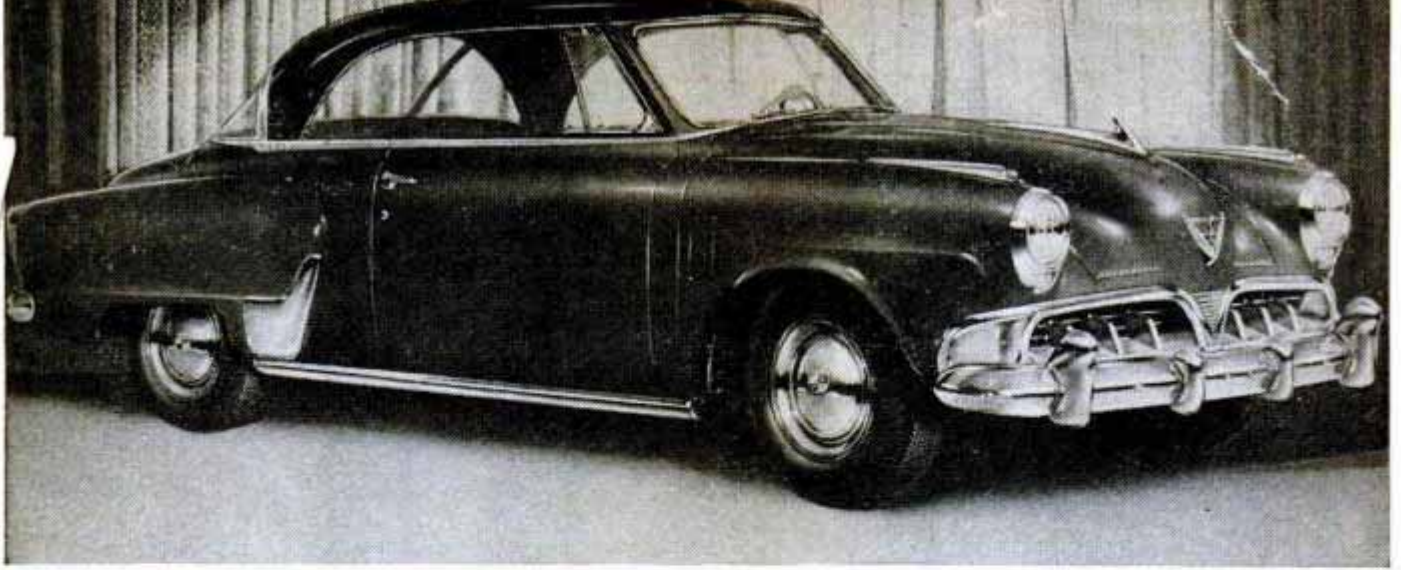

Offered in both Champion and Commander lines, the Starliner is a pacesetter for Studebaker's 1952 models

'52 STUDEBAKER

STUDEBAKER this year joins the long list of passenger-car manufacturers who have gone to "hardtop" styling. This popular model is being made in both the Champion and Commander series, being displayed in dealers' showrooms.

Studebaker's offering also carries on the tradition of the industry of a colorful name for the hardtop, its contribution being the Starliner. It is a five-passenger coupe with large wrap-around windows, no pillars in the center and an underslung look that makes it distinctive.

Studebaker is offering 11 two-tone combinations in the Starliner. On the interior, it offers two styles of nylon upholstery. Leather upholstery is an extra-cost item for those who prefer it to nylon.

The 1952 Studebaker shows more changes than the average 1952 model of the rest of the passenger-car manufacturers. Hoods

are longer and lower in the new models.

Grilles have wrap-around styling. Bumpers look more massive than ever, and come equipped with four vertical guards. Headlamps are redesigned. Parking lights are larger.

In the rear, the 1952 Studebaker has taillights which appear to be integral parts of the rear fenders and seem to extend the sweep and make the bodies look longer. Trunk-lid handles are new.

Mechanically, Studebaker has improved brake action by changes in the pedal linkage, adoption of floating rear shoes and linings which have greater resistance to fading. The "floating" brake shoes make them self-adjusting.

Both the V-8 and the six-cylinder engines are unchanged.

For the convertible enthusiasts, Studebaker is pioneering Orlon fabric tops in light colors. It is highly resistant to shrinkage and weathering and cleans easily, it is claimed.

With entirely new front-end treatment, '52 Land Cruiser also has redesigned trunk-lid handles and taillights





Customers at Warner Hardware, Minneapolis, find:

"Production" Sandpaper lasts 10 times longer!

"We've learned plenty about sandpaper in the last 76 years," reports Lloyd Kelly, salesman at Warner Hardware, Minneapolis. "This new 3M Home Workshop Sandpaper surprises everybody. It's the longest-lasting sandpaper we've ever sold!"

What makes it last 10 times longer than flint, garnet or emery? It's "Production" Sandpaper, coated with aluminum-oxide . . . the world's toughest abrasive mineral. Woodworking plants have used it for years.

And now, for the first time, this super-tough sandpaper is pre-cut to fit most home power tools, plus the solid-rubber 3M Sanding Block. Packaged in fine, medium and coarse grits for easy selection, too.

Look for the bright yellow packs the next time you're in your hardware store. Stock up!



SANDING BLOCK of solid rubber holds pre-cut sandpaper firmly on six spikes. Fits the hand comfortably for wet or dry sanding.



DISC SANDERS take "Production" Paper Discs. Universal Centerhole* — 1/4" to 1" arbor, 5" and 6" diameter. Fine to very coarse grits.



BELT SANDERS take "Production" Cloth Belts. Six sizes fit most portable belt sanders. Fine, medium and coarse grits.



OSCILLATING SANDERS and the 3M Sanding Block take "Production" Paper Sheets. Two sizes for most machines. Fine to coarse grits.



*PATENT APPLIED FOR

Made in U.S.A. by Minnesota Mining & Mfg. Co., St. Paul 6, Minn.—also makers of "Scotch" Brand Pressure-sensitive Tapes, "Scotch" Sound Recording Tape, "Underseal" Rubberized Coating, "Scotchlite" Reflective Sheeting, "Safety-Walk" Non-slip Surfacing, "3M" Abrasives, "3M" Adhesives. General Export: Minn. Mining & Mfg. Co., International Division, 270 Park Avenue, New York 17, N. Y. In Canada: Minn. Mining & Mfg. of Canada, Ltd., London, Canada.



Portable LIGHT PLANT

PUSH BUTTON START
500-700 watts 110-120 v. - 60 cyc. A.C. Powered by a sturdy dependable, easy starting, air cooled 1 3/4 hp. gas engine. No wiring necessary. Just plug in and operate. Plenty of current for any oil burner, freezer, brooder, pump, emergency lights, etc. which require up to 700 watts. Ideal for Civil Defense, Fire Depts; trailers & camps. Complete with Voltmeter and built-in winding to charge 6 v. auto batteries. Wt. 85 lbs. Fully guaranteed. Be prepared if war or storm knocks out power lines.

(Item 24) etc. which require up to 700 watts. Ideal for Civil Defense, Fire Depts; trailers & camps. Complete with Voltmeter and built-in winding to charge 6 v. auto batteries. Wt. 85 lbs. Fully guaranteed. Be prepared if war or storm knocks out power lines. **\$143.50**
1000-1200 Watt Plant (Item 45) same as Item 24, but larger generator & engine. **\$199.50**

GIANT 2000-2500 WATT PLANT

110-120 V. 60 cyc., A.C. Absolutely the best made - exclusive dynamically balanced armature; heavy windings develop up to 5000 watt overload for motor starting. Skid mounted - portable. Powered by easy starting Briggs or 6 hp. Wisconsin engine - complete with all accessories; engine easily disconnected for other uses. Big outlet box, voltmeter, no wiring necessary. Ample current for all purposes. Factory warranty and instructions included. Wt. 220 lbs. Reg. \$585.00. Special at... **\$299.50**
With Electric Self Starter (Item 179) **\$359.50**
GENERATOR ONLY and control box. **\$169.50**
Drive it with your engine or tractor

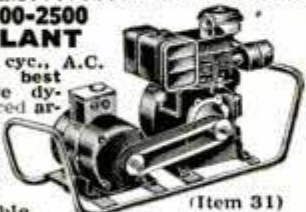

(Item 31)

HI-LINE 6000 WATT PLANT (Item 162) Push Button Start, 115-230 v. 60 cycle A. C. A brute of a power plant with a rugged 13 hp. Wisconsin engine. Plenty of electricity for ranges, water heaters, freezers, pumps, machinery, etc. Affords both 110 and 220 volts. Ideal where heavy current is needed. Wt. 590 lbs. Easily worth \$995.00. (with self starter) **\$645.00**
Factory special. **\$585.00**
Same plant (with crank starter) (Item 168) Wt. 570 lbs. **\$585.00**
Generator and control box only, belt driven. Use your engine or tractor. **\$345.00**
Wt. 240 lbs.

We are World's Largest Mail Order Distributors of Light Plants

VARIABLE SPEED SELECTOR

Heavy duty, made by B. F. GOODRICH for industrial use. Provides instant speed changes for any drive. For machine tools, dryers, printing, conveyors, production lines, hoists - any operation requiring variable speed. Ideal for midgeut autos. Employs reliable "trouble free" planetary system. No hydraulic power losses or creeping. Infinite range, smooth operation, easy installation. 3 sizes: 1/2-1 hp. wt. 36 lbs.; 1-2 hp. wt. 55 lbs.; 2-3 hp. wt. list \$228, \$252 and \$352. Brand new, in Goodrich boxes and guaranteed. Complete installation data included. Unprecedented surplus sacrifice **\$79.50, \$89.50 and \$114.50.**



(Item 68)

HEATING & VENTILATING FAN

(Item 10) Easily installed in furnace pipes. Forces even heat to all rooms. Over range, removes kitchen smoke and odors. Powerful continuous duty motor, 110-120 V. A.C. Quiet, super efficient fan moves huge volume of air (400 to 600 c.f.m.) 8" Fan, wt. 5 lb. **\$6.35**; 9" Fan, wt. 6 lbs. **\$7.45**; 10" Fan, wt. 7 lb. **\$8.45**; 12" Fan, wt. 8 lbs. **\$9.45.**



HIGH PRESSURE HAND PUMP

(Item 53) Positive displacement type. Cap. 550 gph. Completely self priming. 3/4" pipe thread inlet and outlet. Use for fuel or water transfer on boats, trailers, air craft, etc. Ideal for insecticides, emerg. sump pump or as vacuum pump. Wt. 15 lbs. Govt. cost \$95. Our Special. **\$12.95**



GAUGE TESTER (Item 27) Precision made of solid bronze and steel by Ashcroft. (Cat. #1300-5). Calibrated weights (incl.) acting against hydraulic piston provides quick accurate testing of all pressure gauges up to 500 psi. Brand new. Wt. 90 lbs. Reg. \$318.00. Our Spec. **\$95.00**



IMMEDIATE DELIVERY—ALL ITEMS HEAVY DUTY ARC WELDER



(Item 38) Use as portable or shop welder. 250 amps, D.C., Senior model. Made for years of trouble-free, continuous service. Will handle light or heavy jobs. Weld up to 1/2" plate using 1/4" rods. Built-in air-cooling system. Arc is easy to strike and hold, because of specially designed arc stabilizer. Hi-lo switch and dial control gives wide range of welding heats. Run welder at 2600 rpm. with tractor, jeep or 15 hp. gas engine, or 7 hp. elec. motor. Complete with instructions, guar. and double V belt or flat pulley. Wt. 110 lbs. **\$99.75**

MAGIC TERMINAL model same as above but with built-in 3rd terminal for low heat soldering and brazing. Special. **\$119.50**
WELDING KIT. Two 10 ft. leads, welding helmet, electrode holder, ground clamp. Sold only with welder at... **\$10.50**

A-C ARC WELDER (Item 168) Master Hi-Line A-C Arc Welder. 20-190 amp. output. Welds or cuts iron, steel, brass, etc. from 24 gauge to 5/8" with single pass. Operates from 220/230 V. 50/60 Cycle A-C line. None better. Meets REA requirements. Handles 1/16" to 1/4" rods. Adjustable output for any job. In sturdy steel cabinet, on casters. Full instr. and 1 yr. guar. incl. Wt. 210 lbs. Reg. \$250 value. (Item 169) 20-100 amp. A-C Welder operates on 110 or 220 V. Wt. 65 lbs. Worth \$125. (Item 181) Welding Kit incl. helmet, 2 leads, electrode holder, ground clamp, power cord and rods (sold only with welder) **\$12.50**
Wt. 12 lbs.



\$159.50

\$64.95

\$12.50

CARRY-AIR



(Item 32) Stainless steel tank—capacity 500 cu. in. at 400 lbs. press. complete with inlet and shutoff valves, press. gauge, detachable air hose, tire chuck. Fill at any service station. Carry air for tire inflation, blowing out lines, spray painting, insecticides, etc. One emergency pays back cost. Wt. 10 lbs. Worth \$20.00. Our price... **\$8.95**
(Item 55) With big double tank (1000 cu. in.) **\$11.95**

POTTERS WHEEL



(Item 47) Complete, prof. equip. for making finest ceramics and pottery. Large dynamically balanced cast-aluminum reversible turntable with variable speed drive (38 to 140 rpm) controlled by foot-pedal. Built-in adjustable arm rests, water cup and wedging wire. 16x12" enclosed throwing table—ample area for largest pieces. Reg. 1/4 hp. motor (not incl.). Can be set up on 20x24" table and stored on edge. Complete with pulleys, belts and instructions. Wt. 26 lbs. **\$59.95**
\$145 value at...

ANGLE DRILL



(Item 23) Fits into chuck of any electric or pneumatic drill or flex. shaft. Operates at any angle in a full 360° arc. Makes possible drilling, grinding, carving, routing, etc. in close cramped quarters. Makes impossible jobs easy. Made by Kett Tool Co. Complete with built-in chuck (1 1/4" capacity) and adjusting key. Hardened alloy gears. Precision built for heavy duty. Lists at \$39.95—while they last... **\$9.95**

RUBBER HOSE



New genuine Neoprene Hose - outlasts ordinary rubber 3 to 4. Reinforced with super tough cotton cord plies. Flexible. Easy Flo brass couplings with standard pipe threads for quick connections. included. Pump water for irrigation, stock tanks, home, barn, fire fighting, etc. Pump Gas or Fuel Oil. Save more than 80%.

TERRIFIC VALUES!

	1"	1 1/4"	1 1/2"
Length	10 ft.	25 ft.	30 ft.
Price	5.95	9.25	14.75

If specified we will send special hose for gas or oil at same prices. Send 10c for a Big War Surplus Catalog. Included Free with Every Order.

MAKES SNOW REMOVAL REAL FUN!



SNOW-BLO

The sensational device that makes snow removal real fun. Easy - a child can operate it. Safely guarded whirling impeller quickly scoops up the snow and blows it 25' either side. Big timesaver. Clears driveway and walks in a jiffy. Eliminates dangerous exhaust and overtaxed heart, which kills so many every winter. BOYS! Make big money clearing snow for neighbors. Easily converted to lawn mower when desired. New silent electric model powered by 1/2 hp. motor clears 16" swath. Complete with shockproof 100' cord (Item 72)... **\$139.50**
Gasoline Model with easy starting 2 hp. 4 cycle engine (Item 73)... **\$159.50**
For large areas (2 1/2 hp. engine) (Item 74)... **\$179.50**

We pay freight on Snow-Blos. FREE with purchase of any model, an extra 100' extension cord.

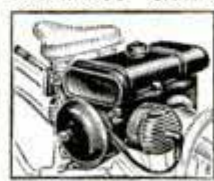

COMMANDO BIKE MOTOR

(Item 90) New, super-modern 1952 model. This job is the Cadillac of all bike motors. Sensational Auto-Clutch prevents killing motor at each stop. Also selects proper ratio on hills. Mounts behind and drives rear wheel with Dynarotor. Free Wheeling lever permits pedaling if desired. Rear Mounting eliminates fumes, heat, dirt, and hard steering. Easily installed in 15 minutes with home tools. Sturdy, trouble-free, easy starting, light weight. Airplane type engine: up to 150 miles per gallon. Fully guar. Ride for fun or profit. Ideal for deliveries, paper routes, messenger service, etc. Ride to work and save. The Commando Captain, 1 cylinder 1 1/2 hp. **\$99.75**
The Commando General, 2 cylinder 3 hp. (Item 91)... **\$125.00**
All Commandos shipped prepaid in U.S.

FIRE EXTINGUISHER

(Item 39) Fully charged at 1,000 lbs. P. S. I. or more) with CO2 (carbon dioxide), the proven miracle fire fighting chemical that smothers oil, gasoline and electrical fires. Play safe; keep one in your car, garage and home. Heavy ICC approved steel cylinder, valve and 3000 lb. gauge that shows available remaining pressure. REFILLABLE at nominal cost. Hose included for emergency tire inflator or air blast. Wt. 4 lbs. **\$19.50**
Special... **\$6.95**

LARGE FIRE EXTINGUISHER (Item 57) commercial size, 5 x 14 in. (275 cu. in.) heavy ICC approved steel cylinder charged at 1000 lbs. or more with CO2. Equipped with genuine Kidde Valve. Refillable. Hose incl. Suitable for fire depts., stores, garages, homes, etc. Wt. 18 lbs. **\$42.50** value. Spec. **\$15.85**



EXTENSION CORD

(Item 16) 40 ft. heavy duty, made of specially insulated No. 14 2-conductor wire. So tough that you can drive over it and yet amazingly flexible and easy to handle. Resists oil, grease or water. Extends electricity up to 400 ft. without voltage drop. Use indoors or out. Complete with heavy rubber plug and outlet. Wt. 2 1/2 lbs. Usually \$4.50—Special 40 ft. **\$1.99**
Comb. 2-40 ft. and 1-20 ft. (total 100 ft.) **\$4.95**
100 foot length (one piece)... **\$4.85**
WIRE ONLY (Item 50) No fittings, 100 ft. **\$4.00**
TRENCH-LAY WIRE. (Item 51) Anaconda #10-2 cond., for buried service to barns, outdoor lights, etc. Absolutely impervious to soil and moisture. Wt. 25 lbs. per 100 ft. Special surplus price. 100 ft. coils, 19c per ft.; 250 ft., 18c per ft.; 500 ft., 17c per ft.

34 pc. SOCKET SET

(Item 59) Highest quality guar. non-breakable sockets made by Plomb, Snap On, etc. Complete range of 22 sockets from 1/4" thru 3/4" in 3/4" drive and 7/16" thru 1-1/16" in 1 1/2" drive. 2 speeder handles, 2 extensions, 2 slide heads, double 3/8 x 1/2 in. "L" handle, reversible ratchet. Adapter bit, 2 end wrenches and metal tool box. For professional mechanics who want the best. Wt. 14 lbs. Easily worth \$34.50 while they last... **\$16.95**
TIRE CHAINS (Item 43) Extra heavy for dual truck tires. 7.50x20, triple side links, made by Intl. Chain. Reg. list \$57.50—our special... **\$19.50**

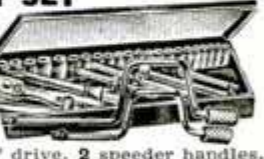

Broadcast Thru Any Radio

Talk! Sing!
Play!

with **NEW Micro-Vox Microphone and Portable Wireless Transmitter**



Imagine **YOUR VOICE** suddenly, dramatically coming over a radio in another room, another house or even over car radios! You'll thrill and surprise your friends by talking, playing or singing. Put on surprise programs, quiz shows, plays, musical productions, do imitations, broadcast games, news events, announce games, etc., etc.

Practise and improve your voice and playing. Save many dollars in lessons. Read the **HUNDREDS OF USES** and the fun you can have! How you can save time and money! How you can make money with it! Micro-Vox picks up and amplifies any sounds over any radio within 75 feet (or farther under favorable conditions). Produces high fidelity, professional performance with full bodied, clear tone, amplified as loud as your radio can make it! **NO WIRING! NO CONNECTIONS OF ANY KIND!**

HOW DO YOU SOUND?

Test & Improve Your Voice!
Play Better! Speak Better! Sing Better!

Easy to develop your ability to talk, sing or play yet save money on expensive lessons. It actually makes practising fun! Increase your popularity by developing your own personality and talent. Learn useful techniques worth many dollars! Did you know that most singers and announcers speak in a low voice, letting the microphone pick up, improve and amplify their voice, so that it comes out loud, strong and clear, with wider range! Let Micro-Vox improve your voice as it does for famous radio stars!

Fun! Jokes! Home Entertainment!

Fun in many ways. You can fool your friends by injecting "fake" announcements and news broadcasts. Mystify your neighbors with surprise announcements. Or, if you are having some friends over, it provides plenty of fun and home entertainment. Everyone wants to "try their voice" or to "broadcast". Imitate Bing Crosby, Bob Hope, etc. Every-time your friends drop in, they'll want to use it. Watch children "do their act." Even broadcast to car radios!

Public Address Amplifier

Call People - Announce Games & Events

Almost no limit to the many practical uses for Micro-Vox. Use it with 1, 2 or more radios for powerful public address system, music amplifier, etc. For games, parties, events it comes in very handy.

Broadcast your own games, news events, etc. Announce plays, scores, etc. Used by barkers at shows. Wonderful for any type of public, party or club events. Make money by renting it out or doing these services - and have fun, too! Because it is wire-less, you can **TALK AS YOU WALK** - no wires to bother with.

Intercommunication System

Many people and places use it to call out orders or make announcements to another room or another location. Talk from room to room, house to garage, office to shop, etc. Makes good private phone system. Used individually, you can make announcements one way. For two-way communication, two units are necessary. A cheap, practical, portable inter-communication set that needs no wiring, no hook ups.

Secret Detectaphone

Overhear Private Conversations

Imagine being able to conceal Micro-Vox in another room, then "listen in" on the conversation! It can be embarrassing and fun. It can be practical. Use as baby or burglar alarm. Fine for baby or sick room. Similar instruments used by detectives and spies to overhear plans, secrets, as well as suspicious noises. One fellow set up Mike downstairs in living room while his folks were having a party, then sat up in his room and listened over radiol! Overhear the girls and you're in for some real laughs! Stop and think! Isn't there someone you'd like to hear when they don't know you're listening?

Ready for Immediate Use! A Buy You'll Never Regret! Years of Use!

Use It Anywhere! Broadcast to Portable or Car Radios Too!

"CALLING ALL CARS! SPECIAL ANNOUNCEMENT!!" Yes, you can "Call All Cars" and make announcements to come over your radio. Even call from one car to another as you are driving along! Imagine the fun and the many practical uses. It will be the most exciting, the most useful instrument you've ever had. A time saver, money saver and money maker. Stores, clubs, schools, etc., will pay you to use it!

No Wiring! No Connections! No Adapters! Do Not Touch Radio! Radio Works Normally!

Wireless Micro-Vox Radio Microphone is self-contained, complete, portable transmitter. Nothing to do but turn on the switch, tune mike dial and **IT'S READY FOR IMMEDIATE USE.** No wiring; no experience. Operates indoors or outdoors. Marvel of electronic engineering. High fidelity, professional level performance. Full bodied, clear tone, fine modulation. Electronic 1-tube unit, complete with batteries. Tube lasts indefinitely; batteries easily replaced for few cents when their long life is through. Adjustable volume, beautiful streamline walnut plastic housing, 6-inches high. Amazingly low priced; limited quantity. **Order Now! Money Back Guarantee Protects You!** Get two if you wish to talk back & forth between two places, car to car, etc. (2 for \$16.95 Postpaid).

MICRO-VOX, Ready for Immediate Use \$8.98 (2 for \$16.95) Complete, Each Postpaid.

JOHNSON SMITH & CO., Dept. 475, Detroit 7, Michigan
Since 1914 America's Leading Novelty House—Mammoth Catalog 10c

Read What Users Say: "Made our party a riot of laughs—I use it in many other ways, too!" "Improved my voice and playing—saved me a lot of money on lessons!" "Most useful thing we've had around the home or shop. I get more use from it than with my camera, guns or field glasses!" "For schools, clubs & churches, it can't be beat!" "A bargain! Was pleasantly surprised how well it worked. Does the work of a unit costing over \$50.00."

Order Today! Money Back Guarantee

JOHNSON SMITH & CO., Dept. 475, Detroit 7, Michigan

Rush Micro-Vox Microphones \$8.98 Each \$16.95 for 2 Postpaid

Enclosed is \$

Name & Address

AMAZING TOOL BARGAINS!

ALL BRAND NEW MERCHANDISE

112 PIECE ASSORTMENT FOR ELECTRIC GRINDERS

Here's what you get! Mounted Stones on 1/8" mandrel, Drum Sander, Sanding Sleeves for sander, Rotary Cutters, Wire Scratch Brush, Bristle Brushes, Circular Saw, Buffing Wheel, Grinding Wheel, Rubber Polishing Wheel, Cut-off Wheels, Rubber Cylinder, Mandrels to fit above tool, asst'd. Sanding Discs, Sharpening Stone, etc. **\$10.00 VALUE ONLY \$3.95 P.P.**

18 ROTARY CUTTERS \$5.85

Post Paid Value \$13.50

Assorted sizes cutter on 1/8" or 3/32" shank. Will fit all hand grinders. Ideal for cutting wood, metal, or plastic. Brand new.

2 CIRCULAR SAWS ON 2 MANDRELS — ALL AT ONE LOW PRICE \$1.50

1" diameter saws on 1/8" Mandrels. For cutting wood, plastic, or soft metals. Order at once! Send Check or Money Order. U.S.A. Post Paid in U.S.A.

12 MOUNTED WHEELS \$2.95

and points on 1/8" Mandrel. For grinding on plastic, wood, soft and hard metals. Regular \$8.40 List Val. 12 wheels on 1/4" Mandrel \$3.60 18 MOUNTED POINTS ON 3/32" MANDREL \$2.50

2 DRUM SANDERS \$1.50

With 12 Bands in Assorted Grits. 1 1/2" dia. x 1" long on 1/4" arbor with 12 bands. ONE DRUM, 1" DIA. x 1" LONG ON 1/4" ARBOR WITH 6 EXTRA SLEEVES \$1.00 P.P. in U.S.A.

FLEXIBLE SHAFT — ONLY \$4.95

P.P. Fits all electric drills & hand power tools. 35 3/4" long. Oilite bearings. Core of specially wound, high carbon steel wire in flexible steel casing. Will accommodate tool shafts up to 1/8" dia. For lathes, electric drills, etc.

7 HIGH SPEED TWIST DRILLS \$1.00

15 DRILLS FOR ONLY \$2.00! Order Today! Postpaid 7 Popular Sizes — up to 1/4". Brand new, ideal for home or shop use. Fits all standard chucks.

ADAPTER CHUCK \$1.50

With 2 interchangeable collets, opening from 3/32" to 0, on 1/8" mandrel. Price each only. P.P.

SURPRISE VALUE 100 Pieces \$1.00

FOR ELECTRIC GRINDERS Post Paid in U.S.A. Grinding Wheels, Cut-off Wheels, Sanding Discs, Mounted Stones, Sharpening and Honing Stones, Rotary Cutting Burs, Abrasive Cartridges, Mandrels, and many other items.

18 GRINDING WHEELS \$1.00

and rubber polishing wheels up to 1" dia. P.P. For grinding & polishing metals, plastic, wood. With one 3/32" mandrel. 10 HIGH SPEED CUT-OFF WHEELS 1 1/2" DIA. WITH 1/8" MANDREL \$1.00

BUFFING WHEELS—5 for \$2.00

8 inch diameter muslin wheels — 1/2 inch thick. Ideal for coarse and fine polishing. Post Paid U.S.A.

SCHUPACK SUPPLY CO., 7331 Cottage Grove, Dept. M-26, Chicago 19, Ill. Illustrated Catalog 10c

12 MINIATURE CUTTERS



\$1.00

FOR CUTTING WOOD, PLASTIC, or METAL. Actual size. Ass't. shapes on 3/32" shank. For die makers, home workshop, etc. POST-PAID



20 ABRASIVE ROLLS, cloth, and 1/8" mandrel ONLY \$1.00

for grinding, sanding, deburring metal, plastic, wood or rubber. Post Paid

SCHUPACK SUPPLY CO. 7331 COTTAGE GROVE, DEPT. M-26 CHICAGO 19, ILL.

Illustrated Catalog 10c



BUILD NOW!

for BEAUTY and PLEASURE in YOUR YARD . . . Detailed plans or precision built knock-down kits make home and garden projects easy for you.

AUTHENTIC DUTCH WINDMILL (B-10 hexagon style, 40" high, plans 75c)



LAWN CHAIRS, illustrated above, styles B, C, A, plans 50c ea., all 3 only \$1.00. TRELLISES, 12 designs, all for 50c.

Send 10c for catalog illustrating many fine lawn figures, lawn animals, Dutch windmills, lighthouses, arbors, many other home and garden projects.

CRAFTSMAN'S MODEL CO. DEPT. P36 DELAFIELD, WISCONSIN

Opportunity OF A LIFETIME!

SELL AIR CUSHION SHOES



Build a permanent "repeat" business of your own without one penny of investment! Sell John Neil Air-Cushion Shoes Direct from famous New England factory. Firestone Foamex cushions — complete line of men's dress, work, safety shoes! DuPont Neoprene non-marking soles. Women's and children's shoes. Fast deliveries from our mammoth stock department.

Earn up to \$30.00 per day! JOHN NEIL SHOE CO. DEPT. 12 — Brockton 64, Mass.

MAGNETS 5 FOR \$1.00

IMAGINE five useful permanent magnets in assorted shapes and sizes at the factory-to-you price of only \$1.00 ppd. Magnets save time and money in home, shop or office. They are useful in school science classes. We guarantee satisfaction and send a large list of uses for magnets. This ad will appear this month ONLY. Clip it now; send your dollar.

RONALD EYRICH, 1219 W. Meinecke Ave., Milwaukee 6, Wis.

WELD \$1475 F.O.B. complete!

BRAZE, SOLDER, and CUT →



No experience needed. Follow simple instructions, weld on iron, steel, bronze, brass, aluminum, and other metals. Plugs into any properly wired 110 volt A.C. or D.C. line. Make or save time and money doing repair work for yourself and others. Repair men, farmers, tinsmiths, home and auto owners, hobbyists, etc., say FOUR-WAY pays for itself over and over. Order today or send for Free details.

Larger Equipment Available on Request FOUR-WAY WELDER COMPANY, Dept. F2-AC 2326 S. Michigan Ave. • Chicago 16, Illinois

ORDER NOW 10 DAY TRIAL

WELLWORTH BARGAINS - ALL NEW EQUIPMENT

Wellworth AIR COMPRESSOR

For Farm and Home Workshop



Compressor has 2" bore, 1 3/4" stroke, 2.8 cfm up to 150 lb. pressure. Motor required: 1/4 h.p. at 100 lbs.; 1/2 h.p. at 125 lbs.; 3/4 h.p. at 150 lbs. or equivalent gas engine. V-belt drive, intake muffler and cleaner, bronze bearings, splash lubrication. Wt. 16 lbs. Replacement parts always available.

\$20.50



6"x24" Steel Tank 200 lb. Pressure 2-1/4" openings

COMPLETE OUTFIT. Compressor, pressure tank, air gauge, air chuck, 20 ft. hose, pop valve, copper tubing with 4 brass flared fittings for connecting compressor to tank, 4-way cross and 3 nipples. **COMPLETE OUTFIT, wt. 30 lbs. \$32.45**
Equipment less compressor **\$12.45** Tank only. **\$6.25**

WELLWORTH COMPRESSOR BUY

1 Year Guarantee

FEATURES:

2 compression and one oil ring, aluminum alloy connecting rod. Stainless steel valves with brass seats and retainers. Cool-flo cylinder head, spray mist lubrication to every moving part. 10 1/4" V groove fly wheel for 5/8" B section belt.



MODEL W3

2 1/2"x2". 2.55 to 4.80 c.f.m. up to 150 lb. pressure. Operates with 1/2-1/2-3/4 HP motor.

\$27.95

Special Price. Shipping wt. 24 lbs.

MODEL W7

2 cylinder 2 1/2"x2". 5.10 to 8.50 c.f.m. up to 150 lb. pressure. Operates with 1/2-3/4-1-1/2 HP motor.

\$54.50

Special Price. Shipping wt. 45 lbs.

WELLWORTH V-BELT CLUTCH



Takes starting load off engines or motors. When speed is reached, a flip of handle shifts clutch from idling to driving position. Handles "A" belts, 2.35" pitch diameter, 5/8" bore. Ideal for use with lawn mowers, garden tractors, home workshop motors, etc. 3 1/4" long. Safe, easy to mount, sealed bronze bearings, positive action. Shpg. wt. 3 lbs. **\$7.50**
BUSHING FOR 1/2" SHAFT 15c

"Wellworth" BLOWER BARGAIN



Quiet operating. Double wheel inlet, double width blower. For heating, ventilating, cooling, air washing, exhausting and forced draft. DIMENSIONS: 10" wheel; outlet 13 1/4"x11 3/4"; inlet 8 3/4"; Height 19"; Width 18"; Depth 16 1/2". C.F.M., 1/4" S.P. 1600; outlet vel. 1575. Wt. 45 lbs. **\$27.50**

BLOWER LESS MOTOR AND DRIVE variable speed pulleys. \$2.50 extra. With belt and complete with 1/4 h.p. motor, \$47.50.

140 CFM "WELLWORTH" BLOWER

5 1/4"x4" mounting flange with 2 1/2" square discharge, 3 1/2" dia. blower wheel powered by direct-connected 1/15 H.P., 110 V. 60 C., A.C. motor with conduit box and 20" leads, 7 1/2" wide less flange by **\$16.20**
7 1/4" H. x 6 3/4" D. Shpg. wt. 6 lbs. **50 CFM BLOWER, 2 1/2" discharge. \$10.95**



OUR LUCKY BUY SAVES YOU \$18.00!

DRILL-O-MATIC ELECTRIC POLISHER and 1/4" DRILL

Polishes floors, furniture, automobiles; does sanding, drilling and buffing jobs. Handy family Work-Aid. Limited number available. Act fast. Drill and Polisher combination, 110 volt AC-DC. Disc Polishing Bonnet; 1/4" Jacobs chuck; horizontal bench stand; 12" polishing handle; wire wheel brush; 2-mounted wheels; 2-drill bits; spindle adaptor; buffing wheel; 6-amb right side discs; 1-grinding wheel; paint mixer; 12 ft. cord & plug; drill handle; steel hinged carrying case with handle and lock clamp. Wt. 9 lbs. 24 Pieces. 50,000 were sold at \$28.95. Our special price, only **\$10.95**



AIR REGULATOR and EXTRACTOR

1/4" Air Regulator, Gauge and filter. Wt. 5 lbs. New. **\$8.95**
Regulator and Gauge only. **\$5.95**

AIR CYLINDER & Moisture Trap

5" x 8" tank 400 lb. test with 1/4" air regulator, gauge, safety valve and shut-off cock. Complete as shown. **\$12.95**
Shipping weight 6 lbs.



INSECT DUST SPRAYER

For dusting plants, shrubbery, etc. Easy-to-use, light weight gun. Also flock gun. Operates on Compressed Air, requires 2 c.f.m. at 40 lbs. pressure, 14" long. Weighs 2 lbs. **\$5.00 Value ONLY \$2.95**



AUTOMATIC COMPRESSOR UNIT

1/3 H.P. heavy duty capacitor motor, AC 110/220 volt, 60 cycle, 2x1 3/4 inch piston type compressor, splash feed lubrication. 12x24 inch tank, automatic pressure switch. CFM 2.8 at 100 lb. pressure, or 150 lbs. pressure for intermittent duty. Check valve, safety valve, air regulator with gauge and filter, 20 ft. air hose with air chuck for inflating tires. V. belt drive. Mounted on 2 wheels, ball bearing, with 2"x10" semi-pneumatic tires. Portable with handle. Shipping wt. 90 lbs. With 1/3 h.p. motor **Less With 1/2 h.p. \$160 Value Motor gas engine**

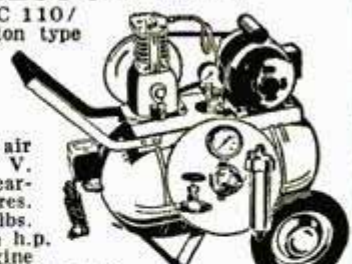

\$98.50 \$79.50 \$124.50

2000-2500 WATT LIGHT PLANT

Heavy duty windings

110 v. 60 cy., A.C., takes starting overload up to 5000 watts. Floating Base for Automatic Belt Adjusting, 2-Groove Engine Pulleys, V-Belts, Bolts, etc. 5 H.P. Wisconsin or Briggs & Stratton Model 14 Engine. Voltmeter, 2 plug-in receptacles. Portable Tubular Steel Skid Type Carrier. Dim.: L 34 3/4" x W 17" x H 20". Wt. 180 lbs. **\$299.50**

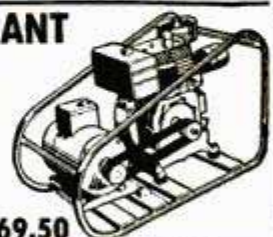

Generator only, with voltmeter, 2 plug-in receptacles. Shipp. Wt. 75 lbs. **\$169.50**

RED SEAL CONTINENTAL GAS ENGINE



BRAND NEW. 1 1/2 HP with 6 to 1 reduction gear. Operates at 450 R.P.M. For lawn mowers, scooters, garden tractors, pumps, compressors, generators, etc. List Price \$79.50 Shipping wt. 54 lbs. **\$47.50**
SPECIAL PRICE..



1/12 H.P. MOTOR

Delco 110V. 60-cy. A.C., 1 phase 1750 r.p.m. 2 amps., will take 50% overload. Shaft 3/8x1 1/4. Heavy duty, bronze sleeve bearing. Size 6" long, 5" high, net wt. 12 lbs. List **\$13.50**
Special. **\$21.00.** Special. **\$12.50**
LOTS OF 3, EA. **\$12.50**



LELAND GENERATORS

2500 to 3000 watts, 110 v. 60 cy. single phase 1800 r.p.m., self excited. Fungus treated for long life. 1951 model. Brand new, in original factory crate. Shipp. wt. 135 lbs. List \$375. **\$237.50**
SPECIAL PRICE..

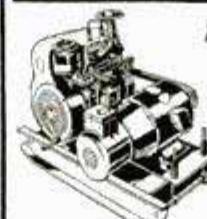

5000 WATT LIGHT PLANT

1952 Model. 110/220 volts, 60 cy. AC, one phase, 50 amps. Takes starting overload up to 87 amps. Integrally mounted separate exciter giving exceptional overload and surge capacity for starting motors. Drip-proof constr. Ball bearing, lifetime lubrication. Voltmeter, 2 plug-in receptacles. Wise, air cooled, 2 cyl. 4 cy. 10 1/2 HP engine.

SPECIAL PRICE \$645
Wt. 575 lbs.
GENERATOR ONLY \$325
Wt. 225 lbs.



AIR TANK and ACCESSORIES

Brand New Steel 6"x24", 400 lb. test. Ideal wherever compressed air is needed. Equipped with 500 lb. combination air gauge and inflation valve with core for retaining pressure in tank; tire chuck. 3 ft. high test air hose. **\$7.95**
Ship. Wt. 12 lbs. Complete outfit.

PORTABLE SPRAY OUTFIT

1/4 H. P. HEAVY DUTY MOTOR EXTERNAL ATOMIZING GUN

Paint Sprayer mounted on 6x24 inch tank, 1/4 H.P. 110 V. 60 cy. Heavy duty motor with overload relay, 10 ft. cord and plug. V belt drive. Piston type Compressor with 2 Compression rings, 1 oil ring, 2 inch Bore, 1 3/4 inch stroke, displacement 2.86 C.F.M. at 60 lbs. pressure. Safety Valve. Gun external atomizing. Flat and round spray, quart cup; maintains 35 to 40 lbs. working pressure. Oil and water extractor, 1 air gauge, 20 ft. heavy duty two-braid air hose with leakproof fittings. Complete with carrying handle. Wt. 60 lbs.



OUTFIT LESS MOTOR . . . \$52.00 COMPLETE \$67.50
SPRAY GUN AND 20 FT. HOSE . . . \$12.95 OUTFIT

PRICES F.O.B. CHICAGO. MONEY BACK GUARANTEE. SEND CHECK OR MONEY ORDER TODAY. PROMPT SHIPMENT. WRITE FOR CATALOG. SEND 10c FOR POSTAGE.

WELLWORTH TRADING CO.

1832 S. WABASH AVE. Dept. D-152 CHICAGO 16, ILL.



U.S. NAVY PHONE SET

Used by the Navy for flight deck and gunnery control. An ideal emergency communication system because they require no power supply. Perfect for office-to-shop, house-to-garage or barn, or any point-to-point within a 1/2 mile radius. These sets are fully Sound Powered. Each set includes 2 phones on chestplate, 2 headsets, button switches & approx., 35 ft. of cable. **995**

USAF THROAT Microphone

Genuine USAF, Type T-30-O. Gives distinct voice reproduction for aircraft or amateur radio broadcasting. Consists of two microphones mounted on rubber neckpiece & elastic neck band. Operates between 100 & 300 ohms. **SPECIAL AT 139**

4" ALNICO SPEAKER

Model No. S10540-2 Permanent magnet type. Sturdy, die-stamped steel frame with four hole mounting. Requires only two wire hook-up. Makes an ideal speaker for small radios, multiple communication systems, inter-office, test equipment, etc. **249**



ARMY SIGNAL CORPS TEL. KEY

The new, model J5A with ball type, flame-proof metal key. Perfectly balanced to permit positive contact with minimum effort. An ideal instrument for "ham" or professional use. **A BUY AT 189**

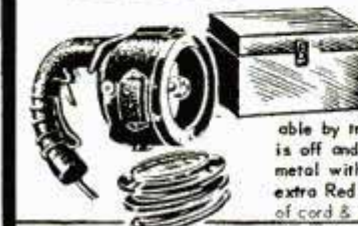

SIGNAL LIGHT

New, Double Trigger Signal Light Kit. Has interchangeable colored filters and controlled, directional beam. The 4 inch Parabolic, Pyrex mirror reflector is movable by trigger in the handle. Other trigger is off and on switch. Lamp housing is all metal with crackle finish. Kit comes with extra Red & Violet filters, 2 bulbs, 25 ft., of cord & handy wooden carrying case. **595**



BELT KITS for TOOLS

For the Mechanic, Electrician, Machinist, Radio & TV technician, etc. Made of bark tanned, top grain cowhide and worn on the belt. Saves wear & tear on clothing. A convenient, handy place to carry all small tools. Re-inforced with rivets.

- A- ELECTRICIAN'S, 7 POCKET KIT - Holds Tape, pencil, tools, etc. **349**
- B- EXTRA CAPACITY KIT - Main pocket is 1 1/2" box type, 2 extra pockets. **319**
- C- METAL WORKERS KIT - Has 5 pockets & hammer holder. Roomy. **339**
- D- GENERAL UTILITY KIT - Has just 1 large pocket for all uses. **179**
- E- FLASHLIGHT HOLDER KIT - Handy holder for 2 cell lights. **109**
- F- RADIO & TV INSTRUMENT KIT - 1 large & 2 small pockets. **279**



PRECISION BOX JOINT PLIER SET

Top Quality, Imported, Precision, Box Joint Pliers. Set consists of 1 pair, Flat Nose for general work, 1 pair Needle Nose for fine work and work and 1 pair Round Nose for looping, etc. May be purchased separately for **175**

The complete set of three is ideal for the radio, TV repairman, hobbyist, inventor, electrician, silversmith, etc. All 3 with case. **495**

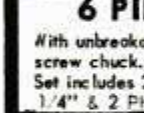

6 PIECE SCREWDRIVER SET

With unbreakable, shock-proof amber plastic handle and aluminum screw chuck. Blades are hardened, tempered and cross ground. Set includes 2 cabinet blades, 1/8" & 3/16", 1 mechanics blade 1/4" & 2 Phillips type blades No. 1 & 2 in wrap-around case. **ONLY 109**

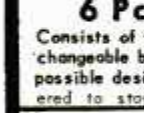

6 Pc. WOOD CARVING SET

Consists of wood handle with screw type chuck and five interchangeable blades. These blades are designed to carve every possible design in wood & linoleum. Hammer forged and tempered to stay sharp longer. All 6 pieces in leather holder. **195**



AN-JC-48 HARNESS WIRE 20,16,12 GAUGE

Handy for emergency repairs on radios, aircraft, autos, boats, etc. Sold only in bundles of 6 pounds or more. These bundles are in mixed gauges & lengths, very clean & unraveled. This wire normally sells for 4¢ to 5¢ per foot. Here is your opportunity to have a stock of wire for approx., 1/4¢ per ft. - 6lbs. for **ONLY 295**



CLAMP-ON ANYWHERE LAMP

One of the handiest lights a photographer can own! Clamps on anywhere. Fully adjustable, swivel lets reflector move freely. Can be used with photoflood or photoflash lamps. Also used as reading lamp, work lamp, etc. Socket assembly, includes clamp, adjustable swivel, cord and plug. **LAMP ALONE 139**
Spot reflector (5" diameter) } **109 EA.**
Parabolic flood Reflector (9" diameter) }

SURPLUS WINCH



Originally used by the Navy to control gunnery targets when being towed by an airplane. Ideal for many uses. This winch will pay out, hold or reel in cable or rope. It has a capacity for 4500 feet of 3/32" cable or 2500 feet of 1/8" cable. The rotating drum is gear driven and is operated by a crank handle. Drum may be rotated at 1 to 1 or 8 to 3 ratio. A brake holds drum with with ratchet & pawl to set. Size 29" x 13 1/2" x 13" **ONLY 32.50**

NEW 1/2 TON CAPACITY HOIST WINCH PULLER

For LIFTING - STRETCHING - PULLING. Does the job Easier, Faster & Safer. Made of high tensile Manganese Bronze; Duraluminum; Aircraft Cable and Steel - weighs only 6 lbs. Has a 14 to 1 power ratio and guaranteed 1000 pound capacity. Tested to 100% overload. Fast, dependable operation. No chains to kink, no ropes to tangle. Does the job of bulky chain hoists **ONLY 17.95** costing many times as much. Saves time & labor.

Attention GADGETEERS

ELECTRIC GYRO

Turns up to 50,000 RPM. Electric drive motor is integral part of balance wheel. Has double end shaft to drive precision tools or machinery at precise, controlled speeds. Full ball bearing mounted. Operates high or low voltage. A highly precise instrument. Ideal for experimental work, science labs, hobbyists & technical engineers. **495**
A TREMENDOUS BUY!

2 Heat SOLDERING IRON

This is really TWO IRONS in ONE!!! A control button in handle selects 150 or 300 watt heat. Full size iron for light & heavy work. Removable, solid copper tip. Complete with cord and tip. **495**

PLASTIC PARALLEL STRAIGHT EDGE

A valuable asset to the navigator, engineer, draftsman or mechanic. Has adjustment knobs. Rubber pods prevent slipping. **ONLY 97c**



PRECISION GERMAN MICROMETER

One of the finest quality, imported, precision tools on the market. Reads from .001. It has a ratchet stop for absolute accuracy and a lock ring to hold setting secure. Head contains decimal chart. **9.75 NEW**



INSIDE-OUTSIDE VERNIER CALIPER

Measures Inside - Outside & Depth from .001 to 6 in. Reads both English & Metric scales. Specially hardened jaws. Sliding jaw has lock nut to hold setting. Made by one of the leading specialists in precision instruments. **9.75 NEW**

6 IN. SOLID STEEL STARRETT SQUARE

Has specially hardened beams and edges, accurately ground to insure parallelism and straightness. Made of finest quality materials and highly regarded for its use as a standard square. A PALLEY VALUE for ONLY. **13.50 VALUE 8.72**



MECHANICAL DRAWING SET

NEW 7 PIECE
A REAL PALLEY BARGAIN! Made in Germany. Has a 4 1/2" compass with pen and pencil part; a 4 1/2" divider; one 3 1/2" reverse bow compass for pencil and ink; 4 1/2" ruling pen; capsule with extra lead. Complete in velvet lined case, for only **3.25**



WESTINGHOUSE AIR COMPRESSOR

CONTINENTAL GAS ENGINE
THAT FAMOUS SINGLE CYLINDER, 4 CYCLE, ENGINE with a GENUINE RED SEAL, Air Cooled 'L' Head. Comes complete with all accessories such as: mesh type air cleaner, flywheel, magneto, float type carburetor, fuel tank, starter pulley, muffler, blower housing, etc. An ideal power plant for small farm machinery, lighting plants, air compressors, power tools, small boats, etc. Weighs only 43 lbs. **49.50**

1000's now in use for spraying, inflating, air tools, in garages, laboratories, shops & on trucks, tractors, jeeps, etc. Lightweight but powerful. Operates on 1/2 HP. gas or electric motor. Runs either direction. Delivers approx 3.27 CFM at 600 RPM or 6.54 RPM at 1200 Rpm. Has 2" bore, 1 1/2" stroke. We have motors, tanks and fittings to adapt this unit. **23.95**

SEE OPPOSITE PAGE FOR TERMS

SAVE TO 85% AT "GADGETEERS HEAVEN"

NOW! MAKE YOUR OWN ARC WELDER!



HERE'S A REAL BUY! Finest, Precision built, R-1 Generators, Originally used on B-29 airplanes. These generators cost the Government approx. \$400.00 each. Gives from 300 to 400 amps at 27 volts. Ideal for all welding, light and heavy, up to 5/8" thickness. Free instructions for converting to welding unit **2795**



3 SPEED TRANSMISSION
Converts a high RPM, low power input into low, RPM, high torque output. Has 2 take-off shafts at 4 to 1 & 16 to 1 ratio. Gear box has worm drive bronze gears & throw-out clutch. Will operate forward or reverse directions. Adaptable to many uses on power machinery. **1995**



VICKERS HYDRAULIC TRANSMISSION
Self contained, 2 H.P., constant torque at all speeds with variable volume reversible, piston pump (controlled by outside lever) supplying piston hydraulic motor. Automatic pressure, dash pot for smooth control. Power output RPM -0 to 1/3 input RPM in both directions. Input RPM 1800 continuous, 4000 intermittent. Dash pot can be removed for greater RPM. Ideal for lathes, duplicator set-up of mills, conveyors, small cars, drives, gearings, etc. **3750**

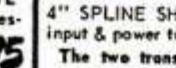

4" SPLINE SHAFTS for input & power take-off . . . **250 PR.**
The two transmissions above can be combined to make an excellent "power booster" or speed controller for many types of power machinery.

OTHER AIRCRAFT GENERATORS
E-5A . . . 12 to 15 Volts 50 Amps \$12.95
P-1 . . . 27 VOLTS . . . 200 AMPS \$15.95
1273-1A. 27 VOLTS . . . 75 AMPS \$15.95
03 . . . 27 VOLTS . . . 100 AMPS \$25.00

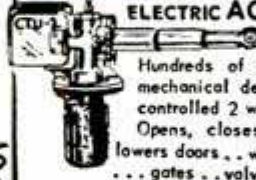

ELECTRIC ACTUATOR
Hundreds of uses for any mechanical device needing controlled 2 way action. Opens, closes, raises or lowers doors, windows, gates, valves.

CTU-2 Foote linear actuator. 24V. A.C. or D.C., 8500 R.P.M., 1/6 H.P. - Series wound motor. 4 1/2" stroke in 13 1/2 seconds. Compression and tension loads up to 750 pounds. Adjustable micro-switch for limits of travel. Overall length retracted: 11" **695**



GEAR HEAD MOTORS
Heavy duty G.E. Gear Head Motor. 1 1/2 H.P., 24 volt D.C., 125 Amp. reversible motor will drive reduction gear box unit 44.5 to 1, resulting in 168 R.P.M. at 5/8" diameter take-off shaft. Motor contains electro magnetic brake. **1095**

UNIT COMPLETE MOTOR 495
GEAR BOX ALONE 795

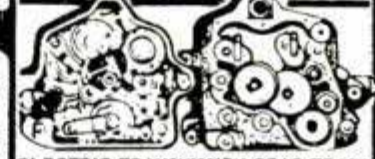

ELECTRIC TRANSMISSION GEAR TRAIN
GT-1 - approx. 50 Bronze Spur & Pinion Gears, 3/8" to 4" dia., 5 sets of 7 cluster gears, 2 complete worm and worm gear drive sets. 40 N.D. ball bearings 1 1/2" to 1 1/4" dia., watch springs bushings, posts, face plates, housings, micro-switches, 2 miniature controlled clutches, etc. Gears in multiple size and sequence, identical teeth ratio, giving 100's of gear reduction combinations. Weight: 19 pounds **849**

VALUABLE GEAR BARGAIN
Ideal for revolving radio antenna, television antenna, etc. **675**

GEAR BOX VTG-1 - 90° - Bevel gear
1 1/2 to 1 reduction. **395**
A lifetime value. Size: 7" x 6"
Has lever control for engaging and disengaging positive clutch. Dust-proof housing, pre-lubricated bearings . . . Can be adapted to Vickers Transmission.

ELECTRIC MOTORS

LEAR ELECTRIC MOTOR. 24 volt, 6 amps, series wound reversible motor . . . with overload clutch. Motor turns 11,000 RPM. Has 11 to 1 gear reduction box turning 1000 RPM at take-off. Adaptable to flex or rigid drive. Limit switch **795**
box. Size: 10" x 4"

SAMSELL MOTOR
27 volts, 16 amps, 1/5 H.P. reversible, series wound on motor. 3800 RPM, shaft 9/32" diameter. 12-spline. 4-1/8" x 2-3/8". ONLY **395**

SURPLUS MOTORS
No. 500 - New 1/2 H.P. 27 Volt, D.C. - A.C. This motor can be readily adapted to deliver up to 1/2 H.P. on 110 Volts, A.C. by the simple method of rearranging armature brush-leads. Free Diagram with each order. A SENSATIONAL VALUE. **595**
No. 500-A - Converted to 110 Volts, A.C. Equipped with plug and 3 1/2 ft. heavy duty cord . . . **849**

PIANO HINGE
Overall - Width - Length - Price ea.
1 1/2" (5/8" side) 72" alum. \$1.99
3 1/2" (1 1/4" - 54" st. steel 1.69
BRASS HINGE - 1 1/4" (5/8" side)
.040 thick) Any length at . . . per ft. .29

1952 CATALOG - 230 PAGES
COMPLETELY ILLUSTRATED, SHOWING 1000'S OF ITEMS IN NEW and WAR SURPLUS! Some at SAVINGS UP TO 85%! Clothing, Household Items, Hand & Power Tools, Camping & Outdoor Equipment, and a huge stock of Hydraulic Equipment, including Cylinders, Valves, Pumps, Motors, Fittings, etc. Send only 50¢ for your copy of this amazing, bargain catalog today.



PALLEY SUPPLY CO

6321 SAN FERNANDO RD. DEPT. PM.1 GLENDALE 1, CALIF.

PALLEY'S FAMOUS MIXES! Prepared especially for the HOME CRAFTSMAN, HOBBYIST, INVENTOR, GADGETEER, or SHOP MECHANIC.

GADGET MIX - Rivets, spacers, Bolts, Screws, Gears, Wheel bearings, Springs & Clamps. No. 106, 5 lbs. **119**

BEARING MIX - No. 170A. Approx. 20 needle, Ball & Roller Bearings. New & used. Sizes: 1/2" to 4". Some of these cost Gov't \$10 apiece . . . Never such a value . . . 5 lbs. for ONLY **159**

HINGE MIX - No. 170H. 12 pairs of strap & butt hinges, hasps, 1" x 1" to 7/8" x 10" in length and 8" strap. 2 lbs. **109**

ABRASIVE AND GRINDING WHEEL MIX - 50 pieces including honing stone, wheels, pencil rolls, etc. . . . A sharp value! No. 170AG . . . **99c**

SPRING MIX - No. 206. Torsion, Compression & Tension Springs. Ass't sizes. A treasure trove for emergencies. Scores of springs. 5 lbs. **169**

RIVET MIX - 3 POUNDS - Consisting of sizes from 1/4" to 3" long in many diameters and alloys . . . **119**

FILE MIX - Ten ass't files - 4" to 12". Includes Vixens, half rounds, mills, bastards, etc. in seconds & used but good condition. 1 Vixen alone is worth our price of entire mix . . . **99c**

PULLEY MIX - You'll want this one around. 10 micarta & metal pulleys, ranging from 1" to 5" with ball and one piece bearings. These are aircraft pulleys, the best made, with hundreds of uses **295**

SCREW MIX - 5 lbs. including assortment of wood and machine screws. Many sizes. Save dollars & always have plenty of screws on hand . . . **139**

NUT MIX - 3 lbs. approx. 500 Nuts, Anchor, Lock, Castle, Hex, Elastic Stop Nuts, etc. You'll always have plenty of nuts in the shop. NM-1 **139**

SUPER COMBO MIX - No. SC-2 - Here's a real bargain! ALL 10 ABOVE MIXES FOR ONLY **1295**

AIRCRAFT CABLE

Rust resistant, alloyed steel. Extra flexible. Pre-formed, 7 x 19 strand. On reels.
1/16" - 4 1/2 ft. 7/32" - 10 1/2 ft.
5/64" - 5 ft. 1/4" - 12 1/2 ft.
3/32" - 5 1/2 ft. 9/32" - 15 ft.
1/8" - 7 ft. 5/16" - 16 1/2 ft.
5/32" - 7 1/2 ft. 3/8" - 18 ft.
3/16" - 9 1/2 ft. 1/2" - 20 ft.

SPECIAL! 3/16" cable, 18 feet long, with tumbuckle ends. **99c**

Stainless Steel Cable - Pre-Formed
1/16" - 6 ft. 5/32" - 20 ft.
3/32" - 14 ft. 1/4" - 26 ft.

Bronze Cable - Not Pre-Formed
1/16" - 5 ft. 3/16" - 23 ft.
1/4" - 17 ft. 1/2" - 38 ft.

Plow Steel Cable - Hemp Center 6 x 19
7/8" 25¢ ft. - 1" 28¢ ft.

FIRE EXTINGUISHER

Kiddle Lux - CO² Type. Built to Gov't specifications. Heavy, shatter-proof case. Recent hydrostatic test. Reconditioned and fully charged. LIKE NEW! READY FOR INSTANT USE!!

2 lb. size with Swing Nozzle . . . 13.75
3 1/2 lb. size with Swing Nozzle . . . 17.95
7 1/2 lb. size with Horn 23.75
10 lb. size with New Squeeze Grip Handle & 3/4" flex hose with Horn. 29.75
15 lb. size with Squeeze Grip hd, 4ft. flex hose, plastic hom. . . 42.50
15 lb. size with Wheel Control . . . 37.95

ORDER FROM THIS AD. All sales final. Prices F.O.B. Glendale. Pay by M.O. or Check. P.O.'s accepted from D & B. Firms. 1/2 deposit with C.O.D.'s.

20,000 lb. thrust (push-pull) using 1500 PSI line pressure as obtained from our hyd. pumps. Or will produce 40,000 lb. thrust with 3,000 lb. line pressure. Can ALSO BE OPERATED ON LOW PRESSURE AIR SYSTEMS. 4" Bore, 1 1/2" dia. piston shaft, 18" stroke, length: 30 1/2". Equipped with ball bearing loaded clevis type mounting and swivel type high pressure steel pipe bracket for easy use. Ideal for road, farm, & shop machinery, presses, etc. Cost Gov't \$390.00. **295**

We carry the World's largest supply of Special Hydraulic Equipment featuring over 20,000 cylinders in 61 sizes and types. Can also supply all accessories such as Pumps, Valves, Tanks, Hose and Fittings. Write for information.

No. 3 HYDRAULIC CYLINDER
Double action. Bore is 1". Shaft is 1/2". Has a stroke of 2 1/2" to 4". Stroke can be adjusted with internal sleeve stops. Overall length is 8 1/2". Will take 1500 lbs. continuous duty. 3000 lbs. intermittent. Will lift or push up to 1100 lbs. **575**

No. 9-E HYDRAULIC CYLINDER
Double action cylinder. Has a bore of 1-3/8" and shaft of 1". Stroke is 9". Overall length 15 1/4". Built for 1500 lbs. continuous duty. 3000 lbs. intermittent. Will lift or push up to 2300 lbs. Can be adapted to hundreds of uses **975**

FOUR WAY VALVE
V-9A - LARGE VOLUME PRESSURE RELIEF VALVE
1/2" Standard pipe ports. Pressure setting - approx. 1200 PSI. Range - 1000 to 2100 PSI. **575**

STRATO-POWER PUMP
With built-in variable flow control valve in head. Positive displacement piston type. Displaces .450 cu. in. per revolution. 2 gal. per min. cap. at 1500 RPM at 1250 PSI. Pressure limit, 1250 PSI continuous, 1400 PSI for 15 sec. Operates at 3750 RPM, intermittent maximum 4500 RPM. Rotates either direction without adjustment **1950**

VICKERS HYD. VARIABLE DISPLACEMENT PUMP
Will deliver maximum volume at any pressure setting between 600 & 900 PSI. Desired pressure settings obtained with adjusting screw. Pump housing serves as reservoir for system. Has built-in compressed air supercharger which makes system independent of outside atmospheric pressure. Rotation is left hand only. Maximum speed for continuous duty is 3750 RPM. Displacement is .484 cu. in. per revolution or approx. 4 GPM at 1750 RPM. **3250**

ROPER HYDRAULIC PUMP UNIT
Here is a complete Hydraulic pumping unit. Consists of a 300 PSI Roper pump with a 1/3 HP, Leland, heavy duty, roller bearing motor. Motor operates on 110 V AC - 60 cycle current and is directly coupled to pump with rubber universal joint. Unit is mounted on aluminum base with carrying bar. Can be used for transfer pump, power for small hyd., presses, cooling for lathes or in most cases where hydraulic power is used. **1795**

SOUTH BEND

The past half-century of industrial progress in the United States has brought a corresponding advance in the living standard of the American people. Through the use of better tools, workers have been able to produce more and better goods at lower costs. This has permitted lower selling prices which enable more people to buy.

For the past forty-five years, South Bend Lathe has been a part of the machine tool industry which has supplied the tools that made this possible. Through all these years we have strived to build more efficient machine tools so industry could manufacture more and better products at lower costs. The success of these efforts is best indicated by the fact that more South Bend Lathes have been sold than any other make. This leadership is a challenge to continually produce even better machines. The way we have met that challenge is shown by the superior performance and dependability of South Bend machine tools.

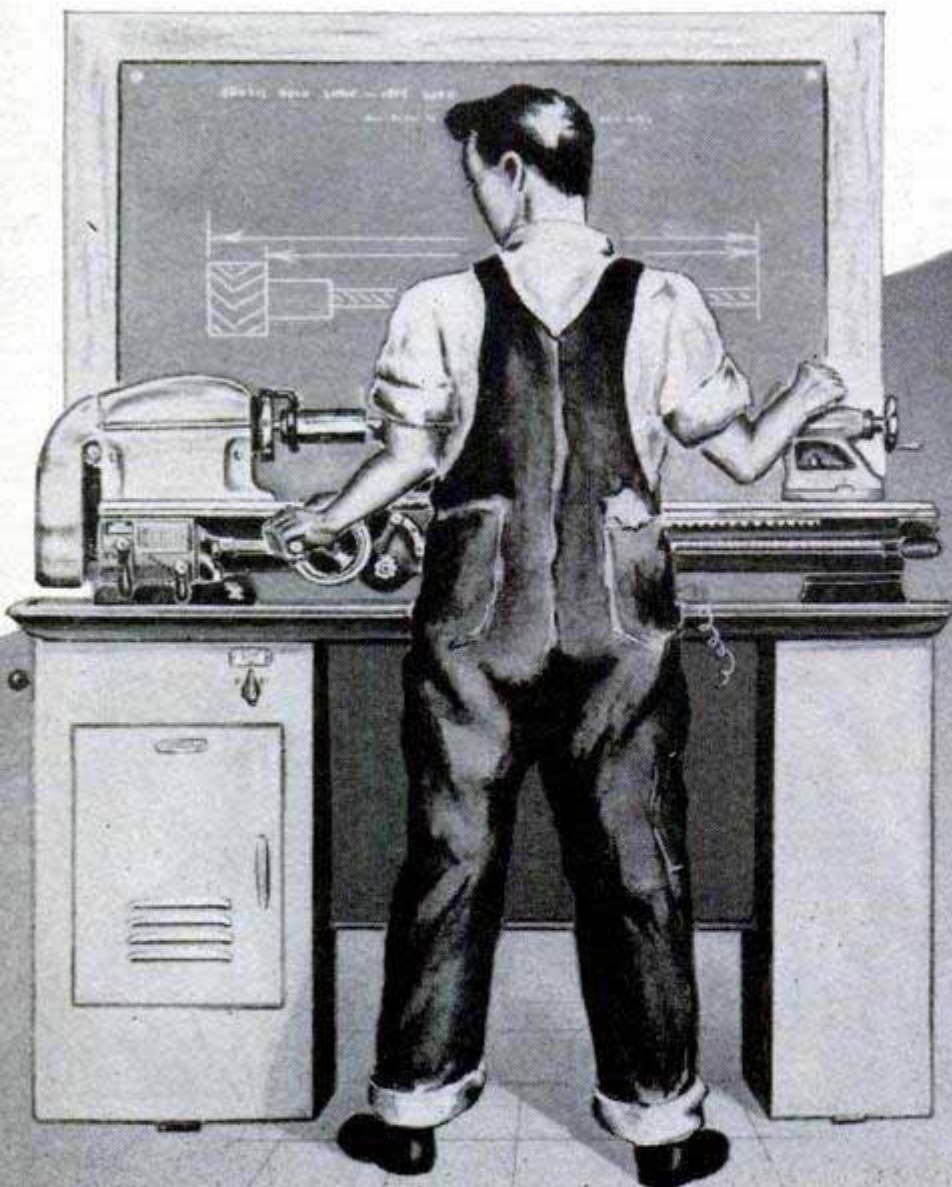

1952

**SOUTH BEND
LATHE WORKS**

South Bend 22, Indiana

*Building Better Tools
Since 1906*

LATHES

1906

REMEMBER THIS AD?

LATHES—Foot or Power as desired

This cut shows our No. 4 Bench Lathe, swings 8 inches, takes 21 inches between centers



Price, \$25.00

Send for Catalog

SOUTH BEND MACHINE TOOL CO. Johnson St., South Bend, Ind., U.S.A.

This South Bend Lathe advertisement appeared in POPULAR MECHANICS, Feb. 1908

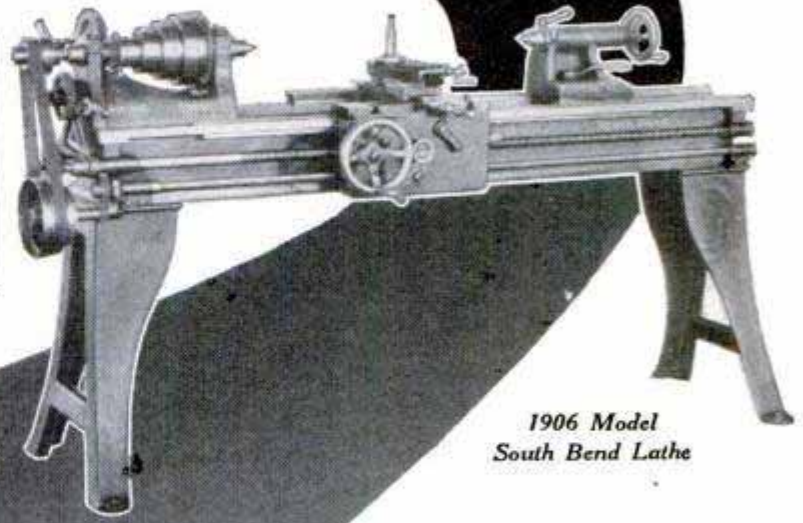

1906 Model
South Bend Lathe

LATHES

DRILL PRESSES

ATTACHMENTS

SHAPERS

1952 Model Bench Lathes 9" and 10" swings in Standard Change Gear, Quick Change Gear and Toolroom types.

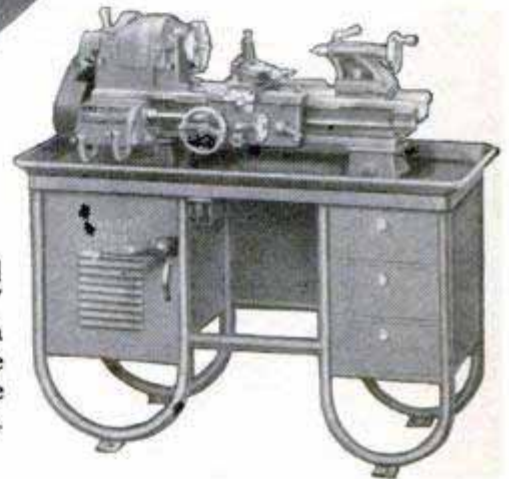

1952 Model Floor Lathes—10", 13", 14½", and 16" swings in Quick Change Gear and Toolroom types; also 16-24" Large Swing Lathes. Complete line of practical attachments available for all sizes and types of lathes.

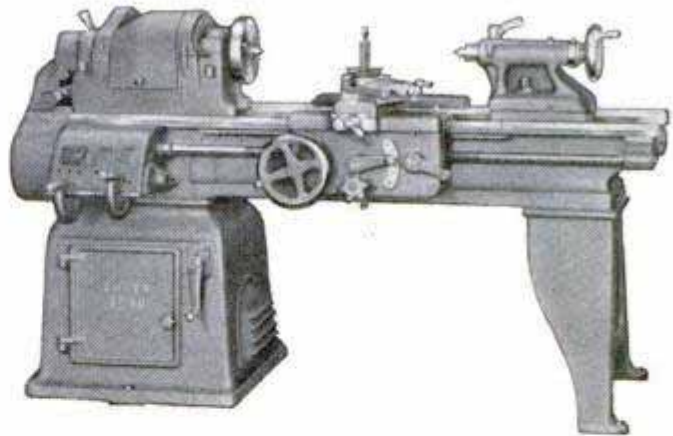

1952 Model Turret Lathes—No. 2-H with 1" collet capacity, 16" swing, universal carriage, power feed ram-type turret; Series 1000 with 1" collet capacity, 10" swing, handlever double tool cross slide, handlever turret; Series 900 with ½" collet capacity, 9" swing, handlever double tool cross slide, handlever turret.

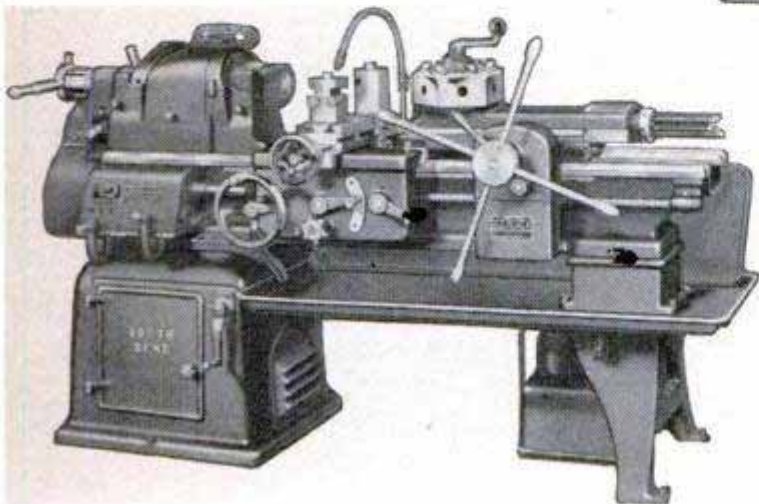

YES! You can examine ALL these MONEY-SAVING books for 10 days FREE!



HOW TO MAKE YOUR OWN FURNITURE

By HENRY LIONEL WILLIAMS. Why pay high prices for furniture? Make it yourself! Easy-to-follow, step-by-step directions in this BIG new book show you professional methods and tricks of the trade. Everything you need to know to make attractive, sturdy pieces for every room in the house. Have fun—and save up to 80% of cost of store-bought articles! You get complete step-by-step directions on how to make: Chest of drawers. Lamp table. Cutlery tray. Drop leaf table. Wing chair. Chaise longue. Modern bedstead. Framed desk. Corner cupboard. Side chair. Arm chair. Standing bookshelf. And many other useful pieces. ALSO BUILT-INS SUCH AS: Recessed bookshelf cupboard. Closet and dressing table alcove. Corner seat. Divan with drawers. Bathroom, kitchen or bar counter. Closets. Bunks. Desks. AND MUCH MORE!

Every job explained in careful detail. Large clear illustrations show exact working procedure for each step. Professional methods given for cutting and joining operations; scraping, raising the grain, staining, varnishing, bleaching, toning, antiquing, de signing furniture; etc. 211 pages, 8 $\frac{3}{4}$ x11 $\frac{1}{4}$. Price \$3.95.



HOW TO EXPAND AND IMPROVE YOUR HOME

By LEE FRANKEL. Gives you step-by-step instructions on how to: Finish an expansion attic. Build or enclose a porch. Modernize a kitchen. Build a garage and breezeway. Build a cellar playroom. Make two rooms out of one. Build closets and storage

areas. Hang doors. Build stairs. Install kitchen cabinets. Make screens and storm sash. Lay flooring. AND MUCH MORE. You get authentic "inside" know-how, straight from the building trade itself. Every project thoroughly described and pictured, step-by-step. Nothing else like it ever before published! This is the ONLY book that shows you EXACTLY WHAT TO DO to make home expansions and home improvements with professional skill! 1225 DRAWINGS AND PHOTOS guide you on every detail. Price \$5.95.



HOUSE CARPENTRY AND JOINERY

By NELSON L. BURBANK. Every step of carpentry in and around a house is clearly explained and illustrated in this big useful book. It shows you how to build

forms for foundations, footings, walls, steps, walks — How to build sills, girder supporting posts and girders—How to figure loads for house-framing — How to lay out, cut and erect floor joists — How to lay flooring — How to construct stairs — How to make closets, shelving and built-in equipment — How to insulate — and How to do dozens of other big jobs. "I built my entire 5-room house myself with no other instruction except your book." — James Sidwell, Twin Falls, Idaho.

248 Pages, 950 illus., 8 $\frac{1}{2}$ x11 $\frac{1}{4}$. Price \$4.50



PRACTICAL JOB POINTERS

More than 850 "tricks of the trade," short cuts, kinks and modern methods of doing all kinds of carpentry and building repair jobs. Saves you time, money and labor by showing you professional short cuts and "speed ups"—tested and proven in actual use. Cross-indexed for quick reference. Fully illustrated.

212 pages, 8 $\frac{1}{2}$ x11. Price \$4.50



HOUSE CONSTRUCTION DETAILS

By NELSON L. BURBANK. Here is your exact working guide on every detail of house construction from

foundation to finish. Tells you dimensions, materials, processes, step-by-step working methods. Hundreds of scale drawings and photographs make every step easy to follow. Can be used for alterations in a set of stock plans, for making additions or changes in a building, or for complete construction of a dwelling. Conforms with modern practice and building regulations in all parts of the country. Includes pre-fab construction. A book you will refer to for years!

314 pages, 1,500 illus., 8 $\frac{1}{2}$ x11 $\frac{1}{4}$. Price \$4.75

Simmons-Boardman Pub. Corp.
30 Church St., New York 7, N. Y.

PM-152

Send me the book(s) checked below. If I am not completely satisfied, I will return book(s) within 10 days. Otherwise, I will remit price indicated, plus few cents postage.

- | | |
|---|--------|
| <input type="checkbox"/> How to Make Your Own Furniture..... | \$3.95 |
| <input type="checkbox"/> How to Expand and Improve Your Home..... | 5.95 |
| <input type="checkbox"/> House Carpentry and Joinery | 4.50 |
| <input type="checkbox"/> House Construction Details | 4.75 |
| <input type="checkbox"/> Practical Job Pointers | 4.50 |

Name _____

Address _____

City _____ Zone _____ State _____

"Let me show you how to make all these beautiful objects of art, giftwares, and costume jewelry at home in spare time"



FOR PLEASURE or PROFIT!

Make as much as \$5.00 for One Hour's Work

Yes, I will send this to you free. It tells all about one of the most astonishing discoveries of recent years. Shows how 56¢ worth of material can be turned into a \$5.00 profit. Shows how to make "something from nothing." A handful of twigs is transformed into a gorgeous coral-like necklace—a stunning dresser box is made from a penny's worth of rice and a few navy beans — a metal-like lapel pin from a live leaf. You need no knowledge of design—no artistic training. The countless forms of nature provide your designs. The simple art of "Ceramizing" can be learned in a few minutes' reading by even a child. It's an activity in which the entire family can take part. It's a fascinating hobby that makes friends marvel



at your artistic ability—yet it's so profitable that it can be turned into a big money business, operated from your home. Many men find in Ceramizing the opportunity to establish a spare time home business without sacrificing job or paycheck—and gain confidence for the future in knowing that at any time they can expand into full time work—taking profits from three different branches of the business. Women, too, find in Ceramizing a satisfying expression of their creative gifts—both as a hobby and as a means of making extra money. One of the big advantages is that no expensive equipment, machines, or tools are required. And I show you how and where to go to get the few materials necessary at low cost,

FREE!

This beautiful eight page book in full color shows you

HOW TO..

- Learn all the secrets of Ceramizing.
- Turn twigs, leaves, flowers, into gorgeous costume jewelry.
- Transform inexpensive articles into valuable objects of art.
- Get the thrill of artistic creation without learning to draw or design.
- Start a spare time hobby that can bring extra money every week.
- Establish a home business that can be expended into full time operation any time money is needed.

FREE!

JUST SEND NAME



NO CHARGE Now or at any other time **JUST MAIL COUPON**

NO SALESMAN WILL CALL—ALL MAILED FREE!

Send your name to me today. A penny postcard will do, or mail the coupon. I will send you a beautiful eight page book filled with pictures in natural colors showing scores of the things you can make and explain the entire process and the steps necessary to get started. No salesman will call to bother you—and the information is all free and postage prepaid. Whether you want to start now or at some future time—get the information at once. You'll be glad you wrote. Address me,

Raymond E. Brandell, Warner Electric Co.
1512 Jarvis Ave., Dept. 3-A, Chicago 26, Ill.

Dear Mr. Brandell: With the understanding that there is no charge, no obligation, and that no salesman will call, you may mail postpaid a copy of your big eight page book in full color showing scores of pictures of things I can make, either as a hobby or as a spare time money making home business.

Name.....
Address.....
City.....State.....



You can even preserve and beautify baby shoes to look like silver, gold, bronze, or glistening kiln fired china by this amazing process. They bring profits of \$10.00 for every dollar of material cost.

R. E. BRANDELL, WARNER ELECTRIC CO. 1512 Jarvis Ave., Dept. 3-A Chicago 26, Illinois

HASTINGS

STEEL-VENT PISTON RINGS

TOUGH...but oh so gentle

TOUGH
ON OIL-PUMPING
GENTLE
ON CYLINDER WALLS

HASTINGS
Motor Engineered
STEEL-VENT SET
★

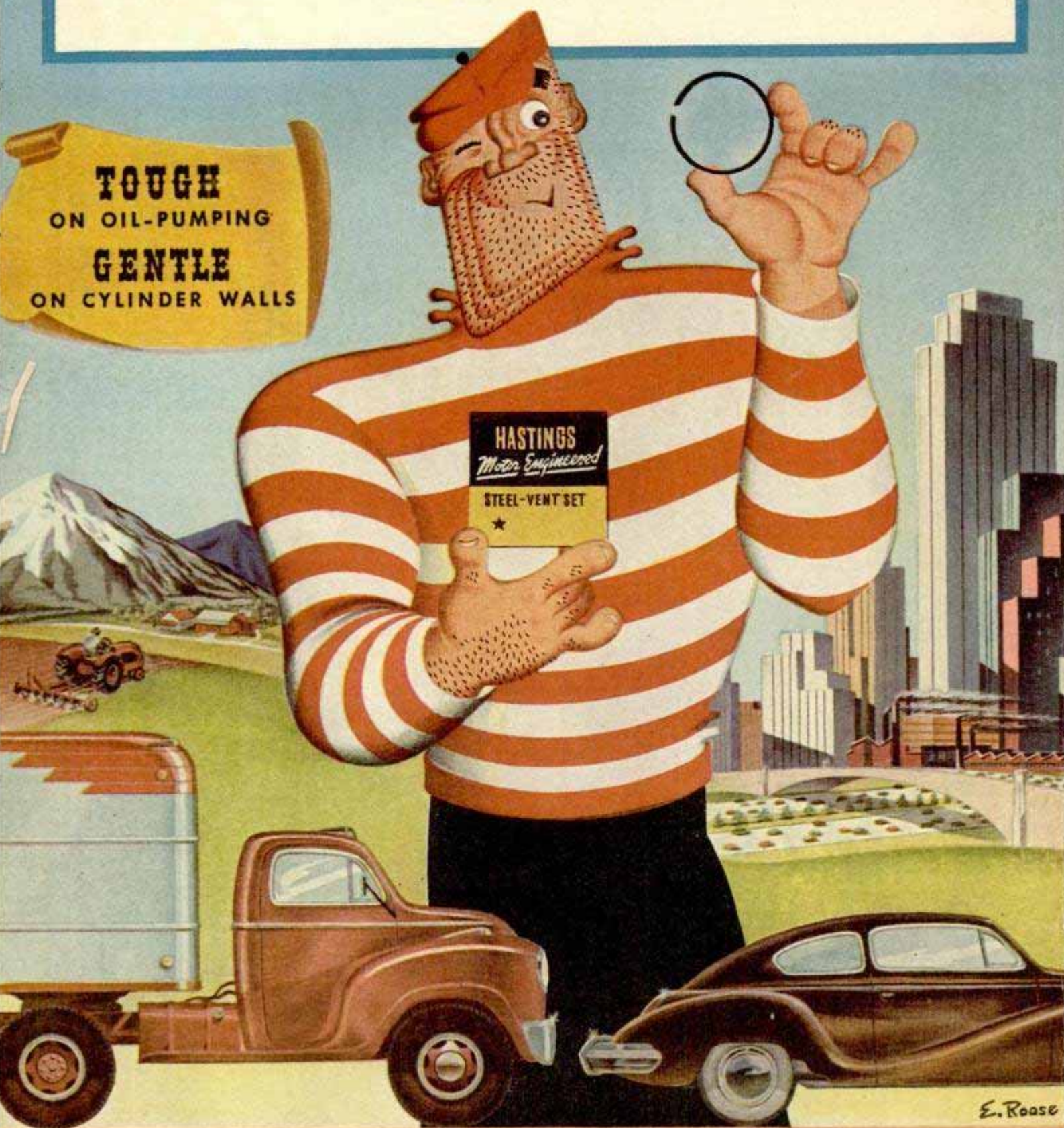

E. Roose

For more than a quarter century, Hastings has set the pace in piston rings