

# POPULAR MECHANICS

## MAGAZINE

WRITTEN SO YOU CAN UNDERSTAND IT

REGD. TRADE MARK, GREAT BRITAIN, No. 40428

REG. U.S. PAT. OFF.

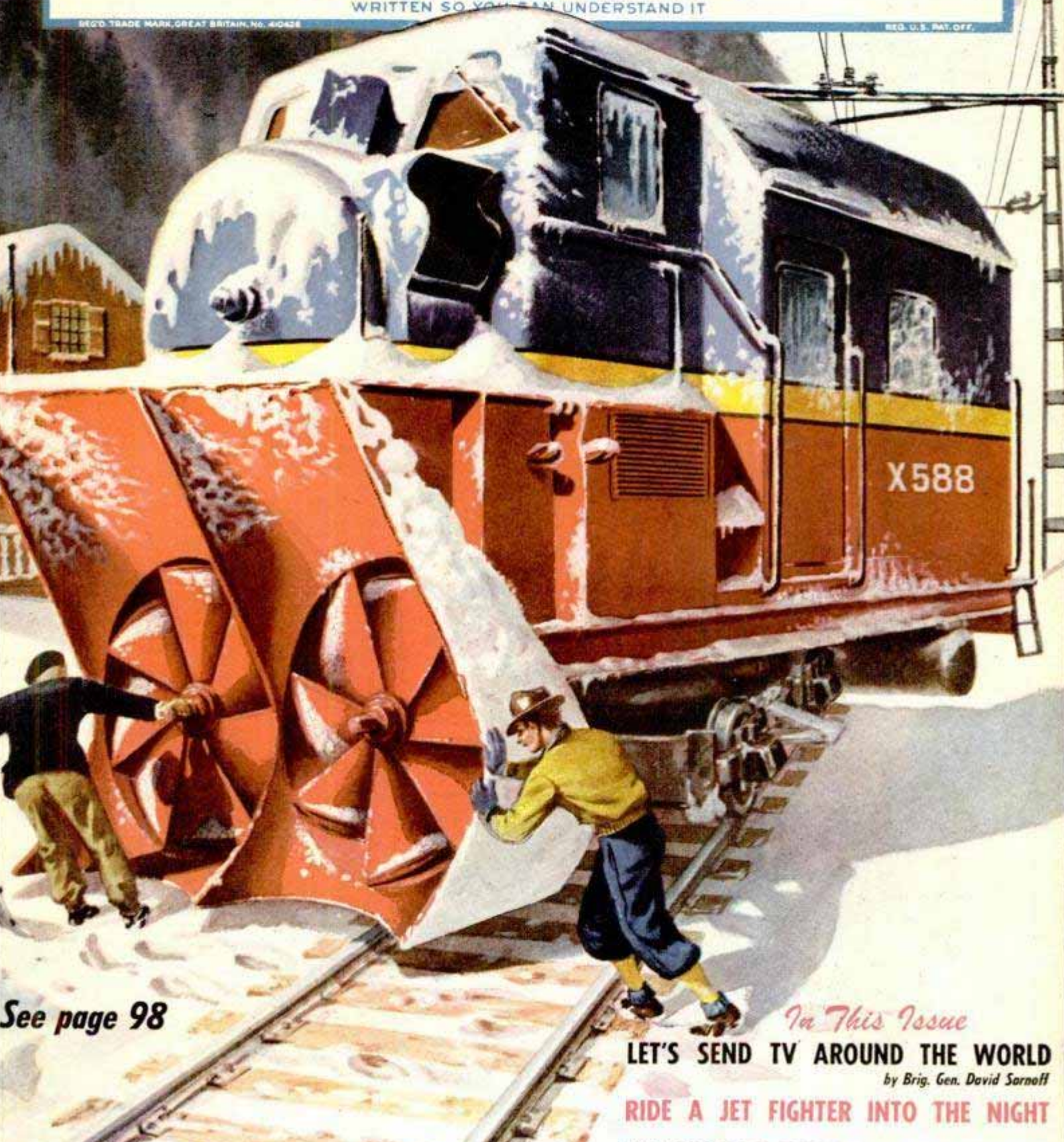

See page 98

*In This Issue*

LET'S SEND TV AROUND THE WORLD

by Brig. Gen. David Sarnoff

RIDE A JET FIGHTER INTO THE NIGHT





Pikes Peak, Colorado, near the famous resort, Colorado Springs, showing the turning, twisting course which rises to a height of 14,110 feet.

AL ROGERS' 5th Victory scores 24th consecutive win for dependable CHAMPIONS.



## “World’s Toughest Uphill Race” Proves **CHAMPIONS** Tops For Sustained Power

The Pikes Peak Hill Climb is the world’s toughest uphill race. Starting at an altitude of 7415 feet, it runs 12½ miles over 120 hairpin turns and switchbacks, ending at an elevation of 14,110 feet!

Here is a test of spark plugs that is really rough. It calls for split second acceleration, and ability to withstand mounting temperatures as the cars roar into higher altitudes.

The record of dependable Champion Spark Plugs speaks for itself—24 consecutive victories. The qualities that made this record breaking performance possible will make *your* car perform better, too. So insist on Champions every time!

**CHAMPION SPARK PLUG COMPANY, TOLEDO 1, OHIO**



***FOLLOW THE EXPERTS***

**Get CHAMPIONS  
for your car**

*The Sign of Dependable Service!*





**CRESTOLOY LINEMEN'S  
SIDE-CUTTING PLIERS.**

No. 1950, in 6, 7 and  
8" sizes.

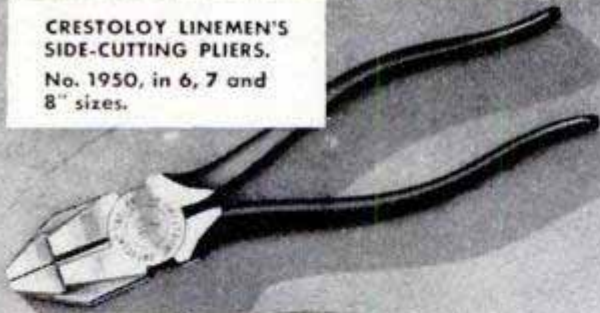

**CRESTOLOY END  
CUTTING NIPPERS.**

No. 72, in 6 & 7" sizes.



**CRESTOLOY DIAGONAL  
CUTTING PLIERS.**

No. 942, in 4, 5, 5 1/2  
and 6" sizes.

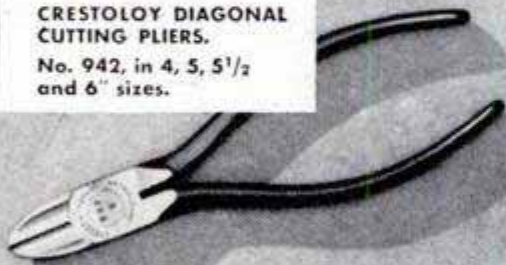

**CRESTOLOY LONG  
NOSE PLIERS.**

No. 1033, in 6 & 7" sizes.  
Also No. 654, same  
except with side cutter.



**CRESTOLOY HEAVY  
DIAGONAL CUTTING PLIERS.**

No. 542, in 7" size only.



**CRESTOLOY LONG FLAT  
NOSE, SIDE-CUTTING PLIERS.**

No. 650, in 7" size only.

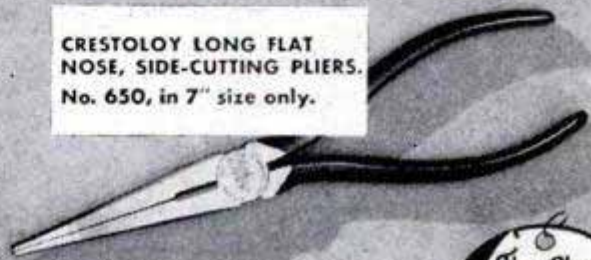

## CRESTOLOY PLIERS

*are individually tested!*

Crestoloy Pliers take all the guesswork out of plier buying, because Crescent has taken all the guesswork out of plier making. Rigid specifications establish the material, design, workmanship, tests and inspection of these better tools. Strict adherence to these specifications is maintained by continuous tests and relentless inspection of the *individual* tools. Every plier carries the Crestoloy tag certifying that it has been individually tested.

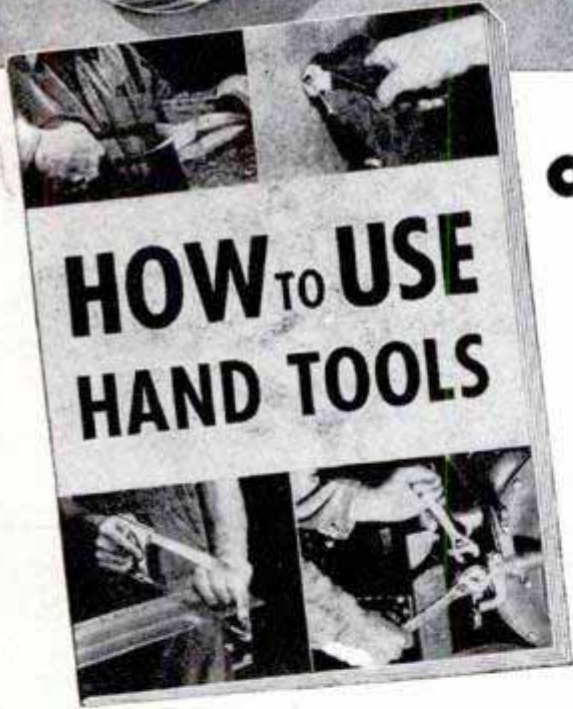

**GET YOUR FREE COPY . . .**

This new 20-page booklet provides many useful how-to-do-it ideas both for amateurs and professional mechanics, as well as basic information on the proper selection, use and care of hand tools. 93 illustrations. Write today.

**CRESCENT TOOLS**

*Give Wings to Work*

*Sign of the Artisan  
Symbol of Excellence*

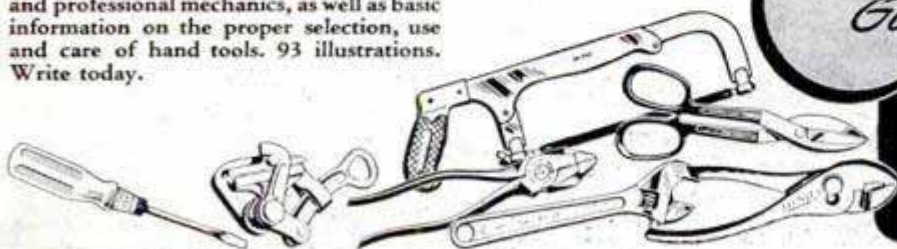

Crescent is our trade-mark, registered in the United States and abroad, for wrenches and other tools. Sold by leading distributors and retailers everywhere and made only by **CRESCENT TOOL COMPANY, JAMESTOWN, NEW YORK**







## Accent on Opportunity

Until recently Private First Class Myron Jarman of Beverly Hills, California, was a student at Santa Monica City College and U.C.L.A. One day he read of the 45 career fields in the U. S. Air Force training program, and recognized his chance to combine his interests and aptitudes in creating a responsible job for himself.

Soon after enlisting he became a student machinist. In the photo, he is "blanking out a lathe model." Under his instructor, Staff Sergeant Albert D. Clark of Loveland, Colorado, Airman Jarman will learn mechanical drawing, blue print reading, use of small hand tools, lathes, milling machines, contour machines, shapers, heat treating and grinding.

After 21 weeks of school, Myron will be an apprentice machinist. As he advances in experience and ability, his rank and pay will increase. He can find a vital and interesting career in the U. S. Air Force.

*You, too, can have this opportunity!* You can earn while you learn, in the field where you qualify. Find *your* place in one of the more than six hundred job specialties in the Airman Career Program. For details visit your nearest U. S. Army and U. S. Air Force Recruiting Station.

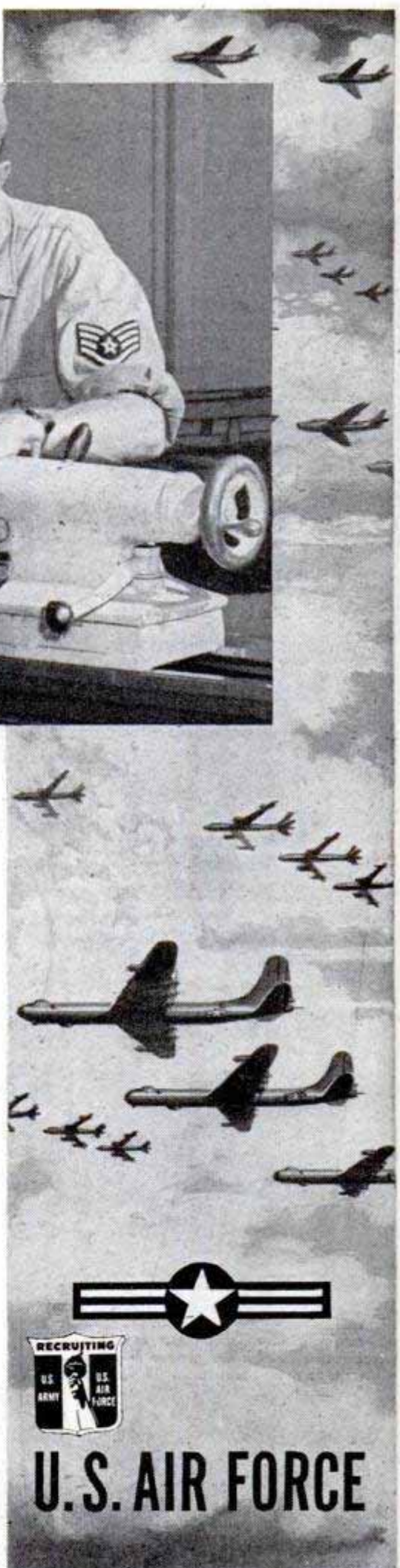



# Popular Mechanics Magazine

Registered in U. S. Patent Office and Canada

H. H. WINDSOR, *Founder*

H. H. WINDSOR, JR., *Editor and Publisher*



## this month's cover

HIGH IN THE ALPS, two Swiss railwaymen pivot a strange, twin-rotor snowplow on its built-in turntable. The merry-go-round maneuver may well be necessary, for thousands of tons of fresh snow can smother the tracks behind the plow just about as fast as the machine clears the rails. Result: the only instrument for saving the rail line is trapped. The snowplow on our cover can whirl a thumping 1500 pounds of snow a distance of 100 to 165 feet every second. On page 98 you'll find pictures of the plow in action, and on the following page begins the chilling story of how the little village of Blue River, B.C., now is sharpening its plows for the annual battle to clear the Canadian National's rails. Keep a heavy blanket handy when you read about the carload of frozen pigs, Christmas packages delivered in April, and the 1100 kegs of black powder used to blast through a snowslide that has grown into legend

Published monthly by Popular Mechanics Company, 200 E. Ontario St., Chicago 11, Ill. H. H. Windsor, Jr., president; William Harrison Petridge, vice president; D. F. Windsor, vice president and secretary-treasurer; H. H. Windsor III, vice president; Clover L. Perkins, advertising manager; Alan M. Deyoe, circulation manager. Single copy in the United States and Canada, 35 cents; subscription rates in United States and possessions, Canada, Philippines and countries of the Pan-American Postal Union, 1 year \$3.50; 2 years, \$6.00; 3 years \$8.00. To all other countries add \$1.00 a year over United States prices for overseas postage. If you plan to move, notify us at least 30 days in advance so you will not miss an issue. Give both your old and new addresses. Entered as Second Class Matter, September 15, 1903 at the Post Office at Chicago, Illinois, under Act of March 3, 1879. Entered as Second Class Matter at Post Office Dept., Canada. Registered as Second Class Matter at the Post Office at Mexico, D. F., Mexico, June 20, 1950. Copyright 1951 by Popular Mechanics Company. Copyright under International Copyright Union. Copyright in France. All rights reserved under Pan-American Copyright Union. Printed in the United States of America.

Volume 96 DECEMBER 1951 Number 6

Managing Editor.....Roderick M. Grant  
 Assistant Managing Editor.....Wayne Whittaker  
 Shop Notes and Crafts Editor.....James R. Ward  
 Radio-Television, Electronics Editor.....Frank L. Brittin  
 Associate Editor, Aviation.....Aubrey O. Cookman, Jr.  
 Associate Editor.....Clifford B. Hicks  
 Associate Editor.....Donald R. Brooks  
 Assistant Shop Notes and Crafts Editor.....Wayne C. Lekey  
 Automotive Editor.....Siler Freeman  
 Art Director.....Frank Beatty

### Assistant Editors

W. Clyde Lamme  
 Arthur R. Railton  
 Eastern Editor.....Richard F. Dempewolf  
 Empire State Bldg., Room 2906, New York 1, N. Y.  
 Western Editor.....Thomas E. Stimson, Jr.  
 302 23rd St., Santa Monica, Calif.  
 London Manager.....Douglas W. Wedderspoon  
 77 Baker St., London W. 1, England  
 Director, Bureau of Information.....Allan Carpenter  
 200 E. Ontario St., Chicago 11

## IN THIS ISSUE

Taconite Is Tomorrow's Iron	- - - - -	73
Let's Send TV Around the World	- - - - -	83
One-Room Railroad	- - - - -	89
Electric Snowplow	- - - - -	98
Canada's Battle With Snow Begins	- - - - -	99
Things to Hint About for Christmas Shoppers	- - - - -	104
Churches of Modern Design	- - - - -	108
The Owners Report on the Hudson	- - - - -	114
Australia Starts Her Own "TVA"	- - - - -	126
Ride a Jet Fighter Into the Night	- - - - -	134
Ice Cutting—an Almost Lost Art	- - - - -	142
They Said Good-by to Broadway	- - - - -	152

## For the Craftsman

Christmas Lighting	- - - - -	157
Dumb-Waiter Saves Steps	- - - - -	174
Dinnerware in Wood	- - - - -	185
Novelties From Tubing	- - - - -	189
Servicing Automatic Chokes	- - - - -	194
"Dubbing In" Sound in Your Home Movies	- - - - -	198
Protect Your Lathe	- - - - -	203
How to Use End Mills	- - - - -	208
Shopping for Tools	- - - - -	216
Radio, Television and Electronics	- - - - -	219
Clinic for Homemakers	- - - - -	230

Other items, and manufacturers of available products described, are listed on pages 12, 14 and 16





# A KENTILE FLOOR COSTS SO LITTLE when you install it yourself!..



**ONLY \$19<sup>95</sup>\***  
FOR A 9'x11'  
KENTILE FLOOR

and you get *lasting* beauty  
at this low price!

**KENTILE  
GUARANTEE**  
FOR SELF-INSTALLED KENTILE

Kentile, Inc. will provide new tile without charge for any Kentile that wears out... and on which colors wear off... during your own occupancy of your home wherein you have installed Kentile. This guarantee does not apply to damage caused by improper handling, or failure to follow the instructions for installation and maintenance available at your Kentile dealer's.

## GUARANTEED KENTILE IS SO EASY TO INSTALL

**T**ILE by tile installation is quick, fun. And your Kentile Floor lasts for years... sheds dirt... resists stains and scuffs... sparkles like new with an occasional no-rub waxing. Only your Kentile Dealer has low-cost, guaranteed Kentile Floors... the Ken-Kit with the tools you need. Get an estimate... look in your classified phone

book under FLOORS... in Canada at T. Eaton Co., Ltd.

**FREE BOOKLETS.** Send for a copy of the Kentile Self-Installation Folder and the Kentile Color Line. You'll see how easy it is to install your own Kentile Floor in your choice of the 26 modern colors. Kentile Inc., Dept. G-4, 58 2nd Avenue, Brooklyn 15, N. Y.

Why buy floor coverings with just a colored surface that soon wears off? It costs so little more to get wear-resistant **KENTILE** with colors that go all the way through the tile and backed by this **GUARANTEE!**

\*Price quoted is for a 9'x11' Kentile Floor installed by you. Price may be lower or slightly higher depending on size of room, colors chosen and freight rates.



**KENTILE.**

The Asphalt Tile of  
Enduring Beauty 



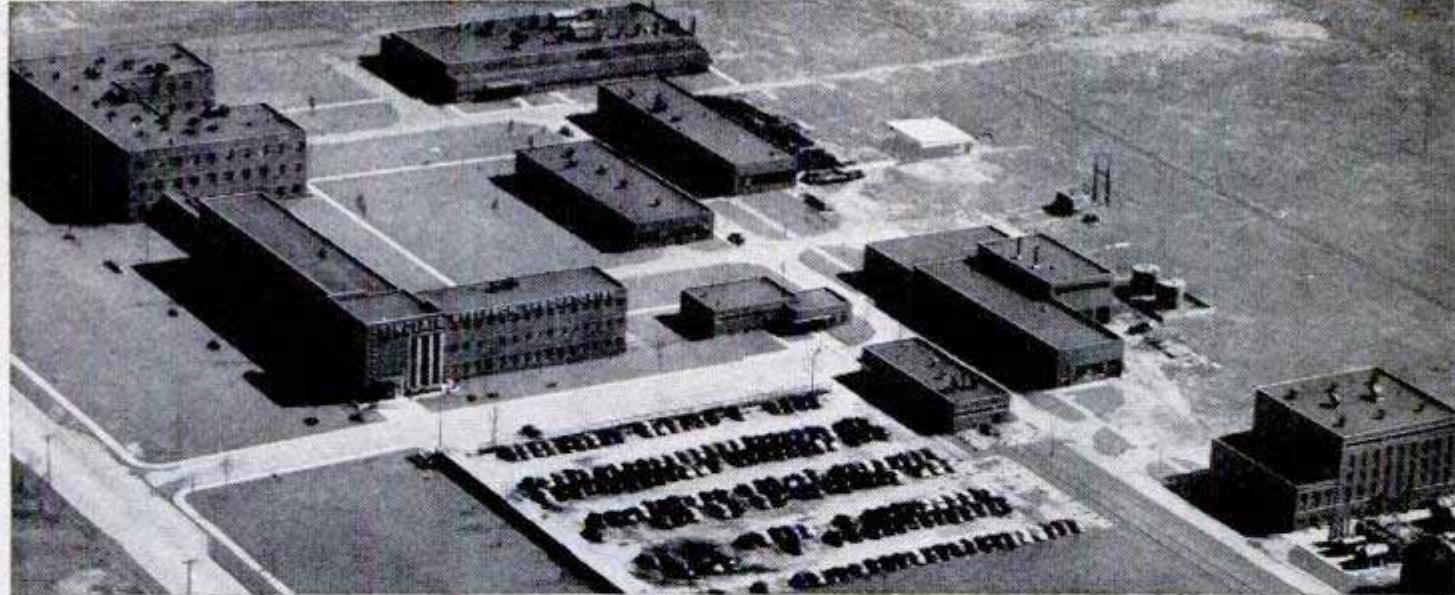

**SINCLAIR RESEARCH LABORATORIES**—nine buildings containing the most modern testing equipment known—have contributed many of today's most important developments in petroleum products, production and

refining. Under the Sinclair Plan, the available capacity of these great laboratories is being turned over to work on the promising ideas of independent inventors who have no such facilities within their reach.

# An Offer of Research Facilities To Inventive Americans Who Need Them

*The Sinclair Plan is opening up the Company's great laboratories to every American who has an idea for a better petroleum product*

**I**NVENTIVE Americans are often at a loss today. Not because of any lack of ideas, but because of a need for large and expensive facilities to find out if and how their ideas work.

This was no obstacle in our earlier days. The Wright Brothers designed their first airplane with the help of a foot-square homemade "wind box"—and the plane flew.

In contrast, the man with a new idea in airplane design today often needs a supersonic wind tunnel costing millions.

In short, science and invention have become so complex that a man with an idea for a better product often needs the assistance of an army of specialists and millions worth of equipment to prove his idea has value.

Within the petroleum field, the Sinclair Plan now offers to provide that assistance.

Under this Plan, Sinclair is opening up its great research laboratories at Harvey, Illinois, to independent inventors who have sufficiently good ideas for better petroleum products or for new applications of petroleum products.

If you have an idea of this kind, you are invited to submit it to the Sinclair Research Laboratories, with the provision that each idea must first be protected, in your own interest, by a patent application, or a patent.

#### **The inventor's idea remains his own property**

If the directors of the laboratories select your idea for development, they will make, in most cases, a very simple arrangement with you: In return for the laboratories'

investment of time, facilities, money and personnel, Sinclair will receive the privilege of using the idea for its own companies, free from royalties. This in no way hinders the inventor from selling his idea to any of the hundreds of other oil companies for whatever he can get. Under the Plan, Sinclair has *no control* over the inventor's sale of his idea to others, and has *no participation* in any of the inventor's profits through such dealings. Moreover, it is a competitive characteristic of the oil business that the new products adopted by one company are almost invariably adopted by the whole industry. This means that the very fact of his agreement with Sinclair should open up to the inventor commercial opportunities which might otherwise be hard to find.

*How to proceed:* Instructions on how to submit ideas under the Sinclair Plan are contained in an Inventor's Booklet available on request. Write to: W. M. Flowers, Executive Vice-President, Sinclair Research Laboratories, Inc., 630 Fifth Avenue, New York 20, N. Y. for your copy.

**IMPORTANT:** *Please do not send in any ideas until you have sent for and received the instructions.*

## **SINCLAIR**

### **A Great Name in Oil**



# THEY GO

## BETTER TOGETHER

# Pyroil and WINTER OIL

When you change to winter oil — remember to add Pyroil — and forget a lot of wintertime driving headaches. In cold weather, you need low viscosity oil to help you get started — but you need the *extra protection* of PYROIL to keep you GOING. Winter oil quickly drains off piston rings and cylinder walls, exposing them to rust and corrosion caused by dampness and cold.

Pyroil has the extraordinary property of making oil (yes, low viscosity oil, too) protect these important engine parts with a blanket of oil at all times. Pyroil prevents damaging "dry starts", Pyroil permits oil rings and piston rings to work freely without "pumping" due to gum and sludge.

Pyroil and winter oil GO better together — you'll GO better, longer, at less maintenance cost, with Pyroil.

When you add winter oil — add Pyroil — add miles to your car.

### Pyroil for Aircraft Engines

Use Aircraft Pyroil B for lubricating oil, Aircraft Pyroil A for gasoline.

#### GIVEN!

An attractive Pyroil metal savings bank—takes coins up to 50¢ pieces. **MOTORISTS**, it's yours for the asking—sent postage paid.

Manufactured and Guaranteed by Pyroil Company, 122 Pyroil Bldg., La Crosse, Wisconsin

Canadian Distributors: Central Purchasing Agencies, Ltd., Toronto, Ontario



#### PYROIL COMPANY

122 Pyroil Bldg., La Crosse, Wisconsin

I want my car to last and run properly. Please tell me more about Pyroil and how it can accomplish this for me.

Name \_\_\_\_\_

Address \_\_\_\_\_

City or Town \_\_\_\_\_ State \_\_\_\_\_



in this corner.....

## THE EDITORS

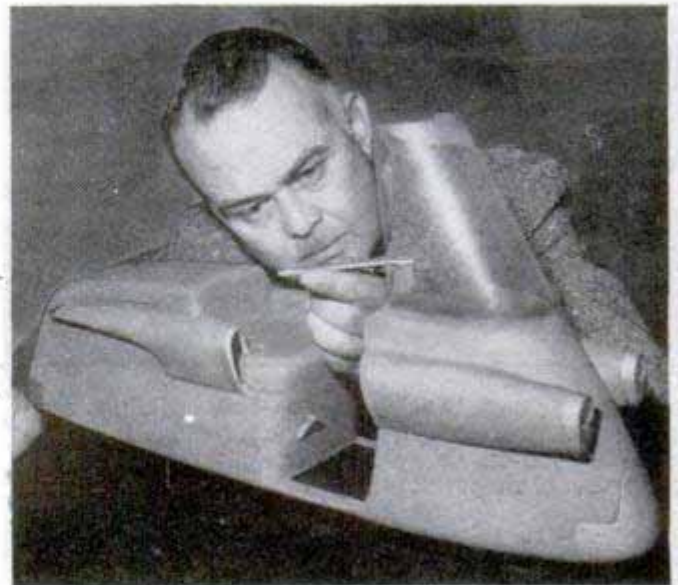

**G**EORGE JERGENSON, who is tinkering with the modernistic motor scooter, heads one of the most unusual schools in the U. S. It has no full-time faculty members and no clocks. Classes last all day and students fight to get into the Art Center School in Los Angeles. The students handle problems of industrial design and many of their products are snapped up by manufacturers. An outstanding article about this school appears in the 50th-Anniversary issue of *Popular Mechanics* next month.

### Turn on the Molasses

When Michael Day told the story of George W. Rappleyea's molasses house (September 1951), Mr. Rappleyea thought it might open a market for his revolutionary plastic material in Latin America. The avalanche of mail that resulted from the article changed his mind: North Americans may get it first! Here's the latest word from him:

#### To the Editor:

As a result of the announcement in the August issue that the story would appear in September, we received five to ten letters a day from readers who did not want to wait until the September issue appeared. Since the September issue was released, we have been getting 35 to 50 letters a day... on one day alone, phone calls came in from Dayton, Cleveland, Winchester, Va., Dallas and Davenport, Iowa.

This large response constitutes a "consumers' market survey" far more complete

(Continued to page 8)



# 5 reasons why ACCOUNTANCY

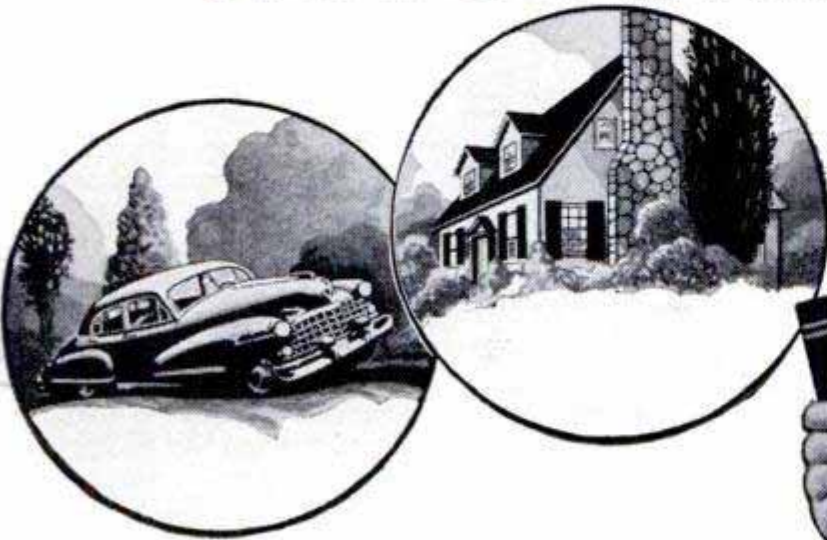
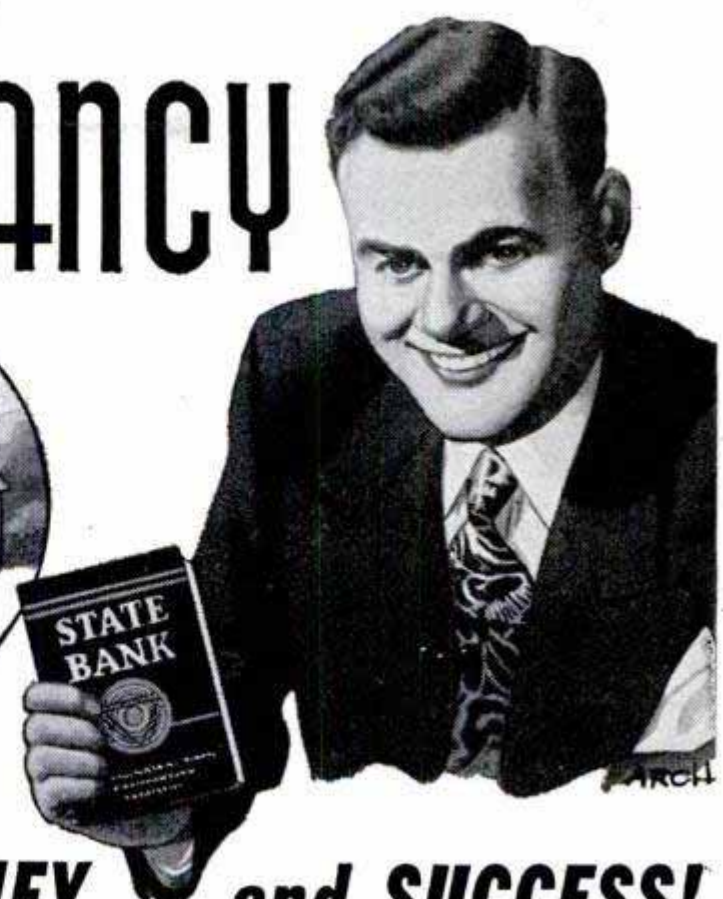

**offers you MORE MONEY . . . and SUCCESS!**

**REASON #1.** If you were an expert accountant right now, chances are you would find yourself among the highest-paid of all professional men and women. Even back in "depression years," surveys showed that accountants earned more on the average than men in other major professions.

**REASON #2.** The demand for accountants is great—everywhere. All businesses must have trained accountants to cope with ever-growing requirements. It's a profession offering wide opportunity—always—to the man who knows.

**REASON #3.** You can fit into any business, anywhere in the country—because accounting principles are universal. Think what this means in terms of security and independence!

**REASON #4.** Accountancy is open to all. Any man or woman of good intelligence, who enjoys figure work and is willing to follow LaSalle's systematic "problem method" plan, can rapidly qualify for a highly profitable, enjoyable lifetime career . . . and he doesn't have to finish his training before beginning to "cash in."

**REASON #5.** Without losing a day from your present work, you can prepare in spare hours at home, at low cost, under LaSalle's step-by-step "Problem Method" of "learning by doing." This famous plan accounts for LaSalle's remarkable record of having trained nearly 10 per cent of all Certified Public Accountants in the U. S. . . . and of having put many thousands of others into high-paying careers.

Send today for LaSalle's interesting booklets, "Accountancy, the Profession That Pays," and "Success Reports." Learn about the five great fields of opportunity . . . and LaSalle's time-tested plan for helping men and women to rapid advancement, higher income, greater prestige and professional standing. The coupon below will bring these fact-filled booklets to you—without cost or obligation—also, a free sample lesson showing LaSalle's famous "Problem Method" plan of instruction.

**GET FREE SAMPLE LESSON**

**WHICH . . . ?  
can help you most ?**

- Accounting—Elements to C.P.A. Coaching
- Bookkeeping
- Cost Accounting
- Auditing
- Income Tax
- C.P.A. Coaching

**LaSalle Extension University**  
— A Correspondence Institution —

**Dept. 1264HR, 417 S. Dearborn St., Chicago 5, Ill.**

Please send me, free of all cost or obligation, a sample lesson in Accounting . . . also, your 48-page illustrated books, "Accountancy, the Profession that Pays," and "Success Reports."

Name..... Age.....  
Address.....  
City, Zone, State.....

**LASALLE**  
417 S. Dearborn St.,  
CHICAGO 5, ILL.



# Schick Injector Razor Outshaves All Others 5 to 1\*



**USES FAMOUS "GOLD PACK" BLADES THAT  
GIVE FINER SHAVES THAN ALL OTHERS  
—INCLUDING OUR OWN OLD BLADES!**

**WORLD'S ONLY RAZOR** with all these big advantages:

Blades change *automatically*—"lock" at same, precise angle—no adjusting!

Light weight makes shaving easier! Safety-Bar smooths down skin . . . "Fits" face—around nose, lips . . . Uses new "Gold Pack" Blades!

**\*HERE'S FULL SCORE FROM SHAVING TESTS**

*Smother Shaves* 5½ to 1    *Safer Shaves* 7 to 1  
*Cleaner Shaves* 5 to 1    *Faster Shaves* 5 to 1  
More Shaves per blade, nearly 2 to 1

\*Men in 10 cities—nationwide—compared New Schick Injector Razor and "Gold Pack" Blades with whatever they had been using. About 80% of the men had a preference. Of these, the votes were in the ratios shown above.

**Either You Get the Finest Shaves of Your Life—  
or Your Money Back, Quick!**

© 1951 Eversharp Inc., 350 5th Ave., N.Y.C.

**SCHICK INJECTOR**  
RAZOR and BLADES

than if we had spent \$100,000 for such a purpose. Readers have opened their hearts and suggested more uses for Plasmofalt than there are for cellulose tape.

I was surprised to learn how many corporation heads read *Popular Mechanics*. The vice-president of the Bell Telephone System in St. Louis . . . sent me a picture of a very beautiful log-cabin summer home. He had trouble finding a material that would "chink" the space between the logs, and as Plasmofalt sticks to wood tenaciously he thought it would solve the problem. The vice-president of the International Marine Plywood Company in Mobile flew to Southport in his private plane, wanted Plasmofalt as a substitute for expensive resin glues for cheap plywood. One of the largest building-stone contractors in the South thought Plasmofalt would be good for sealing joints of cut stone. Since I started this letter I was interrupted by a phone call from an official of the firm that owns the largest papermaking machine in the world. . . . Those are just a few in what the advertising experts love to call "the upper income purchasing bracket."

We are receiving checks and cash through the mail, and returning them immediately. Our pilot plant will supply the requirements for an experimental contract . . . [it] produces 100 pounds an hour. The proposed commercial plant will produce 10,000 pounds an hour.

Our policy will be to make at the main plant only the concentrate. . . . State distributors will make Plasmofalt from the concentrate and furnish it to dealers and contractors to make into brick, building plastic, flooring, paving and sewer pipes. . . .

Plasmofalt was developed from the two materials available on every tropical sugar plantation—molasses and bunker fuel oil—to solve the tropical housing shortage. Now your readers have shown us there is a U.S.A. housing shortage just as serious as the one in the tropics. Like the "Blue Bird of Happiness," you look the whole world over and find it right in your back yard.

George W. Rappleyea,  
Tropical Agricultural  
Research Laboratory,  
Southport, N. C.

*One of the letters Mr. Rappleyea received follows—and the inventor of the molasses plastic comments that "as long as there are mothers like Mrs. O'Neil, there will be free enterprise in America":*

Dear Mr. Rappleyea:

"Home, Sweet Home," the most wonderful words in the world! I have just finished

(Continued to page 10)



# WILL YOU BE CLIMBING?

# OR

# STUCK?

WHAT you'll be doing *one year* from today depends on what you do *today*.

Take advantage of today's opportunities and you're sure to move ahead. Put off doing anything about them and you chance being left behind.

The opportunities open to trained men are greater today than at any time in the past five years. Skilled technicians and specialists are the *men of the hour*. And thousands of them are I. C. S. students.

Start now! Study at home, in your spare time, with the world's largest school—I. C. S. Mail the coupon today for full information. It may be later than you think!

## INTERNATIONAL CORRESPONDENCE SCHOOLS

BOX 5517-L, SCRANTON 9, PENNA.

# 60

## th Anniversary

Without cost or obligation, please send me full particulars about the course BEFORE which I have marked X:

- |   |  |   |  |
|---|--|---|--|
| <ul style="list-style-type: none"> <li><input type="checkbox"/> <b>Business and Academic Courses</b></li> <li><input type="checkbox"/> Accounting <input type="checkbox"/> Advertising</li> <li><input type="checkbox"/> Bookkeeping</li> <li><input type="checkbox"/> Business Administration</li> <li><input type="checkbox"/> Business Correspondence</li> <li><input type="checkbox"/> Business Law</li> <li><input type="checkbox"/> Cartooning</li> <li><input type="checkbox"/> Certified Public Accounting</li> <li><input type="checkbox"/> Commercial <input type="checkbox"/> Commercial Art</li> <li><input type="checkbox"/> Cost Accounting</li> <li><input type="checkbox"/> Fashion and Book Illustration</li> <li><input type="checkbox"/> Federal Tax <input type="checkbox"/> First Year College</li> <li><input type="checkbox"/> Forumanship</li> <li><input type="checkbox"/> Good English <input type="checkbox"/> High School</li> <li><input type="checkbox"/> Higher Mathematics</li> <li><input type="checkbox"/> Industrial Supervision</li> <li><input type="checkbox"/> Motor Traffic</li> <li><input type="checkbox"/> Personnel—Labor Relations</li> <li><input type="checkbox"/> Postal Civil Service <input type="checkbox"/> Retailing</li> <li><input type="checkbox"/> Retail Business Management</li> <li><input type="checkbox"/> Salesmanship <input type="checkbox"/> Secretarial</li> <li><input type="checkbox"/> Sign Lettering</li> <li><input type="checkbox"/> Stenography <input type="checkbox"/> Traffic Management</li> <li><input type="checkbox"/> <b>Aeronautics Courses</b></li> <li><input type="checkbox"/> Aeronautical Engineer's, Jr.</li> <li><input type="checkbox"/> Aircraft Drafting and Design</li> </ul> | <ul style="list-style-type: none"> <li><input type="checkbox"/> Aircraft Mechanic</li> <li><input type="checkbox"/> Engine Mechanic</li> <li><input type="checkbox"/> <b>Air Conditioning and Plumbing Courses</b></li> <li><input type="checkbox"/> Air Conditioning <input type="checkbox"/> Heating</li> <li><input type="checkbox"/> Plumbing</li> <li><input type="checkbox"/> Refrigeration</li> <li><input type="checkbox"/> Refrigeration, Domestic</li> <li><input type="checkbox"/> Refrigeration &amp; Air Conditioning</li> <li><input type="checkbox"/> Steam Fitting</li> <li><input type="checkbox"/> <b>Chemical Courses</b></li> <li><input type="checkbox"/> Chemical Engineering</li> <li><input type="checkbox"/> Chemistry, Analytical</li> <li><input type="checkbox"/> Chemistry, Industrial</li> <li><input type="checkbox"/> Food-Plant Sanitation</li> <li><input type="checkbox"/> Petroleum Production &amp; Refining</li> <li><input type="checkbox"/> Plastics <input type="checkbox"/> Pulp and Paper Making</li> <li><input type="checkbox"/> <b>Civil Engineering and Architectural Courses</b></li> <li><input type="checkbox"/> Architecture <input type="checkbox"/> Architectural Drafting</li> <li><input type="checkbox"/> Bridge and Building Foreman</li> <li><input type="checkbox"/> Building Estimating</li> <li><input type="checkbox"/> Civil Engineering</li> <li><input type="checkbox"/> Contracting and Building</li> <li><input type="checkbox"/> Highway Engineering</li> <li><input type="checkbox"/> Reading Structural Blueprints</li> <li><input type="checkbox"/> Sanitary Engineering</li> </ul> | <ul style="list-style-type: none"> <li><input type="checkbox"/> Structural Drafting</li> <li><input type="checkbox"/> Structural Engineering</li> <li><input type="checkbox"/> Surveying and Mapping</li> <li><input type="checkbox"/> <b>Communications Courses</b></li> <li><input type="checkbox"/> Electronics <input type="checkbox"/> Practical Telephony</li> <li><input type="checkbox"/> Radio, General <input type="checkbox"/> Radio Operating</li> <li><input type="checkbox"/> Radio Servicing</li> <li><input type="checkbox"/> Television</li> <li><input type="checkbox"/> Telegraph Engineering</li> <li><input type="checkbox"/> <b>Electrical Courses</b></li> <li><input type="checkbox"/> Electrical Drafting</li> <li><input type="checkbox"/> Electrical Engineering</li> <li><input type="checkbox"/> Electric Light and Power</li> <li><input type="checkbox"/> Lighting Technician</li> <li><input type="checkbox"/> Practical Electrician</li> <li><input type="checkbox"/> Power House Electric</li> <li><input type="checkbox"/> Ship Electrician</li> <li><input type="checkbox"/> <b>Diesel Engines Courses</b></li> <li><input type="checkbox"/> Diesel Engines</li> <li><input type="checkbox"/> Internal Combustion Engines</li> <li><input type="checkbox"/> <b>Mechanical Courses</b></li> <li><input type="checkbox"/> Forging <input type="checkbox"/> Foundry Work</li> <li><input type="checkbox"/> Heat Treatment of Metals</li> <li><input type="checkbox"/> Industrial Engineering</li> <li><input type="checkbox"/> Industrial Instrumentation</li> <li><input type="checkbox"/> Industrial Metallurgy</li> <li><input type="checkbox"/> Machine Shop <input type="checkbox"/> Mechanical Drafting</li> </ul> | <ul style="list-style-type: none"> <li><input type="checkbox"/> <b>Mechanical Engineering</b></li> <li><input type="checkbox"/> Mold-Loft Work</li> <li><input type="checkbox"/> Patternmaking—Wood, Metal</li> <li><input type="checkbox"/> Reading Shop Blueprints</li> <li><input type="checkbox"/> Sheet-Metal Drafting</li> <li><input type="checkbox"/> Sheet-Metal Worker</li> <li><input type="checkbox"/> Ship Drafting <input type="checkbox"/> Ship Fitting</li> <li><input type="checkbox"/> Tool Designing <input type="checkbox"/> Toolmaking</li> <li><input type="checkbox"/> Welding—Gas and Electric</li> <li><input type="checkbox"/> <b>Railroad Courses</b></li> <li><input type="checkbox"/> Air Brake <input type="checkbox"/> Car Inspector</li> <li><input type="checkbox"/> Diesel Locomotive</li> <li><input type="checkbox"/> Locomotive Engineer</li> <li><input type="checkbox"/> Locomotive Fireman</li> <li><input type="checkbox"/> Locomotive Machinist</li> <li><input type="checkbox"/> Railroad Section Foreman</li> <li><input type="checkbox"/> Steam-Diesel Locomotive Engineer</li> <li><input type="checkbox"/> <b>Stationary Engineering Courses</b></li> <li><input type="checkbox"/> Power Plant Engineering</li> <li><input type="checkbox"/> Stationary Fireman</li> <li><input type="checkbox"/> Stationary Steam Engineering</li> <li><input type="checkbox"/> <b>Textile Courses</b></li> <li><input type="checkbox"/> Cotton Manufacturing</li> <li><input type="checkbox"/> Loom Fixing <input type="checkbox"/> Rayon Manufacturing</li> <li><input type="checkbox"/> Textile Engineering</li> <li><input type="checkbox"/> Woolen Manufacturing</li> </ul> |
|---|--|---|--|

Name \_\_\_\_\_ Age \_\_\_\_\_ Home Address \_\_\_\_\_

City \_\_\_\_\_ State \_\_\_\_\_ Working Hours \_\_\_\_\_ A. M. to \_\_\_\_\_ P. M.

Present Position \_\_\_\_\_ Employed by \_\_\_\_\_

Special tuition rates to members of the Armed Forces. Canadian residents send coupon to International Correspondence Schools Canadian, Ltd., Montreal, Canada.



# VOTE TODAY

## FOR THE FUTURE YOU WANT!

AMERICAN SCHOOL, Dept. G945, Drexel at 58th, Chicago 37, Ill.  
Without obligation, please send FREE and postpaid, full particulars about the subject checked below.

- |  |   |   |
|--|---|---|
| <input type="checkbox"/> Accounting              | <input type="checkbox"/> Drafting—Building Trades | <input type="checkbox"/> Plastic Engineering  |
| <input type="checkbox"/> Air Conditioning        | <input type="checkbox"/> Drafting—Machine Trades  | <input type="checkbox"/> Plumbing—Practical   |
| <input type="checkbox"/> Architecture & Building | <input type="checkbox"/> Electrical Engineering   | <input type="checkbox"/> Private Secretary    |
| <input type="checkbox"/> Automotive Technician   | <input type="checkbox"/> Electricity—Practical    | <input type="checkbox"/> Refrigeration        |
| <input type="checkbox"/> Batter Foremanship      | <input type="checkbox"/> Electronics—Industrial   | <input type="checkbox"/> Retail Merchandising |
| <input type="checkbox"/> Bookkeeping             | <input type="checkbox"/> High School Courses      | <input type="checkbox"/> Salesmanship—Outside |
| <input type="checkbox"/> Business Management     | <input type="checkbox"/> Machine Shop Operations  | <input type="checkbox"/> Sheet Metal Work     |
| <input type="checkbox"/> Contracting             | <input type="checkbox"/> Mathematics & Slide Rule | <input type="checkbox"/> Test Making          |
| <input type="checkbox"/> Diesel Technician       | <input type="checkbox"/> Mechanical Engineering   |   |

NAME ..... OCCUPATION .....  
 HOME ADDRESS ..... AGE .....  
 CITY ..... STATE .....

### THIS IS YOUR BALLOT

Find the subject that interests you most and then... Check, Sign and Mail Today

• Today, choose the job you want — and prepare for it in spare time at home. Or if you are already engaged in the work you like best, start training now for quicker promotion. In hours you might otherwise waste, gain the knowledge and skill that can help you to get ahead faster, make more money, and have greater security.

#### Training Backed by 54 Years of Experience

For over half a century American School has helped ambitious men and women toward success by providing specialized training for commercial and technical advancement. Its study program for you has been planned by experts with years of experience in the subject you select and they will give you needed guidance every step of the way.

#### Don't Delay Your Start

Give serious thought to the list of training courses listed above. Pick the opportunity that interests you, check it and add your name and address. (Check more than one if you are undecided as to which appeals most.) Finally clip out and mail the "ballot" and full information will be supplied, without cost or obligation.

AMERICAN SCHOOL  
DEPT. G945, DREXEL AT 58th, CHICAGO 37, ILL.

THE SOONER YOU START, THE SOONER YOUR GOAL CAN BE REACHED

reading for the tenth time "You'll Build Your Next House of Molasses" in *Popular Mechanics* magazine.

While at the newsstand looking through various house-plan books (and there are so many picturing cheeseboxes, proclaiming "Build this beautiful five-room, low-cost house for only \$9000," which is really a small fortune for a family of seven trying to live on \$200 per month), I happened to glance through a *Popular Mechanics* hoping to find something on cement-block construction. Instead, I found your wonderful Plasmofalt! I promptly bought my first *Popular Mechanics* magazine, took it home and read it through six times. . . .

Results of your "Home, Sweet Home" (wonderful, wonderful words) article in *Popular Mechanics* were that it launched us on a plan to build our own home, perhaps hiring some outside help for roof and plumbing.

We have in mind a four-bedroom, low-roof, ranch-type home made of Plasmobricks. . . . As soon as Plasmofalt is on the market, we are planning to build the foundation and main walls, at first finishing only the main rooms such as kitchen, bath and two bedrooms for immediate occupancy. Then as our pocketbook allows it, complete the rest of the house. . . .

We believe that with our youth, ambition, time and little plot of ground, plus our terrible need of a home for our children, we have nothing to lose.

Please, please let us know how soon we can begin the biggest and happiest project of our lives.

Sincerely,  
Mrs. Wm. P. O'Neil.



### "Steam Isn't Dead"

So writes Robert E. Ostwald of Staten Island, N. Y., who was a bystander at the finish of *Popular Mechanics'* "race of the relics" between a 1913 Stanley Steamer and a 1911 Stoddard-Dayton in September. Mr. Ostwald plans a new publication for distribution "among steam men." He has built his own steamcar, basically a Studebaker 1940 with a Stanley Steamer engine.



# WHAT Every AUTO MECHANIC Wants to Know

A motor vehicle is a machine of many parts, each part designed and constructed for its own special function.

All good mechanics, like good doctors, should know the working theory and operation of each part and understand what causes trouble and how to remedy it.

## LET AUDELS AUTO GUIDE SOLVE YOUR PROBLEMS

Every auto mechanic, helper, serviceman and operator can use a copy of AUDELS AUTOMOBILE GUIDE. The information it gives saves time, money and worry. Highly indorsed by all users. It presents the whole subject of auto mechanics from A to Z in plain language and simple terms.

This Big Practical Book gives full information with working diagrams covering the principles, construction, ignition, service and repair of modern cars, trucks and buses.

A complete Guide of 1800 pages, with over 1500 illustrations showing inside views of the working parts, with instructions for service jobs. Diesel engines, Fluid and Hydra-matic drives fully explained.

## IT PAYS TO KNOW HOW TO

How to fit pistons—How to locate engine knocks—How to fit connecting rod bearings—How to service main bearings—How to recondition valves—How to time valves—How to adjust fan belts—How to adjust carburetors & chokes—How to rebuild a clutch—How to service automatic transmissions—How to service brakes—How to adjust steering gear—How to cope with ignition troubles—How to service distributors—How to time ignition—How to "tune up" an engine.

## INFORMATION IN A HANDY FORM

73 INTERESTING CHAPTERS—Read this partial list of subjects on which practical information is fully given for quick reference under the headings as shown below. Ready Reference Index.

All Parts of an Automobile—Automotive Physics—The Gas Engine—Gas Engine Principles—Multi-Cylinder Engines—Horse Power—Automobile Engines—Stationary Parts—Moving Parts—Pistons—Piston Rings—Connecting Rods—Crank Shafts—Valves—Valve Gear—Cams and Cam Action—Valve Timing—Cooling Systems—Fuel Feed Systems—Dual Fuel Feed—Mixture—Carburetors—Carburetor Service—Automatic Choke—Super-Chargers—Transmissions—Special Transmissions—Fluid and Hydra-matic Drives—Clutches—Universals and Propeller Shafts

A Ready Reference



—The Differential—Rear Axles—Rear and Front Suspension—Running Gear—Brakes—Wheel Alignment—Knee Action—Steering Gear—Tires—Lubricants and Lubrication—Automotive Electricity—Ignition Systems—Magneto Ignition—Spark Plugs—Ignition Coils—Distributors—Automatic Spark Control—Ignition Timing—Generators—Starters—Generator and Starter Testing—Lighting Systems—Storage Batteries—Charging and Testing—Diesel Engines and Trouble Shooting.

**7 DAYS' FREE TRIAL**  
TO GET THIS ASSISTANCE FOR YOURSELF SIMPLY FILL IN AND MAIL COUPON TODAY.

**\$4 COMPLETE PAY \$1 A MONTH ONLY**

Ask to See It!



## Sent on 7 Days Approval

Step up your own skill with the facts and figures of your trade. Audels Mechanics Guides contain Practical Inside Trade Information in a handy form. Fully illustrated and Easy to Understand. Highly Endorsed. Check the book you want for 7 DAYS FREE EXAMINATION. Send No Money. Nothing to pay postman.

## CUT HERE MAIL ORDER

AUDEL, Publishers, 49 W. 23 St., NEW YORK 10, N. Y.

Please send me postpaid for FREE EXAMINATION books marked (x) below. If I decide to keep them I agree to mail \$1 in 7 Days on each book or set ordered and further mail \$1 monthly on each book or set until I have paid price, otherwise I will return them.

- TRUCK & TRACTOR GUIDE, 1299 Pages \$ 4
- AUTOMOBILE MECHANICS GUIDE, 1800 Pages 4
- DIESEL ENGINE MANUAL, 575 Pages 2
- MACHINISTS HANDY BOOK, 1650 Pages 4
- WELDERS GUIDE, 400 Pages 1
- BLUE PRINT READING, 416 Pages 2
- MATHEMATICS & CALCULATIONS, 700 Pages 2
- SHEET METAL PATTERN LAYOUTS, 1100 Pages 4
- SHEET METAL WORKERS HANDY BOOK, 388 Pgs. 1
- MECHANICAL DRAWING GUIDE, 160 Pages 1
- MECHANICAL DRAWING & DESIGN, 480 Pages 2
- AIRCRAFT WORKER, 240 Pages 1
- TELEVISION SERVICE MANUAL, 384 Pages 2
- RADIOAMANS GUIDE, 914 Pages 4
- ELECTRONIC DEVICES, 216 Pages 2
- ELECTRIC MOTOR GUIDE, 1000 Pages 4
- ELECTRIC WIRING DIAGRAMS, 272 Pages 1
- ELECTRICIANS EXAMINATIONS, 250 Pages 1
- ELECTRIC POWER CALCULATIONS, 425 Pages 2
- HANDY BOOK OF ELECTRICITY, 1440 Pages 4
- ELECTRIC DICTIONARY, 9000 Terms 2
- ELECTRIC LIBRARY, 7000 Pages (12 Book Set) 18
- MARINE ENGINEERS HANDY BOOK, 1258 Pgs. 4
- SHIPFITTERS HANDY BOOK, 250 Pages 1
- REFRIGERATION & Air Conditioning, 1280 Pgs. 4
- MILLWRIGHTS & MECHANICS GUIDE, 1200 Pgs. 4
- POWER PLANT ENGINEERS GUIDE, 1500 Pages 4
- ENGINEERS & FIREMANS EXAMS, 525 Pages 1
- PUMPS, Hydraulics & Air Compressors, 1658 Pgs. 4
- ENGINEERS LIBRARY (3 Book Set) 9
- MECHANICAL DICTIONARY, 950 Pages 4
- GARDENERS & GROWERS GUIDES (4 Book Set) 6
- CARPENTERS & BUILDERS GUIDES (4 Book Set) 6
- PLUMBERS & Steamfitters Guides (4 Book Set) 6
- MASONS AND BUILDERS GUIDES (4 Book Set) 6
- PAINTERS & DECORATORS MANUAL, 450 Pgs. 2
- HOUSE HEATING GUIDE, 1000 Pages 4
- OIL BURNER GUIDE, 384 Pages 1

Name \_\_\_\_\_  
Address \_\_\_\_\_  
Occupation \_\_\_\_\_  
Employed by \_\_\_\_\_

AUDEL, Publishers, 49 W. 23 St., New York 10, N. Y.



# Become an ELECTRICAL ENGINEER

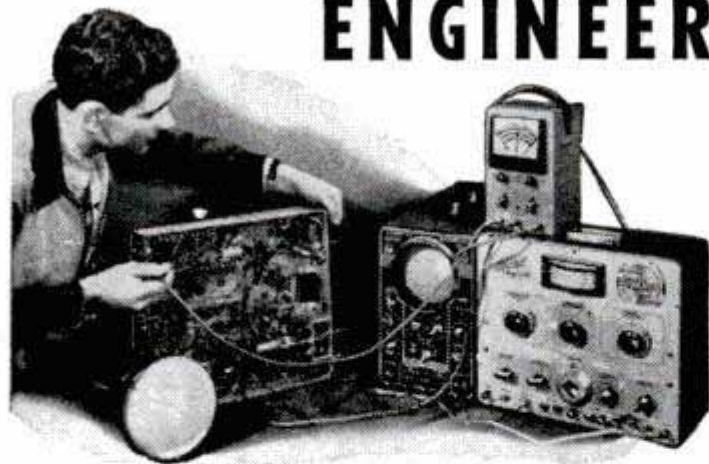

## Major in Electronics or Power ... B. S. Degree in 36 Months

Important advantages are yours at this College of Electrical Engineering. Through optional year-round study, a *valuable year is saved* by gaining your B. S. degree in 36 months. Further—you are guided scientifically toward specialization for design and research, manufacturing and production—or engineering sales and management.

Choose the Course  
That Interests You Most

### SERVICE

- 6 Months
- Electricity
  - Welding
  - Refrigeration
  - Heating

### TECHNICIAN

- 12 to 18 Months
- Radio and Television
  - Electronics
  - Electrical Power
  - Welding
  - Air Conditioning

### ENGINEERING

- 36 Months
- Electrical Engineering — B. S. Degree
  - Major in Electrical Power or Electronics

## A Radio-Television Technician's Certificate can be yours in 18 months

Under this school's **proven plan** you can become a Radio Technician in 12 months — or a Television Technician in 6 additional months. Courses are complete in themselves, and can be applied as **one-third** of the electrical engineering course.

**Practical, Military or Academic Training** will be evaluated for advanced credit.

**Faculty of specialists.** Over 2,300 annually enrolled. 35,000 former students from 48 states and 23 overseas countries.

## MILWAUKEE SCHOOL of ENGINEERING

Terms open Jan., April,  
July, Oct.

Write for free 110-page catalog, 48-page pictorial booklet "Your Career" and "Occupational Guidance" Bulletins

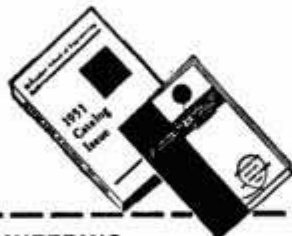

MILWAUKEE SCHOOL OF ENGINEERING  
Department PM-1251, 1025 N. Milwaukee, Milwaukee, Wis.  
Without obligation send catalog and "Your Career" bulletin plus "Occupational Guidance Bulletin" and details on course in

NAME \_\_\_\_\_ AGE \_\_\_\_\_  
ADDRESS \_\_\_\_\_  
CITY \_\_\_\_\_ ZONE \_\_\_\_\_ STATE \_\_\_\_\_  
If veteran, indicate discharge date (\_\_\_\_\_)

## WHERE-TO-BUY-IT INDEX

Source of supply appears after items commercially available

### AUTOMOTIVE

Car watch (Oldsmobile Div., General Motors Corp., Lansing 21, Mich.)	79
Lightweight battery will start car at 65 degrees below zero	79
Graphite spray (AP Parts Corp., AP Bldg., Toledo 1, Ohio)	82
Barrel-shaped rubber boosters inflate to improve spring action (Air Lift Co., Lansing, Mich.)	111
Sports car	125
New French Simca 9 offers gas economy (Hoffman Motor Car Co., 65 E. Water St., Chicago 1)	130
Electric sports car (Boulevard Sales Co., 4020 Lakeshore Blvd. N., Hollywood, Calif.)	132
Builds one-man car powered by motorcycle engine	132
Aluminum-scrap auto costs \$160 and 2500 hours of work	132
Capsules start cold engines (California Oil Co., Box 2, Barber, N. J.)	133
Tissue filters oil (Henderize, Inc., 5667 Freeport Blvd., Sacramento, Calif.)	133
Lock-on lug covers discourage would-be tire thieves (Richard M. Decker Co., Inc., 919 N. Michigan Ave., Chicago 11)	133

### AVIATION

Fog fighter	94
Canvas parasol keeps cockpit cool	110
Rocket metal is flight-tested without leaving the ground	131
"Pint sized" preservers	139
Beacning gear hauls flying boats ashore	147

### CHRISTMAS SPECIALS

Four heavy-duty toys (Charles William Doepke Mfg. Co., Rossmoyn, Ohio)	104
Slicing machine (Hoffritz for Cutlery, 331 Madison Ave., New York City 17)	105
Shave rack (Crown-Craft Products, 246 5th Ave., New York City 1)	105
Lunch bag (Landers, Frary & Clark, New Britain, Conn.)	105
Wickless lighters (Parker Pen Co., Janesville, Wis.)	105
Church kit (M. A. Sales Co., Livermore, Iowa)	105
15-piece tool kit (Hoffritz for Cutlery, 331 Madison Ave., New York City 17)	106
Jiffy label tape (Labelon Tape Co., 100 Anderson Ave., Rochester 7, N. Y.)	106
Aluminum hitch (Kar-Lin Co., 7101 Oliver Ave., South Minneapolis 19, Minn.)	106
Miniature broiler (Hoffritz for Cutlery, 331 Madison Ave., New York City 17)	106
Belt lighter (Krimstock Bros., 112 N. 9th St., Philadelphia 7, Pa.)	106
Electric flour sifter (Romart, Box 8012, Chicago 7)	106
Slide projector (Three Dimension Co., 4555 W. Addison St., Chicago 41)	107
Handy memo pencil (Gaylord, Dept. MO 24, 5th and Hamilton, Pittsburgh 6, Pa.)	107
Floor conditioner (Red Devil Tools, Irvington, N. J.)	107
Safety-fuse plug (Noma Electric Corp., Noma Bldg., 55 W. 13th St., New York City 11)	107
Floating knife (Hoffritz for Cutlery, 331 Madison Ave., New York City 17)	107
Star finder (Tri-G Co., Linden, Mo.)	107
Christmas-tree lamp shade (H. Grabell & Sons, Inc., 1128 Madison Ave., Paterson, N. J.)	110
Christmas-tree apron (Brittain Products Co., Inc., 380 E. Exchange St., Akron 4, Ohio)	156

### FARM

Plastic "tent" fumigates soil (Firestone Plastics Co., Pottstown, Pa.)	78
Asparagus harvester	103
Blacksmith shop travels to farms	121
Strawberry weeder is hand cranked	121
Cattle scratcher (Bill Kirk, Kirk Products Co., 5601 N.E. Airport Bldg., Box 5297, Amarillo, Tex.)	125
Refrigerator "shock cools," filters and aerates milk	130
Streptomycin cures plants	132
Tractor light (Harlan Mfg. Co., Inc., Harlan, Iowa)	156

### HOUSE AND HOME

Self-sticking felt (Products Research Co., 5426 San Fernando Rd., Glendale 3, Calif.)	96
Rotary snowplow cleans sidewalks (Jari Products, Inc., 2938 Pillsbury Ave., Minneapolis, Minn.)	110
Outdoor fireplace built in three hours (Majestic Co., Huntington, Ind.)	120
Plastic gasket seals casement window (Draftite Products Co., 6 Canterbury Drive, Dayton 9, Ohio)	121
Electric snow shovel (Sensation Mower, Inc., 7577 Burlington St., Ralston, Neb.)	262

### INDUSTRY

Hydraulic gravel mining	88
Concrete test	88
Welded steel rods strengthen masonry (Cedar Rapids Block Co., 650 12th Ave. S.W., Cedar Rapids, Iowa)	96
Chemical bonds rubber to steel	103
Machine staples iron	103
Mechanical refrigerator can be transferred from car to car	130
Nonvibrating chain drive (Morse Chain Co., 7601 Central Ave., Detroit 8, Mich.)	150

### MEDICAL

Mobile electric lift raises and transports patients	111
Compact aspirator	119
Miniature camera (Bolsley Corp. of America, 118 E. 25th St., New York City 10)	119

### MILITARY

Jeep power plant	82
Lightweight revolvers	82
Remote steering for ships disabled by enemy fire	120

(Continued to page 14)



# INVENTORS

**L**earn how to protect your invention. The U. S. Patent Laws provide that any new and useful art, machine, article of manufacture, or composition of matter, or any new and useful improvement thereof, may be patented if the act of invention is involved. Therefore, every inventor with a valuable invention should take advantage of the Patent Laws and proceed for patent protection in order to safeguard his rights.

A patent gives the inventor the exclusive right to prevent others from making, using, or selling the invention claimed in the patent for a period of seventeen years.

The Patent Laws were enacted for the benefit of the inventor to give him protection for the features of his invention which are patentable. These features must be properly and concisely set forth and claimed in a formal application for patent, in order to comply with the requirements of the Patent Laws. For that reason, unless the inventor is familiar with patent matters, he should engage a competent registered patent attorney or agent to represent him. We are registered to practice before the U. S. Patent Office and are prepared to serve you in the handling of your patent matters.

A specially prepared booklet entitled "Patent Guide for the Inventor", containing detailed information with respect to patent protection and procedure, together with a "Record of Invention" form will be promptly forwarded to you without obligation upon request.

**CLARENCE A. O'BRIEN & HARVEY JACOBSON**

*Registered Patent Attorneys*

**11 - M DISTRICT NATIONAL BUILDING**

**WASHINGTON 5, D. C.**



**RADIO & TV CATALOG**

★  
**FREE**

★  
**1952**  
212-Page  
Edition

★  
**ALLIED'S**  
**BIG COMPLETE**  
**BUYING GUIDE**  
Save on Everything  
in Radio and TV



**NEW**  
UP-TO-DATE  
SEND FOR IT NOW

**Everything for Experimenters,  
Builders, Amateurs, Service-  
men, Engineers and Soundmen**

Send for ALLIED'S 212-page 1952 Catalog, the value-packed guide to everything in Radio and Television! Latest home radios, TV equipment, Amateur supplies, P.A. Systems, Hi-Fidelity Sound, recorders, test instruments, builders' kits—plus the world's largest stocks of electronic parts, tubes, tools, books and diagrams. Get more for your money—send today for your FREE 1952 ALLIED Catalog!

**Get Radio's Leading  
Buying Guide Today**

**FREE!**

**ALLIED RADIO**

ALLIED RADIO CORP., Dept. 5-MM-1  
833 W. Jackson Blvd., Chicago 7, Ill.

Rush FREE 1952 ALLIED 212-Page Catalog.

Name \_\_\_\_\_

Address \_\_\_\_\_

City \_\_\_\_\_ Zone \_\_\_\_\_ State \_\_\_\_\_

U.S.S. Forrestal—queen of the flattops.....122  
Helicopter litter carrier eliminates claustrophobia.....139  
Navy scientist invents test to spot color blindness.....150

**PHOTOGRAPHY**  
Projector attachment (York Industries, 1931 Lansing St., Detroit, Mich.).....82  
Print-a-minute camera photographs oscillograph (Fairchild Camera & Instrument Co., 88-06 Van Wyck Blvd., Jamaica 1, N. Y.).....111  
Inexpensive underwater movies (Fenjohn Underwater Photo and Equipment Co., Ardmore, Pa.).....151

**RECREATION**  
Game for small lawn combines billiards and croquet.....112  
Porpoise in harness pulls surfboarders.....112  
Gas-electric boat can crawl or zoom.....124  
Water "toboggan".....125

**TOYS AND NOVELTIES**  
Plastic "sandwich" artistry.....80  
Suitcase piano.....96  
"Flying" house.....131  
He sells sea shells.....140  
Temple of miniatures.....148  
Talking doll (Effanbee Doll Co., 200 5th Ave., New York City 10).....151  
Nonswat mosquitoes.....156

**MISCELLANEOUS**  
Bus rolls from highway to rails.....78  
Expanding mixer (Fisher Scientific Co., 717 Forbes St., Pittsburgh 19, Pa.).....78  
Bomb windows (Pittsburgh Plate Glass Co., 632 Duquesne Way, Pittsburgh, Pa.).....79  
"Scootermobile".....88  
Test couplers (Belvidere Aluminum Co., 1200 Cedar St., Rockford, Ill.).....96  
Space station?.....112  
What makes salmon run?.....113  
Shoulder roller.....119  
Propeller-equipped rudder may eliminate tugboats.....120  
Race-horse relaxer.....139  
Wheels for broom (JEF Mfg. Co., 310 W. Monument Bldg., Dayton 2, Ohio).....146  
Concrete tank is "wind tunnel" in electrical prospecting.....146  
"Peel paste".....146  
Flashlight magnet grip (Sheridan Style-Crafts, Box E, Highland Park, Ill.).....151  
Pigeon preventive (National Bird Control Laboratories, 1035 W. Lake St., Chicago 7).....156  
Screwdriver gift set (Vaco Products Co., 317 E. Ontario St., Chicago 11).....268

**Craftsman and Shop Notes Index**

**AUTOMOTIVE**  
Gas-cap lock kept from freezing by plastic bowl cover.....163  
Car touched-up with shoe polish.....163  
Repairing dented car molding.....168  
Speed of windshield wiper controlled with rheostat.....178  
Water level in car radiator checked with dip stick.....184  
No-draft ventilating system improves car heater.....184  
Auto skid chains kept tight with rubber strips.....188  
Kitchen tongs clamp pistons in cylinder while repairing brakes.....191  
Thawing car-door lock.....192  
Faulty acceleration of car sometimes may be caused by slipping fan belt.....214  
Extension cord to operate starter of car having solenoid switch.....218

**CHRISTMAS SPECIALS**  
Inexpensive Christmas decorations.....166  
Novelty Christmas trees.....169  
"Ounce" of fire prevention regarding Christmas tree.....172  
Christmas-tree stand.....193

**CLAMPS AND FIXTURES**  
Homemade clamp for light work.....168  
Hand grinder supported by floodlight clamp.....178  
Soldering-iron stand improvised from empty tape spool.....188  
Nonslip clamp grips small parts.....192  
Soldering clamp for small work.....197  
Stands for supporting stock trailer easily adapted as axle blocks.....214  
Accuracy plus speed in aligning work attained by using this welders' jig.....215  
Universal clamp on milling machine.....218

**FARM**  
Harrow disk anchors standard for rural mailbox.....172  
Handling rat poison safely.....206  
Wire along front of nest prevents roosting.....206  
Old implement lever and quadrant has many uses around a farm.....214  
Fuel tank mounted on trailer provides farm "gas truck".....215  
Automatic poultry fountain.....218

**HOUSE AND HOME**  
Single-door clothes closet made into wardrobe type.....163  
Tubular furniture padded with length of hose.....170  
"Ironing" laundered ribbon.....170  
Door provides wallpaper-pasting table.....170  
Candle wax used to clamp broken pottery.....171  
Pouring spout formed in milk carton.....171  
Drying garments indoors.....171  
Cork holder.....171  
Bobby pin helps lace baby shoes.....171  
Paraffin has many uses that will help lighten the home-maker's tasks.....173  
Keeping bed slats from falling.....178  
Toothbrush on polish applicator cleans perforations in shoe.....178

(Continued to page 16)



# INVENTORS

If you believe that you have an invention, you should find out how to protect it. The first step is to have a search made of the prior pertinent U. S. patents. If a report on this search indicates that the invention appears patentable you can apply for a patent, and the specifications and claims should be prepared.

The firm of McMorrow, Berman & Davidson, with offices in Washington, D. C., is qualified to take the necessary steps for you. We can make a preliminary search on your invention, advise you whether we think it can be patented, and prepare your application for patent.

Unless you are fully familiar with the U. S. Patent Laws, we recommend that you engage the services of a Registered Patent Attorney to protect your interests. The patent laws are *your* laws. A patent gives you the right to prevent others from making, using or selling the invention claimed in your patent for a period of 17 years.

Use these patent laws for your protection. Investigate whether your invention can be patented. If you have what you believe to be an invention, we suggest that you have this firm make a search for you.

*Send for a copy of our Patent Booklet entitled "How To Protect Your Invention," containing information about patent protection and patent procedure. Along with this we will also send you an "Invention Record" form, for your use in writing down and sketching details of your invention. We will mail them promptly. No obligation. They are yours for the asking.*

**McMORROW, BERMAN & DAVIDSON**

*Registered Patent Attorneys*

**PATENTS • COPYRIGHTS • PATENTS**

**1352 VICTOR BUILDING, WASHINGTON 1, D. C.**



# 9 BIG BUILDING BOOKS

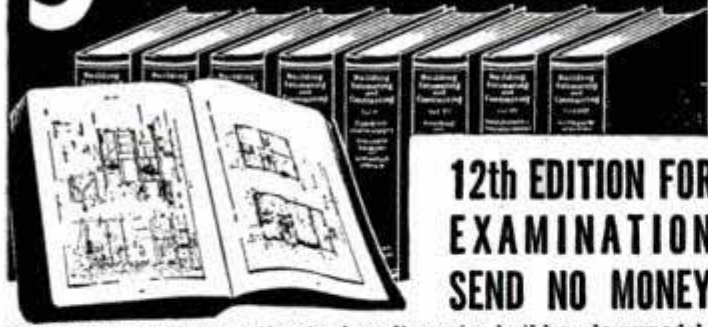

**12th EDITION FOR EXAMINATION SEND NO MONEY**

Learn to draw plans, estimate, be a live-wire builder, do remodeling, contracting. These 9 practical, profusely illustrated books cover subjects that will help you to get more work and make more money. Masonry, concrete forms, carpentry, steel square, roof framing, construction, plumbing, heating, painting, decorating and many other subjects. More than 4000 pages — 2750 illustrations.

**BETTER JOBS — BETTER PAY UP-TO-DATE EDITION**  
 A nationwide building boom is in full swing and trained men are needed. Big opportunities are always for **MEN WHO KNOW HOW**. These books supply quick, easily understood training and handy, permanent reference information that helps solve building problems.

**Coupon Brings Nine Big Books for Examination**

**AMERICAN TECHNICAL SOCIETY—Publishers since 1898**  
 Dept. G919 Drexel at 58th Street Chicago 37, Ill.  
 You may ship me the Up-to-Date edition of your nine big books, "Building, Estimating and Contracting," without any obligation to buy. I will pay the delivery charges only, and if fully satisfied in ten days, I will send you \$3.00, and after that only \$4.00 a month, until the total price of only \$34.80 is paid. I am not obligated in any way unless I keep the books.

Name \_\_\_\_\_  
 Address \_\_\_\_\_  
 City \_\_\_\_\_ State \_\_\_\_\_  
 Please attach a letter stating your age, occupation, employer's name and address, and name and address of at least one business man as a reference. Men in service, also please give home address.



**Start As High As \$3,450.00 A YEAR**

**MEN—WOMEN**

- Postoffice Clerks-Carriers
- Railway Postal Clerks
- Stenographers
- Accountants
- Immigrant Inspectors
- Typists
- Customs Inspectors
- Many Other Early Jobs
- Veterans Get Preference

**Franklin Institute**  
 (Not Government Controlled)  
 Dept. C-83,  
 Rochester 4, N. Y.

Gentlemen: Rush to me, FREE of charge, list of U. S. government big pay jobs. Send FREE 32-page book describing salaries, vacations, hours, work, etc. Tell me how to qualify for one of these jobs.

Name \_\_\_\_\_  
 Street \_\_\_\_\_  
 City \_\_\_\_\_ Age? \_\_\_\_\_

**MAIL COUPON TODAY SURE**

(Continued from page 14)

Order in the closet.....	177
Handle on knob to open door when hands are full.....	187
Correcting windows that "stick".....	184
Lazy Susan rotates on bearing.....	188
Preventing removal of shoelaces.....	192
Insulated box protects delivered milk against weather and prowling animals.....	197

**NOVELTIES**

Fish lure provides key holder.....	163
Candle-tray centerpiece.....	167
Artificial plants.....	173
Scrolled kitchen shelf.....	181

**OFFICE, SHOP AND STORE**

Bottle warmer used as gluepot.....	166
Sandpaper holder on bench top aids smoothing small blocks.....	168
Razor blades stored safely when embedded in eraser.....	168
"Ringed" pencil easily stored.....	172
Transferring typewritten copy from paper to book cover.....	172
Powder puff on drawing board cleans artist's equipment.....	172
Quick way to count typewritten characters when taking speed test.....	181
Making indexed files easier to use.....	214
Oil drum with ends removed utilized as hood for ventilating fan.....	215

**OUTDOOR RECREATION**

Tube unit concentrates breath when blowing on campfire.....	166
Protecting sportsmen's equipment.....	168
Testing campfire wood.....	188

**PHOTOGRAPHY**

Window shade provides background for photographing small subjects.....	201
Clothespin holds print tongs on edge of developer tray.....	201
Stopping film-holder light leaks.....	201
Retractable lens brush always at hand when carried on key chain.....	202
Hair drier is useful in photo lab.....	202
Emergency substitute for ground-glass viewer of camera.....	202

**TOOLS**

Preventing breakage of small drills.....	188
Homemade blower for your jigsaw keeps work free of sawdust.....	196
Large lathe dog made adjustable for use with various-size faceplates.....	206
Magnet holds jointer blades when resetting in head.....	206
Disk sander from lathe headstock.....	207
Mortar-joint raker (Goldblatt Tool Co., 1919 Walnut St., Kansas City 8, Mo.).....	216
Flashlight screwdriver (Vaco Products Co., 317 E. Ontario St., Chicago 11).....	216
Toolholder for bench grinders (Stuhlman Engineering Co., 400 Desplaines Ave., Forest Park, Ill.).....	216
Buffing-bonnet cleaner (O'Brien Machine Co., 1620 W. Highland Ave., Chicago 26).....	216
Panel-cutting fixture (J. D. Wallace & Co., 150 S. California, Chicago).....	217
Spot welder (Perfex, 16 Boulevard Jules Ferry, Paris 11 <sup>e</sup> , France).....	217
Open-end ratchet wrench (Tubing Appliances Co., 10321 Anza Ave., Los Angeles 45, Calif.).....	217
Light shop equipment padded with self-adhesive felt strips.....	218

**TOYS**

Curling iron used to stuff rag doll.....	163
Play cottage.....	164
A "new" buggy for sister.....	182

**MISCELLANEOUS**

Staples insulated with rubber pads.....	168
Fruit jar used as mixing "hopper".....	168
Safety "key" prevents picking lock.....	178
Tip for masonry repair.....	178
Coloring copper and brass.....	180
Guard for garden-hose nozzle provided by handle-bar grip.....	180
Countersunk nut tightened with two pairs of pliers.....	180
Locating chimney leaks.....	188
Wallpaper held while trimming by coat hanger hooked to table.....	192
Materials for emergency repairs obtained in medicine cabinet.....	192
Washer aids operating locknuts on drill-press depth-gauge rod.....	192
How to prevent rotting of timbers exposed in crawl space under house.....	193
Pliers drive brads safely.....	197
Storage for plumb-bob line improvised from tape spool.....	218

**Radio-Television, Electronics**

Sound marches on (Multiple speaker unit, Eastman Kodak Co., Rochester 4, N. Y.; magnetic sound projector, RCA Victor Corp., Camden, N. J.; transistor amplifying device, Bell Telephone Laboratories, 463 West St., New York City 14; parabolic-type microphone, National Broadcasting Co., New York City).....	219
Radio-set testing units for experimenters.....	220
Television today (Mounting bracket for antenna, Kenwood Engineering Co., Inc., Kenilworth, N. J.; image-correcting lens, American Optical Co., Southbridge, Mass.; snack wagon, Baroda Mfg. Co., Baroda, Mich.; television glasses, Bausch and Lomb Optical Co., 626 St. Paul St., Rochester, N. Y.).....	223
Radio and television service hints (Converter for TV, Allen B. Du Mont Laboratories, Inc., New York City).....	224

**IMPORTANT NOTICE**—It is the intention of this magazine to provide its readers with information regarding the latest developments in the mechanical arts. We take no responsibility as to whether the disclosures contained in our articles are covered by patents and advise readers to investigate this subject before making, using, or selling any of the products, machines, or processes described in order to avoid possible liability for patent infringements.



# SECURITY



**Y**ou want your family to be secure. But their security depends on you. If you are unhappy in your job, if you're in a "dead end," if you're just getting by . . . then you aren't secure . . . and neither is your family.

The best way to insure their security is to make the most of your ability. And that means training. It's the trained man who steps into that "better" job; and gets the promotions and the pay increases.

You can get that training from I. C. S. And you can get it at home . . . in your spare time. Yes, you can do it! The 100,000 men and women who are now studying with I. C. S. are proving that it can be done.

So fill out the coupon today! It lists over a hundred of the 400 I. C. S. Courses you have to choose from. You'll get full information and you'll be taking the first step toward real security for yourself and your family.

## INTERNATIONAL CORRESPONDENCE SCHOOLS

BOX 5518-L, SCRANTON 9, PENNA.

# 60

## th Anniversary

Without cost or obligation, please send me full particulars about the course BEFORE which I have marked X:

### Air Conditioning and Plumbing Courses

- Air Conditioning
- Heating
- Plumbing
- Refrigeration
- Refrigeration, Domestic
- Refrigeration & Air Conditioning
- Steam Fitting

### Aeronautics Courses

- Aeronautical Engineer's, Jr.
- Aircraft Drafting & Design
- Aircraft Mechanic
- Engine Mechanic

### Automotive Courses

- Automobile
- Auto Technician
- Auto Electric Technician
- Auto Body Rebuilding & Refinishing

### Chemical Courses

- Chemical Engineering
- Chemistry, Analytical
- Chemistry, Industrial
- Food-Plant Sanitation
- Petroleum Refining
- Pulp and Paper Making
- Plastics

### Civil Engineering and Architectural Courses

- Architecture
- Architectural Drafting
- Bridge and Building Foreman

- Building Estimating
- Civil Engineering
- Contracting and Building
- Highway Engineering
- Reading Structural Blueprints
- Sanitary Engineering
- Structural Drafting
- Structural Engineering
- Surveying and Mapping

### Communications Courses

- Electronics
- Practical Telephony
- Radio, General
- Radio Operating
- Radio Servicing
- Television
- Telegraph Engineering

### Electrical Courses

- Electrical Drafting
- Electrical Engineering
- Electric Light and Power
- Lighting Technician
- Practical Electrician

### Diesel Engines Courses

- Diesel Engines
- Internal Combustion Engines

### Mechanical Courses

- Forging
- Foundry Work
- Heat Treatment of Metals

- Industrial Engineering
- Industrial Instrumentation
- Industrial Metallurgy
- Machine Shop
- Mechanical Drafting
- Mechanical Engineering
- Mold-Loft Work
- Patternmaking—Wood, Metal
- Reading Shop Blueprints
- Sheet-Metal Drafting
- Sheet-Metal Worker
- Ship Drafting
- Ship Fitting
- Tool Designing
- Toolmaking
- Welding—Gas and Electric

### Railroad Courses

- Air Brake
- Diesel Locomotive
- Locomotive Engineer
- Locomotive Fireman
- Locomotive Machinist
- Railroad Section Foreman
- Steam-Diesel Locomotive Eng.
- Car Inspector

### Stationary Engineering Courses

- Power Plant Engineering
- Stationary Fireman
- Stationary Steam Engineering

### Textile Courses

- Cotton Manufacturing
- Loom Fixing
- Textile Engineering
- Rayon Mfg.
- Woolen Manufacturing

### Business and Academic Courses

- Accounting
- Advertising
- Bookkeeping
- Business Administration
- Business Correspondence
- Business Law
- Cartooning
- Certified Public Accounting
- Commercial
- Commercial Art
- Cost Accounting
- Fashion & Book Illustration
- Federal Tax
- First Year College
- Foremanship
- Good English
- High School
- Higher Mathematics
- Industrial Supervision
- Motor Traffic
- Personnel—Labor Relations
- Postal Civil Service
- Retailing
- Retail Business Management
- Salesmanship
- Secretarial
- Sign Lettering
- Stenography
- Traffic Management

Name \_\_\_\_\_ Age \_\_\_\_\_ Home Address \_\_\_\_\_

City \_\_\_\_\_ State \_\_\_\_\_ Working Hours \_\_\_\_\_ A.M. to \_\_\_\_\_ P.M.

Present Position \_\_\_\_\_ Employed by \_\_\_\_\_

Special tuition rates to members of the Armed Forces. Canadian residents send coupon to International Correspondence Schools Canadian, Ltd., Montreal, Canada.



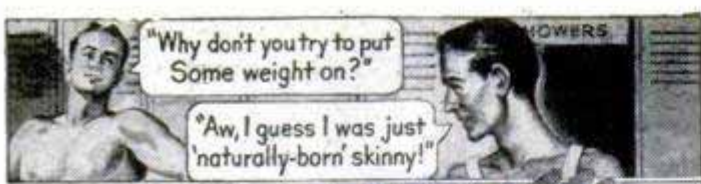

# BUNK! NOBODY IS JUST "Naturally" SKINNY!

Give Me 15 Minutes A Day And I'll Give YOU A New Body

WOULD you believe it? I was once a skinny 97-pound weakling. I was ashamed to strip for sports or for a swim. Girls snickered at me behind my back. Folks said I was just "naturally-born skinny!"

Then I discovered my marvelous new muscle-building system—"Dynamic Tension." And it turned me into such a complete specimen of manhood that today I hold the title, "The World's Most Perfectly Developed man."

## WHAT'S MY SECRET?

When you look in the mirror and see a healthy, husky fellow smiling back at you—then you'll be astonished at how fast "Dynamic Tension" gets results! And you'll be using the method which many great athletes use for keeping in condition—prize fighters, wrestlers, baseball and football players, etc.

"Dynamic Tension" is the easy natural method that you can practice in the privacy of your own room—just 15 minutes each day—while your scrawny chest and shoulder muscles begin to swell . . . those spindly arms and legs bulge . . . and your whole body starts to feel full of zip, self-confidence, new energy!

**FREE** My 48 Page Illustrated Book is Yours — Not for \$1.00 or 10c — But FREE

Send NOW for my famous book, "Everlasting Health and Strength," 48 pages, packed from cover to cover with actual photographs, valuable advice, answers to many vital questions. Page by page it shows what I can do for YOU. This book is a real prize for any fellow who wants a better build. Yet I'll send you a copy absolutely FREE. Just glancing through it may mean the turning point in your whole life! Rush the coupon to me personally: Charles Atlas, Dept. 8M, 115 East 23rd St., New York 10, N. Y.



CHARLES ATLAS, Dept. 8M,  
115 East 23rd St., New York 10, N. Y.

Send me—absolutely FREE—a copy of your famous book, "Everlasting Health and Strength"—48 pages, crammed with actual photographs, answers to vital health questions, and valuable advice to every man who wants a better build. I understand this book is mine to keep, and sending for it does not obligate me in any way.

Name..... Age.....  
(Please print or write plainly)  
Address.....  
City..... State.....



## ARE YOUR GUNS WORTH \$4.00?

That's all it costs for a whole year of the AMERICAN RIFLEMAN, big monthly magazine exclusively about guns. You'll get a real thrill from this grand old friend, long the favorite of shooter-sportsmen. Too, you'll get prompt notice

whenever your right to own and use your guns in sports is threatened by "anti-gun" legislation. And you can apply for membership in the National Rifle Association, with many extra benefits at no additional cost! Send only \$4.00 for an annual subscription now . . . and get a FREE copy of the NRA Manual HOW TO SHOOT A RIFLE (\$1 extra value), plus a confirming application for annual NRA membership.

**NATIONAL RIFLE ASSOCIATION**  
1608-D Rhode Island Ave., N.W., Wash. 6, D.C.

## Watch Repairing Pays Big Money Learn at home



Watchmakers in great demand. Train step-by-step under experts. We furnish all tools and 15 jewel watch and practice movement. Turn spare time into cash. 10 easy lessons. A licensed school. Low cost. Send for FREE book today.

**ILLINOIS SCHOOL OF WATCH REPAIRING**  
2870 Elston Ave., Dept. PM 12, Chicago 18, Ill.



No More Frozen Car Locks, Windshields, Garage Locks, Gas Caps, etc., with the

## JET LOCK DEFROSTER

This compact, precision-built, scientific instrument works on a chemically-proven principle and will defrost the most stubborn lock or frozen surface in about twenty seconds. A jet of superheated steam does the trick, and is guaranteed to work every time.

ONLY \$1.00

Postpaid or C.O.D. plus postage.

**COMMERCIAL SALES CO.**  
Dept. PM-12, 1303 Fulton Street, Brooklyn 16, N.Y.

## LEARN CARTOONING Get in the BIG MONEY

Former Landon students are really cleaning up. Creators of "Steve Canyon", "Freckles", "Out Our Way", "Winnie Winkle", "Regular Fellers", "The Neighbors", "Strange as it Seems" are just a few of them. Simplified Landon Picture Chart method makes progress quick, exciting, easy. Earn while learning. Rush 10c for Picture Chart (to test your ability) and full details. Please state age.



Landon School of Cartooning, 5112 CTS Bldg., Cleveland, O.



## Money In Hamsters

The new wonder animals from Syria. Often called Toy Bears. Delightful pets. Everyone wants them. Laboratories use thousands. Clean, odorless. Raise anywhere. NOW, spotted and golden breeds. We furnish breeders, equipment and manual of instruction. Write today for free illustrated literature.

**GULF HAMSTERY** 1536 BASIL ST., MOBILE 17, ALA.

## SHORTHAND in 6 Weeks at Home

Famous Speedwriting system. No signs; no symbols; no machines; uses ABC's. Easy to learn; easy to write and transcribe. Low cost. 100,000 taught by mail. For business and Civil Service. Also typing. 28th year. Write for FREE booklet to:

# Speedwriting

Dept. 1512-1, 55 W. 42 St., New York 18 (R)



Prepare in our  
Big Training  
Shops for these

# GREAT OPPORTUNITY FIELDS!



This big fire-proof building is occupied entirely by Coyne.

## TRAINED YOUNG AND OLDER MEN — VITALLY NEEDED IN NATION'S GIANT DEFENSE PROGRAM

Where do you fit in today's gigantic Defense Program and Industrial expansion? Trained young and older men will play an important part in vital fields. Electricity and Television-Radio are essential to our Defense Program in both Industry and Armed Forces. Don't wait to be assigned to a dull, low pay, no future job. Get training and be ready to pick one of many job opportunities or get a better rating if drafted. Today it's not how young or how old you are that counts, but how prepared you are for jobs that demand skilled men. So, whether you are 16 or up to 50 you are needed. Qualify now for:

1. **BETTER RATING, HIGHER PAY IF DRAFTED.**
2. **A VITAL JOB IN INDUSTRY, IF NOT IN DRAFT.**

### NOT "HOME-STUDY" COURSES

Our famous Television-Radio Practical-Technical method gives you practical experience on a massive outlay of equipment. Not by correspondence, but actual shop work plus necessary technical training. You are trained right here in the great Coyne shops that have been training men and young men for over 50 years.

## TELEVISION-RADIO      ELECTRICITY

A great opportunity field and vital to Defense. Here at COYNE you're trained for Construction, Testing, Trouble-Shooting on Radio, Public Address, Sound Units. Training includes FM, Television Installations, Servicing, etc. Many Coyne trained men in good jobs or own well paying Television-Radio businesses of their own.

### INCLUDING INDUSTRIAL ELECTRONICS

The Power behind the entire Defense Program. Big future in Power Plant Work, Motors, Armature Winding, Home and Factory Wiring, Appliances, Refrigeration, Maintenance, Illumination, etc. Lifetime job service to Coyne graduates. Send for BIG FREE BOOK.

## LARGEST, OLDEST, BEST EQUIPPED SCHOOL OF ITS KIND IN THE U.S.

### Mail Coupon for Big FREE Book!

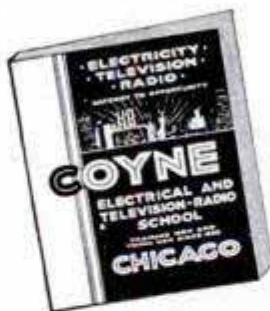

Whether you prefer Television-Radio or Electricity, train on actual equipment at Coyne. We will send you a Big, fully Illustrated Book, indicate below, which course interests you most. No salesman will call. Mail coupon TODAY.



### START NOW—PAY LATER

Don't let lack of money hold you back. You can finance most of your tuition and pay for it later, in easy monthly payments. Special plan for men of draft age. We'll help you get part time work, if you need it, to help pay living costs while at Coyne.

G. I. APPROVED

B. W. COOKE, President

# COYNE

SCHOOL

A TECHNICAL TRADE INSTITUTE  
CHARTERED NOT FOR PROFIT  
Established 1899  
500 S. Paulina Dept. 91-72H  
Chicago 12, Illinois

ELECTRICITY ★ TELEVISION ★ RADIO ★ REFRIGERATION ★ ELECTRONICS

B. W. Cooke, President  
COYNE SCHOOL, 500 S. Paulina St.  
Dept. 91-72H, Chicago 12, Ill.

Send me your Big Free book, and details of your special plan for men of draft age. I am interested in field checked below. This does not obligate me.

TELEVISION-RADIO       ELECTRICITY

NAME.....

ADDRESS.....

CITY.....STATE.....



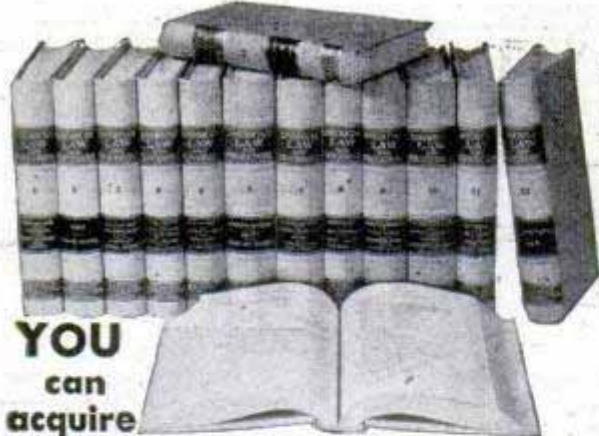

**YOU  
can  
acquire**

## LAW NIGHTS AT HOME! L. L. B. DEGREE

LaSalle's famous Law Library—used as reference in many Law libraries and Law offices—has enabled thousands to master Law surprisingly fast, in spare hours at home, for business and professional advancement.

These 14 remarkable volumes, compiled by leading professors and lawyers, cover the whole basic field of Law in condensed, orderly, simplified manner.

You advance rapidly with this great library, plus special lectures furnished. We guide you step-by-step with personalized Problem Method of instruction . . . you *learn by doing*—handling legal problems—not by memorizing rules.

Send for two FREE 48-page booklets, "Law Training for Leadership," and "Evidence," answering questions about Law and its value to you, and telling how LaSalle Law graduates are winning rapid advancement in business and public life. Mail coupon below. No obligation.

### LA SALLE EXTENSION UNIVERSITY A Correspondence Institution

417 S. Dearborn St. Dept. 1264L Chicago 5, Ill.

Send me your two FREE booklets described above, without obligation.

Name..... Age.....

Street.....

City, Zone & State.....

# No Experience Needed To PRINT YOUR OWN POST CARDS

The GEM STENCIL DUPLICATOR saves money . . . gets results quickly! Hundreds of uses for every type of business and organization. We ship the GEM complete with all supplies, Guide Board for accurate printing and 60-page Book of Ideas at the special low price of only \$8.50 (a \$15 value).

**FREE TRIAL OFFER**

Our  
21st Year

Use the GEM FREE at our expense! SEND NO MONEY. Write and complete GEM outfit will be sent you postpaid. After ten days, send us only \$8.50 or return the GEM. You must be satisfied!

**BOND EQUIPMENT CO. Dept. 48**  
6633 Enright • St. Louis 5, Mo.



## HOME PLANS THAT SAVE YOU MONEY

New popular Home Plan Books showing actual photos or color pictures (and floor plans) of over 233 popular sizes and styles of homes, Working drawings, material lists, specifications available for each plan—AT LOW COST. Order your books today.

Choice Selected Homes . . . . . 50c } Both Books Postpaid  
Over 75 designs, 32 in color, } \$1.00 2-to 4 bed-  
Ranch and Suburban . . . . . 50c } room sizes.  
158 designs, town and country.

America's Pioneer Residential Plan Service.

**L. F. GARLINGHOUSE CO., INC., Box PM-13 TOPEKA, KANSAS**

# RUPTURE

RELIEF...OR YOUR MONEY BACK  
Users say it's the best ever,  
widely copied never matched.  
Unconditionally guaranteed.  
Write for free book.



**WEB TRUSS CO., Dept. M-12, Hagerstown, Md.**



## ITALIAN ACCORDIONS

Hand Made. Very Best. Buy Direct from Factory Representative at lowest wholesale prices and Save Money. Send Name and Address for FREE catalog.

**ITALIAN ACCORDION MFG. CO.**  
7600 Cottage Grove Ave., Dept. PM-12, Chicago 19, Ill.

# REAL ESTATE BE A BROKER

**PAYS BIG! SEND FOR FREE, BIG, ILLUSTRATED CATALOG NOW!** No obligation. Graduates report making substantial incomes. Start and run your own business quickly. Men, women of all ages, learn easily. Course covers Sales, Property Management, Appraising, Loans, Mortgages, and related subjects. **STUDY AT HOME** or in our classrooms in big cities. Diploma awarded. G.I. approved. Nationally known.

**WEAVER SCHOOL OF REAL ESTATE (Est. 1936)**  
Suite 300 Law Bldg., Dept. PM, Kansas City, Mo.

FREE  
BOOK  
TELLS  
HOW

Don't Neglect Slipping

# FALSE TEETH

Do false teeth drop, slip or wobble when you talk, eat, laugh or sneeze? Don't be annoyed and embarrassed by such handicaps. **FASTEETH**, an **alkaline** (non-acid) powder to sprinkle on your plates, keeps false teeth more firmly set. Gives confident feeling of security and added comfort. No gummy, goopy, pasty taste or feeling. Get **FASTEETH** today at any drug store.

## TRIAL PLAN makes it easy to start

HERE'S THE AMAZING WAY TO

# BE AN ARTIST



Let us prove we can teach you to draw at home in your spare time!

Commercial Art, Designing, Cartooning—all in one complete course—only WSA offers you this art training, famous since 1914. TWO big artist's outfits furnished. Send today for new, illustrated free booklet that shows how you can enjoy a profitable art career—and tells success stories of our graduates.

## MAIL COUPON FOR FREE BOOK

**WASHINGTON SCHOOL OF ART**  
Studio 1212A, Washington 5, D. C.

Send Free Book, "Art for Pleasure & Profit."  
No salesmen. (Please print)

Name..... Age.....

Street.....

City..... Zone..... State.....

I am interested in your new Trial Plan





GET INTO A

# MONEY MAKING TRADE-NOW!



L. J. ROSENKRANZ, President

## LET ME SEND YOU THESE BIG FREE BOOKS!

These Big FREE Books and Sample Lessons show how we train you. Get all the facts—send today for your choice of our valuable book on Radio-Television, OR Diesel-Automotive Opportunity. Check coupon at right. No cost or obligation.

## TAKE YOUR CHOICE OF 2 BIG FIELDS OF

# RADIO TELEVISION ELECTRONICS

## TODAY'S SHORTAGE OF TRAINED TECHNICIANS CREATES BONUS OPPORTUNITY FOR YOU!

Radio, Television, Electronics is a dominant factor in the national emergency. How well these essential services will do the big job they have been given depends upon the supply of trained men. Prepare yourself now to step into a good-paying job with a real future! New developments in color TV, guided missiles, radar, other electronics fields are only the beginning! National Schools Master Shop Method Home Training is complete—you master all phases of Radio, Television, Electronics.

### WE SEND YOU EVERYTHING YOU NEED TO LEARN AT HOME

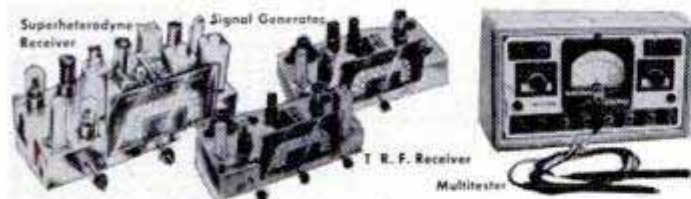

Above are some of experimental units you build with kits of standard parts we send you: Signal Generator, Audio Oscillator, T. R. F. Receiver and many other units and circuits, including a big modern Superheterodyne Receiver. We send you all the tubes and a valuable professional quality Multimeter. No extra charges. You learn by doing!

### HAVE A PROFITABLE BUSINESS OF YOUR OWN

National training qualifies you for your choice of many job opportunities in radio and television broadcasting, manufacturing, servicing, sales. Also installation & maintenance of laboratory electronics equipment, sound systems, police radio, and many others. You can start a good paying business of your own, as many other National Schools graduates have done!

### TELEVISION TRAINING

A complete series of up-to-the-minute TV lessons is an important part of your course. They cover all phases of TV repairing, servicing and construction.

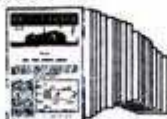

# NATIONAL SCHOOLS

Technical Trade Training Since 1905  
Los Angeles 37, California

## GET THE FACTS . . . MAIL COUPON TODAY

National Schools, Dept. B-121  
4000 South Figueroa Street  
Los Angeles 37, California

Mail in envelope or paste on penny postal

Send me Free the book checked below and the sample lesson. I understand no salesman will call on me.

- "My Future in Radio, Television & Electronics."
- "My Future in Diesel, Automotive & Allied Mechanics."

NAME \_\_\_\_\_ AGE \_\_\_\_\_

ADDRESS \_\_\_\_\_

CITY \_\_\_\_\_ ZONE \_\_\_\_\_ STATE \_\_\_\_\_

Check here if you were discharged from the service less than 4 years ago.

Use coupon to get your choice of these FREE illustrated books and actual sample lessons.

Let National Schools, of Los Angeles, a practical Technical Resident Trade School for almost 50 years, train you for today's unlimited opportunities.



APPROVED FOR ELIGIBLE VETERANS

# OPPORTUNITY DIESEL AUTOMOTIVE & ALLIED MECHANICS



## IF YOU LIKE MECHANICS, THERE'S A BRIGHT FUTURE FOR YOU IN DIESEL-AUTOMOTIVE!

Trained engine mechanics are needed in increasing numbers in the Armed Forces and civilian production—everywhere that engine power is used! National Schools gives you complete training for this great industry.

### YOU GET MASTER SHOP METHOD TRAINING RIGHT IN YOUR HOME

With our practical home training, you learn Diesel Fuel Injection, Automotive Motor Tune-up, Diesel Engine Maintenance, General Garage Mechanics, Thermodynamics, Auto Electrical Service and all other phases. Your National Course covers Gasoline and Special Fuel Engines; Diesels, High Speed and Heavy Duty; Semi-Diesels; Allied Mechanics. Get all the facts—use the coupon above.

### WE SEND YOU TOOLS OF YOUR TRADE

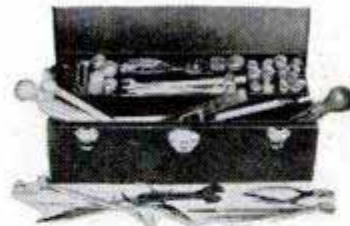

In addition to all lesson texts, Diesel Chart Manual, Spare Time Lessons, Service Manuals & other material, you receive a full kit of high-quality tools and equipment... all a part of your course.

No extra charge for this valuable kit of tools and equipment.

### EARN WHILE YOU LEARN

You can earn extra money and get valuable experience in spare time. Special Spare Time Work Lessons show you how! Many National students pay for all or part of their course this easy way.

Use the coupon now to get valuable Free Book about the great Diesel-Automotive Industry and the Sample Lesson, plus full information about how we train you.

**BOTH RESIDENT & HOME STUDY COURSES OFFERED**



SHAVES A WEEK'S  
GROWTH SLICK  
AS ONE DAY'S



**Whisker** THE SHAVER

**THAT CONVINCED THE BARBERS**  
Many Barbers use a *Whisker* to shave themselves and recommend it to customers. *Whisker's* refined hair-clipper action and .002" thin blade removes 1 to 7 day beards clean and close. Fast ... 14,400 strokes per minute. Quiet ... operates on 110 v., 60 cycle AC. No TV or radio interference. Women like *Whisker*, too, for safely removing superfluous hair on legs and under arms. Get *Whisker* at your Barber or Dealer.  
**ELECTRO TOOL CORPORATION**  
DEPT. W521-M • RACINE, WISCONSIN

See your Barber or Dealer. If he cannot supply you,  
**USE THIS COUPON TO ORDER**

**ELECTRO TOOL CORP., Dept. W521-M, Racine, Wis.**

- Enclosed find \$15.95 (check or money order).  
Send *Whisker* POSTPAID.  
 Enclosed find \$5. Send *Whisker* C.O.D.  
I'll pay postman balance plus postage.

Name \_\_\_\_\_

Address \_\_\_\_\_

City \_\_\_\_\_ Zo. \_\_\_\_\_ State \_\_\_\_\_

**High School  
at Home**

**Many Finish in 2 Years**

No classes. No time wasted going to and from school. Progress as fast as your time and abilities permit. Standard H. S. texts supplied. Thousands enroll each year in this 54-year-old school. Send for FREE descriptive booklet.

**AMERICAN SCHOOL, Dept. H945  
Drexel at 58th St., Chicago 37, Ill.**

Without obligation, please send FREE descriptive booklet.

Name \_\_\_\_\_

Address \_\_\_\_\_

How to Always Have **HOT WATER**

Make Your Own Automatic Electric Water Heater **\$19.95**  
now for only

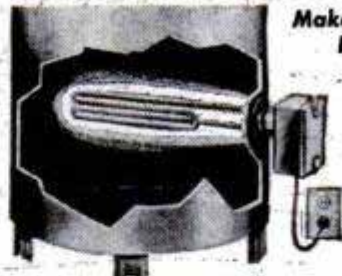

**ONE YEAR GUARANTEE**  
U. L. Approved Heater

**INSTALL IN 5 MIN.**  
No disturbing or draining of tank or pipes

Why suffer without hot water? Enjoy lots of it to wash, bathe, shave. Heater keeps water HOT in your present tank. Turns ON when needed—shuts OFF when water is heated. No flue, dirt, fire!

Ideal for 30-gal. tanks! Heater screws into any size boiler tap as shown. Plugs into outlet ... 1320 w. 110 v. AC. (Also 2000 w. 220 v. model for BX cable \$19.95) ... works automatically thereafter. Temperature adjustable between 120 to 180 degrees. Replaces coal, oil, gas in home, store, summer cottage, green house, farm, barn, stock tank, poultry scalding, factory. Uses only 1/4 to 1/2¢ electricity per gallon hot water. Why burn expensive main furnace unit for hot water? Send check or M. O. NOW; save postage, shipping charges. **ORDER NOW ... TODAY. Money back in 10 days if not delighted.**

**COLLOID EQUIPMENT CO., INC.** Dept. PM12, 50 Church Street, New York 7, N. Y.

**LAW FREE BOOK**



Your **FREE** copy of "The Law-Trained Man" shows how to gain prestige and greater earnings through Blackstone home law study. All instruction material furnished including 17-volume Law Library written by 65 well-known law authorities. Lawyers, judges among our graduates. LL.B. degree. Low cost; easy terms. Write today.

**BLACKSTONE COLLEGE OF LAW** 225 N. Michigan Ave. Dept. 59, Chicago 1, Ill.  
A Correspondence Institution Founded in 1890

**Learn ACCOUNTING BOOKKEEPING**

This nationally renowned school has demand for graduates in good salary positions thru National recognition and placement service. Write Department PME today for Big 32 page Success Book to be sent to you **FREE**



**Hills BUSINESS UNIVERSITY AND EXTENSION SCHOOL**  
619 W. MAIN ST. OKLAHOMA CITY 2, OKLAHOMA

**LEARN MEAT CUTTING**  
At Home — In Spare Time



Get into the vital meat industry. Concise, practical Home Training based on 25 years proven instruction methods used at National's famous resident school. Prepares you for bigger pay as Meat Cutter, Supervisor, market manager or more money in your own store. Go as rapidly as your spare time permits. Diploma. Start NOW to turn your spare hours into money. Send for FREE bulletin today. No obligation.

**NATIONAL SCHOOL OF MEAT CUTTING, INC., Div. U-135, Toledo 4, Ohio**

**LEARN WATCH REPAIRING**



**AT HOME.** By our modern and original system of instruction you can learn every part of the **WATCH REPAIRING TRADE AT HOME.** Prepare yourself for a well-paying position or start in business after completing our course of instruction. Good watch repairers are in demand and generally earn very good salaries. For particulars apply to the **WISCONSIN SCHOOL OF WATCH REPAIRING** 759 North Milwaukee St., Milwaukee 2, Wis.

**"It Measures As It Rolls"**  
**ROLLER RULE**  
**HANDY MECHANICAL PENCIL**  
Measures Curves and Straight Lines. Any Shape. Any Distance. Any Surface.

**\$1.29**  
POST PAID

Roll head over surface. Inches and fractions record accurately on "Inch-O-Meter". Excellent pencil too! Order Now! **10 Day Money Back Guarantee!** C.O.D. (postage extra). In Calif. add 3% Sales Tax.

**PENCIL SALES CO., Dept. PM12**  
Room 6, 1213 E. Ocean Blvd., Long Beach, California



**NOW... GET EVERYTHING YOU  
NEED TO LEARN AND MASTER**

# TELEVISION

**RADIO-ELECTRONICS  
...AT HOME!**

Use REAL commercial-type equip-  
ment to get practical experience

Your future deserves and needs every advantage you can give it! That's why you owe it to yourself to find out about one of the most COMPLETE, practical and effective ways now available to prepare AT HOME for America's billion dollar opportunity field of TELEVISION-RADIO-ELECTRONICS. See how you may get and keep the same type of basic training equipment used in one of the nation's finest training laboratories... how you may get real STARTING HELP toward a good job or your own business in Television-Radio-Electronics. Mail the coupon today for complete facts — including 89 ways to earn money in this thrilling, newer field.



**Here's the  
REAL THING!**

**SET UP YOUR OWN  
HOME LABORATORY**

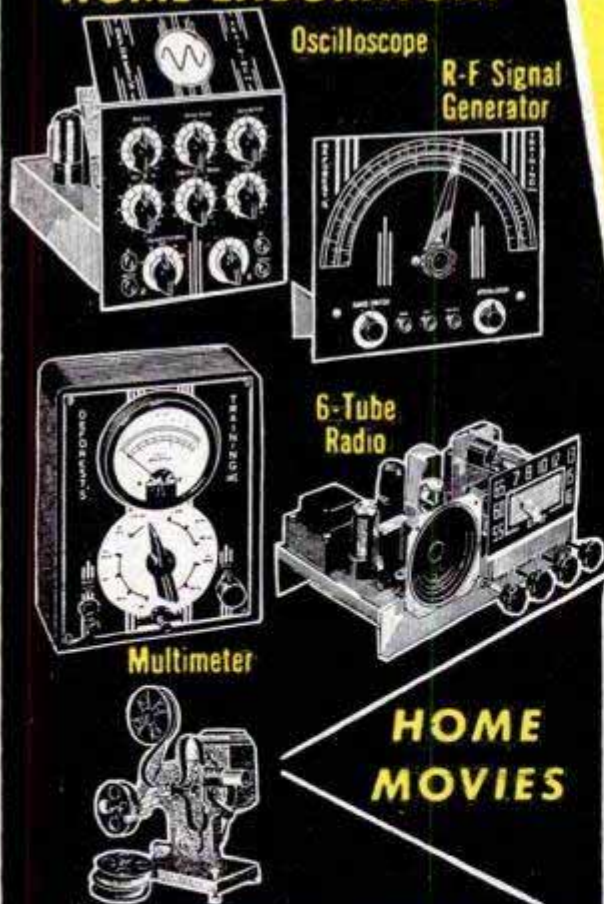

Oscilloscope

R-F Signal  
Generator

6-Tube  
Radio

Multimeter

**HOME  
MOVIES**

ABOVE: Build and keep a real 16 INCH commercial TV receiver. Optional after completing regular training at moderate added cost.

**D.T.I., ALONE, INCLUDES BOTH MOVIES and HOME LABORATORY**  
In addition to easy-to-read lessons, you get the use of HOME MOVIES — an outstanding training advantage — plus 16 big shipments of Electronic parts. Perform over 300 fascinating experiments for practical experience. Build and keep real commercial-type test equipment shown at left.

**MODERN LABORATORIES**

If you prefer, get all your preparation in our new Chicago Training Laboratories—one of the finest of its kind. Ample instructors, modern equipment. Write for details!

**'MILITARY SERVICE!'**

If you're subject to military service, the information we have for you should prove very helpful. Mail coupon today.

**Get BOTH of these  
information packed  
publications FREE!**



**ACT NOW! MAIL COUPON TODAY!**

DeFOREST'S TRAINING, INC., Dept. PM-12-H  
2533 N. Ashland Ave., Chicago 14, Ill.

Without obligation, I would like your late News-Bulletin showing 89 ways to earn money in Television-Radio-Electronics... and how I may prepare to get started in this thrilling field.

Name..... Age.....  
Street..... Apt.....  
City..... Zone..... State.....

**De FOREST'S TRAINING, INC.**  
CHICAGO 14, ILLINOIS  
A De VRY INSTITUTION



# Throw Away NICOTINE\*



Switch to

# MEDICO FILTER PIPES



\* When filter turns brown—in Medico Pipes or Cigarette Holders—throw it away, with the nicotine, juices, flakes and tars it has trapped. Insert fresh filter for cooler, cleaner, drier, sweeter smoking. Imported Briar.

**NEW: MEDICO CREST—\$3.00**  
Finest Medico ever! Exquisite Burgundy finish.  
**MEDICO V.F.Q. — \$2.00**  
**MEDICO MEDALIST—\$1.50**

Wide variety of styles and sizes.  
Write S. M. Frank & Co., N.Y., for Booklet M

**MEDICO CIGARETTE HOLDERS—\$1**

# AERONAUTICAL ENGINEERING

Design Aircraft & Components—Study with Jets & Rockets—  
Great Future—Advanced Aeronautical Subjects—World-Wide  
Enrollment—Fully Accredited—Established 1929—Approved  
for Vets—CAL-AERO grads in heavy demand.

WRITE TODAY for Special Information. PM-12

NAME \_\_\_\_\_ AGE \_\_\_\_\_  
ADDRESS \_\_\_\_\_  
CITY \_\_\_\_\_ ZONE \_\_\_\_\_ STATE \_\_\_\_\_

**CAL-AERO TECHNICAL INSTITUTE**  
GRAND CENTRAL AIR TERMINAL • GLENDALE 1, CALIFORNIA

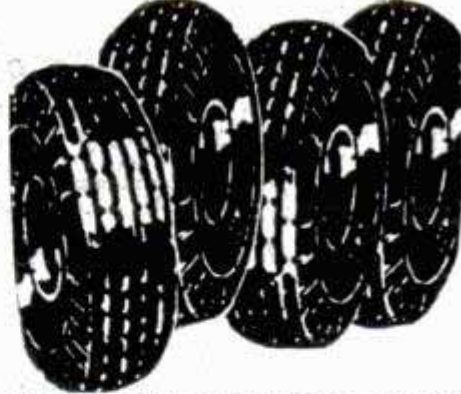

WRITTEN GUARANTEE SENT WITH EVERY TIRE YOU BUY

PLEASE NOTE: Our Tires are NOT Retreaded or Re-Capped

GOOD USED TIRES

A TRIAL OF ONE TIRE WILL CONVINCE YOU.

TUBE GIVEN WITH EACH PASSENGER & TRUCK TIRE AT NO EXTRA COST—SEND THIS AD!

If your size is not listed, write for prices. 18 YEARS AT THIS ADDRESS

600x16 \$5.12	670x15 \$6.12	710x15 \$6.12	760x16 \$7.72
650x15 5.52	700x15 5.92	750x16 6.52	820x15 6.72
650x16 5.52	700x16 5.42	760x15 5.92	850x17 5.22



600x20 \$9.52	32-6(8) \$10.42	1000x20 \$18.02
650x20 9.52	32-6(10) 13.82	1100x20 18.42
700x20 11.62	825x20 17.92	1000x22 17.42
750x20 11.92	900x20 17.72	1100x22 18.02

No extra charge for tubes—Tube given with every pass. and truck tire purchased, regardless of grade.

600x16 \$5.39	670x15 \$6.20	710x15 \$6.32	760x16 \$7.95
650x15 5.75	700x15 6.50	750x16 6.86	820x15 6.95
650x16 5.86	700x16 5.75	760x15 6.42	850x18 5.02



600x20 \$9.75	32x6(10) \$14.02	1000x20 \$18.35
650x20 9.95	750x16(8) 8.95	1100x20 18.35
700x20 11.75	825x20 18.50	1000x22 17.35
750x20 12.75	900x20 18.50	1100x22 18.35

Thousands of tires shipped all over U.S.A. All tires shipped F.O.B. Phila. Send Check or M.O. with this ad. Dept. 2.

**STANDARD 834 N. Broad St., Philadelphia 30, Pa.**

## STOPS FOGGY WINDSHIELDS NEW Chemical Mitt



Amazing Discovery! Autoists will love new FOG-STOP Windshield Cleaner. Simply glide over windshield chemically-treated Mitt—at once glass sparkles crystal clear. Blurry mist, frost, sleet, snow disappear like magic. Stops fogging. *Sells like wild!*

**SAMPLES FOR AGENTS** Sample offer sent immediately to all who send name once. Hurry. Postcard will do. **SEND NO MONEY—just your name.** KRISTEE CO., Dept. 689, AKRON 8, OHIO

## 'How to MAKE MONEY with Simple CARTOONS'



A book everyone who likes to draw should have. It is free; no obligation. Simply address **FREE BOOK**

**CARTOONISTS' EXCHANGE**  
Dept. 912A Pleasant Hill, Ohio

## BOYS-IT'S FREE!



### "THE WONDERS OF CHEMISTRY"

This exciting new book shows how to amaze your friends with chemical magic, describes many fascinating home experiments, tells of fun, thrills and big future opportunities for boys who know chemistry. Special atomic energy feature. Send today!

**THE PORTER CHEMICAL COMPANY**  
141 Prospect Avenue, Hagerstown, Maryland

# RUPTURED?

Get Relief This Proven Way

Why try to worry along with trusses that gouge your flesh—press heavily on hips and spine—enlarge opening—fail to hold rupture? You need the Cluthe. No leg-straps or cutting belts. Automatic adjustable pad holds at real opening—follows every body movement with instant increased support in case of strain. Cannot slip whether at work or play. Light. Waterproof. Can be worn in bath. Send for amazing **FREE** book, "Advice To Ruptured" and details of liberal truthful 60-day trial offer. Also endorsements from grateful users in your neighborhood. Write:

**CLUTHE SONS, Dept. 31, Bloomfield, New Jersey.**



**NOW!**

**BRAND-NEW,  
UP-TO-THE-MINUTE**

**Edition of Famous Manual**

# MAKES *Any* AUTO REPAIR JOB

## Your "Meat!"

**ENLARGED!**

MORE Words!  
771 BIG Pages!  
More Chapters! More Facts!

**REVISED!**

MORE Pictures—  
Over 2300 In All! Covers  
ALL Automatic Transmissions!

**NEW!**

Now You Can Repair  
ALL 1951 MODELS—As Well  
As Any Car Built Since 1935!

**TRY BOOK FOR A WHOLE WEEK—FREE**

*Return and Pay Nothing if Not Satisfied!*

HERE it is! — the brand-new, revised, enlarged 1951 edition of MOTOR'S Auto Repair Manual! Now you can "lick" any auto repair job on any car built since 1935 — including all 1951 models! Just look up make, model, and job in quick index — and go to it.

### EVERYTHING YOU NEED TO KNOW TO REPAIR ANY CAR!

771 BIG pages; 2300 "how-to-do-it" pictures; 200 "quick-check" specifications, charts, and tables; over 225,000 facts make every operation a "snap"! Includes ALL automatic transmissions; new GM Rochester carburetor. Beginners will find in this giant book the most helpful guidance on every kind of service and repair job imaginable. Expert mechanics will be amazed by the short-cuts they'll discover.

#### Win Prestige! Earn More Money!

Factory engineers from every auto plant in America worked out these time-saving procedures. Now you get all this wealth of "know-how" from over 150 Official Shop Manuals, "boiled down" into clear terms in one handy book! Now you can tackle jobs you wouldn't think of trying before. And you'll

win more prestige, more money!

Right at your fingertips you have every "How-to-do-it" fact you want. Over 38,000 essential dimensions on 800 car models! Whether you want to make a simple carburetor adjustment or completely rebuild a transmission, step-by-step instructions show exactly WHAT to do, HOW to do it. Used by U. S. Army, technical schools, thousands of auto service men.

Used by  
U. S. ARMY  
and NAVY

**COVERS 800  
MODELS—ALL  
THESE MAKES!**

Buick Ford  
Cadillac Frazer  
Chevrolet Henry J.  
Chrysler Hudson  
Crosley Kaiser  
De Soto Lafayette  
Dodge La Salle

Lincoln  
Mercury  
Nash  
Nash Rambler  
Oldsmobile  
Packard  
Plymouth  
Pontiac  
Studebaker  
Terraplane  
Willlys

ALSO complete tune-up adjustments for:  
American Bantam •  
Auburn • Austin •  
Cord • Graham •  
Hupmobile • Pierce  
Arrow • Reo

### SEND NO MONEY

Send no money. Enjoy this brand-new book—at our risk—for a full week, FREE! Test it right in your own garage or shop. If book doesn't more than pay for itself in 7 days, simply return it and pay nothing. Mail coupon NOW to MOTOR Book Dept., Desk 112, 250 West 55th St., New York 19, N. Y.

**MOTOR**

Published  
by MOTOR  
The Leading  
Automotive  
Business  
Magazine



ABOVE—Showing operation of Buick Dyna-Flow — and BELOW: How to Adjust Ford Clutch. Every moving part is covered in simple words and BIG, CLEAR Pictures.

### Same FREE Offer on MOTOR'S TRUCK & TRACTOR MANUAL



Covers EVERY job on EVERY popular make gasoline truck and farm tractor built from 1936 thru 1951! Over 1400 pictures, 925 pages, 300,000 facts. All types Gasoline Engines, Fuel Systems, Governors, Lubrication, Ignition, Starters, Clutches, Axles, Brakes, etc., etc.

ALSO covers many buses, contractor and road building equipment, stationary power machinery. Check box in coupon.

### MAIL COUPON NOW FOR 7-DAY FREE TRIAL

**MOTOR BOOK DEPT.**  
Desk 112, 250 West 55th St., New York 19, N. Y.

Rush to me at once (check box opposite book you want):  
 MOTOR'S New 1951 AUTO REPAIR MANUAL. If O.K., I will remit \$1 in 7 days (plus 35c delivery charges), \$2 monthly for 2 months and a final payment of 95c one month after that. Otherwise I will return the book postpaid in 7 days. (Foreign price, remit \$8 cash with order.)  
 MOTOR'S New 1951 TRUCK & TRACTOR REPAIR MANUAL. (Described at left.) If O.K., I will remit \$2 in 7 days, and \$2 monthly for 3 months, plus 35c delivery charges with final payment. Otherwise I will return book postpaid in 7 days. (Foreign price, remit \$10 cash with order.)

Print Name.....Age.....

Address.....

City.....State.....

Check box and save 35c delivery charge by enclosing WITH coupon entire payment of \$5.95 for Auto Repair Manual (or \$8 for Truck & Tractor Repair Manual). Same 7-day return-refund privilege applies.



# Stop

## Work Glove Discomfort...



### WEAR WOLVERINE PIGSKINS

#### They Dry Soft... STAY SOFT

It's almost unbelievable that any work gloves can be so hickory-tough—outwear all others—and still be as soft as fine buckskin. It's true of *Wolverine Pigskins*, though. Here's why. They're made of finest native pigskin tanned by the same secret process used for Wolverine Shell Horsehide Work Shoes. Try a pair and FEEL the difference.

**FREE Wolverine Pencil** No obligation . . .  
Just write for name of nearest Wolverine dealer and we'll send you this fine mechanical pencil FREE! Offer limited to Continental U.S. only.

### WOLVERINE

Dept. HG-12 Rockford, Mich.

## Learn this Profitable Profession



### IN 90 DAYS AT HOME

#### Money-Making Career Open to Men and Women, 18 to 60

Hundreds of men and women between 18 and 60 make \$10 to \$20 in a single day giving scientific Swedish Massage and Hydro-Therapy treatments. There is big demand from doctors, hospitals, sanatoriums and clubs. Graduates earn large full time incomes from these or in private practice in their own offices. Others make good money from home treatments given in spare time. Learn this interesting money-making profession in your own home, through our home study course. Same instructors as in our nationally known resident school. You can win independence and prepare for future security by qualifying for your Diploma. Course can be completed in 3 to 4 months. Many earn while they learn. Begin your training at once.



#### NEW 32-PAGE BOOKLET FREE

Fill in the coupon below (please print name and address) and mail it for your FREE copy of 32-page Information Booklet. If you act at once we will include Anatomy Charts and Success Booklet which supply additional information you should have. All will be sent postage paid.

THE COLLEGE OF SWEDISH MASSAGE  
Dept. 164R, 41 E. Pearson St., Chicago 11, Illinois  
Please send me FREE and postpaid New 32-Page Illustrated Booklet, Anatomy Charts and Success Booklet at once.

Name \_\_\_\_\_ Age \_\_\_\_\_  
Address \_\_\_\_\_  
City \_\_\_\_\_ State \_\_\_\_\_

## MAKE EXTRA MONEY PLASTICS LEARN AT HOME

LEARN HOW TO MAKE fast selling PLASTIC NOVELTIES FURNITURE JEWELRY SIGNS TOYS LAMPS

There are RICH OPPORTUNITIES for MEN and WOMEN with "know-how" in Plastics. Interstate's amazing new Plastics course tells and shows how to make hundreds of fast selling items out of Plastics. Gives complete training in fabrication, casting, lamination, molding, etc., in simple, easy, step-by-step language and pictures.

START A PLASTICS BUSINESS OF YOUR OWN. No other industry holds such promise for the future. You can make big money manufacturing novelties, toys, signs, etc., in your own home in spare or full time. Don't wait! Learn NOW how Interstate's Plastics Training qualifies you for success in the plastics field.

Write for FREE Information Today!

### INTERSTATE TRAINING SERVICE

School of Plastics  
PORTLAND 13, OREGON (Dept. C-3N)

## Rupture Troubles Ended

Advanced method has healed thousands. No leg straps, no elastic, no plasters. No pressure on hips or spine. Flexo-pad. Entirely different. Endorsed by doctors, mechanics, clerks. Very light. **INEXPENSIVE. GUARANTEED.** Write for information and trial.

SMITH MANUFACTURING COMPANY  
EST'D 1893 DEPT. PM PRESTON, ONTARIO

## TASOPE PHOTO-ENGRAVING PLANTS



Establish your own profitable PHOTO-ENGRAVING business. Make cuts for newspapers, printers, and advertisers. Make etched name plates, plaques etc. Instructions furnished, no experience necessary. Sold direct from factory since 1931. First five hundred cuts sold locally or by mail will pay for plant and pay you well for your time. Write for FREE catalog.

Material Cost Of This Cut 3/4c Selling Price \$1.00 And Up

TASOPE DEPT. PM10, AURORA, MO.

## Bar Bells



Buy Direct From Factory \$8.95 up  
Approved and Recommended by Karl Koberle (Foremost Ex-Army Instructor on Weight Training).  
Write for free booklet and price list.  
**INDEPENDENT IRON WORKS**  
2416 East 23rd Street, Dept. C  
Los Angeles 58, Calif.

## Learn CARTOONING

HAVE FUN! MAKE MONEY! Cash in on your sense of humor at HOME—BY MAIL. No experience needed to start. Write today for FREE TRIAL LESSON and full particulars.



MOON Gag Cartoon School, Dept. N, Fall Creek, Wis.

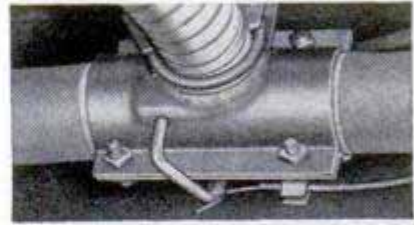

## HURRICANE CUT-OUT EXHAUST

This specially engineered cut-out enables you to install special pipes and mufflers without removing the original muffler.

Now control your exhaust tone from a dash control button. Cut back into your original muffler in restricted areas at will. Fits all exhaust pipes from 1 3/4" to 2 1/4" size.

This cut-out is well constructed; actually strengthens exhaust pipe; made of heavy plate steel, designed for easy installation—no special tools required. Sent post-paid for only \$6.95 check or money order. Satisfaction guaranteed or your money back.

ST. LOUIS PRODUCTS CO., Box 24-A, Normandy 21, Mo.



# NOW-Be a Fully Trained, Qualified RADIO TELEVISION TECHNICIAN IN JUST 10 MONTHS OR LESS!



**I Send You  
18 BIG  
KITS  
OF RADIO-  
TELEVISION  
EQUIPMENT**



**TRAIN AT  
HOME IN  
SPARE HOURS!**

**New "Package" Unit Training Plan—Pay As You Learn—You Set The Pace!—No Monthly Payment Contract to Sign!—Train at Home in Spare Hours!**

Now . . . be ready for Radio-Television's big pay opportunities in a few short MONTHS! Frank L. Sprayberry's completely new "Package" training unit plan prepares you in just 10 MONTHS . . . or even less! There is NO monthly payment contract to sign . . . thus NO RISK to you! This is America's finest, most complete, practical training—gets you ready to handle any practical job in the booming Radio-Television industry. In just 10 months you may start your own profitable Radio-Television shop . . . or accept a good paying job. Mr. Sprayberry has trained hundreds of successful Radio-Television technicians—and stands ready to train you in less than one year, even if you have no previous experience!

### Valuable Equipment Included With Training

The new Sprayberry "package" plan includes many big kits of genuine, professional Radio-Television equipment. While training, you perform over 300 demonstrations, experiments and construction projects. In addition, you build a powerful 6-tube standard and short wave radio set, a multi-range test meter, a signal generator, signal tracer, many other projects. All equipment is yours to keep . . . you have practically everything you need to set up your own service shop. The Sprayberry book-bound lessons and other training materials . . . all are yours to keep.

### Earn Extra Money While You Learn!

All your 10 months of training is AT YOUR HOME in spare hours. Keep on with your present job and income while learning . . . and earn EXTRA CASH in addition. With each training "package" unit, you receive extra plans and ideas for spare time Radio-Television jobs. Many students pay for their entire training this way. If you expect to be in the armed forces later, there is no better preparation than good Radio-Television training.

## FREE 3 BIG RADIO-TELEVISION BOOKS

I want you to have ALL the facts about my new 10-MONTH Radio-Television Training—without cost! Rush coupon for my three big Radio-Television books: "How to Make Money in Radio-Television," PLUS my new illustrated Television Bulletin PLUS an actual sample Sprayberry Lesson—all FREE. No obligation and no salesman will call. Mail coupon NOW! I will rush all three books at once!

Sprayberry Academy of Radio, Dept. 10-D  
111 North Canal St., Chicago 6, Ill.

**Mail  
Coupon  
Today!**

**SPRAYBERRY ACADEMY OF RADIO, Dept. 10-D  
111 North Canal St., Chicago 6, Ill.**

Please rush to me all information on your 10-MONTH Radio-Television Training Plan. I understand this does not obligate me and that no salesman will call upon me.

Name . . . . . Age . . . . .  
Address . . . . .  
City . . . . . Zone . . . . . State . . . . .

Please Check Below About Your Experience  
 Are You Experienced?  No Experience

**IF YOU ARE  
EXPERIENCED IN RADIO**

Men already in Radio who seek a short intensive 100% TELEVISION Training with FULL EQUIPMENT INCLUDED are invited to check and mail the coupon at the right.

**NO OBLIGATION  
No Salesman  
Will Call**



**For  
FUN  
and  
PROFIT  
learn  
to  
MOUNT BIRDS**



**AND ALL KINDS OF ANIMALS**

**SPORTSMEN, SAVE YOUR TROPHIES!** Learn at home in spare time to mount all kinds of birds and animals. Decorate your den with trophies of field and stream. We teach you this **FASCINATING SPORTSMEN'S HOBBY**. Quickly, easily learned. Wild game is growing **scarcer**. Trophies now more valuable than ever! Shoot **FEWER** and **MOUNT** them true to life. **IT'S PROFITABLE!** Many report earning \$25 to \$75 a month mounting specimens for hunters. Why not **YOU?** Learn to make **USEFUL** articles from mounted specimens such as book ends, lamps, etc., etc. (See squirrel lighter to left.)

**WILD GAME NOT NEEDED.** If you hunt you can mount **COMMON** specimens: Owls, crows, pigeons, hawks, rabbits, even frogs. **Real FUN.**

**LEARN TANNING** We also teach you to tan furs soft and pliable and new method to **TAN GENUINE LEATHER** from all kinds of hides. Great spare time money maker.

**FREE BOOK** Send right now for beautiful free 48-page booklet, illustrated, telling how easily **YOU** can learn to be a Taxidermy Artist. Contains many fine pictures. Intensely interesting. Get **YOUR** copy today. No cost or obligation. **Send now!** State **AGE**. N. W. SCHOOL of TAXIDERM, 2512 Elwood Bldg., Omaha, Neb.

**Can a Man MY Age Become a  
Hotel Executive  
Even Though He Has No Previous Hotel  
Experience?**

Would you like to step into a well-paid position in a Hotel, Club, Restaurant, essential Defense Cafeteria or Housing Project? Would you like to look forward happily to the future? The success of Lewis graduates from 18 to 50 **PROVES** you can — though you have no experience in hotel work.

**Harry E. Roorbach Wins Success as  
Hotel Executive**

"While I was in the hospital awaiting discharge from the U. S. Navy, I enrolled for Lewis Training. Shortly after I had completed the course, the Lewis National Placement Service informed me of an opening near my home.

"At present, I am Night Manager in the largest hotel in Rochester. I owe my success to the Lewis course."



**Step Into a Well-Paid Hotel Position  
FREE Book Gives Fascinating Facts**

Our **FREE** Book, "Your Big Opportunity," explains how you can qualify for a well-paid position at home, in leisure time; tells how you are registered **FREE** of extra cost in the Lewis National Placement Service. Most important, it shows how you can be a Lewis Certified Employee—certified to "make good" when placed in a position. Mail the coupon **NOW!**

**Course Approved for Veterans' Training**

**LEWIS HOTEL TRAINING SCHOOL**  
Room TX-324, Washington 7, D. C.

**36<sup>th</sup> SUCCESSFUL  
YEAR**

Send me the Free Book, "Your Big Opportunity," without obligation. I wish to know how to qualify for a well-paid position at home, in my leisure time.

Name \_\_\_\_\_  
(Please Print Name & Address)  
Address \_\_\_\_\_  
City \_\_\_\_\_ Zone \_\_\_\_\_ State \_\_\_\_\_

**EAR NOISES?**

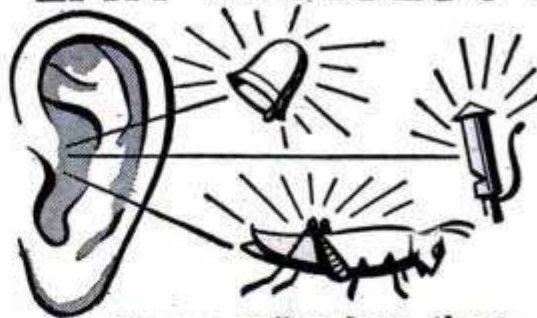

If you suffer from those miserable ear noises and are Hard of Hearing due to catarrh of the head, write us **NOW** for proof of the good results many people have reported after using our simple home treatment. **NOTHING TO WEAR.** Many past 70 report ear noises relieved and hearing improved. **SEND NOW FOR PROOF AND 30 DAYS TRIAL OFFER.**

**THE ELMO CO.**

**DEPT. 2PM9 DAVENPORT, IOWA**

**POSITIVELY NEW!**  
**TWO-SIDED REVERSIBLE NECKTIES**  
SAMPLE NECKTIE \$1.00. **OVER 100% PROFIT!**  
AGENTS WANTED • FREE DETAILS  
**FARRELL COMPANY**  
1377 Van Zandt, Dept. P, CINCINNATI 31, OHIO

**SILVER SOLDER TORCH & KIT \$7.50**  
JOINS ALL METALS PERMANENTLY  
Do your own repairing. KIT includes one tube silver solder "XCEL-FLUX" paste and 10 5-in. lengths silver solder alloy. Hottest **ALCOHOL TORCH** known. 2700° F. flame. Operates in any position, indoors or out. Pint of special fuel included. **TORCH** alone with pint of special fuel \$6.50. **KIT** alone \$1.50. Add 25c on each order towards shipping charges.  
**AMERICAN PRODUCTS CORP., 422 S. Dearborn, Dept. 3-L, Chicago**

**BOYS! MAKE YOUR OWN RADIO**  
Make your own simple, tubeless, batteryless Crystal Radio. **SEND 25c** for a **GENUINE MELOMITE CRYSTAL** with complete illustrated instructions for making your own set. Crystal sent postpaid with instructions and our own publication, "THE MAGIC CRYSTAL" which is full of news, diagrams, questions and answers of interest.  
**SEND 25c FOR YOUR CRYSTAL TODAY!**  
**ALVA ALLEN RADIO Dept. 195 Clinton, Mo.**

**WORLD'S FASTEST BOATS!**  
**BUILD and DRIVE** your own high speed racing boat as hundreds of others are doing! Easy to follow our simplified plans for newest types of racing craft. Large selection of full race Hydroplanes ranging from 6 ft. to 20 ft. lengths. **Service, Racing, Utilities, and 3 Points.** Both Inboard and outboards.  
**SEND 25c for CATALOGUE** containing pictures and descriptions of **Champion Boats** for which plans are designed and distributed exclusively by **CHAMPION BOATS, P. O. Box 9038, Dept. 15-L, Long Beach, California, U.S.A.**



# WHAT SECRET POWER DID THIS MAN POSSESS?

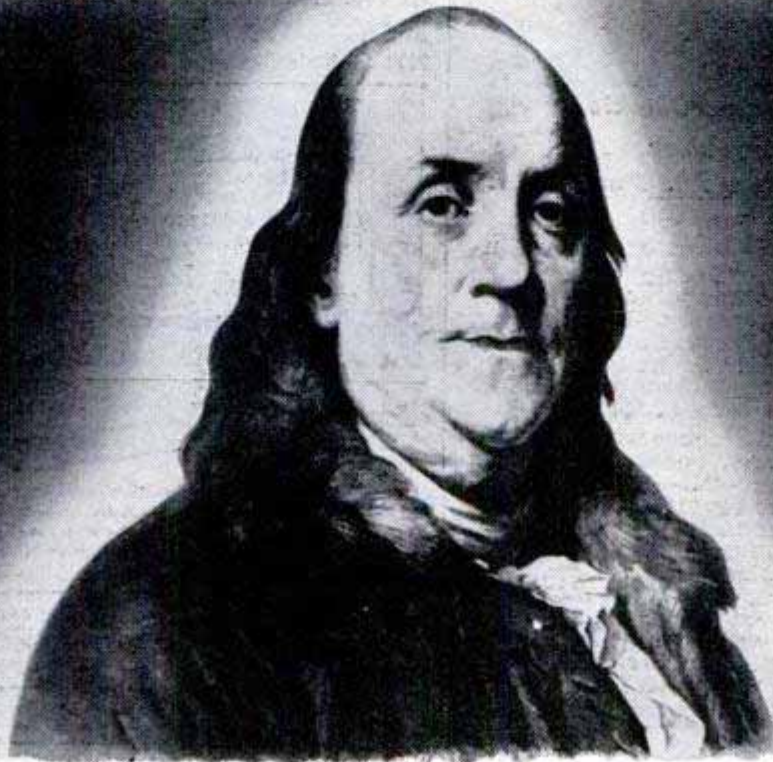

**Benjamin Franklin**  
(A Rosicrucian)

**W**HY was this man great? How does anyone—man or woman—achieve greatness? Is it not by mastery of the powers within ourselves?

Know the mysterious world within you! Attune yourself to the wisdom of the ages! Grasp the inner power of your mind! Learn the secrets of a full and peaceful life! Benjamin Franklin—like many other learned and great men and women—was a Rosicrucian. The Rosicrucians (NOT a religious organization) first came to America in 1694. Today, headquarters of the Rosicrucians send over seven million pieces of mail annually to all parts of the world.

*The* **Rosicrucians**

**SAN JOSE • (AMORC) • CALIFORNIA**

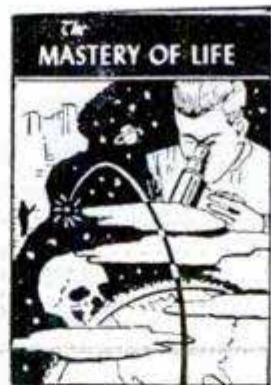

## **THIS BOOK FREE!**

Write for YOUR FREE COPY of "The Mastery of Life"—TODAY. No obligation. No salesmen. A non-profit organization. Address: Scribe C.M.W.

## **SEND THIS COUPON**

Scribe C.M.W.  
The ROSICRUCIANS (AMORC)  
San Jose, California

Please send me the free book, *The Mastery of Life*, which explains how I may learn to use my faculties and powers of mind.

NAME \_\_\_\_\_

ADDRESS \_\_\_\_\_

CITY \_\_\_\_\_

ZONE \_\_\_\_\_ STATE \_\_\_\_\_



# Last Week I Made \$259.92



RAY BARTA

with Science's New Midget Miracle,  
**PRESTO Fire Extinguisher**

So reported RAY BARTA of Wisconsin. Many others  
"cleaning up" — so can YOU!



Science's  
New Midget  
Miracle  
"PRESTO"

**A** MAZING new kind of fire extinguisher. Tiny "Presto" (about size of a flashlight!) does job of bulky extinguishers that cost 4 times as much, are 8 times as heavy. Ends fires fast as 2 seconds. Fits in palm of hand. Never corrodes. **Guaranteed for 20 years!** Sells for only \$3.98!

Show it to civil defense workers, owners of homes, cars, boats, farms, etc., and to stores for re-sale—make good income. H. J. Kerr reports \$20 a day. C. Kama, \$1,000 a month. Write for FREE Sales Kit. No obligation. MERLITE INDUSTRIES, Inc., Dept. 512, 201 East 16th St., New York 3, N. Y. **IN CANADA:** Mopa Co., Ltd., 371 Dowd St., Montreal 1, P.Q. (If you want a regular Presto to use as a demonstrator, send \$2.50. Money back if you wish.)

## PHOTOGRAPHY



EARN BIG MONEY! PERSONAL ATTENDANCE TRAINING in News-Magazine-Fashion-Portrait-Advertising-Natural Color Photography. Splendid equipment, glamorous models. Or—our COMPLETE HOME STUDY COURSE provides you with a spare time short-cut to success.

Our 42nd year. Write immediately for BIG FREE BOOK!

**NEW YORK INSTITUTE OF PHOTOGRAPHY**  
Dept. 49, 10 West 33 St., New York 1, N. Y.

John  
Sill  
Jowett  
Pupil

"Hey, You SKINNY BAG of BONES!"  
the boys shouted at me  
only A FEW SHORT WEEKS ago



But look at me now, PAL... A  
**TROPHY-WINNING ALL-AROUND  
HE-MAN as YOU can be SOON  
in 10 Thrilling Minutes a day.**

YOU can WIN this  
big 15" Silver Trophy  
as John Sill just did!

Your Name on it.  
Send me **10c**  
only  
Like John Did—  
And get ALL  
**5 PICTURE-PACKED  
HE-MAN BUILDING  
COURSES** and get also



Yes! Today everyone admires John Sill's movie-star Champion BUILD. His big mighty ARMS. His heroic CHEST. His broad BACK. His rock-like TORSO. His wide military SHOULDERS. His newly-won POPULARITY.

Be A Winner at  
Anything YOU  
Tackle with  
Progressive Power-  
SPORTS! JOB!  
SCHOOL! FRIENDS!

GEORGE  
F.  
JOWETT  
"Champion  
of  
Champions!"



**FREE!** Jowett's Photo Book of Famous Strong Men!  
JOWETT INSTITUTE, Dept. PM-112  
230 Fifth Avenue, New York 1, N. Y.  
Dear George: Please mail to me prepaid FREE  
Jowett's Photo Book of Strong Men, plus all 5  
Muscle Building Courses, "How to Become a  
Muscular He-Man." ENCLOSED FIND 10c in complete  
payment for EVERYTHING.

NAME \_\_\_\_\_ AGE \_\_\_\_\_  
(Please Print Plainly, Include Zone Number)  
ADDRESS \_\_\_\_\_ NO C.O.D.'s  
CITY \_\_\_\_\_ ZONE & STATE \_\_\_\_\_



**OPPORTUNITIES AHEAD!**  
TRAIN FOR A FUTURE IN  
**DIESEL**

Prepare for the big earning power of Diesel Trained Men. Start learning at home, in spare time. UEI's easy, practical training covers all phases of DIESEL engine operation, fuel systems, auxiliary equipment, repairs and maintenance. Also new Scientific Auto Motor Tune-up. After home course, you come to Chicago for actual practice in UEI's modern shop under experienced instructors. **GET ALL THE FACTS FREE. WRITE TODAY!**

**DIESEL DIVISION UTILITIES ENGINEERING INSTITUTE**  
2521 Sheffield Avenue, Dept. DC-16 Chicago 14, Illinois

Big Profit **CHINCHILLAS** Fun Educational

Breed Chinchillas for the fur market. Chinchilla garments sell from \$8,000-\$35,000! Establish your own 'gold chip' business. Clean, tame, easy to raise. Write experts. Chapman Chinchilla Farms, originators of Chinchilla breeding farms in America. Send for illustrated catalog full of pictures and instructions today. \* P. O. Box 221, 4957-P West 104th Street, Inglewood, Calif.



**CHAPMAN CHINCHILLAS**

A "GOOD HAND" HELPS YOU SUCCEED!  
**LEARN TO WRITE WELL**

Your Name  
beautifully  
written, plus  
special pen-  
point for  
shaded  
writing.  
Only 10c

Handwriting quickly improves with our easy-to-understand picture lessons! Put your spare time to good use; send today for  FREE BOOK, "How to Become a Good Penman", or check volumes wanted below at \$1 each:  Business Writing  Artistic Writing  Card Writing  Bird & Design Flourishing  Engrossing Alphabets. COMPLETE SET \$4.50

**TAMBLYN SCHOOL of PENMANSHIP**  
S. A. Ziller, Pres. 442 Ridge Bldg., Kansas City, Mo., USA

SAY YOU SAW IT IN POPULAR MECHANICS

**ENGINEERING DEGREE IN  
27 MONTHS**

**INDIANA  
TECHNICAL  
COLLEGE**

**B. S. DEGREE**, Aeronautical, Chemical, Civil, Electrical, Mechanical and Radio Engineering (inc. television), Drafting, 1-yr. Government approved for G.I.'s. Low rate. Earn board. Large industrial center. Students from 48 states, 21 countries. Demand for graduates. Enter December, March, June, September. Write for catalog, 16121 E. Washington Boulevard, Fort Wayne 2, Indiana.

**BECOME AN EXPERT IN  
TRAFFIC**

Traffic men earn \$4,000 to \$10,000 and up. Thousands of firms need experts on rates, tariffs, regulations. We train you thoroughly in spare time at home for executive traffic jobs. Personal training under traffic authorities. Placement counsel and help. Write for free 48-page book "Traffic Management—the Fast Growing Profession."

**LASALLE Extension University, 417 So. Dearborn St.**  
A Correspondence Institution Dept. 1264T Chicago 5, Ill.

**DRIVING COMFORT at its best!**  
The New **Electric Throttle**  
With Foot Control

The Electric Throttle ("Speed-selector") sets whatever speed you choose electrically — releases instantly at a touch on the toe-button, or by applying foot brake. Banish foot and back strain for good! Install it yourself. Price, \$17.50 F.O.B. Check or C.O.D. Salesmen, Dealer and Manufacturer agent inquiries welcome.



WRITE FOR DETAILS  
**D & M MFG. CORP., Anderson, Ind.**



**MILLIONS OF APPLIANCES NEED REPAIR!**

# EARN BIG MONEY..WORK PART OR FULL TIME IN ELECTRIC APPLIANCE REPAIRING!

- ELECTRIC REFRIGERATORS
- WASHING MACHINES
- VACUUM CLEANERS
- ELECTRIC RANGES
- MOTORS
- SEWING MACHINES
- TOASTERS
- WAFFLE IRONS
- MANGLES
- HEATING PADS
- FREEZERS
- ELECTRIC FANS
- ELECTRIC IRONS
- LAMPS
- ETC., ETC.



**ELECTRONIC KIT TROUBLE DETECTOR**  
(Checks shorts, wattage, continuity, etc.)  
is sent to all students

**MAIL COUPON FOR FREE BOOK**

Learn this fascinating big money paying profession at home in your spare time. Learn by doing, by working with your hands building, testing, repairing electrical appliances of all kinds. Electrical appliance repairmen are needed everywhere — wherever electricity is used. You need no special previous training or experience. Age is no handicap. CHRISTY has trained over 33,000 men in all parts of the world. Men who today command big wages or own profitable businesses of their own.

**PAY LATER FROM EARNINGS WHILE LEARNING**

CHRISTY shows you how to make money while still learning, what to charge, how to set up your own shop, how to build power tools from spare parts, etc. It will pay you to write today.

CHRISTY TRADES SCHOOL, Dept. D-103  
4432 N. Kedzie Ave., Chicago 25, Ill.  
Send me your FREE book on Electrical Appliance Repairing and special form for "paying later from earnings while learning."

NAME \_\_\_\_\_ AGE \_\_\_\_\_  
ADDRESS \_\_\_\_\_  
CITY \_\_\_\_\_ STATE \_\_\_\_\_

**HERE IS THE NEW SENSATION IN LOW-COST TRANSPORTATION**

Truly, Cushman EAGLE is the new sensation in its field. It operates for only 3/4¢ per mile, cruises to 50 m.p.h., gets over 75 miles per gallon. Dealer inquiries invited.



*Cushman*  
**EAGLE**

WRITE FOR DETAILS AND SPECIFICATIONS  
DEPT. 23-M

**CUSHMAN MOTOR WORKS Lincoln, Nebr.**

## LEARN MEAT CUTTING AT NATIONAL Pay After Graduation



The steady dependable trade of Meat Cutting taught easily in 8 short weeks. YOU LEARN BY DOING under actual meat market conditions in big modern school at Toledo.

For beginners or men with experience. Get a profitable store of your own. Remember, PEOPLE MUST EAT! Big pay jobs. Free employment help. Thousands of successful graduates.

Buying, cutting, percentage, pricing, advertising, selling, etc. A complete retail meat education. National School established over 25 years. Get National training NOW. Pay your tuition in easy weekly payments

after you graduate. G. I. approved. Send coupon for FREE 52 page school catalog — TODAY.

**National School of Meat Cutting, Inc., Dept. 50Z, Toledo 4, Ohio**  
Send me your FREE school catalog on National Training at Toledo in Meat Cutting, Meat Merchandising and Self Service Meats. No obligation. No salesman will call.

Name \_\_\_\_\_  
Address \_\_\_\_\_  
City \_\_\_\_\_ State \_\_\_\_\_  
( ) Check here if Veteran of World War II





**KNOW YOUR  
COASTER BRAKE  
INSIDE and OUT!**

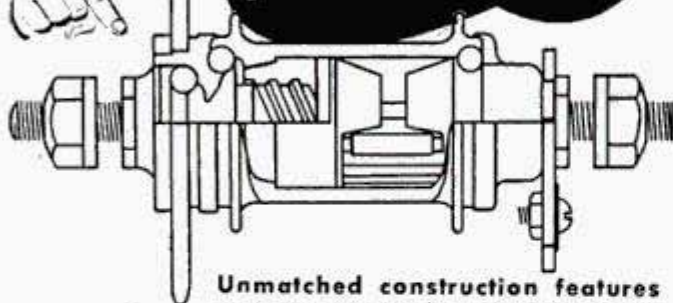

**Ride  
a Bike  
- it's  
Fun!**

Unmatched construction features make the Bendix\* Coaster Brake the outstanding performer in its field. That's why Bendix Coaster Brakes—stop quicker—pedal easier—coast farther—last longer. Your bicycle dealer will put on the brake you want—so just say "Bendix Coaster Brake."

\*REG. U. S. PAT. OFF.

**DOUBLE THE FUN  
WITH A  BENDIX  
COASTER BRAKE**

ECLIPSE MACHINE DIVISION of  
Elmira, New York



## FIRST AID FOR TV SET OWNERS!

### H. G. CISIN's "TV DOCTOR"

Shows you how to fix your own set rapidly and SAFELY!



**YOURS TO TRY  
5-DAYS FREE!**

Save money, throw away service contracts. Here's a real "fix-it-yourself" book—an amazing, quick, copyrighted method of locating & fixing TV troubles. Written by a noted inventor & educator in language you can understand.

**TUBES CAUSE 80% OF TV TROUBLES!**

"TV DOCTOR" shows you how to quickly locate and change all defective tubes with complete safety.

**WITHOUT EXPERIENCE!—PICTURES & TEXT  
MAKE FIXING IT YOURSELF EASY**

Reveals many closely guarded TRADE SECRETS. Lists over 123 trouble conditions. Method applies to all TV sets, even newest RCA's, Philco's or any 2,000 models, old & new. Copyrighted TROUBLE SHOOTING GUIDE pin-points hundreds of troubles.

11 money-saving, fact crammed, detailed, illustrated chapters include: practical ways to combat interference & ghosts; how to appraise & buy a TV set, valuable information on antennas, lead-ins, color, explains TV terms, lists names & addresses of TV mfgs.—a veritable encyclopedia.

**Save Expensive Service Calls!**

**Be Assured of Continual TV Pleasures!  
Only \$1. — you'll say it's worth hundreds.**

**SPECIAL OFFER:** A new "TV PICTURE GUIDE" with illustrations explaining TV terms & selling for \$1. H. G. Cisin's famous "TV TROUBLE SHOOTING METHOD", which trains you to be a TV diagnostician & TV serviceman... sells for \$1. PLUS the "TV DOCTOR"—all 3 for only \$2. postpaid... you save \$1.

**RUSH COUPON** with your name & address. Enclose \$1.50-days to read without risk or return for refund.

H. G. CISIN, Consulting Engineer,  
Dept. PM-1,  
200 Clinton St., Brooklyn 2, N. Y.

Enclosed find \$2. full payment for "TV DOCTOR", "TV TROUBLE SHOOTING METHOD" & "TV DICTIONARY"—rush copies postpaid.  
 Enclosed find \$1. in full payment for "TV DOCTOR," rush copy postpaid.

Name \_\_\_\_\_  
Address \_\_\_\_\_  
City \_\_\_\_\_ Zone \_\_\_\_\_ State \_\_\_\_\_

**ORDER  
NOW  
POSTPAID**

**WAR  
SURPLUS  
BARGAINS!**

**STARK'S**

**WAR  
SURPLUS  
BARGAINS**

**\$500,000.00 INVENTORY  
for QUICK LIQUIDATION**

Surplus items—hundreds of them for home, shop, factory, farm and outdoor use. New items, used items, reconditioned items—all at tremendous savings—all priced for quick sale.

**Page After Page of Values**

This big catalog shows page after page of amazing money saving values. Write for your copy today. Send 10c to cover postage, mailing, etc. Write today!

**SEND TODAY FOR YOUR COPY**

**10c**

**STARK'S** Dept. 509 So. STATE STREET  
PM-12 CHICAGO 5, ILLINOIS

## 1952 HARLEY-DAVIDSON HYDRA-GLIDE® with the MIGHTIEST MOTOR in MOTORCYCLING!

Built like the costliest car. Has the newest deluxe features... super-power OHV motor, Hydra-Glide steering ease and riding comfort, 4-speed foot shift-hand clutch, Parco-Lubrizal valves. A lifetime of fun! See your dealer. Write for FREE "Enthusiast" magazine and literature on 1952 models. HARLEY-DAVIDSON MOTOR CO. Dept. P, Milwaukee 1, Wisconsin



## HOT RUNNING WATER!

Attaches easily, quickly to any standard faucet. Regulates temp. by turning faucet. Operates AC or DC. Comes with 8-ft. rubber cable and plug. Our DELUXE heater has delighted many thousands of users. Send \$4.95 cash, check or M.O. — we will ship prepaid or, if you wish, we will ship C.O.D. — you pay postman \$4.95 plus few cents postage. Order 3 for \$12—save \$2.85.

METROPOLITAN ELECTRONICS CO.  
Dept. 350, 106 Fifth Ave., New York 11, N. Y.



**GIVE A HULL AUTOMOBILE COMPASS  
AND GIVE YEARS OF  
"Sure Directions Without Stopping"**

ACCURATE INSTRUMENTS that add beauty to any car interior. Mount easily on divider strip or top moulding of one-piece windshields. Insist on a Hull—the one famous name in automobile compasses for 19 years. Write for local dealer's name, free literature.

**HULL MFG. CO.**  
P. O. BOX 246-012 WARREN, OHIO

**Beaconlite** \$6.95  
Illustrated

**STREAMLINE** \$4.95  
Standard for its class

**RADIO ENGINEERING.** Broadcasting, Television, FM, Servicing, Electronics, Aviation, Marine & Police Radio taught thoroughly. Engineering course equivalent to 3 years' college radio work. Approved Veteran Training. Catalog free. VALPARAISO TECHNICAL INSTITUTE, Dept. D, Valparaiso, Ind.

SAY YOU SAW IT IN POPULAR MECHANICS

## NEW—Sensational! GEIGER COUNTER



**"The SNOOPER"**

**LOW PRICE ONLY \$24.95**

**COMPLETE**

Find a fortune in uranium with this new, super-sensitive-Geiger Counter. Get one for atom bomb defense. So small it fits in the palm of the hand or in the hip pocket, and yet more sensitive than many large, expensive instruments. Weighs only 1 1/4 lbs. Uses flashlight battery. Low price includes earphone, radio active sample, instructions. Sold with ironclad moneyback guarantee.

**ORDER YOURS TODAY**—Send \$5.00 with order or payment in full to save C.O.D. Write for free catalog on treasure finders for gold, silver, etc. and larger, more elaborate Geiger Counters.

Dealer Inquiries Invited **PRECISION RADIATION INSTRUMENTS**  
4113 PM W. Jefferson, L. A. 16, Calif.



# STOPS AUTO THIEVERY!

SENSATIONAL NEW ROYLES  
FOOLPROOF - TAMPERPROOF

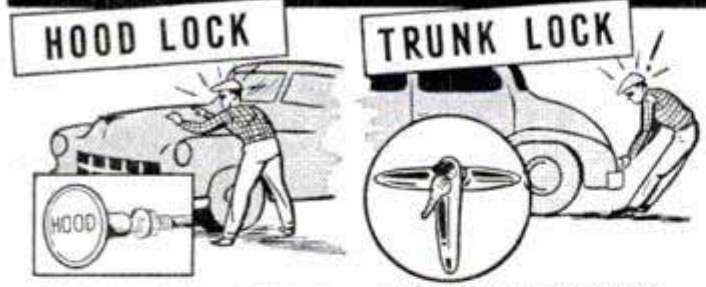

FOR 1950-51 DE SOTO,  
DODGE, PLYMOUTH,  
CHEVROLET

FOR 1950-51 CHRYSLER,  
DODGE, DESOTO, PLYM-  
OUTH. ALSO DOORS,  
GMC PANEL.

Positive action hood lock protects against theft of horns, batteries, other valuable parts. Royles trunk lock handle revolves freely when locked, no shear pin, cannot be opened without key. Tamper-proof.

EASY TO INSTALL. Both hood and trunk lock come in simple kit with all parts, complete instructions. MONEY BACK GUARANTEE. Send money order or check to:

HOOD LOCK \$4.95  
TRUNK LOCK \$4.95  
BOTH FOR \$8.90  
POSTPAID

## ROYLES PRODUCTS COMPANY

1017 Magazine St., New Orleans, La.

## FOAM RUBBER CUT SHAPES

Select from this—one of the largest Foam Rubber stocks—whatever shape or thickness you want—Cut circles or squares for upholstering or padding chairs, mattresses or pads for twin or regular beds, auto seat cushion tops—auto wedges—all new fresh stock—expertly cut to exact size. Lowest prices—satisfaction guaranteed. One day delivery.

Uncovered Foam Pads 1 1/2" thick	Auto Seat Pads 24" X 60"
12" X 14".....\$1.25	1 1/2" thick.....\$6.45
16" X 16".....1.35	2" thick.....7.95
16" X 22".....1.75	Mattress Pads
18" X 24".....2.00	Twin Size.....\$19.55
22" X 24".....2.95	Full Size.....23.95

Add 10% to these prices for postage and packing.  
NO C.O.D. PLEASE — PLEASE PRINT NAME  
Ask for catalog No. 201  
RIOR RUBBER COMPANY, Dept. 201 50 E. CERMAK RD.  
CHICAGO 16, ILL.

## ENGINEERING B.S. DEGREE IN 27 MONTHS

WORLD FAMED SCHOOL • ESTABLISHED 1884

Mechanical, Civil, Electrical, Chemical, Aeronautical, Radio (Television) Engineering; Business Administration and Accounting. Also 36-weeks diploma courses in Surveying and Drafting. Personalized instruction. Accelerated courses. For ambitious earnest students. Preparatory department. Heavy demand for Tri-State graduates; hold positions of responsibility the world over. Placement service. Serious shortage of engineers indicated for immediate future. Prepare now for the opportunities ahead. Technical training helpful in military assignments. Extensive campus. Well equipped, new and modernized buildings; up-to-date labs. Low cost. New terms start quarterly. Enter January, March, June, September.

Write today for free catalog and special information.  
**TRI-STATE COLLEGE**  
4121 COLLEGE AVENUE ANGOLA, INDIANA

# "I NEVER DREAMED I COULD PLAY MUSIC... until I discovered this 'EASY AS A-B-C' way to learn!"

Even if you don't know one note NOW —you can play piano, guitar, accordion, any instrument. No boring exercises. No "talent" needed. FREE BOOK tells all about it.



HOW would you like to find yourself playing your favorite instrument so well — and in so short a time —that your friends will be amazed? Not just "picking out a tune"—but playing all your favorite pieces, easily, confidently, and properly, by note!

IMAGINE what good times that would mean. The new friends you would meet. The exciting invitations that would pour in upon you. The fun you would get out of your leisure hours. The deep-down happiness of putting such an accomplishment into your life.

### Some Things To Forget About

Forget about special "talent"—most of our 850,000 students didn't know a single note of music when they started. Forget about tiresome exercises and scales — you learn by playing delightful pieces in your very first week. Forget about "having the time" — you learn in the spare time of your own choosing; free from the rigid schedule imposed by a teacher. Forget about expense—lessons cost only a few cents each; and that includes sheet music.

This tried-and-proven simplified method takes the drudgery out of learning; cuts out all that is boring; and really HOLDS your interest and enthusiasm because you find yourself progressing so rapidly!

Let us tell you all about it — without obligation. See for yourself how simple, interesting, and successful our method really is.

### Masters Many Tunes in First 3 Weeks

"I was able to play many pieces of popular current tunes in the first 3 weeks. My family and friends certainly were surprised. I play for various social functions and dances, etc." —Peter H. Kozyra, Manitoba, Canada.

### Now Plays Accordion Professionally

"I can now play any selection on the accordion with ease... I have you to thank for helping me play the accordion professionally. I found your lessons very easy." —James G. Collar, Macleod, Alta.

### How Famous Orchestra Leader Got His Start

"I got my start in music with a U.S. School Course. How easy it is to learn to read notes and play an instrument this 'teach yourself' way! In fact, this school did so much for me that I've enrolled my two daughters." —Lawrence Weik, famous orchestra leader.

## Free Book

### And Free Instruction-Sample

Simply send us your name and address on a postcard. Tell us the instrument you'd like to play, and if you own one. You will receive, by mail, our free illustrated book and a Free Sample of our simplified, copyrighted method of instruction. So drop us a postcard AT ONCE. Don't delay putting this wonderful accomplishment into your life. Write: **U. S. School of Music, Studio X3012, Port Washington, N.Y.** (Special Reduced Prices on instruments to our students.)





# EARN MORE IN DRAFTING



More Opportunities for Employment and Promotion

"Here I am at work making good money as a draftsman. I'm glad I sent the coupon to Chicago Tech for that Free Trial Lesson and found out how easy it is to learn Drafting in spare time at home. Today I feel secure in my job because the draftsman's work comes first on any new project. And, in addition, draftsmen can't be replaced with machines. What's more, I feel I'm slated for promotion and more pay, because I see so many draftsmen advancing to high-pay jobs."

## LEARN IN SPARE TIME — AT HOME!

(or at the College in Chicago)

A few hours of pleasant home study every week—that's all. No interference with your present job. All the tools you need; drawing outfit included. With Chicago Tech's help, you train yourself step by step. This tested method—developed over 47 years of C.T.C. progress—prepares men quickly for good positions in industry.



### FREE INFORMATION—SEND COUPON

To prove to you how easy it is to learn Drafting at home by the Chicago Tech method, we will send you this FREE TRIAL LESSON. No charge for this lesson, now or later. Fill out and mail coupon, or send post card today.

## CHICAGO TECHNICAL COLLEGE

S-214 Tech Bldg., 2000 So. Michigan Ave., Chicago 16, Illinois

Mail me FREE Lesson with information about big opportunities in DRAFTING.

Name \_\_\_\_\_ Age \_\_\_\_\_

Address \_\_\_\_\_

City \_\_\_\_\_ Zone \_\_\_\_\_ State \_\_\_\_\_

## ENGINEERING DEGREE IN 27 MONTHS

### Big Demand for Graduates

Aeronautical, Chemical, Civil, Electrical, Mechanical and Radio Engineering (including Television)

Hundreds of young men are earning engineering degrees in this recognized institution each year—continuous operation. New terms start quarterly. Many students earn a major part of their college expenses in this large industrial center.

Low tuition. Competent instruction. Thorough, intense, practical program. Modern laboratory facilities including new physics lab. and modernized wind tunnel. Individualized instruction emphasized.

Approved for Veterans. Engineering preparatory courses. Students from 48 states and 21 foreign countries. Enter December, March, June or September. Send coupon for free catalog and full information. Enroll now.

SEND COUPON TODAY

## INDIANA TECHNICAL COLLEGE

5121 E. Washington Boulevard  
Fort Wayne 2, Indiana

Please send me free information on B.S. Engineering Degree in 27 months as checked.

Aeronautical,  Chemical,  Civil,  Electrical,  
 Mechanical,  Radio-Television

Name \_\_\_\_\_

Address \_\_\_\_\_

# PORTABLE GARAGE

\$1095

(Extra Heavy Gauge)

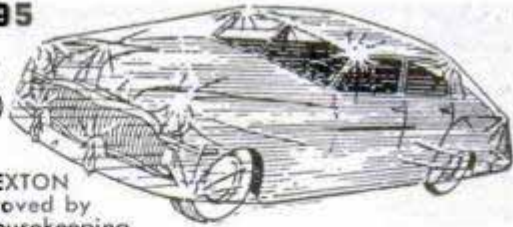

\$895

(Heavy Gauge)

FLEXTON  
Approved by  
Good Housekeeping

USE IT ANYWHERE!

- Goes wherever your car goes • Folds compactly • Keeps rain, snow, dust, salt air, sun or sleet away • Will withstand Extreme cold without cracking and protects your car's finish
- Perfect for storage of Cars, Furniture, Machinery Equipment
- Durably constructed of clear transparent vinyl plastic that is long wearing and tough • Nylon threads and grommets for extra security • Spring-tite elasticized bottom, holds securely in all kinds of weather • Fits all makes and models
- Direct from manufacturer • 10 Day Money Back Guarantee
- Enclose check or money order, or sent C.O.D.

MARDO SALES CORP., Dept. 588

480 Lexington Ave.

New York 17, N. Y.

## BIG MUSCLES don't just happen

### Build Them the York Barbell Way!

Don't be fooled! There's no easy way to strength, health, and a beautiful body. But it's fun the York Barbell way. Let Bob Hoffman, famous Olympic weight-lifting coach, show you how! Send postcard, ALL THIS FREE: Copy of *Strength & Health*, York Barbell Catalog, Bob Hoffman's Tips.

"Muscle town"

YORK BARBELL CO. York 22, Pa.

## FREE "THE AGE OF REASON" by Thomas Paine YOURS WITHOUT OBLIGATION

Write for your copy of the world's most famous treatise on logical thinking—Thomas Paine's masterpiece, "The Age of Reason". 190 pages; complete and unexpurgated. No obligation on your part; sent free as part of a national educational campaign, but please add 10¢ to cover cost of postage and handling.

THE THOMAS PAINE FOUNDATION

Dept. 17, 370 W. 35th St., New York 1, N. Y.

*Hand Guide!*

POSITIVELY controls movement of hand until one's Penmanship is corrected. Write,

INVENTOR "OZ," 34-P. ST. LOUIS, MO. (BX665)



## REAL LEATHER NAVY HELMET

NO HOOKS, TUBES OR HOLES

Brand new NAVY helmet of rich Cordovan Brown leather lined with soft warm fleece. Detachable chin strap. Ideal for flyers, cyclists, farmers, hunters. Children love them! Cost Gov't. \$10.00. Small, medium, large sizes. Send cash, chk. 25% dep. plus postage on COD. Money back \$2.00 PPD. guarantee.

GRAND-HAWTHORNE SURPLUS

Dept. PM12-51

1439 S. E. GRAND — PORTLAND, OREGON

## Learn CARPENTRY BRICK LAYING

Get into the billion dollar building trades. Learn now while opportunities are greatest. Train in our completely equipped shops under expert instructors. Enroll now. Limited classes. Resident and Home Study. Write for FREE Catalog.

MIDWEST SCHOOL OF BUILDING TRADES, Dept. PM-12

411 N. Center St.

Bloomington, Ill.

SAY YOU SAW IT IN POPULAR MECHANICS

## Learn PHOTOGRAPHY at Home

Splendid opportunities. Prepare in spare time. Practical basic training. Long-established school. Send for free book, "Opportunities in Photography." No obligation.

American School of Photography, 835 Diversoy Parkway, Dept. 1359, Chicago 14, Ill.





# High-Fidelity

THE NEW MAGAZINE FOR AUDIO-PHILES\*

\*People Who Enjoy Fine Musical Entertainment at Home

tells you why *it's fun to be an*  
**AUDIO-PHILE**



**MOST FOR YOUR MONEY:** If you are planning your first hi-fi FM-phonograph installation, be sure to read the feature article: "Budget Your High Fidelity." It explains how to make a well-balanced selection in choosing your amplifier, turntable, pickup, and loudspeaker, so as to get maximum performance for whatever amount you plan to spend. (16 pages, 21 illustrations)

**DECORATIVE APPEARANCE:** When you walk in with an armful of hi-fi gear, if your wife greets you with, "Don't take that junk in the living room," get out HIGH-FIDELITY Magazine, and show her all the pictures of attractive installations in fine homes. Win her enthusiastic approval by getting her to help you plan a really beautiful FM-phonograph installation. (16 illustrations)

HIGH-FIDELITY is a big quarterly magazine, 8 3/4 x 11 1/8 inches, handsomely illustrated, with nearly 100 photos and drawings, and beautifully printed on fine paper. It is published in September, November, February and April.

**ABOUT TAPE RECORDING:** With the new tape equipment, you can become a recording expert in a single evening. In your own home, you can make amazingly realistic recordings of everything from family conversations to instrumental music and singing, or make your own programs from radio shows (omitting commercials) by connecting the recorder to your radio receiver. (12 pages, 19 illustrations)

**CHOOSING RECORDS:** Maybe you like to sweat it out in music-shop listening booths, but you can save time, keep cool, and get a world of help in building your record library from "Schubert on Records," "Tops for the Juke Box," "The Music Between," and "Records in Review," by such leading critics and commentators as C. G. Burke, Carl Eaton, Edward Merritt, Jr., and John Indcox. (18 pages)

## CHRISTMAS SUBSCRIPTIONS

As a Christmas present, High-Fidelity will win you the year-round gratitude of every friend who enjoys fine music on radio or records. Just mark your order "For Christmas" and we'll announce the coming of High-Fidelity with a gift card bearing your name. Special Gift Price: **3 one-year subscriptions \$6.00.**

**HIGH-FIDELITY**  
Published by Milton B. Sleeper

Mr. Charles Fowler, Editor, High-Fidelity  
121 Audio Bldg., Great Barrington, Mass.  
Please enter my subscription to High-Fidelity:  
 \$6.00 for three years (SAVE \$6.00)  
 \$3.00 for one year (SAVE \$1.00)

Name.....  
Address.....  
Add 50¢ per year in Canada, \$1.00 foreign

## Amazing Attachment MAKES OLD REFRIGERATORS INTO MODERN Automatic Defrosters!

Thirty Million Prospects. Sell without "selling pressure" on sensational Free Trial Plan. Just plug it in and leave it. Frees women from drudgery and mess of defrosting. Saves electricity. Keeps food longer, better. Gives longer life to refrigerator. Secret "follow-up" Plan often brings five additional sales by making every user your agent. Big season now on!

**SENT FREE... JUST SEND NAME!**

Don't send a cent—just your name on penny postcard. We'll send you the biggest money-maker you ever got your hands on and guarantee your sales at profits as high as \$5.00 on each sale. Rush your name!

**MAXILUME COMPANY, 125 West Hubbard Street, Dept. D-812, Chicago 10, Illinois**

**Women buying by the thousands!**

**Salesmen Cleaning up on "Free Trial" Sales Plan Sent Free with Instructions.**

**Make as high as \$5 on Every Sale!**



## EXAMINE FIRST... FREE! FASCINATING NEW PROFIT PLAN

I'LL SEND YOU EVERYTHING TO EXAMINE IN YOUR OWN HOME, LOOK IT OVER — THEN DECIDE!

SHOES

Tired of monotonous — low-pay jobs — of working for the other fellow? Tap rich profits in huge NEW field. Have your own lifetime business—make REAL money—say goodbye

forever to time clocks—bosses! Become part of tremendous expanding industry—have your own business, spare or full time. No big investment, no long leases, operate at home.

PAINT WITH SUEDE COVERS ANY SURFACE



AUTOTRUNK INTERIORS  
RADIO  
PHONOGRAPH TURNTABLES  
JEWELRY BOXES  
LAMP

**PROFIT UP TO \$500 PER HOUR**

**LEARN IN A FEW DAYS THROUGH PROVED, TESTED METHODS** to start making more money with this amazing MIRACLE finish—gives a velvety, luxurious surface to radios, lamps, toys, signs, store displays, figurines, auto dashboards — hundreds of items. FREE PROFIT PLAN offers everything you need to start learning at once. Mail coupon today. Do it NOW! Be first in your area!

**USE COUPON FOR FREE SAMPLE-PROFIT PLAN**

**COAST INDUSTRIES Dept. 2C**  
1004 S. Los Angeles St., Los Angeles 15, Calif.  
Gentlemen: Please rush me your FREE Profit Plan.

NAME.....  
STREET.....  
CITY..... STATE.....

**FLOK KRAFT**  
SEND NO MONEY Get Facts FREE!

**BIG DEMAND FOR NEW MIRACLE FINISH**  
We show you every step. ... Fill huge year-round-demand... easy to understand instructions tell you how. Earn up to \$5 an hour spare—full time. A few cents' worth of materials — brings you dollars! Here is the opportunity you have been waiting for!

**GRASP THIS OPPORTUNITY TODAY.** It's too good to miss... Fill our coupon, mail today. Get FREE sample. FREE plan, big IDEA booklet. No salesman will call! Do it NOW... be first in your community to cash in on this huge new market!

**COAST INDUSTRIES Dept. 2C 1004 S. Los Angeles St., Los Angeles 15, Calif.**



# "Put Your Finger" ON Any Car Trouble

**IN A JIFFY!**

**Handy Guide Helps You Find "What's Wrong" FAST!**

Don't waste time and work trying to track down car and truck troubles. Let **MOTOR'S New TROUBLE-SHOOTER** find them for you **FAST**. Prepared by Editors of famous **MOTOR'S Manuals**. Lists 1760 specific causes of auto trouble—knocks, misses, noises, breakdowns, etc. If car has Connecting Rod noise—just turn to Connecting Rod Section for the 8 things that can be wrong. Covers engines, clutches, brakes, ignition, automatic transmissions, etc. Fits right in pocket for instant use. Spiral binding lets book stay open while you work. Cross-section **PICTURES**. Valuable help for beginners, experienced repair men.



**SEND NO MONEY**

Pay postman \$1 on delivery, plus C.O.D. charges. If not satisfied, return book in 7 days for refund. Or **SAVE** C.O.D. charges by sending only \$1 **NOW**. Same return privilege. **MOTOR Book Dept.**, Box AP, 250 W. 55th St., New York 19, N. Y.

**Tells how to Spot 87 Automatic Transmission Troubles, 8 Causes of Connecting Rod Noise, 82 Causes for Engine "Misses", 45 Causes of Excessive Oil Consumption, 14 Common Causes of Crankshaft Noise, 73 Checks for Clutch Troubles, 66 Causes of Rear-Axle Trouble, 81 Causes of Brake Trouble, 27 Checks for Faulty Springs and Shock Absorbers, 84 Different Types of Wheel Troubles . . . LOTS MORE.**

## Art Lesson

**FREE!**



Seriously interested in art? 14 or over? Let us send you a full-length, richly illustrated art lesson—free! Shows how to draw figures, heads, cartoons. Mailed without charge or obligation. Write for yours **TODAY!**



Send name, age, address (including county) to

**ART INSTRUCTION, INC., Dept. L-12131, 500 S. 4th St., Minneapolis 15, Minn.**

## INVENTORS

Before you make any effort to market your invention, you should take the first steps toward proceeding for patent protection.

I shall be pleased to furnish you with information relative to patent procedure, upon request from you, and this will be without any obligation on your part.

**PATRICK D. BEAVERS**

*Registered Patent Attorney*

934 Columbian Building Washington 1, D. C.

## PATENTS PATENT LAWYER

**GUSTAVE MILLER**

**REGISTERED PATENT ATTORNEY**

121-PM-WARNER BLDG. WASHINGTON 4, D. C.

ASSOCIATE EXAMINER U. S. PATENT OFFICE 1922-1929  
Patent Attorney and Advisor U. S. NAVY DEPT. 1930-1947

Send for **PATENT INFORMATION** book and **"INVENTOR'S RECORD"** without obligation

## INVENTORS

Whether an invention is patentable can be substantially determined by a search of the U. S. Patent records. Without obligation, write for information explaining the steps you should take to secure a patent.

**JOHN N. RANDOLPH**

*Registered Patent Attorney*

201 Columbian Building, Washington 1, D. C.



**PATENTS**  
**C. A. SNOW & CO.**  
REGISTERED PATENT ATTORNEYS  
WRITE FOR INFORMATION TO  
428 SNOW BUILDING, WASHINGTON 1, D. C.

## INVENTORS

Send today for "Patent Protection for Inventors" outlining preliminary steps to take toward patent protection, also convenient "Evidence of Invention" Form.

**VICTOR J. EVANS & CO.**

630-P Merlin Building • Washington 6, D. C.

## INVENTORS

IF YOU WISH TO PROTECT YOUR INVENTION, You should take steps to protect it by a U. S. Patent. Write me for "INVENTION RECORD" form

**CARL MILLER**

**REGISTERED PATENT ATTORNEY**

WOOLWORTH BLDG., 35th FLOOR, 121A NEW YORK CITY



# new, easy way to.. STRIPE with PAINT

## Do Perfect Paint Striping at Home with New Kind of PAINT STRIPING TOOL

This Master Painters' Striping Tool makes it easy to do expert striping on furniture, bikes, model planes, autos, signs, toys, linoleum, wall board, etc. Makes plain, painted walls look like tile. Paint straight lines... curved... circular or evenly spaced parallel lines the same way a professional painter does. Simply fill Tubular-Glass Paint Fountain with any color paint and wheel tip feeds paint evenly. Tips interchangeable—jaws split apart for easy cleaning. Tool complete with tips for 1-16 in. stripe only \$1.00 postpaid. Other complete tools with 1-64, 1-32, 3-64, 5-64, 3-32, 1-8 inch tips, \$1.50 ea. Extra tips — 75c each. COMPLETE KIT with tool and 7 tips. \$5.00. Here's the handiest tool in your whole painter's kit. C.O.D.'s post. coll.



**\$1  
ONLY**

**POSTPAID  
ATTENTION  
Home Craftsmen  
and Hobbyists**

### DEALERS Paint Striping Tool

packed in attractive display cartons of 1 doz. Fast, profitable seller. Write for illus. circular, discounts.

Just the tool you've been waiting for! New PAINT STRIPING tool gives "professional" results every time, yet simple and easy to use as a fountain pen. Adjustable guide keeps lines straight as an arrow. Just as easy to make curves or free hand designs. Adds new beauty and finished look to everything you paint. Send dollar today.

WENDELL MFG. CO., 4234 N. Lincoln Ave., Dept. 312, Chicago 18, Ill.

**GET  
UP TO  
40%  
OFF!**

## BUY IT WHOLESALE!

**START A BUYING SERVICE** at home, spare time. Get big-name merchandise for clients (and yourself) at up to 40% and more below the regular list price. Make fat commissions. Folks eagerly buy through you to get sizeable discounts. Send postcard for details.

AMERICAN BUYERS' SERVICE, 629-PM Linden Ave., Buffalo 16, N. Y.

## When You Can Earn More in WATCHMAKING LEARN By KCSW's Outstanding Method

**WRITE  
TO**

High-paying jobs now open. Pleasant work. Or build a business for yourself right in your own home, repairing clocks and watches.

Inquire today about the opportunities in this high-paying trade, through the latest HOME STUDY TRAINING. Also Resluent School.

**KANSAS CITY SCHOOL OF WATCHMAKING**  
1218 Admiral Blvd. Kansas City 6, Missouri

## BIG LEATHER & CRAFT CATALOG!

1000's of items for Leathercraft, Textile Painting, Copper Tooling, Kits, Projects, Tools, Supplies, Etc. Send 25c (refunded with 1st order) to:

**RUSSO HANDICRAFT SUPPLIES** Dept. CD-6, 245 S. SPRING, LOS ANGELES 12, CALIF.

**SAVE UP TO 50%  
AND MORE**

**OUT OF PAWN**

**GENUINE  
DIAMONDS**

VALUES FROM \$10  
TO \$10,000



**TIME PAYMENTS  
ARRANGED**

Send for  
Illustrated  
**FREE  
Catalog**

All diamonds reset in brand new modern mountings. Sold with a written iron-clad money back guarantee. Over 100,000 satisfied customers have bought diamonds from Berman's.

Our Reference — Your own Bank or any Mercantile Agency  
**Berman's Diamond Loan Bank**  
Dept. P — BERMAN BLDG., BALTO. 1, MD.

Diamonds from estates, banks, unsecured pledges offered at substantial savings.



## Northland SKIS

**B**ecome a top skier, have more fun by using the skis of champions. Northland skis are balanced and matched for better control - better skiing. You can depend on Northlands.

**IMPROVE YOUR SKIING.** Send for  
*Free Ski Manual, edited by Hannes*

*Schneider. (Offer good only in U.S.A.)*

**NORTHLAND SKI MFG. COMPANY**  
95 Northland Park • North St. Paul 9, Minn.

PICTURE BOOKLET  SENT FREE

# CONVAIR

in Sunny San Diego

has a **JOB** for you:

OPPORTUNITIES NOW OPEN:



1. TOOL DESIGNERS
2. TOOL PLANNERS
3. PATTERN MAKERS
4. TOOL & DIE MAKERS
5. JIG & FIXTURE BUILDERS
6. MACHINISTS
7. LOFTSMEN

San Diego offers you California living at its best — and Convaair gives you the top working conditions. Employee Retirement Plan. Group Insurance. Two weeks vacation. Eight holidays annually. Free Housing Office and much more — plus that wonderful San Diego climate.

Send this coupon now for booklet, details and Application Blank.

Employment Office  
Consolidated Vultee Aircraft Corporation  
3302 Pacific Hiway  
San Diego, California Dept. 700

NAME \_\_\_\_\_

OCCUPATION \_\_\_\_\_

ADDRESS \_\_\_\_\_

CITY \_\_\_\_\_ STATE \_\_\_\_\_



**"I'M EARNING \$300 A MONTH!"**



.... says Leonidas Burgoyne of Chicago, Illinois, "Expert individual instruction in the fully equipped shops of Greer Shop Training gave me the right start to get my good paying job."

**GREER SHOP TRAINING** . . . . established 1902, is one of America's largest trade schools. Over 48,000 successful graduates. You learn by tearing down, repairing and rebuilding. Day and evening classes. Mail this coupon today!

**LEARN A TRADE NOW!**

GREER SHOP TRAINING, Desk 211, 2230 S. Michigan Avenue, Chicago, Ill.

Gentlemen: Please send me information about trade I have checked below. (Specify if you are VET  or NON-VET .

**IN OUR CHICAGO SHOPS**

<input type="checkbox"/> AUTO MECHANICS	<input type="checkbox"/> BODY, FENDER REPAIR
<input type="checkbox"/> DIESEL	<input type="checkbox"/> WELDING—ARC, GAS
<input type="checkbox"/> REFRIGERATION	<input type="checkbox"/> TOOL & DIE
	<input type="checkbox"/> PIANO TUNING

Above courses approved for Vets and Civilians.

**ALSO THE FOLLOWING HOME STUDY COURSES**

<input type="checkbox"/> REFRIGERATION	<input type="checkbox"/> DIESEL	<input type="checkbox"/> PLASTICS
--	---------------------------------	-----------------------------------

Name \_\_\_\_\_ Age \_\_\_\_\_  
 Address \_\_\_\_\_  
 City \_\_\_\_\_ State \_\_\_\_\_

**GREER SHOP TRAINING**

**THIS HANDBOOK FOR AMBITIOUS MEN FREE!**



Have you had your copy? 150 pages of guidance to best-paid positions. Up-to-the-minute information for men who want to climb to the top. Tells how to get promotion, security and better pay through home study courses. This handbook "Engineering Opportunities" is free and entirely without obligation. Send the coupon. Make this your big year! Describes over ninety courses including:

- |                 |               |             |
|-----------------|---------------|-------------|
| Mechanical Eng. | Electrical    | A.F.R.Ae.S. |
| Aeronautical    | Radio         | A.M.I.C.E.  |
| Television      | Automobile    | B.S. (Pure  |
| Building        | A.M.I.Mech.E. | Science)    |

**--- SEND COUPON TODAY ---**

Canadian Institute of Science & Technology Limited, 527 Century Building, 412, 5th Street, N.W., Washington, D.C.

Please forward free of cost or obligation your handbook, "ENGINEERING OPPORTUNITIES".

Name.....  
 Address.....

Course interested in..... Age.....

Canadian enquiries: 263 Adelaide St. W., Toronto 1

**I need 500 Men to wear SAMPLE SUITS!**



**Pay No Money—Send No Money**

My plan is amazing! Just take a few easy orders for my sensational values in made-to-measure suits. Get your own suits **without a penny cost** and make money too! Men can't resist the outstanding style, long wear and low price of my made-to-measure suits. You need no experience. Spare time pays big profits. Rush name and address today for complete details. **Big Free Sample Outfit** contains more than 100 actual woolen samples, style illustrations, etc. Write now! **PROGRESS TAILORING CO., Dept. A-216 500 S. Throop St., Chicago 7, Illinois**

**MEN! WOMEN! PAINT IT WITH SUEDE! SPRAY ON RAINBOW COLORS FOR PROFIT—PLEASURE**

**FREE!! Sample—Plan**



**Complete Instructions—YOURS TO EXAMINE!**

Your own lasting, successful business—be your own boss. Huge demand waiting for new Miracle Finish. Big profits. Gives velvety, luxurious surface to lamps, toys, signs, displays, figurines, auto dash-boards—hundreds of other items. Full starting kit, complete step-by-step instructions yours to examine without risk. Details and sample FREE. Const. Dept. 211, 1004 South Los Angeles Street, Los Angeles 15, California.

**DRIVE 3 TO 6 DAYS A MONTH Gas Free!**



Better performance, more power, quicker starts, faster acceleration on all cars, light trucks—any make or model. Tested in Engineering Department leading U. S. University. Reduces gas consumption—may actually pay for itself in cash savings. **TEST IT 30 DAYS ON YOUR OWN CAR BEFORE DECIDING. Prove for yourself outstanding benefits this new miracle development by actual road test. TRY IT AT OUR RISK.** Send today for FREE details, technical data and 30 day Examination Request Blank. **G. B. SCHUYLER, Dept. 412, 2804 10th STREET, BERKELEY, CALIF.**

**WRITE SONGS AS A HOBBY OR FOR PROFIT**

**YOU WRITE THE WORDS — WE WILL WRITE THE MUSIC**

Send words for FREE examination. No obligation.

**FREE: 30 QUESTIONS AND ANSWERS ABOUT SONG WRITING**

**FIVE STAR MUSIC MASTERS, 224 Beacon Building, Boston 8, Mass.**

**BOYS—IT'S FREE!**

**"THE WONDERS OF CHEMISTRY"**

This exciting new book shows how to amaze your friends with chemical magic, describes many fascinating home experiments, tells of fun, thrills and big future opportunities for boys who know chemistry. Special atomic energy feature. Send today!

**THE PORTER CHEMICAL COMPANY**  
 43 Prospect Avenue, Hagerstown, Maryland



**Develop Hidden Earning Power**

**STUDY LAW**

**at home! LL.B. Degree**

Qualify yourself in spare time for advancement, greater earnings, business success. Now, more than ever, legal ability is in demand! Easy-to-understand step-by-step lessons and text material furnished — invaluable for permanent reference. 42 years expert teaching. 114,000 students enrolled. Easy payments. Find out now, at no cost, how study of law can help you. Write today for FREE Book "Law and Executive Guidance."

**AMERICAN EXTENSION SCHOOL OF LAW**  
 Dept. PM-45, 646 N. Michigan Ave., Chicago, Ill.





THE MOST AMAZING OFFER IN USED  
TIRE HISTORY. EVERY PASSENGER TIRE  
**UNCONDITIONALLY  
GUARANTEED**  
plus TIRE INSURANCE FREE

**10% OFF** ON ORDERS FOR TWO OR MORE TIRES  
Here's DOUBLE proof that we bear the loss if your tire wears out within the guarantee period or is damaged in any way (except willfully). Don't take risks; we send FREE insurance certificate PLUS written unconditional guarantee with your order.

**TRIPLE INSPECTED PASSENGER TIRES**  
Unconditional One Year Guarantee plus Tire Insurance Free

600-16	\$5.59	700-16	\$7.59	700-15	\$5.59	550-16	\$5.95
600-16(8)	6.50	600-15	5.59	750-16	12.25	550-17	5.75
650-16	5.79	650-15	5.59	550-15	5.59	475-19	5.75

**LO-PRESSURE TIRES FOR EASY RIDING**  
Unconditional One Year Guarantee plus Tire Insurance Free

640-15	\$5.75	710-15	\$6.50	820-15	\$7.50	760-16	\$7.50
670-15	5.95	760-15	6.75	670-16	6.95		

**MUD AND SNOW TIRES**  
2 YEAR WRITTEN GUARANTEE  
600-16 \$6.95 | 900-16 \$12.95 | 750-20 Regular \$12.50 | Special \$15.95

**EXTRA VALUE TRUCK TIRES**  
ONE YEAR WRITTEN GUARANTEE

600-20	\$10.75	750-20	\$14.50	825-20	\$21.50	1100-20	\$26.95
650-20	11.75	32x6(8)	11.75	900-20	19.50	1100-22	24.50
700-20	12.50	32x6(10)	12.50	1000-20	20.00	750-20(10)	18.00

TRACTOR TIRES available in all sizes. Complete line of High Mileage Tires in stock. Write for price list for sizes not listed. Take off 10% on orders for two or more tires. Prices subject to change.  
MAIL ORDERS PROMPTLY FILLED. Send check or money order with this ad.  
**THE SAFTYRE CO.**  
"FOR THAT SAFE TIRE"  
Dept. PM, 920 W. CARY ST., PO BOX 2254, RICHMOND, VA.

TAKE THE STEPS NOW THAT WILL GIVE YOU LIFETIME SECURITY IN AVIATION!

Booming aviation industry urgently needs properly trained young men! Big paying jobs are open right now, with more to come! Embry-Riddle offers maximum training in minimum time. Fully accredited 8-mo. to 26-mo. courses in all aeronautical phases. Job-fitting instruction backed by 25 yrs. experience training today's aviation leaders. Be prepared. Enroll now! Illustrated catalog, address: REGISTRAR, EMBRY-RIDDLE, DEPT. 99, MIAMI 30, FLA.

**Embry Riddle**

SAY YOU SAW IT IN POPULAR MECHANICS

# NEW K-R-O WARFARIN KILLS RATS

WARFARIN, the newest in rat and mouse killers from the University of Wisconsin, now comes to you backed by the dependable, 50-year-old K-R-O label. K-R-O Warfarin kills rats gently, slowly —without "warning" other rats. Tasteless, odorless; there's no "bait shyness." Safer around poultry, pets, livestock. Household size (2 oz.) makes 2½ lbs. rat bait, \$1.00; farm size (4 oz.) makes 5 lbs. rat bait, \$1.75. Money-back guarantee. At drug, seed, and feed stores. *The K-R-O Co., Springfield 99, Ohio.*

Something New in Home  
**FIRST AID For BURNS**

**Bactine**  
BRAND Reg. U. S. Pat. Off.

- RELIEVES PAIN
- HELPS HEALING BY PREVENTING INFECTION
- CLEANS BURNS
- KILLS GERMS
- IT'S GREASELESS
- DOESN'T STAIN

"NOTHING BETTER FOR FIRST AID!"

COMMENDED BY PARENTS' MAGAZINE

Guaranteed by Good Housekeeping

Don't Try To Treat a Serious Burn!  
**CONSULT YOUR DOCTOR**

AT ALL DRUG STORES  
30c and 70c SIZES

**Now!**

## Be a Well-Paid Expert ON ALL ELECTRICAL REPAIRS and MAINTENANCE

Defense Program Means Bigger Pay in Essential Field for Top Electrical Repair Men

Prepare NOW for a good-paying, ESSENTIAL job. Defense plants need expert electrical repair, maintenance men. Get the "know-how" from this Electrical Maintenance and Repair Library.

5 Volumes; 2072 Pages; 1834 Pictures

Starts at beginning, takes you step by step through every phase of connecting, altering, testing, repairing all types of equipment. How to install motors, generators, rewind motors; inspect, repair starters; locate trouble; test induction motors, and MUCH MORE! One entire volume crammed with trouble-shooting charts. Simple diagrams make everything crystal-clear. Gives best on-the-job practices of experts. Will help to put you in big-pay class and to rate as an ESSENTIAL worker.

Send no money. Mail coupon for FREE 10-DAY TRIAL. Note special price, easy payments.



**FREE  
10-DAY  
TRIAL**

McGraw-Hill Book Co., Dept. PM-12-51  
327 West 41st St., New York 18, N. Y.

Send me for FREE 10 days' examination the Electrical Maintenance and Repair Library. If not satisfied I will return books. Otherwise I will send \$3.50, plus postage, then and \$4 a month for 4 months (a saving of \$2 under regular price of \$21.50).

Name \_\_\_\_\_

Home Address \_\_\_\_\_

City & State \_\_\_\_\_ PM-12-51

WE PAY POSTAGE if you enclose \$3.50 first payment WITH coupon. Same return privilege for full refund.



# RELIEVES PAIN OF HEADACHE • NEURALGIA NEURITIS

# FAST

The way  
thousands of  
physicians  
and dentists  
recommend



Anacin® relieves headache, neuralgia, neuritis pain fast because Anacin is like a doctor's prescription—that is, Anacin contains not just one, but a combination of medically proven, active ingredients in easy-to-take tablet form. Thousands have been introduced to Anacin through their own dentist or physicians. If you have never used Anacin, try these tablets yourself for incredibly fast, long-lasting relief from pain. Don't wait. Buy Anacin today.

## KLEENSMOKS® ARE COSTLY!

Cost 3 times as much to build as the best of old-fashioned pipes. But **KILL TONGUE BITE, STOP DRINK. FREE** circular tells **WHY**. Send postcard to:

**KLEENSMOK PIPE CO.**

P. O. No. M-597, Johnson City, Tenn.  
R-Reg. U.S. Pat. Off. Pat's. and Pat's. Pend.

## NOW MAKE YOUR OWN ACCURATE SURVEYS...

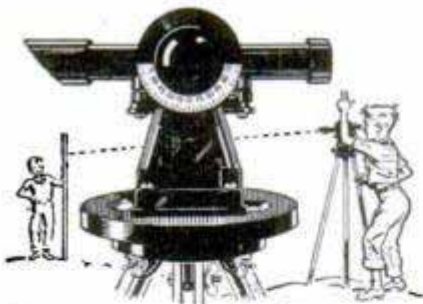

Here's a junior size surveying kit that makes it easy to do your own accurate surveying. You can lay out patios, fences, barbecue pits, baseball diamonds, camp sites. Use it for leveling or for measuring angles. The complete outfit includes scope, base, legs, uprights, tape, rod, plumb bob and a handbook of practical problems and instructions. A swell Christmas present — an educational gift for boys — a useful item for home-owners. Only \$8.95 prepaid or C.O.D. plus shipping charges. Add 3% sales tax if you live in California.

### SURVEYOR JUNIOR \$8.95

Use this handy coupon today!

Surveyor Junior Co.  
Box 19034, La Tijera Station  
Los Angeles 43, California

Enclosed is check— Money Order— Send C.O.D.—

Name \_\_\_\_\_

Address \_\_\_\_\_

Town \_\_\_\_\_ State \_\_\_\_\_

## Print your own postcards!

Print your own postcards or start your own advertising business with a real postcard duplicating machine! NOT A TOY! Complete with one stylus, ink, correcting fluid, signature writing plate, and one full quire of 24 stencils without extra charge. Automatic feed, roller release.

### Send No Money

A postcard brings you KARD-KWICK Duplicator. Pay the postman \$12.95 (a \$15.50 value), plus postage. Your money back if not satisfied. Or save postage charges by sending your check or money order for \$12.95 NOW!

UNCONDITIONAL MONEY-BACK GUARANTEE

The KARD-KWICK CO.

1364 So. Lafayette  
Denver 10, Colorado

1 Quire Stencils FREE with each order

Many uses; businesses, churches, hobbies, clubs, etc.

**GREAT PROFITS**  
MAKE YOUR OWN RUBBER MOLDS

**X.L. RUBBER MOLDS**  
will realize you great profits quickly!  
WRITE FOR NEW FREE CATALOG

YOU can EASILY learn to cast thousands of perfect plaques, book ends, figurines, ash trays, etc. IT'S EASY, FUN, PROFITABLE! X.L. Rubber, Pts. \$2.50; Qts. \$4.00 (postage extra). Molds and enough for 3 molds \$1.50 prepaid.



SEND FOR FREE FACTS

PLASTIC ARTS STUDIO Address Dept. 2  
3403 S. Madison St.

Muncie, Ind.

## QUICK STARTS IN COLDEST WEATHER



### CALROD ENGINE PRE-HEATER

Reduce engine wear, get quick, easy starts all winter with a G. E. Calrod engine heater. Safe. Fits all cars... attaches to water hose... easily installed. Use any AC outlet. Engine warms in a jiffy. **WON'T OVERHEAT.** Not affected by Anti-Freeze. Kit includes pre-warmer unit, 2 cord sets, complete instructions. State make and model of car. (Chevrolet's \$9.95). ALL OTHERS \$8.95 p.p. Money back guarantee. Send check, cash or M.O. (COD's send \$1.00, you pay postage.)

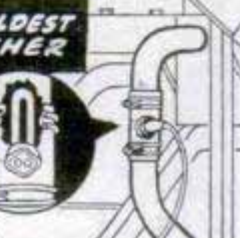

Coast Auto Supply, Dept. P.M., 110 N.W. Broadway, Portland 9, Oregon

## GROW MINIATURE TREES

FOR PROFIT & PLEASURE



Fabulous Money—Real Fun! Grow genuine live dwarf (Ming) trees. A terrific new business and hobby. Astounding details Free. Write —

**DWARF TREES, Dept. 28**  
P. O. Box 355, Briggs Station  
Los Angeles 48, Calif.

## LEARN AT HOME LOCKSMITHING

YOU CAN MAKE GOOD PROFITS ALL YEAR ROUND IN FULL OR SPARE TIME!

Locksmiths are always in big demand! Age is no disadvantage in this respected, permanent field. Learn how to make keys, fix locks, make duplicates, etc. Practical, illustrated lessons by experts show you how! All materials and special tools supplied. Send for FREE booklet.

INSTITUTE OF LOCKSMITHING

Dept. P-25

15 Park Ave.

Rutherford, N. J.

Licensed & Approved by State of New Jersey



## WARN HUB CAP MAKES 2 JEEPS OUT OF 1

Ends front wheel drag on 4-wheel drive Willys Station Wagons, Pick-ups and Jeeps

\$20.00

Prepaid - U.S., Canada

Saves gas up to 5 miles per gallon, tire wear, front axles, increases speed and power. Stops shimmy—front wheels coast out of gear! 4-wheel drive handles, performs, climbs like 2-wheel. Install or remove WARN HUB CAPS in 10 minutes. Polished aluminum, guaranteed. Rush check, M.O., or C.O.D. Write for circular.

WARN MFG. CO. - 1625 Third Ave., Seattle 1, Wash.

## Learn BAKING At Home

Baking is one of America's high industries in wages. Nearly depression-proof. Thorough basic home course lays sound foundation. If you have aptitude, write for FREE BOOKLET, "Opportunities in Commercial Baking."

NATIONAL BAKING SCHOOL

Dept. 1359

835 Diversey Pkwy.

Chicago 14



POPULAR MECHANICS



# FULLY GUARANTEED TIRES COST LESS!

Nationally famous FIRESTONE, GOODRICH, U.S. ROYAL, GOODYEAR, and other makes. Every tire selected and inspected for your safety.

New Tread Tires Guar. 24 Mos. (Mud & Snow Tires \$2. Extra)										
550x16	9.98	600x16(6)	11.98	650x20(8)	21.95	700x16(6)	16.48			
550x17	9.98	650x15	11.98	640x15	10.98	710x15	12.48			
600x15	9.98	650x16	12.48	670x15	11.98	760x15	13.98			
600x16	9.98	650x16(6)	14.48	700x15	13.48	820x15	14.98			

GOOD TIRES GUARANTEED 12 MONTHS										
600x16	4.14	700x16	5.14	32x6(8)	8.84	825x20	14.24			
650x16	4.54	670x15	4.74	32x6(10)	10.84	900x20	13.34			
650x15	4.34	650x20	7.84	750x20(8)	8.54	1000x20	14.14			
700x15	4.64	700x20(8)	8.94	750x20(10)	9.94	1100x20	16.14			

AAA PREMIUM GRADE GUARANTEED 18 MONTHS										
600x16	5.58	700x16(6)	7.98	600x20	9.78	825x20	18.68			
600x16(6)	6.58	750x16(6)	8.98	650x20	10.88	900x20	18.98			
650x16	5.98	820x15	7.48	700x20	12.88	1000x20	19.98			
650x16(6)	6.98	710x15	6.48	32x6(8)	10.48	1000x22	21.98			
650x15	5.98	550x18	5.98	32x6(10)	12.48	1100x20	20.98			
700x15	6.68	700x15	6.78	750x20(8)	12.98	1100x22	21.98			
700x16	6.78	550x17	5.88	750x20(10)	14.98	1100x24	23.98			

MILITARY AA Guaranteed 12 Months—					MILITARY				
SPECIAL 900x16 11.98   1000x20 19.98					New Tread Guar. 24 Mos.				
750x20 12.89   1100x20 21.98					600x16 10.98				
AAA GUARANTEED 18 MONTHS					600x16(6) 11.98				
900x16 14.98 • 750x20 16.48					750x20(8) 26.98				
Passenger Tubes—Water Tested—					All Sizes.....\$1.25				
Truck Tubes—Water Tested—					All Sizes.....\$2.95				

Largest stock of used tires in the East. Thousands of satisfied customers. Write for sizes not listed. MONEY ORDER OR CHECK WITH ORDER. NO C.O.D.'s

**PYRAMID TIRE CO.**  
1333-35 North 5th St.  
Dept. M., Phila. 22, Pa.

## BOAT KITS For Home Assembly

**PRAMS \$39<sup>60</sup> up**  
8 TO 11 FT.  
ALSO WITH SAILS

**NEW CATALOG MOST COMPLETE EVER OFFERED**

- 1 - BOAT KITS 26 MODELS
- 2 - MARINE HARDWARE
- 3 - MARINE ENGINES
- 4 - MARINE CONVERSIONS
- 5 - PAINTS & COLOR CHARTS

**U-MAK-IT PRODUCTS** 703P-WHITTIER ST. Bronx 59, N. Y. City

Build the Best U-MAK-IT KITS

SAY YOU SAW IT IN POPULAR MECHANICS

## 6-INCH ALL-METAL SLIDE RULE

**22 SCALE LOG LOG TRIG**

**MOST POWERFUL POCKET RULE EVER OFFERED**

Serious students — professional engineers! Get this new PICKETT Pocket Rule. Solves most difficult mathematical problems easily, swiftly. **MORE POWERFUL THAN ORDINARY 10-INCH RULES** — accurate to 4th decimal. All metal, precision built, most advanced scale arrangements ever devised. Fewer settings... back-to-back scales. Has **UNQUALIFIED ENGINEERING FACULTY APPROVAL**. Free 28-page instruction manual included, clear, easy to use. **Special** — your name imprinted on leather pocket carrying case free — act now!

**30 DAY MONEY-BACK GUARANTEE**

Rule, carrying case and manual, including postage **895** only (West of Denver \$9.75)

Write for free folder showing 17 other famous Pickett & Eckel Rules... over 350,000 now in use! Sold in leading stationery stores.

**MULTIPLIES SQUARES CUBES DIVIDES PROPORTIONS finds SINES CO-SINES LOGARITHMS SQUARE AND CUBE ROOTS**

**BAUER-LEE & CO. • SIERRA MADRE, CALIF.**

BRING REAL XMAS JOY... GIVE THE FINEST GIFT FOR MAN AND BOY

## A NOBLE .22 Cal. Slide Action Rifle

Whatever the target, score more hits in the field or on the range with this streamlined, fast-shooting, NOBLE 22. Dependable and accurate, yet lowest priced. Has visible feeding mechanism. The ideal gift for man and boy. Write for free folder on Rifle & Shotgun.

LOWEST PRICE ON MARKET

HAS NEW SAFETY FEATURES

Only **\$35<sup>65</sup>** East of Rockies

**NOBLE MFG. CO., Inc.**  
DEPT. P, HAYDENVILLE, MASS.

**YOURS FOR ONLY 10¢**

## OVER 50 AWARD-WINNING DESIGNS FOR PLYWOOD BUILT-INS

Here in a handy, file-size portfolio are designs judged best by a jury of architects and builders in national "Better Living Home" contest—history's biggest architectural competition. Contains over 50 outstanding designs selected from 2,727 entries. Ideas for every room in your home. Practical, work-saving, space-saving built-ins you can build with easy-to-use fir plywood. Ideal for home work shop projects.

**PARTIAL CONTENTS**

- Storage Planning
- Living Room Built-Ins
- Dining Area Built-Ins
- Kitchen Built-Ins
- Bedroom Built-Ins
- General Storage Units
- Room Dividers
- 4 Top House Designs
- Plywood Grade Data
- Finishing Suggestions

**MANY OTHERS!**

**MAIL TODAY FOR VALUABLE IDEA PORTFOLIO**

(Good USA Only)

Douglas Fir Plywood Assn., Dept. 5012, Tacoma, Wn.

Please rush Built-Ins Portfolio. I enclose 10c.

Name.....  
Address.....  
City.....State.....



The Perfect Gift for Everyone On Your List!

# ANTIQUE AUTO SETS

Only \$1.95 to \$3.95

Miniature 3/4" Scale Models—Such Fun and So Easy to Build!



1906 Columbia Electric \$2.50





1911 Maxwell—\$2.50    1904 Olds—\$1.95

Recapture the days of the early automobiles in these exciting miniatures—each 6" to 10 1/2" in length when completed. Easy to build because they come completely pre-fabricated, with all ready-shaped parts, cast wheels, lights, radiator, horn, etc. Easy to follow instructions included. At toy, hobby and department stores.

Check "OLD TIMERS" You Want to Give:    1910 Model "T" Ford \$2.50

- |  |  |  |
|--|--|--|
| <input type="checkbox"/> 1911 Maxwell \$2.50             | <input type="checkbox"/> 1911 Buick "Bug" \$2.50         | <input type="checkbox"/> 1910 Model "T" Ford \$2.50      |
| <input type="checkbox"/> 1904 Olds \$1.95                | <input type="checkbox"/> 1903 A Ford \$2.50              | <input type="checkbox"/> 1910 Internat. Harvester \$2.95 |
| <input type="checkbox"/> 1910 T Ford \$2.50              | <input type="checkbox"/> 1902 Franklin \$2.50            | <input type="checkbox"/> 1900 Packard \$2.50             |
| <input type="checkbox"/> 1909 Stanley Steamer \$2.95     | <input type="checkbox"/> 1906 Columbia Electric \$2.50   | <input type="checkbox"/> 1903 Cadillac \$2.50            |
| <input type="checkbox"/> 1909 T Ford \$2.95              | <input type="checkbox"/> 1910 Internat. Harvester \$2.95 | <input type="checkbox"/> 1914 Stutz Bearcat \$3.95       |
| <input type="checkbox"/> 1903 Rambler \$2.50             | <input type="checkbox"/> 1900 Packard \$2.50             | <input type="checkbox"/> 1914 Stutz Bearcat \$3.95       |
| <input type="checkbox"/> 1913 Mercer Raceabout \$3.95    | <input type="checkbox"/> 1903 Cadillac \$2.50            |  |
| <input type="checkbox"/> 1906 "Old 16" Locomobile \$3.95 | <input type="checkbox"/> 1914 Stutz Bearcat \$3.95       |  |

Write to us—Add 25c for postage and handling. No. C. O. D.'s please

hudson miniatures **OLD TIMERS**

"Originators of Antique Autos in Miniature"

SCRANTON HOBBY CENTER, Dept. 14, Scranton 10, Pa.

**LUFKIN SUGGESTS...**

## CHROME-CLAD MEZURALL tape-rules



You can stop shopping around right now—here's the one gift that everybody appreciates... a genuine LUFKIN Mezurall Tape-Rule

Chrome-Clad non-glare finish blade will not chip, crack, peel or corrode! Markings are easy-to-read—durable. Patented self-adjusting end hook provides accurate butt-end and hook-over measurements. Blades are replaceable. Case handsomely finished in two colors. Select the size you want or tool store.

C-926—6 ft. • C-928—8 ft.  
C-9210—10 ft.

**Buy LUFKIN** 104-A

THE LUFKIN RULE CO. • TAPES • RULES • PRECISION TOOLS  
SAGINAW, MICHIGAN • New York City • Barrie, Ontario

# F-L-A-S-H YOUR TURNS

INSTALL FLASHING DIRECTIONAL TURN SIGNALS ON YOUR CAR. ELIMINATE HAND SIGNALLING



ONLY \$6.95 POST-PAID

C.O.D.'s EXTRA

All wire, bulbs, fixtures and materials supplied in complete kit, plus handsome control switch with reminder light that flashes when signals flash. Use existing parking & tail lights. No drilling necessary. No outside mountings. Easy-to-follow instructions. Tested and Approved to meet S.A.E. standards.

Specify make & year of car when ordering. Money-back guarantee.

**RAY PRODUCTS CO., 139-M N. Clark St., Chicago 2, Ill.**

## MANUFACTURE BUILDING BLOCKS

Easy to start your own profitable business. General high speed, low cost Concrete Vibrator Block Machine produces 1000 blocks in 8-hour day. All sizes and shapes. Complete details FREE. Mail \$1 for wonderful book, "How to Build Your Own Concrete Block Home."

Only \$218



**GENERAL ENGINES CO.**  
307 HUNTER ST., M-121 GLOUCESTER, N. J.

## STAIRWAYS TO THE STARS

This beautiful new designed What-Not Shelf is just the thing for your living room, club basement, kiddies room. One boy is supplying ten stores with this shelf. Full size pattern is specially designed for production work. Send only 50c to

**STAIRWAYS TO THE STARS**  
BOX 136  
BALTIMORE 20, MARYLAND



## WONDER-PASTE Paint Remover

The modern, easy way to strip paint, varnish, enamel, lacquer, etc. AT PAINT AND HARDWARE STORES

## SWISS MUSIC MOVEMENTS

Surprise yourself with the amazing number of uses for these fine imported units. Put them in your favorite stuffed toys, make novelty and cigarette boxes musical. Specify CHRISTMAS, NURSERY, WALTZES, POPULAR. Full size patterns for Christmas Church, Musical Fireplace, Christmas Manger, Cake Plate, Doll Cradle 15c ea. SPECIAL—one free pattern with first purchase. Get started now! Send \$2.50 for sample unit. Results guaranteed to delight you. Complete information upon request.

MARITIME—13 East 60—New York 22, N. Y.



## "YOU ARE UNDER ARREST!"

There's a Thrill in Bringing a Crook to Justice Through Scientific

### CRIME DETECTION!

We have taught thousands this exciting, profitable, pleasant profession. Let us teach you, too, in your own home. Learn Finger Printing, Fire Arms Identification, Police Photography and Criminal Investigation thoroughly, quickly and at small cost.

**Over 800 of All American Bureaus of Identification** employ students or graduates of I. A. S. You, too, can fit yourself to fill a responsible crime detection job with good pay and steady employment. But don't delay—get the details now. Let us show you how easily and completely we can prepare you for this fascinating work, during spare time, in your own home. You may pay as you learn. Write today . . . Now . . . Be sure to state age.

**Be A FINGER PRINT Expert**

**FREE!!!** Send for Thrilling "BLUE BOOK OF CRIME"

**INSTITUTE OF APPLIED SCIENCE**  
1920 Sunnyside Ave., Dept. 1359, Chicago 40, Ill.



# YOUR FORTUNE and YOUR FUTURE!

CATALOG NO. 20 is now ready! The only catalog of its kind offering you hundreds of NEW things you've NEVER SEEN BEFORE . . . ideas you've never DREAMED OF and an easy plan for starting a LIFETIME BUSINESS you never thought was within your reach! CATALOG NO. 20 offers you ASTOUNDING OPPORTUNITIES to start your own prosperous business ON A SHOESTRING! A four-way GUARANTEED PROFIT AND SUCCESS PLAN, designed to give you a BIG START, BIG PROFITS and your own ESTABLISHED BUSINESS almost OVERNIGHT!

Don't answer this ad unless you are ready for BIG THINGS! Here's all you have to do to get started . . . send only 25¢ for CATALOG NO. 20 and full details of the FOUR-WAY GUARANTEED SUCCESS PLAN. Send for it today . . . right now . . . don't put off anything that could mean so much to your future! Be sure to mention Catalog 20!

**PLASTICAST CO., (Dept. D-C)**

P. O. Box 6737  
Chicago 80, Ill.

(write to  
nearest address)

P. O. Box 987  
Palo Alto, Calif.

## CARBURETOR TOO RICH MAKES MOTORIST TOO POOR



Car owners who are wasting money and not getting proper gas mileage due to over-rich mixtures will be pleased to learn how to save gasoline by VACU-MATING over-rich mixtures. VACU-MATIC fits all cars, trucks and tractors. It is automatic and operates on the supercharge principle. Easily installed in a few minutes.

**SALESMEN WANTED! Big Profits!** Send name, address on penny postcard for free particulars and how to get yours for introducing.

VACU-MATIC CO., 7617-1828 W. State St., WAUWATOSA, WIS.

Tune in the  
**AUTO-LITE**  
Show

**"Suspense!"**

CBS Radio Mondays  
CBS Television Tuesdays



## "RED-E" GARDEN TRACTORS

**SAVE—Buy Direct From Manufacturer** You'll like the smooth, powerful, gear-driven, 1952 styles in the Walking Model, 2, 3, 4 1/2, 6 H.P. with power turning clutch for each wheel or the Riding Model—7 1/2 H.P. with automatic type differential. Attachments for plowing, sowing, cultivating, wood-sawing, snow-plowing, etc. EASY TERMS. Special: Discount to User Agents.

FREE CATALOG!  
**RED-E TRACTOR CO.**  
RICHFIELD 217, WISCONSIN

## STUDY TO BE A DOCTOR of Psychology or Metaphysics

Obtain a Ps.D., Ms.D., D.D., or Ph.D. degree. Be a Teacher, Lecturer or Accredited Practitioner. Teach others how to achieve Health, Happiness and Contentment. Chartered by State. Write for FREE book telling how.

THE NEOTARIAN COLLEGE OF PHILOSOPHY  
Desk 8, Pickwick Building Kansas City 6, Missouri

## Watchmakers WANTED!

Learn this high-pay trade. Copyrighted Sweazey System shows you how . . . quickly, successfully . . . at home or in our Chicago School (founded 1908). We furnish tools, supplies, practice watches for home study course. No previous experience needed. Try it without obligation!

FREE SAMPLE Home Study LESSON

**CHICAGO SCHOOL OF WATCHMAKING**  
1608 N. Milwaukee Ave., Dept. 1121, Chicago 47, Ill.

# TITANIUM Rutile

## The New WONDER GEM of the Century

HUDSON\* BRAND (PATENT PENDING)

For the first time in history and as a result of intensive experimentation and research on a vital military project brilliant scientists of one of America's largest corporations suddenly hit upon the solution of the ages. The secret of how to crystallize in the laboratory a gem with a refractive index higher than and a dispersion factor greater than a DIAMOND was DISCOVERED. The discovery is TITANIUM RUTILE so widely acclaimed by leading reportorial mediums such as Reader's Digest, The Saturday Evening Post & Pop. Mechanics.

This is the same atom-age wonder-gem development widely sold at much higher prices under various colorful trade names.

REFRACTIVE INDEX ABOUT 10% HIGHER THAN DIAMONDS

Compare: Refractive Index of Rutile is between 2.62 and 2.90 as compared to the diamond's 2.42. Dispersion of Rutile ranges between 0.155 and 0.205 in comparison to the diamond's 0.025.



(Actual Photograph of Our Product)

You are living in an age of miracles. As you know, atoms are being split. Actual basic materials are being re-arranged. Fantastic as it may seem to the layman, the secret of what has formerly been referred to as the DIAMOND is now known beyond a shadow of a doubt. YOU PROFIT. No longer need you invest large sums of money in a tiny stone the value of which is determined largely by scarcity and control. YOU can enjoy the beauty and prestige and the envy of your friends with a stone that no one of lesser ability than a REAL JEWELER working with a magnifying glass in his eye under good light can detect as not being a real DIAMOND.

A handsome engagement ring made of our remarkable gem presented to any girl will inspire her devotion. The hundreds of dollars thus saved will go far towards building a happy, permanent home.

Hudson Gem Co. sells RUTILE only in the cut stones. Each stone is perfectly cut with full 58 facets per BRILLIANT stone. By law we cannot refer to our products as DIAMONDS so we ask you to order them in the three most popular DIAMOND shapes namely the round or BRILLIANT, the oblong or EMERALD and the oval or MARQUISE cuts. You may order these stones for setting by your local, friendly, trusted jeweler who will be glad to verify your purchase.

We do not sell mountings nor do we go in for costly catalogues nor expensive time payment plans. You get the benefit of direct to consumer possession of a valuable product which you can then have mounted and SAVE THE MONEY YOURSELF.

**IMPORTANT NOTE:** The Hudson brand is finished with our exclusive process. More fire, more sparkle and more durable. Thus—**10 YEAR REPLACEMENT GUARANTEE.** Accept no substitute regardless of price. Deal with only coast to coast concern—be sure. **UNCONDITIONAL MONEY BACK GUARANTEE. 30 DAY TRIAL IN YOUR HOME.** You are the **SOLE JUDGE.** In this advertisement you are assured that if for any reason whatever you are dissatisfied with your purchase from us you may, within 30 days, return

your purchase for **100% CASH REFUND WITHOUT QUESTION.**

Order with confidence. Select the shape you want, either BRILLIANT or EMERALD or MARQUISE shapes. Then select the number of Carats you want, either 1, 1 1/2, 2, 2 1/2, 3, 3 1/2, 4, 4 1/2, 5, 5 1/2, 6, 6 1/2, 7, 7 1/2, 8, 8 1/2, 9, 9 1/2, or 10. Remember each BRILLIANT is full 58 facets. Check this with your trusted jeweler. Price \$10.00 per carat. Add 20% Fed. Tax. Send Check or Money Order (do not send cash). Add 50¢ for postage and handling. Write Dept. PM-12.



**TAJ MAHAL STAR SAPPHIRES and STAR RUBIES**

These exquisite masterpieces of the 1st rank are of the same physical components and exactly resemble natural mined gems worth about \$1,500.00 per carat. Yours for just \$10.00 per carat plus 20% fed. tax. Accept no substitute for these HUDSON achievements regardless of price. 1-30 carats.

**HUDSON GEM CO., 574 5th Ave., N.Y.C., N.Y.**

ALSO . . . 1213 Capitol, Houston, Tex. • 607 Market St., San Francisco, Cal. • 601 Leonhardt Bldg., Oklahoma City, Okla. • White-Henry-Stuart Bldg., Seattle 1, Wash. • 108 N. State St., Chicago 2, Ill. • 416 West Eighth St., Los Angeles, Cal. • Gas and Electric Bldg., Denver 2, Colo. • 110 Federal St., Boston, Mass. • 1424 K St., N. W., Washington, D. C.

## GREATEST SAVING EVER OFFERED!

U. S. GOV'T SURPLUS



## "BARGAIN BOOK"

SAVE ON WINTER NEEDS!

It's loaded with bargains in genuine Gov't Surplus for farm-home-industry. Save up to 85% on clothing, hardware, sporting goods, etc. The "Book of the Year". Send 10c for yours today.

MAIL TODAY Only  
**10¢**

500 BARGAINS  
• FARMS • SPORTS  
• HOME • SHOP

**FISLER SALES CO.**

723 WALNUT ST., DESK M-12, KANSAS CITY, MO.

SAY YOU SAW IT IN POPULAR MECHANICS





# NEW MOSSBERG CATALOG

To make your Christmas selection easy

Complete lineup of rifles, shotguns, telescope sights and spotting scope, — all at low Mossberg prices — each readily obtainable at your dealer's.

Clip and fill in coupon now so you'll have plenty of time to pick a "Mossberg"



**O. F. MOSSBERG & SONS, INC.**  
 19712 St. John St., New Haven 5, Conn.

Send me without delay your new Christmas catalog of Mossberg Firearms available at my dealer's.

Name.....  
 Street.....  
 City..... (Zone)..... State.....

**NEW!** POLARVISION SAFETY LIGHT

A revolutionary new light discovery recently released for civilian use.

**STOP HEADLIGHT GLARE**

Fits All Cars & Trucks FOR SAFETY AND COMFORTABLE DRIVING

The Amazing "Ergon Glass Lens" is an integral part of the Polarvision Light. It produces a Black Light (barely visible to the eye) which Counteracts oncoming headlights, street lights, etc. without interfering with your visibility. Easy to install above windshield—beautiful accessory. Light encased in high grade chrome holder. Works off car's central lighting circuit. Limited Supply. Complete (including all parts) **\$6.95**

Send cash, check, or money order. Guaranteed

ELECTRONIC DEVELOPMENTS, Dept. B12, Box 775, Portland 7, Oregon

**Brand New!**

**7 JEWELS!**  
**3 YEAR SERVICE GUARANTEE**

- Shock Resist
- Sweep Sec. Hand
- Chromed Case
- Radium Dial
- Gift Boxed
- Leather Band

LADIES' WATCH \$8.95 plus 90c tax  
 As described above—smaller size  
 Money back guarantee! Order today!  
 Sorry, no C.O.D.

**ELCO PRODUCTS**  
 Dept. P12, 166 W. Washington St., Chicago 2, Illinois

**\$7.95**  
 POST PAID  
 Plus 80c Tax

**"How to Make Money with Simple Cartoons"**

A book everyone who likes to draw should have. It is free; no obligation. Simply address **FREE BOOK**

**CARTOONISTS' EXCHANGE**  
 Dept. 912D Pleasant Hill, Ohio

**ARRO-PING** —the Original Arrow Sling-Shot has accuracy and power for small game or target with swift ping of an arrow. Sturdy, smoothly-made wood stick, guided-flight barrel, slender metal-tipped 12-inch arrows. Powerful rubber propulsion sends arrow 300 feet. Try skill in a new hunting thrill.

Postpaid, with five Arrows, \$1.  
 Or Arrows alone 20 for \$1.

**ARRO-PING CO.**  
 Box 25H West End Station, Colorado Springs, Colo.

**Become a Doctor of PSYCHOLOGY**

Win the degree of Ps.D. Teach the secret of contentment, happiness. Solve mental worries. Experience the revelation of truth. Chartered college. Individual help. Write for FREE book. **COLLEGE OF UNIVERSAL TRUTH, 5153-B North Clark St., Chicago.**

**BIG OPPORTUNITIES OPEN IN THE METAL TRADES**

Machinist Trade *Only 60 school days - 360 Hours -*  
 Tool & Die Making *of practical*  
 Tool & Die Designing *Shop Training or Mechanical*  
 Drafting—all branches *Structural or Aircraft Drafting*

Allied will train you easily and quickly for these Important Trades and place you on a Good Paying Job.

Inquire about our **PAY AFTER GRADUATION PLAN**

INDICATE PREFERENCE - RESIDENT or HOME STUDY

**ALLIED SCHOOL** 1338 S. Michigan Avenue  
 412 Allied Building  
 Chicago 5, Illinois

Write for **Free Books** a 1¢ postcard will do!

**START YOUR TANK COLLECTION NOW**

With this perfectly detailed model of the Walton Walker Bulldog, America's newest tank.

Scale: 1" to 108"

Featured in October Popular Mechanics

**Price \$1.95** ppd.

Illustrated Catalog Sent With First Order  
 No C.O.D.'s please

**Military Miniatures**  
 America's Foremost Miniature Figure Shop  
 Dept. M121 1384 Lexington Ave. New York 28, N. Y.



**Give a MILLION THRILLS**

33 FAMOUS MODELS \$17.95\* UP

FREE — name in gold



**at 50% SAVINGS!**

Magnify his or her enjoyment at sports... hunting... theater... everywhere! SPECIAL Cases imprinted in 24K gold — FREE! 30 day return privilege. MONEY BACK GUARANTEE! TERMS!

WRITE TODAY!

\*Add usual 20% Fed. Tax

NEW 8 power, 30mm Shur-Grip design Featherlight, COATED. **\$39.50\*** \$135 Value!

**FREE!** NEW XMAS CATALOG AND "HOW TO SELECT" BOOK

BUSHNELL BINOCULARS

DEPT. MA32 Bushnell Bldg., Pasadena 1, Calif.



# MOTORISTS



**New ACCELA-ROD To Solve Your Motor Idling Problem on Cold Days**

**Positive-Convenient-Inexpensive**

Install an ACCELA-ROD so that you can run your car at faster-than-idling speeds at a flip of the hand! Perfect for warming car on cold days or repair work. Folds neatly out of the way when not in use. Attach with single bolt. Works on all cars. Get one today! Send \$1.50 for fast delivery, postpaid.

Dealer Inquiries Invited—Profitable arrangement.

ONLY **1.50**

ARGYLE MFG. CO., Colchester, Ill.

# BUY PLUMB TOOLS

## Amazing Midget Wrist Radio

**\$2.98**

Enjoy music, sports, programs with your own private, portable Wrist Radio! Use indoors or outdoors! Brings in local stations up to 50 miles!

Worn like wrist watch, yet receives regular radio stations. Has super-sensitive crystal diode (worth \$1.95 alone!) & needs NO BATTERIES! NO TUBES! NO ELECTRICAL PLUG-INS! Lasts for years with NO EXPENSE! Built-in earphone. Complete with 2 clips. Just connect & set is ready for use. About 2 1/2-in. diameter, colorful plastic case, adjustable lm. leather band. Only available at this low price while war-surplus diodes last so order now! **\$2.98** (2 for \$4.98) EACH COMPLETE POSTPAID ONLY..... JOHNSON SMITH & CO., Dept. 433, Detroit 7, Michigan

## To Every Dad...

Your boy loves tools—every boy does! Making things is a boy's natural inclination—encourage it! Working with tools makes him a doer, a thinker—a "practical" man. Start him now. You can spark his enthusiasm with a sturdy steel chest complete with hammer, saw, plane, square, screwdriver, chisel, level, pliers, wrench, brace, auger bits, etc., in all 19 practical tools.

All made well enough for Dad to borrow. Sent postpaid for only \$5.95. Immediate delivery. Your money back if not completely satisfied. Send check or money order to

ASSOCIATED CRAFTS, Dept. 612 6134 N. Clark Street Chicago 26, Ill.

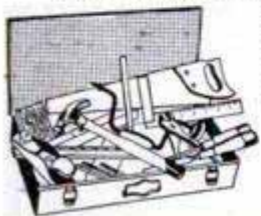

Here's a MAN'S gift



A fast-cutting, keen-sharpening CRYSTOLON® oilstone makes a welcome and necessary addition to any home workshop. Coarse grit on one side for quick sharpening. Fine side for super-keen edges on all edge tools. Pre-saturated with oil for free-cutting, long life — an exclusive feature of NORTON Abrasives oilstones. There's a big difference in stones — remember to ask for a CRYSTOLON JB-8 stone. At better hardware stores everywhere, or direct.

Add the "HOW TO SHARPEN" book to your gift—32 illustrated pages give full directions for all sharpening jobs. Send 10c to Dept. PM-12.



BEHR-MANNING • Troy, N.Y.

Division of Norton Company

Coated Abrasives · Sharpening Stones · Masking Tapes

give HIM the key to his hobby!

## an EXTENSION RULE!

This year give the man in your life the "key" to countless hours of pleasure... a handy extension rule. Not just another folding rule, the extension rule by Master takes the "guess" out of those annoying in-between measurements. Made of the finest straight grain white maple; clamps and extension are of solid brass. Just open to within one stick of the measurement you need... slip out the extension blade and you have your measurement. Available in better hardware stores everywhere **Only \$1.85.**

Master Rule Manufacturing Company, Inc., Middletown, New York I am enclosing \$\_\_\_\_\_ Please send me \_\_\_\_\_ EXTENSION RULES

NAME \_\_\_\_\_ ADDRESS \_\_\_\_\_ CITY \_\_\_\_\_ ZONE \_\_\_\_\_ STATE \_\_\_\_\_

**MASTER**

MASTER RULE MFG. CO. INC. Middletown, New York WOOD AND STEEL TAPE RULES



# Rich New Beauty for Dingy Walls!

**A**MAZING new Gold Bond Color Texture goes on like paint, covers walls like plaster! Covers plaster surface-cracks, gives drab walls new "sculptured" beauty. Perfect decoration for gypsum wall-board. Comes in eight brand-new colors.

**3 EASY STEPS.** Gold Bond Color Texture mixes with water, goes on smoothly with roller or brush. Then texture the surface with sponge or whiskbroom to get your own finish!

Get Gold Bond Color Texture Now at your paint store or your local Gold Bond Lumber and Building Materials Dealer.



**NATIONAL GYPSUM COMPANY**  
BUFFALO 2, NEW YORK

## STOP FURNACE LEAKS

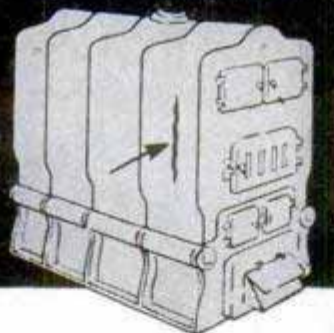

Cut this winter's fuel bills. Seal *tight* every heat-wasting crack, opened seam and other leak in your furnace, boiler, tank, radiators and piping — as professional repair men do — with Smooth-On No. 1 Iron Cement. Keep a can of Smooth-On handy for tightening loose parts and many other repairs around your home. Buy Smooth-On No. 1 in 1 3/4-oz., 7-oz., 1-lb. or larger sizes at your hardware store. If they haven't it, write us.

## FREE Repair Handbook

40 pages of ingenious, tested, short-cut repairs. Simple directions. 170 illustrations. Write today for YOUR free copy of the Smooth-On Handbook. 50 379

SMOOTH-ON MFG. CO., Dept. 37M  
570 Communipaw Ave., Jersey City 4, N. J.

Do it with  
**SMOOTH-ON**  
THE IRON REPAIR CEMENT OF MANY USES



# PACKAGED BOAT KITS

**LARGEST CATALOG EVER OFFERED!**

16 pages — 80 construction and action photos PLUS specifications and performance data.

**\$38.95 UP**



**COMPLETE LINE — SKIFFS, OUTBOARDS, RACERS, CRUISERS.**  
23 Models! Kits, Semi-finished and Custom-finished boats, hardware, paint.

Send 35c for Boat Catalog

Boat Catalog PLUS booklet on boat building, \$1.00

## BOAT PATTERNS-BLUE PRINTS

Over 70 modern plans and full size patterns. Racing classes, cruisers, inboards, outboards, sail boats. By famous designers. 6' to 30'. DESIGN CATALOG 35c. Design catalog and boat building handbook, \$1.00.

**MARINE MART-DEPT. 52-BUFFALO 7, N. Y.**

## TIME FOR CHRISTMAS DELIVERY

### GIANT BALLOONS



Neoprene; Surplus Govt. Weather and Target Balloons. Terrific attention getters for Lodges, Civic Events, School Functions, Conventions, Exhibitions, Trade Shows. Advertise your special events in the Hollywood manner. Make any occasion a success. Great back-yard fun. Marvelous for parties, dances, fairs, picnics, all festivities.

3 Ft. Dia. 39c; 6 Ft. Dia. 79c; 13 Ft. Dia. \$1.39

Postage Paid On Pre-Paid Orders  
Calif. Res. Add Sales Tax

## WAR ASSETS DIV.

Volume Sales Co.

Dept. M-12-51, 3930 Sunset Blvd., Los Angeles 29, Calif.

## Secrets of VENTRILOQUISM Now Revealed!



Easy to learn in 60 to 90 days with our Home Study Course. **RESULTS GUARANTEED.** Make Money! Be Popular! Have Fun! Big Opportunity! Radio, Television, Stage Appearances! For FREE Information regarding price and terms, WRITE. You must state your age. Dummy Catalog 25c.  
**FRED MAHER SCHOOL OF VENTRILOQUISM**  
Box 36, Studio L Kensington Station  
Detroit 24, Michigan



### SPORTONE MUFFLERS

Ford & Chevrolet.....	\$ 4.45
All other popular cars.....	5.45
V-8 Dual Sets.....	15.95
Chromed Silentips.....	2.95

(Please state make & year of car on all orders.)  
**SANDY MUFFLER CO.**  
5643 Corryne Place • Culver City, California

## NOW YOU TOO CAN BUILD 15 RADIOS



The Progressive Radio "Edu-Kit" is a Home Radio Course in kit form. No previous knowledge of radio is required. No additional parts necessary. Tools included. Easy-to-follow instructions. Theory, Practical Work, Trouble-shooting are taught. Used in many radio schools. Excellent background for television.

Kit includes all parts, instructions, radio tester, electric soldering iron, trouble-shooting guide, quizzes, television book, consultation service. \$19.95 is complete price. Nothing else to buy. Everything you build is yours to keep. All parts and equipment guaranteed.

Order your kit today, or send for further information. You risk nothing. 10 Day Money-Back Guarantee.

Postage prepaid on cash orders. C.O.D. orders accepted in U.S.A.

**PROGRESSIVE ELECTRONICS CO.**  
497 Union Ave., Dept. P.M.-1 Brooklyn 11, N. Y.



# HAVE FUN MAKING MONEY

Fill Your Spare Time with Pleasure, Creating Objects of Art at Home by "Ceramizing." Turn 56c Worth of Material into Profits as high as \$5.00 for One Hour's Work

LEARN—in less than an hour—how to turn twigs, leaves, flowers, into gorgeous costume jewelry—how to transform inexpensive articles into valuable objects of art. Amaze your friends with your overnight success as a creative artist—without learning to draw or design. Send your name—no money. We will mail, postage paid, a big tabloid newspaper size book printed in all the colors of the rainbow—showing the endless variety of beautiful giftwares and exclusive jewelry you can make in your home.

Explains entire "Ceramizing" process and shows steps necessary to get started. Delightful as a hobby. Exciting as a source of ready money for spare hours at home.

## FREE!—Just Send Name

Put your name and address on a penny postcard and mail it to us. We will mail the book on "Ceramizing" at once. No salesman will call. And there is no charge now or at any other time. See what fun it is to make money in this new home art—"Ceramizing."

WARNER SHOPS, 1512 Jarvis Ave., Dept. 312, Chicago 26, Ill.



## BURN WATER in your CAR

with the AMAZING OCTA-GANE "50"

This amazing all bronze, "fog type", exhaust operated injector will burn water, alcohol or both. It is adjustable to burn up to one gallon of water with every 10 gallons of gasoline.

Agricultural Dept. scientists say: "THE GASOLINE MILEAGE OF NEW HIGH COMPRESSION AUTO ENGINES CAN BE INCREASED UP TO 30% WITH ALCOHOL-WATER-GASOLINE FUELS."

**\$24.95** Post-paid  
Send \$2 balance  
C.O.D. List car year, make, # cyl.

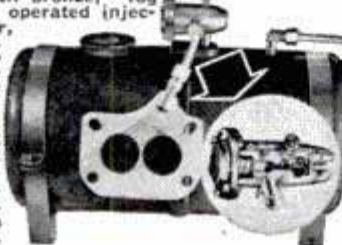

DEALERSHIPS AVAILABLE

World's Largest Distributor of Hi-Speed & High-Performance Equipment

NEWHOUSE AUTOMOTIVE INDUSTRIES, Dept. B-12, 5807 E. Beverly Blvd., Los Angeles 22, Calif.

WRITE FOR FREE ILLUSTRATED LITERATURE



128 Page Library Edition Over 300 Illustrations

## SPEED & POWER

"SOUP UP" ANY CAR



LEARN HOW TO GET 150 MILES PER GALLON WITH YOUR OWN CAR!

Fascinating construction drawings actually show how you can build fast stock cars, California roadsters, 200 MPH hot rods.

EASY STEP BY STEP METHODS help you save by building your own dual manifolds, superchargers, hot cams, water injectors, high compression heads.

LEARN HOW ANY CAR CAN ATTAIN LIGHTNING SPEED AND SUPER POWER

50 BREATHE TAKING CHAPTERS TELL ABOUT: Tuning techniques, speed tricks, economy secrets, formulas for getting racing speed and dynamic power.

Includes Information On: Racing frames, reciprocating masses, jet engines, wheel geometry, dynamometers. 34 pages of photos and diagrams show how to restyle and customize all cars. Also info. on dual pipes, gears, fuels, porting, relieving, lowering, balancing.

THIS GREAT BOOK... PLUS BIG 1952 "SPEED EQUIPMENT CATALOG"... PLUS 46 PAGE "ECONOMY DRIVING MANUAL"... PLUS "150 MPG BOOKLET"... ALL FOUR ITEMS... \$1.98 ppd.

## AMAZING NEW FLASHLIGHT

Operates without batteries

Here at last a wonderful new imported invention that never leaves you unprepared. Self Generating power that gives a strong white beam. Useful in the Home, AUTO, Boat or anywhere you need an ever-ready flashlight. \$4.98 cash, check or money order.

SEND NO MONEY! Try for 5 DAYS at OUR RISK! Rush your name and address right now. Pay postman \$4.98 plus postal charges. If not delighted return for refund within 5 days.

IMPERIAL SALES CO., Dept. 492, 114 East 47th St., New York 17, N. Y.

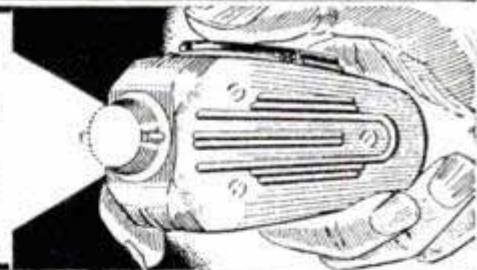

Watch for the Golden Anniversary Issue—January 1952

## CUT-TO-FIT HOMES CUT BUILDING COSTS

ORDER NOW

SAVE UP TO 1/3

CHOICE OF 57 DESIGNS



Build your own home and save the builders' profit—plus savings in lumber and labor with Sterling Ready-Cut-Homes. Anyone can assemble with simple, easy to follow plans furnished. Every house complete with all lumber, roofing, nails, glass, hardware, paint, doors and windows marked ready to erect. Freight paid. Complete building plans ready for filing at low cost. Sold separately if desired. Write today!

PRICED FROM \$2150 up

Five Easy Payment Plans

Send 25c for NEW COLOR CATALOG

INTERNATIONAL MILL AND TIMBER CO. DEPT. P.M.121 BAY CITY, MICHIGAN



**COME TO THE  
UNIVERSITY OF HOUSTON  
FOR YOUR  
TECHNICAL AND VOCATIONAL  
TRAINING**

ONE OF AMERICA'S LARGE AND MOST MODERN UNIVERSITIES

*Select* from these fascinating fields

- |   |   |
|---|---|
| <input type="checkbox"/> Aeronautics                        | <input type="checkbox"/> Industrial mechanics   |
| <input type="checkbox"/> Air conditioning and refrigeration | <input type="checkbox"/> Drafting               |
| <input type="checkbox"/> Automobile trades                  | <input type="checkbox"/> Machine shop           |
| <input type="checkbox"/> Body and paint                     | <input type="checkbox"/> Welding                |
| <input type="checkbox"/> Mechanics                          | <input type="checkbox"/> Woodworking            |
| <input type="checkbox"/> Upholstery and trim                | <input type="checkbox"/> Photography            |
| <input type="checkbox"/> Diesel                             | <input type="checkbox"/> Radio                  |
| <input type="checkbox"/> Electricity                        | <input type="checkbox"/> Stationary Engineering |
| <input type="checkbox"/> Electronics                        | <input type="checkbox"/> Television             |

**PREPARE FOR YOUR FUTURE NOW . . .** with the very latest methods and equipment, at the modern University of Houston School of Technology. For entrance: high school diploma, or over 18 and ability to profit from instruction. Beautiful campus—250 wooded acres in Houston, Texas—the city of tomorrow. Full college activities . . . sports . . . social life. Day or night, short or longer courses. Cooperative work and study programs . . . earn part of tuition and expenses with part-time job in your own career field, while you learn. Personal vocational counselling. Diploma or B.A.S. degree on completion—and job placement assistance. Sept., Feb., June semesters. G.I. approved. — V. A. on campus. Send for Free illustrated brochure now!



EZEKIEL W. CULLEN BUILDING

**University of Houston, School of Technology**  
Dept. 191—HOUSTON 4, TEXAS

Without cost or obligation, please send me fully-illustrated brochure and full particulars. I am interested in subject marked X above.

Name.....Age.....

Address .....

City.....State.....

**WANT TO BE PAID  
FOR "GIVING AWAY"  
NYLONS AT 49¢?**

That's all they cost if they run or snag within guarantee period up to THREE MONTHS! Just write orders. We deliver & collect. Earn up to \$26 weekly in spare time. Advance cash & big bonus. No experience needed. Write for FREE sample stocking and money-making outfit postage prepaid.

**KENDEX CORP. • BABYLON 846, N.Y.**

**TEST YOUR OWN RADIO AND  
TELEVISION TUBES AT HOME!!!**



**CONDUCTANCE  
TUBE TESTER**

No knowledge of tubes necessary — 100% accurate for direct shorts, opens, burned out tubes. Buy it — Try it — If not satisfied, return in 5 days — Money cheerfully refunded.

**ONLY  
\$3.98**

**SEND NO MONEY—ORDER C.O.D., or send check, cash or money order & we pay postage.**  
**E-Z TESTER CO. (Dept. P. M.) Macon, Ga.**

**POWERFUL-LONG RANGE**



MADE IN U.S. ZONE  
**GERMANY**  
AMAZING VALUE!

NOT 19.95  
**2.95**

Compare with domestic binoculars selling up to \$9.95, for clarity, light weight, rugged construction! GERMAN KLAROVIS ground lenses give terrific magnification, wide field of view, and sharp, brilliant detail! Smooth, SYNCHRONOUS centre focusing mechanism, 42 mm objectives. **NEW!** Different! **CAUTION!** Do not confuse with crudely made binoculars claiming 18 mile ranges! You can depend on **GUARANTEED KLAROVIS QUALITY!** Manufactured by German artisans.

**TRY AT OUR RISK!**  
SEND NO MONEY! Pay only 2.95, plus postage on arrival! (Or send only 2.95 and save postage!) Try 10 days at our risk! Thrilling satisfaction **GUARANTEED** or money back!

**THORESEN DIRECT SALES, Dept. 6N-134  
131 West 33rd Street, New York 1, N. Y.**

**KLAROVIS**

**DYNAMIC POWER TOOL  
COMBINATION**



**INCLUDES:** Cummins 1/4" Electric Drill; Cummins Saw Attachment; Combination Saw Blade; Set of Drills; Lambs Wool Bonnet; 6 Sanding Disks; Steel Arbor and Attachments; Cloth Buffing Wheels; Grinding Wheel; Wire Wheel Brush; Steel Paint Mixer; Steel Bench Stand; Portable Steel Carrying Case.

Price of Dynamic Power Tool Combination complete is \$26.95

**SHIPPED ON APPROVAL  
NO MONEY WITH ORDER—NO C.O.D.**

Try it ten days before you buy. If completely satisfied then send \$2.95 and pay balance at rate of \$4.00 per month for 6 months—**No Interest or Carrying Charges Added**, if not completely satisfied, return to us, no explanation necessary.

**KAPNER HARDWARE, INC.  
Dept. A-14, 2248 Second Ave., N. Y. 29, N. Y.**



**WORLD'S  
BEST  
WANT AD  
MEDIUM**

# CLASSIFIED Advertisements



Advertisements in this section 85 cents per word, each insertion, minimum 10 words, payable in advance. To be inserted under proper classification, copy must be in our office the 20th of the second month preceding date of issue  
F. W. Johnson, Manager, Classified Advertising  
Popular Mechanics Magazine, 200 East Ontario Street, Chicago 11, Illinois

## YOU'LL PROFIT

By reading and answering the classified ads in this section. Hundreds of opportunities for you to make and save money

### AUTOMOBILES, MIDGET CARS

**TACHOMETERS**—The Rev-Master electric r.p.m. indicator fits all cars. Cuts driving costs and maintenance bills. 15 minute installation. Complete at \$29.95 postpaid. Write for free literature. V. F. Hadley Co., Inc., Newark, New York State.

**AUTOMOBILE Nuts**—Get old, new and foreign car literature; glossy photos, engineering papers, shop manuals, data books, free motor magazines. Contact auto bugs everywhere. Write today; get name on free mailing list. Auto Maniacs, Stockbridge, Mich.

**SAVE**—California custom accessories headquarters. Buy direct from original designers. Chrome dash panels, electric push button door-trunk conversions, fender skirts, dual mufflers, lowering kits, speed-dress up equipment. 40 page catalog, hundreds of photos—25c. Eastern Auto, 3319A South Grand, Los Angeles 7, Calif.

**MOTORISTS**—Save gas with proven automatic alcohol-water injector. Only \$5.95! Free literature. Vaporizer Company, Box 7033U, Los Angeles 37, Calif.

**BIGGEST** Speed equipment catalog in world! Save, order direct. Hollywood mufflers \$4.95, dual mufflers \$18.95, headers \$27.50, cut outs \$6.95, dual intake manifolds \$12.95, racing cams \$29, hi-compression heads \$26.95, water injectors \$6.95, customizing kits \$1.98, chrome accessories at discounts! Catalog plus Hot Rod Handbook 25c. Almquist Engineering, Milford 64P, Penna. Dealers wanted.

**CUSTOMS**, Race cars, hot rods, antiques. Also engines, parts, etc. Buy, sell, trade. All listed in Autolog #10, 25c. Speed Specialties, Box 5983-M, Indianapolis 20, Ind.

**WIGLESWORTH**—Chasteen's Automobile History Scrapbook. 160 pages. Old time pictures and advertisements of automobiles from 1899 to 1934. \$1.50. Deluxe binding \$3.50. Wiglesworth-Chasteen, 7134 PM Alhambra, Mission, Kansas.

**FROM** Speedway to roadway! Track-proved hi-speed heads and manifolds for your passenger car! No special tools needed! Increase horsepower 30%! Astounding getaway! Free illustrated catalog. (Dealers wanted.) Speedsport, 4866-D Milwaukee, Chicago 30.

**BUY** Racing heads, dual manifolds. Hot coils, etc., without money. Information free. Newhouse Automotive Industries, Los Angeles 22.

**WATER** Injection. Also economy, power, methods. Free illustrated information. Neher Industries, La Verne, California.

### AUTO SUPPLIES AND EQUIPMENT

**ELECTRIC** Automobile clocks, completely repaired, \$3.50. Guaranteed. Electric Clock Service, 133 West 20th St. No. 15, Indianapolis 2, Ind.

**PLASTIC** Auto car cover. Serves as portable garage. Resists elements such as rain, snow, dust, salt-air, etc. Finest quality clear vinyl plastic with elasticized bottom. Good in winter or summer. Fits all standard cars. Price \$8.95. Send check, money order or c.o.d. to Ames Auto, 1182-4 Bedford Ave., Brooklyn 16, N. Y.

**MOTORISTS**: Reporting 3 to 5 more miles per gallon. Guaranteed gasoline vaporizer; increases power. Easier starting. \$3.50 each. Turb-O-Vane, 1024 West Vine, Stockton, Calif.

**HILLHOLDER** And overdrive selector only \$1.00 postpaid. Fully automatic, easily installed. Gives greater mileage, acceleration. Fits all cars with overdrive. Hans Faltn, 609 Norway, York, Penna.

**AIR Horns!** Bermuda bells, etc. Free catalog. John McCanna, 148½ East 40th, New York 16.

**CHEVROLET** Owners—Let the Hydraulic Spring in oil adjusting screw stop your tappet noise. Will last the life of your motor. Simple and easy to install. Complete set \$5.95. Kaye Products, P.O. Box 1423-P.M., Milwaukee, Wisconsin.

**HOW** To Soup-up Your Car, Hot Rod Handbook plus equipment catalog. 25c postpaid. Almquist Engineering, Milford 66P, Pennsylvania.

**STOP** Burning oil! Proven guaranteed product will help your car get new powerful compression, reduce oil consumption. Only \$3.95. Free folder! Advanced Engineering, Box 7013S, Los Angeles 37, Calif.

**YES** It puts babbit type bearings on the pistons. Lachapelle's treatment. (Patented.) \$3.00 postpaid. Ferns, 8120-B Walnut Dr., Los Angeles 1, Calif. (Data on request.)

**ELECTROPLATE** Auto parts, giftwares, novelties. \$5.95 includes portable electroplater, plating salts, formulas, instruction manual. Tyco Metals, Box 13231-BB, Houston 19, Texas.

**SPEED** Equipment. New catalog loaded with speed information: Send 25c plus postage. Urzi's Auto Supply, 98 East San Salvador, San Jose, Calif.

**MOTORIST** Save gasoline by Vacuumating overrich mixtures. Fits all cars. For free particulars write Vacuumatic, Dept. 1829, Wauwatosa, Wis.

**SPEEDOMETERS** Rebuilt, most types only \$7.35 returned postpaid, pack carefully. Also new speedometers exchange, outright. Marko, Box 1448, Oroville, Calif.

**1951 SUPERIGNITIONER**: Starting, pep, mileage \$4.50. 200 pound barbells; course \$28. EG Mfg., Elmsford, N. Y.

**AUTO** Parts and accessories. Briggs Automotive Engineering of Chicago, P.O.B. 3454 Merchandise Mart, Chicago 54, Ill.

**OFFENHAUSER'S** New catalog available. Send 25c. Complete line of speed equipment. Offenhauser Equipment Corp., 5054-p Alhambra Ave., Los Angeles 32, California.

**AUTO** Bed—Convert your car into a single or double bed when needed. Works on 2 or 4 door sedans, club coupes and convertibles. Send \$1.00 for complete plans. Auto Bed Company, 305 East Sixth Street, Panama City, Florida.

**HOW** To buy speed equipment without money. No selling. Information free. Newhouse Automotive Industries, Los Angeles 22.

**LATEST** 1952 Edition! Just out — 100 new pages! Get world's largest auto accessory and parts catalog and save money. Over 50,000 items, including Hollywood accessories, hi-speed equipment, rebuilt engines, all parts and accessories for all cars and trucks. We have that hard-to-get part! Jam packed with bargains. Completely illustrated. Send 25c (refundable). J. C. Whitney, 1919 Archer, Chicago 16.

**NEW** And used guaranteed parts for civilian and army cars and trucks. Largest stock in America. Mail orders. Pioneer Auto Wrecking Co., 734 W. 13th Ave., Denver, Colorado.

**NEW** Government surplus. Low voltage circuit tester in steel box cost \$202. Our price \$27.50. Will test batteries, starters, generators, voltage regulators, grounds, short circuits. Wilt Electrical Company, 7829 S. Racine Ave., Chicago 20, Ill.

**SEND** For free life membership card. "Water Burners" of America, La Verne, California.

**FOR** Free descriptive literature on alcohol-water injection for cars, trucks, tractors write Shade, Webster, New York.

**BRUSH** Plating outfits connect to a battery. No tanks or shop required. Free particulars. Gunmetal Co., Avenue J, Decatur, Illinois.

### AUTO TRAILERS

**BUILD**. Streamlined, telescoping house trailer. No canvas used. Plans \$2.00. Literature and pictures 10c. Thomas C-Stock, 820 No. 17th, Parsons, Kansas.

**PLANS**—16' Sportsman trailer, expertly prepared, ideal for craftsmen, \$2.00. Freeland Engineering, 16587 Freeland, Detroit 35, Michigan.

**BUILD** Your own trailer! Plans for all kinds. Illustrated catalog 10c. Jim Dandy, 125-M, Wausau, Wisconsin.

### MOTORCYCLES, BICYCLES, MOTORSCOOTERS AND SUPPLIES

**WHIZZER**, All attachments, \$20; Cushman motorscooter \$20; Indian motorcycle \$30; engines \$3 up; motorbike frame \$3. Rush 25c (35c first class mail) for catalog #949 listing many other amazing bargains in motors, midget cars, motorscooters, motorbikes, etc. Associated, Box 1764-CS, Toledo, Ohio.

**RECONDITIONED** Motorcycles and motors. Chromium accessories. Complete stock Indian parts. Expert rebuilding. Fast service. Indian Motorcycle Sales, Kansas City 1, Mo.

**GATERPILLAR** Kid-size crawler tractor — Electric motor driven! Rugged full-track pulls loads easily over lawns, fields, pavements. Most sensational child's vehicle made! Catalog free. Mystic River Sales Co., Box 312-P, Mystic, Conn.

**HARLEY**—Davidsons—All models and prices. Genuine late and old model supplies. Expert service. Send 25c for bulletin; Knuth's, 1753 Muskego, Milwaukee, Wis.

**MOTORCYCLES** And parts. List ten cents, new 19-400 and 18-400 tires \$9.95. Cycle Co., 813 Ohio, Wichita Falls, Texas.

**U. S. Govt.** surplus "45" Harley Davidson motors, complete with carburetor and generator, in running condition — \$69.50 f.o.b. Chicago. 25% deposit with order. Parts and accessory catalog 25c. Triangle, 2157 Harrison, Chicago.

**MIDGET** Car \$10, motorbike \$7, Safety-cycle, \$15 less engines; Whizzer motor \$6; Smith motorwheel \$10; Evinrude outboard motor \$8. Four airplane type tires \$3 (mailorder only). Send 25c for new catalogue Number 43, just out listing these and hundreds of other bargains in new and used midget cars, motorscooters, homebuilders parts, plans, engines, transmissions, war surplus, etc. (35c by first class mail). Midget Motors Directory, Athens, Ohio.



**MOTORCYCLE Magazine**—Worldwide coverage. Yearly subscription \$2.00. Sample 20c. Motorcycle News, 5424-A Sawyer, Chicago 25.

**REBUILT Gasoline engines** \$17.00 to \$37.00. Cauffiel Motor Industries, Temperance, Michigan.

### AVIATION

**PROPELLERS.** For sleds and boats. Standard Aircraft, Box 387, Ft. Worth, Texas.

**PROPELLERS, Plans, skis, engines** for snow sleighs, air boats. Fastest service, lowest prices. Catalog 20c. Banks-Maxwell, Box 3301E, Ft. Worth, Texas.

### BATTERIES, GENERATORS

**EDISON Non-acid storage batteries.** Amazing long life. Any voltage. 37 to 600 ampere hour sizes. Lighting plants, generators, motors. Literature. Hawley Smith Co., Croton Falls 1, N. Y.

### ELECTRICAL SUPPLIES

**LAMP Supplies**—Wholesale. Any amounts. Prompt shipment on all parts for repairing and building lamps. Illustrated catalog 15c. Brown Lamp Co., Box 501, Wellston Sta., St. Louis 12, Missouri.

**FREE**—New catalog. Bargains in welders, motors, generators, surplus equipment. Or, build your own kits—save. LeJay Company, Minneapolis, Minnesota.

**ELECTRIC Pencil:** Engraves all metals \$1.50. Beyer Mfg., 10511-H Springfield, Chicago 43.

**LAMPS**—Had trouble finding repair parts? Your search is ended. 25c brings 64 page illustrated catalog also containing wiring charts. Gyro Lamps, 5402P Clark, Chicago 40.

**BIG Profits** in small workshop rebuilding automobile generators. Introductory operating manual \$1. Modern, Box 4704, Kansas City, Mo.

**BE Independent, be secure, have your own profitable business**—Earn \$20.00 and more a day making beautiful, fast-selling lamps at home. No equipment needed. Illustrated course teaches you quickly. Course, parts catalog, wholesale price list—only \$2. Gearon Co., Dept. 200-B12, 27 S. Desplaines, Chicago 6, Ill.

**ELECTRIC Pencil**—Writes, engraves all metals. \$2.95. Reb Industries, Elmhurst, Illinois.

### WELDING, SOLDERING, PLATING

**ACETYLENE Welding outfits** new \$49; used \$29; arcwelders \$49. Eagle Welding, Dept. PM, 5085 Broadway, Chicago 40, Ill.

**A.C. Welders.** 4 sizes, lowest prices. Free literature. Holgerson's Service, Canton 1, Kans.

**ARC Welders**—180 amp.; versatile, complete, only \$129.50. Guaranteed. Also other models. Free information. Champion Welders, 241 Canal St., New York City.

**BUY Direct from factory.** Welding and cutting equipment. All makes of equipment repaired. Established 1913. Box 331, Hamilton, Ohio.

**VOLCANO Gas torch,** 2270° F. Operates without compressed air, with natural, manufactured, propane and butane bottled gas. For light silver brazing, soldering, and numerous other uses. Name kind of gas you will use, \$3.50. Miller Metal Products, Box 4026, Roanoke 15, Virginia.

### MACHINERY, TOOLS, SUPPLIES

**NOTICE!** Send \$1.00 for full value credit certificate and receive special monthly catalog. Hardware, power tools, supplies. Save! Many items below wholesale. Satisfaction guaranteed! American Hardware Company, 412 North Irving, Minneapolis 5, Minnesota.

**FLEXIBLE Shaft tool** by Fairchild for grinding, polishing, sanding, buffing, carving. Original price \$19.95. While they last! Special price \$12.95. Public Sport Shops, 11 S. 16th Street, Philadelphia 2, Penna.

**FREE Catalog.** Full line hobby and light industrial power wood working tools. Guaranteed. Dealers wanted. Backus Machine Co., Chippewa Falls, Wisconsin.

**WATCHMAKERS' Staking set,** 50 punches, 6 stumps, \$39.50. Larger set 100 punches, 20 stumps, \$49.50. Public Sport Shops, 11 S. 16th Street, Philadelphia 2, Penna.

**DRILL Grinder** for twist drills, \$2.95. See ad on page 253.

**100 ASSORTED Springs** \$1.10. Spring Distributors, Box 561, Pittsburgh 30, Penna.

### BOATS, OUTBOARD MOTORS

**MARINE Conversions** for Ford and jeep engines. Catalog 10c. Lehman Manufacturing Company, 927D Broad Street, Newark 2, N.J.

**WATER Ski**—Southland skis; designed by skiers in the heart of the water-ski country. Instructions by champ skiers make skiing easy, tell how to rig your outboard, inboard; free with each pair hispeed, white ash, adjustable skis. Priced amazingly low at \$28.75. ¼ down, balance on delivery. All types skis, boards. Southland Ski Co., Pensacola, Florida.

**'38 Belly tanks,** steel, \$9.95. Free picture. Bucks Auto Parts, Box 89, Merced, Calif.

**BOAT Patterns, kits.** Descriptive literature and 24 page illustrated book on boat construction 40c postpaid. Germain Boat Company, West Saginaw 3, Michigan.

**ARE You interested in boats?** Write for free copy The Rudder, a magazine on boats and boating. 15 Murray St., New York 7.

**FULL Size, cut to shape boat patterns, blueprints,** 7½-38 feet. Illustrated "Build a Boat" catalog, 25c (coin). "How to Build Boats" book, \$1.00. PolyWog houseboat plans \$10. Marine catalog \$1.00. Marine Specialty Mfg. Co., 3107 Detroit Ave., Cleveland 13, Ohio.

**NEW, Used, rebuilt marine motors.** Marine conversions, fittings. Free catalog. Stokes Marine Supply, Dept. 24, Coldwater, Michigan.

**CONVERT Fords and Jeep to 100% marine engines** with Osco's world famous Convo-Kits. Deluxe catalogue 25c (coin). Oscomotors, 3627B Lawrence, Philadelphia 40, Penna.

**OUTBOARD Motor parts**—New, used for all makes. Send stamp for price quotation. Outboard Motor Mart, Inc., 309 Atlantic Avenue, Boston 10, Massachusetts.

**SAVE ¾ Cost.** Assemble your own boat. We furnish parts. No experience necessary. Rowboats, cruisers. Illustrated catalog 25c. Midwest Boat Company, Menomonee Falls, Wisconsin.

**FASTEST Boats in the world**—Build now. Complete plans available for sleek three point racing hydroplanes, runabout and others. Send 25c immediately for illustrated catalogue. Champion Boats, P.O. Box 9038, Dept. 22-L, Long Beach 7, Calif.

**INBOARD Speed boat hulls,** \$365 up. Literature 10c. Huebl Boats, LeSueur, Minn.

### ENGINES, MOTORS, DYNAMOS

**REBUILT Gasoline engines** \$17.00 to \$37.00. Cauffiel Motor Industries, Temperance, Michigan.

**WINDING Data,** listing 225 motors, single and three phase, \$1.00. Motor Data Co., Box 7631, Kansas City 3, Mo.

### ATHLETIC EQUIPMENT, BODY BUILDING COURSES

**100 TRICK Knockouts** for self defense, \$1.00; 1c each. Priest, Box 251, Evanston; Ill.

**DEADLY Judo**—Fiercest fighting technique. Trick knockouts. (Over 200 illustrated pictures.) Expert instructions; three volumes. Complete \$2.25. Variety House, Box 46-B Wall Station, New York 5.

**BUILD Powerful arms, chest, shoulders,** 22 exercises, \$1. Fonsad Studio, Box 601, 1100 Market Street, Wilmington 99, Del.

**BARBELLS.** Exercise equipment. Courses. Free booklet. Good Barbell Co., Reading, Penna.

**STRENGTH** With natural rubber exercisers. Super course. Write Comborep, 79 Oakland Terr., Newark 6, N. J.

**GAIN Weight!** 4 exercises will increase weight. Complete \$1.00. Body Builders, 36 Nevada Street, Winthrop, Mass.

**TRAINING Bags,** to develop punch and speed. List 15c (stamps). Andre's Gym, 3466 Mt. Elliott, Detroit 7, Michigan.

### SPORTING GOODS, GUNS, FISHING TACKLE, ARCHERY, TRAPPING

**SHOTGUNS, Rifles, Revolvers,** 500 modern, obsolete. Also cartridges. Each list 10c coin. Ed Howe, 52 Main, Coopers Mills, Maine.

**NYLON Tennis strings,** \$1.85. Southern Tennis Co., 622 Preston Place, Charlottesville, Virginia.

**CAST Iron molds**—For casting your own sinkers. Free booklet. Reading Instrument Co., Box 78, Reading, Penna.

**LEARN Gunsmithing!** Details, copy "Guns and Gunsmithing," free information. Gunsmith's Service, 3118 Montrose, Chicago, Illinois.

**DUCK, Crow calls,** hardwood, reduced, postpaid, choice, \$1.00. Aero Parts, 8102 Lockheed, Houston, Texas.

**H&R .22, With holster** \$20; Winchester .44 rifle \$5; .22 rifle \$10; 1828 musket \$13; arrowhead collection 70c; German officer swords \$5; pistols \$2 up. Rush 25c for catalog #509 listing many other bargains in guns (new and old), swords, relics, etc. Jefscow, Box 1682-CS, Toledo, Ohio.

**5000 BARGAINS, Firearms, binoculars, war relics.** Catalog 50c. Smith Firearms, Runnemed, N. J.

**MOLDS, (For fisherman's sinkers, squids, jigs and lures.)** Handled and hinged. Quality fishing tackle. Free catalogue. E. L. Sweet & Son, Tonawanda, New York.

**120 PROFUSELY Illustrated pages** antique and modern pistols, swords, daggers, armor, etc. 50c. Robert Abels, A860 Lexington Ave., New York 21.

**BOUGHT, Sold, swapped.** Barlow's, 5565 So. Howell Ave., Milwaukee 7, Wisc.

### TAXIDERM Y

**TAXIDERM Y Supplies, books, instructions.** Everything! Catalog 10c. Vandyke's, Wessington Springs 12, S. Dak.

**MODERN Taxidermist Magazine,** Greenfield Center 2, N. Y. Devoted entirely to taxidermy, photos, articles, methods. Trial year's subscription, \$1.00.

### BINOCULARS, TELESCOPES, MICROSCOPES, MAGNIFIERS

**SAVE 50% On new binoculars!** Free catalog. Free book, "How to Select Binoculars." Write today! Bushnell's, 43-M212 Green, Pasadena 1, California.

**BINOCULARS, Field glasses, telescopes, watches, diamonds, guns.** Schweer's, Donnellson, Iowa.

**FREE 20-Page binocular catalog.** Over 60 different models. United, Dept. ARF-3308, 9043 S. Western, Chicago 20.

**AMAZING Prices, imported precision binoculars.** Free trial. Pricelist, folder "Selecting Binoculars" free. Prentiss Importers, Mercury Bldg., Los Angeles 25, Calif.

**BINOCULARS, Telescopes, microscopes.** Our 20th year of leadership in optical values. Bargain catalog free. Brownscope Co., 24 West 45th Street, New York.

**ASTRONOMICAL Telescopes, binoculars, microscopes, bought, sold, repaired.** Books. Lists 10c. Rasmussen-Reece, Amsterdam, N. Y.

**POWERFUL Astronomical telescopes** easily made. Perfect lenses and instructions; 100X \$3.00; 100X and 200X \$4.00; 100X, 200X and 400X \$6.00. Full power, clear vision guaranteed. Instructions alone 10c. Suffolk Science Service, Riverhead, N. Y.

**MAKE Your 6" telescope reflector.** Glass, abrasives, instructions—\$8.50. F. Cameron, Box 65, Inwood, N. Y.

**REFLECTOR Telescope kits, refractors.** Free illustrated bulletin. Esco Products, 911 Willow Ave., Hoboken, N. J.

**GIANT Astronomical telescope** with 6 ft. tripod \$15.00, f.o.b. factory. 100 power. (10,000 area magnification). Clear vision, full power guaranteed. Ready for use. Suffolk Science Service, Dept. BT, Riverhead, N. Y.

**REFLECTING Telescopes, 60X, completely assembled** \$25.00. Guaranteed observatory clearness. Free information. Skyscope, 475 Fifth Avenue, New York 17.

**ALUMINIZED Telescope mirrors, 3" to 12" diameters.** Eyepieces, prisms, tubing, accessories. Priced right. Postcard brings plans, lists. Pfleeger Optical Co., PM-12, Sunbury, Penna.



**WAR Surplus bargains, binoculars, telescopes, sextants, millions of lenses, prisms, reticles, eyepieces, objectives, etc.** Mail 10c for big "Catalog CH." Send \$1.00 for Stock CH. 10-piece lens kit and big instruction booklet. Edmund Scientific Corp., Barrington, N. J.

### **PETS—DOGS, BIRDS RABBITS, HAMSTERS, ETC.**

**NATURALIST'S Catalog** 10c. Chameleon 50c. 25 Mexican jumping beans 75c. Quivira Specialties, Topeka 51, Kansas.

**BEAUTIFUL Pure white pedigreed police puppies.** Ansonia Kennels, Mose, N. Dak.

**HAMSTERS—Golden or spotted.** Perfect Christmas gift. Free illustrated details. Lakeview Hamster Colony, Newfield, New Jersey.

**NO Money needed.** Raise rabbits for me. Stock furnished. Details for dime. Knickerbocker, 2 Franklin Rd., Coventry, R. I.

**BOOKLET "Treatise on Breeding and Raising Canaries"**—\$1.00. Audubon Publishing Co., 3449-PM N. Western, Chicago 18, Illinois.

**BOXERS, St. Bernards.** Hof Kennels, 5136 Cascade Rd. S.E., Grand Rapids 6, Mich.

**RAISE Mink:** Free booklet, pen plans, inside "secrets", feed, care. Mink are money makers. Investigate today. Lawrence Molgard, Brigham City 12, Utah.

**SPORTSMEN:** 200 Pointers, Setters, straight Cooners, combination hunters, rabbit and fox hounds. Reasonable. List free. Ramsey Creek Kennels, Ramsey, Ill.

**RAISE Rabbits.** Profitable business. Literature free. Tayco Rabbitry, Hapeville, Georgia.

**MAKE Big money!** Raise Chinchilla rabbits. Cash markets supplied. Write today! Rockhill Ranch, Sellersville 15, Penna.

**INCREASE Your income by raising domestic rabbits.** Small space needed. Ready market for delicious meat, fur and wool. Largest magazine in the industry tells you how. \$1.50 per year. Sample 15 cents. No stamps. Small Stock Magazine, Lamoni 20, Iowa.

**EARN Up to \$400 monthly raising Angora or New Zealand rabbits.** Plenty markets. Particulars free. White's Rabbitry, Newark 38, Ohio.

**RAISE Guinea pigs.** Money makers. Booklet free. Taylors, B426A, Hapeville, Georgia.

**MINK Raising information free.** Complete. Lake Superior Mink Farm, Superior, E.E.I., Wisconsin.

**A Practical beginning to successful rabbit raising.** 48 page illustrated booklet. Dime. American Rabbit Breeders Association, 36 AR & CBA Bldg., Pittsburgh, Penna.

### **PLANTS, SEEDS, NURSERY AND GARDEN SUPPLIES**

**HIMALAYAN Flower seeds, orchids.** Catalogue free. Ghose, Townend, Darjeeling (India).

### **FARMS, FARM LANDS, REAL ESTATE**

**FLORIDA—Hunting, fishing, fruit growing.** 5 acres. \$245.00. \$10.00 down, \$10.00 month. G. B. Potterfield, Union Building, Charleston, W. Va.

**\$5.00 PER Acre;** Ozark land. Cash or monthly payments. Write for free list and maps. Box M165, Cole Camp, Mo.

**OZARK Retirement farming acreages.** Biggest selections, lowest prices. Easiest terms. Big free listings. Send for yours today. Armstrong 34, Shook, Mo.

**UNITED Farm Agency's big free winter catalog of farm and country real estate bargains can help you plan soundly for your future security in the country.** Hundreds of America's newest bargains, good pictures, many states, easy terms, many equipped. For special service, state requirements, desired location. Write for your catalog today. It's free! United Farm Agency, 220-PM South State St., Chicago 4, Ill.

**OZARKS Cottage sites—New resort.** \$150. \$5 monthly. Write. Ozarkia, Kirby, Ark.

**STROUT'S Fall catalogs.** East and mid-west red cover; west coast edition blue. Farms, homes, businesses, bargains galore. Either mailed free. Strout Realty, 7 So. Dearborn St., Chicago 3, Ill.

**FLORIDA.** New Lake County development adjoining Ocala National Forest. Best fishing, hunting. Safe from bombs. Nice homesites \$245 at \$10 monthly. Folder free. Howard Vernor, DeLand, Florida.

**HOMESITES \$300—Convenient payments.** California's finest garden section. On Morro Bay's scenic shores. Wonderful fishing, boating, bathing. Fertile soil, softest water, temperate climate, congenial community. Free literature. Richard Otto, Department M, San Luis Obispo, Calif.

**WESTERN Ranch lands.** Virgin timber. Hunting, fishing, river and highway frontage tracts. \$5 to \$10 acre full price. Easy terms. 10c (coin) brings Land Catalog, pictures. Pacific Lands, Box 2350BW, Hollywood 28, California.

**GOOD Farms—Ranches.** Washington, Minnesota, Montana, Idaho, Oregon, North Dakota. Dependable crops, favorable climate. Write for literature, lists describing typical farm opportunities. Specify which state. J. W. Haw, 119 Northern Pacific Ry., St. Paul 1, Minn.

**\$5.00 MONTHLY Buys 40 acres near town.** Price \$200. Free list. Box 425-P, Carthage, Mo.

### **POULTRY, FARM SUPPLIES**

**POULTRY Farmers, broiler growers.** turkey raisers read the new American Poultry Journal for latest ideas and greater profits. 12 months, 50c. Special offer, 4 years, \$1.00. American Poultry Journal, 530 South Clark, Chicago.

**KNOW How to raise poultry for profit.** Read Poultry Industry. Every issue packed with helpful hints and practical suggestions. Latest articles on breeding, feeding and management. Subscribe now. 1 year 65c. 2 years one dollar, foreign subscriptions \$1.00 a year. Poultry Industry, Dept. P.M., 376 Boylston St., Boston 16, Mass.

**RAISE Turkeys the new way.** Write for free information explaining how to make up to \$3000 in your own backyard. Address National Turkey Institute, Dept. 3, Columbus, Kansas.

### **PROFITABLE OCCUPATIONS**

**WANT A diesel job?** Our approved, up-to-the-minute diesel training program can help you qualify for steady, big pay jobs or specialized military training. Covers diesel, tractor, heavy equipment repair, service, operation. Easy to master. High grade mechanics tools, worth \$50 come with course. No loss of present income. Job placement advisory service. Investigate! We invite comparison of material and service. Write for information today. Interstate Training Service, Dept. 3N, Portland 13, Oregon.

**TURN Your spare time into cash.** Make quick-selling, highly profitable lamps—every home a prospect. No experience or special tools required. New 1951 56-page illustrated catalog shows shades, shade frames, figurines and bases, oil lamp converters, boring compounds, and dozens of similar items. Also all kinds of sockets, cords, pipes, harps, finials, bases, and hundreds of other parts—everything you need. Special 8-page section shows 6 beautiful lamps in kit form ready to assemble. You buy wholesale, sell at retail—make big profits. Hundreds doing it. You can, too. Send 25c today for catalog and wholesale price list. Refundable first order. Gearon Co., Dept. 500-B12, 27 S. Desplaines, Chicago 6, Ill.

**"HOW To Make Money With Simple Cartoons"**—A book everyone who likes to draw should have. It is free; no obligation. Simply address Cartoonists' Exchange, Dept. 912-CP, Pleasant Hill, Ohio.

**"EVERYBODY Likes candy"**—Learn to make professionally. (Our 40th year.) Ragsdale Candies, D6, East Orange, New Jersey.

**RAISE Fishworms easy.** Profitable. Complete instructions 25c. Huffman's Worm Ranch, Rives Junction, Mich.

**FREE Book "505 Odd, Successful Businesses."** Work home. Expect something odd! Pacific, Oceanside, Calif.

**GROW Mushrooms.** Cellar, shed. Spare, full time. We pay \$3.00 pound. Free book. Mushrooms, 2954 Admiral Way, Seattle, Wash.

**OWN A printing business.** Good profits printing cards, stationery, etc., in spare time. Easy rules furnished. Have home shop. Send dime for illustrated printer's supply book and samples. Kelsey, Inc., T-24, Meriden, Conn.

**EARN Up to \$400 monthly raising Angora or New Zealand rabbits.** Plenty markets. Particulars free. White's Rabbitry, Newark 61, Ohio.

**MAKE Flexible molds!** Cast plaques, bookends, figurines! Free sample! H. Tooker, 630-M Chestnut, Hamilton, Ohio.

**RAISE Pheasants on the \$100 week plan.** Little capital and space can make you independent. Free details. Great Central Game Management System, Columbus 1, Kansas.

**\$40.00 WEEKLY Made growing mushrooms, fresh, dried.** Dominion patent 331583. Free spawn. North American, 169P Yonge, Toronto, Canada.

**BE The Popular Mechanics representative in your neighborhood and earn big profits in your spare time.** Write Popular Mechanics Magazine, Room 408M, 200 E. Ontario St., Chicago, Ill.

**FOREIGN And Latin American employment.** 1951 "Foreign Service Directory" gives up-to-minute facts on military and civilian construction, government jobs, major oil listings, aviation, transportation, steamship lines, mining, importers, exporters, how-when-where to apply, application forms, hot list firms hiring. \$1.00 postpaid. Global Reports, P.O. Box 883-P, Hollywood 28, Calif.

**FOREIGN Employment construction men, building trades, helpers, office men, others, interested in foreign projects.** High wages, quarters, trans. Listings of firms actively working on U.S. foreign, inter-continental projects. Send \$1 for foreign construction compendium and application forms. Foreign Service Bureau, Dept. PM-12, Box 295, Metuchen, New Jersey. (Not an employment agency—No fees.)

**MAKE Money with frogs.** Particulars free! Specialties House, Whiting 12, Ind.

**MUSHROOMS Grown.** Boxes. Barrels. Instructions 50c. Spawn \$1.00. Manureless process. \$2.00. Gordons, 328 Bannerman, Winnipeg, Manitoba.

**FOREIGN Jobs.** Contracts underway and soon starting in Africa, South America, Canada, England, Europe, South Pacific, Middle East, Mexico and Alaska. Send \$1.00 for foreign jobs news, information, application forms, etc. DCS Foreign Jobs News, Dept. 268-JB, Bridgeport, Ill.

**CONSTRUCTION Workers.** Want to make better jobs? Longer jobs? Latest information. Jobs breaking. Jobs underway. North, South, East, West. The best. Big job list. Accurate. Up to date. Send one dollar. Dempster's Construction Scout News, Dept. 268-JA, Bridgeport, Ill.

**ALASKA! Just released!** Over 50 giant/e new construction contracts! Names, addresses companies hiring. \$1.00 complete. Alaskan Opportunities, (O L) Box 362, Kenmore, Wash.

### **BOOKS, PERIODICALS, PICTURES POSTCARDS**

**MACHINISTS Compact reference book.** Tables, shop and drafting helps. Send \$1.00. A. Knudsen, 523 48 St., Brooklyn 20, N. Y.

**HOW To buy a new or used car.** Amazing guide book exposes 36 selling tricks; 100 ways to save money. \$1 postpaid. Midwest Co., 247 Kenworth, Columbus 14-A, Ohio.

**LITTLE Humor library—24 real illustrated gag books only \$1.00,** with fascinating catalog. Aladdin Book Co., 210P Fifth Ave., New York 10.

**MAGAZINES (Back dated)—Foreign, domestic—Arts, books, booklets, subscriptions, etc.** Catalog 10c (refunded). Cicero's, 86-22 Northern Blvd., Jackson Heights, N. Y.

**BOOKHUNTERS! All subjects.** Send wants! Jaher Book Service, 620-P East 178 Street, New York 57.

**ILLUSTRATED Comic booklets, 12 for \$1.00, 24 for \$2.00,** all different. Free gift with each \$2.00 order. V. M. Rogers, Dept. PM-4, Box 14738, Cimarron Station, Los Angeles 18, California.

**BOOK "Breeding of Parakeets" and cage-bird magazine—\$1.00.** Audubon Publishing Co., 3449-PM N. Western, Chicago 18, Illinois.

**BOOKHUNTERS! Scarce, unusual, miscellaneous books supplied.** Atlantic Book Service, Lawrence Avenue, Charlestown 29, Massachusetts.



USED And out-of-print books. Catalogue free. Balliol, Box 85, Station K, Toronto, Canada.

RENT Fiction, non-fiction. Catalogue free. Santens, 2700-A Ann, St. Louis 4, Mo.

### MAGIC TRICKS, PUZZLES, JOKER NOVELTIES

MAGIC Monthly, Year 25c. New 1952 Magic catalogue 10c. New joke lists 3c. Magic Factory, Minneapolis 2, Minn.

23 TRICKS, Joker items and catalog, postpaid \$1.00. Clausen, 119 North Alamo, San Antonio, Texas.

8 AMAZING Mystifying tricks, no gadgets \$1. Edwards, 16751 Ashton Road, Detroit 19.

ESCAPE From handcuffs, bank vault, trunk, etc. Eight professional secrets, 50c. Charles, Box 271, Ballston Spa, N. Y.

MAGICIAN'S Catalog, amateur and professional magic, send 25c. Merv Taylor Magic, 11303 Chandler Blvd., North Hollywood, California.

VENTRILQUISM Self taught. Quick, easy instructions, 25c. "Ventriloquist," Cal Allen, Texas.

WORLD'S Largest professional magic shop, keeps you in touch with latest tricks. To receive mailings, send \$1.00 for new catalog. Holden's, M220 West 42nd St., New York.

FREE Trick and catalog only 5c. Furr, Box 1882-D, Norfolk, Va.

BIG Fun kit! Tricks, jokes, novelties, books. Real clever stuff. Howls galore, \$1.00. Johnson, 414 McRae, Wilmington, N. C.

16 CARD Tricks and catalog 25c. Sterling Magic, Royal Oak, Mich.

200 ELECTRIC Stunts \$1. Cards \$1. Kutting Sons, Los Altos, Calif.

FREE Trick and large illustrated catalog, 35c. Lerro Magic, 509 80th Street, Brooklyn 9, N. Y.

LATEST Magic for pocket, parlor, stage. Catalog 500 tricks, only 10c. Unequaled magic service for 30 years. Douglas Magicland, Dept. 1, Dallas, Texas.

512-PAGE Catalogue of 2500 tricks, pocket, parlor, stage. World's finest magic. Send \$1.50 for catalogue (refunded first \$6.00 order). Kanter's, M-1311 Walnut, Philadelphia 7.

PROFESSIONAL Catalog, 124 pages, 25c. Williams, 900 Plymouth, Ellwood City, Penna.

BE A magician. Large professional magic catalog of latest tricks, 35c. Ireland, C-109 North Dearborn, Chicago 2.

### COINS, TOKENS, CURRENCY

WE Pay \$5 to \$500 each for hundreds of old or odd U. S. and foreign coins. Keep all until posted. Send 20 cents for illustrated coin value book, with bargain lists free. 45 years in business. Coin Exchange, Le Roy 7, N. Y.

GET Profit and pleasure in collecting old coins. Send 10c for 56 page illustrated coin catalog. You'll be delighted with it. Send for it now. B. Max Mehl, 370 Mehl Bldg., Fort Worth, Texas. Largest rare coin establishment in U. S. Established 50 years.

SCARCE 1950D Nickel uncirculated and lists 25c. Bolus, 1139 11th NW, Canton, Ohio.

GREEK Money, goddess, etc., wooden nickel, and "Coin Collector's" Magazine 10c. Lawrence Brothers, Anamosa, Iowa.

ALL Different: 10 Morgan dimes \$2.50; 10 Morgan quarters \$4.50; 10 Morgan halves \$8.50; 10 liberty nickels \$1.75; set flying eagles \$1.30. Fairway Company, Box 121, Rye, N. Y.

40 DIFFERENT Coins, \$1.00. 100 different bills, \$1.00. Oddehon, Box 482, St. Louis, Mo.

FREE! Foreign coin, banknote and coin collectors illustrated catalog to approval service applicants. Send 3c postage. Tatham Coinco, Springfield 30, Mass.

FIFTY Assorted Indian cents, \$1.50. Rare 1931-S cents, \$1.00. Giant fifty-two page illustrated bargain catalog, 10c. Ben's PM Department, 31 North Clark, Chicago 2.

COIN Collector's Magazine. Largest independent, over 1000 pages per year. Sample copy 30c; \$3.00 per year. Hewitt, 5450-J Clark, Chicago 40.

3c STAMP For lists. Press, 1480 Frebis Ave., Columbus, Ohio.

JAPANESE Invasion notes for United States 1c to \$1,000.00; set \$2.00. Illustrated coin catalogue 25c. Shultz, Salt Lake 10, Utah.

GENERAL MacArthur set (2) \$3.75; Vatican Holy Year set (4) \$1.00; 256 page retail guidebook \$1.50; premium handbook \$1.00; giant bargain catalogue 25c. Bebee's, 1180 East 63rd, Chicago 37, Illinois.

OLD Money wanted. Will pay \$100.00 for 1894 Dime, S. Mint, \$50.00 for 1913 Liberty Head Nickel (not Buffalo). Big premiums paid for all rare coins. Send 4c for large coin folder. May mean much profit to you. Numismatic Co., Dept. 20, Fort Worth, Texas.

### STAMP COLLECTING

SENSATIONAL! Set each Honduras, Martinique, Guadeloupe, Guiana, also \$2.-000.000 stamp, Brunel, over 100 different others. Everything 10c with approvals. Whitehead, 315P South 5th Ave., Canton, Illinois.

FREE! "Carnival" packet of midget, giant, other "freak" stamps. Yours with bargainful, temptingly-different approvals. Niagara Stamp Company, 12 Queensway, Niagara-on-the-Lake, Canada.

APPROVAL Selections that are different. Free stamps with purchases. Write today. LeRoy Stamps, 645 W. 2nd Street, Winston-Salem, N. C.

EXCHANGE Plan—U.S. mixture, 2# \$1.00, 5# \$2.00. Superior, Grafton, Ohio.

GOYA Nude—3c, with approvals! Stearns, 1249-B Griswold, Detroit 26, Michigan.

UNITED States and foreign approvals. Reasonable prices. Charles Mekeel, 2101 East Market, York, Penna.

UNITED States approvals—Select, used, mint. Kingsbury, South Woodbury 2, Vt.

NUDES Set and colorful approvals—10c! Atlas, 2830-a Eisenhower, Racine, Wis.

MINT (Unused) U.S. approvals. Patrick Agencies, 3650A Central, Indianapolis 5, Ind.

SAN Marino—25 different, 10c! No approvals. Erie, Box 2642, Lakewood, Ohio.

555 MIXED Worldwide plus unused set 10c to approval applicants. Wethly, 15-H Stegman Court, Jersey City 5, N. J.

FREE U. S. and Confederate states catalog. Stone, 45 Bromfield, Boston 8, Mass.

ALBUM! Holds 2000 stamps! Only 10c! Glamore Company, Manchester, Conn.

\$3.00 REFUNDED Unless satisfied, 200 different from 60 countries, \$3.00. Beautiful stamps, high catalog. Approvals when requested. Concord Stamp Co., Beeville, Texas.

START Your own stamp business. Send for free circular. Donald Shepard, Box 1147, Chicago.

FREE Sample—Interesting, informative, illustrated. National Stamp News, Anderson, South Carolina.

WORLDWIDE Variety collections, 1000, \$1.00; 5000, \$13.75. List free. Philatelic House, Rockville Centre, N. Y.

USED \$2 Harding stamps 3 for \$1 or 50c each, (stamps or coin) postpaid. Robert Damm, 1956 Champa, Denver, Colorado.

FREE! Colorful Cyprus pictorial set (complete) with temptingly-priced approvals. "FG," 195 Park, Lewiston, Maine.

RARE! One pound Egypt #240 only 25c. Approvals. Royal Stamp Company, Tamqua, Penna.

LIBERIAN Triangulars, 10c with approvals. Vargo Stamps, 6044 South Fairfield, Chicago 29, Illinois.

FLAG Stamp—Free with hygrade U.S. approvals. Wenigman, 1933 Patterson, Chicago 13.

SPORTS On stamps album—Fully illustrated. Sample page free. F. Voker, 232m East 77, New York 21.

1000 MIXED U. S. and foreign 25c. Monjar, Fairmount, Cincinnati 14, Ohio.

FREE 50 Different stamps to serious approval applicants. Stanley Zajac, 710 Shaw St., Toronto, Canada.

VENEZUELA'S Only "first day cover," \$1 greenback or stamps. Apartado 2554, Boca, Caracas, Venezuela.

TASMANIA, Thailand, Israel, Victoria. Free with approvals. A to Z Stampco, Box 36, Miami Beach 39, Florida.

MONACO Pope triangles; Zanzibar, 5c, approvals. Potomac Stamps, Washington 15, D. C.

FREE! 100 Different China. Contains airs, commemoratives, twin map stamp, others, to new approval applicants. C. Moublow, 740 Hegney, Bronx 56, N. Y.

ALL Stamps at 1c each. Collection of 10,000 different, divided in 20 \$5 lots each containing 500 stamps. You just buy one lot at a time as often as you like. Each lot delivered as soon as paid for. No contract. No obligation. Real savings. N. V. Robillard, 812 West Vantrees Street, Washington, Indiana.

STAMPS, Albums, packets! Big 44 page illustrated catalog free! "Stamps By Mail," 2133 Lunt, Chicago 45.

FREE With approvals, commemorative sheet, catalogue, 40c. Stamp House, 1463 Drexel Ave., Miami Beach 39, Florida.

GIANT Selection, penny stamp, Wahl's Stamp Exchange, 7008P Farragut, Chicago 31.

FRENCH Colonies 300 different pictorials \$1.00. Burtner, 709 Washington, Reading, Penna.

GEORGIA, Schleswig packet with approvals! Stampart, Box 28A, Rutherford, N. J.

1000 DIFFERENT Foreign \$1.00. Dolins, 31 Park Row, New York City 38.

100 DIFFERENT U.S. commemoratives, one dollar. Request approvals. Harold Holub, 18 East 198 Street, New York 68, N. Y.

10,000 DIFFERENT 1c Each! Gordon Davison, Box 1019S, Manchester, N. H.

200 DIFFERENT U. S. nice selection. No post cards or cut square envelopes. 60c. C. P. Steger, Steger, Ill.

U. S. Commemoratives 100 different, beautiful hand picked, only 70c, 50 same 30c. Condict, 56 W. 65th, New York 23, N. Y.

PENNY Approval bargains. Write Department PM, 1267 Tutwiler, Memphis 7, Tennessee.

100 NETHERLANDS. All different. Beautiful assortment, 10c with approvals. Thomson's, Box 4074-P, Miami, Florida.

SENSATIONAL Free offer, 50 different beautiful commemoratives, selected approvals. Morrison, Milmont Park, Penna.

AMAZING Collections can be built from my approval books. Mounted 1000 per book. Entire book \$7.50. You pick 'em, 500 for \$5.00. Many catalogue 15c or more. T. D. Hayes, 4374 Ventura Canyon, Sherman Oaks, California.

FREE—Giant philatelic mail. No approvals. Wilbur Errickson, Englishtown, New Jersey.

SAN Marino collection free, 25 different, old and new issues, airmails, commemoratives, high values, absolutely free with approvals. Viking, 130-ZZ Clinton St., Brooklyn, N. Y.

100 DIFFERENT Stamps from Old Mexico, \$1.00. Charlie Gray, 1005 North Edward, Carlsbad, New Mexico.

FREE—Complete set of famous Americans, flags, parks and presidentials to approval buyers. Send 3c for 15 of the above stamps plus full particulars. Triboro Stamp Company, 145 Nassau Street, Dept. 112, New York 38, N. Y.

UNITED States stamps! Cheap! Catalogs. Sullivan, 115-F Endicott, St. Paul 1, Minnesota.

GIVEN—Approval applicants—50 mint including Monaco Rapiers, Broadmoor Stamp Co., Pittsburgh 34, Penna.

NEED Higher wages? Not when buying our stamps. Try our books of 1,000 at 1c and 2c each, or economy U. S. approvals, Clark, Box 544P6, Muskegon, Michigan.

PAY Check gone? Are you paying too much for approvals? Try our books of 1,000. Priced at 1c and 2c each. Reference appreciated. Roseland Stamp Co., Dept. 10-A, Spring Lake, Michigan.

ZANZIBAR, Pitcairn Islands, Turks, Caicos, Gilbert, Ellée, Solomon, Borneo, Gambia, Tanganyika and others. Complete collection free. Send 5c for postage. Gray Stamp Company, Dept. PM, Toronto 5, Canada.

FREE! Big illustrated catalog listing everything for the stamp collector. Har-risco, 202 Transit Bldg., Boston 17, Mass.

312 MIXED U.S. only 10c to "gold nugget" approval applicants! Nothing like them. Kessel's, Folsom, California.



**BEAUTIFUL** Mint set 10c with approvals to serious collectors. W. Langford, 53 Durham Road, San Anselmo, Calif.

**WORLDWIDE** Stamps. 1050 all different \$1.00; 2000, \$2.50; 5000, \$12.50. Bargain lists free. Beacon Sales, Maynard, Mass.

**UNITED** States and foreign approvals. Profit sharing plan. Seminole Stamps, Box 1138-P, Coral Gables 34, Florida.

**OLD** Scarce U. S. seconds on approval. Slightly defective. Bargain prices. Hernefield, Clintonhill Station, Newark 8, N. J.

**FREE**—Monaco holy year short set, including two triangles. Sent to approval applicants. Pegasus Stamp Company, 716-M DeKalb Ave., Brooklyn 16, N. Y.

**BARGAIN!** 100 Different United States stamps—Including commemoratives, airmails, only 10c to approval applicants. Sunset Stamp, Dept. W, Box 47, South Gate, Calif.

**233 DIFFERENT**, Including 19th Century; diamonds, jubilees, souvenir sheet—10c. Approvals. Brooks, 2352D East 23rd Street, Brooklyn 29, New York.

**ITALIAN**, Africa pictorials, worth 55c. Free to approval buyers. Pleasure Stamps, 1865P 52nd Street, Brooklyn 4, N. Y.

**70,000 STAMPS** Sale. Grabbag 30c. Box, hundreds all different, blocks, sets and free gift \$1. Schollmeyer, Box 48, Brooklyn 25, N. Y.

**100 DIFFERENT** U.S. old, new. 25c. Lists. Weatherby, Medina, Ohio.

**FREE**, Scott's International Album. Other big premiums. Full particulars with approvals. Raymax, 123-Z William St., New York City 38.

**FREE!** Big United States catalog! Invaluable guide and check list. Hundreds of illustrations. Harrisco, Boston 17-W, Mass.

**GIVEN** Free U. S. \$5 Presidential plus valuable foreign stamps to customers. Bala Stamps, Bala, Penna.

**54 DIFFERENT** Bohemia 25 cents. Penny approvals included. Reed, Box 980, Chicago 90, Illinois.

**50%-75% DISCOUNTS!** Approvals from 33,000 collection—1/2c up! Schur, Box 235, Buffalo 12, N. Y.

**GERMANY**—Colonies, offices, states. Mostly 1/2-1/5 catalogue. Approvals—lists 3c. Myers, VanZandt Ave., Little Neck, N. Y.

**FREE!** "What's My Name?" Fascinating illustrated quiz booklet. Barrels of fun for everyone; valuable prizes for correct answers. This booklet absolutely free! Send today. Approvals! Stamp Quiz, Calais 600, Maine.

**ROOSEVELTS** Complete; plus 25 other U.S., 10c with United States approvals. Locust, Box 305-T, Harmon-on-Hudson, New York.

**750 FRANCE** And colonies stamps 10c. Littleton Stamp Co., Littleton 25, N. H.

**FREE!** 50 Different Japanese stamps! Approvals, Star Stamps, 225 Willard, Jamestown, New York.

**FREE!** \$10,000 Airmail! Philippines! Pezzan! Uruguay! Approvals. Keating, 2520-P Boulevard, Jersey City 4, New Jersey.

**POUND** Mixtures, U. S. or foreign, \$1.00. Book Nook, Willmar 61, Minnesota.

**300 DIFFERENT** Given free with approvals. Postage 3c. Windsor Stamps, 1435 East 67th Place, Chicago 37.

**FREE** Collection—50 different glamorous French Colonies—animals, natives, villages, bicolours, pictorials, all to approval buyers; also Scott Albums and Catalogs. Bell Stamp Service, Dept. S-3, Bell, Calif.

**WONDERFUL** Offer. 7 complete mint sets Manchukuo, Bohemia, etc., only 10c with approvals. Reich Stamp Co., 4647 Kenmore, Chicago 40, Illinois, Dept. M23.

**50 DIFFERENT** U. S. 10c. No approvals. Seidenberg, 944, Appleton, Wis.

**STAMPS** Wanted. Collections, duplicates, surplus stock, mint and used. Buy outright if bargain. What have you? Vandro Shirk, Lebanon, Penna.

**PENNY** Approvals that satisfy. Neil Gronberg, Box 5441-P, Philadelphia 43, Penna.

**500 DIFFERENT** 40c With approvals at wholesale to clear. K. S. Holmes, London, Canada.

**77 DIFFERENT** United States—25c. Approvals. Utechts, 1143-D North Keeler, Chicago 51.

**307 ALL** Different—Only 15c! Beautiful collection: commemoratives, triangles, high values, bicolored stamps, etc. Garceion, Calais 400, Maine.

**NOTHING** Free. Just good stamps reasonable. Send dime for seventy-four page catalog. Ben's Stamp Shop, 31 N. Clark, Chicago 2.

**"HOW** To Recognize Rare Stamps." Free book illustrated! Kenmore, Richford, H-57, Vermont.

**FREE** U. S. price list, postage 3c. Mark Hanna, 335 5th Ave., Pittsburgh 22, Penna.

**FREE** "Stamp Finder." Tells instantly country to which any stamp belongs. 32 pages profusely illustrated. Garceion, Calais 17, Maine.

**FIRST** U. S. (1847) government reissues 5c, 10c, plus giant bargain U. S. collection—only 5c to applicants U. S. approvals. Metropolitan, Box 312G, Jackson Heights, N. Y.

**AMAZING** Offer! 500 United States stamps—including commemoratives, airmails, high values to \$5.00. Only 10c to approval applicants! Illustrated bargain lists free. Mystic Stamp Co., Dept. 80, Camden, New York.

**WOW!** 203 All different Germany 10c! Zeppelins, semipostals, airmails, high values, etc. to new customers. Jamestown Stamp, Jamestown 512, New York.

**WORLD'S** Largest stamp (7 1/2 x 14 inches). A real curiosity! Retail for 50c, only 3c to approval applicants. Tatham Stamp Co., Springfield 30, Mass.

**UNITED** States stamps nearly 100 years old, Roosevelt set, others, 40c value—only 5c to applicants United States approvals. Wakonda, Box 272K, Jackson Heights, N. Y.

**500 STAMPS** For only 10c! This mammoth value includes airmails, pictorials; stamps from strange countries, cataloging up to 25c each! Also approvals. Mystic Stamp Company, Camden 80, New York.

**COLUMBIANS**, Trans-Mississippi, Pan Americans, Pan Pacific, ten other different commemoratives. All 10c with your request for U. S. approvals. Moda Stamps, Box 251-X, C.S.A., New York 8.

**FREE!** Powerful magnifying glass. Jamestown Stamp, Jamestown 202, New York.

**200 DIFFERENT** Including Roosevelt triangle, 5c to approval applicants. M. Avalon Stamp Company, Springfield, Mass.

**OVER** 1,000,000 Sold; 200 different stamps 10c with approvals. Carlton's, Tujunga, Calif.

**500 EXOTIC** Japan stamps—10c. Kenmore, Richford, J-57, Vermont.

**FREE**—Illustrated catalog! Kenmore, Richford, C-57, Vermont.

**U. S. Collectors**—Write today for free material. Eagle Stamp Co., 2221-A Romine, Pittsburgh 26, Penna.

### ANTIQUES, RELICS, INDIAN GOODS, CURIOS

**4 PERFECT** Ancient arrowheads \$1.00. Grooved tomahawks \$2.00 and \$3.00. 4 tiny perfect bird arrowheads \$1.00. List free. Lear's, Glenwood, Arkansas.

**INDIAN** Relics, fossils, minerals, firearms, curios. 2 tomahawks \$1.00. 12 arrowheads \$1.00. Catalogue 25c. Museum, Burlington 3, Wisconsin.

### PRECIOUS STONES, MINERALS

**"GENUINE"** Red Arizona rubies (garnets). Send quarter for packet. Bitner's, Box 1025-B, Scottsdale, Arizona.

**SAMPLE** Uranium ore postpaid for dollar bill. Prospector, Box 592, Truth or Consequences, N. M.

**JADE**, Agates, titanite. Free list. North West Gems, Box 305, Tacoma 1, Wash.

**GEMCUTTING**, Silvercraft authority. Illustrated magazine tells how. Cut rocks, make jewelry. 150 ads illustrating equipment, offering gems for collectors, cutters. Postal brings literature. Lapidary Journal, Drawer B, Palm Desert, Calif.

**RUTILE-Titanite**: New synthetic gem. More brilliant than a diamond. Write today for illustrated literature. Marsam Jewelers, 607-B South Vermont, Los Angeles 5, Calif.

**GEMS**, Precious and semi-precious, all genuine, from world wide sources. Deal direct, no overhead, save money. Catalog 10c. Hill Co., Route 7, Salem, Oregon.

**GEMSTONES**, Mineral specimens. Every variety. Lowest prices. Postcard brings free booklet. Plummer's, 2183C Bacon, San Diego 7, California.

### HOBBIES AND COLLECTIONS

**50 DIFFERENT** Army embroidered patches \$1. Other bargains. Insignia Mart, 703A Broadway, New York 3, N. Y.

**COLLECT** Cartophilic cards! New fascinating hobby. Interesting packet containing birds, butterflies, aeroplanes, flowers, trains and other rare cards. Plus big illustrated catalogue. All for 10c. International Cartophilic Co., Dept. PM, 1152 Yonge Street, Toronto, Ontario.

**WANTED:** Cigarette, tobacco, cards. Write Charles Bray, East Bangor, Penna.

**UNUSED** Matchbook covers—100 different \$1.00 36-page catalog 25c. Charles Edelman, 1311C East 84, Cleveland 3, Ohio.

**INVENTING** Can be an interesting and profitable hobby. Write for complete particulars. Institute of American Inventors, Dept. 40-E 631-E St. N.W., Washington 4, D. C.

### CAMERAS, PHOTO SUPPLIES

**20% TO 50% Off** new and used cameras to reduce inventory. Free list. Ramon's, 110-E Worth Avenue, Palm Beach, Fla.

**PHOTOMURALS**, Your negative or ours. Catalogue 25c. Photomammoth Murals, Dept. M, 12048 Vanowen Street, North Hollywood, California.

**BUY** Photographic supplies wholesale. Films, cameras, binoculars. Free catalog. Capitol Photo Supplies, 2428 Guadalupe, Austin, Texas.

**BASS** Says: Trading cameras a national habit since 1910. Write to Bass the old "horse trader." A postcard will do. Simply say: "Bass, I have and I want. How much will you allow me?" It's fun to trade with Bass. Satisfaction guaranteed. Bass buys, sells, and trades. Bass Camera Company, Dept. AG., 179 W. Madison St., Chicago 2.

**FREE** Photographic bargain book packed with hundreds of sensational values in still and movie cameras, lenses and latest accessories. Super savings for you in new and used equipment. Liberal trade-in allowances, too, on your equipment. Write now for your free copy to Central Camera Company, Dept. 9L, 230 S. Wabash Ave., Chicago 4. (Photographic headquarters since 1899.)

### PHOTO FINISHING

**PHOTOSTAT** Copies made, legal documents, birth certificates, army discharge papers, marriage licenses, etc. Up to 8 1/2 x 11, 45c; 11x14, 55c; 18x24, \$1.25. Returned same day. Denis Studio, 38 Old Arcade, Cleveland, Ohio.

**CUSTOM** Photofinishing absolutely guaranteed. 8 exp. 35c; 12, 50c; 16, 70c. 35-mm. \$1.00. Free mailer. Flash Foto, Parkville Station, Box 36, Brooklyn 4, N. Y.

**PHOTOCOPY** Anything—Papers, books. No darkroom. 8 1/2" x 11" complete \$6.95. Potoflek, 8555 Plainfield Lane, Cincinnati 36, Ohio.

**MAIL** Us your films. Prompt service. 8 exposures developed and printed 30c. Foto Art Studio, Box 406, San Francisco, Calif.

**10 PHOTO** Postcards from your negative \$1.00. W. Dornfeld, Iron Ridge 9, Wis.

**8 CONTACTS** 30c, Jumbos 40c, 12-45c, jumbos 55c, reprints 4c, jumbos 5c. Western Photo, Dept. PM121, Box 298, San Francisco 1, Calif.

**16 PRINTS** Or 8 jumbos from roll, 25c with this ad. S. Skrudland, Lake Geneva, Wis.

**6 OR 8** Picture roll 35c, 12 or 16 picture roll 55c. Each roll printed and developed. Handy album pack. If you fail to get pictures on your film a new roll will be sent you without extra cost. Send coin with roll. No c.o.d.'s. Mailing containers sent free. DeLuxe Film Service, Box 1268-A, Shreveport, Louisiana.

### MOTION PICTURES AND SOUND EQUIPMENT

**LEARN** Free lance, educational, Hollywood, and television film technique at home. State licensed. Write for free catalog. Motion Picture Institute, Birmingham 4, Michigan.

**FREE** Sample kodachrome titles for your movies, list. Box 526M, Minneapolis.



**ALMOST Free**—with Blackhawk's big 28-page film bargain catalog—one brand new film (our selection) postpaid; 100' 16mm. sound, 98c; or 100' 16mm. silent, 59c; or 150' 8mm., 99c—as special get-acquainted offer. Typical Blackhawk bargains: New 1-reel 16mm. sound films, \$7.95 (formerly \$19.75); new 1-reel 16mm. silents, \$2.19 (formerly \$9.75); used 1-reel 8mm. \$1.19 (formerly \$5.50). Used Panoram 100' 16mm. musicals, \$9.98 per dozen. Similar bargains in used films of all types. Used sound projectors—Ampros, Bell & Howells, Victors—often available low as \$129.95. Write today for Blackhawk's free catalog. Blackhawk Films, Inc., "Sixteen's Super Market," 1205 Putnam Bldg., Davenport, Iowa.

**BARGAINS 16MM** sound films. Also for exchange. Bedner, 5300 So. Talman, Chicago.

**FREE Movies.** Thousands of subjects. Interesting. Entertaining. Fascinating. New Directory, only 50c. National Cine, 125 Lexington, New York 16, N. Y.

**UNUSUAL 8-16MM.** movies. Full-color projection length sample, \$1.00. Color Tru-Art slides, three samples \$1.00. Big catalog, 25c (refundable). National Film Supply, Toledo 9-H, Ohio.

**5000 NEW-Used 8-16mm.** silent-sound films. International, 2120 Strauss, Brooklyn 12.

**8-16MM.** Silent-sound films. Complete rental library. All latest subjects. Free catalogue, sample film 10c. Garden Film, 317 West 50th, New York 19.

**BASS SAYS:** Leadership since 1910 guarantees satisfaction. Finest Cine equipment: 8mm., 16mm., and 35mm., silent and sound. Write the old "horse trader." Satisfaction or your money back always! Bass Camera Company, Dept. A, 179 W. Madison St., Chicago 2.

**RENT 16MM.** sound films, 50c reel. Large selection; free catalog. Film Service, 123 Chestnut St., Roselle Park, N. J.

**GUARANTEED Fresh 8mm.** roll, magazine; 16mm. roll, magazine movie films. Color, b&w. Free catalog. ESO-S, 47th Holly, Kansas City 2, Missouri.

**MOVIE Camera film:** 8mm. roll \$1.50, 16mm. 100' \$3.00. Free processing. Better Films, 742 New Lots, Brooklyn, N. Y.

## MUSIC AND MUSICAL INSTRUMENTS

**LATEST Player piano rolls,** 75c. Durrell Armstrong, 222 South Vassar, Wichita, Kansas.

**SONG Poems** wanted. Write, John Wigginton, Box 240, Owensboro, Ky.

**MUSICAL Instruments** for Christmas, accordions, guitars, 10-day trial, free bargain list. Meyers, 454-A Michigan, Detroit 26, Michigan.

**MUSIC Arranged.** Songs printed. Frank Wildt, Music Publisher, Lancaster, Penna.

**WORDS Given melody;** recorded; radio broadcast offer. Write, Wescourt, 216-A West Jackson, Chicago.

**ACCORDIONS**—Save 50% and up. Cash or terms. New and used. All brands. Wholesale to every one. Free catalogue. Del Principe, 307 South Wabash, Chicago, Ill.

**RECORDS.** Guaranteed new latest Hill-billy, Pops, Blues, Spirituals, low as 4 for \$1.00. Free catalog. CH Mailor, 570 N. Gay Street, Baltimore, Maryland.

**SONGWRITERS!** Outstanding, ethical offer. Hibbler, C-5, 2157 N. Avers, Chicago 47.

**ELECTRIC Guitars,** amplifiers, wholesale. Free catalog. Carvin PM, Baldwin Park, Calif.

**SEND For free booklet,** How To Write and Sell Songs. Get the facts first. Poems examined free. Reliable Music Service, Box 430-P, Hollywood 28, California.

**SONGWRITERS!** Protect your ideas! Hold all songs; poems! Write for Safe Correct Procedure first! Song Service, Dept. P, 333 W. 56th St., New York 19, N. Y.

**POEMS Wanted.** Broadcast consideration. Sooner Song Co., 22PM North West 8th, Oklahoma City 2.

**SONGWRITERS!** Send poems, songs. Music Service, 243 West 72nd St., PM, New York 23.

**SWING Piano**—By mail. 30 self-teaching lessons \$3. (Samples.) Phil Breton Publications, P.O. Box 1402, Omaha 8, Nebr.

**POEMS Wanted.** Poems to be set to music. Free examination. Send poems. McNeil, Master of Music, 510-PM S. Alexandria, Los Angeles, California.

**WRITE Songs.** Big money and reputation. Write for information. J. Gordon Pub. Co., 4700 South California Avenue, Chicago.

**WANTED!** Poems for musical settings. Write Songwriters' Service, Clifton, N. J.

**1951 ACCORDIONS**—Wholesale. Free catalog. American Accordion Center, 5329 Belmont, Chicago.

**YOUR Voice** made loud, clear and powerful with my diaphragm exerciser. Write, Inventor "Oz," 34V, Box 665, St. Louis, Mo.

## RADIO AND TELEVISION

**RADIO Control** from car. Plans 35c. Apco, 1553 Plainfield, Grand Rapids 5, Michigan.

**6-BAY, 8-Bay** diagrams, fringe area instruction manual, \$1.00. Television Engineering Co., 303-34th, Bakersfield, Calif.

**TELEVISION Tubes.** Fluorescent fixtures. Wholesale prices. Naturalite, 1520 Ardmore, Chicago 26.

**24 PAGE Plans** "18 long distance crystal sets" 25c, including "Radiobuilder," catalog. Laboratories, 1131-C Valota, Redwood City, Calif.

**AMATEURS**—Radio engineering questions answered \$1.00. With schematics \$2.50. Henry Twillmann, R.R. #1, Chesterfield, Missouri.

**CRYSTAL Radio** experimenters. Write Leslie Hulet, R2, Lakewood, New Jersey.

**RADIO Tubes,** surplus radio equipment, bargains. Ask for list. Kay Electronics, Box 25, Hollis, New York.

**LONG Distance TV** and FM antennas. Yagi beams, stacks, etc. Wholesale Supply Co., Lunenburg 1, Mass.

**POWERFUL Television** antenna. Illustrated building instructions. 35 cents. R. Fischbach, 513 South Kendall St., Aurora, Illinois.

**FREE! 212 Page Radio-Television-Electronic Catalog!** World's largest stocks, lowest prices. Complete supplies for builders, experimenters, amateurs, servicemen. Latest radios, phonos, television, recorders, sound equipment. Thousands of parts, tubes, test instruments, books, diagrams. Top quality money saving values. Get yours now! Allied Radio Corp., 833 W. Jackson Blvd., Dept. 34, Chicago 7, Ill.

**BUILDER'S "Pictorial Construction Plans."** Free list. Alena, Box 24, Astoria 6, New York.

**MAKE Simple,** tubeless, batteryless, distance-getting crystal radios. Crystal and illustrated instructions 25c postpaid. Allen, 427-P, Clinton, Mo.

## BUSINESS OPPORTUNITIES

**BE A publisher** by co-operative plan. Make money in own home. Samples 2 different magazines and plan 25c. Clement Moore, Pub., New Egypt, New Jersey.

**MAKE Perfumes** at home. Write, "Carey Laboratories," 1914 Chouteau PM-12, St. Louis 3, Missouri.

**ARM-Chair farmer** plan 25c. Lazy money making. No land, no experience. Sabetha Enterprises, Sabetha, Kansas.

**ANTI-Freeze;** does not evaporate. Similar to well known brands. Make-sell this amazing product. Complete formula. \$1.00. Kemico, Park Ridge 19, Ill.

**RADIO Advertising** without risk! Pay "per order." Data, 10c (refundable). Simon-P3, 59 Park Avenue, New York City 16.

**BE Independent!** Start your own business at home in spare time. Free details. R & L Studios, Tryon Road, Michigan City, Ind.

**"WATERLESS (Lanolin) Hand Cleaner."** (Oil base.) Make, sell. No machinery. Build profitable business. Complete formula \$1.00. Ideal Service, Park Ridge 13, Ill.

**LEARN Professional** candy making profitable home business. Details free. Pate, Kissimmee, Florida.

**MIRROR Resilvering.** Wonderful home business. Complete formula 50c. Magic two-way mirrors. You can see out—no one can look in. Formula 50c. How to make coppered mirrors, vases, glasses. Formula 50c. All three \$1.00. Nelko Chemical Service, Box 3462-M-12, Chicago 54, Ill.

**\$10 HOUR!** Possible! Home! Full or part time! With the world's most complete invisible reweaving instructions and automatic latch steel tool assembly, that makes moth holes, cuts, tears, burns in clothing disappear like magic, including material for life \$3. Complete. 27 other unusual home projects. Satisfaction guaranteed. Details free. Waish, 892 Main, Buffalo 2, New York.

**SELL Books** by mail! Complete professional instructions \$1. Paramount Book Service, 39 Hopedale Street, Allston 34, Boston, Mass.

**NEW Exceptionally** profitable plans, ideas for home operated mail business. Rush name. Miller, 1772-P Carlyon Road, East Cleveland 12, Ohio.

**INVENTS New** cheap oil burner. \$29.50 for furnaces. \$14.75 for all stoves. Write today for wholesale prices. Northwest Mfg. Co., C-427 Main, Mitchell, S. Dak.

**HERE'S How:** Over 750,000 articles wholesale. Write Millheiser, Route 5, Fayetteville, Arkansas.

**HOW To make** money with your hobby. Write Nemaha Sales, 319 S. 13th Street, Sabetha, Kansas.

**PROFITABLE Office** mailing address for individuals and manufacturers. Ask for details. Mail Center of Chicago, 216 West Jackson, Chicago 6.

**START Home** manufacturing business making cleaning compounds, soaps, insecticides, cosmetics, polishes, food flavors. No machinery. Literature free. Kemix, Park Ridge 13, Ill.

**BIG Money!** Spare or full time in your home. No selling! Spray new miracle finishes, plush and suede, on signs, radios, automobiles, figurines, lamps, toys, etc. Our business is booming. Help us fill huge demand. New easy Flok-Kraft methods. Material costs few pennies. You get dollars. Free samples, complete powerful money-making plan free. Write now! Coast, 1002R S. Los Angeles St., Los Angeles 15, Calif.

**TO \$35.00 Weekly.** Spare time, home operated mail order business. Successful small "beginner's" plan. Everything supplied. Lynn, 5710-M Bankfield, Culver City, California.

**OPPORTUNITY** of a lifetime. Manufacturer world's most beautiful concrete fireplaces. Nationally advertised. \$4 worth of sand and cement makes a fireplace that sells on sight for \$125 and up. Molds on exclusive franchise with protected territory. Write: Fireplace Department, General Engines Co., Gloucester, N. J.

**BUY Wholesale**—Million articles. Supply source directory, dime. Nelko, Box 3462-DR-12, Chicago 54, Ill.

**INVISIBLE Reweaving.** Men-women. Instructions shipped for no-risk examination. \$5.00 hour possible spare-time. Reweave burns, tears, moth-holes like new at home. Free details. Skilweave, 1717-AV Westwood, Los Angeles 24.

**GET \$3.00 Orders.** Keep money. Orders filled free. Details free. Corcoran, 2333 N. Winchell, Portland 17, Oregon.

**START A venetian** blind laundry. Profit opportunity for lifetime business. New machine method. Free booklet on request. F. C. Co., 442 N. Seneca, Wichita 12, Kans.

**MAKE Perfume.** Catalogue free. Write "International," 6347 Parnell-PM-12, Chicago 21, Illinois.

**LEARN Sewing** machine repair. Electrify, rent, trade, sell. Make "big money" at home, spare time. New motors, machines, etc. wholesale. Details free. Taylor Service Co., Hamilton PM-12, Ohio.

**START Your own** business on credit. Always your own boss. 1437 dealers sold \$5000 to \$28,500 in 1950; their average \$6704. We supply stocks, equipment on credit. 200 home necessities. Selling experience unnecessary to start. Wonderful opportunity to own pleasant, profitable business backed by world-wide industry. Write Rawleigh's, Dept. L-U-PPM, Freeport, Ill.

**SALES Letter** writing—Earn \$10 to \$25 per letter, as I do, from home without capital. Easy, fascinating work. Big pay. Complete instructions, sample letters. \$2. Refund guaranteed. Free details. Copy Craft Advertising, 6227-A 32nd Avenue N.E., Seattle 5, Wash.

**ELECTROPLATE** Giftwares, novelties, baby shoes, jewelry, auto parts, mirrors. \$5.95 includes portable electroplater, plating salts, formulas, instruction manual. Tyco Metals, Box 13291-MB, Houston 19, Texas.



**WHY Job worry?** Start electroplating, metal finishing business. Free information, trade secrets. Plater M Hyde, 327 West 120th Street, Los Angeles 61, California.

**MAKE \$6.73** Every time you sell one—And they're amazingly easy to sell! We have new adding machines in original factory cartons you can sell for only \$14.95 and you make 45%. They're executive model portables, precision built with automatic clearance, direct subtraction, fully guaranteed. Send for life size color photo with full details. Write today to Lightning Adding Machine Co., Inc., Dept. P-12, 1260 West Second Street, Los Angeles 26, Calif.

**BOOKKEEPERS.** Keep books, small firms spare time. Manual latest technique by C.P.A., \$3.00. Modern Business, Box 406, Youngstown 1, Ohio.

**FIX Typewriters.** Free booklet describes our modern, inexpensive home-study course. Factory methods taught. Write: Typewriter, 1215 Corbet, Tarentum, Penna.

**DEALERS, Agent, distributors, wanted.** High grade plastic wall tile. Large profits. Write manufacturers, Artistic Tile, 3010 W. Irving Park, Chicago 18, Illinois.

**FREE Book "505 Odd, Successful Businesses."** Work home! Expect something odd! Pacific, Oceanside, Calif.

**BE Listed to receive latest mail order offers, propositions, samples, etc.** Write: National, Box 88-P, Dorchester 22, Mass.

**NATURAL Molding Latex.** Extra thick. Free sample. W. Wooley, 115-A Donald, Peoria, Ill.

**MAKE Mail order business pay.** Necessary basic knowledge, recommended by mail order experts. Only 50c. Maxted's Book Agency, Western Springs 4, Ill.

**112 FORMULAS \$2.00.** One- and two-ingredient. Sensational Disinfecto formula, sample and plan included. Pharmacist, 750 East 225th, New York 66, N. Y.

**FREE Money-making mail ideas.** Publisher-30, 4121 Wyoming, St. Louis 16.

**\$46 FROM Square foot plywood;** jigsaw necessary. Write: Woodarts, Bridgewater, Mass.

**MAKE Big money at home with Magic Pearl Finish.** Free plan. Pearl-Art, 7216 Bear, Bell, Calif.

**RUBBER Molds!** New catalog illustrating over 100 professional molds, 10c. Castcraft Studios, 508-P Marion St., Brooklyn 33, N. Y.

**MAKE Money at home—Mail literature offering fast selling merchandise.** Everything furnished. Revealing information free. Hickory Lane, East Kingston, N. H.

**COFFEE Compound wholesale.** Sell "Kick" the new coffee compound. Retail 65c lb. Sample shipment 4 lbs. and details \$2.50 prepaid. "Kick," P.O. Box 936, Wichita, Kansas.

**SPECIAL Rubber for making molds.** Literature and sample free. Universal, Box 1076-A, Peoria, Ill.

**BUY Direct wholesale 750,000 articles.** Write Lawson, Box 106, Detroit 11.

**TIN-Cans.** Turn them into cash. Nine methods. Instructions 50c. Charles Company, 12-BWX, Norwood, Ohio.

**GET Dollars in your mail—Keep 90c.** Everything furnished. Write: Genmerco, Box 142-P, Dorchester 24, Mass.

**SELL Profitable items.** Start selling Woolskin dust and polishing mitt \$2.00 value. Your sample \$1.00 postpaid. Write Braun, P.O. Box 1227, Milwaukee, Wis.

**YOUR Name and address on postal will bring many local and mail business opportunities.** Apex Supply, Box 165, New York 18, N. Y.

**MAKE Money spare or full time, casting metal toys and novelties.** Big 1952 wholesale and chain store orders for cast metal autos, soldiers, ashtrays, banks, etc., keep manufacturers busy. Production molds furnished for up to 100 and more castings per hour. No experience or special place necessary. Write for information and illustrations of patterns needed. Metal Cast Products Co., Dept. A, 1696 Boston Road, New York 60, N. Y.

**RESURFACE Butcher's chopping blocks with easy, fast-working, portable electric machine.** Unique service in wide demand with little competition. Large steady profits from full or part-time work. Hill Machine Company, Box 677B, Rockford, Ill.

**MAKE Rubber stamps, repair dolls, repair sewing machines.** Learn invisible reweaving. Catalogue of "40 Ideas" free. Universal, Box 1076-A, Peoria, Ill.

**SAWDUST.** Turn it into cash. Twenty methods. Instructions 50c. Charles Company, 12-BWV, Norwood, Ohio.

**UNPAINTED Bookends, plaques, novelties.** Free list. Plastercraft Arts, 1611 East Fifteenth, Cheyenne, Wyo.

**BUY Direct from manufacturers, wholesalers, thousands articles.** Artie Barnes, P.C., Wichita, Kansas.

**TRADE Magazines help you to success.** Get latest copies through our easy-to-get-acquainted service. Hundreds of business, professional, craft, electrical, construction, health, motel, oil, travel, mail order, hobby, music, art, pets, photography, plastics, sports, television, selling, insurance, agricultural and others covering all interests. Send for list today. It's free. Commercial Engraving Publishing Company, 34C North Ritter, Indianapolis 19, Indiana.

**IMPORT-Export!** Represent manufacturers. Conduct barter exchange. War-peace time big profit business. Buy-sell by mail. Let experts show you how. International Trades, 246-P, Fifth Ave., New York 1.

**MAKE Tough, durable plastic—1c pound.** Makes attractive floors, walls, built-ins, roofs. Build good home, \$150.00 room. Bays Laboratory, Oklahoma City 9.

**CONVERT Hand mowers to power mowers.** Do it now, this winter. Sell the Handy-Dandy conversion kits. Easily installed on 16 to 20" mower. Use any small gasoline or electric motor. Quick delivery. Kits purchased with or without engines. Also new garden cultivator. Cultivates 3" deep. Attachments available: weed cutter, lawn mower and snow plow. Discount to dealers. LeClaire Manufacturing Company, LeClaire, Dept. PM, Iowa.

**MAKE Money in your own home—Selling by mail.** We teach you how. Supply everything. Smith, Box 1427-P, Burlington, N. C.

**COLOR Concrete with chemicals.** Marble-gaze cement benches, pottery, garden ornaments. Home—shop. 10c brings sample, pictures. Hollywood Cementcraft, 8527-R Wonderland, Hollywood 46, Calif.

**QUICK Money!** Repairing car batteries! At home! Easy too! Batteryman, Grand Junction, Colorado.

**EXTRA Money—No selling, operate vendors.** Amazing profits, details free. Silver King, Suite 220, 622 Diversey, Chicago 14.

**PROFITABLE Home mfg. business.** Make waterless hand cleaners, household and auto specialties, etc., by simply adding water to basic concentrates. Over 300% profit, up to \$500 monthly, on steady repeat orders. Formulas free. Western B Aircraft, Los Angeles 19.

**WANTED! At once!** Home producers by manufacturers in our clearing house service. Become a sub-contractor casting plastic products for these companies. Thousands of easy to make items required. Cash in at home, without previous experience. For details write Plastic Service Guild, Dept. SPM, E. Boston 28, Mass.

**"YOUR Phone Is Your Fortune."** Tells how to turn your telephone into dollars. Complete \$1.00. Sales, Box 675, Richmond, Virginia.

**BABY Shoe metallizing.** Amazing offer. Send card. Schoettle, Friendship 12, Ohio.

**PRINTING, Salesbooks, envelopes, tags.** Free illustrated catalog. Ersco, 1935 Patterson Ave., Bronx 72, New York.

**BUY It wholesale!** Manufacturers, distributors offer 850,000 items. Literature free. Olsen, 1231-A East Third St., Duluth 5, Minn.

**OWN Night school business.** \$85 gross profit from every \$100. Famous home study school teaching popular course in understanding people expanding with local privately owned night schools. Exceptional opportunity for ambitious men and women, full or spare time. Man-wife opened school October 1950, now want ten schools. Tell about yourself in longhand. Sample lesson, details free. IGAS, Inc., 800 Wilhoit Bldg., Springfield, Mo.

**BOOKKEEPERS.** Earn up to \$520 month serving small firms part or full time. Proved plan; simplified system. Particulars free. Tax Saver System, Dept. A, Ft. Worth 2, Texas.

**OPERATE Profitable mail order business.** Splendid opportunity. For details write Walter Bitterman, 133-A Boren Ave. N., Seattle 9, Wash.

**EARN Money at home with your typewriter.** Spare time! Details free. Edwards, Publisher, 3915-PM, 12th, Des Moines 13, Iowa.

**STOP Wage slavery.** New publication tells "Seven Ways to Start a Private Business Without Capital." Particulars free. Write Reliance Business Service, 15a Park Row, New York 38, N. Y.

**BIG Money and fun growing live miniature Ming trees on your window sill.** Write for free rare tree seed and plan. National Nurseries, 8620A Ruthelen, Los Angeles 47, California.

**TELEVISION: Make big money.** Repair sets. Our "Television Book" tells all in simple language. \$1.00. Money back guarantee. Leary's, 56 East Hennepin, Minneapolis, Minn.

**FIGURINE Molds and many others,** liquid rubber, statuary plasters, flock finishes, etc. Illustrated catalog and "Plastercraft" manual free. Blue Rapids Supply, Blue Rapids, Kansas.

**SUCCESS—Your own profitable business by mail order from your home.** No special training or knowledge necessary. Details free. Bowden Business Service, Box 2204, San Diego 12, Calif.

**WANTED—Unused U. S. postage stamps.** Small discount. Advance Stamp Co., 24 East 23rd Street, New York 10, N. Y.

**\$25 WEEKLY Working two hours daily.** No canvassing. No manufacturing. Lycke, Box 2471-A, Cleveland 12, Ohio.

**MOLDING Rubber \$2.95 quart, \$9.95 gallon prepaid!** Plastercraft Supply Company, 3051 St. Clair Avenue, Cleveland 14, Ohio.

**FREE Booklet "How to Make Backyard Profits!"** Pickett's, Florence, Kentucky.

**MAKE Gifts, novelties, jewelry,** from sea shells, fish scales, plastics. Secret pearlizing, bronzing, luminizing, metallizing, dyeing, tinseling processes disclosed. No tools or experience needed. Book of 165 beautifully photographed designs \$1.00. Giftcrafts, Box 4550-MX, Coral Gables, Florida.

**SELL By mail; free details; instructive booklet 25c.** Manhattan House, P.O. Box 51-M, St. Albans 12, N. Y.

**MAKE Money at home as renewal headquarters for all magazines.** Big Christmas sales profits now. Liberal commissions. Supplies furnished. Write for free catalog. McGregor Magazine Agency, Dept. 500B, Mount Morris, Ill.

**WATERLESS Hand cleaner.** Cleans thoroughly. (No ammonia, no kerosene.) Easily prepared. Good profit. Formula \$1.00. Nelko Chemical Service, 3462-WH Merchandise Mart Sta., Chicago 54, Ill.

**HOW And where to obtain capital,** details free. Star Service, Wapakoneta, Ohio.

**BEST Tested moneymakers.** Over 40,000 words 25c. Business secrets, formulas, wholesale supply, sources galore. Money-back-guarantee. VeeJay, Box 14707M, Los Angeles 18, Calif.

**EARTHWORM Breeding?** First, get unusual story, "An Earthworm Turned His Life." Free. Earthmaster, Dept. 14, El Monte, Calif.

**MONEY In new greaseless doughnuts.** Start in kitchen. No smoke. Sell stores. Free recipes. M. Ray Company, 3605 South 15 Ave., Minneapolis 7, Minnesota.

**WHERE To buy at wholesale 100,000 articles.** Free list. Also extra-income literature. Maywoode, 1133 Broadway, New York.

**GROW Mushrooms.** Cellar, shed. Spare, full time. We pay \$3.00 pound. Free book. Mushrooms, 2954 Admiral Way, Seattle, Wash.

**INCOME From local information.** No selling. Write Neherco, La Verne, Calif.

**MAKE Flexible molds!** Cast plaques, bookends, figurines! Free sample! H. Tooker, 630-R Chestnut, Hamilton, Ohio.

**NEW Profitable home business repairing zippers.** Thousands of customers waiting. No experience required. We furnish everything. Write Texas Specialty Company, 204-B Texas, Texarkana, Texas.

**UNPAINTED Bookends, plaques, statues, figurines.** List. Haverty Products, 823-17th St., Altoona, Penna.

**START Mailorder bookshop — Everything furnished.** 25c brings booklet, samples, exciting ideas. General Publications, Ossining, N. Y.

**THOUSAND Articles wholesale.** "Supply Source Directory" 10c. Ideal Service, Park Ridge 30, Illinois.



**YOUR Own profitable home business.** Preserve live flowers to last for years. New simple discovery. Enormous demand all year 'round. Tremendous profits! Light fascinating work. Send \$2.00 for working equipment, instructions, and valuable sales plans. Satisfaction guaranteed or money promptly refunded. Alfred Hermansen, 210 Fifth Ave., Suite 1102A, New York 10, N. Y.

**OPERATE Profitable mail order business.** Write Walter Service, 4159-A East 112th, Cleveland 5, Ohio.

**DOLLARS** In personalized baby record books. Sell by mail. Use same literature we do. No-Co-Ro, Oakland 6, Calif.

**FABULOUS Earnings**—Fascinating pastime. Growing genuine, living miniature (ming) tree. New sensational business or hobby. Astounding information free. Dwarf Gardens, Box 355B, Briggs Station, Los Angeles 48, Calif.

**BRUSH** Plating outfits connect to a battery. No tanks necessary. Good paying business at home plating autoparts, bathroom fixtures, bicycles, reflectors, silvering mirrors. No shop or experience required. Outfits furnished. Free booklet. Gunmetal Co., Ave. H, Decatur, Ill.

**COMMERCIAL Deep frying course.** Mock chicken legs, potatoes. New and proven methods. Learn about this money-making field. \$2.50 p.p. Concession, Toledo 13, Ohio.

**RECAST** Old batteries into new. Latest achievements. Battery Laboratories, Minneapolis.

**MADE \$24,500** Using money making plans from Schemer Magazine, world's oldest mailorder publication. Box 275M, Canfield, Ohio. Year \$2.00. Sample 20c.

**MINK** Raising information free. Complete. Lake Superior Mink Farm. Superior, E.E.I., Wisconsin.

**POPCORN** And potato chip equipment. Long Eakins Company, 5160 High, Springfield 99, Ohio.

**COPUBLISH** Leading m.o. paper. Latest copy Mail Sale Advertiser, details, dime. Vanroy Shirk, Lebanon, Penna.

**COLORGLAZED** Concrete pottery made without molds. Patented method. Cemetery products, novelties, tiles. Basement leak-sealing. Money-making projects. Booklet, details free. Men only. National Potteries Company, Grand Rapids, Minnesota.

**READ "Advance"**—The voice of mail order. Offers money-making opportunities, sources of supply, personal guidance, etc. Issued monthly. Sample copy 25c. Yearly subscription \$2.00. Advance Publishing Company, 313 East 21st Street, Suite 450, New York 10, N. Y.

**LIQUID Rubber.** Make flexible molds. Free sample. Chaney, 1130 E. 16th St., Jacksonville 6, Fla.

**MAILING** Postcards selling repeat merchandise is profitable. Everything supplied. Details free. Gordan Publishers, Box 23, Pawtucket, R. I.

**MEN—Women.** Everybody likes candy. Learn to make professionally. Our 40th year. Ragsdale Candies, D5, East Orange, New Jersey.

### MONEYMAKING OPPORTUNITIES

**EARN** Money evenings, copying and duplicating comic cartoons for advertisers. Adservice, Argyle (1) Wisconsin.

**START A** profitable subscription business in spare time! We need men and women (young or old) as representatives for all leading national magazines. Liberal commissions paid for new and renewal subscriptions. Start earning money in this pleasant work at once! Clip this ad and send with your name and address to: International Circulation Division, Dept. PM, Hearst Magazines Inc., 250 W. 55th St., New York 19, N. Y.

**100% PROFIT** in small item. Sample 25c. Wrap coin. C. Seibold, 6621 S. Bishop, Chicago 36, Ill.

**BUILD** Quick photo cameras. Plans \$2.00. Martin, 3943 Ottawa, Chicago 34.

**NOT Riches** but extra dollars made at home, particulars dime. Bell, 177 Woods, Oceanside, New York.

**EARN** Extra income in spare time at home. Our information reveals how. Only 30c. Business Bureau, Dept. 52-M, P. O. Box 2224, St. Louis, Mo.

**"HOW To Make Money With Simple Cartoons"**—A book everyone who likes to draw should have. It is free; no obligation. Simply address Cartoonists' Exchange, Dept. 912-CM, Pleasant Hill, Ohio.

**\$100-\$200 WEEKLY.** No selling or manufacturing. Part or full time. Mahaffey, 3032-B Weldon, Los Angeles 65.

**INCOME** Tax consultants earn \$100.00 daily. Good part time earnings. Nationally accepted course available without cost. Information furnished. No obligation. Universal, Box 684-M, Springfield, Missouri.

**PARTICULARS** Free. 155 ways to make money. Cartledge, Middle Bass 10, Ohio.

**FORTUNE** In county franchise for Henry's Floating Hamburger. No canvassing. Jesse and Jesse, P.C. Box 936, Wichita, Kansas.

**START A** moneymaking war surplus business of your own. Tremendous profits. Information 10c. S. & S. Publications, Goldthwaite 1, Texas.

**580 MONEY** Making secrets, \$1.00. Book Service, P.O. Box 453, Port Chester, New York.

**WIN** Contest money. General Contest Bulletin gives hundreds of tips. List current contests and rules. Sample 25c. General Contests, 1609 1/2 East 5th, Duluth, Minnesota.

**HOBBIES** That make money. Free details. Cornell, 421 Ocean Ave., Lynbrook, New York.

**SPARETIME** Cash, home, with America's finest folios. Terrific! Sample, catalog 25c. Merrill, 9 Stoddard, Glens Falls, N. Y.

**WE** Pay you highest rates for hand-decorating greeting cards. Work home. Experience unnecessary. No selling required. Greetings, 108 Madison, Detroit 26.

**TIE-Breaker** picture puzzles exposed, \$1.00. Wenograd, Box 1495, Philadelphia 5, Penna.

**FREE** Book "505 Odd, Successful Businesses." Work home. Expect something odd! Pacific, Oceanside, Calif.

**RESILVER** Mirrors at home. Formula 25c. Ideal Service, Park Ridge 6, Illinois.

**BE** Appointed State Notary Public now! Details: Stationers, Helotes, Texas.

**GROW** Mushrooms. Cellar, shed. Spare, full time. We pay \$3.00 pound. Free book. Mushrooms, 2954 Admiral Way, Seattle, Wash.

**PUBLISH** Your own magazine. Hand-some 52 page format, well edited, illustrated. Cost low as \$1.00 month. Brings you prestige, profits. 25c brings sample, details. National, Ord, Nebr.

**READ** Progressive Mailtrade, the magazine that tells how to make money by mail. Dime brings sample and special offer. Progressive Mailtrade, Box 357, Sheboygan, Wisconsin.

### FORMULAS, PLANS, ETC.

**LATEST** Manufacturing formulas, for profitable, easy to make chemical specialties. Lists free. Automotive Chemical Laboratories, Box 393-A, Hicksville, N. Y.

**ANY** Formula \$2.00. Satisfaction guaranteed. Jack, 4292 Parkside Ave., Philadelphia 4.

**BOOK**—10,000 Formulas, processes, \$3.98. Free literature. K. Paullin, Loudonville, Ohio.

**YOURS.** Free catalog profitable formulas. Consultants, Box 201, Cincinnati 14, Ohio.

**FORMULAS** For big profit, fast-selling products. Free literature. Majestic, 530 1/2 S. Main, Elkhart, Indiana.

**REAL** Manufacturing formulas. Lists free. Cummings, Chemist, Gordon Ave., Syracuse 4, N. Y.

**FORMULAS.** Latest, best. Catalog and chemical instruction sheet 10c, (refundable). Nelko Chemical Service, 3462-F Merchandise Mart Sta., Chicago 54, Ill.

**MAKE**—Sell cleaners, soaps, polishes, flavors, cosmetics. No machinery. Formula literature free. Kemico, Park Ridge 16, Illinois.

**FORMULAS.** Trade secrets, for nearly everything. Catalog free. Creative Publishers, Winnetka 6, Illinois.

**TESTED** Formulas. Interesting descriptive booklet free. Pont, Box 635-PM, Terre Haute, Indiana.

### PLASTICS

**NEW** Liquid plastic. Clear, colors. Cast without heat. Embed flowers, insects, coins. Saw, drill, carve. Send 25c for wholesale catalog and new sales manual, showing how to make money at home. Castolite, Dept. P-101, Woodstock, Illinois.

**PERFUMER** With hand carved flowers \$3. You apply color. Write for folder illustrating Art-point Line available to hobbyists. Lighters, shakers, night lights, etc. Plastic Center, Dept. M, 9877 MacArthur, Oakland, California.

**LEARN** Plastics at home. Small cost—Spare time. Dime brings sample plastic, three experiments, full details. Plastic Projects, Box 5151, Detroit 35, Mich.

**PLEXIGLAS,** Acetate, cellophane. Book covers, folders, specialties. Major's, 3510 Palmer, Chicago 47.

**HI-PROFITS.** Gifts, jewelry. Free catalogue, details. Pilot Plastics, 67C Fulton St., New York City 38.

**PLASTIC**—Crafters supplies wholesale. Literature 20c. Cosmopolitan, Box 176-PM, New York 8, N. Y.

**LUCITE,** Plexiglas, acetate; casting, molding plastics, findings. Dye manufacturer. Quantity prices. Special bargain lots, immediate shipment. Complete catalog 10c. 25c airmailed. Gem-O'-Lite, Box 6863, North Hollywood, Calif.

**LUCITE,** Plexiglas. Any size sheets, masked. Square foot (12 x 12) cost, 1/16" \$1.20; 1/8" \$1.40; 3/16" \$1.75; 1/4" \$2.08. Include 10% postage. Almac Plastics, 230 Fifth Ave., New York 1, N. Y.

**PLASTIC,** Sheets, rods, tubes, etc. Free list. Plastic Supply Co., 2901 N. Grand Blvd., St. Louis 7, Mo.

### CHEMISTRY

**CHEMICALS** And apparatus for industrial, analytical, and private laboratories. Catalog 20c. Dept. M-50, Biological Supply Co., 1176 E. Hope Ave., Rochester 20, N. Y.

**OH Boy!** New Book of Science. Experiments, formulas, secret processes, together with catalogue of laboratory supplies, only 25c. National Scientific Company, Dept. 16, 2204 W. North Avenue, Chicago 47, Illinois.

**SAVE** Money! Supplies catalog 15c, refundable. Laboratory Sales, Box 161, Brighton, Mass.

**CATALOG** Of chemicals, apparatus, kits, minerals, uranium ore, 10c. Rex Laboratories, 2849-A Birchwood, Chicago 45, Ill.

**LABORATORY** Apparatus, chemicals, microscopes, complete chemistry sets, minerals, uranium ore. 10c brings catalog. Porter Chemical Company, Hagerstown 1, Maryland.

**SPECTROSCOPE** For quick chemical analysis \$3. Kutting Sons, Los Altos, Calif.

**NEW** Idea chemical and apparatus outfits for home experimenting. Photo-scales, microscopes, chemicals, biological and laboratory supplies in small quantities. Catalog 25c. Established 1931. John H. Winn, 124A West 23rd Street, New York, N. Y.

**ILLUSTRATED** Catalog: Chemistry, mineralogy, biology, 10c. Tracey Laboratories, Evanston, Illinois.

### HELP WANTED

**TIRED** Of no money, second rate jobs? Like to start a real career with a lifetime of high salaries? Write me about two growing fields that really need men. Ed. Howes, Chief, 456 W. Santa Barbara Avenue, Los Angeles 37.

### AGENTS WANTED

**WHOLESALE.** Guaranteed. Silverplate tableware, nationally advertised. Murphy-Yale, Meriden, Connecticut.

**"FOG-Stop"** Windshield cloth. Instantly removes blurry mist, frost, sleet, snow. Stops windshield fogging. Samples sent on trial. Kristee 139, Akron, Ohio.

**MAKE** Wedding profits. Sell invitations, napkins, matches. Samples free. Dunbar's, Middlebush 3, N. J.

**EXTRA** Money quick. Sell "NuSilver Polish and Plating Liquids." Cloth applied. Particulars free. NuSilver, 508-PM12, New York St., Aurora, Illinois.

**\$500 MONTHLY** Possible. Free catalog. Bava, 3655 E. Canfield, Detroit 7, Mich.



IS \$210 A week worth a penny postcard to you? Then rush card with name and address for special free trial plan that sells amazing new automatic refrigerator defroster "Like hot cakes!" Write to Mr. Lewis, D-Frost-O-Matic Corp., Dept. C-102, 6 N. Michigan, Chicago 2, Illinois.

**BUY Wholesale** — 25,000 items. Catalogue 25c. Matthews, 1472-B5 Broadway, New York City.

**\$60 RING** And valve job for \$6.00—while you drive! Guaranteed for life of car! Increases mileage. Stops oil pumping. Patented. Nerlino, Box 7, Inglewood, Calif.

**BIG Daily profits**—Selling embroidered wool and cotton uniforms, initialed buckles, belts, badges, choice 3000 emblems. Free sales kit. Hook-Fast, Box 480PM, Roanoke, Virginia.

**STRANGE "Dry Window Cleaner."** Sells like wild. Replaces messy rags, liquids. Simply glide over glass. Samples sent on trial. Kristee 138, Akron, Ohio.

**I'LL Put a "shoe store business"** in your pocket! Nation's leader trains you to make big money! Fit men, women. Free sample outfit. Write today! Consolidated Shoe System, Dept. 335-F-15, Chippewa Falls, Wis.

**SELF-Propelled rotary mowers.** 20"-32". All-purpose. Extra discount—now. Farm Products-PM, Excelsior Springs, Mo.

**1000 EMBOSSED Business cards.** \$2.50. Velazquez, 696-P Elton Ave., New York 55.

**MEXICAN Feather pictures.** Terrific Christmas item, sell gift shops, etc. Adelpi, Box 57-B, Bellerose 6, N. Y.

**BIG Profits selling ties.** (\$2.00 values) \$6.50 dozen. Free catalog. Empire Cravats, P648 Broadway, New York 12.

**EXCELLENT Sideline salesmen** calling factories, stores, restaurants, etc. Over 50% profits. Write Bacon Co., 782 N. Wilson Ave., Pasadena, Calif.

**ABSOLUTELY Free!** Big package actual sample fabrics and style presentation of dresses, lingerie, hosiery, etc. Take orders. Commissions big. Send no money. Melville Co., Dept. 6540, Cincinnati 25, Ohio.

**FREE Samples, and amazing plan,** giving you gorgeous dress without penny cost. Rush name today with dress size. Harford, Dept. G-135, Cincinnati 25, Ohio.

**MEXICAN Feather pictures.** Sell on sight; 200% profit! Free details; sample 10c stamps. Sylvia-PS, Apartado 9036, Mexico City.

**SALESMEN — Agents — crew managers:** It's new; selling like wildfire. Over 100% profit, irresistible demonstration creating huge earnings selling Nite-Tel-Lite. No competition. Be first. Write today. Nite-Tel-Lite, Inc., 514 Second St., S.W., Canton, Ohio.

**"WISHING Well"** collects coins galore! Cafes, taverns, anywhere. Call periodically, gather collections. Dozen, \$59.40; sample, \$7.50 prepaid. Industries 14, Box 929, Long Beach 1, Calif.

**NYLONS—Amazing get rich quick.** 100% bonus offering. Essential Products Co., 210 Fifth Ave., New York 10, New York.

**HOW** Would you like to get paid for "giving away" first quality nylon stockings at 49c? That's all they cost if they run within guarantee period to three months! Advance cash; big bonus. No experience needed. Just write orders. We deliver, collect. Postcard brings you free sample stocking and sales outfit prepaid. Kendex Corp., Babylon 33, N. Y.

**BUY Wholesale** thousands nationally advertised products at big discount. Sent free "The Wholesale Plan." American Buyers' Service, 629-J Linden, Buffalo, N. Y.

**100% PROFITS.** Free goods. Money back guarantee. Vaporine Medicated Oil, 1512 Chamberlain, Chattanooga 4, Tenn.

**SCHOOL Seniors!** A postal will bring you our wonder. Kwick-Sell Cardalog of popular graduation name cards. Biggest profits! Only firm giving free Golden Memory Book and Souvenir Chest. Don't miss out. Hurry that postal! Craftcards, Box 235L, Pittsburgh 30, Penna.

**YOUR Own business—Used overcoats** 50c; mackinaws 34c; shoes 12½c; ladies' coats 30c; dresses 10c. Enormous profits. Catalog free. Moro, 558-AA Roosevelt, Chicago 7.

**SCHOOL Seniors—Earn sensational profits** selling classmates America's most beautiful graduation name cards. Largest selection. Outsell all others. Free sample kit. Printerart, Dept. M, 1425 E. Elm St., Scranton 5, Penna.

**HI-Profits.** Gifts, jewelry. Free catalogue, details. Pilot Plastics, 67C2 Fulton St., New York City 38.

**BE A money maker.** Represent magazines year around. Wonderful home work. Big Christmas profits now. Liberal commissions. Everything furnished. Write for free catalog. McGregor Magazine Agency, Dept. 500A, Mount Morris, Ill.

**OWN A big moneymaking new and used clothing business.** Men's used suits \$2. pants 35c, topcoats \$1.25, jackets 60c, shoes 20c. No experience necessary. Free wholesale catalog. Superior, 1250-A Jefferson, Chicago 7.

**GOLD Lacquered and silver sign letters.** Windows, doors, trucks. Standard sizes. Penny each. Free samples. Atlas-P, 544 West 79th, Chicago 20.

**SALESMEN, Distributors,** fast selling costume jewelry direct from factory. Big picture catalog, free. Pickcraft, M19 Bank, Attleboro, Massachusetts.

**DRESSES, Used 18c; Coats \$2.00, blouses 35c.** Free catalog. Crown, 184-P Monroe Street, New York.

**\$50 WEEKLY** Selling finest razor blades, other items. Free details. Edison, Department 274, Far Rockaway, N. Y.

**NEED Extra cash?** Take orders for personal initialed belts and buckles, cap badges, tie holders, etc. Choice of 3000 emblems. Free sales kit. Hook-Fast, Box 1425PM, Providence, R. I.

**EXCELLENT Sideline** for printing and advertising salesmen. Decalcomania name plates in small quantities. Great demand. Also, make money with our line of automobile initials and sign letters. Free samples. "Ralco" XL-Roxbury, Boston 19, Mass.

**AGENTS:** Stamping names on key protectors. Sample 25c. Stamping outfits, checks, social security and name plates. Hart Mfg. Co., 303 Degraw St., Brooklyn, N. Y.

**AGENTS — 300% Profit** selling genuine gold window letters; stores and offices. Free samples. Metallic Letter Co., 438-B North Clark, Chicago.

**WANTED—Purchasing agents.** No money or experience required. Write Dept. C, Purchasing Manager, 2719 Lawrence, Chicago, Ill.

**SELL Big money-maker** to men and women. Easy handwork makes fast-selling useful articles. Sunmade Company, Brockton 64, Mass.

### HIGH-GRADE SALESMEN

**WRITE 3 Words—Collect \$7.65** on 10-second demonstration to merchants. Write on glass with amazing magic crayon—Presto! 5 color advertising message takes fire—glows like brilliant-Neon. Three sales daily bring \$22.95 profit. Rush postcard for details. Complete sales kit, free! Maxilume Co., 125 W. Hubbard, Dept. CL-812, Chicago 10, Illinois.

**UP To \$50.00** in a week spare time and tailored suit for yourself without paying one cent. Write for plan and free sample case. J. C. Field, Dept. A-1717, Harrison & Throop, Chicago 7, Ill.

**MAN To earn \$100 week up.** Long needed invention. Advertised Saturday Evening Post, Colliers. Prospects everywhere. Full or part time. Exclusive. No investment. Free samples. Write Red Comet, Inc., Dept. 58-A, Littleton, Colo.

**ADVERTISING Book matches—Cash** in on big demand; sell union label matches. Cuts for all businesses and political parties. Free powerhouse selling kit, low prices, protection guaranteed on repeat orders. Cash commissions. Superior Match Co., Dept. M-1251, 7530 Greenwood, Chicago.

**EARN Big money fast!** Sell finest-quality advertising work uniforms to garages, factories, filling stations, etc. Free selling kit. Topps, Dept. 5312, Rochester, Ind.

**AD Matches!** Sell amazing designs—20, 30, 40 and 240-light book matches. Bigger spot cash commissions; every business a prospect. Low prices for high quality. Repeats. Start without experience; men, women; full, part time. Buy nothing! Sales kit furnished. Match Corp., Dept. PM-24, Chicago 32, Illinois.

**MONUMENT Salesmen.** Steady business selling guaranteed granite memorials. Prices below competition. Profits extremely large. Artcraft Memorials, Box 191, St. Cloud, Minnesota.

**SELL Drill saw attachments** calling on mechanics, all trades. Stackhouse, 219 N. 63 St., Philadelphia 39, Penna.

**SALESMEN—Jobbers.** We manufacture the quality plastic houseware line sold in leading stores everywhere. Dependable repeat business assures high profits. Protected territories with our line establishes your own business that is sure to win. Plastic Metal Mfg. Co., 3552 N. Spaulding, Chicago 18, Illinois.

**MAKE Money** showing neighbors how to beautify yards with glorious flowering shrubs and trees. Quick-bearing dwarf fruit trees; world-famous Stark patented varieties produce abundant harvests champion-quality apples, pears, peaches, other fruits. Even small plots produce fruit for family-use and to sell. Beautiful sales kit free. Stark Bro's, Dept. 30182, Louisiana, Mo.

**A Fine income,** your own nyions free! Show nyions, lingerie, men's socks with amazing free replacement guarantee against runs, snags, tears. Write for free sales kit. Group organizers invited. Rosalee Hosiery Co., Clifton 58, N. J.

**NEW Jobs open in selling!** Send name, address for five free issues of Opportunity Magazine's money-making guide, listing hundreds of companies who'll pay you well, full or part-time. No experience needed. Opportunity, 28 E. Jackson, Dept. 17, Chicago 4, Ill.

### EDUCATIONAL AND INSTRUCTION

**CODE, Radio, Morse.** Career or hobby. Information free. Harry Cater, 1259 Westlake Ave., Cleveland 7, Ohio.

**HIGH School—No classes.** Study at home. Spare time. Diploma awarded. Write for free catalog HF-15, Wayne School, 2527 N. Sheffield, Chicago 14, Ill.

**PIANO Tuning pays.** Learn this profitable profession at home. Our Tonometer and mechanical aids make learning easy. No knowledge music necessary. Diploma granted. Largest and oldest school—53rd year. G.I. approved. Write for booklet. Niles Bryant School, 78 Bryant Bldg., Washington 16, D. C.

**EARN Free instruction.** Accounting, mathematics, law, taxes. Professor, 7621—2nd Ave. South, Birmingham, Alabama.

**SECRET Investigation.** Experience unnecessary. Investigators particulars free. George Wagner, M125 West 86th, New York 24.

**BE A real estate broker** through home study or classroom instruction. Write for free book. Approved for Veterans. Weaver School of Real Estate, Suite 300 Law Bldg., Box CP-12, Kansas City, Mo.

**START A collection agency business.** Very profitable. Quickly learned. Write Cole & Associates, Syracuse 2, N. Y.

**BOOKKEEPERS!** Increase your earnings! Operate your own simplified "Dollar-A-Week" bookkeeping and tax service. Full or spare time. Details free. No obligation. Ellis, Box 200-N, Cedar Grove, North Carolina.

**MAKE Up to \$45-\$55 week** as a trained practical nurse! Learn quickly at home. Booklet free. Chicago School of Nursing, Dept. M-12, Chicago.

**"HOW To Break and Train Horses"—A** book every farmer and horseman should have. It is free; no obligation. Simply address Beery School of Horsemanship, Dept. 11012-C, Pleasant Hill, Ohio.

**LISTEN And learn a language** by Linguaphone. At home, quickly, easily, correctly master Spanish, French, German, Russian, Asiatic—any of 29 languages through Linguaphone Conversational Method. Add to service, job, travel opportunities. Send for free book. Approved for Veterans' Training. Linguaphone Institute, 8312 Rockefeller Plaza, New York 20.

**AUCTIONEERING.** Learn by mail. New method. Nelson Auction School, Renville, Minn.

**SECRET Service, fingerprint training,** also books on palm prints, tracing, self defense, criminology, etc. Write Associated Special Investigators, Box 474, Saint John, N.B., Canada.

**WELDING Training** pays at Hobart Welding School, Box M-1212, Troy, Ohio. VA contract. Best equipment. Catalog free.

**LEARN Drafting** easily at home. Monroe Institute, PM-12, Alton, Illinois.

**INCREDIBLE! Unprecedented!** Look under "Miscellaneous!" Bijou, Box 1727-K, Hollywood 28, California.



**LEARN** Naturopathic medicine and laboratory technic, 1410 Central, Kansas City, Missouri.

**USED** Correspondence courses and educational books bought, sold, rented. Catalog free. Educational Exchange, Summer-ville, Ga.

**I Dare** you to be somebody and get somewhere. Wake up your mind with our home-study behavior control plan. Many helped. Smash worries, fears and problems. Rush request for amazing free lecture. Personal Psychology, Inc., Box 1924-M, Louisville 1, Kentucky.

**PRACTICAL Nursing**—Learn easily at home, spare time. Big demand, good earnings. High school not necessary. Write for free facts. Wayne School, Dept. FG-5, 2525 Sheffield, Chicago 14, Ill.

**A College degree** by home study. B.A., M.A., Ph.D., degrees by home study. Previous credits recognized. Remain employed and still attain a college education. No residence requirements. State chartered. Fremont College, Santa Fe 34, New Mexico.

**LEARN Electrical contracting**, earn while learning. Estes, P.O. Box 2103, Louisville 1, Ky.

**LEARN Priceless secrets** of technical metaphysics. Easy, simple. Write Canada School of Technical Metaphysics, 2532 McKenzie St., Vancouver, B.C. Canada for amazing information.

**3800 USED** Correspondence courses; catalog \$1.00. 3 cartoonist course \$3.95. EG, Elmsford, New York.

**TIRED** Of no money, second rate jobs? Like to start a real career with a lifetime of high salaries? Write me about two growing fields that really need men. Ed. Howes, Chief, National Schools, 4000 S. Figueroa Street, Los Angeles 37.

**YOU Can learn piano tuning** inexpensively. Information free. Piano Tuners Exchange, 3434 Urban Ave., Santa Monica, California.

**PREPARE** For career in private investigation or public law enforcement work. Write for free booklet. National Detective Academy, 239-P So. Oxford Ave., Los Angeles 4, Calif.

**STUDY** For game warden, fish, park, forestry, patrol and wildlife conservation service. Details free. Write Delmar Institute, D11, Whittier, Calif.

**BUY** Used correspondence courses direct from owners. Eliminate dealer profits. Catalog 25c. Press, Liberty Center, Ohio.

**BECOME** Electrical control expert. Write Electrical Instructions, Audubon Station, Baton Rouge, Louisiana.

**"DYNAMIC Mind-power"** directs your powerful sub-conscious mind to bring you positive personal success! \$1. Psychology Publishing, Dept. M, 673 S. Coronado St., Los Angeles 5, California.

**YOU** For president of your own credit-collection business. Many who answered our ads now have their names on office doors. Franklin Credit, Roanoke 7, Virginia.

**INVESTIGATOR** Training. Phillips Secret Service System, 1917-B North Kenneth, Chicago 39.

**USED** Correspondence courses and books sold and rented. Money back guarantee. Catalog free. Courses bought, Lee Mountain, Pisgah, Alabama.

**MEDICAL Laboratory Technicians** in great demand. We train you in your own home. Catalogue free. Imperial Technical Institute, Box 973-J, Austin, Texas.

**HOME** Study course, drugless therapy. Free literature. Institute of Drugless Therapy, Tama, Iowa.

**300 PROJECTS** You can make in Popular Mechanics 32-page Blueprint Catalog. Send 3c stamp for copy. Popular Mechanics Press, Dept. BP, 200 East Ontario St., Chicago 11, Ill.

## PLAYS, STORIES, MANUSCRIPTS

**MUSICAL** Comedy plays. Dorby Publications, P.O. Box 131, Brier Hill, New York.

**"TEN Steps to Writing Success"** reveals how you can write stories, poems, articles for publication. Details free. Will Herwell, 7016 Euclid, Cleveland 3, Ohio.

**I Want** new writers to cash checks of \$1 to \$100 offered daily. The easiest way to write for pay. No previous experience necessary. Free details. Saunders M. Cummings, 468-11 Independence Bldg., Colorado Springs, Colo.

## SPECIAL SERVICES

**ROYAL** Hawaiian Mailers Association, #3 Campbell Block, Honolulu, Hawaii, re-mails letters \$1.00, extras 25c. Volume rates available.

**LETTERS** Remailed 25c each. 8 scenic postcards \$1.00. Los Angeles help wanted and business opportunities columns air-mailed \$1.00. Stadler, Box 2335, Hollywood 28, California.

**FLORIDA:** Remail letters 20c each, postcards 10c each. Kinsella, 2626—22 St. South, St. Petersburg, Florida.

**CHICAGO** Remail service 25c. Donald French, 7526 Eggleston, Chicago 20, Ill.

**VENEZUELA,** 3 Letters, Xmas cards re-mailed \$1 greenback or stamps. Baca, Apartado 2554, Caracas, Venezuela.

**LETTERS** Remailed 25c each (coin). Commissions accomplished. Lorenzo, 510 West 135 St., New York 31, N. Y.

## CARTOONING, COMMERCIAL ART, SHOWCARD WRITING, SIGN PAINTING

**"HOW To Make Money With Simple Cartoons"**—A book everyone who likes to draw should have. It is free; no obligation. Simply address Cartoonists' Exchange, Dept. 912C, Pleasant Hill, Ohio.

**ORIGINAL** Drawing. Earn while learning at home. Free drawing kit offer. Pacific Art Institute, Box 1284, San Jose, California.

**TWELVE Alphabets**—Ten numerals, \$1.35. Three different, \$3.50. Demonstrators, 639PS Paulina, Chicago 12.

**PENMANSHIP:** Be an expert penman for pleasure and profit. Increase your prestige. Improve your chances for advancement. Business writing; ornamental writing; text lettering; speedball lettering; bird, eagle and swan flourishing. Name cards, greeting cards. Details free. T. M. Tevis, Box 25A, Chillicothe, Mo.

**CHALK** Talks. Laugh producing program, \$1.00. Catalog 10c. Balda The Cartoonist, Oshkosh, Wisconsin.

## ADVERTISING AGENCIES, LETTER WRITERS, FOR ADVERTISERS

**500 CIRCULARS** Mailed first class mail \$1.00. Israel Company, Dept. 12, 6051, Washington 5, D. C.

**ADVERTISE** At no cost. \$4,000 sales from free ads. Publicity Advertising, 1501 Trailsend, Kalamazoo, Mich.

**ADS** Placed in out of town newspapers and magazines. Low rates. Catalogue free. Ideas that pay. Baker Advertising Agency, Successors Ankrum Agency, 189 W. Madison, Chicago 2.

**ADVERTISERS!** Reach nearly 18,000,000 readers. 25 Sunday national key newspapers, 18 words, \$59.00. "Terrific pullers." 20 popular newspapers, \$11.50. Free booklet. Special—One inch display 2-821,198 circulation, \$51.10. Newmark's Advertising Agency, (Established 1893), 217-7th Ave., New York 11.

**MAILING** Lists: \$5.00-1000 up. Write Dixie Service, King, N. C.

**24 WORDS** In 50 weeklies, \$4.96. J. Darnell, 730 Hays, Jackson, Tenn.

**ADVERTISE:** 24 Words, 40 newspapers \$3.50. Lists free. Advertising Bureau, 10511-C Springfield, Chicago 43.

## TYPEWRITERS, DUPLICATORS, OFFICE DEVICES

**TYPEWRITERS** \$22.50. Duplicators \$13.50, adders. Typewriters, 118 Spruce, Wichita 7, Kansas.

**DUPLICATOR** Under \$3.00. Plans, formula 75c. Donald Harse, New Tripoli, Penna.

**ADDRESS** Thousand envelopes, cards in minutes. Amazing new machine. Costs very little. Free details. Dorsett's, 2217 So. Walnut, Muncie, Indiana.

**ADDING** Machines, typewriters, new portables, office size typewriters wholesale. Enclose 10c for catalogues. Apple, 993A Westchester Ave., New York City 59.

**AUTOMATIC** Mimeographs, original factory cartons, quantities \$15.80. Electro-Aid, Hopkins, Minn.

**PRINTOMATIC** Selffeeding post card printing duplicator \$15.75. Envelope addressing machines \$24.50. Pittsburgh Typewriter Company, 336-R Fourth Avenue, Pittsburgh 22, Penna.

**RECONDITIONED** Typewriters, printing devices, office machines, equipment. DixieGraph, King, N. Car.

## RUBBER STAMPS AND OFFICE SUPPLIES

**QUALITY,** 3 Lines \$1.50, inked pads 35c. Columbia Stamp, Chinook, Washington.

**LINE** 25c; 2—45c; 3—65c. Stamp Works, Auburn, Nebraska.

**3 LINES** 50c; Pads 35c; signature \$2. Stampright, Wauwatosa, Wis.

## PRINTING, MULTIGRAPHING, MIMEOGRAPHING GUMMED LABELS

**PRINTING**—5000 5½ x 8½ Circulars \$18; 3¼ x 5½ \$8.25; folders, books, everything. Garrison Press, Harrisonburg, Va.

**50 LETTERHEADS** And envelopes \$1.00. Hargraves, Box 517, Corning, N. Y.

**FREE** Letter opener with order 110 bond letterheads, 100 envelopes \$2.00 postpaid. Ideal Xmas gift. Guaranteed! V. Muratori, 1010 Findlay Ave., Bronx, N. Y.

**ENVELOPES,** Letterheads, statements, etc. Samples, prices. Mercury Press, Box 69M, Marengo, Iowa.

**ADVERTISING** Lithoffset, forms, cards. Printing. Johnson, Box 72, Upper Darby, Penna.

**1000 BUSINESS** Cards, \$2.40 postpaid. Samples free. Tickets Inc., 35th-Arcade Bldg., Chicago 16.

**OFFSET** Printing, ruled forms, letters, circulars, pricelists, illustrations. United Printing, Pottstown, Penna.

**1000 EMBOSSED** Business cards, \$3.45. Ortiz, 1050 Fox Street, New York 59.

**PRINTED** Scotch tape, three lines on 2595 inch roll \$3.50. 3 rolls \$10.00. Modern Litho, Jefferson City, Missouri.

**FREE** Samples, prices. Quality work, postpaid. Fast service. Sutton Printing, Box 853-M, Waycross, Georgia.

**8½x11 HAMMERMILL** Letterheads, 225 for \$2.00! Envelopes, same price. Quality Service Press, Mansfield, Illinois.

**EXPERT** Mimeographing. Quick service. Reasonable. Robinson, 269-D Liberty, Paterson 2, New Jersey.

**100 LETTERHEADS** (8½x11 Hammermill), 100 envelopes, \$2.00. Samples. Farleyprint, 205 Cedar, Kingsport, Tennessee.

**SEND** 10c Now for our 48 page 1952 price list—refunded first order. McCall Press, 1326 South 27th, Omaha, Nebraska.

**ENGRAVED-Effect,** process embossed business cards, \$3.95 thousand. Samples free. Universal Line, PM-3, Orange, Mass.

**BUSINESS** Cards. Raised lettering. 1000 \$3.95. Samples free! Vine Ad Press, 582A Courtlandt Avenue, New York 51, New York.

**MIMEOGRAPHING**—Letters, pricelists, formulas, instructions. Lowest prices. Lem's Letter Shop, 5710 Stanton, Detroit 8.

**100 8½x11 HAMMERMILL** Letterheads and 100 envelopes \$2.00. H. Hudson, Centredale, R. I.

**BUSINESS** Printing. Samples, prices free. Howprint, 723-M Eunice, Webster Groves 19, Missouri.

**MIMEOGRAPHING**—24 Hour service. Free samples and prices. Speed Printers, Box 151, Miami (Northwest Branch) 47, Florida.

**QUALITY** Printing. Samples, prices free. Thompson, Box 164, Mattapan 26, Mass.

**QUALITY** Printing. Booklets, publications, circulars, stationery. Free price list. Adams, 30 West Washington, Chicago 2, Illinois.

**125 8½x11 LETTERHEADS** And 125 6¾ envelopes \$2.00, postpaid. 250 of each \$3.50. Going Print Shop, Box 1544A, Muskogee, Oklahoma.

**1000 BUSINESS** Cards \$2.50 prepaid. Samples free. Reliable Print Shop, 907 East Jefferson, Louisville 6, Ky.

**MIMEOGRAPHING**—Reasonable. Any copy. Mailers Service, Box 606-B, Chicago 90, Ill.

**500 ¾x2¼ FOUR** Line gummed stickers 50c. Red border \$1.00. Moritz Printery, Saginaw, Mich.

## PRINTING OUTFITS AND SUPPLIES

**MAKE** Your own, self-molding, rubber printing cuts. Plexirubber, Argyle 1, Wis.

**PRESSES,** Type, cabinets, supplies. List for stamp. Lincoln Press Company, 220-C Hartwell, Fall River, Mass.



PRESSES, Supplies, paper. Catalog 10c. Custom, Box 211-P, Springfield, Missouri.

PRINT Your own cards, stationery, circulars, advertising. Save money. Simple rules. Print for others, nice profit. Raised printing like engraving too. Have home shop. Details free. Kelsey Presses, L-11, Meriden, Conn.

PRINTING Presses, type, supplies. Lists 3c. Turnbaugh Service, Loysville, Penna.

## PATENT ATTORNEYS

**INVENTORS**—If you consider your invention to be something of importance, take steps to protect it with a United States Patent which gives you the right to exclude others from making, using and selling your invention as claimed. "Patent Protection for Inventors" outlines steps to take to secure patent protection. Mailed promptly without obligation. Victor J. Evans & Co., Merlin M. Evans, Registered Patent Attorney, 631-P Merlin Building, Washington 6, D. C.

**INVENTORS**—If you believe that you have an invention, you should find out how to protect it. The firm of McMorro, Berman & Davidson is qualified to take the necessary steps for you. Send for copy of our patent booklet "How to Protect Your Invention" and "Invention Record" form. No obligation. McMorro, Berman & Davidson, Registered Patent Attorneys, 134-B Victor Building, Washington 1, D. C.

**HERMAN Lewis Gordon**, registered patent attorney, patent investigations and opinions. Warner Building, Washington 4, D. C.

"**INVENTOR'S Guide**" free. Frank P. Ledermann, Registered Patent Attorney, 154 Nassau Street, New York.

**INVENTORS**: Learn how to protect your invention. Unless the inventor is familiar with patent matters, he should engage a competent registered patent attorney or agent to represent him. We are registered to practice before the U.S. Patent Office and prepared to serve you in handling your patent matters. "Patent Guide for the Inventor" containing detailed information concerning patent protection and procedure with "Record of Invention" form will be forwarded to you upon request; without obligation. Clarence A. O'Brien & Harvey Jacobson, Registered Patent Attorneys, 11B-K District National Building, Washington, D. C.

**INVENTORS** — For "Invention Record" form, contact Carl Miller, Registered Patent Attorney, Woolworth Building, New York.

**REGISTERED Patent attorney** offers services. Sanders, 6430 Evans, Chicago 37, Ill.

**INVENTORS**: When you are satisfied that you have invented something of value write me, without obligation, for information as to what steps you should take to secure a patent. Write Patrick D. Beavers (Formerly Randolph & Beavers) Registered Patent Atty., 985 Columbian Bldg., Washington 1, D. C.

**PATENTS**. "Proof of Invention" folder mailed without obligation. E. E. Vrooman, Registered Patent Attorney, 507 McKim Building, Washington 5, D. C.

**INVENTORS**: Write for free brochure "Evidence of Invention." Labiner, World Building, New York 38.

**C. A. Snow & Co.**—M-427, Snow Building, Washington 1, D. C. Registered Patent Attorneys. Write for information.

**INVENTORS**: Without obligation, write for information explaining the steps you should take to secure a patent. John N. Randolph, Registered Patent Attorney, 203 Columbian Bldg., Washington 1, D. C.

**PATENTS**—Irving L. McCathran, 315 McLachlen Bldg., Washington 1, D. C. Registered Patent Attorney.

**CANADA**—Ramsay Company Registered, 273 Bank Street, Ottawa, Canada.

## FOR INVENTORS

**INVENTORS**—If you believe that you have an invention, you should find out how to protect it. The firm of McMorro, Berman & Davidson is qualified to take the necessary steps for you. Send for copy of our patent booklet "How to Protect Your Invention" and "Invention Record" form. No obligation. McMorro, Berman & Davidson, Registered Patent Attorneys, 134-A Victor Building, Washington 1, D. C.

**PATENT Searches**, \$5.00, including patent copies. Same reliable search as conducted for patent attorneys. Free protection forms, 48 hour service. Patent Service Institute, 945-A Pennsylvania Avenue, Washington 4, D. C.

**INVENTORS**—If you have a good patented, patent pending invention to offer manufacturers, read our free booklet first. Write for it today. Market Contacting & Data Service, 719-A3 Magnolia Drive, Tupelo, Miss.

**INVENTORS**—This form is registered to practice before the United States Patent Office and is available to assist you in the preparation and prosecution of your patent application. "Patent Protection for Inventors" booklet containing detailed information and steps to take toward patent protection will be sent upon request. No obligation. Victor J. Evans & Co., 632-P Merlin Building, Washington 6, D. C.

**INVENTORS!** For "Copyright, Design and Patent Guide" contact Patent Attorney Metzler, 11 West 42nd, New York 18.

**PATENT Search service**, detailed report with closest patents, \$5.00. Product Development Associates, Box 4275, Washington 12, D. C.

**PATENT Searches** \$5.00. Protection forms free. Patent drawings prepared. Write Patent Engineering Service, 1404 New York Avenue, Washington 5, D. C.

**PATENT Searches** \$5.00. Record of invention forms free. 48-hour service. Write Miss Ann Hastings, P.O. Box 176, Washington 4, D. C.

**SEARCHES** \$5.00. Reliable reports airmailed within 48 hours. "Record of Invention" free. Capitol Patent Service, Box 664-P, Washington 4, D. C.

**IF You** have a new idea, development or invention get an expert appraisal and opinion before you spend hundreds of dollars. Over 25,000 inventions screened and reviewed. Also sales and distribution advice. Free details or send \$3.50 for each specific problem. Marketing Bureau, Gables Building, Evanston 1, Illinois.

**INVENTIONS**, Sold, leased. Complete services. M. Joyce Humphries, 1424 Landtitle, Philadelphia 10.

**INVENTORS**: Learn how to protect your invention. Unless the inventor is familiar with patent matters, he should engage a competent registered patent attorney or agent to represent him. We are registered to practice before the U.S. Patent Office and prepared to serve you in handling your patent matters. "Patent Guide for the Inventor" containing detailed information concerning patent protection and procedure with "Record of Invention" form will be forwarded to you upon request; without obligation. Clarence A. O'Brien & Harvey Jacobson, Registered Patent Attorneys, 11A-K District National Building, Washington, D. C.

**INVENTORS** — For "Invention Record" form, contact Carl Miller, Registered Patent Attorney, Woolworth Building, New York.

**PATENT Searches** \$5.00, 48-hour service. Protection forms free. Write Raymond L. Smith, Patent Searcher, 410 Bond Building, Washington 5, D. C.

**INVENTORS**: Without obligation, write for information explaining the steps you should take to secure a patent on your invention. John N. Randolph, Registered Patent Attorney, 202 Columbian Bldg., Washington 1, D. C.

**CASH For** your idea, 280 manufacturers need inventions, patented or unpatented. List free. Invention Bureau, 208M Clinton, Oak Park, Ill.

**PATENT Owner** representative. Years of experience. Can I help you? Charles A. Scott, 773PM Garson Avenue, Rochester 9, N. Y.

**CASH In** on your ideas! Learn which inventions are profitable: how to sell or finance and market your invention. Send only \$2.50 for the big 144-page book "Money From Ideas," a primer on inventions and patents by a real, successful inventor. Popular Mechanics Press, 200 E. Ontario St., Chicago 11, Ill.

**SEARCHES**—Put your patent searches in the hands of a registered patent attorney or agent, as he qualifies to give a worthwhile patentability report. Record of invention form upon request and information on patent protection. Patrick D. Beavers, Registered Patent Attorney, 936 Columbian Bldg., Washington 1, D. C.

**INVENTORS**: If you have an invention for sale, patented or unpatented, write Institute of American Inventors, Dept. 40A, 631-E St. N.W., Washington 4, D. C.

## INVENTIONS WANTED

**INVENTORS**—What have you patented, patent pending to offer manufacturers? Write for free booklet. Market Contacting & Data Service, 719-A2 Magnolia Drive, Tupelo, Miss.

**CASH-In** on your ideas. Get the "Inventors Guide." Gives step by step helpful instructions, before going to expense of patents, how to make money from inventions, list of needed products, record of invention forms. Send only 50c. Inventors Creative Service, 354 South Spring Street, Los Angeles 13, Calif.

**INVENTIONS Wanted** by manufacturers. Patented-pending only. Free details. Inventors Exchange, Dept. B, Hartford 1, Conn.

**INVENTIONS Promoted**, Patented or unpatented. Established 1911. Write Adam Fisher Company, 61 Enright, St. Louis, Mo.

**INVENTIONS Wanted**, Patented or unpatented. 20 years experience promoting inventions. National Service Bureau, 3130 Meramec, St. Louis 18, Mo.

**INVENTORS**: Hundreds of manufacturers have requested our assistance in locating marketable new products. Complete information free. Institute of American Inventors, Dept. 40-D, 631-E St. N.W., Washington 4, D. C.

## PATENTS FOR SALE

**TWO Patented wonder toys** for sale. Write Arvin Gussa, 2123 Burrough St., San Diego 11, Calif.

**INVENTORS**: Test the commercial value of your patented or unpatented inventions, quickly and inexpensively. Write for free information. Institute of American Inventors, Dept. 40-B, 631-E St. N.W., Washington 4, D. C.

## MANUFACTURING

**MODELS** — Small lot manufacturing. Metals, plastics, etc. Milburn, Burlington, Kentucky.

## MODELS, MODEL SUPPLIES

**HOME Models** and doll houses are fun to build—profitable to sell. Design your own or use our suggestions. It's easy, economical and time-saving with our accurately-scaled plywood panels of brick, siding, shingles and plastic doors, windows, etc. Send 10c for samples and booklet, "How You Can Build Model Homes." Architectural Model Materials, Inc., Dept. M121, 4208 Armitage Ave., Chicago 39, Ill.

**FAMOUS Catalogs**. Ships (120 pg. historic models, hundreds fittings) 50c. World's electric trains and accessories 50c. H.O. scale trains (ready Dec.) 50c. Old time vehicles 15c. Hobby books 10c. Collectors soldiers 25c. Polks Hobbies, 314M 5th Ave., New York City 1, N. Y.

**REDDI-Built** built-up HO cars and engines to your order. Specials every month. Send for free catalogue. Custom-Craft Co., Waymart, Penna.

**ANTIQUE Surrey**, stage coach, buckboard, horses, 20 kits. 1/2" Scale. Folder 10c. Sample top buggy \$1.25. Tontz' Country Store, Elsinore 10, Calif.

**BUILD**, Fly three "Quicky" 18" scale models for only \$2.00. Glue 15c extra. Airplane catalog 3c. Cleveland Model, 4507TC201 Lorain, Cleveland 2, Ohio.

**AMAZING!** Flying saucer model, plans \$1.00. Future Craft Model Co., Box 467, El Reno, Okla.

**BRASS Gears** and model supplies for the inventors. Send 10c for catalog. Pierce Model Works, Tinley Park, Ill.

**LIONEL**, American Flyer, illustrated catalog free. Ben's PM Department, 134 North Dearborn, Chicago 2.

**BUILD Historic ship models**, complete kits 50c to \$9.00. Catalog 15c. Ideal Models, 19 W. 18th, New York 11, N. Y.

**SHIP Models** and yacht supplies complete. Large 64 page catalogue 30c. Bill Wild's, 510 East 11 St., New York City 9.

**SHIP And yacht model fittings**; blueprints. Send 25c for illustrated catalog No. 26—listing hundreds of items. A. J. Fisher, 1002-1 Etowah Ave., Royal Oak, Mich.

**STEAM Locomotives**, 1 1/2", 1", 3/4", 1/2" 1/4" scales. Castings, rail, steam fittings! Thorough drawings with instructions. Catalog 50c. Little Engines, Wilmington, California.



**WHEELS**, Rubber, with brass bushings, for making your own toys. 24 assorted; 1-3/16" diameter and 1/16" diameter \$1.00. Harison, Box 199, Levittown, N. Y.

**90 ALL New**, full size lawn ornament and novelty patterns, up to 20" high. Only \$1.00. Mastercraft, 122M, 7041 Olcott, Chicago 31, Illinois.

**"TOPS"** In everything for leathercraft. Low priced kits, leathers, tools, lacing. Catalog 10c. Crown Leather, 22 Spruce Street, New York 38.

**WHOLESALE Shellcraft book 15c**. Large shellcraft kit \$1.85 postpaid. Shell-Art Novelty, 5th and Moore, Philadelphia 48, Penna.

**JIGSAW Owners attention!** Start earning money at home cutting out wooden novelties and souvenirs. Write H. Cook, Dept. A, 4407 S. Normal Ave., Chicago 9, Illinois.

**LEATHERCRAFT**. Everything needed by beginners, advanced hobbyists and professional leatherworkers. Largest stock of supplies in U.S. Moderate-priced tooling leathers, top quality calfskins, tools, supplies, kits. Send 10c for big catalog. J. C. Larson Co., 820 S. Tripp, Dept. 1475, Chicago 24.

**OUR Biggest leather and craft catalog yet!** 1000's of items. Send 25c (refunded with first order). Russo Handicraft Supplies, Dept. C-11, 245 S. Spring, Los Angeles, California.

**89 FULL Size jig saw patterns** of beautiful shelves, ornaments, toys, novelties. Plus "How, Where to Sell." Only \$1.00. Mastercraft 124M, 7041 Olcott, Chicago 31, Illinois.

**OZARK Wood samples**. Eleven varieties prepaid. \$1.50. Davis Lumber, Cabool, Missouri.

**BUILD Over 100 power machinery** with Kimo Blues, Box 307-P, New York 19. Descriptives 25c (refundable).

**\$46 FROM Square foot plywood**; jigsaw necessary. Write: Woodarts, Bridgewater, Mass.

**LEATHERCRAFTERS** — Metal ornaments, buckles, pocketbook accessories. Cosmopolitan Metalcrafters, Box 176-PM, New York 6.

**LEATHERCRAFTERS**: Big illustrated catalog of materials, tools, kits, 10c. Art Leather, 411 Joseph Ave., Rochester 5, N. Y.

**HAND Wood-carvings**, elaborately tooled, give your next project that artistic touch. Sample center piece, \$1.25; 3 piece group ornament, \$1.60. Walnut or mahogany. Satisfaction guaranteed. Hasse, Carvings, 35 S. Oxford, Indianapolis 1, Ind.

**RARE Desert hardwoods**. Ironwood, Casahuate, many others. 8 large samples, 50c. List, 15c. G. McCarthy, Redlands, Calif.

**"FREE Instructions"**. Make powerful telescopic camera. Carl Jamer, Manorville 1, N. Y.

**FIGURINE Hobbyist**. A complete line of figurine paints, glazes, brushes, powders, figurines—Plaques, lamps. As new items are added you automatically will receive catalogue sheets at no extra cost to you. Send us your name and address for our original catalogue along with one dime to cover cost of mailing. Cimarroni Sales, P.O. Box 277, Sparta, Wis.

**SWISS Music movements**, finest make, lowest price. Ask for leaflet. Helaxe Company, 233 West 72nd Street, New York.

**STREAMLINED Kitchen construction plans 50c**. Playnecabinets, 4617 Johnson, Western Springs, Illinois.

**SOMETHING New and profitable**. Log cabin bank. Makes ideal Christmas presents for everyone. Send \$1.00 for sample and instructions. Robert Butler, 208 Troy Street, Dayton 4, Ohio.

**WOODCRAFT Patterns**—Large whatnots, Lawn Ornaments, novelties. Large assortment \$1.00. Joannes P. O., Box 141-E, Omaha 7, Nebr.

**KNOCKDOWN Cedar chests**. Lumber and veneers. Free price list. Giles & Kendall Company, Huntsville, Ala.

**HAVE Fun! Make money!** "Working With Leather." 64-page booklet tells how. Send 25c for copy. Free gift if you mention this magazine. Valuable information included. No foreign orders. Wilder & Company, 1039 Crosby, Chicago 10.

**FURNITURE Furniture kits**. Solid cherry. Easily assembled. Large selection. Catalog 20c. Culver Miniatures, 194 Sixty First St., Dept. A, Niagara Falls, N. Y.

**30 LAWN Ornament patterns**. Ready cut. Full size. Color indicated. \$1.00 postpaid. Lincoln Craft Studio, Columbia, Conn.

**REPAIR Kits for sagging furniture bottoms**. Details free. A. Dourlian, Wilson Hall, Otisville, N. Y.

**100 FULL Size jig saw patterns up to 20" high**, only \$1.00. Pattern Service, Medway 9, Mass.

**LEATHERCRAFT Supplies**. Tremendous stock. Send 10c today for 1951 catalogue. Sax Bros., 1111 North 3rd, Dept. PM, Milwaukee 3, Wis.

**LEATHERCRAFT**, Copper tooling, textile painting, many other crafts. Big free catalog shows everything you need. Kit Kraft, 7377 Melrose, Hollywood 46, Calif.

**LEATHERCRAFT Supplies catalog**. Pleasure and profit. New style handbag patterns, belts, Leathercraft school G.I. approved. 25c for catalog (refund 1st order). Dept. PM, Apache Leather Co., 2004 E. Washington St., Phoenix, Arizona.

**BANDSAW**, Jigsaw owners, let your machine bring extra profits, fun. Free details. Nu-Art, Dept. B, Box 2235, Boston, Mass.

**80 FULL Sized patterns**, lawn ornaments, toys, novelties, \$1.00. Modern Woodcraft, Saginaw, Mich.

**LEATHER**, Tools, lacings, supplies. Free catalog. National Handicraft, 199 William St., New York 7.

**HOW-To-do-it books** on every subject. Written in Popular Mechanics' famous easy-to-understand style and profusely illustrated. Subjects include workshop planning and practices, projects, hobbies, household repairs, motoring, outdoor sports, photography, home building, and many others. Also booklets on specific topics. Write for free illustrated catalog. Popular Mechanics Press, 200 E. Ontario St., Chicago 11, Ill.

**MAKE IT YOURSELF**

**STREAMLINED**, Built-in kitchen cabinets to fit any kitchen. Illustrated manual describes designing and construction. All for \$1.00. Thombert Company, Newton, Iowa.

**PATTERNS**, Ready-cut kits—Junior furniture, large toys. Send 25c for sample clown clothes rack pattern plus free catalog. Tom Tot Furniture, Box 741, Helena, Montana.

**"MIX"** Makes 3 pounds, quality brushless shave cream. \$1.00. Graubard, 61-PM Howard, Rochelle Park, N. J.

**BUILDING Plans** for small apartment size home. Has 490 sq. ft. Includes living-room, bedroom, kitchen, bath and fireplace. Brick and concrete construction. Saves time and material. Can be built for \$1000. Plans \$1.00. Portercraft, P.O. Box 87, Mt. Washington, Cincinnati 30, Ohio.

**BUILD Your own concrete blockmaker**. Easy. Inexpensive. Motor or hand. Make block per minute. Write. C. Lee, Mountain View, Oklahoma.

**RIDING Garden tractor**, three speeds. Details dollar. Tractorman, Pleasant Plain, Elkhart, Ind.

**BOW And arrow plane**. Great pastime. 10c for plans. The Mailman, 4025 N. Kostner Ave., Chicago 41, Ill.

**GRANDFATHER Clock** easily built. Big savings. See ad on page 235.

**PICTURE Framing**, 1" embossed raw molding 6c per foot. Frames mitered 5c each. Homaker's Supply, Rockland, Mass.

**FREE Handbook**, build sawmills, block machines, freezers, tractors, scooters, 250 shop, farm, home machines. Nichols Co., Dept. C-1601, Purvis, Mississippi.

**MAKE Any wood cutting band saw cut steel**. Plans \$1.00. Wasco, Box 111, Blue Island, Ill.

**TRACTOR—You build**, our plans. Two and four wheel drive, walking, riding, from auto parts. Information. Pauls Tractor, 1301 West Arrow, Fontana, California.

**SEND 25c Today** for new large catalogue of supplies for 21 popular crafts. Dept. D-11, Dearborn Leather Company, 8625 Linwood Avenue, Detroit 6, Michigan.

**BUILD Your own "tractor"**. Free information. Eltraco, D-1, Camptonville, California.

**"CONCRETE Block Homes"**. 32 page booklet on how to build. \$1.00. H. C. Lightfoot, Civil Engineer, Richboro 1, Penna.

**WATCHES, OLD GOLD, JEWELRY**

**WRIST Watches**, U. S. Air Corps, Waltham, 16 jewel, water and shock proof, stainless steel case, reconditioned. Value \$55.00—special \$17.95. Public Sport Shops, 11 S. 16th Street, Philadelphia 2, Penna.

**WATCHMAKERS' Complete informative catalogue 20c** deductible. Bengal Company, Culver City, Calif.

**"THE Modern Clock"**. All about clock repair. 562 pages. 173 illustrations. \$4.95, postpaid. 10-day return privilege. North American, Dept. 11-M, 2018 North Avenue, Chicago 47, Illinois.

**RHINESTONES**, Jewelry settings, cameos, sequins, beads. Send 10c for illustrated catalog. J & M Novelties, Dept. CP-3, Griffith, Ind.

**WATCH Bands—Stainless steel expansion bands** for men. Regular \$3.50 value, \$1.25 postpaid. Nat. Army Store, 109 W. Water, Sandusky, Ohio.

**STUN Your friends** with genuine, sparkling, brilliant-white zircons. Cut, polished, mounted like diamonds. 100 gorgeous latest-style rings to choose from. Low prices. Send for big free catalog. U. S. Zircon Syndicate, 139 N. Clark, Dept. 60, Chicago 2.

**HIGHEST Prices** paid for old gold, silver, platinum, diamonds, watches, gold teeth, spectacles. Cash immediately. Goods returned if offer unsatisfactory. United Smelting Works, (The Old Reliable), 39-B South State, Chicago 3.

**WATCHMAKERS! Beginners!** Watches, movements. Descriptive list 15c. Box 150, Chicago 90.

**KLONDIKE Novelty and jewelry findings**. Swept from manufacturers tables. Make fascinating novelties and jewelry from this bountiful supply of parts for bracelets, brooches, earrings, pins, necklaces, rings and many other items, sample lb. bag \$2.00; 5 lb. lot \$7.50. Imported cut stones for jewelry and novelty items, all shapes, colors, sizes, sample 100 stones assorted \$1.50 lot; 1000 lots \$5.00. Imported beads all colors, sizes, sample lb. \$1.00; 5 lb. lots \$4.00. Merchandise Distr. Co., Dept. C, 19 East 16th St., New York 3.

**NEW Catalog lists over 5000 styles!** Gold plated jewelry supplies, Rhinestones, pearls, etc. Complete details, only 10c. Barry's, 47-11 Branford Place, Newark 2, N. J.

**HIGHEST Cash** paid for old, broken jewelry, gold teeth, watches, silverware, diamonds, spectacles, platinum. Free information. Satisfaction guaranteed. Rose Smelting Company, 29-A East Madison, Chicago.

**TOBACCO, SMOKERS' SUPPLIES**

**AROMATIC Agents** increase smoking pleasure. Information free. Cozza, Pharmacist, Pequannock, N. J.

**CIGARS**, 25 Havanas \$2.00. S & E. Company, Red Lion, Penna.

**HAD 22 Pipes** with tongue-bite; applied simple principle—Presto, enjoyable smoke in each. Send \$1.00 to: Royal Smoke, 1156 Greenfield Ave., Pittsburgh 17, Penna.

**CIGARS—Clear Havana**, handmade. Regularly 15c. \$5.50 for fifty, postpaid. Save \$2.00! Check or money order. C.O.D. (You pay charges). Seco Cigars, Rochelle Park, New Jersey.

**PIPEMAKING Kit \$1.00**. Circular, instructions 10c. Carvapipe, 2829-G Dixie, Hamilton, Ohio.

**SMOKE Genuine Havana cigars**, \$9.50 for 25; \$36.00 for 100. Money order to Abel Camacho, Apartado No. 989, Havana, Cuba. References: Bank of Boston, Havana, Cuba.

**ROLL 200 Pleasingly mild cigarettes** for 75c, particulars free. Pete Moberly, Box 845, Owensboro, Kentucky.

**RAZORS, BLADES, SHARPENING**

**NEW German steel outlasts anything**. Send \$1.00 to Razor Blades, Postlagernd, Göttingen, Germany, for trial.



## OF INTEREST TO WOMEN

**NAME** The baby. 1000 pretty names \$1. Leeway, Mountain View, Oklahoma.

**BIG PROFITS**—Make fast-seller chenille monkey trees. Christmas poinsettias, Santas. Literature free. Velva, Bohemia 16, N. Y.

## FOR SALE—MISCELLANEOUS

**METAL** Bottle capper and opener, positively keeps beer, soda fresh until consumed 35c p.p. satisfaction guaranteed. George Kearney, 180 Seventh Avenue, New York 11.

**FREE** Catalog! War surplus clothing. Amazing bargains. N. Y. Clothing Co., New York 29A.

**FOR SALE**—Small toy motors. We have approximately 4,000 motors which will sell at a special close-out price of \$1.00 each—cash in advance or c.o.d.—no returns. Small permanent magnet type d.c. motor—will operate on 1 to 4 flash light cells obtaining speeds as high as 12,000 r.p.m. Precision 5 pole armature on brass insert bearings—can be used to operate toy autos, locomotives, boats, remote structures, switches, etc. Gold Cup Model Boats, Inc., 1407 Washington Boulevard, Detroit 26, Michigan.

**TOYS**, Gifts, novelties, gadgets, including the unusual. Illustrated lists free. Jtg, Box 245, Sheboygan, Wisconsin.

**DELICIOUS** Plantation sausage. 3 1/2 lb. can \$1.90. Goodwill Bargains, Fullerton, Louisiana.

**SAVE** Money on chrome cabinet hardware. Write Box 89, Troy, Ohio.

**SAVE** Money on army, navy and factory surplus. Write today for new 60-page illustrated catalog. Tennusa Sales Co., Dept. AN, 1451 Market, Chattanooga, Tenn.

**HANDSIGHTING** Levels, improved, new model, used for grading land, contouring and laying out fences, piers, roads and gardens, price \$2.50 postpaid. Public Sport Shops, 11 S. 16th Street, Philadelphia 2, Penna.

**DRESSES**, Used, 18c; coats \$2.00; blouses 35c. Free catalog. Crown, 164-PA Monroe Street, New York.

**TRIPODS**, All wood, solid leg with four inch circular metal head, can be threaded, 55" tall, value \$27.50—special \$6.95. Public Sport Shops, 11 S. 16th Street, Philadelphia 2, Penna.

**WATCHMAKER'S** Lathe with Racine jewelers' lathe motor—foot pedal control for forward and reverse action, \$85.00. Miller's Sport Shop, Dept. P, 142 North 8th Street, Philadelphia 7, Penna.

## WANTED—MISCELLANEOUS

**MANY** Firms, individuals buy, trade anything. Rush 25c for big list. Toole, Bernardin Apts., Evansville, Ind.

**SCRAP** Mercury (quicksilver) tantalum, bismuth, tungsten. Metallurgical Products Company, Established 1909. 35th & Moore Sts., Philadelphia 45, Penna.

## PERSONAL

**BORROW** By mail. Loans \$50 to \$300 to employed men and women. Easy, quick. Completely confidential. No endorsers. Repay in convenient monthly payments. Details free in plain envelope. Give occupation. State Finance Co., 210 State Finance Bldg., Dept. F-14, Des Moines 8, Iowa.

**CLAIMS** Adjusters needed. Exciting, fascinating, big pay. Many earning up to \$125 week. Qualify now. Write today! Universal Schools, M-52, Box 8202, Dallas 5, Texas.

**NO** Swindle. Merry Xmas. Cut your own and children's hair easy. Amazing invention. No blades. Price \$2.00 gives the family haircuts forever. Eok Haircutter, Box 2833, Washington 13, D. C.

**VALUABLE** Big mails, four months listing, 25c. Wright Publications, 2270 Hubbard, Memphis 8, Tenn.

**PAPERHANGERS**: Mix Mannatex Compound with paste. Prevents mold; keeps wall paper from cracking, makes it stick. Guaranteed trial size \$1.00 p.p. Paperhangers Supply Co., P.O. Box 37B, Louisville 1, Kentucky.

**LOW** Cost hearing device. No batteries. No wires. No upkeep. Many satisfied users. Beaudry, 4337-H 30th Ave. S., Minneapolis 6, Minnesota.

**LETTERS** Sent, 1771 Cleveland Rd., Miami Beach 25c. Sandy, 1771 Cleveland Rd., Miami Beach.

**INTERESTING** Mails. 25c keeps name on mailing list three months. Bentz, (Desk-E/18), Chatawa, Mississippi.

**SURPRISE** Your friends. Have us mail, remail 25c each. Let Welldoing do it. Welldoing, 1712 1/2 Nebraska, Tampa, Florida.

**"HOW** Can I find out?" You can! Information discreetly developed. Any matter, person, problem, anywhere. Worldwide. Officially licensed, bonded service. Established 1922. Reasonable. Confidential. William Herman, 170 Broadway, New York.

**NATIONAL** Capital postmarks, letters remailed 25c, post cards 3 for 25c. Bob's, Box 2121, Washington, D. C.

**MEXICAN** Law practice reliably conducted. Box 1736, El Paso, Texas.

**HERE'S** How and where to borrow \$50.00 to \$300.00 by mail. Confidential. Free particulars. Postal Finance Company, Dept. 45, Sioux City, Iowa.

**MEXICAN** Law. General Practice Attorney. 1203 Arizona St., El Paso, Texas.

## MISCELLANEOUS

**SEPTIC** Tanks, outdoor toilets, cesspools cleaned, deodorized easily. Make this amazing cleaner yourself. Sell to others. Complete formula \$1. Kemiklean, Park Ridge 12, Ill.

**CAN** You make \$40 a week, typing at home, in your spare time? Write Hood's, Kannapolis 12, N. C. (Inclose stamped, addressed envelope.)

**CESSPOOL** Trouble? Use Peps-It. Rejuvenates fermentation action, saves pumping costs, deodorizes, reduces masses. Costs only \$2.50. Safe. Sanitary. Free descriptive literature. Chemical Cesspool Cleaning Co., Boston 34, Mass.

**ADD** Spice to home projection shows with colorful old-time Nickleodeon slides. 2x2. Write for free list. Nickleodeon Co., New Fleidner Bldg., Portland 5, Oregon.

**EARN** Up to \$200 month, inventing toys, games, gadgets. Write, Hendrickson, Argyle 1-A, Wisconsin.

**BOXES**, Paper. Small quantities. Printed, plain. Also display cards, easels. Burch Carton Co., Route 5, Kalamazoo, Mich.

**REVOLUTIONARY** Toilet tank ball and guide works every time. Anyone can install in five minutes. Instructions included. Fits practically all toilets. \$2.00 check or money order postpaid. Completely satisfactory or money back. Specialties, P.O. Box 6032, Station B, Albuquerque, New Mexico.

**INCREDIBLE!** Unprecedented! Become a mental superman overnight! Floor everybody! No studying! "Memoprop" does all your thinking! It's uncanny! Revolutionary! Write: Bijou, Box 1727-K, Hollywood 28, California.

**SENSATIONAL** Offer! American Flyer 501T Atlantic freights complete—smoke, "choo-choo," track, transformer—guaranteed one year. Regular \$23.95—only \$19.95. 5108W Santa Fe Diesel passenger, regular \$69.50—only \$57.95. Send check or money order. Northern Hardware Company, Broad and Roekland Streets, Philadelphia 41, Penna. C.O.D.'s accepted! For complete train catalog and sensational price list send 10c. Over 1000 sets in stock!

**SMASH** Worries, fears and problems. Wake up your mind with our home-study behavior control plan. Be what you desire. Many helped. Rush request for amazing free lecture. Personal Psychology, Inc., Box 1924-N, Louisville 1, Kentucky.

**MEXICAN** Palm hats, novelties, curios. Request price. F. L. de Arkos, 904 Scott St., Laredo, Tex.

**LEATHER** Jackets repaired. New knit, zippers or relined. Work fully guaranteed. Jackets made to order. Free circular. Taubers, 689 Mission, San Francisco 5, Calif.

**INTERESTING** Booklet, "Baseball's Hall of Fame," 25c postpaid. Wells Publications, Box 241B, Alton 4, Illinois.

**PEARL** Bracelet, value \$17, price \$4.98. Croninger, Postlagernd, Gottingen, Germany.

**BALL** Point pens. Your name gold stamped. Send \$3.00 for 12 pens. Free postage. Makes ideal gift. Write for quantity prices. George Rosen, 245 Summit Avenue, Mt. Vernon, N. Y.

**HUSBANDS**, Young, older, accidents disastrous! Be wise, make a will. Complete set legal will forms, explicit easy instructions, only \$1.00. Rankin Legal Forms, Drawer 202M, Gary, Indiana.

**A** Dozen orchids air mailed special delivery from Hawaii to your loved one, only \$3.00. Fresh delivery guaranteed. H. E. Kohler, Box 745, Fort Wayne, Ind.

**LUMINOUS** Paint—Glow in the dark. Sky blue, yellow, green, green-blue. Spray or brush. Waterproof. Weatherproof. 2 oz. Jar \$1 postpaid. Write Nite Glo, Box 490, New Haven, Conn.

**DECORATE** Costume jewelry, china, metals, etc., with Oven-Decor Paints. Glossy finish. Ten colors, brush, directions. \$3.00 postpaid. Write Oven-Decor, P.O. Box 191, Mar Vista, Calif.

**MEDICAL** Laboratory Technicians in great demand. We train you in your own home. Catalogue free. Imperial Technical Institute, Box 973-J, Austin, Texas.

**HOMES** You can build for \$4500 to \$7046. Books that take you through every step. Popular Mechanics Famous Concrete Block House, \$2.00. Your Home and How to Build It Yourself, \$3.00. Also full-sized builder's plans for each home at nominal price. Popular Mechanics Press, 200 E. Ontario St., Chicago 11, Ill.

**OUTDOOR** Toilets, cesspools, septic tanks cleaned, deodorized with amazing new product. Just mix dry powder with water; pour into toilet. Safe, no poisons. Save digging, pumping costs. Postcard brings free details. Burson Laboratories, Dept. C-36, Chicago 22, Illinois.

**GENUINE** Buckskin jackets, gloves, Send 50c for buckskin money pouch and free catalogue. Berman Buckskin Co., Minneapolis, Minnesota.

**YOUR** Leather jacket renovated expertly. Free circular. Berlew Mfg. Co., Dept. 8, Freeport, N. Y.

**PLYMOUTH** Owners save money with big 288-page manual. Tells how to keep your Plymouth in tip-top shape; how to make repairs and recognize troubles. Hundreds of diagrams, drawings and illustrations. \$3.50 postpaid or order c.o.d. Popular Mechanics Press, 200 E. Ontario St., Chicago 11, Ill.

**70** BIBLE Lessons, 25c. Bulletin, Box 87, Cathedral Station, New York 25.

**DRESSES**, Used, 18c; coats \$2.00; blouses 35c. Free catalogue. Crown, 164-PM Monroe Street, New York 2.

**CESSPOOL** Trouble? Use Peps-It. Rejuvenates fermentation action, saves pumping costs, deodorizes, reduces masses. Costs only \$2.50. Safe. Sanitary. Free descriptive literature. Chemical Cesspool Cleaning Co., Boston 34, Mass.

**REACH** Spanish-speaking mail-order buyers. Great new market for your merchandise. Your classified ad in the Spanish Edition of Popular Mechanics will bring you some nice business from this new field. Rate only 25c per word. Circulation 100,000 copies. Mail a trial ad right now. Popular Mechanics Magazine (Spanish Dept.), 200 E. Ontario Street, Chicago 11, Ill.

**SQUARE** Dance instructions, thirty dances, \$1.00. Wesley Rader, 3926 Alcott, Denver 11, Colorado.

**RECEIVE** Giant mails, magazines, catalogs! Three months 25c, year 50c. Waddell's Directory, 341B East 76th, New York 21.

**TREASURE** Finders for gold, silver and minerals. Money back guarantee, best available. Also Geiger counters for uranium prospectors, free information. Write Goldak Company, 1541 West Glenoaks, Glendale 1, Calif.

**"RECEIVE** Mail." Moneymaking offers, opportunities, catalogs. Name listed 10c. Ideal Service, Park Ridge 10, Ill.

**PANNING** Gold lesson and catalogue. Beginners supplies, books, "maps where to go" free. Old Prospector, Box 729D1, Lodi, Calif.

**TREASURE**—M-Scope Geiger counters, mineral locators. Why buy something inferior when you can buy the best at a lower price? Backed by years of experience. Fully guaranteed by factory. Detects minerals, metals, gold, silver, coins. Payment plan available. Proven superior performance. Free 16 page illustrated booklet. Fisher Research Lab., Inc., Palo Alto, California.



# AT LAST

## A Really COMPLETE AUTHENTIC Book on Auto BRAKES and Wheel ALIGNMENT

Auto Mechanic's Manual On **BRAKES and STEERING**

(Including Wheel Alignment)

by **JUD PURVIS**  
Technical Editor  
Motor Service Magazine  
**FOR REPAIRMEN, CAR OWNERS**

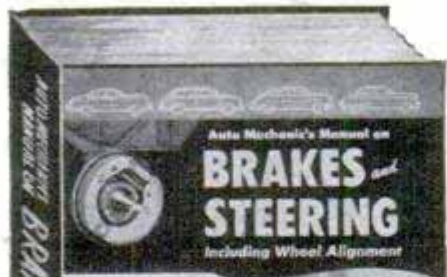

Covers All Systems  
Crystal Clear Illustrations

Purvis' new Auto Mechanic's Manual takes the mystery out of servicing auto brakes and wheel alignment . . . covers all systems used on American passenger cars and trucks. Confusing and highly technical terms used by engineers have been eliminated and the complicated operation of natural and mechanical forces is explained in easy-to-understand terms.

Extensive use is made of crystal clear illustrations to explain operational principles not readily acquired by observation and experience, and to show WHAT needs to be done, WHY and HOW to do it. Clip this ad and mail with name and address and check, money order or cash for \$3.50. Postpaid delivery guaranteed. Money back if you are not pleased.

Here in handy, usable form is the real "gospel" written by an acknowledged expert in these fields . . . all the information you need to quickly and accurately locate trouble and fix it FAST.

**GOODHEART-WILCOX CO.** Dept. 173, 1321 S. MICHIGAN AVE., CHICAGO 5



### MEN! send for this MONEY-MAKING OUTFIT **FREE!**

### MAKE \$15.00 IN A UP TO 15 DAY

Do you want to make more money in full or spare time . . . as much as \$15.00 in a day? Then mail coupon below for this **BIG OUTFIT**, sent you **FREE**, containing more than

150 fine quality fabrics, sensational values in made-to-measure suits and overcoats. Take orders from friends, neighbors, fellow-workers. No experience needed. You'll say it's the greatest way to make money you ever saw.

### SAMPLE SUITS TO WEAR

**Pay No Money! Send No Money!**

Our plan makes it easy for you to get your own personal suits and overcoats without paying 1c, in addition to your big cash earnings. This offer is limited. Rush coupon for **FREE OUTFIT**—today!

**PIONEER TAILORING CO., Dept. A-1116 Congress & Throop Sts., Chicago 7, Ill.**

PIONEER TAILORING CO., Dept. A-1116 Congress & Throop Sts., Chicago 7, Ill.

Dear Sir: I WANT A SAMPLE SUIT TO WEAR AND SHOW, without paying 1c for it. Rush Valuable Suit Coupon and Sample Kit of actual fabrics, **ABSOLUTELY FREE.**

Name.....Age.....

Address.....

City.....State.....

SAY YOU SAW IT IN POPULAR MECHANICS

## WEATHER DAMP—Car Won't Start?

### SHORTSTOP



### starts damp motors quick

Just press button on handy aerosol can and spray plugs and wires. New, improved formula contains silicone. One treatment protects for months.

Get Shortstop at your service station, garage or auto supplies store.

**ZACO LABS • 1360 W. 9th, Cleveland, O.**

### HOW TO GET BETTER PAINT RESULTS WITH ONE COAT



### NEW FREE BOOK ON ALUMINUM PAINT TELLS HOW

Write for your free copy of 24-page illustrated fact-packed book, "Paint it Bright". Prepared by Alcoa experts to help you get best paint results. Absolutely free—no obligation. Write to:

**ALUMINUM COMPANY OF AMERICA, 1718M Gulf Building, Pittsburgh 19, Pa.**

### DEPENDABLE CRAFT SUPPLIES

WRITE FOR CATALOG SINCE 1928

LEATHER CRAFT • PLASTICS • POTTERY CRAFT • BLOCK PRINTING • BELT CRAFT • TEXTILE COLORS • POWER TOOLS • WOOD BURNING • INSTRUCTION BOOKS • ETC.

**DWINNELL CRAFT SHOP**  
Dept. PM-1251—Wheeling, W. Va.

## START YOUR OWN MONEY-MAKING BUSINESS

Clean rugs on customers' floors with highly efficient electric machine which is making **BIG MONEY** for others and giving them independence. Special skill or experience not required. No shop necessary. Write today for complete **FREE** information. Address: **VON SCHRADER MFG. CO., W10PL, RACINE, WIS.**

### MAKE YOUR HANDS MORE *Creative*



### with X-acto Knives and Tools

For **FUN** and **PROFIT**—from 25¢ to \$30.

SEND 15c TO COVER POSTAGE FOR NEW ILLUSTRATED 28-pg. CATALOG X-ACTO CRESCENT PRODUCTS CO. INC., 440 FOURTH AVE., N.Y. 16, N.Y.

### MEN-WOMEN LEARN French Invisible REWEAVING

MAKE GOOD MONEY AT HOME

EXAMINE EVERYTHING AT OUR RISK

New method shows how to reweave burns, tears and moth holes in suits, dresses, etc., like new. No previous experience needed. Amazing visual-weaver makes learning easy. Big-profit orders come from Homes, Cleaners, Dept. Stores—also mail orders. Up to \$5 an hour possible, spare or full time. No overhead or expense for materials. Complete instructions yours to examine at home, **WITHOUT RISK.** **FREE** details—write **NOW.** Airmail reaches us overnight. **SKIL-WEAVE CO., 1715-BR Westwood, L.A. 24, Calif.**



WAR SURPLUS

# OPTICAL BARGAINS

## 35 POWER ERECTING MICROSCOPE

Amazing clarity. "All-Position" Universal mount. 3" of working space from objective to platform. Prism Erectors give you an erect image—exactly as your eye sees it. Ramsden Eyepiece permits fine precision focusing. 3-Element color corrected objective—1" diameter. Microscope body is of brass with black crackle finish. . . 6 1/2" long with base 7"x9". Easily worth \$75.00.



Stock No. 970-H. . . . . \$29.50 Postpaid  
**SLIDE PROJECTOR SETS** Consists of all unmounted lenses you need to make the following size projectors:  
 Stock #4029-H—35 mm. . . . . \$2.85 Postpaid  
 Stock #4038-H—2 1/4"x2 1/4". . . . . \$3.35 Postpaid  
 Stock #4039-H—2 1/2"x3 1/2". . . . . \$3.35 Postpaid

**SIMPLE LENS KITS**—Include plainly written, illustrated booklet showing how you can build lots of optical items. Use these lenses in photography and for dozens of other uses in experimental optics, building TELESCOPES, low power Microscopes, etc.  
 Stock #2-H—10 lenses. . . . . \$ 1.00 Postpaid  
 Stock #5-H—45 lenses. . . . . 5.00 Postpaid  
 Stock #10-H—80 lenses. . . . . 10.00 Postpaid

We Have Literally Millions of War Surplus Lenses and Prisms for Sale at Bargain Prices. Numerous Types of Instruments, Too! Write for FREE CATALOG-H  
**EDMUND SCIENTIFIC CORP., Barrington, N. J.**

## Use Your Spare Time Learn ENGRAVING As a Career or a Hobby

Build a business for yourself. Engrave Silver—Jewelry—Trophies right in your own home. Learn this fascinating craft by the NEW "SILENT TEACHER" HOME STUDY METHOD. Inquire today — or at our resident school.

**KANSAS CITY SCHOOL OF WATCHMAKING**  
 -1218 Admiral Blvd. Kansas City 6, Missouri

## DRAINS Cellars, Laundry Tubs; CIRCULATES Oil; IRRIGATES Gardens

Original "Type P" Pump has 2400 GPH capacity. 360 GPH 75' high, or 1500 GPH from 25' well. Use any 1/4 to 1/2 HP motor. DOES NOT CLOG. 1" intake; 3/4" outlet.  
 Only \$6.95 postpaid if cash with order. (West of Mississippi, add 50c.)  
**\$6.95**  
 SATISFACTION GUARANTEED OR MONEY BACK!



LABAWCO PUMPS, BELLE MEAD 7, N. J.

**Mustang** LIGHTWEIGHT  
**\$362.20**  
 (Fed. tax paid, at factory)

9.5 hp. 4-cycle. 3-speed. Foot-shift. Over 70 miles per gal. Over 60 m.p.h. Write for free circular.

**MUSTANG, Dept. PM**  
 635 W. Colorado, Glendale 4, Calif.

**PAGE**  
**Garden Tractors**  
 NEW 1952 MODELS! MORE FEATURES!  
 Both riding and walking models 2 to 6 HP with complete gear drive and reverse . . . no chains, ratchets, or belts. Quick-hitch for easy changing. Over 50 attachments for all farm and home chores.  
 Also new, handy 1 wheel Page "Bantam."  
**LOW PRICES, EASY TERMS**  
 26 years' experience behind every Page tractor. Every model guaranteed!

**PAGE FARM EQUIPMENT**  
 1904 S. 81st St., Milwaukee, Wis.

Write for Free Catalog

# FREE

HOW TO REPAIR ELECTRICAL APPLIANCES  
 64 PAGES

with order for a New Model 50 UTILITY TESTER

## FOR REPAIRING ALL ELECTRICAL APPLIANCES-MOTORS

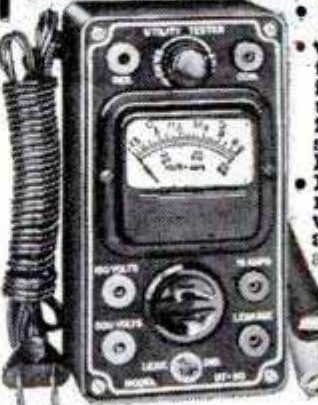

- Measures A.C. and D.C. Voltages, Current, Resistance, etc.
- Will measure the current consumption while the appliance under test is in operation. The appliance or utility may be plugged directly into the front panel receptacle. A special pair of insulated clip-end leads is included for motors, etc.
- Incorporates a sensitive direct-reading resistance range which will accurately measure all resistances commonly used in electrical appliances, motors, etc. Continuity checks and tests for shorts and opens.
- Will test thermostats, radio tube filaments, bulbs, fuses, fluorescent, condensers, switches, field coils, circuit breakers, lighting systems, etc.

Handsome round cornered molded bakelite case 3 1/4" x 5 7/8" x 2 1/4". Complete with all test leads and instructions. **13.90**

### SOLD ON EASY PAYMENTS AT THE NET CASH PRICE

No interest or carrying charges added. Remit \$3.90 with order, pay balance, \$2.00 per month for 5 months.  
**SUPERIOR ELECTRONIC CO., INC.**  
 Dept. B-44 • 227 FULTON STREET • NEW YORK 7, N. Y.

## LIONEL TRAINS SPECIAL OFFER

Send for it for your boy.

Send for Special Coupon Offer!

LIONEL TRAINS, P.O. Box 354, Madison Square Station, New York, N. Y.

Please send me special Lionel Train catalogue offer, postage prepaid. I enclose 25¢ to cover postage and packing.

1. The new 36-page full-color Lionel catalogue.
2. The new 5 1/2" double-faced record\* of whistles, bells, railroad sound effects and Diesel horns.
3. 10 full-color miniature billboards.

Name \_\_\_\_\_  
 Address \_\_\_\_\_  
 City \_\_\_\_\_ State \_\_\_\_\_

\*Plays on all 78 RPM phonographs except some fixed spindle or automatic changers.



Improved Americanized

# JUDO

"THE BIGGER THEY ARE — THE HARDER THEY FALL!"

Two Big Books Clearly Illustrated. Over 1200 Show-How Photos. Many New Holds! 71 Complete Lessons.

Protect yourself and others. Size and strength mean nothing. Knowledge and skill enable you to master any situation even against biggest bullies and armed thugs. Illustrations showing each hold from start to finish. Complete satisfaction guaranteed or your money refunded.

NOW VOL. I & VOL. II \$5.00 pp'd. or \$3.50 ea. \$1.00 deposit with C.O.D.'s.

No C.O.D.'s outside U.S.A.

IMPROVED JUDO, INC. Dept. PM-12, P.O. Box 7355, Sta. L, Los Angeles, Calif.



10 DAY FREE TRIAL!

## ADD BEAUTY and VALUE to YOUR HOME with beautiful wood-paneled walls

Install Plankweld yourself, quickly, easily — in genuine Philippine mahogany, walnut, birch, knotty pine — for as little as \$60 for an average wall.

Plankweld is Weldwood® Plywood pre-cut to room height in 16¼" wide panels. Edge-grooved to provide a neat lap joint. Pre-finished — no staining or waxing required.

See Plankweld at your lumber dealer.

### PLANKWELD®

Manufactured and distributed by UNITED STATES PLYWOOD CORPORATION 55 West 44th Street, New York 18, N. Y.



## For Portable and Emergency ELECTRIC POWER

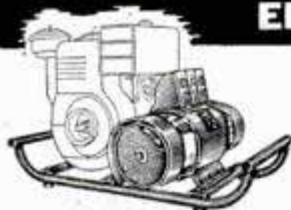

Choose a **Wincharger** POWER INSURANCE A. C. GENERATOR

TRACTOR POWERED OR GAS ENGINE SETS

Pictured is a 3000 Watt 115/230 Volt 60 Cycle AC Gas Engine Generator. Engine-Generators in 1250 and 300 Watt capacities; Farm Tractor powered Generators from 3000 to 10,000 Watts for use as stand-by power Generators for shop use, for radio amateurs, for portable power plant needs including welding. Generators are available with or without gas engines. For Complete Information Write to

WINCHARGER CORPORATION Dept. M12 Sioux City 2, Iowa

## NEW PORTABLE GENERAL PURPOSE SPOTLIGHT with Sealed Beam Unit

- Requires No Installation. Plugs into light bulb or cigar lighter socket.
- Stands By Itself . . . Beam can be Pointed in any Direction.
- Hangs Under Dashboard . . . or Stores in Glove Compartment.

Complete with 10 ft. cord, hanging hook, off & on switch.

**\$8.75** GIFT BOXED Prepaid

Here is the perfect all-purpose or trouble light for motorists, truckers, campers, sportsmen, etc. Comfortable pistol grip handle affords easy direction of broad, powerful light beam wherever needed. Full chromium plated body and handle. 5" portable spotlight. An Indispensable Aid to Every Motorist . . . The Perfect Christmas Gift!

Satisfaction fully guaranteed. Send check or money order to: SPOT-LITE SALES CO., 343 S. Dearborn Street, Chicago 4, Illinois

## PROPANE GAS ON YOUR CAR



with normal operation on gasoline. Switch to either instantly—Save up to ½ on fuel. SEND \$2.00 for "How-to-do-it" booklet, photos, drawings and low prices on complete outfits. (refunded on parts order) Rush order today — NOW!

LPG PRODUCTS, Dept. PM-12, KEARNEY, NEBRASKA

## POWER HACKSAW \$52.75

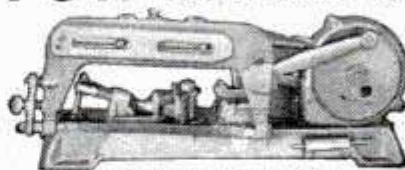

LESS MOTOR F. O. B. Benton Harbor

• Rugged cast iron construction. Wt. 56 lbs. bronze bearings. Draw cut. Auto. return lift. Auto. shut-off. Vise swivels 45°. Cap. 4"x4".

Send for full details and name of nearest dealer.

EXCEL MACHINE TOOLS Dept. PM-121 BENTON HARBOR, MICHIGAN

## MAKE YOUR OWN!



GRIFFIN LEATHERCRAFT KITS Best assortment of tools, materials in U.S.A.! Send 25¢ for 116-page catalog. (money refunded first order)

GRIFFIN CRAFT SUPPLIES SINCE 1924

5626-A Telegraph Ave., Oakland 9, Calif

## Make Your Own POWER LAWN MOWER with this DRIVE CUTTER ASSEMBLY

Constructed for those who desire to build their own mower or to replace your old cutter assembly. Complete with 18" blade and double ball bearing drive, only

**\$12.95**

Add 50c to cover handling & shipping. No COD's

ATLAS EQUIPMENT CO., Dept. P.M. 11 229 SW BLVD. KANSAS CITY, MO.



## POPULAR or HILLBILLY RECORDS 12 TOP HIT TUNES FOR \$2.98

on 6 ALL NEW UNBREAKABLE RECORDS

Your choice of Standard 78 □ or 45 □ RPM records in (1) LATEST HIT PARADE SONGS □ or (2) LATEST HILLBILLY SONGS □. Satisfaction or your money back. Send no money, we'll ship for \$2.98 plus C.O.D. postage and 35¢ handling charge; or, send \$3.33, we'll pay postage. CLIP THIS AD—send with your name and address. Be sure to check records you want.

Dept. PM12, GALGANO DISTR. CO. 4142 ARMITAGE AVE. CHICAGO 39, ILL.



SEND FOR THIS FREE!

Make money. Know how to break and train horses. Write today for this book FREE, together with special offer of a course in Animal Breeding. If you are interested in Galting and Riding the saddle horse, check here ( ) Do it today—now.

BEERY SCHOOL OF HORSEMANSHIP Dept. 11012D Pleasant Hill, Ohio



SAVE TIME WORK MONEY

**SHAW DU-ALL**

FOR FARM OR GARDEN WALKING OR RIDING TYPE

These rugged walking or riding tractors are ideal for farm, truck garden. FREE Illustrated catalog giving complete details, price lists—write today.



SHAW MFG CO.

4512 Front St., Galesburg, Kans. 6686 North St., Columbus, O.



POWER TOOLS WORK BEST when they're oiled, polished, rust-free. For lathes, drills, saws, etc.—get and use

**Ever-Ready OIL**



# ANALYZE HANDWRITING

**MORE INCOME, Prestige, Success, Fascinating; uncrowded profession-business, full or spare time. FREE illustrated lesson & Year Book shows how men and women in home, business and professions analyze handwriting to understand people. MAKE MONEY. FREE lesson and information about unusual opportunities if over 21.**



**I. G. A. S., Inc., 716 Wilhoit Bldg., Springfield, Mo.**

## 12 Months Driving for \$4.95

A new tire guarantee with each used tire. Positively Not Re-Caps—Every Tire Machine Inspected

600-16 \$4.95 Two for \$9.50 650-16 \$5.50  
670-15 \$5.95 700-15 \$5.95

Send this ad with order. Mail orders rushed on receipt of check or money order for the size desired.

West Park Tire Sales, 14018 Beech Ave., Cleveland, O.

## Build Shelves, Furniture, Games, Novelties, Ornaments!

New... plans for over 100 items that you can build at home. Finest selection available. Easy to make, full instructions included. Furniture for kitchen, living room, lawn, plus novelties, games and shelves. Send \$1 to...

### WOODCRAFT PLANS, Dept. 22

3933 N. 28th ST. • MILWAUKEE 16, WIS.

## DUST-O-VAC FOR ALL MACHINES

For Home Workshops & Industry. DUST-O-VAC collects & bags wood & plastic chips, wood & metal dust, wood shavings. Free Bag. Attaches to circular saw, planer, band saw, grinder, belt or disc sander, shaper, drill press with shaper or sander attachment, spindle shaper, wood lathe, jig saw. 110 A.C., D.C. Send for mounting instr. for all machines.

**\$19.95**

F.O.B. Yonkers

**HEAVY CAST ALUMINUM BLOWER — ONLY \$11.25**  
For workshop, lab., kitchen, cellar, app. 100 CFM. Send for circular. UN VERSAL YONKERS CORP., 137 Alexander St., M-12, Yonkers 2, N. Y.

## 60 POWER TELESCOPE \$3.95

VARIABLE EYEPIECE 20 x 40 x 60 — BRASS BOUND

**NEW!** Three telescopes in one. 3 different magnifications. 20 power for ultra-bright images with 40 and 60 power for extra long range. Guaranteed to bring distant objects, people, sports events, ships, moon, stars, etc. 60 times as close. Most powerful for anywhere near the money. 5 Sections. Closes to 1 ft. long. Contains 4 ground and polished lenses. Also used as a powerful compound microscope. Directions included. Mass production enables us to offer this high-powered instrument at the amazing price of only \$3.95. We pay the postage. Get yours immediately. All aluminum model with case \$5.95

CRITERION CO., Dept. PMB-2  
438 Asylum St. Hartford 3, Conn.

## D. C. ARC WELDER

\$300 VALUE — ONLY \$97.50

200 Amperes Continuous Duty. Up to 250 amps. intermittent duty. Easily mounted on your tractor. Welding range from 0-up by dial type control. 1-yr. guarantee with money back 10-day trial period. Write for FREE literature. OR send 35c for PLAN "Build Your Welder from Aircraft Generator." Write today.

LEJAY MFG.  
841 LeJay Bldg., Minneapolis 8, Minn.

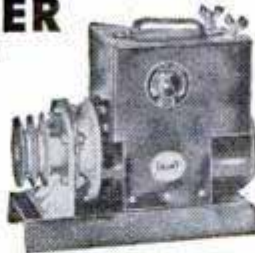

## NOW! Stop Leaks and Noises!

Noisy, bothersome toilet leaks and noises are stopped with new Flush-Rite guide. This new guide positively stops leaky toilets. Cuts water waste. Fits any size over-flow pipe. Uses any standard ball. Frictionless operation. Solid brass construction. Easy to install. Takes only a few minutes. Money back guarantee. Order today from your local dealer or send \$1.00 post paid. COD postage extra to

### PORTLAND DIE AND STAMPING COMPANY

Dept. P.M.  
1500 S.W. FIRST AVE., PORTLAND 1, OREGON



## FREE BOOK AND ACTUAL SAMPLE

Screen Print, Dept. 212  
1010 So. Los Angeles St.  
Los Angeles 15, California  
Dear Mr. Nawok: Please rush me FREE BOOK, ACTUAL SAMPLES, and your amazing new PRINTING PLAN  
Name \_\_\_\_\_  
Address \_\_\_\_\_  
City \_\_\_\_\_ State \_\_\_\_\_



C.J. NOWAK  
General Manager  
AT HOME SPARE TIME

IT'S AMAZING! I'll show you how to make up to \$12.50 per hour  
**PRINTING**  
WITHOUT A PRINTING PRESS

### AMAZING NEW COLOR PRINTING METHOD

A fascinating new miracle-way to print—a secret method that lets you print colorful signs, posters, banners, drapes, wallpaper, flags, glass, fabrics—ANYTHING without an expensive printing press or costly equipment. This new process is revolutionizing the entire printing industry—it's one of America's fastest-growing businesses—it's your "chance of a lifetime" to make Big Money Now! Be the FIRST in your area to profit. The secret can be yours—just mail the coupon above today!

**EASY TO LEARN! NO EXPERIENCE NECESSARY!** Simple fascinating method! No artistic ability needed. It's possible for anyone (young or old) to make up to \$50 PER WEEK printing in SPARE TIME alone—AT HOME!

**START YOUR OWN BUSINESS—BE YOUR OWN BOSS** Wouldn't you be happy if you could take only one hour of your time and \$1.00 worth of materials—and sell your printing for \$15 or more. It's that easy! It's amazing! Your home can be your office—No selling because there's a huge demand everywhere. GOVERNMENT CONTRACTS AVAILABLE TO BID. Biggest opportunity in America—costs you nothing to receive all CONFIDENTIAL FACTS—Mail coupon today!

SCREEN-PRINT, Dept. 212  
1010 S. Los Angeles St., Los Angeles 15, Calif.



## PROTECT YOUR CAR'S CHROME FROM SALT PITTING — RUST — CORROSION

**PROTEX** Chrome Protective Coating keeps the chrome on your car looking like new through the meanest weather. Gives bumpers, trim, etc. a tough, acid resistant coating that laughs at snow, salt, mud, calcium chloride and other elements that rust and corrode. Easy to brush on—one application lasts all winter. PROTEX also protects brass, copper and aluminum from pitting, rust and corrosion. Keeps unused tools, sports equipment, and TV antennas in top shape. Comes in transparent, green, gold, blue, or bronze. Satisfaction absolutely guaranteed or money refunded.



COMPLETE KIT ONLY **\$2.00**

Send today. State color wanted.

**PROTEX CO.**  
2465 W. Davison, Dept. PM1, Detroit 6, Mich.

## LOCKSMITHING & KEYMAKING

HOME TRAINING OUTFIT INCLUDES KEY MACHINE, SUPPLIES AND TOOLS TO GET STARTED IN BUSINESS

Professional outfit. Get practical training from Master Locksmiths. Learn to cut keys by code, master locks, change combinations, quickly identify key blanks, many profitable "tricks of the trade." Booklet of Information FREE. Write today. UNITED SUPPLY & SERVICE, 3231 Washington Blvd., Dept. PM-12, Chicago, Illinois.

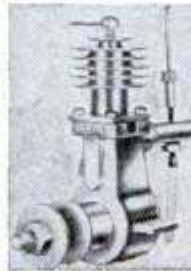

## Our 433rd Advertisement REAL DIESEL ENGINE

**\$2.95**

- for planes, boats, midget cars
- 7500 RPM; 1/7 HP; ht. 3 1/2"; wt. 5 oz.
- precision machined for smooth operation

You just can't beat this price for a precision diesel engine! Streamlined, compact, easy to install. Thousands of satisfied users all over the world. Fast delivery if you ORDER TODAY! Send \$2.95 plus 25c postage.

**GOTHAM HOBBY CORP.** Dept. P, 107 E. 126th St. New York 35, N.Y.



REMEMBER IT'S DANGEROUS finest (non-skid) USED TIRES

# GOOD YEAR Firestone

GOODRICH, UNITED STATES, GENERAL & OTHERS, NOT RECAPS

Our policy is to select your tires so carefully, as if our very future depended on the service given by that particular tire.

**FREE TUBE WITH "ALL" BLATT'S GOOD GRADE TIRES**

GOOD GRADE, 16 MONTHS GUARANTEE BOND.	700-15	650-20	32x6 (8)	32x6 (10)
600-16 \$4.14	\$4.54	\$7.94	\$8.54	9.94
650-16 5.42	6.70-15 4.74	700-20 8.54	900-20 13.94	650-15 4.44
700-16 5.04	710-15 4.94	750-20 8.64	1000-20 13.94	650-15 4.44
650-15 4.44	550-17 4.64	825-20 15.92	1000-20 13.94	

**FINEST GRADE, 26 MONTHS GUARANTEE BOND**

THIS GRADE MADE THE BLATT NAME "WORLD FAMOUS"	700-15(8)	750-16(8)	900-20	1000-20
450-20 \$6.00	\$6.00	\$10	\$15	\$15
600-16 5.49	650-15 5.95	600-20 9.94	900-20 18.54	650-16 6.42
650-16 6.42	670-15 6.24	650-20 9.94	1000-20 18.54	700-16 7.94
700-16 7.94	700-15 6.54	700-20 11.94	1100-20 18.54	750-16 7.94
750-16 7.94	710-15 6.34	32x6 (8) 10.54	1000-22 17.54	550-17 5.94
550-17 5.94	760-15 6.54	32x6 (10) 13.92	1100-22 18.54	525-18 5.54
525-18 5.54	820-15 7.04	750-20 12.54	1200-22 22.54	650-19 9.00
650-19 9.00	475-19 5.94	825-20 22.84	1100-24 21.54	

**FACTORY REBUILT NU-TRED SNOW TIRES - 26 MONTH GUARANTEE**

640-15	650-15	550-16	700-15	600-16
670-15	760-15	650-16	710-15	820-15
710-15	820-15	550-17		

**ANY SIZE \$11**

**MILITARY • NOT RECAPS RUGGED GUAR. 30 MOS.**

750-20 STD. \$10  
" RUGGED \$16  
750-16 RUG. \$19  
900-16 RUG. \$11

**BLATT** BLATT BLDG., GIRARD & LANCASTER AVES., DEPT. PM., PHILADELPHIA 31, PA.  
Send check or money order and this ad for rush shipment. We won't ship a tire we wouldn't use. The name to trust in rubber. PRICES SUBJECT TO CHANGE  
Shipments RUSHED Down South, Up North and Far West

## WHAM-O SPORTSMAN

\$1.25 POSTPAID

45-LB. PULL!

HITS LIKE A .22 RIFLE—KILLS RABBITS, SQUIRRELS. Powerful, silent, accurate. For hunting, target, routing pests. Sportsman's choice sold world over!



### HUNTING SLINGSHOT

Heavy duty 7" ash stock. 40 steel balls, extra rubber, target. GUARANTEED - at dealers, or send \$1.25 to Wham-O Mfg. Co., Box 87, South Pasadena, Calif. \* Professional model of Nat'l Slingshot Assn. Extra steel ball ammunition, 75c for 200

# CASITE GUARANTEES BETTER AND SMOOTHER MOTOR PERFORMANCE



**MAKE PERSPECTIVE DRAWINGS THE EASY WAY**  
Just turn the dial and your PERSPECT-O-MAT gives accurate details for making FRONT, CORNER, and AERIAL VIEW Perspective Drawings. Saves time, bother, and muddle for designers, draftsmen, builders, architects, and students. Shipped postpaid... send \$1.00 today to INVENTORS' SALES CO. BOX 899 SYRACUSE, N. Y.

# FOAM RUBBER FOR HOBBYISTS, CRAFTSMEN, EXPERIMENTERS



**Lowest Prices—SAVE 50%**

16 x 16 x 1 1/2" .. ea. \$1.35	<b>AUTOSEAT TOPPER PADS</b>
16 x 22 x 1 1/2" .. ea. 1.75	Place under seat cover.
18 x 24 x 1 1/2" .. ea. 2.00	24" x 60" x 1 1/2" .. ea. \$6.45
24 x 24 x 1 1/2" .. ea. 2.95	24" x 60" x 2" .. ea. 7.95
	12" x 14" x 1 1/2" .. ea. 1.25

Use for furniture cushion fillers, mattresses, mattress pads, cushions. Foam Rubber is available in any size or thickness. Send For Free Price List. Immediate delivery. No C.O.D.'s. Add 10% for Postage & Handling to Above Prices. Please print.

**FOAM-KING RUBBER CO., Dept. MP-12**  
P.O. Box 2676, 1174 W. Monroe St., Jacksonville, Florida



It's New! It's Different! Get world's largest Auto Accessory & Parts Catalog and save money. Over 50,000 items, including Hollywood Accessories, Hi-Speed Equipment, Rebuilt Engines, all parts & accessories for all cars & trucks. We have that Hard-To-Get part! Jam packed with bargains. Completely illustrated. (100 pages) Send 25c (refundable).  
**J. C. WHITNEY & CO., 1917-XP Archer Ave., Chicago 16, Ill.**

## MARCOT KEY MACHINE



**MARCOT No. 8 KEY MACHINE**, less motor... \$110.00  
Auto Code Book and Depth Keys... 12.50  
75 Dz. Popular Key Blanks... 60.00  
Set — Key File, Follow-Through Rods, Lock Picks, Bit Key Gauge, Thimble, Pins, Springs... 10.50  
"Locksmith Trade Books"... 6.75  
How to Open Locks without Keys or Picks; Secret of Locksmithing; How to Make Keys by the Impression Method; Master Key Systems.  
TOTAL COST... \$199.75

Immediate Delivery  
**A. J. MARCOTTE CO., 1200 N. Kedzie Ave., Dept. PM, Chicago 51, Ill.**

## make your own Gems 29.50 F.O.B.

All necessary lapidary equipment is furnished, including a super-charged diamond blade for sawing, and all wheels for grinding, shaping and polishing; also complete instructions. The complete equipment as shown, less motor and belt, for only \$29.50, f.o.b., Burlington, Wisconsin. Write today for information and literature.

**B&I MANUFACTURING CO.**  
Dept. S Burlington, Wis.

## MASTER MIND!



**Learn Short-Cut Mathematics**  
Juggle figures, do baffling number tricks. Make people gasp at your marvelous lightning-quick mind. Multiply 4 figures by 4 figures without using old-fashioned multiplication! Big cloth-bound volume; fully illustrated course.  
**Sharpen up Your Brain Power**  
Includes worked-out problems, answers, etc. Sensational bargain, only \$1.95, postpaid or COD plus postage. Satisfaction guaranteed or refund. Order this amazing "Short-Cut Mathematics" today!  
**NELSON-HALL CO., 210 S. Clinton St. CHICAGO 6, ILL. \$1.95 Complete**

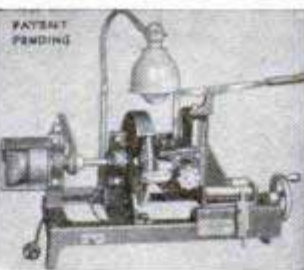

## Start a NEW BUSINESS!

or Add to your present Repair Business  
**SHARPEN DULL PIPE WRENCHES**  
PIPE TAPS & DIES  
"GUM" CIRCULAR SAWS  
Write for Information  
**J. C. MOORE INDUSTRIES**  
BOX M 276 FREDONIA, PA.



## IDEAL CHRISTMAS GIFT 16x50 \$69.50

The ultimate in a fine binocular. Tremendous power. Featherweight (weighs only 24 ounces!). Precision made in every detail. COATED providing sharper, brighter images. Individual focus. Objective lens is 50 MM (2 inches) across! UNCONDITIONALLY GUARANTEED. Complete satisfaction or your money refunded. Prices include genuine leather carrying case and straps. Add tax. \$2.00 deposit required on C.O.D.'s. Cash orders prepaid. Dealers wanted.  
United Binocular Co., 9043 S. Western, Dept. ARF-3408, Chicago 20 Display Sales Room open Mon. through Fri. 9:00-3:30

## BULL DOG HITCHES



Heavy Drop Forge Steel Construction. Strong — Safety-Engineered Reliable

Model No. 1-B NOW ONLY \$4.95 Post Paid (when paid in advance)  
Made for trailers with up to 2,500 pounds capacity. 1 3/8" dia. shank Fits 1 1/4" pipe tongue  
**HAMMER BLOW TOOL COMPANY**  
Wausau 131, Wisconsin





*Sensationally NEW for 1952!*

# MIDWEST TELEVISION



A Magnificent New Line of Beautiful CONSOLES and Complete CHASSIS featuring the Mammoth

## 20-Inch

RECTANGULAR PICTURE TUBE

FACTORY-TO-YOU

*Special Bonus*



### GIFT!

Illuminated

TELEVISION CLOCK

Given With Every Purchase of a MIDWEST RADIO or TELEVISION LIMITED TIME ONLY!

THE New 1952 MIDWEST "VIDEO GRAND"

20-Inch Television-Radio-Phono

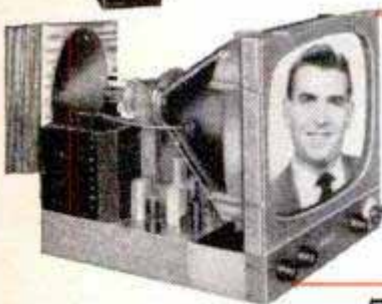

**MIDWEST**  
20-Inch TELEVISION CHASSIS and SPEAKER  
—for easy installation in your own cabinet.



### 30 DAYS TRIAL

New 1952 MIDWEST "CONSTELLATION" 20-Inch TELEVISION CONSOLE

Also—Powerful New 1952 World-Ranging **MIDWEST Series of RADIOS**  
For Beautiful Consoles and Complete Chassis



An entirely new line of radios featuring the powerful Series 16 five wave band AM-FM Radio Chassis and the magnificent Symphony Grand Radio-Phonograph with 3-Speed Automatic Intermix Record Player.

*Easy Terms*



*We Pay Transportation Charges*

**WRITE or PHONE**  
For This NEW 1952 **FREE MIDWEST TELEVISION RADIO CATALOG**



If You Live In One of These Cities Phone and Ask for Your Catalog

- NEW YORK MURRAY Hill 2-6810
- CHICAGO State 2-5600
- PITTSBURGH Grant 1-0609
- CLEVELAND Prospect 1-7450
- DETROIT Woodward 3-1233
- ST. LOUIS Grand 1161
- PHILADELPHIA Locust 4-1035

*or Send Coupon Below*

WRITE IN NAME AND ADDRESS (PLEASE PRINT) ON COUPON OR 1c POSTCARD

MIDWEST RADIO & TELEVISION CORP.  
Dept. 255, 909 BROADWAY • CINCINNATI 2, OHIO

Please send me your new FREE 1952 Catalog.

NAME \_\_\_\_\_

ADDRESS \_\_\_\_\_

CITY \_\_\_\_\_ ZONE \_\_\_\_\_ STATE \_\_\_\_\_

**MIDWEST RADIO & TELEVISION CORP.**  
DEPT. 255, 909 BROADWAY, CINCINNATI 2, OHIO



# PORTABLE GARAGE

Try 10 Days at OUR risk!



*Goes wherever your car goes*

DELIVERED  
**\$10**

**HEAVY DUTY PLASTIC LOW COST MODEL**  
Compare with \$9.95 and \$10.95 Plastic models.  
**\$8.69**

**TRANS-KLEER** — the ideal garage — travels with your car everywhere. Resists ravages of snow, sleet, rain, salt air, etc. Whisks on or off quick and easy! Takes little storage space. Folds away like a handkerchief. Unique, elasticized **GRIP-PLEAT** bottom offers complete security, winter or summer. Pays for itself many times over.

Compare with Garages to \$19.95. Do not confuse with inferior materials! Thoresen's is **QUALITY** made of 100% **HEAVY DUTY TRANS-KLEER**, thick, tough, yet silky! Resists cracking or peeling even in coldest weather. The **TRANS-KLEER** is our very best quality, longest wearing garage. Send only \$10 for **FREE**, prompt insured delivery right up to your door! No collect charges for expressage or cartage. C.O.D.'s cost 25 cents more. **TRY 10 DAYS AT OUR RISK!** Your \$10 back **QUICK** if not fully satisfied! Mention car make, year and model!

**THORESEN DIRECT SALES, Dept. 6N-140**  
131 West 33rd St., New York 1, N. Y.

## ELECTRIFY your SEWING MACHINE

**NEW LOW PRICE!**

**\$11.50** 1 YR. GUARANTEE



Buy direct from manufacturer and save! Kit comes fully wired, installed in a jiffy. Fits all machines! You get **ALL NEW PARTS!**

- Motor & Bracket
- AC-DC 115v 60c
- Multi-speed foot control
- Cord set & block
- Easy instructions
- Steel pulley & belt

**FREE . . . reg. \$2.95 chrome SEWLITE** given with every kit.

**10 DAY FREE TRIAL — ORDER NOW!**

Send no money, pay COD or send money order and we'll pay postage. Please state whether wheel on your machine turns toward you or away from you. Shipping wt. 6 lbs.

**SENIOR SEWING MACHINE CO.**

1046 BEDFORD AVENUE Dept. PM-32 Brooklyn 5, N. Y.

## FORCED AIR

INSTALL IT YOURSELF AND SAVE \$100 OR MORE.

CONVERT YOUR GRAVITY FURNACE TO MODERN EFFICIENT FORCED AIR HEAT. INSTALL MCLARTY FANS IN YOUR COLD AIR PIPES. NO SHEET METAL WORK REQUIRED. PLUGS INTO ANY 110V A.C. OUTLET. LOWEST COST SYSTEM ON THE MARKET.

FREE CIRCULAR

MCLARTY SYSTEMS

2607 DICKMAN RD. BATTLE-CREEK MICH.

## PORTO-VISE

WITH "MULTI-SET" CLAMP

Most versatile vise made! Clamp permits changing vise to standard, vertical or horizontal working positions in seconds — no bolts needed. Semi-steel casting. Perfect gift. Wt. 5 lbs. **4.95**

Money back guarantee. Postpaid with check or money order.

**Ideal for hobbyist, plumber, electrician, mechanic, carpenter.**

Dealer inquiries invited.

**NORTHERN INDUSTRIES, INC.**  
310 North Water St., Milwaukee, Wis.



5" Width  
2 1/2" Depth  
Pressed wood inserts. Full length pipe grooves.

## A TERRIFIC BUY! Lectro PAINT PEELER



Removes paint to bare wood in one easy stroke

Reg. \$4.95  
**SALE PRICE \$2.95**

**SUITABLE FOR:**  
Woodwork, Cabinets, Furniture, Storm Windows, Screens, Doors, Boats and 100 other uses.

De Luxe Model U.L. Approved

175 Watt, AC-DC current. Automatic safety stand for rest position. Blade 2"x 3 3/4".

Send check or M.O. Money back guarantee within 15 days.  
**JOB LOT TRADING CO. 53 Vesey St., NYC**

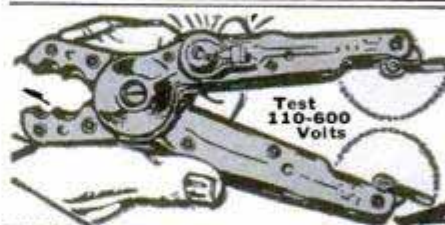

**TEST** Circuits, Fuses, Outlets easily, quickly, safely. Shockproof. Pull fuses 10 to 100 Amp.

**STAR TEST-PLIERS**

\$2.75 \$1.50 add'l for 2' leads  
At Dealers . . . or from us POSTPAID.  
**STAR FUSE CO., 233 Canal St., New York 13, N. Y.**



## BULL HACKSAW

for any 1/4" electric drill or drill press  
Easy to carry, easy to use—a "must" for every home craftsman! Full chip clearance on any wood, metal or plastic stock up to 3/4". No gears, no bearings, nothing to wear out. Weight: 11 ozs. Guaranteed and only \$4.95!

**POWERFUL! PORTABLE! POCKET-SIZE!**  
**\$4.95**

Send Cash, Check or M. O. Today!  
**BERTRAM S. ENGINEERING AND SUPPLY CO.**  
3127 Harrison St. Kansas City, Mo.



## COURTESY LIGHT

For All Makes of Cars  
State Year and Make  
**FOR SAFETY and CONVENIENCE. \$3.00 pr.**

**QUIK CLAMP MFG. CO.**  
702 Evergreen, S. E. Grand Rapids, Michigan

## MAKE EXTRA MONEY!



### SELL QUICK-BEARING NEW FRUIT TREES

**GORGEOUS FLOWERING SHRUBS, ORNAMENTALS, ROSES**  
Get **FREE** Sales Kit—make money fast demonstrating world-famous Stark Patented Apple, Pear, Peach and other fruit trees, Grapes and Berries. Gorgeous flowering shrubs, roses, ornamentals sell fast to home owners. Sensational hardy, Quik Bearing new varieties. Enormous demand for small farms, home yards, etc. No experience needed. Rush your name for Giant Kit and Color Plate Book—**FREE!**  
**STARK BRO'S, DEPT. 5562, LOUISIANA, MISSOURI**

## PIPE SMOKERS!

Make your own filters from household tissue with **PIPE BOBBIN!** Wipes out shank, tamps, digs out bowl. Slips into pouch or can. Hand-finished, machined and buffed aluminum alloy. 2 1/2" long.  
Send \$1 to **PIPE BOBBIN CO., 6141 W. Stevenson St., Milwaukee 13, Wisconsin**

## HELPFUL BOOKS

Send post card asking for **FREE** catalog  
Popular Mechanics Press, 200 E. Ontario, Dept. 601, Chicago 11



## SHARPEN YOUR CIRCULAR SAWS

The **RIGHT** WAY on your own saw table. Sharpens rip, cutoff, hollow ground and combination blades—6" to 10". Saws stay round with correct bevel. Precision made, easy to use. **GUARANTEED**. Only **\$8.95**. Includes \$3.00 Grinding wheel.

"**TRU-CIRCLE**" saw set automatically sets teeth at 10° or more. **\$2.95**  
**AT DEALERS OR POSTPAID**

**A. D. McBurney, 317 E. 4th St., Los Angeles 14, Calif., Dept. A-12**



**100 POWER IMPORTED MICROSCOPE 5.95**  
**& Complete Kit—12-Pc. Set** POSTPAID



includes full 100 power adjustable focus imported microscope with adjustable plano substage mirror, excellent optical qualities, strong construction. Kit includes four blank slides for your own specimens, one small inspection magnifying glass, one eye dropper, one pair tweezers, one tickler, two specimen holders with tops, one sturdy metal field case. A wonderful gift for all occasions. Sent postpaid for \$5.95! Send check, cash or money order. Catalog free on request or included with your order.

**AKRON ARMY-NAVY STORES** 4400 Sunset Blvd. 4400  
 Los Angeles 27, Calif. Dept. 12-P

**STUDY AT HOME**  
 WITH AN EDUCATIONAL INSTITUTION

Courses in **ARTS AND SCIENCES:** Philosophy; Education; Letters; Public Health; Medical Jurisprudence; Psychology; Sociology; Physics; Chemistry; Geology; Pol. Science; Theology; Law; Business and Commerce; Accounting; Mathematics; Statistics; Agriculture. Courses in **ENGINEERING:** Electrical, Civil, Mechanical, Drafting, Architectural, Automotive, Steam, Diesel, Aeronautical, Radio, Structural, Mining, Industrial, Petroleum, Marine, Refrigeration, Air Conditioning, Chemical. Send for free catalog.

McKinley-Roosevelt Incorporated, 4610-K3, Sheridan Rd., Chicago 40, Illinois



**HE-MAN VOICE!**

STRENGTHEN your voice this tested scientific way. Yes—you may now be able to improve the POWER of your speaking and singing voice . . . in the privacy of your own room! Self-training lessons, mostly silent. No music required.

**FREE BOOK** Write TODAY for Eugene Feuchtinger's great booklet "How to Develop a Successful Voice." It's absolutely FREE! You must state your age. Booklet mailed postpaid in plain wrapper. No salesman will call. Send your name and age RIGHT NOW! Perfect Voice Institute, 210 S. Clinton St., Studio M-2, Chicago 6, Ill.

**15-inch Swing**

Four inches more than other heavy-duty lathes. 33" between centers. Extra features. Compare SHOPSMITH! It's a saw, sander, vertical and horizontal drill, too. Write for free catalog.

**SHOPSMITH, Dept. 180-B**  
 12819 Coit Rd., Cleveland 8, O.



**\$7.75**

Money with order Postpaid

**ALL-PURPOSE TORCH FOR YOUR SHOP**

Adjustable Soldering-Brazing Torch for delicate or heavy work

Air and gas valves adjust flame from needle-point to pencil size. Torch uses air compressor or can be breath-blown. Ideal for silver soldering; light brazing; hardening drills and bushings. Excellent for radiator, electrical and sheet metal work. Lights instantly. Made for natural, artificial or bottled gas. Specify type of gas when ordering. Brass torch, 11½" long. 30 day money-back guarantee.

**MASS COMPANY, 1123 W. 4½ St., Davenport 12, Iowa**

**LAWN ORNAMENT-NOVELTY PATTERNS**

28 Lawn Ornament Patterns, 25c. Other Patterns; 15-20" high; Dutch Girl, Dutch Boy, Pirate, Bull Terrier, Mexican Girl, Mexican Boy, Dwarf, Penguin, Flower Girl, 10c each. 25 Novelty Patterns, 30c. All 62 Full Size Patterns, \$1.00 Postpaid. Strother Pattern Service, Dept. CP-8, Box 129, Belington, W. Va.

**NEW! CHEAP! OIL BURNER**  
 SWEEPING THE COUNTRY!



**SALESMEN BIG MONEY**

SLIPS INTO ANY COAL RANGE, STOVE OR FURNACE

Amazing quick, intense heat. By finger-tip control. Cheaper than coal. No more shoveling coal or ashes. SENT ON TRIAL. Prove it pays for itself quickly by what it saves. Big bonus for testing. We'll

let you try one in your own home for one month. Write for details today. **NORTHWEST MFG. CO., 360 P Main, Mitchell, S. Dak.**

**FREE! 10 HITLER STAMPS!**



**10 SCARCE STAMPS—ALL DIFFERENT SENT FREE TO SECURE NAMES FOR OUR MAILING LIST**

MAIL coupon at once. We'll send you this fascinating set of 10 Hitler stamps. Different sizes, colors, values. NO COST TO YOU. Stamps were issued by short-lived nation of Bohemia-Moravia. Much sought after. Now becoming SCARCE. Our supply is limited. Don't ask for more than one set. We'll also include other interesting offers for your inspection—PLUS a FREE copy of our helpful, informative book, "How to Collect Stamps."

This special offer may have to be withdrawn soon—so rush coupon NOW to: Littleton Stamp Co., Dept. PM-12, Littleton, N. H.

**LITTLETON STAMP CO.**

Dept. PM-12, Littleton, N. H.

Send—AT NO COST TO ME—the ten Hitler stamps and informative booklet, "How To Collect Stamps."

Name \_\_\_\_\_

Address \_\_\_\_\_

City \_\_\_\_\_ State \_\_\_\_\_

**make BIG MONEY**

**LEARN SIGN PAINTING AT HOME**

NOW . . . a complete book on the art of Sign Painting

★  
**"EARN WHILE YOU LEARN"**

Whatever your age or occupation, here is your opportunity to earn from \$3.00 per hour up. ATKINSON'S SIGN ART, a complete book on sign painting, shows you how. Many thousands of ATKINSON BOOK OWNERS now earn \$6,000 to \$25,000 per year, as Sign Painters, Pictorial Artists and Sho Card Writers. Top-Flight opportunities are virtually unlimited . . . the field is wide open and highly profitable. START EARNING SHORTLY AFTER RECEIPT OF BOOK. First job will more than pay for book. ACT NOW.

**ACME PUBLISHING CO., Dept. M, P.O. Box 764 Jackson, Miss.**

Please send me, Postage prepaid "ATKINSON'S SIGN ART" book. I enclose \$5.00 to cover cost, or send COD plus postage ( ).

NAME.....

STREET.....

CITY..... STATE.....



**WANT TO SAVE GAS? BE PREPARED IF RATIONING COMES**

**AMAZING GANE NEEDLE TRY ONE FREE IN YOUR CAR!**

**1/2 MILLION NOW IN USE!**



MANY GANE NEEDLE USERS REPORT UP TO 25% more mileage, faster pickup, easier starting and smoother idling.

**NOW TEST A GANE NEEDLE IN YOUR CAR** for ten days, then compare your mileage and performance. If satisfied, send \$1.50 per needle (8 cyl. cars take 2). If not satisfied, just return it—fair enough? Since authorities differ on its merits and some users report no improvement, **TRY BEFORE YOU BUY!** (Gane Needle replaces idling adjustment screw in carburetors—easily installed in a few minutes.)

**WRITE TODAY. ENCLOSE NO MONEY.** Just send us your name, address, and make.

**NATIONAL AUTOMOTIVE RETAIL CORP., Dept. J-12**  
350 W. Washington Blvd. Venice, California

**FREE Auto Economy Manual**

Tells how to save gas, tires, brakes, etc. Also introduces many new economy products. (Sent absolutely free to all who try Gane Needles.)

**PAY POSTMAN NOTHING.** and year of car.

**CASH IN YOUR SPARE TIME! BIG MONEY IN OWN BUSINESS**

**YOU CAN MAKE UP TO \$40 a DAY** sharpening and setting circular saws for factories, builders, lumber yards—with **LIFE-TIME SECURITY YOUR OWN BUSINESS**

**NEW BELSAW COMPLETE CIRCULAR SAW SHOP.** Low Cost, only \$15 down, sharpens 4 to 5 saws an hour. No experience needed! Instructions furnished. Send Postcard Today for **FREE BOOK.**

**BELSAW MACHINERY CO 3703 Field Bldg. Kansas City 2, Mo.**



**EASY TO WORK WITH! FOAM RUBBER DO IT YOURSELF AND SAVE 50%!**

Your money back if you aren't satisfied with the perfect Foam Rubber! Re-cushion chairs, make your own pillows, mattresses, chair-pads, cushions! You'll save up to 50%—because you buy direct! **SEND FOR FREE PRICE LIST.** No C.O.D. Add 10% for postage and handling.

16 x 16 x 1 1/2" .....	\$1.30
16 x 20 x 1 1/2" .....	1.65
18 x 24 x 1 1/2" .....	2.00
24 x 24 x 1" .....	2.60
24 x 60 x 1/2" .....	4.30

All sizes approximate

Shaped to fit **AUTO SEAT TOPPER PADS**  
24x60x1 1/2" .. \$6.45

**ADAMS FOAM RUBBER** DEPT. 12  
5611 Broadway • Chicago 40, Ill.



**MARVEL Mystery Oil**

- Frees Sticky Valves
- Stops Hydraulic Valve Clatter

Buy it at your favorite gas station



**WOODWORKING VISE** for amateurs and professionals  
**USE UPRIGHT — FLAT — AT ANY ANGLE**  
MAIL CARD FOR FREE FOLDER TODAY  
**THE WILL-BURT CO., Dept. PM-10, Orrville, Ohio**



**NEW TINYTONE RADIO**

Really Works — World's Smallest. New Preset Crystal eliminates All Tubes, Batteries or Electric "Plug-ins" Forever! Sweep band dial—Beautiful Red Plastic case. **GUARANTEED TO WORK** on local stations if used as directed or money refunded—use most anywhere—**SEND ONLY \$1.00** (bill, c.k., m.o.) and pay postman \$3.99 C.O.D., postage or send \$4.99 for P.P. delivery. **COMPLETE WITH EXTRA LONG DISTANCE AERIAL KIT AND PHONE.**

LIMITED SUPPLY — SO ORDER NOW!  
**MIDWAY CO., Dept. BPM-12, KEARNEY, NEBRASKA**



**NEW, IMPROVED CALCULATOR FOR WOODWORKERS only 25c**

Instantly gives information on lumber, nails, concrete mixes, painting materials, etc. Convenient, simple to read. Just set dial for nail specifications, to convert linear to board feet, find bit sizes for screws, compare characteristics of woods. 6" diameter heavily varnished card-board. Send 25c, no stamps, please to **Greenlee Tool Co., 2112 Columbia Avenue, Rockford, Illinois.**



**John Middleton Est. 1856 PIPE-MATE**

Cleans! Scrapes! Reams!

**\$1**

Lifetime stainless steel. Send \$1. We will include a 30c pkg. of Walnut tobacco. **John Middleton, Inc., S.A., 1211 Walnut Street, Philadelphia 7, Pa.**



**LEATHERCRAFT TEXTILE PAINTING COPPER TOOLING**

**PAY-OFF**

Yes, these crafts "pay off" in pleasure and profit. You can do it! Everything you need in Kit Kraft's big illustrated catalog. Send 10c (credited to first order) for catalog today!

**KIT KRAFT 7377 Melrose Ave., Dept. 27 Hollywood 46, California**



**KEEP BATTERY UP**

For quick starts in coldest weather!

Cold weather reduces battery power by 50% but the G.E. Vitalizer maintains battery at full strength... even in coldest weather. Regular use increases battery life. Fits all cars. Portable. Easy to use. Hang Vitalizer on steering wheel. Plug one cord end into cigar lighter, other into any AC outlet. Instructions included. State make and model of car. \$9.95 p.p. Money back guarantee. Send check, cash or M.O. (C.O.D.'s send \$1.00. You pay postage.) **Coast Auto Supply, Dept. P.M., 110 N. W. Broadway, Portland (9), Oregon.**



**Clark EXPANSIVE BIT**

**CUTS BETTER • COSTS LESS!**

Accurate, fast; cuts smooth holes in hard or soft wood. Chrome vanadium steel blades, all chrome body. No. 250, 1/2" - 1 1/2", \$1.89; No. 251, 3/8" - 3", \$2.19. **GUARANTEED.** At your dealer or write Dept. PM-12

**ROBERT H. CLARK COMPANY • Beverly Hills, California**



**ADJUSTABLE HOLLOW AUGER**

USUAL \$7 VALUE **\$2.00**

YES. We said \$7 VALUE! CUTS TENONS or WHEEL SPOKES. Adjusts 1/4 to 1 1/4" Diam. Send cash, check or money order, plus 25c for mailing to **E. G. HOWARD, 2240 S.W. 19th Terr., Miami, Fla.**



**Learn TATTOOING At Home**

Earn extra MONEY—Tattoo blood types and designs in your community. Splendid opportunity in every town. Prepare in spare time. Practical instructions. Send for Free details and list of Tattoo Supplies. No obligations. **ZEIS SCHOOL OF TATTOOING • 728 Leslie, Rockford, Ill.**

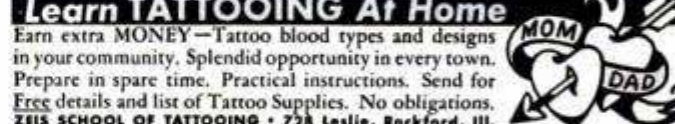

**Build your own JET ENGINE!**

Order these plans today

1. JET PROPELLED BICYCLE. Assemble your own. Photo and instructions, \$1.00.
2. HOW TO MAKE EXPERIMENTAL JET ENGINES. Seven sheets drawings with information and instructions \$2.95.
3. BOTH OF ABOVE in one order \$3.75. SEND NO MONEY. Order both at once \$3.75 C.O.D. in USA plus c.o.d. postage. Send check or Money Order and we pay postage. Get other information too. Rush Order.

**J. HOUSTON MAUPIN, Dept. 55, Tipp City, Ohio**





# FAMOUS 15 & 17 JEWEL BULOVA WRIST WATCH \$16.95 PLUS TAX

UNLIMITED WRITTEN GUARANTEE

# SAVE \$44 ON THIS 17 JEWEL WRIST WATCH \$14.95 PLUS TAX



WERE UP TO \$59.50  
Save \$42.55

Also Choice of  
• BENRUS  
• GRUEN  
• WALTHAM  
• ELGIN

You get these unredeemed UNLIMITED GUARANTEED famous make watches in latest style Yellow Gold Cases at this sensationally low price because we bought out SURPLUS STOCKS of leading New York and Md. jewelers. Order now while they last. Specify make preferred and whether men's or ladies! Only \$16.95, plus \$1.70 tax. Order right now!

FREE 10 DAY TRIAL

FREE EXPANSION BAND WITH EACH ORDER

FORMERLY SOLD FOR \$59.00  
**INCABLOC** SHOCK PROTECTED  
WATER & DUST PROOF  
Worn by ARMY, NAVY & MARINES

Luminous dial, sweep second hand. Super Accurate. Imported Swiss precision movement and case. You get these brand new UNLIMITED GUARANTEED watches now for a small fraction of the original price. You save \$44, because we bought out surplus stocks. Order men's style \$14.95 plus \$1.50 tax or ladies' and nurses' style, \$16.95, plus \$1.70 tax. Order now at this low price.



NURSES' MODEL \$16.95 Plus tax

**WEAR AT OUR RISK!**  
Money Back guarantee in 10 days if not delighted!

SEND ONLY \$1 DOWN PAYMENT with order. Pay balance to postman on arrival plus postage. Or we pay postage if you enclose full payment plus tax. AIR MAIL XMAS DELIVERY GUARANTEED!

**MARYLAND DISTRIBUTORS, Dept. 337**

501 E. BALTIMORE ST.

BALTIMORE-2, MARYLAND

**FREE!** WATCH AND JEWELRY CATALOG AT ALMOST WHOLESALE PRICES!

# POWERFUL MIDGET MOTOR

DRIVES MODEL PLANES, BOATS, CONSTRUCTION SETS, Etc. WITH AMAZING SPEED! RUNS ON FLASHLIGHT BATTERIES!

**BOYS! MODEL-MAKERS!** Get this new MIGHTY MIDGET D. C. Electric Motor. It's a honey! Looks and runs just like a big one. Motor is powerful yet measures only 1 x 1 x 1 1/4 inches; weighs one ounce! Turns up to 6,800 r.p.m.'s. REVERSES instantly. Motor is in durable black plastic housing. Comes complete with two 1 1/2 volt batteries in clip holder, transparent plastic gearbox—PLUS ten extra gears and pulleys for working out your own ratios. No shocks, sparks or shorts. And no transformer is needed. Endless hours of fun. Educational, too! Money back guarantee!



ONLY \$2.98



Runs on Ordinary Flashlight Batteries!



Multi-Ratio Gearbox Included!

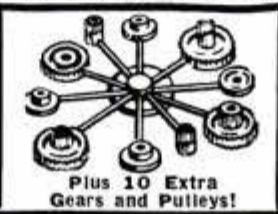

Plus 10 Extra Gears and Pulleys!

Send no money. Order today. Pay postman only \$2.98 plus postage when delivered. Or send \$2.98 with order and we will pay postage. Supply is limited. Write NOW!

**IMPERIAL SALES CO., Dept. C-008**  
114 East 47 Street New York 17, N. Y.

Say You Saw It in Popular Mechanics

## LEARN MOVIE PROJECTION THEATRE MANAGEMENT

The Motion Picture Theatre Business offers big opportunities for trained men. Get into a fascinating field with a peace time future. Train at home in spare time. Free catalog. Established 24 years.

**THEATRE INSTITUTE, 370 Washington St., Elmira, New York**

## FILE your own SAWS... easy!



A SPEEDCOR TOOL!

Do expert saw filing without experience. Keep your hand saws extra sharp, true-cutting. Easy to use. Money back guarantee. Cash with order, prepaid. (COD postage extra.)

COMPLETE \$2.95 WITH FILE

**THE SPEED CORP. PM-12**  
512 N.E. 73 Ave., Portland, Oregon

## SHEET METAL BRAKES

Forms angles, flanges and Pittsburgh locks. 26 gauge steel, heavier aluminum. Cam locking. Portable, can be bolted to bench, or clamped to truck. All steel, reinforced.

Shipped Exp. Coll. 30" size. Wt. 54 lbs. \$26.50. 36" Wt. 66 lbs. \$31.00. 48" Wt. 100 lbs. \$45.00. Floor mountings, portable, 32" high, 30 lbs. \$7.00. 12" BRAKE. Fits in vise to form difficult compound bends, up to 20 gauge steel. Not illustrated. \$12.50 PP.

HYDRAULIC PRESS BRAKE forms 1/4x4, or 1/4x2-in. 3/4" Pipe Bender and Bar Bender and Straightener up to 1/2" thick. Uses your 5 ton jack and forms various small parts in heavy steel. \$18.50

24" CURVE FORMER, 2 roll, 16 gauge, 2" to 2" dia. \$10.00 P.P.

IRON BENDER, 1/4x2" capacity. 10 parts. All steel. \$10.00 P.P.

Immediate Delivery. Order direct, cash or C.O.D. or send for folder.  
**VYKE BRAKE CO., P-1116 So. 27th St., Omaha 5, Nebr.**



30"-36"-48"

A necessity for EVERY home owner, hobbyist, mechanic & repairman. Ideal for general soldering, electrical, radio, TV, home & hobby



all for only \$3.95 Post Paid!

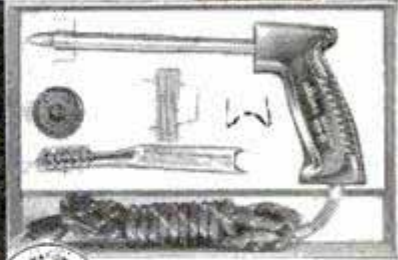

80 watt, ac-dc 110-120 volt UNCONDITIONALLY GUARANTEED

Look what you get: ELECTRIC SOLDERING IRON with heatproof pistol-grip that fits hand. SOLDERING IRON STAND WIRE CLEANING BRUSH WIRE SOLDER & FLUX

USE HANDY ORDER COUPON

atkins INDUSTRIES, INC. Dept. P.M. 12 1435 Hubbard St. Chicago 22, Ill.

Enclosed \$3.95 (check, money order). Send Kit POSTPAID.

Enclosed \$1.00 part payment, will pay bal. on C.O.D. delivery.

Name \_\_\_\_\_

Address \_\_\_\_\_ Zone \_\_\_\_\_

City \_\_\_\_\_ State \_\_\_\_\_



To bring  
him joy

GIVE  
**PRINCE  
ALBERT**  
AMERICA'S LARGEST-  
SELLING SMOKING TOBACCO



● Say "Merry Christmas" by giving Prince Albert to your pipe-smoking friends and those who like to roll their own cigarettes. With Prince Albert, "The bite's out and the pleasure's in!" The choice tobacco is specially treated to insure against tongue bite!

The big one-pound tin is colorfully gift-packed, ready to give . . . with a built-in gift card on top!

THE NATIONAL JOY SMOKE

R. J. Reynolds Tob. Co.,  
Winston-Salem, N. C.



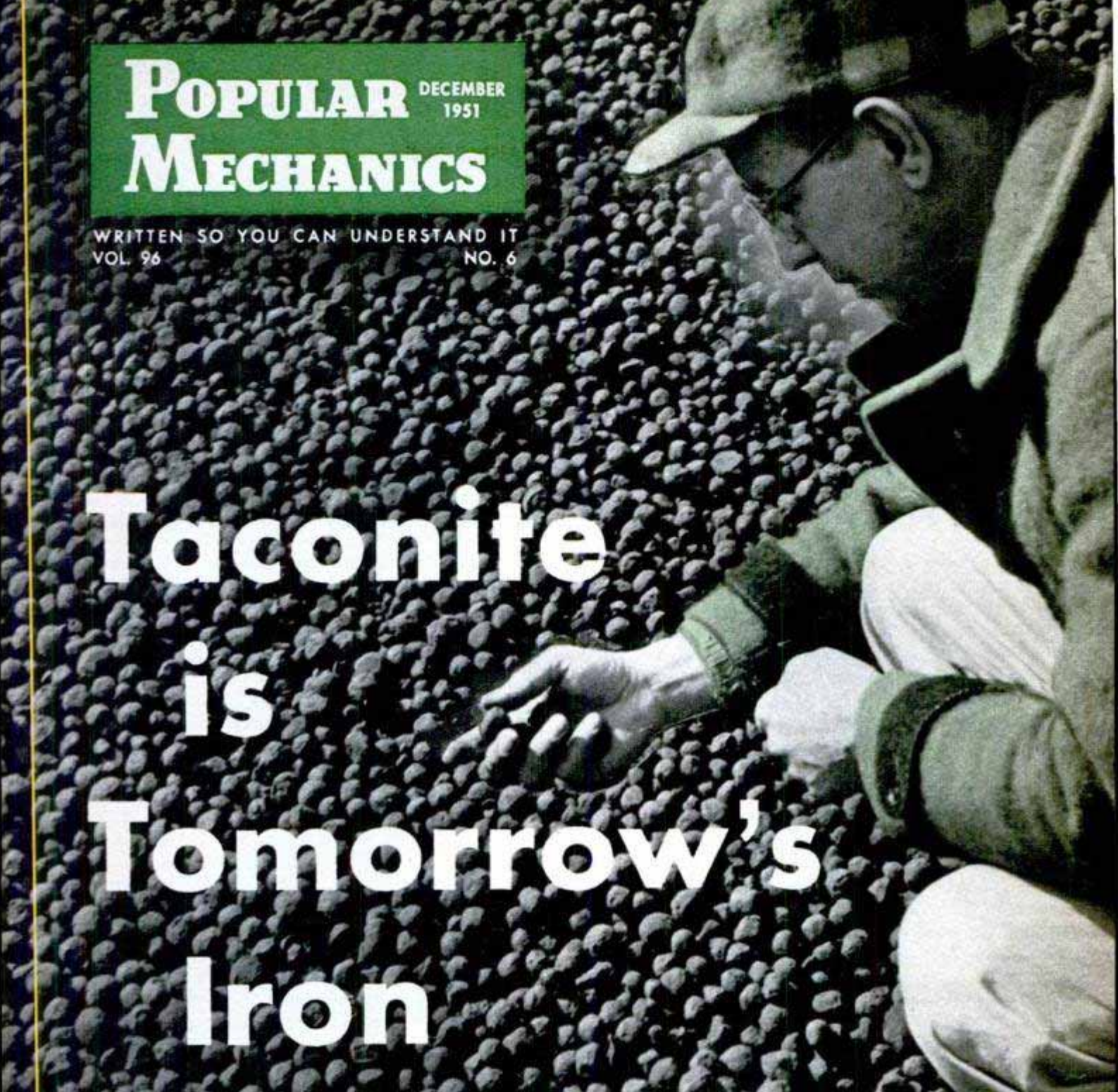

# Taconite is Tomorrow's Iron

By Clifford B. Hicks

**N**EAR THE LITTLE TOWN of Aurora, Minn., a rough gravel road strikes north from Highway 35 and snakes through the spruce and birch wilderness that smothers the iron range. The road skirts a weed-grown railroad track for a mile or more, then crosses over and comes to an end smack up against one of the most modern and significant factories in the world.

Inside the huge factory, men are at work 24 hours a day, seven days a week, turning out mud balls. You might call them half-billion-dollar mud balls, for if this factory and similar plants ring the bell, about that

Marbles of taconite are pouring out of the Minnesota wilderness by the thousands of tons. Pellets are the end result of a long battle with the flint-hard rock

much money will be scattered across the iron range. The cash will be used to turn out lowly mud balls—and cinders—by the millions of tons. They'll be remarkably rich in iron, iron extracted from a rock almost as tough and unmanageable as flint.

Taconite promises to be America's newest—and probably richest—treasure. One look at the jagged rock would convince you it wouldn't even make a good gravel road. Yet steel and mining companies already have committed some \$43,000,000 just for research on the stuff. It's highly probable that another \$150,000,000 will pour out





Big shovel bites into a plain rock quarry that will yield iron. Above, taconite can be fused into cylinders instead of pellets.

before long. But these commitments are mere pennies compared to the huge investments that may follow later.

Making iron out of worthless rock isn't a new process—a small plant near Coleraine, Minn., started treating low-grade sandy ores as far back as 1910. After World War II, all the big steel companies started wrestling with the knotty problem of how to force the stubborn rock to surrender its iron content. The significant news is that now, for the first time, huge taconite plants are looming above the tall pines of the iron range. They represent a new basic industry.

The industry is based on Nature's work of a billion years ago. That's when the story of the wilderness factories really started, though in those days there wasn't a footprint, animal or human, across the face of the primeval world. A vast ocean covered the northern part of what, aeons later, was to become the United States. For millions of years the water patiently deposited a sediment on the ocean floor, a gelatinlike accumulation with a high iron content. As the ocean receded, the gelatin turned into a layer of flint-tough rock. Then even this blanket of rock was drifted over with

tons and tons of various surface materials.

Eventually, vast forces within the earth tilted and folded the rock, exposing it to slow but sure erosion on the surface. Water percolated down through the tilted layers in a few places and, over a long period, cut the rock and washed away much of the sand, leaving pockets of fluffy, earthy material rich in iron. Then came the glaciers, scraping away many of these pockets.

And last came men who discovered the remaining pockets and began ripping them out. In 100 years man took 2,300,000,000 tons of ore from the Lake Superior deposits. That's a lot of ore, but actually it's only the raisins in a vast, rich cake.

Nature didn't have time to complete her work before man started gouging the ores from the ground. On the western end of the Mesabi, Nature's job is half done. Here miners have found big deposits of ore with the rock broken up, but little of the resulting sand leached away.

The result of this billion-year erosion is a broad range of materials in the Lake Superior region, from high-grade ores with more than 50-percent iron to tough taconite with 30 percent and less. The in-between

## TACONITE—FROM SOLID ROCK TO BLAST-FURNACE PELLETS

From left to right are the steps in making taconite pellets. Big chunks of solid rock are crushed into smaller pieces. These are further crushed into a powder, and the iron-rich particles separated from rock by magnets. Iron-rich powder then is "snow-balled" into pellets and baked

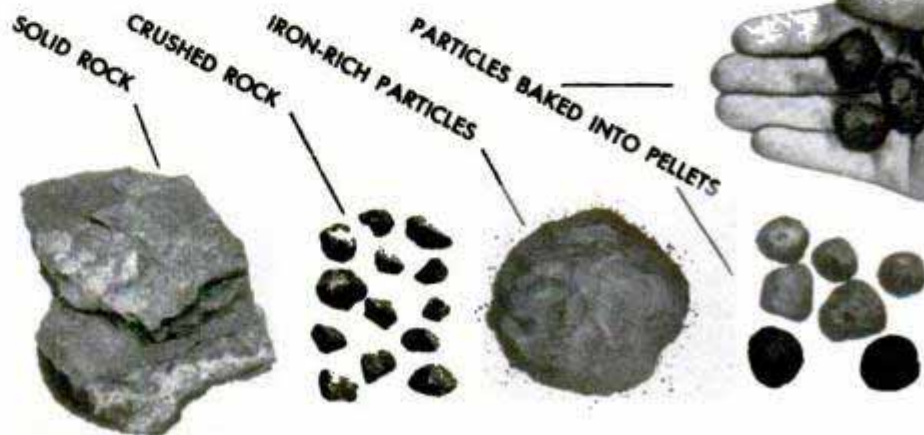



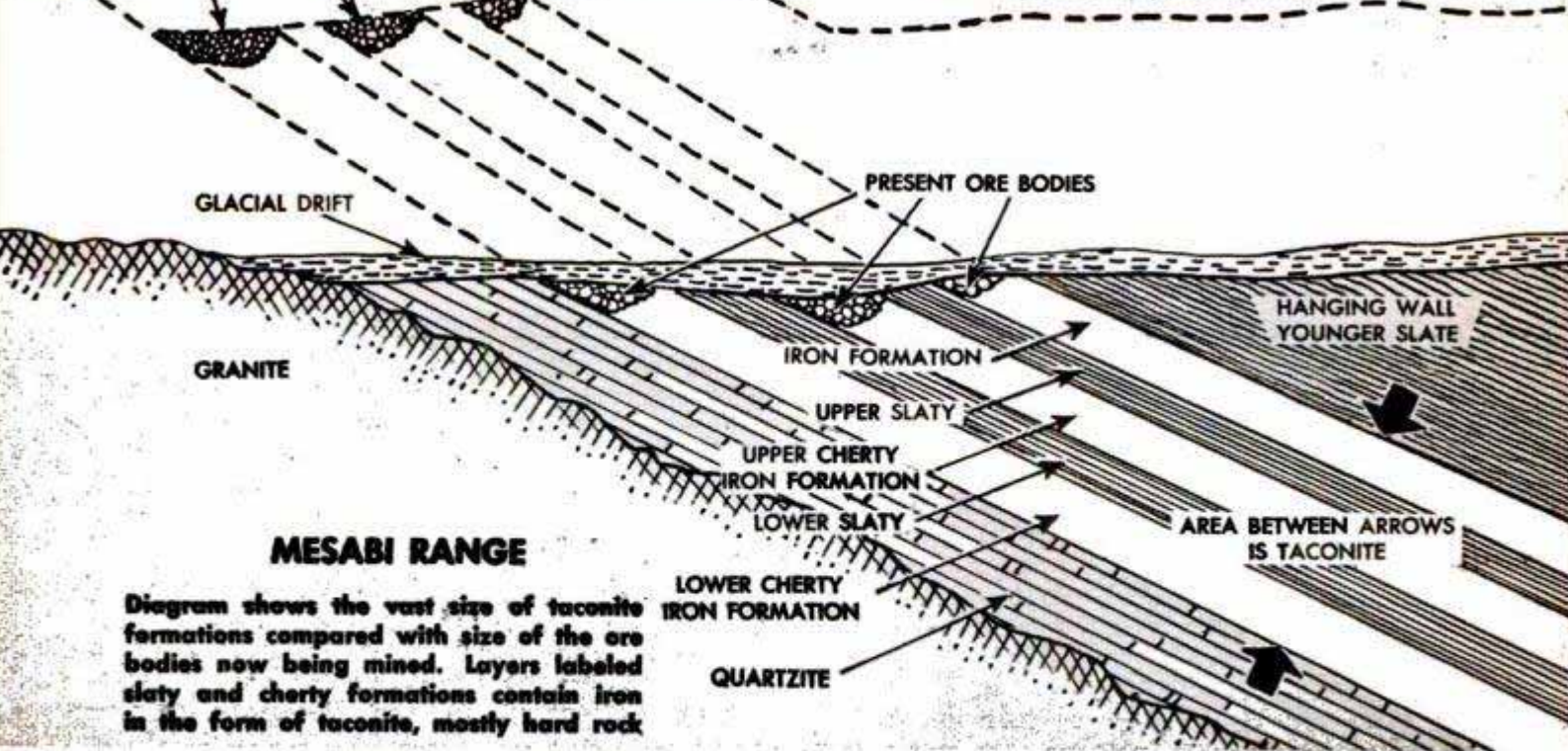

stages, where Nature started but couldn't finish her work, are called "intermediate" and "wash" ores. Miners concentrate wash ores simply by washing away the grainy sand with water. Intermediate ores can be smashed to sand-size particles, then treated like wash ores. For the past decade about 25 percent of the shipments from Minnesota have been these concentrated ores. Now at last, miners are shipping taconite. Today, when blast furnaces are turning

out a swelling river of molten metal, authorities report there's cause for worry but no cause for panic in surveying our iron-ore reserves. Some experts say that, roughly, about two thirds of the direct-shipping ores in Minnesota have disappeared. According to these authorities, the remaining rich ore will last anywhere from 15 to 37 years. Meanwhile the blast furnaces will devour ever-higher ratios of wash and intermediate ores.

Paddles of a washer agitate "wash" ores, carry away the sand. Such ores now are replacing richer ones  
 Oliver Mining Co. photos

With these rigs, miners are test-drilling all over the iron range to learn extent of the taconite deposit

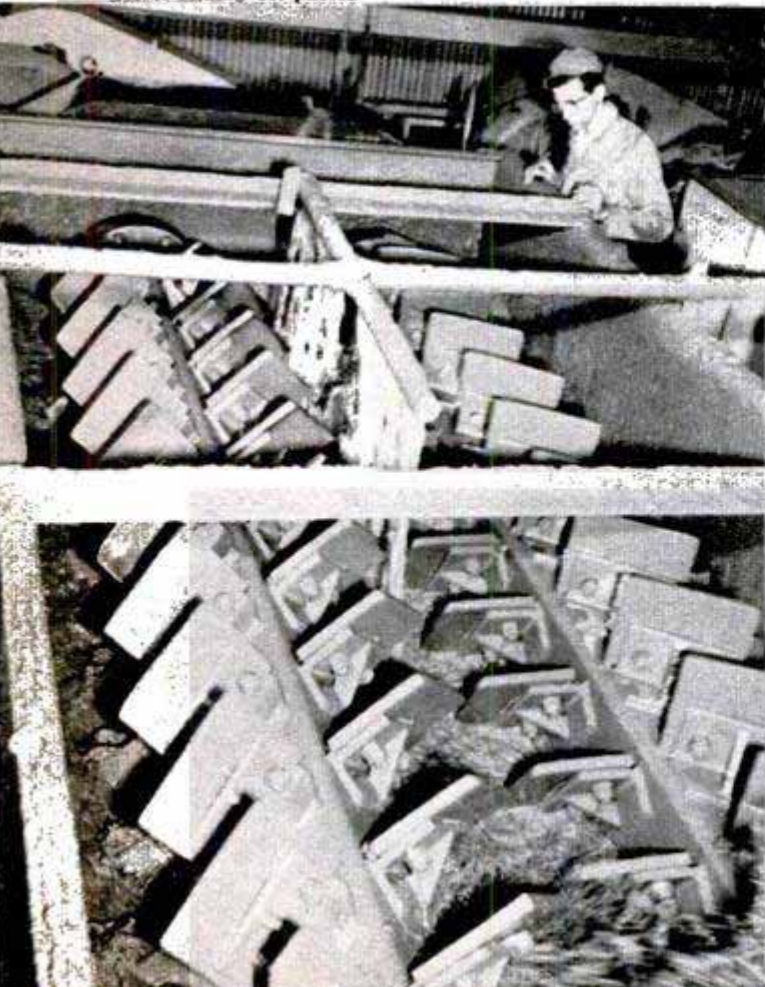



Chicago 1, 2, 3

Steel companies, though, think in generations instead of years. Where will America find its iron when the direct-shipping ores and even the intermediate ores are exhausted? Steelmen already are importing Venezuelan ores and casting long looks at the deposits up Labrador way. But even more earnestly they are tackling taconite, the hard rock that serves as flour in the vast cake. One authority has estimated that there are 67 billion tons of taconite underlying the Lake Superior area. That's a whale of a cake.

Can iron be extracted economically from this flinty rock? Research men say yes. Inside their factories in the wilderness they propose to do the same job, in a few minutes, that Nature could accomplish only in a billion years.

"We'll make it work, too," says an old-time mining engineer. Then he adds grimly, "We've got to!"

Here's the problem, sample size. The miner of the future will blast a chunk of hard rock from the earth. He'll grind it to particles as fine as sifted flour, then patiently sort out the iron-bearing particles from the plain rock particles. Most difficult of all, he'll stick the iron bits back together again to cook up a diet acceptable to the blast furnace.

Down in Ashland, Ky., the Armco Steel Corporation has a million-dollar plant going full blast, making 70,000 tons of iron-rich mud balls a year. But the major investment will go to the iron range itself. The big Aurora plant of Erie Mining Company is the first of several such factories. At Virginia, Minn., the Oliver Mining Company now is constructing a plant to produce a million tons of taconite concentrates a year. At Babbitt, Minn., another plant will be turning out pellets very shortly. This big factory is the first installment of Reserve Mining Company's \$70,000,000 project at Beaver Bay, Minn., which by 1955 is expected to roll out a thumping 2½ million tons of pellets each year. It's a major revolution in the steel industry.

Turn up the gravel road off Highway 58 and you'll find concrete evidence of the revolution. The Aurora plant of the Erie Mining Company is perched on the edge of its own iron mine. Actually, it isn't a mine but a plain rock quarry that yields everything from boulders to pebbles.

Old-time miners swear that taconite is tougher than anything but old-time miners. Ordinary mining drills chew themselves right out of existence trying to penetrate the stuff. Luckily, the new jet-piercing drill came along just in the nick of time. The drill is a towering, searing flame-thrower, using oxygen to create fantastically high

(Continued to page 254)

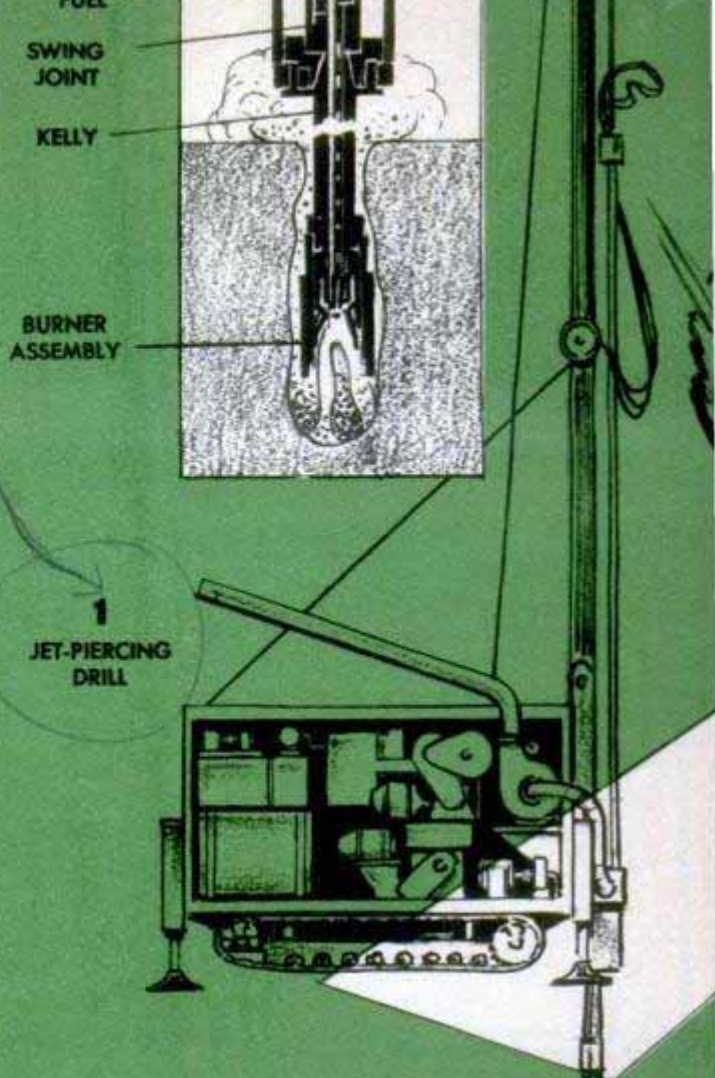

1  
JET-PIERCING  
DRILL

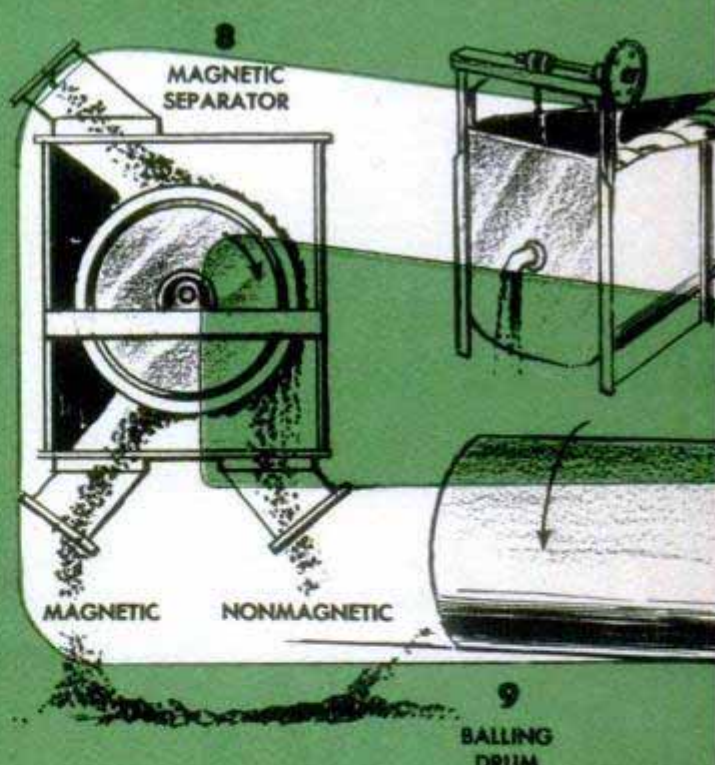

9  
BALLING  
DRUM



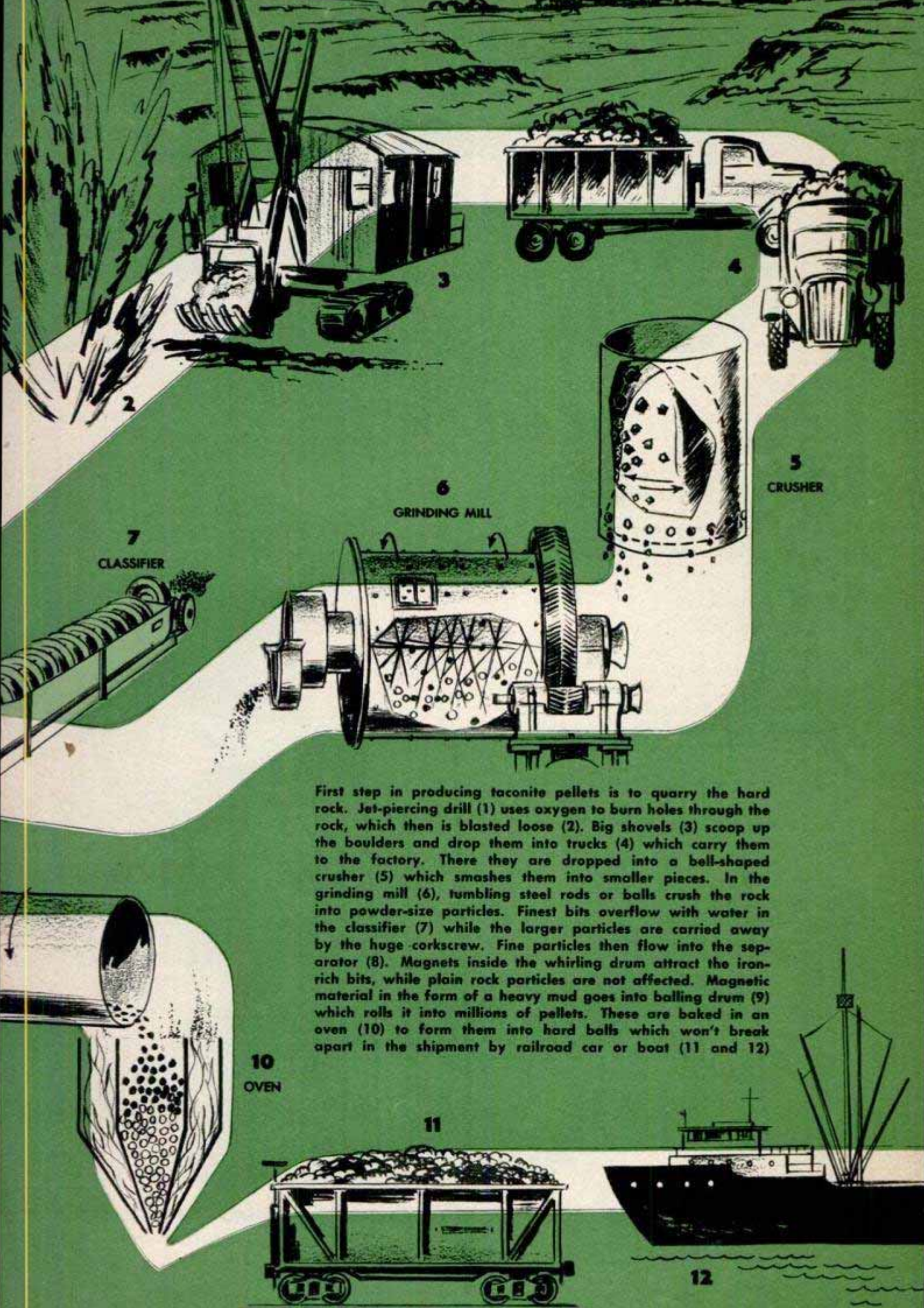

7  
CLASSIFIER

6  
GRINDING MILL

5  
CRUSHER

10  
OVEN

11

12

First step in producing taconite pellets is to quarry the hard rock. Jet-piercing drill (1) uses oxygen to burn holes through the rock, which then is blasted loose (2). Big shovels (3) scoop up the boulders and drop them into trucks (4) which carry them to the factory. There they are dropped into a bell-shaped crusher (5) which smashes them into smaller pieces. In the grinding mill (6), tumbling steel rods or balls crush the rock into powder-size particles. Finest bits overflow with water in the classifier (7) while the larger particles are carried away by the huge corkscrew. Fine particles then flow into the separator (8). Magnets inside the whirling drum attract the iron-rich bits, while plain rock particles are not affected. Magnetic material in the form of a heavy mud goes into balling drum (9) which rolls it into millions of pellets. These are baked in an oven (10) to form them into hard balls which won't break apart in the shipment by railroad car or boat (11 and 12)



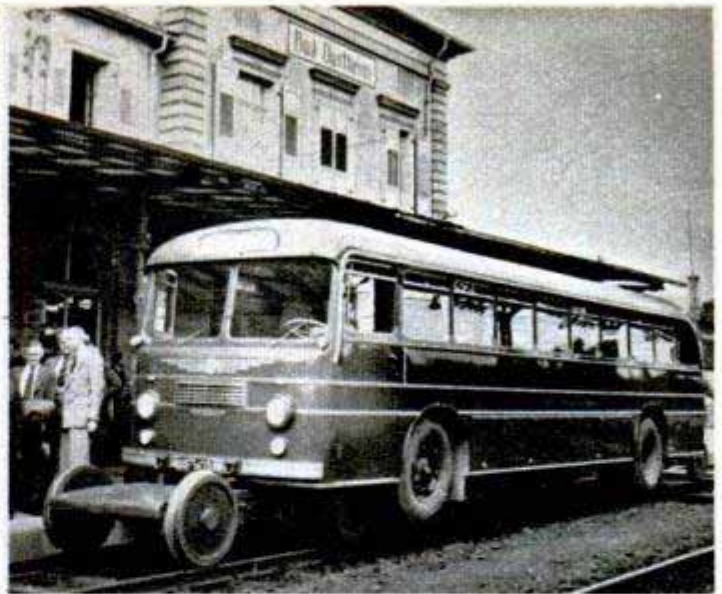
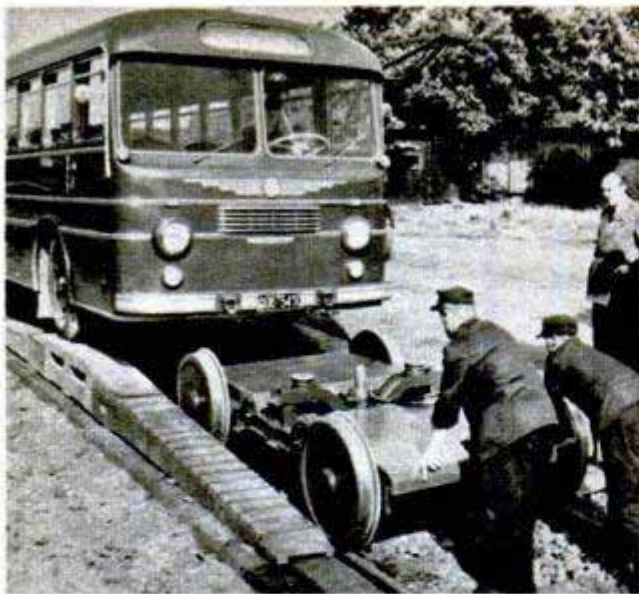

## Bus Rolls From Highway to Rails

Busses in Germany soon may turn off the highways and start rolling down the rails. In tests for the German Federal Railways, two four-wheel carriages were slipped under a bus to support it on the rails. The back wheels of the bus rest on the rails to provide traction, yet the two carriages support the weight. In the tests the bus was

driven up a ramp and the carriages then were pushed beneath the vehicle, but if the system becomes standard the busses will be lifted by hydraulic pressure. Railway officials say the busses can travel 50 miles an hour down the rails. It is planned to run the road-rail busses to remote rural sections which have no rail service.

## Plastic "Tent" Fumigates Soil

Weed and insect pests are completely eliminated from seedbeds by covering the plots with a plastic "tent" and fumigating the soil before planting. The tent is a lightweight vinyl film, gastight and moistureproof. A low framework of boxes and boards is erected over the bed, and the sheet of plastic unrolled to cover the framework. All the edges are sealed with packed-down earth. Cans of methyl bromide, the fumigant, are opened beneath the cover, which is left in place for 24 hours while the gas released

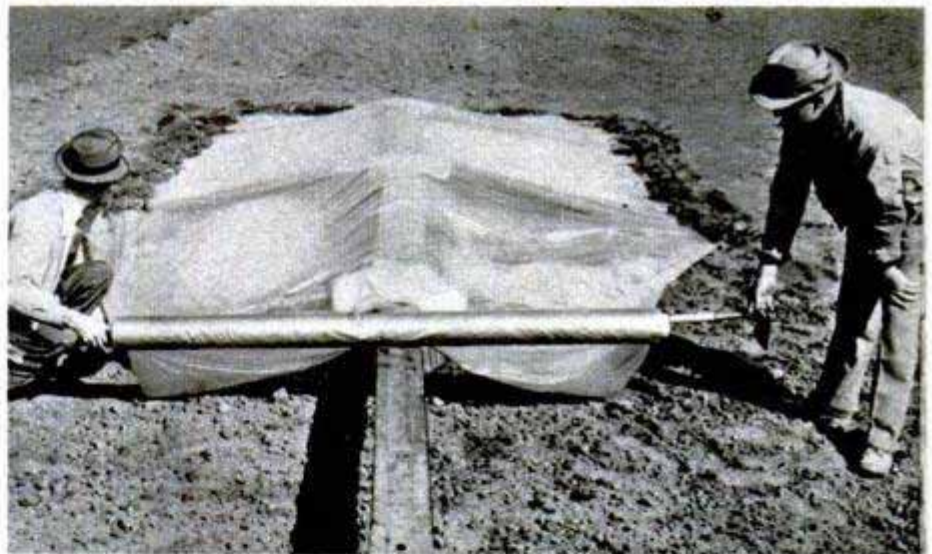

from the chemical kills all plant and insect life in the soil. The bed then is aerated 48 hours before planting. The fumigant comes packed in handy storage cartons.

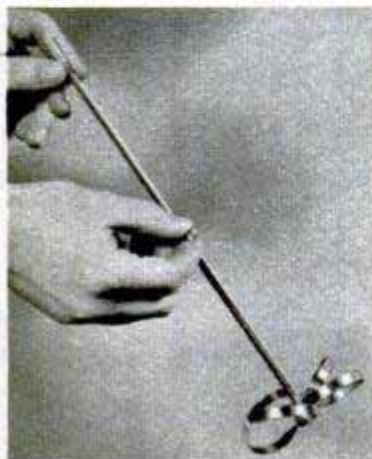

## Expanding Mixer

Slender enough to slip through the narrow neck of laboratory flasks and bottles, an expandable mixer opens like an umbrella to four inches wide. In addition, its shape can be altered to produce the particular type of stirring, mixing or agitation required by the technician. It is especially suitable for stirring food products and biological preparations that should not be exposed to air.



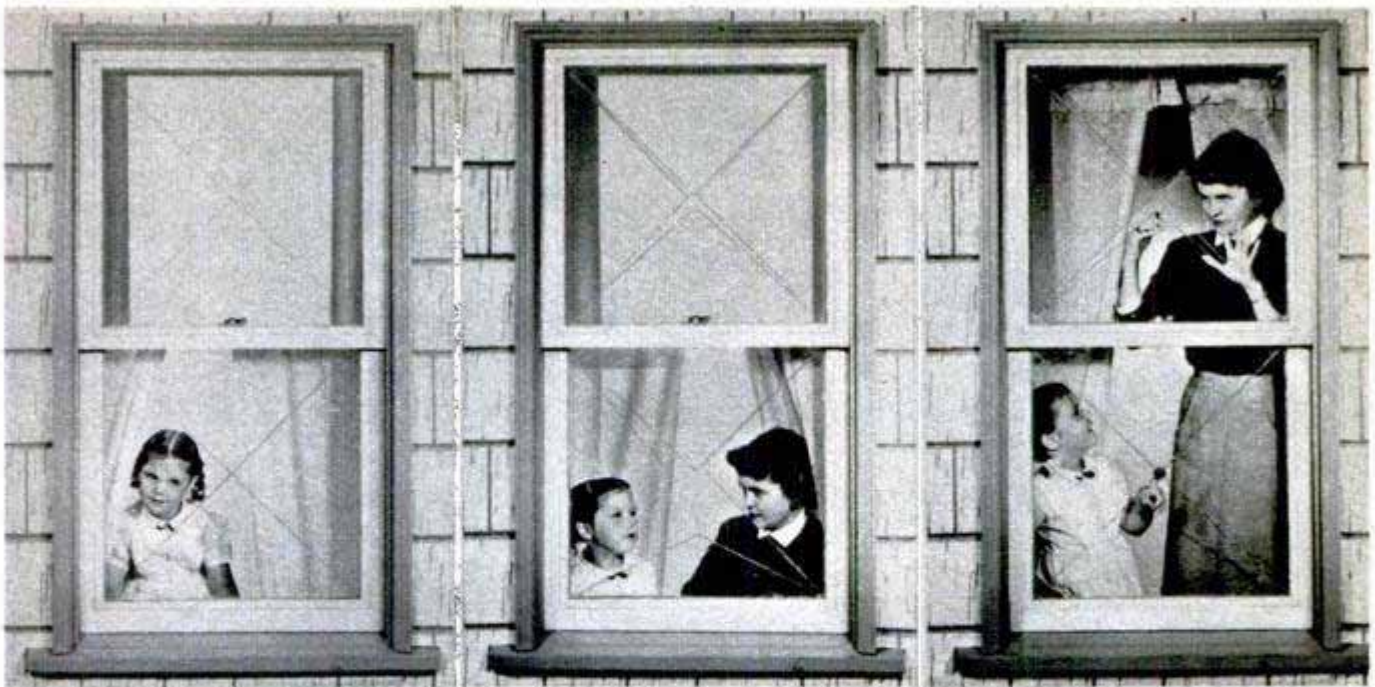

Window with plastic "hinges" has normal appearance except for criss-cross lines marking off the panes

When blast wave from explosion strikes, panes part and swing into room instead of shattering apart

Window can be repaired temporarily with bolt and washers, adhesive tape or a wad of chewing gum

## Bomb Windows

Glass-plastic windows of a new design won't blow into a room, frame and all, from the blast of a heavy near-by explosion. The windows, developed by the Pittsburgh Plate Glass Company, open up like doors if an outer layer of glass is broken. A pane consists of the outer glass, a middle layer

of plastic which extends beyond the glass edges and is bolted to the frame, and an inner layer of four triangular-shaped pieces of glass. When the outer glass is broken, the inner glass segments open like doors with the plastic serving as hinges. The window can be temporarily repaired with adhesive tape, a bolt and washers or even chewing gum.

## Car Watch

Movement of the steering wheel winds a new car watch automatically. The time-piece, optional equipment on the 1951 Oldsmobile, is mounted on the steering wheel. Turning the wheel actuates pendulum weights to wind the watch's Swiss movement. Five miles of city driving or 20 miles of highway driving will keep the watch running about two days. It also can be fully wound by rotating a flange around the face. A red arrow on the dial can be set at the departure time when starting a trip, then checked upon arrival to show the elapsed time. The watch is shock-resistant and antimagnetic, and the protective lens is made of shatterproof plastic.

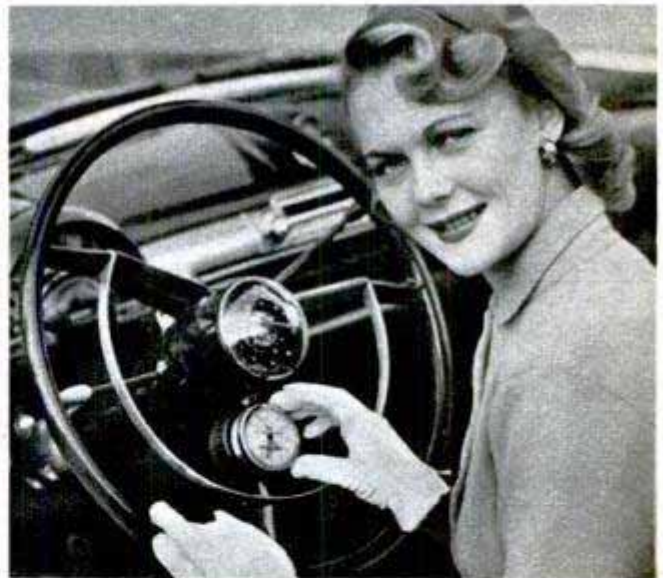

## Lightweight Battery Will Start Car at 65 Degrees Below Zero

At a temperature of 65 degrees below zero, a new lightweight storage battery will immediately start a car. Furthermore, the battery is expected to save large amounts of lead, and it maintains its charge for a long period. Developed at the University of Michigan under sponsorship of the Army Ordnance Corps, the battery is made by lead-plating certain materials ordinarily

corroded by sulphuric acid. Aluminum, brass, iron or copper can be used in the battery. In tests it has operated effectively in temperatures from 165 degrees above zero to 65 below. Due to its low self-discharge rate it can start a car after it has been stored all winter. Research men who developed the battery expect it to be available commercially.





Smilie polishes a huge bowl, four feet in diameter, decorated with leaf design. Right, he prepares a plastic "sandwich" for heating in his baker's oven

BUTTERFLIES and leaves, wheat stems and feathers—almost anything of natural beauty—may show up in the colorful handiwork of Spencer Smilie. The Beverly Hills, Calif., craftsman has developed a unique method of molding plastics around such objects without pressure. Most lamination processes require immense pressures. Smilie bakes crushed plastic crystals in pans to form large sheets. Then he places the leaves or butterflies between two sheets and bakes the "sandwich" until the plastic has melted and completely encased the objects. The sheet then is cut and fashioned into lamp shades, bowls, screens, murals and tabletops.



## PLASTIC "SANDWICH" ARTISTRY

Artist works out a beautiful pattern of wheat stems in a mold. Occasionally he uses impressions of natural objects instead of encasing objects permanently

Decorative screen, made of large curved panels of plastic, has a gleaming leaf design. The craftsman does his work without subjecting plastic to pressure





Color of leaves tends to fade during baking, so the artist paints them first with a special dye which enhances their natural color



Huge bowl has a lacy design made with real ferns. Design is first embedded in a flat sheet of plastic, which is then reheated and worked into shape of bowl

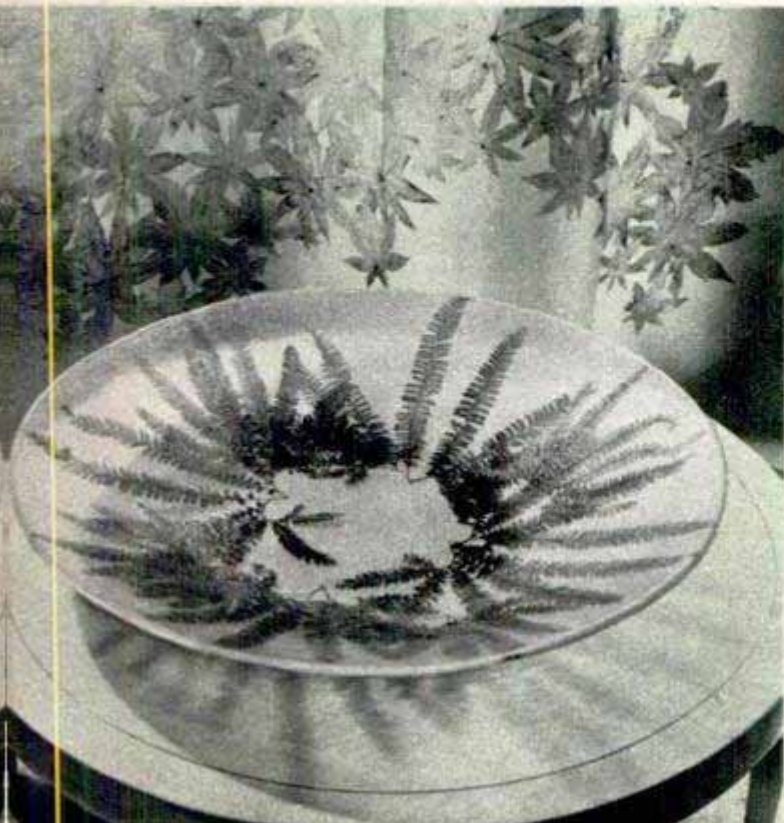

Smilie fastens curved sections of a screen together. It has a wheat-stem design. Such screens sometimes are used as light baffles to cast a colorful glow







Defense Department photo

## Jeep Power Plant

Through the classic GI system of scrounge, borrow, modify and make-do, officers and airmen at Haneda Air Force Base in Tokyo have built a roving power plant for quick servicing of airplanes. The Jeep-mounted unit replaces cumbersome and time-consuming generators and compressors required to service aircraft. Four

different power sources are available on the Jeep. An alternating-current generator powers lights, drills, soldering irons and other tools. A direct-current generator produces at least 200 amperes for starting aircraft engines. One air compressor yields 100 pounds of pressure for air rivet hammers and drills, while another produces 1500 to 2000 pounds for servicing hydraulic units on the planes.



## Lightweight Revolvers

Snub-nosed revolvers of various types are being tested by the Air Force as possible replacements for the .45-caliber automatics now in use. Developed to Air Force specifications, the new .38-caliber models all have 2-inch steel barrels, but the frames and cylinders are made of a lightweight aluminum alloy.

☛ A new attachment converts any 16-mm. movie projector to a slide projector showing single frames of filmstrip.



## Graphite Spray

Synthetic graphite under aerosol pressure makes it easy to lubricate new or rebuilt automotive engines before the final assembly. Two or three ounces of graphite, according to the manufacturer, sprayed on engine parts provide a tough, oil-retaining and acid-resisting film that protects the parts during the critical break-in period. The graphite is sprayed by pressing a button on the container.



# LET'S SEND TV AROUND THE WORLD

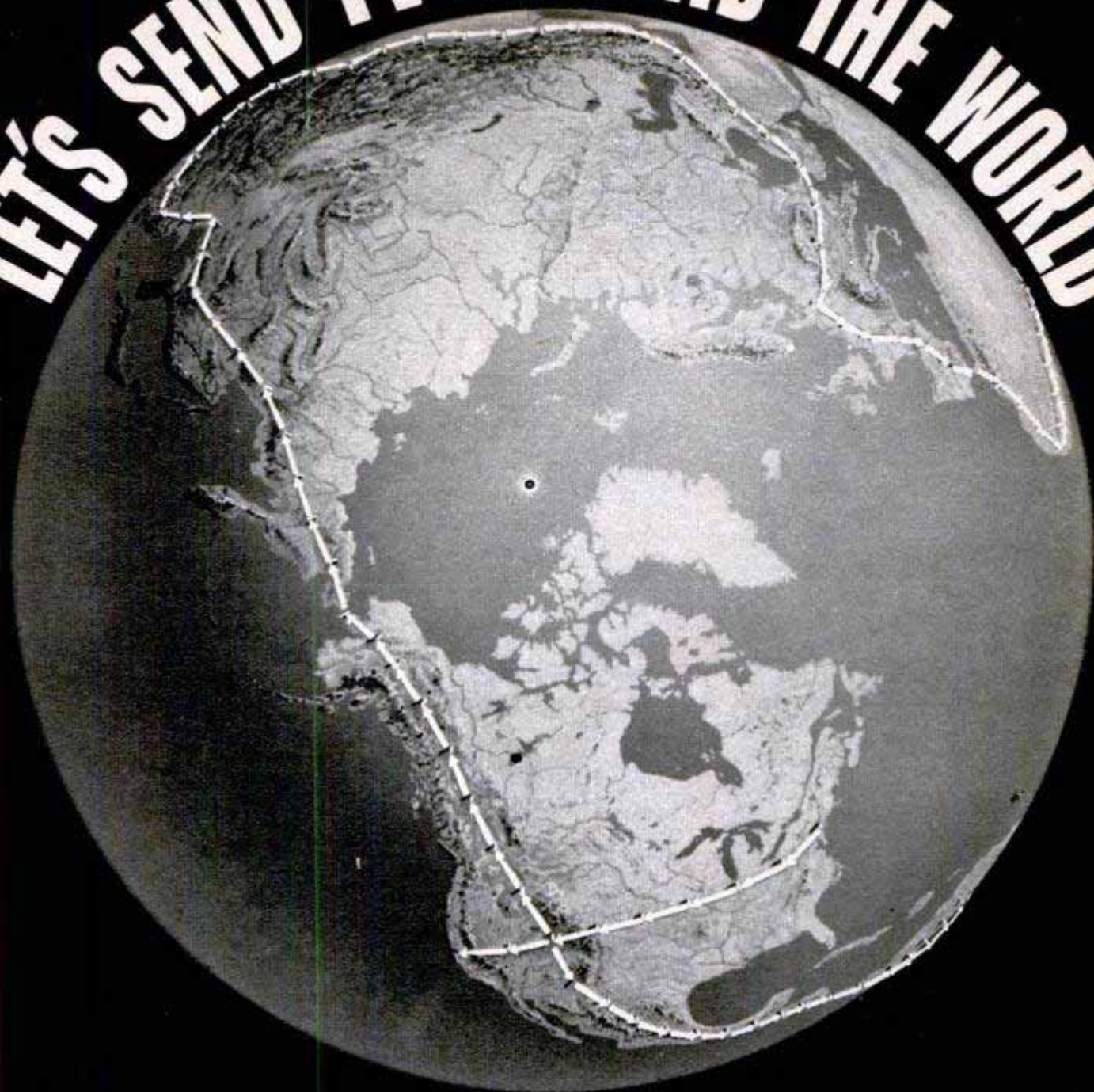

Illustration by Leydenfrost

Microwave towers could march up West Coast, jump the Bering Strait, traverse Asia, Africa and Europe

## By Brig. Gen. David Sarnoff

Chairman of the Board, Radio Corporation of America

**B**EFORE *Popular Mechanics* celebrates many more birthdays — the magazine will be 50 years old next month—the television screen in your living room promises to be far more than just a fascinating stage for domestic events and entertainment. It may well be a picture window with an instantaneous view of the whole world.

We know the scientific principles for sending TV signals soaring across oceans and linking continents. Only details and economics must still be worked out. When they are, the horizons through your TV

picture window will move out to the corners of the world. At the flick of a dial, you'll be able to bring the sound and sight of exciting events in distant lands to your armchair side. They will be the events going on at the instant—not yesterday's or last week's.

You'll watch the progress of an expedition moving through the heart of Africa, an international sports event in Scandinavia, a shopping excursion in an Oriental bazaar, a beauty contest in progress on a beach in Rio, an international meeting of minds



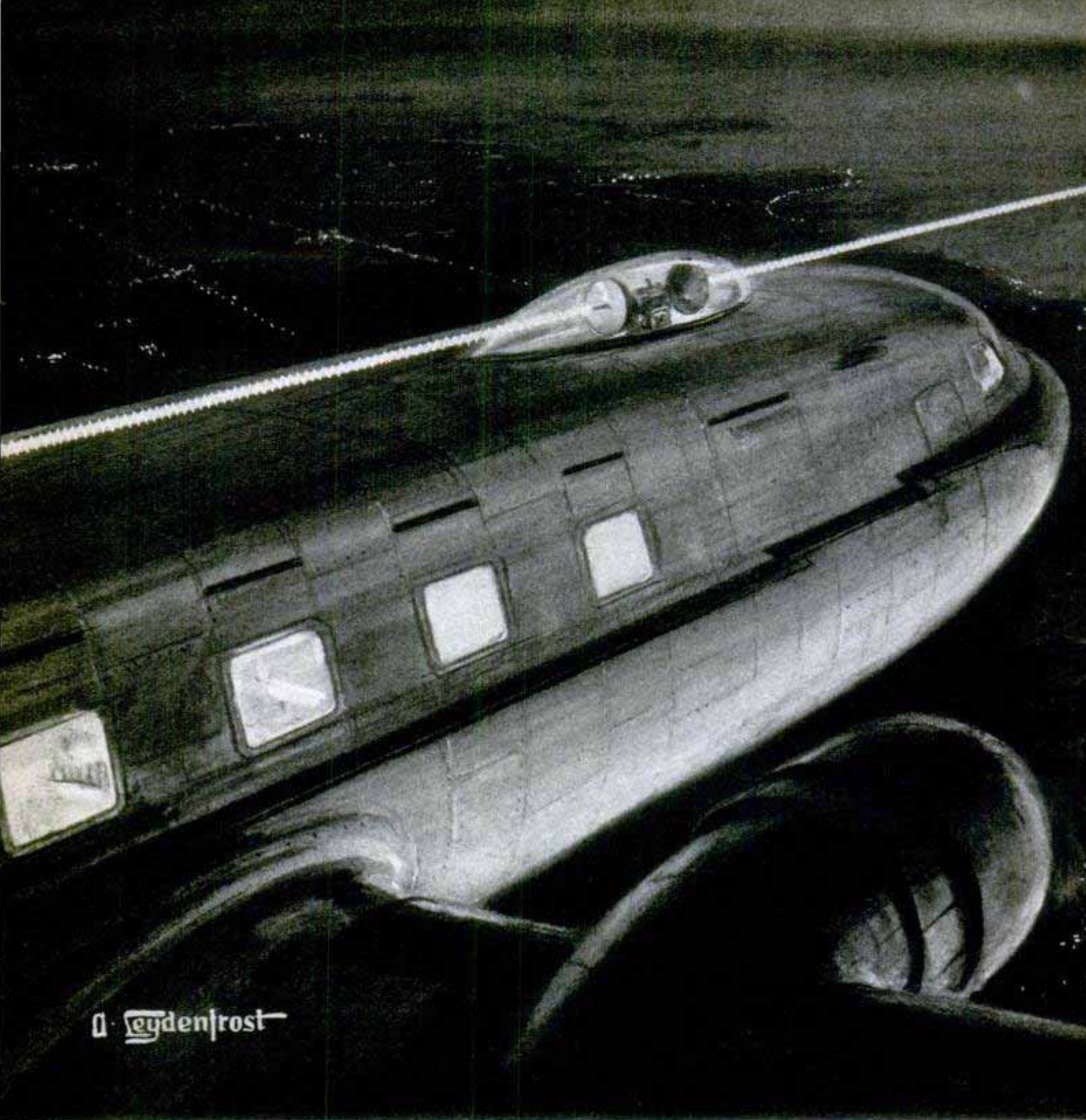

Leidenfrost

being held, perhaps, somewhere in Europe.

How can these wonders be achieved? Although the range of television signals is limited today, several specific ways of beaming programs around the world are known. One is to set up chains of microwave relay towers that would march across the countries of the globe like rows of pins on a battle map, each one picking up, boosting and sending signals along to the next.

Such a network of towers, spaced about 20 to 50 miles apart, would have to girdle the world by land routes. If you look at your map you'll see it's possible. From Patagonia to Alaska, one tower chain

would link the west coasts of the Americas, with tie-in chains to major cities. Across the Bering Strait from Alaska to Asia is only 40 miles—a normal hop between towers. You can actually *walk* to Russia in the wintertime when the channel is frozen over.

From here the tower chain might trail down across Siberia, China, India, Iran and Iraq, where it would split—one branch heading out across the deserts and the veldts of Africa; the other probing up into the countries of Europe. Thus the world would be encompassed by one communications net.

There's nothing fantastic about this idea.



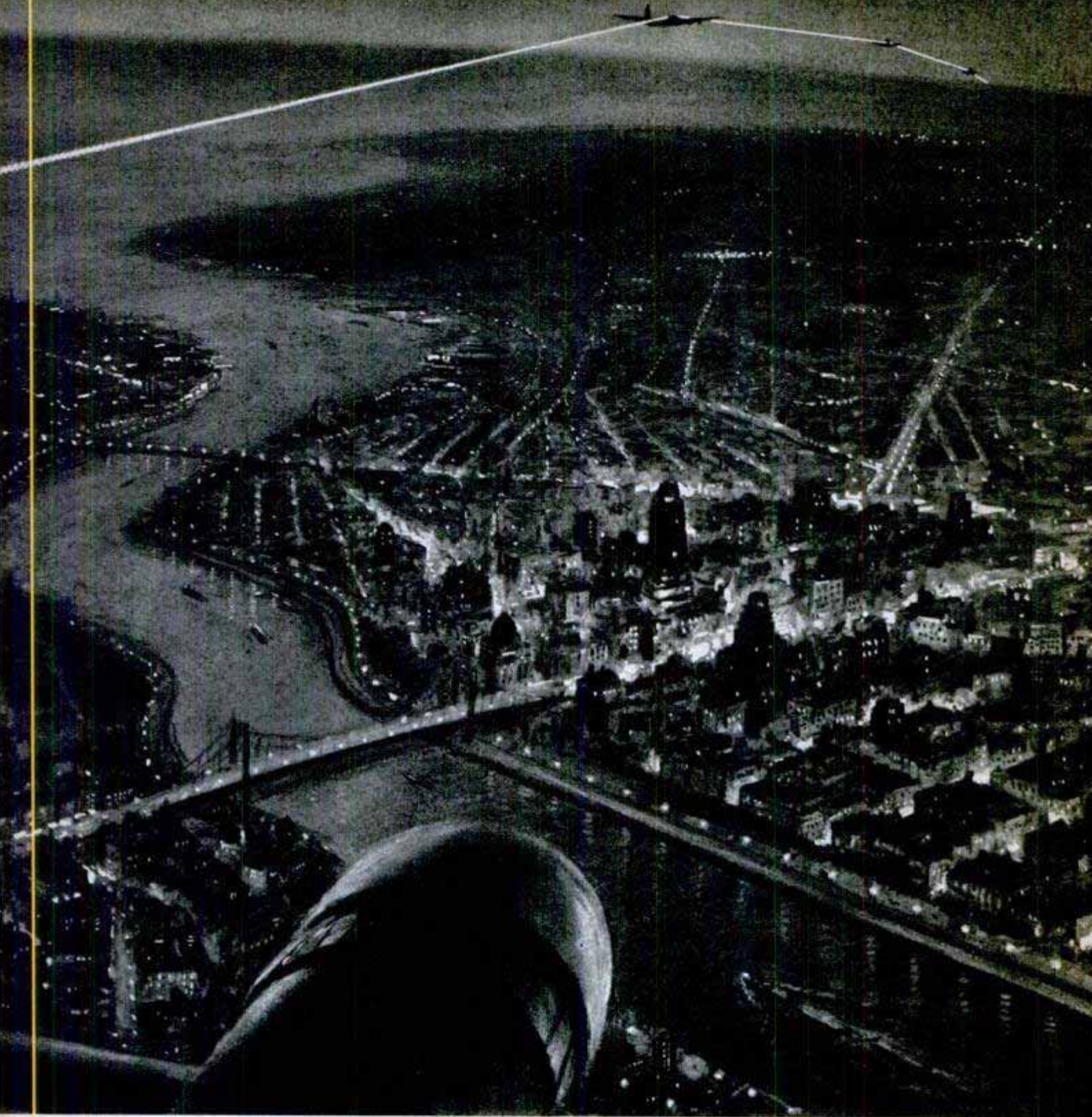

There were plans for a telegraph land line over the same route exactly 90 years ago. Engineers had begun to build it when Cyrus Field came along with his Atlantic Cable. Furthermore, no wishful thinking is involved in the practicality of long chains of microwave relay towers. Last summer, men and trucks laden with materials beat their way to America's high spots, erecting the 105 towers that now link New York and San Francisco by microwave relay. True, it wasn't an easy job. Sites had to be chosen carefully to avoid having the microwave beams cross flat areas of earth that might reflect and distort them. Since the waves

Planes may someday transmit TV signals across the Atlantic. They could fly 300 miles apart at 20,000 feet and still do the job. Scale of miles between planes in the drawing is exaggerated for clarity

follow line-of-sight paths, towers had to be high—but not so remote they couldn't be reached in case of breakdown in deep winter snows. Old maps used in the first surveys were fine, but when the men got to the location they'd picked, they found new radio stations and farm buildings there ahead of them. Such problems always will face us. But the point is that, despite troubles, the first microwave relay chain is a



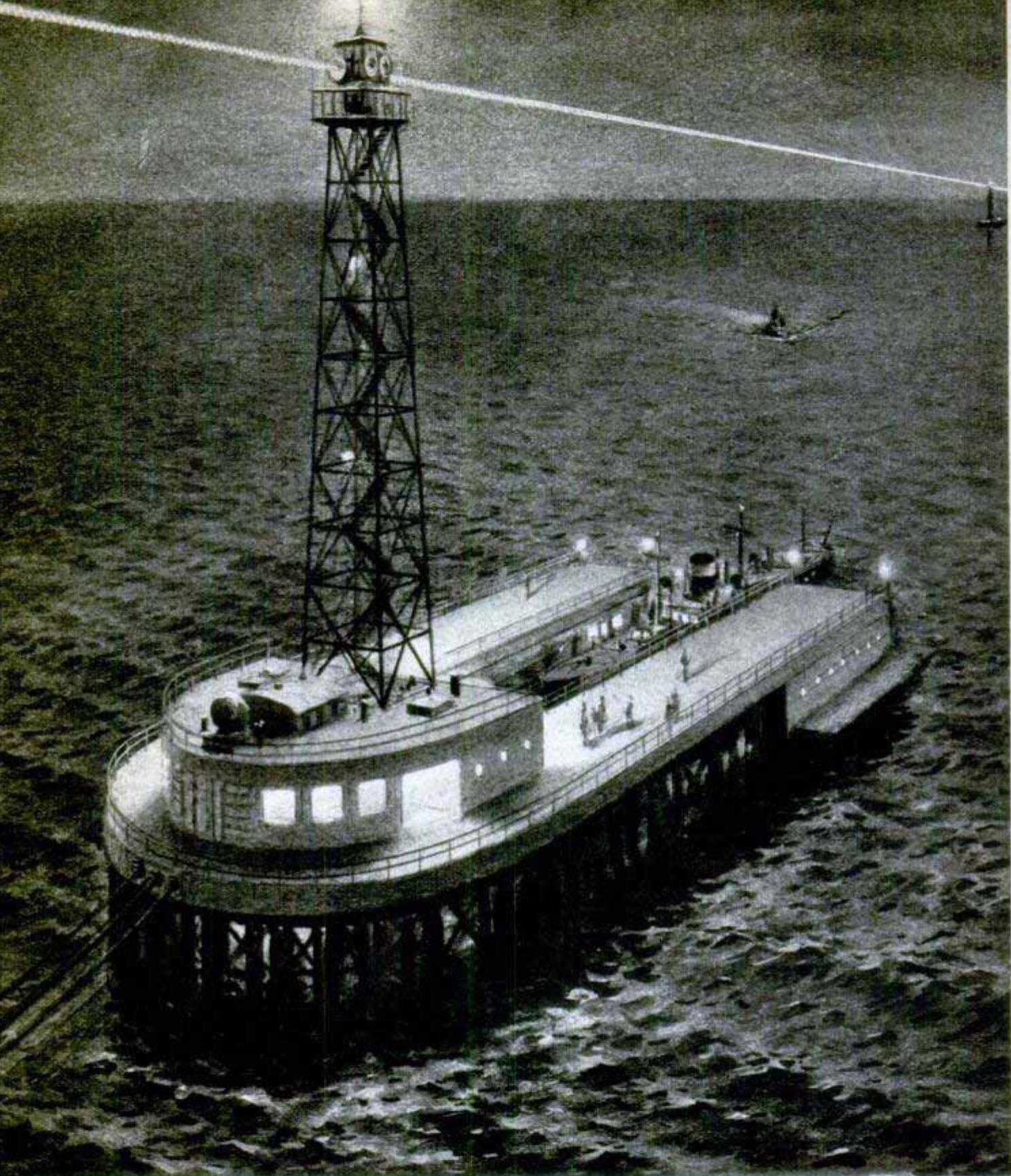

Illustration by Leydenfrost

**Artificial islands spaced 200 miles apart could carry 1000-foot towers for relaying signals across Atlantic**

reality, and can be expanded indefinitely. It's no daydream to say that the Americas will be linked before many years pass.

Not everyone knows what microwave relay is, so take a closer look at this new chain of towers across the United States. You may have seen them from the highways—massive spires of steel and concrete, some more than 100 feet tall, jutting from hills and mountain tops like untapered versions of the Washington Monument, and each

crowned by four huge antennas that resemble overgrown loudspeakers on a soundtruck. The net operates in extremely high-frequency ranges, where the radio waves are very short—about three inches, actually. You get an idea of how short that is when you know that the radio waves you receive on the standard band of your own radio are about 1000 feet long.

Those three-inch waves are called microwaves, and they have some remarkable



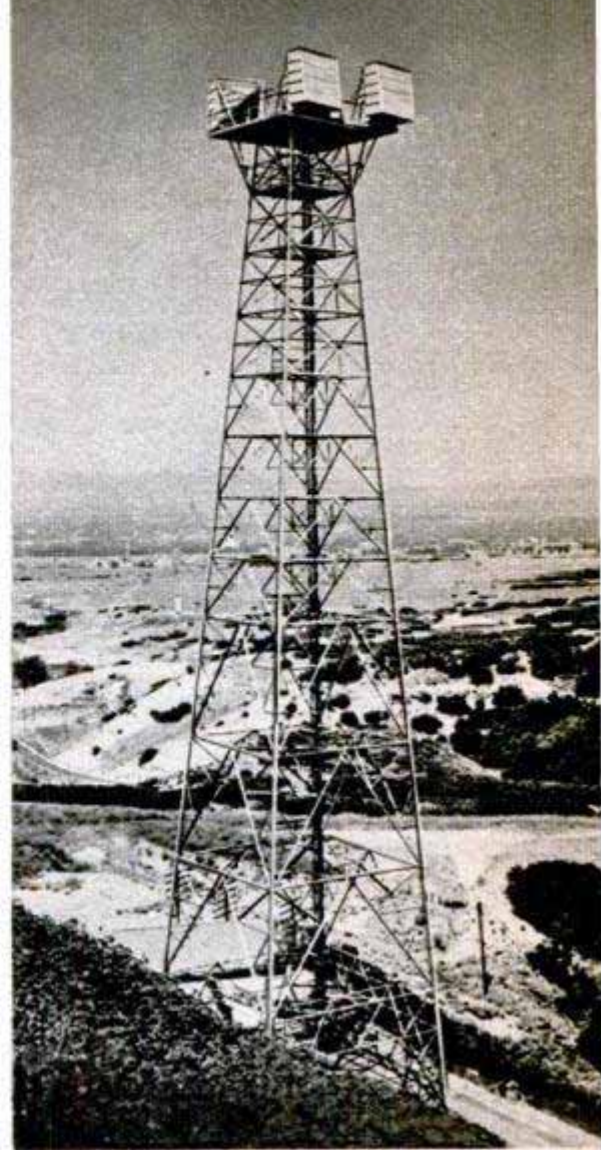
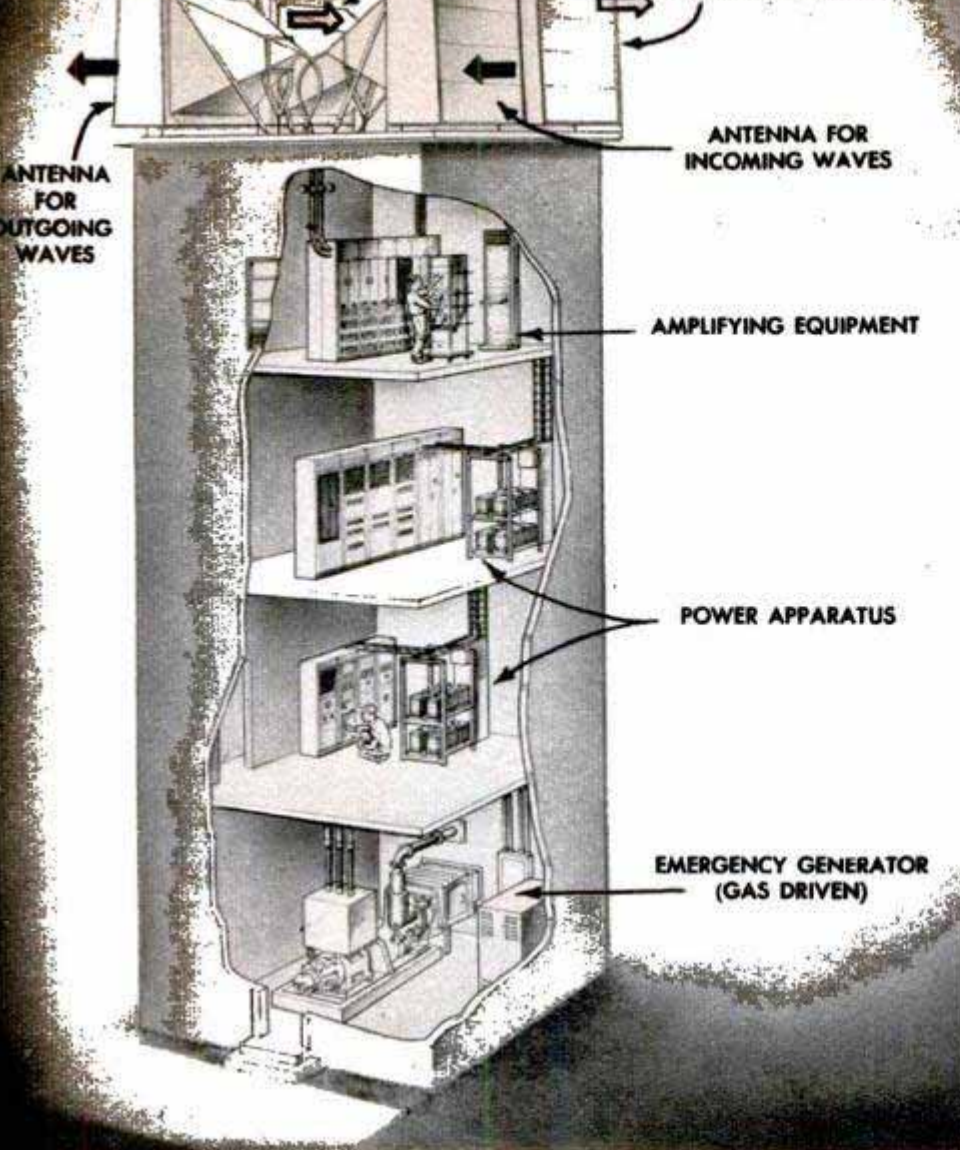

American Telephone & Telegraph Co. photos

Drawing shows typical installations in a transcontinental-TV relay tower. Above right, 200-foot steel tower overlooking Salt Lake City is one of 105 stations. Right, another possible method of sending TV across ocean is by cable, similar to this amplifying telephone cable

characteristics. They refuse to follow the curvature of the earth, but take a straight-line route off into space. Like light waves, they have the annoying habit of reflecting off flat surfaces such as lakes or sandy plateaus and messing up the signal. But, also like light waves, they can be focused into a narrow beam and directed in a line-of-sight path at any target we may choose. And that's where the towers come in. Each one is like a big reflector, that picks up a beam from the one behind it, catching the focused radio waves in a funnel-shaped antenna. The beam is then brightened by amplification to restore the intensity it may have lost en route. Up it goes to the "lens antenna" on the other side of the tower roof, where it is focused into a straight, narrow ray again and aimed at the antenna target on the next tower some 25 to 60 miles away. The reason for having two pairs of reflectors on each tower is so that signals can be beamed in both directions at the same time.

The beauty of microwave relay is that it can be made to handle all kinds of traffic. Not just television programs, but multitelephone messages, telegraph signals, frequency modulation, facsimile—even ultrafax, the fantastic system by which all of *Gone With the Wind* was transmitted in 2 minutes and 20 seconds—can be carried by this amazing radio-relay system. Unlike cables and land lines, storms don't affect the tower networks because

(Continued to page 240)







## Hydraulic Gravel Mining

Pounding against a wall of rock and clay under terrific pressure, 1500 gallons of water a minute separate the clay from the rock in a hydraulic gravel pit. The clay is washed away with the water and carried to a settling basin where the water clears for reuse. The rocks, washed to the base of

the cliff, are hauled to the crusher for final cleaning. About 80 percent of the clay and dirt is washed from the rock in the mining operation, thus cutting processing time to a minimum. Two pumps are used in the operation. One, a 250-horsepower model, pumps the water from the settling basin. The other, 300-horsepower, is a booster pump that produces the required pressure.

## "Scootermobile"

When Sgts. Robert J. Petry and Raymond A. Romberger of the 315th Air Division (Combat Cargo) landed in Japan, they soon began to long for some means of private transportation. Deciding to try their ingenuity, they started collecting parts for a "Scootermobile." First to join the pile of parts was a six-horsepower engine, followed by a discarded jinrikisha horn and Japanese motorcycle transmission.

Wheels and brakes were taken from a broken-down scooter and other necessary parts, including axles, were collected in a near-by town. Two weeks of sparettime work plus one six-day rest leave were required to assemble the vehicle which, Sergeant Petry says proudly, "has one reverse and three forward speeds, seats three besides the driver and does 40 miles per gallon using regular gasoline."



USAF photo

## Concrete Test

Engineers at the University of Wyoming are working on a valuable, nondestructive test for measuring the strength of concrete structures. The new test uses sound waves, the speed with which they pass through the concrete providing a measure of its strength. The new test can be made on the actual structure without destructive effect.



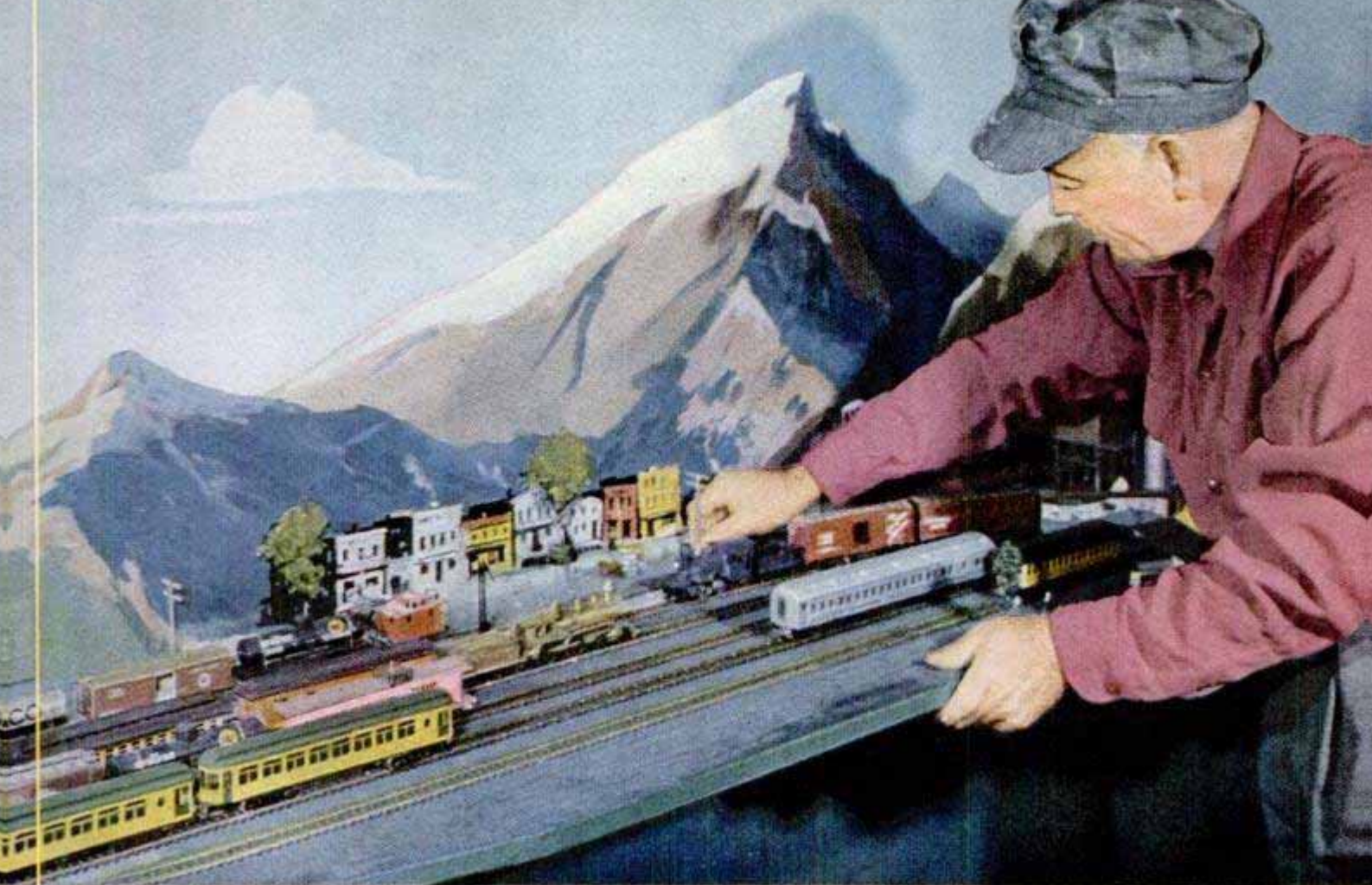

***Our art director is the boss of just one room in his home. In it he operates his own hand-painted railroad. Lift the bridge at the door to see what you can do with a . . .***

## ONE-ROOM RAILROAD

*By Clifford B. Hicks*

ON THE FACE of the boss not long ago appeared a strange, harassed expression. He pitched his problem to me in the form of an assignment.

"Take a run out to Frank Beatty's home and look over his model railroad," he ordered. "Tell Frank it's a very nice little railroad indeed, but break the news to him it's no different from thousands of other layouts. Make him understand we can't use a story on just another basement railroad — we need something special. Then maybe he'll throttle down the railroad lingo around here."

Frank has been art director of *Popular Mechanics* for 10 years. He's a nice guy,

Beatty, 20 years a commercial artist, adds wispy clouds to the background he painted around the room

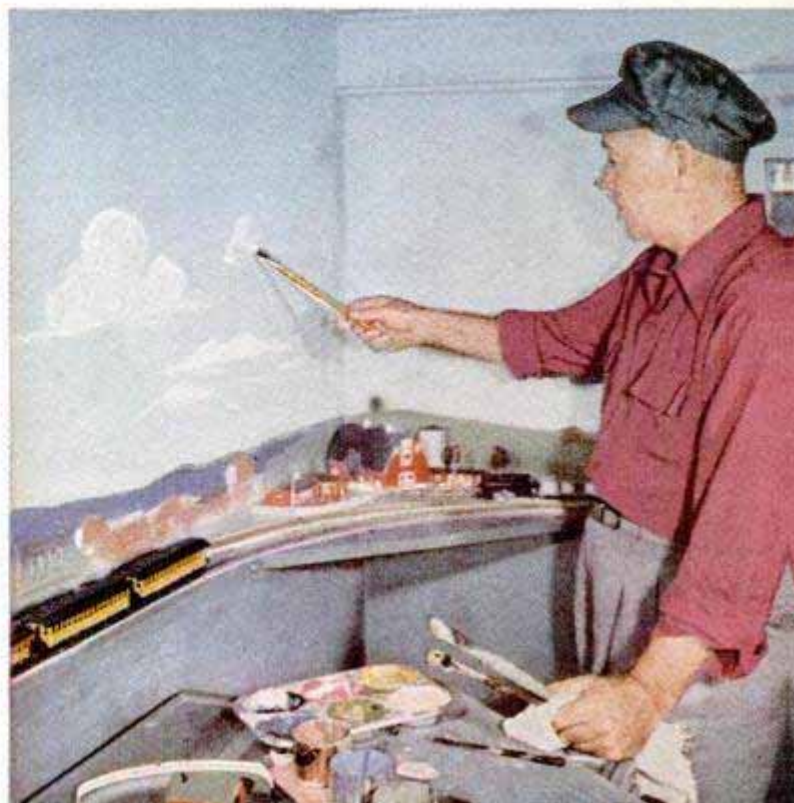



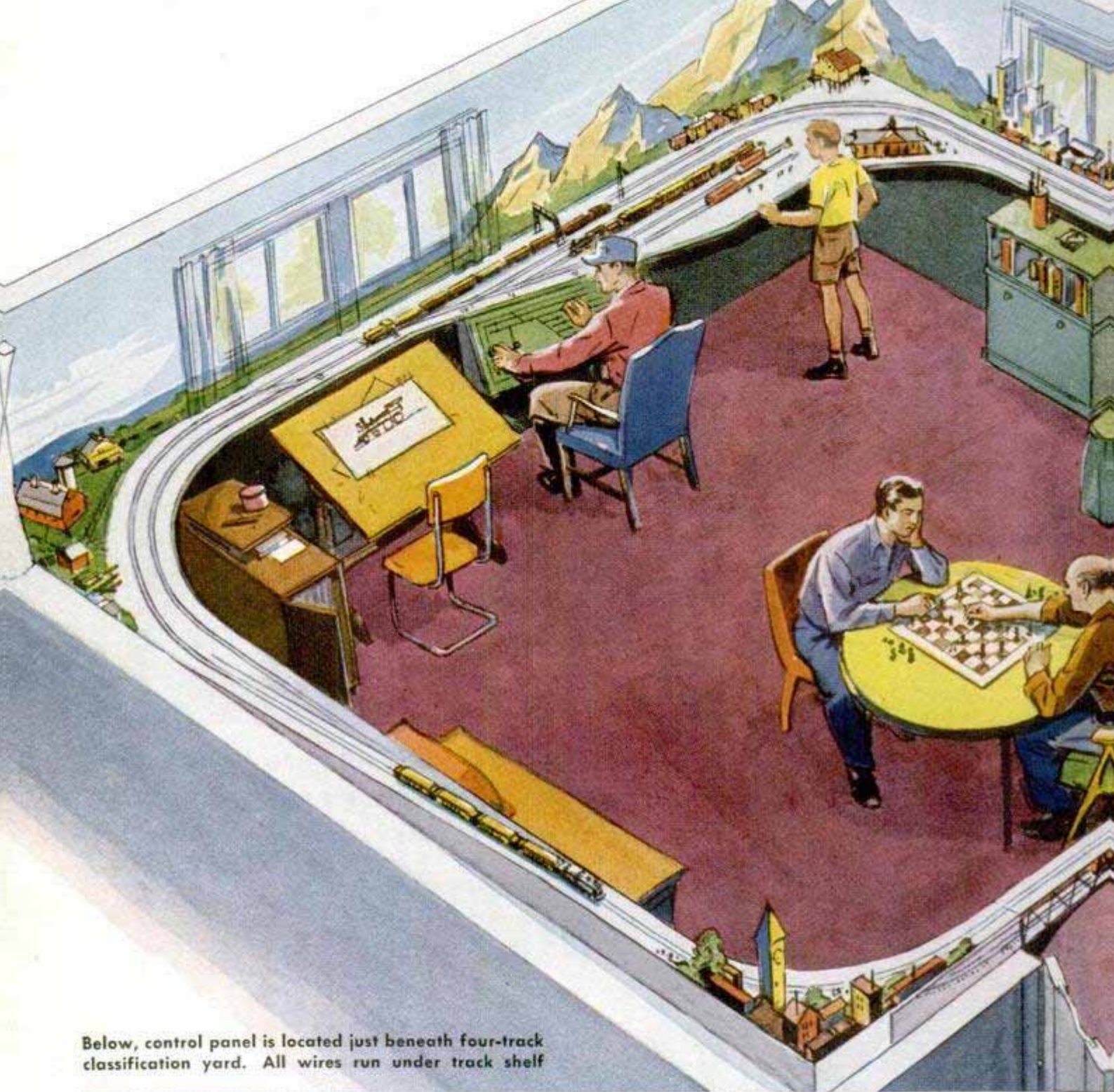

Below, control panel is located just beneath four-track classification yard. All wires run under track shelf





With his art training, Beatty is adept at scaling down a drawing and free-lancing his model locomotives

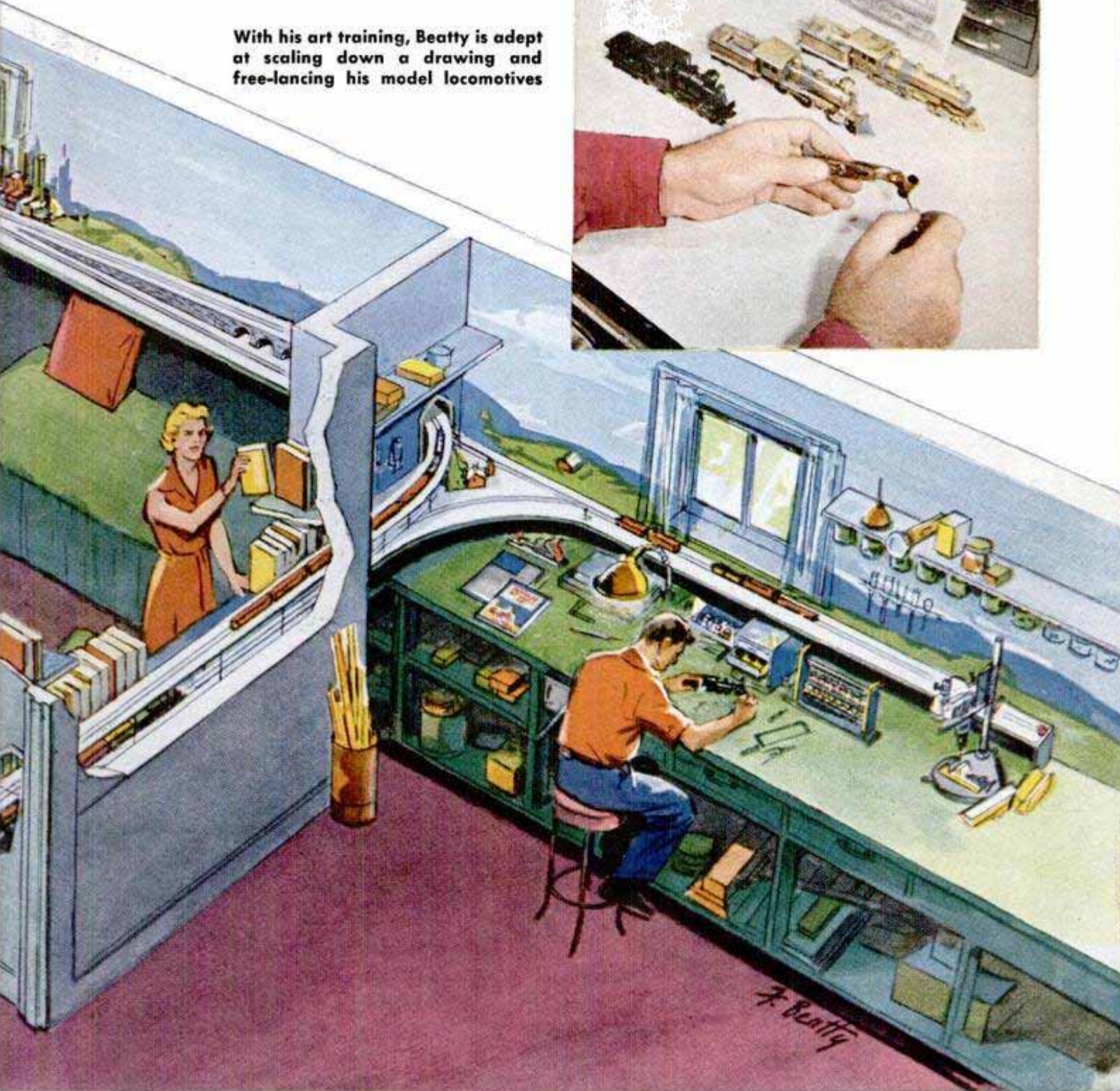

Railroad circles the room, yet doesn't cut down the usable space. From the control panel Beatty can shunt a train to the siding above his workbench. Note the drawbridge at the door, the tunnel behind the bookcase

but recently there's been a glaze over his headlights and he's been tooting about reefers and roadbeds, couplers and cowcatchers. When you try to switch him back to his main track—art work—he rolls right on up the spur line.

In the basement of Frank's home I took one look at his layout, then put in a call to the photo department. A few minutes later a photographer showed up, gave a long low whistle and went to work.

Next day we placed some color transparencies on the viewer in the boss' office. The managing editor took one look. "Lay it out for full color in December," he said.

"Casey" Beatty has nothing extraordinary in the way of rolling stock, nothing unusual in switching gear. But his layout is unique because he has combined his hobby—railroading—with his talent as an artist; he's thrown in a good measure of ingenuity as a home craftsman, and he's shown other model railroaders how they can build a fairly elaborate track layout without wasting a square foot of basement floor area.

The best way to describe Beatty's layout is to tell how it grew. Three years ago he bought his son Tom an electric train. Basement space was at a premium so he had to





Double-deck bridge spans the doorway, swings up when not in use. Precise fit avoids disastrous derailments

run the train on a 4 by 6-foot sheet of plywood, hinged to the basement wall. Tom and the other small-fry engineers of the neighborhood had fun with it; so much fun that Pop bought some kits and built several scale-model buildings for the layout.

Trouble was, the buildings were scaled for HO trains—much smaller than Tom's electric job. A normal man would have replaced the few buildings to fit the train. Not Frank. He built a new train to fit the buildings.

He started with a short length of HO track ( $\frac{5}{8}$  inch between rails) and, still

rolling backward into his hobby, constructed a caboose to fit the track. By then the bug had really stung him, and in the resulting fever he worked through a good many midnights to build a small switch engine. The reason? He wanted a loco to pull the caboose that fit the track which was scaled to the buildings that were wrong in the first place.

Next he needed a long track on which to maneuver his masterpiece. Long before, Frank's wife, Ruth, had assigned him his own space in the basement—a 15 by 15-foot

(Continued to page 228)

Through effective use of color, the three-dimension bridges and buildings melt into two-dimension background

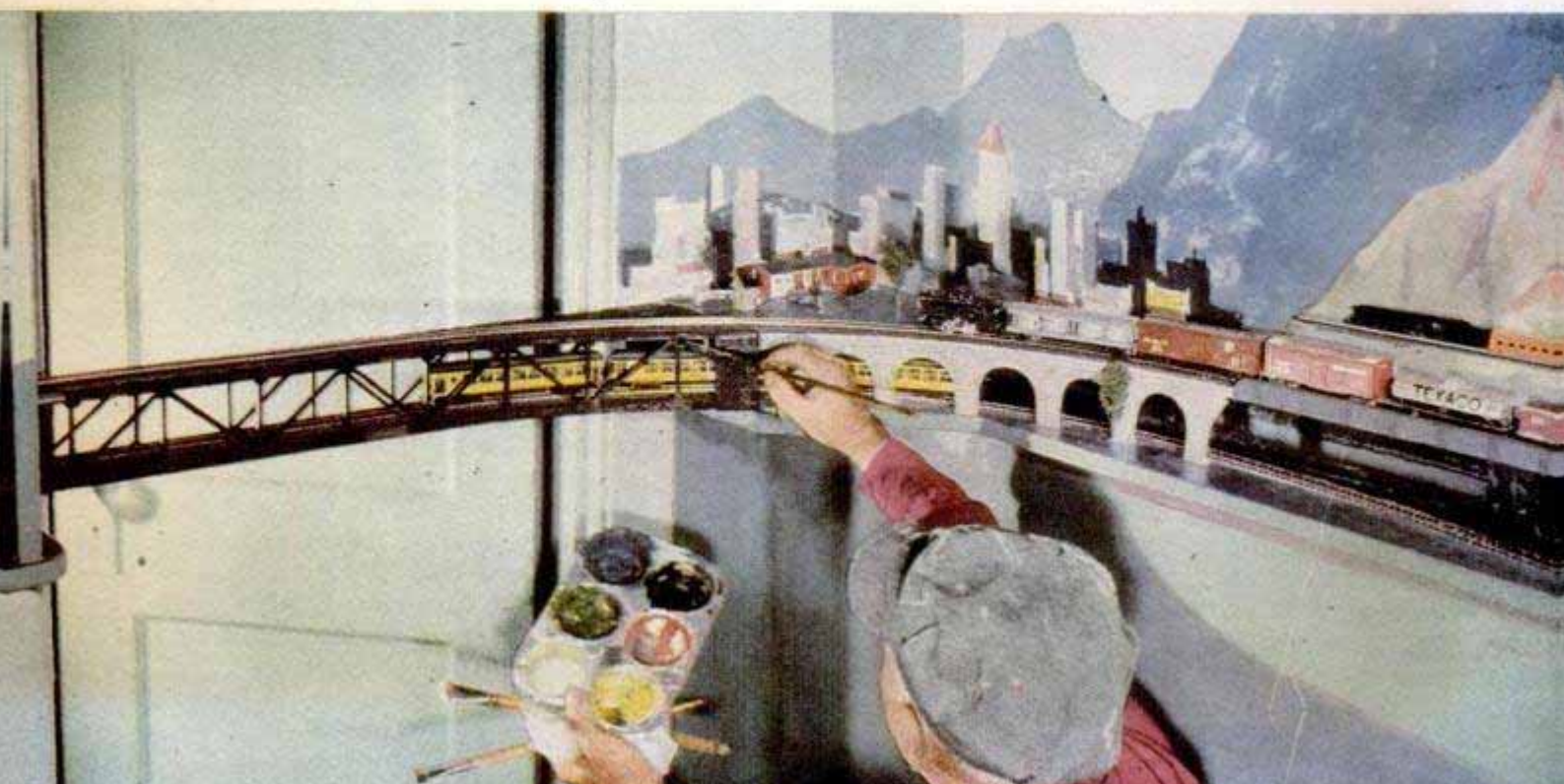





# Detroit Listening Post

*By Siler Freeman*

**T**HE 1952 MODELS already out and those about to come out show no more than the ordinary amount of changes. In other words, they are face-lift jobs, to which the industry has become accustomed during the postwar years. Occasionally, there has been a "radical" change which soon becomes standard throughout the industry, and once in a while the industry is startled by some innovation such as the high-compression engine, a new type of automatic transmission or a power-steering device.

But with the dual-economy and two-sided operations in which the automotive industry finds itself, even the present changes, small though they may appear, are an achievement.

The 1952 Dodge, now on display, is the first of the Chrysler lines to be shown in dealers' showrooms. Exterior changes are mainly face lifting, with a redesigned front grille, new wheel covers and hub caps. Inside, however, there are more changes. Dodge is using a new textured-weave upholstery. In the Coronet models, rayon is combined with cotton for more durability.

As optional equipment, Dodge is offering the new tinted glass which reduces glare and heat inside the car. Unlike the General Motors cars which use the tinted glass, Dodge's is not graduated, with a heavier tint at the top, but is the same density throughout.

All 1952 Dodges will offer Gyromatic transmissions and will also have waterproofed ignition systems, electric windshield wipers and Oriflow shock absorbers.

The first 1952 DeSotos show less change than an ordinary yearly shift in new cars. Outwardly, the only distinguishing marks are the revised name plate and the taillights. The taillights have one bar of chrome across instead of two.

Inside, the upholstery is made of rayon combined with cotton in varying textures. Tinted glass will be offered as optional equipment in a limited number of 1952 cars.

But there is something new ahead for DeSoto buyers. Early in 1952, the real 1952 models will be shown, embodying the new V-8 engine, power steering and many sheet-metal changes which will affect the looks of the car. The early 1952 will have the same six-cylinder engine used in the 1951 car.

Major changes are predicted for the 1952 Lincoln. This division of the Ford Motor Company has not done as well in its race with Cadillac and Chrysler as has the Ford car in its efforts to "beat Chevrolet." So Benson Ford, general manager, and Joseph E. Bayne, sales manager, are eagerly awaiting some time in February or March to show their dealers in the Lincoln-Mercury division what their offering is. And from advance reports, it will be a real challenge to the luxury field.

The new Lincoln will be new inside and outside. The long-heralded V-8 high-compression engine will compare favorably with Cadillac, and with Chrysler's Imperial and New Yorker. The introduction date for public showings is around mid-March, unless it is postponed again.

Ford and Mercury have been set back to some time in March. The scarcities in

(Continued to page 276)



1952 DeSoto shows few changes over '51 models. Tinted glass is offered as optional equipment on a limited number of cars



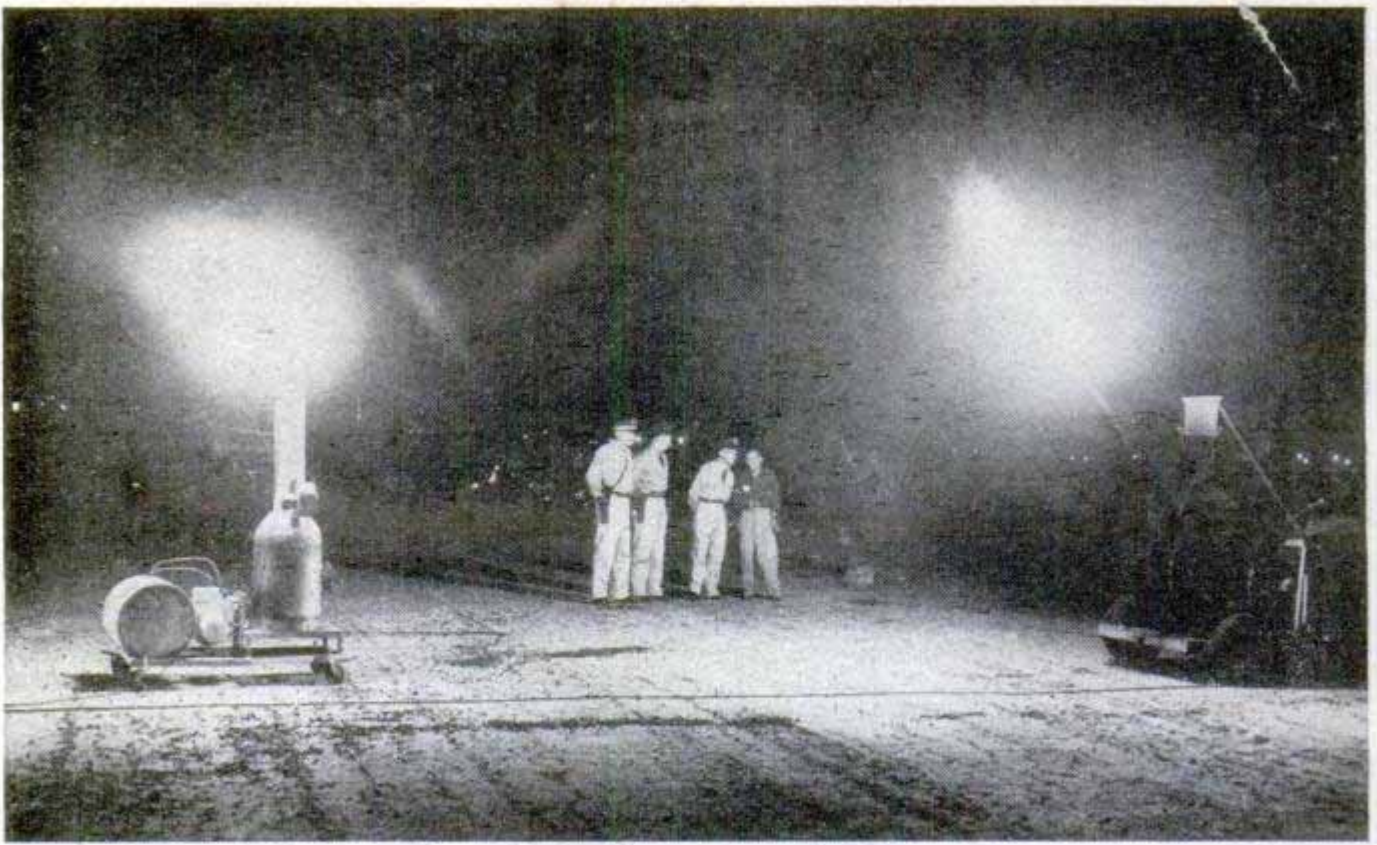

Air Force officers being briefed by Harry Langdon on theory and operation of his latest fog-dispersal units

**D**URING World War II, Harry Langdon, 49-year-old technician from Prescott, Ariz., became intensely interested in the serious problem of fog over airports.

While in charge of a salvage section of the Naval Bureau of Aeronautics at San Diego, Calif., Langdon recalls testing a jet engine one foggy night when he noted that the jet blast tended to clear fog from the immediate vicinity of the engine. From this observation, he decided upon experiments to determine what effect, if any, hygroscopic material would have on fog. This material soaks up moisture.

He attached a hopper to the exhaust tail pipe of the salvaged jet engine. The hopper was filled with hygroscopic matter and, with a worm-gear arrangement, he fed this material into the jet exhaust so it would be blasted into the fog. "I was able to punch big holes in the heaviest fog of the season at San Diego," recalls Langdon. "I knocked holes in fog 1000 feet thick."

When his Navy employment terminated, Langdon continued the experiments. Returning to Prescott, he subsequently developed new equipment, now being tested for the U. S. Air Force at the USAF Reserve Base (Municipal Airport) in Long Beach, Calif.

Components of the latest fog-dispersal units include a mobile stand with attached fuel tank (for diesel oil), a combustion chamber lined with firebrick, a jet fuel injector with ignition system and a fan for supplying an air blast into the after-burner. The units are connected in parallel with a

# FOG FIGHTER

Artist's drawing illustrates fog fighters in operation. Hygroscopic-jet units are spaced 100 feet apart on one side of the runway

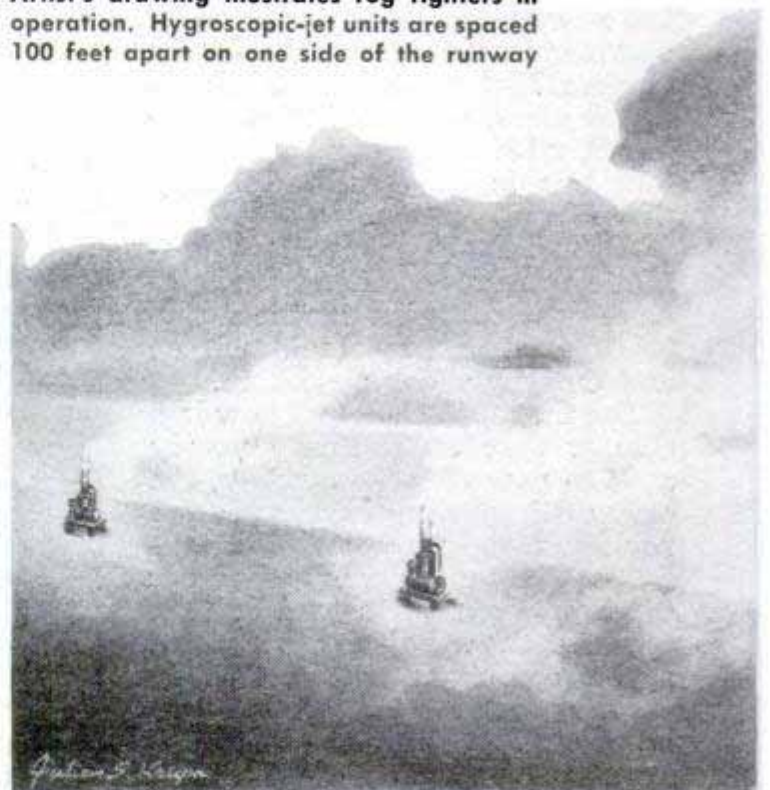



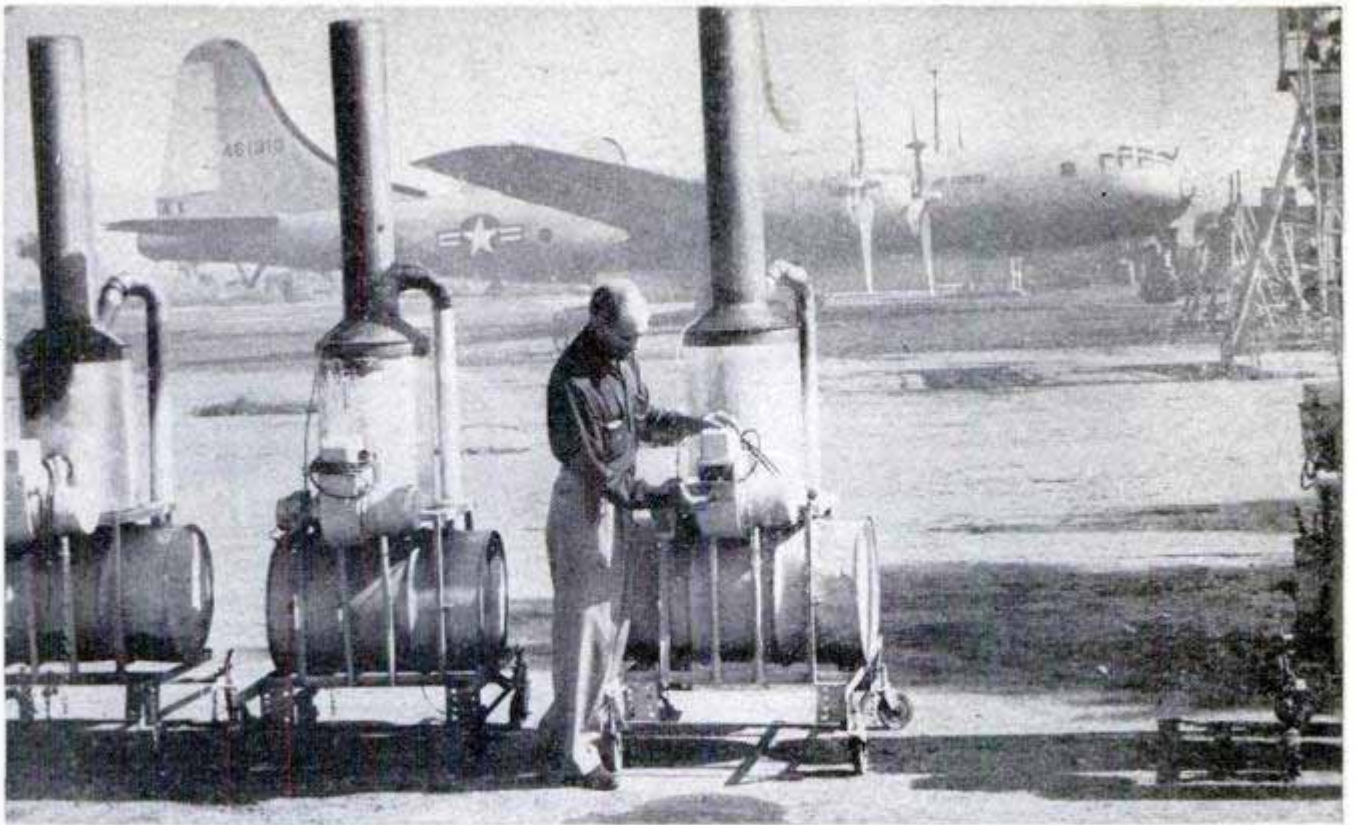

Ready for tests at USAF Reserve Base in California, Langdon checks ignition system on each fog-burner unit

portable field generator, which sparks the ignition system and activates the fans. Equipped with four-foot stacks, the stainless-steel casings of the units weigh about 275 pounds each. Rate of fuel consumption per unit per hour is 12 to 15 gallons. The hygroscopic matter is loaded into a stainless-steel can about the size of a two-pound coffee can, which is located just below a circular hole in the chamber wall.

The temperature within the combustion chamber reaches 1300 degrees, which, according to Langdon, is sufficient to melt the hygroscopic matter. "After the hygroscopic material is blasted into the fog, I just let nature take its course," says Langdon.

He plans to space the units 100 feet apart along one side of a runway, and promises to "clear out zero-zero fog sufficiently to permit an aircraft to land."

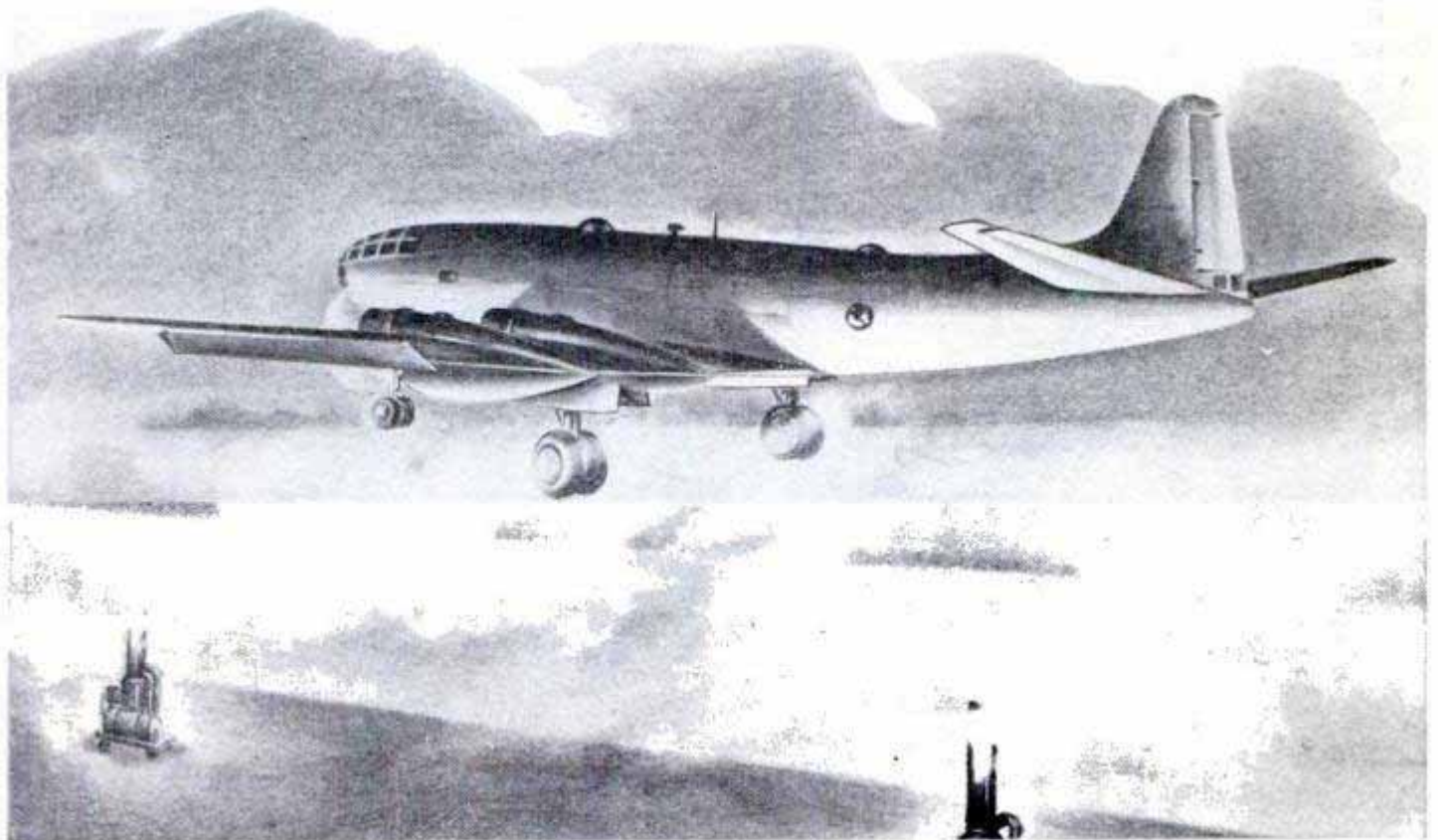





## Welded Steel Rods Strengthen Masonry

Adding strength to masonry walls, a steel reinforcing member prevents cracks and provides more rigid construction. Available in 10-foot lengths, the electrically welded reinforcing comes in widths for walls from 4 to 13 inches thick. It ties face brick to backup blocks. It reinforces all double-wall construction. It can be used with concrete blocks, clay tile or brick. Placed between the courses, the reinforcing is embedded in the mortar to make a strong bond.



## Suitcase Piano

You don't need muscles of steel to carry a portable piano that weighs only 37 pounds and folds into a case that looks like a large piece of luggage. Invented by Karl Gage, the piano has a four-octave keyboard and a lid that raises to become the music rack. The legs and pedal fold to make the piano easy to carry. It is designed for schools.

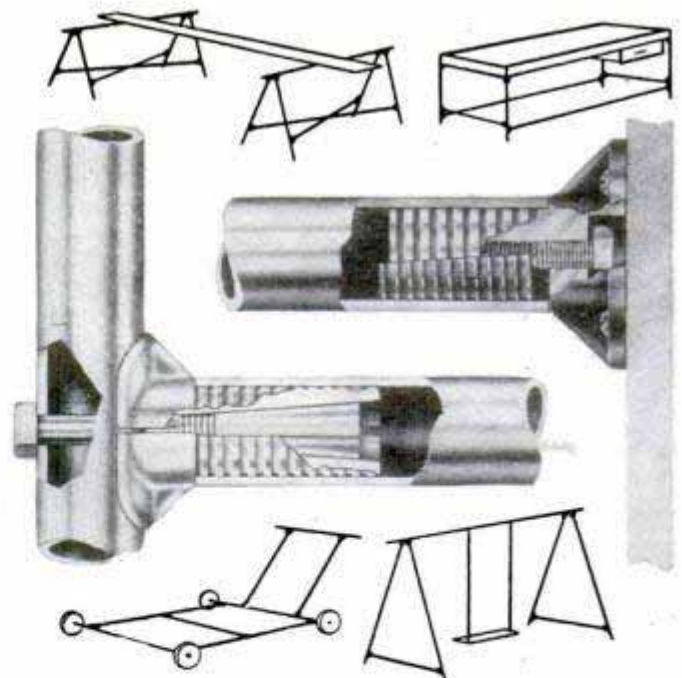

## Tube Couplers

Lengths of metal tube can be joined in almost any pattern with new couplers, then dismantled and used again. The couplers make it possible to construct scaffolding, worktables, supports and other frameworks without damaging the tubes. When a connecting bolt on the coupler is tightened, two wedge-shaped metal pieces press firmly against the sides of the tube. To loosen the bond, the bolt is turned in the other direction. A special type of coupler, flat on one side, makes it possible to bolt a framework to the floor or wall.

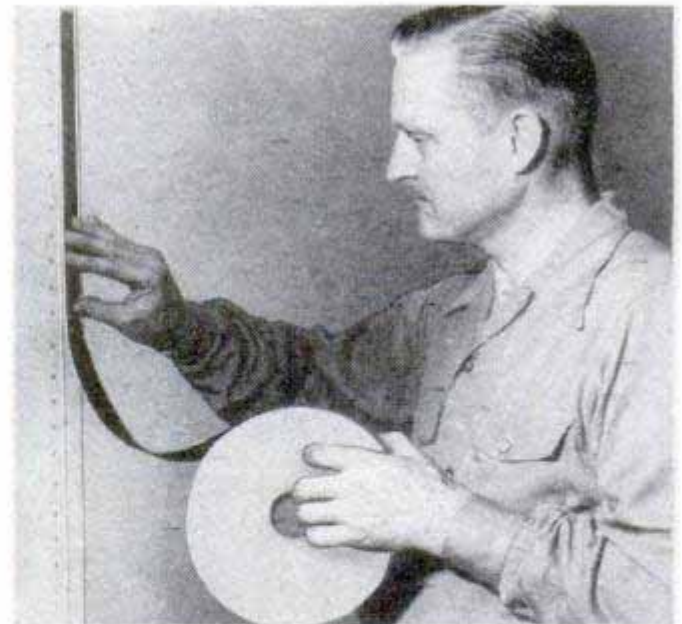

## Self-Sticking Felt

As easy to apply as adhesive tape, a reinforced felt tape seals out dust and also deadens rattles and squeaks. Its adhesive back holds it firmly in place when applied with finger pressure. The felt can also be used as pads on objects that may scratch adjacent surfaces.



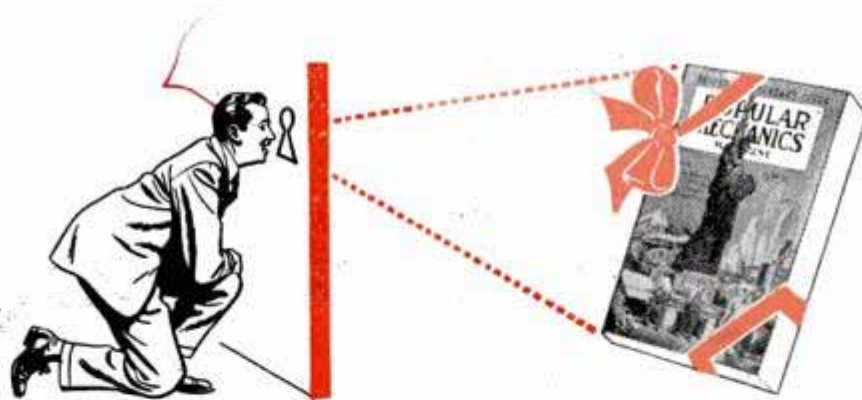

# Take a Peek at Our BIRTHDAY PACKAGE

*It's for you!*

With the January 1952 issue, *Popular Mechanics Magazine* celebrates its 50th Anniversary. For a year the editors have been planning and assembling for you the greatest magazine in a half century of *Popular Mechanics*.

Here's just a glimpse of what you can look for next month — probably the biggest picture magazine ever printed:

- ★ About 500 pages — your regular *Popular Mechanics* plus a big bonus . . .
- ★ 700 pictures — packed with action, excitement, nostalgia . . .
- ★ 16 pages of full-color photographs and paintings . . .
- ★ Prize-winning pictures of our Golden Anniversary photo contest . . .
- ★ The story of Fifty Years of Craftsmanship . . .
- ★ Great articles on aviation, science, automobiles, radio and television by Eddie Rickenbacker, Karl Compton, Charles F. Kettering, Lee deForest . . .
- ★ The Owners Report on the Buick by Floyd Clymer . . .
- ★ *Popular Mechanics'* Hall of Fame — the 50 outstanding scientists from 1902 to 1952 . . .

## ***We've dug into our past . . .***

for pages of history you'll remember from the good old days . . . the story of the 1907 International Balloon Race . . . Winston Churchill's prophecy of the atomic bomb . . . quaint advertisements and nostalgic inventions from the days of the back-yard hammock and the horseless carriage. . . .

## ***Make a date to pick up your birthday package . . .***

It will be on the newsstands December 28. Although we're printing more copies than ever before, they won't last long. Ask your dealer now to save your copy, or send your order today for a whole year of anniversary issues.



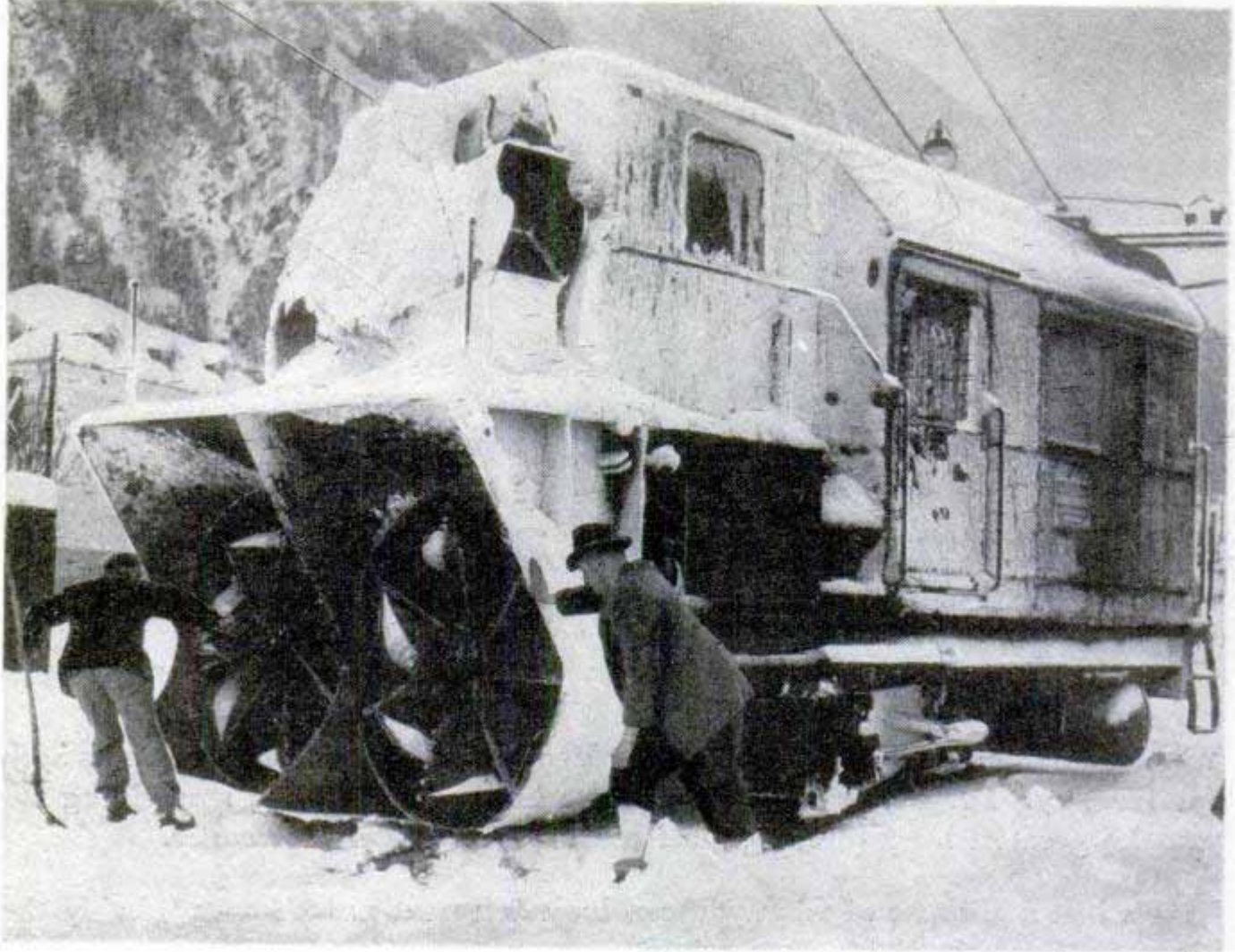

Novel snowplow is mounted on a turntable, which in turn is mounted on a single truck. No need for a "Y" in the tracks to reverse the plow—two men merely revolve it on turntable

## ELECTRIC SNOWPLOW



SNOW — up to 1500 pounds of it — is hurled a distance of 100 to 165 feet per second by a snowplow on a rail line in Switzerland. The plow is pushed by an electric locomotive, which also provides power for the two whirling rotors. Scoops force the snow into the rotors which throw it to either side of the track. The use of two side-by-side rotors eliminates the "dead corners" which are inevitable when a single, large rotor is used. The twin rotors also reduce the power required to push the plow. The machine clears a strip more than 10 feet wide and moves along at a speed of one to six miles an hour. Two men can reverse the direction of the plow anywhere along the track by pushing it around on the turntable truck on which it is mounted.

Plume of snow geysers up from the electric plow, which clears a strip more than 10 feet wide and travels one to six miles per hour



Blue River, B.C., is the spot to watch when the big snows start falling. Here is where . . .

# Canada's Battle With Snow Begins

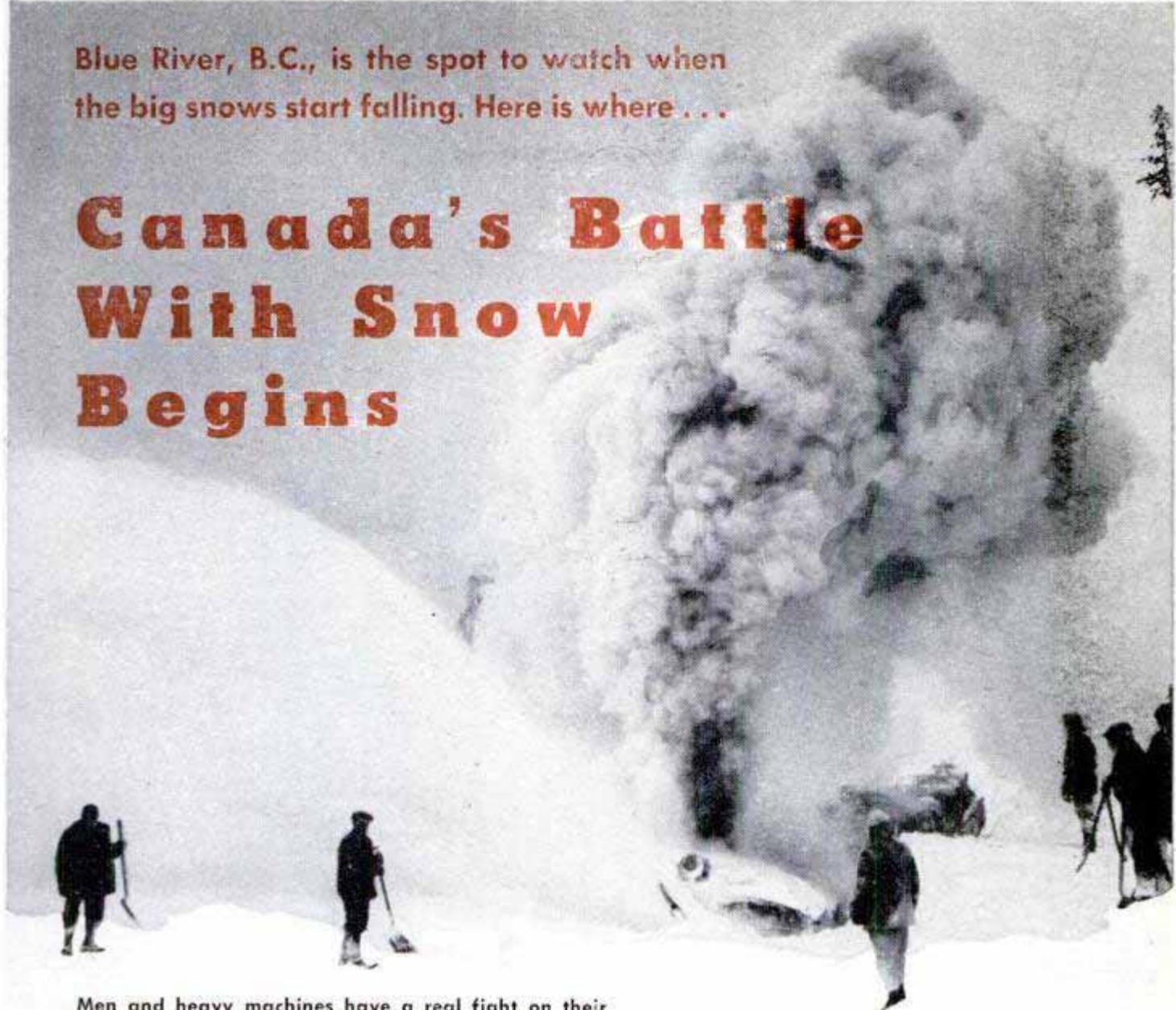

Men and heavy machines have a real fight on their hands when tightly packed drifts pile up along Canadian National's rail network. Men often work 24 hours a day to clear rails of 20-ft. drifts, below

Canadian National Railways photos



By Harry Rowed

**B**LUE RIVER is a compact little village in British Columbia's valley of the North Thompson River. In summer garb it has the flowered and lawned appearance of most settlements in Canada's western mountains. Fish abound in glacial streams of the vast alpine area at its back door. Summer at Blue River is a time for relaxation. There is little direct contact with the outside world beyond the fact it is a divisional point on Canadian National Railways' main line, and each day sees transcontinental passenger trains halt for brief intervals while locomotives are switched and new crews take over.

About mid-September a different atmosphere pervades the village. Blue River's citizens, majority of them railway people, become weather conscious. Each morning snow appearing on the balding summit of Mount Cook and other near-by mountains creeps a fraction lower into the valley timber. Homeowners check roof supports while men in the railway shops are assigned





Snow fighters with heavy-duty rotary plows clear C.N.R.'s tracks near Blue River, which consistently records heaviest snowfall of any point along network

Giant snow melter (below) and trained "snow battling" crew are always on the alert during critical snow season to keep tracks clear in Montreal terminal

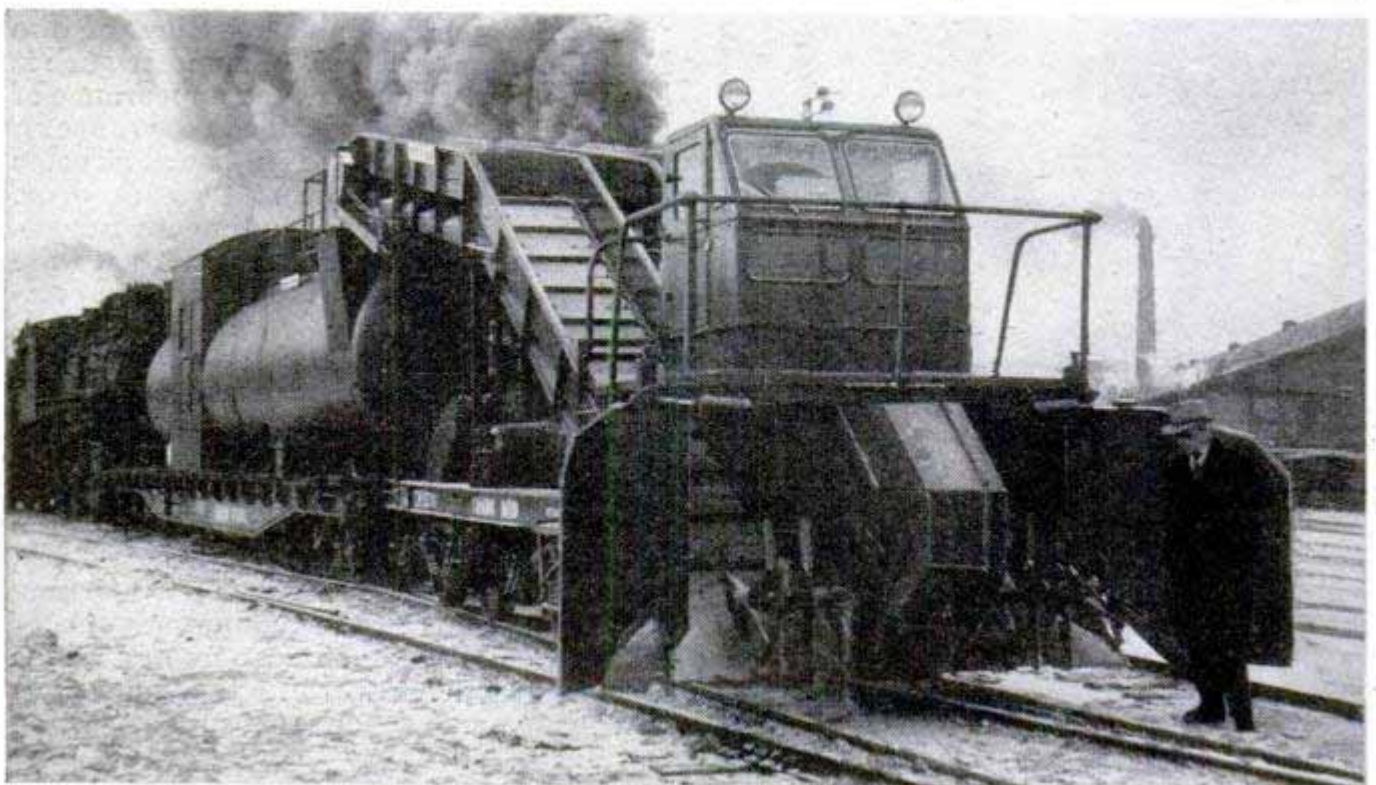



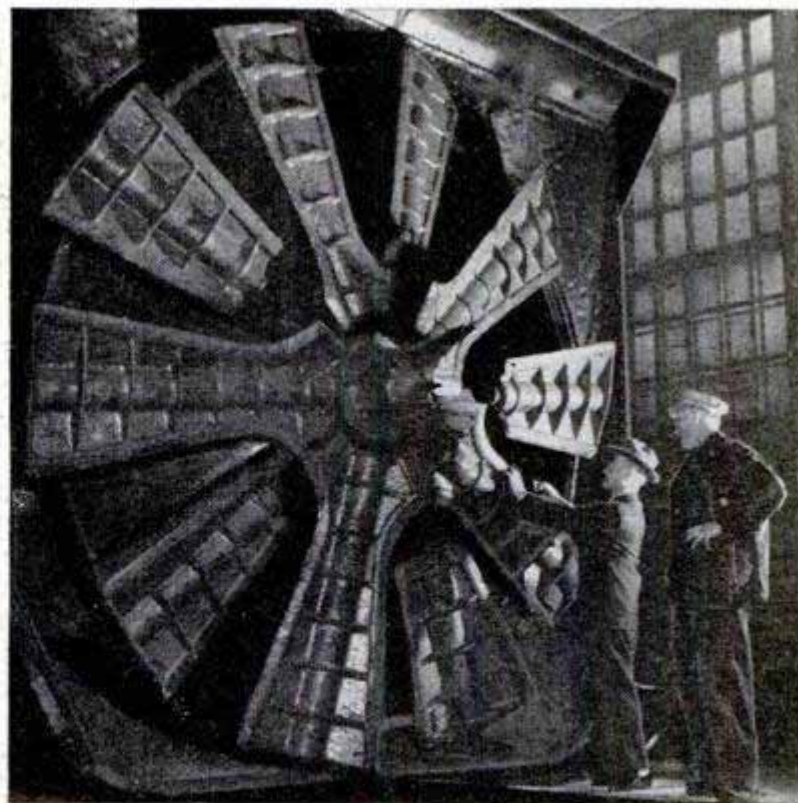

**At door of wedge plow, foreman Joe Medori of Jasper hasn't missed a single snowplow trip since 1940**

**Ben Miller, C.N.R. master mechanic, explains proposed improvements on rotary wheel to veteran engineer**

hours for overhaul of snow-clearing equipment, the wedge plows, the huge rotaries, spreaders and locomotives which must be ready to shunt out on the main line with winter's first fall. For Blue River consistently records the heaviest snowfall of any point along the 25,000 miles making up Canadian National's gigantic network of rails.

Blue River's winter can ride in overnight. Huge "pancake" flakes literally sift into the virtually windless valley and falls of fresh snow four feet in depth are more commonplace than unusual. Homes are covered to their eaves and resourceful residents spade out windows and door openings, often tunnel to the neighbor's rather than digging out deep paths. This gives them two strata of traffic . . . a labyrinth of subterranean passages between homes and shops, with break-throughs here and there to make contact with the solid upper surface. Blue River's youngsters don skis as toddlers; to get to the other side of the yard, they simply herringbone to the roof top and coast down the opposite side.

For the railwaymen winter presents a more serious picture. The snows mean "S.A.P." calls in the middle of the night, the soon-as-possible summons to get out for snowplow duty. It means days and nights of endless work as the railway battles the elements, to clear the lines, even to free marooned trains snowbound in the mountainous passes.

Secret of snow fighting in the Rockies is

preparedness, and the ability of both men and machines to move promptly to the scene of rail blockades. Even in midsummer, the rotaries stationed in known snow belts like Blue River are being checked, extra parts are being spotted for immediate emergency pickup, and men are being groomed for the rough schedules ahead.

Tom Young of Jasper, Alta., a retired railwayman with 48 years of snow-fighting experience in the west, likes to relate the story of the frozen hogs, his railway's first lesson in preparedness, or lack of it. Young, posted at Lucerne, B.C., as locomotive foreman in 1915, just after the young railway (Canadian Northern) had been transferred to the operating department, was advised that en route was the first shipment of livestock ever to be hauled to the coast over the new rails. As top brass of the railway and the packing company were watching the shipment with vigilant eyes, the train and its cargo of pigs were to receive special attention. A storm was brewing so Young wired that a rotary snowplow should precede the train over the section from Mount Robson to Blue River. Unfamiliar with mountain storms, a superior overruled the request and the stock train chugged past Lucerne without escort. When Young and his crew finally were permitted to get into action, the train was stalled near Albreda in a blizzard which completely covered the cars. The pigs were frozen stiff. Chortles Young today: "The railway learned a lesson. Since then they've always tried to beat the storm to the draw."



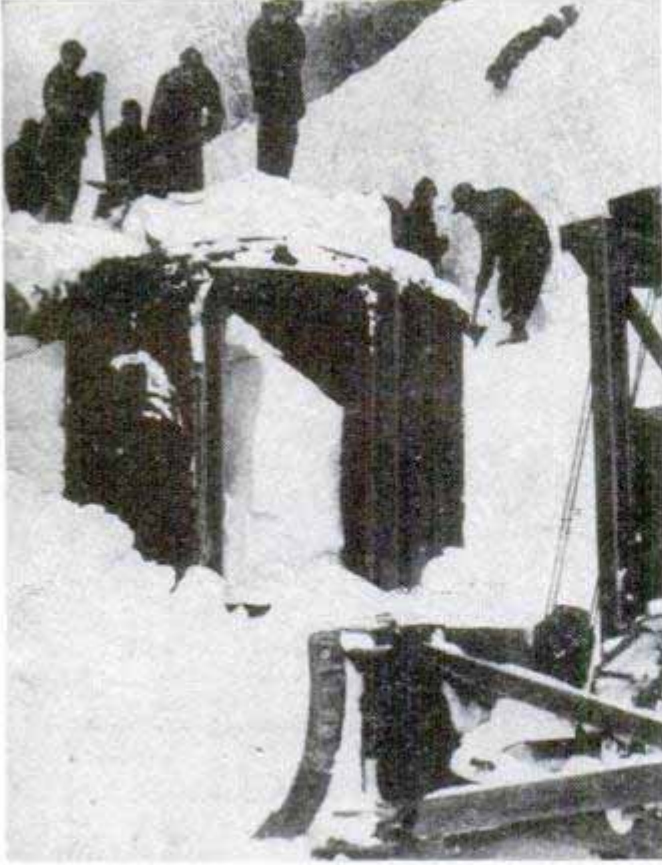

Driving winter winds across Canadian prairies sometimes completely bury rail cars. Workmen, above, extricate a car in B.C.'s Fraser Valley and, below, lend a helping hand to sturdy snow-clearing equipment

Tom Young, like most of the mountain snow battlers, broke into the business on western prairies where windblown snow packs with dust to cement hardness. Once, in early days of prairie railroading, a new line north of Brandon, Man., was blocked from mid-December to spring. Young, then a locomotive engineer operating a rotary, delivered Christmas parcels in March and April. Constant vigilance and improvement in the mechanical equipment now has boosted Canadian National snow crews to a ranking of most efficient in the world.

Their resourcefulness was put to its most severe test during the winter of 1950. In January of that year both of Canada's transcontinental lines faced almost insurmountable snow conditions in the great canyons of the Fraser River. Rotaries, bulldozers, extra locomotives and more than 300 men were sent to the C.N.R. area where warm weather, following on the heels of unprecedented snowfall, unleashed tons of snow from high country couloirs and rock depressions. Slides balked all rail traffic for almost two weeks, trapped passenger trains, almost endangered the economy of the west coast. While the weather tightened after the thaw with blizzards and

(Continued to page 274)





## Chemical Bonds Rubber to Steel

Silicone rubber now can be joined to steel in a permanent bond stronger than the rubber itself. The secret is a new glue-like chemical. The thin chemical "primer" also will bond rubber to glass, ceramics, aluminum, tin and copper, according to General Electric chemists. Development of the bond will increase the usefulness of silicone rubber in such applications as engine and instrument mountings. The liquid simply is brushed on the surface and permitted to dry. Then the rubber to be glued is clamped against the steel surface under light pressure at about 250 degrees F. The resulting bond withstands

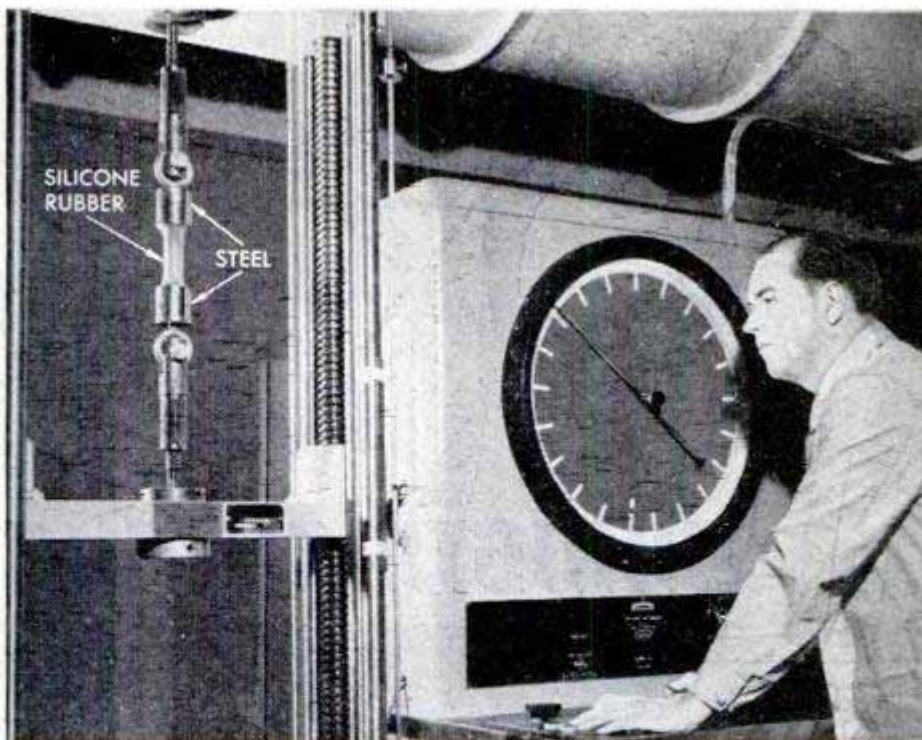

temperatures of 85 degrees below zero to 500 degrees above, and has a strength of about 700 pounds per inch of holding area.

## Asparagus Harvester

Asparagus harvesters ride on a tractor-drawn trailer that carries them along the rows. Each picker sits in a comfortable seat and fills the crate in front of him. At the end of each row, the full crates are removed. The trailer was built by a welder in Demotte, Ind., for John Kooy, asparagus grower.

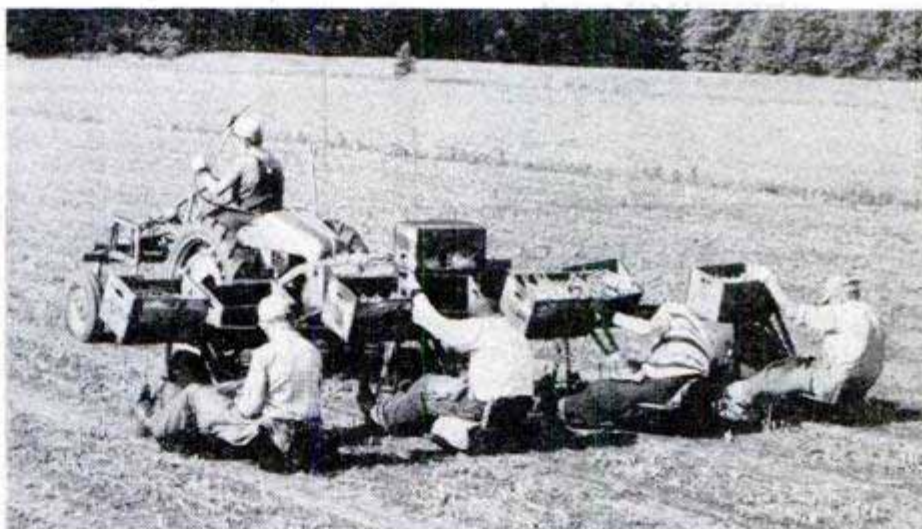

## Machine Staples Iron

Reinforcing rods for concrete are stapled together by a hand tool developed in Germany. The tool, which eliminates hand-tying of the rods, is simply an oversize stapler using heavy binding wire. The staples hook over one rod and around the transverse rod, clamping the two rods firmly together.

Sources of available products described in this issue are indexed on pages 12, 14 and 16. Sources of further information on other articles are listed in the WHERE-TO-FIND-IT LIST, which is available to readers without charge from Bureau of Information, *Popular Mechanics*, 200 East Ontario Street, Chicago 11





# Things to HINT ABOUT for CHRISTMAS SHOPPERS

FOUR PAGES OF  
TIMELY NEW  
CHRISTMAS-GIFT IDEAS

FOUR HEAVY-DUTY TOYS for the young construction engineer include: 1. Combination earth scraper and hauler, above right, made of auto-grade steel; 2. Road grader, right, fitted with individually mounted, rubber-tired wheels; 3. Mobile crane, below right, equipped with a clamshell bucket that bites deep into a sand pile; 4. Fire truck fully equipped with extension ladders that look and work like real ones





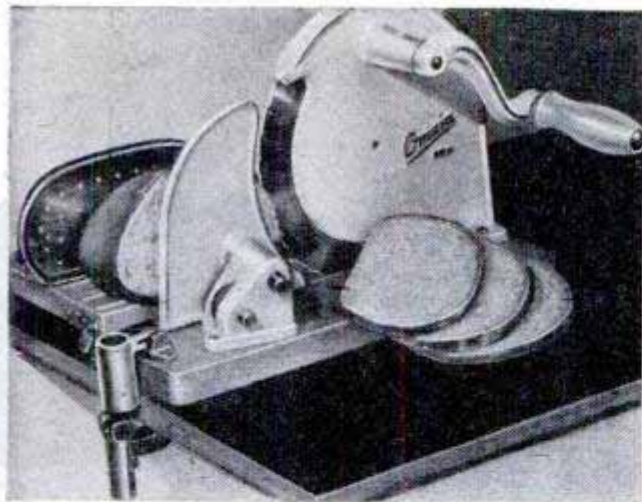

**SLICING MACHINE** has steel blade with serrated edge that will stay sharp for years



**SHAVE RACK** in barber-pole design holds razor, brush and used blades

**LUNCH BAG** with adjustable over-shoulder strap looks just like a purse



**WICKLESS LIGHTERS**, in pocket and table models burn butane gas, table style giving 10,000 lights from a single cartridge of fuel. Empty fuel tanks are replaced by low-cost cartridges

**CHURCH KIT** contains everything needed to build a musical church for holiday decoration in homes, stores and offices. Opening church door starts music box which plays a Christmas carol

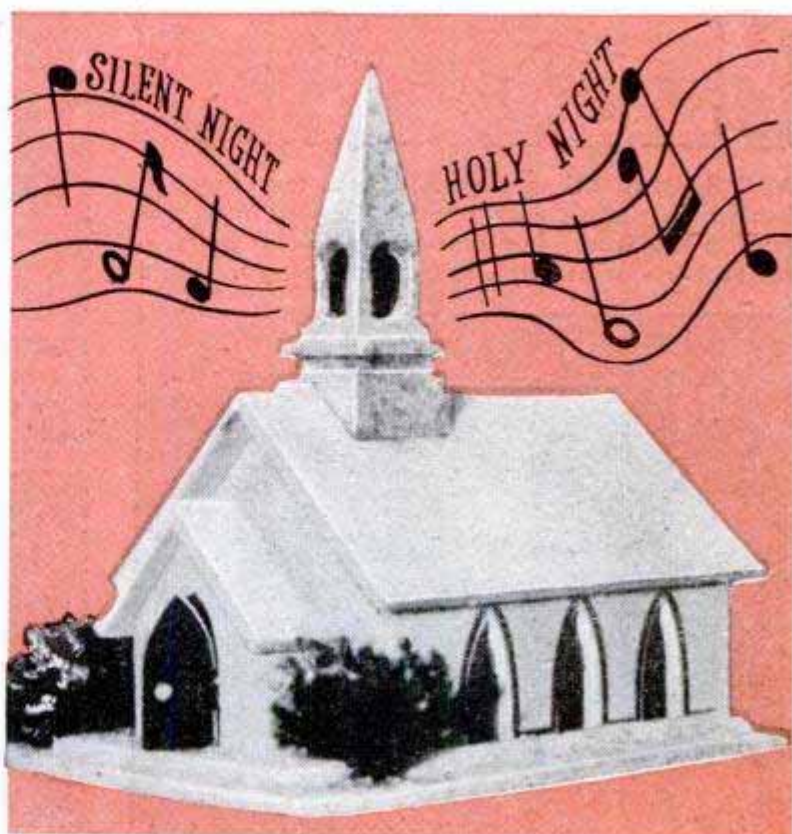





# Things to HINT ABOUT for CHRISTMAS SHOPPERS

(Continued from preceding page)

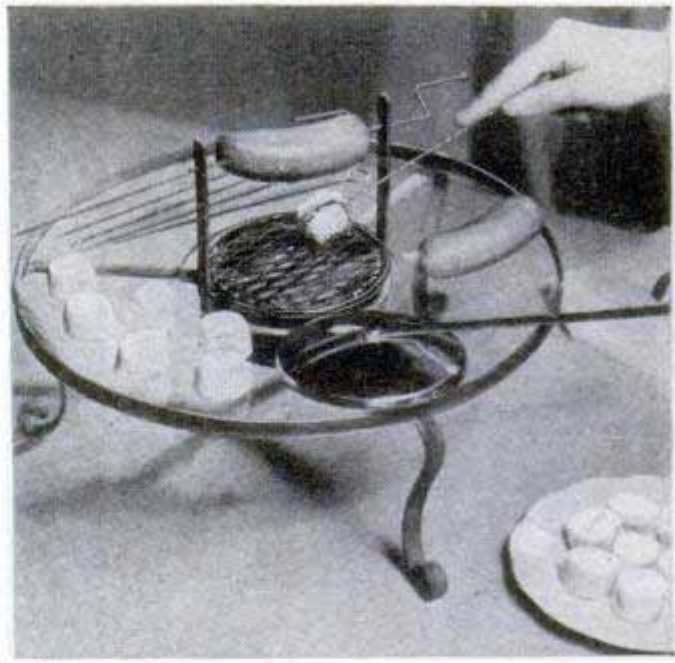

**MINIATURE BROILER** in wrought-iron stand can be used on dining table. It is fired with denatured alcohol

**15-PIECE TOOL KIT**, imported from Germany, folds in leather case only seven inches long. Safety handle locks tools in place automatically upon insertion

**JIFFY LABEL TAPE** comes in handy container with serrated tear-off edge. Waterproof and acid-resistant, the tape sticks to metal, paper, glass or plastics

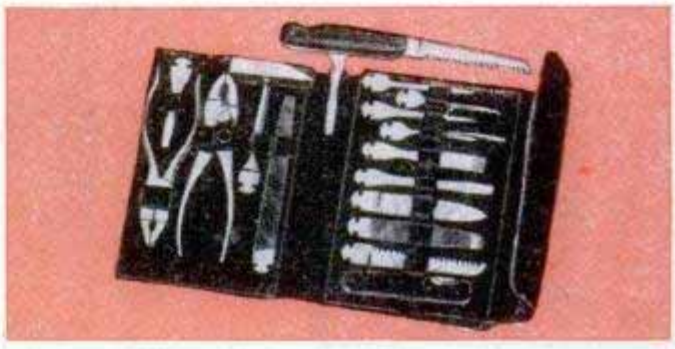

**BELT LIGHTER**, below, is easy to slide on and off. Small and compact, "sure fire" buckle holds chrome-finished lighter which has full-size fuel capacity

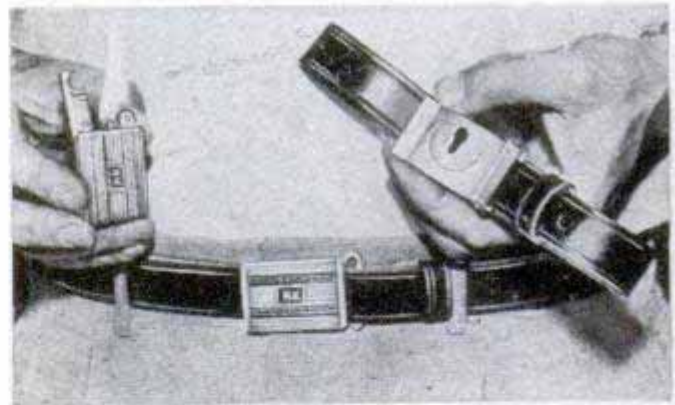
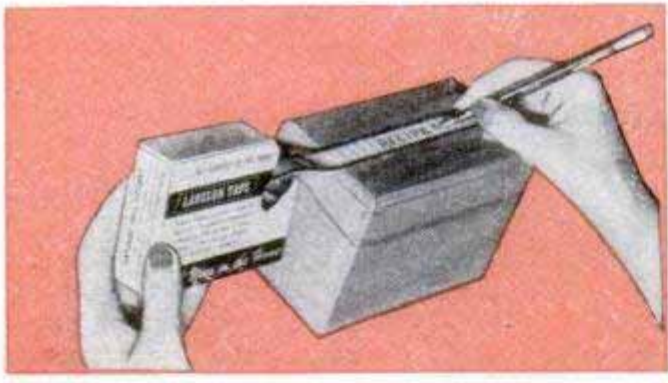

**ALUMINUM HITCH** enables children to tow a wagon behind their tricycle or bicycle. Tricycle hitch fastens to the frame bar and bicycle model bolts to the rear fender and axle to distribute wagon weight

**ELECTRIC FLOUR SIFTER** is another timesaver for the housewife, making it possible for her to sift flour completely in a single, easy operation. "Deep well" container holds over three full cups of flour





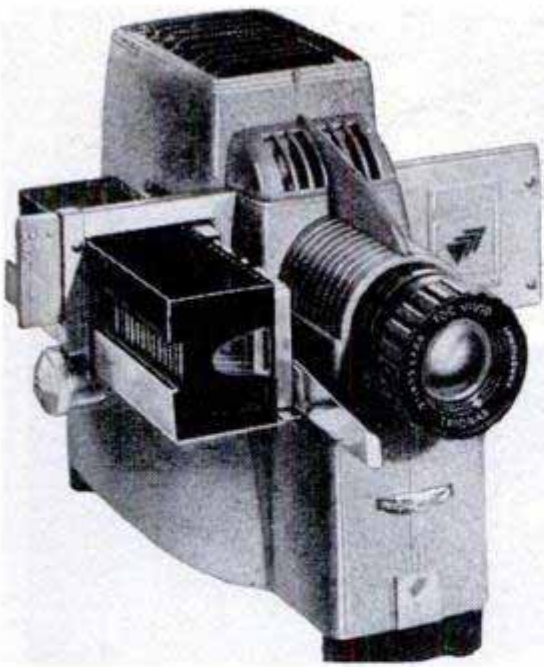

**SLIDE PROJECTOR** with tray-loading changer is fitted with powerful blower for maximum slide cooling

**SAFETY-FUSE PLUG** for tree-lighting sets contains two cartridge-type fuses to guard against overloads

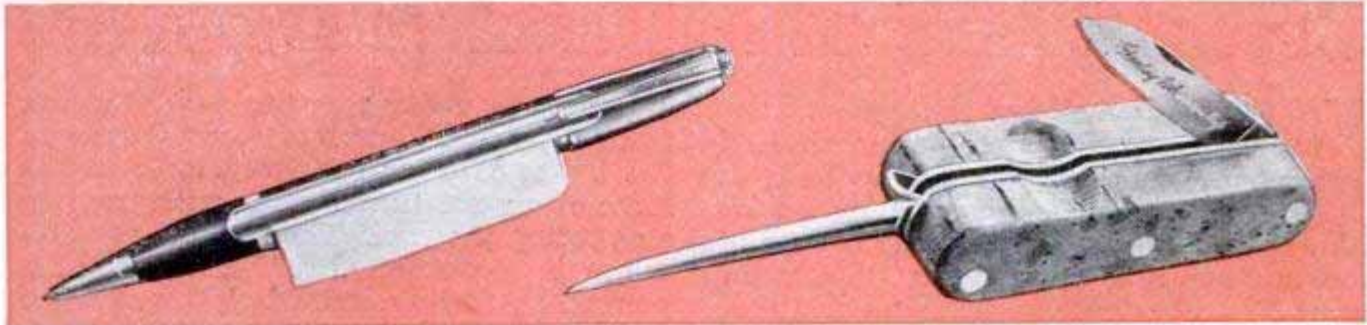

**HANDY MEMO PENCIL** styled in maroon plastic holds a full yard-long roll of memo paper in its barrel  
**FLOOR CONDITIONER** weighs only 19 pounds. It "sweeps" a wide path in scrubbing, polishing, waxing

**FLOATING KNIFE** for well-equipped fishermen has cork handles, three-inch blade and a marlinespike  
**STAR FINDER** is a pleasant pastime for young and old in learning to identify stars and constellations

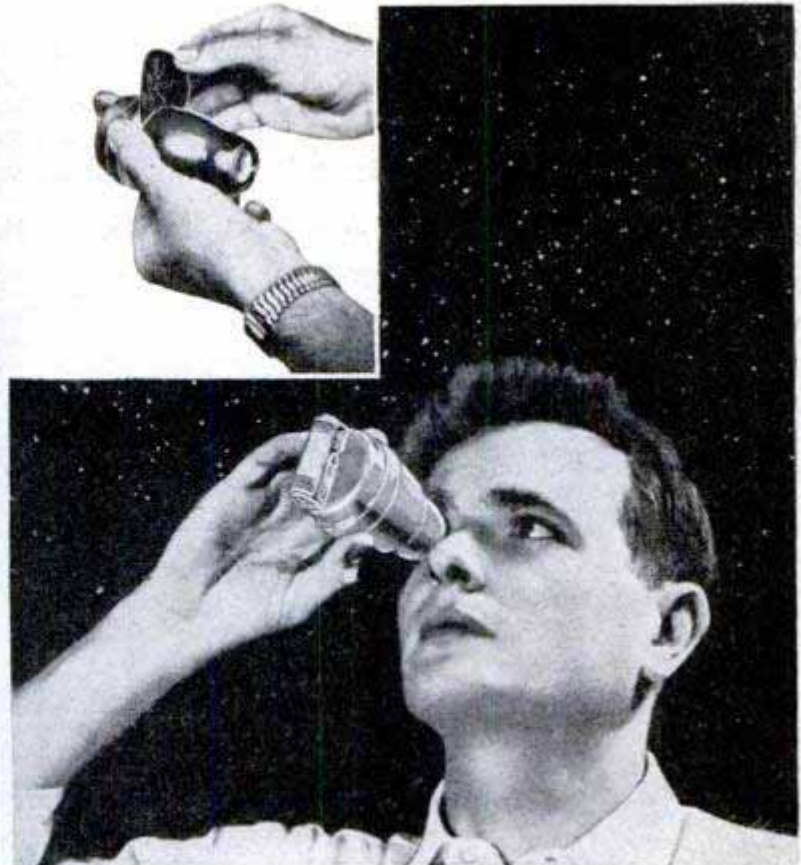



With a seating capacity of 200, glass chapel in Palos Verdes Hills of California brings exterior beauty inside

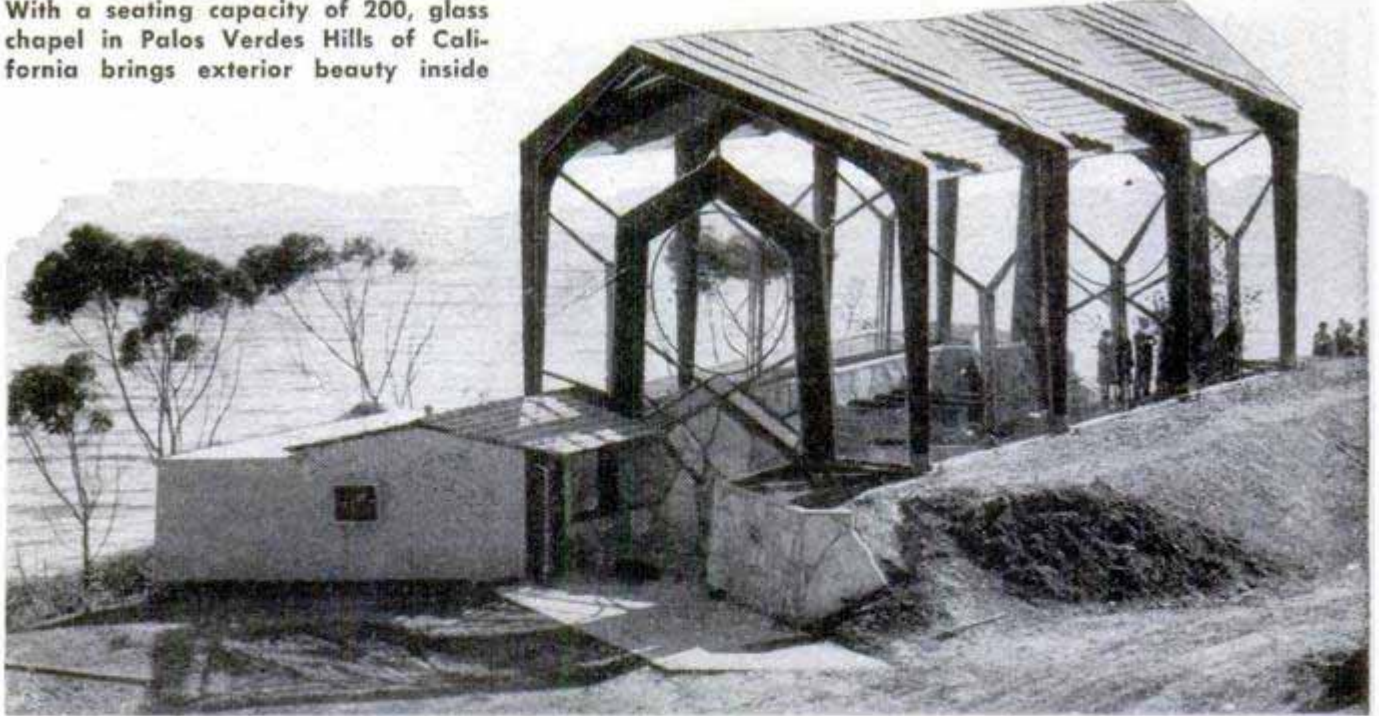

## CHURCHES of MODERN DESIGN

**V**IRTUALLY nothing but glass surrounds those who worship in an unusual little chapel in the Palos Verdes Hills of California. The chapel was designed by Lloyd Wright, who felt that the beauty of the surrounding countryside should be brought inside the church. Wall and roof trusses are made of  $\frac{5}{8}$ -inch redwood laminates, and the panes which form the walls and most of the roof are  $\frac{1}{4}$ -inch plate glass. Portions of the roof are blue tile to provide partial shade below. The true appearance of the chapel will not be apparent for 25 years or more, when a recently planted grove of redwoods will have grown tall enough to protect the structure and provide shade.

Extreme beauty in simplicity is readily

apparent to visitors at the new Oneonta Congregational Church of South Pasadena, Calif. Its exterior architecture is in the form of an overturned ship, with the ribs supporting the roof. The chancel reredos, uniquely constructed of cast stone, is pierced by 64 tiny stained-glass quatrefoil windows that tell the story of religion from the beginning of Judaism to modern times.

In Kansas City, Mo., the St. Francis Xavier Church is shaped like a fish, giving churchgoers a clear view of the sanctuary and altar from either side of the 88-foot main isle. Between the large statue of St. Francis Xavier and the main entrance, a long cement canopy over the driveway protects people as they leave their cars during rainy weather.

To provide shade, portions of roof are covered with blue tile. Plate-glass sides can withstand 55-m.p.h. wind

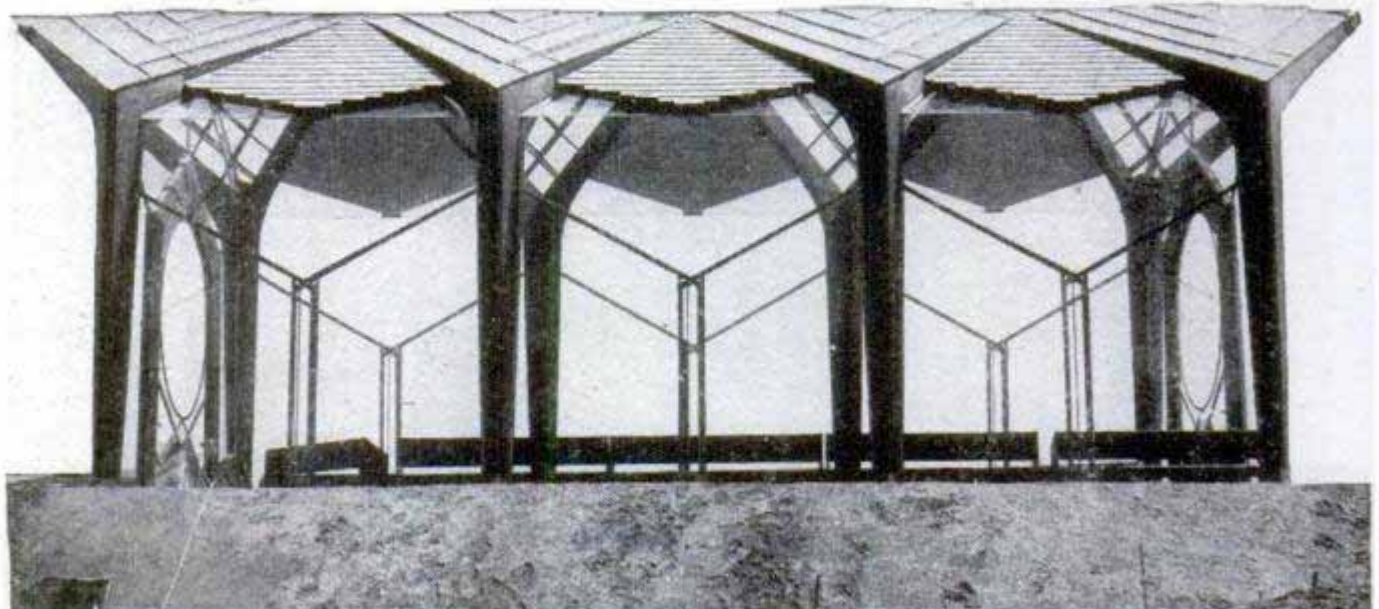



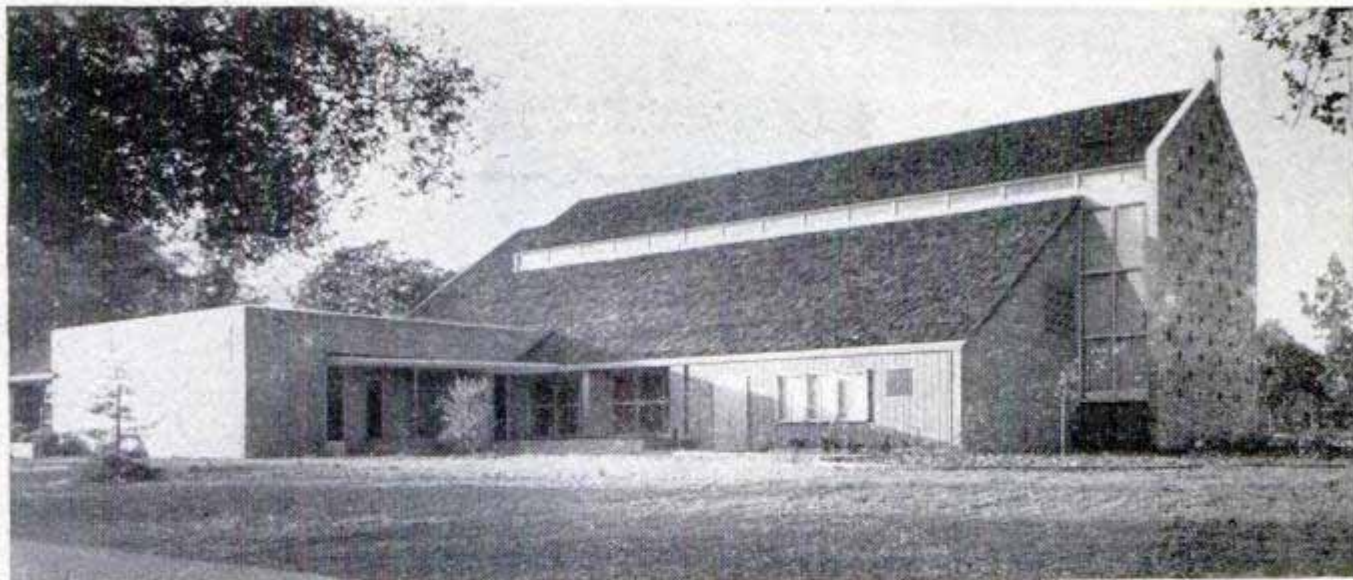

Turn this modern church upside down and it would look like an early-day ship, with heavy ribs supporting the roof. Simplicity is main design feature

Constructed of cast stone, chancel reredos of Oneonta Congregational Church, right, is studded by 64 stained-glass windows that tell story of religion

Choir loft and pulpit, below right, show the beauty of simple lines maintained in "ship shape" church

Modern in every respect, St. Francis Xavier Catholic Church in Kansas City, Mo., includes a soundproof room for mothers equipped with loudspeaker system and fitted with a large plate-glass window that permits mothers to see the altar during the services

Pittsburgh Plate Glass Co., photo

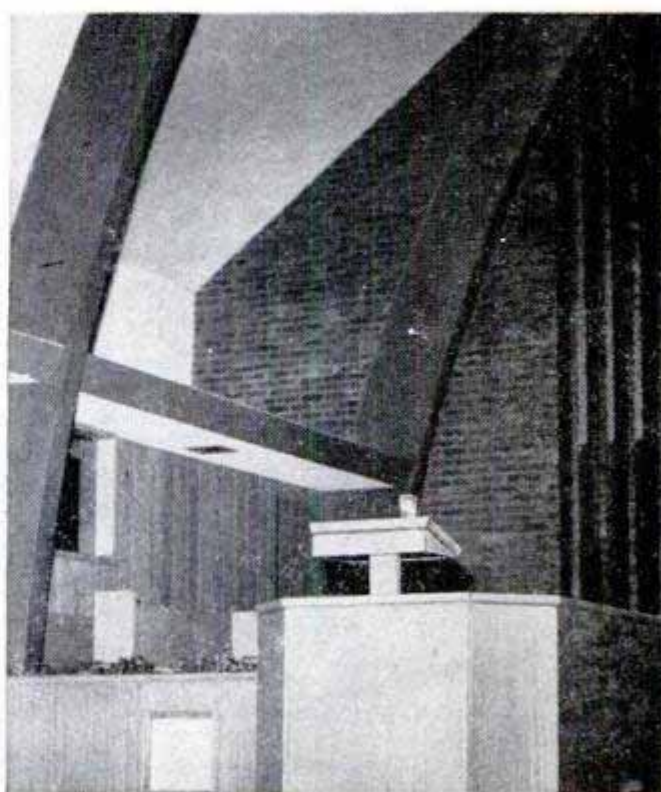
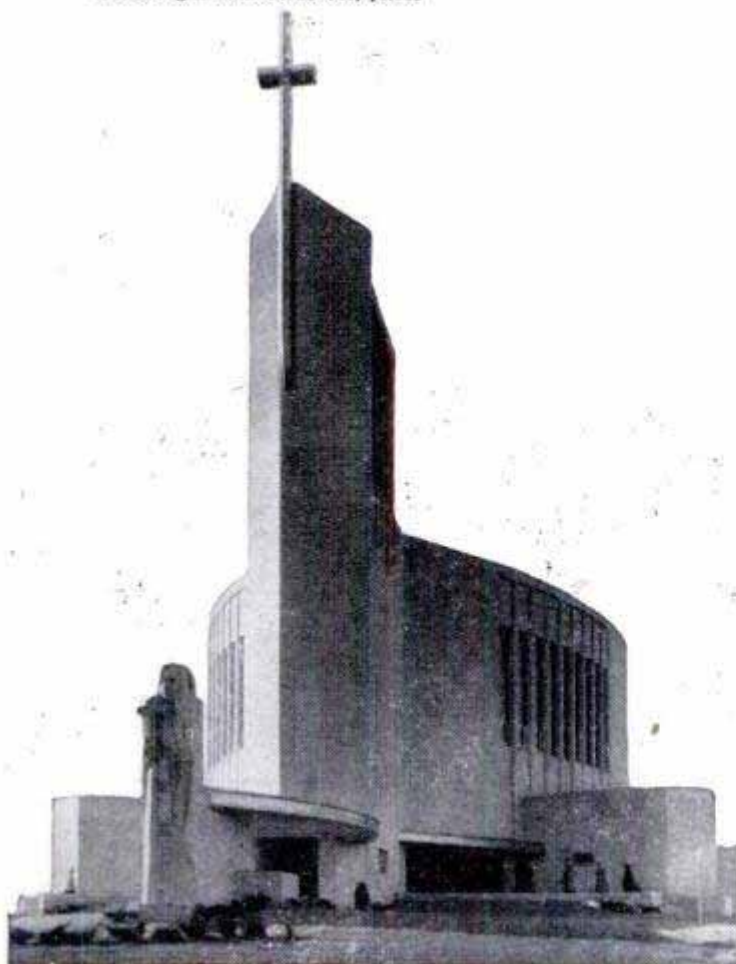
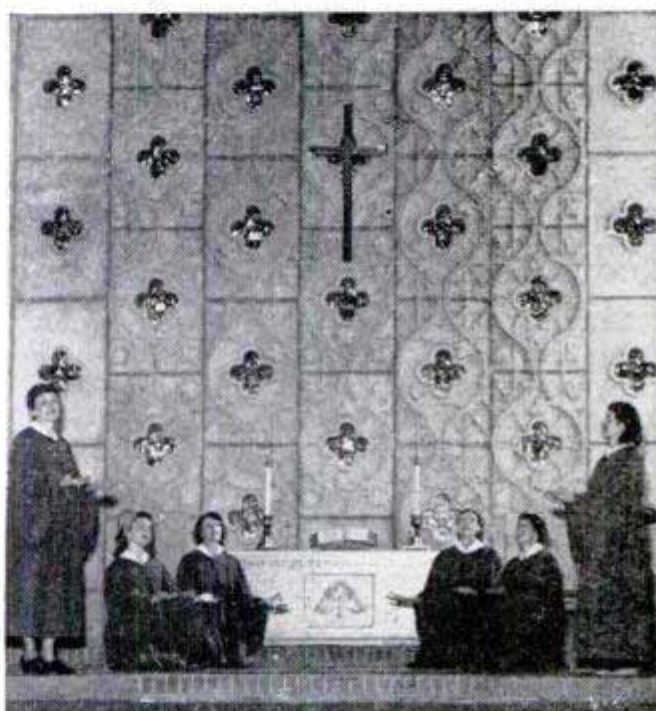





## Rotary Snowplow Cleans Sidewalks

One man can quickly remove snow from sidewalks and driveways with a small rotary plow. Instead of shoving packed snow to one side, the new plow chews it into a powder and hurls it through an adjustable casting chute to out-of-the-way places. A rotary rake breaks up the snow before it is scooped into the mechanism. The plow clears a path 16 inches wide in one pass. It is self-propelled, powered by a 1½-horsepower gasoline engine.

## Canvas Parasol Keeps Cockpit Cool

Shading the cockpit from the desert sun, a canvas "parasol" keeps ground-crew technicians cool as they work in cockpits while ground-testing jet planes at Muroc, Calif. Developed by Northrop Aircraft technicians, the canopy straps to the fuselage, keeping the entire cockpit areas in shade. Test pilots also like the parasol because it keeps the plane interior cool during preflight make-ready at the hot air base.



## Christmas-Tree Lamp Shade

Simply by replacing the shade on a table lamp with one decorated like a fir tree, you can have a Christmas tree for any room in the house. Cone-shaped, the "tree" is realistically colored and even has projecting "twigs" and "branches" on which to hang ornaments. In rooms and small apartments where the traditional tree is impractical, the lamp-shade version makes a convenient substitute.

If you do not find the information you need in the index on pages 12, 14 and 16, sources of further information are available without charge from *Popular Mechanics*. Write to the Bureau of Information, 200 East Ontario St., Chicago 11



## Mobile Electric Lift Raises and Transports Patients

Just one nurse can move a hospital patient from a bed to a stretcher or wheel chair with the aid of a new electrical lift that can be wheeled from one room to another. The patient is supported by broad straps that pass beneath his body and are fastened on either side to a framework of aluminum tubing. When the nurse operates the controls, cables draw up the framework to lift the patient off the bed. He then can be moved anywhere in the hospital. The lift also permits changing bed linen without disturbing the patient, and can be used to weigh bedfast patients accurately. It has a capacity of 1000 pounds, providing a wide safety margin for any patient, plus heavy plaster casts.

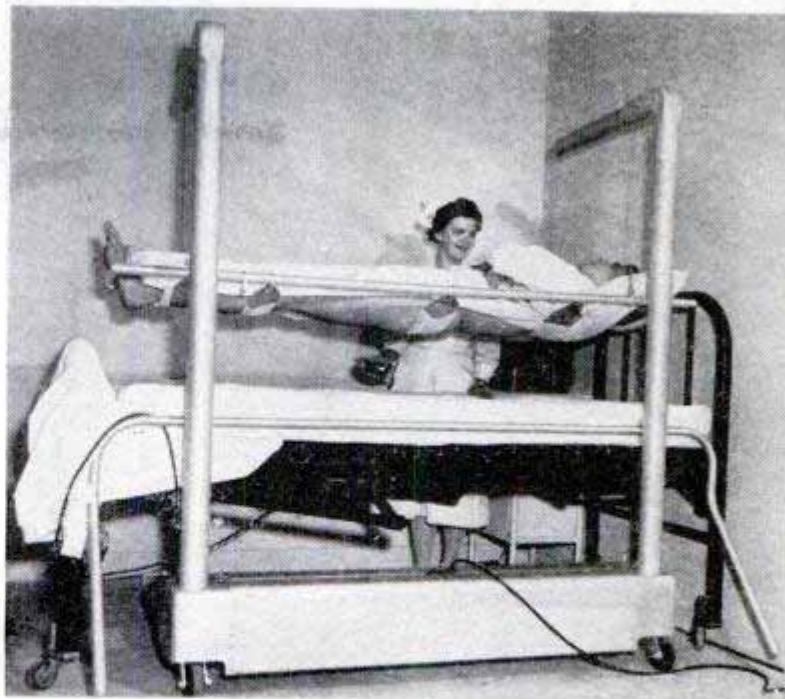

## Barrel-Shaped Rubber Boosters Inflate to Improve Spring Action

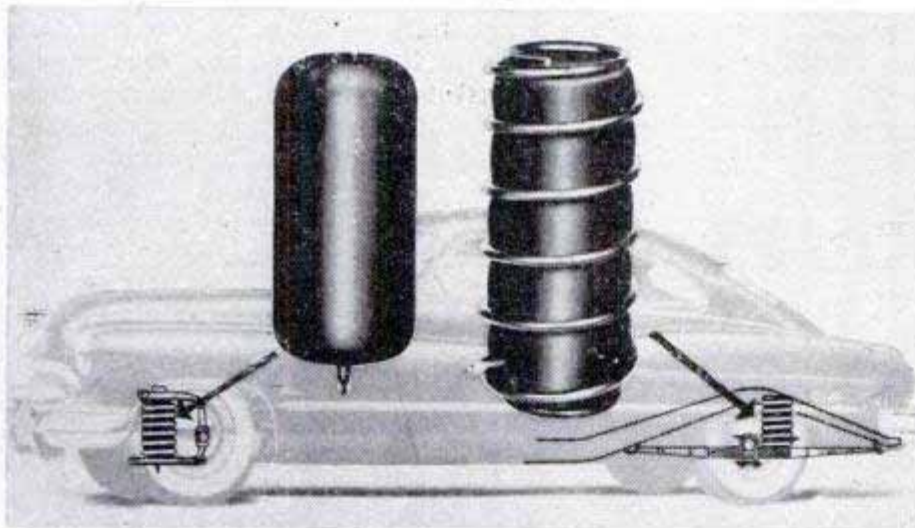

Installed inside coil springs, air-inflated rubber cylinders improve or restore spring action under all driving conditions. The cylinders are inflated to any desired pressure. When mounted inside the rear springs, they permit adjustment for overloads and prevent bottoming of the suspensions on rough roads. On the front-coil springs, the rubber boosters decrease the tendency to lean on curves.

## Print-a-Minute Camera Photographs Oscillograph

Copying the image on the screen of a cathode-ray oscilloscope, a recording camera adapted from the Polaroid print-a-minute camera provides engineers with a valuable research tool. Designed for use with any standard five-inch oscilloscope, the recording device consists of an adapter that locks against the tube face, a hood that assures proper focus and the Polaroid-Land camera with several changes including a special f:2.8 or f:1.9 lens for close-up work.

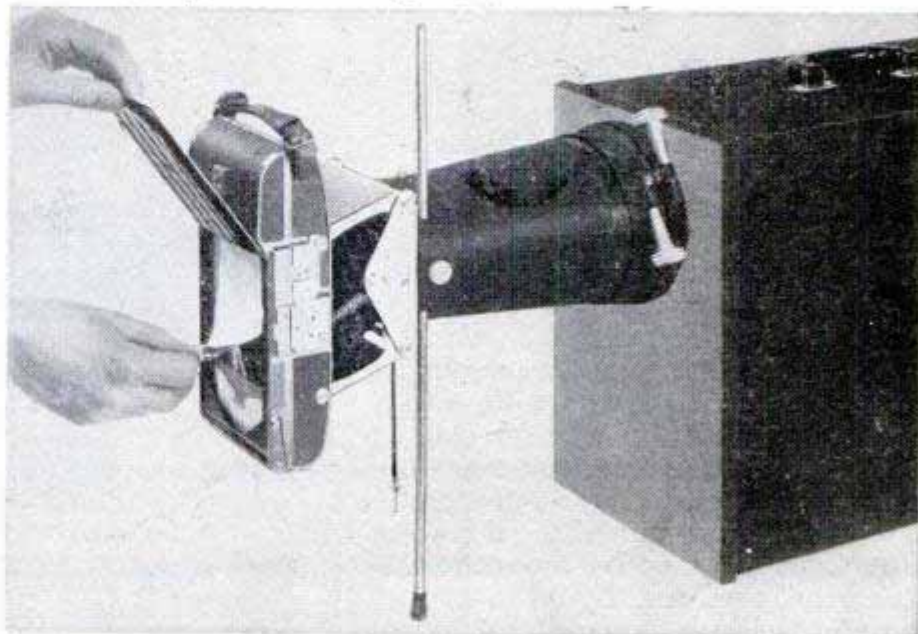



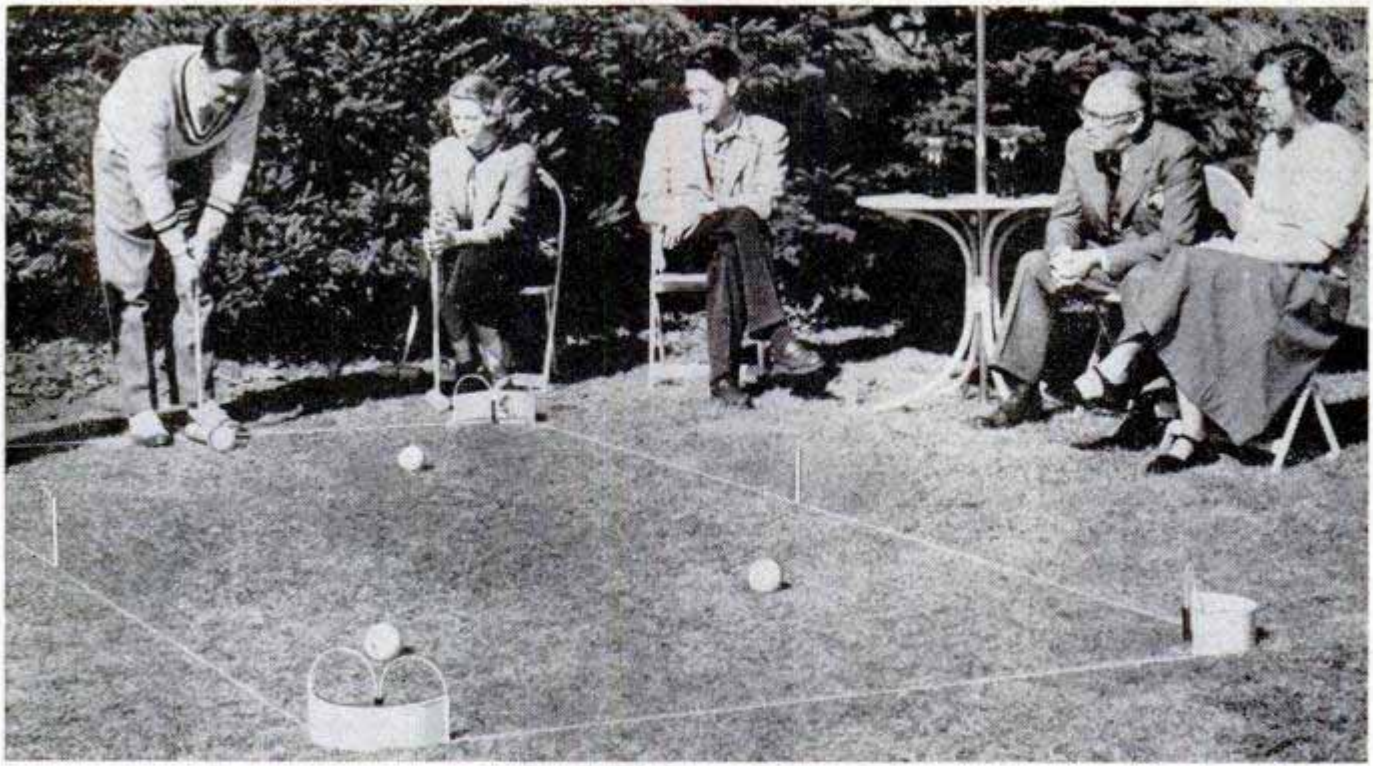

## Game for Small Lawn Combines Billiards and Croquet

Features of croquet and billiards are combined in a new lawn game laid out on a court measuring only 10 by 20 feet. The game thus can be enjoyed on a small lawn. In the game, which can be played by two, three or four persons, each player tries to drive his ball into a succession of pockets. In order to earn the privilege of shooting

for a pocket, he first must hit one or more of the balls in the same play. The equipment, including mallets, plastic balls, wickets, pockets and string for making sidelines is conveniently stored in a lawn table. The same equipment can be used to play the conventional game of croquet where a larger area of lawn is available.

## Porpoise in Harness Pulls Surfboarders

Porpoise-power is the newest means of locomotion for surfboard enthusiasts at Marineland, Fla. "Flippy," a dolphin being used in experiments to determine the I. Q. rating of these water-dwelling mammals, fills the assignment with utmost ease.

## Space Station?

In years to come, a giant "doughnut" 200 feet in diameter may be traveling constantly around the earth 1075 miles up in the sky. That's the prediction of Dr. Werner von Braun, credited with inventing the German V-2 rocket and now an Army rocket expert. The space station would be carried to its orbit in a three-stage rocket, and assembled by men in pressurized suits. They would then live in the outer rim of the doughnut, kept in place by a synthetic "gravity" produced by its rotation around the hub.

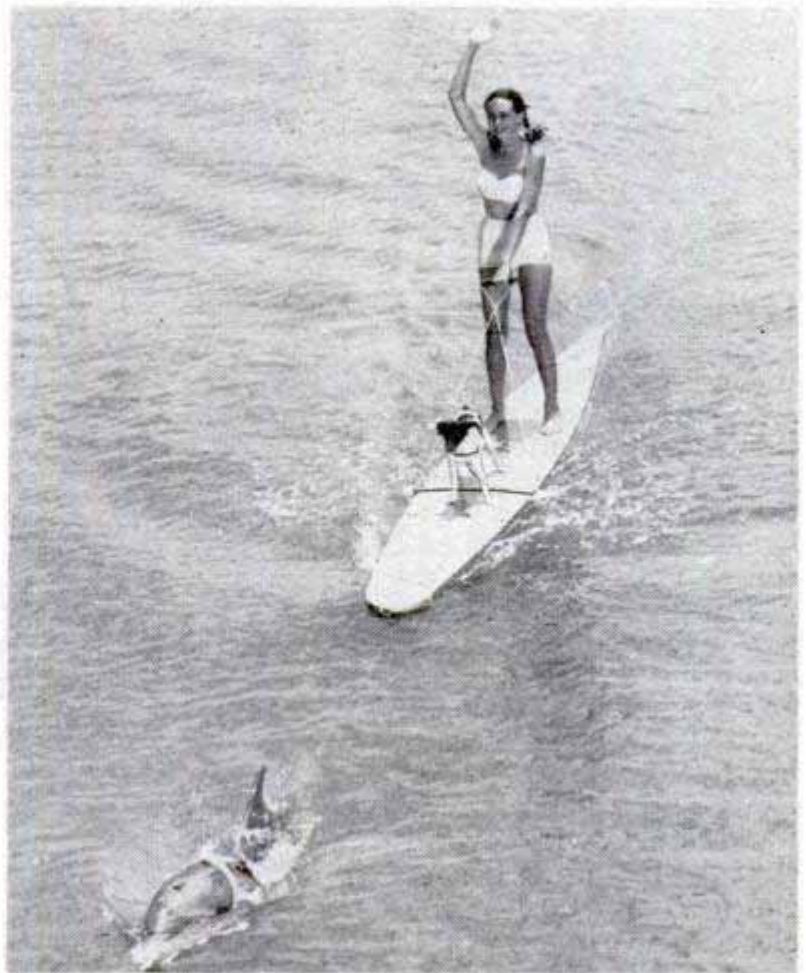



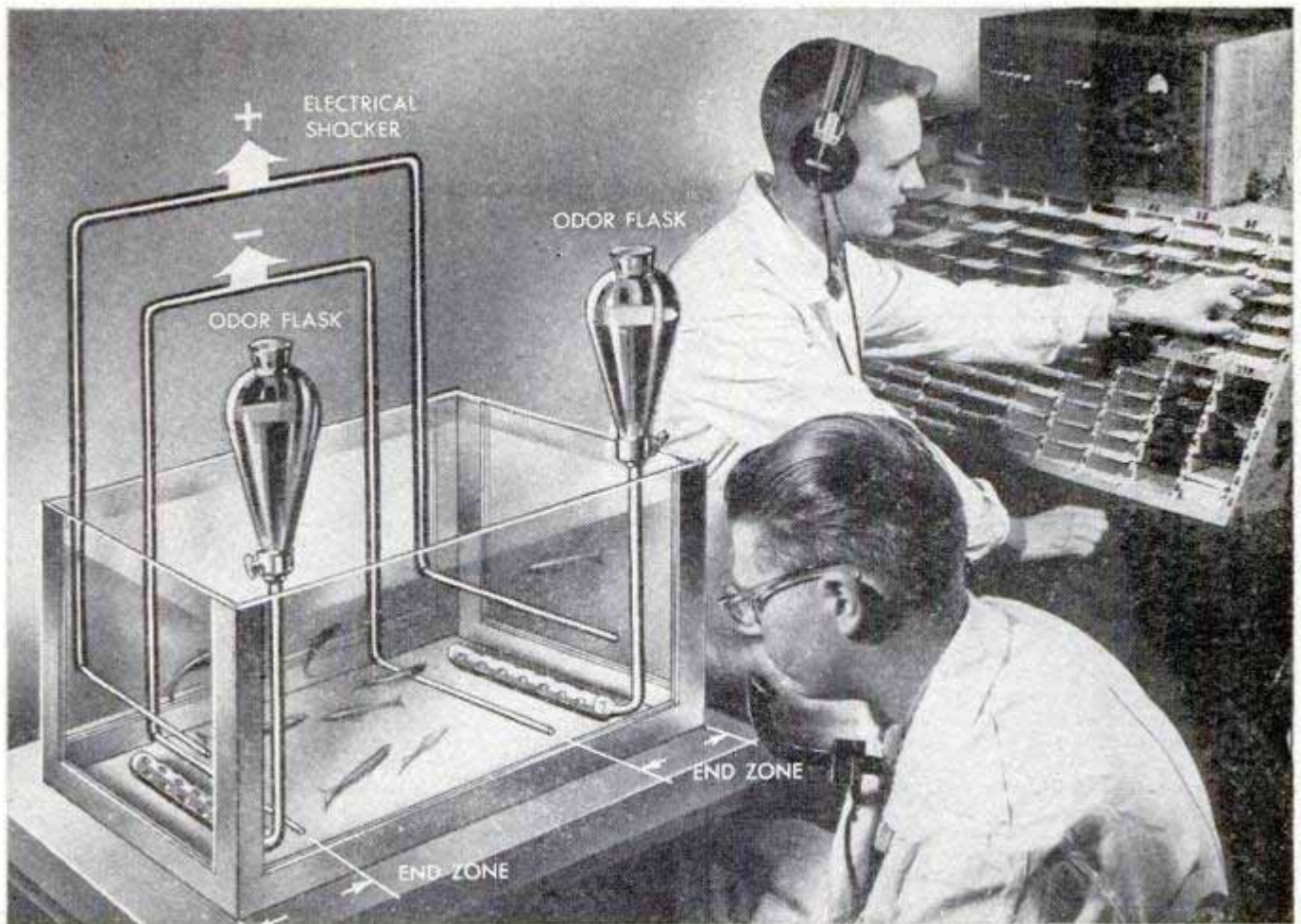

Test tank has shockers at each end to teach fish that certain odors are "bad." Food accompanies "good" odors

## WHAT MAKES SALMON RUN?

HOW DO mature salmon find their way back to rivers in which they were born to lay their eggs and die? Prof. Arthur D. Hasler of the University of Wisconsin thinks they do it by smell. He introduces different odors to minnows: One odor just before feeding; another when an electric shocker is operating around the feed trough. The fish soon learn to go to the trough when the feed odor is introduced;

Fish are identified during smell tests by colored beads which are attached to them with a fine wire

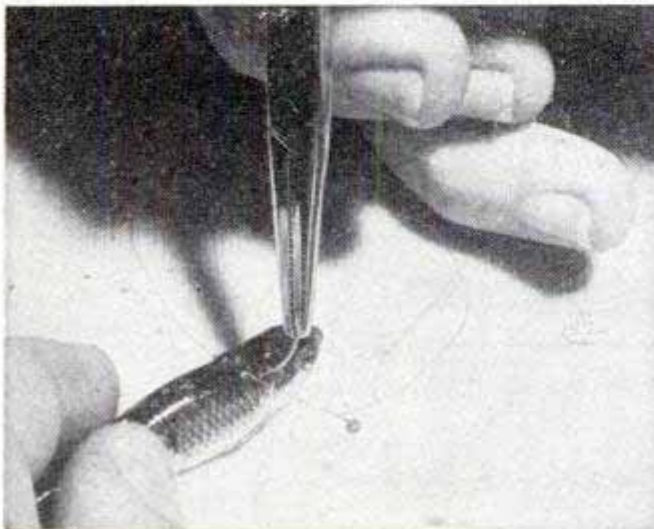

to stay away when they smell shocker odor. Fish are graded as they swim into or out of zones where food and shocker bars are. They learned to distinguish the odors of 12 different water plants. Hasler also discovered that rivers have individual odors and fish can tell them apart. Thus, he reasons, salmon catch a sniff of their "home" river's odor in the ocean and trace it back upstream like a bloodhound.

Fish enter end zone to eat when one odor is present. Bar behind them shocks when second odor is released

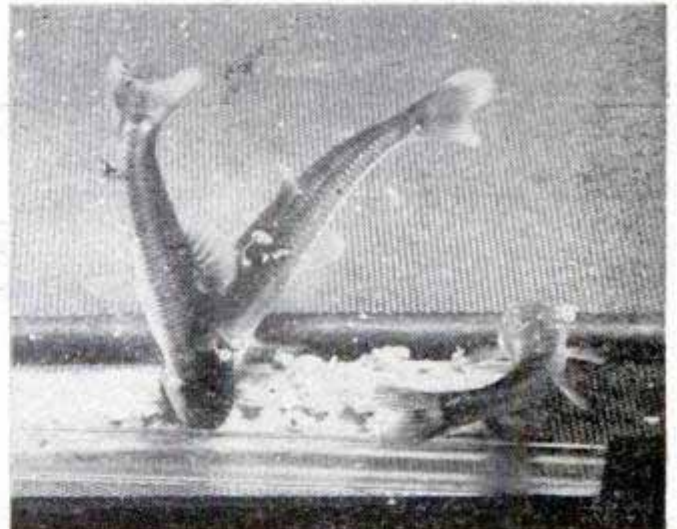



# The OWNERS REPORT on

*We use this car for racing*  
 THE POPULAR MECHANICS MOTOR SURVEY  
 AS CONDUCTED BY FLOYD CLYMER

*dr. for this year savings stand at \$5500 - we can't complain!*

I am the owner of a 1951 Hudson. Model: Pacemaker  Super Six  Commodore  Hornet  Commodore Eight

I have owned it about 4 months. Speedometer mileage is now 22,000

I use regular gasoline  - I use premium (high test) gasoline  special racing

My approximate gas mileage in the city is average 10 m.p.g. racing MPG; in country, fuel MPG.

I CHANGE OIL  every race miles; I ADD OIL  - one quart every \_\_\_\_\_ miles.

My car has: Standard transmission  Hydra-Matic Drive  \_\_\_\_\_  
 Overdrive  Super-Matic Drive

How does the car handle on the road? Excellent track car

Maneuverability seems to be: Excellent  Average  Unsatisfactory

Acceleration is: Outstanding  Very Good  Average  Poor

Curb and Road Clearance is: Satisfactory  Too High  Too Low

Why did you buy a Hudson? Stock car racing

What features about the car do you especially like? Dependability and  
I believe that it's the finest mechanically engineered

Do you like Hudson's "step down" interior? Yes; it's interior finish? Yes;  
 It's increased visibility? Yes; it's body styling in general? Not too bulky

If you own a Hudson Hornet, what is your opinion of it's new 6-cylinder engine?  
Very good, above average in workmanship

What do you dislike about the car? The overhang on sides + fenders

Have you ever owned a Hudson before? Yes If so, how many? one

Would you buy another Hudson? Yes  Possibly  No

Do you secure good dealer service? Yes  Average  No

How would you rate your new Hudson? Excellent  Good  Average  Poor

**GENERAL INFORMATION**

What type of engine would you prefer in your next new car? In-line  V-type

Cylinders: 6  8  Valves: Side  Overhead

Based on my present experience, I want my next car equipped with: Standard trans.   
 Overdrive  Hydra-Matic Drive  Super-Matic Drive  Other type automatic

Please state reasons: \_\_\_\_\_

Do you like the new, low-pressure, super-cushion tires? Yes

Do you carry the recommended pressure? Yes  No  How much more? 6 lbs.

Please answer all questions (  ). Your name will be held in strict confidence.

Please mail promptly to:

FLOYD CLYMER  
 1268 SO. ALVARADO ST.  
 LOS ANGELES 6, CALIF.

My Name: \_\_\_\_\_  
 Address: \_\_\_\_\_  
 City & State: La Brea 32, California  
 Occupation: Toolmaker

(Use other side for additional remarks.)

## ACCELERATION TEST

Hudson Hornet 4-Door Sedan  
 With Hydra-Matic Drive

1/4 mile from zero.....		19.70 sec. - Drive range only 18.90 sec. - Low and Drive
1/2 mile from zero.....		31.80 sec. - Drive range only 31.10 sec. - Low and Drive
0 to 30 m.p.h.....		4.30 sec. - Low range only
0 to 60 m.p.h.....		14.20 sec. - Drive range only 13.70 sec. - Low and Drive

Top speed (by speedometer) - 108-110 m.p.h. Actual top speed about 8 percent less



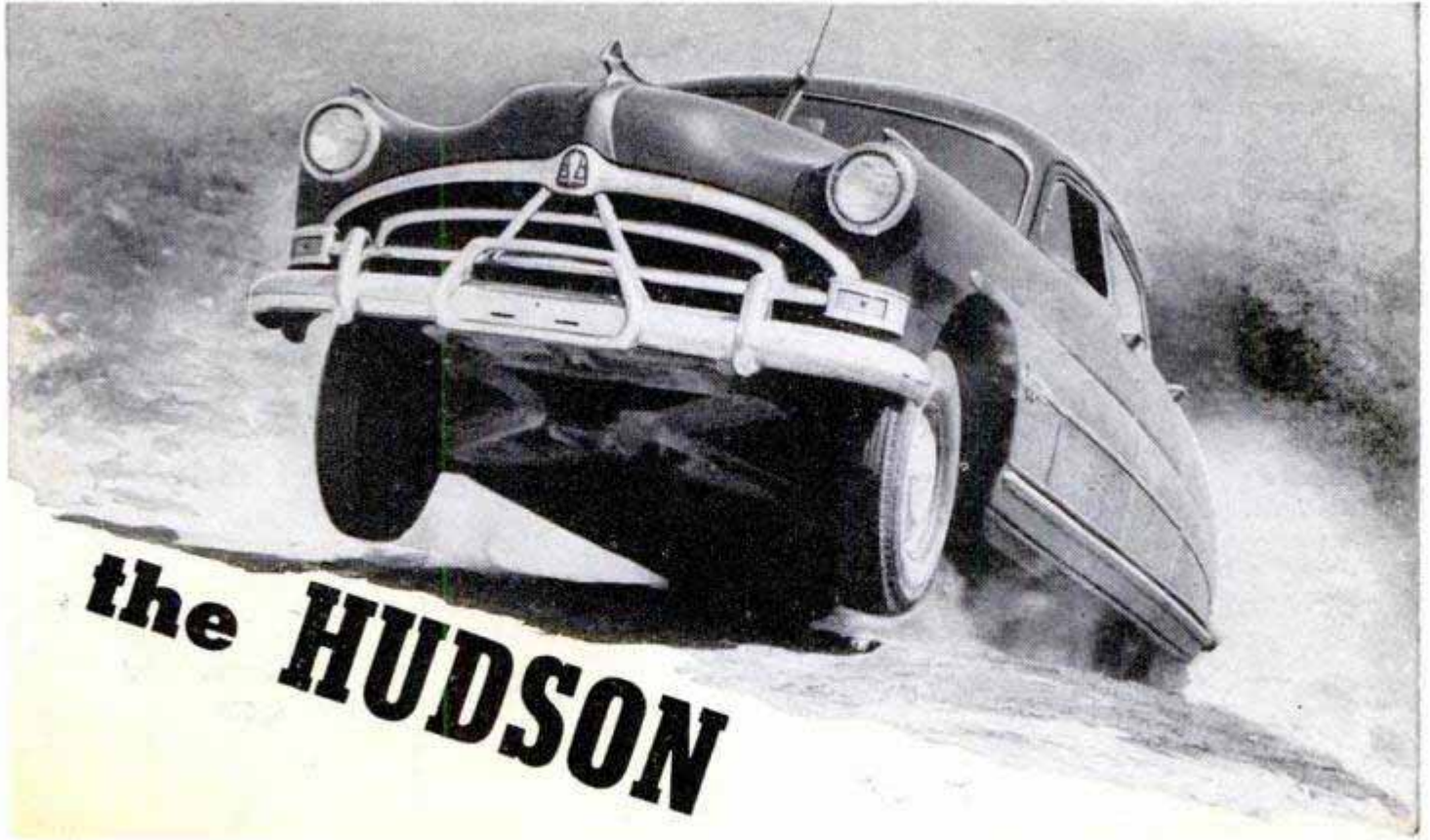

**The true test of an automobile begins when the owner takes the wheel. This is another report from owners of cars who answered questionnaires sent by Popular Mechanics to 1000 Hudson owners from coast to coast**

*By Floyd Clymer*

**T**HE FRATERNITY of Hudson owners seems in general to be just as enthusiastic about its choice of car as any other group we have yet surveyed. In fact there seemed to be an exceptionally high percentage of "repeaters"—owners who bought the 1951 Hudson because they had driven one or more Hudsons in the past and were satisfied.

Of all owners who answered the direct

Photo below was taken over Clymer's shoulder when speedometer on Hornet he tested showed 109 m.p.h.

question, "Would you buy another Hudson?" only one percent said "No."

A Minneapolis insurance man said he bought a Hudson because his family had driven Hudsons since 1921. This sort of reply was quite common, as was the reason given by a Washington, D. C., transportation supervisor: "I have owned Hudson products since 1926 and saw no reason to change."

Dotted lines indicate where mechanical brakes apply if the hydraulic system should ever fail





# Percentages From P. M. Poll

Owners of Hornet models .....	36%
Pacemaker models .....	26%
Others .....	38%
Owners of Standard transmission .....	30%
Hydra-Matic transmission .....	43%
Overdrive transmission .....	25%
Super-Matic transmission .....	2%
Use premium gas .....	46%
Use regular gas .....	54%
Gasoline Mileage:	
City	Country
Comm. 8 .....	15.1 m.p.g. 18.6 m.p.g.
Hornet .....	13.7 m.p.g. 17.1 m.p.g.
Pacemaker .....	16.4 m.p.g. 19.5 m.p.g.
Change oil .....	99%
Average mileage for change of oil .....	1579
Owners who add oil (change periodically) .....	3%
Average mileage for adding oil .....	1422
Maneuverability excellent .....	84%
average .....	15%
unsatisfactory .....	1%
Acceleration outstanding .....	40%
very good .....	47%
average .....	11%
poor .....	2%

## Best-Liked Features

Step-down feature .....	91%
Visibility offered .....	98%
Interior finish .....	95%
Body styling in general .....	95%

(These percentages are based on the answers to direct questions on the questionnaires)

## Owners' Rating of Car

Excellent .....	67%	Average .....	5%
Good .....	27%	Poor .....	1%

## General Information

Prefer in-line engine .....	78%
Prefer V-type engine .....	22%
Prefer eight cylinders .....	35%
Prefer six cylinders .....	65%
Prefer side-valve arrangement .....	68%
Prefer overhead-valve system .....	32%
Prefer automatic transmission .....	54%
Prefer standard transmission with overdrive .....	33%
Prefer standard transmission only .....	13%
Prefer Hydra-Matic drive .....	85%
Prefer makes other than Hydra-Matic or Super-Matic drive .....	15%
Like low-pressure tires .....	87%
Inflate above recommended pressure .....	58%
Previous Hudson owners .....	63%
Previous owners of five or more Hudsons .....	13%
Will buy another Hudson .....	74%
Might buy another Hudson .....	25%
Will not buy another Hudson .....	1%
Dealer service good .....	51%
average .....	29%
poor .....	20%

Most frequent objections: 1. Trunk space and location of spare tire; 2. Interior finish, seating; 3. Paint job (exterior); 4. General body fitting, assembly

(17% reporting could find no objections)

A Seattle clothing man remarked: "My wife and I have just about played the field in cars — many different makes — but we never have found anything like a Hudson. My wife says it drives itself, and that's about right. . . . What an automobile!"

In reply to one of our survey questions, "How does your car handle on the road?" 84 percent of the answers were "Excellent." This complimentary proportion is unusually high for our surveys.

"It rides as easily as a streamlined Pullman," said a St. Louis, Mo., telephone-company manager.

One Los Angeles couple responding to the survey said they use their Hudson exclusively for stockcar racing. "It is an excellent track car," they wrote. "We do not drive this car for pleasure; it is strictly a business enterprise. So far this year its earnings stand at \$5500. We can't complain." (Hudson Hornets have won a

"I gave that Hornet the worst beating of any car I ever tested," says Clymer. "It's a wildcat on wheels"





Both rear and front seats of the Hudson are 64 inches wide, and when stood on end alongside the Hornet are higher than car

majority of important stockcar races during 1951, including first and second places in the 500-mile N.A.S.C.A.R. stockcar race at Darlington, S. C., which is America's foremost stockcar race.)

A Los Angeles race driver who owns a Hornet for private use said: "All mechanical parts are the best. My car would perform much better with a Borg-Warner-type automatic transmission. The Hydra-Matic shifts through the lower gears very fast. . . . The first gear should be eliminated, and it should start in second gear."

Here are a few comments on the new Hornet engine:

"It has the fastest acceleration in high gear of any car I've ever driven."—Memphis, Tenn., manufacturing foreman.

"Very good on getaway and also on long trips."—Milwaukee, Wis., estimator.

"The best, smoothest, most powerful car on the market."—Detroit grinder.

"The six-cylinder Hornet is very good, but a bit noisy."—Minneapolis accountant.

"Pickup is excellent, but top speed is not equal to my 1949 Commodore Six."—Minneapolis department manager.

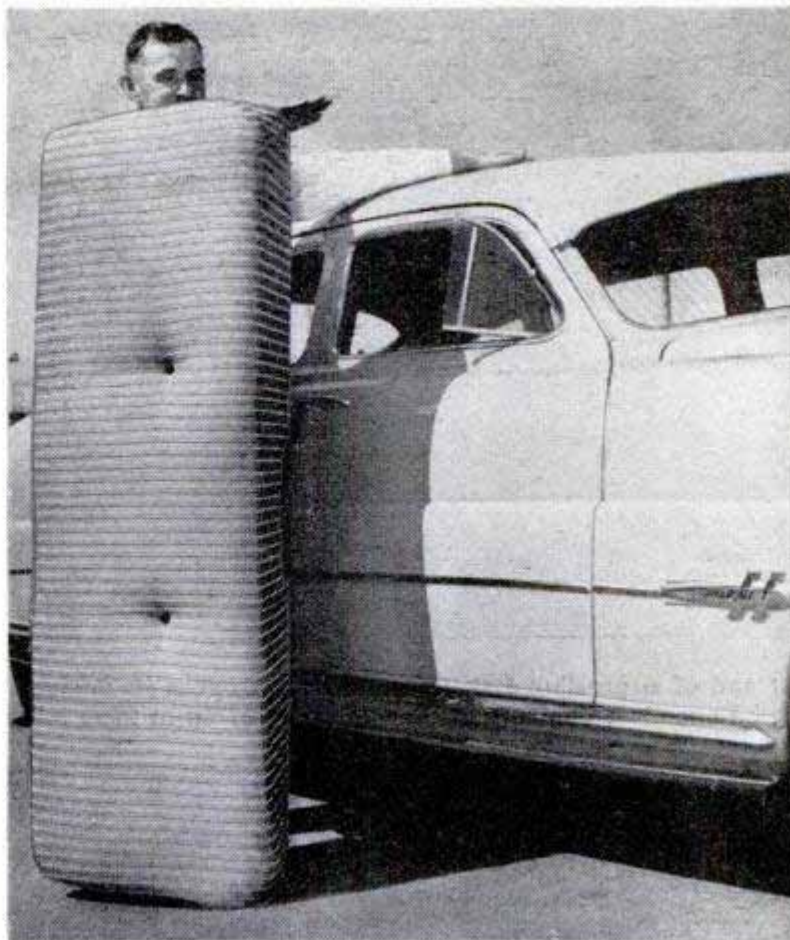

"It is a wonderful motor; with a V-8 engine it would be the best car on the road."—Washington, D. C., clergyman. And a San Antonio, Tex., salesman writes: "If Hudson were to come out with a V-8, I would be the first to give it a try; however, if they don't I'll stick to the Hornet in '52 and trade my wife's car in for another Hornet. Hudson owners are bound to give their cars a good boost—they are excellent automobiles. I like the low cost of upkeep, safety and performance."

All automobile owners have their special peevs, and Hudson owners are not exempt.

"This car was not designed for inclement weather," wrote a Fayetteville, N. C., Teletype supervisor. "Rain seeps into doors and comes out through the upholstery. Very irritating." Said a Salina, Kans., man: "It is the first car I ever owned in which I had to wear a raincoat and rubber boots when it rained."

A second complaint dealt with inadequate trunk space. "The spare tire takes up too much baggage space," wrote a retired policeman in Nashville, Tenn.

Some other miscellaneous dislikes:

"The door latches are hopeless. Doors have to be slammed hard to close tightly."—San Jose, Calif., operating engineer.

"The paint is very poor."—Dayton, Ohio, federal-government worker. This man also wrote: "As far as I'm concerned, the Hudson is a fine car but the dealer service I have received could stop me from buying

### ECONOMY TEST

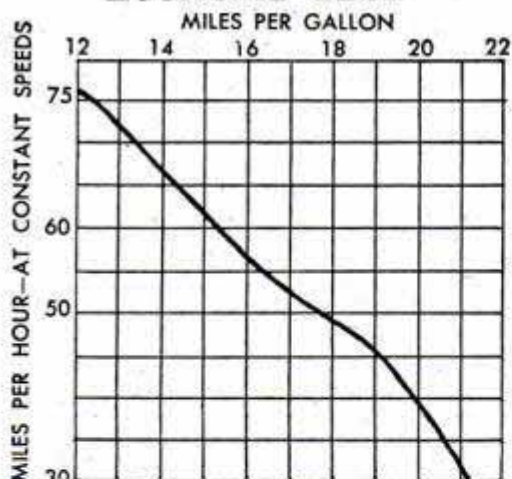

Hudson Hornet 4-Door Sedan  
With Hydra-Matic Drive

At constant 30 m.p.h.	21.10 m.p.g.
At constant 50 m.p.h.	17.80 m.p.g.
At constant 60 m.p.h.	15.15 m.p.g.
At constant 75 m.p.h.	12.30 m.p.g.

#### Cross-Country Mileage

Detroit to Chicago (car new, traffic heavy)	16.10 m.p.g.
Chicago to Denver, Colo. (via Kansas City)	17.20 m.p.g.
Denver to Salt Lake City (over Rocky Mountains)	16.70 m.p.g.
Salt Lake City to Los Angeles (via Ely, Nev.)	19.80 m.p.g.





At end of a grueling test, Clymer's Hornet opens its "mouth" as he examines engine that used one pint of oil in 2750 miles



Emergency handbrake lever is conveniently located for operation by the right hand. Below, owners like the "step down" feature of the Hudson; attractive door fittings are recessed



another." (The survey showed that 80 percent of the owners replying received satisfactory dealer service.)

"The car is good, body is exceptional, but it is about \$500 to \$700 overpriced." — Ephrata, Wash., welder. (Overpricing was mentioned by several owners, such as the Gary, Ind., insurance executive who said: "The car is way overpriced. Perhaps this is why it has high trade-in value." Most previous surveys showed many owners who thought all makes overpriced.)

"The Hornet body seems to be noisier than it should be; it could be helped by insulation and undercoating." — Nashville, Tenn., finance executive.

"The front seat does not conform to the driver's back." — Minneapolis manufacturer.

"The 'step down' interior is hard for children—also hard on women's narrow skirts." — Warner Robins, Ga., physician. (Of those who replied, 91 percent like the "step down" feature.)

"The dealer who sold me the car has spent a lot more on it than I have—or would." — Salina, Kans., architect.

How does the Hudson compare with other makes as to gasoline consumption? Apparently about the same for cars of comparable size and horsepower. Many owners wish they could get more mileage, but that holds true of any car on the American market.

A Rome, Ga., transportation executive said: "I don't get the mileage on my 1951 Commodore Six that I did on my other Hudsons. My average was 20.4 miles per gallon over 244,000 miles on the 1940 model, and 18.8 on the '48 model for 86,000 miles. Up to now I have been getting 15 and 17 miles per gallon on the new model."

However, a frozen-food salesman of Madison, Wis., was pleased with his mileage. He wrote: "On a recent trip to the West Coast in a '51 Pacemaker, I averaged 19.6 in gas mileage; there was no oil consumption at a cruising speed of 65 miles per hour. Absolutely troublefree. I felt as though no other car could give me more per dollar."

The survey showed that Hudson

(Continued to page 260)





### Compact Aspirator

Developed at the School of Aviation Medicine at Randolph Field, a compact aspirator drains liquids from the mouth of paralyzed or unconscious patients during evacuation flights to hospitals. Patients with bulbar polio tend to discharge an unusual amount of saliva which may drain into the lungs because the muscle at the entrance to the windpipe is paralyzed. The aspirator prevents the saliva from drowning the patient. It is powered by an electric motor that plugs into a plane's electrical system. The aspirator is also valuable in the evacuation of soldiers with mouth wounds or basal fractures of the skull. Previous aspirators have been too large for use in operational aircraft. The new aspirator weighs only 25 pounds.

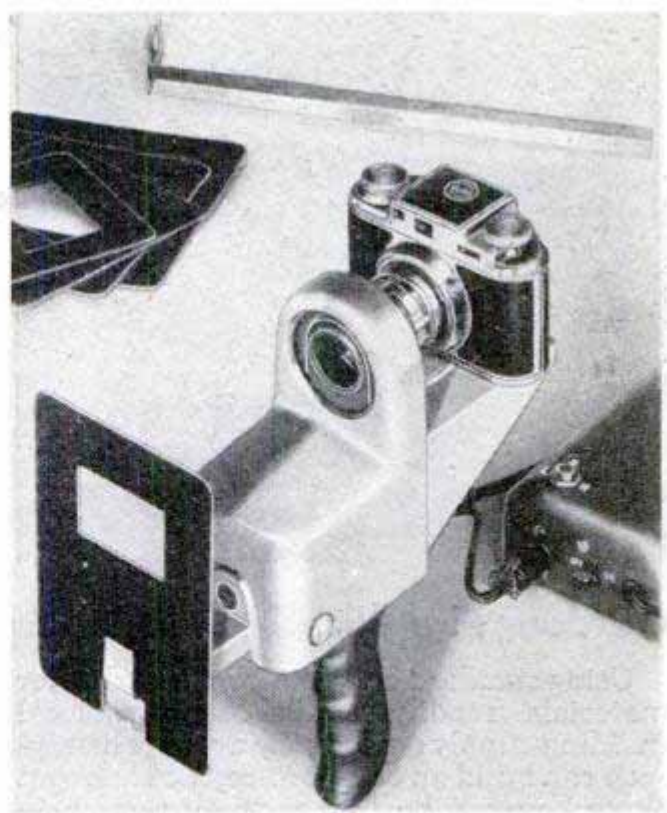

### Miniature Camera

Researchers and doctors can take sharp, close-up photographs of surgical incisions, the mouth and throat and other body cavities with a small camera equipped with a built-in stroboscopic light unit. The light source is a small ring-shaped tube around the camera lens that provides strong, shadowless lighting. The daylight quality of this illumination permits use of daylight color film. The whole light unit is part of a stand that is equipped with a pistol-grip handle. Masking frames covering various areas mount on the front end of the stand to provide accurate framing of the subject matter.

### Shoulder Roller

Road shoulders are rolled and surfaced during widening operations by a machine that moves along with one wheel in the ditch. The axle of the roller is adjustable to keep the machine level with the roller as much as 25 inches below the road surface. It is powered by a four-cylinder gasoline engine, and travels at a top speed of  $3\frac{1}{2}$  miles an hour. The large roller prevents the crushed stone from being "shoved" aside during compression.

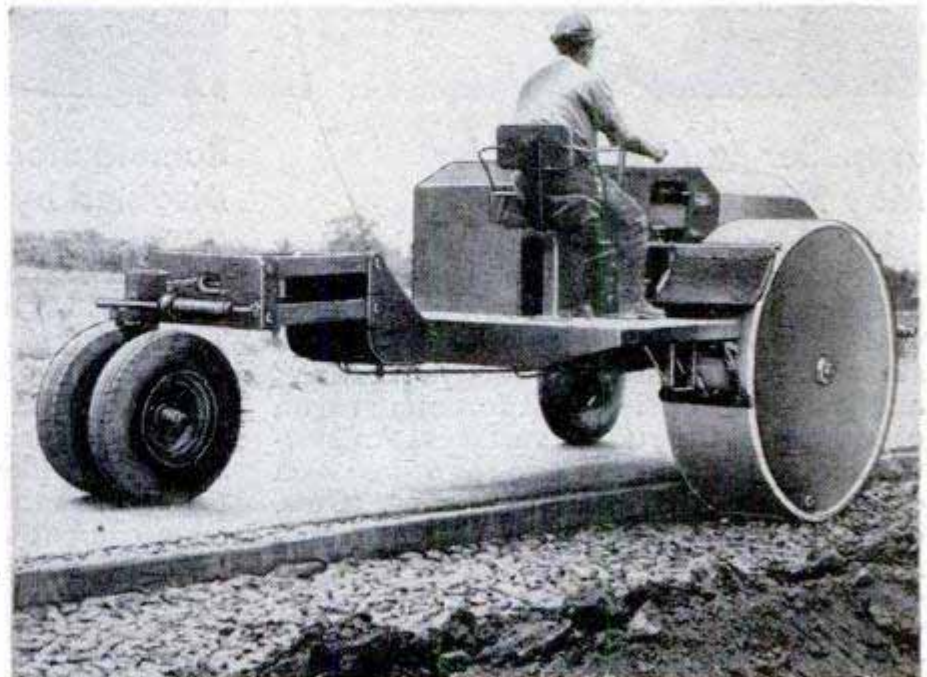



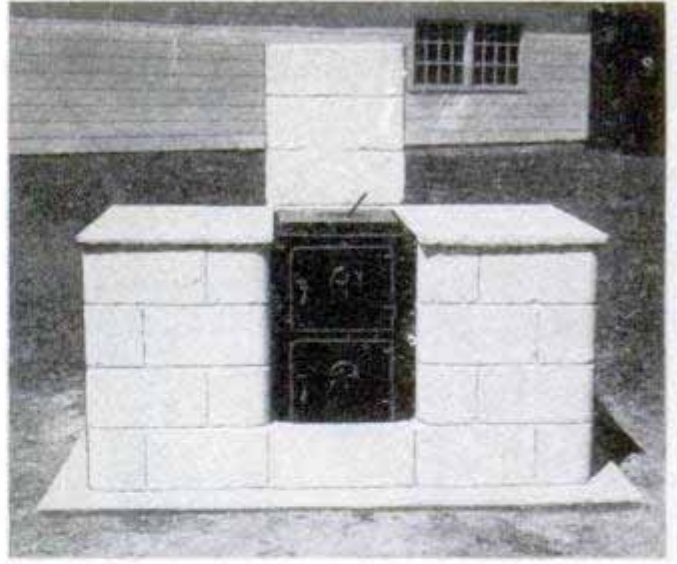
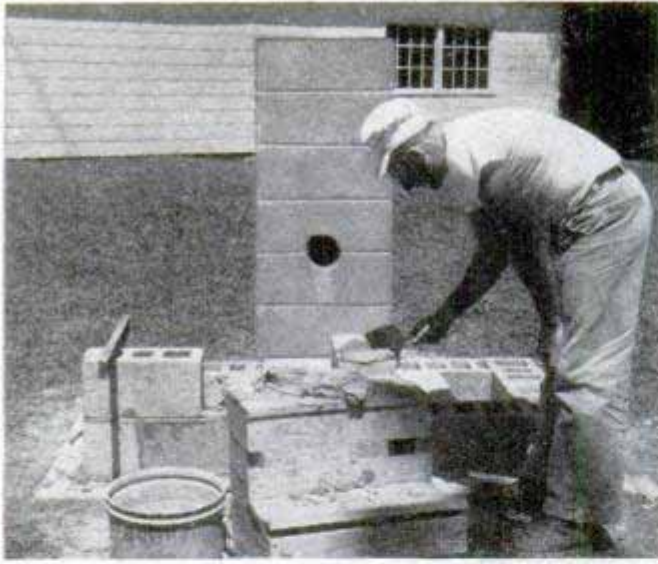

## Outdoor Fireplace Built in Three Hours

Using standard concrete blocks and other materials readily available from local building-supply dealers, the average handyman can build an outdoor fireplace in about three hours. The unit rests on a six-inch reinforced concrete slab and is constructed

around a strong, all-metal fireplace insert which has a heavy angle-iron frame, cast-iron bottom grate and grill in removable sections. Cement paint is applied to the finished fireplace to harmonize with other lawn furnishings.

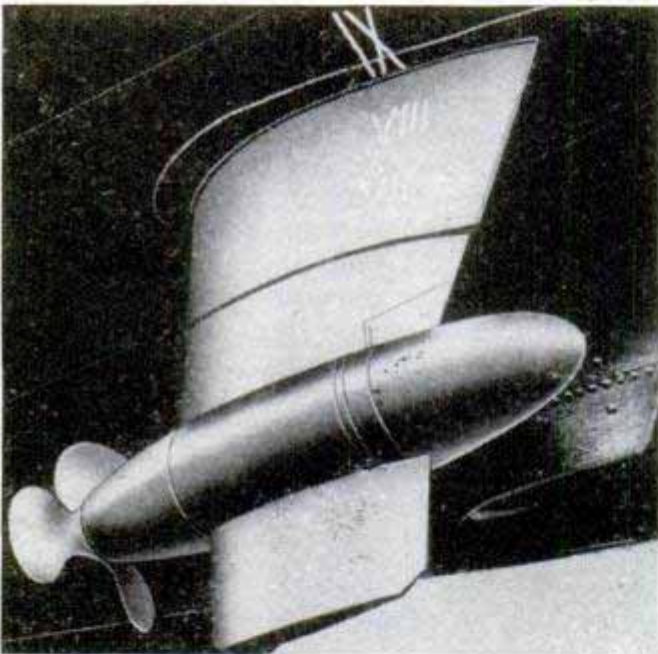

## Propeller-Equipped Rudder May Eliminate Tugboats

Normally, ships can steer only when they are moving, because of the characteristics of the rudder, but a new German invention enables ships to steer even with engines stopped. It is called an "active rudder," and it has a propeller that forces a stream of water past the rudder surfaces. An electric motor inside a torpedo-shaped section of the rudder drives the propeller. Thus, even with the ship at a standstill, the movement of water past the rudder provides steerageway. It is claimed that the rudder permits steering into docks and may eliminate the need for tugboats.



## Remote Steering for Ships Disabled by Enemy Fire

When enemy fire has disabled a ship's steering stations, a new "electric helmsman" guides the vessel by remote control. The instrument is controlled by a small knob on top of a metal box that is hung on a strap around the user's neck. It is plugged into the steering-control system at outlets located at widely separated, strategic points throughout the vessel. In addition to possible combat use, the device can be utilized for "close in" direction of docking, breeches-buoy transfers and other normal or emergency maneuvers. The unit was developed by General Electric engineers.



## Blacksmith Shop Travels to Farms

Handicapped by the loss of one hand, David Boley still carries on his services as a blacksmith by rolling his shop right into the barnyard of customers. The complete shop has been built in a panel truck, which is fitted with a long telescoping rack that carries an anvil and a big machinist's vise. A portable forge straddles the telescoping rack when the shop is closed for traveling. Horseshoes are stored on the sides of the truck.

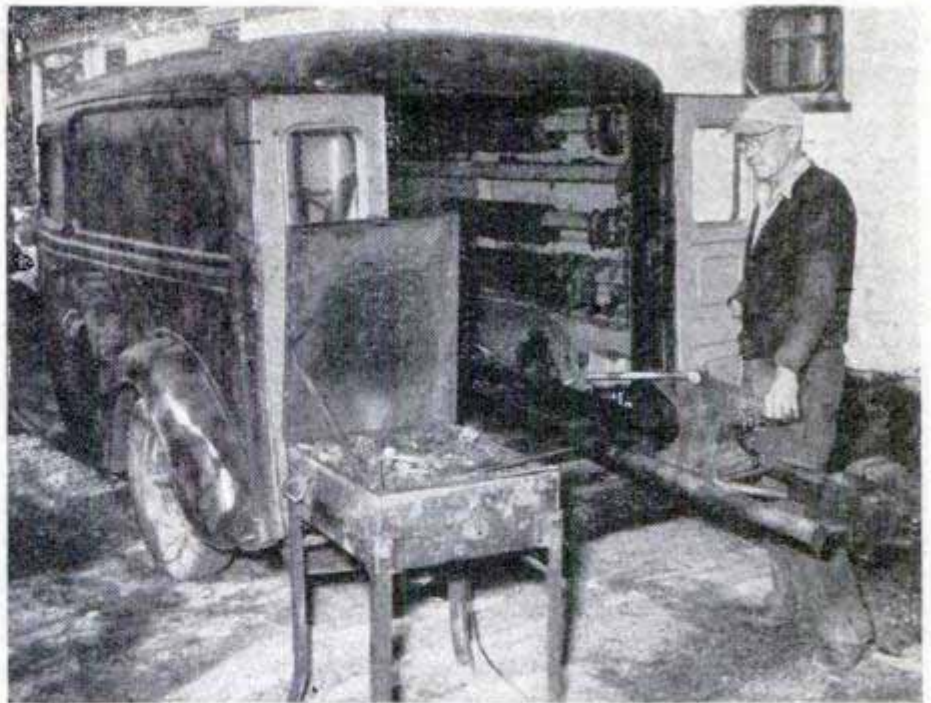

## Strawberry Weeder Is Hand Cranked

Moving slowly and regally across a strawberry patch, Robert V. Lewis weeds the garden comfortably from the seat of his home-made "chariot." Lewis, a retired businessman and now a successful strawberry farmer of Salmon Falls, Me., built the floorless chariot so he could weed his plants without suffering a lame back. He cranks two handles to move along between the rows. His cultivating tools rest on an adjustable tray in front, and overhead there's a big sunshade to keep him cool as he weeds.

## Plastic Gasket Seals Casement Window

Slipped snugly over the inside edge of a metal window frame, a vinyl-plastic gasket seals out drafts and dust. It also seals out heat in air-conditioned homes and offices. The flexible lip of the gasket is compressed between the frame and the window, eliminating all metal-to-metal contact. The gasket, available in 38-inch lengths, can be left in place all year without deterioration, if desired. Installation requires no tools except a pair of scissors and takes about five minutes for each window.

☐ Multiply the number of seconds in a billion years by the speed of light (186,000 miles per second) and you'll discover how far away are the most distant objects seen through the 200-inch Hale telescope at Mount Palomar.

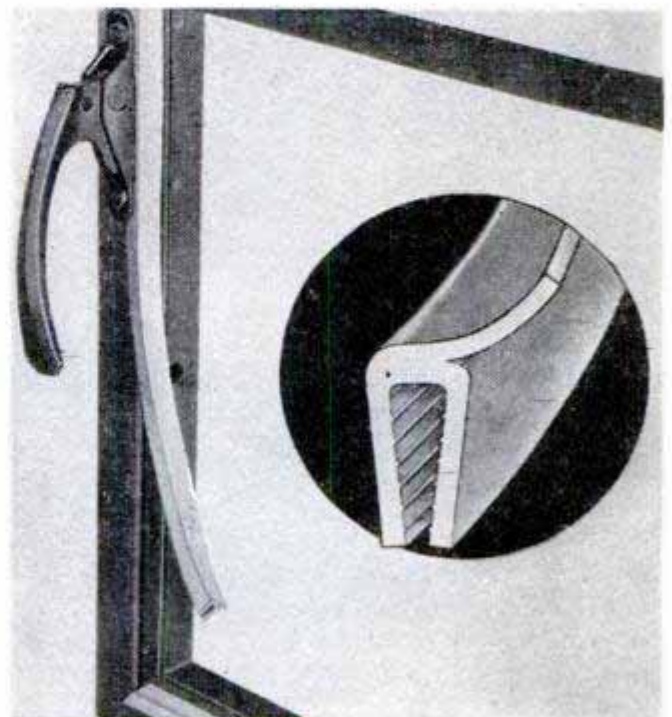



# U.S.S. FORRESTAL—New Queen of the Flattops

**A**LMOST LIMITLESS mobility will be possible for United States air striking power when the U.S.S. Forrestal is completed in 1955 as the world's largest aircraft carrier. Plans call for the 59,900-ton ship's keel to be laid next summer. The Forrestal will be the Navy's first flattop with a retractable bridge, clearing the flight deck of any obstructions to take-offs and landings. It will have an over-all length of 1040 feet and an extreme width at one point of 252 feet, making it capable of handling the largest carrier planes. The twin-engined P2V Neptune patrol bombers can take off from, but not land on, the biggest carriers now in service. In addition to four catapults for launching, the ship will have four elevators to raise planes to the flight deck quickly, and Escalators to carry airmen up

from the ready rooms. More comfort and efficiency for the Forrestal's 3500 men, including her air-group personnel, will be provided by air-conditioned quarters. The craft's equipment will include some 1600 electric motors, graduated in size from .02 to 300 horsepower, and will have about 750 tons of steel piping and tubing. A secret television system will aid aircraft in landing. The giant ship, named for James V. Forrestal, the late secretary of defense, will cruise at a speed of 30 knots. The estimated cost of the new carrier, which will be built by the Newport News Shipbuilding and Drydock Company, is \$218,000,000.

**Artist's concept of U.S.S. Forrestal, which will operate as a floating, heavily armed air base, with 3500 men, and planes capable of carrying atom bombs**

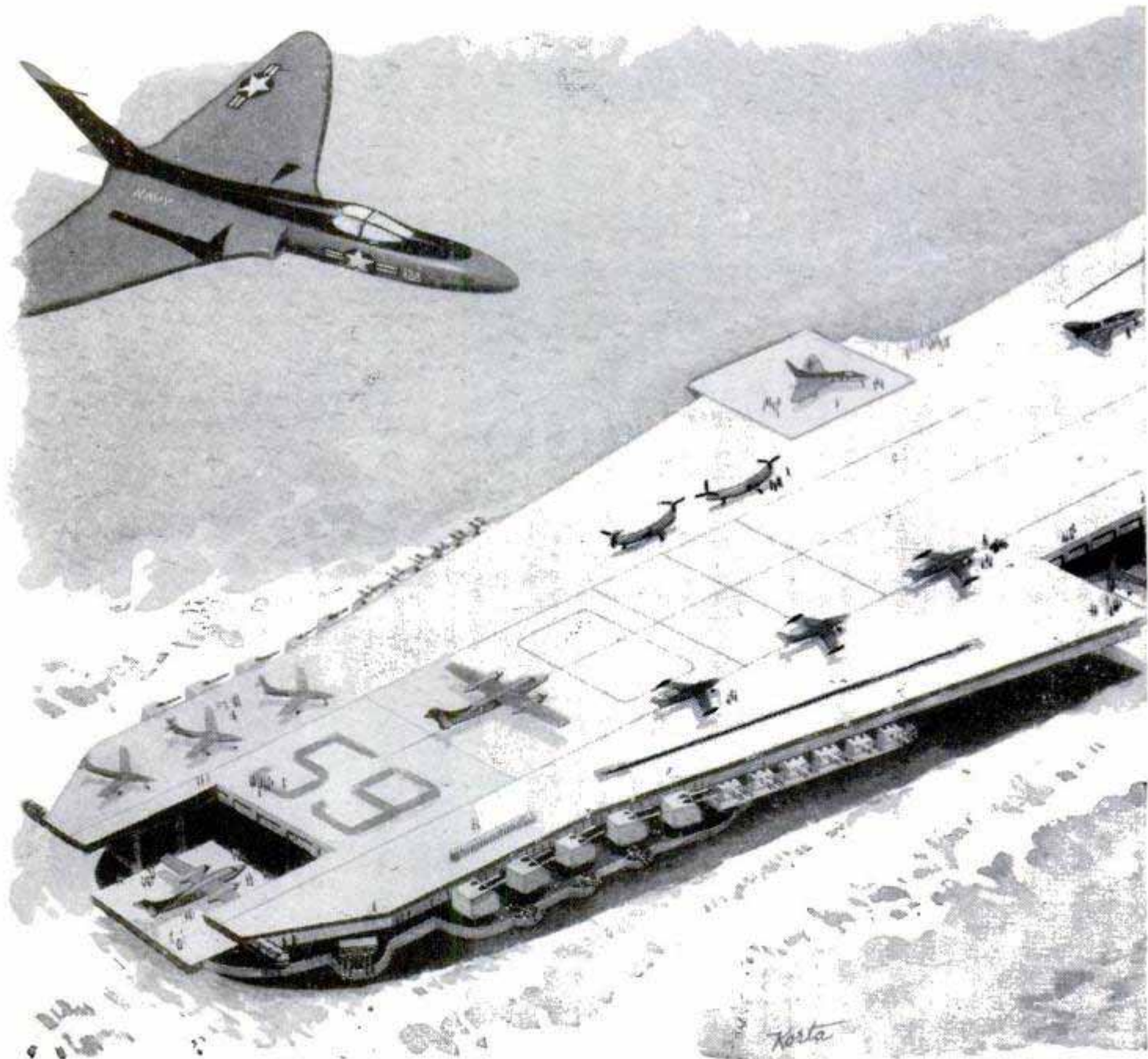



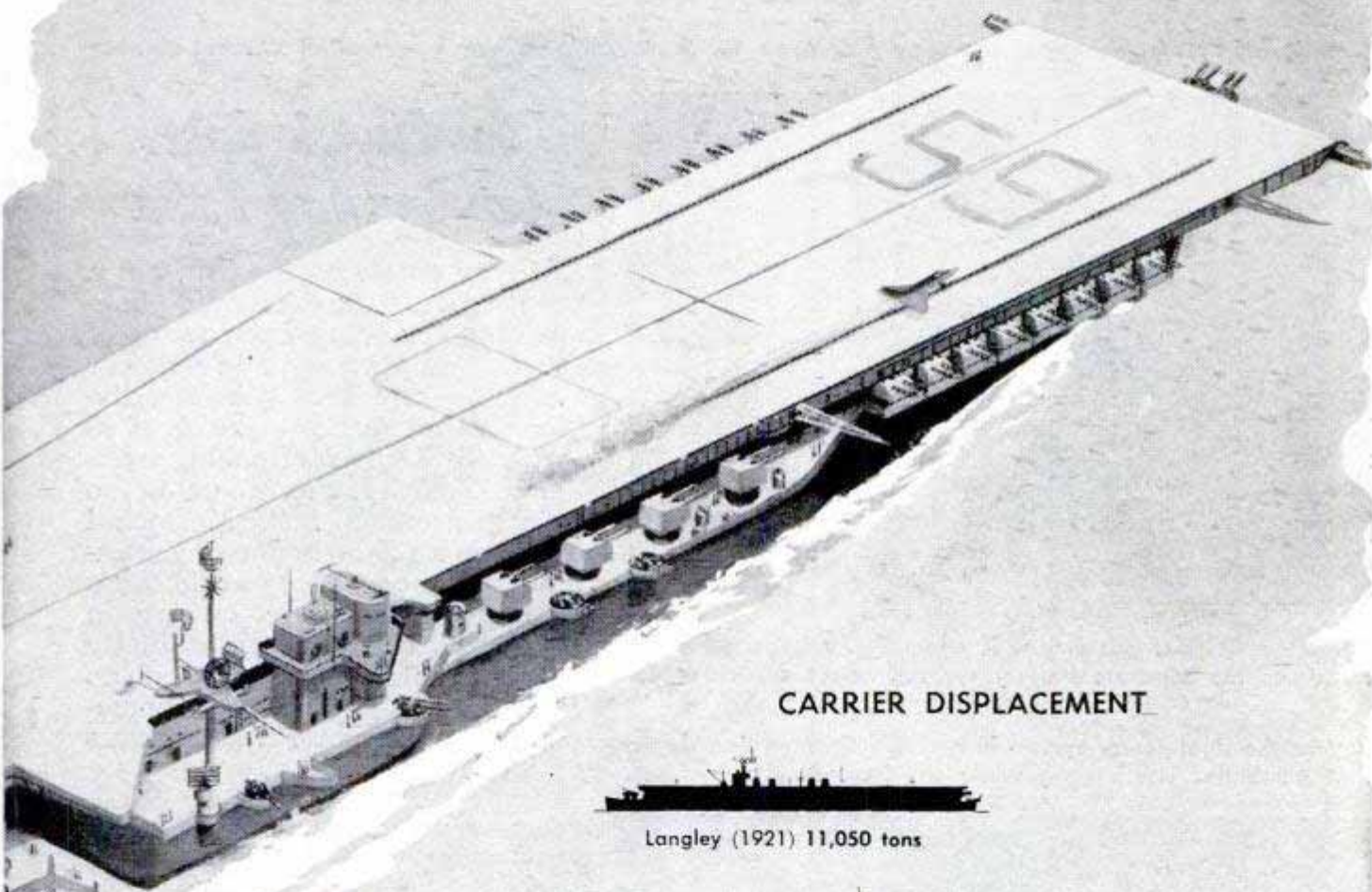

**CARRIER DISPLACEMENT**



Langley (1921) 11,050 tons



Lexington (1927) 33,000 tons



Franklin D. Roosevelt (1945) 45,000 tons



New Carrier 59,900 tons





With its 125-horsepower gasoline engine wide open, the "convertible" fishing boat will hit 33 miles an hour

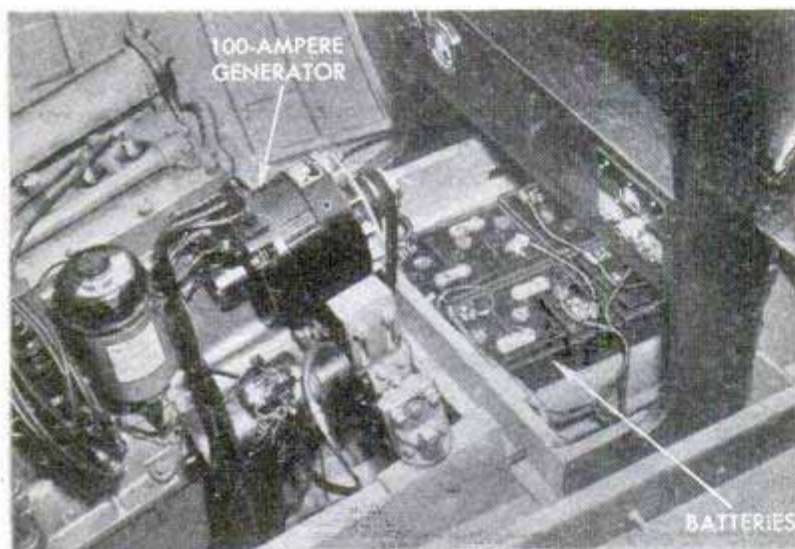

When the Chrysler gas engine is operating, a large generator recharges the separate battery for the boat's electric motor

Key to the dual-power system is a clutch-disconnecting device that eliminates clutch drag while the boat is electric-driven

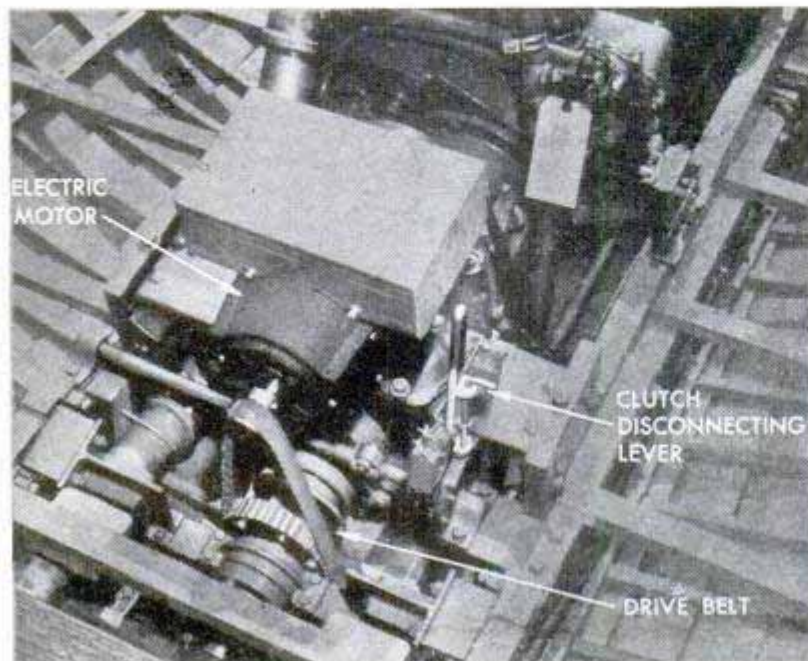

## Gas-Electric Boat Can Crawl or Zoom

It may not catch the fish, but a "convertible" boat should help sportsmen bring back more of them. Equipped with two power systems—one uses gasoline, the other electricity—the boat is owned by Gene McDonald, president of Zenith Radio. To get to the fishing grounds fast, McDonald opens up a 125-horsepower gas engine and zooms along at 33 miles an hour. Once there, he cuts in the electric drive and trolls quietly without clutch slippage at one to four miles an hour. The 1/2-horsepower electric motor runs 12 hours on a fully charged battery.

Remote-control unit simply plugs into any of several outlets located about the boat





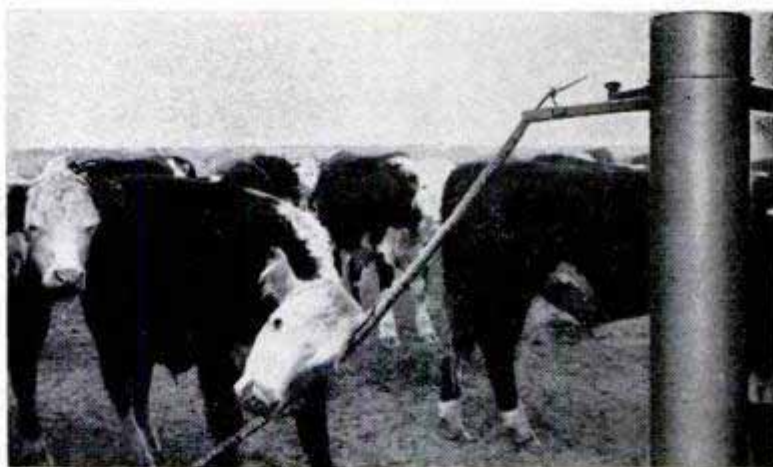
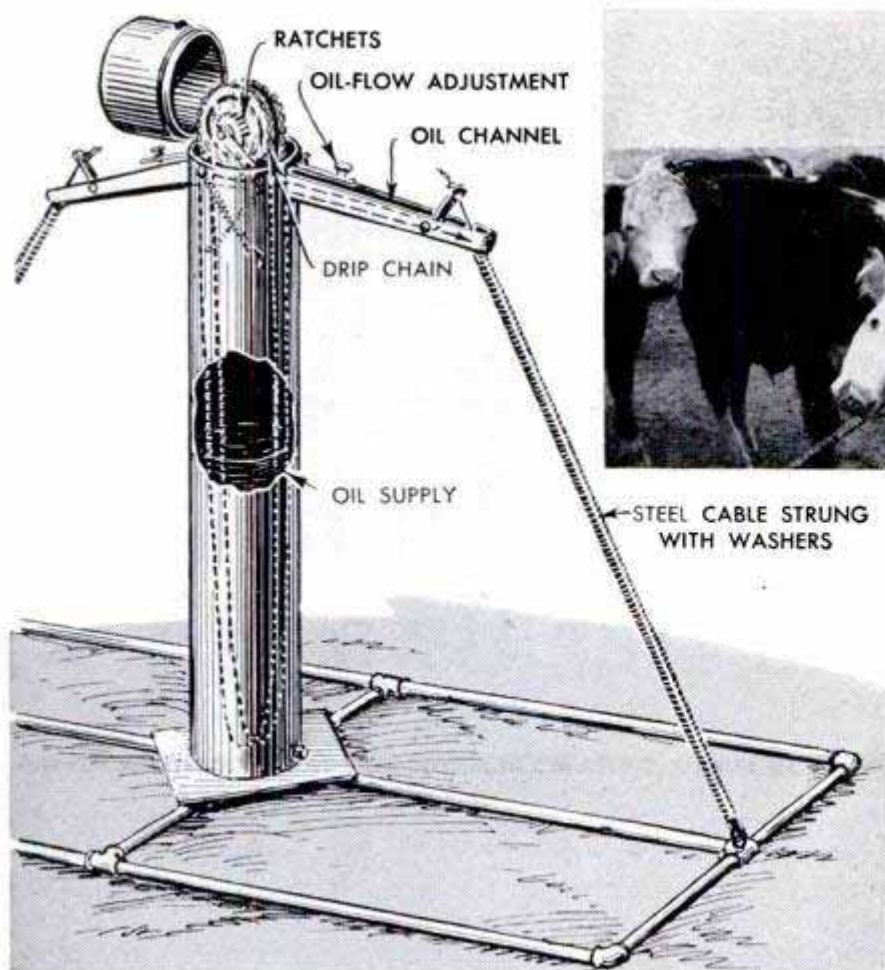

## Cattle Scratcher

Cattle rid themselves of lice and skin diseases with a device that rubs oil into the skin. Two oiling "wicks" run from the center post to the base. As the wicks are moved by the cattle, a ratchet cranks a chain through the oil in the post, transferring it to the wicks, which consist of steel washers strung on a steel cable.

## Sports Car

Top speed of a new custom-built sports car is 125 miles per hour, and it can accelerate from standstill to 60 miles an hour in only  $8\frac{1}{2}$  seconds. The sleek car, built as a gift for baseball's Ted Williams, is powered by a six-cylinder Nash Ambassador engine equipped with an aluminum racing head. Body panels and many structural parts are aluminum. The \$25,000 car was designed by William Flajole of Detroit.



## Water "Toboggan"

Speeds of 40 miles an hour are possible on a homemade water "toboggan" powered by a 12-horsepower outboard. The bow of the toboggan, which supports the motor, is made of aluminum. At slow speeds the driver is partially submerged. The toboggan, made by Vern Perry of St. Paul, Minn., weighs about 120 pounds.



2 500 000



Part of the existing irrigation system on the Murrumbidgee River, this weir will be duplicated many times when the Australian "TVA" is finally completed

CAPACITY IN KILOWATTS

1,000,000

# AUSTRALIA Starts Her Own "TVA"

By Clarence H. Tolley

**R**OARING THROUGH tunnels that honeycomb granite mountains, thousands and thousands of tons of water will do double-duty for Australia, providing both power and irrigation. Located near the capital city of Canberra, the project will be the biggest engineering project south of the equator.

Engineering-wise, it is a job that, in many respects, is more ambitious and complicated than the world-famed Tennessee Valley development after which it is patterned. Set up to handle the tremendous task by the Australian Federal government and the state governments of Victoria and New South Wales is the "Snowy River Hydroelectric Authority," similar to our TVA.

New project, extreme left bar, will triple kilowatt output of the two Australian states  
500,000

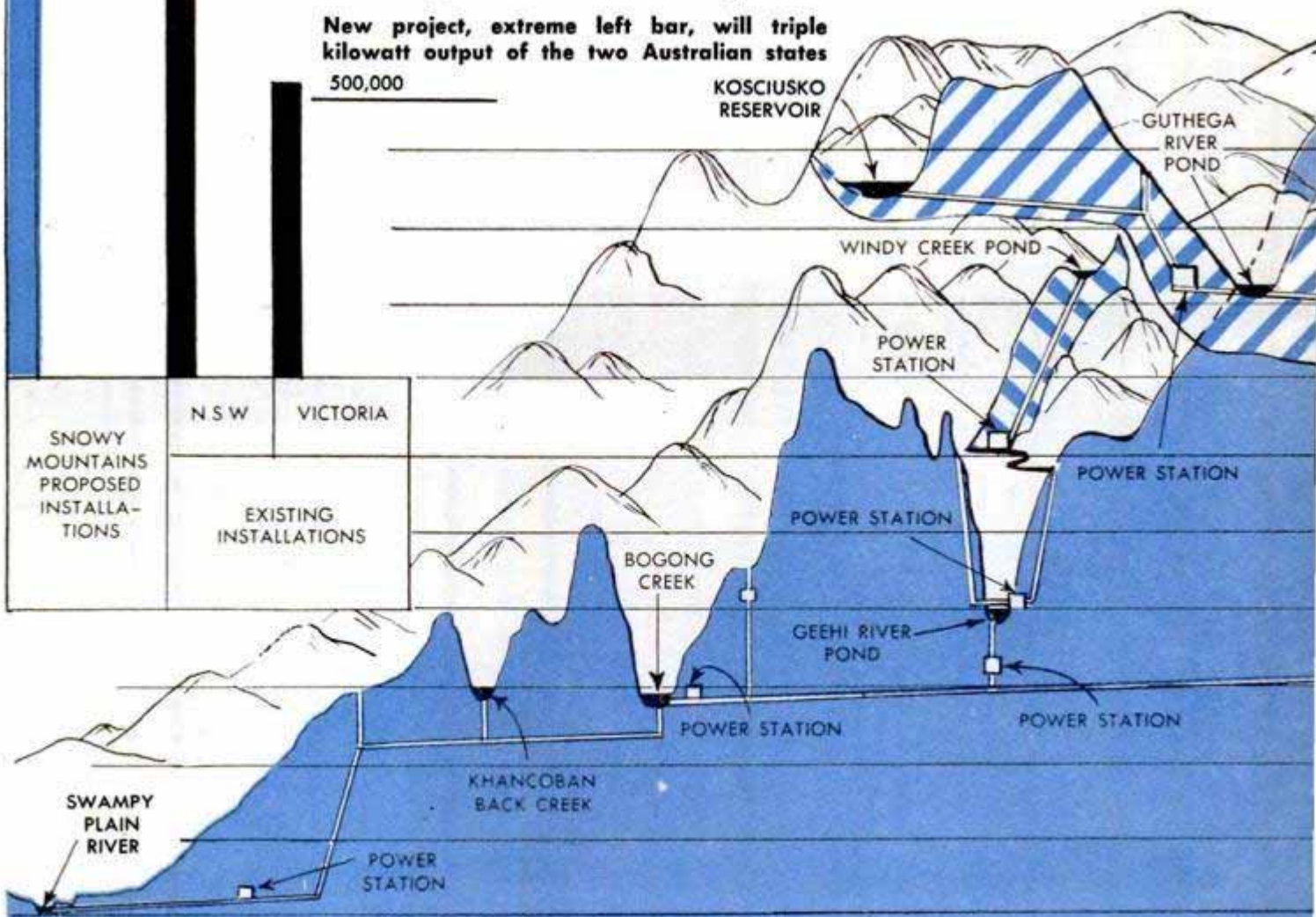



**Ambitious power and irrigation projects are afoot "down under." Aussie engineers are drilling one tunnel 30 miles through solid granite, and in another—precisely horizontal—water will flow in two directions!**

This board has jurisdiction over an area of almost 5000 square miles, which is called the roof of Australia and contains the Snowy Mountains and Australian Alps. In it is Australia's highest mountain peak, the 7316-foot Mount Kosciusko.

This mountain region has an average elevation of 3000 to 7000 feet and is snow-clad from four to six months of the year. It is a natural reservoir, which releases stored water during the summer when it is most needed.

Four rivers have their beginnings in these mountains. They are the Murrumbidgee and its tributary the Tumut, the Murray and the Snowy. The Murrumbidgee eventually flows into the Murray, many miles to the west. The Murray is Australia's largest river, 1600 miles long. It irrigates flatlands adjacent to it before flowing into the sea.

The Snowy River, which begins on Mount Kosciusko, receives most of the region's run-off waters. In its short dash of 300 miles southeast to the Pacific, it drops 7000 feet, carrying half a million gallons of water per minute.

To prevent these waters from being wast-

ed, the plan calls for storing them at the higher elevations. After their power has generated electricity, they will be diverted into the Murray and Murrumbidgee River system for irrigation. The Snowy River flows through the country which has adequate rainfall, while the other two, flowing west, pass through land which becomes progressively drier.

Seven major dams will be built with a total storage capacity of 4¼ million acre-feet of water. Plans call for 16 power stations, most of them deep underground, immune from any air attack even with atomic bombs. Eighty-six miles of tunnels varying in diameter from 20 to 45 feet will be cut through rock. Almost 500 miles of race lines (concrete-lined water channels) will pick up mountain streams at high elevations and lead them to various collecting points.

In the Snowy-Murray section of the project, a dam at Jindabyne will divert all the Snowy River except its main tributary, the Eucumbene. This will be done through a main tunnel 30 miles long under the mountains to the Swampy Plain River, a tributary of the Murray.

Mountain tunnels in Snowy-Murray project connect reservoirs from high point at Kosciusko to the outlet at Swampy Plain

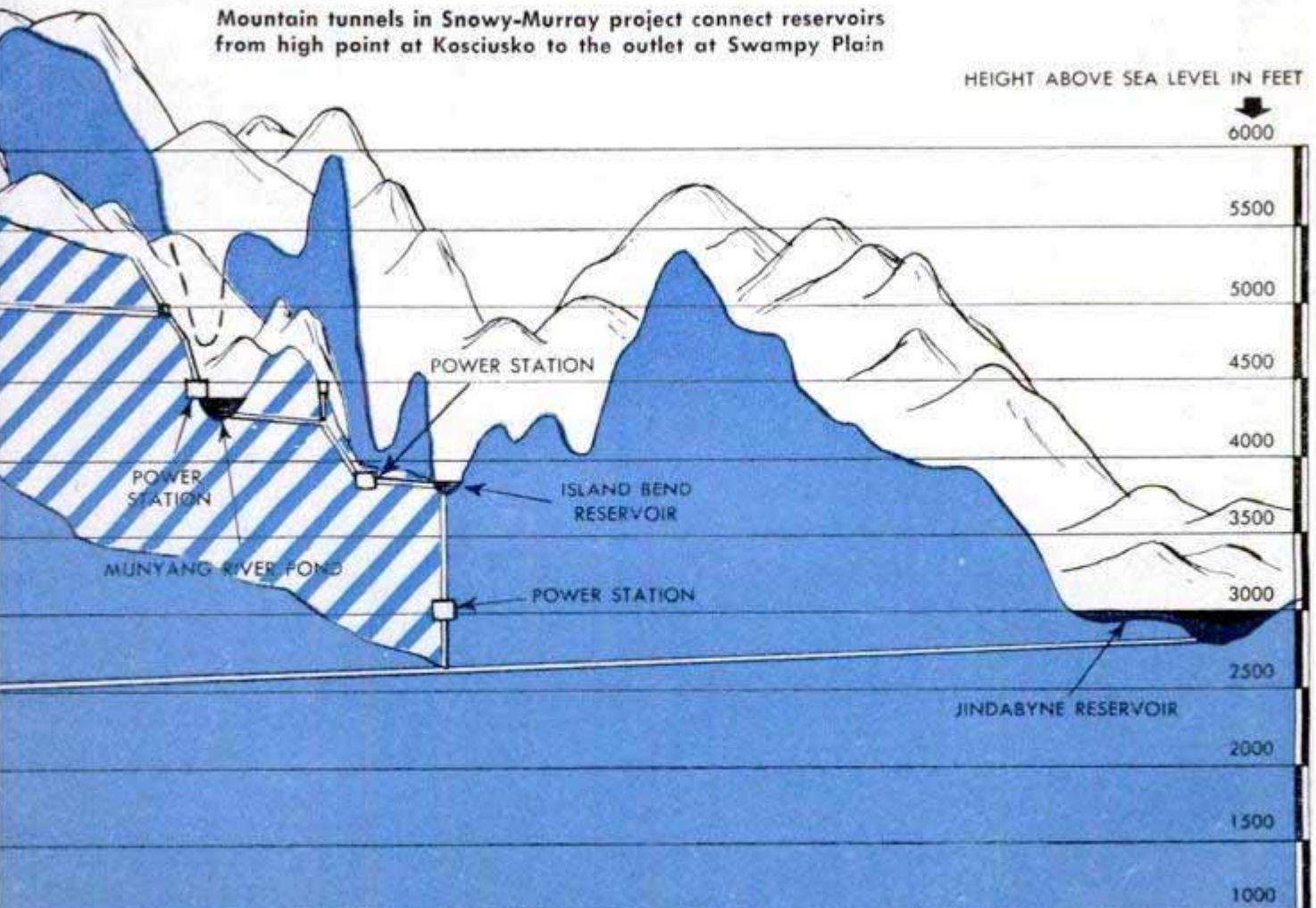



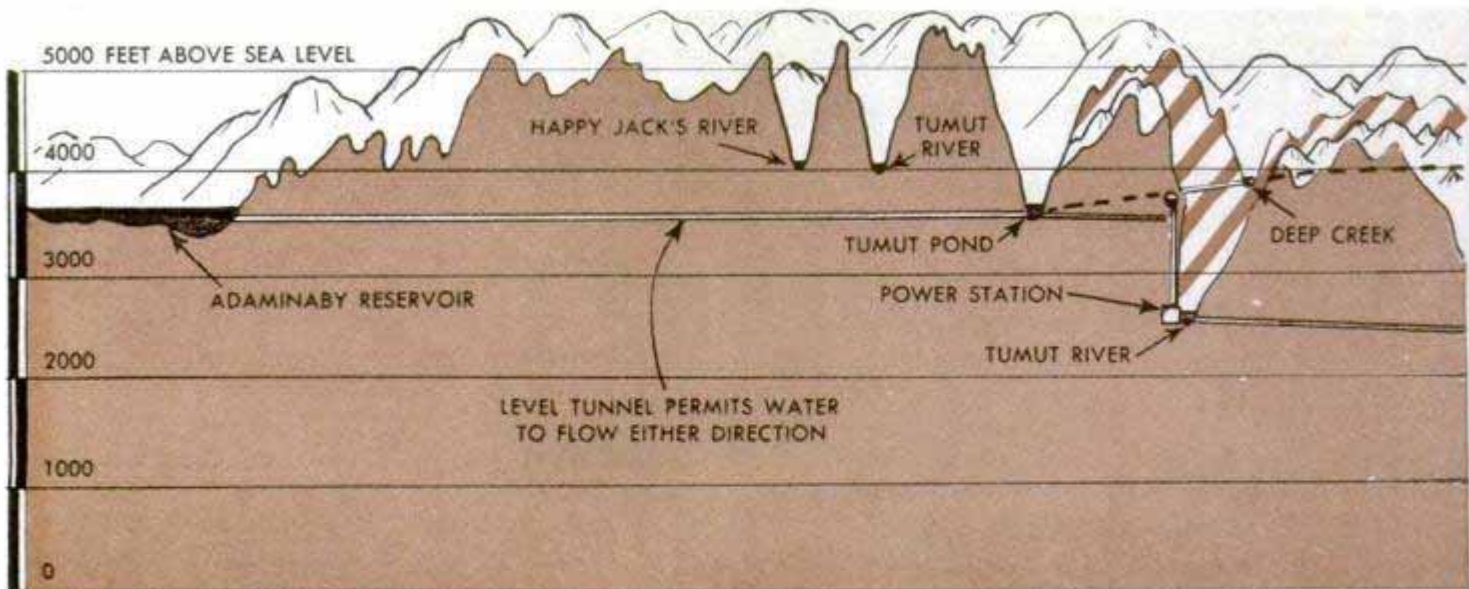

Profile of Tumut project shows outlet, extreme right. Water flows either way in 15-mile-long tunnel, above

This tunnel will be one of the world's largest. Parts of it will be 3000 feet under the mountains. It will vary in diameter from 30 to 45 feet and will be drilled through solid granite.

Spencer Creek is the highest tributary of the Snowy and it will be dammed to form the Kosciusko Reservoir for the storage of 30,000 acre-feet of water. A tunnel will take the water to Guthega River Pond, where the first power station of 60,000 kilowatts is to be erected.

Four power stations will be built along the 10 miles of tunnel from Kosciusko to Island Bend Reservoirs. At Island Bend, a vertical shaft, 1000 feet long, joins the main tunnel to Swampy Plain River. A power station will use the force of this long fall

of water down from the high reservoir.

Five more power stations will be built along the main tunnel, making a total of nine altogether. These will generate 1,680,000 kilowatts for the Snowy-Murray section.

In the other half of Australia's "TVA," the Snowy-Tumut section, the main dam will be built near the town of Adaminaby. This reservoir, formed by damming the upper Eucumbene River and its tributaries, will provide storage for the Tumut system.

Here the engineers propose one of the most remarkable aspects of the whole project—a tunnel 15½ miles long and perfectly level so the water can flow in either direction. The 24-foot tunnel will run from Adaminaby Reservoir through the dividing mountains to Tumut Pond on the other

West end of the Tumut project is Adaminaby Reservoir which will submerge part of this 400-inhabitant village





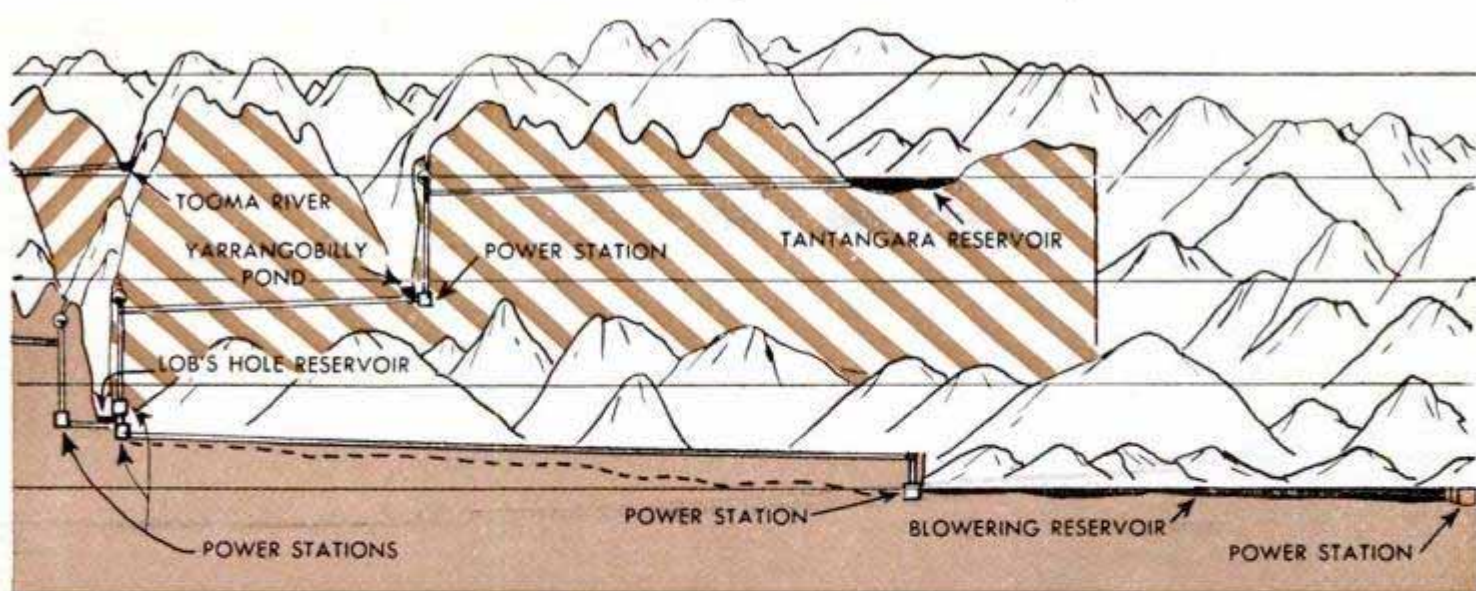

side. Tumut Pond will get additional water from the upper Tooma River through race lines and a five-mile tunnel. If this water, added to the flow of the upper Tumut River into Tumut Pond, is more than necessary for power generation, the surplus will flow back through the level tunnel into the 1,000,000-acre-feet storage at Adaminaby. When there is less water than needed for power generation in Tumut Pond, the water flow is reversed, from Adaminaby storage into Tumut Pond.

The river from Tumut Pond drops 2000 feet in 11 miles to Lob's Hole, where another dam with a storage capacity of 50,000 acre-feet is to be erected. A 12½-mile tunnel from Tumut Pond will carry this water to Lob's Hole through two power stations.

(Continued to page 246)

Workmen are transported by truck to Tumut Pond over snow-covered roads at altitudes of almost 4000 feet

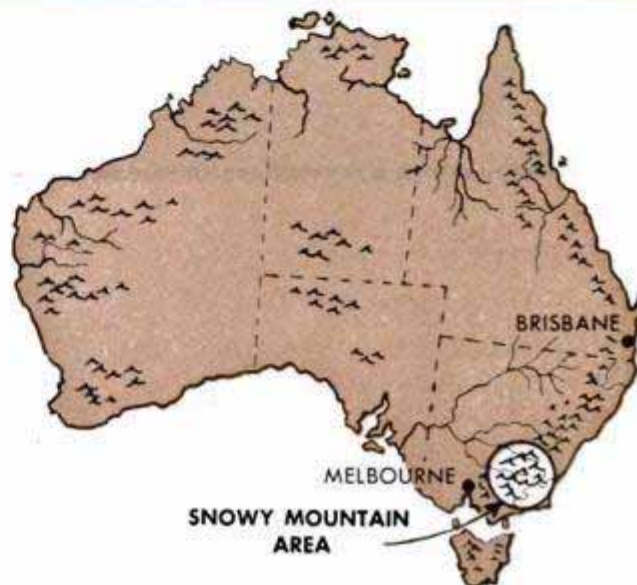

Above, the Snowy River project, Australia's version of the TVA, is in the southeast part of the island continent. It includes parts of two states, Victoria and New South Wales, and is near the capital city, Canberra. Below, surveyors at work on the project





## Mechanical Refrigerator Can Be Transferred From Car to Car

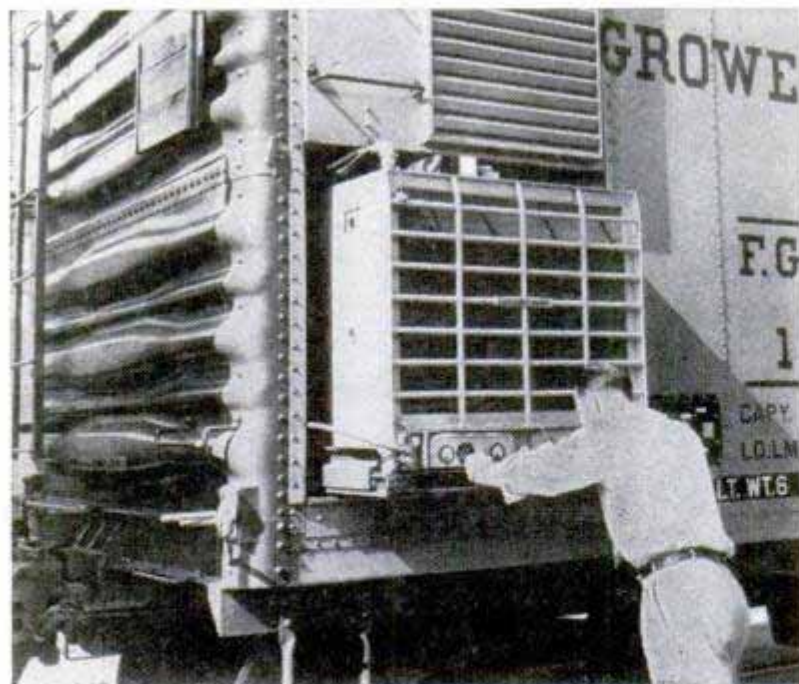

Fabricated in a "package" form which is quickly installed in a reefer car, a mechanical refrigeration unit costs one third as much to operate as the conventional ice method of cooling. A 28-horsepower gasoline engine powers the compressor. Two 155-gallon fuel tanks, mounted under the car, supply the engine. This is said to be more than enough for a transcontinental trip. The complete unit, including controls, weighs about 1100 pounds and can be transferred from one car to another in a few minutes. A control panel is installed on each side of the car adjacent to the refrigerating unit. It includes thermometers, thermostat and a system of signal lights.

## New French Simca 9 Offers Gas Economy

Operating economy is a feature of the new French Simca 9 that travels 28 miles to a gallon with a full load at a constant speed of 56 miles an hour. Its four-cylinder engine has a compression ratio of 6.7:1 and develops 45 horsepower at 4400 revolutions per minute. Described as a four-passenger car, it measures 13½ feet over all and weighs 1900 pounds. An additional feature of the car is a jack which can be placed anywhere under the front or rear bumper or either side of the car.



## Refrigerator "Shock Cools," Filters and Aerates Milk

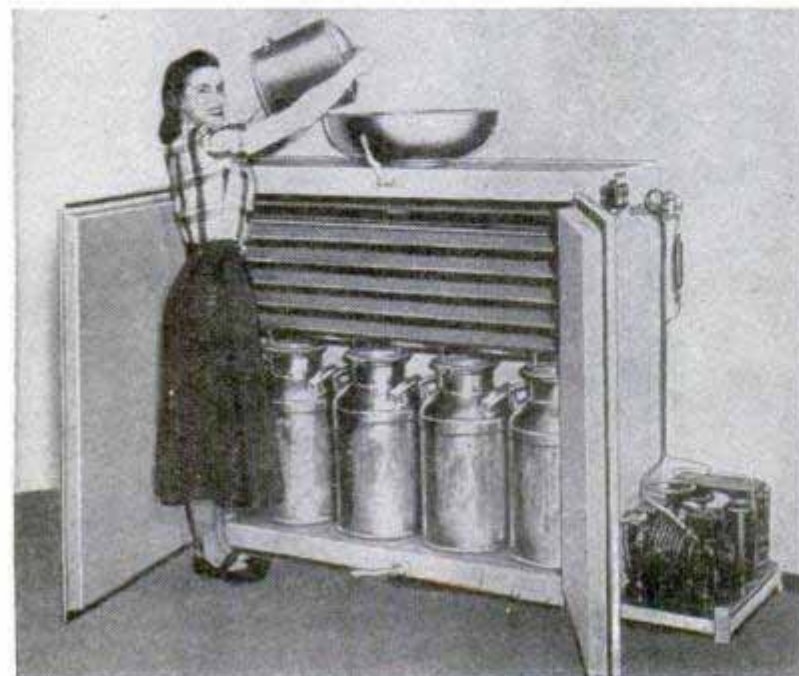

"Shock cooling" milk to below 40 degrees in less than one minute, a milk cooler also filters and aerates the liquid before it flows into pre-cooled cans. The flow of milk is automatically shut off as each can fills. A refrigerating unit cools the stainless-steel aerator, which lowers the milk temperature 56 degrees in a minute.

☐ The United States has eight advanced types of jet fighters and five jet bombers in production; jet pods have been added to the U. S. intercontinental bomber, one eight-jet bomber has been tested, and two new eight-jet, long-range bombers are scheduled to fly late this year.



## "Flying" House

Supported only at one end by three concrete "stems," a German building appears to be floating in air. The building was erected to demonstrate a new construction technique. It can be set on a plot as small as 10 yards square. Three concrete columns support a huge balcony. The roof is cantilevered in a similar manner. The designers say the structures could be used as auditoriums and restaurants. The building will support 1900 persons.

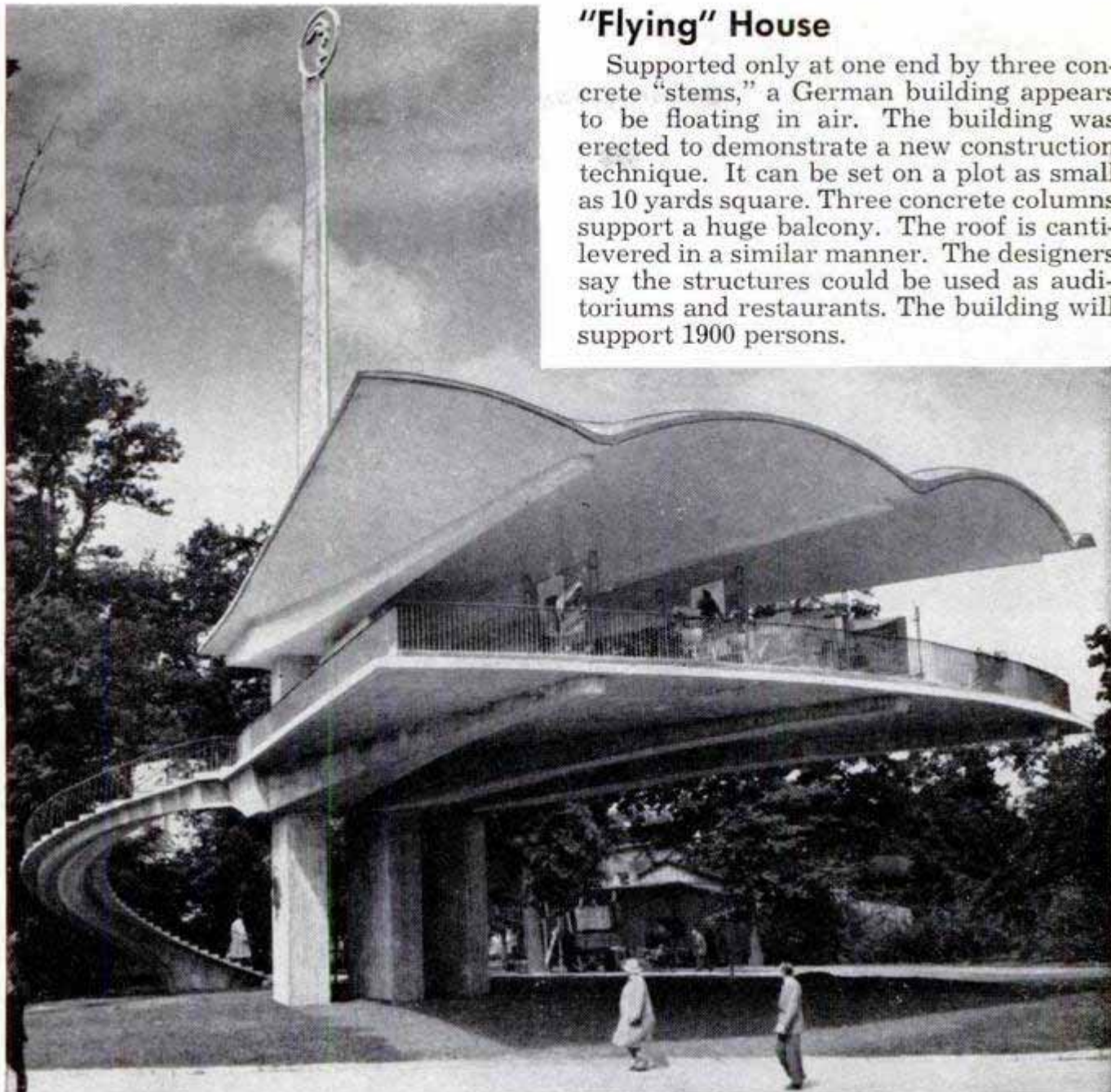

## Rocket Metal Is Flight-Tested Without Leaving the Ground

Undergoing all the hazards of high-speed rocket flights without moving from the laboratory bench, metals are tested under simulated flight conditions. It has been found that the temperature of the outer skin of missiles goes up as much as 80 degrees a second to a high of 1500 degrees. In the laboratory these heat conditions are simulated by electric currents. Heat changes are measured by thermocouples. Stress is provided by heavy weights. One of the most successful metals tested is a cheap grade of low-carbon, cold-rolled steel.

☐Credited with a top speed of 600 miles per hour, Britain's jet bomber, the Canberra, covered the distance from London to Melbourne, Australia (12,677 miles), in 25 hours and 27 minutes at an average speed of 490 miles per hour.

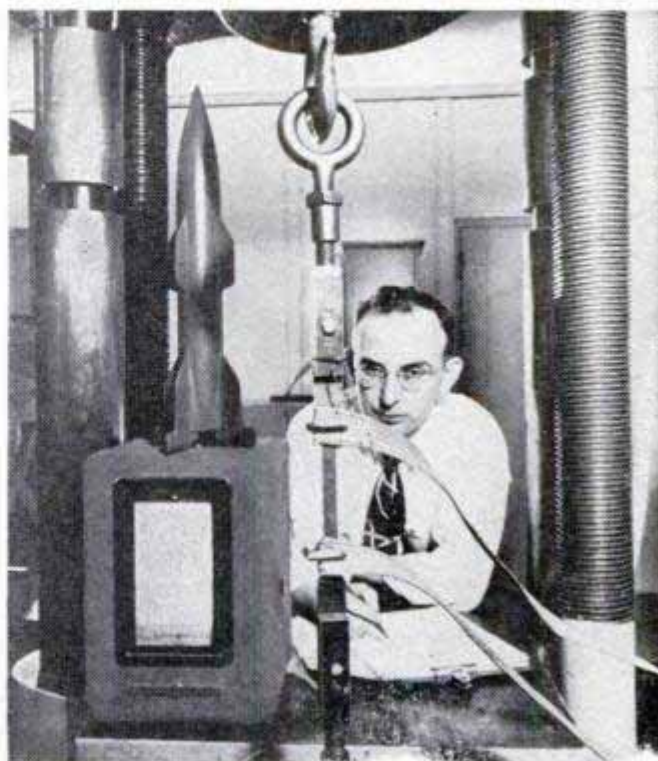





## Electric Sports Car

Operating on a 24-volt battery, with a  $\frac{3}{4}$ -horsepower electric motor on each wheel, a miniature sports car will go 35 miles an hour. It has seven forward speeds and travels 200 miles on one battery charge. The entire body can be lifted up to simplify work on the chassis.

## Streptomycin Cures Plants

Certain plant diseases may be controlled by streptomycin, according to tests by Prof. Peter A. Ark of the University of California. The tests show the drug to be effective in treating seeds infected with certain diseases, such as bacterial speck and canker of tomato.

## Builds One-Man Car Powered by Motorcycle Engine

Powered by a motorcycle engine, a one-man car built by Theron W. Huish of Los Angeles speeds along at 60 miles an hour and travels 38 miles on a gallon of gas. The body is a reinforced, surplus airplane drop tank. The car has conventional motorcycle wheels and tires, with front and rear mechanical brakes. Springs, axles, steering gear and the frame were made by hand. The 10-foot car has a wheelbase of 85 inches.



## Aluminum-Scrap Auto Costs \$160 and 2500 Hours of Work



Using scrap aluminum, Conrad Greenemeier of Denver, Colo., has built a car that travels 45 miles on a gallon of gas. The little auto is powered by a 6-horsepower industrial motor and rolls along on airplane tires. Greenemeier reports he spent about \$160 and 2500 work hours in building the car.

☐ There are 8,300,000 trucks operating in the U. S. now, compared with 4,850,000 at the peak of World War II.



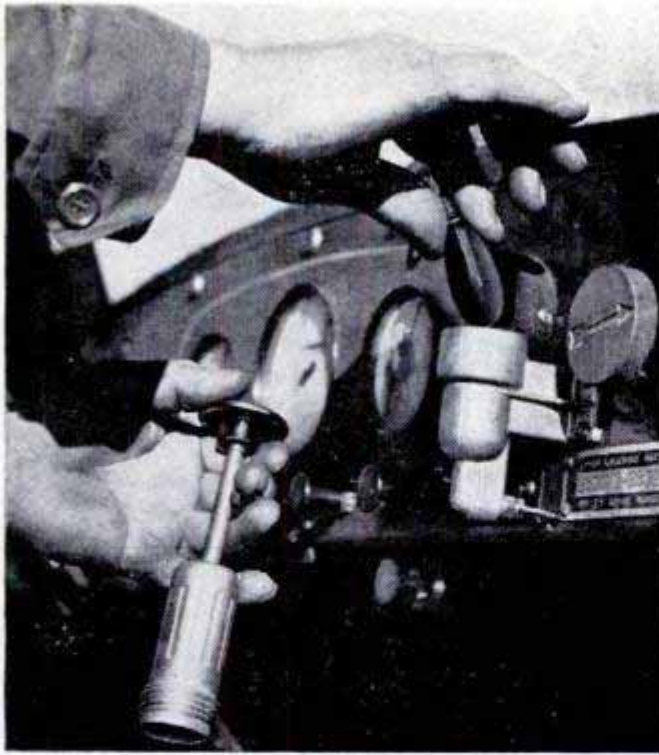

## Capsules Start Cold Engines

To provide easier starting for diesel and heavy-duty gasoline motors in subzero weather, an auxiliary fuel is now available in capsule form. The fuel, packaged in 7 and 17-cc. capsules, is placed in a special tool permanently connected to the intake-manifold system. The tool has a dual purpose of puncturing the capsule and priming the engine. Capsule packaging, reports the manufacturer, prevents all spillage and evaporation, and eliminates wastage usually accompanying the pouring of such liquids. In addition to its use in diesel engines, the fuel is suitable for tractors, cranes, shovels and draglines.



## Tissue Filters Oil

Ordinary toilet tissue is the filtering element in a new oil cleaner for automobiles. The aluminum housing for the filter has a universal mount for installation on any car. The roll of toilet tissue, which slips inside the housing, removes dirt, dust, grit and other abrasive materials from the oil. One roll of tissue is effective as long or longer than a conventional filter cartridge, according to the manufacturer, and it costs several times less than a conventional filter cartridge. When the motorist wishes to change the filter he merely loosens a wing nut, removes the cover, takes out the old roll and inserts a new one.

## Lock-On Lug Covers Discourage Would-Be Tire Thieves

Tires are locked to the car by a simple, tamperproof cap that covers the wheel lug so it cannot be loosened by a would-be thief. The cap comes in two sections. One of these sections is placed under the nut. When the nut has been tightened, the top portion of the cap is placed over the nut and locked in position. The locking device can be used on all wheels, including the spare.

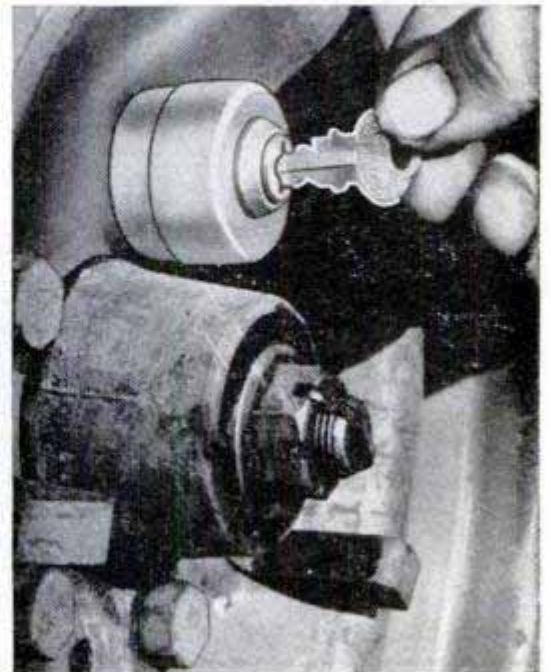

*Popular Mechanics* provides two sources of information concerning articles published in each issue; the WHERE-TO-BUY-IT INDEX on pages 12, 14 and 16, and the WHERE-TO-FIND-IT LIST, available without charge from the Bureau of Information, 200 E. Ontario, Chicago 11





This is the F3D, the Navy's new and deadly radar-equipped night fighter on which Tom Stimson, the Western editor of *Popular Mechanics*, had a jet ride

U. S. Navy photo

**"It's an old-lady's airplane, really," the Commander said as they strapped me in the cockpit to . . .**

## ***Ride a Jet Fighter***

**By Thomas E. Stimson, Jr.**

**F**IGHTING with your eyes closed at better than 500 miles per hour sounds like a nightmare and yet that, literally, is what the Navy's crack night-fighter pilots are learning to do.

In their new and secret F3D killer jets they can be catapulted from a carrier in pitch-black darkness, track and shoot down enemy aircraft without ever seeing them, and land again with only one short look

over the side, a peek that they get about two seconds before their wheels hit the deck. Aside from that, radar and other radio circuits can do all their seeing for them.

Today, at Moffett Field, Calif., the pilots of Composite Squadron Three are working on the new tactics that the plane's radar eyes make possible. Over a large area off San Francisco Bay that is restricted for their exclusive use they fly almost every

Ground-crew member uses illuminated wands swinging up and down to guide F3D pilot to parking location

Crossing wands overhead means "Stop" to the pilot of plane waiting to take off into the darkness

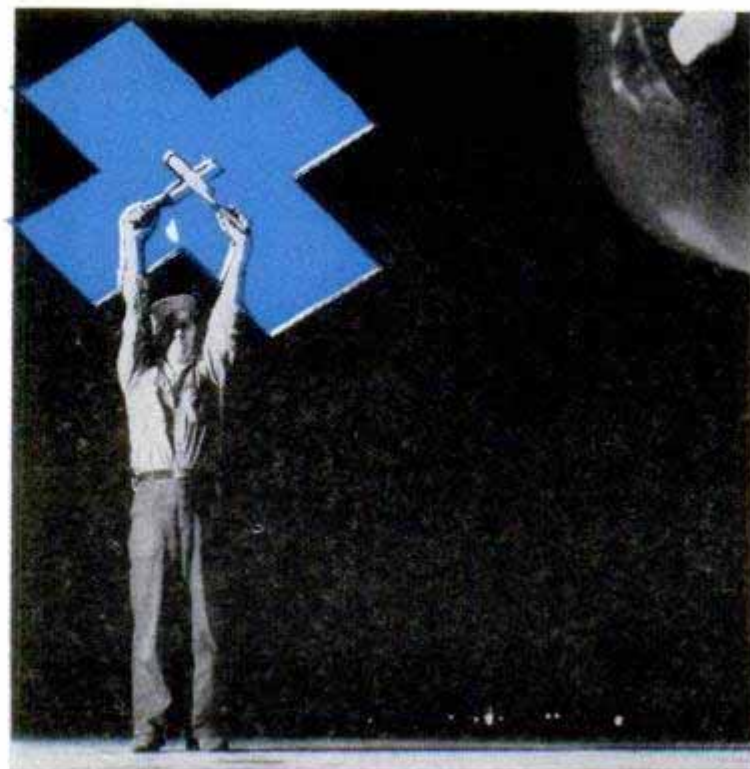





## Into the Night

Stimson (wearing glasses) occupies radar operator's seat in flight demonstration for Navy night fighters

night on blacked-out missions. Usually they work in pairs with one plane simulating an oncoming enemy bomber and the other making the kill.

Playing blindman's buff with other planes at close to sonic speeds isn't my idea of fun, and when Westinghouse and Douglas arranged with the Navy for a representative of *Popular Mechanics* to participate in a practice mission, I took it up with Comdr. Richard E. Harmer, the squadron's commanding officer.

"Just a ride around the field after lunch is all I need," I suggested, "in the daylight."

"Nonsense," he replied briskly, "The pilots are asleep now. They don't come on duty until dark. I'll put you down as radar operator on Lunatic 88. That's code for Lieut. George C. Hathaway's plane. The F3D is an old-lady's airplane, really. You'll enjoy a real operations flight."

But you begin to appreciate that night fighting isn't the world's safest job when you start dressing after dinner in the red illumination of the pilot's ready room.

"Nylon shirt? Take it off," one of the pilots advises. "Nylon sticks to the skin if it burns and there's always a chance of a cockpit fire. No nylon."

You strap on a .38 revolver loaded with tracer bullets and pull on the Mae West

Darker-blue area in front of plane shows where the pilot can see target on his radar scope. Beyond is outer limit of radar operator's search equipment. Arrow points to area covered by tail-warning radar

survival vest, its pockets and straps loaded with gear that includes a can of shark repellent and a folded radar reflector that can be seen on a plane's scope 10 miles away. The orders are to jump if the plane gets into trouble over the water during a night flight. You don't jump, actually, you slide. You get out of an F3D by going down a chute in the rear of the cockpit. By the time you can get your hand on the rip cord you are free of the aircraft and are slowing down to a safe opening speed.

"That sheath knife at your left shoulder," a pilot instructs you, "that's for just one job. The chute pack in the cockpit also contains a one-man life raft. If you have to leave the plane in a hurry you may accidentally inflate the raft while twisting

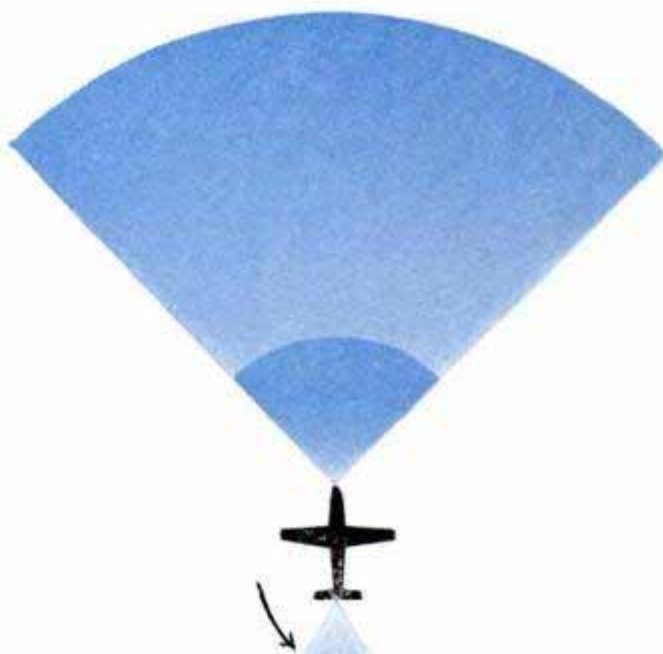





Even though radar permits flying blind, a helper cleans off cockpit's transparent canopy — just in case

duced for the Air Force by Lockheed, is designed for catching and destroying enemy bombers including those that are carrying atomic weapons. Each of these planes can do the job at any altitude the bomber can use and in any kind of weather.

The F-94 is powered with a jet and afterburner, the F3D with two jets. Each carries a pilot and radar operator and each is a big airplane, judged by World War II fighter standards. The F3D,

around in your seat. Then you can't get out. The raft is too big for the escape chute. That's where the knife comes in. Grab it and stab the raft."

You'll get down to the water, you reflect grimly, and then what do you do, swim a hundred miles or so?

One man lends you a cloth helmet with earphones, another contributes a crash helmet that fits over it. The crash helmet will keep your head from being slammed into cockpit projections if there is severe buffeting. "Rest your head firmly against the backrest during the take-off," you are told.

The Navy's Douglas-built F3D Skyknight, like its "opposite number" the F-94 pro-

for example, weighs about the same as a DC-3 transport. It carries as much fuel in its fuselage as does a Flying Fortress. With a pair of 300-gallon fuel tanks carried outboard on its wings it could cruise across the country nonstop.

Aside from its basic use as a night fighter, the F3D is also being tested by Navy airmen as a patrol plane, as a light bomber, and even as a close-support vehicle.

Its pair of Westinghouse axial flow turbojet engines delivers more than 6000 pounds of thrust, equal to a good 6000 horsepower at 325 miles per hour or twice that at 600 miles per hour. More than half a ton of Westinghouse radar is carried by the plane,

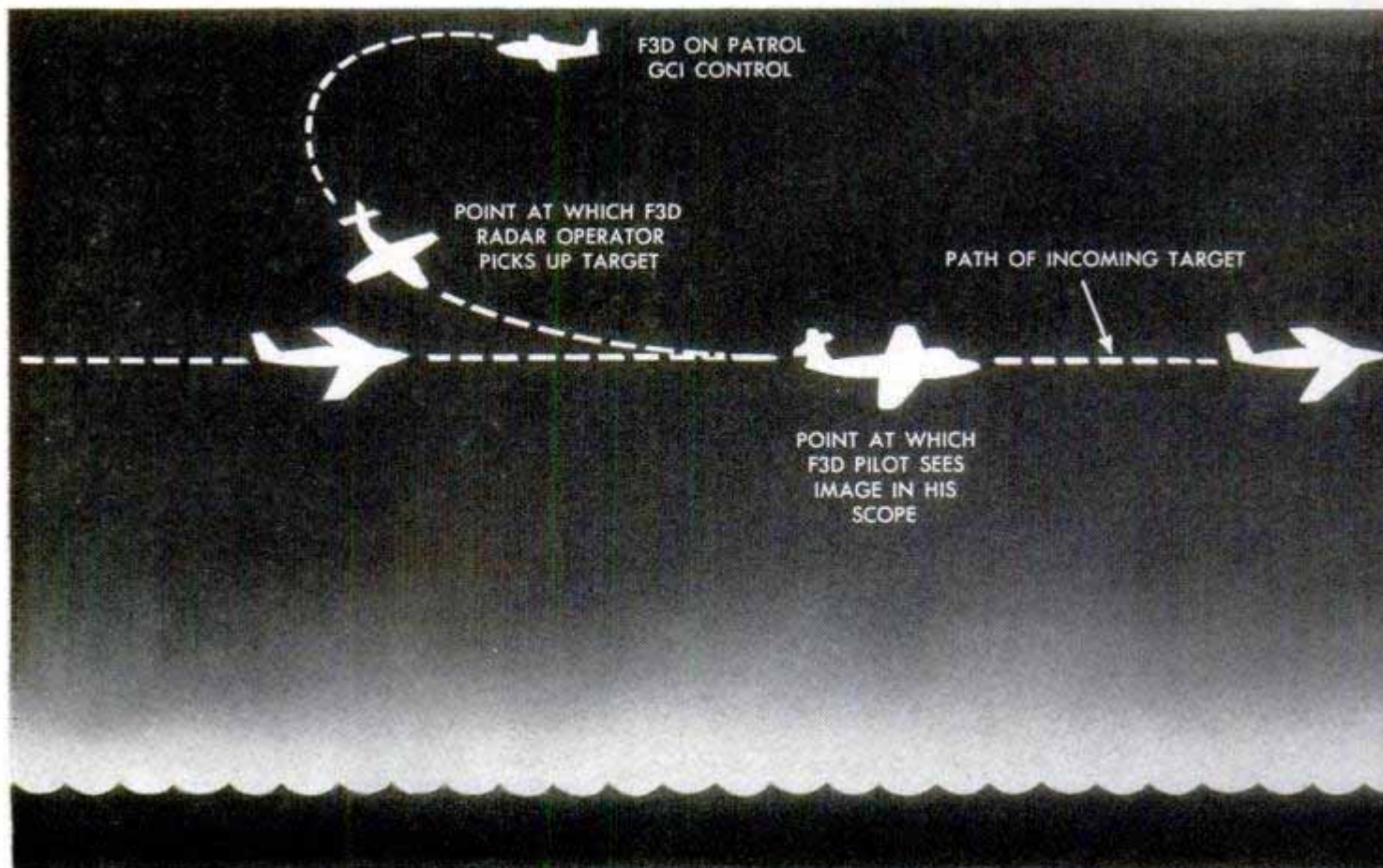



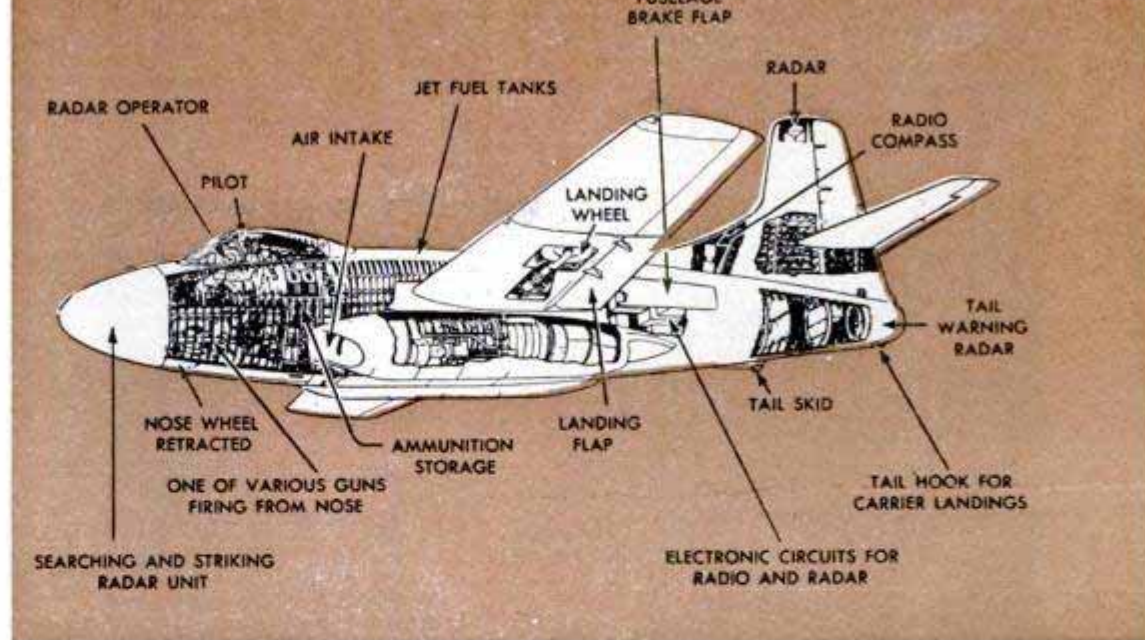

Diagrammatic drawing shows the intricate and compact F3D, which carries as much fuel in its fuselage as a Flying Fortress and matches a DC-3 in weight



F3D in the air offers a small and fleeting target to enemies

Sketches across bottom of pages show an F3D which has been guided by ground radar station to a point where the fighter's radar operator picks up target

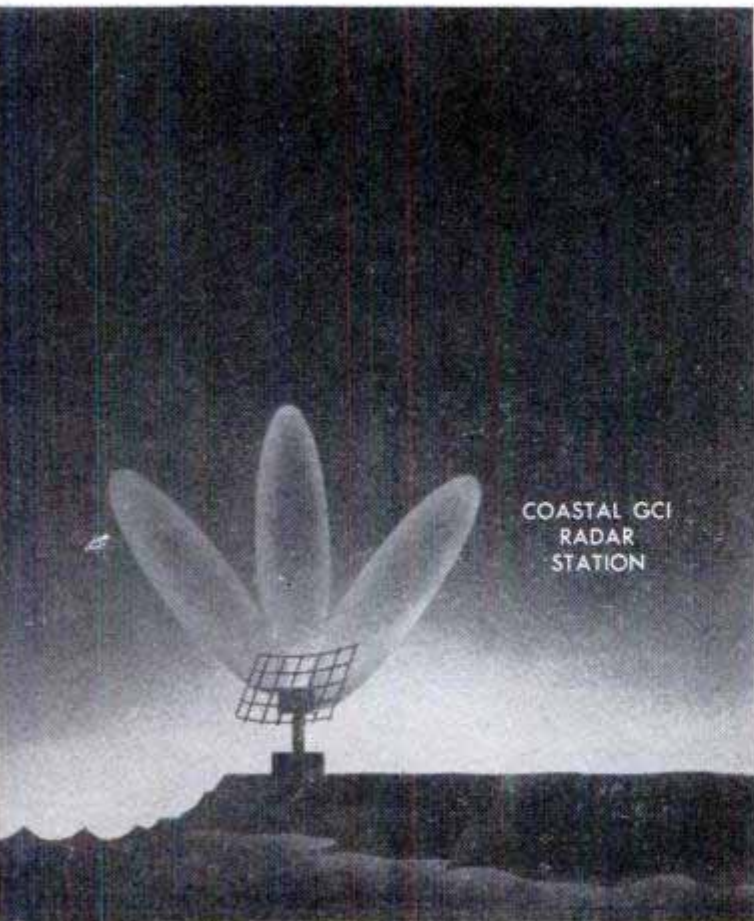

with the various antennas housed in non-metallic portions of the nose, tail, tail tip and fin. The radar installation is described as a "self-contained searching and striking unit" and Navy spokesmen won't go into much greater detail about it.

One of them, however, puts it this way: "Any modern all-weather fighter should be capable of detecting another aircraft some distance away with its own equipment, though it may be guided into the general area by a more powerful search station on the ground.

"Radar should be able to tell a pilot whether the unknown aircraft is a friend or foe, and it should warn him if an enemy gets on his tail.

"After a pilot brings his plane close to the target, electronics should be able to do all the rest. That is, radar should be able to 'lock on' to the target and constantly figure out the range and deflection, and automatically fire the guns or rockets at the instant when hits are assured."

Tonight I'd be able to see what radar could do, but I wouldn't see how it did it. I was occupying the "scopie's" seat and I'd need months of instruction to operate his instruments. Tonight we'd simply play target for another F3D.



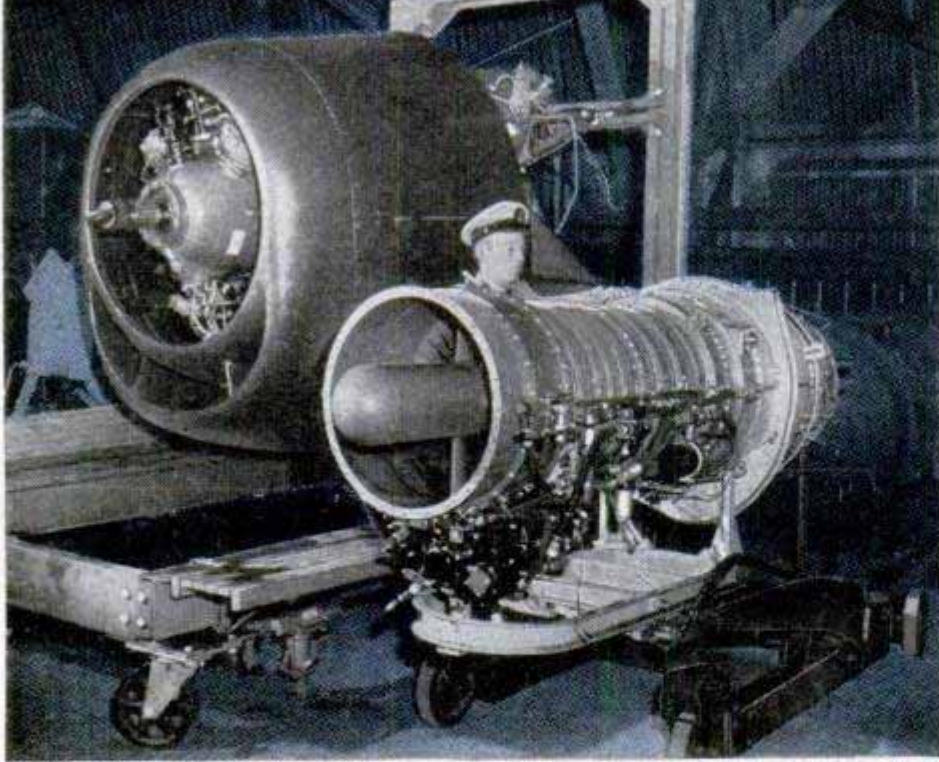

One of the pair of Westinghouse J-34 turbojet engines is partially torn down for servicing and inspection. One of these 1200-pound engines develops almost the same thrust as the big radial engine beside it. At 375 m.p.h. an F3D pilot has more than 10,000 horsepower at hand

In the dark cockpit Lieutenant Hathaway helps to tie you down. The only light comes from the faint red glow of the instrument dials. With or without radar, a first qualification for a good night-fighter pilot is that he must have exceptional night vision, and red is the one safe shade that doesn't reduce his ability to see in the dark.

Chute straps are buckled, safety belt snapped on, then the shoulder straps. Phone wires are plugged in. The oxygen mask is handy although for tonight's medium-altitude flight it won't be needed in the pressurized cockpit.

"You'll have to do some copiloting," Lieutenant Hathaway comments. "Those switches at the right, snap them on one at a time when I'm ready to start the jets. And the knob that controls the plane's lights is right at your elbow. You'll turn off the lights when we are told to darken ship. Now, set the cockpit altimeter at zero."

The cocked-up wings descended and locked into place while we taxied to the head of the runway, then the plane raced along the marker lights between Moffett's two big dirigible hangars and climbed away from the ground. I was thinking that this was just like any other take-off when I noticed the 100-foot hand of the altimeter. It was winding around the dial with the speed of a stop-watch needle. We were really going up!

The F3D has power-assisted controls and a cigarette lighter, two items that help describe the plane in terms of high performance and comfort. In normal flight the plane is smoother than most transports and

yet many F3D pilots wear G-suits to keep from blacking out while maneuvering at high speed. To help make up for the punishment that the crew may receive, everything possible is done for their comfort, which explains the lighter and ash trays in the cockpit.

At 10,000 feet, well offshore in the hazy moonlight, there were suddenly two extra yellow moons right in front of us. "Those are the exhausts of Lunatic 3, the other night fighter," Hathaway says. "We're looking right into his tail pipes." He applied the fuselage brakes and I surged forward, tight against the shoulder straps. There had been no sensation of speed until now; the brakes gave you an idea of the forces involved at the speed we were flying.

In tonight's problem, one of the stations

(Continued to page 238)



For landing on carrier deck, F3D has plowlike arm forward of landing gear to catch safety barrier in case tail hook fails to pick up an arresting wire



## Helicopter Litter Carrier Eliminates Claustrophobia

Providing complete protection from cold and wind without creating a sense of confinement, a new litter carrier has been developed for the Bell helicopter. The carrier is an aluminum platform that mounts on the skid-type landing gear. A transparent-plastic cowl serves as a windshield to protect the head and shoulders of the injured man. Warm air is piped inside the cover to keep the patient comfortable. Previous litter carriers were covered with fabric, and the dark interior bothered patients suffering from claustrophobia, or fear of confined spaces.



## Race-Horse Relaxer

Mechanical horsepower takes race horses for a long walk after they've worked out on a track at Yonkers, N. Y. The horses are tethered to the long bars of a mechanical merry-go-round driven by a small motor. The mechanical trainer leads them on a three-mile-per-hour walk for a slow cool-down, eliminating the need for a human trainer to exercise the horses.

## "Pint Sized" Preservers

Junior-size life preservers have been designed for children on overwater flights in military transports. Previously there has been no special protection for youngsters traveling with their parents to new duty stations if their planes were forced down at sea. One size is for tots from six months to six years old and the other fits those up to 14. The preservers are like the grown-ups' version, except that the carbon-dioxide cylinders and inflation valve are located behind the neck out of the wearer's reach—to prevent tampering with the devices.

¶ In Guatemala, where corn is expensive and bananas are cheap, agricultural chemists have discovered that ripe bananas, including skins, are as good as corn for fattening pigs.







# HE SELLS SEA SHELLS

Planters for cacti, ivy and small assorted house plants are the most popular items that Rudy Hanacek makes from sea shells. Two large shells are cemented together and pressed into disks of plaster that form a base. The decorative shells are later embedded in the completed plaster base

**I**NJURY caused by man-made shells led to a new career that Rudy Hanacek of Cleveland has built on a foundation of thousands of sea shells. Until wounded in the leg while in the Marianas with the Seabees, Hanacek had been a machinist. During months in a hospital, where he attended handicraft classes conducted by the Red Cross, the subject that interested him most was the making of jewelry and other novelties from sea shells.

On returning home, Hanacek found that his leg injury would not permit him to resume his old trade operating machine tools; long hours on his feet would be too much.

So he turned to the shellcraft he had learned during his convalescence.

Hanacek has developed numerous little kinks and methods of his own. For example, he worked out a special recipe for a cement-plaster to fasten shells together and to fashion bases and other molded details. He adds colored pigment to the plaster mix as required.

His shell products range from elaborate religious shrines to simple, humorous animals. His most popular item has been a planter for ivy, cacti and other small house plants. It consists of two large snail shells (from a form of whelk) cemented together,

Two novelty shell lamps flank a lighted shrine. The lamps' soft glow doesn't affect images on TV screens

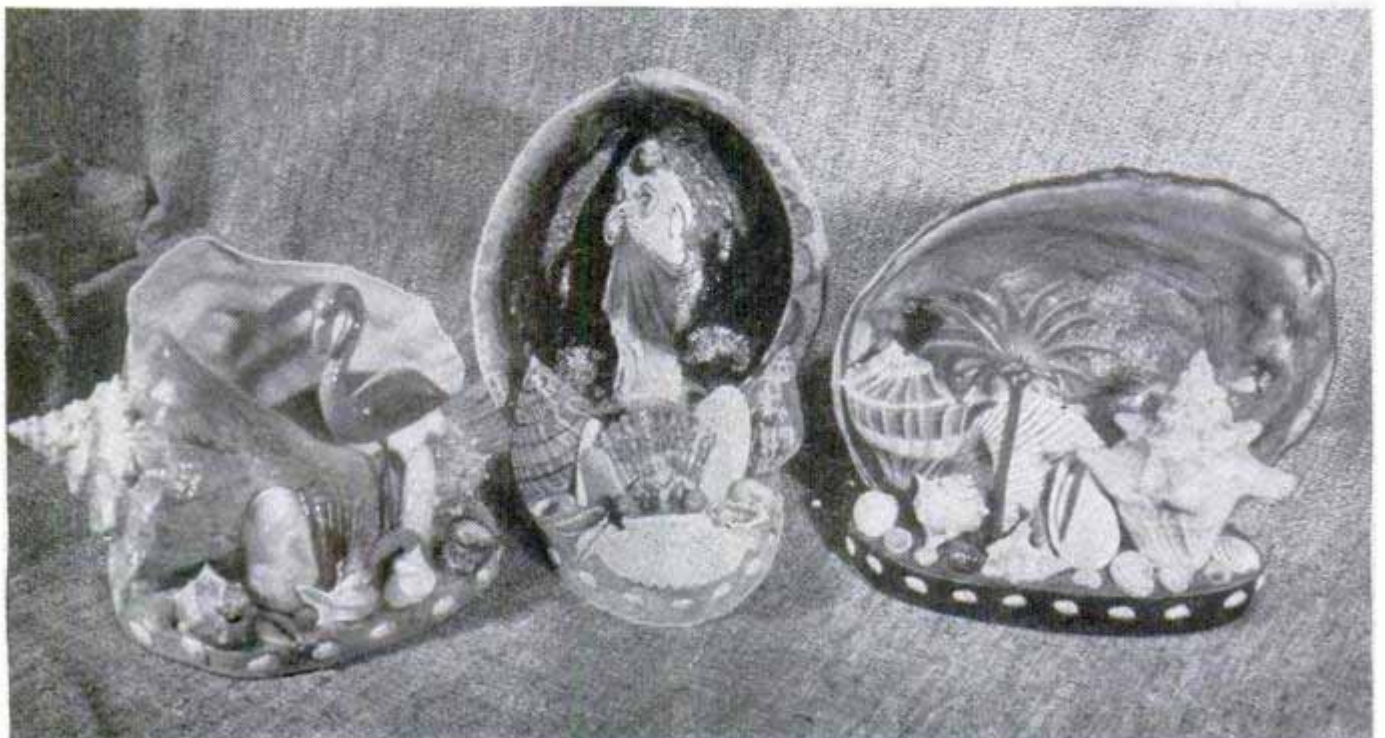



with smaller shells embedded in the cement for decoration. It rests on a molded-plaster base decorated with small embedded shells.

Hanacek's trays, made of large, flat shells, are useful as sewing aids and for holding bobby pins and other small objects on the dressing table or desk. His shell lamps feature large shells that conceal small electric-lamp bulbs. When a lamp is burning, its shells become translucent and display various color patterns. Television has created a considerable demand for these shell lamps, for their soft glow will illuminate a room without affecting the image on a TV screen.

Conch shells and the like have to be ground on an abrasive wheel to smooth the edges and remove sharp points that might cause injury. Many shells have to be bleached or dyed a brilliant color to improve their looks. After Hanacek has assembled a piece of shell sculpture and the cement has set, he finishes it with transparent varnish, and glues a piece of felt or soft cloth to the bottom.



As added decoration, the dog above has ears made of pine-cone segments and the doll consists of pipe cleaners, ribbon and 37 small sea shells

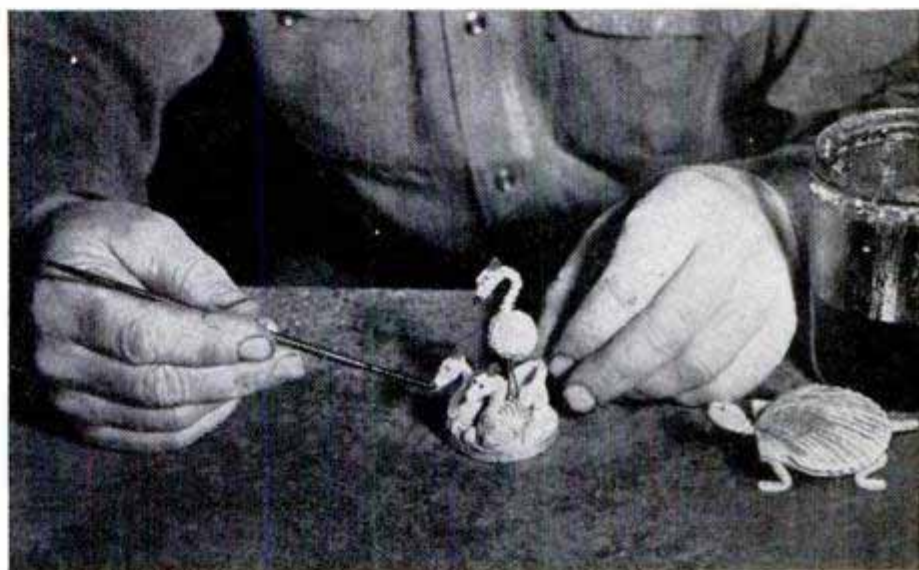

Humorous figures of birds and animals are among Hanacek's specialties. Here he applies varnish to a group of birds while a turtle awaits its turn. Below, part of the wounded veteran's menagerie. The fabric on which the display rests is used to cover the bottoms of shell articles





# ICE CUTTING

## —an almost lost art



*By Marjorie and Grant Heilman*



On runners, the power saw makes a scoring cut. Guides on each side control the width of the blocks

Snow is tamped into the scoring cuts to prevent water from running in and freezing solid again

**C**HANCES are that some future generation will be puzzled to discover a tumble-down shed with insulated double walls, standing forgotten beside a pond. And near by there may be a few giant saws, some heavy steel bars and hooks, all rusted by the dampness. But it will be unlikely that this finder will recognize these tools of the ice-cutting trade because by then ice cutting will probably be a lost art.

Even today it has all but disappeared in the United States. Although there are still small operations going on, most major cutters have





Ice is floated to the loading end in large sections, which are broken into blocks before going up the chute

been compelled to quit. The Handy family in northern Vermont is among the last survivors. Once, the rasp of Handy saws could be heard on ponds all over the top of the state. But nowadays the Handy operation is confined to one pond just north of Lyndonville, and its annual haul is only about 4000 tons.

Major reason for the disappearance of ice cutting has been, of course, mechanical refrigeration. Ned and Charlie Handy claim they can produce natural ice for about one third the cost of artificial ice. However, their competition comes from refrigeration units that do



Key blocks, first to be taken out, have to be cut loose by hand. The rest are broken free with a chisel



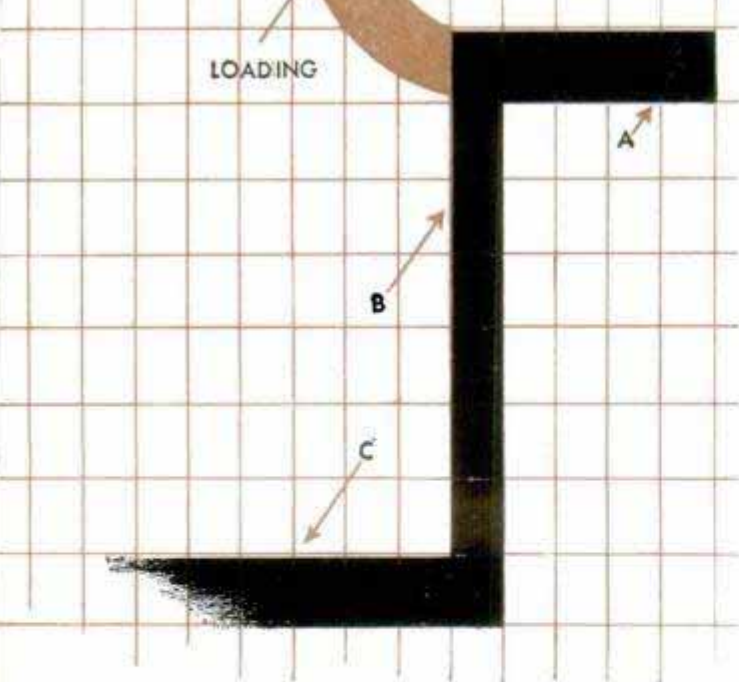

After ice is scored and a loading channel opened up, strips A, B and C are cut by hand to free the blocks

away with the need for any kind of ice.

There are plenty of tricks to ice cutting. It takes planning to get the maximum ice with a minimum of work. First step is the scoring of the ice into blocks 22 inches by 44 inches. Ordinarily, ice is about 15 inches thick when cut and the circular saw used to score the ice cuts about nine inches deep. This leaves the ice solidly together, but allows it to be broken apart into blocks with a blow from the heavy breaking chisel. The circular saw has a 30-inch blade with replaceable teeth. It is powered by a four-cylinder gasoline engine. The whole unit is mounted on skids, from which steel rods extend to hold guides that can be set for

Teeth on the 30-inch blade of the power saw are replaceable. The saw scores the ice with 9-inch cuts



Large sections are broken into blocks by driving a heavy chisel into score cuts made by the power saw

any desired block width. The guides slide in the adjacent saw cut to serve as a ripping fence for the saw.

While the ice is being scored, a curved channel is cut with a handsaw to provide access to the loading chute. Then a handsaw cuts a strip adjacent to the access channel. Only the lengthwise cuts are made by the saw as the crosscuts can be broken out with the big chisel. Once this first strip has been removed, there is room to work.

A second strip, running the length of the pond and at right angles to the first strip, is cut and broken out, two or three blocks at a time, leaving a narrow channel down the center of the pond. As these blocks are

Inside the insulated icehouse, workers jockey the 500-pound cakes of slick ice into place for storage

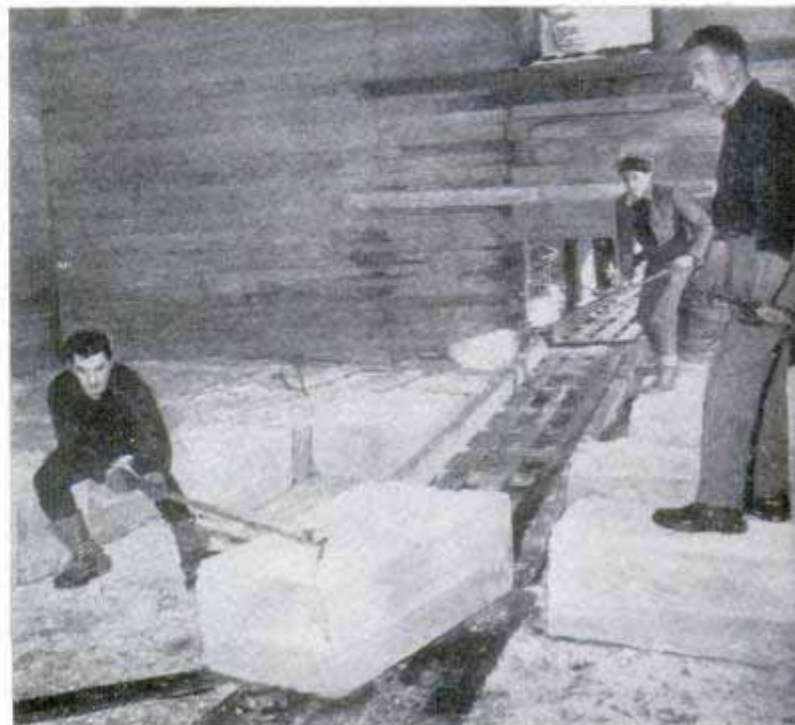



broken free, large sections adjacent to them are split off and broken into individual blocks. As cutting progresses farther from the loading channel, it becomes more important to keep sections of blocks intact so they can be moved to the loading area more easily.

Before each cut, snow is packed into the scored ice just beyond the point where the cut will end. This prevents water from seeping into the blind cut and freezing.

After the ice on one side of the center strip has been removed, the men at the handsaws again go to work. They cut two long lines to remove a strip across the far end of the pond. This ice is floated along the de-iced section to the loading channel. Now, as the crew works back toward the loading channel, whole sections of blocks are broken out by chisel after they have been sawed free at the shore line. The whole object is to cut so there is always an area of solid ice between the section you are cutting and the loading channel for the crew to walk on.

Blocks are hauled up a chute into the icehouse by a power-driven cable. At the top, the ice slides on another trough into the building.

By now, the 500-pound cake is sliding rapidly. Workers dig into it with pike poles and swing it into place as it comes off the trough. Layer by layer, the blocks are piled up. It's a tough job, bucking these fast-sliding blocks, and anyone who happens to get in the way of one of them is likely to end up with a broken leg.

The top layer is insulated with a coating of sawdust. The house itself is well insulated and kept tightly closed.

That's the story of ice cutting. If you happen to be up North and see an ice-cutting crew on a pond, you'd better stop for a look because it soon may be as extinct as the dodo!



Here's an ice pond in full operation as seen from the top door of the icehouse. Blocks can be seen floating into the loading channel where they are picked up by the cable and hauled to the top of the chute to slide into the house. Workers ride ice floats like lumberjacks on logs



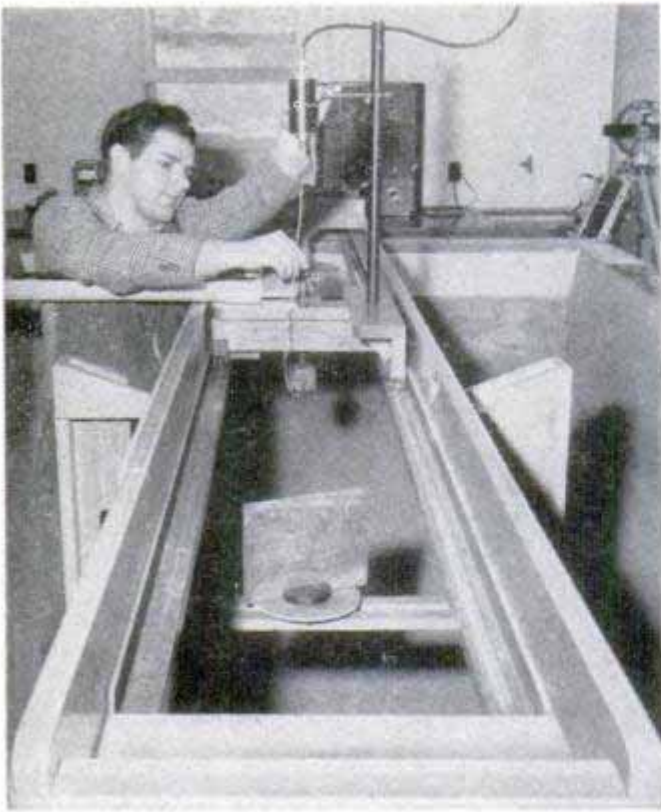

Left, pickup head of the detector passes over the metal sheet inside the concrete tank. The metal is a "buried" ore body in the test. Above, metals of many sizes and shapes are used. Some are shown here

## Concrete Tank Is "Wind Tunnel" in Electrical Prospecting

Serving the same function in electrical prospecting as a wind tunnel does in aeronautics, a large concrete tank is used to improve methods of locating ore below the earth's surface. Nearly any condition, so far as relative electrical conductivity of ore and earth is concerned, can be simulated inside the tank. Running over the top of the tank is a wooden track which supports the measuring devices, the electrical

equipment and the ore body to be studied. By placing a small particle of metal that represents ore buried in a part of the tank, researchers study the action of an oscillating magnetic field set up by a near-by generator. This is what happens when an electric prospecting device is used in the field. These studies are being conducted at the electromagnetic laboratory of the University of California at Los Angeles.

## Wheels for Broom

Large brooms for sweeping big floor areas are maneuvered with less effort when equipped with a new two-wheel chassis. The two casters permit the operator to wheel the broom backward on the return stroke instead of lifting it. The chassis is mounted on wood-backed brooms with lag screws; a special attachment is available for fastening it to metal-backed brushes.

## "Peel Paste"

Movie makers, by using a new "peel paste," can strip wallpaper off their sets in a few minutes, making the walls available for reuse almost immediately. The paste, which has supplanted the usual starch pastes, is a mixture of glycerin, cellulose and water. The glycerin keeps the paste flexible even after it dries.

☐ Since late in World War II, 53 different jet types of military planes (three with rocket engines) have been developed in the United States.





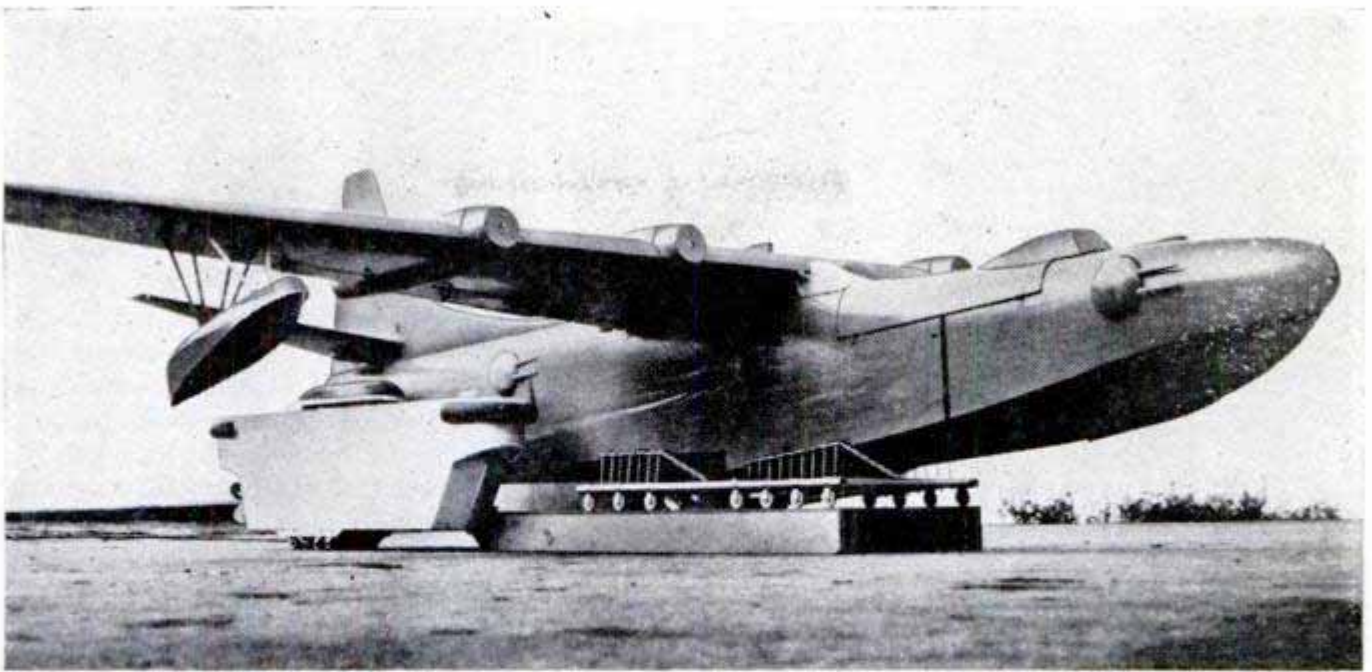

Resting on wheeled pallet of beaching gear, huge Navy flying boat is transferred to parking platform ashore

## Beaching Gear Hauls Flying Boats Ashore

CAPABLE of crawling under a 300,000-pound flying boat in the water, floating it toward shore and then carrying it on dry land to a parking platform, this seaplane beaching gear resembles floating docks used to handle large surface ships. Built for the U. S. Navy, the gear is self-powered, can submerge itself, move forward, backward or sideways. It has two flotation units spaced to accommodate the hull of a flying boat. Separating these units is a horizontal platform on which is located a removable pallet with adjustable wheels on which the plane hull rests. The gear is propelled by two engines located at diagonally opposite ends of the floats. As the shore is approached, the operator transfers power from the propellers to three Caterpillar treads, mounted in tri-cycle-gear fashion, which move the plane over normal beaches. A tractor or winch is used to transfer the wheeled pallet, on which the plane rests, from the beaching gear to a repair platform ashore.

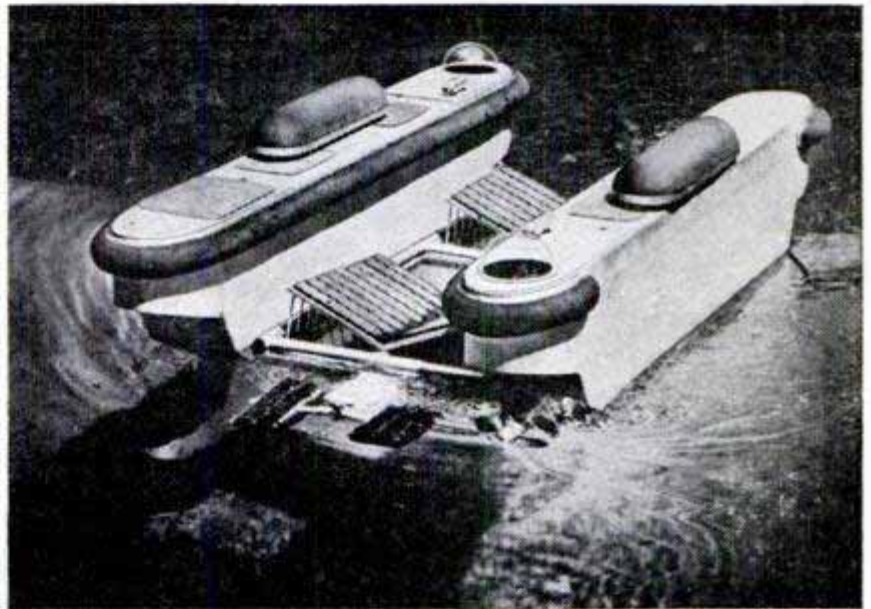

Beaching gear, above, is capable of lifting a 300,000-pound flying boat, carrying it ashore and wheeling it off on a repair platform. Two power units are located in diagonally opposite ends of the gear. Below, scale model shows how compact gear maneuvers under plane





# TEMPLE OF MINIATURES



LITTLE THINGS are big things to William G. Klassen of Hagerstown, Md. In his Temple of Miniatures—a 13-foot exotic structure weighing over a ton—Klassen has depicted the fabulous court of Louis XIV and the sixth-century knights of King Arthur.

This hobby of Klassen's requires plenty of spare time and patience. Only a few simple tools are used. So filled with materials is his room in the Alexander Hotel, where he is *maitre d'hotel*, that he can hardly move around. Extra chests of drawers keep his supplies in order.

His work is done to a scale of one inch to the foot, although, of course, he has no blueprints to work with—the ideas he uses coming from a combination of research and imagination.

Once a year, Klassen puts his handiwork on display in the hotel lobby. It can be shown complete, as it is here, or in sections. Below, King Arthur's Court





The court of Louis XIV boasts a real marble floor which was once part of a soda-fountain counter. The stairway and balustrades in the rear look like marble, but they were carved from pine wood and painted to match the floor. Incidentally, he put 23 coats of paint on them!

Ingenuity is an essential part of Klassen's hobby. He uses inexpensive materials to reproduce luxurious decorations. He makes crystal chandeliers of cheap glass beads and candleholders from midget plastic pipes. The knights of King Arthur's Court wear armor devised from metal mesh used in ladies' handbags. Their helmets are plastic Easter eggs cut in half, painted silver and surmounted with decorations.

Each of the many turrets on the Temple of Miniatures has as its base a plastic drinking tumbler on top of which are a pepper shaker and a knob from a lamp shade. The uppermost piece is an inverted golf tee. The temple, made of carved wood, is given a stonelike appearance by a paint that is mixed with gravel.

Klassen estimates that he works on each scene about 700 hours, not including planning and research. He doesn't call it work, though, it's relaxation to him and right now he's intent on finishing scenes from early America featuring Mount Vernon and Monticello.

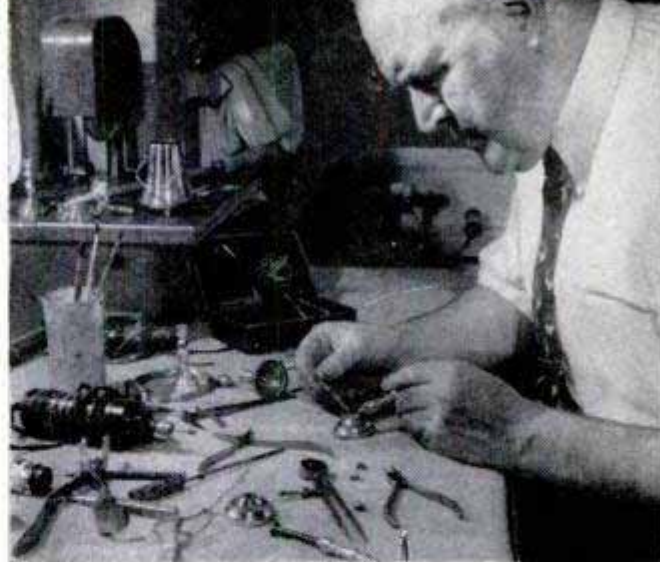

Klassen has turned his hotel room into a workshop. He uses a few small power tools, but most of his work is by hand

Below, four separate items, left, form one of the many turrets that decorate the temple. Bottom, Louis XIV's salon

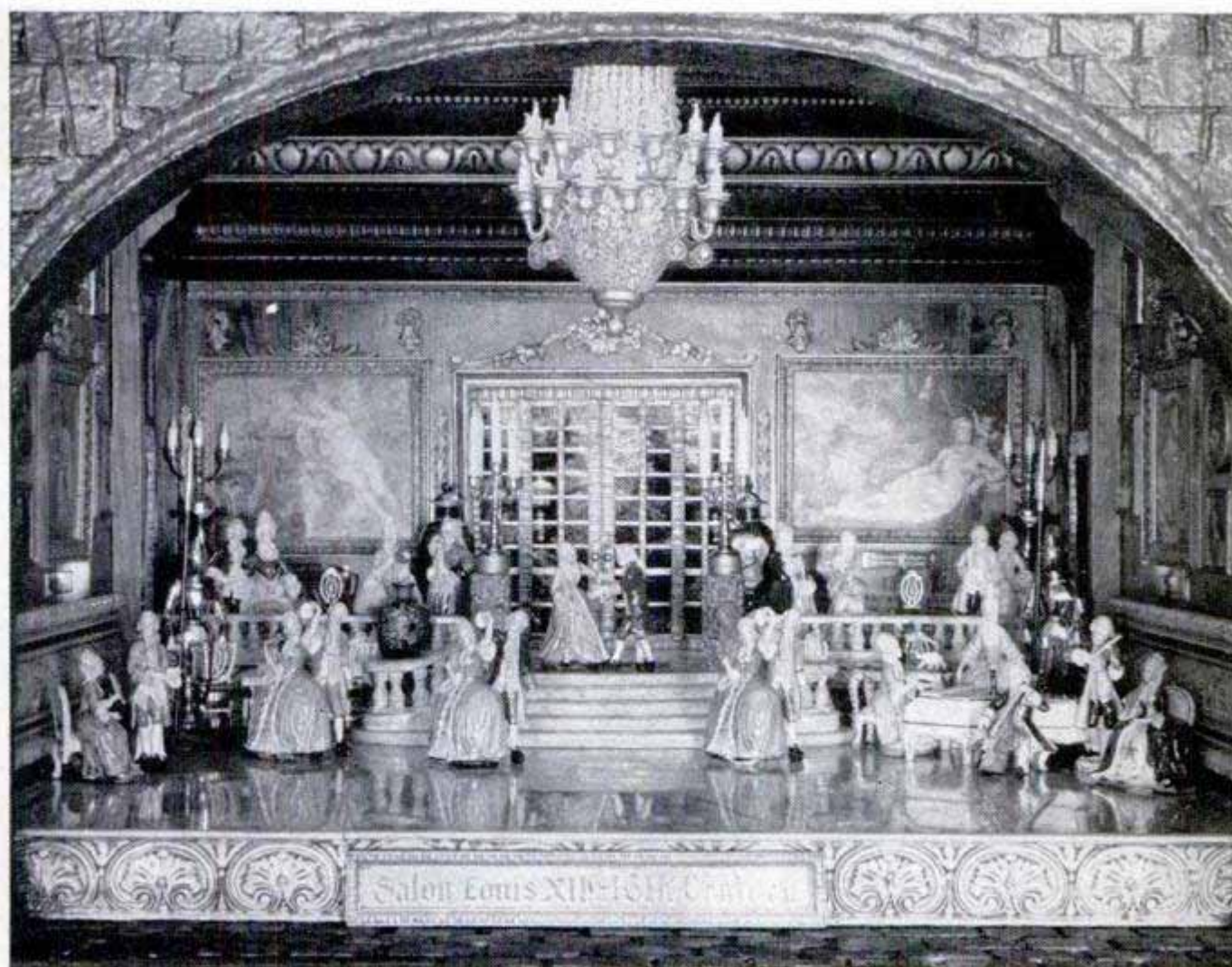
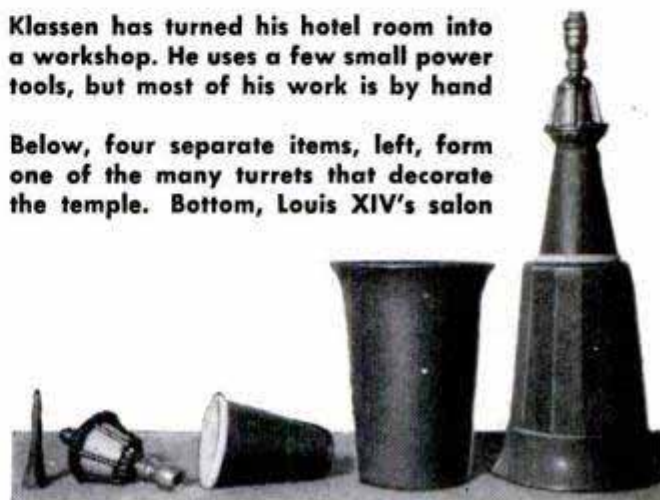



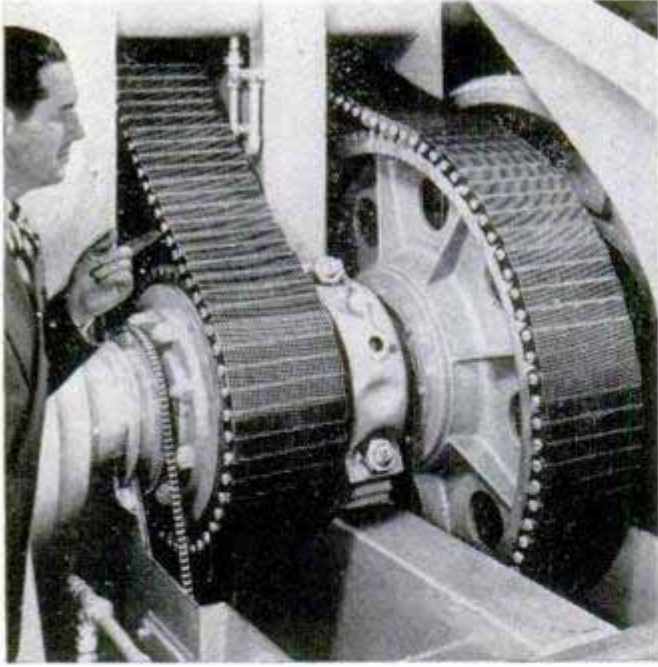

Left, these chain drives transmit 1500 h.p. at 600 r.p.m. Right, comparison of belt and chain of equal rating

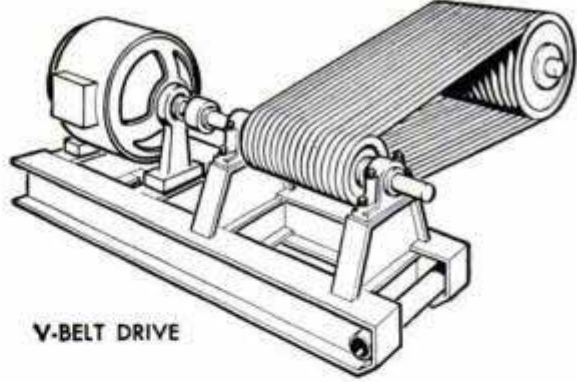

V-BELT DRIVE

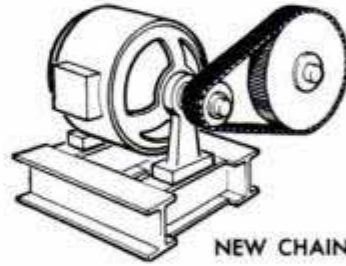

NEW CHAIN DRIVE

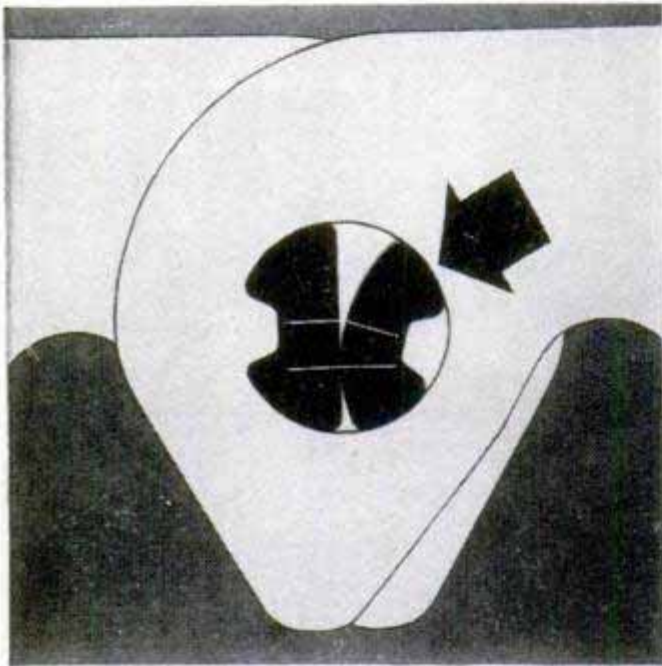

Left, compensating rocker joint on the drive makes the difference. Right, close-up shows action of new chain

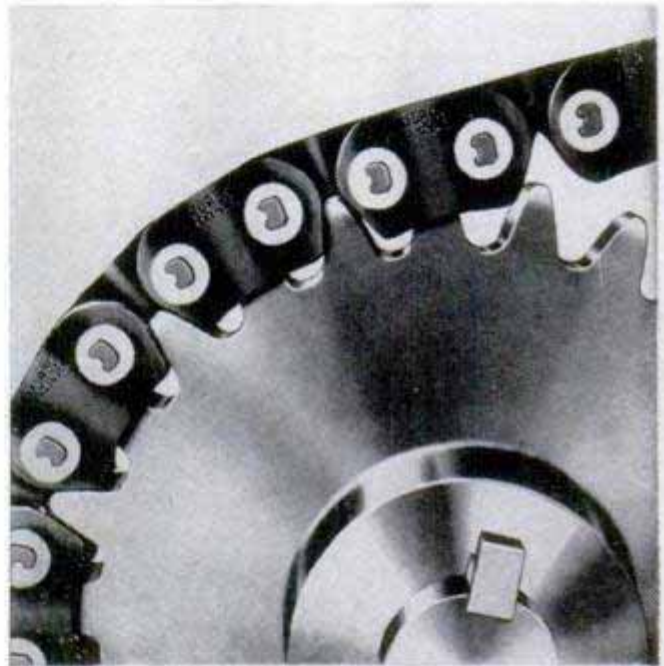

## Nonvibrating Chain Drive

Running almost as smoothly as a V-belt, a newly designed chain drive can transmit as much as 5000 horsepower at speeds up to 3600 revolutions a minute. The new design combines, for the first time, the ruggedness of a gear drive with the smoothness of a belt. Providing for tremendous in-

creases in speeds with much narrower widths than conventional drives, the chain eliminates the need for costly shaft extensions. A six-inch chain does the work of a 24-inch belt. Basis of the design is a chain-and-sprocket-engagement principle that gets rid of the slapping common to previous chain drives. It also runs quieter and cooler than former designs.

## Navy Scientist Invents Test to Spot Color Blindness

Color blindness has long baffled science, but today more information on the subject is becoming available. One of the newest devices to detect the many different types of color defectives has been invented by Lt. Comdr. Dean Farnsworth of the Navy's Medical Research Lab at New London, Conn. On it a person who is extremely

color deficient will match a gray spot on a transparent disk with a red, violet or green spot on a master diagram beneath. Others, not quite so deficient will say the gray doesn't quite match any spot, but is close to one of them. The device not only shows up color defectives, but immediately indicates which colors an observer confuses.



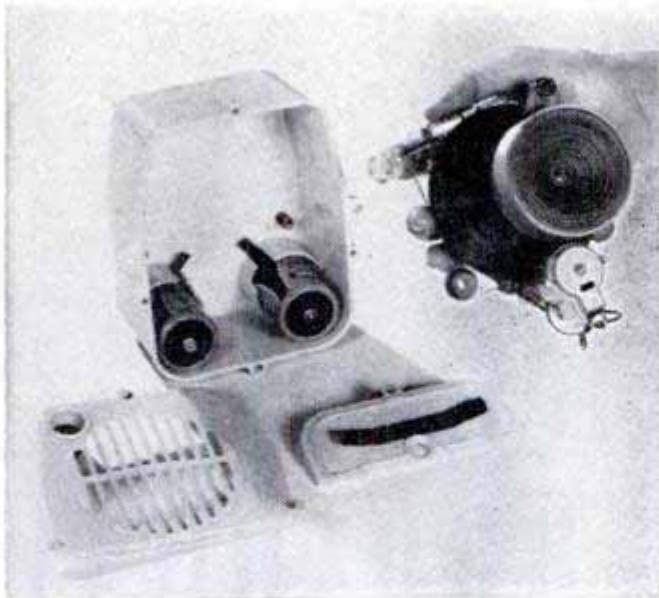

## Talking Doll

Make-believe mothers have a new playmate in a doll that talks when a button is pushed. The secret of the doll is a built-in record player operated by two standard flashlight batteries. The disk record is four inches in diameter and plays for about one



minute. When the button is pushed the doll sings songs, laughs, recites nursery rhymes and says her prayers. The front of the record player can be removed when the batteries need replacing. Pushing the button automatically starts the record revolving and places the needle in the proper place at the beginning of the recording.



## Flashlight Magnet Grip

You can aim your flashlight anywhere you want when it is held in position by a magnetic holder that grips an iron surface. A swivel joint enables you to swing the light in all directions. The magnet has a 27-pound grip, strong enough to hold on curved surfaces as well as flat ones. It is adjustable to fit any standard flashlight.



## Inexpensive Underwater Movies

Underwater movie cameras—custom-made until recently—now are available for the amateur photographer. A new 16-mm. camera is driven by a small power pack of flashlight batteries. From 1000 to 2000 feet of film can be run through the camera before the power has been depleted. The camera has a cast-aluminum housing and weighs 3¾ pounds underwater.



To Di and Drich Bowler the stage was glamorous enough if they could eat regularly. But they traded one successful career for another and, heading west with a pottery "bug" and their ingenuity,

# They said GOOD-BY to BROADWAY

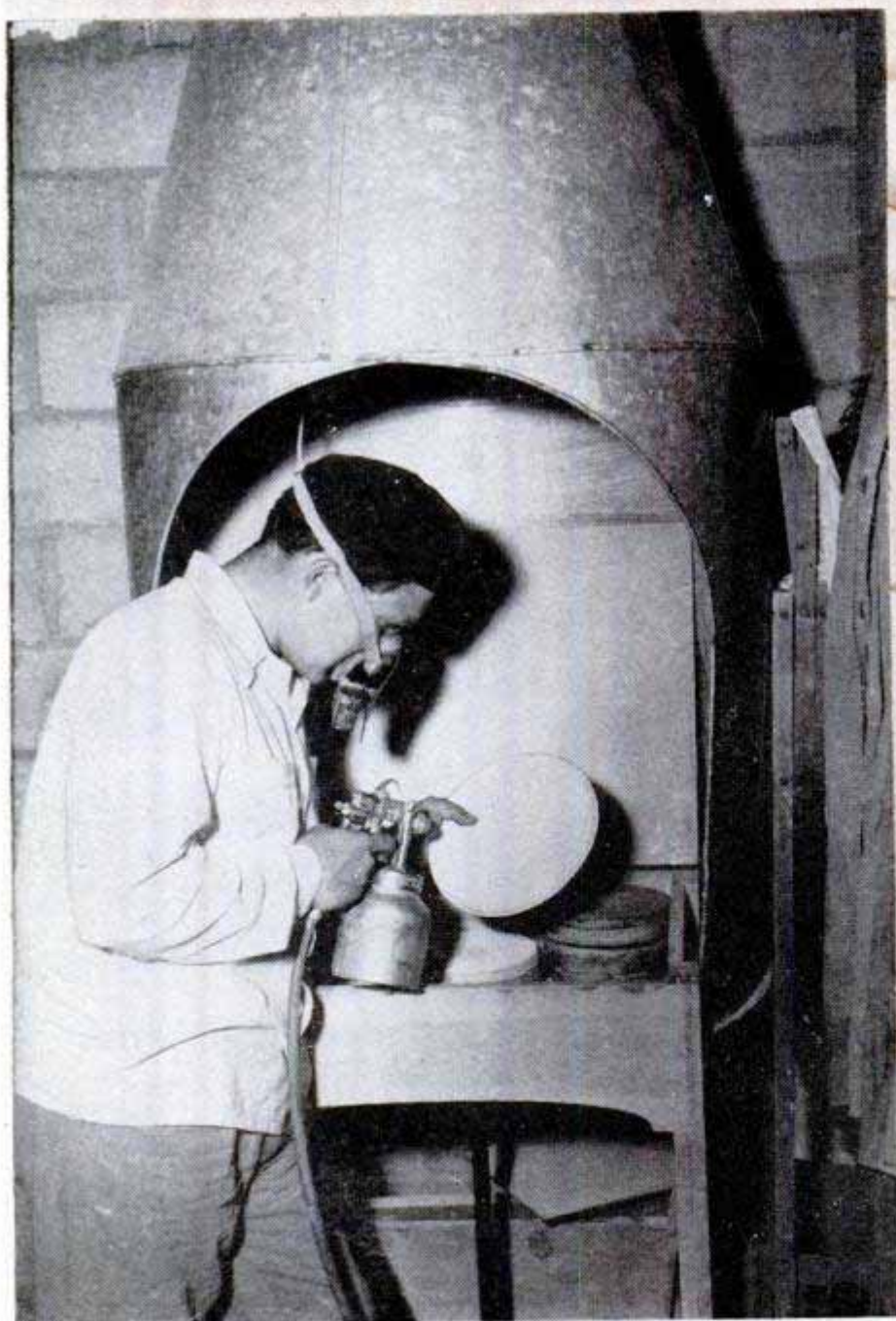

*By Rafe Gibbs*

Lungs protected by a respirator, Drich Bowler glazes a handmade plate. A 12-inch fan draws the excess material out of the air



**I**N NEW YORK CITY on January 1, 1951, there were over 50,000 persons seeking a livelihood in the theatrical profession, one way or another. By the end of this year, five percent will have decided that they just can't eat regularly enough. What then?

These artists who walk away from the bright lights face a difficult problem. Most are afraid to turn to some other creative art. But not two young Thespians named Di and Drich Bowler.

In 1946, chucking good Broadway stage parts, the Bowlers migrated west in a Jeep, seeking the simple, secure life—with a form of art thrown in. Although lacking both money and experience, they wound up establishing their own successful pottery business near Bliss, Idaho.

Drich, who had served with the Air Force in the South Pacific during World War II, had some GI-Bill education coming, so he and Di first enrolled in pottery making at the University of Idaho, doing



Former Thespians, the Bowlers turned their creative urge to the potter's wheel. Dominant designs are from frontier days of the West



odd jobs to help the budget. As a thesis project, Drich built a kiln. Now estimated to be worth about \$1000, it cost only \$70 to build. The secret—most of the parts were obtained from junk yards.

Came June of '47 and the Bowlers loaded their prized kiln in a trailer behind their Jeep along with Wanda, a goat they had acquired to cut down milk costs on their new venture. Their destination was Hagerman Valley in southern Idaho, noted for its lush, irrigated crops nudging parched sage. Through the valley winds the Snake River, and along its banks are buttery, red-clay deposits.

At a bend in the river the Bowlers picked their homesite, three cheap acres with a three-million-dollar view — sage-covered hills that blended into willows on the river. Around a picture window to frame that view, the Bowlers built their combined home and pottery workshop — with borrowed funds, sweat and ingenuity.

Construction block made of pumice from Idaho's Craters of the Moon was utilized

Di shapes a bowl on the wheel her husband made from the flywheel of a scrapped car, two old engine blocks and a vast amount of ingenuity





Kiln made of junked parts cost \$70, now is valued at \$1000. Six electric switches give precise heat control

for the walls of the modern, flat-roofed home. Water-mellowed driftwood picked up from the banks of the Snake became beams and decorative pieces.

"Building plans were sometimes changed daily to make the driftwood fit," says Drich.

But the end product is both practical and beautiful.

Vital to pottery making are the right humidity and temperature. This called for more ingenuity, more improvising.

Handy to the Bowlers' place are some springs. Tapping these as a water supply, Drich rigged up a highly efficient air-conditioning unit. Utilized in it are a vegetable atomizer and an old furnace blower, driven by an equally old electric motor, to pull saturated spray through a baffle filter.

As the house took form, so did the props for pottery making. The kiln—and Wanda—had arrived safely, but more was needed.

Assembling such parts as the flywheel from an old Chevrolet and the bearings from two discarded engine blocks, Drich constructed a standard potter's wheel for about two dollars.

That project was easy. But also required was another wheel with variable speed for certain ware such as large bowls. Taking a transmission that had once powered a mobile-gun unit during the war, Drich soon had a second wheel he didn't have the money to buy.

In pottery making there are inevitable failures—ware that cracks in the first fir-

ing. If the imperfect ware is ground up, however, the materials can be used again.

Search for a grinder ended on a faded Indian trail. There the Bowlers found a stone mortar and pestle used by the red men for grinding corn.

"We had finished grinding out corn on the Broadway stage," says Di, "but decided the mortar and pestle would be just the thing for grinding up our pottery grog. It was, too—but slow."

That was also the comment of Jim Henry, a plumber and ex-miner, when he saw Drich one day squatted Indian fashion before the mortar, laboriously oscillating the pestle.

"Got something at home I think you can use," he said.

Next day Henry returned with a small ore-crushing mill. It was soon crushing 40 to 50 pounds of cracked pottery per hour.

That speed-up started Drich thinking about a quarter-century-old washing machine Di had acquired. With hesitation he broached an idea to his partner in pottery.

"We're taking too much time mixing our clay by hand," he said. "Why don't we use the washing machine?"

Di had washed clothes by hand in a Greenwich Village cold-water flat. Why not in Idaho? "Okay," she agreed.

With the washing machine the Bowlers found they could mix a week's supply of clay in two hours.

Since then, the profits have been coming





**Ore crusher, once used by an assayer, now grinds up imperfect pottery. Material then can be used again**

in. You can find the Bowlers' handmade Snake River pottery, bearing the seal of a Western rattler, in smart gift shops from Sun Valley to Manhattan. But they've worked hard for the applause.

There were times when money was so short that Di took to teaching school at near-by Gooding. Drich traded time in a neighbor's hayfield for carpentry help.

Their successful venture is the story of two artists who never let their creative urges die, who found what they had sought on Broadway beside an Idaho river.

Recently the Bowlers adopted a baby



**Drich converted an ancient washing machine into a mixer. It whips up week's supply of clay in two hours**

boy, a handsome, chubby masterpiece. Not long ago the lad became ill. Rushed to the doctor's office, he received a shot of penicillin. Di and Drich were worried, busy parents. Then in the evening the fever abated and the lad fell asleep. The clock said 11 p.m.

The Bowlers, though, wouldn't call it a night. They put on their smocks, began to turn the potter's wheels, to feel wet clay taking shape in their hands. The tired lines seemed to spin away with the movement of the wheels. The Bowlers were creating, and in their hands they held happiness.

**Pond, formed by damming a spring to supply power, has a more important use—it's stocked with trout!**





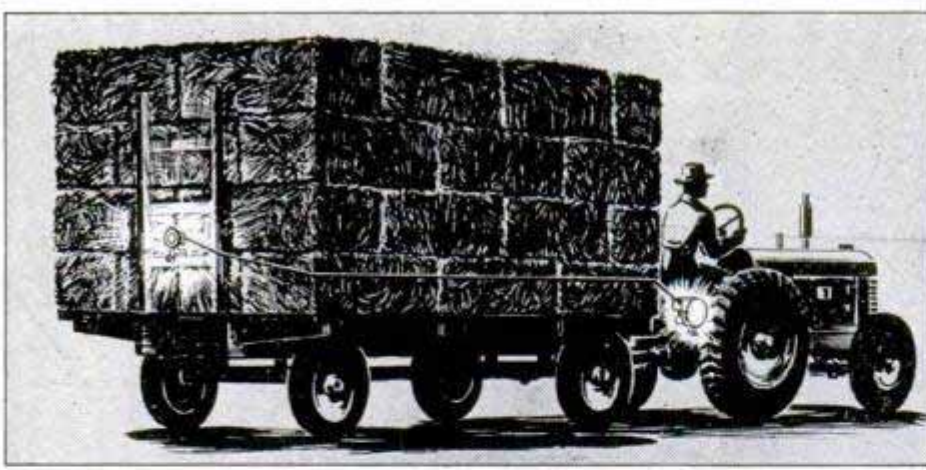

## Tractor Light

Double protection against night accidents is provided for trailers by a taillight with an auxiliary light at the end of a 35-foot cable. The main mounting is permanent but the extension can be stretched out and clamped on pulled vehicles. Its cable is on a spring-driven reel to maintain constant tension and prevent tangling. The extension light becomes a floodlight when the red lens is swung aside.

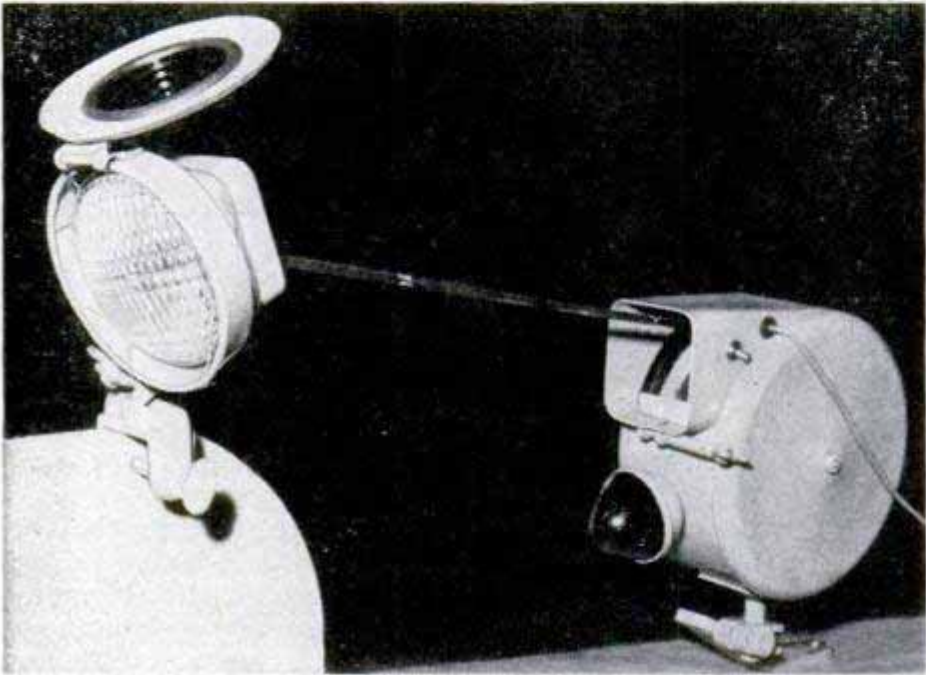

## Pigeon Preventive

Pigeons don't like a new puttylike chemical. It's a gelatin compound which prevents pigeons, starlings and other feathered pests from roosting on the ledges of buildings. The chemical is applied with a caulking gun to favorite roosting spots. Ribbons of the compound are run along the surface two or three inches apart. One application lasts a year.

## Nonswat Mosquitoes

Making ferocious mosquitoes from gourds is the unique hobby of Herbert Klein, a cafe owner of Conroe, Tex. Klein uses long, curved gourds for the bodies, cup gourds with pointed ends for the heads and beaks. Sheet plastic forms the wings, pipe cleaners the antenna and legs. Klein paints a grotesque face and striped body on the resulting monster. So appealing are the mosquitoes that tourists have left a backlog of orders—at \$15 per insect.

## Christmas-Tree Apron

Covering the floor beneath the Christmas tree to protect the carpet, a red plastic apron, five feet in diameter, also forms an attractive background for gifts. Resistant to fire and water, the circular apron is quickly cleaned with soap and water. Three snap fasteners hold it closed after it has been slipped around the tree.





the

POPULAR  
MECHANICS

# CRAFTSMAN



Sparkling like a gem in a snowy setting, this ranch house says "Merry Christmas" to all who come within view

## CHRISTMAS LIGHTING

**F**ROM THE GREEN HILLS of southern California to the snow-clad landscape of New England, Americans traditionally celebrate Christmas by adorning their homes, business establishments and public buildings with elaborate decorations. Your home, too, can spread the cheer of the holiday season, so join in the fun and "outshine" your neighbors on Christmas Eve. If the budget is strained, as it often is around Christmas, you'll be surprised at what can be done with only a few dollars and some odds and ends of hardboard, oil-cloth and evergreen trimmings. Strings of colored lights and possibly a floodlamp or two are, of course, essential for after-dark

A wooden frame, a string of lights, some greens and a red bow form a striking wreath for the front door







The little balcony is an ideal spot for setting up this oilcloth Santa, but there are many places on or near the house where he'll look just as effective

Utilizing minimum tinsel decoration, this house is dramatized by colored floodlights hidden under the second-floor overhang and behind the evergreens



In scene from a Christmas-poem series, cutout child figures "hang" stockings on a simulated fireplace

displays but, in many cases, you will find that the cost of the lights is the only extra expense involved.

The three photos above picture a portion of a unique neighborhood project that depicts scenes from a famous children's poem. After the residents had built the various scenes in their home workshops as part of the cooperative effort, the settings were assembled in their proper order, one in front of each house. With each scene illuminated by a weatherproof spotlight, the entire poem could be viewed in proper sequence by passing motorists. Sketches made for all the settings were followed closely when building the props. The figures are bandsawed from hardboard or waterproof plywood and "dressed" in cloth







In another scene, showing children in bed, blankets and canopy are cloth, mock bed and cradle of plywood

remnants or painted to simulate clothing. Brightly colored yarn is used to represent hair. Other parts of the scenes, such as the fireplace and bed, are also assembled from plywood or hardboard and painted to suit. Note that the line of the poem corresponding to each scene is lettered on a hardboard panel, which is mounted so the lettering can be seen clearly from the street. The entire sequence is dismantled after the holidays and stored for use the following year.

The elaborate display pictured below features the ever-popular reindeer in a brilliant Christmas setting which attracts parents and their youngsters from miles



A third scene from the poem sequence features Santa's sleigh mounted on a framed backdrop of plywood

around. The reindeer is modeled from papier-mache or plaster of paris mixed with tow or excelsior. This is applied to a form of screen wire or hardware cloth fitted over a wooden or metal frame. The completed figure is finished with white texture paint.

For outside decorations, be sure that your strings of colored lights are the type made especially for outdoor use, and that the floodlamps and spotlights are of the weatherproof type. If you do not have a standard outdoor receptacle, use a protected outlet on the porch or in the garage. If one is not available, you can run an extension cord from the house. Pass the cord

Bathed in colored light, this prancing reindeer changes an average suburban lawn to a scene of fairy-tale enchantment. Papier-mache figure is modeled over a wire form which is fitted to a framework of wood or metal

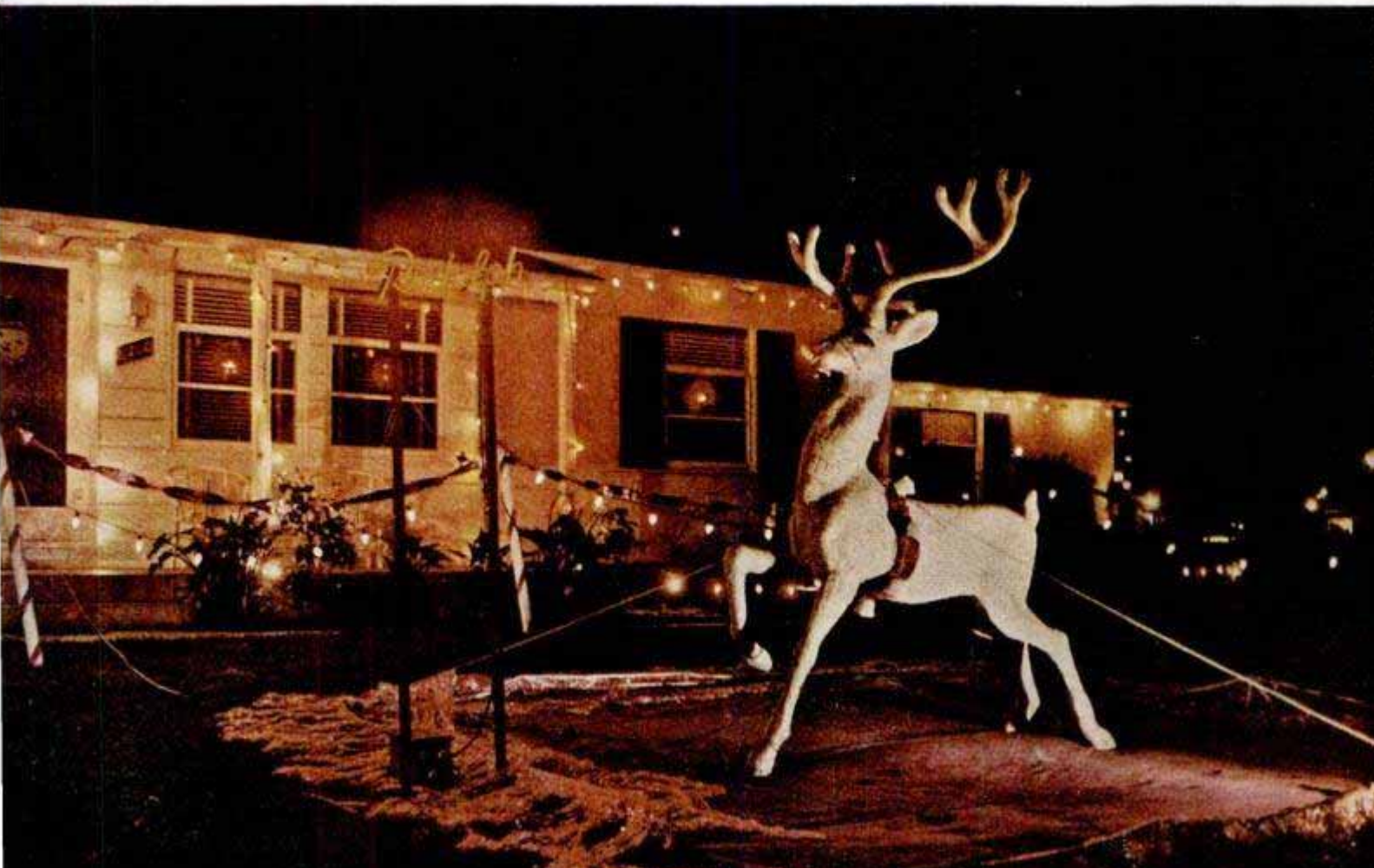





Above, this festoon of white lights and evergreen cuttings, topped with a star, sets off a simple shuttered window. Below, angel cutouts, spotlighted at night, flank driveway to herald arrival of guests



through a hole drilled in a board and fit the board directly under a lower window sash. If the window is not fitted with a burglar lock, it can be locked against the wooden insert with a stick wedged between the top of the sash and the window casing.

The following two pages detail several ways of making simple and effective Christmas decorations, but these are just a few of the hundreds of different ideas which can be employed. The upper right-hand detail on the next page shows how evergreen trimmings can be used to form a large wreath around a door or window. A horse-shoe-shaped wooden frame is built to the desired size and poultry wire or hardware cloth is stapled to the frame. A string of lights is fastened to the wire and sprigs of evergreen are inserted through the mesh so they completely conceal the wire but leave the lights exposed. The wreath is topped with a large oilcloth bow.

Another popular doorway treatment is attained by installing a large candle on either side of the door. The candles can be made in several ways depending on the type of lighting to be used. One of the simplest candles consists of two pine boards or lengths of hardboard mounted vertically, one in front of the other and separated by spacer blocks. A string of colored lights is fastened between the boards, and a flood-lamp or spotlight is mounted on the upper



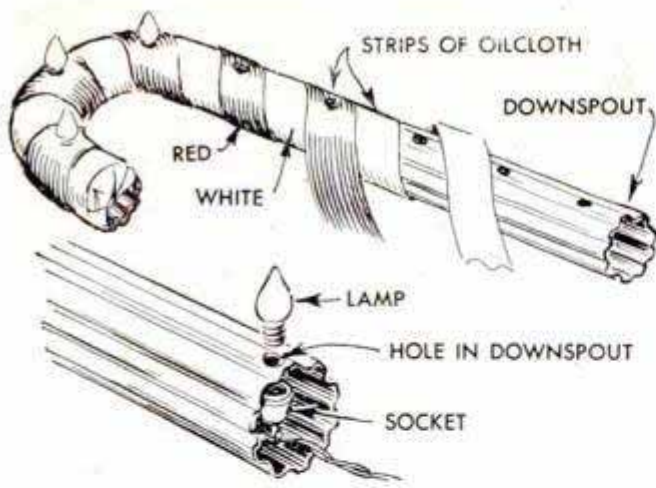

Lengths of ordinary downspout provide form for giant candy cane. Peppermint stripes are duplicated by wrapping spirally with strips of red and white oilcloth

spacer block to cast its beam from the top of the candle. A flame can be simulated by clipping a spiral of wire to the floodlamp lens and covering the spiral with colored cellophane. Candles also can be improvised by covering a wooden frame or half of a cardboard rug-shipping tube with translucent plastic or oilcloth, using a spotlight at the base or a string of lights inside the tube.

The life-size Santa pictured on the following page, and also shown in full color on page 158, is supported by a wooden frame, with lengths of stiff wire being used to hold the arms in position. The jacket and trousers are made of red oilcloth. These are fitted over the frame and stuffed with old

One homeowner used his large picture window to display this cheery greeting. He painted the scene on the inside of the window with show-card colors

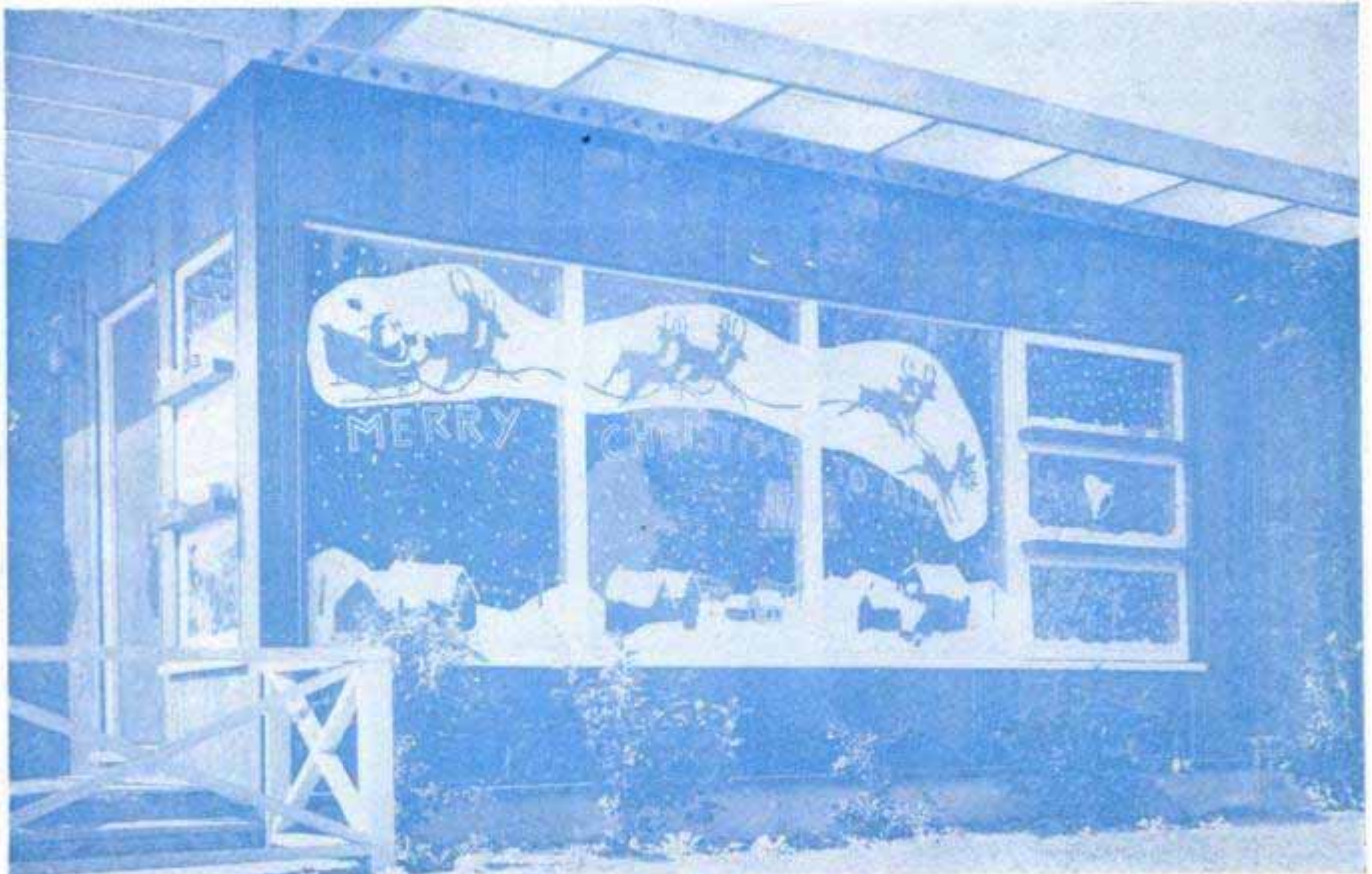



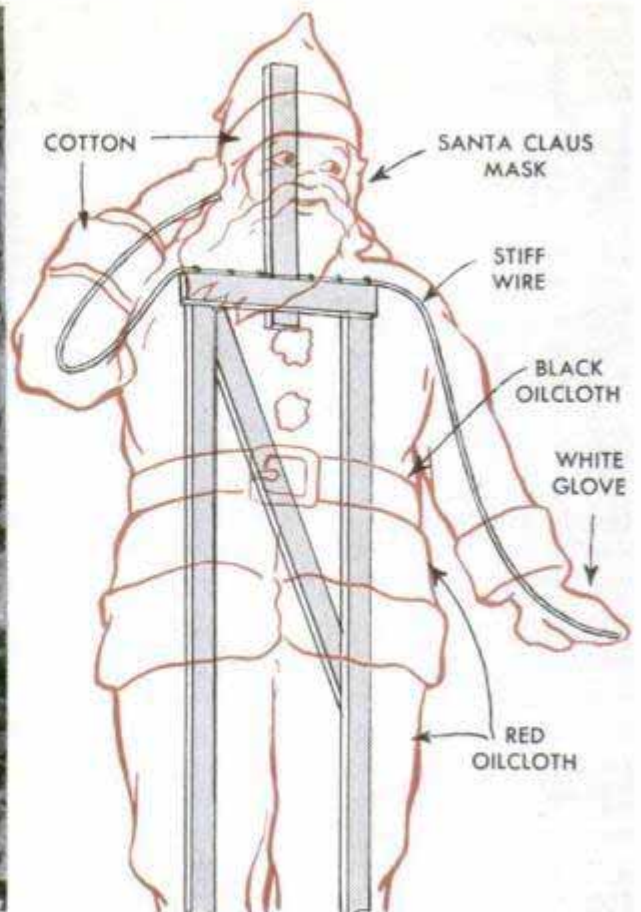

SILHOUETTE      LIGHT-COLORED BACKGROUND      COLORED LIGHTS

Shadow picture of the Three Wise Men, above, is one of many silhouettes which are attractive when set on window sill or on the lawn. Colored lights are hidden between cutouts and light-colored background

clothing or papers to fill them out. A Santa Claus mask and hat, gloves, belt and cotton trim complete the outfit.

Two varieties of lawn cutouts are detailed below. These are of hardboard or weatherproof plywood, held upright with a stake driven into the ground. The Santa cutout at the left is illuminated with a clear spotlight, the shadow cast by the cutout being tinted with a color-capped floodlamp concealed behind the figure. The angel cutout at the right is drilled to allow the lamp sockets to be inserted through the cutout from the rear thus outlining the figure with a number of white or colored lights.

Certain photos and information courtesy General Electric Co.

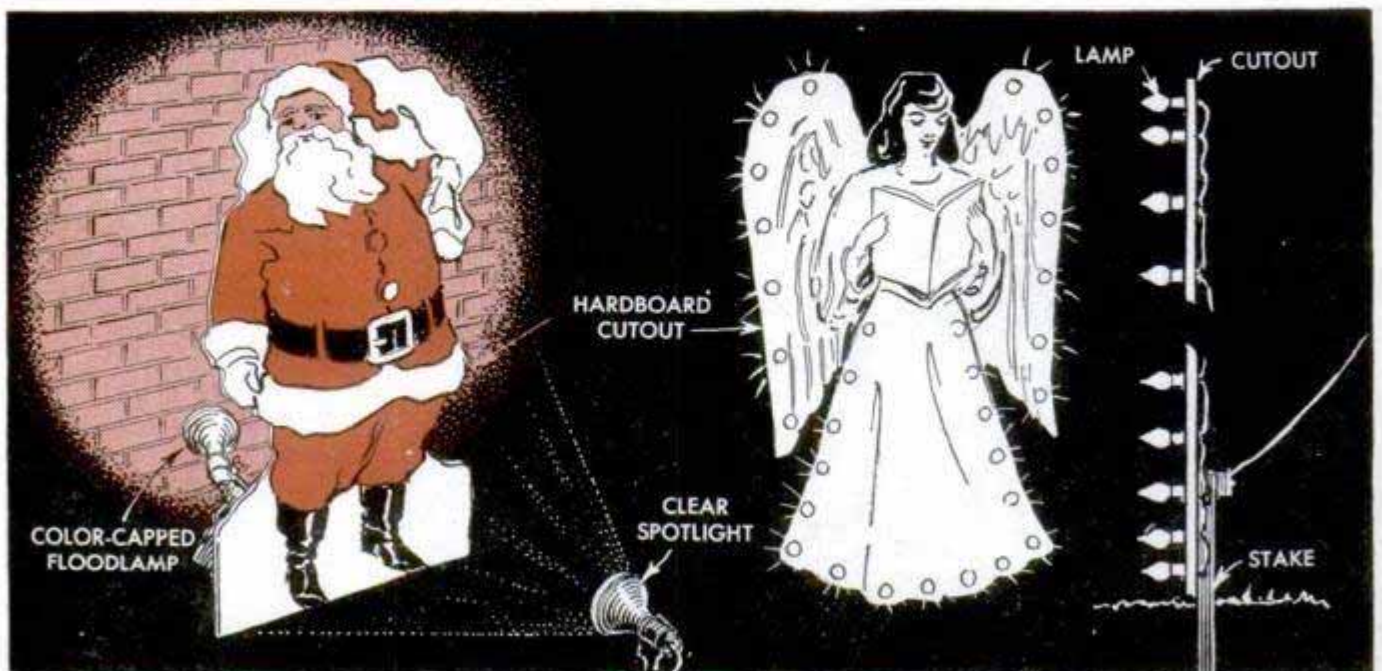



## Gas-Cap Lock Kept From Freezing By Plastic Bowl Cover



When a lock-type gas cap is used on the filler tube found on older-model cars, water can be kept out of the lock by covering the cap with a plastic bowl cover and thus lessen the chance of freezing. A suitable size to fit snugly over the cap can

be purchased at a dime store. Another stunt that will prevent the lock from freezing is to place a few drops of glycerin in it.  
J. Shields, Bloomington, Ill.

## Car Touched-Up With Shoe Polish

One motorist temporarily refinishes worn and faded spots on his car with shoe polish. After washing the car, the polish is applied to the spots with a cloth and rubbed like wax. Then, regular wax is used over the entire body.

P. R. Wilson, Brooklyn, Ont., Can.

## Curling Iron Used to Stuff Rag Doll

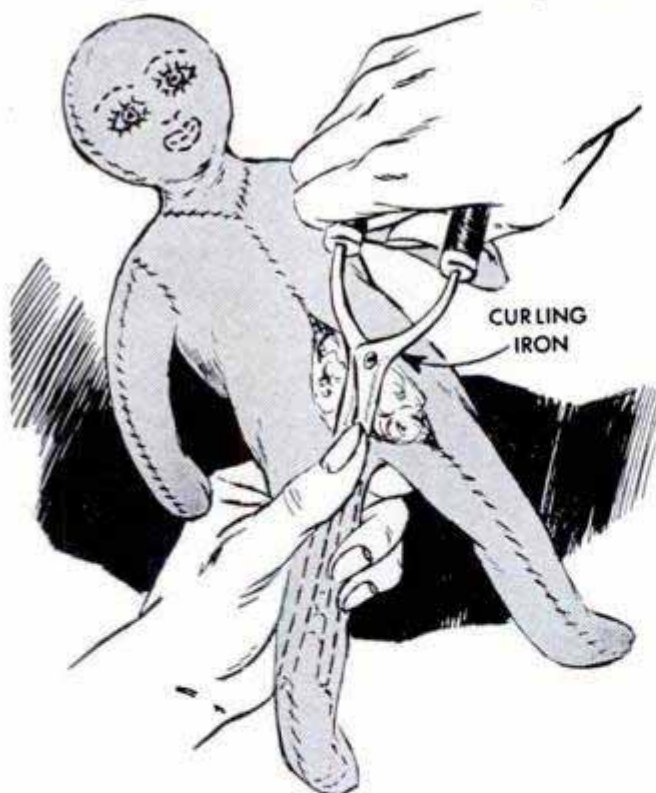

The difficulty of inserting cotton or other padding in the narrow parts of rag dolls can be overcome by using a curling iron. The tool is used like tongs to place the padding and, with the jaws closed, it also can be used for tamping.

DECEMBER 1951



## Single-Door Clothes Closet Made Into Wardrobe Type

In order to make accessible the area on each side of the door to a small clothes closet, one homeowner widened the door opening, reframed it and hung two 24-in. doors, which close together and are held by friction catches. This permitted installing the clothes-hanger rod parallel with the length of the closet, and provided extra space on the inside surfaces of the doors for attaching shoe bags, a tie rack and a rack for holding purses. Note that a small chest of drawers utilizes space under one end of the hanger rod, on which clothes such as suits, shirts and blouses are hung. The full-length, overhead shelf is within easy reach.—Harold W. Wyatt, Cincinnati, Ohio.

## Fish Lure Provides Key Holder

A plug-type fish lure, mounted on a plaque with wood screws and hung on the wall, makes an appropriate key holder for the angling enthusiast. The barbs and points of the hooks should be filed off and the entire unit finished with a coat of spar varnish.

George Kapitan, Bronx, N. Y.

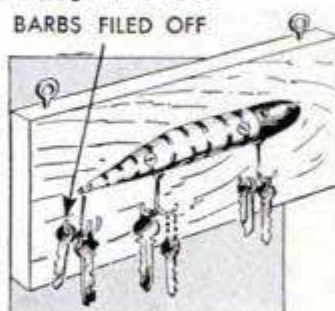

☐ Nicks and scratches in furniture and woodwork can be repaired by staining them to the proper tone and then covering them with two coats of clear shellac.

163



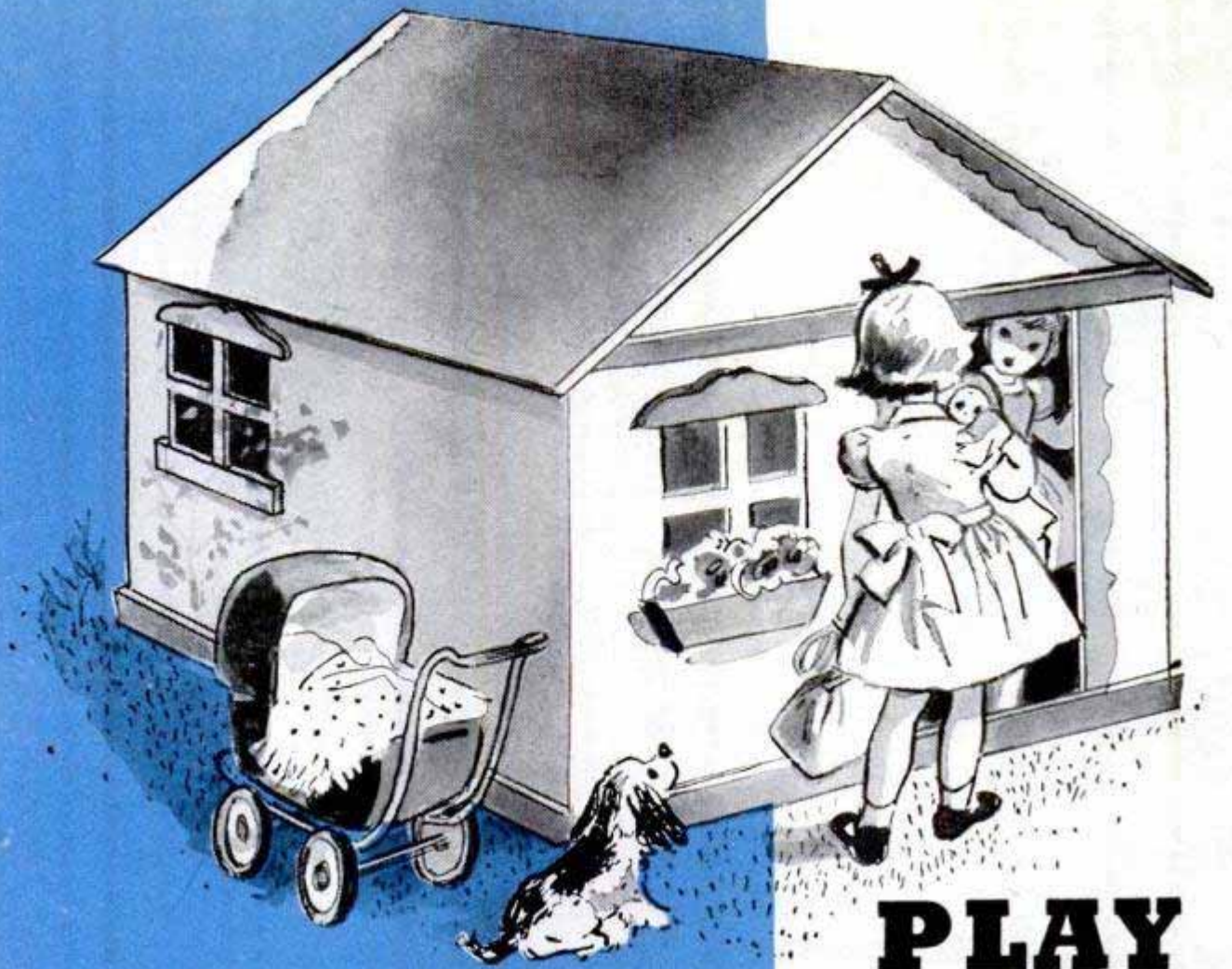

# PLAY

There are few toys that delight a little girl like a walk-in playhouse. This plywood cottage is a yard toy that will bring many hours of pleasure and it is small enough for indoor use in rainy weather or during the cold months

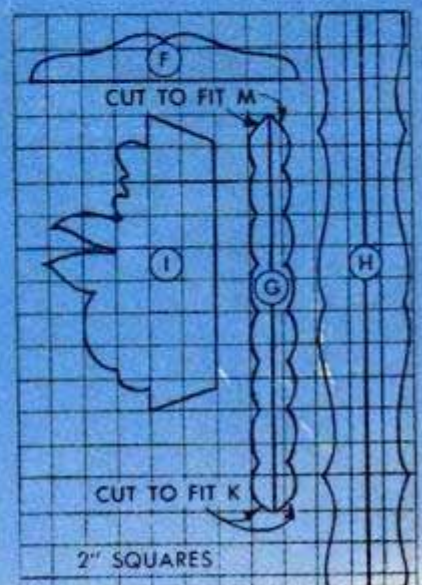
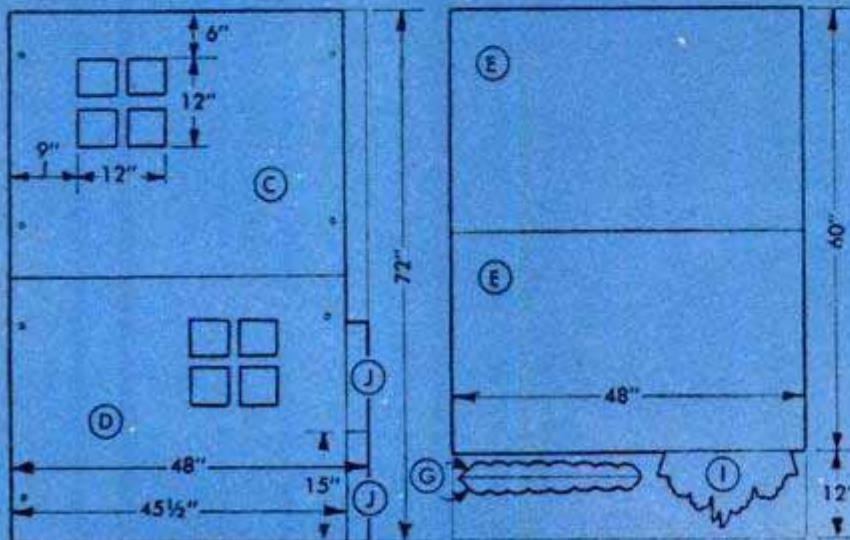
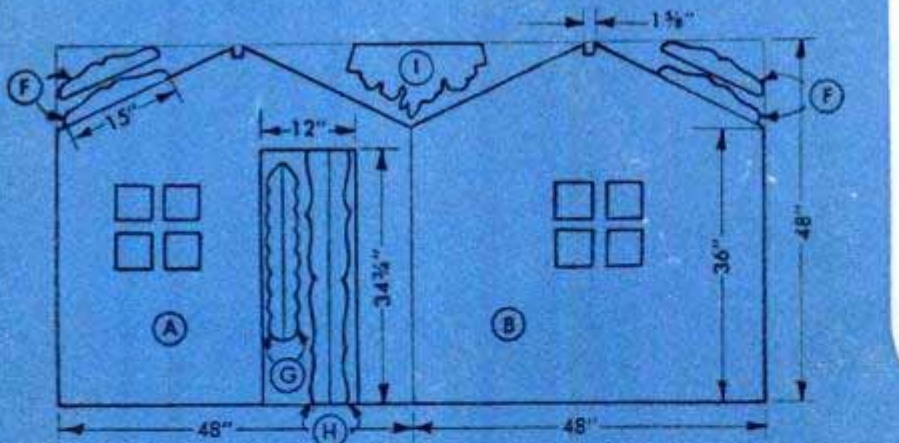



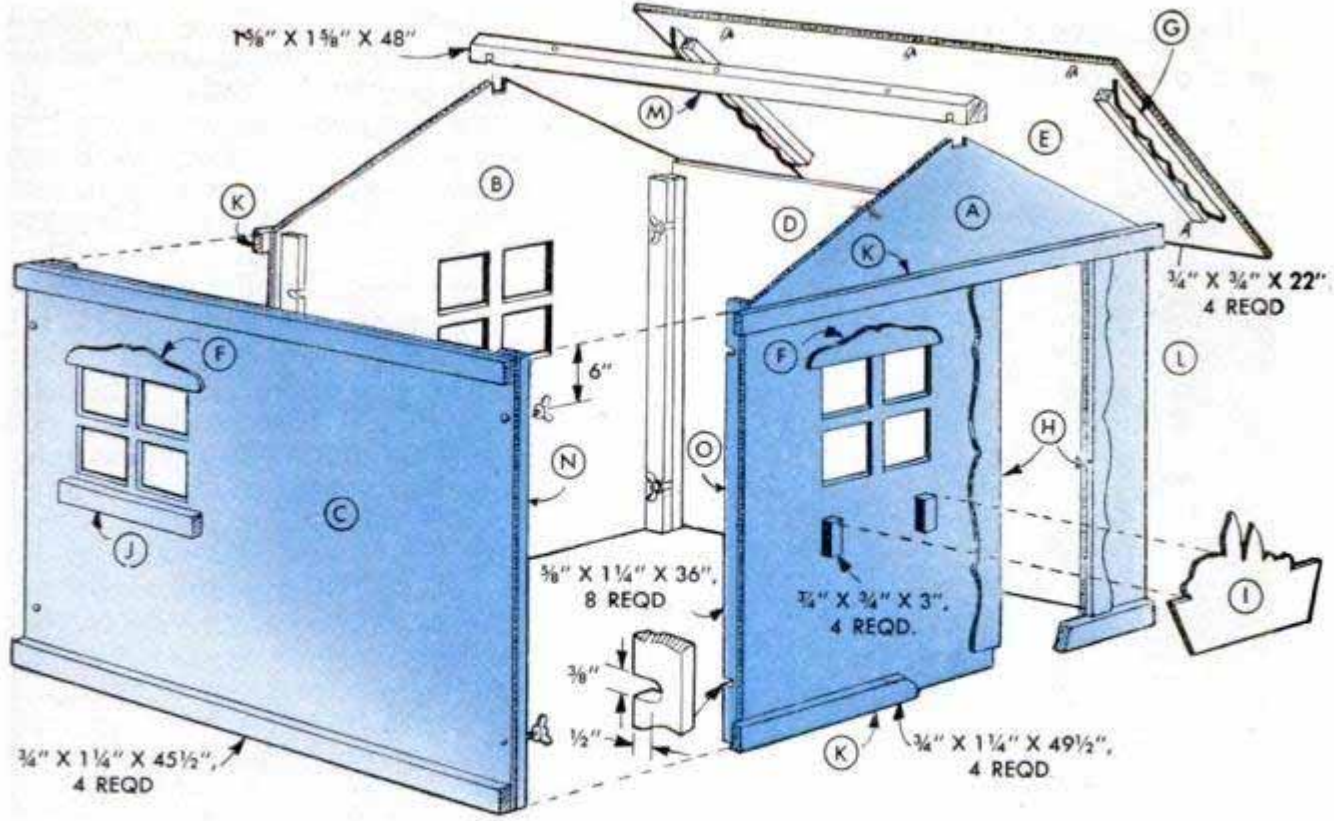

# COTTAGE

**D**ESIGNED to be set up or taken down in just a few minutes, this quaint little play cottage collapses to form a compact unit that can be stored under a bed or in a closet. The sides, roof and trim are cut from three 4 x 8-ft. sheets of plywood, and a few lengths of solid stock are required for uprights, plates, cleats and ridge board. Although  $\frac{3}{8}$ -in. plywood was used on the original house,  $\frac{1}{4}$ -in. plywood or hardboard will serve the purpose. If the house is to remain outdoors during the summer months, be sure to use weatherproof

(marine-type) plywood for the walls and roof. Note in the details how the corner uprights of the sidepieces are fitted with bolts which engage notches cut in the corner uprights of the end panels. Wing nuts lock the uprights together for quick assembly. The ridge board is notched to fit over the gables and drilled to receive dowels inserted near the upper edge of each roof panel. Valances and cleats form channels near ends of the roof panels. The channels engage the edges of the gables. Sills, lintels and doorway trim are glued and screwed directly to the plywood panels, but the window boxes are given the effect of depth by mounting them on  $\frac{3}{4}$ -in.-sq. spacer blocks fastened to the plywood. If the house is intended primarily for outdoor use, it will be worth while to include a raised floor to keep the children off the damp ground. The floor can be made by screwing a sheet of plywood or hardboard to 1 x 2-in. joists set on edge. The joists should be spaced not more than 12 in. apart. To facilitate storage, make the floor in two parts, hinging them together if desired. Notch the corners of the floor to clear the uprights when the walls are set up around it. The floor can be painted with porch enamel or marine varnish, and made even more attractive by covering it with a remnant of linoleum. Paint the walls, roof and trim of the house in bright colors and, if you wish, hang plastic or oilcloth curtains at the windows. Although a door is not necessary, a simple one can be made by hinging a plywood panel to the doorway, fitting the panel with a knob-type drawer pull on each side.

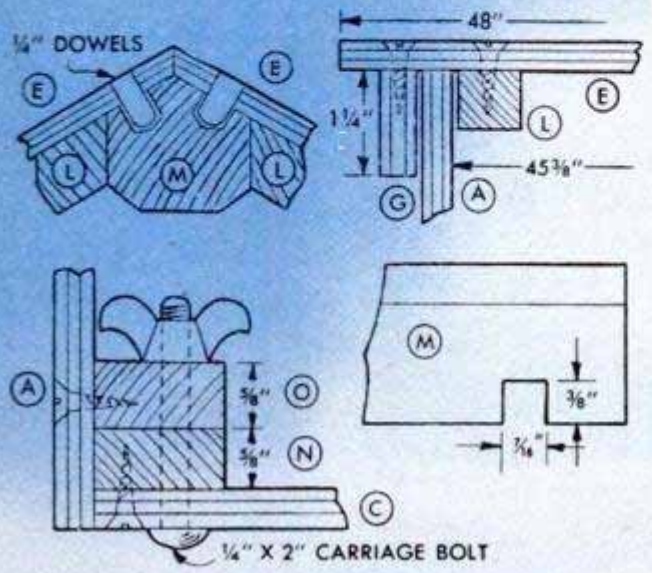



## Tube Unit Concentrates Breath When Blowing on Campfire

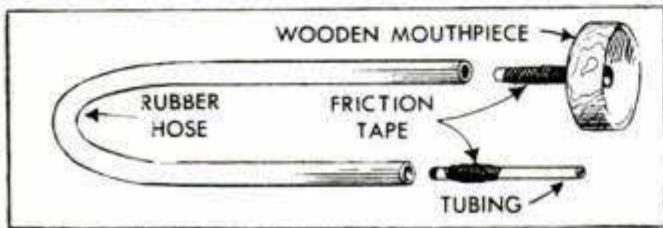

Finding a bellows too cumbersome to carry on hikes, but wanting a blower to aid him in starting campfires, one boy scout devised this handy "helper." A length of rubber hose was fitted at one end with a short piece of  $\frac{1}{4}$ -in. copper tubing and at the other with a wooden mouthpiece as indicated in the detail. Note that in using the blower, the camper need not put his face near enough to the fire to be in danger of burns from flying sparks.

Russell B. Smith, Minneapolis, Minn.

## Inexpensive Christmas Decorations

Decorating your home for the Christmas season need not be an expensive proposition if you utilize materials which, in most homes, are already at hand. For instance, to letter greetings on door and window panes, use a thick paste of flour and water. Sprinkle coarse salt over the lettering while still wet and the result will be an appropriate, frosty appearance. If desired, greatly magnified snowflakes can be taped to the panes around the lettering. These are provided in realistic designs simply by cutting out sections of intricately patterned paper doilies. On windows fitted with Venetian blinds, a novel effect will be attained by pasting or taping a large, seasonal picture to one side of the blind when the slats are closed, and cutting the picture in strips

by drawing a razor blade along the edge of each slat. When the blind is open, the picture will not be visible, but a pull of the slat cord brings it suddenly into view. Pine cones always can be counted on to help supply a Yuletide atmosphere, and can be used in a number of ways. But first, brighten them up by brushing with rubber cement and then sprinkling liberally with metallic powders. Tie the cones to the Christmas tree with ribbons, use them in making wreaths, or fasten three or four of the cones together to form a holder for candles. And if you wish some giant-size candles, make them by placing regular candles vertically in tin cans and then filling the latter with melted paraffin. When the paraffin has hardened, cut the bottoms out of the cans to make the giant candles easy to remove. If you use milk cartons as molds, square candles can be made in the same way. Colorful, miniature Christmas trees are made by inserting long knitting needles through the centers of paper plates, and slipping tree-ornament balls over the needles. Place the largest balls at the bottoms of the needles and graduate them in size to the tops. Adorn the edges of the plates with crinkled foil paper or lace from a doily. The names of family members and guests, printed in befitting colors on the dinner dishes or glassware, will serve as a unique way to place the diners, and at the same time add to the spirit of festivity. Use red nail polish for the lettering, and trim it with clear nail polish tinted green by adding a crushed food-coloring tablet.

## Bottle Warmer Used as Gluepot

An electric baby-bottle warmer makes an ideal gluepot that is especially useful for heating small quantities of glue. Often a warmer that has outlived its regular use can be utilized in this manner. The glue container is a tin can of a size to fit into the warmer.—Ken Murray, Colon, Mich.

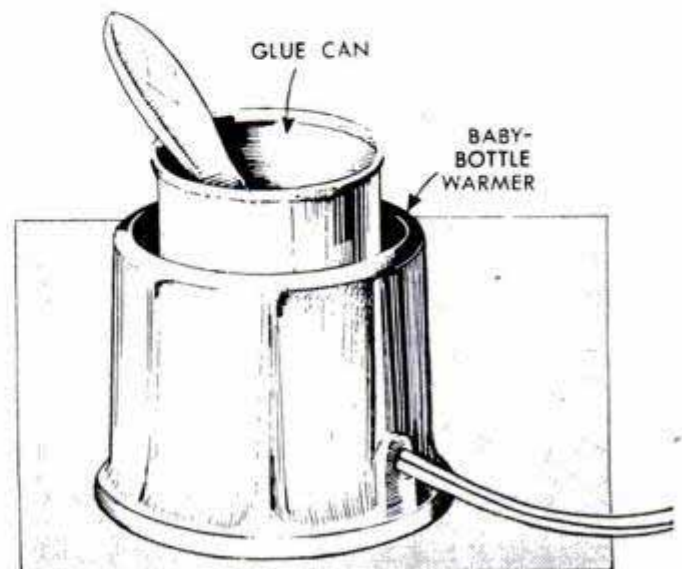



# CANDLE-TRAY CENTERPIECE

By Roberta L. Fairall

WOOD and hammered metal are utilized in novel and attractive combination in these decorative candle trays. Although two designs are detailed, construction is essentially the same. In both designs, the base is scrollsawed from plywood or hardwood such as birch, and the outer edges are smoothed with fine sandpaper. The base is finished with shellac and wax. The metal trays and candleholders should be cut from colonial brass, which is a reddish-gold color. One tray is heart-shaped, the other round, and both have scalloped edges as indicated in the details below. After the trays have been hammered, buffed and lacquered they are attached to the wooden bases with brass escutcheon pins. On both designs, the candleholders are cut to the shape indicated on  $\frac{1}{2}$ -in. squares and are attached to the trays with pins before bending, as indicated in the left-hand detail below. The candleholders also should be covered with a coat of clear metal lacquer to prevent tarnishing.

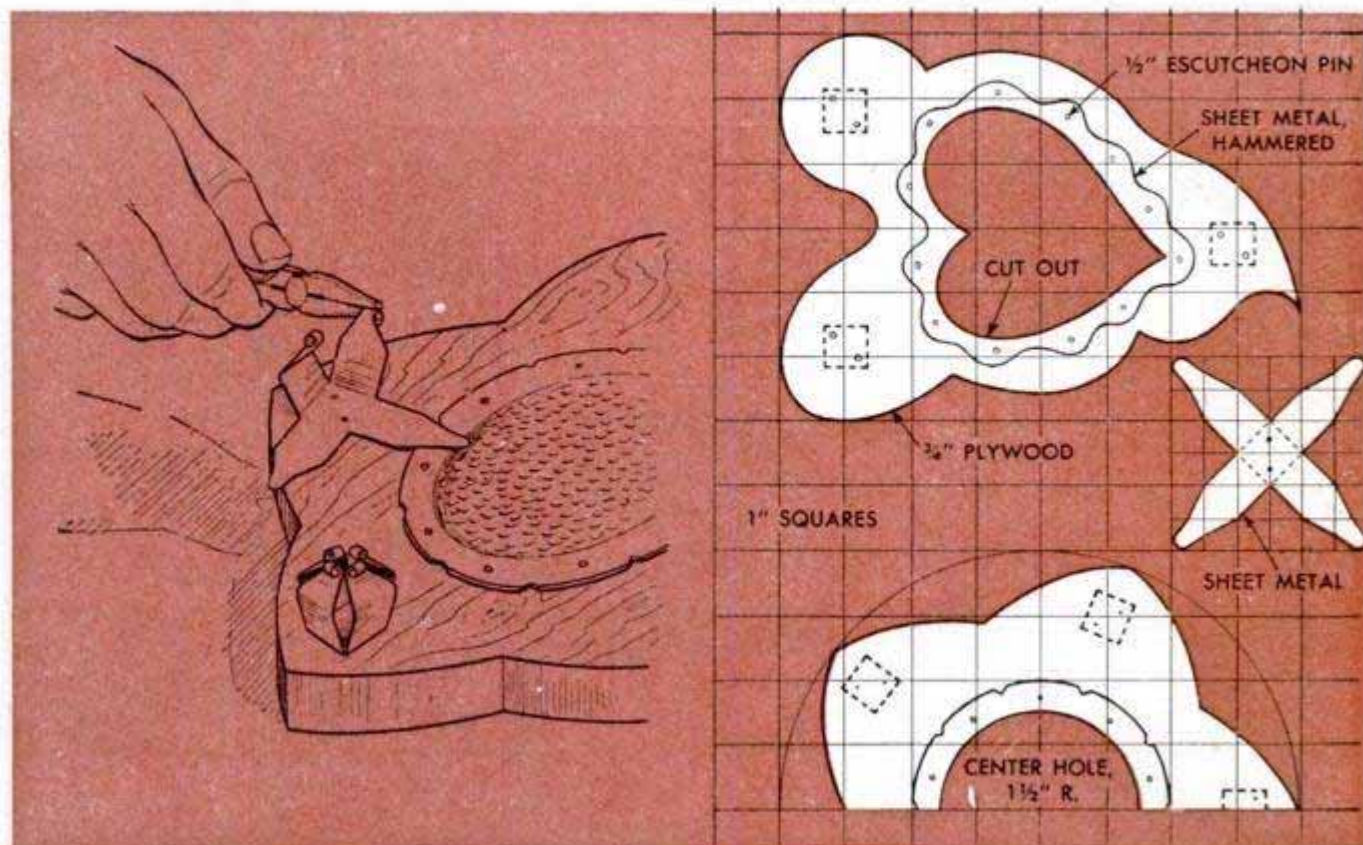
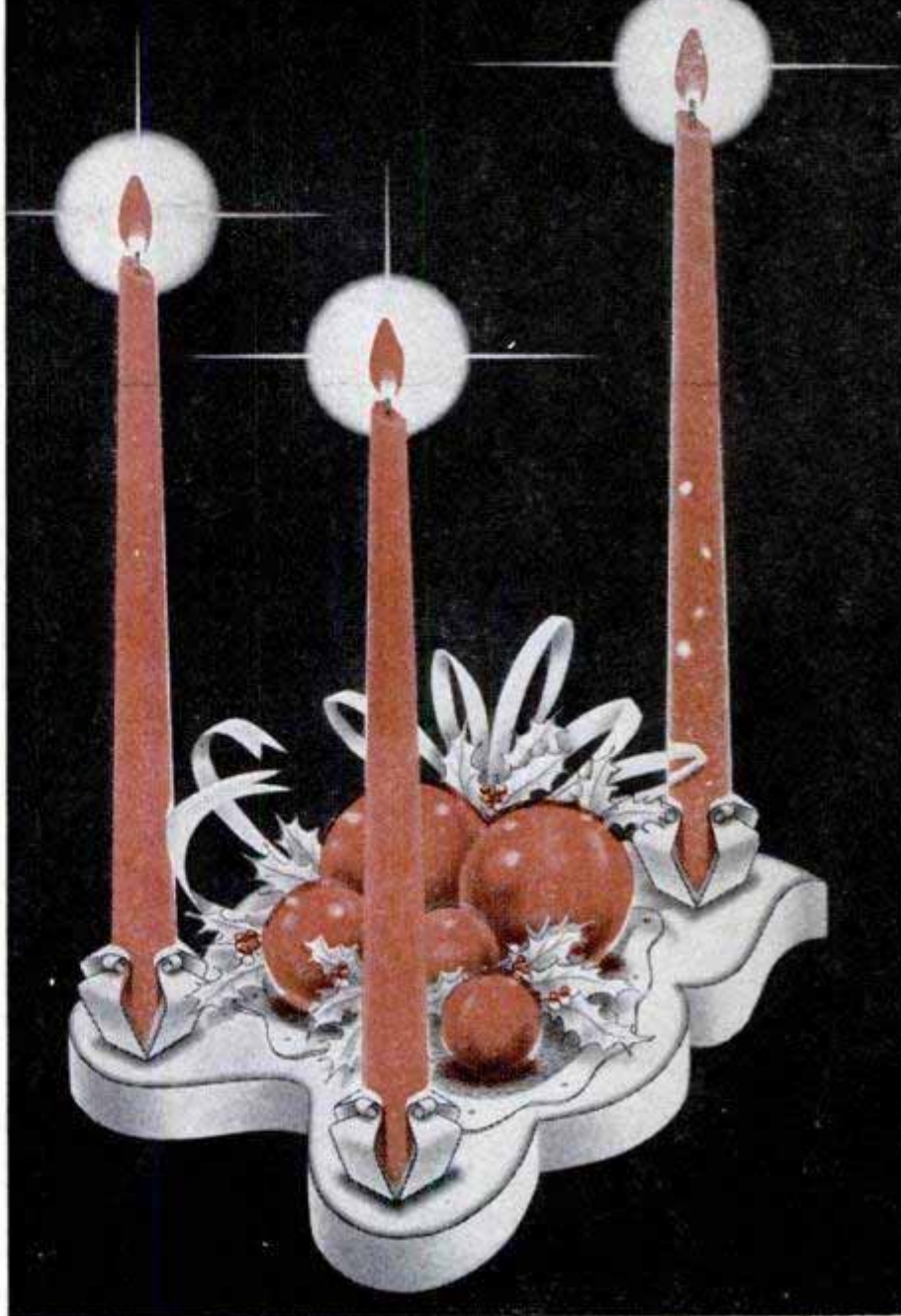



## Sandpaper Holder on Bench Top Aids Smoothing Small Blocks

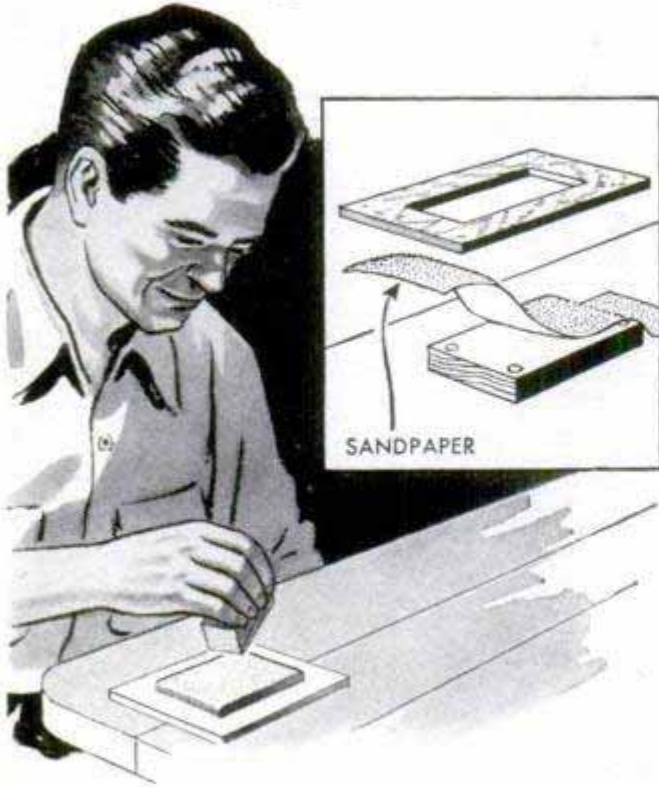

You will find a small sanding block attached to your workbench very handy for quickly sanding small pieces of work. A block of  $\frac{3}{4}$ -in. wood is nailed to the bench, the abrasive paper stretched over it and held with a "clamp" made by cutting a window in a piece of hardboard or plywood.

## Fruit Jar Used as Mixing "Hopper"

Mixing small quantities of plaster, cement, etc., can be done quickly by using a fruit jar as a mixer. Just place the materials in the jar, screw the lid on tightly and mix by shaking the jar.

R. F. Donovan, Guttenberg, N. J.

## Homemade Clamp for Light Work

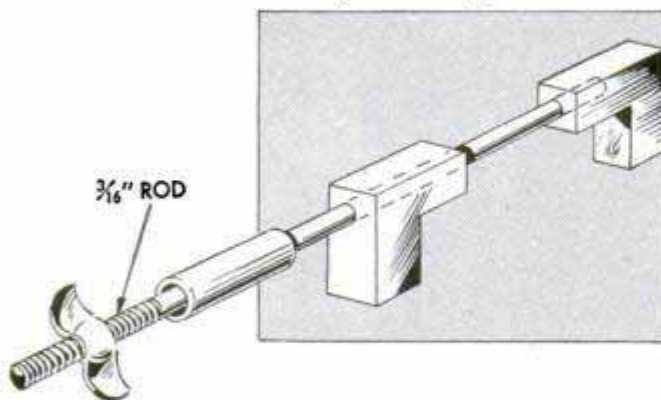

There is no trick to making a small bar clamp if you do it as indicated in the sketch. This one consists of a suitable length of steel rod threaded on both ends, two steel or aluminum jaws, a piece of tubing and a wing nut. The jaws can be any size re-

quired, one being drilled and tapped to take the rod and the other drilled to slide freely over the rod. Different lengths of tubing are used as spacers.

M. B. Birge, Hinsdale, Ill.

## Staples Insulated With Rubber Pads

When insulated staples for electrical work are not at hand, try this trick. Use regular staples padded with small pieces of rubber cut from an inner tube.

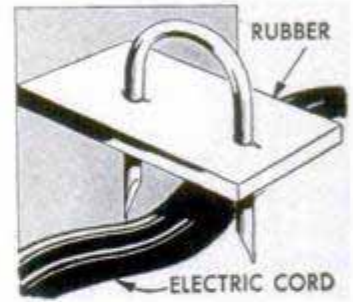

## Protecting Sportsmen's Equipment

Expensive sporting equipment, such as binoculars, telescopes, cameras and compasses, can be kept dry and free of dust on hunting or fishing trips with the aid of a plastic bag of the type used for storing food in refrigerators. Place the article in its case and then put the case in the bag. In this way, the case also will be protected from damage.—Richard Hanscom, Elmhurst, Ill.

## Razor Blades Stored Safely When Embedded in Eraser

Hobbyists or craftsmen who use razor blades in their work can keep them from being dulled when stored in a tool kit or drawer by embedding them in an eraser. This also will make the blades easier to find when needed and will prevent cutting your fingers accidentally. Several blades can be kept in a large eraser.

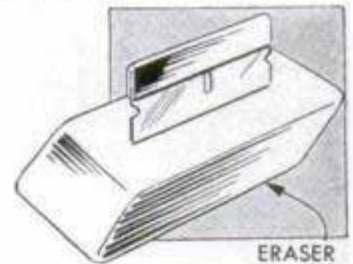

## Repairing Dented Car Molding

Slightly dented car molding often can be bumped out by using a lead die that is cast in the proper shape from an undamaged section of the molding. To make the die, first remove the molding and use fine sand to block off a section on the inside about 2 in. long, and fill it with molten lead. When the latter has hardened, place the dented area of the molding over a block of wood, slide the die inside the molding to contact the dents and then tap the die against the dents with a hammer. When the repairs have been finished, saw the die in half lengthwise so that it can be removed. A hacksaw blade can be used for this purpose.

D. B. Owens, Toledo, Ohio.



# Novelty CHRISTMAS TREES

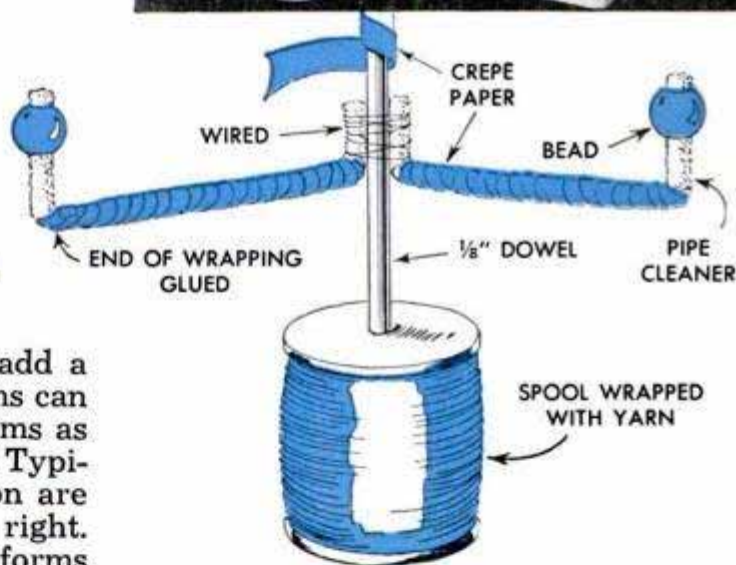
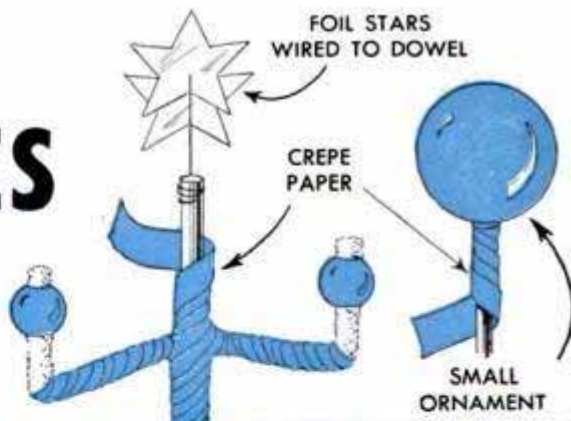

**MINIATURE** Christmas trees that add a novel touch to gay holiday decorations can be assembled from such common items as pipe cleaners, crepe paper, beads, etc. Typical trees suitable for table decoration are pictured and detailed above at the right. A spool wrapped with colored yarn forms the base and a length of  $\frac{1}{8}$ -in. dowel serves as a tree trunk. On one of the trees shown a small bell is used as a base. Pipe cleaners are wired to the trunk to form branches, the outer ends of the cleaners being bent up or down, depending on the type of tree desired. By turning the ends up and forcing small colored beads over the upturned ends, a remarkably realistic simulation of candles is achieved. When the ends of the branches are turned down and curved inward they form hangers for bells or other miniature ornaments. After the branches are wired in position on the trunk, both the trunk and branches are wrapped with narrow strips of colored crepe paper. Colored balls or foil stars form effective top ornaments. Stars are wired to the top of the trunk and ball ornaments can be at-

tached with a drop of liquid glue. Another type of tree, pictured above at the left, forms a secondary shade over a reading lamp. Make a tall cone of heavy colored paper, the open end of the cone being of the same diameter as the lamp shade. Cut round, diamond, or star-shaped holes in the cone and glue squares of colored tissue or cellophane paper over them to simulate tree ornaments. Decorate with a fringe and spiral wrapping of tinsel as shown. When the lamp is lighted the effect is attractively realistic. Utilizing the same idea, larger decorative trees can be made by gluing or tacking paper cones in graduated sizes to a length of dowel or a broomstick. The cones should overlap, the largest one being placed at the bottom.



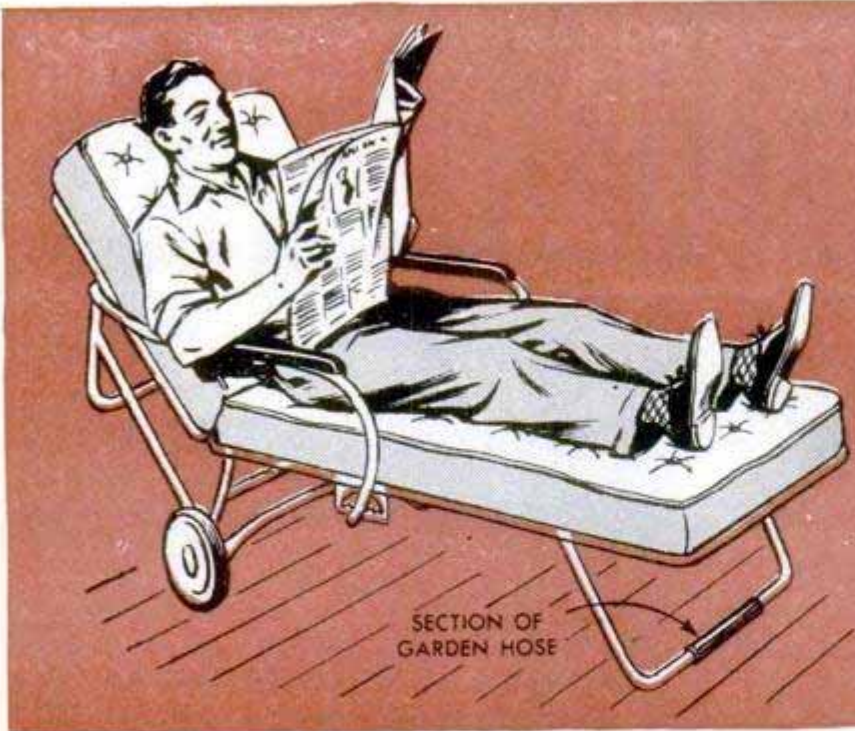

**TUBULAR FURNITURE** such as a chaise longue or glider used the year 'round on a sun porch, will not mar a painted floor if the U-shaped legs are padded with a length of garden hose. One wall of the hose is slit lengthwise with a sharp knife and then spread apart to fit over the tubing. The natural curl of the hose provides a self-gripping action as the inside diameter of the hose usually is less than the outside diameter of the tubing. Rubber crutch tips are ideal for capping the open ends of legs that are not U-shaped

# Solving HOME PROBLEMS

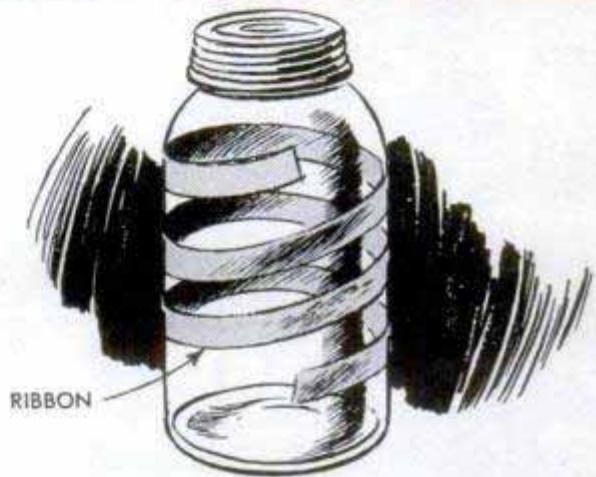

**LAUNDERED RIBBON** does not have to be ironed if it is dried by wrapping spirally around a glass fruit jar. When the ribbon has dried, it will fall from the jar and will be as smooth as though newly ironed

**WALLPAPER-PASTING TABLE** improvised from flush-type door is handy for an occasional small job. Just remove the door from its hinges and support it at a convenient height on the padded backs of two kitchen chairs. To protect the door from cuts and eliminate the need for cleaning off paste smears, cover the door with sheets of cardboard. Fasten the cardboard to the door with pieces of masking tape. If a flush door is not available, a panel door may be used by building up the panel recesses with layers of cardboard

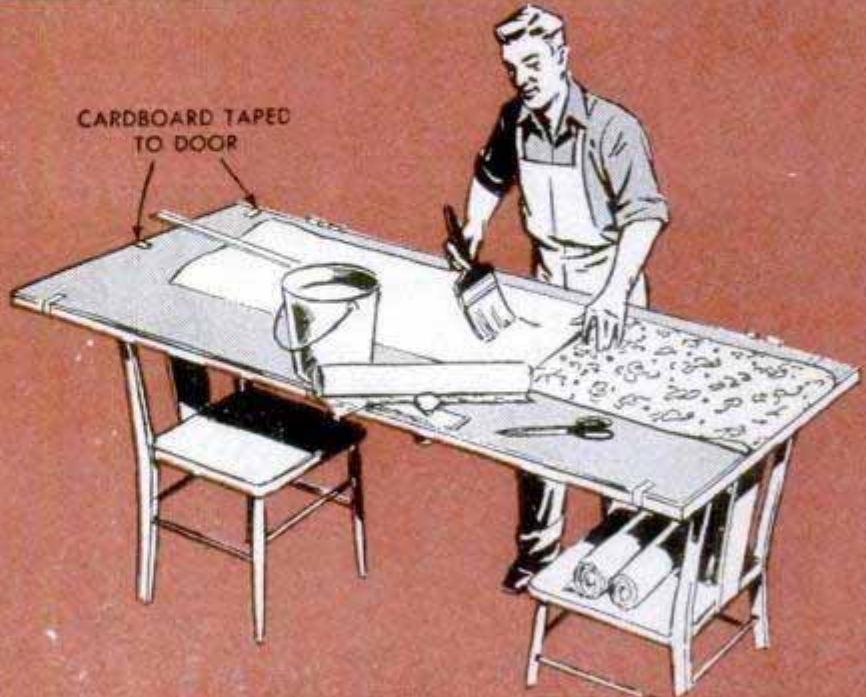



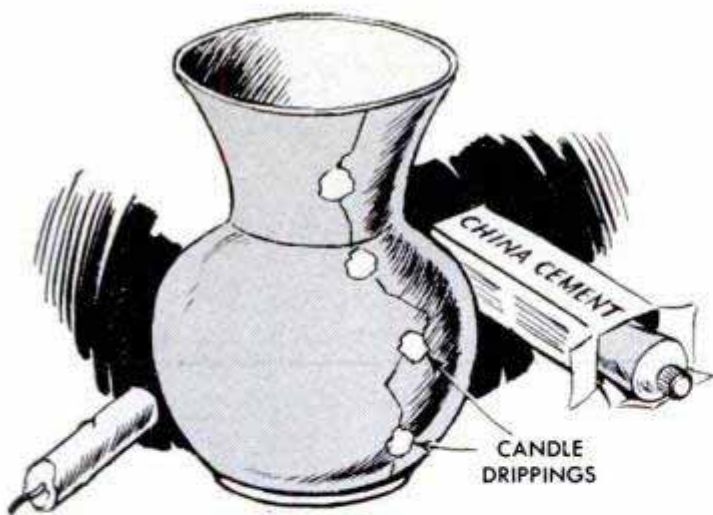

**CANDLE WAX CLAMPS** broken pieces of pottery together while mending cement dries. After cementing the pieces, drop wax from a lighted candle at intervals over crack. When cement dries, remove wax

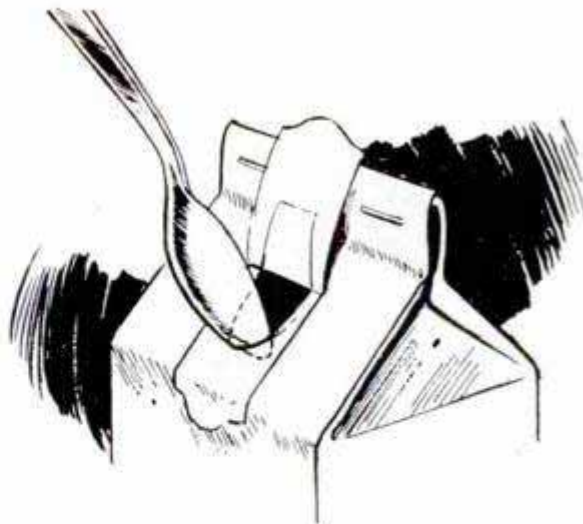

**MILK CAN BE Poured** from a carton easily and without waste if the opening is shaped to a pouring lip with a teaspoon. Insert the teaspoon in the opening, as above, and press lower edge of the opening outward

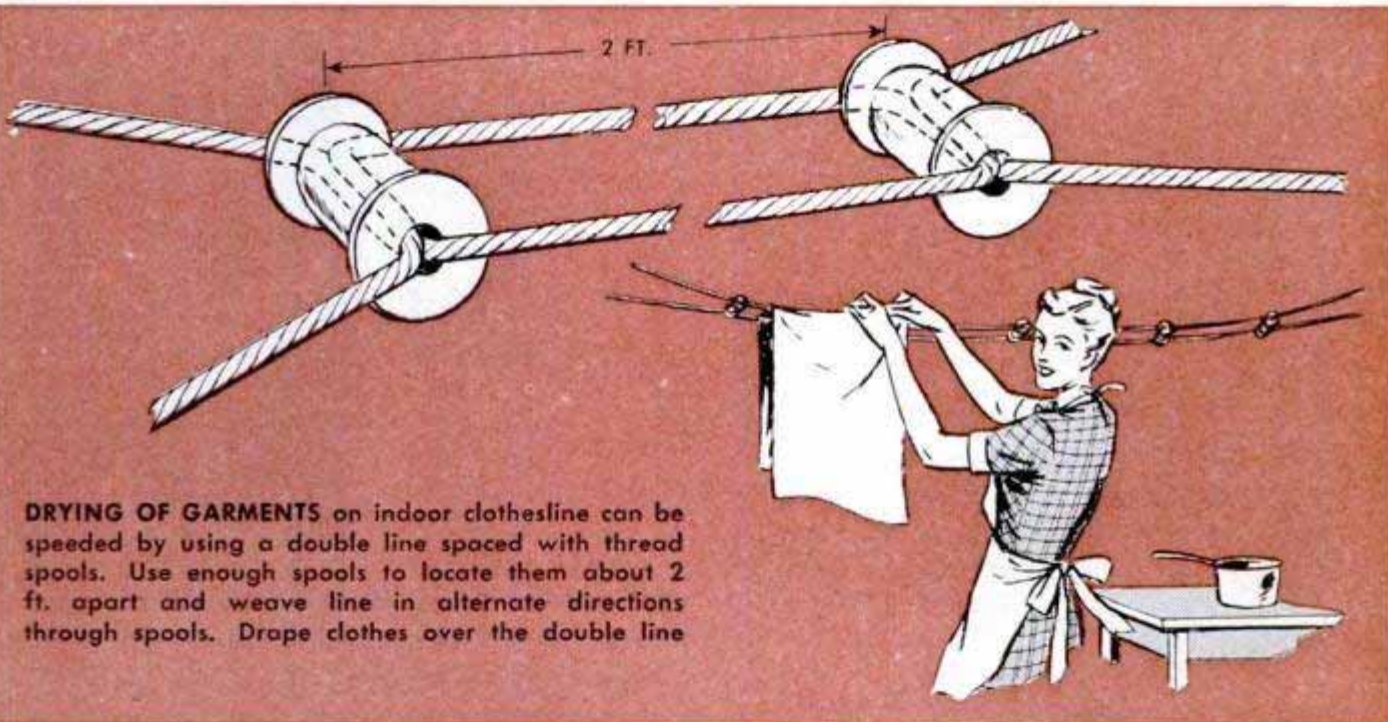

**DRYING OF GARMENTS** on indoor clothesline can be speeded by using a double line spaced with thread spools. Use enough spools to locate them about 2 ft. apart and weave line in alternate directions through spools. Drape clothes over the double line

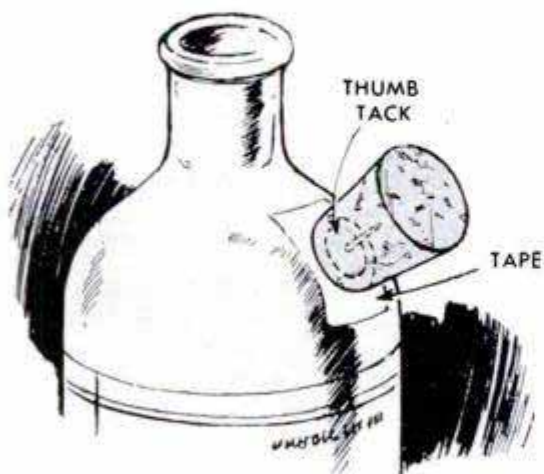

**THUMB TACK TAPED TO BOTTLE** provides convenient holder for the cork. Press tack through adhesive side of tape and stick tape to bottle. Then impale cork on projecting point of tack. This is especially handy when using polish or cleaning solutions

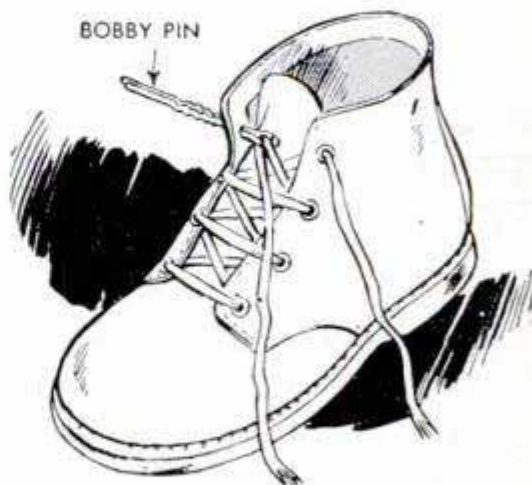

**TODDLERS' SHOES** are easy to lace when the tips have broken off the laces if the latter are threaded through the holes with a bobby pin. Spread the pin to place it over the lace and pass the pin through the holes as you would a needle and thread



## Harrow Disk Anchors Standard For Rural Mailbox

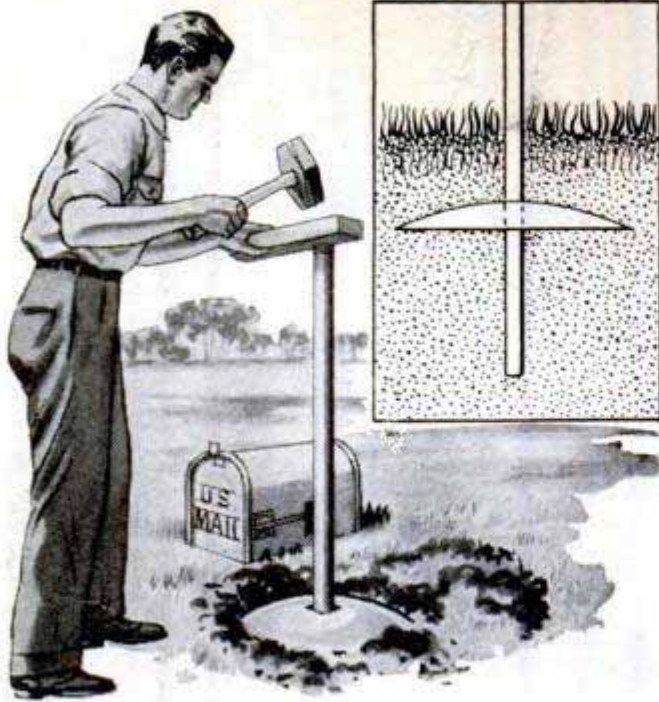

If the standard that supports a roadside mailbox must be set in soft ground, it can be braced by using an old harrow disk as shown. Just place the disk a few inches underground and then drive the standard through the hole in the disk and into the ground.—G. E. Hendrickson, Argyle, Wis.

## Powder Puff on Drawing Board Cleans Artists' Equipment



A powder puff makes an ideal pen wiper for artists or draftsmen. Thumbtacked to a drawing board, it also will serve as a handy cleaner for the edges of angles and T-squares.

## "Ounce" of Fire Prevention Regarding Christmas Tree

Highly inflammable and difficult to extinguish once they have been ignited, gaily decorated Christmas trees can be turned into blazing bonfires by a tiny spark from an electric cord. Following are a few tips on how to minimize such danger: The drier the tree, the more inflammable, so select one that has been cut late in the season. To keep it from drying out rapidly, saw about an inch off the lower end of the trunk, cut a number of notches in the bark and, after putting the tree in its stand, submerge the latter in a pail or small tub of water. If desired, a pail of wet sand can be used in-

stead, in which case, water should be added frequently. Another precaution to take against fire is that of inspecting the cords and sockets of the tree lights for loose connections or frayed insulation. Also, check to see that a sufficient number of the proper-size electrical fuses are on hand. When decorating the tree, instead of covering the pail and the area under the tree with cotton or a white sheet, as is sometimes done, use metal foil of the type sold for wrapping vegetables. This can be purchased in rolls at a grocery store and attractively crinkled. The foil will not burn if a spark should fall on it. If cheesecloth is used for decorations or for costumes, it can be made fire resistant by dipping it in a solution of water, 1 gal., borax, 9 oz., and boric acid, 4 oz. Dry the material, but do not iron it.

Bess Ritter, New York City.

## "Ringed" Pencil Easily Stored

Instead of tying a string loop to a pencil to hang it in the shop or on the kitchen wall, put a ring in the eraser, which makes it easier to hang. A ring can be made of wire, the ends sharpened and then forced into the eraser with pliers.—Benj. Nielsen, Aurora, Neb.

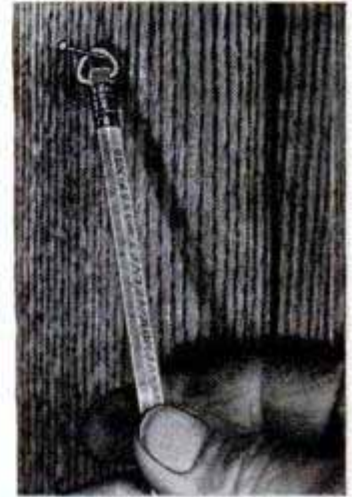

## Transferring Typewritten Copy From Paper to Book Cover

Typewritten material can be transferred from a sheet of paper to book covers, or other surfaces that cannot be placed in a typewriter, by the following method: Place the coated side of a sheet of carbon paper against the back of a white sheet of paper, insert both in the typewriter and type the wording desired. With the papers placed back to back in this manner, the typed characters will appear in reverse on the back of the white paper. To transfer the typing, simply place the paper face down on the magazine and rub over the wording briskly with a knife blade. The transferred lettering may be protected from smudging by covering it with transparent cement or fixative.

Walter E. Burton, Akron, Ohio.

Driving a brad into the edge of a cigar-box lid provides a convenient handle to open the box when it is used for storing small parts.



# Artificial Plants

By A. E. Fenn

Bare corners and walls of your home, as well as dark niches and mantels where nothing seems to fit in, often can be brought to life with "boxed" artificial plants. Plain arches, windows and similar places, too, can be improved in appearance with simulated "potted" plants. It is possible to make beautiful arrangements so realistic that it is difficult to tell the plants from live ones. Material for making plants of many types is available at little cost. Those pictured in the photo were made by using small-size philodendron leaves in the foreground and large leaves of the same type in the background. Other combinations

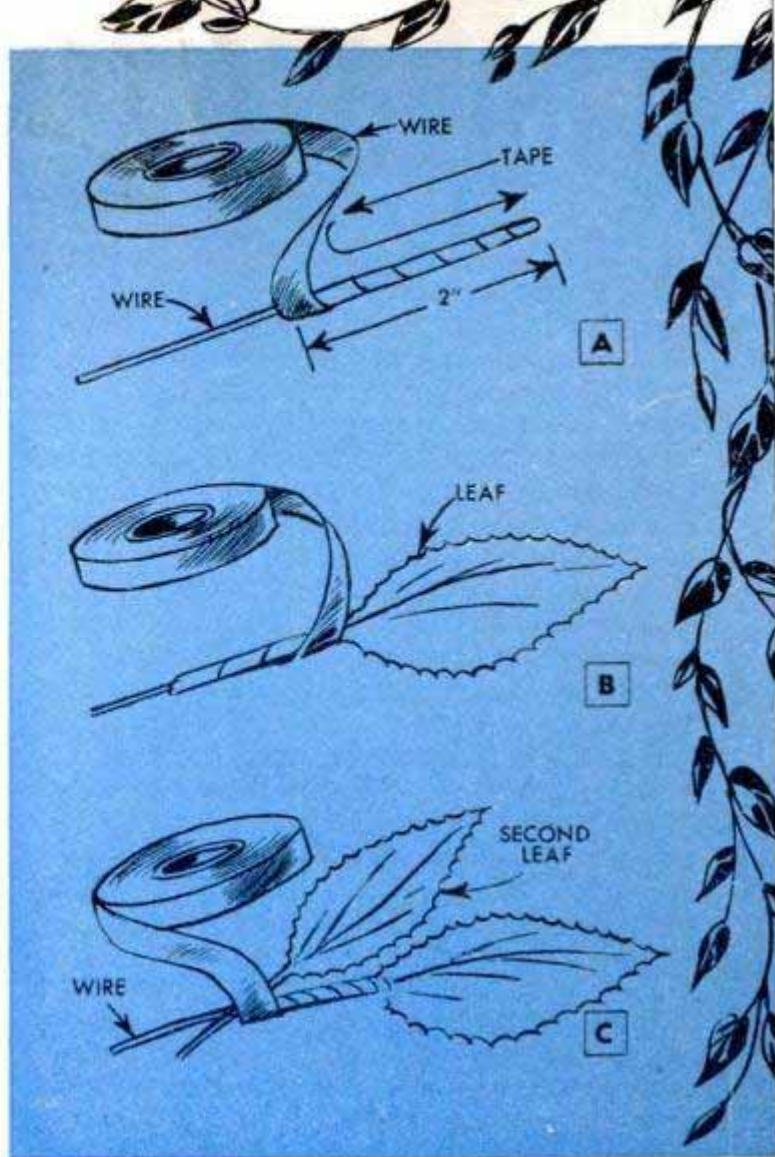
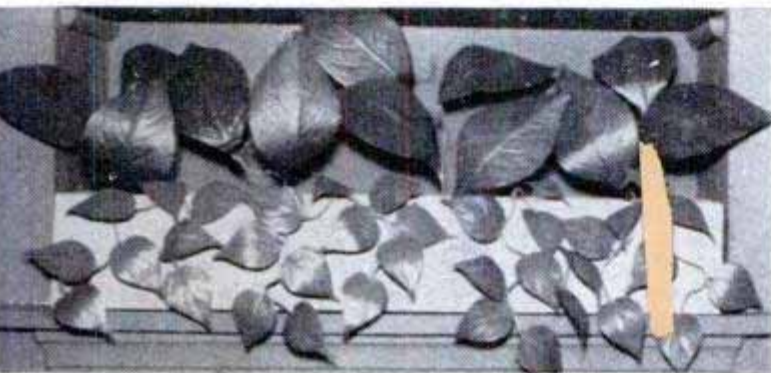

can be used effectively; such as, philodendron leaves with mother-in-law tongues, apple leaves with sumac leaves, Chinese evergreen with spotted chestnut leaves, or hydrangea with phlox leaves. The leaves, which are of cloth or paper, are bound to lengths of wire with green-colored tape. After the end of the wire is taped, as in detail A, the tape is brought back to the tip

of the wire to catch the stem of the first leaf, as in B. Then the tape is wrapped spirally down the wire to engage the stems of the following leaves. The leaves are curved with the fingers and the wire is shaped to suit. To hold the leaf sprays in the box or planter, use a frog made by tightly rolling strips of corrugation cut from a cardboard box.

## Paraffin Has Many Uses That Will Help Lighten the Homemaker's Tasks

A cake or two of paraffin, kept handy in an old teapot or other pouring vessel, will be found helpful in many ways in the home. For example, to make an inexpensive wax for hardwood floors, mix melted paraffin, 1 part, with turpentine, 2 parts. Melt the wax by placing it and its container in a pot of water and then heating the water. *Caution: It is a fire hazard to melt paraffin by applying direct heat.* A furniture cleaner that is especially effective for removing water marks can be made by mixing a small amount of paraffin with olive oil. The job of scrubbing tile or linoleum floors can be made easier, and the floors will come out brighter, if a half cup of paraffin is added to the scrub water. However, the water must

be hot enough to keep the paraffin melted. When mixed in equal proportions with vinegar, paraffin can be applied to gilt and silver trimmings to keep them from tarnishing. To prevent snow from sticking to a snow shovel or dust to a dustpan, just rub a little paraffin on them. Your pot of paraffin also will assist you when it is necessary to perform some handyman's task, such as driving a nail or screw for hanging a picture. Coat the nail or screw with paraffin and it will be less likely to split wood or crumble plaster. If a furniture caster becomes so loose that it won't stay in its socket, pour hot paraffin in the socket, insert the caster and, after the paraffin hardens, there will be no further trouble.



# DUMB-WAITER SAVES STEPS

By *Hi Sibley*

A SIMPLE dumb-waiter is "hard to beat" for moving items between floors in the home, especially in a home where food, laundry, packaged goods, etc., must be carried to the second floor. It also will make quick work of taking heavy baskets of laundry to and from the basement, and getting things into the attic for storage becomes a pleasure. The simplest and most inexpensive type consists of a cab, or carriage, which is raised and lowered in a shaft by means of a rope running over a large rope sheave. Such a unit usually is equipped with a manually operated brake so that the cab can be stopped at any floor and held in this position until the brake is released. It is suitable for light loads and is practical for as many as three floors. Similar types are used in restaurants and often in stores for elevating food or goods from the basement. Usually, the upper delivery door is installed under a counter. These units also are operated by hand, but with the elevating crank, traction sheave and brake located in the basement rather than at the top of the shaft as is common practice in other types of installations.

More elaborate types of waiters serving two or more floors are driven electrically by means of a reversing motor. "Send" and

"call" switches on each floor operate through a system of relays and limit switches in such a manner that the cab can be sent up or down from any floor. All mechanical and electrical parts necessary in the construction of any type can be purchased from dealers handling elevator equipment.

Two types of hand-operated brakes are detailed below. One is cam-operated, the other is locked and released by means of an over-center lever. In the cam-type brake, the linings are riveted to shoes which pivot from the same point. When the cam is in the released position, the shoes are forced away from the brake drum as shown in the detail, permitting the drum and traction sheave to turn freely. When the cam-actuating lever is moved to the "on" position, as shown by the dotted lines, the brake shoes are forced together by springs, causing the linings to grip the drum tightly until the brake is released manually. In the over-center type of hand brake the lining forms the shoe and is continuous, one end being fixed while the other is attached to the over-center lever. When the brake is in the on position, the shoe contacts the brake drum over approximately one half of its circumference.

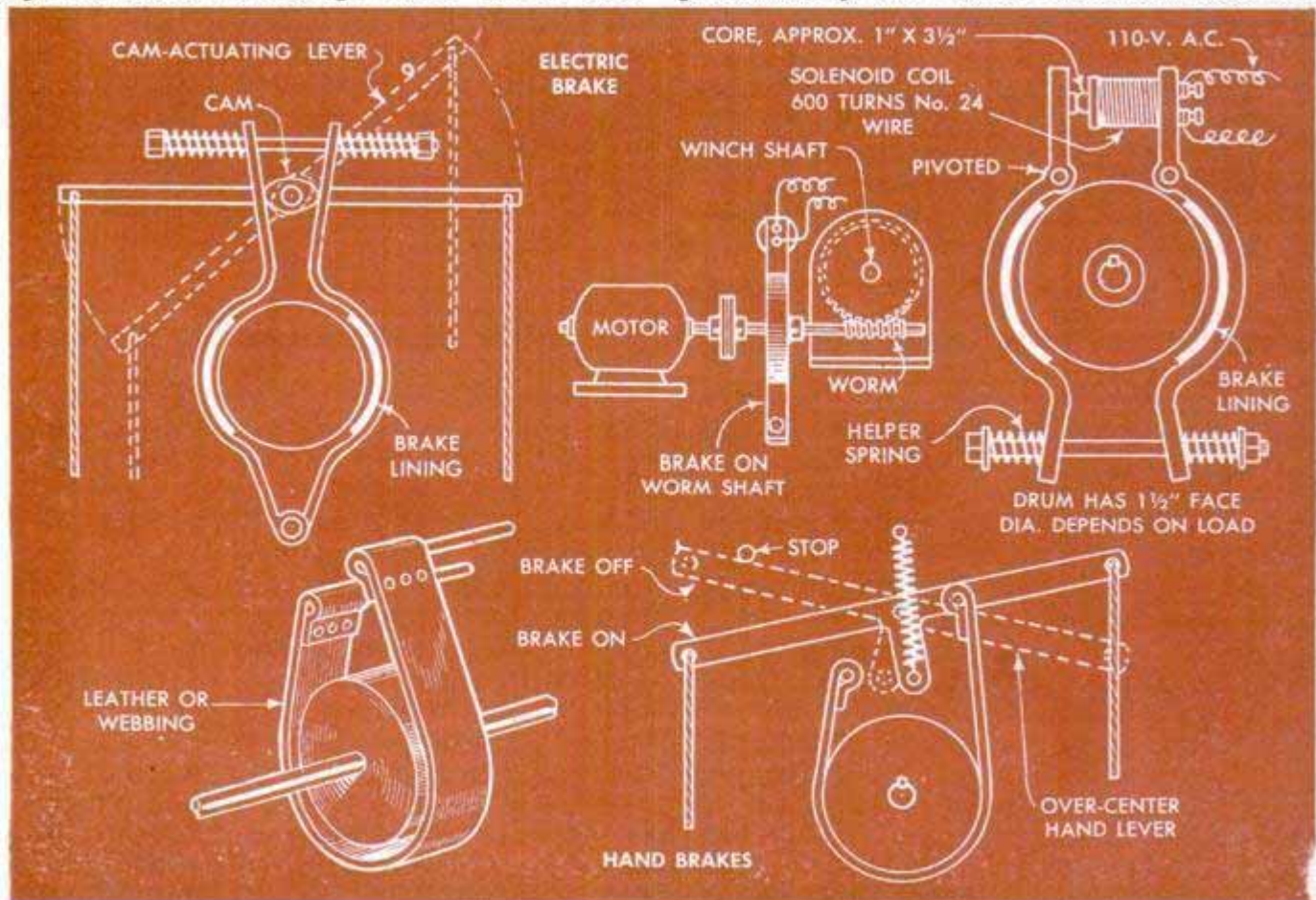



The principal advantage of this type of hand brake is its positive toggle action in releasing and tightening the brake shoe without drag or chatter. This is due to the action of the tension spring which snaps the over-center lever to the release, or on, position when the control rope is pulled lightly. The electric, or solenoid, brake is used in the electric-drive installations and, as will be noted in the detail on the opposite page, it is placed between the motor and the worm gear, the drum being on the worm shaft. Operation is similar to the cam-type hand brake, except that the cam is replaced by a solenoid. Each shoe is pivoted individually and when the solenoid is energized the braking action is similar to that of the hydraulic auto-type brake, the solenoid acting to force the arms of the brake shoes apart and bring the linings in contact with the drum. In all types of brakes, the drum should be keyed to the shaft. Do not rely on a pin or setscrew. It should be kept in mind that, in most states, laws governing the operation of elevators and dumb-waiters require suitable brakes on all types of installations. Also, the speed of the cab in feet per minute is usually specified by law.

In the details blueprinted on the following pages no dimensions are given for the various types of installations. The specifications are only general, as each installation offers an individual problem. However, some variations should be noted. In the traction-type system, where the cable is hand-operated or electrically driven, a counterweight is used. But, in the electrically driven winch type for under-counter installation, the counterweight is not required when the cable is wound on a spirally grooved drum. However, when two or more floors are served by the electrically driven waiter, the driving mechanism is installed at the top of the shaft and a traction sheave and counterweight are used in place of the winch. Note that in all types generally it is necessary to install deflecting sheaves in order to bring the lifting cable into the center of the shaft. In the hand-operated, or hand-pull, type serving two or more floors, the pull rope is made continuous by a special swiveling splice and runs through brass guides on both the up and down sides. The traction sheave must be located so that the pull rope clears the cab. Wiring diagrams for two and three-floor installations are given on the blueprint. Note that hatchway-type limit switches are used to stop the cab at the extremes of travel and at any floor between. Although only one set is shown in the diagram, three push-button switches on each floor of the three-landing installation allow the cab to be sent as well as called to any floor.

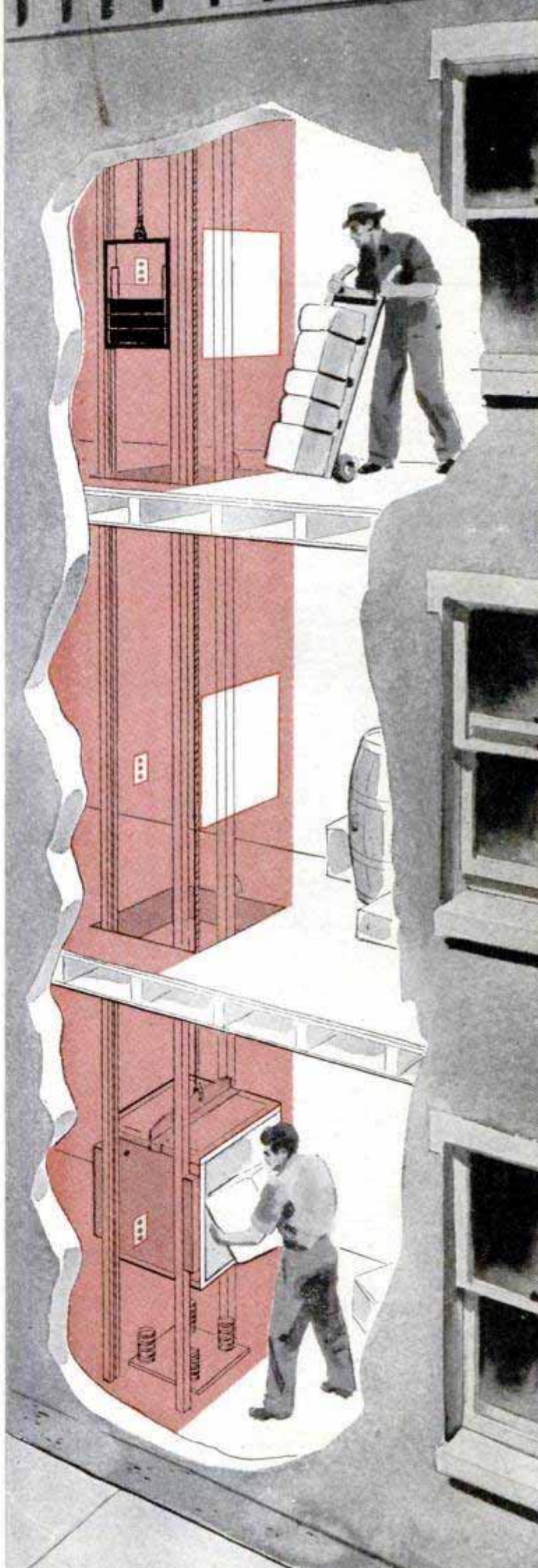



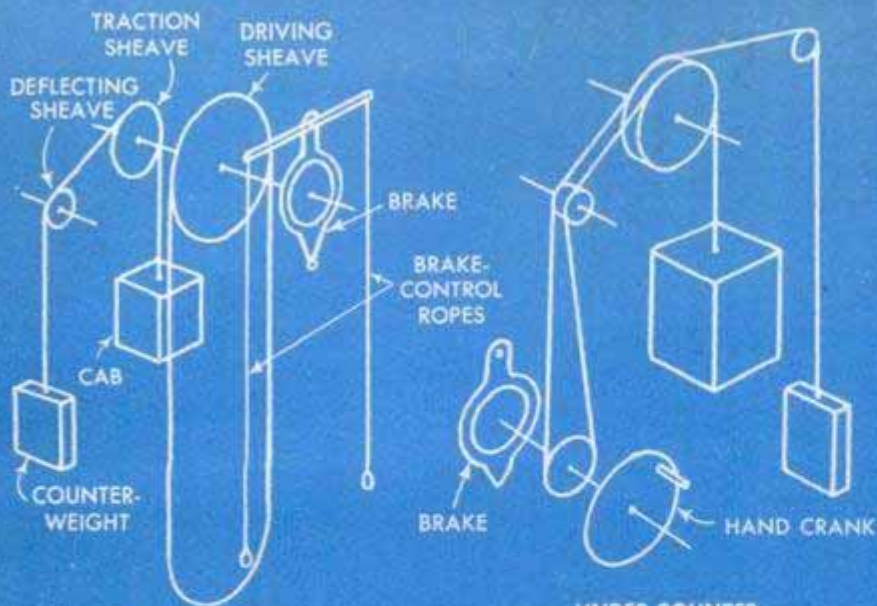

HAND-PULL TYPE  
FOR TWO OR MORE FLOORS

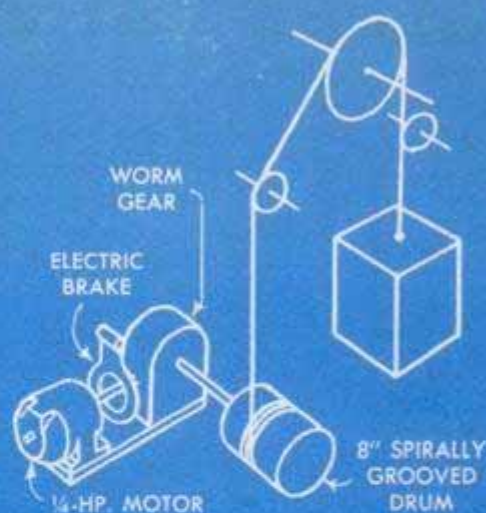

UNDER-COUNTER ELECTRICALLY  
DRIVEN TYPE

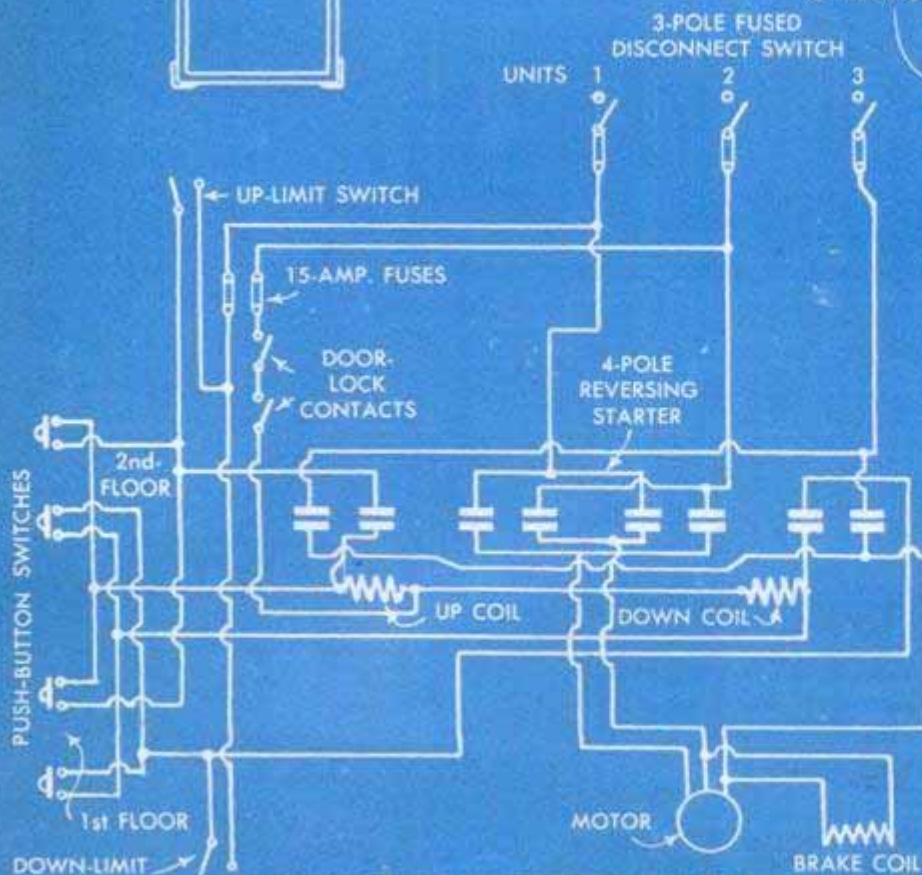
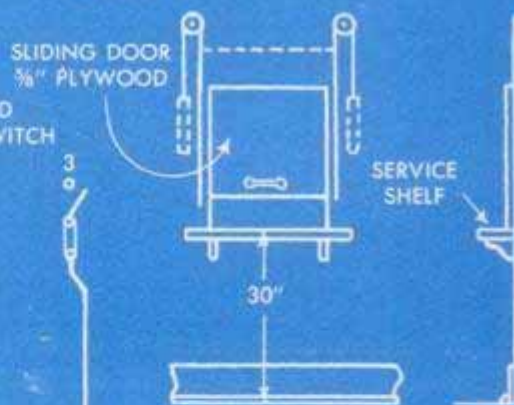
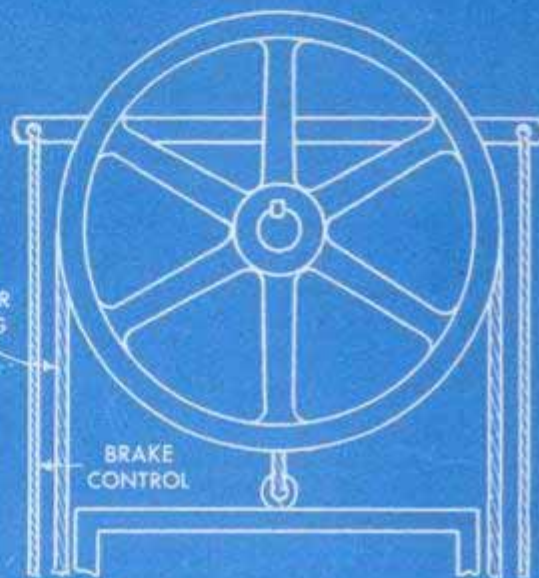
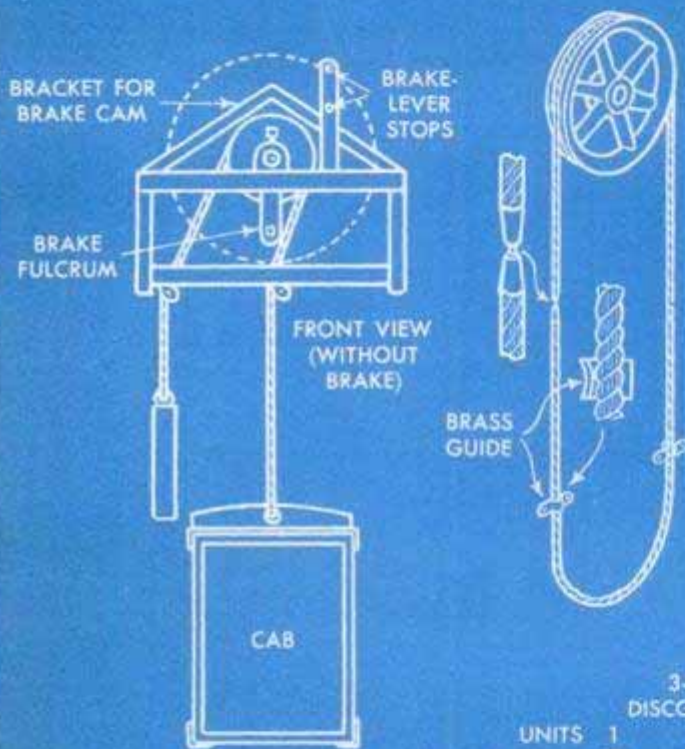

WIRING DIAGRAMS FOR TWO LANDINGS

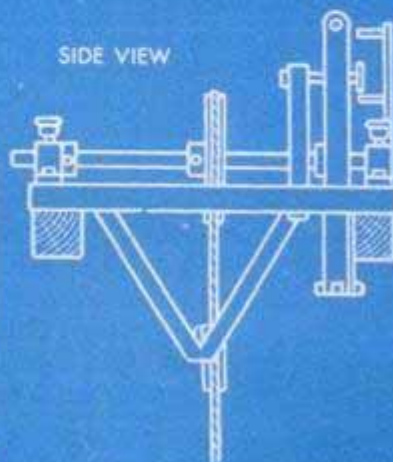



ELECTRIC-TRACTION TYPE FOR TWO OR MORE FLOORS

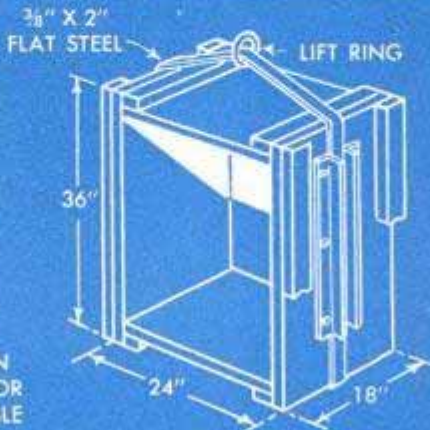
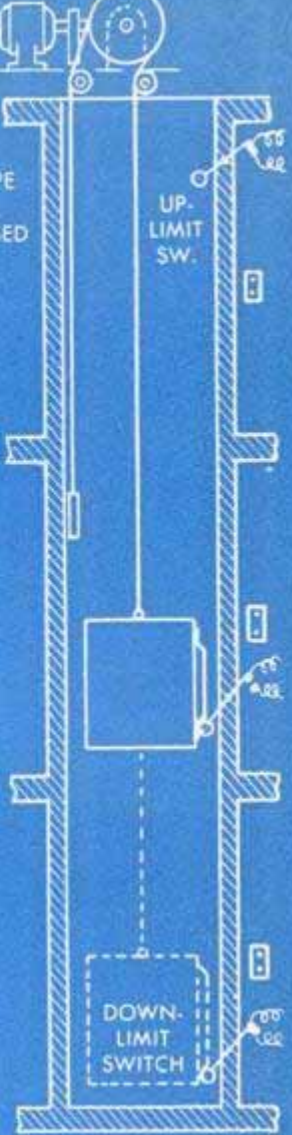
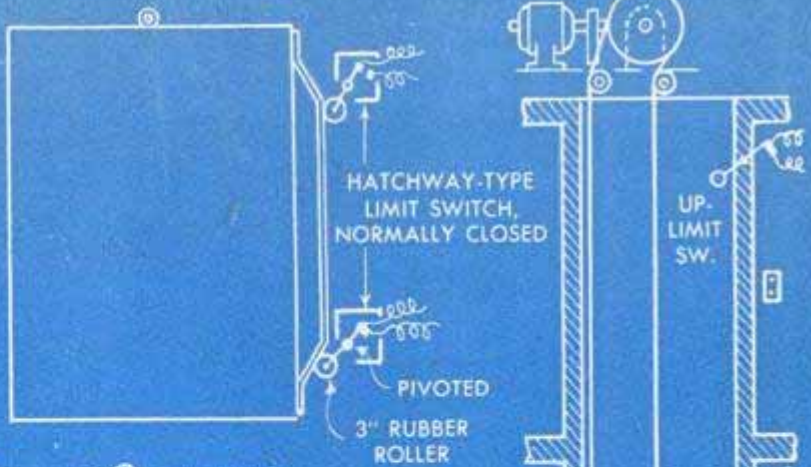

CAB, 9 CU. FT.

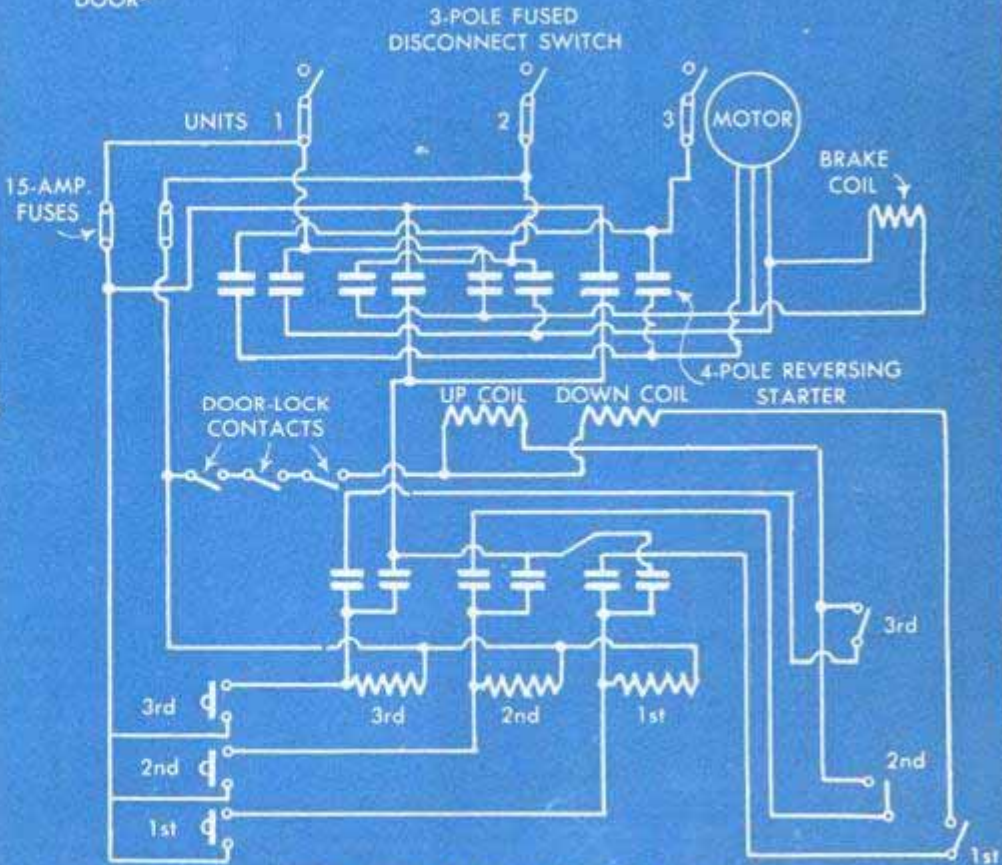
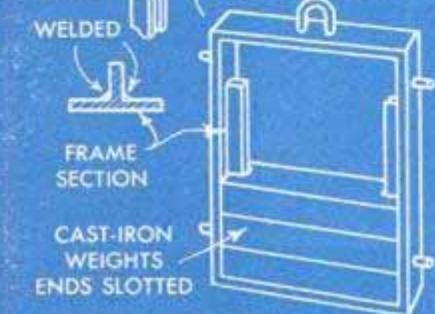
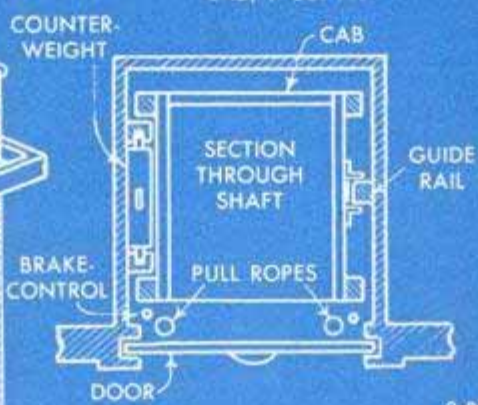
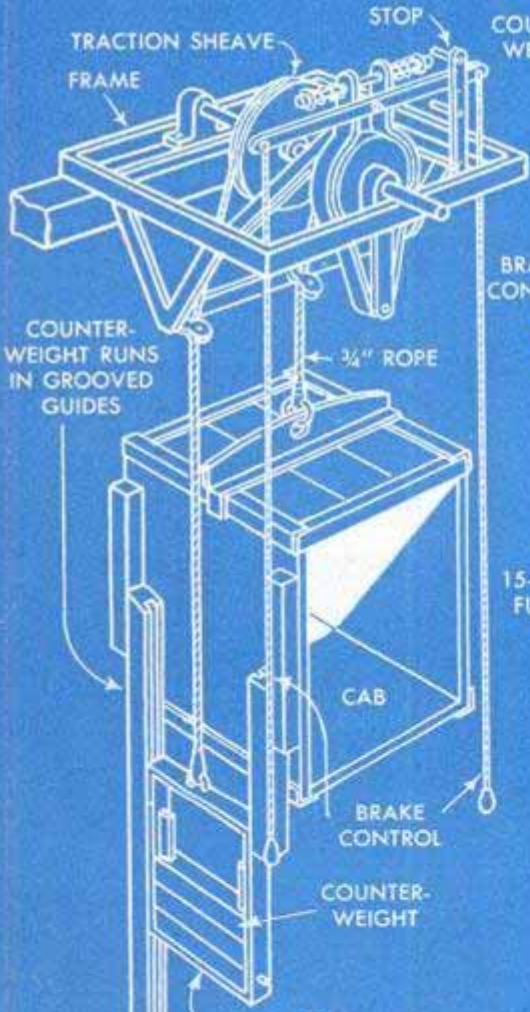
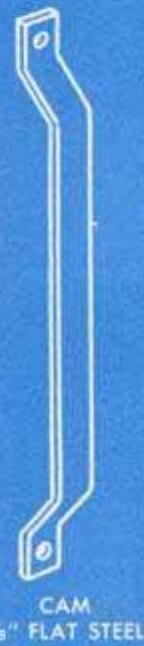

WIRING DIAGRAMS FOR THREE LANDINGS



## Hand Grinder Supported By Floodlight Clamp



Where a mounting stand is not available to hold a small hand grinder stationary, try a clamp from a photo floodlamp. It permits adjusting the grinder to nearly any angle desired, and also makes it possible to mount the grinder almost any place.

Henry Hanscom, Elmhurst, Ill.

## Safety "Key" Prevents Picking Lock

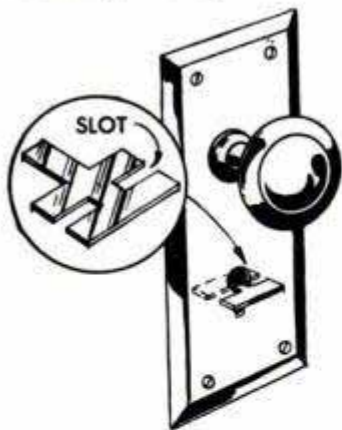

Even though the key to a certain type of lock is left in the keyhole, some burglars are able to remove the key and open the lock with special tools. However, one homeowner prevents this possibility with a special guarding device, which is

made as detailed from a piece of thin metal. In use, the device is inserted in the keyhole and force-fitted by turning it.

William B. Eagan, Louisville, Ky.

## Tip for Masonry Repair

When repairing crumbled sections of a masonry wall, remove all loose pieces and clean the area with a wire brush. Then, use a cold chisel to roughen the surface of the area to be repaired so that fresh mortar will adhere to it.

## Keeping Bed Slats From Falling

If you have had the experience of bed slats slipping off the rails and causing the mattress and springs to fall to the floor, you will want to try this idea. Just drive a screw eye into each rail in

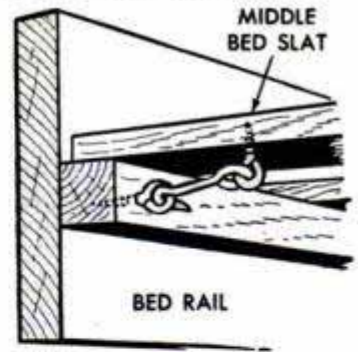

position to take a door hook driven near each end of the center slat as shown.

Rexford F. Mortimer, Altus, Okla.

## Speed of Windshield Wiper Controlled With Rheostat

The speed of a car windshield wiper that is electrically driven can be controlled by connecting a rheostat in series with the wiper motor. The type of rheostat used on a car heater is ideal for this purpose and can be obtained at any auto-supply store. In some cases, it may be more convenient to remove the windshield-wiper switch and replace it with the rheostat.

M. H. Hadley, San Jose, Calif.

## Toothbrush on Polish Applicator Cleans Perforations in Shoe

Finding the bristles of his shoe-polish applicator too flexible to reach into the perforations and around pinked edges on shoes, one man utilizes an old toothbrush for this purpose. For convenience, the bristle end of the brush was cut off and screwed to the back of the applicator, where it can be used either for cleaning the shoes or to remove deposits of polish.





# ORDER IN THE CLOSET

By Edna Mae DeMarce

LIKE ALL DEEP, narrow closets having a clothespole stretched across the back, ours held comparatively few clothes and forced us to wade through a pile of suitcases, shoes and boxes. Moving the pole to the front of the closet was little help, as then we had to work our way through the clothes to reach the things stored in the back of the closet. We finally solved the problem to our complete satisfaction by installing a retractable clothespole along one side as in the lower photograph. Two L-shaped shelves were built at the top of the closet, the lower shelf supporting the clothespole. As a board wide enough to provide clearance for the clothes was not available, we used plywood for the lower shelf. The outer corner of this shelf is hung from the door casing with a length of flat steel, as in the details below. In addition to the top shelves, we installed a shoe shelf directly under the clothes. This is simply a board nailed to the top edge of the baseboard and supported at the front with a flat-steel angle brace screwed to the door casing. With the clothes now hanging on only one side of the closet, we had easy access to the rear, and as the clothes now could be pulled out of the closet for selection, we decided to include drawer space at the rear of the closet. This was done inexpensively by setting up a tier of used filing cabinets, which were painted and lined with wallpaper.

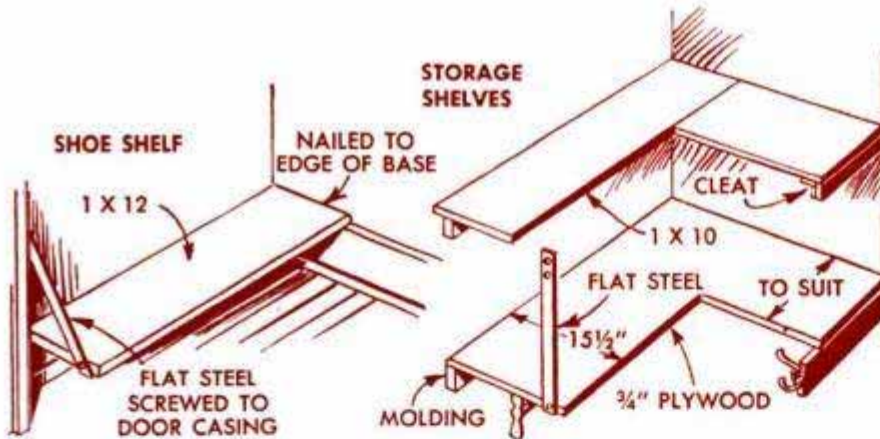

*From This*



*to This*





### Guard for Garden-Hose Nozzle Provided by Handle-Bar Grip

To pad the nozzle of a garden hose so that it will not scratch the finish of a car, cut the closed end from a bicycle handle-bar grip and slip the latter over the nozzle as shown. This will not interfere with adjusting the water stream or removing and replacing the nozzle. Place the grip so that it extends not more than  $\frac{1}{4}$  in. beyond the nozzle.

### Coloring Copper and Brass

Interesting effects sometimes can be achieved when working with copper or brass by changing the natural color of the metal. For instance, to obtain a brown finish on copper, dissolve a piece of potassium sulphide about the size of a walnut in  $\frac{1}{2}$  gal. of water. Then add 1 oz. of caustic soda. Clean the copper thoroughly and immerse in the solution for a few seconds, or until it turns brown. Remove and wash in cold water, then dry and burnish the high lights with a piece of fine emery paper, finishing with a coat of clear lacquer. Brass can be given a permanent brown finish with copper nitrate. The latter can be obtained by dissolving scraps of copper in nitric acid. Keep adding the scraps until the acid stops boiling. *Caution: Wear rubber gloves and a rubber apron when handling either nitric acid or copper nitrate.* Using a swab of cotton on the end of a stick, coat the surface of the brass. Heat with a blowtorch until the metal becomes first green, and then brown. Dust off the slag and, if not evenly colored, repeat the operation. Burnish the high lights with fine emery paper, coat with ordinary floor wax, and polish. A gun-metal black can be obtained by giving the metal three such treatments and waxing and polishing without burnishing. A mottled-green finish on either copper or brass involves coating the metal very lightly with copper nitrate and

allowing it to dry for a few days in a warm place. A coat of lacquer will tone down this finish and time will add to its beauty as the colors intensify with age. To obtain the green patina often desired on copper roof trimmings and outdoor hardware, coat the metal with copper nitrate and allow to dry. If this is done during hot weather, a finish that would require years for nature to effect can be produced artificially in a few days. An antique finish on brass can be had simply by heating the metal with a blowtorch. When the surface turns dark, let it cool, and then wax and polish. Various degrees of heat applied to copper will turn it golden yellow, red or even various light shades of brown. Use gentle heat on copper—not a blowtorch. Antique finishes on heat-treated copper can be had by burnishing, waxing and polishing. To produce permanent black or colored lines on copper, first obtain the desired color or colors by heat-treating the surface of the metal. After it has cooled, paint in the lines with asphaltum varnish. When the varnish has dried, remove the background color with clear nitric acid, and then wash with cold water. Remove the varnish with lacquer thinner to disclose the colored lines, buff the background, wax and polish.

Dick Hutchinson, El Monte, Calif.

### Countersunk Nut Tightened With Two Pairs of Pliers

When you have to turn a countersunk nut and haven't a socket wrench at hand, try this kink. Grip the nut with a pair of thin-nose pliers, then grip and turn the latter with a second pair of pliers, placing them as close to the nut as possible.

Louis Hochman, Sherman Oaks, Calif.





# "SCROLLED KITCHEN SHELF"

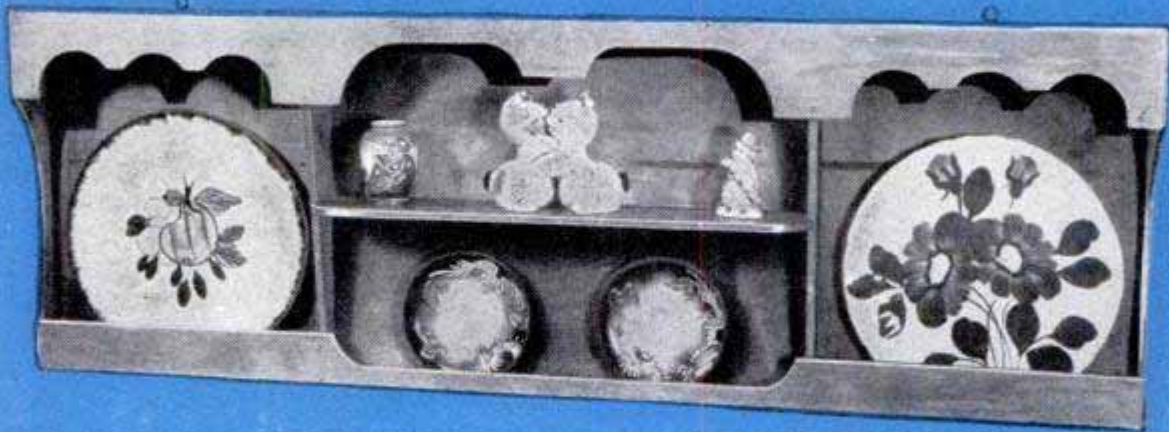

By R. J. De Cristoforo

USUALLY a small hanging shelf is the answer to the decorative problem posed by a bare wall in the kitchen. Although pictured above as a china and knickknack shelf, this one, with its scrolled cornice, also serves equally well as a storage space for spices and condiments. The back is cut from  $\frac{3}{4}$ -in. plywood and all other parts are of  $\frac{1}{8}$  and  $\frac{1}{4}$ -in. plywood as indicated. Note especially the method of fitting the scrolled parts A, B and C. Part C is notched to fit inside the open end of the shelf while part B is an overlay. After sanding, join all parts with glue and brads and finish in the natural color of the wood with shellac, or in color with two coats of enamel.

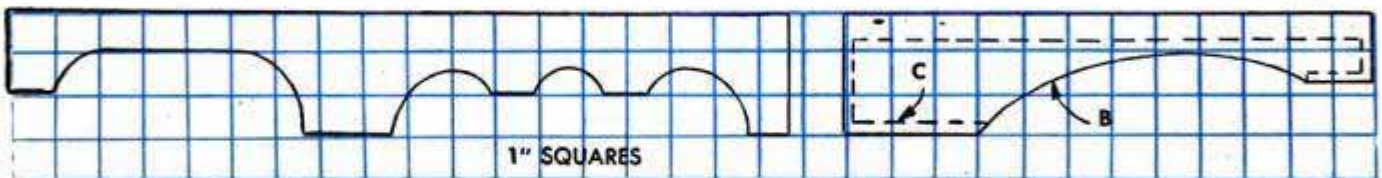
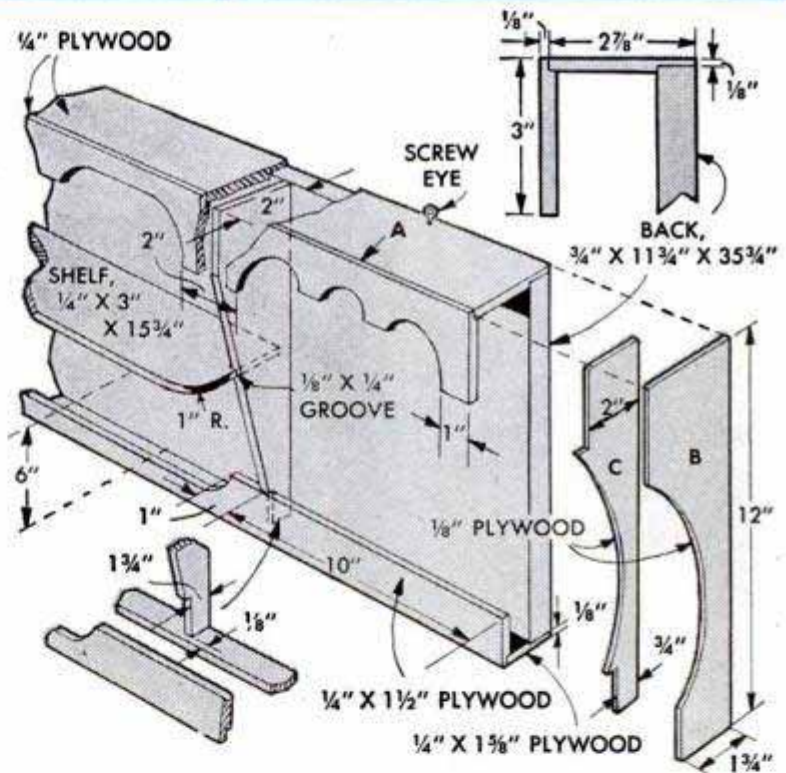

## Quick Way to Count Typewritten Characters When Taking Speed Test

Typists who make a practice of giving themselves speed tests will appreciate this simple system for quickly counting the number of characters in the test copy. Before starting the test, set the left and right-hand margin indicators exactly 75 spaces apart. For example, set the left-hand indicator at 15 and the right-hand one at 90.

Select the test copy from a book or magazine and time yourself while typing it. Then simply count the number of lines typed and multiply the total by 75 to get the number of characters typed. The number of characters typed per minute is found by dividing the total character count by the number of minutes.



# A "NEW" BUGGY FOR SISTER

By Louisa and Walter Burton



WITH A FEW repairs and a new paint job, Mary's old doll buggy will make a thrilling Christmas gift for little sister—or it will form an appreciated donation to some worthy group that is gathering used toys for the local orphanage. You probably will find that although the buggy looks battered it does not require much in the way of actual repairs and, possibly, little more than a cleaning and painting. First, completely disassemble the buggy, placing the small parts in a jar or box so they won't be mislaid. Clean and repaint the frame, but if one of the steel members has been broken, solder the break or have it welded beforehand. The photos below describe a procedure that is typical for rejuvenating most buggies. If a new lining is needed, corduroy remnants will be found excellent for the purpose.



Apply rust remover to metal parts and rub with steel wool, as above. When clean, rinse parts in rust remover and wipe dry. Old paint is scraped or sanded from the frame, below, or removed with solvent. Broken underframe is repaired by soldering or welding

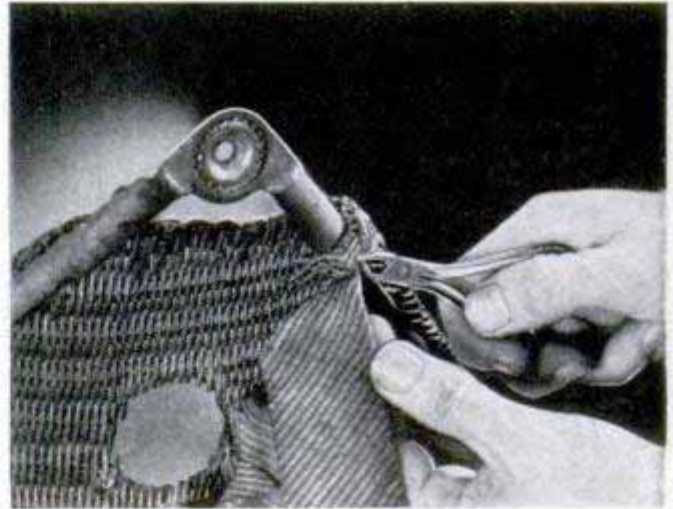

Original lining is removed and either laundered or replaced with new material. Gimp tacks are pulled with pliers, as above. Lining of body can be glued to fitted cardboard panels, and hood lining is tacked in place or held with nonstaining glue, as below

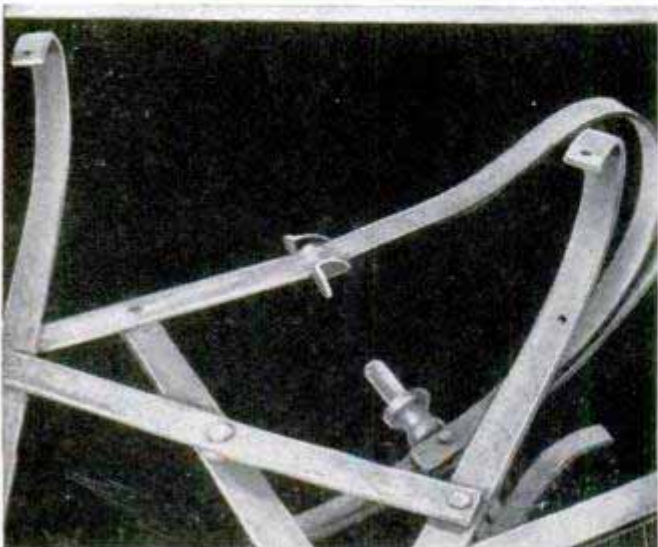





Hood and body of woven fiber are scrubbed thoroughly with soap and water, as above. Rinse off soap and, while fiber is still wet, remove any dents. After fiber dries, paint it the desired color by coating with well-thinned auto lacquer or model-airplane dope

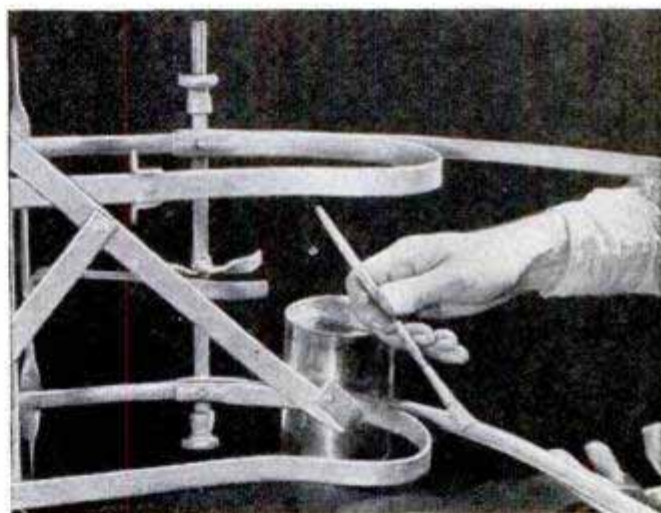

Cleaned metal parts are repainted with lacquer or enamel. Aluminum paint will simulate original finish, as above. Wheels also are cleaned thoroughly, and spokes and hub caps are painted to suit. Rubber tires can be made to look like new with auto-tire coating

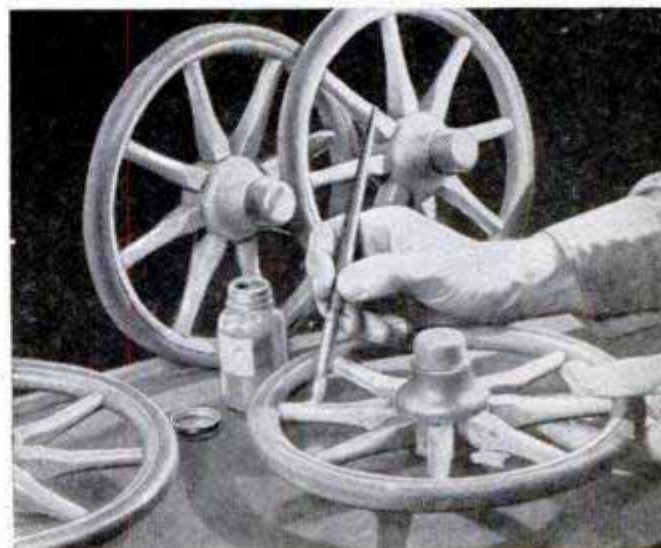
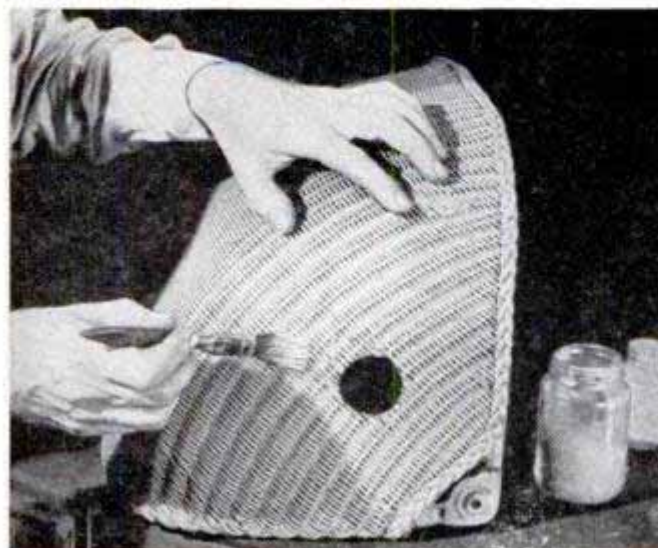



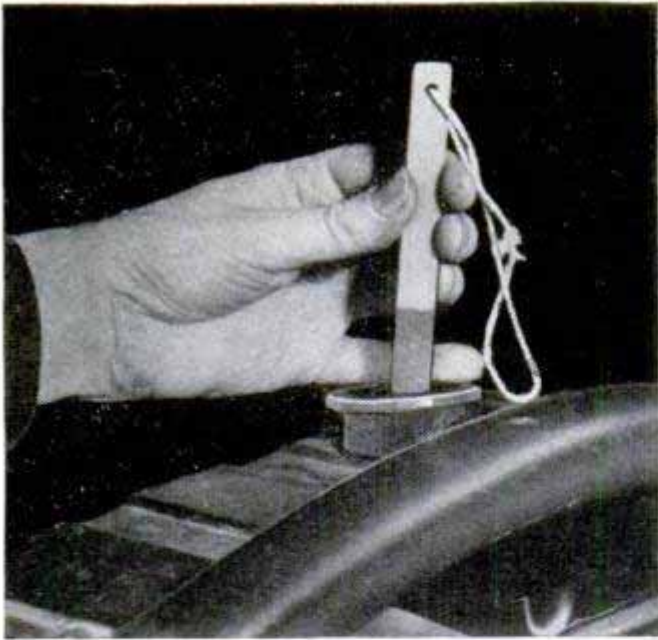

### Water Level in Car Radiator Checked With Dip Stick

The level of liquid in a car radiator can be checked quickly, especially in dim light, with a simple dip stick carried in some convenient place under the hood. A strip of wood or composition board will do. A hole drilled near one end and a length of cord will permit the stick to be hung on a projecting bolt in the car when not in use. On many cars, the stick will ride safely if simply laid on the cowl beneath the rear part of the hood.

### Handle on Knob to Open Door When Hands Are Full

An extending rod fitted to the knob of a garage or basement door makes it easy to open the door with your knee or elbow when carrying bulky objects or when your



hands are covered with grease or paint. To install the rod, close the door and scribe a line across the knob at a right angle to the doorframe. Then remove the knob and drill a hole in one side to take the rod, and an undersize hole on the other into which threads on one end of the rod can be turned. Another way is to drill only one hole, fill the knob with a fairly thin mixture of plaster and then set the rod in the plaster, after first bending it slightly at the end to help anchor it in the plaster.

### No-Draft Ventilating System Improves Car Heater

Especially useful on cars having the type of heaters that take air in from the outside, a ventilating system can be provided with about 15 ft. of defroster hose and eight ports similar to those used on some model Buicks.

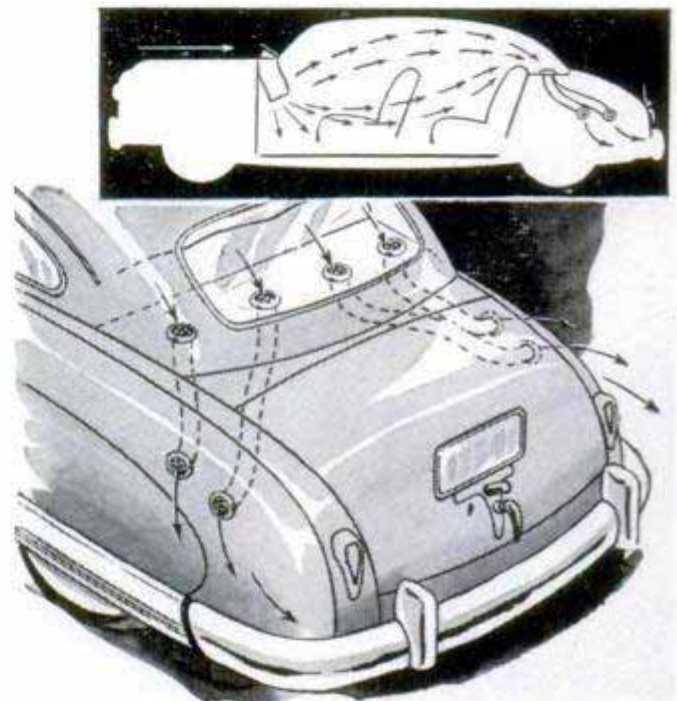

Four lengths of hose are attached to holes cut in the shelf behind the rear seat of the car and extend to holes in the fenders. All openings are trimmed with the ports.—Eugene R. Lemieux, Middle Village, L.I., N.Y.

### Correcting Windows That "Stick"

Windows that are difficult to open and close after they have been painted can be corrected by the following method: First, smooth the inside surfaces of the stops with fine sandpaper and wipe off all dust. Then, rub the stops with floor wax. Slide the windows up and down several times and apply a second coat of wax.

Charles L. Funnell, Yonkers, N. Y.

☐ Tied to the string on a child's pull toy, a rubber ring from a fruit jar makes a handle that can be easily grasped.





# DINNERWARE IN WOOD

By Otha C. Spencer

**T**O COMBINE real luxury with easy informality, there's nothing quite like a complete service of wooden dinnerware, done in mahogany or other good turning wood of your choice. Whether gleaming in the candlelight beside your best crystal or waiting for the "hot dogs" at a back-yard picnic, these versatile dishes are right at home. The cost of the wood comes to a small fraction of the price of a complete set of similar tableware. The photo above pictures two place settings, including optional coasters for the tumblers, sugar-and-cream service, salt-and-pepper shakers and large salad bowl. The 14-in. serving plate is not shown, but is made in the same pattern as the smaller plates.

The plates and bowls are simple faceplate turnings. The same pattern is used for plates of different sizes, only the diameters being varied as indicated in the detail. The small salad bowls also follow the same contours as the large one. A mahogany turning block,  $\frac{3}{4}$  in. thick for the plates and 2 or 3 in. thick for the bowls, is sawed to a diameter about  $\frac{1}{4}$  in. greater than that of the finished piece. The blank is centered on the faceplate and the underside of the plate or bowl is turned. Then the work is reversed on the faceplate, and the top surface is turned,  $\frac{1}{4}$ -in. faceplate screws being used so they will not penetrate the thin bottom of the piece. Blind holes formed by the screws on the undersides of the pieces are filled before finishing. Because of their

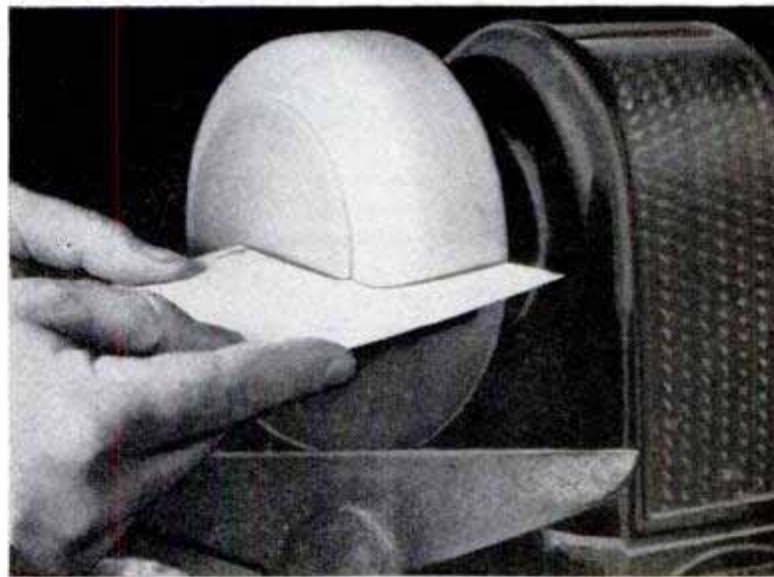

Contours of bowl turnings are checked with cardboard template as above. Photo below shows hole drilled in exact center of turning squares for salt-and-pepper shakers. Headstock plug fits tightly in hole

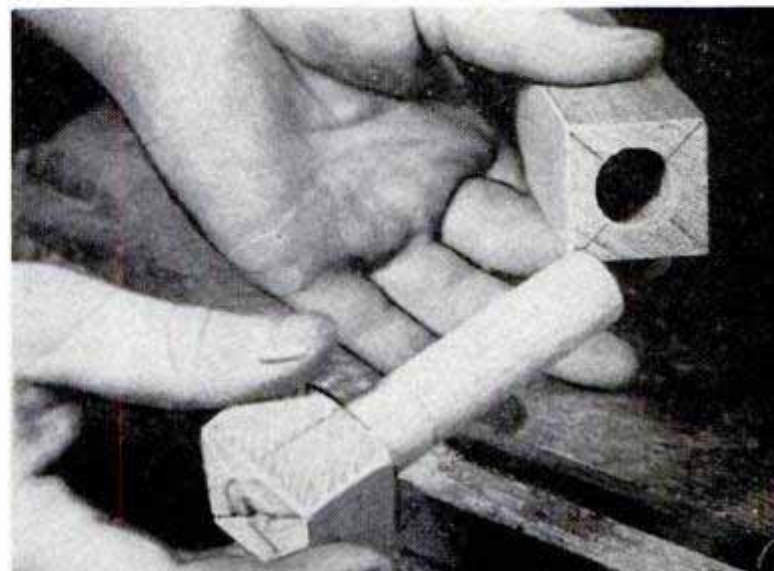



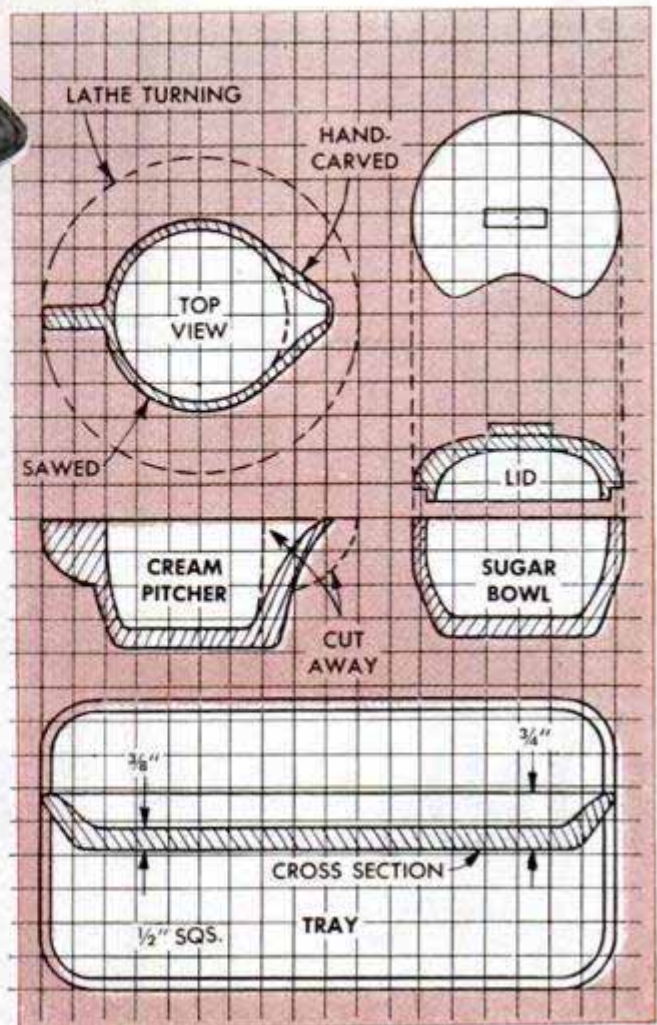

Blanks for handle and spout of cream pitcher are sawed from flange on turning. Sugar spoon is half-size version of salad spoon shown on opposite page

location, the holes are unnoticeable when the service is in use. However, if you wish to eliminate the need for filling screw holes, glue the work temporarily to a block of scrap stock with paper sandwiched between the pieces, and screw the scrap to the faceplate. The large salad bowl is provided with a fork-and-spoon set which is made according to the squared pattern.

The tray for the sugar-and-cream service is made from a rectangular block of  $\frac{3}{4}$ -in. mahogany. The inside of the tray is dished out with a round-nosed chisel, the chisel being worked from each end of the tray toward the center to prevent splitting the wood. Note in the details of the cream pitcher that a wide flange is turned on the upper portion of the work. After both the inside and outside contours of the pitcher have been turned to shape, waste stock is jigsawed from the flange, leaving only the blanks for the spout and handle. These are finished by hand with a wood rasp, pocket-knife and sandpaper. The sugar bowl is turned in the same way as the salad bowls. The lid is a separate turning and is completed without reversing the work in the lathe, the top of the lid being turned to the same diameter as the length of the handle

before cutting off the stock. After the turning has been cut off, the handle is cut to its rectangular shape with a coping saw.

The salt-and-pepper shakers are tapered turnings, drilled out from the bottom and plugged with a cork. The holes at the top of each shaker are made with a hand drill after the turning has been completed, and a thin score line around the shaker simulates a cap. Turning the shakers is simplified by drilling them first and fitting them with a wooden plug to facilitate mounting between centers. In the exact center of the turning square, a  $\frac{3}{4}$ -in. hole is drilled deep enough to allow for any waste at the bottom of the turning and still leave a hole  $2\frac{1}{4}$  in. deep in the shaker itself. This hole is fitted with a flanged plug turned from scrap lumber, as in the detail, the plug being sufficiently tight to keep the work from slipping. After one turning has been made, the plug is used again for the other shaker.

The pieces are finished by staining, sealing with a thin "wash" of shellac, filling and waxing or varnishing. Applying two coats of varnish that is both alcohol and heat-resistant results in a finish that will remain beautiful for years. The pieces are especially attractive when stained with a two-tone effect. This is done by staining the inside surfaces light mahogany and the outside portions dark.



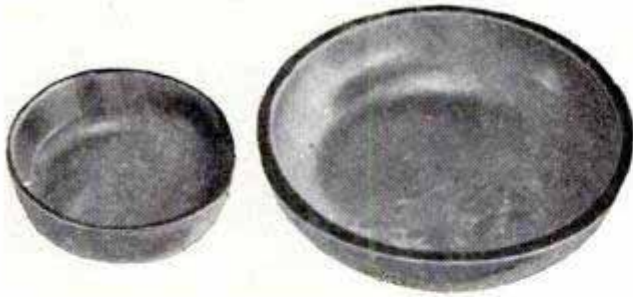

*Salad Bowls*

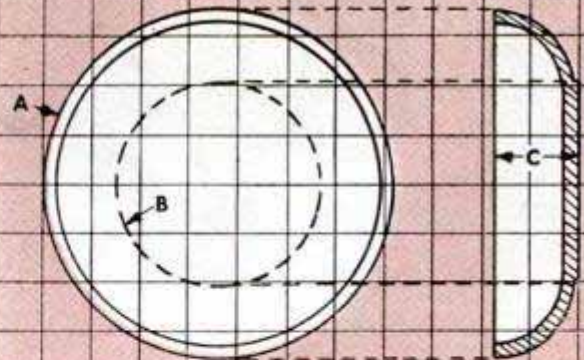

	A	B	C
LARGE BOWL	8 $\frac{3}{4}$ "	4 $\frac{3}{4}$ "	2 $\frac{1}{2}$ "
SMALL BOWL	6"	3 $\frac{1}{2}$ "	1 $\frac{3}{4}$ "

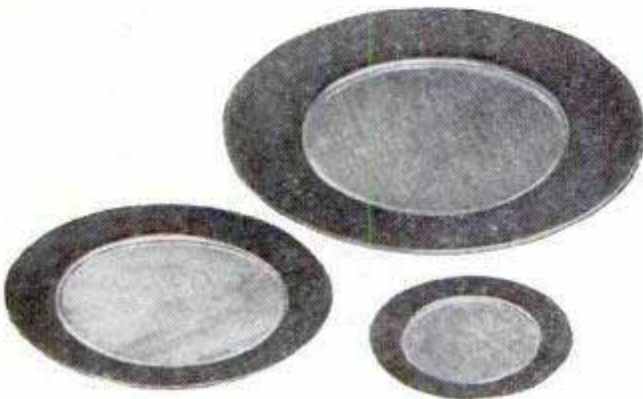

*Serving Plates*

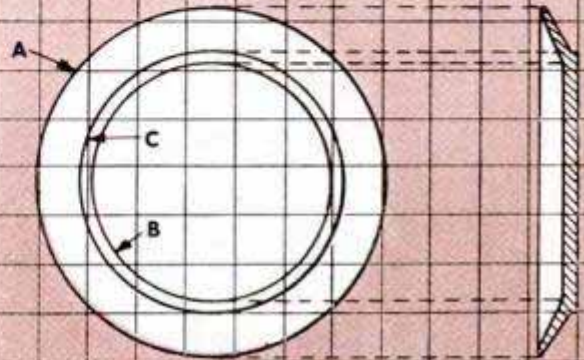

	A	B	C
SERVING PLATE	14"	9 $\frac{3}{4}$ "	10 $\frac{1}{2}$ "
DINING PLATE	10"	7"	7 $\frac{3}{4}$ "
SALAD PLATE	6"	4"	4 $\frac{1}{2}$ "
COASTER	4"	2 $\frac{1}{2}$ "	3"



*Salt-and-Pepper Shakers*

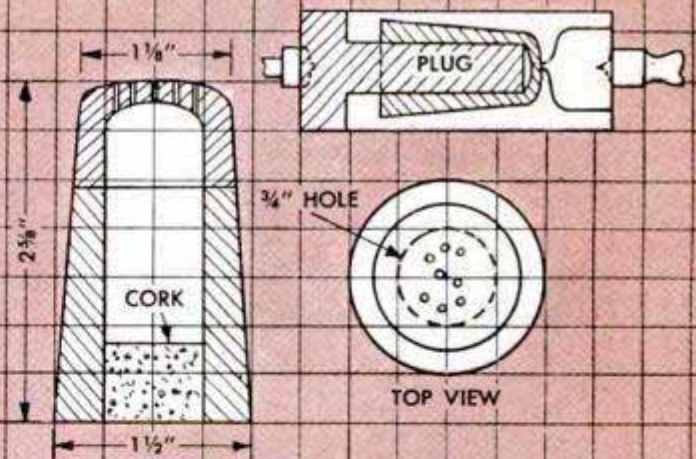

*Fork and Spoon*

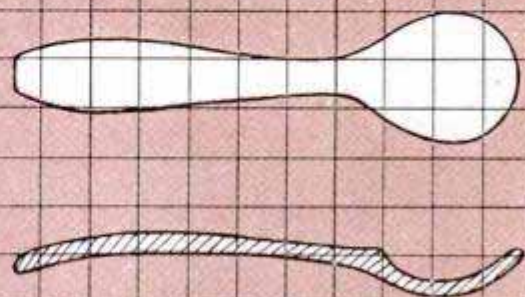

1" SQUARES



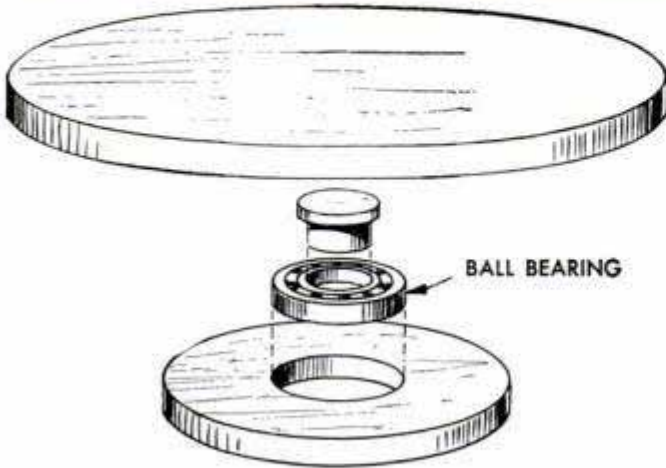

### Lazy Susan Rotates on Bearing

If you want a Lazy Susan that rotates easily, try this idea. Use two hardwood disks, one about half the size of the other, and make a hole in the smaller one for a ball thrust bearing, which you can obtain at an auto junk yard. Turn a hardwood plug to fit tightly into the bearing, forming a shoulder on the upper end. Glue and screw the shouldered end to the large disk, as indicated, and finish the Susan to suit.

Grover Brinkman, Okawville, Ill.

### Soldering-Iron Stand Improvised From Empty Tape Spool

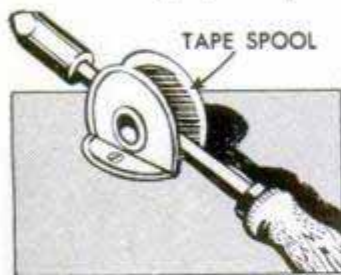

Just bend the sides of the spool out to form "feet." If desired, the stand can be screwed to the bench.

An ideal stand for a soldering iron, or a wood or leather-burning tool, can be made from a metal spool, such as those used for adhesive tape and wire solder.

### Locating Chimney Leaks

To find the positions of leaks in a chimney, place a cover on the top of the chimney and throw sawdust in the furnace to produce a large quantity of smoke. Then, mark the places on the chimney where the smoke is leaking out.

### Preventing Breakage of Small Drills

The tendency for small drills to break or bend when used in a drill press can be reduced by altering the chuck of the press so that drills can be gripped as close to the cutting end as possible. This is done simply by drilling a  $\frac{3}{16}$ -in. hole vertically in the spindle deep enough to take the longest drill used on the machines.

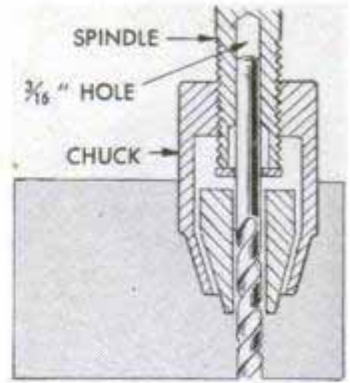

W. Shields, Bloomington, Ill.

### Testing Campfire Wood

When selecting fuel for a campfire or fireplace, remember that hardwood will produce the most satisfactory fire. It is, of course, more difficult to ignite than softwood, but once ignited it produces a hot, slow-burning fire. If you are unfamiliar with the types of woods, a simple test for fuel purposes is to press your fingernail into it where the bark is off. If the surface of the wood dents easily under pressure of your nail, it is softwood.

Warren G. Moore, Hyattsville, Md.

### Auto Skid Chains Kept Tight With Rubber Strips

The skid chains on your car should be kept tightly on the wheels to avoid possible damage to the tires, or to prevent the annoyance of having the cross chains strike the undersides of the fenders. Tighteners can be made at no cost by using wide strips of rubber cut from an inner tube and attaching cross chain hooks at the ends of the

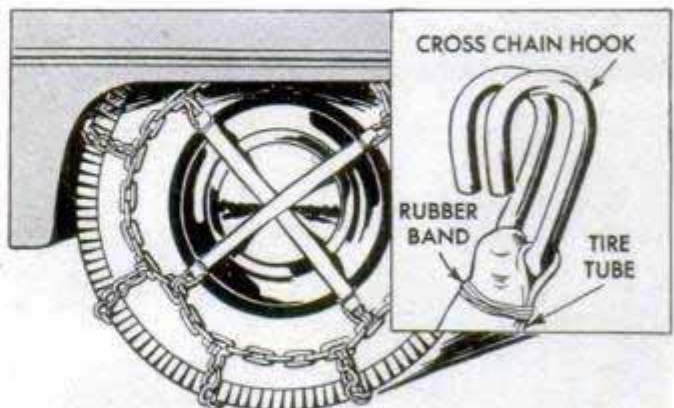

strips. The hooks can be attached by folding the ends of the strips through them and wrapping rubber bands or fine wire tightly around the folded portion as shown.

C. V. Moberly, Graysville, Ohio.



# from TUBING



*Costume Jewelry*

**By R. J. DeCristoforo**

**C**RAFTING with short pieces of metal tubing is an interesting and economical hobby as it lends itself to innumerable projects and utilizes the short lengths of stock that usually are discarded as waste.

After you have tried some of the suggestions given, many other uses in projects are sure to come to mind. Suitable scraps of tubing are to be found in most home workshops. Sizes begin at less than  $\frac{1}{4}$ -in. outside diameter, and the different metals, copper, brass, and aluminum, vary in hardness so that it is easy to select the right one for your particular project. A hacksaw will do for cutting, if you use a fine-tooth blade and are careful.

The photo above pictures attractive pieces of costume jewelry made from  $\frac{1}{4}$ -in. sections of 1-in. outside-diameter aluminum and copper tubing. Napkin rings, shown in the center photo, are easily made from large-diameter tubing. Those pictured were cut from 2-in. aluminum, which was flattened on one side to form a base. There are, of course, many shapes in which the material can be cut for the rings. The details on page 191 show several ways of doing this. The rings are polished or peened and the inner surfaces are brightened with emery cloth or steel wool after forming.

The toolholder shown in the lower photo at the right is used for storing extension bits and lengths of drill rod, the sections which form the holders being soldered

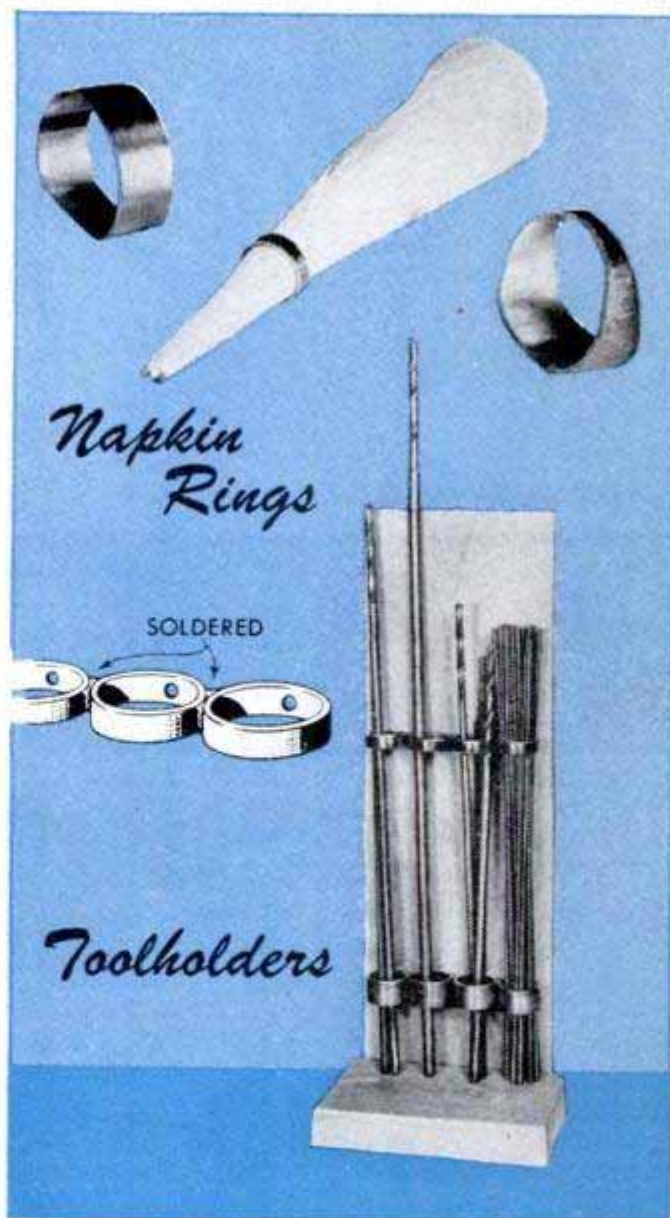

*Napkin Rings*

*Toolholders*





*Candle Sockets*

together and then bolted to a wooden back. This type of holder can be adapted to screwdrivers, chisels and similar tools simply by changing the spacing between the individual tubing sections.

Tubing forms a ready-made candle socket, and candleholders of various types are designed quickly by starting with a tube section of the desired diameter. The section can be used by flaring the top and bottom ends slightly. This is done by hammering the ends over the rounded end of a

## Drawer Pulls

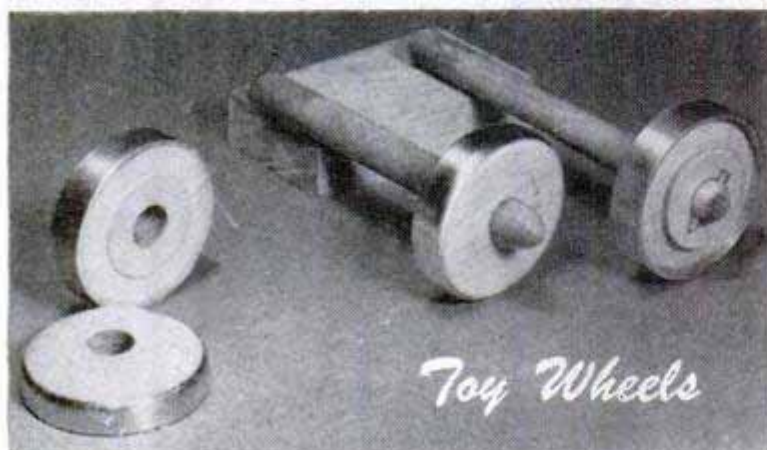

*Toy Wheels*

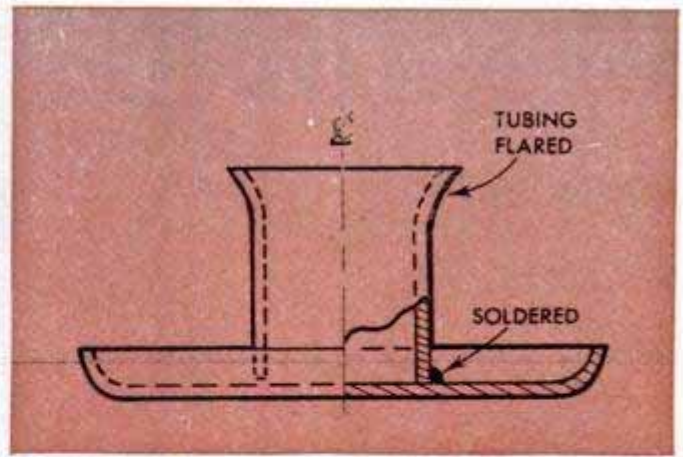

Simple candle sockets at left are short lengths of tubing, hammered or polished. Candleholder detailed above is made by soldering tubing to dished base

metal bar. A base may be added by soldering the section to a piece of sheet metal cut to the desired geometrical shape. The base can be dished, peened or merely left flat and buffed to a high polish.

As shown in the detail directly below, tubing sections provide decorative ferrules for knobs and pulls of various designs. Wood, plastic or metal can be used for the pull itself. The only requirement for attaching the sections is to turn a shoulder on the pull to provide a press fit for them.

Metal-rimmed wooden wheels for homemade toys are shown at the bottom of the page. The tubing sections are cut to size and press-fitted on disks turned to the inside diameter of the tubing. Another way to make the wheels is to press a length of tubing over a wooden dowel or mandrel. Mount the dowel between centers in the lathe and use a parting tool to cut through the metal and partially through the dowel. The wheels are cut apart with a hacksaw after removing the work from the lathe, the narrow hacksaw cut leaving a slight

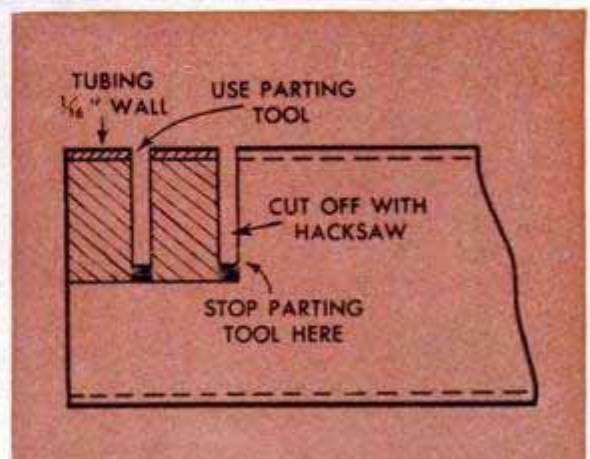



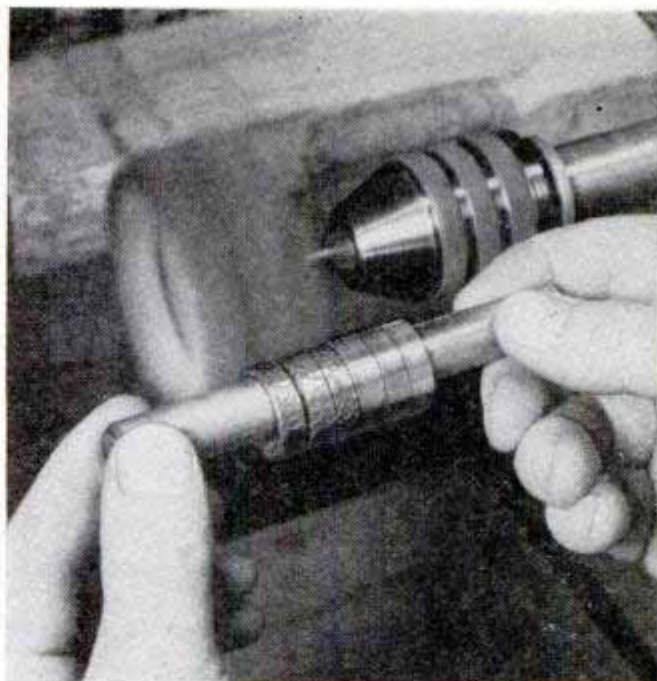
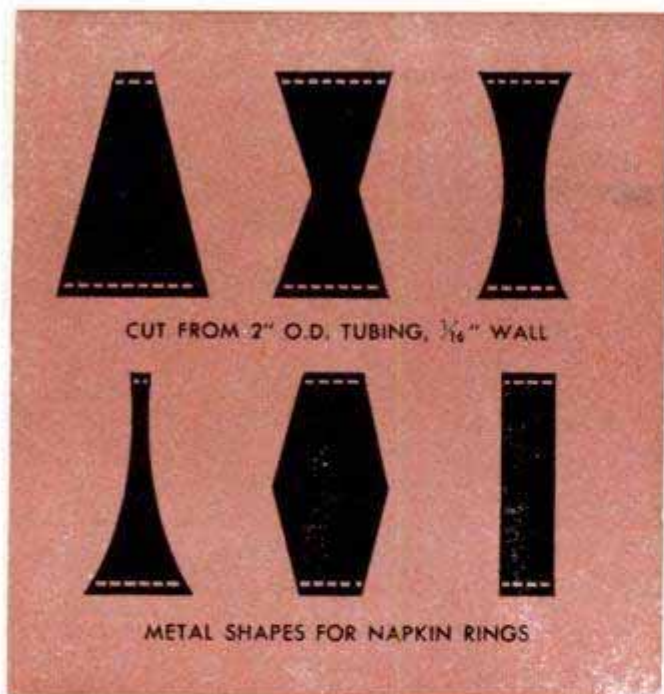

boss on each wheel to simulate a hub. Finally, the wheels are center-drilled for mounting on the axles.

The wheel rims can be cleaned and polished by locking the wheels together with a bolt and nut, and then holding the rims against a wire brush or buffing wheel. Unmounted sections of tubing can be polished in the same way by slipping them over a rod or dowel. When wire-brushing, use just enough pressure to clean the metal, as pressing too firmly against the brush will result in scratches on the surface.

Broken or loose tool ferrules may be replaced with sections of tubing, as in the photo at the right. Select tubing of a diameter slightly less than the original ferrule and drive the section over the handle tenon with a mallet. If you wish the ferrules to add a decorative touch, hammer the metal or polish it to a high luster.



Photo at top of page shows how tubing sections can be held for polishing by slipping over bar. Above, tubing forms replacement ferrule for tool handle

## Kitchen Tongs Clamp Pistons in Cylinder While Repairing Brakes

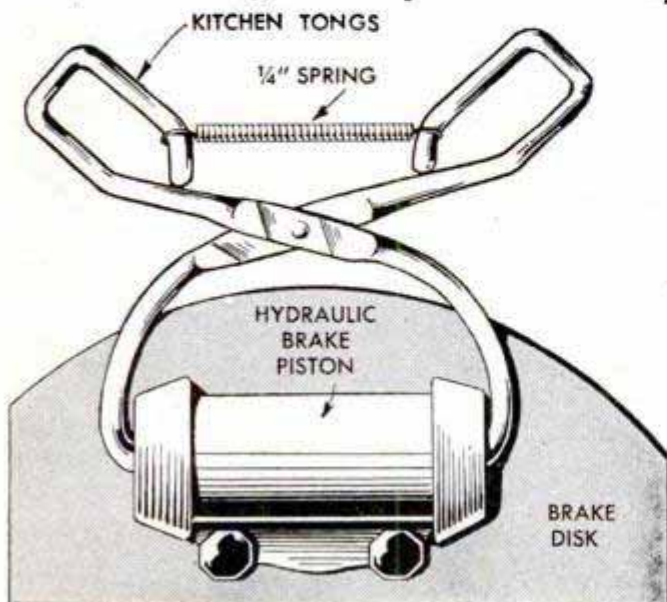

When relining brakes on a car or when making other repairs that require removal of the brake shoes, you can avoid the necessity of bleeding the wheel cylinders by using this simple tool to hold the pistons in place. The tool is made from a pair of tongs of the type used in kitchens. First, cut the jaws off the tongs, bend the remaining ends inward and then attach a short coil spring between the handles to apply a gripping force. In use, the tongs are placed over the cylinder, as illustrated, so that the ends will hold the pistons in place while the brake shoes are removed.

Charles Pierre, Philadelphia, Pa.

☞ Paint will wash off your hands easily if you rub them with lard before painting.



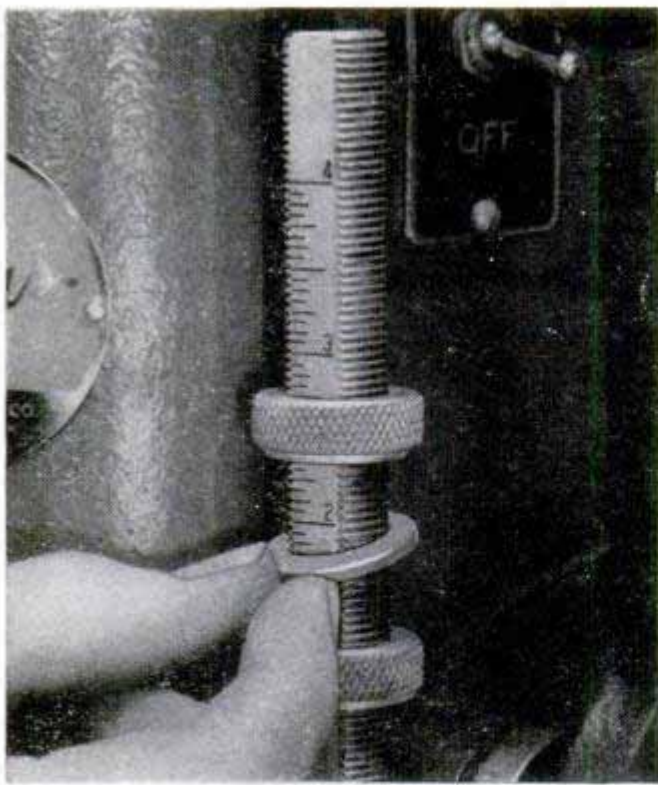

### Washer Aids Operating Locknuts On Drill-Press Depth-Gauge Rod

Placed between the locknuts on the depth-gauge rod of a drill press, a washer will make it easier to tighten the upper nut against the lower one without disturbing the setting. A regular washer can be used for the purpose by enlarging the hole in it with a drill or a round file.

### Preventing Removal of Shoelaces



If your child has acquired the habit of pulling the laces from his shoes, try this kink. Just clip a fishing-line sinker of the split-shot type near the ends

of the laces. The sinkers should be slightly larger than the eyelets of the shoes. They can be obtained at any sporting-goods store.

### Thawing Car-Door Lock

A frozen door lock on your car that cannot be thawed by the usual methods can be thawed with a piece of small copper tubing about 12 in. long. Heat one end of the tube and then immediately hold it against the lock and blow through the other end. The air being blown into the lock will be heated and will quickly thaw it.

By pouring melted wax in the saw cuts of a wooden miter box, a saw will not bind in the cuts and will be waxed automatically each time it is used.

### Wallpaper Held While Trimming By Coat Hanger Hooked to Table

To keep wallpaper from rolling up when laid out on a paste table, use this holder made from a wire coat hanger. Just bend it to fit over the roll and then hook it to the end of the table.

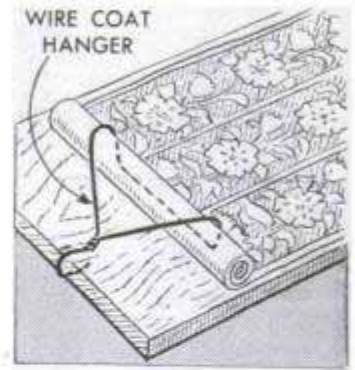

### Materials for Emergency Repairs Obtained in Medicine Cabinet

When a search through your tool kit fails to provide certain materials or small tools needed to make an emergency repair, satisfactory substitutes for them often can be found in the home medicine cabinet. For instance, adhesive tape is suitable for use in many places that ordinarily call for masking or friction tape. Petroleum jelly is ideal as a lubricating grease, and dental floss is sometimes better for a sewing job than thread. Fingernail polish, whether clear or colored, will serve the purpose where a small quantity of lacquer is vital. Maybe a pair of cuticle scissors, a nail file, or an emery board will provide just the right small tool for some odd job. A medicine dropper will usually "stand in" for a missing oilcan. A worn toothbrush can be used as an applicator, a cleaning tool or even for spatter painting.

### Nonslip Clamp Grips Small Parts

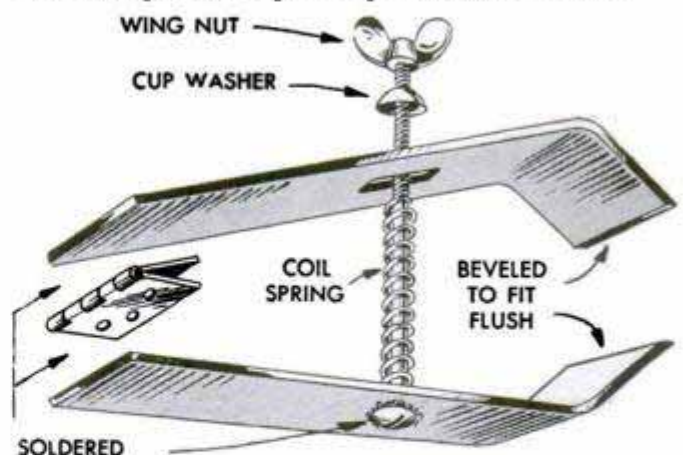

Modelmakers or other hobbyists who have need of a clamp that will hold small parts without "creeping" will find this one ideal. Easily assembled from odds and ends, as detailed, the clamp can be closed on the work by hand and then tightened, thus permitting positive placement and avoiding all possibility of slippage.

Ralph Lambert, Los Angeles, Calif.



# CHRISTMAS-TREE STAND

By Benj. Nielsen

If you are one of the parents who struggle every year with an unsafe, make-shift tree stand, use this self-gripping one and eliminate your troubles. It consists of two parts bandsawed from hardwood, which fit together at right angles and provide both a gripping and wedging action on the tree trunk. After the openings are bandsawed as detailed, the parts are notched in the manner indicated to form a half-lapped joint at the bottom edges. Saw cuts, run each way from the bandsawed openings, are stopped about 3 in. from the ends. Stop screws, turned into counterbored holes, keep the wood from splitting when the stand is opened to admit the tree trunk.

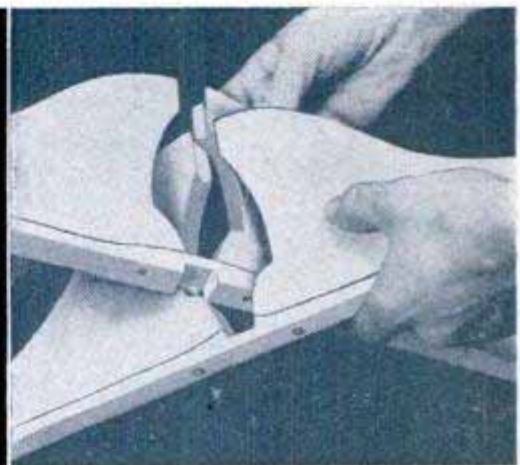
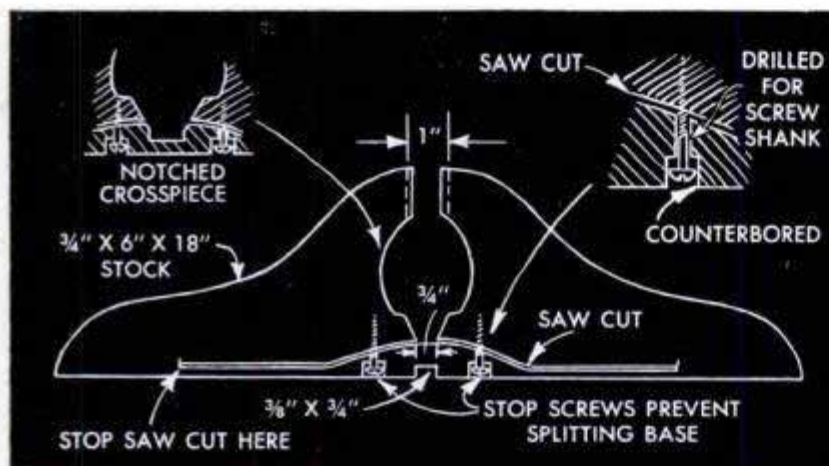
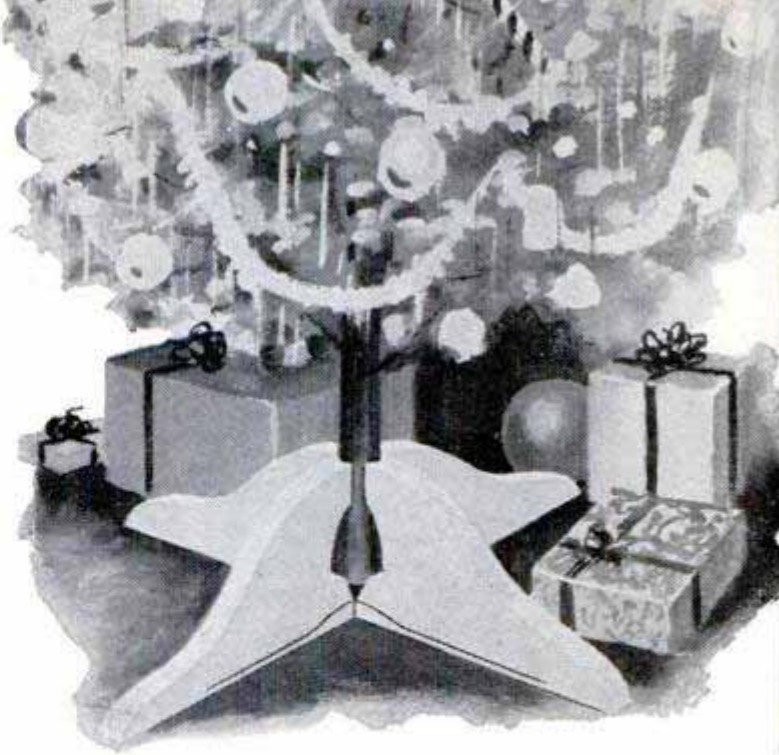

## How to Prevent Rotting of Timbers Exposed in Crawl Space Under House

Rotting of sills and joists in houses having crawl spaces under the floors sometimes is caused by moisture from the soil condensing on them. To determine whether or not sufficient moisture is present to cause such damage, enter the crawl space in the early winter and inspect the sills, joists and other exposed wood surfaces. If, on each of several inspections, the wood is found to be moist or even damp, the condition should be corrected immediately. This can be done either by covering the soil under the floor or by providing more thorough ventilation of the crawl space. The material recommended for use as a soil covering by the U. S. Department of Agriculture is asphalt roofing (not paper), which should be approximately 55 lbs. per roll of 108 sq. ft. All that is necessary to cover the soil properly is to lay the roofing with the edges lapping about 2 in. No staking, cementing or other fastening is needed and the soil need be only moderately leveled before the roofing is laid. Thus, the cost of

making the improvement can be kept at a minimum. If conditions are more suited to ventilating the crawl space than to covering the soil, the recommended total vent-opening area should be determined by figuring 2 sq. ft. for each 100 lineal ft. of wall around the crawl space, plus  $\frac{1}{3}$  sq. ft. for each 100 sq. ft. of ground area therein. For example, a crawl space that is 20 x 30 ft. would have 100 lineal ft. of wall around it, which, according to the formula, would call for an opening area of 2 sq. ft. However,  $\frac{1}{3}$  sq. ft. for each 100 sq. ft. of ground area must be added to this figure. As the ground area is 600 sq. ft., the total area of all ventilator openings would be 2+2, or 4 sq. ft. If the vents are to be covered with fine screen or louvers, the area of the openings should be doubled. If covered with both screen and louvers, it should be tripled.

☛ To protect sheer stockings from damage, place cellulose tape over rough spots and edges on legs of desks and chairs.



# SERVICING AUTOMATIC CHOKES

Here are several simple checks that car owners can make periodically to assure proper operation of automatic-choke mechanisms

*By Ed Packer*

ESSENTIALLY, the automatic choke in your car consists of a choke valve pivoted off-center in the carburetor air intake, its open and closed positions being controlled by a simple mechanism actuated by heat and vacuum. Here's how it works: When you close the starter switch, with all parts of the choke mechanism in the cold position, vacuum in the intake manifold acts on a vacuum piston connected by a linkage to the choke valve, Fig. 2. Movement of the piston, due to manifold vacuum, sets the choke valve in a partially open position and prevents overchoking. In some cars, the initial set of the choke valve is accomplished by operation of a magnetic coil which is energized when the starter switch is closed, Fig. 3. To hold the valve in this position until the engine starts to warm up, two forces are utilized. First, a thermostatic coil, tensioned to the cold position by cooling of the engine, tends to hold the valve closed until heat from the manifold gradually causes the coil to lose its tension. Simultaneously, the flow of air past the partially opened valve opposes the thermostat and tends to exert opening pressure on the valve body, which is pivoted off-center on its shaft, as in the photo below. However, when the engine is cold, the thermostat provides sufficient tension

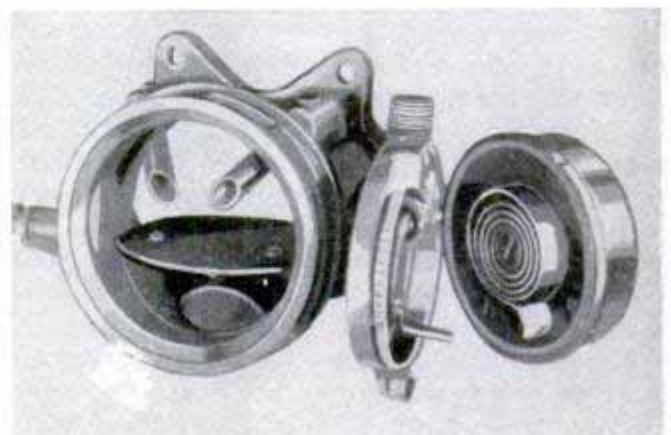
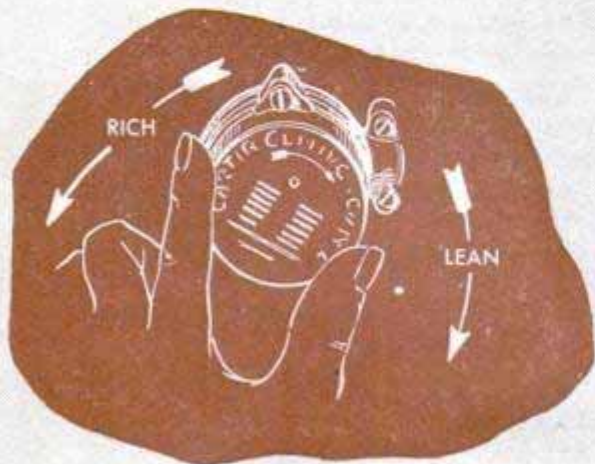
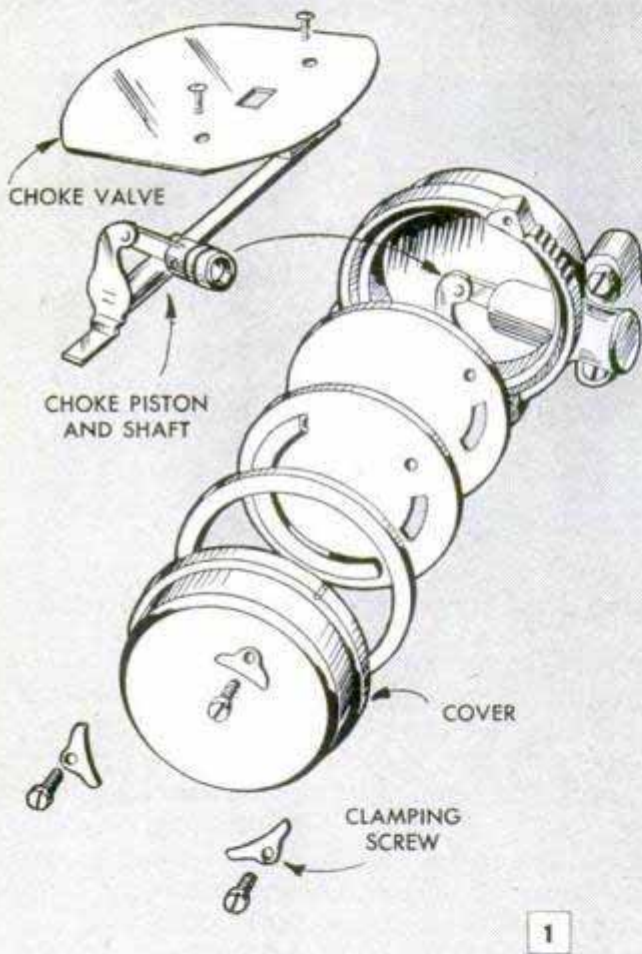
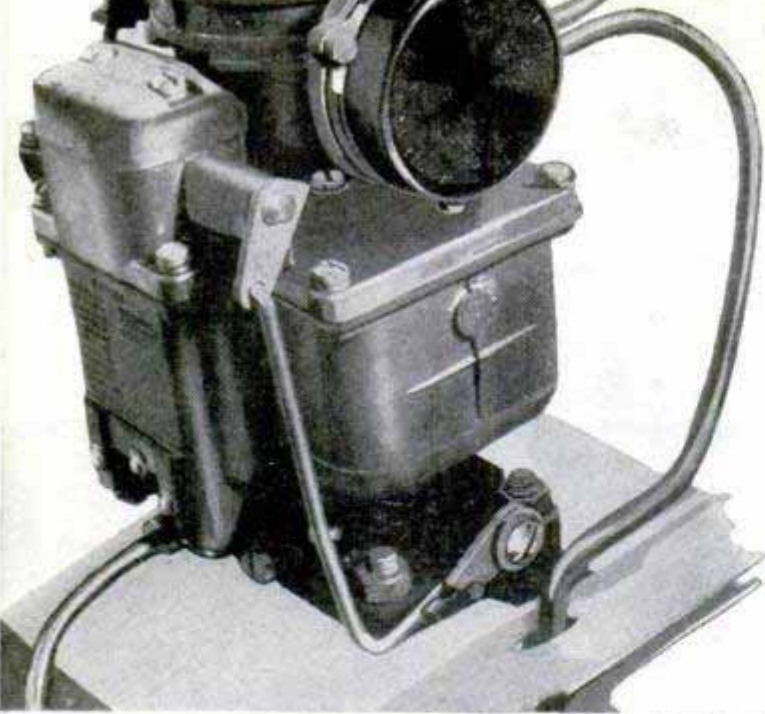



on the valve to overbalance the pressure of the air flowing past it. Now, as the engine warms, heat piped from the manifold to the thermostatic coil causes it to release its tension and permit the valve to open as the engine temperature rises. Thus, by the time the engine has reached its normal operating temperature, the valve will be fully opened. A somewhat similar cycle occurs when a magnetic coil is used to set the choke valve for a cold start, except that in this case there are two controlling mechanisms, electrical and thermostatic. In later-model cars the choke is interlinked with a fast-idle mechanism which prevents stalling when the engine is cold by providing a somewhat wider throttle opening than that required for smooth idle at operating temperature. As the choke valve is opened by the thermostat, the fast-idle linkage gradually closes the throttle so that when the engine reaches operating temperature it will be running at its normal idling speed. Many automatic chokes are fitted with a manually operated climatic control, Fig. 1, which provides a means of adjusting the fuel mixture by changing the operating cycle of the choke mechanism. Thus, by setting to lean or rich fuel mixtures as indicated on the cover of the coil housing, you can provide proper fuel mixtures for cold starts at almost any seasonal temperature.

Any condition that causes the operation of the choke mechanism to lag behind the temperature rise of the engine can result in trouble. However, as a rule the remedy is quite simple to carry out. If the mechanism "unchokes" too slowly, one of the first things to check is the condition of the screen in the coil housing. If the screen is clogged, even partially, that's usually the cause of the trouble. A thorough cleaning of the screen frequently will restore the original choke action. Although a comparatively rare cause of trouble in choke mechanisms, it is possible for dirt to find its way into the vacuum passage, Fig. 2, and interfere with the action of the vacuum piston. A few particles of carbon or other foreign matter can cause a partial stoppage of the small passageway and may prevent the initial set of the choke valve by vacuum acting on the piston. When this occurs, it usually is necessary to disassemble the unit so that the passageway can be cleared with compressed air. Another possible source of trouble is an accumulation of grime and hardened oil on the exposed parts such as the choke lever, Fig. 3, and the fast-idle link and cam, Fig. 2. To prevent possible trouble from this source, it's a good idea to clean these parts occasionally by brushing them, either with white gasoline or with carbon tetrachloride.

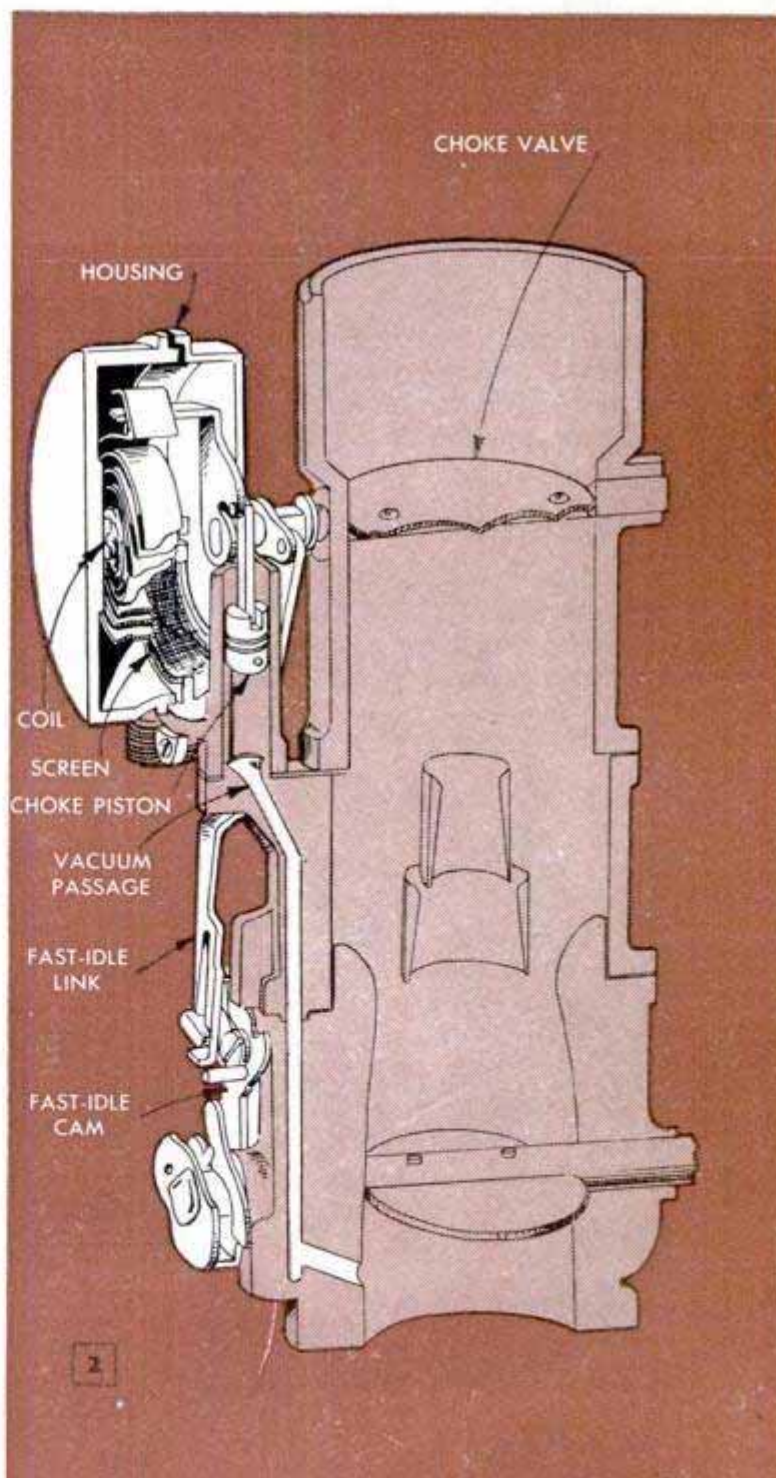
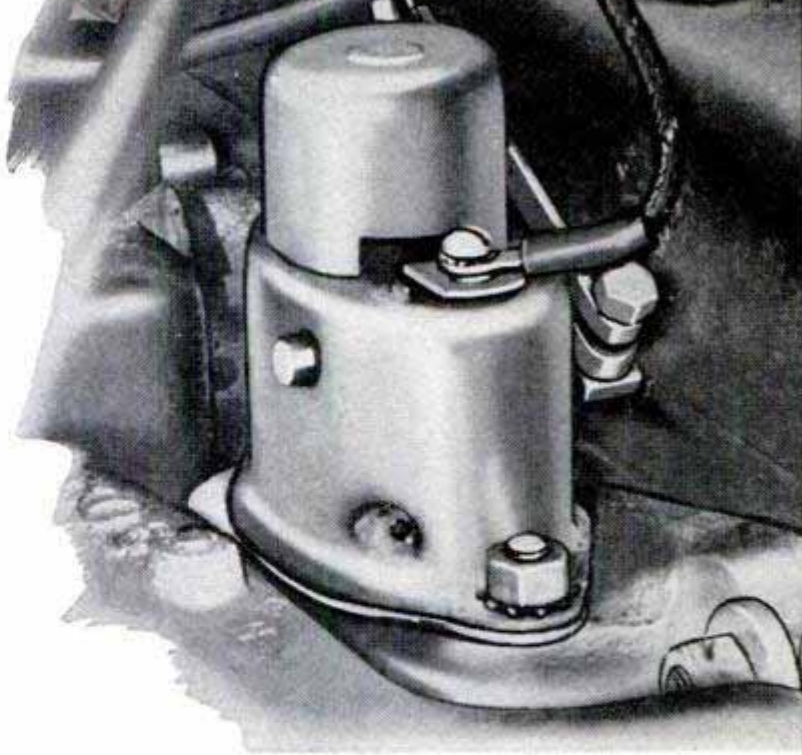



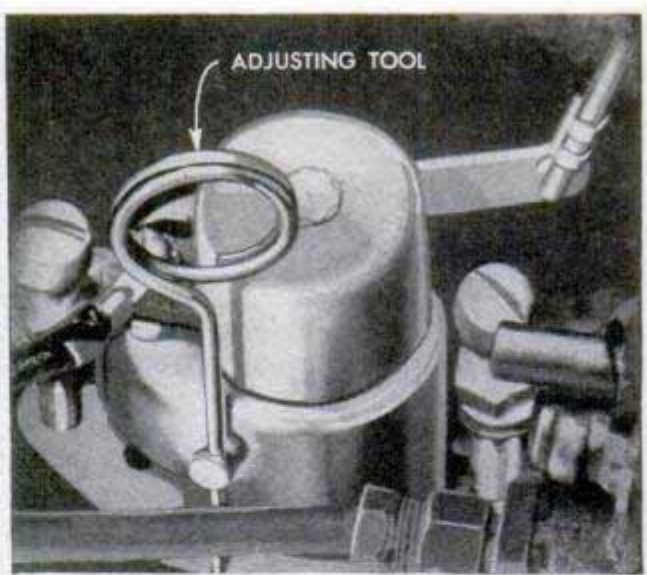
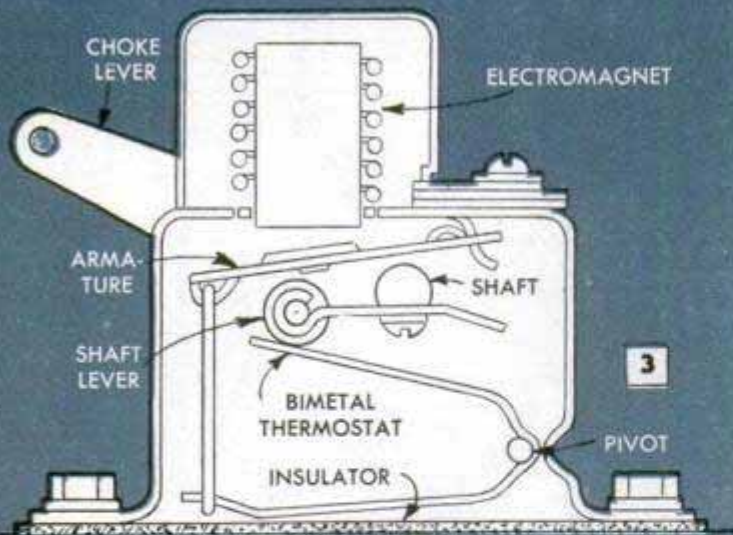

On choke mechanisms in which the initial setting of the choke valve is done electrically, adjustment of the choke to the carburetor is made with a special adjusting tool as in the photo above

**Caution:** Disconnect the battery ground cable before cleaning parts of the engine or carburetor with gasoline. Never oil any parts of the choke or fast-idle mechanisms. The oil will gather dust and eventually cause trouble.

Should the electrically operated unit, Fig. 3 and the photo above Fig. 2, unchoke too rapidly and starve the engine before it is fully warmed up, it is probable that the special insulator, Fig. 3, has been damaged or has deteriorated to the point where it no longer provides insulation between the unit and the manifold. Replacing the insulator

generally corrects the trouble. The thermostatic unit in this type of choke should never be altered. Adjustment of choke to carburetor is made on the outside of the unit and requires the use of a special adjusting tool as in the photo above at the right. Some experimentation may be required in order to adjust the climatic control on other types of chokes at the end of each season. Specific instructions cannot always be given, as the unit must be adjusted in accordance with the peculiarities of each engine. Usually it is necessary to adjust the fuel mixture also.

## Homemade Blower for Your Jigsaw Keeps Work Free of Sawdust

A jigsaw not equipped with a blower to prevent sawdust from obscuring the line of cut can be provided with a homemade blower of the type detailed. This one is

made from a length of large metal tubing that will fit over the spring housing on the head of the saw. It must fit tightly to be as nearly airtight as possible, and may be

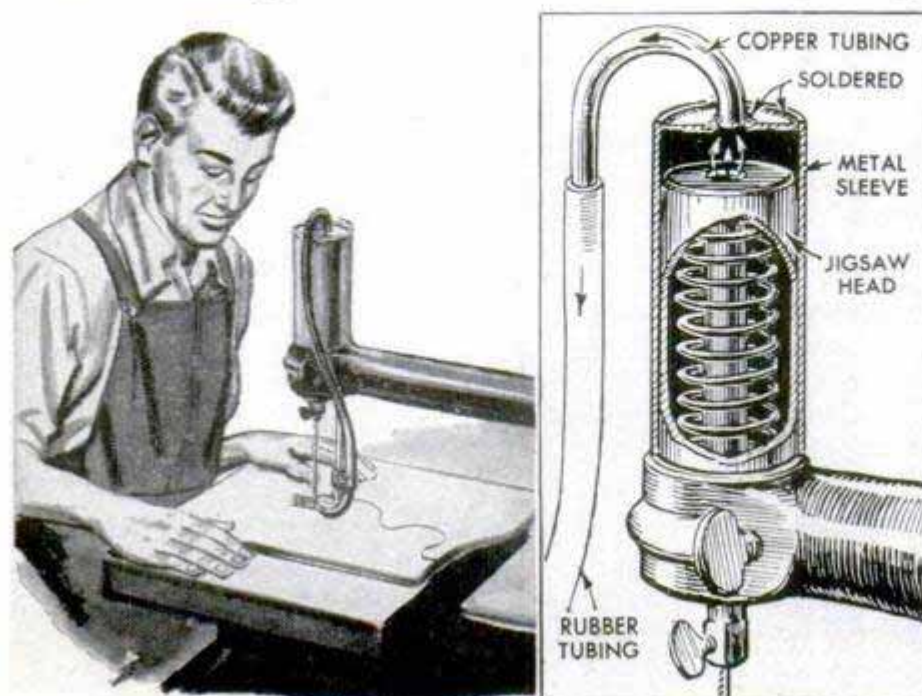

bushed at the lower end if necessary. A tin can that will fit over the head may be substituted for the tube. The upper end of the tube is closed with a disk, which is then drilled for a short length of copper tubing. This serves as a nipple over which a piece of rubber tubing is slipped to carry air to the pressure foot of the saw. In operation, reciprocal movement of the shaft inside the spring housing of the saw head acts as a miniature air compressor to operate the blower.—James F. Bennett, Lakewood, Ohio.



Milk and other dairy products delivered to your home will be well protected for several hours if an insulated box like this one is used to receive them. It is made from  $\frac{3}{4}$  or  $\frac{1}{2}$ -in. material, such as waterproof plywood, and is lined with  $\frac{3}{4}$ -in. insulating board. It can be made any size required and can be mounted any place convenient for the milkman. Another method of making an insulated container is to set one box inside another and fill the space between them with loose-type insulating material. Space between the two boxes should be at least 2 in. It is a good idea to cover the bottom of the box with oilcloth or other material that can be cleaned easily, otherwise accidental spillage or condensed moisture from the cool milk bottles may, in time, damage the insulating material. If, instead of being mounted permanently, the box is just set on the steps or walk as shown in the photograph, it can be taken along on picnics to serve as an ice box. In

## Insulated Box Protects Delivered Milk Against Weather and Prowling Animals

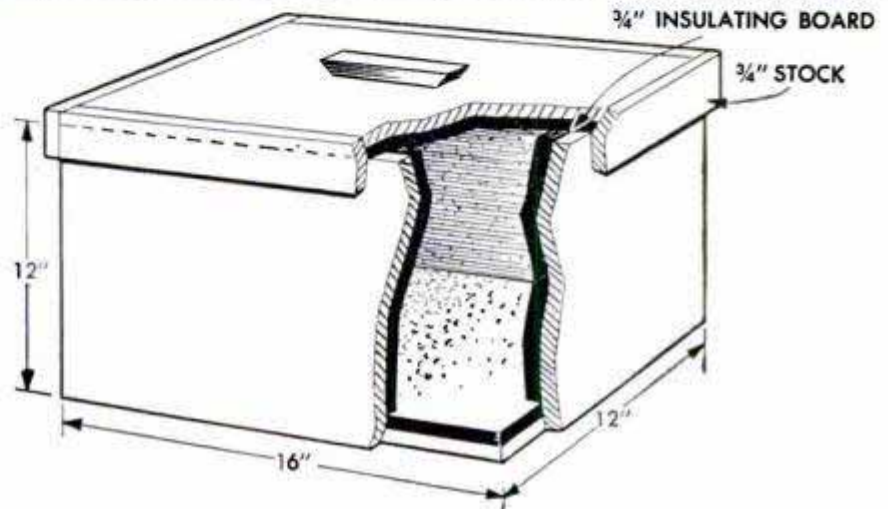
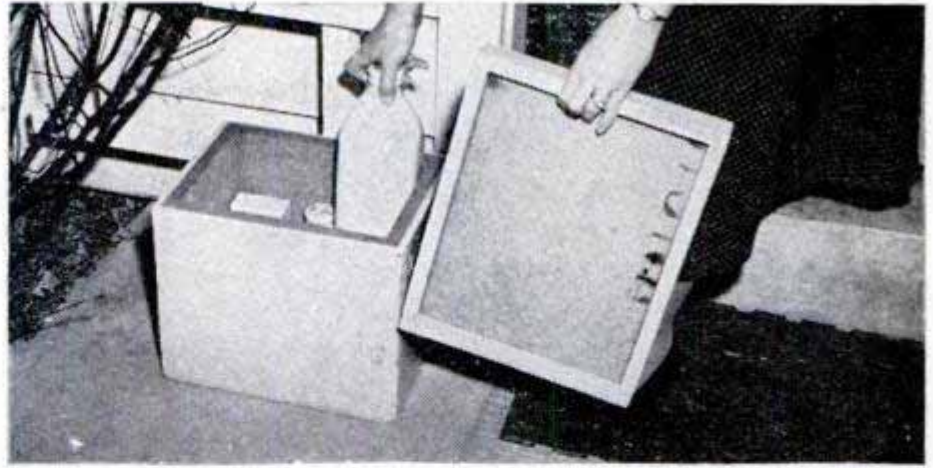

this case, the ice should be put in a water-tight container and then placed inside the box.—Mrs. Virginia Hackett, Chicago.

## Pliers Drive Brads Safely

When mounting a picture in a wooden frame by driving brads into the frame, the possibility of marring the wood can be eliminated by using a pair of the type pliers shown to drive the brads. Pad the lower jaw of the pliers with adhesive tape.

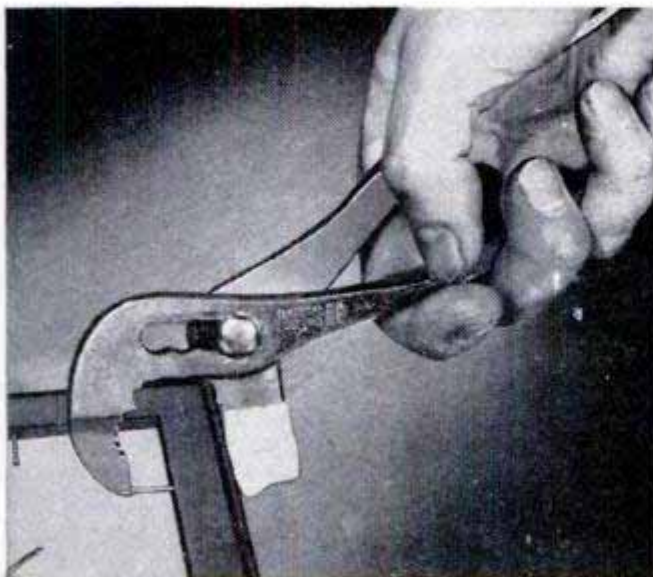

## Soldering Clamp for Small Work

Bolted to the side of a soldering-iron tray, a spring-type paper clamp is ideal for holding small parts in position for soldering. Often, two clamps placed side by side can be used advantageously to hold two or more parts for assembly.

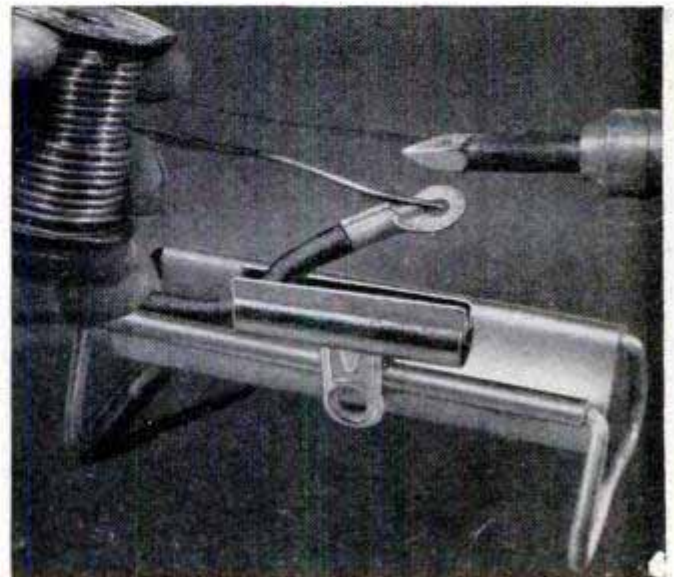



# "Dubbing in" SOUND IN

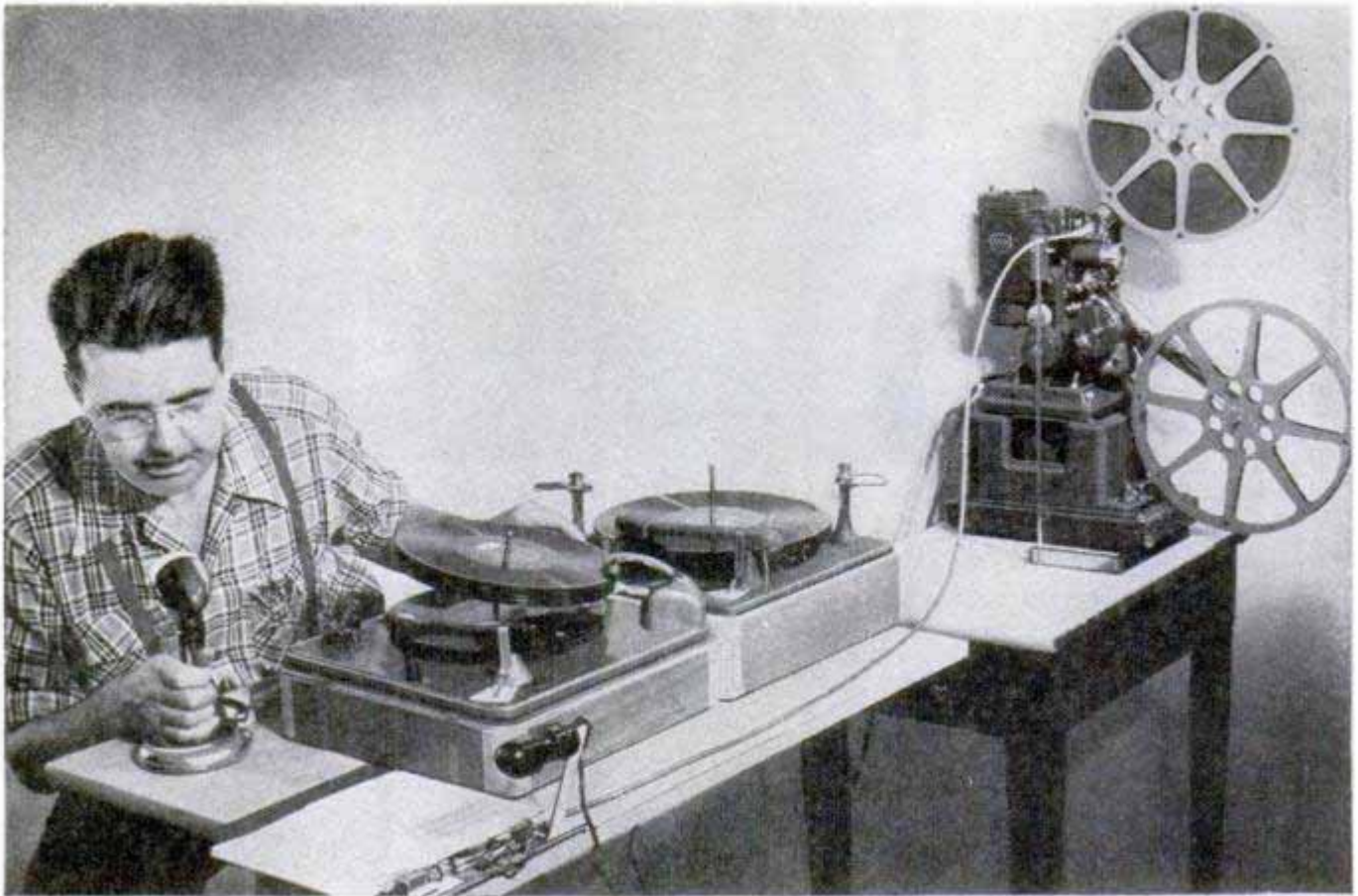

Coupled counter provides means of "timing" two turntables with movie continuity. Author is making recording

**Simple coordinator coupled to projector with flexible cable makes it easy to "dub in" sound in perfect timing with the presentation of your home movies**

*By M. G. Winterton*

**A**DDING SOUND or dialogue to your home movies injects a professional quality that rates you high with friends who are invited to view your prize vacation shots. Being able to present a smooth-running narration of your experiences makes for greater enjoyment for both audi-

ence and operator, as the usual practice of watching the screen and attempting to synchronize voice and music with the changing scene results in an irregular and less-interesting presentation. Actually, "dubbing in" the sound is easy with the aid of this "timer." It may be used directly

**A.** Spring clamp on clipboard does double duty in holding both plastic cable holder and small notebook conveniently at hand for listing recording data

**B.** Speedometer cable is placed in half-round notches of plastic holder before sliding under spring clamp on clipboard. Counter fits in notched end of holder

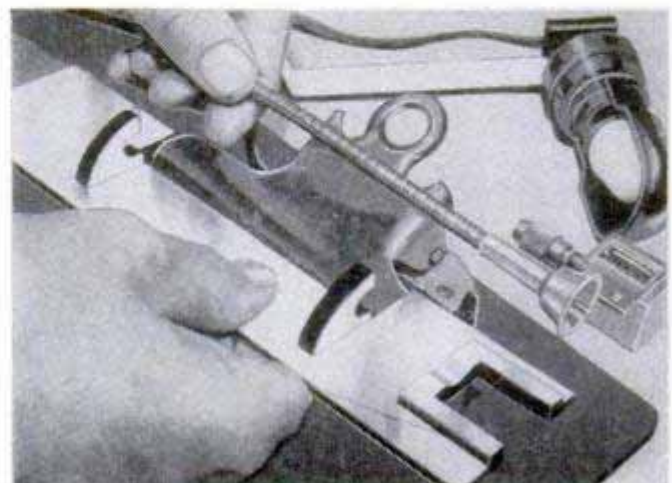
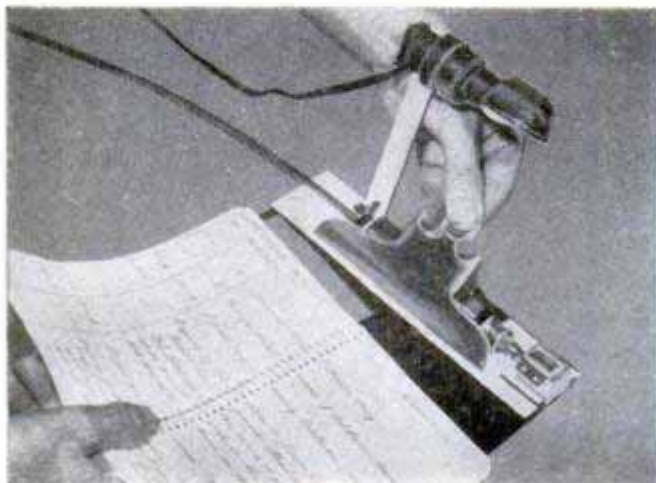







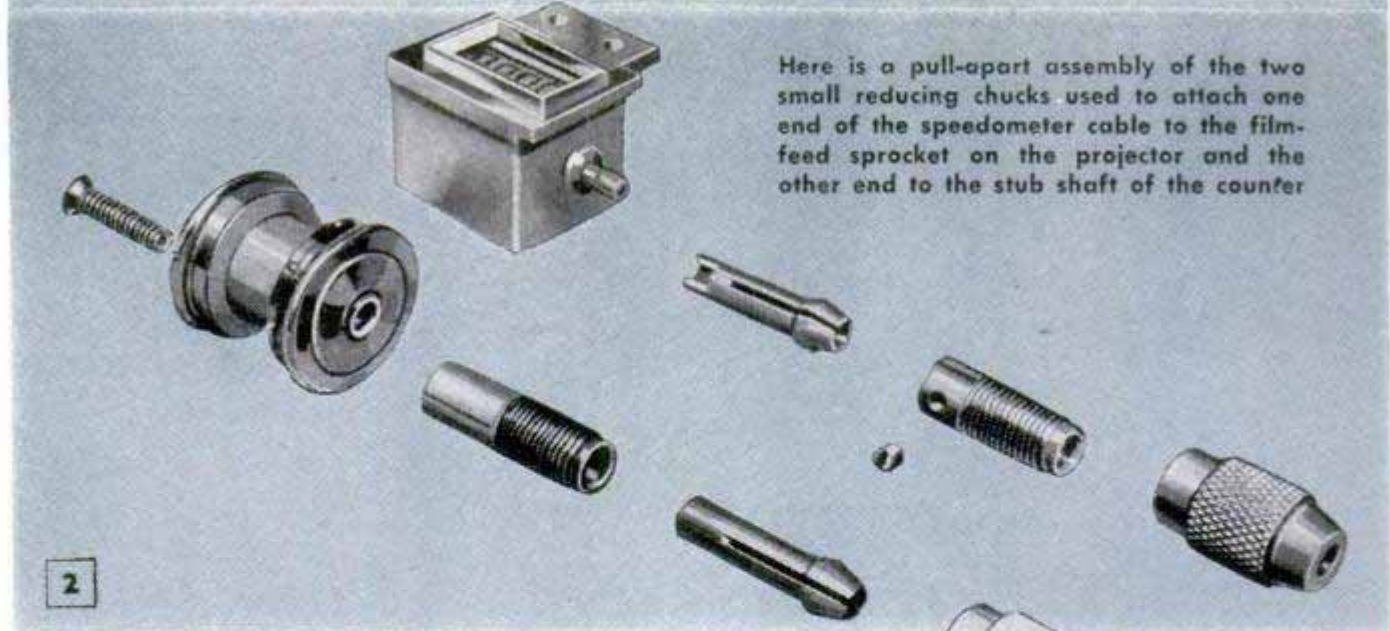

Here is a pull-apart assembly of the two small reducing chucks used to attach one end of the speedometer cable to the film-feed sprocket on the projector and the other end to the stub shaft of the counter

around the paper clamp on a regular clipboard so that when the cable is in position in the holder, the clamps will hold it securely. Photo E shows the unit in place, a small lamp, such as one used on a sewing machine, being mounted on the plastic holder. A notebook of the spiral type is placed under the clasp for listing reference data, photo A. A cardboard strip pasted onto the cover of the notebook permits clamping and still allows turning the pages.

In preparation for recording, the first thing to do is to establish a zero mark on the film leader so that when the film is at that particular point, the counter is always at zero. After this, proceed by running the projector to the point where the first musical transition or change is to be made. At this point, mark down the exact number under a column in the notebook labeled "Counter Number." This arrangement makes it a simple matter to backtrack, if you happen to "go by" the first time. When this happens, reverse the projector and

start over again as the counter automatically subtracts the correct amount when rotated in reverse, regardless of the number of times the procedure is repeated. When you have established counter numbers for all the scenes and narration, the appropriate recorded music is selected and marked down under a column labeled "Record." In cases where only music is desired, a notation to that effect is made under a column, "Notes and Narration," and when narration is to be used, the actual wording is written down in the same column, and given an extra number to designate the exact starting point for the narration. You'll find it simply a matter of converting scenes or groups of scenes to numbers and, when this has been completed, it is even a more simple matter to enter the right musical score, sound effects

**E.** Small lamp, of the type made for sewing-machine use, is ideal to illuminate dial of counter and the recording data during presentation in a darkened room

**F.** If counter does not have separate knob for resetting, it can be done quickly by merely holding reducing chuck against spring rewind belt of projector

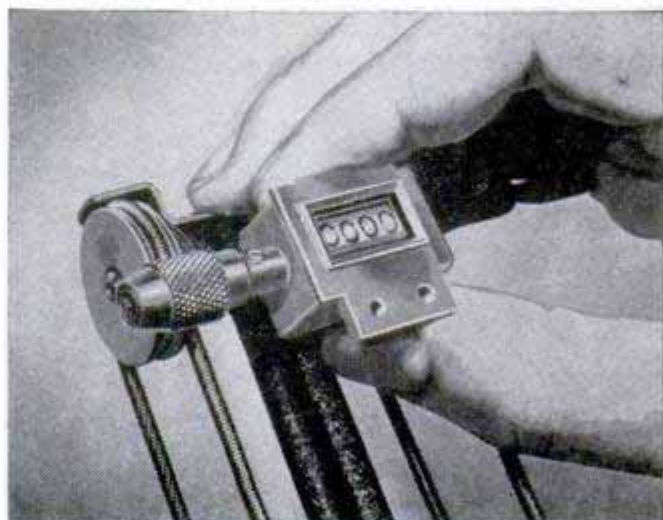
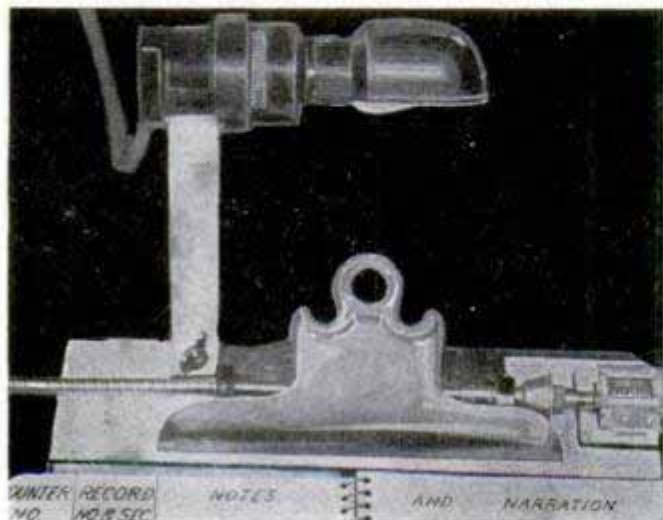



and narration in their proper places in perfect timing with the picture. Thus, the cable-counter combination provides a most efficient means of controlling both turntables and microphone by predetermining exactly when the change should be made.

Here's how it actually works: As a number denoting a change approaches on the counter, you have a chance to get ready. By starting about five digits in advance to make the actual changeover in the music, you'll find this interval just right for the picture. Two turntables and a microphone are plugged into a common mixer, as this is by far the best arrangement. Actually, two persons are better than one to make the recording, as one may take care of the music while the other is left free for the narration. Even with little practice you'll be surprised by the professional results you can attain with this inexpensive equipment. The cable, by the way, should be at least 6 ft. long to keep the microphone from picking up projector noise.

There is a wide variety of suitable counters available, some as war surplus. Some of the smaller and less-expensive ones do not have a hand knob for resetting, but this can be done by merely running the side of the small chuck against the rewind belt as shown in photo F. The counter should register each revolution as one digit.

In using recordings as background music for amateur films, seldom can a record be used in its entirety, as only parts of the record may be suitable for the particular scene. Thus, in order to place the pick-up arm on the record in the correct position for playing the desired portion, the position indicator and scale shown in photo G is most useful. It is also a good idea to number all records used for home-movie purposes. In this way, when making notes of records to be used, it is only necessary to list the number for setting the indicator.

**G.** Metal pointer attached to pick-up arm indicates position of arm at any point on recording. Cardboard scale and metal pointer are simply cemented in place

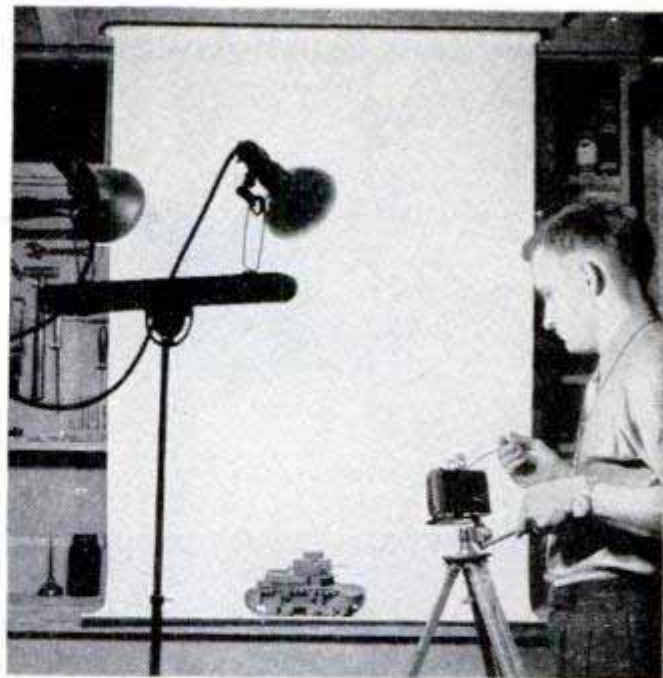
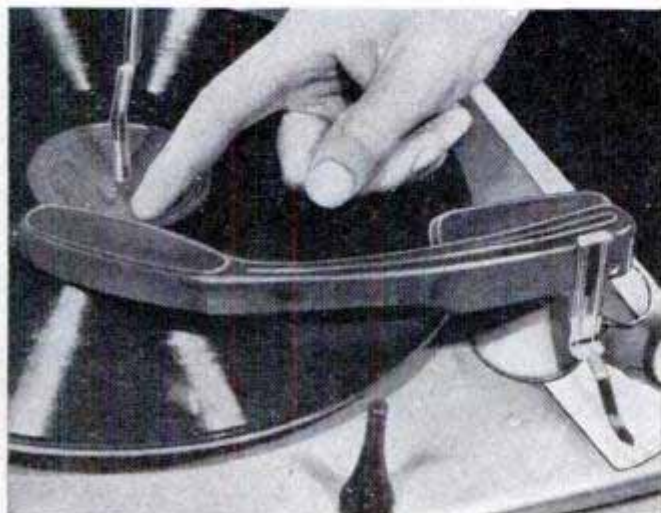

### Window Shade Provides Background For Photographing Small Subjects

One amateur photographer, who also builds models and likes to photograph his handiwork, finds a light-colored window shade an ideal background. The shade is hung on brackets screwed to a joist over the workbench where it is readily pulled down when needed. Note that enough of the shade is pulled down so that a portion of it lies flat on the workbench. The subject is placed on top of the shade, thus eliminating the distracting horizontal line usually caused by the edge of a stiff background.

Tom Griberg, Moline, Ill.

### Clothespin Holds Print Tongs On Edge of Developer Tray

Pressing a small plastic clothespin over the edge of a developer tray provides a convenient "hook" for supporting print tongs on the edge of the tray. When the tongs are slipped over the clothespin, as in the photo, they are held out of the way, and any solution is allowed to drain back into the tray.

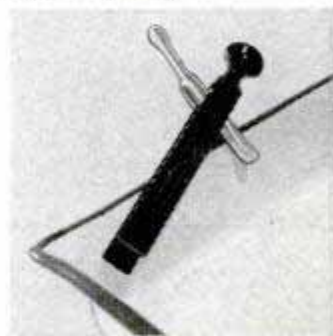

### Stopping Film-Holder Light Leaks

If light leaks have developed in your cut-film holders, the first place to look for the leaks is at the joints where the metal, light-trap strips are fitted into the wooden frames. Tiny cracks at these points usually are the cause of the leaks and, if so, are easily filled with wood putty.



## Retractable Lens Brush Always at Hand When Carried on Key Chain



Inserting the bristle end of a water-color brush in a plastic pencil-lead container forms a lightweight lens brush which can be carried conveniently on a key chain. After the handle of the brush has been cut off just above the metal ferrule, a short length of wire is fastened to the brush with a small screw driven into the wood remaining in the ferrule. Then the wire is passed through a hole drilled in the bottom of the plastic container, and the end of the wire is bent to form a loop. The brush is drawn inside the container simply by pulling on the wire loop and is pushed out when needed. The cap of the container keeps the bristles free from dust.—John J. Rea, Urbana, Ill.



## Hair Drier Is Useful in Photo Lab

A home-type hair drier can be put to good use in several ways in a photo lab. Blowing either hot or cold air, it can be used to ventilate darkrooms or to quicken the drying of prints and film or mucilage used in mounting. The drier also can be used to raise the temperature of developing solution by directing hot air over it, or to retard cooling by using warm air.

## Emergency Substitute for Ground-Glass Viewer of Camera

In an emergency, a substitute for a ground glass can be made from ordinary glass by covering it with strips of cellulose tape. However, before applying the tape, draw your finger over the gummed surface to roughen it. This will cause the necessary deflection of light.

Eugene Lee Burner, Morgantown, W. Va.

☞ Satisfactory close-up lenses can be made by cutting the bottoms out of sink stoppers and inserting ordinary eyeglass lenses in the remaining rings.

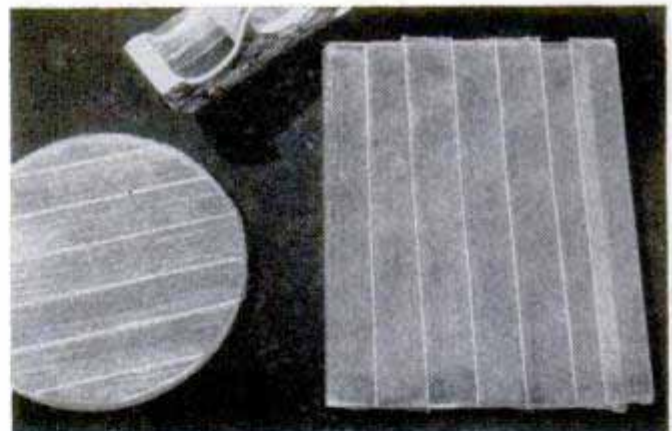

## Popular Mechanics Plans for Projects in Hardboard

Are you, like many other home craftsmen, experiencing difficulty in obtaining suitable wood for your shop projects? Why not try hardboard as a substitute for wood in some of them? Often called the "wonder wood of 1000 uses," this board has great structural strength, is hard enough to resist denting and scratching, and can be sawed, nailed or glued. Unlike indoor plywood, it has no grain, is resistant to moisture and can be stained, waxed, varnished or painted.

Believing that many craftsmen and manual-training teachers would be interested in hardboard for their projects, *Popular Mechanics* has prepared large plans on 36 proj-

ects that can be made of this material. The plans include such projects as a dog bed, bird feeder, lawn ornaments, magazine racks, waste baskets, photo frames, clothes hamper, birdhouses, bric-a-brac cabinets, a child's rocker, etc. There are also plans for larger projects, such as dollhouses, window valances, tool chests, toy chest and a modern desk. All plans are 17 x 22 in. in size and are completely detailed. A postal card with your name and address will bring you an illustrative pamphlet that pictures and describes each project. Plans are 25 cents each and are available from Popular Mechanics Book Dept., 200 E. Ontario St., Chicago 11.



Rep. Shop Notes' 53 p. 9

## PROTECT YOUR LATHE

Good work habits help to retain precision of metal-turning lathes. Here are pointers on care, cleaning and protecting the machine

By E. R. Haan

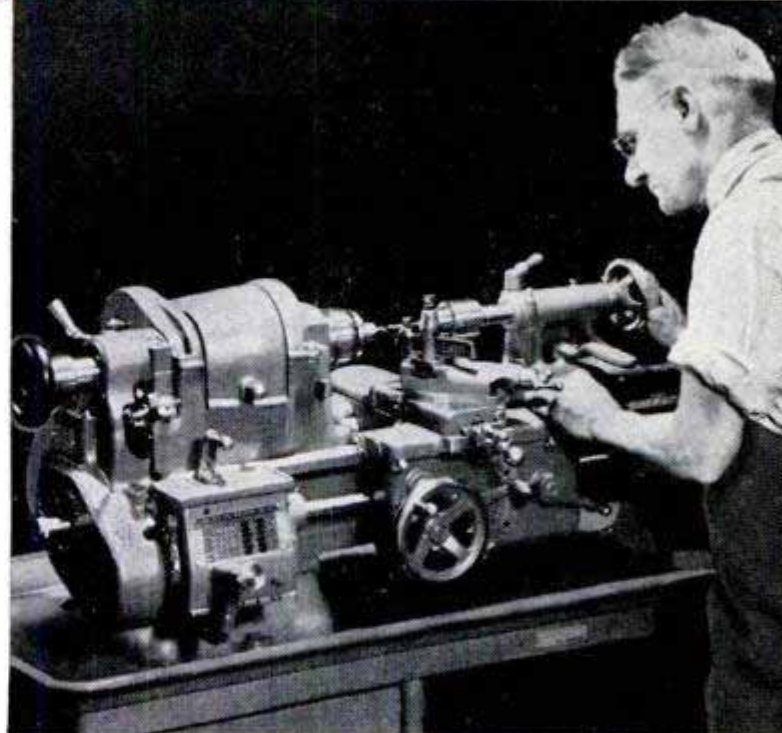

All photos courtesy South Bend Lathe Works

**EXPERIENCED MACHINISTS** say that neglect and abuse are the main causes of premature "old age" in metal-turning lathes. This is especially true of lathes in small job shops and also in the home workshop, as the machines are put to widely diversified use. Unless properly cared for, the lathes may be exposed to conditions which can cause rust and accumulations of abrasive materials that accelerate wear and affect accuracy. With periodic good care any lathe will retain its precision almost indefinitely.

**Avoid damage to the bed ways:** On high-quality lathes the V-ways and flat ways of the bed are precision-ground and hand-scraped within extremely close tolerances. Preserving the accuracy of the bed is of the first importance and this can be done in any shop, without loss of time, by careful

observance of routine procedures. For example, always place a block of wood across the bed ways, Fig. 1, before attaching or detaching chucks, faceplates or other heavy accessories. Never lay tools, especially files, across the ways. Instead, use a wooden tool tray as in Fig. 2. Cleats across the bottom of the tray should have felt-faced notches cut to fit over the V-ways. When filing in the lathe, never tap the file against any part of the machine to clear it. Clean the file with a file card as in Fig. 3. Avoid using any part of the lathe as an anvil to straighten bent work. Pounding on the lathe bed can destroy entirely the fine accuracy of the machine.

**Control grinding dust:** The hard abrasive particles thrown off by a grinding wheel will cause considerable damage to the ways and other moving parts of the lathe unless

1 PROTECT BED WAYS WITH A WOODEN BLOCK

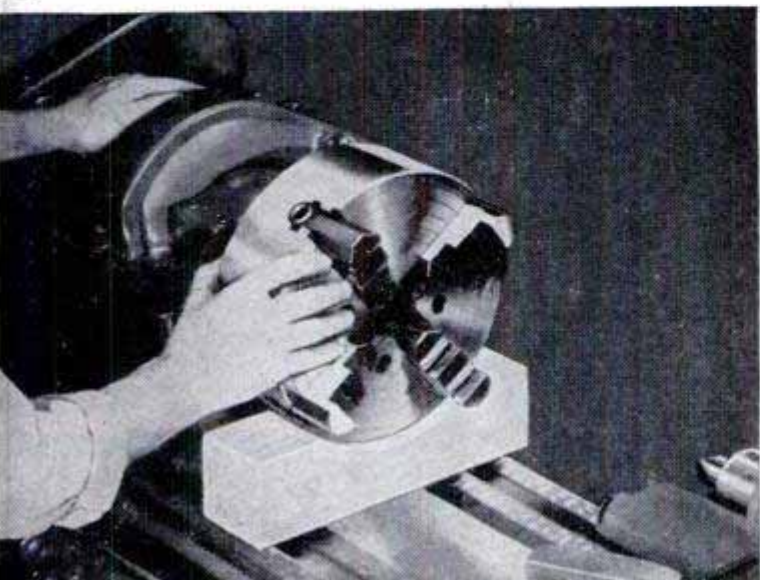

2 KEEP SMALL TOOLS IN A WOODEN TRAY

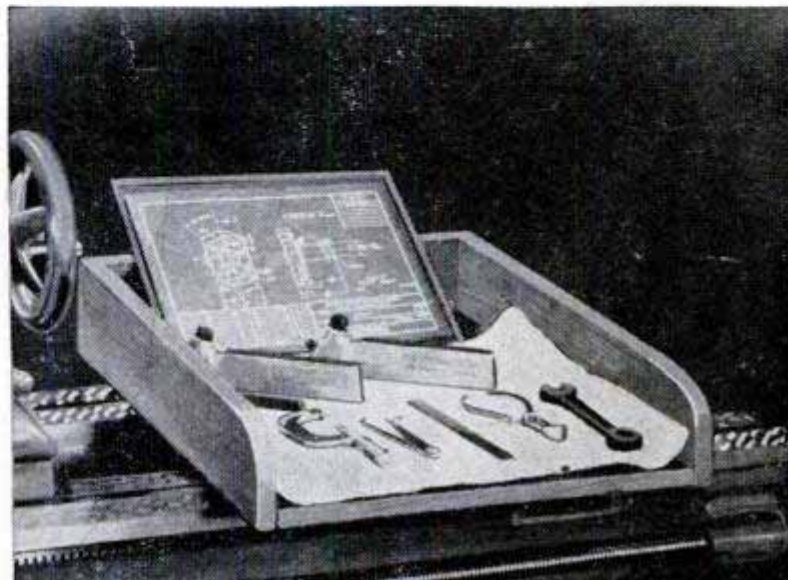



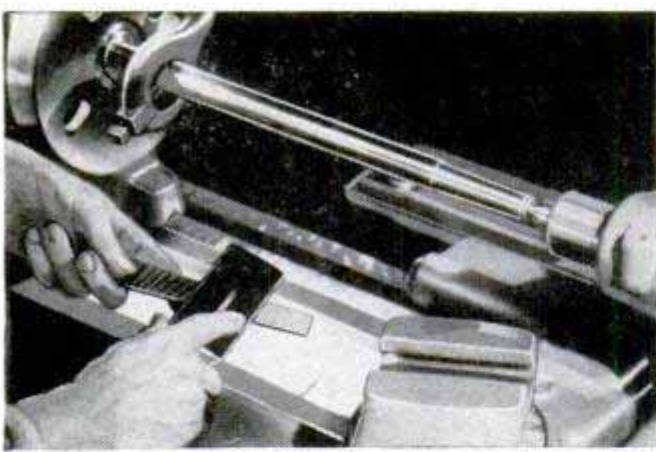

3 CLEAN FILES WITH A REGULAR FILE CARD

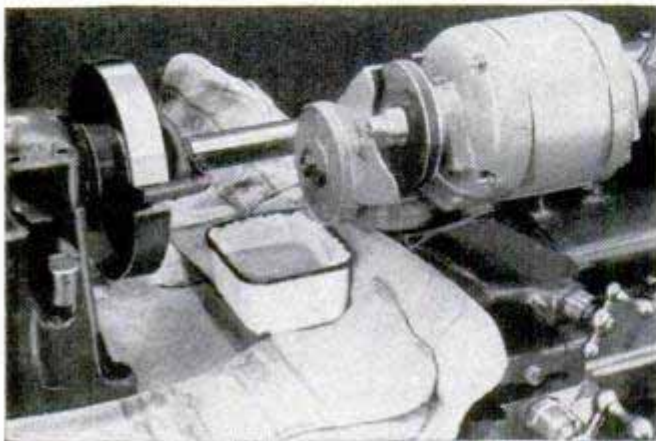

4 USE A DUST COLLECTOR WHEN GRINDING



5 PROTECT LATHE WITH A DUST COVER

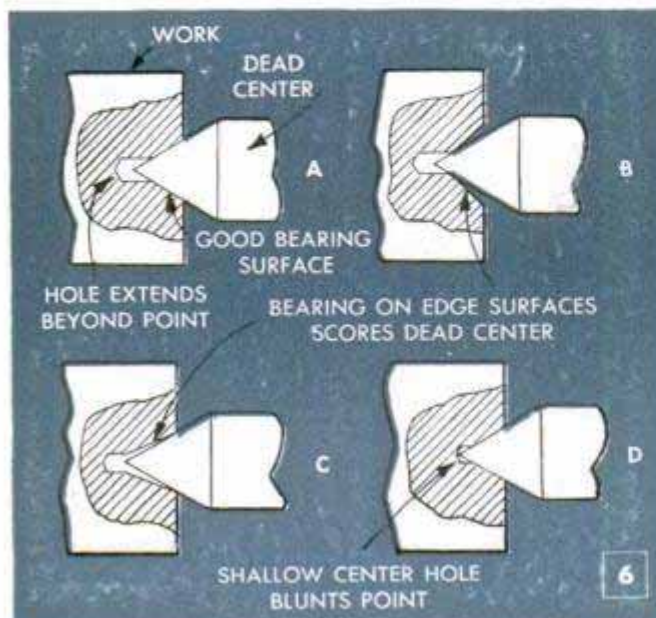

precautions are taken when you are using a tool-post grinder. Cover the ways and the carriage with paper or canvas as in Fig. 4. Place a shallow pan partly filled with water or oil just below the grinding point to catch and retain dust. After grinding, remove the protective covers carefully and vacuum-clean the surfaces, then wipe them thoroughly. A dust collector for use when grinding rubber, fiber and plastics can be made from a vacuum cleaner. When a lathe is not in use, keep it covered as in Fig. 5.

**Guard the centers:** Drill the center holes in the work with a center drill having the same angle as the lathe centers, Fig. 6A, to assure good bearing surface. If only one edge of the countersink rides on the lathe center, Fig. 6, B and C, the center may be scored. Also, the center hole in the work must be deep enough to prevent the point of the lathe center from touching the work, Fig. 6D. As the work expands along its length due to heat generated by the cutting tool, it usually is necessary to adjust the dead center during a prolonged turning operation to prevent damage to the center from excessive heating. Striking the centers with the work while mounting or removing it may also damage the points. When removing the live center from the spindle with a knockout bar, always hold the center to prevent it from dropping on the lathe bed or onto the floor. Avoid scratching or marring centers and taper sleeves by storing them separately from other tools. Centers having the points or tapers damaged will not seat accurately.

**Use the right wrench:** To tighten nuts and cap screws on the machine, use the wrench provided for the purpose by the manufacturer, such as the tailstock wrench, Fig. 7. Don't tap a wrench with a hammer. If necessary, strike it lightly with the palm of the hand. Avoid using pipe wrenches or pliers and make it a habit to remove the chuck wrench from the chuck when not in use. Belt tension on the headstock pulleys should be just sufficient to prevent slippage. Too much tension puts an excessive strain on the bearings and may cause heating and excessive wear.

**Keep lathe clean:** Remove accumulations of steel chips and shavings with tongs, hook or magnet. Then use a bench brush for cleaning. A small brush is handy for cleaning spindle threads, Fig. 8. This always should be done before mounting a chuck or faceplate. To clean internal threads, use a wire scraper as in Fig. 11. Clean the lead screw with a cord of suitable size, holding it taut in the thread while the screw is turning, Fig. 9. Clean the inside of the spindle with a bottle brush.

After brushing, wipe off parts with a rag. Neither brushing nor wiping should



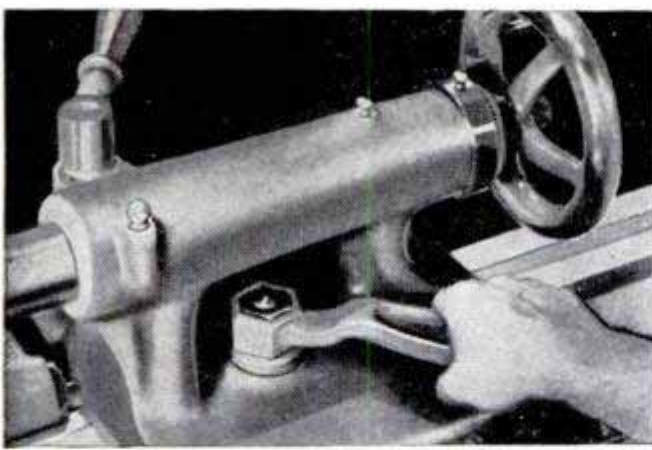

**7** ALWAYS USE THE CORRECT WRENCH

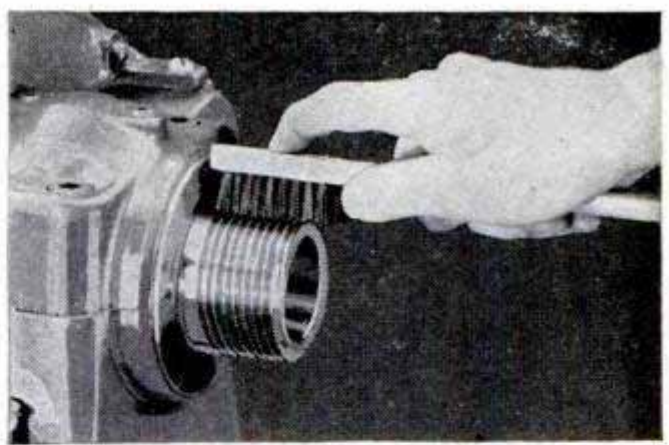

**8** CLEAN SPINDLE THREADS WITH BRUSH

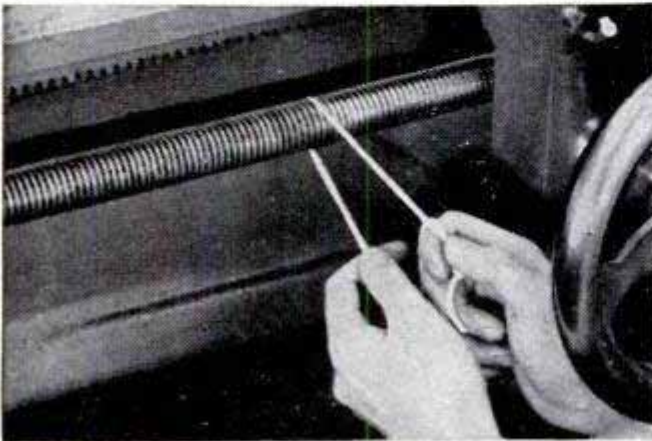

**9** CLEAN LEAD SCREW WITH A CORD

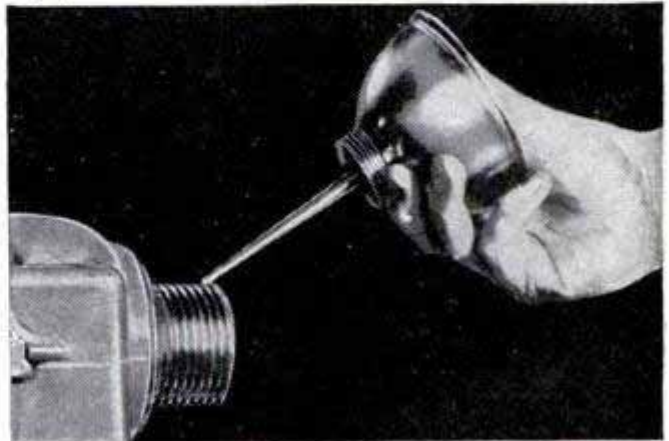

**10** OIL THE SPINDLE THREADS FREQUENTLY

be done while the lathe is running. Don't use compressed air for cleaning a lathe as metal chips and stray grains of abrasive may be blown into oilholes or forced into bearings. To remove heavy oil, use a cloth dampened with kerosene. Before mounting collets, centers, sleeves and drill chucks, wipe tapers clean, as dirt or a chip on the tapers may cause an error of several thousandths of an inch. Chips between gibs and dovetail bearing surfaces may make sliding members difficult to move. Chips between the base and swivel of a compound rest may cause chattering. The felt wipers at the ends of the carriage, or saddle, should be removed occasionally, cleaned with kerosene and reoiled. Belts should be kept clean and free from oil.

**Regular, thorough oiling:** Oiling specifications vary on lathes of different makes according to bearing tolerances and speeds used. Therefore the manufacturer's instructions on oiling should be followed. Most oilholes and cups require filling daily and more frequently if the lathe is in continuous use. The daily oiling schedule does not apply to motors which usually are fitted with wool-packed bearings that do not require frequent oiling. Oiling always should be done before starting the lathe. To avoid overlooking some bearings, it is best to lubricate the machine in a definite order. In some shops, oilholes and lubricators are

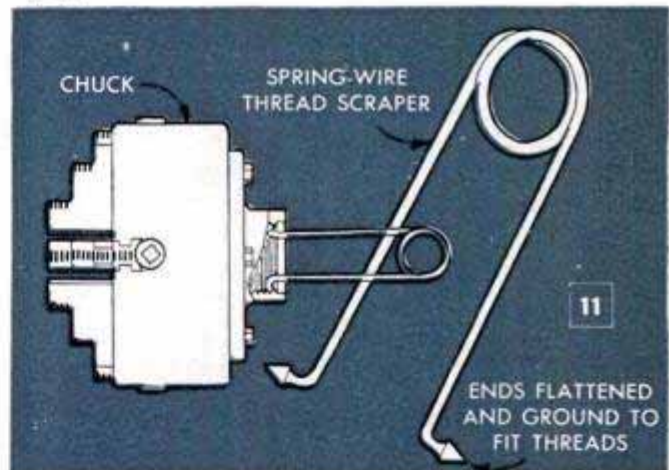

outlined with brightly colored paint so that they are more easily located. Wipe off surplus oil that runs outside of oilholes and also close all oilhole plugs and cup covers after oiling to prevent entrance of dirt and chips. Always keep an oil film on the ways even when the lathe is not in use. Before attaching faceplates and chucks, oil the threads of the spindle, Fig. 10, after cleaning them. However, don't oil the taper shank of the centers, spindle-adapter sleeves and drill-chuck shanks, as a film of oil prevents them from seating properly. When the tailstock center is in use, lubricate the point with a thick cream made by mixing dry red lead and machine oil. Keep the mixture at hand near the tailstock and apply it as required.



## Handling Rat Poison Safely

Ridding farms and estates of mice and rats has been made simple and safe by use of baits containing warfarin, a newly developed poison that is deadly to rodents but comparatively harmless to other animals and humans unless consumed in large quantities. Fruit-jar lids make ideal containers for baits that are placed about the home. As mice will not wander far from familiar territory, the bait need be placed only in rooms to which it is known they have access. An old box or crate, placed over a tray filled with bait, can be used as a bait station for rats. Portions of the sides should be removed to allow easy entrance. One station placed in the average-sized outbuilding is usually sufficient, although two or three sometimes can be used effectively in large barns. If stations are placed in the open, they should be covered with a piece of roofing paper or sheet metal to protect the bait from rain. As neither rats nor mice will eat moldy or dirty bait, it should be checked at frequent intervals and the supply replenished when necessary.

Tom McHugh, Moran, Wyo.

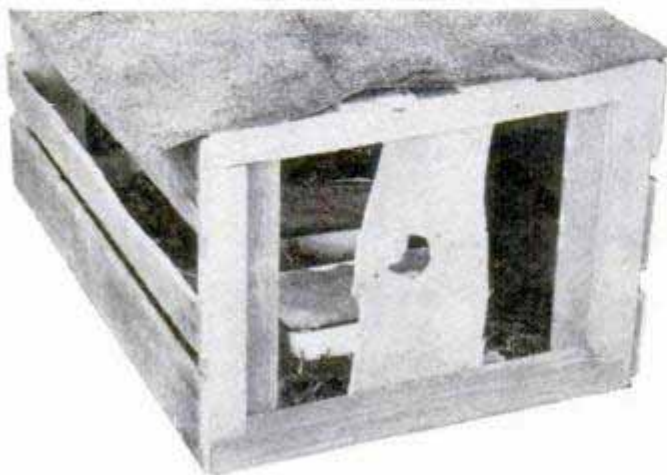
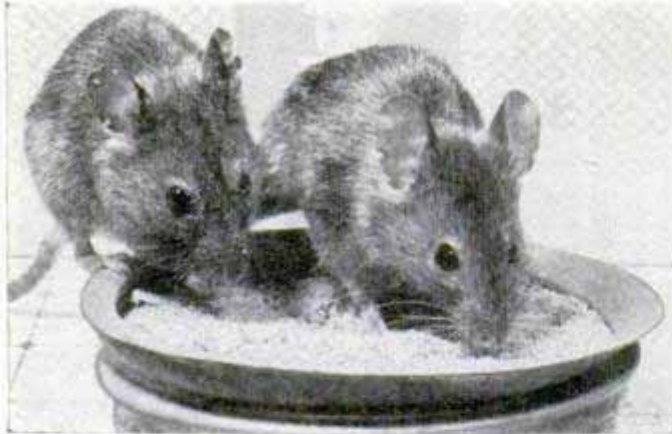

## Large Lathe Dog Made Adjustable for Use With Various-Size Faceplates

It is a simple matter to make a large lathe dog adjustable for use on work where the length of the dog is too great to permit engaging it in the slot of the faceplate at hand. To make such a dog adjustable, drill and tap three or four equally spaced holes in the shank of the dog. Then provide a stud which can be screwed into any one of the holes. The tang of the dog can be re-

moved if desired as the stud, when located in the proper hole, will serve in place of the tang to engage the faceplate. — Frank Butrick, Alma, Mich.

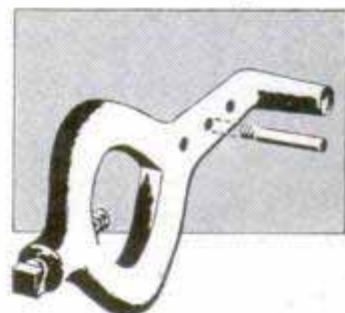

## Magnet Holds Jointer Blades When Resetting in Head

The job of installing jointer blades can be made easy by using a strong magnet such as one from a magneto. This is laid on the rear table to extend over the opening, where it will suspend each blade for tightening in exactly the same position.

Ed Packer, Chicago.

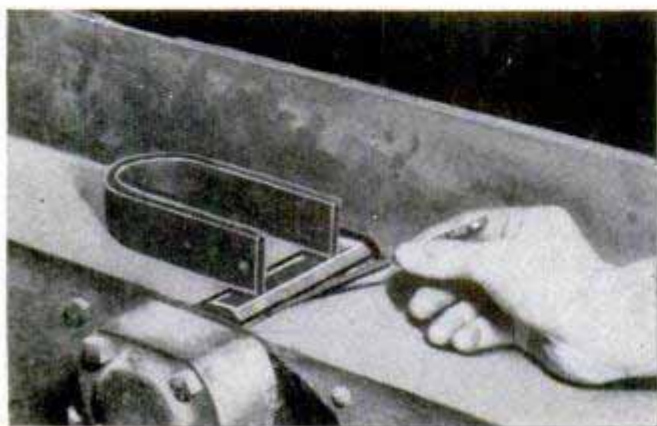

## Wire Along Front of Nest Prevents Roosting

One of the simplest methods and one of the easiest to install to prevent hens from roosting on the edges of nests is to staple wire in front of them as indicated. The wire should be stretched fairly taut. When installed in this way, the wire does not prevent hens from entering the nests. It does, however, make it impossible for them to sit on the front edges.

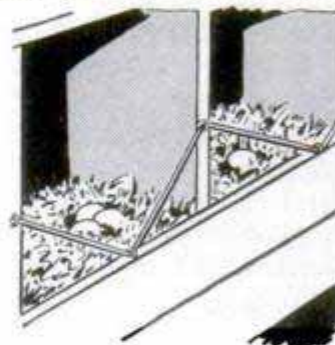

☐ To determine which plates in a car battery are short circuited, look into each cell while the starter is being pressed. The water in the cell where the short is located will boil rapidly.



# DISK SANDER

from lathe  
headstock

SN 56  
LLB 81  
60 Power Tools

By Harry L. Truchelut

FOR SQUARING small pieces of wood, rounding corners and sanding end grain, you can't beat a large disk sander. The driving head of the sander pictured was adapted from an old wood-lathe headstock, but a grinding head or a small ball-bearing saw arbor can be utilized for the same purpose. In any case, the driving head must be fitted with a faceplate to which the sanding disk can be attached and detached readily when it is necessary to change the abrasive disks. In some instances, a ready-made disk with either a plain or threaded hub to fit the spindle can be utilized. Complete dimensions in the lower detail at the right are not given, as it is necessary to improvise a suitable table mounting, and this will depend on the diameter of the disk and on the type of driving head used. For all-around use, the disk should be 10 or 12 in. in diameter and the table should be fitted with trunnions which permit it to be tilted. The table should be made of plywood, or solid hardwood, and grooved so that a miter gauge can be used to sand the end grain on stock cut to compound angles. Provide a dust chute and bag, as shown, and attach the table trunnions to the machine base, or bench, so the table can be removed when changing the abrasive disks.

Calibrated scale glued to edge of slotted quadrant permits accurate setting of table from 0 to 45 deg. Plywood table is hinged to beveled edge of support with a length of piano hinge to provide a rigid mount

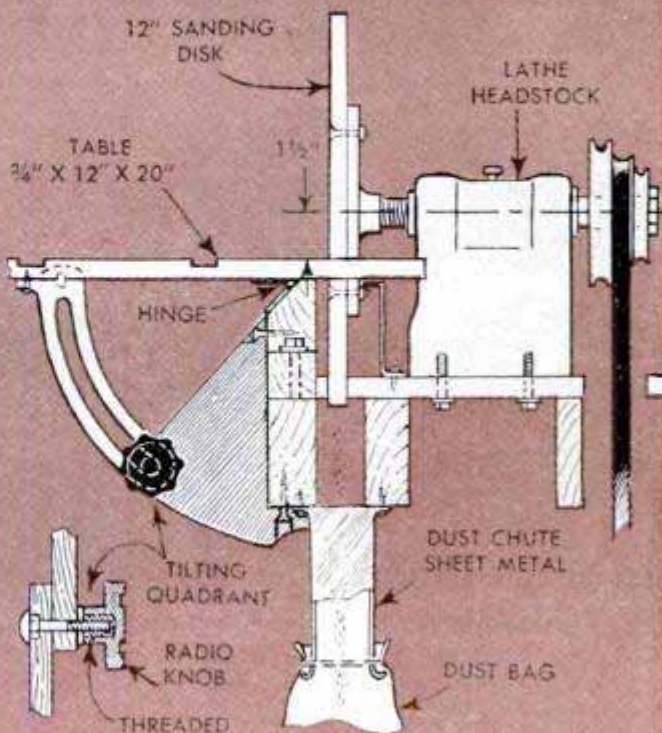
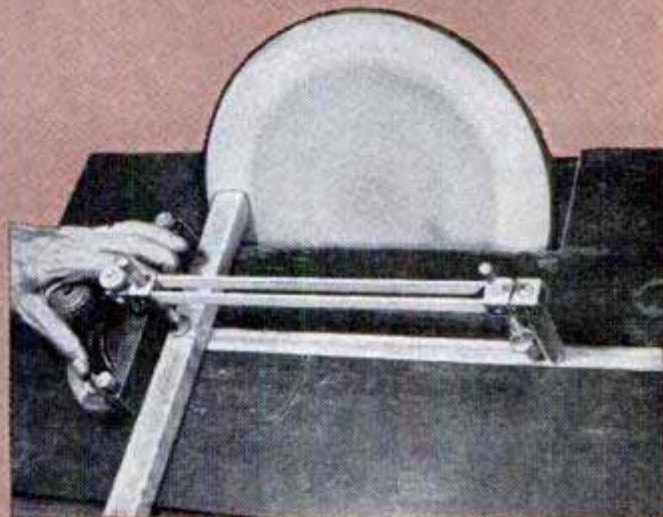
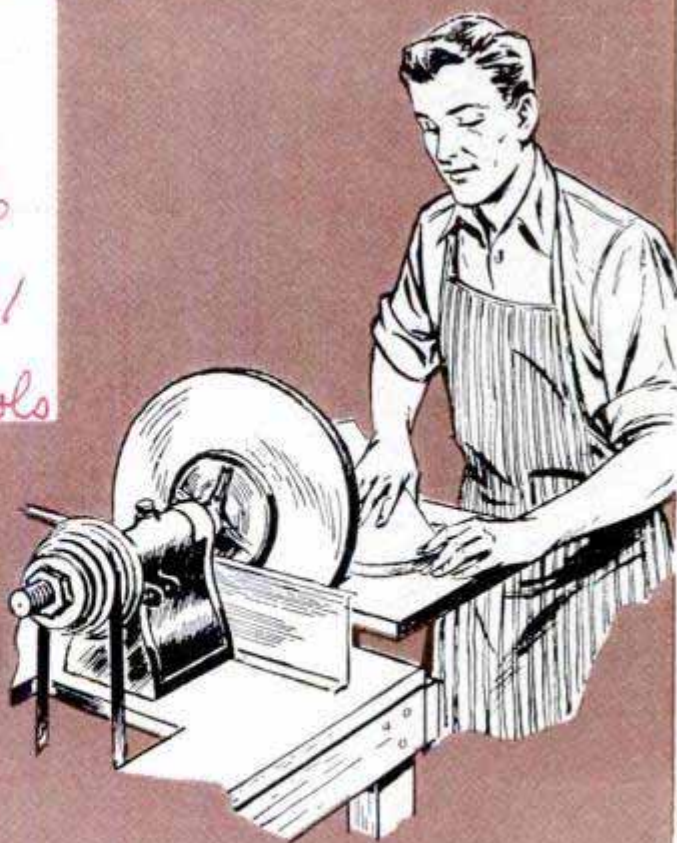
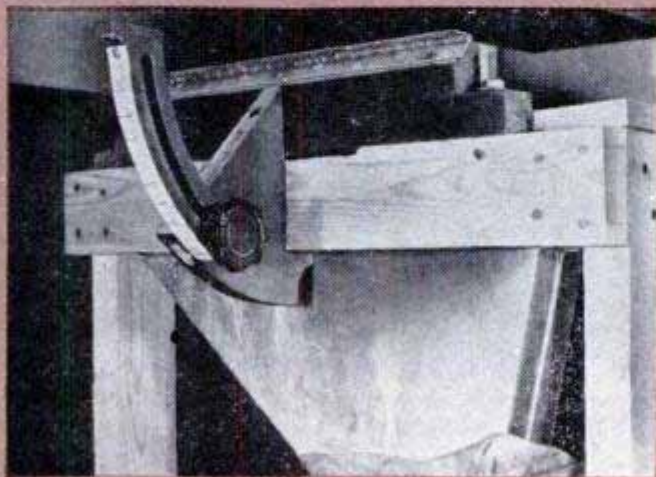



# How to Use END MILLS

By Sam Brown

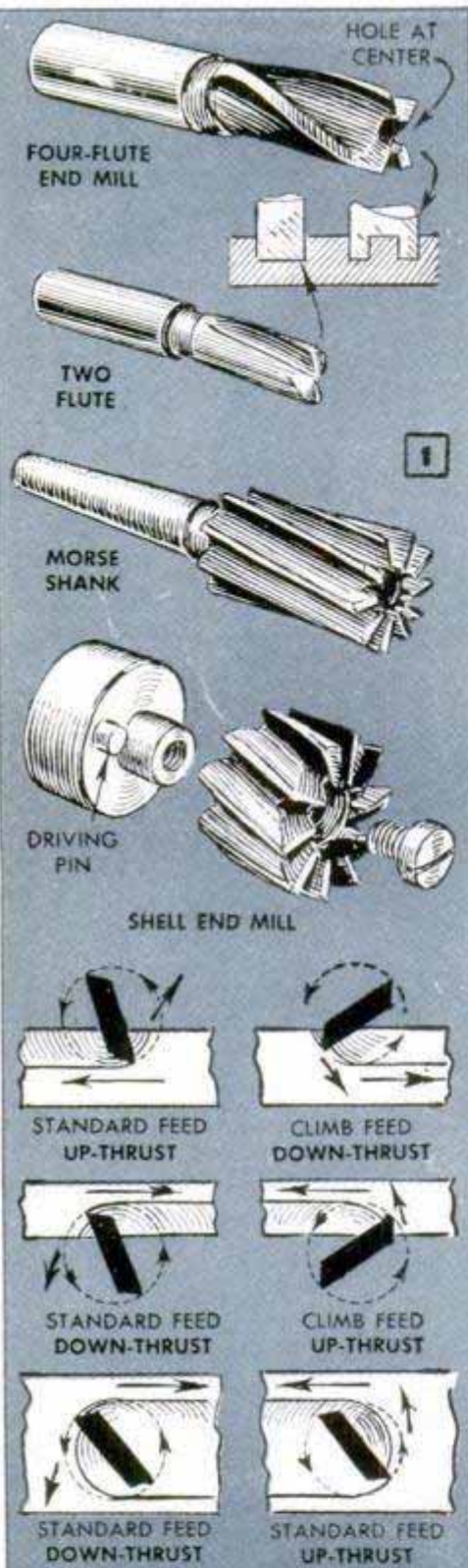

**E**ND MILLS are simply metal-cutting router bits and they are supplied in a variety of sizes and types suitable for a wide range of work in metals of varying degrees of hardness. Milling cutters must be driven at comparatively slow spindle speeds and the relationship of cutting speeds to work feeds is much more critical than that of any woodworking tool. End mills are available with both straight and tapered shanks which adapt them to use in a lathe, drill press or milling machine. Both the end lips and the longitudinal flutes have sharpened cutting edges, which means that an end mill of the type having two flutes and a solid center will cut straight in, like a twist drill, and also will cut sidewise in either direction, depending on the direction of feed and whether the flutes are designed for right or left-hand cuts. End mills of various types are supplied for right or left-hand rotation and also are furnished with straight and spiral flutes.

**Cutter types:** Cutters in the common sizes range from  $\frac{1}{16}$  to 3 in. in diameter in solid end mills, and from  $1\frac{1}{4}$  to 6 in. in diameter in shell end mills. The shell end mill, Fig. 1, fits over a driving sleeve which turns onto the threaded end of the milling-machine spindle. Of all milling cutters it is the most rigid. In solid end mills, the four-flute style with straight shank, Fig. 1, is the most widely used. The two-flute slotting end mill will enter the work and then complete the cut in a transverse direction, but other types having a hole at the center to facilitate sharpening must move into the work from the side. Nominal small-shop equipment should include several small slotting end mills, a set of four-flute end mills ranging in size from  $\frac{1}{8}$  to  $\frac{1}{2}$  in., and one or two shell end mills about 2 in. in diameter.

**Feed direction:** As is the case with all toothed tools, the work should move against the rotation of the cutter, as shown in Fig. 1. In the opposite technique of climb feed, the work moves in the same direction as

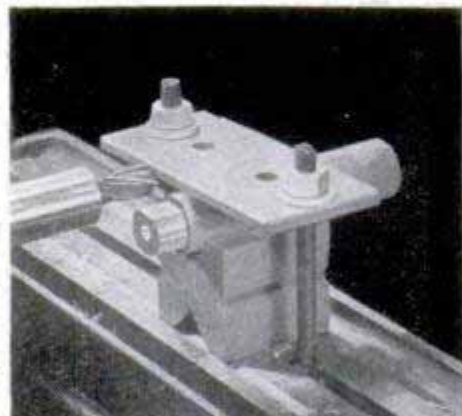
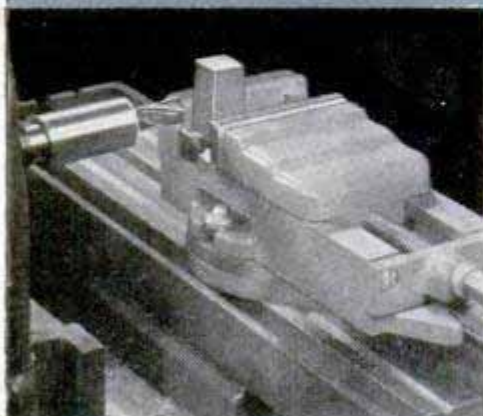

**2** **HOLDING BAR STOCK FOR END CUTTING** is done with milling vise, left. Job is flattening carriage-bolt head to make T-bolt. Mounting work on index table, center, is solid, good for angle cuts. V-block, right, should have aligning bar fitted to the underside to permit quick and accurate placement on machine table



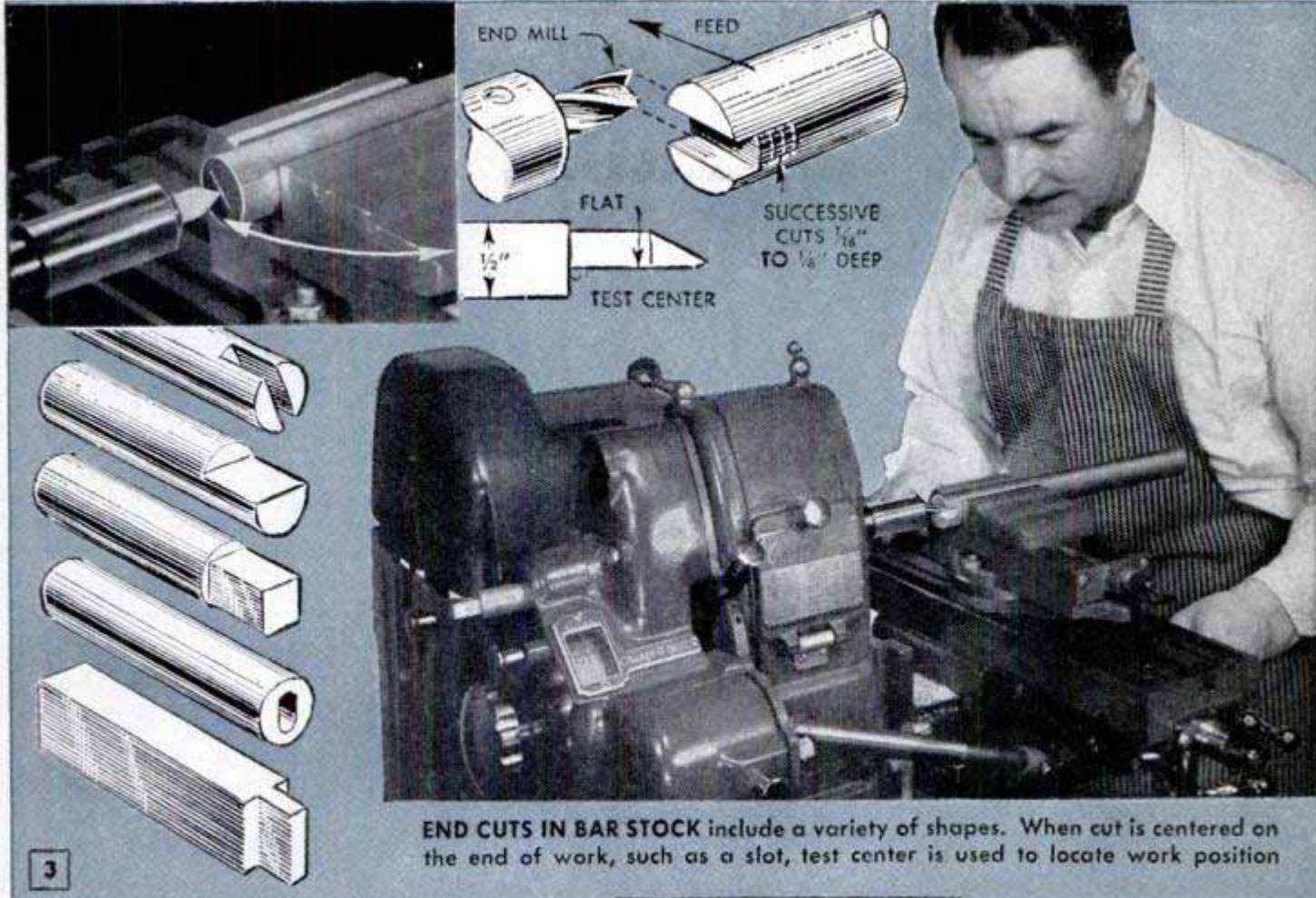

**END CUTS IN BAR STOCK** include a variety of shapes. When cut is centered on the end of work, such as a slot, test center is used to locate work position

3

cutter rotation. With small cutters under  $\frac{1}{2}$  in. in diameter, climb feed can be used to advantage for certain types of work, but only with the power feed and never with hand feed. The disadvantage of climb feed is that since cutter thrust and feed are in the same direction, the feed is often at an irregular rate because of play in the feed screw. As a rule, it's best to use only standard feed. A secondary consideration is concerned with the thrust of the cutter. The lower details in Fig. 1 show the various possibilities. When practical, the cutter thrust should be down since this presses the work against the milling-machine table or other holding device. Nearly all types of work can be set up to satisfy both conditions, that is, standard feed against rotation which provides a down thrust. The matter of thrust is not too important when the work is solidly mounted, but it should be kept in mind as a possible cause of chatter and rough work.

**Methods of working:** Certain common devices are used for mounting the work, most popular and practical being the milling vise, Figs. 2 and 10. Additional

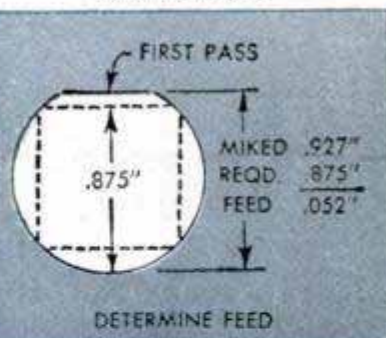
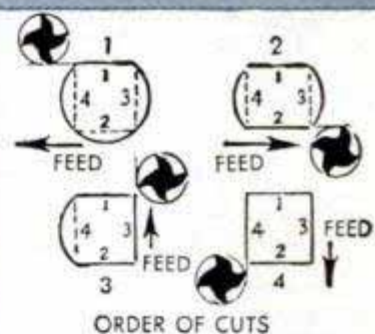
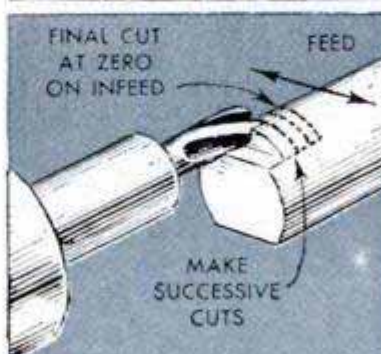
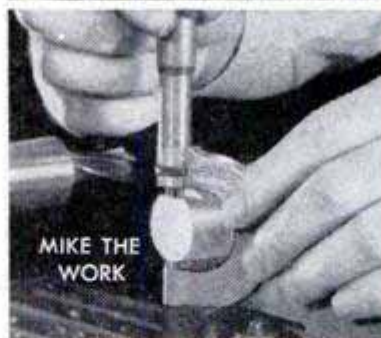
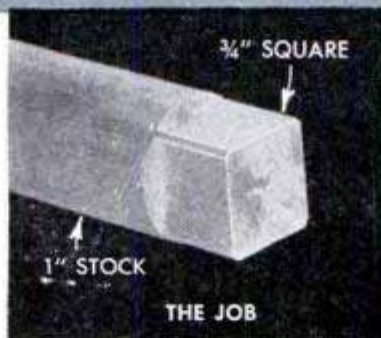

4

**SQUARING A SHAFT** is done with small end mill as in photos and details above. Note successive cuts



## SPEEDS for MILLING (All Cutters)

MATERIAL	LOW-HIGH F.P.M.	DIAMETER OF CUTTER												
		1/8"	1/4"	3/8"	1/2"	3/4"	1"	1 1/4"	1 1/2"	1 3/4"	2"	2 1/4"	2 1/2"	3"
ALUMINUM MAGNESIUM CAST PLASTICS	200	6000	3000	2000	1500	1000	764	612	510	436	382	340	306	254
	800	24000	12000	8000	6000	4000	3000	2400	2000	1700	1500	1300	1200	1000
BRASS and BRONZE—SOFT	150	4500	2300	1500	1150	764	573	458	382	327	287	255	229	191
	300	9000	4600	3000	2300	1528	1146	916	764	654	574	510	458	382
BRASS and BRONZE—MED.	120	3600	1800	1200	917	611	458	367	306	262	229	204	183	153
	180	5500	2800	1800	1400	916	688	550	458	392	344	306	276	230
SOFT STEEL SOFT CAST IRON	80	2400	1200	815	611	407	306	244	204	175	153	136	122	102
	120	3600	1800	1200	917	611	458	367	306	262	229	204	183	153
MACHINE STEEL LOW CARBON STEEL CAST IRON—MED.	70	2100	1070	713	535	357	267	214	178	153	134	119	107	89
	100	3000	1500	1019	764	509	382	306	255	218	191	170	153	127
MALLEABLE IRON MED. CARBON STEEL THERMOPLASTICS	50	1500	764	509	382	255	191	153	127	109	96	85	76	64
	80	2400	1200	815	611	407	306	244	204	175	153	136	122	102
MED. ALLOY STEEL HARD CAST IRON	40	1222	612	408	306	204	152	122	102	88	76	68	62	52
	65	2000	993	662	497	331	248	199	166	142	124	110	99	83
TOUGH ALLOY STEEL CAST STEEL	30	917	458	306	229	153	115	92	76	66	57	51	46	38
	50	1500	764	509	382	255	191	153	127	109	96	85	76	64
ALLOY TOOL STEEL	20	611	306	204	153	102	76	61	51	44	38	34	31	26
	40	1222	612	408	306	204	152	122	102	88	76	68	62	52

FOR HIGH-SPEED STEEL CUTTERS. USE ANY SPEED BETWEEN LOW-HIGH LIMITS SHOWN IN BODY OF TABLE. IF SPEED GIVEN EXCEEDS RANGE OF MACHINE, USE HIGHEST PRACTICAL SPEED AVAILABLE

### Recommended FEED PER TOOTH

MATERIAL	1/8" and 1/4" END MILLS	3/8" and OVER END & SHELL
SOFT METALS PLASTICS	.002 to .006	.002 to .008
SOFT CAST IRON	.002 to .004	.002 to .006
MALLEABLE IRON MED. CAST IRON	.002 to .003	.002 to .005
SOFT STEEL HARD CAST IRON	.001 to .002	.001 to .004
LOW CARBON STEEL MACHINE STEEL	.001 to .002	.001 to .003
HARD STEEL	.0004 to .001	.0004 to .001

### FEED PER TOOTH to FEED PER REV.

FEED PER TOOTH	NUMBER OF TEETH IN CUTTER							
	2	3	4	6	8	10	12	14
.0002	.0004	.0006	.0008	.0012	.0016	.002	.0024	.0028
.0004	.0008	.0012	.0016	.0024	.003	.004	.0048	.0056
.0007	.0014	.0021	.0028	.0042	.0056	.007	.0084	.011
.001	.002	.003	.004	.006	.008	.010	.012	.014
.0015	.003	.0045	.006	.009	.012	.015	.018	.021
.002	.004	.006	.008	.012	.016	.020	.024	.028
.003	.006	.009	.012	.018	.024	.030	.036	.042
.004	.008	.012	.016	.024	.032	.040	.048	.056
.005	.010	.015	.020	.030	.040	.050	.060	.070
.006	.012	.018	.024	.036	.048	.060	.072	.084

### FEED PER REVOLUTION to FEED IN INCHES PER MINUTE

FEED PER REV	REVOLUTIONS PER MINUTE OF CUTTER																
	50	75	100	125	150	175	200	250	300	350	400	450	500	600	700	800	900
.001	.05	.07	10	12	15	17	20	25	30	35	40	45	.50	.60	.70	.80	.90
.002	10	15	20	25	30	35	40	50	60	70	80	90	1.00	1.20	1.40	1.60	1.80
.003	15	22	30	37	45	52	60	75	90	1.05	1.20	1.35	1.50	1.80	2.10	2.40	2.70
.004	20	30	40	50	60	70	80	1.00	1.20	1.40	1.60	1.80	2.00	2.40	2.80	3.20	3.60
.006	30	45	60	75	90	1.05	1.20	1.50	1.80	2.10	2.40	2.70	3.00	3.60	4.20	4.80	5.40
.009	45	62	90	1.12	1.35	1.57	1.80	2.25	2.70	3.15	3.60	4.05	4.50	5.40	6.30	7.20	8.10
.012	.60	.90	1.20	1.50	1.80	2.10	2.40	3.00	3.60	4.20	4.80	5.40	6.00	7.20	8.40	9.60	10.80
.015	.75	1.12	1.50	1.87	2.25	2.62	3.00	3.75	4.50	5.25	6.00	6.75	7.50	9.00	10.50	12.00	13.50
.018	.90	1.35	1.80	2.25	2.70	3.15	3.60	4.50	5.40	6.30	7.20	8.10	9.00	10.80	12.60	14.40	16.20
.021	1.05	1.57	2.10	2.62	3.15	3.67	4.20	5.25	6.30	7.35	8.40	9.45	10.50	12.60	14.70	16.80	18.80
.025	1.25	1.87	2.50	3.12	3.75	4.37	5.00	6.25	7.50	8.75	10.00	11.25	12.50	15.00	17.50	20.00	22.50

WHITE AREAS SHOW PRACTICAL WORKING RANGE FOR BENCH MILLERS. ALWAYS START WITH A SLOW FEED (.003" TO .006" PER REV.) AND THEN INCREASE IF SATISFACTORY



mounting methods are illustrated by the various photographs. Where a choice of mountings is possible, the mounting which supports the work closest to the table is generally the most rigid.

On jobs requiring centering of the cutter with the work, such as the slotting job shown in the upper detail in Fig. 3, a test center is useful. If this is chucked and the work centered to it as shown, the cutter which takes its place will also be centered. The six steps pictured and detailed in Fig. 4 are typical setup procedure, the job being to square a shaft. The work is mounted in the vise and the four sides are worked in order as detailed at the upper right in Fig. 4 without changing the vise mounting. Cutting is started with a roughing cut on No. 1 side, after which the work is miked as shown. The simple calculation shows the amount of feed needed—.052 in. The vertical feed is zeroed and the table is then raised .052 in. to set the work for the finish cut as shown in the lower photo. On certain types of work, the technique of making the end of the end mill do most of the cutting, as shown in the detail, is preferable to making a wide, shallow cut employing the flutes.

**Speeds and feeds:** Suitable speeds for milling are given in the table of speeds and feeds, the general values being about the same as for lathe work. In many instances, when using small end mills, Figs. 5, 6 and 9, the permissible speed will exceed the maximum speed of the machine spindle. In this case, the highest practical speed should be used, usually about 500 r.p.m., if power feed is used, or 900 r.p.m. for hand feed. Otherwise, the speeds listed should be followed closely.

The feed of the work is a more difficult problem to solve because of the many variables in the work, the depth of cut, and the setup. The fundamental basis for feed is feed-per-tooth or, in other words,

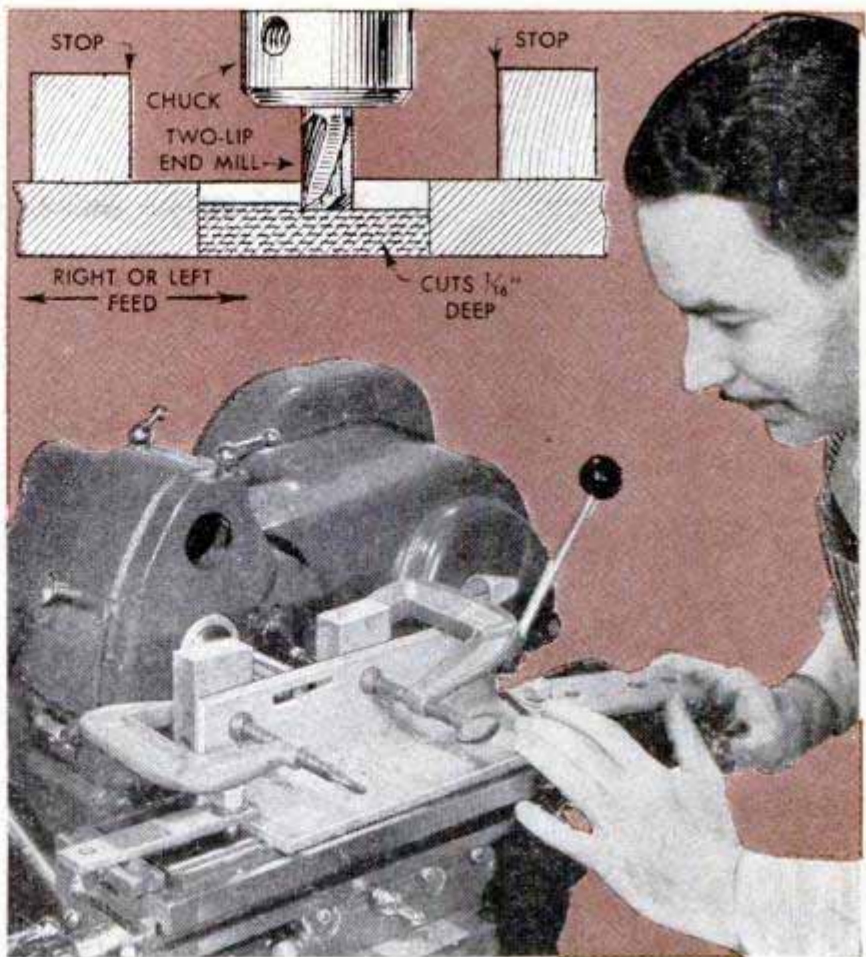

**5** INTERNAL CUTS such as slots, should be made with a two-lip end mill. These small cutters can be used with either the standard or climb feed without regard to the cutter thrust

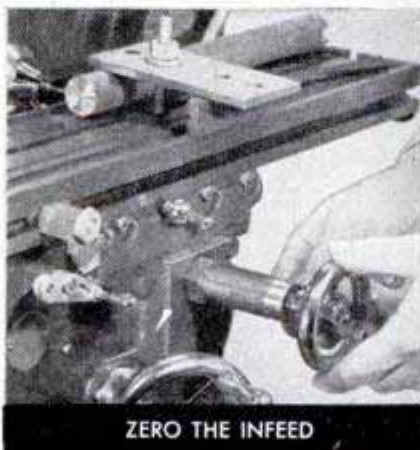
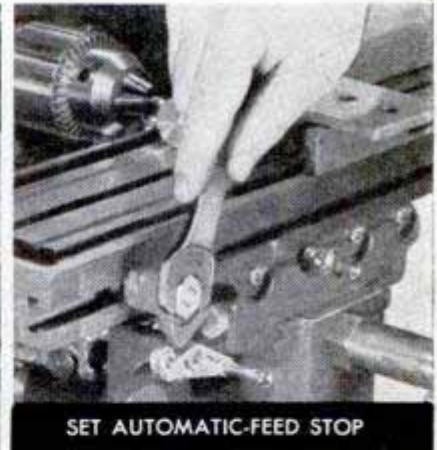
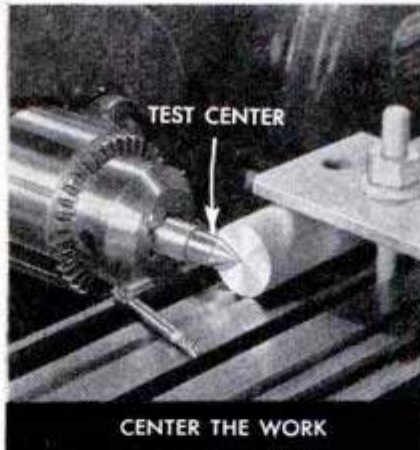

**6** CUTTING A KEYWAY with an end mill often is a necessary operation. Use the test center to locate the work. Set the table stop to stop the feed at the desired position



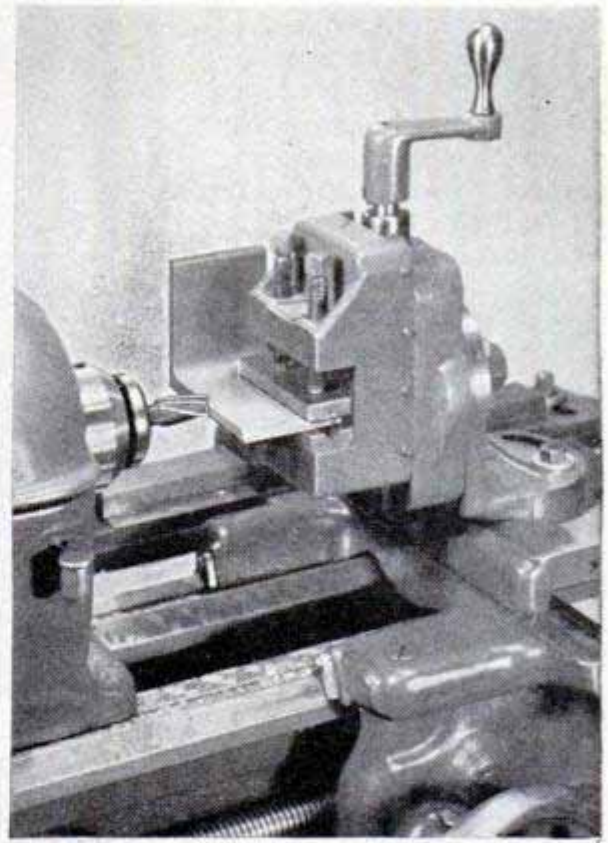
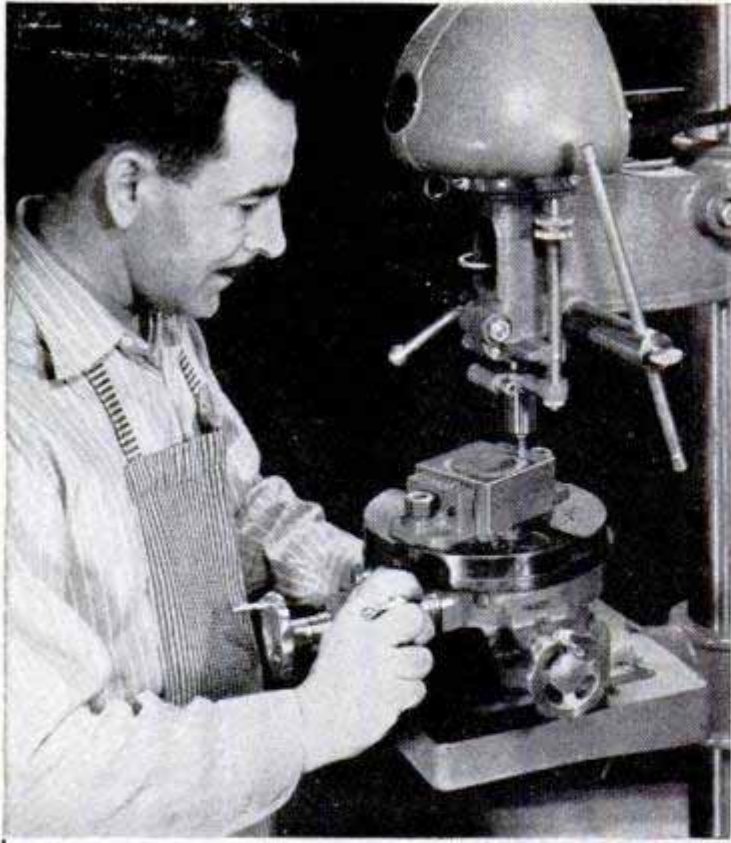

**7** DRILL PRESS AND LATHE are good substitutes for a milling machine on light work. Rotary type of milling table is used on drill press to permit circular cuts. Wide variety of milling can be done in a lathe

the thickness of chip which each tooth in the cutter is required to lift. The table gives the average feed-per-tooth range for various materials. It also converts feed-per-tooth to feed-per-revolution, and to feed in inches, which is the most common expression of milling feeds. Feeds from 1 in. to 6 in. per minute are most practical for bench-miller work because they satisfy the operator's sense of timing. On new work or work of an experimental nature, the simplest approach to the whole subject of what the feed should be is to use the lowest feed available, usually .003 in. per revolution. Then, the feed can be gradually stepped up to full capacity. It is a mistake to feed too slowly as a slow feed produces fine chips that tend to wedge into the flutes of the cutter and cause heating and scoring of the work. The chip should always lift clean and readily clear from the cutter.

**Depth of cut:** The maximum cut with any kind of cutter when using a bench miller is about  $\frac{1}{8}$  in. More practical values are  $\frac{1}{16}$  in. for soft metals and  $\frac{1}{32}$  in. for steel. A lot depends on how much of the cutter is engaged. For example, a 2-in. shell mill working on a  $\frac{3}{8}$ -in. edge, as in the left-hand photo above Fig. 8, can take a deeper cut than when the cutter engages a wider area, utilizing the full cutting width of the flutes. In milling cast iron, a fair average speed is 200 r.p.m., using a feed of .025 in. per revolution (5 in. per min.) with the depth of

cut about  $\frac{1}{32}$  in. In all cases, a general technique which balances maximum cutter speeds with medium feeds and fine cuts will give best results. In a slotting job, Fig. 5, or milling a keyway, Fig. 6, you don't remove all the waste in one pass, but rather make the cut in several passes, maintaining as high a speed as possible. When using very small cutters, often it is best to use a high cutter speed with the hand feed rather than a lower speed with the power feed.

**Drill press and lathe:** Due to its vertical spindle, the drill press offers an ideal work setup for certain types of light milling. The job is commonly mounted on some type of milling table, most useful being the rotary type which has a circular feed as well as longitudinal and cross feeds, Fig. 7. Neither the spindle nor table of the average drill press is rigid enough for heavy milling cuts. Use only small cutters at maximum speed with fine feed and shallow cuts. A lathe fitted with a milling attachment does excellent work and is similar in all mechanical characteristics to the bench miller. The considerable overhang of the milling attachment prohibits extremely heavy cuts, but in all cases the setup is more rigid than any on a drill press. Both solid and shell end mills can be used. Cutter speeds should be maintained with feeds reduced about one half from rates suggested for the bench miller. For smooth work with a milling attachment, use power feeds when possible.



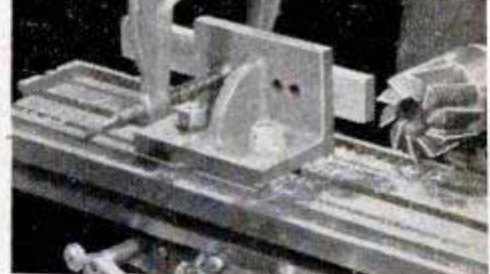

**MACHINING EDGES** is done easily with work clamped to milling-machine table. An angle plate, left and right photos above, is used to back up the work. When thin stock, center, is being edged, the thrust action always should be down to prevent chattering of work

**SURFACING SMALL WORK** usually is done by clamping the stock to an angle plate as in detail at right. Example: Aluminum being cut with shell mill. Cutter speed should be 450 r.p.m., table feed .012 in. per revolution which is equal to work travel of  $5\frac{1}{2}$  in. per min.

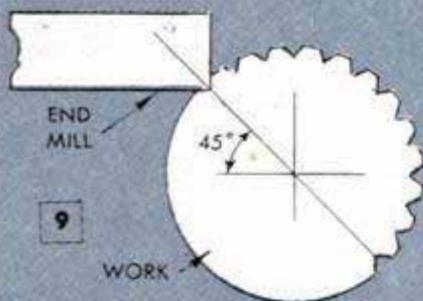
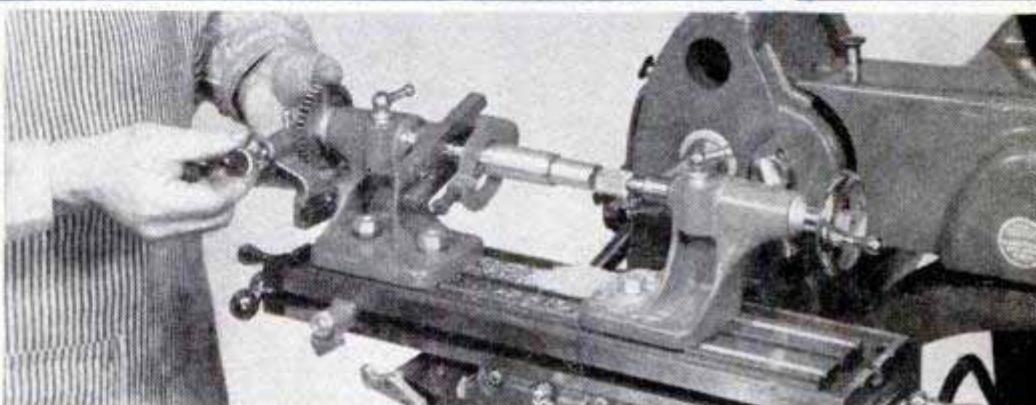
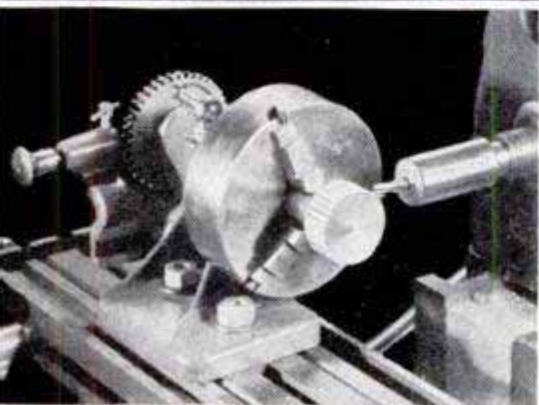
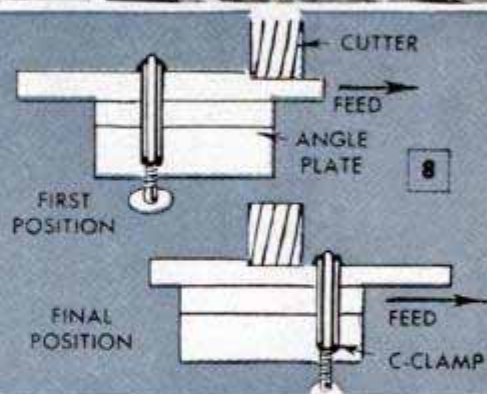

**SQUARING A SHAFT**, above, is done with an index head. End mill works on underside and automatic stop controls table feed. Machining data: Work is machine steel. Use speed of 450 r.p.m. with feed set at .006 in. per revolution. Cut made in successive passes, .025 in. deep

**CUTTING SERRATIONS ON HANDWHEEL** is another indexing job. Setup is shown in photo and detail at left. One pass is used to make this light cut and speeds and feeds are as high as capacity of machine will permit. Work is supported in a three-jaw universal-type chuck

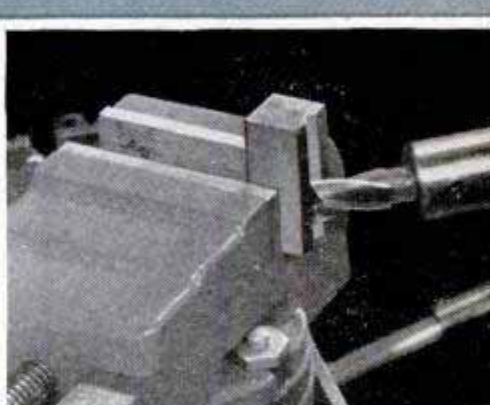
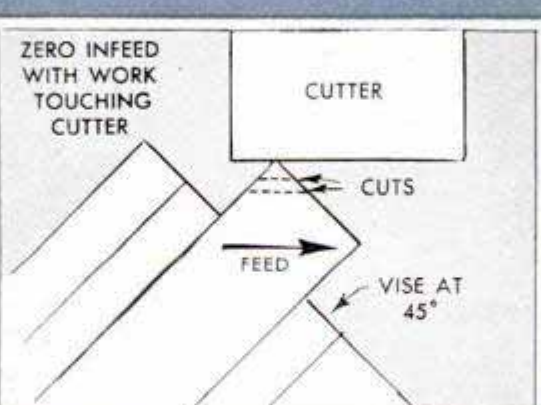
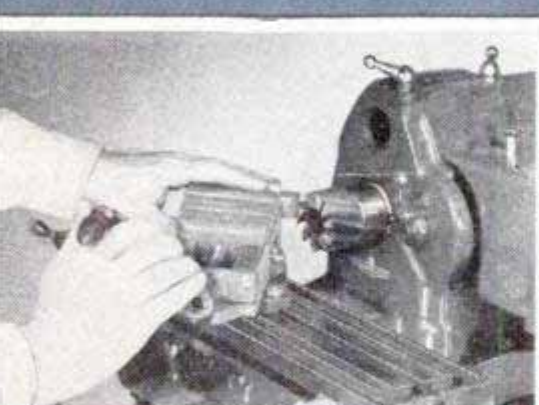

**BEVELING EDGES**, above, requires changing the work for each successive edge. Accurate depth of cut is obtained by setting work in contact with cutter, zeroing infeed sleeve and then feeding in a specified distance

**V-CUTS** are made by setting the vise at 45 deg. and using vertical hand feed. Vee should be marked on work so cutter can be positioned to work down one side of cut as shown in the detail at the right

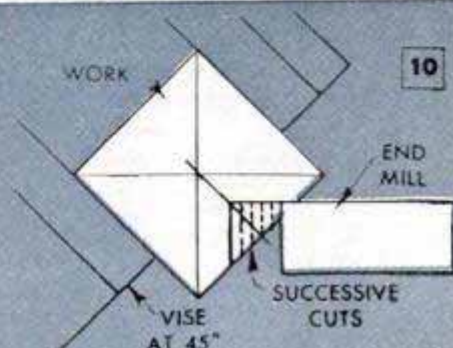



## Stands for Supporting Stock Trailer Easily Adapted as Axle Blocks

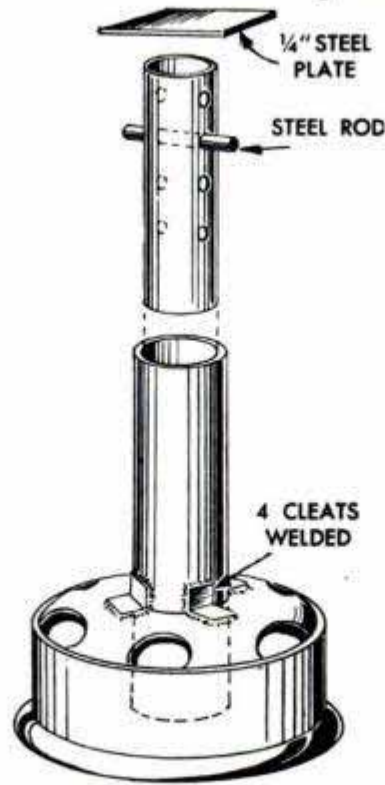

Needing a set of adjustable stands as supports for the front end of a stock trailer when it was unhooked from the truck, one garage owner made them from a pair of old truck wheels and two pieces of heavy steel pipe, one of which telescopes into the other. The wheels provide ideal bases for the stands, which also can be used to block up the axles of trucks, tractors or cars, with no danger of tipping. However, if used in this manner, omit the  $\frac{1}{4}$ -in. steel plate shown in the detail, and cut a large V-notch in the upper end of the vertical member of each stand to provide seating for axles.

## Faulty Acceleration of Car Sometimes May Be Caused by Slipping Fan Belt

When a car won't accelerate properly or cannot be made to hit top road speed, the trouble may be due to a slipping fan belt if the latter drives the generator. A loose belt will, of course, reduce the amount of voltage output by the generator. Thus if the battery is not fully charged there will be insufficient voltage to provide a satisfac-

tory spark at high speed. Also, a consistent low reading on the ammeter may be caused by a slipping belt, even though a well-charged battery may for a short time keep the acceleration of the car normal. However, the battery will soon become discharged under such conditions, and faulty acceleration of the car will follow.

## Old Implement Lever and Quadrant Has Many Uses Around a Farm

Lever and quadrant units which can be taken from various types of junked farm machinery can be put to many good uses around the farm. For instance, one farmer mounted such a unit on a feed-lot gate, as illustrated, where it is used to operate the sliding latch. It also could be used to advantage, if installed on a windmill, to pull and hold the control wire. A third use is to lift and hold a gate at the bottom of a feedbin at the desired height.

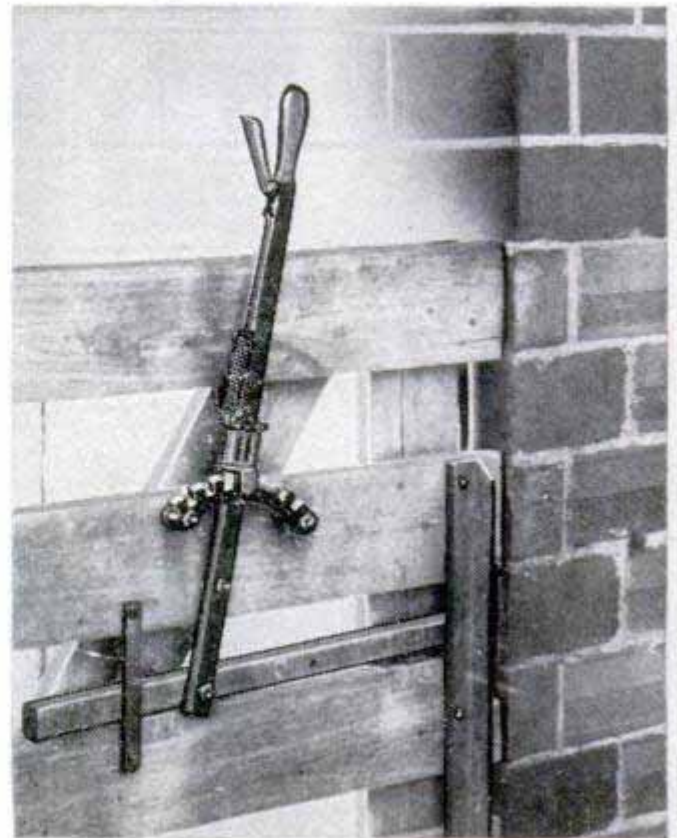

## Making Indexed Files Easier to Use

The difficulty of reading long titles on the index-card tabs of files, in which each tab laps the left side of the following tab (and thus obscures the first word or so of the title), can be overcome simply by reversing the index cards. This will cause the right sides of the tabs to be covered rather than the left, and as a result enough of the first words of the titles will be in view to make them intelligible.

Mrs. Michael Fey, New York City.



Welders will find this angle jig a timesaver when welding together pieces of small work, such as rounds, flats or even narrow plates. It also can be used when welding a small part at an angle to a large, flat surface. Made from two lengths of angle steel that are joined by flat-steel struts, the jig can be made to hold work at any given angle. Thus, welders who frequently have jobs calling for several groups of parts to be welded at various angles can make a separate jig for each group. Large work can be held in a similar type jig if the latter is made from heavier material than indicated.—Herman J. Adolf, Richmond, Calif.

## Accuracy Plus Speed in Aligning Work Attained by Using This Welders' Jig

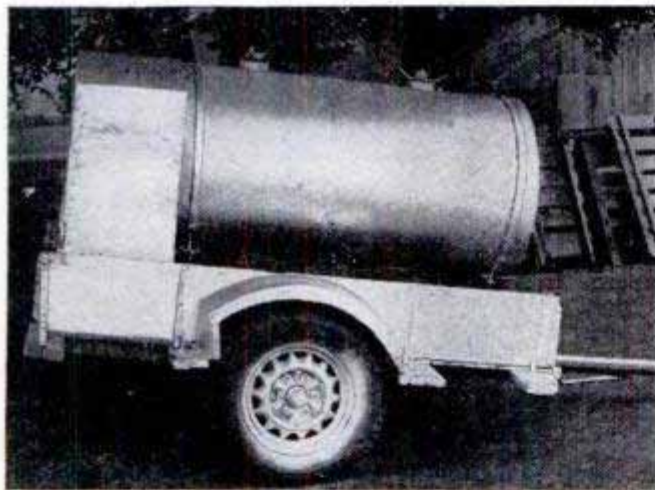
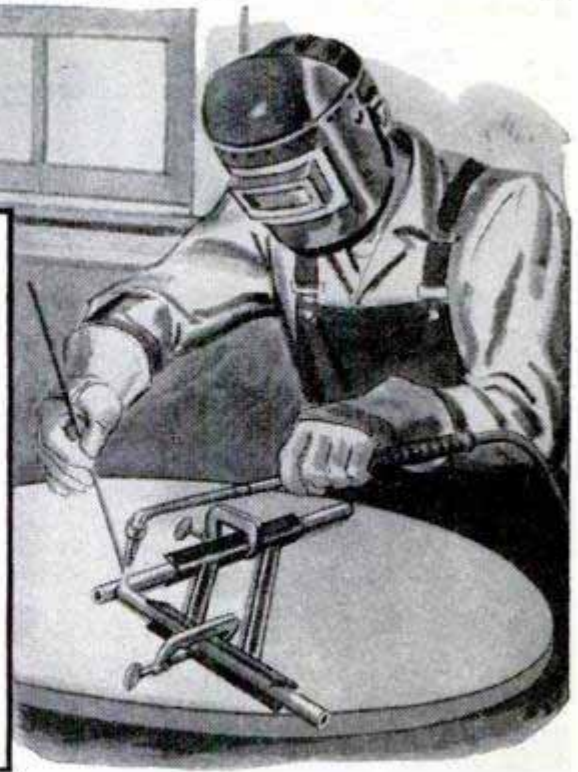
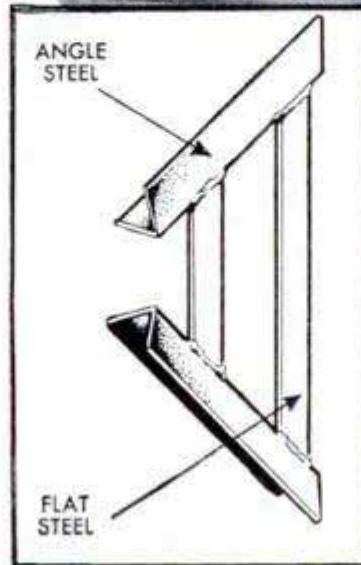

## Fuel Tank Mounted on Trailer Provides Farm "Gas Truck"

A privately owned "gas truck" is a real help around the farm, especially when it is used to service motor-driven implements in the field. The one shown in the photograph was made by mounting a 150-gal. oil tank on a utility trailer. A roomy cabinet was installed at the rear of the trailer for carrying lubricating oils, a hose, funnels and other necessary equipment. The cabinet was lined inside and out as a measure of safety and to simplify cleaning.

L. H. Houck, Jefferson City, Mo.

## Oil Drum With Ends Removed Utilized as Hood for Ventilating Fan

Instead of going to the expense of having a heavy-duty ventilating fan installed in his shop, one mechanic purchased a small motor, two adjustable shaft hangers and a three-bladed fan, and made the rest of the ventilator from scrap parts. In this case, the unit was mounted over a small overhead window. To make a suitable hood, he cut the ends out of an oil drum and mounted the motor on two lengths of steel angle, which were welded to one side of the drum. The shaft hangers were mounted on a T-shaped bracket made from steel angles and welded to the inside surface of the drum as pictured. Collars placed on the shaft between the hanger bearings take the thrust of the fan and prevent end play.

George R. Harrison, Valparaiso, Ind.

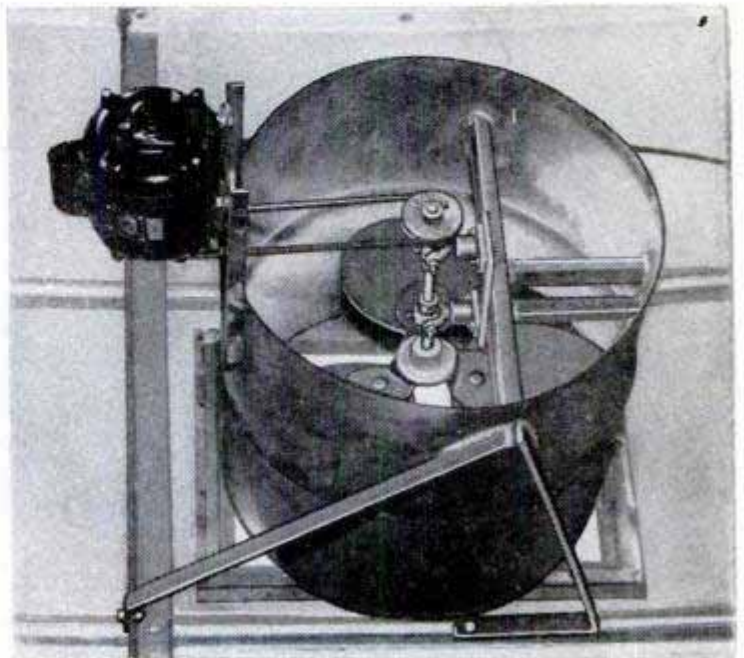



# SHOPPING

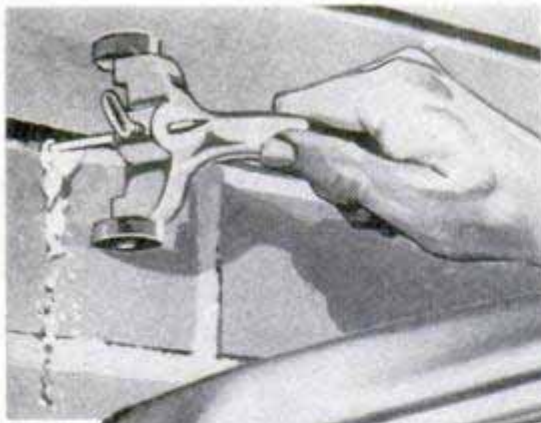

**MORTAR-JOINT RAKER** can be adapted for use on both old and new work. Although designed primarily for raking old mortar joints preparatory to tuck pointing either brick or stone work, the tool can easily be adapted to the raking of new mortar joints. A one-piece casting is designed to provide a handle and mounting spindles for two rollers which travel on the surface of the masonry and keep the depth of cut uniform. Cutting tool, or raker, is an ordinary 10d nail inserted in the holder as shown

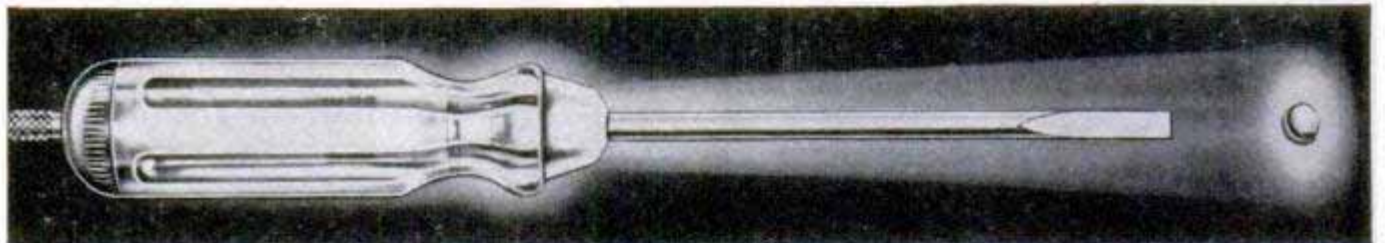

**FLASHLIGHT SCREWDRIVER** has a small flashlight built into the plastic handle. Light beam is directed to the point of the driver and spotlights the head of a screw in deep shadow or hidden in total darkness. Light is turned on by knurled knob at the end of the handle. Uses penlight dry cell and is available in two sizes

**TOOLHOLDER FOR BENCH GRINDERS** is ideal for grinding a square edge on plane irons, wide, flat chisels and cabinet-scraper blades. Will take any edged cutting tool up to 5 in. wide. The holder is designed so that the tool being ground can be removed from the slide and immersed in a suitable coolant at regular intervals. Base of the holder is attached to the bench and adjustments are provided for aligning the holder

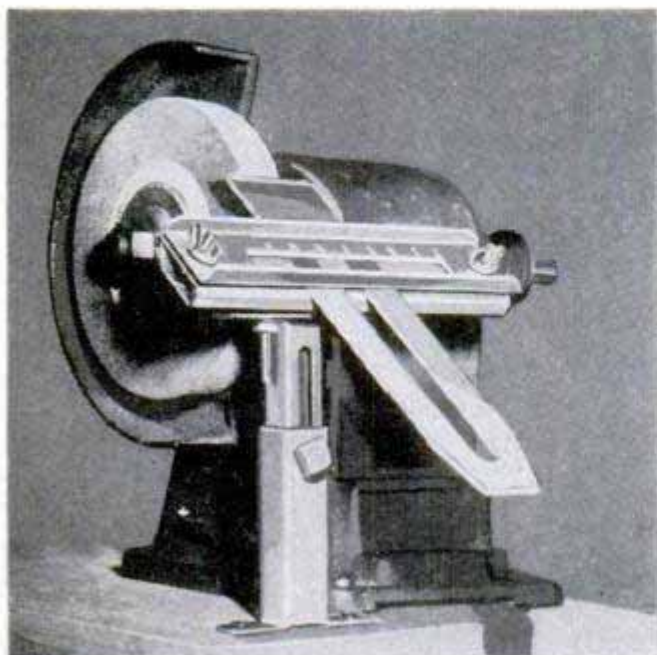

**BUFFING-BONNET CLEANER** renews glazed and hard-packed bonnets in a few seconds, saves valuable time in plating and polishing shops. Entirely eliminates tedious washing and dry-cleaning of bonnets used for various purposes. It is not necessary to remove the bonnet from the driving spindle; simply hold the cleaner against the surface of the rotating bonnet. Works on the same principle as a grinding-wheel dresser





# FOR TOOLS

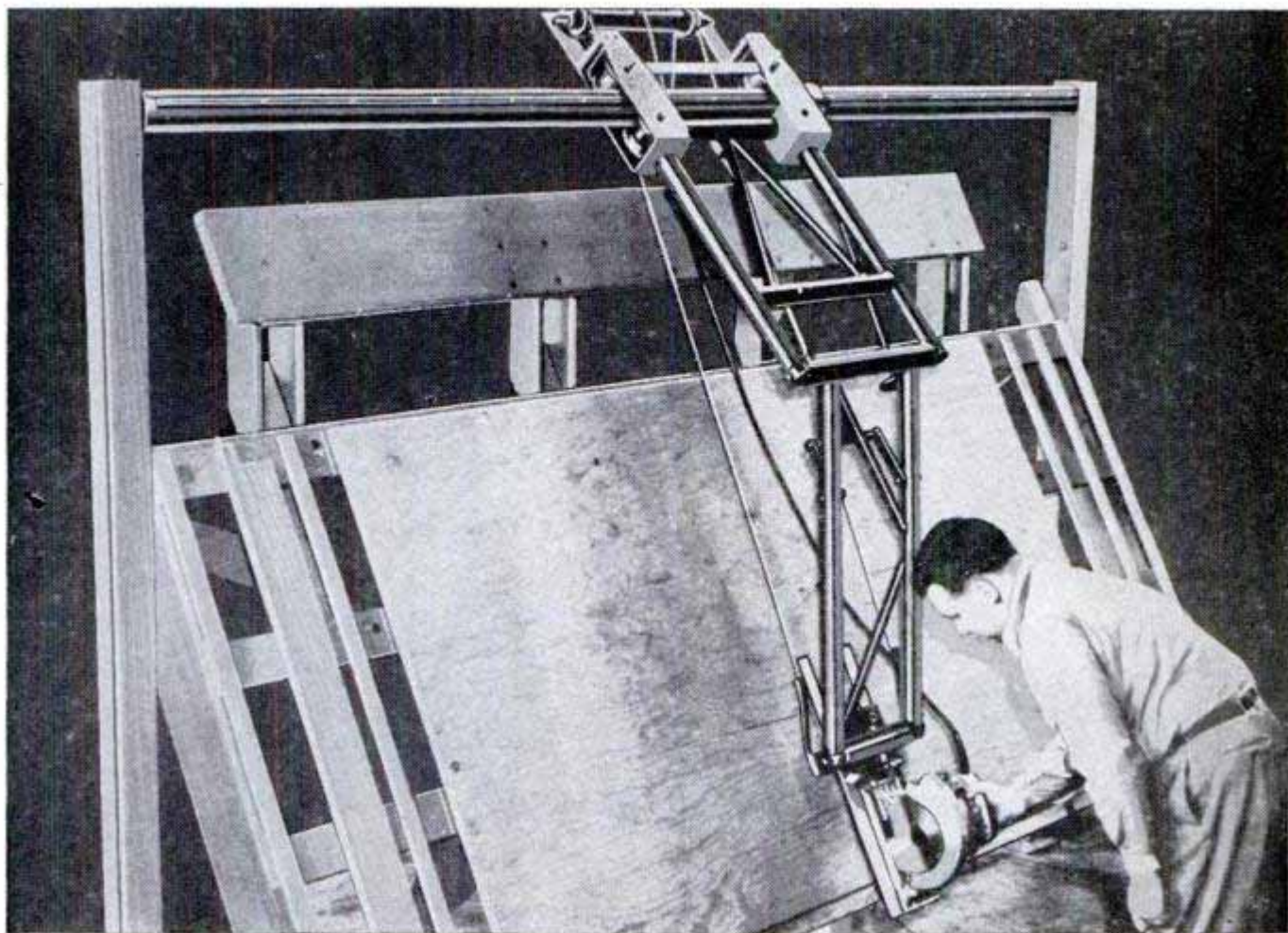

**PANEL-CUTTING FIXTURE** for lumberyards, cabinet shops and builders speeds up the job of cutting large plywood panels to any size required. Saw arm can be adjusted for crosscutting or ripping 4 x 8-ft. panels. Unit can be set to cut panels of duplicate sizes without necessity of measuring and pencil-marking each piece

**SPOT WELDER** is designed for fast hand operation on light work. A plier-type handle closes the electrodes on the work and at the same time closes the welding circuit. When handles are released the current is turned off automatically. A dial on relay box indicates welding time from  $\frac{1}{2}$  to  $1\frac{1}{2}$  sec., as work requires

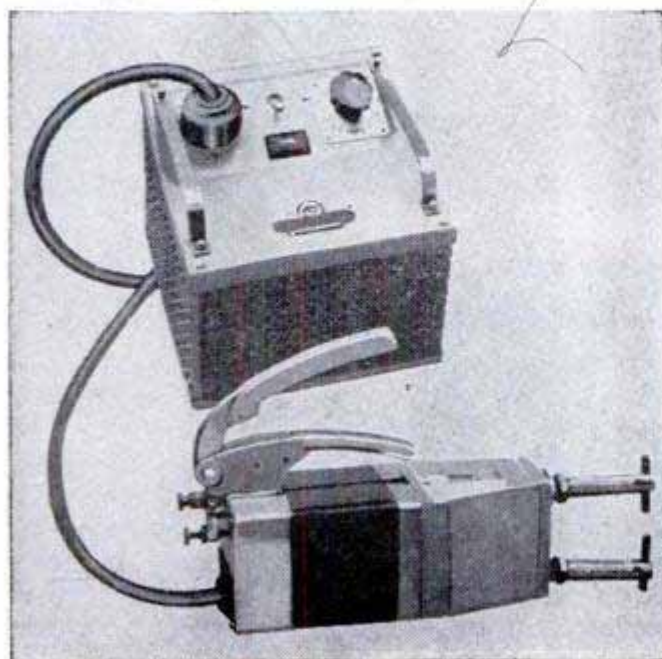

DECEMBER 1951

**OPEN-END RATCHET WRENCH** permits reaching past obstructions to tighten or loosen nuts or other fittings that are inaccessible to ordinary ratchet-type wrenches. Ratchet mechanism is built into a U-shaped jaw which can be slipped over nut or fitting. Available in a range of sizes permitting wide application

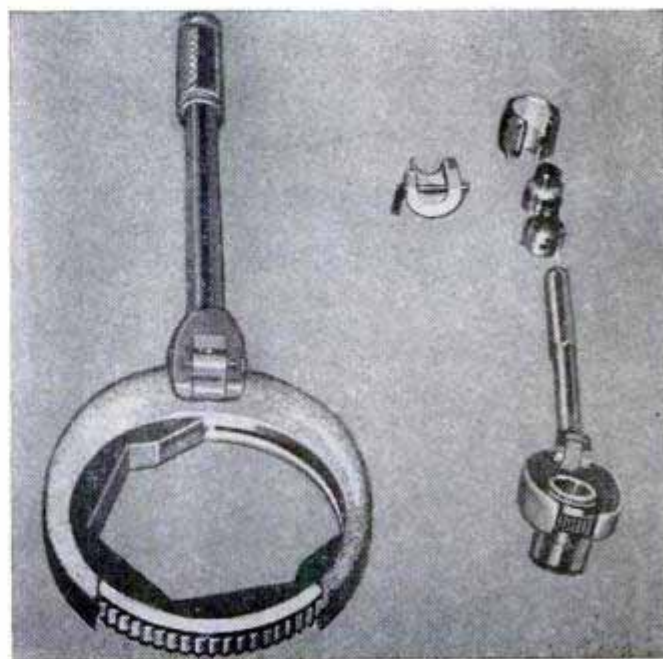

217



## Light Shop Equipment Padded With Self-Adhesive Felt Strips

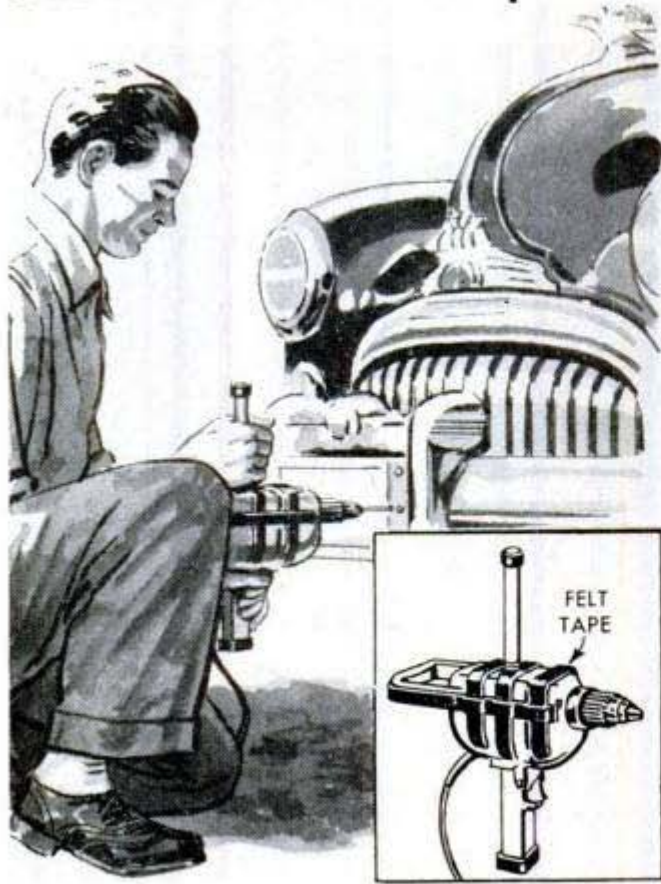

To prevent cracking or marring the housing of such equipment as hand drills through contact with hard surfaces, one shop owner pads the tools with self-adhesive felt tape. This, he found, also reduces the number of rejects of highly polished work, which often was damaged when tools were laid on it. The tape adheres strongly to any clean surface and can be applied in either single or double thicknesses.

G. Everett Fiedler, Bloomfield, N. J.

## Automatic Poultry Fountain

Requiring only periodic draining for cleaning, this automatic fountain for poultry saves one chicken farmer considerable time and trouble. It was made from an old hot-water tank by cutting a wide slot

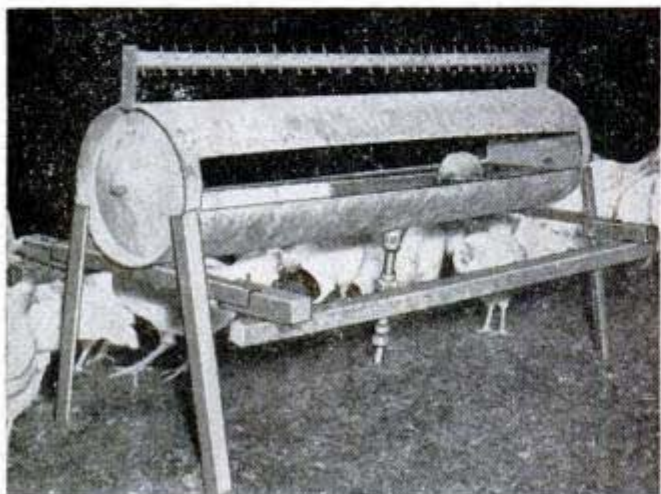

lengthwise in opposite sides and welding lengths of angle steel to it for legs. Angle-steel cross members bolted to the legs support a perch on each side of the tank. Water is piped in through an intake valve, which is controlled by a float, both the valve and the float being the type used in a water-closet tank. A drain is provided by an elbow turned into the bottom of the tank and fitted with a plug. If desired, a regular drain valve can be fitted to the elbow instead.—A. M. Wettach, Mt. Pleasant, Iowa.

## Universal Clamp on Milling Machine

A C-clamp, having the lower part cut off and a round pad welded to the severed end to slide in the T-slot of a milling-machine table, will provide a clamp for which many uses can be found on these machines. It will replace the regular clamp assembly and it will not interfere with the cutter or arbor. Also, you will find it much faster and easier to set up than the usual clamp assembly.

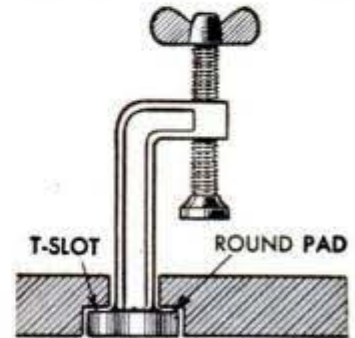

## Storage for Plumb-Bob Line Improved From Tape Spool

An adhesive-tape spool, complete with its snap-on cover, can be put to ideal use for storing a plumb bob. Just tie the free end of the cord to the spool, wind up the cord and snap the cover closed. In use, the cover can be snapped over the cord to hold it at any desired point.



Warren B. Howe, Longview, Wash.

## Extension Cord to Operate Starter Of Car Having Solenoid Switch

When working on a car that has a solenoid starter switch, which, of course, makes it impossible to operate the starter from under the hood for positioning pistons, etc., try this kink. Connect a push-button switch to one end of an extension cord and then connect the latter to the solenoid switch. Equipped with such an extension, the starter can be operated from any position within the limit of the cord.



## SOUND MARCHES ON

GOOD audio reproduction is becoming increasingly important to manufacturers of sound equipment for homes, schools, churches and industry. Recent commercial consumer surveys have indicated a surprising interest in high-fidelity sound. New and better ways for reproducing sound are keeping audio engineers busy.

The multispeaker unit illustrated in photo A is for use with a 16-mm. Kodak sound projector, and is used with the regular speaker of the projector. It permits greater flexibility in sound distribution in classrooms. A magnetic sound projector recently developed by RCA provides an efficient means for recording sound magnetically on the edge of 16-mm. picture film. Photo B shows the recorder-projector used for recording commentary to accompany a training film on surgical procedures.

The spidery object in photo C is the newest type of transistor, a tiny amplifying device invented at Bell Telephone Laboratories to replace tubes. One of television's high-fidelity-sound problems was recently solved with the new parabolic-type microphone shown in photo D. Dubbed "big ear" by NBC engineers, it can pick up high-quality sounds from distances up to 35 feet.

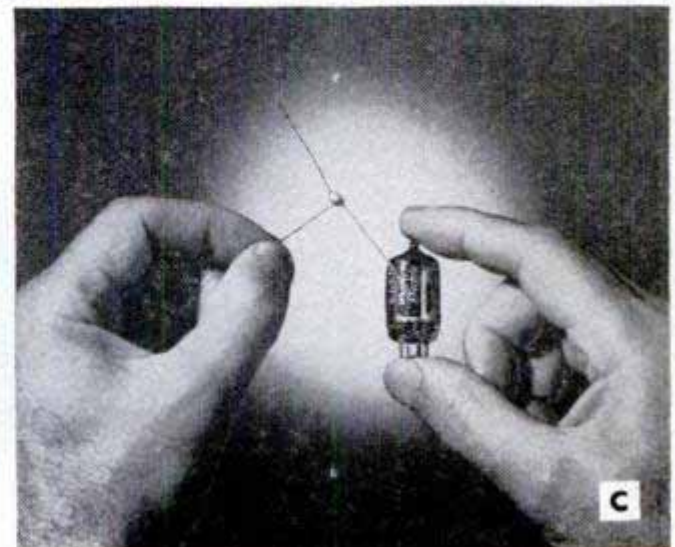
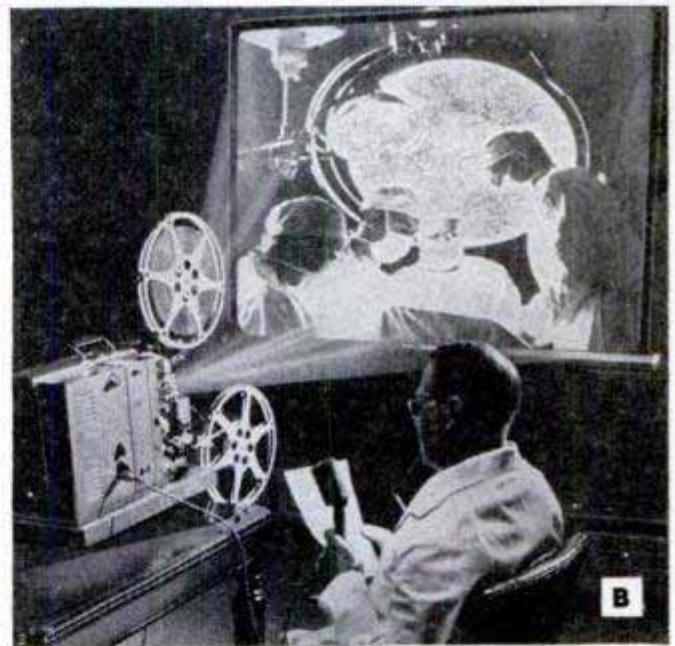



# RADIO-SET TESTING UNITS

By Lothar Stern

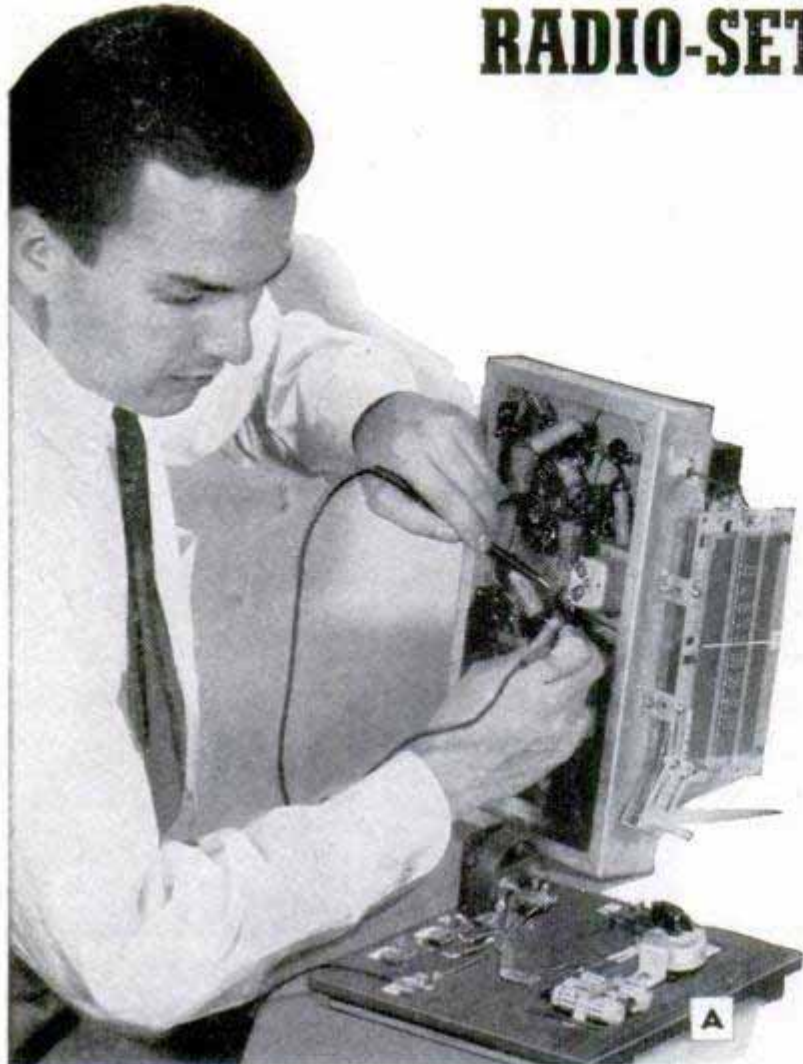

MANY EXPERIMENTERS, especially beginners in the field of radio, are temporarily handicapped and unable to enhance their knowledge by actual tests and measurements because lean pocketbooks do not permit them to buy expensive commercial test instruments. The units to be described are inexpensive, easy to build and they employ only standard components that are available from any radio mail-order house. The parts have been carefully selected to keep cost to an absolute minimum and yet maintain sufficient accuracy for ordinary radio work.

The first unit is a simple d.c. volt-ohmmeter that can be used to measure d.c. voltage and resistance. Photos A, B and C show various views of this breadboard-type unit, the schematic circuit diagram for which is given in Fig. 1. Four d.c. voltage ranges are provided so that the meter can easily be read from 0 to 500 volts. These ranges are divided to provide readings from 0-10, 0-50, 0-100 and 0-500 volts. It will also measure resistors between the values 0-100,000 ohms. No power is required to operate the meter on the voltage ranges. The voltage under test provides the necessary power. For resistance measurements, three small 1½-volt penlight cells are connected in series to furnish the current for the meter. The 0-1 ma. meter is an inexpensive Emico model RF-2C which is listed in radio-parts catalogues for \$3.16. This

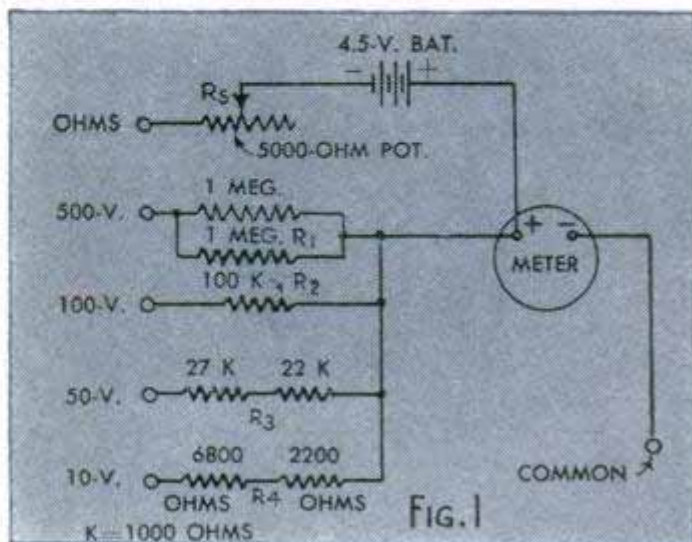
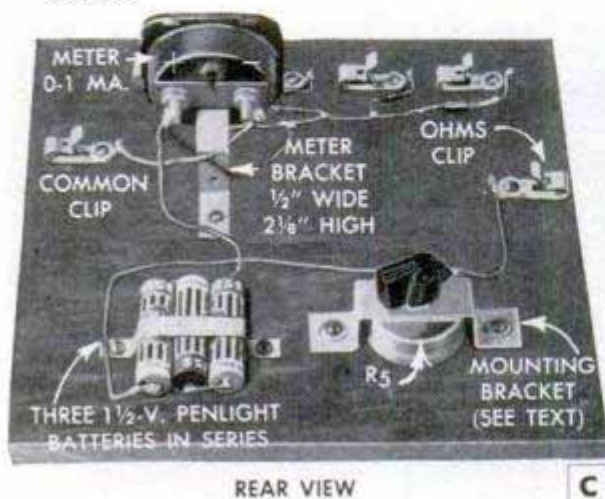
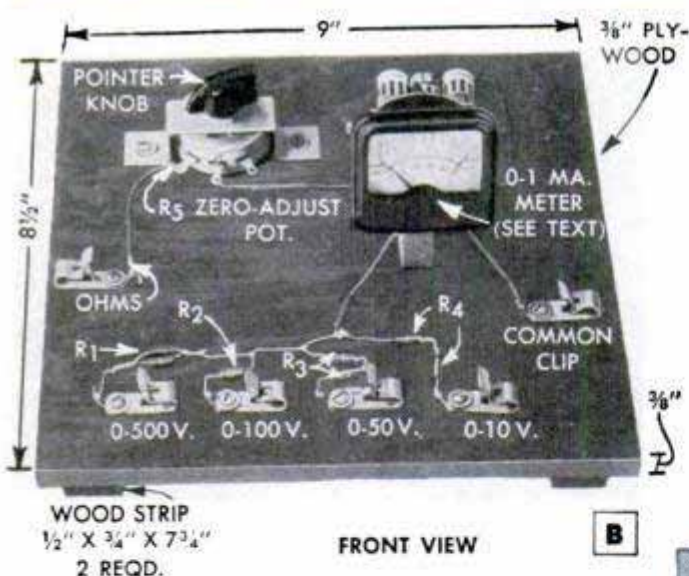



# for EXPERIMENTERS

meter movement has an internal resistance of 1000 ohms and, therefore, the series resistors had to be chosen to take the milliammeter resistance into account particularly on the low-voltage ranges. Standard  $\frac{1}{2}$ -watt carbon resistors with 10-percent tolerances were used. In order to obtain correct resistance values it was necessary to connect two resistors in parallel for R1. For R3 and R4, two resistors are used in series.

The zero-adjust potentiometer should be a wire-wound unit. All parts are mounted on a plywood board,  $\frac{3}{8} \times 8\frac{1}{2} \times 9$  in., which has been stained and given a coat of varnish. The breadboard is supported on two wood strips, or cleats,  $\frac{1}{2} \times \frac{3}{4} \times 7\frac{3}{4}$  in., as indicated in photo B. The Fahnestock clips are fastened to the instrument board with wood screws and metal washers. The various resistors are soldered to the clips and to each other by their own pigtail leads. The common end of these resistors is soldered to the lug on the positive terminal of the meter. A standard volume-control mounting bracket is used to mount the potentiometer on the instrument board. The mounting bracket for the penlight batteries can be made from a thin strip of aluminum. The mounting bracket for the meter is supplied with it. A  $\frac{1}{8}$ -in. hole is drilled in one end of the bracket in order to mount it on the board.

The scale that is supplied with the meter is not used, as it is graduated from 0-1 ma. This scale must be replaced with the one shown in Fig. 3. This scale is full size and can be cut out of the magazine and pasted over the scale furnished with the meter. The front cover of the meter is held in place by eight small metal tabs. Bend these up to free the front cover which can then be lifted out. Cut out the new paper scale and glue it tightly to the metal plate. The new scale must be lined up to coincide exactly with the old one.

Voltage measurements can be made by inserting a black test lead into the common clip and the red test lead into the voltage clip for the range desired. Voltages which are negative with respect to ground or negative B can be measured by merely reversing the test leads. To measure resistances from 0-100,000 ohms, insert the black lead into the common clip and the red test lead into the clip marked ohms. Rotate the potentiometer fully clockwise so that the entire resistance is in series with the meter and then short the two open ends of the test leads together. The needle will swing towards the right as these leads are shorted. By carefully adjusting the potentiometer

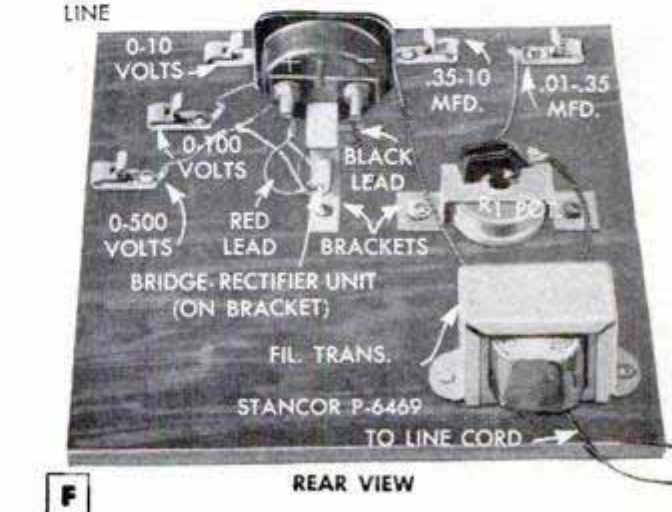
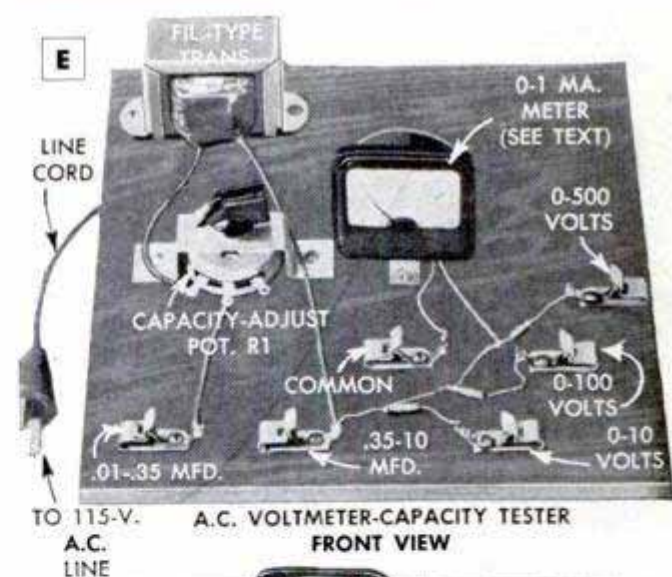
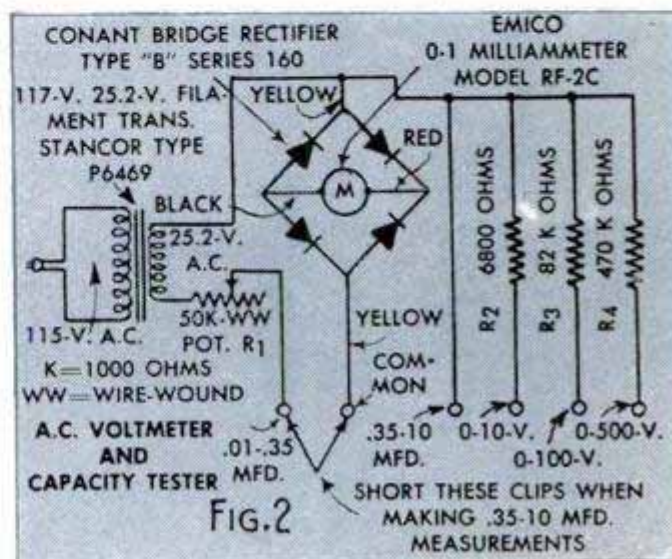



the meter needle can be set to zero on the ohms scale. An unknown resistor can be measured by placing it between the two test leads.

The a.c. voltmeter and capacity tester shown in photos D, E and F is assembled on the same size baseboard. With it, you can check the values of capacitors from .01 to 10 mfd. with sufficient accuracy for radio and television work. The a.c. voltmeter can be used to check line voltage, test power transformers and determine the turns ratio of old output transformers and coupling transformers, the specifications of which are unknown. The schematic circuit diagram is shown in Fig. 2. Mount the various parts with small wood screws. The meter used is the same type of 0-1-ma. meter specified for the volt-ohmmeter. Cut out the meter scale in Fig. 4 and glue it to the meter face so that the line representing the voltage scale coincides exactly with the top line of the scale which is printed on the meter. Cut the new scale so that the top and the left-hand edges are even with the top and left-hand edges of the metal plate of the original dial scale.

Solder the line cord leads to the rear terminals of the transformer and tape the connection carefully. Label the various Fahnestock clips according to their respective functions as shown in the photos and circuit diagram, Fig. 2. To use the instrument, connect one test lead to the clip marked common and the other test lead to the proper clip for the measurements you wish to make. For capacity measurement .01 to .35 mfd., plug the line cord into the 110-volt house line. Insert one test lead in the common clip and the other in the clip marked .01 to .35 mfd. Now, short the two test leads together and adjust the potentiometer so that the needle points to the black line representing .35 mfd. Next, break the short and place the capacitor to be measured between the test leads. Do not touch both test-lead tips with your hand at the time you are taking the reading because the body resistance shunting the capacitor under test will make the reading inaccurate. For capacity measurements .35 to 10 mfd., connect a piece of wire between "common" and the .01 to .35-mfd. clips so that these clips are shorted. Adjust the meter scale with the potentiometer so that the needle points to the outer edge of the black line designating .35 mfd. on the .35 to 10-mfd. scale of the meter. Place the capacitor to be tested between the test leads as indicated in photo D, and read the capacity on the .35 to 10-mfd. scale. For a.c. voltage measurements, the line cord need not be plugged into the a.c. house line. Insert one test lead in the "common" clip and the other in the 0-500-volt clip and

measure the unknown voltage. Read the 0-500-volt scale on the meter. If the voltage under test is known to be less than 100 volts, the 0-100-volt scale should be used. For low-voltage measurements between 0 and 10 volts, use the 0-10-volt clip and read the 0-100-volt scale—but divide the reading by 10. To determine the turn ratio of

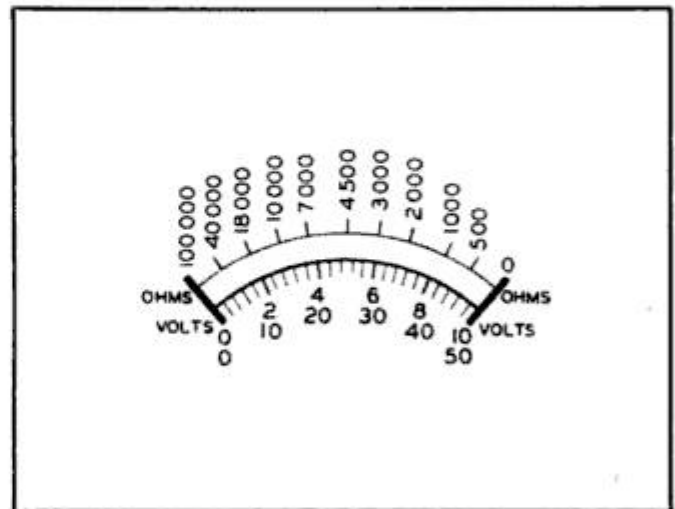

Fig. 3—New meter scale for d.c. volt-ohmmeter. Exact size; cut out and mount on meter face

an output transformer, connect the primary winding to the 110-volt a.c. line. Measure the primary voltage to obtain its correct value because of possible line-voltage variations. The secondary voltage will be much lower than the primary because of the step-down effect in the output transformer. From transformer theory we know

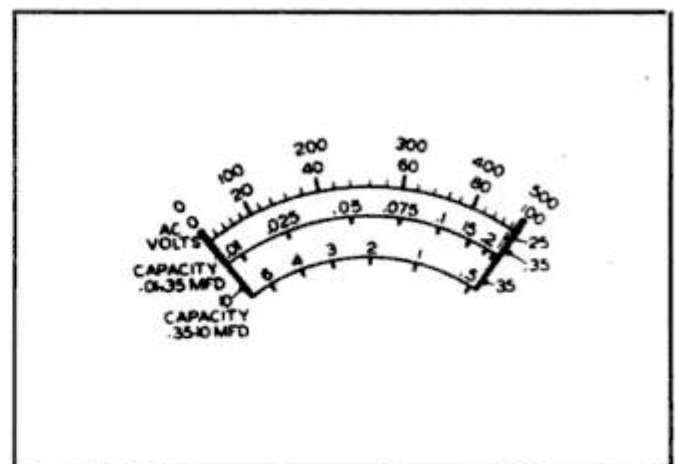

Fig. 4—New meter scale for a.c. voltmeter and capacity tester unit. Exact size for cutout (see text)

that the turns ratio of a transformer is equal to the voltage across the primary divided by the voltage across the secondary. Thus if the primary voltage is 120 volts, for example, and the secondary voltage is 4 volts, the transformer has a turns ratio of 120 to 4, or 30 to 1. Detailed student material list R-406 for these test sets is available from Popular Mechanics Radio and Electronics department upon receipt of ordinary letter postage.



# TELEVISION TODAY

TV GLASSES, developed especially for relief of eye discomfort when viewing television programs, are coated with a new preparation which is permanent and as hard as the glass itself. These lenses are available from a large American optical company and can be easily finished in an optometrist's prescription shop. Actress Cynthia Stone demonstrates them in photo A. Other suggested methods of avoiding eyestrain when viewing TV pictures include proper room lighting. Never watch television programs in a totally dark room. A single lamp placed 6 or 8 feet on either side of the screen, or behind the viewers, will relieve eyestrain at night. A combination TV light and numeral-type clock is now available for this purpose, photo E. When placed on top of the television cabinet a diffused soft amber light, through a clear plastic back, illuminates the area around the cabinet. It accentuates the image and eases the strain of continuous viewing.

Among other novel things designed for the comfort and convenience of the modern home and TV set owner is the TV Snack Wagon illustrated in photo B. This easy rolling double-deck cart is made of chrome-plated 1-in. tubular steel, and it stands 37 in. high at its highest point. The plastic shelves provide easily cleaned surfaces. This handy cart enables TV fans to enjoy their favorite programs without interruptions for meals.

Theater television today provides large audiences with special-events programs that are not available on TV sets in the home. They are transmitted by private wires, or radio beams, to theaters. Projection of improved 15 x 20-ft. television pictures, magnified by Schmidt-type optical systems, on theater screens is made possible by the new giant image-correcting glass lens shown in photo C. The spherical mirror at the right, showing the girl's face, magnifies TV images and projects them onto the screen. Distortions introduced by the magnification are corrected by the giant lens at the left. The lens is more than 22 in. in diameter and it is made of special optical glass.

Parapet mounting brackets for TV antenna arrays solve difficult installation problems on roofs where there are no conveniently located chimneys to support masts. The one shown in photo D consists of a sturdy frame with four clawlike members which clear the coping and extend to the wall. A cam at each side of the frame can be adjusted to give positive vertical support on tile or stone copings regardless of contour.

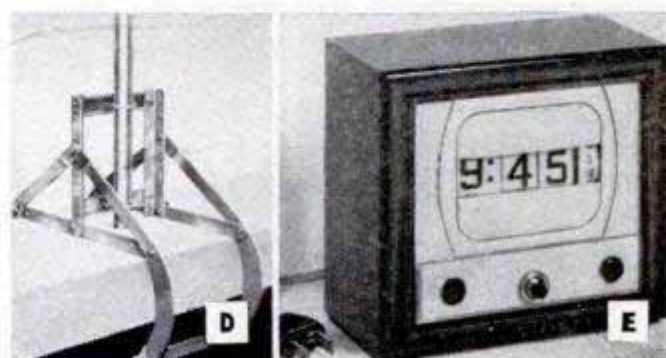



# RADIO and TELEVISION SERVICE HINTS

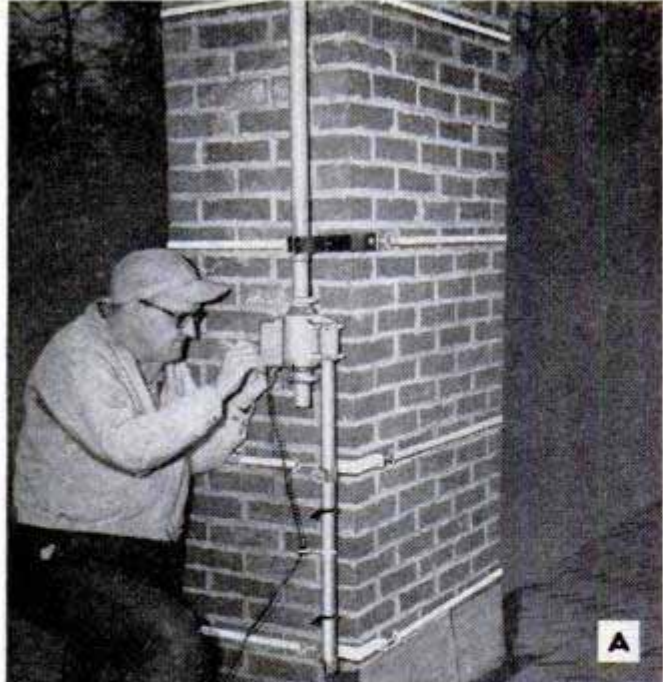

A

**A**—Instead of mounting the TV-antenna-rotating mechanism just below the antenna array, high above the roof, this serviceman installs the rotating unit just above the roof level, within easy reach if repairs are necessary. The outside pipe is stationary; a smaller inside pipe fits in a sleeve bearing

**B**—Color-television adapter enables viewers to see every type of color transmission available today in black and white on their present sets. It switches the regular 525-line reception to the 405-line system to get the color pictures in good black and white

**C**—Fiber fuse holders with insulated wires on each end of the detachable parts are used for safety fusing TV circuit leads where trouble recurs. Fuses range from  $\frac{1}{4}$  to 4 amp., depending on circuit

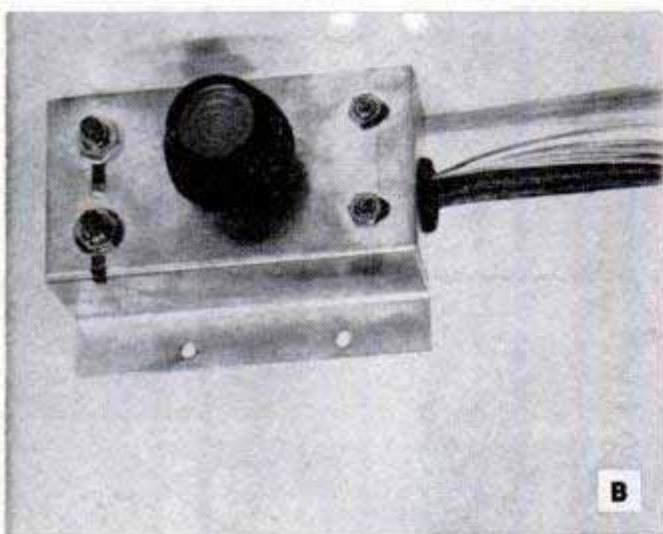

B

**D**—To clean surface of TV picture tube, first disconnect the power to the set, then remove the safety-glass implosion-guard retainer brackets or strips. Clean the tube face and guard with a soft damp cloth

**E**—Open fixed condensers in radio-set circuits often can be located by shunting a good condenser across the one suspected, as shown in the photo. Small clips attached to test probes hold the new condenser

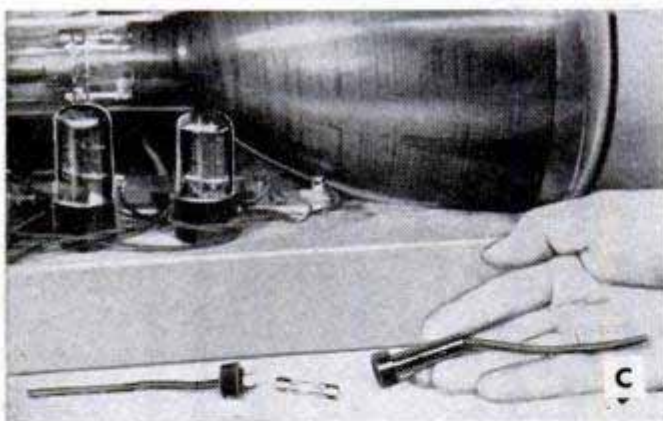

C

**F**—**RADIO-TV and ELECTRONICS HANDBOOK** is written for millions of radio and TV set owners, radio beginners, students and experimenters by Frank L. Brittin, Radio-TV and Electronics Editor of *Popular Mechanics*. You need no knowledge or experience to put the information contained in the book into immediate money-saving use.

Learn how you can install TV and FM antennas, how to adjust and tune TV receivers, and how to make radio repairs and TV-tube replacements, eliminating unnecessary service calls.

Find out how you can build your own radio sets, amplifiers and many other useful electronic devices. There are complete instructions, detailed material lists and pictorial and schematic diagrams to guide you. Find out how you can join the ever-growing ranks of amateur radio "hams."

Over 500 photographs, drawings and diagrams illustrate the 160 fact-packed pages of the new second printing. Glossaries of commonly used radio and TV terms and color codes are included. Order your copy of **RADIO-TV and ELECTRONICS HANDBOOK** today from your local bookstore or send your order direct to Popular Mechanics Press. Price \$2.50.



D

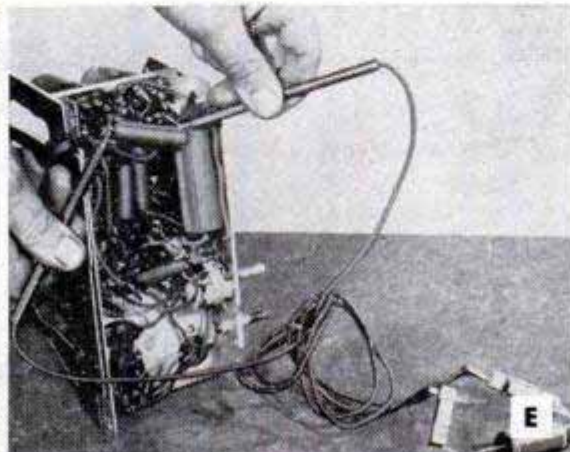

E



F



# HOW TO SEPARATE THE MEN FROM THE BOYS

The gear a man packs when he takes to the woods marks him as either a tenderfoot or an old hand. The old timer travels light—no excess baggage. But every piece of equipment will be the very best.

It's like that with mechanics, too. A kit of well kept tools, and every tool Class A, is a pretty sure sign of a Class A mechanic. Chances are the wrenches in that kit will be Bonneys.

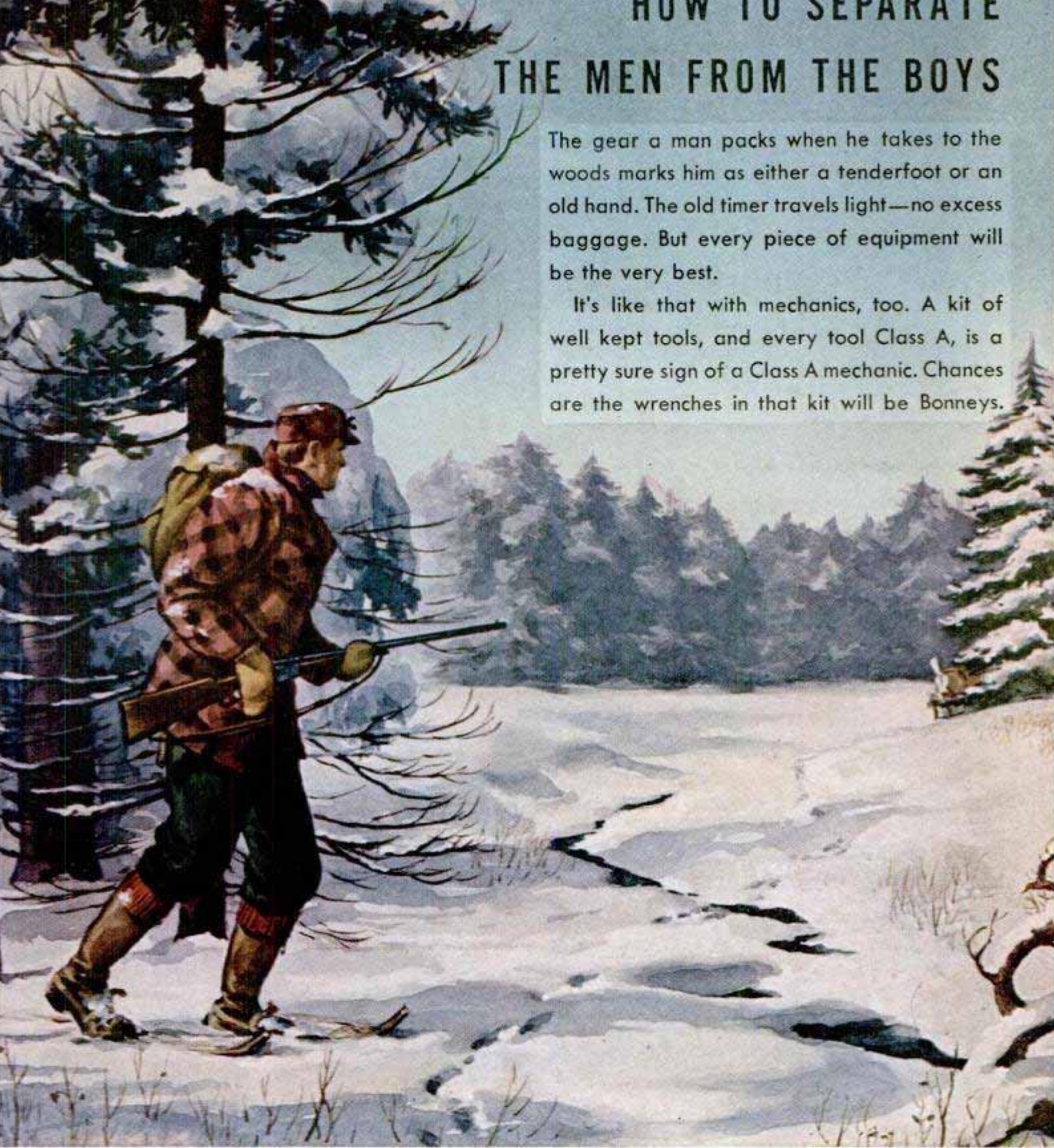

*This is one of a series of spirited sporting scenes (in full color, without advertising) available on request. Write for your free set today.*

**"CHEAP TOOLS ARE FOR CHUMPS"** say the men who know tools best—America's ace mechanics. And the best recommendation for Bonney Wrenches is the kind of men who use them.

As thousands of good mechanics can testify, for lightness, strength, balance and precision you can't beat a Bonney.





1903

Barney Oldfield lowers track record at Indianapolis.

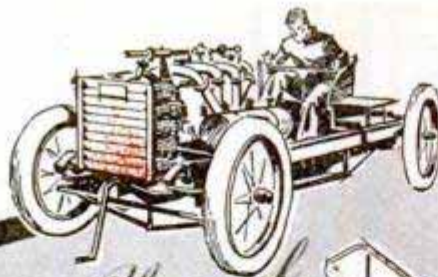

1909

Wright Brothers make new flight record.

1925

Popular Mechanics sensational Superheterodyne Eight.

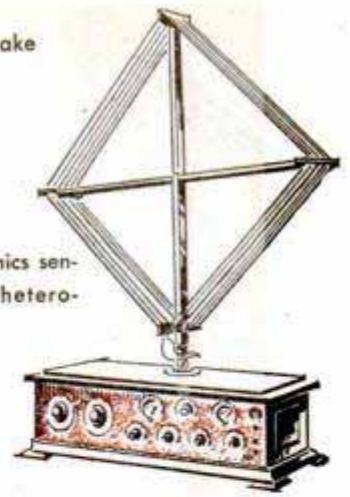

1944

The atomic powered auto.



POPULAR MECHANICS

*Fifty Years of*  
**POPULAR MECHANICS**  
*A Book You Will Be Sure to Want ... to Keep ... to Treasure Forever*

### See It Happen All Over Again!

Thrill again as the years unfold in FIFTY YEARS OF POPULAR MECHANICS. See the great inventions and scientific developments of 50 fabulous years happen all over again in articles and pictures, prepared and first printed when the events took place. Thrill to the accounts of the first channel flight and the jet-propelled airplane . . . to the pedal-propelled submarine and to the terrifying atom bomb.

### History-Making Inventions • World-Shaking Events

Live again from the days of the first motorized sewing machine to the age of nylon and cellophane. See the automobile emerge; the birth of the airplane, the phonograph, motion pictures, radio and television. Follow the scientific development of two world wars. Read the fascinating articles by and about such personages as Pierre Curie, Guglielmo Marconi, Jules Verne, Winston Churchill, Lammot Dupont, Thomas Edison, the Wright Brothers and hundreds of other famous people.

### The Once-in-a-Lifetime Book

FIFTY YEARS OF POPULAR MECHANICS is without a doubt one of the most fascinating, informative and entertaining books you can own or give to others. It's a big book too—Size 8½ x 11 inches with 320 pages and more than 600 illustrations. The final chapter is devoted to things to come and a glimpse into fifty years from now. Price \$5.00. Order your copy, with your name in gold on the cover, today.

### The Awe-Inspiring Story of American Progress Depicted in Memorable Pages from a Half Century of Popular Mechanics

Since 1902 Popular Mechanics has faithfully recorded and accurately reported, in word and picture, the greatest 50 years of mechanical and scientific progress in human history.

More than 150,000 fascinating pages have been printed. A selection of these pages, with explanations and comments printed in an extra color in the margins, has been put into a big 320-page book by Simon and Schuster, New York publishers. The title of the book is FIFTY YEARS OF POPULAR MECHANICS.

Here is a book you will want to own — to cherish and keep forever. Your name stamped on the cloth-bound cover without extra charge. Order on coupon below.

**YOUR NAME IN GOLD ON THE COVER FREE — MAIL COUPON!**

**POPULAR MECHANICS PRESS,  
200 East Ontario Street, Chicago 11, Ill.**

Send at once \_\_\_ copies of FIFTY YEARS OF POPULAR MECHANICS at \$5.00 each, postpaid, with names stamped in gold. Remittance enclosed \$\_\_\_\_\_. (Please print name below exactly as you want it to appear on book. When more than one book is ordered use margin or separate sheet for extra names.)

NAME \_\_\_\_\_

ADDRESS \_\_\_\_\_

CITY \_\_\_\_\_ STATE \_\_\_\_\_



# American Flyer

(Engineered by the makers of ERECTOR)

World's only scale model trains with 2-rail track—smoke—"choo-choo" sounds.

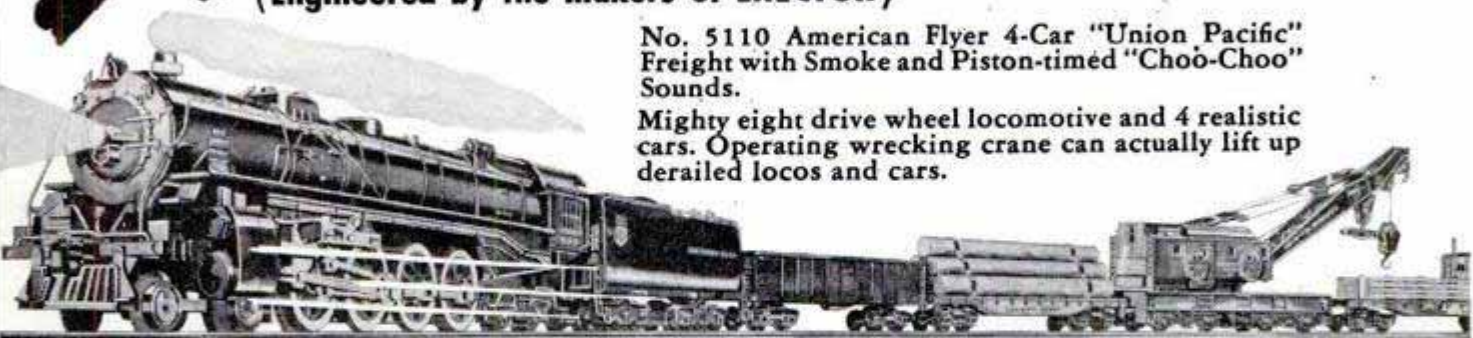

No. 5110 American Flyer 4-Car "Union Pacific" Freight with Smoke and Piston-timed "Choo-Choo" Sounds.

Mighty eight drive wheel locomotive and 4 realistic cars. Operating wrecking crane can actually lift up derailed locos and cars.

Only American Flyer trains are true scale models throughout—built to 3/16" "S" gauge. Only American Flyers have piston-timed smoke and "choo-choo" sounds—so that the faster your train goes, the more smoke it puffs—the louder are the

"choo-choos." Only American Flyers have the new Air Chime Whistle—exactly reproducing the melodious whistle real railroads are adopting. For the finest in electric trains, look to American Flyer.

Prices start at \$19.95



American Flyer has the *MOST* and *BEST*. More passenger cars. More freight cars. More accessories. Two kinds of bridges. Automatic log loader. Automatic coal loader. Everything you need to build the railroad empire of your dreams.

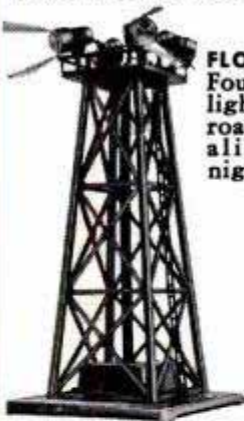

**FLOODLIGHT TOWER**—Four powerful floodlights give your railroad system added realism—spectacular night effects.

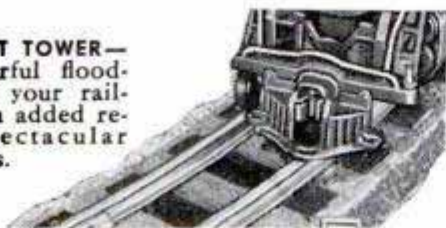

**REAL 2-RAIL TRACK**—Looks like track of real railroad. No old-fashioned third rail in the middle. For further realism, track can be mounted in new American Flyer Rubber Roadbed, finished to resemble real ballast.



**TALKING RAILROAD STATION**—The most thrilling electric train accessory you can own. Produces life-like station sounds: hissing steam, whistle, voice of train announcer, etc. Stops train by remote control. Starts it automatically.



**OPERATING STOCKYARD AND CAR**—Watch the steers mill around—climb up ramp and enter car—when you press remote control button. Then make them file out of car and down to stock pen again.

No. 5108W American Flyer Santa Fe Diesel Passenger Train with new Air Chime Whistle, Vista Dome Pullman, *Two* Motors!

Powered by two giant motors, this sleek, streamlined beauty streaks over the rails like the real *Santa Fe*. Four aluminum illuminated cars.



## SEND FOR GIANT TRAIN BOOK

48 big pages. Over 100 color pictures. Cost over \$175,000.00 to produce. Only 10¢.

Gilbert Hall of Science, 233 Erector Square, New Haven 6, Conn.

Rush giant train book. I enclose 10¢.

Name.....

Street.....

City..... State.....

This offer good only in U. S. A.





For any camera with built-in "synch." Includes 2-Way Flash-guard. **Kodak Flash-older, Model B, \$12.35.**



Connects to Flashholder, for multiple-flash pictures. **Kodak Flash-older Extension Unit, Model B, \$13.65.**



For use with new Brownie Hawkeye Camera, Flash Model. Easy to attach. **Kodalite Flashholder, \$3.95.**



For flash pictures with any camera that has a "T" or "B" setting. **Kodak Photo Flasher, \$1.55.**



Condenser-type power for dependable "flash." **Kodak B-C Flashpack, \$2.95** (without 22½-volt battery).



Sensational new battery-condenser flash system. **Kodak Ekta-lux Flashholder, standard bracket, \$34.75.**



Cool, circline fluorescent lamp, integrating-sphere lamphouse are prominent features in each enlarger. **Kodak Hobbyist Enlarger (left), \$49.50,** complete with f/6.3 lens. Versatile **Kodak Fluorolite Enlarger (right), \$112.50,** without lens.



Lenses for the Fluorolite Enlarger range from 50mm. f/4.5 "Ektanon" to 4-inch f/4.5 "Ektar." From \$15.75.



2 x 2 projector and screen in a single unit. Use in lighted room. **Kodaslide Table Viewer, 4X, \$49.50.**



Self-contained projector, screen, and slide changer. **Kodaslide Table Viewer, Model A, \$97.50.**



Projects images up to 7 ft. wide for brilliant shows. **Kodaslide Projector, Model 2A,** with 5-inch lens, \$49.50.



Can deliver more light than any 2 x 2 slide projector. **Kodaslide Projector, Master Model.** From \$169.



Protects 140 cardboard or 55 glass slides — keeps them organized. **Kodaslide File Box, \$1.50.**

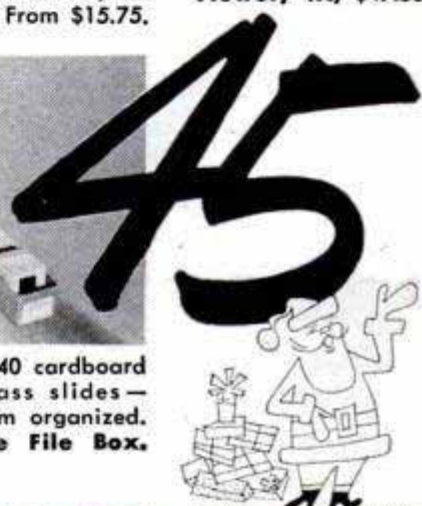

12 compartments swing out — hold 240 cardboard or 96 glass slides. **Kodaslide Compartment File, \$3.75.**



New-type slide-feeding mechanism, cool operation, elevating device. **Kodaslide Merit Projector, \$24.50.**



Focuses from narrow to wide beam for flood shots. Adjusts for heights from 3 to 5½ feet. **Kodak Vari-Beam Standlight (left), \$16.** **Kodak Vari-Beam Clamp-light (right),** lamp portion of Standlight mounted on flexible locking bracket, \$10.50.



Easy-to-use materials for printing pictures — ideal for beginners. **Kodacraft Printing Kit, \$4.85.**



Essentials for developing and printing, including roll-film tank. **Kodacraft Photo-Lab Outfit, \$8.50.**



Complete developing, printing equipment, incl. metal printer. **Kodacraft Advanced Photo-Lab, \$13.95.**



Easy to use, load, and pour. Takes 620-120, 616-116, and 127 films. **Kodacraft Roll-Film Tank, \$2.95.**



Permits loading and processing of 35mm. films to be carried out in daylight. **Kodak Day-Load Tank, \$9.85.**



Handsome chemical-resistant plastic housing protects all working parts. **Kodak Chemical Scales, \$9.90.**





Gives precise timing in contact and projection printing, 1 to 57 seconds. **Kodak Electric Time Control**, \$13.50.



Tilting base, minute and split-second hands, large dial. Covers intervals to 60 minutes. **Kodak Timer**, \$6.75.



Permanent mounting. **Kodak Thermount Iron**, \$9.75. **Kodak Thermount Tissue**, from \$.20 per pkg.



Frees both hands for handling equipment and material in the darkroom. **Kodak Utility Footswitch**, \$10.



Will trim prints up to 6 1/2 x 8 1/2 in. Rigid single-piece metal body. **Kodak Guide-Rite Trimmer**, \$5.85.

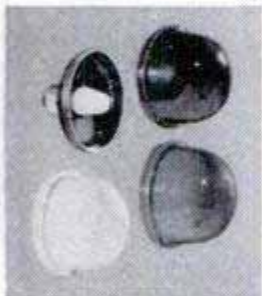

Includes cups for all types of darkroom work. **Brownie Darkroom Lamp Kit**, \$1.95.



Converts tray to efficient print washer. **Kodak Automatic Tray Siphon**, \$5.25.

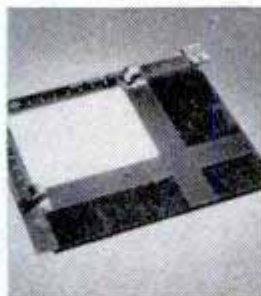

For use with any vertical enlarger. **Kodak Masking Easel**, 11 x 14, \$11.25.



Now use economical 828-size color films. **Kodak 828 Adapter for Kodak Reflex Cameras**, \$5.35.



Adapts de luxe model Kodak Tourist Cameras to take Kodachrome Film. **Kodak Tourist Adapter Kit**, \$15.50.

# Gift Ideas: for Photo Fans

Your photo dealer will be glad to show you many wonderful gift ideas. Visit him soon.



Automatically trips shutter, permits photographer to get into picture. **Kodak Auto-Release**, \$4.50.



Keep negatives dirt- and dust-free, safe from scratching and marring. **Kodak Negative Files**. From \$2.25.



For accurate darkroom temperature control. Choice of 4 **Kodak thermometers**, from \$.45.



Adjustable—accepts all sizes of negatives up to 4 x 5 1/2 in. **Kodak Auto-Mask Printing Frame**, \$3.25.



Convenient for handling prints in a tray or for stirring solutions. **Kodak Stirring Paddle**, \$.35.



Expertly made, offers sound protection together with smart appearance. **Kodak carrying case**. From \$2.65.



Folds to only 22 1/2 inches—extends to 5 feet. Weight, two pounds. **Kodak Eye-Level Tripod**, \$23.33.



Holds 4 filters, adapter ring, lens hood. **Kodak Combination Filter Case**, \$4.25, \$4.95.



Made of strong, waterproof vinyl plastic. **Kodak Darkroom Apron**, \$2.25, \$3.00.



Shades the lens, attaches directly to adapter ring. **Kodak Lens Hood**. From \$1.60.



Darkens the sky in color pictures. **Kodak Pola-Screen**. From \$6.50.

Prices subject to change without notice and include Federal Tax where applicable. Consult your dealer.





# Care and Feeding of Engines

BY S. P. CORP

## WHEN YOU HAVE "PULL"

When your car pulls right or left, check spring height. Always do this, too, before aligning wheels. This check can be made on any level drive or garage floor. *First*, make sure car is empty. Then bounce car up and down to get springs and shock absorbers into their natural position. Measure from floor to fittings at A and B. (See diagram). There should not be more than  $\frac{1}{4}$  inch difference between A and B. Before making any front correction, check rear spring heights by measuring from top of rear axle to car frame.

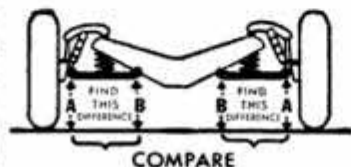

Any variation of more than  $\frac{3}{4}$  inch in rear will affect front, and must be corrected first, by re-arching or replacing. If rear is O.K., correct front spring variation by placing spacers on top of coil springs. One spacer will raise low side  $\frac{3}{8}$  inch. Never use more than two spacers.

## GETTING RID OF VIBRATION NOISE

Vibration can cause squeaks and rattles. One of the common causes of vibration is an unbalanced propeller shaft. On most cars, the propeller shaft is not enclosed, and sometimes catches a load of undercoating. Look for this if you hear a low rumble, and clean

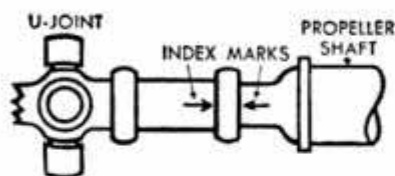

the shaft. If your car has two universal joints, you will find balance marks (see diagram). If these are out of line, shaft will vibrate. Disconnect and remove spline shaft from propeller shaft, then replace with balance marks properly lined up.

## IF YOUR CAR SPENDS TOO MUCH

If your car spends too much of your good money for gas and oil make yourself a Christmas present of new Sealed Power Piston Rings. Sealed Power MD-50 is the best steel oil ring ever built—controls oil even in badly tapered and out-of-round bores. Ask for free booklet, "7 Ways to Save Oil." Just address a card to Sealed Power, Dept. G-12, Muskegon, Mich. For triple wear compression rings, get Sealed Power Chrome-Faced Rings.



## One-Room Railroad

(Continued from page 92)

area partitioned off into a room. He knew his layout would have to go into this room, but he didn't want to ruin the space for parties.

The sill of the basement foundation ran around the room on three sides, and Frank had previously installed a shelf 6 inches wide atop this sill to hide the concrete. He fastened two strips of track to the shelf, wired them (the wire running beneath the shelf) and soon Casey Jones Beatty had his railroad in operation.

As a main line it was a flop. A train would travel 45 feet around three sides of the room, but then had to back up the same distance before making another forward run. You can't highball a freight over a track like that, and there were jeers from the neighborhood gang as they watched Frank try.

Beatty solved the problem by building another track shelf along the fourth wall. When he came to a built-in bookcase he merely cut a hole through it so the train would vanish behind a fine collection of art books. This, to the small fry, was a pretty tricky arrangement. Encouraged by their cheers, Frank solved the hardest problem of all.

The track circled the room except for the doorway, and to fill this gap he built a double-deck bridge 31 inches long, with track laid on both decks. One end of the bridge he hinged to one side of the doorway. The opposite end of the structure swings down and clicks into place, exactly in line with the track behind the bookshelf. This is a real accomplishment on a 31-inch bridge, for an error in alignment of  $\frac{1}{32}$  inch will produce a spectacular derailment of these little HO trains.

Today the bridge is left up except when Frank and Tom are routing freight around the room. When they enter, they simply swing down the bridge and are ready for action. Once Frank, upon arriving home from a hard day at the office, discovered the bridge down across the doorway. Son Tom denied any knowledge of it. Frank now suspects, darkly, that his wife has found a new type of recreation for her leisure moments. The thought gives him the jitters; in his mind he sees a beautiful handmade passenger train racing eastbound, throttle wide open in the hands of a rank amateur who may not see that string of flats pulling out of the siding—westbound.

The beauty of this around-the-room layout is that Frank has the benefit of a long track, yet he hasn't subtracted a square

(Continued to page 234)



# Lifetime Christmas Gifts

**Every Man Wants  
ELECTRIC TOOLS**

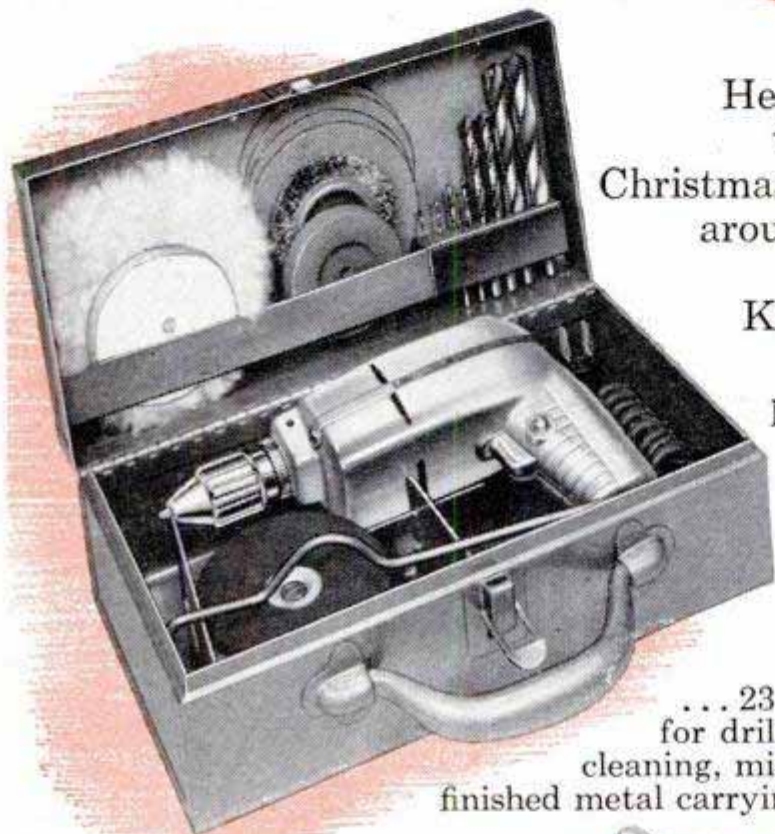

He will appreciate your thoughtfulness when you give him a PET Tool this Christmas. He can then do hundreds of jobs around the house, on the farm, or in his shop—easier—faster—better. Known for their light weight, modern streamline design, and dependable performance, PET Tools are packed with power, safe and easy to use, and priced right. Truly great gifts that will give years of usefulness and enjoyment to any man.

**ZEPHYR 1950—HDK De Luxe Drill Kit**  
... 23 pieces with 1/4" electric drill and accessories for drilling, grinding, sanding, polishing, buffing, cleaning, mixing paint, etc. Complete with beautifully finished metal carrying case. **\$27.35**



**ZEPHYR 1950-H 1/4" Electric Drill** with hand-operated chuck, AC-DC motor. **\$18.95**  
Drill stands available—extra.

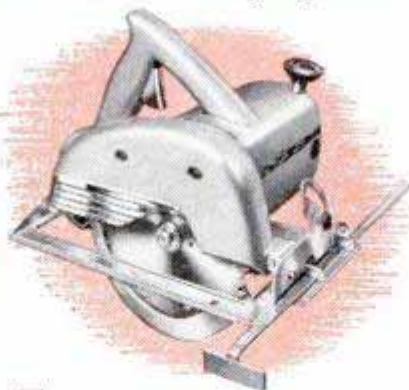

**ZEPHYR 625 Electric Hand Saw.** Depth of cut, 2 1/8". Adjustable for depth and angle. AC-DC motor. **\$47.50.** Tables extra for converting to table power saw.



**ZEPHYR SM-25 Spraymaster Portable Spray Outfit** for paint, lacquer, insecticides, etc. Complete with AC-DC motor. . . . **\$28.95**

**Insist on PET Tools from your dealer—write for general catalog.**



**PORTABLE ELECTRIC TOOLS, INC.**

324 West 83rd Street, Chicago 20, Illinois

In Canada: Portable Electric Tools, Ltd., 369 Danforth Rd., Toronto 13, Ontario



# Here's how for home painters



**Trick to make painting windows easier.** To keep ladder from breaking through window pane, nail a flat board across the ladder to straddle window. The ladder will rest on the frame of the window rather than on the glass.

**How to keep paint can from dripping on floor.** A simple way to prevent paint from dripping on floor is to tie or glue a paper pie plate underneath the can. The pie plate catches the paint drippings—also provides convenient place to put the brush.



**How to figure how much paint your house needs.** Add up the square feet for all sides and then divide total by 500, which is the number of square feet a gallon of Devoe One-Coat House Paint will cover. The answer is the number of gallons you'll need.

**How to keep your cellar free of spider webs.** Devoe makes a wonderful DDT paint that is death on most insects. Just one coat of this paint on cellar window woodwork and beams and you won't be troubled with spider webs.

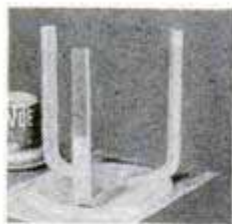

**How to enamel furniture.** Turn the chair or table upside down and start at the bottom. Paint each part (leg, rocker, etc.) completely in one operation. Work from the inside and finish on outside. For a smooth finish use Devoe Mirrolac Enamel.

You can get all the painting accessories that you need at the sign of the Devoe Diamond. Stop in and see your Devoe Dealer very soon. His name is listed in the Classified Phone Book.



## Clinic for Homemakers

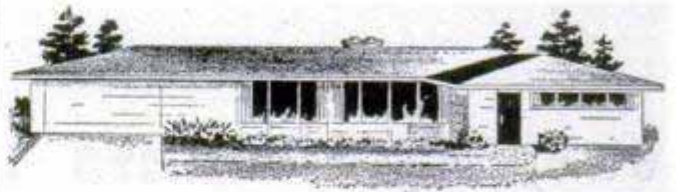

As a service to our readers in solving the hundreds of problems pertaining to a home—inside or out—the editors of *Popular Mechanics* invite you to present your problems to The Clinic Editor for help and advice. Address your questions to The Clinic Editor, *Popular Mechanics Magazine*, 200 East Ontario Street, Chicago 11, Ill.



### Painting Siding Corners

**Q**—What causes paint to peel from metal siding corners? I built my own home last year and used wide siding. I lapped the ends of the siding boards and also primed the boards before applying the metal corners. Then I applied the finish coats of paint, covering the corners at the

same time. Now the paint is peeling badly from the metal although it has been on less than six months. What should I do to prevent the paint from peeling? R.M., Ill.

**A**—The metal corners should have been coated with a metal primer before installation. It's a good idea to coat both sides of the metal as an added precaution against rust. Be sure that the primer is thoroughly dry before applying paint. In your case, probably the best thing to do is remove all loose paint by wire brushing and sanding and then permit the surfaces to weather for a month or two before repainting. If the paint comes off readily with a wire brush, then remove all of it and apply a metal primer. Allow the primer to dry at least a week before repainting. In new installations builders sometimes allow the metal corners to weather for two to six months before painting, first with a suitable metal primer, then with the finishing coats. Metal gutters are often treated in the same manner. In this way chemical residues remaining from the galvanizing process will be sufficiently neutralized to prevent injury to the paint. Dipping the metal corners in common household vinegar often is done and found effective as a neutralizer.



### "Plaster Pops"

**Q**—My new home (about one year old) has plastered walls, the plaster being applied over what was called a plaster base. Now, in some rooms, the plaster has broken out, leaving small holes about  $\frac{1}{4}$  to  $\frac{3}{8}$  in. deep with irregular edges. These holes occur in irregularly spaced patterns over the walls and ceilings

of several rooms. I have made a number of inquiries, but so far no one has been able to tell what causes the plaster to break in this manner. Can you tell me the cause? W.S., Mich.

(Continued to page 232)





INSTALL **MATICO** YOURSELF  
for as little as **13¢** a sq. ft.



**SO EASY!  
YOU LAY IT  
TILE BY TILE**

New, perfected  
**MA-TI-CO**<sup>®</sup>  
install-it-yourself  
**METHOD**  
makes anyone a  
floor craftsman

**Create exclusive designs from unlimited color combinations!**

Beat high flooring costs! Install MATICO yourself! You can floor an entire room in only a few spare-time hours. MATICO offers everything you need — simplified instructions . . . special tool kit . . . and tile so outstanding in color richness, finish and durability that it is ideal for every room in your home.

Superior MATICO resists scuffs and mars . . . washes easily . . . gleams like new with occasional no-rub waxings . . . wears for years and years . . . and comes in 27 rich colors, including lovely pastel "Petal Tones." Colors and marbling can't wear off — they go clear through each tile. Ask your dealer for details or mail coupon today!

*\*Your cost may be less, or slightly more, depending on where you live, and the colors you select.*



**Mail Coupon for instruction booklet NOW!**



**MASTIC TILE CORP. OF AMERICA**  
Dept. M212, Box No. 986  
Newburgh, N. Y.

Please send complete install-it-yourself instruction kit, illustrated literature and color charts. Enclosed is 10c to cover mailing.

NAME .....

ADDRESS .....

CITY..... ZONE.... STATE.....



**MASTIC TILE CORPORATION OF AMERICA**

Member Asphalt Tile Institute  
Factories:

Joliet, Ill. • Long Beach, Calif. • Newburgh, N. Y.

For faster cleaning . . . more beautiful asphalt tile floors, always use MA-TI-CO Wax and MA-TI-CO Cleaner.

1C45



# REMODELING

you can do yourself  
with the

**WESTERN PINES\***



Whether you want to panel a dining room in pine, do over a kitchen or build in some needed storage units, you'll find these easy-to-work, light-to-handle Western Pines\* just suit your purpose.



Home craftsmen everywhere know the Western Pines\* for their fine even grain and soft texture—so easy to shape, nail and finish. Their mellow, cheerful charm adds lifetime beauty to any room or article. Cabinets and furniture, hallways, doors and walls, bunk bedrooms, breakfast nooks, kitchens and playrooms . . . unlimited are the uses of these versatile, practical woods of the Western Pines\*.

For how-to-do-it instruction sheets and colorful new booklet, "Enchanting Homes of Western Pines"—with 71 pictures of ways others have used these glorious Western Pines\*—send for *Free Idea Packet No. 314*. Write today to Western Pine Association, Dept. 314-N, Yeon Building, Portland 4, Oregon.

These are the Western Pines

\* IDAHO WHITE PINE  
\* PONDEROSA PINE  
\* SUGAR PINE

(Continued from page 230)

A—Plaster fractures of the type you describe are known to builders as "plaster pops," and usually the trouble occurs on walls which are plastered over a plaster base. It is sometimes due to using nails of the wrong specification, but more often is caused by failure to drive the nails to the proper depth when installing the plaster base. Manufacturers of plaster bases generally specify the length and wire size of the special type of nails that are to be used, and that the nails shall be driven in just far enough to compress, but not to break the surface of the material. In your case it probably will be necessary to enlarge and undercut the holes slightly, drive the nails in if they project, and fill the holes with patching plaster before decorating the walls. It also will be necessary to sand the patches lightly to bring them flush with the surface of the wall. Be sure that the patching material is thoroughly dry before applying a wall size or paint primer.



## Drain Tile Up-End

Q—Recently my septic-tank disposal system failed and the tank overflowed. On digging up the tile lines in the dispersal field I found several of the individual tiles standing on end at a point considerably below the bottom of the original tile ditch, or excavation. Of course, in each instance the rest of the tile line was clogged. Several of the lines were affected in the same manner. What is the cause of the tile being displaced in this way?—L.A., Mo.

A—When open-joint tile are laid in certain soils that contain sand pockets (quicksand) or sand layers at irregular levels, this trouble sometimes occurs. When the subsurface water level rises as a result of prolonged heavy rains, floods, or the presence of underground springs, the excess water which collects in the sand pockets "floats" the tile in the sense that the wet sand does not provide sufficient support under these conditions to hold the individual tiles in place. Gradually the tile sinks, drops out of line and up-ends. Unfortunately, in connection with a septic-tank disposal system in a limited area, the problem has no simple solution. About the only permanent remedy is to move the affected tile lines into more stable soils. Usually it is difficult to locate the subsurface quicksand pockets beforehand but sometimes stunted vegetation over the pocket will give a reliable clue to its location. Only by running the dispersal tile lines through more stable soils can you be sure of avoiding a repetition of the trouble.

## Finishing Asphalt Tile

Q—My kitchen and bathroom floors are covered with asphalt tile and after two years of use the areas subjected to heavy wear are beginning to look dull and rather discolored. Is there a protective finishing material which will renew the colors and make the floor more wear resistant? If so, how is this finish applied? L.T., Ga.

A—First, clean the tile thoroughly with an asphalt-tile cleaner which is supplied for this purpose. This cleaner comes as a dry powder and is mixed with water in the proportions specified by the manufacturer. Follow the cleaner with two coats of special asphalt-tile finish, sometimes referred to as a sealer. This material provides a non-slip, grease and stain-resistant surface that will withstand hard wear for a long period of time without renewal. Usually the important thing in the preparation of the surface to assure a satisfactory job is to make sure that the tile surface is thoroughly clean before applying the sealer. This means that all dust, lint and sand, if any, must be removed from the surface before application of the sealer. Make sure that the brush or applicator is clean and that the room is kept as nearly dust-free as possible until the sealer is dry. Areas subjected to unusually hard wear often can be protected with rubber mats to prolong the life of the finish.





THIS YEAR MAKE IT A

# Dremel Christmas



## DREMEL QUALITY TOOLS ARE IDEAL GIFTS TO GIVE OR GET!

Lucky the man, woman, or child who receives Dremel quality gifts for Christmas! For these are America's finest power-in-hand tools. We invite you to compare them with any similar products made—point by point, feature for feature. Then you'll know

why Dremel guarantees finer performance, longer life, than anything your money can buy. For shop projects, home maintenance, or favorite hobby—it pays to insist on DREMEL and accept no substitute. Order yours today — in time for Christmas!

**1 MOTO-TOOL KIT No. 2**—Dremel's Model 2 Moto-Tool is the fastest, most powerful tool in its class—delivers approximately 27,000 R.P.M. It grinds, carves, routs, drills, engraves, sharpens, etc.—works well in wood, plastics, metal. Saves plenty on home maintenance jobs. Performs hundreds of shop operations, and for hobbies it's a must. Precision made, shockproof, 110-120 V. A.C.-D.C. Motor, Moto-Tool No. 2 only, \$16.50. Complete Kit with 23 high quality, shop-tested accessories (High-Speed Steel Cutters, Grinding Wheels, Polishers, etc.), Only . . . . **\$23.50**

**2 MOTO-TOOL KIT No. 1**—Contains lighter capacity No. 1 Moto-Tool with 34 accessories (steel cutters, grinding wheels, etc.) in attractive, lacquer-finish wood case. **Biggest bargain in the field!** Tool alone with 1 emery wheel point is only \$9.85. Complete kit, Only . . . . . **\$17.50**

**3 PORTABLE DRILL PRESS**—(Uses No. 2 Moto-Tool) Adds versatility to Moto-Tool operations. Ideal for model-making, wood carving, routing, etc. Precision built, 12" high. Price (less Moto-Tool) Only . . . . . **\$9.95**

**4 MODEL 2000, SANDER-POLISHER**—Fastest seller in the field. Straight-line reciprocating action guarantees scratch-free finishes. A fast-cutting production sander (14,400 sanding strokes per min.) for heavy-duty craft and wood-working projects, refinishing and redecorating. Gives you necessary power—easy one-hand opera-

tion—and 21 sq. in. of sanding surface for furniture making, boat building or refinishing, resurfacing large areas, building operations such as dry-wall joints, woodwork, siding and exteriors. Does a superb polishing job! Weighs 5 lbs.; needs no oiling; permits 10-second paper change; dustproof. Over-all size 3 1/2" x 4 1/2" x 7"; 110-120 V., 60 cycle A.C. With steel carrying case, 25 asst'd. abrasive sheets, sheepskin pad, Only . . . . . **\$24.50**

**5 MODEL "A" SANDER-POLISHER-MASSAGER**—A lighter-capacity machine with same construction features as larger model—including straight-line action for scratch-free finishes and 14,400 strokes per min. By far, the most popular sander ever offered home owners, house-wives, hobbyists for all their sanding, polishing, refinishing tasks. Also a soothing massager! Wt. 2 1/2 lbs.; sanding pad 2 1/4" x 5 1/2". Complete with asst'd sandpapers, a felt and sheepskin polishing pad, Only . . . . . **\$14.85**

**6 ELECTRIC COPING SAW**—Safe as a handsaw—cuts scrolls like magic—sands as it saws! For home, hobby, repair work—no other tool pleases so much for so little cost. Works in any direction—smoothly delivers 7200 strokes per min. Saws through 3/4" medium-hard wood at foot-a-minute speed. Trigger-touch foolproof action. Only 2 moving parts, never needs oiling, 110-120 V., AC. Free plans packed with each saw for 6 useful wood projects, and for making your own table-type jig saw! With 3 saw blades, Only . . . . . **\$5.85**

**DREMEL** Electric TOOLS  
for SHOP and HOME



SOLD BY BETTER DEALERS EVERYWHERE—If yours doesn't carry, remit in full for postpaid shipment. Or send only \$2 now, pay postman balance plus postage and COD fee. Five-day trial, money-back guarantee!  
DREMEL MFG. CO. Dept. 111-M Racine, Wis.

## SAVE THREE WAYS WITH A NEW Cushman

WRITE  
FOR FOLDER  
AND PRICES  
DEPT. 24-M



Get the big three Cushman economies—low purchase price, low operating cost, low maintenance. Ride the Cushman scooter to work, school or shop. Less than a penny per mile to operate. Dealer inquiries invited.

**CUSHMAN MOTOR WORKS Lincoln, Nebr.**





# WITH BOWES COMBUSTION AID

## For Fast Starts; Driving Protection

Be *sure* of quick, easy starting this winter! BOWES Combustion Aid absorbs the water in your fuel lines, keeps them free of gums, softens and removes carbon. Easy to use . . . just put it in your gas tank . . . and have dependable, inexpensive cold weather protection! Your Bowes "Seal Fast" dealer can supply you.

**START**  
*Faster . . .*  
**DRIVE**  
*Smoother!*

It will pay you to visit your nearest Bowes dealer for tire and tube repairs . . . fan belts . . . oil filter cartridges . . . battery cables with terminals that *can't corrode* . . . and other fine automotive services and accessories "for smoother motoring."



**DRIVE IN WHERE YOU  
SEE THIS BOWES EMBLEM**

BOWES "SEAL FAST" CORP., INDIANAPOLIS

foot from the usable area of the basement.

By the time he finished the bridge he had built several complete trains, either assembling the cars from kits or scaling them down to the last rivet from photos, as only a combined artist-craftsman could do. Probably his proudest work is an 1873 loco, scaled down and reproduced perfectly from a single woodcut in an old history book.

It was about this time that Frank began ordering, each morning, a "string of flats" (hotcakes) for breakfast. At the office he'd tell the artists on his staff to "highball" a piece of art work or "shunt it onto the siding." He was plumb loco over locos.

He wanted to make the entire basement room a background for the railroad. The only reason he decided to redecorate the room, according to Frank, was to give Tom some art training. Tom, on the other hand, reports that Pop let him paint some of the blue sky, but not much else. In any case, the two stayed up through the graveyard run one night, sketching what they wanted in the way of a background. Soon the ceiling and walls were as blue as the Western sky. With artists' oils and ordinary house paint they painted a vast scene around the room. To the scene they added scale-model buildings. The result is so effective it's difficult to tell where the three-dimension models end and the two-dimension art work begins.

In one corner, lofty mountains look down on an abandoned mining town. The coal tiple and oldtime false-front buildings show the effect of years of neglect. Still legible are the once-gaudy signs which drew customers to Tom's Place (a Chinese laundry), Ruth's Place (a dance hall) and Dave's Emporium (everything from buffalo robes to bootlaces). To the left, the mountains melt into foothills, and the foothills roll out into the long prairies. There's an entire farm, from pigeon loft to pig pen. The prairies rise once more into mountains, with a deserted hunter's cabin up near the timberline. Beyond the pass is a city, with real buildings. And beyond the city is the bridge (doorway) followed by the smoky darkness of the bookcase-tunnel. Moving downgrade now, the railroad passes rolling farmland, and the trip ends in a modern city, skyscrapers reaching high toward the ceiling. When this jagged city skyline encounters a basement window it doesn't falter—the buildings march right on across the window, draperies and all.

Weaving through this scenic splendor are railroad tracks—151 feet 3½ inches of them, according to Beatty, who drove every spike in the thousands of ties. In one corner a classification yard with four sidings

(Continued to page 250)



**OWN a Business . . . a life income**



**Clean & Mothproof Rugs, Upholstery**

Would you like to own a nationally advertised business which can earn you \$15 in profits a day on EACH of your service men? Easy to learn. Start full or part time. No overhead. No shop needed. Service rendered in homes, hotels, offices, etc.

**DURACLEAN** cleans, revives, brightens carpets and upholstery . . . used again within a few hours with no inconvenience to customers. Eliminates scrubbing . . . soaking . . . shrinkage.

**DURAPROOF** protects fabrics from moths and carpet beetles. Backed by a world-wide Money Back, 4 YEAR WARRANTY.

Send for **FREE 16 page booklet** explaining details. 21 yrs. of proven success. We furnish enough material to return your **TOTAL investment**. Easy Terms. Territories are limited. Write today!

**DURACLEAN CO.** 1-16D Duraclean Bldg. Deerfield, Ill.

**NEW 1952 KING MIDGET AUTO**

**World's Lowest Priced 2 Passenger Car** Drive it for 75¢ per week. Amazing performance. Surprising comfort. All steel construction. Full accessories, top and heater. Ready to run or assemble it with our bolt together parts. Rider agents wanted, earn your car free. Send 25¢ for detailed literature or \$1 (refunded first order) for actual assembly book and service manual filled with photos, drawings, specifications, etc.

**MIDGET MOTORS MFG. CO.**  
ATHENS, OHIO

**BUILD FINE GRANDFATHER CLOCK NOW**

The simple sensible Red-i-Kut way as thousands have — **SAVE HALF. SHOP TESTED PLANS "SPIRIT OF THE CENTURY"** Narrow waist 83" tall or stately straight side **"SPIRIT OF AMERICA."** **EASY-TO-FOLLOW photopark PLANS** tell all — plus **BROCHURE** of heavy brass weight Westminster, tube chime, movements, gorgeous dials, 3/4" solid mahogany case kits. Send \$1.00 today — Both plans \$1.50 NOW.

**KUEMPEL CHIME CLOCK CO., #4 Kuempel Bldg., Minneapolis 16, Minn.**

**5 BIG POWER TOOLS in ONE**

**8" TILTING TABLE SAW**  
**30" LATHE**  
**HORIZONTAL DRILL PRESS**  
**GRINDER**  
**SANDER**

**RETAIL PRICE \$125.00**  
**FACTORY TO YOU \$79.95**

**SUPERSHOP** is a **PRECISION-BUILT WORKSHOP**. 100% ball bearing. All running parts precision ground. Big capacity. Extra rugged. Amazing value. Write for **FREE** catalog.

**BUY ON EASY PAYMENTS**

**POWER TOOLS, INC.** 130 YATES AVENUE  
BELOIT, WISCONSIN

**VERTICAL DRILL PRESS**

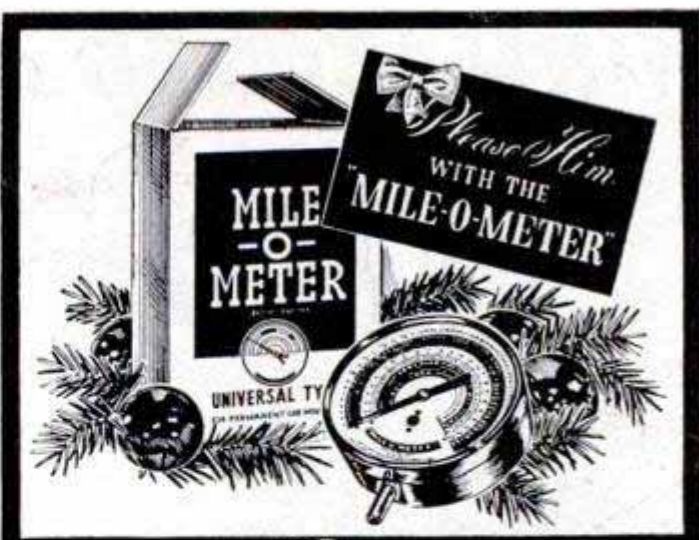

*The Gift That Every Man Wants*

The perfect and practical gift for every and any man as well as for "the man who has everything" . . . with the "Mile-O-Meter" on the car's instrument panel he'll be a proud driver. He'll know just how many miles per gallon he's getting at all times, at every speed . . . He'll save gas and repair bills by getting more miles per gallon . . . He'll know just how efficiently his engine is operating . . . when it's time for a tune-up. He'll think of you every time he drives his car. "Mile-O-Meter" makes any dashboard look even better. Built with fine watch precision and appearance, it lasts a lifetime — quickly transfers to any new car he may buy. Comes complete with 24-page booklet of easy-to-follow instructions. This wealth of economy operating information brings him up-to-date . . . tells him how to drive for maximum gasoline performance . . . explains 31 ways "Mile-O-Meter" helps tune and check his motor. Fits every car, regardless of year or make — can be installed by anyone in a few minutes. Fully guaranteed — over 1,000,000 in use. A fascinating gift that any man will thrill to. We will gift-wrap the gauge for you — enclose any card you may send with your order — mail to any address. "Your gift occasion is our business" — our motto for almost 100 years. Deluxe model in Kifer Maroon Leatherette case embossed in gold. A perfect Jewel Box — no charge. "Mile-O-Meter" sent prepaid. "Mile-O-Meter" drivers are safe drivers — Standard the world over.



**DELUXE CHROME MODEL** 3 3/4" Dia. \$14.95 P.Pd.  
**STANDARD MODEL** 2 3/4" Dia. \$ 9.75 P.Pd.  
Both include Fed. Tax

**MAIL THIS COUPON—TODAY!**

order from **GALE HALL Engineering Dept. 14**  
107 Northampton St., Boston 18, Mass.  
World's Largest Producer of Tune-Up Gauges

Please send \_\_\_\_\_ DELUXE \_\_\_\_\_ STANDARD Mile-O-Meters at \$ \_\_\_\_\_

NAME \_\_\_\_\_

ADDRESS \_\_\_\_\_

CITY \_\_\_\_\_ ZONE \_\_\_\_\_ STATE \_\_\_\_\_

Check enclosed  C.O.D.  Gift Wrapped (Free)

Makes a perfect gift. **MONEY BACK GUARANTEE**



**UNMATCHED at this Low Price!**

**CRAFTSMAN**  
OUR OWN TRADE MARK

**Tilting-Arbor  
Bench Saw**

Saw Only

**\$57.50\***  
Cash

Complete with blade, miter gauge,  
rip fence, two pulleys and V-belt  
\$6 Down, \$5 Monthly



**Complete Outfit**  
**\$129.95\***  
Cash  
With guard, motor,  
extensions, bench,  
light and Powr-Panl  
\$13 Down

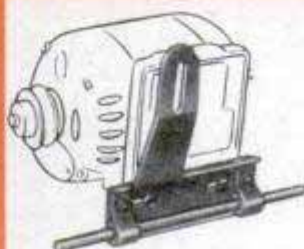

**FLOATING  
DRIVE**

Greatest improve-  
ment in Tilting-Ar-  
bor Saws in years!

Special floating motor mount lessens strain  
on saw. Smothers vibration, permits much  
easier tilting; protects motor from sawdust;  
automatically controls belt tension. Elim-  
inates the need for a special motor.

**Only \$6 Down puts this big,  
sturdy Saw in your shop!**

Meets the most exacting requirements of pro-  
fessional craftsmen! Look at these superior  
features! ONE wheel controls BOTH angle and  
depth of cut. Special high-speed tilting and  
depth adjustments; no locking device needed.  
ONE lever locks fence at BOTH front and  
back. "Super-lubricated" ball bearings have  
much larger oil chambers. Largest table area  
of any bench saw in this price range!

Precision-ground cast semi-steel table. 8-in.  
combination blade (1/2-in. bore) has 2 1/2-in.  
depth of cut; tilts any angle to 45°. Saw has  
blade; miter gauge; rip fence; machine and  
motor pulleys; V-belt; motor mount. Complete  
Outfit (as shown) includes saw guard assembly  
(with automatic leveling guard, splitter, non-  
kickback pawls); CRAFTSMAN 1/2-H.P. 3450  
R.P.M. ball-bearing capacitor motor (110-120  
volt 60-cycle AC); 2 side table extensions;  
front roller extension; adjustable steel power  
tool bench; tool light; and Powr-Panl for  
plugging in. See this sensational saw at your  
nearest Sears Retail Store TODAY!

\*Prices slightly higher south of the Ohio  
and west of the Mississippi rivers.

**Handy Accessories for Your Bench Saw**

**CRAFTSMAN 6-in. Dado Set, \$9.50.** Dados, rabbets, grooves. 1/2 or 3/8-in. arbor.

**CRAFTSMAN Molding Cutter Head, \$4.50, and Cutter Bits (styles \$2.95 per set, up).** Make your own moldings! Has dozens of uses! 4-in. diameter cutter head (with Allen wrench), fits most bench saws with 1/2 or 3/8-in. arbor. 1-in. wide bits cut styles as shown.

Your nearest Sears Retail Store will furnish you with exact selling prices which will not exceed ceiling prices under applicable price regulation of O.P.S.

**CRAFTSMAN Carbide-tipped Saw, \$10.95 and up.** New! Safer — has only 8 teeth projecting only .020 in. above non-cutting edge. Tungsten carbide tipped blades last 20 times longer than ordinary circular saw blades! No need to resharpen at frequent intervals. For ripping, cross-cutting or mitering. 5/8 to 10-in. diameters; all arbor sizes.



**CRAFTSMAN** Hand and Power Tools by **SEARS, ROEBUCK and CO.**  
Famous for fine quality . . . precision performance . . . low price!



# NOW!

# A Whole Shop-full of Tools in One!

Complete Outfit

**\$26<sup>95</sup>\***  
cash

With 52 accessories  
in convenient workshop case

\$3.00 Down on Sears Easy Terms

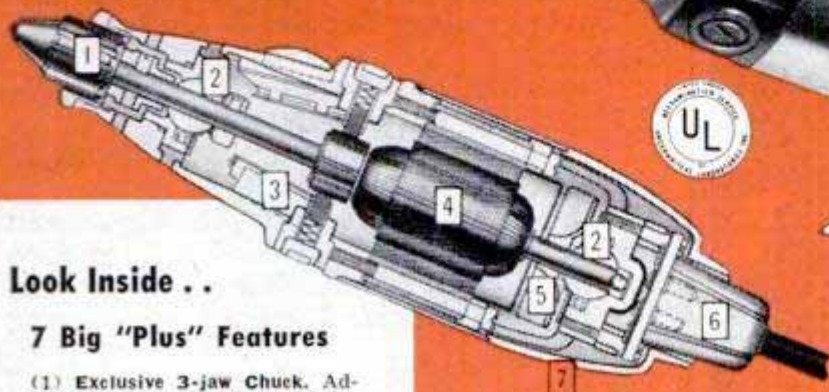

Look Inside . .

### 7 Big "Plus" Features

(1) **Exclusive 3-jaw Chuck.** Adjustable from 1/64 to 1/4-in. Takes 3/32 and 1/8-in. shank tools, AND holds wire gauge drills, etc., without special adaptors or collets.

(2) **Big Tool Construction.** Shaft straddle-mounted on two bearings. Also has ball thrust bearing.

(3) **Built-in Condenser.** Reduces radio and television interference.

(4) **Rugged Motor.** Has 50% more power than any other rotary tool we know of in this class.

(5) **Scientifically-designed Fan.** Helps make this the coolest running rotary tool we've seen. Temperature rise hardly noticeable even after hours of tough usage.

(6) **Plug-in type Cord.** Latest design. Easily removed.

(7) **New functionally streamlined overall design.** Easy to hold; easily clamped. Measures 7 1/2-in. overall.



**DEBURRING.** Also cleans, brushes, sands, cuts.



**POLISHING.** Can buff, rout, sharpen, too.



**GRINDING.** Also drills, engraves and etches.



Bench stand swivels 120

## CRAFTSMAN Rotary Electric Tool Set

See it . . compare it . . try it yourself! Has 50% extra power over other rotary tools this type and size; takes **HEAVIER** loads without stalling! Guaranteed to meet the most rigid requirements of precision tool-room work and production line uses. And ideal for hobbyists. Actually has hundreds of uses! Can be used on wood, metal, glass, plastics, leather, etc. **Approved by Underwriters' Lab.** Powerful 15,000 R.P.M. motor for 110-120-volt, 25 to 60-cycle AC or DC. Exclusive chuck; on-off switch. Strong, light aluminum alloy housing. Complete with 52 accessories, including cutters, saws, drills, brushes, polishing and sanding wheels, extra mandrels, etc.; bench stand, 6-ft. cord, 11x8 3/4 x 2 1/2-in. case. Act quickly. Available at nearest Sears retail store today!

### Economy-priced CRAFTSMAN Rotary Tool Set

(IMPORTANT: Don't confuse this CRAFTSMAN rotary electric tool with similar tools selling in this price range. This is the quality for which you would expect to pay much more.) Ideal for home or shop use.

Performs the same operations described above. Has powerful 15,000 R.P.M. universal motor for 110-120-volt, 25 to 60-cycle AC or DC. Fan cooling system; built-in condenser; on-off switch. **Underwriters' Lab. approved.** Removable pistol-grip handle. Collet chuck with 2 collet inserts (capacities, 3/32- and 1/8-inch). With 5 1/2-ft. rubber cord; plug. Overall length 7 inches. With 52 accessories as above . . . in workshop case. Available NOW at your Sears retail store.

\* Prices are slightly higher south of the Ohio and west of the Mississippi rivers.

Complete Outfit  
**\$19<sup>50</sup>\***  
cash

\$2.00 Down



**CRAFTSMAN** Hand and Power Tools by **SEARS, ROEBUCK and CO.**  
Famous for fine quality . . . precision performance . . . low price!



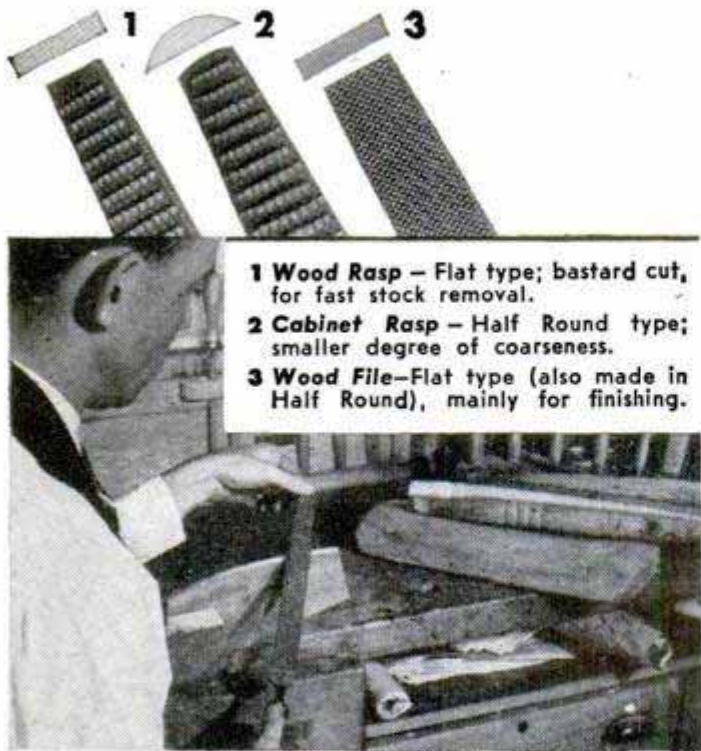

- 1 **Wood Rasp** — Flat type; bastard cut, for fast stock removal.
- 2 **Cabinet Rasp** — Half Round type; smaller degree of coarseness.
- 3 **Wood File** — Flat type (also made in Half Round), mainly for finishing.

**FOR**  
**wood fix-ups**

Mr. Fixerupper is again setting up business in the home basement, garage or tool shed. Repairing and restoring old, and building new, furniture and cabinets can be both a hobby and practical household economics.

Good wood shaping, fitting and finishing results can be obtained with a modest selection of files. Such a selection is also a thoughtful contribution toward the conservation of steel which is so important to the nation just now.

Buying *good* files—Nicholson or Black Diamond, for instance—also helps. Because they last long, they ultimately use up less steel than poorly made, short-lived files. Good hardware stores carry Nicholson brands—and will gladly help you pick out a non-wasteful assortment for your particular needs.

**HOW TO USE AND TAKE CARE OF FILES** — to make them last long — is worth knowing. "*File Philosophy*," Nicholson's famous 48-page book, tells you. **FREE** — send for it today.



**NICHOLSON FILE COMPANY**  
22 Acorn Street, Providence 1, R. I.  
(In Canada, Port Hope, Ont.)



**NICHOLSON**  
**FILES** FOR EVERY PURPOSE

## Ride a Jet Fighter Into the Night

(Continued from page 138)

of the coast's radar network would act as Ground Controlled Intercept. First GCI would move the two planes apart, then vector Lunatic 3 toward us again.

"Partial calling Lunatic 88. Turn right to 345 degrees."

That was us. Hathaway brought up the wing in a tight turn, leveled off and put the plane on autopilot, and sat back for a smoke. Both planes were blacked out and a high haze was obscuring the moon. It would be really black when the stalk began.

"Partial calling Lunatic 3. I have a customer for you. Turn right to 40 degrees."

"Partial calling Lunatic 3. Go left to 35 degrees."

"Partial calling Lunatic 3. Your bogie at 12 o'clock. Distance 30 miles."

"Partial calling Lunatic 3. Bogie at 12 o'clock, distance 20 miles."

Watching both planes on its big search scopes, the GCI station near San Francisco had rapidly put Lunatic 3 on a course that would intercept us. Now we were being overtaken.

"Lunatic 3 to Partial. I see him. Thanks."

This meant that the other plane had picked us up on his scope and had taken over radar control. Now the GCI station was free to watch for other intruders. Behind us, presumably, Lunatic 3 was diving at us or veering in from an angle. Lunatic 88 was a sitting duck for this kind of rehearsal, of course, and yet the denouement came surprisingly soon.

"Splash one F3D!"

The laconic radio message told us that the problem had been finished and that in theory we had been shot down. Lunatic 3 had closed in, made a visual "cateye" approach to identify us positively, then had backed off to shooting distance for the kill. There was one final radio message before the game began all over again.

"Lunatic 88, you are high on my port beam."

I looked down through the right cockpit window, squinting into the darkness, and barely made out a large black shape keeping pace with us. The planes would stay together for safety until GCI moved them apart again.

The two top-notch pilots had made the operation seem easy; actually they have one of the toughest jobs in aerial warfare. A pilot needs every bit of help that electronics can give him when following an invisible target that probably is engaging in evasive actions. Too, the bomber that he was following normally would carry

(Continued to page 240)



# LOOK!

**A CRAFTSMAN**  
REG. U.S. PAT. OFF.

**8-tooth  
Carbide Tipped Saw**

as low  
as . . . **\$10<sup>95</sup>** 5 7/8 inch

**Costs you MUCH LESS  
than similar blades!**

Actual tests PROVE this CRAFTSMAN outperforms similar blades selling for much more! Rips, crosscuts, miters—handles more jobs smoother and faster. Needs less sharpening, outlasts ordinary all-steel blades 20 times! Tungsten-carbide tipped teeth project only .020 inch above non-cutting surface: saw can't grab—protects you from kickback injuries! Cuts woods, plastics, formica, masonry, wallboard, abrasive building materials, transite, asbestos, aluminum and asphalt roofing and siding. (Not for masonry, steel, iron or other ferrous metals.) See table below for sizes . . . and see this sensational new saw at your Sears Retail Store!

Diameter	Arbor Hole	Fits these saws	Price
5 7/8 in.	diamond . . . . .	6-in. Skil-saw . . . . .	\$10.95
6 1/8 in.	1 1/8 in. round . . . . .	6-in. Black & Decker	10.95
6 in.	square . . . . .	Mall	10.95
6 1/2 in.	1/2 in. round . . . . .	CRAFTSMAN 6 1/2-	
		in. hand saws;	
		bench saws . . . . .	10.95
6 in.	5/8 in. round . . . . .	Porter-Cable;	
		bench saws . . . . .	10.95
7 in.	diamond . . . . .	Skil-saw . . . . .	11.95
7 in.	square . . . . .	Mall . . . . .	11.95
8 in.	1/2 in. round . . . . .	CRAFTSMAN 8-	
		in. hand saws;	
		bench saws . . . . .	12.95
8 in.	5/8 in. round . . . . .	Bench saws . . . . .	12.95
8 in.	diamond . . . . .	Skil-saw . . . . .	12.95
10 in.	1 in. with step-	Bench saws; build-	
	down bushings	ers' saw; radial	
	for 3/4 or 5/8-in.	saw; swing saw . . . . .	14.95
	arbor sizes		

New, improved tools with  
**TWICE AS  
MUCH POWER**

as former models!



**\$17<sup>50</sup>\***  
With steel  
carrying case

**CRAFTSMAN Sander-Polisher-  
Massager . . Just plug it in!**

Designed as a finishing sander—not for removing paint, varnish, or deep scratches. 14,400 "Dual-arc" strokes per minute give super-smooth surfaces. Entire tool and cord approved by Underwriters' Laboratories, Inc. For 110-120 volt 60-cycle A.C. only. See it at your nearest Sears Retail Store TODAY.

**CRAFTSMAN 11-in.  
Reactance motor  
Jig Saw**

Only  
**\$13<sup>95</sup>\***



- Just plug it in!
- Really a grand gift!

NOT a toy—but a rugged, well-made power tool for making models, puzzles, lawn ornaments, etc. For 110-120 volt, 60-cycle A.C. only. Gives a super-smooth cut that needs no sanding. Entire tool and cord approved by Underwriters' Laboratories, Inc. See it NOW at your nearest Sears Retail Store.

\*Prices slightly higher south of the Ohio and west of the Mississippi rivers.

**CRAFTSMAN** by SEARS, ROEBUCK and CO.  
REG. U.S. PAT. OFF.

**CRAFTSMAN** by SEARS, ROEBUCK and CO.  
REG. U.S. PAT. OFF.



# SELF-CONTROL STARTS HERE



and to restore

**CAR PERFORMANCE**

## OIL-CONTROL STARTS HERE

**To stop oil-pumping, replace worn engine connecting rod bearings**

In your car engine—as in your work—control is all-important for best performance!

When connecting rod and main bearings are worn, they lose control of oil flow. They no longer "meter" exact amounts of oil for proper engine lubrication. Excess oil reaches combustion chambers, burns to performance-stealing carbon on spark plugs, valves, pistons and rings. *Performance goes up in smoke!*

Give new piston rings a chance to do their own job—replace worn engine bearings, too! Genuine Federal-Mogul bearings are engineered for the job of oil-control. They restore smooth performance and economical operation. *Ask your mechanic!*

**FEDERAL-MOGUL SERVICE**  
(Division of Federal-Mogul Corporation)  
DETROIT 13, MICHIGAN



**CONTROL OIL-PUMPING**

WHERE IT STARTS—REPLACE WITH

# FEDERAL-MOGUL

**OIL CONTROL BEARINGS**



radar-controlled guns that will be fired automatically when he approaches. The fighter has to get in the first punch if he is to win the radar battle.

Down on the "deck" when chasing a low-flying airplane, the night-fighter pilot needs an extra sense in addition to everything else. The altimeter, the radio altimeter, and the radar can all tell him his distance above the surface and yet in the tense excitement of the chase he may drop too low and fly right into the water in the dark.

There are a hundred other things that can happen before a pilot is ready to seek his carrier by radar or is talked down to it by Carrier Controlled Approach.

To help the night fighter in his crucial battles, the Navy recently developed two new auxiliary kinds of aircraft, the AD-4W that is loaded with radar equipment and that serves as a high-flying early warning radar search center, and the AD-4Q, a countermeasure aircraft whose main job is to scramble an intruder's radar signals.

Teamed together, the two types of planes are expected to detect enemy aircraft at greater distances than are now practical, and to spoil the accuracy of his radar equipment without affecting the radar on our own F3Ds and other friendly aircraft.

The whole subject starts getting pretty complicated right about here; the Navy's electronic experts are certain that they'll have the upper hand if and when the actual test of battle comes.

## Let's Send TV Around the World

(Continued from page 87)

there are no wires to come down. Last year, during the worst ice storm ever to hit the East Coast, the New York to Philadelphia microwave link operated by Western Union carried 100 telegraph-printer channels without interruption, while many land-line communications experienced severe breakdowns because of the storm.

On top of all this, microwave relay is being improved daily. Its beams can be bent by mirrorlike reflectors to bring television signals up from behind mountains and down again into mountain-bound towns. Recently, a video station in Binghamton, N. Y., needed a link with its transmitter whose tower barely peeked over the top of a hill three miles away. Cable was too expensive, so engineers put a dish-type antenna atop the building in town. They couldn't put a receiving antenna on the part of the tower that showed because of installation problems. So they built a seven-foot aluminum mirror on the tower,

(Continued to page 242)



# A Christmas Bonus Every Day!

YOURS FOR YEARS WITH

# DELTA POWER TOOLS

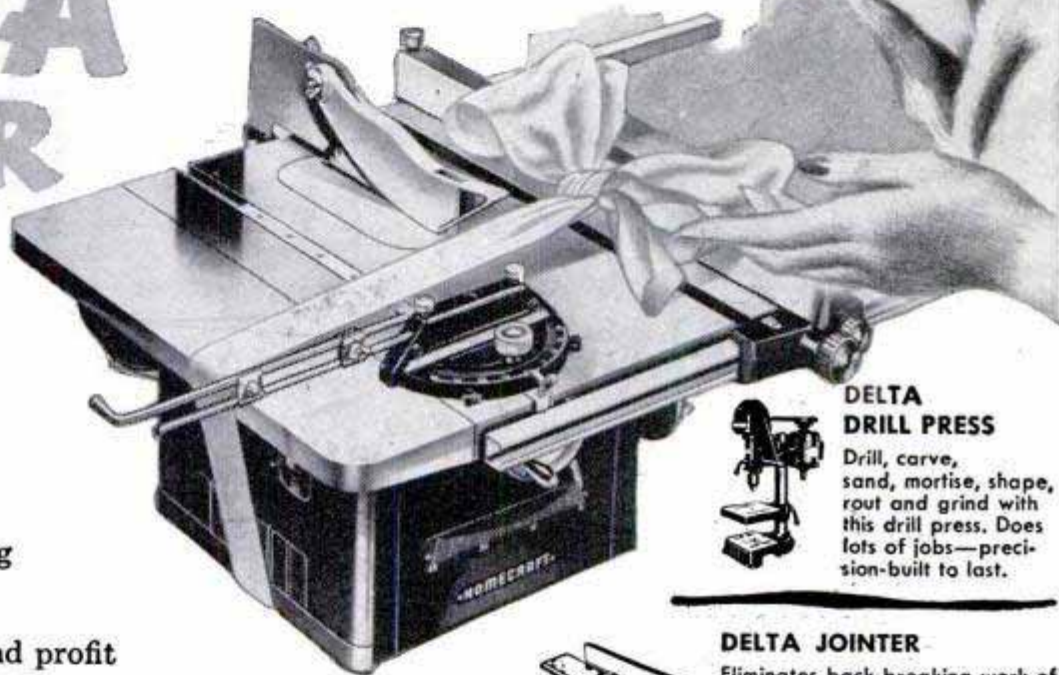

What better Christmas bonus, what finer gift, can you imagine for *yourself* than Delta Power Tools? It's a lasting bonus, too, that keeps on paying year after year in pleasure and relaxation and profit—for these quality tools soon pay for themselves in actual money saved on the things you make for yourself, for the home, for the family.

So, drop a hint where it will do the most good, or earmark that Christmas bonus or gift money for a *real* bonus for *you* . . . Delta Power Tools . . . a lifetime investment in pleasure and profit!

**BASIC TOOL** in any workshop, to perform ALL the basic woodworking operations, a Delta circular saw pays for itself in worthwhile home improvements—and pleasure!

**JUST A FEW OF THE THINGS YOU CAN MAKE RIGHT AT HOME WITH DELTA TOOLS!**

**For the House:**

Kitchen Snack Bar  
Coffee Table  
Storage Cabinet  
Baby Beds  
Wall Shelves

**For the Children:**

Trucks Pull Toys  
Doll Beds Tanks  
Cranes Guns  
Tops Boats  
Doll Houses

**For the Family:**

Men's Wardrobes  
Television Table  
Picnic Table  
Dressers  
Bird Houses

Delta "How to do it" Books Make Welcome Gifts—  
Scores of Titles—Get Them at Your Delta Dealer.

**DELTA  
DRILL PRESS**

Drill, carve, sand, mortise, shape, rout and grind with this drill press. Does lots of jobs—precision-built to last.



**DELTA JOINTER**

Eliminates back-breaking work of hand-planing—makes true, smooth edge for precision fit Heavy duty.



**DELTA BAND SAW**

Big capacity band saw cuts wood up to 6" thickness, curved or straight line cutting to make valance boards, etc.



**DELTA SCROLL SAW**

This safe machine does almost any kind of sawing. Cuts wood, plywood, plastic or metal in attractive, intricate shapes.



DELTA POWER TOOL DIVISION

**Rockwell**  
MANUFACTURING COMPANY

803N E. VIENNA AVE. • MILWAUKEE 1, WIS.

Send me the name of my Delta Dealer and latest Delta literature.

Name \_\_\_\_\_

Address \_\_\_\_\_

City \_\_\_\_\_ Zone \_\_\_\_\_ State \_\_\_\_\_



# Protection



The New AC

*Aluvac* Oil Filter Element

Guards Your Engine Against Hidden Enemies

Constantly picking off the enemies that shorten engine life—removing the grit that grinds and the sludge that clogs—the new AC *Aluvac* Oil Filter Element gives vital protection to any engine.

Dirty oil comes in—clean, safe oil goes out, in an endless stream of protection for all moving parts. You'd be amazed to know how little wear takes place when engine oil is always clean.

You'd be equally astonished to know how fine and uniform the filtering pores of the AC *Aluvac* Element are. They take out dirt particles as small as 1/100,000th of an inch in size.

You'll get a lot of mileage—low cost mileage—out of your AC *Aluvac* Element, too. Size for size, it has 10 times the filtering surface of ordinary elements—double the sludge-retaining capacity.

So there's both quantity and quality for you, in one precision-built package.

And remember this: It's the filter element that does the work in an oil filter. The next time your filter element needs changing, replace with an AC *Aluvac* Element. There's a size and type to fit almost every oil filter.

AC SPARK PLUG DIVISION



GENERAL MOTORS CORPORATION

at an angle that reflected the microwave beam down to an antenna on the transmitter's rooftop—well below the hill. That mirror has been bouncing microwaves over the hill successfully ever since.

There are other ways to beam our microwave-radio signals across the ocean and such techniques might come even sooner.

With what we know right now, we could develop what I call a "radio air lift"—transoceanic planes, equipped with compact microwave-radio relay apparatus that would operate automatically. A continuous string of aircraft so equipped could pass a television signal from one plane to the next until it reached its destination. In effect, the planes would simply be microwave antennas at stratosphere height.

Today, a plane takes off every 35 minutes for Europe. That's enough planes to do it, since it would require only 16 properly spaced planes from New York to Amsterdam at any one time to turn the trick. By timing present commercial and military departures properly, a chain of airplanes, flying at 20,000 feet or more, could be as much as 200 to 300 miles apart and still transmit line-of-sight microwave-radio relay signals from one to the other.

With two groups of 15 Constellation-type planes a two-way circuit could be operated simultaneously, or one ultrafax circuit, or 500 two-way phone channels, or 5000 two-way Teletype channels. So, in between television shows, there would be plenty of work to keep the radio air lift busy.

What about getting good television transmitting and receiving equipment down to airplane size and weight? Way back in 1940, RCA staged a pioneer venture when it sent a television plane up over New York City. In that craft was a small video station, consisting of cameras and a lightweight relay transmitter. The whole outfit weighed 700 pounds. The plane picked up and telecast to a local station for relay a bird's-eye view of the city in a successful 45-minute show. A year earlier a plane with a receiver on board was picked up by the television camera of a mobile unit at a New York airport, relayed to RCA's station atop the Empire State Building, and retelecast. The plane's receiver was tuned in on the channel, and men on board looked at the screen and watched themselves coming in to land.

These were early experiments, but they proved that airborne radio-relay equipment was practical. Since then, tremendous strides have been made. A few years ago, a young television engineer developed a system involving nothing more than a compact microwave-radio relay for aircraft. Signals picked up by the plane,

(Continued to page 244)



PREPARE NOW FOR POWER FAILURE! IMMEDIATE DELIVERY—LARGE STOCK—MANY SIZES

# A. C. GENERATING PLANTS

DESIGNED FOR CONTINUOUS OR INTERMITTENT SERVICE

Item #133—3 KW—120 Volt—60 Cycle A.C. Single Phase HEAVY DUTY  
 PLENTY OF CURRENT TO OPERATE YOUR—OIL BURNER • REFRIGERATOR  
 • HOME FREEZER • SUMP PUMP • POWER SAW • BROODER • CREAM  
 SEPARATOR • INCUBATOR • VENTILATING FANS • MILKING MACHINES  
 • BLOWERS • YARD LIGHTING • OTHER APPLIANCES

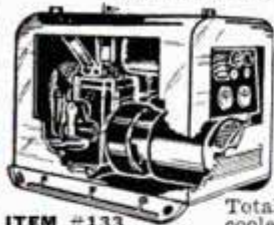

ITEM #133 Totally enclosed power unit with 2 cylinder water-cooled Hercules Model BXB engine direct coupled to generator. Magneto ignition, crank start, 4 gallon gas tank, 3 qt. oil capacity. Skid mounted with handrails for carrying. Instrument panel including killer button, oil pressure, water temp. gauges, voltmeter, ammeter. Shipping wt. 560 lbs. F.O.B. Chicago.

Item #133 395.00

Write for information on other size generating plants ranging from 350 watts to 25 KVA.

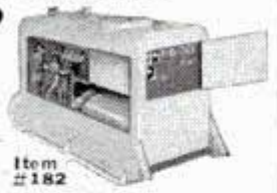

Item #182—5KW—120/240 volt—60 cycle A.C. single phase, direct coupled to Willy's Jeep 4 cylinder engine. Shpg. Wt. 1200 lbs. F.O.B. Chicago. 895.00



Item #178—350 watt—110 volt—60 cycle A.C. direct coupled to 1 cylinder Mico engine. Shpg. Wt. 116 lbs. F.O.B. Chicago. 125.00

## GROBAN'S Guaranteed WAR SURPLUS BARGAINS

ORDER TODAY & SAVE!

### NEW MODEL 353—DUAL RANGE D.C. ARC WELDER

for Stationary or Portable Use. Heavy Duty Range to 250 amps. New 'Magic Terminal' For Low Current 30 to 100 amps.

Ideal for: FARM, GARAGE, FACTORY WORKSHOP.

These precision engineered D. C. Arc Welders contain the highest quality War Surplus aircraft components built to exacting government specifications. They are light in weight, have oversized lifetime grease-sealed ball bearings, air cooled commutator, dial type rheostat for easy pin-point control, a high-low rheostat switch, reactor coil for even arc and the new 'MAGIC TERMINAL' low current welding range for welding lighter materials. Designed for many years of trouble-free service. Run welder from drive pulley or power take off of a tractor or Jeep. 7 1/2 HP electric motor or 10 HP gas engine at 2500 R.P.M. Uses two V belts or flat belt. Continuous output rating 200 amps. Intermittent welding rating 250 amps, 30 volts. This sensational price includes double V or flat belt pulley and complete operating instructions. Shipping weight 107 lbs. \$350.00 Value Now Only..... 119.50 F.O.B. Chicago

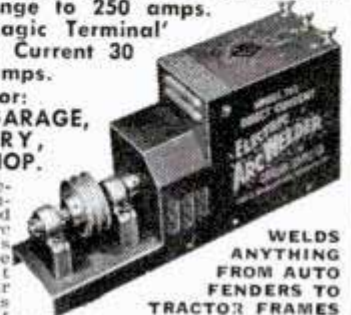

WELDS ANYTHING FROM AUTO FENDERS TO TRACTOR FRAMES

ALL ITEMS BRAND NEW

### General Motors—Allison CENTRIFUGAL PUMP

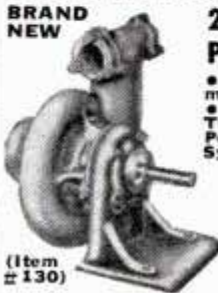

200 GALLONS PER MINUTE

- For Draining Basements
- Fire-Fighting
- Irrigation
- Fuel Transfer
- Swimming Pools
- Home Water Systems
- Dewatering

These General Motors—Allison Centrifugal Pump—designed for use on U. S. Air Force Mustang fighters, now converted for commercial, home, and industrial high volume pumping applications. Inlet, 2 1/2" standard pipe thread, twin outlets with 1 1/4" pipe thread, ball bearing supported 3/4" shaft. Easy, fast simple priming. Rotation, counter-clockwise facing shaft. Shipping wt. 35 lbs. Gov't acq. cost \$145.00. F.O.B. Chicago Now Only..... 39.50

Suction Lift	Head Pressure	Gal. Per Min.	H.P.	R.P.M.
10'	75'	260	6.0	3500
10'	65'	200	5.2	3500
10'	80'	40	1.5	2500
10'	50'	140	5.0	3500
10'	30'	100	3.0	2500

### HYDRAULIC EQUIPMENT

Large supply of new labor-saving, economical hydraulic equipment in many types and sizes. Use these positive, highly efficient smooth pressure hydraulics on presses, arbors, lifts, loaders, power control, positioning, brakes, plastic dies, auto frame alignment, etc., etc.

ITEM #70—Puristolor hydraulic oil filter. Permanent element type, 3/4" female pipe thread ports. Capacity 16 gallons per minute. A \$13.00 value, now postpaid..... 4.95

ITEM #127—Double acting hydraulic cylinder, 1" bore, 1" stroke, 1/2" diam. shaft, 1/4" tubing thread ports. Over-all length closed—6 1/2". Clevis mounting at both ends. Perfect for clamping and feeding. Postpaid..... 5.95

ITEM #33C—Double action hydraulic cylinder, 1 1/2" bore, 4 1/2" stroke. Clevis mountings at both ends. Uses 1/4" pipe fittings. Postpaid..... 8.95

ITEM #16C—Double acting hydraulic cylinder, 1 1/2" bore, 26" stroke. Will lift 1760 lbs. with 1000 PSI line pressure. Weight 8 lbs. A \$55.00 value. Now Only, Postpaid..... 16.95

ITEM #39—VICKERS HYDRAULIC PUMP—PISTON TYPE—Ideal for use with hydraulic cylinders and valves described in this page and Vickers constant displacement piston type pump delivery. 507 cubic inches per revolution, 8 gallons per minute at 3750 RPM, 1000 PSI. Has 1/2" diam. shaft, 3/4"-18 thread inlet and outlet ports. Rotation—clockwise. Postpaid..... 19.90

ITEM #126—Four-way, open center control valve with built-in adjustable relief valve. Factory set at 1000 PSI., spring-loaded neutral position, for use with one double acting cylinder. Fully balanced plunger type, smooth, positive, easy operation, can be used as single unit or mounted in series of any combinations desired. Has 3/4" pipe thread inlet and outlet, 1/2" pipe thread cylinder ports. Newly manufactured to our specifications. Shipping weight 8 1/4 lbs. An outstanding buy! F.O.B. Chicago..... 21.50

ITEM #103—Double acting hydraulic cylinder, 2 1/2" bore, 17" stroke. Clevis mounting. Will lift 4900 lbs. with 1000 PSI line pressure. 1 1/4" diam. shaft, 3/4" tubing thread ports. Overall length closed 28". Shpg. wt. 11 lbs. F.O.B. Chicago..... 21.50

ITEM #31C—Double action hydraulic cylinder, 3 1/2" bore, 11" stroke. Aluminum alloy cylinder wall and all steel 1 1/4" piston rod. Clevis mounting at base and shaft. 1 1/2" over-all length closed. Will lift 625 lbs. using 1000 PSI from Logan Heavy Duty Hydraulic Pump. Uses 3/4" tubing fittings. Value \$102.00. Shipping wt. 11 lbs. F.O.B. Chicago..... 22.50

ITEM #6—Double action hydraulic cylinder, 3" bore, 24" stroke. Will lift 7070 lbs. with 1000 PSI line pressure. Steel barrel, 1 1/8" stainless steel shaft. Gov't. acq. cost \$176.00. Ship. wt. 26 lbs. F.O.B. Chicago..... 28.00

ITEM #42—Double action hydraulic cylinder, 4" bore, 18" stroke. Rated lift capacity with 1000 PSI line pressure is 12,500 lbs. Ship. wt. 30 lbs. F.O.B. Chicago. An Excellent Buy for..... 32.50

### HYDRAULIC SPEED REDUCER WITH FINGERTIP CONTROL

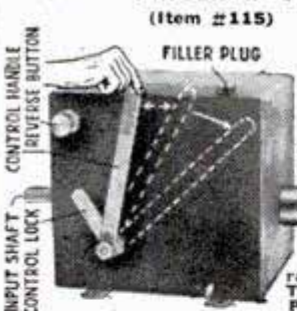

- USE FOR:
- Reamer Drives
  - Midget Cars
  - Feed Mills
  - Canning Machines
  - Conveyors
  - Lathes
  - Milling Machines
  - Motor Boats
  - Cream Separators
  - Garden Tractors
  - Pumps

Variable output speeds ranging from 0 to input speed now available. Merely move control handle until desired speed is attained. Then turn locking handle to maintain the setting. Internal relief valves prevent overloading. Use input power of 1/4 to 1 1/2 H.P.

This Westinghouse-Oil Gear Unit converted to commercial use from 40 MM anti-aircraft traversing mechanisms consists of a variable displacement hydraulic pump feeding a fixed displacement hydraulic motor. These components are contained in a crackle-finish steel oil reservoir (capacity 2 qts.). Adjustable relief valves set at factory for 100 inch pounds of torque may be reset up to 180 inch pounds. Independent reverse control allows full output power and speed selection in either direction of rotation. Both input and output shafts measure 3/4" diam., include keyway. Input rotation is counter-clockwise facing shaft. Recommended input speeds not to exceed 750 R.P.M. Over-all dimensions 7 1/2" x 7 1/2" x 11 1/4". Gov't acquisition cost, \$428.00. Shipping weight 31 lbs. Complete with 2 qts. of oil and full instructions. F.O.B. Chicago..... 54.50

### HAND FLUID PUMP

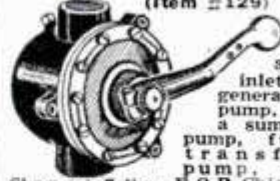

Item #129—Type D4—Bronze and aluminum construction, 3/4" pipe thread inlet and outlet. Fine general utility hand pump. May be used as a sump pump, barrel pump, fuel transfer pump, etc. Shipping weight 7 lbs., F.O.B. Chicago..... 11.95

### D.C. GENERATORS

For welders, plating, truck and marine use, D. C. appliances, lights, etc. Aircraft quality—lifetime grease sealed ball bearings. Heavy duty.

Item #90—Type P-1, rated 200 Amps.—28 Volts, 2500 RPM. Mfd. by General Electric, Ford, Deleo-Remy and Westinghouse. Gov't. Acq. Cost \$300.00. Shpg. wt. 53 lbs. F.O.B. Chicago..... 22.50

Item #91—Type R-1, rated 300 Amps.—30 Volts. Mfd. by Jack & Heintz. Gov't. Acq. Cost \$380.00. Shpg. wt. 59 lbs. F.O.B. Chicago. Each individually packed in wooden box..... 35.00

FREE: NEW 1952 48-PAGE CATALOG  
 Jam-packed with War Surplus Bargains. You save on everything. Write today!

ORDER DIRECT FROM AD — SEND PAYMENT OR PURCHASE ORDER TODAY — SATISFACTION GUARANTEED

GROBAN SUPPLY CO. 1139 SO. WABASH AVE., CHICAGO 5, ILL. DEPT. PM-12



flying in circles some 25,000 feet up in the stratosphere, were retelecast earthward by this sky-high antenna. In one demonstration, a television program of a world-series game was relayed from the plane. The signal spread out like an inverted ice-cream cone, reaching the receivers of set owners in 55 communities in six states beneath the plane.

By relaying the television signals from plane to plane, instead of beaming them earthward, the experimenters at that time estimated that eight specially equipped planes, flying 400 miles apart at 25,000 feet, could make up a transcontinental microwave-radio relay net. In addition, each plane could transmit programs to ground receivers over an area 500 miles in diameter around them, bringing television to scores of out-of-the-way places.

For many reasons, the plan did not materialize. But it certainly was possible. Something similar to it could be our answer to transoceanic television tomorrow.

There are two other ways of building our transoceanic television network, both more remote, because of the problems involved. For years the military has toyed with the idea of building a series of multidecked floating islands, like huge aircraft carriers on pontoons instead of hulls. The idea has been to spot these islands across the At-

lantic, to serve as weather stations, emergency landing strips for aircraft, repair depots for crippled ships, and a host of other sound purposes.

Microwave-radio relay to Europe would provide one more reason why they might be built. For on such a chain of islands towers could be erected to carry the beaming apparatus for many channels of communications via television, telephone, teleprinter, ultrafax, or what you will. Towers 1000 feet high on artificial islands spaced 75 miles apart could beam their microwaves to each other without trouble. You've already seen how that would work for television, since it's just another way of extending the tower-chain network.

One problem here is the designing of such towers that would be strong enough to stand the stresses of buffeting by the elements. Another lies in anchoring such islands. To be properly spotted across the ocean, some would be in very deep water. The strain of ocean currents and other pressure movements of water on a long expanse of anchor cable can create tremendous drag. A few pounds of stress on cables a mile long could pull such a huge floating island right under water. One of our own engineers at RCA anchored his 30-foot boat in 150 feet of water in Long Island Sound

(Continued to page 252)

## UNCLE WALTER

**IT SMELLS GRAND**



SNIFF A WHIFF—  
IT SMELLS RIGHT JOLLY!

**IT PACKS RIGHT**



CUT TO PACK JUST RIGHT, BY GOLLY!

**IT SMOKES SWEET**



A MERRY SMOKE—*Sir Walter Raleigh!*

**IT CAN'T BITE!**



SIR WALTER RALEIGH'S BLEND OF CHOICE KENTUCKY BURLEYS IS EXTRA-AGED TO GUARD AGAINST TONGUE BITE. THE LARGE SIZE CANISTER OF SIR WALTER RALEIGH—IN A BEAUTIFUL YULETIDE PACKAGE—MAKES THE PERFECT CHRISTMAS GIFT!



# This Christmas, See How Little It Costs To Give Famous Professional Quality Westcraft Tools

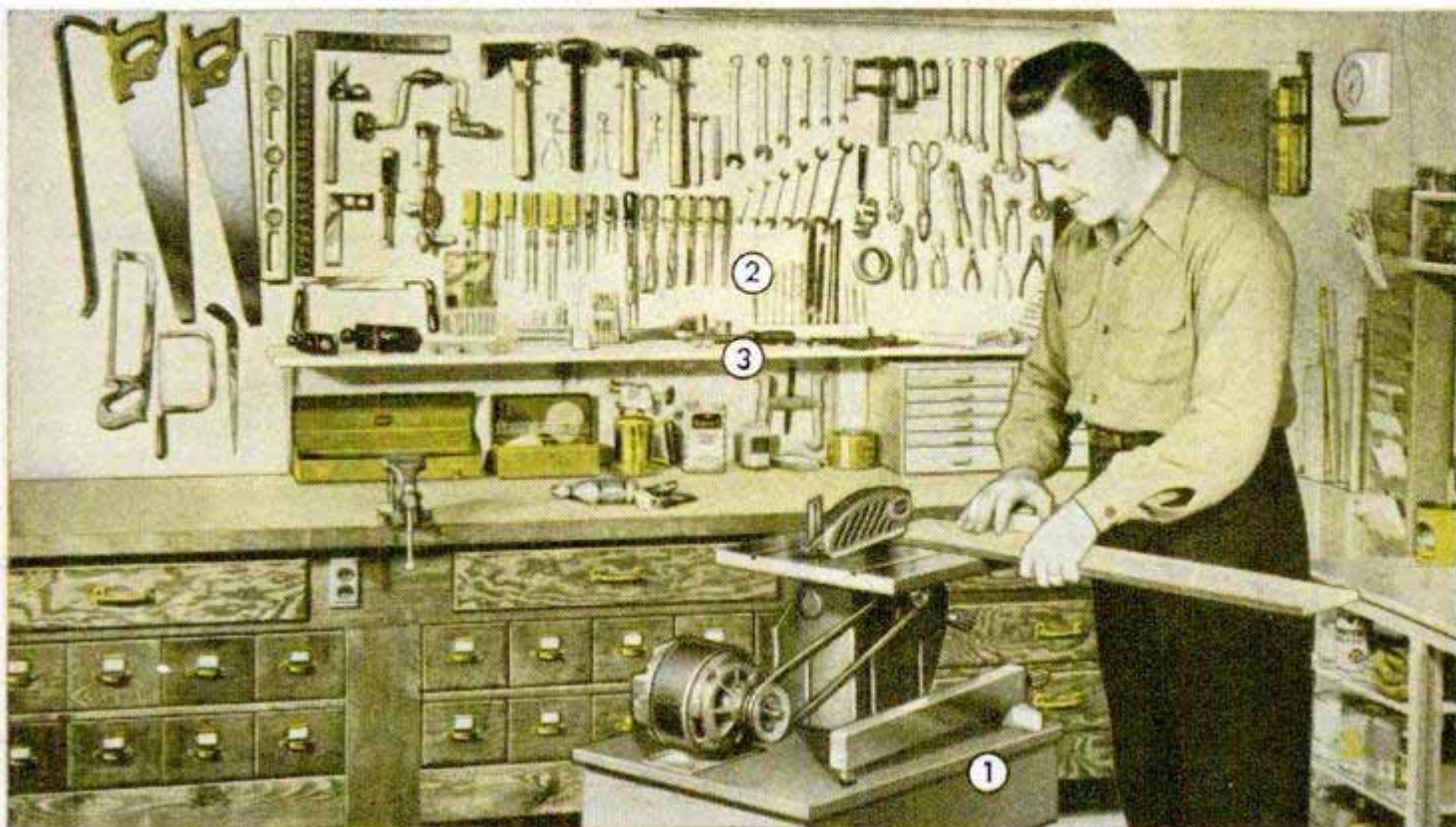

**Why pay fancy prices for fine tools?** See, try and compare Westcraft—you'll discover that these famous, shop-tested tools give you the same precision manufacturing and lasting accuracy of other brands costing far more. Westcraft Tools are fully guaranteed and are yours on easy terms. Here are a few from our complete selection—see them this week at Western Auto! . . .

- ① **7" Tilt Table Bench Saw.** 14"x16" table. Performs 8 different cutting operations. Ball bearing arbor. 2 3/16" cutting depth. Only . . . (2HR1002) . . . **\$3940**
- ② **Auger Bits,** solid center, hand forged from high grade tempered steel. Tapered shank fits any standard bit brace. 13 sizes, as low as . . . (4HR6730-36) . . . **79¢**
- ③ **Soldering Iron,** 100 watt. 7/8"x1 3/4" copper tip. Nickel-chrome sealed element . . . (4HR4316) . . . **\$200**



**Punch & Chisel Set,** precision ground and tempered. Chrome plated, polished alloy steel. 4 pieces in carrying kit. (HR1677) **\$1.63**



**Ball Pein Hammer,** 16 oz. Heat treated, tempered tool steel. Selected hickory handle. Specially ground, polished . . . (4HR4084) **\$1.75**



**1/2 HP Electric Motor,** 1725 rpm, 115 v., 60 cyc. AC. Split phase. GE guaranteed for 1 full year. Only . . . (2H1601) . . . **\$18.50**



**Wrench Set** for hollow-head set screws with hexagon socket. Plated to resist rust. 7 sizes in plastic case. Only . . . (4HR2550) . . . **54¢**

Professional Quality—Wizards of Performance

## WESTCRAFT TOOLS

Sold by the largest group of associated tool departments in America

**WESTERN AUTO**  
STORES & ASSOCIATE STORES

Sold Only By

NOTE: Western Auto Associate Dealers own their own stores and set their own prices. Terms quoted are recommended terms, subject to variance. © 1951 Western Auto Supply Co., K. C., Mo. (PM121)





For youngsters 8-to-80!

# STANLEY TOOLS

Good tools make good gifts for men of all ages. Give Stanley Tools this Christmas . . . complete sets in sturdy chests or individual tools in Woodcraft boxes. Now on display at your dealer's. Look for this famous trade mark (STANLEY)



## Tool Chests

Hobby House Set No. 910. Five other tool sets available in prices ranging from \$12.00 up.

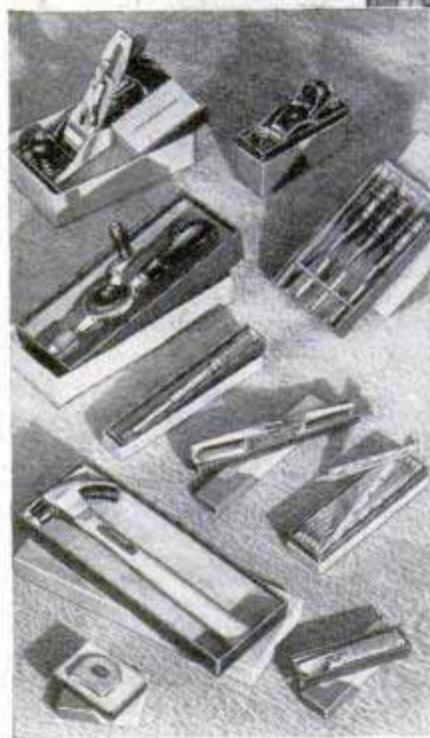

## Gift Packages

Complete assortment of 10 most wanted tools: Bench and Block Planes, Chisel Set, Torpedo Level, Hand Drill, "Yankee" Push Drill, Extension Rule, Nail Hammer, Trimming Knife, "Pull-Push" Rule.

**TOY PATTERNS**  
**2 NEW SETS**  
**25¢ each**

Two sets of 6 patterns. Full size, easy to trace and cut out. Cover folder gives suggestions for finishing.

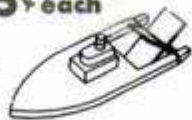

**STANLEY**

Reg. U.S. Pat. Off.

Stanley Tools  
New Britain, Connecticut  
THE TOOL BOX OF THE WORLD

Hardware • Tools • Electric Tools • Steel Strapping • Steel

## NEW TOY PATTERNS

Stanley Tools, 3121 Elm St., New Britain, Conn.  
(In Canada: Stanley Tool Co. of Canada, Ltd., 3121 Stanley St., Roxton Pond, Quebec.)

Check:  Set(s) Patterns P1. 25c each.  
 Set(s) Patterns P2. 25c each.

Name.....  
Street.....  
City..... State.....

## Australia Starts Her Own "TVA"

(Continued from page 129)

At Lob's Hole, it meets water from the Tantangara Reservoir, formed by damming the upper Murrumbidgee River. This reservoir will have a capacity of 300,000 acre-feet. On the way to Lob's Hole, it picks up water from the Yarrangobilly River at Yarrangobilly Pond. From Tantangara to Yarrangobilly Pond, the 8½-mile tunnel will serve one power station. From Yarrangobilly Pond, the tunnel continues for five miles to Lob's Hole and another power station. These two stations will develop 265,000 kilowatts.

From Lob's Hole Reservoir, a canal conveys the water to the power station and Blowering Dam on the Tumut River. Blowering Reservoir has a capacity of 800,000 acre-feet and is primarily for water-regulation purposes. Water may be released higher up to generate power, when not needed for irrigation at the time. So this water won't be wasted, it will be stored at Blowering and released only as required for irrigation. The power station below Blowering Dam will make use of this water.

Combined, the 16 power stations of the Snowy-Murray and Snowy-Tumut sections will produce 2,860,000 kilowatts, slightly more than that of the Tennessee Valley Authority. The project will make 2,000,000 acre-feet of water per year available for irrigation on the Murray and Murrumbidgee Rivers. This is four times the amount now used yearly by the Murrumbidgee area alone. It is enough to irrigate 3,500,000 additional acres of land on the lower reaches of these two rivers. A fertile country, needing only water to produce bumper crops, the land will settle between 50,000 to 100,000 people. Increased agricultural production of this area will be worth over \$50,000,000 annually.

Australian engineers have done most of the planning for this project, which has aroused worldwide interest because of its size and the many problems involved. The Australian Ministry of National Development has asked the United States Bureau of Reclamation to design some major works of the project. The bureau is considered a world authority on hydroelectric practices.

The demand for trained engineers has created a problem in Australia's present labor shortage. For most of its technical staff, the Snowy River Authority has gone abroad to avoid pirating men from other Australian projects.

Many engineers have come from Europe. It is anticipated that 75 percent of the men required will be immigrants. A large flow

(Continued to page 248)





# Gifts For Year 'Round Fun and Savings!

**40<sup>TH</sup> YEAR**  
*Atlas*  
**POWER KING**  
**WOODWORKING TOOLS**

When you and your wife talk about practical gifts this year, put in a plug for the Power King tools you need in your shop. Have her see them at your Atlas-Power King dealers. PK tools, better than any others, give you the capacity and accuracy you want *plus* rugged construction and proper bearings for long service. They're fun to operate and, used wisely for home improvement and furniture building, can save you hundreds of dollars. FREE — new catalog with operating views and hints — send a postcard, we'll rush it.



**7" BENCH SAW**  
**\$44.75**

Extensions \$4.35 each



**8" BENCH SAW**  
**\$61.75**

Extensions \$7.65 each



**12" WOOD LATHE**  
**\$78.50**



**SPINDLE SHAPER**  
**\$48.00**

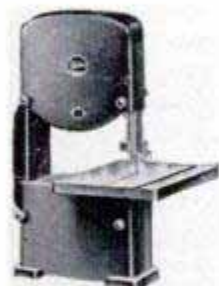

**12" BAND SAW**  
**\$92.00**



**18" JIG SAW**  
**\$39.95**



**9" WOOD LATHE**  
**\$43.50**



**12 3/4" DRILL PRESS**  
**\$74.50**



**4" JOINTER PLANER**  
**\$49.95**



**BELT AND DISC SANDER**  
**\$73.50**

**40<sup>TH</sup> YEAR**  
*Atlas*  
**PRESS COMPANY**

**PRESS COMPANY**

1243 N. PITCHER STREET  
KALAMAZOO, MICHIGAN

Prices shown  
F.O.B. Kalamazoo



from 0.0001" to 100'

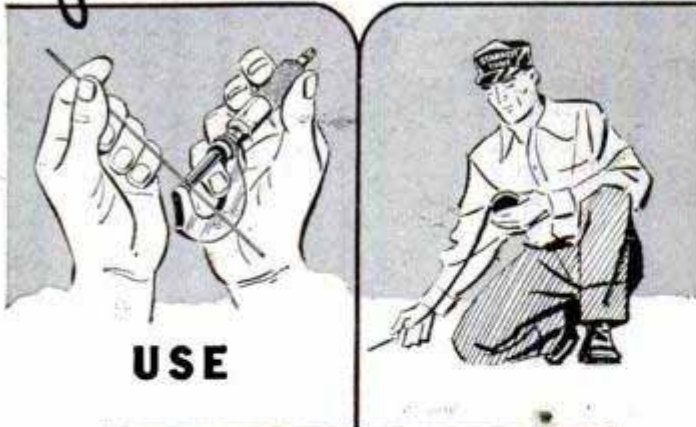

USE

**Starrett**

**PRECISION MEASURING TOOLS**

Here are just a few of the more than 3000 fine precision tools that make skilled work easy for millions of American craftsmen. See them at your Starrett Tool Distributor's.

Quick Reading Steel Tape No. 530 25, 50, 75 and 100' lengths



"Last Word" Dial Test Indicator Graduated .001" Range .030"



"Satin Chrome" Micrometer No. 231 1" capacity, tapered frame, sycamore case. Graduated .0001"



Apprentice Kit No. 902B The same fine tools skilled mechanics use



Flexible Steel Rule No. 327 6" length, graduated two sides



SEND FOR IT — ONLY 10¢ Starrett "Tools and Rules" Book 50 page booklet shows the right tools for any precision measuring job. 100 pictures plus helpful reference tables. Send only one dime. Address Dept. AP.

THE L. S. STARRETT COMPANY • ATHOL, MASS., U.S.A.



BUY THROUGH YOUR DISTRIBUTOR MECHANICS' HAND MEASURING TOOLS AND PRECISION INSTRUMENTS • DIAL INDICATORS • STEEL TAPES • PRECISION GROUND FLAT STOCK • HACKSAWS, BAND SAWS and BAND KNIVES

of immigrants from Europe is now entering Australia to help build up and develop the country.

The scarcity of domestic materials needed for the project has caused the authority to go abroad for many of them. Even prefabricated houses are being bought overseas to conserve building materials.

Much of the heavy earthmoving equipment is imported from the U.S.A. Other machinery will be imported from Europe and America as the work progresses.

Seven lakes will be created when all the dams are finished. These lakes will provide a huge reserve of fresh water to be released as needed for irrigation and power. Australia has no large fresh-water lakes, so these will prove popular for fishing and other recreation.

As most of the 16 power stations will be deep underground and safe from air attack, the power provided by them will go to many military-research projects.

This electricity will link up with power systems of Melbourne and Sydney, Australia's two largest cities with over 3,000,000 people between them. The apportionment of power, after making allowance for the inappreciable amount used by the Australian capital territory, will be between two states. Victoria will share one third and the New South Wales two thirds.

The 2,750,000 million kilowatts of electricity of the project is the equivalent of the combined output of all steam and hydroelectric power stations operating in Australia today. It will mean the saving of 4,000,000 tons of coal annually.

Roads, camps and communication lines are being built first. The isolated camps communicate with each other by radio and telephone. Work crews use walkie-talkies.

In addition to the construction of new roads to work sites, the problem of keeping them open in the winter is a huge one. For clearing snow, U. S. equipment is used.

Already the towns in the area are taking on the air of a Klondike gold rush. The town of Cooma, headquarters of the authority, is referred to as the Dawson City of the New Yukon. The old gold-mining towns of Kiandra and Adaminaby, are experiencing a revival of boom times as workers flow in and new buildings spring up almost overnight.

This task, which Australia has embarked upon to improve the welfare of her people, is tremendous, considering its population. While as large in area as the U.S.A., she has a population of only 8,300,000.

It is estimated that the total cost for the project will be about \$560,000,000. The time required to complete it all will be 25 years, according to present plans.



# Crosman

"CO<sub>2</sub> POWERED" GUNS



**POWER  
WITHOUT POWDER  
WITHOUT PUMPING**

Expert or beginner, you'll get a thrill without a "kick" shooting these amazing guns. Safe to shoot indoors or out, thanks to Crosman's "no-ricochet" type Super-Pells. Available in .177 and .22 cal. models. See them at your Crosman dealer's. Write for literature.

CROSMAN ARMS CO., Inc., ROCHESTER 20, N.Y.

## MODERN LAWN MOWER SHARPENER

**FOR LAWN MOWER SHOPS  
FIX-IT SHOPS  
GOLF COURSES • PARKS  
101 OTHER JOBS**

Sharpens All Reel Type Mowers • Hand, Power or Gang  
• 10 to 20 Minutes • No Dismantling • No Extra Attachments Needed.

All reel type mowers, from 5-inch edgers to 36-inch power mowers, are quickly sharpened to extreme ends of both left and right twist blades.

Handle, wheels, roller and motor remain in place when sharpening is in process. Bed knife is sharpened in same brackets. Grinding head rides on five ball bearing races. Easy to operate. Also sharpens chisels, jointer knives, planer blades, Big profit maker. Own your own business. Send Today for **FREE** Illustrated Bulletin No. 10-C. Prices Subject To Change Without Notice.

**ORDER NOW**  
Immediate Delivery

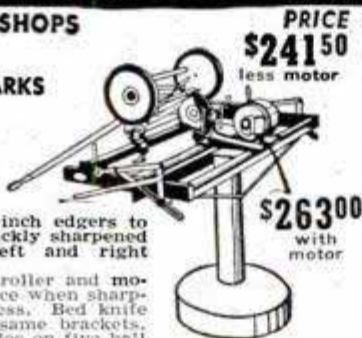

PRICE  
**\$241.50**  
less motor

**\$263.00**  
with motor

**MODERN MFG. CO.** 160 N. FAIR OAKS AVE.  
PASADENA 1, CALIFORNIA



C2

## COLORCRETE

Lifetime beauty comes out of a gun! Colorcrete is a cementitious plastic, applied by pneumatic pressure to new or old concrete, stucco, etc. Tough, tenacious, enduring. Can be washed or scrubbed. Dirty, drab surfaces become sparkling white or tinted from a range of 30 colors.

## "Building-Beautifying" - Your Big Opportunity

Colorcreting is a fascinating and profitable opportunity for men who want to build a substantial, long-term business. Colorcreting is exclusive. Rich in sales appeal to building owners. Income potentials are high; investment is low. We supply complete equipment, full instructions and liberal cooperation. Requires no previous experience or special ability. Write or wire for the Opportunity Book today. Be the first in your community.

**COLORCRETE INDUSTRIES, INC.**  
570 Ottawa Ave., Holland, Mich.



# Give Him a MAN'S Gift for Christmas!



HOME-UTILITY 5"  
SANDER-POLISHER  
only \$32.95

HOME-UTILITY  
1/4" DRILL  
only \$22.95

HOME-UTILITY  
SANDER-POLISHER  
KIT only \$49.95

**MANY USEFUL ACCESSORIES!** Stands, Wire Brushes, Masonry Bits, Buffing & Polishing Kits, Abrasive Kits, lots more!

Drilling, sanding, polishing, sharpening, wire brushing, buffing—these versatile BLACK & DECKER Home-Utility Tools speed up no end of jobs, make perfect gifts for a man's Christmas! They're quality - built by BLACK & DECKER. Easy to operate, fun to use, priced for every pocketbook. Try them, buy them at your local hardware, electrical or department store displaying the Home-Utility SANTA CLAUS!

**BLACK & DECKER**

**ELECTRIC  
HOME-UTILITY  
TOOLS**

THE BLACK & DECKER MFG. Co., Dept. H12M, Towson 4, Md.



**This Year —  
don't miss  
those  
Christmas  
snapshots**



*Add a*  
**KALART**  
*Speed Flash*

**to your camera**



Take snapshots of the children round the Christmas tree — candids of parties — other holiday pictures *indoors — night or day*. They're easy when you add a Kalart Speed Flash to your camera. No need to say "hold still." The flash of the lamp is so quick it stops most motion. Click the shutter and your Kalart automatically lights the flash lamp at just the right moment — gives you a flood of light equal to bright sunshine. Models for most cameras — *old or new*. At leading camera, drug and department stores.

Send for free illustrated booklet "How to Take Speed Flash Pictures of Baby," Kalart, Plainville, Conn. Dept. PM-12.

flanks the line's two main tracks. The through tracks go all the way along one wall and turn the corner of the room, where the outside rail heads up a 4½-percent grade. When there's enough clearance, the inside track ducks under it. On this two-level main line the trains pass over the bridge and through the bookcase.

From the control board across the room Beatty can operate a switch which shunts the lower train through the wall and out into his workshop in the adjoining room. As the train comes rolling along the spur line just above the workbench, it passes over a contact point on the rail. The weight of the locomotive causes a signal light to flash on the control panel, and Beatty then brings the train to a stop at a convenient working level a few inches above his bench.

Like any other model railroader, Frank gets ideas faster than he can execute them. Just now he's improving the painted background and installing more scale-model buildings. He's determined to do something about an electric wall outlet he considers unsightly — figures he'll cover it with a model grain elevator made of balsa wood, fashioning it so the electric plugs can be inserted through the windows.

He also says something must be done about the bridge. Not long ago he was seated at the control panel, his back to the bridge, when someone swung up the structure to enter the room. A moment later a crack eastbound freight failed to leap the gap and there was a fearful crash as box-cars and reefers smashed into the cement floor. Frank repaired the damage and now is working on new safety measures to prevent a recurrence.

At the office, the boss still has that harassed expression on his face, for Frank is worse than ever these days. Between verses of the "Wabash Cannonball" he talks about his new hot-shot freight and plans for a "water level route" past the laundry tubs.

He's rolling westbound up a blind siding all right.

**Model Railroading is more fun  
than you imagine, and less  
expensive than you think!**



● 250,000 people can't be wrong. They are having real fun with the world's fastest growing hobby. Get this picture-packed book that tells how simple it is to start . . . and how surprisingly little money is needed.

Fully illustrated, this book tells how constructive this hobby is. Enjoyed by anyone from 7 to 70. Send 10c today

for your copy of "Model Railroading for You," written by a well-known authority.

**MODEL RAILROADER MAGAZINE**

Dept. 1560 — Milwaukee 3, Wis.



# Increase Compression Up to 10% with Miracle Power in Gas and Oil

Miracle Power contains colloidal synthetic graphite—considered by automotive experts as one of the finest aids to better lubrication.

As Miracle Power circulates in the engine, the graphite clings to vital metal parts forming a graphoid film. This film helps oil maintain a better compression

seal. Result: Increased power. In addition, Miracle Power protects your engine against rust, acids and DRY STARTING—major cause of "Engine Ulcers"—and provides effective top cylinder lubrication at "red hot" combustion chamber temperatures. Check your compression before and after using Miracle Power—see for yourself.



THE AP PARTS CORPORATION • *Miracle Power Division* • 73 AP BUILDING, TOLEDO 1, OHIO

## Now! Push-Button Lubrication!

Miracle Power Lubri-Sprayer is ideal for car engines as well as general household lubrication. Just push the button for a fine Miracle Power spray that reaches all the hard-to-get-at places.



Also available are Lubri-Sprayers containing dgf 123—companion product to Miracle Power for use as a dry pre-lubricant during engine re-assembly.

At better service stations, garages and car dealers, or use this coupon for introductory offer.

THE AP PARTS CORPORATION  
73 AP BUILDING, TOLEDO 1, OHIO

Enclosed find \$\_\_\_\_\_ for which please send me *postpaid*:  
\_\_\_\_\_ trial cans of Miracle Power at 75c each (1 for gas, 1 for oil)  
\_\_\_\_\_ dgf 123 Lubri-Sprayers at \$1.95 each  
\_\_\_\_\_ Miracle Power Lubri-Sprayers at \$1.45 each  
 Please send me free literature on making my car last longer.

Name \_\_\_\_\_  
Address \_\_\_\_\_  
City \_\_\_\_\_ Zone \_\_\_\_\_ State \_\_\_\_\_

## ELECTRICITY *Anywhere*

FOR PORTABLE, EMERGENCY OR HOME USE

ONAN Electric Plants generate 110-volt, 60-cycle current for homes, farms, cabins and resorts beyond the highline. Lightweight, portable plants cut costs, speed work for contractors. Standby plants protect units against power failure. 400 to 55,000 watts. Gasoline or Diesel-powered. Priced from \$219.00.

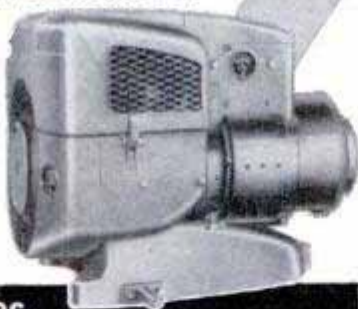

WRITE FOR CATALOG

**D. W. ONAN & SONS INC.**

5852 UNIVERSITY AVE., MINNEAPOLIS 14, MINN.

## V-PLEX

AUTOMATIC TRANSMISSION CLUTCHES



for ... POWER LAWNMOWERS,  
MOTOR SCOOTERS, GARDEN  
TRACTORS, MOTORBIKES, ETC.

*The Way to transmit Power Smoothly*

V-PLEX CLUTCHES automatically tighten drive belt as throttle is opened, eliminate belt slippage, cut wear, permit idling engine. Easily installed on any gas engine; practically indestructible. Fit 1/2, 3/8, 3/4" drive shafts. See dealer or write.

SEND  
POSTCARD  
FOR  
FOLDER

MFG BY V-PLEX CLUTCH DIVISION  
LIGHT INSPECTION CAR WORKS — HAGERSTOWN, INDIANA

# FREE

## NEW BIG RADIO CATALOG



Ready now! Complete with everything in radio, TV and electronics. Newest parts as well as old, standard lines. Paste coupon on penny postcard and mail today!

*Lafayette Radio* DIV.: RADIO WIRE TELEVISION, INC.

NEW YORK 13..... 100 Sixth Avenue  
NEWARK 2..... 24 Central Avenue  
BOSTON 10..... 110 Federal Street  
BRONX 58..... 542 E. Fordham Road

**30 YEARS  
OF  
VALUES**

LAFAYETTE RADIO, Dept. LL  
100 Sixth Avenue, New York 13  
Please rush Free catalog to:

Name.....

Address.....

City..... State.....

PASTE  
ON  
PENNY  
POSTCARD



SANTA SAYS:  
"A WONDERFUL HOBBY  
WORKSHOP GIFT!"

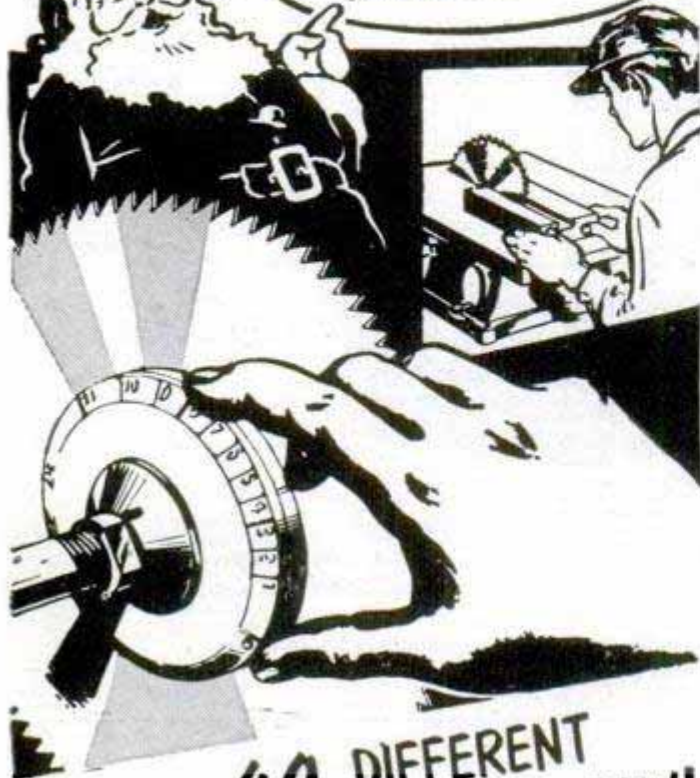

NOW 40 DIFFERENT  
CUTS ON YOUR SAW!



WITH

**Warren**

**DADO SAWING WASHERS**

Cut clean, accurate, parallel grooves—40 widths, any angle. No chatter, burning, chewing—or sanding! No more blade vibration—no screws to fuss with—just four balanced washers. Simply dial desired width with Micro-matic adjustment. Can be left on blade for straight cuts. Available in 4 sizes— $\frac{1}{2}$ ",  $\frac{3}{4}$ ",  $\frac{5}{8}$ ", 1". A perfect gift for woodworkers. See your dealer or write—

YOUR  
SAW  
IN ACTION

\$4.95  
SET

**WARREN WASHERS CO.**

Dept. 32 • 70 Medbury • Detroit 2, Mich.

recently. A strong current was running at that spot, and his bow went under. He nearly lost the craft before he cut that anchor loose.

But those are problems for the structural engineers. Given enough attention, they may be solved. If they are, transoceanic microwave-relay networks can go ahead in this fashion.

Though microwave relay appears to be the most adaptable method for carrying television signals, it is conceivable that some day coaxial cables may be perfected to carry video signals across the ocean floor, just as cables carry telephone and telegraph signals today. This, at present, is a remote possibility, since underwater coaxial cables still pose huge problems. If it should become necessary to solve them, however, I feel that it could be done.

I have no doubt of the ultimate practicality of transoceanic television. The idea of putting this new means of communication on an international scale is exciting. Think how television beamed abroad could show democracy at work to the rest of the world. To see democracy at work is to believe it, and that's one of television's big jobs of the future. Indeed, international television offers us a great opportunity to promote real understanding among people, and to build a lasting peace among men.

**ELECTRIC MOTOR BARGAINS!**



$\frac{1}{2}$ HP	3450 RPM	1975	$\frac{3}{4}$ HP	3450 RPM	3200
1 HP	3450 RPM	3900	$1\frac{1}{2}$ HP	3450 RPM	4750

Every Motor Fully Guaranteed

Heavy Duty, Repulsion Induction and Capacitor Types, 110-120 Volts, 60-cycle, Single-phase. Standard Makes (G. E., Wagner, Leland, Westinghouse, etc.). Rush your order TODAY—large stock of motors—1 & 3 phase. Prices f.o.b. Chicago.

**DOUBLE SHAFT MOTORS at 50% Saving**

$\frac{1}{6}$  HP—\$1000  $\frac{1}{4}$  HP—\$1100  
1750 RPM Split Phase —  $\frac{1}{2}$ "x3" Shafts  
 $\frac{1}{3}$  HP—\$1400  
1750 RPM Split Phase —  $\frac{5}{8}$ "x3" Shafts

These motors are new, shopworn, but all in perfect condition, and fully guaranteed. Resilient mounted for quiet operation on 110-volt, 60-cycle AC current. Ideal for Blowers, Grinders and Tool layouts.



ALL PRICES F.O.B.

Write for 32-Volt Bargain List

ROBERTS ELECTRIC CO., 849 W. Grand, Dept. 17, Chicago

Exhibit this authentic model!

**Douglas  
SKYROCKET**

Realistic Jet-Rocket solid-wood model, all parts ready-shaped for quick assembly. Complete with full-color decals, plastic canopy, and display stand, 69¢. At your hobby dealer.

Wingspan,  $\frac{4}{8}$ "  
Fuselage,  $\frac{8}{2}$ "



**StromBecker**

Send for free circular describing all models.

STROMBECK-BECKER MFG. CO.  
Moline, Illinois • Dept. PM-12



# You CAN Take It With You!

## BECKER *Self-Contained* SPRAY GUN

**NOTHING ELSE TO BUY**

TAKE IT ANYWHERE—the first completely portable spray gun. Needs no compressor, motor, or electrical outlet. Pressure-powered with an inexpensive CO2 cartridge that sprays up to 21 liquid ounces, depending on viscosity. Extra cartridges, 10 for \$1, postpaid, or buy from your dealer.

PAINTS • VARNISHES • ENAMELS  
MOTH-PROOFS • INSECTICIDES

Every home needs a Becker Spray Gun for dozens of jobs in the house, workshop, garden or garage. Complete instructions furnished for effective results. Order yours today for the season ahead.

**HOW TO ORDER**—If your dealer can't supply, send \$15.95 and we ship postpaid—or \$2 now and pay postman balance plus postage and fee. Money back if not delighted after 5 days' trial.

**SULLIVAN-BECKER CO.**  
Dept. 111-M, Kenosha, Wis.



ONLY  
**\$15.95**  
with 3  
cartridges



## 100,000 WASHER REPAIR PARTS

Start Your Own Washing Machine Repair Business

RETAIL CUSTOMERS MAIL IN OLD PARTS OR MODEL NO. AND SERIAL NO.

Tremendous field, excellent profits! Get our large complete wholesale catalogue showing thousands of repair parts illustrations; wringer rolls, V-belts, motors, gears, etc. Price \$2.00 per copy postpaid in U.S. Send check or money order today — Established 20 years

**WESTERN APPLIANCE CO., Inc.**  
5650 GRAND RIVER AVE., DETROIT 8, MICH.



## NONE BETTER! SUPER DRILL GRINDER



Sharpens round shank drills from 3/32" to 1/2" in diameter, up to 6" long. Grinds old drills like new in 4 different point angles, using hand or power grinding wheels. Money-back guarantee.

Price only \$2.95  
At Dealers or Postpaid

**CRANDALL MFG. CO.** 1512 W. Slauson, Dept. P-12  
Los Angeles 44, Calif.

## BRIKCRETE



## High Earning Power for Local Manufacturers

More local Brikcrete plants are needed. You can be one of a country-wide chain manufacturing the world's most modern masonry. Ties in with today's economic conditions that demand elimination of wastefulness in production. Brikcrete is locally made, of local materials, by local labor, for local use. Saves the high costs of transportation and distribution. Brings fine masonry down to the price levels of lumber. Rich in sales appeal to builders who are masonry-minded but cost conscious.

### World's Most Modern Masonry

Brikcrete is modern in design, proportion and size. Has exclusive buttressed web. Supplied in wide range of colors. Local manufacturers have broad opportunities for expansion under franchise privileges. High income potentials. Requires only nominal investment. We supply all equipment; easy terms if desired. Write or wire for Brikcrete Book No. 2.

**BRIKCRETE ASSOCIATES, INC.**

4679 Division Avenue, S.  
Grand Rapids 8, Michigan



B1

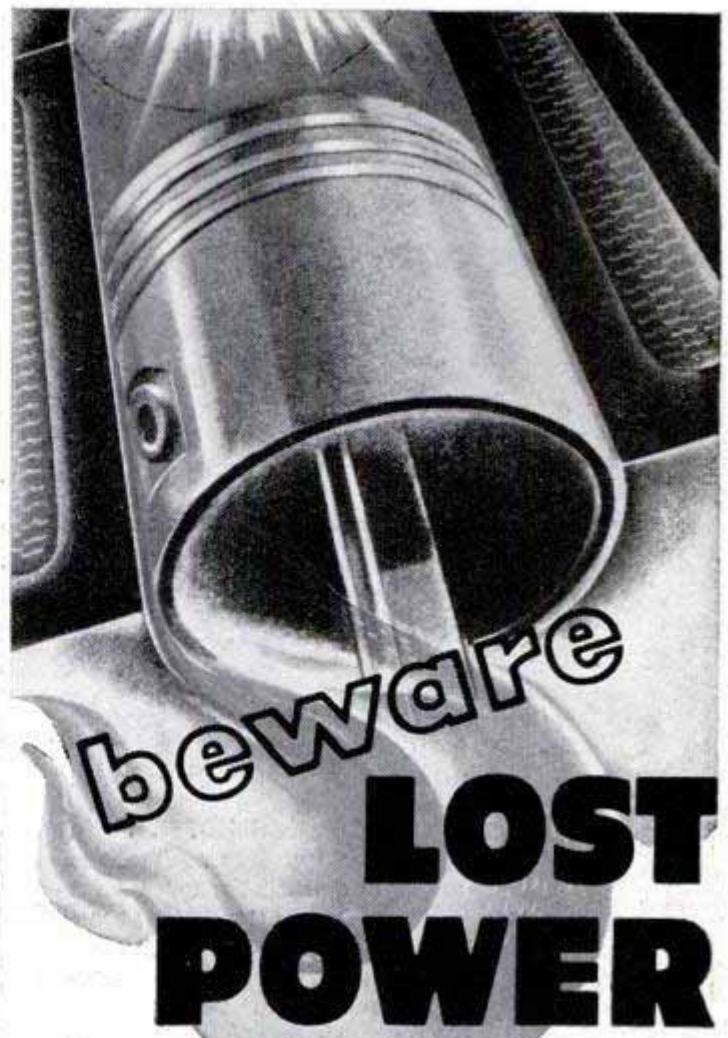

...it tells you your engine is heading for  
**PREMATURE OLD AGE**

Don't neglect replacing worn piston rings... the life of your car depends on it! First sign of worn rings is often LOST POWER. Ramco 10-Up Piston Rings not only restore your engine to new power and economy but they actually CURB cylinder WEAR... guaranteed 10,000 miles (one year)! LOOK for the RAMCO RE-POWERING SIGN. It's the sign of an engine repair expert on Compression, Carburetion, Ignition and Cooling services. Many also offer RE-POWERING on the budget finance plan.

## RAMCO 10<sub>up</sub> Piston Rings

Restore Power... Actually Curb Engine Wear!

**NO GAP Spiro-Seal!** A feature in every Ramco 10-Up Piston Ring Set. A unique patented design that compensates for engine wear with minimum friction. Send for free booklet; gives the reasons why worn rings prematurely shorten engine life.



5673P24





AMERICA'S TOP GUN EDITORS

say

"Marlin CAL. .35 REM.

# TOPS in Brush Guns"

**ELMER KEITH** in *American Rifleman*: "Up to 200 yards the .35 Rem. is one of the best guns for deer, black bear and similar-size game. It will produce more clean one-shot kills than any smaller caliber."



**PETE KUHLOFF . . .** in *Argosy*: "For both woods and brush, the new Marlin .35 Cal. Rem. is unbeatable. Plenty of knockdown power, and the low-mounted 'scope sight makes for accurate shooting."



**EDWARDS ("Pete") BROWN** in *Sports Afield*: "The new Marlin Model 336 lever-action (Cal. .35 Rem.) packs the knockdown power needed when the bullet is not placed in a vital spot."



See your local dealer. If none available, write us for name and address of nearest one. Try Marlin's new, sensational magnetized double-edge razor blades. Marlin products are available in Canada.

Model 336 Cal. .35 Rem. Sporting Carbine

The Name for Game

# Marlin

FINE GUNS SINCE 1870

## Taconite is Tomorrow's Iron

(Continued from page 76)

temperatures that burn a hole right down through the rock. With the aid of the jet-piercing drill, miners are able to blast loose big chunks of taconite. Massive power shovels then bite into the jagged stuff, swing it overhead and dump it into waiting trucks which tote it to the factory.

Inside the plant, the management is faced with the knottiest problem in the steel industry. Nine hundred miles away, along the lower rim of Lake Erie, blast furnaces are gobbling up iron ore with tremendous appetites. A blast furnace is one of the most cantankerous giants in existence. Although it has an enormous appetite, it's mighty particular about its diet. It refuses to cooperate if the feed is too rich or too poor, the chunks too big or too little. Somehow thousands of tons of rock must be converted into a palatable feed for the furnace.

The first step is to smash the boulders to powder-size particles. The big chunks of rock are dumped off the trucks into the preliminary crusher, which resembles a gigantic bell suspended in the middle of a circular hopper. There's a space measuring only a few inches between the rim of the bell and the hopper. The boulders tumble down the sides of the bell until they are squeezed into this space. Then the bell is "rung" by a powerful motor, repeatedly smashing the boulders until they are small enough to fall on through. Two other crushers take over the chunks, knocking them into slingshot-size pieces.

Then into the grinding mill—a huge revolving drum—flow the pebbles. Inside the drum, an inferno of tumbling, clashing steel rods or balls smash the rocks to smithereens. Carried along in a swirl of water, the resulting powder-size particles flow into a machine called a classifier. It's nothing but a big bathtub, overflowing with water, which selects the smaller particles and rejects the larger. Two huge steel corkscrews, tilted on end, continually revolve up through the tub. As they revolve they carry away the coarser particles, the "fines" overflowing with the water.

By now these powder-size particles have picked up one of two personalities. Each speck is either loaded with iron or is mostly plain rock. Mix a quarter cup of pepper with a cup of flour and you'll get the proper proportions.

How is the pepper sorted from the flour? Nature very thoughtfully provided a key to the puzzle. Some taconite is highly magnetic, other weakly. That's why most of the wilderness factories, at least the first ones,

(Continued to page 256)

### VALUABLE COUPON—MAIL TODAY!

THE MARLIN FIREARMS CO.

Dept. PM-12, New Haven, Conn.

Please send me your catalogue with full information and photo-illustrations of Marlin Guns. I understand you will also send me a pack of (please check preference) . . . single or . . . double-edge magnetized Marlin Razor Blades. I enclose 10¢ for postage.

NAME . . . . .

ADDRESS . . . . .

CITY . . . . . ZONE . . . . . STATE . . . . .



# Precision-Built DADO SAW DIAL

YOUR SAW CUTS GROOVES  
FROM 1/8" TO 9/16"

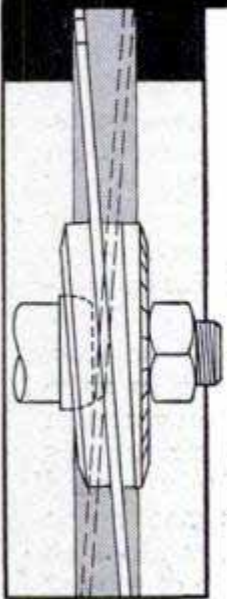

• Amazing new dado device features exclusive automatic alignment. Fast one-hand dial adjustment on outside only because only ONE dial to set. 100% visibility. Precision machined parts. Ball bearing action. Cuts clean smooth grooves at any angle. Order direct from factory. Postpaid.

## FACTORY TO YOU

15 Day Trial Guarantee  
Give Arbor Sizes 1/2"-5/8"-3/4"  
ORDER NOW — CASH OR C.O.D.  
COMPLETE SET **\$4.95**  
POSTPAID ONLY  
WRITE FOR FREE BOOKLET

**POWER TOOLS INC.**

112 HENRY ST., BELOIT, WISCONSIN



## MAKE BIG MONEY!

Be a floor surfacing contractor and sand both new and old floors. Sanders are easy to operate and better still, you're your own boss. Write for latest "tell-all" booklet entitled "Opportunities in Floor Surfacing", enclosing 25 cents in coin or stamps to cover handling.

**AMERICAN**  
FLOOR SURFACING MACHINE CO.  
335 So. St. Clair Street - Toledo 2, Ohio

## BUILD YOUR OWN MIL-LATHE!

Save 100% by assembling this new Mil-Lathe yourself. The Mil-Lathe is a vertical mill with protruding arm to hold bracket for center to turn the work on centers. All parts machined—easily assembled in 6 hours. Takes 1 1/2" 8 thread chuck. Price \$220.00 f.o.b. L.A. Does not include vise, motor or chuck. Write today for folder. Satisfaction guaranteed.



TURNING LATHE  
surface grinding, drilling, etc.



VERTICAL MILL USE

J. C. Grant  
Machine Works

5917 Lemona Ave., Dept. PM-11, Van Nuys, Calif.

INDUSTRIAL  
QUALITY  
AT LOW COST

## SHOP ACCESSORIES

FULLY  
GUARANTEED

### Circular Saw Blades for 1/2-5/8-3/4" Arbors

MADE FROM CHROME-NICKEL  
MOLYBDENUM STEEL



#### FLAT GROUND

RIP • CROSSCUT • REGULAR  
OR NOVELTY COMBINATION

6" dia. \$1.88 8" dia. \$2.39  
7" dia. \$2.18 10" dia. \$3.18

#### HOLLOW GROUND

MITER OR PLANER BLADES  
FOR SMOOTHER CUTTING

6" dia. \$2.75 8" dia. \$3.85  
7" dia. \$3.19 10" dia. \$4.80

#### SHAPER HEADS

FOR YOUR TABLE SAW

1/2-5/8-3/4" ARBOR

Only \$4.50

MOULDING CUTTERS

Only \$3.85 per set

CHOICE OF 38 PATTERNS

#### 6 IN. DADO HEADS

CHROME-NICKEL-MOLY STEEL

1/2-5/8-3/4" ARBOR

Only \$9.95

Cuts 1/8 to 13/16" in steps of 1/16"

2 Hollow Ground Blades

5 Inside Chippers

#### 8 IN. SANDING DISCS

FOR YOUR TABLE SAW

1/2-5/8-3/4" ARBOR

Includes 1 coarse, 1 fine on each side

Only \$4.95

Extra Sandpaper 5 grits 80¢

Sanding Disc Cement 40¢

SEND CHECK OR M. O. All prices prepaid—WRITE FOR FREE CATALOG P-12

JAXON COMPANY • 369 ELLICOTT ST. • BUFFALO 3, N. Y.



1927

# AMERICA'S FIRST

# AND FINEST

# FUEL PUMPS



1951

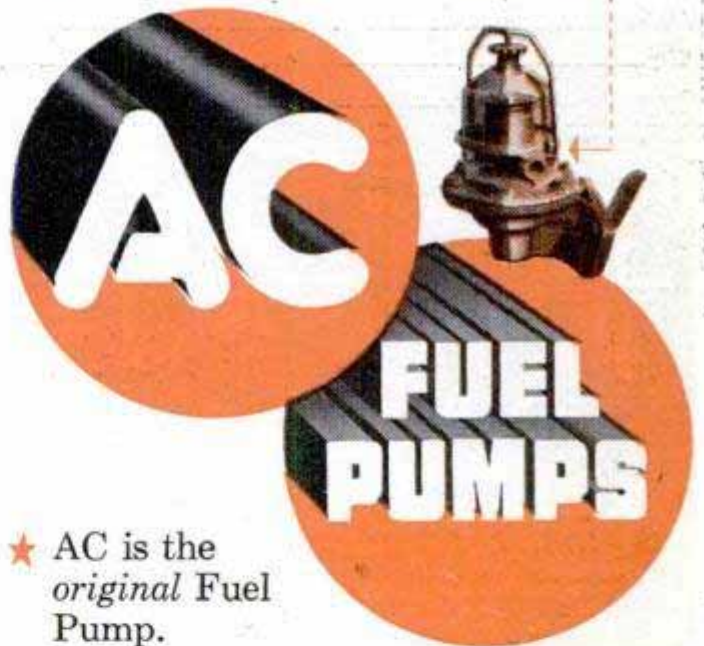

- ★ AC is the original Fuel Pump.
- ★ More than 100,000,000 have been built.
- ★ More than 40,000,000 are in daily use.
- ★ More than 90% of the gas-powered vehicles now in service were factory-equipped with AC's.
- ★ Backed by 24 years of "know-how"—there are none better.



AC SPARK PLUG DIVISION

GENERAL MOTORS CORPORATION



**ENJOY  
Yourself And  
Win \$500**

with "Marvello, the Million Puzzle Game"

The tiles in the square shown above look so simple, but would you ever suspect that these few tiles may be re-arranged in far more than a thousand different ways and still form the same square? Try to be the **first** person to show a solution for the square not copyrighted by Marvello, and win \$500.

**BE A WINNER**, fill in the coupon today, and send for the "First Guide to Marvello, the Million Puzzle Game," 24-pages with 30 different puzzles and their solutions, plus directions for a world of other fun, mailed to you with four different sets of "Marvello."

Only \$1.00 Send check or M.O.  
No Stamps, please

MARVELLO, 639 N. Columbus Blvd., Tucson, Arizona

I enclose \$\_\_\_\_\_ Send me \_\_\_\_\_ "First Guide(s) to Marvello"  
4 sets of Marvello & \$500 contest participation blank(s).

Name \_\_\_\_\_

Address \_\_\_\_\_

City \_\_\_\_\_ Zone \_\_\_\_\_ State \_\_\_\_\_

Occupation \_\_\_\_\_



**Send for this  
BIG NEW  
Hunt's  
WOODWORKERS  
CATALOG NO. 18**

**ONLY 15c**

**NEW LOW PRICES**

Offers greatest selection of fine domestic and imported woods--and hundreds of woodworkers items at bargain prices!

You'll save time and money with this big, new catalog. Contains everything wood craftsman needs. Shows 32 rare and fancy woods in color...43 veneer designs...275 scroll patterns...multicolor inlays, overlays, bandings...all kinds of tools, machinery, cabinet hardware, ornaments, mouldings...and pages of valuable tips, ideas, information, instruction. Send for your copy NOW. Only 15c

**QUICK DELIVERY**

- on maple, poplar, oak, mahogany, red cedar, cherry, walnut, and many others—
- all properly seasoned and kiln dried.

**144 PAGES**

**MAIL THIS COUPON--TODAY!**

**CRAFTSMAN WOOD SERVICE CO.**  
2729 S. Mary St., Dept. A-12  
Chicago 8, Illinois

Send me the big, new, money-saving Catalog No. 18.  
Enclosed is 15c.

Name \_\_\_\_\_

Address \_\_\_\_\_

City \_\_\_\_\_ Zone \_\_\_\_\_ State \_\_\_\_\_

are being built on the eastern end of the Mesabi, for here the ore is strongly magnetic. The secret of the separation process, of course, is to attract the iron particles with a magnet.

Each separator consists of one or more spinning drums — actually electromagnets. The soupy water flows against the magnets, and the iron-laden particles snap out and whirl around the drum. The rock particles flow on past, unaffected by the magnets. The result is a river of worthless sand and a rivulet of muddy water, heavy with iron.

Water is filtered from the resulting soupy taconite by a fabric-covered drum.

The result? Fine particles, black as midnight, rich in iron.

Yet dust in this form is utterly useless, as useless as rock dust. A blast furnace that was fed the stuff would bog down with acute indigestion. Somehow the dust has to be stuck back together again into mud balls. And the mud balls must meet some very precise requirements. They must be acceptable to the touchy stomach of a blast furnace, they must be reasonably small in size and, most important, they must be extremely rugged, for they'll be handled like lumps of coal in shipment. They must withstand rain without crumbling. That's quite an order for a mud ball.

The first faint hope of solving this problem occurred a few years ago in the laboratory of Dr. E. W. Davis of the University of Minnesota. Doctor Davis patted the taconite concentrate into mud balls, then baked the balls in an oven. The heat fused the iron particles, making tough little balls that seemed ideal. But how could the balls be patted together by the billions? One day someone in the laboratory hit on the idea of rolling the mud into balls in the same way snowballs form when snow starts sliding downhill. Some of the damp powder was shoveled into a horizontal drum and the drum rotated. As if by magic, little balls of taconite appeared.

Today, at the Aurora plant, the wet powder flows into one end of a slightly tilted rotating drum eight feet in diameter and about 24 feet long. You can stand at the opposite end of the drum and watch the balls magically appear by the millions. The tilt of the drum keeps them moving gradually toward you until they roll off at your feet—round, wet, shiny little pellets weighing only a few ounces apiece, yet rolling out by the ton. They drop onto a conveyor belt which carries them to a big circular furnace to be baked into hard nubbins.

The baked pellets seem an ideal solution. They meet all the strength requirements for shipping; and most important of all,

(Continued to page 258)



**FIX IT or FASTEN IT**  
*Better and Faster!*



**NEW TINNEMAN**  
**Speed Nut®**

**TINKER KIT**



**SPEED NUT**—the one-piece, self-locking, vibration-proof fastener—famous throughout industry... **NOW READY FOR HOME USE!** Handy assortment of 10 popular sizes of **SPEED NUTS** and matching screws. Over 100 home repair and hobbycraft uses. Once on—they stay on! Replace threaded nuts and lock washers.

**ONLY \$1.00**  
POSTAGE INCLUDED  
SEND CASH OR CHECK—NO STAMPS

**TINNEMAN PRODUCTS, INC.**  
DEPARTMENT 13 • CLEVELAND 1, OHIO

*BeMaCo Dependable*

**AUTOMATIC SAW SET**

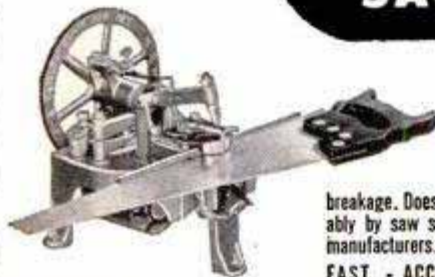

Sets 400 teeth per minute on hand or band saws 4 to 16 point. Hammer and anvil action sets teeth accurately and uniformly... No tooth breakage. Does a perfect job. Used profitably by saw shops everywhere and saw manufacturers. Every machine guaranteed!

**FAST - ACCURATE - DEPENDABLE**

★ INCREASES PROFITS

**BEAVER MFG. CO.**

Saw Machine Div. #9M  
800 SO. ISIS AVE. • INGLEWOOD, CALIF.

**NEW!**



**Electric Drill**  
**PLANE CONVERTER**

**Fast • Accurate**  
**Speed Planing**

- Beveling
- Ripping

**NOW!** Convert your 1/4" electric drill for fast, accurate planing, beveling, ripping, in a matter of minutes. Rips up to 1 1/4" strip, planes 1/4" at one stroke, 15 times faster than any hand plane. Rips boards up to 1 3/4" thick. Nothing like it exists. Too many uses to mention. Order completely assembled or ready-to-assemble, all parts and instructions furnished. You need only 14" piece of 2x4 and your own electric drill. 2 planing blades made of finest High Speed steel available included. Blades are 1/4" diameter, 2" cutting surface. Saves you \$50 to \$140! Send cash, check, or money order. Shipped same day. Use for 10 days. If not satisfied return. Money-back guarantee. Parts ready to assemble \$9.95.

Completely Assembled

**\$14.95**

Electric drill not included

**International Twist Drill Corp.**  
7th & Wyandotte, Room 632  
Kansas City 6, Mo.

**FREE**



★  
**1952**

**ALLIED RADIO & TV CATALOG**  
**EVERYTHING IN RADIO AND TV AT LOWEST PRICES!**

SEND FOR IT

**212 PAGES**  
**Value-Packed**

**Everything for Experimenters, Builders, Amateurs, Servicemen, Engineers, Soundmen...**

Save money on every Radio and TV need! Get the big 212-page 1952 ALLIED Catalog featuring the world's largest selections of top-quality electronic equipment at lowest, money-saving prices. See the latest in TV, home radios, Amateur equipment, P.A. systems and Hi-Fidelity custom sound, recorders, test instruments, builders' kits—plus thousands of parts, tools, books and diagrams. Get more for your money from the World's Largest Radio Supply House. Send today for your **FREE 1952 ALLIED Catalog!**

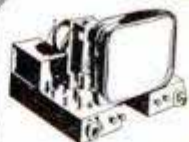

Save on Everything in Radio & TV



**FREE CATALOG**

SEND FOR IT TODAY

**ALLIED RADIO**

ALLIED RADIO CORP., Dept. 5-M-1  
833 W. Jackson Blvd., Chicago 7, Ill.

Rush FREE 1952 ALLIED 212-Page Catalog

Name \_\_\_\_\_

Address \_\_\_\_\_

City \_\_\_\_\_ Zone \_\_\_\_\_ State \_\_\_\_\_



be SURE of STARTING in any kind of weather!



buy the SENSATIONAL NEW  
**Redi-Warm**  
TRADE MARK  
AUTOMATIC ENGINE TENDER

**Thermo Stop-Start Engine Warmer**

At last the luxury of knowing your car will start as easily on a sub-zero morning as it will on a summer day. With a Redi-Warm Automatic Engine Tender in your car, it makes no difference where you park — how long you park. No outside electrical connections necessary — no smudge pots — no spark boosters. Just touch your starter, and you're off in a jiffy.

Widely acclaimed by automotive engineers, Redi-Warm is a marvel of simplicity. It consists of only three small units — a thermostatic control which clamps easily to the engine head; a neutral switch which permits Redi-Warm to operate only while the car is in neutral; and a dash switch with which to put Redi-Warm in operation.

**Saves Engine Wear—Saves Gas**

It is a well-known fact that the most wear on an engine occurs during the minutes required to start it. Redi-Warm, by keeping the engine at normal temperature — regardless of weather conditions — insures quick, easy starting — preserves the motor, saves on gas. Besides the comfort and convenience it affords, Redi-Warm will more than pay for itself in a few cold weather months.

Why risk loss of time — loss of temper — expensive towing charges? If your local dealer does not have Redi-Warm in stock, send for it direct from the factory. It costs only \$24.95 postpaid; comes with complete instructions for the simple wiring. Do it yourself, or ask your neighborhood serviceman. Sold on an absolute guarantee of full satisfaction.



MAIN UNIT



NEUTRAL SWITCH



DASH SWITCH

only \$ **24.95**  
postpaid

- KEEPS ENGINE ALWAYS AT STARTING TEMPERATURE REGARDLESS OF WEATHER.
- CAR CANNOT BE STARTED WHILE REDI-WARM IS SET FOR OPERATION; THIEF-PROOF — FOOL-PROOF. DOUBLE BATTERY LIFE
- SAVES WEAR ON ENGINE; SAVES GAS ORDINARILY USED IN CHOKING.
- SAVES TIME — SAVES TEMPER — ELIMINATES COSTLY TOWING CHARGES.
- PAYS FOR ITSELF OVER AND OVER.

**CRAY-LINCOLN**

Eng. & Mfg. Co., Inc.  
CRAY OIL BLDG.  
North Walpole, N.H., U.S.A.

Agents  
Wanted

blast furnaces gobble them up like dessert. Still other ways of treating taconite are being investigated. In Duluth, the research laboratory of Oliver Mining Company, a subsidiary of U. S. Steel, is running all kinds of tests to determine what can be done with the stuff. On the big floor of the laboratory virtually any kind of pilot plant can be set up within hours, then torn down to make way for another type.

Once the taconite has been reduced to a black dust, there are other methods of "agglomeration," as sticking it back together again is called. One, showing great promise, is to sinter it—mix it with coke and fuse it into cinder, similar to the clinker in a coal stove—then break the cinder into small pieces. The two remaining methods are briquetting, pressing it into forms, then baking the resulting "bricks"; and nodulizing, in which heat plus the rotating action of the furnace produce lumps.

What will be the cost of iron made from rock? Taconite is more expensive to mine than direct-shipping ores; it must be treated by expensive equipment; two or three times the labor force is required. One authority estimates that about \$25,000,000 will have to be invested in new plants for every million tons of annual pellet production. When you start multiplying such figures you plunge into deep economic waters: for an annual capacity of 30,000,000 tons, some six to seven hundred million dollars will have to be invested. Can taconite be made to yield its iron without boosting the price of steel sky-high?

The best guess by authorities in the industry is that the price will go up but not out of sight. There are substantial savings that aren't immediately spotted.

For example, shipping costs are reduced. In one recent year, about 70,000,000 tons of ore were shipped from the Lake Superior area to the blast furnaces. The ore contained 11.5 percent water. About \$21,500,000 was spent during that one year shipping useless water all around the Great Lakes. The pellets, on the other hand, contain virtually no water.

And the pellets, received at the blast furnace, contain 60 to 65 percent iron oxide, while direct-shipping ores average 51.5 percent iron oxide. A ton of taconite pellets obviously pays off in more pig iron.

The end of the taconite story won't be written for centuries. Already thoughtful men in laboratories on the iron range are investigating how nonmagnetic taconites can be forced to surrender their iron. Three or four hundred years from now, America may once more start looking for a new source of ore. But even to the steel companies, that tomorrow is a long way off.



THIS WIRE HAS NOT BEEN OVERSEAS

This high quality two conductor communication wire offered in No. 18 and No. 22 gauge is ideal for intercoms, lead-ins, telephones, indoor and outdoor speaker extensions, doorbells, signal and burglar alarm systems, shotfiring, etc., etc. **SAMPLES ON REQUEST.**

## U.S. GOV'T CLOSEOUT



*Wire*

U. S. Signal Corps  
Communication Wire

**\$3.50** per 1000 ft. TWISTED TWO CONDUCTOR No. 22 STRANDED  
**\$3.50** per 1000 ft. TWISTED TWO CONDUCTOR No. 18 STRANDED

**ABSOLUTELY NEW AND PERFECT**  
Mfgd. to rigid Signal Corps specifications

Won't Last Very Long at These Prices

Stock Up Now — Subject to Prior Sale — Order Today

**W-110-B—TWO CONDUCTOR #18 STRANDED** (four steel and three copper strands) rubber covered plus weatherproof cotton braid and twisted. 5,280 feet per steel reel. Only **\$3.50** per thousand feet (3/5c per ft.) or **\$18.25** per reel.

**W-130—TWO CONDUCTOR #22 STRANDED** and twisted (one copper and six steel strands) in your choice of rubber or plastic insulation. 10,000 feet per steel reel. Only **\$3.50** per thousand feet (3/5c per ft.) or **\$35.00** per reel.

(Note: Steel strands are incorporated for extra tensile strength and are tinned and treated for efficient conductivity.)

All these wire below market prices, our stock will not last long. Take advantage of this exceptional closeout and **STOCK UP NOW!** Minimum order—one reel.

Prices F.O.B. Chicago. Include approx. postage on orders paid for in advance. C.O.D. orders enclose 25% balance sent C.O.D. WRITE FOR FREE ILLUSTRATED CIRCULAR.

**U. A. S. Corp.** Dept. PM12, 5637 W. 63rd Pl. Chicago, Illinois



**Snap-on Tools**  
THE CHOICE OF BETTER MECHANICS

4000 fine tools, available direct from factory to user. Snap-on catalog free—send for it today.

Snap-on Tools Corporation  
8062-L 28th Ave., Kenosha, Wis.

## MICRO CUT SAFETY SAW \$3.90 6" SIZE



BUY DIRECT — PROMPT DELIVERY  
HIGHEST QUALITY GUARANTEED

FAST CUTTING—SAFE—NO KICKBACK—

Try This Saw—You'll Be Amazed

OTHER SIZES 7"-4.80—8"-5.70—10"-7.20

Sent Postpaid on Receipt of Check or Money Order. Sizes Available for Electric Hand Saws.

Charleston Saw Works, Inc.  
PINE & BIGLEY — CHARLESTON, W. VA.

## INTERNATIONAL ROTARY HI-SPEED COPE-SAW DRILL-BIT IT DRILLS IT SAWS IT REAMS



DRILL PRESS SAW-CUTTING

ELECTRICIAN'S MANDY CUTTER

DRILL, SAW, REAM ... metal, pipe, wood, plastic, Transite, etc. Use with any electric drill, slow drill press, lathe or milling machine. Drills own starting hole—upper part of bit is used to cut, saw or ream circles, ovals, squares or scrolls. Easy to operate. Ideal for carpenters, mechanics, electricians, plumbers, hobbyists, many others. Abrasive resistant, high speed steel. Flutes ground from solid. Will withstand severe continuous use without breaking. Resharpened at no charge. Takes place of up to \$50 in tools. 1/2" diameter, 2" cutting sections, total length 3 1/2". Also available specially designed for wood or metal and in 2 1/2" and 1 1/2" lengths. Write for details. Specify all-purpose bit. Shipped same day. Money-back guarantee. Dealer inquiries invited.

SEND CASH. CHECK OR MONEY ORDER

Manufactured and distributed by:

**INTERNATIONAL TWIST DRILL CORP.**

624 Wyandotte, Rm. 636, Kansas City 6, Mo.

only **\$3.95** POST PAID

—INLINE—  
ANTENNA

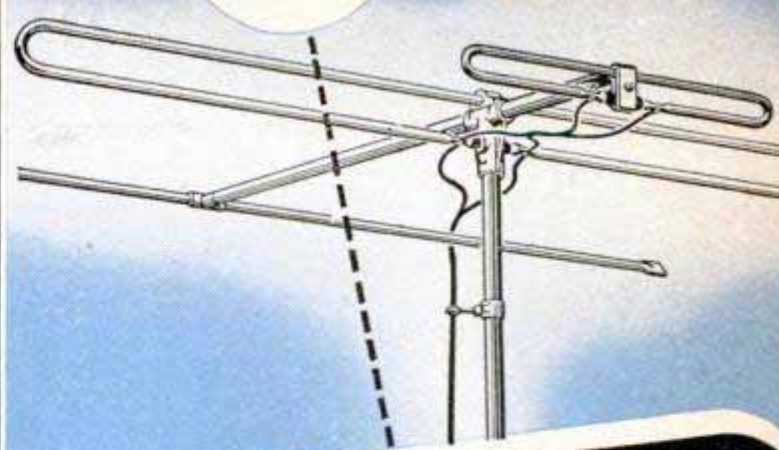

# Better TV PICTURE Quality

The Amphenol INLINE TV Antenna is engineered by the same experts who have perfected complicated antenna systems for radar, submarines, railroads, aircraft and mobile communications. Every mechanical and electrical factor of the INLINE TV Antenna is coordinated to create the best possible picture quality. It is a broadbanded antenna system which has a single, powerful forward radiation lobe to capture the strongest television signal from one direction with no minor lobes off the sides to pick up reflected signals and interference.

To be sure you are getting the best TV picture your set can produce, --- send 10¢ for this 20 page book containing complete information on all the factors determining --- Better TV Picture Quality.

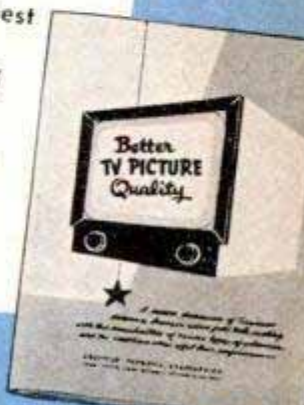

**AMPHENOL**

Address Dept. 66



# The Owners Report on the Hudson

(Continued from page 118)

owners average (depending on model) from 17.01 to 19.5 miles per gallon in country driving, and 13.7 to 16.4 in the city.

As usual, opinions differed on the automatic-transmission question, but 85 percent of the owners who want automatic transmission said they want Hydra-Matic on their next car. However, only 54 percent want a self-shifter and 46 percent want standard transmission (33 percent of these want overdrive). A Sterling, Ill., farmer expressed the general opinion that "overdrive saves gas and is easier on the motor."

"Hydra-Matic drive is old enough now to be standard equipment," wrote a Detroit internal-revenue man. "My Hydra-Matic operates just perfectly and as far as I can tell is troublefree," said a retired Army officer of Dublin, Ga.

However, an enthusiastic Hudson owner in Chicago said he wants standard transmission next time because, "With automatic transmission, when the motor is missing there is no way to control your car unless you shift your gear to neutral every time

you come to a stop sign. Also, in winter when it snows, you can't push another car or get pushed easily when your car does not start. With standard shift there is no problem."

Another standard-transmission devotee is a Washington, D. C., agronomist who said, "I buy a car for transportation. The extra cost of automatic transmission does not seem to provide more economical transportation."

Super-Matic drive drew a bitter reproof from a St. Petersburg, Fla., advertising man. "For my money, Super-Matic drive is a disgrace to the Hudson Motor Co.," he wrote. "I drove my 1950 Commodore 6000 miserable miles with it and was glad to trade it off in nine months."

The transmission question was settled once and for all in this survey by a San Antonio, Tex., psychiatrist, who said he wanted neither standard transmission, overdrive nor Super-Matic drive in his next car; he wanted Hydra-Matic because of "emotional satisfaction!" He added: "I wish Hudson would build a car that didn't look like an inverted bathtub and would develop a new

(Continued to page 262)

## 1951 HUDSON SPECIFICATIONS

### ENGINE

Type	Pacemaker	Sup. 6	Comm. 6	Comm. 8	Hornet
	6-cyl., in-line, L-head	6-cyl., in-line, L-head	6-cyl., in-line, L-head	8-cyl., in-line, L-head	6-cyl., in-line, L-head
Bore and Stroke	3.5625 in. x 3.875 in.	3.5625 in. x 4.375 in.	3.5625 in. x 4.375 in.	3 in. x 4.5 in.	3.8125 in. x 4.5 in.
Piston displacement	232 cu. in.	262 cu. in.	262 cu. in.	254 cu. in.	308 cu. in.
Brake Horsepower	112	123	123	128	145
Compression Ratio	6.7:1	6.7:1	6.7:1	6.7:1	7.2:1
Transmission	3-speed conventional is standard, Super-Matic drive, Drivemaster automatic-shifting units available on all models except Hornet. Hydra-Matic drive, or overdrive, is available on all models.				

### GENERAL

Weight (4-door sedan)	3460 lbs.	3565 lbs.	3600 lbs.	3620 lbs.	3600 lbs.
Wheelbase	119 <sup>7</sup> / <sub>8</sub> in.	123 <sup>7</sup> / <sub>8</sub> in.	123 <sup>7</sup> / <sub>8</sub> in.	123 <sup>7</sup> / <sub>8</sub> in.	123 <sup>7</sup> / <sub>8</sub> in.
Tread, Front	58.5 in.	58.5 in.	58.5 in.	58.5 in.	58.5 in.
Tread, Rear	55.5 in.	55.5 in.	55.5 in.	55.5 in.	55.5 in.
Over-all Height	60 <sup>3</sup> / <sub>8</sub> in.	60 <sup>3</sup> / <sub>8</sub> in.	60 <sup>3</sup> / <sub>8</sub> in.	60 <sup>3</sup> / <sub>8</sub> in.	60 <sup>3</sup> / <sub>8</sub> in.
Over-all Width	77-1/16 in.	77-1/16 in.	77-21/32 in.	77-21/32 in.	77-21/32 in.
Over-all Length	201 <sup>1</sup> / <sub>2</sub> in.	208-3/32 in.	208-3/32 in.	208-3/32 in.	208-3/32 in.

### Interior Dimensions (4-door Sedan)

Front Seat Width	64 in.	64 in.	64 in.	64 in.	64 in.
Rear Seat Width	64 in.	64 in.	64 in.	64 in.	64 in.
Legroom, Front	43 <sup>1</sup> / <sub>4</sub> in.	43 <sup>1</sup> / <sub>4</sub> in.	43 <sup>1</sup> / <sub>4</sub> in.	43 <sup>1</sup> / <sub>4</sub> in.	43 <sup>1</sup> / <sub>2</sub> in.
Legroom, Rear	38 in.	38 in.	38 in.	38 in.	38 in.
Headroom, Front	38 <sup>3</sup> / <sub>4</sub> in.	38 <sup>3</sup> / <sub>4</sub> in.	38 <sup>3</sup> / <sub>4</sub> in.	38 <sup>3</sup> / <sub>4</sub> in.	38 <sup>3</sup> / <sub>4</sub> in.
Headroom, Rear	37 <sup>1</sup> / <sub>4</sub> in.	37 <sup>1</sup> / <sub>4</sub> in.	37 <sup>1</sup> / <sub>4</sub> in.	37 <sup>1</sup> / <sub>4</sub> in.	37 <sup>1</sup> / <sub>4</sub> in.
Tire Size	7.10 x 15	7.10 x 15	7.10 x 15	7.10 x 15	7.10 x 15
Recommended Tire Pressure	26 lbs. F 24 lbs. R	26 lbs. F 24 lbs. R	26 lbs. F 24 lbs. R	26 lbs. F 24 lbs. R	26 lbs. F 24 lbs. R
Road Clearance	8 <sup>1</sup> / <sub>8</sub> in.	8 <sup>1</sup> / <sub>8</sub> in.	8 <sup>1</sup> / <sub>8</sub> in.	8 <sup>1</sup> / <sub>8</sub> in.	8 <sup>1</sup> / <sub>8</sub> in.
Turning Radius	R—19.65 ft. L—19.65 ft.	R—21 ft., 2 in. L—20 ft., 5 in.	R—21 ft., 2 in. L—20 ft., 5 in.	R—21 ft., 2 in. L—20 ft., 5 in.	R—21 ft., 2 in. L—20 ft., 5 in.
Steering Wheel, Lock to Lock	5 <sup>1</sup> / <sub>2</sub> turns	5 <sup>1</sup> / <sub>2</sub> turns	5 <sup>1</sup> / <sub>2</sub> turns	5 <sup>1</sup> / <sub>2</sub> turns	5 <sup>1</sup> / <sub>2</sub> turns
Steering Ratio	18.2:1	20.4:1	20.4:1	20.4:1	20.4:1

### CAPACITIES

Oil	7 qts.	7 qts.	7 qts.	7 qts.	7 qts.
Water	18 <sup>1</sup> / <sub>2</sub> qts.	18 <sup>1</sup> / <sub>2</sub> qts.	18 <sup>1</sup> / <sub>2</sub> qts.	18 <sup>1</sup> / <sub>2</sub> qts.	18 <sup>1</sup> / <sub>2</sub> qts.
Gasoline	20 gal.	20 gal.	20 gal.	20 gal.	20 gal.



# BUY from C&H - you'll save and be sure!

**ALL ITEMS GUARANTEED AS REPRESENTED**  
*Order with confidence from C&H*

## 80-1 ratio GEAR REDUCER

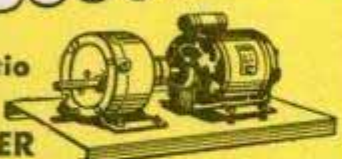

Double reduction. Operates on any 1/6 to 1/2 HP electric motor. 22 RPM. Can be used as winch, barbecue, dummy elevator, operate turntable, electric garage door opener, television antenna. REGULARLY \$45.00. NOW ONLY \$22.00

## 54 to 1 BOSTON Speed Reducer



Reduces speed of ordinary 1750 rpm electric motor to 33 rpm. Lists at \$55.00. Our price \$29.50



## CLUTCHES

For motor scooters, motor bikes, lawn mowers, etc. Centrifugal action enables electric motors or small gas engines to handle heavy starting loads. 3" A belt pulley. NEW. 5/8" bore \$9.95; 3/4" bore \$10.95 1" bore \$11.95

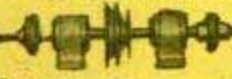

## BALL BEARING ARBORS

Grinding and saw arbor, has 1/2" double end shaft, 1 1/2" long with 2" center pulley. New Departure double roll ball bearings. Right and left hand thread. Self aligning Dodge pillow block, 10,000 RPM. Bearings alone list at \$10. NEW \$6.95

## ALARM HORNS - SIRENS



Motor driven not a vibrator. Heavy duty with great power and long life. Adjustable for high, medium or low tone. 110v. AC current. Weather proof. For alarm or signal horn on boats, school yards, factories, air raid siren, etc. List price \$47.00. Our price NEW \$15.45

## HOT ROD SUPERCHARGER



Extra soup and go at a price you can't afford to miss. SEE HOW SIMILAR SUPERCHARGER is used in PICTURE and article on p. 67 AUG. '50 issue of POPULAR MECHANICS. Mfr'd. by Borg-Warner. Specifications: 7 1/2" deep, 7" high. Wgt. 17 lbs. Compact and sturdy. 4" base mounting holes, 3/4" outlet, 5/8" shaft with female Lovejoy coupling. Priced today at \$85. OUR SPECIAL SALE PRICE \$31.00

## POWER and HAND WINCHES

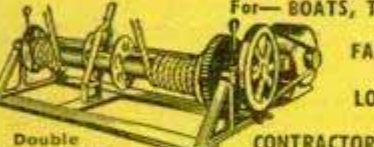

For - BOATS, TRUCKS, FARMERS, LOGGERS, CONTRACTORS, ETC.  
 Double drum model WINCHES, 1,000 lb. cap. Hand oper. \$ 9.95  
 WINCHES, Hand operated ball bearing model, 1,500 lb. capacity, 3-1 ratio, hand brake, two speeds drum, \$ 39.50  
 WINCHES, 6,000 lb. double drum, Hand operated \$ 49.50  
 WINCHES, 1,500 lb. electric drive, \$ 89.50  
 WINCHES, 6,000 lb. electric drive, \$188.50  
 WINCHES, Single drum, 3/4 HP. Motor 110 or 220 AC. Start, stop and reversing switch, belt, pulleys, 100 ft. 3/16" steel cable, 2000 lb. pull. Ratio 12 to 1. NEW \$125.00. Double drum model \$135.00  
 CABLE, 1/4" preformed stainless steel aircraft, 100 ft. or less \$17c/ft. Over 100 ft. \$15c/ft.

## BOOSTER FANS

Fits any 8", 9", 10" furnace pipe. 1500 RPM motor with 6" cord, mounting frame, 7" blade. Motor 110 volt 60 cycle 1550 RPM. Easy to install. Silent operation. Warm those rooms with long runs. Stock #583. Regular \$11.95. Your price \$6.95

10" ball bearing fan Mfg. by Redmond. Can be run vertically or horizontally. 110 volt AC, 60 cycle motor with plug and cord. New in original box. Use it for the kitchen as an exhaust fan, heat booster, etc. High pitch blade, 1/225 HP 1550 RPM only \$11.95



## High Volume BLOWERS

Top performance for forced draft, ventilating, exhausting, cooling and drying. 110 volts AC, Intake 3", discharge 2 1/2", 75 cubic ft. per min. \$10.95 Intake 5", discharge 3", 150 cubic ft. per min. \$13.95



# SAVE OVER 50% ON THESE BRAND NEW WAR SURPLUS POWER UNITS



## BE PREPARED for any emergency!

300 WATT 110-220 volt AC, 60 cycle light plant powered by 1 HP gas engine, direct drive, mounted base, wgt. 40 lbs. Ideal for campers, P.A. systems, house trailers, etc. Equipped with handle for easy carrying. \$99.00  
 750-1000 WATT 110 volt AC, powered by Briggs & Stratton gas engine \$169.00  
 1000-1200 WATT 110 volt AC \$194.00  
 2000-2500 WATT 110 volt AC, 60 cycle, slow speed generator, 5.10 HP Briggs & Stratton gas engine. NEW \$294.50 To make plant 110-220 add \$40.00 for transformer.  
 2500-3000 WATT 110 volt AC, 60 cycle, Leland generator-runs at slow speed (1800 r.p.m.) for longer life. 8.25 HP Briggs & Stratton gas engine. You can rely on this plant for all average home needs—freezer, stoker, pump, hot plate, radio, etc.—and overloads from starting motors. Reconditioned and fully guaranteed. \$295.00, NEW \$345.00 Plants, same as above, built in 1951, with tools and spare parts. Lists at \$790.00. Our price \$426.00 To make plant 110-220 add \$48.00 for transformer.  
 3000 WATT, 110-220 volt with push button starter. Starter battery is automatically charged by plant. Gas engine same as in plant above \$465.00  
 5000 WATT, 120 volt, 60 cycle AC, Hercules 4 cyl. gas engine. Generator mfr'd by Hobart Bros. Unit includes remote control cable, 150' 2-wire #6 and 150' 3-wire #18, exhaust pipe, power cable plug, spare parts, manual, battery, radio and TV filtered. Unit is completely automatic. List price today \$1910. Now priced for you at \$675. used, NEW \$895. To make plant 110-220 add \$72. for transformer.  
 For complete information and specifications on the following plants, WRITE for our FREE circular.  
 7500 WATT 110 volt AC, 4 cyl. gas engine, NEW \$995.00  
 10,000 WATT 110-220 AC. Recond'nd \$1195, NEW \$1494  
 25,000 WATT 220 v. AC, 3 phase, or 110-220 v. AC, single phase. Reconditioned. \$1995.00. NEW \$2495.00  
 35,000 WATT 110-220 volt, Diesel. Rebuilt. \$2995.00  
 50,000 WATT 240 v. AC, 3 phase. Diesel. NEW. \$5900.00

## HEAT CONTROL

Made by Minneapolis-Honeywell—a name known for the best in controls. 1000 watts—115 to 220 volts. Element length 10 ft. Range 70° to 212° Fahrenheit. Control fans, motors, furnaces. This control makes an ideal automatic combination when hooked up to the heat boosters at left. List price \$16.00. Your price \$5.95



## PORTABLE ELECTRIC HOT WATER HEATER

Complete unit consisting of 10 gal. steel tank; thermostatically controlled Westinghouse or Calrod immersion heating unit. 110 v. AC adjustable from 312-525, 1250 watts and automatic cutoff valve. Ideal unit for household use, milk-houses, poultry water warmer, etc. Valued at \$59.50. Our price \$34.95 Without controls \$24.95

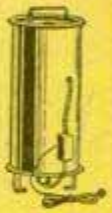

IMMERSION HEATING UNIT alone as above, worth \$42.50. Only \$5.95  
 Combination price with heat control above \$59.95

## "JANITROL" AIRCRAFT HEATERS

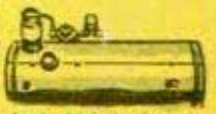

Warms up fast—just the thing for heating trucks, buses, garages, etc. Has an output of 50,000 BTU's per hour. 24 volts DC. Length 23", diameter 13", weight 14 lbs. Original cost \$130. Our special sale price NEW only \$19.95

## GAS ENGINES

New Briggs & Stratton A sensational buy in gas engines. All are guaranteed and in the original crate. Rope start, 1750 RPM. Model AM 1, 1 1/4 HP \$42.50 Model N, 6 to 1 reduction gear, 2 HP \$49.50 Model BP, 5.10 HP \$94.50 Model ZZ, 8.25 HP \$109.50



## Flexible Shaft Grinder

"MALL" PORTABLE 1/2 HP, 3450 RPM, 110-220 volt dustproof motor mounted on universal trunnion. Heavy base has a convenient tool tray and large easy rolling casters. Flexible shaft is equipped with both full speed, angle spindle and straight spindle. List price \$172.00. Your price with all attachments, NEW \$109.00



NEW TOOL POST GRINDER 1/2 HP, AC-DC 7000 rpm motor with 3 1/2" x 3/8" external grinding wheel, smaller internal wheel, 7' rubber cord, switch and attachments. List \$90. Only \$49.50

## GENERATORS

300 Watt, R.P.M. 3400, 110 and 220 volt, 1/2" shaft, \$40.00. 2500-3000 Watt, R.P.M. 1800, 115 volt, AC, \$235.00. 3000 Watt, R.P.M. 2800, 110 volt, DC, Delco ball bearing, 1" shaft, List \$243.00. To you at only \$99.00. 5000 Watt, 115 volt, R.P.M. 1800, single phase \$259.00. 10,000 Watt 110-220 volts with floating mount to keep belts tight \$287.00. Generator only \$235.00



## and other bargain items

AIR COMPRESSORS from 1/2 HP, 12 gal. tank at \$99.00, to 10 HP, 80 gal. tank at \$777.00  
 WELDING ROD—Manufactured by Murex. All purpose type S, AC-DC 5/32", 50 lb. box \$3.00  
 OHMMETERS, Read 25 to 0. In leather carrying case. Reg. \$29.95. Only \$7.95  
 FVR FYTERS, Fire extinguisher approved by Underwriter's Reg. \$14.95. Only \$6.95  
 1/2 TON SHOP UTILITY WAGONS, steel frame, rubber tires, ball bearings. \$48.50  
 50 Watt TRANSFORMER, 115 to 20 volts AC. For chimes, doorbells, or ignition. \$1.95

## HEAVY DUTY RUBBER ELECTRIC CABLE

(Nothing less than 50 ft.)  
 4-Wire #18 Neoprene standard, per ft. 7c  
 2 Wire #14 18 ft. with plug \$3.00  
 Wire #14 18 ft. NO plug \$2.60  
 Wire #14 50 to 225 ft., per ft. 17c  
 Wire #12 12 ft. with plug \$3.50  
 Wire #10 50 to 225 ft., per ft. 30c  
 4 Wire #10 75 ft. length, per ft. 40c  
 Wire #6 150 ft., with connector \$125.  
 Wire #6 150 ft., with connector, 90.  
 Wire #4 75' reel and connectors, 80.  
 2 Wire #4 Concentric 50 to 250 ft. underground, per ft. 60c  
 1 Wire #10 Rubber, 50-300', per ft. 94c  
 15 Cond. #18 GE Stranded 50-300' O.D. 13/16", per ft. 50c  
 10 Cond. #18 Solid, per ft. 10c  
 Telephone wire—250', per ft. 2c; 1000' 14/2c

## SPRAY BOOTH FAN

18 Inch Handles all spray booth and air exhausting jobs with absolute safety in atmospheres containing flammable and exhaustive gases. Totally enclosed 1 HP Motor, 220/440, 3 phase, 3400 RPM. Reconditioned \$109.00



ORDER DIRECT from this ad! All prices F.O.B. Milwaukee. 25% deposit required on all C.O.D. orders. No C.O.D.'s under \$10.00. Many other bargain items not listed. Write for our FREE CIRCULARS!

**C&H ELECTRIC MACHINE Co. Inc.**  
 434 W. Juneau Ave., Milwaukee 3, Wisconsin

INDUSTRIAL BUYERS When you can't find a scarce item — try C & H



engine with durability as well as real efficiency."

An Air Force jet pilot from Milwaukee, Wis., had really put his Hudson to the test. He wrote, "My '51 Pacemaker performs as follows: Actual stop-watch timing, standstill to 90 miles per hour in 45.3 seconds. Not bad—almost as good as our jets. Jets actually aren't much faster on initial take-off acceleration."

The survey showed that 58 percent of Hudson owners use more than the recommended pressure in the new low-pressure tires, but the fat tires themselves were approved in 87 percent of the answers.

Some owners indicated a preference for V-8 engines, but a Dayton, Ohio, federal employee said: "If my Super Six lives up to the durability claimed by Hudson owners I have known, I will have nothing to dislike about the car. I have owned four V-8s before and I think I will stick to a six-cylinder if all the models run as smoothly as this six. I honestly can't say that the cars I previously owned ran as smoothly as this six."

"Hudson's 'step down' feature gives the lowest center of gravity, brakes are better than any other car as the mechanical foot

(Continued to page 264)



## Electric Snow Shovel

Electricity does the work when you clear your sidewalks and driveways with an electric snow shovel. The impeller vanes throw the snow up to 20 feet on either side, clearing a 12-inch wide path at a walking pace. The machine can, with a conversion unit, be changed into a power lawn mower come spring. The 1/2-horsepower motor has a 100-foot cord.

**MAKES SNOW REMOVAL REAL FUN!**  
(Item 72)

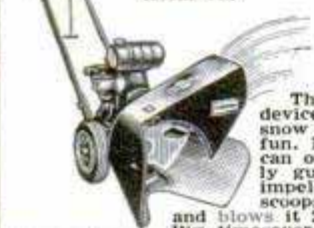

## SNOW-BLO

The sensational device that makes snow removal real fun. Easy — a child can operate it. Safely guarded whirling impeller quickly scoops up the snow

and blows it 25' either side. Big timesaver. Clears driveway ways and walks in a jiffy. Eliminates dangerous exhaustion and overtaxed heart, which kills so many every winter. BOYS! Make big money clearing snow for neighbors. Easily converted to lawn mower when desired. New silent electric model powered by 1/2 hp. motor clears 16" swath. Complete with shockproof 100' cord (Item 72)...

**\$139.50**

Gasoline Model with easy starting 2 hp. 4 cycle engine (Item 73)...

**\$159.50**

Self Propelled Model for large areas (2 1/2 hp. engine) (Item 74)...

**\$229.50**

With 5 hp. engine (Item 75)...

**\$269.50**

We pay freight on Snow-Blos. FREE with purchase of any model, an extra 100' extension cord.

## ANGLE DRILL

(Item 23) Fits into chuck of any electric or pneumatic drill or flex. shaft. Operates at any angle in a full 360° arc. Makes possible drilling, grinding, carving, routing, etc. in close cramped quarters. Makes impossible jobs easy. Made by Kett Tool Co. Complete with built-in chuck (1/4" capacity) and adjusting key. Hardened alloy gears. Precision built for heavy duty. Lists at \$39.95—while they last... **\$9.95**

## GEM CUTTER

(Item 49) Complete Prof. Lapidary mach. for cutting, shaping, grinding and polishing precious and semi-precious stones. Precision built with big horiz. power driven gem cutter, built-in cutting lubricator; genuine 6" supercharged diamond saw, lap wheel, abras. whls., 2 scratch whls., 4 felt whls., grinding and polishing compounds, brushes, dop cement and sticks, cutting oil, ext. cord, asstd. gems, complete instructions. Requires 1/4 hp. motor (not incl.). Wt. 22 lbs. Worth \$99.50. Our Special... **\$39.95**



## MASTER MECHANIC FACTORY SURPLUS PRICES

### A-C ARC WELDER

(Item 168) Master Hi-Line A-C Arc Welder. 20-190 amp. output. Welds or cuts iron, steel, brass, etc. from 24 gauge to 5/8" with single pass. Operates from 220/230 V. 50/60 Cycle A-C line. None better. Meets REA requirements. Handles 1/16" to 1/4" rods. Adjustable output for any job. In sturdy steel cabinet, on casters. Full instr. and 1 yr. guar. incl. Wt. 210 lbs. Reg. \$250 value. (Item 169) 20-100 amp. A-C Welder operates on 110 or 220 V. Wt. 65 lbs. Worth \$125 **\$64.95** (Item 181) Welding Kit incl. helmet, 2 leads, electrode holder, ground clamp, power cord and rods (sold only with welder) **\$12.50** Wt. 12 lbs.

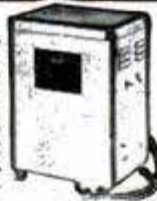

**\$159.50**

**\$64.95**

**\$12.50**

### AUTOMATIC ELECTRIC WATER HEATER

(Item 76) Immersion type 115 v. AC—1250 watts. Convert your present tank to modern automatic hot water heater. Long life Westinghouse or Chromalox element screws into std. 1 1/4 in. opening in tank. Adjustable thermostat keeps water at desired temp. Can also be used in washing machine or tub. Wt. 8 lbs. Heater element and thermostat regularly \$49.50. Special... **\$14.95** Heater only, for manual control, Wt. 3 lbs. **\$7.95**



### GAS ENGINE

(Item 25) Air-cooled, 1 1/2-2 h.p. Complete with gas filter, air cleaner, governor, fuel tank. Ready to run. Speed range 2000-3600 r.p.m. 5/8" shaft. Rope start. Ideal for pumps, air compressors, power tools, generators, etc. Factory warranty and instructions incl. One of the best made. Wt. 40 lbs. Worth \$72.50. Special... **\$46.50**



GAS-ELECTRIC PLATFORM TRUCKS (Item 41) 5 ton cap.; platform 90" x 40" x 17" hi. Chrysler eng. Equipped with coupler; very maneuverable; USED but in exc. operating cond. Will ship on appr. to well-rated firm. New price \$4000—our special... **\$1350**

Send 10c for a Big War Surplus Catalog. Included Free with Every Order

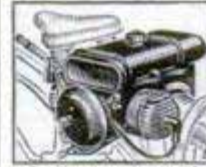

## COMMANDO BIKE MOTOR

(Item 90)

New, super-modern 1952 model. This job is the Cadillac of all bike motors. Sensational Auto-Clutch prevents killing motor at each stop. Also selects proper ratio on hills. Mounts behind and drives rear wheel with Dynarotor. Free Wheeling lever permits pedalling if desired. Rear Mounting eliminates fumes, heat, dirt, and hard steering. Easily installed in 15 minutes with home tools. Sturdy, trouble-free, easy starting, light weight. Airplane type engine; up to 150 miles per gallon. Fully guar. Ride for fun or profit. Ideal for deliveries, paper routes, messenger service, etc. Ride to work and save. The Commando Captain, 1 cylinder 1 1/2 hp. .... **\$99.75** The Commando General, 2 cylinder 3 hp. (Item 91).... **\$125.00** All Commandos shipped prepaid in U.S. Removable handle

### 1/2" DRILL

(Item 33) DeLuxe model—powerful, smooth running, precision built. Handles toughest jobs. Cutler-Hammer switch, Jacobs key chuck. 110-120 v. AC-DC 300-450 rpm. Alum. alloy case for high strength and easy handling. Built-in blower assures cool operation. Cap. 1/2" in steel, 1 year written guar. Wt. 11 lbs. Should be \$65. Special... **\$34.50**



### 8" TILTING ARBOR SAW

Terrific Value. Heavy duty 3/4" double ball-bearing arbor. Saw blade tilts, table remains level. Big 12"x18" precision ground table. (Extensions to 24"x18" avail.) Micrometer hand wheel controls tilt and depth—2 1/2" cut. Cross-cutting, ripping, da-doing, sanding, bevel and angle cutting, all easily performed. Essential for all cabinet work. Motor carriage, mitre-gauge, rip-fence, splitter, guard and blade incl. Compares with saws selling at \$89.50. DeLuxe Ball-Bearing model (Item 69) wt. 34 lbs. .... **\$44.95** Bronze-bearing model (Item 70) 1/2" arbor, table 10"x13", wt. 34 lbs. .... **\$27.50**



TIRE CHAINS (Item 43) Extra heavy for dual truck tires, 7.50x20, triple side links, made by Intl. Chain. Reg. list \$57.50—our special... **\$19.50**

All items brand new. Prices f.o.b. Chicago area. 10 day Money back guarantee. Send check or M. O.

MASTER MECHANIC MFG. CO., Dept. 92, Burlington, Wis.





**Portable LIGHT PLANT**  
**PUSH BUTTON START**  
 500-700 watts 110-120 v. - 60 cyc. A.C. Powered by a sturdy dependable, easy starting, air cooled 1 3/4 hp. gas engine. No wiring necessary, just plug in and operate. Plenty of current for any oil burner, freezer, brooder, pump, emergency lights, up to 700 watts. Ideal for Civil Defense, Fire Depts; trailers & camps. Complete with Voltmeter and built-in winding to charge 6 v. auto batteries. Wt. 8.5 lbs. Fully guaranteed. Be prepared if war or storm knocks out power lines. **\$143.50**  
**1000-1200 Watt Plant (Item 45)** same as Item 24, but larger generator & engine. **\$199.50**

**GIANT 2000-2500 WATT PLANT**

110-120 V. 60 cyc., A.C. Absolutely the best made because of heavy windings develop up to 5000 watt overload for motor starting. Skid-mounted—portable. Powered by 5 h. p. easy starting Briggs or Wisconsin engine—complete with all accessories; engine easily disconnected for other uses. Big outlet box, voltmeter, no wiring necessary. Ample current for all purposes. Factory warranty and instructions included. Wt. 220 lbs. Reg. \$585.00. Special at... **\$299.50**  
 With Electric Self Starter (Item 179) **\$359.50**  
**GENERATOR ONLY and control box.** **\$169.50** Drive it with your engine or tractor  
**HI-LINE 6000 WATT PLANT (Item 162)** Push Button Start, 115-230 v. 60 cycle A. C. A brute of a power plant with a rugged 13 hp. Wisconsin engine. Plenty of electricity for ranges, water heaters, freezers, pumps, machinery, etc. Affords both 110 and 220 volts. Ideal where heavy current is needed. Wt. 500 lbs. Easily worth \$995.00. (with self starter) **\$645.00** Factory special.  
 Same plant (with crank start) **\$585.00** (Item 166) Wt. 570 lbs.  
 Generator and control box only, belt driven. Use your engine or tractor. **\$345.00** Wt. 240 lbs.

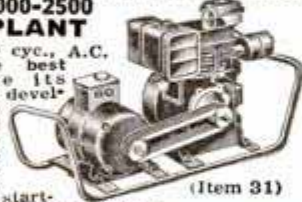

**We Are World's Largest Mail Order Distributors of Light Plants**  
**HEATING & VENTILATING FAN**  
 (Item 10) Easily installed in furnace pipes. Forces even heat to all rooms. Over range, removes kitchen smoke and odors. Powerful continuous duty motor, 110-120 V. A.C. Quiet, super efficient fan moves huge volume of air (400 to 600 c.f.m.) 8" Fan, wt. 5 lb. **\$6.35**; 9" Fan, wt. 6 lbs. **\$7.45**; 12" Fan, wt. 7 lb. **\$8.45**; 12" Fan, wt. 8 lbs. **\$9.45**



**HIGH PRESSURE HAND PUMP**  
 (Item 53) Positive displacement type. Cap. 550 gph. Completely self priming. 3/4" pipe thread inlet and outlet. Use for fuel or water transfer on boats, trailers, air craft, etc. Ideal for insecticides, emerg. sump pump or as vacuum pump. Wt. 15 lbs. Govt. cost \$95. Our Special... **\$12.95**

**VARIABLE SPEED SELECTOR**  
 Heavy duty, made by B. F. GOODRICH for industrial use. Provides instant speed changes for any drive. For machine tools, dryers, printing, conveyors, production lines, hoists—any operation requiring variable speed. Ideal for midgut autos. Employs reliable "trouble free" planetary system. No hydraulic power losses or creeping. Infinite range, smooth operation, easy installation. 3 sizes: 1/2-1 hp. wt. 30 lbs. 1-2 hp. wt. 55 lbs.; 2-3 hp. wt. 105 lbs. Reg. list \$228, \$252 and \$352. Brand new, in Goodrich boxes and guaranteed. Complete installation data included. Unprecedented surplus sacrifice **\$79.50, \$89.50 and \$114.50**



**ELECTRIC HAND SAW**  
 (Item 36) Most perfectly balanced and smoothest running saw made. Advanced design provides max. power and light weight. Easily adjusted for all angles, depth and width of cut. Comes complete with 6 1/4" comb. blade, ripping guide and 10 ft. hvy. duty cord. Built-in saw telescoping guard. 110-120 v. AC-DC. Depth of cut 2 1/4". 1 year written guar. Wt. 12 lbs. Drastically reduced... **\$39.95**



**IMMEDIATE DELIVERY FOR XMAS HEAVY DUTY ARC WELDER**

(Item 38) Use as portable or shop welder. 250 amps, D.C., Senior model. Made for years of trouble-free, continuous service. Will handle light or heavy jobs. Weld up to 1/2" plate using 1/4" rods. Built-in air-cooling system. Arc is easy to strike and hold, because of specially designed arc stabilizer. Hi-lo switch and dial control gives wide range of welding heats. Run welder at 2600 rpm. with tractor, jeep or 15 hp. gas engine, or 7 hp. elec. motor. Complete with instructions, guar. and double V belt or flat pulley. Wt. 110 lbs. **\$99.75** A \$400 value at...

**MAGIC TERMINAL** model same as above but with built-in 3rd terminal for low heat soldering and brazing. Special... **\$19.50**  
**WELDING KIT**. Two 10 lb. loads, welding helmet, electrode holder, ground clamp. Sold only with welder at... **\$10.50**

(Item 39) Fully charged at 1,000 lbs. P. S. I. or more with CO2 (carbon dioxide) the proven miracle fire fighting chemical that smother's oil, gasoline and electrical fires. Play safe; keep one in your car, garage and home. Heavy ICC approved steel cylinder, valve and 3000 lb. gauge that shows available remaining pressure. RE-FILLABLE at nominal cost. Hose included for emergency tire inflator or air blast. Wt. 4 lbs. **\$19.50** value. Special... **\$6.95**

**LARGE FIRE EXTINGUISHER (Item 57)** commercial size, 5 x 14 in. (275 cu. in.) heavy ICC approved steel cylinder charged at 1000 lbs. or more with CO2. Equipped with genuine Kidde Valve. Refillable. Hose incl. Suitable for fire depts., stores, garages, homes, etc. Wt. 18 lbs. **\$42.50** value. Spec... **\$15.85**

**GAUGE TESTER (Item 27)** Precision made of solid bronze and steel by Ashcroft. (Cat. #1300-5). Calibrated weights (incl.) acting against hydraulic piston provides quick accurate testing of all pressure gauges up to 500 psi. Brand new. Wt. 90 lbs. Reg. \$318.00. Our Spec... **\$95.00**

**34 pc. SOCKET SET (Item 59)** Highest quality guar. non-breakable sockets made by Plomb, Snap On, etc. Complete range of 22 sockets from 1/4" thru 3/4" in 3/8" drive and 7/16" thru 1-1/16" in 1/2" drive. 2 speeder handles, 2 extensions, 2 slide heads, double 3/8 x 1/2 in. "L" handle, reversible ratchet. Adapter bit, 2 end wrenches and metal tool box. For professional mechanics who want the best. Wt. 14 lbs. Easily worth \$34.50 while they last... **\$16.95**

**SPRAY OUTFIT (Item 37)** Twin cyl. piston type compressor direct-connected to powerful 110-120 v. AC-DC motor. Built-in air tank eliminates pulsation and provides steady flow of air at 25-30 lbs. Does lacquers, enamels, insecticides, etc. Spray beautiful work on autos, furniture, farm equip. 1 qt. spray gun, relief valve and 10 ft. air hose incl. Full instructions and 1 year guar. Wt. 11 lbs. **\$22.95** Regularly \$50. Spec... **\$22.95**

**RUBBER HOSE**  
 New genuine Neoprene Hose—outlasts ordinary rubber 3 to 1. Reinforced with super tough cotton cord plies. Flexible. Easy Flo brass couplings with standard pipe threads for quick connections. Included. Pump water for irrigation, stock tanks, home, barn, fire fighting, etc. Pump Gas or Fuel Oil. Save more than 60%!  

(Inside Diam.)	1"	1 1/4"	1 1/2"
Length	10 ft.	25 ft.	30 ft.
Price	5.95	9.25	14.75

 If specified we will send special hose for gas or oil at same prices.

**HYDRAULIC HOSE**  
 High pressure, heavy duty, complete with swivel fittings. Pipe thread connections. Ideal for farm equip., bulldozers, grease guns, airbrakes, etc. Any length. Minimum \$1 per ft. **INSIDE DIAMETER**, 1/4" \$50c per ft. 3/8" 60c. 1/2" 80c. 3/4" 90c. Send 10c for a Big War Surplus Catalog. Included Free with Every Order.

**EXTENSION CORD**  
 (Item 16) 40 ft. heavy duty, made of specially insulated No. 14 2-conductor wire. So tough that you can drive over it and yet amazingly flexible and easy to handle. Resists oil, grease or water. Extends electricity up to 400 ft. without voltage drop. Use indoors or out. Complete with heavy rubber plug and outlet. Wt. 2 1/2 lbs. Usually \$4.50—Special 40 ft. **\$1.99** Comb: 2-40 ft. and 1-20 ft. (total 100 ft.) **\$4.95** 100 foot length (one piece)... **\$4.85**  
**WIRE ONLY (Item 50)** No fittings, 100 ft. **\$4.00**  
**TRENCH-LAY WIRE.** (Item 51) Anaconda #10—2 cond., for buried service to barns, outdoor lights, etc. Absolutely impervious to soil and moisture. Wt. 25 lbs. per 100 ft. Special surplus price. 100 ft. coils, 19c per ft.; 250 ft., 18c per ft.; 500 ft., 17c per ft.

**38 Pc. DRILL KIT (Item 35)** Includes hi-power smooth-running guar. 1/4" drill, buffers, polishing bonnet, sanding discs, grinding wheels, wood bits, steel bits, wire wheels, bench stand, paint mixer, burrs. Complete in steel case. Wt. 13 lbs. 38 pc's. all highest quality. Complete kit worth \$58.50. Our Spec. only... **\$19.85**

**ACCESSORIES FOR 1/4" DRILL**  
 Make complete workshop out of your 1/4" drill, using these practical accessories. Quick change—merely insert shaft in drill chuck. Sturdy, heavy duty tools for real work. Precision built of hardened tool steel. Factory guaranteed against breakage.

**POWER HACK or JIG SAW (Item 64)** makes straight or curved cuts easily in plywood, 3/4" boards, sheet metal, plastics, etc. Uses broken hack saw blades. Will do filing, jig saw, coping saw and sabre saw work. Compares with \$50 tools. Wt. 3 lbs. Special... **\$16.95**

**ELECTRIC HAND SAW (Item 66)** The famous Arco-Saw converts any 1/4" or 3/8" drill into a powerful electric saw. Exclusive features—one hand operation, visual guide, bevel and angle adjustments, rip gauge depth gauge. Depth of cut 1-5/16". Self lubricated for life. Wt. 3 lbs. Complete with 4" blade... **\$11.50**

**Power Sander & Polisher (Item 65)** Make quick work of slow tedious sanding jobs. Big 21 sq. in. sanding surface. Produces powerful lengthwise sanding stroke which results in beautiful smooth finish. Built-in rubber pad. Sandpaper held in place by quick-change spring-clips. No messy adhesives. Use felt pad for polishing. Using drill motor for power gives you equivalent of an \$85 sanding machine. Wt. 3 lbs. Terrific value at... **\$16.50**

**28 pc. BENCH GRINDER KIT (Item 71)** A rugged precision Grinder powered by 1/4 hp AC 110 v. 3500 rpm heavy duty motor. Equipped with tool rests and non-breakable safety eye-shields. 28 pc. kit incl. 2 grinding wheels, wire wheel, drill chuck, arbor, asst'd drills, 14 sanding and polishing discs, buffs, etc. All highest quality. 1 year guar. Wt. 17 lbs. Drastically reduced... **\$21.95**

**CARRY-AIR (Item 32)** Stainless steel tank—capacity 500 cu. in. at 400 lbs. press. complete with inlet and shutoff valves, press. gauge, detachable air hose, tire chuck. Fill at any service station. Carry air for tire inflation, blowing out lines, spray painting, insecticides, etc. One emergency pays back cost. Wt. 10 lbs. Worth \$29.00. Our price... **\$8.95** (Item 55) With big double tank (1000 cu. in.)... **\$11.95**

**POTTERS WHEEL (Item 47)** Complete, prof. equip. for making finest ceramics and pottery. Large dynamically balanced cast-aluminum reversible turntable with variable speed drive (38 to 140 rpm) controlled by foot-pedal. Built-in adjustable arm rests, water cup and wedging wire. 16x12" enclosed throwing table—ample area for largest pieces. Reg. 1/4 hp. motor (not incl.). Can be set up on 20x24" table and stored on edge. Complete with pulleys, belts and instructions. Wt. 26 lbs. **\$59.95** \$145 value at...



# FREE PLAN

Tells How to Start  
Your Own Business

## FILING SAWS

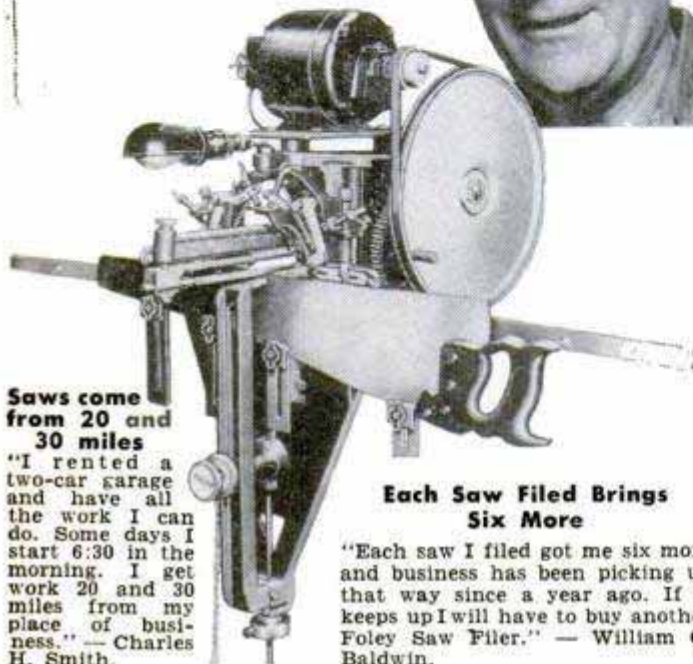

Saws come from 20 and 30 miles

"I rented a two-car garage and have all the work I can do. Some days I start 6:30 in the morning. I get work 20 and 30 miles from my place of business." — Charles H. Smith.

Each Saw Filed Brings Six More

"Each saw I filed got me six more and business has been picking up that way since a year ago. If it keeps up I will have to buy another Foley Saw Filer." — William C. Baldwin.

### FOLEY FILED SAWS BRING NEW CUSTOMERS

Here is a steady repeat CASH business you can start in your own basement or garage in your spare time. Every saw you sharpen with the machine accuracy of the Foley Saw Filer is an ad that brings you more customers. S. M. Hollingshead wrote to us: "I am doing very well with my Foley Filer, and I am glad I invested in your machinery. It is very satisfactory and works very well in the small community in which I live."

You can file all hand saws, also band and cross-cut circular saws on the Foley Saw Filer. The adjustments are simple — there is no eyestrain — and you can start right away to turn out perfect cutting saws. "The first saw I sharpened with my Foley Filer came out 100%. I think it is a marvel of perfection." — writes Clarence E. Parsons.

### FREE BOOK Shows How to Start

#### "INDEPENDENCE AFTER 40"

explains how you can get business from hardware stores, home owners, farmers, carpenters, schools, mills, factories, etc. Just think — with a modest investment, no overhead, no stock of goods to carry, you can start right in on a cash business that will help pay the rent, buy groceries, or a new car. Start now — send coupon today. No salesman will call.



Send For **FREE BOOK**

FOLEY MFG. CO., 1216-1 Foley Bldg.  
Minneapolis 18, Minn.

Send me free book "INDEPENDENCE AFTER 40!"

Name \_\_\_\_\_

Address \_\_\_\_\_

brake takes hold in an emergency, so I say Hudson is the safest car as well as the best car money can buy, and I bar none. I've owned 27 cars; Hudson beats them all," said a Los Angeles salesman.

A surprisingly large number of owners said they bought a Hudson this time because they got the best trade-in allowance.

A Gary, Ind., boilermaker gave the highest possible rating to his Commodore Six somewhat belligerently. He announced: "I think the new Hudson is a dependable car and the best-looking car on the road, and I don't care who knows I said it. P. S.: It's a poor man's car to buy and keep."

**And now for my own test of the Hudson Hornet:** They say confession is good for the soul and I must confess here and now that I have had a change of heart from my previous opinion of Hudson cars, which wasn't too high.

Frankly, I had never been too sold on Hudson, although back in 1916 I owned a Hudson Super Six and found it to be an outstanding performer in its day. But my 2750-mile road test in a 1951 Hudson Hornet four-door sedan, Hydra-Matic equipped, from Detroit to Los Angeles (via Kansas City, Denver and Salt Lake City), including tests on side roads, definitely changed my opinion of the modern Hudson.

I had heard a lot about Hornet performance, so it was selected since it is the most popular model in Hudson's line, and therefore I probably gave it the worst beating of any car I've tested to date. Here is what I found. The Hornet is a wildcat on wheels, due to its very high horsepower-to-weight ratio. It is a dynamic performer which responds to the throttle like a thoroughbred. The snap and fast getaway, top speed and power, make it a thriller to drive. The low center of weight, due to Hudson's exclusive "step down" design, makes it a fine road car and it is noticeably steady at all speeds. There is no road wandering, it takes the corners more like a racing car than a stock job and it handles over rough roads with much ease of operation. I drove many miles in a heavy cross wind which had little effect on car control.

If I were asked to name America's safest car I would honestly have to say Hudson for the following combination of reasons:

1. The exclusive "step down" design affords the lowest possible center of gravity so that the center of weight is low—also the top of the car. Hudson is wider than it is high. Thus the car handles as near like a racing car on corners and rough spots as is possible for any stockcar, which definitely makes it one of the best road-holding cars on the highway. It is easy to control in a

(Continued to page 266)



# 65 KW. 225 Volt D.C. DIESEL ELECTRIC GENERATING UNIT

**RECONDITIONED**

Equipped with 6 cyl. DRXC Hercules DIESEL engine, 45 1/2" bore, 5 1/4" stroke, 133 H.P. at 2000 R.P.M. Complete with injector, pump, nozzles and electrical equipment. Generator attached to engine. Complete as shown.

Each \$1375.00  
Lots of 2 each \$1295.00

RADIATOR for above unit.....

\$89.50

Write for price on DIESEL ENGINE only.



## 1952 EDITION

It's NEW! Get the world's largest Auto Accessory & Parts Catalog & Save money. Over 50,000 items, including Hollywood Accessories, Hi-Speed Equipment,

Rebuilt Engines, all parts & accessories for all cars & trucks. We have that Hard-to-Get part. Completely illustrated, 100 pages, Send 25c (refundable)



FOR GAS, OIL, WATER, NEW! 5 GAL. CANS

- Self locking cap.
- Compact in size.
- Sturdily made.
- Floats when full.
- 3 bar strong handle.
- 18" high, 6 1/4" thick, 13" wide.

Ea. \$2.95 \$2.49  
Lots 5, or more ea.

SEND 25% CASH WITH ORDER, BALANCE C.O.D.

**J. C. WHITNEY & CO.**

1917SP ARCHER AVE.

CHICAGO 16, ILL.

# MONEY for MEN ALL DATA FREE

THE PLASTEX Industry needs manufacturers on small scale and for big production of Lamp and Clock Stands, Art Goods and Novelties in Plastex and Marble imitation. Experience unnecessary. 1/2c material makes regular 10c store sellers. Rubber moulds furnished for speed production. Small investment brings good returns. We are now placing big Chain Store Orders with manufacturers. Ambitious men have chance for real prosperity. Our Free booklet will interest and benefit you.

PLASTEX INDUSTRIES, Dept. A  
3400 Third Ave. New York 6, N. Y.



## OWN A Printing Business

Cards, Tickets, Stationery, etc. Good profit in spare time. PRINT YOUR OWN greeting cards, movie titles, church work, etc. Save money. Easy rules supplied. Raised printing like engraving too. Have home shop. Sold direct from factory only. Pays for itself in short time. Write for free catalog of outfits, and all details. KELSEY PRESSES, 0-37, MERIDEN, CONNECTICUT

## VARIABLE SPEED

HYDRAULIC POWER TRANSMISSION



It has Infinite Speeds 0 to 550. Reverse, Automatic Overload Protection; Adjustable Torque up to 180 inch pounds. 5/8" Input and Output Shafts. It will handle 1/2 to 1 1/2 H.P. Motor. Case measures 7 1/2" long 7" high 6 1/2" wide. VALUE OVER \$300. Shipping Wt. 25#. On C.O.D. Orders we require a 10% only deposit. Fob. Chicago

\$54.50

DIRZIUS MACHINE SHOP "I" 1423-25 So. 52nd Ave., Cicero 50, Ill.

\$14 POST PAID

## PRECISION CALIPER

M.Z.B. Mauser-Type Vernier Calipers guarantee highest accuracy for any kind of precision work. This chrome-steel, spring-tempered instrument measures inside, outside, thread and depth to .001" and 1/20mm (#30-64) or .001" and 1/128" (#30-61) 8" overall 6" graduation. Glass hard measuring surfaces. This is your opportunity to buy a first class precision tool at about half the price of comparable tools. Either one also available in stainless steel at \$16.50 each.

Other models also available. Shipment from stock. Order yours now. Leather Cases \$1.00 extra. You pay postage on C.O.D. Money Back Guarantee.

Send for descriptive literature, also on our fine imported precision pliers.

INTER-CONTINENTAL TRADING CORP.  
90 WEST STREET, NEW YORK 6, N. Y.

# BIG New Cummins COMBINATION DRILL and SAW KIT

SPECIAL OFFER...FOR LIMITED TIME ONLY

Order NOW and SAVE!

Only \$19.95

\$27.95 VALUE!

Here's YOUR chance to let power—Cummins Power—do the work! Does hundreds of jobs faster, better AND SO ECONOMICALLY!

This offer is good for a limited time only, SO ACT TODAY!

Model 190 Drill!



Portable Saw Attachment!

Saw Blade!

MAKES A PERFECT CHRISTMAS GIFT



Steel Drill Stand!



Three Drills!

JUST LOOK AT WHAT YOU GET!

Complete kit for all-around sawing and drilling — You'll use it on 90% of ALL the jobs around the house and in the shop! Cool running, perfectly balanced, 115 volt motor—2-1 planetary reduction gear for surging power—die-cast aluminum body—ball bearings for long life—1/4" chuck for drilling—4 inch saw blade—base adjusts for maximum depth of cut of 1 5/16"—Can be used as a portable saw, right on the job, or can be mounted in the sturdy, steel, horizontal base as a bench saw!

BUILT TO LAST AND BUILT TO WORK!

SEND ONLY \$1.00!

And pay the postman the balance, plus postage and small C.O.D. charge—or send \$19.95 and WE pay the charges.

ADAMSON SALES CO.

7301 So. Halsted—Chicago 21, Illinois

I enclose \$1.00. Send me the Big Combination offer. I will pay the postman balance, plus postage and C.O.D. charges.

I enclose \$19.95. Send me the big Combination offer postpaid.

Name \_\_\_\_\_

Address \_\_\_\_\_

City \_\_\_\_\_ State \_\_\_\_\_



QUALITY PLUS  
PRECISION...

# Shopmaster

Tools and  
Accessories

for  
**BUDGET-MINDED  
Hobbyists**

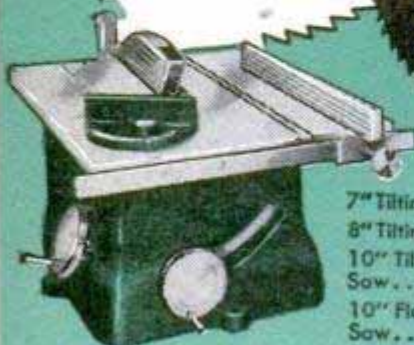

8" Tilting Arbor Bench Saw \$76.95

7" Tilting Arbor Bench Saw \$47.95

8" Tilting Table Bench Saw \$51.50

10" Tilting Arbor Bench Saw \$86.95

10" Floor Model Tilting Arbor Saw \$105.00



12" Drill Press... \$46.95

12" Floor Model Drill Press... \$54.00



15" Jig Saw (Tilting Table) \$27.95



Saber Saw \$17.95



6" Jointer-Planer... \$79.95

4" Jointer-Planer... \$47.95



12" Band Saw... \$79.95

10" Band Saw... \$46.95

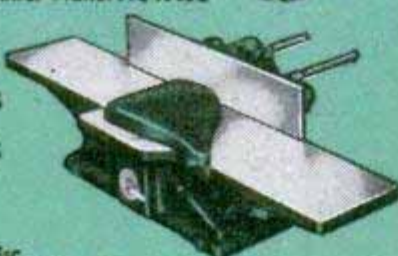

Belt and Disc Sander... \$51.50

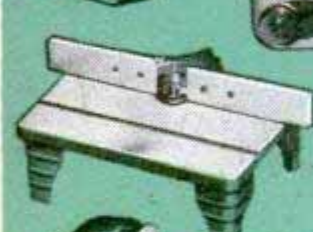

Spindle Shaper... \$45.95

10" Wood Turning Lathe \$45.95

Zone 2 prices, slightly lower in zone 1.



WRITE TODAY FOR  
FULL COLOR CATALOG.

**SHOPMASTER, INC.**

1214 Third St. S., Minneapolis, Minn.

skid and weight distribution is excellent;  
2. The welded, all-steel Monobilt body and frame construction makes the body and chassis one solid unit. The frame extends to the extreme edge of the car and thus affords protection from collision or overturning to the passengers, who sit down and within (not on top) of the surrounding box-section steel-girder frame;

3. Brakes are soft and easy to operate, and there is less tendency for the front of the car to dip down as some cars do when the brakes are applied suddenly. I found there was little tendency for brakes to fade at high speed or on mountain grades. On models with no clutch pedal, I would like a wider brake pedal. However, when the hydraulic brakes go out because of lining wear, or loss of fluid, Hudson drivers have the added protection of mechanically operated brakes applied on the rear wheels for the last inch or more on the same foot-pedal movement. This, in my opinion, is an excellent added safety feature Hudson has

(Continued to page 268)

## BLACK EBONY SEAT COVERS SWEEP TO SENSATIONAL NATIONAL POPULARITY



Salesmen jamming  
pockets with  
\$1000 bills

TAKING ORDERS  
FOR KEY  
EXPERTLY  
TAILORED  
AUTO SEAT COVERS

### LOOK AT THESE FEATURES

- 7 Styles
- 7 Price Ranges
- A Complete Line of Sensational New Designs
- For All Cars — All Makes — Models — Years

## BIG SEASON Now Starting!

You've seen the huge color advertisements in Saturday Evening Post on the new seat cover sensation—miracle SARAN. Now it is available in the beautiful new BLACK EBONY pattern... with bold black and grey "Watermelon" stripes and with gleaming black quilted Seal-tuft plastic trim. SARAN—the plastic, woven like cloth, that has the color permanently "locked" right into each thread! Car owners everywhere are demanding "Black Ebony". Now you can serve that eager demand at a fraction of the cost the customers expect to pay! Salesmen are making money hand over fist with this sensational new Key line. Take orders from car owners everywhere. Beat all competition with covers cut to accurate patterns like the finest suit of clothes... Slick, smooth, wrinkle-free fit just like an original upholstery job!

**RUSH NAME FOR FREE OUTFIT GIVE MAKE, YEAR AND MODEL OF YOUR CAR**

Anyone working full or spare time can realize big money in this business. No need to search for prospects. Every car owner is one. Be first to cash in. Make year around STEADY PROFITS. Get your FREE Selling Kit at once for some real money. ACTUAL SEAT COVERS GIVEN FREE TO PRODUCERS FOR OWN USE! Write for full details.

**KEY PRODUCTS CORP.**  
Dept. 4-W  
800 N. CLARK, CHICAGO 10, ILL.



OFFICIAL MILITARY 35mm SLIDES



RUSSIAN T-34 TANK

Identified. Slides come in sets of 50, available in choice of any of 3 classifications: 1. NAVAL SHIPS - 2. MERCHANT SHIPS - 3. ARMORED VEHICLES. When ordering, specify which classification is wanted. Set of 50 slides, any classification—plus FREE Viewer—postpaid in U.S.A. . . . .

**SENSATIONAL BARGAIN!**

• 50 brand new 35mm B. & W. authentic U. S. Army Air Force recognition slides of military equipment of many nations — for only \$3. And with each set you get a new big value slide Viewer absolutely FREE of any added cost! Gov't. surplus slides, each heavy 4-ply mounted, numbered, and fully

WITH NEW  
**FREE VIEWER**  
AT NO EXTRA  
CHARGE!

**\$3.00**

**MAKE YOUR OWN ELECTRIC WELDERS**

With P1 Generator — 28 Volt 200 Amp. output. Gov't. surplus; excellent condition. Shipping Wt. approx. 65 lbs. Order No. 2D1. . . . .

**\$18.95**

F. O. B. LIMA, O.

**6 VOLT AC or DC MOTOR**

Ideal for auto heaters, fans, defrosters, models, etc. Used by Gov't. in aircraft. Shaft size: 1/4" x 3/8". Order No. 3D1 Postpaid, U. S. A. . . . .



**\$2.00**



← **HEATER UNIT** — Gasoline or oil forced air heater used to pre-heat army tank engines. Easily adapted to other uses. Operates from 24 VDC source. Has electric igniter, thermostat control, forced air blower, autopulse electric fuel pump. Approx. 35,000 BTU. Size 26" H x 12" W x 10" D. Removed from unused Gov't. vehicles. Shipping Wt. approx. 65 lbs. Order No. 4D1. . . . .

**\$29.95**

Prices F.O.B. Lima, O. • 25% Deposit With Order — Balance C.O.D.

**FAIR SALES 132 SOUTH MAIN ST. LIMA, OHIO**

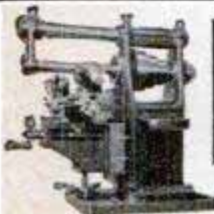

**BUILD YOUR OWN MACHINE TOOLS CASTINGS - DRAWINGS**



Catalog with complete construction drawings of this No. 2 Bench Miller or six inch crank shaper 25 cents per set post-paid or send one dollar for drawings of shaper, three millers and three lathes. Refund on castings order. **POOTACK CORPORATION, 100 Sammis Pl., Stratford, Conn.**

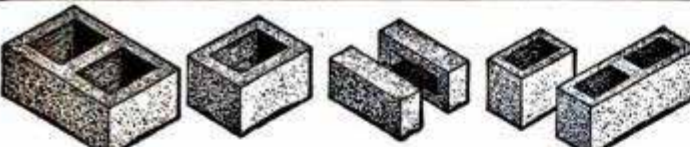

**Make Concrete Blocks and Bricks**

New superior method makes square, true, easy-to-lay units which will pass any building code. Small investment, high production, big profits. One \$30.00 machine will make four 5"x8"x12" blocks per minute—1000 per day. Pays for itself in a few days. Sell blocks or save 2/3 building cost by making and laying your own.

POST CARD BRINGS FREE FOLDER

**Economy Manufacturing Company Dept. P Stone Mountain, Georgia**

Cut glass easily ask your dealer for **Red Devil** glass cutters

Send for the **NEW 96 page Red Devil** catalog No. 21

Address Dept. P.M.

**RED DEVIL TOOLS, IRVINGTON 11, N. J., U. S. A.**

# CARTER



## FUEL PUMPS

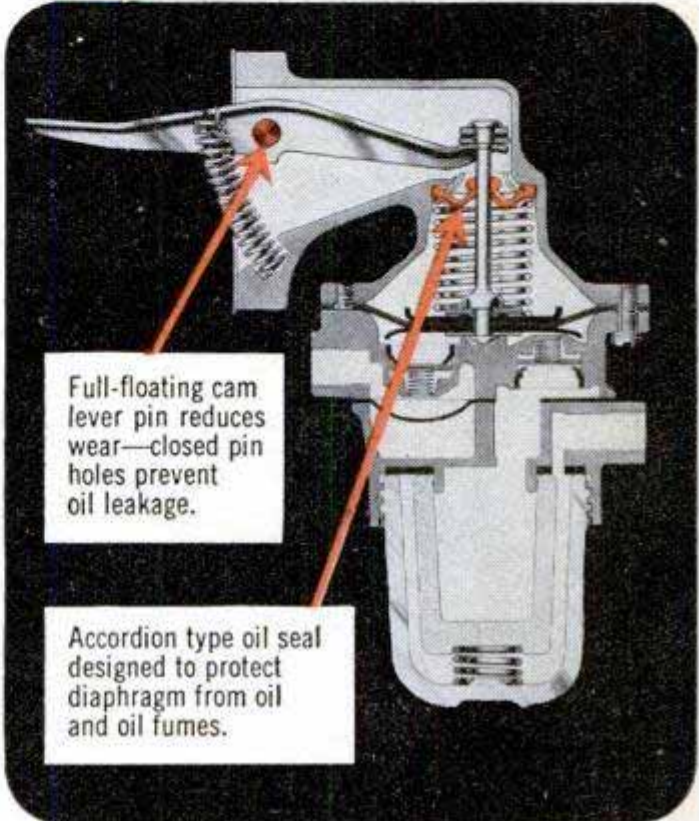

Full-floating cam lever pin reduces wear—closed pin holes prevent oil leakage.

Accordion type oil seal designed to protect diaphragm from oil and oil fumes.

### Advanced DESIGN FEATURES PREVENT OIL LEAKAGE at Vital Points

See your car dealer, garage or service station for a

**LIBERAL TRADE-IN ALLOWANCE ON YOUR OLD FUEL PUMP**

Oil and oil fumes are a major factor in deterioration of ordinary fuel pumps. Carter, recognizing this, has built in seals at vital points to prevent oil leakage and prolong the pump life.

**CARTER CARBURETOR CORPORATION**  
St. Louis 7, Missouri  
Division of American Car and Foundry Company



**GET THIS  
"How to do it"  
BOOK FREE!**



**PARTIAL LIST  
OF CONTENTS**

- "Better Painting"
- "Refinishing Antiques"
- "A Superb Furniture Polish"
- "Protecting Tools"
- "Waterproofing"
- "Finishing Gun Stocks"



Here are 101 useful ways to use America's finest 100% pure linseed oil. Perfect for painting and the handiest item for every housewife, homeowner and farmer. Available at all stores.

**EARN \$2.00 EASY**

We will pay \$2.00 for each new practical idea for using Pol-mer-ik Linseed Oil, which is acceptable to our research laboratory. Write Archer Daniels Midland, 603 Roanoke Bldg., Minneapolis, Minnesota.



★  
Guaranteed by  
Good Housekeeping  
IF NOT AS ADVERTISED THEREIN

**ARCHER  
Pol-mer-ik  
100% PURE LINSEED OIL**

**BETTER TOOL VALUES!**

SEND FOR NEW FREE CATALOG

**INDESTRO  
TOOLS**



Ready Soon—Brand New Mechanic's Catalog of Low-Cost, Long-Service Indestro Tools. Full of photographs and detailed descriptions of regular or special tools your dealer can supply for home workshop or professional use.

Tells how to select good tools and why you get Better Value when you select Indestro Tools—for instance, all sockets "Hot Broached" to make them wear longer.

Offers you big values in Tool Sets, from 5-pc Punch and Chisel Sets to 114-pc DeLux Workshop Sets. Reserve your copy of this Dollar-Saving Pocket-Size Tool Catalog.



**FILL OUT AND MAIL NOW FOR FREE COPY**

Send to INDESTRO MANUFACTURING CORP.  
2649 N. Kildare at Schubert, Chicago 39, Ill.

*Write your name and  
address in margin space*

offered for years—so long, in fact, that I think Hudson and its dealers have lost sight of their exclusive and wonderful idea;

4. Tremendous acceleration, enabling the driver to get out of a tight spot, as ability to speed or maneuver away from possible disaster sometimes is as important as being able to stop;

5. Ease of steering in that the ratio is as good or better than expected with modern cars using fat, low-pressure tires. Although there is a slight steering-wheel vibration at certain spots when driving at extreme high speeds, it is not noticeable at ordinary speeds;

6. Because in my own test of the car an unscheduled event occurred. I blew a left-rear tire doing 90 miles an hour and I've never handled a car in similar circumstances which came to a stop after a blow-out with less careening or sideways than this Hudson test car. Actually, it was no worse than hitting a hard bump and at no time in stopping did I feel in danger or that the car was not under complete control. The low center of weight, I'm sure, helped maintain that control.

For these six reasons I would rate Hudson tops in safety!

Hudson owners pulled a surprise when 78 percent stated a preference for in-line engines rather than the V-8, and 65 percent preferred six cylinders rather than eight. Hudson builds its own engines and the Hornet I tested has a big (308-cubic-inch) well-engineered, six-cylinder engine of 145 horsepower, and a high compression ratio of 7.2 to 1. (For speed-minded drivers, Hudson even offers a two-carburetor setup as optional equipment on the Hornet.) Hudson owners also are offered optional compression-ratio cylinder heads such as 8 to 1 on the Super Six. A Pacemaker head installed on a Hornet will give a ratio of

(Continued to page 270)

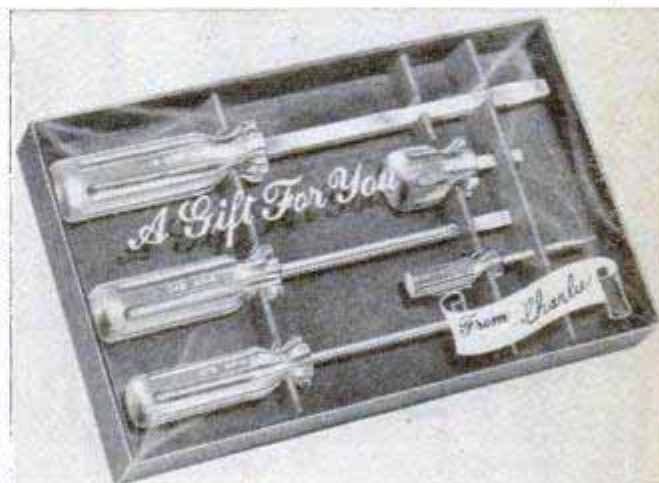

**ALL-PURPOSE** screwdriver gift set is packaged in a transparent plastic box with inscription on cover



## BUILD YOUR OWN ARC WELDER OR LIGHT PLANT

DELCO P-1 D-C GENERATOR

Save \$250 to \$500

\$22.50



Instructions included. Rated 200 Amps 28 Volts 2500 R.P.M. Ship. wt. approx. 50 lbs. Stock No. 707

PRICE F.O.B. K. C., MO.

CONVERTS TO ARC WELDER 200-250 AMP. OR LIGHT PLANT CAP. LOAD 5000 WATTS

Stock No. 711 D. C. Generator R-1 Jack & Heitz, rated 300 Amp. 30 Volts. Gov't cost \$300.00. Instruction for converting to welder or light plant incl. Also instructions and diagram for converting the R-1 or P-1 generator to Combination Welder and Light Plant included. Only **\$32.50**

## CARBON PILE GENERATOR VOLTAGE REGULATOR

For use with 24 or 32 Volt D. C. Generators. Also recommended for the P-1 and R-1 type generators in "build your own" Light **\$12.50** plant. Only postpaid



## R-21 HEAVY DUTY RHEOSTAT

Brand New for regulating voltage on ELECTRIC WELDERS, model trains, electric blankets, lights, control photoflood lamps, etc. Rated 16-32-ohms. Size 3 1/2" x 2 1/2" postpaid **\$7.50**

## WEAVERS HYDRAULIC HAND PUMP

BRAND NEW INCL. BUILT IN CHECK & RELIEF VALVE. For hydraulic Jacks, presses, hoist, etc. For operating hydraulic cylinders to pump oil or hydraulic fluid under pressure, and is capable of delivering 1000 lbs. pressure. Wt. 10 1/2 lbs. A \$50.00 post-value. Instr. incl. Price **\$14.50** paid

**Valuable Gears — Bargains — Speed Reducers** 10-1 or 5-1 ratio, 90 degree angle. Shaft driven 1/2" spline Shaft with 3 mounting holes 5/16". Gears held in forged and machined aluminum housing with two needle bearings, one bronze bearing, and three high speed shielded bearings. Rated 2 H.P. at 1750 R.P.M. **\$5.95**

## New Amplidyne MOTOR GENERATOR

#5AN31N18A—Use as 24/32 Volt D.C. motor, puts 1 1/2 H.P. or 0/60 V. D.C. Can be adapted to 110 V. A.C./D.C. 10,000 R.P.M. 1/2 H.P. by simple changes in connections. This unit can be adapted to independent and rural lighting, power, etc. Instructions incl. (Stock #790). Gov't cost \$140.00. Wt. 30 lbs. Only **\$8.95**

## SENSATIONAL SELSYNS

Two or more connected together, work perfectly on 110 V. A.C. For weather vanes, rotating directional antennas or controlling distance operations. Complete with diagram and instructions. Wt. 3 1/2 lbs. PER PAIR **\$7.95** Postage paid

## Hydraulic Solenoid Control Valve

BENDIX. No. 81560 24V. D.C. For remote control operation and to operate one single action or double action hydraulic cylinders with 24 V. D.C. Recommended pressure 800 to 1500 P.S.I. connections are .550"—18thd. Diagrams & Data incl. \$35.00 value. **\$3.50** ea. **\$6.50** per pair

## D C GENERATOR Brand New

Delivers 430 Volt at 3450 R.P.M. Ball bearing supported, air cooled armature, base mounted. Wt. 23 lbs. Navy Type #211220-A **\$8.95**

## CUNO OIL FILTER — Brand New

Aircraft type. Filters oil without cartridge replacements. Just turn handle and cartridge is clean. Standard 3/8" inlet and outlet ports to accommodate 12 gallons per minute. STOP CHANGING OIL. Instructions **\$4.95** (Plus 35¢ incl. postage)

ELECTRIC MOTOR 1/2 H.P. 24 Volt D.C. R.P.M. 2500. Amp. 22 #HCA24. Gov't cost \$75.00. Brand New. **\$5.50**

ELECTRIC MOTOR 1/4 H.P. 28 Volt D.C. R.P.M. 4000 #2832 with simple instructions to convert to 28-32 Volt A.C. Gov't cost \$82.84. Brand New. **\$4.95**

ELECTRIC MOTOR 6 Volt D.C. Deico — New Handles 6" fan blade. Use as windshield wiper motor, hot water car heater motor, commercial or toy applications. 1/4" Dia. 1 1/8" long shaft. Size 3" long x 3". 2 mounting studs. 1200-2000 R.P.M. **\$2.95** post-paid New. Only

SOLA CONSTANT VOLTAGE REGULATOR PRI. 190 to 250 Volts. Rated V.A. 5300. Secondary output 230-115 A.C. Amps. 11.3-23.3. Gov't cost over \$700.00. **\$295.00** KC.Mo. Close out price.

## AIR FILTERS

Aircraft type. Removes dirt, dust, etc. For industry, home & laboratories. For forced warm air, conditioning units, etc. Made of heavy metallic mesh with metal frame. Permanent, needs no refills. Size 4 1/2" x 6 5/8" x 2". Special price for quantity users. Wt. approx. **\$3.50** ea. 8 lbs. \$25.00 value.

## BEAM ROTATOR MOTOR

Brand new with complete operating instructions for 110 V. A.C. 60 cycles or 24 V. A.C. or 12 V. D.C. Powerful highly geared motor for TV aerials, ham stations, FM antennas, etc. Reversible, light weight, rugged. Approx. 7 RPM free swing. Stock #6918. **\$7.95** post-value.

## Thompson Motor Driven PUMP

Including Built in Motor. Applicable for 24 V. D.C./A.C. or 110 V. A.C. The motor is explosion proof constructed, making it ideal for pumping GASOLINE, FUEL TRANSFER, HOT WATER HEATING CIRCULATOR, USE IT AS COOLANT PUMP, FUEL BOOSTER, OIL PUMP, etc. Discharge connection is for 1" hose. Rated Capacity 300 G.P.H. Direction & Engineering data incl. A tremendous bargain! Stock No. 1200—Only **\$9.95**

## PESCO FOUR VANE ROTARY

Positive Displacement Lg. Vol. Pump Including built in relief and by pass valve. Capacity 400 G.P.H. 1/2" drive spline shaft, 3/4" pipe inlet and outlets. Rotates either direction or in any position. Ideal for gasoline, oils, water and various types of sprayers. Engineering data incl. (Stock #600) only **\$8.95** post-data

## UTILITY PUMP ROTARY VANE TYPE

For WATER, OIL, INSECTICIDES. Also applicable as Automobile Crankcase Drain Pump. Pressures 70 lbs. 12 gal. per minute at 200 R.P.M. Using 3/4 HP as vacuum pump for milking machines, compressors, lab. use, etc. Delivers 26" vacuum, 8 cu. ft. per min. at 1500 RPM using 3/4 HP., rotates either direction. 1/2" pipe thread ports, .650 splined shaft. Data & instructions incl. **\$16.50** post-Stock #27

## Adel Self-Priming ELECTRIC PUMP

For pumping light oils, oil burners, fluid metering, fuel pump, tool post grinder, coolant, pressure lubricating pump, etc. 1/30 H.P. rated 12000 R.P.M. Applicable for 24 V. D.C./A.C. or use on 110 Volt A.C. Size 6 3/4" x 3 1/2" x 3 1/4", rated 3 G.P.H. Dia. **\$9.95** Post-gram and instr. incl. \$50.00 val.

## LUBE PUMP Brand New

Precision Gear Impeller Pump pumps Liquid up to 3 gal. per minute. Pressure up to 200 lbs. per sq. in. For high vacuum, air pressure, Hydraulic units, etc. Std. 1/2" threaded & keyed shaft. Instruction Inc. \$50.00 value. **\$9.95** post-Ship. wt. 4 lbs. Price

## HYDRAULIC HOSE High Pressure Heavy Duty

Complete with swivel fittings. Stock No. 2 hose is 22 1/2" long, 5/8" I.D. 1" O.D. for 3/4" tubing fitting. **\$1.65** Stock No. 12, 16" long 1 1/4" I.D., 3/4" O.D. Connections 1/4" male & female swivel fittings. **98c** Stock No. 30 is 30" long, 3/4" I.D., 3/4" O.D. connections are 5/16" **\$1.25**

Send check or Money Order. Prices f.o.b. K. C. except when marked postpaid U.S.A. only



## Stratopower Constant Displacement HEAVY DUTY PUMP

For operating Hydraulic cylinders, tractors, bulldozers, construction machinery, lift trucks. For fuel or oil transfer. Industrial applications, etc. Delivers up to 400 G.P.H. at 3750 R.P.M. Rated 1250 to 1400 P.S.I. 3750 to 4500 R.P.M. HAS BUILT IN RELIEF AT HEAD. Rotation either direction without adjustment. \$100.00 value. Engineering data and instr. **\$19.50** incl. Stock #37. Wt. 8 lbs.

## AIR OR OIL HYDRAULIC CYLINDERS

Stock No. 512 Double action hydraulic cylinder 2 1/8" Bore, 4" Stroke, Dia. 3/4" shaft including built in Hydraulic control valve which may be operated with rod or lever. Clevis mounting. Overall length shaft retracted 14". \$75.00 value. **\$14.95** f.o.b. value. Wt. 9 lbs. KC, Mo. Stock No. 11 Double Action 1 1/2" Bore, 6" Stroke, 5/8" Dia. Shaft. Clevis mounting base and shaft end. Capacity 1180 lbs. with 1000 P.S.I. input. Has a capacity of 1625 lbs. with our STRATOPOWER 1400 P.S.I. A \$50.00 value. **\$9.95** Postpaid Only

Stock #303—Double Action 2" Bore, Stroke 11 3/4", Dia. 1 1/2" shaft. Overall length shaft retracted 23". 2000 lbs. capacity with 1000 P.S.I. gives 2800 lbs. with our **\$16.95** f.o.b. stratopower. Wt. 14 lbs. KC, Mo. Stock No. 12 Hydraulic Cylinder Double Action output 12500 lbs. with 1000 P.S.I. input. Gives 17584 lbs. with our STRATOPOWER PUMP 1400 P.S.I. or will produce 34168 lbs. with 3000 line pressure. Can also be operated on low pressure system. 4" Bore, 10 1/4" Stroke 1-5/16" Shaft, clevis mounting. O. Gov't cost **\$27.50** f.o.b. \$300.00 KC, Mo.

## Pesco Hydraulic Flow Equalizer & Pressure Balancer Valve

Brand New. Guarantees equal flow and equal pressure for two cylinders or two systems. Capacity 300 G.P.H. 1500 P.S.I. Data & instructions incl. A \$75.00 value. **\$14.50** Stock 1-D-397 only postpaid

## HYDRAULIC CONTROL VALVE

Adel Precision #B-10329. For controlling 2 single action or 1 double action cylinder. Including built in toggle lever. When lever is in one direction it puts pressure on one cylinder connection and opens exhaust, from opposite cylinder. When lever is released it returns to the neutral position and locks cylinder. Brand new. A tremendous bargain. **\$9.95** post-Brand new.

## VICKERS Hyd. Control valve #137

For two double action cylinders allowing operator to raise or lower the both cylinders simultaneously or raise one and lower the other at predetermined rate **\$14.95** post-and speed.

## FOUR WAY HYDRAULIC CONTROL VALVE

Poppet type Valve shuts off on neutral position. Has 3/8" A.C. Tube ports - 9/16-20 thread capacity 1500 P.S.I. Brand new Stock #1032... **\$5.95** post-paid

## FOUR WAY VALVE. Large Volume

hydraulic control and pressure relief valve. 3/4" ports, spring loaded. Range 1250 P.S.I. adjustable up to 3000 P.S.I. Brand New **\$5.50** Postpaid

## Parkers 3 Way Rotary Valve

Brand New. With off position and is manual operated. All connections are 3/4" Female I.P. This valve is ideal for 3 branch line and for fuel, water, air, or liquids. **\$5.95** post-Stock No. 23... **\$5.95** paid

## ALTERNATING SHUT-OFF VALVE

Brand New. High pressure. Operates by worm-gear cam operating poppets to alternately close & open either pair of four ports. Standard 3/8" pipe ports. \$50.00 value **\$8.95** post-only.

## Vickers Pressure Relief Valve

Brand new adjustable for protecting hydraulic systems using positive displacement pumps. 1/2" AC tube size. Tapped 3/4". 18 thread. Stock No. 501. Postpaid **\$5.95**

## VICKERS UNLOADING VALVE Brand New

By passes full amount output of the pump while the cylinder is not in operation. Takes starting load off of electric motor driving the pump. 1/2" AC TUBE PORTS **\$9.95** Post-(34"-18) thread. Price





# UNUSUAL!

THIS AD BACKGROUND IS MADE FROM AN UNRETOUCHED PHOTO OF SYNCRO SANDED WORK MAGNIFIED 14 TIMES . . . SHOWS HOW SYNCRO SANDER'S EXCLUSIVE DOUBLE ARC MOTION DOES A PERFECT SANDING FINISHING JOB. IT COMBINES THE BEST PARTS OF ORBITAL AND STRAIGHT-LINE MOTIONS!

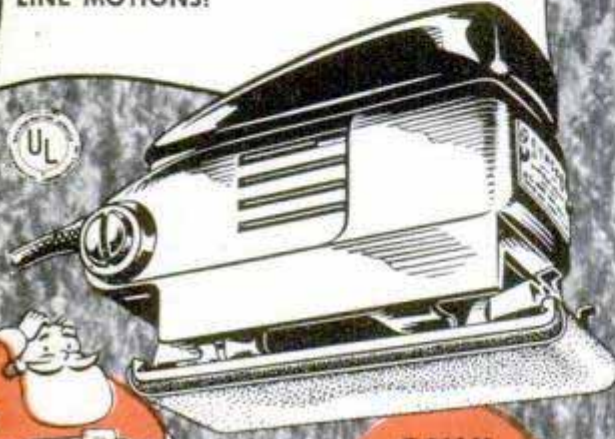

NOW SEE How Ribbed and Coarse Work Looks After Straight-Line Motion . . . 14 Times Magnified. From Unretouched Photograph.



ONLY  
**\$19.95**  
MOTOR  
INCLUDED

SYNCRO POWER UNITS  
**GUARANTEED**  
AGAINST BURN-OUT DURING  
YOUR OWNERSHIP OR  
REPLACED FREE!

## Double Arc Motion Doubles the Sanding Action

The amazing new SYNCRO NO. 504 now has DOUBLE its previous sanding action—gives a scar-free, BETTER, smoother finish—twice as fast! Finer finish guaranteed or money back! Simply wonderful for finishing fine furniture . . . ideal for overhead sanding . . . perfect for window sills . . . any hard-to-sand place. Get yours now. COMPLETE with New BUILT-IN Reactance Type Electric Motor, \$19.95 at dealers or direct. Operates 60 cycle, 110-120 volt, AC. (Dealers, Jobbers write!)

**SYNCRO** ELECTRIC  
QUALITY TOOLS SANDER

*World's largest manufacturer of reciprocating electric sanders with double arc motion which gives double the sanding action.*

SYNCRO CORP., DEPT. D-121, OXFORD, MICHIGAN, U. S. A.

ORDER. I enclose \$19.95. Send No. 504 Sander postpaid on 10 Day Money Back Trial.

FREE CIRCULAR. Send new SYNCRO CIRCULAR showing new, safe JIG SAW and amazing new SANDER!

WRITE NAME, ADDRESS BELOW and MAIL!



engine compression as powerful as 9 to 1. The engine is smooth in operation and few six-cylinder cars I've driven have had less engine vibration. The cylinder block, as in other models, is high-chrome alloy and the hardest used in any make, which machines to a hard supersmooth finish; thus cylinder wear is reduced to a minimum. Hudson claims its blocks outwear softer blocks used by other makers.

Hudson pistons are full-skirt design aluminum alloy and piston rings are pinned, a practice I don't like. Hudson's fan is unique in that variably spaced blades are used and it is claimed that this practice reduces noise and affords greater air circulating ability at low speeds. In my tests—and some were very severe in back-road desert and mountain country—I could not overheat the Hornet, even in the heat of the Mojave Desert in California.

The test car had Hydra-Matic drive, which operated satisfactorily—no better and no worse than General Motors' cars so equipped, insofar as the transmission is concerned. The shift-lever indicator was lighted, a good idea. Hudson also offers its Super-Matic transmission, which I don't care for. A three-speed transmission also is available, as is overdrive. Top gear ratio with Hydra-Matic is 3.58 to 1; 4.10 to 1 with conventional transmission; 3.18 to 1 with overdrive, and 4.55 to 1 as standard in the overdrive unit.

Hudson's clutch (called Fluid-Cushion) as used on conventional-transmission models is unique in that it operates in a cushion of oil. Hudson owners generally like it, as it is a "toughie" and will take a lot of abuse. Worst feature is that in cold weather there is some "grab" or "chatter" when the car is first engaged in low or reverse, but when the clutch oil is warmed up the chatter is hardly noticeable.

The seating position is comfortable and the "step down" feature reminds me somewhat of entering an airplane cockpit rather than a motor car. At first the "step down" idea is a little confusing, but after a few hours I found it really easy to enter and get out of the car. The cushions are comfortable and seats are very wide. The recessed door panels are unusual in that window and door control levers are out of the way of knees and elbows, thus allowing more elbow room and front seat space. Upholstering is unique and durable.

Cigarette smokers should find it easy to test many brands at one ride in a Hudson, with a separate ash tray for each of five brands. My test Hornet had five—yes, five—ash trays, one on each door and one on the cowl, and the door trays were nicely

(Continued to page 272)



# Let your family know you want MILLERS FALLS TOOLS FOR CHRISTMAS

Now is the time to drop a hint that you'd like fine tools this Christmas. Your family will welcome your suggestions — and you'll be the winner Christmas morning. Remember, too, Millers Falls tools make perfect gifts for your craftsmen friends and the boys on your list. Their quality is the highest . . . their performance the best. See them at your hardware dealer's — ready for Christmas giving.

MILLERS FALLS COMPANY, Greenfield, Mass.

**No. 77 Hand Drill**  
\$3.30\*

**No. 106 Carving Tool Set**  
\$4.60\*

**No. 590 Torpedo Level**  
\$1.80\*

**No. 188A Automatic Drill**  
\$3.80\*

**No. 29 Automatic Screw Driver with Attachments**  
\$3.80\*

**No. 725 Nest of Saws**  
\$2.95\*

**No. 1950 Bit Brace**  
\$4.80\*

**No. 2120 Buffing and Sanding Attachment**  
\$8.45\*

**No. 814 Jack Plane**  
\$4.60\*

\*Prices slightly higher in the West and Canada



*The Mark of Superiority*

SW-54 \$49<sup>95</sup>



Amazing broadcast and shortwave radio by the makers of professional radio equipment for the

# KON-TIKI

expedition of book and movie fame

**COVERS THE RADIO WORLD!**

Covers all frequencies (broadcast, police, ships, aircraft, amateur) between 540 kcs. and 30 mcs. Uses new miniature tubes for maximum sensitivity. Precision-built. Measures only 11" x 7" x 7"!

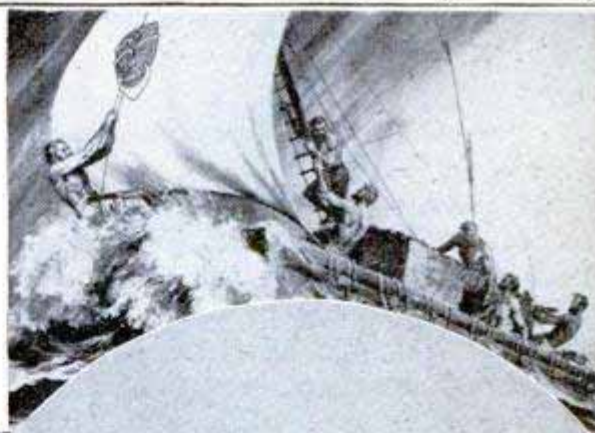

Yes, a radio receiver and transmitter built by National, world's most respected maker of professional radio equipment, kept the famed Kon-Tiki Expedition in touch with civilization despite storms, salt spray and even total immersion! Now, at modest cost, you can enjoy a broadcast and shortwave radio with the same rugged, built-in dependability!

Write for name of nearest supplier.



# SWITCH TO

## MILD

# KENTUCKY CLUB

The Thoroughbred  
of  
Pipe Tobaccos



### Get Fine Pipes at Worth-while Savings

— You bet it pays to switch to Kentucky Club. It's the thoroughbred of pipe tobaccos—choice white Burley specially blended to give you a mild, smooth smoke with grand taste and aroma. In addition, every package of Kentucky Club contains a valuable Dividend Coupon. Save these Coupons and get your choice of fine pipes at *big savings*. Beautiful pipes of imported briar made by expert craftsmen. 14 shapes. Do these two things today. Buy your first tin of Kentucky Club.

Mail coupon for free catalog.



### FREE

Illustrated catalog showing Kentucky Club Dividend pipes and other premiums.

Mail Pouch Tobacco Co., Dept. 47  
Wheeling, West Virginia

Please send—free—Kentucky Club Catalog.

Name.....  
Street.....  
City..... State.....

placed in the recessed panel, out of the way.

The side windows are quite narrow due to the lowness of the car, and the side of the body up to the windows is quite high. I noticed this most when the window was down; it was too high to drive with my arm on the lower window sill, as I sometimes like to do. However, again on the safety side, the short distance from the bottom window frames to the roof of the car is quite narrow, thus offering good protection in a crash or turnover.

The body seemed tight and no squeaks developed. No water came in during about four hours of quite heavy rain. There is some hood "flutter" or vibration above 65 miles per hour on rough roads. One rattle troubled me for 300 miles or so, then disappeared. Doors open easily by push button, and close with little effort. There is ample head room. The hood locks from inside the car—I like that idea. I would like to see a little more glass in the rear window. Here is an excellent example of Hudson streamlining, which I think is fine: In a rain storm at 60 miles per hour, not a drop of rain hit the rear window, the air flow carrying it over and beyond the window. When I slowed to 40 miles per hour, the window was soon covered with water. Hudson's aerodynamic qualities certainly are advantageous when it comes to pushing a car through the air at high speed.

The heat and ventilation system works well, and by extremely simple one-lever operation. Hudson sticks to the cowl ventilator, which I like.

The car parked more easily and handled better in traffic than I expected. Being wider (77<sup>21</sup>/<sub>32</sub> inches) than it is high (60<sup>3</sup>/<sub>8</sub> inches), the car creates an illusion of extreme width—but Hudson has less outside width than some other makes by as much as three inches.

During my test I drove the car wide open many miles in long stretches on the Western plains with practically no traffic, and also on the Rosamond Dry Lake in Southern California. By stop watch it is a good, honest 100-mile-per-hour car, and that's a fast buggy in my book. The speedometer would hit 108-110 miles per hour, but speedometer variation is apparent in all makes of cars. In a test check by highway markings in Utah, the speedometer was .3 of a mile slow in five miles—rather unusual for a mileage reading.

I found that regular gas worked okay, even in the 7.2-to-1 compression ratio of the Hornet. Hudson engineers say regular gas is satisfactory and 54 percent of Hudson owners use it, according to the survey.

If there is one thing our survey showed

(Continued to page 274)



**FLEXIBLE SHAFT MAGNET**

Strong ALNICO V Magnet on 18" flexible, Cadmium Plated shaft.

For picking up cotter pins, nuts, wrenches, etc., from inaccessible places. Removes Bobbie Pins, etc., from drains. Lifetime Magnetism Guarantee. Highly polished magnet and handle. **\$2.00** postpaid

**LOW VOLTAGE CIRCUIT TESTER**

Made for U. S. Ordnance Dept. to rigid specifications. Portable steel hand carrying unit is a self-contained trouble shooting device for making a complete and rapid check of the generator battery circuit, including any circuit and voltage regulators. Battery voltage, regulators, cut-out settings and generator performance can be easily determined. A terrific testing unit for garages, mechanics, truck fleet owners, boat and marine mechanics. Can be used on any 6 or 12 volt system. Govt. cost approx. \$175. NEW—complete with instruction book—only **\$32.50**. Shipping weight, 20 lbs.



**POCKET-PACK PRECISION WRENCHES**

Made of first quality chrome-molybdenum steel, heat treated and hardened for extra strength. Each wrench accurately broached to close tolerances. Open end wrench on one end and twelve point box on the other means double usefulness and double value. NEW, complete with plastic case—**\$1.75** ea. complete—postpaid in U.S.A.



**SOCKET-PACK WRENCH SET**

Chrome-plated alloy steel, heat treated, broached to close tolerances. Reversible ratchet handle, with screwdriver bit on reverse side. Built-in spring-loaded ball retainer on both handle and extension. Clear top plastic kit. 10 piece set—NEW—complete **\$3.75**. POSTPAID in U.S.A.



**U.S. NAVY HEAT MASK ASSEMBLY**

Unit comprises safety helmet, fiber welder's face shield. Hood includes bib and snood of high resistant asbestos, treated with flame-proof resin. Great for fire fighting (volunteer fire companies) and welding. Govt. cost \$75—NEW—Price **\$5.95**.



**HIGH SPEED DRILLS**

All new. Fractional & numbered. Orig. value \$18. Nationally known brand. Assorted sizes. Set of 30, **\$3.50**

**HIGH SPEED STRAIGHT SHANK DRILLS**

10 different size H.S. Straight Shank Jobber Length Drills, 1/4" to 1/2". (shank same diameter as drill). \$25 value. NEW—**\$3.50**.



**EXTENSION DRILLS**

High speed steel. Like new. Assorted sizes from No. 1/2 to 40. Lengths from 6" to 12" Approx. \$25 value. Set of 12—**\$3.75**.

**PORTABLE WELDER**

Will weld, braze, solder and cut all metals up to 3/16". No experience needed, full instructions included. Weld iron, steel, brass, aluminum and other metals. Plug into any 110 Volt A.C. or D.C. line. Save hundreds of hours and money doing repair work for yourself and others. A great item for any mechanic or hobbyist, etc. Not a toy. Comes complete with electrode and carbon holders and an ample supply of electrodes, carbons, flux and necessary components to do a thorough welding job of any type. This unit cannot be duplicated for many times its price. NEW—price **\$12.00**.



**MICROMETERS**

Chrome plated, precision engineered, carefully tooled to give long life. All new. 0-1" capacity—**\$2.25** ea. 1-2" capacity—**\$3.50**.



**BRAND NEW PUMP AND MOTOR**

Pump has 1" connections, built-in relief valve, adjustable up to 1500 lbs. Max capacity 6 GPM. 1 1/2 H.P., 24-volt motor. 4000 RPM. Can be used on 12 or 36 volts. Govt. cost approx. \$350—our price—NEW—**\$12.75**.

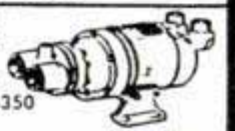

**ADEL SELF-PRIMING ELECTRIC PUMP**

For pumping light oils, oil burners, fluid metering, fuel pump, aquariums, tool post grinder, coolant, pressure lubricating pump, etc. Double ball bearing series wound motor, continuous duty. 1/30 H.P., rated 12,000 R.P.M. Applicable for 24 V. D.C./A.C. or use on 110 Volt A.C. Size 6 3/4" x 3 1/2" x 3 1/4", rated 2 1/2 G.P.H. Remove pump and use motor as high speed grinder, etc. Diagram and instructions incl. Govt. cost approx. \$75. Only **\$8.95**.



**"BALTIC" SWEDISH TOOLMAKERS VERNIER CALIPER**

ULTRA PRECISION—0-6" in .001 graduations. Quick, accurate depth, inside, outside measurements, fine engraving. Extra heavy rule, hand-fitted sliding head, no side play. Rockwell C.60, lapped measuring surfaces. For the extra particular mechanic who must have the best—used and recommended by most critical experimental and research machinists at Lockheed, Douglas, Bendix, GM, RCA, General Electric. Save 50%! A \$37.50 value—only **\$17.25**, leather case incl. Also a standard grade Mauer Design Caliper made in Germany. For the production machinist, 0-6" in thousandths, the most accurate caliper of this type on the market, 1000's of satisfied users. Only **\$12.95**, leather case incl. These Calipers are of acceptable quality for precision aircraft work. Both are guaranteed buys, money back if not entirely satisfied. Order now!

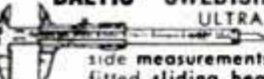

**WET BATTERY PLATE**

Extra long life, rechargeable, ideal for portable radios, mobile units, etc. 2 V. 20 Amps. Only 5" high ball float hydrometer, built-in Lucite case. Shipped dry. Used singly or in multiples. Shipping wt. 3 1/2 lbs. Govt. cost approx. \$8—NEW—**\$1.95**.



**HAND MITRE**

It pays its way in just 1 day! It's sensational! New HAND MITRE saves 100's of hours, requires only a "flick" of the hand for a precision mitre every time. HAND MITRE will cut any desired angle. Its rugged construction handles hard and soft wood mouldings, plastic trim, base shoe, laminated materials, rubber extrusions, etc. Made of heavy gauge stainless steel. **\$3.95** postpaid.



**MICROSCOPE**

**100 and 150 Power**  
A fine precision instrument—not a toy. Highly ground and polished lenses. Overall ht. 8 1/2". Designed for easy portability, yet stable enough for laboratory use. Microscope, leather case for barrel, four slides and carrying case. **\$9.95** postpd. in U.S.A.



**K-VISE SAFETY LOCK WRENCH**

Ideal for mechanics, factory, home, garage, electricians, pipe-fitters, etc. Has 1 ton tested non-slip grip, cad-plated. No more skinned knuckles! A flip of the finger releases a 1 ton pressure. Ten inch size. Price **\$2.50**.



**MAGNETIC BASE INDICATOR HOLDER**

For all types of dial indicators with guaranteed lifetime ALNICO magnets. V-slotted base has a 45 to 50 lbs. pull, permits immediate application without clamps or special attachments and mountings can be made on cylindrical surfaces. For machinists, tool-makers and inspectors. Base 3 1/2" long by 1 1/2" wide. NEW. **\$3.50** ea.



**"WRAPLOCK" KITS**

Make your own clamps to fit any size hose tubing, etc. Kit contains ratchet to take up slack, enough steel band and yokes for 100's of jobs. New. Wt. 4 lbs. **\$1** ea. complete.



**CANNED HEAT**

Each can generates enough heat to cook from 3 to 6 meals. Great for sportsmen, emergency heating of all types and a "must" on picnics. Packed 12 cans (6 ea. of 2 oz. and 6 ea. of 4 oz.). NEW—case of 12—**\$1.50**.



**RIVET SETS**

Universal type, case hardened tips. Set of dies will head up any brazier or round head rivet from 1/16" to 1/4". With adapters for air gun or hand use. All new—cost Govt. approx. \$27.00. Complete 15 piece set (wt. 2 lbs.) **\$5.00**.



**DRILL GRINDER**

Sharpens round, square or tapered drills up to 6" long. Even an amateur mechanic can get a new, factory finish on a drill in 25 seconds. New protractor feature gives every drill sharpening angle, with 5 convenient angles already marked off. Usable with hand or power stone. A brand new development. All New. **\$2.80** ea. Postpaid in U.S.A.



**B-7 PULL OUT LIGHT**

For aircraft, boats, cars, workshops. Gives white or red light. Snap-out light unit pulls out six feet from self-rewinding reel. For 6, 12 or 24 volts. Small case (3"x3 1/4"x4 1/4"), mounts anywhere. Only **\$2.50**.



**SAVE UP TO 90% ON WAR SURPLUS**

**NEW, BIG 1952 CATALOG** Bargains for everyone. Send 25c for your copy today.

**AIRBORNE SALES CO., INC.** Dept. PM1251 CULVER CITY, CALIF.

Send check, money order or cash. 25% deposit required on C.O.D. orders. All prices F.O.B. Culver City, Calif., unless otherwise stated.



it is that Hudson owners, by and large, are real dyed-in-the-wool boosters. Many don't want any other make of car and never even shop around. They just buy Hudsons again and again. In fact, 63 percent of those who replied were previous Hudson owners, and 13 percent have owned five or more.

So, as in the early Super Six days, Hudson history again may repeat itself, for the Hornet is again catching the fancy of red-blooded motorists who like top performance. After 14 years, Hudson still holds the three most important official A. A. A. stock-car records made in 1937 on the Salt Flats at Bonneville, Utah: 104.724-mile-per-hour average for 500 miles; 103.08 miles per hour for 1000 miles, and for 2000 miles, 101.93 miles per hour. These amazing records never have been beaten.

## Canada's Battle With Snow Begins

(Continued from page 102)

further extensive snowfall, the damage was done and emergency orders went out to snow crews from Jasper to Vancouver.

Ben Miller, master mechanic of the C.N. R. Kamloops division, was among those who faced the grim business of crashing the slides. "We knew it was coming," Ben relates. "Just at the year-end we had a taste when fierce storms whistled into the Fraser area and tied up traffic at Boston Bar. I didn't have my shoes off for 13 days when it did break and some of the boys went far longer than that before they grabbed the chance for a few hours rest."

While crews were struggling to clear rails leading to marooned trains and other slide-locked equipment, a blizzard of freezing Pacific snow closed in behind the work trains. At the same time, temperatures slumped to 25 below zero. The railmen hooked up a train of three locomotives flanked by a rotary at each end, one headed west and the other east. The maneuver enabled plows and locomotives to move back through the fresh snow for water necessary to operate boilers of the steam equipment. "All three locomotives were dangerously low on water when we stalled within hailing distance of a water tower at Chapman," Miller recalls. "We got going again after 40 men with shovels had worked like fools for more than two hours. Finally released, we backed up two of the locomotives and the westbound rotary and took a 'do or die' run at the remaining snow face. I can still feel the vibration of the wheel blades. We got through. If we hadn't the whole Pacific system would have been bottled up, possibly for days." The work train then blasted through to Stout where stranded passengers were taken aboard and

moved to Boston Bar. The snow had piled up to the point where five hours were required to push back over the 18 miles. The 75 passengers, in good humor despite their isolation, boarded a special train heading for Edmonton. It was almost a week later when rotaries and crews working from the east hooked up with those from the Vancouver end.

The enormity of even the final operation is outlined in reports in railway records. As the East-West forces neared contact, there still remained a five mile stretch of track:

"Mileage 19.8—200 feet long slide, 25 feet high; Mileage 20.3—300 feet long and 35 feet high; Mileage 20.4—300 feet long and 20 feet high; Mileage 20.5—300 feet long and 10 feet high; for the next half mile there were seven slides, none more than 200 feet long and averaging under 20 feet high; seven cars of No. 2's train at Mileage 21.3 were mostly under 30 feet of snow; from this equipment to the tunnel at Mileage 21.7 the track was solidly under slides of varying depth; in the tunnel there was a drift 100 feet long and six feet high; Mileage 22 to 23, six to 10 feet of snow; Mileage 23, 700 feet long and 12 feet high; Mileage 23.2, 700 feet long and 15 feet high; Mileage 23.5—where equipment now working—six to 10 feet of snow." The rotaries at times were laboring in solid ice, one being derailed six times in a short distance. Bulldozers and wedge plows were brought to the front to clear slides which had carried down trees up to 15 inches in diameter. Dynamite helped blast the ice, but progress was laboriously slow.

Miller's story is one of a major operation, the saga of the railway's triumph over one of Nature's most potent forces. Determined men, dogged and worn out from labor and worry and constant hours in extreme cold, some manning machines weighing hundreds of tons, others using shovels in equally vital jobs, had succeeded in clearing the tracks.

The Fraser Canyon challenge, fortunately, isn't an annual occurrence as only a series of unusual weather conditions springs the gigantic slides. More regular are the late-winter difficulties of the Mount Robson sector and the heavy snowfalls of Blue River. Rotary engineers like Harry Finley of Jasper can tell of a slide 45 feet deep near Gosnell, an avalanche which roared down from a glacier several miles back from the tracks. And engineers along the line to Prince Rupert recall a slide near Pacific which measured 600 feet long and 40 feet deep, one which became so hard packed that 1100 kegs of black powder

(Continued to page 276)





**NEW**

# PLASTIC-DRAWERS ALL-PURPOSE METAL CABINETS

The lowest-cost, handiest storage for shop, lab, office, stockroom, store, home, dentists, etc.!



# J-8  
3-Drawer  
Wgt. 4 lbs. **3.95**



# J-16  
6-Drawer  
Wgt. 6 lbs. **7.45**

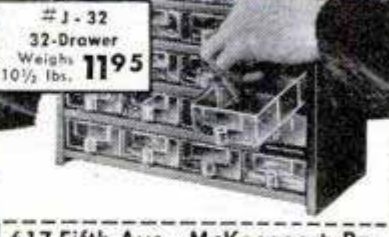

# J-32  
32-Drawer  
Weighs 10 1/2 lbs. **11.95**

At last—the 100% answer to convenient handy, lightweight, strong storage cabinets. Easy to organize—you see thru the crystal-clear plastic drawers, each on a separate guide in heavy welded all-steel cabinets. Drawers 5 3/4" deep, 2 3/4" wide, 1 1/4" high, safety catch prevents spilling. For parts, tools, screws, nuts, nails, seeds, stamps, drugs, etc.

ALSO ORDER BY MAIL:

- J-12, 12 Drawers (5 lbs.) . . . 5.45
- J-24, 24 Drawers (8 lbs.) . . . 9.95
- J-64, 64 Drawers (21 lbs.) 22.95

**M-S OUTLET** 617 Fifth Ave., McKeesport, Pa.

Send \_\_\_\_\_ Plastic Storage Cabinets, Model # \_\_\_\_\_  
@ \$ \_\_\_\_\_ each. I have figured out postage/freight charges and enclose  check,  Money Order to include same. Send COD  I enclose \$2 deposit. **Money-Back Guarantee!** Print name and address in margin

## New MOTOR BARGAINS for Home, Farm & Industry



- New General Electric 1/2 H.P. Induction Type 3450 RPM 110 V, 60 cy. 1 Ph. A. C. Motor. #GEH-5. Fob. . . . **\$23.50**
- New General Electric 1/2 H.P. Cap/Ind. Ball Brg. 1750 RPM, double 1/2" shaft. 110 V. 60 cy. . . . **\$29.75**
- 1 Ph. A. C. Motor. #GE-17. Fob. . . .
- New General Electric 3/4 H.P. Cap/Ind. Ball Brg. 1750 RPM, double 1/2" shaft. 110 V. 60 Cy. 1 Ph. A. C. Motor. #GE-75. Fob. . . . **\$34.50**
- New Dayton 1 H.P. Heavy Duty, Cap or Repulsion Induction, 3450 RPM, 110/220 V. 60 Cy., 1 Ph. A. C. Motor. #EH-1. Fob. . . . **\$52.00**
- Same as above, 2 H.P. 220-V. 3450 RPM #EH-20. . . . only. . . . Fob. . . . **\$75.00**
- Same as above 3 H.P. 220-V. 3450 RPM, #EH-30. . . . Only. . . . Fob. . . . **\$97.00**

Write for FAN CIRCULAR: listing Blades, Guards, Motors, All Sizes for building your own Attic Fan, Window Fan or Room Cooler.  
**C. MARSHALL SALES,**  
3546 W. Fullerton Ave., Dept. P-12, Chicago 47



## 16 to 1 SPEED REDUCERS

For Display Table — Barbecue Spits — Toy Auto Gear Box — Experimental Uses, Etc. Gears Enclosed in Aluminum Housing. Bronze Gear, Hardened Worm, Input Shaft 1/4 in. Output Shaft 3/8 in. Speed Reducer #R 161 **\$3.95** Post Paid

## MOTORS FOR ABOVE SPEED REDUCER

- Motor 1/20 HP. 110 V. 3000 RPM. #1M252. . . . . **\$7.50** PPAID
- Motor 1/40 HP. 110 V. 1500 RPM. #4K244. . . . . **\$6.50** PPAID

## SPECIAL BARGAIN OIL BURNER MOTOR

Oil Burner Motor M'fd. by Piqua Electric. Replaces 90% of domestic oil burners requiring 2-bolt flange. 6 1/2" dia. flanges, 7 1/4" bolt holes, 1/2" shaft, CW rotation. Shopworn but never used, 110-V, 60 cy., 1750 RPM. PIQUA OIL BURNER MOTOR. . . . . **\$12.50** fob.  
Same as above, GENERAL ELECTRIC OIL BURNER MOTOR. . . . . **\$17.50** fob.

## LOW VOLTAGE A.C. BACKGEAR MOTORS



For Power Displays — Toys — Experimental Work, Etc. Slow Speed 1 1/2 RPM, from double 5/16 in. shafts. Low Voltage 18 to 24 volts 60 cy. A.C. Operates from toy transformer or connect in series with light bulb. Sturdy gears and bearings. Five higher speeds possible with shaft extension. Special Low Price. #BG 15 Postpaid. **\$5.95**

## Buy the Mechanic's FIRST Choice

### ...EMPIRE LEVELS For Home, Farm, all Trades



See Empire Levels at your dealer, or write for free booklet "Choice and Care of your Level."  
Empire No. 151 Aluminum Level: Adjustable vial cases, twin levels, plumbs, 45° vials — 24" — **\$7.50.**



**EMPIRE LEVEL MFG. COMPANY**

10930 West Potter Rd., Dept. PM., Milwaukee 13, Wis.

## PARTS FOR MILITARY TRUCKS

FOR JEEP, DODGE, CHEV., GMC, STUDEBAKER, 4 WHEEL DRIVE AND 6 WHEEL DRIVE. ALSO PARTS CATALOG. WRITE

### AXLES FOR TRAILERS

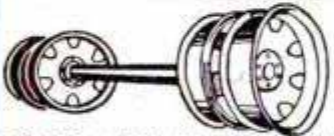

(Surplus) Heavy Duty axles suitable for building of many types of trailers, farm wagons, etc. Standard width straight axle, 2 inch square and is complete with Hubs, Timken bearings, 6 Hole **\$69.50**

750x20 or 825x20 wheels, without brakes, only. . . . . Dual Wheels. . . . . add \$15.00 extra.

All prices quoted good 30 days FOB, Kansas City 25% DEPOSIT REQUIRED ON ALL ORDERS

**American AUTO PARTS CO. INC.**  
1830 LOCUST — DEPT. PM  
KANSAS CITY, MISSOURI

## A REAL HE-MAN CHRISTMAS GIFT

**WELD**  
BRAZE, SOLDER,  
and CUT →

ONLY **\$1475**  
F.O.B. complete!



No experience needed. Follow simple instructions, weld on iron, steel, bronze, brass, aluminum, and other metals. Plugs into any properly wired 110 volt A.C. or D.C. line. Make or save time and money doing repair work for yourself and others. Repair men, farmers, tinsmiths, home and auto owners, hobbyists, etc., say FOUR-WAY pays for itself over and over. Order today or send for free details.

Larger Equipment Available on Request  
**FOUR-WAY WELDER COMPANY, Dept. F2-NB**  
2326 S. Michigan Ave. • Chicago 16, Illinois

**ORDER NOW  
10 DAY TRIAL**

## TOOLS AT WHOLESALE

### DIRECT FROM FACTORY

Full line of top quality, fully guaranteed, chrome, factory-new mechanics hand tools. You save **HALF REGULAR PRICE** for tools of this quality.

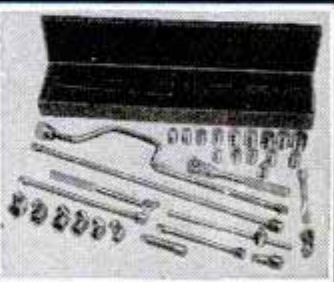

Pay **EASY MONTHLY TERMS**

WRITE TODAY FOR FREE CATALOG

## MECHANICS CO-OP

Dept. A OAKLAND 8, CALIFORNIA



were used to shake it up. Joe Medori, Italian-born snowplow foreman who has been working on wedge plows from Jasper through the Rockies since 1940, tells of hitting slides at speeds which rocked the plow, modestly admits he hasn't missed a single snowplow trip out of Jasper since he took over the job.

Two types of plows, the rotary and the wedge, form the basis for snow clearing through Canada's mountains. The heavier rotaries are used principally for deep slides, as in the Fraser operation. They weigh well over 100 tons, have their own steam power for revolving the huge rotary blade wheels, depend upon locomotives for propulsion through the heavy slides. Manned by an engineer and fireman, as are the locomotives, the plow combines with the weight of a locomotive to total above 400 tons.

Wedge plows are shaped as the name implies, generally operate at fairly high speeds, precede passenger trains through the mountains to clear fresh falls of snow and "ram out" any small slides which may have rolled over the tracks. Compressed air enables the operator, or foreman, to manipulate the plow's nose and wings at short notice. From the danger point of view, most plowmen agree that operation of a wedge is slightly more hazardous than that of a rotary as they crash slides at high speed and, being lighter, are more susceptible to serious derailment should they contact ice or rocks.

Fatalities in the snowplowing business are rare, but the jobs themselves are nerve-racking. The operator, perched in his pilot house with his myriad of controls and gauges, cannot relax a moment while the equipment is on the move. Accidents have brought about improvement in equipment. Several years ago, a slide near Mount Robson crashed through the wooden top of a rotary's pilot house, killing three men. Since then, all plows are constructed of heavy metal throughout. On a run north of Edmonton, two plowmen died when their signal to the engineer of the locomotive, calling for an emergency stop, failed to function. Investigation showed that the cord to the locomotive whistle, direct from the plow, had become sheathed in ice. Tom Young, then locomotive foreman of Lucerne, immediately recommended a change in the signal system and it was adopted.

Railways are constantly carrying out research and subsequent improvements to ensure safety. "Slow orders" are strictly observed over some sections. This year, too, the Canadian National completed installation of an improved block system through the mountain passes from Jasper to Jackman, near Blue River. Incorporated

at certain points are slide-detector fences, an overhead protector network which shorts the block mechanism and flashes warning to approaching trains even if only a small stone falls on one of the wires. The new detector is regarded by Canadian National officials as one of the most important of safety precautions. In addition, mountain engineers and firemen are schooled to be constantly on the alert for anything unusual in heavy snowfall areas. As one engineer puts it: "You get so you smell weather. There are certain combinations of snowfall and temperatures which spell trouble. Somehow, after years on the road, you can sense just where there might be grief and where the sailing will be good."

This is the time of year when mountain railroaders are girding for the midwinter snowfalls. At Jasper, Kamloops, and down the Fraser to Vancouver, long-range forecasts are being studied and snow structures above the rail lines are coming under the scrutiny of ski-going engineers. At central snow-clearing points like Blue River, the equipment and men are "on call." All are keyed toward the same goal: To keep traffic moving over the mountain divisions and to ensure top safety over the mountain lines.

---

## Detroit Listening Post

(Continued from page 93)

machine tools have unsettled all plans for complete changeovers in the automobile industry and the Ford Company is among the worst of the sufferers. But it is determined to come out with a more complete change than anything since it introduced its restyled job in 1949.

Another company looking forward eagerly but patiently to a startling changeover is Nash. Some time ago it hired the Italian designer Farini. From all reports, he has done his job well. But like Ford, Nash could not get its tools and dies out in time and now plans to show its new car in March. But this will also represent a departure from standard and should be worth-while.

So don't let the seemingly simple changes made so far lead you astray. Unless something drastic happens to the economy or the peaceful outlook ahead, this year's real changes will come during 1952.

The battle of horsepower will be continued. Cadillac's engine has been stepped up to what the company now rates at 190 horsepower. To meet the competition, Chrysler may advertise its V-8 Firepower engine at 185 or 190 horsepower.

(Continued to page 278)



# BUILD YOUR OWN RADIO CONTROLLED DOOR OPENER

...and 23 other electronic labor-savers

● This book gives complete instructions for building an electronic door lock, a charger for small dry batteries, a radio-controlled relay, pocket stroboscope, remote control for model trains, doorbell "booster", a photoelectric relay, photographic interval timer, simple crystal radio and a dozen other valuable gadgets.

All you need is some inexpensive Sylvania Crystal Diodes and a few everyday materials. Book gives easy-to-follow, illustrated how-to-do-it instructions.



Get Sylvania's 40 page book, "Electronic Shortcuts for Hobbyists" today.

**Only 25¢**

Send coin or stamps to: Sylvania Electric Products Inc., Department E-1212, Emporium, Pa.

## STOP THAT OIL EATER!



GET NEW CAR PERFORMANCE WITH **PISTON SEAL** WITHOUT COSTLY OVERHAULING

Piston Seal—the amazing compound that forms a self expanding, pliable lubricating seal around pistons that compensates for wear. Eliminates oil burning, restores power and compression. Can be applied in a few minutes.

**GOOD FOR 10,000 MILES**



**SIMPLY REMOVE SPARK PLUG AND SQUEEZE**

FOR COMPLETE, FREE DETAILS WRITE TO

**RICHIE DISTRIBUTING CO.** 1628-G COHASSETT AVE. LAKEWOOD 7, OHIO

# Burden's Gigantic Fall MAIL SALE

Midwest's leading surplus firm offers, subject to prior sale, a \$650,000.00 inventory of new perfect condition:

- WAR SURPLUS
- EXCESS INVENTORY
- BANKRUPT STOCKS

During Sale We Will Pay All Shipping Charges!

## Power Plants and Generators



- Kato Generators. 115-V, 60-C, 5000-Watt, 1800 R.P.M. Single Phase, Ball Bearing. Complete with control panel. Cost over \$550.00 . . . . . \$259.50
- Onan Plants. 115-V, 60-C, 5000-Watt, 4-cyl. engine, complete control panel. Push button start. Cost over \$1,200.00 . . . . . \$715.50
- Homelite Plants. 115-V, 60-C, 1500-Watt, 1-cyl. engine. Exceptionally fine. Cost over \$450.00 . . . . . \$258.70
- Burdex-Briggs Plants. 115-V, 60-C, 2000-Watts, 1-cyl. engine. Excellent size for home emergency power. List \$585.00 . . . . . \$297.50
- Delco-Remy Generators. 25-30 Volt, 200-amp. Direct current. Makes excellent welder (full instructions for building), also fine for emergency lights, power, etc. Cost over \$250.00 . . . . . \$19.95
- A-C Generators. 115-V, 800-C, 1 KW . . . . . \$18.95

## Air Compressor Equipment

Paint, blow up tires, clean gas lines with compressed air. Build your own portable hi-pressure unit.

- Basic Compressor Kit. Finest 1-cyl. piston comp., stainless steel storage tank, 160 lb. gauge, paint gun, blow gun, fittings, tire chuck, hose, relief valve, instr. for portable unit, air reg. . . . . \$45.49
- Air Components. 1-cyl. compressor . \$20.50, 2-cyl. comp. \$49.50, Automatic pressure switches (on 50, off 75) . \$4.95, pressure regulator (0-150 lb.) \$2.65, gauges (60, 100, 160 lb.) . \$1.89, tanks (small \$5.60, large \$9.95), air hose, 20' 1/4" with fittings . \$2.89, adj. safety valve . \$1.95, top quality paint gun, \$8.95, 3-gal. paint tank . . . . . \$18.95

Write for special Air-Compressor-Paint Spray catalog, data

## Winches, Clutches — Engines — Blocks

- Heil Power Winches. Heavy duty 15,000 lb. with clutch and 150' 1/2" cable. Cost \$275 \$169.70
- DeLuxe Hand Winches. Dual ratio 1-3, 1-9. Finest construction. Powerful 2,000 lb. 100s uses, farm & business . . . . . \$29.87
- Truck Hand Winches. 1-3 ratio, 1000 lb. Excellent for loading trucks, contractors, etc. Top quality . . . . . \$19.89
- Utility and Boat Winches. 1-1 ratio, 1500 lb. \$19.95
- Double Sheave Blocks. All steel for rope, 5". Fr. \$7.76
- Snatch Block. 4" steel. 3000 lb. . . . . \$5.49



## Water Pumps, Water Systems, Weed Spray Units

- Automatic Pressure Water System. Leading make. Farms, cabins, etc. 110-volt 60-cy, 300 g.p.h. 22' lift . . . . . \$69.50
- Bronze Medium Pressure Rotary Pumps. Up to 25 lbs. Stainless shaft. Self priming. Lift 10' without foot valve, 22' with. Efficient. 1 1/2" 6 g.p.m. . . . . \$12.95  
3/4" 10 g.p.m. . . . . \$16.95  
1" 19 g.p.m. . . . . \$22.95
- Bronze High Pressure Rotary Pumps. Up to 150 lbs. Stainless shaft. self priming. Lift 10' without foot valve, 22' with. Top quality unit. Move 1/2" 5 g.p.m. \$14.50, 3/4" 8 g.p.m. \$20.95, 1" 17 g.p.m. \$27.95
- Centrifugal Irrigation & Flood Pumps. Cast iron-bronze, stainless shaft, 7500 gal. per hr. 2" suc. 1 1/2" dis. Ball bearing. . . . . \$34.79



## Miscellaneous Close-Out Equipment Bargains

Limited quantities. Order promptly to get in on these.

- All Brass DeLuxe Tractor Weed Spray Outfit. Popular make at over 40% saving. Consists 4-row brass boom with genuine T-jet 5 g.p. acre, nozzles, easy mount any tractor, gauges, valves, hose, direct drive tractor pump, relief valve, etc. A guaranteed value . . . . . \$79.50
- G.E. Dictation Magnetic Recorders. 110-v, 60-c. For home or office. Records over and over. Brand new with tubes . . . . . \$29.50
- Rural Magneto Phones. Wall type. Modern case, 5-bar . . . . . \$12.40
- Private Magneto Phones. Wall type. Modern, 3-bar . . . . . \$10.25
- City Up-Right Desk Phones. Many uses. Instructions . . . . . \$ 1.99
- Motor-Gyro Units. 24-v, D-C (will run on A-C) fascinating. \$ 1.98
- Electric Hand Saw. 6 1/4", Portable, 110-V. Leading make. \$ 31.68
- Gasoline Chain Saw. 1-man, 30-in. blade. Leading make . . . . . \$299.50
- Car Battery Charger. 110-v, 60-c, deluxe type . . . . . \$ 13.49
- Abrasive Wheels Kit of ten 1 1/2" bore, finest stones . . . . . \$ 3.98
- Electric Hot Water Heaters. 20-gal. 110-v. list \$85.50 . . . . . \$ 53.96
- Transformers (Westinghouse), 110-220-v. 1 kw. . . . . \$ 17.95
- Binoculars. 7x50, with case, Tax paid. Top quality . . . . . \$ 45.95
- Precision Hand Level. Farmer contractor . . . . . \$ 5.84
- Drawing Instruments. 13-piece German, excellent quality. \$ 9.89
- Farm A-C Welding-Brazing Outfit. 110-220-v. . . . . \$ 54.70
- Bench Dual-Stone Grinder. 110-v. 3500 rpm. 1/8 H.P. . . . . \$ 17.49
- Saw Attachment. (4") Use with 1/4" electric drill. . . . . \$ 7.84

## GUY CABLE-TURNBUCKLE UNITS

12 ft. flexible steel cable, 14" turn-buckle. Fine for guying television antennas, strengthening gates, bldg., etc. Cost \$1.10. 10 for . . . . . **\$389**



BURDEN'S 30-Year Policy: ● Everything guar. We pay shipping charges in U.S.A.

ORDER FROM AD or Write for Free General Catalog!



**BURDEN SALES COMPANY**

804 "O" ST.

LINCOLN, NEBR.



# HOBART Arc Welding PAYS BIG!

If you have this versatile, all around HOBART arc welder, you're equipped to start your own welding business—to cash in on the demand for dependable arc welding.

**Costs LESS than you think!**  
This big 250 amp. gas drive welder is today's biggest value

A FULL CAPACITY WELDER THAT STANDS THE GAFF... OPERATES ON ALL TYPES OF JOBS.

YES, AND YOU CAN TAKE THIS GAS DRIVE WELDER AND WELD ANYWHERE, IT MAKES ITS OWN POWER

Hobart is made in gas and electric drive models—port. or stationary.

Welds anywhere... plus power for lights and tools

## You learn RAPIDLY at the HOBART TRADE SCHOOL

Prepare now to step into a big pay defense job or to start your own profitable welding business. Learn to do all kinds of welding quickly, easily, at low cost in America's most modern welding school... the non-profit Hobart Trade School. Complete or partial courses. Best equipment, experienced instructors, thorough training. Check coupon for full details



HOBART BROTHERS CO., Box M-121, Troy, Ohio

"One of the world's largest builders of arc welders"

Start your own welding shop. Earn big, extra profits monthly. All you need is a Hobart "Simplified" Welder and average mechanical ability. You'll soon be swamped with work.

Hobart Welders are used in leading production plants everywhere—give you 1,000 combinations of heat, let you make fine adjustments at the job—no returning to machine.

● **Procedure & Practice.** Complete text and lessons book. Covers every phase of welding. 544 pages, over 600 illus. \$3.00

● **Lessons Book.** Complete operator's training course. 200 pages, illustrated. \$1.00

● **Check the coupon for Complete Details**

● HOBART BROTHERS CO., Box M-121, Troy, Ohio

Please send complete information and literature on items checked.

- Electric Drive Welders     Gas Drive Welders  
 Hobart Trade School  
 Send books checked— Lessons Book  
 Procedure & Practice     Cash encl.  
 Send COD

**Free**  
New booklet  
"Guide to Better Welding"



NAME \_\_\_\_\_

ADDRESS \_\_\_\_\_

CITY \_\_\_\_\_

STATE \_\_\_\_\_

Production prospects become darker with each month. Already on the pessimistic side, the outlook for the first quarter of 1952 gives no solace. Defense-production officials have decreed no more than 950,000 passenger cars for the first three months.

A high General Motors official expressed the feeling of the industry recently when he told this writer:

"It will mean more unemployment in the industry. Also, it means that again new cars will be as sought after as gold."

One thing it will certainly mean to the various passenger-car manufacturers: fewer body styles in each line. The Chrysler Windsor line for 1952 will have only four offerings in the regular and three in the de luxe. The Saratoga will have four, the New Yorker three and the Imperial and Crown Imperial, two each. Hardtops, however, will be maintained in the Windsor, New Yorker and Imperial lines.

The success of the hardtop continues in both high and low-priced fields. It is getting a disproportionate share of the market, but with the blessings of the manufacturers. The upper-body structure has been strengthened, but the original concept of the design has been retained and the customers have flocked to that field.

A new feature to be offered in the 1952 models by Packard, that promises to be as sensational as the power-steering device will be power brakes, recently unveiled by Bendix for passenger cars, and called Treadle-Vac. Packard has decided to test the brakes in its higher priced models.

Treadle-Vac offers an answer to the increasing horsepower of the modern car. Chrysler has used a similar device but Bendix claims its unit is even better.

Although chrome—like other necessary materials—is as scarce as ever, it is not being de-emphasized as yet. The efforts of the automotive engineers have stretched out the supply and new cars should retain their shine for some time.

Some precautions are necessary, however, in dealing with the very light film of chrome which embellishes cars. Restrictions on the use of nickel in the brightwork used for radiator-grille bars, name plates, hood ornaments, window frames, hood ornaments and other nonfunctional parts make it wise to heed the instructions which the engineers have issued to make the shine last.

On all chrome parts except bumpers and buffer plates, new-car owners should use only clean cold water and wash frequently for the first 90 days. No polish or wax should be used during this period. After 90 days, a coating of wax may be applied periodically to maintain the luster.



# EVERY 1/4" ELECTRIC DRILL A PORTABLE SAW IN ONE MINUTE!

"ARCO-SAW" (Over 100,000 Sold)

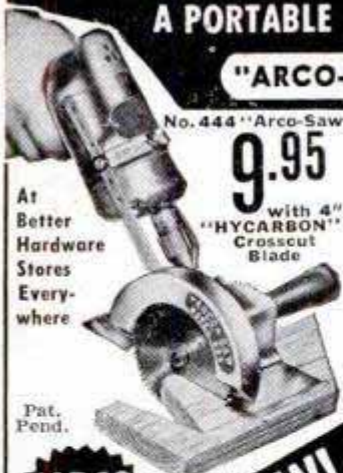

At  
Better  
Hardware  
Stores  
Every-  
where

No. 444 "ARCO-SAW"  
**9.95**  
with 4"  
"HYCARBON"  
Crosscut  
Blade

CAN BE USED WITH ONE HAND!  
"ARCO-SAW" works like a high priced Portable Saw. RIGHT ANGLE GEAR DRIVE eliminates clumsy, dangerous direct drive with drill sideways.  
**CUTS 1-5/16"** or 2x4 by turning over.  
FEATURES: Safety-yoke assures rigid connection and absolute safety. Visual guide and wide shoe-plate for straight, square cuts. Big handle affords firm grip for two hand operation. Precision one-piece gear box. Self-lubricating lifetime bearings.

Pat. Pend.

**NEW!** No. 445 "ARCO-SAW" for  
DEPTH & BEVEL CUTS

"ARCO-SAW"

No. 445 "ARCO-SAW"  
**11.50**  
with all Gages and 4" "HYCARBON" Crosscut Blade.  
(Also Available! No. 444G DEPTH-BEVEL-RIP GAGE. Easily attaches to any No. 444 "ARCO-SAW". . . \$1.95)

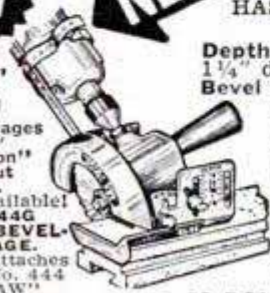

HAS ALL FEATURES LISTED ABOVE PLUS:  
Depth gage graduated from 0 to 1 1/4" depth (for grooves, dados), Bevel gage graduated from 0 to 45° angle (for dovetails, bevels). Rip gage with sideways adjustment. Visual guide with adjustment to follow lines on both straight and bevel cutting.

"HYCARBON" REPLACEMENT BLADES.  
4" Crosscut or 4" Combination. . . **\$2.00**

90-DAY FACTORY GUARANTEE

ORDER TODAY at your dealer or send us check or M. O. (Postpaid). C.O.D.'s—postage extra. Ask for literature of other tools.

**UNCONDITIONAL 10-DAY MONEY BACK GUARANTEE**

DEALERS—Write for nearest jobber.

**ARROW METAL PRODUCTS CO.**

DEPT. PM-12, 140 WEST BROADWAY, NEW YORK 13, N. Y.



## New DUMORE ROUTER

Ideal tool for inlay and cabinet work, lock and hinge mortises, weather stripping, door hanging, etc. Full 1/16 HP, 19,000 RPM. Handles all 1/4" shank bits and cutters.



No. 22-011 Router, for use on 115V, AC or DC. **\$29.50\***  
No. 22-200 Router Attachment Kit, consisting of Fence Guide and Template Guide. **\$4.50\***

## DUMORE HOBBY-FLEX



A big favorite with plastic carvers, model railroaders, etc. Light pen-shaped handpiece for precise work in hard-to-reach places. 1/20 HP, 15,000 RPM. Handles all 1/8" and 3/32" mounted accessories.

No. 19-021 Standard Hobby-Flex. **\$24.50\***  
No. 19-011 DeLuxe Hobby-Flex in steel case with 10 accessories. **\$29.50\***

## Hobby-Tool HANDGRINDER



Tool of a hundred uses—sands, grinds, saws, drills, polishes, sharpens, carves, etc. Full 1/40 HP, 28,000 RPM. Handles all 1/8" and 3/32" mounted accessories. Handsome red and black housing. . . Instant quick-change chuck.

No. 4-021 Hobby Tool Handgrinder in attractive carton with 2 accessories. **\$19.50\***  
No. 4-011 Same as above in handsome steel case with 50 accessories. **\$27.50\***

## DUPLEX GRINDER



Most powerful hobby handgrinder, handles 1/4", in addition to 1/8" and 3/32", mounted accessories. 1/14 HP, 17,000 RPM. Full line of attachments available for converting Duplex to flexible-shaft tool, lathe or bench grinder, and sander.

No. 3-011 Standard Duplex Grinder with 9 accessories in attractive carton. **\$24.95\***  
No. 3-021 DeLuxe Duplex, in attractive steel case with 51 accessories. **\$34.50\***

## CARVIT Duplicator



Learn skilled woodcarving in 20 minutes. . . turn out beautiful, saleable carved signs, bookends, plaques, statuettes, etc., in wood or plastic. Just guide Carvit tracer pin over model you want to duplicate. A complete, profitable hobby in one tool.

No. 15-100 Complete Carvit for flat work, including sample model and instructions. **\$67.50\***  
No. 15-105 Index attachment and instructions for doing 3-dimensional work. **\$9.75**

If your dealer cannot supply you, send check or money order. We'll ship the tool you want, post-paid—anywhere within U.S.A.



\*Prices slightly higher West of Rockies.

DL-7

**The DUMORE Company**  
1300 17th St., RACINE, WISCONSIN  
Export address: 13 E. 40th St., New York, N.Y., U.S.A.

P & C Hot Forged Tools  
**Stay on the job Longer!**

Really tough jobs—in industry or at home—prove that special analysis alloy steel and scientific heat treating make P&C tools last longer. More than 300 P&C tools are easier and faster in everyday use or on special jobs. Ask your hardware dealer for the P&C tools you need; he will recommend them.

Write for the new folder on P&C tools—"the BEST tools money can buy."

**P & C**

P&C HAND FORGED TOOL COMPANY  
PORTLAND 22, OREGON

DECEMBER 1951





# for Christmas

## The Utica MagneKit with magnetic tool holder

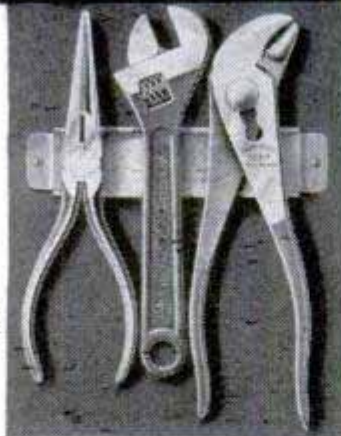

Set of 3 quality tools—

6" Long Chain Nose Side Cutting Pliers, 6" Adjustable Wrench, 7" Angle Nose Pliers — PLUS powerful Magnetic Holder.

ONLY \$5.85

Three top-quality tools that will do just about ANY job that comes along.

And to keep 'em handy and always in sight—Utica's amazing Magnetic Holder (holds up to 13 lbs. of tools).

A fine set to own. A fine GIFT for any man who works with tools. There's someone on your Christmas list for whom the MagneKit would be perfect.

At your local hardware store.  
If they can't supply you, write us.

Utica Drop Forge & Tool Corporation • Utica 4, New York

It pays to buy



quality tools

## SHARPEN CIRCULAR SAWS LIKE AN EXPERT



**THE SUPER GADGET FOR HOME WORKSHOP**  
Two simple adjustments. Gets hollow-ground, cross-cut or combination saw blades true and sharp. Fits 6" to 12" blades 1/2" to 13/16" centers. Includes file, complete instructions. \$6.95 postpaid. (C.O.D. postage extra.) Guaranteed—Money back if not satisfied after 10-day trial. Soon pays for itself. Order today. Free Folder.  
**SURE SHARP MFG. CO., Dept. M-12-1**  
P. O. Box 24 Santa Ana, Calif.

\$6.95

## The Chief WORK BENCH

*Built to Last a Lifetime!*

With Bottom Shelf and 18" Sq. Drawer. 2"x6", Solid Plank, Grooved and Dovetailed Top and 1"x8" Back Rail, Shellacked to a Smooth, Satiny Finish.

MOHAWK LUMBER CO. Dept. 33 • 6 Ft. Long • 34" High • 26" Deep. Shipped Knock-down, with Bolts, Nuts and Screws and ABC Chart for Quick, Simple Assembly.

Enclosed  Check  Money Order for \$.....  
Ship.....CHIEF WORK BENCHES at Quantity

\$19.95 each, F.O.B. Detroit, Mich.

Send C.O.D., \$5 Deposit Enclosed.

NAME.....

ADDRESS.....

CITY.....STATE.....

*Prompt Delivery*

**MOHAWK LUMBER CO.**

14525 W. Chicago Boulevard  
DETROIT 27, MICHIGAN

## NEW AIR COMPRESSORS

Fully guaranteed—Backed by 45 years of air equipment experience

• Piston type • Fully automatic • Splash lubrication • Heavy duty capacitor motor (for one phase.) • High pressure welded steel tank. • Gauge, safety and drain valve. • Comes complete with motor ready for use.

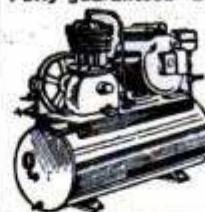

Motor	No. of Cyl.	Tank	C.F.M.	Phase	Price
1/4 H.P. ONE	12"x24"	2.10	79.50	1	
1/2 H.P. TWO	12"x30"	3.28	119.50	3	
3/4 H.P. TWO	14"x36"	5.00	189.50	3	189.50
1 H.P. TWO	14"x36"	7.70	209.50	3	199.50
1 1/2 H.P. TWO	14"x36"	9.30	239.50	3	215.00
2 H.P. TWO	16"x42"	12.5	365.00	3	325.00

FULLY GUARANTEED FOR ONE YEAR

Make your own motor more useful... Work in hard-to-get-at places



### Multi-Purpose FLEXIBLE SHAFTS

For buffing, grinding, drilling, filing, power transmission  
53 1/2" long, 3/8" dia. Ideal for garages and shops, 50 ft. long, 3/4" O. D. Fits 1/2" motor shaft or 3/4" collet. Use your 1/6 or 1/3 H. P. motor up to 3400 R.P.M. Neoprene covering.

5.95

For buffing, grinding, drilling, filing, power transmission  
53 1/2" long, 3/8" dia. Ideal for garages and shops, 50 ft. long, 3/4" O. D. Fits 1/2" motor shaft or 3/4" collet. Use your 1/6 or 1/3 H. P. motor up to 3400 R.P.M. Neoprene covering.

37.50



### Ventilator, Blower, Dust Collector

Very versatile, can be adapted to many uses in home or shop. For ventilating darkrooms, labs, kitchenettes. For cooling instruments, forced draft furnaces. For collecting, by vacuum, wood, metal dust, shavings and chips. (When ordering specify intended use.) Motor, 3" intake, 2" discharge. Approx. 100 C.F.M.

10.95

F.O.B. WAREHOUSE, N.Y.C. Send Check or M.O. Prompt Shipment  
ELECTRIC TRADING CO., Dept. P.M., 313 Canal St., N.Y.C.

## 2 DRILLS in 1

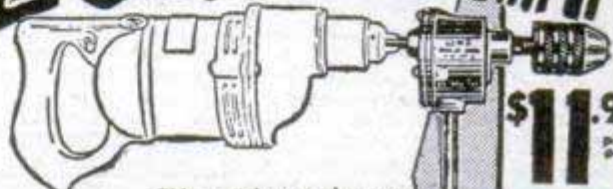

\$11.95  
post paid

This attachment gives you two drills in one. It converts any 1/4 inch electric drill to 1/2 inch capacity. Reduction gears reduce the drill speed 5 to 1, the average speed of a 1/2 inch drill, and thereby increases the power. Absolutely indispensable for all shop work and home craftsmen.

Send check or Money Order  
Satisfaction guaranteed  
Order yours now

G. M. CO. MANUFACTURING, INC.  
1308 43rd AVE.  
LONG ISLAND CITY 1, NEW YORK

## ONE-MAN SAWMILL AS LOW AS \$50.00 DOWN



Take BELSAW Portable Sawmill right to the trees—turn out valuable lumber for local yards—do "custom sawing" for neighbors. BELSAW lasts a lifetime. No crew needed. Power with old auto engine. Beginners get excellent results. Send postcard for FREE BOOK, "How To Make Lumber."

**BELSAW MACHINERY CO**  
8116 Field Bldg. 315 Westport Rd, Kansas City 2, Mo.

SAY YOU SAW IT IN POPULAR MECHANICS

A CHRISTMAS PRESENT HE'D APPRECIATE



\$19.95  
F.O.B. DETROIT

Send Check or Money Order, or Will Ship C. O. D. (\$5 Deposit)



## HIGH SPEED DRILLS

1/4" to 1/2" with 1/4" Shanks  
1/2" to 1" with 1/2" Shanks



For the first time at these low prices! HIGH SPEED DRILL BITS UP TO 1/2" FOR YOUR 1/4" DRILL AND HIGH SPEED DRILL BITS UP TO 1-3/16" FOR YOUR 1/2" DRILL. The Tungsten steel content of these drills means they will outlast carbon and regular steel drills many, many times!

DRILLS UP TO 1/2" FOR YOUR 1/4" DRILLS! Will Fit Any Size Chuck 1/4" and Larger.

SIZE	PRICE EA.	SIZE	PRICE EA.
1/4	\$ .30	25/64	\$ .60
17/64	.45	13/32	.60
9/32	.45	27/64	.65
19/64	.48	7/16	.65
5/16	.48	29/64	.73
21/64	.50	15/32	.73
11/32	.50	31/64	.75
23/64	.55	1/2	.80
3/8	.55	33/64	.90
		17/32	.90

DRILLS UP TO 1-3/16" FOR YOUR 1/2" DRILLS! Will Fit Any Size Chuck 1/2" and Larger.

SIZE	PRICE EA.	SIZE	PRICE EA.
33/64	\$ .91	25/32	\$1.86
17/32	.91	51/64	2.05
35/64	1.14	13/16	2.05
9/16	1.14	53/64	2.15
37/64	1.24	55/64	2.25
19/32	1.24	7/8	2.25
39/64	1.30	15/16	2.43
41/64	1.43	31/32	2.50
21/32	1.43	1-1/32	2.80
43/64	1.55	1-1/16	3.05
47/64	1.80	1-5/64	3.56
3/4	1.80	1-5/32	3.98
		1-3/16	4.10

## HIGH SPEED MORSE TAPER SHANK DRILLS



SET 15 Different Size High Speed Morse Taper Shank Drills up to 9/16" with No. 1 and 2 tapers. \$50 value. Priced at only..... \$6.49

SET 20 Different Size 10V High Speed Morse Taper Shank Drills from 1/4" to 1". \$70 value. Priced at only..... \$12.95

SET 10 Different Size High Speed Morse Taper Shank Drills from 1/2" to 1 1/4". \$50 value. Priced at only..... \$9.95

SET 8 Different Size High Speed Morse Taper Shank Drills from 1" to 2" with No. 3, 4, and 5 tapers. \$125 value. Priced only... \$29.95

## HIGH SPEED STRAIGHT SHANK CHUCKING REAMERS



SET 20 Different Size High Speed Straight Shank 16V Chucking Reamers up to 1/2". Priced at only..... \$7.95

SET 15 Different Size High Speed Straight Shank 18V Chucking Reamers from 1/4" to 1" Priced at only..... \$6.95

## HIGH SPEED

Slightly Used  
SIZE PRICE EA.  
8-36 (new) \$ .35  
1/4-NC or NF .26  
5/16-NC or NF .29  
3/8-NC or NF .33  
7/16-NC or NF .39



## HAND TAPS

Excellent Condition  
SIZE PRICE EA.  
1/2-NC or NF \$ .47  
9/16-NC or NF .60  
5/8-NF .66  
3/4-NF .80  
1-NF 1.25

## NEW SEMI-HIGH SPEED COMBINATION DRILLS AND COUNTERSINKS

SIZE	60° Angle of Countersink	DRILL SIZE	BODY	EACH
C2	1/16	13/64	\$0.49	
E1	3/32	3/10	.49	
F1	5/32	7/16	.69	
F2	3/16	7/16	.69	

5% discount for purchase of 1 doz. of any size or mixture of above.

## 4 SLITTING SAWS WITH MANDREL

SET 4 Different Size H. S. Slit 14V ting Saws. 2 3/4" dia. by 1" arbor. Thickness from .040 to .071. Cuts wood, aluminum, brass, steel, etc. Plus special mandrel which enables use of saws in 1/2" or 3/4" electric drill. Added FREE of charge two 3/2" arbor grinding wheels which will fit above mandrel. All 7 of above items. \$3.49



## NEW MOUNTED STONES

SET Mixture of 12 Mounted 27V Stones with 1/4" shanks... \$1.98



SET 39V 24 of above..... \$3.95

## HIGH SPEED STRAIGHT SHANK DOUBLE END END MILLS

SET 4 Right-hand twist 7/16 shank end mills, size 5/16 to 7/16. Used surplus only..... \$3.95



## VEEDER ROOT COUNTERS

3 Digit clockwise rotation type (New)..... \$1.49  
4 Digit clockwise rotation type (New)..... \$1.89  
5 Digit clockwise rotation type (Reconditioned)..... \$2.89  
5 Digit ratchet type (Reconditioned)..... \$2.49

5 Digit clockwise rotation type with key reset, complete with key, counts in fives. (Reconditioned)..... \$2.75  
5 Digit ratchet type, with key reset complete with key, counts in singles. New cost about \$17.00 when available. (Reconditioned) Only..... \$3.49  
All counters guaranteed against mechanical defects

Money-Back Guarantee—All Mdse. Mixture of New and Reconditioned Tools Unless Specified Brand New—All Orders (Except Those Specified F.O.B. Tulsa) Are Shipped Post Paid, saving you up to 25% on total delivered cost.

Write for Free Catalog Describing Thousands of Bargain Cutting Tools.

**T & T TOOL** 221 W. SECOND TULSA, OKLA.

## Bargain Tool & Shop Mixes!—PPD

FILE MIX—BRAND NEW: Set of 12 different files, lengths 6, 8, 10, 12 in. Half rounds, bastards, knife, mills, etc. First line Nichols, Heller and other brands..... \$3.49

SPRING MIX: 300 new springs, compression, tension and torsion types up to 6" in length, only..... \$1.79

HAND REAMER MIX: 8 different size hand reamers up to 5/8" including 3 taper pin reamers. Majority of reamers in new condition..... \$3.69

MICRO SWITCH MIX: Assortment of 5 micro switches, only..... \$1.69

MILLING CUTTER MIX: Assortment of 4 various size H. S. milling cutters, all with 1" arbors; up to 3" dia. only..... \$3.98

GRINDING WHEEL MIX: 30 grinding wheels with 1/4" arbors, up to 3" in dia., plus mandrel, only..... \$3.29

COUNTER BORE MIX: 4 H. S. eclipse type, sizes up to 1 1/4", only... \$4.49

NEW ROTARY FILE MIX: 7 different size H. S. files, 1/4" shanks. New cost as high as \$2.00 ea. Only..... \$4.49

DRILL BIT MIX: Over 300 pcs. (2 lbs.) of used H. S. drill bits up to 1/4". Some require sharpening. Ideal for pin punches, drift pins, etc. Less than 1¢ ea. at..... \$2.98

90° HEAVY DUTY GEAR BOX: Ball-bearing throughout with 1/2" drive spline. 1:1 gear ratio which can be changed by different size pulleys or gears. Wt. 5 1/2 lbs. Length 11", beveled gears. Excellent for hot rods, power mowers, etc. Only..... \$5.95



10 TO 1 GEAR BOX: Throw-out type clutch, ball-bearing throughout. 1/2" drive spline. 3 1/4" output gear. Rated up to 6 H. P..... \$6.49

NEW MASTER HYDRAULIC CONTROL VALVE For controlling two single or double action cylinders separately or simultaneously. Valve is close center type. 1500 PSI rating. Only..... \$9.98

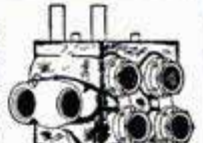

LARGE VOLUME RELIEF VALVE: 1/2" pipe ports, range 1000 to 1575 PSI; included with above valve ONLY, at..... \$2.49

P1A PESCO PUMP gear type, displacement 1 1/4 GPM at 1,500 PSI. Continuous operating speed, 3,750 RPM. Pump is driven by 1/2" spline..... \$9.49  
Dis. on Quantities

Control Valve, Relief Valve, P1A Pesco Pump as above, all for only \$18.95

# WAR SURPLUS INSTRUMENTS—RADIO—CAMERAS



**ELGIN—WALTHAM—BULOVA**  
Waterproof, shockproof, Type A-11 hack watch. 16 J black face, white numerals. Sweep second hand. Used by AAF. Built to exact specifications of U.S. Govt. Genuine War Surplus. State first and second choice as limited quantity available.  
ONLY..... \$19.75  
Add \$1.98 Federal Tax

**35MM FILM**  
War Surplus outdated but guaranteed. Load your own cartridges. 35MM x 100'  
\$1.29



**SOUND POWERED PHONE**  
No batteries needed. Your voice generates current. O.K. for 25 miles. Perfect intercom for shop, office, farm, darkroom. WAR SURPLUS. Orig. Govt. Cost \$58.00 ea.  
NOW..... \$10.95



**MAGNESYN INDICATOR**  
For remote indicating compass. Automatic direction finder. Calibrated from 0 to 360 degrees.  
Govt. Cost \$90.00.... NOW \$3.75



**HEAD PHONES**  
Govt. specification Head Sets. Used but guaranteed.  
ONLY..... \$1.59



**KOLLSMAN ALTIMETER**  
For auto or airplane. Used, guaranteed accurate. Govt. cost \$168.00.  
NOW..... \$10.95

All merchandise guaranteed. Order these Surplus Bargains Today  
20% Deposit on C.O.D.'s Minimum Order \$2.00.

**Semlers' ASSOCIATED SURPLUS** Dept. PM-12, 5730 WILSHIRE BLVD., LOS ANGELES 36, CALIF.



# Make Your Drill a Power Saw with

## FEDCO

MADE IN U.S.A.

### Saw-Rite

You will never use a handsaw again!

Fits Any 1/4" Drill Model 605

only **\$10<sup>95</sup>**

Complete with Combination 4-Inch Blade and Bevel-Tilt Rippage. Fully Adjustable.

Most popular tool of its kind... zips through wood, plastics, wallboard, etc.

The Unique BEVEL-TILT-DEPTH-RIPPAGE allows depth of cut from 1/8" to 1 1/2". Bevel cuts any angle from 0 to 45 degrees with no screws to move. Rippage adjustable for accurate width molding, etc.

### EASY ONE-HAND OPERATION

Tens of thousands of FEDCO "Saw-Rites are now in use all over the country. Careful design, rugged precision manufacture, and a better blade make the "Saw-Rite" the best in the field. Quick-acting, worm-drive, patented clamp gets it on and off your drill in seconds. Combination blade is chrome nickel alloy steel, precision ground, correctly heat treated, balanced and fitted. Grooves, dadoes, cross-cuts, rips, hour after hour without sharpening. Cuts plywood, shelving, wallboard, 2 x 4's to 2 x 10's, in two cuts, one from each side. Special sighting guide notch enables you to accurately follow line in both straight and bevel cuts. Extra wide base plate for better balance. One of two-hand operation with hand knob. Lifetime Oilite bearings, finest quality hardened shafts, and coppo-steel gears. One-piece aluminum housing.

### 90-Day Factory Guarantee

#### FEDCO Replacement Blades:

- #504C 4" Combination .....\$2.00
- #504R 4" Rip.....\$2.00
- #504M 4" for Soft Metals.....\$3.00

Try FEDCO "Saw-Rite" for 15 Days... Money Fully Refunded if Not Satisfied. Order from your Dealer, or send us your Check or Money-Order. All prices post-paid, except C.O.D.'s.

DEALERS... Write for Nearest Jobber, Dept. M. 2

FEDERAL ENGINEERING CO., M. 1, 37 Murray St., New York 7, N. Y.

## Portable BATTERY CHARGER \$8<sup>70</sup>

### Starts Cars Coldest Mornings:

DOUBLE your battery life. Cut out towing bills by charging your own battery. Charges any 6 volt battery without unhooking cables or removing from car, truck or tractor. Four amp. output costs only fraction of cent to operate. No danger of overcharging. No moving parts, condensers, tubes to replace, liquids to spill. Noiseless. No radio interference. Automatic reset. Easily moved from car to car. Hang from wall or stand up. Operates on 110 volts, 60 cycles, A.C. Generate power for battery radios, electric drains, electric outboard motors, etc. Sold F.O.B. Minneapolis, cash with order prepaid. Send cash, check or M.O. C.O.D.'s extra. Dealers and Agents wanted. Write for literature.

ELECTRIC SERVICE SYSTEMS, INC.

1331 QUINCY STREET N.E.

MINNEAPOLIS 13, MINN.

## "NO DRAFT"—PLASTIC STORM WINDOW

**\$1<sup>00</sup>** complete

PROTECT ENTIRE HOME against drafts, colds, etc. Windproof, rainproof, transparent, saves fuel costs. Easily installed by anyone in any size windows. Complete kit, size 36" x 72". Order now—one for every window.

GAYLORD

Dept. PM-8, 5th & Hamilton, Pgh. 6, Pa.

Send.....Storm Window Sets @ \$1.00 each postpaid.

Check  M. O.  C. O. D.

Money back guarantee.

## Brand New! 24 V DC AMMUNITION BOOSTER

USE FOR OPERATING MOTION DISPLAYS, CRAFT TOOLS, MIXERS, CONVEYOR BELTS, TURN TABLES, ETC.

### How to Mount Booster

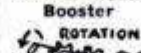

ROTATION

MTG. PANEL  
Attach with 3 No. 10-32 screws.

This precision engineered Ammo Booster was designed to feed .50 cal. bullets into machine guns on AAF fighters. Offered at a fraction of its value, it can be used for many jobs in home, shop, and lab requiring moderately low speed electric power. The Booster consists of a 24v DC 3500 r.p.m. motor operating a built-in gear reduction assembly, and a rotating metal housing. Gear ratio to motor is 35-1, 100 rpm rotating housing speed. Cover plate on one end has 3 tapped holes for mtg. complete unit. Motor and gear assembly can be taken out and used independently. What's more, the Booster is of great value to experimenters, inventors, hobbyists for the many parts that go to make it up.

### MANY VALUABLE PARTS

In addition to the motor and gear assembly, the Booster has an array of fine instrument ball bearings, small screws, springs, washers, brushes, coaxial connectors. The bearings alone are worth much more than the price of the complete outfit. Size, 5 3/8" x 2 1/2" dia. Shpg. wt. 4 lb. Cost Gov't. \$65.00. **NOW ONLY \$5.95**

### GAS LINE STRAINER

Brand New! For All Cars, Trucks, Tractors and Boats

Made to Air Corps specs, type C4A. Removes foreign particles, water, prevents sludge formation. Connect to gas line in a few min. Design allows for use either right or left handed without changes. Stainless steel filter screen is easily removed for cleaning or replacement. 1 1/8" pipe inlet and outlet ports. Quick opening drain cock. Capacity up to 60 GPH. 2 mtg. ports. Protects fuel pump and carburetor. saves you money. Shpg. wt., 2 3/4 lb. **\$3.95**

### SUBMERGED-TYPE FUEL PUMP

Ideal for pumping gasoline, light oils, water, hyd. fluid. Capacity 5 to 6 GPM. Totally enclosed 1/4 H.P. 24v DC motor. 7/8" pipe outlet. Has 3/8" dia. flange with 6 holes for mtg. Precision built by Canadian Aircraft Instruments, type EP-1A-V. Will shoot a stream of water clear across a room. Size, 10 1/4" H. 2 1/4" dia. casing. Shpg. wt. 3 lb. Reconditioned, guaranteed. Cost Gov't. \$105.00 **\$9.95**

Include postage with check or M. O. Money Back Guarantee!

Edw. Aguado Trdg. Co. 689-D Arcade Bldg., St. Louis 1, Mo.

### PUROLATOR OIL FILTERS

Permanent Type

Brand New! #G159J-40

The perfect filter to keep motor oil or hyd. fluid clean at all times. Protect your pump, engine, mid-let racer or boat with this unit. Just turn handle and element is clean. Inlet and outlet ports take pipe or straight threads up to 3/4". Accommodates 16 GPM at 30 PSI. Mtg. bracket. Shpg. wt. 4 lb. \$13 value. **\$3.95**

### Order From This Ad!

Prices F.O.B. St. Louis. Money Back Guarantee!

## SELL GOLD & SILVER WINDOW LETTERS

**300% PROFIT!** Fast, easy sales to stores, offices, doctors, lawyers, etc. Individual orders for merchants interested in saving \$\$\$\$ doing their own window lettering. Letters easily applied on glass, wood, metal with varnish-glue (not water). Won't wash off; withstands frost. Write for samples. **METALLIC SIGN CO., 430 N. Clark St., Chicago 10, Ill.**

## HOBBYISTS! SHOPMEN! Special \$54<sup>50</sup> ONLY

### PALMGREN "HOBB-E" Rotary, Index, Milling Table

Ideal for Model Parts or Shop Work  
Mill-Grind-Drill-Index-Rout curved or straight-Rabbit and Mortise on drill press or lathe. 8" Table, 4" Cross Feed, 360° Rotation, Accurately Graduated, Bolts to table. Order NOW! SAVE \$100. Only \$54.50. Less Rotary Feed \$43.75. Write for "HOBB-E" Tool Circular.  
CHICAGO TOOL and ENGINEERING CO. 8365 South Chicago Ave. Chicago 17, Ill.

## Gerstner Tool Chests

Tried and proven by the most exacting machinists and toolmakers for 45 years. Free catalog for machinists and toolmakers.  
**GERSTNER TOOL CHESTS**  
451 Columbia St., Dayton 7, Ohio

## ALNICO MAGNETS LIFT 175-lb.

AMAZING PERMANENT MAGNETS — WILL NOT WEAKEN! NON-ELECTRIC. Retrieve guns, tackle, tools and other steel items from lake, river, plating tanks, drains or other hard-to-reach spots. Recover drills, taps, etc. from floor sweepings. Clear alley of harmful tacks, nails. Many other uses listed. Pays for itself quickly. **GUARANTEED:** Try any magnet one week. Money refunded if you are not well-pleased.  
Cat. No. 075 (Has pull of 175 lbs. on a flat steel block).....\$10.50  
Cat. No. 650 (150 lb. pull) \$8.50 Cat. No. 530 (30 lb. pull) \$3.00  
Cat. No. 550 (50 lb. pull) \$4.00 Send M.O. or check. We pay postage.  
Cat. No. 30—Hobbyist assortment of six medium magnets.....\$1.50  
**MIAMI MAGNET CO.,**  
3240 N.W. 27th Ave., Aviation Bldg. No. 43, Miami, Florida



# NEW DREMEL *Electric* RAZOR BLADE SHARPENER

**100 SHAVES  
FROM  
ONE BLADE**



Only  
**\$9.85**

**EVERY SHAVE A** (Pat'd)

**SMOOTH ONE!**

For Double Edge Blades

Get the sharpest, smoothest cutting blades ever — months of perfect shaving from just one blade—even with toughest whiskers. In 15 to 20 seconds your blade is electrically *hollow-honed* and *stropped* . . . sharper than any blade you ever used. Thousands of satisfied users have proved it!

solves **CHRISTMAS GIFT** problems

Any man will be thrilled with the years of shaving comfort he receives from this unusual gift. **FREE TEN-DAY TRIAL MONEY BACK GUARANTEE.** Order yours today! Send check or money order for \$9.85 postpaid. If not satisfied, return Sharpener in good condition within ten days for prompt cash refund.

**DREMEL MANUFACTURING CO., Dept. 111-M, RACINE, WIS.**



## ELECTRIC WELDER AC or DC 110 Volts

"The Little Marvel" All-Metal welder. 5-year written guarantee. Welds 1/8" thick metal or money back. Repairs tanks, tools, fenders, machine parts, etc. Comes complete with everything—rods, unit, eye shield, and directions. We also make a welder for 16 to 22 gauge metal . . . \$3.95 complete. On C.O.D., postage extra.

**\$6.45**  
Complete

**ESSAY MFG. CO., Inc., Dept. 51, Quincy 69, Mass.**

## BUILD YOUR OWN POWER TOOLS—TILT/ARBOR SAW

Exclusive **GIL-BILT** Build-It-Yourself Features

- No machining—build easily with hand tools only
- No blueprint reading—step-by-step pictorial plans, full scale patterns, actual photographs
- Sturdy wood, aluminum, and steel construction
- Capacity and performance of commercial saws selling for \$60 and up

**BANDSAW  
BELT SANDER  
SAVE \$50.  
OR MORE**

### GIL-BILT 10-INCH TILTING ARBOR SAW



- 27x28 in. table, 13 1/2 in. capacity in front of blade
- 10 in. blade cuts 3 1/4 in. deep, tilts full 45 degrees
- Floor model 34" high, table always stays level

- New Departure ball bearing arbor, 3/4" precision shaft turned down for 5/8" bore blades, alum. housing, shipped ready to run
- Jackscrew and 4 1/2 in. dia. handwheel lowers and raises blade
- Cast aluminum miter gauge and self-aligning rip fence guide

GIL-BILT Metal Parts Kit includes Plans, ball bearing arbor, miter gauge and bar, rip fence guide, dado insert, lock knobs, jack screw mechanism and handwheel, and all other metal parts (less blade) . . . \$20.95  
Same Kit with 10" Combination Blade \$24.90  
Same Kit with 8" Combination Blade \$23.90

### GIL-BILT 12-INCH BAND SAW



- Cuts to center of 24 inch circle
- Handles stock up to 6 inch thick
- 18x18 inch table tilts 45 degrees
- Lower wheel and drive pulley runs on sealed New Departure Ball Bearings; Upper wheel runs on two 3/8" bore Oilite Bronze bearings.

- Upper wheel tension and tilt mechanism of cast aluminum, completely assembled.
  - Upper and lower blade guides. Each has ball thrust bearing, self-lub bronze jaws
  - Rigid cast aluminum wheels fully machined ready-to-install. Heavy rubber tires.
  - Uses standard 78 inch blades up to 3/4 in. wide.
  - Fully enclosed mechanism for utmost safety.
- GIL-BILT Metal Parts Kit includes Plans, rubber tires, aluminum wheels, 1/4 in. blade, ball bearing spindle, tilt mechanism, blade guides, table tilt segments, and all other metal parts . . . \$20.95

Return Kits in 10 days for refund if not satisfied.

(Prices include postage within 300 miles. Over 300 add 5%)  
Also available—Plans and Parts Kit for Belt Sander and 8" Tilt/Arbor Saw. Order Plans at \$1.00 each—Send postpaid anywhere in the world or write for FREE descriptive catalog.

**GILLIOM POWER TOOLS** P. O. BOX 1-PM, Lambert Field St. Louis 21, Missouri

# A Toolshop in Your Hand

**HANDEE**<sup>®</sup>  
tool of 1001 Uses

**FINEST IN POWER TOOLS**

Plus 51 Accessories

Complete . . . designed for every hobbyist and mechanic! Grind, drill, polish, carve, sand, saw, etc. Packs plenty of power in the 25,000 r.p.m. motor, with approved 7-segment commutator. Handsome fitted steel carrying case.

Complete, with liberal 10-day money back trial offer . . . . . **\$27.50**  
with 7 accessories . . . **\$19.95**



## HANDEE WORKSHOP

Tornado-Powered  
with NEW HANDEE "85"

Versatile, with 41 accessories . . . suitable for shop or home use. For novice or expert . . . precision routing, molding cuts. HANDEE "85" a production wizard . . . automatically air-cooled, pin-point accuracy. Sensational power! Complete, packed in handsome case . . . . . **\$29.95**

Write for  
64-Page Catalog

**Chicago Wheel & Mfg. Co., Dept. PM**  
1101 West Monroe St., Chicago 7, Ill.

## BRONZE FOUNDRY

Schools and Home Workshops



Make your own castings of aluminum, copper, bronze, silver. Foundry sets are available in three sizes including 2400 Deg. F. blast Furnaces. \$22.50; \$29.50; and \$42.00. f.o.b. Kansas City. Free Circular.

**KANSAS CITY SPECIALTIES CO.** P. O. BOX 6022, DEPT. P-12  
KANSAS CITY, MO.

**Made \$2,600  
Last Season**

"Last year we sharpened and repaired about 1000 lawn mowers for a net profit of \$2,600." says E. G.

**FREE PLAN** tells how to start in spare time. **FREE BOOK** shows how to sharpen all power mowers. You make 99% profit! Low prices — easy payments. Write today.

**FOLEY MFG. COMPANY**

1207-1 Foley Building  
Minneapolis 18,  
Minn.

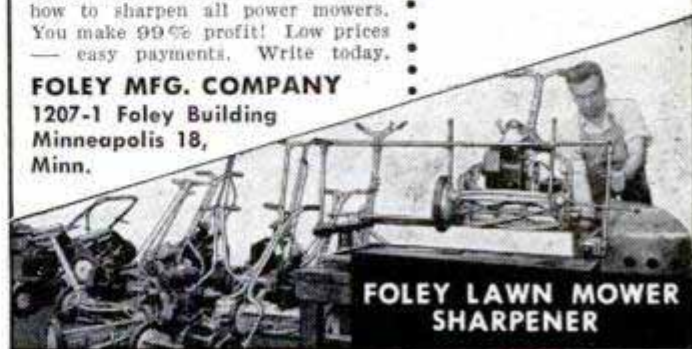

**FOLEY LAWN MOWER  
SHARPENER**





GIVE THE WORLD'S  
BEST HAND TOOL

# WISE-GRIP WRENCH



LOWAS  
\$1.85

No Other Tool  
Does So Much So Easily

WISE-GRIP gives one hand Ton Gripping power—can't slip! Has 1000s of uses as a Locking Wrench, Adjustable End-Wrench, Pipe Wrench, Pliers, Vise and Clamp. It's positively the handiest tool a man can own.

Order From Your Dealer.

PETERSEN MFG. CO., Dept. M-12, DeWitt, Nebr.



## AMAZING TOOL BARGAINS!

ALL BRAND NEW MERCHANDISE

**12 MINIATURE CUTTERS \$1.00**  
FOR CUTTING WOOD, PLASTIC, or METAL. Actual size, Ass't. shapes on 3/32" shank. For die makers, home workshop, etc.

**SURPRISE VALUE 100 Pieces FOR ELECTRIC GRINDERS \$1.00**  
Post Paid in U.S.A.  
Grinding Wheels, Cut-off Wheels, Sanding Discs, Mounted Stones, Sharpening and Honing Stones, Rotary Cutting Burs, Abrasive Cartridges, Mandrels, and many other items.

**12 MOUNTED WHEELS \$2.95**  
and points on 1/8" Mandrel. For grinding on plastic, wood, soft and hard metals. Regular \$8.40 List Val.  
**12 wheels on 1/4" Mandrel \$3.60**  
**18 MOUNTED POINTS ON 3/32" MANDREL \$2.50**

**112 Piece Assortment FOR ELECTRIC GRINDERS \$3.95**  
P.P. ONLY  
Here's what you get! Mounted Stones on 1/8" mandrel, Drum Sander, Sanding Sleeves for sander, Rotary Cutters, Wire Scratch Brush, Bristle Brushes, Circular Saw, Buffing Wheel, Grinding Wheel, Rubber Polishing Wheel, Cut-off Wheels, Rubber Cylinder, Mandrels to fit above tool, ass't'd. Sanding Discs, Sharpening Stone, etc.  
**\$10.00 VALUE \$3.95 P.P. ONLY**  
SCHUPACK SUPPLY CO., 7331 Cottage Grove, Dept. M-25, Chicago 19, Ill.  
Illustrated Catalog 10c

**MAGNETS OF ALL TYPES - 10c UP**  
AMAZINGLY POWERFUL!  
1/2 lb. magnet lifts 25 lbs. \$1.95  
Our Leader, 1 lb. magnet lifts 40 lbs. \$2.05. New alloy—will not weaken! Useful for lifting valuables from tanks, jakes, or rivers easily! 7 small magnets \$1.25 with list of many shop and home uses. Satisfaction guaranteed.  
R. EYRICH, 1219 W. MEINECKE AVE., MILWAUKEE, WIS.

**DRILL PRESS OWNERS!**  
**HERE'S 1 TOOL WITH 5 DISTINCT USES**  
**THE BARRON MULTI-PURPOSE ROTARY WOOD PLANER**  
PLANES & SURFACES • PANELS & BEADS  
ROUTS & GROOVES • RABBETS • TENONS  
FINEST precision performance—certainty of skilled workmanship—time-saving, money saving short cuts—yours with world famous Barron Drill Press Tools. Fifteen important operations—all available on any standard drill press—with Barron Accessories. Equip your shop with these versatile exclusively designed tools—and save up to \$500. 200,000 Barron owners have bought on our liberal 10 day full money back guarantee. Order, or write for catalog.  
**BARRON TOOL CO. INC.**  
365 Architects Bldg., Detroit 1, Mich.

**\$7.50 COMPLETE**

**FREE Workshop Guide & Catalog**

**SHARPEN SKATES!**  
**NEW ICE SKATE GRINDER**  
grinds all makes and types of ice skates!

Here's a speedy way to make extra money all winter! Sharpen ice skates of any type on the new Ideal Model 50 Bench Grinder, with skate grinder attachment. It's the finest—and FASTEST—method. Write TODAY for free folder with complete money-making facts!

THE FATE-ROOT-HEATH CO., Dept. J-3, Plymouth, O.

POPULAR MECHANICS

**Spare Time**  
**\$3.00 AN HOUR**  
**PAYS 3 HOUR**  
**and MORE**  
**with**

## UNIVERSAL Lawn Mower Grinder

Here is a business you can start in your own garage or basement. Sharpen hand and power mowers on the Universal Grinder and make \$3.00 to \$5.00 an hour.

G. Spurlock of Arkansas writes: "I have had my Universal Grinder only 2 months. Live 2 1/2 miles from town. Yet have already made \$227 net profit." J. L. Peterman of Pa. says: "I averaged \$100.00 a week in May, and made \$1,000.00 spare time this season."

**REMEMBER—Only on the UNIVERSAL GRINDER can the inside face and edge of the stationary blade, as well as all of the reel blades, be ground to the proper clearance**

**ALL IN ONE SET-UP**

**WITHOUT REMOVING ANY BLADE FROM THE MOWER**  
Rogers Mfg. Co., Dept. M-121, Lindsey, Ohio

### SEND THIS COUPON NOW

**ROGERS MFG. CO., Dept. M-121, Lindsey, Ohio**  
Please send me full facts about the Universal Lawn Mower Grinder and its big money making opportunities.

NAME \_\_\_\_\_  
ADDRESS \_\_\_\_\_  
CITY \_\_\_\_\_ STATE \_\_\_\_\_





## Wellworth AIR COMPRESSOR

**For Farm and Home Workshop**  
Compressor has 2" bore, 1 3/4" stroke, 2.8 cfm up to 150 lb. pressure. Motor required: 1/4 h.p. at 100 lbs.; 1/3 h.p. at 125 lbs.; 1/2 h.p. at 150 lbs. or equivalent gas engine. V-belt drive, intake muffler and cleaner, bronze bearings, splash lubrication. Wt. \$20.50  
16 lbs. Replacement parts always available.

**COMPLETE OUTFIT.** Compressor, pressure tank, air gauge, air chuck, 20 ft. hose, pop valve, copper tubing with 4 brass flared fittings for connecting compressor to tank, 4-way cross and 3 nipples. **\$32.45**  
**COMPLETE OUTFIT, wt. 30 lbs.**.....  
Equipment less compressor **\$12.45**  
Tank only. **\$6.25**



**NEW!**

**\$32.45**  
All Brand New Equipment

## BARGAIN LIGHT PLANT

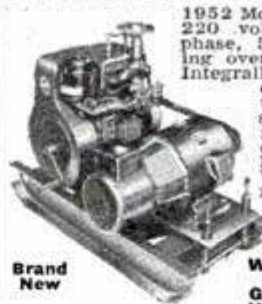

1952 Model. 5000 watts, 110/220 volts. 60 cy. AC, one phase, 50 amps. Takes starting overload up to 87 amps. Integrally mounted separate exciter giving exceptional overload and surge capacity for starting motors. Drip-proof constr. Ball bearing. Lifetime lubrication. Voltmeter, 2 plug-in receptacles. Wisc. air cooled, 2 cyl. 4 cy. 10 1/2 HP engine. Special Price **\$525**  
Wt. 575 lbs..  
Generator only **\$325**  
Wt. 225 lbs..

Brand New

## WELLWORTH COMPRESSOR BUY

### 1 Year Guarantee

**FEATURES:**  
2 compression and one oil ring, aluminum alloy connecting rod. Stainless steel valves with brass seats and retainers. Cool-flo cylinder head, spray mist lubrication to every moving part. 10 1/4" V groove fly wheel for 5/8" B section belt.



#### MODEL W3

2 1/2"x2", 2.55 to 4.80 c.f.m. up to 150 lb. pressure. Operates with 1/3-1/2-3/4 HP motor. Special Price **\$27.95**

Shipping wt. 24 lbs.

#### MODEL W7

2 cylinder 2 1/2"x2", 5.10 to 8.50 c.f.m. up to 150 lb. pressure. Operates with 1/2-3/4-1-1 1/2 HP motor. Special Price **\$54.50**

Shipping wt. 45 lbs.

## 1/12 H.P. MOTOR



Delco 110V. 60cy. A.C., 1 phase 1750 r.p.m. 2 amps., will take 50% overload. Shaft 3/8" x 1 1/4". Heavy duty, bronze sleeve bearing. Size 6" long, 5" high, net wt. 12 lbs. List **\$21.00**

Special Price **\$13.50**

Lots of **\$12.50**

3, ea....

## GENERATORS

### ... Big Values

500 to 750 watt, A.C., 110-120 volt, 60 cycle. 1 phase output. Also 100 watt D.C. battery charging output. May be used at the same time. Voltmeter, 2 outlet boxes. Wt. 55 lbs. Price **\$99.50**  
Furnished with 1 1/2 HP Engine with drive **\$142.50**



## RED SEAL CONTINENTAL GAS ENGINE



**BRAND NEW.** 1 1/2 HP with 6 to 1 reduction gear. Operates at 450 R.P.M. For lawn mowers, scooters, garden tractors, pumps, compressors, generators, etc. List Price **\$79.50**

Shipping wt. 54 lbs. SPECIAL PRICE **\$47.50**

(BRAND NEW)

## WELLWORTH V-BELT CLUTCH



BRAND NEW

Takes starting load off engines or motors. When speed is reached, a flip of handle shifts clutch from idling to driving position. Handles "A" belts, 2.35" pitch diameter, 5/8" bore. Ideal for use with lawn mowers, garden tractors, home workshop motors, etc. 3 1/4" long. Safe, easy to mount, sealed bronze bearings, positive action. Shpg. wt. 3 lbs. **\$7.50**  
**BUSHING FOR 1/2" SHAFT 15c**

## "Wellworth" BLOWER BARGAIN



**BRAND NEW**  
Quiet operating. Double wheel inlet, double wheel blower. For heating, ventilating, cooling, air washing, exhausting and forced draft. DIMENSIONS: 10" wheel; outlet 13 1/8"x11 3/8"; inlet 8 3/4". Height 19". Width 18". Depth 10 1/2". C.F.M., 1/4" S.P. 1600; outlet vel. 1575. Wt. 45 lbs. **\$27.50**

**BLOWER LESS MOTOR AND DRIVE**  
With belt and variable speed pulleys, \$2.50 extra. Special price to dealers in lots of 5 or more. Write us.

## SAVE \$10.00 ON A DRILL-O-MATIC ELECTRIC POLISHER and 1/4" DRILL



Polishes floors, furniture, automobiles; does sanding, drilling and buffing jobs. Handy family Work-Aid. Limited number available. Act fast. **IDEAL GIFT.** Drill and Polisher combination, 110 Volt A.C. Disc Polishing Bonnet; 1/4" Jacobs chuck; horizontal bench stand; 42" polishing handle; wire wheel brush; 2-mounted wheels; 2-drill bits; spindle adaptor; buffing wheel; 6-abrasive discs; 1-grinding wheel; paint mixer; 12 ft. cord & plug; drill handle; steel hinged carrying case with handle and lock clamp. Wt. 9 lbs. **24 Pieces. IDEAL GIFT, 50,000** were sold at **\$28.95.** Our special price, only **\$14.95**

PRICES F.O.B. CHICAGO. MONEY BACK GUARANTEE. SEND CHECK OR MONEY ORDER TODAY. PROMPT SHIPMENT. WRITE FOR CATALOG. SEND 10c FOR POSTAGE.

## 2000-2500 WATT LIGHT PLANT

Heavy duty windings

110 v., 60 cy., A.C., takes starting overload up to 5000 watts. Floating Base for Automatic Belt Adjusting, 2-Groove Engine Pulleys, V-Belts, Bolts, etc. 5 H.P. Wisconsin or Briggs & Stratton Model 14 Engine. Voltmeter, 2 plug-in receptacles. Portable Tubular Steel Skid Type Carrier. Dim.: L 34 3/8" x W 17" x H 20". Wt. 180 lbs.

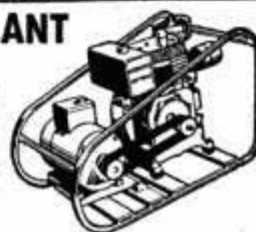

**\$299.50**

Generator only, with voltmeter, 2 plug-in receptacles. Shipp. Wt. 75 lbs. **\$169.50**

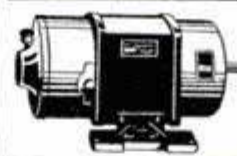

## LELAND GENERATORS

2500 watts, 110 v. 60 cy. single phase 1800 r.p.m., self excited. Fungus treated for long life. 1951 model. Brand new, in original factory crate. Shipp. wt. 135 lbs. List \$375. SPECIAL PRICE **\$237.50**

## AIR TANK & ACCESSORIES

Brand New steel 6"x24", 400 lb.-test. Ideal wherever compressed air is needed. Equipped with 500 lb. combination air gauge and inflation valve with core for retaining pressure in tank; tire chuck. 3 ft. high test air hose. Ship. wt. **\$7.95**  
12 lbs. Complete outfit.....



## "Wellworth" PRESSURE TANK

7"x25" Welded Steel. 3/8" opening on each end, 1/4" and 3/8" opening at centers. Convex Head and Bottom. 100 lbs. working pressure. Shipping wt. 17 lbs. **\$9.75**

Same tank, 9"x27" wt. 28 lbs. **\$14.50**

## WELLWORTH TRADING CO.

1832 S. WABASH AVE. Dept. D-12 CHICAGO 16, ILL.

## Communication Problems Solved! with ARMY FIELD TELEPHONES & WIRE



Construction men, engineers, farmers, and industrial men everywhere are using portable Army Field Telephones for quick, dependable 2-way to 8-way communication. These phones were built to serve combat forces reliably under battlefield conditions. Simple to install. Just string this 2-conductor wire, attach phones, ring and talk any distance up to 17 miles! Powered by flashlight batteries. No maintenance required.

**ACT NOW! LIMITED SUPPLY!**

All prices FOB Sacramento. No COD. (Calif. residents add 3% for sales tax.)

Write for **FREE FOLDER.** Send check or money order  
**LORIS SALES, P. O. Box 1896-B12, Sacramento, California**

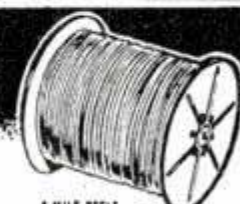

## TELEPHONE WIRE

ALL-PURPOSE — ALL-WEATHER

This is genuine W110B Army Field Wire on original steel reels. Insulated, 2-conductor, copper-steel strands. Excellent for all types of communication. Used extensively by telephone companies, industry, engineering projects, ranches, public address systems, etc.

**GRADE 1 — Unused, excellent condition.**  
Mile Reels **\$19.50** Half-Mile Reels **\$10.00**  
(wt. 160 lbs.) (wt. 80 lbs.)  
500 ft. reels, **\$4.95**

**E68 FIELD TELEPHONES**  
Factory reconditioned.  
Ea. **LIKE-NEW.** Per pr. **\$16.50** **\$32.50**  
**USED—FACTORY TESTED**  
Ea. Per pr. **\$15.00** **\$29.50**  
**GUARANTEED**



**SAVE 85% in WAR SURPLUS**

**FAMOUS GSAP**

**16MM CAMERA**

That famous "gun camera" used by the Navy & USAF. Now adapted to hand use for making professional or amateur movies. Takes pictures in B & W or full Color. Has 1-3/8" lens, built-in exposure guide and shade. Adjustable for 3 SHUTTER SPEEDS - 16, 32 & 64 frames per second. Uses regular Eastman magazines (50 ft). Requires no winding - no film threading. Comes complete with "ZOOM" Range-finder & Battery Box. Operates on 24 volt current supplied ordinary flashlight batteries. **READY TO USE!** (Needs only film & batteries).



**44<sup>95</sup>**

**150 POWER ALL PURPOSE COMBINATION MICROSCOPE**

A TRIPLE PURPOSE INSTRUMENT. Small and compact yet Powerful! Has a tilting stand with mirror reflector and slide stage for USE IN THE LABORATORY. . . Will magnify surface views up to 150 POWER when separated from stand to USE AS A POCKET MICROSCOPE. . . Has an attachment to hold slide directly in the instrument for using as FIELD MICROSCOPE. COMPLETE WITH SLIDES & LEATHER CASE.



**7<sup>95</sup>**

**WATCHMAKER'S LOUPE'**

An indispensable aid to the Jeweler, Scientist, Watchmaker, Instrument Repairman, Lab Technician, Machinist, etc. Available in several powers. 2-1/2 - 2-3/4 - 3-1/4 - 4 and 5 Power. EACH -

**7<sup>9</sup>**



AN IDEAL XMAS GIFT

**8 POWER COATED LENS TELESCOPE**

A very handy instrument for spotting distant objects. Small as a pocket pen yet has full 8 POWER magnification. Has expertly ground, precision polished lenses. Body is made of fine grade, polished metal with pocket clip. Easy focusing. 8X expansion. A \$10.00 Value.



100% VALUE \$4<sup>95</sup>

**SWISS PATTERNED NEEDLE FILES**

The ideal set for the model maker, technician, repairman, etc. Made of the finest quality, Sheffield Steel, specially hardened and accurately machined for precision filing. Set of 12 ass't shapes - A \$5.00 Value -

**2<sup>95</sup>**



**LUND TRAILWAY SNOW SHOES**

Genuine LUND Snow Shoes. Size of frame is 10" by 52". The one-piece, special hardwood frames are faced with good quality, water-proof, thongs. Designed for faster, easier travel. . . . 7 Ft. G.I. SKIS with metal edges. . \$13.50

22.50 VALUE 14<sup>95</sup>

**SKI POLES**

Natural cane or laminated steel pole with leather faced snow ring. Pole is metal tipped. Has wrist straps. Length is 4 feet. Ideal for use with skis or snow shoes. A Palley Value at

Only 3<sup>95</sup>

**NEW! GENUINE ARMY SKI PATROL PARKAS**

Made of heavy White Duck. Wind and water resistant. Slip-over type with draw strings on each cuff and around waist and hood. Neck has four tie-straps for adjustment. Body is finger-tip length with 2 large outer pockets. Ideal weather protection for the outdoor sportsman, hunter, farmer, rancher, etc. A BUY!

**2<sup>49</sup>**



**NEW GOGGLES**

Soft, molded rubber frames, chamois lined. Comes with 8 lenses, 2 clear, 2 amber and 4 Green. All lenses are easily and quickly inter-changeable. COMPLETE

**3<sup>95</sup>**



**PALLEY SUPPLY CO.**

DEPT. P.M.12  
6321 SAN FERNANDO RD  
GLENDALE 1, CALIF.

SEE AD ON OPPOSITE PAGE FOR TERMS!

**GET 150 MILES PER GALLON**

**ENGINEERS HAVE PROVEN THIS POSSIBLE WITH MODERN CARS!**

The Electronic Spark Intensifier is only one of many ways you can gain "peak" performance. The manufacturer guarantees the following results or it costs you nothing!

- More Power
  - Better Mileage
  - More Speed
  - Quicker Starting
- Easily installed in the center hole of the distributor cap of all cars, trucks and tractors, the intensifier boosts the high voltage passing through the distributor . . . giving a "hotter spark." This permits a wider spark gap which reduces misfiring and consequent ring and cylinder wear. **FREE TRIAL**, send \$2.00 cash, check or money order . . . if not fully satisfied, return for full refund.



**ELECTRONIC DEVELOPMENT CO.**

Dept. PM-12, Box 17716 Los Angeles 34, Calif.



**CAPE COD CHAIRS TRELLISES • ARBORS DUTCH WINDMILLS**

ent trellis designs PLAN of all 12 only 50c. Authentic 40" high Dutch Windmill Detailed PLAN only 75c. Unique 40" high Light-house having copper lantern, ideal for garden or on lake shore of summer home. Large detailed PLAN 75c. **SPECIAL ALL PLANS ABOVE \$3.00 VALUE ONLY \$2.50** SEND 10c for catalogue of many fine projects.

Chairs style B-C-A PLANS 50c Ea., all 3 only \$1.00. 12 different

**CRAFTSMAN'S MODEL CO. DELAFIELD, WISCONSIN**



**NEW SAW SHARPENER**

Improved #64 Hand Gummer sharpens all types circular saws 4" to 20" diam. Ideal for saw shops. Self-centering adjustment for quick, easy set-ups. Complete with 1/4 HP motor, 1 grinding wheel & cord. \$79.50 FOB Portland. Wt. 70#. SEND FOR FREE LITERATURE.

**P. T. HOBBS MACHINERY**  
8375 N. INTERSTATE AVE.  
Dept. P.M.-61, PORTLAND 17, OREGON

**DO MORE PLANING JOBS WITH LOW-COST BELSAW \$215<sup>00</sup>**

**AMAZING 12 1/4-IN. PLANER Does All Ordinary Planing Mill Jobs.** Provides attachments for Jointing, Rabbeting, Tongue, Groove, Matching, 12 1/4 x 6-in. capacity, 3-knife solid round all-steel cutterhead. Power feeds at 24 feet per minute, 42 cuts per inch. Provides for full line of accessory attachments—Grind and Joint knives IN THE CUTTERHEAD WITHOUT REMOVING.



FREE BOOK

**BELSAW MACHINERY CO**  
1018 Field Bldg., 315 Westport Rd., Kansas City 2, Mo.

POSTPAID ANYWHERE IN U.S.A.

WE FURNISH ALL MACHINED METAL PARTS, EVERY SCREW, NUT, BOLT, WASHER, AND COMPLETE PLANS FOR THIS . . .



**BIG 10" POWER SAW**

\$10<sup>95</sup> FULL REFUND IF LESS GUARD NOT SATISFIED & WOOD IN 10 DAYS

ASSEMBLE IT YOURSELF WITH SIMPLE HOUSEHOLD TOOLS!

COMPLETE PLANS 10c  
**MARCUS-POLLAK**  
DEPT. N, ROYERSFORD, PA.

**DELCO MOTOR**

**\$5<sup>25</sup>**

You can't beat this sensational buy! Triple Rubber Mounted DELCO Motor for fans, refrigeration, air conditioning units, etc.

1/75 H.P. 115 Volt 50-60 Cy. A.C. 1500 R.P.M. Over-all Ht. 7 3/4".  
Tested! Guaranteed! Powerful! Quiet! Cool Running! Immediate delivery. ORDER NOW!  
Weight, 5 lbs. complete with suction blade.  
10 day money back guarantee  
Send check or money order



**FREE: WRITE FOR LARGE ELECTRICAL, PLUMBING, AND REFRIGERATION CATALOG**

Dept. PM 12 4300 N. W. 2nd Avenue  
**MARKEL INDUSTRIES, INC. MIAMI 37, FLORIDA**



## FOAM RUBBER

**In Slabs, Sheet stock & molded, preformed Cushions, Mattresses & Pads.** Use for upholstery, beds, pillows, nooks, chairs, sofas, patio & yard furniture, auto seats, boat deck pads, etc. Priced FAR BELOW current market.

**CORED STOCK**—Smooth one side, "cored" on other side to give maximum resilience & reduce weight. Ideal for chairs, cots, beds, bunks.

thick. — per sq. ft. thick — per sq. ft.			
1" .....	.80	3" .....	\$1.70
1 1/2" .....	1.10	4" .....	3.00
2" .....	1.50	4 1/2" .....	3.14

**SLAB STOCK**—Smooth both sides. A solid but spongy material. Used for pads or shock-absorbing layer pads.

Thick	Per sq. ft.
1/4" .....	\$.25
1/2" .....	.50
3/8" .....	.38
3/4" .....	.75
1" .....	1.00

**PALLEY'S WILL CUT** the Slab or Cored Sheet Stock to your needs. However all pieces must be rectangular or square in shape, at least 1 sq. ft. or larger.

**TOPPER PADS**

25" x 60" x 1 1/4"	\$7.95
25" x 60" x 1 1/2"	8.95
25" x 65" x 2"	9.95

**SEAT PADS**

22" x 18" x 3"	\$5.00
22" x 20" x 3 1/2"	\$5.00
35" x 18" x 4"	\$10.75
20" x 20" x 5"	\$6.00

## 17 Power Telescope

A fine quality, IMPORTED instrument. Gives a bright, clear image with a wide field of view. An ideal telescope for all-around use. **ONLY 7.95**

**20 inch TANK TELESCOPES**  
3 Power..\$4.95—20 Power..\$8.95

## EXACTOR HYDRAULIC REMOTE CONTROL MASTER & SLAVE

Consists of two units. Designed to operate controls on boats, machinery, engines, motors, etc. without need for rods, cables, pulleys, etc. When connected with 1/2" tubing & filled with oil they act as a precision, remote controller. When Master handle is moved, Slave arm responds in exact motion. Range is 0 to 90 degrees. **42.50**  
Combination Master & Slave for MASTER only — For an extra control... **21.25**

## MICROPHONE

Telephone type, highly sensitive with excellent, clear tone. This was the Signal Corps favorite. An ideal instrument for the radio "ham" and professional recording studio, broadcasting, home recording, public address, etc. Complete with cord & plug... **3.29**  
A SENSATIONAL BUY!

## 200Pg. CATALOG

1000's of MONEY SAVING BARGAINS for the Mechanic, Housewife, Manufacturer, Hobbyist, etc. Clothing, Tools, Machinery, Metals, Electrical Supplies, Motors, Rubber, Plastics, Hydraulic supplies (cylinders, pumps, motors, valves, fittings, hose, etc.) SEND Only 50¢ to cover mailing & handling

**PALLEY SUPPLY CO**  
DEPT. PM2, 6371 SAN FERNANDO RD.  
GLENDALE 1, CALIF.

# SAVE UP TO 85% IN WAR SURPLUS

## PORTABLE GEIGER COUNTER RELIABLE

A SUPER-SENSITIVE, RADIO-ACTIVITY DETECTOR! Small enough to fit into a pocket or the palm of your hand, yet powerful enough to detect the slightest presence of radio-active matter. Now anyone can get in on the search for valuable mineral deposits with the prospect of RICH REWARD! An ideal instrument for use in PROSPECTING, CIVILIAN DEFENSE, LABORATORIES or SCHOOLS. You'll marvel at its reliability under any conditions — you'll appreciate its clear, audible "click". Size: 1 1/2" x 3" x 5". Weighs only 1 1/4 lbs. Fully guaranteed. Complete with headset and ready to use. **24.95**

## D.C. ARC WELDER

300 AMPS CONTINUOUS  
350-400 AMPS. INTERMITTANT  
For light or heavy duty work. Will easily handle welding up to 1/2" plate. Made to operate continuously, giving years of trouble free service. Built around that famous B-29 (R-1) generator incorporating many features no other generator has. Unit includes pulley re-actor output controls. Hi-lo switches & rheostats. All assembled on heavy steel frame and easily adapted to mounting on jeep or tractor for portability & power supply. Can be run on 7 1/2 H.P. electric or 10 H.P. gas motor. Generator alone cost Gov't \$400! **NOW ONLY 97.50**

## NAVY Sealed Beam LAMP

U.S. NAVY portable search-spot light. Has pistol grip and aiming sight. Makes an ideal search, spot or emergency light for auto, boat, etc. **3.29**  
12V. light — 4" lens... **3.79**  
24V. light — 4" lens... **9.95**  
Set of 3 filters: red, green, amber (specify type lamp).....

## NAVIGATORS LAMP

A handy light for desk, workbench, chart table, engine room, etc. Can be used on 6-12-24 & 110 Volt by changing bulb. 3 ft. shaft has 4 joints to adjust position. **3.29**

## TACHOMETER

Operates on direct drive with a flex shaft from camshaft or at 2 to 1 reduction from crankshaft. Range is 0 to 4500 R.P.M. Ideal for planes, boats, autos, etc. **4.75**

## HUNTING KNIVES

GENUINE G.I. EQUIPMENT. Has a 6 inch, polished Vanadium blade & Handle made of leather and fibre discs. Complete with tanned leather sheath. Only **1.98**

## Hunting & Field BOOTS

Has 14", sturdy leather uppers & genuine, all-rubber shoe with felt inner sole. Designed to wear over ordinary shoes and protect feet from water — ice and snow. An excellent ALL WEATHER BOOT. **3.95**

## HAND LINE

Rot-proof, weather resistant, hard linen line. Originally used as hand line in fishing for tuna, marlin, etc. Also has many uses around farm, factory, etc. NEW in 300 ft. lengths. **1.69**

## CHEMISTRY SET

Made for Chemical Warfare Division for testing water, etc. A handy addition to the chemistry lab, or an exciting experiment for the amateur. Set includes test tubes, complete instructions, 15 different items. Packed in attractive lucite box with cover and dividers... **1.89**

## A.F. FLEECE LINED JACKET

GENUINE LEATHER Will keep you warm and comfortable in the roughest weather. Has fleece lining throughout... sleeves & body. Two roomy, slash pockets & full zipper front closure. Really an ideal jacket for all Outdoorsmen... Hunters, Farmers, Mechanics, Ranchers. RE-CONDITIONED in WONDERFUL CONDITION. **14.95**

## B-15 JACKET

That "cold weather" jacket you will be proud to wear! Water repellent, wind resistant, Nile Green, Oxford Cloth Full, sturdy, zippered front. 100% Alpaca Wool lining in body & sleeves. Has a large Mouton Fur collar & 2 roomy slash pockets. Ribbed cuffs. Sizes: 36 to 46... **15.95**  
A PALLEY SPECIAL

## FLYING HELMET

Fine grade leather — Chamois lined with chin cup and strap. Intermediate weight. **1.59**  
NEW — ONLY  
ALL NEW! Winter type with fleece or chamois lining. Has ear puffs and chin cup. Ideal for pilots, cycle-drivers and sportsmen. **ONLY 1.95**

## Aviators (AN-5310) Windproof & Durable GOGGLES

Rubber or chamois covered frame. Clear or green GROUND LENSES are interchangeable. Adjustable nose bar. Ideal for flying, motorcycling, etc. **2.19**

## GO-1 GOGGLE KIT NEW! U.S. NAVY

Has soft sponge rubber frame. 4 Polaroid lenses, 2 green; 1 red; 1 clear. Perfect for racing, cycling, etc. **SPECIAL 89¢**

## SILK PARACHUTE, CAR COVER—24 ft in diameter (approx. 50 sq. ft.) Enough to cover any car or small truck. Heavy, double stitched seams. **16.95**

## 16 POCKET VEST

The ideal jacket for the Rifleman or Hunter... Has 14 individual, outside pockets for shells, glasses & other accessories. 2 large (11" x 8") inner pockets, a leather holder for knife, gun or tool. Sturdy, yet lightweight with tie-straps at back for adjustable fit... **3.49**

## T.V. ANTENNA

Tune in on this amazing offer. A complete "V" Cone, Antenna Kit containing a 6 ft mast, 60 feet of lead-in wire, 25 ft of guy wire, 3 roof hooks and 3 brackets. \$13.50 Value... **SPECIAL 8.95**

## Navy WADING SUIT

Adds real pleasure to surf & deep stream fishing. Made of rubberized canvas. Vulcanized seams. Has inner air pockets, to give buoyancy & balance in deep water. Finest quality, rubber gloves & 1/2 length rubber boots attached to sleeves and pants legs... **6.95**  
SIZES: small; medium; large

ORDER FROM THIS AD. All sales final. Prices F.O.B. Glendale. Pay by M.O. or Check. P.O.'s accepted from D & B. Firms. 1/2 deposit with C.O.D.'s.

# LARGEST FIRM OF ITS TYPE IN THE WORLD

DECEMBER 1951



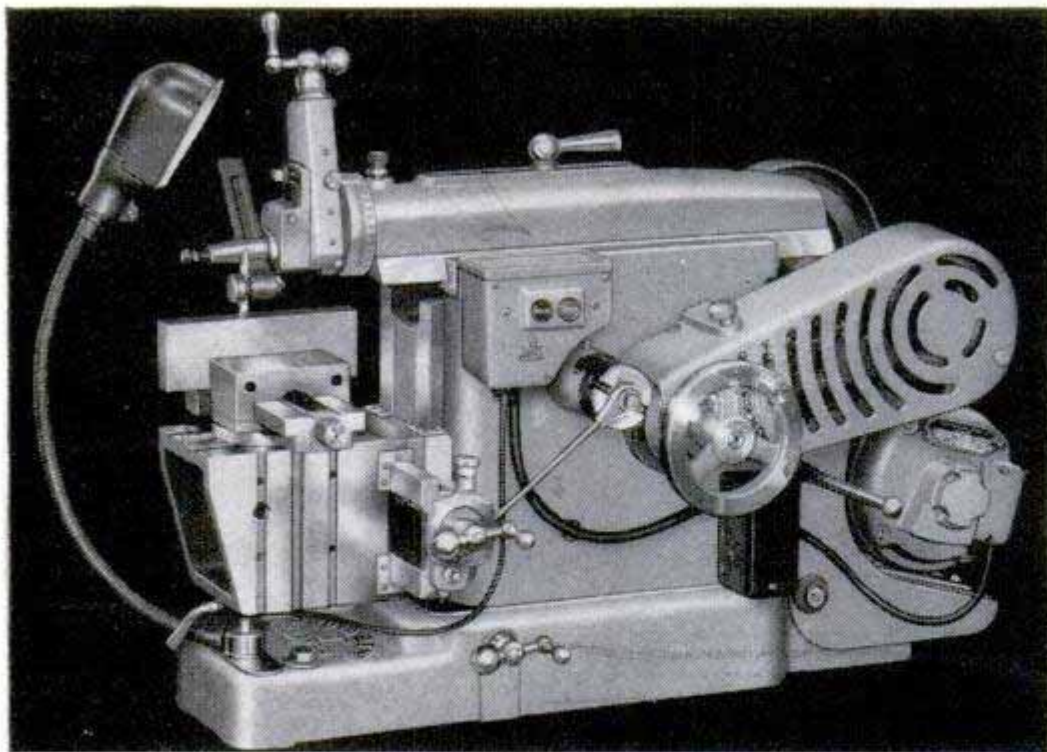

## SOUTH BEND 7" PRECISION SHAPER

Precision engineered and sturdily constructed, this compact bench shaper has the built-in accuracy and rigidity for rapid machining on small parts. The stroke rate per minute is higher than for larger shapers, permitting greater production on work within its capacity. The ease of setting up work in the bench shaper, its high operating speeds, and low power consumption keep costs at a minimum. A number of practical attachments can be supplied to increase its versatility on toolroom, production, or maintenance work. Check coupon for literature.

**SPECIFICATIONS: RAM**—Stroke length—0 to 7". Strokes per minute (4)—42 to 195. Cutting speeds—3 to 114 feet per minute.

**TOOL HEAD**—Vertical feed—3". Swivels—360°. Tool post opening—13/32" x 7/8".

**TABLE**—Horizontal travel—9 1/2". Vertical travel—5". Power cross feeds (6)—.002 to .012". Ram clearance—1/2 to 5-1/2". Table size—5-3/8 x 5 x 6-5/16".

**WISE**—Jaw width—4". Jaw depth—1". Maximum opening—4". Swivel base.

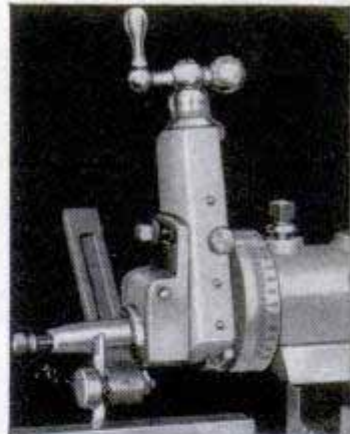

Tool head locks in any position. Rugged clapper box is adjustable.

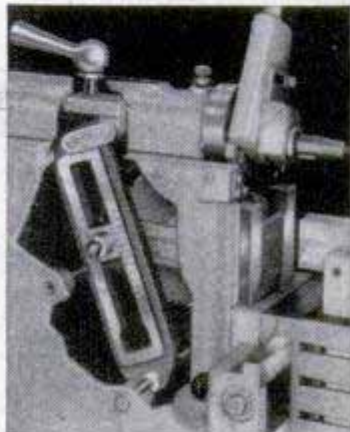

Rocker and crank with graduated eccentric adjustment for stroke.

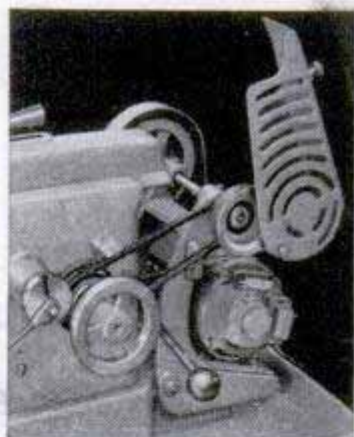

Guards on all pulleys and belts. Quick-acting belt tension release.

SEND INFORMATION  
CHECKED:

\_\_\_\_\_



9" and 10"  
BENCH LATHES



10" to 16-24"  
FLOOR LATHES



1/2" and 1" Collet  
TURRET LATHES



14"  
DRILL PRESSES



7"  
BENCH SHAPERS

Name \_\_\_\_\_ Company \_\_\_\_\_

Street \_\_\_\_\_ City & State \_\_\_\_\_

Building Better Tools Since 1906 • SOUTH BEND LATHE • South Bend 22, Indiana



Printed by Popular Mechanics Company, Chicago, Ill., U. S. A.





PATENTED  
**CORALOX**  
INSULATOR

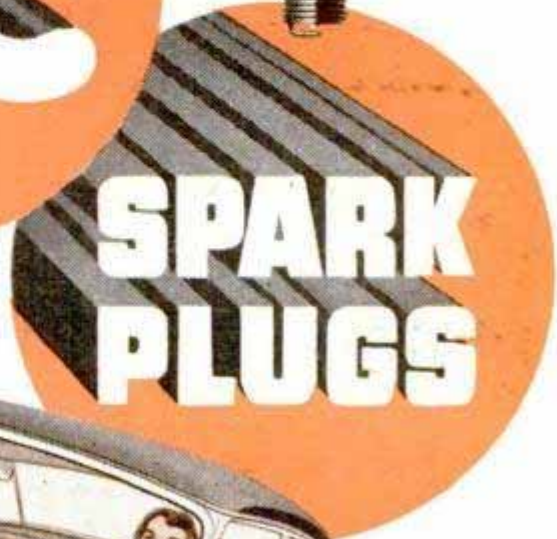

**SPARKING  
THE OLDSMOBILE  
"ROCKET"...**



**... and used as factory  
equipment on more of America's  
new cars than any other make**

What have AC Spark Plugs for Oldsmobile got that other plugs haven't? They have *CORALOX*, AC's patented Insulator, which has set the engineering world a-buzzing.

Oldsmobile was quick to see the advantages of this revolutionary invention—and to cooperate with AC in selecting a plug type exactly suited to the famous "Rocket" engine.

Necessity was the mother of *CORALOX*. This rugged insulator simply *had* to be invented, because previous types of spark plug insulators couldn't stand up under the operating conditions imposed by modern high-compression engines and modern fuels. They cracked and blistered under the extreme heat—they fouled and misfired under heavy load, when power was needed most.

*CORALOX* ended all that—brought spark plugs to an all-time pinnacle of efficiency.

AC Spark Plugs with patented *CORALOX* Insulator are therefore standard, not only on the Oldsmobile "Rocket," but on more of America's new cars than any other make. That's how good the newest AC Spark Plugs are. They are helping thousands of Oldsmobile owners to preserve top engine performance—and they'll do the same for you.

• • •

***IF YOUR CAR ISN'T AN OLDSMOBILE*** you, too, can have the superior performance ensured by *CORALOX*. AC's engineering staff has worked with engineers of most American cars. Therefore, there is an AC Spark Plug type, with patented *CORALOX* Insulator, engineered for your engine.

AC SPARK PLUG DIVISION



GENERAL MOTORS CORPORATION



# YOU'RE SET...

# YOU'RE SAFE...

# YOU'RE SURE!



Here's a tip! Many anti-freezes are made of methanol—which is actually boil-away alcohol. Be sure to ask your anti-freeze dealer before you buy any brand. Remember, there's not one drop of boil-away alcohol in "Prestone" anti-freeze. It's guaranteed!

# "PRESTONE"

BRAND

## ANTI-FREEZE

*One shot lasts all winter!*

NATIONAL CARBON COMPANY • A Division of Union Carbide and Carbon Corporation  
30 EAST 42nd STREET, NEW YORK 17, N. Y.

"Prestone" and "Eveready" are registered trade-marks of Union Carbide and Carbon Corporation

