



POPULAR MECHANICS

MAGAZINE

WRITTEN SO YOU CAN UNDERSTAND IT

REG. U.S. PAT. OFF.



See Page 100



The Owners Report on the
'51 CHRYSLER
 You'll Build Your Next Home
 of **MOLASSES!**
 Popular Mechanics Sponsors

TODAY'S BIG VALUE IN AUTO POLISH

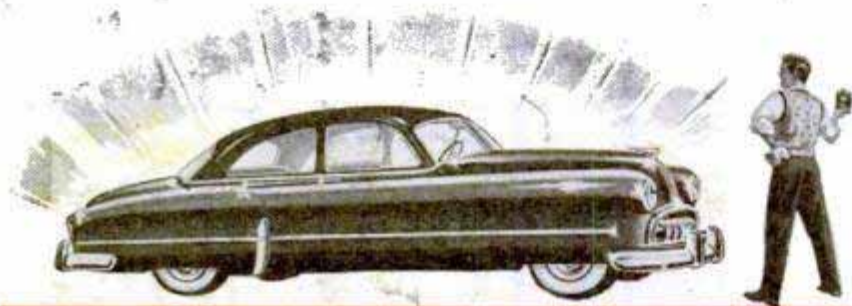

DuPont No. 7 Polish

1. SHINES AS IT CLEANS!

You clean off dirt film . . . put on a super-shine at the *same time* with Du Pont No. 7 Polish. It's the quick, easy way to keep your car beautiful.

2. MUCH LESS WORK!

Does the job faster because it contains "stroke-saving" methyl cellulose, found only in the Du Pont patented formula.

3. SAFE FOR ALL CARS!

No. 7 Polish is made by Du Pont, maker of "Duco" and "Dulux," leading automobile finishes. It's absolutely safe for all car finishes.

4. SAVES YOU MONEY!

Still only 75¢ for a pint. And it does the *whole* job. Cleans up, shines up! Get a can today at your service station or dealer's.

Only

75¢

A PINT

AT MOST STORES



BETTER THINGS FOR BETTER LIVING . . . THROUGH CHEMISTRY

MAKES *Gas* FROM *Oil!*

TIMKEN
Silent Automatic

**WALL-FLAME
OIL BURNER**

**CONVERTS FUEL OIL
INTO A GAS, THEN
BURNS THE GAS WITH
AMAZING EFFICIENCY!**

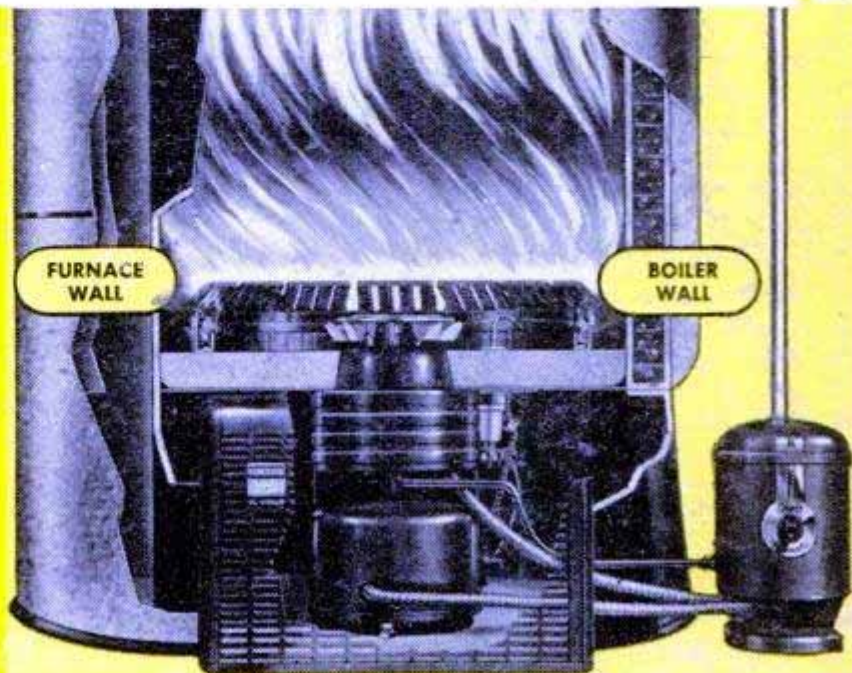

Scientific flame placement, as illustrated in the sectional view above (left side shows furnace, right side boiler), is a major factor in the extraordinary operating efficiency of the Timken Silent Automatic Wall-Flame Oil Burner, famous for fuel oil savings up to one gallon in every four used by ordinary burners.

Every useful Btu. of heat is extracted from every drop of fuel oil—thanks to the exclusive design of the Timken Silent Automatic Wall-Flame Oil Burner. This is the one and *only* type of automatic fuel burner that combines all the best features of oil heat with the clean-burning efficiency of gas heat. Your local Timken Silent Automatic Authorized Dealer will be glad

The unique chrome-steel flame rim shown at right converts fuel oil into a gas, thus: Oil droplets strike glowing-hot flame rim and are instantly vaporized. Resultant mixture of oil-gas and air rises through grills, is superheated, and burns with same blue color characterizing a gas flame.



to show you operating units as well as cut-away models. See for yourself the exceptional efficiency of this advanced development in heating science; ask for free literature with detailed data for your further study. Without any obligation on your part, your Dealer will make a scientific heating survey of your home, using approved laboratory-type instruments—and give you a written guarantee of fuel oil savings if you are changing over from an ordinary burner. Examine his findings and then decide for yourself whether you can afford to remain without Timken Silent Automatic Oil Heat. *Phone him today!*—or use coupon below.

MAIL THIS COUPON TODAY FOR ILLUSTRATED LITERATURE!

Timken Silent Automatic, Jackson, Michigan
Please mail illustrated literature. I am interested in:

(type of equipment)

NAME _____

STREET ADDRESS _____

CITY and STATE _____

If you are a student, please check here () for special information.



TIMKEN
Silent Automatic
HEAT

TIMKEN SILENT AUTOMATIC DIVISION
The Timken-Detroit Axle Company • Jackson, Michigan
The Timken-Detroit Axle Company of Canada, Ltd., Toronto, Ont.

Accepted AS Standard
TRADE MARK REGISTERED

PM-861

This One



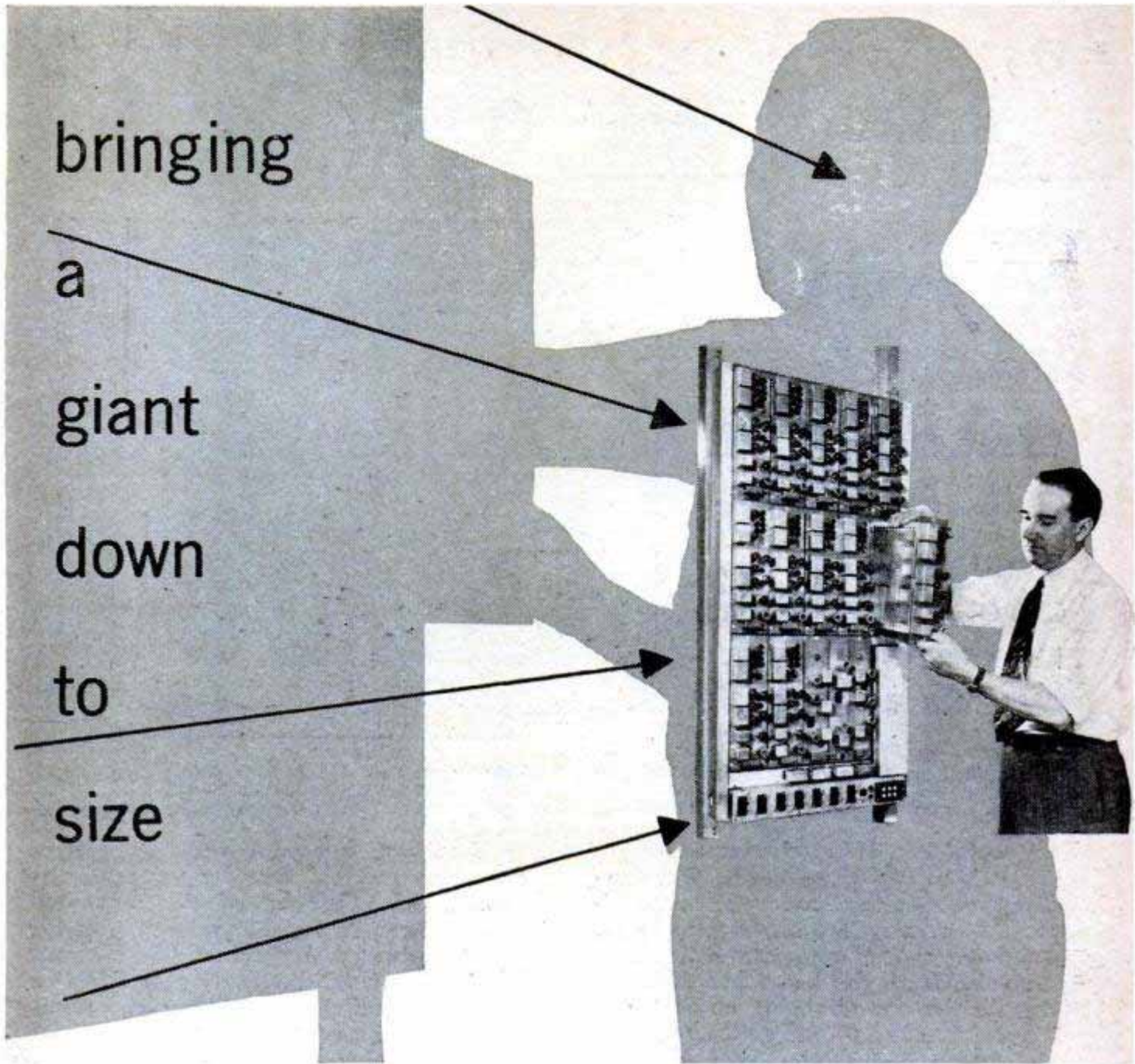

bringing

a

giant

down

to

size

New type N Repeater installation. Engineer shows ease of servicing—a spare unit can be plugged in with little or no interruption to service when repairs are needed.

“CARRIER SYSTEM” telephony is economical, because many voices use the same pair of wires. But the extra equipment needed once limited it to the longer distances.

Now Bell Laboratories have developed new short-haul carrier, economical down to 25 miles, sending 12 conversations on two pairs of wires in a cable.

Keys to the new system are new circuits, miniature tubes, pocket-size wave filters and Permalloy “wedding ring” transformer cores that will barely slip over a man’s finger. New

manufacturing processes were developed in co-operation with the Western Electric Company. Components are pressed into a plastic mounting strip with heat, a score at a time, instead of being mounted separately.

With this new carrier system more service can be provided without laying more cables. Tons of copper and lead can now be conserved for other uses. It’s another example of how science takes a practical turn at Bell Telephone Laboratories, to improve service and to keep its cost down.

BELL TELEPHONE LABORATORIES

WORKING CONTINUALLY TO KEEP YOUR TELEPHONE SERVICE ONE OF TODAY’S GREATEST VALUES



Popular Mechanics Magazine

Registered in U. S. Patent Office and Canada

H. H. WINDSOR, Founder

H. H. WINDSOR, JR., Editor and Publisher



this month's cover

THEY'RE AFLOAT in the lonely vastness of the Pacific with only their Mae Wests to hold them up. Most of their hope went down with the plane. But suddenly they hear the drone of a searching aircraft. As the rescue plane approaches, it launches a torpedo toward them. At least it looks like a torpedo as it leaves the plane, but suddenly a parachute blossoms out to lower the big tube into the water. Precisely two minutes later the torpedo suddenly erupts into a 20-foot nylon-rubber rescue craft. What's more, an engine somewhere in the craft springs to life and the boat swings out in a big arc, then moves toward the two men in the water, guided by radio from the plane above. As it spins around them in a tight circle the motor cuts out and the men scramble aboard. They discover enough fuel to carry them 300 miles, food, water, even a canopy. To find out more about this rescue boat turn to page 100

Published monthly by Popular Mechanics Company, 200 E. Ontario St., Chicago 11, Ill. H. H. Windsor, Jr., president; William Harrison Fetridge, vice president; D. F. Windsor, vice president and secretary-treasurer; H. H. Windsor III, vice president; Clover L. Perkins, advertising manager; Alan M. Deyoe, circulation manager. Single copy in the United States and Canada, 35 cents; subscription rates in United States and possessions, Canada, Philippines and countries of the Pan-American Postal Union, 1 year \$3.50; 2 years, \$6.00; 3 years, \$8.00. To all other countries, add \$1.00 a year over United States prices for overseas postage. If you plan to move, notify us at least 30 days in advance so you will not miss an issue. Give both your old and new addresses. Entered as Second Class Matter, September 15, 1903 at the Post Office at Chicago, Illinois, under Act of March 3, 1879. Entered as Second Class Matter at Post Office Dept., Canada. Registered as Second Class Matter at the Post Office at Mexico, D. F., Mexico, June 20, 1950. Copyright 1951 by Popular Mechanics Company. Copyright under International Copyright Union. Copyright in France. All rights reserved under Pan-American Copyright Union. Printed in the United States of America.

SEPTEMBER 1951

Volume 96 SEPTEMBER 1951 Number 3

Managing Editor.....Roderick M. Grant
 Assistant Managing Editor.....Wayne Whittaker
 Shop Notes and Crafts Editor.....James R. Ward
 Radio-Television, Electronics Editor.....Frank L. Brittin
 Associate Editor, Aviation.....Aubrey O. Cookman, Jr.
 Associate Editor.....Clifford B. Hicks
 Associate Editor.....Donald R. Brooks
 Assistant Shop Notes and Crafts Editor.....Wayne C. Leckey
 Automotive Editor.....Siler Freeman
 Art Director.....Frank Beatty

Assistant Editors
 W. Clyde Lammey Arthur R. Railton Frank N. Stephany
 C. E. Mitchell Dorothy Hoffmann Carlton H. Ihde
 Eastern Editor.....Richard F. Dempewolf
 Empire State Bldg., Room 2906, New York 1, N. Y.
 Western Editor.....Thomas E. Stimson, Jr.
 302 23rd St., Santa Monica, Calif.
 Representative in Great Britain.....Douglas W. Wedderspoon
 77 Baker St., London W. 1, England
 Director, Bureau of Information.....Allan Carpenter
 200 E. Ontario St., Chicago 11

IN THIS ISSUE

The Hunter's Big Wallop	73
Race of the Horseless Carriages!	84
They Make Jewels at Home	89
Radio Pilots Self-Inflating Lifeboat	100
The Owners Report on the '51 Chrysler	102
What's New for Your Home	108
You'll Build Your Next House of Molasses	110
Fever Charts Plot a Better Automobile	120
Fighting Infernos Underground	125
Football Is a Pageant	136
They're Breeding New Forest Trees	143
GI Rations "Up Front"	152

For the Craftsman

Workbenches and Wall Cabinets—Part I	158
Modern Lamp Shades in Wood	166
What to Do About Condensation	180
Build Your Own Nursery Furniture—Part III	186
Reline Your Brakes	194
Fitting a Chuck to Your Lathe	203
Taper-Turning Attachments	212
Shopping for Tools	216
Radio, Television and Electronics	219
Clinic for Homemakers	230

Other items, and manufacturers of available products described, are listed on pages 12, 14 and 16



A SPECIAL MESSAGE

FOR HIGH SCHOOL GRADUATES

Your United States Army's Signal Corps has a special message for intelligent high school graduates. It is a call to the world's finest technical training . . . the training that produces the specialists who help keep your Army great.

Signal trained soldiers are the men who bind an Army together with modern communications. They work with the latest electronic equipment . . . from the smallest handie-

talkie to globe-girdling radio nets, from field telephones to all-seeing radar. These men are the "nerve specialists" of modern combat.

You may qualify for a fine Signal Corps school after basic training. This will give you even better chances to get ahead fast in your growing U. S. Army. Ask for the details, *today*, at your U. S. Army and U. S. Air Force Recruiting Station.



U. S. ARMY

THE MARK OF A MAN!

These crossed flags, insignia of the U. S. Army Signal Corps, mark a man who has measured up to the mark.



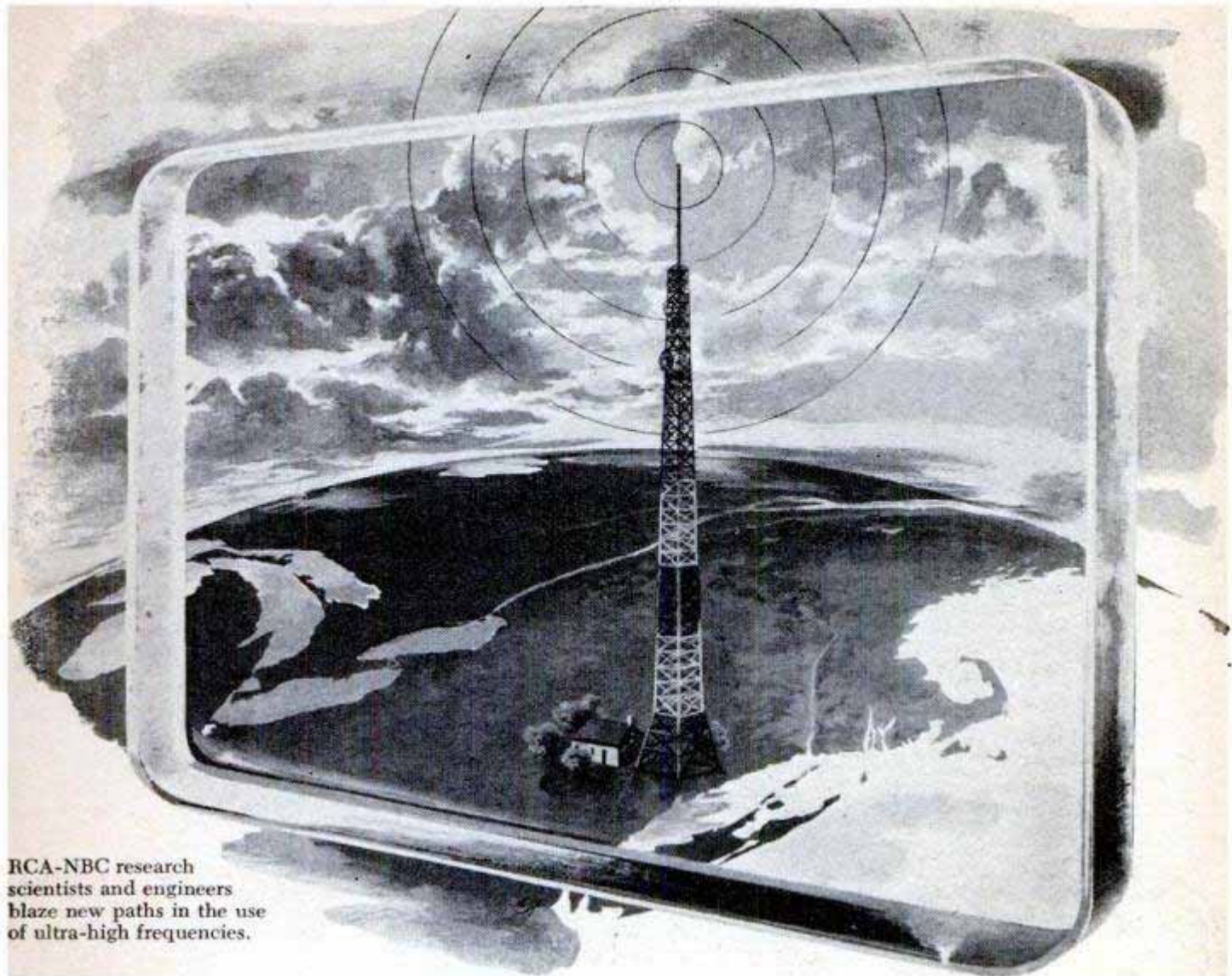

RCA-NBC research scientists and engineers blaze new paths in the use of ultra-high frequencies.

*World's first custom-built UHF station
—points the way to more TV for more people*

Although television now reaches 45 million people in more than 12 million homes, thousands of communities are still too far from existing stations to be reached by *any* programs. Moreover, under present conditions, many cities with limited program service want, but can't have, additional stations.

In preparation for the establishment of a country-wide television service, RCA has pioneered for many years in ultra-high-frequency (UHF) research.

Today—an experimental station built by RCA at Bridgeport, Conn., is supplying the practical experience and engineering facts

needed to design the best UHF equipment—including transmitters, receivers, and converters. NBC programs on the air during the full broadcast day are used by RCA—and other manufacturers, too—for field tests.

From results of this pioneering, RCA engineers have determined that practical UHF television equipment can be built to serve the public, and that present RCA Victor television sets can be adapted to give equally fine performance on both UHF and VHF.

* * *

See the latest in radio, television, and electronics at RCA Exhibition Hall, 36 West 49th Street, N. Y. Admission is free. Radio Corporation of America, RCA Building, Radio City, New York 20, N. Y.



RADIO CORPORATION of AMERICA

World Leader in Radio — First in Television

How to win MILES and influence car PERFORMANCE buy: PYROIL

Pyroil is a best seller on the "good riding" list year after year. Such popularity must be deserved. In case you're one of the few car owners who don't know about Pyroil, here's the Pyroil story.

Pyroil contains the remarkable property of making ordinary oil form a protective film of lubrication on vital engine parts. This actually creates a cushion of oil between piston rings and cylinder walls, eliminating friction and corrosion. Pyroil prevents contamination—and keeps your motor clean. That's why Pyroil means more miles for your car, and less repair bills for you.

Your gas station attendant knows "How to win miles and influence car performance". Just ask him. He'll say, "Add Pyroil—add miles to your car".

Pyroil for Aircraft Engines

Use Aircraft Pyroil B for lubricating oil, Aircraft Pyroil A for gasoline.

GIVEN!

An attractive Pyroil metal savings bank — takes coins up to 50c pieces. MOTORISTS, it's yours for the asking — sent postage paid.

Manufactured and Guaranteed by Pyroil Company, 119 Pyroil Bldg., La Crosse, Wisconsin

Canadian Distributors: Central Purchasing Agencies, Ltd., Toronto, Ontario



PYROIL COMPANY

119 Pyroil Bldg., La Crosse, Wisconsin

I want my car to last and run properly. Please tell me more about Pyroil and how it can accomplish this for me.

Name _____

Address _____

City or Town _____ State _____



in this corner.....

THE EDITORS



Letter to the Editor

I have just finished reading your article, Detroit Listening Post, in the June issue.

In speaking of the hardtop coupe you have aroused a pet peeve of mine . . . You, among others, have credited Buick and Pontiac as the first to invade this field . . . Kaiser was *the first* with this hardtop innovation. I do not say this merely because we have been a two-Kaiser family, a '49 and '51 and we like them fine, but because many of the other so-called experts evade the actual truth in relation to this subject.

Honestly I think you will recall that in 1949 the Kaiser Virginian included the make-believe convertible with a nylon covering. A short while later Buick came out with the same pattern. I am just a person who likes to see credit given where credit is due . . .

Len Vellek,
Tyndall, S. Dak.

Editor's Note: We didn't say Buick was the first to start the hardtop styling. Buick was the first to invade the field and made it completely popular by keeping the price just above the regular coupe. K-F did come out with the first type of hardtop convertible—hardly the hardtop we see today. It had a steel top covered with nylon fabric and windows that slid down all around. The present hardtop is no doubt a development of the Kaiser Virginian, which was quite high priced. Buick's first Riviera was what set the whole industry off on hardtops. It was produced in volume where the Kaiser was strictly a custom job.

Siler Freeman,
Automotive Editor.

Letter to the Editor

In the June issue I saw a picture of a "cradle" used by baseball players to practice catching. It is stated in the article that this was originated by Branch Rickey.

I do not know whether this has ever been used by baseball players before, but the cradle is at least 40 years old, to my knowledge. I have seen and used it in England, Toronto, Canada and Philadelphia; the last time about 20 years ago in Toronto. The cradle, as I knew it, was made for cricket players to practice catching, particularly the persons who played in the "slips" where

(Continued to page 8)

5 reasons why ACCOUNTANCY

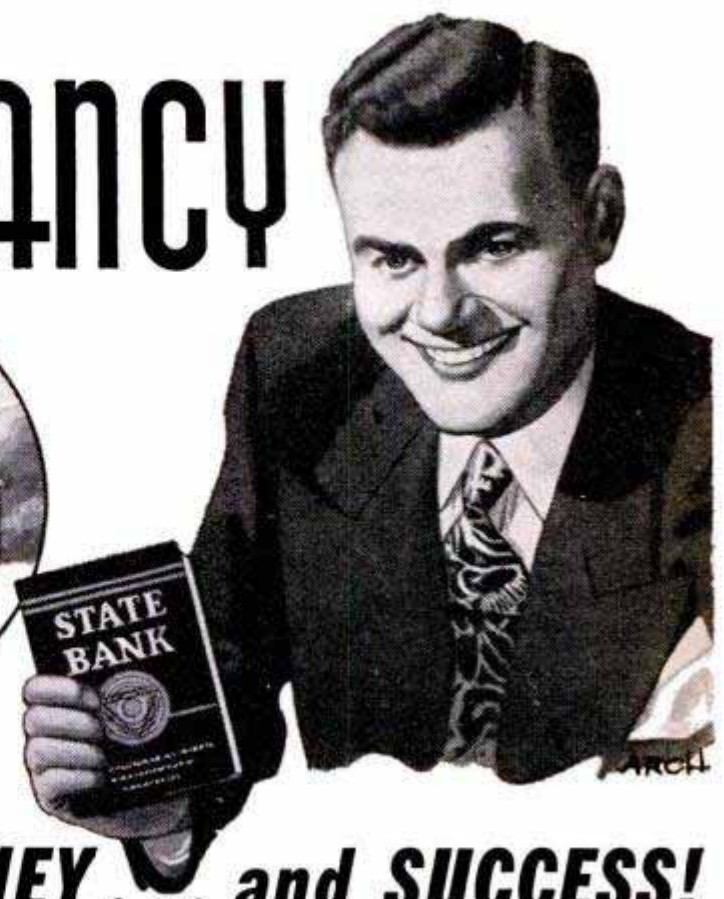

offers you MORE MONEY . . . and SUCCESS!

REASON #1. If you were an expert accountant right now, chances are you would find yourself among the highest-paid of all professional men and women. Even back in "depression years," surveys showed that accountants earned more on the average than men in other major professions.

REASON #2. The demand for accountants is great—everywhere. All businesses must have trained accountants to cope with ever-growing requirements. It's a profession offering wide opportunity—always—to the man who knows.

REASON #3. You can fit into any business, anywhere in the country—because accounting principles are universal. Think what this means in terms of security and independence!

REASON #4. Accountancy is open to all. Any man or woman of good intelligence, who enjoys figure work and is willing to follow LaSalle's systematic "problem method" plan, can rapidly qualify for a highly profitable, enjoyable

lifetime career . . . and he doesn't have to finish his training before beginning to "cash in."

REASON #5. Without losing a day from your present work, you can prepare in spare hours at home, at low cost, under LaSalle's step-by-step "Problem Method" of "learning by doing." This famous plan accounts for LaSalle's remarkable record of having trained nearly 10 per cent of all Certified Public Accountants in the U. S. . . . and of having put many thousands of others into high-paying careers.

Send today for LaSalle's interesting booklets, "Accountancy, the Profession That Pays," and "Success Reports." Learn about the five great fields of opportunity . . . and LaSalle's time-tested plan for helping men and women to rapid advancement, higher income, greater prestige and professional standing. The coupon below will bring these fact-filled booklets to you—without cost or obligation. Mail the coupon NOW.

**LASALLE EXTENSION
UNIVERSITY**
417 S. Dearborn St., Chicago 5

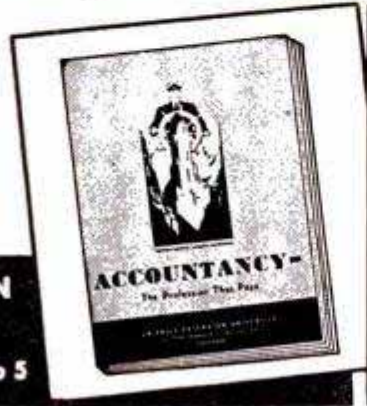

LaSalle Extension University
A Correspondence Institution

Dept. 964H, 417 S. Dearborn St., Chicago 5, Ill.
Please send me, free of all cost or obligation, your 48-page illustrated book "Accountancy, the Profession That Pays," and the booklet "Success Reports"—send also "Ten Years' Promotion in One"—a book which has helped many men.

Name Age
Address
City, Zone, State

Make Money Selling SERVICE SHOES Direct to Fellow Workers!

THEY ALL WANT
NEW
AIR-CUSHIONED
COMFORT



Would you like to earn from \$15.00 to \$60.00 a week EXTRA in spare time? Take orders for Consolidated's sensational service shoes—wanted *everywhere*! Sell to people where you work—to service station attendants, factory workers, barbers, waiters, to friends and neighbors.

17 SPECIAL TYPES

Now, a wonderful selection to choose from! Rugged Horsehide Shoes, Steel-Toe Safety Shoes, Gro-Cork Slip-Resistant soles, and the long-wearing Service Shoes, pictured above, with DuPont Neoprene Oil-Resistant soles and heels, and famous Velvet-Eez comfort features. Notice the special air-cushion insole and instep arch support. Marvelously restful for people who are on their feet a lot. Also, all kinds of Dress Shoes for men and women—sizes 4 to 16, Widths AAA to EEEE. See how easy it is to make extra cash for yourself while helping fellow workers save money—everyone can afford to buy at our low direct-from-factory prices!

WE SHOW YOU HOW!

You don't need experience; we show you how to become successful! You get a Free Selling Outfit, and our famous Automatic Selling Plan that helps you make BIG MONEY from the first hour you start. Don't delay a minute—rush coupon now!



RUSH COUPON NOW

CONSOLIDATED SHOE SYSTEM
Dept. S-168, Chippewa Falls, Wis.

I want to make BIG MONEY taking orders for popular Consolidated Shoes. Please rush your great Sales Outfit, including Special Service Shoes and Demonstrator, with everything else I need to get started RIGHT AWAY!

Name

Address

Town..... State.....

(Continued from page 6)

they may be anywhere from 10 to 30 feet back of the batsman and are there to catch snicks from the bat. These men, in most cases, have opportunity to use only one hand in making catches and also must learn to catch barehanded as they are not allowed to use gloves. The ball comes out of the cradle at all sorts of angles and heights. I think it could be very good practice for any ball player, but I do not think Mr. Rickey was the original inventor.

William Webb,
Librarian,
Flint, Mich.

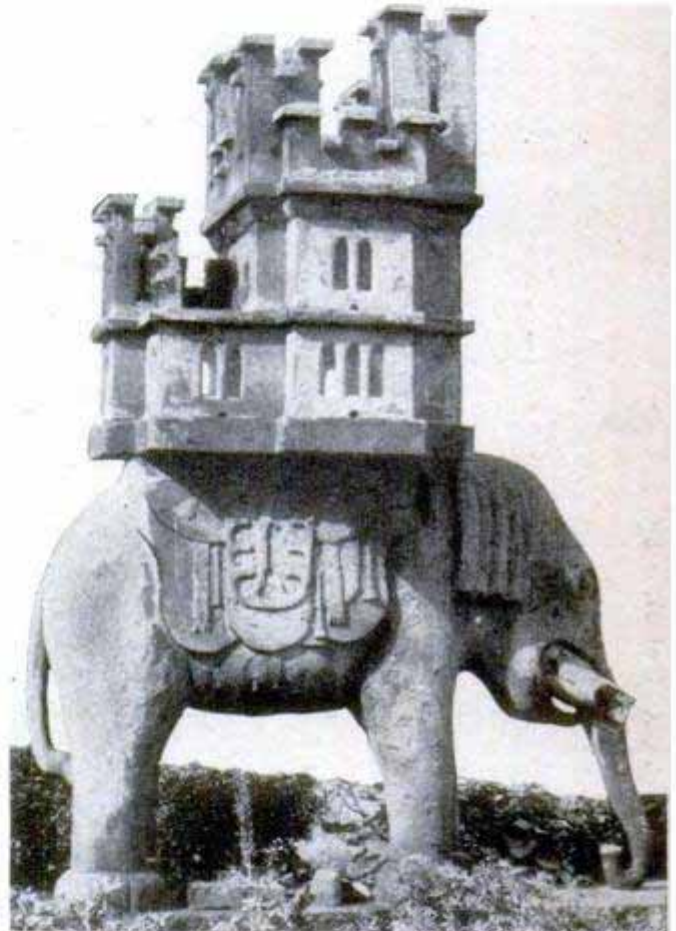

Copyright by P. H. Lovell

A Bee's Home Is Its Castle

Even the English bee has a castle for its home. This stone elephant, reputed to have been carved about 90 years ago, stands 12 feet tall in an English garden. Its castle is a beehive, whose residents buzz home through small holes beneath the windows.

Letter to the Editor

Thank you indeed for your letter giving the formula used in solving problems pertaining to reels or drums of wire, etc. . . .

In both high school and college teaching I have maintained . . . that the better science magazines, such as *Popular Mechanics*, are an excellent source of material in

(Continued to page 10)

A TRUE I. C. S. STORY taken from an actual letter



I was a World War II pilot ...



A prisoner of war in Germany ...



Back home, I was hired by National ...

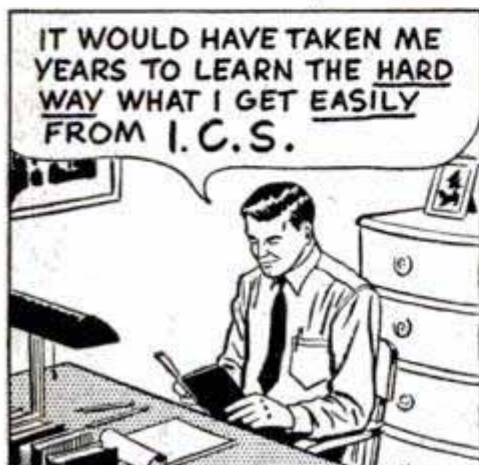

Studied with I. C. S. in my spare time ...



I. C. S. sent reports to my employer ...

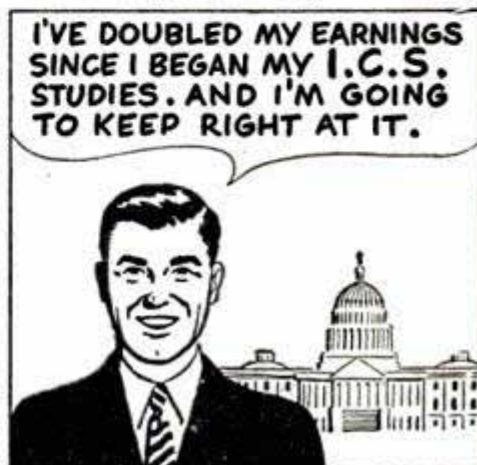

I am now Washington District Manager.

Parke Wright
PARKE WRIGHT

How have you done since the war? Start now to get the training that leads to advancement. Mail coupon *today!*

INTERNATIONAL CORRESPONDENCE SCHOOLS



BOX 5508-L, SCRANTON 9, PENNA.

Without cost or obligation, please send me full particulars about the course BEFORE which I have marked X:

- | | | | |
|--|---|--|--|
| <p>Air Conditioning and Plumbing Courses</p> <p><input type="checkbox"/> Air Conditioning <input type="checkbox"/> Heating</p> <p><input type="checkbox"/> Plumbing <input type="checkbox"/> Refrigeration</p> <p><input type="checkbox"/> Refrigeration, Domestic</p> <p><input type="checkbox"/> Refrigeration & Air Conditioning</p> <p><input type="checkbox"/> Steam Fitting</p> <p>Aeronautics Courses</p> <p><input type="checkbox"/> Aeronautical Engineer's, Jr.</p> <p><input type="checkbox"/> Aircraft Drafting & Design</p> <p><input type="checkbox"/> Aircraft Mechanic</p> <p><input type="checkbox"/> Engine Mechanic</p> <p>Automotive Courses</p> <p><input type="checkbox"/> Automobile <input type="checkbox"/> Auto Technician</p> <p><input type="checkbox"/> Auto Electric Technician</p> <p><input type="checkbox"/> Auto Body Rebuilding & Refinishing</p> <p>Chemical Courses</p> <p><input type="checkbox"/> Chemical Engineering</p> <p><input type="checkbox"/> Chemistry, Analytical</p> <p><input type="checkbox"/> Chemistry, Industrial</p> <p><input type="checkbox"/> Food-Plant Sanitation</p> <p><input type="checkbox"/> Petroleum Refining <input type="checkbox"/> Plastics</p> <p><input type="checkbox"/> Pulp and Paper Making</p> <p>Civil Engineering and Architectural Courses</p> <p><input type="checkbox"/> Architecture <input type="checkbox"/> Architectural Drafting</p> <p><input type="checkbox"/> Bridge and Building Foreman</p> | <p><input type="checkbox"/> Building Estimating</p> <p><input type="checkbox"/> Civil Engineering</p> <p><input type="checkbox"/> Contracting and Building</p> <p><input type="checkbox"/> Highway Engineering</p> <p><input type="checkbox"/> Reading Structural Blueprints</p> <p><input type="checkbox"/> Sanitary Engineering</p> <p><input type="checkbox"/> Structural Drafting</p> <p><input type="checkbox"/> Structural Engineering</p> <p><input type="checkbox"/> Surveying and Mapping</p> <p>Communications Courses</p> <p><input type="checkbox"/> Electronics</p> <p><input type="checkbox"/> Practical Telephony</p> <p><input type="checkbox"/> Radio, General <input type="checkbox"/> Radio Operating</p> <p><input type="checkbox"/> Radio Servicing <input type="checkbox"/> Television</p> <p><input type="checkbox"/> Telegraph Engineering</p> <p>Electrical Courses</p> <p><input type="checkbox"/> Electrical Drafting</p> <p><input type="checkbox"/> Electrical Engineering</p> <p><input type="checkbox"/> Electric Light and Power</p> <p><input type="checkbox"/> Lighting Technician</p> <p><input type="checkbox"/> Practical Electrician</p> <p>Diesel Engines Courses</p> <p><input type="checkbox"/> Diesel Engines</p> <p><input type="checkbox"/> Internal Combustion Engines</p> <p>Mechanical Courses</p> <p><input type="checkbox"/> Forging <input type="checkbox"/> Foundry Work</p> <p><input type="checkbox"/> Heat Treatment of Metals</p> | <p><input type="checkbox"/> Industrial Engineering</p> <p><input type="checkbox"/> Industrial Instrumentation</p> <p><input type="checkbox"/> Industrial Metallurgy</p> <p><input type="checkbox"/> Machine Shop</p> <p><input type="checkbox"/> Mechanical Drafting</p> <p><input type="checkbox"/> Mechanical Engineering</p> <p><input type="checkbox"/> Mold-Loft Work</p> <p><input type="checkbox"/> Patternmaking—Wood, Metal</p> <p><input type="checkbox"/> Reading Shop Blueprints</p> <p><input type="checkbox"/> Sheet-Metal Drafting</p> <p><input type="checkbox"/> Sheet-Metal Worker</p> <p><input type="checkbox"/> Ship Drafting <input type="checkbox"/> Ship Fitting</p> <p><input type="checkbox"/> Tool Designing <input type="checkbox"/> Toolmaking</p> <p><input type="checkbox"/> Welding—Gas and Electric</p> <p>Railroad Courses</p> <p><input type="checkbox"/> Air Brake <input type="checkbox"/> Car Inspector</p> <p><input type="checkbox"/> Diesel Locomotive</p> <p><input type="checkbox"/> Locomotive Engineer</p> <p><input type="checkbox"/> Locomotive Fireman</p> <p><input type="checkbox"/> Locomotive Machinist</p> <p><input type="checkbox"/> Railroad Section Foreman</p> <p><input type="checkbox"/> Steam-Diesel Locomotive Eng.</p> <p>Stationary Engineering Courses</p> <p><input type="checkbox"/> Power Plant Engineering</p> <p><input type="checkbox"/> Stationary Fireman</p> <p><input type="checkbox"/> Stationary Steam Engineering</p> | <p>Textile Courses</p> <p><input type="checkbox"/> Cotton Manufacturing</p> <p><input type="checkbox"/> Loom Fixing <input type="checkbox"/> Rayon Mfg.</p> <p><input type="checkbox"/> Textile Engineering</p> <p><input type="checkbox"/> Woolen Manufacturing</p> <p>Business and Academic Courses</p> <p><input type="checkbox"/> Accounting <input type="checkbox"/> Advertising</p> <p><input type="checkbox"/> Bookkeeping</p> <p><input type="checkbox"/> Business Administration</p> <p><input type="checkbox"/> Business Correspondence</p> <p><input type="checkbox"/> Business Law <input type="checkbox"/> Cartooning</p> <p><input type="checkbox"/> Certified Public Accounting</p> <p><input type="checkbox"/> Commercial <input type="checkbox"/> Commercial Art</p> <p><input type="checkbox"/> Cost Accounting</p> <p><input type="checkbox"/> Fashion & Book Illustration</p> <p><input type="checkbox"/> Federal Tax <input type="checkbox"/> First Year College</p> <p><input type="checkbox"/> Foremanship</p> <p><input type="checkbox"/> Good English <input type="checkbox"/> High School</p> <p><input type="checkbox"/> Higher Mathematics</p> <p><input type="checkbox"/> Industrial Supervision</p> <p><input type="checkbox"/> Motor Traffic</p> <p><input type="checkbox"/> Personnel—Labor Relations</p> <p><input type="checkbox"/> Postal Civil Service <input type="checkbox"/> Retailing</p> <p><input type="checkbox"/> Retail Business Management</p> <p><input type="checkbox"/> Salesmanship <input type="checkbox"/> Secretarial</p> <p><input type="checkbox"/> Sign Lettering <input type="checkbox"/> Stenography</p> <p><input type="checkbox"/> Traffic Management</p> |
|--|---|--|--|

Name _____ Age _____ Home Address _____

City _____ State _____ Working Hours _____ A.M. to _____ P.M.

Present Position _____ Employed by _____

Special tuition rates to members of the Armed Forces. Canadian residents send coupon to International Correspondence Schools Canadian, Ltd., Montreal, Canada.

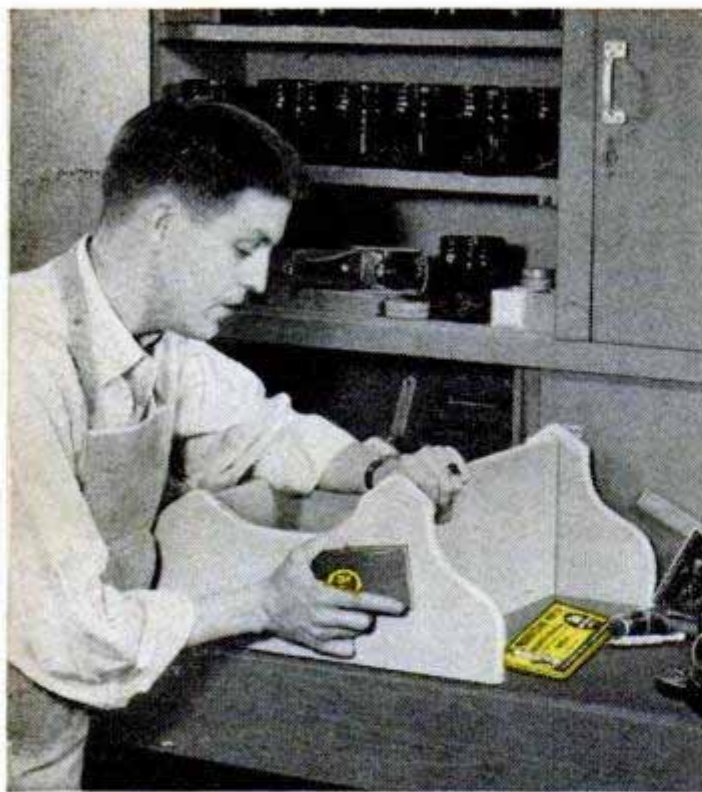

Now . . . try world's toughest sandpaper!

Sand home projects *twice* as fast, twice as easy with 3M Home Workshop Sandpaper! It's coated with aluminum-oxide mineral that's so tough it actually sharpens chisels and knives. And it lasts 10 times longer than ordinary sandpaper because it *stays* sharp. That's why professional woodworkers have used it for years.

Now, for the first time, this super-tough "Production" Sandpaper is pre-cut to fit most home power tools, *plus* the popular 3M Sanding Block. Packaged in fine, medium and coarse grits for easy selection, too.

Look for this *completely new* home workshop sandpaper the next time you're in your hardware store. Bright yellow packs identify it. Stock up now and be ready to handle any sanding job *right* with 3M Home Workshop Sandpaper!



Made in U.S.A. by MINNESOTA MINING & MFG. CO., St. Paul 6, Minn., also makers of "Scotch" Brand Pressure-sensitive Tapes, "Scotch" Sound Recording Tape, "Underseal" Rubberized Coating, "Safety-Walk" Non-slip Surfacing, "3M" Adhesives. General Export: Minn. Mining & Mfg. Co., International Division, 270 Park Avenue, New York 17, N. Y. In Canada: Minnesota Mining & Mfg. of Canada, Ltd., London, Canada.

(Continued from page 8)

condensed form for pupils and students to learn sound basic principles—to be preferred in most cases to what is normally presented in classrooms. This is only another example of proof of such a statement . . . Many, many thanks and very best wishes for the special work you are doing in education.

Frederic E. Hofmann,
Syracuse, N. Y.



Self-Service Gas Station

At Fanwood, N. J., a local inventor has installed a self-service filling station where the customer can buy gasoline by dropping coins in a slot. The number of quarters dropped determines the gallons delivered, and when the dial indicator shows the coin supply is exhausted, a horn blows. A special feature of the invention is a thumb valve on the hose nozzle which controls a flow of carbon-dioxide snow to prevent explosions and combat flash fires.



Little Fish Survive

Shallow-water fingerling trout and salmon are indestructible in the crushing pressures of the sea 2000 feet below the surface where a man—even in a diving suit—cannot live. The experiments were conducted by Andreas Rechnitzer of La Jolla, Calif., to observe the reaction of young fish to high hydrostatic pressures. The frail-looking fish withstood pressures up to 1000 pounds per square inch. Now engineers know the fish can survive rapid descents down dams in passages to be constructed.

WHAT Every AUTO MECHANIC Wants to Know

A motor vehicle is a machine of many parts, each part designed and constructed for its own special function.

All good mechanics, like good doctors, should know the working theory and operation of each part and understand what causes trouble and how to remedy it.

LET AUDELS AUTO GUIDE SOLVE YOUR PROBLEMS

Every auto mechanic, helper, serviceman and operator can use a copy of AUDELS AUTOMOBILE GUIDE. The information it gives saves time, money and worry. Highly indorsed by all users. It presents the whole subject of auto mechanics from A to Z in plain language and simple terms.

This Big Practical Book gives full information with working diagrams covering the principles, construction, ignition, service and repair of modern cars, trucks and buses.

A complete Guide of 1800 pages, with over 1500 illustrations showing inside views of the working parts, with instructions for service jobs. Diesel engines, Fluid and Hydra-matic drives fully explained.

IT PAYS TO KNOW HOW TO

How to fit pistons—How to locate engine knocks—How to fit connecting rod bearings—How to service main bearings—How to recondition valves—How to time valves—How to adjust fan belts—How to adjust carburetors & chokes—How to rebuild a clutch—How to service automatic transmissions—How to service brakes—How to adjust steering gear—How to cope with ignition troubles—How to service distributors—How to time ignition—How to "tune up" an engine.

INFORMATION IN A HANDY FORM

73 INTERESTING CHAPTERS—Read this partial list of subjects on which practical information is fully given for quick reference under the headings as shown below. Ready Reference Index.

All Parts of an Automobile—Automotive Physics—The Gas Engine—Gas Engine Principles—Multi-Cylinder Engines—Horse Power—Automobile Engines—Stationary Parts—Moving Parts—Pistons—Piston Rings—Connecting Rods—Crank Shafts—Valves—Valve Gear—Cams and Cam Action—Valve Timing—Cooling Systems—Fuel Feed Systems—Dual Fuel Feed—Mixture—Carburetors—Carburetor Service—Automatic Choke—Super-Chargers—Transmissions—Special Transmissions—Fluid and Hydra-matic Drives—Clutches—Universals and Propeller Shafts

A Ready Reference

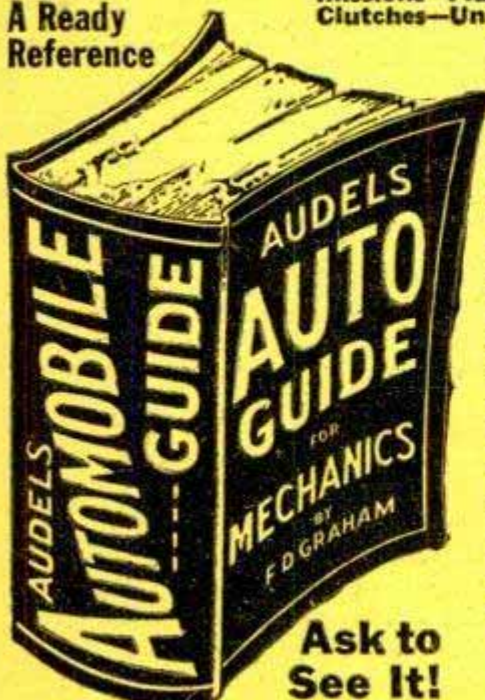

—The Differential—Rear Axles—Rear and Front Suspension—Running Gear—Brakes—Wheel Alignment—Knee Action—Steering Gear—Tires—Lubricants and Lubrication—Automotive Electricity—Ignition Systems—Magneto Ignition—Spark Plugs—Ignition Coils—Distributors—Automatic Spark Control—Ignition Timing—Generators—Starters—Generator and Starter Testing—Lighting Systems—Storage Batteries—Charging and Testing—Diesel Engines and Trouble Shooting.

7 DAYS' FREE TRIAL
TO GET THIS ASSISTANCE FOR YOURSELF SIMPLY FILL IN AND MAIL COUPON TODAY.

\$4 COMPLETE PAY \$1 A ONLY 1 MO.



Sent on 7 Days Approval

Step up your own skill with the facts and figures of your trade. Audels Mechanics Guides contain Practical Inside Trade Information in a handy form. Fully Illustrated and Easy to Understand. Highly Endorsed. Check the book you want for 7 DAYS FREE EXAMINATION. Send No Money. Nothing to pay postman.

MAIL ORDER

AUDEL, Publishers, 49 W. 23 St., NEW YORK 10, N. Y.

Please send me postpaid for FREE EXAMINATION books marked (x) below. If I decide to keep them I agree to mail \$1 in 7 Days on each book or set ordered and further mail \$1 monthly on each book or set until I have paid price, otherwise I will return them.

- TRUCK & TRACTOR GUIDE, 1299 Pages . . . \$ 4
- AUTOMOBILE MECHANICS GUIDE, 1800 Pages . . . 4
- DIESEL ENGINE MANUAL, 575 Pages . . . 2
- MACHINISTS HANDY BOOK, 1650 Pages . . . 4
- WELDERS GUIDE, 400 Pages . . . 1
- BLUE PRINT READING, 416 Pages . . . 2
- MATHEMATICS & CALCULATIONS, 700 Pages . . . 2
- SHEET METAL PATTERN LAYOUTS, 1100 Pages . . . 4
- SHEET METAL WORKERS HANDY BOOK, 388 Pgs. . . 1
- MECHANICAL DRAWING GUIDE, 160 Pages . . . 1
- MECHANICAL DRAWING & DESIGN, 480 Pages . . . 2
- AIRCRAFT WORKER, 240 Pages . . . 1
- TELEVISION SERVICE MANUAL, 384 Pages . . . 2
- RADIOMANS GUIDE, 914 Pages . . . 4
- ELECTRONIC DEVICES, 216 Pages . . . 2
- ELECTRIC MOTOR GUIDE, 1000 Pages . . . 4
- ELECTRIC WIRING DIAGRAMS, 272 Pages . . . 1
- ELECTRICIANS EXAMINATIONS, 250 Pages . . . 1
- ELECTRIC POWER CALCULATIONS, 425 Pages . . . 2
- HANDY BOOK OF ELECTRICITY, 1440 Pages . . . 4
- ELECTRIC DICTIONARY, 9000 Terms . . . 2
- ELECTRIC LIBRARY, 7000 Pages (12 Book Set) . . . 18
- MARINE ENGINEERS HANDY BOOK, 1258 Pgs. . . 4
- SHIPFITTERS HANDY BOOK, 250 Pages . . . 1
- REFRIGERATION & Air Conditioning, 1280 Pgs. . . 4
- MILLWRIGHTS & MECHANICS GUIDE, 1200 Pgs. . . 4
- POWER PLANT ENGINEERS GUIDE, 1500 Pages . . . 4
- ENGINEERS & FIREMANS EXAMS, 525 Pages . . . 1
- PUMPS, Hydraulics & Air Compressors, 1658 Pgs. . . 4
- ENGINEERS LIBRARY (3 Book Set) . . . 9
- MECHANICAL DICTIONARY, 950 Pages . . . 4
- GARDENERS & GROWERS GUIDES (4 Book Set) . . . 6
- CARPENTERS & BUILDERS GUIDES (4 Book Set) . . . 6
- PLUMBERS & Steamfitters Guides (4 Book Set) . . . 6
- MASONS AND BUILDERS GUIDES (4 Book Set) . . . 6
- PAINTERS & DECORATORS MANUAL, 450 Pgs. . . 2
- HOUSE HEATING GUIDE, 1000 Pages . . . 4
- OIL BURNER GUIDE, 384 Pages . . . 1

Name _____

Address _____

Occupation _____

Employed by _____ 48A

AUDEL, Publishers, 49 W. 23 St., New York 10, N. Y.

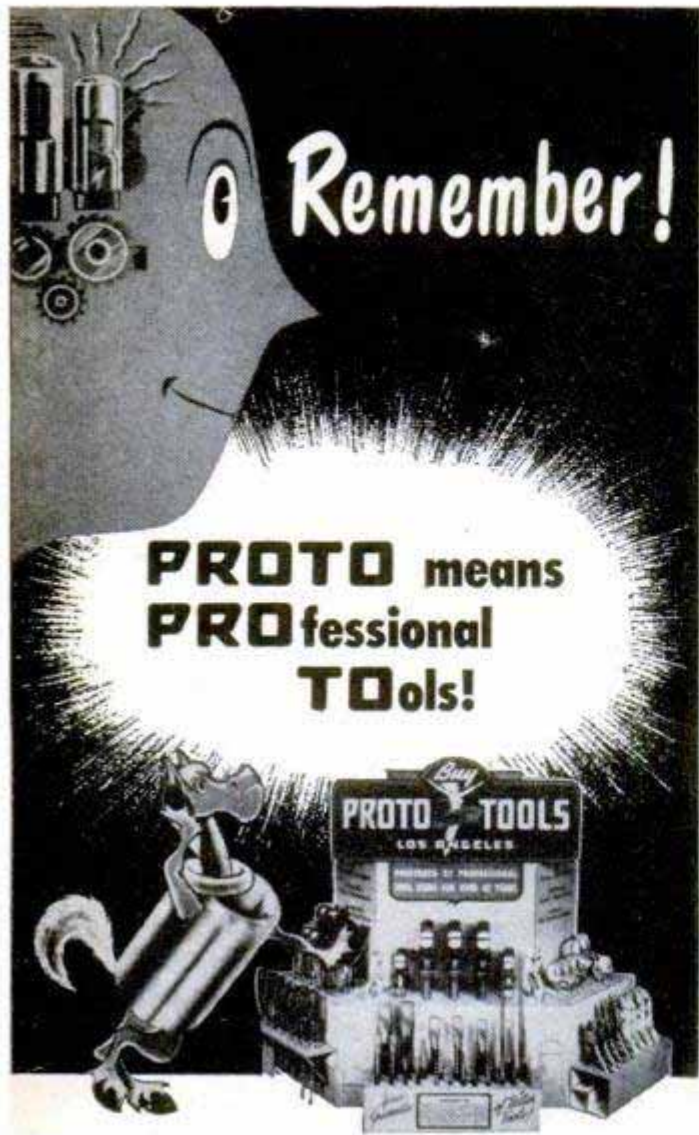

Remember!

PROTO means
PROfessional
TOols!

That Power Sockorse pose is a reminder to remember that PROTO signifies highest professional standards. PROTO tools are light but strong, balanced, easy handling, snug fitting. They're properly forged from special steels and scientifically heat treated to impart extra strength, toughness and life! Buy PROTO tools from your dealer's big selection, while still obtainable. Send 10¢ for 68-page catalog to

PLUMB TOOL COMPANY
2255J Santa Fe Ave., Los Angeles 54, Calif.

TOOLAGRAM



PROTO pipe wrenches are designed without excess weight but withstand hard use. Major steel parts are forged and heat treated, and strain points are strengthened.

5184

PROTO TOOLS

REG. U. S.
PAT. OFF.

LOS ANGELES

MADE
IN U. S. A.

WHERE-TO-BUY-IT INDEX

Source of supply appears after items commercially available

AUTOMOTIVE

Detroit listening post.....	118
Inspection 'scope "sees" inside conditions (Testa Mfg. Co., 418 S. Pecan St., Los Angeles 33, Calif.).....	123
Mercury switch stops engine when automobile overturns (Clapp Co., 4327 Rawlins St., Dallas 4, Tex.).....	123
Wiper clears side window (Park Sales, Box 73, Forest Park, Ill.).....	123
Ignition tracer (Champion Spark Plug Co., Toledo, Ohio).....	123
Exhaust gas made safe (Oxy-Catalyst Mfg. Co., Inc., 392 W. Lancaster Ave., Wayne, Pa.).....	134
Automatic starter for cold weather (Cray-Lincoln Engineering & Mfg. Co., North Walpole, N. H.).....	156

AVIATION

"Wigglin' Willy".....	79
Anti-icing features in turbojet engine.....	96
Tank-track-type landing gear for airplanes.....	96
Mid-air refueling increases range of jet fighters.....	98
British jet flying boat.....	98
"Retractable" wings on flying laboratory.....	119
Douglas Skyrocket.....	124
114-foot conveyor speeds cargo handling.....	135
Paratrooper's "snood".....	147
Cotton-strip chute brings down heavier loads.....	147
MATS flies 400,000 passengers.....	156

BOATS

Submarine sight-seeing.....	78
LSU rides big brother to work.....	94
"Dew floating" speedboat.....	135

COMMUNICATIONS

Telephone for invalid.....	79
Two-way interphone for fire fighters speeds instructions....	82
Tiny radio transmitter relays data from rocket.....	82
Transparent screen provides clearer television picture.....	99

FISH AND FISHING

Bottle provides oxygen for fish (Mann Instrument Co., 2126 Tarayal St., San Francisco 16, Calif.).....	83
Gas-powered spear gun.....	134
Sonar fish finder (Pacific Div., Bendix Aviation Corp., 11600 Sherman Way, North Hollywood, Calif.).....	142
Motor doesn't scare fish (LeJay Mfg. Co., 2908 Emerson Ave., S., Minneapolis 8, Minn.).....	254

HOBBIES AND NOVELTIES

One-man fire department.....	80
Pocket protector.....	98
Trains go through hotel lobby.....	99
Toothpick violin.....	142
You name it!.....	148
"Rumble seat" scooter.....	156
Robot orchestra.....	252

HOUSE AND HOME

Channel strips make shelving (Unistrut Products Co., 1013 Washington Blvd., Chicago 7).....	99
Compact kitchen (General Air Conditioning Corp., 4542 E. Dunham St., Los Angeles 23, Calif.).....	108
Food chopper (Landers Frary & Clark, 100 Center St., New Britain, Conn.).....	108
Cream siphon (George E. Davis, Delmar, N. Y.).....	108
Lathercap (Gordon Strubler, Inc., 76 Court St., Brooklyn 2, N. Y.).....	108
Foldaway fence (Crown Wire Mfg. Corp., 2469-75 2nd St., New York City 35).....	109
Instant pocket (Alt Mfg. & Distributing Co., Inc., 201 Summit St., Toledo 3, Ohio).....	109
Window cornice (S. R. Palmer, Peachtree Products, 3110 Roswell Rd., N.E., Atlanta, Ga.).....	109
Razor-blade sharpener (Dremel Mfg. Co., 2439 18th St., Racine, Wis.).....	109

INDUSTRY

Breaker-tamper.....	79
Fuel from waste.....	82
Supervacuum bottle.....	83
Collapsible "barrel" made of rubber-fabric (U. S. Rubber Co., Rockefeller Center, New York City 20).....	97
Nitrogen package keeps food fresh (Linde Air Products Co., Carbide & Carbon Bldg., 30 E. 42nd St., New York City 17).....	117
Expanding paste rejuvenates engine (G. C. Treglown Co., 200 W. 7th St., Plainfield 90, N. J.).....	142
Steel-ball storage for liquid nitrogen.....	150
Heat-resistant paint.....	150
Metal floor bridging (Glover Mfg. & Sales Co., 2491 Manchester Rd., Akron, Ohio).....	151
Beta-ray gauge.....	151

MILITARY

Floating plastic.....	83
Hypodermic gun has no needle.....	107
Tasty water purifier.....	147

OFFICE, SHOP AND STORE

Folding slide projector (FR Corp., 951 Brook Ave., New York City 56).....	82
Scribble sculpture (Ben Walters, Inc., 125 W. 26th St., New York City).....	116
Check-cashing machine delivers bills in rolls (Burroughs Adding Machine Co., Box 418, Detroit 32, Mich.).....	254

(Continued to page 14)

INVENTORS

Learn how to protect your invention. The U. S. Patent Laws provide that any new and useful art, machine, article of manufacture, or composition of matter, or any new and useful improvement thereof, may be patented if the act of invention is involved. Therefore, every inventor with a valuable invention should take advantage of the Patent Laws and proceed for patent protection in order to safeguard his rights.

A patent gives the inventor the exclusive right to prevent others from making, using, or selling the invention claimed in the patent for a period of seventeen years.

The Patent Laws were enacted for the benefit of the inventor to give him protection for the features of his invention which are patentable. These features must be properly and concisely set forth and claimed in a formal application for patent, in order to comply with the requirements of the Patent Laws. For that reason, unless the inventor is familiar with patent matters, he should engage a competent registered patent attorney or agent to represent him. We are registered to practice before the U. S. Patent Office and are prepared to serve you in the handling of your patent matters.

A specially prepared booklet entitled "Patent Guide for the Inventor", containing detailed information with respect to patent protection and procedure, together with a "Record of Invention" form will be promptly forwarded to you without obligation upon request.

CLARENCE A. O'BRIEN & HARVEY JACOBSON

Registered Patent Attorneys

11-J DISTRICT NATIONAL BUILDING

WASHINGTON 5, D. C.

MISCELLANEOUS

Bright yellow indicator signals mail deliveries (Manitowoc Equipment Works, Manitowoc, Wis.)..... 78
 Plastic motorcycle cover..... 79
 Human mineral "mine"..... 79
 Gondoliers get traffic tickets..... 97
 Tiny life preserver holds 250-pounder (Res-Q-Pak Sales, 308 E. 4th St., Long Beach 12, Calif.)..... 97
 Table for drill-powered saw (Atkin's Industries, Inc., 5823 N. Ravenswood Ave., Chicago 26)..... 99
 Self-erecting weather station..... 107
 "Sawdozer" slices big trees..... 115
 Lights in aluminum arches control traffic on bridge (Aluminum Co. of America, 801 Gulf Bldg., Pittsburgh 19, Pa.)..... 119
 Bee post office..... 131
 Restoring Goethe's home..... 132
 Pink icebergs?..... 142
 Newsstand in a California bus..... 147
 Wagon-sled turns at high speed (Atomic Scooter Sled Co., 77 W. Corbin St., Concord, N. C.)..... 150
 "Scarecrow" with sound..... 151
 Pulse seismograph..... 156
 Charcoal barbecue (Allan Kahn, Master Metalcraft, 1060 El Camino Real, Belmont, Calif.)..... 256

Craftsman and Shop Notes Index

AUTOMOTIVE

Wire-solder map scale determines distances..... 178
 Plywood platform in back seat of car makes "traveling playpen" for child..... 189
 Theftproofing your car wheels..... 193
 Cleaning cloth kept in hub cap..... 198
 Cylinder wear measured with feeler gauge..... 205
 Small "desk" for truck driver mounted on instrument panel..... 205
 Section removed from oil drum to make washer for car parts..... 206
 Proper pre-storage treatment of water-cooled engine minimizes deterioration..... 209

DRAWING AND LAYOUT

Powder puff and small finger ring make hand rest for letter artist..... 172
 Pounce bag and letter patterns used to lay out signs..... 189
 Trimming worn shaving brush adapts it for stenciling..... 192
 Removing grease-pencil lines from lettering layouts..... 205
 Artist's brushes protected when stored in fly box..... 218

ELECTRICAL

Conserving flashlight cells..... 170
 Tester circuit fitted with socket to take variety of resistors..... 174
 Socket for small light bulb made from paper clips..... 193
 Homemade jumpers in flashlight permit use of fewer dry-cell batteries..... 197

FARM

Portable "garage" services farm implements in field..... 205
 Dairy barn quickly warmed by blower-type heater..... 206
 Skinning gambrel from singletree..... 208
 Automatic stanchion row for dairy..... 210
 Welding generator is mounted on knee-action trailer..... 211
 Water in stock tank kept cool by oil drum and burlap sacks..... 214
 Skids protect feeding trough when towed behind truck..... 214
 Fifth-wheel steering arrangement adapted to spray trailer..... 214
 Long-life fence posts..... 218

HOUSE AND HOME

Door bolts on baby crib lock sliding gate..... 170
 Renewing floor "traffic lanes"..... 172
 Room data and measurements stored on picture backing..... 174
 High-grade floors at low cost..... 175
 Rubber sponge provides wallpaper cleaner..... 176
 Ridding your house of ants..... 176
 Loose drawer pulls..... 176
 Cleaning walls in a bathroom..... 176
 Removing ashes from a fireplace..... 176
 Small leaks in water pipes..... 176
 Lipstick container pulls and stores thumbtacks..... 176
 Powder puff applies paste wax..... 177
 Drying blankets and bedspreads..... 177
 Scatter rugs sized with laundry starch..... 177
 Keeping curtain measurements..... 177
 Rubber hammer opens stubborn jars..... 177
 Paper match aids in sewing on buttons..... 177
 Rust stains removed with lemon juice or vinegar..... 177
 Notched clothes-hanger rod prevents bunching of garments..... 192

LAWN AND GARDEN

Unique garden tool cultivates soil or digs holes for setting bulbs..... 164
 Shells of halved coconuts provide picturesque bird houses and baths..... 164
 Lawn ornaments easily replaced if equipped with stepped anchors..... 170
 Wheeled basket for leaf disposal..... 179
 Nonfreezing sprinkling system drains into catch basin..... 192

NOVELTIES

Scrolled bookshelf..... 165
 Glamourize your dining table..... 169
 Fan-shaped vase in walnut..... 171
 Colorful jewelry for children from plastic brush handles..... 190
 Woven screen..... 191

OFFICE, SHOP AND STORE

Dime-store lock on telephone prevents unauthorized use..... 172
 "Humidifying" paste-brush holder made from fountain-pen cap..... 174

(Continued to page 16)

VOTE TODAY FOR THE FUTURE YOU WANT!

AMERICAN SCHOOL, Dept. G645, Drexel at 58th, Chicago 37, Ill. Without obligation, please send FREE and postpaid, full particulars about the subject checked below.

- Accounting
- Air Conditioning
- Architecture & Building
- Automotive Technician
- Better Farmship
- Bookkeeping
- Business Management
- Contracting
- Diesel Technician
- Drafting—Building Trades
- Drafting—Machine Trades
- Electrical Engineering
- Electricity—Practical
- Electronics—Industrial
- High School Courses
- Machine Shop Operations
- Mathematics & Slide Rule
- Mechanical Engineering
- Plastics Engineering
- Plumbing—Practical
- Private Secretary
- Refrigeration
- Retail Merchandising
- Salesmanship—Outside
- Sheet Metal Work
- Tool Making

NAME..... OCCUPATION.....
 HOME ADDRESS..... AOB.....
 CITY..... STATE.....

THIS IS YOUR BALLOT

Find the subject that interests you most and then... Check, Sign and Mail Today

Today, choose the job you want — and prepare for it in spare time at home. Or if you are already engaged in the work you like best, start training now for quicker promotion. In hours you might otherwise waste, gain the knowledge and skill that can help you to get ahead faster, make more money, and have greater security.

Training Backed by 54 Years of Experience

For over half a century American School has helped ambitious men and women toward success by providing specialized training for commercial and technical advancement. Its study program for you has been planned by experts with years of experience in the subject you select and they will give you needed guidance every step of the way.

Don't Delay Your Start

Give serious thought to the list of training courses listed above. Pick the opportunity that interests you, check it and add your name and address. (Check more than one if you are undecided as to which appeals most.) Finally clip out and mail the "ballot" and full information will be supplied, without cost or obligation.

AMERICAN SCHOOL

DEPT. G645, DREXEL AT 58th, CHICAGO 37, ILL.

THE SOONER YOU START, THE SOONER YOUR GOAL CAN BE REACHED

INVENTORS

If you believe that you have an invention, you should find out how to protect it. The first step is to have a search made of the prior pertinent U. S. patents. If a report on this search indicates that the invention appears patentable you can apply for a patent, and the specifications and claims should be prepared.

The firm of McMorrow, Berman & Davidson, with offices in Washington, D. C., is qualified to take the necessary steps for you. We can make a preliminary search on your invention, advise you whether we think it can be patented, and prepare your application for patent.

Unless you are fully familiar with the U. S. Patent Laws, we recommend that you engage the services of a Registered Patent Attorney to protect your interests. The patent laws are *your* laws. A patent gives you the right to prevent others from making, using or selling the invention claimed in your patent for a period of 17 years.

Use these patent laws for your protection. Investigate whether your invention can be patented. If you have what you believe to be an invention, we suggest that you have this firm make a search for you.

Send for a copy of our Patent Booklet entitled "How To Protect Your Invention," containing information about patent protection and patent procedure. Along with this we will also send you an "Invention Record" form, for your use in writing down and sketching details of your invention. We will mail them promptly. No obligation. They are yours for the asking.

McMORROW, BERMAN & DAVIDSON

Registered Patent Attorneys

PATENTS • COPYRIGHTS • PATENTS

135-Y VICTOR BUILDING, WASHINGTON 1, D. C.

Become an ELECTRICAL ENGINEER

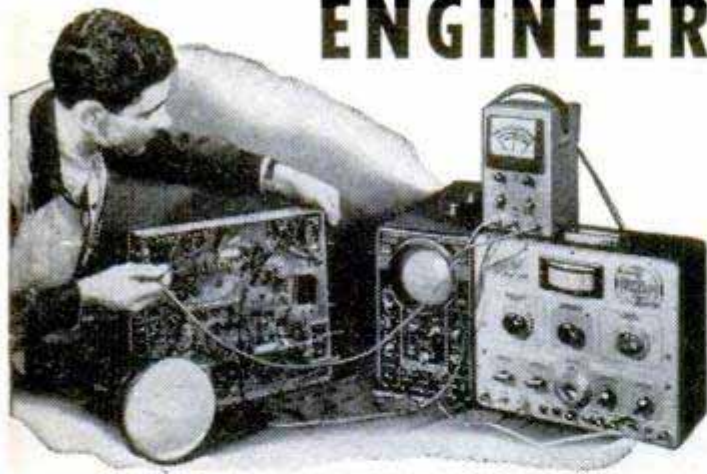

Major in Power or Electronics ... B. S. Degree in 36 Months

Important advantages are yours at this nonprofit institution of higher learning. Through optional year-round study, a *valuable year is saved* by gaining your B. S. degree in 36 months. Further—you are guided scientifically toward specialization for design and research, manufacturing and production—or engineering sales and management.

Choose the Course
That Interests You Most

SERVICE

- 6 Months
- Electricity
 - Welding
 - Refrigeration
 - Heating

TECHNICIAN

- 12 to 18 Months
- Radio and Television
 - Electronics
 - Electrical Power
 - Welding
 - Air Conditioning

ENGINEERING

- 36 Months
- Electrical Engineering — B. S. Degree Major in Electrical Power or Electronics

A Radio-Television Technician's Certificate can be yours in 18 months

Under this school's **proven plan** you can become a Radio Technician in 12 months — or a Television Technician in 6 additional months. Courses are complete in themselves, and can be applied as **one-third** of the electrical engineering course.

Practical, Military or Academic Training will be evaluated for advanced credit.

Faculty of specialists. Over 2,300 annually enrolled. 35,000 former students from 48 states and 23 overseas countries.

MILWAUKEE SCHOOL of ENGINEERING

Terms open Oct., Jan.,
April, July

Write for free 110-page catalog, 48-page pictorial booklet "Your Career" and "Occupational Guidance" Bulletins

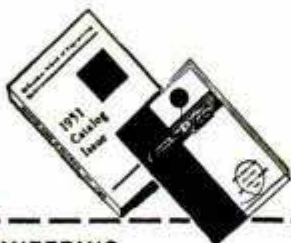

MILWAUKEE SCHOOL OF ENGINEERING
Department PM 951, 1025 N. Broadway, Milwaukee, Wis.

Without obligation send catalog and "Your Career" bulletin plus "Occupational Guidance Bulletin" and details on course in

NAME _____ AGE _____

ADDRESS _____

CITY _____ ZONE _____ STATE _____

Check if World War II Veteran

(Continued from page 14)

Blocks cradle bar clamps to hold them upright.....	178
Leather "lining" for vise jaws prevents damaging soft work.....	178
Cloth padding attached to workbench top prevents scratching furniture.....	185
Clothespin and folding rule help transfer angles.....	185
Yardstick's usefulness increased by slot to direct straight cuts.....	190
Wide work supported on saw table by roller units clamped to sawhorse.....	198
Stepped holder keeps small tools grouped conveniently at hand.....	198
Dowel tipped with rubber holds Linotype slugs.....	206
String wrapped around cardboard quickly cut into equal lengths.....	208
Parts salvaged from scrap pile used to make welding-shop floor fan.....	215
Glycerin speeds handling papers.....	215
V-blocks for holding round drill-press work designed to utilize stock materials.....	215
Rustproofing quenching pots on bench grinder.....	218

OUTDOOR RECREATION

Tape identifies your picnic dishes.....	170
Stand holds outboard motor in vertical position.....	174
Lazy Susan and corrugated box speed drying of fishline.....	190
Boat oar adapted for sculling by adding second leather and collar.....	197

PHOTOGRAPHY

Transparency viewer from bond box.....	199
Broomstick and Xmas-tree holder provide photoflood-lamp stand.....	200
Making settings after dark.....	200
Brush hung in rubber cement kept pliable for use.....	200
Light near darkroom clock dimmed with special unit.....	200
Quick-change filter holder utilizes large paper clip.....	200
Extended scale for enlarger lens.....	201
Holder for ground-glass magnifier attached to tripod leg.....	202
Paper clip used on dial-type photo guide aids in making camera settings.....	202

TOOLS

Boring tools for modelmakers.....	172
Improvised soft-faced hammer.....	190
Improvised sheet-metal seamer.....	197
Punch-type can opener provides ideal wire-splicing tool.....	198
Improvised bushing reamer.....	206
Drum sander for your workshop.....	207
Saw has easily removed motor for use on other tools.....	208
Stiffening a socket-wrench joint.....	208
Make yourself a miter box.....	209
Stud driver with stop pin easily backed off thread.....	214
Mill-file cleaning tool made from steel bar.....	214
Combination sharpening and reinstallation jig (Hartmeister Mfg. Inc., 2020 W. Barbary Place, Denver 4, Colo.).....	216
Vertical rotary attachment (Allan Mfg. Co., 22-76 Steinway St., Long Island City 5, N. Y.).....	216
Abrasive band (DoALL Co., Desplaines, Ill.).....	216
Electric paint remover (Slik Products Co., Manitowoc, Wis.).....	216
Face shields (Mine Safety Appliances Co., Braddock, Thomas & Meade Sts., Pittsburgh 8, Pa.).....	217
Resistance soldering unit (Sunrise Products Co., Electrical Div., Box 173, Hawthorne 1, N. J.).....	217
Pocket-size wire stripper (Ideal Industries, Inc., 5136 Park Ave., Sycamore, Ill.).....	217
Adjustable wrench (Chicago Specialty Mfg. Co., 2604 W. Loomis, Chicago).....	217
Odd-shaped faceplate work held with drill-press vise.....	218

MISCELLANEOUS

"Third hand" to hold flashlight made from piece of corrugated cardboard.....	164
Chalked edges of outlet box mark opening in wallboard.....	174
Finding wall-cabinet area.....	174
Wallboard removed intact by cutting around nails.....	178
Headlight lens and rim from car glaze doghouse window.....	178
Bushing flush-tank ball prevents loosening.....	189
White stripe painted on bolt lock tells if door is locked.....	190
Spillproof dog-feeding pans supported by special rail.....	192
Servicing cigarette lighters.....	192
Overhead tank primes jet pump.....	197
Preserving metal water tanks.....	208
Removing rust from steel.....	211
Corner posts of poured concrete eliminate diagonal bracing.....	211
Stringer for basement stairs made from waste blocks.....	218

Radio-Television, Electronics

Rockefeller Center trains for civil defense.....	219
Simple 80-meter code receiver for the new novice ham band.....	220
How to build a small cubical exponential horn.....	222
Radio and electronics today (Geiger counter, J. A. Batson Electronics Corp., 1031 S. 27th St., Omaha, Neb.; antenna in flowerpot, J. H. Rasmussen & Co., 1445 Merchandise Mart, Chicago 54; electronic secretary, Electronic Secretary Distributors, Inc., Milwaukee 4, Wis.; phono turntable, Gale Dortha Mechanisms, Elmhurst, L. I., N. Y.; emergency alarm, Kenyon & Eckhardt, Inc., 247 Park Ave., New York City 17; portable FM radiophone, Doolittle Radio, Inc., 7421 S. Loomis Blvd., Chicago 36).....	224
Fringe-area TV antenna easily serviced.....	225

IMPORTANT NOTICE—It is the intention of this magazine to provide its readers with information regarding the latest developments in the mechanical arts. We take no responsibility as to whether the disclosures contained in our articles are covered by patents and advise readers to investigate this subject before making, using, or selling any of the products, machines, or processes described in order to avoid possible liability for patent infringements.

LEARN

ELECTRICITY

ON REAL EQUIPMENT

IN THE GREAT SHOPS OF **COYNE**



ALSO TRAINING IN
RADIO-TELEVISION

Plays a Vital Roll in Nation's Defense



The tremendous growth of this new field is almost unbelievable. New stations are rapidly bringing television to all parts of the country. RADIO-TELEVISION and their applications are vital to our Defense Program. Unusual opportunity to get in on ground floor of this vital field that also offers a world of opportunities for a real future when the emergency is over. Train quickly on actual equipment at Coyne by practical-technical methods. Get big Free Book today.

ELECTRICITY-

The Power Behind Our Defense Program

A great opportunity field and vital to Defense. Thousands of trained Electrical men needed in good jobs with a real future when the emergency is over. Why be satisfied with a "no future" job? Get Free Book that tells how thousands have prepared quickly for a good job with a real future in Electricity at Coyne.

TRAIN QUICKLY AT COYNE FOR VITAL FIELDS

ELECTRICITY-RADIO-TELEVISION-VITAL in Industry and Armed Forces. TRAIN QUICKLY at Coyne for better rating, if drafted-vital job in Industry, if not. Trained men whether 16 or up to 50 needed. Many men with physical handicaps can qualify. Prepare now for steady, well paid, essential jobs in A FIELD THAT ALSO OFFERS A REAL FUTURE WHEN THE EMERGENCY IS OVER.

Not "Home-Study"

We do not teach by mail. All training is given in our Great Training Shops in Chicago, plus necessary theory. No advanced education or previous experience needed.

START NOW-PAY LATER

Enroll now, pay most of tuition later. If you need part-time work to help out with living expenses while at Coyne, we'll help you get it. G.I. approved.



1 You are TOLD the how and why of each job.



2 You're shown how to do typical jobs by trained instructors.



3 You DO practical job YOURSELF on equipment.

Mail Coupon for Big FREE BOOK

Whether you prefer Electricity or Television-Radio, train on actual equipment, at Coyne. We have a Big, fully illustrated book we'll send you if you will indicate below which course you are interested in. Fill in and mail coupon TODAY. Paste it on a penny postcard if you wish. Complete details will come by return mail. No salesman will call.

B. W. Cooke, President
COYNE ELECTRICAL & TELEVISION-RADIO SCHOOL
An Institution not for Profit
500 S. Paulina St., Chicago, 12
Dept. 61-72H



B. W. COOKE, President
COYNE ELECTRICAL & TELEVISION-RADIO SCHOOL
500 S. Paulina St., Chicago 12
Dept. 61-72H

Send your BIG FREE BOOK and details of your training offer. This does not obligate me and no salesman will call. I am interested in

ELECTRICITY TELEVISION-RADIO

NAME.....

ADDRESS.....

CITY.....STATE.....

The 97 Pound Weakling

who became "The World's Most Perfectly Developed Man"

"I'll Prove that YOU, too, can be a NEW MAN!"

Charles Atlas

I KNOW, myself, what it means to have the kind of body that people pity! Of course, you wouldn't know it to look at me now, but I was once a skinny weakling who weighed only 97 lbs.! I was ashamed to strip for sports or undress for a swim. I was such a poor specimen of physical development that I was constantly self-conscious and embarrassed. And I felt only HALF-ALIVE.

Then I discovered "Dynamic Tension." It gave me a body that won for me the title "World's Most Perfectly Developed Man."

When I say I can make you over into a man of giant power and energy, I know what I'm talking about. I've seen my new system "Dynamic Tension" transform hundreds of weak, puny men into Atlas Champions.

Only 15 Minutes a Day

Do you want big, broad shoulders — a fine, powerful chest — biceps like steel — arms and legs rippling with muscular strength — a stomach ridged with bands of sinewy muscle — and a build you can be proud of? Then just give me the opportunity to prove that "Dynamic Tension" is what you need.

No "if's," "and's," or "may-bes." Just tell me where you want handsome, powerful muscles. Are you fat and flabby? Or skinny and gawky? Are you short-winded, peepless? Do you hold back and let others walk off with the prettiest girls, best jobs, etc.? Then write for details about "Dynamic Tension" and learn how I can make you a healthy, confident, powerful HE-MAN.

"Dynamic Tension" is an entirely NATURAL method. Only 15 minutes of your spare time daily is enough to show amazing results — and it's actually fun! "Dynamic Tension" does the work.

FREE — My 48-Page Illustrated Book Yours — Not \$1 or 10c — But FREE



Send NOW for my famous book, "Everlasting Health and Strength." 48 pages, packed from cover to cover with actual photographs and valuable advice. Shows what "Dynamic Tension" can do, answers many vital questions. Page by page it shows what I can do for YOU.

This book is a real prize for any fellow who wants a better build. Yet I'll send you a copy absolutely FREE. Just glancing through it may mean the turning point in your whole life! Rush the coupon to me personally: Charles Atlas, Dept. 8-J, 115 East 23rd St., New York 10, N. Y.

CHARLES ATLAS, Dept. 8-J, 115 East 23rd St., New York 10, N. Y.

Send me—absolutely FREE—a copy of your famous book, "Everlasting Health and Strength"—48 pages, crammed with actual photographs, answers to vital health questions, and valuable advice to every man who wants a better build. I understand this book is mine to keep, and sending for it does not obligate me in any way.

Name _____ Age _____
 (Please print or write plainly)
 Address _____
 City _____ State _____



CHARLES ATLAS

Holder of Title
 "The World's Most Perfectly Developed Man"

Peace or War Business



Patented Equipment

Are YOU the Man?

... if you are honest, willing to work to enjoy success — write today for details on how to Own a Business of Your Own. No experience necessary. You can have your business operating in a very few days.

Clean and Mothproof Rugs and Upholstery

Duraclean cleans and sanitizes. Duraproof protects against moths and carpet beetles. Furnishings are serviced right "in the home" or business building.

No overhead expense. Some dealers open a shop or an office . . . others operate from their own home. Profits up to \$15 a day on EACH of your service men.

Duraclean and Duraproof are Nationally Advertised in quality magazines to create voluntary orders for you in this year 'round, lifetime business of "your own." Send now for free booklet. No obligation.

DURACLEAN CO., 1-169 Duraclean Bldg., Deerfield, Ill.

HOME REPAIR TIP NO. 17



PATCH PLASTIC BALLOONS and toys—make them "good as new" with "SCOTCH" Brand No. 33 Electrical Tape. Professional electricians have used it for years on all kinds of wiring jobs. Carries UL seal. 39¢ at your hardware store.

'How to MAKE MONEY with Simple CARTOONS'



A book everyone who likes to draw should have. It is free; no obligation. Simply address **FREE BOOK**

CARTOONISTS' EXCHANGE
 Dept. 99D Pleasant Hill, Ohio

Learn ACCOUNTING BOOKKEEPING

This nationally renowned school has demand for graduates in good salary positions thru Nationwide recognition and placement service. Write Department PMB today for Big 32 **FREE** page Success Book to be sent to you

Hills BUSINESS UNIVERSITY AND EXTENSION SCHOOL
 619 W. MAIN ST. OKLAHOMA CITY 2, OKLAHOMA

BE A DETECTIVE

WORK HOME or TRAVEL. Experience unnecessary. DETECTIVE Particulars FREE. Write to GEO. P. M. WAGNER, 125 W. 86th St., N. Y.

WORLD'S FASTEST BOATS!

BUILD and DRIVE your own high speed racing boat

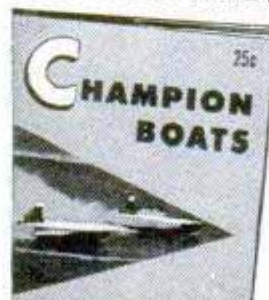

as hundreds of others are doing! Easy to follow our simplified plans for newest types of racing craft. Large selection of full race Hydroplanes ranging from 6 ft. to 20 ft. lengths. Service, Racing, Utilities, and 3 Points. Both inboard and outboards.

SEND 25c for CATALOGUE

containing pictures and descriptions of **Champion Boats** for which plans are designed and distributed exclusively by **CHAMPION BOATS, P. O. Box 9038, Dept. 15-1, Long Beach, California, U.S.A.**

"Impossible," they say

MAYBE they're right about money growing on trees. But here's a success-proved fact: a career firmly rooted in good, practical *training* bears rich and wondrous fruit. Money, promotions, prestige, security—many of the things you really want in life.

Do you want the rewards that come from *training*? I. C. S. can help you—just as it has helped thousands of men who today are leaders in business and industry. You have over 400 courses to choose from. And the coupon brings full information. Why not mail it *today*?

INTERNATIONAL CORRESPONDENCE SCHOOLS



BOX 5509-L, SCRANTON 9, PENNA.

Without cost or obligation, please send me full particulars about the course BEFORE which I have marked X:

- | | | | |
|---|---|---|--|
| <p>Business and Academic Courses</p> <ul style="list-style-type: none"> <input type="checkbox"/> Accounting <input type="checkbox"/> Advertising <input type="checkbox"/> Bookkeeping <input type="checkbox"/> Business Administration <input type="checkbox"/> Business Correspondence <input type="checkbox"/> Business Law <input type="checkbox"/> Cartooning <input type="checkbox"/> Certified Public Accounting <input type="checkbox"/> Commercial <input type="checkbox"/> Commercial Art <input type="checkbox"/> Cost Accounting <input type="checkbox"/> Fashion and Book Illustration <input type="checkbox"/> Federal Tax <input type="checkbox"/> First Year College <input type="checkbox"/> Foremanship <input type="checkbox"/> Good English <input type="checkbox"/> High School <input type="checkbox"/> Higher Mathematics <input type="checkbox"/> Industrial Supervision <input type="checkbox"/> Motor Traffic <input type="checkbox"/> Personnel—Labor Relations <input type="checkbox"/> Postal Civil Service <input type="checkbox"/> Retailing <input type="checkbox"/> Retail Business Management <input type="checkbox"/> Salesmanship <input type="checkbox"/> Secretarial <input type="checkbox"/> Sign Lettering <input type="checkbox"/> Stenography <input type="checkbox"/> Traffic Management Aeronautics Courses <input type="checkbox"/> Aeronautical Engineer's, Jr. <input type="checkbox"/> Aircraft Drafting and Design | <ul style="list-style-type: none"> <input type="checkbox"/> Aircraft Mechanic <input type="checkbox"/> Engine Mechanic Air Conditioning and Plumbing Courses <input type="checkbox"/> Air Conditioning <input type="checkbox"/> Heating <input type="checkbox"/> Plumbing <input type="checkbox"/> Refrigeration <input type="checkbox"/> Refrigeration, Domestic <input type="checkbox"/> Refrigeration & Air Conditioning <input type="checkbox"/> Steam Fitting Chemical Courses <input type="checkbox"/> Chemical Engineering <input type="checkbox"/> Chemistry, Analytical <input type="checkbox"/> Chemistry, Industrial <input type="checkbox"/> Food-Plant Sanitation <input type="checkbox"/> Petroleum Production & Refining <input type="checkbox"/> Plastics <input type="checkbox"/> Pulp and Paper Making Civil Engineering and Architectural Courses <input type="checkbox"/> Architecture <input type="checkbox"/> Architectural Drafting <input type="checkbox"/> Bridge and Building Foreman <input type="checkbox"/> Building Estimating <input type="checkbox"/> Civil Engineering <input type="checkbox"/> Contracting and Building <input type="checkbox"/> Highway Engineering <input type="checkbox"/> Reading Structural Blueprints <input type="checkbox"/> Sanitary Engineering | <ul style="list-style-type: none"> <input type="checkbox"/> Structural Drafting <input type="checkbox"/> Structural Engineering <input type="checkbox"/> Surveying and Mapping Communications Courses <input type="checkbox"/> Electronics <input type="checkbox"/> Practical Telephony <input type="checkbox"/> Radio, General <input type="checkbox"/> Radio Operating <input type="checkbox"/> Radio Servicing <input type="checkbox"/> Television <input type="checkbox"/> Telegraph Engineering Electrical Courses <input type="checkbox"/> Electrical Drafting <input type="checkbox"/> Electrical Engineering <input type="checkbox"/> Electric Light and Power <input type="checkbox"/> Lighting Technician <input type="checkbox"/> Practical Electrician <input type="checkbox"/> Power House Electric <input type="checkbox"/> Ship Electrician Diesel Engines Courses <input type="checkbox"/> Diesel Engines <input type="checkbox"/> Internal Combustion Engines Mechanical Courses <input type="checkbox"/> Forging <input type="checkbox"/> Foundry Work <input type="checkbox"/> Heat Treatment of Metals <input type="checkbox"/> Industrial Engineering <input type="checkbox"/> Industrial Instrumentation <input type="checkbox"/> Industrial Metallurgy <input type="checkbox"/> Machine Shop <input type="checkbox"/> Mechanical Drafting | <ul style="list-style-type: none"> <input type="checkbox"/> Mechanical Engineering <input type="checkbox"/> Mold-Loft Work <input type="checkbox"/> Patternmaking—Wood, Metal <input type="checkbox"/> Reading Shop Blueprints <input type="checkbox"/> Sheet-Metal Drafting <input type="checkbox"/> Sheet-Metal Worker <input type="checkbox"/> Ship Drafting <input type="checkbox"/> Ship Fitting <input type="checkbox"/> Tool Designing <input type="checkbox"/> Toolmaking <input type="checkbox"/> Welding—Gas and Electric Railroad Courses <input type="checkbox"/> Air Brake <input type="checkbox"/> Car Inspector <input type="checkbox"/> Diesel Locomotive <input type="checkbox"/> Locomotive Engineer <input type="checkbox"/> Locomotive Fireman <input type="checkbox"/> Locomotive Machinist <input type="checkbox"/> Railroad Section Foreman <input type="checkbox"/> Steam-Diesel Locomotive Engineer Stationary Engineering Courses <input type="checkbox"/> Power Plant Engineering <input type="checkbox"/> Stationary Fireman <input type="checkbox"/> Stationary Steam Engineering Textile Courses <input type="checkbox"/> Cotton Manufacturing <input type="checkbox"/> Loom Fixing <input type="checkbox"/> Rayon Manufacturing <input type="checkbox"/> Textile Engineering <input type="checkbox"/> Woolen Manufacturing |
|---|---|---|--|

Name _____ Age _____ Home Address _____

City _____ State _____ Working Hours _____ A. M. to _____ P. M.

Present Position _____ Employed by _____

Special tuition rates to members of the Armed Forces. Canadian residents send coupon to International Correspondence Schools Canadian, Ltd., Montreal, Canada.

In Your Mind's Eye

The Secret of MENTAL CREATING

IF you just like to dream, read no further. There comes a time when your fancies *must be* brought into light—and stand the test of every-day, hard realities. Are you one of the thousands—perhaps millions—whose thoughts never get beyond the stage of *wistful wishing*? Do you often come to from a daydream with the sigh, "If only I could bring it about—*make it real*?"

All things begin with thought—it is what follows that may take your life out of the class of those who hope and dream. Thought energy, like anything else, can be dissipated—or it can be made to produce actual effects. *If you know how to place your thoughts* you can stimulate the creative processes within your mind—through them you can assemble things and conditions of your world into a happy life of accomplishment. *Mental creating* does not depend upon a magical process. It consists of *knowing how* to marshal your thoughts into a power that draws, compels and organizes your experiences into a worth-while design of living.

ACCEPT THIS *Free* BOOK

Let the Rosicrucians tell you how you may accomplish these things. The Rosicrucians (not a religious organization), a world-wide philosophical fraternity, have preserved for centuries the ancients' masterful knowledge of the functioning of the inner mind of man. They have taught men and women how to use this knowledge to *recreate their lives*. They offer you a free copy of the fascinating book, "The Mastery of Life." It tells how you may receive this information for study and use. Use coupon opposite.

The ROSICRUCIANS
(AMORC)

SAN JOSE

CALIFORNIA

SCRIBE: A.G.X.
The Rosicrucians (AMORC),
San Jose, California.

Please send free copy of "The Mastery of Life,"
and I shall read it as directed.

Name.....

Address.....

City.....

**GET INTO A
MONEY MAKING
TRADE—NOW!**



**L. J. ROSENKRANZ,
President**

**LET ME SEND YOU THESE
BIG FREE BOOKS!**

These Big FREE Books and Sample Lessons show how we train you. Get all the facts—send today for your choice of our valuable book on Radio-Television, OR Diesel-Automotive Opportunity. Check coupon at right. No cost or obligation.

**TAKE YOUR CHOICE OF
2 BIG FIELDS OF**

**RADIO
TELEVISION
ELECTRONICS**

**TODAY'S SHORTAGE OF TRAINED TECHNICIANS
CREATES BONUS OPPORTUNITY FOR YOU!**

Radio, Television, Electronics is a dominant factor in the national emergency. How well these essential services will do the big job they have been given depends upon the supply of trained men. Prepare yourself now to step into a good-paying job with a real future! New developments in color TV, guided missiles, radar, other electronics fields are only the beginning! National Schools Master Shop Method Home Training is complete—you master all phases of Radio, Television, Electronics.

**WE SEND YOU EVERYTHING YOU
NEED TO LEARN AT HOME**

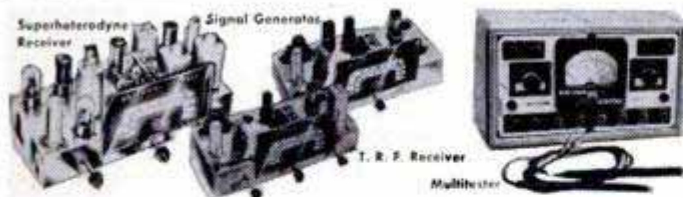

Above are some of experimental units you build with kits of standard parts we send you: Signal Generator, Audio Oscillator, T. R. F. Receiver and many other units and circuits, including a big modern Superheterodyne Receiver. We send you all the tubes and a valuable professional quality Multimeter. No extra charges. You learn by doing!

**HAVE A PROFITABLE
BUSINESS OF YOUR OWN**

National training qualifies you for your choice of many job opportunities in radio and television broadcasting, manufacturing, servicing, sales. Also installation & maintenance of laboratory electronics equipment, sound systems, police radio, and many others. You can start a good paying business of your own, as many other National Schools graduates have done!

TELEVISION TRAINING

A complete series of up-to-the-minute TV lessons is an important part of your course. They cover all phases of TV repairing, servicing and construction.

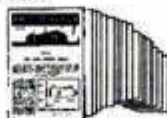

NATIONAL SCHOOLS Technical Trade Training Since 1905
Los Angeles 37, California

GET THE FACTS . . . MAIL COUPON TODAY

National Schools, Dept. 9-PMC
4000 South Figueroa Street
Los Angeles 37, California

Mail in envelope
or paste on
penny postal

Send me Free the book checked below and the sample lesson. I understand no salesman will call on me.

"My Future in Radio, Television & Electronics."

OR

"My Future in Diesel, Automotive & Allied Mechanics."

NAME _____ AGE _____

ADDRESS _____

CITY _____ ZONE _____ STATE _____

Use coupon to get your choice of these FREE illustrated books and actual sample lessons.

Let National Schools, of Los Angeles, a practical Technical Resident Trade School for almost 50 years, train you for today's unlimited opportunities.



**OPPORTUNITY
DIESEL
AUTOMOTIVE &
ALLIED MECHANICS**

**IF YOU LIKE MECHANICS, THERE'S A BRIGHT
FUTURE FOR YOU IN DIESEL-AUTOMOTIVE!**

Trained engine mechanics are needed in increasing numbers in the Armed Forces and civilian production—everywhere that engine power is used! National Schools gives you complete training for this great industry.

**YOU GET MASTER SHOP METHOD
TRAINING RIGHT IN YOUR HOME**

With our practical home training, you learn Diesel Fuel Injection, Automotive Motor Tune-up, Diesel Engine Maintenance, General Garage Mechanics, Thermodynamics, Auto Electrical Service and all other phases. Your National Course covers Gasoline and Special Fuel Engines; Diesels, High Speed and Heavy Duty; Semi-Diesels; Allied Mechanics. Get all the facts—use the coupon above.

**WE SEND YOU TOOLS
OF YOUR TRADE**



In addition to all lesson texts, Diesel Chart Manual, Spare Time Lessons, Service Manuals & other material, you receive a full kit of high-quality tools and equipment...all a part of your course.

No extra charge for this valuable kit of tools and equipment.

EARN WHILE YOU LEARN

You can earn extra money and get valuable experience in spare time. Special Spare Time Work Lessons show you how! Many National students pay for all or part of their course this easy way.

Use the coupon now to get valuable Free Book about the great Diesel-Automotive Industry and the Sample Lesson, plus full information about how we train you.

**BOTH RESIDENT
& HOME STUDY
COURSES OFFERED**

C. T. C. TRAINING IN DRAFTING

PREPARES FOR PROMOTION
MORE MONEY
SUCCESS

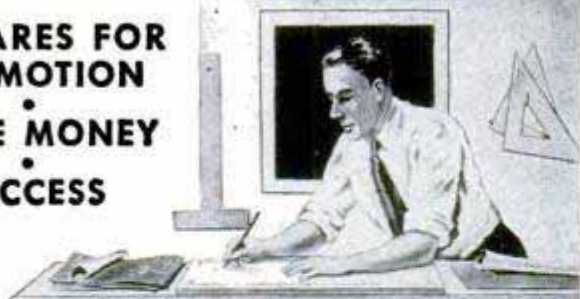

"Here I am at work making good money as a draftsman. I'm glad I sent the coupon to Chicago Tech for that Free Trial Lesson and found out how easy it is to learn Drafting in spare time at home. Today, I feel secure in my job. What's more, I feel I'm slated for promotion and more pay."

LEARN IN SPARE TIME—AT HOME! (or at the College in Chicago)

A few hours of pleasant home study every week—that's all. All the tools you need; drawing outfit included. This tested method—developed over 47 years of C.T.C. progress—prepares men quickly for good positions in industry.



FREE INFORMATION — SEND COUPON

To prove to you how easy it is to learn Drafting at home, we will send you this FREE TRIAL LESSON. Mail coupon or send post card today.

CHICAGO TECHNICAL COLLEGE

M-214 Tech Bldg., 2000 So. Michigan Ave.
Chicago 16, Illinois

Mail me FREE Lesson with information about big opportunities in DRAFTING.

Name _____ Age _____

Address _____

City _____ Zone _____ State _____

John Sill
Jowett
Pupil

"Hey, You SKINNY BAG of BONES!"
the boys shouted at me
only A FEW SHORT WEEKS ago

But look at me now, PAL... A
TROPHY-WINNING ALL-AROUND
HE-MAN as YOU can be SOON
in 10 Thrilling Minutes a day.

YOU can WIN this
Big 15" Silver Trophy
as John Sill just did!
Your Name on it.

Yes! Today everyone admires John Sill's movie-star Champion BUILD. His big mighty ARMS. His heroic CHEST. His broad BACK. His rock-like TORSO. His wide military SHOULDERS. His newly won POPULARITY.

Send me only 10c

Like John Did—
And get ALL

5 PICTURE - PACKED
HE-MAN BUILDING
COURSES and get also



Be A Winner at
Anything YOU
Tackle with
Progressive Power-
SPORTS! JOB!
SCHOOL! FRIENDS!

GEORGE
F. JOWETT
"Champion
of Champions"



FREE! Jowett's Photo Book of Famous Strong Men!

JOWETT INSTITUTE, Dept. PM-19
230 Fifth Avenue, New York 1, N. Y.
Dear George: Please mail to me prepaid FREE
Jowett's Photo Book of Strong Men, plus all 5
Muscle Building Courses, "How to Become a
Muscular He-Man." ENCLOSED FIND 10c in complete
payment for EVERYTHING.

NAME _____ AGE _____
(Please Print Plainly, Include Zone Number)
ADDRESS _____ NO C.O.D.'s
CITY _____ ZONE & STATE _____

PORTABLE GARAGE

USE IT ANYWHERE!

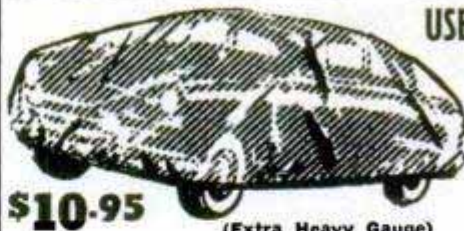

\$10.95
(Extra Heavy Gauge)

- Goes wherever your car goes
- Takes little room
- Keeps rain, snow, dust, salt air, sun or sleet away & protects your car's finish

- Durably constructed of clear transparent — heavy gauge vinyl plastic that is long wearing and tough
- Spring-tite elasticized bottom, holds securely in all kinds of weather
- Fits all makes and models
- Direct from manufacturer
- \$10.95
- Enclose check or money order, or sent C.O.D.

DOMAR SALES CO., 480 LEXINGTON AVE.,
DEPT. GN-14, NEW YORK 17, N. Y.

SHORTHAND in 6 Weeks at Home

amous Speedwriting system. No signs; no symbols; no machines; uses ABC's. Easy to learn; easy to write and transcribe. Low cost. 100,000 taught by mail. For business and Civil Service. Also typing. 28th year. Write for FREE booklet to

Speedwriting
Dept. 1509-1, 55 W. 42 St., New York 18

LEARN WATCH REPAIRING



AT HOME. By our modern and original system of instruction you can learn every part of the WATCH REPAIRING TRADE AT HOME. Prepare yourself for a well-paying position or start in business after completing our course of instruction. Good watch repairers are in demand and generally earn very good salaries. For particulars apply to the WISCONSIN SCHOOL OF WATCH REPAIRING 759 North Milwaukee St., Milwaukee 2, Wis.



GOLD-SILVER-COINS

Easily located with new Lightweight M-Scope Detector. Superior performance, lowest price, monthly payment plan.

FREE LITERATURE
FISHER RESEARCH LAB., INC.
PALO ALTO CALIF.

GREAT PROFITS
MAKE YOUR OWN RUBBER MOLDS

Make your own rubber molds quickly, cheaply with X.L. RUBBER. Cast thousands of perfect figurines, book ends, plaques, ornaments, ash trays, etc. GREAT PROFITS! Write for NEW Catalog.

X.L. Rubber, Pts. \$2.50;
Qts. \$4.00; Models and enough rubber for 3 molds \$1.50 postpaid.



SEND FOR FREE FACTS

PLASTIC ARTS STUDIO Dept. 2, 3403 S. MADISON ST., Muncie, Ind.

A "GOOD HAND" HELPS YOU SUCCEED! LEARN TO WRITE WELL

Handwriting quickly improves with our easy-to-understand picture lessons! Put your spare time to good use; send today for FREE BOOK, "How to Become a Good Penman", or check volumes wanted below at \$1 each: Business Writing Artistic Writing Card Writing Bird & Design Flourishing Engrossing Alphabets. COMPLETE SET \$4.50

OUR 53rd YEAR
TAMBLYN SCHOOL of PENMANSHIP
S. A. Ziller, Pres. 442 Ridge Bldg., Kansas City, Mo., USA

**NOW... GET EVERYTHING YOU
NEED TO LEARN AND MASTER**

TELEVISION

**RADIO-ELECTRONICS
...AT HOME!**

**Use REAL commercial-type equip-
ment to get practical experience**

Your future deserves and needs every advantage you can give it! That's why you owe it to yourself to find out about one of the most COMPLETE, practical and effective ways now available to prepare AT HOME for America's billion dollar opportunity field of TELEVISION-RADIO-ELECTRONICS. See how you may get and keep the same type of basic training equipment used in one of the nation's finest training laboratories... how you may get real STARTING HELP toward a good job or your own business in Television-Radio-Electronics. Mail the coupon today for complete facts — including 89 ways to earn money in this thrilling, newer field.



**Here's the
REAL THING!**

SET UP YOUR OWN HOME LABORATORY

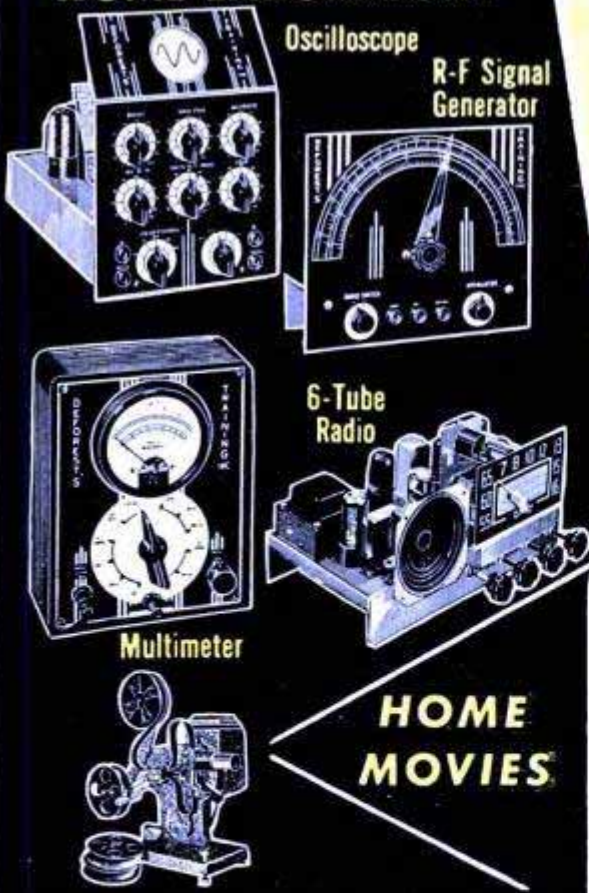

Oscilloscope

R-F Signal
Generator

6-Tube
Radio

Multimeter

**HOME
MOVIES**

ABOVE: Build and keep a real 16 INCH commercial TV receiver. Optional after completing regular training at slight additional cost.

D.T.I., ALONE, INCLUDES BOTH MOVIES and HOME LABORATORY
In addition to easy-to-read lessons, you get the use of HOME MOVIES — an outstanding training advantage — plus 16 big shipments of Electronic parts. Perform over 300 fascinating experiments for practical experience. Build and keep real commercial-type test equipment shown at left.

MODERN LABORATORIES

If you prefer, get all your preparation in our new Chicago Training Laboratories—one of the finest of its kind. Ample instructors, modern equipment. Write for details!

MILITARY SERVICE!

If you're subject to military service, the information we have for you should prove doubly interesting. Mail coupon today.

**Get BOTH of these
information packed
publications FREE!**



ACT NOW! MAIL COUPON TODAY!

DeFOREST'S TRAINING, INC., Dept. PM-9-H
2533 N. Ashland Ave., Chicago 14, Ill.

Without obligation, I would like your late News-Bulletin showing 89 ways to earn money in Television-Radio-Electronics... and how I may prepare to get started in this thrilling field.

Name..... Age.....
Street..... Apt.....
City..... Zone..... State.....

De FOREST'S TRAINING, INC.
CHICAGO 14, ILLINOIS
A De VRY INSTITUTION

**YOU
can
acquire**

LAW NIGHTS AT HOME! L. L. B. DEGREE

LaSalle's famous Law Library—used as reference in many Law libraries and Law offices—has enabled thousands to master Law surprisingly fast, in spare hours at home, for business and professional advancement.

These 14 remarkable volumes, compiled by leading professors and lawyers, cover the whole basic field of Law in condensed, orderly, simplified manner.

You advance rapidly with this great library, plus special lectures furnished. We guide you step-by-step with personalized Problem Method of instruction . . . you *learn by doing*—handling legal problems—not by memorizing rules.

Send for two FREE 48-page booklets, "Law Training for Leadership," and "Evidence," answering questions about Law and its value to you, and telling how LaSalle Law graduates are winning rapid advancement in business and public life. Mail coupon below. No obligation.

LA SALLE EXTENSION UNIVERSITY A Correspondence Institution

417 S. Dearborn St., Dept. 964L, Chicago 5, ILL.

Send me your two FREE booklets described above, without obligation.

Name..... Age.....

Street.....

City, Zone & State.....

Prepare Now! ENGINEERING B.S. DEGREE IN 27 MONTHS WORLD FAMED SCHOOL • ESTABLISHED 1884

Mechanical, Civil, Electrical, Chemical, Aeronautical, Radio (Television) Engineering; Business Administration and Accounting. Also 36-weeks diploma courses in Surveying and Drafting.

Personalized instruction. Accelerated courses. For ambitious earnest students. Preparatory department.

Heavy demand for Tri-State graduates; hold positions of responsibility the world over. Placement service. Serious shortage of engineers indicated for immediate future. Prepare now for the opportunities ahead. Technical training helpful in military assignments.

Extensive campus. Well equipped, new and modernized buildings; up-to-date labs. Low cost. New terms start quarterly. Enter September, January, March, June.

Write today for free catalog and special information.

TRI-STATE COLLEGE

491 COLLEGE AVENUE ANGOLA, INDIANA

Chronograph Wrist Watch

\$5.98
PLUS TAX

LOWEST MARKET PRICE



JEWELLED MOVEMENT

Precision workmanship. Rugged Shock-Resistant Case. Radium hands and numerals. Sweep Hand. Measures Distance, Speed of Cars, Planes, Horses and other moving objects. A Timekeeper and Stop-Watch. Telemeter-Tachometer. **LIFETIME GUARANTEE** (with exception-of-parts). Full operating instructions. Pay Postman \$5.98 plus 60c Federal Tax, total, \$6.58 plus charges or enclose payment and save postage charges.

3 DIAL SPORT CHRONO — \$8.69
(Fed. Tax Incl.)

3 DIAL GILD SPORT CHRONO — \$12.98
(Fed. Tax Incl.)

MARDO SALES CORP., 480 Lex. Ave., Dept. BW-20, N. Y. 17

FALSE TEETH

KLUTCH holds them tighter

KLUTCH forms a comfort cushion; holds dental plates so much firmer and snugger that one can eat and talk with greater comfort and security; in many cases almost **as well as with natural teeth**. Klutch lessens the constant fear of a dropping, rocking, chafing plate. 25c and 50c at druggists . . . If your druggist hasn't it, **don't waste money on substitutes**, but send us 10c and we will mail you a generous trial box.

KLUTCH CO.

Box 5193-I

ELMIRA, N. Y.



LEARN MEAT CUTTING At Home — In Spare Time

Get into the vital meat industry. Concise, practical Home Training based on 25 years proven instruction methods used at National's famous resident school. Prepares you for bigger pay as Meat Cutter, Supervisor, market manager or more money in your own store. Go as rapidly as your spare time permits. Diploma. Start NOW to turn your spare hours into money. Send for FREE bulletin today. No obligation.

NATIONAL SCHOOL OF MEAT CUTTING, INC., Div. U-132, Toledo 4, Ohio



PHOTOGRAPHY

EARN BIG MONEY! PERSONAL ATTENDANCE TRAINING in News-Magazine-Fashion-Portrait-Advertising-Natural Color Photography. Splendid equipment, glamorous models. Or—our **COMPLETE HOME STUDY COURSE** provides you with a spare time short-cut to success.

Our 41st year. Write immediately for **BIG FREE BOOK!**

NEW YORK INSTITUTE OF PHOTOGRAPHY

Dept. 49, 10 West 33 St., New York 1, N. Y.

MAKE MONEY with Bostonian SHIRTS

TAKE orders for old, reliable line finest quality dress and sport shirts. All styles . . . fabrics . . . colors . . . sizes. Sensational **LOW PRICES**. No experience needed.

FREE Samples of actual fabrics and big Style Kit waiting for you! Send no money, but rush name NOW! **BOSTONIAN MFG. CO.**
89 Bickford St., Dept. J-40, Boston 30, Mass.



SHINE WITHOUT 'POLISH'

New Invention! • Sells Like Wild

Replaces messy pastes, liquids. Simply glide over shoes—and **PRESTO!**—you have a lustrous, long-lasting shine. No mess. No muss. No soiled hands. Clean. Handy. **WORKS LIKE MAGIC!** For Men's, Women's and Children's Shoes. Low priced, Lightning seller!

SAMPLES FOR TESTING Sample offer sent immediately to all who send name at once. A penny postal will do. **SEND NO MONEY**—just your name. **KRISTEE CO., Dept. 688, AKRON 8, OHIO**

NOW!

**BRAND-NEW,
UP-TO-THE-MINUTE**

Edition of Famous Manual

MAKES *Any* AUTO REPAIR JOB

Your "Meat!"

ENLARGED!

MORE Words!
771 BIG Pages!
More Chapters! More Facts!

REVISED!

MORE Pictures—
Over 2300 In All! Covers
ALL Automatic Transmissions!

NEW!

Now You Can Repair
ALL 1951 MODELS—As Well
As Any Car Built Since 1935!

TRY BOOK FOR A WHOLE WEEK—FREE

Return and Pay Nothing if Not Satisfied!

HERE it is! — the *brand-new, revised, enlarged 1951* edition of **MOTOR'S Auto Repair Manual!** Now you can "lick" any auto repair job on any car built since 1935 — *including all 1951 models!* Just look up make, model, and job in quick index — and go to it.

EVERYTHING YOU NEED TO KNOW TO REPAIR ANY CAR!

771 BIG pages; 2300 "how-to-do-it" pictures; 200 "quick-check" specifications, charts, and tables; over 225,000 facts make every operation a "snap"! Includes ALL automatic transmissions; new GM Rochester carburetor.

Beginners will find in this giant book the most helpful guidance on every kind of service and repair job imaginable. Expert mechanics will be amazed by the short-cuts they'll discover.

Win Prestige! Earn More Money!

Factory engineers from every auto plant in America worked out these time-saving procedures. Now you get all this wealth of "know-how" from over 150 *Official Shop Manuals*, "boiled down" into clear terms in one handy book! Now you can tackle jobs you wouldn't think of trying before. And you'll

win more prestige, more money!

Right at your fingertips you have every "How-to-do-it" fact you want. Over 38,000 essential dimensions on 800 car models! Whether you want to make a simple carburetor adjustment or completely rebuild a transmission, step-by-step instructions show exactly **WHAT** to do, **HOW** to do it. Used by U. S. Army, technical schools, thousands of auto service men.

SEND NO MONEY

Send no money. Enjoy this brand-new book—at our risk—for a full week, **FREE!** Test it right in your own garage or shop. If book doesn't more than pay for itself in 7 days, simply return it and pay nothing. Mail coupon NOW to **MOTOR Book Dept., Desk 19, 250 West 55th St., New York 19, N. Y.**

Used by
**U. S. ARMY
and NAVY**

**COVERS 800
MODELS—ALL
THESE MAKES!**

Buick Ford
Cadillac Frazer
Chevrolet Henry J.
Chrysler Hudson
Crosley Kaiser
De Soto Lafayette
Dodge La Salle
Lincoln
Mercury
Nash
Nash Rambler
Oldsmobile
Packard
Plymouth
Pontiac
Studebaker
Terraplane
Willys

ALSO complete tune-up adjustments for:
American Bantam •
Auburn • Austin •
Cord • Graham •
Hupmobile • Pierce
Arrow • Reo

MOTOR

Published
by **MOTOR**
The Leading
Automotive
Business
Magazine

**MOTOR'S
AUTO
REPAIR
MANUAL**



ABOVE: Showing operation of Buick Dyna-Flow — and BELOW: How to Adjust Ford Clutch. Every moving part is covered in simple words and **BIG, CLEAR** Pictures.

MAIL COUPON NOW FOR 7-DAY FREE TRIAL

MOTOR BOOK DEPT.
Desk 19, 250 West 55th St., New York 19, N. Y.

Rush to me at once (check box opposite book you want):
 MOTOR'S New 1951 AUTO REPAIR MANUAL. If O.K., I will remit \$1 in 7 days (plus 35c delivery charges), \$2 monthly for 2 months and a final payment of 95c one month after that. Otherwise I will return the book postpaid in 7 days. (Foreign price, remit \$8 cash with order.)
 MOTOR'S TRUCK & TRACTOR REPAIR MANUAL. (Described at left.) If O.K., I will remit \$2 in 7 days, and \$2 monthly for 3 months, plus 35c delivery charges with final payment. Otherwise I will return book postpaid in 7 days. (Foreign price, remit \$10 cash with order.)

Print Name.....Age.....

Address.....

City.....State.....

Check box and save 35c delivery charge by enclosing WITH coupon entire payment of \$5.95 for Auto Repair Manual (or \$8 for Truck & Tractor Repair Manual). Same 7-day return-refund privilege applies.

Same FREE Offer on

MOTOR'S TRUCK & TRACTOR MANUAL



Covers EVERY job on EVERY popular make gasoline truck and farm tractor built from 1936 thru 1949! 1400 pictures, 961 pages, 300,000 facts. All types Gasoline Engines, Fuel Systems, Governors, Lubrication, Ignition, Starters, Clutches, Axles, Brakes, etc., etc.

ALSO covers many buses, contractor and road building equipment, stationary power machinery. Check box in coupon.

"I'M EARNING \$300 A MONTH!"



... says Leonidas Burgoyne of Chicago, Illinois, "Expert individual instruction in the fully equipped shops of Greer Shop Training gave me the right start to get my good paying job."

GREER SHOP TRAINING ... established 1902, is one of America's largest trade schools. Over 48,000 successful graduates. You learn by tearing down, repairing and rebuilding. Day and evening classes. Mail this coupon today!

LEARN A TRADE NOW!

GREER SHOP TRAINING, Desk 211, 2230 S. Michigan Avenue, Chicago, Ill.

Gentlemen: Please send me information about trade I have checked below. (Specify if you are VET or NON-VET .

IN OUR CHICAGO SHOPS

- | | |
|---|--|
| <input type="checkbox"/> AUTO MECHANICS | <input type="checkbox"/> BODY, FENDER REPAIR |
| <input type="checkbox"/> DIESEL | <input type="checkbox"/> WELDING—ARC, GAS |
| <input type="checkbox"/> REFRIGERATION | <input type="checkbox"/> TOOL & DIE |
| | <input type="checkbox"/> PIANO TUNING |

Above courses approved for Vets and Civilians.

ALSO THE FOLLOWING HOME STUDY COURSES

- | | | |
|--|---------------------------------|-----------------------------------|
| <input type="checkbox"/> REFRIGERATION | <input type="checkbox"/> DIESEL | <input type="checkbox"/> PLASTICS |
|--|---------------------------------|-----------------------------------|

Name _____ Age _____

Address _____

City _____ State _____

GREER SHOP TRAINING

TRAVEL for "UNCLE SAM"



START as high as \$3,450.00 Year

Prepare NOW for Next Examinations

VETERANS GET SPECIAL PREFERENCE

Many examinations expected soon

City Mail Carriers
City Postoffice Clerks
Stenographers-Typists
Messengers,
Liquor Inspectors—
and many others.

32-Page Book on Civil Service FREE

Mail Coupon today—SURE

★

FRANKLIN INSTITUTE

(Not Government Controlled)

Dept. Y-83
Rochester 4, N. Y.

COUPON Rush to me, entirely free of charge, 32-page book with:
(1) A full description of U.S. Government jobs; (2) A list of U.S. Government jobs; (3) Tell me how to qualify for a job.

Name.....

Address.....

City.....Age?.....

new, easy way to.. STRIPE with PAINT

Do Perfect Paint Striping at Home with New Kind of PAINT STRIPING TOOL

This Master Painters' Striping Tool makes it easy to do expert striping on furniture, bikes, model planes, autos, signs, toys, linoleum, wall board, etc. Makes plain, painted walls look like tile. Paint straight lines... curved... circular or evenly spaced parallel lines the same way a professional painter does. Simply fill Tubular-Glass Paint Fountain with any color paint and wheel tip feeds paint evenly. Tips interchangeable—jaws split apart for easy cleaning. Tool complete with tips for 1-16 in. stripe only \$1.00 postpaid. Other complete tools with 1-64, 1-32, 3-64, 5-64, 3-32, 1-8 inch tips, \$1.50 ea. Extra tips — 75c each. **COMPLETE KIT** with tool and 7 tips, \$5.00. Here's the handiest tool in your whole painter's kit. C.O.D.'s post. coll.



\$1 ONLY

POSTPAID ATTENTION Home Craftsmen and Hobbyists

Just the tool you've been waiting for! New PAINT STRIPING tool gives "professional" results every time, yet simple and easy to use as a fountain pen. Adjustable guide keeps lines straight as an arrow. Just as easy to make curves or free hand designs. Adds new beauty and finished look to everything you paint. Send dollar today.

DEALERS Paint Striping Tool

packed in attractive display cartons of 1 doz. Fast, profitable seller. Write for illus. circular, discounts.

WENDELL MFG. CO., 4234 N. Lincoln Ave., Dept. 39, Chicago 18, Ill.



Money In Hamsters

The new wonder animals from Syria. Often called Toy Bears. Delightful pets. Everyone wants them. Laboratories use thousands. Clean, odorless. Raise anywhere. NOW, spotted and golden breeds. We furnish breeders, equipment and manual of instruction. Write today for free illustrated literature.

GULF HAMSTERY 1536 BASIL ST., MOBILE 17, ALA.

TASOPE PHOTO-ENGRAVING PLANTS



Establish your own profitable PHOTO-ENGRAVING business. Make cuts for newspapers, printers, and advertisers. Make etched name plates, plaques etc. Instructions furnished, no experience necessary. Sold direct from factory since 1931. First five hundred cuts sold locally or by mail will pay for plant and pay you well for your time. Write for FREE catalog.

TASOPE DEPT. PM9, AURORA, MO.

LAW FREE BOOK



Your FREE copy of "The Law-Trained Man" shows how to gain prestige and greater earnings through Blackstone home law study. All instruction material furnished including 17-volume Law Library written by 65 well-known law authorities. Lawyers, judges among our graduates. LL.B. degree. Low cost; easy terms. Write today.

BLACKSTONE COLLEGE OF LAW 225 N. Michigan Ave. Dept. 56, Chicago 1, Ill.
A Correspondence Institution Founded in 1890

ENGINEERING DEGREE IN 27 MONTHS

INDIANA TECHNICAL COLLEGE

B. S. DEGREE. Aeronautical, Chemical, Civil, Electrical, Mechanical and Radio Engineering (inc. television), Drafting, 1-yr. Government approved for G.I.'s. Low rate. Earn board. Large industrial center. Students from 48 states, 21 countries. Demand for graduates. Enter September, December, March, June. Write for catalog. 1691 E. Washington Boulevard, Fort Wayne 2, Indiana.

HOME REPAIR TIP NO. 14

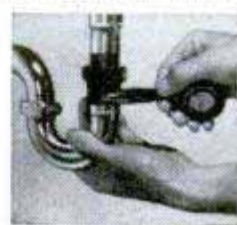

SEAL SINK TRAP JOINTS with a half-lapped layer of "SCOTCH" Brand No. 33 Electrical Tape. Plastic backing stretches to conform to any surface. Sticks tight at a touch. UL seal for wiring, too. 39¢ at your hardware store.

The world on your shoulders

What's ahead for that baby of yours? Happiness? Security? A good education? These, of course, and everything else you can provide. For, above all, you want to be a good father — and a good provider.

That's why you'll find so many young, married men enrolled with the International Correspondence Schools. The average I.C.S. student is 28, employed, married and a father. His biggest concern is security for himself and his family. So he works days and studies nights. And inside of six months, the average student reports a pay raise or a promotion or both. It's a record that we at I.C.S. are proud of — *and a record you can duplicate.*

You owe it to yourself — and your family — to find out more about the "security insurance" that training provides. Information is given free and without obligation. You need only mail the coupon.

Remember, the world is on your shoulders — all ten, precious pounds of it.

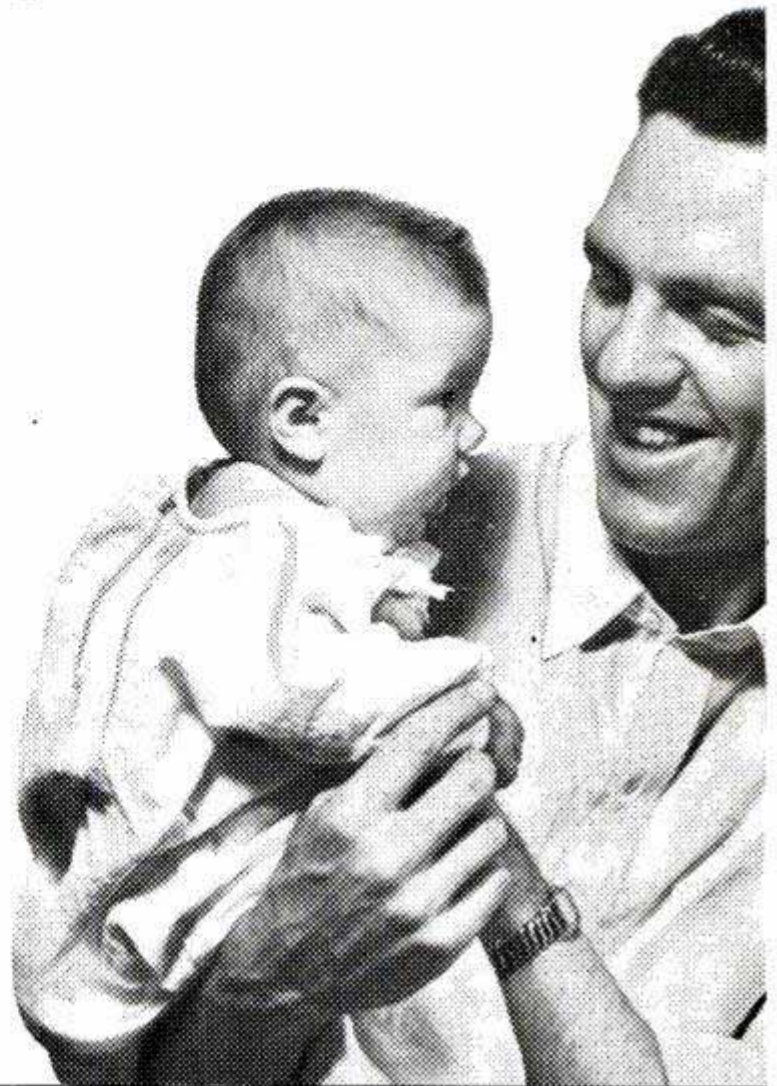

INTERNATIONAL CORRESPONDENCE SCHOOLS



BOX 5507-L, SCRANTON 9, PENNA.

Without cost or obligation, please send me full particulars about the course BEFORE which I have marked X:

- | | | | |
|--|---|--|--|
| <p>Air Conditioning and Plumbing Courses</p> <p><input type="checkbox"/> Air Conditioning <input type="checkbox"/> Heating</p> <p><input type="checkbox"/> Plumbing <input type="checkbox"/> Refrigeration</p> <p><input type="checkbox"/> Refrigeration, Domestic</p> <p><input type="checkbox"/> Refrigeration & Air Conditioning</p> <p><input type="checkbox"/> Steam Fitting</p> <p>Aeronautics Courses</p> <p><input type="checkbox"/> Aeronautical Engineer's, Jr.</p> <p><input type="checkbox"/> Aircraft Drafting & Design</p> <p><input type="checkbox"/> Aircraft Mechanic</p> <p><input type="checkbox"/> Engine Mechanic</p> <p>Automotive Courses</p> <p><input type="checkbox"/> Automobile <input type="checkbox"/> Auto Technician</p> <p><input type="checkbox"/> Auto Electric Technician</p> <p><input type="checkbox"/> Auto Body Rebuilding & Refinishing</p> <p>Chemical Courses</p> <p><input type="checkbox"/> Chemical Engineering</p> <p><input type="checkbox"/> Chemistry, Analytical</p> <p><input type="checkbox"/> Chemistry, Industrial</p> <p><input type="checkbox"/> Food-Plant Sanitation</p> <p><input type="checkbox"/> Petroleum Refining <input type="checkbox"/> Plastics</p> <p><input type="checkbox"/> Pulp and Paper Making</p> <p>Civil Engineering and Architectural Courses</p> <p><input type="checkbox"/> Architecture <input type="checkbox"/> Architectural Drafting</p> <p><input type="checkbox"/> Bridge and Building Foreman</p> | <p><input type="checkbox"/> Building Estimating</p> <p><input type="checkbox"/> Civil Engineering</p> <p><input type="checkbox"/> Contracting and Building</p> <p><input type="checkbox"/> Highway Engineering</p> <p><input type="checkbox"/> Reading Structural Blueprints</p> <p><input type="checkbox"/> Sanitary Engineering</p> <p><input type="checkbox"/> Structural Drafting</p> <p><input type="checkbox"/> Structural Engineering</p> <p><input type="checkbox"/> Surveying and Mapping</p> <p>Communications Courses</p> <p><input type="checkbox"/> Electronics</p> <p><input type="checkbox"/> Practical Telephony</p> <p><input type="checkbox"/> Radio, General <input type="checkbox"/> Radio Operating</p> <p><input type="checkbox"/> Radio Servicing <input type="checkbox"/> Television</p> <p><input type="checkbox"/> Telegraph Engineering</p> <p>Electrical Courses</p> <p><input type="checkbox"/> Electrical Drafting</p> <p><input type="checkbox"/> Electrical Engineering</p> <p><input type="checkbox"/> Electric Light and Power</p> <p><input type="checkbox"/> Lighting Technician</p> <p><input type="checkbox"/> Practical Electrician</p> <p>Diesel Engines Courses</p> <p><input type="checkbox"/> Diesel Engines</p> <p><input type="checkbox"/> Internal Combustion Engines</p> <p>Mechanical Courses</p> <p><input type="checkbox"/> Forging <input type="checkbox"/> Foundry Work</p> <p><input type="checkbox"/> Heat Treatment of Metals</p> | <p><input type="checkbox"/> Industrial Engineering</p> <p><input type="checkbox"/> Industrial Instrumentation</p> <p><input type="checkbox"/> Industrial Metallurgy</p> <p><input type="checkbox"/> Machine Shop</p> <p><input type="checkbox"/> Mechanical Drafting</p> <p><input type="checkbox"/> Mechanical Engineering</p> <p><input type="checkbox"/> Mold-Loft Work</p> <p><input type="checkbox"/> Patternmaking—Wood, Metal</p> <p><input type="checkbox"/> Reading Shop Blueprints</p> <p><input type="checkbox"/> Sheet-Metal Drafting</p> <p><input type="checkbox"/> Sheet-Metal Worker</p> <p><input type="checkbox"/> Ship Drafting <input type="checkbox"/> Ship Fitting</p> <p><input type="checkbox"/> Tool Designing <input type="checkbox"/> Toolmaking</p> <p><input type="checkbox"/> Welding—Gas and Electric</p> <p>Railroad Courses</p> <p><input type="checkbox"/> Air Brake <input type="checkbox"/> Car Inspector</p> <p><input type="checkbox"/> Diesel Locomotive</p> <p><input type="checkbox"/> Locomotive Engineer</p> <p><input type="checkbox"/> Locomotive Fireman</p> <p><input type="checkbox"/> Locomotive Machinist</p> <p><input type="checkbox"/> Railroad Section Foreman</p> <p><input type="checkbox"/> Steam-Diesel Locomotive Eng.</p> <p>Stationary Engineering Courses</p> <p><input type="checkbox"/> Power Plant Engineering</p> <p><input type="checkbox"/> Stationary Fireman</p> <p><input type="checkbox"/> Stationary Steam Engineering</p> | <p>Textile Courses</p> <p><input type="checkbox"/> Cotton Manufacturing</p> <p><input type="checkbox"/> Loom Fixing <input type="checkbox"/> Rayon Mfg.</p> <p><input type="checkbox"/> Textile Engineering</p> <p><input type="checkbox"/> Woolen Manufacturing</p> <p>Business and Academic Courses</p> <p><input type="checkbox"/> Accounting <input type="checkbox"/> Advertising</p> <p><input type="checkbox"/> Bookkeeping</p> <p><input type="checkbox"/> Business Administration</p> <p><input type="checkbox"/> Business Correspondence</p> <p><input type="checkbox"/> Business Law <input type="checkbox"/> Cartooning</p> <p><input type="checkbox"/> Certified Public Accounting</p> <p><input type="checkbox"/> Commercial <input type="checkbox"/> Commercial Art</p> <p><input type="checkbox"/> Cost Accounting</p> <p><input type="checkbox"/> Fashion & Book Illustration</p> <p><input type="checkbox"/> Federal Tax <input type="checkbox"/> First Year College</p> <p><input type="checkbox"/> Foremanship</p> <p><input type="checkbox"/> Good English <input type="checkbox"/> High School</p> <p><input type="checkbox"/> Higher Mathematics</p> <p><input type="checkbox"/> Industrial Supervision</p> <p><input type="checkbox"/> Motor Traffic</p> <p><input type="checkbox"/> Personnel—Labor Relations</p> <p><input type="checkbox"/> Postal Civil Service <input type="checkbox"/> Retailing</p> <p><input type="checkbox"/> Retail Business Management</p> <p><input type="checkbox"/> Salesmanship <input type="checkbox"/> Secretarial</p> <p><input type="checkbox"/> Sign Lettering <input type="checkbox"/> Stenography</p> <p><input type="checkbox"/> Traffic Management</p> |
|--|---|--|--|

Name _____ Age _____ Home Address _____

City _____ State _____ Working Hours _____ A.M. to _____ P.M.

Present Position _____ Employed by _____

Special tuition rates to members of the Armed Forces. Canadian residents send coupon to International Correspondence Schools Canadian, Ltd., Montreal, Canada.

EMPLOYERS NOW BIDDING FOR TELEVISION TRAINED MEN

WE TRAIN YOU AT HOME IN SPARE TIME

TV-Radio-FM Service Technicians in Big Demand! Get top pay faster through RTTA practical shop-training methods right in your own home. We supply everything.

EARN WHILE YOU LEARN!

YOU KEEP ALL EQUIPMENT



RTTA Furnishes Everything! Tubes, Batteries, Large TV Picture Tube!

YOU BUILD AND KEEP THIS GIANT SCREEN TELEVISION SET!

Your choice of 10, 12½ or 16" Picture Television Tube

WE PREPARE YOU FOR FCC LICENSE! U.S. GOV'T. NEEDS FCC MEN



MULTITESTER



SIGNAL GENERATOR



5-TUBE RADIO

YOU GET RADIO EXTRA 15 BIG TELEVISION KITS AT NO COST! YOU BUILD THESE AND FOUR OTHER UNITS

FREE At No Extra Cost YOU GET A ROUND TRIP TO NEW YORK CITY

After completing home study training, your transportation both ways from any point in U. S. or Canada will be paid by RTTA. You visit our affiliated facilities in N.Y.C. as part of your 2 weeks of practical training on newest equipment at RTTA.

NO PREVIOUS EXPERIENCE NECESSARY FREE EMPLOYMENT HELP

RTTA helps you earn while you learn! Open to men of all ages! RTTA prepares you for BIG PAY and to open your own shop.

DRAFT AGE MEN Special "SPEED-UP" Radio Technician program helps you get BETTER SERVICE RATING—BETTER PAY! You can find out by return mail! Send Coupon TODAY!

FREE "SPEED-UP" OFFER—COUPON

Radio Television Training Association

515 Clinton Ave., Dept. 249, Newark 1, N. J.

Rush me FREE Sample Lesson and Catalog "How to Make Money in Television," in spare time, AT HOME, while learning. Also "Speed-Up" Service Rating Plan. I'm under no obligation.

Name..... Age.....

Address.....

Approved by Commissioner of Education of State of N. J.

BOTH FREE



WHAM-O SPORTSMAN * \$1.25 (50¢ PAIR)

45-LB. PULL!

HITS LIKE A .22 RIFLE—KILLS RABBITS, SQUIRRELS. Powerful, silent, accurate. For hunting, target, routing pests.

Sportsman's choice sold world over!

HUNTING SLINGSHOT

Heavy duty 7" ash stock.

40 steel balls, extra rubber, target.

GUARANTEED—at dealers, or send \$1.25 to

Wham-O Mfg. Co., Box 61, South Pasadena, Calif.

*Professional model of Nat'l Slingshot Assn.

BIG MONEY for You
Showing NEW MIRACLE Labor Saving Discovery

MEN! WOMEN! Enjoy amazing profits with new "Miracle" Copper Cote Ironing Pad. Plastic Coating saves housewives time, labor, money. 1-minute demonstration sells it. Experience unnecessary. Write for FREE Sample Offer Send for FREE facts about COPPER COTE, and our other new fast-selling products. SEND NO MONEY. Write for details, sample offer to THE SHELDON CO., Dept. 783 1223 South 23rd St., Milwaukee 46, Wis.



OPPORTUNITIES AHEAD! TRAIN FOR A FUTURE IN DIESEL

Prepare for the big earning power of Diesel Trained Men. Start learning at home, in spare time. UEI's easy, practical training covers all phases of DIESEL engine operation, fuel systems, auxiliary equipment, repairs and maintenance. Also new Scientific Auto Motor Tune-up. After home course, you come to Chicago for actual practice in UEI's modern shop under experienced instructors. GET ALL THE FACTS FREE. WRITE TODAY!

DIESEL UTILITIES ENGINEERING INSTITUTE
2521 Sheffield Avenue, Dept. DC-14 Chicago 14, Illinois



SEND FOR THIS FREE!

Make money. Know how to break and train horses. Write today for this book FREE, together with special offer of a course in Animal Breeding. If you are interested in Gaiting and Riding the saddle horse, check here () Do it today—now.

BEERY SCHOOL OF HORSEMANSHIP
Dept. 1109D Pleasant Hill, Ohio

REAL ESTATE BE A BROKER

PAYS BIG! SEND FOR FREE, BIG, ILLUSTRATED CATALOG NOW! No obligation. Graduates report making substantial incomes. Start and run your own business quickly. Men, women of all ages, learn easily. Course covers Sales, Property Management, Appraising, Loans, Mortgages, and related subjects. STUDY AT HOME or in our classrooms in big cities. Diploma awarded. G.I. approved. Nationally known.

WEAVER SCHOOL OF REAL ESTATE (Est. 1936)
15 E. Pershing Road Dept. PM Kansas City, Mo.

FREE BOOK TELLS HOW

New Way to Improve YOUR ENGLISH



A command of effective English gives you added advantages and better opportunities. Poor English handicaps you more than you will ever realize. You can improve your English through Sherwin Cody's 100% self-correcting invention. If you are embarrassed by mistakes in grammar, spelling, punctuation, or pronunciation, this new free book "How You Can Master Good English in 15 Minutes a Day" will prove a revelation to you. Send for it now. It is free. No obligation. No agent will call. Address SHERWIN CODY COURSE IN ENGLISH, 59 B&O Building, Rochester 14, N. Y.

BE A LOCKSMITH

Learn from experts at home! Age or handicap no disadvantage. Profitable profession. FREE booklet. INSTITUTE OF LOCKSMITHING, Dept. P-22 55 Park Ave., Rutherford, N. J.

BOYS—IT'S FREE!

"THE WONDERS OF CHEMISTRY"

This exciting new book shows how to amaze your friends with chemical magic, describes many fascinating home experiments, tells of fun, thrills and big future opportunities for boys who know chemistry. Special atomic energy feature. Send today!

THE PORTER CHEMICAL COMPANY
40 Prospect Avenue, Hagerstown, Maryland



There's BIG MONEY in UNIFORMS and Work Clothes that ADVERTISE!

Every business and businessman is swinging over to employee uniforms and work clothes, embroidered with company name, trademark, sales message, etc. The field is new. Prospects are everywhere—garages, service stations, factories, coal dealers, dairies—and hundreds more. Profits are huge. You take orders by the dozen and gross! One man made over \$800.00 on a single deal! You get the business everytime because you offer latest style and finest fabrics. Big selling kit sent FREE!

TOPPS, Dept. 619, Rochester, Indiana



Attention!! Limited Edition... SPECIAL



Sensational
NEW TUNE-UP MANUAL

Plus new
"MILE-O-METER" mileage calculator

Both only
\$1.00 p.pd.



HUGE! - 76 pages of information

OVER 300 ILLUSTRATIONS

ALL IN COLOR

The manufacturers of the "Mile-O-Meter," the world-famous miles per gallon and motor tune-up gauge, offer the sensational new huge 76 page book, all in color, plus the new "Mile-O-Meter" mileage calculator for only \$1.00 to the readers of this magazine.

This is done in the interests of better motoring and both of these items are worth ten times their price. This sensational Motorist's Manual makes tune-up very simple. It can be used by a beginner or an expert. The "Mile-O-Meter" Mileage Calculator is a specially designed Calculator that enables a motorist, at a glance, to determine his exact mileage, by computing the amount of miles shown on his speedometer.

This Calculator is all in color and has a swivel disc in the center that turns on a brass grommet.

You, too, can tune your own motor. You can save many hundreds of dollars in tune-up work without difficulty. Simply consult the famous "Mile-O-Meter" Motorist's Manual.

The Gale Hall Engineering reserve the right to restrict the sales of this manual to 50,000 copies only. Both the Manual and the Calculator are sent postpaid. Simply fill in the coupon below and you, too, can become well-versed in automotive tune-up and service.

Some of the information contained in this Manual is heretofore unknown throughout the industry and this Manual is a MUST for every mechanic or every car owner. It is written in a manner that any car owner—without previous experience—can check his entire engine, and tune it.

**ANYONE CAN LEARN EASILY...
SAVE HUNDREDS OF DOLLARS IN REPAIRS
AND LEARN TO TUNE-UP ENGINES**

© 1951

MAIL COUPON TODAY!

order from **GALE HALL Engineering** Dept. 1232b
107 Northampton St., Boston 18, Mass.
World's Largest Producer of Tune-Up Gauges

Please rush my Manuals and Calculators.
Enclosed find Check Money Order for
\$..... No C.O.D.s

Name _____
Address _____ State _____
City _____

Notice

only 50,000 copies available.

The Gale Hall Engineering reserve the right to restrict this printing to 50,000 copies.

Why not order a dozen of these famous "Mile-O-Meter" Manuals and Calculators and use them for gifts. They make a fine gift, to any motorist, at all times.

SEND TODAY!

GET THE WORLD'S LEADING

RADIO & TV CATALOG

★
FREE

★
1952

212-Page
Edition

★
ALLIED'S
BIG COMPLETE
BUYING GUIDE

Save on Everything
in Radio and TV



NEW
UP-TO-DATE
SEND FOR IT NOW

**Everything for Experimenters,
Builders, Amateurs, Service-
men, Engineers and Soundmen**

Send for ALLIED'S 212-page 1952 Catalog, the value-packed guide to everything in Radio and Television! Latest home radios, TV equipment, Amateur supplies, P.A. Systems, Hi-Fidelity Sound, recorders, test instruments, builders' kits—plus the world's largest stocks of electronic parts, tubes, tools, books and diagrams. Get more for your money—send today for your FREE 1952 ALLIED Catalog!



Get Radio's Leading
Buying Guide Today

FREE!

ALLIED RADIO

ALLIED RADIO CORP., Dept. 5-JJ-1
833 W. Jackson Blvd., Chicago 7, Ill.

Rush FREE 1952 ALLIED 212-Page Catalog.

Name _____

Address _____

City _____ Zone _____ State _____

DESIGN YOUR OWN FUTURE
BE A **DRAFTSMAN** *or* BIG PAY!



LEARN AT HOME IN SPARE TIME

Drafting offers trained men excellent starting salaries, unlimited advancement opportunities with big earnings. Machines will never replace the draftsman. Before any production starts plans must be drawn and Draftsmen are the first to be hired. Drafting is light, pleasant work, in pleasant surroundings and leads to top managerial positions.

CTS OFFERS NEW TRAINING PROGRAM

You learn the hows and whys of successful production planning by studying at home. You learn by making actual drawings. CTS gives you professional drafting instruments, a drafting table, drafting supplies, everything you need at no extra cost. For Free catalogue write

CHRISTY TRADES SCHOOL, Dept. DB-1103
4432 N. Kedzie Ave., Chicago 25

SEND FOR
FREE
CATALOG

Learn **WOOD PRODUCTION ENGINEERING**

At Home In Your Spare Time

from
THE ONLY SCHOOL
OF ITS KIND

There are big money making opportunities in furniture drafting, production, or a furniture business of your own. You will quickly attain success through our instruction.

FREE Booklet

KLOK SPECIALIZED TRAINING

Teaches you the arts of Sketching—Drafting—Time Study—Production Scheduling—How to Operate a Successful Business of Your Own, through our Home Study Course or Resident Course at Grand Rapids.

WRITE TODAY—without obligation, for our FREE Booklet. State age, Home Study or Resident Course preference, present occupation.

JOHN H. KLOK, Pres. Woodworking Industry Training Since 1928
KLOK INSTITUTE, Louis St. N.W., Grand Rapids 2, Mich.



BIG LEATHER & CRAFT CATALOG!

1000's of items for Leathercraft, Textile Painting, Copper Tooling, Kits, Projects, Tools, Supplies, Etc. Send 25c (refunded with 1st order) to:

RUSSO HANDICRAFT SUPPLIES Dept. CD-3, 245 S. SPRING,
LOS ANGELES 12, CALIF.

BECOME AN EXPERT IN

TRAFFIC

Traffic men earn \$4,000 to \$10,000 and up. Thousands of firms need experts on rates, tariffs, regulations. We train you thoroughly in spare time at home for executive traffic jobs. Personal training under traffic authorities. Placement counsel and help. Write for free 48-page book "Traffic Management—the Fast Growing Profession."

LASALLE Extension University, 417 So. Dearborn St.
A Correspondence Institution Dept. 964T Chicago 5, Ill.

ARTISTS MAKE MONEY

Do you like to draw? Send name, address, age and occupation for FREE ART TEST, to find out your ability.
ART INSTRUCTION, Inc. 9131 ART INSTRUCTION BLDG.
MINNEAPOLIS 15, MINNESOTA

Tells How You Can Learn to

FREE BOOK MOUNT BIRDS!

Learn At Home

Men, Boys, Hunters, Fishermen, mount and save your lovely wild-game trophies. Be a Taxidermist. Mount Birds, Animals, Heads, Fish, Tan skins. YOU learn easily, quickly in spare time. Have a grand home-museum. The finest and the greatest hobby known, for sportsmen. Fun, real profits.

FREE BOOK

Yes, FREE. Beautiful strange, valuable Book, telling all about Taxidermy. Contains over 100 beautiful game-pictures. And it's yours FREE, if you rush your request. You can mount all kinds of wild-game, and common specimens too. We can positively TEACH YOU, So GRASP this opportunity. RUSH letter or postal for this amazing FREE BOOK. Don't delay. State your AGE.
N. W. SCHOOL OF TAXIDERM, 2509 Elwood Bldg., Omaha 2, Neb.

GET THIS FREE BOOK!

NEW MYSTERY FISH-BOWL

AMAZING

Specially priced at only **2.98**

WHAT KEEPS THE WATER IN THE LOOP?

RUSH YOUR ORDER TODAY!

- ▶ IT'S NEW — IT'S DIFFERENT
- ▶ BEAUTIFULLY MOLDED PLASTIC GYM
- ▶ FISH SWIM THROUGH MAGIC LOOP
- ▶ DECORATES END TABLES, BOOKCASES, ETC.

What keeps the water in the loop? Amaze and mystify your friends with this sensational new "mystery" fish-bowl molded from clear durable plastic with a scientific tube loop. Fill it with approximately 1/2 gallon of water as per our secret instructions, then insert two or three of your pet goldfish. You'll watch them for hours and hours as they frisk and frolic through the loop. The perfect compliment to any room. Decorates end-tables, bookcases, etc. Makes a wonderful gift. **SEND NO MONEY.** (C.O.D. you pay postage. Remit with order, we pay postage.)

NOVELTY MART • 59 East 8th Street; Dept. PM-9, New York 3, N.Y.

Wheels Wheels

Wheels Wheels

5" Disc Wheel 5/8" Tire 5/16" or 3/8" sleeve	30c ea.
6" Disc Wheel 5/8" Tire 5/16" or 3/8" sleeve	35c ea.
7" Disc Wheel 3/4" Tire 3/8" sleeve	45c ea.
8" Disc Wheel 1 1/8" Tire 1/2" sleeve	70c ea.
7" Disc Wheel 1" Tire 1/2" ball bearing	80c ea.
8" Disc Wheel 1 1/8" Tire 1/2" ball bearing	\$1.00 ea.
8" Disc Wheel 2" semi-pneum. T. 1/2" B.B.	\$1.35 ea.
10" Disc Wheel 1.75 semi-pneum. T. 1/2" B.B.	\$1.50 ea.
12" Disc Wheel 1.75 semi-pneum. T. 1/2" B.B.	\$1.85 ea.

Above wheel prices includes hub cap.
Plus Postage, 20%. C.O.D.'s accepted.

UNITED WHEEL STAMPING CO.
2756 W. 115th STREET PM-9 CHICAGO 43, ILLINOIS

Use Your Spare Time

Learn ENGRAVING

As a Career or a Hobby

WRITE TO

Build a business for yourself; Engrave Silver—Jewelry—Trophies right in your own home. Learn this fascinating craft by the NEW "SILENT TEACHER" HOME STUDY METHOD. Inquire today.

KANSAS CITY SCHOOL OF WATCHMAKING
1218 Admiral Blvd. Kansas City 6, Missouri

SAY YOU SAW IT IN POPULAR MECHANICS

ENGINEERING DEGREE IN 27 MONTHS

Big Demand for Graduates

Aeronautical, Chemical, Civil, Electrical, Mechanical and Radio Engineering (including Television)

Hundreds of young men are earning engineering degrees in this recognized institution each year—continuous operation. New terms start quarterly. Many students earn a major part of their college expenses in this large industrial center.

Low tuition. Competent instruction. Thorough, intense, practical program. Modern laboratory facilities including new physics lab. and modernized wind tunnel. Individualized instruction emphasized.

Approved for Veterans. Engineering preparatory courses. Students from 48 states and 21 foreign countries. Enter September, December, March or June. Send coupon for free catalog and full information. Enroll now.

SEND COUPON TODAY

INDIANA TECHNICAL COLLEGE

591 E. Washington Boulevard
Fort Wayne 2, Indiana

Please send me free information on B.S. Engineering Degree in 27 months as checked.

Aeronautical, Chemical, Civil, Electrical,
 Mechanical, Radio-Television

Name _____

Address _____

STOP THAT OIL EATER!

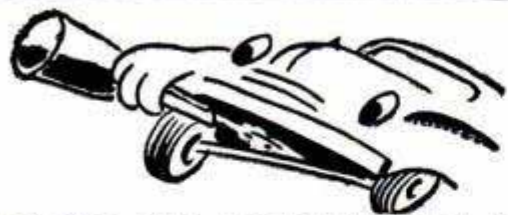

GET NEW CAR PERFORMANCE WITH PISTON SEAL WITHOUT COSTLY OVERHAULING

Piston Seal—the amazing compound that forms a self expanding, pliable lubricating seal around pistons that compensates for wear. Eliminates oil burning, restores power and compression. Can be applied in a few minutes.

GOOD FOR 10,000 MILES



FOR COMPLETE, FREE DETAILS WRITE TO

RICHIE DISTRIBUTING CO. 1628-K Cohasset Avenue Lakewood 7, Ohio

EXTRA CASH



for YOU!
TAKING ORDERS
Full Time—Spare Time for
STARK FRUIT TREES



Send No Money—You don't need experience to Make Money this EASY WAY! Show friends, neighbors, others how to make small back yards, vacant lots, and tiny plots produce bushels of luscious, taste-tempting fruit—Apples, Pears, Plums, Peaches, Cherries, Berries, etc.—and cut food costs to the bone. Take orders for hardy, new, Quick-Bearing Stark Fruit Trees. Sensational U.S. Patent Leaders bring easy orders, pay you rich rewards in extra cash profits. Added income with beautiful Stark Ornamentals, Roses, Shrubs to home owners. Enormous demand for attractive landscaping. Stark Bro's is largest and oldest nursery in the world. Join the leader.

FREE SALES OUTFIT AND BEAUTIFUL PLATE BOOK—Everything you need to make money—given you FREE. Just send name, address on Coupon below. No experience is needed. Giant demonstration Sales Outfit includes beautiful color Photo Plate Book. Write



STARK BRO'S Dept. 5592 LOUISIANA, MISSOURI

Rush FREE Demonstration Sales Outfit. Include your new 1952 Stark Colorphoto Catalog—showing Stark Fruit, Berries, Ornamentals.

PM 9-51

NAME _____
ADDRESS _____ COUNTY _____
TOWN _____ STATE _____

NEW K-R-O WARFARIN KILLS RATS

WARFARIN, the newest in rat and mouse killers from the University of Wisconsin, now comes to you backed by the dependable, 50-year-old K-R-O label. K-R-O Warfarin kills rats gently, slowly—without “warning” other rats. Tasteless, odorless; there's no “bait shyness.” Safer around poultry, pets, livestock. Household size (2 oz.) makes 2½ lbs. rat bait, \$1.00; farm size (4 oz.) makes 5 lbs. rat bait, \$1.75. Money-back guarantee. At drug, seed, and feed stores. *The K-R-O Co., Springfield 99, Ohio.*



TOOTHACHE?

Ask your Druggist for

DENT'S

TOOTH GUM
TOOTH DROPS
POULTICE

Is Your Life Crowned With Success?



LEXIPOWER

WE THINK IN WORDS. THOUGHT IS POWER. Let this New Science show you how to WIN WITH WORDS—financially, socially, culturally. Develop a MASTERFUL VOCABULARY. Influence others, improve your personality, manifest your latent ability. You are judged and rated by every sentence you utter. Start using the POWER of LEXIPOWER after the first Lesson. Write NOW for FREE details about LEXIPOWER. Dime-a-Day LESSON CLUB.

LEXIPOWER LESSON CLUB

517-G W. Deming Place

Chicago 14, Illinois



SILVER SOLDER TORCH & KIT \$7.50

JOINS ALL METALS PERMANENTLY Do your own repairing. KIT includes one tube silver solder “XCEL-FLUX” paste and 10 5-in. lengths silver solder alloy. Hottest ALCOHOL TORCH known. 2700° F. flame. Operates in any position, indoors or out. Pint of special fuel included. TORCH alone with pint of special fuel \$6.50. KIT alone \$1.50. Add 25c on each order towards shipping charges. AMERICAN PRODUCTS CORP., 422 S. Dearborn, Dept. 3-1, Chicago

Learn CARPENTRY BRICK LAYING

Get into the billion dollar building trades. Learn now while opportunities are greatest. Train in our completely equipped shops under expert instructors. Enroll now. Limited classes. Resident and Home Study. Write for FREE Catalog.

MIDWEST SCHOOL OF BUILDING TRADES, Dept. PM-9
411 N. Center St. Bloomington, Ill.

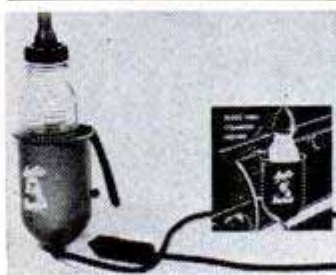

AUTO NURSE bottle warmer . . . for tiny tots who like to travel. Ideal for vacation, picnic, etc. Fully automatic . . . insert plug into cigarette lighter, place baby's bottle in warmer, and within minutes “AUTO NURSE” will reach baby feeding temperature. Holding-arm attaches to glove box of car. Make “AUTO NURSE” part of your auto traveling kit. Only 2.95 ppd. No C.O.D.'s. **WALTER THOMAS**, 2408 So. Veteran Ave., Los Angeles 64, Calif., Dept. 701.

HOME “MECHANICS” Keep household gadgets, garden tools lubricated, polished, rust free with

Ever-Ready OIL



**MAKES LEARNING
MUSIC SO EASY
--IT'S ALMOST
LIKE MAGIC!**

**I DIDN'T KNOW
A SINGLE NOTE
WHEN I STARTED!**

**WHAT I LIKE IS
THE LOW COST
--JUST A FEW
CENTS A LESSON!**

**AND IT'S SO MUCH
FUN--YOU START
RIGHT OUT PLAYING
REAL PIECES!**

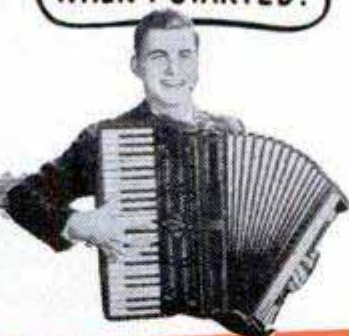

Every One's Talking About This WONDERFUL, EASY WAY TO LEARN MUSIC!

**I'VE LEARNED TO PLAY
SO QUICKLY MY FRIENDS
ARE SIMPLY AMAZED!**

**No Matter WHO You Are, or WHERE You Live,
or How LITTLE You Know About Music, You Can Soon Play Your
Favorite Pieces by Note. FREE BOOK Tells All About It.**

No wonder over 850,000 people have chosen this modern way to learn music! Here at last is a method by which anyone can learn to play his favorite musical instrument quickly and easily.

EVEN IF you don't know a note of music now . . .

EVEN IF there is no music teacher near your home . . .

EVEN IF you couldn't afford private lessons . . .

EVEN IF you can spare only a few minutes a day, or a few hours a week . . .

EVEN IF you are "tied down" to your job or your home . . .

EVEN IF you think "you lack musical talent" . . .

EVEN IF all these things are true of you, we guarantee to show you how to play! So quickly your friends will be amazed. So pleasantly you'll really look forward to each new lesson. So inexpensively you'll never miss the few cents per lesson it costs!

Secret of Rapid Progress

Instead of making you do tedious scales and tiresome exercises, the U. S. School of Music Lessons (in words and pictures) enable you to learn by playing real pieces—right from the start! As a result, your progress is amazingly rapid. Almost before you realize it, you find yourself playing all your favorite pieces by note.

Why not let this famous home study method bring the many pleasures of music into YOUR life? New friends. Extra money from playing or teaching. Greater listening pleasure. Possibly a brilliant career. Best of all, the deep personal satisfaction of being able to make your own music — provide your own entertainment.

SEND FOR Free Book and Free Instruction-Sample

Let us PROVE that what we say is true. See for yourself why our School has been so successful for 53 years. Mail the coupon below and we'll gladly send you our valuable 36-page FREE BOOK — and also a Free Instruction-Sample you can try out right at home. No obligation: no salesman will call on you. U. S. School of Music, Studio A309, Port Washington, N.Y. (Special Reduced Prices on instruments to our students.)



THOUSANDS NOW PLAY WHO NEVER THOUGHT THEY COULD



Now Plays For Dances
"I DIDN'T KNOW ONE NOTE! Three months later I started to play for dances. I have been invited to many parties and made people very happy with my music." — Miss Rosie Montemurro, Vancouver, B. C., Canada.

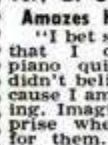

Amazes Her Friends
"I bet some friends that I could learn piano quickly. They didn't believe me—because I am slow learning. Imagine their surprise when I played for them. One said, 'Why, it sounds like you've been playing for years!'" — Louise Gomez, Oakland, Cal.

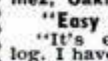

"Easy As Falling Off Log"
"It's easy as falling off a log. I have always wanted to play

and now a life-long dream is being fulfilled." — Mrs. Phyllis B. Jones, Blanding, Utah.



Learns Faster
"I have no special talent — but thanks to your method, I play my guitar 'according to impartial people' better than many students who have taken lessons from teachers for longer periods." — Myrella-Muquette Saint-Andre, Montreal, P.Q., Canada.

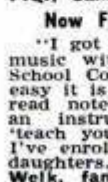

Now Famous Band Leader
"I got my start in music with a U. S. School Course. How easy it is to learn to read notes and play an instrument this 'teach yourself' way! I've enrolled my two daughters." — Lawrence Welk, famous orchestra leader.

U. S. School of Music, Studio A309, Port Washington, N.Y.

I am interested in learning to play, particularly the instrument checked here. Please send me your free illustrated booklet, "How to Learn Music at Home"—also the free Instruction-Sample of your simplified words-and-pictures teaching method. NO SALESMAN IS TO CALL UPON ME.

(Mr.) _____
(Mrs.) _____
(Miss) _____ (Please Print Carefully)

Address _____

City _____ State _____
(Zone Number, If Any)

NOTE: If you are under 18 years of age parent must sign coupon.

- Piano
- Guitar
- Hawaiian Guitar
- Violin
- Piano Accordion
- Saxophone
- Clarinet
- Trumpet, Cornet
- Pipe, Hammond, Reed Organ
- Tenor Banjo
- Ukulele
- Trombone
- Flute, Piccolo
- Modern Elementary Harmony
- Mandolin
- Practical Finger Control

Do you have the instrument? _____

WANT TO MAKE MORE MONEY? CUT OUT, FILL IN AND MAIL THIS COUPON!



**Mechanical Skills or
Interests Can Be Turned
Into Dollars to Buy
Many Things You Want**

We have a tested plan that will increase your earnings, using time many people waste!

● You are now at the beginning of a time when promotions can come fast for men who are alert to opportunities in machine and engineering shops. Such a time may not come again in many years!

Whether you are experienced or are a beginner we can help you climb into one of the high-pay, secure jobs that are begging for men who are building up their know-how. And we can help you to keep on climbing higher and higher.

If you really want to get ahead in both position and pay, using only spare time, send the coupon today. No representative will call on you. We will mail full information on our easy-to-use plan. Just mail the coupon — no obligation.

AMERICAN TECHNICAL SOCIETY, Division M619
Drexel at 53rd Street, Chicago 37, Illinois

Without obligation of any kind, please rush information offered in your advertisement.

Name _____

Address _____

City & Zone _____ State _____

HANDIEST WORKSHOP TOOL

welds • cuts • solders • brazes
...even charges batteries

Turns your spare time to spare cash!

Make money for yourself while you save money for your neighbors. Fix their garden tools, children's toys, car bodies or fenders, build metal furniture and do 1001 other profitable jobs this easy, low cost way. The money you make soon pays for your "Linwelder" ... then helps buy other tools for your workshop.

"LINCWELDER 60" LINCOLN ARC WELDER



- Comes complete with full instructions.
- Approved by Underwriters Laboratories.
- Operates from 115 volt grounded circuit. (No. 12 wire fused for 20 amps.)

- Ship me the "Linwelder 60" with accessories \$48.00. (Including headshield, electrodes, carbons, electrode holder, ground clamp and cable.) Arc Torch \$6.25 extra.
 Battery Charging Attachment \$10.00 extra.
Enclosed is check money order.
 Send me free bulletin on the new "Linwelder 60."

Name _____
Address _____
City _____ State _____ 194

AUTO SEAT COVERS

to fit
all makes
and years!

Only
\$2.98



- Choice of full front and rear seat covers or split front seat
- Leopard skin effect on colorful plastic
- Water-proof and stain proof
- Comfortable and Cool
- Easy to attach—no pins necessary

You must be satisfied or Money Back! Front or rear seat only \$2.98 each or FULL SET for \$5.00. Order now. Enclose payment or pay postman plus postal charges. Specify whether split or solid front seat.

DOMAR SALES CO., Dept. CT 17
480 Lexington Ave., New York 17, N. Y.

OUT OF PAWN

SAVE UP TO 50% AND MORE

GENUINE DIAMONDS

Approx. 1/2 Carat
\$95 Tax Incl. \$200 Value

SAVE ON DIAMONDS FROM ESTATES, BANKS AND UNREDEEMED PLEDGES

MONEY BACK GUARANTEE

All diamonds reset in brand new modern mountings. Values from \$10.00 to \$10,000.

SEND FOR FREE ILLUSTRATED Catalog

BERMAN'S DIAMOND LOAN BANK
DEPT. P—BERMAN BLDG., BALTO. 1, MD.

Our Ref.—Your own bank or any mercantile agency.

WHY DON'T YOU WRITE?

Writing short stories, articles on business, sports, hobbies, travel, shop crafts, local and club activities, etc., will enable you to earn extra money. In your own home, on your own time, the New York Copy Desk Method teaches you how to write the way newspaper men learn—by writing. Our unique "Writing Aptitude Test" tells whether you possess the fundamental qualities essential to successful writing. You'll enjoy this test. Write for it, without cost or obligation.

Veterans: Course approved for Veterans' Training.

NEWSPAPER INSTITUTE OF AMERICA
SUITE 5591-P, ONE PARK AVENUE, NEW YORK 16, N. Y.

BEING PUSHED AROUND??

Why take any more nonsense from bullies, wise guys and other pests? The next time they try to act smart—give them the surprise of their lives! It's easy when you know POLICE JIU JITSU! This complete, fully illustrated course comes to you in one volume. The same as taught to police, marines, "G" men, soldiers, sailors and members of the U.S. Coast Guard. By all means, just pin \$1 to this ad and we will send POLICE JIU JITSU to you postpaid by return mail. Satisfaction guaranteed or your money back.

BOOKS PUBLISHING CO., 56 W. 24th St., N.Y. 10

OIL FILTER REFILLS... 10c

Filters Oil the full length of the Pack

10,000 Sq. In. of Filtering Surface

Plates Last Indefinitely

Here's News! Ordinary toilet paper makes an ideal oil filter. Laboratory tests prove it cleans oil faster and better than popular makes of filter elements. All you need is a simple set of **RETLIF ADAPTER PLATES**... and you can start using ordinary toilet paper rolls in your present oil filter. For proof and descriptive literature, send name and address to:

RETLIF CORPORATION, Dept. 92
1239 No. Highland Ave., Los Angeles 38, Calif.

\$350 IN A SINGLE WEEK **GROSS**



IN MY OWN BUSINESS

Some Make More, Some Less...
Start This Business for **YOUR OWN**

George Held earned \$350 in one week with

ELECTRIC UPHOLSTERY CLEANER

● Here's YOUR chance to start a money-making, year-round business of your own and make the success you've dreamed about. R. O. Donnelly took in \$40 in seven hours. O. W. Ware landed a \$750 hotel job and made a fine profit. J. S. Corbit grossed \$279.50 his first month. P. D. Ash cleaned 23 auto seats at \$5 each in one week. And so it goes. Homes, hotels, offices, clubs, all places where furniture is used, offer you big profit possibilities. Auto seats and interiors, also.

NO SHOP OR OFFICE NECESSARY

You clean furniture on customers' premises. No hauling costs. No high rents. Supplies are in-

expensive and you operate, at low cost, from your home. What you take in is mostly profit. Surely YOU will want to investigate an opportunity like that — right away. Own your own business. Be your own boss. If you are ambitious, honest and courteous, we will help you to start and succeed.

FULL INFORMATION FREE MAIL COUPON TODAY

Send the coupon or write for Furniture Cleaner Booklet. It tells all about this electric cleaner—how to start YOUR business—how to make a profitable success. Don't delay. It's your BIG opportunity.



MAIL COUPON TO

VON SCHRADER MFG. CO., 936 PL, RACINE, WIS.

SAVE THREE WAYS WITH A NEW *Cushman*

WRITE FOR FOLDER AND PRICES DEPT. 18-M



Get the big three Cushman economies—low purchase price, low operating cost, low maintenance. Ride the Cushman scooter to work, school or shop. Less than a penny per mile to operate. Dealer inquiries invited.

CUSHMAN MOTOR WORKS Lincoln, Nebr.

LEARN MEAT CUTTING AT NATIONAL Pay After Graduation



The steady dependable trade of Meat Cutting taught easily in 8 short weeks. YOU LEARN BY DOING under actual meat market conditions in big modern school at Toledo.

For beginners or men with experience. Get a profitable store of your own. Remember, PEOPLE MUST EAT! Big pay jobs. Free employment help. Thousands of successful graduates.

Buying, cutting, percentage, pricing, advertising, selling, etc. A complete retail meat education. National School established over 25 years. Get National training NOW. Pay your tuition in easy weekly payments

after you graduate. G. I. approved. Send coupon for FREE 52 page school catalog — TODAY.

National School of Meat Cutting, Inc., Dept. 50-W, Toledo 4, Ohio

Send me your FREE school catalog on National Training at Toledo in Meat Cutting, Meat Merchandising and Self Service Meats. No obligation. No salesman will call.

Name _____
Address _____
City _____ State _____
() Check here if Veteran of World War II

MORE PAY through HOME STUDY TRAINING in SPARE TIME

Do you want a better position—a larger salary? They are within your reach—now. LaSalle experts will guide you step by step in gaining business training which leads to greater earnings.

The time-saving, interesting LaSalle Problem Method helps you prepare at home, without interference with your present duties.

Simply mark on the coupon the field in which you desire success, and we will mail you a valuable book describing the opportunities in that field—plus "Ten Years' Promotion in One"—a book which has helped many men. Let us tell you how we have started thousands of average men and women on the high road to success and more money. Check and mail the coupon now.

LASALLE EXTENSION UNIVERSITY

A Correspondence Institution

417 S. Dearborn St., Dept. 964R, Chicago 5, Ill.
Send me full information regarding the course I have marked—without obligation—plus "Ten Years' Promotion in One."

- | | |
|--|---|
| <input type="checkbox"/> Higher Accountancy | <input type="checkbox"/> Salesmanship |
| <input type="checkbox"/> C.P.A. Coaching | <input type="checkbox"/> Traffic Management |
| <input type="checkbox"/> Bookkeeping | <input type="checkbox"/> Foremanship |
| <input type="checkbox"/> Law: LL.B. Degree | <input type="checkbox"/> Industr'l Management |
| <input type="checkbox"/> Business Management | <input type="checkbox"/> Stenotypy |
| | (Machine Shorthand) |

Name.....Age.....

Address.....

City.....Zone.....State.....



ART OFFERS A PROFITABLE CAREER

Here's How You Can Learn at Home in Your Spare Time to BE AN ARTIST

Trained Artists Are Capable of Earning \$85, \$100 AND MORE A WEEK

COMMERCIAL ART, DESIGNING, CARTOONING—all in one complete home study course. You can become your own boss. Many students earn extra money while learning by designing posters, simple artwork, lettering, etc. W.S.A. is now in its 37th successful year. No previous art experience necessary. We teach you step-by-step. TWO ART OUTFITS included with training. FREE BOOK, "Art for Pleasure & Profit"—tells about our course, instruction, results enjoyed by our graduates, and commercial opportunities in Art. Low tuition — easy terms.

NEW! Ask for "Trial Plan"

MAIL COUPON FOR FREE BOOK

WASHINGTON SCHOOL OF ART,
Studio 129A, Washington 5, D. C.

Send full information and Free Book, "Art for Pleasure and Profit." (No Salesmen.)

Name.....AGE.....

Street.....

City.....Zone.....State.....

I am interested in your new, special Trial Plan.



INVENTORS

Before you make any effort to market your invention, you should take the first steps toward proceeding for patent protection.

I shall be pleased to furnish you with information relative to patent procedure, upon request from you, and this will be without any obligation on your part.

PATRICK D. BEAVERS

Registered Patent Attorney

934 Columbian Building Washington 1, D. C.

INVENTORS

Send today for "Patent Protection for Inventors" outlining preliminary steps to take toward patent protection, also convenient "Evidence of Invention" Form.

VICTOR J. EVANS & CO.

630-K Merlin Building, Washington 6, D. C.

INVENTORS

Whether an invention is patentable can be substantially determined by a search of the U. S. Patent records. Without obligation, write for information explaining the steps you should take to secure a patent.

JOHN N. RANDOLPH

Registered Patent Attorney

201 Columbian Building, Washington 1, D. C.

PATENTS

C.A. SNOW & CO.

REGISTERED PATENT ATTORNEYS
WRITE FOR INFORMATION TO
428 SNOW BUILDING, WASHINGTON 1, D. C.

PATENTS PATENT LAWYER

GUSTAVE MILLER

REGISTERED PATENT ATTORNEY

91-PM WARNER BLDG.
WASHINGTON 4, D. C.

ASSOCIATE EXAMINER
U. S. PATENT OFFICE 1922-1929

Patent Attorney and Advisor
U. S. NAVY DEPT. 1930-1947

Send for PATENT INFORMATION book and "INVENTOR'S RECORD" without obligation

INVENTORS

IF YOU WISH TO PROTECT YOUR INVENTION, You should take steps to protect it by a U. S. Patent. Write me for "INVENTION RECORD" form

CARL MILLER

REGISTERED PATENT ATTORNEY

WOOLWORTH BLDG., 35th FLOOR, 91A
NEW YORK CITY



Sensational New...
"BLINKER" HANDILITE
AUTOMATIC FLASHER LANTERN



CONSUMER DEMAND RUNNING WILD ON SPECTACULAR ONE SECOND DEMONSTRATION—A "GOLDMINE" FOR SALESMEN AND DISTRIBUTORS

So new only a handful of salesmen have it—yet such crazy things are happening it is unbelievable. Grahm, a spare-time salesman, ordered six. He unpacked them at work and the other employees were so thrilled by HANDILITE that all six were sold in his own office. In 10 minutes he made \$14.70 and had to order 12 more. Dunlop walked into a large office building with the red flasher "on." Within a half hour, he had sold 5 to building employees before even hitting the offices. He sold twelve—all he had—within the hour! But it is no wonder people buy HANDILITE as soon as they see how it works—what it does!

Now at last roadside accidents can be averted when car owners are forced to park their cars at night for tire changes or emergency repairs. For the first time, a vivid F-L-A-S-H-I-N-G RED signal light has been incorporated in a portable, battery-powered electric lantern. The amazing one-second "Wordless Demonstration" makes sales as fast as you turn the switch. Irresistible appeal is already sweeping thousands of Salesmen and Distributors to new money-making successes.

THOUSANDS WANT IT

FORTY MILLION MOTORISTS need and want HANDILITE. **TRUCK and FLEET OWNERS, VACATIONISTS, SPORTSMEN, HOMEOWNERS and FARMERS** want it as perfect emergency light. A perfect warning light—also unequalled as a general purpose lantern—as boat light, for hunting, camping. A thousand uses—in garage, basement, attic—for night-time trips to farm buildings, as tractor or farm wagon light—for summer homes and summer resorts.

LONG NEEDED INVENTION

Make no mistake. HANDILITE is no novelty invention by a hopeful unknown. It is produced by the same manufacturer whose products are already standard with the mighty railroads of the country.

Selling HANDILITE is not like selling anything you have ever sold before. Here is a dazzling, convincing new product that literally sells itself. Walk in anywhere. Flip the switch—immediately your prospect sees the vivid red signal light flash its warning—visible a mile away. A second turn—on comes the white light casting a brilliant beam for 1,000 feet, while the red light continues to blink. A third turn—and

the red light goes off, leaving only the white lantern beam. A fourth turn—all lights are off. **WITHOUT SAYING A WORD, YOU HAVE THE MOST COMPELLING SALES TALK** you've ever given!

MAKE AMAZING EARNINGS SELLING DIRECT & TO STORES

Write at once for complete facts. Learn how you can sell direct at Big Profits—Then, after cleaning up in a territory, sell stores big quantities for resale under a proven plan that moves HANDILITE fast. The first man to *open up* is going to *clean up*. So get the facts, quick. Already territories are going fast. Write, wire, or airmail the coupon—but do it this minute. *Every minute is precious.*

HANDILITE CO. Dept. 4-P, Sturgeon Bay, Wis.

The Handilite Co., Dept. 4-P
Sturgeon Bay, Wisconsin
 I want to get in on HANDILITE. Rush facts and sample offer at once.

Name.....
 Address.....
 City..... State.....

"SHINY FACE"
IS FOR KIDS!



MEN! Here's
How to
DIM that

"FACE SHINE"



USE MENNEN
Talcum FOR MEN!

- ★ Use Mennen Talcum after every shave and later in day to hide whiskers!
- ★ Neutral tint kills face shine... doesn't show itself!
- ★ Hammerized for extra smoothness!

GIANT SIZE FOR ECONOMY **55¢** LARGE SIZE **29¢**

Learn this
Profitable
Profession

IN 90 DAYS
AT HOME

Money-Making Career Open
to Men and Women, 18 to 60



Hundreds of men and women between 18 and 60 make \$10 to \$20 in a single day giving scientific Swedish Massage and Hydro-Therapy treatments. There is big demand from doctors, hospitals, sanatoriums and clubs. Graduates earn large full time incomes from these or in private practice in their own offices. Others make good money from home treatments given in spare time. Learn this interesting, money-making profession in your own home, through our home study course. Same instructors as in our nationally known resident school. You can win independence and prepare for future security by qualifying for your Diploma. Course can be completed in 3 to 4 months. Many earn while they learn. Begin your training at once.

NEW 32-PAGE BOOKLET FREE

Fill in the coupon below (please print name and address) and mail it for your FREE copy of 32-page Information Booklet. If you act at once we will include Anatomy Charts and Success Booklet which supply additional information you should have. All will be sent postage paid.



THE COLLEGE OF SWEDISH MASSAGE
Dept. 164L, 41 E. Pearson St., Chicago 11, Illinois
Please send me FREE and postpaid New 32-Page Illustrated Booklet, Anatomy Charts and Success Booklet at once.

Name _____ Age _____
Address _____
City _____ State _____

No Experience Needed To
**PRINT YOUR OWN
POST CARDS**

The GEM STENCIL DUPLICATOR saves money... gets results quickly! Hundreds of uses for every type of business and organization. We ship the GEM complete with all supplies, Guide Board for accurate printing and 60-page Book of Ideas at the special low price of only **\$8.50** (a \$15 value)



FREE TRIAL OFFER

Our 21st Year

Use the GEM FREE at our expense! SEND NO MONEY. Write and complete GEM outfit will be sent you postpaid. After ten days, send us only **\$8.50** or return the GEM. You must be satisfied!

BOND EQUIPMENT CO. Dept. 48
6633 Enright • St. Louis 5, Mo.



EXTRA DOLLARS EASY

Yes, there's lots of extra money in spare time raising hamsters, particularly the new spotted hamsters. It's fascinating and it's fun, too. So clean, so odorless, can be raised in your kitchen. Get started right with Lakeview's superior breeding stock. Free shipping plan saves money. Amazing details free.

LAKEVIEW HAMSTER COLONY
DEPT. PM-2 NEWFIELD, NEW JERSEY

Learn **TATTOOING** At Home

Earn extra MONEY—Tattoo blood types and designs in your community. Splendid opportunity in every town. Prepare in spare time. Practical instructions. Send for Free details and list of Tattoo Supplies. No obligations. ZEIS SCHOOL OF TATTOOING • 728 Leslie, Rockford, Ill.



**WARN HUB CAP MAKES
2 JEEPS OUT OF 1**

\$20.00
Prepaid
U.S., Canada

Ends front wheel drag on 4-wheel drive Willys Station Wagons, Pick-ups and Jeeps. Saves gas up to 3 miles per gallon, tire wear, front axles, increases speed and power. Stops shimmy—front wheels coast out of gear! 4-wheel drive handles, performs, climbs like 2-wheel. Install or remove WARN HUB CAPS in 10 minutes. Polished aluminum, guaranteed. Rush check, M.O., or C.O.D. Write for circular.

WARN MFG. CO. - 1625 Third Ave., Seattle 1, Wash.

DRAFTING LEARN IN SPARE TIME - AT HOME

Get into this big pay field. No previous training required. We prepare you for the many high salaried drafting jobs in industry. Complete drafting outfit included. Write today for our free booklet giving full details.

MONROE INSTITUTE, 3302 College Ave., Alton, Illinois

GLO-STREAMERS



Foot-long strips of sensational new Glo-Tex fabric that glow like SCOTCH-LITE® when reflected in car headlights. A gay decoration by day. A lifesaver at night. Easily attached to handlebar grips or auto antenna. **\$1.49 pr.**

For Bicycles
Motor Bikes
Auto Antennas

GLO-TRIM

Life-saving, light-reflecting Glo-Tex trim. Vividly outlines your car at night. Easily installed under chrome around rear window and doors 25 to 40 feet for average car. 35¢ per foot. Send Check or Money Order to



Glo-Glove Co., 6141 Fairway, Dallas, Texas

AGENTS WANTED - WRITE TODAY



Sensationally NEW for 1952!
MIDWEST TELEVISION



A Magnificent New Line of Beautiful CONSOLES and Complete CHASSIS featuring the Mammoth

20-Inch

RECTANGULAR PICTURE TUBE

FACTORY-TO-YOU



THE New 1952 MIDWEST "VIDEO GRAND"

20-Inch TELEVISION-RADIO-PHONO CONSOLE

In addition to its mammoth 20-Inch Rectangular Picture tube, this luxurious instrument offers a powerful, long-distance AM-FM Radio plus the newest-type 3-Speed Automatic Intermix Record-Changing Phonograph.

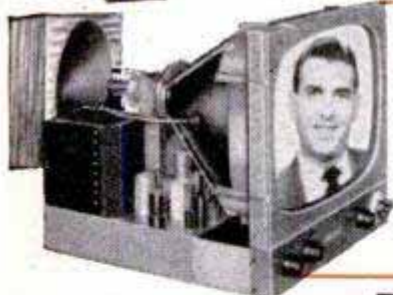

MIDWEST 20-Inch TELEVISION CHASSIS and SPEAKER
 —for easy installation in your own cabinet.



30 DAYS TRIAL

New 1952 MIDWEST "CONSTELLATION" 20-Inch TELEVISION CONSOLE

Also—Powerful New 1952 World-Ranging **MIDWEST Series of RADIOS**
 For Beautiful Consoles and Complete Chassis



An entirely new line of radios featuring the powerful Series 16 five wave band AM-FM Radio Chassis and the magnificent Symphony Grand Radio-Phonograph with 3-Speed Automatic Intermix Record Player.

Easy Terms



MIDWEST RADIO & TELEVISION CORP.
 DEPT. 252, 909 BROADWAY, CINCINNATI 2, OHIO

WRITE or PHONE
 For This NEW 1952 **FREE MIDWEST TELEVISION RADIO CATALOG**
 If You Live In One of These Cities Phone and Ask for Your Catalog

- NEW YORK MURRAY Hill 2-6810
- CHICAGO State 2-5600
- PITTSBURGH GRant 1-0609
- CLEVELAND PROspect 1-7450
- DETROIT WOODward 3-1233
- ST. LOUIS GRand 1161
- PHILADELPHIA LOcust 4-1035

or Send Coupon Below

• WRITE IN NAME AND ADDRESS (PLEASE PRINT) ON COUPON OR 1c POSTCARD •

MIDWEST RADIO & TELEVISION CORP.
 Dept. 252, 909 BROADWAY • CINCINNATI 2, OHIO
 Please send me your new FREE 1952 Catalog.

NAME _____

ADDRESS _____

CITY _____ ZONE _____ STATE _____



Spot ANY Car Trouble



in a jiffy!

Handy, Indexed Guide Helps You Find "What's Wrong" — Quickly, Easily

Don't waste time and work trying to track down car and truck troubles. Let **MOTOR's** new **TROUBLE-SHOOTER** help you find them **FAST**. Prepared by Editors of famous **MOTOR's** Manuals. Lists 1760 specific causes of auto trouble — knocks, misses, noises, break-downs, etc. If car has Connecting Rod noise—just turn to Connecting Rod Section for the 8 things that can be wrong. Covers engines, clutches, brakes, ignitions, automatic transmissions, etc. Fits right in pocket for instant use. Spiral binding lets book stay open while you work. Cross-section **PICTURES**. Valuable help for beginners, experienced repair men.



TELLS HOW to Spot 87 Automatic Transmission Troubles, 8 Causes of Connecting Rod Noise, 82 Causes for Engine "Misses," 45 Causes of Excessive Oil Consumption, 14 Common Causes of Crankshaft Noise, 73 Checks for Clutch Troubles, 66 Causes of Rear-Axle Trouble, 81 Causes of Brake Trouble, 27 Checks for Faulty Springs and Shock Absorbers, 84 Different Types of Wheel Troubles...LOTS MORE.

Only \$1 — On Approval

Send \$1 to get book. If it doesn't make locating car troubles a "breeze" for you—return it in 7 days for prompt refund. **MOTOR** Book Dept., Box T, 250 W. 55th St., New York 19, N. Y.

Listen to this Record!



SPEAK FRENCH-SPANISH

RUSSIAN - GERMAN ITALIAN - BRAZILIAN - JAPANESE

"Learn by Listening" to **CORTINA RECORDS—NEW RECORDINGS, UNBREAKABLE RECORDS**. Learn at home, the **NATURAL** way—quickly, easily, cheaply.

Only 15 Minutes a Day!

THOUSANDS have found it the most fascinating, most effective way to learn languages for Pleasure, Business, Travel, Culture. **INVESTIGATE!**

Send For FREE BOOK!

Illustrated 32-page book, "The Cortinaphone Short-Cut" sent **FREE**. Tells just what you want to know. Interesting. Get it!

Write Today--NOW

CORTINA ACADEMY (Est. 1882)
 Suite 649, 105 W. 40 St., N. Y. 18, N. Y.
 Please send me—without obligation—your free book. I am interested in (check)
 French Spanish German Italian Brazilian
 Russian Japanese
 Name.....
 Address.....
 City..... State.....
 VETS! CHECK HERE IF NOW STUDYING UNDER G.I. BILL.

LEARN ANOTHER LANGUAGE

EASILY, QUICKLY, at HOME with The One And Only

LINGUAPHONE

World's Standard Conversational Method

At home **LISTEN** and **LEARN** to speak French, Spanish, German, Russian, an Asiatic language, any of 29 languages by the **LINGUAPHONE CONVERSATIONAL METHOD**. . . . It's quick, easy, natural . . . you listen—you learn—you understand — you **SPEAK!** Add to job, armed services, travel opportunities. Save time, work, money. Endorsed by educators; used in colleges and by more than one million home-study students. **FREE BOOK** gives fascinating facts about this natural way to learn a language. Write **TODAY!**

Approved for **VETERANS' Training**

LINGUAPHONE INSTITUTE

143-09 Rockefeller Plaza, New York 20, N. Y.

SHOE REPAIRING OFFERS BIG INCOME

Learn in 12 weeks to be a skilled repair man by actually working on shoes. Free big 24-page book. The only old practical school in U. S. Established 1927. Write for Big 24-page Book today.

MODERN SHOE REBUILDING SCHOOL

806 SO. FIGUERO ST., Dept. PM, LOS ANGELES 17, CALIF.

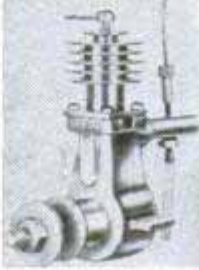

Our 422nd Advertisement

REAL DIESEL ENGINE

\$2.95 • for planes, boats, midget cars
 • 7500 RPM; 1/7 HP; ht. 3 1/2"; wt. 5 oz.
 • comes completely assembled

You just can't beat this price for a complete precision diesel engine! Streamlined, rugged, compact. Starts quickly, easy to install, runs for years. Fast delivery if you **ORDER TODAY!** Send \$2.95 plus 25c postage.

GOTHAM HOBBY CORP. Dept. P, 107 E. 126 St. New York 35



WHY SUFFER TONGUE BITE?

These **NEW** pipes cost little more than the best of old-fashioned pipes. **No TONGUE BITE, No DRINK.** Burn to bottom on one lighting. **FREE Circular tells WHY.** Send postcard to **KLEENSMOK PIPE CO.** 2597 Johnson City, Tenn. Pat's Po. 4

TRAIN in Our SHOPS -

in **AIR CONDITIONING, REFRIGERATION, ELECTRICITY, MAJOR APPLIANCES, AUTOMOTIVE MECHANICS, BODY and FENDER REBUILDING**

If interested write or wire

COMMERCIAL TRADES INSTITUTE Inc. of Ala.

200 S. 20th ST. BIRMINGHAM, ALA.

254 IVY ST. N.E. ATLANTA, GA.

VETERANS ASK ABOUT G I TRAINING

LOCKSMITHING & KEYMAKING

HOME TRAINING OUTFIT INCLUDES KEY MACHINE, SUPPLIES AND TOOLS TO GET STARTED IN BUSINESS

Professional outfit. Get practical training from Master Locksmiths. Learn to cut keys by code, master locks, change combinations, quickly identify key blanks, many profitable "tricks of the trade." Booklet of information **FREE**. Write today. **UNITED SUPPLY & SERVICE, 3231 Washington Blvd., Dept. PM-9, Chicago, Illinois.**

"WOVEN-Gards"

BETTER

Hand Protection

at Amazing Low Cost

"Woven-Gards" are hand protectors, mitts, pads and sleeves made of a new long-wearing safety material. Provide flexibility, comfort, resistance to abrasion and cutting far beyond anything used before. Extremely oil-absorbent, excellent for handling oily, slippery sheets. Porous weave makes them one of the finest protectors for handling lower temperatures. Enthusiastic users say they have never seen values like "Woven-Gards." Excellent protection at lowest cost. Send now for descriptive folder and prices.

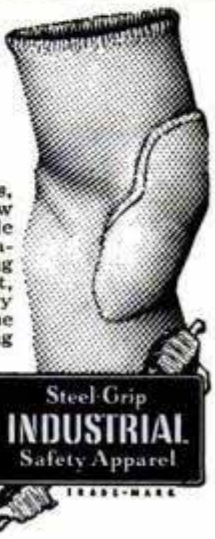

Steel-Grip **INDUSTRIAL** Safety Apparel

INDUSTRIAL GLOVES CO.

A Corporation
 1417 Garfield St., Danville, Ill.
 (In Canada: Safety Supply Co., Toronto)

"A FASCINATING...MONEY-MAKING art career can be yours

America's **12** Most Famous Artists Show You How!"



says **NORMAN ROCKWELL**
WORLD'S MOST FAMOUS COVER ARTIST

We show you our successful methods and art secrets...you learn them at home, in your spare time. Write for our big, handsomely illustrated free booklet that tells how you can have a great new art career! **WRITE TODAY!**

FACULTY

Norman Rockwell	Al Parker
Jon Whitcomb	Ben Stahl
Stevan Dohanos	Robert Fawcett
Harold Von Schmidt	Austin Briggs
Peter Helck	John Atherton
Fred Ludekens	Albert Dorne

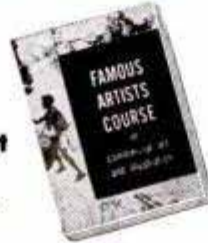

FAMOUS ARTISTS COURSE

Dept. 6-W, Westport, Conn.

FREE

Please send big illustrated booklet about my art career.

Mr. Mrs. Miss Age

(please print)

Street

City, Zone, State

Bass
WEEJUNS
... for leisurely comfort

Bass
QUAIL HUNTERS
... for field and stream

Bass
SKI BOOTS
... for extra control

Bass
SPORTOCASINS
... for better golf

G. H. BASS & CO.
60 Main Street
Wilton, Maine

Aeronautical Technology
Pilot and Specialist
Master Mechanic

AVIATION

Best Serves Your
Country & Yourself

The aviation industry urgently needs properly trained young men for essential civilian aviation positions. Embry-Riddle offers maximum training in minimum time. Fully accredited 8-mo. to 26-mo. courses in all aeronautical phases also aid rapid military advancement if called to armed forces. Thorough, practical instruction backed by 25 yrs. experience training today's aviation leaders. Complete school campus. Be prepared. Enroll now! Illustrated catalog, address:

REGISTRAR, EMBRY-RIDDLE, DEPT. 99, MIAMI 30, FLA.



TRAIN IN MIAMI -- AIR CAPITAL OF THE WORLD

BURN WATER in your CAR

with the **AMAZING OCTA-GANE "50"**
BURN WATER, ALCOHOL, OR BOTH IN YOUR CAR!

The Octa-Gane "50" is the only all bronze, "fog type," exhaust operated pressure injector on the market today. It is adjustable to burn up to one gal. of water or alcohol to every 10 gal. of gas. U. S. Agricultural Dept. scientists say, "THE GASOLINE MILEAGE OF NEW HIGH COMPRESSION AUTO ENGINES CAN BE INCREASED UP TO 30% WITH ALCOHOL-WATER-GASOLINE FUELS."

Only \$24.95
postpaid
(Send \$2, balance C.O.D.)
List car make, year, # cyl.

WRITE FOR: **FREE ILLUSTRATED LITERATURE**

NEWHOUSE AUTOMOTIVE INDUSTRIES, Dept. B-9, 5807 E. Beverly Blvd., Los Angeles 22, Calif.

1952 SPEED and POWER

"SOUP UP" ANY CAR

LEARN HOW TO GET 150 MILES PER GALLON WITH YOUR OWN CAR! ALSO, HOW ANY CAR CAN ATTAIN LIGHTNING SPEED AND SUPER POWER

Fascinating construction drawings actually show how you can build fast stock cars, California roadsters, 200 MPH hot rods.

EASY STEP BY STEP METHODS help you save by building your own dual manifolds, superchargers, hot cams, water injectors, high compression heads.

50 BREATHE TAKING CHAPTERS TELL ABOUT: Tuning techniques, speed tricks, economy secrets, formulas for getting racing speed and dynamic power. Includes Information On: Racing frames, reciprocating masses, jet engines, wheel geometry, dynamometers, 34 pages of photos and diagrams show how to restyle and customize all cars. Also info. on dual pipes, gears, fuels, porting, relieving, lowering, balancing.

THIS GREAT BOOK... PLUS BIG 1952 "SPEED EQUIPMENT CATALOG"... PLUS 48 PAGE "ECONOMY DRIVING MANUAL"... PLUS "150 MPG BOOKLET"... ALL FOUR ITEMS... \$1.98 ppd.

128 Page Library Edition Over 300 Illustrations

NEWHOUSE AUTOMOTIVE INDUSTRIES, Dept. B-9, 5807 E. Beverly Blvd., Los Angeles 22, Calif.

FREE



A NEW HOME INDUSTRY



Let us show you how extremely easy and PROFITABLE it is to make beautiful and useful things out of LIQUID PLASTICS, LIQUID MARBLE, LIQUID IVORY, LIQUID GLASS, CERAMICS, ETC. . . . as easy as pouring water out of a glass! We have started THOUSANDS of people in this fascinating and very PROFITABLE home occupation! Make novelties, jewelry, gifts, artware, toys, tools, dies, gadgets, ceramics . . . a million useful things! We supply everything—**MATERIALS, INSTRUCTIONS and BUYERS!** Send only 25c for 1. Big catalog of 300 casting materials, molds and accessories. 2. A beautiful CASTING FREE to show you what you can do, and 3. Actual INSTRUCTIONS on how to cast and start in the **CASTING BUSINESS!** VALUABLE MOLDS given FREE with orders! Send 25c today — this may be the lucky coin that will start the most fascinating and profitable phase of your life.

BILLIONS for DEFENSE!



The country is preparing the greatest peace-time defensive in history . . . BILLIONS are being spent! Our liquid plastics are being used in THOUSANDS of different operations in defense work! **NO SPECIAL TOOLS OR MACHINERY REQUIRED!** Work can be done at home, garage, shop, etc. Full time or spare time, by the able and the disabled. We help you get defense work and instruct you in all the details! Send 35c for catalog (see above) and details how to take part in this tremendous defense program that offers you a grand opportunity to combine patriotism and profit!

PLASTICAST COMPANY (Dept. C)

P. O. BOX 6737 (Write to) P. O. BOX 987
CHICAGO 6, ILL. either address) PALO ALTO, CALIF.
Canadian customers; send 35c for catalog and order direct from:
Canadian Industrial Plastics, Ltd., 1056½ W. Pender Street,
Vancouver, B. C.

Watchmakers WANTED!



Learn this high-pay trade. Copyrighted Swezey System shows you how . . . quickly, successfully . . . at home or in our Chicago School (founded 1908). We furnish tools, supplies, practice watches for home study course. No previous experience needed. Try it without obligation!

FREE SAMPLE Home Study LESSON

Approved resident courses include chronograph repairing, jewelry repairing, gem setting, and jewelry engraving. Write for full information.

CHICAGO SCHOOL OF WATCHMAKING
1608 N. Milwaukee Ave., Dept. 191, Chicago 47, Ill.

- Send Free Sample Home Study Lesson.
- Send Free Catalog of Resident Courses.

NAME _____
STREET _____
CITY _____ ZONE _____ STATE _____

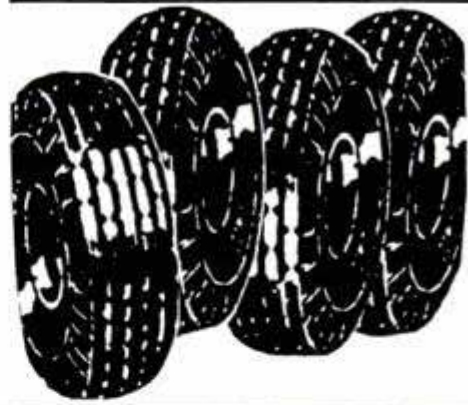

WRITTEN GUARANTEE SENT WITH EVERY TIRE YOU BUY

PLEASE NOTE: Our Tires are NOT Retreaded or Re-Capped

GOOD USED TIRES

A TRIAL OF ONE TIRE WILL CONVINCE YOU.

TUBE GIVEN WITH EACH PASSENGER & TRUCK TIRE AT NO EXTRA COST—SEND THIS AD!

If your size is not listed, write for prices. 18 YEARS AT THIS ADDRESS

600x16 \$6.22	670x15 \$6.20	710x15 \$6.32	760x16 \$6.75
650x15 6.22	700x15 6.50	750x16 8.72	820x15 7.42
650x16 6.25	700x16 6.70	760x15 6.42	550x17 5.75

600x20 \$10.75	32x6(10) \$13.75	1000x20 \$18.95
650x20 10.95	750x16(8) 8.95	1100x20 20.50
700x20 12.95	825x20 18.50	1000x22 18.45
750x20 13.95	900x20 18.50	1100x22 19.95



TUBE GIVEN WITH EACH PASSENGER & TRUCK TIRE

600-16 \$5.42	670-15 \$6.12	710-15 \$6.12	760-16 \$7.72
650-15 5.82	700-15 6.42	750-16 7.72	820-15 7.00
650-16 6.22	700-16 5.92	760-15 6.42	550-17 5.72



600-20 \$9.72	32x6(8) \$10.42	1000-20 \$18.42
650-20 9.92	32x6(10) 13.82	1100-20 18.42
700x20 11.72	825x20 18.00	1000x22 17.42
750x20 12.42	900-20 17.72	1100-22 18.42

Thousands of tires shipped all over U.S.A. All tires shipped F.O.B. Phila. Send Check or M.O. with this ad. Dept. 2.

STANDARD 834 N. Broad St., Philadelphia 30, Pa.

FEBRUARY

S	M	T	W	T	F	S
			1	2	3	
4	5	6	7	8	9	10
11	12	13	14	15	16	17
18	19	20	21	22	23	24
25	26	27	28			

DRIVE 3 TO 6 DAYS A MONTH

Gas Free!

Better performance, more power, quicker starts, faster acceleration on all cars, light trucks, tractors—any age, make or model. Amazing discovery, tested in Engineering Dept. leading U. S. University. Greatly reduces gas consumption—may actually pay for itself in cash savings. It can help you keep rolling if gas rationing comes. **TEST IT 30 DAYS ON YOUR OWN CAR BEFORE DECIDING.** Prove for yourself outstanding benefits of new miracle development by actual day-by-day experience on the road. **TRY IT AT OUR RISK.** Write or wire today for FREE details, technical explanation and 30 day Examination Request Blank. **SEND NO MONEY.**

G. B. SCHUYLER, Dept. 49, 2804 10th St., Berkeley, Calif.

CARTOONING

HAVE FUN! MAKE MONEY! Cash in on your sense of humor **AT HOME—BY MAIL!** No experience needed to start. Write today for FREE TRIAL LESSON and full particulars.

MOON Gag Cartoon School, Dept. M, Fall Creek, Wis.

NEW TINYTONE RADIO

Really Works—World's Smallest. New Preset Crystal eliminates All Tubes, Batteries or Electric "Plug-ins" Forever! Sweep band dial—Beautiful Red Plastic case.

GUARANTEED TO WORK on local stations if used as directed or money refunded—use most anywhere—**SEND ONLY \$1.00** (bill, ck., m.o.) and pay postman \$3.99 C.O.D., postage or send \$4.99 for P.P. delivery. **COMPLETE WITH EXTRA LONG DISTANCE AERIAL KIT AND PHONE.**

LIMITED SUPPLY — SO ORDER NOW!

MIDWAY CO. Dept. BPM-9 KEARNEY, NEBRASKA

FIND OUT FREE—HAVE YOU GOT WHAT IT TAKES...

to be a FINGER PRINT EXPERT or TRAINED INVESTIGATOR?

Send for free IAS Qualification Questionnaire. If in our opinion your answers indicate that you "have what it takes," then you will receive absolutely free the famous "Blue Book of Crime" . . . plus full details on how to train at home in Crime Detection and Finger Printing! IAS graduates are key men in over 800 Police Bureaus. See if YOU can train for this exciting, steady, "good pay" work! No obligation. No salesman will call. Write today, stating age.

INSTITUTE OF APPLIED SCIENCE
1920 Sunnyside Ave., Dept. 1356, Chicago 40, Ill.

WRITE TODAY

New Advertising Machine



Prints & Illustrates 1¢ Post Cards

FREE Learn how thousands of business men, in every line, are boosting sales in spite of conditions—with 1¢ messages—printed and illustrated in a few minutes on gov't post cards—with amazing new patented **CARDMASTER**. Your "today's" ideas, read by your prospects next morning. Not a toy, but a sturdy advertising machine, built to last for years. Low price, sold direct. Guaranteed for five years. Send name today. **SEND NAME** We'll send **FREE** illustrated book of money-making **IDEAS** for your business and complete, unique advertising plans. **RUSH YOUR NAME TODAY.**
CARDMASTER COMPANY
 1920 SUNNYSIDE, Dept. 139, CHICAGO 40, ILL.



HUNTERS!

Thompson ANTI-LEAK DUCK BOATS
 9 MODELS AVAILABLE FOR 1951

Write for **FREE Catalog**



THOMPSON BROS. BOAT MFG. CO.
 2007 Ann St. 1007 Elm St.
 PESHTIGO, WIS. CORTLAND, N.Y.

TIME TO START THINKING ABOUT XMAS



GIANT BALLOONS

Neoprene; Surplus Govt. Weather and Target balloons. Terrific attention getters for Lodges, Civic Events, School Functions, Conventions, Exhibitions, Trade Shows. Advertise your special events in the Hollywood manner. Make any occasion a success. Great back-yard fun. Marvellous for parties, dances, fairs, picnics, all festivities.

3 Ft. Dia. 39c; 6 Ft. Dia. 79c; 13 Ft. Dia. \$1.39

Aqua GOGGLES

Find a new world. Get a "fish eye" view of marine miracles. Twice as much swimming fun. Startle your friends as you swim beneath them. These clear-vision goggles are used by pearl divers, marine observers, Navy frogmen, distance swimmers. Large glass lens. Vacuum fit, adjustable for comfort. Protection from chlorine and salt water. Natural sea-green rubber. Double enjoyment at beach, pool, river, lake.



\$1.25
 Jr. Goggles, unbreakable plastic lens.....79c
 Postage Paid On Prepaid Orders
 Calif. Res. Add Sales Tax

WAR ASSETS DIV.
Volume Sales Co.

Dept. M-951, 3930 Sunset Blvd., Los Angeles 29, Calif.



WORK
 WHERE LIVING'S BEST!

CONVAIR

In beautiful San Diego, California

Needs:

- TOOL DESIGNERS**
- TOOL PLANNERS**
- PATTERN MAKERS**
- TOOL AND DIE MAKERS**
- JIG AND FIXTURE BUILDERS**
- MACHINISTS**

SEND NOW for free information and application form!

Employment Office
 Consolidated Vultee Aircraft Corporation Dept. 700
 3302 Pacific Hiway
 San Diego, California

NAME _____
 OCCUPATION _____
 ADDRESS _____
 CITY _____ STATE _____

Yours to make and keep!



THIS FOOTSTOOL—BOUDOIR CHAIR AND LAWSON CHAIR!

LEARN UPHOLSTERING AT HOME



Upholstering needs more trained men for good, steady jobs! Now you can prepare for a better paying position—or your own business—with this practical home training course—by an accredited, established school, largest of its kind in the country!

YOU LEARN WITH REAL EQUIPMENT—YOU BUILD REAL FURNITURE—YOU GET A COMPLETE TOOL KIT & ALL MATERIALS. ALL AT NO EXTRA COST!

FREE! Big, illustrated brochure, sample lessons and details of "PAY AS YOU LEARN" plan. No obligation.

SEND THE COUPON TODAY!

FIELD SCHOOL OF UPHOLSTERY, DEPT. 010
 39 West 19th Street, New York 11, N. Y.
 Rush **FREE** illustrated brochure, sample lessons and details of "PAY AS YOU LEARN PLAN."

Name _____ Age _____
 Address _____
 City _____ Zone _____ State _____

Now, You Too, Can Own A STUTZ Bearcat!

Measures 10½" in length when completed

It's Easy! It's Fun! It's the New Hobby That Is Sweeping the Country! Easy-to-Build Collector's Miniature! Antique Auto Models in ¼" Scale!



1914 Stutz Bearcat — \$3.95

In a few leisure hours you can build this fabulous STUTZ Bearcat in miniature! Not only this nostalgic gem, but 14 other famous antique autos are yours to build and enjoy! So start today! If you have not built an "Old Timer" yet, you are missing a big thrill! Each one is exquisitely detailed. The pre-fabricated kit includes ready-shaped die-cast parts, cast wheels, lights, horns, radiators, etc. Easy to follow step-by-step instructions included. When complete, they're perfect for your den or library. Easily converted into lamps, etc. Nationally known; satisfaction guaranteed. At hobby, toy and department stores.

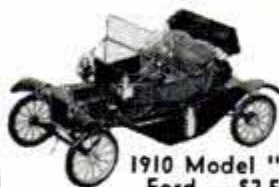

1909 Stanley Steamer\$2.95

1910 Model "T" Ford — \$2.50

1904 Olds\$1.95

1911 Buick\$2.50

1903 "A" Ford\$2.50

1909 "T" Ford\$2.95

1903 Cadillac\$2.50

1900 Packard\$2.50

1903 Rambler\$2.50

1902 Franklin\$2.50

1910 Inter. Harvester\$2.95

1913 Mercer Raceabout\$3.95

1911 Maxwell — \$2.50

1906 "Old 16" Loco.\$3.95

Write to us. Add 25c for postage, handling. No C. O. D.'s, please.

hudson miniatures OLD TIMERS

"Originators of Antique Autos in Miniature"

SCRANTON HOBBY CENTER, Dept. 14, Scranton 10, Pa.

AERONAUTICAL ENGINEERING



Design Aircraft & Components—Study with Jets & Rockets—Great Future—Advanced Aeronautical Subjects—World-Wide Enrollment—Fully Accredited—Established 1929—Approved for Vets—CAL-AERO grads in heavy demand.

WRITE TODAY for Special Information. PM-9

NAME _____ AGE _____

ADDRESS _____

CITY _____ ZONE _____ STATE _____

CAL-AERO TECHNICAL INSTITUTE
GRAND CENTRAL AIR TERMINAL • GLENDALE 1, CALIFORNIA

High School at Home

Many Finish in 2 Years

No classes. No time wasted going to and from school. Progress as fast as your time and abilities permit. Standard H. S. texts supplied. Thousands enroll each year in this 54-year-old school. Send for FREE descriptive booklet.

AMERICAN SCHOOL, Dept. H645
Drexel at 58th St., Chicago 37, Ill.

Without obligation, please send FREE descriptive booklet.

Name _____

Address _____



THE MOST AMAZING OFFER IN USED TIRE HISTORY. EVERY PASSENGER TIRE **UNCONDITIONALLY GUARANTEED** plus TIRE INSURANCE FREE

Here's DOUBLE proof that we bear the loss if your tire wears out within the guarantee period or is damaged in any way (except willfully). Don't take risks: we send FREE insurance certificate PLUS written unconditional guarantee with your order.

10% OFF ON 2 OR MORE TIRES

BEST GRADE PASSENGER TIRES

UNCONDITIONAL ONE YEAR GUARANTEE plus TIRE INSURANCE FREE		UNCONDITIONAL ONE YEAR GUARANTEE plus TIRE INSURANCE FREE		UNCONDITIONAL ONE YEAR GUARANTEE plus TIRE INSURANCE FREE	
600-16	\$5.59	700-16	\$7.59	700-15	\$5.59
600-16 (6)	6.50	600-15	5.59	750-16	12.25
650-16	5.79	650-15	5.59	550-15	5.59
				475-19	6.75

LO-PRESSURE TIRES FOR EASY RIDING

UNCONDITIONAL ONE YEAR GUARANTEE plus TIRE INSURANCE FREE		UNCONDITIONAL ONE YEAR GUARANTEE plus TIRE INSURANCE FREE		UNCONDITIONAL ONE YEAR GUARANTEE plus TIRE INSURANCE FREE	
640-15	\$5.75	710-15	\$6.50	820-15	\$7.50
670-15	5.95	760-15	6.75	670-16	6.95

MILITARY MUD AND SNOW TIRES

2 YEAR WRITTEN GUARANTEE
600-16 \$6.95 | 900-16 \$12.95 | 750-20 Reg. \$12.50, Special \$15.95

EXTRA VALUE TRUCK TIRES

2 YEAR WRITTEN GUARANTEE		2 YEAR WRITTEN GUARANTEE		2 YEAR WRITTEN GUARANTEE	
600-20	\$10.75	750-20	\$14.50	825-20	\$21.50
650-20	11.75	32x6(8)	11.75	900-20	
700-20	12.50	32x6(10)	12.50	(36x8)	19.50
				1000-20	20.00

MAIL ORDERS PROMPTLY FILLED. Send check or money order with this ad.

THE SAFTYRE CO.

"FOR THAT SAFE TIRE"

920 W. CARY STREET • Dept. PM • RICHMOND, VIRGINIA

SAY YOU SAW IT IN POPULAR MECHANICS

New! PRINT YOUR OWN ADVERTISING POST CARDS



ROTO-PRINT STENCIL DUPLICATOR

prints and illustrates Advertising Announcements and Club Notices on 1c Government Post Cards. Also Price Lists, Labels, Order Forms, etc. Easy to use. Gets amazing results in sales and inquiries. Hundreds of uses for every type business and organization.

UNCONDITIONALLY GUARANTEED

Comes complete with necessary supplies, instructions, FREE Book of money-making ideas.

FREE TRIAL OFFER!

Write now! ROTO-PRINT will be sent you postpaid. Try 10 days—then send only \$9.95 (Low, Direct-to-You Price), or return ROTO-PRINT with no questions asked.

Write NOW!

AGENTS WANTED!

ROTO-PRINT CO., 211 North 7th St., Dept. B-5, St. Louis 1, Mo.

complete outfit only \$9.95

MASTER MIND!



Learn Short-Cut Mathematics

Juggle figures, do baffling number tricks.

Make people gasp at your marvelous lightning-quick mind. Multiply 4 figures by 4 figures without using old-fashioned multiplication! Big cloth-bound volume; fully illustrated course. Includes worked-out problems, answers, etc. Sensational bargain, only \$1.95, postpaid or COD plus postage. Satisfaction guaranteed or refund. Order this amazing "Short-Cut Mathematics" today!

NELSON-HALL CO., 210 S. Clinton St. \$1.95
Dept. J-2 Chicago 6, Ill. Complete

FOAM RUBBER

FOR HOBBYISTS, CRAFTSMEN, EXPERIMENTERS



Lowest Prices—SAVE 50% AUTO SEAT TOPPER PADS

16 x 16 x 1½"	ea. \$1.35	24" x 60" x 1½"	ea. \$6.45
16 x 22 x 1½"	ea. 1.75	24" x 60" x 2"	ea. 7.95
18 x 24 x 1½"	ea. 2.00	12" x 14" x 1½"	ea. 1.25
24 x 24 x 1½"	ea. 2.95		

Use for furniture cushion fillers, mattresses, mattress pads, cushions. Foam Rubber is available in any size or thickness. Send For Free Price List. Immediate delivery. No C.O.D.'s. Add 10% for Postage & Handling to Above Prices. Please Print.

FOAM-KING RUBBER CO., Dept. P-19

P. O. Box 2676, 1174 W. Monroe St., Jacksonville, Florida

WEAR AT OUR RISK!
Money Back!
If not delighted in 10 days.

UNLIMITED Written GUARANTEE!
BUY DIRECT AT PRACTICALLY WHOLESALE PRICES
FROM ONE OF AMERICA'S LARGEST DISTRIBUTORS!

BUY WITH COMPLETE
Confidence!
AMERICA'S GREATEST
WATCH VALUE

MEN'S WOMEN'S BULOVA JEWEL MOVEMENTS
15 or 17
Originally sold up to **\$58.95**
16.95 Plus \$1.70 Tax
ALSO GRUEN WALTHAM BENRUS ELGIN
You get these unredeemed FULLY GUARANTEED watches in latest style Yellow Gold Cases, at this sensational low price because we bought out SURPLUS STOCKS of leading N.Y. and Md. Jewelers. Order while they last! Specify make preferred and whether men's or ladies! Only \$16.95 plus \$1.70 tax. Order now!

WAR ON PRICES!

17 JEWEL INCABLOC

- Shock Protected!
 - Water Proofed!
 - Dust Proofed!
 - Anti-Magnetic!
- Worn by Army, Navy & Marines During War
ORIG. \$59

Luminous dial, sweep second Hand, Super Accurate, Imported Swiss precision movement and case. You get these brand new watches now for a small fraction of the original price. You save \$44.00 because we bought out surplus stock!



YOU SAVE \$44
\$14.95
Nurses' Model
FREE EXPANSION BAND! Order men's style \$14.95, plus \$1.50 tax, or ladies' and nurses' style, \$16.95 plus \$1.70 tax. Order now at this low, low price.

17 Jewel Automatic
ORIG. \$71.95 SAVE \$51
● SELF WINDING WATCH!
● SET IT AND FORGET IT!
New Low Price!
Precision self-winding movement, keeps 40 hours reliable time after few hours normal wear. Water-tight case, anti-magnetic; shock-built; professional sweep second hand. 17 full jeweled precision Swiss movement. Wear it at our risk... be completely satisfied. Now only \$21.95, plus \$2.20 tax.

21.95 Plus \$2.20 Tax



17 JEWEL CHRONOGRAPH
SAVE \$52.00! **New Low Price!**
ORIG. \$71.95
● WRIST WATCH
● STOP WATCH
● TELEMETER
● TACHOMETER
Precision 4-in-1 timepiece for professional scientists, aviators, engineers, sportsmen, etc. Nationally advertised. 3 multi-function dials automatically coupled. 30 min. register. Synchronized seconds, 1/5 seconds. Luminous. Instructions included. Unbreakable crystal. Only \$19.95 plus \$2.00 tax. Order now.

19.95 plus \$2 tax



JEWEL SWISS WATCHES

ONLY 6.95 Plus 70c tax
Looks & Performs like a \$25 Watch
Look at these many features found only on expensive watches: Swiss, precision engineered, jeweled movement, both shock and water protected, radium dial, stainless steel back, 1/5 second calibration, hair line sweep section, and hand. Send \$6.95, plus 70c tax. Order now at this low price.



Free! Handsome expansion band included free with your order. Write for FREE WATCH AND DIAMOND RING CATALOG. Practically wholesale prices to user direct.

TRIAL OFFER! Wear at Our Risk! Money Back if not Delighted! Order direct from this Ad. For self and for Thrilling Gifts! Lowest prices ever, for these unlimited guaranteed watches! Order now on famous unlimited written guarantee. Send only \$1 down payment with order. Pay balance to postman on arrival, plus postage. Or we pay postage if you enclose full payment plus tax with your order.

MARYLAND DISTRIBUTORS, Dept. 286, 501 E. Baltimore St., Baltimore 2, Md.

HOME REPAIR TIP NO. 11



PROTECT OUTDOOR WIRING with "SCOTCH" Brand No. 33 Electrical Tape. Stretchy plastic backing resists water, sunlight, abrasion. Carries UL seal. Try it for golf club grips, hose leaks, too. 39¢ at your hardware store.

BOAT KITS - 26 MODELS EASY TO BUILD

- ROWBOATS - OUTBOARDS
- INBOARDS - CRUISERS
- ENGINES - CONVERSIONS
- ACCESSORIES - PAINT CHARTS



NEW CATALOG Only 35c. SEND COIN TODAY
U-MAK-IT PRODUCTS 703P-WHITTIER ST. New York 59, N. Y.

Secrets of VENTRILOQUISM Now Revealed!



Easy to learn in 60 to 90 days with our Home Study Course. **RESULTS GUARANTEED.** Make Money! Be Popular! Have Fun! Big Opportunity! Radio, Television, Stage Appearances! For FREE Information regarding price and terms, WRITE. You must state your age. Dummy Catalog 25c.
FRED MAHER SCHOOL OF VENTRILOQUISM Kensington Station Box 36, Studio 1 Detroit 24, Michigan

Thrilling Work COLORING PHOTOS
Fascinating vocation learned at home by those with aptitude. Thrilling pastime. National method brings out life-like colors. Free booklet.
NATIONAL PHOTO COLORING SCHOOL
835 Diversey Pkwy., Dept. 1356, Chicago 14

Now!
Be a Well-Paid Expert
ON ALL ELECTRICAL REPAIRS and MAINTENANCE

Defense Program Means Bigger Pay in Essential Field for Top Electrical Repair Men

Prepare NOW for a good-paying, ESSENTIAL job. Defense plants need expert electrical repair, maintenance men. Get the "know-how" from this Electrical Maintenance and Repair Library.

5 Volumes; 2072 Pages; 1834 Pictures
Starts at beginning, takes you step by step through every phase of connecting, altering, testing, repairing all types of equipment. How to install motors, generators, rewind motors; inspect, repair starters; locate trouble; test induction motors, and MUCH MORE! One entire volume crammed with trouble-shooting charts. Simple diagrams make everything crystal-clear. Gives best-on-the-job practices of experts. Will



help to put you in big-pay class and to rate as an ESSENTIAL worker.

FREE 10-DAY TRIAL

Send no money. Mail coupon for FREE 10-DAY TRIAL. Note special price, easy payments.

McGraw-Hill Book Co., Dept. PM-9
327 West 41st St., New York 18, N. Y.

Send me for FREE 10 days' examination the Electrical Maintenance and Repair Library. If not satisfied I will return books. Otherwise I will send \$3.50, plus postage, then and \$4 a month for 4 months (a saving of \$2 under regular price of \$21.50).

Name _____
Home Address _____
City & State _____ PM-9
 WE PAY POSTAGE if you enclose \$3.50 first payment WITH coupon. Same return privilege for full refund.

Learn ELECTRIC APPLIANCE REPAIR IN YOUR SPARE TIME AT HOME



START YOUR OWN BUSINESS

WITH A POTENTIAL MARKET OF 50,000,000 CUSTOMERS

New shop-method, home-training system gives you electrical know-how that used to take years to learn. Learn at home by building valuable testing kits, repairing your own and neighbors' appliances. It is not unusual for appliance repairmen to charge on the basis of \$5.00-\$6.00 an hour.

Free Illustrated Book

Shows you how you learn every phase of electrical appliance. How to make money while you learn. Write today for your FREE copy.

CHRISTY TRADES SCHOOL 4432 N. KEDZIE AVE. DEPT. D-9703, CHICAGO 25

"PORTABLE" TAPPING MACHINE

For high speed precision tapping. In use on large production. Convenience and low cost make it particularly ideal for small shops. Weighs only 85 lbs. yet does the work of a heavy expensive machine. Drives a 3/8" tap through cold rolled steel. Three speeds insure accuracy for taps from 1/8" to 3/8". Has efficient cone friction drive. Faster reverse speeds running time. Enclosed mechanism. With or without 1/4 h.p. motor. Try it; if not entirely pleased, money refunded. Sold direct and guaranteed. Write for full details.

MOTOR DRIVEN
No Belts, No Installation Costs
JUST PLUG IT IN



ALTO MFG. CO., 1645 Wolfram St., Chicago 13, Ill.

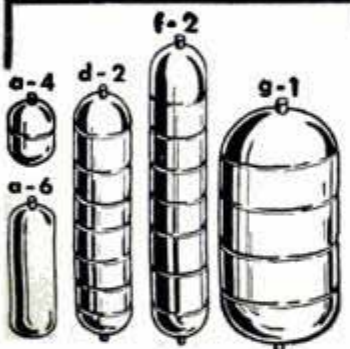

STEEL AIR TANKS

Steel pressure tanks suitable for compressors, pneumatic units, gases, hydraulics, and liquids. Rated at 500 lbs. per square inch pressure. 1/4" standard pipe thread openings on tank ends as shown.

	Size	Wt. Lbs.	Internal Volume	Price
A-4	Stainless Steel—New	7 1/2"x5 1/4"	1 1/2	104 cu. in. \$1.50
A-6	Carbon Steel—New	14 1/2"x5 1/2"	3 1/4	280 cu. in. 3.50
D-2	Stainless Steel—New	24"x6"	5	500 cu. in. 6.50
D-2A	Carbon Steel—New	24"x6"	5	500 cu. in. 5.50
F-2	Stainless Steel—New	45"x6"	11	1000 cu. in. 9.50
F-2A	Carbon Steel—New	45"x6"	11	1000 cu. in. 5.50
G-1	Stainless Steel—New	24"x12"	18	2100 cu. in. 11.50
G-1A	Stainless Steel—Used	24"x12"	18	2100 cu. in. 9.50

Prices F.O.B. Chicago. Include approx. postage on orders paid for in advance. C.O.D. orders enclose 25%, balance sent C.O.D.

U. A. S. Corp. Dept. PM9, 5637 W. 63rd Pl. Chicago, Illinois

LOWER YOUR CAR in 30 MINUTES!

Over One Million In Use
Dealers Write.

with CLARK LOWERING BLOCKS!
Gives any car that sleek, streamlined look! Easy to do! Everything furnished. Adds to safety at high speeds by dropping center of gravity. Fits all makes and models. Please state.

MAKE	DROPS		
	1 1/2"	2"	3"
Chev. (except 1951)	\$3.00	\$3.50	\$5.00
All other (ex. 1951)	3.50	4.00	5.00
All 1951 models having wide springs	5.00		5.00
Special Ford & Merc. set ('32 to '48)	1.00		

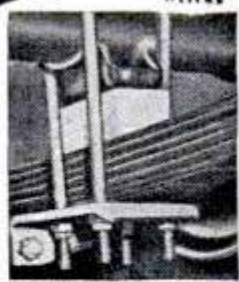

CLARK COMPANY HEADQUARTERS 7018 E. FIRESTONE BLVD. Dept. P-9, DOWNEY, CALIF.



SPORTONE MUFFLERS

Ford & Chevrolet.....\$ 4.45
All other popular cars..... 5.45
V-8 Dual Sets..... 15.95
Chromed Silentips..... 2.95
(Please state make & year of car on all orders.)

SANDEE MUFFLER CO.
5643 Carryne Place • Culver City, California



Bar Bells

Buy Direct From Factory Approved and Recommended by Karl Koberle (Foremost Ex-Army Instructor on Weight Training) **\$8.95** up

Write for free booklet and price list.
INDEPENDENT IRON WORKS
2416 East 23rd Street, Dept. C
Los Angeles 58, Calif.

TITANIUM Rutile MORE BRILLIANT THAN DIAMONDS

Refractive Index About 10% Higher Than Diamonds
Compare: Refractive Index of Rutile is between 2.62 and 2.90 as compared to the diamond's 2.42. Dispersion of Rutile ranges between 0.155 and 0.205 in comparison to the diamond's 0.025. Available in 58 facet BRILLIANT, EMERALD and MARQUISE shapes @ \$10.00 per carat, postpaid—1 to 10 carats. Unconditional 30 Day Trial — Money Back Guarantee

(Actual Photograph of Our Product)
HUDSON GEM CO., Dept. PM-9, 574 5 Ave., N.Y.C., N.Y.

MAIL ORDERS • FREE DELIVERY UNCONDITIONAL MONEY BACK GUARANTEE

Send for FREE WAR SURPLUS CATALOG
New **SPORTSMAN'S DeLuxe SLEEPING BAGS** SAVE up to 50%

100% Water Repellent—Kapak Filled—Zipper Opening
A really good sleeping bag at a thrift price. Vat-Dyed water repellent cover filled with kapak that's so fluffy soft and yet lightweight. Canopy protects you from weather. **\$11.80** FREE DELIVERY

Feather Filled, Single-Double Sleeping Bags
Tops in every detail—water repellent khaki cover, lots of feathers, heavy duty all-around zipper. Double Air Mattress Pockets. Buy 2 and make a double by zipping together. Large Size—34 in. wide, 78 in. long. \$25 value. FREE DELIVERY ea. **\$13.89**

UNIVERSAL ENTERPRISES — 946 S. MAIN, LOS ANGELES 15, CALIF.

HELPFUL BOOKS

Send post card asking for FREE catalog
Popular Mechanics Press, 200 E. Ontario, Dept. 601, Chicago 11

Learn PHOTOGRAPHY at Home

Splendid opportunities. Prepare in spare time. Practical basic training. Long-established school. Send for free book, "Opportunities in Photography." No obligation.
American School of Photography, 835 Diversay Parkway, Dept. 1356, Chicago 14, Ill.

MONTH AFTER MONTH, YEAR AFTER YEAR, YOU SEE OUR AD.

REMEMBER IT'S DANGEROUS to pay less if you want the finest (non-skid) USED tires.

GOOD YEAR Firestone

GOODRICH, UNITED STATES, GENERAL & OTHERS, NOT RECAPS

Our policy is to select your tires so carefully, as if our very future depended on the service given by that particular tire.

FREE TUBE WITH "ALL" BLATT'S GOOD GRADE TIRES

GOOD GRADE, 16 MONTHS	GOLDEN RULE	GUARANTEE	BOND.
600-16 \$4.14	700-15 \$4.54	650-20 \$7.94	32x6 8) \$8.64
650-16 5.42	670-15 4.74	700-20 8.54	32x6 10) 9.94
700-16 5.04	710-15 4.94	750-20 8.64	900-20 13.94
650-15 4.44	550-17 4.64	825-20 15.92	1000-20 13.94

FINEST GRADE, 26 MONTHS GOLDEN RULE GUARANTEE BOND THIS GRADE MADE THE BLATT NAME "WORLD FAMOUS".

450-20 \$6.00	450-21 \$6.00	700-15(6) \$10	750-16(8) \$15
600-16 5.49	650-15 5.94	600-20 9.94	900-20 18.54
650-16 6.42	670-15 6.24	650-20 9.94	1000-20 18.54
700-16 8.94	700-15 6.54	700-20 11.94	1100-20 18.54
750-16 7.94	710-15 6.34	32x6(8) 10.54	1000-22 17.54
550-17 5.94	760-15 6.54	32x6(10) 13.92	1100-22 17.54
525-18 5.54	820-15 7.04	750-20 12.54	1200-22 22.54
650-19 9.00	475-19 5.94	825-20 22.84	1100-24 21.54

900-16	600-16	Military	750-20
Reg. \$10.94	Reg. \$6.75	Reg. 16 months	Reg. \$10.44
Super 19.94	Super 9.75	Super 30 months	Super 18.64

BLATT BLATT BLDG., GIRARD & LANCASTER AVES., DEPT. PM., PHILADELPHIA 31, PA.
Send check or money order and this ad for rush shipment. We won't ship a tire we wouldn't use. The name to trust in rubber. PRICES SUBJECT TO CHANGE
Shipments RUSHED Down South, Up North and Far West

When You **WATCHMAKING** You Can Earn More in
LEARN By KCSW's Outstanding Method

WRITE TO

High-paying jobs now open. Pleasant work. Or build a business for yourself right in your own home, repairing clocks and watches.

Inquire today about the opportunities in this high-paying trade, through the latest HOME STUDY TRAINING. Also Resident School.

KANSAS CITY SCHOOL OF WATCHMAKING
1218 Admiral Blvd. Kansas City 6, Missouri

Develop Hidden Earning Power
STUDY LAW
at home! LL.B. Degree

Qualify yourself in spare time for advancement, greater earnings, business success. Now, more than ever, legal ability is in demand! Easy-to-understand step-by-step lessons and text material furnished — invaluable for permanent reference. 42 years expert teaching. 114,000 students enrolled. Easy payments. Find out now, at no cost, how study of law can help you. Write today for FREE Book "Law and Executive Guidance."

AMERICAN EXTENSION SCHOOL OF LAW
Dept. PM-42, 646 N. Michigan Ave., Chicago, Ill.

MAKE EXTRA MONEY

PLASTICS LEARN AT HOME

LEARN HOW TO MAKE fast selling PLASTIC NOVELTIES FURNITURE JEWELRY SIGNS TOYS LAMPS

There are RICH OPPORTUNITIES for MEN and WOMEN with "know-how" in Plastics. Interstate's amazing new Plastics course tells and shows how to make hundreds of fast selling items out of Plastics. Gives complete training in fabrication, casting, lamination, molding, etc., in simple, easy, step-by-step language and pictures.

START A PLASTICS BUSINESS OF YOUR OWN. No other industry holds such promise for the future. You can make big money manufacturing novelties, toys, signs, etc., in your own home in spare or full time. Don't wait! Learn NOW how Interstate's Plastics Training qualifies you for success in the plastics field.

Write for FREE Information Today!

INTERSTATE TRAINING SERVICE

School of Plastics
PORTLAND 13, OREGON

Dept. C-3J

Build a New Home!
Modernize Your
Present Home!
Make Home Repairs!

SAVE
Over One Half
the Cost



Mail Coupon for

Practical Carpentry

New How-To-Do-It
Cyclopedia of Building

Edited by Floyd Mix,
formerly Book Manager,
Popular Mechanics Magazine
and

Ernest H. Cirou,
Carpentry Department,
Washburn Trade School

Don't let sky-high labor costs keep you from enjoying a new or modernized home. Thousands of families—one out of every five—who are building a new home, modernizing an old one, or making necessary home repairs—are doing all or part of the work themselves and saving thousands of dollars. You can do the same with PRACTICAL CARPENTRY as your guide. Crystal clear HOW-TO-DO-IT text and easy to understand drawings and diagrams reduce every job to simple easy steps, requiring a minimum of spare time and effort. Ready to use stock plans, with lumber and mill lists are available at low cost. Get this big 8½ x 11 inch, cloth bound book that can so easily make your dream home come true, today. See special MONEY BACK OFFER in coupon below.

No Experience
Needed to Do
These Jobs

Build a new home. Like thousands of other families, do the work yourself and save over one-half.

Convert attic or basement into usable rooms.

Add extra bedroom or den.

Install double glass picture windows.

Modernize your kitchen with space-saving cabinets.

Modernize with dormer windows.

Build a new porch and entrance.

Lay a new long-life roof over the old.

Insulate your home and pay for it with fuel savings.

Give your old home the "New Look".

Hundreds of other home improving jobs.

Build a garage.

SPECIAL MONEY BACK OFFER - MAIL COUPON



Check
Titles
Wanted

Examine
Books In
Your Own
Home
Without
Obligation

Money
Back
if Not
Satisfied

Goodheart-Willcox Co., Dept. 165
1321 S. Michigan Ave., Chicago 5, Ill.

Send at once books checked below. I understand I may return any book not satisfactory in 5 days and you will refund full amount paid.

- Remittance for \$_____ enclosed. Send post-paid. (In U.S. only)
- Send COD. I will pay postman, plus delivery charges.
- PRACTICAL CARPENTRY Just Published.....\$5.00
- MERRY OLD MOBILES On Parade. All about Pioneer Autos, with Photos, Drawings..... 2.50
- BRAKES & STEERING. Mechanics Manual. Wheel Alignment included..... 3.50
- MODERN WELDING PRACTICE. New Edition With Latest Developments..... 5.00
- AUTO REPAIR KINKS 3.00
- AUTOMATIC TRANSMISSIONS Simplified Covers all types including new Fordomatic and Merc-O-Matic.) 4.00
- DYKE'S Auto Encyclopedia (new 22nd edition) 7.50
- AUTO Body & Fender Repairs (New 1951 Ed.) 3.50
- DYKE'S Carburetor Book 3.50
- AUTOMOTIVE Service Management..... 5.00
- MODERN Electric & Gas Refrigeration..... 5.00
- MODERN Welding Practice 5.00
- D. C. POWER WIRING..... 4.00
- A. C. POWER WIRING..... 4.00
- PLUMBING & Pipe Fitting..... 2.50
- SHEET Metal Layout..... 3.50
- STORAGE Battery Simplified..... 3.00
- BAILEY'S Handbook for Engineers-Firemen... 2.00

Name _____ (Please Print)

Street _____

City _____ State _____

TERRIFIC VALUES - SURPLUS - SAVINGS UP TO 85%

MANUFACTURERS AND JOBBERS -
Write us about your surplus items



Portable LIGHT PLANT
PUSH BUTTON START
500-700 watts 110-120 v. - 60 cyc. A.C. Powered by a sturdy dependable easy starting, air cooled 1 3/4 hp. gas engine. No wiring necessary, just plug in and operate. Plenty of current for any oil burner, freezer, brooder, pump, emergency lights, etc. which require up to 700 watts. Ideal for Civil Defense, Fire Depts; trailers & camps. Complete with Voltmeter and built-in winding to charge 6 v. auto batteries. Wt. 85 lbs. Fully guaranteed. Be prepared if war or storm knocks out power lines. Reg. \$275.00 value. **\$143.50**
700-800 Watt Plant (Item 44) same as Item 24, but larger engine. **\$169.95**
1000-1200 Watt Plant (Item 45) same as Item 24, but larger generator & engine. **\$199.50**

GIANT 2000-2500 WATT PLANT

110-120 V. 60 cyc., A.C. Absolutely the best made because its heavy windings develop up to 5000 watt overload for motor starting. S.k. id. mounted - portable. Powered by 5 h.p. easy starting Briggs or Wisconsin engine - complete with all accessories; engine easily disconnected for other uses. Big outlet box, voltmeter, no wiring necessary. Ample current for all purposes. Factory warranty and instructions included. Wt. 220 lbs. Reg. \$585.00. Special at... **\$299.50**
GENERATOR ONLY and control box. **\$169.50**
Drive it with your engine or tractor

RADIO TRANSMITTER

(Item 60) Type SCR 578, portable. Only 18 lbs. Ideal for boats, Hams, etc. Crank operated generator produces ample current to send Morse code (built-in hand key), blinker light or continuous automatic SOS, 500 KC. mck. Can be converted to power transmitter. Contains hundreds of valuable parts. Built in antennae and ground. Slightly used for training. Complete instruct. and Morse code incl. Cost govt. over \$200. Terrific value. **\$18.95**



1/4" DRILL
(Item 34) Hi-power, long-life, smooth running. Alloy steel gears; built-in blower. Cutler-Hammer switch. Jacobs hand-drill chuck. 110-120 v. AC-DC 1000-1600 rpm. Cap. 1/4" in steel, 1 year guar. Wt. 4 lbs. Terrific value at **\$12.95**.

38 Pc. DRILL KIT

(Item 35) Includes above illus. guar. drill, buffers, polishing bonnet, sanding discs, grinding wheels, wood bits, steel bits, wire wheels, bench stand, paint mixer, burrs. Complete in a steel case. Wt. 12 lbs. 38 pcs., all highest quality. Complete kit worth \$38.50. Our **\$19.85** Spec. only.

ACCESSORIES FOR 1/4" DRILL

Make complete workshop out of your 1/4" drill, using these practical accessories. Quick change—merely insert shaft in drill chuck. Sturdy, heavy duty tools for real work. Precision built of hardened tool steel. Factory guaranteed against breakage.

POWER HACK or JIG SAW

(Item 64) makes straight or curved cuts easily in plywood, 3/4" boards, sheet metal, plastics, etc. Uses broken hack saw blades. Will do filing, jig saw, coping saw, and sabre saw work. Compare with \$50 tools. Wt. 3 lbs. Special... **\$16.95**

Power Sander & Polisher

(Item 65) Make quick work of slow tedious sanding jobs. Big 21 sq. in. sanding surface. Produces powerful lengthwise sanding stroke which results in beautiful smooth finish. Built-in rubber pad. Sandpaper held in place by quick-change spring-clips. No messy adhesives. Use felt pad for polishing. Using drill motor for power gives you equivalent of an \$85 sanding machine. Wt. 3 lbs. Terrific value at... **\$16.50**

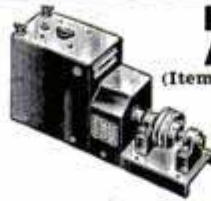

HEAVY DUTY ARC WELDER

(Item 38) Use as portable or shop welder, 250 amps, D.C., Senior model. Made for years of trouble-free, continuous service. Will handle light or heavy jobs. Welded up to 1/2" plate using 1/4" rods. Built-in air-cooling system. Arc is easy to strike and hold, because of specially designed arc stabilizer. Hi-lo switch and dial control gives wide range of welding heats. Run welder at 2600 rpm. with tractor, jeep or 10 hp. gas engine, or 7 hp. elec. motor. Complete with instructions, guar. and double V belt or flat pulley. Wt. 110 lbs. A \$400 value at... **\$99.75**
WELDING KIT. Two 10 ft. leads, welding helmet, electrode holder, ground clamp. Sold only with welder at... **\$10.50**

CARRY-AIR

(Item 32) Stainless steel tank—capacity 500 cu. in. at 400 lbs. press. complete with inlet and shutoff valves, press. gauge, detachable air hose, tire chuck. Fill at any service station. Carry air for tire inflation, blowing out lines, spray painting, insecticides, etc. One emergency pays back cost. Wt. 10 lbs. Worth \$20.00. Our price... **\$8.95**
(Item 55) With big double tank **\$11.95** (1000 cu. in.)
(Item 58) Tank only, 500 cu. in. (no fittings)... **\$5.95**

HIGH PRESSURE HAND PUMP

(Item 53) Positive displacement type. Cap. 550 gpi. Completely self priming. 3/4" pipe thread inlet and outlet. Use for fuel or water transfer on boats, trailers, air craft, etc. Ideal for insecticides, emerg. sump pump or as vacuum pump. Wt. 15 lbs. Govt. cost \$95. Our Special... **\$12.95**

FIRE EXTINGUISHER

(Item 39) Fully charged (at 1,000 lbs. P. S. I. or more) with CO2 (carbon dioxide), the proven miracle fire fighting chemical that smothers oil, gasoline and electrical fires. Play safe; keep one in your car, garage and home. Heavy ICC approved steel cylinder, valve and 3000 lb. gauge that shows available remaining pressure. REFILLABLE at nominal cost. Hose included for emergency tire inflator or air blast. Wt. 4 lbs. \$19.50 **\$6.95** value. Special...

LARGE FIRE EXTINGUISHER (Item 57) commercial size, 5 x 14 in. (275 cu. in.) heavy ICC approved steel cylinder charged at 1000 lbs. or more with CO2. Equipped with genuine Kidde Valve and Gauge to show available pressure at all times. Refillable. Hose incl. Suitable for fire depts, stores, garages, homes, etc. Wt. 18 lbs. \$42.50 value. Spec... **\$15.85**

32 pc. SOCKET SET

(Item 59) Highest quality guar. non-breakable sockets made by Plomb, Snap On, etc. Complete range of 22 sockets from 1/4" thru 3/4" in 3/8" drive and 1/2" thru 1 1/8" in 1/2" drive. 2 speeder handles, 2 extensions, 2 slide heads, double 3/4 x 1/2 "L" handle, reversible ratchet, 12" Phillips type screw driver and metal tool box. For professional mechanics who want the best. Wt. 14 lbs. Easily worth \$32.50, while they last... **\$15.95**

RUBBER HOSE

New genuine Neoprene Hose - outlasts ordinary rubber 3 to 1. Reinforced with super tough cotton cord plies. Flexible. Easy Flo brass couplings with standard pipe threads for quick connections. Included. Pump water for irrigation, stock tanks, home, barn, fire fighting, etc. Pump Gas or Fuel Oil. Save more than 60%.
(Inside Diam.) 1" 1 1/4" 1 1/2" 1 3/4"
Length 10 ft. 25 ft. 40 ft. 30 ft.
Price 5.95 9.25 14.75 14.75
If specified we will send special hose for gas or oil at same prices.

AIR HOSE (Item 11) 1/4" Diam. heavy duty, double braid, suitable for gas stations, spray painting, air tools, etc. 20 ft. with standard swivel couplings. Wt. 4 lbs. Reg. \$6.50 val., only **\$2.95**. Five 20 ft. lths. (100 ft.). Wt. 20 lbs. Only **\$13.75**.



EXTENSION CORD

(Item 16) 40 ft. heavy duty, made of specially insulated No. 14 2-conductor wire. So tough that you can drive over it and yet amazingly flexible and easy to handle. Resists oil, grease or water. Extends electricity up to 400 ft. without voltage drop. Use indoors or out. Complete with heavy rubber plug and outlet. Ct. 2 1/2 lbs. Usually \$4.50—Special 40 ft. **\$1.99** Comb: 2-40 ft. and 1-20 ft. (total 160 ft.) **\$4.95** 100 foot length (one piece)... **\$4.85**
WIRE ONLY (Item 50) No fittings, 100 ft. **\$4.00**
TRENCH-LAY WIRE. (Item 51) Anaconda #10-2 cond., for buried service to barns, outdoor lights, etc. Absolutely impervious to soil and moisture. Wt. 25 lbs. per 100 ft. Special surplus price. 100 ft. coils, 19¢ per ft.; 250 ft., 18¢ per ft.; 500 ft., 17¢ per ft.

POTTERS WHEEL

(Item 47) Complete, prof. equip. for making finest ceramics and pottery. Large dynamically balanced cast-aluminum reversible turntable with variable speed drive (38 to 140 rpm) controlled by foot-pedal. Built-in adjustable arm rests, water cup and wedging wire. 16x12" enclosed throwing table—ample area for largest pieces. Req. 1/2 hp. motor (not incl.). Can be set up on 20x24" table and stored on edge. Complete with pulleys, belts and instructions. Wt. 26 lbs. \$145 value at... **\$59.95**

GEM CUTTER

(Item 49) Complete Prof. Lapidary mach. for cutting, shaping, grinding and polishing precious and semi-precious stones. Precision built with big horiz. power driven gem cutter, built-in cutting lubricator; genuine 6" supercharged diamond saw, lap wheel, abras. whis., 2 scratch whis., 4 felt whis., grinding and polishing compounds, brushes, dop cement and sticks, cutting oil, ext. cord, asstd. gems, complete instructions. Requires 1/4 hp. motor (not incl.). Wt. 22 lbs. Worth \$99.50. Our Special... **\$39.95**

GIANT BUNSEN BURNER

(Item 61) Operates equally well on gas or ordinary alcohol. Economical. 1 pt. burns for hours. Produces intense blue smokeless flame. Ideal for lab. or as emergency cooking unit. Fine for camping. Heavy brass burner with shut-off and adj. valve. Simple and safe. 5 ft. flex. hose, 1 qt. tank incl. Wt. 5 lbs. A \$15 value. Special... **\$4.95**
(Item 62) Metal Cooking Stand for above (not illustrated)... **\$1.49**

ANGLE DRILL

(Item 23) Fits into chuck of any electric or pneumatic drill or flex. shaft. Operates at any angle in a full 360° arc. Makes possible drilling, grinding, carving, routing, etc. in close cramped quarters. Makes impossible jobs easy. Made by Kett Tool Co. Complete with built-in chuck (1/4" capacity) and adjusting key. Hardened alloy gears. Precision built for heavy duty. Lists at \$39.95—while they last... **\$9.95**

HEATING & VENTILATING FAN

(Item 10) Easily installed in furnace pipes. Forces even heat to all rooms. Over range, removes kitchen smoke and odors. Powerful continuous duty motor, 110-120 V. A.C. Quiet, super efficient fan moves huge volume of air (400 to 600 c.f.m.) 8" Fan, wt. 5 lb. **\$6.35**; 9" Fan, wt. 6 lbs. **\$7.45**; 10" Fan, wt. 7 lb. **\$8.45**; 12" Fan, wt. 8 lbs. **\$9.45**.

ELECTRIC HAND SAW

(Item 36) Most perfectly balanced and smoothest running saw made. Advanced design provides max. power and light weight. Easily adjusted for all angles, depth and width of cut. Comes complete with 6 1/4" comb. blade, ripping guide and 10 ft. hvy. duty cord. Built-in saw-dust blower. Autom. telescoping guard. 110-120 v. AC-DC. Depth of cut 2 1/4". 1 year written guar. Wt. 12 lbs. Drastically reduced... **\$39.95**

PRESSURE SWITCH

(Item 30) Penn Electric Model 110 BPO2, best made. For pumps and air compressors. Heavy duty. Will handle up to 250 lbs. press. and up to 5 h. p. Autom. unloader valve, for easy starting. 110-220 v. A.C. or D.C. 2 pole. Wt. 5 lbs. Reg. list \$17.50. Our Spec. **\$9.45**.

All items brand new. Prices f.o.b. Chicago area. 10 day Money back guarantee. Send check or M. O. **MASTER MECHANIC MFG. CO., DEPT. 67 Burlington, Wis.**

**WORLD'S
BEST
WANT AD
MEDIUM**

CLASSIFIED Advertisements



Advertisements in this section 85 cents per word, each insertion, minimum 10 words, payable in advance. To be inserted under proper classification, copy must be in our office the 20th of the second month preceding date of issue
F. W. Johnson, Manager, Classified Advertising
Popular Mechanics Magazine, 200 East Ontario Street, Chicago 11, Illinois

YOU'LL PROFIT

By reading and answering the classified ads in this section. Hundreds of opportunities for you to make and save money

AUTOMOBILES, MIDGET CARS

CATERPILLAR Kid-size crawler tractor-electric power driven. Licensed by Caterpillar Tractor Company. Finest, practical toy in America. Rugged full-track for driving over lawns, open fields, or hard surfaces. Miniature copy of Caterpillar D-4 Diesel. Special at \$65.00 prepaid. Foot powered model \$39.95. Most sensational child's vehicle toy in America! Satisfaction guaranteed. Send for free literature. Mystic River Sales Company, Box 312GP, Mystic, Conn.

MOTORISTS—Restore motor compression, save oil dollars with new engineered product. Only \$3.95. Write Advanced Engineering, Box 7033A, Los Angeles 37, Calif.

MOTORISTS—Save gas with proven automatic alcohol-water injector! Only \$5.95! Free literature. Vaporizer Company, Box 7033G, Los Angeles 37, Calif.

BUY Water injectors, dual manifolds, hot coils, etc., without money. Information free. Newhouse Automotive Industries, Los Angeles 22.

NEWHOUSE Makes another sensational offer. See page 41. Don't miss it.

WIGLESWORTH-Chasteen's Automobile History Scrapbook. 160 pages. Old time pictures and advertisements of automobiles from 1899 to 1934. \$1.50. Deluxe binding \$3.50. Wiglesworth-Chasteen, 7134-PM Alhambra, Mission, Kansas.

"STORY of a Stanley Steamer." 256 pages. Photos. Describes restoring steamer, operating details, steam advantages. \$3.50 postpaid. Murray, 301-A Ridgeway, Rochester 13, New York.

SAVE—California custom accessories headquarters. Buy direct from original designers. Chrome dash panels, electric push button door-trunk conversions, fender skirts, dual mufflers, lowering kits, speed-dress up equipment. 40 page catalog. Hundreds of photos—25c. Eastern Auto, 3319A South Grand, Los Angeles 7, California.

HOW To soup up your car. Handbook plus Equipment Catalog. 25c postpaid. Almquist Engineering, Milford 35P, Penna.

LITERATURE Offered on old, new and foreign automobiles; shop manuals, engineering papers, data books, glossy photos, free motor magazines. Contact auto hobbyists everywhere. Write today; get name on free mailing list. Auto Maniacs, Inc., Stockbridge, Mich.

FROM Speedway to roadway! Track-proved hi-speed heads and manifolds now available for your passenger car! No special tools needed! Increase horsepower 25%! Astounding getaway! Free illustrated catalog. Speedsport, 6215P Diversey, Chicago 39.

WATER Injection. Also economy, power, methods. Free illustrated information. Neher Industries, La Verne, California.

AUTO SUPPLIES AND EQUIPMENT

LATEST 1951 Edition! Just out—100 new pages! Get world's largest auto accessory and parts catalog and save money. Over 50,000 items, including Hollywood accessories, hi-speed equipment, rebuilt engines, all parts and accessories for all cars and trucks. We have that hard-to-get part! Jam packed with bargains. Completely illustrated. Send 25c (refundable). J. C. Whitney, 1919 Archer, Chicago 16.

BIGGEST Speed Equipment Catalog in world! Save, order direct. Hollywood mufflers \$4.95, dual mufflers \$18.95, cut-outs \$6.95, dual intake manifolds \$12.95, racing cams \$29, hi-compression heads \$26.95, water injectors \$6.95, customizing kits \$1.98, chrome accessories at discounts! Free Hot Rod Handbook included, 25c. Almquist Engineering, Milford 33P, Pennsylvania. Dealers wanted.

USED And new auto and truck parts. Send for free catalog. Elgin Salvage Truck & Auto Wreckers, 751 N. State, Elgin, Ill.

AIR Horns on your car will blast like dynamite! Send postcard. John McCanna, 148B East 40th, New York 16.

DON'T look for your car after it's stolen. Automatic device will protect it even when keys are forgotten and left in car. No gadgets to remember or forget. Simple, cheap. Effective. Instructions \$1.00. Anderson, Washington, Illinois.

YES It puts babbit type bearings on the pistons for 100,000 miles. Lachapelle's treatment. Only \$3.00 postpaid. Ferns Products, 8120-B Walnut Dr., Los Angeles 1, Calif. (Data on request.)

JIFFY Hydraulic brake bleeder. Unique, quick change. \$19.95 complete. State distributors wanted. Rex Co., Box 546, Elyria, Ohio.

HOW to buy speed equipment without money. No selling. Information free. Newhouse Automotive Industries, Los Angeles 22.

RUBBERIZED Chrome coating stops tarnish, rust. 300% profit. Rubber Products, New Haven, A. Conn.

SERVICE Station and car owners—Locate most troubles immediately. Automobile testing equipment. 4 instruments in sturdy box. Stroboscopic timing light, battery tester, compression tester, and motor-start. Service your own and other cars; have the tools the experts use. \$9.95. Box 474, Lombard, Illinois.

MOTORIST Save gasoline by Vacuumating overrich mixtures. Fits all cars. For free particulars write Vacuumatic, Dept. 1786, Wauwatosa, Wis.

MOTORIST—Why spend money on costly repairs. Buy at lowest exchange prices. Write for catalog of reconditioned carburetors, generators, starters, fuel pumps, shock absorbers, etc. Auto Electric Service Co., 5858 Broadway, Chicago 40, Illinois.

REMOVE Knocks, raise oil pressure. Hand operated crankshaft grinder \$3.75. Free information. L. D. McGee, 719A Cascade St., Wenatchee, Washington.

INCREASE! Gasoline mileage, three to five miles gallon. Guaranteed vaporizer, increases power; easier starting; \$3.50 each. Turb-O-Vane, 1024 West Vine, Stockton, Calif.

NEW Government surplus. Low voltage circuit tester in steel box cost \$202. Our price \$27.50. Will test batteries, starters, generators, voltage regulators, grounds, short circuits. Wilt Electrical Company, 7829 S. Racine Ave., Chicago 20, Ill.

SEND For free life membership card. "Ward Burners" of America, La Verne, California.

OFFENHAUSER'S New catalog available. Send 25c. Complete line of speed equipment. Offenhauser Equipment Corp., 5054-p Alhambra Ave., Los Angeles 32, California.

AUTO Parts and accessories. Briggs Automotive Engineering of Chicago, P.O. B. 3454 Merchandise Mart, Chicago 54, Ill.

FOR Free descriptive literature on alcohol-water injection for cars, trucks, tractors write Shade, Webster, New York.

BRUSH Plating outfits connect to a battery. No tanks or shop required. Free particulars. Gunmetal Co., Avenue J, Decatur, Illinois.

AUTO TRAILERS

BUILD Your own trailer! Plans for all kinds. Illustrated catalog 10c. Jim Dandy, 125-M, Wausau, Wisconsin.

MOTORCYCLES, BICYCLES, MOTORSCOOTERS AND SUPPLIES

MIDGET Car \$10, motorbike \$7, Safety-cycle, \$15 less engines; Whizzer motor \$6; Smith motorwheel \$10; Evinrude outboard motor \$8. Four airplane type tires \$3 (mailorder only). Send 25c for new catalogue Number 43, just out listing these and hundreds of other bargains in new and used midget cars, motorscooters, home-builders parts, plans, engines, transmissions, war surplus, etc. (35c by first class mail). Midget Motors Directory, Athens, Ohio.

WHIZZER, All attachments, \$20; Cushman motorscooter, \$20; Indian motorcycle \$30; engines \$3 up; motorbike frame \$3. Rush 25c (35c first class mail) for catalog # 949 listing many other amazing bargains in motors, midget cars, motorscooters, motorbikes, etc. Associated, Box 1764-CS, Toledo, Ohio.

MOTORCYCLE Pistons, parts, new, used, Harley, Indian, Henderson. List and wings pin 25c. Ballak, 811 N. 9th, St. Louis 1, Missouri.

MOTORCYCLE Magazine—Worldwide coverage. Yearly subscription \$2.00. Sample 20c. Motorcycle News, 5424-A Sawyer, Chicago 25.

REBUILT Gasoline engines \$17.00 to \$37.00. Cauffiel Motor Industries, Temperance, Michigan.

WHIZZER In Schwinn bike \$20; good motorscooter (twist grips) \$22.50; midget car \$15; Shaw bicycle motor \$15. Send 25c (35c first class mail) for catalog # 19 jammed with other sensational bargains in wheels, motors, clutches, motorscooters, midget cars, motorettes, motorbikes, etc. Gail, 538 Erie, Toledo, Ohio.

RECONDITIONED Motorcycles and motors. Chromium accessories. Complete stock Indian parts. Expert rebuilding. Fast service. Indian Motorcycle Sales, Kansas City 1, Mo.

U. S. Govt. surplus "45" Harley Davidson motors, complete with carburetor and generator, in running condition—\$69.50 f.o.b. Chicago. 25% deposit with order. Parts and accessory catalog 25c. Triangle, 2157 Harrison, Chicago.

HARLEY-Davidson parts, accessories, repair manuals on all models. 24 hour service. Authorized factory dealer. Philadelphia Harley-Davidson Company, 857 North Broad Street, Philadelphia 23, Penna.

AVIATION

HELICOPTER, Build from spare parts or kit. Catalog and blueprints, \$5.00. No model. Aero-Tech, 601 Jefferson Street, Montgomery, Alabama.

PROPELLERS—For seds, airdrive boats. Literature. Standard Aerocraft, Box 387, Ft. Worth, Texas.

PROPELLERS, Plans, supplies for snow sleighs, air boats. Catalog 20c. Banks-Maxwell, Box 3301, Ft. Worth, Texas.

ELECTRICAL SUPPLIES

BE Independent, be secure, have your own profitable business—Earn \$20.00 and more a day making beautiful, fast-selling lamps at home. No equipment needed. Illustrated course teaches you quickly. Course, parts catalog, wholesale price list—only \$2. Gearon Co., Dept. 200-B9, 27 S. Desplaines, Chicago 6, Ill.

STARTER, Generator, electric motor supplies, equipment, manuals. Free circular. Modern, Box 4704, Kansas City, Mo.

LAMPS—25c Brings parts catalog, instructions for building, repairing. Gyro Lamps, 5402P Clark, Chicago 40.

LAMPS—Build own originals, parts wholesale, any amounts. Catalogue 10c. Brown Lamp Co., Box 501, Wellston, St. Louis 12, Missouri.

ELECTRIC Pencil, Writes, engraves all metals. \$2.95. Reb Industries, Elmhurst, Illinois.

NEW Electronic fresh air generator with Westinghouse Odorout 3½ watt ultraviolet bulb. Kills odors, smoke, mildew! Literature and free trial offer. Guarantee Products, 1128 Tower Bldg., South Bend, Indiana.

10% DISCOUNT Nationally advertised electrical appliances. Send wants. Quality, Box 1301, Peoria, Illinois.

ELECTRIC Pencil: Engraves all metals \$1.50. Beyer Mfg., 10511-H Springfield, Chicago 43.

WELDING, SOLDERING, PLATING

ACETYLENE Welding outfits new \$49.00; used \$29.00; arcwelders \$46.50 up. Eagle Welding, Dept. PM, 5085 Broadway, Chicago 40, Illinois.

BUY Direct from factory. Welding and cutting equipment. All makes of equipment repaired. Established 1913. Box 331, Hamilton, Ohio.

MACHINERY, TOOLS, SUPPLIES

BLOCK Machines—Concrete builders standard sizes. \$39.50 up. No pallets needed. 400 daily. Free catalog. Francis "A" Machinery Co., 5129 South Compton, St. Louis 11, Mo.

BUILD Your own power tools. Save 90%. Catalog of 100 plans 25c. Robert Fellows, Caledonia 3, N. Y.

BUILD Power machines with Kimo Plans, New York 19. Descriptives 25c (refundable).

KOOLKUT—Universal cutting coolant. Saves tools, improves work. \$1.00 postpaid. Shop Equipment Co., 337 West 14th St., New York 11, N. Y.

CHUCKS: Independent; Universal—threaded 1½"-8, 1"-8, 1"-10, 1"-12, or with adapter recess. The only complete line of bench lathe chucks built to heavy duty standards. Other chucks to 16" diameter. Write for quotation; free literature. No obligation. Westcott Chuck Co., 3600 Walnut, Oneida, N. Y.

FLEXIBLE Shaft tool by Fairchild for grinding, polishing, sanding, buffing, carving. Original price \$19.95. While they last! Special price \$12.95. Public Sport Shops, 11 S. 16th Street, Philadelphia 2, Penna.

FREE Catalog. Full line hobby and light industrial power wood working tools. Guaranteed. Dealers wanted. Backus Machine Co., Chippewa Falls, Wisconsin.

WATCHMAKERS' Staking set, 50 punches, 6 stumps, \$39.50. Larger set 100 punches, 20 stumps, \$49.50. Public Sport Shops, 11 S. 16th Street, Philadelphia 2, Penna.

300 PROJECTS You can make in Popular Mechanics 32 page Blueprint Catalog. Send 3c stamp for copy. Popular Mechanics Press, Dept. BP, 200 E. Ontario St., Chicago 11, Ill.

BOATS, OUTBOARD MOTORS

BOAT Patterns, kits. Descriptive literature and 24 page illustrated book on boat construction 40c postpaid. Germain Boat Company, West Saginaw 3, Michigan.

MARINE Propellers, 14", \$13.50; 16", \$16.75; marine manifolds for all engines, Jeep, \$35; Model "A", \$36; V-8, \$45 pair; transmissions converted, marine paint, hardware, etc. Money back guarantee. Conversion Parts Company, 278 Adams Street, Boston 22, Massachusetts.

CLASS A outboard stock hydroplane complete plans in July Rudder 40c. Catalog boat building plans 10c. The Rudder, 15 Murray Street, New York 7.

FASTEST Boats in the world—Build now. Complete plans available for sleek three point racing hydroplanes, runabout and others. Send 25c immediately for illustrated catalogue. Champion Boats, P.O. Box 9038, Dept. 22-1, Long Beach 7, Calif.

SAVE 2/3 Cost. Assemble your own boat. We furnish parts. No experience necessary. Rowboats, cruisers. Illustrated catalog 25c. Midwest Boat Company, Menomonee Falls, Wisconsin.

OUTBOARD Motor parts—New, used for all makes. Send stamp for price quotation. Outboard Motor Mart, Inc., 309 Atlantic Avenue, Boston 10, Massachusetts.

MARINE Conversions for Ford and Jeep engines. Catalog 10c. Lehman Manufacturing Company, 972D Broad Street, Newark 2, New Jersey.

CONVERT Fords and Jeep to 100% marine engines with Osco's world famous Convo-Kits. Deluxe catalogue 25c (coin). Oscomotors, 3627B Lawrence, Philadelphia 40, Penna.

STEERING Wheels, windshield brackets, from \$7.95. Modern fittings, water-skis at lowest prices. Complete pre-cut plywood boats. Bargains galore. Folder 10c. Marine, Box 681, Mendota, Minnesota.

NEW, Used, rebuilt marine motors. Marine conversions, fittings. Free catalog. Stokes Marine Supply, Dept. 24, Coldwater, Michigan.

FULL Size, cut to shape boat patterns, blueprints, 7½-38 feet. Illustrated "Build a Boat" catalog, 25c (coin). "How to Build Boats" book, \$1.00. PolyWog houseboat plans \$10. Marine catalog \$1.00. Marine Specialty Mfg. Co., 3107 Detroit Ave., Cleveland 13, Ohio.

"P38 Belly tanks," steel, \$9.95. Free picture. Bucks Auto Parts, Box 89, Merced, Calif.

ENGINES, MOTORS, DYNAMOS

REBUILT Gasoline engines \$17.00 to \$37.00. Cauffiel Motor Industries, Temperance, Michigan.

WINDING Data, listing 225 motors, single and three phase, \$1.00. Motor Data Co., Box 7631, Kansas City 3, Mo.

ATHLETIC EQUIPMENT, BODY BUILDING COURSES

BARBELLS, Exercise equipment, Courses. Free booklet. Good Barbell Co., Reading, Penna.

100 TRICK Knockouts for self defense. \$1. 1c each. Priest, Box 251, Evanston, Ill.

GAIN Weight! 4 exercises to increase weight. Complete \$1.00. Body Builders, 36 Nevada Street, Winthrop, Mass.

BUILD Powerful arms, shoulders, chest. 22 illustrated exercises, \$1. Fonsad Studios, Box 601, Wilmington 99, Delaware.

HANDBALANCING Self-taught, quickly. Write. Power, 923-B W. Vine St., Kalamazoo, Michigan.

DEADLY Judo—Fiercest fighting technique. Trick knockouts. (Over 200 illustrated pictures.) Expert instructions; three volumes. Complete \$2.25. Variety House, Box 46-B Wall Station, New York 5.

SPORTING GOODS, GUNS, FISHING TACKLE, ARCHERY, TRAPPING

LEARN Gunsmithing! Details, copy "Guns and Gunsmithing," 25c. Gunsmith's Service, 3118 Montrose, Chicago, Illinois.

GUNS—Bought, sold, swapped. Barlow's, 5565 South Howell Ave., Milwaukee 7, Wisconsin.

CAST Iron molds for making fishermen's sinkers. Free illustrated booklet. Reading Instrument Co., Box 78, Reading, Penna.

H&R .22. With holster \$20; Winchester .44 rifle \$5; .22 rifle \$10; 1828 musket \$13; arrowhead collection 70c; German officer swords \$5; pistols \$2 up. Rush 25c for catalog #509 listing many other bargains in guns (new and old), swords, relics, etc. Jefscoc, Box 1682-CS, Toledo, Ohio.

GOV'T Surplus flight boots: sheepskin lined. Reconditioned, perfect \$7.95. New \$12.95. Small, medium, large. Pants: Sheepskin, leather top. New \$12.95. Reconditioned \$7.95. Jackets, helmets. Postpaid. Remittance with order. Harris Machinery, Minneapolis, Minnesota.

5000 BARGAINS, Firearms, binoculars, war relics. Catalog 50c. Smith Firearms, Runnemeade, N. J.

AMMUNITION Immediately available for Lugers, Mausers, Japanese, Italian guns. Send 10c; complete list; 100 kinds. Also 8 power pocket telescope, \$5.00; cameras, microscopes, rifles, crossbows, knives. Ashton Company, 1511 North Gardner Street, Hollywood 46, California.

190 PROFUSELY illustrated pages antique and modern pistols, swords, daggers, armor, etc. 50c. Robert Abels, A860 Lexington Ave., New York 21.

MOLDS, (For fisherman's sinkers, squids, jigs and lures.) Handled and hinged. Quality fishing tackle. Free catalogue. E. L. Sweet & Son, Tonawanda, New York.

TAXIDERMISTRY

MODERN Taxidermist Magazine, Greenfield Center 2, N. Y. Devoted entirely to taxidermy, photos, articles, methods. Trial year's subscription, \$1.00.

BINOCULARS, TELESCOPES, MICROSCOPES, MAGNIFIERS

AMAZING Prices, imported precision binoculars. Free trial. Pricelist, folder "Selecting Binoculars" free. Prentiss Importers, Mercury Bldg., Los Angeles 25, Calif.

SAVE 50% On new binoculars! Free catalog. Free book, "How to Select Binoculars." Write today! Bushnell's, 43-M29 Green, Pasadena 1, California.

ASTRONOMICAL Telescopes, binoculars, microscopes, bought, sold, repaired. Books. Lists 10c. Rasmussen-Reece, Amsterdam, N. Y.

FREE 20-Page Binocular catalog. Over 60 different models. United, Dept. ARF-2808, 9043 S. Western, Chicago 20.

WAR Surplus bargains, binoculars, telescopes, sextants, millions of lenses, prisms, reticles, eyepieces, objectives, etc. Mail 10c for big "Catalog CH." Send \$1.00 for Stock CH—10-piece lens kit and big instruction booklet. Edmund Scientific Corp. (Formerly Edmund Salvage Co.), Barrington, N. J.

BINOCULARS, Telescopes, watches, guns. Buy, sell, trade. Schweer's, Donnellson, Iowa.

BINOCULAR Specialists, all makes repaired. Authorized Zeiss, Hensoldt dealer. Tele-Optics, 5514 Lawrence, Chicago 30, Illinois.

BINOCULARS, Telescopes, microscopes. Our 20th year of leadership in optical values. Bargain catalog free. Brownscope Co., 24 West Street, New York.

MAKE Your 6" telescope reflector. Glass, abrasives, instructions—\$8.50. F. Cameron, Box 65, Inwood, N. Y.

REFLECTOR Telescope kits, refractors. Free illustrated bulletin. Esco Products, 911 Willow Ave., Hoboken, N. J.

GIANT Astronomical telescope with 6 ft. tripod \$15.00, f.o.b. factory. 100 power. (10,000 area magnification). Clear vision, full power guaranteed. Ready for use. Suffolk Science Service, Dept. BT, Riverhead, N. Y.

POWERFUL Astronomical telescopes easily made. Perfect lenses and instructions; 100X \$3.00; 100X and 200X \$4.00; 100X, 200X and 400X \$6.00. Full power, clear vision guaranteed. Instructions alone 10c. Suffolk Science Service, Riverhead, N. Y.

REFLECTING Telescopes, 60X, completely assembled \$25.00. Guaranteed observatory clearness. Free information. Skyscope, 475 Fifth Avenue, New York 17.

PETS—DOGS, BIRDS, RABBITS, HAMSTERS, ETC.

FAMOUS Angoras! Giant Chinchillas! World's most profitable rabbits. Finest pedigree, heavy-producing, prize-winners. Catalog free. P. M. Grinsteads, Edwardsville, Illinois.

PRODUCE Low cost, all-white rabbit meat in your own backyard. Get this complete rabbit raising book for only 10c plus a year's subscription to Checkerboard Rabbit News. 52 pages of valuable information and pictures telling you how to raise rabbits the easy way. Also chapters on building markets for domestic rabbit meat, selling skins, angora wool, and laboratory stock. Beginners and veteran breeders alike will want this attractive, plastic-bound book for their reference library. Act now, send for your copy today at this below-printing cost of 10c. Ralston Purina Company, 1911 Checkerboard Square, St. Louis 2, Missouri.

BOXERS, St. Bernards, Hof Kennels, 5136 Cascade Rd. S.E., Grand Rapids 6, Mich.

SPORTSMEN: 200 Pointers, Setters, straight Cooners, combination hunters, rabbit and fox hounds. Reasonable. List free. Ramsey Creek Kennels, Ramsey, Ill.

SEE Gulf Hamstery ad on page 26. Shows picture of hamster.

NATURALIST'S Catalog 10c. Chameleon 50c. Hamsters \$2.75 pair. Turtle 50c. Mexican jumping beans 25 for 75c. Quivira Specialties, Topeka 51, Kansas.

GOLDEN Hamsters, pets and breeders \$1.00 each. Pandas reasonably priced. Fred Battersby, 430 N. 4th St., Vineland, N. J.

HAMSTERS—Moneymakers. Send \$5.00 for beautiful virgin pair, cage, and illustrated instructions. Free prices. Dixie Hamstery, 502-C Trinity Lane, Nashville 7, Tenn.

RAISE Rabbits. Profitable business. Literature free. Tayco Rabbitry, Hapeville, Georgia.

MAKE Big money! Raise Chinchilla rabbits. Cash markets supplied. Write today! Rockhill Ranch, Sellersville 15, Penna.

INCREASE Your income by raising domestic rabbits. Small space needed. Ready market for delicious meat, fur and wool. Largest magazine in the industry tells you how. \$1.50 per year. Sample 15 cents. No stamps. Small Stock Magazine, Lamoni 20, Iowa.

EARN Up to \$400 monthly raising Angora or New Zealand rabbits. Plenty markets. Particulars free. White's Rabbitry, Newark 38, Ohio.

RAISE Guinea pigs. Money makers. Booklet free. Taylors, B426A, Hapeville, Georgia.

MINK Raising information free. Complete. Lake Superior Mink Farm, Superior, EE1, Wisconsin.

A Practical beginning to successful rabbit raising. 48 page illustrated booklet. Dime. American Rabbit Breeders Association. 36 AR & CBA Bldg., Pittsburgh, Penna.

PLANTS, SEEDS, NURSERY AND GARDEN SUPPLIES

GINSENG. Goldenseal. Hundred seeds \$1.50; thousand \$5. Dozen plants \$1.50; fifty, \$5.00. Complete instructions included. M. F. Collins, Viola, Iowa.

FARMS, FARM LANDS, REAL ESTATE

ARMSTRONG'S Best Ozark lands. Lake resorts \$95. Small farms lowest prices, easiest terms. Complete information. Write today. Armstrong, 34, Shook, Mo.

FLORIDA—Hunting, fishing, fruit growing, 5 acres, \$245.00. \$10.00 down, \$10.00 month. G. B. Potterfield, Union Building, Charleston, W. Va.

NEW Farm and business catalog free! Just out! Maine to Florida. Bargains from \$1000 up! West's, M-7, Pittsburgh 17, Penna.

STROUT'S New fall catalogs just out! Eastern and Central Book, also West Coast Catalog. Farms, homes, country businesses. Bargains galore. Mailed free. Strout Realty, 7 So. Dearborn St., Chicago 3, Ill.

BIG Free Fall Catalog! Farm and country real estate bargains, good pictures, many states, easy terms, many equipped, businesses. For special service, state requirements, desired location. United Farm Agency, 220-PM South State St., Chicago 4, Ill.

GOVERNMENT Lands \$2.00 acre up. Information all states twenty-five cents. National Tax Service, 901-A Majestic Bldg., Detroit.

\$5.00 MONTHLY Buys 40 acres near town; price \$200; free list. Box 425-P, Carthage, Mo.

WESTERN Ranch lands. Virgin timber. Hunting, fishing, river and highway frontage tracts. \$5 to \$10 acre full price. Easy terms. 10c (coin) brings Land Catalog, pictures. Pacific Lands, Box 2350BW, Hollywood 28, California.

FLORIDA Security acres — Campsites \$60. \$5 down, \$5 monthly. LE Thompson, 132 Thompson St., New York 12, N. Y.

GOOD Farms — Ranches. Washington, Minnesota, Montana, Idaho, Oregon, North Dakota. Dependable crops, favorable climate. Write for literature, lists describing typical farm opportunities. Specify which state. J. W. Haw, 119 Northern Pacific Ry., St. Paul 1, Minn.

POULTRY, FARM SUPPLIES

KNOW How to raise poultry for profit. Read Poultry Industry. Every issue packed with helpful hints and practical suggestions. Latest articles on breeding, feeding and management. Subscribe now. 1 year 65c. 2 years one dollar, foreign subscriptions \$1.00 a year. Poultry Industry, Dept. P.M., 376 Boylston St., Boston 16, Mass.

EASY Ways to earn extra income are described in Money-Making Hobbies. 132 projects you can make at home and sell anywhere. 160 pages, \$2.00. Popular Mechanics Press, 200 E. Ontario St., Chicago 11, Ill.

PROFITABLE OCCUPATIONS

WANT A diesel job? Our approved, up-to-the-minute diesel training program can help you qualify for steady, big pay jobs or specialized military training. Covers diesel, tractor, heavy equipment. Easy to master. No loss of present income. Job placement advisory service. Investigate! Write for information today. Interstate Training Service, Dept. 3J, Portland 13, Oregon.

TURN Your spare time into cash. Make quick-selling, highly profitable lamps — every home a prospect. No experience or special tools required. New 1951 56-page illustrated catalog shows shades, shade frames, figurines and bases, oil lamp converters, boring compounds, and dozens of similar items. Also all kinds of sockets, cords, pipes, harps, finials, bases, and hundreds of other parts — everything you need. Special 8-page section shows 6 beautiful lamps in kit form ready to assemble. You buy wholesale, sell at retail — make big profits. Hundreds doing it. You can, too. Send 25c today for catalog and wholesale price list. Refundable first order. Gearon Co., Dept. 500-B9, 27 S. Desplaines, Chicago 6, Ill.

"EVERYBODY Likes candy" — Learn to make professionally. (Our 40th year.) Ragsdale Candies, D6, East Orange, New Jersey.

MAKE Your own jewelry. Kit including settings and black fire opals \$1.00. Our Lady's Gift Shop, Box 171, Dept. M. 9, Andover, New Jersey.

MUSHROOMS Grown. Boxes, barrels, instructions 50c. Spawn \$1.00. Manureless process. \$2.00 Gordons, 328 Bannerman, Winnipeg, Manitoba.

OIL Lamps — Electrify. Easy, profitable. Parts catalog, instructions 25c. Gyro Lamps, 5402P Clark, Chicago 40.

FREE Book "How to Make Money With Home Workshop" describes amazing methods used by hundreds of successful craftsmen. Tells what to make, how to sell workshop output spare time. Write at once for details. Remember it's free! Craftsman, 115-A9 Worth St., New York City.

GET Into plastics! Miracle industry of 20th century! Maker of millionaires! Complete course of instructions covering all phases manufacturing, mould making, casting, processes, formulas. Simple to follow! Written, compiled by America's foremost authorities! Not just another book, but a professional "how-to-course" for only \$5.95. Only one of its kind. "How-to-make" information worth fortune. Money back guarantee. For more details, write Plastic Service Guild, Dept. T6, East Boston 28, Mass.

FOREIGN Employment construction men, building trades, helpers, office men. Others, interested in foreign projects. High wages, quarters, trans. Listings of firms actively working on U. S. foreign intercontinental projects. Send \$1 for foreign construction compendium and application forms. Foreign Service Bureau, Dept. PM9, Box 295, Metuchen, New Jersey. (Not an employment agency — no fees.)

\$250 WEEK Reported! Free book 505 Odd, Successful Businesses. Work home. Expect odd! Pacific, Oceanside, Calif.

BOLIVIA Offers unlimited opportunities to wealth in mining, gold washing, coffee, tobacco growing, dairy, constructional engineering, manufacturing. Information 2 dollars airmail. Dr. Jimmy Kay, Casilla 380, Oruro, Bolivia.

"FROG Raising!" New book tells how! Illustrated literature free. Marlboro-A, Box 7002, New Orleans 19, Louisiana.

\$3.00 HOUR! Part or full time. Service aquariums. Send 50c full instructions. Catalog, Box 47, Cathedral Station, New York 25.

GROW Mushrooms. Cellar, shed. Spare, full time. We pay \$3.00 pound. Free book. Mushrooms, 2954 Admiral Way, Seattle, Wash.

OWN A printing business. Good profits printing cards, stationery, etc., in spare time. Easy rules furnished. Have home shop. Send dime for illustrated printer's supply book and samples. Kelsey, Inc., T-24, Meriden, Conn.

EARN Up to \$400 monthly raising Angora or New Zealand rabbits. Plenty markets. Particulars free. White's Rabbitry, Newark 61, Ohio.

MAKE Flexible molds! Cast plaques, bookends, figurines! Free sample! H. Tooker, 630-M Chestnut, Hamilton, Ohio.

RAISE Pheasants on the \$100 week plan. Little capital and space can make you independent. Free details. Great Central Game Management System, Columbus 1, Kansas.

LIFETIME Income as notary public. Appointment assistance. Stationers, Helotes 50, Texas.

\$40.00 WEEKLY Made growing mushrooms, fresh, dried. Dominion patent 331583. Free spawn. North American, 169P Yonge, Toronto, Canada.

BE The Popular Mechanics representative in your neighborhood and earn big profits in your spare time. Write Popular Mechanics Magazine, Room 408M, 200 E. Ontario St., Chicago, Ill.

FOREIGN And Latin American employment. 1951 "Foreign Service Directory" gives up-to-minute facts on military and civilian construction, government jobs, major oil listings, aviation, transportation, steamship lines, mining, importers, exporters, how-when-where to apply, application forms, hot list firms hiring. \$1.00 postpaid. Global Reports, P.O. Box 883-P, Hollywood 28, Calif.

BOOKS, PERIODICALS, PICTURES POSTCARDS

POCKET Novels. Used, 8 for \$1.00. List free. Trunkat, Glenshaw, Penna.

BOOKHUNTER! Scarce, unusual, miscellaneous books supplied. Atlantic Book Service, Lawrence Avenue, Charlestown 29, Massachusetts.

RENT Fiction, non-fiction. Catalog free. Santens, 2700-A Ann, St. Louis 4, Mo.

COMMERCIAL Rabbit Magazine. B-5142-G Miami, Florida. Year \$1.00, sample dime.

MAGAZINES (Back dated) — Foreign, domestic — Arts, books, booklets, subscriptions, etc. Catalog 10c (refunded). Cicerone's, 86-22 Northern Blvd., Jackson Heights, N. Y.

WOODWORKING Ripsaw practice book by Hyler, woodworking wizard. \$1.75. Be a ripsaw expert. Hyler, 231 Rialto Building, Peoria 2, Illinois.

TWO Real illustrated Joke books with our fascinating catalog 25c. Aladdin Book Co., 210-P Fifth Ave., New York 10.

HARD-To-Find Books supplied. Send wants. Pierce's, Winthrop, Iowa.

BOOKHUNTERS! All subjects. Send wants! Jaher Book Service, 620-P East 178 Street, New York 57.

OLD West factual books. Clothbound, postpaid. Yaqui Gold, actual treasure Arizona. \$1.75. Blaze of Gold, Texas coastal treasures. \$1.75. Bad Man of West, gunmen, \$2.95. The Raven (Sam Houston), \$2.00. Smoke Up the Valley, historical Texas frontier novel, \$3.00. The Houston Story, Sam Houston, Houstontown, Texian Frontiers (just published) \$3.00. History of Texas, \$1.50. All seven, \$12.95. Frontier Bookshop, 8102 Lockheed, Houston, Texas.

MAGIC TRICKS, PUZZLES, JOKER NOVELTIES

MAGIC Monthly. Year 25c. Sample and latest magic catalogue free. Magic Factory, Minneapolis 2, Minn.

7 AMAZING New mystery tricks with camera snapshots, \$1. Photomagic, 374 Margaret, San Jose 12, California.

VENTRILLOQUISM Taught. 3c stamp brings particulars. Smith, 801 Bigelow, Peoria 5, Ill.

VENTRILLOQUISM Self taught. Quick, easy instructions, 25c. "Ventriloquist," Cal Allen, Texas.

ANYTHING New? We have it — tricks, jokers, funmakers, puzzles, disguises, cards, bed bugs, sneezing powder, snake matches, etc., gigantic selection 10c. Andersen's, 6815P Ardmore, Chicago 31.

200 ELECTRIC Stunts \$1. Cards \$1. Kutting Sons, Los Altos, Calif.

RUSH 50c For vanishing cigarette trick and large magic catalog. Robbins Company, Dept. V-1, 131 West 42nd St., New York.

PLASTIC Ventriloquist dummy with moving eyes and lips, instructions included 25c. Roalex, 32 West 39th Street, New York.

ADVENTURES In Puzzledom—50 fascinating, instructive puzzles, many varieties, set 1 20c. Graphic Quiz, 1063 Dwane St., So. St. Paul, Minn.

FREE Trick and large illustrated catalog, 35c. Lerro Magic, 509 80th Street, Brooklyn 9, N. Y.

LATEST Magic for pocket, parlor, stage. Catalog 500 tricks, only 10c. Unequaled magic service for 30 years. Douglas Magicland, Dept. 1, Dallas, Texas.

WORLD'S Largest professional magic shop, keeps you in touch with latest tricks. To receive mailings, send 50c for new catalog. Holden's, M220 West 42nd St., New York.

512-PAGE Catalogue of 2500 tricks, pocket, parlor, stage. World's finest magic. Send \$1.50 for catalogue (refunded first \$6.00 order). Kanter's, M-1311 Walnut, Philadelphia 7.

PROFESSIONAL Catalog, 124 pages, 25c. Williams, 900 Plymouth, Ellwood City, Penna.

BE A magician. Large professional magic catalog of latest tricks, 35c. Ireland, C-109 North Dearborn, Chicago 2.

COINS, TOKENS, CURRENCY

OLD Money wanted. Will pay \$100.00 for 1894 Dime, S. Mint, \$50.00 for 1913 Liberty Head Nickel (not Buffalo). Big premiums paid for all rare coins. Send 4c for large coin folder. May mean much profit to you. Numismatic Co., Dept. 20, Fort Worth, Texas.

WANTED Rare coins (stamp please). Samuel L. Bigford, Earville, N. Y.

COIN Magazine, 100 pages. Sample 25c. Hewitt, 5450-J Clark, Chicago 40.

ILLUSTRATED Catalogue with buying and selling prices of all American coins, \$1. Canadian catalogue \$1. List 10c. Charlton, Box 35, Toronto A, Canada.

FOREIGN Money, two wooden nickels, and "Coin Collector's" new magazine, 10c. Lawrence Bros., Anamosa, Iowa.

WHAT Are your coins worth? Amazing Fell's United States coin book. Everything on every single coin minted—Worth, value, how to sell, speculating, investment; other valuable facts on coins. Cloth-bound, 150 illustrations. Send no money. Pay postman only \$1.50 (plus postage) or \$1.50 postpaid (refundable). Order now! Fell Publishers, 386M 4th Ave., New York 16, N. Y.

BARGAINS! Rare collections 45 different Indianhead cents \$5.00, 20 different \$1.00, 1864L cent \$2.00, 40 different dates large cents \$10.00, 15 different \$3.00, 18 dates libertyhead nickels \$2.00, 100 assorted \$8.00, 5 dates 2c pieces \$1.00, Colonial coin before 1790, \$1.00. Complete buying-selling catalogue 25c. Worthycoin Corporation (D-408), Boston 8, Mass.

VATICAN Holy Year set (4) \$1.00. Old large \$1.00 bill \$1.75. Giant bargain catalogue 25c. Bebee's, 1180 East 63rd, Chicago 37, Illinois.

SCARCE 1916D Dime, very good condition, \$4.00. Russell, 3922D Kennerly Ave., St. Louis 13, Mo.

35 DIFFERENT Selected coins. \$1.00. Oddehon, Box 482, St. Louis, Mo.

JAPANESE Invasion notes for U. S. 1c to \$1000.00. Set \$2.00. Burma note and catalogue 25c. Shultz, Salt Lake 10, Utah.

FREE! Foreign coin, banknote and coin collectors illustrated catalog to approval service applicants. Send 3c postage. Tatham Coinco, Springfield 30, Mass.

GET Profit and pleasure in collecting old coins. Send 10c for 56 page illustrated coin catalog. You'll be delighted with it. Send for it now. B. Max Mehl, 370 Mehl Bldg., Fort Worth, Texas. Largest rare coin establishment in U. S. Established 50 years.

GIANT Fifty-two page illustrated price-list of coins, albums, supplies. Send dime to Ben's Coin Shop, 31 N. Clark, Chicago 2.

STAMP COLLECTING

GET Scott's new popular stamp catalog! Makes collecting more fun. Covers all countries, 1,250 pages, thousands of illustrations, handsome flexible cover. Simplified edition of standard catalog. Only \$3.00. If your dealer cannot supply, order from Scott Publications, Inc., 1 West 47th St., New York City 19.

FREE—Silesia, Nigeria! Bonus approvals. Colonial, Box 326A, Passaic, N. J.

AIRMAILS 1/2 Catalogue. Gold Star, 5864 Hollywood Blvd., Hollywood, Calif.

FREE U. S. and Confederate States catalog. Stone, 45 Bromfield, Boston 8, Mass.

LAG Stamp—Free with hydrate U. S. approvals. Wenigman, 1933 Patterson, Chicago 13.

MOUSY Tongue (Mao Tse-tung), other international gangsters on stamps, free with approvals. Conquistador, 15 1/2 Troy Road, Schenectady 9, N. Y.

GIGANTIC Penny approvals. Resch Stamps, 3739 N. Wilton, Chicago, Illinois.

FREE: Mint British Colonies from Brunel, Nauru, Dominica, Ascensions, Solomon Islands, Caymans, Tonga, Gilbert, Ellice, Pitcairns—Free with approvals! Viking Stamp Co., 130-Z Clinton St., Brooklyn 2, N. Y.

U. S. Commemoratives—all different—50-30c; 75-50c; 100-75c. Krick, 511 Fifth, Niagara Falls, N. Y.

LETTERS—Postmarked "Swastika" with Canadian commemorative stamp. Twenty-five cents each. Five for dollar. Northern Novelty, Swastika, Ontario.

EVERYONE Is back. They say my correspondence is helpful. My stamps exceptionally fine. Prices and service so honest they are feeling good. Sophus Jenssen, Coupeville, Washington.

FREE! "King Size" stamp. Attractive approvals. Grey, 46 Lent, Poughkeepsie, N. Y.

FREE Illustrated price list! Foreign new issues. Gibson, Box 213, Indianapolis 6, Indiana.

YOU Stretch your dollar when buying our mounted 1c and 2c foreign approvals. Also U. S. at bargain prices. Don't delay. Write today. Roseland Stamp Co., Dept. 10-C, Spring Lake, Michigan.

PAYING High prices for approvals? If your collection numbers under 15,000 try our 1c and 2c approvals. In books of 1,000 different. Lots to choose from at lowest prices. Also special offer to customers. Clark, Box 544P1, Muskegon, Michigan.

GERMANY — Colonies, offices, states. Mostly 1/2-1/5 catalogue. Approvals, lists 3c. Myers, VanZandt Ave., Little Neck, N. Y.

PRINCESS Elizabeth, Princess Margaret Rose triangles, 10c. Approvals. Miller, Box 600-P, Palo Alto, California.

BUILD Better collections faster with low cost packets. Write for free lists. Myers, Box 122, Lansdowne, Penna.

TRIANGLES! Six bicolored beauties (ferocious beasts, tropical birds, etc.) With colorful approvals—only 10c! Atlas, 2830-t Eisenhower, Racine, Wisconsin.

FREE! First stamps issued by 10 countries, mostly from countries that no longer issue stamps. Free to new approval applicants. Moulblow, 740C Hegney, Bronx 56, New York.

FREE — Nepal, 5 different, catalogue value 51c, to approval applicants. (We pay return postage.) Frank Newman, 3539 Harford St., St. Louis 18, Mo.

FREE—New Monaco holy year issue, six stamps including two triangles, sent to approval applicants. Pegasus Stamp Co., 716 DeKalb Ave., Brooklyn 16, N. Y.

FREE Sample—Interesting, informative, enjoyable. National Stamp News, Anderson 1, South Carolina.

BEGINNER'S Collection of 500 different worldwide stamps—just 25c! "Beginners' Delight" approvals included. Niagara Stamp Company, 14 Queensway, Niagara-on-the-Lake, Canada.

18 VALUE Greece pictorial set. Free to approval buyers. Pleasure Stamps, 1865P 52nd Street, Brooklyn 4, N. Y.

1,031 ALL Different stamps including Tanna Touva collection. 31 triangles, diamonds, giants; everything \$1.00! Approvals included. Stampex, 116-PM Nassau, New York City 38.

NEW Mozambique exotic fish set, together with 100 different world. 10c to approval applicants. Sunset, Dept. D, Box 47, South Gate, Calif.

50%-75% DISCOUNTS! Approvals from 33,000 collection—1/2c up! Schur, Box 252, Buffalo 12, N. Y.

SPANISH Morocco, U.P.U. Free mints, approvals. Raydon Stamps, 2860 Maplewood, Grand Rapids 6, Michigan.

FREE! "Carnival" packet of midget, giant, and other "freak" stamps—yours with bargainful, temptingly-different approvals. Niagara Stamp Company, 12 Queensway, Niagara-on-the-Lake, Canada.

JUMBO Approvals, 1000 different each selection. Just 1c and 2c each. Postage paid both ways. Stone, Box 52-P9, Dorchester 24, Mass.

25 DIFFERENT Uruguay only 6c to approval applicants. Johnson, Box 267, Morgan Hill, Calif.

FREE! 25 Different Switzerland with swell approvals. Kardell, 209 Bower, Santa Fe, New Mexico.

SWITZERLAND—50 Different 10c. No approvals. Erie, Box 2642, Lakewood 7, Ohio.

DEALERS — Wholesale list. Postage 3c. Frank, 5031 Queensberry, Baltimore 15, Maryland.

200 DIFFERENT British Colonies \$1.00. Franklin, Box 388K, New Rochelle, N. Y.

FREE Collection—50 different glamorous French Colonials—animals, natives, villages, bicolours, pictorials, all to approval buyers; also Scott Albums and Catalogs. Bell Stamp Service, Dept. S-3, Bell, Calif.

111 DIFFERENT U. S. commemoratives, \$1.00! List free. Breck, 10516 Clifton, Cleveland 2, Ohio.

233 DIFFERENT, Including 32 19th Century; diamonds, jubilees, souvenir sheet—10c. Approvals. Brooks, 2352B East 23rd Street, Brooklyn 29, New York.

POUND Stamps containing thousands \$1.00. Longacre Shop, 108 West 42nd, New York 18.

FREE—Complete set of famous Americans, flags, parks and presidentials to approval buyers. Send 3c for 15 of the above stamps plus full particulars. Triboro Stamp Company, 145 Nassau Street, Dept. 109, New York 38, N. Y.

ROOSEVELT Set plus 25 different U. S. 10c, approvals. Locust Stamp Co., Box 305T, Harmon-on-Hudson, N. Y.

COLOSSAL Bargain! 50 different San Marino pictorials—just 6c! Colorful, bargainful approvals included. "PG," 195 Park, Lewiston, Maine.

FREE! Rare old Borneo pictorial set (tapir, elephant, etc.)—yours with colorful, temptingly-priced approvals. "PG," 195 Park, Lewiston, Maine.

FREE! Big 36 page illustrated catalog! Special offers on stamps, albums, packets. "Stamps By Mail," 2133 Lunt, Chicago 45.

WONDERFUL Offer. 7 complete mint sets Manchukuo, Bohemia, etc., only 10c with approvals. Reich Stamp Co., 4647 Kenmore, Chicago 40, Illinois, Dept. M23.

BELIEVE It or not: 25 different British, West Indies stamps are yours for the asking. Beautiful pictorials, 19th and 20th century, including free monthly magazine. Send only 5c for postage. Empire Stamp Company, Dept. PM, Toronto 5, Canada.

RARE! One pound Egypt #240 only 25c. Approvals. Royal Stamp Company, Tam-aqua, Penna.

15 DIFF. 19th Century. Given to approval applicants. Rossom, 218 West 59th St., Chicago 21, Ill.

MOZAMBIQUE Triangulars, unused set 10c with approvals. Vargo Stamps, 6044 South Fairfield, Chicago 29, Illinois.

100 DIFFERENT Worldwide plus unusual Mongolian stamps 10c, approvals. E. Ballan, Box 901, Syracuse 1, N. Y.

1000 MIXED U. S. and foreign 25c. Monjar, Fairmount, Cincinnati 14, Ohio.

PRINCE Edward Island, Nova Scotia, Newfoundland, Cat. value over \$12.00 for 45c to approval applicants. Green Co., Box 208, Toronto 1, Canada.

COMPLETE Clearance. Sensational bargain lists free. Beacon Sales, Maynard, Massachusetts.

MOUNTED Penny approvals. Write Department PM, 1267 Tutwiler, Memphis 7, Tennessee.

SEVEN Complete mint sets 10c. Approvals. Queensway, Box 150, Toronto 18, Canada.

TASMANIA, Thailand, Israel, Victoria, free with approvals. A-to-Z Stampco, Box 36, Miami Beach 39, Florida.

FASCINATING Congo idols only 10c with giant foreign approvals. Valuable premiums. Postage paid. Faith, 1339 1/2 Westminster, Alhambra, California.

PENNY Approvals that satisfy. Neil Gronberg, Box 5441-P, Philadelphia 43, Penna.

FINE Approvals. Fast, personal service. What countries do you prefer? I'll send their stamps. Skinner, 438 Locust, Long Beach 12, California.

1c-1c APPROVALS! Bargains galore! Cole, 43-a Rinewalt, Buffalo 21, N. Y.

FREE. Scott's International Album. Other big premiums. Full particulars with approvals. Raymax, 123-Z William St., New York City 38.

500 DIFFERENT 40c With approvals at wholesale to clear. K. S. Holmes, London, Canada.

50 DIFFERENT U. S. 10c. No approvals. Seidenberg, 944, Appleton, Wis.

STAMPS Wanted. Collections, duplicates, surplus stock, mint and used. Buy outright if bargain. What have you? Vanroy Shirk, Lebanon, Penna.

77 DIFFERENT United States—25c. Approvals. Utechts, 1143-D North Keeler, Chicago 51.

UNITED States approvals—Select, used or mint. Kingsbury, Woodbury, Vermont.

307 ALL Different—Only 15c! Beautiful collection: commemoratives, triangles, high values, bicolored stamps, etc. Garcelon, Calais 400, Maine.

NOTHING Free. Just good stamps reasonable. Send dime for seventy-four page catalog. Ben's Stamp Shop, 31 N. Clark, Chicago 2.

"HOW To Recognize Rare Stamps." Free book illustrated! Kenmore, Richford, H-57, Vermont.

FREE U. S. price list, postage 3c. Mark Hanna, 335 5th Ave., Pittsburgh 22, Penna.

OLD Scarce U. S. seconds on approval. Slightly defective. Bargain prices. Hernefield, Clintonhill Station, Newark 8, N. J.

FREE "Stamp Finder." Tells instantly country to which any stamp belongs. 32 pages profusely illustrated. Garcelon, Calais 17, Maine.

10,000 DIFFERENT 1c Each! Gordon Davison, Box 1019S, Manchester, N. H.

100 NETHERLANDS. All different. Beautiful assortment. 10c with approvals. Thomson's, Box 4074-P, Miami, Florida.

AMAZING Offer! 500 United States stamps—including commemoratives, airmails, high values to \$5.00. Only 10c to approval applicants! Illustrated bargain lists free. Mystic Stamp Co., Dept. 80, Camden, New York.

FIRST U. S. (1847) government reissues 5c, 10c, plus giant bargain U. S. collection—only 5c to applicants U. S. approvals. Metropolitan, Box 312G, Jackson Heights, N. Y.

10 ASSORTED U. S. Commemorative 15c. Five U. S. Air Mail 15c. 10 Famous Americans 25c. All for 50c. Ideal Stamp Shop, Box 179, Park Ridge, Illinois.

WOW! 203 All different Germany 10c! Zeppelins, semipostals, airmails, high values, etc. to new customers. Jamestown Stamp, Jamestown 512, New York.

WORLD'S Largest stamp (7 1/2 x 14 inches). A real curiosity! Retail for 50c, only 3c to approval applicants. Tatham Stamp Co., Springfield 30, Mass.

UNITED States stamps nearly 100 years old. Roosevelt set, others, 40c value—only 5c to applicants United States approvals. Wakonda, Box 272K, Jackson Heights, N. Y.

500 STAMPS For only 10c! This mammoth value includes airmails, pictorials; stamps from strange countries, cataloging up to 25c each! Also approvals. Mystic Stamp Company, Camden 80, New York.

COLUMBIANS, Trans-Mississippi, Pan Americans, Pan Pacific, ten other different commemoratives. All 10c with your request for U. S. approvals. Moda Stamps, Box 251-X, C.S.A., New York 8.

FREE! Powerful magnifying glass. Jamestown Stamp, Jamestown 202, New York.

200 DIFFERENT Including Roosevelt triangle, 5c to approval applicants. M. Avalon Stamp Company, Springfield, Mass.

OVER 1,000,000 Sold; 200 different stamps 10c with approvals. Carlton's, Tujunga, Calif.

500 EXOTIC Japan stamps—10c. Kenmore, Richford, J-57, Vermont.

50,000 STAMP Grabbags 25c each. Anderson, 630B, Bingham, Reading, Penna.

FREE—Illustrated catalog! Kenmore, Richford, C-57, Vermont.

FREE—Packet list. Many bargains. Reed, Box 980, Chicago 90, Illinois.

ANTIQUES, RELICS, INDIAN GOODS, CURIOS

FIREARMS, Oddities, antiques, relics unusual. List 25c. Farish's, Vicksburg, Miss.

4 FINE Ancient Indian arrowheads \$1.00. Fine tomahawks \$2.00, \$3.00. List free. Lear's, Glenwood, Arkansas.

PRECIOUS STONES, MINERALS

GEMS, Precious and semi-precious, all genuine, from world wide sources. Deal direct, no overhead, save money. Catalog 10c. Hill Co., Route 7, Salem, Oregon.

TEN N. Mex. mineral specimens \$1.50, six fluorescents \$1.00, fools gold 25c. Free literature. Prospector, Winston, N. Mexico.

FIND Tungsten, mercury, uranium with Mineralight. Free brochure. Write Dept. PM8, Ultra-Violet Products, South Pasadena, California.

GEMCUTTING, Silvercraft authority. Illustrated magazine tells how. Cut rocks, make jewelry. 150 ads illustrating equipment, offering gems for collectors, cutters. Postal brings literature. Lapidary Journal, Palm Desert, Calif.

GEMSTONES, Mineral specimens. Every variety. Lowest prices. Postcard brings free booklet. Plummer's, 2183C Bacon, San Diego 7, California.

HOBBIES AND COLLECTIONS

"TOPS" In everything for leathercraft. Low priced kits, leathers, tools, lacing. Catalog 10c. Crown Leather, 22 Spruce Street, Dept. P, New York 38.

COLLECT Cartophilic cards! New fascinating hobby. Interesting packet containing birds, butterflies, aeroplanes, flowers, trains and other rare cards. Plus big illustrated catalogue. All for 10c. International Cartophilic Co., Dept. PM, 1152 Yonge Street, Toronto, Ontario.

WANTED: Cigarette, tobacco, cards. Write Charles Bray, East Bangor, Penna.

UNUSED Matchbook covers—100 different \$1.00 36-page catalog 25c. Charles Edelman, 1311C East 84, Cleveland 3, Ohio.

INVENTING Can be an interesting and profitable hobby. Write for complete particulars. Institute of American Inventors, Dept. 40-E 631-E St. N.W., Washington 4, D. C.

CAMERAS, PHOTO SUPPLIES

BUY Photographic supplies wholesale. Films, cameras, accessories. Free catalogue. Capitol Photo Supplies, 2428 Guadalupe, Austin, Texas.

50 POWER Telephoto camera easily made. Telephoto lens and instructions \$5.00. Carl Jamer, Manorville 1, N. Y.

FREE Photographic bargain book packed with hundreds of sensational values in still and movie cameras, lenses and latest accessories. Super savings for you in new and used equipment. Liberal trade-in allowances, too, on your equipment. Write now for your free copy to Central Camera Company, Dept. 9H, 230 S. Wabash Ave., Chicago 4. (Photographic headquarters since 1899.)

PHOTOMURALS. Your negatives or ours. Catalogue 25c. Photomammoth Murals, 12048 Vanowen St., North Hollywood, Calif.

PHOTOCOPY Anything—Papers, books. No darkroom. 8 1/2" x 11" complete \$6.95. Fotoflek, 8555 Plainfield Lane, Cincinnati 36, Ohio.

BASS Says: Trading cameras a national habit since 1910. Write to Bass the old "horse trader." A postcard will do. Simply say: "Bass, I have and I want. How much will you allow me?" It's fun to trade with Bass. Satisfaction guaranteed. Bass buys, sells, and trades. Bass Camera Company, Dept. AG., 179 W. Madison St., Chicago 2.

NEW Heart photo pin. Free details. Sparklet, P.O. Box 925, Providence 3, R. I.

PHOTO FINISHING

ENLARGEMENTS 5x7—20c, 8x10—35c. Minimum \$1.00. Lawson, 1505 Southern Blvd., Bronx 60, N. Y.

8 CONTACTS 30c, Jumbos 40c, 12—45c. Jumbo—55c. Reprints 4c, jumbos 5c. Free mailers. Western Photo, PM91, Box 298, San Francisco 1, Calif.

BEAUTIFUL Jumbo enlargements 20, 90c; 36, \$1.25. Free mailer and pricelist. Duplex Photo, Box 1207 General Postoffice, New York 1, N. Y.

8 OVERSIZE Snapshots from roll, 25c with this ad. Foto's, Box 8, Aurora 1, Ill.

SPECIAL Closeout 8mm. sound films with sound on disc. All new full length. \$4.00 each. 5 for \$15.00. No lists sent. Standard Sales, Box 7525, North Kansas City, Mo.

GREAT News! Our famous Century jumbo oversize finishing at contact prices. Our Chicago plant, with new improved equipment, exclusive with Century, produces sensationally magnificent quality work. Any 8-exposure roll finished deluxe style only 35c. 12-exp. 50c. 16-exp. 60c. 36-exp. \$1.35. Oversize reprints 4c each. Free mailers. Send us your next order, you will be delighted with results. Century Photo Service, Box 5208, Chicago 80, Ill.

DOUBLE Size prints. 8 exposure roll 30c; 12, 45c; 16, 55c. Same day service. Send for free mailers. Emerson Photo, Box P, Emerson, N. J.

UNBEATABLE For quality and price. You will be surprised and pleased with the beautiful results from our celebrated jumbo oversize finishing. Low prices, same as contact. 8-exp. roll superfine finish only 35c. 12-exp. 50c. 16-exp. 60c. 36-exp. \$1.35. Oversize reprints 4c each. Send us your order, you will be delighted. Free mailers. Mailbag Film Service, Box 5440A, Chicago 80, Ill.

6 OR 8 Picture roll 35c, 12 or 16 picture roll 55c. Each roll printed and developed. Handy album pack. If you fail to get pictures on your film a new roll will be sent you without extra cost. Send coin with roll. No c.o.d.'s. Mailing containers sent free. DeLux Film Service, Box 1268-A, Shreveport, Louisiana.

MAIL Us your films. Prompt service. 8 exposures developed and printed 30c. Free enlargements. Foto Art Studio, Box 406, San Francisco, Calif.

16 PRINTS Or 8 jumbos from roll, 25c with this ad. S. Skrudland, River Grove, Ill.

MOTION PICTURES AND SOUND EQUIPMENT

ALMOST Free—With your request for Blackhawk's big 28-page catalog of film bargains—One brand new film, postpaid. (We select the title)—100' 16mm. sound, 98c; or 100' 16mm. silent, 59c; or 50' 8mm., 39c—as a special get acquainted offer. Other typical Blackhawk bargains: new 1-reel, 16mm. sound films \$7.95 (formerly \$17.50); new 1-reel 16mm. silents, \$2.98 (formerly \$8.75); new 1-reel 8mm., \$1.89 (formerly \$5.50)—all first quality prints in original cartons. Used Panoram 100' 16mm. musicals—\$6.89 per dozen. Similar bargains in used features, cartoons, sports, comedies, musicals, travels. Used sound projectors—Ampros, Bell & Howells, Victors—often available low as \$129.95. Bargains in reels, cans, supplies. World's biggest stock 16mm. films—over 100,000 prints. Write today for Blackhawk's free catalog and get acquainted offer. Blackhawk Films Inc., "Sixteen's Super Market," 1203 Putnam Building, Davenport, Iowa.

EARN \$8.00 To \$10.00 daily with your movie projector. Write: Beverly, 10806 Glenroy, Chicago 43, Ill.

COLOR Film 8-8mm., 25 ft. \$2.90. Hurry! M-K Photo, 451 Continental, Detroit 14, Michigan.

UNUSUAL 8-16MM. movies. Sample film 50' 8mm. \$1.00; or 16mm. 100' silent \$2.00. Color Tru-Art slides, three samples \$1.00. Big catalog, 25c (refundable). National Film Supply, Toledo 9-H, Ohio.

FREE Movies. Thousands of subjects. Interesting. Entertaining. Fascinating. New directory—only 50c. National Cine Society, 126 Lexington, New York 16, N. Y.

5000 NEW-Used 8-16mm. silent-sound films. International, 2120 Strauss, Brooklyn 12.

8-16MM. Silent-sound films. Complete rental library. All latest subjects. Free catalogue, sample film 10c. Garden Film, 317 West 50th, New York 19.

BASS Says: Leadership since 1910 guarantees satisfaction. Finest Cine equipment: 8mm., 16mm., and 35mm., silent and sound. Write the old "horse trader." Satisfaction or your money back always! Bass Camera Company, Dept. A, 179 W. Madison St., Chicago 2.

RENT 16MM. sound films. 50c reel. Large selection; free catalog. Film Service, 128 Chestnut St., Roselle Park, N. J.

GUARANTEED Fresh 8mm. roll magazine; 16mm. roll magazine movie films. Color, b&w. Free catalog. ESO-S, 47th Holly, Kansas City 2, Missouri.

MOVIE Camera film: 8mm. roll \$1.50, 16mm. 100' \$3.00. Free processing. Better Films, 742 New Lots, Brooklyn, N. Y.

MUSIC AND MUSICAL INSTRUMENTS

SONGWRITERS! Protect your ideas! Hold all songs; poems! Write for Safe Correct Procedure first! Song Service, Dept. P, 333 W. 56th St., New York 19, N. Y.

MUSIC Composed to sacred words. Manuscripts printed. Dorby Publishers, P.O. 738, Morristown, New Jersey.

RECORDS. Guaranteed new latest Hill-billy, Pops, Blues, Spirituals, low as 4 for \$1.00. Free catalog. AF Mallorc, 570 N. Gay Street, Baltimore, Maryland.

SONGWRITERS—Poems wanted for collaboration. Recordings, radio consideration. Arnold Lax, 53 State St., Boston, Mass.

ELECTRIC Guitars, amplifiers, wholesale. Free catalog. Carvin PM, Baldwin Park, Calif.

POEMS Wanted. Broadcast consideration. Sooner Song Co., 22PM North West 8th, Oklahoma City 2.

HARMONICAS, Accordions, zithers, banjos—catalog. Belanger, 51-A Talcott, Rockville, Conn.

SONGWRITERS! Send poems, songs. Music Service, 243 West 72nd St., PM, New York 23.

SWING Piano—By mail. 30 self-teaching lessons \$3. (Samples.) Phil Breton Publications, P.O. Box 1402, Omaha 8, Nebr.

POEMS Wanted for musical setting. Send poems for free examination. Five Star Music Masters, 630 Beacon Bldg., Boston, Mass.

MUSIC Arranged. Songs printed. Frank Wildt, Music Publisher, Lancaster, Penna.

POEMS Wanted to be set to music. Free examination. Send poems, McNeil, Master of Music, 510-PM S. Alexandria, Los Angeles, California.

WRITE Songs. Big money and reputation. Write for information. J. Gordon Pub. Co., 4700 South California Avenue, Chicago.

WANTED! Poems for musical settings. Write Songwriters' Service, Clifton, N. J.

SWISS Musical movements \$1.00. Catalogue 10c. Bell Music, 1610 First Avenue, New York 28, New York.

ACCORDIONS — All brands. New and used. Save 50%. Wholesale to every one. Del Principe, 307 So. Wabash, Chicago, Ill.

1951 ACCORDIONS — Wholesale. Free catalog. American Accordion Center, 5329 Belmont, Chicago.

YOUR Voice made loud, clear and powerful with my diaphragm exerciser. Write, Inventor "Oz," 34V, Box 665, St. Louis, Mo.

RADIO AND TELEVISION

TELEVISION Reception poor? Improve picture 30%. Your antenna plus 14 ft. wire does the trick. 10 minute job. Instructions \$1.00. J. Symonds, 500-M N. Tamarind, Fontana, Calif.

FREE! 212 Page Radio-Television-Electronic Catalog! World's largest stocks, lowest prices. Complete supplies for builders, experimenters, amateurs, servicemen. Latest radios, phonos, television, recorders, sound equipment. Thousands of parts, tubes, test instruments, books, diagrams. Top quality money saving values. Get yours now! Allied Radio Corp., 833 W. Jackson Blvd., Dept. 34, Chicago 7, Ill.

TELEVISION Telescoping 50 foot steel mast, housetop, simple one-man installation, \$49.00. Four-stack V-cone antenna, reception to 200 miles, \$29.00 f.o.b. Television Engineering Co., 303 — 34th St., Bakersfield, California. Cash or money order. Practical detailed fringe area instruction manual and tips, \$1.00.

POWERFUL Television antenna. Illustrated building instructions. 35 cents. R. Fischbach, 513 South Kendall St., Aurora, Ill.

"COLOR Television Patents." Study first hand, including Columbia system. Send \$1.00. Patent Service, 945-C4 Pennsylvania Avenue, Washington 4, D. C.

LOUDEST Crystal, catwhisker, radio plans, catalog: 25c. Amorose, Route Four, Richmond, Virginia.

RADIO And television tubes. Generous discounts. Write for price list. Teljack Company, 2273 East 17 Street, Brooklyn 29, New York.

CRYSTAL Radio experimenters. Write Leslie Hulet, R2, Lakewood, New Jersey.

BUILDER'S "Pictorial Construction Plans." Free list. Alena, Box 24, Astoria 6, New York.

AMATEUR Radio license preparation. Correspondence course. Low cost. Personal coaching. Federal Electronics Institute, 34 E. Putnam, Dept. 8, Greenwich, Conn.

ANTENNAS And equipment for TV and FM. All types, lowest prices. Wholesale Supply Co., Lunenburg, Mass.

ENGINEERING Service—Radio and electrical. Henry Twillmann, R.R. #1, Chesterfield, Missouri.

MAKE Simple, tubeless, batteryless, distance-getting crystal radios. Crystal and illustrated instructions 25c postpaid. Allen, 427-P, Clinton, Mo.

BUSINESS OPPORTUNITIES

FLOOR Maintenance! Free new plans and ideas to start your money-making lifetime business. Send postcard: Don McCanna, 148-B East 40th, New York 16.

BIG Money! Spare or full time in your home. No selling! Spray new miracle finishes, plush and suede, on signs, radios, automobiles, figurines, lamps, toys, etc. Our business is booming. Help us fill huge demand. New easy Flok-Kraft methods. Material costs few pennies. You get dollars. Free samples, complete powerful money-making plan free. Write now! Coast, 1002M S. Los Angeles St., Los Angeles 15, Calif.

BOOKKEEPERS Earn \$100 weekly at home. Details free. Universal, Box 664-M, Springfield, Mo.

MIRROR Resilvering. Wonderful home business. Complete formula 50c. Magic two-way mirrors. You can see out—no one can look in. Formula 50c. How to make coppered mirrors, vases, glasses. Formula 50c. All three \$1.00. Nelko Chemical Service, Box 3462-MJ, Chicago 54, Ill.

MAKE Money publishing a trade magazine, home; spare time. Small capital starts you. Dime brings sample, interesting details. Hill Enterprises, East Atlanta 79, Georgia.

START Home manufacturing business making cleaning compounds, soaps, insecticides, cosmetics, polishes, food flavors. No machinery. Literature free. Kemix, Park Ridge 10, Ill.

NEW Fast low priced game of skill. Big profits. Small. Details free. MO#11 Industries, Box 929, Long Beach 1, Calif.

MAKE Perfume. Catalogue free. "International," 6347 Parnell-PM-9, Chicago 21, Illinois.

MAKE Perfume at home—Tremendously profitable. Everything furnished. Easy as adding cream to coffee. Sample fragrance, details free. Genmerco, Box 142-L, Dorchester 24, Mass.

ESTABLISH Your own business. Free information. Arrow Press, Box 933, Buffalo, N. Y.

ESTABLISHED. Good going mail-order business wanted. Press, Liberty Center, Ohio.

SELL By mail; free details; instructive booklet 25c. Manhattan House, P.O. Box 51-M, St. Albans 12, N. Y.

MAKE Money at home by mail. Amazing new book tells how. 12,000 words. Illustrated. Details sent free. Northmore's, Highland Park 10, Illinois.

EARN Big money at home raising domestic rabbits. Small space needed. Pleasant, profitable. Information, technique, where to sell, etc., 50c. Complete. Priest's, Box 251, Evanston, Illinois.

FIX Typewriters. Free booklet describes our modern, inexpensive home-study course. Factory methods taught. Write: Typewriter, 9915 Corbet, Tarentum, Penna.

MAKE Money at home as renewal headquarters for all magazines. Big Christmas sales profits now. Liberal commissions. Supplies furnished. Write for free catalog. McGregor Magazine Agency, Dept. 500B, Mount Morris, Ill.

WATERLESS Hand cleaner. Cleans thoroughly. (No ammonia, no kerosene.) Easily prepared. Good profit. Formula \$1.00. Nelko Chemical Service, 3462-WH Merchandise Mart St., Chicago 54, Ill.

IMPORT—Export! Men; women. Learn from established World Trader. Your own profitable world wide business by mail order from home without capital; or travel abroad. Experience unnecessary. Free details. Mellinger, C-8 Los Angeles 24.

BOOKKEEPERS. Operate simplified bookkeeping service CPA designed, double entry system. Illustrated manual \$1.00. Kern, 4942 Vineland, North Hollywood, Calif.

START Your own business on credit. Always your own boss. 1437 dealers sold \$5000 to \$28,500 in 1950; their average \$6704. We supply stocks, equipment on credit. 200 home necessities. Selling experience unnecessary to start. Wonderful opportunity to own pleasant, profitable business backed by world-wide industry. Write Rawleigh's, Dept. I-U-PPM, Freeport, Ill.

EXPORT-Import! Represent manufacturers! Conduct barter exchange. Warfare time big business. Buy-sell by mail. "What to Export and Who Wants It" and one 1951 Trade Bulletin \$1, refunded if unsatisfied. International Trades, 246-P Fifth Ave., New York 1.

TRADE Magazines—Help you to success. Get latest copies through our easy-to-get-acquainted service. Nearly 1200 business, vocational, craft, hobby, selling, etc. 235 classifications covering all interests. List free. Commercial Engraving Publishing Company, 34C North Ritter, Indianapolis 19, Indiana.

INVISIBLE Reweaving — Big profit, big demand, easy-to-learn with low-cost complete course—nothing else to buy, ever. Details free, write today: Fabricon, Dept. N-3, 8342 S. Prairie Ave., Chicago 19, Ill.

MAKE Perfumes at home. Write "Carey Laboratories," 1914 Chouteau, PM9, St. Louis 3, Missouri.

TO \$35.00 Weekly. Spare time, home operated mail order business. Successful small "beginner's" plan. Everything supplied. Lynn, 5710-M Bankfield, Culver City, California.

OPERATE Profitable mailorder business. Particulars free. George Lenhoff, Lincoln 8, Nebraska.

101 WAYS To be your own boss. Free information. Sprusil, Box 34P, Corona, New York.

A Penny post card may prove to be the opportunity you are waiting for. Stamp vending machines; part or full time. Small investment warrants the investment. J. Schoenbach, 1645 Bedford Ave., Brooklyn 25, N. Y.

HOW And where to obtain capital, details free. Star Service, Wapakoneta, Ohio.

YOU Need Mail Order World. News, tips, articles by mail-order experts on mail selling, services, home enterprises. Sample 10c. Arthur H. Whelpley, Pine Bush, N. Y.

START Home mail order business. Details. Vee's, Box 301-PM, Decatur, Georgia.

\$10 HOUR! World's most complete invisible textile reweaving instructions, including 17 samples, 48 lessons, steel tool, material for life \$3, complete. Guaranteed as represented or refund. Details free. Walsh, 894 Main, Buffalo 2, N. Y.

BUY Wholesale—Million articles. Supply source directory, dime. Nelko, Box 3462-DR9, Chicago 54, Ill.

DOLLARS Daily, writing. My way guaranteed. Details, ideas, booklet, rush 25c. E. Loeb, Cincinnati 36.

EARN Big money at home. Make genuine rubber molds, plaques, figurines, etc. Complete line of Dresden-Craft supplies. Catalog free. Ken-Dor Studio N, Lake Geneva, Wisconsin.

RELAX! While mailman brings dollars in mail. 10c magazine tells how. Panko, 331 Townsend, New Brunswick, N. J.

START Your own mailorder business. Work at home. Details free. Contax Service, 6621-A Bishop, Chicago 36.

BEST Tested moneymakers. Over 40,000 words 25c. Business secrets, formulas, wholesale supply, sources galore. Money-back-guarantee. VeeJay, Box 14707M, Los Angeles 18, Calif.

LIQUID Marble—Colorful, glossy! Molded, brushed, sprayed! Cast novelties, statuary, colored tiles. Flexible molds. Composition floors. Particulars free. Marbleizing Service, Edwardsville, Illinois.

\$250 WEEK Reported! Free book 505 Odd, Successful Businesses. Work home. Expect odd! Pacific, Oceanside, Calif.

FREE Book, "Make Money With Hobbies" or "Live Without Money," with our successful 137 plans to build own business. Free details. Uribe, 6215 Woodhaven, Rego Park, New York.

WANTED! At once! Home producers to make plastic items for available customers. No experience required. Easy, pleasant work. Rich rewards. Free details. Plastic Service, Dept. AP, East Boston 28, Mass.

SEWING Machine spare time repairmen wanted. \$125.00 week reported. Hang out your shingle. We train, and furnish you everything. Write Taylor Service, Hamilton PM-9, Ohio.

EARN Money at home with your typewriter! Spare time! Details free. Edwards, Publisher, 3915-PM, 12th, Des Moines 13, Iowa.

EARTHWORM Breeding? First, get unusual story. "An Earthworm Turned His Life." Free. Earthmaster, Dept. 14, El Monte, Calif.

MAIL Order men and beginners, get on the right track with 5 principles that spell success. Send postal for information. Robert Sterling, Room 619M, 216 Jackson Blvd., Chicago 6, Illinois.

BUY Direct, wholesale, 750,000 articles. Write Lamson, Box 1302-P9, Detroit 31.

BUSINESS Men, speculators. Buy war surplus from government. Fantastic profits. Details free. Saylor Publications, Goldthwaite 1, Texas.

TIN-Cans. Turn them into cash. Nine methods. Instructions 50c. Charles Company, 12-BWR, Norwood, Ohio.

NEW Exceptionally profitable plans—ideas for home operated mail business. Rush name. Miller, 1772-P Carlyon Road, East Cleveland 12, Ohio.

BRONZED Baby shoe mounting, supplies and equipment. Buy direct from world's largest and oldest manufacturers of bronzed baby shoe mounting. Hollywood Bronze Supply, Technical Department, 1624 East 1st Street, Los Angeles 33, Calif.

1001 OPPORTUNITIES Club, 1495 Westchester Ave., New York 59, offers real money making ideas. Free information.

ROSE Bowls—Beautiful, appealing, sells on sight. Triple your money. Your name brings one dozen. Pay postman \$5.00. Box 474, Lombard, Illinois.

100,000 MONEY-Making ideas. All fields. World's greatest collection. Catalog 25c. Cummings Co., 1321 Arch, Philadelphia 7F, Penna.

MAN! These are hot! Make \$6.35 on every sale. Sales are really easy. New adding machines in original factory cartons you can sell for only \$12.95 and you make over 45%. They're executive model portables, precision built, fully guaranteed. Send for life-size color photo with full details. Write today to Lightning Adding Machine Co., Inc., Dept. P9, 1260 West Second St., Los Angeles 26, Calif.

SMALL, inexpensive Tyco-Plater electroplates metals, mirrors, non-metals. Free booklet. Tyco, Box 13231-HB, Houston 19, Texas.

HAVE Your own business. Big earnings. Local and mail order. Literature free. E. Kester, 4803-MS Chestnut St., Philadelphia 39, Penna.

HAVE Money to invest in sound ideas. Send details. Contacts unlimited. Box 222, San Francisco, Calif.

MAKE Money with Merritt. Sell Davis Air Cushioned shoes, dress, work, heavy duty. Popular priced. Advance commissions. Cash bonuses. Experience unnecessary. Write to Geo. Merritt Shoe Co., C-82, Brockton, Mass.

CASH Backyard income! Unusual businesses! Details free. Pickett's, Florence, Kentucky.

MONEY In new greaseless doughnuts. Start in kitchen. No smoke. Sell stores. Free recipes. M. Ray Company, 3605 South 15 Ave., Minneapolis 7, Minnesota.

YOU Can make \$42 cash profit selling 24 religious necklaces. Miraculous, sacred heart, etc., medals encased in everlasting plexiglas, 18" gold plated chain. Gift boxed. Sample \$1.00 (Retail \$2.50) sent first class mail. Money back guarantee. Free money-making catalog. Stephen Products, 1947 Broadway, Dept. P, New York 23.

EXTRA Dollars. Spinning angora wool for its use. Angora House, PM, Springfield, Illinois.

MAKE Rubber stamps, repair dolls, invisible reweaving, metalize baby shoes, silver mirrors. Catalogue of "40-Ideas" free. Universal, Box 1076-A, Peoria, Ill.

ATTENTION! "Your Phone Is Your Fortune." Tells how to turn your telephone into dollars. Send \$1.00. Sales, Box 675, Richmond, Va.

YOUR Name and address on postal will bring many local and mail business opportunities. Apex Supply, Box 165, New York 18, N. Y.

HOME Business of your own! Full time or spare time earnings up to \$500. monthly. Information free. Western B. Aircraft, Los Angeles 19.

PROFITS! Pleasure! Preserve live flowers and leaves. Rich, untapped market. Ideal home business, hobby or pastime. Easy-to-follow instructions \$1.00. Satisfaction or money back. S. Butowsky, 1918 N. 32, Philadelphia, Penna.

MAKE Tough, durable plastic—1c pound. Makes attractive floors, walls, built-ins, roofs. Build good home, \$150.00 room. Bays Laboratory, Oklahoma City 9.

WHERE To buy at wholesale 100,000 articles. Free list. Also extra-income literature. Maywoode, 1133 Broadway, New York.

FORTUNES Made from sandwiches. New system. Equipment furnished. Dickerson Manufacturing, Drawer 30-A, Springfield, Missouri.

GROW Mushrooms. Cellar, shed. Spare, full time. We pay \$3.00 pound. Free book. Mushrooms, 2954 Admiral Way, Seattle, Wash.

FREE Literature. Your own business. Profitable permanent. Hubbard, 6 North 6th Street, Yakima, Washington.

\$46 FROM Square foot plywood; jigsaw necessary. Literature free, write today. Woodarts, Bridgewater, Mass.

SPECIAL Rubber for making molds. Literature and sample free. Universal, Box 1076-A, Peoria, Ill.

BOOKKEEPERS, Keep books, small firms spare time. Manual latest technique by C.P.A., \$3.00. Modern Business, Box 406, Youngstown 1, Ohio.

ESTABLISH Profitable home mail business. Exclusive built-to-order proposition service. Everything handled for you. Booklet free. NMD Agency, Box 88-W, Dorchester 22, Mass.

MAKE Money spare or full time casting metal toys and novelties. Big wholesale and chain store demand for autos, soldiers, ashtrays, banks, etc., keeps manufacturers busy. Production moulds furnished for up to 100 and more castings per hour. No experience or special place necessary. "Cash-in" on holiday orders now being placed. Write for information and illustrations of patterns needed. Metal Cast Products Co., Dept. A, 1696 Boston Road, New York 60, N. Y.

START A venetian blind laundry. Profit opportunity for lifetime business. New machine method. Free booklet on request. F. C. Co., 442 N. Seneca St., Wichita 12, Kansas.

INCOME From local information. No selling. Write Neherco, La Verne, Calif.

NATURAL Molding Latex. Extra thick. Free sample. W. Wooley, 115-A Donald, Peoria, Ill.

QUICK Sign painting. Use letter patterns, avoid sloppy work, wasted time. Write for folder. John Rahn, A1330 Central, Chicago 51.

MAKE Flexible molds! Cast plaques, bookends, figurines! Free sample! H. Tooker, 630-R Chestnut, Hamilton, Ohio.

NEW Profitable home business repairing zippers. Thousands of customers waiting. No experience required. We furnish everything. Write Texas Specialty Company, 204-B Texas, Texarkana, Texas.

UNPAINTED Bookends, plaques, statues, figurines. List. Haverty Products, 822-17th St., Altoona, Penna.

YOUR Own profitable home business. Preserve live flowers to last for years. New simple discovery. Enormous demand all year 'round. Tremendous profits! Light fascinating work. Send \$2.00 for working equipment, instructions, and valuable sales plans. Satisfaction guaranteed or money promptly refunded. Alfred Hermansen, 210 Fifth Ave., Suite 1102A, New York 10, N. Y.

START Mailorder bookshop — Everything furnished. 25c brings booklet, samples, exciting ideas. General Publications, Ossining, N. Y.

THOUSAND Articles wholesale, "Supply Source Directory" 10c. Ideal Service, Park Ridge 30, Illinois.

BE Appointed state notary public now! Details. Stationers, Helotes 50, Texas.

OPERATE Profitable mail order business. Write Walter Service, 4159-A East 112th, Cleveland 5, Ohio.

DOLLARS In personalized baby record books. Sell by mail. Use same literature we do. No-Co-Ro, Oakland 6, Calif.

FABULOUS Earnings—Fascinating pastime. Growing genuine, living miniature (ming) tree. New sensational business or hobby. Astounding information free. Dwarf Gardens, Box 355B, Briggs Station, Los Angeles 48, Calif.

BRUSH Plating outfits connect to a battery. No tanks necessary. Good paying business at home plating autoparts, bathroom fixtures, bicycles, reflectors, silvering mirrors. No shop or experience required. Outfits furnished. Free booklet. Gunmetal Co., Ave. H, Decatur, Ill.

COMMERCIAL Deep frying course. Mock chicken legs, potatoes. New and proven methods. Learn about this money-making field. \$2.50 p.p. Concession, Toledo 13, Ohio.

RECAST Old batteries into new. Latest achievements. Battery Laboratories, Minneapolis.

MADE \$24,500 Using money making plans from Schemer Magazine, world's oldest mailorder publication. Box 275M, Canfield, Ohio. Year \$2.00. Sample 20c.

MINK Raising information free. Complete. Lake Superior Mink Farm. Superior, EE1, Wisconsin.

POPCORN And potato chip equipment. Long Eakins Company, 5160 High, Springfield 99, Ohio.

COPUBLISH Leading m.o. paper. Latest copy Mail Sale Advertiser, details, dime. Vanroy Shirk, Lebanon, Penna.

READ "Advance"—The voice of mail order. Offers money-making opportunities, sources of supply, personal guidance, etc. Issued monthly. Sample copy 25c. Yearly subscription \$2.00. Advance Publishing Company, 313 East 21st Street, Suite 450, New York 10, N. Y.

BUY It wholesale! Manufacturers, distributors offer 850,000 items. Literature free. Olsen, 1231-A East Third St., Duluth 5, Minn.

LIQUID Rubber. Make flexible molds. Free sample. Chaney, 1130 E. 16th St., Jacksonville 6, Fla.

MAILING Postcards selling repeat merchandise is profitable. Everything supplied. Details free. Gordan Publishers, Box 23, Pawtucket, R. I.

MEN—Women. Everybody likes candy. Learn to make professionally. Our 40th year. Ragsdale Candies, D5, East Orange, New Jersey.

COLORGLAZED Concrete pottery made without molds. Patented method. Cemetery products, novelties, tiles. Basement leak-sealing. Money-making projects. Booklet, details free. Men only. National Potteries Company, Grand Rapids, Minnesota.

MONEYMAKING OPPORTUNITIES

SCHOOL Seniors—Sell classmates America's most beautiful graduation name cards. Largest selection. Highest commission. Outsells all others. Free sample kit. Printcraft, Dept. M, 1425 E. Elm St., Scranton 5, Penna.

RESILVER Mirrors at home. Formula 25c. Ideal Service, Park Ridge 6, Illinois.

OPPORTUNITIES Galore. Fifteen newest books and folios. \$2.00 postpaid. Holmes, Kings Highway, Independence, Mo.

MONEY Making secrets exposed! Write Ferriola Service, 511-B Penn St., Chester, Penna.

REAL Moneymaking plans. Free list. Fresco Sales, Box 65, Hampden Station, Baltimore 11, Maryland.

WIN Contest money. General Contest Bulletin gives hundreds of tips. Lists current contests and rules. Sample 25c. General Contests, 1609½ East 5th, Duluth, Minn.

CAN You make \$40 a week, typing at home, in your spare time? Write Hood's, Kannapolis 12, N.C. (Enclose stamped, addressed envelope).

\$35 WEEKLY! Home! Two hours daily! 227 unusual money making projects. Walsh, 894 Main, Buffalo 2, N. Y.

MAKE Over \$500 weekly. We send arts, crafts, curious samples sets for \$350. Show your friends, businessmen. Book orders. We pay you good commission on your order. Carpets samples cost \$150. Address: Nativity Viegas, Post Box 1477, Bombay, India.

DRIVING Your car. You can make \$75 weekly; lifetime job. No investment, work, or selling. 40 years established business. Rush name. Harry Walters, Mediapolis 2, Iowa.

HOME Workers—Free particulars, many profitable spare time projects. Allen Industries, 219-B Wright St., Shepherd, Michigan.

OPERATE Paying mail order business. 8 pages information, plus other literature. 10c. Olsen, 1231-D East Third St., Duluth 5, Minn.

PROFITABLE Home mail order business selling folios. Sample, catalog, 25c. Merrill, 9 Stoddard, Glens Falls, N. Y.

\$250 WEEK Reported; home! Free book 505 Odd, Successful Businesses. Expect cdd! Pacific, Oceanside, Calif.

BE Appointed State Notary Public now! Details: Stationers, Helotes, Texas.

WHERE To swap-buy-sell anything. Free lists, information. Toole, 5 Bernardin Apts., Evansville, Indiana.

EARN Extra money! Spare time. Write—D'Yarmett, 245 Church, Newark, Ohio.

GROW Mushrooms. Cellar, shed. Spare, full time. We pay \$3.00 pound. Free book. Mushrooms, 2954 Admiral Way, Seattle, Wash.

MAKE Money at home. 101 ideas for full or spare time earnings. Proven winners. All for 25c. Thomas F. Patrick, c/o State Farm, Pikeville, Tennessee.

"WATERLESS (Lanolin) Hand Cleaner." (Oil base.) Make, sell. No machinery. Build profitable business. Complete formula \$1.00. Ideal Service, Park Ridge 3, Ill.

PUBLISH Your own magazine. Handsome 52 page format, well edited, illustrated. Cost low as \$1.00 month. Brings you prestige, profits. 25c brings sample, details. National, Ord, Nebr.

READ Progressive Mailtrade, the magazine that tells how to make money by mail. Dime brings sample and special offer. Progressive Mailtrade, Box 357, Sheboygan, Wisconsin.

LEARN How others earn money at home! Write—A. Sizemore, 4917 Kostner, Chicago 30, Ill.

EARN Money evenings, copying and duplicating comic cartoons for advertisers. Adservice, Argyle 1, Wisconsin.

300 PROJECTS You can make in Popular Mechanics 32-page Blueprint Catalog. Send 3c stamp for copy. Popular Mechanics Press, Dept. BP, 200 East Ontario St., Chicago 11, Ill.

FORMULAS, PLANS, ETC.

FIFTY Years supplying the best in modern manufacturing formulas. Lists free. Miller, Manufacturing Chemist, Tampa, Florida.

10,000 FORMULAS, trade secrets, etc. 900 pages. \$3.98 postpaid. Free literature. K. Paullin, Loudonville, Ohio.

ANY Formula \$1.00. Satisfaction guaranteed. Jack, 4292 Parkside Ave., Philadelphia 4.

REAL Manufacturing formulas. Lists free. Cummings, Chemist, Gordon Ave., Syracuse 4, N. Y.

FORMULAS. Latest, best. Catalog and chemical instruction sheet 10c, (refundable). Nelko Chemical Service, 3462-F Merchandise Mart Sta., Chicago 54, Ill.

MAKE—Sell cleaners, soaps, polishes, flavors, cosmetics. No machinery. Formula literature free. Kemico, Park Ridge 16, Illinois.

FORMULAS. Trade secrets, for nearly everything. Catalog free. Creative Publishers, Winnetka 6, Illinois.

TESTED Formulas. Interesting descriptive booklet free. Pont, Box 635-PM, Terre Haute, Indiana.

PLASTICS

HI-PROFITS. Gifts, jewelry. Free catalogue, details. Pilot Plastics, 67C Fulton St., New York City 38.

PLASTIC-Crafters supplies wholesale. Literature 20c. Cosmopolitan, Box 176-PM, New York 8, N. Y.

NEW Liquid plastic. Clear, colors. Cast without heat. Embed flowers, insects, coins. Saw, drill, carve. Free folder. "Liquid Magic," shows fine things you can make and sell. Write today. Castolite, Dept. K-101, Woodstock, Illinois.

LUCITE, Plexiglas, acetate; casting, molding plastics, findings. Dye manufacturer. Quantity prices. Special bargain lots, immediate shipment. Complete catalog 10c. 25c airmailed. Gem-O-Lite, Box 6863, North Hollywood, Calif.

LUCITE, Plexiglas. Any size sheets, masked. Square foot (12 x 12) cost, 1/16", \$1.20; 1/8", \$1.40; 3/16", \$1.75; 1/4", \$2.08. Include 10% postage. Almac Plastics, 230 Fifth Ave., New York 1, N. Y.

PLASTIC, Sheets, rods, tubes, etc. Free list. Plastic Supply Co., 2901 N. Grand Blvd., St. Louis 7, Mo.

CHEMISTRY

CATALOG Of chemicals, apparatus, kits, minerals, uranium ore, 10c. Rex Laboratories, 2849-A Birchwood, Chicago 45, Ill.

LABORATORY Apparatus, chemicals, microscopes, complete chemistry sets, minerals, uranium ore. 10c brings catalog. Porter Chemical Company, Hagerstown 1, Maryland.

OH Boy! New book of science. Experiments, formulas, secret processes, together with catalogue of laboratory supplies, only 25c. National Scientific Company, Dept. 16, 2204 W. North Avenue, Chicago 47, Ill.

SPECTROSCOPE For quick chemical analysis \$3. Kutting Sons, Los Altos, Calif.

NEW Idea chemical and apparatus outfits for home experimenting. Photo-scales, microscopes, chemicals, biological and laboratory supplies in small quantities. Catalog 25c. Established 1931. John H. Winn, 124-A West 23rd Street, New York, N. Y.

ILLUSTRATED Catalog: Chemistry, mineralogy, biology. 10c. Tracey Laboratories, Evanston, Illinois.

CHEMICALS And apparatus for industrial, analytical, and private laboratories. Catalog 15c. Dept. M-50, Biological Supply Co., 1176 Mt. Hope Ave., Rochester 20, N. Y.

AGENTS WANTED

SCHOOL Seniors—Earn sensational profits selling classmates America's most beautiful graduation name cards. Largest selection. Outsell all others. Free sample kit. Printcraft, Dept. M, 1425 E. Elm St., Scranton 5, Penna.

YOU Can easily make \$27.50 a day selling 50 outstanding Christmas boxes. Up to 100% profit. 40 for \$1.00. Imprinted cards, napkins, stationery; also deluxe lines. Write for free Christmas gift cards, and big money-making catalog. Best-selling assortments on approval. Fanmour Corp., 200 Fifth Ave., Dept. S-25, New York 10.

NEW Sensational money maker. Telephone shoulder cradle. Big profits. Protected territory. Free details. Mission, 425-P 38th, Oakland 9, California.

MAKE Wedding profits. Sell invitations, napkins, matches. Samples free. Dunbar's, Middlebush 3, N. J.

300% PROFIT—Postage stamp photos from negatives or prints, perforated sheet form, gummed backs. Free details, samples. National Photostamp Co., 1418D Third Ave., New York 28.

HI-Profits. Gifts, jewelry. Free catalogue, details. Pilot Plastics, 67C2 Fulton St., New York City 38.

CASH In on spare time. Sell wonderful Regal Christmas cards exclusive with us. 25 sell for \$1.00. Also 50 for \$1.25. Over 150 other boxes. Free samples. Kit on approval. Regal Greetings, Dept. 145, Ferrisdale, Michigan.

EXTRA Cash—Quick, easy! Sell friends newest greeting cards. Profits to 50c per \$1.00 box. 21-card \$1.00, comic Christmas, all-occasion assortments, gift wrap ensembles, exclusive items. Experience unnecessary. Special offers. Bonus. Prompt service. Write for free samples name imprinted Christmas cards, stationery, napkins, book matches, feature assortments on approval, free catalog. Elmira Greeting Card Co., C-2309 Elmira, New York.

BE A money maker. Represent magazines year around. Wonderful home work. Big Christmas profits now. Liberal commissions. Everything furnished. Write for free catalog. McGregor Magazine Agency, Dept. 500A, Mount Morris, Ill.

MAKE Money fast. Sell big value Christmas and everyday card assortments to friends, others. 7 leading 21 card \$1.00 boxes. Religious, metallic, comic, secret pal cards. Gift wrappings, ribbons, scented stationery. Many gifts—rain sandals, automatic telephone pencils, totebrushes, napkins. Over 100 items. Amazing profits. Bonus plan. No experience necessary. Write today for samples on approval and special "Get Started" offer. Hedenkamp, 361 Broadway, Dept. PM-15, New York.

IS \$210 A week worth a penny postcard to you? Then rush card with name and address for special free trial plan that sells amazing new automatic refrigerator defroster "Like hot cakes!" Write to Mr. Lewis, D-Frost-O-Matic Corp., Dept. PMC-9, 6 N. Michigan, Chicago 2, Illinois.

NEW Plastic mending tape. Just press on! Repairs clothing instantly. Lightning seller. Samples sent on trial. Kristee 132, Akron, Ohio.

MAKE Extra money quickly! Take easy orders from friends for outstanding Christmas, all-occasion greeting cards, gift wrappings, novelties. Big profits. Bonus. Experience unnecessary. Request feature assortments on approval, free samples name imprinted Christmas cards, stationery, napkins and free catalog. New England Art Publishers, North Abington 505-C, Mass.

SELL Personalized stationery. Big profits. Quick sales. Every one a prospect. Large line. Free samples. Write Royal, 201 N. 3rd St., Minneapolis 1, Minn.

DO You need money? \$35 is yours for selling only 50 boxes of our 300 Christmas card line. This can be done in a single day. Free samples. Other leading boxes on approval. Many surprise items. Experience unnecessary. Free samples personalized Christmas cards, stationery, napkins. Write today. It costs nothing to try. Cheerful Card Co., 333 White Plains, N. Y.

MAKE Money selling ties. Free catalog. Write to Phillip's Neckwear, Dept. 814, 20 West 22 St., New York.

AT Last! Something new and sensational in Christmas cards. Make extra money fast! Show gorgeous satins, velours, metallics never before offered. Gets easy orders! Pays up to 100% cash profit. Free samples 30 Christmas cards with name, 50 for \$1.25 up. 80 assortments. Personalized book matches and stationery, gifts. Several \$1.00 boxes on approval. Write Puro Co., 2801 Locust, Dept. 140-L, St. Louis, Mo.

GREETING Card salespeople—make \$50 quick, or even more, selling America's lead 21 card Christmas assortments. Samples on approval. Everyday assortments, gifts. Free samples personalized Christmas cards. Write today. Lorain Art Studios, Dept. S-44, Vermilion, Ohio.

BRAND New! Amazingly different and smart Christmas cards bring you big money! Take easy orders fast. Pays up to 100% cash profit. Christmas cards with name 50 for \$1.25, up. Big line. Personal stationery and book matches. Get sample assortments on approval, imprints free. Write today. North Star, 31 Glenwood, Dept. X-18, Minneapolis, Minn.

JUST Out! New, thrilling sensation in Christmas cards. Make big money! Show lustre foils, satins, brilliants. Amazing values bring easy orders! Christmas cards with name 50 for \$1.25 up. Also imprinted book matches, stationery, many gifts. Get 30 free samples with name; several \$1 boxes on approval. Joy Greetings, 507 N. Cardinal, Dept. L-60, St. Louis 3, Mo.

FREE Samples, and amazing plan, giving you gorgeous dress without penny cost. Rush name today, with dress size. Harford, Dept. E-335, Cincinnati 25, Ohio.

ABSOLUTELY Free! Big package actual sample fabrics and style presentation of dresses, lingerie, hosiery, etc. Take orders. Commissions big. Send no money. Melville Co., Dept. 6254, Cincinnati 25, Ohio.

OWN A big moneymaking new and used clothing business. Men's used suits \$2, pants 35c, topcoats \$1.25, jackets 60c, shoes 20c. No experience necessary. Free wholesale catalog. Superior, 1250-A Jefferson, Chicago 7.

SELL Reproductions of world's famous perfumes by outstanding Parisian chemist at fractions of original cost. We defy you to tell the difference. Sample free! Exclusive Imports, 1139-H So. Wabash, Chicago 5, Ill. or 6804-H Fountain, Hollywood 38, Calif.

CALENDARS, Advertising novelties, matches. All styles, including religious, varnished, 12 sheet, girls. Hundreds of advertising novelties, book matches, etc. Fleming Calendar Co., 6539 Cottage Grove, Chicago 37, Ill.

GOLD Lacquered and silver sign letters. Windows, doors, trucks. Standard sizes. Penny each. Free samples. Atlas-P, 544 West 79th, Chicago 20.

CHRISTMAS Cards at jobbers prices! Large selection dollar assortments 35c each in hundred lots. Imprint cards, money folders, gift cards, pictures, etc. Make more profits selling our line! Catalog free! Three sample boxes \$1.00. Elfco, 438 North Wells, Chicago 10.

CALL On friends with sensational Christmas cards in handy assortments. Exclusive designs. Sell for \$1.00. Profit up to 50c. Also popular-priced personal Christmas cards, everyday assortments, stationery, gift items. Samples on approval. Wallace Brown, Dept. C-4, New York 10, N. Y.

ANYONE Can sell Hoover DuPont Nylon uniforms for beauty shops, waitresses, doctors, nurses, others. In white and colors. Exclusive styles. Top quality. Low priced. Exceptional income. Real future. Equipment free. Write fully. Hoover, Dept. R-100, New York 11, N. Y.

\$50 YOURS. Sell only 100 boxes new Xmas cards; other amazing offers. Free samples imprinted cards. Feature box assortments on approval; over 100 profitable items. Work with a national leader. Pen-N-Brush, PM-9, 139 Duane St., New York City 13.

BIG Profits selling Sunshine's famous exclusive Christmas cards. Tremendous values! 21 for \$1.00, holly assortment. All lined envelopes. Snow scenes, religious, gift wraps, stationery, super value imprints, 50 for \$1.25. Many more! Write for samples on approval, free imprint folders. Act now! Sunshine Art Studios, Dept. PM-9, 115 Fulton St., New York 38, N. Y.

ULTRA-Blue stock signs—6c, sell 35c. 1000 slogans, 7" x 11", comedy, religious, general. 15 samples, \$1.00. Lowy, 812-MS Broadway, New York 3.

SENSATIONAL Money maker, washable woolen slacks, skirts, shirts, plaids and solid colors. Nationally advertised "Sanforian" label. Nylon reinforced, children's, teen-age. Terrific repeat business. Bonus plan. Start immediately. Free sales kit. Wash-Em, Westport 14, Conn.

FREE Sample nylon stocking of world's only nationally advertised hosiery line actually guaranteed against runs and snags or replaced free within guarantee period to three months! Complete line from sheerest 15 denier to heavy 70 denier service weight. All gauges. Also complete line men's fine hosiery guaranteed for one full year! Not sold in stores. Good Housekeeping Guarantee Seal. No money or experience needed. Nothing to pay now or later. Easiest and quickest sales. Just show free outfits and write orders. We deliver and collect. Advance cash plus huge bonus to 40%. Big money spare or full time. Become manager—appoint others to sell for you. Man or woman, young or old, beginner or veteran, you can earn more money than you thought possible. Everything needed given free. Rush name and address to Kendex Corp., Babylon 93, N. Y.

BE A Bob-Art representative. Make \$3.00 to \$5.00 an hour in spare time between now and Christmas. Easy—show friends, neighbors, Bob-Art Special Christmas card bargains and other appealing specialties. Also get cash bonuses and valuable merchandise prizes. Send today for sample selling kit with free instructions. Bob-Art Greetings, Dept. 111, 278 Washington Ave., Chelsea 50, Mass.

BELOW Wholesale. Watches, jewelry, appliances, premiums, silverware, cookware. Collins Company, Forsyth, Georgia.

BUY Wholesale thousands nationally advertised products at big discount. Sent free "The Wholesale Plan." American Buyers' Service, 629-H Linden, Buffalo, N. Y.

LADIES' Garters, hankies. Free samples. Holiday, 85B6 96th St., Woodhaven, N. Y.

EVEN Beginners make many extra dollars! Sell big line Christmas, everyday cards, gifts. 21 for \$1.00 assortments, novelties, gift wraps, household items. Big profits. Free samples name imprinted Christmas cards, stationery, napkins. Leader assortments on approval. Bonus. Special offers. Write, Pilgrim Greetings, 111 Summer, Dept. AN-9, Boston, Mass.

SELL Big money Christmas cards! 50 for \$1 up. Free samples, catalog. Hix Craft Greetings, Box 473, Hartford 1, Conn.

GO Into business. Sell 25 Christmas cards 35c. Box retails dollar. Two sample boxes dollar. Buffalo Broadcaster, Buffalo 4, New York.

YOUR Personal lingerie free as bonus—extra cash besides—introducing sensational Curve-Tailored idea to friends. Outfit free. World's Star, Dept. E-36, Grand Rapids, Michigan.

NYLON Uniforms. Immediate delivery, immediate profits. Sell to doctors, dentists, nurses, waitresses, beauticians, housewives. Free sales kit. Superior Fabrics, Dept. P-9, 3936 Market, Philadelphia 4, Penna.

CUTS Everything. Brush, weeds, grass, trees. Fall demand. Farm Products PM, Excelsior Springs, Mo.

\$200 WEEKLY. Sell silverplate, colorful tableware. Yale-Murphy, Meriden, Conn.

BEST Source for nylons. Rich Co., 215 W. 98, New York 25.

MEXICAN Feather pictures. Sell on sight; 200% profit! Free details; sample 10c stamps. Sylvia PP, Apartado 9036, Mexico City.

FREE Merchandise to new customers (\$1.50 retail value—your selection). Sensational "get acquainted" offer. Rush 25c for illustrated wholesale bargain catalog and free merchandise certificate. Save up to 50% on 2000 everyday necessities and novelties. Reliable Jobbers, 311-B North Desplaines, Chicago.

SHINE Shoes without "polish." New invention. Lightning seller. Shoes gleam like mirror. Samples sent on trial. Kristee 133, Akron, Ohio.

SALESMEN, Distributors, fast selling costume jewelry direct from factory. Big picture catalog, free. Pickcraft, M19 Bank, Attleboro, Massachusetts.

SELL Christmas cards, novelties, 100 different assortments. Personal cards low as 25 for \$1.00. Imperial, Dept. P, Los Angeles 13.

LOOK—Big profits, free samples. Personalized Christmas cards, personalized napkins and personalized stationery. G. M. Dunn Co., 484 Broadway, Newark, N. J.

MEXICAN Feather pictures. High profit selling gift shops, etc. Adelphi, Box 57-B, Bellerose 6, N. Y.

\$3.00 AN Hour selling cushioned shoes direct. Advance commissions. Bonus. No investment. Experience unnecessary. Free outfit. Samples. Paragon Shoes, 739 Columbus, Boston, Mass.

DRESSES, Used 18c; Coats \$2.00, blouses 35c. Free catalog. Crown, 164-P Monroe Street, New York.

EVERYBODY Uses handkerchiefs; buy from leading manufacturer. Write Stan-chief, 1 Bond St., New York 12, N. Y.

GORGEOUS Christmas cards. \$50 yours selling 100 boxes. 40 with name, \$1. Personal napkins, stationery. Wrappings, novelties, gifts. Free samples. Approval box, Torres, 373 Fulton St., Brooklyn 1, N. Y.

\$50 WEEKLY Selling finest razor blades, other items. Free details. Edison, Department 274, Far Rockaway, N. Y.

NEED Extra cash? Take orders for personal initialed belts and buckles, cap badges, tie holders, etc. Choice of 3000 emblems. Free sales kit. Hook-Fast, Box 1425PM, Providence, R. I.

PHOTO-Salesmen, agents. Sell beautiful hand colored plastic enlargements and sensational new photo compacts, rings, bracelets, lockets, etc. Collect deposit, we deliver. Profitable sideline. Send card, for free sample kit. Novel Portrait Co., 3343 North Ave., Chicago, Ill.

EARN Big money. Cash bonus. Popular sizes and styles. Free hosiery for your family. Duratest, Dept. PM, Warren, Penna.

EXCELLENT Sideline for printing and advertising salesmen. Decalomania name plates in small quantities. Great demand. Also, make money with our line of automobile initials and sign letters. Free samples. "Raico" XL-Roxbury, Boston 19, Mass.

AGENTS: Stamping names on key protectors. Sample 25c. Stamping outfits, checks, social security and name plates. Hart Mfg. Co., 303 Degraw St., Brooklyn, N. Y.

AGENTS — 300% Profit selling genuine gold window letters; stores and offices. Free samples. Metallic Letter Co., 438-B North Clark, Chicago.

WANTED—Purchasing agents. No money or experience required. Write Dept. C, Purchasing Manager, 2719 Lawrence, Chicago, Ill.

SELL "Big money-maker to men and women. Easy handwork makes fast-selling useful articles. Sunmade Company, Brockton 64, Mass.

HIGH-GRADE SALESMEN

REPRESENT America's largest factory selling advertising pencils. High commissions. Attractive line. Union Pencil Company, 389 Broadway, New York City.

BIG Money taking orders: shirts, ties, Sox, pants, jackets, sweaters, shoes uniforms, etc. Sales equipment free. Experience unnecessary. Nimrod, 4922-AN Lincoln, Chicago.

WANT To make real money? You can positively make \$50.00 a day and up selling a brand new item going to every type of food and beverage store, factories, laboratories, hospitals, etc. First time advertised. Write for free details today. Johnson-Hartmann, 53 West Jackson Blvd., Dept. PM-9, Chicago 4, Illinois.

AD Matches! Sell amazing designs—20, 30, 40 and 240-light book matches. Bigger spot cash commissions; every business a prospect. Low prices for high quality. Repeats. Start without experience; men, women; full, part time. Buy nothing! Sales kit furnished. Match Corp., Dept. PM-21, Chicago 32, Illinois.

ADVERTISING Book matches—Cash in on big demand; sell union label matches. Cuts for all businesses and political parties. Free powerhouse selling kit, low prices, protection guaranteed on repeat orders. Cash commissions. Superior Match Co., Dept. M-951, 7530 Greenwood, Chicago.

EARN Big money fast! Sell finest-quality advertising work uniforms to garages, factories, filling stations, etc. Free selling kit. Topps, Dept. 539, Rochester, Ind.

SELL Our waterproofings, floor mastic, cement hardener, etc. (30 items) to maintenance men, building owners, contractors. Can start part time. Commission. Territory. Write Haynes Products Co., Desk 6, Omaha 3, Nebr.

UP To \$50.00 in a week spare time and tailored suit for yourself without paying one cent. Write for plan and free sample case. Pioneer Tailoring Co., Dept. X-1117, Congress & Throop St., Chicago 7, Ill.

NEW Year party packages. Hat, blow-out, noisemaker, streamers, balloon. Profit plenty. Ellswood's, Pueblo, Colorado.

MAKE Money showing neighbors how to beautify yards with glorious flowering shrubs and trees. Quick-bearing dwarf fruit trees; world-famous Stark patented varieties produce abundant harvests champion-quality apples, pears, peaches, other fruits. Even small plots produce fruit for family-use and to sell. Beautiful sales kit free. Stark Bro's, Dept. 30182, Louisiana, Mo.

A Fine income, your own nylons free! Show nylons, lingerie, men's socks with amazing free replacement guarantee against runs, snags, tears. Write for free sales kit. Group organizers invited. Rosalee Hosiery Co., Clifton 58, N. J.

SALESMEN. Money-making sideline. Calendars and advertising specialties. Highest commissions advanced. Free new cars. Rush name. Advertising Specialties Manufacturing, Brooklyn 36, N. Y.

MAKE Money with famous, easy-selling Bostonian shirts—spare time, full time, sideline. Fabrics, outfit free. Bostonian, 89 Bickford, Dept. G-10, Boston 30, Mass.

NEW Jobs open in selling! Send name, address for five free issues of Opportunity Magazine's money-making guide, listing hundreds of companies who'll pay you well, full or part-time. No experience needed. Opportunity, 28 E. Jackson, Dept. 17, Chicago 4, Ill.

EDUCATIONAL AND INSTRUCTION

IT'S Fun learning a language by Lingua-phone. At home, quickly, easily, correctly master Spanish, French, German, Russian, —any one of 29 languages through Lingua-phone Conversational Method. Add to service, job, travel opportunities. Send for free book. Approved for Veterans' Training. Linguaphone Institute, 8309 Rock Plaza, New York 20.

EASY To improve your writing or become an expert penman in spare moments through my home study course. Talent unnecessary. Write for free details. No obligation. T. M. Tevis, Box 25A, Chilli-cotte, Mo.

REAL Estate. Complete home-study course. Successful students throughout America. Free information. Write School of Real Estate Training, Dept. PM, 128 Broad, Stamford, Conn.

U. S. Gov't jobs! Men—women. 50,000 jobs open now! Start high as \$66.34 week. Experience usually unnecessary. Can you qualify? Get free 32-page book—showing jobs, salaries, requirements, sample tests. Write: Franklin Institute, Dept. A-24, Rochester, N. Y.

HIGH School—No classes. Study at home. Spare time. Diploma awarded. Write for free catalog HF-12. Wayne School, 2527 N. Sheffield, Chicago 14, Ill.

START A collection agency business. Very profitable. Quickly learned. Write Cole & Associates, Syracuse 2, N. Y.

BE A real estate broker through home study or classroom instruction. Write for free book. Approved for Veterans. Weaver School of Real Estate, 15 E. Pershing Rd., Box CP-9, Kansas City 8, Mo.

"HOW To Break and Train Horses"—A book every farmer and horseman should have. It is free; no obligation. Simply address Beery School of Horsemanship, Dept. 1109-C, Pleasant Hill, Ohio.

USED Correspondence courses wanted. Send description. Press, Liberty Center, Ohio.

LEARN Technical Metaphysics. Inure success in life. Valuable information. Canada School of Technical Metaphysics, 2532 McKenzie St., Vancouver, B.C., Can.

BECOME A Doctor of Psychology or Metaphysics. Teach secret of contentment, happiness. Win degree of Ps.D. or Ms.D. Solve mental worries. Free book. College of Universal Truth, 5153-C North Clark, Chicago.

SECRET Investigation. Experience unnecessary. Investigators particulars free. George Wagner, M125 West 86th, New York.

EARN \$50.00 Daily. Rush season coming. Free details. Universal, Box 664-MM, Springfield, Mo.

HAIRCUT As you like it. Booklet tells how, 25c. Mastrolia, 5½-AV, Jane, New York City 14.

INCREDIBLE! Unprecedented! Look under "Miscellaneous"! Bijou, Box 1727-ME, Hollywood 28, California.

WELDING Training pays at Hobart Welding School, Box M-812, Troy, Ohio. VA contract. Best equipment. Catalog free.

USED Correspondence courses and educational books bought, sold, rented. Catalog free. Educational Exchange, Summer-ville, Ga.

WAKE Up your success powers and winning ability. End money worries. Overcome handicaps. Get ahead. Our new method of thought-control and behavior mastery gets results in every case or no cost. Send for free booklet and details. School of Personal Psychology, 1008 Washington Bldg., Louisville 2, Kentucky.

START A big profit collection agency. Own lifetime business. Simple instructions. Write Financial Career, B-740, Chicago 90.

SCIENCE Of memory amazingly simplified. New book. Information free. Memo-riology Studio, 2016-M Sunnyside, Chicago 25, Illinois.

DRAFTING—Learn at home. Booklet free. Monroe Institute, PM-9, Alton, Ill.

PREPARE For civil service examination. pay for course after securing position. Write, Free School, Dept. PM-9, Kokomo 3, Ind.

SUCCESS In business, social life, strengthen your voice! Free booklet. Prefect Voice, Studio 2H-2, 210 South Clinton, Chicago 6.

STUDY To be a doctor of psychology or metaphysics. Obtain Ps.D., Ms.D., D.D. or Ph.D. degree. Chartered by state. Write for free book telling how. The Neotarian Fellowship, Desk 8, Pickwick Building, Kansas City 6, Missouri.

INVESTIGATOR Training. Phillips Secret Service System, 1917-B North Ken-neth, Chicago 39.

USED Correspondence courses and books sold and rented. Money back guar-antee. Catalog free. Courses bought. Lee Mountain, Pisgah, Alabama.

MEDICAL Laboratory Technicians in great demand. We train you in your own home. Catalogue free. Imperial Technical Institute, Box 973-J, Austin, Texas.

BOOKKEEPERS! Increase your earnings! Operate your own simplified "dollar-a-week" bookkeeping and tax service. Full or spare time. Details free. No obligation. Ellis, Box 200, Cedar Grove, North Caro-lina.

HOME Study course, drugless therapy. Free literature. Institute of Drugless Therapy, Tama, Iowa.

PLAYS, STORIES, MANUSCRIPTS

"TEN Steps to Writing Success" reveals how you can write stories, poems, articles for publication. Details free. Will Herwell, 7016 Euclid, Cleveland 3, Ohio.

MUSICAL Comedy plays, pageants. Dor-by Publications, P.O. 738, Morristown, New Jersey.

I want new writers to cash checks of \$1 to \$100 offered daily. The easiest way to write for pay. No previous experience necessary. Free details. Saunders M. Cummings, 468-11 Independence Bldg., Colorado Springs, Colo.

BUSINESS SERVICE

CIRCULARS And advertising matter mailed promptly to guaranteed, carefully compiled and checked classified lists. Low-est rates plus bonus mailing. Amazing details free. Empire Distributors, P.O. Box 331, Leadville, Colorado.

HAVE A Chicago mail address. It's valuable to you. Schultz House, 3116 Semi-nary, Chicago 13.

SPECIAL SERVICES

LETTERS Remailed 25c each. 8 scenic postcards \$1.00. Stadler, Box 2335, Holly-wood 28, California.

LETTERS Remailed from Canada 25c each. 6 scenic postcards \$1.00. Joseph Stan, General Delivery, Main Post Office, Hamilton, Ontario, Canada.

CARTOONING, COMMERCIAL ART, SHOWCARD WRITING, SIGN PAINTING

BE Smart. Get in art. Let me start you free. Nick Nichols Arts, 39 W. Adams, Chicago 3, Ill.

"HOW To Make Money With Simple Cartoons"—A book everyone who likes to draw should have. It is free; no obliga-tion. Simply address Cartoonists' Ex-change, Dept. 99-C, Pleasant Hill, Ohio.

STUDY Showcard art. Free details and Strok-O-Graf, Midwest Art School, Fort Wayne 2, Indiana.

FREE Talent test. Give age. Art, Box 8066, Dallas 5, Texas.

CHALK Talks. Laugh producing pro-gram, \$1.00. Catalog 10c. Balda The Car-toonist, Oshkosh, Wisconsin.

ADVERTISING AGENCIES, LETTER WRITERS, FOR ADVERTISERS

FREE Copy, layout service. Mailorder ad, 1,700,000 nationwide circulation, \$25.90 inch. 24-word classified, 20 big Sunday newspapers, \$30.00. Advertising ratebook free. Chicago Advertising Agency (estab-lished 1900), Chicago 4.

FREE! 1950 Advertisers Rate and Data Directory. 52 pages! E. H. Brown Adver-tising Agency, 20 N. Wacker, Chicago 6.

ADVERTISE: 24 Newspaper group only \$3.36 per inch in all. 19 of them only papers in town. Write Frankel Advertis-ing, 408 Securities Building, Des Moines, Iowa

ADS Placed in out of town newspapers and magazines. Low rates. Catalogue free. Ideas that pay. Baker Advertising Agency, Successors Ankrum Agency, 189 W. Madison, Chicago 2.

ADVERTISERS! Reach nearly 18,000,000 readers. 25 Sunday national key news-papers, 18 words, \$59.00. "Terrific pull-ers." 20 popular newspapers, \$11.50. Free booklet. Special—One inch display 2,-821,198 circulation, \$51.10. Newmark's Advertising Agency, (Established 1893), 217-7th Ave., New York 11.

MAILING Lists; \$5.00-1000 up. Write Dixie Service, King, N. C.

24 WORDS in 50 weeklies, \$4.96. J. Dar-nell, 730 Hays, Jackson, Tenn.

ADVERTISE: 24 Words, 40 newspapers \$3.50. Lists free. Advertising Bureau, 10511-C Springfield, Chicago 43.

TYPEWRITERS, DUPLICATORS, OFFICE DEVICES

PRINTOMATIC Selffeeding post card printing duplicator \$15.75. Envelope ad-dressing machines \$24.50. Pittsburgh Typewriter Company, 336-R Fourth Ave-nue, Pittsburgh 22, Penna.

RECONDITIONED Typewriters, print-ing devices, office machines, equipment. DixieGraph, King, N. Car.

RUBBER STAMPS AND OFFICE SUPPLIES

3 LINES 50c; Pads 35c; signature \$2. Seals. Stamp-Right, Wauwatosa, Wis.

PRINTING, MULTIGRAPHING, MIMEOGRAPHING, GUMMED LABELS

1000 EMBOSSSED Business cards \$3.95 postpaid. Michel, Central Village, Conn.

PRINTING, Multigraphing, mimeo-graphing. Prices free. Progressive, 270H Burkhardt, Cincinnati 15, Ohio.

GOOD Printing since 1883. Free esti-mates. Success Printers, 1738 Mentor Ave., Dallas, Tex.

1000 BUSINESS Cards \$2.50 prepaid. Samples free. Reliable Print Shop, 907 East Jefferson, Louisville 6, Ky.

100 SELF-Seal printed envelopes \$1.25. Kessler, 226 Maple, Jersey Shore, Penna.

BUSINESS Printing. Samples, prices, free. Howprint, 723-M Eunice, Webster Groves 19, Missouri.

SAVE On distinctive two-color business stationery. Samples 3c. Gardner Press, Costa Mesa, California.

100 EACH Noteheads, envelopes printed 3 lines \$1.40. Gooch, 202PM, Hernando, Miss.

NEW Process color duplicating. Sam-ples, prices free. Bowman, 200 Oak, War-rington, Florida.

1000 EMBOSSSED Business cards, \$3.50, postpaid. Bartolotto, 1928 East 1st Street, Brooklyn 23, New York.

50 LETTERHEADS With envelopes \$1.00. Benneville, Box 1931, Pittsburgh 30, Penna.

100 8½x11 HAMMERMILL Letterheads and 100 envelopes, \$2.10. H. Hudson, Cen-tredale, R. I.

250 8½x11 WHITE Bond letterheads \$2.00 postpaid. 5 lines. Envelopes same. Cards or statements 250—\$1.85. L. & F. Printers, Box 5531-A, Chicago 80, Ill.

100 LETTERHEADS (8½ x 11 Ham-mer-mill) \$1.00 postpaid. Envelopes same. Race Printers, Hudson, New York.

1000 2-COLOR Embossed business cards \$4.98, samples. Morrow, 2220 Dean, Brook-lyn 33, New York.

PRESSES, Type, cabinets, supplies. List for stamp. Lincoln Press Company, 220-Z Hartwell, Fall River, Mass.

1000 PRINTED Cards, \$2.75. Free sam-ples. Morey's, 629 Baker, San Francisco 17, Calif.

MIMEOGRAPHING—Reasonable. Any copy. Mailers Service, Box 606-B, Chicago 90, Ill.

PRINTING—5000 5½ x 8½ Circulars \$18; 3¼ x 5½ \$8.25; folders, catalogs, ev-erything. Garrison Press, Harrisonburg, Va.

SEND 10c Now for our 48 page 1951 price list—refunded first order. McCall Press, 1326 South 27th, Omaha, Nebraska.

MIMEOGRAPHING—Letters, pricelists, formulas, instructions. Lowest prices. Lem's Letter Shop, 5710 Stanton, Detroit 8.

500 3¼x2¼ FOUR Line gummed stickers 50c. Red border \$1.00. Moritz Printery, Saginaw, Mich.

PRINTING OUTFITS AND SUPPLIES

PRESSES, Supplies, paper. Catalog 10c. Custom, Box 211-P, Springfield, Missouri.

PRESSES, Bought, sold, list 3c. Exchange, 212 Curtis, Meriden, Conn.

SAMPLE Font type \$1.00. Literature free. Republic, 1103 W. 69th St., Chicago 21, Ill.

PRINT Your own cards, stationery, circulars, advertising. Save money. Simple rules. Print for others, nice profit. Raised printing like engraving too. Have home shop. Details free. Kelsey Presses, L-11, Meriden, Conn.

PRINTING Presses, type, supplies. Lists 3c. Turnbaugh Service, Loysville, Penna.

MAKE Your own printing cuts. Self-molding process. Flexirubber, Argyle 1, Wisconsin.

PATENT ATTORNEYS

INVENTORS—If you consider your invention to be something of importance, take steps to protect it with a United States Patent which gives you the right to exclude others from making, using and selling your invention as claimed. "Patent Protection for Inventors" outlines steps to take to secure patent protection. Mailed promptly without obligation. Victor J. Evans & Co., Merlin M. Evans, Registered Patent Attorney, 631-K Merlin Building, Washington 6, D. C.

INVENTORS—If you believe that you have an invention, you should find out how to protect it. The firm of McMorrow, Berman & Davidson is qualified to take the necessary steps for you. Send for copy of our patent booklet "How to Protect Your Invention" and "Invention Record" form. No obligation. McMorrow, Berman & Davidson, Registered Patent Attorneys, 1345 Victor Building, Washington 1, D. C.

"INVENTOR'S Guide" free. Frank P. Ledermann, Registered Patent Attorney, 154 Nassau Street, New York.

HERMAN Lewis Gordon, Registered Patent Attorney, Patent Investigations and Opinions, Warner Building, Washington 4, D. C.

INVENTORS—For "Invention Record" form, contact Carl Miller, Registered Patent Attorney, Woolworth Building, New York.

INVENTORS: Learn how to protect your invention. Special booklet "Patent Guide for the Inventor" containing detailed information concerning patent protection and procedure together with "Record of Invention" form will be promptly forwarded to you upon request—without obligation. We are registered to practice before the U. S. Patent Office and prepared to serve you in the handling of your patent matters. Clarence A. O'Brien & Harvey Jacobson, Registered Patent Attorneys, 11A-G District National Building, Washington, D. C.

REGISTERED Patent attorney offers services. Sanders, 6430 Evans, Chicago 37, Ill.

INVENTORS: When you are satisfied that you have invented something of value write me, without obligation, for information as to what steps you should take to secure a patent. Write Patrick D. Beavers (Formerly Randolph & Beavers) Registered Patent Atty., 935 Columbian Bldg., Washington 1, D. C.

PATENTS. "Proof of Invention" folder mailed without obligation. E. E. Vrooman, Registered Patent Attorney, 507 McKim Building, Washington 5, D. C.

INVENTORS: Write for free brochure "Evidence of Invention." Labiner, World Building, New York 38.

C. A. Snow & Co.—M-427, Snow Building, Washington 1, D. C. Registered Patent Attorneys. Write for information.

INVENTORS: Without obligation, write for information explaining the steps you should take to secure a patent. John N. Randolph, Registered Patent Attorney, 203 Columbian Bldg., Washington 1, D. C.

PATENTS—Irving L. McCathran, 315 McLachlen Bldg., Washington 1, D. C. Registered Patent Attorney.

CANADA—Ramsay Company Registered, 273 Bank Street, Ottawa, Canada.

CASH In on your ideas! Learn which inventions are profitable: how to sell or finance and market your invention. Send only \$2.50 for the big 144 page book "Money From Ideas," a primer on inventions and patents by a real, successful inventor. Popular Mechanics Press, 200 E. Ontario, Chicago 11, Ill.

FOR INVENTORS

INVENTORS—If you believe that you have an invention, you should find out how to protect it. The firm of McMorrow, Berman & Davidson is qualified to take the necessary steps for you. Send for copy of our patent booklet "How to Protect Your Invention" and "Invention Record" form. No obligation. McMorrow, Berman & Davidson, Registered Patent Attorneys, 1344 Victor Building, Washington 1, D. C.

INVENTORS—If you consider your invention to be something of importance, take steps to protect it with a United States Patent which gives you the right to exclude others from making, using and selling your invention as claimed. "Patent Protection for Inventors" outlines steps to take to secure patent protection. Mailed promptly without obligation. Victor J. Evans & Co., Merlin M. Evans, Registered Patent Attorney, 632-K Merlin Building, Washington 6, D. C.

INVENTORS: Obtain patents without assistance. Save time and money. Eliminate the unofficial disclosure of your invention. Complete, simplified instruction manual, including directions for making your own patent search at home, \$3.50. An invaluable asset to every inventor. Order your copy today. Examine five days, if not satisfied, return for prompt refund. International Patent Library, Post Office Box 7412, Washington 5, D. C.

PATENT Searches \$5.00, including copies of closest patents. Same reliable searches we conduct for patent attorneys. 48 hour airmail service. "Record of Invention" free. Capitol Patent Service, P.O. Box 664-P, Washington 4, D. C.

PATENT Searches, \$5.00, including patent copies. Accurate, reliable reports. Write us first! Free protection forms, 48 hour service. Patent Service Institute, 945-A Pennsylvania Avenue, Washington 4, D. C.

PATENT Office search, includes patent copies, patentability report, \$6.00. Invention record free. Industrial Patent Reports, Box 1081, Massachusetts and North Capitol, Washington 13, D. C.

INVENTORS—For "Invention Record" form, contact Carl Miller, Registered Patent Attorney, Woolworth Building, New York.

SAFEGUARD Your idea—Only \$3! Write for free folder of amazing new service. We are not lawyers. Idea Safeguard Company, Dept. M-1, 511—5th Ave., New York, N. Y.

PATENT Searches conducted for patent attorneys and inventors \$5.00. 48-hour service. Protection forms free. Write Patent Engineering Service, 1404 New York Avenue, Washington 5, D. C.

PATENT Searches \$5.00. 48-hour service, Protection forms free. Write Raymond L. Smith, Patent Searcher, 410 Bond Building, Washington 5, D. C.

PATENT Searches \$5.00. Reports airmailed within 48 hours. Protection forms free. Write Miss Ann Hastings, Patent Searcher, P.O. Box 176, Washington 4, D. C.

BOOKS For inventors on financing, promoting, selling inventions. Box 1434A, Amarillo, Texas.

INVENTORS: Learn how to protect your invention. Special booklet "Patent Guide for the Inventor" containing detailed information concerning patent protection and procedure together with "Record of Invention" form will be promptly forwarded to you upon request—without obligation. We are registered to practice before the U. S. Patent Office and prepared to serve you in the handling of your patent matters. Clarence A. O'Brien & Harvey Jacobson, Registered Patent Attorneys, 11A-G District National Building, Washington, D. C.

INVENTORS Booklet—"Reaching Your Invention Markets;" mailed free. Patented, patent pending only. No obligation. Address, Market Contacting & Data Service, 11106-A3 Longwood, Chicago 43.

INVENTORS: Without obligation, write for information explaining the steps you should take to secure a patent on your invention. John N. Randolph, Registered Patent Attorney, 202 Columbian Bldg., Washington 1, D. C.

CASH For your idea, 280 manufacturers need inventions, patented or unpatented. List free. Invention Bureau, 208M Clinton, Oak Park, Ill.

PATENT Owner representative. Years of experience. Can I help you? Charles A. Scott, 773PM Garson Avenue, Rochester 9, N. Y.

SEARCHES—Put your patent searches in the hands of a registered patent attorney or agent, as he qualifies to give a worthwhile patentability report. Record of invention form upon request and information on patent protection. Patrick D. Beavers, Registered Patent Attorney, 936 Columbian Bldg., Washington 1, D. C.

INVENTORS: If you have an invention for sale, patented or unpatented, write Institute of American Inventors, Dept. 40A, 631-E St. N.W., Washington 4, D. C.

INVENTIONS WANTED

CASH Or royalty for your invention. We provide this opportunity. Free details. Inventors Patent Exchange, Inc., Dept. B, Hartford 1, Conn.

WE Are interested in developing, manufacturing, and distributing new ideas in abrasive tools, fixtures, or devices for finishing, or shaping wood, metal or plastics. Contact Merit Products, Inc., 4023 Irving Place, Culver City, California.

INVENTIONS Promoted. Patented or unpatented. Established 1911. Write Adam Fisher Company, 61 Enright, St. Louis, Mo.

INVENTORS—What have you, patented, patent pending available for manufacturers? Booklet mailed free. Address: Market Contacting & Data Service, 11106-A2 Longwood, Chicago 43.

INVENTIONS Wanted. Patented or unpatented. 20 years experience promoting inventions. National Service Bureau, 3130 Meramec, St. Louis 18, Mo.

INVENTORS: Hundreds of manufacturers have requested our assistance in locating marketable new products. Complete information free. Institute of American Inventors, Dept. 40-D, 631-E St. N.W., Washington 4, D. C.

INVENTORS: Test the commercial value of your patented or unpatented inventions, quickly and inexpensively. Write for free information. Institute of American Inventors, Dept. 40-B, 631-E St. N.W., Washington 4, D. C.

MANUFACTURING

MODELS — Small lot manufacturing. Metals, plastics, etc. Milburn, Burlington, Kentucky.

MODELS, MODEL SUPPLIES

BRASS Gears and model supplies for the inventors. Send 10c for catalog. Pierce Model Works, Tinley Park, Ill.

STEAM Engines, boilers, castings. Catalog 25c. Anton Bohaboy, 2297 Price, Rahway 7, N. J.

RAILROADERS Get new catalog-reference manual. O gauge 75c, HO 50c. Walters, 247 Erie, Milwaukee 2, Wis.

BUILD Historic ship models, complete kits 50c to \$9.00. Catalog 15c. Ideal Models, 19 W. 18th, New York 11, N. Y.

SHIP Models and yacht supplies complete. Large 64 page catalogue 30c. Bill Wild's, 510 East 11 St., New York City 9.

SHIP And yacht model fittings; blueprints. Send 25c for illustrated catalog No. 26—listing hundreds of items. A. J. Fishers, 1002-1 Etowah Ave., Royal Oak, Mich.

STEAM Locomotives, 1½", 1", ¾", ½" ¼" scales. Castings, rail, steam fittings! Thorough drawings with instructions. Catalog 50c. Little Engines, Wilmington, California.

HOME CRAFTSMEN

LEATHERCRAFT. Everything needed by beginners, advanced hobbyists and professional leatherworkers. Largest stock of supplies in U.S. Moderate-priced tooling leathers, top quality calfskins, tools, supplies, kits. Send 10c for big catalog. J. C. Larson Co., 820 S. Tripp, Dept. 1175, Chicago 24.

JIGSAW Owners attention! Start earning money at home cutting out wooden novelties and souvenirs. Write H. Cook, Dept. A, 4407 S. Normal Ave., Chicago 9, Ill.

LEATHERCRAFT Supplies catalog. Pleasure and profit. New style handbag patterns, belts. Leathercraft school G.I. approved. 25c for catalog (refund 1st order). Dept. PM, Apache Leather Co., 2804 E. Washington St., Phoenix, Ariz.

LEATHERCRAFTERS — Metal ornaments, buckles, pocketbook accessories. Cosmopolitan Metalcrafters, Box 176-C, New York 8.

OZARK Wood samples. Eleven varieties prepaid. \$1.50. Davis Lumber, Cabool, Missouri.

BANDSAW, Jigsaw owners, let your machine bring extra profits, fun. Free details. Nu-Art, Dept. B, Box 2235, Boston, Mass.

90 ALL New, full size lawn ornament and novelty patterns up to 20" high. Only \$1.00. Mastercraft 92M, 7041 Olcott, Chicago 31, Illinois.

OUR Biggest leather and craft catalog yet! 1000's of items. Send 25c (refunded with first order). Russo Handicraft Supplies, Dept. C-8, 245 S. Spring, Los Angeles, California.

89 FULL Size jig saw patterns of beautiful shelves, ornaments, toys, novelties. Plus "How, Where to Sell." Only \$1.00. Mastercraft 94M, 7041 Olcott, Chicago 31, Ill.

LEATHERCRAFTERS: Big illustrated catalog of materials, tools, kits, 10c. Art Leather, 411 Joseph Ave., Rochester 5, N. Y.

HAVE Fun! Make money! "Working With Leather," 64-page booklet tells how. Send 25c for copy. Free gift if you mention this magazine. Valuable information included. No foreign orders. Wilder & Company, 1039 Crosby, Chicago 10.

SWISS Music movements, finest make, assorted tunes \$1.90. Direct imports. Helaxe Company, 233 West 72nd Street, New York.

LUMINOUS Coating, glows in dark! Waterproof! Apply like paint. 101 uses! Generous jar \$1.25 postpaid. Guarantee Products, 1128 Tower Bldg., South Bend, Indiana.

VIOLINMAKERS, Amateurs, professionals. Fine tone European wood, materials, supplies, instructions, patterns. Illustrated catalogue 10c, refunded. Premier Violin Supplies, Dept. VZ, 430 South Broadway, Los Angeles 13, California.

MAKE, Sell, artificial flowers, corsages, chenille dolls, jewelry. Starting kits, wood-fiber, leaves, shellcraft, rhinestones, sequins, findings. Wholesale profitcraft catalog, 10c. Cleveland Models, 4507TC92 Lorain, Cleveland 2, Ohio.

MAKE Leather belts, billfolds, purses. Big catalog and genuine steerhide keyholder, 10c. Tandy Leather, Box 397C, Tulsa, Oklahoma.

80 FULL Sized patterns, lawn ornaments, toys, novelties, \$1.00. Modern Woodcraft, Saginaw, Mich.

PROFESSIONAL Type furniture finishing and refinishing supplies. Beautiful new, complete, illustrated catalog and complete simplified instruction manual 25c. Colorall, Dept. M, 515 Cedar Lane, Teaneck, N. J.

LEATHERCRAFT, Copper tooling, textile painting. Make spare time, profitable time. Free illustrated catalog shows everything you need. Kit Kraft, 7377 Melrose, Hollywood 46, California.

KNOCKDOWN Cedar chests. Lumber and veneers. Free price list. Giles & Kendall Company, Huntsville, Ala.

LEATHERCRAFT Bargains! Lacing. Francis Byrd, 3406 Montrose Ave., Richmond, Va.

30 LAWN Ornament patterns, ready cut. Full size, color indicated. \$1.00 postpaid. Lincoln Craft Studio, Farmington, Conn.

LEATHER, Tools, lacings, supplies. Free catalog. National Handicraft, 199 William St., New York 7.

MAKE IT YOURSELF

STREAMLINED, Built-in kitchen cabinets to fit any kitchen. Illustrated manual describes designing and construction. All for \$1.00. Thombert Company, Newton, Iowa.

BELT Sander plans \$1.00—Build your own machinery from salvage. Handbook only 25c (refundable). Free details. Kenneth Reeves, Box 3357-PM, El Paso, Texas.

GRANDFATHER Clock easily built. Big savings. See ad on page 274.

BUILD Your own concrete blockmaker. Easy. Inexpensive. Motor or hand. Make block per minute. Write, C. Lee, Mountain View, Okla.

SLIDE Children love. Easily made at home. Complete plans \$1.00. Sawyer Sales, 18056 Archdale, Detroit 35, Mich.

FREE Handbook, build sawmills, block machines, freezers, tractors, scooters, 250 shop, farm, home machines. Nichols Co., Dept. C-1301, Purvis, Mississippi.

PLANS, Septic tank or water softener, \$1.00 each. Freeland Engineering, 16587 Freeland, Detroit 35, Michigan.

BUILD Your own "tractor." Free information. Eltraco, D-1, Camptonville, California.

"CONCRETE Block Homes." 32 page booklet on how to build. \$1.00. H. C. Lightfoot, Civil Engineer, Richboro 1, Penna.

WATCHES, OLD GOLD, JEWELRY

NEW Catalog lists over 5000 styles! Gold plated jewelry supplies, Rhinestones, pearls, etc. Complete details, only 10c. Barry's, 47-11 Branford Place, Newark 2, N. J.

WATCHES Repaired reasonable. Write for information. Park Watch Repair Service, 132 Wexford S.E., Grand Rapids 8, Mich.

HIGHEST Prices paid for old gold, silver, platinum, diamonds, watches, gold teeth, spectacles. Cash immediately. Goods returned if offer unsatisfactory. Government licensed. United Smelting Works, (The Old Reliable), 39-B South State, Chicago 3.

WATCHMAKERS' Tools, materials, supplies, repairs, catalog. Gales, Box 1000, Chicago 90, Ill.

RHINESTONES, Jewelry settings, cameos, sequins, beads. Catalog free. J & M Novelties, Dept. CK-3, Griffith, Ind.

WATCHES Completely repaired; \$3.50. Guaranteed; Berkowitz, 1265 Olmstead Ave., Bronx 61, N. Y.

FREE Gem offer. Has diamond brilliancy. Gemimports, 432 South Western, Hollywood 5, Calif.

HIGHEST Cash paid for old, broken jewelry, gold teeth, watches, silverware, diamonds, spectacles, platinum. Free information. Satisfaction guaranteed. Rose Smelting Company, 29-A East Madison, Chicago.

WRIST Watches, U. S. Air Corps. Waltham, 16 jewel, water and shock proof, stainless steel case, reconditioned. Value \$55.00. Special \$17.95. Public Sport Shops, 11 S. 16th Street, Philadelphia 2, Penna.

TOBACCO, SMOKERS' SUPPLIES

CIGARS, Fine, mild factory fresh, 10c size. Box of 50 \$3.00, two boxes \$5.00, postpaid. Check or currency. Or four trial cigars send quarter. Money back guarantee. D. Burr Cigar Factory, 5516 Easton, St. Louis, Missouri.

PIPE Smokers — Unique flavors permit blending tobacco to taste. Information free. Cozza Pharmacist, Pequannock, N. J.

BREAK Your pipe in easily. Sensational formula. Satisfaction guaranteed. \$1. Instructions included. Briar Sales, Box 12481, 10587 W. Pico Blvd., Los Angeles 64.

OF INTEREST TO WOMEN

YOU Can make beautiful seamless Afghans from wool pieces; cutwork and many other types of embroidery on your sewing machine without attachments. Send \$1.00 for complete instructions (no stamps please). Shirley Kau, Dayton, Oregon.

MAKE Money at home sewing useful articles. Be ready to sew for holiday business. Liebig Industries, Beaver Dam 10, Wisconsin.

START Profitable sparetime business making artificial flowers, woodfiber corsages, chenille dolls, shellcraft, rhinestone jewelry, novelties. Starting kits, materials. Wholesale profitcraft catalog, business plan, 10c. Cleveland Models, 4507TC93 Lorain, Cleveland 2, Ohio.

FOR SALE—MISCELLANEOUS

BARGAINS: Sporting goods, cameras, instruments, books, etc. Henry, 2815 Boulevard, Jersey City 6, N. J.

LOST Canyon Trading Post. Curio shop. Reptiles, famous cobras, 16 acres. Bldg. 180x36. Trade or sell. Complete info. Owner: H. R. Atkinson, P.O. Box 153, Grants, New Mexico.

SAVE Money on army, navy and factory surplus. Write today for new 60-page illustrated catalog. Tennusa Sales Co., Dept. AN, 1451 Market, Chattanooga, Tenn.

SAVE Money chrome cabinet hardware. Write Box 89, Troy, Ohio.

FREE Catalog! War surplus clothing. Amazing bargains. N. Y. Clothing Co., New York 29A.

100 RAZOR Blades, guaranteed finest quality, double-edge \$1. York Blade Co., New York 29R.

PATENTED Electric cattle branding irons. Safe, economical, reasonable. Charles E. Farrar, Greenwood, Miss.

HANDSIGHTING Levels, improved, new model, used for grading land, contouring and laying out fences, piers, roads and gardens, price \$2.50 postpaid. Public Sport Shops, 11 S. 16th Street, Philadelphia 2, Penna.

DRESSES, Used, 18c; coats \$2.00; blouses 35c. Free catalog. Crown, 164-PA Monroe Street, New York.

TRIPODS, All wood, solid leg with four inch circular metal head, can be threaded, 55" tall, value \$27.50—special \$6.95. Public Sport Shops, 11 S. 16th Street, Philadelphia 2, Penna.

WANTED—MISCELLANEOUS

QUICKSILVER, Platinum, gold, diamonds, sterling, dental-jewelry-optometrist scrap. Ship or write. Wholesale Terminal, Norwood, Massachusetts.

PERSONAL

BORROW By mail. Loans \$50 to \$300 to employed men and women. Easy, quick. Completely confidential. No endorsers. Repay in convenient monthly payments. Details free in plain envelope. Give occupation. State Finance Co., 210 State Finance Bldg., Dept. C-14, Des Moines 8, Iowa.

REMAIL, Coast to coast service. Letters 20c each, cards 5c. Lst of cities free. E. Kimmel, 292 Valley, Dayton 4, Ohio.

LETTERS Remailed 25c, \$3.50 per month. Particulars. HBI, 2029½ Main, Dallas 1, Texas.

"HOW Can I find out?" You can! Information discreetly developed. Any matter, person, problem, anywhere. Worldwide. Officially licensed, bonded service. Established 1922. Reasonable. Confidential. William Herman, 170 Broadway, New York.

RUPTURED? Positive comfort, no understraps, no steel, no elastic. Write Smith Manufacturing Co., Preston, Ont.

LETTERS Remailed from Port of Spain, Trinidad and Caracas, Venezuela. 35 cents each. Money order only. Otto Timm, Jr., Box 744, New Orleans (2), La.

MEXICAN Law. General practice. Attorney, 1203 Arizona St., El Paso, Texas.

ALASKA Letters remailed 25c. Scenic postcards 8 for \$1.00. Richard Calhoun, Sitka, Alaska.

HAVANA, Panama, South America remail 25c. Wierco, Box 6732, Dallas, Texas.

FRANCE, Germany, Switzerland remail. 3 letters \$1. Stamps free. C. Paige, Hauptpostlag, Basel 1, Switzerland.

MEXICAN Law practice reliably conducted. Box 1736, El Paso, Texas.

HERE'S How and where to borrow \$50.00 to \$300.00 by mail. Confidential. Free particulars. Postal Finance Company, Dept. 45, Sioux City, Iowa.

MISCELLANEOUS

ATTENTION Small business men. United States Government approved single book bookkeeping system with instruction book, \$10.00. Free details. Mersand Printing Company, 1906 Strauss, Brooklyn 12, N. Y.

10 BALL Point pens with name imprinted \$1.00 postpaid, no c.o.d.'s. Ideal M. O. Service, 1133 Broadway, New York, N. Y.

100 QUALITY Double edge blades. Guaranteed. Only \$1.00. Refund privilege. Habs, Box 51, York, Penna.

INCREDIBLE! Unprecedented! Become a mental superman overnight! Floor everybody! No studying! "Memoprop" does all your thinking! It's uncanny! Revolutionary! Write: Bijou, Box 1727-ME, Hollywood 28, California.

RESEARCH: We find, locate buyers, or sellers for anything of value. Registration and listing, \$1.00. Refundable. Wright Publications, 2270-S Hubbard, Memphis 8, Tenn.

MEN—I shaved 128 days, with only one single edge safety razor blade. Cost 5 cents. You can do the same. Complete instructions sent for only 25c. Address, Razor Blades, 1001 Montana St., El Paso, Texas. Print your name plainly.

SEEK Gold, uranium, buried treasure! Latest low cost super-sensitive equipment. Free literature. Glen Scientific, Box 151-B, Glen Ellyn, Illinois.

SEPTIC Tanks, outdoor toilets, cesspools cleaned, deodorized easily. Make this amazing cleaner yourself. Sell to others. Complete formula \$1. Neiko Chemical Service, Box 3462-ST, Chicago 54, Ill.

MEN. Gifts, gags, magic, novelties. Free wholesale list. Elnovco, D-43, Camp-tonville, California.

STATE Decals for windshields, luggage. All states available. In demand every-where. Send 25c for samples and whole-sale list. Bristow Novelty Co., Box 403, Dept. 7, Owensboro, Ky.

INTERESTING Mails. 25c keeps name on mailing list three months. Bentz, Desk D/77, Chatawa, Mississippi.

ADD Spice to home projection shows with colorful old-time Nickleodeon slides. 2x2. Write for free list. Nickleodeon Co., New Fleidner Bldg., Portland 5, Oregon.

YOUR Leather jacket renovated expert-ly. Free circular. Berlew Mfg. Co., Dept. 8, Freeport, N. Y.

VERNIER Caliper. Inside, outside, depth measurements. (1000 inch) \$1.25. Corubia, 126 Lexington Avenue, New York City

UNBEATABLE — 130 Double edge razor blades of finest precision steel for ex-tremely low price \$1.00 postpaid. Satisfied customers Maine to California. Save over \$2.00 by price smashing sale. R. D. Enter-prises, Box 253, Portland, Maine.

BUY Direct wholesale 750,000 articles. Directory 25c (refundable). Publishers, Box 1302-P9, Detroit 31.

MAKE Your own will. Easy! Complete set legal will forms with explicit instruc-tions \$1.00. Rankin Legal Forms, Lock Box 202M, Gary, Indiana.

STORM-Proof cigarette lighter. Can't blow out. 2—\$1.00. Corubia, 126 Lexing-ton Avenue, New York City.

HOUSEHOLDS favorite gripe eliminated! Get our castiron, rustproof, bottle opener. 50c. Guaranteed. Synco Manufacturing, 1022 Central, Evanston, Ill.

HARD To fit leather jackets custom made. Motorcycle models our specialty. All type repairing. Free circular. Taubers, 689 Mission, San Francisco 5, Calif.

TWO Letters airmailed \$1. Errands. In-formation. Swords, Casilla Correo, 4342, Buenos Aires, Argentina.

70 BIBLE Lessons, 25c. Bulletin, Box 87, Cathedral Station, New York 25.

TIE-Breakers exposed. Picture puzzle contestants. Now you can win big cash prizes. Your key to fortune \$1.00. Weno-grad, Box 1495, Philadelphia 5, Penna.

DRESSES, Used, 18c; coats \$2.00; blouses 35c. Free catalogue. Crown, 164-PM Mon-roe Street, New York 2.

CESSPOOL Trouble? Use Peps-It. Re-juvenates fermentation action, saves pump-ing costs, deodorizes, reduces masses. Costs only \$2.50. Safe. Sanitary. Free descrip-tive literature. Chemical Cesspool Clean-ing Co., Boston 34, Mass.

GOLD, Silver, metal detectors. Geiger counters for uranium. Mineralights. Sen-sational new fully guaranteed models. None finer. Information free. Detector Co., 5631 Cahuenga Blvd., North Holly-wood, California.

SQUARE Dance instructions, thirty dances, \$1.00. Wesley Rader, 3926 Alcott, Denver 11, Colorado.

RECEIVE Giant mails, magazines, cata-logs! Three months 25c, year 50c. Wad-dell's Directory, 341B East 76th, New York 21.

TREASURE Finders for gold, silver and minerals. Money back guarantee, best available. Also Geiger counters for urani-um prospectors, free information. Write Goldak Company, 1541 West Glenoaks, Glendale 1, Calif.

OUTDOOR Toilets, cesspools, septic tanks cleaned, deodorized with amazing new product. Just mix dry powder with water; pour into toilet. Safe, no poisons. Save digging, pumping costs. Postcard brings free details. Burson Laboratories, Dept. C-36, Chicago 22, Illinois.

"RECEIVE Mail." Moneymaking offers, opportunities, catalogs. Name listed 10c. Ideal Service, Park Ridge 10, Ill.

PANNING Gold lesson and catalogue. Beginners supplies, books, "maps where to go" free. Old Prospector, Box 729D1, Lodi, Calif.

TREASURE—M-Scope Geiger counters, mineral locators. Why buy something in-ferior when you can buy the best at a lower price? Backed by years of experience. Fully guaranteed by factory. Detects min-erals, metals, gold, silver, coins. Pay-ment plan available. Proven superior per-formance. Free 16 page illustrated book-let. Fisher Research Lab., Inc., Palo Alto, California.

EARN Up to \$200 month, inventing toys, games, gadgets. Write, Hendrickson, Argyle 1-A, Wisconsin.

Earn up to \$6,000 a year!

MORE JOBS THAN WE CAN FILL METAL TRADES BACKBONE OF INDUSTRY



Men who are mechanically inclined have a wide open field to choose employment in the Metal Trades Industry. Jobs are going begging for lack of qualified trained men. You need no previous experience to start your training at this school.

SHORT COURSES TO MEET PRESENT JOB DEMAND. **INDICATE YOUR PREFERENCE—RESIDENT or HOME STUDY TRAINING**

ALLIED SCHOOL OF MECHANICAL TRADES, Inc. Write for FREE BOOKS
1338-1340-1342 S. MICHIGAN AVENUE
409 ALLIED BUILDING, CHICAGO 5, ILL. A 1c Postcard will do.

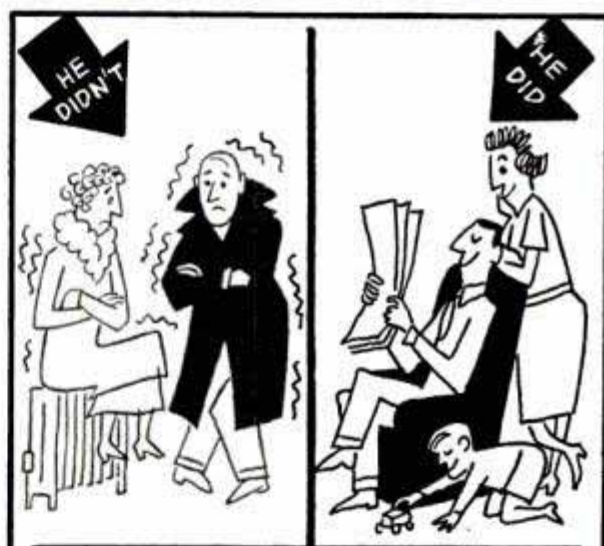

SEAL UP LEAKY DOORS AND WINDOWS WITH

INNER-SEAL Live Rubber
WEATHERSTRIPPING

STAYS LIVELIER LONGER... SAVES MORE FUEL

RESISTS WEAR... water-proof neoprene coating pre-serves it.

TOUGH AND SPRINGY... live sponge rubber bead.

FLEXIBLE, INSTALLS EASY... woven spring-wire attach-ing strip, fits corners easily, accurately.



WHAT'S THE "JUMP TEST"?

Ask at your hardware or building supply store.

IN A FEW SECONDS... FOR LESS THAN 2¢

PLASTIC BIND YOUR OWN ALBUMS • PRESENTATIONS • PAMPHLETS • RIGHT IN YOUR OWN OFFICE!

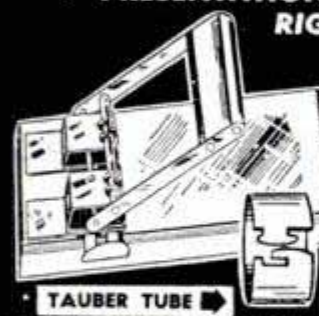

Now... for the same price of an ordinary stapling machine, you can have attractive—colorful reports. Pages will turn freely with loose-leaf advantages. Use any size color cover stock... AND IN A MATTER OF A FEW SECONDS produce a beautifully bound book.

TAUBER TUBE

MONEY BACK GUARANTEE IF NOT COMPLETELY SATISFIED

THE TAUBER MIDGET PUNCH only \$9.90 Complete with over 150 Tauber-Tubes in various colors and sizes.

ORDER TODAY! Or write for illustrated literature.
TAUBER PLASTICS, INC. DEPT. M
200 Hudson St., New York 13, N. Y.

"I'M MAKING MORE THAN \$1000 a Month Haven't Touched Bottom Yet!"



C. KAMA

—reports Charles Kama, Texas, one of many who are "cleaning up" with orders for PRESTO, Science's New Midget Miracle Fire Extinguisher. So can YOU!



Science's New Midget Miracle "PRESTO"

A MAZING new kind of fire extinguisher. Tiny "Presto" (about size of a flashlight!) does job of bulky extinguishers that cost 4 times as much, are 8 times as heavy. Ends fires fast as 2 seconds. Fits in palm of hand. Never corrodes. **Guaranteed for 20 years!**

Show it to civil defense workers, owners of homes, cars, boats, farms, etc. and to stores for re-sale—make good income. H. J. Kerr reports \$20 a day. Wm. Wydal-lis, \$15.20 an hour. Write for FREE Sales Kit. No obligation. **MERLITE INDUSTRIES, Inc., Dept. 59, 201 East 16th St., New York 3, N.Y. IN CANADA: Mopa Co., Ltd., 371 Dowd St., Montreal 1, P.Q.**

(If you want a regular Presto to use as a demonstrator, send \$2.50. Money back if you wish.)

HE-MAN VOICE!

STRENGTHEN your voice this tested scientific way. Yes—you may now be able to improve the **POWER** of your speaking and singing voice... in the privacy of your own room! Self-training lessons, mostly silent. No music required.

FREE BOOK Write TODAY for Eugene Feuchtinger's great booklet "How to Develop a Successful Voice." It's absolutely FREE! You must state your age. Booklet mailed postpaid in plain wrapper. No salesman will call. Send your name and age **RIGHT NOW!** Perfect Voice Institute, 210 S. Clinton St., Studio J-2, Chicago 6, Ill.



Go Into Business For YOURSELF!

Make storekeepers' profits without storekeepers' troubles. We'll put you into business, furnish everything you need, train you, carry stock without your risking one penny. We'll work with you to make you a success. We've done it for others. We'll do it for you providing you are honest, ambitious, and willing to work hard. If you are, write us. You'll hear from us at once with facts. Address Sales Manager, Desk PM-9, 15th Floor, 6 North Michigan Avenue, Chicago, Illinois.

PAY RAISING—EXTRA MONEY BOOKS

Use these books to prepare for a better job — bigger pay — to start a profitable spare time or full time business of your own. Improve your home, or start a hobby. Popular Mechanics specializes in supplying outstanding self-help books on many subjects. Send for our FREE catalog.

- Outdoor Sports Manual: Hunters, Fishermen, Trappers, Campers, Archers, Boatmen. here is your book!... \$2.00
- Shop Notes Library: 5 Vols.—1951, 50, 49, 48, 47 (No Dup. Matter)... \$3.98
- Shop Notes 1951... \$1.00
- Money From Ideas. Patent and sell your invention... \$2.50
- Photo Handbook: An entirely new and different book from our Popular Photo Guide. It's a complete guide to better pictures and dark-room technique, and features dozens of handy gadgets you can make yourself... \$2.00
- Automatic Transmissions Simplified. How to locate trouble, service all types... \$4.00
- Dyke's Auto Encyclopedia: World's Greatest Auto Book. New 1950 Edition... \$7.50
- Garden Book: Build own trellises, lawn furniture, fireplaces, ornaments, etc... \$1.50
- Diving, Cutting and Welding in Underwater Salvage Operations. Only book of its kind... \$2.00
- Picture Framing: Modern methods for making and painting picture frames. Fully illustrated... \$2.75
- Radio-TV and Electronics Handbook. How to service radio and TV sets; build receivers, phonographs, portables, student sets, etc... \$2.50
- Money Making Hobbies. 132 ways to make money... \$2.00
- 210 Deluxe Small Homes \$1.00
- Trailer Coaches by Kums: Complete information for construction of trailers... \$1.50
- Concrete Handbook: New book on using concrete around home, garden, farm... \$2.00
- Veterinary Guide for Farmers by Stamm. What every farmer should know about taking care of farm animals. 288 information packed pages with more than 150 big illustrations. Covers ailments of cattle, hogs, sheep, horses, etc... \$3.50
- Welding, Brazing and Soldering 1950 Ed. How to build your own equipment and how to use it effectively... \$1.75
- Modern Electric and Gas Refrigeration. New 1950 Ed. includes sealed units — home freezers... \$5.00
- Complete Book of Home Repair and Improvements. Radio's famous "Fix-It" book. Everything about repairing and improving your home. Cloth Ed. \$2.98; Deluxe Binding \$3.98
- You Can Make A "Stradivarius" Violin. Instructions. 8 full scale plans... \$3.50
- Oil Burner Handbook... \$2.50
- 23 Boats You Can Build. Rowboats, canoes, sailboats, 25 foot cabin cruiser. Working diagrams, material lists. \$2.00
- House Wiring (No. 89)... 25c
- Turn Scrap Into Money: Convert old auto generators into motors, welders, etc... \$1.00
- Popular Mechanics Farm Manual: Packed with practical ideas and usable information that can easily be worth hundreds of dollars to every farm family and to homeowners everywhere. Send for free descriptive folder giving complete contents!... \$3.00
- Woodworking for Every-body... \$2.75
- Sheet Metal Work... \$3.00
- Tool and Saw Sharpening (No. 92)... 25c
- Forging Practice... \$1.50
- Action Toys (No. 66): Plans for 21 easy-to-make toys... 25c
- Foundry Work... \$2.25
- Pattern Making: Wood, metal... \$2.25
- Forty Power Tools: Build own saw, drill, lathe, sander, etc., from scraps — save money... \$1.50
- Carpentry: The Young Craftsman: Over 450 things boys can make... \$2.00
- Five Acres and Independence: How to make money on small farm... \$2.50
- Your Home and How to Build It Yourself. Step-by-step construction of the famous Popular Mechanics house. Wonderfully illustrated... \$3.00
- Manual for Plymouth Car Owners: How to get the most from your Plymouth and save on repair bills... \$3.50
- 100 Beautiful Pieces of Furniture You Can Build. Complete suites for living room, dining room, bedroom shown in brilliant color. Exclusive styles by John Berzen. Working diagrams... \$3.00
- Motorist's Handbook: Popular Mechanics scores again. A 160 page guide to automotive happiness... \$2.00
- Planning Your Home Workshop: How to use every inch of space. Build cabinets, benches, etc. How to wire... \$2.50
- What to Make for Children: Junior tough on toys? Build him playthings that will last... \$2.00
- LeJay Manual of Homemade Electric Equipment. How to construct 50 items that are scarce and valuable... \$1.50
- How to Estimate for the Building Trades: Material and labor costs for masonry, plumbing, electricity, carpentry, heating, hardware, painting, etc. 629 pages... \$5.50
- Auto Racing—6th Edition... \$2.00
- Tool Making... \$4.00
- Tool Design... \$4.50
- Plumbing Installation & Repair... \$2.00
- Ropp's Calculator: Figuring Made Easy... 75c
- Slide Rule Simplified... \$2.75
- Drake's Refrigeration Service Manual... \$2.00
- Power Tools and How to Use Them: Tools to start with; tools to add; how to use them and where to buy them... \$2.50
- America's Best Low Cost Homes: 125 popular practical designs... \$1.00
- Toys You Can Make of Wood... \$2.50
- A.B.C. of Poultry Raising... \$2.50
- Lawn Furniture: Make attractive sturdy lawn furniture with Popular Mechanics big plans. Save over 50% of the usual cost. Four plans... \$2.00
- Furniture Joinery... \$2.00
- Essentials of Upholstery... \$3.25
- The Frog Industry by Hannaca: Covers every phase of frog farming; shows you how to make big money. Full of valuable information about this fascinating, profitable industry... \$3.00
- Home Haircutting Made Easy by Mercia. Instructions for cutting your family's hair... \$1.00



MAIL THIS COUPON TODAY

Check the books you want, write your name and address below, and mail this advertisement with money order or check. Outside U. S. A. include 15% additional for shipping charges. Books selected will be mailed promptly on our "money back if you're not entirely satisfied" guarantee.

Name _____
 Address _____
 City _____ State _____

Mail to **POPULAR MECHANICS PRESS**
 DEPT. 700 — 200 EAST ONTARIO ST., CHICAGO 11, ILL.

BIG MONEY

WRITING ORDERS FOR AMAZING NYLONS

GUARANTEED AGAINST EVERYTHING



THE world's ONLY complete, nationally advertised nylon hosiery line actually guaranteed against runs, snags or excessive wear. **REGARDLESS OF CAUSE!** It's amazing, but true! No matter what the cause—hard use or deliberate abuse—Kendex nylons are replaced **FREE** if they run, snag or become unfit for wear within entire guarantee period! Every weight from sheerest 15 denier to heavy 70 denier—all gauges up to luxury 60 gauge—all sizes, lengths, popular shades, fancy heels—full fashioned and seamless. How could any woman possibly resist saving money and solving her hosiery problems? **NOT SOLD IN STORES.** Men and women wanted **NOW**, spare or full time, to write orders and earn big money. You can get orders even if you never sold a thing in your life!

NEW SLASHED PRICES!
3 PRS. GUARANTEED NYLONS 2.95

• Just imagine—first quality nylons, **GUARANTEED AGAINST EVERYTHING**—for less than a dollar a pair! This includes postage, your commission and bonus! Every day, women pay 50% more for this same quality hosiery in stores, *without any guarantee at all!* How can any woman say “No” to savings like these? Writing orders isn't “selling”, it's like giving them away.

FREE STOCKING

• **YOU** can easily earn steady income, spare or full time. No money or experience needed. We supply **EVERYTHING FREE** and set you up in business at **OUR** expense. Nothing to buy or deliver. Write orders. We deliver and collect. Big advance pay plus huge cash bonus that increases your earnings up to **40%**! Your name and address on postcard will bring you sample stocking; self-selling sales books with **FULL COLOR** illustrations; 32-page sales manual showing you easy steps to success; color cards; special plan to have others sell for you, etc., etc. You can start making money the minute you receive the complete **FREE** outfits!

YOUR COST ONE CENT!

SEND NO MONEY. Pay nothing now or later. No obligation. Not even a promise to return outfits. Simply write your name and address on a penny postcard and mail to us. We'll immediately rush you everything you need **FREE** and postage prepaid. **WRITE TODAY!**

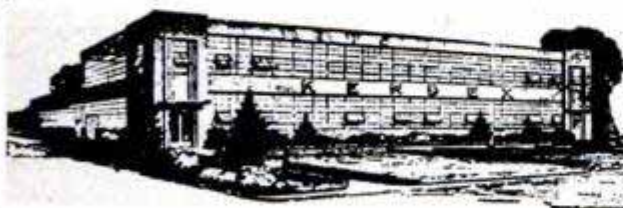

KENDEX CORPORATION • BABYLON 546, N. Y.

Make Big Money—Be Your Own Boss!

Servicing Television!

Complete New Self-Teaching Guide Makes It Easy To Do ANY TV Installation, Service, and Adjustment — Quickly and Expertly!

Prepare now for the big-pay jobs or your own business in the TV field. Learn television servicing quickly AT HOME . . . IN SPARE TIME . . . with this brand-new "Television Servicing" manual.



COVERS EVERY TV SERVICE & REPAIR

Setting Up The Receiver • Antenna Installation • Test-Pattern and Picture Analysis • Tube Installation Adjustment • Circuit Trouble • Sight and Sound Synchronization • Tuning Scanning, and "Poor Picture" Cures • Control Adjustments • High-Voltage and Low-Voltage Power Supplies • Interference Remedies • Video Amplification and D-C Restoration • and MUCH MORE.

Almost 500 Pages—300 Pictures, Diagrams, Charts
Guides you step-by-step from locating the receiver to antenna installation, and all major adjustments and repairs. How the video AM and FM signals originate . . . how each is transmitted and received. "How-to-do-it" illustrations and cross-section diagrams show how to service each circuit block of receiver; localize reception troubles; diagnose interference and breakdowns; trouble-shoot APC Circuit; service Cathode-Ray tubes, etc. No matter what the repair problem—this book shows you how to "lick" it quickly and expertly. Makes it easy for radio servicemen to branch out in TV servicing.

FREE 10-DAY EXAMINATION
Send no money. Mail coupon below to examine "Television Servicing" FREE—without obligation. Mail it NOW.

McGraw-Hill Book Co., Inc., Dept. PM-9
327 West 41st St., New York 18, N. Y.

Send "Television Servicing" for 10-DAY FREE EXAMINATION. If not satisfied, I will return it—pay nothing. Otherwise, I will keep it—send only \$2.00 plus delivery cost, then; and \$2 monthly for 2 months.

Name.....
Address.....
City..... State.....
Company..... Position.....

SAVE POSTAGE. Check here if enclosing \$6 WITH coupon. Then WE pay postage. Money back if you return book.

LEOPARD SEAT COVERS SWEEP TO SENSATIONAL NATIONAL POPULARITY



Salesmen jamming pockets with \$1000 bills . . . TAKING ORDERS FOR KEY EXPERTLY Tailored AUTO SEAT COVERS

Look at These Features
• 7 STYLES—7 PRICE RANGES
• A COMPLETE LINE OF SENSATIONAL NEW DESIGNS
• FOR ALL CARS—ALL MAKES—MODELS—YEARS

7 Styles
BIG SEASON NOW STARTING!

You've heard of the tremendous demand for Leopard auto seat covers that built up overnight from one end of the country to the other when Cadillac introduced a new 1950 model with Leopard Seat Covers. Car owners are paying \$50.00 to \$60.00 and \$70.00 . . . and more for covers with Leopard design. Now you can serve that eager demand at a fraction of the cost the customers expect to pay! No wonder salesmen are making money hand over fist with this sensational new Key line!

Make big money daily. Take orders from car owners everywhere. Beat all competition with covers cut to accurate

patterns like the finest suit of clothes . . . Slick, smooth, wrinkle-free fit adds an accent of elegance to any car . . . just like an original upholstery job!

RUSH NAME FOR FREE OUTFIT Give Make, Year and Model Of Your Car
Anyone working full or spare time can realize big money in this business. No need to search for prospects. Every car owner is one. Be the first to cash in . . . Make year around STEADY PROFITS. Don't put it off—get your Free Selling Kit at once for some real money. ACTUAL SEAT COVERS GIVEN FREE TO PRODUCERS FOR OWN USE! Write for full details!

KEY PRODUCTS CORP.
Dept. 4-P
800 N. Clark, Chicago 10, Ill.

YES! SEND



directly to my door every month

I am enclosing

- \$3.50 for 1 year
- \$8.00 for 3 years

name _____
address _____
city _____ zone _____ state _____
PMC-9

Hand this order to your newsdealer or send it to

POPULAR MECHANICS
200 East Ontario St. Chicago 11, Ill.



NEW POPULAR MECHANICS MAGAZINE LIBRARY FILE

Brand New, Grand New Way to Preserve Each and Every Issue of Popular Mechanics

Now you can preserve every treasured issue of Popular Mechanics in these ingenious, custom-built storage files. Constructed to look like an attractively bound book, Popular Mechanics Magazine Library Files afford neat, orderly, flick-of-the-finger convenience. Handy reference index printed on back records the exact location of selected articles, diagrams, etc. A "must" for every reader of Popular Mechanics Magazine. A sensational Popular Mechanics value scoop. Order yours today. Use the handy coupon.

Only 70¢ PER SET OF 2
(set holds 12 issues) POSTAGE PAID
5 sets only \$3.10
10 sets only \$6.00
POSTPAID

USE THIS COUPON...MAIL TODAY

Popular Mechanics Magazine, Dept. PL P9-51
200 East Ontario Street, Chicago 11, Illinois
Please rush PREPAID _____ set Popular Mechanics Magazine Library Files. (QUANTITY)
Remittance for \$ _____ is enclosed. (AMOUNT)
Name _____
Address _____
City _____ Zone _____ State _____

SAVE 40 TO 72% on Nationally Advertised Watches



Jet-O-Matic Full Swing SELF WINDING 24.95

Super De-Luxe Model—360° FULL-SWING AUTOMATIC. Just set it—then forget it! It winds itself as you wear it. Patented INCABLOC 17 jewel movement of superb accuracy. WATER & SHOCK RESIST—you can drop it, bang it, even SWIM with it! 100% stainless steel screw-back. Radium Luminous Markings. Unbreakable Kleersite Crystal. Hairline sweep-second. SPLIT-SECOND calibrations for precision timing. Handsome thin case. Smart, GILT numerals & hands. CAUTION: Do not confuse with inferior 180° HALF swing automatics! Thoresen's Jet-O-Matic is 360° FULL swing. It's the "high compression" self-winder! Formerly \$75.00. NOW—24.95 plus 10% tax—total 27.45. FLEX-METAL band given!

De-Luxe 17 JEWEL Gold Plate ACCURACY

MASTERPIECE of superb styling! Streamlined 14 Karat Rolled Gold Plate—stainless steel back. Gilt numerals & hands. Hi-Dome crystal. Amazing accuracy! One of the smartest watches today. Formerly \$59.50. Now yours for only 14.00 plus 1.40 tax—total 15.40.

17 Jewel INCABLOC 14.95 WATER & SHOCK Resist

World famous INCABLOC! Radically different! 17 Jewels! You can DROP it. WET it. BANG it! Actually runs UNDER WATER! Try at our risk. De-Luxe Features: Radium-applique numerals—Stainless Steel Screw Back—SafeGuard Gasket—Sweep-second—Thin. GIVEN: Vita-Flex band. Why pay up to \$65.00? Thoresen's sacrifice price—14.95 plus 10% tax, total: 16.45.

Save 40 TO 72%

**FREE
10 DAY TRIAL**

Check watches wanted in coupon below. Remit check or money order for FAST prepaid delivery, or order COD plus postage. Try, appraise, enjoy 10 whole days. Full price back QUICK if not delighted!

UNLIMITED GUARANTEE
Exclusive of Parts! No charge ever for skilled labor, "handling," etc. for LIFETIME of business. All THORESEN watches subjected to 11 special tests before shipment. Save with SAFETY... the THORESEN way!

Tells month, weekday, hour, minute and second INSTANTLY! Triumph of Swiss craftsmanship... uses new, patented REVOLVO dial principle. Amazingly accurate! Luminous dial. Unbreakable crystal. Stainless steel back. Use for work or sports! Protected against shocks, dropping, etc. by world-famous INCABLOC shock absorber. Challenges comparison with ANY watch selling for \$50.00. Terrific value! Only 17.95, plus 10% tax, total: 19.75.

Genuine Recipro-Register CHRONOGRAPH

The ONE and ONLY genuine Recipro-Register CHRONOGRAPH—computes speeds & distances down to 1/5th of second! INCABLOC 17 Jewel Movement resists shocks of work & play. Remembers for you while movement continues to keep time! TIMES: Races, Planes, Sports, Photography, Shop Work, Lab Experiments, Lightning, etc. AUTOMATICALLY! 3 multi-function synchronized dials. Contact clutch starts computation. Brake clutch freezes result. Also ERASES back to zero. Radium dial, hairline sweep-second, all stainless steel back, unbreakable Kleersite crystal. Don't confuse with cheap, troublesome chronographs. Every Recipro-Register Chronograph is INCABLOC equipped—subject to 11 gruelling tests before shipment! Formerly \$79.95. NOW—27.25 plus 10% tax—total: 29.98.

REVOLVO-CALENDAR 17 Jewels—INCABLOC



THORESEN DIRECT SALES, Dept. 6K-200
131 WEST 33rd STREET — NEW YORK 1, N. Y.

RUSH watches checked on 10 DAY FREE TRIAL.
Remittance enclosed—send Prepaid. Send COD plus post.

A B C D E

NAME _____
ADDRESS _____
TOWN _____ STATE _____

Watch for the Golden Anniversary Issue—January 1952

MAGIC-SCREEN INCOME PLAN OFFERS BIG MONEY, AT HOME, SPARE OR FULL TIME



Reproduce any painting, design, trade-mark, picture, printing, in full color, on any surface! Proven new method enables you to cash in on established business where Profits up to \$5.00 or more an hour are being made, right now! Examine complete Plan and equipment without risk!



Write today for free sample — Complete free details! Send NOW!

CALIF. ACADEMY OF SCREEN PROCESS DEPT. 29, 5100 SO VERMONT AVE., LOS ANGELES 37, CALIF.

Amazing Attachment MAKES OLD REFRIGERATORS INTO MODERN Automatic Defrosters!

Thirty Million Prospects. Sell without "selling pressure" on sensational Free Trial Plan. Just plug it in and leave it. Frees women from drudgery and mess of defrosting. Saves electricity. Keeps food longer, better. Gives longer life to refrigerator. Secret "follow-up" Plan often brings five additional sales by making every user your agent. Big season now on!

SENT FREE... JUST SEND NAME!

Don't send a cent—just your name on penny postcard. We'll send you the biggest money-maker you ever got your hands on and guarantee your sales at profits as high as \$5.00 on each sale. Rush your name!

MAXILUME COMPANY, 125 West Hubbard Street, Dept. D-89, Chicago 10, Illinois

Women buying by the thousands!

Salesmen Cleaning up on "Free Trial" Sales Plan Sent Free with Instructions. Make as high as \$5 on Every Sale!



RESET LOOSE HINGES

with

EASY! No skill required. Handles like putty...hardens into wood.

PLASTIC WOOD

A CELLULOSE FIBRE FILLER

IN CANS OR TUBES



WON'T CHIP OR CRACK

P.S. Lubricate bikes, trains, skates and wagons with 3-IN-ONE Oil



LIGHTWEIGHT

\$362.20

(Fed. tax paid, at factory)

9.5 hp. 4-cycle. 3-speed. Foot-shift. Over 70 miles per gal. Over 60 m.p.h. Write for free circular.

MUSTANG, Dept. PM

635 W. Colorado, Glendale 4, Calif.



Limited time offer!



WORK SHIRT BARGAIN

SURPLUS STOCK FROM MID-WEST SUPPLY FIRM!

What a buy! These sturdy, serviceable work shirts, though used, have been washed, sterilized and put in perfect condition. Every shirt is cut from durable wash materials, choice of blue or tan. Well made with reinforced stitching at strain points. Order today at our risk! Money-back guarantee!

SEND NO MONEY! Just send name, address, neck size and color choice. Pay postman plus postage or send cash and we ship prepaid. Inspect 10 days. Return for refund if not delighted!

WORK PANTS TO MATCH 99c

Send waist measure and leg length

COVERALLS \$1.49

Send chest measurement

MILCO SALES, Dept. D-5 9350 Roselawn, Detroit 4, Mich.

79c
3 for \$2.29

Work Clothes Value of the Decade!

YOU CAN BUILD Beautiful Furniture for every room of your home



LIVING ROOM



DINING ROOM



BEDROOM



No Experience Needed Suites for Living, Dining and Bedroom Exclusive Designs Modern and Traditional Styles Scaled Diagrams

Now you can build beautiful furniture for every room of your home—charming, graceful furniture that will give your house an air of elegance and be the envy of your neighbors and friends.

For the Man with Few Tools and Limited Experience

Take your choice from a wastebasket to a complete suite. Choose any one of 100 beautiful articles. Start with a simple project and end up by refurbishing every room in your home. Step-by-step instructions from the Editors of *Popular Mechanics* and scaled diagrams make building easy.

Save Hundreds of Dollars

Why pay skyhigh prices for furniture when with a few evenings' spare time you can build a desk, dresser, bookshelf or even a complete suite and save as much as 67% of the cost? And the furniture you build will be even more attractive and sturdily constructed than the furniture you could buy. Several designs are exclusives by John Bergen, famous furniture designer.

**160 Pages
16 Full Color Plates
Hundreds of Illustrations,
Photographs, Diagrams**

Start building your furniture now. Send only \$3.00 for your copy of "100 Beautiful Pieces of Furniture You Can Build," or you can pay the postman if you prefer. Money back in five days unless you are completely satisfied.

Order on this Handy Coupon

POPULAR MECHANICS PRESS, Dept. 39

200 E. Ontario St., Chicago 11, Ill.

Gentlemen:

Send at once my copy of "100 Beautiful Pieces of Furniture You Can Build" at \$3.00. Unless it is entirely satisfactory I may return it within five days for a full refund.

NAME _____

ADDRESS _____

CITY _____ ZONE _____ STATE _____

Remittance Enclosed

Send C.O.D. (Postage Extra)

DRIVING RELIEF!

New LEFT-FOOT ACCELERATOR

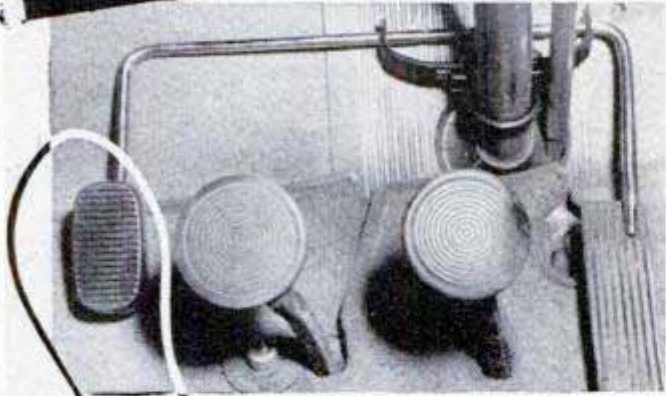

Dealer inquiries invited.

Cut driving fatigue in half with Lefty! Install this new left foot accelerator yourself in 60 seconds with just a wrench—no alterations to your car are necessary. Enjoy relaxed comfort on long drives. Lefty lets you feed the gas with your left foot when you desire, relieves tension and fatigue in leg, back, and foot. Safe, positive and convenient. Swings out of way when not in use. Brings your car up to date. \$5.95 ppd. Specify year and make. No COD's please.

INVENTOR'S MARKETING LAB.

400-B De Young Bldg., 690 Market St., San Francisco, Calif.

WAR SURPLUS OPTICAL BARGAINS

35 POWER ERECTING MICROSCOPE

Amazing clarity. "All-Position" Universal mount. 3" of working space from objective to platform. Prism Erectors give you an erect image—exactly as your eye sees it. Ramsden Eyepiece permits fine precision focusing. 3-Element color corrected objective—1" diameter. Microscope body is of brass with black crackle finish. 6 1/2" long with base 7"x9". Easily worth \$75.00.



Stock No. 970-H. \$29.50 Postpaid
SLIDE PROJECTOR SETS Consists of all unmounted lenses you need to make the following size projectors:
 Stock #4029-H—35 mm. \$2.85 Postpaid
 Stock #4038-H—2 1/4" x 2 1/4" \$3.35 Postpaid
 Stock #4039H—2 1/2" x 3 1/2" \$3.35 Postpaid

SIMPLE LENS KITS—Include plainly written, illustrated book-let showing how you can build lots of other uses in experimental optics, building TELESCOPES, low power Microscopes, etc.
 Stock #2-H—10 lenses. \$ 1.00 Postpaid
 Stock #5-H—45 lenses. 5.00 Postpaid
 Stock #10-H—80 lenses. 10.00 Postpaid

We Have Literally Millions of War Surplus Lenses and Prisms for Sale at Bargain Prices. Numerous Types of Instruments, Too! Write for FREE CATALOG-H
EDMUND SCIENTIFIC CORP., Barrington, N. J.
 (Formerly Edmund Salvage Co.)

HELPFUL BOOKS

Send post card asking for FREE catalog
 Popular Mechanics Press, 200 E. Ontario, Dept. 601, Chicago 11

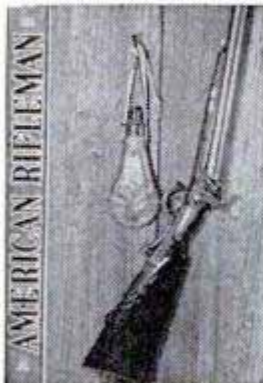

Interested in GUNS and SHOOTING?

The AMERICAN RIFLEMAN will provide you with a wealth of information about guns of all types, rifles—pistols—shot-guns, foreign and domestic, sporting and military, modern and antique; the most effective calibers and loads; the proper iron and scope sights for maximum accuracy; detailed "how-to-do-it" information on re-loading and gun remodeling;

experienced technical advice on new equipment, accessories and gadgets. Every 96-page issue is pack-jammed with interesting and helpful information—exclusively about guns and shooting.

Send \$4.00 for subscription to 12 monthly issues—and receive two back numbers, free. Full price refunded if not satisfied, after receiving first three subscription issues. (If you prefer, just say "Bill Me"; invoice will follow.)

NATIONAL RIFLE ASSOCIATION
 1608-A Rhode Island Ave., N.W., Washington 6, D.C.



Transvener
PLASTIC FILM VENEER

Makes any Smooth Surface look like beautiful . . .

WOODS • MARBLES • LEATHER

TRANSVENEER brings you authentic reproductions of beautiful Mahogany, Walnut, Oak, Blonde Prima Vera, Marble and Leather Comes in film-like sheets you yourself can quickly apply to wood, composition board, glass, metal, plastic, or any smooth surface!

IDEAL FINISH FOR FURNITURE—makes inexpensive pieces look like rare and costly wood! **EASY TO APPLY**, durable, washable, heat-resistant. Application materials and directions come in handy Kit. Buy at Dept., Paint, Hdwe. and Building Supply stores.

FREE! Write for free sample and pattern folder.

TRANSVENEER Division of The DI-NOC Co.
 1005-B Public Sq. Bldg. • Cleveland 13, Ohio

NOW—get more "know-how" with The Complete Book of

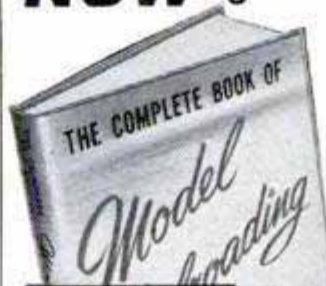

MODEL RAILROADING

by **LOUIS H. HERTZ** nationally-known model railroading expert

EXAMINE 10 DAYS FREE

Here, in one great book, is EVERYTHING you want to know about EVERY aspect of model railroading. It's the BIGGEST—NEWEST—MOST COMPLETE—BEST ILLUSTRATED—MOST UP-TO-DATE—authentic book of its kind. Whether you are a beginner or expert, the full coverage of this wonderful new book will delight you. To get your free-trial copy, mail coupon below.

CONTENTS INCLUDE: Planning a layout. What gauge and scale to use. Space requirements. Table construction. Portable layouts. Grades and two-level operation. Types of track. Design and use of switches. Controlling switches from a distance. Laying curved track. "Sneak-offs." Ways of extending length of the run. Yards and service tracks. Electric motors. Directional route control. AC and DC operation. Building passenger cars. Constructing model locomotives. Estimating power requirements. Control boards. Signals and automatic accessories. Bridges. Outdoor model railroading. Maintaining railroads. Lubrication and care of equipment. Photographing model railroads. AND MUCH MORE! 350 pages, 6 x 9 inches, with 150 ILLUSTRATIONS. You get full instructions and technical data on every phase of this fascinating hobby. Coupon below brings you this great new book on 10 days' approval. Either remit \$4.95 in full payment, or return book in 10 days and owe nothing. **MAIL COUPON NOW.**

Simmons-Boardman Pub. Corp.
 30 Church St., New York 7, N. Y.

PM-951

Send me "The Complete Book of Model Railroading," by Louis H. Hertz. After ten days' trial, I will either remit \$4.95 (plus few cents postage) in full payment—or return book to you and owe nothing.

Name.....
 Street.....
 City..... Zone..... State.....

**Coming...in Mid-October...a Book You Will
Read With Delight and Treasure Forever!**

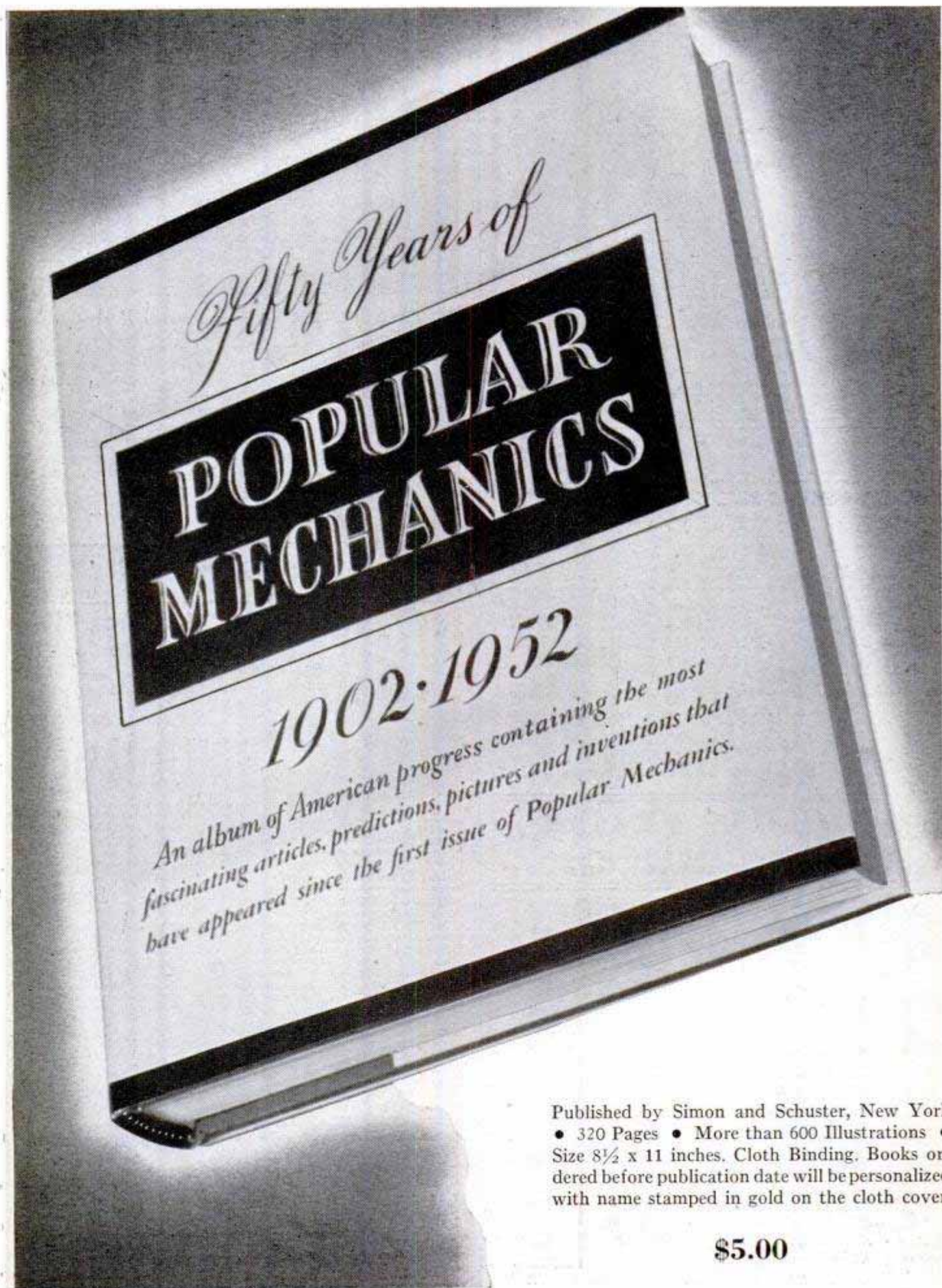

Published by Simon and Schuster, New York
• 320 Pages • More than 600 Illustrations •
Size 8½ x 11 inches. Cloth Binding. Books ordered before publication date will be personalized with name stamped in gold on the cloth cover.

\$5.00

FIFTY YEARS OF POPULAR MECHANICS

*The Inspiring Story of American Progress . . . Depicted in Memorable Pages from a Half Century of Popular Mechanics.
A Great Book . . . A Beautiful Book . . . to Give . . . and to Own.*

YOUR NAME IN GOLD ON COVER . . . SEE SPECIAL OFFER BELOW

Since 1902 Popular Mechanics has faithfully recorded and accurately reported, in words and pictures, the greatest fifty years of mechanical and scientific progress in human history.

Now, appropriately, on the eve of the magazine's Golden Anniversary, Simon and Schuster, noted book publishers, are issuing a big, beautiful, colorful book containing some of the best of the more than 150,000 fascinating pages which have been printed. The title of the book — remember! — is FIFTY YEARS OF POPULAR MECHANICS. If you are devoted to Popular Mechanics, this is the book for you.

Between the covers of this once-in-a-lifetime book appear great articles from Popular Mechanics . . . articles by Guglielmo Marconi, Pierre Curie, Jules Verne, Winston Churchill, Barney Oldfield and others. More than a hundred names and personalities, a who's

who of the leaders in a half century of fabulous accomplishment, appear throughout the pages.

You'll relive the past as you read FIFTY YEARS OF POPULAR MECHANICS . . . in articles written when the events took place. They cover the emergence of the automobile . . . the birth of the airplane, the phonograph, motion pictures, radio, television . . . the invention and development of machines, appliances, devices and gadgets that lighten labor and make for better living.

Actual pages from Popular Mechanics are reproduced with pertinent comments and explanations printed in the margins. The final section is devoted to prophecies of the wonders to come in the fifty years ahead.

FIFTY YEARS OF POPULAR MECHANICS is a book for readers of all ages . . . vastly entertaining . . . thoroughly informative . . . delightfully nostalgic. Order your copy now.



On orders received before November 1, your name, or the name of the recipient to whom the book is to be presented as a gift, will be stamped in gold on the cloth cover. Please use coupon for convenience when ordering.

**POPULAR MECHANICS PRESS, Dept. 85
200 East Ontario Street, Chicago 11, Illinois**

Upon publication send _____ copies of FIFTY YEARS OF POPULAR MECHANICS at \$5.00 each, postpaid, with names stamped in gold. Remittance enclosed \$_____. (Please print name below exactly as you wish it to appear on book. Additional names may be written on margin or on separate sheet.)

Name.....

Address.....

City.....Zone.....State.....

WHOLESALE BY MAIL

GOOD USED TIRES
with a **GOLD BOND GUARANTEE**



NATIONALLY ADVERTISED BRANDS

FREE TUBES with each Passenger Tire.

12 Month GOLD BOND GUARANTEE

600-16	\$4.16	700-16	\$5.06	700-15	\$4.56	710-15	\$4.96
650-16	4.66	650-15	4.46	670-15	4.76	550-17	4.66

24 Month GOLD BOND GUARANTEE

600-16	\$5.56	650-18	\$6.96	820-15	\$7.06	825-20	\$19.98
650-16	5.96	650-15	5.96	475-19	5.96	900-20	20.45
700-16	5.96	670-15	6.26	600-20	9.95	1000-20	22.50
750-16	6.96	700-15	6.56	650-20	10.75	1100-20	22.50
550-17	5.96	710-15	6.36	700-20	12.45	1000-22	19.50
525-18	5.56	760-15	6.56	750-20	13.48	1100-22	20.25

MILITARY MUD AND SNOW TIRES

12 Month GOLD BOND GUARANTEE

600-16	900-16	750-20
Special \$6.50	Special \$10.50	Special \$10.25

24 Month GOLD BOND GUARANTEE

600-16	900-16	750-20
Special \$9.50	Special \$19.50	Special \$18.50

ALL SIZE TRACTOR TIRES

Prices on Request

Send Check or Money Order to

GOLD BOND TIRE COMPANY, Dept. PM
512 North 1st St., P. O. Box 2175
Richmond, Virginia

Watch Repairing Pays Big Money Learn at home

Free Literature Tells How

Watchmakers in big demand. You train step-by-step under experts. You learn to take a watch apart—repair and put in perfect working order. 10 easy lessons. We furnish all tools, and a 15 jeweled watch. Practicemovement with first lesson.



Turn spare time into cash—perhaps a business of your own. A licensed school. Students 18 to 65 have profited by our training. Low cost.

Write Today for All the Facts—No Obligation

ILLINOIS SCHOOL OF WATCH REPAIRING

2870 Elston Ave., Dept. PM-9, Chicago 18, Ill.

BURN WATER IN YOUR CAR

Complete Outfit For Less than \$3.00

Fits All Cars

At Last! It's no longer necessary for you to pay high prices for a water-injection system for your car. You can make one from materials which can be purchased in any hardware store for about \$3.00! Special tools are not required — it's easy! Best of all, your car will perform better and you will get more miles per gallon of gas.

Complete set of plans, showing just what you need and how to assemble and install — only \$1.00 postpaid! Satisfaction guaranteed or money refunded. Get that extra power out of your car! Send \$1.00 today and complete plans will be rushed right back to you.

ECON-O-MATIC, 9048 Via Amorita, Downey, California

SAY YOU SAW IT IN
POPULAR MECHANICS

RADIO ENGINEERING, Broadcasting, Television, FM, Servicing, Electronics, Aviation, Marine & Police Radio taught thoroughly. Engineering course equivalent to 3 years' college radio work. Approved Veteran Training. Catalog free.
VALPARAISO TECHNICAL INSTITUTE, Dept. D, Valparaiso, Ind.

Amazing Invention Defrosts Refrigerators

AUTOMATICALLY

**Pays Salesmen Up To
\$210.00 a Week!**

No wonder our salesmen are getting so rich and happy, with 29,000,000 eager prospects for the sensational Patented D-Frost-O-Matic that defrosts refrigerators. Every Night without much fuss or bother. Saves electricity, wear on refrigerator, food and work.

You, too, should make up to \$210.00 a week on our FREE TRIAL plan that clinches up to 4 orders out of 5, paying you up to \$7.00 each.

Start Spare Time. Yes, just a few hours

in an evening should pay you up to \$18.00

PROFIT! Just plug in D-Frost-O-MATIC — women won't let you take it out.

Profits Guaranteed. No risk — if you don't find this the most fascinating, best paying business you ever heard of.

Rush name and address on postcard TODAY for generous FREE TRIAL plan.

D-Frost-O-Matic

Dept. PMS-9, 6 N. Michigan
Chicago



END THIS FOREVER

SAY YOU SAW IT IN POPULAR MECHANICS

Learn BAKING At Home

Baking is one of America's high industries in wages. Nearly depression-proof. Thorough basic home course lays sound foundation. If you have aptitude, write for FREE BOOKLET. "Opportunities in Commercial Baking."

NATIONAL BAKING SCHOOL
835 Diversey Pkwy. Dept. 1356 Chicago 14, Ill.



**PLEASE
SEND ME**

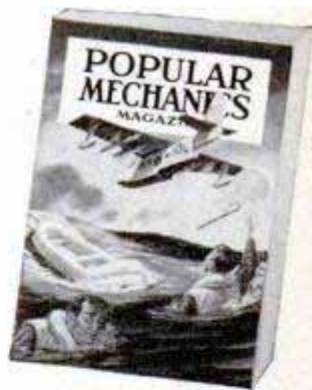

for the
time checked.
I am enclosing . . .

1 year \$3.50
2 years \$6.00

name _____
address _____
city _____ zone _____ state _____
PMB-9

Hand this order to your newsdealer or send it to

POPULAR MECHANICS
200 East Ontario St. Chicago 11, Ill.

For pleasure... or profit

A NEW METHOD



LEARN TOUCH-TYPEWRITING IN ONE DAY

Here's an amazing new system for learning touch-typewriting at home in a matter of hours. The new scientific Tuch-Rite Method does away with old-fashioned drill exercises.

The course includes the unique, patented, Tuch-Rite Keyboard. Takes the place of a typewriter during first few lessons. The new I. C. S. Course offers you a quick, easy, inexpensive way to master typing. Cost . . . \$25.

WOODWORKING A comprehensive course in home-workshop practice. Includes sections on selecting and ordering lumber, operating power tools, joinery, finishing. If you work with wood, this is the course for you. Cost . . . \$25.

LEATHER CRAFT From simple bookmarks to beautifully intricate pistol holsters and weekend bags, this course takes you step-by-step through the art of leather tooling and carving. 40 projects. An ideal course for those who want to start a new hobby. Cost . . . \$25.

HAND WEAVING Hand-loomed textiles command high prices, are fun to weave. Here's a course that shows you how in simple, illustrated lesson form. Includes plans and instructions for building your own loom. Cost . . . \$25.

GRAPHIC ARTS An introduction to modern printing methods. With this course to guide you, you can set up your own small print shop, turn out programs, display pieces, Christmas cards, even bound books—for fun or profit. Cost . . . \$25.

HOW TO MAKE MODERN JEWELRY By the time you complete this course, you'll be making pins, bracelets, rings, etc., from sterling silver and other metals—jewelry that sells on sight. Excellent training for beginners and experts alike. Cost . . . \$25.

HOUSEHOLD MECHANICS Every home-owner or home-builder will find hundreds of ways to save money and improve his home as he studies this course. Detailed, practical, extremely helpful and worth far more than it costs. Cost . . . \$25.

DRAWING Develop your talent and make it pay. This course is presented in two forms: model drawing for beginners, figure drawing for advanced students. Expert criticism of all lesson work submitted. Cost . . . \$25.

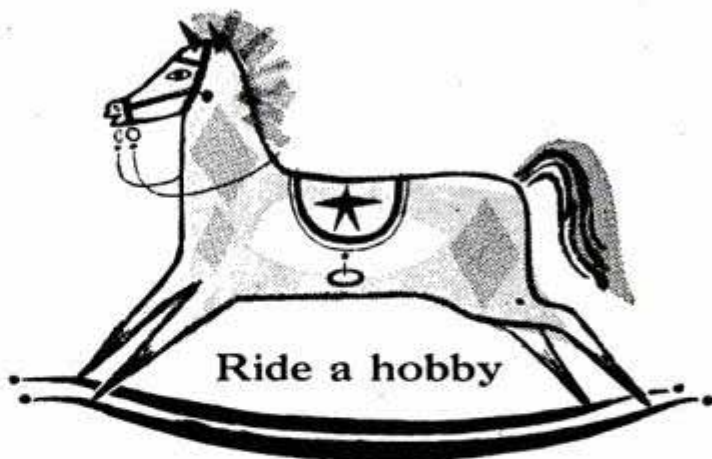

Are you interested in new ideas, new markets for the things you make? Can you benefit from the expert advice of leading craftsmen?

Then you'll want to know more about the new I. C. S. home-study Hobby Courses.

These courses are complete, practical, up-to-the-minute. They bring you detailed, step-by-step instructions, fully illustrated text material, plans, blueprints, profit-making projects and *personalized* guidance and instruction service. All at the low cost of \$25 for each multi-lesson course.

Complete information will be sent to you without cost. Just mark and mail the coupon below.

INTERNATIONAL CORRESPONDENCE SCHOOLS



Box 5510-L, Scranton 9, Penna.

Please send me complete information about the home-study Hobby Course checked below. I understand there's no obligation.

TUCH-RITE TYPEWRITING

- | | |
|--|--|
| <input type="checkbox"/> WOODWORKING | <input type="checkbox"/> MODERN JEWELRY |
| <input type="checkbox"/> LEATHER CRAFT | <input type="checkbox"/> HOUSEHOLD MECHANICS |
| <input type="checkbox"/> HAND WEAVING | <input type="checkbox"/> DRAWING, Beginners |
| <input type="checkbox"/> GRAPHIC ARTS | <input type="checkbox"/> DRAWING, Advanced |

Name _____ Age _____

Address _____

City _____ State _____

EXTRA MILES

PLATED WITH
SOLID CHROME

Alternate HiPressure
spring packed with
each Chrome Oil
Stopper for positive
oil control even in
badly worn engines.

of top engine performance with PERFECT CIRCLE'S

2 IN 1 CHROME PISTON RING SET

Double the life of cylinders, pistons and rings

It's **amazing**—and it's true! Perfect Circle's 2-in-1 Chrome Set gives thousands of extra miles with sustained power and positive oil control.

FIRST, because solid chrome plating on BOTH top compression and oil rings gives unequalled protection against wear, and actually *more than doubles the life* of cylinders, pistons and rings!

SECOND, because two expander springs, **NORMAL** and **HIPRESSURE**, are packed with every Chrome Oil Stopper—giving a choice of spring pressures to assure positive oil control regardless of cylinder condition!

ASK YOUR DOCTOR OF MOTORS, your favorite mechanic, to install a 2-in-1 Chrome Set in your car.

Perfect Circle

The Most Honored
Name in



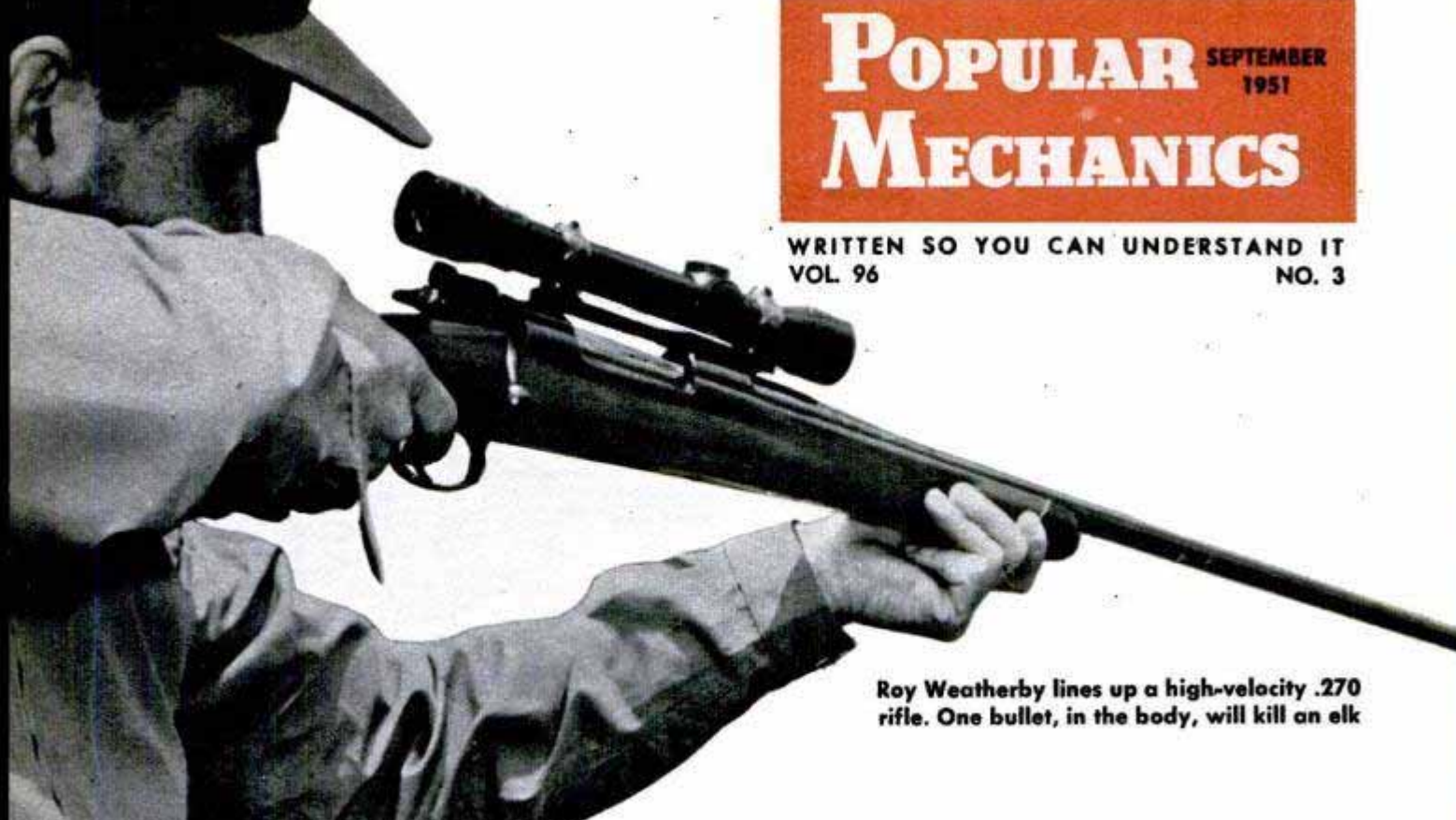

Roy Weatherby lines up a high-velocity .270 rifle. One bullet, in the body, will kill an elk

The HUNTER'S BIG WALLOP

By *Thomas E. Stimson, Jr.*

WITH ONE OF the new high-velocity rifles you can kill any animal in the world with one shot. You can chop down a tree six inches in diameter or shoot right through armor plate barely dented by a bullet fired from an ordinary rifle. Modern high-velocity weapons are the most powerful sporting guns ever built.

Targets are actually larger for them because it's no longer necessary to hit an animal in a small, vital spot. A bullet placed anywhere in the body area usually causes instant death. A five-ton elephant is about the only exception; it must still be hit in the heart or brain.

According to one report, high velocity can actually kill an animal without touching it. There's a story that several years ago one of the armed forces fired an experimental high-velocity bullet at a muzzle velocity of 12,000 feet per second. It was aimed to graze the hair of an animal. The bullet didn't touch the skin, yet the animal dropped in its tracks. Death was ascribed to vibration from the grazing bullet, which

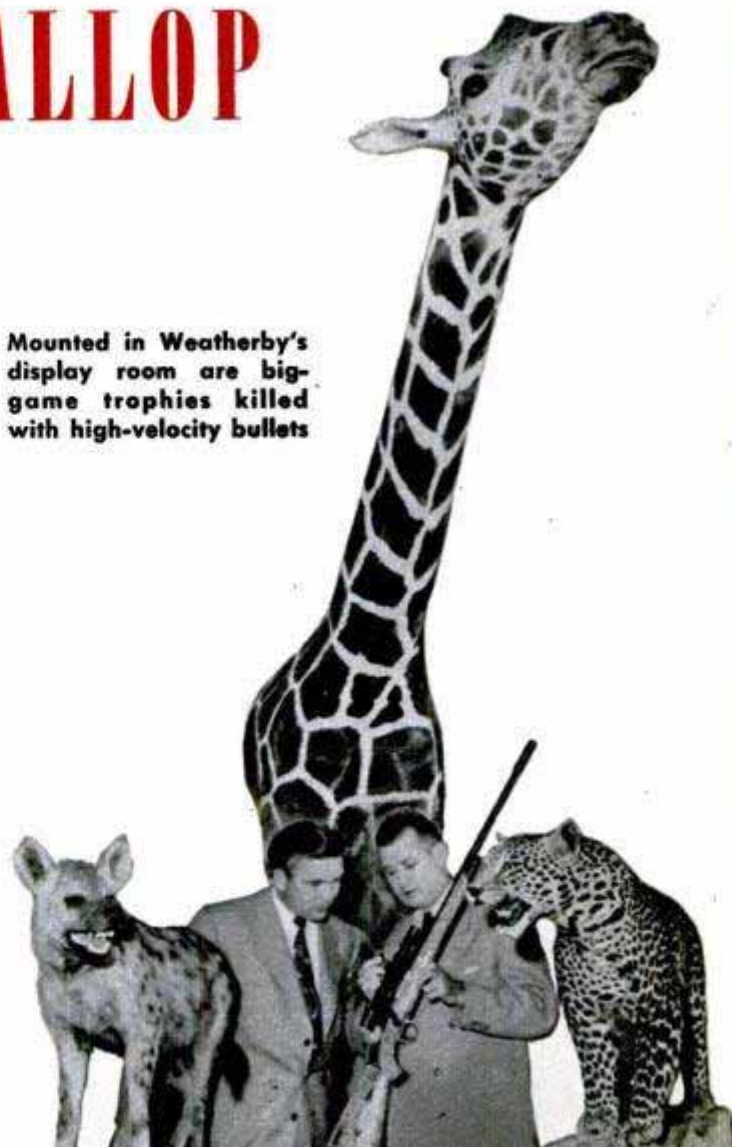

Mounted in Weatherby's display room are big-game trophies killed with high-velocity bullets

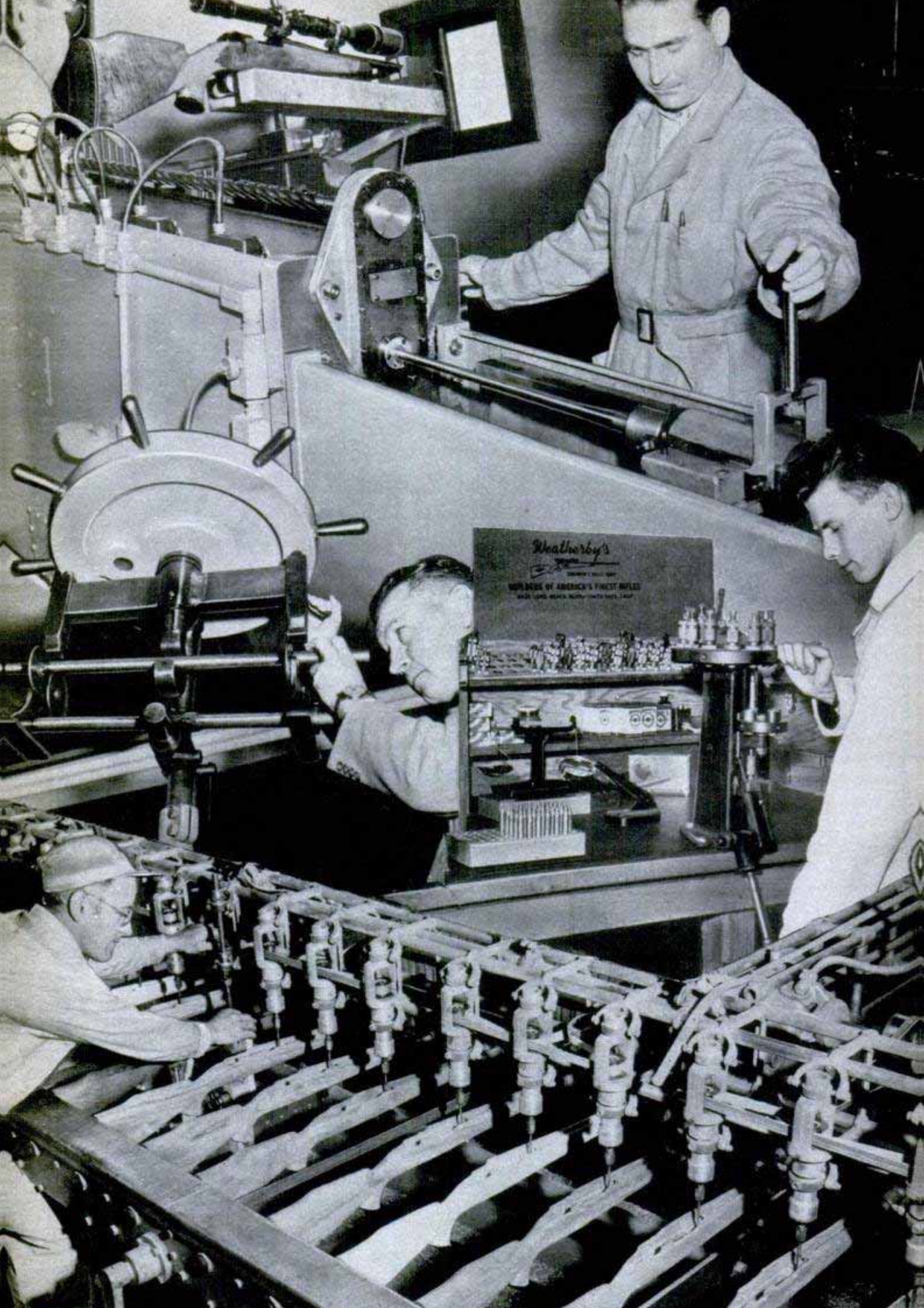

Right, instrument measures muzzle velocity of new rifle. Below, test-fire range extends underground

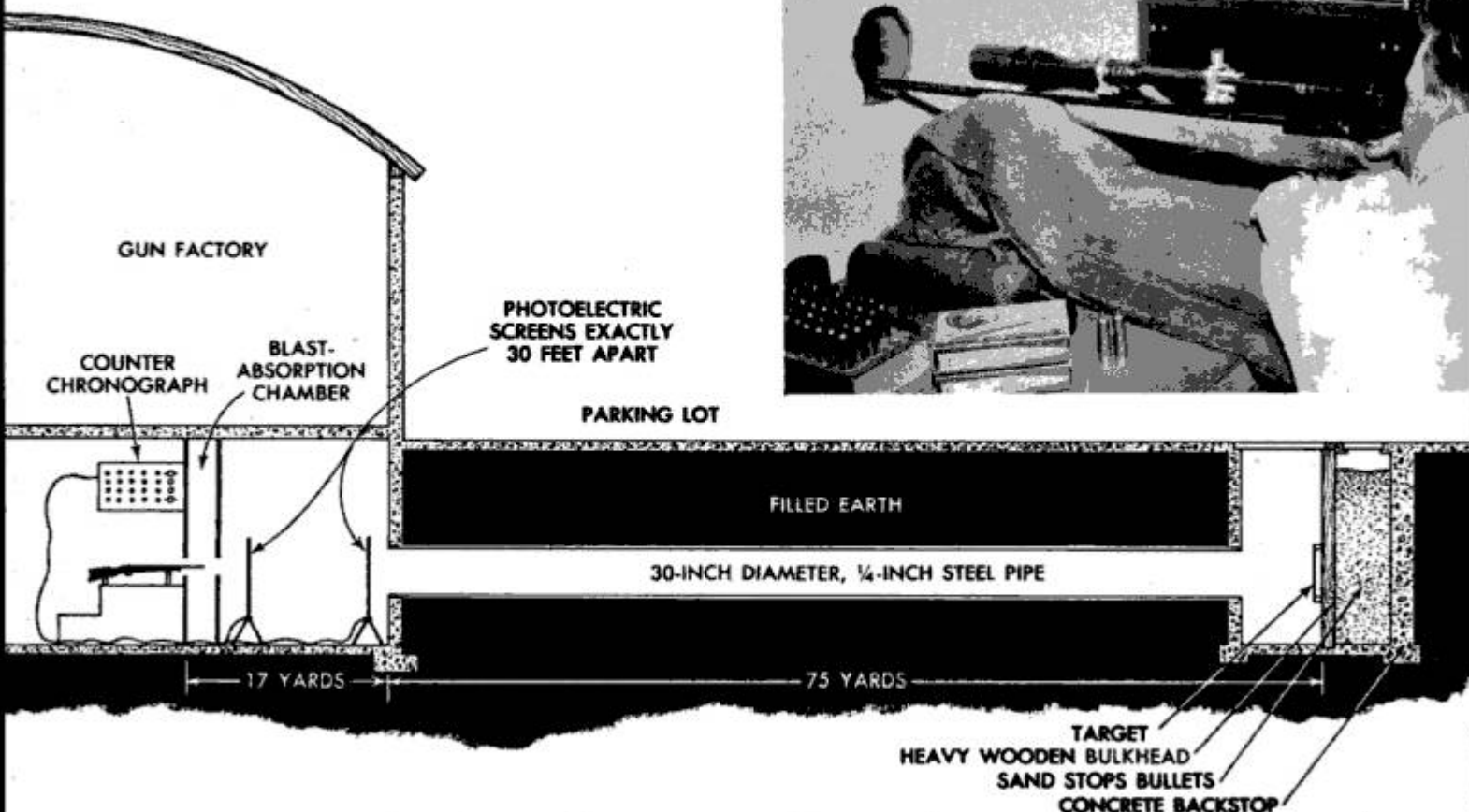

was strong enough to shatter the animal's nervous system.

What is a high-velocity rifle? It's one with a chamber reamed out to take a large cartridge that contains much more than the standard charge of powder for its caliber. This overload gives the bullet greater velocity. The bullet leaves the muzzle at 4000 feet per second instead of 3000 feet per second, to cite one comparison between guns of .257 caliber. Not only does the bullet move faster, it follows the line of sight more closely. You don't need to aim so far in front or hold so high above the target when shooting, say, at a running deer.

Specifically, a .300 Weatherby high-velocity bullet has a drop of about seven inches at 300 yards. A 30-06 bullet of the same weight has a drop of almost twice as much. The .300 Weatherby requires 0.284 seconds to travel 300 yards as against 0.348 seconds for the 30-06. A deer running at 20 miles per hour across a field 300 yards away would travel about two feet in the interval between the bullets.

A high-velocity bullet slows down after a few hundred yards, of course, and for the rest of its flight its characteristics are similar to lower-velocity missiles. But if it hits an animal while still traveling at super-speed it literally blows up in the target.

Opposite page shows various stages in making the superrifles. Top left, scope is matched to rifle. Top right, rifling is cut in barrel. Center left, barrel is checked for straightness. Right, loading high-velocity cartridges. Bottom, shaper cutting 18 stocks at once

The animal receives a tremendous punch and dies instantly.

Big-game hunters who use high-velocity rifles report experiences like these: "Killed a 1500-pound Kodiak bear with one shot." "Just returned from Africa where I got elephant and Cape buffalo with one shot each." "The bull elk that I got in Canada dropped as if hit by lightning." "I'm killing hawks at 300 yards."

The arms companies realize the importance of high velocity, and most of today's standard hunting rifles have muzzle velocities that are at least several hundred feet per second faster than earlier models. Eventually nearly all mass-produced sporting rifles will be of the high-velocity type. Today, however, if you want the ultimate in high velocity, you must get your weapon from an independent gunsmith or one of the small factories that specialize in custom-built guns.

One headquarters for such weapons is a new \$250,000 factory recently opened by Roy E. Weatherby in South Gate, Calif. In addition to building high-velocity sporting rifles, Weatherby rechambers standard rifles to take his magnum cartridges. At present he is turning out nearly 200 guns per month in the following calibers: .220, .257, .270, 7mm., .300 and .375. Although the muzzle velocities of his guns are higher than any others except a few experimental rifles, pressures do not approach the danger point with the barrels and actions that he uses.

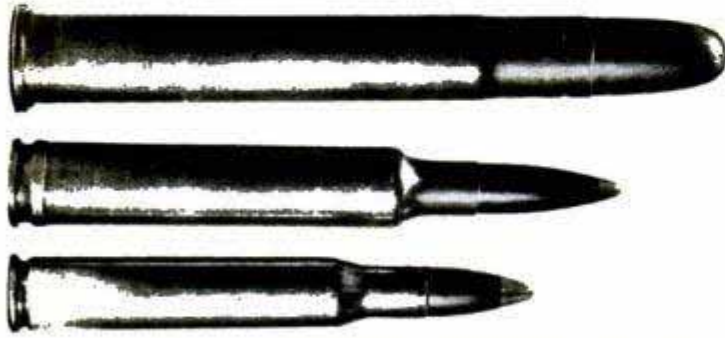
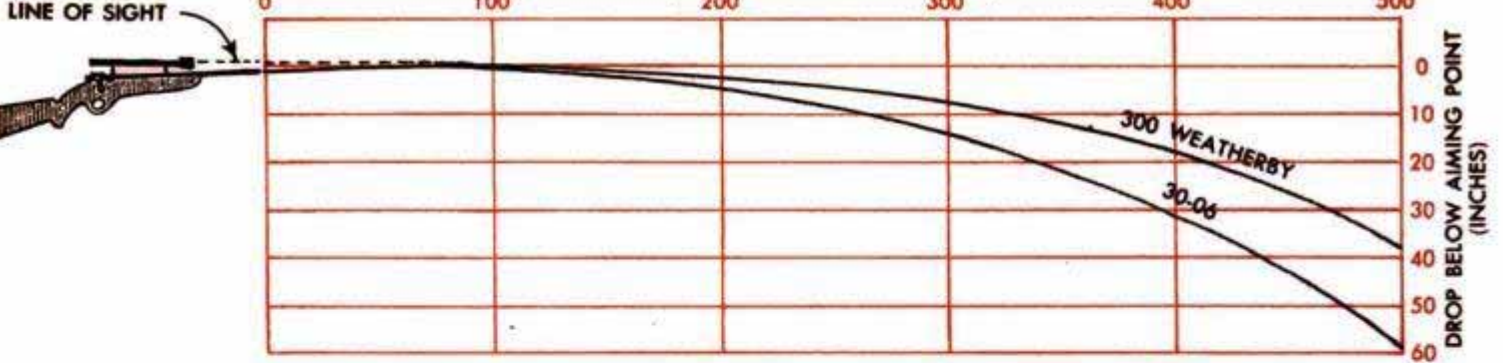

Diagram shows comparatively flat trajectory of a high-velocity bullet, compared with ordinary bullet. Left, .300-caliber magnum is more lethal than .475-caliber above it, far more deadly than 30-06 below

His .300 Weatherby magnum, for instance, has a muzzle velocity 500 feet per second faster than other makes of .30-caliber rifles, using bullets of the same weight, and is 700 feet per second faster than a stock 30-06. At 250 yards the bullet from one of his .300 magnums has almost as much striking energy as a bullet from a 30-06 has at the muzzle.

On a recent trip to Africa to test his weapons personally, Weatherby found that one of his .300 magnums outperformed the

heaviest English elephant gun, a 15-pound weapon that fires a 500-grain bullet of .475 caliber. Weatherby's gun weighs half as much and the bullet weighs only 180 grains, yet has far more killing power. The difference is in the muzzle velocity—2200 feet per second for the elephant gun, 3400 feet per second for the magnum.

For almost all game, except elephants, Weatherby was a dead shot with a .257 magnum using 72 grains of powder to propel an 87-grain bullet. With this weapon he dropped buffalo, zebra and eland with one shot per animal.

Weatherby is strictly a custom builder of fine weapons and his guns aren't cheap. His magnums cost \$235 to \$700, or even more, depending on the kind of wood used for the stock, the amount of decorating and the cost of hunting telescope. Virtually all high-velocity guns are built to take a scope because with these guns a hunter expects to hit game at such great ranges that he needs magnification for accurate sighting.

There's one way to get a high-velocity rifle at much less than the cost of a custom-built weapon. If you happen to own a good, modern bolt-action rifle you can have it rechambered for the heavier Weatherby loads at relatively low cost. Among the guns that can be converted are the Models 54 and 70 Winchesters in various calibers; Models 30S, 720 and 721 Remingtons; 30-06 Springfields with serial numbers above 800,000; 1917 Enfields; Mausers; the .220 Swift and a few others. The price of converting a Springfield is \$33 and includes rechambering the barrel, lengthening the magazine and altering the bolt face.

Weatherby builds all parts of his rifles except the actions and the scopes. The actions are mostly European Mausers built to his specifications. The scopes are selected by the customers. His barrels are chrome-plated inside and then burnished and lapped to a mirror finish, providing a smooth-as-glass surface highly resistant to powder erosion.

Bar of steel on right becomes finished barrel at left. Expensive stock is California mesquite



The hand-finished stocks are made from woods that range from inexpensive walnut to bright-grained California mesquite. One of the latter, carved, sometimes brings \$300 exclusive of barrel and action. Each such stock is tailored to the hunter who is to use it.

Weatherby proof-fires each new barrel and action in his underground shooting range that extends out under a parking lot adjacent to the factory. The muzzle velocity of bullets shot from the gun is measured by an electric counter-chronograph set up on the range. Then the gun is sighted-in for a specified distance so that it hits in the bull at the yardage desired. A paper target through which a number of shots have been fired to demonstrate the accuracy of the weapon is furnished the purchaser with the gun. Weatherby manufactures and distributes ammunition for his magnum guns, and the shells may be hand-loaded for reuse.

High-velocity weapons aren't of much use against small animals and birds except for extermination purposes. A crow or a hawk practically explodes when hit by a fast bullet. Similarly, a fast missile destroys considerable tissue when it hits a deer or moose. But, as Weatherby points out, it's better to lose a small part of a big-game animal and get an instant kill than it is to cripple the beast with low-velocity bullets and then spend hours tracking him. Modern hunters principally are after trophies, he explains, and the meat that they bring home is almost an incidental of the hunt.

For this same reason a high-velocity gun has no value as a military shoulder weapon. It is actually too deadly for warfare. Aside from the international law that prohibits dum-dum bullets, it's better strategy to cripple any enemy soldier than it is to kill him. The wounded man requires the most care from his own army.

Too, the barrel life of a high-velocity rifle is relatively short because of erosion from the large powder charges. Although suitable for a lifetime of ordinary hunting trips, the barrel of a high-velocity gun would be worn out at the end of a week or so of front-line use.

Weatherby believes that with new slow-burning powders, different priming principles and stronger barrels and actions it will be possible to double the present muzzle velocities of his magnum weapons. When that day comes, of course, a rifle that shoots a large bullet will be virtually obsolete no matter how fast its bullet travels. No one will want to carry a heavy gun that kicks like a mule when with a lightweight rifle he'll be able to kill the biggest game animals on the continent. That day may be no more than 10 years away.



Two .300 magnum shots knocked over this eight-inch tree. Below, when bullet struck a "bulletproof" aircraft windshield it blew up inside the laminates

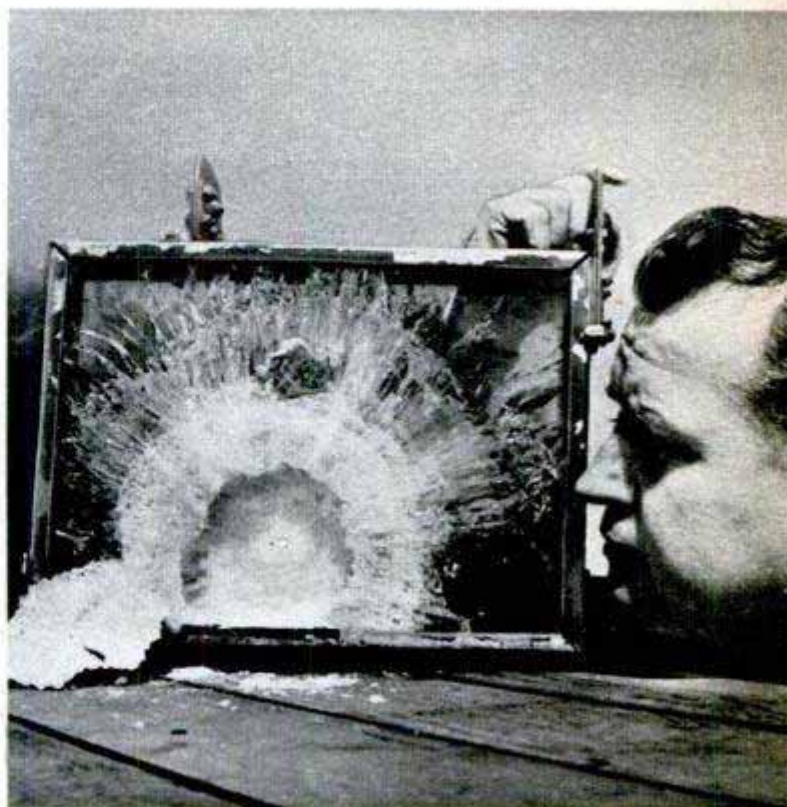



Submarine Sight-Seeing

Sight-seers watch fish, turtles and swimmers in action underwater from the observation deck of an unusual vessel at Rainbow Springs, Fla. The passengers in the boat ride in a steel chamber below the water line, looking into the water through large portholes. The vessel, which looks like a barge from the shore, is powered by a 36-horsepower heavy-duty outboard motor. Fourteen persons can be accommodated in the underwater section of the vessel.

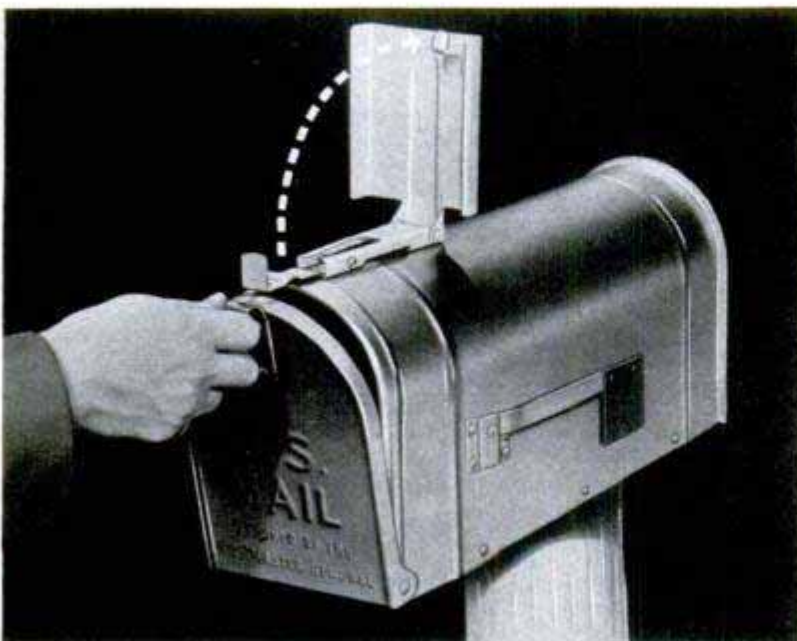

Bright Yellow Indicator Signals Mail Deliveries

Rural mail deliveries are signaled by a yellow indicator that pops up when the carrier opens the box. It saves unnecessary trips to the mailbox. A reflector strip along one side of the steel indicator reduces auto and snowplow damage to the boxes.

Sources of available products described in this issue are listed on pages 12, 14 and 16. Sources of further information on other articles are given in the WHERE-TO-FIND-IT LIST, available from Bureau of Information, Popular Mechanics, 200 East Ontario Street, Chicago 11

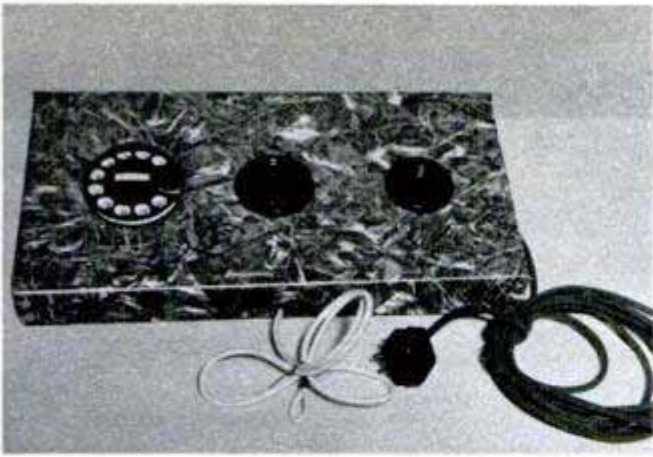

Telephone for Invalid

Up in Winnipeg, Canada, there is a spastic patient who is working as an over-the-telephone salesman even though he cannot move either his arms or legs. Thanks to some friends in the Manitoba Telephone System, this patient, John Cavell, has a special telephone which he operates entirely with his head. To cut into the line, he presses a small button with his chin. Then he dials the number with his tongue on a special dial with reduced spring tension. He rests his ear on the flat-mounted receiver and, from this position, talks into the transmitter. When the call is completed he re-presses the button with his chin to hang up.

Plastic Motorcycle Cover

Motorcycles are protected by a Vinylite plastic film cover that can be rolled into a small package that fits into the saddlebag. The cover is flexible at all temperatures and does not crack or peel.

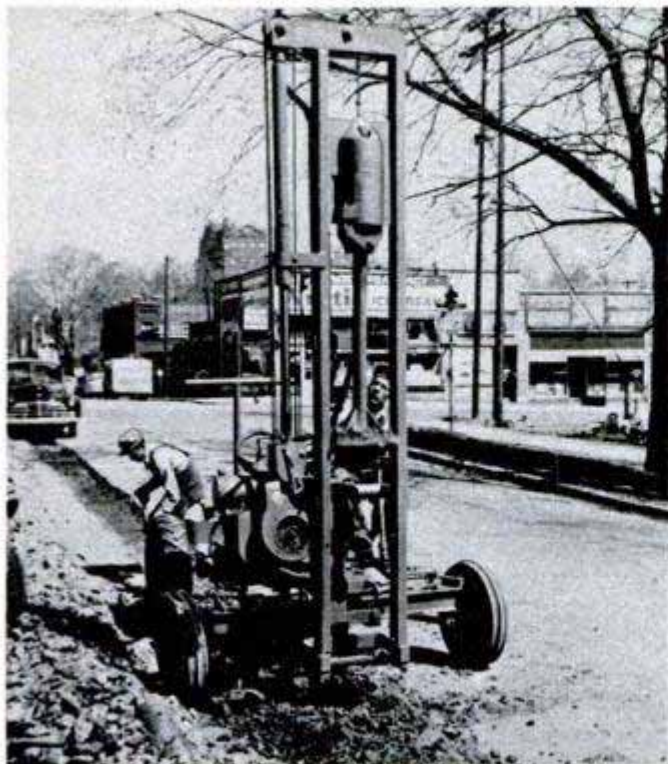

SEPTEMBER 1951

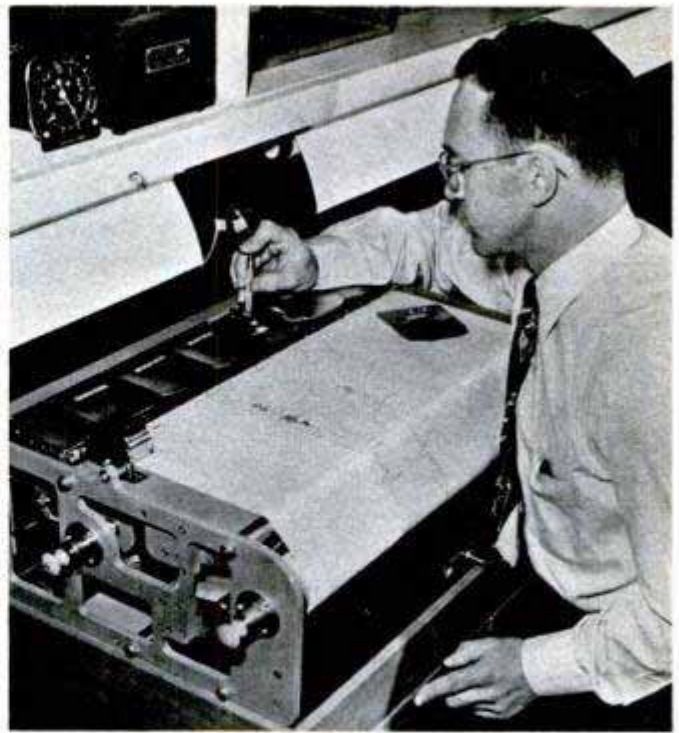

Boeing Aircraft Co.

"Wigglin' Willy"

Six pens writing on moving graph paper enable "Wigglin' Willy" to maintain for engineers a running account of the world's fastest bomber's flight tests. Initial test data on the Boeing XB-47 Stratojet was recorded on 79 indicators and it took two weeks to transcribe the results. One pen on the new machine marks off time intervals on a 150-foot roll of graph paper, while the others record such functions as air speed, angle of pitch, normal acceleration and elevator position. The paper moves at speeds ranging from 1½ to 75 inches a minute, and the information is available as soon as the plane lands.

←Breaker-Tamper

Traveling hydraulically from side to side on a tower, a 400-pound steel hammer makes quick work of pavement breaking. The self-propelled machine can also be used for tamping. According to the manufacturer, it compacts all the material removed when a trench is cut for a new pavement, providing a firm base. Operated by one man, the breaker-tamper does the work of four men with jack hammers.

Human Mineral "Mine"

Human hair, skin and nails contain 19 different metals, according to research conducted at the University of Michigan. Minute quantities of heavy metals such as silver, lead, tin, zinc, iron, copper and aluminum were among those detected. Other metals found were barium, boron, sodium, titanium, strontium, potassium, calcium, phosphorus, magnesium and manganese.

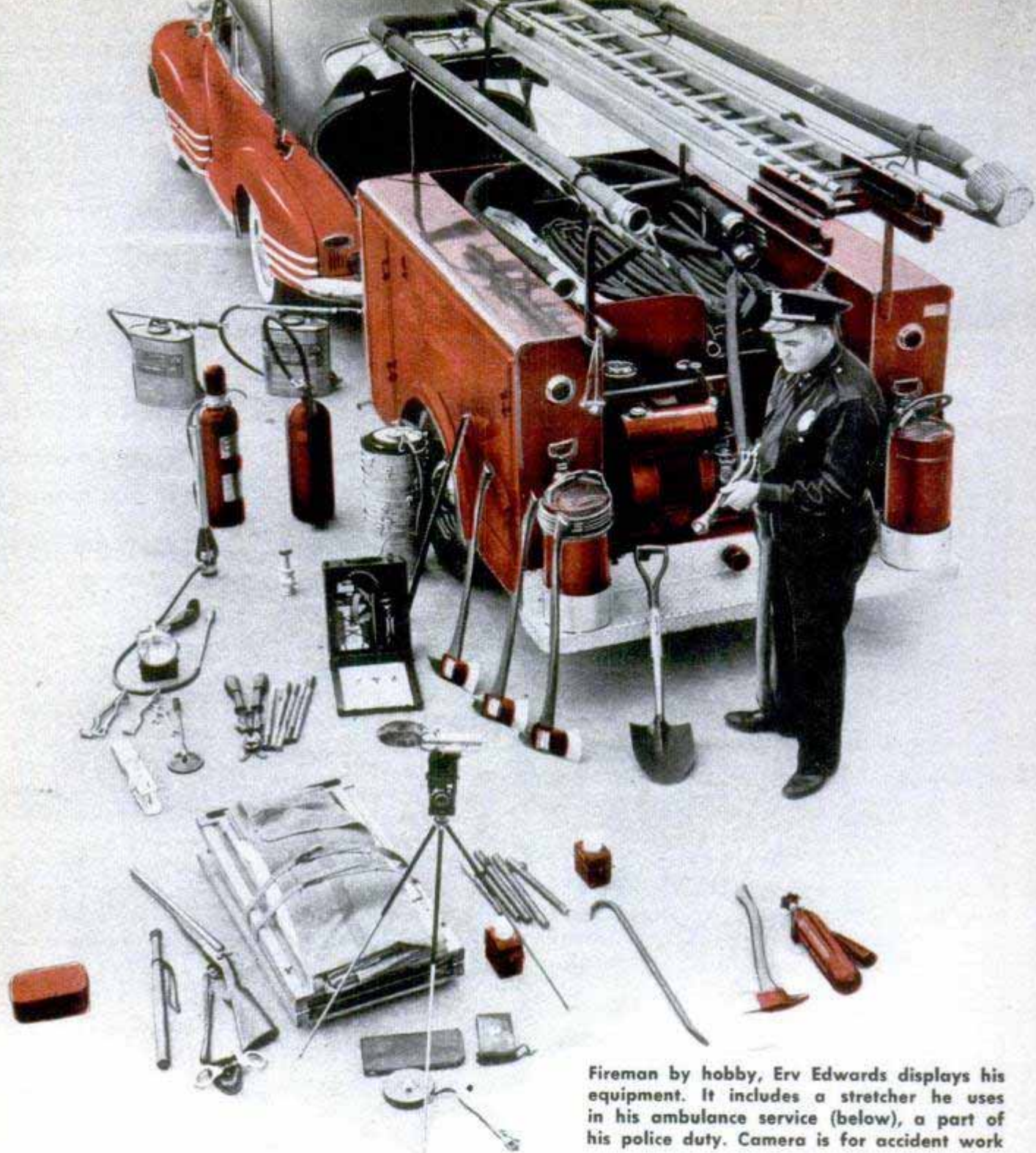

Fireman by hobby, Erv Edwards displays his equipment. It includes a stretcher he uses in his ambulance service (below), a part of his police duty. Camera is for accident work



ONE-MAN FIRE DEPARTMENT

By Al. P. Nelson

FARMERS near Sparta, Wis., are mighty glad that Ervin Edwards is around. And they're glad, too, that he has a hobby, because his hobby is fire fighting.

In two years, he has responded to over 50 farm-fire calls, saving four homes and several farm buildings from total destruction. In addition, he has put out many threatening brush fires.

Edwards earns his living as a Sparta policeman and deputy sheriff. His fire service is free—it's a hobby with him. But grateful farmers often make donations to help pay the bills. Once a year he and his wife put on a dance, the proceeds going into the fire-fighting fund. Farmers always turn out in quantity for that affair.

The one-man fire-fighting organization uses a trailer to haul around the equipment. Packed into the two-wheeled trailer is everything needed to handle all but the biggest fires. Sometimes, Edwards is able to hold down even big blazes until help arrives from a distant city. But his special talent is for putting out fires before they get big. His car has a two-way radio and when a telephone call comes in he gets word of it immediately.

In the trailer are ladders, axes, pails and other equipment including a variety of fire

extinguishers. For large blazes, he uses the portable pump to pour water from a farm reservoir or tank onto the fire.

Edwards brought his idea of a personal fire department to the attention of businessmen and farmers around Sparta a few years ago. They agreed that it was a great idea and raised \$2500 to buy the trailer and its equipment.

But the trailer, with all its efficiency, has limitations and Edwards is planning to get a new truck. It will have a 200-gallon water tank—enough to extinguish a sizable blaze.

Like any hobbyist who is worth his salt, Edwards is never satisfied and is always after new equipment. In his case, however, his hobby has a double payoff—it pays dividends to him and to the community.

Edwards saved this farmhouse from complete destruction. Arrows point to only exterior damage from fire

Fireman Edwards and his hobby are as close as the farmer's telephone. Here the whole fire department is shown in action





Fuel From Waste

European homes may soon be kept warm by a new kind of fuel called Wablo, invented by Franz Herren of Aachen, Germany. Consisting of grease from slaughterhouse remnants and coal or sawdust pressed into blocks, the fuel is said to be useful for domestic and industrial heating. The blocks are manufactured with holes running through them in order to increase their combustibility.

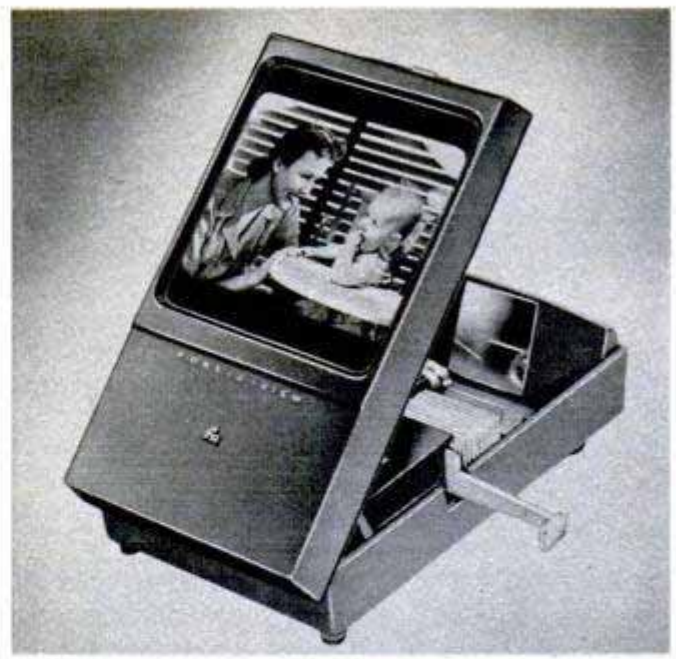

Folding Slide Projector

Folding to a compact size that can be carried in a briefcase, a lightweight slide viewer automatically changes slides at the touch of a plunger. Ideal for salesmen who make slide presentations to small groups, the viewer has a six-inch square screen built into the cover. The slides remain in the changer when the viewer is folded for travel. Illumination is provided by a 50-watt projection lamp.

Tiny Radio Transmitter Relays Data From Rocket

Pilotless rockets, speeding through space miles above the earth, send back data by means of a tiny radio transmitter about the size of a cigarette package. At sea level, its signal travels 20 miles, but above 10,000 feet the range increases to 100 miles. Oper-

ating in the 200-megacycle band, the transmitter has a power output of two watts with low distortion and high stability. The data it relays covers many items, from weather conditions to flight characteristics of the rocket.

Two-Way Phone for Fire Fighters Speeds Instructions



Instructions to fire fighters travel long distances over a two-way phone system that attaches to firemen's breathing masks. It is especially useful when the blaze is some distance from parked apparatus or when heavy smoke obscures the view of assisting crewmen on the ground. Each Maskfone has 125 feet of cable on a revolving reel and cables can be interconnected to span greater distances. No batteries are needed since, in effect, the power is generated by the sound of the speaker's voice.



Supervacuum Bottle

You'll never need anything this cold on a picnic, but scientists at Westinghouse Research Laboratories have developed a supervacuum bottle that keeps really cold liquids cold. It is designed to hold four gallons of liquid helium—the world's coldest liquid—at eight degrees above absolute zero for 100 days. The vacuum bottle consists of two copper spheres. The smaller is placed inside the larger sphere and most of the air between them evacuated. The bottle, with liquid helium inside the smaller sphere, is immersed in a tank of liquid nitrogen where the temperature is 300 degrees below zero. In this manner, heat loss is reduced to a negligible amount.

Bottle Provides Oxygen for Fish

Twice as many live tropical fish can be transported in standard shipping containers if a new chemical bottle is installed to discharge oxygen into the water. Made of Plaxpak plastic, the bottle contains a hydrogen-peroxide solution. Chemical tablets in the top of the bottle are released into the solution shortly before the tank is shipped. A chemical reaction in the bottle discharges oxygen through a tube into the tank.

☐ More than 1,100,000 new motor trucks were sold in the United States in 1950.



Floating Plastic

Honeycombed with tiny nonconnecting air cells, a flexible expanded plastic is molded into life vests and watertight seals around the face openings in Navy battle suits. Being extremely light in weight, the material has great buoyancy. It also has tremendous shock-absorbing qualities and is expected to be used in body pads for athletes. It can be designed into a life vest that will float a stunned man with his face up, thus preventing him from drowning. A similar plastic is used in life rafts, life-ring buoys and other floating equipment. Because of the solid noncommunicative structure, the plastic rafts will not sink even though punctured many times.

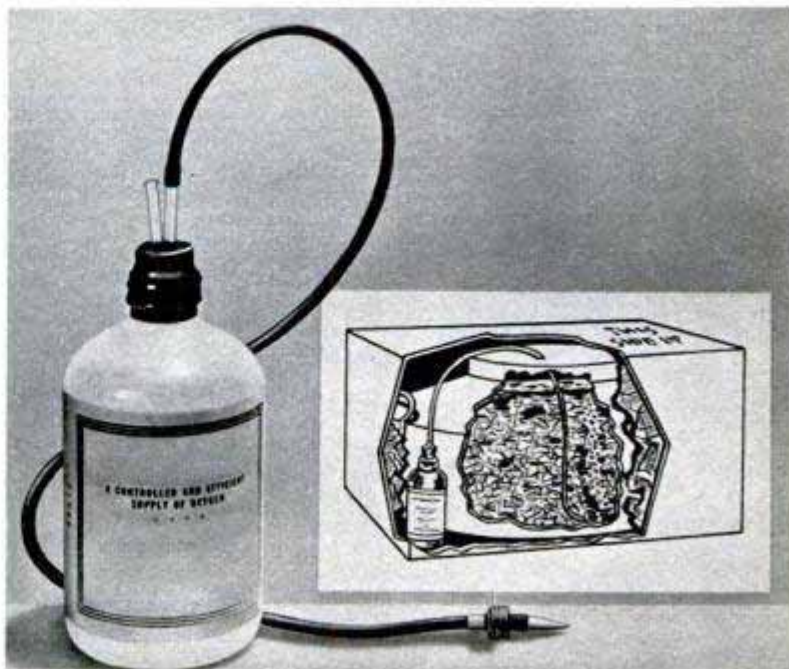

How fast will she go? Jack Brause, in the Stanley Steamer, plans to let her "all out" in the big race

Two old timers will "burn up" the roads from Chicago to New York this month in a trial of the ancient steamer versus the gas buggy. Chicago's Museum of Science and Industry collaborated with Popular Mechanics in readying the 1913 Stanley Steamer and the Stoddard-Dayton of 1911 vintage for the revival.

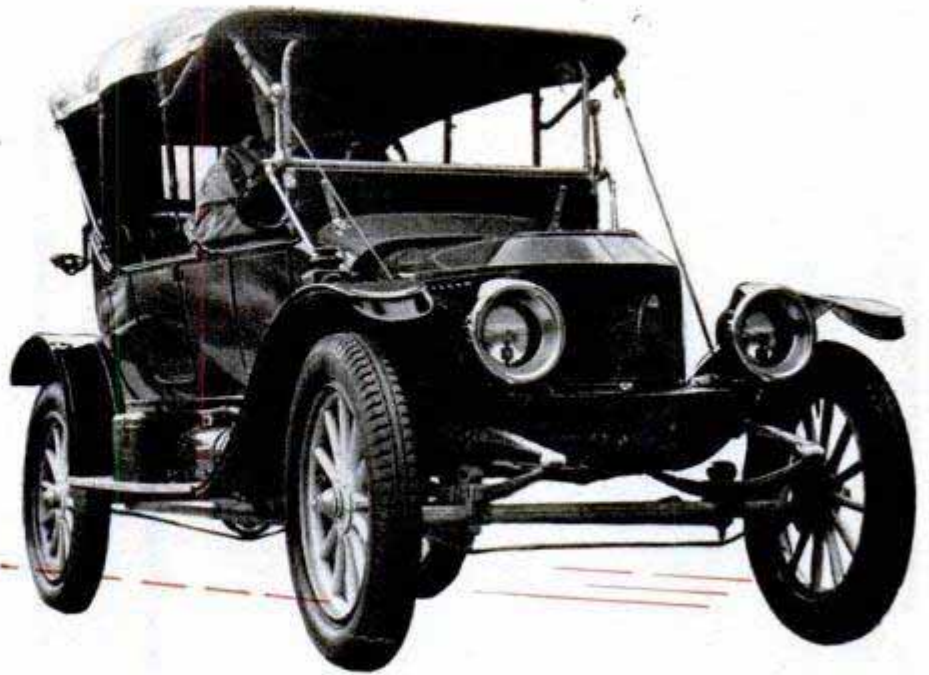

Stand by for the

RACE OF THE

By Aubrey O. Cookman, Jr.

RACING BETWEEN CHICAGO and New York, two perfectly tuned but ancient vehicles this month will attempt to settle an old argument of the automotive world. Could a steamer outrun a gasoline car?

Side by side when Mayor Martin H. Kennelly of Chicago fires the starting gun September 10 will be a 1911 Stoddard-Dayton and a 1913 Stanley Steamer, two out-

Rube DeLaunty, confident he'll win the Chicago-New York dash, checks the plugs on his 1911 "gas buggy"

Some of the cities on the route are shown below. The cars will reach Detroit early the second day

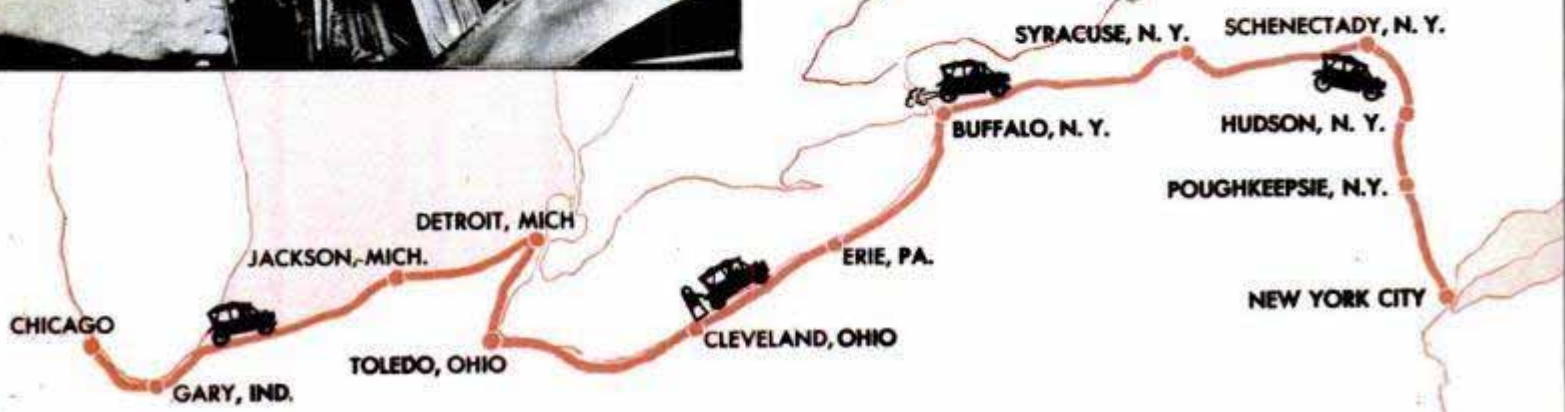
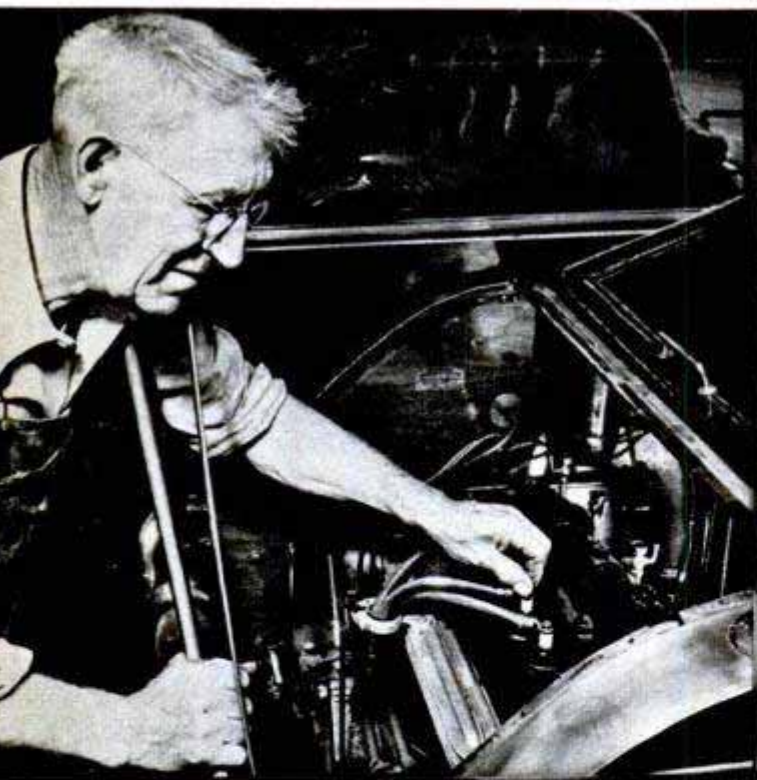

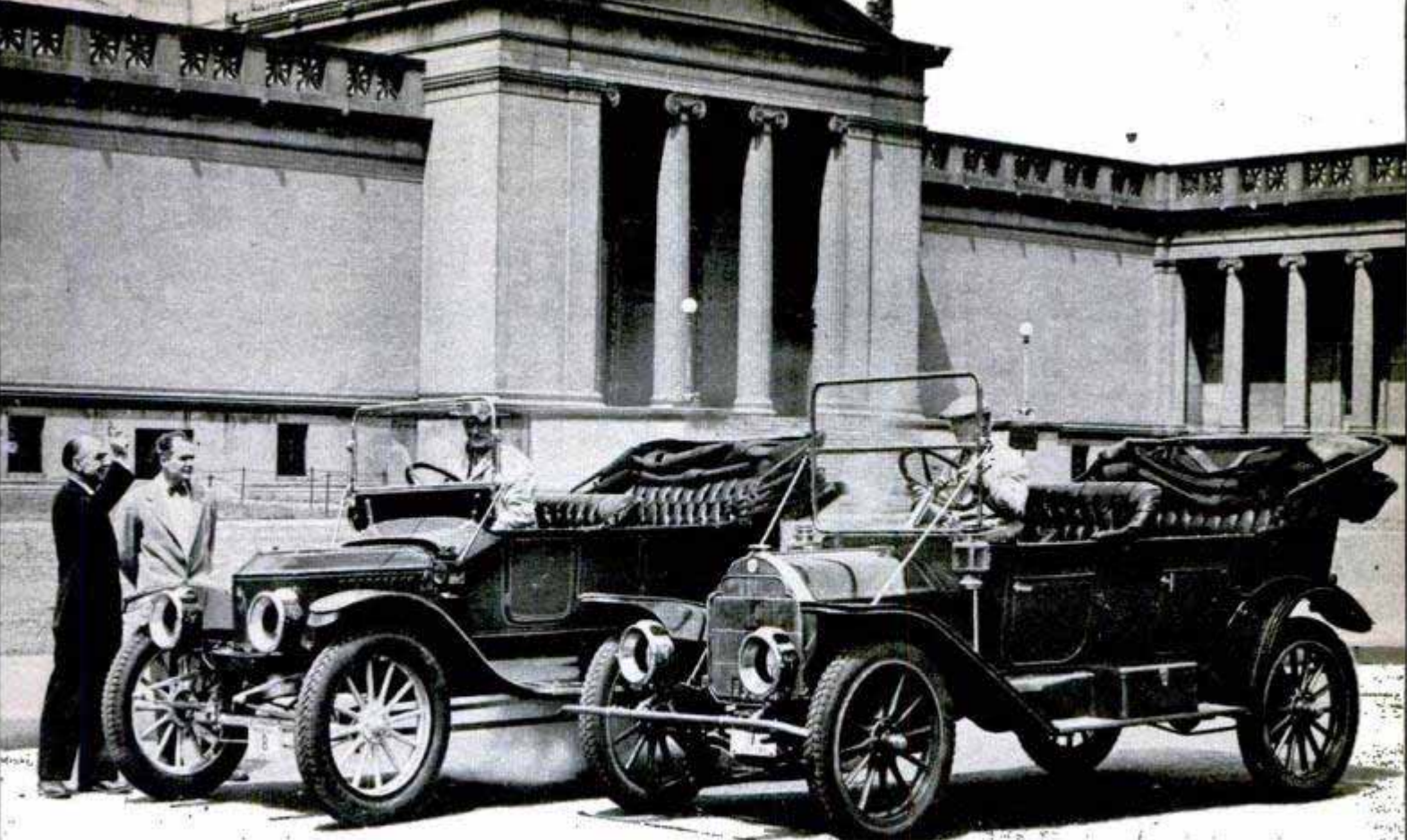

HORSELESS CARRIAGES!

Maj. Lenox R. Lohr lines up the rivals alongside the museum for a practice start. Gas racer is at the right

standing early American cars. Both are owned by Chicago's Museum of Science and Industry. Their 1061-mile race is being sponsored by *Popular Mechanics* Magazine as a preliminary to the celebration of its 50th anniversary next year.

Though the last steam-automobile builder stopped production many years ago, die-hard steam adherents have never conceded that the gasoline car is superior. A Stanley, a White or any of dozens of once-popular steamers, they argue, could always outperform comparable gasoline-driven cars. A 1906 mark of 127 miles an hour by a Stanley, they claim, is still tops for vehicles of less than 30 horsepower. "Percolators" of those early days can still pull ahead of modern cars from a standing start.

Many steamcar admirers are convinced that it was mainly the more-aggressive merchandising tactics of Ford, Olds, Willys and others that tipped the scales in

favor of gas buggies. As a clue to the strong competition they once promised, there were over 100 steamcar manufacturers in the U. S. prior to the '20s.

Popular Mechanics' 50th-anniversary race was inspired by endless steam versus gas-power arguments of two elderly museum mechanics. Rube DeLaunty, 69 years

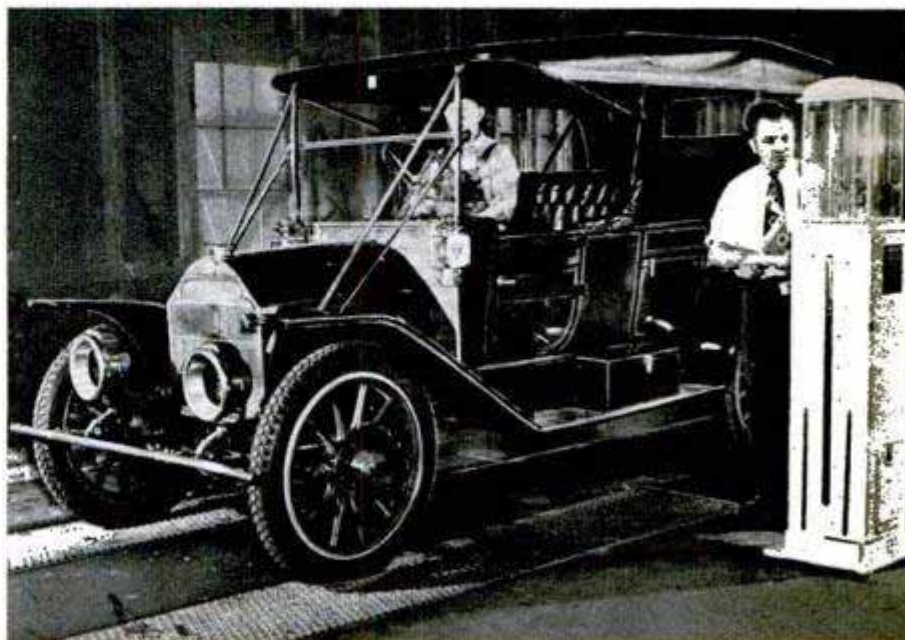

DeLaunty gets the brakes checked at a Chicago vehicle-safety-inspection station

Only expert eyes could identify the assortment of scrap at left, carted in from an Iowa farmer's barn, as the remains of a once-popular 1910 McIntyre car

After months of shop labor, the rusted metal heaped above emerges as the complete, polished car below, in the museum's photo studio



old, and Jack Brause, 76, specialize in restoring for both display and operation some 300 domestic and foreign cars, one of the world's finest collections. Both were in the fledgling automobile industry even before the turn of the century. Since then they have driven or worked on virtually every popular car built.

Neither has much respect for the other's favorite form of automotive power. Rube sneers at the suggestion that the steamcar ever had anything to offer. Jack is equally contemptuous of the gas burner's success.

Learning of the heated controversy, *Popular Mechanics* offered to sponsor a cross-country race that would put the opposing arguments to a decisive test. Rube accepted and said he could win, hands down, with a 1911 Stoddard-Dayton. Jack is already planning a victory speech on behalf

of the 1913 Stanley Steamer he will drive. In addition to public vindication of his claim, each will be spurred on by a \$500 prize for the winner.

Scoring in the race will be based primarily on the shortest elapsed running times between nightly check-in points at Jackson, Mich.; Cleveland, Ohio; and Buffalo, Syracuse and Hudson in New York. Walkie-talkie equipment will keep observers in each of the race cars in contact at all times. An estimated 17 million people along the way will have an opportunity to see the competitors before they reach Rockefeller Center in New York City on Saturday, September 15.

Maj. Lenox R. Lohr, president of the museum and an outstanding authority on early automobiles, and the author will act as judges for any disputes that may arise

during the 1061-mile-long race.

DeLaunty will use a crank to start his four-cylinder gasoline job. Brause will get away swiftly, once 500 pounds of pressure are generated in the Stanley's boiler by a gasoline fire. He'll have to replenish the water in the boiler about every 40 miles. Both mechanic-drivers report their cars are in A-1 running shape, as good as they were four decades ago.

The two colorful old-timers are ideally suited for their roles as protagonists of these rival means of automotive propulsion. Like most of the ingenious tinkerers who kept those first horseless carriages running, Rube was a machinist. His first job was with the Woods Company, building electric automobiles. Later, his own shop in what is now Chicago's Loop became a mecca for motorists with balky new mechanical steeds.

As a sideline, he acted as an "agent" or dealer for many pioneer car makers, including the then popular Locomobile. Agents weren't easy to get and Rube represented them all at the same time, showing whatever advertising materials and price lists seemingly were suited to the wants and pocketbook of the prospect. Demonstrator and display cars were unheard of then because the meager output generally lagged weeks or months behind sales.

He also served as a troubleshooter for the manufacturers. If a man in Milwaukee, for instance, complained that he couldn't operate the car, or that it wasn't running satisfactorily, Rube would be dispatched to iron out the difficulties. Sometimes the builder had neglected something minor but vital, like providing an air hole in the gas tank, and a few turns of a drill or wrench erased the problem.

Tales of his motor magic finally got to millionaire merchant John G. Shedd, of Marshall Field and Company, who was then making the bold switch from horses to autos. Having Rube around full time appealed to him as the perfect antidote for the uncertainties of the newfangled transportation. So, in 1904, DeLaunty started a 30-year career

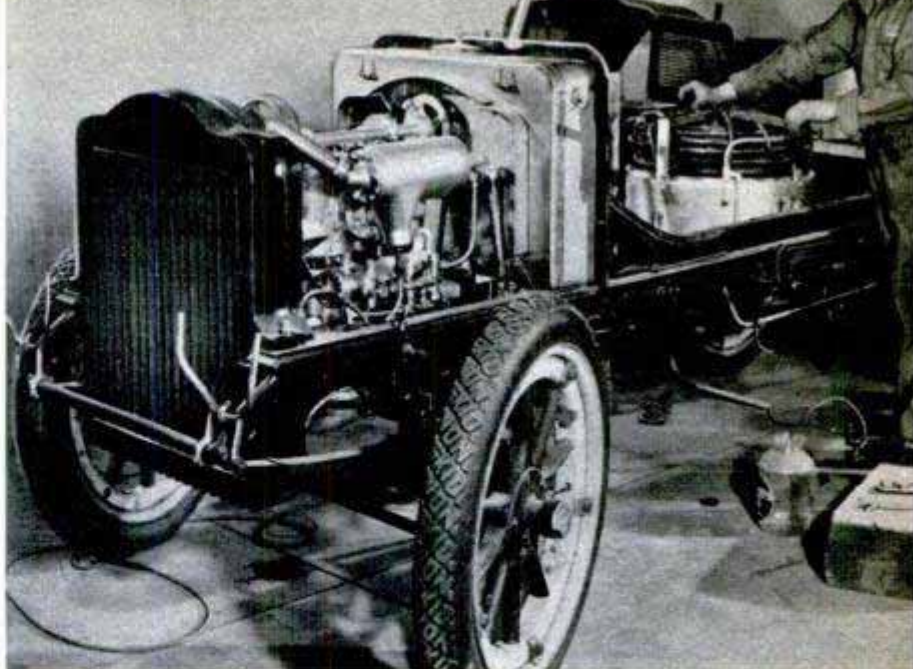

Gradually approaching its original state is this 40-horsepower White Steamer, built in 1906. A White of earlier vintage led the 1905 inaugural parade for Theodore Roosevelt. Below, Ed Komerski of the body shop prepares a horseless-carriage frame for exhibit

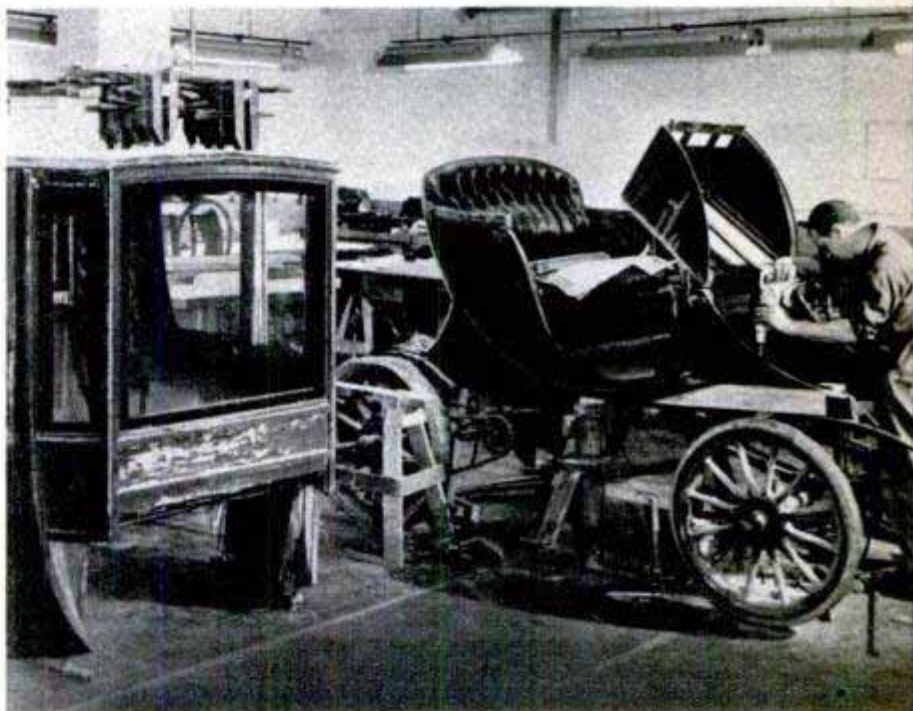

It took four or more strong men to do the job whenever this 1906 Woods Electric "convertible" was ready for its seasonal change

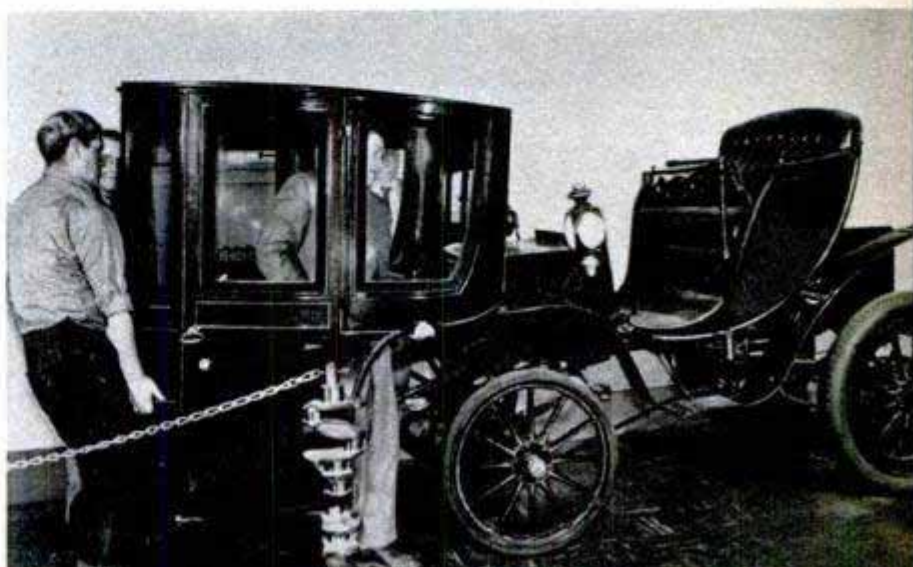



Brause's Stanley Steamer entry will be ready to roll when the pressure in this boiler gets to 500 pounds

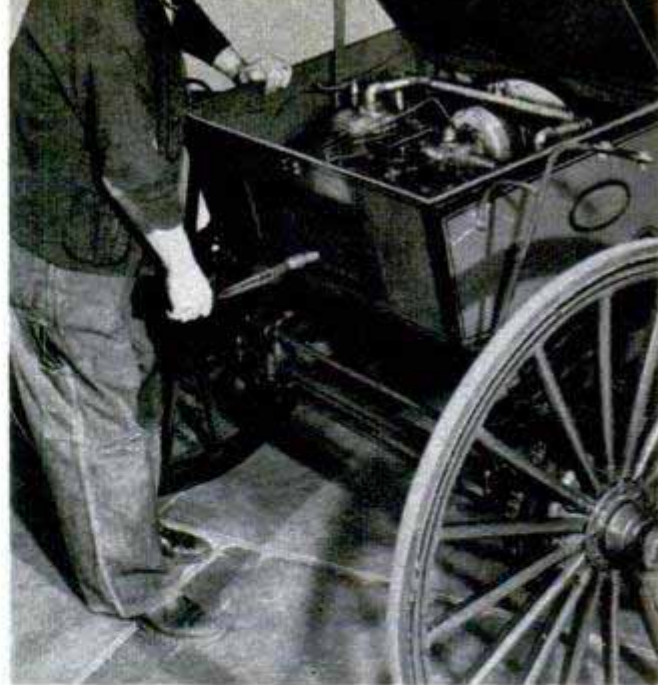

Compact and easily accessible, the power plant of this 1910 Schaact was an early try at rear-engine drive

with the Shedd's as a chauffeur and mechanic. Then, before garages and service stations dotted streets and highways, he spent more time doctoring vehicles so they'd run than he did driving them. The blacksmith shop was the handiest and most dependable place to replace broken parts.

Brause, originally a plumber and steam-fitter, spent three decades with Stanley, probably the most famous of all steamcar companies. Most of that time was spent on the road, selling and demonstrating.

In 1910 the government "borrowed" Jack from Stanley while it experimented in Washington, D.C., with steam trucks for the mail service. He kept the three 10-horsepower test trucks moving on a round-the-clock schedule, each collecting from 1600 storage boxes within 24 hours. Just before Stanley halted production in 1923, Brause bought their Chicago service outlet, operating it until 1927 for the 700 owners of the "orphan" car in that area.

Brause and DeLaunty joined the museum staff near the close of the last war. Their headquarters—the institution's old car factory—sprawls over a large part of the big building's basement. One section, the "graveyard," often has up to 50 old wrecks that have been bought or donated. Many would defy identification as an automobile, except by Rube and Jack, who have a kinship with those paleontologists who can start with one bone and reconstruct entire prehistoric animals.

As one of the museum employees remarked, "If you gave those fellows a hub cap they could build a car around it—except that sometimes they have to make the hub caps, too!"

After a relic is assigned a work priority, usually based on its rarity or its interest as a display item, the car is carried or pushed to the "resurrection center." There the remaining parts are stripped off. Every nut and bolt, including those frozen by rust and age, is removed. Rust on all the parts and what small splotches of paint remain are taken off with a sand blaster or buffed away with a flexible-shaft tool. Finally the car is down to the bare frame and ready for methodical reassembly.

Here is where the long memories and experience of Jack and Rube come into play. They refuse to take similar parts that would work from a storeroom filled with old headlamps, timers, speedometers, ornate radiator caps, carburetors and assorted accessories.

(Continued to page 242)



Eleanore Hall of the museum staff admires a 1911-style station wagon, made by Brush



James L. Kraft, noted industrialist and "rockhound," in his workshop putting final touch to a jade ring

They Make JEWELS at Home

By Wayne Whittaker

THOUSANDS of amateur craftsmen are discovering a hobby that was fascinating to the earliest caveman. That hairy ancestor started it when he picked up a pretty agate pebble along some prehistoric beach, polished it in the sand and presented it to his girl friend. She, of course, showed it to the girl in the next cave who, in turn, gave her male protector no peace until he found a prettier pebble.

Possibly the modern lapidary craze in the home workshop has been spreading in similar fashion. At any rate it has reached

such a peak, especially on the West Coast, that one noted "rockhound"—prospector for gem stones—predicts that in 25 years there will be few gem-quality stones left to pick up.

"All the loose crystalline quartz, chalcedony, agate, jasper, jade and other gem stones now found in the rough will be gone," says James L. Kraft, widely known as America's No. 1 rockhound and amateur lapidarist. "Most of these stones will be piled in basements in another 25 years if the present craze keeps its pace."

Mr. Kraft, who in his "spare" time acts

*Photos by Paul Hutchinson
PM Staff Photographer*

Kraft made the jewels on table from a chunk of variscite like the one shown here. The necklace was made from jade that was picked up in pebble form, polished by the sea, and deposited in a cave at Monterey, Calif.





Mr. Kraft holds a jade butterfly beside display cabinet housing part of his collection. His interest in antique jade (left) led to his setting up a home-lapidary shop and his eventual discovery of fine American jade

as chairman of the board of the cheese company bearing his name, speaks with authority. He is credited with the discovery of American jade. A few years ago when he was proving to the experts that jade did exist in the United States, he discovered a mountain of the stuff in California. He bought the mountain near Happy Camp and made no effort to keep his find a secret. He was overjoyed to find an apparently

endless supply of rough jade of gem quality for his home-lapidary wheels. The word spread and rockhounds from far and near swarmed over his little mountain. Today the top of it is entirely missing—also all the loose jade.

Kraft, like most of his contemporaries, is more concerned with the creation of a piece of beauty from rough stone than the intrinsic value of the gem. He prefers the



This quartz crystal was imported in the rough by Kraft from Brazil. It was cut by an expert into a 280-carat stone with 252 facets, a real beauty



← Brooches made by Kraft rival the rainbow. In front row, the second from right end is a turquoise and the fifth one a stone found on Saipan beach



Photo courtesy of Chatham Research Laboratories

Carroll F. Chatham, who discovered the process for making true synthetic emeralds, inspects emerald crystal

semiprecious stones such as Montana moss agates, variscite, chalcedony, rose quartz, opal, amethyst and, above all, jade. The recent demand for and scarcity of the latter has lifted it almost into the category of a precious stone.

Kraft also collects and works with the synthetic stones, sapphires and rubies, which are chemically identical to the genuine jewels. He thinks titania, newest product of the Linde Air Products Company, is more beautiful than the diamond, which it resembles. Although not so hard as a diamond, it has a higher degree of refraction and dispersion. Like every enthusiast in regard to the new synthetics, Kraft makes a careful

Kraft displays some rough jade and finished products. The chunk in center is Wyoming-gem quality

Earring and ring of this jade set have insets of titania, the new synthetic

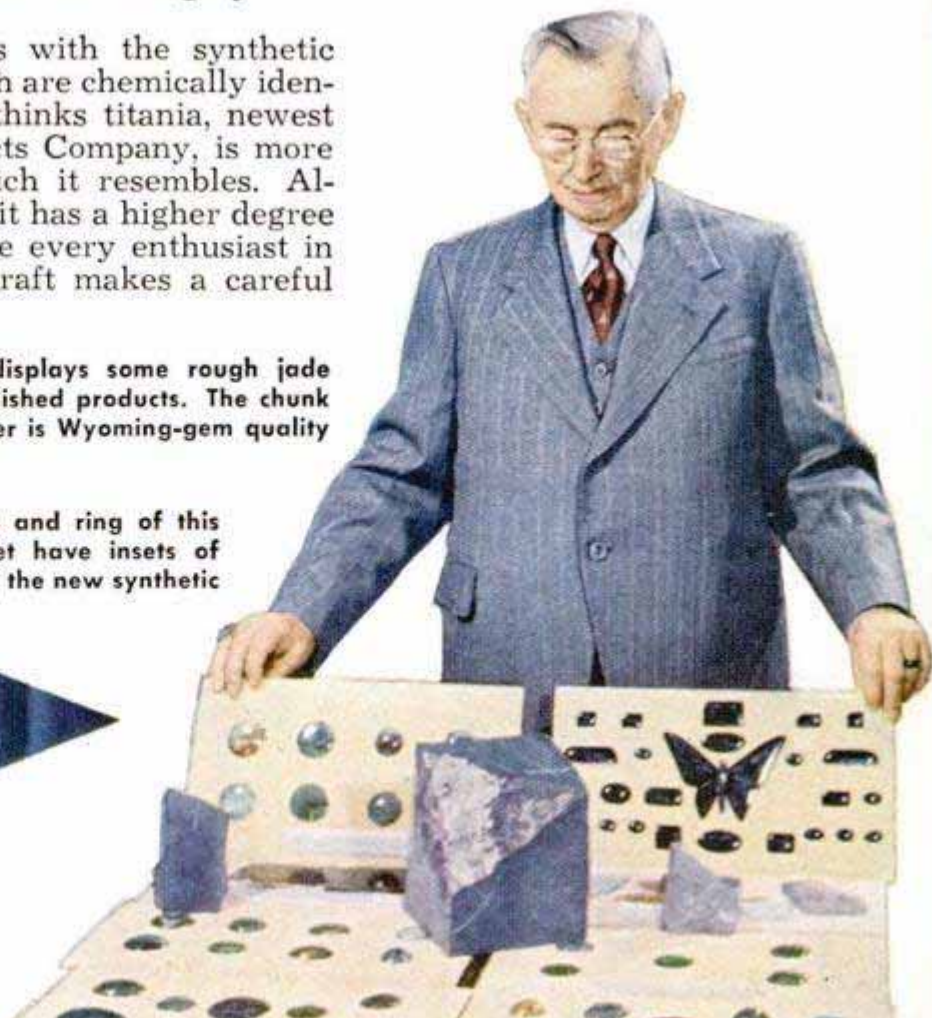



Displayed beside antique jade jewel box are synthetic rubies and sapphires, also a split ruby "boule"



Photo courtesy Linde Air Products Co.

These synthetic sapphires are chemically identical to natural gem. Stones are made from boule at top



Above, model holds carved-jade belt buckle believed to be 5000 years old. Jade ring and agate bracelet were made by Kraft. Below, some synthetic rubies

Photo courtesy Linde Air Products Co.

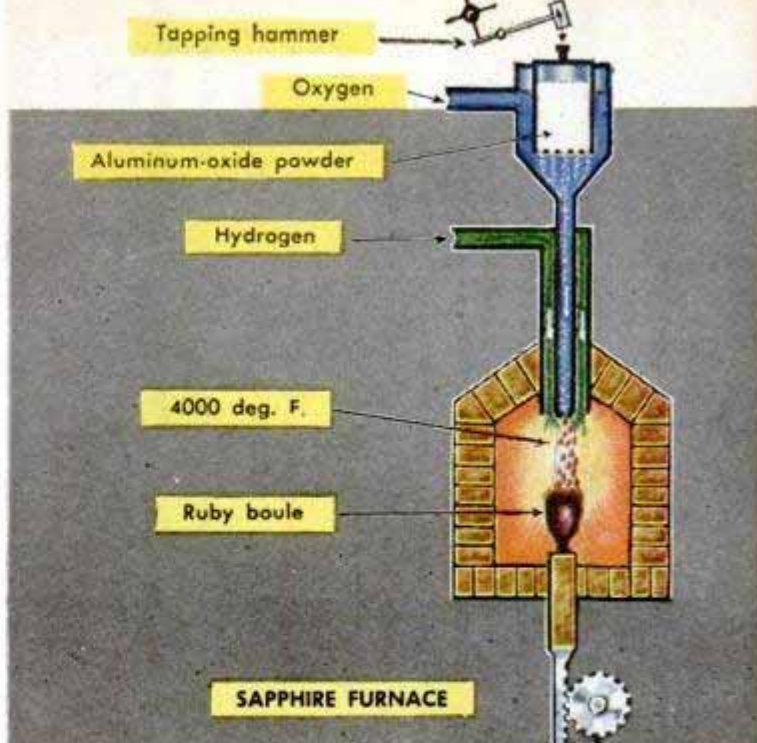

Duplicating the gem-making process of nature, the sapphire furnace builds up boule of true synthetic

distinction between the words "synthetic" and "imitation." For example, an imitation ruby may be made of red glass, while the true synthetic is chemically identical with the natural ruby and is of the same crystal structure. Only an expert with a powerful magnifying glass can tell the difference.

Perhaps one reason for the popularity of gem cutting as a hobby is that it is not necessarily an expensive pastime, but can be geared to any pocketbook. First of all, many raw materials can be obtained without cost. Scores of lapidary clubs organize field trips in their communities for picking up stones. Quartz in its many gem forms is probably the greatest favorite with the home lapidary. These include the violet amethyst, pale yellow citrine or false topaz, transparent rock crystal, rose and smoky quartz. The latter occurs in many shades. Then there is chalcedony ranging in colors from red carnelian to apple green, the variegated agate, onyx and jasper.

One of Kraft's favorites is variscite, a bright, rich green stone with yellow and gray streaks which makes up into attractive gems. If rough stones are not available in one's community they can be purchased at low cost through numerous dealers. They are supplied in the rough, cut into "blanks" of various sizes, or at slightly higher cost in "preform" cabochons which have only to be polished and finished. The cabochon cutting (flat on the back and a smooth rounded top) is the favorite with beginners for it makes a beautiful gem and is far easier than attempting a faceted (brilliant) or emerald (square) cut.

Stones which are easy to obtain from the dealers include jade (black or green),



First step in making stone for a jade ring is to cut the ring blank from slab sliced from the rough

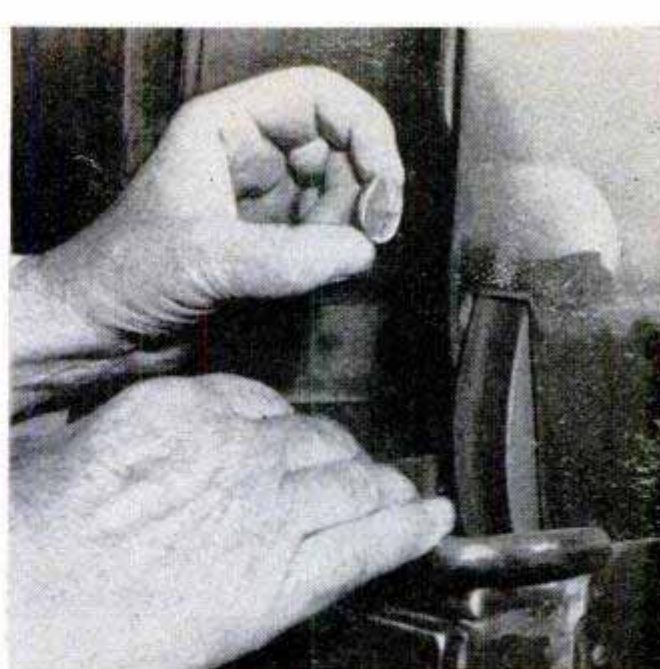

Second step, blank is rounded to dimensions of desired cabochon setting on a silicon-carbide grinding wheel

variscite, aquamarine, amber, garnet, opal, lapis lazuli, tiger-eye, tourmaline and turquoise, in addition to all the quartz family. You can also buy pieces of petrified wood (a reddish-hued favorite is called Arizona) and even petrified dinosaur bones.

From time to time dealers or traders come up with rare and unnamed stones. Many of these are believed to be odd combinations of stones fused by volcanic heat. Recently a prospector in Mexico discovered a strange stone which he called a "peanut" gem. The rough material looks like garnet crystals cemented in obsidian. When sawed in slabs for cabochons, the "floating" garnets look like a cross-section of peanut

(Continued to page 228)



Stone is mounted on dop stick with sealing wax for polishing

Mr. Kraft gives the stone its final polish on hard felt buffing wheel, using tin oxide as polishing aid

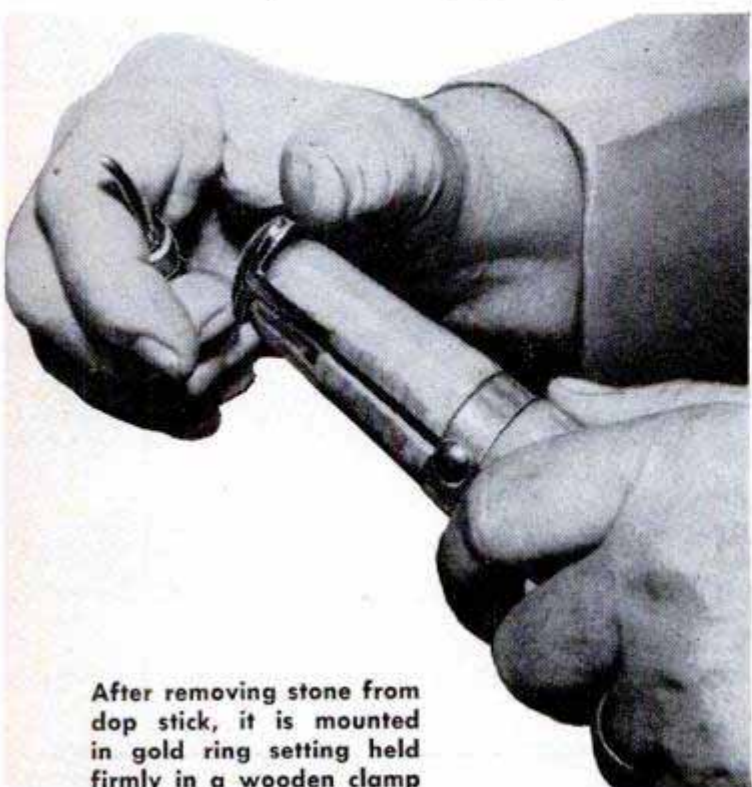

After removing stone from dop stick, it is mounted in gold ring setting held firmly in a wooden clamp

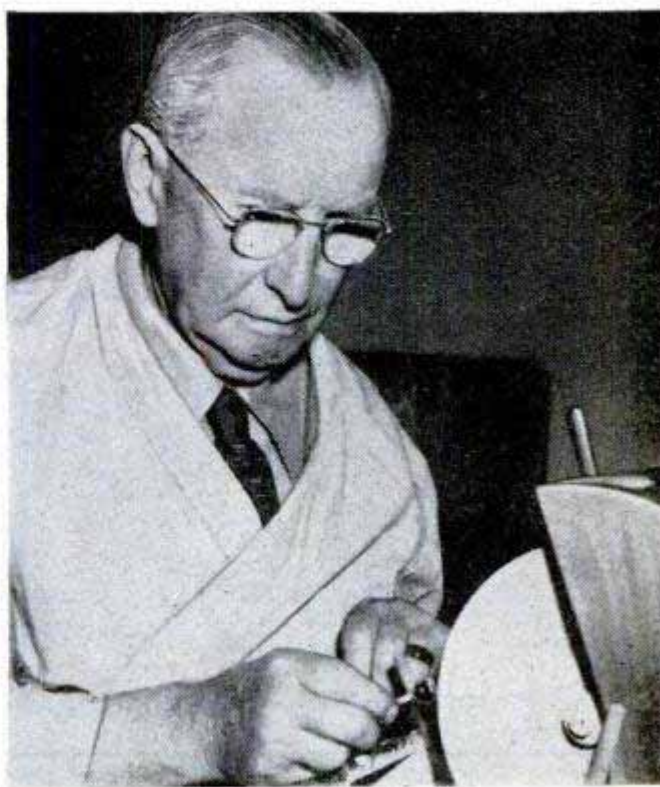



Stopped in mid-air by the Navy photographer, the LSU skids off the deck of the LST on its way into the water

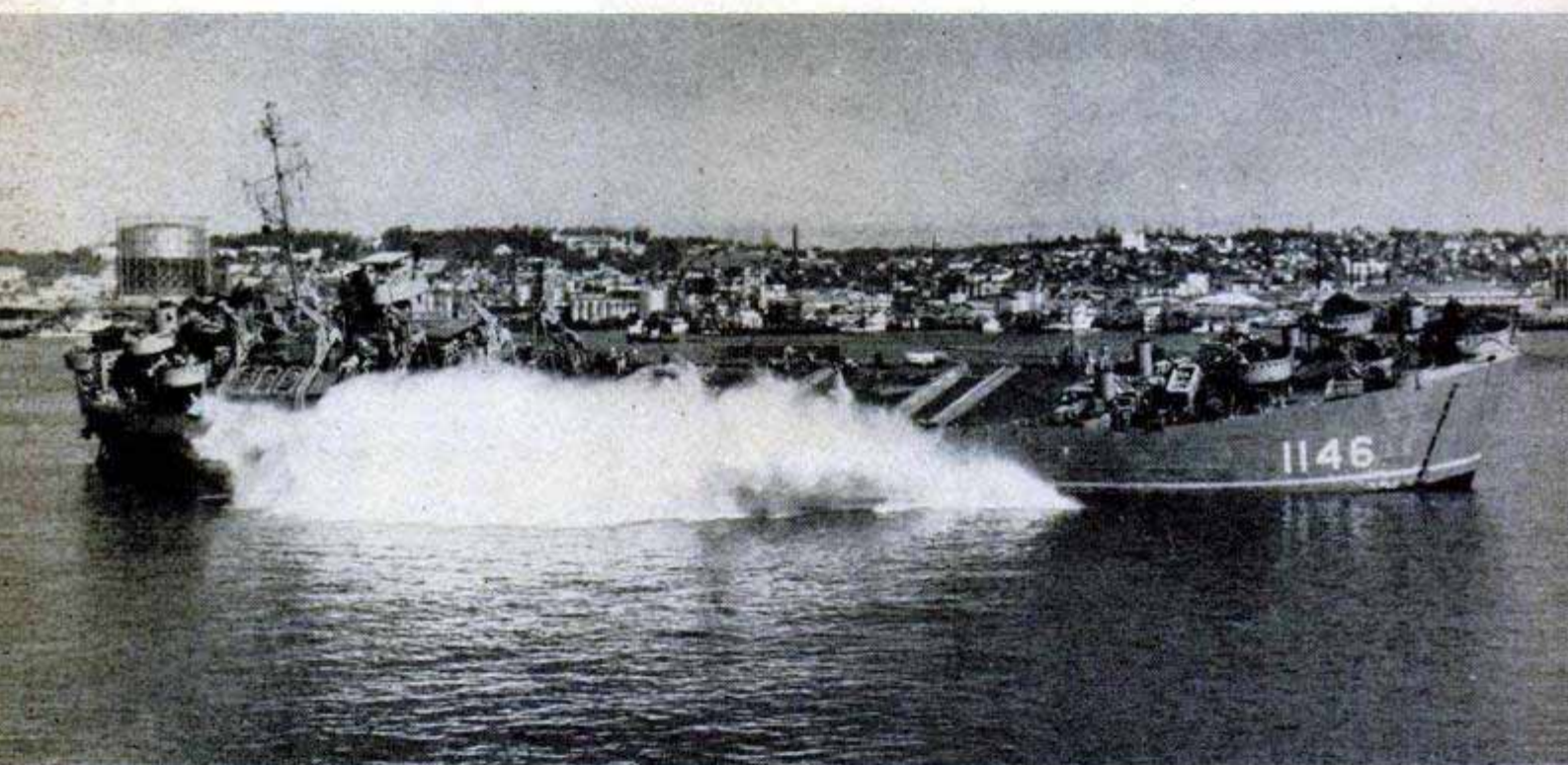

In the world's biggest "bellyflop," the LSU hits the water with a splash that sends up a curtain of spray. Briefly bobbing around like a cork, the LSU soon settles down in the calm water and is ready for boarding.

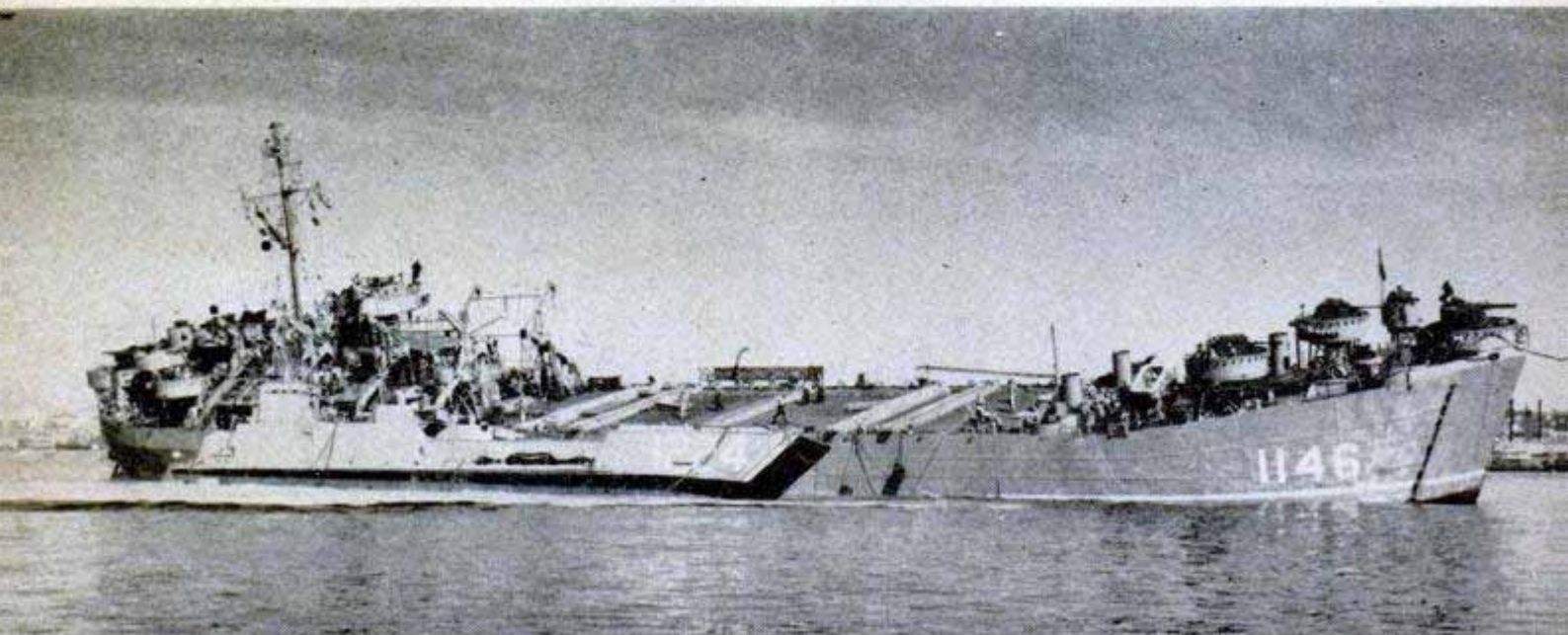

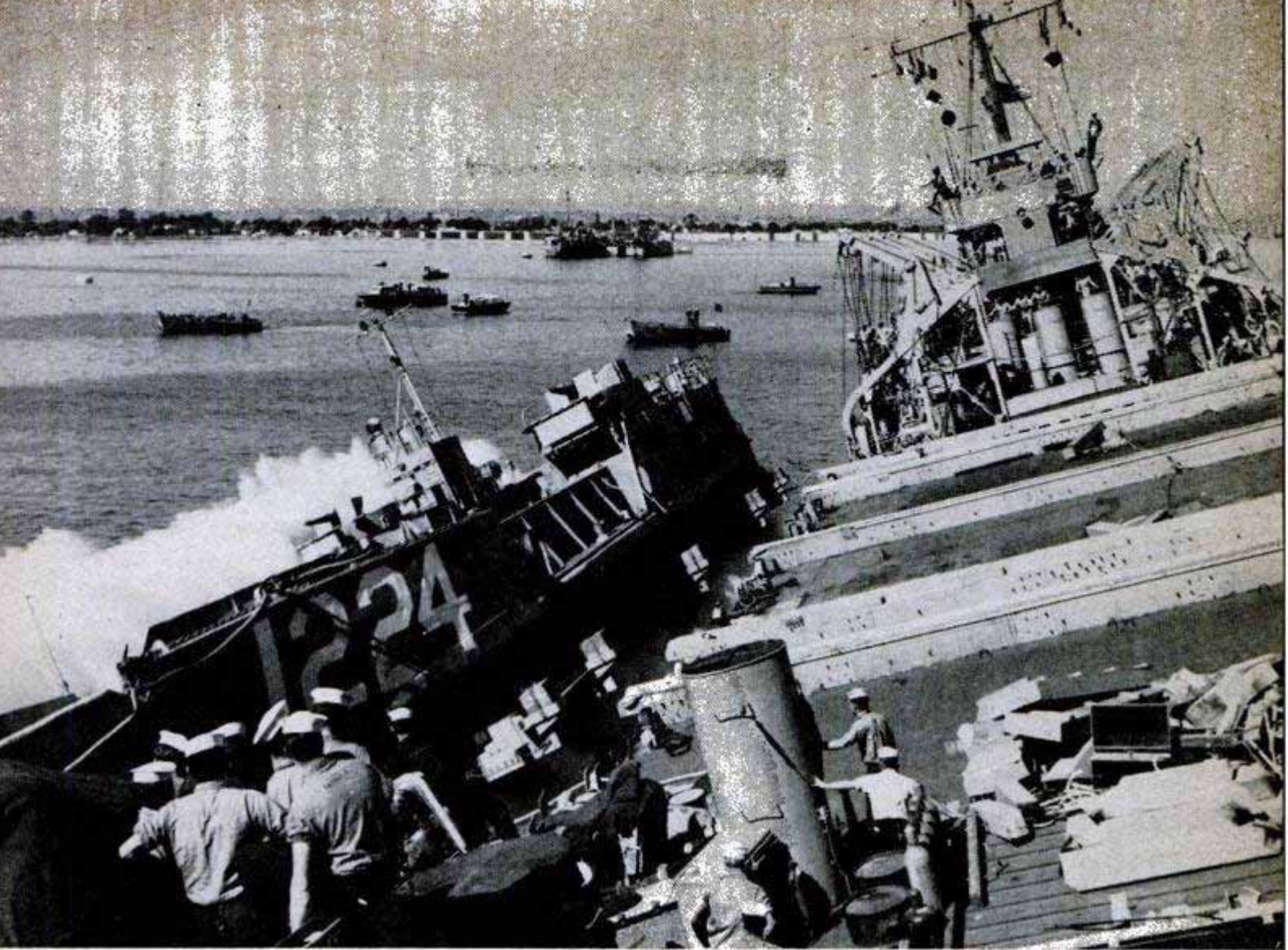

Shipside view of the LSU as it strikes the water. The greased skids on which it slid can be seen at right

LSU Rides Big Brother to Work

LSUs are handy ships to have around a beachhead—they'll haul anything. The "U" in the initials stands for Utility—a most appropriate name. But useful as it is, the LSU has a few drawbacks—it's slow and its range is limited. To overcome these deficiencies, the Navy developed a pickaback launching technique.

The 120-foot work horse of the waterfront has a normal range of less than 500 miles. It can go farther—many have crossed oceans. But generally it is limited to hauling mountains of supplies ashore from freighters.

With the pickaback system, the Navy hauls the LSU anywhere in the world. Lashed to the deck of an LST, its larger and faster brother, the utility ship has unlimited range. It's a seaworthy combination, too. So well is the loading done that LSU-carrying LSTs ride through tropical storms without damage. Yet so expert is the lashing

that in minutes the smaller ship is cut loose for launching.

Water ballast is pumped into tanks on the LST until the proper list (about 30 degrees) is attained. Then the restraining chains are released and the smaller craft slips waterward on well-greased skids. It gathers speed as it slides and strikes the water with a solid slap, sending spray over everything. To prevent damage that might result if the bobbing LSU should bang against the LST, the trick is to "throw" the smaller craft through the air as far as possible. Because of the terrific smash with which the LSU hits, nobody rides it down. It is allowed to bob around on a "tether" until it can be hauled in close.

If you see an LST carrying an LSU don't let some Navy vet pull an old, barnacled joke on you. If you look like a landlubber, he's apt to describe the LSU as the "biggest lifeboat in the whole dern Navy."



Tank-Track-Type Landing Gear for Airplanes

Built along the lines of a tank track, a new-type landing gear permits airplanes to land on the most hazardous terrain. The pneumatic rubber track depresses when

passing over sharp-edged stones and rocks. It was invented by Count Guido Bonmartini of Italy, who has sold the patent rights to his country and to Switzerland.

Anti-Icing Features In Turbojet Engine

With a thrust output so much greater than the J-47 that "it isn't even in the same class," a new turbojet engine is said to be an important advance in the world race for jet supremacy. Developed by General Electric, the engine puts out far more thrust than the 5200 pounds of the present J-47. For security reasons, the engine's power is not revealed. The new model has a "cannular" combustion system, consisting of a single combustion space containing individual "cans." Some accessories, housed in the nose of the present J-47, have been placed beneath the engine to provide a greater air-inlet area to the compressor. "Hot noses," achieved by bleeding hot air to hollow nose parts, and

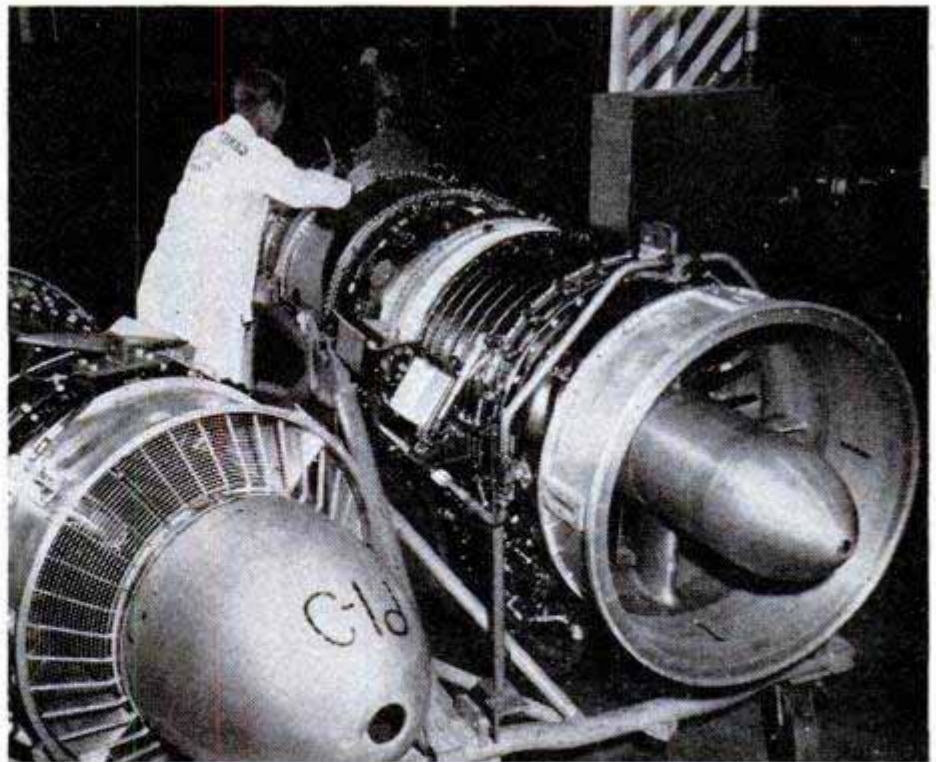

Accessories in the new J-47 engine (right) are located underside instead of in the nose. This permits a greater amount of air to enter compressor

retractable air-inlet screens prevent ice collection on critical parts, making the engine an all-weather model.

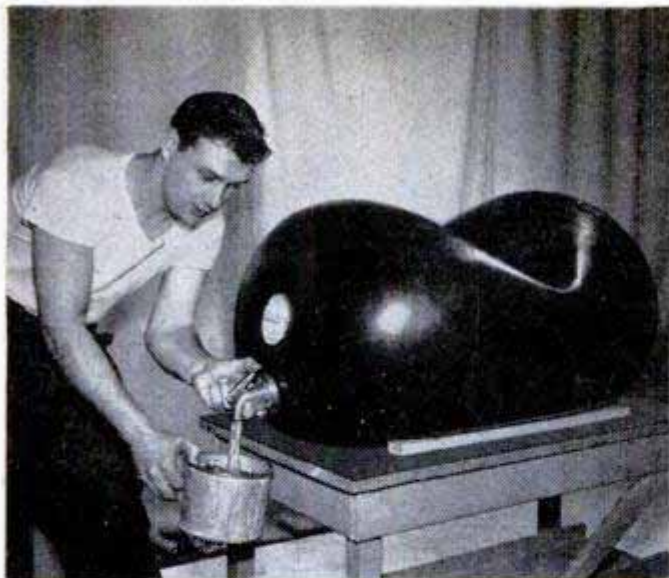

Collapsible "Barrel" Made of Rubber-Fabric

Suitable for the shipment of oils, acids, paints and dry powders, a 55-gallon synthetic-rubber-fabric drum collapses as it is emptied. An advantage of the collapsing feature is that no vent is required as the

liquid is removed. It also saves shipping space when the drums are returned for re-filling. More than 2500 collapsed drums can be shipped in a boxcar that holds only 300 rigid drums.

Tiny Life Preserver Holds 250-Pounder

Palm-sized when deflated, a plastic life preserver will support a person weighing up to 250 pounds. A fastener clips it to clothing or a bathing suit. Even a child's grip can release the carbon dioxide that inflates it into a full-size, two-foot water wing. It inflates when the container is squeezed.

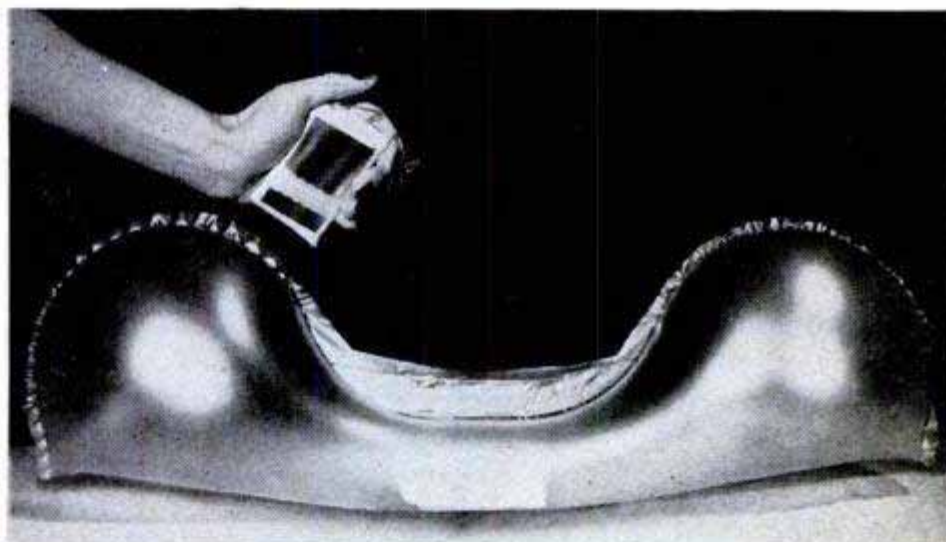

Gondoliers Get Traffic Tickets

Reckless gondoliers in Venice are handed traffic tickets by police who roam the "streets" in small boats. The Venetian taxi driver now is confronted with traffic lights installed along the Grand Canal. More than 400,000 people travel by boat along 500 miles of canals in the city, and a huge increase in water traffic has forced the police to patrol the seaways.

☐ It is estimated that if all the dust in the atmosphere could be gathered together, it would make a cubical mass that would measure 587 feet on a side.



British Jet Flying Boat

First of its kind, a water-based jet fighter built by Saunders-Roe in England has exceeded 500 miles per hour and has landed

at about 100 miles per hour. It is extremely maneuverable. A trap in the nose air intake prevents water from entering in heavy seas. A single-seater, the SR-A1 has nose ports for four 20-mm. cannon.

Pocket Protector

Loose change and other articles are protected by a newly patented spill-proof pocket. Introduced at a Canadian men's fashion fair, the device consists of an extension of material that slants forward over the regular pocket. It is particularly useful when the wearer is sitting in a car seat or in low lounge furniture.

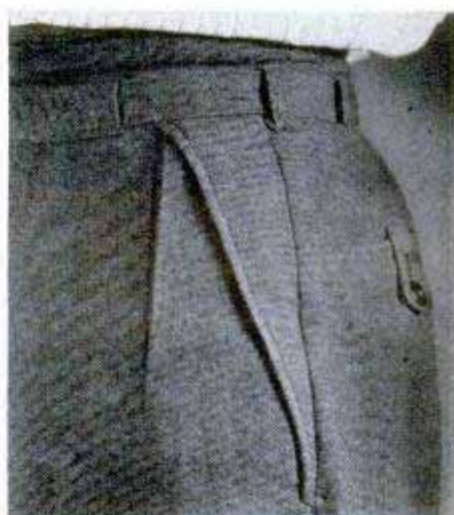

Mid-Air Refueling Increases Range of F-84 Thunderjet Fighters

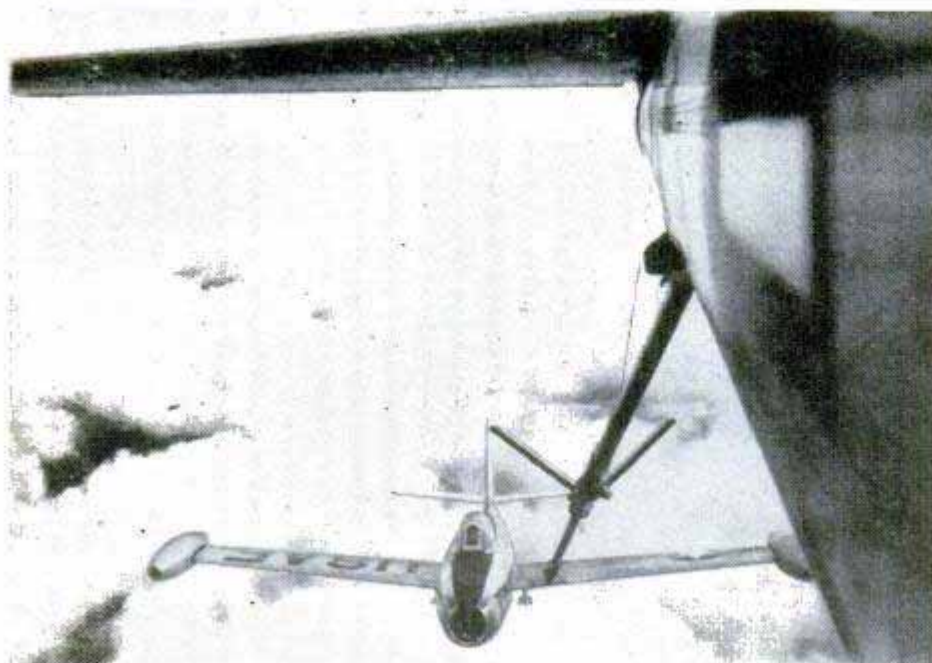

Only 2½ minutes are needed for a complete mid-air refueling of the Air Force's newest Thunderjet fighters. Several hundred gallons a minute pour through a single entry point just above the leading edge of the wing. This permits the plane to take off with a greater armament load. Fuel added aloft increases its fully loaded combat range. The "G" model of the F-84 is the first operational jet fighter to come off the production line completely equipped for mid-air refueling.

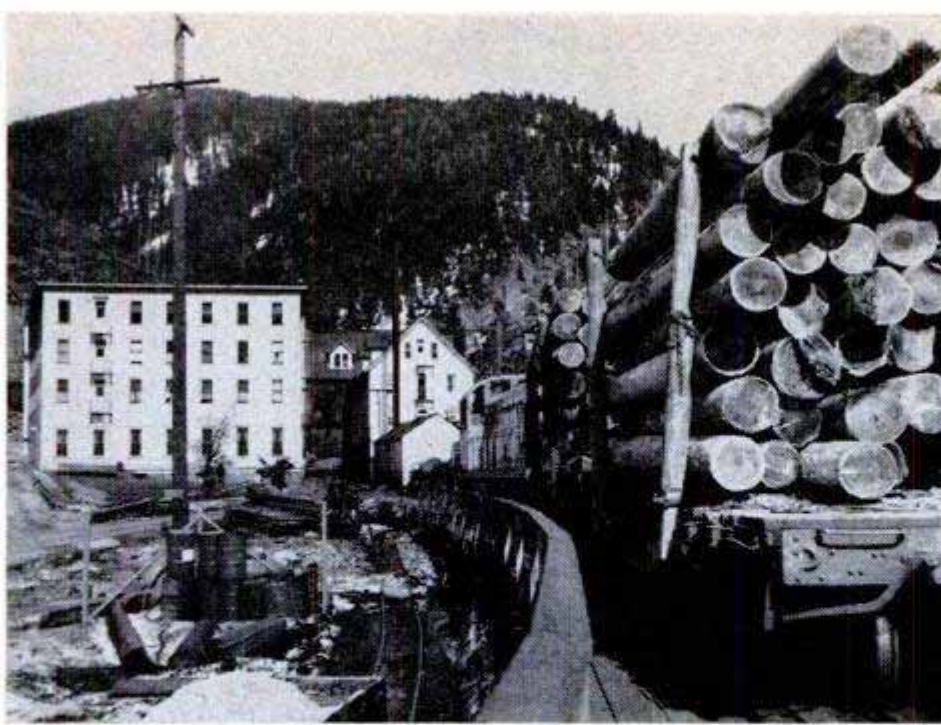

Trains Go Through Hotel Lobby

In the little mountain town of Burke, Idaho, trains run right through the hotel lobby. The town is squeezed into a narrow canyon, with little room for streets or railroad tracks. Consequently cars are parked on the tracks between freight runs, and trains edge through the town within arm's reach of the buildings. The climax to any rail run comes when the train moves through the hotel lobby, where a tunnel had to be cut.

Table for Drill-Powered Saw

Electric-drill owners who have converted their drills into circular saws can now have a small table saw that mounts on a bench or table. The table is seven inches square and made of heavy gauge steel. It has a simple rip fence and the blade tilts to 45 degrees. The complete unit, including the drill, is quickly assembled and clamped into position for sawing.

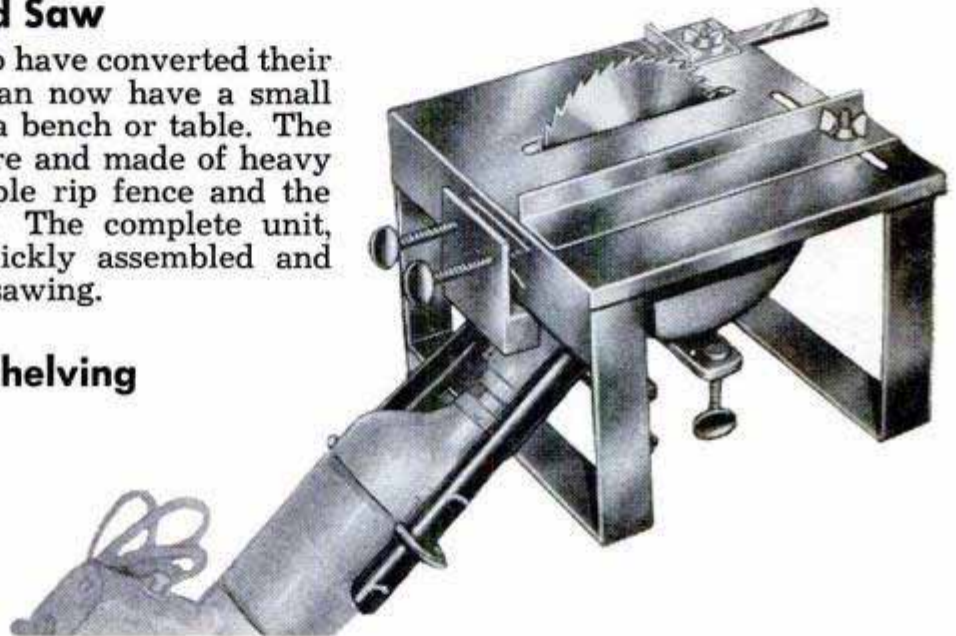

Channel Strips Make Shelving

Shelves can be built to any dimension with strips of steel channel and spring clips. The framework for the shelves is built up from the steel channel. Then the clips are inserted in the channel. The clips are held in place by friction—the heavier the load on the shelves, the tighter

they grip the channel. Teeth on the clips bite into the wooden shelves.

Hunt for Oldest Readers

How long have you been a reader of Popular Mechanics?

As part of our celebration of the Golden Anniversary of this magazine next January, the editors are seeking the names of our oldest regular readers—those who have subscribed to the magazine or bought it regularly at newsstands for nearly 50 years. Some, we believe, have read Popular Mechanics since it began publication in January 1902, and many have very complete files from the beginning.

If you are a "regular" of 40 years or more, send us your name and address and tell us how long you have read the magazine, and how far back your file of the magazine goes.

Address the Managing Editor, Popular Mechanics, 200 East Ontario St., Chicago 11, Ill.

Transparent Screen Provides Clearer Television Picture

Better television pictures are promised with a transparent screen for picture tubes. The transparent coating on the face of the tube will give greater contrast between light and dark areas because the viewer will see through the screen into the dark recesses of the tube. Present tubes are coated inside with a powder which appears white or gray. The shade of this powder is the darkest any portion of the picture can be. With the new transparent coating of zinc fluoride and manganese, the dark areas can be made much blacker. The new screen is under development at General Electric laboratories in Schenectady, N. Y. Dr. Ferd E. Williams discovered the new process.

Survivors climb aboard the new rescue craft after it has been dropped and guided to them by the plane



RADIO PILOTS SELF-INFLATING RESCUE BOAT

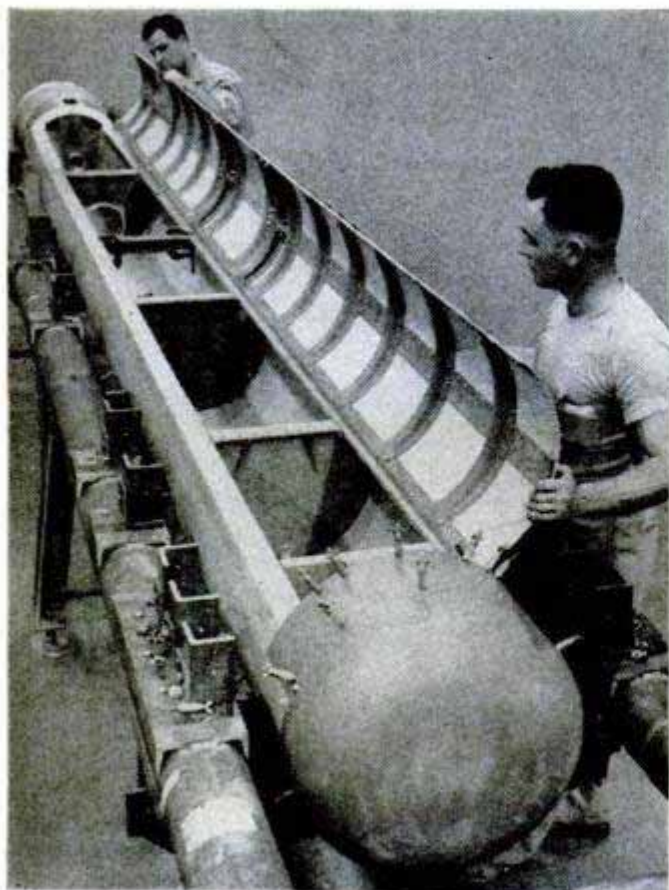

YOU'D THINK the sleek metal cylinder was a torpedo. As a matter of fact, the stern ring is identical with that of a torpedo, and the 21-inch diameter was selected so the cylinder could be fired from standard torpedo tubes of submarines and surface vessels. Actually, the cylinder isn't a destructive weapon of war, but a new radio-steered rescue craft to save the lives of downed aviators and others lost at sea.

Twenty feet long, the aluminum cylinder is dropped from a plane and does just about everything but lift the waterlogged aviator aboard. When the pilot of a rescue plane sights survivors, he descends to a minimum altitude of 75 feet and releases one of the "torpedoes" from his wing. As the cylinder falls, a chute blossoms forth and drops the tube gently into the water. Two minutes after the drop begins, the cylinder suddenly erupts into a de luxe lifeboat. Carbon dioxide fills the nylon sides and opens up the boat, the original cylinder serving as a stiffener and keel. Then an automatic timer

Aluminum hull is divided into compartments which carry fuel, radio, engine, food stores and distillation kit

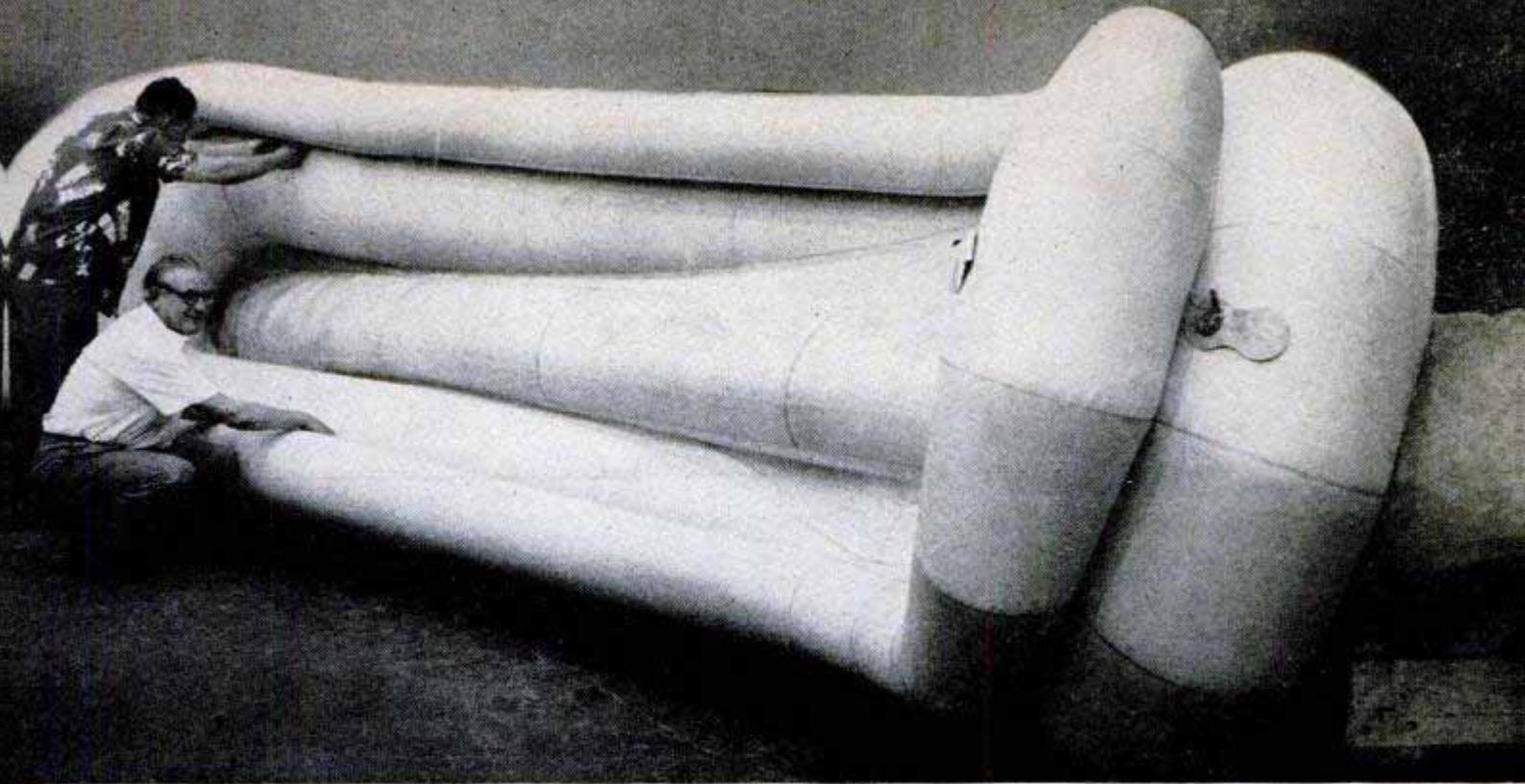

Nylon-rubber fabric pops out from under the cylinder cover, expands around cylinder to form rescue craft

switches on a radio aboard the rescue craft.

The aircraft pilot now transmits a radio signal that opens the fuel valve and starts the engine. As the boat moves ahead the pilot guides it by radio until it reaches the survivors. Then he puts the craft into a tight turn and kills the engine.

When the survivors climb aboard they turn a switch to release the boat from aircraft control and start the engine. In the craft they find an automatic pilot, a two-way radio, dehydrated food, flares, a canopy, a distillation kit and enough fuel to travel 300 miles.

The versatile rescue boats are being built by the Long Beach Division of Douglas Aircraft Company. They were designed for the Air-Sea Rescue Unit of the Air Materiel Command.

Right, propeller is installed in protective ring. Torpedolike cylinder can be fired from torpedo tube

Cross section shows equipment carried in the cylinder. The cover is jettisoned, exposing the rubber craft

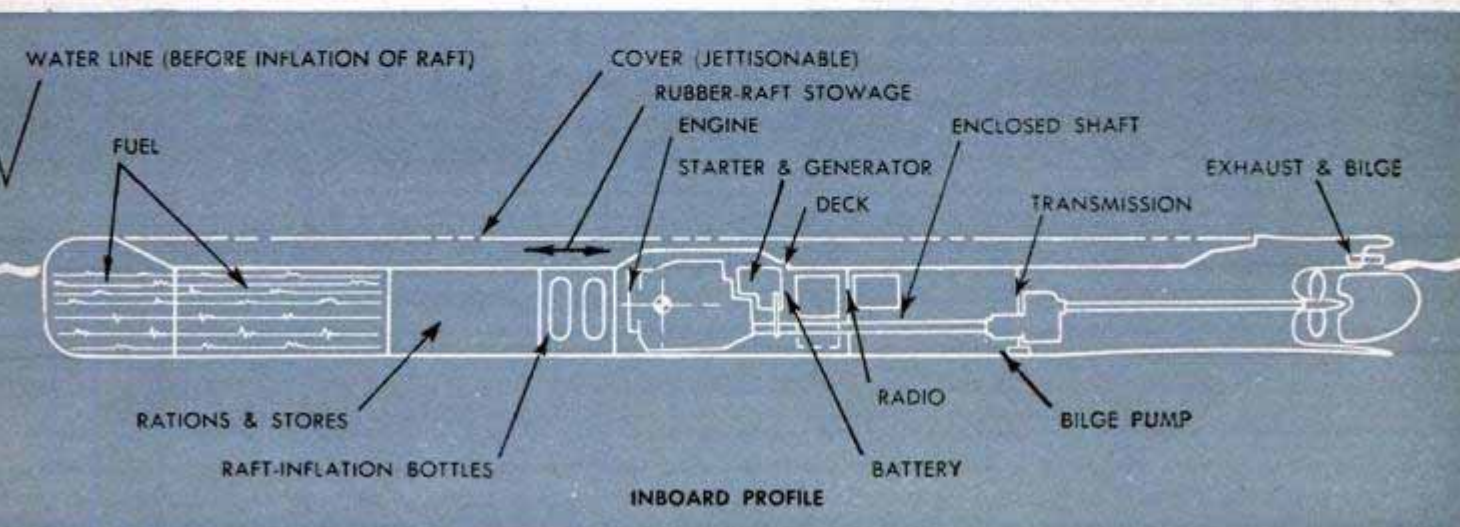

The OWNERS REPORT



THE POPULAR MECHANICS MOTOR SURVEY AS CONDUCTED BY FLOYD CLYMER

I am the owner of a 1951 Chrysler. Model: Windsor Windsor DeLuxe
New Yorker Crown Imperial

I have owned it about 3 months. Speedometer mileage is now 3,724

I use only regular gasoline - I use premium (high test) gasoline

My approximate gas mileage in the city is 15 MPG; in country, 18 MPG.

I CHANGE OIL every 1,000 miles. I ADD OIL - one quart every _____ miles.

My car has: Standard transmission Fluid-Matic Drive

How does the car handle on the road? Excellent

Maneuverability seems to be: Excellent Average Unsatisfactory

Acceleration is: Outstanding Very good Average Poor

Curb and road clearance is: Satisfactory Too high Too low

Why did you buy a Chrysler? Highly recommended

What features about the car do you especially like? The way it handles, Body style,

Motor performance, Fluid-matic drive, Padded instrument panel

Do you like Chrysler's new front-end STYLING? yes; BONDED BRAKES? yes

PADDED INSTRUMENT PANEL? yes; VISIBILITY? yes

INTERIOR FINISH? yes; ORIFLOW SHOCK ABSORBERS? yes

If you own an Imperial, how do you like its DISC-TYPE BRAKES?

HYDRAGUIDE POWER STEERING?

What is your opinion of the new overhead-valve-V8 engine? Too much power for me

What do you dislike about the car? Nothing

Have you ever owned a Chrysler before? No If so, how many? _____

Would you buy another Chrysler? Yes Possibly No

Do you secure good dealer service? Yes Average No

How would you rate your new Chrysler? Excellent Good Average Poor

GENERAL INFORMATION

What type of engine would you prefer in your car of the future? In-line V-type (might consider)

Cylinders: 6 8 Valves: Side Overhead

Based on my present experience, I want my next car equipped with: Standard trans.

Overdrive Chrysler Fluid-Matic Drive Other type of auto. trans.

Please state reasons: Makes it easier to get around in traffic

Do you like the new low-pressure, super-cushion tires? yes

Do you carry the recommended pressure? Yes No How much more? _____ lbs.

Please check all answer boxes (). Your name will be held in strict confidence.

Please mail promptly to:

FLOYD CLYMER
1268 SO. ALVARADO ST.

My Name: _____

Address: _____

City & State: Columbus, Ohio

Why not find the bottom of the instrument panel.

on the '51 CHRYSLER

The true test of an automobile begins when the owner takes the wheel. This is another report from owners of 1951 cars who answered questionnaires sent by Popular Mechanics to 1000 Chrysler owners from coast to coast



By Floyd Clymer

PROBABLY THE FINEST compliment paid the Chrysler '51 by the owners who answered our coast-to-coast 1000-questionnaire survey was the comment of a service-station operator in Hyattsville, Md. He said:

"I learned to respect the Chrysler highly through my auto-service business. The new V-8 engine is the only new one on the market without 'bugs.'"

Least complimentary was a Southern gentleman from Louisville who answered the question, "Why did you buy a Chrysler?" with: "I often wonder."

The survey showed that a very high percentage of '51 Chrysler owners are a contented group.

Typical of enthusiastic responses was this one from a St. Paul, Minn., salesman: "To me Chrysler represents the highest quality in an automobile. I wouldn't trade it for a competitive make . . . Chrysler is the leader in bringing out new things to the public and you get more value for your dollar than in any other car."

SEPTEMBER 1951

Clymer tested the four-door New Yorker sedan, a massive 131½-inch-wheelbase model powered by the new Chrysler V-8 engine

HYDRAGUIDE POWER STEERING

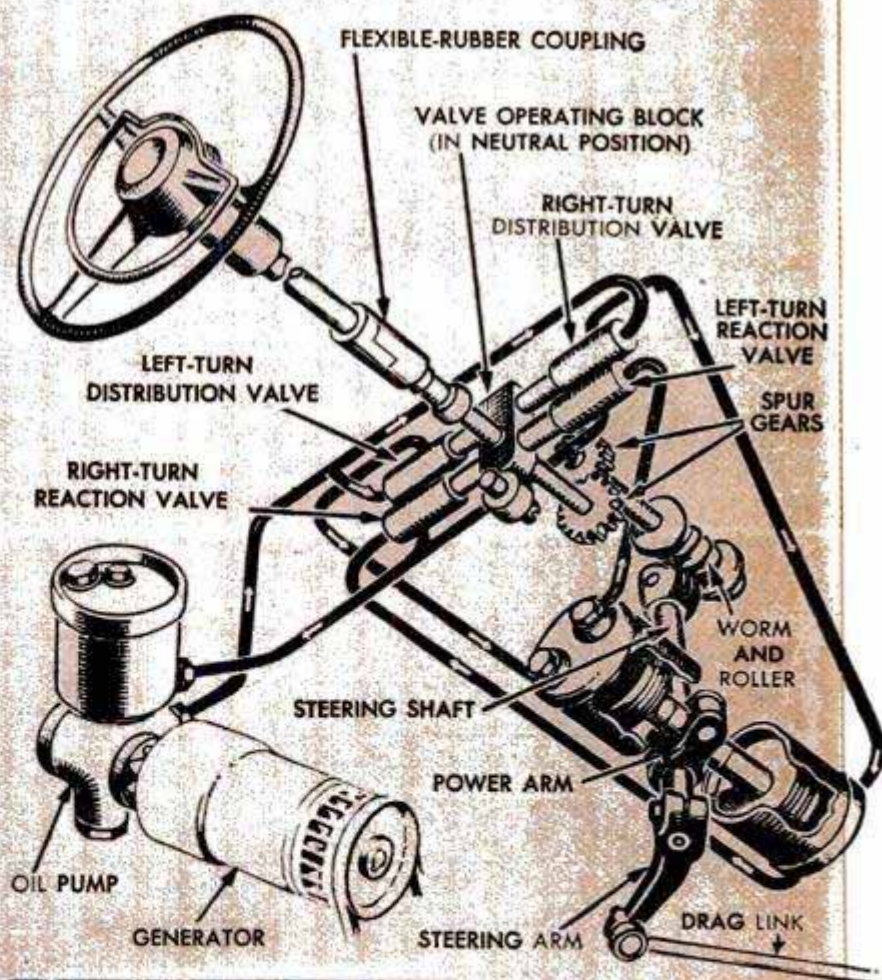

Power steering, detailed above, eliminates wheel tugging. The car can be steered with one finger

A good majority of owners expressed enthusiasm about Chrysler's Fluid-Matic drive. A Marshfield, Wis., osteopath said he likes it because it is "trouble-free, easily repaired and there is no 'jerking' as in other transmissions." An Indianapolis housewife declared she had had less difficulty with Fluid-Matic than some of her acquaintances had with other types of automatic transmission. The smoothness of the Fluid-Matic was mentioned by several owners.

There are literally hundreds of reasons why people like a particular car. A Sioux City, Ia., salesman said he bought a Chrysler "for leg room—I am 6 feet 5 inches tall." An Air Force officer in Arlington, Va., said he bought one because of "the automatic transmission, gas economy, design and because my wife wouldn't let me own any other make!" A Milwaukee salesman went out of his way to express his fondness for the "new, banana-oil smell" of his Chrysler.

"The motor of this car is out of this world!" said a Chippewa Falls, Wis., merchant, who owns a New Yorker model.

"Your hat is not knocked off upon entering the car, you can apply the brake without your knee hitting the steering wheel, and you can sit up and see out," remarked a physician in Swampscott, Mass. An Indianapolis attorney, who has owned 15 Chryslers already, also commented that

"the seat is high so you can see all the road." A Jacksonville, Fla., washing-machine distributor said: "I was greatly surprised at the public interest in this car. A great many strangers ask questions, including the request to see the new V-8 engine. These included many filling-station attendants who were greatly interested . . . I just drove on an 8000-mile trip and on two occasions the speedometer showed slightly over 100 m. p.h. No attempt was made to see how fast the car actually would run." A Texas owner says "The V-8 beats any car I've ever driven. It is a 'pip.' The only objection is it shifts into high gear too slowly."

Less enthusiastic comments included the following:

"No light under dash except when door opens . . . should have stainless steel instead of chromium."—A Chicago editor.

"Lacks the feel of a solid, substantial car, which was a major attraction in previous models."—Accountant, Indianapolis.

"Dislike lack of pep in the Windsor model. It is too sluggish for 116 horsepower."—Railway executive, Dallas, Tex.

"I feel that Fluid-Matic shift must have some bearing on my low gas mileage, because I drive very conservatively."—Roofing contractor, Spokane, Wash.

Poor dealer service was responsible for a few complaints, which seems usual re-

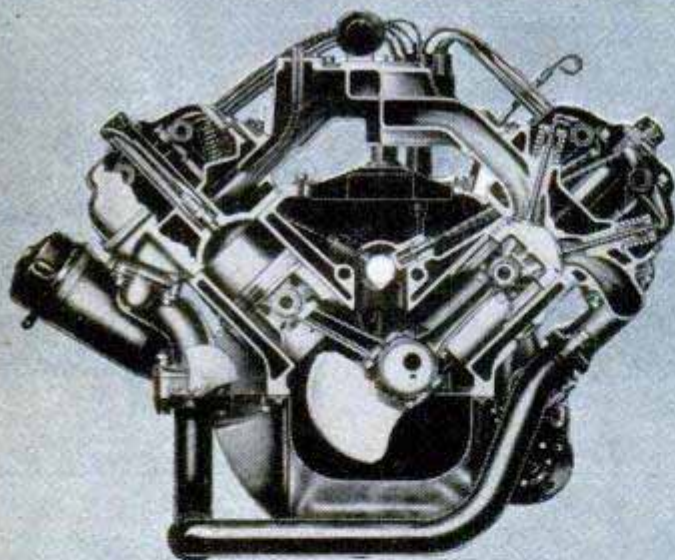

Sectional view of the new overhead-valve V-8 engine of the test Chrysler. Note the hemispherical firing chambers. It is a high-compression model (7.5 to 1)

ACCELERATION TESTS

Chrysler New Yorker (4-door Sedan)

¼ mile from zero....20.0 seconds — Drive range only
19.10 seconds — Low and Drive

½ mile from zero....32.10 seconds — Drive range only
31.60 seconds — Low and Drive

0 to 30 m.p.h..... 4.05 seconds — Low range only

0 to 60 m.p.h.....15.40 seconds — Drive range only
14.80 seconds — Low and Drive

(In tests using Low and Drive, shift from Low to Drive was made at 30 m.p.h.)

Top Speed (by speedometer).....115 m.p.h.

Actual Top Speed, about 10% less
(speedometer variation).



After he had tested the Chrysler New Yorker on the road, Clymer put it on a Clayton dynamometer for analysis. It indicated more than 180 horsepower

ardless of the make we report on. A Frederick, Md., salesman brought up another point when he said, "I would rate the new Chrysler 'excellent' if I could get better gas mileage." A great percentage of the owners replying in the survey made no mention of their mileage in an unfavorable way and many thought mileage was excellent. (See chart for the economy test.)

A Des Moines, Iowa, man reported he got 14 miles to the gallon in city driving and was the only owner to complain that the overhead-valve V-8 engine is too powerful. "Too many horses," he said. "Why not a smaller engine with 20 miles per gallon?"

Chrysler's Oriflow shock absorbers received almost unanimous approval as did the interior finish and padded instrument panel. The Imperial model's disk-type brakes and Hydraguide steering also are proving highly popular, according to the survey.

An automotive tester at Aberdeen Proving Ground, Md., does his own service work on his Windsor and reported it dependable, economical to operate and easy to service. His only complaint was that there is a



On a trip across Kansas in a Chrysler Windsor, M. J. Reynolds of Illinois tells Clymer he gets more than 18 miles per gallon

"loud whistle on both sides at the front when everything is shut tight."

A Lima, Ohio, railroad brakeman complimented the Windsor for "giving a great ride on bad roads," but said he has a little trouble opening the doors because of the height of some curbs. (Several other cars have lower doors than Chrysler.)

In certain cases, owners said they had bought Chryslers because they previously had driven Plymouths and liked them. A Chicago liquor broker said he had driven six Plymouths and then bought a Chrysler

Percentages from P. M. Poll

Owners of Windsor and Windsor De Luxe (6-cyl.)	84%
Owners of New Yorker and Imperial (V-8-cyl.)	16%
Average gasoline mileage in country—	
6-cyl. models	16.7 m.p.g.
V-8 models	16.1 m.p.g.
Average gasoline mileage in city—	
6-cyl. models	14.1 m.p.g.
V-8 models	13.3 m.p.g.
Owners using premium gas	61%
Owners using regular gas	39%
Owners who change oil	99%
Average mileage for change of oil	1432
Owners who add oil (and change periodically)	28%
Average mileage for adding oil	977
Owners who thought maneuverability excellent	85%
average	15%
Owners who thought acceleration outstanding	25%
very good	47%
average	24%
poor	4%
Owners who thought road clearance satisfactory	92%
too low	8%

FEATURES

Owners who like body and front-end styling	94%
Owners who like bonded brakes	96%
Owners who like padded instrument panel	98%
Owners who like visibility offered	97%
Owners who like interior finish	98%
Owners who like Oriflow shock absorbers	96%

(These percentages were tabulated from answers to specific questions in the poll.)

OWNERS' RATING OF CAR

Excellent	67%
Good	24%
Average	7%
Poor	2%

GENERAL INFORMATION

Prefer V-type engine	64%
Prefer in-line engine	36%
Prefer eight cylinders	62%
Prefer six cylinders	38%
Prefer overhead-valve system	61%
Prefer side-valve arrangement	39%
Prefer automatic transmission	97%
Prefer standard transmission with overdrive	2%
Prefer standard transmission	1%
Prefer Fluid-Matic Drive	82%*
(*The above figure means 82% of the 97% preferring automatic transmissions.)	
Prefer makes other than Fluid-Matic	18%
Owners who like low-pressure tires	92%
Previous Chrysler owners	63%
Will buy another Chrysler	77%
Might buy another Chrysler	19%
Will not buy another Chrysler	4%
Dealer service good	73%
average	19%
poor	8%

Most frequent objections:

slow gear-changing of Fluid-Matic transmission, squeaking brakes, two-piece windshield

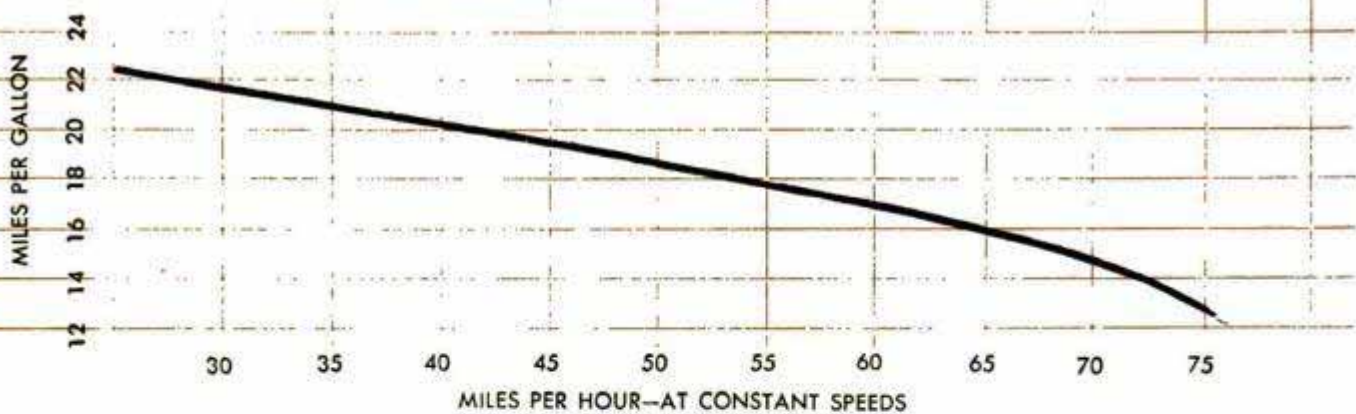

Economy Test of the '51 Chrysler

because he likes Chrysler Corporation engineering features. Others paid similar compliments to Chrysler as an institution. A manufacturer's agent in Shaker Heights, Ohio said: "I have been well pleased with Chrysler products for more than 25 years, having owned two Chryslers, two Dodges and six Plymouths."

Murrell Belanger, of Crown Point, Ind., owns the car which won this year's Indianapolis 500-mile race. He said: "I have driven Chrysler Eights since 1932 and love them . . . I drive about 70,000 miles a year and have another make of car on which I put 20,000 miles, but it just doesn't compare with a Chrysler."

A Denver policeman said his Chrysler outperforms any other car he ever drove, especially on icy streets. Others also complimented the Chrysler on its performance in bad weather.

A Corpus Christi, Tex., trucking contractor said he likes Fluid-Matic drive because "I am lazy." A Clifton Forge, Va., cost engi-

neer said his next car also would have Fluid-Matic because a woman driver can handle it more easily. On the other hand, a Mobile, Ala., man said he wants standard transmission in his next car because "gas mileage and extra costs for any of the special automatic drives are not economical."

A Des Moines, Iowa, owner said that the "hole" in the front grille of his Windsor permits muddy road water to cover the engine when passing or following another car. A woman in Tacoma, Wash., said: "We would have bought our second New Yorker model but it rubbed our driveway, which is under our house. The Windsor doesn't rub, but it still is pretty low."

Asked "Why did you buy a Chrysler?" a Wichita Falls, Tex., yardmaster replied: "Habit." But he was unhappy because his dealer sold a radio and clock with the car and was unable to deliver them. A Louisville, Ky., physician disliked: "1) Chrome rusty in six weeks; 2) lack of dealer know-how; 3) leaks; 4) slow getaway; 5) noisy shock absorbers." (His kicks certainly are not in accord with the vast majority of owners.)

To the same question, a Birmingham, Ala., traveling salesman replied: "To get a car to last the next six years." He said it handles on the road "like a dream." He remarked that his New Yorker has "poor clearance for rough terrain." The latter criticism was denied by a Hammond, Ind., factory executive who said: "The fender clearance in Chrysler cars is sensible." He felt

(Continued to page 260)

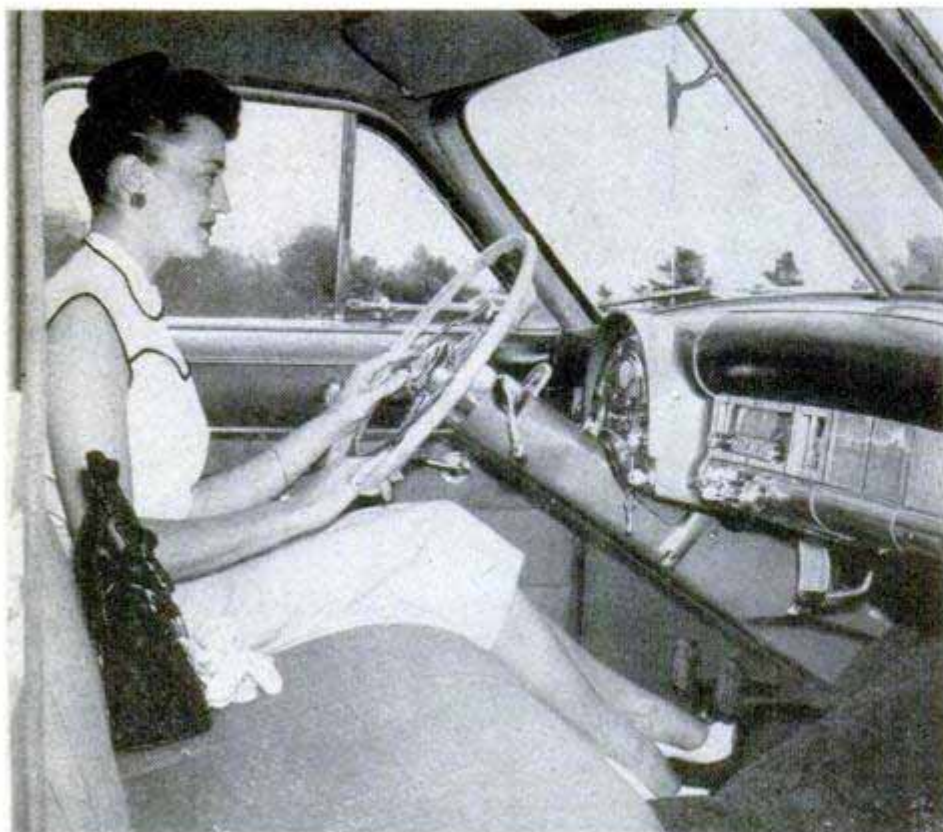

Chair-height seats make Chrysler a comfortable car on long trips. Top of instrument panel at right is padded for safety

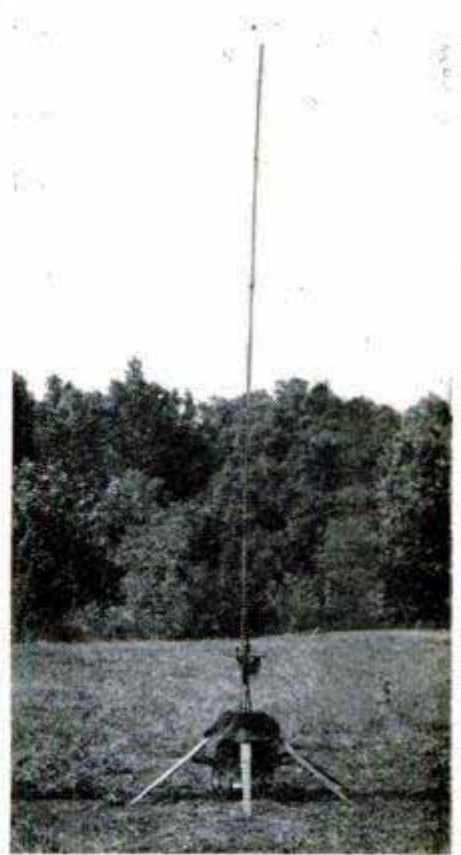
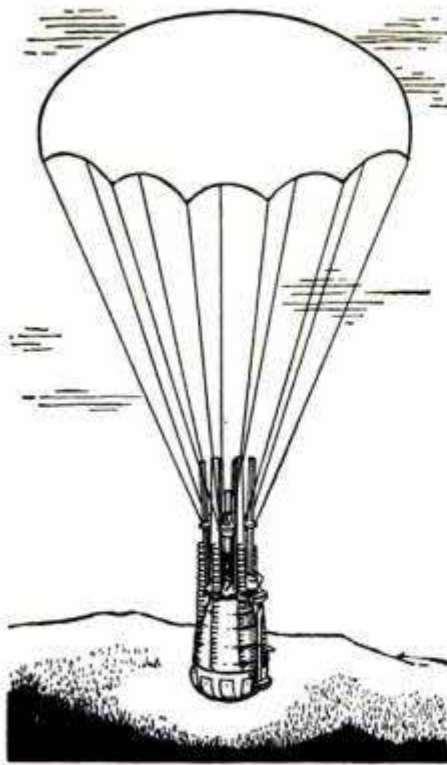

Self-Erecting Weather Station

After it lands, three explosions convert a bomb-shaped container on a parachute into an automatic weather station. It was developed by the National Bureau of Standards to broadcast observations from inaccessible territory. When the station is dropped the parachute opens automatically

and an electric clock that controls subsequent operation is turned on. An initial small explosion on impact with the ground releases the parachute and prevents the equipment from being dragged along the ground. A second charge triggers a leg-release device which raises the unit to an upright operating position and a third extends its telescoped antenna.

Hypodermic Gun Has No Needle

Soldiers who face enemy gunfire unflinchingly but quail at the sight of a hypodermic needle can relax. There's no needle in a multiple-dose injection apparatus shaped much like a pistol, which may be used for the rapid inoculation of large groups with vaccines and antibiotics. The "shot" is forced through the skin by a high-pressure jet. Nothing penetrates the skin except the medication itself. A strong spring suddenly forces the vaccine out in a powerful but tiny spray when the gun's "trigger" is pushed. The jet of medicine penetrates the skin, leaving little or no mark on the soldier's arm.

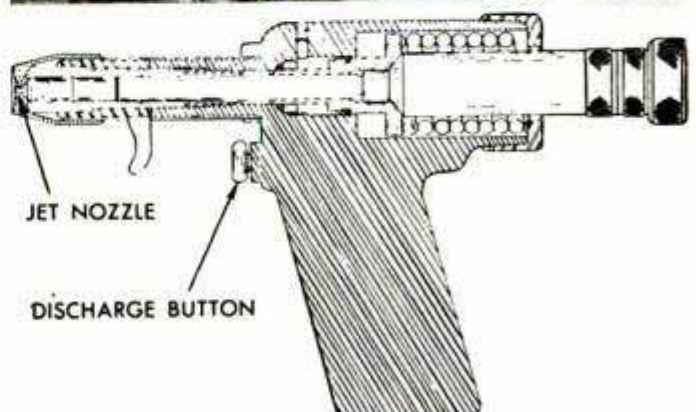
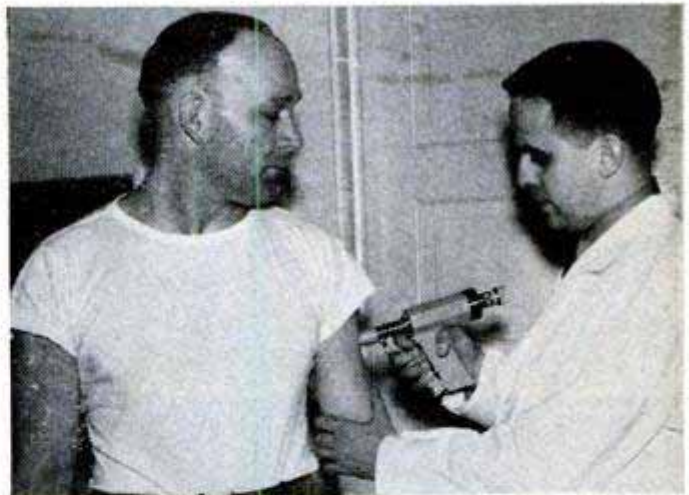

Our WHERE-TO-FIND-IT LIST, giving names of manufacturers and sources of further information for products and articles in this issue, is available free upon request. This index is one of the many services offered to Popular Mechanics readers by the Bureau of Information. For your list, just write to the Bureau of Information, Popular Mechanics Magazine, 200 E. Ontario St., Chicago 11

WHAT'S NEW FOR Your Home



COMPACT KITCHEN has everything, including the well-known kitchen sink! Occupying only 4.1 square feet of floor space, the unit combines a refrigerator, storage drawer, drainboard, sink, gas or electric range

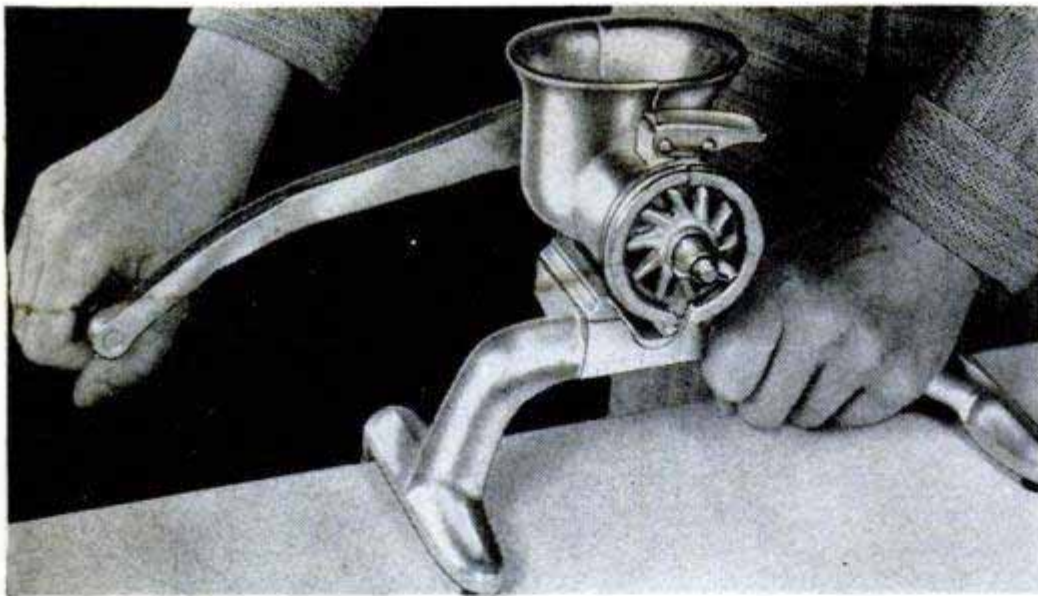

CHOPPER requires no clamping down. A broad base that hooks over the counter edge forms a stable support. One hand will keep it from moving. Rubber pads on feet prevent slippage. It has a trough which drains off all excess food juices

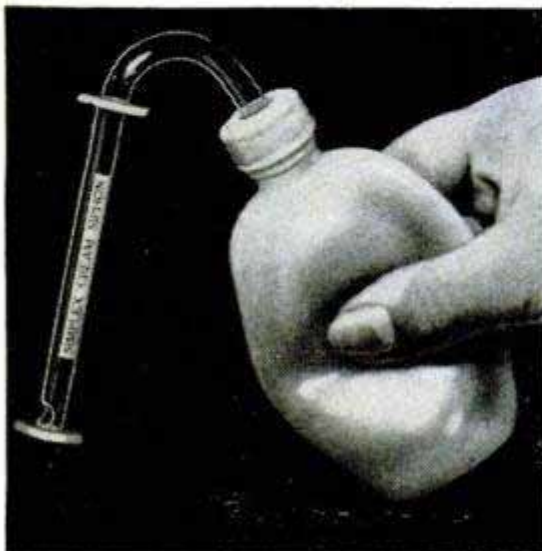

← **SIPHON** draws cream off milk without mess. You squeeze the plastic bottle and insert tube in the cream. Release pressure and the cream siphons from the bottle into the container

DISPENSER fits on a → shaving-cream tube. As tube is squeezed, cream is forced into a small sponge which is moistened and used to spread lather over face



POPULAR MECHANICS



STEEL CORNICE goes up as quickly and as easily as a curtain rod. Made of thin steel enameled in seven decorator colors, the cornice is so light that it can be nailed in place by the housewife in minutes. The slats can be trimmed with ordinary scissors to tailor them to fit any window from 2 to 10 feet in width



POCKET replacement, left, for men's trousers requires no sewing. Cut off the bottom of the worn pocket, slide the replacement over the cut and iron it on. Cleaning won't loosen its grip

FOLDING FENCE, below left, can be stored easily. It comes in 6-foot sections that link up to form longer fences. Or used singly, the sections are excellent for protecting shrubs

SHARPENER, below, makes a razor blade last for more than 100 shaves. It is electric powered and has six leather rollers to hone and stropp the blade to assure you of a sharp edge

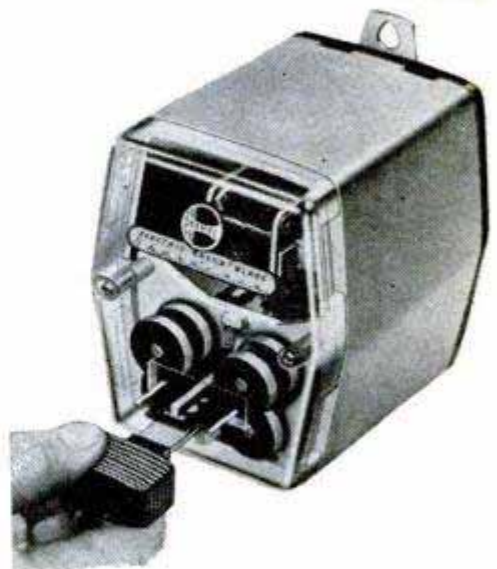
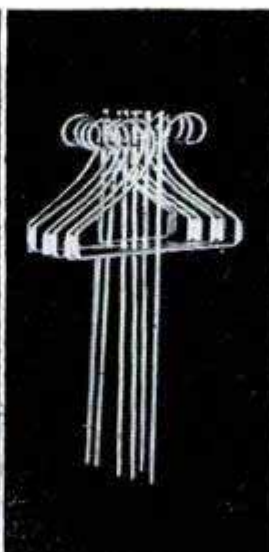
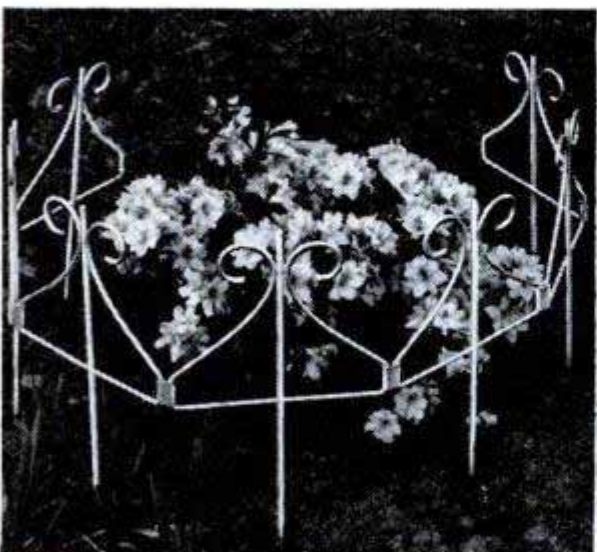

YOU'LL BUILD YOUR NEXT HOUSE of *MOLASSES*

A five-room home for \$1000 plus the plumbing and wiring is the hope of a North Carolina scientist. Drive up his molasses-asphalt driveway—see what's going on in his molasses-plastic garage!

By
Michael Day

MOLASSES USED to be an ingredient of cookies that mother made or something to put on hotcakes if you couldn't get maple syrup.

But today, if you visit George W. Rappleyea in the sleepy town of Southport, N.C., you can hardly turn around without bumping into molasses. Beyond festoons of

Spanish moss behind his home is an entire building made of molasses. It houses the machinery for making more molasses products. To get to it, you walk along a molasses driveway that looks, feels and acts like "black top." Here and there, molasses building bricks are drying in the sun. Inside the building, you walk on a molasses floor, examine samples of hard or flexible molasses sewer pipe that rest on a laboratory table top made of molasses. There are samples of molasses plaques flexible as rubber, molasses

Molasses asphalt is simply raked into place, compacted with roller. Two gallons of molasses paves a square yard

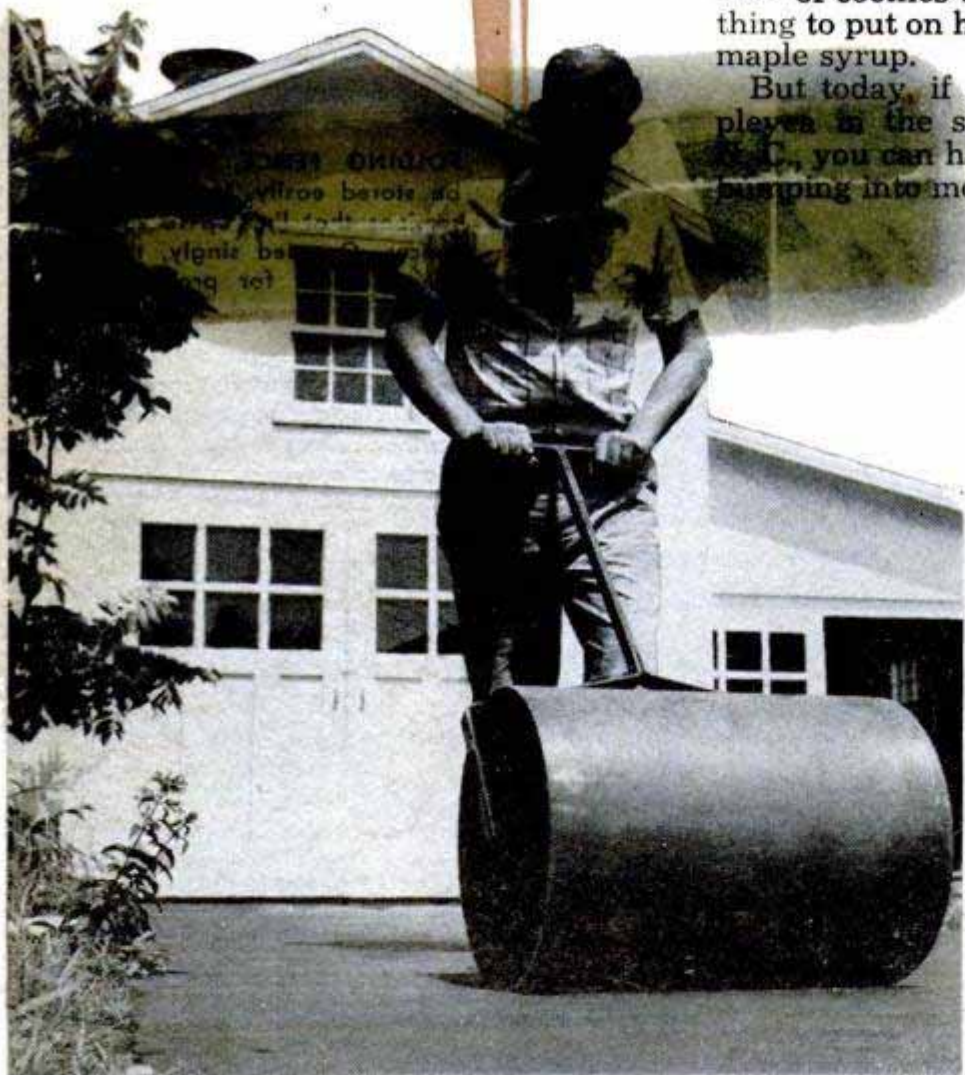

and wire aren't essential but fill notches to save some plastic

plaques as hard as rock.

"What's the point?" asks Mr. Rappleyea, an energetic little white-haired man who used to be vice-president of Higgins Boats, and wouldn't be making molasses houses just for laughs. "That 50-foot molasses black-top driveway you just walked on would cost the average homeowner about \$50. Less if he did it himself. A five-room house built with molasses adobe brick on a molasses slab, finished with molasses stipple spray outside, troweled molasses plastic inside, would cost a man less than \$1000, exclusive of electricity and plumbing. What's more he'd have a house that would stand a hundred years or more—moistureproof, soundproof, self-insulated, termiteproof. It's the cheapest building material in the world."

Naturally, to make these things you don't just take a barrel of pure molasses and start gumming everything up with it. Powdered molasses is the basic ingredient of a new thermosetting plastic that does the trick. By mixing this powdered molasses with plain bunker fuel oil and certain catalysts, Rappleyea has come up with the thick

black concentrate he calls **Plasmofalt** (short for plastic molasses asphalt). By altering the formula slightly, he has made it in three different grades to produce different degrees of hardness.

Rappleyea isn't yet producing the molasses concentrate in quantity, but expects to have it on the market soon.

Plasmofalt, mixed with clay and sand, produces a waterproof adobe brick hard as concrete. A different mixture of the same ingredients makes a cheap, quick-hardening paving material for driveways, highways, parking lots, tennis courts and land-



Plastic molasses sticks to almost anything. Here are construction samples made of bamboo, iron, chicken wire



ing strips. Substitute clay and a fibrous filler for the clay and sand, and a brand-new plastic is formed, which Rappleyea calls Plasmote. This can be mixed with water and sprayed outside a building to give it a tough stucco finish that won't crack or come loose. Troweled like plaster, Plasmote makes smooth inside walls, floors, ceilings and impervious table tops.

There's nothing brand new about using molasses as a building material. For centuries men have known of the terrific "bonding" qualities of the substance. It was done in India years ago, with a molasses concentrate and asphalt. But it took the Indians 17 hours to make up a small batch, and asphalt isn't so cheap anymore. Besides, handling semiliquid molasses is a messy job. Plasmofalt is cheap and easy to handle. It will be turned out at a rate of about 10,000 pounds per hour in a new commercial plant soon to be built in New Jersey.

The real secret of Plasmofalt is Rappleyea's dehydrator, which takes the sticky blackstrap molasses and makes a dry granular substance of it—like brown sand. "We had a tough time devising a drier to do the job," he says. "Centrifuges gummed up in no time. Freeze driers solidified the stuff in gobcs. Hot air only did half the job, and if heat was boosted the molasses caught fire."

Today, in the pilot plant of Rappleyea's



Clay, sand, water and liquid Plasmofalt are mixed into adobe. Mixture then is troweled into brick forms

Tropical Agricultural Research Laboratory in Southport, the blackstrap molasses goes into a hot-air drier of the man's own invention. It looks like a 5000-gallon fuel-oil storage tank standing on end. Blackstrap molasses is pumped into the top of the big drumlike drying chamber under pressure of 2500 pounds per square inch. There it passes through an area of high heat in a

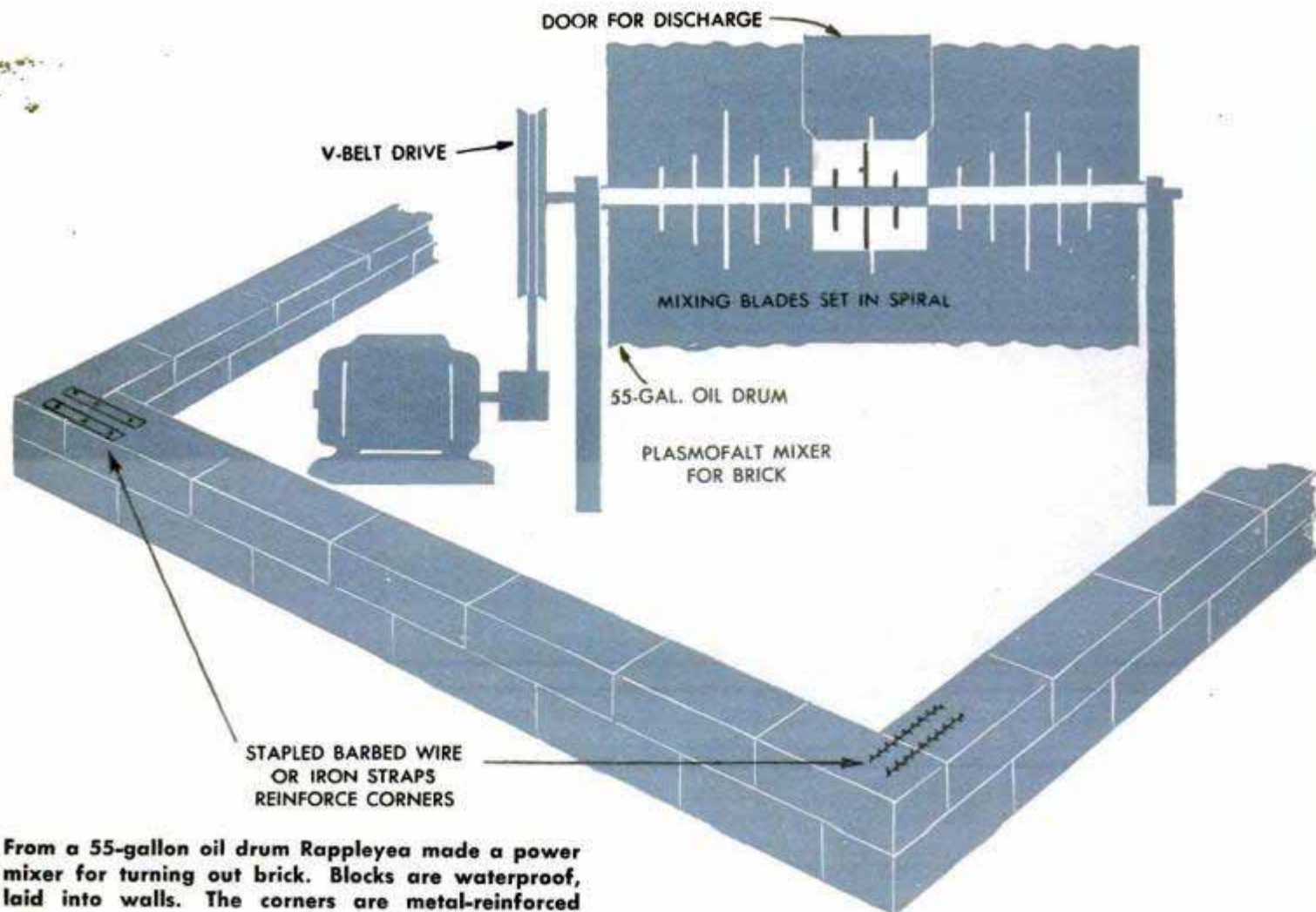

From a 55-gallon oil drum Rappleyea made a power mixer for turning out brick. Blocks are waterproof, laid into walls. The corners are metal-reinforced

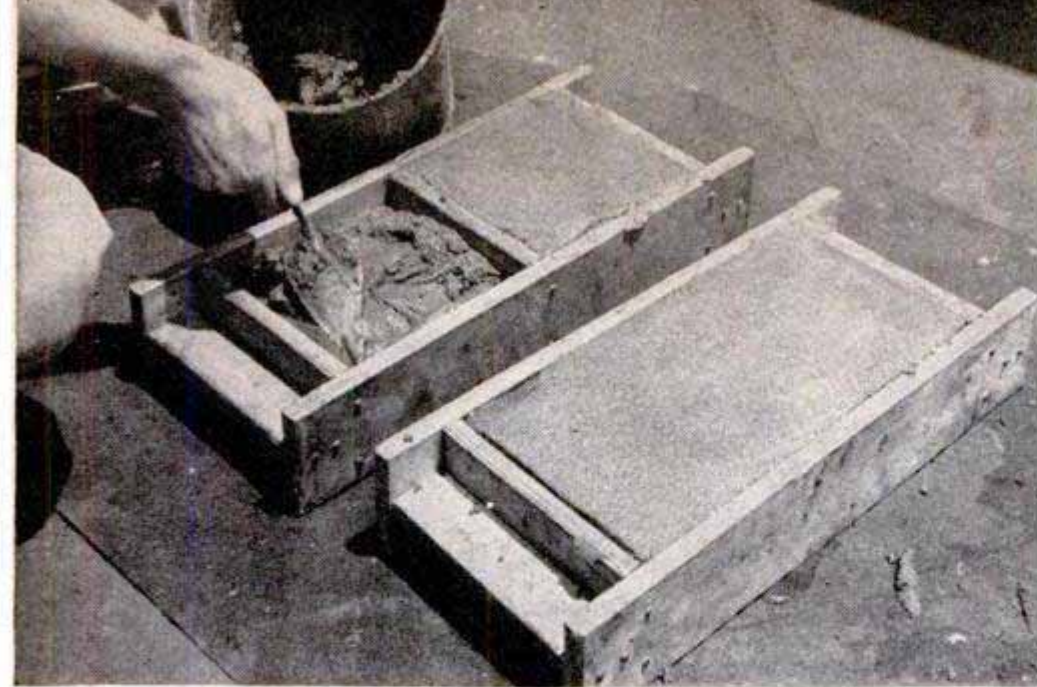

Just as soon as the form is filled it can be removed. Mixture retains the shape of the form until it dries



Resulting bricks, after hardening in the sun, are water-proof, hard as concrete, won't crumble in tropics

split second. "It's powdered before it knows what happened," says "Rapp," "and falls to the bottom of the drier like snow. But it didn't happen overnight. For instance, until we put in strong, stainless-steel pipe, feedlines burst under the tremendous pressure. Hot molasses would geyser all over everything—including me and my assistant. We spent weeks cleaning molasses out of our hair and scraping it off the walls and ceiling."

Once mixed with oil and catalytic agents, the powdered molasses flowing from the drier becomes a regular polymerized plastic with remarkable properties. To show how it works, inventor Rappleyea leads you to his back yard. "Anyone can make Plasmobrics himself," he says, pointing to

Jet-black top-dressing is given a driveway. Plasmofalt mixture simply is spread around with a squeegee

a regular mortar-mixing box, where his assistant is busy hoeing up what looks like cement. It's actually 65-percent plain sand, 30-percent clay and 5-percent liquid Plasmofalt. Water is sprinkled on and hoed in until the mixture has the consistency of stiff mortar. The man trowels this into wooden forms near by. One measures 4 by 8 by 16 inches, or about eight times the size of a regular red brick. The other is 4 by 8 by 8 inches. Off come the forms immediately and, oddly enough, the wet bricks stay set. In three days they're dry enough to stand on end, where they remain baking in the sun for 28 days more. They are laid the same way as conventional bricks. Wire is used to reinforce corners.

There's nothing new about adobe bricks,

Here's a new smooth-as-tile surface for an old floor. Dry, it will be similar to continuous sheet of rubber

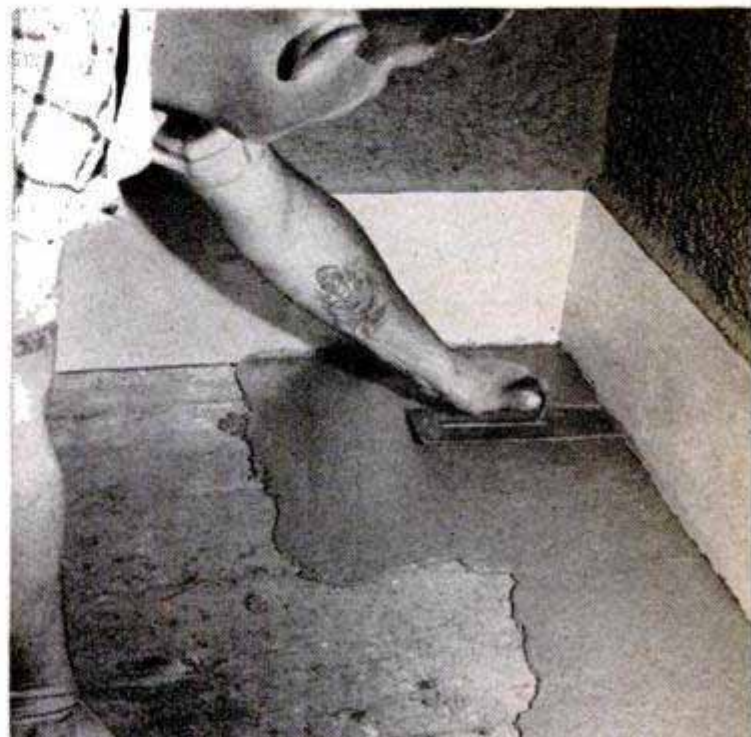



Since Plasmoite sticks to anything, it will make an ideal coating for cheap tropical housing. Half of straw-thatch panel is coated. It's now waterproof, bugproof, stronger

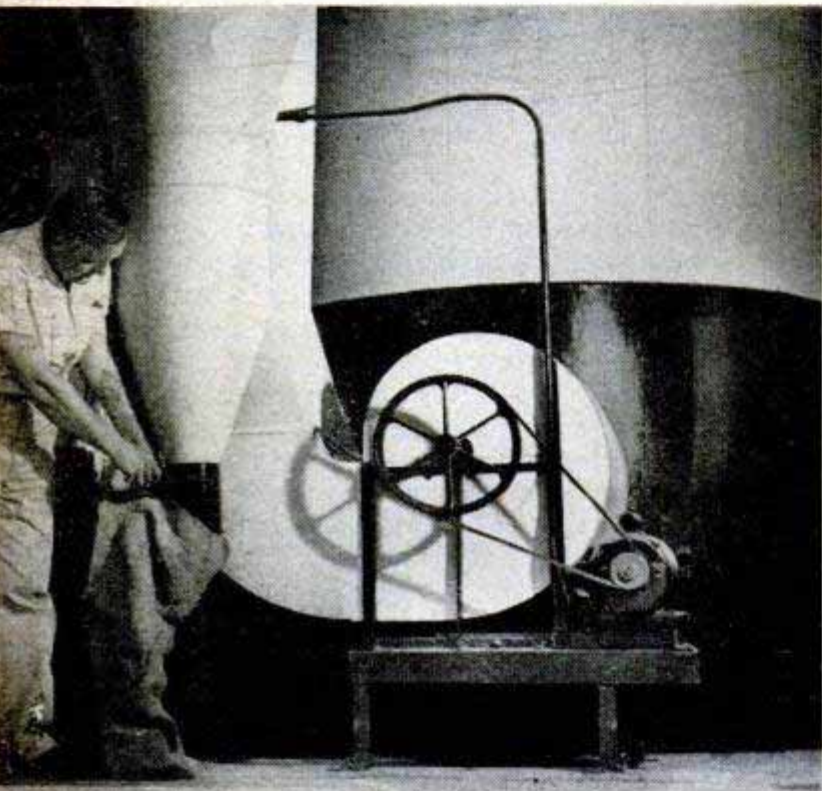

Machine turns blackstrap molasses into a powder. Spray of molasses falls like snow through oven, is drawn off into bags

In some applications a filler is used. This machine shreds cardboard boxes into a fluffy "wood wool" for the mixture

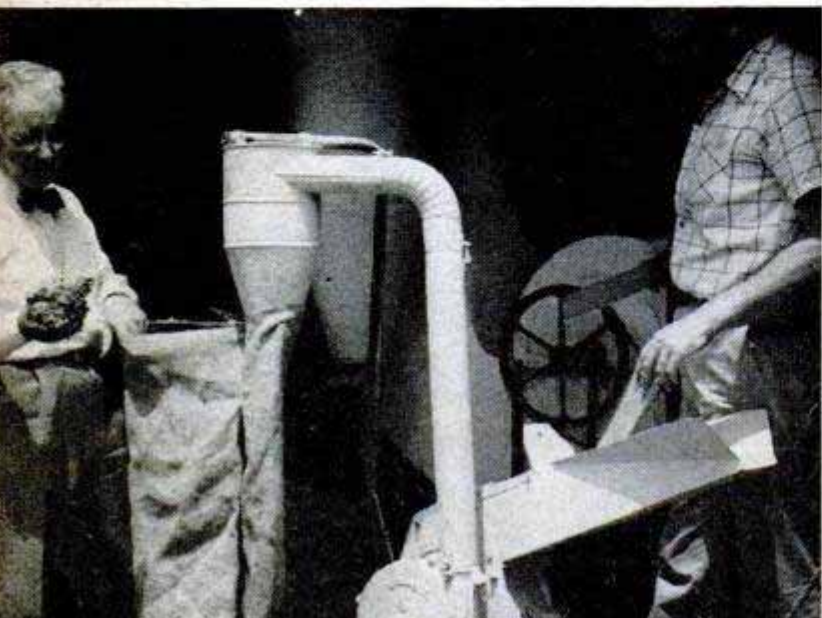

but there's something new about these. The Plasmofalt acts as a binder and makes them as rugged as concrete. Plain adobe has never been practical in wet country because rain washed it away. Plasmofalt makes the brick waterproof. Rappleyea has set his bricks in water for 30 days beside other brick. Plasmobric absorbed two percent moisture, cement brick eight percent, and regular red ceramic brick twelve percent. Plasmobrics have been lying all over the Rappleyea yard in rain, frost and heat for a year. They still look and test as good as new in the jaws of the pressure jack in the laboratory.

"Proper soil is important," says the inventor. "The soil in your backyard might be just the right proportion of sand and clay. A good test is to put a handful in a glass of water, agitate it and let it settle overnight. Sand settles first, and the clay rests on top. Anywhere from 25 to 35-percent clay is fine."

He contends that since the bricks are dirt, "they're cheap as dirt." He has determined that it takes 3050 of the big bricks to make a one-story adobe house of five rooms. "You'd need a dozen barrels of Plasmofalt at \$24 a barrel to do the job," he points out. "That's \$288 for the main shell of your dwelling. You'd set it on a waterproof, Plasmoized adobe slab. Then, use Plasmoite spray on the walls and ceiling—and on the exterior if you want a stucco-type finish. You'll have to buy 2 by 6 rafters and joists." But the whole house should not cost more than \$150 a room, exclusive of plumbing and electricity.

And about that driveway? You can make that yourself, too, if you like and no one will ever be able to tell it from black top. Fifteen pails of plain beach sand to one pail (about two gallons) of Plasmofalt, and you've got about a square yard of driveway. In 24 hours it's ready to use. No heavy compacting machinery is necessary, though the more compacting the harder the surface.

"We compacted our own driveway with an ordinary lawn roller," the inventor reveals. "Just rake out the Plasmofalt as you would an asphalt mix, and start rolling."

The experimental driveway looks as neat and trim as the day it was

(Continued to page 248)



V-shaped blade rams against a tree to slice it off close to ground with one stroke. Blade attaches rigidly to dozer

"Sawdozer" Slices Big Trees

Spectacular is the word for the wood-cutting ability of a six-foot, V-shaped saw blade which is attached rigidly to a bulldozer. The saw blade has no moving parts and merely is rammed against the tree by the bulldozer. Its big teeth slice off trees up to 24 inches in diameter with a single stroke. The "sawdozer" is being used to

clear trees from the reservoir area of Boyesen Dam, now under construction by the Bureau of Reclamation in Wyoming. One saw-equipped bulldozer can fell trees as fast as five crews with chain saws. Another bulldozer blade, equipped with tines, scoops up not only timber but also smaller brush for burning.

Tines beneath the bulldozer blade form a rake to scoop up small branches and brush as well as heavier timber

Bureau of Reclamation photos

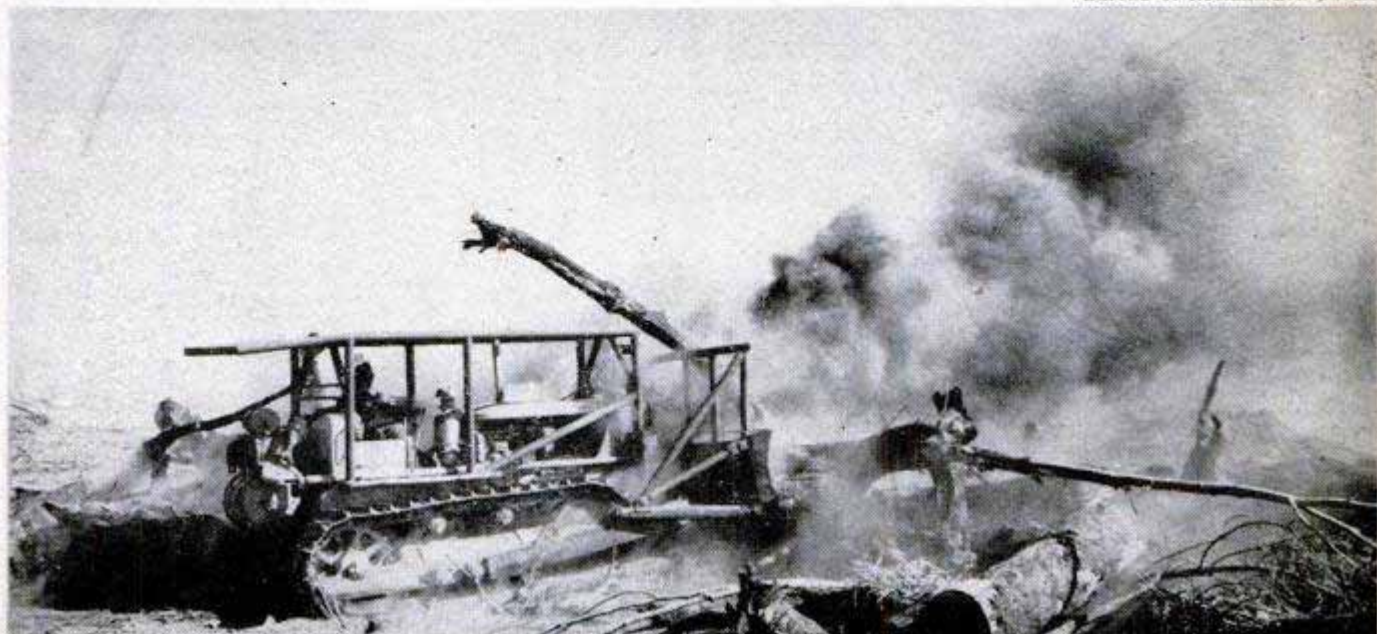



First step in the strange art is to make individual parts of mannequin by "doodling" strips in wet mold



To finish figure, parts are mated with strips of same material, "scribbled" to make invisible joints



Mythical Pan, humorous rabbit and graceful birds show how the flexibility of the material permits unique displays

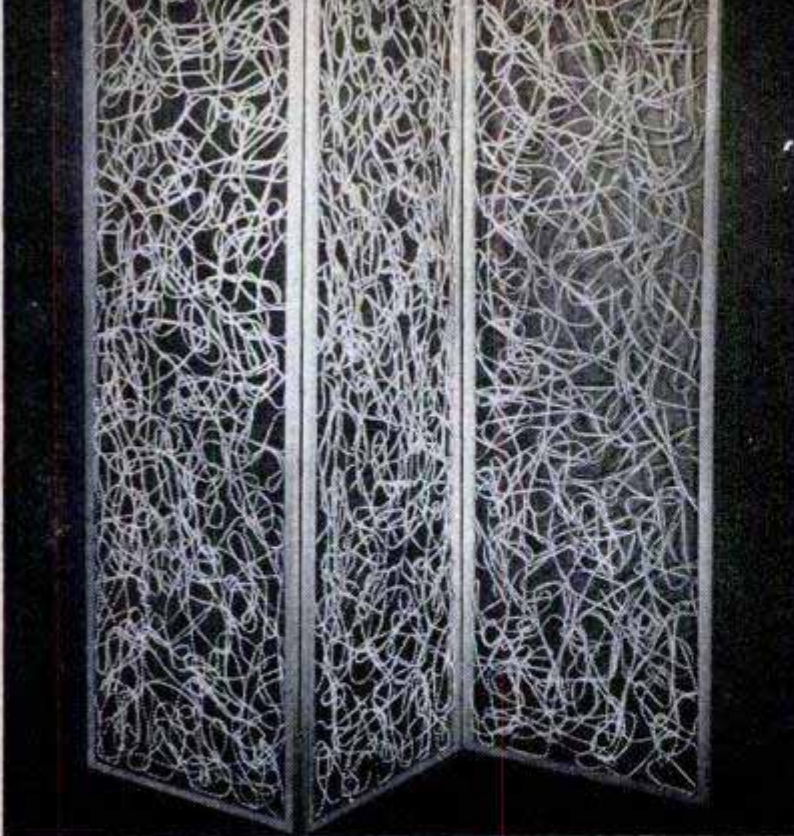

Screen, made of wood frame scribbled with Celastic, is colorful, blends with any modern home decoration



Legs of mannequin are joined solidly to body but arms are jointed. Figure is sprayed with tempera color

By Ronald J. Cristy

THE SHAPES of doodles on a memo pad may give revealing insight to the psychoanalysts, but to Ben Walters, Inc., window-display concern in New York City, doodling led to a new idea and a new look in window-display materials. Interested in mannequins, Walters just naturally scribbled them and one day produced an interesting effect with a series of circles and figure eights. This led to experimentation with Celastic and resulted in what is now gaining national recognition as "scribble sculpture."

Celastic itself is a colloid-treated fabric which becomes very flexible and easy to work when dipped in a special liquid softener. When wet it will bond to itself and other materials with incredible strength so that assembly procedures are accomplished without resort to any form of fastener.

For his scribble sculpture, Walters has the Celastic sliced into narrow strips which are easily worked into the mass of circular and curling lines necessary to produce the scribbled effect. Most of his standard items are formed in multipiece molds which are dampened and coated with a special parting agent before each application. Because the material dries hard in a very short time, the workers can go from mold to mold, assembling the first scribbled pieces while the last ones are drying. Armatures and the usual basic wire forms are not used, but this does not in any way reduce the

strength or rigidity of the finished product. Durability is a Celastic feature.

Parts are joined together with additional strips of the Celastic material, and errors are easily corrected by resoftening the area and reshaping while the material is still wet. Finishing consists of spraying with tempera colors, although any paint or lacquer could be used, and mounting on a suitable base, usually a shaped piece of glass or plastic.

Walters also uses the Celastic in its original sheet form to make full-round castings, draped backgrounds, face masks and many other items supplied by the window-display industry. Scribble sculpture however, is his pride and joy. In a room full of conventional mannequins, his stand out like lighted windows in a dark building.

Nitrogen Package Keeps Food Fresh

Packaging of dry foods in nitrogen instead of the oxygen of the air keeps them fresh much longer, according to experiments by the Linde Air Products Company. Atmospheric oxygen is a cause of food spoilage and rancidity. When such foods as potato chips, roasted nuts, dry soup mixes and dehydrated foods are packaged in a flexible film filled with nitrogen instead of ordinary air they retain "same day" freshness for months or even a year.



Detroit Listening Post

By Siler Freeman

UNDER NORMAL CIRCUMSTANCES, the automobile industry would now be seriously planning when to change over for new models. All else would be in readiness—the tooling, the dies and the orders to suppliers, with a schedule of deliveries.

But these are not ordinary times. The defense program has already taken a toll on third-quarter production and has muddled the picture on new models. Not that the government has banned 1952 models, but its freeze on machine tools has left some of the nation's automobile manufacturers high and dry.

From present indications, some high-compression engines, which had been planned as the feature of the new models, will now be ready in time. Some of the tooling for these jobs is completed and some is not. Although the machine-tool builders have insisted on being paid for the work done, the engines must now be left on the shelf.

The Ford V-8 and the Mercury engines are certain victims of the tooling muddle. The company is hopeful it can complete the tooling somehow next year and put the engines into production.

Those planning only body changes are in much better shape to change over to the new models. Dies are ready and it is only a matter of when to go down and for how long a period of time.

The only factor that does not have uncertainty about it in the new-model picture is the price. The tags on the 1952 cars will definitely be up.

How high depends on the manufacturers' ideas on the amount of improvements and the Office of Price Stabilization. Chrysler set the pattern for new models when it obtained price relief on New Yorkers and Imperials carrying the new V-8 engine and Hydramatic.

Heretofore, OPS held the price line pretty steady. Ford sought relief several times on models on which they were losing money and were turned down. The OPS formula set down in the Chrysler case was that unprofitable operation is not to be the standard, but that changes and im-

provements which called for added costs would be the basis for price increases.

How far this will go remains to be seen in the forthcoming conferences in Washington on prices when new models come out. The dealers also scored their point to get their historic discount on the increase, and not only the dollars-and-cents boost permitted the manufacturers.

Then, of course, the new-car buyer must pay an additional three-percent excise levy. It is a certain conclusion that 1952 cars will be scarcer and higher priced.

The delayed Saratoga is now in the hands of Chrysler dealers as an addition to their line. It had been scheduled for two months ago but the output of V-8 Fire Power engines did not reach expectations until July.

The latest version of Nash's small car, now called the NKI, is causing considerable speculation. George W. Mason, president of the company, is driving one of the jobs and is enthusiastic about the performance. Given the materials and the tooling for a new engine, designed especially for the small car, he would enter the new field as quickly as the company could get ready.

The new engine is 42 horsepower and has a top speed of about 70 miles an hour. It has shown 35 miles to the gallon, which is what Mason has been aiming for.

Originally, Nash had planned to use a foreign engine of low horsepower to get the desired economy and at the same time save the expense of tooling for it. But the customers' answers to a survey last year showed they looked suspiciously on a foreign power plant and wanted more horsepower. The Nash engine combines the desired power and economy. But tooling is blocked by the freeze order.

There has been much discussion on lifting the ban on the fifth tire. Whether the manufacturers will revert to the practice of putting it in the trunk at the factory and charging their lower price on it is debatable. They would like to give the car buyer the advantage of their large purchasing power, but the car dealers have profited by the new practice of selling the tire to the

(Continued to page 240)

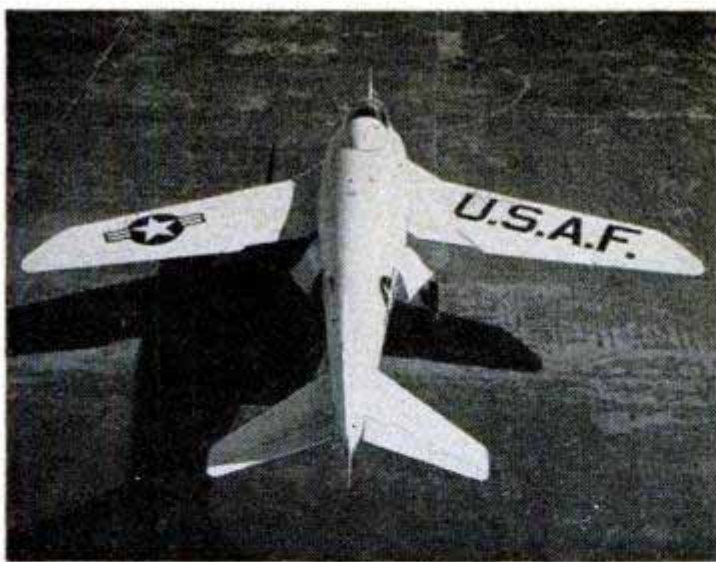

When taking off, climbing or landing, the Bell X-5 has its wings in a forward position to provide maximum lift

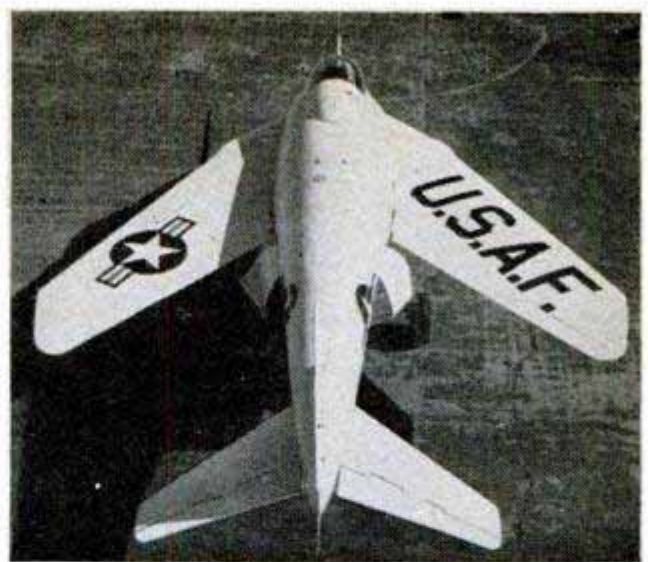

For top speed at high altitude, the pilot pulls the wings back sharply to reduce compressibility

"Retractable" Wings on Flying Laboratory

Wings whose degree of sweepback can be varied in flight will give the Bell X-5 the advantages of conventional design for take-off and of extreme sweepback for speed. Believed to be the first plane to feature such adjustable wings, the X-5 is jet propelled and carries its Allison turbojet engine directly under the cockpit rather than behind the pilot. The tail pipe protrudes beneath the fuselage, giving the plane a

profile like that of a guppy. Each wing has a specially designed fairing to insure that the leading edge presents a smooth airfoil regardless of the sweepback angle. The X-5 is being used as a flying laboratory by the National Advisory Committee for Aeronautics to study the aerodynamic effects of changing the degree of wing sweepback during flight. It is capable of supersonic speeds.



Aluminum Company of America

Lights in Aluminum Arches Control Traffic on Bridge

Indicating which lanes are open to traffic from each direction, the 16 red-and-green traffic lights are mounted on graceful aluminum arches on the Delaware River bridge between Philadelphia and Camden. Spaced at intervals of 750 feet along the

1.8-mile span, the arches permit control of traffic for the full length of the bridge. There are eight traffic lanes on the 79-foot roadway and the number of lanes used in each direction is varied to meet traffic requirements by means of the lights.



Inside this test truck are 308 instruments, showing just what happens to the engine and chassis in operation

FEVER CHARTS PLOT

A BETTER AUTOMOBILE

By Dick Frederic

PLUMES OF DUST swirled behind two shiny black panel trucks as they roared around the banked turns of an abandoned hot-rod track in southern New Hampshire recently. A casual onlooker might have figured them for a pair of delivery wagons gone wild, except for one thing—atop the lead vehicle an airplane pitot tube glittered in the sun and an anemometer whirled at a dizzy speed.

Across the stainless-steel dashboards and the gleaming panels that line the insides of both trucks, lights and dials blinked and whirled in mad confusion. Altimeters and air-speed indicators gave the cabs the look of an airplane. Gasoline on its way to the carburetor bubbled in a tall glass tube beside the steering post; red lights glowed and needles spun every time the driver jammed the gas pedal to the floor. Mercury columns hovered up and down to every waver and murmur of the purring cylinders. Green light danced across the face of a cathode-ray tube beside the driver, painting a continual picture of what was going on inside each cylinder at the instant of combustion and under all degrees of load

and speed. Through ultrasensitive ear-phones, the driver could listen to every pulse of his car—from the racket of a sticky valve to the infinitesimal murmur of metal wearing away on a bearing.

In the back end of the lead truck, a technician flicked switches, taking temperature readings of everything from the oil at the bottom of the dip stick to the cherry-red exhaust valves inside the cylinders.

For years, automotive engineers have known that heat and vibration are the biggest breeders of car breakdowns; that moderate driving produces the best gasoline mileage; that jack-rabbit starts eat up a lot of fuel. But just exactly why these things are so, where they start and how they can be corrected economically has led to a lot of arguments and little else.

About a year ago, Andrew J. White, brusque young head of Gale Hall Engineering in Boston, and a man with genius for devising simple devices to do what everyone considers impossible, got sick of arguing and decided to find answers.

To do this, White bought a farm near Portsmouth, N. H., converted it into a mod-

ern laboratory and, in his spare time, began to fit out a pair of Chevrolet panel trucks until they resemble mobile versions of Frankenstein's laboratory. Actually, each is a self-contained, rolling dynamometer designed to tell the operator exactly what is happening anywhere in the vehicle's innards at any time while it is under way. Exactly 308 dials, switches, lights, meters and indicators stare at you from the stainless-steel panels that line its interior. Inside the hood is a maze of wires leading to dozens of thermocouples, all connected to dials inside the truck.

"If we're driving along at 90 and want to know how hot the rear end is," says White, "we just flick a switch and find out. Our reading also gives us the viscosity of the oil back there."

Just about everything is wired for heat—intake and exhaust manifolds, inside and outside of cylinder walls, muffler, exhaust pipe, air under the hood, radiator top and bottom, air coming into the filter and leaving it, gasoline in the carburetor, fuel in the tank. Name it and you can have its temperature at any time while driving.

Already the test cars have proved that there's plenty of destructive heat coming from places other than the engine. One thermocouple is hooked to a little chrome barrel under the car and catches heat radiated off the road as the vehicle whips along. "Few people realize," says White, "that you can fry an egg on a concrete road on a hot summer day. We've logged that air rising off the pavement and up against

At any time during a run, White can remove a sample of oil from the crankcase or differential and check its viscosity and condition in a built-in test unit

Below, dots show where thermocouples are located to measure temperatures of parts while car is operating. Other major test instruments are shown in the sketch



Some of the external instruments are the pitot tube and anemometer on the roof and a thermocouple near the ground that measures radiant heat from highway

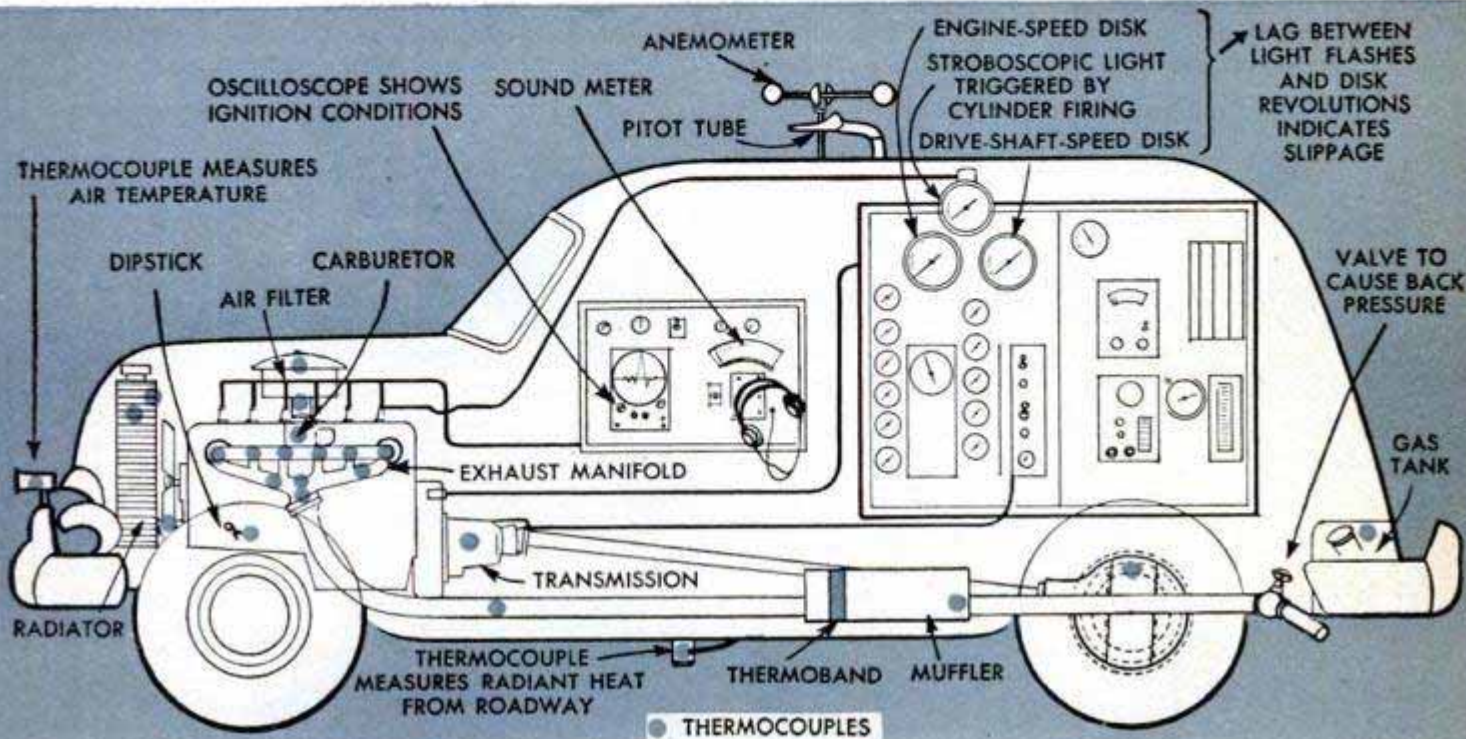



Lined with an impressive array of dials and switches, the truck interior is an efficient mobile laboratory

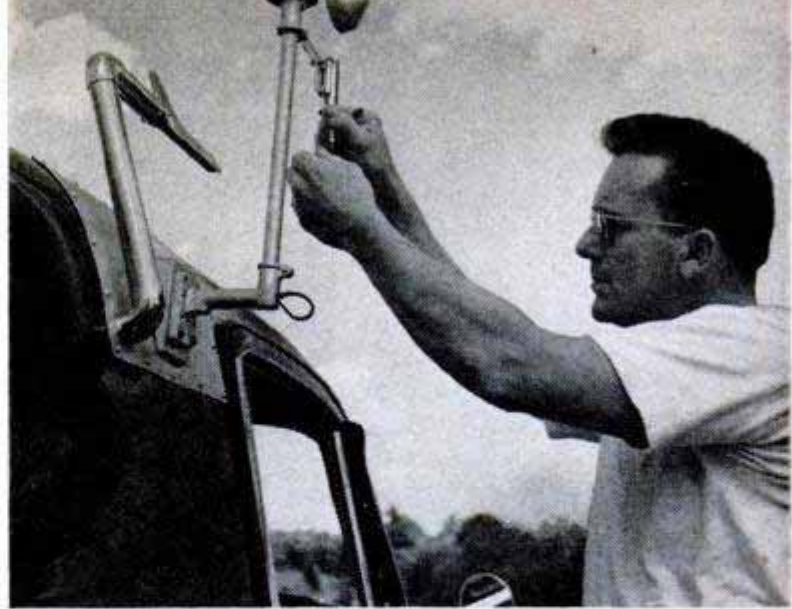

White measures the effect of wind on gas consumption with a pitot tube and anemometer mounted on roof

the bottom of the car at 212 degrees. Our other instruments told us that the oil was boiling in the crankcase. Its viscosity was so low it wasn't able to lubricate the engine properly."

Gasoline consumption is one of Andy White's pet hobbies and his test cars are loaded with instruments to find out where, when and how gasoline goes.

"Want to see how to ruin your gas mileage?" he asks. He flips a switch on a glass vial fixed to the dash panel and a tenth of a gallon gushes into it from the feed line. This is a flowmeter with a calibrated scale in it. Another switch cuts the flowmeter into the system while the car is moving, and blocks off the line from the regular tank. White comes to a stop and idles. The fuel in the glass column drops imperceptibly. Then, brrrrmm — brrrrmm — brrrrmm — brrrrmm — he drums the accelerator against the floor board four times like a nervous

driver at a traffic light. Down drops the gasoline—about a quarter of it at once. Four more times and it's half gone. "And we haven't gone anyplace," he reminds you.

"The average car," says White, "can go 200 feet on four cubic centimeters of fuel. But every time you tramp the accelerator to the floor for an instant, four times that amount of gasoline is sucked through the engine and wasted. Four tramps on the pedal and you sacrifice 3200 feet of transportation—eight, and you've dumped almost 1¼ miles out the exhaust."

You can watch the needle on a meter (which operates off engine vacuum) climb to 47 miles per gallon as the car rolls downhill—then falls back with a jolt to about two miles per gallon when the driver hits the floor board on a hill to pass another car. Everything drops to zero (including that tenth of a gallon) on a jack-rabbit start. And

(Continued to page 268)

Dashboard of the second test truck has specialized instruments that demonstrate wasteful driving habits

Wearing earphones, engineer Len Bell can listen to noises made by various parts of engine and chassis

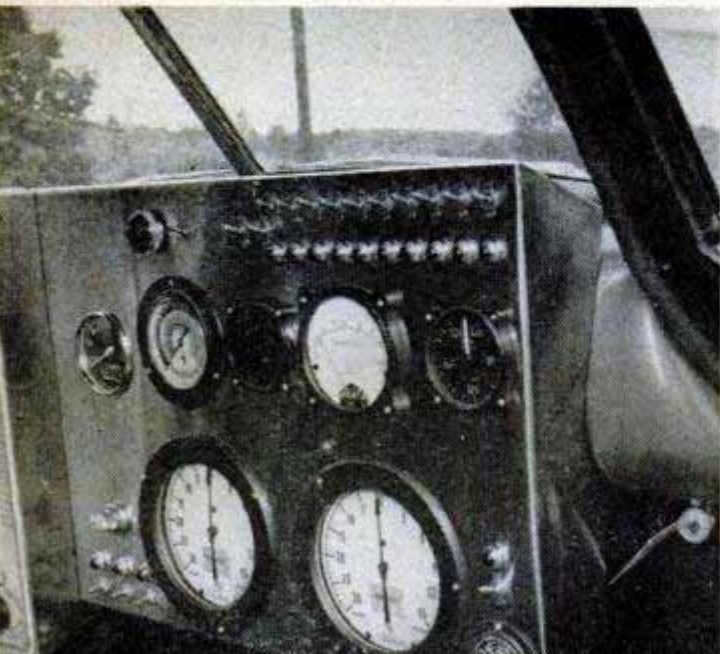

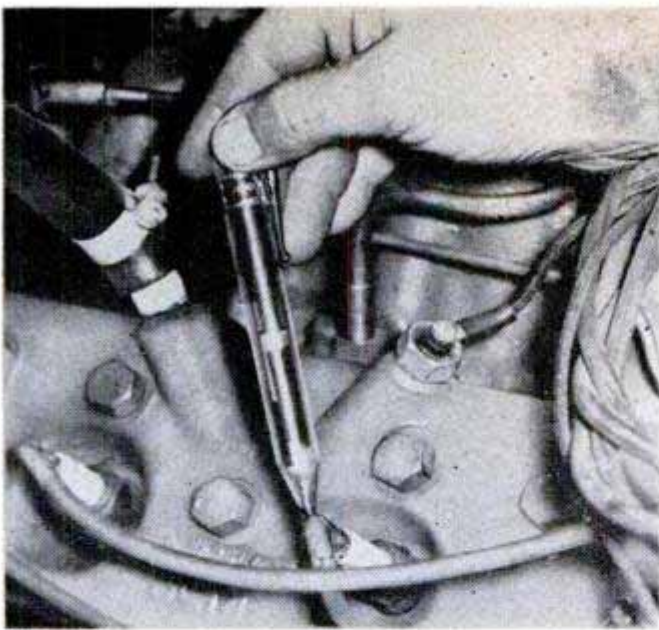

Ignition Tester

Providing a rapid check of voltage at the spark plugs, a pocket-size firing indicator detects ignition defects. The brightness and frequency of the flashes inside the transparent instrument vary with the voltage, giving the mechanic a measure of spark quality.

Mercury Switch Stops Engine When Automobile Overturns

Stopping the engine when the car or truck tips to more than 45 degrees, a simple mercury switch helps prevent fires that often cause fatalities in overturned vehicles. The switch connects to the ignition circuit. When the car tilts excessively, the mercury moves away from the points of the switch, stopping the flow of current. A baffle plate keeps the mercury in position during sudden starts and stops.

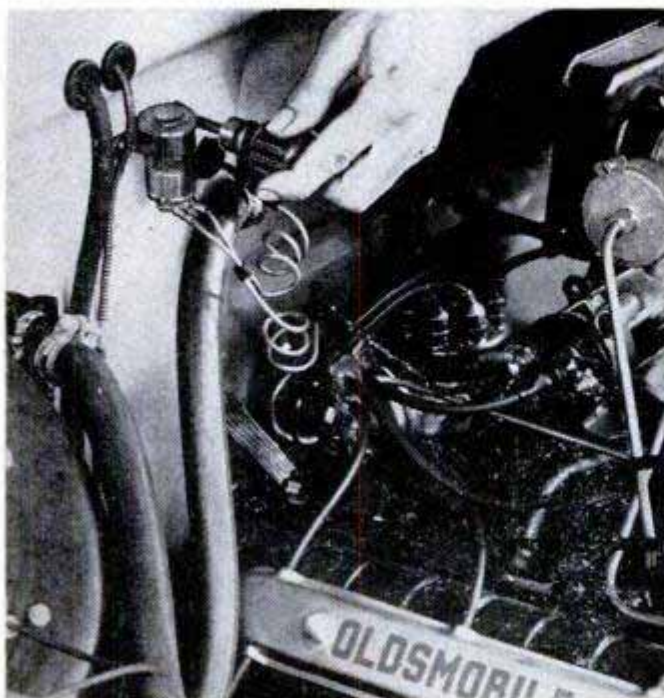

Wiper Clears Side Windows

Driving visibility is aided during rain and snow, particularly when making turns, by a manually operated wiper for the side windows. Quickly removed or attached, it is held rigidly in place by a friction clamp. A small crank operates the wiper from inside the automobile.

Inspection 'Scope "Sees" Inside Conditions

Only a half inch in diameter, a long tubular optical instrument enables inspectors to look at a magnified image of surfaces otherwise inaccessible to the eye. It can be used to investigate inside surfaces of hollow castings, engine cylinders, gun barrels or other interior areas. Electric illumination is built into the tube. A tiny 12-volt bulb provides ample inspection illumination over the area magnified.

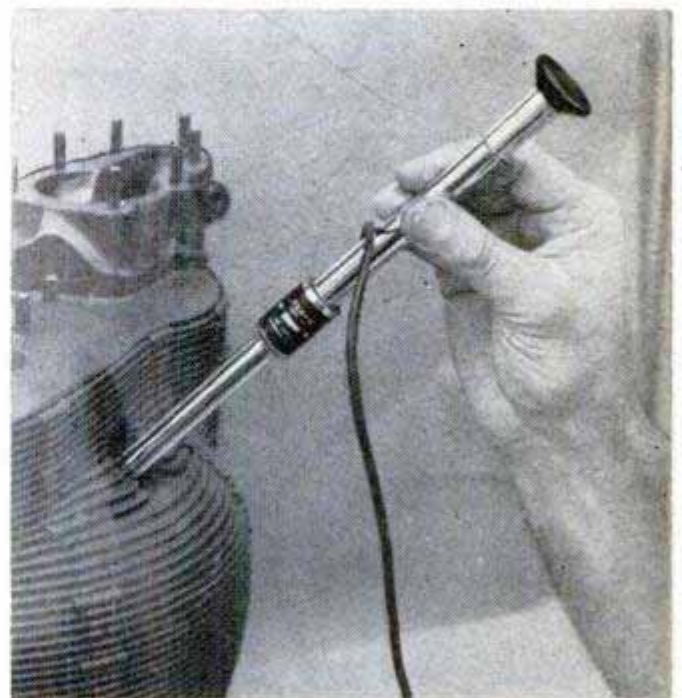



Douglas Aircraft photo

At an altitude of 35,000 feet during speed runs, the Skyrocket was uncoupled from the bomb bay of its "mother ship," a B-29. Then it climbed to about 70,000 feet

70,000 FT. —

DOUGLAS SKYROCKET

COMPLETELY ROCKET POWERED, the Douglas Skyrocket has flown faster and higher than any other airplane, according to the Navy. Security prevented announcement of the actual records, but the needle-nosed research craft is estimated to have approached 1300 miles an hour and 70,000 feet. The Bell X-1 was the unofficial holder of both records. Originally, the Skyrocket used jet for take-off and landing, and rocket power aloft, but to save weight only rockets were used during the tests and the plane was carried up beneath a B-29. After being freed at 35,000 feet, it is believed the plane used a ton of fuel a minute.

LEVEL SPEED RUN

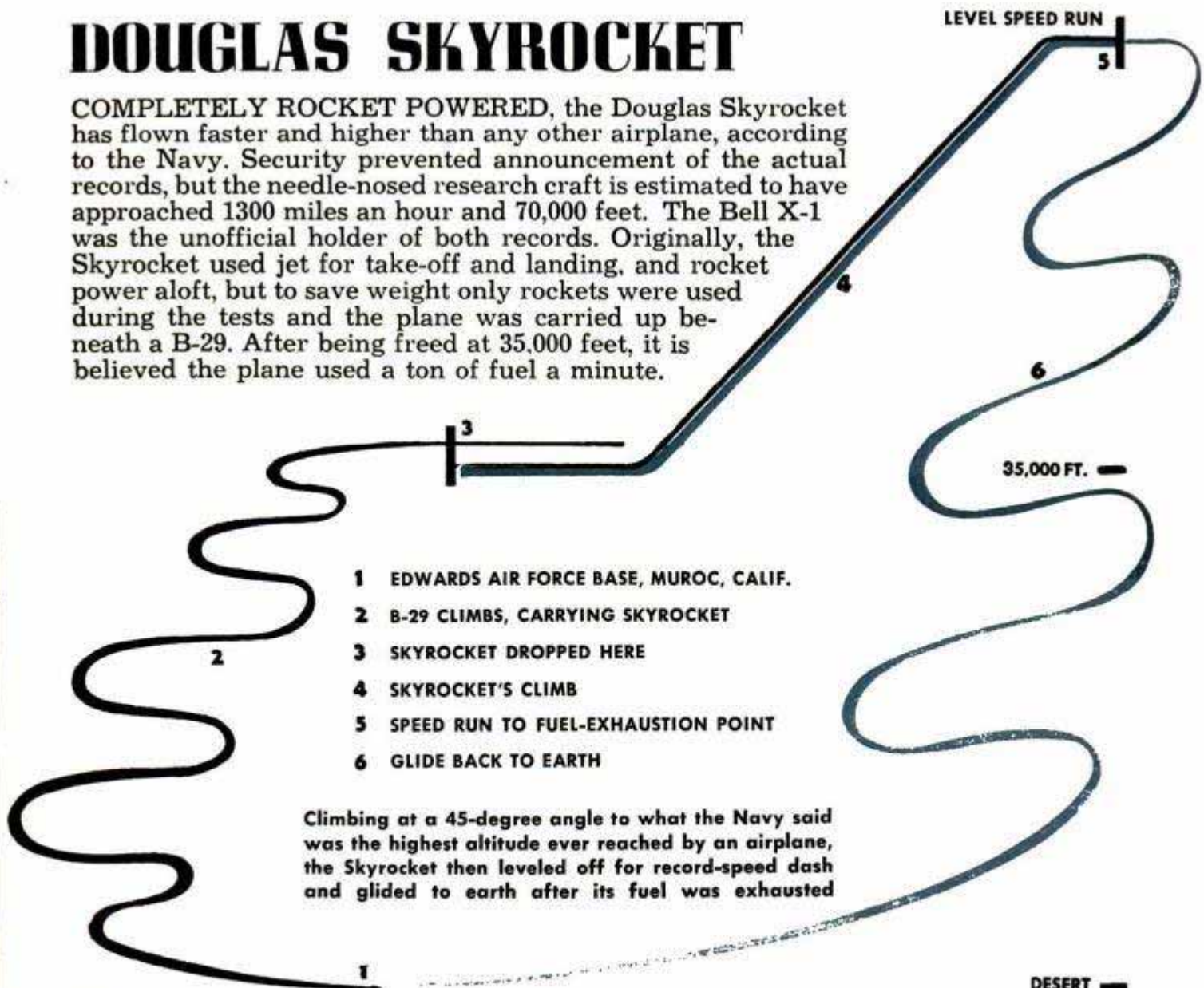

- 1 EDWARDS AIR FORCE BASE, MUROC, CALIF.
- 2 B-29 CLIMBS, CARRYING SKYROCKET
- 3 SKYROCKET DROPPED HERE
- 4 SKYROCKET'S CLIMB
- 5 SPEED RUN TO FUEL-EXHAUSTION POINT
- 6 GLIDE BACK TO EARTH

Climbing at a 45-degree angle to what the Navy said was the highest altitude ever reached by an airplane, the Skyrocket then leveled off for record-speed dash and glided to earth after its fuel was exhausted

DESERT —



Bureau of Mines photo

With a WHOOM coal dust explodes, spewing out burning gas. Research men touched off the explosion in a test

FIGHTING INFERNOS UNDERGROUND

WOODLAND STREAMS around New Straitsville, Ohio, run hot. Acres of forest are dead. Huge cave-ins pockmark the landscape. Everywhere, smoke and steam spew from the earth in geysers. Roads have slumped, tilted and ruptured. Some houses, in a town once numbering 2500 souls but now down to 50, lie in tumbled ruins; others sit at crazy angles.

For 70 years a seething subterranean fire

has been burning through 30 square miles of coal bed under New Straitsville. Already, \$50,000,000 in coal reserves have burned up in this blaze.

Fifteen years ago, few people cared about burning up our coal reserves. There seemed plenty to burn. Even today, after mining some 30 billion tons, we still have a recoverable reserve estimated at one trillion, 200 billion tons—enough to last until

Mine Safety Appliances Co. photo

By

Richard F. Dempewolff

Underground boat is designed to be lowered down a mine shaft. It ferries men and their equipment through flooded levels. The fire fighters are wearing two-hour breathing apparatus

SEPTEMBER 1951



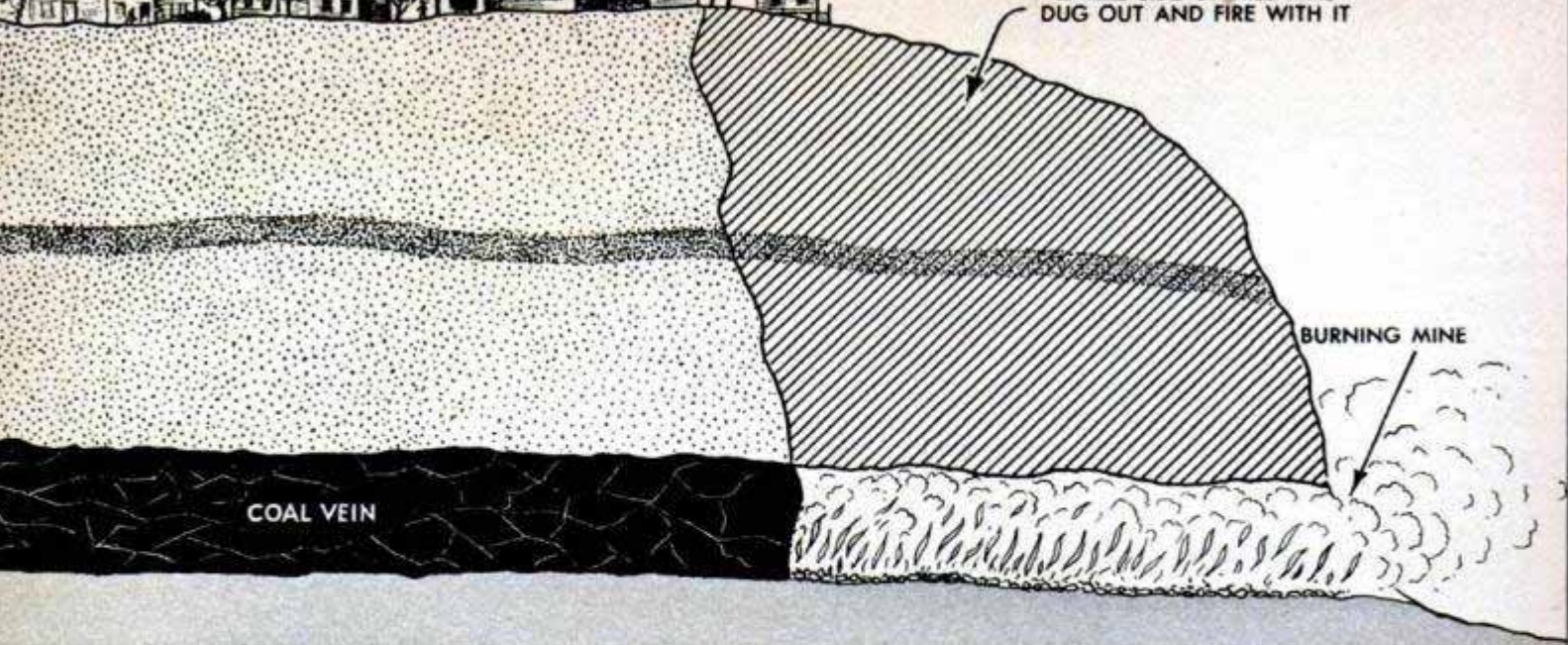

In Fairmont, W. Va., a burning coal mine was literally dug out of the ground to save the city from collapse

the year 3563 at present consumption. It sounds like plenty, until you know that millions of those tons are burning up in the ground. "Few people realize," Frank E. Griffith, chief fire-control engineer for the U. S. Bureau of Mines, will tell you, "that several hundred coal-mine fires are burning out the underpinnings of our country right now. Some have been burning for 40 to 50 years."

How did these infernos start? Careless

burning of rubbish atop old stripping operations is a big cause. Near Pittsburgh, a farmer started one by burning timber slash in sinkholes above an abandoned, collapsing mine. Kids playing Tom Sawyer in abandoned mine openings have started dozens. A mine in Gillette, Wyo., was set ablaze in 1885 by a horse thief who used it as a hideout, and the fire burned furiously until bureau men finally doused it last year.

However fires start, the job of putting

Silt is washed from a large hopper, through a pipe and into a borehole. Soil will block the old passageways

Bureau of Mines photo



them out is always tough. Bureau men have had to start from scratch to learn techniques. At the bureau's experimental mine, 13 miles south of Pittsburgh, an army of experts including underground fire fighters has been studying effects of different types of mine fires, characteristics of explosions, conditions of igniting gases and the efficiency of different extinguishing agents. Specially constructed "rooms" in the mine are lined with coal, insulated against surrounding beds by concrete block, and set afire. If you're around that experimental inferno at the right time, you're likely to see a show that will stand your hair on end. Sometimes, in explosion experiments, gas and coal dust go off with a dull WHOOM, and flames hurtle 500 feet out into space, giving the mine entrance the look of a gigantic flame thrower. Asbestos-clothed fire fighters rush into the smoking hole pushing machines that spout white, powdery clouds before them.

Today, the results of years of these sham battles finally are paying off. Nearly a hundred fires in inactive coal deposits have been investigated. Ten have been controlled in the last two years. Seven others

Right, a coal mine blazed deep beneath this building, shifting the earth and cracking the heavy walls. The fire, at Lloydsville, Pa., has been extinguished

At this man's doorstep in Carbondale, Pa., a geyser of steam shoots into air. Water poured into this bore-hole helps cool the hot coal beneath the city



Landscape around New Straitsville, Ohio, was not a pleasant view before the fire fighting started. Smoke and steam from cave-ins spouted 200 feet into the air

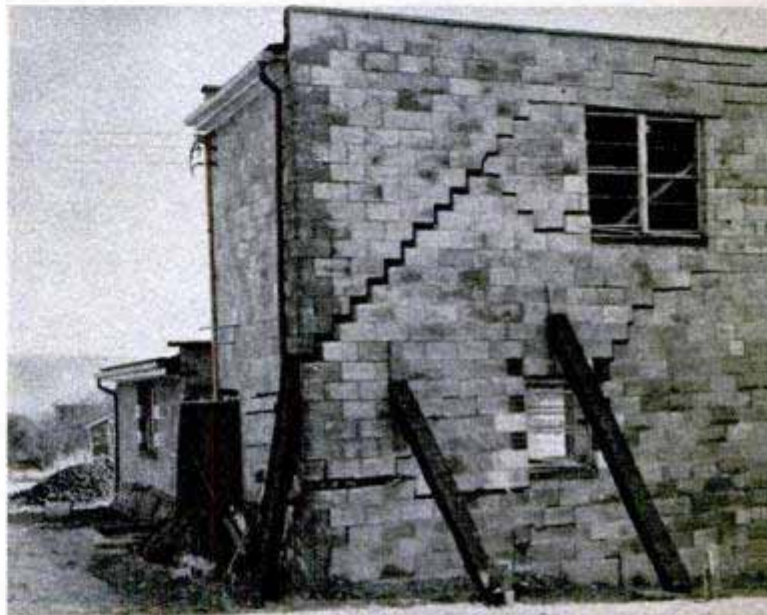

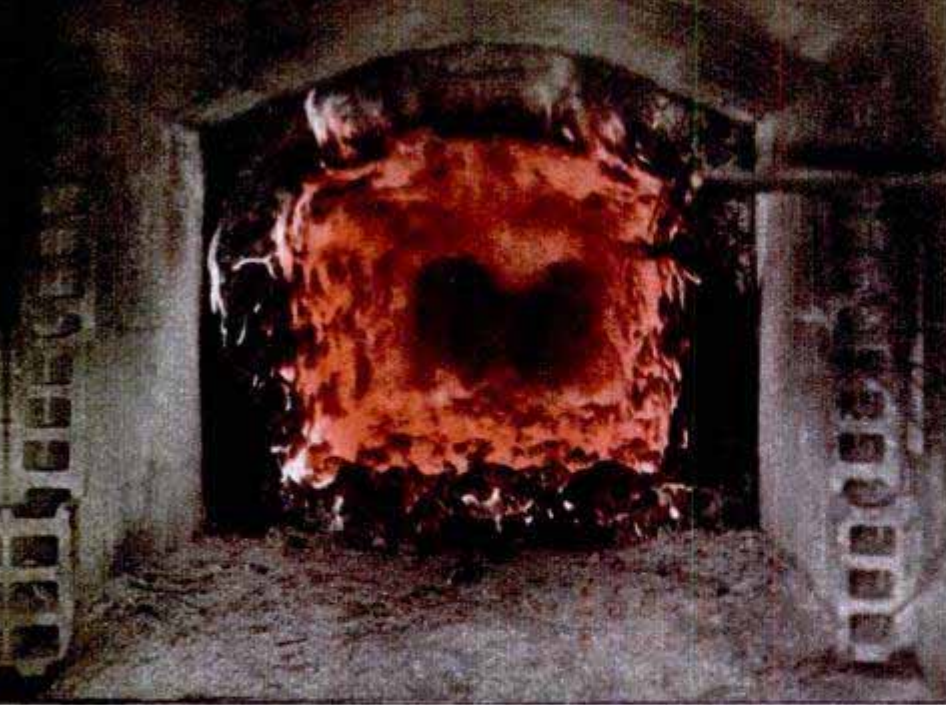

At the bureau's test mine, engineers duplicate the frightening spectacle of a live coal-mine fire. Instruments record temperatures up to 3000 degrees. Right, dusting machine spouts powdered limestone into burning mine

are being conquered. Several cities have been saved from collapse.

The tactics used to conquer these underground infernos are as varied and tricky as the fires themselves. The battle starts when drill rigs move into a fire area. Holes are bored into the ground all around the fire. By dropping thermocouples into these boreholes, engineers can read temperatures and find the limits of the blaze.

Once the limits of fire are known, the blaze can be smothered, isolated and allowed to burn out or cooled down below ignition point. Bureau men also have an-

other way of licking a mine blaze. In Fairmont, W. Va., engineers literally dug a mine fire right out of the ground. Fire had crept 150 feet back under Fairmont's streets when crews of men with monster power shovels began digging recently. A large portion of a mountainside was removed—along with the fire—and Fairmont was saved from sure collapse.

In most western states, and wherever surface conditions are favorable, mine fire fighters use the smothering technique. First, the shafts and entrances to old workings are sealed with walls of concrete block

Bulldozer operator wears a gas mask as he battles through fumes to push burning coal away from a mine

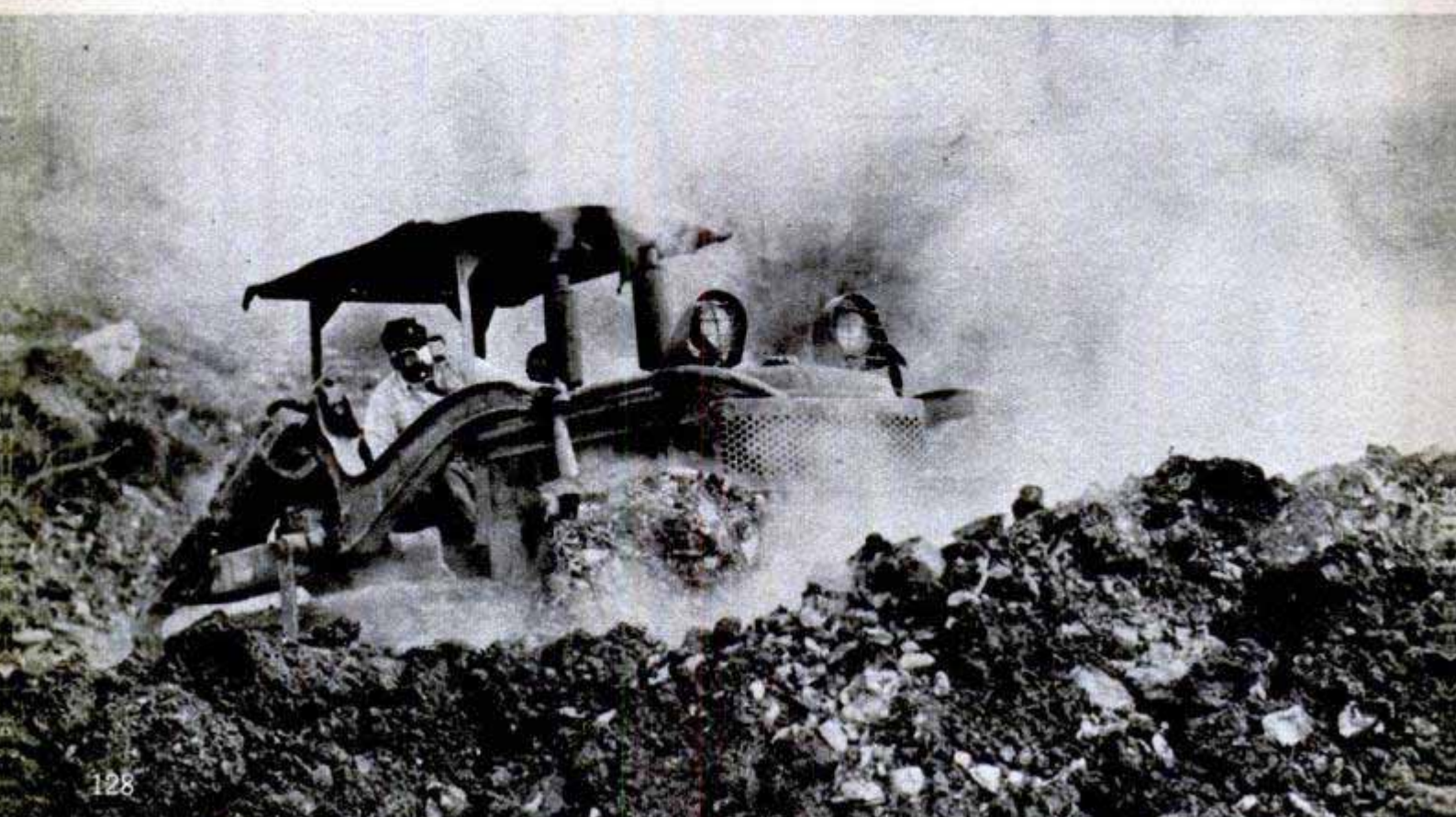



After rock dust has been blown into the test mine, an engineer checks temperature with optical pyrometer, which tells heat by color of flame

or brick, to cut off air supply from that direction. But that's not enough.

In any mine blaze, when supporting columns and seams burn out, the earth above slumps into the cavity. Great crevasses open on the surface with an earthquake-like rumble. Through such rifts in the earth's crust, air rushes to feed flame.

So big power shovels and bulldozers rumble onto the scene, pulverize mountains of soil and spread it over the fire zone, covering cracks and sinkholes. As old cracks widen and new ones are formed, the loose earth filters in and plugs them.

Coal-mine fires sometimes are extinguished by sealing out the air with layers of earth and underground walls

But shutting out a fire this way isn't possible if the burning mine is under a mountain or a city. So other tactics are used. At North Park, Colo., bureau engineers sent out a dragline and heavy earthmoving equipment to a fire that was eating through old workings under a hill. Back of the hill, they cut a trench 850 feet long, 30 feet wide and 85 feet deep right down through the coal bed, filled it with clay, and left the fire to burn itself out. Beyond the trench, 15 million tons of coal lie protected by a sturdy wall.

One of the toughest recent jobs was in Carbondale, Pa., a city of 19,000. Like many mine fires, this one started years ago in a refuse dump on an old strip mine, and finally worked its way under the edge of the city. Residents were puzzled when pets began dying in their cellars. One home developed a miniature steam jet in the basement floor. Another man's furnace wouldn't burn, and neither would the matches he used when he tried to relight it. Carbon dioxide was in charge.

Last June, the bureau put its experts and a contractor on the job. They had to work fast. Where they could, they covered the

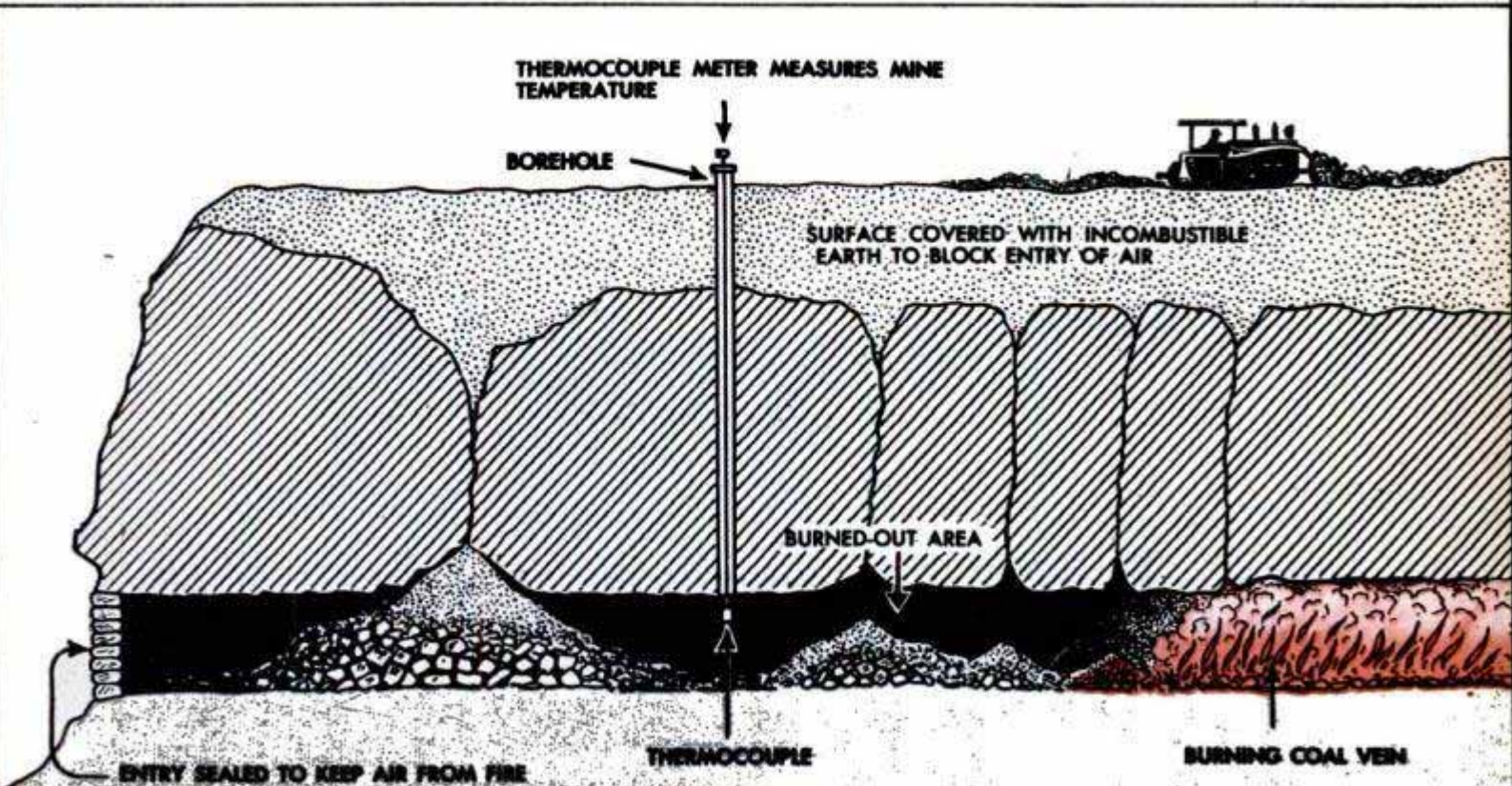



Bureau of Mines photo

Workers seal off a fire area with heavy wall of cinder block. Masks protect them from fire's poisonous gas

slumping surface with soil to seal it tight. Boreholes were drilled some 100 feet down to the fire, which then covered about 15 acres. Into these, the fire fighters flushed incombustible silt. About 74,000 cubic yards of earth have been flushed into Carbondale's burning mine.

To help cool the fire, bureau men tried a new experiment. They poured vast quantities of water into boreholes that led directly to the hottest parts of the subterranean furnace. The result was spectacular to see. Steam geysered skyward from many boreholes and, for a while, Carbondale looked like a miniature Yellowstone.

Today, all of Carbondale's boreholes are sealed or capped. About 20, spotted at

strategic points, have thermocouples and pipes leading out of them for constant checks on temperature and gas generation in various parts of the fire. This way, engineers keep track of their dying giant.

The idea of flushing earth into the ground was also used at New Straitsville. Here the burning beds connected with vast coal deposits beyond them at three points. What the bureau did in 1938, in a vast project carried out under WPA, was to utilize an army of men and machines to drive 12-foot wide tunnels through the coal veins at these three necks. All combustible material was removed from the tunnels, which then were filled with rock. Bulkheads, with slits in them, were built at all openings along the three underground corridors. The ends were sealed and dirt was flushed into the tunnels through boreholes, from above. The water seeped through the bulkheads. But the silt stayed, filled up the spaces in the rubble and formed great barriers through which no fire can burn. One of these barriers is about a mile long and 200 feet underground. The others are shorter. Already the fire has burned all along one barrier and is approaching a second. Some experts believe it will be 100 years before the New Straitsville fire burns itself out, but the millions of tons of reserve coal beyond these barriers have been saved for posterity.

All this is fine, when you're dealing with abandoned mines. When fire gets going in an active coal mine, the story is different.

(Continued to page 236)

Fire burning under a Colorado hill was encircled with ditch up to 85 feet deep, which was filled with clay



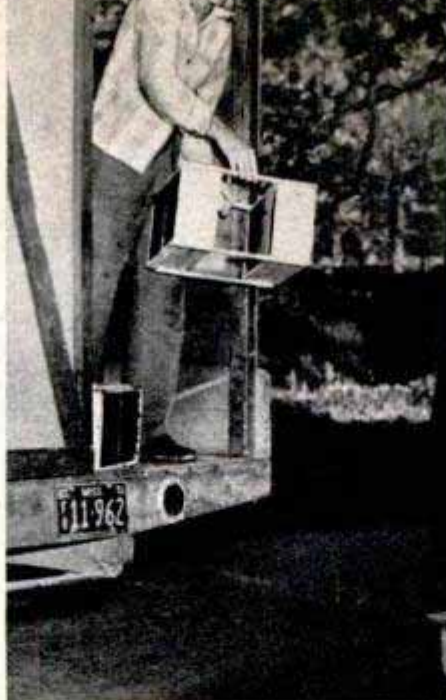
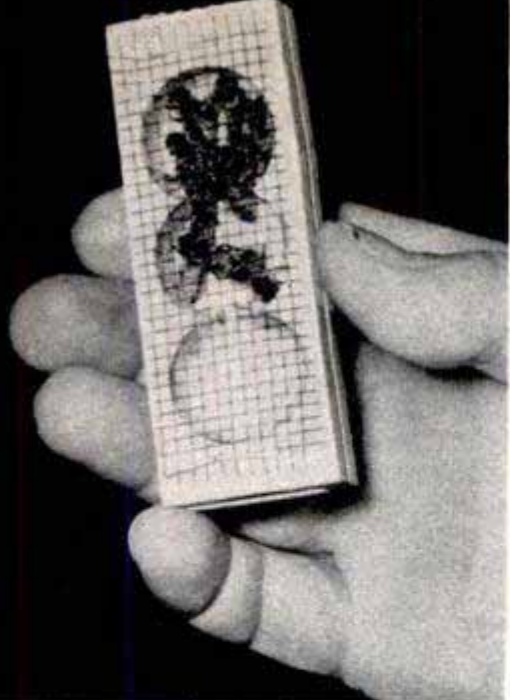

Queen bee attended by a dozen workers rides in small box at left; postmistress Maude Morris stamps crates

BEE POST OFFICE

TWENTY-FOUR MILLION queen and worker bees are mailed annually from a tiny post office at Mayhew, Miss. The shipping season is from March 1 until mid-May, and the bees are sent from a large apiary near Mayhew to every state and to many foreign countries. Without the bees there would be no post-office building in this town and no full-time postmistress. The queens ride in small boxes with a dozen "retainers" and a supply of powdered sugar. Other workers travel in wooden containers with screen-wire sides. Bee by-products shipped by the apiary include stingers, which are removed by tiny tweezers, for use in medical research, and royal-jelly mixture of pollen and honey being tested as a protein-rich baby food.

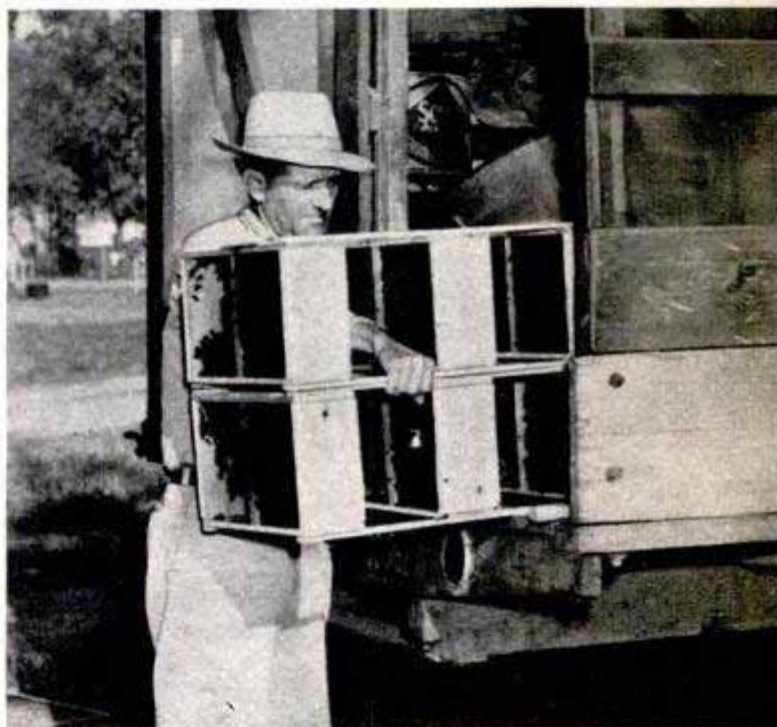

Below, numerous bee yards at huge Mayhew apiary provide rushing seasonal business for tiny post office

Worker bees in handmade crates are loaded on truck for trip to post office, which is "beehive" of activity



RESTORING

GOETHE'S HOME



A TRUE REPLICA of the birthplace of Johann Wolfgang von Goethe has grown out of a heap of debris, which was all that remained of the German poet's dwelling after a bomb raid on Frankfurt. Reconstruction was possible because plans and photos had been stored away. The work included dainty stucco decorations, hand-painted wallpaper and porcelain stoves to re-create the atmosphere of the 18th-century period when the house was built.

So-called giraffe piano, left, some 200 years old, is repaired before resuming its place in the reconstructed Goethe home, which architects check with original blueprints, below left. Some of the old foundation parts, below, were used in rebuilding the home

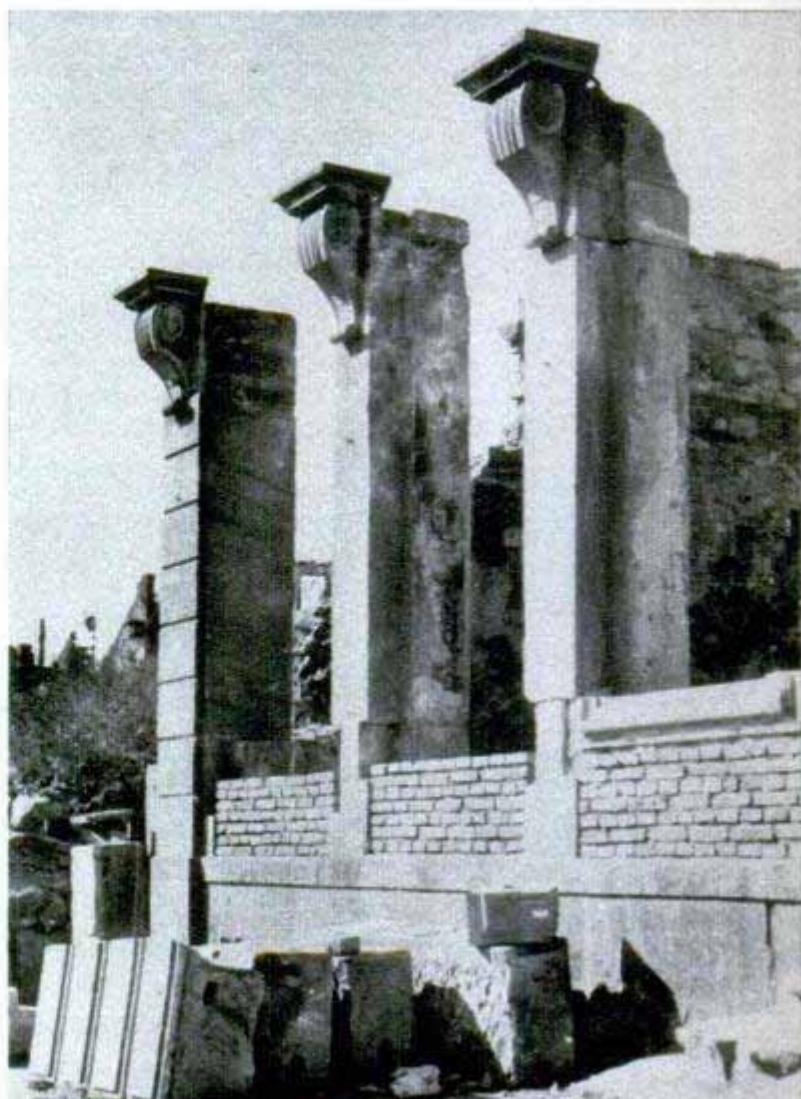
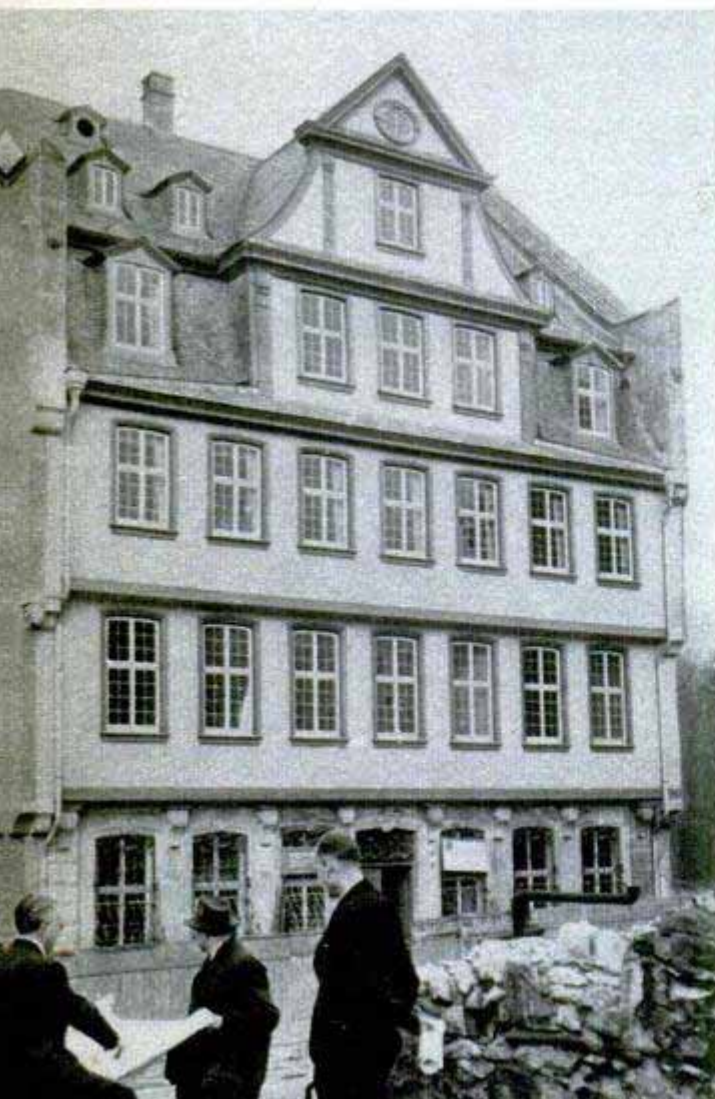



Artists compare paints to be sure they will authentically reproduce exact color of hand-painted wallpaper in the house first constructed about 200 years ago

Beautifully decorated copper kitchenware that belonged to Goethe's mother is carefully polished so it can again be put on display in the kitchen

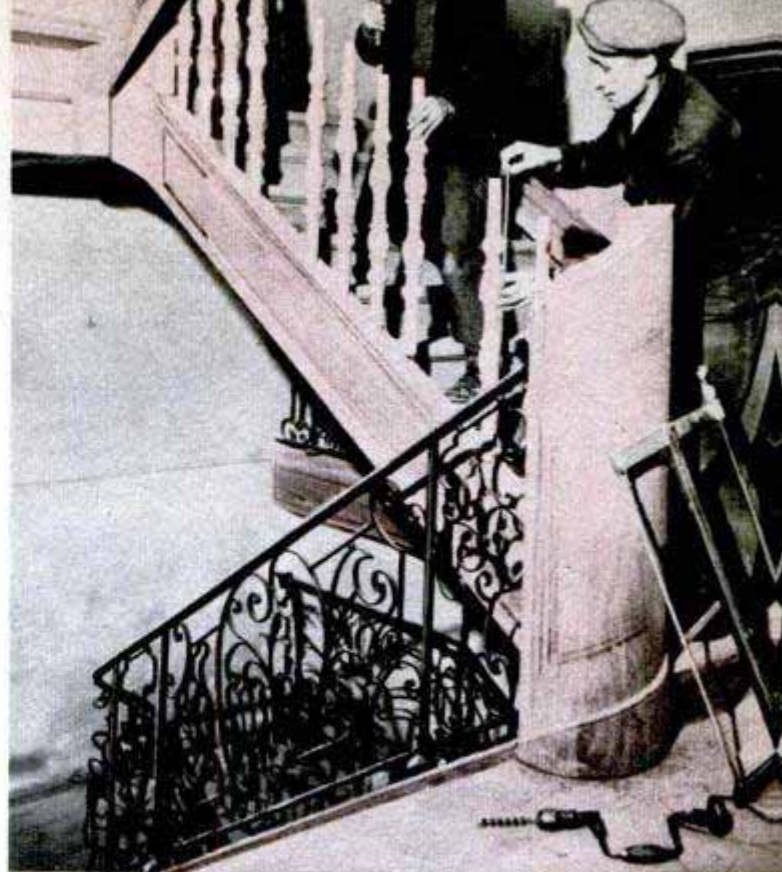

In combing through the pile of twisted rubble, workmen found some of the original iron bannisters, which are again used in rebuilding the interior staircase

Corner of the library where Goethe's father had an extra window installed so he could keep a sharp eye on the youngsters as they played in the street below



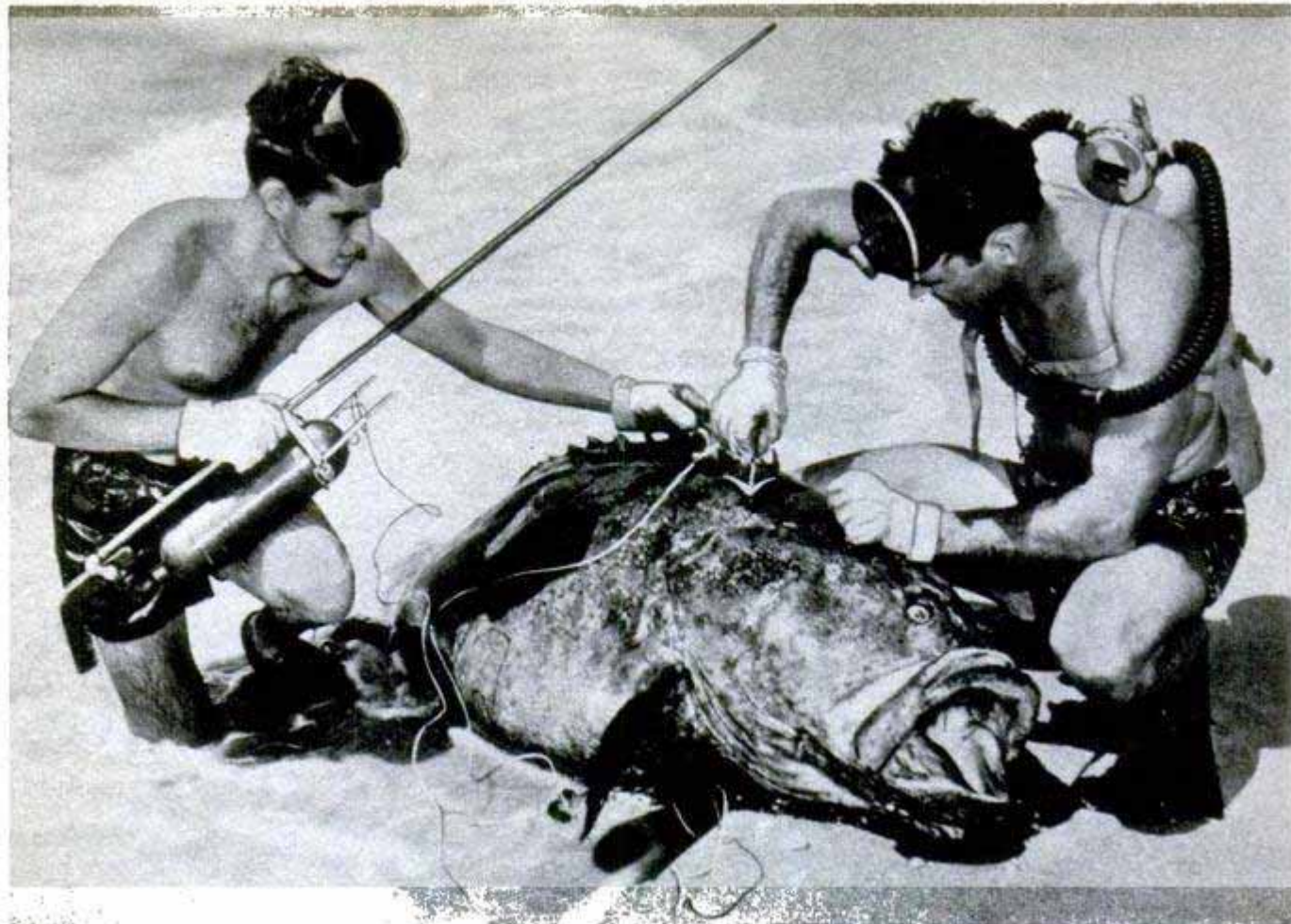

Gas-Powered Spear Gun

Powered by the compressed gas of a carbon-dioxide fire extinguisher, a spear-fishing gun discharges the shaft with enough force to kill even the toughest game fish. Bill McDougall, a Miami underwater-fishing enthusiast, turned the handle of the ex-

tinguisher around to form a stock, added a long tubular barrel and made himself a gun. It can be fired about 50 times without recharging. For big game fish, a barbed head is fitted over the spear to which a strong wire is attached for hauling in the trophy. Fishermen wearing an Aqua-Lung can achieve depths of 200 feet.

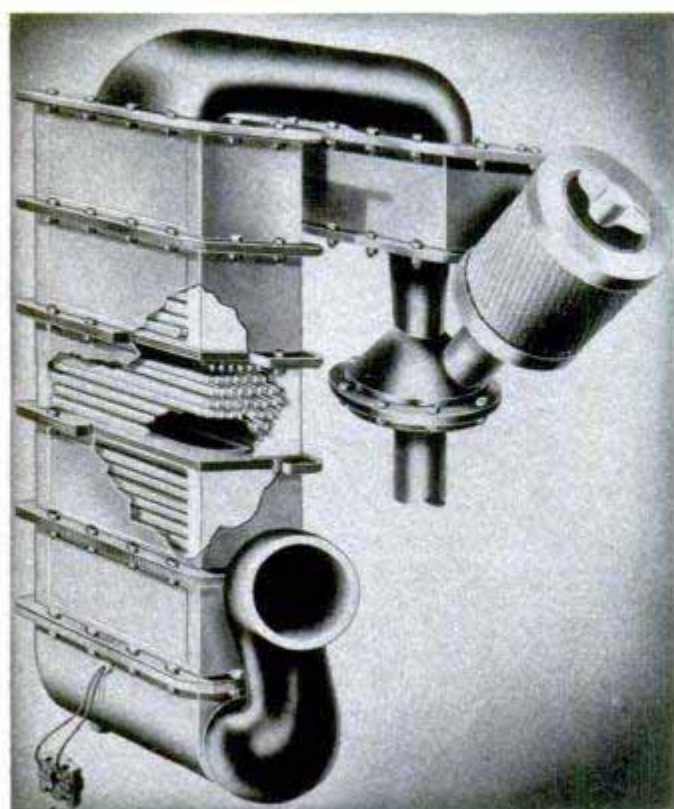

Exhaust Gas Made Safe

Replacing the conventional muffler on a gasoline engine, a catalytic exhaust converts deadly carbon monoxide to carbon dioxide, which is harmless and odorless. As yet, it is available only for vehicles such as lift trucks that use low-grade, nonleaded gasoline, but the manufacturer is testing a model he will market for passenger cars and trucks. Inside the exhaust converter is a catalyst which is mainly platinum plus a number of other elements. It combines with the exhaust gases and, helped by the oxygen of sucked-in air, transforms them into harmless vapors. The exhaust is being sold with lift trucks as optional equipment. It is especially desirable for trucks that operate inside factories where hazardous exhaust is a major health problem.

☐ Glass razor blades, as sharp as those of steel, are produced by a grinding and etching process on which a patent has been issued.

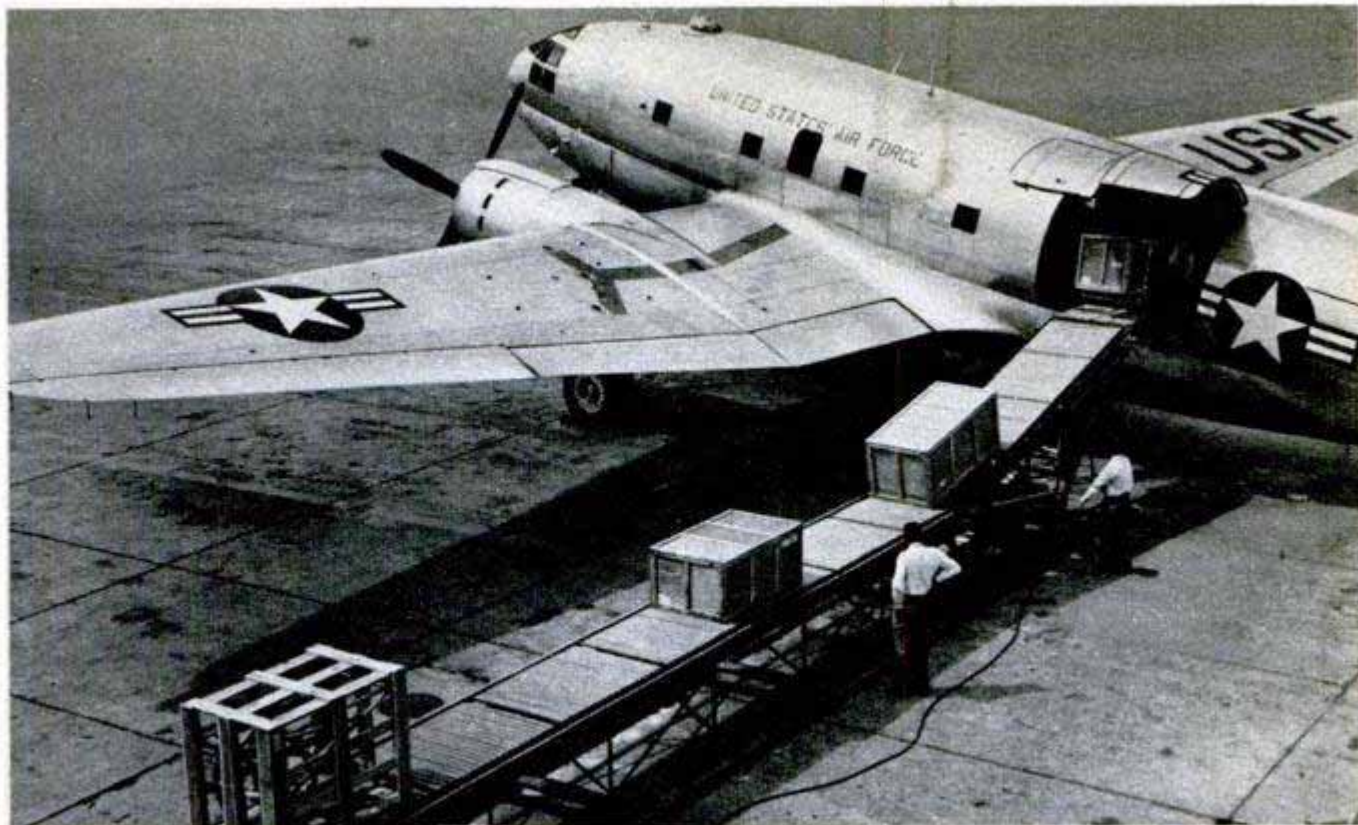

U. S. Air Force photo

114-Foot Conveyor Speeds Cargo Handling

Eliminating trucks and dollies normally used in handling air freight, a 114-foot conveyor carries cargo directly from plane to freight terminal. Half of the conveyor retracts beneath a 58-foot stationary section that has conventional rollers on which parcels are moved by hand. Rollers on the extension are powered and automatically carry freight to or from the cargo hatch of

an airplane. A boom at the end raises or lowers itself to the height of the doors, where a hydraulic transfer leaf makes contact with the plane's deck. In a test it unloaded 4774 pounds of freight in eight minutes—an operation that normally takes an hour or more. The conveyor was built at Kelly Air Force Base, San Antonio, Tex., for the Military Air Transport Service.



"Dew Floating" Speedboat

About all it takes is a heavy dew to float a British speedboat that is powered by a 100-horsepower airplane engine. The single-step boat draws about nine inches fully loaded and at rest. When speeding along at about 50 miles an hour, it draws only one

half inch of water! The skin of the hull is formed by two layers of marine plywood with a layer of fabric between them. Total weight of the boat is slightly less than 1000 pounds. Its two-bladed propeller is six feet in diameter. Designer and builder of the boat, called a hydroglider, is W. F. W. Davies of Dudley, England.



FOOTBALL IS A PAGEANT

Half-time-show stars are Ohio State's drum major, above, and the Rangerettes from Kilgore (Tex.) Junior College

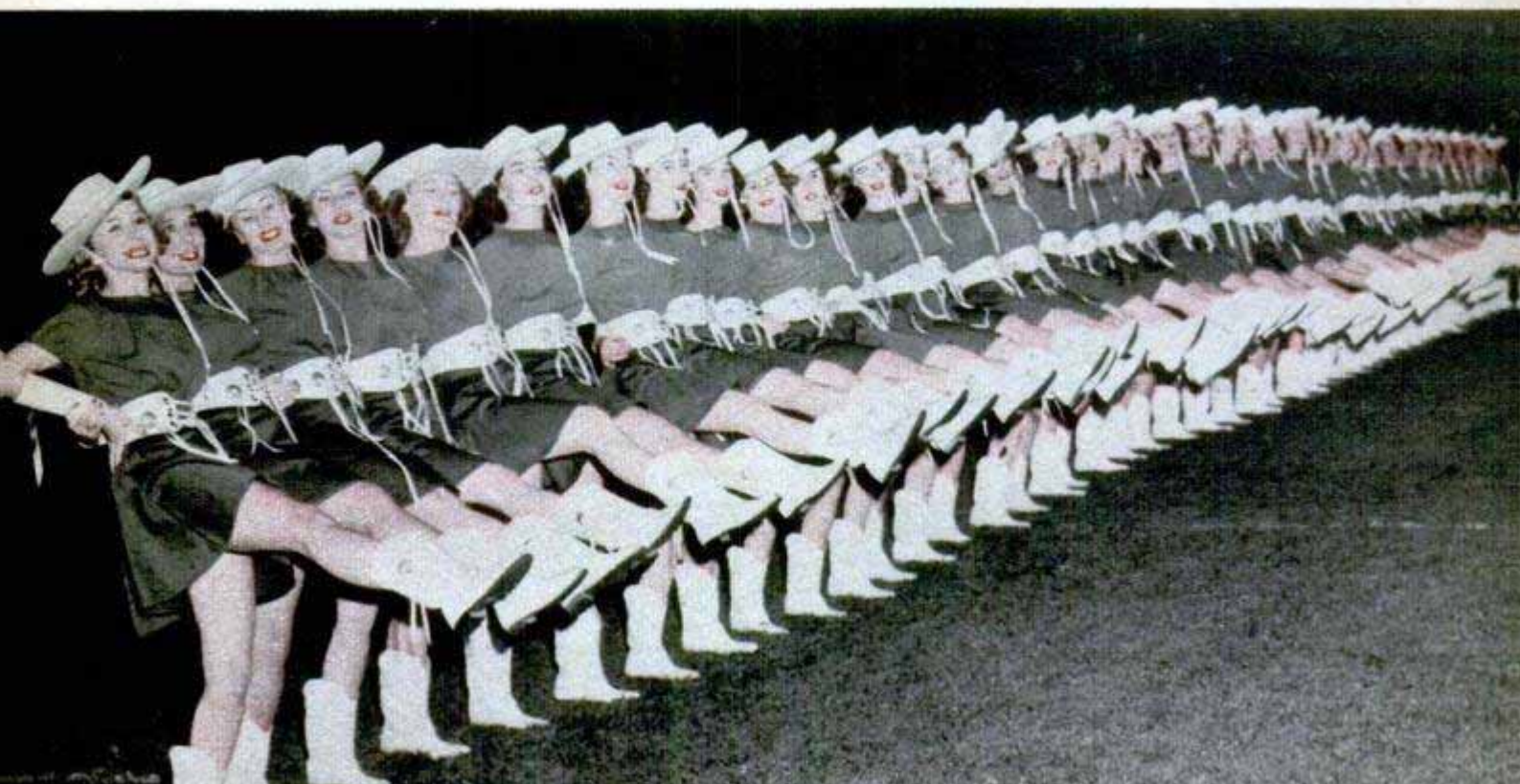

Pieces of dowel rod, with small nuts as their bases, represent bandsmen on Ohio State's planning board. Scaled display shows how formation will look on the field. Jack O. Evans, associate director of the marching band, notes locations on a chart

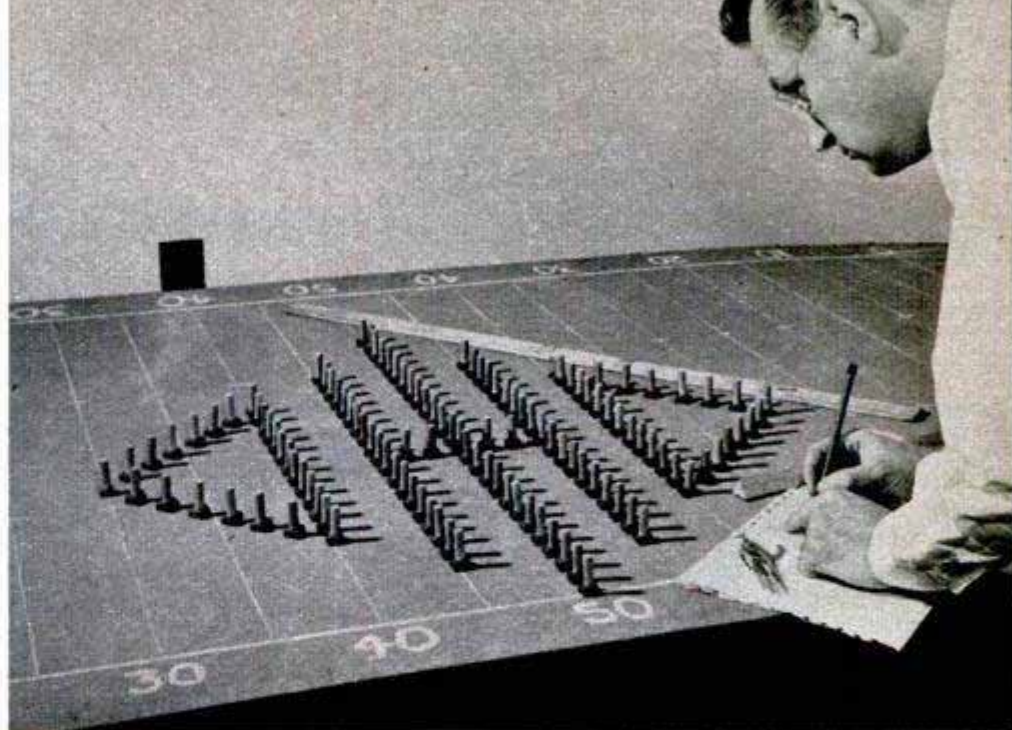

By

Aubrey O. Cookman, Jr.

YOUNG MEN who won't touch a football all season will do some of the liveliest stepping and most expert playing on college gridirons this fall. Their maneuvers will be carefully planned and diligently rehearsed. Teamwork will be their forte. Many won't weigh 150 pounds in full uniform, but they'll be as loudly cheered as the brawniest athletes on the field.

These star performers—the bandsmen—are key figures in the colorful spectacle surrounding today's big college football games. No matter which team wins, the crowd is sure of a spine-tingling show as carefully staged as a Hollywood production. A hundred or more marching and singing musicians from each of the rival

schools will make sure of that at half time.

Decked in their school colors and moving in precise cadence, they shape such intricate and symbolic formations as the Statue of Liberty, tepees, state emblems, profiles of famous people and turning windmills and clocks. They play or sing appropriate selections throughout most of their maneuvers. One band, featuring a cappella vocal arrangements, has over 300 musicians in some formations.

Though they may know what cereal and how many pieces of toast the star halfback ate for breakfast, few fans huddled in the stands on chilly fall Saturdays realize how much effort goes into the band's 15 to 20 minute performance between the halves. At

Caps held high, over 100 marching musicians form famous "Diamond Ohio" (laid out above on planning board)

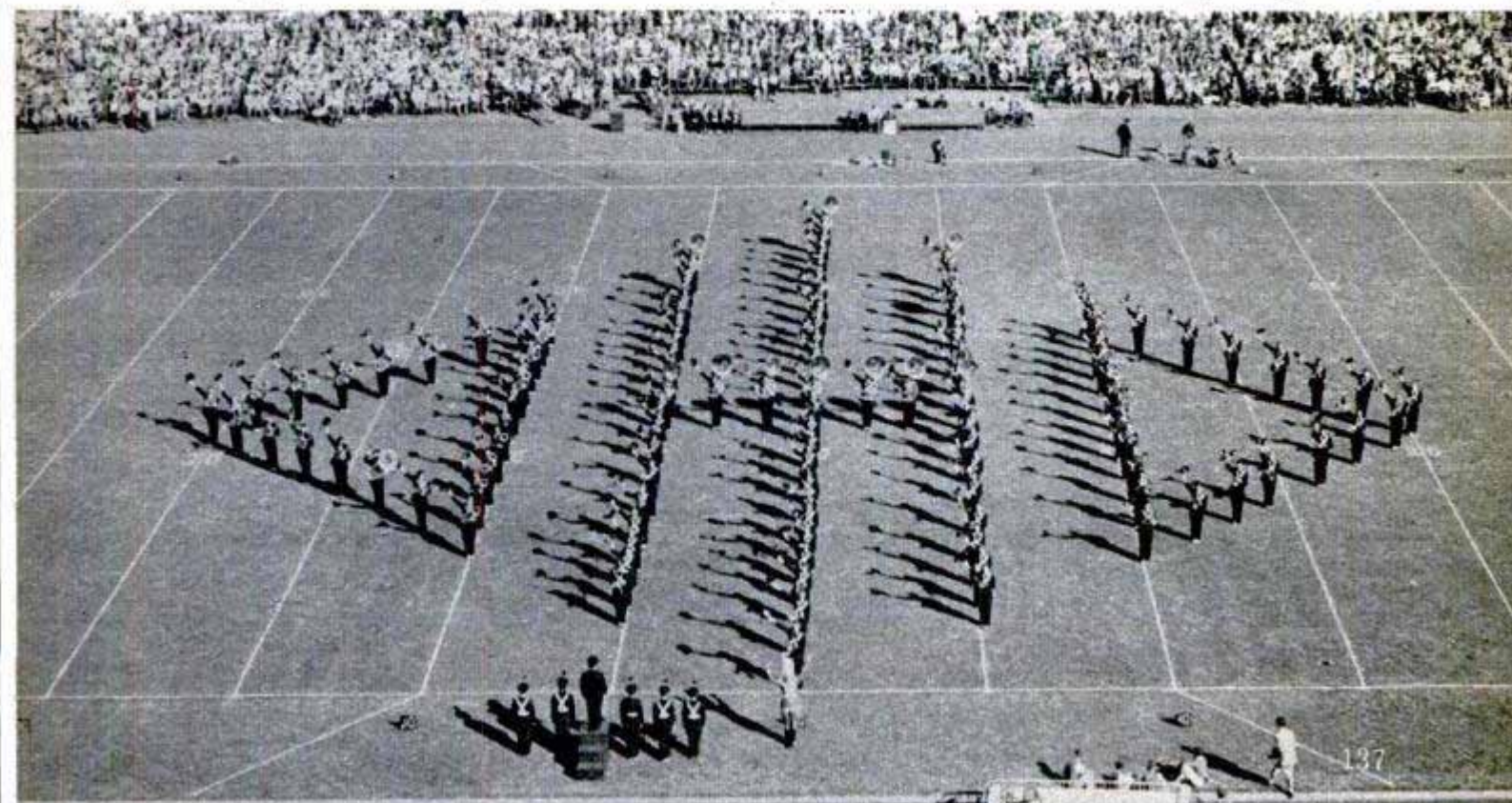



Playing as they move with a very high step, the marchers make the arms of this windmill slowly revolve



As the band plays "Surrey With the Fringe on Top," the wheels on the old-time vehicle (above) turned. Precise marching made Liberty Bell (below) appear to ring. Its crack later was simulated by men moving across bell

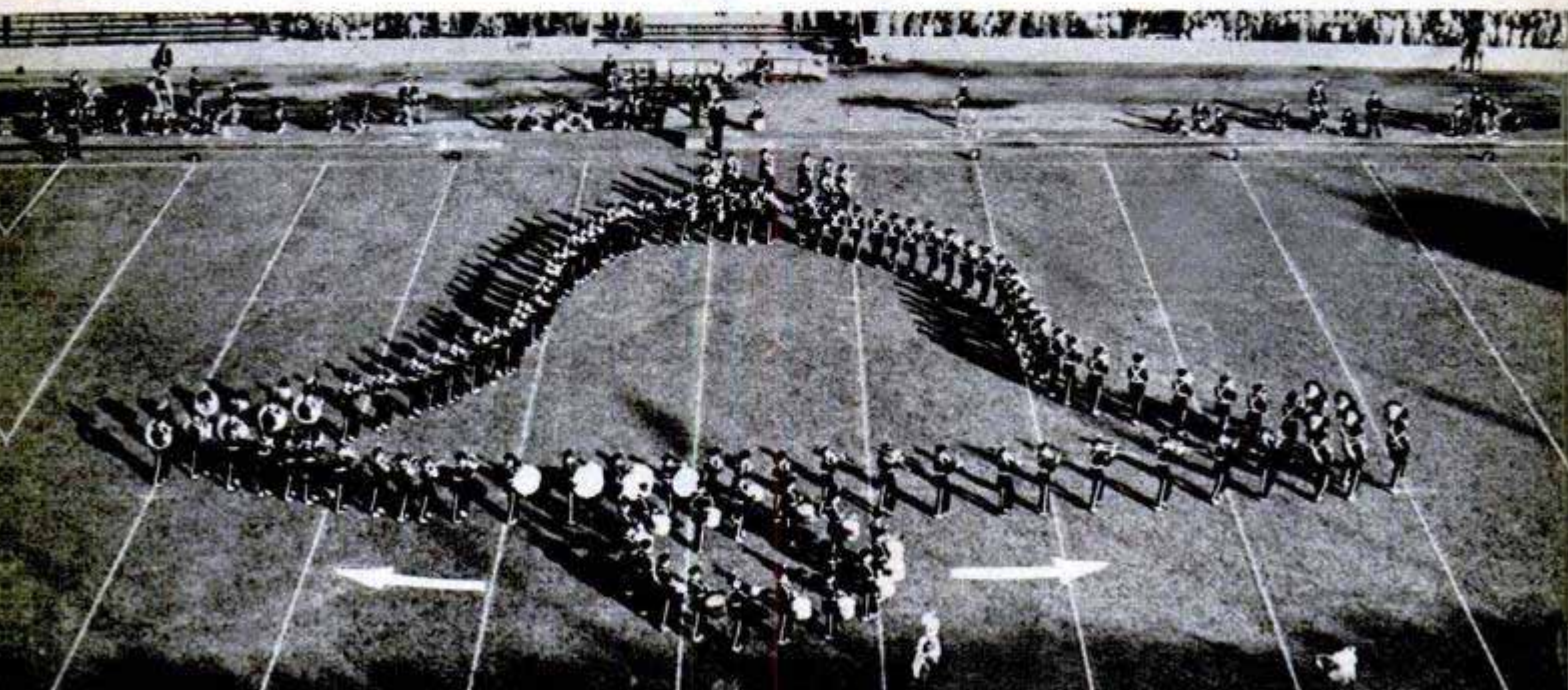

Shaping a romantic note on the gridiron. Graph shows alignment as the arrow moves left toward the two hearts and finally pierces them both

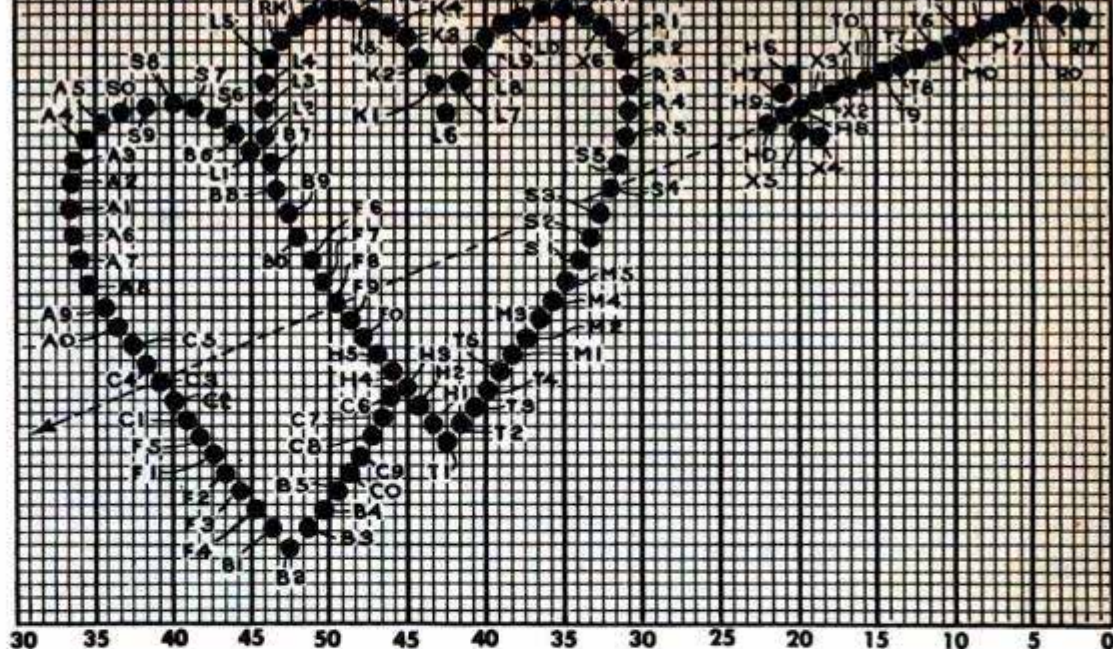

institutions famous for their football bands, like the University of Pittsburgh and Ohio State University, units start training a week before the other students begin classes in the fall.

About 150 Pitt musicians, for example, register early for classes and board busses for a camp where they'll do nothing but eat, sleep and drink band for a week. They drill three times daily on a regulation-size football field.

At these preschool camps, each man is assigned a number or a letter fixing his marching location in the band. He retains that designation the entire season. At the same time he gets blueprints or charts of formations for the first game of the season. On them he finds his number or letter, the key to his role in each maneuver.

Generally the show for each game is built around a special theme. During Pennsylvania Week, for instance, Pittsburgh's band director made the half-time performance a tribute to the state. The formations includ-

ed a keystone, the state emblem; a Liberty Bell that swung back and forth and finally cracked; a surrey with a revolving wheel, representing the typical vehicle of the Amish and Mennonites of eastern Pennsylvania; and a pick and shovel in recognition of the state's coal industry.

Once a theme is chosen the problem is to decide what formations and music will combine best in portraying it to a stadium audience. The latter must be something familiar to the public, since many times the tune or the words are the key to recognition of the formation.

From the rough-drawing stage, the groupings are put on a planning board, with small markers or objects representing each man. This is done to check the way it will look on the field, since perspective is vital in the legibility of formations from the stands. The height and shape of the stadium also have to be considered.

At Ohio State the planning board is made from a sheet of wallboard with dimensions

Halfway through the hearts (below), in a field staging of the formation charted at the top of the page

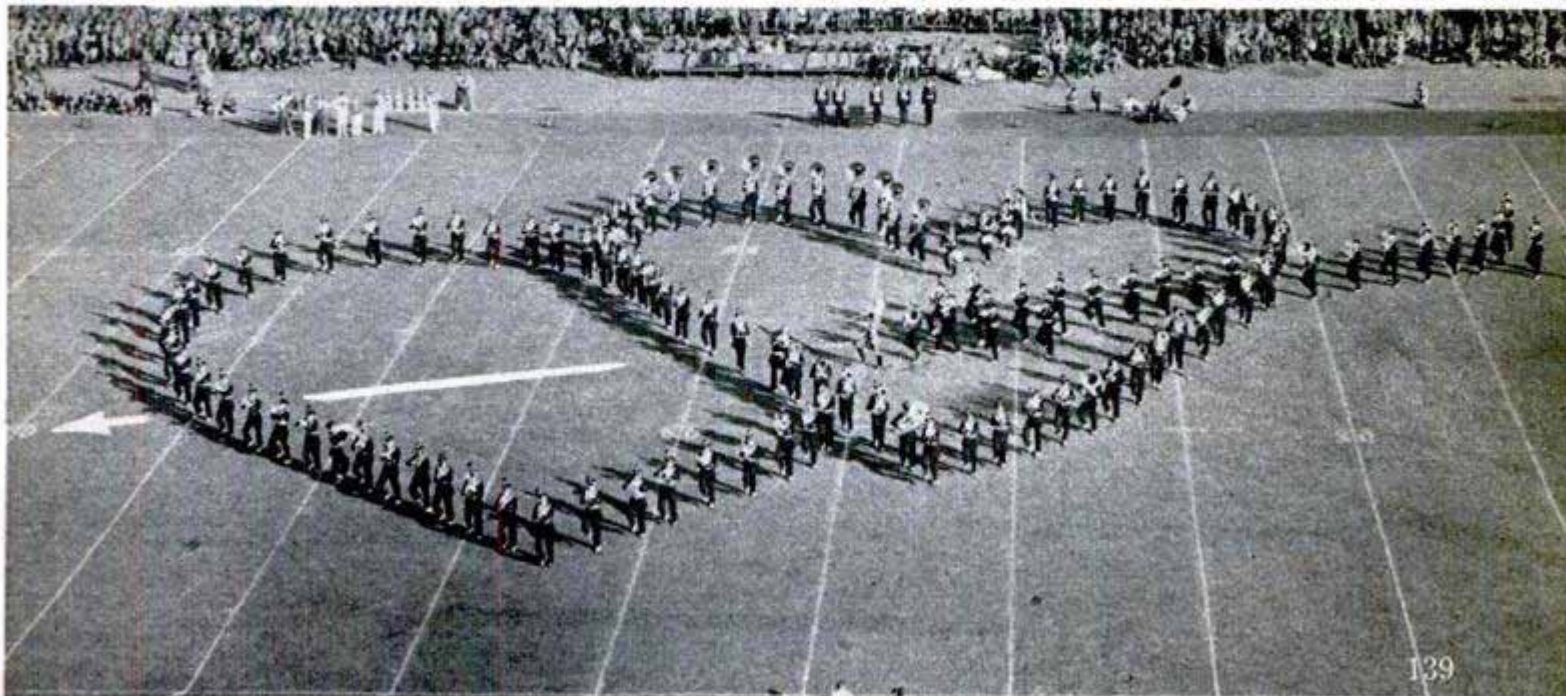

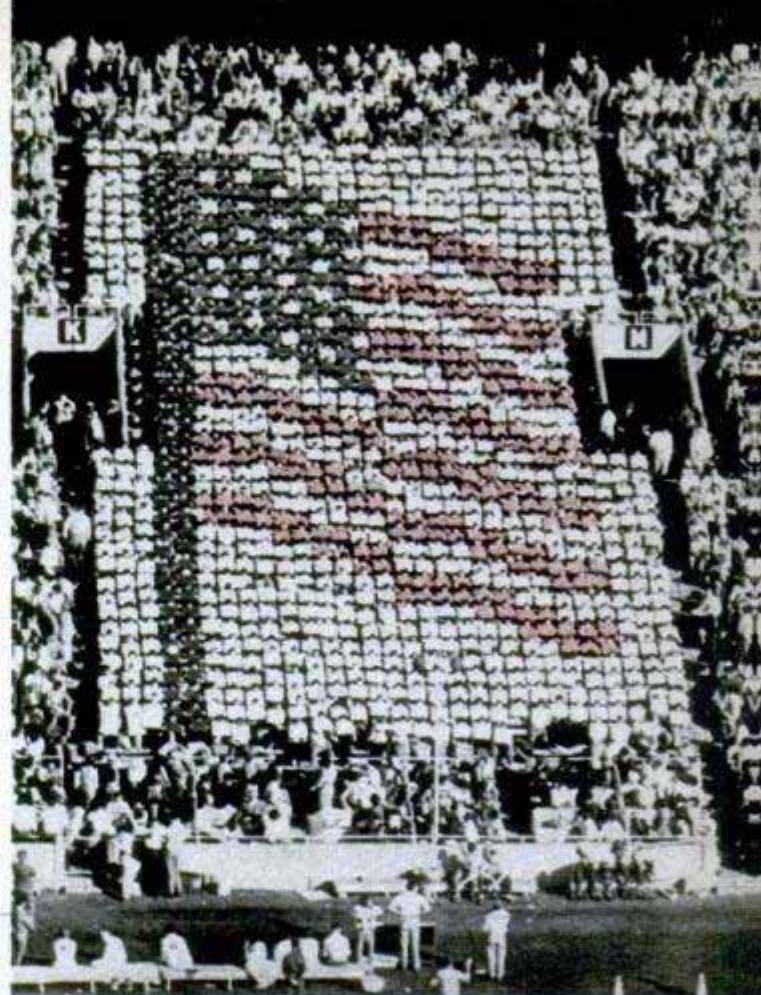
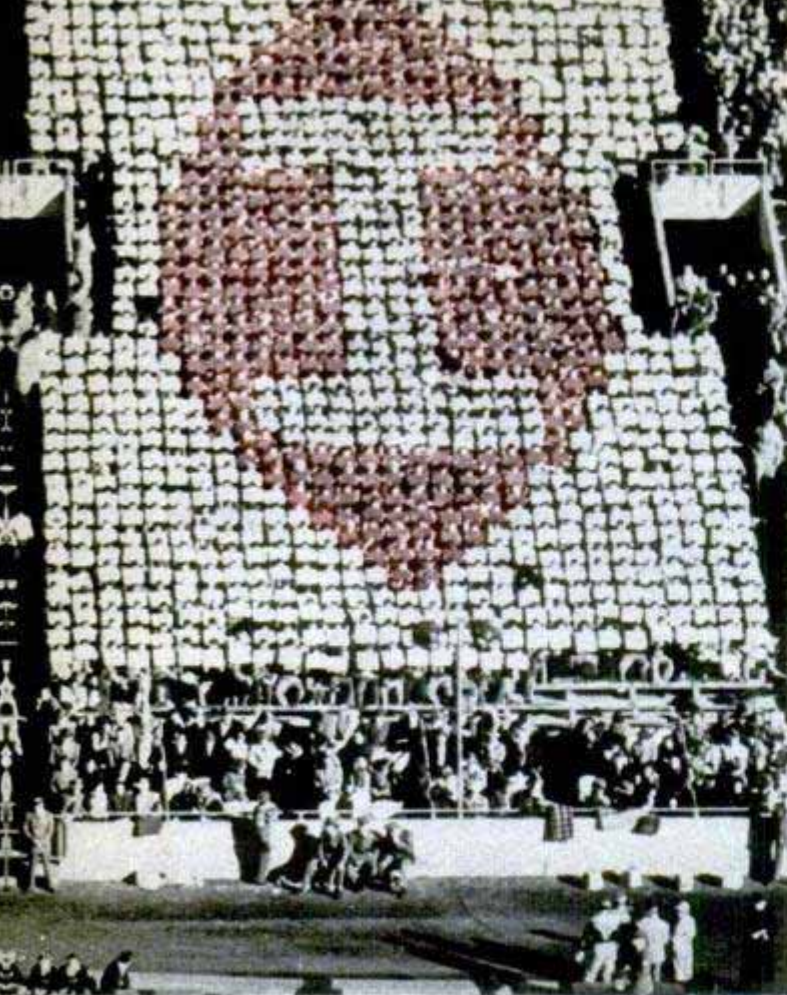

At Illinois, the student cheering section shapes a block "I" within a football with their orange and blue cards. At right they reproduce "Old Glory," raising and lowering the cards so that the flag appears to be waving

Dad isn't forgotten (below) on his "day." Students in cheering sections have the same seats at every game

Props occasionally are used in band formations. The Capitol (below) was in an Ohio State patriotic display

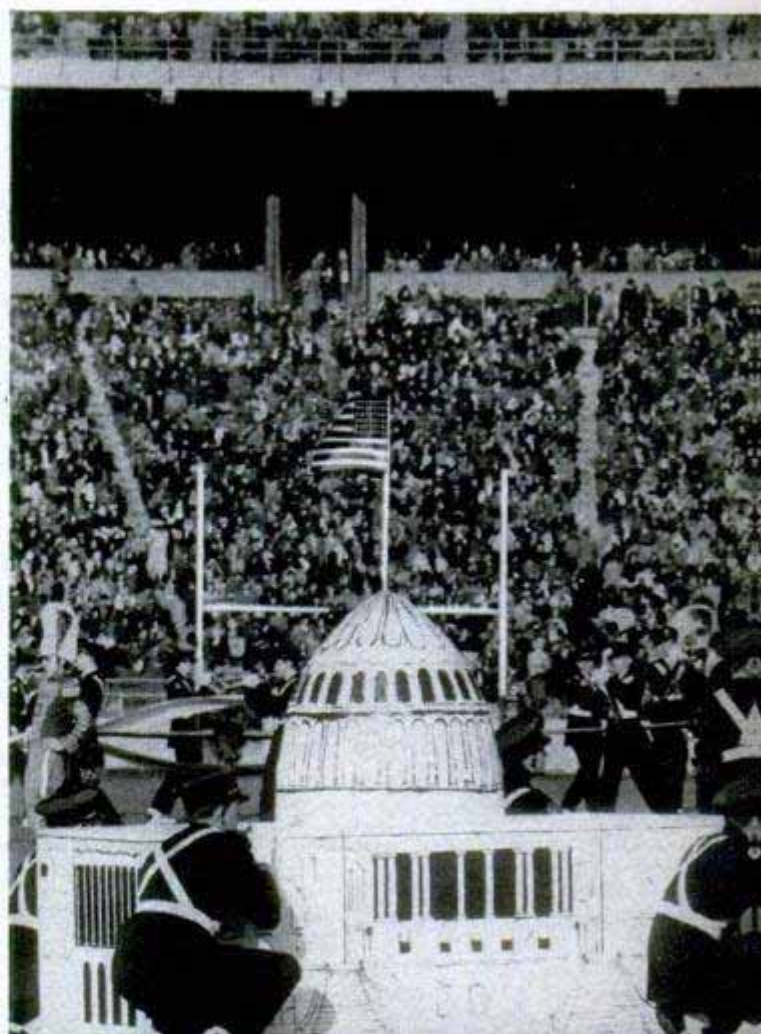
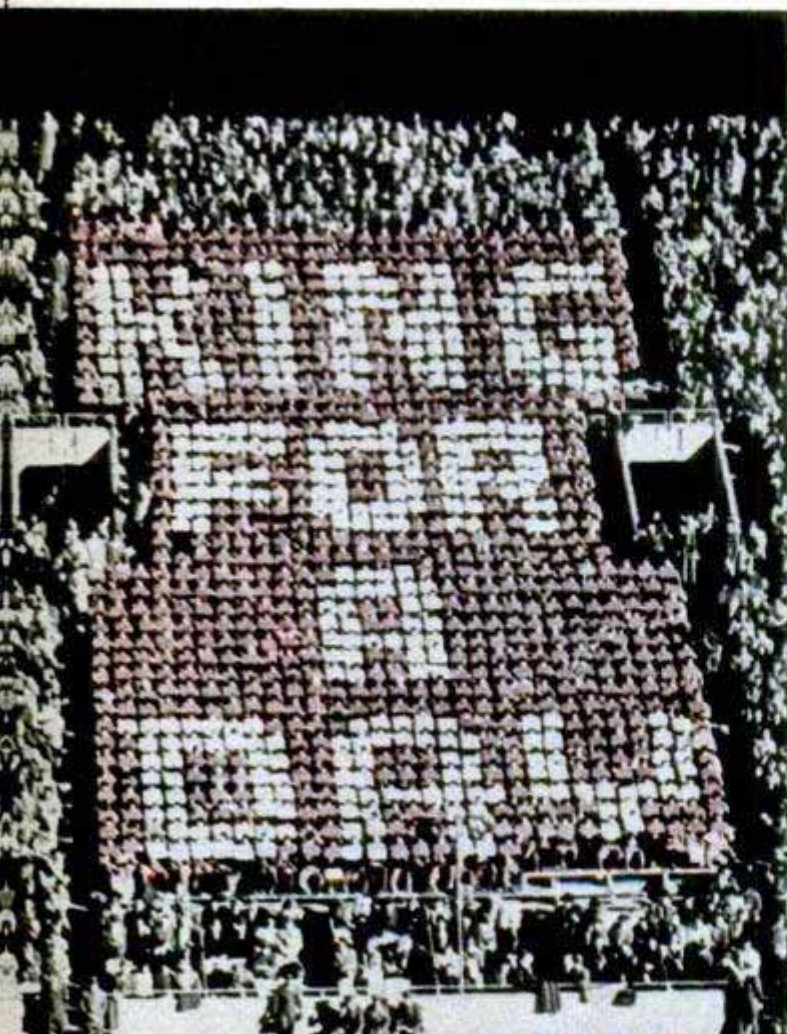

of the field drawn in. For men they use $\frac{3}{8}$ -inch dowel rod, cut to a length proportionate with a man five feet eight inches tall. Each piece is sharpened and screwed into a $\frac{1}{4}$ -inch nut which provides enough weight to make it stand satisfactorily. By measuring proportionate distances from the edge of this miniature, and proportionate heights to various sections of the stadium, the planners can tell exactly how life-size formations will look later from every angle.

When the planning-board arrangement passes muster, the formation is transferred to a sheet of graph paper, with small circles or crosses representing the individual bandmen. Field markings, such as the yardage indicators, the sidelines and inserts that divide the field's width into thirds, serve as guideposts. The goal posts establish the mid-field line.

Each position is assigned to a bandman and identified by his number and letter. Particular attention is paid to placing instruments, because of both their appearance and their sound. Since each formation moves directly into the next, consideration is likewise given the distance any particular man must travel from a previous grouping. The finished charts are duplicated and distributed to the band members.

Charts in hand, the bandmen walk through an initial rehearsal indoors, usually in a gymnasium, to find where they are in relation to the entire figure. Later they shift outdoors to a practice football field and fit music and marching together. Everything is precisely planned, down to the exact number of steps.

The amount as well as the kind of music is important. Very little is used if the formation is a standing one, but considerably more if it involves motion, like the revolving of a wheel or a clock hand. The music, along with everything else in the show, is memorized. Brisk, precise marching doesn't lend itself to perusing music sheets, especially if it is a windy Saturday.

The University of Illinois is usually credited with being the first to time formations to change at specific points in the music, instead of by signaling with pistol shots or whistles. This allows the drum major to drop his role as a leader and become part of the pageantry, pointing up some maneuvers or becoming a feature in his own right.

As one college alumnus expressed it, "We take an awful lot of lickings on the football field, but I've never yet seen a band that measures up to ours. Makes me feel good. I'll gladly make a trip here any time to see those boys put on their half-time show."

Football remains the feature attraction at stadia all over the country this fall, but the bands are playing a mighty strong supporting role!



Football doesn't occupy the time of athletes only. This group at the University of California at Los Angeles plans card displays for the cheering section



Following individual instructions, students in stands hold dark or light cards just below their eye level

From across the stadium, this is how the stunt shown in photos above finally appears to the spectators

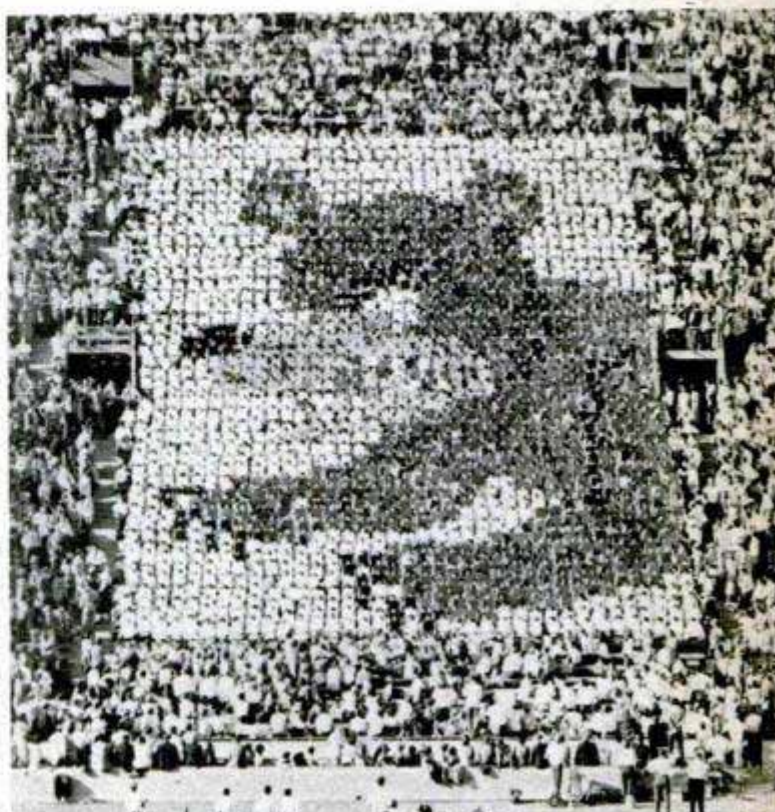



Toothpick Violin

About 8000 toothpicks have been painstakingly fashioned into a violin by George Pearson of Detroit. The resulting instrument has an excellent tone, and Pearson plays it frequently in orchestras. To make the violin, he formed a solid block of white pine into the shape of the instrument. Then he pasted paper over the block and glued the toothpicks together on top of the paper to form the front and back. Later the paper was lifted from the block and sanded away, leaving only the toothpicks. The sides of the instrument also are made of toothpicks.

Pink Icebergs?

Mariners may soon be startled by pink icebergs in the North Atlantic if a suggestion by Dr. Irving I. Schell of the Woods Hole Oceanographic Institution is followed. Schell advises that spraying icebergs with color dust would make them easier to spot and track and would also simplify counting. He would mark them with the color before they break off the glaciers of western Greenland, birthplace of most icebergs that invade the North Atlantic.



Paste Rejuvenates Engines

Squeezed into the firing chamber through the spark-plug openings, a heat-expanding paste, developed in England, is said to lessen piston slap and oil loss while increasing compression. It has been used for some time in Europe and, according to the manufacturer, is guaranteed not to harm any engine. Many British government agencies, including the Royal Air Force, have used it. When the paste is introduced into the firing chamber, the heat of the explosions expands the material, a granular form of vermiculite mixed with oil, causing it to fill excessive clearances that cause inefficient operation. One treatment is said to last about 10,000 miles. Not claimed to be a cure-all, the paste does not eliminate the need for mechanical overhauls. But it is an interim treatment intended to prolong the efficient life of a worn engine.

Sonar Fish Finder

Game fish have lost another round in their battle against science. A miniature sonar fish finder for sportsmen unfailingly tracks them at depths down to 50 fathoms and traces their course on a moving strip of paper. The equipment, which is about the size of a table radio and weighs 15 pounds, also records the bottom contour, rocks, reefs and marine wrecks. Larger models for commercial fishermen have a range down to 400 fathoms.

Ⓒ Burning natural gas, 78 internal-combustion engines totaling 256,300 horsepower drive generators with an output of 176,000 kilowatts to furnish power for an aluminum plant at Corpus Christi, Tex.

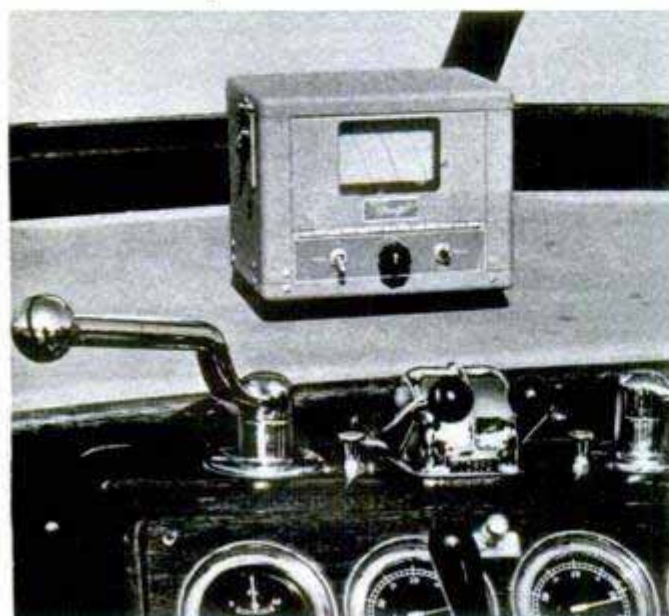

They're Breeding

NEW FOREST TREES

By Ewart Thomas

FAST-GROWING PINE TREES that may mature in half the usual time are being planted in America's forests. They'll be ready for the sawmill in 40 years or less, at about the time their native contemporaries have emerged from the sapling stage.

In one test area that was planted 11 years ago, there are some flourishing native pines that are now seven feet tall. That's good average growth for the seed-parent species, but alongside them are Jack-in-the-Beanstalk hybrids that have shot up 15 feet in the same length of time.

The quality of the wood of the two trees is about equal, but the hybrid is more insect-resistant than is the native.

After years of preliminary research, hybridists have learned how to breed pine trees for woodlot and reforestation plantings that in many ways are far superior to native stock. For the Eastern states they have crossed the eastern and western white pine and have created a tree that greatly outgrows, while still young, the faster-growing of its parents. Now they are engaged in crossing the hybrid with the Balkan white pine in an attempt to produce a timber tree of good form that is resistant

Inset, hybridist examines just a few of the many types of pine cones used in institute's experiments

Hybrid Jeffrey pine at left grew 15 feet in 11 years. Ordinary Jeffrey, right, grew only about 7 feet

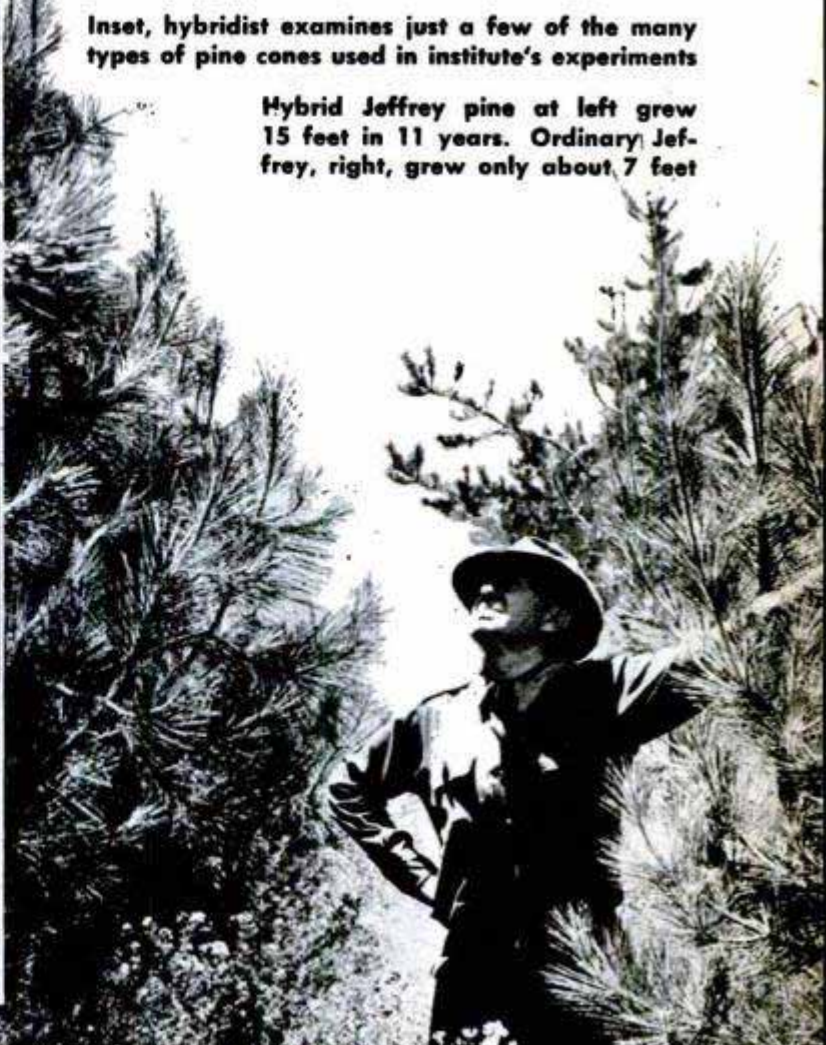
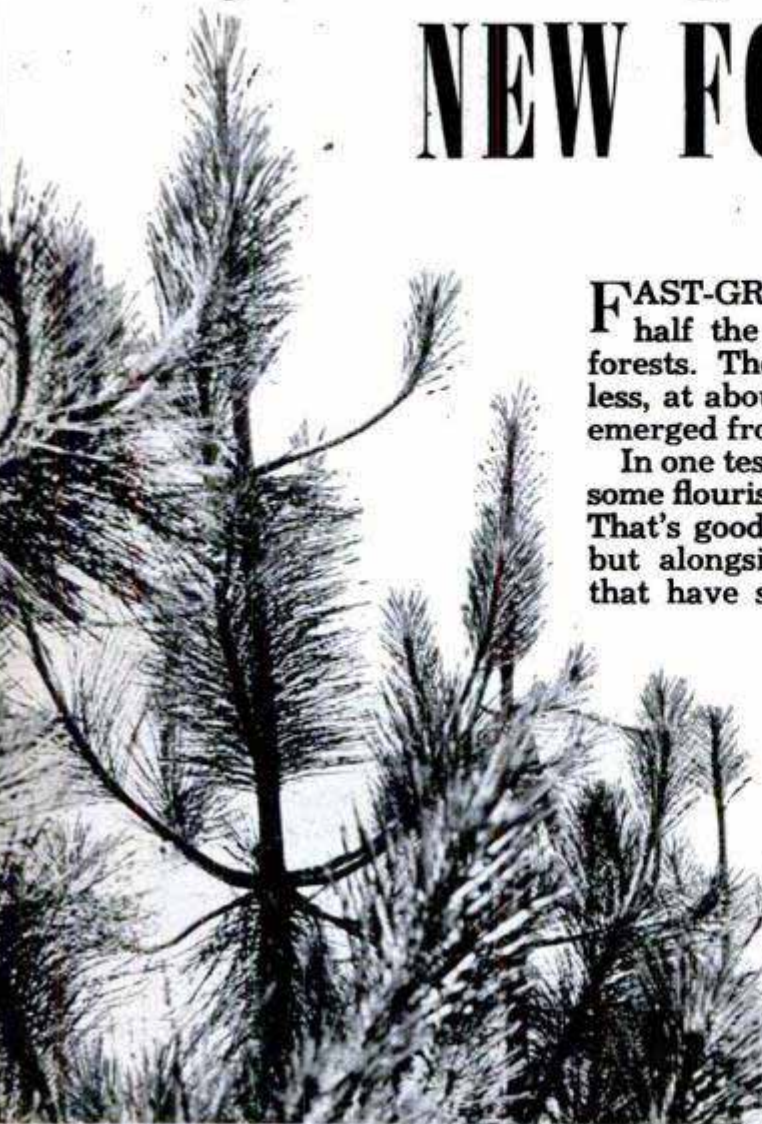



Trunk sections of the three-year-old saplings show fast-growth characteristics of hybrids. Hybrid at left produces more lumber in a given length of time. Below, heavy root system of hybrid shows it could survive better in a dry climate than one-year-old ponderosa-pine seedling

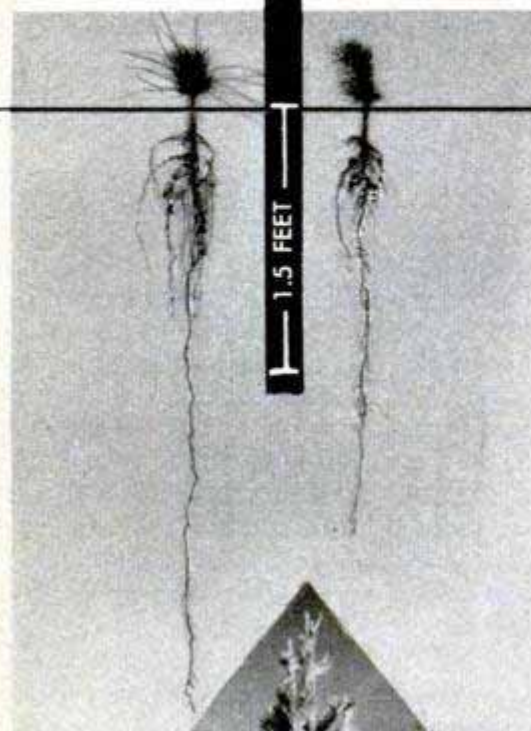

to blister rust. Other white-pine hybrids already show a good degree of resistance to rust.

For the northern Rocky Mountains and the Lake states they have a hybrid with the erect stature of the lodgepole pine and a rate of growth almost equal to the jack pine. It was developed as a logical replacement for the native jack pine that is a poorly formed species.

For California and the Southwest they have an Apache-ponderosa cross that combines the deep-root system and rapid diameter growth of the Apache with the rapid height growth of the ponderosa. The hybrid is tailored for rapid growth in arid climates.

For California there is, among others, a backcross hybrid that combines the excellent wood of the Jeffrey pine with the resistance to serious insect pests that is characteristic of the Coulter pine.

Last year more than 100,000 seeds of these and other hybrids were shipped to many parts of the country by the Institute of Forest Genetics, the western tree-breeding laboratory of the U. S. Forest Service. Next year the resulting two-year-old seedlings will be set out in experimental areas and national forests. In some areas they will be left untended to fend for themselves. If they are unsuitable for the areas in which they are interplanted, they will be crowded out by native stock; if they are superior to native seedlings they will develop into mature stands.

These field trials are the culmination of 25 years of research during which the tree scientists sought out the best seed trees in the forests and worked on the technique for achieving crosses between different species. Only today, relatively speaking, are the hybridists able to say that the breeding of new forest trees is a positive success.

They can't cross an elm with an oak, of course, but inside the same family they often are able to combine two species in a hybrid that retains the desirable characteristics of each. Already thousands of hybrid seedlings have been planted in Western forests to test them against native species.

The Institute of Forest Genetics stems from the foresight of James G. Eddy, a Seattle lumberman who knew the history of forest depletion in New England, the Lake states and the South. He realized that forest depletion had been associated

Monterey pine, grown from a cutting, shot up to 25-foot height when it was only seven years old

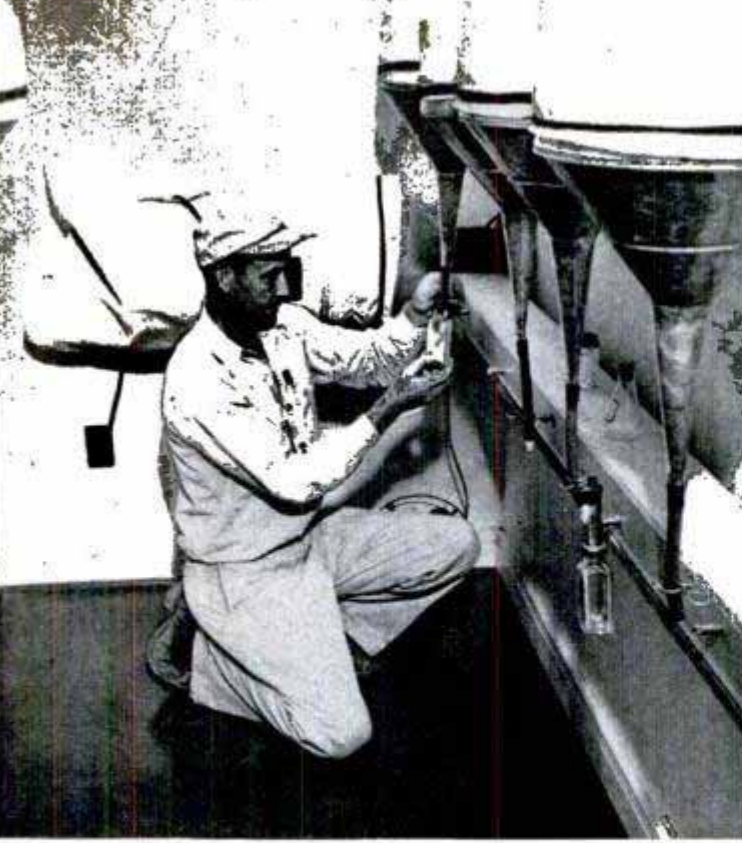

Pollen taken from catkins is dried in cloth containers, then drawn off into bottles for refrigeration



Hypodermic needle is used to inject pollen into bag around the cone of a pine ready for pollination. Below, bags are removed when seed begins to grow. Later, seeds are harvested and planted to grow hybrid giants

with the decline of earlier civilizations in other parts of the world. Early in the century he conferred with Luther Burbank on the possibilities of tree breeding; received encouragement and sought a location for a tree-breeding station. The station would be a long-term project, and the site would have to be climatically comparable to all the milder timber-growing regions of the United States.

Eddy and Lloyd Austin, his director, found an ideal spot in what amounts to the foothills of the Sierra Nevada Mountains a few miles from Placerville, Calif. Here in 1925 they established the Eddy Tree Breeding Station on 106 acres of hilly ground. Within 50 miles of the station the altitude ranges from a few feet above sea level to some 10,000 feet.

Numerous hardwoods and coniferous species were set out as specimens but it was soon decided that the pine family was most suitable for intensive work. The pines supply a good deal of the lumber used in this country, they are widely distributed throughout the Northern Hemisphere and some of them are found in almost every kind of climate.

Although the pine produces good lumber it doesn't create the wood as rapidly as man needs it. The work of the station was dedicated to reducing the number of years needed to produce trees of harvest size. One of the first steps was to collect and plant specimens of about 70 of the 90-odd species of pines that are known. Obtained from as far away as Europe and Asia, the collection now forms a living "reference





Small cutting is grafted to another variety. The cutting will feed on vitamins and water in glass bottle

In 1935 the station became, by gift, the property of the Forest Service and in 1940 a renewed effort was made to develop a hybridizing technique. F. I. Richter, W. C. Cumming and A. R. Liddicoet succeeded in developing the process. Today pollen can be collected from the catkins of one species of pine and stored under refrigeration for weeks, months or even years. It may be used weeks later to pollinate a variety whose cones are not receptive until then, or it can be held over until the following spring to pollinate an early variety.

In summer the large seed trees at the institute bear a strange crop of large white cloth bags high in their branches. These are pollination bags that the hybridists fasten over the cone-bearing branch tips to prevent haphazard natural pollination. Then, when the cones are fully receptive, pollen from a desired variety is injected through the cloth bag by means of a syringe. After the pollination period ends the bags are removed, to be replaced a year later with bags in which the ripened hybrid seeds are caught.

There's a lot of tree climbing involved and the branches of some trees can be reached with the help of a truck-mounted ladder. In the case of larger trees an athletic hybridist tosses a rope over a lower limb, climbs the rope, then uses the upper

(Continued to page 244)

library" from which seeds, pollen and cuttings can be taken at need.

Much of the early work of the station was devoted to selection—the gathering of seeds from the best trees found in the forests with the thought that these seeds would produce trees of exceptional quality. Attempts were made to hybridize different species of pines but proper techniques had not been developed. With a few exceptions, the experiments failed.

Hybrid seed cones are whirled inside this box. Seeds fall through the screen sides and are gathered for storage

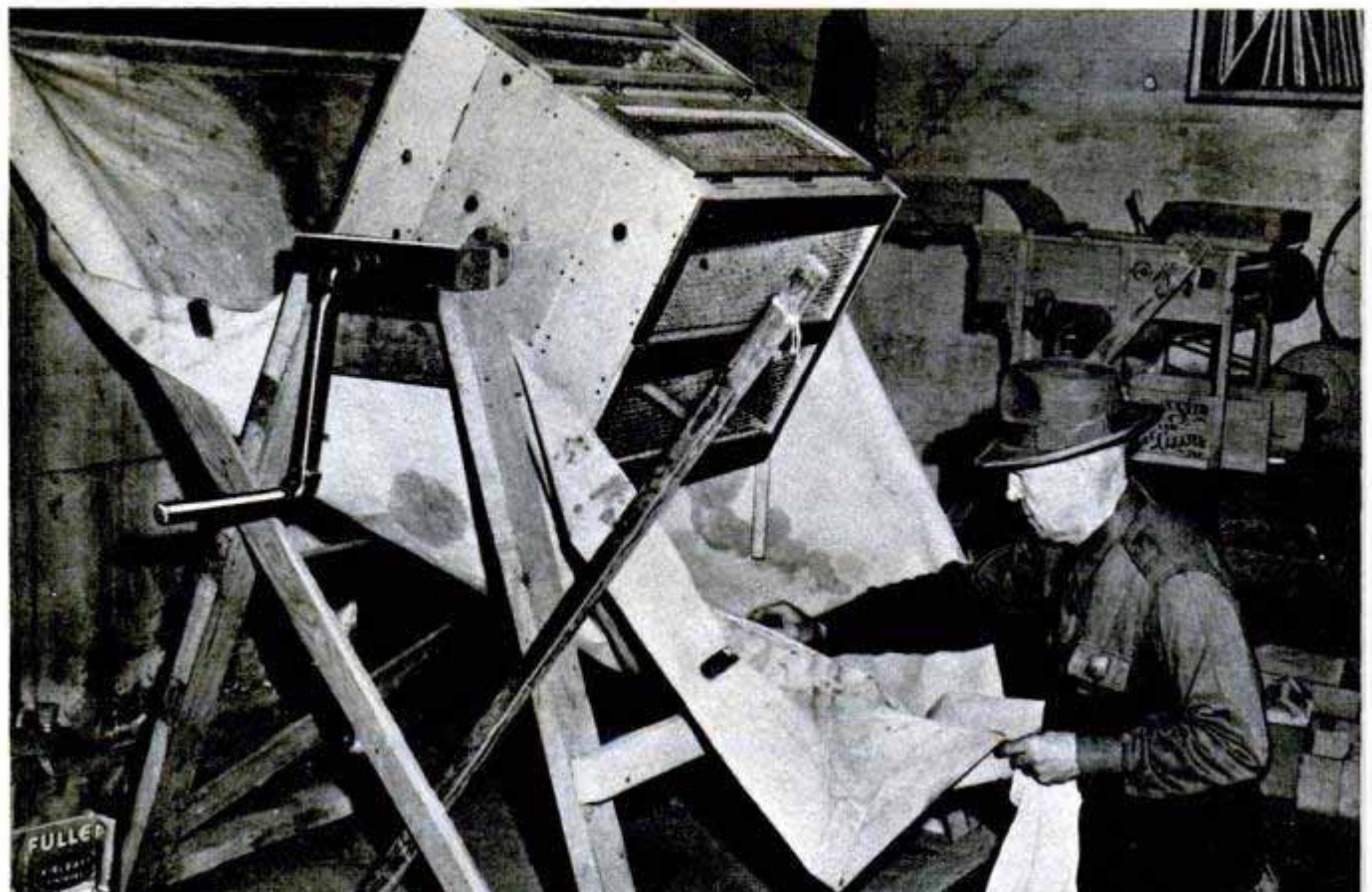



Newsstand in a Bus

Right up front alongside the fare box of the busses in the San Bernardino Valley Transit System is a newspaper-vending machine. Passengers pick up their copy of the San Bernardino (Calif.) Sun as they get aboard the bus for the ride to work. Papers are dispensed by the coin-operated machine so the sales do not interfere with the bus driver's duties.



Paratrooper's "Snood"

Called a "side saddle" safety harness, a nylon crash webbing will protect airborne troops who sit side by side along the walls of planes. The harness, a triangle of nylon mesh, fits snugly over the wearer and his combat pack, protecting him from the force of crash impacts. There is even a built-in pillow to allow soldiers to catch a nap on long flights.

Cotton-Strip Chute Brings Down Heavier Loads

Cotton muslin strips comprise a new expendable cargo parachute devised by the Air Force's Research and Development Command. It can handle twice as much weight as its rayon predecessor and costs only half as much. Nine strips of the material are attached by cotton tapes to form a 28-foot square. Up-rushing air escapes through spaces between the strips, reducing the opening shock and permitting the chute to carry greater loads. In clusters of three or four they are expected to replace the 64-foot nylon chute now used for heavy cargo drops.

Tasty Water Purifier

Purification tablets of a new type, developed for the Army, are said to provide more sanitary and tastier drinking water than the tablets previously used. According to tests, the new tablets, which contain iodine, are more effective against amoebic and other forms of dysentery than the old chlorine tablets. They also impart less taste to the water.

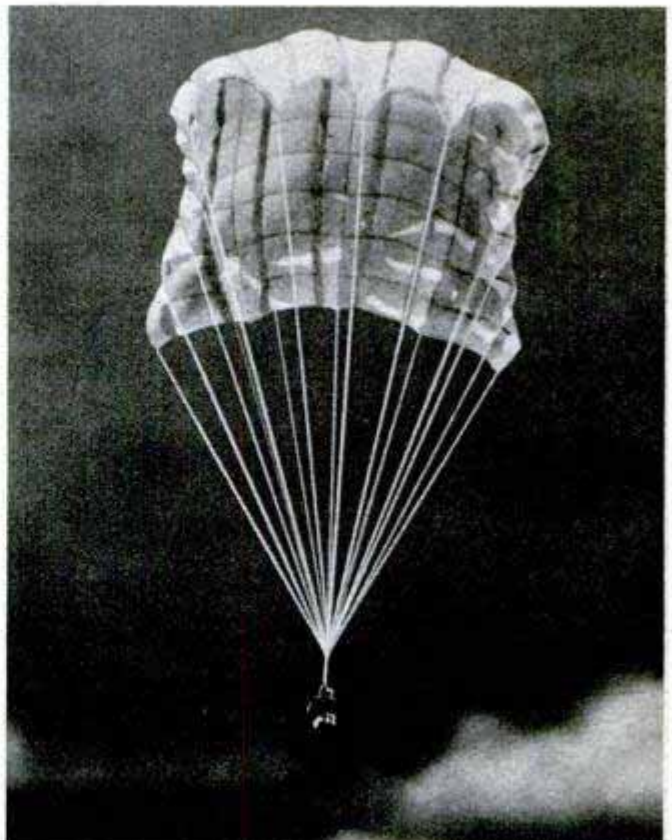

U. S. Air Force photo

You Name It!

Things are not what they seem. Take a look through the cameraman's magnifying glass and the commonest objects appear strange and weird . . . See how many you can identify, then check your list with the answers on page 228



1 _____

2 _____

3 _____

4 _____

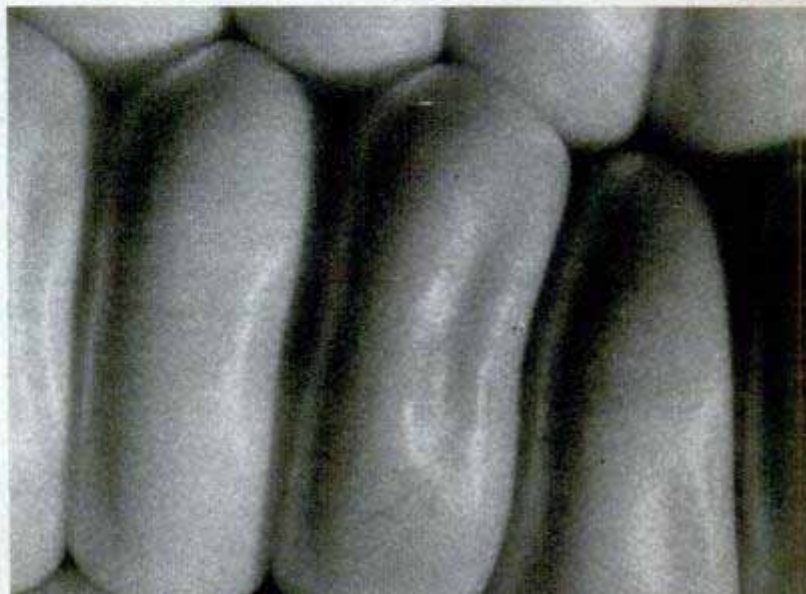
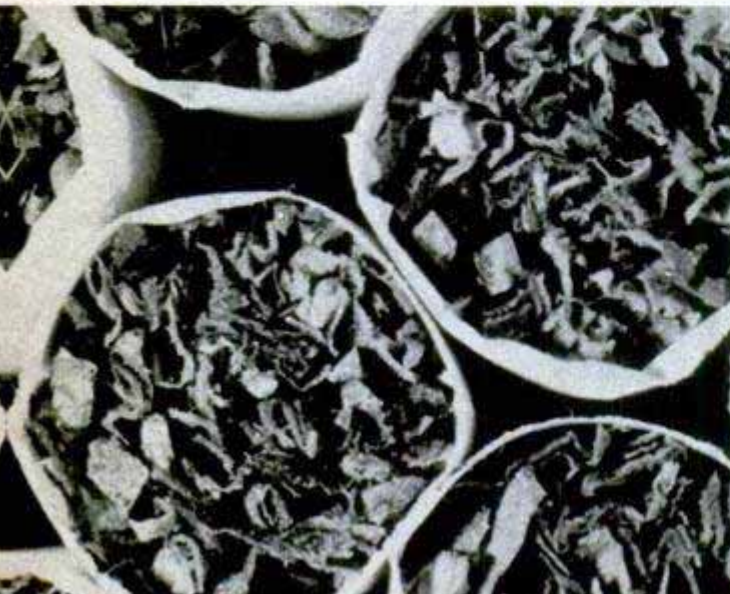



5 _____



6 _____

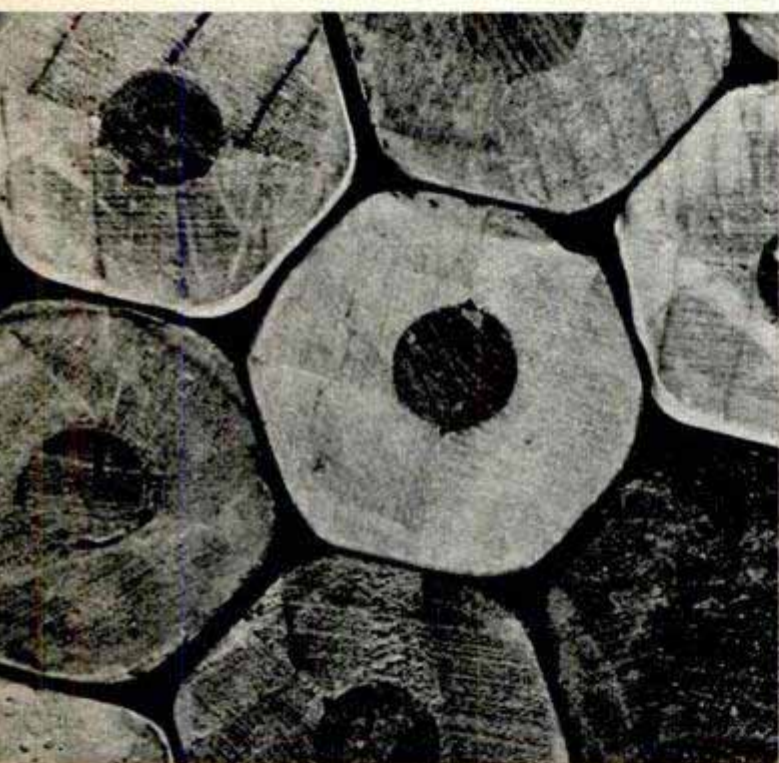

7 _____

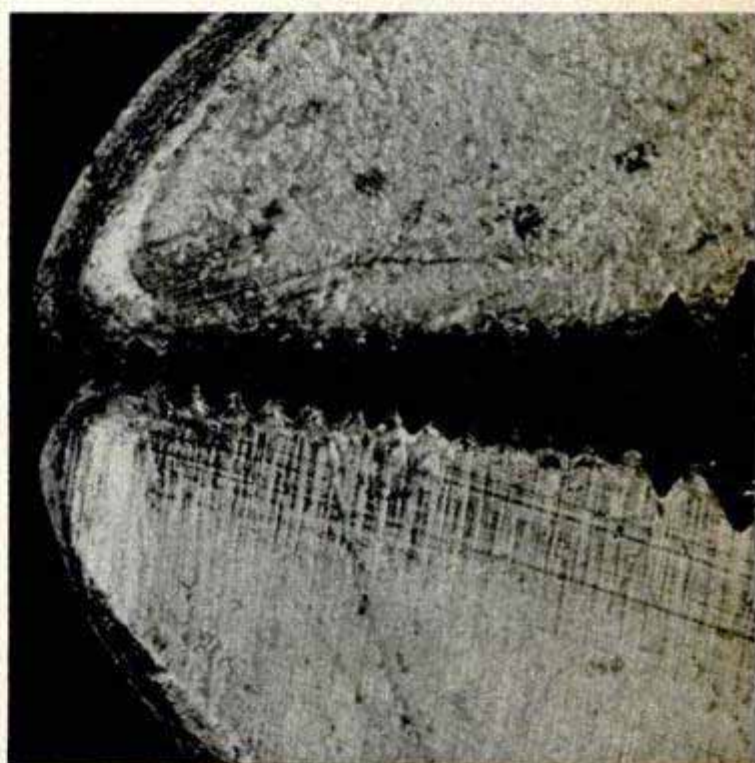

8 _____

9 _____

10 _____

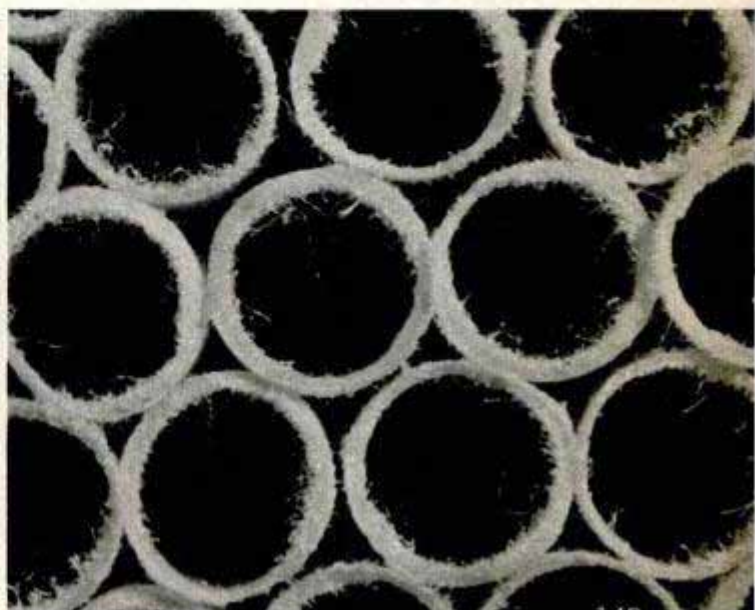
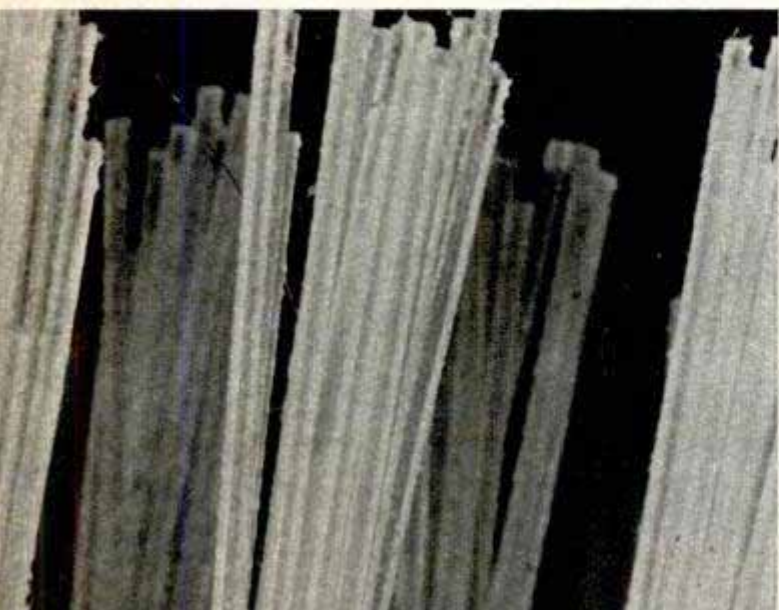

Wagon-Sled Turns at High Speed



Summer or winter, a combination wagon-sled is an exciting plaything for youngsters. The toy can be pulled around like a wagon, ridden downhill on wheels or, when the wheels are removed, used like a sled on snow. It has an unusual steering mechanism. Both front and rear wheels turn when the steering bar is moved, thus permitting sharp turns at high speed without overturning. It also has a braking device.



Heat-Resistant Paint

Dull red heat of 1300 degrees Fahrenheit won't burn a paint the Du Pont Company is testing. A basic ingredient is titanium tetrachloride. Aluminum flake is added later. Problems yet to be solved are getting it to adhere satisfactorily to metal and attaining resistance to salt-water attack. An expected use of the new paint is on ships to protect interior walls and lessen fire hazards by its heat-resistant qualities.

Steel-Ball Storage For Liquid Nitrogen

Because of its spherical design, a welded stainless-steel chamber built to store liquid nitrogen at pressures up to 5500 pounds per square inch weighs only 7500 pounds. Alternate designs, in barrel shapes, would have weighed as much as 15,000 pounds. The liquid, stored at minus 340 degrees Fahrenheit, is used for U. S. Air Force experiments with rocket-propelled aircraft.

Sources of available products described in this issue are listed on pages 12, 14 and 16. Sources of further information on other articles are given in the WHERE-TO-FIND-IT LIST, available from Bureau of Information, Popular Mechanics, 200 East Ontario Street, Chicago 11



Northrop Aircraft photo



Photos copyright Transatlantic News Features

Crows seek more peaceful meals when this "scarecrow" goes into operation. Right, farm girl prepares charge

"Scarecrow" With Sound

British crops are protected from hungry crows and vermin by a noisy "scarecrow" that frightens away the birds with detonating fireworks and a terrific clatter. Made by a British fireworks company, the scare-

crow consists of a length of burning rope, three metal slats and some fireworks. At 20-minute intervals, the rope, which burns for eight hours touches off a firework. A loud bang, accompanied by flapping of the metal slats, makes the birds take off for more peaceful fields.

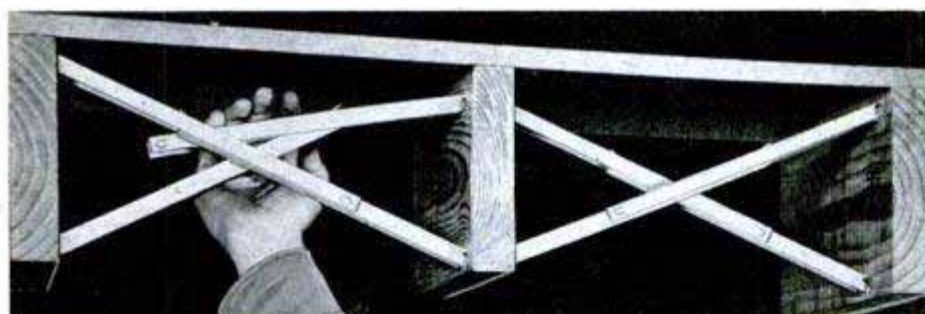

Metal Floor Bridging

Requiring no nails, a new type of metal floor bridging reduces installation time greatly. The bridging comes in two sections which snap together between the joists to lock securely.

Beta-Ray Gauge

Beta radiation is used to measure thickness of moving sheet materials as they come off the production line. Sheets of steel, aluminum, brass, plastic, rubber and many other materials are measured to within a few millionths of an inch accuracy. A source of beta radiation is placed on one side of the material and a detector on the other side. By precise measurement of the amount of radiation penetrating the material, the gauge determines the material's thickness. The measurements are plotted on a continuous graph.

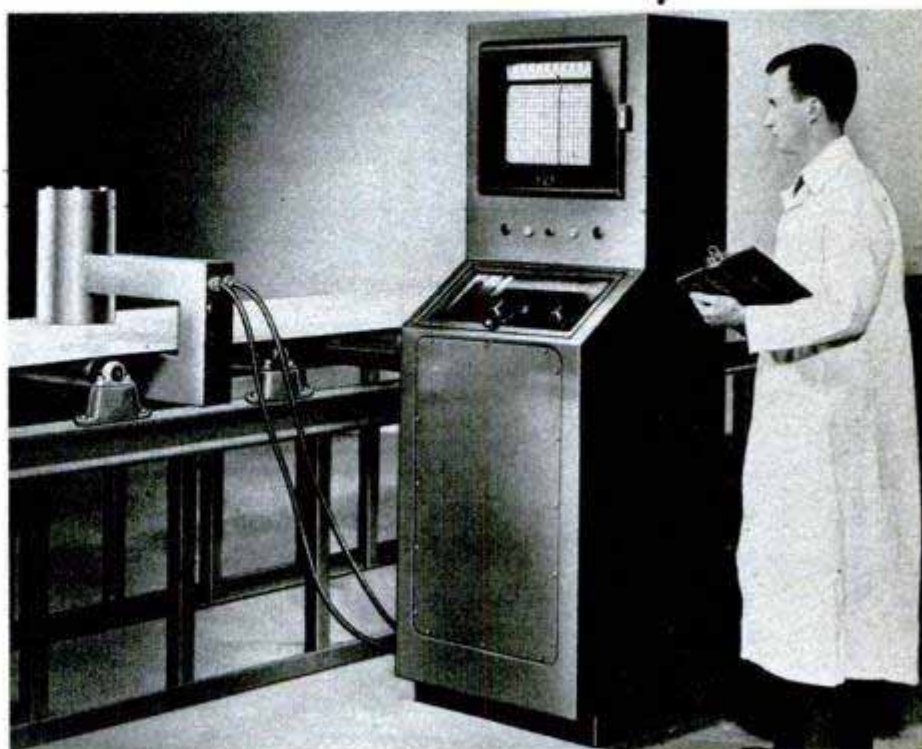



Army Quartermaster Corps photos

Infantrymen in Korea get enough respite from combat to enjoy an A Ration Christmas dinner. Fresh vegetables and fowl are heaped upon their metal trays

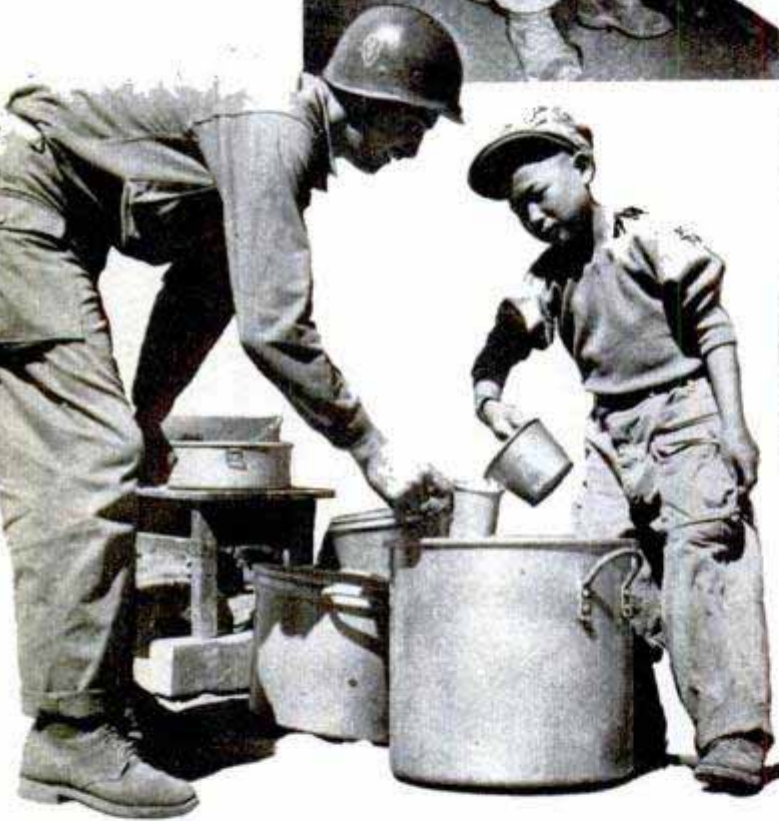

"Up front" in Korea, far from refrigeration facilities, a GI gets a helping of hot soup. Troops in forward areas depend on canned and dehydrated foods

YOU CAN EXPECT 3½ million men for dinner—as well as breakfast and lunch—every day from now on!" Those words that would rip away every shred of a housewife's sanity are a routine daily order at the Army's Quartermaster Corps depot in Chicago. They feed the Army, Navy and Air Force all over the world. Since Congress decided that each soldier in the War of 1812 would have "1¼ pounds of beef or ¾ pound of pork, 18 ounces of bread or flour and 1 gill of rum, whiskey or brandy" to sustain him through a day, the science of feeding has come a long way in

GI RATIONS "UP FRONT"

the armed forces. Now regulations fix the minimum amount of calories in each man's daily ration, varying with its location and assignment, and specify the proper nutritional elements it should contain. A ration is the amount of food authorized for one soldier for one day. Men in temperate climates get 3600 or more calories and those in the Arctic receive over 4400. Seasonal variations are also considered. "Teen age" troops get meals that match their growing appetites. Along with providing proper nutrition, the importance of food that also looks, tastes and smells good hasn't been overlooked. Industrial food laboratories and some of the nation's most famous chefs have helped in this regard with research and special cooking instructions. Field

Ration A, most closely resembling the average civilian diet, is served wherever kitchens and refrigeration are available. Large groups without refrigeration facilities, such as troops on maneuvers, subsist on Operational Ration B, which substitutes canned and dehydrated foods for the perishable items. Other canned rations and food packets are tailored to the needs of individuals and small units in combat—in the air, on the sea or in special situations. Among these are survival packs for life rafts, the arctic and tropical regions.

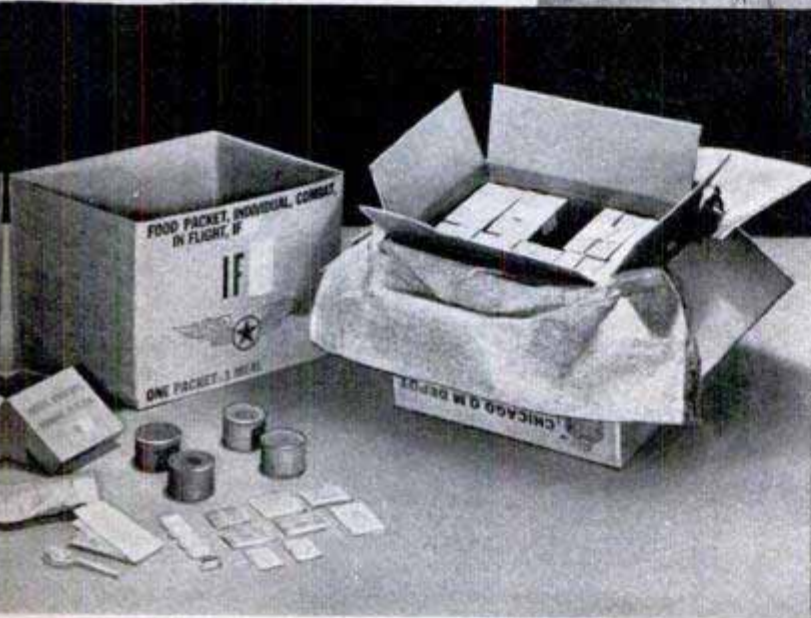

In-flight food packets (above) are provided for crews and passengers on long missions. Each of the small cartons in the box contains cans of meat, fruit, round crackers, cookies and candy. A can opener, eating utensils, soluble milk, soluble tea, coffee and condiments are wrapped separately. Most large planes have heating ovens

Gun crews and other small detachments depend on the Five-in-One ration. The box below contains enough to feed five men for one day, and offers five different menus to avoid monotony. In addition to canned meats, fruit, milk, cheese, puddings and vegetables, it has candy, cocoa, cereal, cigarettes and water-purification tablets

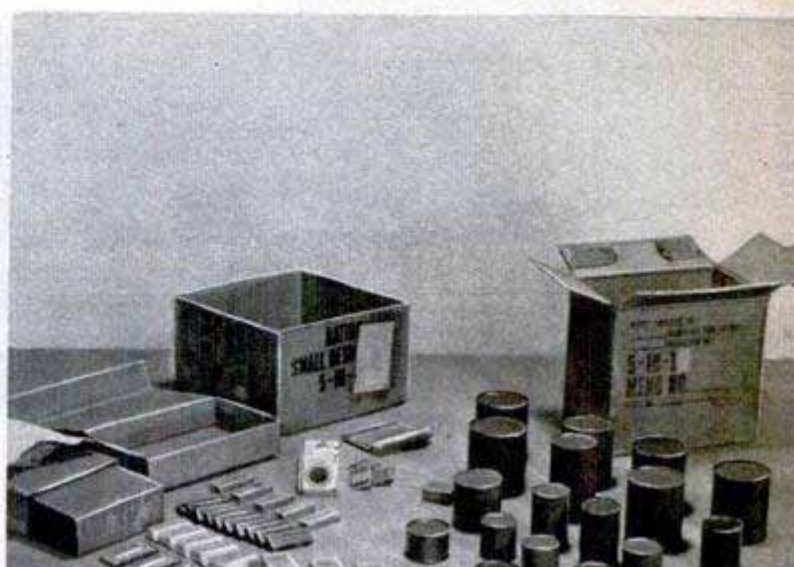



For emergencies in the tropics, when all other sources of food are lacking, there is a compact, low-calorie survival packet that consists mainly of starch jelly bars

Individual troops in the field or in combat get a ration that concentrates on canned meats. The precooked contents can be eaten hot or cold. Each of the six rations in a case provides 3800 calories of food daily





Trail Frigid is a ration for small patrol parties in cold climates. It is packed in a box enclosed in a waterproof bag. Gruel can be made by adding water to the dehydrated meat bars. Also included with the ration are almonds, raisins, chocolate, assorted hard candies and dehydrated soups



In combat, when more complete rations are not available, soldiers have an assault packet that contains a canned meat, such as chicken, a beef and pork loaf or ham and eggs, and another can with cookies and crackers. It is intended for land, sea or air assaults in which the action is expected to last less than 30 hours



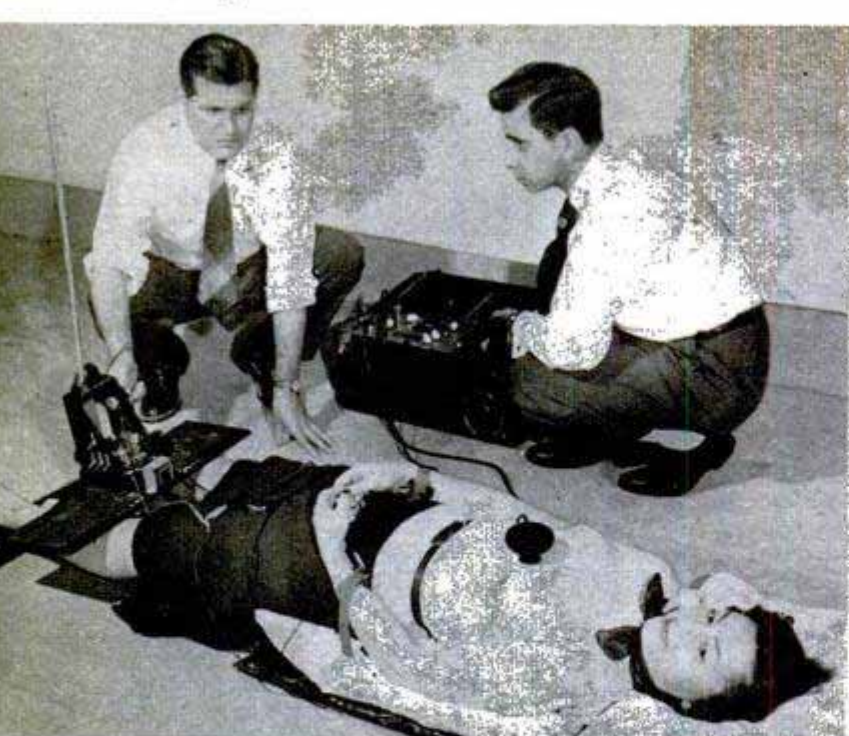

Civil Aeronautics Administration

Pulse Seismograph

Faulty hearts that escape electrocardiograph detection are discovered by a new electronic ballistocardiograph. It operates like a miniature seismograph to record pulse movements. The device consists of a vertical rod mounted on a light wooden span that is placed across the patient's shins. The rod holds a magnet rigidly supported in the field of an electric coil. Each pulse-beat movement of the body shakes the coil and disturbs its magnetic field, sending the information on in the form of electrical impulses to the ballistocardiograph for recording. Developed by medical and electronic specialists of the Civil Aeronautics Administration, it has indicated abnormalities in over 50 cases of known coronary thrombosis.

Automatic Starter For Cold Weather

Automobile and other internal-combustion engines are kept warm even in sub-zero temperatures by a fully automatic starting device. The starter clamps to the engine head or manifold bolt and has four simple connections to the electrical system. As the outside temperature falls it starts the engine and allows it to run a few minutes to restore normal temperature, then shuts it off. Two to four starts are usually sufficient during a cold night. The unit is controlled by a dashboard knob, which glows red when the circuit is on. It will operate only when the gears are in neutral. According to the manufacturer,

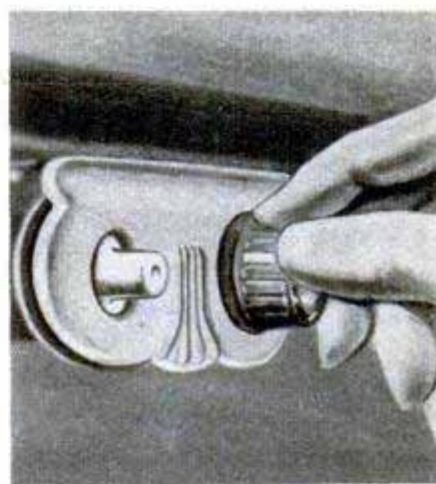

the generator may be advanced so that it will charge rather than drain the battery even at idling speed. It uses no more gasoline than would be needed to warm the engine up from lowest temperatures. The automatic starter will work on all makes of cars with solenoid switch starters.



"Rumble Seat" Scooter

Seating two passengers in a rear-facing "rumble seat," an economical open-air taxi is attracting attention in West Berlin. The vehicle is said to do 50 miles an hour with a full load.

MATS Flies 400,000 Passengers

In its third year of existence, the Military Air Transport Service airlifted 400,000 passengers and 60,000 tons of critical cargo and mail in support of the Armed Forces. Most of this traffic was moved over the Pacific to Japan. On return trips MATS evacuated more than 26,000 casualties from Korea.

the

**POPULAR
MECHANICS**

CRAFTSMAN

How to fit and take care of your lathe chuck is described in story on page 203



Dowels woven through strips of webbing form attractive screen pictured above. See page 191



Korta

The small-shop bench, above, is a sturdy, compact unit that will give many years of service. Bench illustrated below features six large storage drawers

X801)

WORKBENCHES and WALL CABINETS

PART I

N. 53
P. 57
*Blanning
your Hand
Workshop*

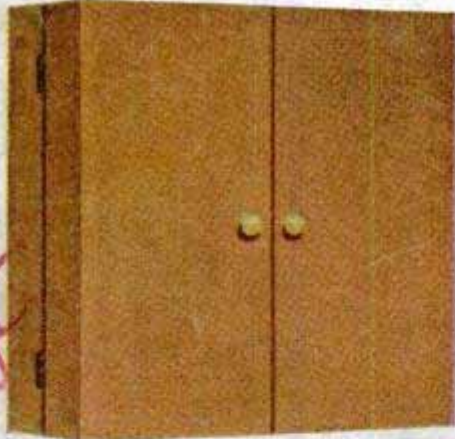



This de luxe bench combined with a spacious wall cabinet meets the needs of the most extensive shop

WHETHER you have a pint-sized shop with only a few hand tools or a fully equipped power shop that's the envy of the neighborhood, you want a workbench that "fits in." You need a smooth, spacious working surface and a good vise, plus storage drawers and a tool panel that will keep everything at your finger tips. With this in mind, furniture-designer John Bergen presents the series of workbenches and wall cabinets illustrated on these pages.

Designed for appearance as well as convenience, they include a small-shop bench with heavy plywood top and large storage drawer, a commodious six-drawer bench for the more elaborate shop, a de luxe job, featuring a 7-ft.-long top and sliding doors, and a unique bench for the apartment or utility room, which can be rolled out of the way on retractable casters.

To complement the workbenches, there are two wall cabinets and a tool panel,

Craftsmen who work in an apartment or utility room will appreciate retractable casters on this bench

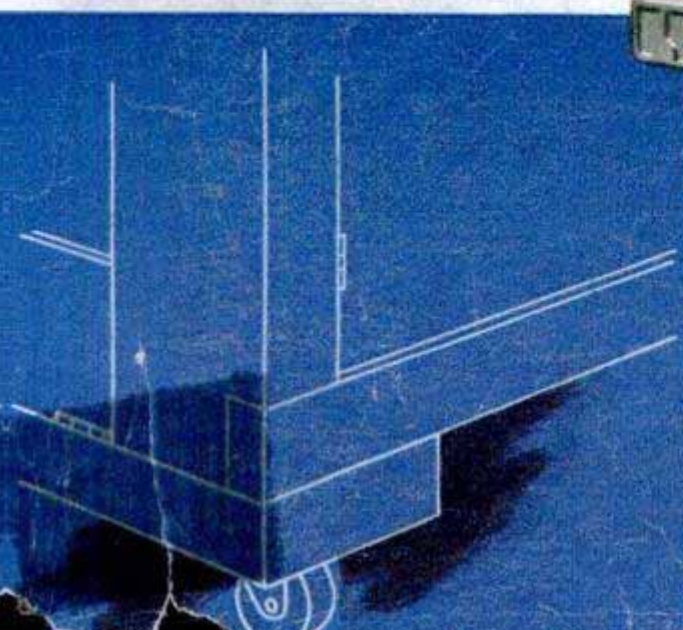

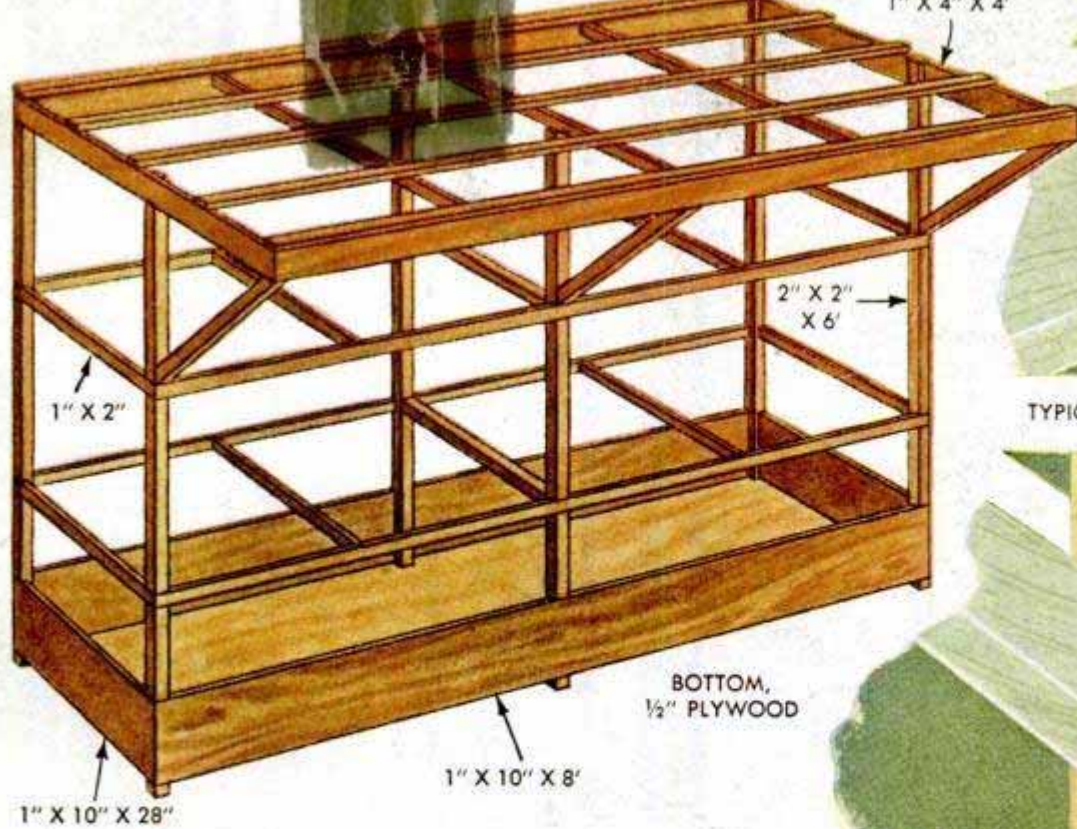

TYPICAL NOTCHES IN POSTS



Lumber-storage problem is solved neatly by this good-looking rack. All joints are flush on the outside of the rack, the posts being notched for rails and braces

which will meet the requirements of the craftsman with few hand tools as well as the man who keeps hundreds of tools and small parts. Like the benches and cabinets, the lumber rack shown above features "cabinetmaker" construction, and is designed to handle standard 4 x 8-ft. sheets of plywood plus a generous supply of lumber in 2 to 8-ft. lengths. The bottom of the rack is intended to provide a convenient bin for scrap lumber.

Construction of the three larger workbenches is detailed on these pages, while building of the wall cabinets, tool panel and apartment-size bench will be covered next month in Part II. Assembly of the three benches is essentially the same, 1 $\frac{5}{8}$ x 3 $\frac{5}{8}$ -in. stock being used for the rails, corner posts and base members. Hardboard or $\frac{1}{4}$ -in. plywood is suitable for the end and back panels. The fronts of the drawers are of $\frac{3}{4}$ -in. stock with the sides and backs of $\frac{1}{2}$ -in. stock, the method of assembly and installation being the same on all the benches. The top of the small-shop bench consists simply of two sheets of $\frac{13}{16}$ -in. maple plywood glued together. On both the six-drawer bench and the de luxe model, the tops are built up of 1 $\frac{3}{4}$ x 2 $\frac{1}{4}$ -in. hard-maple strips, which are doweled and glued as shown.

Note in the lower right-hand detail on page 161 how the members of the six-drawer bench are tenoned and notched to form an interlocking corner joint. The $\frac{1}{4}$ -in. back panel is glued in rabbets cut in the rails and posts. To

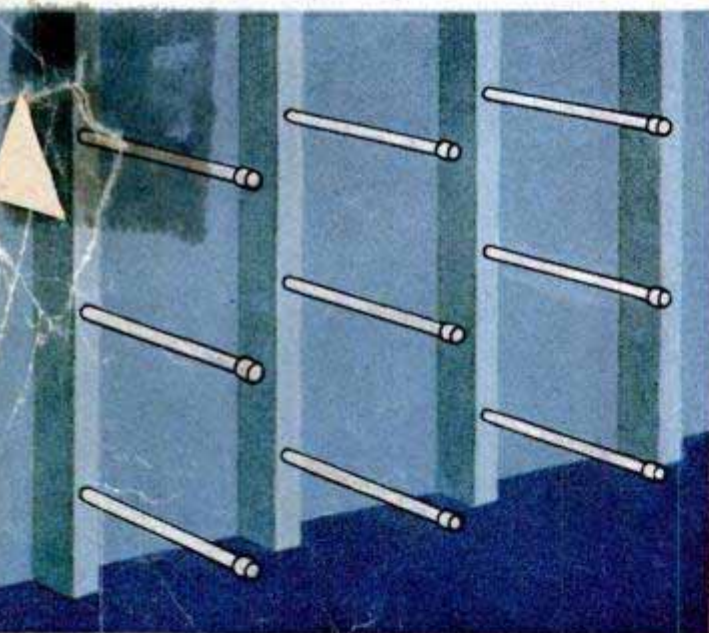

Made from pipe and fittings, these lumber racks are quickly assembled and require minimum space

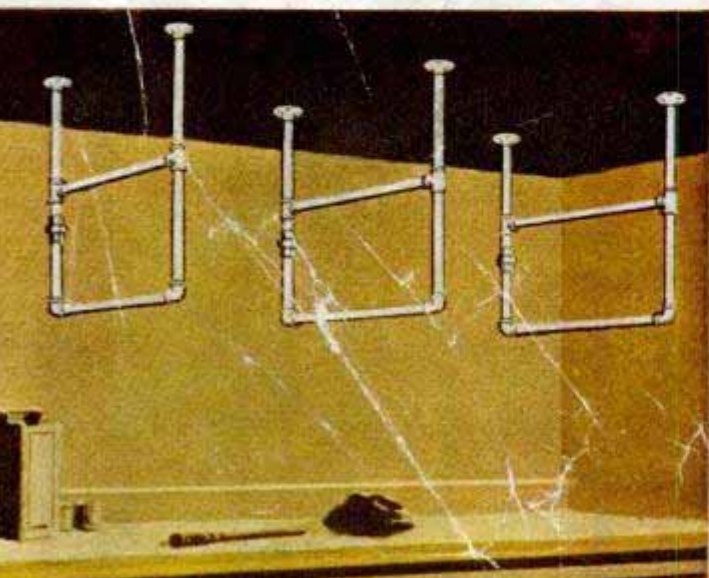

Six-Drawer Bench

1/2" DOWELS, SPACED 15" APART, 5 REQD

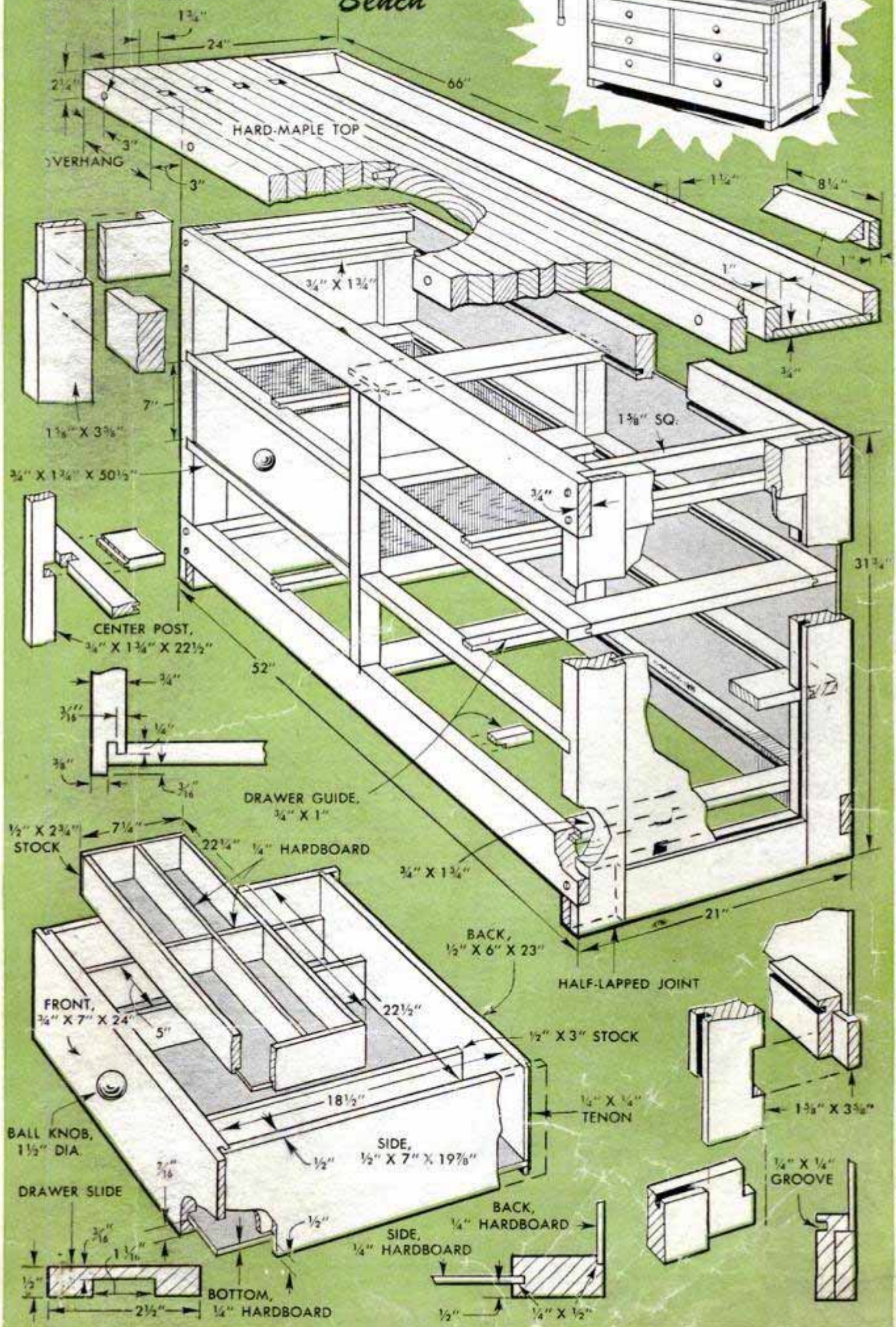

De Luxe Bench

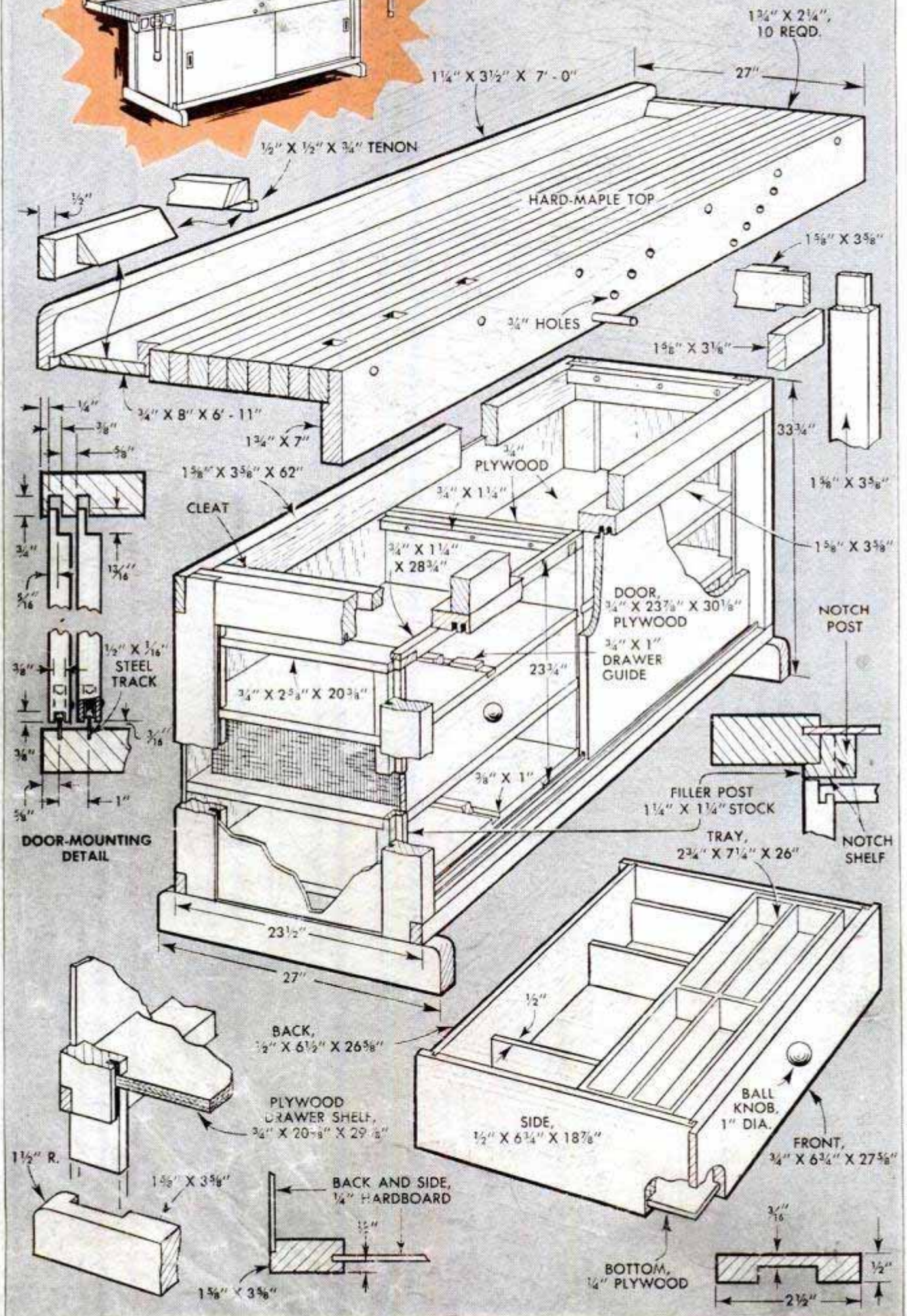

support the tongued-and-grooved drawer frames, notches are cut in the inside faces of the corner posts. The front and back rails of the frames are half-lapped at the center posts. Drawer guides overlap the front rails just far enough to allow clearance for the drawer fronts.

The sliding doors of the de luxe bench ride on sheaves which roll on steel tracks set parallel along the full length of the bottom front rail. Each door is fitted with two sheaves mounted 2 in. from the ends, and the top edge of the door is rabbeted to engage grooves along the underside of the top front rail. These grooves are shown $\frac{3}{4}$ in. deep to allow sufficient clearance for placing the sheaves on the tracks when installing the doors. In this bench, plywood drawer shelves are used instead of frames. Both drawer and storage shelves are set in

grooves in the plywood center rail and are notched at the outer corners to form half-lapped joints with the notched filler posts. The drawer guides are glued in $\frac{3}{8}$ -in.-deep grooves cut in the top faces of the drawer shelves, and the outer ends are cut back to clear the drawer fronts.

The front-post detail, below, shows the typical cuts necessary for assembling the posts and rails of the small-shop bench. If desired, the posts may be grooved to take the edges of the hardboard side panels, or the latter can be fitted against the edges of the posts after inserting their top edges in the center-rail grooves. In this case, 10-in. cleats are screwed to the posts to add rigidity to the end panels. The removable drawer tray is made in the same way as the one detailed for the six-drawer bench.

(To be continued)

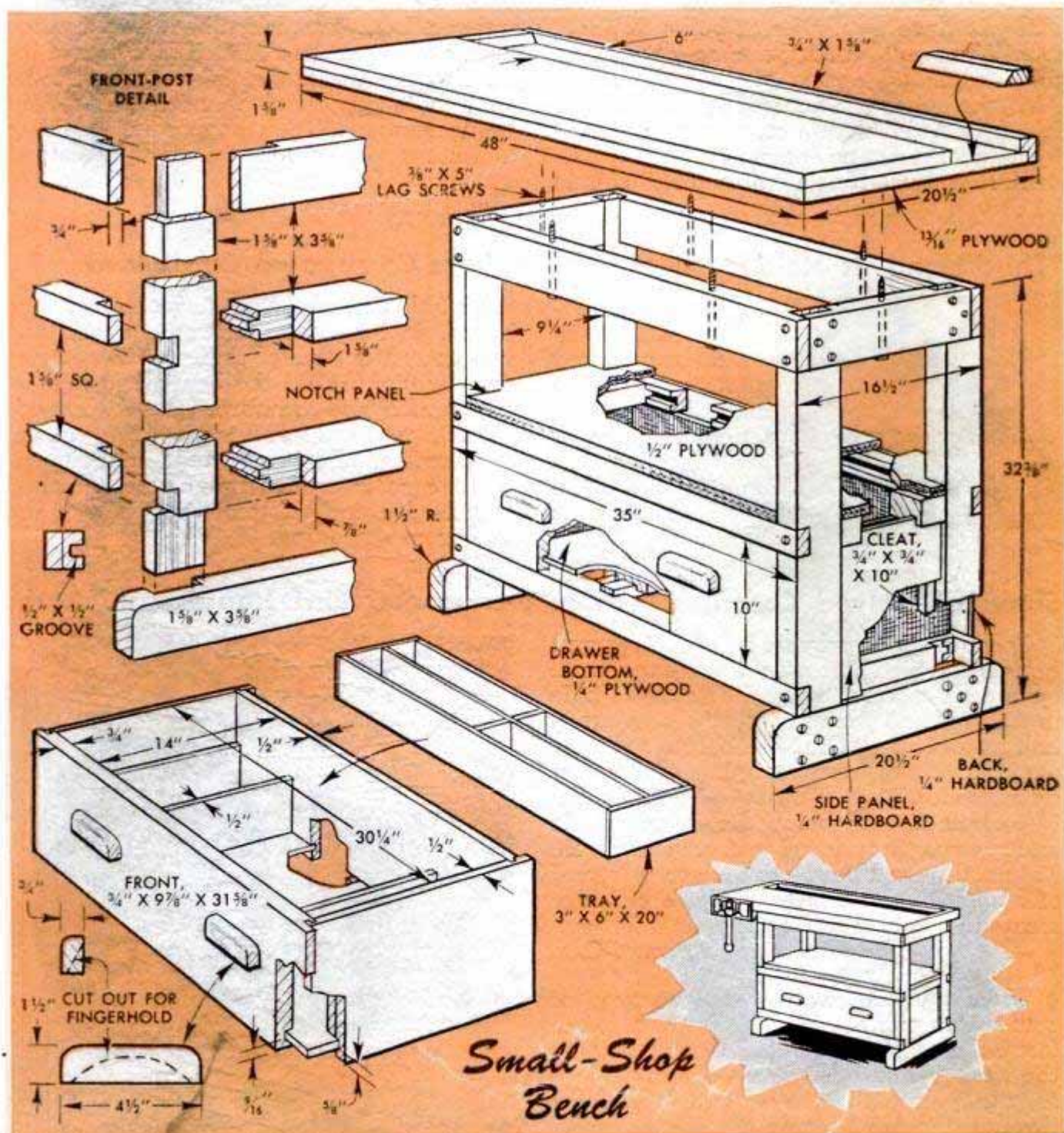

Unique Garden Tool Cultivates Soil or Digs Holes for Setting Bulbs

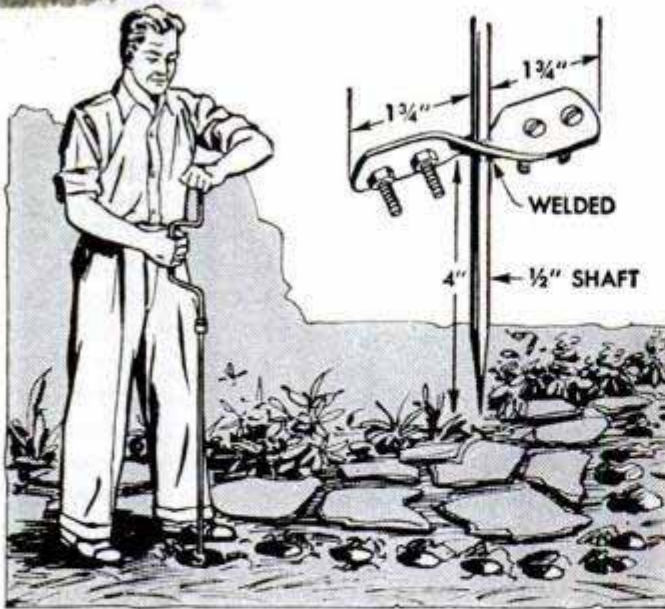

If you have a number of bulbs to plant, it will be well worth your time to make this simple auger for digging the holes. Also, the auger can be used as a cultivator. It can be fitted with a crank and operated by hand or it can be operated by an electric drill. If you use it as a cultivator, it should be driven by a drill. When cultivating, the

auger is held at an angle so that the point rests on the ground and the blades, in rotating, strike the ground and stir it. When used as a cultivator in flower beds and other places where plants are close together, it can be used in a vertical position as for digging holes except that the blades are not permitted to enter the ground. Instead they just strike the surface, the auger being lifted up and down as you move it along. The tool is made by bending a piece of flat steel to form a propeller shape, which is drilled in the center to slip over a piece of $\frac{1}{2}$ -in. steel rod. Weld the propeller in position about 4 in. from the lower end of the rod. The latter should be pointed for easy entrance into the ground. The upper end of the rod can be bent to the shape of a crank or it can be squared to take a speed wrench. Left plain, it can be inserted in the chuck of an electric drill. If you do not intend to use the auger as a cultivator, the small bolts shown in the propeller will not be necessary as their purpose is to aid in loosening the ground when cultivating. For more effective digging, the edges of the blades may be sharpened.

"Third Hand" to Hold Flashlight Made From Corrugated Cardboard

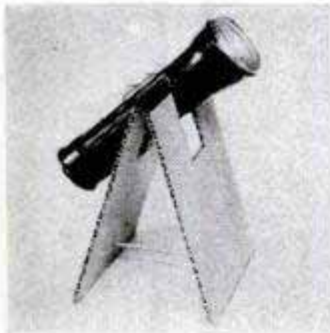

A stand for holding a flashlight in almost any desired position can be made from a rectangular piece of cardboard approximately 6 x 16 in. The corrugations should run with

the width. Cut a rectangular opening in the board, making the length 6 in. and the width slightly smaller than the diameter of the flashlight. Fold the board endways at the center and reinforce the folds with tape. In use, the stand is placed as shown, and the flashlight force-fitted into the opening. A cord, inserted through holes punched in each leg and knotted, will prevent the legs from spreading.

Shells of Halved Coconuts Provide Picturesque Bird Houses and Baths

Coconut shells provide dandy little wren houses and bird baths. To remove the meat, open each coconut by drilling a $\frac{7}{8}$ -in. hole in the side and then sawing the coconut in half as indicated. Glue the halves together again, using a waterproof glue, and mount on a wooden bracket made of 1 x 2s. Drill a $\frac{1}{4}$ -in. hole directly below the entrance hole and insert a short dowel to serve as a perch. To make a bird bath, simply screw a half of a shell to the crotch of a tree or other location suitable for the purpose.

H. Moetzing, Toronto, Can.

When painting walls with the type of cold-water paint that is supplied in paste form, the paste can be used to fill cracks in the wall. Being the same color and texture as the paint, the paste will not show through the finish when dry.

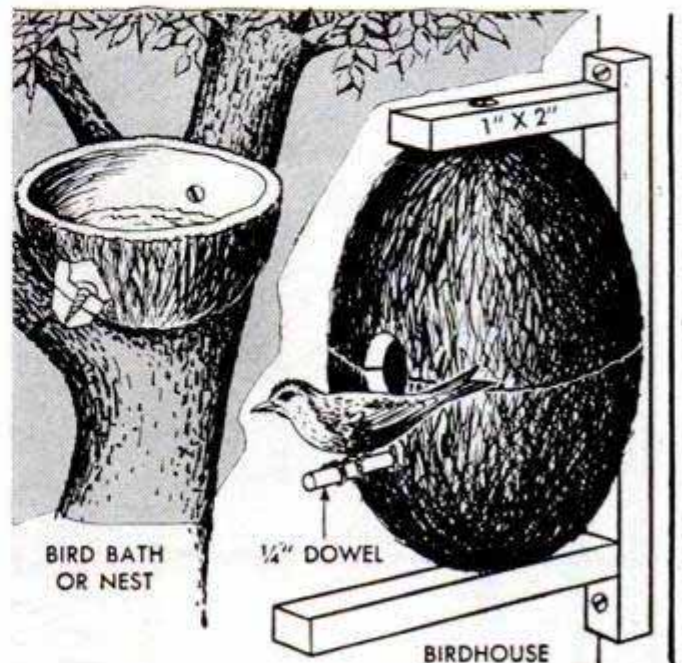

Scrolled BOOKSHELF

By John Bergen

A NOVEL hourglass design in open scrollwork distinguishes this wall bookshelf. Two drawers add to its usefulness and decorative value. If desired, the bookshelf can be built entirely of plywood, or solid stock can be used for the scrolled ends and drawer fronts with plywood for the shelves and back. The shelves are set in blind grooves, or dadoes, cut in the scrolled sides, and the exposed front edges are faced with a cloverleaf molding. The details below show how to lay out the scroll patterns directly on the wood, and also give the radii for cuts on the stepped edges of the side panels. Drawers are of conventional construction.

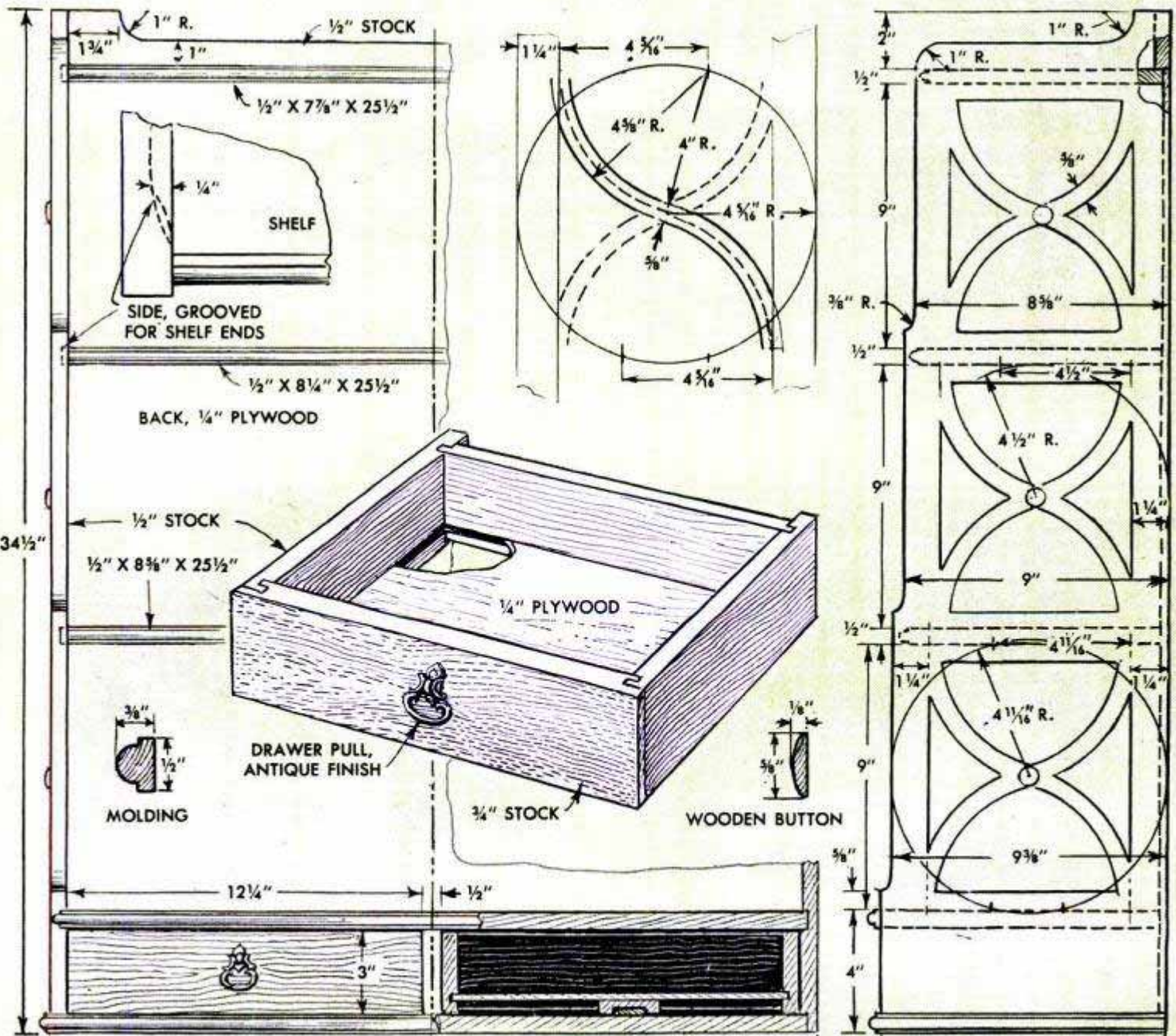
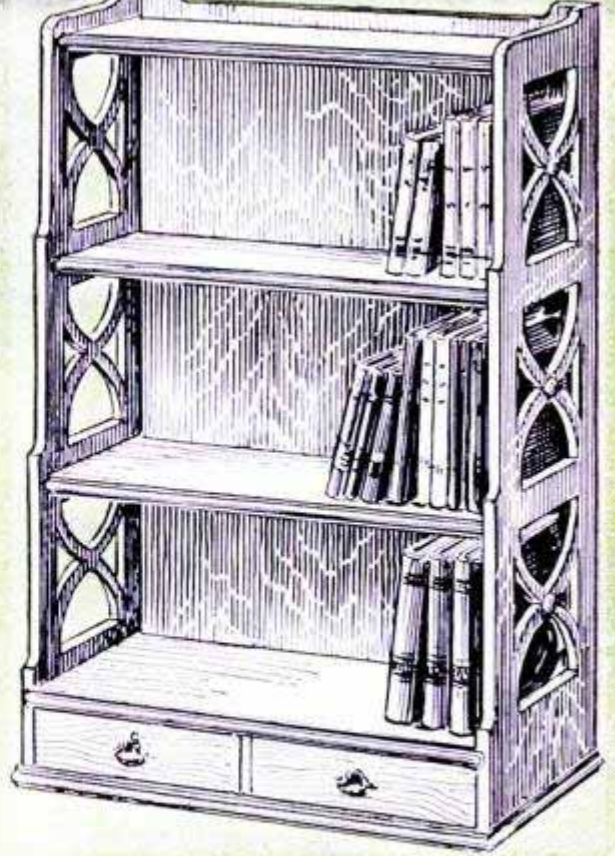

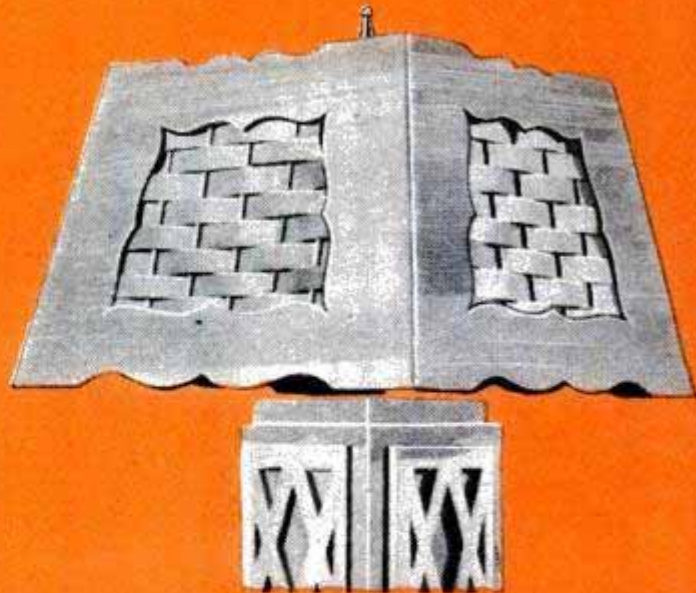

Basket - Weave Shade

MODERN

By Bertram Brownold

ANY OF THE three lamp shades pictured above will add a distinctive touch to your living room or bedroom. Although they are entirely of wood, the shades provide a soft, side-lighting effect resulting from the novel use of translucent basket splint and louvers made of thin slats. As detailed, these shades are too small for the massive lamp bases frequently used in modern furnishings. However, they easily can be enlarged and their proportions varied somewhat if desired. The plywood portions of the shades may be stained, finished natural with clear varnish or shellac, or painted, depending upon your likes and the color scheme of the room.

The basket-weave shade, detailed in Fig. 1, consists of four scrolled sides of $\frac{1}{8}$ -in. plywood. Each side is backed with an insert

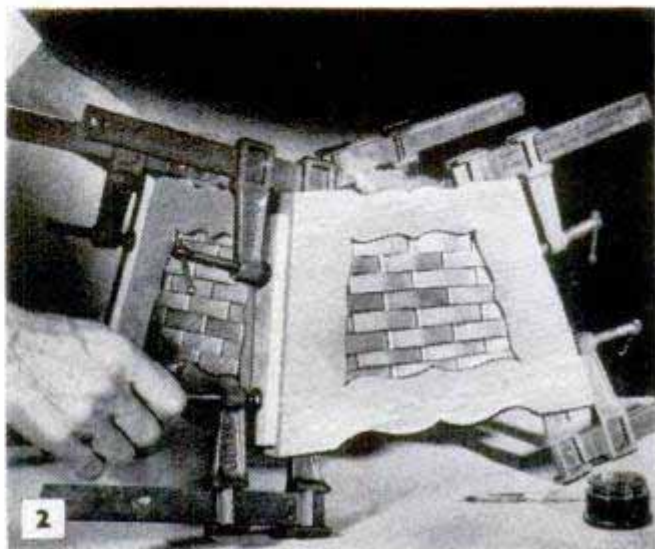
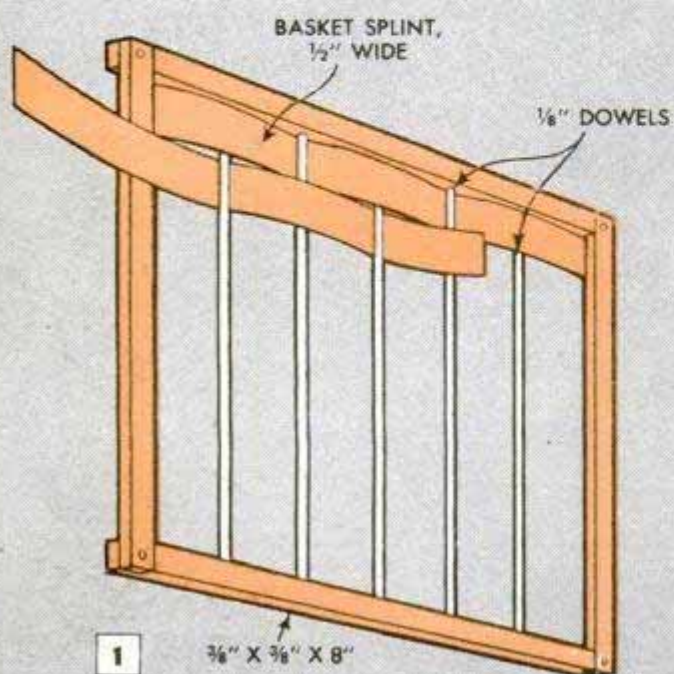
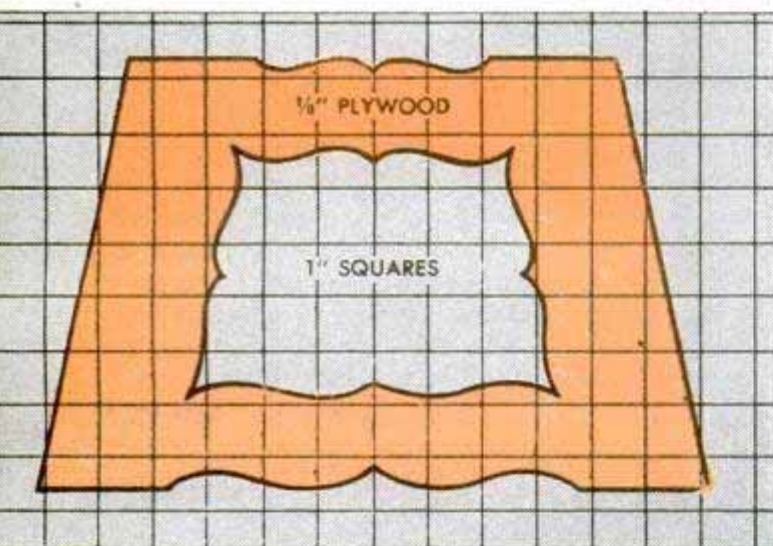



Lower Shade

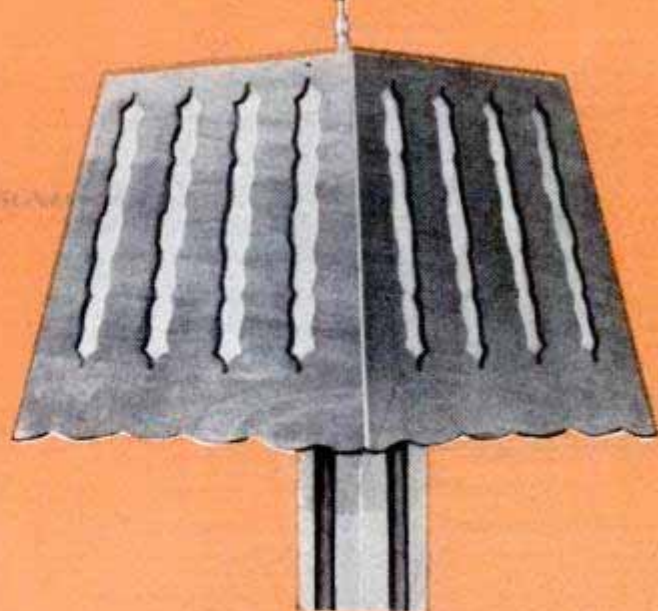

Scroll Shade

LAMP SHADES IN WOOD

made by weaving basket-splint strips through dowels which are mounted vertically in a wooden frame. The sides are cut to size and jigsawed according to the squared pattern. After the basket splint has been cut into $\frac{1}{2}$ -in. strips, it is soaked in water to make it pliable. The strips are woven through the dowels while still wet and the ends of the strips are tacked to the sides of the frames. Note that the top and bottom pieces of the frames are notched so the side members will fit flush. The completed inserts are glued to the inner faces of the shade sides directly over the scrolled cutouts. The sides of the shade are mitered and glued together as in Fig. 2, glue blocks being installed along the joints, as in Fig. 3.

The sides of the louver shade consist entirely of thin wooden slats which are edge-glued in saw kerfs cut at a 60-deg. angle on adjacent faces of the corner members. To

make the shade, first cut the kerfs in the corner pieces as detailed in Fig. 5. This can be done by kerfing one face of a $\frac{5}{8}$ -in. board and then ripping four $\frac{5}{8}$ -in. strips from the board. To kerf the adjacent faces of the strips, join the four side by side with a couple of cleats and cut the kerfs as before. Finally, cut off the ends so each member contains 16 saw kerfs on adjacent faces.

The slats are ripped just thick enough to fit snugly in the saw kerfs. As the scroll, which is shown in the squared pattern in Fig. 5, is the same on all the slats, several of them can be jigsawed at the same time. This can be done by stacking the strips for jigsawing, or by cutting the scroll on one face of a block before ripping off the strips. Note in the upper detail how the 16 slats for each side are laid out and cut, one longer than the other, to give the desired taper to the shade. Gluing the slats in the saw kerfs

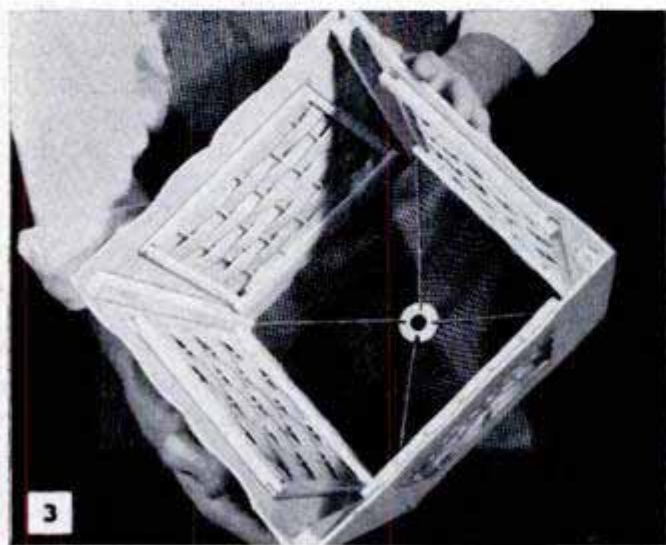

3

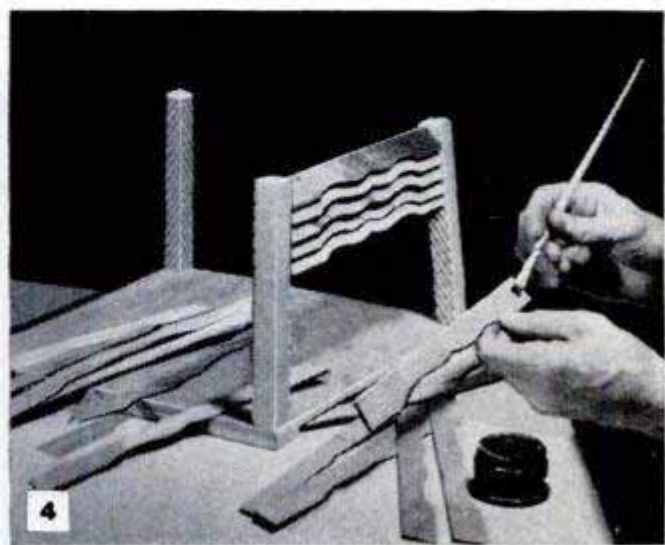

4

HOW SLATS ARE MARKED FOR LENGTH

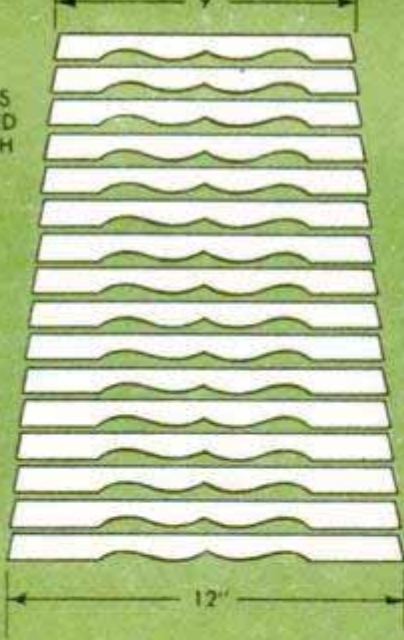

1/2" SQUARES

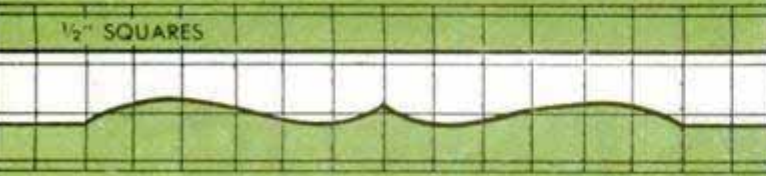

SAW KERFS

5

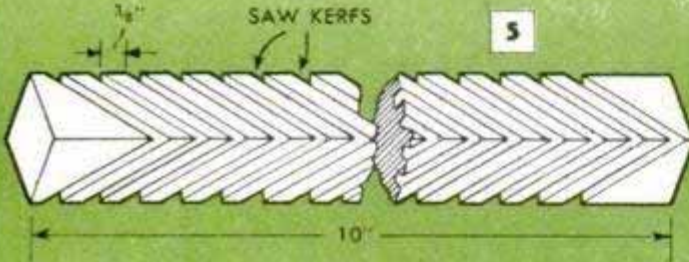

1" SQUARES

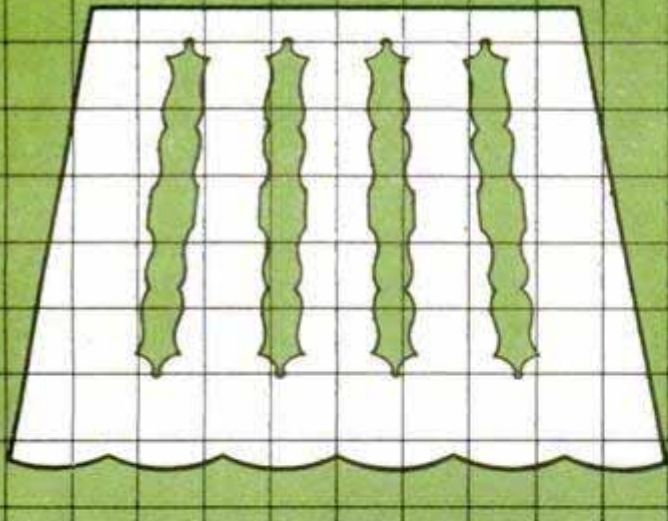

6

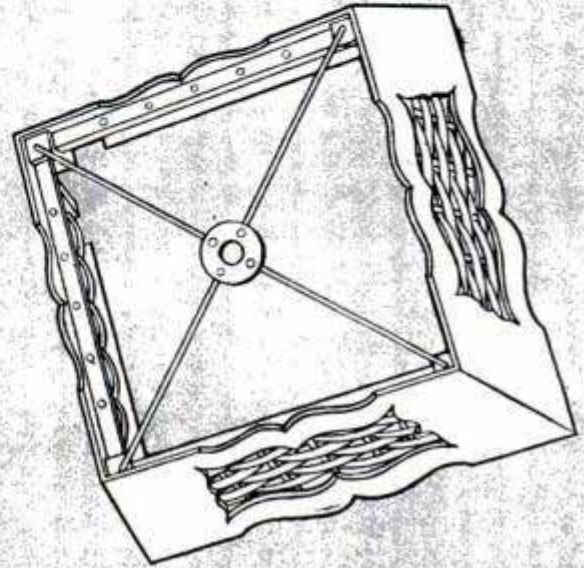
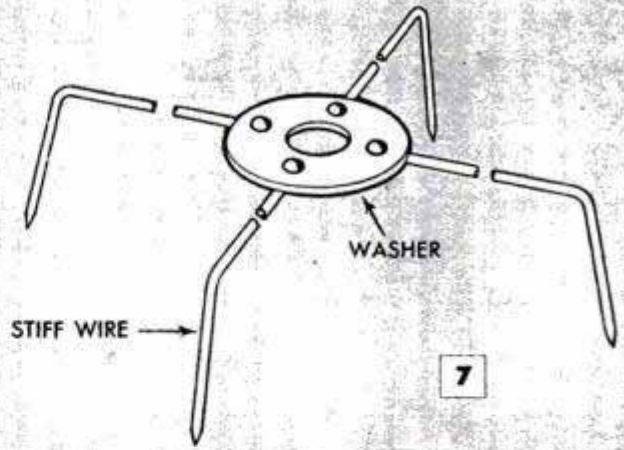
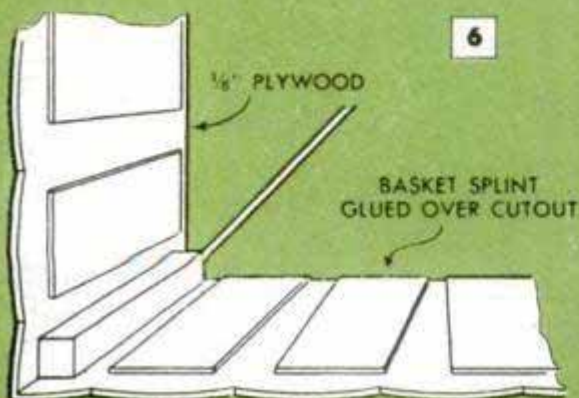

is done easily by mounting the four corner members on a wooden base as in Fig. 4. These can be held at the correct angle by setting pegs in the base to engage holes drilled in the lower ends of the corners. Or, the members can be supported with nails driven through the underside of the base. To attain the proper angle for the corner members, temporarily fit the top and bottom slats of the four sides in the saw kerfs.

The scroll shade, detailed in Fig. 6, is made in the same way as the basket-weave shade. Strips of basket splint are glued over the scrolled cutouts, and the sides of the shade are assembled as before. Excellent splint for this purpose can be obtained from the thin wooden containers used for packing vegetables and berries, and the translucency of the wood can be increased appreciably by applying a thin coat of oil over the inside surfaces of the strips.

The finished shade is supported on the lamp harp by four lengths of stiff wire held together with a metal washer as in Fig. 7. The inner ends of the wire are inserted through four holes drilled in the washer and are peened over to lock them in place. The outer ends of the wire are pointed and bent downward at right angles so they can be driven into the corner members. Coat-hanger wire is satisfactory.

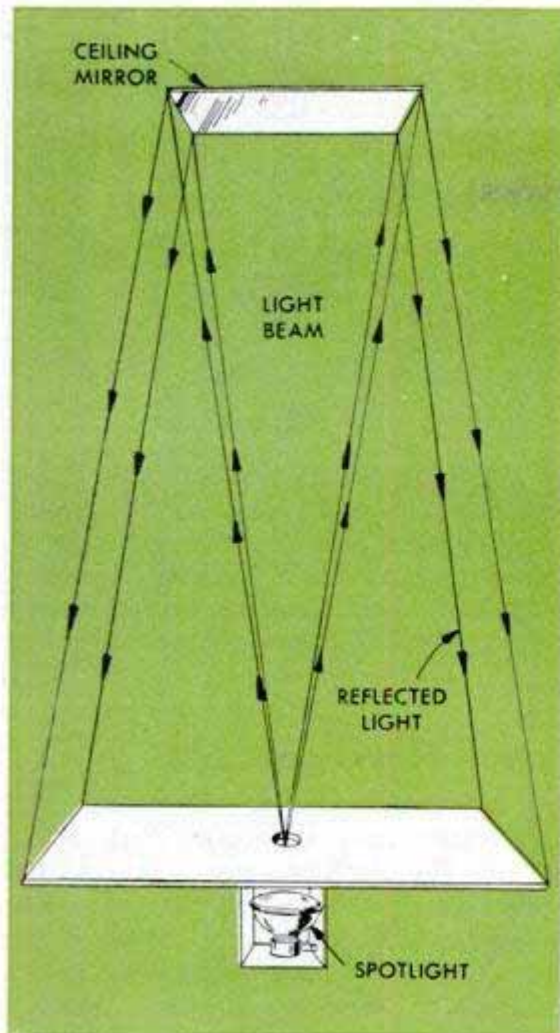

Photos courtesy General Electric Co.

GLAMOURIZE Your DINING TABLE

By Morris Tanenbaum

INDIRECT lighting reflected from the ceiling above your dining table adds sparkle to the formal dinner without the tiring glare of direct lighting or the shadowy uncertainty of candles. The diagram above shows the setup, the spotlight under the table being trained on a mirror attached to the ceiling. The light beam passes through a 2 $\frac{5}{8}$ -in. hole bored in a table leaf. The size of the mirror, which is centered over the table, should be one half that of the table

top. Use a projector-type spot lamp of 100 to 150 watts and mount it below the table top in a porcelain socket attached to a bracket. Enclose the light in a metal housing provided with a series of holes or louvers for ventilation. The wooden table leaf adjacent to the hole is protected with asbestos, and a glass centerpiece can be used to conceal the lamp. By forming flanges at the top of the metal lamp house, you can fasten it in place with screws.





Door Bolts on Baby Crib Lock Sliding Gate

If your baby crib has no safety catch to hold the movable side in the raised position, it might be forced down when the baby leans on it and let the child topple out. To prevent such an accident, attach a door bolt, of the type illustrated, near each end of the crib.

R. A. Bridgewater, Urbana, Ill.

Chalked Edges of Outlet Box Mark Opening in Wallboard

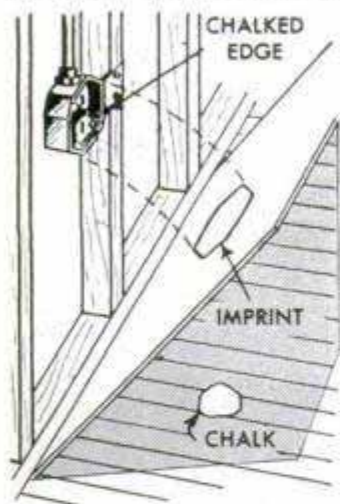

When installing wallboard, a simple and accurate way of locating openings to be cut for electrical outlet and switch boxes consists of transferring the shapes of the openings to the back side of the wallboard before it is nailed in position. To make the transfer, the edges of

the box are coated with carpenter's chalk and the section of board for that area of the wall is placed in position and pressed against the box. This transfers the chalk to the board, leaving a clear mark around the portion of the board to be removed.

Victor H. Lamoy, Upper Jay, N. Y.

Tape Identifies Your Picnic Dishes

Print your initials on the adhesive side of strips of cellulose tape and apply them to the undersides of dishes used on picnics or other group gatherings, and you will be able to identify your own dishes easily. The tape will keep the initials legible for a few washings. It is best to use a ball-point pen for the lettering as you can better apply just the right amount of ink with it and thus avoid smearing when you press the tape against the dish.

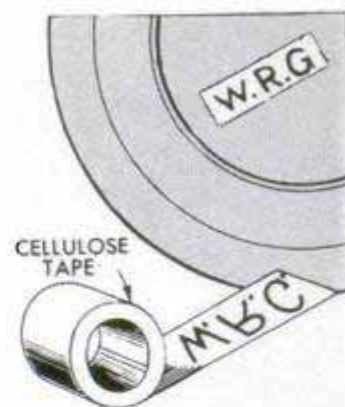

G. E. Hendrickson, Argyle, Wis.

Conserving Flashlight Cells

Simply by keeping three sets of cells for your flashlight and interchanging them daily, if the flashlight is used that often, you can increase the life of the cells. For convenience, each set of cells should be numbered. To assure the maximum amount of recuperation while not in use, the cells should be placed in a closed, glass or plastic container and stored in the refrigerator. However, before putting them back in the flashlight, the cells should be allowed to "thaw" for at least an hour as they will not emit maximum power when cold.

Steve Hannagan, New York City.

Lawn Ornaments Easily Replaced If Equipped With Stepped Anchors

Instead of mowing around a lawn ornament, use an anchor like the one shown, which permits the ornament to be removed and replaced easily. The anchor is a length of $\frac{1}{4}$ or $\frac{3}{8}$ -in. steel rod, which is bent as indicated so that it can be pushed into the ground with your foot. The method of attaching the anchor to the ornament is a matter of preference. In this case, it was stapled.

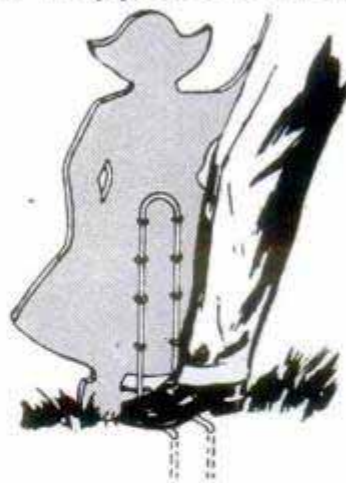

☐ If ink is spilled on a carpet, cover immediately with salt. Scoop it up as it absorbs the ink and repeat until the salt comes off clean. Put on more and leave overnight.



FAN-SHAPED VASE IN WALNUT

By *Benj. Nielsen*

CRAFTSMEN with a liking for tricky lathe projects will find this turned fan vase a fair test of skill. The endpieces of the vase are formed from a split turning having one flared end and uniformly spaced beading along the spindle. After the turning is finished and split apart, the halves are grooved as in the detail below. The sidepieces are segments of a built-up disk which is turned on the faceplate. A tenon is cut on the edges of each piece, and then the four members of the vase are glued together. After the glue is dry the vase is mounted in the lathe, as in the lower right-hand detail, and a tenon is turned at the lower end to fit into a hole drilled in the base. The latter is turned to the dimensions given in the detail below.

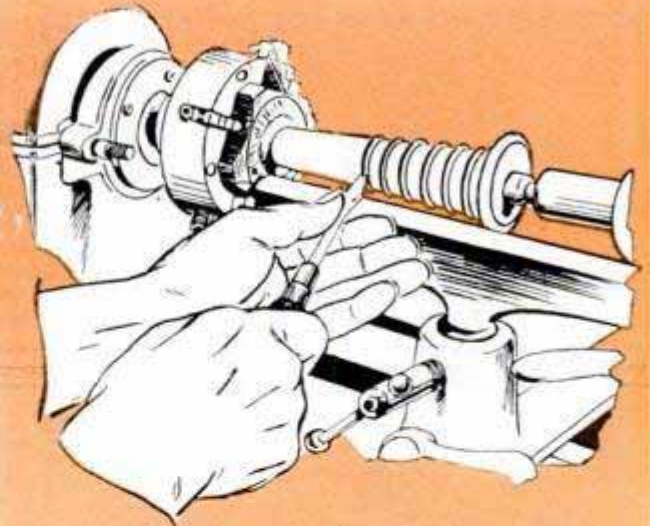
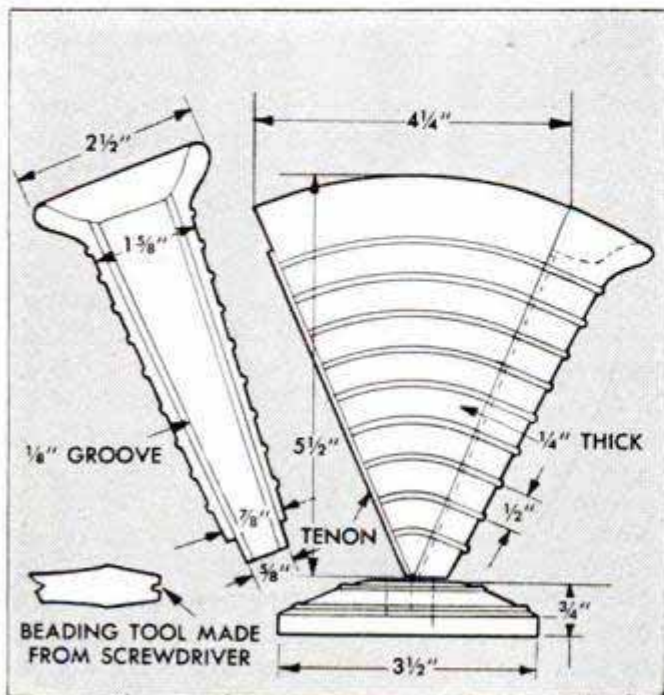

TURNING BEADS
ON VASE ENDS

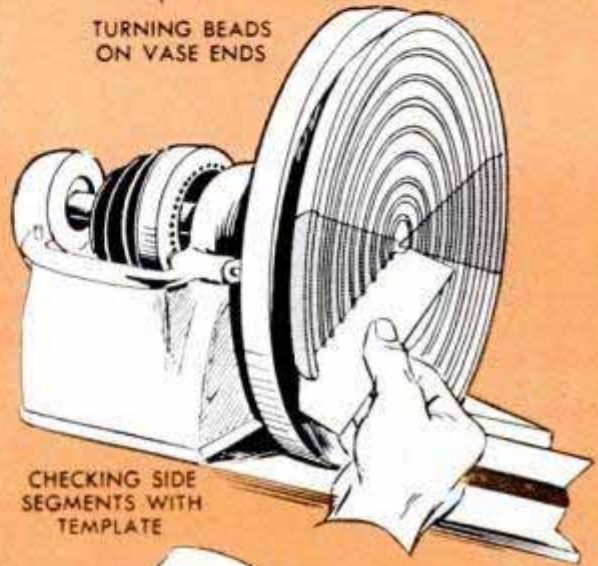

CHECKING SIDE
SEGMENTS WITH
TEMPLATE

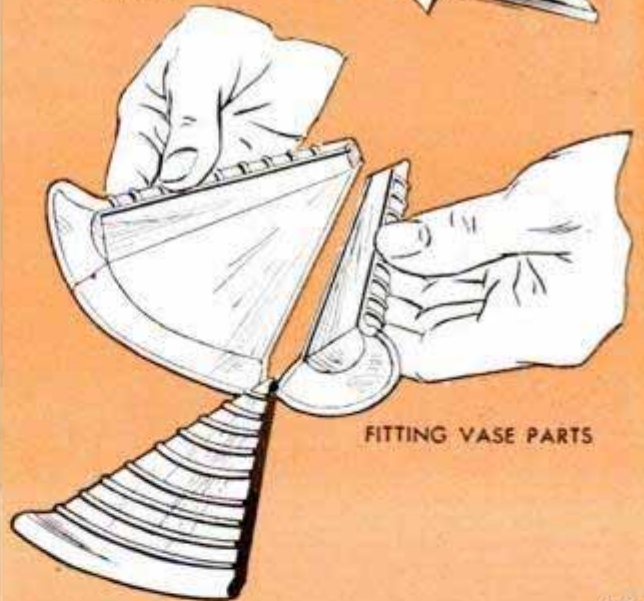

FITTING VASE PARTS

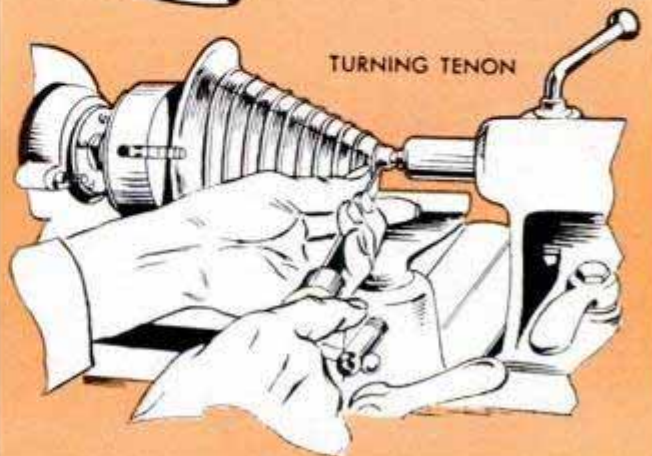

TURNING TENON

Powder Puff and Small Finger Ring Make Hand Rest for Letter Artist

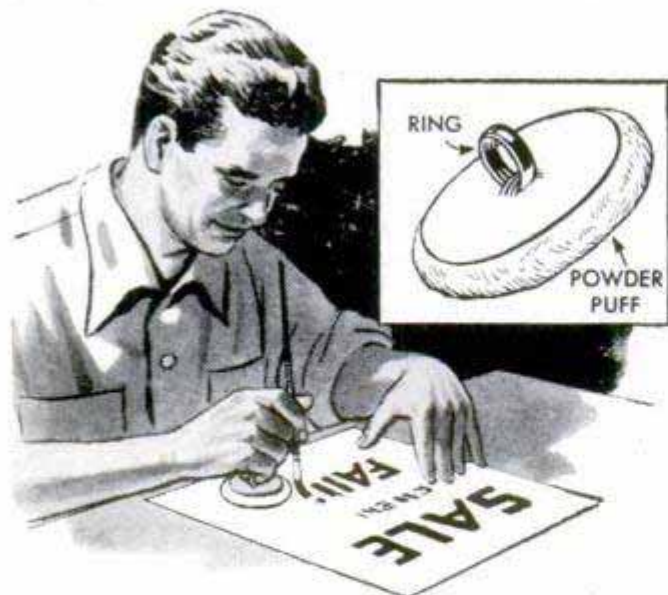

To avoid soiling show cards when lettering them, one artist made a hand rest from an inexpensive finger ring and a small powder puff. The ring was sewed to the center of the puff and, in use, is slipped over the little finger to hold the puff in position.

Renewing Floor "Traffic Lanes"

"Traffic lanes" in the home, or the areas of shellacked floors that receive the most wear, can be renewed easily to match the rest of the floor. Just sand the worn portions and apply two coats of thin, white shellac. Do not use stain unless the entire floor is being refinished.

Dime-Store Lock on Telephone Prevents Unauthorized Use

Unauthorized use of an office or private telephone can be prevented without having to attach special equipment to the instrument. Just put a small lock through the first hole of the dial, as shown in the photograph. This will prevent the dial from being rotated past the finger stop.



BORING TOOLS

By Rudolph G. Kopp

MODEL BUILDERS often solve difficult machining problems on small-scale parts by making special tools suited to the purpose. Frequently the scale to which the model is being built reduces machined parts and also openings, holes, slots and slides to such small sizes that ordinary tools cannot be used. The specifications may call for pin-sized holes to be reamed, or drilled and reamed in one operation, to accurate dimensions. The requirements repeatedly call for flared holes to form jets, or counterbores to form ball seats. Often flats must be milled on parts of decimal-inch size and, on certain types of work, the scale specifications may require accurate milling of tiny slots for slides or attached fittings.

For example, you need a boring tool of minute size to finish a hole in a rough casting to close limits. Details A and B on the opposite page show how to make two types, both useful in handling extremely fine work. Of course, both tools will require a special holder of the type shown in detail B. A tool bit specially ground for reaming and flaring a hole is shown in detail C. By grinding straight cutting edges, or edges with an outside curve instead of an inside curve as shown, you can ream and counter-sink a tiny hole for either a flat-headed screw or a ball seat. Also, by grinding cutting edges square across you have a combination reamer and counterbore for small hex-head machine screws. Detail D pictures a special bit which also serves as a milling cutter, slotter and drill. Made from $\frac{1}{16}$ -in. drill rod and properly hardened and ground, it will do a first-class job as an end mill for facing and squaring cuts. It also is suitable for certain types of contour work and for milling slots or grooves of hairline width. On softer metals, such as brass, die metals and aluminum, it will operate satisfactorily without hardening. Details E and F show versatile boring tools with fixed pilots which serve not only as single and double counterbores, but also for spot-facing on small castings. Note that on all tools the cutting edges are relieved 4 deg., an average cutter relief for fine work.

For machining mild steel and harder alloys, the tools must be hardened. For the harder metals, heat the tool to a light yellow and quench in clean water. For machining mild steel and gray (cast) iron, heat to a dark yellow. Although hardening is not

for MODELMAKERS

necessary for intermittent work in brass and softer metals, hardened tools will hold a cutting edge longer. Heat to a reddish-brown purple and then quench in water. Another way of hardening drill rod and spring steel completes the process in two stages. First, heat the metal to a cherry red and quench in oil or water. Then clean the quenched tip with a wire brush and hold it on a piece of metal previously heated to a medium bright red. Watch the change of colors closely as heat transfers to the tool bit. When the latter shows a medium yellow at the tip, plunge quickly in water and move with a circular motion until cooled. Tiny tool bits made from high-speed steel can be air-hardened satisfactorily. Heat slowly to a cherry red and allow the tool to cool without quenching.

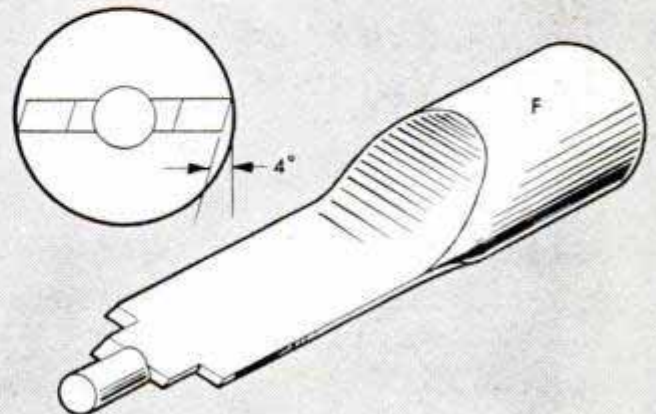
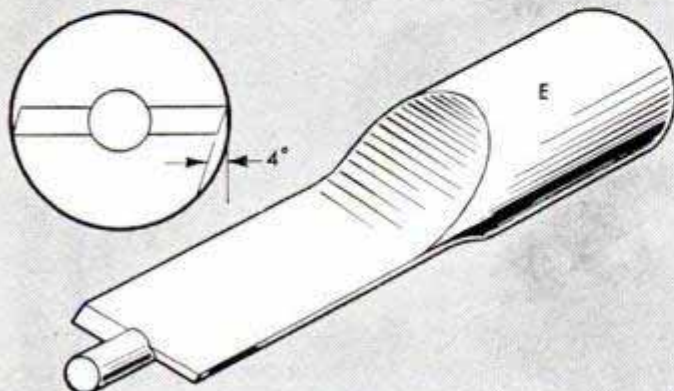
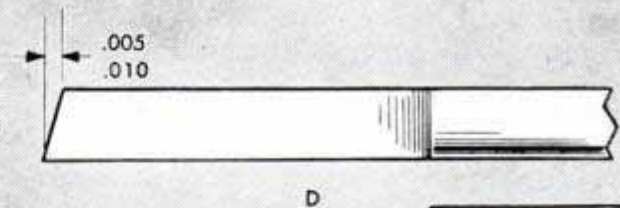
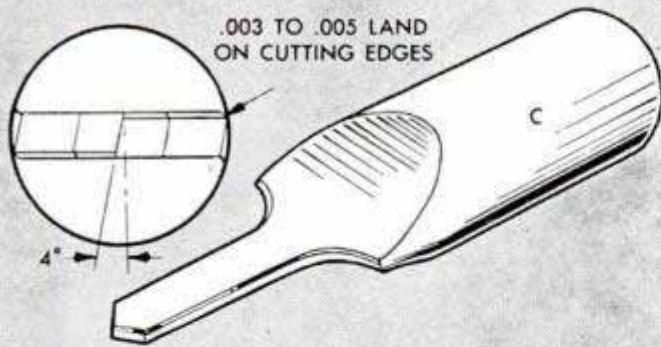
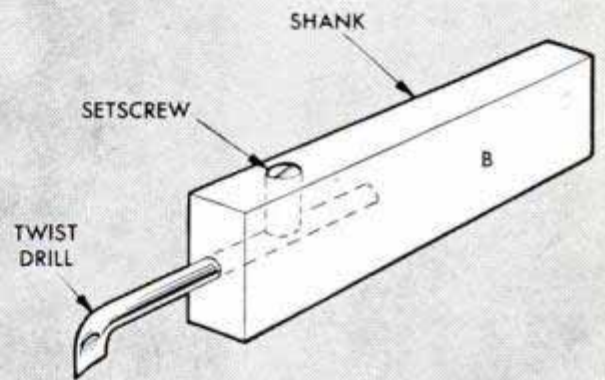
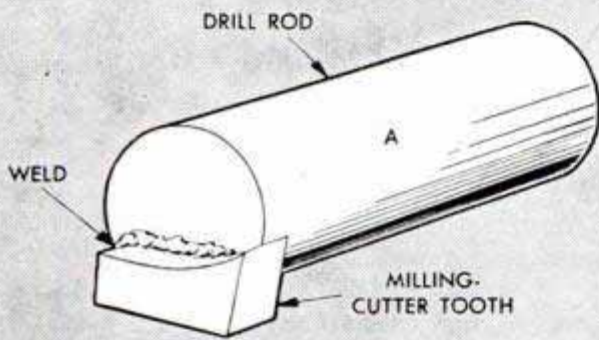
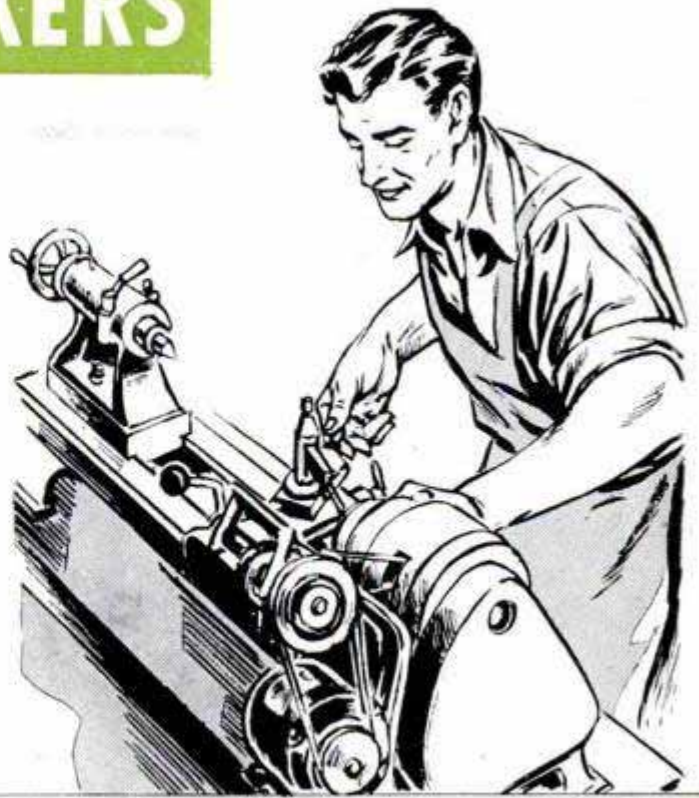

Stand Holds Outboard Motor In Vertical Position

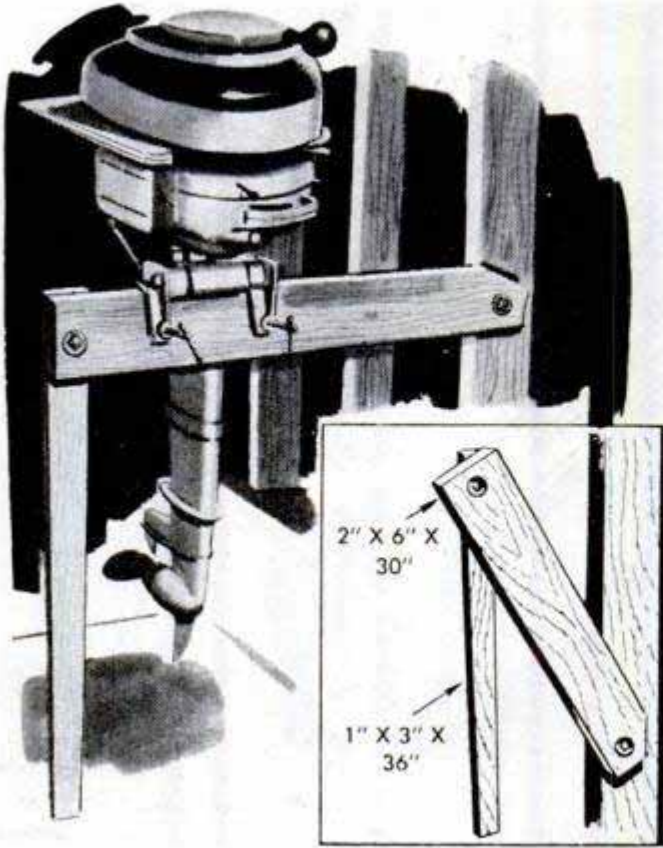

Since most manufacturers recommend that an outboard motor be stored in a vertical position, this simple stand for supporting it is ideal because it can be swung out of the way when not in use. The stand consists of two members pivoted together with a bolt and then pivoted to a stud in the garage or boathouse. Be sure that the pivot bolts are pulled up to just the right tension to permit the stand to be folded yet rigid enough to support the motor safely.

Finding Wall-Cabinet Area

To estimate the total area of a wall cabinet to be painted, first find the front area by multiplying the height by the width. Then multiply the answer by five. Present your paint dealer with this information and he will supply the amount of paint needed.

Tester Circuit Fitted With Socket To Take Variety of Resistors

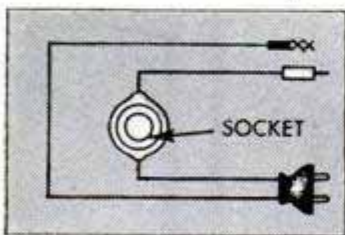

A common porcelain socket wired in series with a male plug as shown will provide an inexpensive tester for your electrical bench

that will take resistors of various types and wattages. For example, it will take a $\frac{1}{4}$ -watt neon test lamp or a heating element

up to 600 watts. Also, by inserting a female plug in the socket, a toaster or even an electric iron can be plugged in to serve as a resistance. One of the testing wires is fitted with a probe and the other with a clip. The latter should always be the positive side of the line and the probe the negative side.

Paul Woodruff, Chicago.

"Humidifying" Paste-Brush Holder Made From Fountain-Pen Cap

Library paste will not dry in the brush used to spread it if the cap of an old fountain pen is attached to the paste jar with cellulose tape for use as a holder. Place a small piece of sponge in the bottom of the cap and, each time the paste is used, pour a few drops of water into the cap to keep the brush moist.



Room Data and Measurements Stored on Picture Backing

You'll save time when decorating or making repairs on your home if you keep pertinent information and measurements at hand. Information, such as floor areas, window sizes or the amount of paint or wallpaper needed to cover the various rooms, can be stored conveniently in an envelope pasted to the back of one of the pictures hanging on the wall.

R. F. Donovan, Guttenberg, N. J.

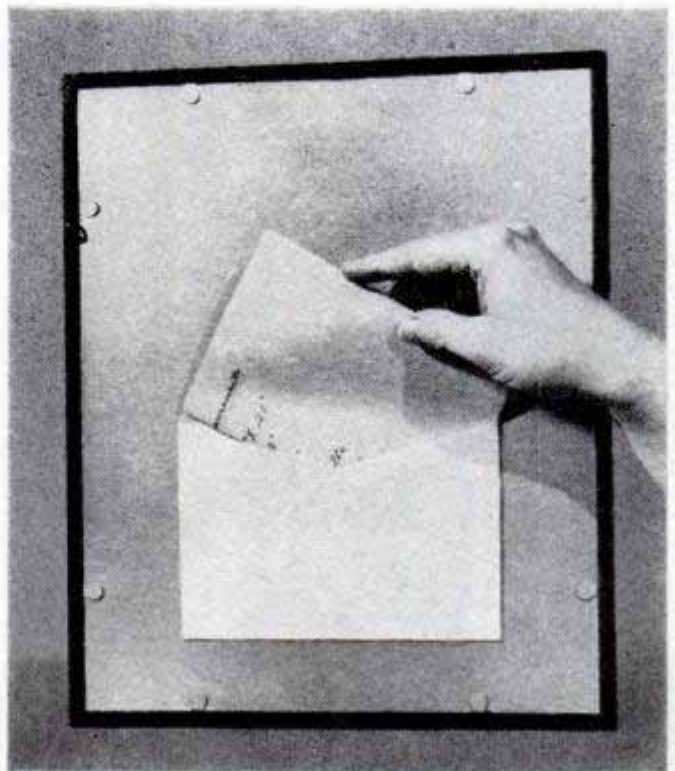

High-Grade FLOORS AT LOW COST

By John P. Arnold



AN AVERAGE 9 x 12-ft. rug covers about 108 sq. ft. of the floor area in each room and this portion of the floor you never see except at house-cleaning time. This fact makes it possible for craftsmen who do their own home remodeling, including the laying of new hardwood floors, to save money. By using selected-grade flooring on the exposed areas between the walls and points just inside the edges of the rug, and then covering the area under the rug with a cheaper grade of flooring, you can effect a substantial saving in the cost of the flooring material in only one room. Where several rooms are involved, the saving runs into real money. In square or rectangular rooms, it's easy to calculate the areas which are to be covered with the selected and inferior grades of flooring. The exposed flooring (selected grade) should extend under the edges of the rug from 4 to 6 in. Remail the subfloor boards wherever they appear to be loose and plane off any offsets at the joints between warped boards. Then cover the subfloor with a layer of building paper and begin laying the top floor at one side

of the room, using the selected grade of material. Be especially careful to get the first board laid perfectly straight. Now, snap chalk lines lengthwise and crosswise of the room to indicate points about 6 in. inside the edges of the rug. These lines serve as witness marks when laying the two grades of flooring. Note in the detail below that the ends of the short pieces of inferior-grade flooring, placed inside the area covered by the rug, are laid with butt joints fastened with finishing nails driven through from the top. Only the selected pieces are edge-nailed to the subfloor. Note also that the butt joints are broken uniformly over the whole area. This makes a stronger, more rigid floor with less tendency to slight movements between adjacent boards, which are the cause of squeaks. When nailing the butt joints from the top, set the nailheads slightly below the surface so that they do not interfere with sanding. After the flooring has been laid it is machine-sanded with coarse and fine abrasives and then filled and finished with sealer, wax or varnish in the regular way.

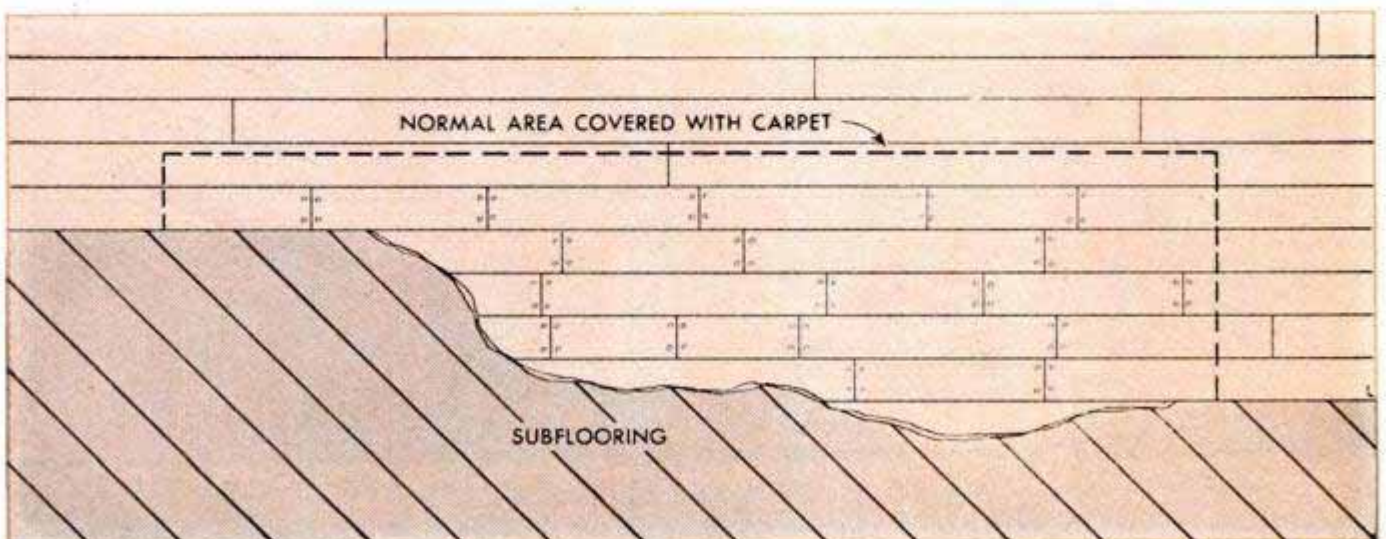



RUBBER SPONGE provides an excellent wallpaper cleaner. Use dry sponge and wipe excess dirt from it with soft cloth after each stroke across paper. Soiled sponge is washed with soap and water

RIDDING YOUR HOUSE OF ANTS can be done quickly by placing a few pieces of cucumber peel in spots ordinarily frequented by the insects. The peel will be equally effective placed in the yard

LOOSE DRAWER PULLS of the wood-screw type will hold tightly if dipped in fingernail polish. If the hole has become enlarged, it can be filled with a mixture of sawdust and fingernail polish

CLEANING WALLS in a bathroom is speeded by running hot water in bathtub for a few minutes beforehand. Steam will condense on tile surfaces and loosen the dirt for easy wiping

JUST BEFORE REMOVING ASHES from a fireplace, burn a few sheets of crumpled newspaper in the pit. This creates sufficient draft to carry dust up the chimney so it won't be scattered on the rug

Solving HOME



SMALL LEAKS IN WATER PIPES can be temporarily sealed by wrapping them with tape and coating the tape with shellac. This will stop the leak for a few days, allowing time for a permanent repair

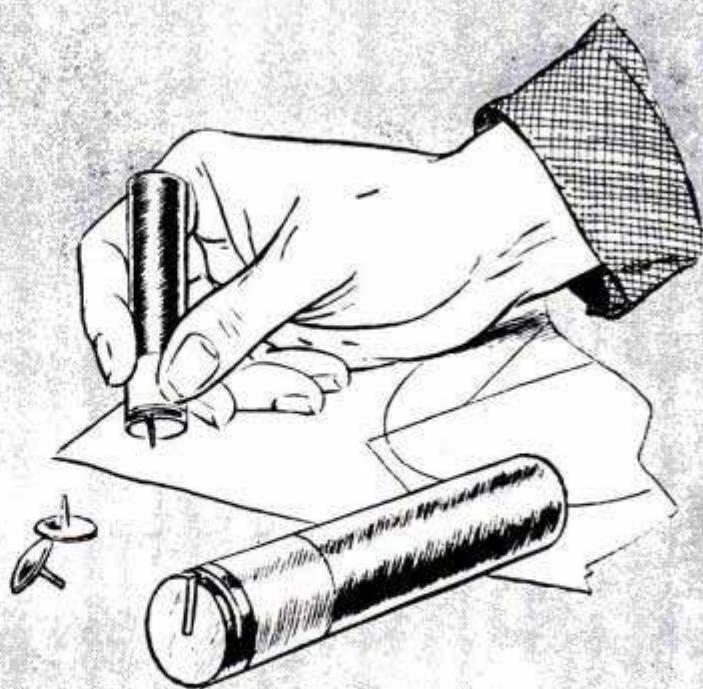

METAL LIPSTICK CONTAINER is just the thing for pulling and storing thumbtacks. Bottom of the container is slotted, as shown, to lift the tacks. Extra tacks are dropped in container and cap replaced



FOR APPLYING PASTE WAX to furniture or woodwork use an old powder puff as an applicator. The powder puff forms a soft pad which does not bunch up under the hand like a cloth. Wash the puff before using.



PROBLEMS

AFTER WASHING A BLANKET or bedspread, hang it between two clotheslines instead of draping it over a single line. This method facilitates drying and distributes the weight of the blanket to two lines, thus reducing the possibility of breaking the line.

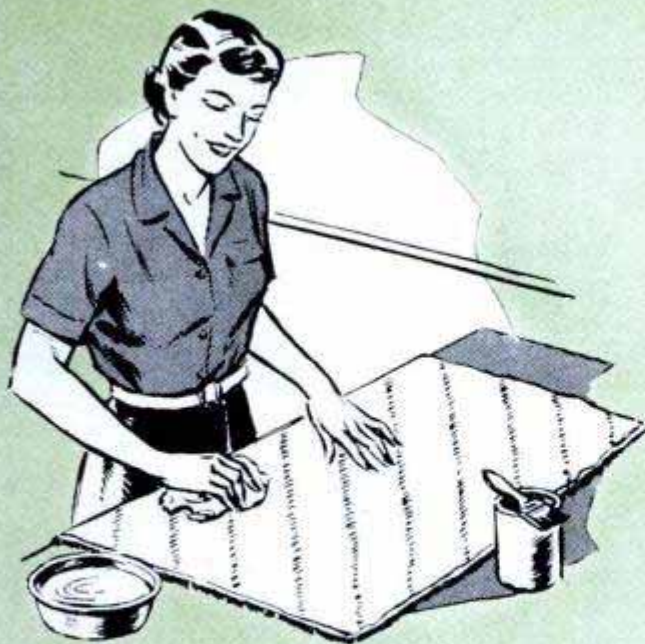

WRITE CURTAIN MEASUREMENTS on a tag and tie to your curtain stretcher. Then, for instance, instead of measuring the living-room curtains before adjusting stretcher, just refer to the tag.

A TOY RUBBER HAMMER is a handy kitchen aid for opening stubborn jar lids. Strike the lid a few hard blows with the hammer. This will loosen the lid without danger of breaking the glass.

WHEN SEWING A BUTTON on a coat, place a paper match between holes in the button and sew over match. After sewing, pull out match, leaving thread sufficiently slack for easy buttoning.

SCATTER RUGS WILL LIE FLAT if they are sized with laundry starch. First, seal the underside of the rug with a coat of shellac, apply a thin solution of starch and allow to dry before using.

LEMON JUICE OR VINEGAR often will remove light rust stains from the surface of an enameled sink. Apply to the stained area and allow to stand for an hour or so. Then rinse with water.

Headlight Lens and Rim From Car Glaze Doghouse Window



A novel, modern-type window can be installed in your dog's house by using a headlight lens and rim from an early model car. Cut the window opening slightly smaller than the lens, and mount the lens and rim over the opening by driving wood screws through the bolt holes in the rim.

Blocks Cradle Bar Clamps To Hold Them Upright

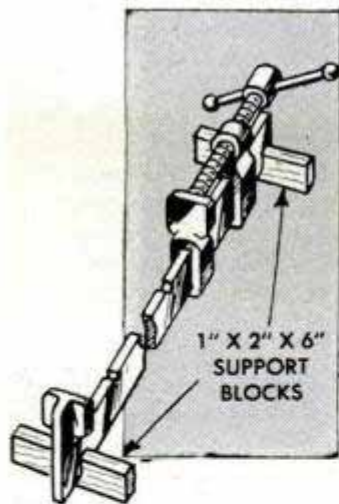

position at the same time. The blocks are pieces of 1 x 2 x 6-in. stock, which are notched in the centers to receive the bars.

Frank M. Butrick, Jr., Alma, Mich.

Wallboard Removed Intact By Cutting Around Nails

While it is difficult to remove wallboard from walls and ceilings without marring it, the damage can be kept at a minimum and the board left suitable for reuse if it is removed after cutting around the nails with

a hollow punch. The latter can be made from a 6-in. length of pipe or steel tubing, the inside diameter of which is slightly larger than the width of the nailheads. Grind a long bevel at one end to form a sharp cutting edge. In use, the punch is placed over the head of the nail and driven through, after which the board is removed from the wall intact. When reusing, just space the nails between the holes. The holes will be covered by the same wooden strips used to cover the nails.

D. Casperson, El Cajon, Calif.

Leather "Lining" for Vise Jaws Prevents Damaging Soft Work

Softer and more easily installed than ordinary vise clamps, a leather "liner" for vise jaws provides an ideal guard against marring such work as plastic or very soft metals. A piece of leather belting, about 13 in. long and as wide as the vise jaws, is all the material needed. A

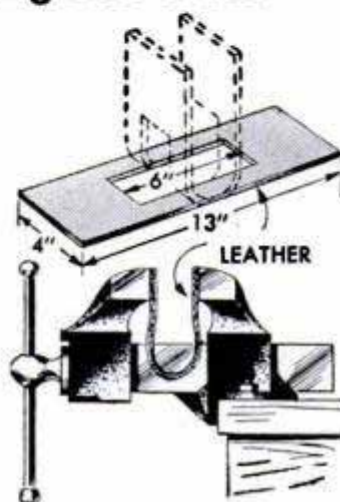

rectangular opening, 6 in. long and of the same width as the slide bar of the vise, is cut in the center of the belting. Then, the belting is folded lengthwise and the opening fitted over the slide bar, as illustrated. Installed in this manner, the liner requires no further means of attaching and can be quickly removed when hard material is to be held in the vise.

Leonard A. Kroll, Brooklyn, N. Y.

Wire-Solder Map Scale Determines Distances

To get a close approximation of the distance of motor trips, first mark a length of wire solder or other soft wire at intervals corresponding to the mileage scale on your road map. Then lay the wire on the map, bending it to follow the

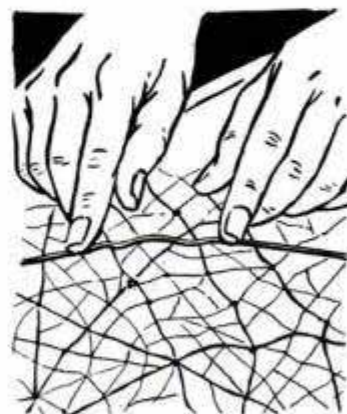

route in question and note the distance in miles by the marks. Airplane routes can be estimated by marking the mileage on a straightedge instead of a wire.

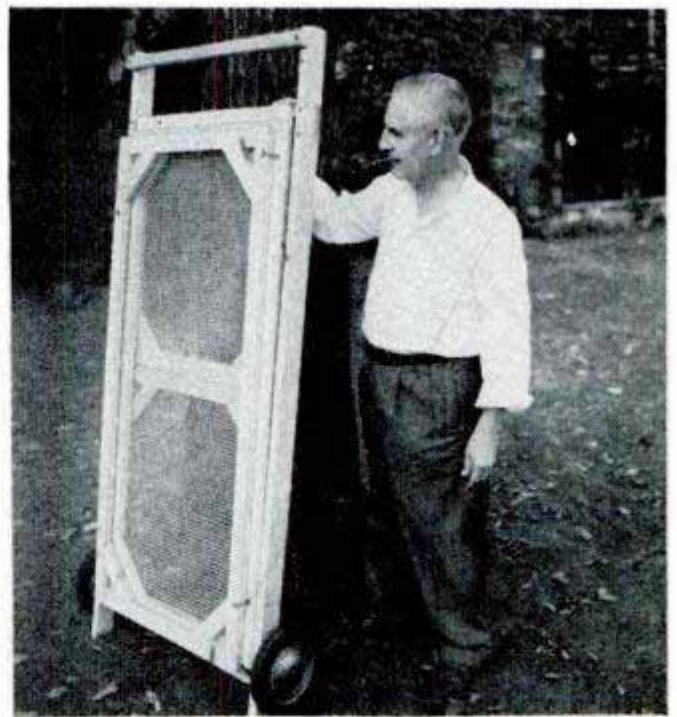
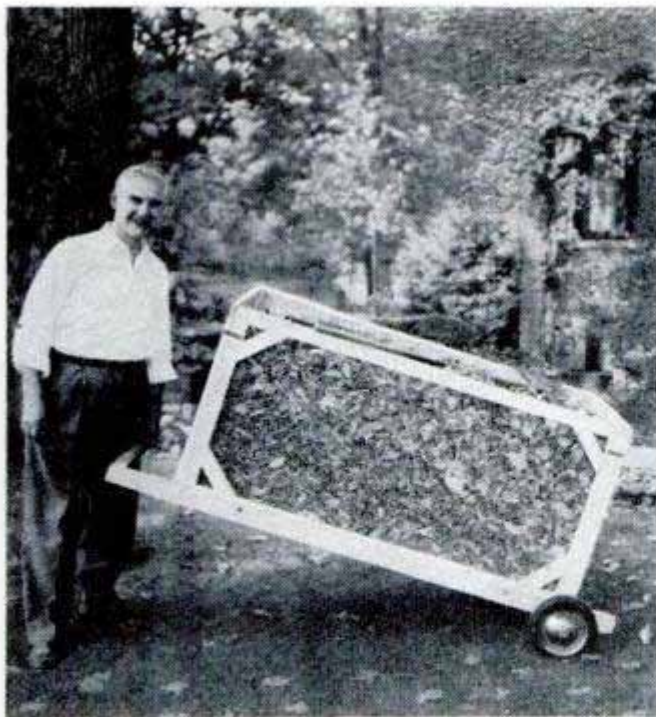

WHEELED BASKET for LEAF DISPOSAL

By Ed Packer

THIS COLLAPSIBLE wheeled basket helps solve the perennial problem of leaf disposal and at the same time saves a lot of extra work, as you can quickly gather leaves from a large lawn and wheel them to a central point for burning or composting. The basket has a capacity of about 20 bu. and collapses flat for storage. The sides, ends and bottom are built as separate

frames and covered with $\frac{1}{2}$ -in.-mesh hardware cloth. Details below give the dimensions and show how the frames are made and then braced. When setting up the rack, the sides are fastened to the bottom frame with bolts and wing nuts, and endpieces are joined to the sides with slotted flat steel latches and screws. Use wheels with semi-pneumatic tires to avoid damaging the lawn.

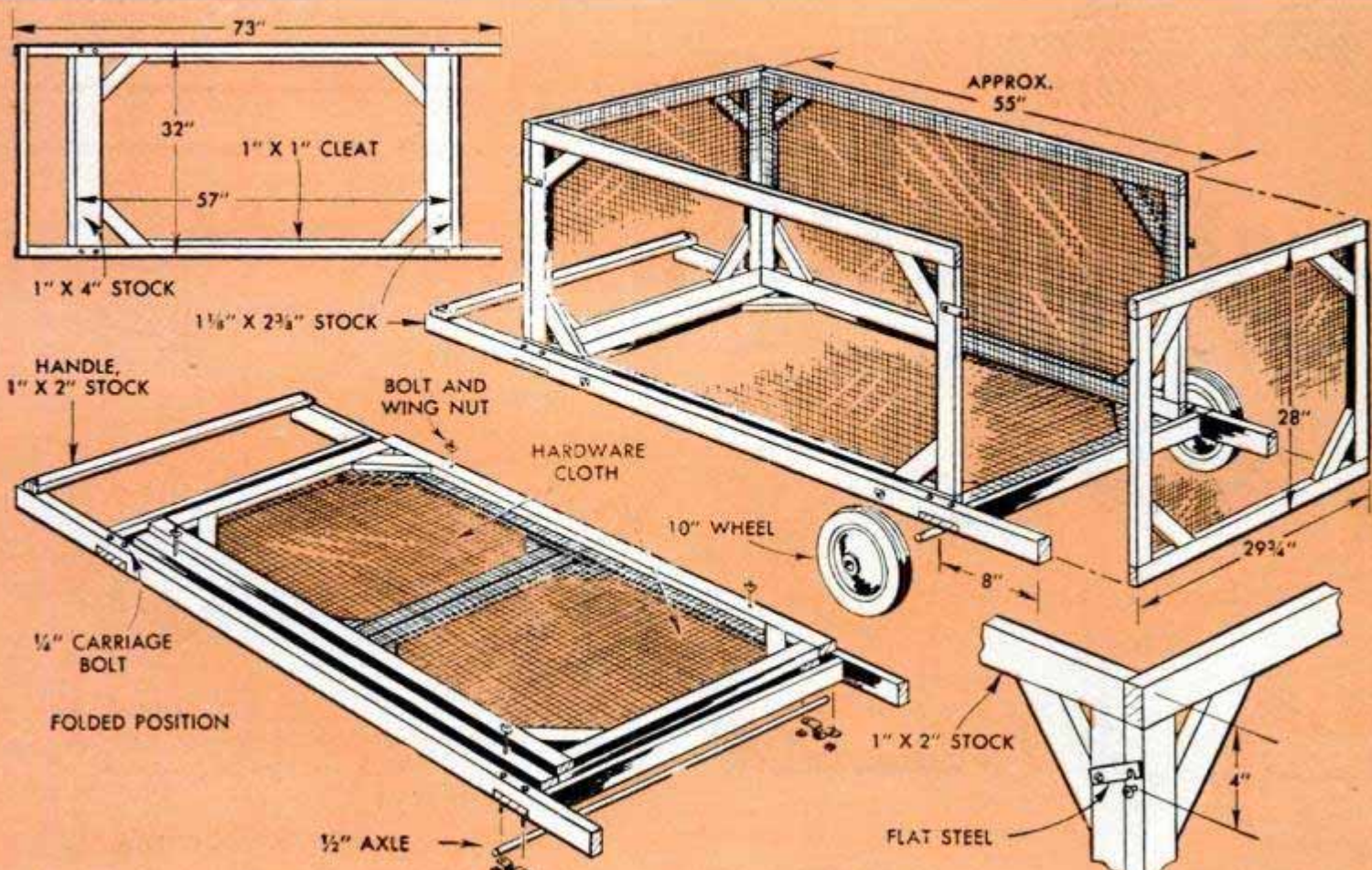

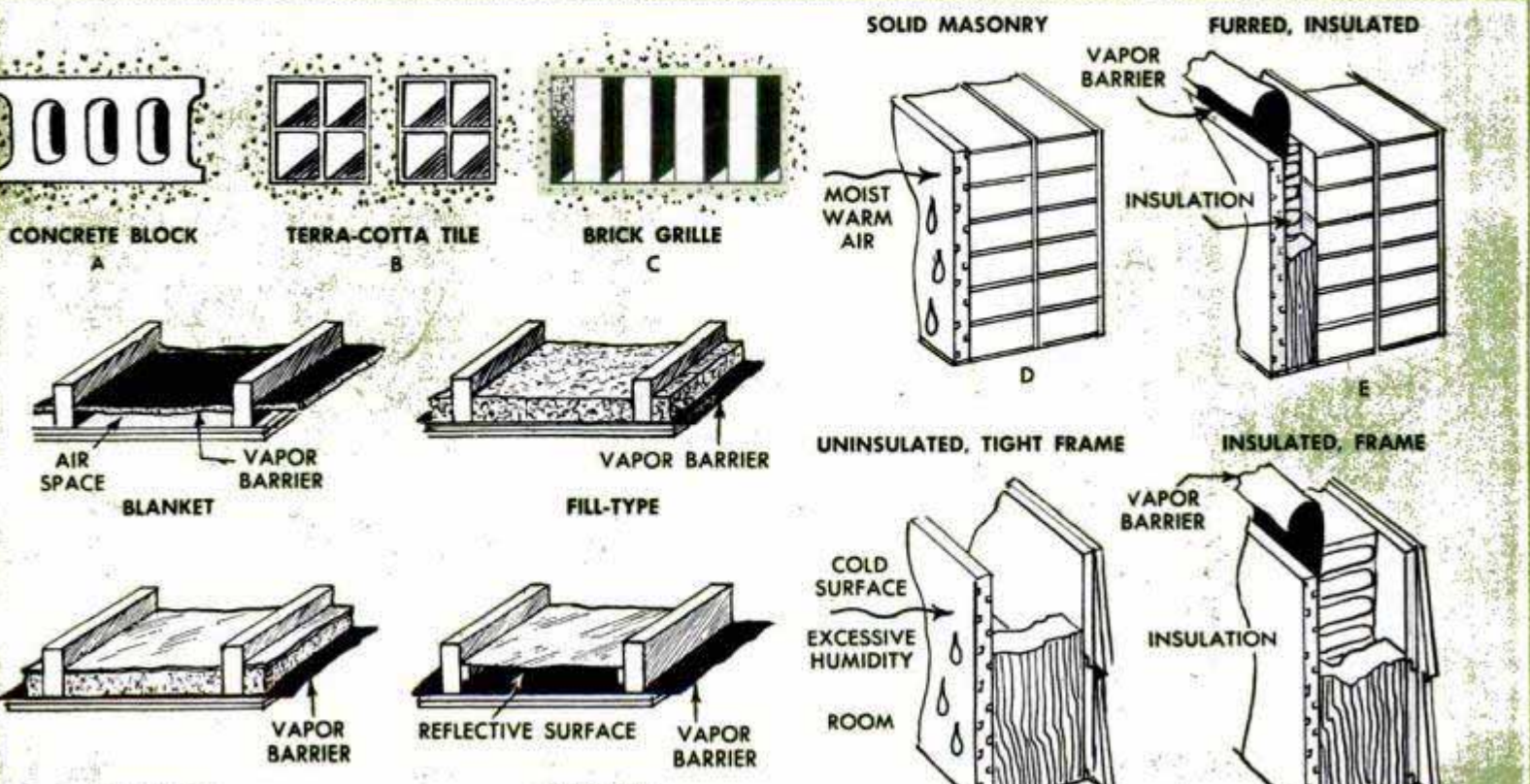

What To Do About CONDENSATION

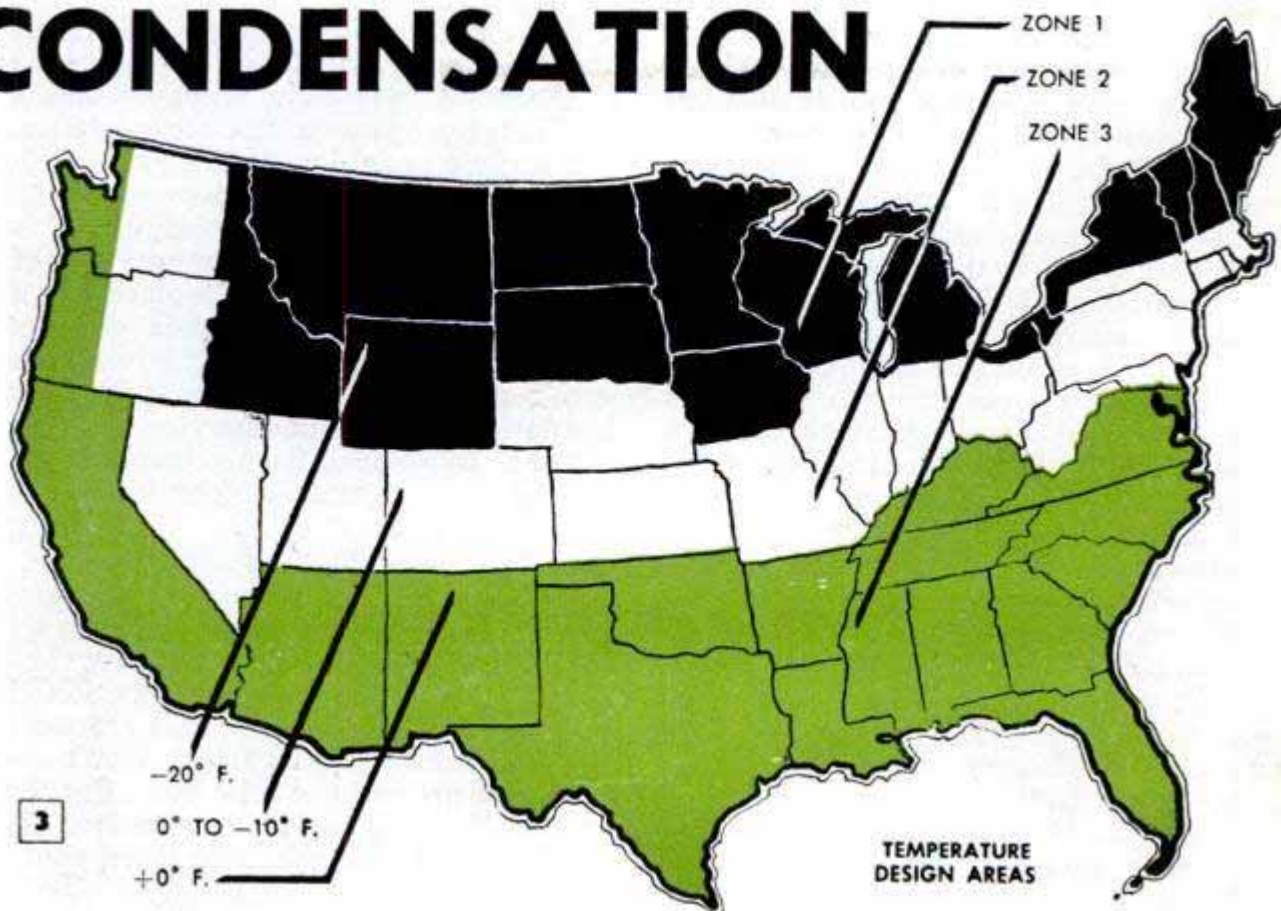

By Stanley Schuler

IF YOU LIVE in an insulated home, either new or old, you may have a moisture-condensation problem and not be aware of it. In some homes the damage caused by condensation may never become excessive and may affect only comparatively small areas in the house, but condensation becomes a real problem for the homeowner when it occurs on or within the walls and ceilings of the structure. The end results are certain to be water spots on the room side of the wall, peeling paint and, eventually, badly rotted framing members such as sills, studding, joists, plates and roof boards.

All air contains moisture in the form of water vapor, which ordinarily is invisible. When this vapor comes in contact with a cold surface, it condenses and forms tiny water drops or frost, depending on the temperature of the surface. The tendency of moisture-laden air to move to drier (lower pressure) areas generates what is known as vapor pressure. It is this pressure that forces moisture from a warm room through the walls of the house to the drier, colder air outside the walls. In uninsulated walls, the building materials are kept warm enough by continual heat loss to prevent condensation of moisture within the wall. That's why owners of older, un-

insulated frame houses seldom experience condensation trouble. In newer homes, built at the time when walls were insulated without vapor barriers, insulating materials prevented heat loss through the walls but did not eliminate the passage of moisture-laden air from inside the house. As a result, the space between inner and outer surfaces of the wall becomes very cold in severe winter weather. At some point within the wall the temperature of the air falls below the dew point and the moisture condenses. That's when the trouble begins.

While this brief outline of the basic cause of condensation is not all-inclusive, it does suggest some of the cures for this condition and certain steps that can be taken to control the generation of excessive amounts of water vapor at the source. The cutaway view of the typical 1½-story house in Fig. 1 shows some of the principal sources of water vapor in the average home. Note that the direction of the green arrows indicates an almost vertical travel of vapor from such common sources as the laundry, sink and dishwasher, gas stove and bath. Here, for purposes of illustration, it is assumed that the home is uninsulated and is covered with wooden shingles. In this case, although vapor pressure is more or less constant in all directions, the course of the

warm air will be generally upward through the ceilings and roof as well as through the walls. Snow will melt quickly from the roof area exclusive of the roof overhang at the cornices and over the dormers. This means that both heat and moisture-laden air are passing directly through the ceilings and roof. If the house has a composition shingle roof, heat will still pass through, but more of the green arrows would follow a horizontal course to the walls, as the composition roof is a fairly effective vapor barrier. Add insulation of the blow-in, or fill type, and the arrows would still follow much the same course through walls and ceilings. But add a vapor barrier, either a separate membrane or one attached to the insulation batts or blankets, and the arrows would turn back at the ceilings and walls. That's the answer to the condensation problem in modern homes.

Of course, there are other related factors. For example, in newer homes having no basement there is the problem of condensation on the joists and underside of the floor over a crawl space. Frequently, moisture generated in the crawl space will find its way upward through the walls and into the low attic, forming a damaging condensate in these areas of the building. One remedy is to provide adequate ventilation under the floor by means of openings formed by concrete blocks set sidewise in the foundation wall as at A in Fig. 2, or terra-cotta tile or bricks placed as in details B and C. Ordinarily, vents formed in this manner are placed near the corners of the foundation, rather than at the center. In this way adequate cross-circulation of air will be assured. In some cases, it will help to cover the ground inside the foundation walls with roll roofing laid with 4-in. lapped and cemented joints, as in Fig. 4. Then the underside of the floor should be insulated by either of the methods detailed in Fig. 4, A and B. In older, uninsulated homes

of masonry or of tight, frame construction, and especially those with inadequate heating systems, trouble often is experienced with condensate forming in upstairs rooms, generally on the walls on the coldest side of the house. Here the walls become very cold and the vapor in the air condenses on the surface as in details D and F in Fig. 2. Often this trouble can be overcome, at least temporarily, by providing additional heating facilities to raise the temperature of the air in the rooms and thus indirectly warming the walls. Where the walls are of solid masonry, the permanent remedy, of course, is to replaster the walls over furring strips, insulation and a vapor barrier as in Fig. 2, detail E. In walls of frame construction, install insulation and a vapor barrier as in Fig. 2, detail G.

In any case, to be fully effective, the vapor barrier must be continuous and unbroken over walls, ceilings, and also where used under floors. When applying the barrier in either old or new construction, don't fail to make an adequate seal around ceiling and wall-light fixtures. Don't forget the space around the attic door, Fig. 7, and be sure that the barrier is correctly placed at the junction of the attic floor, roof and side wall, Figs. 5 and 8. Be especially careful when installing membrane-type barriers at the junction of dwarf walls with the attic floor and roof rafters, Fig. 5. Other precautions to be taken when building or remodeling are detailed in Figs. 6 and 8. Frequently, in newer homes with low attics, damp spots will appear on the ceilings for no apparent reason. These spots, which usually show on the north side of the building and near the wall, often are attributed to condensation, when actually the cause is an ice dam on the roof over the cornice as in the right-hand detail, Fig. 6. Water from snow melting on the roof at a higher level seeps downward to a point over the inner edge of the cornice and just over the plate,

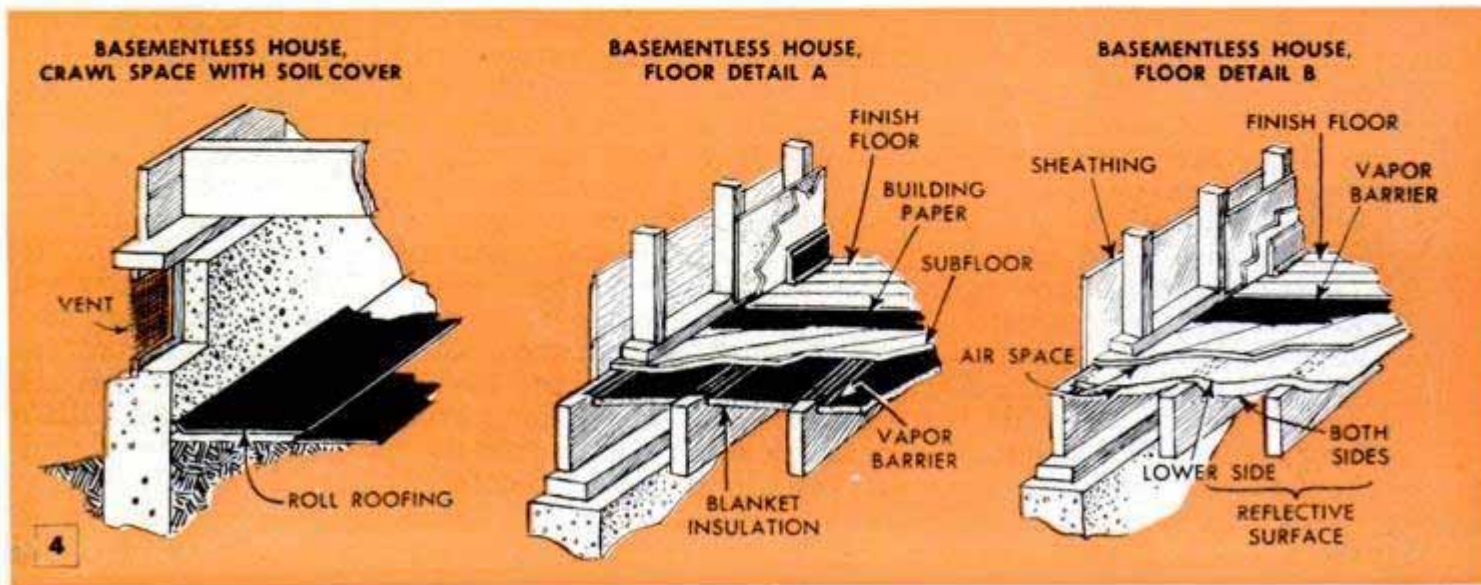

5

JUNCTION OF DWARF WALL, FLOOR AND ROOF

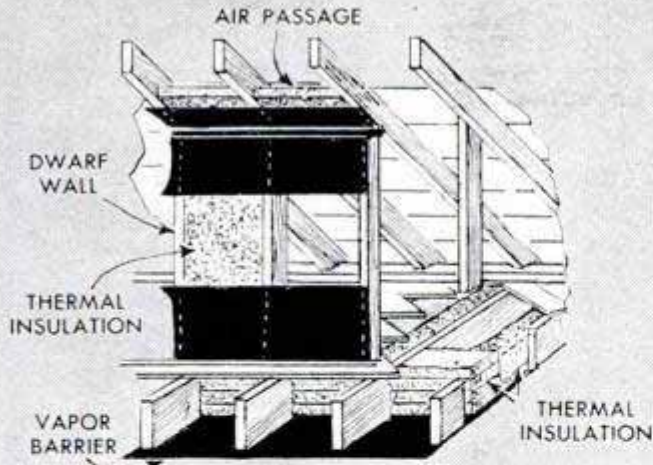

JUNCTION OF ATTIC FLOOR, ROOF AND SIDE WALL

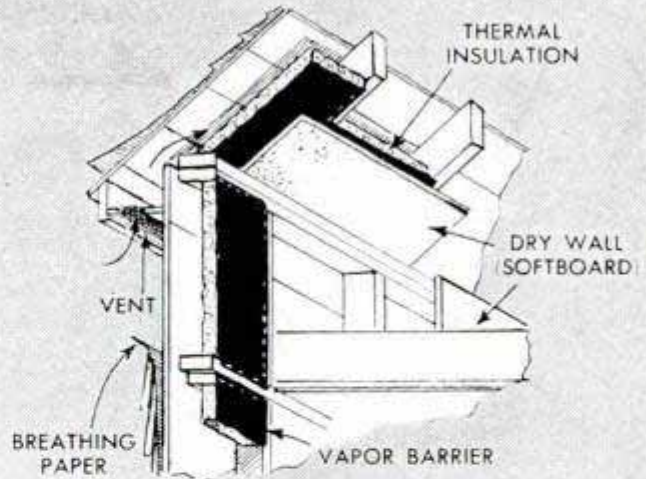

6

LOUVER-TYPE GABLE VENTILATOR

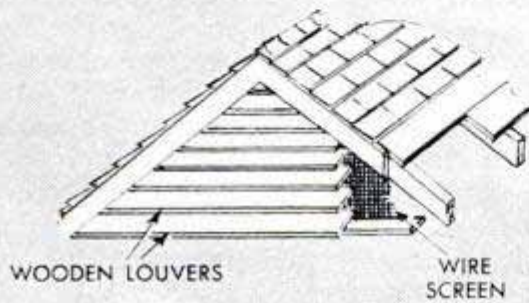

ICE DAMS AT EAVES CAUSE LEAKS

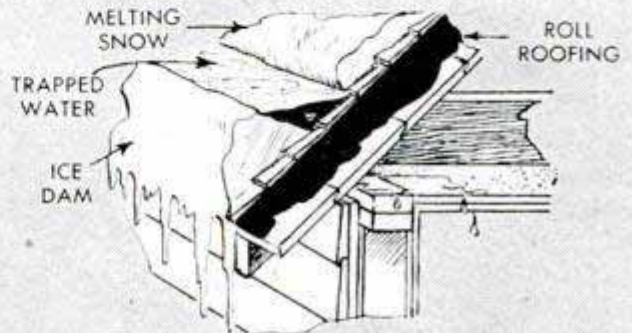

7

ICE KNOBS FORM ON PROTRUDING NAILS

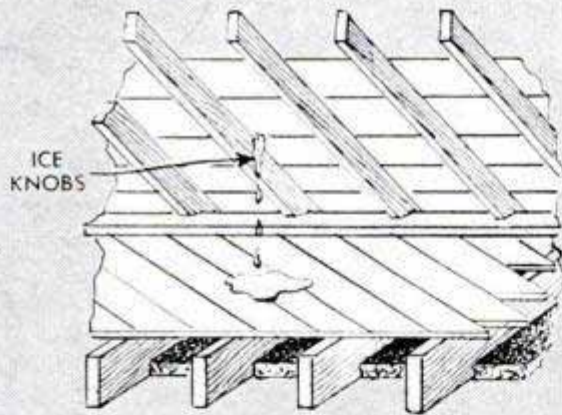

WEATHER-STRIPPING DOOR TO UNHEATED ATTIC

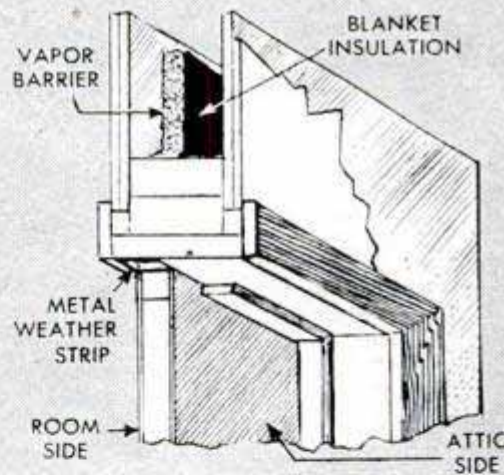

SIDE-WALL CONSTRUCTION, FIRST FLOOR

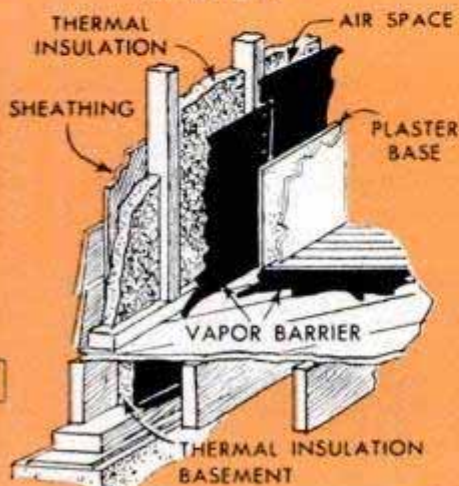

SIDE-WALL, FIRST-FLOOR FIRE STOP

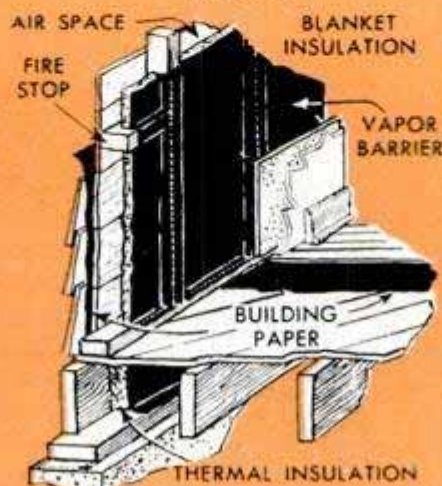

JUNCTION OF ATTIC FLOOR, ROOF AND SIDE WALL

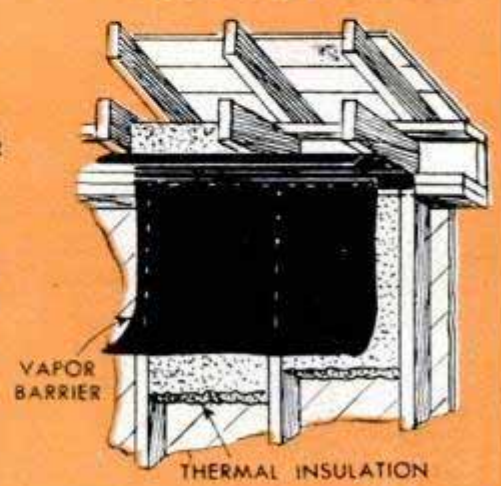

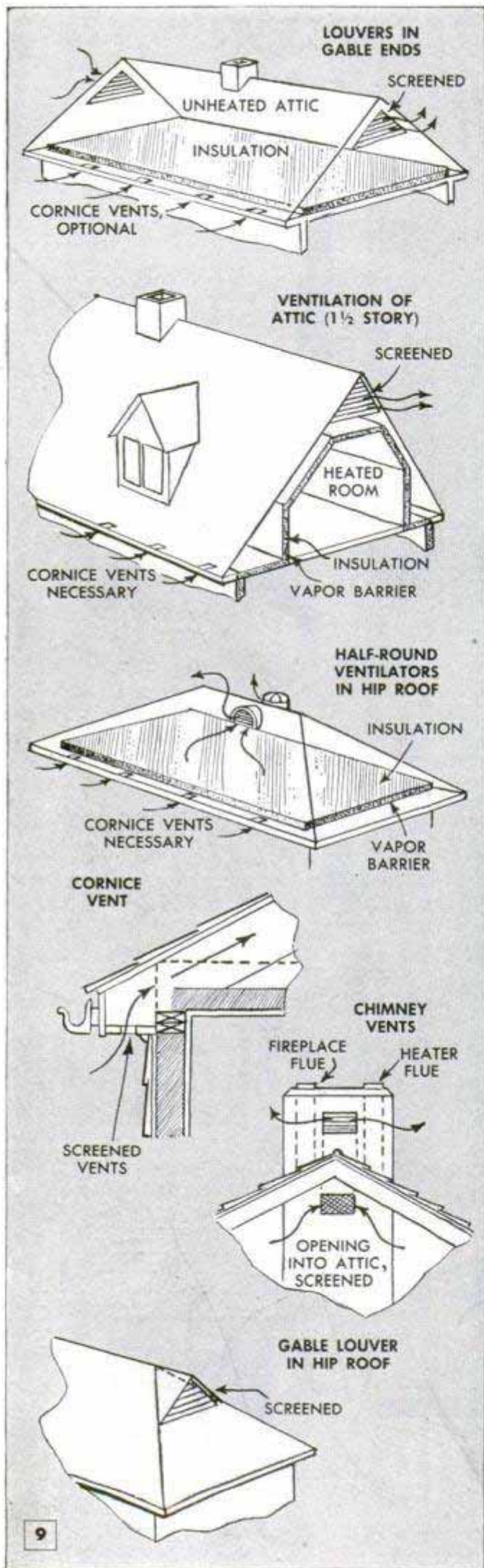

where it freezes, forming a dam. During mild winter days water will be trapped above the dam in considerable quantity and may seep back underneath the shingles to the roof boards, through which it drops onto the plaster or insulation. The remedy is shown in the sketch. Simply place one or two widths of roll roofing under the shingles so that the upper edge of the roofing extends 18 to 24 in. above the plate. Another cause of trouble is presented by long nails driven through the roof boards or shingles so that they project into the attic. The nails are better conductors of heat than wood, and as a result, they become the coldest surfaces in the attic during severe winter weather. Frequently, due to the presence of excessive amounts of water vapor, large ice knobs form on the nails as in the left-hand detail in Fig. 7. When these knobs melt during mild weather they are a source of mysterious leaks into the rooms below. Probably the simplest remedy is to clip the nails off close to the boards, but inasmuch as the basic cause is the presence of excessive moisture in the attic, the permanent remedy is to control the generation of water vapor at the source.

Although ventilation is not a cure for condensation, it does provide the homeowner with a means of controlling excessive humidity, at least to a certain extent. Provision for proper ventilation of an attic is essential, and a cold-air duct with an outside air intake permits drier air to be introduced through the warm-air heating system. Tests have shown that approximately 40 percent of the moisture liberated in the preparation of meals over a period of one week is contributed by the cooking process. The remainder, roughly 60 percent, is liberated by the combustion of gas in a gas-burning range. Many homeowners have found that a kitchen ventilating fan, operated at regular intervals, effectively prevents an excessive concentration of water vapor from this source. Much can be accomplished simply by keeping cooking utensils and the washing machine, dishwasher and the clothes drier covered when in use. It also should be kept in mind that the furnace humidifier, the shower bath, unvented gas-burning space heaters and clothes drying in the basement contribute to the high humidity in modern homes of tight construction. These sources of water vapor can be controlled and, in some cases, eliminated entirely by simple measures carefully carried out. Usually, it is possible to vent a gas-burning space heater and a clothes drier. Shut off the furnace humidifier during mild weather when the cycle of operation lengthens. In some cases, it is possible to eliminate the

humidifier entirely when a gas-burning range is used in the preparation of food. The same would be true of evaporating pans on hot-water or steam radiators. In some homes, particularly in bathrooms, basements and upstairs bedrooms, window-mounted exhaust fans can be used to advantage in minimizing condensation. The capacity of the fan should not exceed 300 cu. ft. of air per minute. If a fan is operated regularly in a home of tight construction, it may be found necessary to install at least one outside air intake near the floor. This will permit fresh air to be drawn in and will prevent possible back drafts through chimneys and ducts.

Ventilation of the attic by natural air movement is essential in most homes, even when ceilings and walls are properly insulated and provided with vapor barriers in any of the four ways detailed at the lower left in Fig. 2. Control of excess water vapor in both old and new homes by means of insulation, vapor barriers and ventilation is now conceded to be generally necessary in the three zones roughly outlined in the map of temperature design areas in Fig. 3. The temperatures given on the map are only approximations of the average winter low temperatures. Some recommendations specify these control measures in any areas where the average January temperature is 35 deg. F. or less. Adequate ventilation of the attic is an important part of these control measures, and the details in Fig. 9 show several approved methods of attic ventilation by means of louvers and screened cornice vents. This is especially true of certain types of homes where the construction makes it practically impossible to prevent a certain amount of water vapor from reaching the attic space. Where proper insulation and installation of vapor barriers eliminate moisture from the attic, ventilation is still necessary to remove excessive heat which accumulates during a hot summer day. In flat-roofed and shed-roofed homes, the problem and remedy are essentially the same: Install cornice vents and leave an air space between the insulation and roof boards to permit free circulation of air. On flat-roofed homes a mechanical ventilator usually is necessary, as air currents alone cannot be relied upon to force hot air out through cornice vents.

The cost of installing membrane-type vapor barriers in homes already built usually is prohibitive. However, ordinary oil-base interior paints are a fairly reliable substitute, provided they are applied over a tight, smooth surface. Before applying the paint, fill cracks with a putty made by mixing paint of the color to be used with a small quantity of whiting. Allow this filler to dry thoroughly before painting.

Cloth Padding Attached to Bench Prevents Scratching Furniture



A heavy piece of cloth, such as burlap, denim or a section of a floor rug, tacked at one end to the overhang of a workbench top, provides a convenient padding for furniture placed on the bench. When not in use, the cloth hangs in front of the bench where it is out of the way. When needed, it is merely placed over the bench top. The lower edge of the cloth is hemmed to take a wooden slat, which prevents the cloth from lying in folds on the bench.

Clothespin and Folding Rule Help Transfer Angles

When using his folding rule to transfer an angle — simply by folding two of the sections of the rule to the angle to be transferred — one craftsman guards against disturbing the setting by use of an ordinary clothespin.

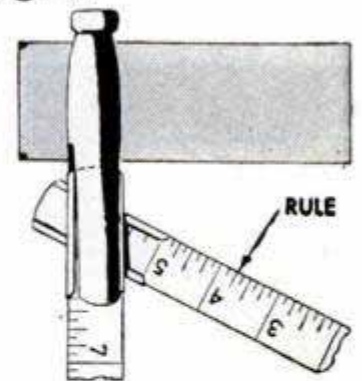

After the angle is set, the clothespin is merely forced over the joint of the rule, or apex of the angle.

H. O. Schoenfisch, Mountainside, N. J.

☞ To find the cause of a smoky fireplace, notice whether it smokes intermittently or constantly. If the former, the cause is usually from faulty construction that results in permitting downdrafts, which are probably due to an excessively damp chimney.



Build Your Own

Part III

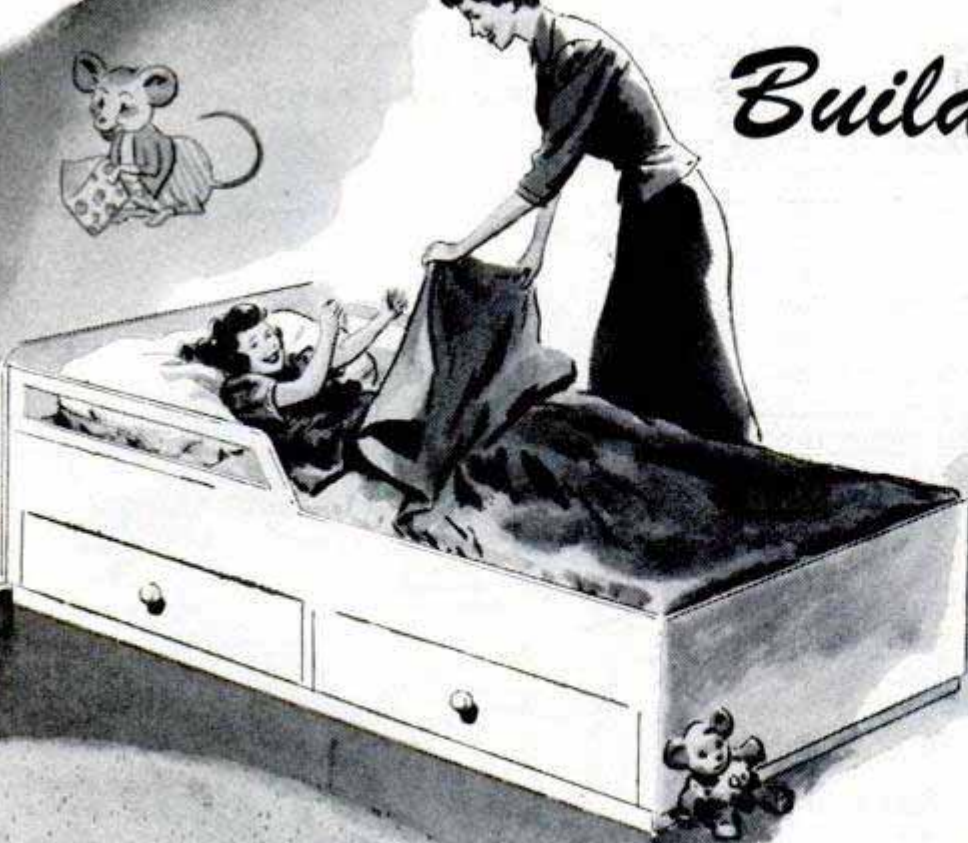

Youth Bed

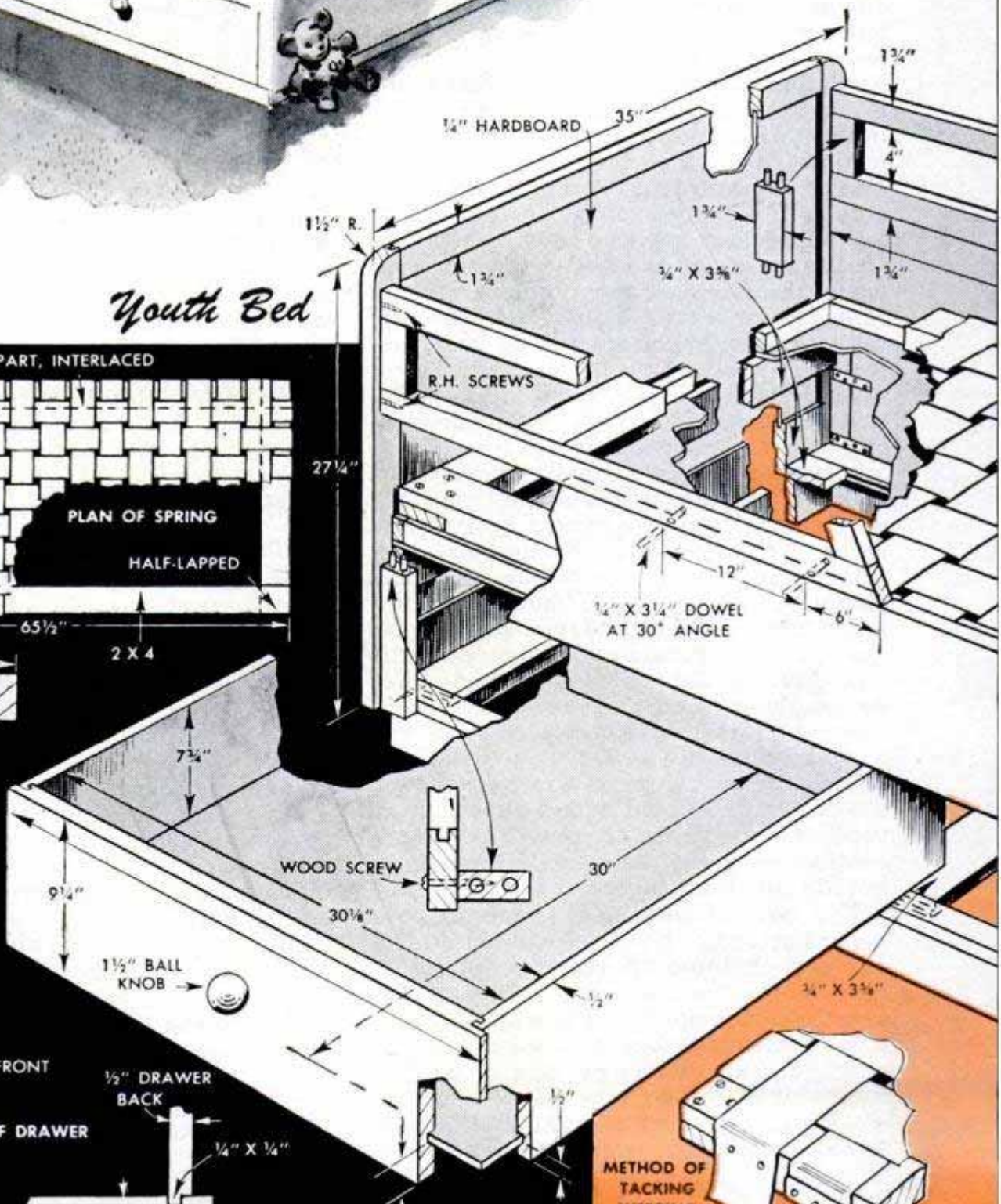
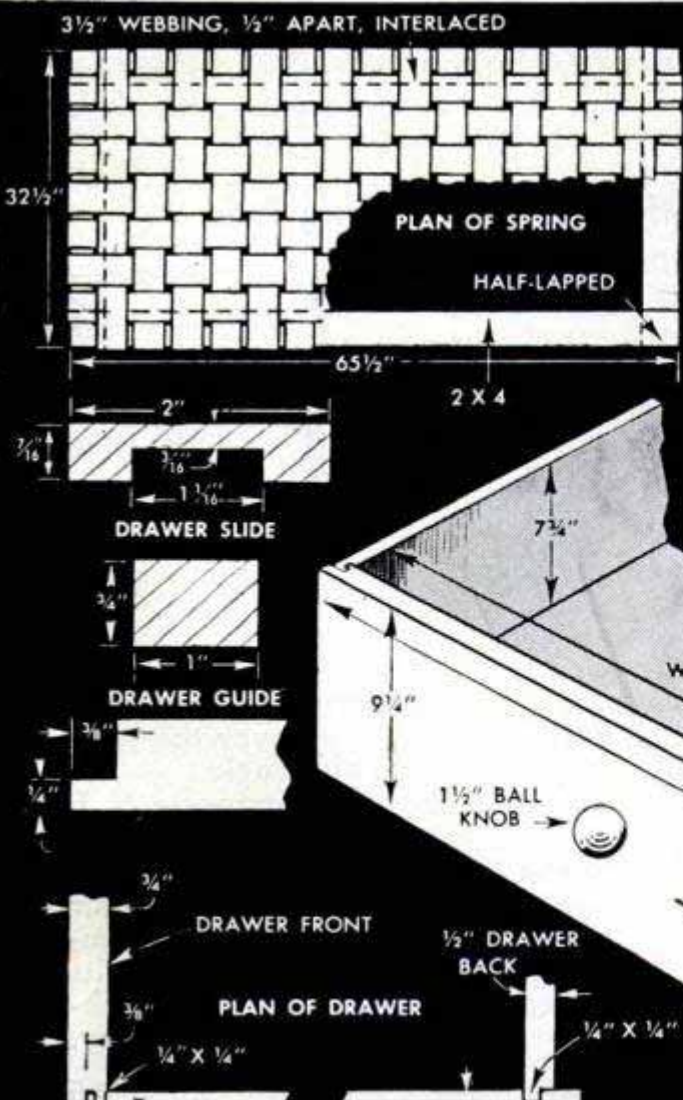

NURSERY FURNITURE

THE YOUTH BED and the giraffe lamp-costumer detailed on these pages complete the set of nursery furniture, description of which began in the July issue. The side rails, footboard and drawer fronts of the youth bed are of $\frac{3}{4}$ -in. plywood while the drawer sides and backpieces are of $\frac{1}{2}$ -in. plywood. The base of the bed, which is of $\frac{3}{4}$ x 3-in. stock, is mitered at the corners. Triangular-shaped blocks of 2 x 4 reinforce the corners of the base and also provide mounting blocks for casters. The side drawer rails, which run the length of the bed, are grooved to receive tenons cut on the front, back and center rails. The rails are assembled, together with the tenoned drawer guides, and screwed directly to the base.

A $9\frac{1}{4}$ -in. upright is screwed to the edge

of the drawer frame at each corner of the bed and doweled and glued to the bottom edge of the side rails. The two drawers can be installed so they will open from either the right or left-hand side of the bed, the other side being enclosed with a panel of $\frac{3}{4}$ -in. plywood. This panel is fastened only with mending plates so it can be removed and replaced on the other side of the bed, should it be desired to reverse the drawer arrangement. Cleats are screwed to the inside of the bed on all four sides. These support the spring frame and also provide a nailing surface for a dust panel of $\frac{1}{4}$ -in. wallboard. The side cleats are notched for the ends of the center dust-panel support.

The center section of the giraffe lamp-costumer is cut from a single 22 x 42-in. sheet of $\frac{3}{4}$ -in. plywood. This sheet, as well as the two pieces required for the hind legs, are cut according to the squared pattern. The two seats, which are fitted between the center member and the hind legs, are of $\frac{3}{4}$ -in. plywood grooved $\frac{1}{2}$ in. from the side edges to take $\frac{1}{4}$ -in.-sq. tenons on the side rails. The plywood is painted to simulate the markings of a giraffe, and the

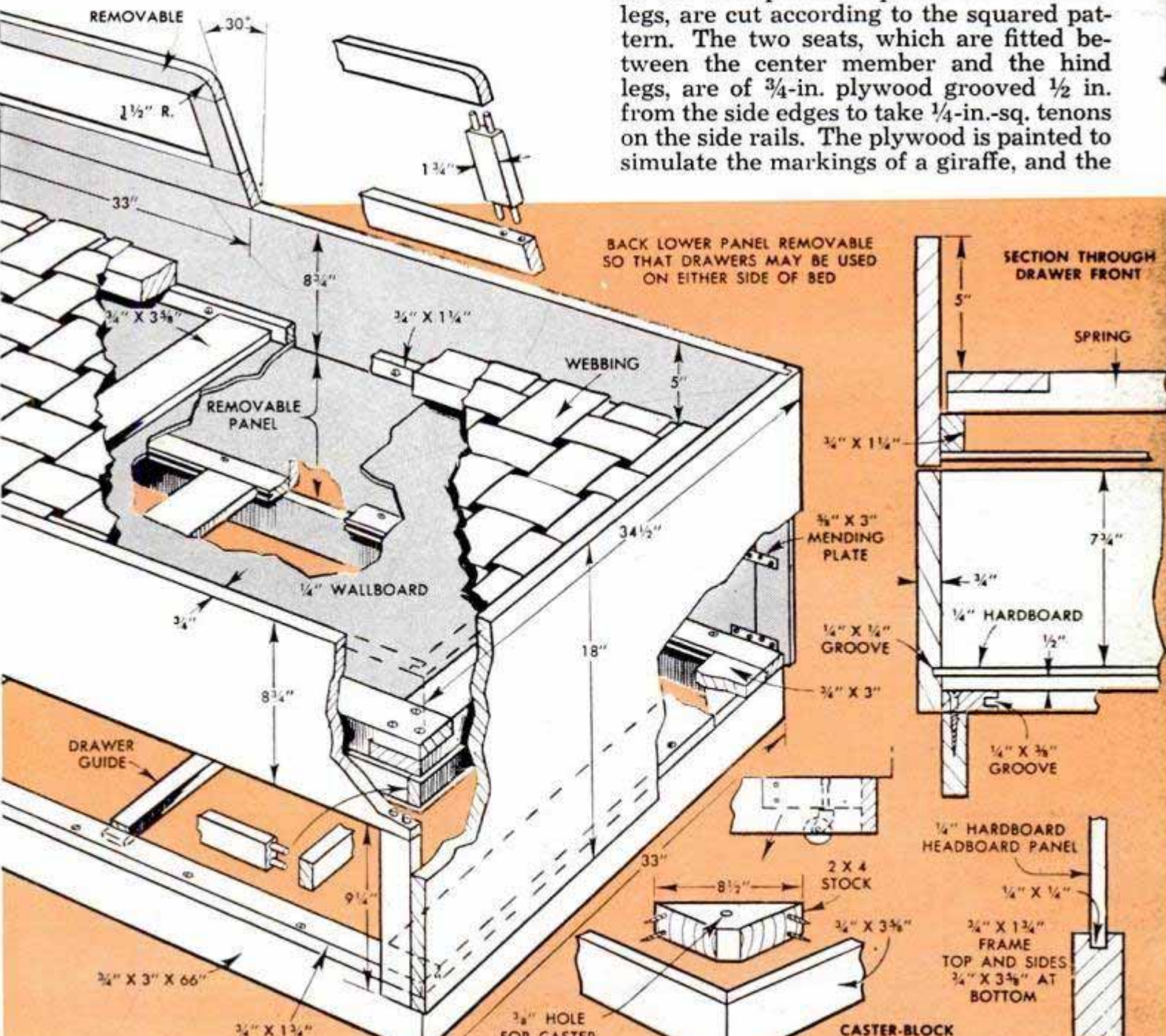

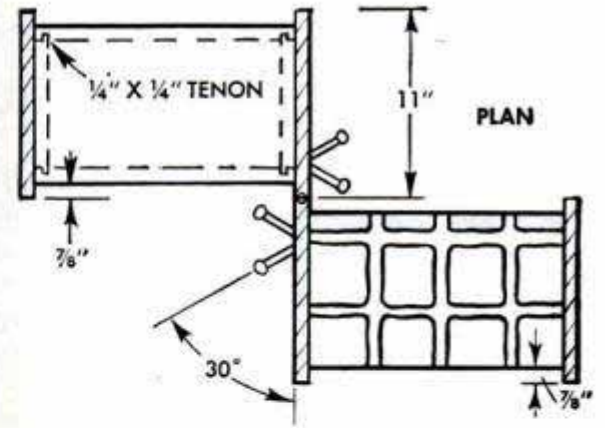

Giraffe Lamp-Costumer

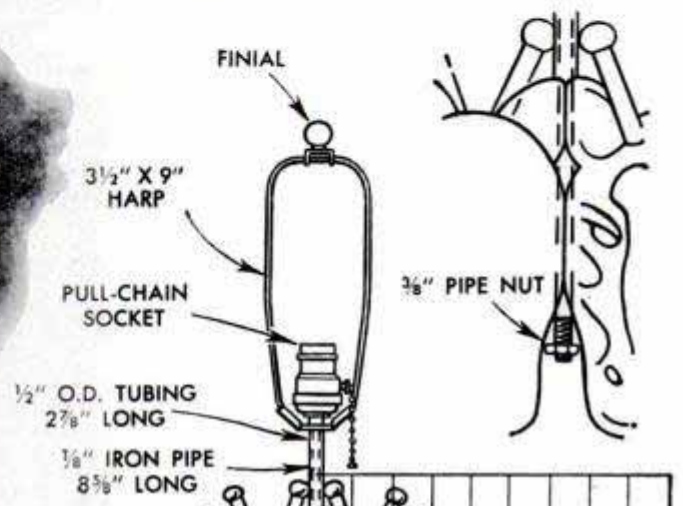

seat may be similarly painted or upholstered. Note that the center member is drilled vertically at the top to take a length of 1/8-in. iron electrical pipe which provides a standard for the lamp. A short length of tubing slipped over the upper portion of the pipe forms a spacer, and a nut turned on the bottom of the pipe holds the standard in place. The lamp cord is passed through the pipe and may be brought straight down or stapled to the edge of the cutout.

(The End)

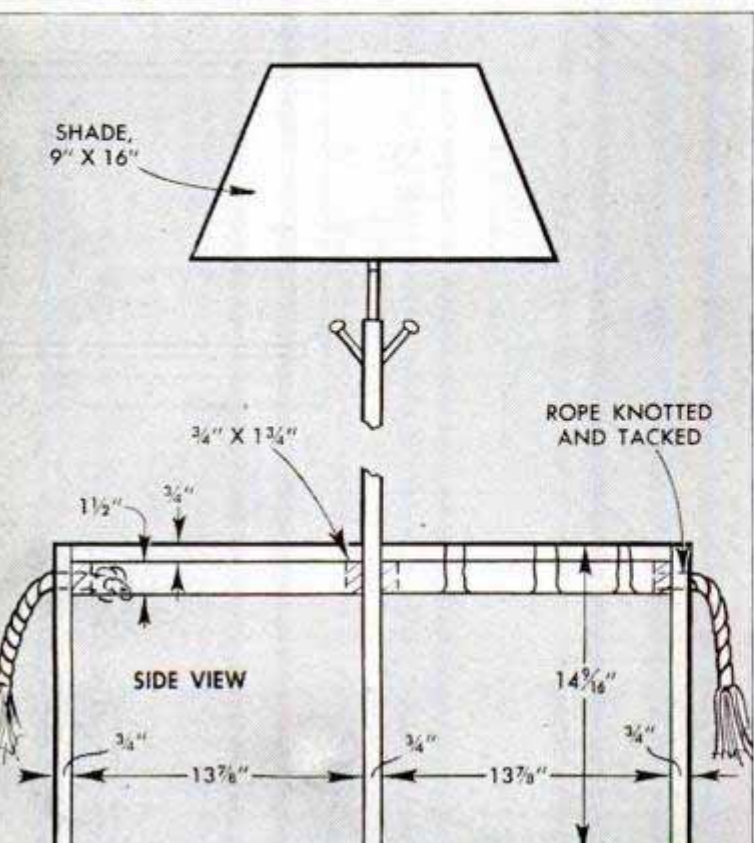
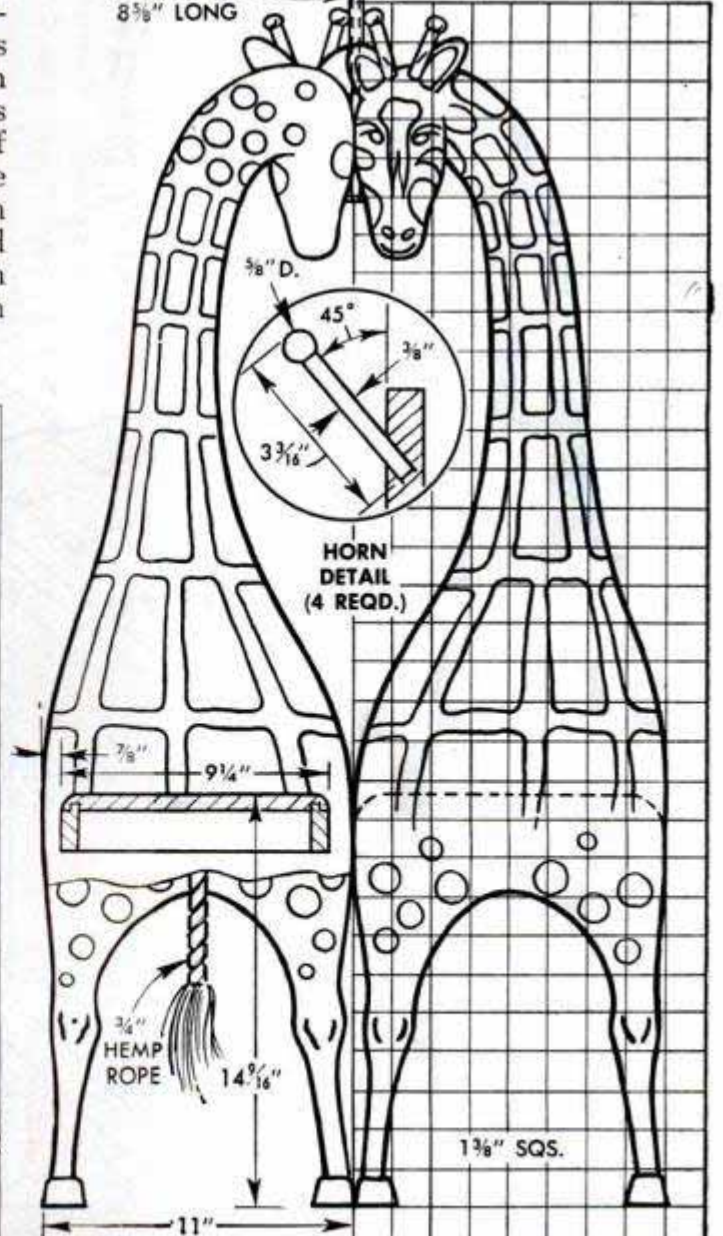

Plywood Platform in Back Seat of Car Makes "Traveling Playpen" for Child

Provided with ample room for herself and her toys, a small child will enjoy her own "traveling playpen" in the back seat of the family car. Also, there is less possibility that the child will be injured if a sudden stop of the car is necessary. The playpen is nothing more than a panel of $\frac{1}{2}$ -in. plywood cut to fit between the front and rear seats as shown. One end is supported on a wide, folding leg and the other end rests on the rear-seat cushion, this end being cut to fit around the armrests. The leg also is made of plywood and is hinged to the underside of the panel. If desired, cabinet-door friction catches can be attached to the panel and leg to keep the latter folded when stored. After rounding all sharp edges of the platform and sanding it well, finish with sealer and apply two coats of spar varnish to guard against

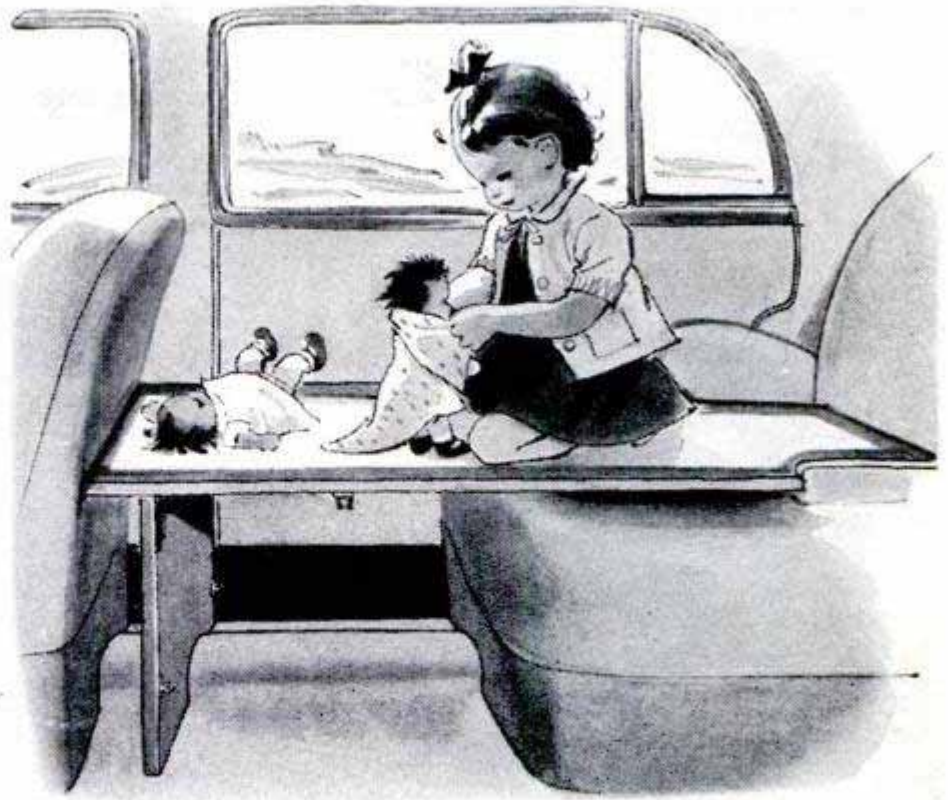

warpage. Plastic upholstering material makes an easily cleaned padding for the platform, or an old blanket can be used for this purpose.

J. L. Bethurum, San Antonio, Tex.

Pounce Bag and Letter Patterns Used to Lay Out Signs

A Minnesota sign painter saves considerable time in making layouts by use of a pounce bag and cardboard patterns of letters. The pounce bag is a small, cloth sack, similar to a tobacco sack, which is about

half filled with talcum powder or powdered charcoal. Several fonts of various styles and sizes of letters are cut from thin cardboard and kept in stock. When making a layout, the desired letters are simply laid in position on the sign and dusted with the pounce bag, thus leaving an easily followed outline of the lettering.

Elmer Vandrey, Truman, Minn.

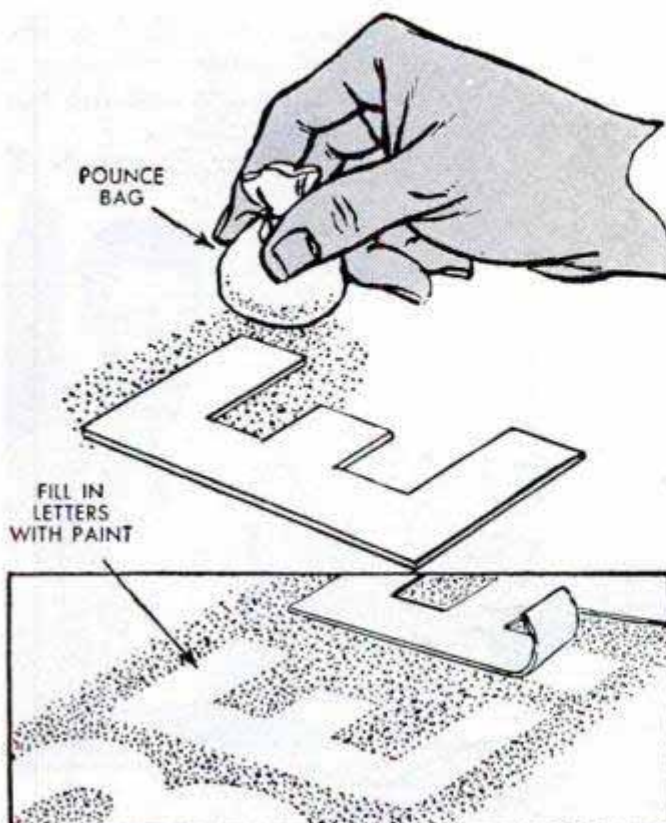

Bushing Flush-Tank Ball Prevents Loosening

After unsuccessfully trying several methods of preventing the ball valve in his toilet flush tank from unscrewing from the rod that supports it, one homeowner bushed the valve with small pieces of rubber, which overcame the trouble. Several short sections were cut from an ordinary rubber band, and the pieces dropped into the threaded hole of the ball. Then the ball was screwed onto the supporting rod. The small pieces of rubber provided sufficient pressure on the threads to prevent the ball from loosening, yet were resilient enough to permit the ball to be screwed onto the rod easily. Being unaffected by water, the rubber will last indefinitely. However, if exposed to oil, it would rot away in time.

Colorful Jewelry for Children From Plastic Brush Handles

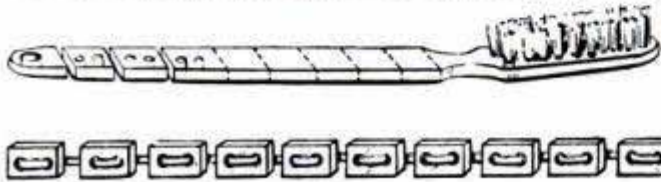

Discarded toothbrushes, or other brushes having plastic handles, can be used to make colorful belts, bracelets or necklaces for little girls. Cut the handles into sections and drill each section as indicated. Then give the sections and a length of cord to the child and let her thread them to make what she wishes.

Fred Cornelius, El Paso, Tex.

White Stripe Painted on Bolt Lock Tells If Door Is Locked

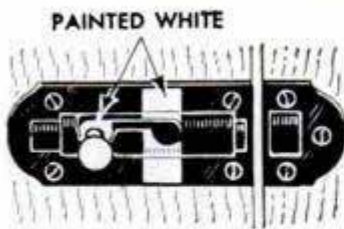

By painting a white, phosphorescent stripe across bolt-type locks, in the manner shown, you can tell from a distance, either in daylight or dark,

if the bolts are open or closed. Note that the stripe is painted across the width of the lock at the point where the bolt handle is located when fully closed. When the painted handle is out of line with the rest of the painted portion, it is easy to see that the bolt is open.—R. Galluzzo, Chicago.

Improved Soft-Faced Hammer

A handy, soft-faced hammer for removing dents from sheet metal and for light forming and planishing operations can be improvised by fitting an ordinary tack hammer with a rubber tip cut from a medicine-

dropper bulb. Cut the rubber tip squarely off at a point about halfway from the rounded end. Then press a small pledget of cotton into the rounded tip to form a cushion and force the tip over the small poll of the hammer. If necessary, use adhesive or cellulose tape to hold the rubber tip firmly in place on the hammer.

John J. Rea, Urbana, Ill.

Yardstick's Usefulness Increased By Slot to Direct Straight Cuts

A guide for making straight cuts in corrugated cardboard can be provided by sawing a narrow slot down the center of a yardstick. The slot in no way impairs the regular use of the stick and, when

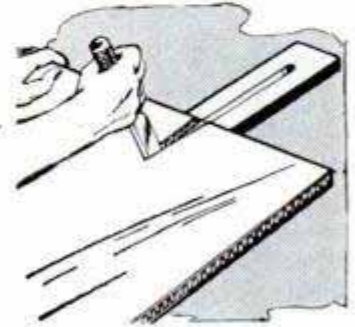

placed under or over a sheet of cardboard, provides a straight channel through which a knife blade can be directed.

Lazy Susan and Corrugated Box Speed Drying of Fishline

To dry a fishline quickly and easily, try winding it around a cardboard box taped to the top of a Lazy Susan. Start the line on the box and then rotate the turntable to unwind the line from the reel, holding the reel so that the turns of line will lay side by side on the box. When the line has dried, just "reel it in." A similar setup can be used for rolling yarn into a ball. The hank of yarn is slipped over the box and several thicknesses of folded newspaper are inserted between the yarn and the box to provide the necessary tension.

David S. Hogmer, Bronx, N. Y.



WOVEN SCREEN

By Allan Carpenter

HERE'S SOMETHING distinctively new in weaving—an unusually attractive and colorful folding screen woven entirely without a loom from materials you can obtain almost anywhere. Hardwood dowels, which form the woof in this type of weaving, are woven through a fixed warp consisting of alternate strips of upholstery webbing, carpet tape and gold braid arranged in harmonizing color combinations. In the screen pictured at the right, $\frac{1}{4}$ x 60-in. dowels were used. In preparing the warp, select alternate strips of equal length and tack them to a strip of wood as in the upper left-hand detail. Tack the lower ends to a strip of the same length, then hang from the wall, or a frame, with the warp strips in the vertical position. Weave the dowels through the warp strips in a simple, over-and-under basket weave as pictured in the photo at the right. As the weaving progresses from the bottom upward, keep the dowels pressed tightly down on the warp. When the job is finished, tape the ends of the warp strips to a dowel at the top and bottom as in the upper right-hand detail. Now, after removing the wooden strips at the ends, roll these dowels inward against the first and last dowels of the roof as in the lower left-hand detail. Fasten with brads or tape as shown. Tie the ends of the dowels with raffia or colored cord to hold the warp in place as in the lower right-hand detail.

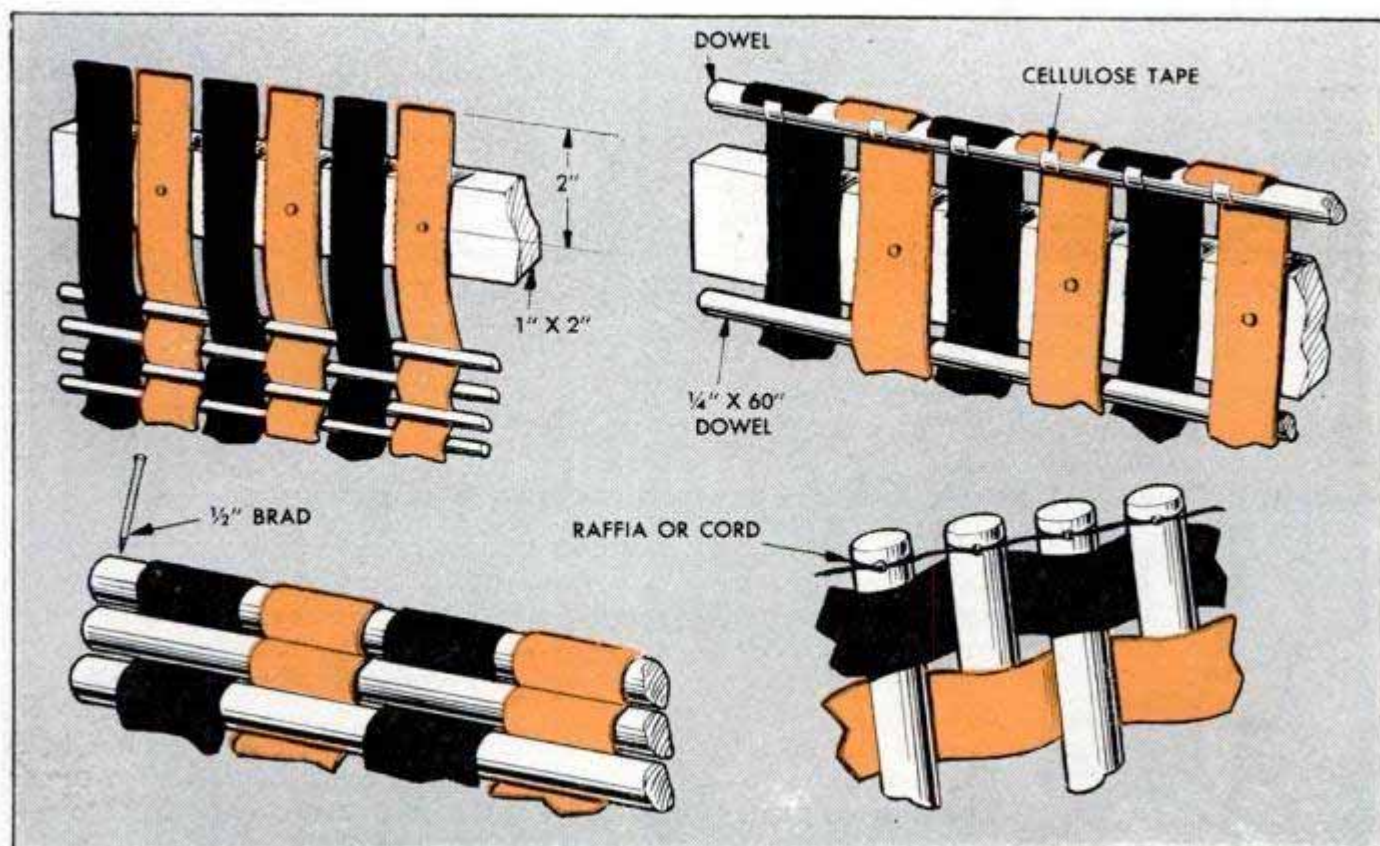
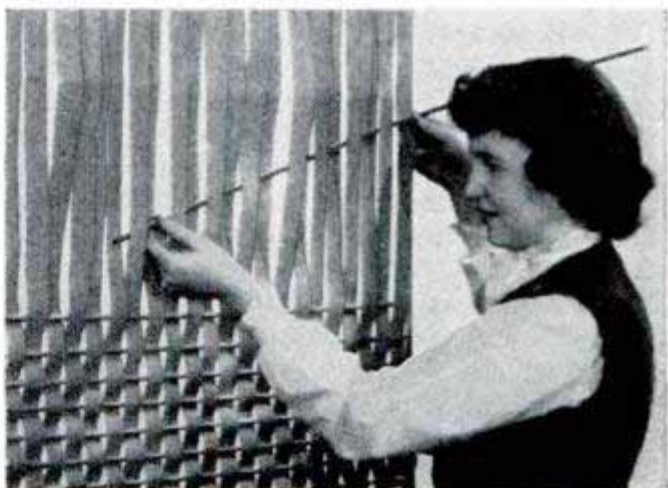
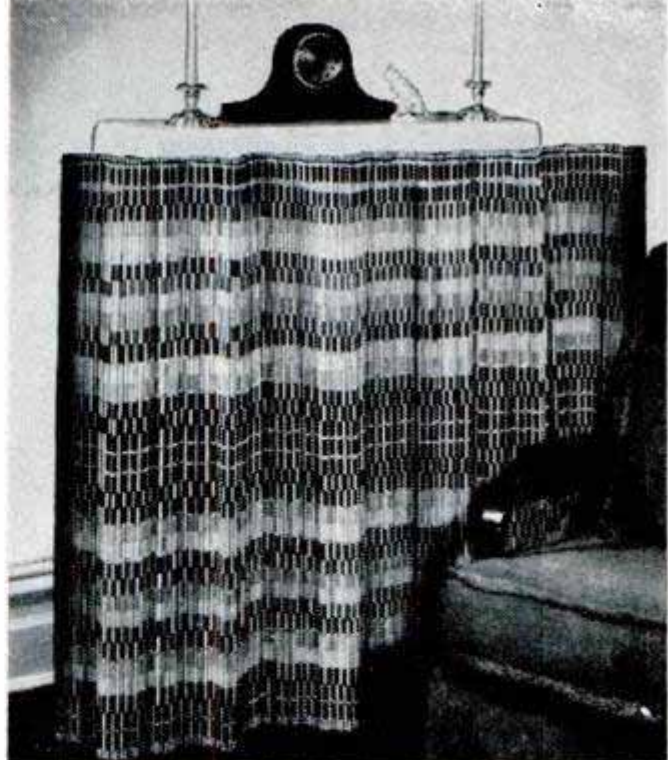

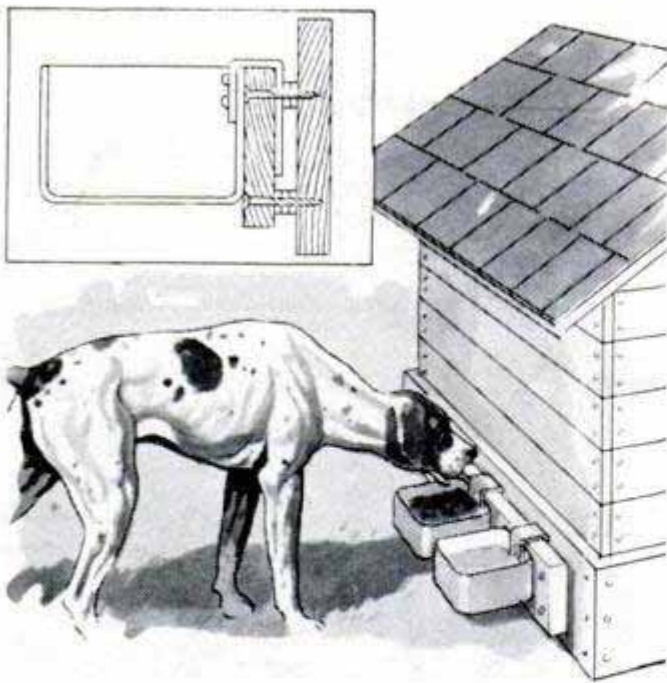

Spillproof Dog-Feeding Pans Supported by Special Rail

To provide your dog with food and water pans that he cannot tip over, obtain cooking pans having vertical sides and long handles of the type found on dippers. Bend the handles to fit over a wooden rail screwed to the base of the doghouse as shown. Note that washers are placed over the screws so that enough clearance for the handles will be left between the rail and the doghouse.

George Kapitan, Bronx, N. Y.

Trimming Worn Shaving Brush Adapts It for Stenciling

A worn shaving brush can be made into an ideal brush for stenciling. Just trim the bristles square about 1 in. from the handle, leaving them stiff and even to provide a blunt inking surface.



Servicing Cigarette Lighters

When your cigarette lighter begins to misfire and at best sparks only weakly, it's likely that the wheel needs cleaning. To do this, scrape the accumulated grit and dirt from the grooves of the wheel with the point of a pin or needle and then brush vigorously with an old toothbrush. In time, the follower spring which maintains pressure on the flint becomes weakened by corrosion and rust and should be replaced. Action of the follower spring often can be improved, at least temporarily, by fitting the head of a pin into the forward end of the spring. Cut the body of the pin about $\frac{1}{4}$ in. below the head and insert in the open end of the spring. This will increase the pressure on the flint.

Nonfreezing Sprinkling System Drains Into Catch Basin

While underground lawn-sprinkling systems save a lot of work, it is difficult to keep them from freezing in the winter. However, a system such as the one illustrated is equipped with a valve that permits draining the water from the entire system into a catch basin. This is made possible by laying the pipe on a rise of approximately 3 ft. in 90 ft. and locating the drain at the low point in the line. If there is no catch basin in your yard, a small one can be built by digging a hole of suitable depth, filling it about a third of the way with crushed rock and walling the upper portion of the hole with brick.

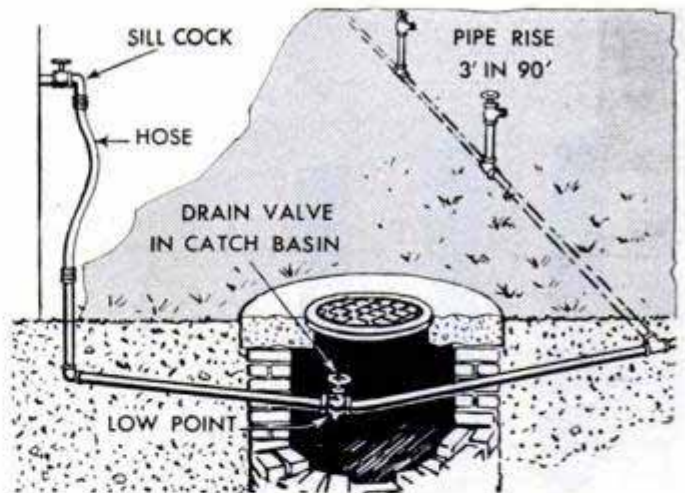

Notched Clothes-Hanger Rod Prevents Bunching of Garments

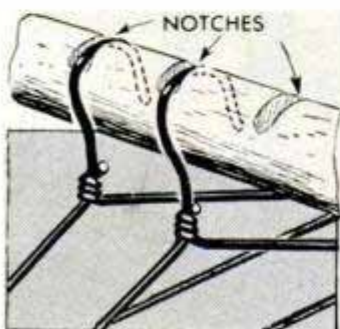

Clothes hung on hangers can be kept from "bunching up" on the hanger rod by cutting equally spaced notches in the top of the rod. Thus, when placed in the notches, the

hangers will not slide on the rod and clothes will be kept in neat order. However, do not cut the notches deep enough to weaken the rod when heavily loaded.

Thomas Trail, Catonsville, Md.

By joining a light bulb and socket with wrappings of cellulose tape at the top of the socket, you can prevent young children from removing the bulb.

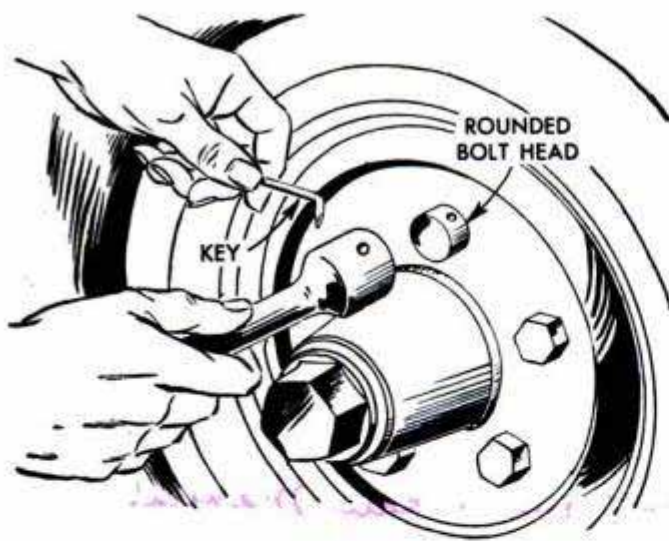

THEFTPROOFING *your car wheels*

By M. A. Patrick

PREVENTING the theft of car wheels and tires can be done without adding locks or other parts simply by rounding the hex head of one bolt in each wheel hub and altering the regular socket wrench supplied with the car tool kit. Details above and at the right show clearly how it's done. Pry off the hub caps and remove one bolt from each wheel. Then drill a hole in the bolt head as in the upper right-hand detail, drilling a little over halfway through the head. The hole should be of a size that will take the end of a 20d nail freely. Now file off the corners of the hex head as in the center detail, and round the head sufficiently so that no socket wrench of that bolt size will hold at any point. Finally, drill a hole through one side of the wrench socket as in the lower detail, the hole being of the same size as that drilled in the bolt head.

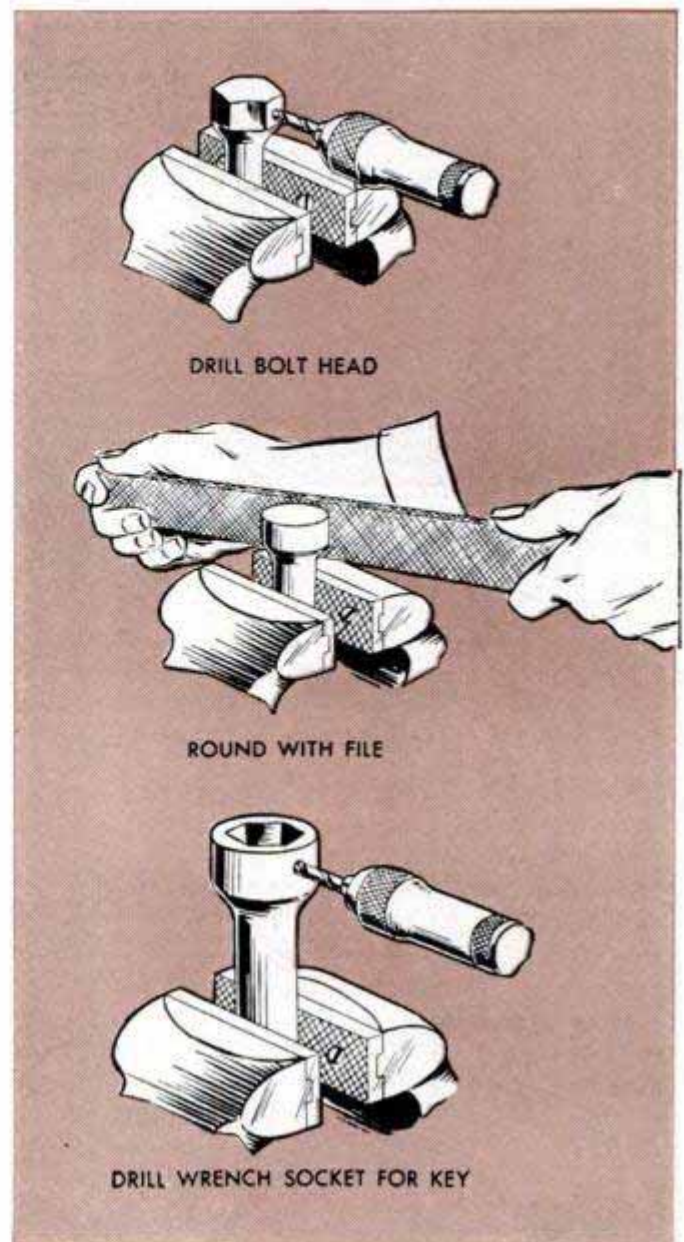

Bend the nail at right angles at a point about $\frac{1}{2}$ in. from the end. Then turn the altered bolt back into the hub, running it up finger-tight. Place the wrench socket over the head and register the holes. Then insert the nail and tighten the bolt.

Socket for Small Light Bulb Made From Paper Clips

In low-voltage experimental work where a small test lamp might be needed and a midget-base socket is not at hand, one can be improvised quickly by using two com-

mon paper clips and a couple of thumbtacks. Both wire clips are straightened and the end of one is wrapped around the threaded base of the bulb to form a coil that will engage the threads. About $\frac{1}{2}$ in. below the coil, the clip is bent at a right angle and anchored with a tack. Then a small loop is bent into the end of the second clip and it is bent and anchored in such a position that the loop will be held against the contact point at the base of the bulb. Connections from either dry cell or transformer are made by merely twisting the wires to the paper clips or securing them with a drop of solder. These paper-clip sockets also are ideal for wiring a dollhouse.

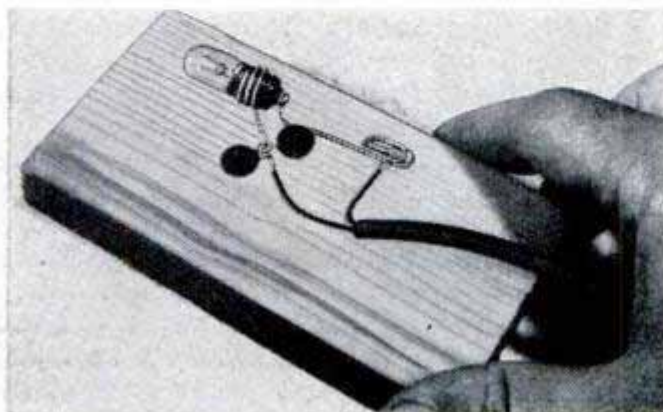

Louis Hochman, Sherman Oaks, Calif.

RELINE *your* BRAKES

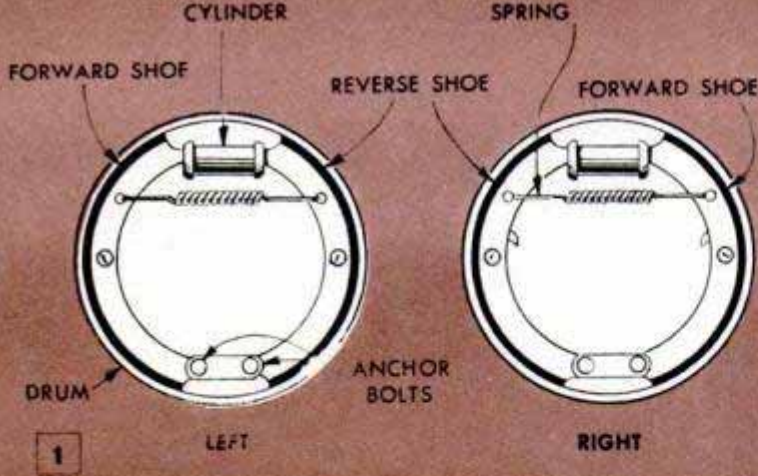

1974 auto Repair Manual
By John R. Dluski

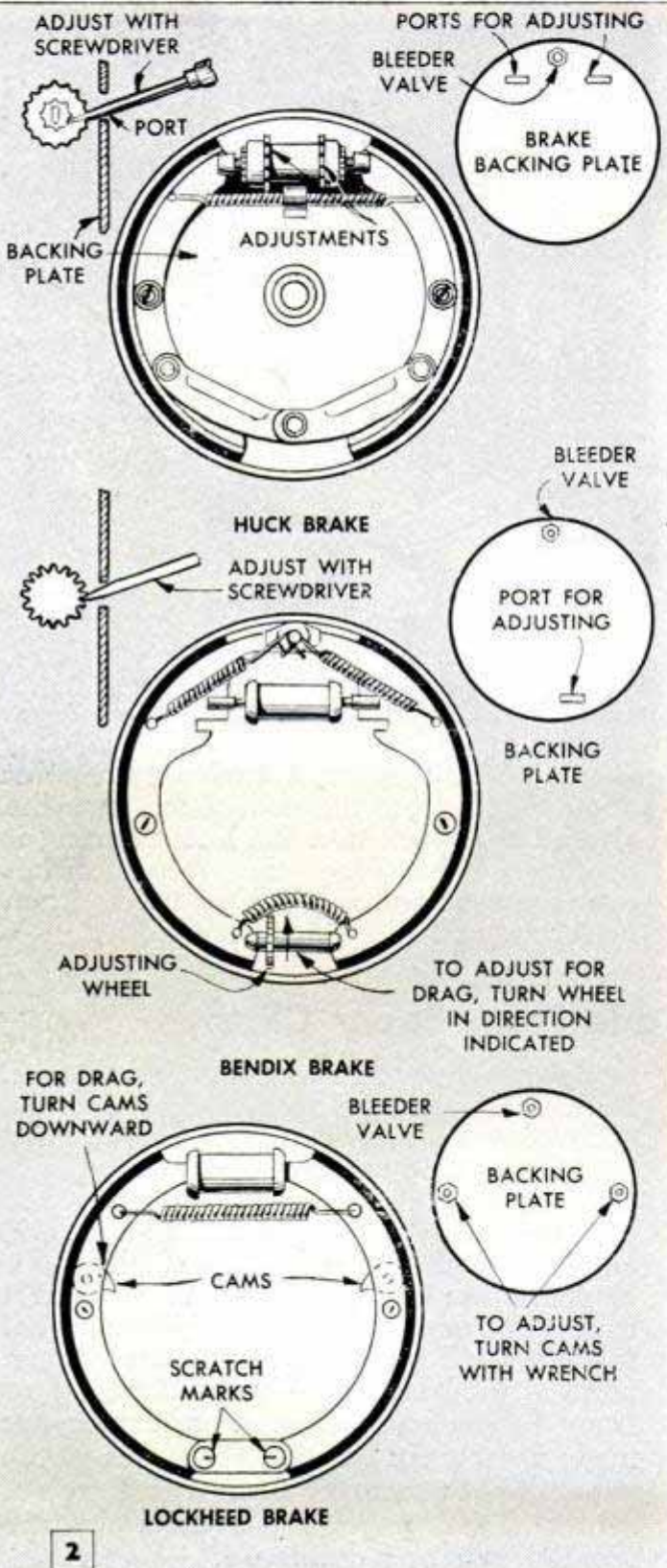

WHEN YOU tramp hard on the brake pedal in an emergency on the highway or at a street intersection — that's when brake performance really counts. Whether or not you stop in time may depend on the condition of the brake linings. You can inspect the linings on your car in five minutes and you can reline the brakes for a fraction of the cost of a reline job and save yourself the inconvenience of being without the use of the car for a day or more. Jack up a front wheel and remove the wheel and then the drum. On new linings, the rivetheads are in countersunk holes and if the linings are worn down within less than $\frac{1}{32}$ in. of the rivetheads that's your cue. If wear continues, the rivetheads will score the contact surfaces of the drums.

Brakes vary as to the location of springs, anchor bolts and methods of adjusting the shoes, but the details in Figs. 1 and 2 give a good general idea of the different types of modern hydraulic wheel brakes. Before tackling the relining job, the first thing to do is to check the toeboard clearance of the brake pedal as in Fig. 3. It will be noted that the specification calls for $\frac{1}{4}$ to $\frac{1}{2}$ in. of free travel of the pedal, but manufacturers' instructions vary on this adjustment. It's a good idea to consult the instruction book for the recommended pedal movement and also for detailed directions on making the clearance adjustment near the end of the push rod on the master hydraulic cylinder. The instruction manual usually will direct you to loosen the locknut and turn the yoke until the required clearance is obtained.

Now, you'll need a complete relining kit, which includes linings for your car and the necessary rivets, a holder fixture for the combination knockout punch and clincher tool, brake-spring pliers and a bleeder hose. With these parts at hand, block the rear wheels securely and jack up the front end of the car so that the

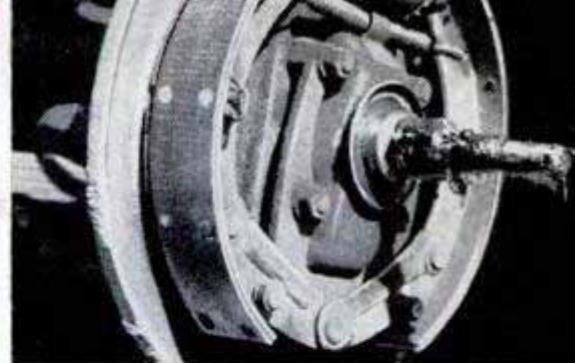
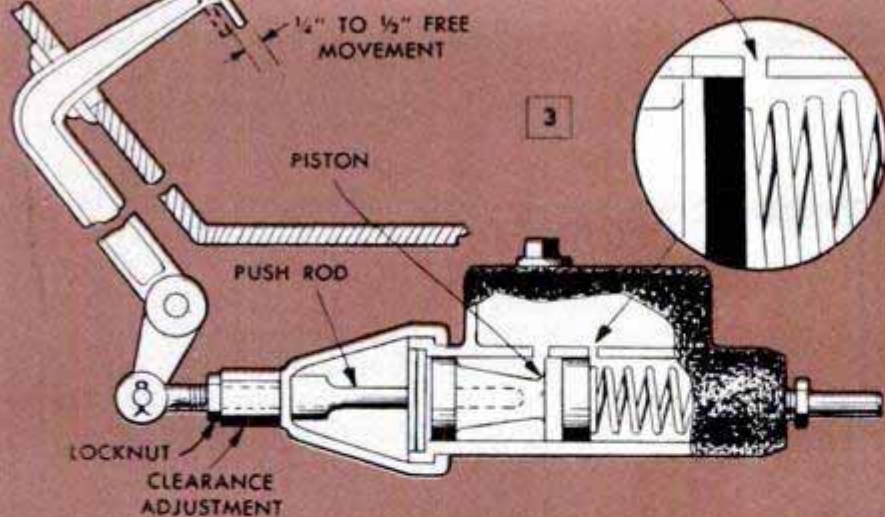

This brake needs a relining job although linings are not yet worn badly enough to permit the rivets to score the contact surfaces of the drums. Note rivetheads

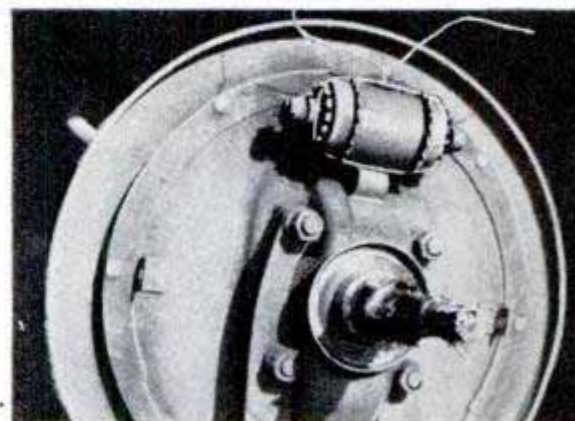

Unless your brakes are provided with piston stops, be sure to wire the pistons in the retracted position before removing shoes. Don't forget to remove wire

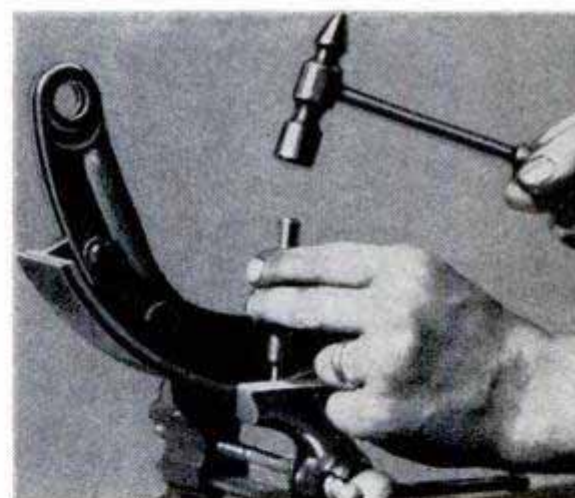

Above, use a punch to remove rivets holding the old lining. Below, when riveting the new lining in place, begin at the center of shoe and work outward

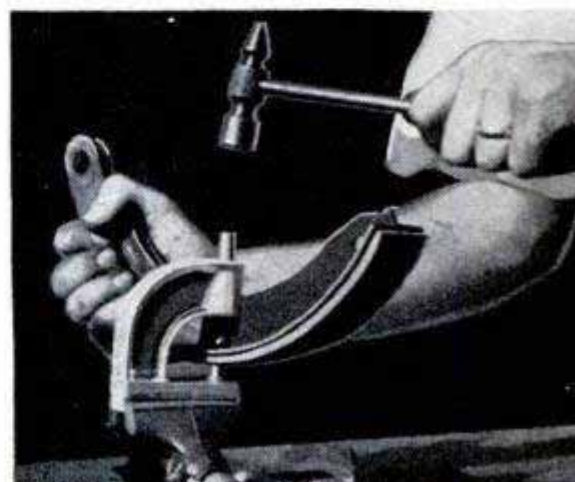

front wheels clear. Then remove hub caps, grease cups, cotter pins, spindle nuts and the outer wheel bearings. Pull the wheels from the spindles. Before removing any parts from the brake assembly, upper right-hand photo, wrap a piece of fine wire around the hydraulic brake cylinder as in the photo at the right and twist it tight. On some brakes, piston stops are provided, making the wires unnecessary. In most brake assemblies, removal of the retracting springs and anchor pins will release the brake shoes. Keep the parts in order so that you can reassemble them correctly. To remove the worn lining, place the shoe in a vise and knock out the rivets with a punch as in the third photo from the top at the right. Be careful not to enlarge or indent the rivet holes in this process. After the old lining has been removed, clean the face of the shoe thoroughly. One lining of each individual set will be marked "forward" and the other "reverse." It is necessary to make sure that you rivet the lining marked forward on the forward shoe, Fig. 1, and the reverse lining on the reverse shoe. These are sometimes referred to as primary and secondary linings. Before riveting, check the alignment of the holes in the lining with those in the shoe. Now place the holder fixture in the vise as in the lower right-hand photo, insert a rivet in one of the center holes through the lining and place the head of the rivet over the fixture anvil as pictured. Clinch the rivet tightly by striking the clincher with a hammer. Then turn the shoe and insert the second rivet in a hole opposite the first. Clinch as before, then work outward toward the ends of the shoe, proceeding in the same manner until all rivets have been inserted and clinched. Apply the lining to the second shoe in the same manner. To avoid a mix-up in the right and left forward and reverse shoes it's a good idea to reassemble them on the brake unit from which they were removed as soon as you finish relining each one. Note that the forward lining is shorter than the reverse lining. After replacing the relined shoes in both front brake units, replace the retracting springs as in the upper photo on the following page, and remove the wire holding the pistons in the wheel cylinder. Now, turn the adjusting screw all the way in to retract the shoes so that the drum will slide over them. The adjusting screws, usually fitted with star wheels, are turned with an ordinary screwdriver inserted through a port in the backing plate as in Fig. 2. Generally it is possible to turn the star wheels by hand when the brake drum has been removed.

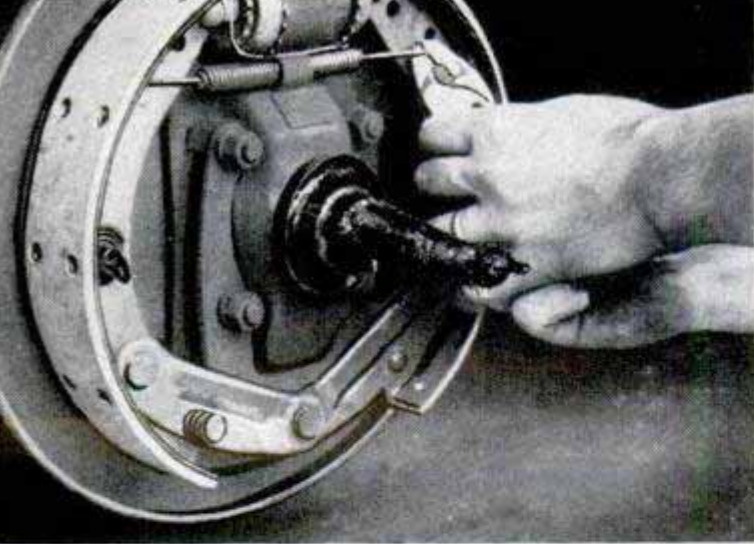

After relining the shoes, replace them in the same order as they were removed. Replace the retracting springs and don't forget to remove wire from cylinder

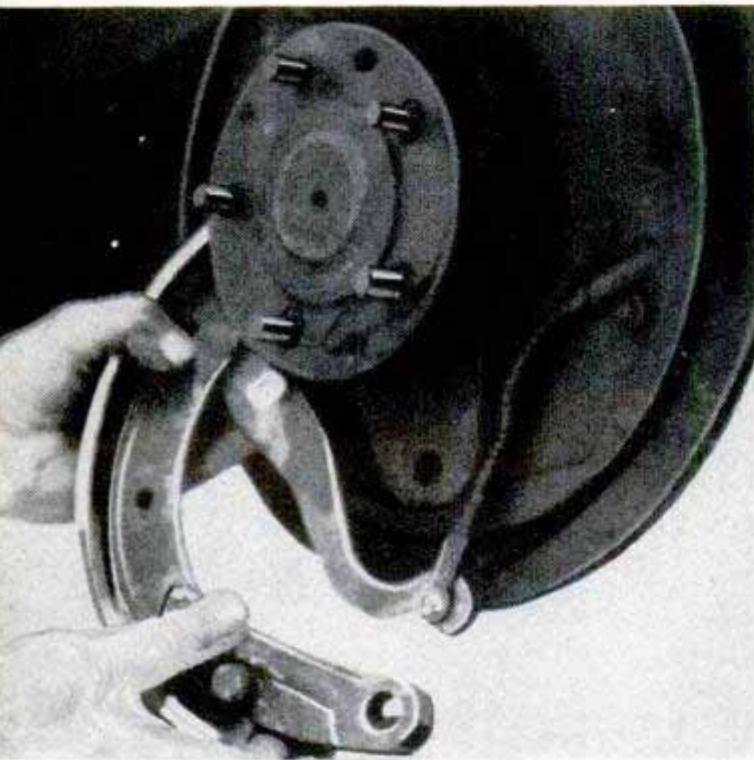

Cable-operated emergency brakes should be checked for free movement of the cables before relined shoes are replaced. Note position of linkage on backing plate

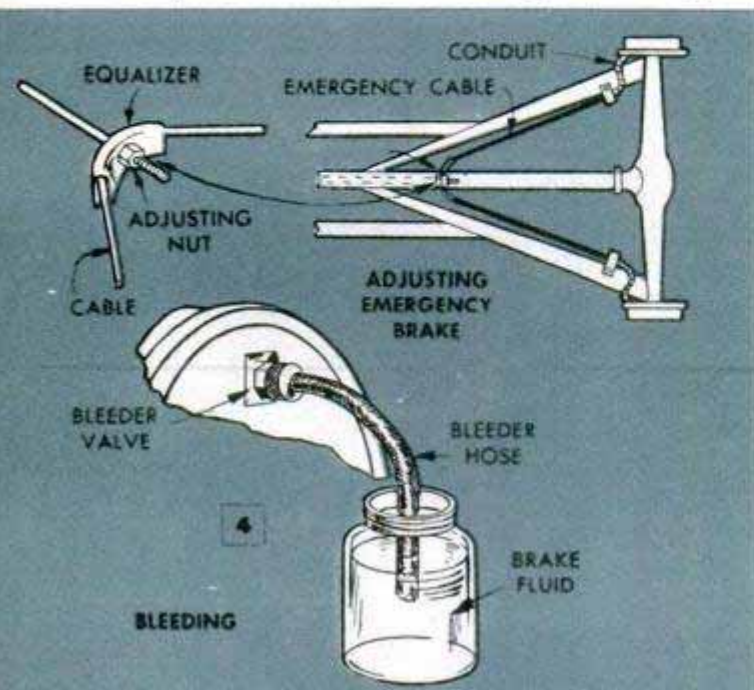

Replace bearings, drums, washers, castle nuts, cotter pins, grease caps and the wheels and hub caps. If grease has been wiped off the wheel spindles it will be necessary to replenish the lubricant, using the type specified by the manufacturer of the car. Adjust the relined brakes by turning each adjusting star wheel until both shoes drag uniformly. This can be determined by turning the road wheel in opposite directions. Then back off the adjustment until the shoes just release the wheel and permit it to turn freely. Relined brakes should always be adjusted a second time after a short period of use.

Now, block the front wheels and jack up the rear axle so that the wheels clear. Remove the wheels. On cars equipped with a Huck brake, removal of the drums is simple as they are attached by means of stud bolts. On cars having Bendix or Lockheed brake units, it is necessary to use a special shock-type puller. Remove the cotter pin and castle nut from the shaft and screw the puller on the threaded end of the shaft. Strike the end of the puller sharply with a hammer to loosen the drum. Remove the other drum in the same way. Then remove the brake shoes and wire the wheel cylinders, if necessary. If your car has a cable-operated emergency brake, disconnect the cable from the rear shoes, as in the center photo at the left. Reline the shoes in the same manner as the front shoes but, before reassembling them, have a helper tighten the emergency-brake lever. Note the movement of the cable inside the backing plate. If both cables move uniformly, the linkage is probably in good working order. After reassembling the shoes, drums and wheels, adjust the road brakes as before. Then adjust the emergency brakes, tightening the adjustment until the shoes drag, and backing off the adjustment until the wheels turn freely, Fig. 4. After all adjustments have been made, try the brake pedal. It should take up firmly after passing the clearance point of free movement. If the pedal feels soft, or spongy, it will be necessary to bleed the air out of the system. This is a simple operation and is done on each individual brake unit, as in the lower detail in Fig. 4. First, fill the master cylinder with brake fluid, attach the bleeder hose to the bleeder valve at the top of the backing plate and insert the other end of the hose in a glass jar half filled with brake fluid. Then open the bleeder valve about $\frac{1}{2}$ turn. Have a helper pump the brake pedal several times, until bubbles no longer appear on the surface of the fluid in the jar. Then close the valve and remove the hose. Repeat on the other three brake units, refilling the master cylinder each time with the recommended brake fluid.

Boat Oar Adapted for Sculling by Adding Second Leather and Collar

As I like to scull my rowboat when duck hunting or casting for bass and trout, I fitted the transom of the boat with a third oarlock in order to use one of the regular oars for sculling. To hold the handle of the sculling oar at the proper height, I added a second leather and a leather collar to the oar several inches below the original leather. The collar permits releasing the oar without having it slip from the sculling lock. The original leather is left in place for conventional rowing.

Clinton R. Hull, Costa Mesa, Calif.



Overhead Tank Primes Jet Pump

Owners of hunting lodges and summer camps often experience considerable trouble priming a jet-type well pump from

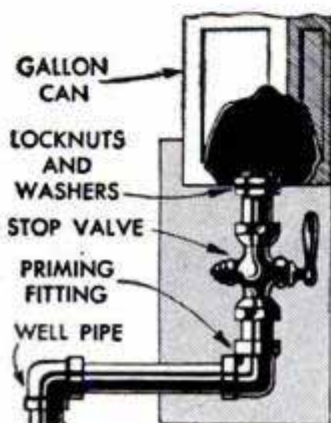

which the water has been drained between visits or over the winter. The problem is to get sufficient water into the pump at one time to maintain a seal. By providing a priming tank in the manner detailed, the job is greatly simplified. A 1-gal.

can, a stopcock or valve, and a few pieces of pipe are the materials required. Turn the pipe fittings together tightly as shown and attach the can with brass locknuts and washers. Open the cock and pour water into the can until the well pipe is filled and water rises in the can an inch or so. Then close the cock quickly and start the pump. The chances are that it will catch the first time.—Harry J. Miller, Danboro, Pa.

Improvised Sheet-Metal Seamer

A sheet-metal seamer, for crimping seams or other sharp bends, can be inexpensively made from two lengths of angle steel and a pair of ordinary utility pliers. The steel pieces are welded to the jaws of the pliers, as shown. The proper length of the steel pieces, or the width of the seamer, will usually vary with each seaming job to be done. Therefore, as the expense is slight, it is convenient to make several seamers of various widths to have on hand.

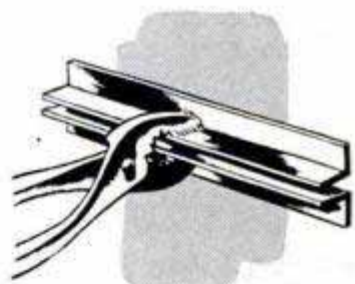

William Watson, Racine, Wis.

Homemade Jumpers in Flashlight Permit Use of Fewer Dry-Cell Batteries

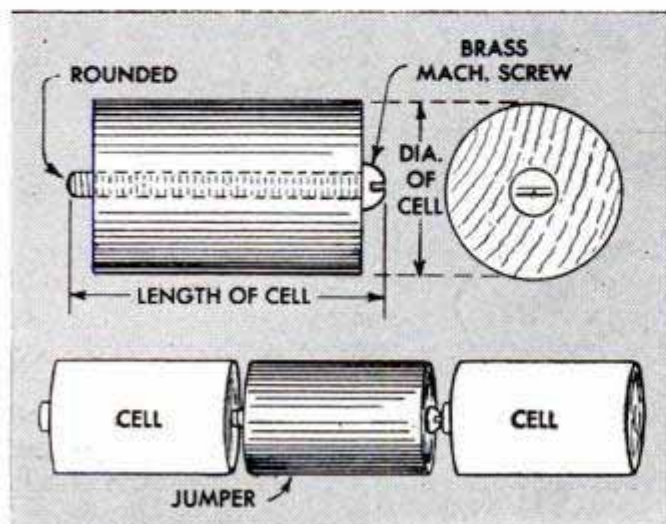

Dowel-rod jumpers, of the same diameter as a flashlight battery, can be used to replace two cells in a five-cell flashlight or one cell in a three-cell flashlight. In either case the original bulbs are replaced with lower-voltage bulbs and a slight reduction in light is tolerated for the sake of battery economy. Undersize holes are drilled lengthwise through the dowels, and round-headed brass machine screws are turned through the holes. The screws must be exactly as long as the cells they replace. Thus, the dowels simply hold the screws in place while the latter serve as the contact between the cells.

Arthur Trauffer, McClelland, Iowa.

Wide Work Supported on Saw Table By Roller Units Clamped to Sawhorse

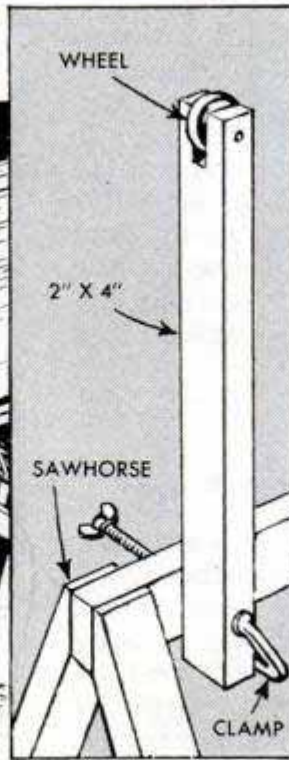
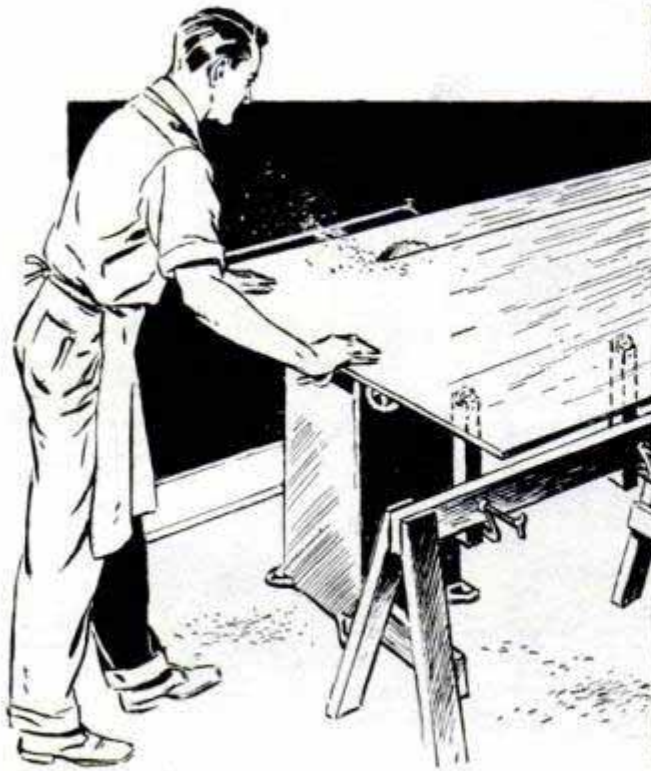

Owners of small circular saws will find these portable supports especially helpful when cutting large pieces of work such as plywood or hardboard panels. The supports also can be used to steady long lengths of work as they come off the saw table. Each support is a length of 2 x 4 with a slot cut in one end and a roller bearing or roller-skate wheel bolted to turn in the slot. The outer race of the bearing, or surface of the wheel, should extend slightly beyond the end of the support. When needed, two or three supports may be attached to a sawhorse at the desired height with C-clamps.—R. S. Leland, Sherborn, Mass.

Stepped Holder Keeps Small Tools Grouped Conveniently at Hand

Small tools that never seem to be at hand when needed will always be available if you keep them in this portable holder. It is made inexpensively from four blocks, which are glued, nailed or screwed together to form a stepped holder. The blocks can be any length desired, and are 1 in. thick with widths of 1, 2, 3 and 4 in. When set on edge and fastened together, blocks of

these widths will produce a stepped holder in which holes are drilled to take a variety of tools as pictured in the photograph.—J. T. Stinchcomb, Culver, Ind.



Punch-Type Can Opener Provides Ideal Wire-Splicing Tool

A can opener of the type used to punch holes in beverage cans makes an ideal tool for splicing wire. The two ends of wire to

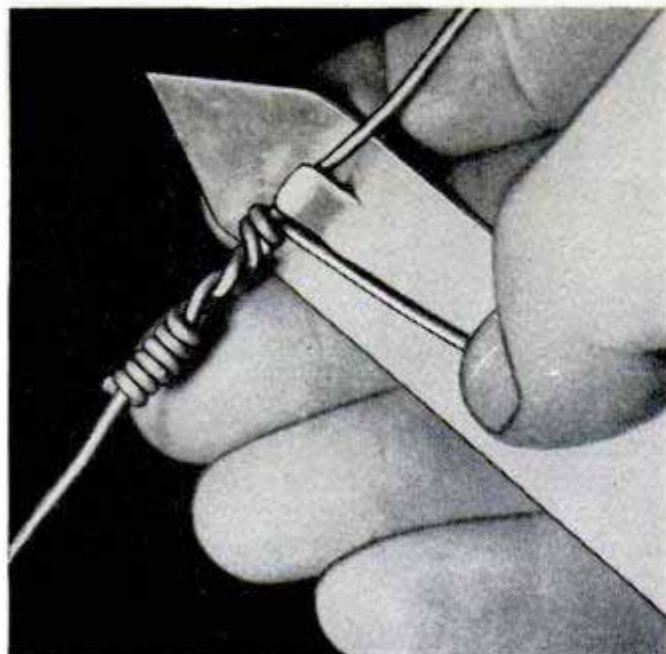

be spliced are first twisted together, making two or three turns by hand. These turns should be quite open to provide a place for soldering, when needed, and so that the portion of the wire under the greatest stress will not be bent too sharply. The splice is finished by hooking the can opener in position, as shown, and using it as a lever for making the outer turns of the splice coil very close together.

John M. Avery, Dexter, N. Y.

Cleaning Cloth Kept in Hub Cap

Have you ever finished changing a tire or making some other minor repair on a remote country road and then searched the car in vain for a cloth with which to wipe dust and grime from your hands? After experiencing this difficulty, one motorist placed clean cloths in each of the rear-wheel hubs so that they would always be available when making repairs on the road.

John Krill, North Lima, Ohio.

TRANSPARENCY VIEWER

From Bond Box

UNABLE to find a commercially built, electrically operated viewer which would handle transparencies up to $2\frac{1}{4} \times 3\frac{1}{4}$ in. and yet be small enough to be tucked under the arm, L. H. Georger of Buffalo, N. Y., made himself a neat one by starting out with a metal bond box. In addition to the viewer, there's room for storing as many as 200 transparencies. When not in use, the cord can be placed inside and the box locked, preventing unauthorized use and affording excellent protection for your prized transparencies.

A suitable bond box can be purchased at almost any book or stationery store. The partition which is added to divide the box into two compartments is cut from 20-ga. sheet metal, drilled for a toggle switch and flanged at each end for installing with small machine screws. Note that a small opening at one corner of the partition is provided for the electric cord. Ventholes are drilled in the lamp-house end of the bond box and suitable holes also are made for attaching two candle-base porcelain sockets to take 6-watt, 120-volt bulbs. The opal glass, mask



and ground glass are supported by the partition and a sheet-metal angle bolted to the ventilated end of the box, the edges being covered with strips of felt cemented in place. Extra masks of different sizes can be made for viewing 35-mm. transparencies, $2\frac{1}{4} \times 2\frac{1}{4}$ -in. etc. The lamps are wired in parallel according to the diagram and fitted with a 10-ft. length of cord.

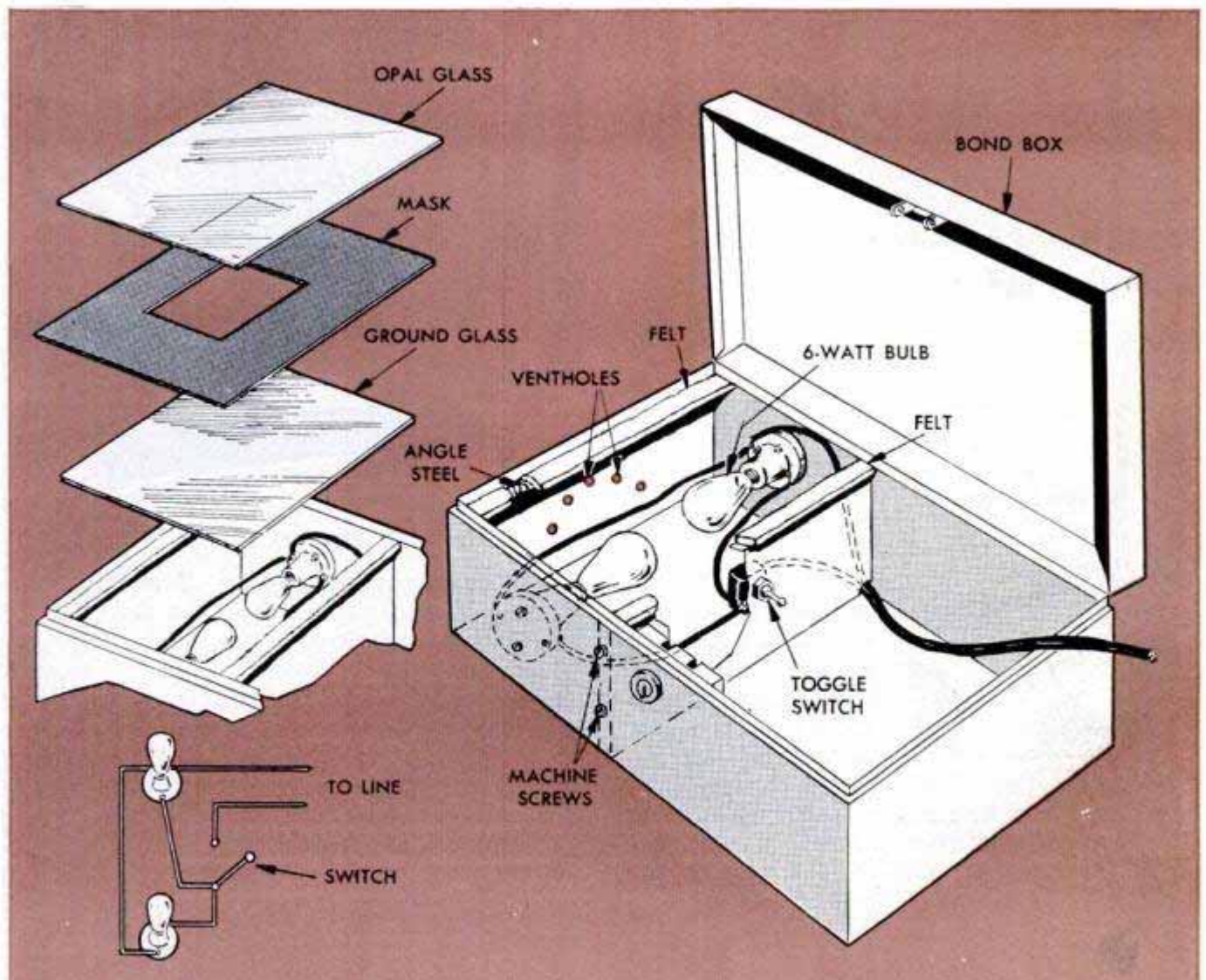

Broomstick and Xmas-Tree Holder Provide Photoflood-Lamp Stand

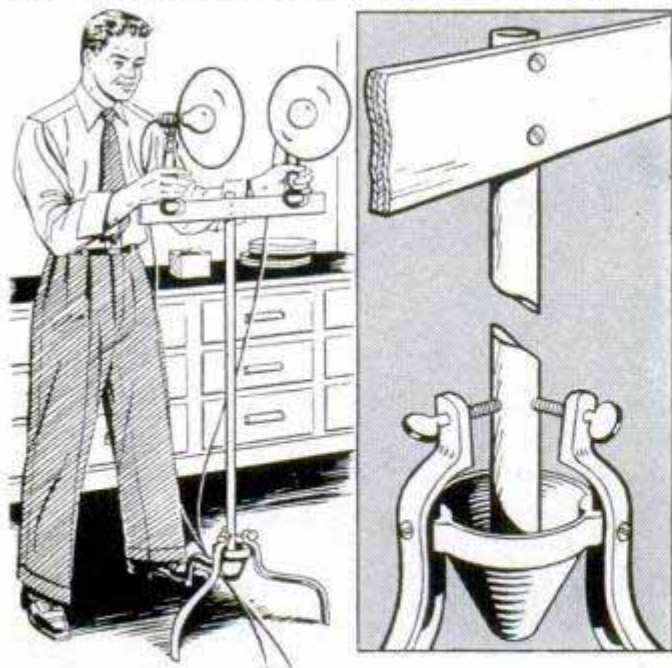

A Christmas-tree holder, that ordinarily must be stored for the greater part of the year, can be put to good use as a base for a photoflood-lamp stand. Simply attach a plywood crosspiece to the handle of a discarded broom, as illustrated, and fasten the broom handle in the holder as you would a Christmas tree. Clamp-on photofloods then can be clipped onto the crosspiece.

Making Settings After Dark

A miniature flashlight, similar to those sometimes carried on key chains, is useful for making settings in the dark. By keeping it in a clip attached to the camera, the light will always be at hand when needed.

Brush Hung in Rubber Cement Kept Pliable for Use

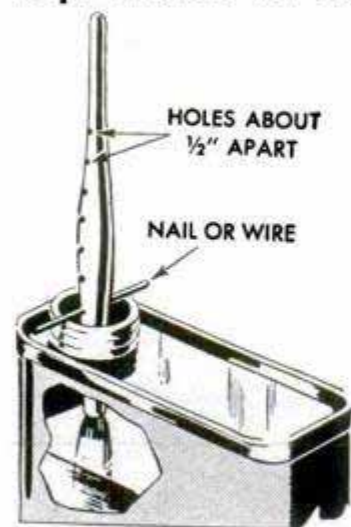

Photographers who use rubber cement for photo mounting will find that one sure way to keep the cement brush in a usable condition is to suspend it in the container with the bristles submerged in the liquid. To provide the necessary height adjustments, drill a row of equally spaced holes through the

handle of the brush. A finishing nail or short length of wire is passed through one of the holes and rests on the rim of the

opening in the container. To lower the brush as the contents of the container are used, withdraw the wire from the first hole in the handle and insert it in the next hole above.

Light Near Darkroom Clock Dimmed With Special Unit

If the red light in your darkroom is too bright to be used for illuminating the clock while prints are being processed, a device to dim the light, such as the one in the photograph, can be attached to the lamp socket. It can be purchased at most electrical-supply stores.



H. Leeper, Canton, Ohio.

Quick-Change Filter Holder Utilizes Large Paper Clip

One photographer speeded the process of using filters on an enlarger by substituting a spring-type paper clip for the regular filter holder. Held in the clip, as shown, the filters can be removed and replaced much more quickly than before. When it is necessary to adjust the projector lens,

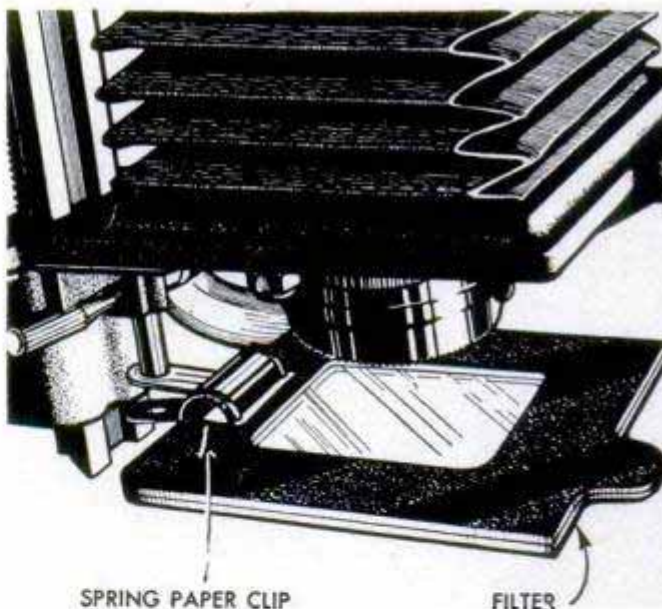

the filter is not in the way. The hole in a handle of the paper clip was simply enlarged to fit tightly over the rod which supported the original holder. Then the handle was bent slightly so that the clip would hold the filter in a horizontal position.

M. B. Clary, Seattle, Wash.

Small ferrotype tins can be stacked without being scratched if they are placed in between the pages of magazines.

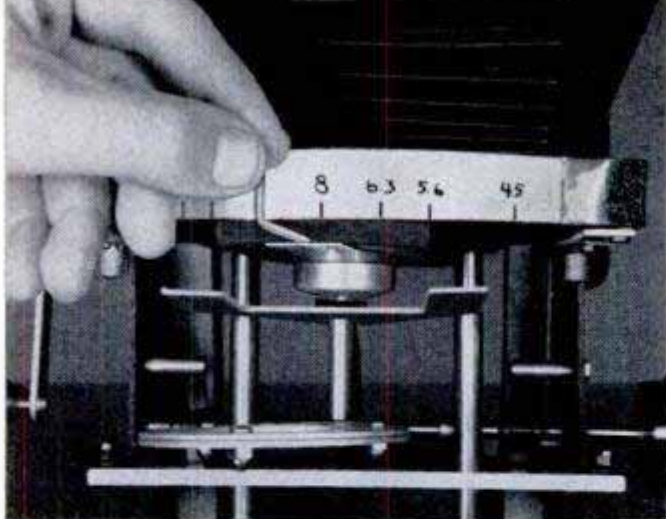

Above, the extended diaphragm scale is clearly visible even in the uncertain light of the darkroom. The pointer is adjustable. Right, when alternate lenses are used they are fitted with separate scales

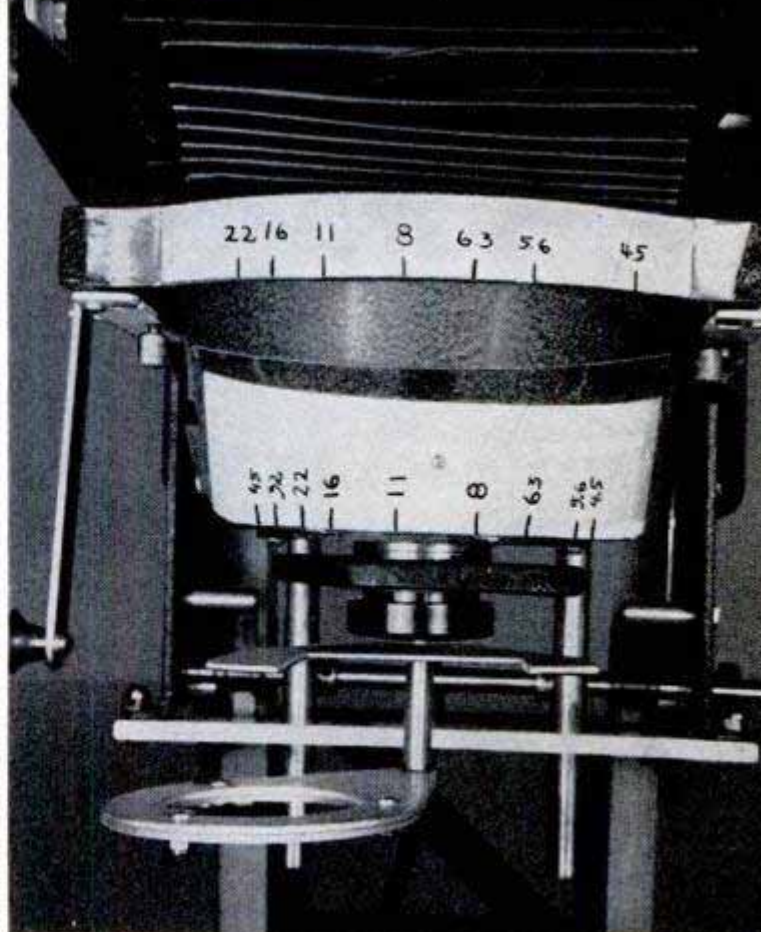

EXTENDED SCALE FOR ENLARGER LENS

By M. Richard Marx

IN THE UNCERTAIN glow of a darkroom safelight, it's usually difficult to see the small diaphragm scale on the enlarger lens clearly enough to make precision changes in settings. One photographer solved this problem by fitting his enlarger lens with a wire-pointer attachment and a scale fastened to the edge of the lens board. First, a piece of $\frac{3}{8}$ -in. hardwood was cut to the shape shown below to fit snugly over the diaphragm ring of the lens. Then an "L" pointer was bent from wire and attached to the block with a pressure plate cut from sheet metal. Finally, a strip of white paper was glued to the lens board and the stops and divisions transferred to the paper with pen and ink, the pointer being used to locate each division. Placing cellulose tape over the scale will protect it. For an auxiliary lens, use a separate scale, as shown.



Photos above and below show how a hardwood block and L-shaped pointer are fitted to the diaphragm ring

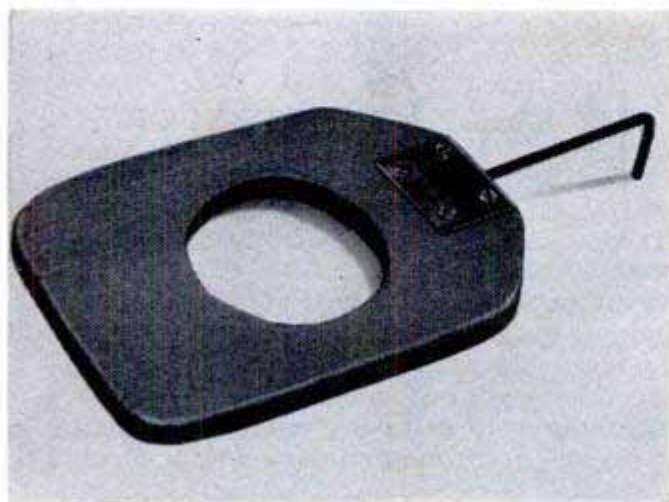

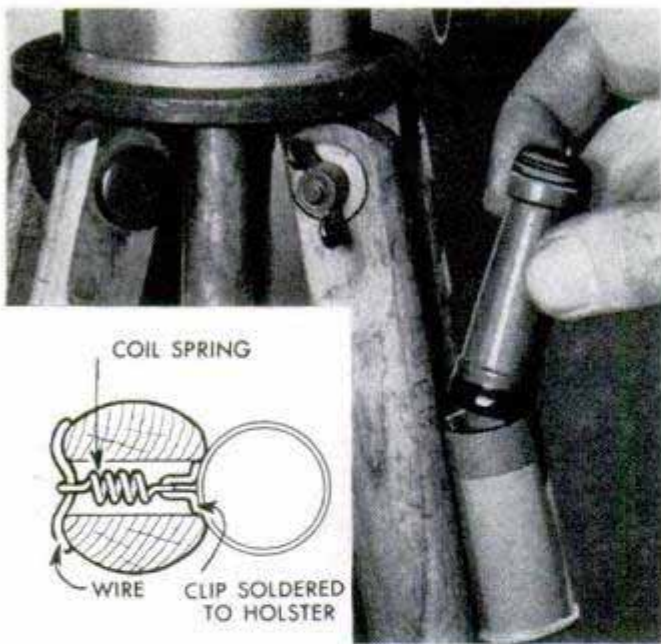

Holder for Ground-Glass Magnifier Attached to Tripod Leg

One photographer, who frequently uses a tubular-shaped magnifier to focus images sharply on the ground glass, made a holder for the magnifier by utilizing a small bouillon-cube can. After padding the can by placing a pledget of cotton in the bottom and covering the sharp rim at the opening with adhesive tape, a short length of wire is formed into a clip and soldered to the side of the can as shown in the detail. To attach the holder to a leg of the tripod, the latter being a split type, one end of a short

coil spring is hooked to the clip. Then, the spring is stretched through the opening in the leg and the other end hooked to a second short length of wire. Attached in this manner, the holder can be removed easily.
Walter E. Burton, Akron, Ohio.

Paper Clip Used on Photo Guide Aids in Making Camera Settings

When making camera settings from a dial-type photo guide, a paper clip will assist you in two ways. Placed in the proper position, it will mark selected settings for quick reference or recheck. The clip also will hold the various dials in place so that they will not accidentally be shifted while the guide is being handled. Should you ever put your camera away loaded and later forget what type of film it contains, a glance at the guide, with the paper clip still attached, will give you the answer.



Andrew Brennan, Philadelphia, Pa.

Brilliant, spot-free "glossies" can be assured by first washing the plates with a soapy, cellulose sponge.

Popular Mechanics Blueprint Service

With the vacation season past and long winter evenings just ahead, it's time to plan your winter's workshop program. It's just as easy and just as much fun to make practical and worth-while projects as it is to "tinker." At the same time, you will be saving money and, if you have a young son or daughter, here is a good opportunity to get them interested in a recreational as well as an instructive hobby under your supervision. *Popular Mechanics* has 330 interesting projects in blueprint form which range from a simple scrollsawed wall plaque to large boats and house trailers. Every project is completely detailed and dimensioned in perspective and exploded views so that even the most inexperienced person can follow it easily. A postal card addressed to Popular Mechanics Book Department, 204 East Ontario Street, Chicago 11, Illinois, will bring you a free catalogue of all our plans. For example, we have:

10-FT. DUCK BOAT, No. 703, which you can build in time for the duck season this fall. It is framed and canvas-covered, yet light in weight and seaworthy. Price 25 cents.

HOUSE TRAILER, No. 1091-1096, is a beautiful 17-ft. job complete with bedroom, kitchen, cabinets and running water, as well as toilet, closets, dressing table, etc. It is sturdily framed and covered with plywood. Price \$1.50.

LIVING-ROOM FURNITURE, No. 1118, covers a beautiful living-room suite consisting of chairs, tables, desk and sectional davenport. Built of solid wood and hardwood-faced plywoods, the suite is designed to look well in any setting, and is simplified in construction so that anyone can build it, even a manual-training student. Price \$4.00.

THREE EASILY MADE WORKBENCHES, No. 896-897, shows how to make a simple folding type of bench, a cabinet type with one drawer or a de luxe type having three drawers. All three are sturdily constructed. Price 50 cents.

WOODWORKERS' JOINTS, No. 544-545, pictures in detail most of the common wood-working joints used in furniture, cabinetry and other types of wood construction. It is especially helpful to the amateur carpenter and manual-training student. Price 50 cents.

FITTING A CHUCK *To Your Lathe*

SN 56

ONE OF THE MOST interesting turning jobs you'll want to do after buying your metal-turning lathe, and one that will save you money, is machining the chuck back when fitting the new chuck to the lathe. As supplied by the manufacturer, the chuck back is a rough casting and must be machined all over and internally threaded to fit the spindle nose. Most lathe chucks of professional quality are recessed to take the chuck back in a light, press fit and this calls for some accurate machine work.

For mounting a small, light chuck, the back can be turned from a tool-steel round. But for the larger, heavier chucks, it is best to use the cast back supplied by the manufacturer or make your own by turning a wooden pattern, as in Fig. 1, and having the back cast at a local foundry. The dimensions given are for a spindle having a diameter of 1½ in. with 8 threads to the inch, and may be varied to suit your particular spindle. To allow for machining, the casting pattern is made ⅛ in. oversize, and sufficient draft is provided so the pattern can be easily withdrawn from the molding sand. Note, also, that the center hole is tapered sharply. After turning the pattern, sand it smooth and apply two or three coats of shellac, sanding between coats.

To machine the rough casting, center it, hub outward, on the lathe faceplate and clamp it in place. Machine the flange and outer surface of the hub to size, and bore the hole for the threads, remembering that the hole must be 1½ in. in diameter less the depth of the threads. Then, grind an internal threading tool to the proper shape, checking it with a thread gauge as in Fig. 2, detail A. Give this tool slightly more front clearance than an external threading tool to prevent the heel of the tool from rubbing against the work. Insert the tool in a heavy boring bar, setting the tool exactly on the horizontal lathe center line as in detail B. Unscrew the faceplate from the spindle, and adjust the threading tool



A chuck that is fitted properly and handled carefully will give many years of satisfactory service

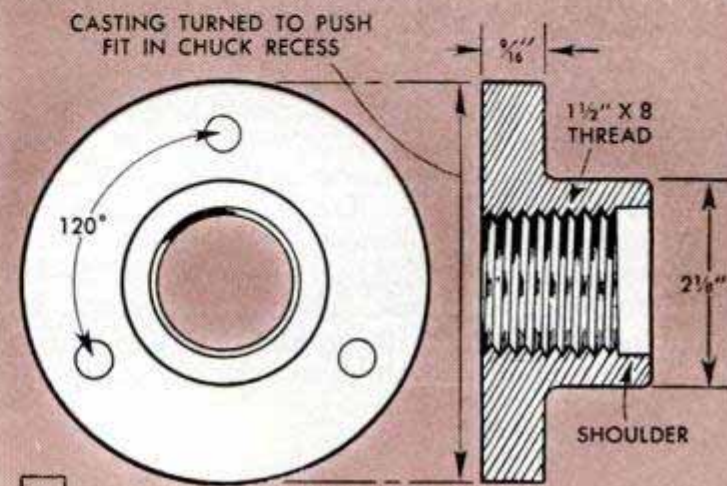
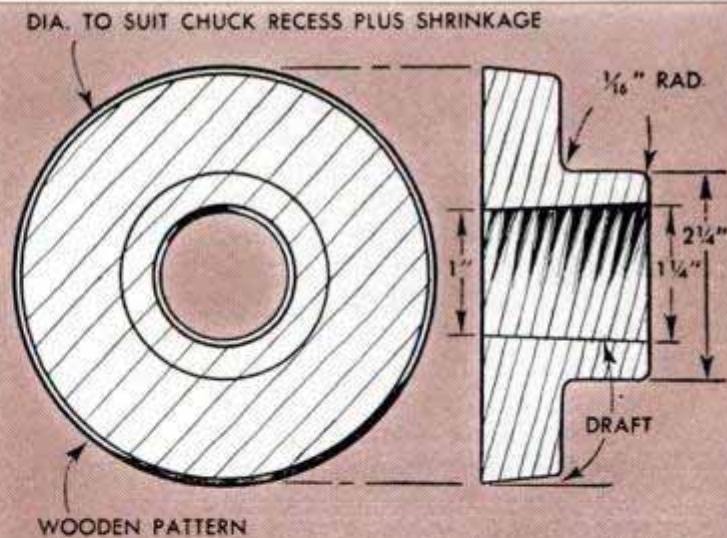

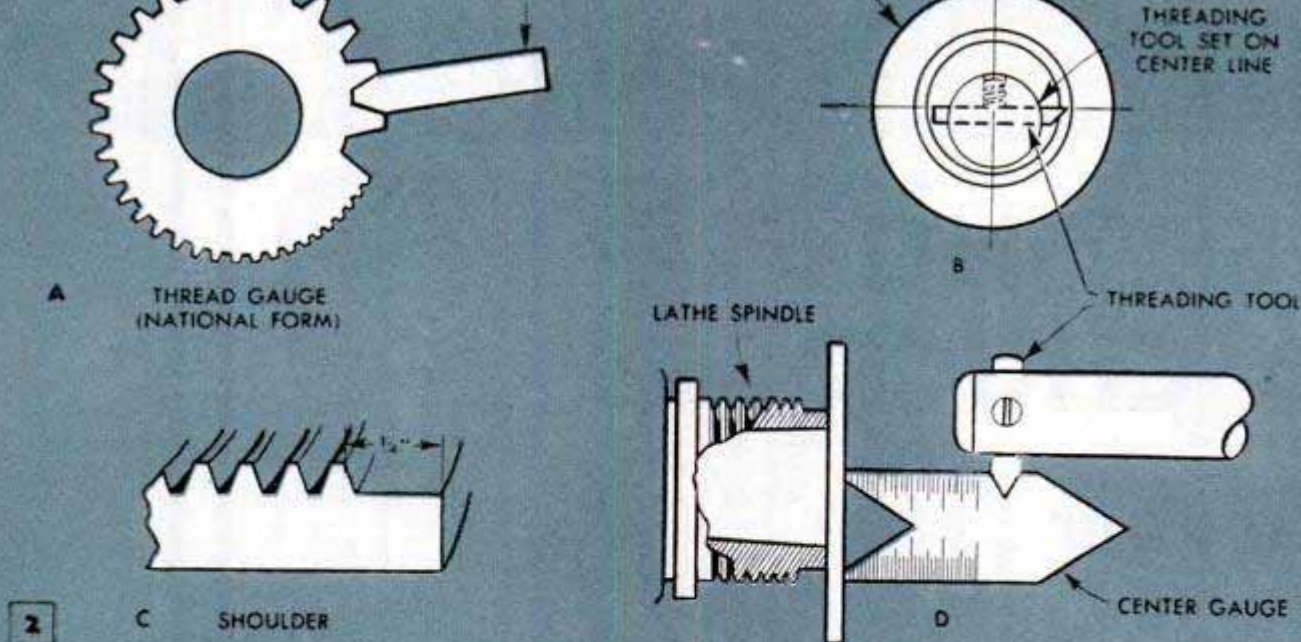

square with the work by fitting the point into a center gauge. The gauge is positioned on a disk held against the end of the spindle as in detail D. Adjust the boring bar in its holder with as little overhang as possible to prevent springing, and then replace the faceplate on the spindle.

When the threads are nearly completed, unscrew the faceplate from the spindle, with the work attached, and test the threaded hub of the chuck back for fit on the lathe spindle. If the threads are too tight, replace the faceplate on the spindle and take several finishing cuts with the thread-cutting tool. Repeat until a perfect fit is obtained.

Note in detail C that a $\frac{1}{4}$ -in. shoulder must be cut on the inside of the newly threaded hub. This allows the chuck back to be turned firmly against the shoulder on the spindle nose. The inside edge of the hole in the hub should be beveled slightly and the machined surfaces polished smooth with fine emery cloth.

Now, the work can be removed from the faceplate and the hub of the chuck back screwed onto the lathe spindle. The chuck back is faced square and the flange is turned to a firm push fit in the chuck recess. Take light finishing cuts, and frequently press the chuck over the flange to check the fit.

When the chuck back fits perfectly, remove it from the spindle. Chalk the face of the flange heavily and insert it in the chuck recess. Then tap the flange with a soft hammer to transfer the location of the bolt holes in the chuck to the chalked surface of the flange. Drill the bolt holes in the chuck-back flange $\frac{1}{16}$ in. larger than the diameter of the bolts used to fasten the back to the chuck. This is important, as binding of the bolts against the sides of the holes will impair the accuracy of the chuck.

After bolting the back to the chuck, mount the chuck on the lathe spindle, and use a dial indicator on the outer diameter of the chuck to check the alignment.

To insure long life and satisfactory results from your chuck, keep it clean. Be sure that no chips or dirt become embedded in the seating surfaces of the spindle, chuck or threads. The shoulder, face and pilot of the headstock spindle determine the accuracy of the chuck, so be careful not to nick or bump the shoulder and pilot.

When mounting the chuck, oil the threads of the spindle and chuck back. To turn the chuck onto the spindle, hold the chuck in the hand and turn the spindle pulley with the left hand until the chuck is just tight enough to hold securely. Do not switch on the lathe motor to screw the chuck onto the spindle and don't spin the chuck up to the shoulder, as doing this is likely to make the chuck difficult to remove. Lubricate your chuck frequently with No. 10 oil.

Overloading the chuck by mounting work that has a diameter larger than that of the chuck body extends the jaws to the point where undue strain is exerted on the screws or scroll. In addition, always use a wrench of the size provided with the chuck. Using a larger wrench for greater leverage will result in permanent damage to the scroll or screws, and also to the chuck jaws. If the jaws seem to be jammed, do not force them. Instead, disassemble the chuck and find the cause of the obstruction.

The chuck probably will need cleaning. When doing this, be sure to remove any chips that have worked into the jaw slots, screws or scroll. Oil all moving parts before reassembling. When the chuck is not in use, store it in a cabinet or on a shelf where it will be protected from dirt, chips and accidental damage.

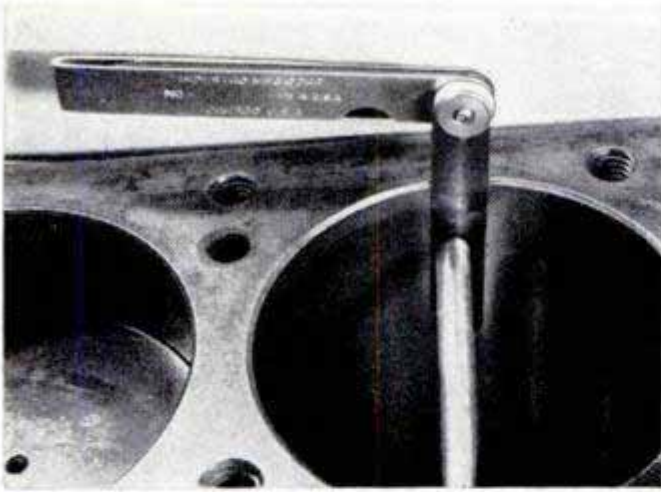

Cylinder Wear Measured With Feeler Gauge

In an emergency, one mechanic was able to gauge fairly accurately the amount of wear in the cylinders of an engine by using a length of steel rod and a feeler gauge. The rod was cut and the ends rounded slightly so that it would just fit crosswise inside the cylinder at the top where it was not worn. As the length of the rod then represented the original diameter, the amount of wear was determined by holding the rod at right angles to one wall of the cylinder and using the feeler gauge to check the space between the end of the rod and the opposite wall of the cylinder.

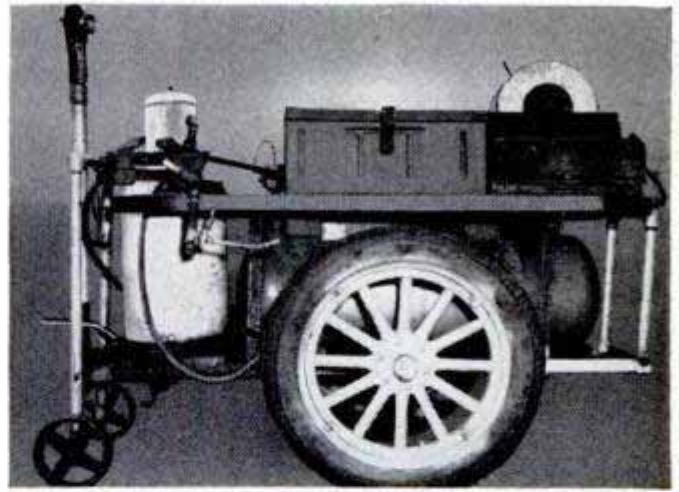

Portable "Garage" Services Farm Implements in Field

Originally designed and built as a power sprayer for paint and insecticides, the owner of this unit saw its possibilities for saving time when servicing farm equipment. He added a reel for a long air hose and tire chuck, built in a pressure greasing unit and fitted a two-wheeled front truck to support the trailer in the level position when the drawbar is unhooked. A small air-cooled engine supplies power for the compressor and grease gun and a hardwood plank attached to angle-steel brackets on one side of the unit serves as a bench for making minor repairs.

Small "Desk" for Truck Driver Mounted on Instrument Panel

Drivers of delivery trucks and cars will find this "desk" a real help in doing paper work involved in their jobs. Consisting of two sides and a top, the desk is made of solid stock and attached to the instrument panel by means of a thin strip of metal, the

latter being screwed to the underside of the desk and the ends bolted to the panel. To cut the profile of the panel in the edges of the sidepieces, first make a rough cut and then use a small compass to transfer an outline of the more intricate contours. A circular shaped piece of wood, approximately $\frac{1}{2}$ in. thick, is screwed to the desk to provide a convenient holder for a pocket watch. A large, spring-type paper clip or the type of clips shown will hold papers or pads to the desk.

Peter G. Gordon, Lansing, Ont., Can.

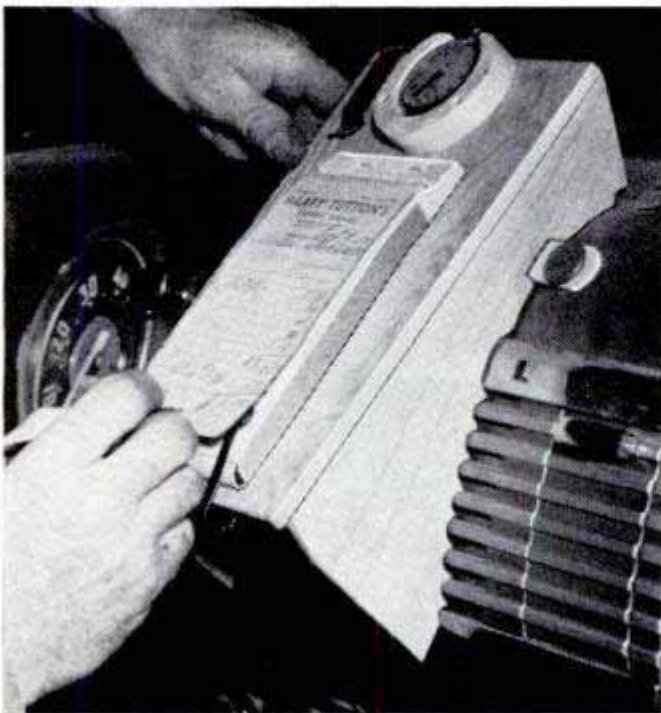

Removing Grease-Pencil Lines From Lettering Layouts

Laying out painted signs on oilcloth and other glossy-surfaced material usually requires the use of a grease pencil, but the pencil marks always present a problem when it comes to removing them after the sign is painted. In using turpentine, the tendency has been to smear the lettering. However, one sign painter found that a wad of cotton dipped in boiled linseed oil could be rubbed lightly over the work to remove the lines without spoiling the lettering.

Paul Will, Chicago.

Section Removed From Oil Drum To Make Washer for Car Parts

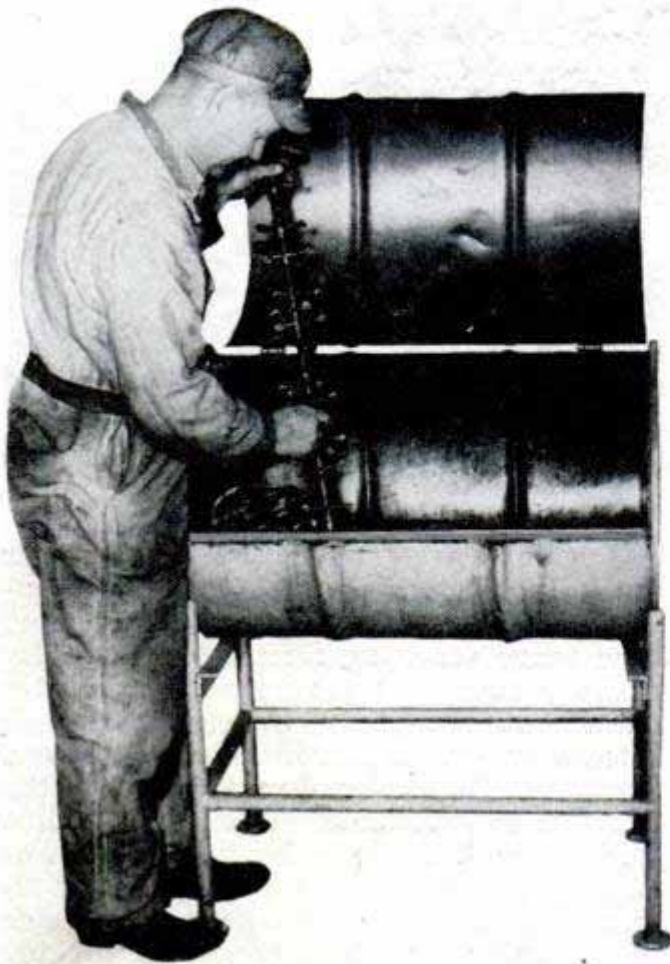

By cutting out one side of an oil drum and hinging it in place, a mechanic made an ideal washer for car parts. The portion of the drum removed was approximately one third of the circumference, the ends of the drum being left intact. To have the drum at a convenient height, it was mounted on a stand of pipe and angle steel welded together. The legs of the stand were fitted with flanges so it could be bolted to the floor. If desired, the pipe legs can be bushed and casters substituted for flanges to make the washer portable.

L. H. Houck, Jefferson City, Mo.

Improved Bushing Reamer



On a job that required enlarging the holes in several small fiber bushings, a cotter pin and a strip of emery cloth were used to improvise a reamer for this purpose. One end of the cloth was gripped between the legs of the cotter pin and then wound around the pin to provide a diameter just slightly less than the diameter of the holes

to be reamed. The cloth was wound in the same direction as the rotation of a hand drill, which was used to rotate the improvised reamer. This idea could be applied to many other jobs of this type where only a slight enlargement is necessary and a reamer is not available.

Dowel Tipped With Rubber Holds Linotype Slugs

To hold Linotype slugs in position in galleys while moving them about, one printer makes a special holder from a short length of dowel rod and two rubber pencil erasers of the slip-on type. The dowel is cut to a length slightly less than the inside width of the galley and the erasers are pressed over the ends. Then when the slugs have been placed in position in the galley, the holder is pressed against them to hold them in place. Because of the wedging action of the eraser-tipped dowel the slugs cannot slide out.

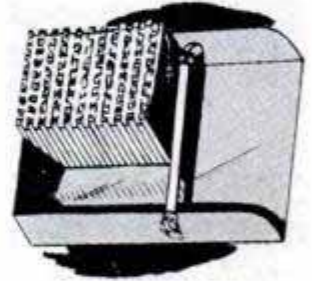

Dairy Barn Quickly Warmed By Blower-Type Heater

A bottle-gas heater, mounted on an overhead platform in his cow barn, allows one farmer to raise the temperature of the interior to 35 degs. in 10 to 30 min. As the added warmth is needed only at milking time, the rapidity with which it can be supplied is a special convenience. The heater (in this case a 45,000 B.T.U. blower-type unit) provides heat for the comfort of the milkers and helps prevent chapping of the cows' udders which sometimes is caused by washing them in cold weather.

A. M. Wettach, Mt. Pleasant, Iowa.

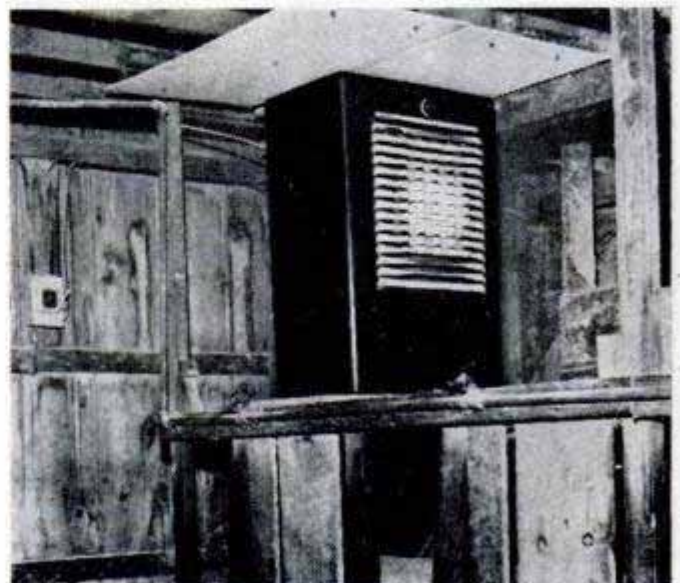

DRUM SANDER

For Your Workshop

By Dick Hutchinson

FOR LITTLE MORE than the cost of the wood, plus a pair of pillow blocks, you can make this efficient drum sander that will handle almost any surface-sanding job in the shop. Common lumberyard stock is used for the base as well as the two table units. Both of the units are made removable from the base to facilitate renewal of the abrasive. As it is important that the drum run dead true, it must be turned to size after being mounted on its shaft. This is done by drilling a hole lengthwise through the block and then cross-pinning it to the shaft with finishing nails set well below the surface. The assembly is mounted between lathe centers and turned down. Be careful to see that the drum is of the same diameter at both ends. To compensate for the double thickness of abrasive paper at the point where it is lapped, a shallow groove is run lengthwise in the drum as indicated. The height of each table unit is determined by the pillow blocks, plus the height of the brackets supporting them.

The abrasive strip is cut $\frac{3}{8}$ in. longer than the circumference of the drum to allow an overlap at the joint. To obtain a good glue joint, remove the grit from the end of the strip by soaking and scraping clean.

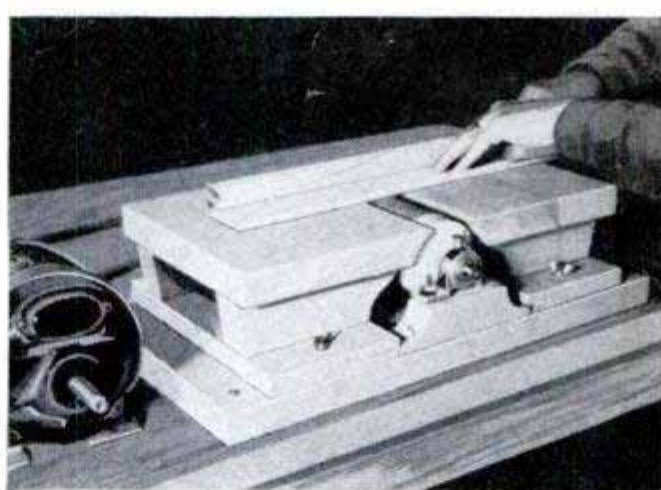

Two-piece table, bolted to the base of the sander, accommodates stock up to $7\frac{3}{4}$ in. wide. Wooden strip may be clamped over table to provide fence

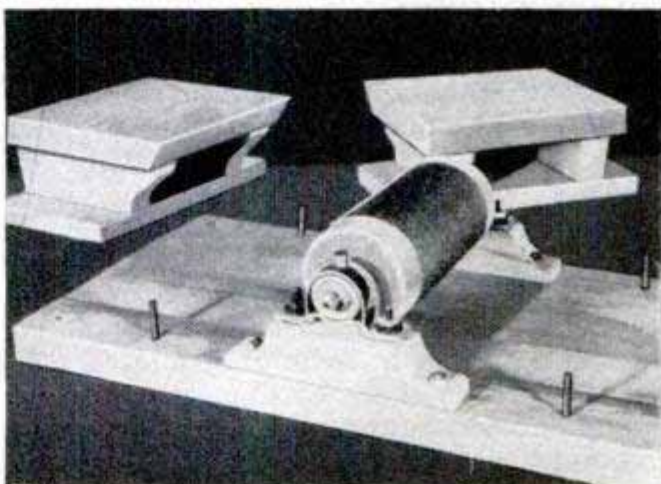

With the table removed, the abrasive drum is fully exposed for sanding curved work. Rubber washers or strips of rubber inserted under pillow blocks permit making fine adjustments in height of the drum

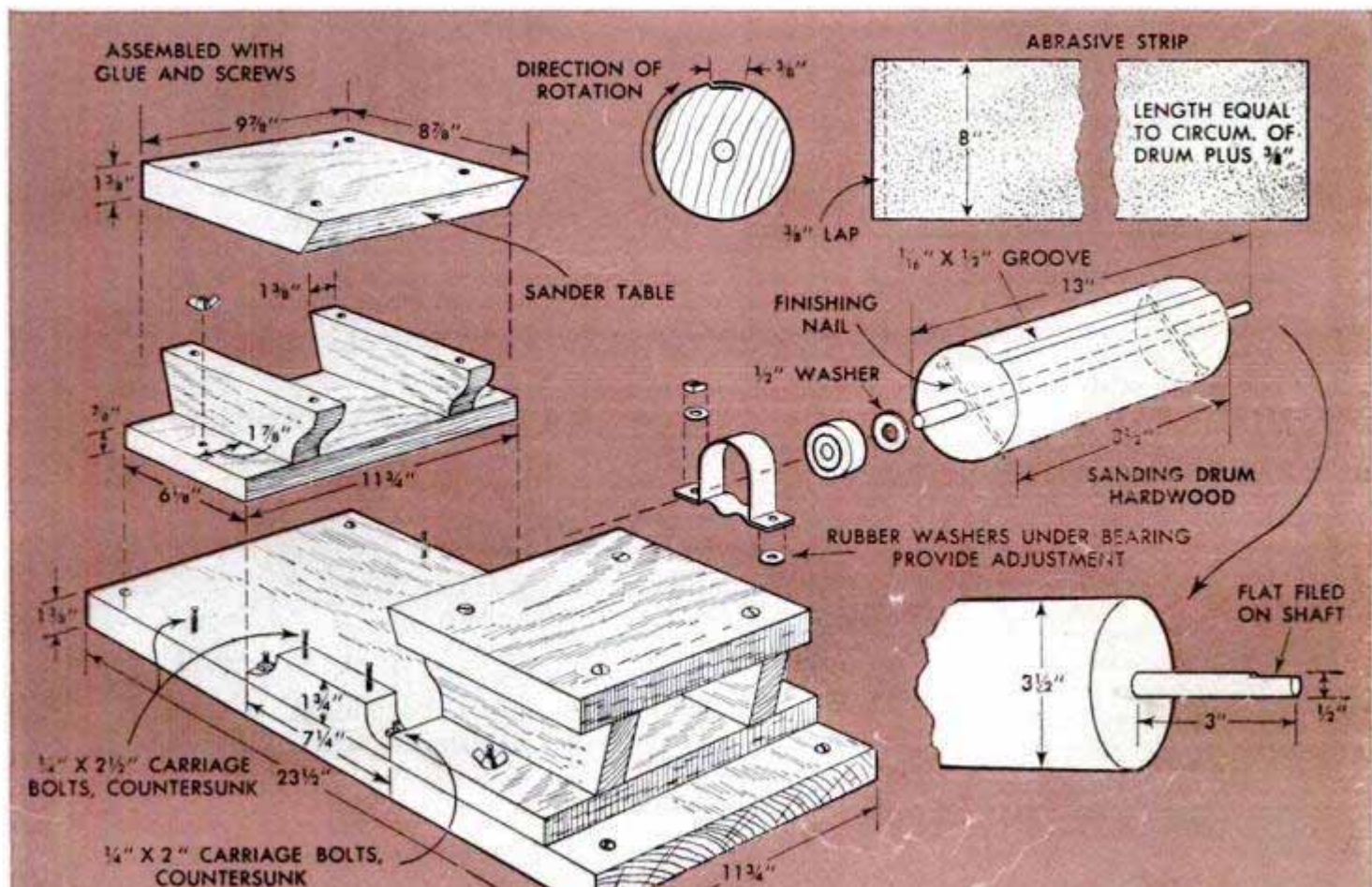



String Wrapped Around Cardboard Quickly Cut Into Equal Lengths

To save time when cutting a number of short lengths of string for tying shipping or labeling tags, use a piece of cardboard and a paper cutter of the type in the photograph. First, cut the cardboard to a width slightly more than half the required string length. Then wrap the string around the cardboard, anchoring the ends in slots cut in the cardboard. Trimming about $\frac{1}{4}$ in. from one edge of the cardboard will cut as many short strings as there are wrappings around the cardboard.

Preserving Metal Water Tanks

Painting metal water tanks once a year with a good grade of aluminum paint will help prevent rust deterioration. The tank should be emptied, thoroughly cleaned and allowed to dry before being painted. Apply paint inside and out, giving the tank at least two coats if it has never been painted before, and one coat yearly thereafter.

H. W. Strobe, Danville, Pa.

Hunt for Oldest Readers

How long have you been a reader of Popular Mechanics?

As part of our celebration of the Golden Anniversary of this magazine next January, the editors are seeking the names of our oldest regular readers—those who have subscribed to the magazine or bought it regularly at newsstands for nearly 50 years. Some, we believe, have read Popular Mechanics since it began publication in January 1902, and many have very complete files from the beginning.

If you are a "regular" of 40 years or more, send us your name and address and tell us how long you have read the magazine, and how far back your file of the magazine goes.

Address the Managing Editor, Popular Mechanics, 200 East Ontario St., Chicago 11, Ill.

Skinning Gambrel From Singletree

When butchering a beef many farmers use an ordinary singletree as a skinning gambrel. The singletree is supported by a tackle block as detailed, and the beef carcass is prepared by first skinning out the hind legs and then cutting away the flesh on each leg

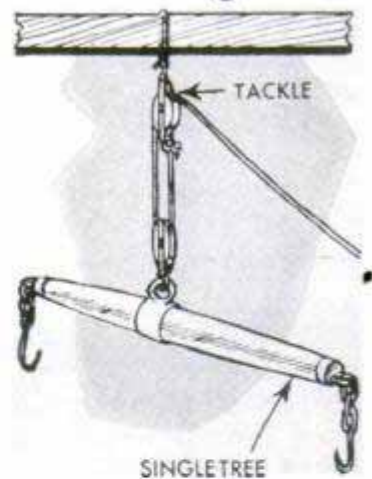

above the hoof to expose the tendon. The trace hook at each end of the singletree is then hooked around the tendon of each leg. In this manner, the carcass is easily raised by stages as the skinning progresses. A short singletree can be used in the same way to raise the carcass of a hog for cleaning and removing the bristles.—Kenneth Gabrosek, Fly Creek, New York.

Leas Refback & Company
Saw Has Easily Removed Motor
For Use on Other Tools

*W. Worthington & South, Norman
Chicago, Ill.*

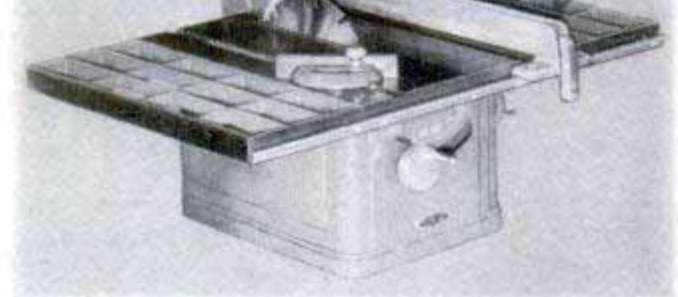

Tilting arbor, grid table extensions plus many accessories, such as dado cutter, molding head, cutoff wheels, etc., all combine to make this ball-bearing saw ideal for the home craftsman. Also, the motor can be removed easily and used to operate other tools for a one-motor shop.

Stiffening a Socket-Wrench Joint

If you've ever tried to fit a socket wrench equipped with universal joint over a nut in a hard-to-reach place, you'll appreciate this simple kink. Just slip a short length of light coil spring over the joint. This will hold the joint stiff but will not interfere with the operation of the wrench.



Make Yourself a MITER BOX

The common wooden miter box is a handy item to have for repairs around the home and can be made in a few minutes from a scrap board. Cut a straight 1 x 4 into three convenient lengths and nail them together, as shown, using three nails on each side, one at the center and one near each end. Additional nails are driven after cutting the saw kerfs. From both ends of a reference line drawn across the bottom of the box at 90 deg. to the sides, lay out 45-deg. lines. Then extend perpendiculars from opposite ends of each 45-deg. line to the top edges of the sides. Set the box right-side-up, locate the saw on the diagonals between opposite perpendiculars and cut two saw kerfs down through the sides.

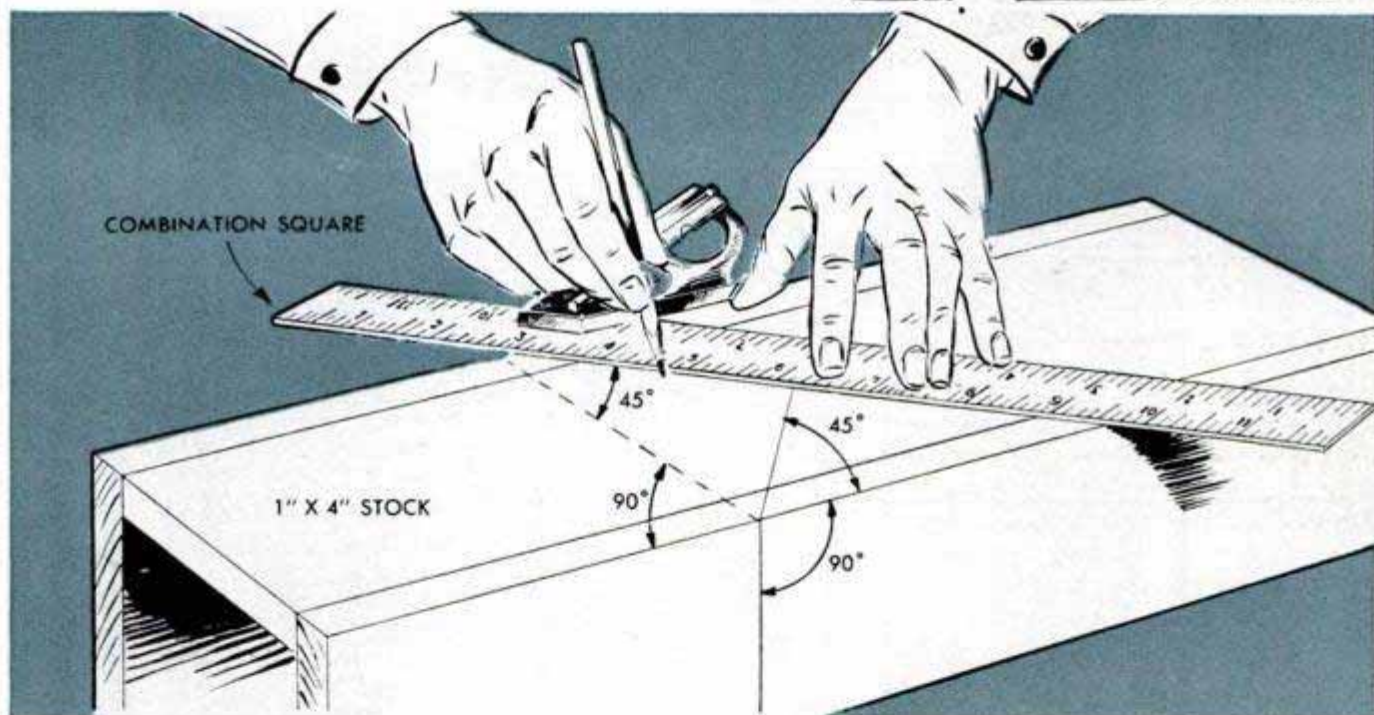

Proper Pre-Storage Treatment of Engine Minimizes Deterioration

A few days before putting a water-cooled engine in storage, drain the radiator and refill with water containing rust preventive. Immediately prior to storing, run the engine an hour or so on unleaded fuel having the proper octane value. Then change the oil, drain the radiator and start the engine again, running it one minute to circulate the oil and dry out the block. Stop the engine by removing the air cleaner and pouring a cup of oil containing rust preventive into the intake. Pour slowly, at first, then rapidly so as to stall the engine with the last of the oil. Remove the spark plugs and pour about a tablespoon of oil into each

cylinder. Then turn the engine over twice. If it is the type having overhead valves, remove the valve cover and check for moisture. If present, allow to dry thoroughly and then brush or spray a coat of oil over the valve springs, stems, rocker arms and other parts. Then replace the cover. Drain the carburetor and fill with a mixture of light oil and kerosene. Moisture accumulation due to sweating can be avoided by storing the engine in a dry, well-ventilated place. Turn the engine over with a crank periodically during storage to redistribute the oil and to alternate the valve springs being held under compression.

AUTOMATIC STANCHION ROW

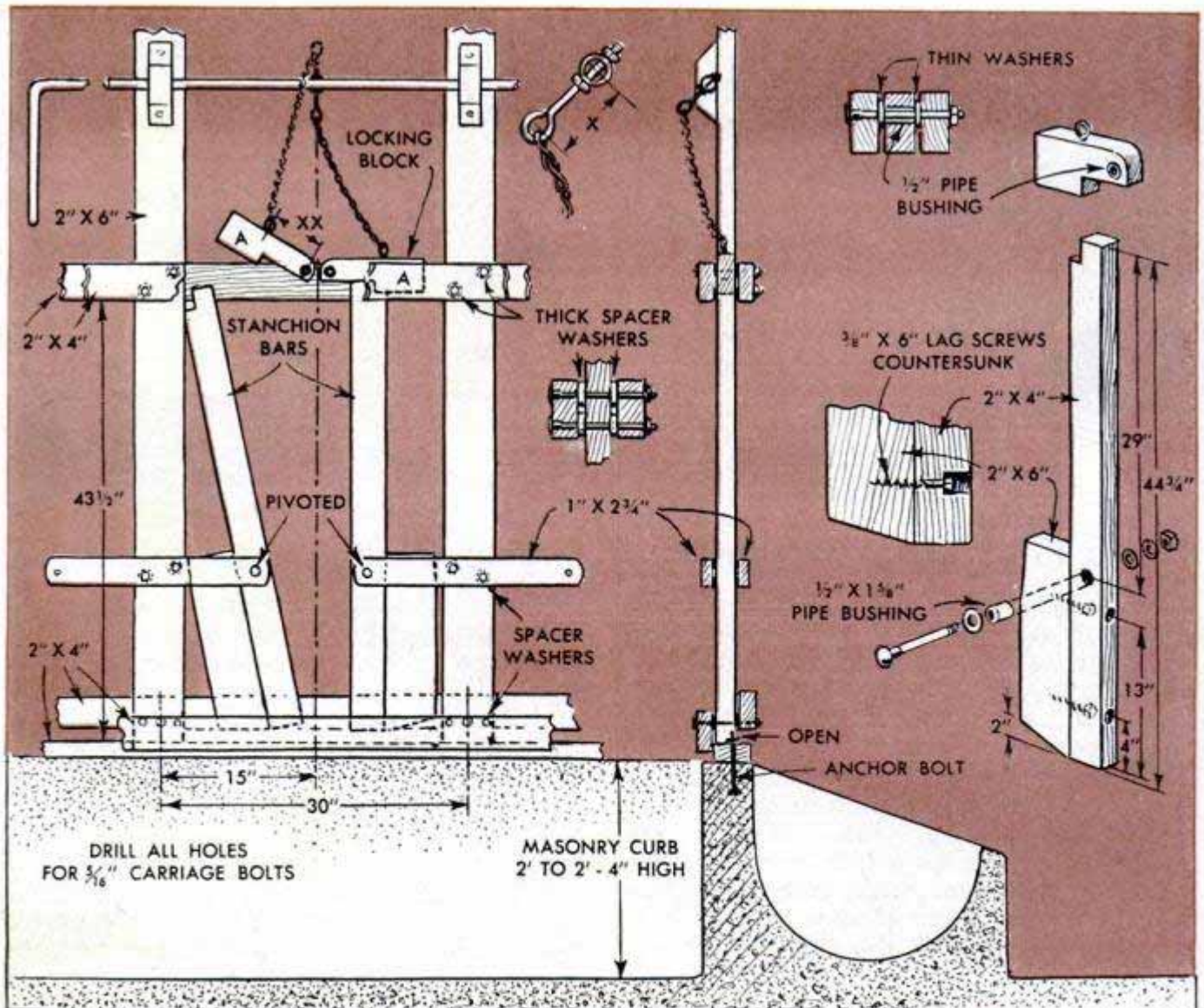
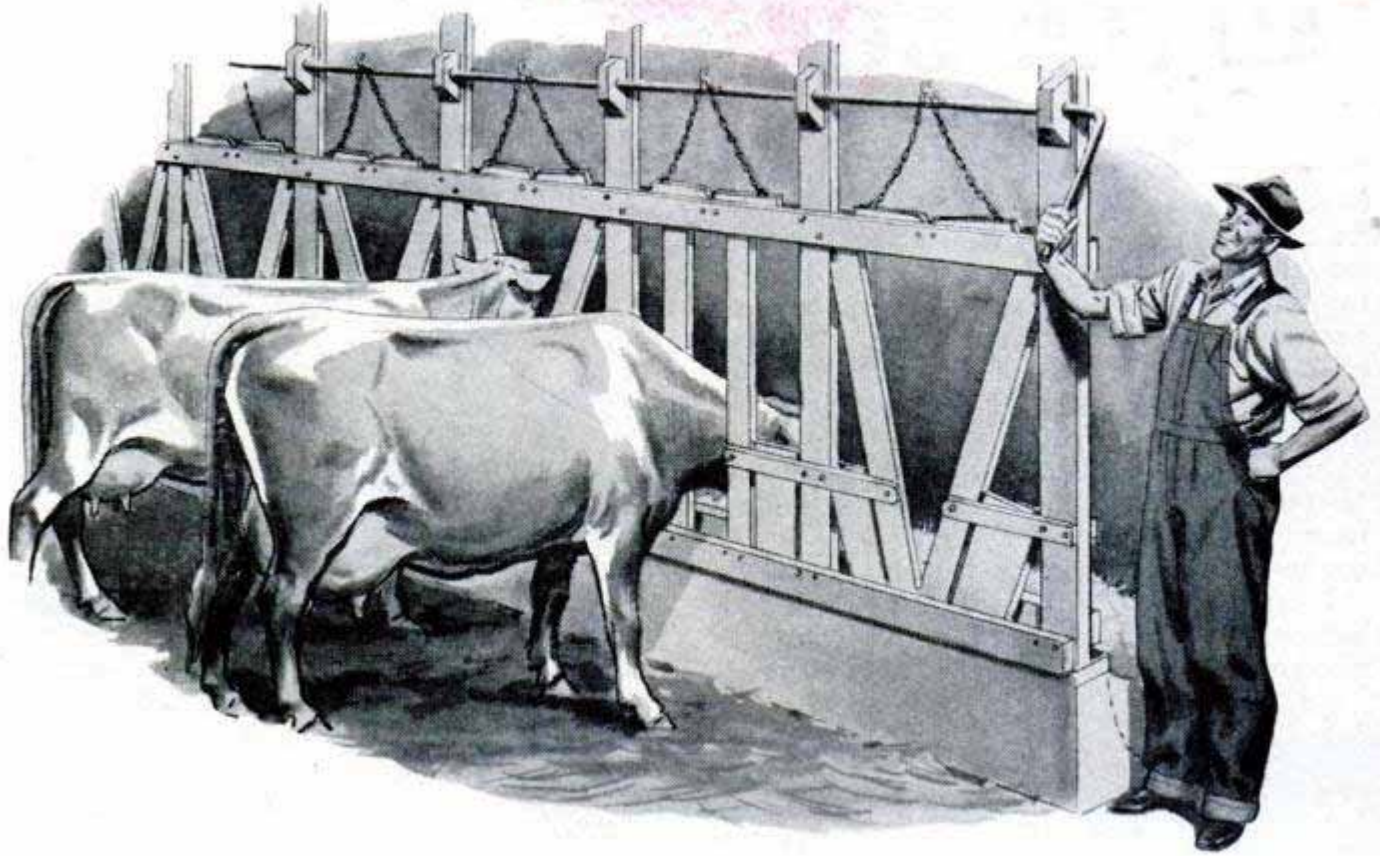

FOR DAIRY

IDEALLY SUITED to use on the farm where dairy cows are allowed free range at all times except when feeding and milking, this automatic stanchion row can be built in any barn in units of five or ten individual stanchions. As shown in the sectional view on the opposite page it is designed to be built on a concrete curb 2 ft., or 2 ft. 4 in. high. The entire stanchion row is controlled by a single lever at one end as shown in the upper illustration. Pulling up on the lever, as pictured, raises the locking blocks A and permits the stanchion bars to open, releasing the animals. At milking or feeding time, as each cow returns to her individual stanchion and lowers her head to reach the feed in the concrete manger, the stanchion bars close and lock automatically. For purposes of clarity, the single eyebolt is shown in two positions in the detail on the opposite page. The chain at the left in the detail is shown taut, the eyebolt being in a raised position. When the eyebolt is in the down position, the chain is slack, as shown at the right. Actually, in the assembly, both chains are attached to one eyebolt, as in the upper illustration. Dimensions X and XX on the detail must be worked out for each installation to assure that the locking device works freely on each unit. Adjustment of each eyebolt is provided by threading the body of the bolt for a distance equal to at least half its length. The main frame of the stanchion row is set up first, bolting the upright members to the ceiling. Horizontal members are bolted to the uprights with spacers between the members to permit free movement of the stanchion bars and locking blocks, as shown in the sectional view. Although the horizontal and vertical members of the frame can be built of pine or fir, the unit will be much more serviceable and durable if built entirely of hardwood, such as oak. Note that both stanchion bars and locking blocks are fitted with bushings to prevent undue wear. The control rod is made from a length of $\frac{3}{4}$ -in. pipe and extends the full length of the stanchion row. Ordinarily, the control rod is placed about 18 in. above the horizontal members, but it can be placed somewhat higher when more clearance is necessary. After the unit has been completed, sand the inner edges of the stanchion bars and round the corners slightly.

This Automatic Stanchion is covered by Babson Patent No. 1953875 but may be built by (or for) you for your own use. Permission to build this stanchion or copy these plans for resale purposes is NOT granted.

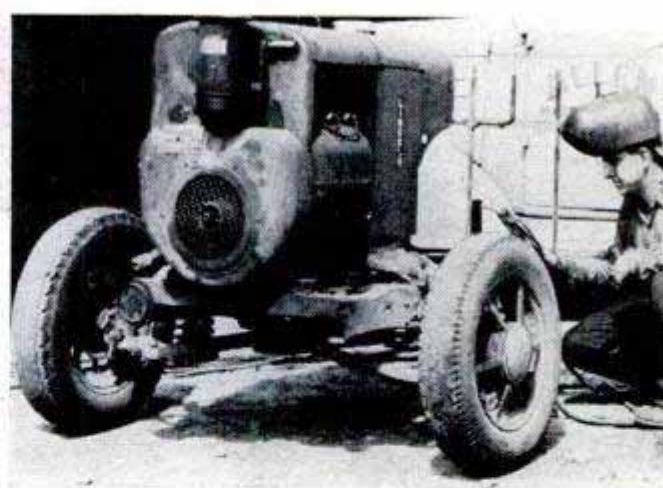

Welding Generator Is Mounted On Knee-Action Trailer

Needing a trailer for his welding generator that could travel over rough roads without damage to the equipment, one farm serviceman mounted the generator unit on a knee-action front end taken from an old car. All that was necessary was to provide mounting pads for the welder on top of the knee-action unit and add a suitable drawbar made from steel channel. A toolbox and racks for welding rods and materials can be added to suit individual requirements.

Removing Rust From Steel

Try this kink to remove light rust from steel surfaces. Rub the rusted areas with sweet oil and do not remove for at least 24 hrs. Then sprinkle unslaked lime over the oil and scour the rust off by rubbing with a coarse cloth.

Corner Posts of Poured Concrete Eliminate Diagonal Bracing

Heavy concrete corner posts made up as shown in the detail will eliminate the need for diagonal bracing in the fence corners. The ends of the wire are attached to lengths of galvanized pipe which are inserted through large eyebolts set in the concrete.

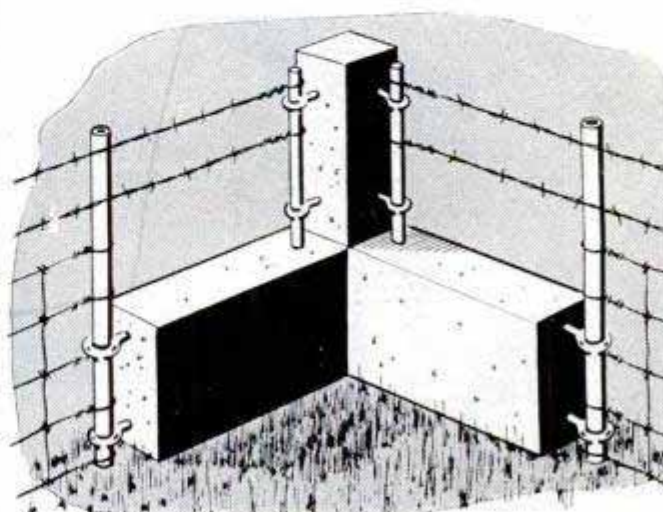

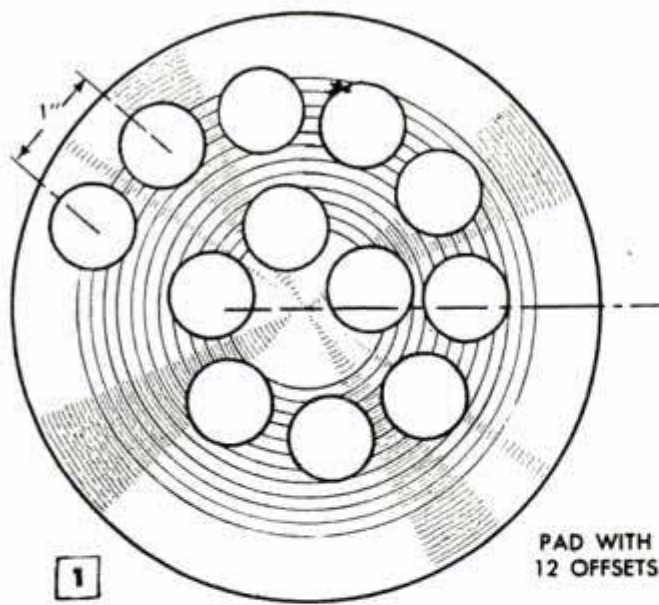

PAD WITH 12 OFFSETS

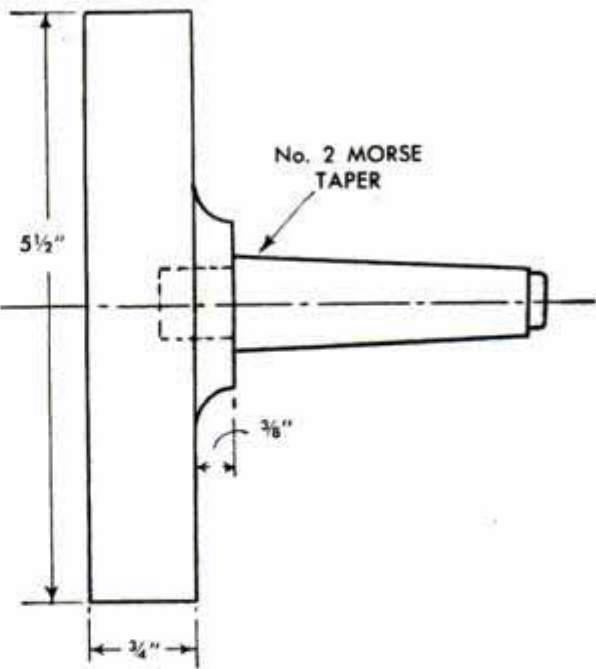

By

C. W. Woodson

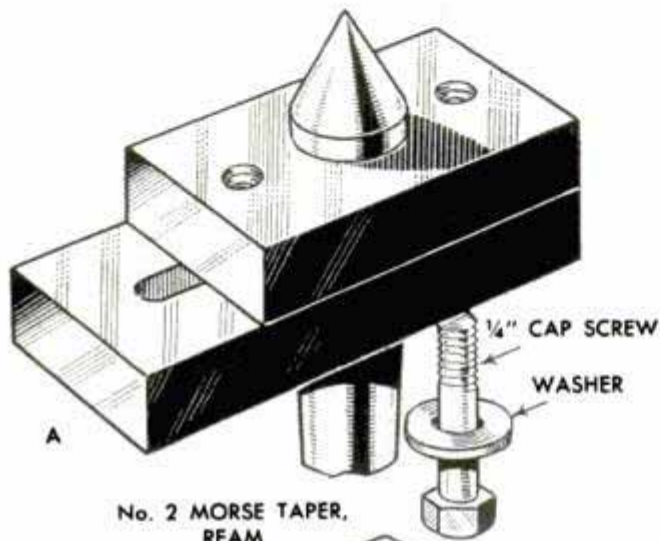

No. 2 MORSE TAPER, REAM

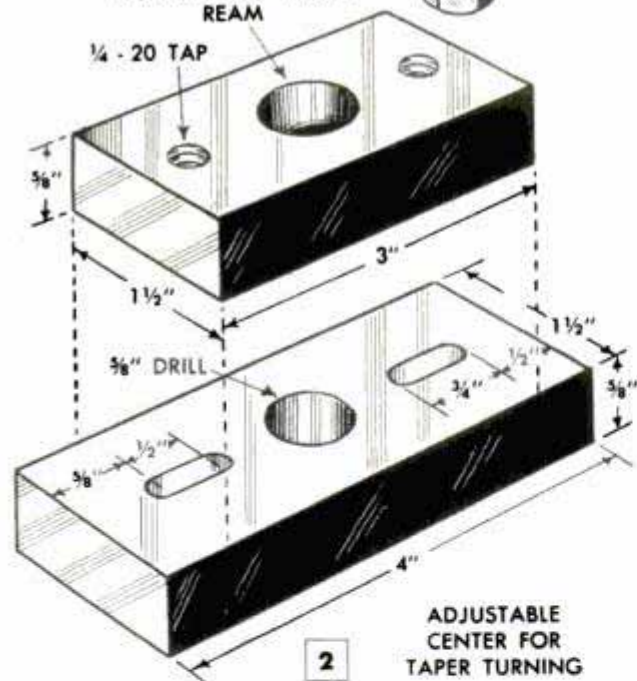

ADJUSTABLE CENTER FOR TAPER TURNING

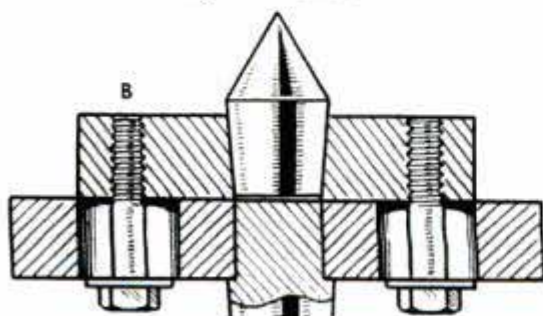

IN THE SMALL SHOP, nearly all ordinary taper turning can be handled with the lathe compound or with offset centers, thus saving the cost of a taper attachment. Steep tapers on short turnings are easily turned by hand-feeding the compound, the work being held in the chuck. Offset centers of the adjustable and nonadjustable types designed to fit in the tailstock quill are easily made from stock materials. For repetitive work, a single-offset nonadjustable center, made as in the upper detail in Fig. 3, is especially handy as setup time is reduced to the minimum. It consists of a rectangular block of steel through which holes are drilled and taper-reamed for a tapered chuck arbor and a standard 60-deg. lathe center. The holes are accurately offset to give the degree of taper required. A similar type of center providing three offsets is shown in the lower detail in Fig. 3, also in Fig. 4, the latter being made by drilling and taper-reaming three holes in an ordinary drill pad to take 60-deg. centers in three different positions. On all three types the distance from the master center, or the degree of the taper, is stamped on the body of the unit so that the center for turning the desired taper is easily selected.

Some lathe operators prefer to mount the work to be taper-turned on a ball center of the type detailed at the right in Fig. 4. When turning tapers on large-diameter work, the ball center gives somewhat better results as the semicircular contact surface tends to prevent heating and scoring of the center hole in the work. The semicircular hole, or recess, in the end of the work is formed with a round rotary file. The ball-

TAPER-TURNING ATTACHMENTS

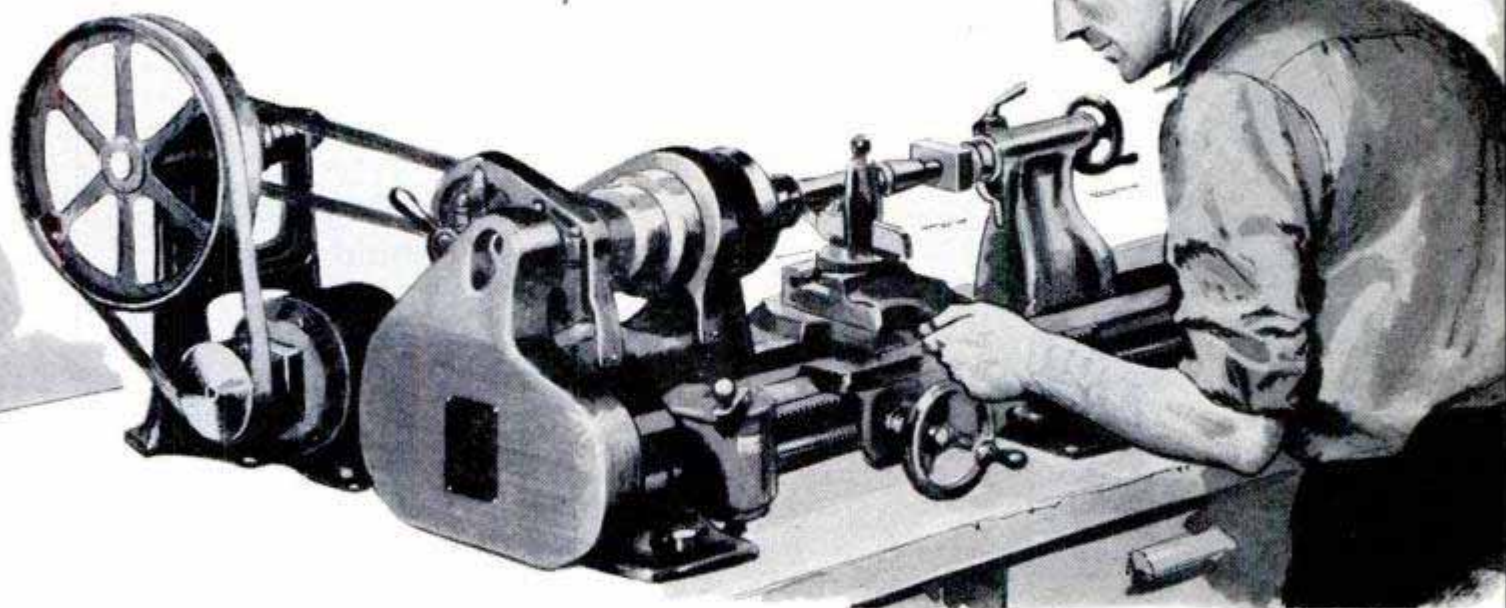

type center can be used in any of the units pictured and is especially useful in the offset units having multiple centers. All centers, either of the 60-deg. type or the ball type, should be machined and ground all over and if subjected to continuous, heavy-duty work, they should be hardened.

Another type, similar to the drill-pad adaptation detailed in Fig. 4, is shown in Fig. 1. This consists of a pad and separate tapered shank, the large end of which is shouldered and ground to a drive fit in a hole drilled and reamed in the center of the pad. After assembly, the face of the pad is scored with a spiral line as indicated, the spiral advancing $\frac{1}{8}$ in. per turn. Then a spiral line of holes is laid out on the spiral pattern as indicated. The holes are drilled to a uniform depth of $\frac{5}{8}$ in. and taper-reamed to take a single removable center either of the 60-deg. type, or the ball type.

An adjustable offset center, preferred by many machinists, is detailed in Fig. 2, A and B. This is built up by using two $\frac{5}{8} \times 1\frac{1}{2}$ -in. tool-steel blocks, the shorter block carrying the offset center being held in position on the longer block by means of cap screws inserted through slots cut in the larger block. Loosening the screws permits the smaller block to slide in either direction from center to the desired amount of offset. As shown in the sectional view B, Fig. 2, the offset center is fitted in a tapered hole while the stationary tailstock center is shouldered and ground to a drive fit in a straight hole drilled in the longer block. The slots in the stationary block should be filed or milled to exact width.

Taper turning by means of offset tailstock centers saves small machine shops cost of taper attachment

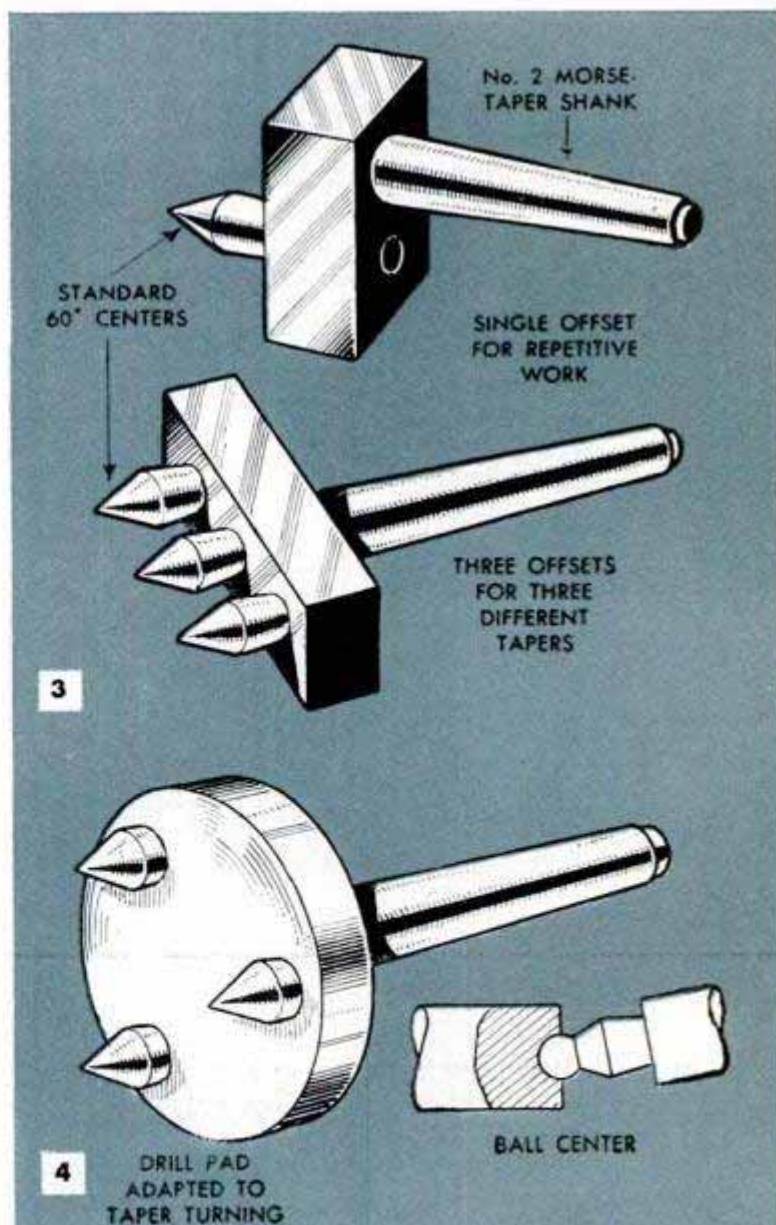

Water in Stock Tank Kept Cool By Oil Drum and Burlap Sacks



Water in a stock tank can be cooled to some extent by using an oil drum and two burlap sacks. Just place the drum in the tank bottom end up and drape the sacks over it as shown. Water drawn up into the sacks will evaporate and cause the drum to be cooled, which, in turn, will cool the water.

Stud Driver With Stop Pin Easily Backed Off Thread

The advantage of this stud-bolt driver is in the cross pin, which serves as a removable seat for the stud. When the latter has been driven, the pin is tapped out to provide easy removal of the driver from the stud. Made to fit two different sized studs, the driver is a 3-in. length of 1-in. hex stock, drilled and tapped lengthwise from each end, one hole running into the other. At the point where the holes meet, a hole is drilled transversely for insertion of the pin. The latter is cut from 1/4-in. drill rod and chamfered on both ends.

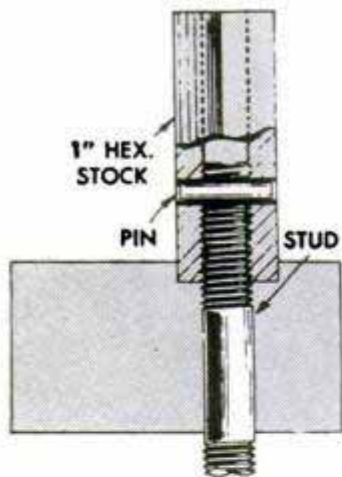

Mill-File Cleaning Tool Made From Steel Bar

An excellent cleaner for a single-cut mill file can be made from a piece of 1/2-in. cold-rolled bar steel in the following manner: First, the file to be cleaned is held by its edges in a vise, the face being slightly above the top of the vise jaws. Now, holding the

steel bar as you would a chisel, place it on the file near the tang and push the edge of the bar firmly across the face of the file, keeping the stroke in the same direction as the teeth. This will produce matching "teeth" in the edge of the bar, forming a comb which is used to rake the file teeth clean by merely meshing the comb with the grooves in the file.

John Eichberger, Franklin Park, Ill.

Skids Protect Feeding Trough When Towed Behind Truck

To permit towing a heavy feeding trough safely with a truck, one farmer equips it with skids made from the main leaves of two car springs and a length of steel rod. The leaves are screwed to the under edges of the trough end and the rod passed through the eyes of the leaves, as shown, and stapled to the top edges of the trough. A large screw eye is turned into the edge of the trough to permit hooking it to the truck.

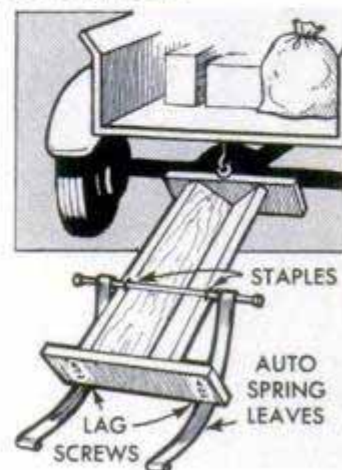

Fifth-Wheel Steering Arrangement Adapted to Spray Trailer

In order to increase the maneuverability of his spray trailer, one farmer converted the conventional front-wheel assembly, which was taken from a car, to a fifth-wheel arrangement. First, the wheels were

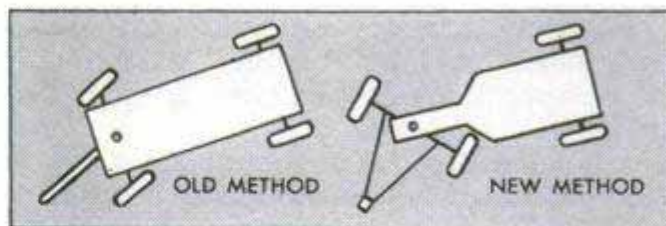

locked by welds at the steering knuckles. A short length of 6-in. channel steel was drilled to take the kingpin and welded across the top of the axle, web side up. Then, a ball-thrust bearing and kingpin assembly were mounted on the channel steel, the bearing being taken from the transmission of an old Mack truck. Finally, the sides of the trailer bed were cut back, as shown in the diagram, to provide wheel clearance when making sharp turns.

☐ A crack in a distributor cap can be temporarily sealed by applying nail polish.

Designed to take advantage of the various shapes of stock materials, the drill-press V-blocks shown can be made with a minimum of machining. The upper illustration shows a block made from cold-rolled steel to which two heavy side bars are screwed. The bars should be clamped together and the notches cut on a shaper or miller. The block at left center is made in a similar manner, the notches being cut in vertical members of two lengths of angle iron. These are screwed to a cold-rolled steel base. Illustrated at right center is a V-block that is made by cutting notches in a large pipe flange, while the block at lower left is simply a short length of channel iron with notches cut in the flanges. Of course, it is important that the two notches cut in each of the four blocks mentioned be exactly the same size and

V-Blocks for Holding Round Drill-Press Work Designed to Utilize Stock Materials

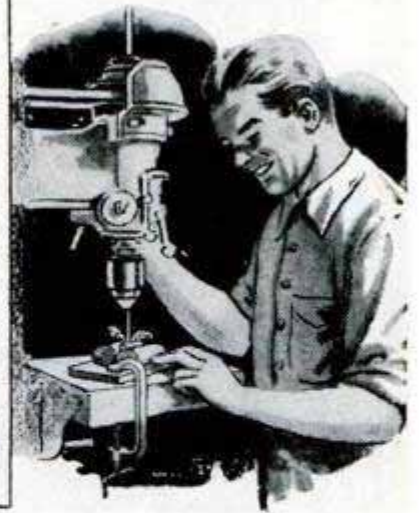
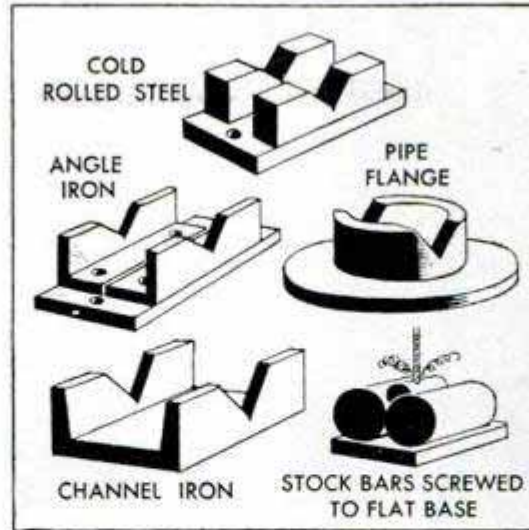

depth so that when used the work will be supported at a right angle to the drill. However, the block shown at lower right can be made without cutting any notches, as it consists only of two round-stock bars that are screwed side by side to a cold-rolled-steel base. Here, the work is cradled between the two rods which form a vee.

Parts Salvaged From Scrap Pile Used to Make Welding-Shop Floor Fan

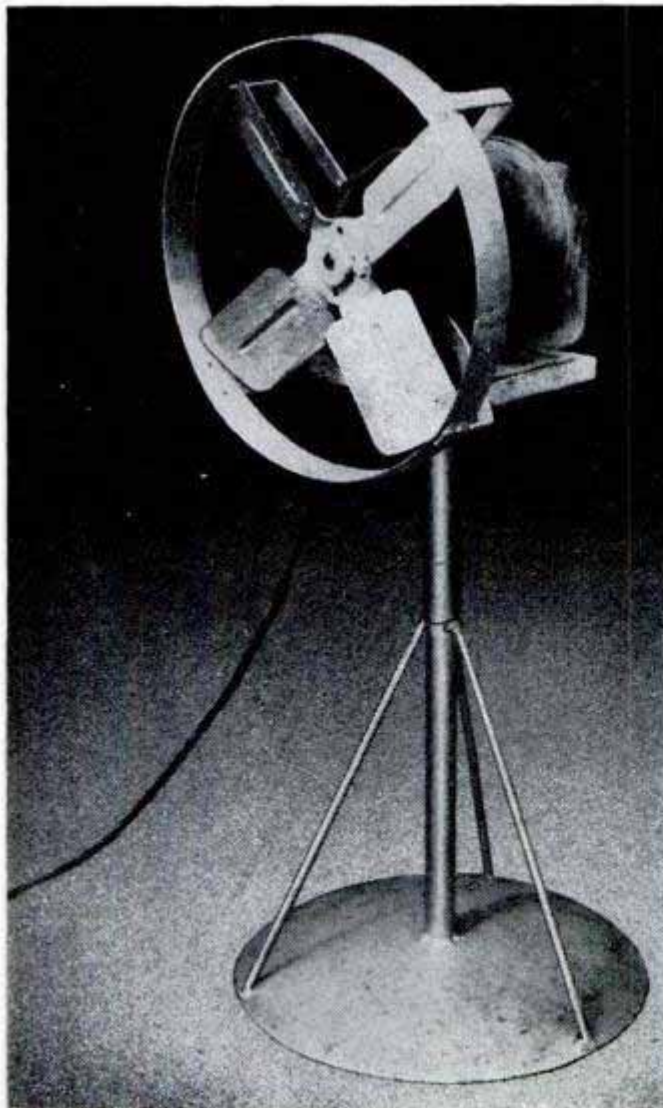

Needing a floor fan to drive off fumes and smoke when working in a closed shop, a welder made one that cost him little more than the $\frac{1}{4}$ -hp. motor. All other parts were taken from the scrap pile. A fan from an old-model car was fitted directly to the shaft of the motor and a simple guard was formed from a strip of sheet metal. This was held in position by four flat-steel braces that were welded to the guard and bent at right angles to bolt to the motor. To make the stand for the motor, a steel pipe was welded to a disk-harrow blade and braced with three steel rods as shown. A $\frac{1}{2}$ -in. steel plate was welded to the top end of the pipe and drilled to provide for bolting the motor. If desired, the front of the guard can be covered with coarse-mesh screen as a further safety measure.

Glycerin Speeds Handling Papers

Office workers or others who handle large quantities of papers or currency will find that a small amount of glycerin rubbed on the hands will make their job easier. The glycerin provides friction between the fingers and the papers, making the use of cumbersome rubber "fingers" or other mechanical devices unnecessary. A light application of glycerin will last for several hours and is not harmful to the skin. It can be obtained at any drugstore.

Alton M. Weiss, Nedrow, N. Y.

SHOPPING

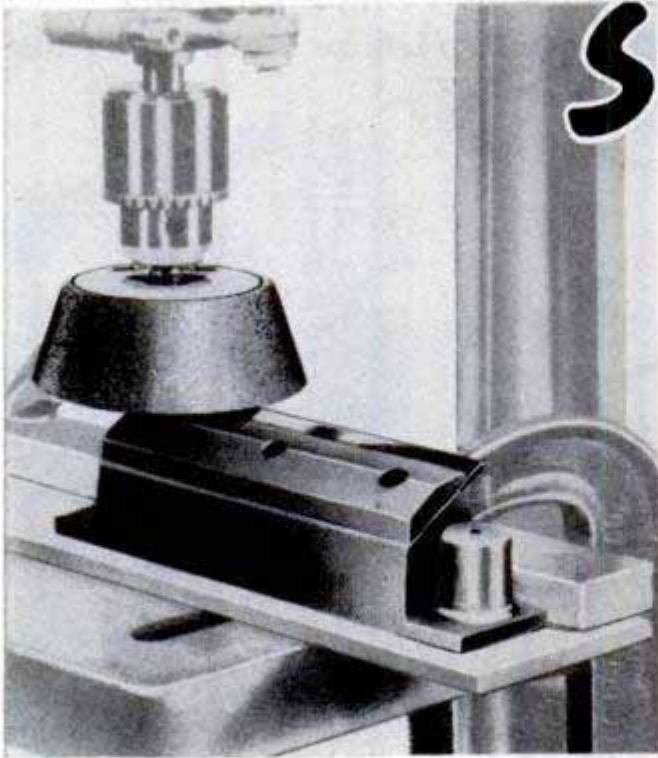

COMBINATION SHARPENING and reinstallation jig for 4 and 6-in. jointers has been developed for use with a cup-type grinding wheel driven by a drill press. The cup wheel is furnished with the jig and is fitted with a special arbor for use in the drill-press chuck. In use, the jig holds the knife at the correct angle for grinding. Installation of the knives in the jointer head is made easy by a gauge built into the jig



VERTICAL ROTARY ATTACHMENT for small screw-cutting lathes replaces the compound slide and permits work to be handled in the horizontal plane at any angle to the lathe spindle. Thus, jig boring, circular and radial milling, graduating and cam work are possible to do on small lathes in the popular sizes. Spindle nose is threaded to take standard lathe chucks and other attachments designed for use with these lathes

ABRASIVE BAND for use on industrial contour-grinding machines has been recently made available for grinding hard alloys; also glass, quartz, marble and granite. It consists of an alloy-steel band to which spaced abrasive matrices are attached by a welding process, and in the cutting action there is an equalized balance between the bonding and abrasive grits which constantly exposes new abrasive as the band wears. Made in two designs and two grit sizes to permit a variety of operations on hardened metals and wear-resistant, nonferrous alloys

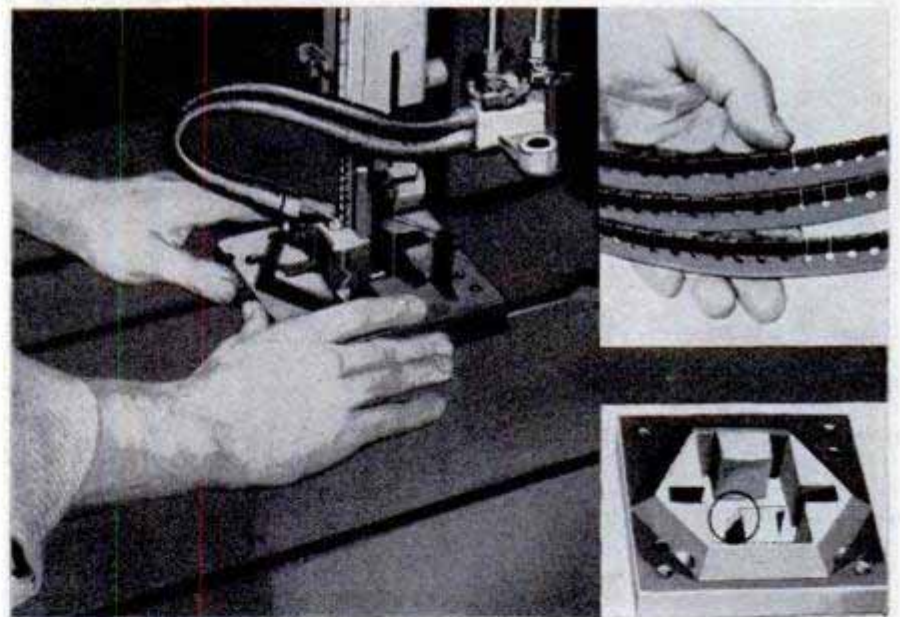

ELECTRIC PAINT REMOVER peels paint, enamels and varnish to the bare wood in one easy stroke. The 200-watt heating element heats quickly to operating temperature. Unit is fitted with a 2-in. scraper blade of special design for lifting the softened paint film from the surface. In use, the remover is placed on the paint with the bottom, or shoe, parallel with the surface and is moved in a short, back-and-forth stroke

FOR TOOLS

FACE SHIELDS with interchangeable visors designed to protect against injury from impact of flying particles and chemical splash are available with three new headgear types furnished with and without spark guards. Basic headgear is fitted with a crown strap which supports the weight of the visor without the necessity of a tight fit around the wearer's head. Basic unit is constructed of hard, preformed fiber and is adjustable to a range of head sizes. Sweatband is padded to prevent chafing. Finger-controlled friction joints on each side of the headband permit quick adjustment of tension for holding the spark guard and visor in the desired position

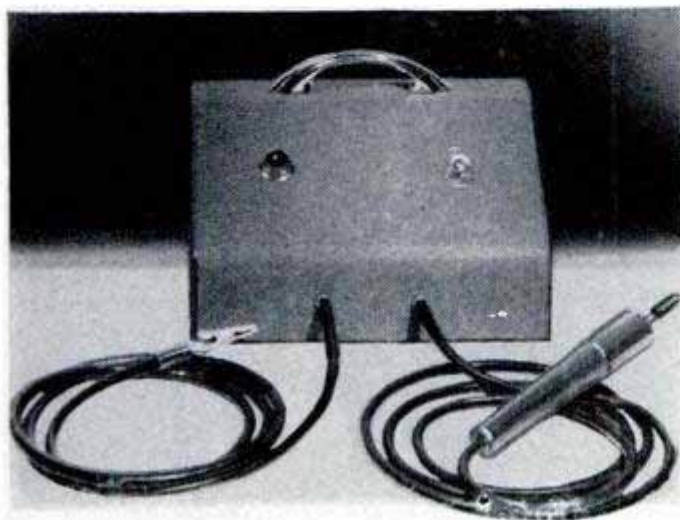

RESISTANCE SOLDERING UNIT is safer, faster on duplicate and multiple soldering operations on small parts. Unit is of the instant-heat, resistance type and operates on essentially the same principle as an arc welder. When used according to the manufacturer's instructions, unit is shockproof and highly efficient

POCKET-SIZE WIRE STRIPPER now being manufactured features an automatic camming action that eliminates crushing of stranded wire while stripping. Squeezing the handles causes the tool to grip the wire, cut the insulation and strip it free in one operation. Made in four models and sizes to handle all common wire gauges from No. 8 to No. 22. Blades are interchangeable on all models. A fifth model is especially designed for radio and television servicemen. Average weight of about 10 oz. makes it easy to use the stripper continuously over long periods of time without causing undue fatigue

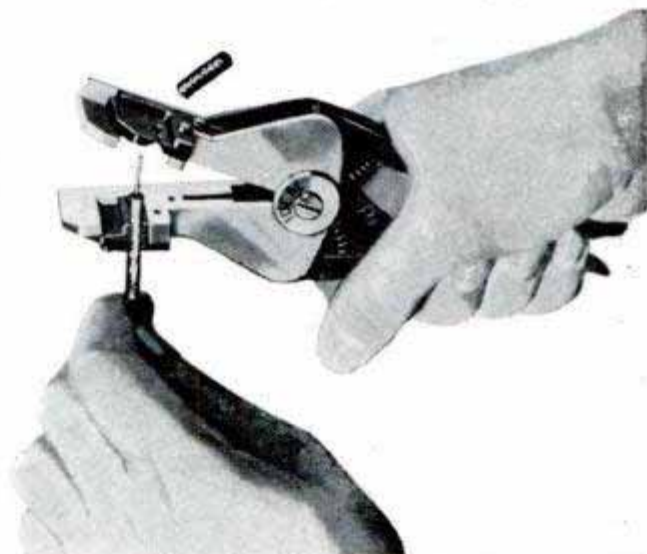

ADJUSTABLE WRENCH is especially designed for use on chrome-plated nuts without marring or otherwise damaging the plated surface. The jaws are instantly adjustable from 0 to 2½ in., an adjustment range which makes the wrench particularly useful to plumbers when assembling chrome-plated fittings on lavatories, bathtubs and sinks. The movable jaw is locked in any position by means of a spring-actuated ratchet arrangement which holds firmly

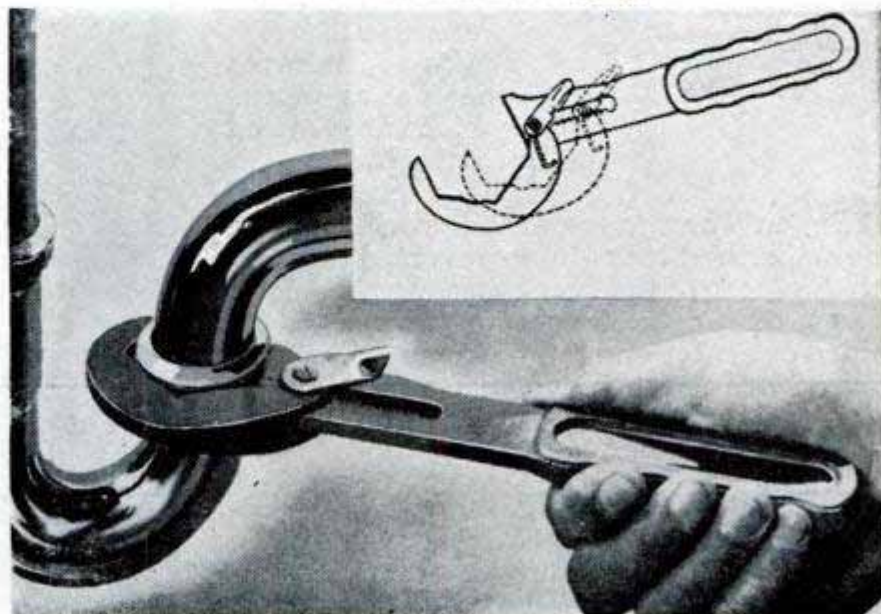

Odd-Shaped Faceplate Work Held With Drill-Press Vise

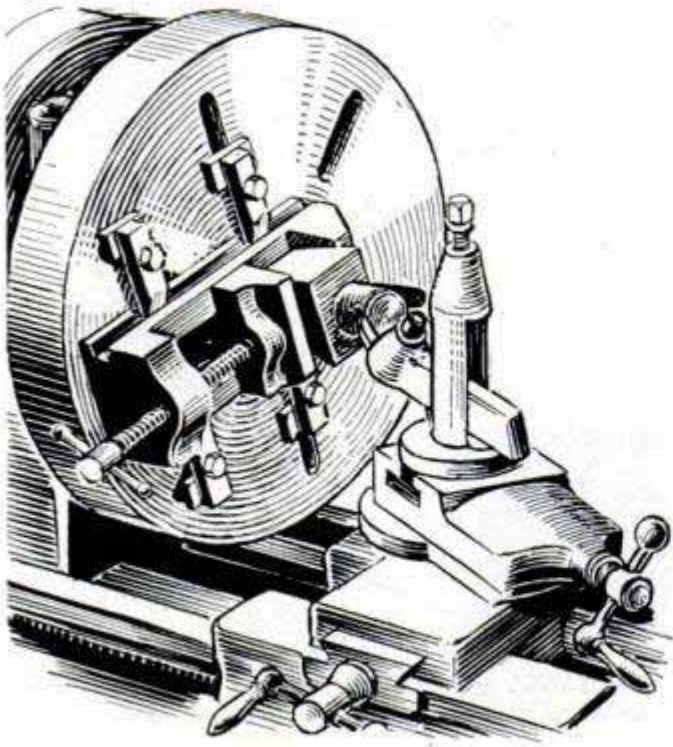

Odd-shaped work that is difficult to hold securely in a lathe chuck can sometimes be placed in a drill-press vise and the vise clamped to a faceplate. For safety purposes, the handle of the vise should be fastened down, and if high speeds are needed to turn the work, a weight should be attached to counterbalance the vise.

Stringer for Basement Stairs Made From Waste Blocks

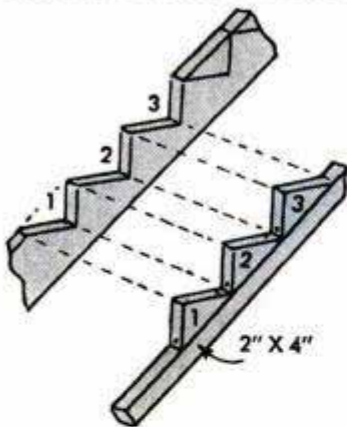

Instead of using two planks to make a pair of stringers for a basement stairway, one carpenter does the job with only one plank and a 2 x 4. To do so, he saves the waste blocks which are sawed from the plank when cutting one

stringer. Then to make the other stringer, he nails the blocks in an inverted position to the 2 x 4. In the event three stringers are required for an extra-strong stairway, the third or center one can be made from waste blocks of the other two stringers.

Long-Life Fence Posts

Improvement cutting in wood lots besides being good for the trees usually can be made to yield a number of fence posts. The posts should be stripped of about 30

in. of bark and placed in an oil drum filled with a solution of pentachlorophenol, 5 percent and range or fuel oil, 95 percent. After a 48-hour soaking, such posts will last at least 20 years, as compared with untreated posts which last only from 3 to 5 years.

Charles L. Stratton, Hollis, N. H.

Artist's Brushes Protected When Stored in Fly Box

Fly boxes, of the pocket type used by fishermen for storing and carrying dry flies, make excellent storage cases for small quills and brushes used by artists and sign painters. Remove the felt pad

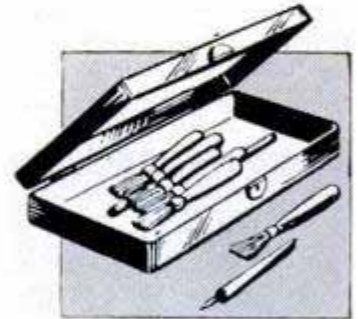

from the bottom of the box so that the full depth is available for storage of brushes. Before the brushes are placed in the container they should be thoroughly cleaned in turpentine or other suitable solvent, and then dipped in lard oil to prevent hardening of any residues remaining in the bristles.

Rustproofing Quenching Pots On Bench Grinder

The quenching pots on a bench grinder can be kept from rusting by coating the inside with collodion or airplane dope. First remove any accumulation of rust and then apply two or three coats to the inside surfaces, allowing each coat to dry thoroughly before applying the next one.

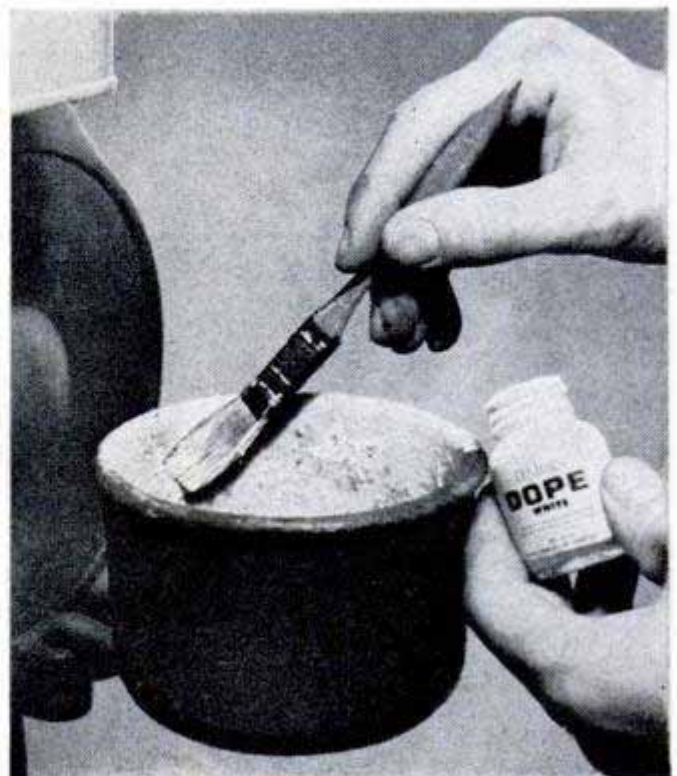

ROCKEFELLER CENTER *Trains for Civil Defense*

BECAUSE of its concentrated 15 modern buildings, Rockefeller Center might form a bull's-eye on Manhattan Island for enemy A-bombs. Keenly aware of this possibility, the center is girding itself for any emergency. After months of study, organization and training, the center recently conducted a series of tests under simulated air-raid conditions.

The total organization includes more than 1000 volunteers, and utilizes a wide variety of special equipment including Motorola FM two-way "handie talkie" portable radiophones and "pack sets." These permit instantaneous contact between points anywhere on the 12-acre development. Photo A shows one emergency squad in action putting out a fire in a corridor.

Photo B shows warden William Rodgers in the 16-story Eastern Air Lines building receiving a call for medical assistance from an upper floor over the house-phone system. He is relaying the request for aid to medical headquarters by means of the portable radiophone. The nerve center of the defense organization is the control board, photo C, located on the second floor of the 70-story RCA building. As the man at the left receives calls from the building wardens, instructions to first-aid and fire-fighting squads are relayed by the dispatcher.

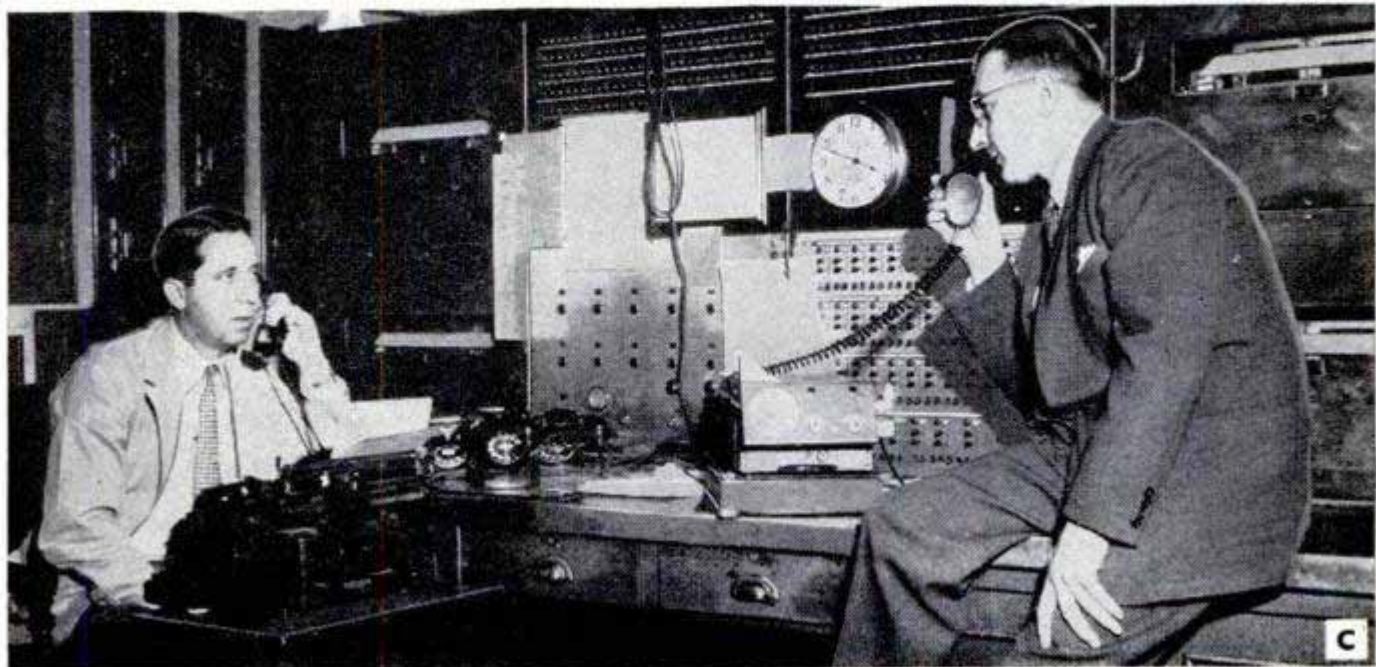

SIMPLE 80-METER CODE RECEIVER

By S. A. Johnson WØLBV

PERHAPS you have had a desire to become a radio amateur and participate in private two-way radio communication or experimentation, but have been discouraged in taking it up because of the 13-word-per-minute code examination. The new novice-class license, made available July 1, 1951, was good news for such would-be radio amateurs, as the code requirement is reduced to only five words per minute. This means that with a little practice using a key and a buzzer, and some concentrated listening with a homemade receiver like the one described in this article, you can build up sufficient code speed to pass the test and get on the air. The examination consists of the code test, sending and receiving at five words per minute and a short, simple examination in radio theory and law designed to test the very basic qualifications of the applicant. This novice "training on the air" license is issued for a one-year period only.

Once on the air, the "novice ham" can get the experience needed to go after a more advanced type of license. The new license sets aside frequencies within the 80-meter code band—and this band is ideal for the newcomer. It is a good year-round band, especially for middle-distance "rag chews" and it is a band for which it is easy to build equipment. The receiver described for construction in this article is an example of the kind of simple equipment that can be built, and it is adequate for the reception of code signals in the novice band. In addition, it will pull in the 80-meter phone stations and the 49-meter short-wave broadcasting stations, including DX. Only a short 10 or 15-ft. indoor antenna is required and this receiver can be used as part of a station without the necessity for an antenna changeover relay or other complications. It is designed with the idea that it is to become a part of a complete station for the novice. A suitable transmitter will appear in the October issue of *Popular Mechanics*. Photos A, B, C and D show various views of the completed receiver. The use of a short antenna improves selectivity—an important feature in a set which has only one tuned circuit for the sake of simplicity. A schematic circuit diagram with parts specifications appears in Fig. 1; the plug-in coil, Fig. 2, is wound clockwise.

The set is built up on a simple chassis made of a couple of strips of hardboard mounted on wooden cleats. The strips are spaced the proper distance to permit

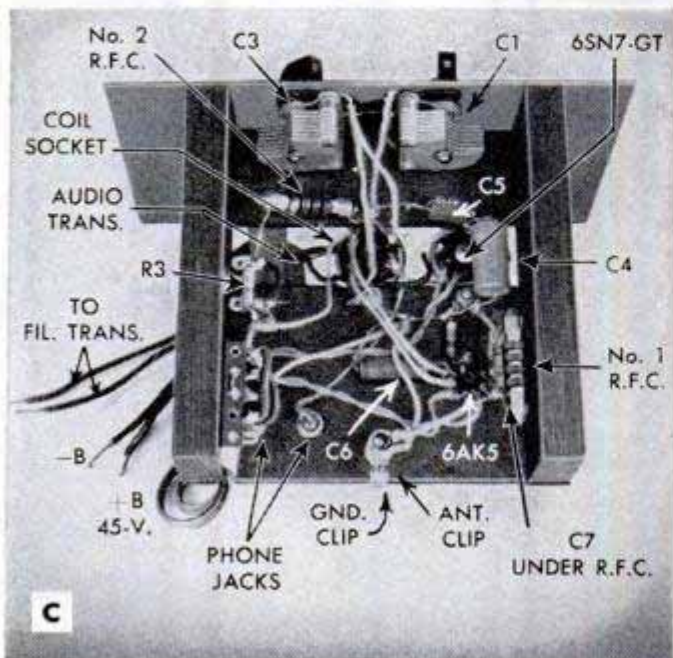
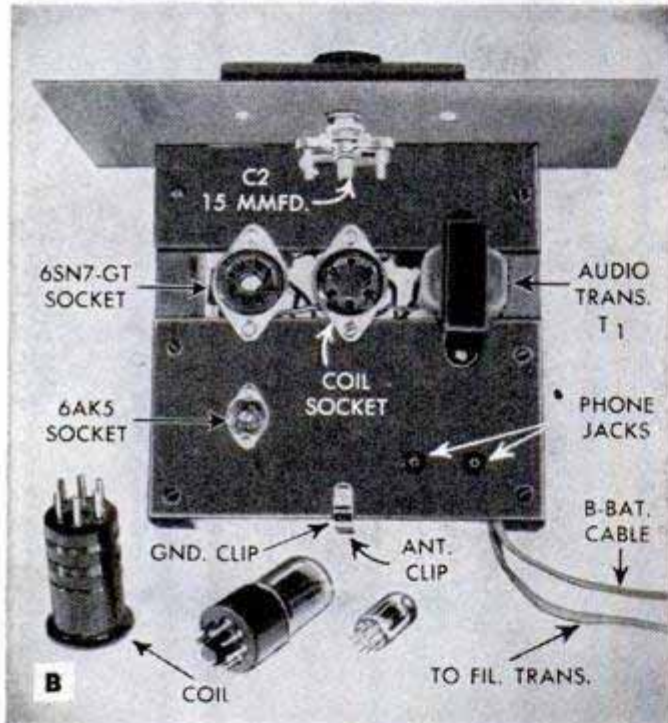
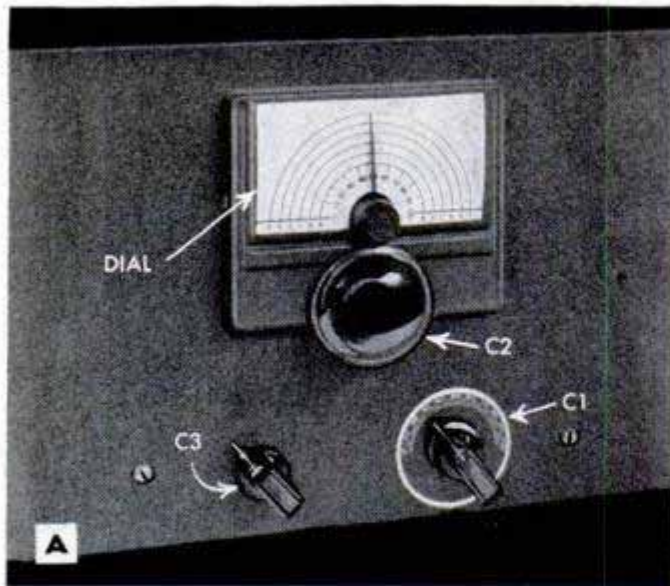

FOR THE NEW NOVICE HAM BAND

mounting the large sockets, thus eliminating the need for drilling. The chassis may be given a coat of dead black to harmonize with the black-crackle-finish metal panel. A 45-volt, B-battery and an inexpensive 6.3-volt 1-amp. filament transformer supply power for the receiver. An external ground connection is recommended for the set, as it will reduce noise and hum. In tuning the set, advance the regeneration control C3 until a soft "plop" is heard. Then rotate C1 (the band-setting condenser) until you hear stations in the 80-meter band. An easy way to locate this band is to first tune in 80-meter phone stations—the 80-meter code band is lower in frequency—just below the phone band. Lower in frequency, of course, means that condenser C1 is more fully closed than for the phone stations.

After the band-setting condenser has been set, final tuning is done with the C2 vernier hand-calibrated center dial, which tunes broadly and makes it easy to separate stations. No on-off switch is provided for in the diagram, Fig. 1, as it goes in series with the primary of the filament transformer and can be mounted at any convenient point on the operating table. Of course, the transformer is merely turned off to silence the receiver. This arrangement will be altered if the receiver is used in connection with the transmitter. The detailed student material list for this receiver is R-403.

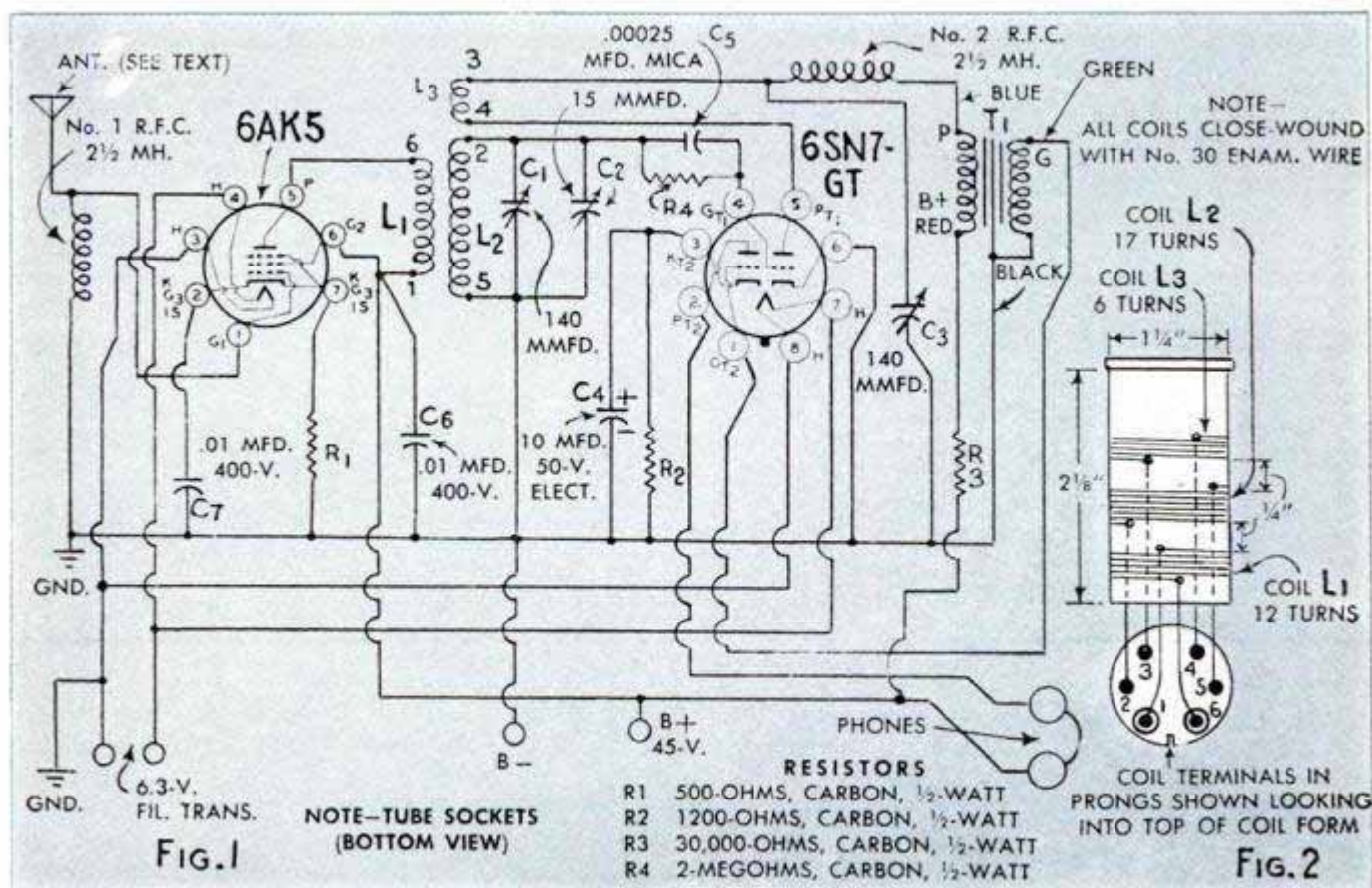
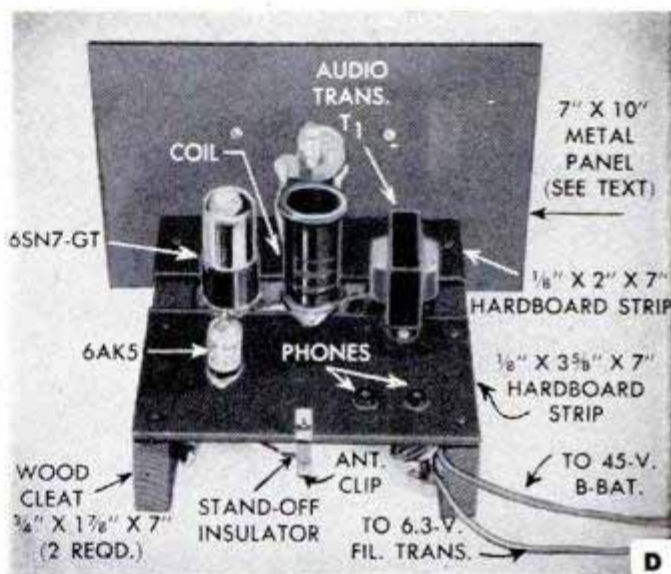

SMALL CUBICAL

By Dr. Richard C. Hitchcock

THIS FOLDED exponential horn, in a 20-in. cube, has remarkable range of frequency response. Previous exponential horns have pleased the music lover and high-fidelity enthusiast, but they were either too high for use in a living room or, if they were low enough, they lacked high-note response. It is well known that high audio frequencies leave a speaker diaphragm as a narrow beam, and with earlier low speakers the beam was too low to reach the listener's ear.

A simply constructed acoustic prism solves this problem as shown in the accompanying diagrams. The speaker is inclined 30 deg., and the prism also bends the high notes 30 deg., so that you can hear the beam even if you are standing. A good 8-in. PM speaker is small enough to reproduce the high notes of fine music, yet large enough to move air for the bass tones. The bass tones come from the back of the diaphragm, and the exponential horn carries them around so that they emerge from the front of the assembly. Low tones bend readily as they have no beam effect.

Since no absorption is required, or desired, the efficiency is high, and $\frac{3}{8}$ -in. plywood is adequate for construction. All joints should be carefully glued and nailed. The 8-in. speaker should be an extended-range type with a power-handling ability of about 7 watts. From the 8-in. driver, the horn reproduces low notes as well as 15-in. speakers. Further, the use of a single reproducer eliminates crossover networks and intermodulation distortion. This distortion is present in many two and three-element loudspeaker systems. It is prevented in this design because the horn loads the

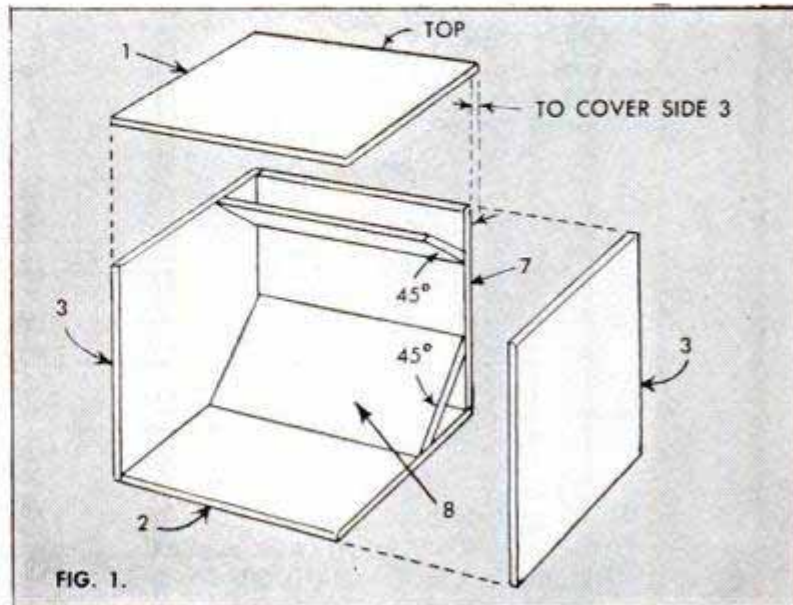
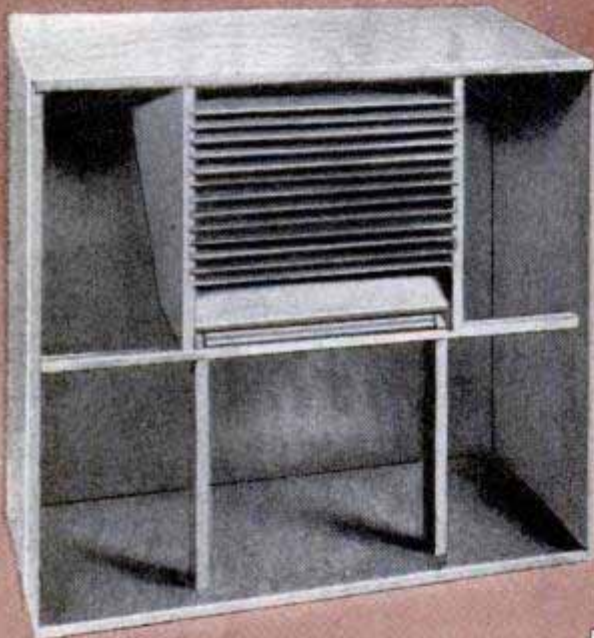

FIG. 1.



A



B

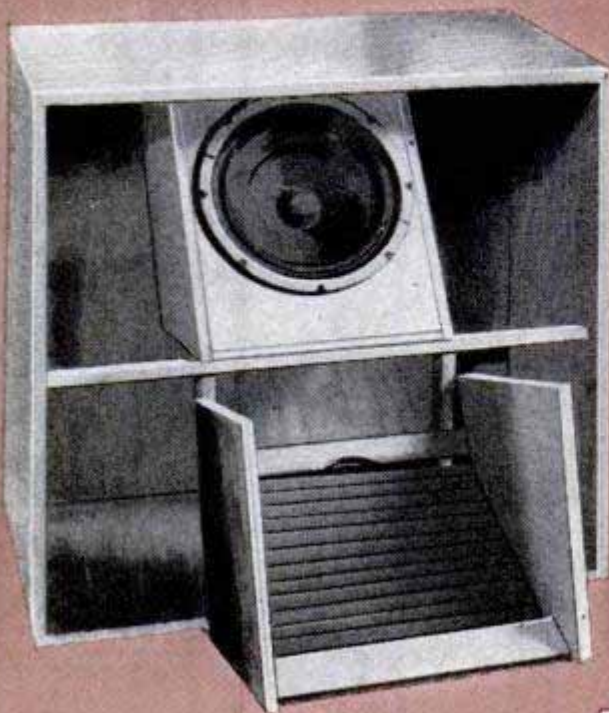

C

EXPONENTIAL HORN

single diaphragm. You will find that this speaker-horn combination sounds as loud with 7 electrical watts input, as 28 watts to a speaker equipped with an infinite baffle (a tight box lined with absorbent material). You gain an additional advantage as your amplifier has less distortion at lower power outputs, and less than 7 watts will drive the horn so clearly that you will not have to turn up the gain on your amplifier.

Photos A, B and C show various views of the completed unit. The acoustic prism, which bends the high notes, is a series of parallel and horizontal sheets glued into the sidepieces, $\frac{3}{8}$ in. apart. These sheets can be heavy cardboard, plastic or metal. Fig. 1 shows the first step in assembly with the right-hand side and top removed. The speaker panel, housing and braces are detailed in Fig. 2. All dimensions can be easily checked in the material list. Fig. 3 is a cross section through the middle, showing the prism. Note that the back of the speaker housing is open to the horn. Fig. 4 shows the acoustic prism, partly and fully assembled. The front grille detail is quite simple as will be noted in photo A. Either heavy grille cloth or brown flock-coated grille screening may be used. This grille screening is galvanized wire mesh, flocked on both sides. Another grille material now available is Lumite-plastic grille cloth. It requires no backing and is of the wide-mesh basket-weave type.

Operating as an auxiliary speaker, this folded exponential horn can be used with any high-grade radio receiver or audio amplifier. With an amplifier, such as the super-fidelity type described in the February 1951 issue of *Popular Mechanics*, excellent results are possible.



MATERIAL LIST

Item	Reqd.	Name	Dimensions	Inches
1	1	Top	20 X 20 X $\frac{3}{8}$	
2	1	Bottom	20 X 19 $\frac{1}{4}$ X $\frac{3}{8}$	
3	2	Sides	20 X 19 $\frac{3}{8}$ X $\frac{3}{8}$	
4	1	Speaker Panel	10 $\frac{1}{2}$ X 8 $\frac{1}{2}$ X $\frac{1}{2}$; 30°, 30°	
5	2	Sides, Speaker Housing	9 X 13 X $\frac{3}{8}$ (See Fig. 3)	
6	1	Slant Panel	8 X 19 $\frac{1}{4}$ X $\frac{3}{8}$; 45°, 45°	
7	1	Back	19 $\frac{1}{4}$ X 19 $\frac{1}{4}$ X $\frac{3}{8}$	
8	1	Slant Panel	12 X 19 $\frac{1}{4}$ X $\frac{3}{8}$; 45°, 45°	
9	1	Bottom Speaker Housing	9 $\frac{1}{4}$ X 10 X $\frac{3}{8}$	
10	1	Brace	1 X 19 $\frac{1}{4}$ X $\frac{1}{2}$	
11	2	Brace	1 X 9 $\frac{3}{4}$ X $\frac{3}{4}$	
12	2	Prism Sides	7 X 9 X $\frac{3}{8}$	
13	2	Prism Braces	$\frac{3}{4}$ X $\frac{3}{4}$ X 9 $\frac{1}{4}$	
14	17	Prism Vanes	Cut to fit prism sides (Item 12)	

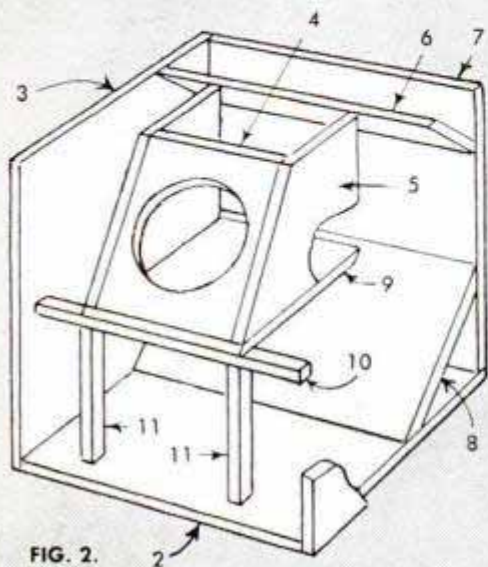

FIG. 2.

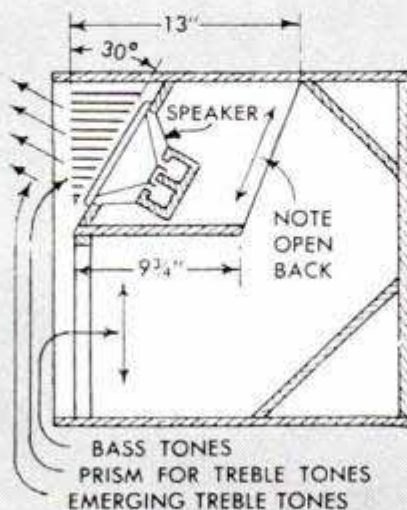
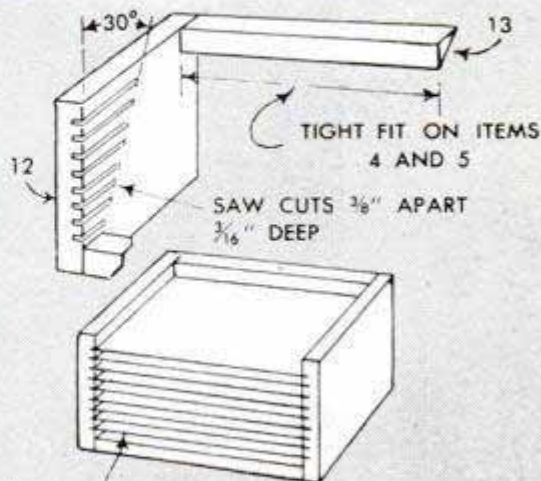

FIG. 3. CROSS SECTION SHOWING PRISM



VANES: 14 CARDBOARD, PLASTIC OR METAL

FIG. 4. ACOUSTIC PRISM

RADIO and ELECTRONICS TODAY



A—Geiger counter employs loudspeaker instead of headphones for safety of uranium-ore prospectors working in rattlesnake-infested regions. Headphones prevented the prospector from hearing the rattlesnakes and brought some unpleasant surprises. The loudspeaker can be heard up to 35 ft. away under ordinary conditions. Neon blinker also records count

B—Electronic secretary not only answers the phone during absence of office personnel and records the caller's message, it also includes a complete standard wire recorder which serves as a handy dictation machine. These electronic telephone-answering machines tell the caller when his party will return to the office or where he can be reached in an emergency

C—Increased range is claimed for this portable FM radiotelephone. It is a compact two-way self-contained radio station, weighing only 14 pounds, and the rated output is 2 watts. The FM transmitter employs 10 tubes; there are 12 tubes in the receiver, all contained in one compact crystal-controlled unit. Operates efficiently on either wet or dry batteries

D—If you are one of the many TV-set owners using a "rabbit ear" indoor antenna, you probably will be interested in this camouflaged version in a flowerpot base recently demonstrated in the Chicago Merchandise Mart. The extended rods are seated in turning sockets for easy tuning positions. The ceramic flowerpot comes in green, yellow, black and maroon

E—The small electronic device shown at the left of the table-model receiver is an automatic alarm that is attached by a plug to any radio or TV set and acts as a silent sentry during the periods of the day or night when the home receiver is turned off. In case of attack, civil-defense authorities have control signals transmitted from one or more broadcasting stations which activate the alarm and turn on the radio or TV set for loudspeaker signals to awaken and alert the household so that CD warnings and instructions can be transmitted in emergencies

F—Small light-duty turntable comes in several useful variations including vertical, horizontal and upside-down types for special-purpose applications

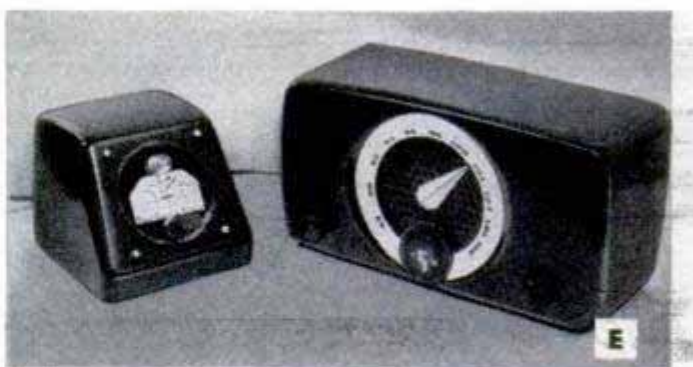

FRINGE-AREA TV ANTENNA EASILY SERVICED

GOOD television reception in rural areas, remote from broadcasting stations, usually depends on the height of the TV antenna aboveground. A local welding engineer, in an area where a height of 65 ft. was necessary, worked out the installation illustrated which has been enthusiastically received by residents of the community.

Its advantages are easily understood at a glance, as all the owner has to do to bring down the TV array for repairs is to unfasten the lower end of the balanced mast, as in photo A, and pull down the top end with a rope as illustrated in B, C and D. Then make the necessary soldered connections to broken twin-line leads, or other repairs, and rotate the mast back up into position. A heavy 35-ft. pole eliminates the need for a tower, and no guy wires are required. Built of ordinary pipe in $\frac{3}{4}$, 1 and $1\frac{1}{4}$ -in. sizes, with the heaviest pipe in the center, the mast is welded throughout. The pipe alone, of course, is far too weak to bear the strains imposed upon it so the welder designed an ingenious system of "fiddle" braces and struts, which strengthen the mast for the terrific strain which the center, or hub, must bear when it is rotated in "propeller" fashion. There are four sets of these braces. The long hub braces extend 20 ft. from the center. The mast is mounted on the supporting pole by means of a metal sleeve, which slips down over the top of the pole and to which a bearing is attached. A heavy kingpin, welded horizontally at the center of the mast, fits in the bearing to provide the means for balanced pivotal rotation.

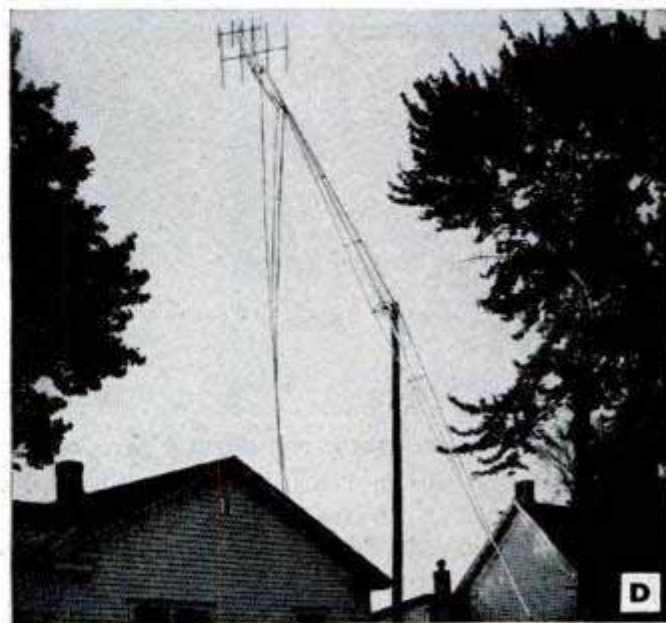

Color Cues

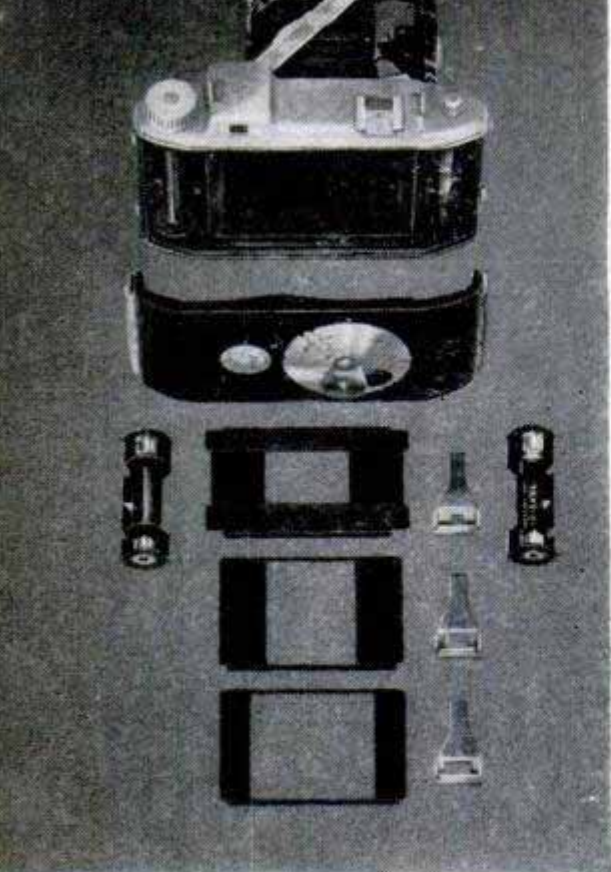

Inexpensive kits adapt Kodak Tourist and Reflex Cameras for Kodachrome Film

Kodak Tourist Adapter Kit, \$15.50 (left), and the Kodak 828 Adapter for Kodak Reflex Cameras, \$5.35 (lower left), permit picture taking in gorgeous full color on Kodachrome or Kodacolor 828 Film. The Tourist Adapter Kit, for de luxe "Tourist" models, also lets you take economical half-size and square pictures on all Kodak 620 Films. Both kits include back-frame masks, view-finder masks, and special spool baskets.

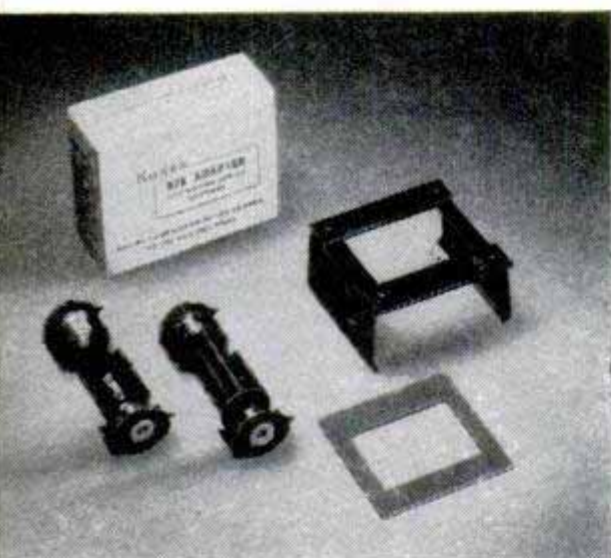

For dramatic skies without changing other color tones

By polarizing sunlight, a Kodak Pola-Screen can change a vacation snapshot into a prize-winning photo. For color, black-and-white. Accessory Kodak Pola-Screen Viewer slips over handle—"previews" varying sky tones you can obtain. Pola-Screens, from \$6.50. Viewer, \$6.50.



Get in the picture yourself

The Kodak Auto-Release automatically trips shutter 10 seconds after you set it. For cameras with cable release socket. \$4.50 (cable release not included).



Share color prints with friends

From 35mm. or Bantam-size Kodachrome transparencies you can now get Kodacolor Prints (3½x5 inches), \$.36 each, plus \$.40 for negative on first print from each slide.

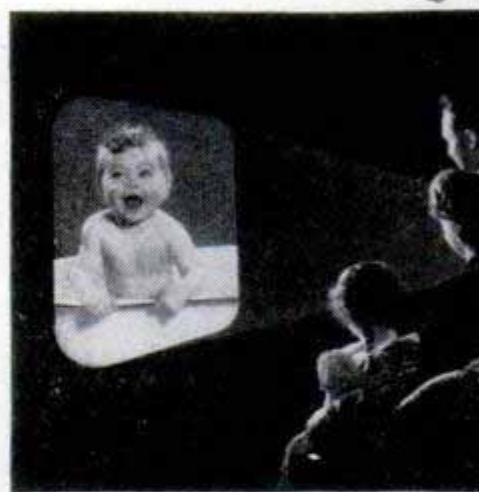

Share duplicate slides, too

For friends with projectors or viewers, there's no more welcome gift than "dupes" of your favorite slides. One to three duplicate slides, mounted, \$.25 ea.

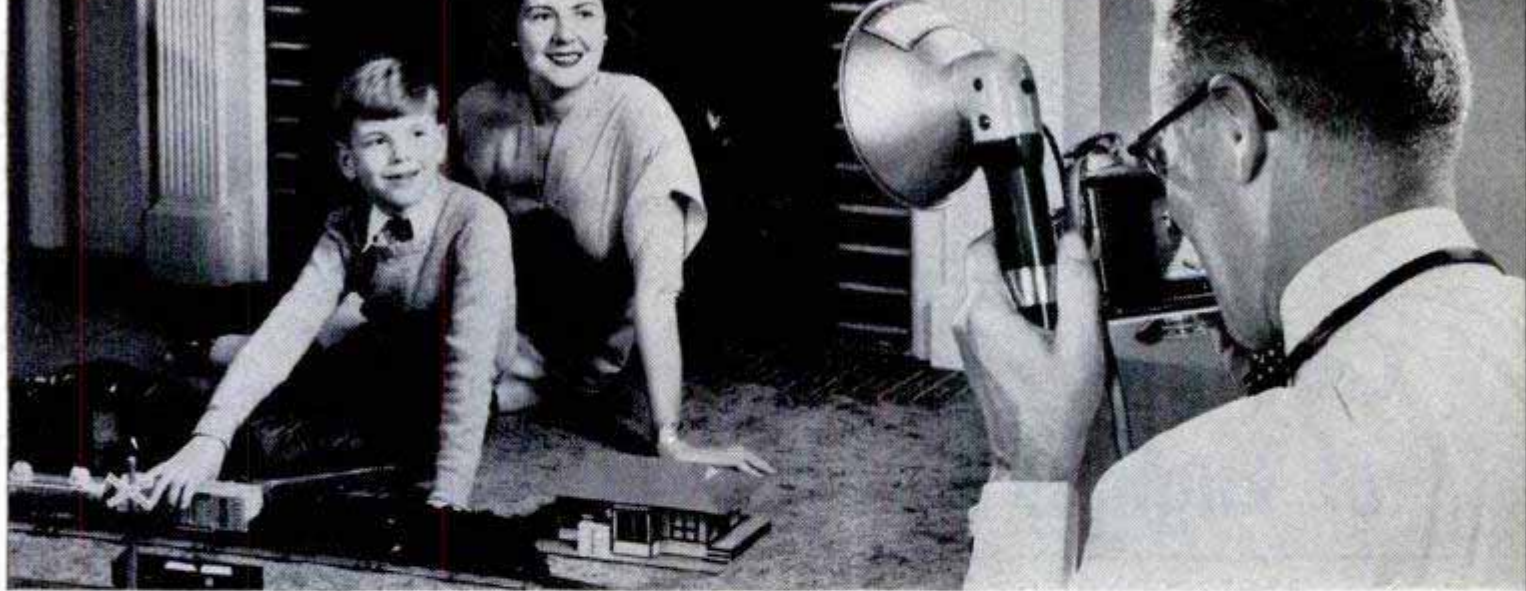

"Never-fail" flash! Ingenious new device assures correct flash synchronization every time!

In single flash or multiple flash, you may have experienced costly flash failures. Or perhaps you've been disappointed with shots "out of synch." But now there's a simple adapter made by Kodak that puts an end to worries like these once and for all. It's the Kodak B-C Flashpack. Here's how it works:

If your present flash unit accepts two "C" batteries end to end, remove these batteries. Take the Kodak B-C Flashpack, insert a 22½-volt photoflash battery, and substitute this combination for the two "C" batteries.

Replace the reflector and you're ready to take pictures. The battery in the Flashpack charges the condenser, which releases an unflinching abundance of energy to ignite the lamp. Fires up to three extension units in perfect synchronization. Disk for shorting out battery contact in extension unit is supplied with Flashpack. Price (without battery), \$2.95.



Highly popular Flashholder

Kodak Flashholder, Model B, with Flashguard, attaches easily to any camera that has a flash shutter. Back of reflector carries exposure data. Kodak 2-Way Flashguard (not illustrated), a hood that slips over reflector, offers protection in case lamp shatters. Diffuse side of Flashguard produces softer illumination for color shots. Price, complete, \$12.35.

Be sure to see all of these accessories at your dealer's.

Prices subject to change without notice, include Federal Tax where applicable. Consult your dealer.

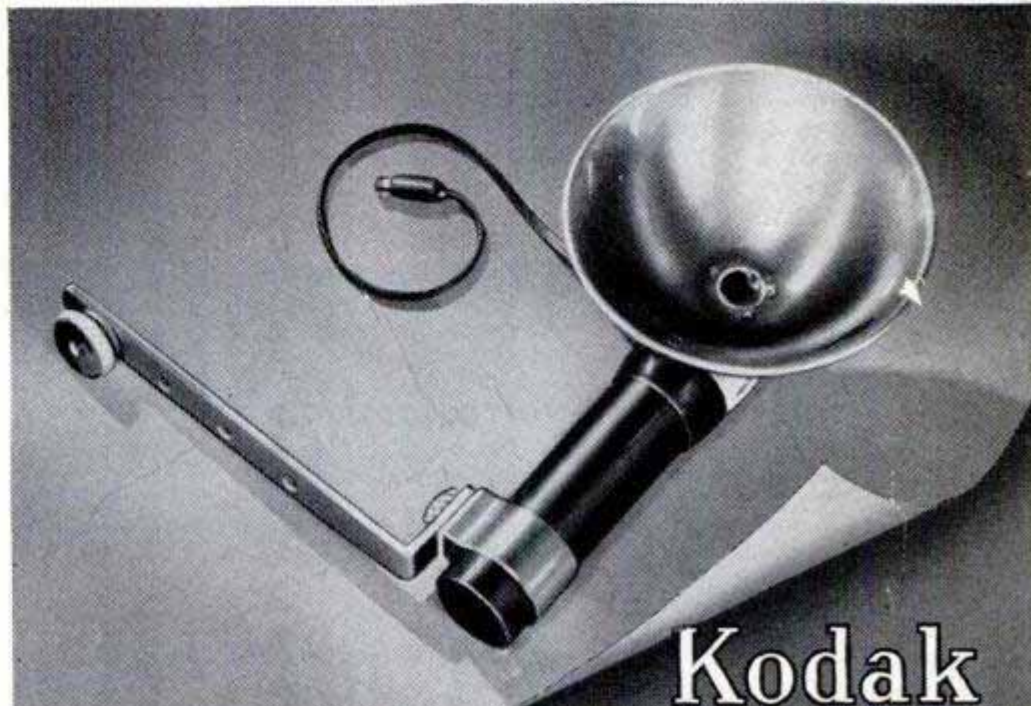

Kodak



Care and Feeding of Engines

BY S. P. CORP

PROSPECTING FOR OIL?

Are you hunting for the oil that disappears from your crankcase? Oil leaks can cost you real money. Hot weather is a good time to hunt for them. Gaskets dry out and let oil seep through. Such leaks and others can be located by placing a large piece of clean paper on the garage floor and driving the car over it so the paper is under the engine, after the engine has been run enough to be thoroughly heated.

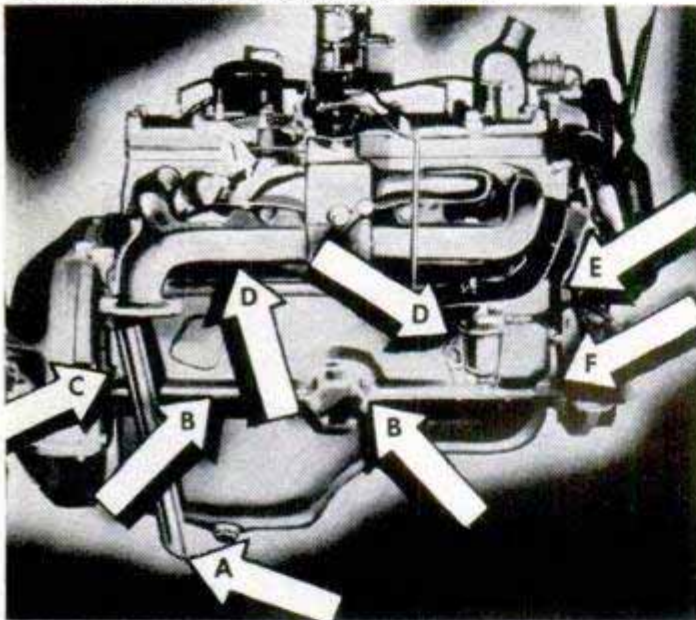

Let car stand over paper all night, then check spots of oil in relation to the engine. Look for leaks at the points indicated in the picture:

- A. DRAIN PLUG**—Check oil pan drain plug for a leak.
- B. OIL PAN AND GASKETS**—Look all along gasket surface; check tightness of screws.
- C. REAR MAIN BEARING OIL SEAL**—Oil on under side of clutch housing indicates a leak here.
- D. VALVE COVER GASKETS**—Make sure they are tight and not misplaced. This is the gasket around the top of a valve-in-head engine.
- E. TIMING GEAR COVER GASKET** around cover at front of engine should be tight. Can be seen best when car is on hoist.
- F. FUEL PUMP**—Oil on engine block below fuel pump or under side of oil pan at this point indicates fuel pump mounting bolts are loose or that gasket is cracked.

YOU MAY NEED NEW RINGS

If your car is *burning* oil, you need new Sealed Power Piston Rings. Sealed Power MD-50 is the best oil control ring ever built, the only ring with the Full-Flow Spring. Sealed Power Chrome-Faced Rings deliver triple mileage. Write for free illustrated booklet, "7 Ways to Save Oil." Address Sealed Power, Dept. G-9, Muskegon, Michigan.

You Name It!

Here are the correct answers to the "You Name It!" Photo Quiz on pages 148 and 149.

- | | |
|----------------|----------------------|
| 1. Red cabbage | 6. Crystallized salt |
| 2. Walnut | 7. Pencils |
| 3. Cigarettes | 8. Pliers |
| 4. Corn on cob | 9. Hairbrush |
| 5. Feather | 10. Soda straws |

They Make Jewels at Home

(Continued from page 93)

brittle. Most lapidaries have some nameless stone of rare beauty in their collection.

There are four basic steps to cutting a gem: sawing, grinding, sanding and polishing. There are numerous lapidary outfits on the market to perform these operations ranging in price from about \$30 (without electric motor) on up. Most outfits include a grinding wheel, convex sanding lap, a leather or felt polishing buff, diamond saw, a lubricating attachment with a metering spigot, polishing compound, dop sticks and dopping wax. The simplest outfits are designed for cabochon cutting in many shapes and the more elaborate ones have accessories for faceting and sphere cutting.

Kraft says anyone with a little patience can turn out a satisfactory cabochon. He demonstrated the steps with a piece of jade in the well-equipped shop in the basement of his Wilmette, Ill., home. First he took a chunk of rough Wyoming jade, clamped it in the holder, and with slight pressure on the saw arm neatly sliced off a slab about one quarter of an inch thick, the desired size for a ring setting.

Then he cut a square piece of approximate gem size from the slab. On the grinding wheel he then shaped the jade into an oval, holding the stone in his fingers and rotating it constantly against the edge of the grinding wheel. The back of the cabochon is smoothed off by holding it against the flat side of the grinding wheel. Lubricants are used for both sawing and grinding, a mixture of kerosene and motor oil for sawing and water for the grinding.

After the stone has been formed it is fastened to the end of the dop stick with wax. This makes it much easier to handle for the two final operations. The stone is moved around with a sweeping motion on the sanding lap, or wheel, and lifted frequently so that it will not overheat as this is a dry operation. Kraft explains that there is less danger of cracking jade than most stones. The sanding operation continued until all ridges and grinding marks were gone. Then he carefully washed the stone, dampened

(Continued to page 234)

The inside story of your battery- See how it works!

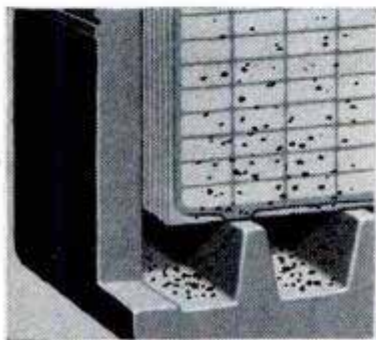

1 In ordinary batteries, small particles keep flaking off positive plates, so ordinary design batteries must have large sediment wells at bottom of case to hold these particles.



2 If sediment wells in ordinary design batteries aren't big enough to hold flaking particles from positive cells, particles pile up and short circuit cells, causing cell failure.

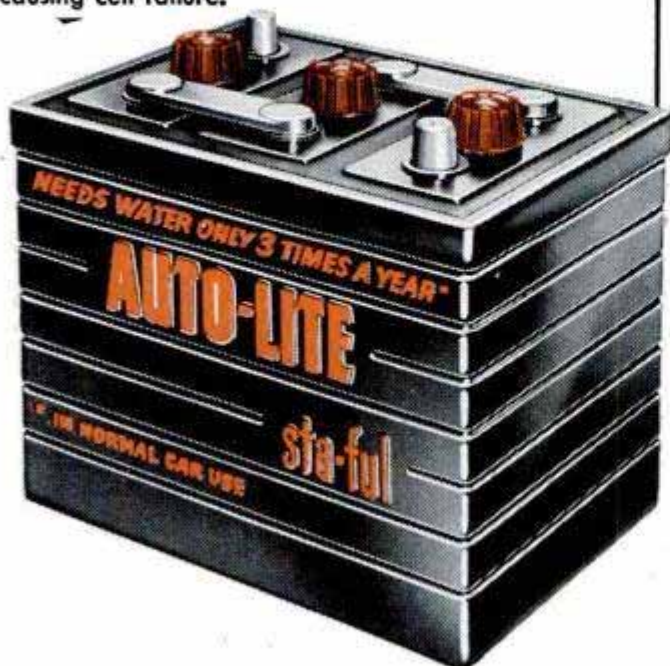

3 In the Auto-Lite "Sta-ful" Battery, every positive plate has a Fibre-glass retaining mat protecting it and holding the active materials in place to reduce shedding and flaking.

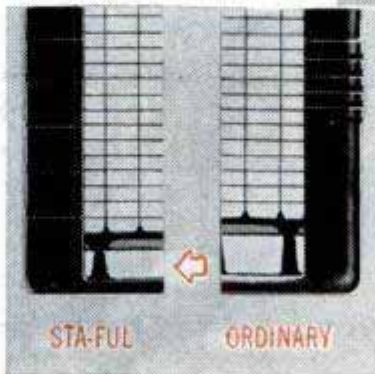
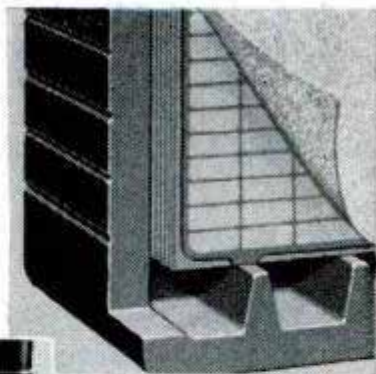

4 Side-by-side view shows that the "Sta-ful" Battery doesn't need all the extra space at bottom as ordinary design batteries do. So extra space in "Sta-ful" Battery is moved to top where . . .

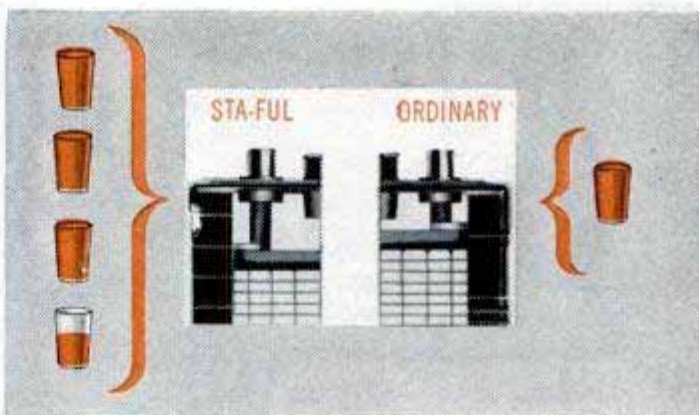

5 . . . extra space can be used to hold more battery electrolyte, giving room for over 3 times the liquid reserve in the "Sta-ful" as in ordinary batteries. That's why the "Sta-ful" needs water only 3 times a year in normal car use. "Sta-ful" Batteries give longer life, too, in tests conducted according to minimum life cycle standards.

AUTO-LITE BATTERY CORPORATION

Toledo 1

Ohio

Auto-lite sta-ful
...needs water
only 3 times a year

IN NORMAL CAR USE

You Can Apply

**YOUR
UPSON CEILING**



**RE-COVER UNSAFE AND UNSIGHTLY
CRACKED CEILINGS WITH**

UPSON KUPER-KRAK PANELS



**FOLLOW THESE SIMPLE STEPS
TO NEW HOME BEAUTY!**

No need to suffer an ordeal of house-cleaning caused by re-plastering.

In a matter of hours, you can apply a modern characterful Upson ceiling that will be forever crackproof. Pebbled surface matches walls perfectly—takes paint beautifully. No visible face nailing. Amazing Upson Floating Fasteners anchor Upson Ceilings securely from back.

Hundreds of thousands now installed. Mail 10c now for 32-page Idea Booklet and free detailed instruction sheet.

THE UPSON COMPANY

989 Upson Point, Lockport, N. Y.

I enclose 10c for your 32-page Idea Booklet and free detailed Instruction Sheet for applying Upson Ceilings.

Name _____
Street _____
City _____
State _____



1 Nail furring on 16' centers, right over old plaster.



2 Nail Upson Fasteners to furring strips, 8' apart.



3 Clinch Fasteners. See Direction Sheet for simple method.



4 Apply mouldings supplied by your lumber dealer.



Clinic for Homemakers

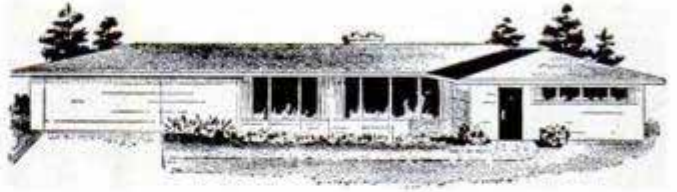

As a service to our readers in solving the hundreds of problems pertaining to a home—inside or out—the editors of *Popular Mechanics* invite you to present your problems to The Clinic Editor for help and advice. Address your questions to The Clinic Editor, *Popular Mechanics Magazine*, 200 East Ontario Street, Chicago 11, Ill.

Linoleum Repair



Q—The linoleum on my kitchen floor is cracked in several places and to repair cracks and breaks I've been advised to use linoleum shavings, crushed and mixed with linseed oil. Will this make a satisfactory repair and, if so, how do I obtain the linoleum shavings?

W.R., Ind.

A—This method of repairing worn linoleum cannot be recommended without some reservation. As a rule only inlaid linoleum can be repaired satisfactorily in this manner and then much depends on where the breaks are in relation to the pattern. The main problem, of course, is to obtain a filler of the right color to match the pattern so that the repair will be more or less invisible. Shavings can be taken from a waste piece of the same type and pattern as that on the floor. Use a sharp hand plane set to take a thin shaving. Discard the first shavings and use only the second shavings as these will not be discolored. Crush the shavings to fine granulations and mix with raw linseed oil. Allow the mixture to soak for a time, then add a very small amount of japan drier and sufficient whiting to make a thick paste. Press the paste, or putty, into the crack with a putty knife and allow it to become thoroughly dry before using the floor. Then smooth the patch with fine steel wool and coat with wax or linoleum varnish.

Inside Window Trim

Q—I'm finishing a room in knotty-pine paneling and am puzzled as to how to trim the windows. Because of the added thickness of the paneling, it has seemed to me that regular trim placed over the boards would make the windows appear too deeply inset, especially in a small room. Can you suggest a method? Also, can I attach the paneling to the walls by driving screws through the plaster and into the lath?—R.M., Calif.

A—We are assuming you plan to apply pine paneling directly over the plastered wall without furring strips. This is not an orthodox practice although, of course, it is done. It's a good idea to apply a vapor barrier over the plaster and under the paneling. Although on most jobs conventional window trim is used over the paneling, the trim is sometimes omitted and the exposed edges of the window frames are built out with strips that extend beyond the outer face of the panel boards about 1/8 in. The exposed edge of the strip is often fluted or beaded to add an ornamental detail. The fluted or beaded strips are mitered at the upper corners of the window frame.

(Continued to page 232)

want better results
in your workshop...

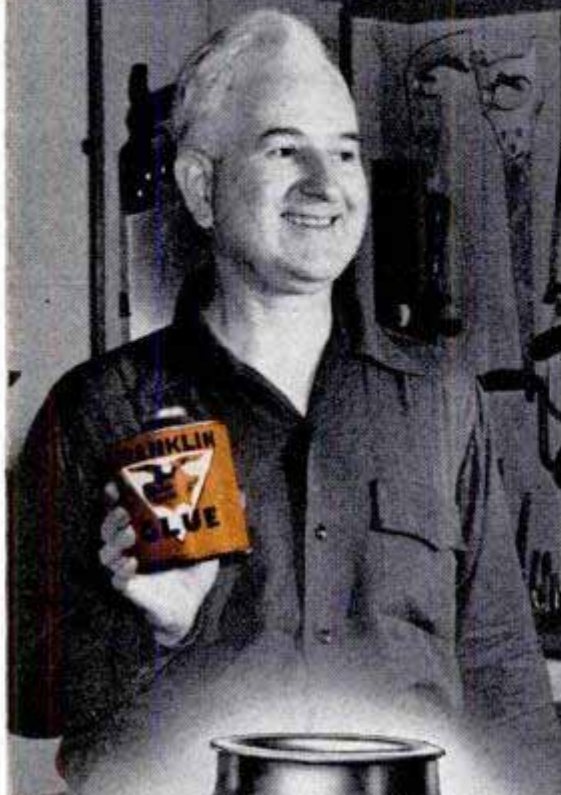

The one best thing
for you to do
Is use the genuine
Franklin Glue!
No mixing, heating,
odor, mess.
It costs no more;
in fact costs less!
It's liquid. hide;
keep on your shelf.
Makes glue joints
stronger than wood itself.

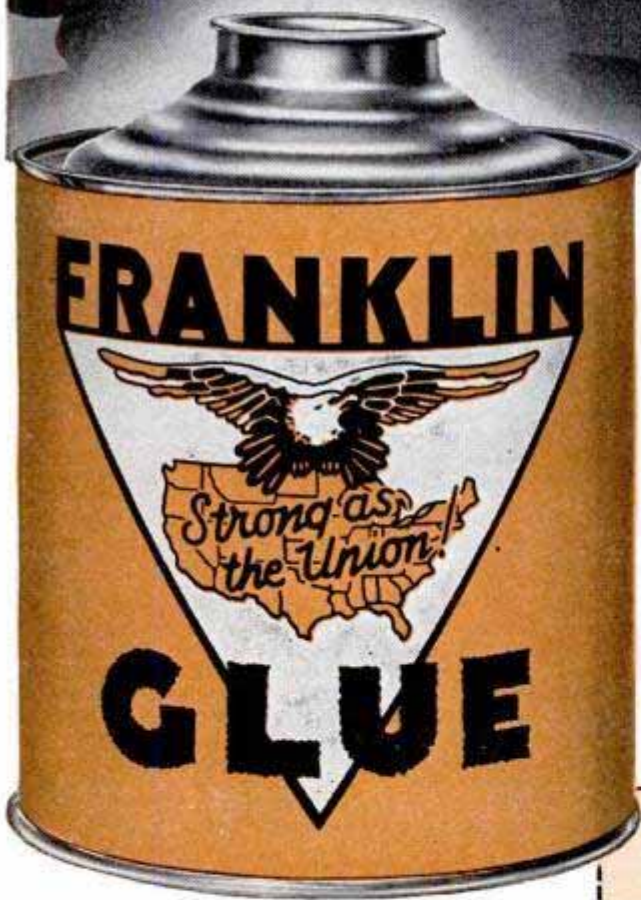

FRANKLIN GLUE IS BEST FOR ALL WOODWORK

Genuine HIDE glue, strongest known. Easy to use . . . no mixing, no heating. No odor. Eliminates chilled joints. Actual laboratory tests prove Franklin Glue holds more than 4000 lbs. per sq. in. and shows 100% wood failure. Spreads thin, goes farther. Costs no more than ordinary glues. Ideal for all home uses. If your dealer cannot supply you, send this coupon with 20¢



The FRANKLIN GLUE CO., 121 W. CHESTNUT ST.
Columbus 15, Ohio

Enclosed 20c (15c plus 5c postage and handling charge) for trial tube of Franklin Liquid Hide Glue.

NAME.....

ADDRESS.....

SIX SIZES: Available in tubes 15c; quarter pints 50c; half pints 85c; pints \$1.50; quarts \$2.65; gallons \$7.50.

Do it yourself!



with easy-to-work **WESTERN PINES***



Build your lady of the house a cheerful Western Pine kitchen . . . turn that idle basement into a family fun room . . . with these easy-to-work, lovely-to-live-with Western Pines*.

These fine, soft-textured woods, with their straight, even grain and adaptability to all sorts of finishes, are a real inspiration to the home craftsman. Light to handle, they cut and work like a charm—nails drive in easily. Best for most workshop projects—cabinets, trophy shelves, bookcases, kitchen cabinets, bunk beds, all sorts of built-in storage space. And whether you remodel a whole room or build yourself a gun-and-gear locker, you can't choose better than the beautiful, long-lasting woods of the Western Pines*.

To find out how to begin, and what to do, send today for *Free Idea Packet No. 311*. Contains helpful illustrated how-to-do-it instructions, and colorful new booklet, "Enchanting Homes of Western Pines," with 71 imagination-sparking pictures. Write to Western Pine Association, Dept. 311-N, Yeon Bldg., Portland 4, Oregon.

THESE ARE THE WESTERN PINES

*IDAHO WHITE PINE
*PONDEROSA PINE
*SUGAR PINE

Space Heater

Q — Several times last winter, during exceptionally cold weather, our oil-burning space heater did not operate properly, especially during the night. The flame burned low, smoked considerably, and several times went out entirely. We are still wondering what was wrong. Can you tell us what was the cause and how to remedy it?
C.Y., Minn.



A—Of course, there could be several causes for the faulty performance of the oil-burning space heater, but from your description we are inclined to suspect that the trouble was due to an accumulation of frost in the chimney flue which greatly restricted the passage, perhaps even closed it entirely at some time during the cold nights. It is unlikely that the frost would form in sufficient quantity to restrict the draft and affect the operation of the heater, except in periods of extremely low temperatures. This makes this particular trouble the exception rather than the rule. In your case, the construction of the chimney and the degree of exposure to cold winds are undoubtedly contributing causes. Although you did not say, we assume your heater is equipped with an atmospheric, or gravity, damper. We suggest that you try adjusting this damper to a more nearly closed position at night. Although this lowers the efficiency of the heater and also increases the fuel consumption somewhat, the closed, or nearly closed, position of the damper permits more heat to escape to the chimney. This generally raises the temperature of the flue sufficiently to prevent the formation of frost.

Top-Dressing Lawn



Q — My lawn is rather rough, although the whole area is very nearly level, and the sod is thin. The grass is growing in individual bunches over a large part of the area, and there is considerable weed growth. The soil seems to be mostly clay with very little topsoil. It has seemed to me that the best way to renew this lawn is to top-dress the whole thing either

with black soil or with peat moss and apply a commercial fertilizer before seeding. But which top-dressing should I use? — H.S., Okla.

A—In general, we'd recommend that you use black soil as a top-dressing, as it already contains plant food suitable for the growth of lawn grasses and the humus content is normally quite high. Although the early spring is the regularly accepted time for the application of a top-dressing, it can be done successfully at any time during the growing season, particularly on an old lawn in poor condition. First, apply a weed killer to get rid of the weeds. Allow the grass to reach a height of at least 3 in. Then scatter the top-dressing and rake it to a depth of about 1 to 1½ in., never more, for each application. In raking the dressing, try to lift and expose as many of the grass blades as possible. In the absence of rain, sprinkle the lawn daily for a week or more. Grass seed may be sown on top of the dressing and the lawn rolled lightly after raking the seed into the soil. If seed is sown either in the fall or early spring, sprinkle the lawn regularly until germination takes place and the first blades of new grass appear. At the beginning of the following season apply a second top-dressing to a depth of 1 in., raking and seeding as before. Thereafter, apply a lawn fertilizer once or twice during each season to sustain growth.

**THE
TECHNICAL STORY BEHIND
THE **AUTHORIZED**
RECONDITIONED
FORD ENGINE**

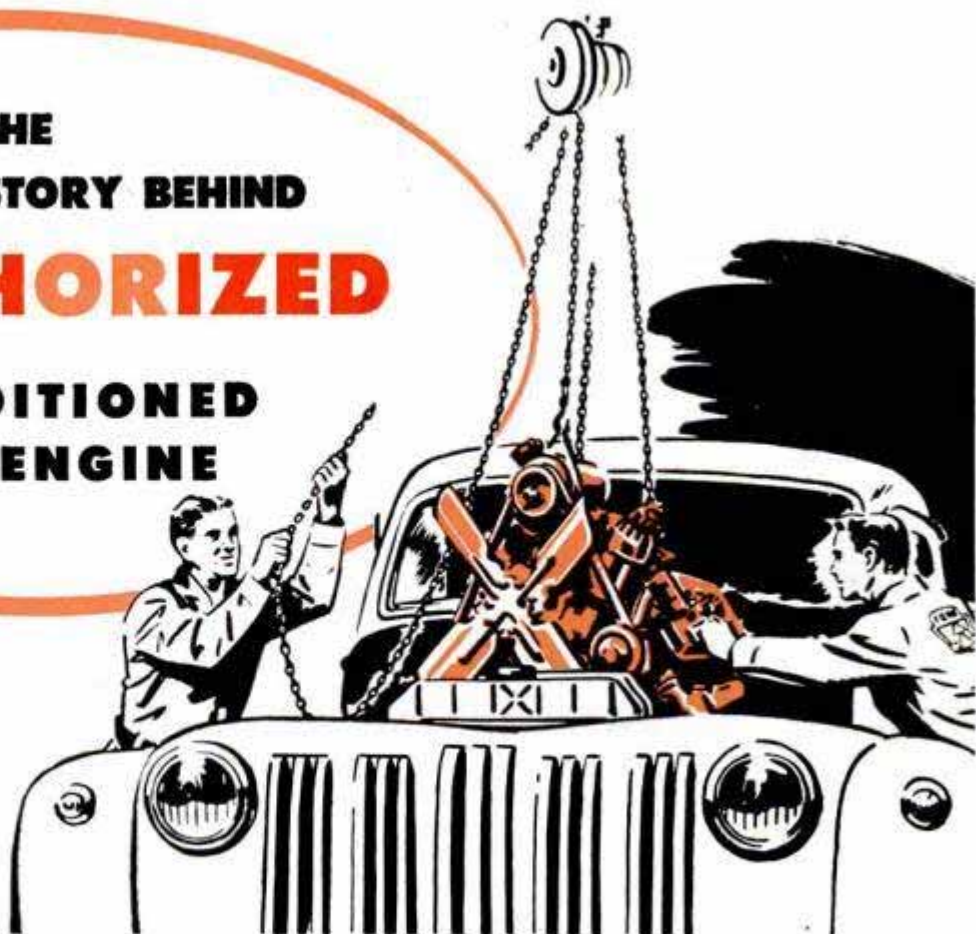

**Why it delivers
new-engine power and
economy for about
half the cost of
a new engine**

**Factory-precision reconditioning assures
Ford Quality**

New engine power and economy because: Every AUTHORIZED Reconditioned Ford Engine is *completely* rebuilt. Over 150 brand new or thoroughly reconditioned Genuine Ford Parts. Cylinders re-bored and honed to rigid factory specifications. Checked with the same rigorous tests as a new engine. And it's *warranted* the same as a new engine!



Modern multi-reboring machine insures accurate alignment of cylinder bores!



Crankshaft bearing surfaces precision-ground, polished; new Ford main bearing liners fitted.



Honing of cylinder bores assures proper seating of rings for new-engine performance!



Each engine is checked under its own power for peak performance, just like a new engine!

So see your Ford dealer about this low-cost way to get the new engine power hundreds of thousands of other Ford owners enjoy. (Of all car manufacturers, Ford alone authorizes reconditioners to offer authorized reconditioned engines). Your Ford dealer can arrange for one day installation and easy terms. See him today.

**Save money too, with
these AUTHORIZED Reconditioned Ford Units!**

Carburetors • Fuel Pumps • Clutch discs and pressure plates • Distributors
Voltage Regulators • Generators • Starting Motors • Brake Shoes

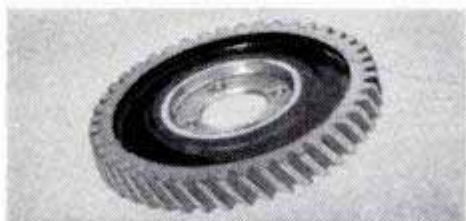
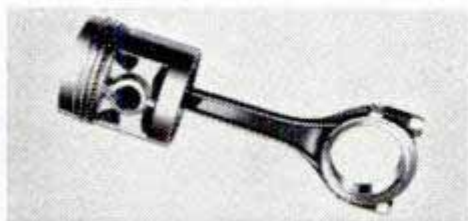

Over 150 completely reconditioned or new Genuine Ford Parts, like the controlled expansion piston and the laminated timing gear shown above, keep your Ford all Ford!



**Look for
this emblem**

... on the engine and parts you buy. It's backed by the Reconditioner's Warranty. Any defect in material or workmanship appearing in 90 days or 4000 miles ... whichever occurs first ... will be remedied at no extra charge.

**FOR SURE
QUICK STARTS**

INSIST ON

BOWES



Corrodeless

TERMINAL

Battery Cables



Most battery cable trouble starts at the terminal because of corrosion or bad fit. Bowes "Seal Fast" battery cable terminals positively will not corrode. They are specially engineered, tailored to fit the posts snugly, assuring longer cable life and full power from your battery. Stop battery cable trouble before it begins. For sure, positive starts insist on Bowes "Corrodeless Terminal" Battery Cables—then you'll get all the power your battery is designed to give you.

BOWES

DEPENDABLE

SPARK PLUGS

Assure

**SMOOTHER
MOTORING**

There is a Bowes Spark Plug specially designed for your car! Oversize Special Alloy Electrode—with welded construction for positive connection assures longer life. One-piece, leakproof construction.

Every Bowes Plug is individually tested to assure complete motoring efficiency. **INSIST ON BOWES SPARK PLUGS FOR SMOOTHER MOTORING.**



BOWES "SEAL FAST" CORPORATION
INDIANAPOLIS 7, INDIANA

the buffing lap and started the final polishing. Some kind of polishing agent is generally used in this process. The stone was then removed from the dop stick, cleaned free of wax and was ready to be set. All sorts of settings from dealers are available for the home lapidary if he chooses to set his own stones. Mounting stones is a simple operation.

Practice is all that it takes, according to Kraft, to make jewels of extraordinary beauty that rival the work of a professional lapidary. His vast collection of semiprecious gems of almost every imaginable stone, running the gamut of the rainbow, proves this. Other proof is found in the distinguished wearers of the jewels made in his basement shop, among them Britain's Princess Elizabeth, who wears a set of Kraft-cut jade.

Thousands of amateur gem cutters do not own so much as a single buffing lap. In many large cities they use the facilities provided in schools or park-district workshops where adult classes are conducted by recreational leaders. In Chicago, for example, more than 20,000 persons attended these gem-cutting classes last year. Students worked with almost every known stone with the exception of the diamond, the emerald and synthetic emerald.

The latter, unlike the synthetic sapphire and ruby, is not available to the garden variety of home lapidary. However, sometime in the distant future emerald crystals may be obtainable in limited quantities. The synthetic emeralds are much harder to "grow" than sapphires and rubies, and the story behind them is one of the most intriguing in the history of gems. The true synthetic emerald was developed by Carroll F. Chatham of the Chatham Research Laboratories, San Francisco, and the process is secret. Chatham, who has been experimenting for 20 years, is now growing 1000 carats of average gem quality a month, but he reports the process is still in a "developmental" stage. This means that cut stones of perfect quality cannot be consistently produced at present. At any rate, the synthetic emeralds may never be too plentiful for it takes nine months to grow a finished crystal of a size suitable for cutting. Meanwhile, Chatham is deluged with orders from all over the world, which he, as a one-man corporation, cannot begin to fill. Experts agree that the Chatham emerald matches the beauty and durability of the genuine stone in every test.

One of the biggest thrills of the amateur lapidary is amazing his friends with his craftsmanship. If he is like James L. Kraft, his generosity with his cut gems will also

(Continued to page 236)

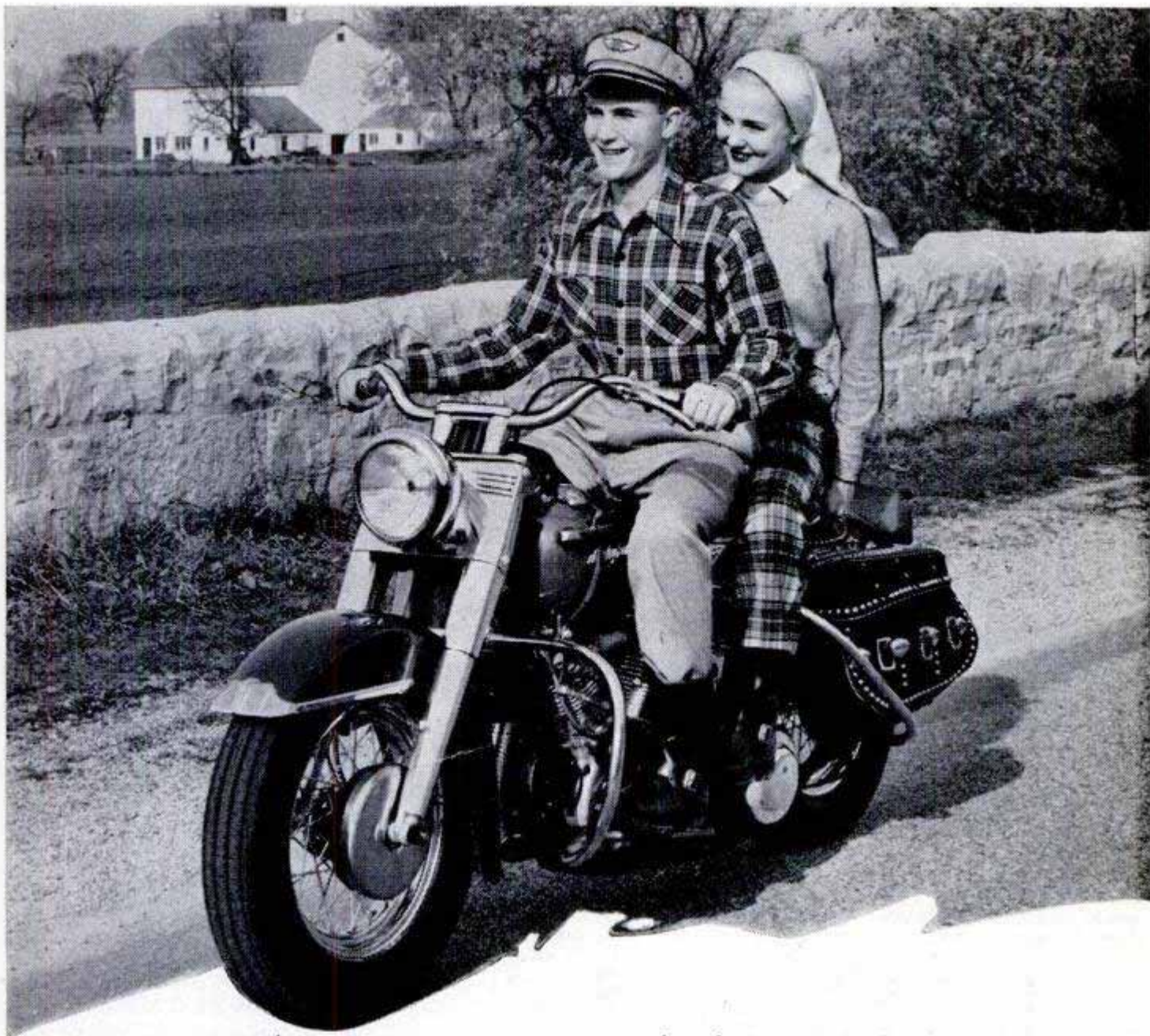

Thrilling Sport and Thrifty Transportation

HARLEY-DAVIDSON *HYDRA-GLIDE*®

Every mile is money saved, every moment a thrill... when you ride this swift, smooth "streamliner"! It takes you comfortably to daily work or distant points... at amazingly low cost. It brings you endless good times at race-meets, tours and other exciting motorcycling fun events. With it you can play a vital part in your local defense program. Easy terms. See your dealer. Mail coupon.



Send me free copy of **ENTHUSIAST** Magazine filled with motorcycle action pictures and stories; also literature on new models.

HARLEY-DAVIDSON MOTOR CO., Dept. P, Milwaukee 1, Wisconsin

Name.....

Address.....

City..... State.....

DEALERS: Valuable franchises available for the full line of famous Big Twins and the 125 Model. Write today.

POINTERS FOR HOME PAINTERS



**How to increase your painting skill . . .
make your brushes last longer**



When painting flat surfaces, use long, steady strokes. Don't bear down on your brush. Heavy strokes don't distribute paint properly.



Brush oil-based paints out in thin, even coats. This makes the finish more durable, and thin coats of paint dry much faster.

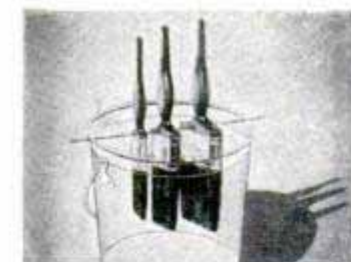

Clean brushes with thinner after daily use. Suspend brushes in thinner overnight. Bristle tips should not touch bottom of can. Work out thinner before painting again.



For storage, clean brush with thinner, then scrub bristles on a board with warm water and cleanser, rinse in clear water, comb bristles, wrap in paper to store.

For best results use NYLON PAINT BRUSHES

Job after job, you'll get best results with a well-tipped nylon paint brush. Durable Du Pont nylon bristles don't break off, even on roughest surfaces. They last 3 to 5 times longer than ordinary bristles . . . paint smoother . . . are clean and sanitary. Nylon paint brushes are made by leading manufacturers in all types and sizes. Look for the word NYLON on the handle.



Better Things for Better Living
... through Chemistry

The best brushes have
**DU PONT NYLON
BRISTLES**

surprise his guests. Kraft has given away hundreds of jade pieces to employees and friends. He also presented a boulder of Wyoming jade weighing 2495 pounds to the Chicago Museum of Natural History. It is one of the largest chunks of jade found on this continent.

Being a lifelong enthusiast over stones, Kraft frequently carries a piece of jade in his pocket "just to feel of." Once when he was in Tiffany's Fifth Avenue shop he amazed a clerk by showing him a sample of white jade from his California mountain and asking if a set of dinner plates could be made from the material.

"The clerk recognized the material as jade and was startled," Kraft recalls. "He told me, yes, indeed, that it would make into a fine set of plates, and that Tiffany's would like a carload of the stuff. Of course, he thought I was crazy." Kraft grinned. "Well, I guess every lapidary and rock-hound is a little that way."

Fighting Infernos Underground

(Continued from page 130)

Such a blaze calls for direct attack with men and machines tested for the job in the bureau's experimental mine.

Frank Griffith, who is a big ruddy-faced fellow with an unassuming, capable manner, has led his engineers into many such fires. "You never know what they'll do," he says. "I've seen heat from one burning pillar of coal [left by miners to support the mine roof] loose volatile gases which exploded and carried the fire to the next pillar, and so on in rapid succession until an immense underground area was a raging inferno."

Most regular chemicals can't be used to douse a coal-mine fire. Carbon tetrachloride, for instance, makes phosgene—a war gas—when it hits burning coal. So, modern underground fire fighters use other extinguishing agents. Looking like Martians, they charge into a fire pushing a small cart with a big hose sticking out in front. This machine works like your vacuum cleaner in reverse. Into its hopper goes powdered limestone. Whirling fan blades whip it out through the hose in a billowing cloud that settles over the burning coal, smothers and cools it.

But there's more to think of than just dousing flame in a burning mine. Fighters must constantly be alert to shifting air currents, which may carry explosive gases into a blaze, or blow the fire into new parts of a mine.

In active mine fires, miners are sometimes trapped, and the fire fighters must

(Continued to page 238)

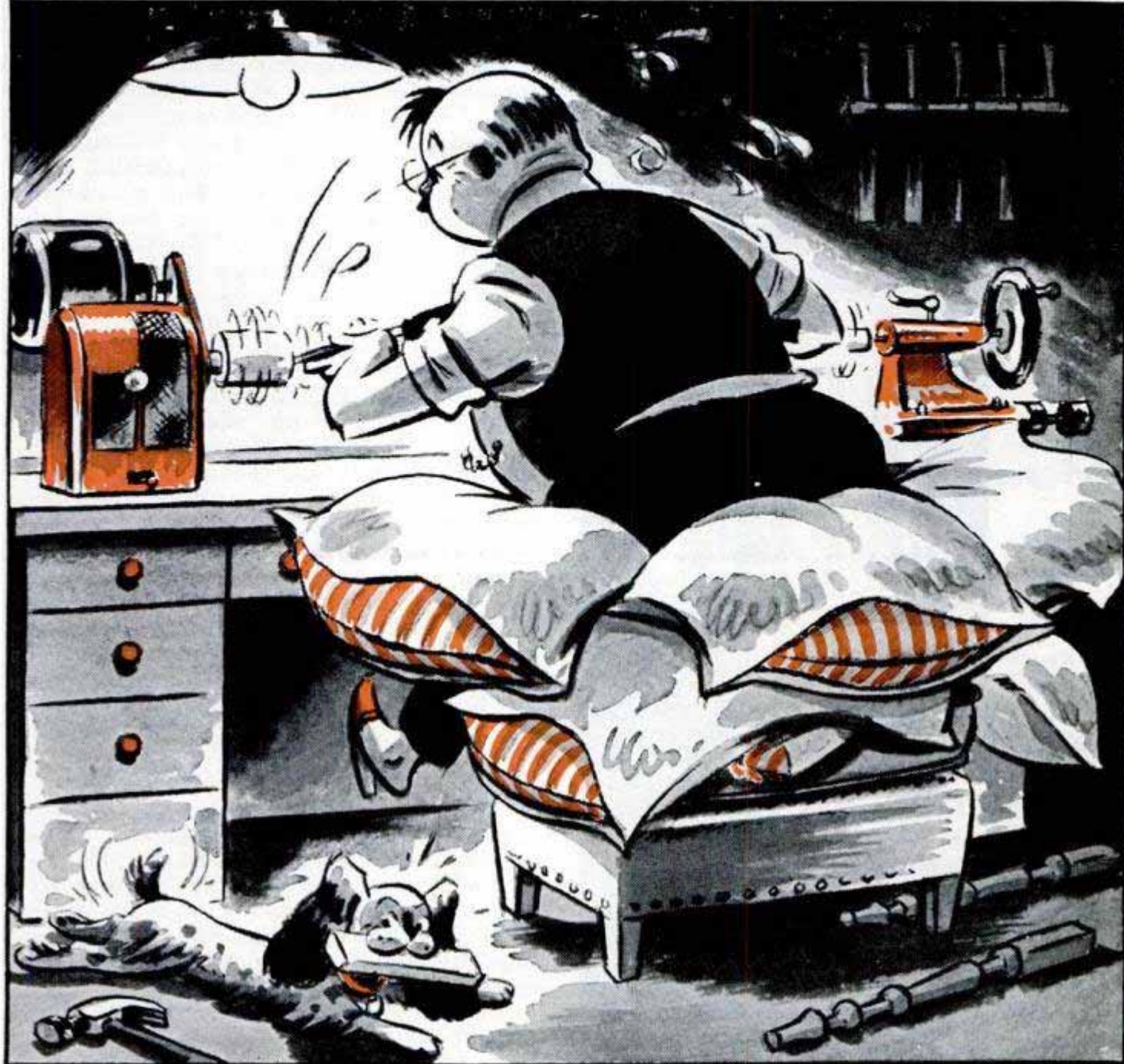

MARFAK MADE HIS CAR RIDE SO CUSHIONY HE'S SPOILED



Forget about "rough riding." Get longer lasting *Marfak* chassis lubrication, and enjoy "cushiony" driving for 1,000 miles or more! Tough, stretchy *Marfak* is made to resist wash-out, jar-out, squeeze-out. It protects against wear and friction far longer. Get *Marfak* lubrication today. See your Texaco Dealer, *the best friend your car ever had.*



THE TEXAS COMPANY
TEXACO DEALERS IN ALL 48 STATES

Texaco Products are also distributed in Canada and in Latin America

YOU CAN TELL A GOOD ELECTRIC DRILL BY ITS CHUCK



If it's a JACOBS
It bears the name... look for it!

Jacobs Plain Bearing Key Chuck... the most widely used drill chuck in the world. You can trust the tool that has one.

Jacobs Rubber-Flex Hex-Key Chucks on home workshop power tools prove that their makers put quality first.



Jacobs Rubber-Flex Hand-Tite Chuck. One-piece RUBBER-FLEX jaw assembly holds tools true and tight. No loose jaws or springs.

IF IT'S A

JACOBS

IT HOLDS

The Jacobs Manufacturing Company
West Hartford 10, Connecticut

move in fast to save them if possible. They'll take unusual chances, too. Griffith tells of one mine in Ohio, where a miner noticed some loose roof material. He pried at it, and the whole ceiling came down, bringing a trolley wire and a short circuit with it. Fire took off. Four hours later, Griffith and his crew groped their way four miles underground, met up with one blaze, and doused it with rockdust. "We started up ahead," he recalls, "when suddenly the whole tunnel ahead of us took off like a giant flame thrower. Fortunately it went ahead of us, not into us. Heat and gas did it." Some 66 men were trapped behind that fire. They had fled to side rooms off the main corridors of the mine, barricading themselves with piles of coal chinked with their clothing to seal the tunnel. But old airways behind them sucked the gas through from the fire, anyway, and by the time fire fighters got to them, all had died.

Miners arrange "brattice" cloth—huge drapes—to direct air currents into dead ends, where they work, to carry off explosive gas fumes. The penalty for failing to rig one is usually grim. One miner in Ohio left his down one day some years ago. A static spark from his mining machine set off a gas explosion, which flashed over a powder magazine and set it off. Seventy men were killed.

So, for obvious reasons, bureau fire fighters prefer to fight mine fires from above-ground. But even this has its hazards. At a southern Pennsylvania mine, a fire started in bales of hay. Men sealed up five openings, drilled holes to the exact fire location, and shot carbon dioxide right into the blaze to smother it. The holes were capped, and the mine left to simmer down. Two weeks later, air samples showed the mine was safe enough to open. The boys began to unseal all the openings simultaneously. Griffith was with a group at one opening when the seal was removed. "I felt the suction of air as it was being hauled back into the mine," he recalls. "A second later, the whole mine exploded. Evidently the gas had hit some burning coal. Two of us were standing near the opening, and we really took off."

What hit them was a column of air ahead of the flame. It knocked them 10 feet and sent them sprawling—a lucky thing, because a split second later, jagged flame shot from the headframe like the flash of a big gun and passed over them.

Anyone interested in preserving the nation's coal can be thankful it did. Without men like Frank Griffith, and the rugged lads he directs, it wouldn't be long before we found ourselves without any solid earth to stand on, at least at the rate we've been going.

Here is some interesting news about your automobile

Just suppose you are driving at 40 miles an hour on a level road. The power, of course, comes from the gasoline you feed your motor. Yet 50% of the power generated by the motor doesn't do a thing to make your car go farther or faster, or climb a steeper hill.

Why? Because that power never gets to the rear wheels. It is used to overcome *engine friction*. And we don't ask you to take our word for it—America's automotive engineers have *proved* it.

Now, along comes a motor oil that proves it *further reduces* this engine friction. Which means the engine delivers the same power with *less gasoline*.

It's simple as ABC: The *less engine friction*, the *less gas* it takes to run your car.

This has been strikingly demonstrated in recent months. Hundreds and hundreds of cars—cars of all makes and ages—cars that had been using *every* nationally known brand of motor oil—were given the Dynamometer Test. This is a machine devised by engineers to measure the power an engine delivers to the rear wheels.

And what happened? After the oil in these cars had been changed to Macmillan, the *same power was developed with an average of 8% less gasoline*.

The minute you change to Macmillan, you'll get an increase in power and gasoline mileage. You cut down on "drag"—your gasoline "pushes" easier than before. After the second or third drain, the average motorist gets an increase in gasoline mileage of 8%!

That's because Macmillan has not only reduced engine friction but also has reduced carbon and gum deposits in the combustion chamber, on rings, valves, and valve stems. This results in higher compression because of better piston seal—smoother operation, and less tendency for the motor to ping.

Do you know what this means in money? Figuring gasoline at an average of 25¢ a gallon, it means you save 2¢ a gallon—simply by changing your motor oil to Macmillan.

That's a big saving— isn't it? Yet it's small when you realize *how much more* you save in repair bills. Because: The less friction, the less wear and tear on your car. New motors stay newer longer.

Finally, remember this Macmillan Motor Oil not only *fight friction* but *removes carbon* from your motor—cleans your motor as you drive.

Ask for this fine motor oil at independent dealers where you see the sign of the big red "M." It means Money in your pocket, Mileage in your car. Try the *OIL* that makes your *GAS* go farther!



President

MACMILLAN PETROLEUM CORPORATION
530 W. 6TH STREET, LOS ANGELES
50 W. 50TH, NEW YORK • 624 S. MICHIGAN, CHICAGO

P.S. If you are unable to locate a Macmillan dealer, write to me and I'll be glad to direct you to the one nearest you. R.S.M.

Detroit Listening Post

(Continued from page 118)

customer as an accessory and charging him the full retail price.

Buick's delay on its new V-8 power plant may prove of benefit to its customers, when it is finally brought out. This should be on the 1953 models, provided conditions clear up by that time.

Buick engineers have perfected a new combustion chamber, something which is reported to be unique. It will require some accurate machining.

Chrysler focused attention on the combustion chamber in its new V-8 high-compression power plant. It changed the shape of the burning area with good results. Buick engineers are also said to have designed a newly shaped burning area.

Although no official word is given out from the factory, reports from Oldsmobile indicate the Super 88 may replace the 98 in the future. The plan for 1952 is to concentrate on lower-priced models.

Chrysler's success with the hydraulic steering device has inspired others to consider similar systems for their new models. Cadillac and Buick Roadmaster may be the next to offer it to customers. Packard is also interested in a device which will offer easier steering and parking. Chrysler has

not found the \$175 price tag on Hydra-guide any obstacle to its sale.

An interesting but little noticed change is noted on the floorboards of the new cars. It is due to the increasing popularity of automatic transmissions.

Because the left foot has nothing to do, the automotive engineers are trying to re-educate the drivers to exercise it on the brake and use the right foot exclusively for the gas pedal. To accomplish this, the brake pedal is being moved casually from its former position toward the left side and is made larger so the left foot can operate it without interference.

If you examine the Buick Special, you will find the brake pedal at least 2½ inches to the left and nearly doubled in size. Packard also has moved the brake pedal. Ford and Studebaker changed the contour to encourage the driver to try his left foot on it. The manufacturers approach changes like this with extreme caution.

The pioneers haven't had a field report on the success of their schemes to reactivate the left foot. The position of the steering post may halt the leftward drift with the brake pedal. But some daring engineer may just happen to place it directly under the left foot and make it plain that it is for that foot, while the right foot is for the gas pedal only.



THE MOST

Versatile TOOL

ON YOUR BENCH!

CHANNELLOCK PLIERS

Made only by CHAMPION DEARMENT

In almost any job you can think of—Pliers are necessary—and Channellock pliers are the best you can buy. Whether you are working on your car, electrical repairs, plumbing work or just tightening nuts and bolts Channellock pliers do it better.

And remember, Only Champion DeArment makes Channellock—
More than 3/4 of a Century of experience
in producing highest quality tools. Send
for Catalog D15—today.

CHAMPION DEARMENT TOOL CO.
Meadville, Pa.

Channellock pliers are listed
in the Yellow Pages of
most Telephone Directories

under "Tools"



ONLY Champion DeArment makes

CHAN NEL LOCK

TRADE MARK REG.

U. S. PATENT OFFICE

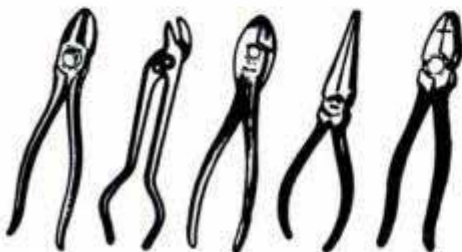

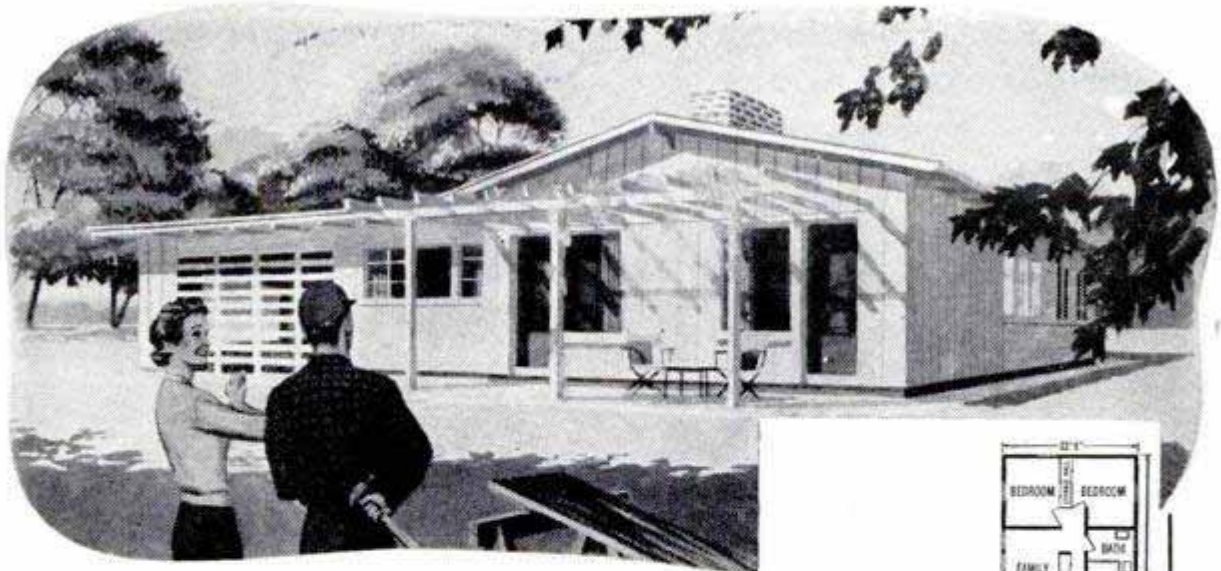

Believe it or not—

YOU CAN BUILD THIS HOUSE YOURSELF!

... Save up to *half* the cost! Use **WELDWOOD® Plywood** and new **Easi-Bild Patterns!**

You'll be surprised how easily you can build this attractive, comfortable house, using the simple, step-by-step patterns offered here.

These full-size Easi-Bild† patterns do away with hard-to-read blueprints. They show exactly how to make all angle cuts on the rafters, gable studs, etc. Every step, from staking out the ground to hanging the closet doors, is clearly pictured and explained.

Use the coupon to order Easi-Bild patterns for the house. Or, if you're not quite ready to build, get the Shopping Guide now. This provides floor plan, interior views and a complete list of materials required. With it, you can get accurate cost estimates for all needed materials. Also, you can use it to file your building permit.

†T. M. Easi-Bild Pattern Co.

Weldwood Plywood

**Interior grade Weldwood Plywood is guaranteed for the life of the building in which it is used.*



You can build the above house, originally designed with only one bedroom. And then add the two other bedrooms and carport whenever you're ready.

One New Jersey couple built the complete 3-bedroom house, with heating system, for \$9000, even including hired labor costing \$2400.

(An architect estimated their house to be worth \$18,000... *double* what it actually cost.)

There's a sunlit family dining room with built-in barbecue grill, a parlor with fireplace, 3 bedrooms, bath, kitchen, laundry and carport, with work and storage space.

One of the biggest time-effort-and-money-savers in this quality house is Weldwood Plywood*... inexpensive fir for sub-flooring... side and roof sheathing... Weldwood Hardwoods for wall and built-in units. The large 4' x 8' panels go up fast and easily. Learn how you can build this house yourself and save up to half, or merely *manage* the job and save up to one-third!



MAIL TODAY

UNITED STATES PLYWOOD CORPORATION
Box 61, New York 46, N. Y. PM-9-51

- Enclosed is 25¢. Please send illustrated booklet, "Beautiful Wood for Beautiful Homes," plus new Weldwood installation manual.
- Enclosed is \$5. Please send Easi-Bild Pattern # 502 containing step-by-step directions and complete list of materials.
- Enclosed is 50¢ for # 502 Shopping Guide so I can get local costs.

Name _____

Address _____

City _____ Zone _____ State _____

Stand By for the Race Of the Horseless Carriages!

(Continued from page 88)

They'll settle only for cars equipped as they were originally. Despite the extra time and labor this authenticity involves, they have the complete backing of Major Lohr, who privately owns one of the country's better antique-automobile collections.

From their personal knowledge, augmented by stacks of age-yellowed catalogues, handbooks and advertising pamphlets that described the car when it was new, they can plot near-perfect restorations. Henry Stemme, the museum's shop superintendent and an experienced patternmaker, then goes to work. After a mold is made from his pattern, a rough casting is poured, machined and made ready for assembly.

Wooden-spoke wheels, trunk racks, tool boxes, steering wheels, running boards and similar outmoded items are likewise turned out by the shops. Rebuilding a Brush, for example, calls for a wooden frame and axles. A socket for the whip, used to chase off dogs, was another peculiarity of early models.

The bicycle-size tires are generally either missing or petrified. Replacements have to come from the museum's dwindling

stock pile of pre-1920 model tires, or from a large rubber firm now making one commonly used size for car collectors.

Reassembly of the working parts has to be especially accurate and complete, since one of the requirements for display cars is that they run, and run reliably. Far from being strictly showpieces, some are even loaned or rented out for parades and celebrations. Many ran several times daily for months in a pageant at the Chicago Railroad Fair.

Interiors and seats oftentimes present problems. Patent leather, frequently used to cover seats and even fenders in the old days, is difficult to find now. But Ole Injerd, the museum's upholstery man, always comes up with enough to satisfy the immediate demand. Careful attention also has to be paid to the stitched and braided trim authentic for the make and model.

Now, looking unmistakably like an automobile, the car is ready for the paint shop, to get another stamp of genuineness. Some of the oldsters were almost as quickly recognizable by their distinctive colors as they were by their lines. The familiar bright red, yellow and blue of the racy Stutz Bearcat is one example. Others likewise held, for years, to strong prime colors

(Continued to page 244)

UNCLE WALTER

IT SMELLS GRAND



AROMA SWEET AS ANY ROSE -

IT PACKS RIGHT



PACKS TO PLEASE YOU -
GOODNESS KNOWS!

IT SMOKES SWEET



WITH EVERY PUFF
YOUR PLEASURE GROWS!
with Sir Walter Raleigh!

IT CAN'T BITE!

SIR WALTER RALEIGH'S BLEND OF CHOICE KENTUCKY BURLEYS IS EXTRA-AGED TO GUARD AGAINST TONGUE BITE, AND SIR WALTER RALEIGH NEVER LEAVES A SOGGY HEEL IN YOUR PIPE. STAYS LIT TO THE LAST PUFF.

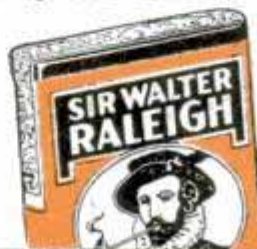

*It costs
no more
to get
the best!*



**Easy to make it yourself with
this versatile,
all-purpose,
low-cost**

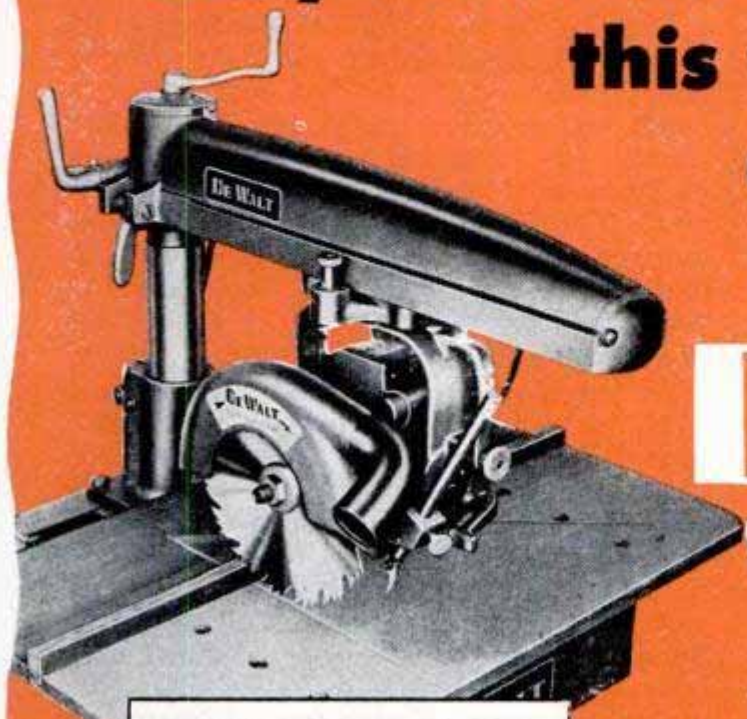

**DE WALT
"power shop"**

**SELLS FOR \$229
motor included**

does everything in woodworking!

MANY MACHINES IN ONE!

It's a SAW



It's a DADO



It's a SHAPER



It's a ROUTER



It's a JIG SAW



It's a LATHE

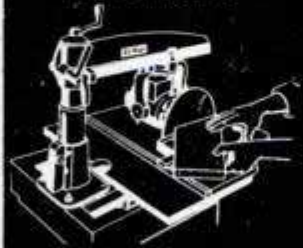

It's a DISC SANDER

Here, in one compact, space-saving unit, is the ideal all-purpose machine for your home workshop.

DE WALT—world-famous radial power saw—works wonders with wood, metals or composition materials. It's super fast! It's super safe! In fact, it is so easy to operate and so flexible that with each quick change of a cutting tool, you have another precision machine. It's *many* machines in one!

Using this multi-purpose machine you can make *any* number of things with ease—cabinets, shelves, furniture, even a garage or an addition to your house!

Send for literature which describes what you can make—and the many different cutting operations you can achieve—with a DE WALT.



Send for Free Folder

DE WALT, INC.
Dept. PM-9, Fountain Ave., Lancaster, Penna.
Please send me descriptive literature on the DeWalt Power Shop.

Name.....
Address.....
City.....State.....

DE WALT INC.

A Subsidiary of American Machine & Foundry Co.



make your **HANDS** **MORE CREATIVE** with **x-acto Knives and Tools**

Creative hands can be your greatest asset... X-acto knives and tools help the intelligent coordination of active minds and agile fingers... they can develop skill and dexterity in any art or handicraft you select.



Whether it's boat whittling, model airplanes, wood-carving, leathercraft, model railroads or any other handicraft, you can make your hands more creative with "designed-for-the-job" precision-engineered X-acto knives, tools and handicraft kits.



X-acto offers the complete line of handicraft knives, interchangeable blades, tools and attractive kits



From 25¢ to \$30.—at dealers everywhere.



No. 82
X-ACTO KNIFE CHEST
\$4.20



Send 15c to cover postage for our new illustrated 28-page Catalog.



X-acto Crescent Products Co., Inc.
440 Fourth Avenue, New York 16, New York

that almost became regular trademarks.

Though hand striping today is almost an extinct talent, in Louis Loftus the museum has a man who can execute the required fine hairlines along the fender rims and the fancy curlicues and swirls on the wheel spokes. When Louis' handiwork dries the car is ready to roll.

Looking back over a half century in the industry, Rube and Jack can rattle off dozens of improvements that were slow to catch on and become popular. The 1909 Brush, for instance, gave the public an early taste of the "knee action" ride principle. The Schaact, early in the century, was rear-engine driven. The Benz, in 1893, had a shifting lever on the wheel—a "change" that was greeted with enthusiasm nearly a half century later.

An early convertible, though not quite equaling the quick changeover facilities of today's models, was the 1906 Woods Electric. Four or five strong men could lift and bolt on an enclosure for cold-weather travel. Before World War I the Owen Magnetic featured a noiseless electric transmission that required no mechanical clutch. Scripps-Booth boasted of its electrically operated push-button doors in 1914, just about the time Pierce-Arrow pioneered headlights in the fenders.

Jack and Rube saw them all, and drove or worked on many of them. Now, through the old cars they help to restore so authentically, they are passing along those memories to generations that never saw America's first cars chugging along brick streets and dusty roads.

This month, though, they're concentrating on reminding the oldsters and showing the youngsters that fast automobiles aren't strictly phenomena of the '50s.

They're Breeding New Forest Trees

(Continued from page 146)

branches in order to climb to the crown.

Another phase of the work involves propagation by cuttings and grafting. One "study" tree has had possibly a dozen different branches from other varieties grafted to its limbs, and all are flourishing.

Interest in reforestation with new breeds of trees is international and many forest scientists from other countries have visited the institute to study at firsthand the methods developed there.

Huge reforestation projects will be vital in the future but already there are enormous areas in the United States that need to be restocked with timber. "It would be shortsighted to plant these areas with the

(Continued to page 246)

In 20 minutes- without rubbing- CAR-PLATE waxes your car with

longer-lasting protection!

Raindrops prove it
in test after test!



"Water beads" demonstrate protection!
When rain "beads up" on a clean car (see above), you know there is a solid film of wax on the finish to give tough protection against the weather. On a Car-Plate finish the wax protection lasts for a longer period of time than with any ordinary wax or polish.



When rain flattens into pools (see above) on a clean car, you know there is little or no wax protection left on the car's finish. When ordinary waxes or polishes are used, the wax protection doesn't last as long as when you use Car-Plate!

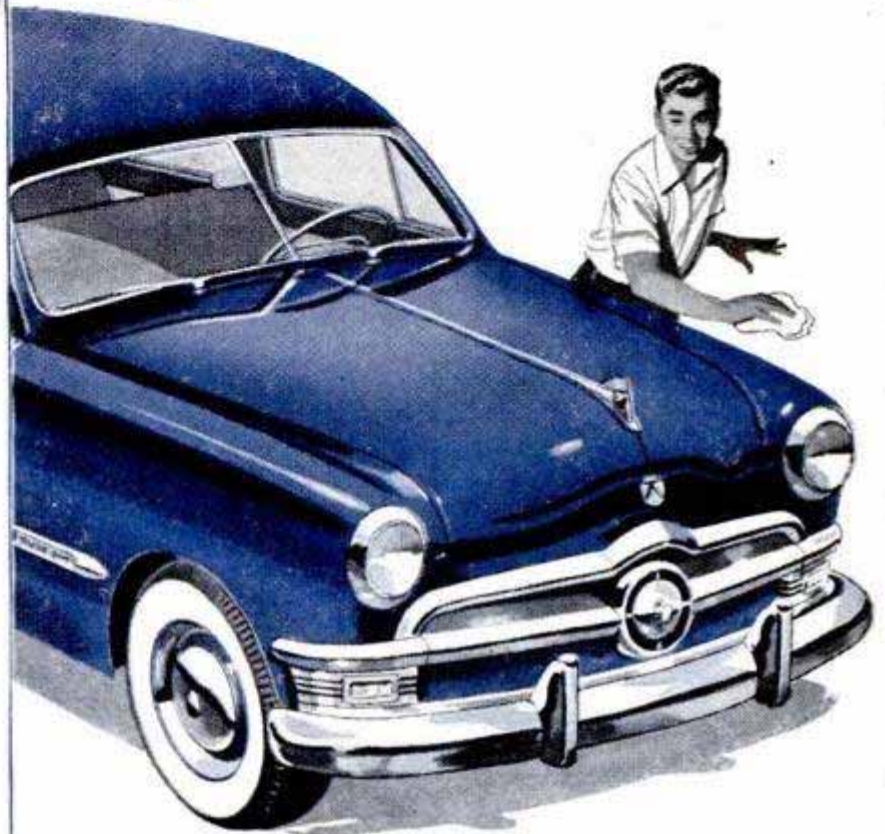

The easy Car-Plate way to wax
your car is the best way!

These pictures prove it! In test after test, the Car-Plate finish was still smooth and gleaming with wax protection after weeks of driving . . . while other waxes and liquid polishes had worn away!

Today . . . get Johnson's Car-Plate at your service station or wax dealer's. Spread it on the cleaned finish* . . . let it dry . . . then wipe it off. That's all you do to give your car the smoothest, brightest, longest-wearing waxing it has ever had!

*The easy way to prepare the finish of your car for a Car-Plate waxing is to clean it super-clean with Johnson's Carnu. For exceptionally dirty cars, ask your dealer for Johnson's Heavy-Duty Cleaner.



Even a hard-rub
professional
wax job costing
\$15 and more
doesn't give
your car more
protection than
Johnson's
20-minute
Car-Plate!

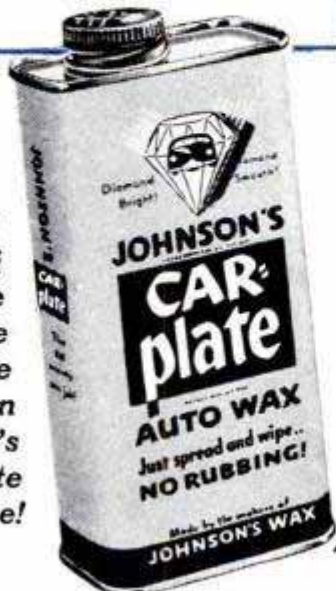

Johnson's CAR-PLATE

— the 20-minute auto wax described in Reader's Digest!



HANDYMAN HANK
keeps all his shop and garden tools gleaming and rustfree—he "Krylon-izes" them.



FISHERMAN FRED
"Krylon-ized" his precious fishing rod—and all his metal sports equipment. No rusting!

If you prize it— "KRYLON-ize" it!

Krylon seals metal, wood, leather, paper surfaces in a tough, waterproof ACRYLIC coating. Protects, beautifies, makes things last longer. Won't change color or crack.

Krylon will do things for you nothing else can—for there's never been anything like Krylon before! You press the red cap, and spray on a coating of tough *Acrylic*. Acrylic is the miracle material that seals out water, air, moisture, dirt; rustproofs metal. You can become an expert sprayer in 30 seconds! Krylon is waterproof, non-flammable. Won't discolor, crack or dry out. The touch of a damp cloth cleans "Krylon-ized" objects. Get Krylon today! KRYLON, INC., 2601 N. Broad St., Philadelphia 32, Pa.

"KRYLON-ize"

- | | |
|--------------------------------|--|
| Metal screens | Chipped spots on refrigerator, other enameled surfaces |
| Kitchen cabinets | Radiators |
| Valuable papers | Washable walls |
| Garden tools | Children's playground equipment |
| Leather bags and luggage | Window sills |
| Black and white photographs | |
| Wood or metal garden furniture | |

Hundreds of other uses to protect, preserve, waterproof, rustproof!

3 COLORS OF KRYLON

At hardware and paint counters everywhere
in 12 oz. aerosol spray cans



CRYSTAL CLEAR
(transparent as glass)



BRIGHT WHITE
(goes farther, stays whiter, cleans easier, lasts longer than enamel)



ALUMINUM
(use wherever you'd use aluminum paint)

native stock when hardier, faster-growing trees can be made available," one of the hybridists remarks.

"Likewise, there are some forest areas that today are understocked because the native trees are not resistant to disease or aren't flourishing for some other reason. It seems possible to create just the kind of hybrids that would be most suitable for these areas.

"In the case of a desirable timber pine it's now possible to extend its range by adapting it to greater differences of altitude or by providing it with a greater resistance to cold."

As an instance of this the institute has been able to cross the knob-cone pine, a scraggly but frost-resistant tree, with the rapid-growing but frost-tender Monterey pine. The hybrid offspring has much of the frost resistance of its knob-cone parent and should be useful for timber production and as a fast-growing ornamental, or for erosion control in localities that are somewhat too cold for the Monterey parent.

Forests of hybrid trees are expected to be self-perpetuating even though some of the second-generation hybrids would be worthless. Experiments over several generations at the institute show that many of the second generation of hybrids are almost as good as the first-generation hybrids. In a stand of such trees there would be enough superior trees to continue repopulation and to crowd out the inferior seedlings. Hybrids of many crop plants are sterile but this is not true of the pines.

Today the institute is conducting more than 100 different experiments with hybrids in its seedbeds, in addition to the work being conducted in the forests. In the past it was expected that years, even decades, would elapse before a new hybrid could be evaluated; now methods have been developed so breeders can evaluate certain important characteristics while the seedlings are still in the nursery.

Projects being worked on now include the mass collection of hybrid seeds and determination of the best methods of mass-producing hybrid stock. These studies are necessary for bringing down costs. The Institute of Forest Genetics does not produce hybrid seed or stock for sale but only for its own experimental purposes. It is pointing the way to a future increase in production of both lumber and pulpwood.

☞ It may be a hot day when you read this so it will probably comfort you to know that in February 1947 up in the Yukon at a lonely airport called Snag, the mercury dropped to 82 below zero, lowest official temperature recorded in North America.

TOUGH *but*
oh so gentle

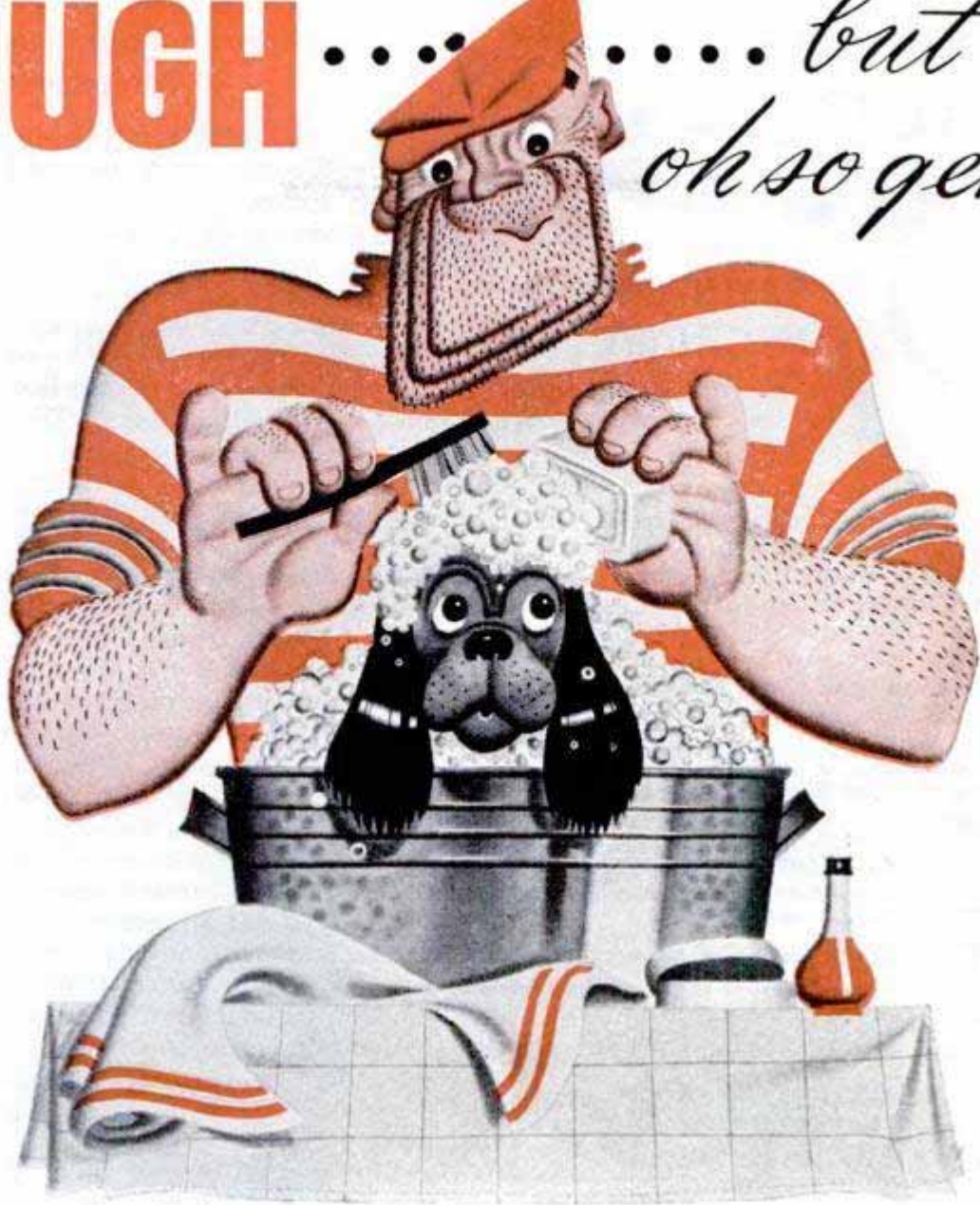

TOUGH ON OIL-PUMPING • GENTLE ON CYLINDER WALLS

When your car first starts using too much oil, look out for worn-out piston rings. They cause oil-pumping . . . loss of power . . . destructive engine wear.

Fortunately, it's comparatively easy and inexpensive to replace worn-out piston rings—but the more you delay, the more you pay.

At the first sign of oil-pumping, replace your rings with Hastings piston rings. They're engineered for *replacement* service. They *stop* oil-pumping, *check* cylinder wear, *restore* engine performance.

It's the best money you can spend on your car.

KEEP YOUR CAR OUT OF THE DANGER ZONE

Ask your motor service man for a Danger Zone check-up. And write for the free Hastings Danger Zone booklet which shows you how to save money on engine repairs. Dept. P, Hastings Manufacturing Co., Hastings, Michigan. Hastings Ltd., Toronto.



HASTINGS

STEEL-VENT PISTON RINGS

PISTON RINGS • SPARK PLUGS • OIL FILTERS • CASITE • DROUT

OWN THE FINEST! Starrett



SATIN CHROME* MICROMETERS

Pioneered and Developed by
The L. S. Starrett Company

Often imitated, never equaled, Starrett Micrometers are the standard by which all others are judged. Precision made throughout by Starrett methods based on over 70 years of micrometer manufacturing know-how . . . plus 12 big features for better, faster precision measuring. Ask your distributor to show you these finest micrometers ever to carry the Starrett name.

* No-glare, rust resisting *Satin Chrome Finish* is standard on thimble and sleeve of all Starrett micrometers and also on frame of all full finish micrometers.



SATIN CHROME MICROMETER NO. 230
Range 0-1" by .001". Also available as No. 231 reading by .0001".



BLACK FRAME MICROMETER NO. 436
24 sizes from 1 to 24". Available singly or in sets with .001" or .0001" graduations.



INTERCHANGEABLE ANVIL MICROMETERS NO. 224
Ranges 0-4, 2-6, 6-9, 6-12, 9-12, 12-16, 16-20 and 20-24 by .001". Singly or in sets.



SATIN CHROME INSIDE MICROMETERS

With hardened and ground contact surfaces.
Capacities up to 32".

NO. 823
with tubular rods.

NO. 124
with solid rods.



SEND FOR IT — ONLY 10¢

Starrett "Tools and Rules" Book

50 page booklet shows the right tools for any precision measuring job. 100 pictures plus helpful reference tables. Send only one dime. Address Dept. AP.



THE L. S. STARRETT COMPANY • ATHOL, MASS., U.S.A.



TRADE MARK
Starrett
REG. U.S. PAT. OFF.

SINCE 1880
WORLD'S GREATEST TOOLMAKERS

BUY THROUGH YOUR DISTRIBUTOR MECHANICS' HAND MEASURING
TOOLS AND PRECISION INSTRUMENTS • DIAL INDICATORS STEEL TAPES PRECISION
GROUND FLAT STOCK • HACKSAWS, BAND SAWS and BAND KNIVES

You'll Build Your Next House of Molasses

(Continued from page 114)

laid. "We've torn it up and laid it down a dozen times," he says, "testing different formulations. They're all good. Some are harder than others. We even used rubber crumbs for a filler to add 'give.' The only thing that didn't work was sea shells. They crumbled under wear." An odd thing about Plasmofalt paving is that if you gouge it, it will heal itself in time. That's one reason the military is interested in it for landing strips. Another is its simple convenience and compactness for shipment.

To make a landing strip 60 feet wide and 3000 feet long, a military supply ship would only have to tote along 40 barrels of Plasmofalt concentrate. One such barrel could be sent ashore, mixed with 10 barrels of "Bunker C" fuel oil from the ship's bunkers, to make a total of two tons of synthetic asphalt. This would be worked into exactly 30 tons of ordinary sand from the beach—and out of one barrel, you suddenly have 32 tons of paving material. Since most people don't spend much time around landing strips, you get an even better idea of what this means when you know that only 20 barrels of the concentrate are enough to make a road 18 feet wide and a mile long.

Probably the most versatile of all the molasses products is Plasmote—which is simply Plasmofalt mixed with clay and a filler. This will come ready-to-use in 10-gallon moistureproof bags, which Rappelyea hopes to sell for about 60 cents a gallon.

Thinned with water, it can be sprayed on the outside of an old house like stucco, troweled on old uneven floors to level them and give them a continuous surface like rubber tile, spread on table and counter tops to give them a flat surface impervious to acids and alkalis, laid on interior walls like plaster or molded into forms. Since it's waterproof, it's ideal for lining anything from showers to old-farm outbuildings. Eventually, the material will come impregnated with a variety of color, so no painting will be necessary.

"We're still finding things it will do," says the inventor, who sees in it a perfect spray-on coating for cheap tropical housing. "Spray it over thatch, inside and out, and you've got a waterproof, bugproof, beautifully insulated dwelling."

The material has a slight rubbery quality when dry, and sticks to any surface, as Rappelyea puts it, "like a friend with no money." He discovered its adhesiveness when he threw a handful of wet Plasmote on a junk pile, where it fell between two

(Continued to page 250)

NEW and DIFFERENT work shoe gives COMPLETE FOOT COMFORT!

STAR BRAND

Cush-N-Bilt

WORK SHOE

#286

cushion innersoles of sponge rubber absorb the shock of every step you take!

Are you one of those men whose feet take a beating on the job? This *new* shoe was specially engineered for your kind of work! Look at its construction features that absorb work shock, give rare on-the-job comfort, foot support. *LOOKS* like a dress shoe, *FEELS* like a slipper . . . yet specially built for hard work and long wear!

built for the man who works on
HARD CONCRETE
OR
OILY SURFACED
floors, pavements, etc.

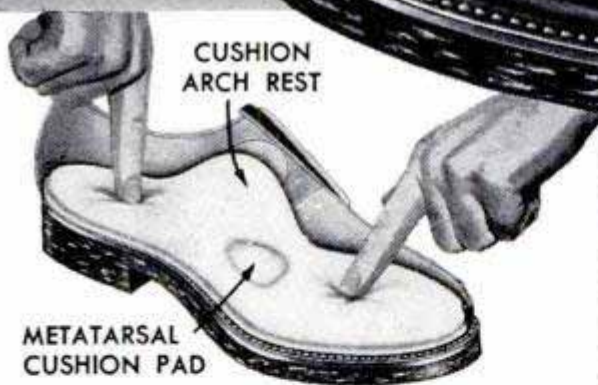

here's how the

Cush-N-Bilt

innersole rests your feet while you work

Resilient innersole, made of a molded cushion of extra-soft sponge rubber is covered with a walking surface of genuine cowhide leather. It rises on the inside, gives snug support and comfort to the arch. Metatarsal pad massages and relaxes busy muscles. Your entire foot rests in comfort while you work!

EXPERTLY FITTED by your local Star Brand shoe dealer!

**OIL RESISTANT, NON-SKID
CORDED SOLES AND HEELS!**

BUILT IN

STEEL SHANK ARCH SUPPORT

braces the arch, holds down foot fatigue!

GENUINE rich, cordovan-colored

COWHIDE LEATHER UPPERS

that give easy-going comfort, longer wear!

Fine Goodyear Welt Construction

FOR DEALER NEAREST YOU, WRITE: Roberts, Johnson & Rand, DIV. OF INTERNATIONAL SHOE COMPANY - ST. LOUIS 3, MO.

best
white tape
made

ONLY
98¢*



The new "Evans White-Tape" has everything you'll find in tapes costing over \$1.50—plus.

- snow-white blade with bold, legible, jet-black numerals and graduations. Graduated in 32nds for first 6 inches.
- sturdy die-cast case heavily chrome-plated, calibrated for quick reading inside and outside measurements.
- blade 1/2" wide made of finest high carbon steel—tempered—Bonderized—enamelled—baked.
- blade replaceable in seconds—without tools—without even opening case. And Evans replacement blades cost far less.
- every "Evans White-Tape" is unconditionally guaranteed.
- exclusive Evans automatic brake gives smoother push-pull action with absolutely no "creeping" of tape into case.
- underside is white, too. Mark with ordinary pencil, remove mark with flick of thumb.
- unheard-of low price*: 10-ft. \$1.49; 8-ft. \$1.19; 6-ft. 98¢. Prices higher in far west and Canada.

Evans

Sold only through retailers.

& CO. • Newark 5, N. J.

© 1949

Makers of Evans 6-ft. Folding Rule and "Folding Yardstick"



Send for this
BIG NEW
Hunt's
WOODWORKERS
CATALOG NO. 18

NEW LOW PRICES

ONLY
15¢

Offers greatest selection of fine domestic and imported woods—and hundreds of woodworkers items at bargain prices!

You'll save time and money with this big, new catalog. Contains everything wood craftsman needs. Shows 32 rare and fancy woods in color...43 veneer designs...275 scroll patterns...multicolor inlays, overlays, bandings...all kinds of tools, machinery, cabinet hardware, ornaments, mouldings...and pages of valuable tips, ideas, information, instruction. Send for your copy NOW. Only 15¢



• 144 PAGES

• **QUICK DELIVERY**

• on maple, poplar, oak, mahogany, red cedar, cherry, walnut, and many others—
• all properly seasoned and kiln dried.

MAIL THIS COUPON—TODAY!

CRAFTSMAN WOOD SERVICE CO.

2729 S. Mary St., Dept. A9
Chicago 8, Illinois

Send me the big, new, money-saving Catalog No. 18.
Enclosed is 15¢

Name _____

Address _____

City _____ Zone _____ State _____

pieces of lumber. Later he couldn't pull the two pieces of wood apart.

Rappleyea has tested Plasmote all over his place, in different forms, using make-shift machinery to mix and apply it. A homemade revolving oil drum with paddle rod axle—like a baker's dough mixer—churns the raw materials. To make his filler, he has a homemade "chewer" that makes "wood wool" out of old cardboard boxes. Cardboard goes in one end, is torn to pulpy shreds by teeth on a revolving drum, and comes out looking like yellow cotton with dried leaves tangled in it. This gives the plastic a fibrous binder. For spraying the stuff on buildings, the inventor got an old Model-A Ford front end, put on a compressor head and a tank, and devised a one-gallon container over the spray nozzle.

His handyman puts water-thinned Plasmote in the container and sets the Model-A going. Out spurts the stucco finish. Unlike stucco, which takes two weeks to apply and dry, then is subject to cracking, checking and chipping, the Plasmote is ready to paint in 24 hours, refuses to crack and can be applied in no time. And it only costs 20 percent as much. The handyman covered Rappleyea's entire factory building—about the size of a six-room house—in exactly eight hours. It took only 20 gallons of material to cover the building.

To show how it can work on an old building, the inventor is now "Plasmoizing" a 150-year-old cookhouse on his property. It was falling apart. Using the spray, he has put a complete new surface over the inside walls and ceiling, using about \$6.00 worth of Plasmote. The handyman is now troweling the thick material on the old, uneven wood floor.

"You use a mixture of mostly sand to fill in the low spots," points out the inventor. "Then a thin layer of standard Plasmote is laid on top." When the floor of the cookhouse is finished, the outside will be sprayed—right over the old shiplapping. "We usually nail tarpaper and fine chicken wire over the surface," says Rappleyea, "so we don't have to fill in all the hollows and consequently use three or four times as much Plasmote."

When complete, the old cookhouse will be what he calls "tight as a battery box upside down"—sealed inside and out against weather, termites and moisture. All for a materials cost of about \$25.

Besides its unique qualities, Rappleyea expects the demand for his molasses plastic to be high largely because of its low price—which he believes will always be low. "Blackstrap molasses has jumped from nine to thirty cents a gallon since we started,"

(Continued to page 252)

It's *Safer* to Drive
a Quick Responsive Car—

Get Dependable

CHAMPION

Spark Plugs

For Powerful Acceleration!

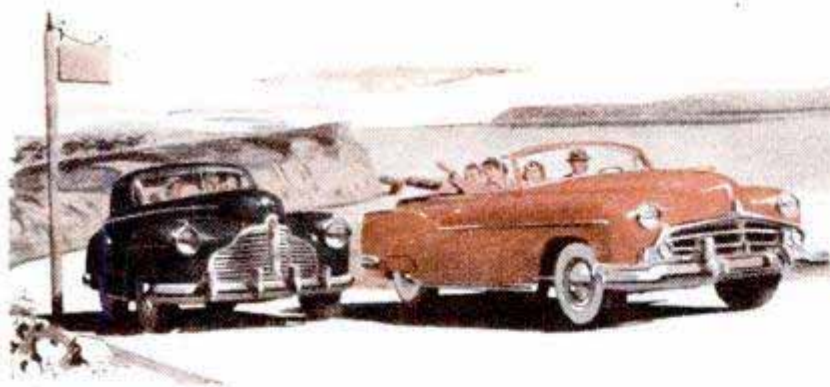
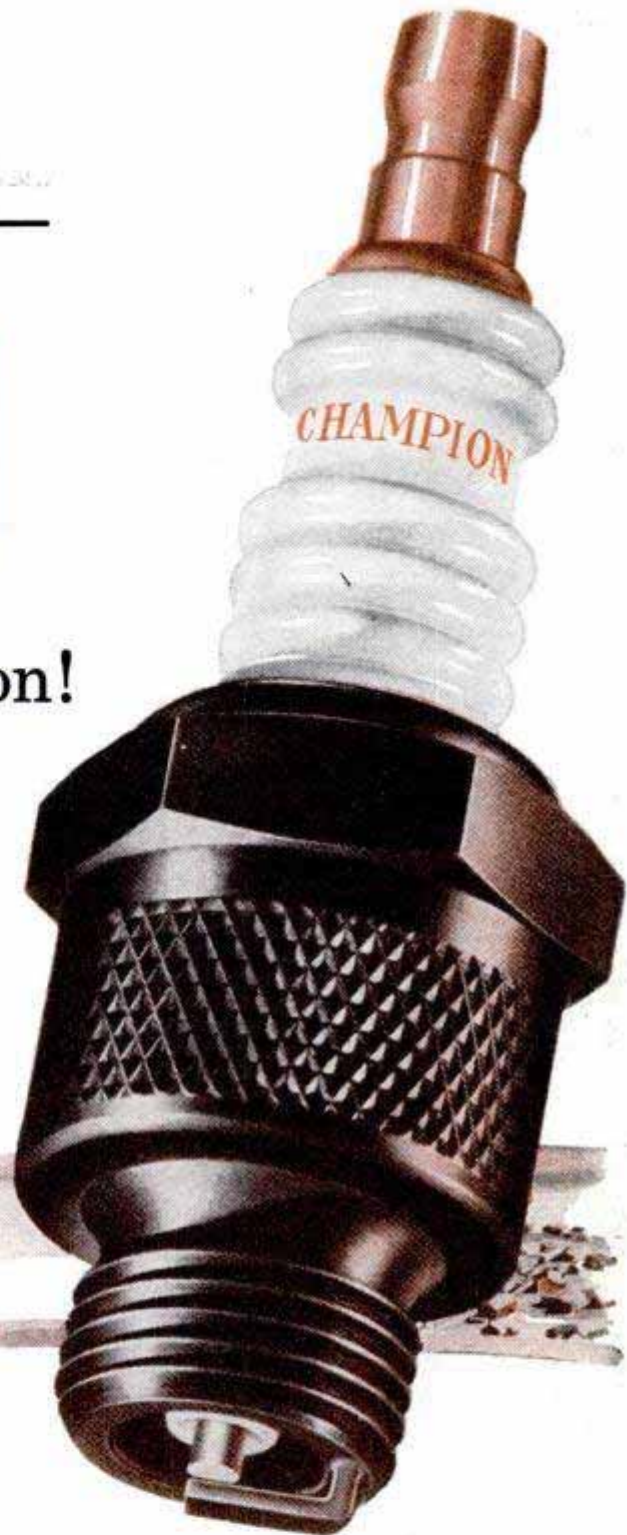

BE A CHAMPION DRIVER . . . *Regular Spark Plug Service
Insures Greater Driving Safety!*



Gradual erosion of electrodes will alter gap settings, resulting in unresponsive engine performance—noticeable most when you need peak performance most.

Keep plugs efficient! Let your Champion dealer check and clean them every three or four thousand miles. It results in longer plug life, better performance and economy.

There's a positive safety factor in powerful acceleration—impossible without good spark plugs. That's why nearly all racing champions and airlines use Champions.

CHAMPION SPARK PLUG COMPANY, TOLEDO 1, OHIO

Listen to the CHAMPION ROLL CALL . . . Harry Wismer's fast sportscast every Friday night, over the ABC network

he points out. "That's still cheap. But if it gets any higher, we'll switch to wood molasses, which is just as good and much cheaper. Sure it will be synthetic molasses, but Plasmofalt is synthetic asphalt. How synthetic can you get? As synthetic as necessary."

A number of people have questioned the inventor about the wisdom of using sugary substance like molasses for building material. "One woman wanted to know what we'd do to prevent ants and flies from eating her molasses driveway," he chuckles. "I told her all Plasmofalt driveways and roads would have to be posted with ant-sized signs saying 'Please Do Not Eat The Highway.'"

Actually, since the molasses has been completely polymerized, there is no sweetness or food value to be found in it. The Rappleyea experimental driveway only has a normal quota of ants and none of them look like they're eating it. "But," says the inventor, "you've got to admit that a molasses house really would be 'Home, Sweet Home.'"

Robot Orchestra

Robot musicians, built by a Japanese craftsman, work as an orchestra to play

several popular tunes. The orchestra consists of 17 members made of brass, each about 18 inches high. They play a variety of musical instruments. Before each number the director salutes the audience, then turns and starts directing the musicians.



WHAT LASTS FOREVER?



THIS DEAD BLADE still looks new but it blurs rain, smears muck, streaks glass. DEAD blades make dead drivers!

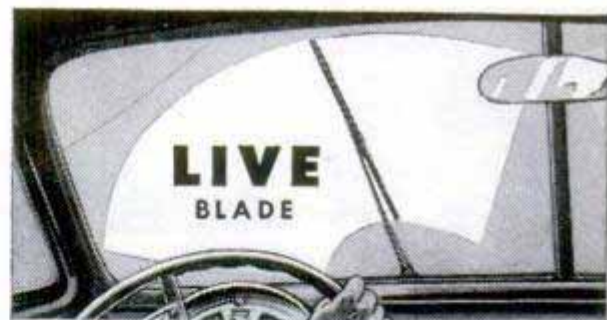

THIS LIVE ANCO BLADE wipes clean, clears rain, clears road muck . . . lets you SEE. Protects your loved ones.

WHAT LASTS FOREVER? Nothing does. This is especially true with Windshield Wiper Blades—even though made of finest natural rubber. Corrosive windshield film, wind burn and hot sun BAKE the life out of wiper blades, often in six months or less. DEAD blades cause dangerous windshield smear. DEAD blades make dead drivers. Make sure your car has live, new windshield wipers.

Change Your Wiper Blades

Next time you buy gas, change to LIVE,

NEW ANCO BLADES . . . RAIN-MASTER for Flat windshields . . . CLEAR-FLEX for Flat or Curved windshields. They fit all cars—wipe quicker and cleaner than any other blades.

Mr. Dealer: ANCO Wiper Motors give lots more power, lots less stall. Controlled wiping arc prevents blade slap. Six models only . . . COMPLETE replacement for ALL Cable Linkage, Bar Linkage, and Direct Drive original equipment vacuum wiper motors.

THE ANDERSON COMPANY
GARY, INDIANA

The .22 with the **SHORT SLIDE ACTION**

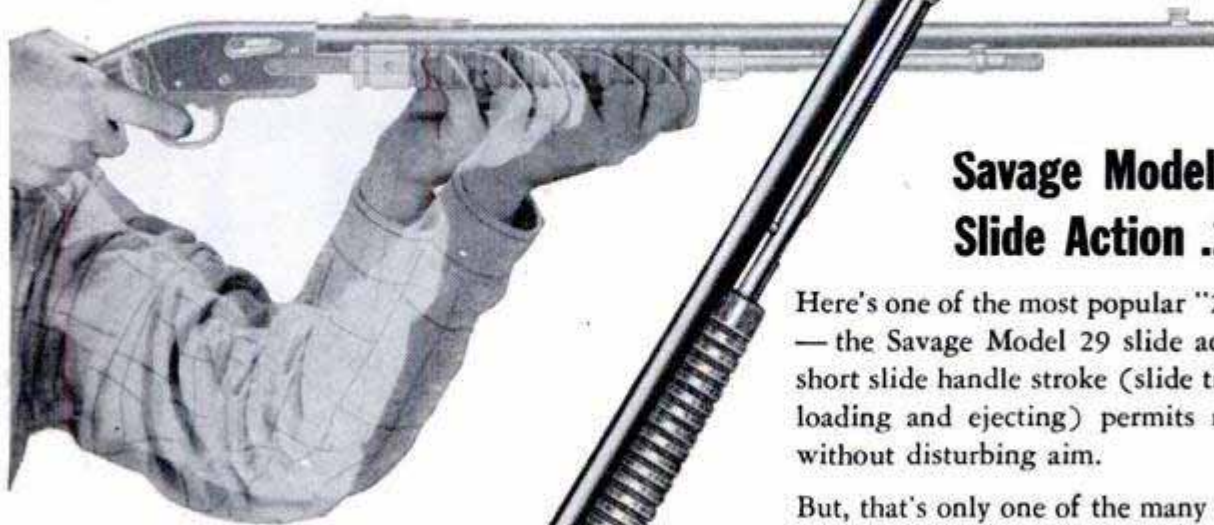

Savage Model **29** Slide Action .22 Cal. Rifle

Here's one of the most popular "22" rifles ever built — the Savage Model 29 slide action repeater. The short slide handle stroke (slide travels only 1½" in loading and ejecting) permits rapid fire shooting without disturbing aim.

But, that's only one of the many features you'll find in this rifle. Its tubular magazine permits continuous firing at any desired speed . . . holds 14 .22 long rifle, 16 long or 20 short cartridges . . . knobbed assembly screw allows quick take-down . . . one-piece bolt removable without tools for cleaning . . . extra long knurled slide handle adaptable to the reach of any shooter . . . stock of American walnut . . . in all, one of the finest hammerless, slide action .22 rifles you can buy.

But, "seeing is believing," so see the accurate, dependable Savage "29" at your dealer's and check its features for yourself. Write for free catalog of Savage, Stevens and Fox shotguns and rifles.

SAVAGE ARMS CORPORATION
Firearms Division Chicopee Falls, Mass.



SAVAGE • STEVENS • FOX Rifles and Shotguns

SAVAGE • WORCESTER Power and Hand Lawn Mowers

SAVAGE "3-in-1" .22 AUTO-LOADERS

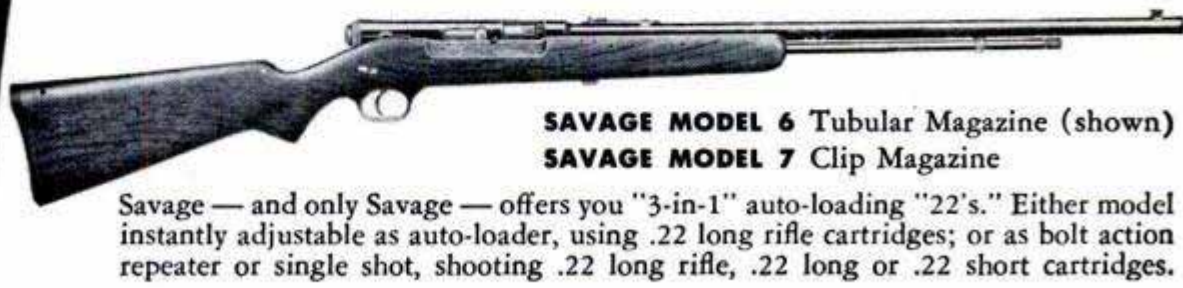

SAVAGE MODEL 6 Tubular Magazine (shown)
SAVAGE MODEL 7 Clip Magazine

Savage — and only Savage — offers you "3-in-1" auto-loading "22's." Either model instantly adjustable as auto-loader, using .22 long rifle cartridges; or as bolt action repeater or single shot, shooting .22 long rifle, .22 long or .22 short cartridges.

PEEL OFF PAINT with Klean-Strip



**New-type
remover is fast,
safe, clean, and
easy to use!**

No wash! • Non-inflammable!
Sold at leading paint, hardware and
department stores everywhere.
Product of W. M. BARR & CO.
2360 S. Lauderdale
Memphis 2, Tenn.

KLEAN-STRIP TAKES OFF ANY FINISH



**SIMPLE DESIGN
and FEWER PARTS
MEAN TROUBLE FREE
PERFORMANCE!**



**Ride
a Bike
- it's
Fun!**

For lasting satisfaction you can't beat a Bendix* Coaster Brake. Built to give you quicker stops—easier pedaling and longer coasting—it's the outstanding performer in its field. Your bicycle dealer will put on the brake you want—so just say "Bendix Coaster Brake." *REG. U. S. PAT. OFF.

**DOUBLE THE FUN
WITH A  Bendix
COASTER BRAKE**

ECLIPSE MACHINE DIVISION of
Elmira, New York

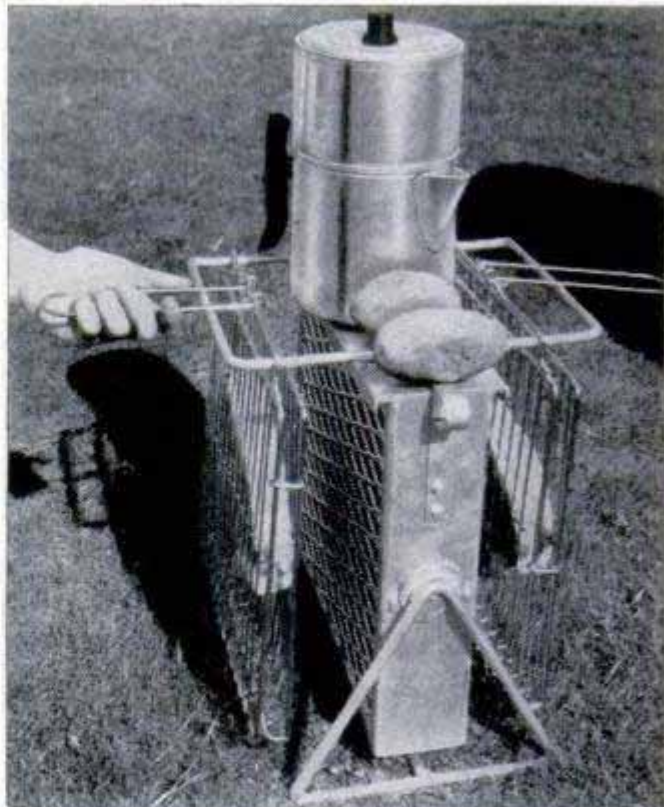

Charcoal Barbecue

Pivoting on a broad non-tipping base, a two-way barbecue can be used horizontally to make coffee and heat a skillet or vertically to broil steaks. The unusual design also makes it easy to light. You fill it with charcoal and light a fire under it. When the charcoal starts to glow, you can begin cooking. Two sandwich-type steak holders hook over the handles when the unit is used vertically for broiling.

☐ Of the nation's 60,000 private airplanes, 10,500 are used by farmers and ranchers for tasks such as pest control, crop improvement and livestock operations.

the right prescription
for today's biggest engine ailment
— hydraulic valve clatter!

MARVEL *mystery oil*

Tops as a top-cylinder lubricant, Marvel is unequalled for freeing and protecting valves . . . *all* vital power-producing parts. A *proven* lubricating formula used in the most intricately designed engines for more than 30 years.

BE ENGINE WISE...MARVELIZE NOW!

Use M.M.O. in the Marvel Oiler, gas tank, or as a crankcase additive.



Write for free information and the name of your nearest supplier—Dept. 121

EMEROL MANUFACTURING CO. INC.

242 West 69th Street, New York 23, N. Y.

For Better Work — FASTER — EASIER

THE ZEPHYR Electric Drill



only \$17⁹⁵

Handy . . . Speedy . . . Powerful. Has many uses around the home . . . in the shop . . . on the farm. Built to Last. Full 1/4" Capacity.

DRILL STANDS Add Many Uses for Zephyr Drill



Horizontal Drill Stand— for Polishing, Buffing, Grinding, etc.

Price \$1.00



Adjustable Vertical Drill Stand— for drill press operations

Price \$10.95



De Luxe Electric Work Saver Kit

Includes above ZEPHYR Drill, plus 28 accessories for buffing, cleaning, drilling, grinding, mixing paint, polishing, sanding, sharpening, waxing, and wire brushing.

Price \$26.35

At Hardware, Implement, and Building Materials Dealers, and Department Stores—or Write Direct



PORTABLE ELECTRIC TOOLS, INC.

324 West 83rd Street, Chicago 20, Illinois

In Canada: Portable Electric Tools, Ltd., 369 Danforth Rd., Toronto 13, Ont.

a "Must" for every mechanic
FREE, NEW CATALOG of those

"doggone good"

DURO-CHROME TOOLS

Makers of Nationally Advertised DURO Power Tools



Soon to be released—a new Duro-Chrome Mechanic's catalog. Crammed with pictures and detailed descriptions of the latest ideas in tools. Shows the right Duro-Chrome Quality Tool for every mechanic's needs, PLUS hard-to-find and "special job" tools your dealer has or can get for you.

Explains why Duro-Chrome Tools have been preferred by professional shop men for over 30 years. Tells what to look for in picking good tools; how Duro puts

Extra quality into every tool; for example, gets 25% more wear on Sockets, by exclusive Hot Broaching process.

Shows Duro-Chrome Tool Sets from 5-pc Punch and Chisel Sets up to 114-pc DeLuxe Workshops Sets. Reserve your copy of this "cyclopedia" of fine tools.

5399 R

USE THIS COUPON NOW TO GET FREE COPY

SEND IT TO DURO METAL PRODUCTS COMPANY

2649 N. Kildare Avenue, Chicago, Ill.

Write your name and address in margin space



Check-Cashing Machine Delivers Bills in Rolls

Checks are cashed automatically and an accounting record made of the transaction by a dispensing device that attaches to an adding machine. The entire operation requires only five seconds as compared with the 30 seconds taken by the normal method. The paper money is dispensed in banded rolls of varying amounts.

Motor Doesn't Scare Fish

Powered by an automobile battery, a new electric outboard motor runs so quietly it does not disturb the fish. The motor runs several hours on a six-volt battery and has twice the power and speed on a 12-volt battery. It is equipped with a steering brake, set by a thumbscrew, which holds the motor on the desired course and leaves the operator's hands free for fishing. The electric motor weighs only 25 pounds.

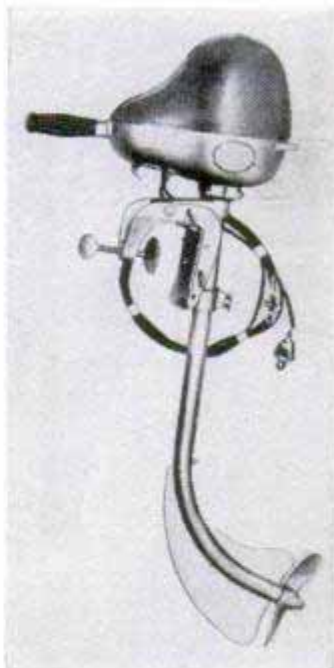

Some weed seeds are such hardy pests that they can lie dormant in a field for 30 years, then sprout and flourish.

"Shopsmith saved me \$100



**on this modern
17" television set"**

"I built my own TV set. Seventeen-inch tube. Assembled chassis. Birch veneer cabinet. Modern design. The cabinet materials cost me \$34.50. I figure I saved over \$100. And I had the fun of doing it myself. What's more, it's just what I want in size, design and finish.

"On this job alone, SHOPSMITH saved half its own cost. I used it for everything—sawing, sanding, drilling and turning. It took me less

than 60 seconds to change from tool to tool. In fact, I saved hours on jigs and adjustments, thanks to SHOPSMITH's time-saving features and precision settings.

"For accuracy, capacity, flexibility and all-around usefulness, you can't beat SHOPSMITH. It's a man-size tool, weighs over 200 pounds. Let me show you just a few of the things you can do with it."

SHOPSMITH is a complete power workshop . . .

- 8" circular saw
- 12" disc sander
- 33" wood lathe
- 15" drill press
- Horizontal drill

Five-tool unit complete except for motor*..

\$189.50

*Special 1/2-hp., capacitor-type motor \$34.50



SEE SHOPSMITH DEMONSTRATED AT LEADING HARDWARE AND DEPARTMENT STORES OR ANY MONTGOMERY WARD STORE. WRITE FOR FREE CATALOG.

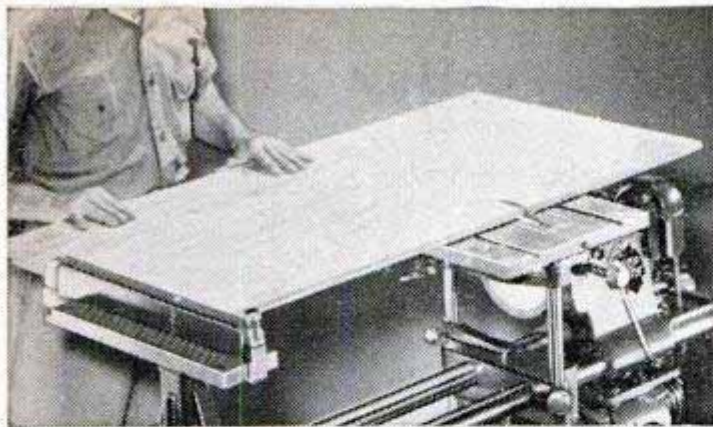

1 "Sawing large panels. SHOPSMITH has the capacity of a production-type saw. By putting the rip fence on the table extension, you get a maximum blade-to-fence distance of 48"—or right to the center of a standard size plywood panel."

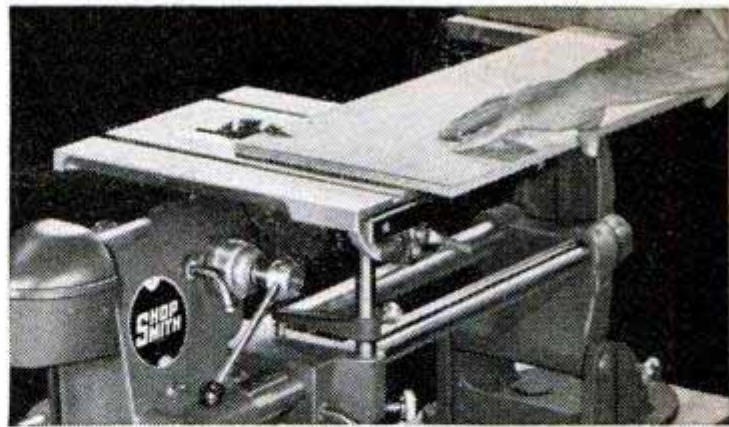

2 "Accurate cuts are easy with SHOPSMITH. Large miter gauge has automatic spring stops. Self-aligning fence has rugged front and back locks. For quick, accurate fence settings, the micro-quill adjustment makes hairline adjustments easy."

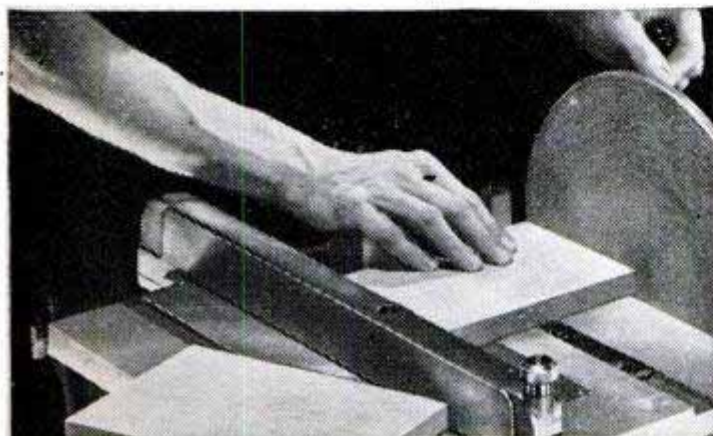

3 "Duplicate sanding is still another exclusive SHOPSMITH feature. You set up SHOPSMITH as a disc sander using fence and miter gauge as ready-made jigs. Set depth stop-nuts and feed disc into work. Pieces come out exactly the same length with precision-sanded ends."

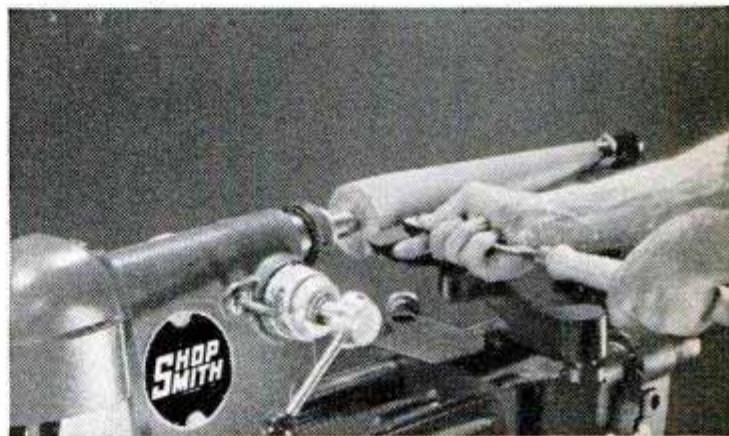

4 "It's a lathe, too! Yes, SHOPSMITH is a heavy-duty wood lathe with 15" swing and 33" between centers. In turning pieces like the legs for my TV cabinet, the SHOPSMITH tool rest certainly proves its worth. Always slides parallel to work, and locks quickly, securely."



5 "Parallel drilling is another operation that's a cinch with SHOPSMITH. Rip fence serves as instant-set guide. Large table supports big workpieces. Vertical drill press features 4" quill feed, 4 ball bearings in headstock, extra-big capacity."

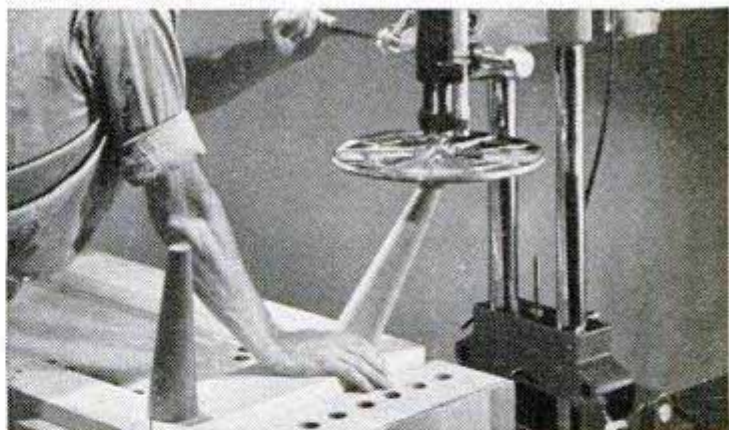

6 "Another SHOPSMITH extra. To level legs of cabinet, I swung SHOPSMITH to vertical position, attached sanding disc and set depth stop-nuts. With workpiece upside down, I fed disc into each leg until it stopped. All legs were identical in length."

FREE! 16-page information-packed catalog. Gives full details and specifications on SHOPSMITH and accessories. Write for it.

MAGNA ENGINEERING CORPORATION, Dept. 177-B, at factory nearest you:
12819 Coit Rd., Cleveland 8, Ohio, OR Menlo Park, California

Name _____
Address _____
City _____ State _____

Burgess Batteries



always fresher!



BURGESS Flashlight Batteries!

You can be sure that the Burgess Flashlight Batteries that you buy are *Fresh!* Nearly a half century of painstaking research and product development—backed by scientific control of quality has built an enviable reputation for the Burgess name.

- SEALED IN STEEL AND PLASTIC
- PLAINLY DATED
- IMPROVED BATTERY DESIGN
- GUARANTEED FRESH

BURGESS BATTERIES

BURGESS BATTERY COMPANY
FREEPORT, ILLINOIS • Niagara Falls, Can.

The Owners Report On the '51 Chrysler

(Continued from page 106)

it afforded a maximum amount of safety. A Los Angeles doctor said: "The new Hydraguide steering is out of this world. It requires no effort. Surely all cars must come to power steering as the next improvement. Chrysler always shows the way to new things in car design."

Chrysler's "reliability of the factory in standing behind its cars" was mentioned by several owners, including a Rocky River, Ohio, salesman, as a prime selling point. "Durability of all Chrysler products," as mentioned by a Taunton, Mass., sales manager, was another. A Norfolk, Va., contractor thinks that his Chrysler "gets more gas mileage than most lighter cars."

The Chrysler owners' report in general had a definitely enthusiastic and favorable tone. This was exemplified by the remarks of a Manassas, Va., minister, who wrote: "My wife recently said, 'I think we have the best automobile on the road today—our car has everything one could hope for!'"

And now for my own test of Chrysler. I drove the 1951 New Yorker four-door sedan from Detroit via Indianapolis to Denver, then over the Rocky Mountains to Los Angeles, approximately 2900 miles, including some extra test miles over rough back roads and in the desert.

The New Yorker is a big, roomy, 131½-inch wheelbase car that needs (and has) a lot of "horses." The new 180-horsepower engine is really something to shout about, and even when the car was new it had a lot of "zip" and acceleration. It is a thrill to drive and without doubt is a definite advancement in high-compression overhead-valve engines (7.5 to 1), due partially to the hemispherical design of the cylinder heads. The power (180 horsepower) to weight (4225 pounds) ratio is outstanding. Its power seems to flow without effort and vibration is practically nil. The ignition system is waterproofed.

Even more surprising than the thrill of the power-packed engine is the new power-assisted Hydraguide steering (maybe because it's an innovation). Until you get used to Hydraguide, there is an inclination to "oversteer," so slight is the pressure required to turn the wheels. One finger will do the job even when parking. There is no sensation or "feel" of the tires on the road. The device works only when the engine is running, and seems to "steer like a truck" when turning the wheels without the engine running after becoming accustomed

(Continued to page 262)

IMMEDIATE DELIVERY — LARGE STOCK — MANY SIZES

GENERATING PLANTS

3 KW-120 VOLTS-60 CYCLE
Single Phase

**ALTERNATING CURRENT
HEAVY DUTY — DESIGNED FOR
CONTINUOUS OR INTERMITTENT
SERVICE**

PLENTY OF CURRENT TO OPERATE
YOUR— • OIL BURNER • REFRIGER-
ATOR • HOME FREEZER • SUMP
PUMP • POWER SAW • BROODER •
CREAM SEPARATOR • INCUBATOR •
VENTILATING FANS • MILKING MA-
CHINES • BLOWERS • YARD LIGHT-
ING • OTHER APPLIANCES

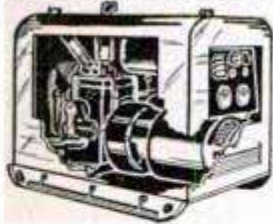

(Item #133)

Totally enclosed power unit with 2 cylinder water-cooled Hercules Model BXB engine direct coupled to generator. Magneto ignition, crank start, 4 gallon gas tank, 3 qt. oil capacity. Skid mounted with handrails for carrying. Instrument panel, killer button, oil pressure, water temp. gauges, volt-meter, ammeter. Shipping wt. 560 lbs.



(Item #88)

395.00

Item #133
Write for information on
other size generating
plants ranging from 600
watts to 25 KW.



(Item #86)

GENERAL MOTORS — ALLISON

BRAND
NEW

**CENTRIFUGAL PUMP
200 GALLONS PER MINUTE**

- For Draining Basements • Fire-Fighting •
- Irrigation • Fuel Transfer • Swimming Pools
- Home Water Systems • Dewatering

This General Motors-Allison Centrifugal Pump—designed for use on U. S. Air Force Mustang fighters, now converted for commercial, home, and industrial high volume pumping applications. Inlet, 2 1/2" standard pipe thread, twin outlets with 1 1/4" pipe thread, ball bearing supported 3/4" shaft. Easy, fast simple priming. Rotation, counter-clockwise facing shaft. Shipping wt. 35 lbs.



(Item #130)

Suction Lift	Head Pressure	Gal. Per Min.	H.P.	R.P.M.
10'	75'	260	6.0	3500
10'	65'	200	5.2	3500
10'	80'	40	1.5	2500
10'	50'	140	5.0	3500
10'	30'	100	3.0	2500

Gov't. acq. cost
\$145.00.
F.O.B. Chicago
Now Only

39.50

D. C. GENERATORS

For welders, plating, truck and marine use, D.C. appliances, lights, etc. Aircraft quality—lifetime grease sealed ball bearings. Heavy duty.



Item #131—Brand new Electric Auto-Lite 12 volt Direct Current electric generators, rated 18 amps. Complete with blower and pulley. Use for trucks, tractors, boats, battery chargers, etc. Part No. GEF-4805A. In original sealed U. S. Army cartons. \$50.00 value. Shpg. wt. 27 lbs.

15.00

Item #90—Type P-1, rated 200 Amps.—28 Volts, 2500 RPM. Mfd. by General Electric, Ford, Delco-Remy and Westinghouse. Gov't. Acq. Cost \$300.00. Shpg. wt. 53 lbs.

22.50

Item #91—Type R-1, rated 300 Amps.—30 Volts. Mfd. by Jack & Heintz. Gov't. Acq. Cost \$380.00. Shpg. wt. 59 lbs.

35.00

**Vickers HYDRAULIC
PUMP**



(Item #39)

**PISTON
TYPE**
Ideal
for use
with hy-
draulic
cylinders
and valves

described in this page ad. Vickers constant displacement piston type pump delivers .507 cubic inches per revolution, 8 gallons per minute at 3750 RPM, 1000 PSI. Has 1/2" diam. shaft, 3/4"-18 thread inlet and outlet ports. Rotation—clockwise.

19.90

**HYDRAULIC CONTROL
VALVE**

(Item #26)

Four-way control valve for use with two hydraulic double-action cylinders.



Each cylinder may be operated independently of the other or in conjunction with the other. Oil may be locked in any of the cylinders to hold the piston at any required position. Ship. wt. 6 lbs. A \$60.00 value.

12.95

BYRON-JACKSON "PUP"

\$3800.00 value

**CENTRIFUGAL PUMP UNIT
COMPLETE WITH FULL ENGINE
AND PUMP INSTRUCTIONS**

2 STAGE MODEL "PUP"
PUMP DRIVEN BY AN 8 CYL-
INDER MODEL C-36 CHRYSLER
INDUSTRIAL ENGINE.
ENGINE SPEED 2400 RPM —
100 H.P.
600 GPM AT 175 PSI —
PARALLEL CONNECTION
300 GPM AT 375 PSI —
SERIES CONNECTION



Item #132)

IDEAL FOR: Pick-up, Gath-
ering, Fire Fighting, Salt Water Disposal, Sprinklers,
Irrigation, Dewatering, Construction, etc.
These skid-mounted Pumping Units are standard production models with parts and service readily available. Designed for a wide range of operating conditions particularly where wide variation in head and capacity are required. Twin suction and discharge ports are cast on the same side and so arranged that external piping is interchangeable for either parallel or series pumping applications. Overall dimensions, 114" L x 20" W x 62" H. Weight 2480 lbs. Now, complete with operating instructions, performance data. F.O.B. Chicago.

1495.00

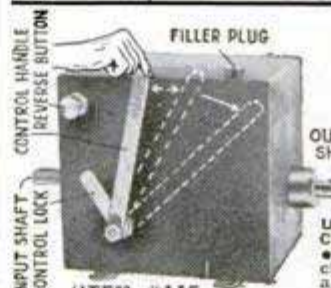

(ITEM #115)

**HYDRAULIC
SPEED
REDUCER**

with FINGERTIP CONTROL

USE FOR: • Reamer Drives • Midget Cars • Feed Mills • Canning Machines • Conveyors • Lathes • Milling Machines • Motor Boats • Cream Separators • Garden Tractors • Pumps

Variable output speeds ranging from 0 to input speed now available. Merely move control handle until desired speed is attained. Then turn locking handle to maintain the setting. Internal relief valves prevent overloading. Use input power of 1/4 to 1 1/2 H.P. This Westinghouse-Oil Gear Unit converted to commercial use from 40 MM anti-aircraft traversing mechanisms consists of a variable displacement hydraulic pump feeding a fixed displacement hydraulic motor. These components are contained in a crackle-finish steel oil reservoir (capacity 2 qts.). Adjustable relief valves set at factory for 100 inch pounds of torque may be reset up to 180 inch pounds. Independent reverse control allows full output power and speed selection in either direction of rotation. Both input and output shafts measure 5/8" diam., include keyway. Input rotation is counter-clockwise facing shaft. Recommended input speeds not to exceed 750 R.P.M. Over-all dimensions 7 1/2"x7 1/2"x11 1/2". Gov't. acquisition cost, \$428.00. Shipping weight 31 lbs. Complete with 2 qts. of oil and full instructions. F.O.B. Chicago

54.50

AIRCRAFT QUALITY HYDRAULIC CYLINDERS

Large supply of new labor-saving, economical hydraulic equipment in many types and sizes. Use these positive, highly efficient smooth pressure hydraulics on presses, arbors, lifts, loaders, power control, positioning, brakes, plastic dies, auto frame alignment, etc., etc.

ITEM #70—Purolator hydraulic oil filter. Permanent element type, 3/8" female pipe thread ports. Capacity 16 gallons per minute. A \$13.00 value.

4.95

ITEM #4—All steel double action hydraulic cylinder. 1 1/2" bore, 27" stroke. Clevis mounting. Will lift 1000 lbs. with 1000 P.S.I. line pressure. Perfect for positioning and feeding movements.

4.95

ITEM #127—Double acting hydraulic cylinder, 1" bore, 17" stroke, 1/2" diam. shaft, 1/4" tubing thread ports. Over-all length closed—61 1/2". Clevis mounting at both ends. Perfect for clamping and feeding. Postpaid

5.95

ITEM #33C—Double action hydraulic cylinder, 1 1/2" bore, 41 1/2" stroke. Clevis mountings at both ends. Uses 3/4" pipe fittings. Postpaid

8.95



(Item #42)

ITEM #16C—Double acting hydraulic cylinder, 1 1/2" bore, 26" stroke. Will lift 1760 lbs. with 1000 PSI line pressure. Weight 8 lbs. A \$55.00 value.

16.95

ITEM #103—Double acting hydraulic cylinder, 2 1/2" bore, 17" stroke. Clevis mounting. Will lift 4900 lbs. with 1000 PSI line pressure. 1 1/4" diam. shaft, 3/8" tubing thread ports. Overall length closed—38".

21.50

ITEM #31C—Double action hydraulic cylinder, 3 1/2" bore, 11" stroke. Aluminum alloy cylinder wall and all steel 1 1/4" piston rod. Clevis mounting at base and shaft, 19 1/2" overall length closed. Will lift 9625 lbs. using 1000 PSI from Logan Heavy Duty Hydraulic Pump. Uses 3/8" tubing fittings. Value \$102.00. Shipping wt. 11 lbs.

22.50

ITEM #6—Double action hydraulic cylinder, 3" bore, 24" stroke. Will lift 7070 lbs. with 1000 PSI line pressure. Steel barrel, 1 1/2" stainless steel shaft. Gov't. acq. cost \$176.00. Shpg. wt. 26 lbs. F.O.B. Chicago

28.00

ITEM #42—Double action hydraulic cylinder, 4" bore, 18" stroke. Rated lift capacity with 1000 PSI line pressure is 12,500 lbs. Ship. wt. 30 lbs. F.O.B. Chicago

32.50

FREE: NEW 48-PAGE CATALOG chuck-full of unsurpassed War Surplus Bargains for the farm, home, factory and workshop at far-below-cost prices.

ORDER DIRECT FROM AD — SEND PAYMENT OR PURCHASE ORDER TODAY — SATISFACTION GUARANTEED

GROBAN SUPPLY CO. 1139 SO. WABASH AVE., CHICAGO 5, ILL. DEPT. PM-9

BARGAINS FROM AMERICA'S Leading BINOCULAR RETAILER



16 x 50

**FEATHERWEIGHT
COATED**

The ultimate in a fine binocular. Tremendous 16 Power. Featherweight (weighs only 25 ounces!). Precision made in every detail. COATED providing sharper, clearer images. Individual eye focussing. Objective lens is 50mm (2 inches) across!

\$69.50

COATED!!

FEATHERWEIGHT!!



6x30 — \$27.95

8x30 — 32.50

10x30 — 39.50

Three (3) superb FEATHERWEIGHT glasses. Weigh only 16 to 18 ounces each. COATED for sharper, clearer images. Each measures a compact 4 1/2" x 6". Only in power and price do they differ. Each offers an excellent field of view.

- 7x35 Coated (Center Focus)..... \$49.50
- 7x40 Coated (Center Focus)..... 52.50
- 7x50 Coated 39.50
- 8x40 Coated 54.50
- 10x50 Coated 62.00
- 12x50 Coated 65.00



**15 to 40
POWER**



**\$29.50
COATED**

SIX TELESCOPES IN ONE! American-made Wollensak telescope. Instant focussing at 15x, 20x, 30x, and 40x, etc. Turn power tube to click—no guesswork. Telescope measures 9" closed, 27" when extended. Weighs only 18 oz.! Has rustproof chrome tubes, large 40mm objective lens. All 12 optic surfaces are COATED. See .22 bullet holes clearly at 300 feet. Use also for astronomical observation. \$29.50 price includes tax and fine leather case.

**6 POWER
BINOCULAR
Now \$16.95**

7 POWER — \$21.95

COATED! Pocket size—weigh only 4 oz. and 7 oz. respectively! Precision constructed PRISM binoculars. Not field glasses. Field of 375 ft. at 1000 yds.! Made of lightweight, durable black and chrome metal. Achromatic lens. Genuine leather case and straps. Carry the United Seal of Quality.



WEIGHS 17 OUNCES!

**7 x 35
COATED
\$45.50**

An all purpose 7 power binocular that will give you exceptionally sharp, brilliant images. Has individually focussing eye pieces. For sportsmen wanting long range viewing. Another opportunity to save by buying from UNITED. Genuine leather case and straps included. SAME MODEL IN CENTER FOCUS with individual focussing right eye piece. 7x35—\$49.50. 7x40—\$52.50.

UNCONDITIONAL GUARANTEE

Try for 20 days at our risk! If not fully satisfied return for full refund! Cash orders rushed postpaid. On C.O.D.'s include \$2.00 deposit. Add Federal tax. P.P.'s include genuine leather case and straps.

UNITED BINOCULAR COMPANY

9043 S. Western Ave., Dept. ARF-2708, Chicago 20, Ill.
Display Salesroom open Monday thru Friday 9:00 AM—3:30 PM

to power steering. Power steering definitely is here to stay and more and more new models of various makes will have it soon. But hold your breath: It costs a little less than \$200 at present for this "lazy man's" steering gear.

For a big four-door sedan, the roadability of the car is good, although I would prefer stiffer springing in front. The front end is inclined to "float" a little at high speed and, believe me, it really has high speed. It is the fastest stock four-door sedan I've

1951 CHRYSLER SPECIFICATIONS

ENGINE	New Yorker & Imperial Models	Windsor & Windsor De Luxe
Type.....	V-8-cyl., OHV	6-cyl., "L" head
Bore and stroke.....	3-13/16 in. x 3 5/8 in.	3-7/16 in. x 4 1/2 in.
Piston displacement...	331.1 cu. in.	250.6 cu. in.
Brake horsepower.....	180	116
Compression ratio.....	7.5 : 1	7.0 : 1
Transmission.....	Fluid-Matic (4-speed automatic transmission on Windsor, 4-speed plus fluid coupling) Fluid-Torque Drive (4-speed auto. trans. plus torque converter) on Crown Imperial models, optional on Imperial models.	3-speed conventional on Windsor, 4-speed De Luxe (optional on Windsor.)

GENERAL

	Imperial	New Yorker	Windsor
Shipping weight (4-door sedan)...	4315 lbs.	4225 lbs.	3595 lbs.*
Wheelbase.....	131 1/2 in.	131 1/2 in.	125 1/2 in.
Tread, front.....	57 1/8 in.	57 1/8 in.	56-5/16 in.
Tread, rear.....	58-9/32 in.	58-9/32 in.	59-9/16 in.
Height.....	65 1/2 in.	65 1/2 in.	65 1/4 in.
Over-all width.....	76 in.	75 1/2 in.	75 1/2 in.
Over-all length.....	213 1/8 in.	213 3/8 in.	207 3/8 in.

*Wind. De luxe — 3743 lbs.

Interior Dimensions (4-door sedan)

Front-seat width.....	57 in.	57 in.	57 in.
Rear-seat width.....	58 7/8 in.	58 7/8 in.	58 7/8 in.
Leg room, front.....	41 7/8 in.	41 7/8 in.	41 7/8 in.
Leg room, rear.....	41 1/2 in.	41 1/2 in.	41 1/2 in.
Headroom, front.....	39 in.	39 in.	39 in.
Headroom, rear.....	35 1/2 in.	35 1/2 in.	35 1/2 in.
Tire size.....	8.20 x 15	8.20 x 15	7.60 x 15
Recommended pressure.....	24 lbs.	24 lbs.	24 lbs.
Road clearance.....	8 3/4 in.	8 3/4 in.	8 3/8 in.
Turning circle.....	L-45'-1", R-44'-1"	L-45'-1", R-44'-1"	L&R-40'-4"
Steering wheel, lock to lock.....	5 1/2 turns	5 1/2 turns	5 1/2 turns
Steering ratio.....	20.4 : 1	20.4 : 1	18.2 : 1

CAPACITIES

Oil.....	5 qts.	5 qts.	5 qts.
Water.....	25 qts.	25 qts.	15 qts.
Gasoline.....	20 gal.	20 gal.	17 gal.

ever driven. For mile after mile on long open stretches, with practically no traffic, the speedometer needle showed from 112 to 115 miles an hour. The speedometer, like those on all other makes I've tested, is fast by about 10 percent, but even so this new Chrysler really "flies." There is good stability and a "safe" feeling in the car even at high speed. The new Oriflow shock absorbers do a fine job of controlling the ride at all speeds. Leg and head room is wonderful. Chair-height seats with soft Airfoam-rubber cushions offer a very comfortable

(Continued to page 264)

UNMATCHED at this Low Price!

CRAFTSMAN
OUR OWN TRADE MARK

**Tilting-Arbor
Bench Saw**

Saw Only
\$57.50*
Cash

Complete with blade, miter gauge,
rip fence, two pulleys and V-belt
\$6 Down, \$5 Monthly



Complete Outfit
\$129.95*
Cash
With guard, motor,
extensions, bench,
light and Powr-Panl
\$13 Down



**FLOATING
DRIVE**

Greatest improve-
ment in Tilling-Ar-
bor Saws in years!

Special floating motor mount lessens strain on saw. Smothers vibration, permits much easier tilting; protects motor from sawdust; automatically controls belt tension. Eliminates the need for a special motor.

**Only \$6 Down puts this big,
sturdy Saw in your shop!**

Meets the most exacting requirements of professional craftsmen! Look at these superior features! ONE wheel controls BOTH angle and depth of cut. Special high-speed tilting and depth adjustments; no locking device needed. ONE lever locks fence at BOTH front and back. "Super-lubricated" ball bearings have much larger oil chambers. Largest table area of any bench saw in this price range!

Precision-ground cast semi-steel table. 8-in. combination blade (1/2-in. bore) has 2 1/2-in. depth of cut; tilts any angle to 45°. Saw has blade; miter gauge; rip fence; machine and motor pulleys; V-belt; motor mount. Complete Outfit (as shown) includes saw guard assembly (with automatic leveling guard, splitter, non-kickback pawls); CRAFTSMAN 1/2-H.P. 3450 R.P.M. ball-bearing capacitor motor (110-120 volt 60-cycle AC); 2 side table extensions; front roller extension; adjustable steel power tool bench; tool light; and Powr-Panl for plugging in. See this sensational saw at your nearest Sears Retail Store TODAY!

*Prices slightly higher south of the Ohio and west of the Mississippi rivers.



Handy Accessories for Your Bench Saw

CRAFTSMAN 6-in. Dado Set, \$9.50. Dados, rabbets, grooves. 1/2 or 3/8-in. arbor.

CRAFTSMAN Molding Cutter Head, \$4.50, and Cutter Bits (styles \$2.95 per set, up). Make your own moldings! Has dozens of uses! 4-in. diameter cutter head (with Allen wrench), fits most bench saws with 1/2 or 3/8-in. arbor. 1-in. wide bits cut styles as shown.

CRAFTSMAN Carbide-tipped Saw, \$10.95 and up. New! Safer — has only 8 teeth projecting only .020 in. above non-cutting edge. Tungsten carbide tipped blades last 20 times longer than ordinary circular saw blades! No need to resharpen at frequent intervals. For ripping, cross-cutting or mitering. 5/8 to 10-in. diameters; all arbor sizes.

Sears Easy Payment Plan makes it easy for you to buy your Bench Saw NOW . . . pay for it as you use it!

CRAFTSMAN Hand and Power Tools by **SEARS, ROEBUCK and CO.**
Famous for fine quality . . . precision performance . . . low price!

QUALITY PLUS
PRECISION . . .

Shopmaster

Tools and
Accessories

for
**BUDGET-MINDED
Hobbyists**



8" Tilting Arbor Bench Saw \$76.95

7" Tilting Arbor Bench Saw \$47.95

8" Tilting Table Bench Saw \$51.50

10" Tilting Arbor Bench Saw \$86.95

10" Floor Model Tilting Arbor Saw \$105.00



12" Drill Press \$46.95

12" Floor Model Drill Press \$54.00



15" Jig Saw (Tilting Table) \$27.95

Saber Saw \$17.95



6" Jointer-Planer \$79.95

4" Jointer-Planer \$47.95



12" Band Saw \$79.95

10" Band Saw \$46.95

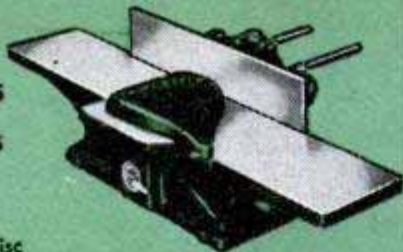

Belt and Disc Sander \$51.50

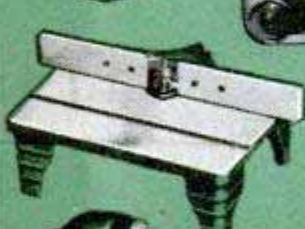

Spindle Shaper \$45.95

10" Wood Turning Lathe \$45.95



Zone 2 prices, slightly lower in zone 1.



WRITE TODAY FOR
FULL COLOR CATALOG.

SHOPMASTER, INC.

1214 Third St. S., Minneapolis, Minn.

driving position, and the larger center arm rest in the New Yorker is very convenient for long-distance driving.

Brakes are highly satisfactory with no sign of "fading" either at high speed or on long, steep mountain grades and pedal pressure is light. Chrysler's Safeguard hydraulic brakes, power-assisted by vacuum were on my test car, which aided the smoothness and ease of brake-pedal operation and made quick stopping possible. While Chrysler engineers are pioneers of hydraulic brakes, they still stick to the mechanically operated parking brake located on the propeller shaft.

Inside the car are many fine features. The panel (speedometer and instruments) is rather "cheese cakey" but Chrysler seems to favor such styling and it is attractive. The crash pad is a good idea and adds to safety. The hand brake is easily operated by a "T" lever at the left of the steering column.

I used the new Fluid-Torque Drive model with four-speed automatic transmission. It is smooth, with no jerking; the new converter multiplies the torque a maximum of 2.34 to 1, thus giving tremendous acceleration. In my opinion it is much better than the ordinary fluid coupling where the converter is not used.

I think some improvement could be made on the shift lever and the position indicator. It's a little difficult to operate between low and reverse. This is no serious objection, but is not in keeping with Chrysler standards. There should also be a light on the indicator for night operation. There is still a clutch pedal, which must be used before moving the shift lever after starting the engine. You can then forget the pedal, which Chrysler has plainly marked "Safety Clutch." Unless the clutch pedal is depressed after the engine starts, the car will start moving if the lever is in "R," "D" or "L" position. At speeds above 55 miles per hour you cannot "kick down" to a lower ratio. At any speed the upshift to high after removing foot from throttle is delayed too long. It's too sluggish. The downshift could be smoother.

The body is not only roomy but solid. The vision is outstanding, both front and rear. There are few blind spots and there is a clear view in every direction. I found no dust or water leaks in rainstorms. No squeaks or rattles developed.

The windshield is two-piece, of which I approve, as replacement costs are less than the curved, one-piece style.

The electric windshield wipers have two speeds and function well.

Chrysler still sticks to the cowl ventilator

(Continued to page 266)

"New-Engine" Your Car Now With A Wizard-ized Engine for \$16 Down

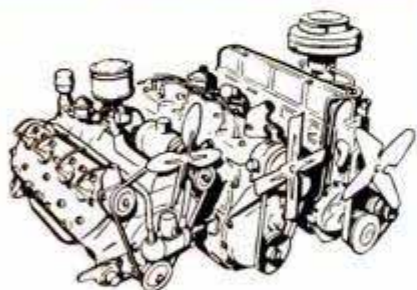

FORD PLYMOUTH CHEVROLET
as low as as low as as low as
\$16⁰⁰ \$17⁰⁰ \$14⁰⁰
Down Down Down

Terms vary by area, make, and model of car.

The Biggest Money-Saving Idea In Car Maintenance In Over 20 Years!

Now you can say goodbye to high upkeep costs and never-ending repair bills . . . enjoy new car power with a Wizard-ized Engine.



Not just "rebuilt"—but fully remanufactured in 5 large factories. Every original manufacturing step repeated, using original factory block. Backed by over 3000 Western Auto Stores and Associate Stores!



Every moving part brand new top quality, or completely remanufactured to function like new. That's why you can buy a Wizard-ized Engine with new car confidence.

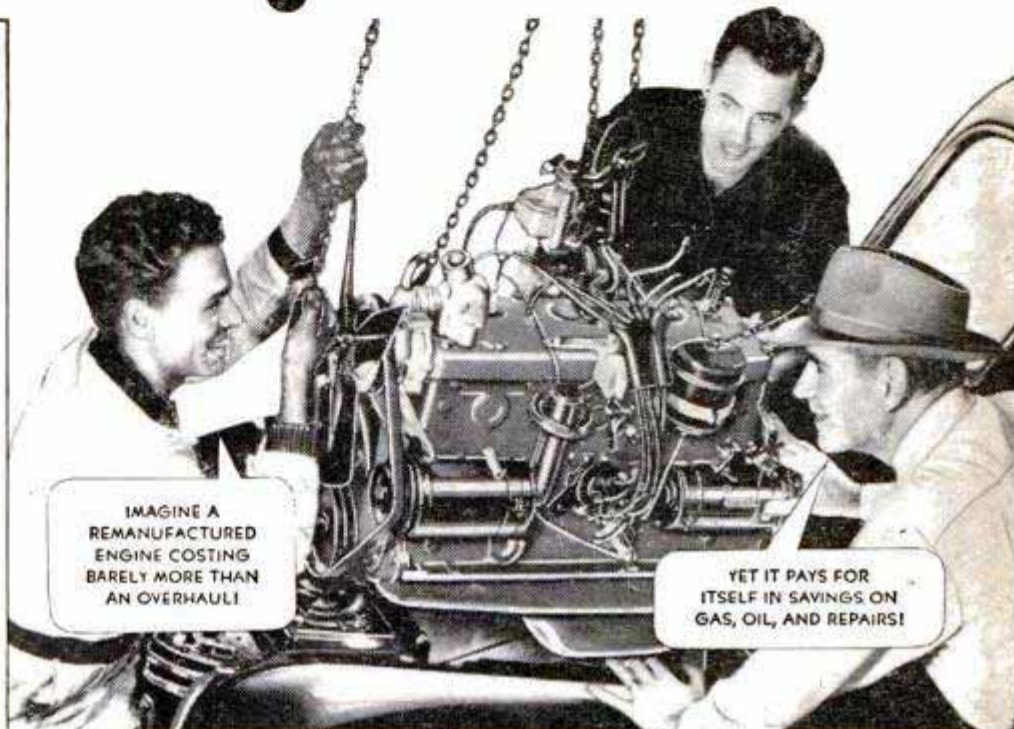

IMAGINE A
REMANUFACTURED
ENGINE COSTING
BARELY MORE THAN
AN OVERHAUL!

YET IT PAYS FOR
ITSELF IN SAVINGS ON
GAS, OIL, AND REPAIRS!

*Your easy, low-cost solution for "tired" Chevrolets, Fords, Plymouths, Pontiacs, Mercurys, Dodges, Chryslers, DeSotos, Oldsmobiles, Studebakers, and other

popular makes. Wizard-ized Engines are fully remanufactured in 5 large factories. Engine accessories used from your old engine, or may be replaced new.



Get Another 50,000 Miles or More from Your Car With A WIZARD-IZED ENGINE THAT Pays for Itself!

Thousands have discovered this easy new way to stop constant costly engine repair bills—simply by replacing their old engine with a low-cost guaranteed Wizard-ized Engine . . .

No other engine—no overhaul—can give you more miles for so little cost. And, you get . . .

The same engine guarantee that comes with a new car—plus free 500-mile service check of our installation. Each Wizard-ized Engine gets a . . .

Complete factory inspection and then a final test-run. Our installations are made by trained mechanics in fully equipped garages. You can buy a Western Auto Wizard-ized

Engine with new car confidence! And, best of all, it's . . .

Priced far below a new engine . . . or about the same as a bearing, ring and rebore overhaul.

Why waste money on extra gas, oil, and repairs for a worn-out engine? You can enjoy a Wizard-ized Engine for . . .

Less than 1/2¢ per mile . . . and you get years of new miles without the high cost of a new car!

See your Western Auto man now . . . about his guaranteed trade-in allowance for your old engine!

EASY TERMS AS LOW AS **\$3⁰⁰** weekly
(Terms vary by area, make, and model of car.)

Wizard-ized Engines

FACTORY REMANUFACTURED*

The Engine You Can Buy with New Car Confidence!



NOTE: Western Auto Associate dealers own their own stores and set their own prices. Terms and conditions quoted are recommended, and subject to variation. © 1951, Western Auto Supply Co., K. C., Mo. (M31)

Instant Flame

with a
Twist of
Your
Fingers!



The new principle
with the

TORCH

**THROW AWAY
FUEL TANK**

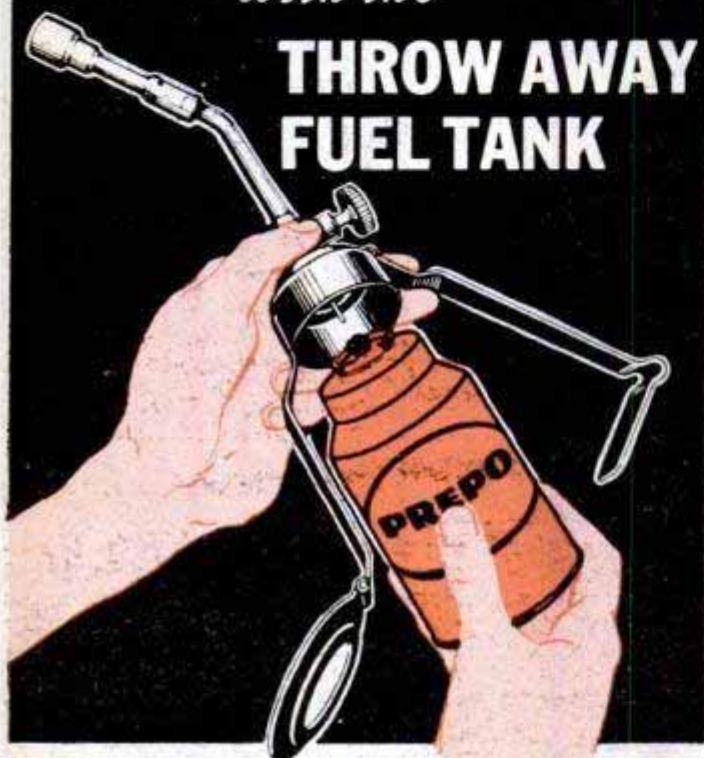

IT'S SAFE!

**ECONOMICAL
CONVENIENT**

Everybody's talking about Prepo—the safe torch you light with a twist of a valve. No messing around with bulk fuel pouring, no priming, no pumping—Prepo gives you a hot blue flame, ready for soldering, removing paint, puttying, or any of the 101 uses you expect from a torch. Prepo Fuel comes in replaceable tanks—each good for several hours of steady work. No storing of dangerous bulk fuel. Prepo is easy to use—fits your hand—weighs only a few ozs.—puts 2200°F. flame where you want it. Get Prepo Torch and Prepo Replaceable Fuel Tanks at your favorite store.

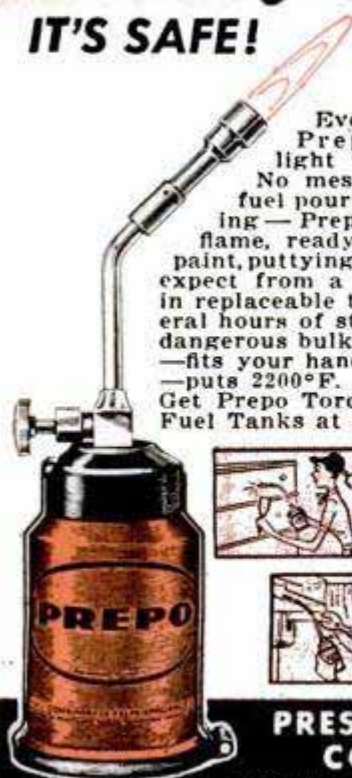

**101 USES for
Home or Shop**



**PRESSURE PRODUCTS
CORPORATION**

140 N. Dearborn Street Chicago 2, Illinois

operated by a lever. I like it, as the air enters high above the ground, eliminating much dust and fumes from vehicles in front. The hood is long and on rough roads there is a little hood vibration. I think a shorter and more sloping hood in front would aid close-to-the-ground vision and eliminate any hood "flutter" on rough roads. With the short V-8 engine, a shorter hood could be used. The hood locks from the inside and therefore offers protection for under-hood equipment that might otherwise tempt thieves.

The starter is conveniently located and is operated by a turn of the key . . . it's good. The choke is automatic. The trunk space is large, and the lid opens easily. The ventilation system is excellent, either in hot or cold weather. The radio is average.

For a large four-door sedan, heavily loaded, I consider the gas mileage very good (see economy chart). The new engine is designed to use regular gasoline. I experimented with both premium and regular gasolines of various brands and, while 61 percent of the Chrysler owners reported using premium gas, I found nonpremium gas to be satisfactory for ordinary use in the V-8. Only a few times in very hot weather did the engine "ping" when using regular gas.

In the 1951 A.A.A. Grand Canyon Economy Run from Los Angeles to Grand Canyon, Ariz., a Chrysler Imperial won Class G, averaging 21.178 miles per gallon at 40.-765 miles per hour for the 840.05 miles. At the same time, a Chrysler Windsor did 20.-886 miles per gallon.

After beating the new V-8 over all kinds of roads (some off the highway in mountains and desert) in every conceivable kind of test, I'll say Chrysler has come up with a "toughie." I abused it and tried to find the "bugs," but I found none of consequence. I couldn't make it heat, rattle or squeak. It responded to every conceivable kind of test and came through with flying colors. I've never found the perfect car and I don't expect to; there are things about every make that I like or dislike. I do like the new Chrysler. For my money and under present conditions it's a top buy.

I interviewed several Chrysler owners on my trip west and I'll say they are a bunch of boosters. Many are "die hard" Chryslerites . . . I mean owners who buy Chryslers over and over again; many wouldn't own any other make.

Chrysler engineers again have rung the bell with new advanced ideas in design and construction in the 1951 models. The late Walter P. Chrysler would be proud of the corporation he founded and the cars it continues to build.



Wilbur Shaw says . . .

"It's hard to describe this new Chrysler without going off the deep end!"

Here's why America's most famous driver picked Chrysler to pace the 1951 Indianapolis 500 Mile Race . . . as recorded on tape during his first drive in our beautiful new car.

"It's a whale of an automobile . . . the most powerful—and probably one of the fastest stock sedans manufactured in the U. S."

"It's pretty hard to describe this car without going off the deep end!"

"This engine . . . (the revolutionary new 180-horsepower Chrysler FirePower Engine) . . . I can't get over the amount of power and snap . . .!"



"As astonishing as the performance of this engine is, it's only half the story! The rest is power steering . . . (Hydraguide, an exciting new Chrysler first) . . . the first on any U. S. passenger automobile, and a new Chrysler Fluid-Torque Drive."

"This steering combined with the automatic transmission . . . is the nearest thing to an automatic pilot for a car I can imagine."



"That makes a lot of automobile in one package . . . In fact, I think so much of this car that I've selected it as the pace car in the 1951 Indianapolis 500 Mile Race."

★ ★ ★

Remember . . . the above words are Wilbur Shaw's own, reported on a tape recorder in the car. Your own reactions will be equally enthusiastic. With the revolutionary new FirePower Engine—with Hydraguide, the first power steering in a passenger car—with Oriflow Shock Absorbers that double your comfort on rough roads—Chrysler brings you the most thrilling developments in the automobile in many years. Your nearby dealer will be happy to let you feel these new thrills for yourself.

Mr. Shaw's comments are reprinted through the courtesy of POPULAR SCIENCE Magazine.

CHRYSLER

finest engineered cars in the world

you! can earn
\$5,000 to \$10,000 a year
in your **SPARE TIME**

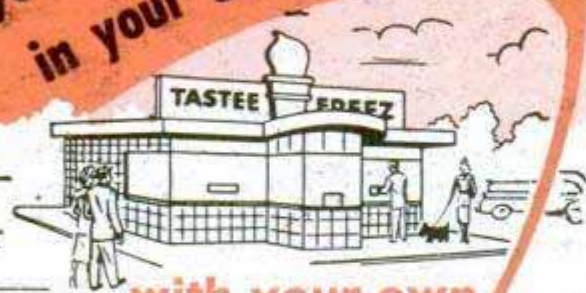

with your own

TASTEE-FREEEZ STORE

Privately Owned —
Nationally Supervised —
Nationally Advertised



CONES — CUPS
Sundaes
Malts — Shakes
Pints — Quarts
Served Fresh From
the Freezer!

Increase your family income. Work evenings and weekends to start. Build up to full time and add more stores with the tremendous profits you earn. Become a part of this nation-wide chain of Tastee-Freeez stores. Dish out the most delicious soft ice cream treat ever conceived for thrilling the taste of millions. Nutritious dairy product, smooth and refreshing... frozen seconds before serving. Our machine is the only truly automatic freezer on the market. So simple even a child can operate it.

EASY TO START — NO EXPERIENCE NEEDED

For men or women who may have retired too soon and have time on their hands — for those whose health demands easy work — for ex-servicemen who are seeking a sure-fire, money-making opportunity — in fact for any person or family desiring a bigger income, TASTEE-FREEEZ is the ideal business. Only \$2500 capital required to purchase all the equipment necessary to operate. If qualified, financing can be arranged, thus reducing the cash outlay. Your profits begin immediately. No franchise to buy. This is your golden opportunity to have your own business — a secure future and an income beyond your fondest dreams. Get all the facts. Prompt action may prove to be the turning point in your life. Write or wire NOW!

Harlee Manufacturing Co.

2518 W. Montrose, Dept. PM9, Chicago 18, Ill.

FRANCHISED TERRITORIES AVAILABLE. 67 franchises now operating. A few choice territories open to men who can supervise installations and operation of Tastee-Freeez stores. Must be able to finance self at the start. For details of our franchise plan address your letter to Dept. DM.

Fever Charts Plot a Better Automobile

(Continued from page 122)

the most economical speed, according to all the instruments, is not the steady 40 miles an hour you've heard about, but a loping 20. Anything above 50, and all the needles drop into the red, or "very poor" section, and that tenth of a gallon runs out like water through a funnel.

With his fuel-consumption indicators, White has verified a number of things that contribute to poor mileage. The dials showed, for instance, that running a standard vacuum windshield wiper without a booster cuts down the miles per gallon by 10 percent!

"Since the gas-consumption meter works off engine vacuum," says White, "we found out why. With a windshield wiper running full open, we were dropping six to seven inches of vacuum in the engine. We flicked switches, took temperature readings in the engine and learned something else: As a result of the vacuum loss, our mixture was leaned out. As a result of that, engine heat was soaring. The temperature of the exhaust valves registered 2300 degrees. They start going soft at 2100 degrees. No wonder valve heads warp and no wonder fuel that never gets to burn shoots through leaky exhaust valves when the wipers are on! Electric wipers on every car is the answer to this one. It's got to come."

Other road tests already have proved that when tire pressures are eight pounds too low, cars burn seven percent more fuel.

"But most of all," says White, "we've found that fuel economy is lost under the foot of the man at the wheel."

The instruments prove that a heavy throttle, a jerky driver, a man who guns on hills and turns, is losing a third of his potential mileage. Best is the steady pacer, who "feels" his throttle on hills. "Ease up on the gas pedal when you climb a hill sometime," says White. "Most people will be able to come halfway up on the accelerator before power starts falling off. Depressing the extra distance just wastes fuel."

From his driver's seat, White can watch the green patterns on the oscilloscope screen beside him and tell you exactly what's happening inside any one of his six cylinders. The cathode ray is activated by the electrical system in each cylinder. You can see the sparks jumping in a strong, even pattern across the screen. But how they jump can tell a story of incomplete combustion, leaky valves, or any other abnormality, depending on the pattern they make. "If we're

(Continued to page 270)

BUILD YOUR OWN ARC WELDER OR LIGHT PLANT

JACK & HEINTZ R-1 D-C GENERATOR

Save \$250 to \$500

Only \$27.50

instructions included rated 300 Amps. 30 Volts. Ship. wt. approx. 70 lbs.

PRICE F. O. B. K. C. MO.

CONVERTS TO ARC WELDER 300 AMPS: 350 AMPS. OR LIGHT PLANT CAP. LOAD OVER 7500 WATTS

Stock No. 517—D C Generator P-1 Delco 200 amp 28 Volt. Gov't. cost \$300.00. Instructions for converting to welder or light plant included. Including directions and diagram for converting to COMBINATION WELDER AND LIGHT PLANT. Wt. approx. 70 lbs. **\$17.50**

CARBON PILE GENERATOR VOLTAGE REGULATOR
For use with 24 or 32 Volt D. C. Generators. Also recommended for the P-1 and R-1 type generators in "build your own" Light plant. Only **\$6.50**

ROMEC FUEL PUMP

Or use as hydraulic pump or for Vacuum drawing. Rated 150 Gallons per hour at 1750 R.P.M. Has cushioned self lubricating 1 1/2 splined shaft. Ports are 1/2" and 1/4" Pipe thread. Here's non-pulsating dependable performance data \$7.50 post-included. Stock No. RD-4550.

WEAVERS HYDRAULIC HAND PUMP

BRAND NEW INCL. BUILT IN CHECK & RELIEF VALVE. For hydraulic jacks, presses, hoist, etc. For operating hydraulic cylinders to pump oil or hydraulic fluid under pressure. Has built in check valve, and is capable of delivering 1000 lbs. pressure. Wt. 10 1/2 lbs. A \$50.00 value. Instructions incl. Price **\$12.50**

Valuable Gears — Bargains — Speed Reducers

10-1 or 5-1 ratio, 90 degree angle. Shaft driven 1/2" spline shaft with 3 mounting holes 5/16". Gears held in forged and machined aluminum housing with two needle bearings, one bronze bearing, and three high speed shielded bearings. Sealed self lubricating chamber. Price **\$5.95** paid

New Amplidyne MOTOR GENERATOR

#5AN31N18A—Use as 24/32 Volt D.C. motor, pulls 1/2 H.P. or 0/60 V. D.C. Can be adapted to 110 V. A.C./D.C. 10,000 R.P.M. 1/2 H.P. by simple changes in connections. This unit can be adapted to independent and rural lighting, power, etc. Instructions incl. (Stock #790). Gov't cost \$140.00. Wt. 30 lbs. Only **\$7.50**

SENSATIONAL SELSYNS

Two or more connected together, work perfectly on 110 V. A.C. For weather vanes, rotating directional antennas or controlling distance operations. Complete with diagram and instructions. Wt. 3 1/2 lbs. PER PAIR **\$6.95** Postage paid

Hydraulic Solenoid Control Valve

BENDIX. No. 81560 24V. D.C. For remote control operation and to operate one single action or double action hydraulic cylinders with 24 V. D.C. Recommended pressure 800-1500 P.S.I. connections are 3/8"-18thd. Diagrams & Data incl. \$35.00 value. **\$3.50** ea. **\$6.50** per pair

Brand New PUROLATOR GASOLINE FILTER

For all cars, trucks, tractors or boats. Permanent type. Data incl. **\$4.95** Postpaid

CUNO OIL FILTER — Brand New

Aircraft type. Filters oil without cartridge replacements. Just turn handle and cartridge is clean. Standard 3/8" inlet and outlet ports to accommodate 12 gallons per minute. STOP CHANGING OIL. Instructions incl. **\$4.95** Postpaid

ELECTRIC MOTOR 1/2 H.P. 27-V. D.C. R.P.M. 4000 No. 750. For Intermittent or Continuous Duty. 5/8" SHAFT. VARIABLE SPEED MOTOR CAN BE ADAPTED TO 110 V. A.C. OR R.E.A. line by simple arranging armature brush leads. UNUSED. **\$5.95**

Instructions incl. **\$4.95**
ELECTRIC MOTOR 1/2 H.P. 24 Volt D.C. R.P.M. 2500. Amp. 22 #HCA24. Gov't

cost \$75.00. Brand New. **\$4.95**
ELECTRIC MOTOR 1/4 H.P. 28 Volt D.C. R.P.M. 4000 #2832 with simple instructions to convert to 28-32 Volt A.C. Gov't cost \$82.84. Brand New. **\$4.50**

ELECTRIC MOTOR 6 Volt D.C. Delco — New Ideal as wiper motor, car heater motor, toy applications 1/4" dia. 1 1/8" long shaft. 2 mounting studs. **\$2.35** Plus \$3.35 New. Only Postage

D. C. GENERATOR

Brand New For Farm—Home—Ranch. Delivers 430 Volts D.C. at 3450 R.P.M. Ball bearing supported. Fan cooled armature. Self lubricating bearing. #211220-A **\$7.50** Wt. 21-lbs. Now only

ECLIPSE MOTOR & GEAR UNIT

Brand new including built in 24 V. D.C. motor. Has 1-horizontal and 1-vertical take off shaft. Overall gear ratio to motor is 40-1, can be adapted for 2-1 or 20-1 ratio. Ideal as OVERHEAD GARAGE DOOR OPERATOR DRIVE FOR SMALL HOIST WELP PUMP JACK, LAWN MOWER DRIVE, DRIVE FOR POST DRILL, etc. Wt. 23 lbs. Gov't cost, \$221.00. Instructions free, including simple directions for converting unit for 110 V. A.C. so as to be belt driven by a separate motor. **\$12.95** f.o.b. Only KC, Mo.

AIR FILTERS

Aircraft type. Removes dirt, dust, etc. For industry, home & laboratories. For forced warm air, conditioning units, etc. Made of heavy metallic mesh with metal frame. Permanent, needs no refills. Size 4 1/4"x6 3/4"x2". Special price for quantity users. Wt. approx. **\$3.50** ea. 8 lbs. \$25.00 value.

Brand New Wonderful ROTATOR MOTOR

For rotating TV, Ham, FM antennas, turntables, etc. Applicable for 110 V. A.C., 60 cycles or for 24 V. A.C. & 12 V. D.C. Approx. 7 R.P.M. Free swing, reversible, light weight, rugged, quiet. Motor & gears oil sealed. Simple instruction and diagrams for converting incl. Wt. approx. 4 1/2 lbs. Stock #6918. \$50.00 value **\$7.95** post-Now only

Thompson Motor Driven PUMP

Including Built in Motor. Applicable for 24 V. D.C./A.C. or 110 V. A.C. The motor is explosion proof constructed, making it ideal for pumping GASOLINE, FUEL TRANSFER, HOT WATER HEATING CIRCULATOR, USE IT AS COOLANT PUMP, FUEL BOOSTER, OIL PUMP, etc. Discharge connection is for 1" hose. Rated Capacity 300 G.P.H. Direction & Engineering data incl. A tremendous bargain! Stock No. 1200—Only **\$9.95**

Pesco Four Vane Rotary Positive Displacement Large Volume Pump

Including built in relief and by pass valve. Capacity 400 G.P.H. 1/2" drive spline shaft, 3/4" pipe inlet and outlets. Rotates either direction or in any position. Ideal for gasoline, oils, water and various types of sprayers. Engineering data incl. (Stock #600) only **\$7.95** Post-Data incl. **\$7.95** paid

Pesco Vacuum Air—General Purpose Pump

Here is a pump for air, fluid, pressure or vacuum. Standard 1/2" pipe thread. Delivers 300 G.P.H. at 2000 R.P.M. Runs forward or reverse. Self aligning shaft. Spline terminal for direct drive, readily replaced with a pulley. Use them for oil burners, MILKING MACHINES, COMPRESSORS, VACUUM PUMP, etc. Engineering report and instructions incl. Now only **\$9.95** Postage Paid

Adel Self-Priming ELECTRIC PUMP

For pumping light oils, oil burners, fluid metering, fuel pump, tool post grinder, coolant, pressure lubricating pump, etc. Double ball bearing series wound motor, continuous duty. 1/30 H. rated 12000 R.P.M. Applicable for 24 V. D.C./A.C. or use on 110 Volt A.C. Size 6 3/4"x3 1/2"x3 1/4", rated 3 G.P.H. Remove pump and use motor as high speed grinder, etc. Diagram and instructions incl. \$50.00 value. **\$9.95** Post-Only

Send check or Money Order. Prices f.o.b. K. C. except when marked postpaid U.S.A. only



Stratopower Constant Displacement HEAVY DUTY PUMP

For operating Hydraulic cylinders, bulldozers, Construction machinery, Lift trucks. For fuel or oil transfer. Industrial applications, etc. Delivers up to 400 G.P.H. at 3750 R.P.M. Rated 1250 to 1400 P.S.I. 3750 to 4500 R.P.M. HAS BUILT IN RELIEF AT HEAD. Rotation

either direction without adjustment. Can be used as hydraulic motor. \$85.00 value. Engineering data & instructions incl. **\$17.50** Stock #37. Wt. 8 lbs.

AIR OR OIL HYDRAULIC CYLINDERS

Stock #10 This is a double action 1" bore, 4" stroke 3/4" shaft, clevis mounting, overall length 9". Capacity 700 lbs. with 1000 P.S.I. or 9800 lbs. with our stratopower **\$4.95** Post-pump 1400 P.S.I. Stock No. 512

Double action hydraulic cylinder 2 1/8" Bore, 4" Stroke. Dia. 3/4" including built in Hydraulic control valve which may be operated with rod or lever. Clevis mounting. Overall length shaft retracted 14". \$75.00 value. Wt. 6 lbs. **\$14.95** KC, Mo. Stock No. 11

Double Action 1 1/2" Bore, 6" Stroke, 5/8" Dia. Shaft. Clevis mounting base and shaft end. Capacity 1160 lbs. with 1000 P.S.I. input. Has a capacity of 1625 lbs. with our STRATOPOWER 1400 P.S.I. A \$50.00 value. **\$8.95** Postpaid Only

Stock #303—Double Action 2" Bore, Stroke 1 1/4", Dia. 1 1/2". Overall length shaft retracted 23". 2000 lbs. capacity with 1000 PSI gives 2800 lbs. with our f.o.b. stratopower. Wt. 14 lbs. **\$17.50** KC, Mo.

Stock No. 12 Hydraulic Cylinder Double Action output 12560 lbs. with 1000 P.S.I. input. Gives 17584 lbs. with our STRATOPOWER PUMP 1400 P.S.I. or will produce 34168 lbs. with 3000 line pressure. Can also be operated on low pressure system. 4" Bore, 10 3/4" Stroke, 1-5/16" shaft, clevis mounting. O. Gov't cost **\$25.50** f.o.b. \$300.00 KC, Mo.

Pesco Hydraulic Flow Equalizer & Pressure Balancer Valve

Brand New. Guarantees equal flow and equal pressure for two cylinders or two systems. Capacity 360 G.P.H. 1500 P.S.I. Data & instructions incl. A \$75.00 value. Stock 1-D-397 only **\$14.50** postpaid

HYDRAULIC CONTROL VALVE

Adel Precision #B-10329. For controlling 2 single action or 1 double action cylinder. Including built in toggle lever. When lever is in one direction it puts pressure on one cylinder connection and opens exhaust, from opposite cylinder. When lever is released it returns to the neutral position and locks cylinder. Brand new. A tremendous bargain. **\$8.95** post-Data incl. **\$8.95** paid

FOUR WAY HYDRAULIC CONTROL VALVE

Poppet type Valve shuts off on neutral position. Has 3/4" A.C. Tube ports -9/16-20 thread capacity 1500 P.S.I. Brand new. Stock #1032... **\$5.95** post-Data incl. **\$5.95** paid

Large Volume hydraulic control and pressure relief valve, 3/4" ports, spring loaded. Range 1250 P.S.I. adjustable up to 3000 Postpaid P.S.I. Brand New. **\$5.50**

VICKERS CONSTANT DISPLACEMENT HYDRAULIC PUMPS

Brand New Stock No. PP-713-20. For any type liquid pumping job. 375 gal. per hr. at 3750 R.P.M. 1000 P.S.I. .410 cu. in. per rev. **\$17.50** Gov. cost \$100.00. Postpaid

HYDRAULIC ACCUMULATORS—BENDIX BALL TYPE.

Di. 5 1/2". Built to stand 2000 P.S.I. Stock #A-65. **\$5.50** Wt. 4 lbs. only. **BENDIX ACCUMULATOR.** Ball Type. Dia. 10". Built to stand 2000 P.S.I. **\$17.50** Wt. 15 lbs. Stock #A-85. Only

Vickers Pressure Relief Valve

Brand new adjustable for protecting hydraulic systems using positive displacement pumps. 1/2" AC tube size. Tapped 3/4". 18 thread. Stock No. 501. Postpaid **\$4.95**

VICKERS UNLOADING VALVE

Brand New—By passes full amount output of the pump while the cylinder is not in operation. Takes starting load off of electric motor driving the pump. 1/2" AC TUBE PORTS Post-3/4"-18 thread. Price **\$8.95** paid

Buy HOME-UTILITY Accessories!

Get the most out of your
HOME-UTILITY Tools!

Dozens of new ways to use your Home-Utility Tools! Plenty of new jobs you can do around the house and in your shop! They're all yours when you buy Home-Utility accessories like those shown below. Try them at your hardware, electrical, implement or department store!

HORIZONTAL STAND
for 1/4" Drill or Sander-Polisher

LECTRO-SAW PROTRACTOR

VERTICAL STANDS,
two types for 1/4" Drill or Sander-Polisher and 1/2" Drill

LECTRO-BLADES
for 6" and 8" Saws

ROTO-HONE ATTACHMENT

DISC SANDING TABLE

PILE FABRIC PADS

WIRE WHEEL and CUP BRUSHES

SANDING DISCS

LAMBSWOOL BONNETS

AUTOMOBILE POLISH

ELECTRIC WAX

PLUS auger bits, masonry bits, countersinks, twist drills, chucks, arbors, abrasive kit, buffing and polishing kit.

Products of HOME-UTILITY Div.,
BLACK & DECKER Mfg. Co.,
Dept. H9M, Towson 4, Maryland

ELECTRIC HOME-UTILITY TOOLS

1/4" - 1/2" DRILLS • SANDER-POLISHERS • 6" - 8" LECTRO-SAWS

about to warp a valve head, we'll know it before it happens," he boasts. "And our other instruments will tell us what's causing it."

A water flowmeter brings the radiator fluid into the cab of the truck, so it can be watched continually; a velometer measures the air going through the carburetor. Two instruments behind the driver's seat tell the horsepower output of the engine at any given moment. Voltages throughout the electrical system are continually registered on dials in the back end of the truck.

Through the earphones of his sound-level meter, White listens to any part of his vehicle simply by moving the pickup around. It's so sensitive you can hear the whish of a pin dropping through the air 30 feet away. Through this instrument, White listens to the click, click, click of his engine valves; the whirring of gears, or a tiny vibration in the rear end that may some day cause serious wear.

In the car is the device for measuring slippage in the clutch or fluid transmission—a big source of power and fuel loss. White calls it a "stroboscopic gain gauge." On one inside wall of the truck is a strobe light, triggered by the firing of a cylinder. Its light flashes across to the other side, where two disks, each with a black dot on its rim, are spinning. One disk is driven by the crankshaft, in front of the transmission; the other by the drive shaft, behind the transmission. If there's no power loss in the transmission or clutch, the dots rotate in unison, passing a marker point on the dial rim simultaneously and the strobe light flashes at the same instant. Any lag, however, and the dot on the drive-shaft disk gets farther and farther behind on its rounds. By measuring the distance it lags, White can tell just how much slippage there is, and how much horsepower is being used to churn oil or clutch plates instead of to turn the rear wheels.

"Our strobe gain gauge," says White, "is going to tell us exactly how much extra fuel is used up because of this lost-power delivery. Also, we're going to settle the argument about just how many miles per gallon are sacrificed in automatic transmissions for the convenience of not having to shift."

Streamline and design aren't left out of White's calculations. A tiny instrument on back of the truck measures the vacuum and drag created when the vehicle is under way. His anemometer and pitot tube give him his air speed for the same reason. "What a head wind does to gasoline consumption is pathetic," he claims. "Already

(Continued to page 272)



EARN \$25 AND MORE A DAY!
NO SCHOOLING!

STEADY ALL-YEAR
WORK!

THOUSANDS
ARE SUCCESSFUL!

MAKE BIG MONEY BE YOUR OWN BOSS!

WANTED—men with ambition and desire to get ahead and *make money* in something for themselves. *Act now*—do as thousands of successful men have done—start on your own in floor surfacing with American Machines!

Take advantage of this opportunity if you want steady year 'round work—earnings of \$25 and more a day—pleasant indoor working conditions—and a lifetime of comfortable living for yourself and your family. No schooling—no experience needed. Sanders are easy to operate. Hundreds of prospects—new and old homes. Send coupon for "money-making" booklet entitled "Opportunities in Floor Surfacing"—enclose 25c in coin or stamps to cover handling.

The American Floor Surfacing Machine Co.
535 So. St. Clair St., Toledo 3, Ohio

Enclosed find 25c in stamps or coin for booklet "Opportunities in Floor Surfacing", telling me how I can start my own floor sanding business.

Name _____
Street _____
City _____ State _____

AMERICAN FLOOR MACHINES



PACKAGED BOAT KITS

LARGEST CATALOG
EVER OFFERED!

16 pages—80 construction and action photos PLUS specifications and performance data.

\$38.95 UP



COMPLETE LINE — SKIFFS, OUT-BOARDS, RACERS, CRUISERS. 23 Models! Kits, Semi-finished and Custom-finished boats, hardware, paint.



Send 35c for Boat Catalog

Boat Catalog PLUS booklet on boat building, \$1.00

BOAT PATTERNS-BLUE PRINTS

Over 70 modern plans and full size patterns. Racing classes, cruisers, inboards, outboards, sail boats. By famous designers, 6' to 30'. DESIGN CATALOG 35c. Design catalog and boat building handbook, \$1.00.

MARINE MART-DEPT. 52-BUFFALO 7, N. Y.

Just one of many
stoning jobs
that calls for



abrasives INDIA® FILES

These handy formed file stones give that final touch of keenness to auger bits, countersinks, formed plane cutters and other hard-to-reach edges. Indispensable, too, for work on gun parts, reels, jewelry. They come in all needed shapes and last a lifetime. At most hardware stores—or write direct.



Get the "How to Sharpen" Book 32 pages of pictures and data on professional tool sharpening. Send 10c to Dept. PM-9.



BEHR-MANNING • TROY, N. Y.
COATED ABRASIVES
SHARPENING STONES • MASKING TAPES
Also Manufacturers of Abrasive Paper and Cloth

ACE TOOLS

Be permanently
tooled-up for every operation
on your Metal Cutting Lathe.

No. 8-A Ace Tool Set for 9" and 10" Swing Lathes—fits shank size 3/8" x 3/4". Includes Turning, Cutting-off, Boring, Knurling and Threading Tools with high speed cutters, blades and wrenches. 8 complete tools in fitted steel case—nothing else to buy. See your local dealer or order direct.

ARMSTRONG BROS. TOOL CO.
5268 W. Armstrong Ave., Chicago 30, Ill.

\$26⁹⁵

**NOW A TRULY
LOW COST
QUALITY BUILT SAW!**



Only
\$33.95!

Less Motor. Table extensions \$4.95 pair.



8" SAW

SAVES YOU MONEY

on **SHELVES, CUPBOARDS, REPAIRS, FURNITURE**



Join the millions of men who are really saving money this year building things for their homes—and having fun as well. This Atlas Workshop saw is the basic tool you need. You can't touch its value at the price!

Precision-ground grey-iron table gives you 12 1/4" x 16" working surface. 8" blade cuts 2 1/2" deep—table tilts for all angles up to 45°. Steel fence is 14" long. Guard, splitter, and motor rail furnished. You've never seen a saw like this at such a price. Ask your Atlas Workshop dealer, or send coupon.

SEND FOR FREE CATALOG



Please send your Workshop tool catalog, showing all 5 tools, and operating views.

Name _____

Street _____

City, State _____



ATLAS PRESS COMPANY

943-W N. Pitcher Street, Kalamazoo, Michigan

we've learned that a station-wagon design is the worst possible for economy and speed. The square hind end creates suction that starts at 20 miles an hour, pulls back on the car with tremendous force at anything over 50 and results in very poor gas mileage."

Fancy, streamlined front ends don't add a thing, according to White's findings on the telltale instruments of his trucks. It's the shape of the back that counts.

Realism and facts are what Andy J. White is after. His big ambition is to take his roving dynamometers out to Indianapolis and run them around the track wide open until everything in them starts to collapse, so he can watch and tabulate the failure of each part. That way, he figures, he'll learn a few things no one ever knew before.

Aluminum Pipes to Supply Army

Aluminum pipe will be used by the Army and Air Force to supply fuel, oil and water to bases of operations. The lightweight pipes can be carried by helicopter to the site. This will eliminate traffic congestion and, by reducing the number of trucks required, will save large quantities of gasoline. A standard load for a helicopter is 240 feet of pipe, approximately 780 pounds.

HOLD-E-ZEE

The Original
**AUTOMATIC GRIP
SCREWDRIVERS**

Hold, start and set up screws in unhandy places. Gripper instantly released by **SPRING ACTION**, sliding up out of way when not in use. Highest quality throughout.

New Models FOR RECESSED
HEAD SCREWS  

UPSON BROS., INC., ROCHESTER 4, N.Y.

At Leading Dealers Everywhere



Amazing New

**FOLEY Power
SAW SETTER**

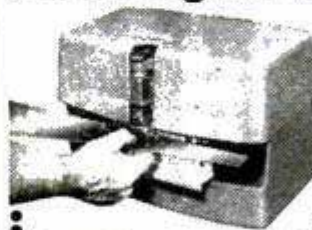

For hand and band saws

A perfect set on 26" hand saw in 32 seconds

The new Foley Automatic Power Setter with exclusive "Twin Hammer" action has two hammers (one for each side of saw) operating from a single spring, insuring utmost accuracy. ONCE through turns out a perfectly set, true-cutting saw. Relieves eye-strain, no tooth breakage. Sets all hand saws (with handles left on) and band saws from 4 to 16 points per inch. 1-year Guarantee. **FREE**—Foley Price Guide of actual 1951 saw sharpening charges. A valuable help to any saw repair shop. Write for it today, also Foley Setter circular. No salesman will call.

FOLEY MFG. CO., 975-1 Foley Bldg., Minneapolis 18, Minn.

Build A MODERN READY-CUT HOME! *Costs You Less!*

Shipped Direct from Our Mill

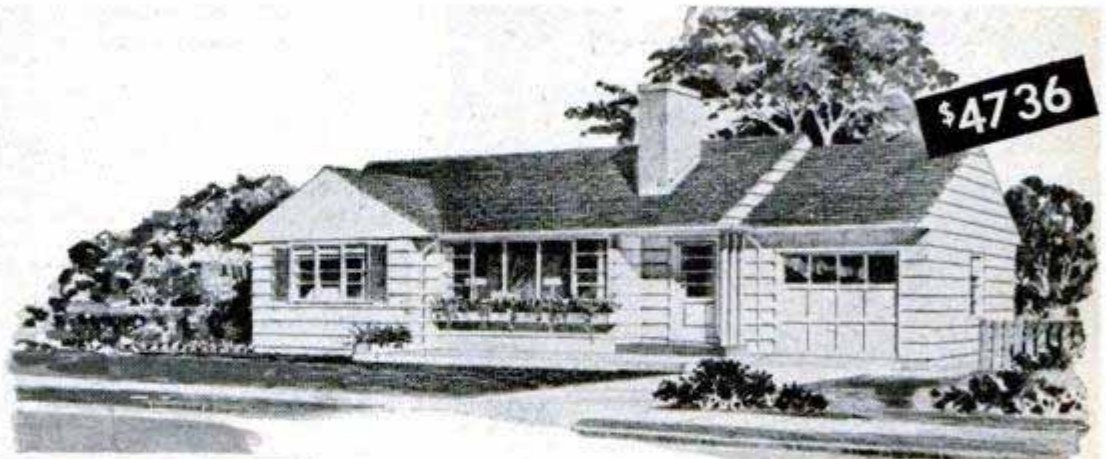

Liberty Homes

\$3184



31 Designs to Choose From
AS LOW
AS . . . \$2180

Recommended by Banks and Building and Loan Associations

Save 30% to 40% on Your New Home..

Don't pay several hundred dollars more than necessary when you build a home! Buy direct from our mill at our low factory price. We ship you the lumber cut-to-fit, ready to erect. Paint, glass, hardware, nails, etc., all included in the price—no extra charges. Plans furnished—also complete building instructions. No wonder our customers write us that we saved them 30% to 40%. Architecturally approved construction. (Not built in sections.)

Visit a Liberty Home!

Many thousands of Liberty Homes have been built in all parts of the country. There is one near you that you can visit and inspect. Write us and we will give you its location.

Handsome Big CATALOGUE

Pictures wonderful homes in colors at money-saving prices. Designs to suit everyone. Send 25c for catalogue today.



LEWIS MANUFACTURING CO.

1219 LAFAYETTE AVE.,
BAY CITY, MICH.

LARSON

The Foremost Name in LEATHERCRAFT



GET STARTED RIGHT . . . MAKE FASTER PROGRESS

Easy-to-Assemble Kits for Beginners . . . Supplies and Tools for Experts

If you are a beginner, just becoming interested in the fascinating hobby of Leathercraft, get off to the very best start with LARSON Ready-Cut Kits of purses, belts, gloves, billfolds, woolskin animals, etc. No experience or tools needed . . . complete instructions for easy assembling included. SEND 10c TODAY for big new illustrated catalog of ideas, kits, materials, supplies for both beginners and experts.

J. C. LARSON COMPANY
820 SO. TRIPP AVE. DEPT. 718
CHICAGO 24, ILLINOIS

For more experienced leatherworkers, our stock of supplies, tools, top quality calfskins and moderate priced tooling leathers is the most complete and varied in America.

J. C. LARSON CO., Dept. 718,
820 S. Tripp Ave., Chicago 24, Ill.
I am enclosing 10c. Please send me latest big illustrated Leathercraft catalog.

Name _____
Address _____
City _____ State _____

MAIL COUPON →

How to **SAVE MONEY**
on your
POWER TOOLS

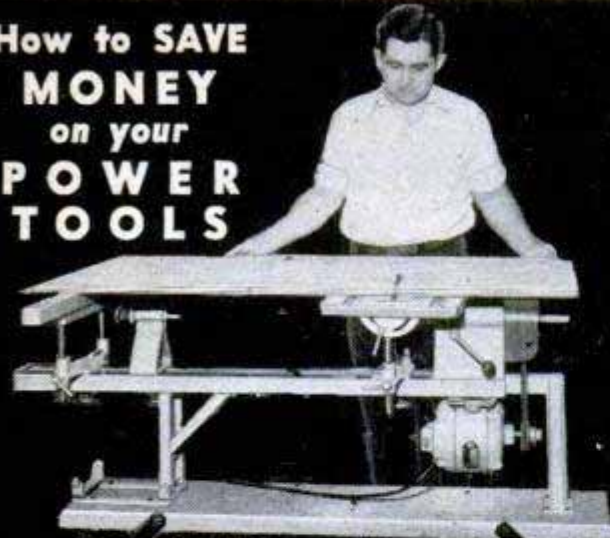

8" TILTING TABLE SAW

Compare

SUPERSHOP
FEATURE for FEATURE
DOLLAR for DOLLAR

Buy SUPERSHOP direct from factory and save 47.96%. Lifetime lubricated ball bearings. Precision-built. RUGGED. Handles BIG jobs. Complete line of accessories available. 15 day FREE trial. Money back guarantee. Mail postcard for FREE CATALOG.

RETAIL PRICE \$125.00
FACTORY TO YOU

\$79⁹⁵

POWER TOOLS INC.

127 YATES AVENUE,
BELOIT, WISCONSIN

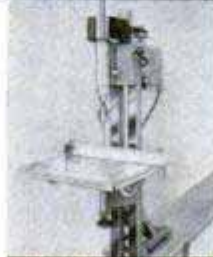

DRILL PRESS



SANDER



LATHE

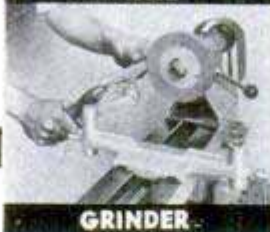

GRINDER

Turn Darkness Into Daylight!

Get a
Quality
Built

Big Beam Jr.

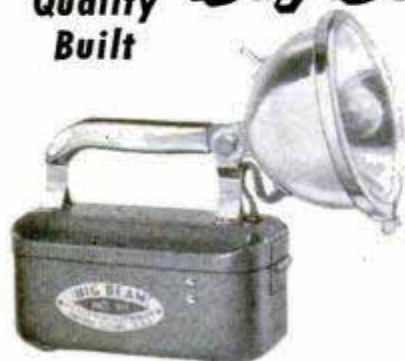

Indispensable
around the Home,
also for Motorists,
Farmers and
Sportsmen

\$6⁷⁵

less battery

See your dealer or
write for folder

U-C LITE MFG. CO., 1066 W. Hubbard St., Chicago 22, Ill.

IN HOT WEATHER

Get top-notch performance from your electric razor. In sticky, perspiry days of summer when shaving is most uncomfortable, this amazing preparation:



1. Evaporates sticky, razor-clogging perspiration.
2. Lubricates skin for faster, more comfortable shaving.
3. Tautens skin—"brings out" your beard for closer, better-looking shaves.
4. Lubricates your shaver's cutting head.

FREE! Try Letric Shave at our expense. It is avail-

able at drugstores or toilet goods counters. Only 49¢ plus tax—enough for 80 shaves. For a generous free sample, send name, address to The J. B. Williams Co., PM-6, Glastonbury, Conn. (Offer good only in U.S.A.)

HOME REPAIR TIP NO. 15



GET COMPACT SPLICES in junction boxes and fittings with "SCOTCH" Brand No. 33 Electrical Tape. Super thin. Carries UL seal. Also mends shoe lining, plastic raincoats, torn rubbers. 39¢ at your hardware store.



BUILD FINE GRANDFATHER CLOCK NOW

The simple sensible Red-i-Kut way as thousands have — SAVE HALF. SHOP TESTED PLANS "SPIRIT OF THE CENTURY" Narrow waist 83" tall or stately straight side "SPIRIT OF AMERICA." EASY-TO-FOLLOW photopack PLANS tell all — plus BROCHURE of heavy brass weight Westminster, tube chime, movements, gorgeous dials, 3/4" solid mahogany case kits. Send \$1.00 today — Both plans \$1.50 NOW.

KUEMPEL CHIME CLOCK CO., #4 Kuempel Bldg., Minneapolis 16, Minn.

BULL DOG HITCHES



Heavy Drop Forge Steel Construction. Strong — Safety-Engineered Reliable

Model No. 1-B
NOW ONLY
\$4.95

Post Paid (when
paid in advance)

Made for trailers with up to 2,500 pounds capacity.

1 3/4" dia. shank Fits 1 1/4" pipe tongue

HAMMER BLOW TOOL COMPANY

Wausau 131 Wisconsin

HOBBYISTS! SHOPMEN! Special ONLY \$54⁵⁰

PALMGREN "HOBB-E" Rotary, Index, Milling Table
Ideal for Model Parts or Shop Work

Mill-Grind-Drill-Index-Route curved or straight-Rabbit and Mortise on drill press or lathe. 8" Table, 4" Cross Feed, 360° Rotation, Accurately Graduated. Bolts to table. Order NOW! SAVE \$100. Only \$54.50. Less Rotary Feed \$43.75. Write for "HOBB-E" Tool Circular.

CHICAGO TOOL and ENGINEERING CO.
8365 South Chicago Ave. Chicago 17, Ill.



ELECTRICITY Anywhere

FOR PORTABLE, EMERGENCY OR HOME USE

ONAN Electric Plants generate 110-volt, 60-cycle current for homes, farms, cabins and resorts beyond the highline. Lightweight, portable plants cut costs, speed work for contractors. Standby plants protect units against power failure. 400 to 55,000 watts. Gasoline or Diesel-powered. Priced from \$219.00.

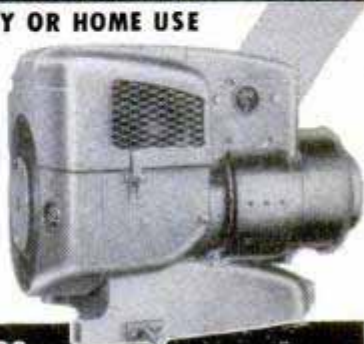

WRITE FOR CATALOG

D. W. ONAN & SONS INC.
5849 UNIVERSITY AVE., MINNEAPOLIS 14, MINN.

**NEW! NOW YOU CAN
EARN \$5 PER HOUR
PRINTING
WITHOUT A PRINTING PRESS
OR ANY SPECIAL EQUIPMENT**

CLIP AND MAIL FOR FREE SAMPLE—Send No Money

SCREEN-PRINT CO., DEPT. 29
1010 SOUTH LOS ANGELES ST., LOS ANGELES 15, CALIFORNIA
Dear Mr. Nowak; Please rush FREE sample and all information necessary

Name _____
Address _____
City _____ State _____

**START IN YOUR SPARE TIME
IN YOUR HOME**

**GET MY FASCINATING NEW
FREE PROFIT PLAN NOW—
yours for the asking
OFFER LIMITED—
MAIL COUPON TODAY!**



**ABSOLUTELY
FREE**

**SEND NO MONEY!
PAY POSTMAN NOTHING!**

- JUST MAIL COUPON**
—Examine ACTUAL SAMPLE and facts about this AMAZING BOOK that tells you **HOW**
- to do Screen Printing
 - to set up Screen-Print Shop of your own
 - to get customers COMING TO YOU
 - to start spare time and GROW
 - to have TWO INCOMES instead of one
 - TO CHARGE (on some jobs you make \$10 or more per hour)
 - to EMPLOY OTHERS to help you
- ...EVERYTHING YOU NEED TO START!**



Written in **EASY-TO-UNDERSTAND SHOP TALK**... complete with **MANY ILLUSTRATIONS**. Yes, that is my **AMAZING OFFER**... Read it all **WITHOUT RISKING A PENNY**. This **OFFER IS LIMITED**—mail coupon **TODAY!**

Easy to learn—no experience necessary.
ANYONE—(young or old) can profit handsomely with the sensational Screen-Print method.
EARN \$50 EXTRA PER WEEK TO START.
It's easier than you think—materials cost you only 10%—**YOU EARN 90%**. Few businesses make this big profit.

SCREEN-PRINT IN DEFENSE!—Instrument faces, insignias, flags, etc.—hundreds of defense products are produced by **SCREEN-PRINTING**—materials are **NEVER SCARCE!** **SCREEN-PRINT** offers you a way to make **Big EXTRA MONEY** if your wages are Frozen too.

One of America's FASTEST GROWING BUSINESSES—Thousands already are making **BIG MONEY** using the **MIRACLE** new **SCREEN-PRINT** method. Yes, they're printing signs, posters, banners, drapes, wall paper, show cards, flags, fabrics, etc. **WITHOUT A PRINTING PRESS OR ANY SPECIAL EQUIPMENT**. Now!—the secret can be yours to read, learn, and decide your future... just mail coupon now.

GET INTO BUSINESS FOR YOURSELF—Be your own boss—make your home your office in this profitable business. Make **EXTRA** money in your **SPARE TIME** or start your own **FULL TIME** business **IT'S EASY**. Get orders from stores, markets, gas stations, theaters—from every kind of business—A **HUGE** ready-made **DEMAND**.

Print paper of all kinds (even greeting cards)

NEW OFFER!

PRINT BANNERS



PRINT FABRICS



PRINT INSTRUMENTS



PRINT POSTERS

FOR SALE

PRINT SIGNS



PRINT TIES

YOU CAN PRINT ANYTHING AND EVERYTHING WITH THE NEW SCREEN-PRINT METHOD



1818 SO. LOS ANGELES ST., LOS ANGELES 15, CALIF.

Ball-Bearing SPEED WHEELS



JUVENILE WHEELS (No bearing, solid tires)

4"	40c	6"	65c
5"	45c	7"	75c

(Semi-pneumatic tire, ball bearing)

8 x 1.25	1.85	10 x 1.25	2.20
8 x 1.75	1.95	10 x 1.75	2.30
8 x 2	2.20	10 x 2.00	2.65
12 x 1.75	3.45		

INDUSTRIAL WHEELS

Lug Base, Semi-Pneumatic tire

5 x 1.75	3.65	10 x 2.00	6.10
6 x 2 SW	3.45	10 x 2.75	5.15
6 x 2.00	4.00	12 x 2.00	6.90
8 x 2.00	5.20	12 x 3.00	9.20
8 x 2.50	5.40	16 x 4.00	15.15

Smooth Base, Pneumatic tire and tube

8 x 3.00	11.00	12 x 4.00	12.10
10 x 2.75	6.80	4.00 x 8	13.10
10 x 3.50	10.55	14 x 4.50	13.40

Dealers, Jobbers, and Manufacturers! Our new prices will interest you.

Available Now — **CASTERS**
Write for circulars on all wheels.
Prices F.O.B. our plant.

JIM BROWN TOY COMPANY
1093 HOME AVENUE AKRON 10, OHIO

NEW—Sensational! GEIGER COUNTER



"The SNOOPER"
LOW PRICE ONLY \$24.95
COMPLETE

Find a fortune in uranium with this new, super-sensitive Geiger Counter. Get one for atom bomb defense. So small it fits in the palm of the hand or in the hip pocket, and yet more sensitive than many large, expensive instruments. Weighs only 1 1/4 lbs. Uses flashlight battery. Low price includes earphone, radio active sample, instructions. Sold with ironclad moneyback guarantee.

ORDER YOURS TODAY—Send \$5.00 with order or payment in full to save C.O.D. Write for free catalog on treasure finders for gold, silver, etc. and larger, more elaborate Geiger Counters.

Dealer Inquiries Invited **PRECISION RADIATION INSTRUMENTS**
4113 PM W. Jefferson, L. A. 16, Calif.

Say You Saw It in Popular Mechanics

Made \$900 IN SPARE TIME

"I did very well last year with my Foley equipment, about 950 saws and 240 lawn mowers, in my spare time. About \$900 for me."—Leo H. Mix.

You can make up to \$2 or \$3 an hour in Spare Time. With a Foley Automatic Saw Filer you can file hand, band and circular saws better than the most expert hand filer. Cash business—no canvassing. No eyestrain, no experience needed.

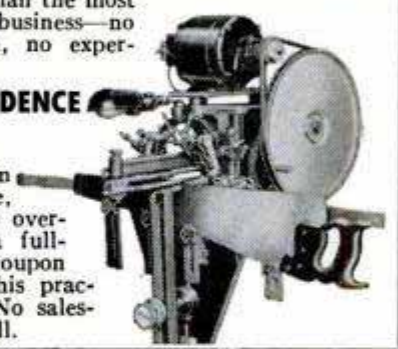

FREE BOOK "INDEPENDENCE AFTER 40"

shows just how you can start at home in spare time, with small investment, no overhead—and develop into a full-time repair shop. Send coupon today for this practical plan. No salesman will call.



SEND COUPON FOR FREE BOOK

FOLEY MFG. CO. 916-I FOLEY BLDG., MINNEAPOLIS 18, MINN.

Send **FREE BOOK**—"Independence After 40."

Name _____
Address _____

FREE

★
1952

ALLIED RADIO & TV CATALOG

EVERYTHING IN RADIO
AND TV AT LOWEST PRICES!

SEND FOR IT

212 PAGES
Value-Packed

Everything for
Experimenters, Builders, Amateurs,
Servicemen, Engineers, Soundmen...

Save money on every Radio and TV need! Get the big 212-page 1952 ALLIED Catalog featuring the world's largest selections of top-quality electronic equipment at lowest, money-saving prices. See the latest in TV, home radios, Amateur equipment, P.A. systems and Hi-Fidelity custom sound, recorders, test instruments, builders' kits—plus thousands of parts, tools, books and diagrams. Get more for your money from the World's Largest Radio Supply House. Send today for your FREE 1952 ALLIED Catalog!



Save on
Everything
in Radio & TV

FREE
CATALOG

SEND FOR IT TODAY

ALLIED RADIO

ALLIED RADIO CORP., Dept. 5-J-1
833 W. Jackson Blvd., Chicago 7, Ill.

Rush FREE 1952 ALLIED 212-Page Catalog

Name _____

Address _____

City _____ Zone _____ State _____

STOPS LEAKS PERMANENTLY

Cut your fixture replacement, water and fuel bills with Economy Renewable Seats. Make economical, permanent repairs quickly and easily with the Junior Kit (illus.). Repair bathroom, kitchen and laundry fixtures. Everything you need included in steel box. This is a natural for the "Fixit" shops — get extra income from making permanent repairs on your customers' faucets.

Senior Master Kit also available—repairs faucets and valves up to 1" pipe. Write for illustrated circular and prices.



ECONOMY VALVE SEAT CO.

1430 N. Keating Ave.

Chicago, Ill.

Say You Saw It in Popular Mechanics

NEW! CHEAP! OIL BURNER

SWEEPING THE COUNTRY!

\$14.75 for Stoves
\$29.50 for Furnaces

BIG CASH DISCOUNT FOR INTRODUCING. SLIPS INTO ANY COAL STOVE, RANGE OR FURNACE. Amazing, quick intense heat—by finger-tip control. No more shoveling coal or ashes. We'll let you try it in your own home for one month. **BIG BONUS FOR TESTING.** Prove it pays for itself by what it saves. Write today for **BIG CASH DISCOUNT OFFER.**
NORTHWEST MFG. CO., 360-L Main, Mitchell, S. Dak.

Low
Cost
Way
To
Brighten
Your
Home

New free illustrated booklet shows easy, low-cost ways to brighten cellars, attics. Use aluminum paint—the right kind. We don't make paint, but offer this book to help you get best results. Write for free booklet "Paint it Bright."



Aluminum Company of America,
1718J Gulf Bldg., Pittsburgh 19, Pa.

1951 BUZZ MASTER

8 MODELS — \$99 up

More cutting—"Tomorrow's BUZZ MASTER Today!" See the deluxe riding model. Nothing else like it. Made by the oldest firm in the business—now in our 47th year. Many special features used only on Ottawa Saws. Write today for FREE DETAILS.
OTTAWA MFG. CO., 1-127 Brush Ave., OTTAWA, KANS.



NOTE
THIRD
WHEEL

MAKE
Big
MONEY
WITH THE

Universal LAWN MOWER GRINDER!

Enjoy a profitable lawn mower sharpening business of your own. No previous experience needed. Place a hand or power mower on the UNIVERSAL GRINDER. With only ONE SET-UP you quickly grind the stationary blade and all the reel blades to proper clearance WITHOUT REMOVING A SINGLE BLADE from the mower.

PROOF

G. Spurlock, of Arkansas, writes: "I have my Universal Grinder two months and made a net profit of \$227.00".

C. E. Hardy of Miss. writes, "I am doing a fine business with the Universal Grinder. I spent 40c for a newspaper ad and have done nearly \$500.00 of business." Write today for FREE FACTS about Big Profits in Lawn Mower Sharpening.

ROGERS MFG. CO., DEPT. M-91
LINDSEY, OHIO

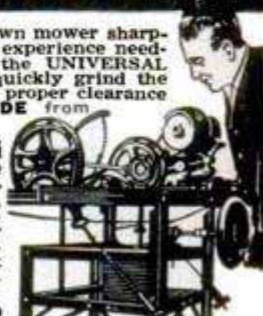

SURPLUS MACHINE SHOP TOOLS AT PRICES YOU CAN AFFORD



DRILL BIT MIX

Over 300 pcs. (2 lbs.) of used High Speed Drill Bits up to 1/4". Some require sharpening.

Ideal for pin punches, drift pins, etc. Less than 1c ea. **\$2.98** at.....

HIGH SPEED MORSE TAPER SHANK DRILLS

SET 10S 20 Different Size High Speed Morse Taper Shank Drills from 1/4" to 1". \$70 Value. Priced at only..... **\$12.95**

SET 10 Different Size High Speed Morse Taper Shank Drills from 1/2" to 1 1/4". \$50 Value. Priced at only..... **\$9.95**

SET 8 Different Size High Speed Morse Taper Shank Drills from 1" to 2" with No. 3, 4, and 5 tapers. \$125 Value. Priced at only..... **\$29.95**

High Speed Taper Shank Chucking Reamers

SET 15 Different Size High Speed Morse Taper Shank Chucking Reamers up to 1/2" with No. 1 and 2 tapers. Priced at only..... **\$6.95**

SET 8 Different Size High Speed Morse Taper Shank Chucking Reamers from 1/4" to 1". Priced at only..... **\$4.95**

SET 10 Different Size High Speed Morse Taper Shank Chucking Reamers from 1 1/2" to 1 1/2". \$65.00 value. Priced at only..... **\$9.95**

HIGH SPEED STRAIGHT SHANK CHUCKING REAMERS

SET 20 Different Size High Speed Straight Shank Chucking Reamers up to 1 1/2". Priced at only..... **\$7.95**

SET 10 Different Size High Speed Straight Shank Chucking Reamers from 1 1/2" to 1 1/8". Priced at only..... **\$9.95**

SET 15 Different Size High Speed Straight Shank Chucking Reamers from 1/2" to 1". Priced at only..... **\$6.95**

6 SLITTING SAWS with MANDREL

SET 6 Different Size High Speed Slitting Saws, 23/4" dia. x 1" arbor. Thickness from .040 to .071. Cuts wood, aluminum, brass, steel, etc. PLUS SPECIAL MANDREL which enables use of saws in 1/4" or 1/2" elec. drill. \$25 Value. Priced at only..... **\$4.95**

NEW MOUNTED STONES

SET 27S Mixture of 12 Mounted Stones with 1/4" shanks. **\$2.95**

SET 39S 24 of 39S above..... **\$4.85**

HIGH SPEED WOODRUFF KEY SEAT CUTTER

SET 5 Different Size Cutters. Can be used as mounted 4S milling cutter or circular saw. All with 1/2" shanks, widths up to 3/4", diameters up to 1 1/2". Priced at only..... **\$3.95**

HIGH SPEED STRAIGHT SHANK DOUBLE END END MILLS

SET 29S 4 Right hand twist 7/16 shank end mills, size 5/16 to 7/16. Used surplus only..... **\$3.95**

HIGH SPEED STRAIGHT FLUTE EXPANSION REAMERS

NEW reamers now in stock. Size 8-17/32 to 19/32, D-21/32 to 23/32, E-23/32 to 25/32. Mfg. by Cleveland Twist Drill. Price on any one of above three sizes — only..... **\$3.25 ea.**

HAND REAMER SET

SET 8 different size hand reamers up to 3/8" including 3 taper pin reamers, majority of reamers in new condition. \$16.00 value, only..... **\$4.49**

10 different size hand reamers 1" to 1-13/16". ALL NEW including one No. 11 taper pin reamer. Original cost over \$60.00. Only..... **\$18.95**

F.O.B. TULSA

NEW HIGH SPEED COMBINATION DRILL AND COUNTERSINKS

SET 8 selected sizes from C2 to F2 (1/16 drill x 13/64 body to 3/16 drill x 25 7/16 body) 60 degree angle of countersink. New cost on these countersinks 75c to \$2.50 when available. Your price for set of 8 only..... **\$4.95**

BRAND NEW PUMP AND MOTOR

Pump has 1" connections, built-in relief valve, adjustable up to 1500 lbs. Max. capacity 6 GPM. 1 1/2 H.P., 24-volt motor. 4000 RPM. Can be used on 12 or 36 volts. 500 units available at quantity discounts. Both pump and motor only..... **\$13.95**

F.O.B. TULSA

GOOD USABLE HIGH SPEED MILLING CUTTERS

SIDE MILLING CUTTERS				STAGGER TOOTH CUTTERS				PLAIN MILLING CUTTERS			
Dia.	Width	Arbor Hole	Price Each	Dia.	Width	Arbor Hole	Price Each	Dia.	Width	Arbor Hole	Price Each
4"	3/8"	1"	\$3.95	4"	5/16"	1"	\$3.95	2 1/2"	2	1	\$ 3.00
4"	3/16"	1 1/4"	3.95	5"	1/16"	1 1/4"	\$2.49	4	4	1 1/4	9.95
4"	1/4"	1"	3.49	4"	3/16"	1 1/4"	2.49	4	3	1 1/4	9.95
4"	1/8"	1"	3.49	60° double angle 1 1/4" arbor				6	3 3/8	1 1/4	26.50
3"	5/16"	1 1/4"	1.95	2 1/2" dia. \$2.95				7	3 3/4	1 1/4	39.50
2 1/2"	3/8"	3/4"	1.79	30° single angle 1" arbor 2 7/8" dia. \$2.95				7	5 1/2	1 1/4	49.50
2"	1/4"	7/8"	1.49	3/32" convex cutter 5/8" arbor. 1 1/2" dia. \$1.29							

Money-Back Guarantee—All Mds. Mixture of New and Reconditioned Tools Unless Specified Brand New—All Orders (Except Those Specified F.O.B. Tulsa) Are Shipped Post Paid, saving you up to 25% on total delivered cost.

Write for Free Catalog Describing Thousands of Bargain Cutting Tools.

HIGH SPEED HAND TAPS

SET 15 8 Different Size High Speed Standard Thread Hand Taps up to 3/4" including 2 std. High Speed Pipe Taps..... **\$2.95**

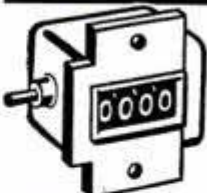

NEW VEEDER ROOT COUNTER

3 Digit clockwise rotation type (New)..... **\$1.49**

4 Digit clockwise rotation type (New)..... **\$1.89**

5 Digit clockwise rotation type (Reconditioned)..... **\$2.89**

5 Digit ratchet type (Reconditioned)..... **\$2.49**

5 Digit clockwise rotation type with key reset, complete with key, counts in fives, (Reconditioned)..... **\$2.75**

5 Digit ratchet type with key reset complete with key, counts in singles. New cost about \$17.00 when available. (Reconditioned) Only..... **\$3.49**

All counters guaranteed against mechanical defects

GEAR BOX BARGAINS

Excellent for small hoist or winch. 3/8" sq. for hand crank with 15:1 gear ratio and 1/2" spline for motor drive with 20:1 gear ratio. Large gear 10" in dia. Throw-out type clutch. Ball bearing through-out. Rated up to 6 H.P. Weight 30 lbs. **\$8.95**



F.O.B. TULSA

90° HEAVY DUTY GEAR BOX

Ball bearing through-out with 1/2" drive spline. 1:1 gear ratio which can be changed by different size pulleys or gears. Wt. 5 1/2 lbs. Length 11". Beveled gears. Excellent for hot rods, power mowers, etc. Only... **\$5.95**



FILE MIX — NEW!

6 first line Hells, Nichols, etc. 10", 12" and 14" flat, mill bastards, half rounds, squares, etc. Set of 6 post paid to you. **\$3.79**



T & T TOOL 221 W. SECOND TULSA, OKLA.

KINKADE GARDEN TRACTOR and Power Lawnmower

A Practical Power Plow and Cultivator for Suburbanites, Gardeners, Florists, Estates, Fruit, Nursery & Poultrymen. Easy Terms - Write Today American Farm Machine Co. 1068 33rd Ave. S. E. Minneapolis, Minn. Catalog Free



HIGH POWER TELESCOPES

40 Power—opens to 36 inches. Precision & Polished Lenses. Ideal for Studying Stars, Plane Spotting or Interesting Pleasures. Satisfaction Guaranteed or Money Refunded.

Send Check or Money Order to **CRITERION CO., DEPT. PM11 438 ASYLUM ST. HARTFORD 3, CONN. \$3.49 Postpaid**

A COMPLETE PLIER SET!

4 INDISPENSABLE TOOLS NEEDED IN EVERY TOOL KIT

Amazing value! First time offered. Unconditionally guaranteed. Never before such a "buy". Genuine Forged Steel. Professional quality. Set includes 6" Lineman's Pliers, 6" Front Cutter or Carpenter Pincer, 5 3/4" Long Nose Pliers, 5 3/4" Diagonal Side Cutter. All 4 for only \$3.95 postpaid. Send M.O. or check or \$1.00 and pay balance C.O.D. Satisfaction or money back. Send TODAY.

THE STAR-CRAFT CO., Dept. 29, 33 N. Wabash Ave., Chicago 2, Ill.



ONLY \$3.95

Never be without power!

FAIRBANKS-MORSE GENERATING SETS

Fairbanks-Morse
1800 Watt
A.C. Generator



Even though storms, accidents or calamities cut off your power supply, you can still have plenty of power to operate lights, utilities, tools etc., if you install a Fairbanks-Morse stand-by generating set—*now!*

Fairbanks-Morse Generating Sets are available in capacities from 600 to 35,000 watts, A.C. or D.C., with manual, remote or automatic starting. There are sizes for all shops, filling stations, garages, farms, homes, stores, and other businesses. For complete details, see your local Fairbanks-Morse dealer, or write Fairbanks, Morse & Co., Chicago 5, Ill.



FAIRBANKS-MORSE,

a name worth remembering

A HOLLOW GROUND Hand Saw

World's First and Only Saw Blade
That Has Maximum Clearance
WHERE YOU NEED IT MOST!

The ONLY BLADE
with full clearance in the
WORKING AREA

Patent
Pending



For the easiest, fastest, smoothest sawing action known, get a hollow ground saw!

FREE Valuable tips on easier sawing, and hints on saw care. New folder shows amazing advantages of hollow ground hand saws over ordinary taper-ground saws. Send for free copy today.

THEY
COST
NO
MORE!

Sold thru
dealers only

The LARSAN Mfg. Co. 673—17th Ave., Columbus 3, Ohio

You Can Make DRAIN TILE

and Build a Profitable Community Enterprise



Farm drainage, home building, reclamation projects, highway construction. From these and other sources come the biggest demand for drain tile in history. More local plants are urgently needed.

Millions of dollars' worth of drain tile are used annually. Much of it, ordinarily, is shipped from far distant points. Local manufacturing is economical, logical, profitable. The Champion Drain Tile Machine makes manufacturing easy. Pares production costs. Requires no skilled labor. Makes all sizes from 3" to 12". Yet requires only a moderate investment.

Outstanding Manufacturing Opportunity

Champion-made cement tile are dense, strong, and truly round. No distortion, no shaling. Worth more than clay tile, but can be sold for less — and still leave a handsome profit margin.

Write for the Drain Tile Book. Tells about cement tile as a local manufacturing enterprise. Tells about easy-payment terms. Write today.

Concrete Equipment Company
522 Ottawa Ave., Holland, Michigan



E2



CAPE COD CHAIRS TRELLISES • ARBORS DUTCH WINDMILLS

Chairs style B-C-A PLANS 50c Ea., all 3 only \$1.00. 12 different trellis designs PLAN of all 12 only 50c. Authentic 40" high Dutch Windmill Detailed PLAN only 75c. Unique 40" high Light-house having copper lantern, ideal for garden or on lake shore of summer home. Large detailed PLAN 75c.

SPECIAL ALL PLANS ABOVE \$3.00 VALUE ONLY \$2.50

SEND 10c for catalogue of many fine projects.

Dept. P32
CRAFTSMAN'S MODEL CO. DELAFIELD, WISCONSIN

CRESCENT TOOLS

Give Wings to Work

ASK YOUR
HARDWARE
DEALER

NU-WAY HEAVY DUTY CUTTING UNIT

with Timken Roller Bearings

PRICE

\$16.50

WHY PAY MORE



Build your own rotary type lawn or weed cutter.

Take the hard work out of weed cutting. Build yourself an up-to-date weed and lawn mower with the Nu-Way heavy duty unit.

Write for Free Circular—We Supply Cutting Unit Complete
TRACTOR-LITE MFG. CO., Spirit Lake, Iowa

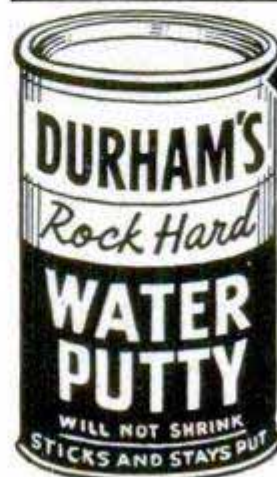

The Modern PLASTIC for lasting Home Repairs

PERMANENTLY mends cracks or holes in wood, tile, stone or plaster. Sticks and stays put—Does not chip, shrink or fall out. Easy to use. Economical. Mold it, chisel it, polish or paint it. If unobtainable from your lumber, paint or hardware dealer, the big 4-lb. can will be sent you post-paid (in U.S.) for only \$1.15. Full money-back guarantee, order now.

DONALD DURHAM CO.
Box 804-U, Des Moines, Iowa

NOW—A FLUSHING TOILET and SEWAGE DISPOSAL UNIT

Easily Installed

IN RURAL HOMES, TRAILER HOMES AND SUMMER COTTAGES . . .

This modern McPherson flush-type toilet with its sewage processing feature grinds, liquifies and aerates fully all sewage for quick absorption into the soil thru an inexpensive sub-surface irrigation system. Real expensive plumbing installations are no longer necessary with this entirely new water-driven sewage disposer. Because of the ease of installation and operation the McPherson Disposal Flush-Type Toilet is standard equipment in thousands of House Trailers in use today.

The McPherson is a full size aluminum toilet chrome plated. It automatically ventilates and is equipped with the famous 'Healthguard' valve that even a child can operate. It is frost proof.

Satisfaction guaranteed or your money back.
NO CHEMICALS—NO SEPTIC TANKS

Write Today for **FREE Catalog**

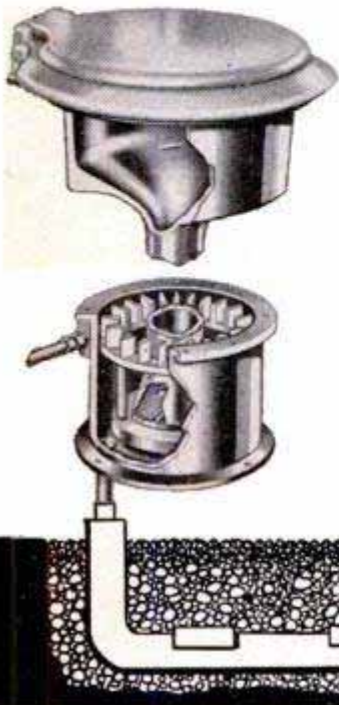

New HEALTHGUARD VALVE

APPROVED BY THE
AMERICAN SOCIETY OF
SANITARY ENGINEERS



McPHERSON, INC.

7450 N. Milwaukee Chicago 31, Ill.

NOW—40 different CUTS with AMAZING, NEW



Warren

DADO SAWING WASHERS On Your Saw Blade

Just dial widths to cut parallel grooves perfectly smooth. No warp, vibration

or trick screws. Strengthens blade, perfect balance. **GUARANTEED!** At your dealer's or order direct. Give arbor size— $\frac{1}{2}$ ", $\frac{3}{8}$ ", $\frac{3}{4}$ ", 1".

Send for free booklet

WARREN WASHERS COMPANY
70 Medbury, Detroit 2, Michigan

**ONLY
\$4.95
PER
SET**

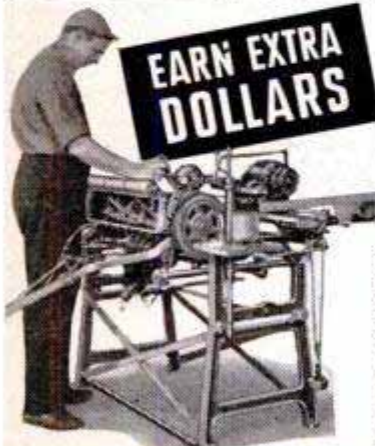

EARN EXTRA DOLLARS

IDEAL LAWNMOWER SHARPENER

Saves work, saves time, helps you earn extra dollars! Sharpens hand, power mowers without disassembling. Complete shop in one machine — equipped with Bed Knife Grinder and "lapping-in" Reconditioner. Home owners, parks, clubs, cemeteries pay good money for efficient sharpening; get your share!

WRITE NOW FOR FREE CATALOG

THE FATE-ROOT-HEATH CO., Dept. 1-3, Plymouth, Ohio

SEPTEMBER 1951

Start a Business in Your Backyard



Earn BIG MONEY MAKING BUILDING BLOCKS

General Concrete Vibrator BLOCK MACHINE

CAPACITY 1000 BLOCKS A DAY

only \$218 LESS MOTOR
F.O.B. PLANT

SHIPPING WEIGHT 400 LBS.



Here is a business you can start on small capital—in your own backyard—that earns 100 to 150% profit, with unlimited opportunities. Make concrete or cinder blocks. Millions used for homes, factories, public buildings, garages. Sell all you make to building trade. Do it with a General—and you're headed for success.

1000 BLOCKS A DAY

The General is a high speed, power-driven block machine at amazingly low cost. Rugged all-steel construction. Simple to operate indoors or outdoors. Makes superior 3 core type block meeting all code requirements. Produces up to 1000 blocks per day. Full operating instructions and mixing formulas supplied. Write for **FREE** details.

Dealer inquiries invited

Wonderful
Book Written
& Illustrated
by Experts

**HOW TO
BUILD
YOUR OWN
CONCRETE
BLOCK
HOME**
Only \$1 Prepaid

GENERAL ENGINES CO.

DEPT. M-91 • 307 HUNTER ST. • GLOUCESTER, N. J.

Includes floor plans for 6 beautiful, easy to build concrete block bungalows. Shows ways to save money. How to lay blocks, lay out building lines, mix concrete, build steps, porches and concrete floors. Mail coupon at once with \$1.

Name.....
Address.....
City.....Zone...State.....

ONE REASON YOU GET

BETTER SERVICE

FROM UTICA TOOLS

When you buy tools — pliers and adjustable wrenches — look for the Utica red diamond box and the name "Utica" on the tool. That means it's skillfully drop forged — and it means top quality and long service.

DROP FORGED FOR STRENGTH

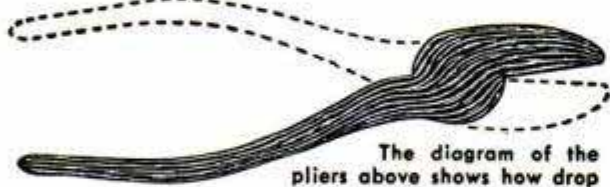

The diagram of the pliers above shows how drop forging aligns steel fibre structure with shape of tool. This means rugged strength.

CONTRAST THIS WITH



STAMPING

Fibre structure is straight — does not conform to the shape. Fibres are cut off. The tool is relatively weak.

CASTING



Ordinary casting lacks fibre structure for toughness. Relatively very brittle.



DROP FORGE AND TOOL CORPORATION

UTICA 4,

NEW YORK



EASY-ON

SPEED NUTS® WON'T VIBRATE LOOSE!

NOW in handy kit for home use

The most practical fastener you can have around the house! Replaces threaded nuts and lock washers. Hundreds of repair and hobby uses on toys, equipment, etc. Kit contains over 100 parts—SPEED NUTS and matching screws in popular sizes. Price: only \$1.00. Send check or cash to Tinnerman Products, Inc., Dept. 13, Box 6688, Cleveland 1, Ohio.



2 DRILLS in 1

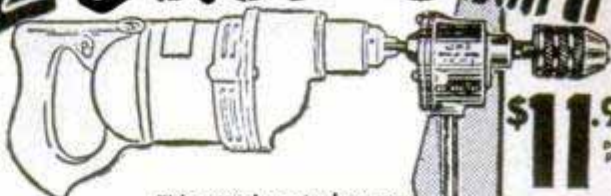

\$11.95
post paid

This attachment gives you two drills in one. It converts any 1/4 inch electric drill to 1/2 inch capacity. Reduction gears reduce the drill speed 5 to 1, the average speed of a 1/2 inch drill, and thereby increases the power. Absolutely indispensable for all shop work and home craftsmen.

G. M. CO. MANUFACTURING, INC.
1308 43rd AVE.
LONG ISLAND CITY 1, NEW YORK

Send check or Money Order
Satisfaction guaranteed
Order yours now

WELD

BRAZE, SOLDER, and CUT →

ONLY \$1475 F.O.B. complete!



No experience needed. Follow simple instructions, weld on iron, steel, bronze, brass, aluminum, and other metals. Plugs into any properly wired 110 volt A.C. or D.C. line. Make or save time and money doing repair work for yourself and others. Repair men, farmers, tinsmiths, home and auto owners, hobbyists, etc., say FOUR-WAY pays for itself over and over. Order today or send for Free details.

FOUR-WAY WELDER COMPANY, Dept. F2-JB
2326 So. Michigan Ave. • Chicago 16, Illinois

ORDER NOW
10 DAY TRIAL

The FIFTH Essential Instrument

HULL AUTOMOBILE COMPASS

Like your other important instruments, a Hull Automobile Compass gives you... quickly, easily, accurately... a vital fact about your car — the DIRECTION it is going. Know your way, anywhere, with a Hull. Proved dependable for 18 years.

Write for local dealer's name and free literature.

HULL MFG. CO.
P. O. BOX 246-89, WARREN, O.

Beaconlite \$6.95
Illuminated
STREAMLINE \$4.95
Standard (not illus.)

CARBURETOR TOO RICH MAKES MOTORIST TOO POOR



Car owners who are wasting money and not getting proper gas mileage due to over-rich mixtures will be pleased to learn how to save gasoline by VACU-MATING over-rich mixtures. VACU-MATIC fits all cars, trucks and tractors. It is automatic and operates on the supercharge principle. Easily installed in a few minutes.

SALESMEN WANTED! Big Profits!

Send name, address on penny postcard for free particulars and how to get yours for introducing.

VACU-MATIC CO., 7617-1787 W. State St., WAUWATOSA, WIS.



WAR SURPLUS BARGAINS

\$500,000.00 INVENTORY for QUICK LIQUIDATION

Surplus items—hundreds of them for home, shop, factory, farm and outdoor use. New items, used items, reconditioned items—all at tremendous savings—all priced for quick sale.

Page After Page of Values

This big catalog shows page after page of amazing money saving values. Write for your copy today. Send 10c to cover postage, mailing, etc. Write today!

SEND TODAY FOR YOUR COPY

10c

STARK'S Dept. 509 So. STATE STREET
PM-9 CHICAGO 5, ILLINOIS

YOU CAN HAVE

all the
precision
of industrial
machine tools
in your own
home shop



**DELTA
8-INCH
TILTING ARBOR
SAW-Table Model**

Home shop work is a real joy when things come out according to plan . . . when cuts are true . . . joints fit snugly into place . . . drawers slide smoothly . . . all without the exasperating nuisance of refitting.

Of course, it takes precision machines to turn out accurate work. That's why smart folks buy Delta Homecraft Tools. For remember, Delta has spent years building the finest precision machine tools for industrial use. And the same accuracy and hair-line precision that is required for these Delta-Milwaukee Tools is built into the Homecraft Tools *you* buy. We just don't know how to build them any other way.

So . . . buy the best . . . buy Delta . . . have machine tool precision and lifetime service in your own home workshop.

There's a Delta Power Tool for your Job-

WOOD OR METAL WORKING

53 MACHINES—246 MODELS—MORE THAN 1300 ACCESSORIES

For Delta Dealers, see your Classified Phone Directory under "Tools".

These Delta 8" Tilting-Arbor Saw Features INSURE ACCURACY AND PRECISION

1. Lubricated-for-life ball bearings—keep dirt out, lubricant in
2. Precision-bored bearing seats—fit close, cannot become loose
3. Pre-loaded bearings—eliminate arbor end-play
4. Precision-ground arbor—assures even contact between arbor and bearings, means greater accuracy
5. Dynamically balanced pulleys—prevent wear-producing vibration

These excellent features, typical of Delta precision quality, are fully described in the new Delta Homecraft Catalog—packed full of valuable information and suggestions on how to get the utmost of fun and satisfaction out of your home workshop and your Delta Homecraft Tools. Send for your copy—it's free. Use the coupon.

**DELTA
MILWAUKEE**



DELTA POWER TOOL DIVISION

Rockwell

MANUFACTURING COMPANY

803 K E. VIENNA AVENUE • MILWAUKEE 1, WIS.

Please send me the new Delta Homecraft Catalog.

Name _____

Address _____

City _____ Zone _____ State _____

The easy way to paint!

Speedy Sprayer

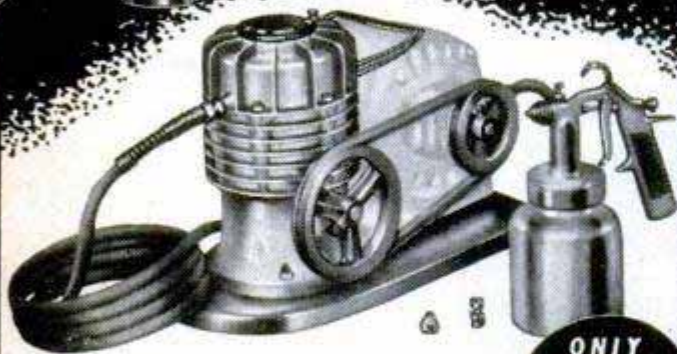

Favorite of home owners and craftsmen for 20 years! SPEEDY SPRAYER gives your work that professional paint finish everyone admires. Sprays paint, enamel, varnish, lacquer, etc. . . . 4 to 7 times faster than hand brushing! Lightweight, portable, uses any 1/4 H.P. motor. Improved diaphragm principle assures clean, oil-free air. You'll find dozens of time and money saving uses for SPEEDY SPRAYER, including spraying insecticides 2-4-D and DDT. Complete outfit, without motor, only \$32.50.

At leading hardware, lumber, and auto supply dealers. FREE—write for handy booklet "How to Spray."

W. R. BROWN CORPORATION

2635 N. Normandy • Chicago 35, Ill.

ONLY
\$32.50
LESS
MOTOR

THOUSANDS SOLD!



\$49.95

SW-54

**COMPACT TABLE RADIO
BRINGS IN STATIONS FROM ALL
OVER THE WORLD!**

Tunes all shortwave radio stations (code or voice) from 540 kcs. to 30 mcs., including the standard broadcast band. Hear stations from London, Moscow, South America, etc., as well as radio amateurs, ships, police and airports. Made by the world's foremost maker of professional radio receivers. Write for complete details and name of nearest supplier.

NATIONAL COMPANY, Inc.

61 Sherman St., Malden, Mass.

MODERN LAWN MOWER SHARPENER

**FOR LAWN MOWER SHOPS
FIX-IT SHOPS**

**GOLF COURSES • PARKS
101 OTHER JOBS**

Sharpens All Reel Type Mowers • Hand, Power or Gang • 10 to 20 Minutes • No Dismantling • No Extra Attachments Needed.

All reel type mowers, from 5-inch edgers to 36-inch power mowers, are quickly sharpened to extreme ends of both left and right twist blades.

ORDER NOW

Immediate Delivery

Handle, wheels, roller and motor remain in place when sharpening is in process. Bed knife is sharpened in same brackets. Grinding head rides on five ball bearing races. Easy to operate. Also sharpens chisels, joiner knives, planer blades. Big profit maker. Own your own business. Send Today for FREE Illustrated Bulletin No. 10-C. Prices Subject To Change Without Notice.

MODERN MFG. CO. 160 N. FAIR OAKS AVE. PASADENA, CALIFORNIA



PRICE
\$241.50
less motor

\$263.00
with motor

MONEY for MEN ALL DATA FREE

THE PLASTEX Industry needs manufacturers on small scale and for big production of Lamp and Clock Stands, Art Goods and Novelties in Plaster and Marble imitation. Experience unnecessary. Ice material makes regular 10¢ store sellers. Rubber moulds furnished for speed production. Small investment brings good returns. We are now placing big Chain Store Orders with manufacturers. Ambitious men have chance for real prosperity. Our Free booklet will interest and benefit you.

PLASTEX INDUSTRIES, Dept. A

3400 Third Ave. New York 56, N. Y.



4000 fine tools, available direct from factory to user. Snap-on catalog free—send for it today.

Snap-on Tools Corporation
8062-1 28th Ave., Kenosha, Wis.

Genuine MAHOGANY Wood

Large Batch \$1.00 Postpaid. Other Usable Scrap Bargains Postpaid
Sample 25c — Price List 3c

S. R. MARKS CO., Dept. C-9, Montgomery 5, Ala.

make your own Gems 29.50
F.O.B.

All necessary lapidary equipment is furnished, including a super-charged diamond blade for sawing, and all wheels for grinding, shaping and polishing; also complete instructions. The complete equipment as shown, less motor and belt, for only \$29.50, f.o.b., Burlington, Wisconsin. Write today for information and literature.

B&I MANUFACTURING CO.
Dept. S Burlington, Wis.



AUTOMATIC RETOOTHOR

MAKES NEW PROFITS

for **HAND SAWS**

Cuts new teeth in 50 seconds — any size 4 to 16 points. Old teeth fall off as chips. Easy to operate. A perfect job.

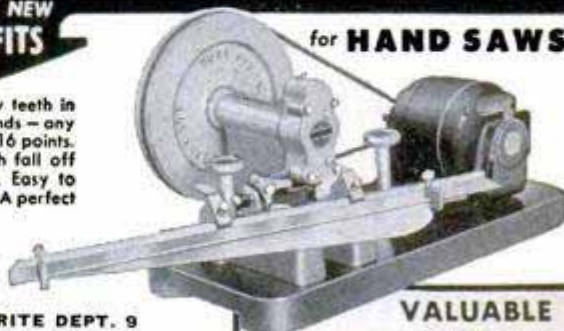

WRITE DEPT. 9

BURR MFG. CO.
8933 VENICE BLVD.
LOS ANGELES 34, CALIFORNIA

VALUABLE BOOK

25¢

Order Burr's Blue Book of Coast to Coast prices for saw shop services

New!
GRAVELY
Portable
Power-driven **SAW**



Clear land for crop or pasture! Saw for fells, trims trees, 19 other attachments for lawn, garden, field jobs. All gear drive; reverse. Write for catalog, "Power vs. Drudgery."

FREE

GRAVELY MOTOR PLOW & CULTIVATOR CO.
BOX 963 DUNBAR, WEST VA.

Burden's Gigantic Fall MAIL SALE

Midwest's leading surplus firm offers, subject to prior sale, a \$650,000.00 inventory of new perfect condition:

- WAR SURPLUS APPARATUS
 - EXCESS INVENTORY STOCKS
 - BANKRUPT AND CLOSE-OUT EQUIPMENT
- During Sale We Will Pay All Shipping Charges!

Power Plants and Generators

- Kato Generators. 115-V, 60-C, 5000-Watt, 1800 R.P.M. Single Phase. Ball Bearing. Complete with control panel. Cost over \$550.00. **\$259.50**
- Onan Plants. 115-V, 60-C, 5000-Watt, 4-cyl. engine, complete control panel. Push button start. Cost over \$1,200.00. **\$715.50**
- Homelite Plants. 115-V, 60-C, 1500-Watt, 1-cyl. engine. Complete. Exceptionally fine. Cost over \$450.00. **\$258.70**
- Homelite Plants. 115-V, 400-C, 1400-Watt, 1-cyl. engine. Fine for lights, irons, heaters, but not motors. Cost \$630.00. **\$129.60**
- Burdex-Briggs Plants. 115-V, 60-C, 2000-Watt. Excellent size for home emergency power. List \$585.00. **\$297.50**
- Delco-Remy Generator. 25-30 Volt, 200-amp. Direct current. Makes excellent welder (full instructions for building), also fine for emergency lights, power, etc. Cost over \$250.00. **\$19.95**
- A-C Plant. 115-V, 60-C, 7.5 KW. **\$691.70**
- A-C Generator. 115-V, 800-C, 1 KW. **\$18.96**

Air Compressor Equipment

- Paint, blow up tires, clean gas lines with compressed air. Build your own portable hi-pressure unit from best parts.
- Basic Compressor Kit. Finest 1-cyl. piston comp., stainless steel storage tank, 160 lb. gauge, paint gun, blow gun, fittings, tire chuck, hose, relief valve, complete instructions for building portable unit. **\$39.90**
 - Air Components. 1-cyl. compressor. **\$19.95**, 2-cyl. comp. **\$49.50**, Automatic pressure switches (on 50, off 75). **\$4.95**, pressure regulator (0-150 lb.). **\$2.65**, gauges (60, 100, 160 lb.). **\$1.89**, tanks (small **\$5.60**, large **\$9.95**), air hose, 20' 1/4" with fittings. **\$2.89**, adj. safety valve. **\$1.95**, top quality paint gun, **\$8.95**, 3-gal. paint tank. **\$18.95**

Winches, Clutches — Engines — Blocks

- Heil Power Winches. Heavy duty 15,000 lb. with clutch and 150' 1/2" cable. Cost \$275 **\$169.70**
- DeLux Hand Winches. Dual ratio 1-3, 1-9. Finest construction. Powerful 3,000 lb. 100s uses, farm & business. **\$29.87**
- Truck Hand Winches. 1-3 ratio, 2000 lb. Excellent for loading trucks, contractors, etc. Top quality. **\$19.77**
- Utility and Boat Winches. 1-1 ratio, 1500 lb. **\$18.97**
- Double Sheave Blocks. All steel for rope, 5". **\$7.76**
- Snatch Block, 4" steel, 3000 lb. Latest type. **\$5.49**

Water Pumps, Water Systems, Weed Spray Units

- Complete Automatic Pressure Water System. Leading make. Fine for farms, cabins, etc. 110-volt 60-cy. 300 g.p.h. 22' lift. **\$69.50**
- Bronze Medium Pressure Rotary Pumps. Up to 25 lbs. Stainless shaft. Self priming. Lift 10' without foot valve, 22' with. Efficient. **\$12.95**
- 1/2" 6 g.p.m. **\$12.95**
- 3/4" 10 g.p.m. **\$16.95**
- 1" 19 g.p.m. **\$22.95**
- Bronze High Pressure Rotary Pumps. Up to 150 lbs. Stainless shaft, self priming. Lift 10' without foot valve, 22' with. Top quality unit. Move 1/2" 5 g.p.m. **\$14.50**, 3/4" 8 g.p.m. **\$20.95**, 1" 17 g.p.m. **\$27.95**
- Centrifugal Irrigation & Flood Pumps. Cast iron-bronze, stainless shaft, 7500 gal. per hr. 2" suc. 1 1/2" dis. Ball bearing. **\$34.79**
- All Brass DeLux Tractor Weed Spray Outfit. Popular make at over 40% saving. Consists 4-row brass boom with genuine T-jet 5 g.p. acre, nozzles, easy mount any tractor, gauges, valves, hose, direct drive tractor pump, relief valve, etc. A guaranteed value. **\$84.50**

Miscellaneous Close-Out Equipment Bargains

- We have limited quantities of items listed below all subject to prior sale. Order promptly to get in on these.
- G.E. Electronic Dictation Magnetic Recorders. 110-v, 60-c. Useful for home or office. Records can be used over and over. Brand new with tubes. **\$29.50**
 - Rural Magneto Phones. Wall type. Modern case, 5-bar. **\$12.40**
 - Private Magneto Phones. Wall type. Modern, 3-bar. **\$10.25**
 - City Up-Right Desk Phones. Many uses. Instructions. **\$ 1.99**
 - Motor-Gyro Units. 24-v, D-C (will run on A-C) fascinating. **\$ 1.98**
 - Direct Reading Tachometers. 0 to 4000 R.P.M. Leading make **\$ 6.79**
 - G.E. Arc Welders. Complete outfits. 220-v, A-C. **\$139.50**
 - DeLux Farm-Business D-C Arc Welder. Built by leading Chicago firm. Will furnish up to 250 amperes of voltage stabilized smooth welding current. Complete with driving pulley, instructions, etc. Ready to use. **\$99.50**
 - Buy of the Month. Guy Cable-Turnbuckle Units. Consists of 12 ft. flexible steel cable, 14" turnbuckle. Wonderful for guying television antennas, strengthening gates, fences, bldgs., etc. cost \$1.10 **10 for \$ 3.89**

BURDEN'S 30-Year Policy:

- Everything we sell guaranteed perfect.
- We pay all Frt., P.P. or express charges in U.S.A.
- We offer only outstanding buys.

ORDER FROM AD or Write for Free Catalog!

BURDEN SALES COMPANY

811 "O" ST.

LINCOLN, NEBR.

HOME REPAIR TIP NO. 25



STOP HOSE LEAKS with water-resistant "SCOTCH" Brand No. 33 Electrical Tape. Plastic backing is flexible, withstands abrasion and sunlight. Carries UL seal for indoor and outdoor wiring, too. 39¢ at your hardware store.

MARCOT KEY MACHINE



MARCOT No. 8 KEY MACHINE, less motor. **\$110.00**
Auto Code Book and Depth Keys. **12.50**
75 Dz. Popular Key Blanks. **60.00**
Set — Key File, Follow-Through Rods, Lock Picks, Bit Key Gauge, Thimble, Pins, Springs. **10.50**
"Locksmith Trade Books" **6.75**
How to Open Locks without Keys or Picks: Secret of Locksmithing: How to Make Keys by the Impression Method: Master Key Systems. **\$199.75**
TOTAL COST

Immediate Delivery

A. J. MARCOTTE CO., 1200 N. Kedzie Ave., Dept. PM, Chicago 51, Ill.

BUILD YOUR OWN



Lawn Chairs • Bird Houses • Corner or Wall Shelves from available scrap lumber. Send only \$1.00 for set of full size plans of all items mentioned above. In addition, we will include 80-page Hobby & Handcraft Reference Book FREE. Send check, dollar bill or money order to:



THE CRAFTERS OF PINE DUNES
Formerly Jackson Studio
109 POPLAR STREET • OOSTBURG, WISCONSIN

HOBBY AND HANDCRAFT HEADQUARTERS

Now — **ONE** Tool Does 1000's of Jobs!

WISE-GRIP WRENCH

Low as **\$1.85**

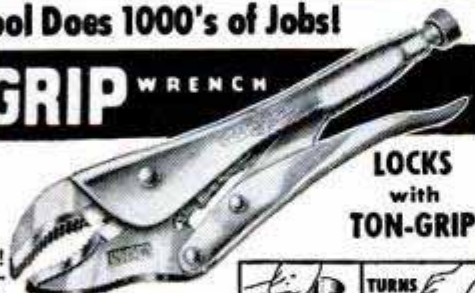

LOCKS with **TON-GRIP**

What power! **LOCKS** with Ton-Grip! Holds anything—can't slip. Easily adjusted to plier action. Makes handy Pipe Wrench, Adjustable End-Wrench, Pliers, Wire Cutter, and Toggle Press. With Cutter—No. 7W, 7", \$2.25; No. 10W, 10", \$2.60. Without Cutter—No. 7C, 7", \$1.95; No. 10C, 10", \$2.25. Straight Jaw model—No. 7, 7", \$1.85; No. 10, 10", \$2.15. Order From Your Dealer.

PETERSEN MFG. CO., Dept. P-9, DeWitt, Nebr.

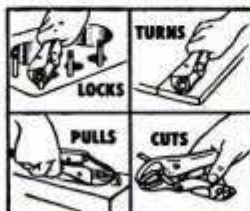

WAR SURPLUS AND OTHER BARGAINS

DRILL GRINDER

... Sharpens round, square or tapered drills up to 6" long. Even an amateur mechanic can get a new, factory finish on a drill in 25 seconds. New protractor feature gives every drill sharpening angle, with 5 convenient angles already marked off. Usable with hand or power stone. A brand new development, manufactured by Ten Eyck. Shipped postpaid



All New.
\$2.80 each.

MICROSCOPE 100 and 150 POWER

A fine precision instrument ... not a toy. Highly ground and polished lenses. Overall height 8 1/2 inches. Designed for easy portability and yet stable enough for laboratory use. Microscope, leather case for barrel, four slides and hardwood carrying case box \$9.95 postpaid.



MICROMETERS

Chrome plated, precision engineered and carefully tooling to give long life. All new. 0-1" capacity . . . each \$2.25 1-2" capacity . . . each 3.50



HIGH SPEED DRILLS

All New. Fractional & numbered. Orig. Val. \$15. Nationally known brand. Ast'd. sizes. Set 30. \$3.50



EXTENSION DRILLS

High Speed Steel, like new. Asst'd sizes from No. 1/4 to 40. Lengths from 6" to 12". Approximately \$20 value. Set of 12 \$3.75

HIGH SPEED DRILL BITS

Like New! Original value over \$16.00. 25 assorted sizes and lengths, \$2.50

FLEXIBLE SHAFT MAGNET

For picking up cotter pins, nuts, wrenches, etc., from inaccessible places. Removes Bobbie Pins, etc., from drains. Lifetime Magnetism Guarantee. Highly polished magnet and handle. Cadmium Plated. \$1.70 postpaid



RIVET SETS

Universal type, case hardened tips. Set of dies will head up any brazier or round head rivet from 1/8" to 1/4". With adapters for air gun or hand use. All new . . . cost Government about \$27.00. Complete 15 piece set, wt., 2 lbs.. \$5.00



HAND MITRE

"It pays its way in just one day!" It's sensational! New HAND MITRE saves hundreds of hours . . . requires only a "flick" of the hand for a precision mitre every time. The HAND MITRE will cut any desired angle. Its rugged construction will handle hard and soft wood mouldings, plastic trim, base shoe, laminated materials, rubber extrusions, etc. Made of heavy gauge stainless steel. \$3.95 postpaid



Send check, money order or cash. 25% deposit required on C.O.D. orders. All prices F.O.B. Culver City, California, unless otherwise stated. Send 25c for New 1957 Illustrated Catalog.

AIRBORNE SALES CO., INC. DEPT. PM 9-51 CULVER CITY, CALIF.

MAGNETS OF ALL TYPES—10c UP

AMAZINGLY POWERFUL!! 1/4 lb. magnet lifts 25 lbs. \$1.95. Our Leader, 1 lb. magnet lifts 40 lbs. \$2.95. New alloy—will not weaken! Useful for lifting valuables from tanks, lakes, or rivers easily! 7 small magnets \$1.25 with list of many shop and home uses. Satisfaction guaranteed. R. EYRICH, 1219 W. MEINECKE AVE., MILWAUKEE, WIS.

DYNAMIC POWER TOOL COMBINATION

INCLUDES: Cummins 1/4" Electric Drill; Cummins Saw Attachment; Combination Saw Blade; Set of Drills; Lambs Wool Bonnet; 6 Sanding Disks; Steel Arbor and Attachments; Cloth Buffing Wheels; Grinding Wheel; Wire Wheel Brush; Steel Paint Mixer; Steel Bench Stand; Portable Steel Carrying Case. Price of Dynamic Power Tool Combination complete is \$26.95

SHIPPED ON APPROVAL NO MONEY WITH ORDER—NO C.O.D.

Try it ten days before you buy. If completely satisfied then send \$2.95 and pay balance at rate of \$4.00 per month for 6 months—No Interest or Carrying Charges Added. If not completely satisfied, return to us, no explanation necessary. KAPNER HARDWARE, INC. Dept. A-3, 2248 Second Ave., N. Y. 29, N. Y.



Remove PAINT

THIS FAST, EASY WAY

WONDER-PASTE, applied with a paint brush, softens up the toughest paint, varnish, enamel or shellac right down to the surface. Comes off clean at every stroke of your putty knife. Try it. At paint and hardware stores. . . . Write for leaflet on Wonder-Paste and advice on your particular removing problem.

Wilson-Imperial Company, 119 Chestnut Street, Newark 5, N. J.

PROPANE GAS ON YOUR CAR—TRUCK OR TRACTOR
SEND \$1.00 for booklet of details and special prices on equipment.
ORDER NOW
LPG PRODUCTS Dept. PM-9 KEARNEY, NEBR.

TEST Circuits, Fuses, Outlets easily, quickly, safely. Shockproof. Pull fuses 10 to 100 Amp.
Test 110-600 Volts
STAR TEST-PLIERS
\$2.75 \$1.50 add'l for 2' leads
At Dealers . . . or from us POSTPAID.
STAR FUSE CO., 235 Canal St., New York 13, N. Y.

Print Your Own
Cards, stationery, circulars, tags, labels, photo and movie titles, advertising, etc. Save money. Print for Others, Good Profit; easy rules sent. Raised Printing like Engraving, too. Sold direct from factory only. Write for free catalog of outfits and all details. KELSEY PRESSES, M-37, Meriden, Conn.

\$ Free Course! Big Profits! \$
Flocks & Sandblasts
Dual Purpose Spray Gun! Uses only 25 lbs. Air Pressure
• Thousands of uses in Home, Shop, Industry: Makes Auto Interiors Clean & New, Lines drawers, Marproofs lamp bases, Refinishes any object. All in colorful Flock. Etch & Frost windows, glassware, etc. Removes Paint & Rust from Autos, Tools. Guaranteed! Send \$24.75 or write for free information. Flocking supplies!
BLASTO SPRAY GUN MFG.
Dept. PM-9, 7007 Haas Avenue, Los Angeles 47, Calif.

Scrape paint quickly
ask your dealer for
Red Devil
Wood Scrapers

Send for the NEW 96 page
Red Devil catalog No. 21
Address Dept. P.M.
RED DEVIL TOOLS, IRVINGTON 11, N. J., U. S. A.

DRY OUT DAMP WORKSHOPS!



Amazing little Fedders Electric Dehumidifier dries damp rooms without messy chemicals! Plugs in like a radio, removes up to 3 gals. of moisture from the air every 24 hours. Stops damage from rust, mildew, rot, warp. Protects tools,

wood, guns, luggage, furniture, linens. Compact and portable. No service worries. Runs for a few pennies a day. Write today for details on 5-day FREE home trial offer. Fedders-Quigan Corp., Dept. PM-3, Buffalo 7, New York.

fedders

A GREAT NAME
IN COMFORT

STEADY PROFITS!

Your Own Business With

CORADIO

Coin Operated Radio

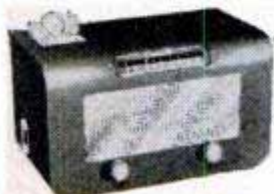

Place these specially built radios that play 1 or 2 hours for 25c in the thousands of available hotel rooms, tourist courts, etc. They yield immediate profits and steady income. Minimum capital required \$750 for equipment. Expansion unlimited. For further information write:

CORADIO Coin Operated Radio

DEPT. NO. 9 PM Phone: 212 BROADWAY, NEW YORK 7, N. Y. BEekman 3-0038-9

Clark EXPANSIVE BIT



CUTS BETTER • COSTS LESS!

Accurate, fast; cuts smooth holes in hard or soft wood. Chrome vanadium steel blades, all chrome body. No. 250, 1/2" - 1 1/2", \$1.89; No. 251, 3/8" - 3", \$2.19. GUARANTEED. At your dealer or write Dept. PM-9

ROBERT H. CLARK COMPANY • Beverly Hills, California

AIR COMPRESSORS WESTINGHOUSE

Reg. \$60.50 **26⁹⁵**

Model T-1 Complete FOB PGH

New shipment—just received! With new larger direct-drive pulley for easier operation. These are top-quality brand-new Surplus Westinghouse double-piston type compressors, 6.54 CFM volume, at a big saving from the \$60.50 list price. Made to most rigid gov't. specifications. Runs off power take-off or 1/2 H.P. motor. For farm, home, industry, painters. Instructions included. Send check or money order.

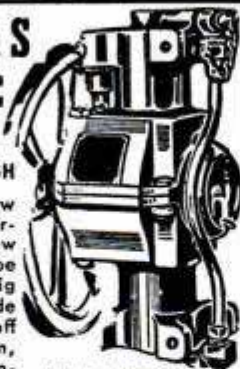

(Weight 23 lbs.)

AIR HOSE to fit, 25-ft. length with fittings & chuck \$3
Terrific Gov't. Surplus Value! Complete ALL NEW Portable Automatic Air Compressor Unit on wheels, using above compressor and Double Pressure Tank Assembly. Maintains any desired pressure up to 150 lbs. Measures 52"x23"x21". Everything included. Write for specifications.

68⁸⁰

FOB
PGH

SPARE PARTS — COMPLETE LINE!

NATIONAL EQUIPMENT CO.

Westinghouse Ave. P. O. Box 66 Wilmerding, Pa.

*This bright and efficient kitchen for only \$185**



SKIL Home Shop Tools

HELPED ME SAVE \$250

ON THESE MODERN
KITCHEN CABINETS!



There's a new look to our kitchen! Now my wife has plenty of storage space, plenty of work space, and all because of the neat efficient cabinets I built in my spare time. And they cost us just the \$185 I paid for materials. You can do this too, with the free SKIL-Chart No. 105 and SKIL Home Shop Tools!

I bought a six-inch SKIL Home Shop Saw that did all the work! It was easy to make bevel, miter and rip cuts, since the adjustments were so simple and quick. When mounted in the SKIL Home Shop Saw Table, the unit becomes a tilting arbor table saw—unbeatable for more accurate work.

There are dozens of things you can build for the house with SKIL Home Shop Tools. And the great thing about these fine tools is the way they pay for themselves with the money they save!



SKIL Home Shop Saw—Model 520. Fast, accurate, powerful 6" saw. Full adjustments for bevel and depth of cut. No-load speed: 5800 r.p.m. Automatic blade guard. Overall length: 10 1/8". Weight: 10 1/2 pounds. \$59.50.

Prices subject to change without notice.
*For materials only. Local prices vary.

Made only by Skilsaw, Inc.
5033 Elston Avenue,
Chicago 30, Ill.

SKIL home shop Tools

In Canada: Skiltools, Ltd.,
3601 Dundas Street West,
Toronto 9, Ont.

Skilsaw, Inc., Dept. C-91
5033 Elston Ave., Chicago 30, Ill.

FREE! SKIL-Chart No. 105 shows you how to buy materials and build the kitchen cabinets shown above.

Name.....

Street.....

City..... State.....

MENDS

Pottery, Toys,
Furniture, Books



It's transparent, waterproof,
flexible and durable.
Get a tube
today.



DU PONT
REG. U. S. PAT. OFF.
DU CO CEMENT

FREE

NEW BIG RADIO CATALOG

Ready now! Complete with everything in radio, TV and electronics. Newest parts as well as old, standard lines. Paste coupon on penny postcard and mail today!

Lafayette Radio DIV.: RADIO WIRE TELEVISION, INC.

NEW YORK 13 100 Sixth Avenue
NEWARK 2 24 Central Avenue
BOSTON 10 110 Federal Street
BRONX 58 542 E. Fordham Road

**30 YEARS
OF
VALUES**

LAFAYETTE RADIO, Dept. LI-1
100 Sixth Avenue, New York 13
Please rush Free catalog to:

Name.....
Address.....
City..... State.....

PASTE
ON
PENNY
POSTCARD

YOU CAN MAKE THESE WITH POPULAR MECHANICS PLANS AND BLUEPRINTS

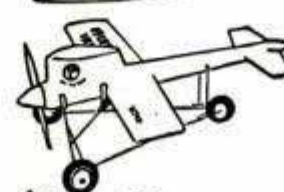

- 501—Colonial Grandfather's Clock. 25c
- 507-508—Doll-House, 5-Rooms, Open staircase, fireplace. 50c
- 526—Queen Anne Coffee Table: True replica of antique. 25c
- 528—Duncan Phyfe Console Table: 30 in. high. 25c
- 529—Lawn Chair: Southern style. 25c
- 593—Three Attractive Corner Shelves: Scroll-sawed. 25c
- 596—Three Hanging Type Shelves: Hold books, china, etc. 25c
- 661—Rocking Horse: Scroll-sawed from plywood. 25c
- 707—12 Ft. Rowboat: Flat-bottom, four seats. 25c
- 795—Two Handsome Cedar Chests. 25c
- 811-812—16 Ft. Canoe: Canadian type, cedar planking. 50c
- 813-814—Pops Outboard Racer: 10 ft. long, stepped bottom. 50c
- 828-835—Sovereign of the Seas: English warship model. \$2.00
- Sovereign of the Seas: Instruction Book. \$1.00
- 836—12 in. Bandsaw: Uses plywood, cuts two in. stock. 25c
- 839—Melrose Corner Cabinet: Old Colonial design. 25c
- 846-848—Governor Winthrop Desk: True copy of original. 75c
- 896-897—Three Easily Made Workbenches—Simplified construction. 50c
- 906-909—Midget Auto: 58 in. wheelbase, 1/2 to 3/4 h.p. \$1.00
- 910—Circular Saw Table: Hardwood, 24" x 36". Stationary. 25c
- 917—Outdoor Fireplaces: Several simple but practical. 25c
- 920-922—Lawn and Garden Furniture: Swings, arbors, tree seat. 75c
- 923—Indoor Fireplaces: Standard Sizes. 25c
- 926-927—Venetian Blinds: Three different styles. 50c
- 930—Hooked Rug Frame—Quilting Frame. 25c
- 933—Cape Cod Cupboard: 4 ft. wide, 5 ft. 8 in. high. 25c
- 935—Knee-Hole Desk: 40 in. long, 30 in. high, 31 1/2 in. wide. 25c
- 936—Modern Coffee Table: 24 in. long, 15 in. wide. 25c
- 952—Colonial Crib in Maple. 25c
- 958—Colonial Corner Cupboard: 6 ft. 8 in. high. 25c
- 961—Hanging China Cabinet: 38 in. long, 40 in. high. 25c
- 969—Combined Chest and Writing Desk: 35 1/4 in. high. 25c
- 970—Modern Clothes Chest: Built of Plywood. 25c
- 977—Bookcase in Chippendale Style: 47 in. high, 10 in. wide. 25c
- 978—Lawn Chair on Wheels: Lightweight, easy to wheel. 25c
- 981—Colonial Wall Shelf: 30 in. high, 19 in. wide. 25c
- 984—Duncan-Phyfe Drop-Leaf Table: Reproduction of historic piece. 25c
- 986-987—Utility Trailers: Built of old auto parts. 50c
- 989-990—Speedy Motor Scooter: Gas engine, 40 to 60 miles on gal. of gas. 50c
- 991—Gun Cabinet: Handy cabinet includes rack for rifles. 25c
- 993—Twin-Deck Beds: 6 ft. 4 in. long, 3 1/2 ft. wide. 25c
- 1106-1112—SEACRAFT—25 FT. CABIN CRUISER: Adaptable as sport fisher, express cruiser, or utility boat. Cruises at 15 knots with marine engine or converted auto engine. Cabin sleeps four. Galley has fresh-water tank, sink, and cook stove. Set of seven large-sized blueprints scaled 1 in. per ft. plus 40-page two-color illustrated booklet, only. \$10.00
- 1011—Fireplace Fittings: Andirons, log rack, etc. 25c
- 1080-1081—Banta: 12 Ft. Plywood Runabout: Vee-Bottom, 3-passenger. 50c
- 1086—Black Forest Corner Shelf: Scroll-sawed. 25c
- 1089-1090—Home-Constructed Freezing Unit: reaches minus 30 degree temp. 50c
- 1091-1096—17 ft. trailer, 7 ft. wide. Steel chassis. \$1.50
- 1102-1105—Midget Trailer: "Tear-drop" body. Sleeping quarters for two. \$1.00
- 1113-1114—Gold Rush of '47: The A.M.A. Open Class B Record Holder Plane Model. \$1.00

FILL OUT AND MAIL THIS COUPON NOW

POPULAR MECHANICS COMPANY, Dept. 19
200 E. Ontario St., Chicago 11

Please send the following plans.....

I am enclosing \$.....

Name.....

Address.....

COMPARE THIS !!

300 AMP. - DC. - WELDER KIT
ASSEMBLE YOUR OWN - SAVE HALF!

\$39.95

Never Before at Such an Unbelievable Low Price!

Now you can make your own welder using any aircraft generator and save many dollars. Only a pair of pliers and a few minutes are needed to assemble this kit into a sturdy welder giving you many years of useful service. Satisfaction guaranteed.

HERE'S WHAT YOU GET: No. AW5-Kit includes Special Hook-up Leads, Amperage control with leads, Mounting Plate, Pillow Bearings, Bearing Supports, Shaft Extension, Flexible Coupling splined to fit your generator, Triple Groove "B" Type Pulley. Plan included.

- No. AW5-Kit Complete \$39.95
 - No. AW6 Includes AW5-Kit above plus Arc Stabilizer — \$49.95
 - No. AW7 Includes AW6-Kit plus R-1-300 Amp. Generator \$67.90 (R-1 Generator Cost Gov't. approx. \$400.00).
- EXTRA! A \$15.95 Accessory Kit Complete for only \$12.95! Includes Welding Helmet, Electrode Holder, 5 lbs. Ass't. Rods, Two 10 ft. Welding Leads with Terminals and ground clips, plus Audel's Welding Guide. Sold with any Welder Kit . . . Special Price **\$12.95**



PLANS 35c LeJay's proven plan for building your own Welder using aircraft generator. Catalog included.

Order Direct from This Ad
FREE! BIG NEW CATALOG OF ELECTRICAL BARGAINS - WRITE FOR IT!

LEJAY MFG. CO. 947 LEJAY BUILDING
MINNEAPOLIS 8, MINN.

NEW, IMPROVED CALCULATOR FOR WOODWORKERS only 25c

Instantly gives information on lumber, nails, concrete mixes, painting materials, etc. Convenient, simple to read. Just set dial for nail specifications, to convert linear to board feet, find bit sizes for screws, compare characteristics of woods. 6" diameter heavily varnished cardboard. Send 25c, no stamps, please to Greenlee Tool Co., 2109 Columbia Avenue, Rockford, Illinois.

DRAINS Cellars, Laundry Tubs; CIRCULATES Oil; IRRIGATES Gardens

Original "Type P" Pump has 2400 GPH capacity. 360 GPH 75" high, or 1500 GPH from 25" well. Use any 1/8 to 1/2 HP motor. DOES NOT CLOG.

Only \$6.95 postpaid if cash with order. (West of Mississippi, add 50c.)

\$6.95

SATISFACTION GUARANTEED OR MONEY BACK!

LABAWCO PUMPS, BELLE MEAD 7, N. J.

1/2" ELECTRIC DRILL ADAPTER

Fits any small 1/4" Drill—in a SECOND!
Takes all larger size drills—Sturdy—A Mighty Handy Tool.

DANIELS PRODUCTS CO.
M-9-822W 22nd, Kearney, Nebraska

\$2.95 Postpaid in USA

"RED-E" GARDEN TRACTORS

SAVE—Buy Direct From Manufacturer

You'll like the smooth, powerful, gear-driven, 1952 styles in the Walking Model, 2, 3, 4 1/2, 6 H.P. with power turning clutch for each wheel or the Riding Model—7 1/2 H.P. with automotive type differential. Attachments for plowing, sowing, cultivating, wood-sawing, snow-plowing, etc. **EASY TERMS.** Special: Discount to User Agents.

FREE CATALOG!

RED-E TRACTOR CO.
RICHFIELD 202, WISCONSIN

SHEET METAL BRAKES

Forms angles, flanges and Pittsburgh locks. 26 gauge steel, heavier aluminum. Cam locking. Portable, can be bolted to bench, or clamped to edge of truck. All steel, reinforced.

Shipped Exp. Coil, 30" size, Wt. 54 lbs. . . . \$26.50. 36" size, Wt. 66 lbs. \$31.00. 48" size, Wt. 100 lbs. \$45.00. Floor mountings, portable, 32" high, 30 lbs. \$7.00. 12" BRAKE. Fits in vise to form difficult compound bends, up to 20 gauge steel. Not illustrated \$12.50 P.P.

5" Wide Pliers forms locks \$2.50

24" CURVE FORMER, 2 roll, 16 gauge, 2" to 2" dia. . . . \$10.00 P.P.

IRON BENDER, 1/4x2" capacity, 10 parts. All steel \$10.00 P.P.

Immediate Delivery. Order direct, cash or C.O.D. or send for folder.

VYKE BRAKE CO., P-1116 So. 27th St., Omaha 5, Nebr.

BIG MONEY USING AMAZING NEW, SAFE JIG SAW

AT HOME!



ONLY \$22.95 MOTOR INCLUDED



MOST POWERFUL SAW OF ITS KIND!



CUTS 1" WOOD, THIN METAL, PLASTIC! QUIET!

Ready — America's most amazing jig saw for home fun or profit! Largest, most powerful saw of its kind! QUIET, ideal for apartments! SAFE . . . blade does NOT pull fingers toward it. No belts, gears or oiling! Adjustable "any length cut" arm. With BUILT-IN New Reactance Type Electric Motor, \$22.95 at dealers or postpaid.

Arm adjustable for cutting any length material!

SYNCR0 POWER UNITS GUARANTEED AGAINST BURN-OUT DURING YOUR OWNERSHIP OR REPLACED FREE!

The Name You Can Trust

SYNCR0

QUALITY TOOLS

ELECTRIC JIG SAW

U.S.A. Model No.201.
60 Cycle, 110-120 Volt AC. Other Voltages, Cycles available. Dealers, Jobbers — Write!

USE COUPON FOR CIRCULAR OR DIRECT ORDER

- SYNCR0, INC., DEPT. D-91, OXFORD, MICHIGAN, U.S.A.
- ORDER.** I enclose \$22.95. Send No. 201 Saw postpaid on 10 Day Money Back Guarantee.
 - FREE CIRCULAR.** Send new SYNCR0 CIRCULAR showing new SAW and NEW SANDER.
- WRITE NAME, ADDRESS BELOW — MAIL TODAY!**

Buy the Best...WISS!

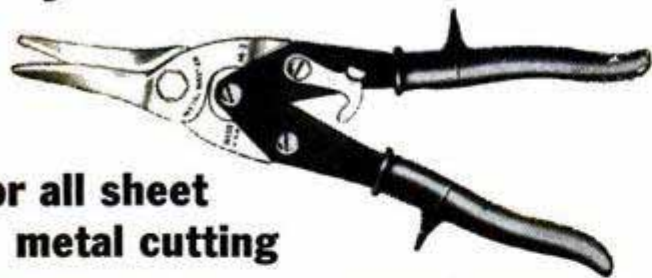

for all sheet
metal cutting

WISS Metal Master Compound Action Snips

#M-3. Easily cuts 18 gauge sheet metal. Cuts curves and circles as well as straight. Ideal for the home workshop. \$4.25. Rubber grips recommended, 60¢ extra.

WISS Straight Cut Snips

#9. Crucible steel inlaid blades. The basic snips for straight metal cutting. Gun metal handles. Overall length 12½". \$5.25.

WISS Combination Snips

#V-13. Solid steel, with gray japanned handles. Cuts curves and irregular shapes with ease. Handy pocket size. 7" long. Accurately tempered jaws and strong bolts. \$1.85.



Prices slightly higher
Denver and West



Quality for more than a Century

J. WISS & SONS CO. • NEWARK 7, N. J.

EVERY ¼" ELECTRIC DRILL A PORTABLE SAW IN ONE MINUTE!

"ARCO-SAW" (Over 100,000 Sold)



No. 444 "Arco-Saw"
9.95
with 4"
"HYCARBON"
Crosscut
Blade

At
Better
Hardware
Stores
Every-
where

Pat.
Pend.

CAN BE USED WITH ONE HAND!
"ARCO-SAW" works like a high priced Portable Saw. RIGHT ANGLE GEAR DRIVE eliminates clumsy, dangerous direct drive with drill sideways.

CUTS 1-5/16" or 2x4 by turning over
FEATURES: Safety-yoke assures rigid connection and absolute safety. Visual guide and wide shoe-plate for straight, square cuts. Big handle affords firm grip for two hand operation. Precision one-piece gear box. Self-lubricating lifetime bearings.

No. 445 "ARCO-SAW" for
NEW! DEPTH & BEVEL CUTS

HAS ALL FEATURES LISTED ABOVE PLUS:

Depth gage graduated from 0 to 1¼" depth (for grooves, dados). Bevel gage graduated from 0 to 45° angle (for dovetails, bevels). Rip gage with sideways adjustment. Visual guide with adjustment to follow lines on both straight and bevel cutting.

"HYCARBON" Replacement Blades,
4" Crosscut or
4" Combination. **\$2.00**

90-DAY FACTORY GUARANTEE

ORDER TODAY at your dealer or send us check or M. O. (Postpaid). C.O.D.'s—postage extra. Ask for literature of other tools.

UNCONDITIONAL 10-DAY
MONEY BACK GUARANTEE

DEALERS—Write for
nearest jobber.

ARROW METAL PRODUCTS CO.

DEPT. PM-9, 140 WEST BROADWAY, NEW YORK 13, N. Y.



VALVE
WEAR
NOISE
SLUDGING
STICKING

\$9.95

SPENDING MONEY
ON YOUR **CHEVROLET**

ADD THOUSANDS
OF EXTRA
TROUBLE FREE **MILES**
TO THE LIFE OF
YOUR CAR



For ALL Chevrolet engines 1940-51
Purolator Micronic Filter Element
Cleans ALL oil at point of wear!
No extra fittings. Lasts life of car.
If local dealer cannot supply—order direct.

Easily Installed **WOLFER CORP.**
Complete Instructions 3723 Wilshire Blvd. Dept. P-9
Los Angeles 5, Calif.



GERSTNER Tool Chests

There is nothing quite so satisfactory for the good tools of machinists and toolmakers, as a Gerstner chest. Free catalog.

H. GERSTNER & SONS
451 Columbia St., Dayton 7, Ohio

SPECIAL OFFER!

LOCK-STITCH
SEWING AWL

\$1.
Postpaid

Famous, patented lock-stitch sewing awl complete with needles, waxed thread and direction folder. Hundred uses — sewing, repairing leather goods, canvas, belting, harness, saddles, gun cases, awnings, golf bags. Extra needles and thread available. Satisfaction guaranteed or money back. Send currency, check or money order. Yates Mfg. Co., 611-H Main St., Lake Geneva, Wisconsin

SELL GOLD & SILVER WINDOW LETTERS

300% PROFIT! Fast, easy sales to stores, offices, doctors, lawyers, etc. Individual orders for merchants interested in saving \$\$\$ doing their own window lettering. Letters easily applied on glass, wood, metal with varnish-glu (not water). Won't wash off; withstands frost. Write for samples. METALLIC SIGN CO., 430 N. Clark St., Chicago 10, Ill.



FILE your own SAWS... easy!



Do expert saw filing without experience. Keep your hand saws extra sharp, true-cutting. Easy to use. Money back guarantee. Cash with order, prepaid. (COD postage extra.) **COMPLETE \$2.95 WITH FILE**

A SPEEDCOR TOOL!

THE SPEED CORP. PM-9
512 N.E. 73 Ave., Portland, Oregon



Find HIDDEN TREASURES

GEIGER COUNTERS for Uranium Detection. (see at left). TREASURE DETECTORS for gold, silver, etc. Lightweight, ultra sensitive. None finer at ANY PRICE. Information FREE.

Detector Co.
5631 Cahuenga, No. Hollywood, Calif.

BUILDING YOUR OWN

SPEEDBOAT



Every item of marine hardware from one source. The only single supplier in America of a complete line of marine hardware, fittings and racing equipment for full-race or pleasure hydros and runabouts. Write today, enclosing 25¢, for our big 32 page fully illustrated 1951 catalogue full of speedboat information, pictures and instructions.

I.E. DEBOLD'S

MARINE SUPPLY CO.
10366-P LONG BEACH BLVD.
LYNWOOD 1, CALIFORNIA

AMAZING TOOL BARGAINS!

ALL BRAND NEW MERCHANDISE



2 DRUM SANDERS \$1.50
 With 12 Bands in Assorted Grits, 1/2" dia. x 1" long on 1/2" arbor with 12 bands
 PP. in U.S.A.
ONE DRUM, 1" DIA. x 1" LONG ON 1/4" ARBOR \$1.00
 WITH 6 EXTRA SLEEVES
 PP. in U.S.A.



2 CIRCULAR SAWS \$1.50
 ON 2 MANDRELS — ALL AT ONE LOW PRICE
 1" diameter saws on 1/4" Mandrels. For cutting wood, plastic, or soft metals. Order at once! Send Check or Money Order, U.S.A. Post Paid in U.S.A.



18 ROTARY CUTTERS \$5.85
 \$13.50 Value
 Post Paid in U.S.A.

Assorted sizes cutter on 1/4" or 3/32" shank. Will fit all hand grinders. Ideal for cutting wood, metal, or plastic. Brand new.



7 HIGH SPEED TWIST DRILLS \$1.00 POSTPAID IN U.S.A.
 15 DRILLS FOR ONLY \$2.00!
 7 Popular Sizes — up to 1/4". Brand new, ideal for home or shop use. Fits all standard chucks. ORDER TODAY!

SCHUPACK SUPPLY CO., 7331 Cottage Grove, Dept. M-22, Chicago 19, Ill. ILLUSTRATED BARGAIN CATALOG FREE



FREE BOOK SHOWS HOW — this FALL, to Do WONDERS with Soil Improvement Crops!

REVOLUTIONARY new low-cost Rote opens up countless new soil improvement possibilities for home gardeners! Patent-pending Roto-Miller attachment makes planting and mixing into soil so easy for green manure and cover crops of rye, buckwheat, clovers, vetches, millets, etc.,—now, this fall, and all year 'round! Big 68-page, illustrated FREE BOOK by Ed Robinson gives whole wonderful story! Also shows many other new ways to apply POWER to garden and yard jobs—Seedbed Preparation, Cultivating, Composting, Lawn Making and Mowing, Wood Sawing, Snow Plowing, etc.—all with quick-change, low-cost attachments! Just send 10 cents (postage, handling) for big illustrated FREE BOOK by return mail! Rototiller, Inc., Dept. 309, Troy, N. Y. (Some choice dealerships still open. Please write if interested.)



Now! SAVE AT LEAST 1/2

BY ASSEMBLING YOUR OWN FINE MOVABLE INSIDE SHUTTERS

Here's a wonderful, new SHUTTER KIT that contains everything you need to assemble your own beautiful Movable Interior Shutters for any window or door in your house. You merely send us size of opening and the proper Shop Craft Shutter Kit comes to you complete, including hardware, pre-cut and partially-assembled by our experts. You Save at Least 1/2 by doing your own assembling, fitting, finishing and installing. No special tools required. Same Shutters that are now in fine homes. Printed and illustrated instructions with each Kit. Send only \$1 for Sample Panel 6"x12", or

Send for FREE CATALOG
SHOP CRAFT SHUTTERS •••
 P. O. BOX 656-B, BEVERLY HILLS, CALIFORNIA

New ORBITAL SANDER



At last a POWERFUL Motor-Driven FINISHING SANDER

MODEL 106

AT A PRICE EVERY MAN CAN AFFORD **\$49.50** ONLY . . .



IDEAL FOR FURNITURE, BUILT-INS, INLAY WORK
 Leaves no fur — provides smooth, flat surfaces having a professional look.



LEVELS GLUED, BUTT, MITER JOINTS
 Can't be surpassed for blending spots where opposing grains or different woods meet.



CHAMFERS EDGES; FITS FRAMES
 Ideal for sash, screens, doors. Smooths plywood without chipping.

NOW — a radically new orbital sander that produces a fine piano finish — even better than hand sanding! And 10 times faster! Abrasive pad travels at high speed in 1/4" orbit. Grits move in overlapping circles in all directions — with, against, across the grain. Therefore, no tendency to dig or burn . . . can't track. Doesn't gouge. Regardless of direction of grain — or variations in wood density — Guild 106 makes the surface smooth, even, uniform. Won't ripple.

NEW FROM TOP TO BOTTOM

Powerful AC-DC motor — not a vibrator. 4,000 RPM under load. Gearless drive — assures trouble-free operation. Dust-free air intake. Patented paper clamp pulls 1/3 of standard 9" x 11" sheet smooth and tight. Weighs only 6 lbs.

AT YOUR GUILD DEALERS
 Test the new Guild 106. Prove its better finishing, yourself! For name of nearest dealer and all the facts, mail coupon below.

PORTER-CABLE MACHINE CO.
 6069 N. Salina St., Syracuse 8, N. Y.

Send me complete description and uses of Guild 106 Orbital Sander . . . also name of nearest Guild dealer.

Name.....
 Street.....
 City..... Zone..... State.....

Manufacturers of SPEEDMATIC and GUILD Electric Tools
 In Canada write: Strongridge, Ltd., St. Catharines, Ont.



When Screws Won't Stay TIGHT, Use SMOOTH-ON

Apply Smooth-On No. 1 Iron Cement to screw threads and into the screw hole. Insert and tighten up the screw. It will take hold and, when set, will **STAY TIGHT**, for Smooth-On expands slightly as it hardens, wedging the screw in place. This is only one small use for this general-purpose iron cement. With it you can stop leaks and seal cracks in cast metal parts, tighten loose knobs, casters, tool and utensil handles, make many auto repairs. Buy it in 1 3/4-oz., 7-oz., 1-lb. or larger size at your hardware store. If they haven't Smooth-On, write us.

FREE 40-page Repair Handbook

Many original uses for Smooth-On around the house, on the car, etc. Simple directions. 170 illustrations. Send for **YOUR** free copy. 50 377

SMOOTH-ON



SMOOTH-ON MFG. CO., DEPT. 37J
570 Communipaw Ave., Jersey City 4, N.J.

Please send me **FREE** Repair Handbook

Name.....
Address.....
City..... State.....

MILLER ROTARY HI-SPEED COPE-SAW DRILL-BIT

IT DRILLS IT SAWS IT REAMS

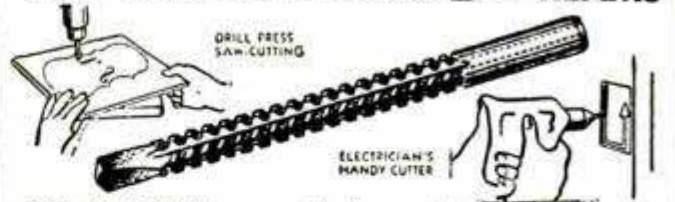

DRILL, SAW, REAM metal, pipe, wood, plastic, Transite, etc. Use with any electric drill, slow drill press, lathe or milling machine. Drills own starting hole—upper part of bit is used to cut, saw or ream circles, ovals, squares or scrolls. Easy to operate. Ideal for carpenters, mechanics, electricians, plumbers, hobbyists, many others. Abrasive resistant, high speed steel. Flutes ground from solid. Will withstand severe continuous use without breaking. Resharpener at no charge. Takes place of up to \$50 in tools. 3/4" diameter, 2" cutting sections, total length 3 1/2". Also available specially designed for wood or metal and in 2 3/4" and 1 3/4" lengths. Write for details. Specify all-purpose bit. Shipped same day. Money-back guarantee. Dealer inquiries invited. **SEND CASH CHECK OR MONEY ORDER** Manufactured and distributed by: **INTERNATIONAL TWIST DRILL CORP.** 624 Wyandotte, Rm. 633, Kansas City 6, Mo.

only **\$3.95** POST PAID

BRAND NEW 30 DAY FREE TRIAL High Power BINOCULARS



Finest Precision Optics
Featherlight
Money Back Guarantee
Easy Pay Plan
Leather Case Incl'd.
Free! Catalog & Book "How to Select Binoculars"
Dealer Inquiries Invited
Bushnell Bldg., Dept. M29, Pasadena 1, Calif.

33 MODELS \$14.95 up

BUSHNELL Binoculars

Start Your Own Welding Business with a **HOBART "Simplified" arc welder**

Go after WELDING jobs that Pay Big Money!

Write today for complete details on this **PROFIT-MAKING EQUIPMENT**. No Obligation.

Never before has the demand for welding been so great—the profits so large. That's why smart operators everywhere are setting up their own welding business... and you can do the same.

HOBBART BROTHERS CO., Box M-91, Troy, Ohio

SIMPLY CHOOSE from our complete line, the welder that best suits your needs—gas or electric drive—portable or stationary. The big pay jobs are waiting, so don't miss this opportunity. Write today.

"One of the world's largest builders of arc welders"

3-SHOT REPEATING SHOTGUNS WITH NEW C-LECT-CHOKE* and VENTILATED BARREL

Any choke desired, instantly, with a twist of the fingers—muzzle jump greatly reduced. Choke-settings are instant, positive, and visual, like a micrometer... Ask for **MOSSBERG SHOTGUNS** at your dealer's



No. 185K, 20 ga. \$29.95 (\$30.95 west of Rockies)
No. 190, 16 ga. \$31.95 (\$32.95 west of Rockies)
Prices include C-LECT-CHOKE* and Ventilated Barrel. **CAN YOU BEAT IT?**

FREE Catalog Send for it

No Sales at Factory *Pat. pend.

HUNTER'S BEST FRIEND
Best friend the hunter has is the property owner. Good hunters are careful and considerate of the property on which they hunt.

19709 St. John Street, New Haven 5, Conn.

NEW! GENERAL ELECTRIC RUNNING TIME METERS

For registering operating time of receivers, transmitters, rectifiers, or any electronic or electrical equipment operating from 115V, 60 C. AC. Includes transformer and Telechron synchronous motor, type BB; self-starting. Steel case. Registers in 1/10 hr. steps to 9999.9 hrs. and starts over. Size: face 3" sq.; 2 1/2" deep. GE Cat. #94X930, Mod. 8K18-(23). Shpg. wt., 1 lb. Original cost approx. \$25. **NOW..... \$14.95**

Terminal Strips

New! Slotted metal binding posts. Takes wire up to size 10. Terminals spaced on 1" centers. Molded plastic insulation. Mtg. holes spaced on 1" centers between posts. From 2 posts up to 12 posts per strip. Price, postpaid 5c per post. Min. order \$1.

RELAYS. New. Type B7A. Guardian Elec. Mfg. Co. 24V, 200 amp contactor, DC, 2 pole. Dbl. throw. Single coil. Silver contacts. 2 terminals. Side bracket. Shpg. wt. 1 lb. \$12 value **NOW \$1.50**

AIR FILTER ELEMENTS FOR PESCO PUMPS. New. AAF type B11-A. Part #3F568A. Cylindrical. Hollow screen roll filter. 3/4" port. Has mtg. flange with 4 holes. Shpg. wt., 1 lb. \$3.30 value. **NOW..... 75c ea. 3 for \$1.95.**

ORDER FROM THIS AD! Prices F.O.B. St. Louis, except Terminal Strips. Include postage with cash, check or M.O. **MONEY BACK GUARANTEE!**

Edw. Aguado Trdg. Co. 689 Arcade Bldg., St. Louis 1, Mo.

PURULATOR OIL FILTERS

Permanent Type

New! #G159J-40. The perfect filter to keep motor oil or hyd. fluid clean at all times. Protect your pump, engine or midget racer with this unit. Just turn handle and element is clean. Inlet and outlet ports take pipe or straight threads up to 3/8". Accommodates 16 GPM at 30 PSI. Mtg. bracket. Shpg. wt., 4 lb. \$13 value. **NOW..... \$4.95**



New Projects For your Workshop

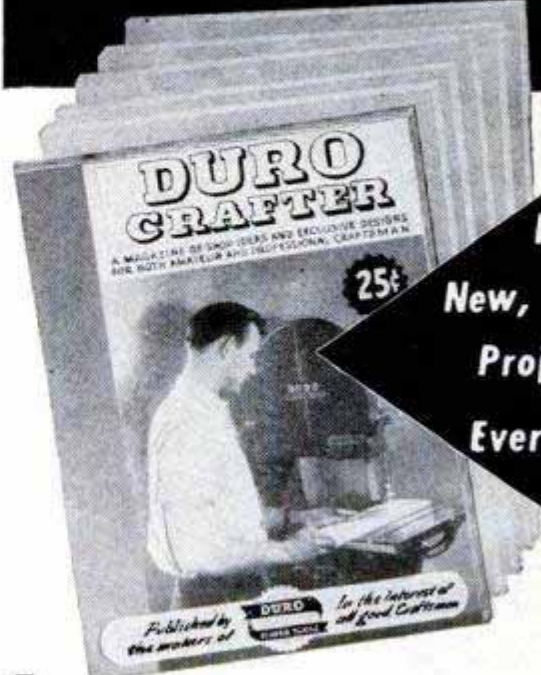

Fresh New, Modern Projects in Every Issue!

6 ISSUES OF A NEW KIND of Project Magazine

Prepared by a practical craftsman especially for the home workshop. Refreshingly new material—up to the minute—presented with photographs, plan drawings, step by step instructions, that even a beginner can follow easily. For the home craftsman who is looking for stimulating, different and modern ideas.

Only \$1.00

A Goldmine of Project Ideas

A year's issues bring you complete how-to-make instructions for furniture, household equipment, toys, novelties, wood and plastic jewelry, home accessories, games, puzzles, garden furniture, shop equipment—all new, different and "off the beaten path." for only 25c an issue—or you can save 33 1/3% and get 6 issues for only \$1.00.

Send Coupon Today

Send \$1 today for bargain value of 6 full issues. Any time you are not delighted—your subscription will be refunded.

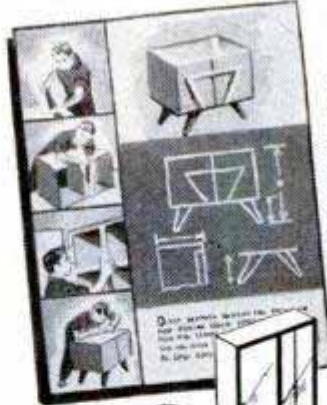

DURO METAL PRODUCTS CO.,
2677 North Kildare Avenue, Chicago 39, Illinois

- I enclose \$1 for one year's subscription to the "DURO CRAFTER" (6 issues). I understand satisfaction is guaranteed or money refunded.
- I enclose 25c for single copy of "DURO CRAFTER."

Name.....
Address.....
City..... Zone..... State.....

B & I VARI-SPEED

This variable speed transmission provides approx. 3 1/2 to 1 speed ratio. Speed ratio lever can be fixed in any operating position. Brass bearing with grease cup lubrication. Ideal for power tools where immediate variable speed is desired. speeds changed while unit is in operation.

Order today **\$8.95** post-only

B & I MFG. CO., BURLINGTON, WISCONSIN



MAKE YOUR OWN!

GRIFFIN LEATHERCRAFT KITS
Best assortment of tools, materials in U.S.A. Send 25c for 116-page catalog. (money refunded first order)
GRIFFIN CRAFT SUPPLIES
SINCE 1924

5626-A Telegraph Ave., Oakland 9, Calif



DUST-O-VAC FOR ALL MACHINES

For Home Workshops & Industry. **DUST-O-VAC** collects & bags wood & plastic chips, wood & metal dust, wood shavings. Free Bag. Attaches to circular saw, planer, band saw, grinder, belt or disc sander, shaper, drill press with shaper or sander attachment, spindle shaper, wood lathe, jig saw. 110 A.C., D.C. Send for mounting instr. for all machines. **\$19.95** F.O.B. Yonkers



HEAVY CAST ALUMINUM BLOWER — ONLY \$11.25
For workshop, lab., kitchen, cellar, app. 100 CFM. Send for circular.
UNIVERSAL YONKERS CORP., 137 Alexander St., M-9, Yonkers 2, N. Y.

Say You Saw It in Popular Mechanics

PARTS FOR MILITARY TRUCKS

FOR JEEP, DODGE, CHEV., GMC, STUDEBAKER, 4 WHEEL DRIVE AND 6 WHEEL DRIVE. ALSO PARTS CATALOG. WRITE

AXLES FOR TRAILERS

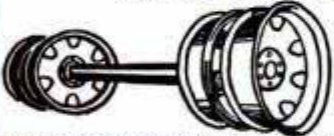

(Surplus) Heavy Duty axles suitable for building of many types of trailers, farm wagons, etc. Standard width straight axle, 2 inch square and is complete with Hubs, Timken bearings, 6 Hole

750x20 or 825x20 wheels, without brakes, only **\$69.50**

Dual Wheels.....add \$15.00 extra

All prices quoted good 30 days FOB, Kansas City
25% DEPOSIT REQUIRED ON ALL ORDERS

American AUTO PARTS CO. INC.

1830 LOCUST—DEPT. PM
KANSAS CITY, MISSOURI

The NEW Model 50 UTILITY TESTER
FOR REPAIRING ALL ELECTRICAL APPLIANCES-MOTORS
an all-around electrical trouble shooter



- Measures A.C. and D.C. Voltages, A.C. and D.C. Current, Resistances, etc.
- Will measure the current consumption while the appliance under test is in operation. The appliance or utility may be plugged directly into the front panel receptacle. A special pair of insulated clip-end leads is included for motors, etc.
- Incorporates a sensitive direct-reading resistance range which will accurately measure all resistances commonly used in electrical appliances, motors, etc. This range will enable continuity checks and tests for shorts and opens.
- Will test thermostats, radio tube filaments, bulbs, fuses, fluorescents, condensers, switches, field coils, circuit breakers, lighting systems, etc.

Handsome round cornered molded bakelite case 3 1/4" x 5 7/8" x 2 1/4". Complete with all test leads and instructions.

\$13.90

SOLD ON EASY PAYMENTS AT THE NET CASH PRICE

No interest or carrying charges added. Simply remit \$3.90 with order, pay balance, \$2.00 per month for 5 months.
SUPERIOR ELECTRONIC CO., INC.
 Dept. B-30 • 227 FULTON STREET • NEW YORK 7, N. Y.

GREATEST SAVING EVER OFFERED!
 U. S. GOV'T SURPLUS

"BARGAIN BOOK"

JUST OFF THE PRESS!

Greatest Bargain Book ever offered low, low prices, terrific savings on scarce war surplus.
 Mail 10c TODAY — NOW — begin saving on hundreds of items for farm, home, shop, sports. Get your Bargain Book by return mail.

500 BARGAINS
 • FARMS • SPORTS
 • HOME • SHOP

MAIL TODAY Only 10c

FISLER SALES CO.
 723 WALNUT ST., DESK P-9, KANSAS CITY, MO.

Make Your Own POWER LAWN MOWER
 with this DRIVE CUTTER ASSEMBLY

Constructed for those who desire to build their own mower or to replace your old cutter assembly. Complete with 18" blade and double ball bearing drive, only...
 Add 50c to cover handling & shipping. No COD's

\$12.95

ATLAS EQUIPMENT CO., Dept. PM9
 229 SW BLVD. KANSAS CITY, MO.

SAVE TIME, WORK, MONEY!

SHAW DU-ALL
 and "PEPPY PAL" TRACTORS

LOW FACTORY PRICES Buy direct or through your dealer.
FREE Illustrated folders giving complete details, price lists—write today.

SHAW MFG. CO.
 4509 Front St., Galesburg, Kans.
 668 G North 4th St., Columbus, O.

DEPENDABLE CRAFT SUPPLIES

LEATHER CRAFT • PLASTICS • POTTERY CRAFT • BLOCK PRINTING • BELT CRAFT • TEXTILE COLORS • POWER TOOLS • WOOD BURNING • INSTRUCTION BOOKS • ETC.

DWINNELL CRAFT SHOP
 Dept. PM-951—Wheeling, W. Va.

TREADLE SEWING MACHINE MOTOR KIT

Convert your treadle sewing machine to a modern electric machine. Kit includes: Sewing machine motor, rheostat, light, wiring, etc. Easy to install on any make treadle sewing machine.

\$14.95

SUPERIOR APPLIANCES
 6009 Whittier Blvd., Los Angeles 22, California

POSTPAID (or send \$1.00 deposit and balance C.O.D. plus postage.)

LAWN ORNAMENT-NOVELTY PATTERNS

28 Lawn Ornament Patterns, 25c. Other Patterns: 15-20" high; Dutch Girl, Dutch Boy, Pirate, Bull Terrier, Mexican Girl, Mexican Boy, Dwarf, Penguin, Flower Girl, 10c each. 25 Novelty Patterns, 30c. All 62 Full Size Patterns, \$1.00 Postpaid.

Strother Pattern Service, Dept. CM-8, Box 128, Belington, W. Va.

SAY YOU SAW IT IN POPULAR MECHANICS

SAW SHARPENER

Table model, gums and sharpeners rip saws, combination saws & cut-off saws. Ideal for "Skill-saw" blades. Cap. 4" to 20" diam. Complete with 1/4 h.p. motor & 1 grinding wheel & cord — \$64 f.o.b. Portland. Shipping weight, 63#. SEND FOR FREE LITERATURE.

P. T. HOBBS MACHINERY
 Dept. PM-58, Portland 17, Ore.

GET THIS "How to do it" BOOK FREE!

101 Money-Saving Ideas!

PARTIAL LIST OF CONTENTS

- "Better Painting"
- "Refinishing Antiques"
- "A Superb Furniture Polish"
- "Protecting Tools"
- "Waterproofing"
- "Finishing Gun Stocks"

Here are 101 useful ways to use America's finest 100% pure linseed oil. Perfect for painting and the handiest item for every housewife, homeowner and farmer. Available at all stores.

EARN \$2.00 EASY

We will pay \$2.00 for each new practical idea for using Pol-mer-ik Linseed Oil, which is acceptable to our research laboratory. Write Archer Daniels Midland, 603 Roanoke Bldg., Minneapolis, Minnesota.

ARCHER Pol-mer-ik 100% PURE LINSEED OIL

Guaranteed by Good Housekeeping

Life-like RUBBER SKULL
and **LUMINOUS Ghost Mask!**

"Comes to Life"

When Worn Eat, drink, smoke, smile, laugh; change your facial expressions. This mask changes realistically created, fully formed face. **DAY:** looks like real skull. **NIGHT:** lights up like live ghost. On and off in seconds.

Lights Up At Night!
Use for magic, supernatural tricks all year long. Lasts indefinitely. Scare people! Sorry, no C.O.D. **\$1.49** (2 for \$2.59) EACH
JOHNSON SMITH & CO.,
Dept. 414, Detroit 7, Mich.

Send 10c for Mammoth 600 Page Catalog of 7500 Novelties!
Jokes, tricks, hobbies, timesavers, gadgets, sport goods, radios, scientific equipment, jewelry, animals, music, cameras, accessories.

Send 10c for 600 Page Catalog of 7500 Novelties



Unbreakable Fire-Safe Amber Hammer Proof Shock Proof

Ask Your Hardware Store for FULLER'S Unbreakable Amber Handle SCREW DRIVERS

TOOL STEEL PRICED FROM 5c TO \$1.00 EACH

America's most popular line of moderately-priced screw drivers! Wide range of sizes. **FULLER TOOL COMPANY, Inc.** 911 Faile St. New York 59
World's largest makers of Amber-Handle Tools



CIRCULAR SAWS USE YOUR OWN saw table. Sharpen combination, rip and hollow ground saws from 6" to 10". Makes hand filing obsolete. Saws last twice as long... and stay round... with correct tooth bevel... for cleaner work.

ONLY \$8.95 includes \$3.00 grinding wheel & instructions. At dealers or postpaid. Guaranteed.

"Tru-Circle" Automatic Saw Set. Sets teeth at 10° or more. Only \$2.95. At dealers or postpaid.

A. D. McBurney, 317 E. 4th St., Los Angeles 14, Calif., Dept. A-9



DO MORE PLANING JOBS WITH LOW-COST BELSAW **\$215.00**

AMAZING 12 1/4-IN. PLANER Does All Ordinary Planing Mill Jobs. Provides attachments for Jointing, Rabbling, Tongue, Groove, Matching. 12 1/4 x 6-in. capacity, 3-knife solid round all-steel cutterhead. Power feeds at 24 feet per minute, 42 cuts per inch. Provides for full line of accessory attachments—Grind and Joint knives IN THE CUTTERHEAD WITHOUT REMOVING.

BELSAW MACHINERY CO
1018 Field Bldg., 315 Westport Rd., Kansas City 2, Mo.

FREE BOOK



ASTONISHING NEW LIGHTER

Lights and takes first **3 PUFFS** of your cigarette **SAFELY—while you drive!**

Lights cigarette for you. Eliminates fumbling with hot lighter or match while driving. Plugs into present lighter socket. A WONDERFUL GIFT. Specify car. **\$2.95**

Remote Control Crankcase Valve Eze Oil Drainer

lets you drain motor oil without crawling under car. Push button located under hood opens and seals valve under crankcase. Save—buy more economical bulk oil and change oil yourself without muss or fuss. Pays for itself. Specify car. \$5.95 complete. Check, M.O., or C.O.D. Satisfaction guaranteed or money back.

LESTER M-9, 1743 Milwaukee, Chicago 47, Ill.



No. 150 **SpeedWay Speed Sander**

SANDS SMOOTHS **RUBS BURNISHES**

\$34.50



Makes dull, tiresome jobs fun. With this professional, motor-driven, orbital-motion SpeedSander, you can quickly and easily re-surface and refinish furniture, woodwork, walls or metal... can sand-off old paint, stain, enamel, rust or corrosion; smooth rough plaster; or buff, burnish or rub to a "piano finish." Operates with wet or dry abrasives. Three 4 1/2" x 6 1/2" covers cut from 9"x11" sandpaper or abrasive sheet. Your local dealer will gladly demonstrate.

No. 150K SpeedWay SpeedSander Kit

Everything you need in fitted steel carrying case—18 each of 5 grades of sheet abrasive, 2 free abrasive felts, thick neoprene contour pad, steel surfacing plate, lambs wool polisher and cover template.

\$49.50



SpeedWay Speed Drills

No. 400 1/2" (in steel) **\$39.50**

No. 79 3/8" (in steel) **\$22.50**

No. 200 1/4" (in steel) **\$16.50**

Far advanced in design and construction these new SpeedDrills are lighter, handier, yet more powerful and faster-drilling than more costly old type drills. Drill steel, wood or concrete. Quality built for lifetime service, of die-cast aluminum with cast-in air cooling system and self-lubrication. Heavy cut-steel gears. Ball thrust bearings. Your SpeedWay Dealer will point out the many other superior features.



SpeedWay Kits Make Ideal Gifts

Any craftsman or "Mr. Fix-it" will be thrilled with a SpeedDrill Kit that drills, grinds, sands, buffs, polishes. No. 79 Kit provides a No. 79 3/8" capacity (in steel) SpeedDrill, a SpeedStand, wire brush, sanding discs and backer plate, cloth and lambs wool polishers, paint stirrer and 5 steel drills—31 pieces in all in fitted steel carrying case, complete **\$32.50**

No. 79 KIT

No. 200 Kit. (Not illustrated) Similar to No. 79 Kit but with No. 200 1/4" capacity (in steel) SpeedDrill and 28 accessories in fitted case, complete **22.50**

GA Kit. 20,000 r.p.m. SpeedWay No. 129 Hand Grinder with 16 mounted cutters, brushes, and wheels, complete in leatherette case. **\$14.50**

No. 128 Bench SpeedGrinders **\$16.50 to \$32.50**—Ask your dealer to show them to you.

SpeedWay MANUFACTURING CO.
1863 SO. 52nd AVE., CICERO 50, ILL.



**RELIEVES
HEADACHE
NEURALGIA
NEURITIS PAIN**

FAST



Here's Why...

Anacin® is like a doctor's prescription. That is, Anacin contains not one but a combination of medically proved active ingredients. Anacin is specially compounded to give FAST, LONG LASTING relief. Don't wait. Buy Anacin today.

BRUSH PLATING OUTFITS

for re-plating articles in the home and shop. No tanks necessary. Free particulars.

GUNMETAL CO., AVE. M, DECATUR, ILLINOIS

BUILD YOUR OWN POWER TOOLS - TILT/ARBOR SAW

Exclusive GIL-BILT Build-It-Yourself Features

- No machining—build easily with hand tools only
- No blueprint reading—step-by-step pictorial plans, full scale patterns, actual photographs
- Sturdy wood, aluminum, and steel construction
- Capacity and performance of commercial saws selling for \$80 and up

**BANDSAW
BELT SANDER
SAVE \$50.
OR MORE**

GIL-BILT 10-INCH TILTING ARBOR SAW



- 27x28 in. table, 13 1/2 in. capacity in front of blade
- 10 in. blade cuts 3 1/4 in. deep, tilts full 45 degrees
- Floor model 34" high, table always stays level

- New Departure ball bearing arbor, 3/4" precision shaft turned down for 5/8" bore blades, alum. housing, shipped ready to run
 - Jackscrew and 4 1/2 in. dia. handwheel lowers and raises blade
 - Cast aluminum miter gauge and self-aligning rip fence guide
- GIL-BILT Metal Parts Kit includes Plans, ball bearing arbor, miter gauge and bar, rip fence guide, dado insert, lock knobs, jack screw mechanism and handwheel, and all other metal parts (less blade)..... \$20.95
Same Kit with 10" Combination Blade \$24.90
Same Kit with 8" Combination Blade \$23.90

GIL-BILT 12-INCH BAND SAW



- Cuts to center of 24 inch circle
 - Handles stock up to 6 inch thick
 - 18x18 inch table tilts 45 degrees
 - Lower wheel and drive pulley runs on sealed New Departure Ball Bearings: Upper wheel runs on two 5/8" bore Oilite Bronze bearings.
 - Upper wheel tension and tilt mechanism of cast aluminum, completely assembled.
 - Upper and lower blade guides. Each has ball thrust bearing, self-lub bronze jaws
 - Rigid cast aluminum wheels fully machined ready-to-install. Heavy rubber tires.
 - Uses standard 78 inch blades up to 3/8 in. wide.
 - Fully enclosed mechanism for utmost safety.
- GIL-BILT Metal Parts Kit includes Plans, rubber tires, aluminum wheels, 1/4 in. blade, ball bearing spindle, tilt mechanism, blade guides, table tilt segments, and all other metal parts..... \$20.95

Return Kits in 10 days for refund if not satisfied. (Prices include postage within 600 miles. Over 600 add 5%)

Also available—Plans and Parts Kit for Belt Sander and 8" Tilt/Arbor Saw. Order Plans at \$1.00 each—Send postpaid anywhere in the world or write for FREE descriptive catalog.

GILLIOM POWER TOOLS P. O. Box 1-PJ, Lambert Field St. Louis 21, Missouri

MAKE A "Stradivarius" VIOLIN

—For Pleasure
—For Profit
—For Your Own Use

BOOK AND PLANS ALL YOU NEED

**You Can Do It at Little Cost!
It's Easy! It's Fun!**

Here is the "tops" of all home crafts projects. Make a violin—a replica of a famous "Strad"—the original of which sold for \$80,000.00. Joe Reid who has made hundreds of fine violins makes the job so easy—so inexpensive—in his new book "You Can Make a 'Stradivarius' Violin." You don't need any tools. Reid shows you how to make all the tools you need from old table knives, worn out files, sheet metal, etc. Eight full-size plans, 16x23 inches, folded into the book give you every detail in actual size.



Violins Bring High Prices

Make a violin—and you probably will never want to sell it. But good tone modern violins bring terrific prices, yet the materials cost comparatively little. With Reid's plans and step-by-step instructions you can make such a violin for yourself. 15 chapters guide you in selection of wood, fashioning the belly, back, sides, mold, lining, neck, scroll, purfling. Other chapters cover varnishing, finishing, stringing. Others show how to make tools and clamps at little or no cost.

**Order Book Today.
Money Back if Not Satisfied.**

Make your own violin for pleasure or profit. Get book and plans now. Clip this ad and mail with check, money order or cash for only \$3.50 or we will send C.O.D. Money back in 5 days if not satisfied.

**Complete Instructions
8 Actual Size Plans
How to Make the Tools You Need
Where to Get the Materials**

You trace or work direct from actual size plans. No measurements to translate or confuse you. You see the entire violin in the plans. You read the how-to-do-it instructions in the book.

POPULAR MECHANICS PRESS Dept. 30 200 E. Ontario St., Chicago

Handy Mail Order List

Little Library of Useful INFORMATION

**5 for \$1.00
12 for \$2.00
25¢ Each**

- Here at amazingly low cost is the practical help and information you have always wanted. Articles in previous issues of Popular Mechanics have been classified according to subject and are now available in these handy reprint booklets.
- How to Use Measuring Tools—Micrometers, Calipers, etc.—106
 - Power Driven Saws—74
 - Drill Presses, Grinders, Etc.—79
 - Wood, Metal Turning—Lathes—81
 - Filing Machine, Hacksaw, Cutoff Wheel, Shaper—82
 - Lathe Tools You Can Make—101
 - Workbenches—Tool Cabinets—47
 - Spray Painting—94
 - From Pattern to Casting—91
 - Tool and Saw Sharpening—92
 - Sharpening Drills, Wood Bits—90
 - Successful Wood Turning—32
 - How to Read Blueprint—71
 - Metal Turning Lathe Kinks—89
 - Operating a Metal Lathe—100
 - Heat Treating, Hardening—102
 - Working With Glass—103
 - Servicing Elec. Motors—75
 - Electromagnets & Solenoids—44
 - Transformer Construction—41
 - The Boy Electrician—43
 - Soldering and Brazing—17
 - Arc and Spot Welders—5
 - Electroplating With Nickel, Chromium, Cadmium, Etc.—86
 - Plating Leather, Wood, etc.—87
 - Lower Your Fuel Costs—31
 - Curing Leaky Basements—45
 - Fitting Home Game Room—55
 - Indoor & Outdoor Fireplaces—88
 - Backyard Gardening—39
 - Lawn and Garden Novelties—72
 - Trellises, Pergolas, Fences—76
 - Lawn and Garden Furniture—77
 - Playground Equipment—73
 - How to Use Your Drill Press—125
 - Making Serving Trays—53
 - Knobs and Ropework—105
 - Sanders—80
 - Wire Wiring—89
 - Hanging Wallpaper—38
 - Built-in Fixtures—78
 - Bird Houses—7
 - Magazine Racks—49
 - Clock Cases—50
 - Book Ends—52
 - Small Tables—54
 - Smoking Stands—56
 - Desks—58
 - Book Cases—59
 - Action Toys—66
 - High Flying Kites—67
 - Telescopes—20
 - Metal Craft—28
 - Small Looms—37
 - Gem Cutting—42
 - Photo Enlargers—1
 - Photo Kinks—98
 - Cleaning Formulas—11
 - Taxidermy—9
 - Photo Lighting—119
 - Training Dogs—35
 - Small Furnaces—36
 - Working With Plastics—61
 - Simple Home Improvements—104
 - Ridding Home of Insect Pests—107
 - Children's Room Furniture—51
 - Jigsawed Novelties—57
 - Doll House & Doll Furniture—60
 - 25 Shelves You Can Make—64
 - Novelties Turned on Lathe—62
 - Inlay Pictures—Veneering—63
 - Wood, Soap Carving—65
 - Windmills & Weathervanes—68
 - Lamps from Wood, Metal—69
 - Rustic Furniture—18
 - Wood Finishing—40
 - How to Fix Electrical Appliances—111
 - Painting Your House—117
 - Build Your Own Relays—123
 - Rowboats, Small Dinghy—83
 - Small Sail Boats—84
 - Two Outboard Runabouts—85
 - Build Own Canoe, Kayak—30
 - Build Class-E Ice Yacht—22
 - Auto Kinks, Shortcuts—10
 - Lawn and Garden Equipment—124
 - Motor-Driven Midget Cars—34
 - Stop Auto Elect. Troubles—95
 - Photo Printers and Dryers—25
 - Photo Darkroom Equipment—96
 - Trick and Table Top Photos—97
 - Home Movie Equipment—118
 - Poultry Houses—108
 - Guns and Decoys—109
 - Re-Silvering Mirrors—70
 - Chemical Experiments—93
 - Log Cabins, Tourist Houses—14
 - Using Basic Tools—120
 - Farm and Garden Tractors—8
 - Building Extra Attic Rooms—23
 - Attractive Basement Rooms—24

Check Titles Wanted, Clip, Mail with Remittance to
POPULAR MECHANICS PRESS, Dept. 23, 200 E. Ontario, Chicago 11

65 KW. 225 Volt D.C. DIESEL ELECTRIC GENERATING UNIT



RECONDITIONED
 Equipped with 6 cyl. DRXC Hercules DIESEL engine, 4 1/2" bore, 5 1/4" stroke, 133 H.P. at 2000 R.P.M. Complete with injector, pump, nozzles and electrical equipment. Generator attached to engine. Complete as shown.
 Ea. \$1375.00
 Lots of 2 \$1295.00
 ea.

RADIATOR for above unit. \$89.50

Write for price on DIESEL ENGINE only.

60 HP. JEEP ENGINE

Reconditioned, tested & Guaranteed in perfect order, ready to run. **192.50**

SEND 25% CASH WITH ORDER, BALANCE C.O.D.



FOR GAS, OIL, WATER. NEW **5 GAL. CANS**
 • Self locking cap.
 • Compact in size.
 • Sturdily made.
 • Floats when full.
 • 3 bar strong handle.
 18" high, 6 1/4" thick, 13" wide.
 Ea. \$2.95
 Lots 12, ea. \$275

Latest 1951 EDITION! Just Out—100 New Pages! Get World's Largest Auto Accessory & Parts Catalog and Save Money! Over 50,000 items, including Hollywood Accessories, Hi-Speed Equipment, Rebuilt Engines, all parts & accessories for all cars & trucks. We have that Hard-To-Get Part! Jam packed with Bargains. Completely illustrated. Send 25c (refundable).

J. C. WHITNEY & CO.

1917SP ARCHER AVE. CHICAGO 16, ILL.



BULL HACKSAW

for any 1/4" electric drill or drill press Easy to carry, easy to use—a "must" for every home craftsman! Full chip clearance on any wood, metal or plastic stock up to 3/4". No gears, no bearings, nothing to wear out. Weight: 11 ozs. Guaranteed and only \$4.95!

POWERFUL!
 PORTABLE!
 POCKET-SIZE!

\$4.95

Send Cash, Check or M.O. Today!
 Bertram N. Engineering and Supply Co.
 3125 Harrison St. Kansas City, Mo.

Build your own JET ENGINE!



Order these plans today
 1. JET PROPELLED BICYCLE. Assemble your own. Photo and instructions, \$1.00.
 2. HOW TO MAKE EXPERIMENTAL JET ENGINES. Seven sheets drawings with information and instructions \$2.95.
 3. BOTH OF ABOVE in one order \$3.75. SEND NO MONEY. Order both at once \$8.75 C.O.D. in USA plus c.o.d. postage. Send check or Money Order and we pay postage. Get other information too. Rush Order.

J. HOUSTON MAUPIN, Dept. 55, Tipp City, Ohio

WAR BARGAINS
 Over 200 terrific ALSO FACTORY SURPLUS VALUES!
SURPLUS
 SEND FOR FREE SIoux FALLS SURPLUS STORE SIoux FALLS, S.DAK. Catalog

SAY YOU SAW IT IN POPULAR MECHANICS

New POWER MOWER



FREE Building Instructions Write For Them

Amazing invention makes whirl-blade mower pull and steer itself as well as cut grass and weeds. Convert your mower or build a complete mower with screw-driver & pliers. Send name and address. 1c postcard will do.

PULLS ITSELF, STEERS ITSELF

Convert Your Mower Or Build A New One

T & H Mfg. Co., Dept. MPC-9, 811 E. 31 St., Kans. City, Mo.



Spindle—Platform—Wheels—Fork—Handles—Driving & Steering Parts All parts available—kit or separately.

BUILD AN EXTRA ATTIC ROOM



...this quick, low-cost way! Use handy Gold Bond Sealed Blankets made of fireproof Rock Wool to keep summer heat out, furnace heat in. Then nail big, fireproof panels of Gold Bond Gypsum Wallboard to studs or over old material. It saws like lumber, resists moisture, won't expand, contract or warp. Seal joints with Gold Bond Perforated Tape Joint System. Decorate with Gold Bond Sunflex wall paint, or with amazing Color Texture—brushes on like paint, covers wall like plaster. For full details of these quality products, write Division W, Dept. PM-91.

Available at your local Gold Bond Lumber and Building Materials Dealer!

NATIONAL GYPSUM COMPANY
 BUFFALO 2, NEW YORK

48 ROTARY CUTTERS ONLY \$3.00 POSTPAID



The above is an enlarged illustration of cutter heads. Assorted sizes (approximately 1/32" to 3/32") and shapes, these miniature cutters are ideal for the home workshop. Used for cutting metal, wood, or plastic.

- 12 Miniature cutters, assorted sizes and shapes, 3/32" shafts. \$1.00
- 2 Circular saws, HS steel, 1" and 1 1/4" x .025", and 2 1/2" mandrels. \$2.25
- 2 Circular saws, tungsten steel, 3/4" x .025", and 2 1/2" mandrels. \$1.50
- 12 Abrasive stones for mandrels, assorted shapes and sizes. \$1.25
- 12 Mounted points, assorted shapes and sizes, 1/8" shafts. \$2.75
- 24 Mounted points, assorted shapes and sizes, 1/8" shafts. \$5.25
- 20 Tungsten steel cutters, assorted shapes and sizes, 1/8" shafts. \$7.50
- 15 HS steel cutters, assorted shapes and sizes, 1/8" shafts. \$9.00
- 45 Rubber abrasive wheels and points, 3 mandrels. \$2.50
- Transparent plastic container, holds forty 1/8" shaft cutters. \$1.20
- 12 Felt polishing wheels to 1" diameter. \$1.15
- 6 Muslin buffs to 2" diameter. \$1.45
- 12 Imported Swiss files, length 5 1/2", all different. \$6.00
- 300 Accessories for handgrinders and flexible shaft equipment. Burs, cutters, brushes, mounted stones, buffs, felts, mandrels, rubber wheels, etc. \$8.95
- 20 Wire gauge twist drills from No. 61 - 80. \$3.75
- Drill case for No. 61 - 80 drills. \$1.00
- Reversible collet pin vise and hand drill, capacity 0 - .125. \$1.50
- Vernier caliper 5" capacity, measures to 1/128". \$2.00
- Imported Swiss jewelers screw drivers, set of 8. \$2.50
- Transparent hinged plastic boxes. Ideal for small tools or parts. Specify number of compartments.

Size	Number of Compartments	Price Each
8 1/4" x 4 1/4" x 1 1/4"	18 - 12 - 6 or 1	\$1.00
7" x 3 1/2" x 1 1/4"	12 - 7 or 1	.75
4 3/4" x 2 3/4" x 1"	8 - 6 - 4 or 1	.50

Orders over \$2.00 for above items shipped postpaid in U.S. If less please include postage. All the above merchandise is new, and fully guaranteed.

80 page illustrated catalog of accessories for handgrinders and flexible shafts, small tools, brass and other metals for the model maker, gold and silver for the amateur jeweler, 25c. Illustrated price list of over 30 sizes of plastic boxes free. WRITE DEPARTMENT PM51

SCHRADER INSTRUMENT CO., INDEPENDENCE, IOWA

Live Better FOR LESS MONEY



THIS NEW **Free** BOOK TELLS HOW!

Learn how you can enjoy the comfort and privacy of a home of your own... a modern, convenient and *satisfying* way of life that you CAN afford for



BUDGET LIVING **NEW JOB LOCATION**
MILITARY LIVING **GETTING MARRIED**
RETIREMENT OR VACATION

Send today for the new free book covering ALL the above needs. State which interests you most. Schult, the "old reliable" of the business, has up-to-date answers for YOU. Address Dept. 3209.



Leaders in Mobile Homes

SCHULT CORP. ELKHART INDIANA

Faster, Smoother

**CHAMFERING
ROUTING
CARVING
FILING
BURRING**



**Ford's new rotomaster set,
6 all-purpose rotary tools**

Used in drill press, lathe, portable drills or flexible shaft tools, Ford's new rotomasters will give you more speed, finer finishes in cutting metal, leather, plastic, hard rubber, wood. These high speed steel, industry engineered cutters give long, long life, and can be re-ground by Ford if ever necessary. 1/4" shanks. Specially priced now. Order today.

\$5.65

cash with order prepaid



**M. A. FORD MFG. CO., INC.
DAVENPORT, IOWA**

New POPULAR MECHANICS CRAFTSMAN LIBRARY



Start your workshop library with these four brand new volumes—the first books of the Popular Mechanics Craftsman Series. Other books to be published under this series are: Woodworking, Cabinetmaking, Metalworking and Plastics.



Planning Your Home Workshop

How to plan and set up the kind of home workshop you have always dreamed of having. The editor, Sam Brown, will show you the easy, low-cost way to set up a home workshop your friends will envy. Whether you work in cramped quarters or have plenty of room this book will show you how to make use of every inch of space. Includes floor plans, wiring layouts, power tool hook-ups and shop furniture you can build. Special buyer's directory and many interesting projects. 128 pages. 250 photographs. 100 scale drawings. **\$2.50**

Radio-TV Electronics Handbook

By F. L. Brittain, Radio-TV Editor, *Popular Mechanics*.

How to service radio and TV sets. Instructions and diagrams for building receivers, transmitters, phones, record player, etc. Glossary of parts, symbols, color codes. 160 pages. Hundreds of illustrations. **\$2.50**



100 Beautiful Pieces of Furniture You Can Build

Build lovely modern furniture for every room of your home. Complete suites for living, dining and bedroom—occasional and odd pieces. Many exclusive designs by John Bergen, famous furniture stylist. Scaled diagrams and plans. 144 pages, 48 in brilliant full color. **\$3.00**

Power Tools and How to Use Them

By W. Clyde Lammey, Asst. Crafts Editor, *Popular Mechanics*.

Get the most from your power tools. Covers selection and use of power tools; what you can do with the tools in the form of exciting projects, which tools to start with, which ones to add as you go along and how to use them. 144 pp. 375 illus. **\$2.50**



USE THIS HANDY COUPON

**POPULAR MECHANICS PRESS, Dept. 18
200 E. Ontario St., Chicago 11, Illinois**

Send the books checked below:

- | | |
|---|---|
| <input type="checkbox"/> Planning Your Home Workshop \$2.50 | <input type="checkbox"/> Power Tools and How to Use Them \$2.50 |
| <input type="checkbox"/> 100 Beautiful Pieces of Furniture You Can Build \$3.00 | <input type="checkbox"/> Radio-TV Electronics \$2.50 |
| <input type="checkbox"/> Remittance Enclosed (Send postpaid) | <input type="checkbox"/> Send C.O.D. (Postage extra) |

NAME _____

ADDRESS _____

CITY _____ ZONE _____ STATE _____

NEW 1951 KING MIDGET AUTO

World's Lowest Priced 2 Passenger Car Drive it for 75c per week. Amazing performance. Surprising comfort. All steel construction. Full accessories, top and heater. Ready to run or assemble it with our bolt together parts. Rider agents wanted, earn your car Free. Send 25c for detailed literature or \$1 (refunded first order) for actual assembly book and service manual filled with photos, drawings, specifications, etc.



MIDGET MOTORS MFG. CO.
ATHENS, OHIO

ATTENTION!
CHEVROLET
OWNERS

INSTALL

CLUTCH-EZE

\$250
Postpaid

ALL-AROUND SHIFTING PERFORMANCE

- Stops Chatter and Jerking Gear Rattle
- Faster Shifting Action by Engaging Clutch More Rapidly
- Softer Clutch Action.

For All Chevrolet Cars and Trucks (1938-50)
Average Installation Time Only 30 Minutes
Order Today... Money Back Guarantee



Pat. Pend.

(Graphite Processed)

LARRY'S AUTO PARTS 1721 E. FLORENCE AVE.
LOS ANGELES 1, CALIF.

STANDARD GARDEN AND SMALL FARM TRACTORS



RIDE-WALK

Powerful Gas Tractors for Small Farms, Gardeners, Florists, Suburbanites, Fruit and Poultrymen.
1 & 2 Cylinders
Rubber or Steel Tires.

Plow
Seed
Cultivate
Mow Haul
Belt Work

Easy Terms — Free Catalog

STANDARD ENGINE COMPANY
MINNEAPOLIS, MINN. NEW YORK, N. Y.
3221 Como Avenue 617 West 26th Street

SAY YOU SAW IT IN
POPULAR MECHANICS

A Toolshop in Your Hand

HANDEE®

tool of 1001 Uses

FINEST IN POWER TOOLS

Plus 51 Accessories

Complete . . . designed for every hobbyist and mechanic! Grind, drill, polish, carve, sand, saw, etc. Packs plenty of power in the 25,000 r.p.m. motor, with approved 7-segment commutator. Handsome fitted steel carrying case.

Complete, with liberal 10-day money back trial offer \$27.50
with 7 accessories . . . \$19.95



Write for
64-Page Catalog

HANDEE WORKSHOP

Tornado-Powered
with NEW HANDEE "85"

Versatile, with 41 accessories . . . suitable for shop or home use. For novice or expert . . . precision routing, molding cuts, HANDEE "85" a production wizard . . . automatically air-cooled, pin-point accuracy. Sensational power! Complete, packed in handsome case \$29.95

Chicago Wheel & Mfg. Co., Dept. PM
1101 West Monroe St., Chicago 7, Ill.

HERE IS THE NEW SENSATION IN LOW-COST TRANSPORTATION

Truly, Cushman EAGLE is the new sensation in its field. It operates for only 3/4¢ per mile, cruises to 50 m.p.h., gets over 75 miles per gallon. Dealer inquiries invited.



Cushman

EAGLE

WRITE FOR DETAILS
AND SPECIFICATIONS
DEPT. 17-M

CUSHMAN MOTOR WORKS Lincoln, Nebr.

New MOTOR BARGAINS for Home, Farm & Industry



New General Electric 1/2 H.P. Induction Type 3450 RPM 110 V. 60 cy. 1 ph. A. C. Motor. #GEH-5. Fob. \$23.50

New General Electric 1/2 H.P. Cap/Ind. Ball Brg. 1750 RPM, double 1/2" shaft. 110 V. 60 cy. #GE-17. Fob. \$29.75

1 Ph. A. C. Motor. #GE-17. Fob. \$29.75

New General Electric 3/4 H.P. Cap/Ind. Ball Brg. 1750 RPM, double 1/2" shaft. 110 V. 60 Cy. 1 Ph. A. C. Motor. #GE-75. Fob. \$34.50

New Dayton 1 H.P. Heavy Duty, Cap or Repulsion Induction, 3450 RPM, 110/220 V. 60 Cy., 1 Ph. A.C. Motor. #EH-1. Fob. \$52.00

Same as above, 2 H.P. 220-V. 3450 RPM #EH-20 . . . Only . . . Fob. \$75.00

Same as above 3 H.P. 220-V. 3450 RPM, #EH-30 . . . Only . . . Fob. \$97.00

Write for FAN CIRCULAR: listing Blades, Guards, Motors, All Sizes for building your own Attic Fan, Window Fan or Room Cooler.
C. MARSHALL SALES,
3546 W. Fullerton Ave., Dept. P-9, Chicago 47

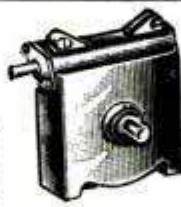

16 to 1 SPEED REDUCERS

For Display Table — Barbecue Spits — Toy Auto Gear Box — Experimental Uses, Etc. Gears Enclosed in Aluminum Housing. Bronze Gear. Hardened Worm. Input Shaft 1/4 in. Output Shaft 3/8 in.
Motor 1/20 HP. 110 V. 3000 RPM. #1M252 \$7.50 PPaid
Motor 1/40 HP. 110 V. 1500 RPM. #4K244 \$6.50 PPaid



WATER PUMP AND MOTOR

Capacity 500 Gals. per hour for emptying and filling tanks, fountains, photo work, sprinklers and irrigation, etc. Approx. 10 in. High. Intake and Outlet 1 inch. Delco, 3000 RPM Universal Motor—Rubber Impeller—110 V AC./DC. 1/8 HP. Pump & Motor Complete. #P-1 \$9.75 PPaid

LOW VOLTAGE A.C. BACKGEAR MOTORS



For Power Displays — Toys — Experimental Work, Etc. Slow Speed 1 1/2 RPM, from double 5/16 in. shafts. Low Voltage 18 to 24 volts 60 cy. A.C. Operates from toy transformer or connect in series with light bulb. Sturdy gears and bearings. Five higher speeds possible with shaft extension. Special Low Price #BG 15 Postpaid. \$5.95

SAVE OVER 50%
ON THESE BRAND NEW
WAR SURPLUS POWER UNITS



BE PREPARED
for any emergency!

LIGHT PLANT BUYERS—
in emergency telephone
5 KW Plant, 120 volts,
60 cycle AC. List today
\$1910.00. Used \$675.00
NEW. Your price only
\$895.00

BARGAIN SPECIALS!!

Ball-bearing Arbor... \$ 6.95
 Alarm Siren or Horn... 15.45
 Mercury Heat Control... 6.95
 Barn Ventilator... 69.50
 Electric Hot Water
 Heater, 10 gal... 24.95
 Hot Rod Supercharger 31.00
 NEW 2 1/2 HP Briggs & Strat-
 ton AP Lists at \$103... \$69

collect—unit shipped same day!
 2500 Watt, AC, 110 volts, 60 cycle,
 Slightly used but reconditioned and
 fully guaranteed ONLY... \$295.00
 NEW, same as above... \$345.00
 Plants built in 1951... \$426.00
 3000 Watt, 110-220 volts, with
 AUTOMATIC battery starter \$465.00
 300 Watt, Reg. \$145, Now \$ 99.00
 750 Watt... \$232.00
 1000 Watt AC... \$248.00
 3000 Watt DC Contractor's PORT-
 ABLE, Rubber tired wheels,
 5 to 7 HP gas engine. Used
 like new \$220.; New... \$279.00
 7500 Watt 4 cyl. engine;
 New... \$995.00
 10,000 Watt Used \$1195.00; New
 \$1495.00
 25,000 Watt Used \$1995.00; New
 \$2495.00
 35,000 Watt Diesel, Rebuilt \$2995.00
 50,000 Watt Diesel, New \$5900.00

Electric MOTORS AC & DC 50% off list!
 Single and three phase. 1/4 to 100 HP. GUARANTEED.

SENSATIONAL WINCH VALUES

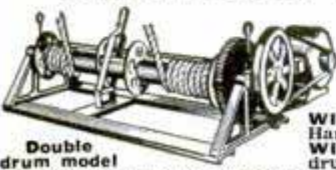

For — CONTRACTORS, BOATS,
FARMERS, TRUCKS, LOGGERS, ETC.
WINCHES, 1,000 lb. capacity,
 Hand operated... \$ 8.50
WINCHES, 6,000 lb. capacity,
 Hand operated... \$29.50
WINCHES, 1,500 lb. capacity
 Hand operated... \$39.50
WINCHES, 6,000 lb., double
 drum, Hand operated... \$49.50
WINCHES, 1,500 lb. capacity,
 Electric drive... \$ 89.50
WINCHES, 6,000 lb. capacity,
 Electric drive... \$188.00

CABLE, preformed stainless steel aircraft: 100 ft. or less, 17c per ft.
 over 100 ft., 15c per ft.

Below are just a few of the many items we have in stock at
 sensationally low prices:
 Pumps Air Tanks Fire Pumps Gear Reducer
 Grinders Drop Cords Saws Clutches
 Air Compressors Generators Winches Motors

Write today for free catalog. Thousands of \$\$ saving buys.

C & H ELECTRIC Co.
 434 W. JUNEAU AVE.
 MILWAUKEE 3, WISCONSIN

SAY YOU SAW IT IN
POPULAR MECHANICS



"YANKEE" VISES
hold work through every step
without a misstep



Any job locked in a "Yankee" Vise, is correctly positioned for every operation... hand or machine. Lifts on and off swivel base at bench. Machined accurately... top, bottom, sides and front end... V-grooved block for rounds. Four sizes, with and without swivel base... 1 1/2", 2", 2 3/4" and 4" jaw widths. At your dealer's.

Write for "Yankee" Tool Book

NORTH BROS. MFG. CO. YANKEE TOOLS NOW A PART OF
 217 W. Lehigh Ave., Phil. 33, Pa. **STANLEY**
 THE TOOL BOX OF THE WORLD



Save Over 50%
Remodel Your Kitchen Yourself

It's Easy — It's Fun — No Experience Needed

Why put up with an old inefficient kitchen that takes hours of extra work and drudgery when with some inexpensive materials and a few days or evenings of sparetime work you can transform your kitchen into a sleek, modern beauty with plenty of working space just like those you see in the big full color advertisements in home magazines? And not only will your new kitchen mean a savings in work hours, but it can add as much as a thousand dollars more value to your home.

Eight big plans, drawn to exact scale, guide you every step of the way

Eight large sized plans show you everything you need to know to make your kitchen a room of beauty and efficiency. There are layouts for all different sizes and shapes of rooms. Detailed diagrams show you how to make your own cabinets, snack bar, shelves, stools, sink cabinets, valances, built-in fixtures and many other articles of modern kitchen furniture. Order your plans today on Popular Mechanics famous money-back guarantee. Entire set of eight 17"x22" plans only \$5.00.

POPULAR MECHANICS PRESS, Dept. MK 200 E. ONTARIO ST.
 CHICAGO 11, ILL.

SEND ME

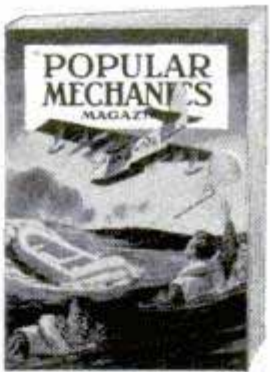

every month so I am sure to see each new issue. Here's

- \$3.50 for 1 year
- \$8.00 for 3 years

name _____
 address _____
 city _____ zone _____ state _____
 PMA-9

Hand this order to your newsdealer or send it to

POPULAR MECHANICS
 200 East Ontario St. Chicago 11, Ill.

\$69 PORTABLE ELECTRIC SAW

FOR THE PROFESSIONAL CARPENTER

Bevel Cuts, Pocket Cuts, Straight Cuts
Designed and built for the heavy construction etc. Here's the portable electric power saw with the balance for one hand operation. Lightweight aluminum alloy frame. Husky 115V. AC-DC motor. Ball bearings throughout. Hardened steel alloy worm gear. Telescopic safety guard. Built-in blower keeps cut line clear of sawdust. 1-yr. guar. Saves you \$30. Your special price \$37.50 plus \$1.00 shipping charge.



\$37.50



1/2" JACOBS KEY CHUCK DRILL

1/2" capacity in steel, 1" in wood. Sealed self-aligning, pre-lubricated ball bearings in aluminum alloy body. Lock-type trigger switch. 3 conductor rubber cord and the new improved built-in fan cooling system. Built to outperform any 1/2" drill in this price range. For production work and home workshop.

\$28.95

110-120V. AC-DC motor. Removable side handle. 1-yr. guar. Your special price \$28.95 plus \$1.00 shipping charge.

FREE CATALOG SENT ON REQUEST OR INCLUDED IN ORDER. 10-DAY MONEY BACK GUARANTEE

AKRON ARMY-NAVY STORES Dept. 9-P
4400 Sunset Blvd. Los Angeles 27, Calif.

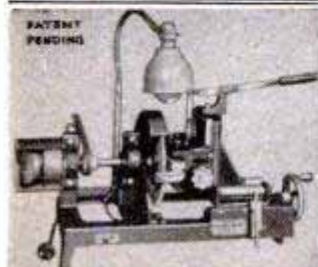

Start a NEW BUSINESS!

or Add to your present Repair Business

SHARPEN DULL PIPE WRENCHES

PIPE TAPS & DIES
"GUM" CIRCULAR SAWS

Write for Information

J. C. MOORE INDUSTRIES
BOX M 276 FREDONIA, PA.

VARIABLE SPEED

HYDRAULIC POWER TRANSMISSION



It has Infinite Speeds 0 to 550. Reverse. Automatic Overload Protection; Adjustable Torque up to 180 inch pounds. 5/8" Input and Output Shafts. It will handle 1/2" to 1 1/2 H.P. Motor. Case measures 7 1/2" long 7" high 6 1/2" wide. VALUE OVER \$300. Shipping Wt. 25#. On C.O.D. Orders we require a 10% only **\$54.50** Fob. Chicago

DIRZIUS MACHINE SHOP "F" 1423-25 So. 52nd Ave., Cicero 50, Ill.

HOME REPAIR TIP No. 9



PATCH PLASTIC RAINCOATS quickly, dependably with "SCOTCH" Brand No. 33 Electrical Tape. Ideal for shower curtains, too. Sticks at a touch. Gives professional splices on wiring jobs. UL seal. 39¢ at your hardware store.

Say You Saw It in Popular Mechanics

How to Always Have HOT WATER

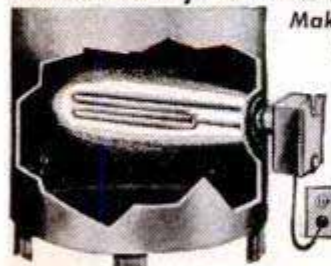

Make Your Own Automatic Electric Water Heater now for only **\$19.95**

Why suffer without hot water? Enjoy lots of it to wash, bathe, shave. Heater keeps water HOT in your present tank. Turns ON when needed—shuts OFF when water is heated. No flue, dirt, fire!

Ideal for 30-gal. tanks! Heater screws into any size boiler taps as shown. Plugs into outlet . . . 1320 w. 110 v. AC. Also 2,000 w.—220 v. (Handles Biggest tanks) \$21.95. Install in 5 min. . . works automatically thereafter. Temperature adjustable between 120 to 180 degrees. Replaces coal, oil, gas in home, store, summer cottage, green house, farm, barn, stock tank, poultry scalding, factory. Uses only 1/4 to 1/2 electricity per gallon hot water. Why burn expensive main furnace unit for summer hot water? Send check or M.O. NOW; save postage, shipping charges. ORDER NOW . . . TODAY. Money back in 10 days if not delighted.

ONE YEAR GUARANTEE
U. L. Approved Heater

COLLOID EQUIPMENT CO., INC. Dept. PM9, 50 Church Street, New York 7, N. Y.

GRINDS • CARVES • ENGRAVES
DRILLS • ROUTS • SHARPENS

DREMEL Electric MOTO-TOOL

FASTEST MOST POWERFUL TOOL OF ITS KIND . . . 27,000 R.P.M.

Most practical tool a man can own—more powerful than any similar tool you can buy. Works well in wood, plastics, and metal. For home maintenance jobs you'll wonder how you got along without it. For model making it's a must. And for general shop operations it saves time and money. Compare it, try it, buy it. You be the judge!

Check These Important Features

- Oilless sealed bearings • Dynamically balanced armature • Shockproof, Bakelite housing • Dust-filtered air cooling system • Sturdy 110-120 V., A.C.-D.C. motor • Wt. only 13 oz. • A precision tool widely used in industry for many years.



MOTO-TOOL No. 2
(with 1 emery wheel point)

\$16.50



MOTO-TOOL Kit No. 2
With 23 Accessories
(High-Speed Steel Cutters, Grinding Wheels, Polishers)

\$23.50



WHERE TO BUY DREMEL TOOLS. Dremel Tools are sold everywhere. If your dealer cannot supply you, send remittance in full and we will ship postpaid. Or send only \$2. and pay postman balance plus postage and fee. Money back if not delighted after 5 days' trial.

DREMEL MFG. CO., Dept. 111-J, RACINE, WIS.

ALNICO MAGNETS LIFT 175-lb.

AMAZING PERMANENT MAGNETS — WILL NOT WEAKEN! NON-ELECTRIC. Retrieve guns, tackle, tools and other steel items from lake, river, plating tanks, drains or other hard-to-reach spots. Recover drills, taps, etc. from floor sweepings. Clear alley of harmful tacks, nails. Many other uses listed. Pays for itself quickly. **GUARANTEED:** Try any magnet one week. Money refunded if you are not well-pleased. Cat. No. 675 (Has pull of 175 lbs. on a flat steel block) . . . \$10.50 Cat. No. 650 (150 lb. pull) \$8.50 Cat. No. 530 (30 lb. pull) \$3.00 Cat. No. 550 (50 lb. pull) \$4.00 Cat. No. 17 (14 lb. pull) \$1.50 Send M.O. or check. We pay postage. Cat. No. 30—Hobbyist assortment of six medium magnets . . . \$1.50

MIAMI MAGNET CO., 3240 N.W. 27th Ave., Aviation Bldg. No. 43, Miami, Florida

earn BIG PROFITS

Sharpening Hand Saws

Cut new teeth in a jiffy with FOLEY POWER RETOOTHER

You can earn a good spare-time income in the saw repair business. The Foley Saw Retoother cuts brand new teeth right over old ones without removing saw handle, and saves you HALF your filing time. Takes all hand saws 4 to 16 points per inch. Relieves eye-strain. No experience needed.

FREE—Foley Price Guide of 1951 saw sharpening charges. A valuable chart of actual prices. Send coupon today. No salesman will call.

FOLEY MFG. CO., 970-1 FOLEY BLDG., Send FREE Price Guide and Foley Retoother circular.

Name _____
Address _____



WEAR?
I'LL SAY...BUT MAN!
SO SOFT!

WOLVERINE Pigskins

Dry Soft... Stay Soft

Here's a new high in work glove comfort. Enjoy it! You'll find that it doesn't cost a cent because Wolverine's famous secret process tans tough native pigskin soft as buckskin yet retains all its enormous resistance to wear. No other work gloves on earth made like 'em.

Try a pair and see!



Free WOLVERITE PENCIL

A genuine *Wolverite Mechanical Pencil* sent FREE if you write for name of nearest Wolverine dealer. No obligation. Offer limited to Continental U. S. only.

WOLVERINE

Dept. HG-9

Rockford, Michigan



**ADDRESS
IT QUICK**

\$10.95

Complete with
Supplies

• Address anything mailable—tags, labels, envelopes of any size—with a swift, one-hand motion. Does one hour's work in 12 minutes at amazing low cost of 6c per 1,000 names! No messy inks, plates, ribbons! Money back if not satisfied. By HEYER, creators of fine duplicating equipment since 1903.

See your Office Supply Dealer or use coupon.

THE HEYER CORPORATION,
1856 S. Kostner Ave., Chicago 23

- Send literature and name of nearest dealer.
 Ship 1 Model 100 ADDRESSER postpaid at \$10.95.
 Check or Money Order enclosed. Send C. O. D.

Name _____

Address _____

City _____ State _____

PRICES HIGHER IN CANADA - CONTACT BROWN BROS., LTD., TORONTO

BE YOUR OWN BOSS

Make Hundreds of \$ Spare or Full Time Work

You can make
simply and
cheaply



GARDEN URNS



NOVELTIES



TILE



STATUARY

NO EXPERIENCE NEEDED

Here is the ideal business with no previous experience or large investment required and no high-priced equipment to buy. A business that will return dollars for the pennies you invest.

YOU CAN CAST ANYTHING

With *Flexible Mold Making and Ornamental Casting*, an amazing fact-packed book, you learn how you can cast practically any article in concrete, plaster, imitation marble or any other casting material using a marvelous new process. You can make ash trays, novelties, garden and lawn ornaments and hundreds of other highly profitable items that cost you but a few cents and sell for as much as \$5.00 and more. Why you can even make true-to-life full-sized busts of your neighbors and friends.

NO EXPENSIVE MOLDS TO BUY

Why buy high-priced molds from others? Learn how you can make your own molds quickly, easily and inexpensively with materials that can be used over and over. You get copyrighted formulas, complete instructions and detailed how-to-do-it photographs as well as complete sources of supply for the few inexpensive materials you need. This is the only book printed in America today that contains instructions for making profitable papier-mache casts.

MONEY BACK GUARANTEE

Start on your road to extra income and independence today. Send only \$3.00 for your copy of *Flexible Mold Making and Ornamental Casting*. Complete satisfaction guaranteed or your money refunded within seven days.

POPULAR MECHANICS PRESS, Dept. 46

200 E. ONTARIO ST., CHICAGO 11, ILL.

Now Available FROM YOUR NEWS DEALER

NEW 1952 EDITION

Each year *Popular Mechanics* publishes four famous books—*Home Kinks*, *Useful Ideas*, *Shop Notes* and *What to Make*. This year, one of these volumes is being published every three months to bring you wonderful practical information throughout the year. Now—*Useful Ideas* is ready. It's chock-full of time and money saving ideas for you. Get your copy at your newsstand today for only 35c. or order direct. Be on the look-out for *Shop Notes* in August and *What to Make* in October.

POPULAR MECHANICS PRESS

200 E. Ontario St., Chicago 11, Ill.



TRAILER COACHES

Here's everything you want to know about trailers, with plenty of pictures and plans and instructions for building three different types. Covers also, history of trailers, trailer parks, camps and overnight-stops information, furniture, furnishings, materials and engineering data. If you want to build a trailer, live in a trailer, or just want to know more about trailers, get this book. Only \$1.50 postpaid. Rush order to:

POPULAR MECHANICS PRESS • Dept. 350, 200 E. Ontario St., Chicago

Build it Yourself!

Complete Trailer Book
and Construction Data
for 10, 16 and 22 Foot
Trailers — Only \$1.50

Partial Contents

Trailer Parks—Living in a Trailer—Towing a Trailer—Floor Plans—Service—Classifications—Balance—Dollies—Jacks—Weight Distribution—Construction—Working Drawings for a Two-Place, Standard Travel and Standard Dwelling Trailers. Size 8 1/2 x 11 1/4 inches.



Wellworth AIR COMPRESSOR

For Farm and Home Workshop
Compressor has 2" bore, 1 3/4" stroke, 2.8 cfm up to 150 lb. pressure. Motor required: 1/4 h.p. at 100 lbs.; 1/2 h.p. at 125 lbs.; 3/4 h.p. at 150 lbs. or equivalent gas engine. V-belt drive, intake muffler and cleaner, bronze bearings, splash lubrication. Wt. 16 lbs. Replacement parts always available. **\$20.50**

COMPLETE OUTFIT. Compressor, pressure tank, air gauge, air chuck, 20 ft. hose, pop valve, copper tubing with 4 brass flared fittings for connecting compressor to tank, 4-way cross and 3 nipples. **COMPLETE OUTFIT, wt. 30 lbs. \$32.45**
Equipment less compressor **\$12.45**
Tank only, **\$6.25**



\$32.45
All Brand New Equipment

AIR REGULATOR and EXTRACTOR

1/4" Air Regulator, Gauge and filter. Wt. 5 lbs.

BRAND NEW \$8.95

Regulator and Gauge only **\$5.95**
Air Filter only **\$3.25**



Red Seal Continental Gas Engine

BRAND NEW. 1 1/2 HP with 6 to 1 reduction gear. Operates at 450 R.P.M. For lawn mowers, scooters, garden tractors, pumps, compressors, generators, etc. List Price \$79.50. Shipping weight 54 lbs.

SPECIAL PRICE.. \$47.50
(BRAND NEW)



LIGHT PLANTS

Brand New! War Surplus

Signal Corps Power Unit PE 197

115 volt 60 cycle A.C. single phase 5 K. W. Hobart, water cooled, 14 h.p. 4 cylinder Hercules engine. Remote Control, complete panel board with instruments, 150 ft. automatic remote control cable with reel; 150 feet #8 heavy duty wire with reel; housed in metal case with replacement parts and tools. Cable with reels along worth \$400. Regular price of unit \$1900. Shipping wt. 1250 lbs. Our price, complete. **\$895.00**



Wisconsin GAS ENGINES

at a big saving!

BRAND NEW

Model A.D., 4 H.P. 2 1/2" bore, 2 3/4" stroke, 13.5 cu. in. Wt. 60 lbs. List Price, \$90.00. **\$76.00**
Special Price...
Model A.K., 3.5 to 4.7 H.P. 2 1/2" bore, 2 3/4" stroke, 17.8 cu. in. Wt. 70 lbs. List Price \$160.50. **\$86.50**
Special Price.....

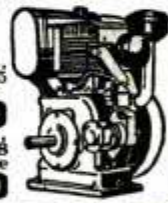

WELLWORTH V-BELT CLUTCH



Takes starting load off engines or motors. When speed is reached, a flip of handle shifts clutch from idling to driving position. Handles "A" belts, 2.35" pitch diameter, 3/4" bore. Ideal for use with lawn mowers, garden tractors, home workshop motors, etc. 3 1/4" long. Safe, easy to mount, sealed bronze bearings, positive action. Shpg. wt. 3 lbs. **\$7.50**
BUSHING FOR 1/2" SHAFT, 15c

BRAND NEW SAME CLUTCH FURNISHED WITH 3/4" BORE \$8.50

"WELLWORTH" BLOWER BARGAIN



BRAND NEW
Quiet operating. Double wheel inlet, double width blower. For heating, ventilating, cooling, all washing, exhausting and forced draft. DIMENSIONS: 10" wheel; outlet 13 1/8" x 11 3/8"; inlet 8 3/4". Height 19". Width 18". Depth 16 1/2". CFM, 1/4"; S. P. 1600; outlet vel. 1575. Wt. 45 lbs. **\$27.50**
BLOWER LESS MOTOR \$27.50
AND DRIVE.....
With belt and variable speed pulleys, \$2.50 extra. (Motor required, 1/4 h.p.)
Furnished with 1/4 h.p. motor **\$47.50**

PRICES F.O.B. CHICAGO. MONEY BACK GUARANTEE. SEND CHECK OR MONEY ORDER TODAY. PROMPT SHIPMENT. WRITE FOR CATALOG. SEND 10c FOR POSTAGE

WELLWORTH TRADING CO.
1831 S. STATE ST., Dept. D-9, CHICAGO 16, ILL.

2000-2500 WATT LIGHT PLANT

Heavy duty windings

110 v., 60 cy., A.C., takes starting overload up to 5000 watts. Floating Base for Automatic Belt Adjusting, 2-Groove Engine Pulleys, V-Belts, Bolts, etc. 5 H.P. Wisconsin or Briggs & Stratton Model 14 Engine. Voltmeter, 2 plug-in receptacles. Portable Tubular Steel Skid Type Carrier. Dim.: L 34 3/8" x W 17" x H 20". Wt. 180 lbs.

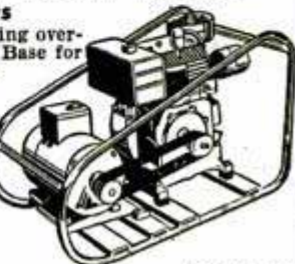

\$299.50
Same unit less mounting base **\$275.00**
Generator only, with voltmeter, 2 plug-in receptacles, Shipp. Wt. 75 lbs. **\$169.50**

GENERATORS

... Big Values

500 to 750 watt, A.C., 110-120 volt, 60 cycle, 1 phase output. Also 100 watt D. C. battery charging output. May be used at the same time. Voltmeter, 2 outlet boxes. Wt. 55 lbs. Price **\$99.50**
Furnished with 1 1/2 HP Engine with drive **\$142.50**



Say You Saw It in Popular Mechanics

WELD IT YOURSELF! IN A JIFFY!

Weld, Cut, Braze, Solder IRON, STEEL, BRONZE, BRASS, ALUMINUM & OTHER METALS

Tool and Equipment breakdowns are always annoying and costly. Don't let them bother you. Get a Dynamic Arc Welder. You can do expert work on your very first job. Welders operate from any properly wired 110 V. AC line. The handiest "tool" in your workshop. A Dynamic Welder will save its low cost over and over again in time and money.

DYNAMIC INDUSTRIAL type transformer Arc Welder 75 amp. output for Industrial or Workshop use.

DYNAMIC WELDER CO.
Dept. D2-JB, 13 E. 23rd St. Chicago 16, Ill.

Everything YOU NEED

One low price gives you a complete welding outfit ready to use. Save Money! Buy direct! Sold on 10 day money back guarantee. Send today for FREE details.



Free Details and "How to Weld"

for home - farm - shop
you'll find **101 USES**
for this basic shop tool

Only Desmond gives you all these valuable features, at no extra cost:

- Steel slide greater strength
- One-piece handle non-pinching type
- Swivel base full 360°
- Cut-off tool for wire, leather, etc.
- Anvil with horn
- Removable steel jaw inserts
- Semi-steel body
- Accurately made

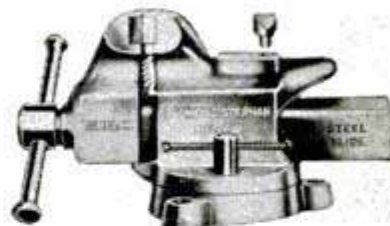

Make all your shop work easier, faster, with a Desmond-Simplex Utility Vise; it gives you the most practical features and versatility, yet costs no more than ordinary vises. See it at your local hardware store. Ask for free new valuable folder showing many ways to use your Desmond-Simplex Utility Vise.

THE DESMOND-STEPHAN MFG. CO.
URBANA, OHIO

DESMOND-SIMPLEX VISES

BUILD YOUR OWN RADIO CONTROLLED DOOR OPENER

... and 23 other electronic labor-savers

● This book gives complete instructions for building an electronic door lock, a charger for small dry batteries, a radio-controlled relay, pocket stroboscope, remote control for model trains, doorbell "booster", a photoelectric relay, photographic interval timer, simple crystal radio and a dozen other valuable gadgets.

All you need is some inexpensive Sylvania Crystal Diodes and a few everyday materials. Book gives easy-to-follow, illustrated how-to-do-it instructions.

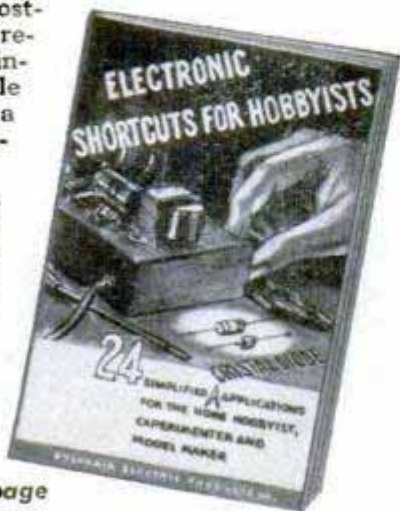

Get Sylvania's 40 page book, "Electronic Shortcuts For Hobbyists" today.

Send coin or stamps to: Sylvania Electric Products Inc., Department E-1209, Emporium, Pa.

Only 25¢

WANTED!

MEN AND WOMEN TO EARN SPARE TIME MONEY

Many Popular Mechanics neighborhood representatives are making extra cash for easy, after-hours work. A few more are needed.

For details, write:

POPULAR MECHANICS
ROOM 408
200 E. ONTARIO STREET
CHICAGO 11, ILLINOIS

HELPFUL BOOKS

Send post card asking for FREE catalog
Popular Mechanics Press, 200 E. Ontario, Dept. 601, Chicago 11

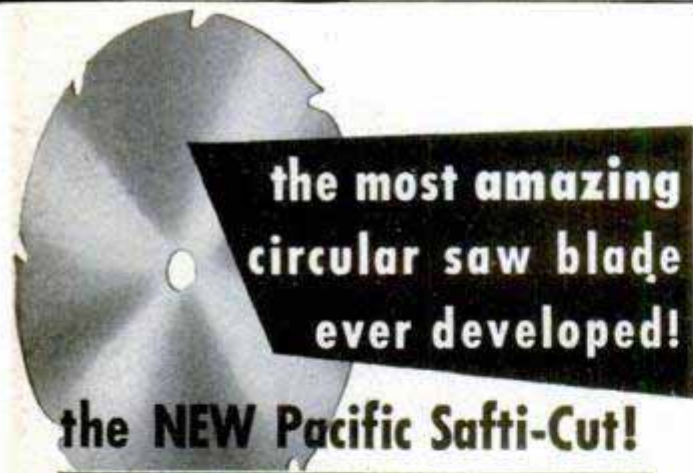

the most amazing
circular saw blade
ever developed!

the NEW Pacific Safti-Cut!

11 improved features... gives truer, smoother cuts ready for edge-gluing without additional finishing.

Using a wedge-like cutting action similar to that of a plane or jointer, the new Pacific Safti-Cut gives cuts so smooth they're ready for gluing without additional finishing! "Kick back" and serious injuries are almost eliminated because the cutting teeth (only 8 or 12) project on 20/1000" above the non-cutting edge. This makes it practically impossible for the blade to pick up the wood and hurl it back at the operator.

OTHER IMPORTANT ADVANTAGES... fewer teeth make resharping easy... reduces noise and blade stalling... operates on 30% less power... teeth stay sharper longer because they're made from nickel chrome steel.

Order your Safti-Cut NOW!

Dia.	8 tooth	12 tooth
6"	\$3.60	
7"	4.25	\$4.25
8"	4.89	4.89
10"	6.09	6.09

Specify arbor hole dia.

Send check or money order to: WESTERN SAW MFR., INC., 1840 B West Washington Blvd., Los Angeles 7
Agents and dealers wanted

Bet You Don't Know
This About Advertising
by Susan



Quiz No. 2

How much does it cost per dozen to advertise the well-known brands of oranges? Is it 2¢? 3¢? 5¢ a dozen?

Answer: It costs less than 1/2¢ a dozen to advertise the big-name brands of oranges.

That's only half the story. Advertising lowers your cost two ways:

Cuts the selling costs. And by helping make mass production possible, lowers the production costs, too.

So advertising saves you many times that 1/2¢ per dozen.

HYDRAULIC CYLINDER SPECIAL
 Gives 20,000 lb. thrust (push pull) using 1500 PSI line pressure as obtained from our hyd. pumps. Or will produce 40,000 lb. thrust with 3,000 lb. line pressure. CAN ALSO BE OPERATED ON LOW PRESSURE AIR SYSTEMS. 4" Bore, 1 1/2" dia. piston shaft, 18" stroke, length 30 1/2". Equipped with ball bearing loaded clevis type mounting and swivel type high pressure steel pipe bracket for easy use. Ideal for road, farm & shop machinery, presses, etc. Cost Gov't \$394.00 **29.95**

We carry the World's Largest Supply of Special Hydraulic Equipment featuring over 20,000 Cylinders in 61 Sizes and Types. Can also supply all accessories such as Pumps, Valves, Tanks, Hose and Fittings. Write for information.

No. 3 HYDRAULIC CYLINDER
 Double action. Bore is 1". Shaft 1/2". Has a stroke of 2 1/2" to 4". Stroke can be adjusted with internal sleeve stops. Overall length is 8 1/2". Will take 1500 lbs. continuous duty. 3000 lbs. intermittent. Will lift or push to 1100 lbs. **5.75**

No. 9-E HYDRAULIC CYLINDER
 Double action cylinder. Has a bore of 1-3/8" and shaft of 1". Stroke is 9". Overall length 15 1/2". Built for 1500 lbs. continuous duty. 3000 lbs. intermittent. Will lift or push up to 2300 lbs. . . . Can be adapted to hundreds of uses. **9.75**

FOUR WAY VALVE
 Poppet type. Valve shuts off at neutral position. Has 3/8" A.C. Tube Ports - 9/16 - 20 thread. Will stand 1500 PSI. **6.75**

V-17 - Poppet type, pressure balanced
 Has piston with built-in relief valve to limit cylinder strokes. Inlet and outlet parts have 1/2" std. pipe ports. 1/2" A.C. tube to cyl. (1/4" x 18 thread) **9.75**

STRATO POWER PUMP
 With built-in variable flow control valve in head. Positive displacement piston type. displaces .450 cu. in. per revolution. 2 gal. per min. cap. at 1500 RPM at 1250 PSI. Pressure limit, 1250 PSI continuous, 1400 PSI for 15 sec. Operates at 3750 RPM, intermittent maximum 4500 RPM. Rotates either direction without adjustment. **19.50**

GEROTER TYPE PUMP
 Logan Geroter type. For operating hydraulic systems on trucks, tractors, etc. Delivers 8 GPM at 1200 RPM at 1000 PSI with 5 H.P. Can also be used as Hydraulic fluid motor. 3/8" std. pipe ports, 1/2" splined shaft for pulley or direct attachment. 5 1/2" dia., 7" long. Used but condition guaranteed. **19.50**

GEAR BOX - VTG-1 - 90° - bevel gear 1 1/2 to 1 reduction. A lifetime value. . . . Size: 7" x 6" . . . **3.95**
 Has lever control for engaging & disengaging positive clutch. Dust proof housing, pre-lubricated bearings. . . . Can be adapted to Vickers Transmission.

SAVE UP TO 85% IN WAR SURPLUS 1951 CATALOG
 1000's of MONEY SAVING Bargains for the Mechanic, Housewife, Manufacturer, Hobbyist, etc. Clothing, Tools, Machinery, Metals, Electrical Supplies, Motors, Rubber, Plastics, Hydraulic supplies (cylinders, pumps, motors, valves, fittings, hose, etc). Send ONLY 25¢ for your copy Today.

PALLEY SUPPLY CO
 6321 SAN FERNANDO RD.
 Dept. PM-9 GLENDALE 1, CALIF.

SAVE UP TO 85% IN WAR SURPLUS AT GADGETEERS HEAVEN

NOW! MAKE YOUR OWN ARC WELDER!
 HERE'S A REAL BUY! Finest, Precision built, R-1 Generators, originally used on B-29 Airplanes. These generators cost the Government approximately \$400.00 each. Gives from 300 to 400 amps at 27 volts. Ideal for all welding, light & heavy up to 5/8" thickness. Free instructions for converting to welding unit. **27.95**

Other AIRCRAFT GENERATORS
 P-1 27 Volts 200 Amps **15.95** E-5A 12 to 15 Volts 50 Amps **12.95**
 1273-1A 27 Volts 75 Amps **15.95** O3 27 Volts 100 Amps **25.00**

VICKERS HYDRAULIC Transmission
 Self contained, 2 H.P., constant torque at all speeds with variable volume reversible, piston pump (controlled by outside lever) supplying piston hydraulic motor. Automatic pressure, dash pot for smooth control. Power output RPM -0 to 1/3 input RPM in both directions. Input RPM 1800 continuous, 4000 intermittent. Dash pot can be removed for greater RPM. Ideal for lathes, duplicator or set-up on mills, conveyors, small cars, drives, gearings, etc. **32.50**
 4" SPLINE SHAFTS for input & power take-off. **2.50 PR**

ELECTRIC MOTORS
LEAR ELECTRIC MOTOR. 24 volt, 6 amps, series wound reversible motor with overload clutch. Motor turns 11,000 R.P.M. Has 11 to 1 gear reduction box turning 1000 R.P.M. at take-off. Adaptable to flex or rigid drive. Limit switch box. Size 10" x 4". **57.95**

SAMELL MOTOR
 27 volts, 16 amps 1/5 H.P. reversible, series wound on motor. 3800 R.P.M., shaft 9/32" diameter, 12-spline. 4-1/8" x 2-3/8". **3.95**

SURPLUS MOTORS
 No. 500 - New 1/2 H.P. - 27 Volt, D.C.-A.C. This motor can be readily adapted to deliver up to 1 1/2 H.P. on 110 Volts, A.C. by the simple method of rearranging armature brush-leads. Free diagram with each order. A sensational value. **5.95**
 No. 500-A - Converted to 110 Volts-A.C. Equipped with plug and 3 1/2 ft. Heavy duty cord. **8.49**

D.C. METERS
AMMETERS
 -30-0-30+ **0-30** **4.95**
 -60-0-60+ **0-60**
 -120-0-120+ **0-120**
 0-120-0-240 **0-300**
 Any above ammeters. **3.95** Only **4.95**

ABOVE AMMETERS HAVE 2" FACE EXCEPT 0-300 WHICH HAS 3" FACE
 IT IS NECESSARY TO USE SHUNTS WITH ALL D.C. AMMETERS
 30-A 60-A 120-A **1.25**
 150-A 240-A 300-A

PIANO HINGE
 Overall - - Width - - Length - - Price ea.
 1 1/2" - (5/8" side) - 72" alum. - \$1.00
 2" - (1" side) - 9" alum. - \$1.75
 3 1/2" - (1 1/4" side) - 54" st. steel - \$1.69
BRASS HINGE - 1 1/2" (5/8" side) .040 thick) Any length at . . . per ft. .29

ATTENTION GADGETEERS
Electric GYRO
 Turns up to 50,000 R.P.M. Electric drive motor is integral part of balance wheel. Has double end shafts to drive precision tools or machinery at precise, controlled speeds. Full ball bearing mounted. Operates high or low voltage. A highly precise instrument, ideal for experimental work, science labs, hobbyists, & technical engineers. A tremendous buy **4.95**

Electric ACTUATOR
 Hundreds of uses for any mechanical device needing controlled 2-way action. Opens, closes, raises or lowers doors, windows, gates, valves.

CTU-2 Foote linear actuator. 24 Volt, A.C. or D.C., 8500 R.P.M., 1/6 H.P. - Series wound motor. 4 1/2" stroke in 13 1/2 seconds. Compression and tension loads up to 750 lbs. Adjustable micro-switch for limits of travel. Overall length retracted 11" . . . **6.95**

GEAR HEAD MOTORS
 Heavy Duty G.E. Gear Head Motor. 1 1/2 H.P., 24 volt DC, 125 amp reversible motor will drive reduction gear box unit 44.5 to 1, resulting in 168 R.P.M. at 5/8" diameter take-off shaft. Motor contains electro magnetic break.

UNIT COMPLETE 10.95 MOTOR 4.95 GEAR BOX ALONE 7.95

HI-SPEED TAPS
 DEFENSE PLANT SURPLUS Slightly used but perfect.
 1/4-20 26¢ 7/16-14 39¢
 5/16-18 29¢ 1/2-13 47¢
 3/18-16 33¢ 5/8-18 66¢
PIPE TAPS
 1/8- 48¢ 1/2- \$1.32
 3/8- 69¢ 3/4- \$1.83

FIRE EXTINGUISHER
 Kiddie Lux - CO² Type. Built to Gov't specifications. Heavy, shatter-proof case. Recent hydro-static test. Reconditioned and fully charged. **READY FOR INSTANT USE !!**
 2 lb. size with Swing Nozzle . . . 13.75
 3 1/2 lb. size with Swing Nozzle . . . 17.95
 7 1/2 lb. size with Horn 23.75
 10 lb. size with 3 1/2 ft. flexible hose and Horn. . . 29.75
 15 lb. size with Wheel Control . . . 34.95

TWO HEAT SOLDERING IRON
 This is really TWO IRONS in ONE!! A control button in handle selects 150 or 300 watt heat. Full size iron for light & heavy work. Removable, solid copper tip. Complete with cord & tip. **4.95**

PALLEY FAMOUS MIXES!! Prepared especially for the HOME CRAFTSMAN, HOBBYIST, INVENTOR, GADGETEER or SHOP MECHANIC.

GADGET MIX - Rivets, Spacers, Bolts, Screws, Gears, Wheel bearings, Springs and Clamps. No. 106, 5 lbs. **1.19**

BEARING MIX. No. 170A. Approx. 20 needle, Ball & Roller Bearings, New & Used. Sizes: 1/2" to 4". Some of these cost Gov't \$10a piece. Never such a value! 5 lbs. ONLY **1.59**

HINGE MIX, No. 170H. 12 pairs of Strap and butt hinges, Hops, 1" x 1" to 7/8" x 10" in length and 8" strap. 2 lbs. **1.09**

ABRASIVE AND GRINDING WHEEL MIX - 50 pieces including honing stone, pencil rolls, wheels, etc. A sharp value. No. 170AG **99¢**

SPRING MIX, No. 206 - Torsion, Compression & Tension Springs. Ass'd. sizes. A measure true for emergencies. Scores of springs - 5 lbs. for ONLY. **1.69**

RIVET MIX - 3 POUNDS - Consisting of sizes from 1/4" to 3" long in many diameters & alloys. **1.19**

FILE MIX - Ten assorted Files - 4" to 12". Includes Vixens, half rounds, mills, bastards, etc. - in seconds and used but good condition. 1 Vixen alone is worth our price for entire mix. . . **99¢**

PULLEY MIX - You'll want this one around. 10 micarta & metal pulleys ranging from 1" to 5" with ball and one piece bearings. These are aircraft pulleys, the best made - with hundreds of uses. A WONDERFUL BUY! **2.95**

SCREW MIX - 5 lbs., including assortment of wood and machine screws. Many sizes. Save dollars and always have plenty of screws on hand. **1.39**

NUT MIX NM-1-3 lbs. approx. 500 nut. Anchor, Lock, Castle, Hex, Elastic Stop Nuts, etc. You'll always have plenty of Nuts in the shop. NM-1 **1.39**

SUPER COMBO MIX - No. SC2. Here's a real bargain. All ten 3 above mixes for ONLY. . . . **12.95**

AIRCRAFT CABLE
 Rust resistant, alloyed steel. Extra flexible. Pre-formed, 7 x 19 strand. On reels.
 1/16" - 4 1/2 ft. | 3/16" - 9 1/2 ft.
 5/64" - 5 ft. | 7/32" - 10 1/2 ft.
 3/32" - 5 1/2 ft. | 1/4" - 17 1/2 ft.
 1/8" - 7 ft. | 9/32" - 15 ft.
 5/32" - 7 1/2 ft. | 5/16" - 16 1/2 ft.
 1/2" - 20 ft. | 3/8" - 18 ft.
 * Special 1 3/16" cable, 18 ft. long with tumbuckle ends. **99¢**
 Stainless Steel Cable - Pre-formed
 1/16" - 6 ft. | 5/32" - 20 ft.
 3/32" - 14 ft. | 1/4" - 26 ft.
 Bronze Cable - Not Pre-formed
 1/16" - 5 ft. | 3/16" - 23 ft.
 1/4" - 17 ft. | 1/2" - 38 ft.

Electronic Transmiss. Gear Train
 GT-1 - approx. 50 Bronze Spur & Pinion Gears, 3/8" to 4" dia., 5 sets of 7 cluster gears, 2 complete worm and worm gear drive sets, 40 N.D. ball bearings 1/2" to 1 1/2" dia., watch springs, bushings, posts, face plates, housings, micro switches 2 miniature controlled clutches, etc. . . . Gears in multiple size and sequence identical teeth ratio, giving 100's of gear reduction combinations. **8.49**
 Wt. 19 lbs.

LARGEST FIRM OF ITS TYPE IN THE WORLD



CENTERS AND DRILL PADS

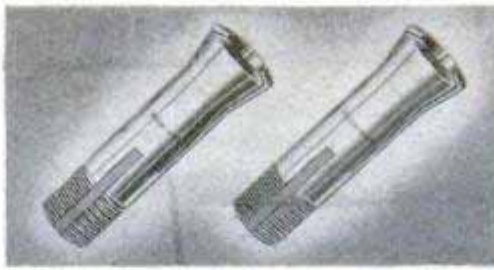

STEEL AND BRASS COLLETS

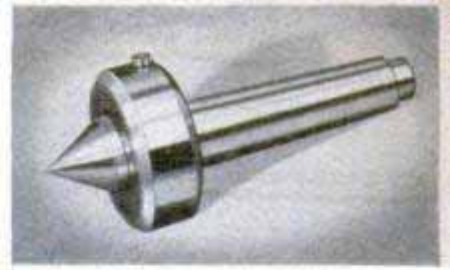

BALL BEARING LIVE CENTER

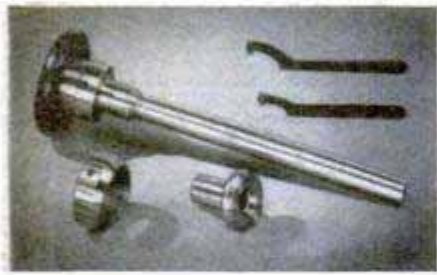

HANDWHEEL COLLET ATTACHMENT

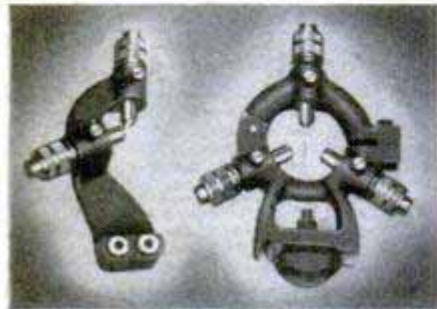

FOLLOWER AND STEADY RESTS

Get More Use Out
of Your Lathe
WITH THESE
SOUTH BEND
ATTACHMENTS

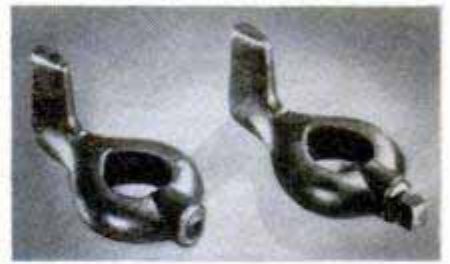

SAFETY and STANDARD LATHE DOGS

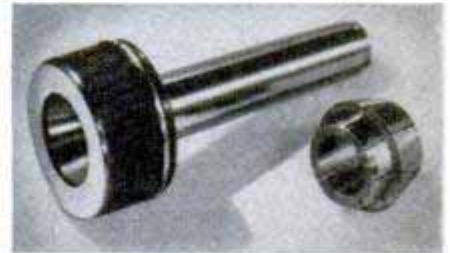

ADJUSTABLE COLLET BUSHING CHUCK

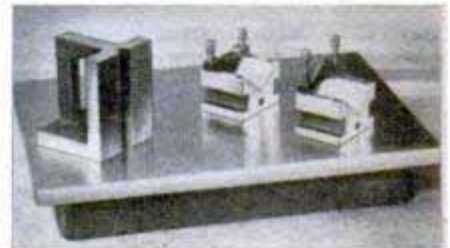

SURFACE and ANGLE PLATES, V-BLOCKS



South Bend Attachments will enable you to do more and better lathe work. Write for Attachment Catalog No. 5111.

SOUTH BEND LATHE
BUILDING BETTER TOOLS SINCE 1906 • SOUTH BEND 22, INDIANA

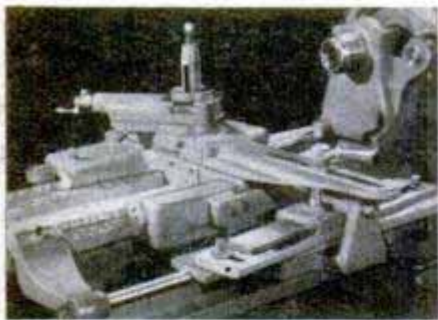

TELESCOPIC TAPER ATTACHMENT

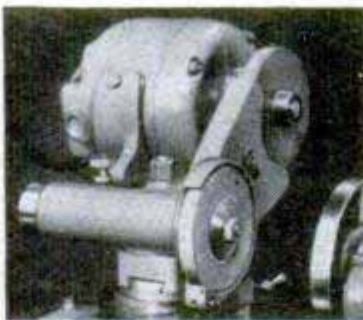

EXTERNAL GRINDER

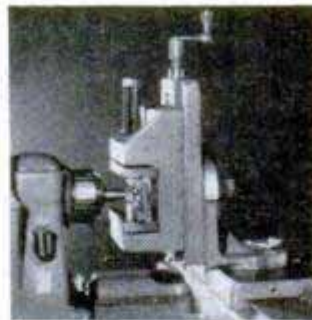

MILLING ATTACHMENT

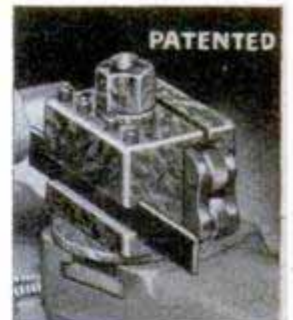

PATENTED
10 in 1 TOOL BLOCK

Send this Information:



CATALOG 5111

LATHE TOOLS, ATTACHMENTS



9" and 10" BENCH LATHES

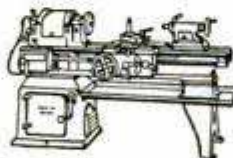

10" TO 16-24" FLOOR LATHES



14" DRILL PRESSES



7" BENCH SHAPERS

Name _____

Street _____

City _____ Zone _____ State _____

1/2" and 1" Collet TURRET LATHES



" Let me show you how to make all these beautiful objects of art, giftwares, and costume jewelry at home in spare time "



FREE!

This beautiful eight page book in full color shows you

HOW TO..

- Learn all the secrets of Ceramizing.
- Turn twigs, leaves, flowers, into gorgeous costume jewelry.
- Transform inexpensive articles into valuable objects of art.
- Get the thrill of artistic creation without learning to draw or design.
- Start a spare time hobby that can bring extra money every week.
- Establish a home business that can be expanded into full time operation any time money is needed.

FREE!

JUST SEND NAME

FOR PLEASURE or PROFIT!

Make as much as \$5.00 for One Hour's Work

Yes, I will send this to you free. It tells all about one of the most astonishing discoveries of recent years. Shows how 56¢ worth of material can be turned into a \$5.00 profit. Shows how to make "something from nothing." A handful of twigs is transformed into a gorgeous coral-like necklace—a stunning dresser box is made from a penny's worth of rice and a few navy beans — a metal-like lapel pin from a live leaf. You need no knowledge of design—no artistic training. The countless forms of nature provide your designs. The simple art of "Ceramizing" can be learned in a few minutes' reading by even a child. It's an activity in which the entire family can take part. It's a fascinating hobby that makes friends marvel



at your artistic ability—yet it's so profitable that it can be turned into a big money business, operated from your home. Many men find in Ceramizing the opportunity to establish a spare time home business without sacrificing job or paycheck—and gain confidence for the future in knowing that at any time

they can expand into full time work—taking profits from three different branches of the business. Women, too, find in Ceramizing a satisfying expression of their creative gifts—both as a hobby and as a means of making extra money. One of the big advantages is that no expensive equipment, machines, or tools are required. And I show you how and where to go to get the few materials necessary at low cost.



NO CHARGE Now or at any other time
JUST MAIL COUPON

NO SALESMAN WILL CALL—ALL MAILED FREE!

Send your name to me today. A penny postcard will do, or mail the coupon. I will send you a beautiful eight page book filled with pictures in natural colors showing scores of the things you can make and explain the entire process and the steps necessary to get started. No salesman will call to bother you—and the information is all free and postage prepaid. Whether you want to start now or at some future time—get the information at once. You'll be glad you wrote. Address me,

Raymond E. Brandell, Warner Electric Co.
1512 Jarvis Ave., Dept. 39, Chicago 26, Ill.

Dear Mr. Brandell: With the understanding that there is no charge, no obligation, and that no salesman will call, you may mail postpaid a copy of your big eight page book in full color showing scores of pictures of things I can make, either as a hobby or as a spare time money making home business.

Name.....
Address.....
City..... State.....



You can even preserve and beautify baby shoes to look like silver, gold, bronze, or glistening kiln fired china by this amazing process. They bring profits of \$10.00 for every dollar of material cost.

R. E. BRANDELL, WARNER ELECTRIC CO. 1512 Jarvis Ave., Dept. 39
Chicago 26, Illinois

Why did you
change to Camels,
BUDDY ROGERS?



I MADE THE
DIFFERENT MILDNESS
TESTS. NO OTHER CIGARETTE
HAS CAMEL'S RICH FLAVOR
—AND THEY AGREE
WITH MY THROAT!

Buddy Rogers likes to try things out. He plays every instrument in the band. His curiosity also led him to try different cigarette mildness tests. The thorough 30-day Camel test convinced him.

"After smoking Camels for thirty days, I knew it was Camels for me," says Buddy "Only Camels give me such flavor, mildness and enjoyment!"

Smokers all over have made mildness tests. And the more they test, the more Camel leads in popularity! Published figures show *Camel leads all other brands by billions of cigarettes!*

Smoke only Camels for 30 days. See how rich and flavorful Camels are, pack after pack. Then you'll know why—

After all the mildness tests,
**CAMEL LEADS
ALL OTHER BRANDS
BY BILLIONS!**

R. J. Reynolds Tobacco Co., Winston-Salem, N. C.

Not one single case of throat
irritation due to smoking

CAMELS

That's what noted throat specialists reported in a coast-to-coast test of hundreds of people who smoked only Camels for 30 days!



Make your own
30-Day Camel
MILDNESS Test
in your "T-ZONE"
(T for Throat—
T for Taste)!